

Program EVALPLOT  
(Version 2017-1)

by

Dermott E. Cullen  
(Present Contact Information)

Dermott E. Cullen  
1466 Hudson Way  
Livermore, CA 94550  
U.S.A.

Tele: 925-443-1911

E.Mail:redcullen1@comcast.net

Web:redcullen1.net/HOMEPAGE.NEW

Press Mouse Button to Start

MAT 5658

Major

293 Kelvin Cross Sections

56-Ba-141

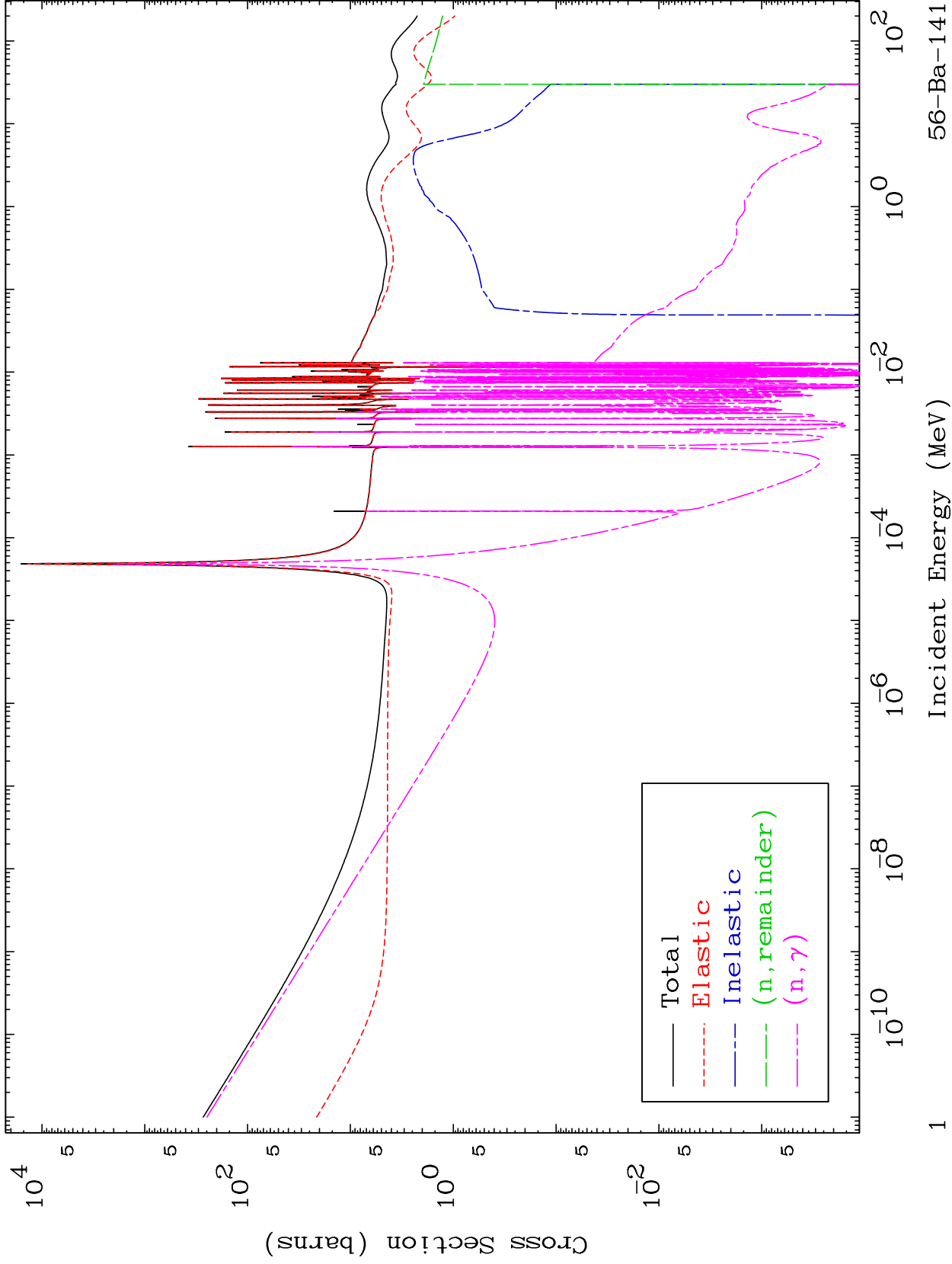

MAT 5658

Neutron Production  
293 Kelvin Cross Sections

56-Ba-141

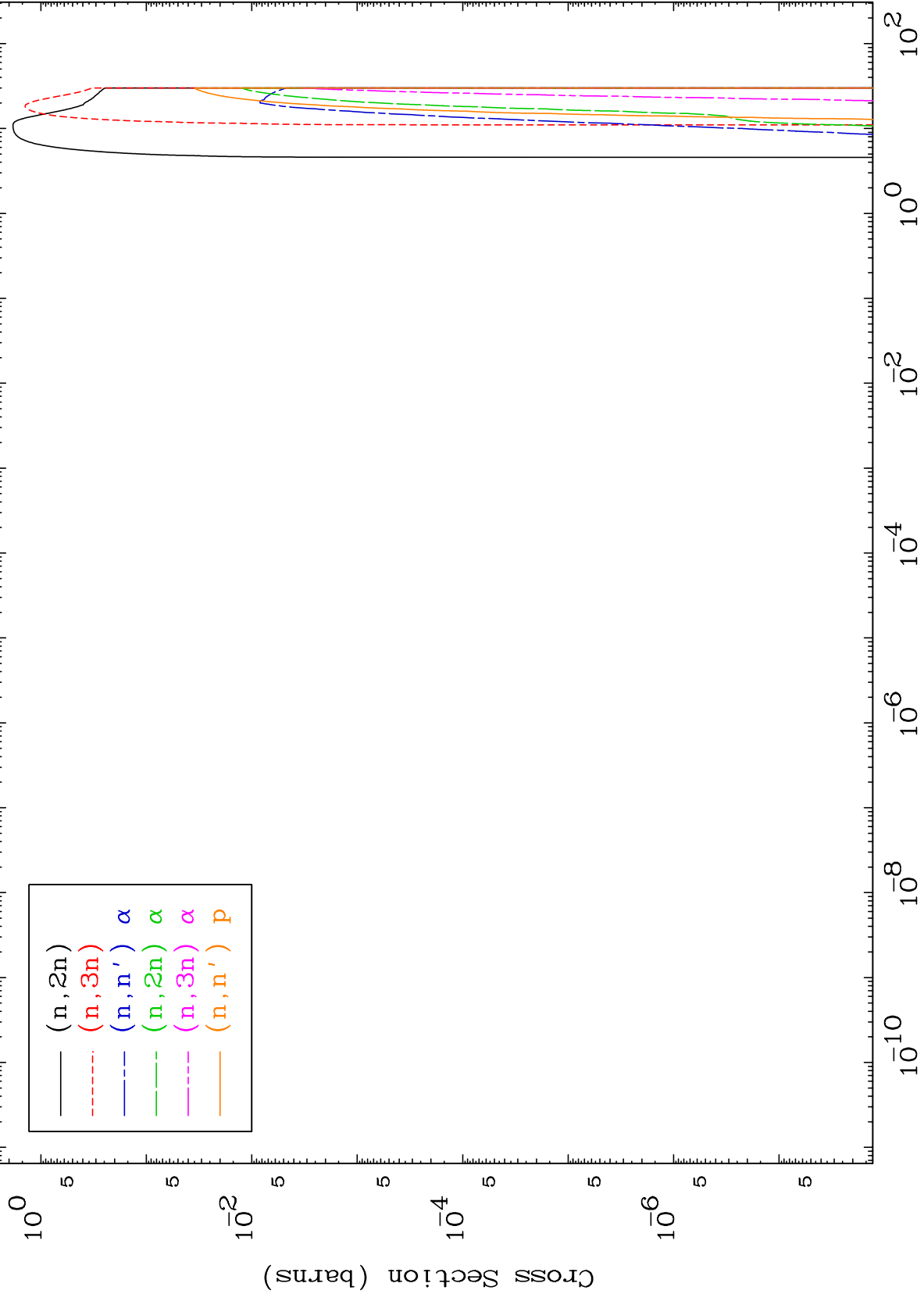

56-Ba-141

Incident Energy (MeV)

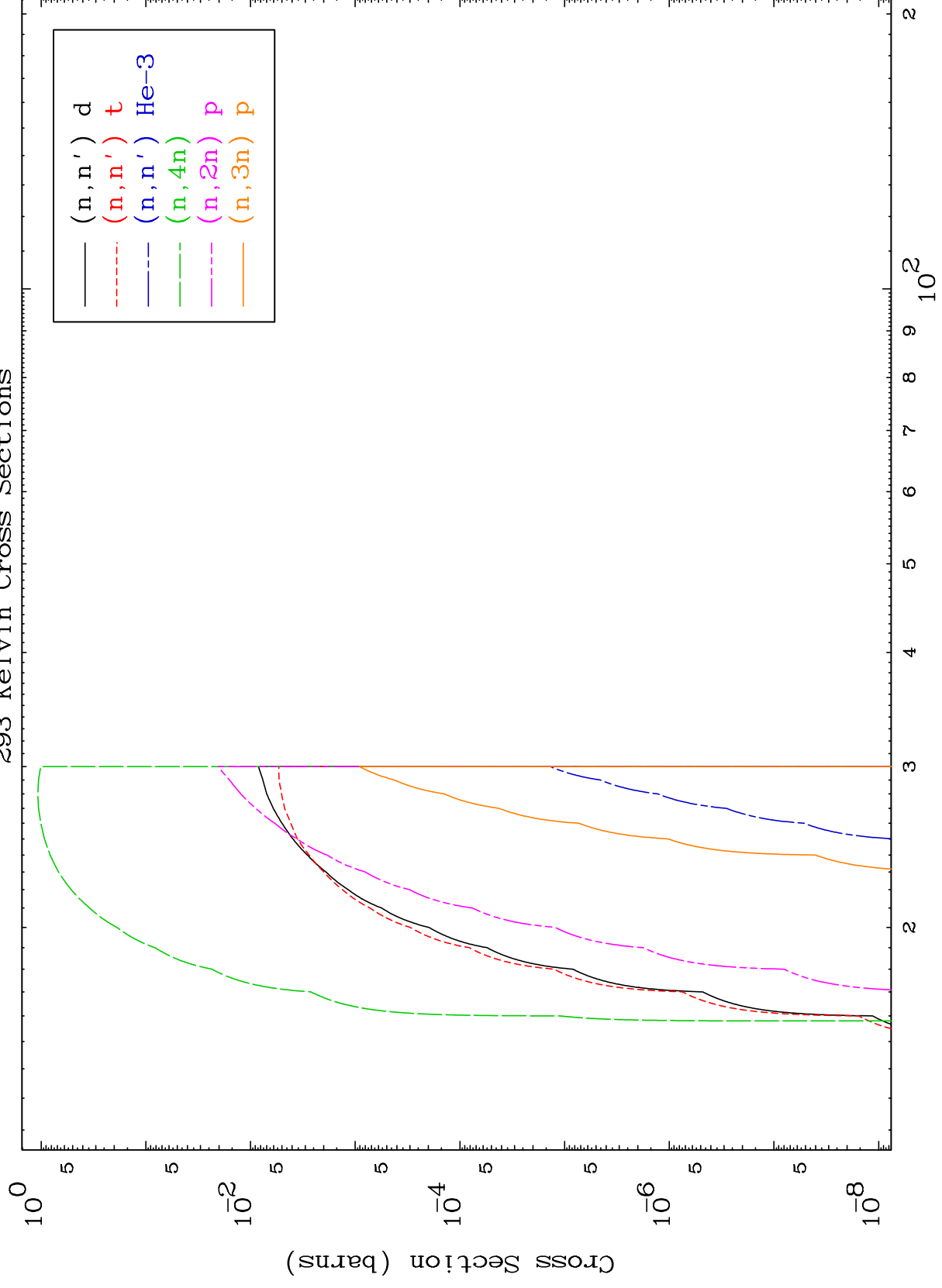

MAT 5658

Charged Particle  
293 Kelvin Cross Sections

56-Ba-141

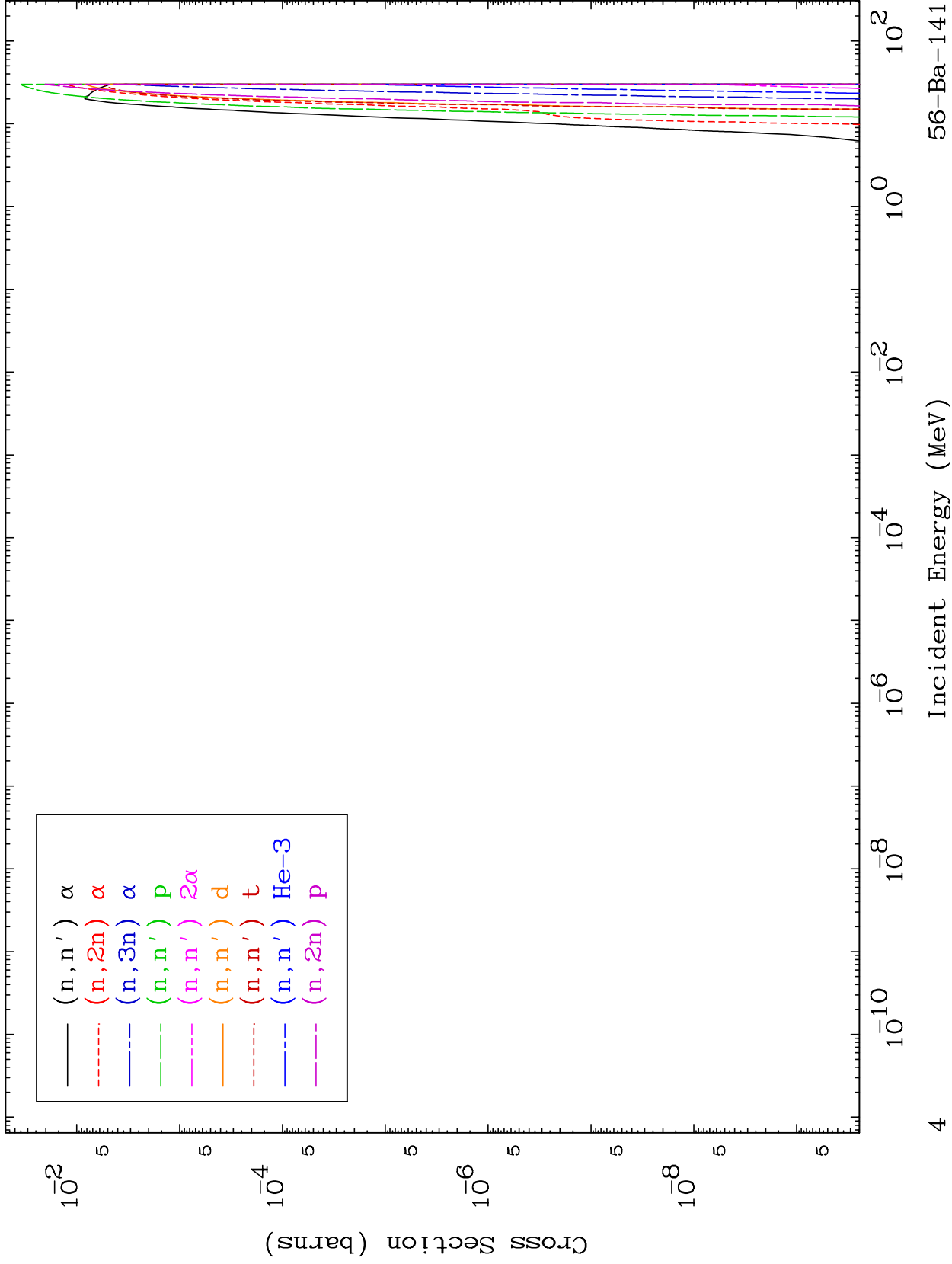

MAT 5658

Charged Particle  
293 Kelvin Cross Sections

56-Ba-141

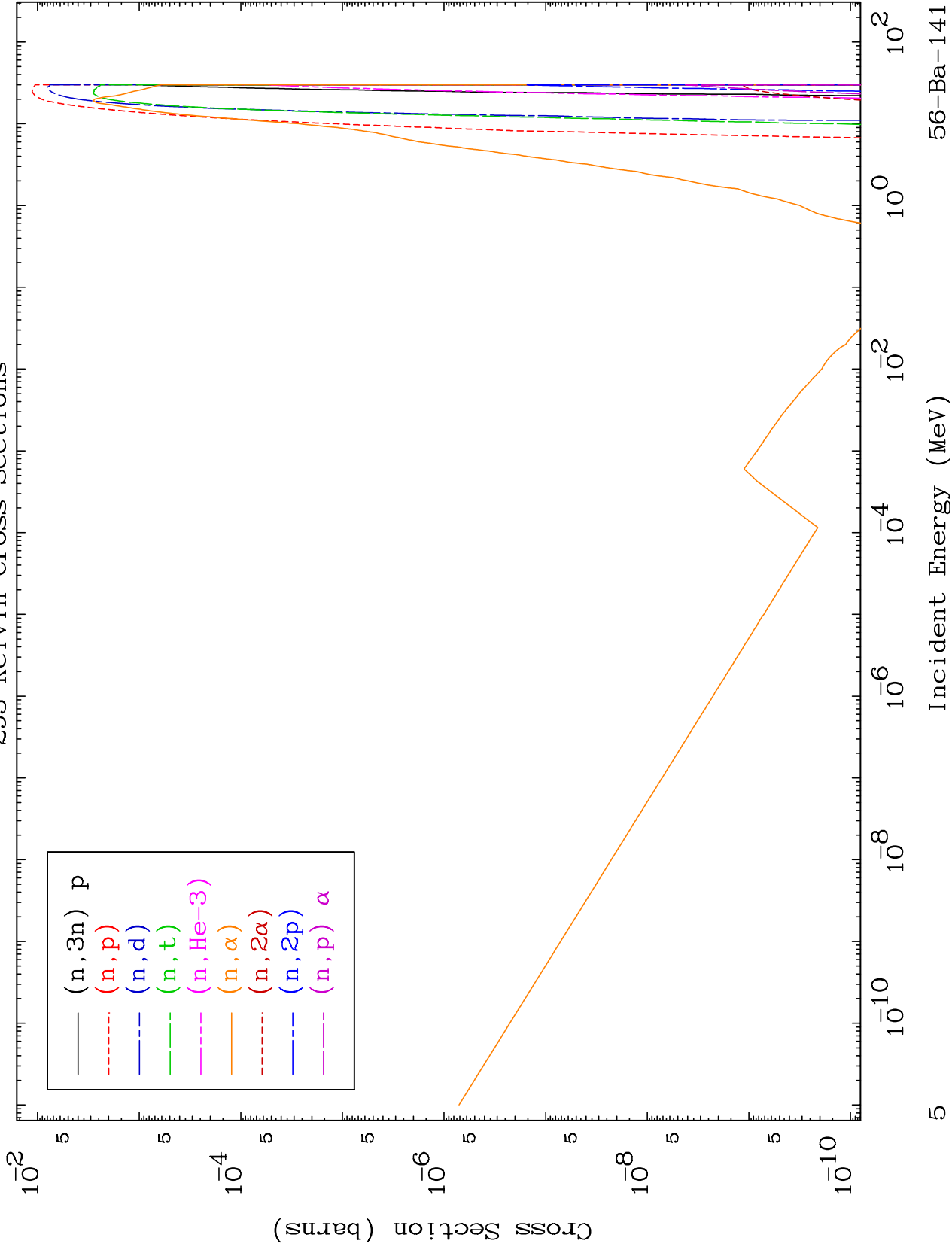

5

56-Ba-141

MAT 5658

Particle Production  
293 Kelvin Cross Sections

56-Ba-141

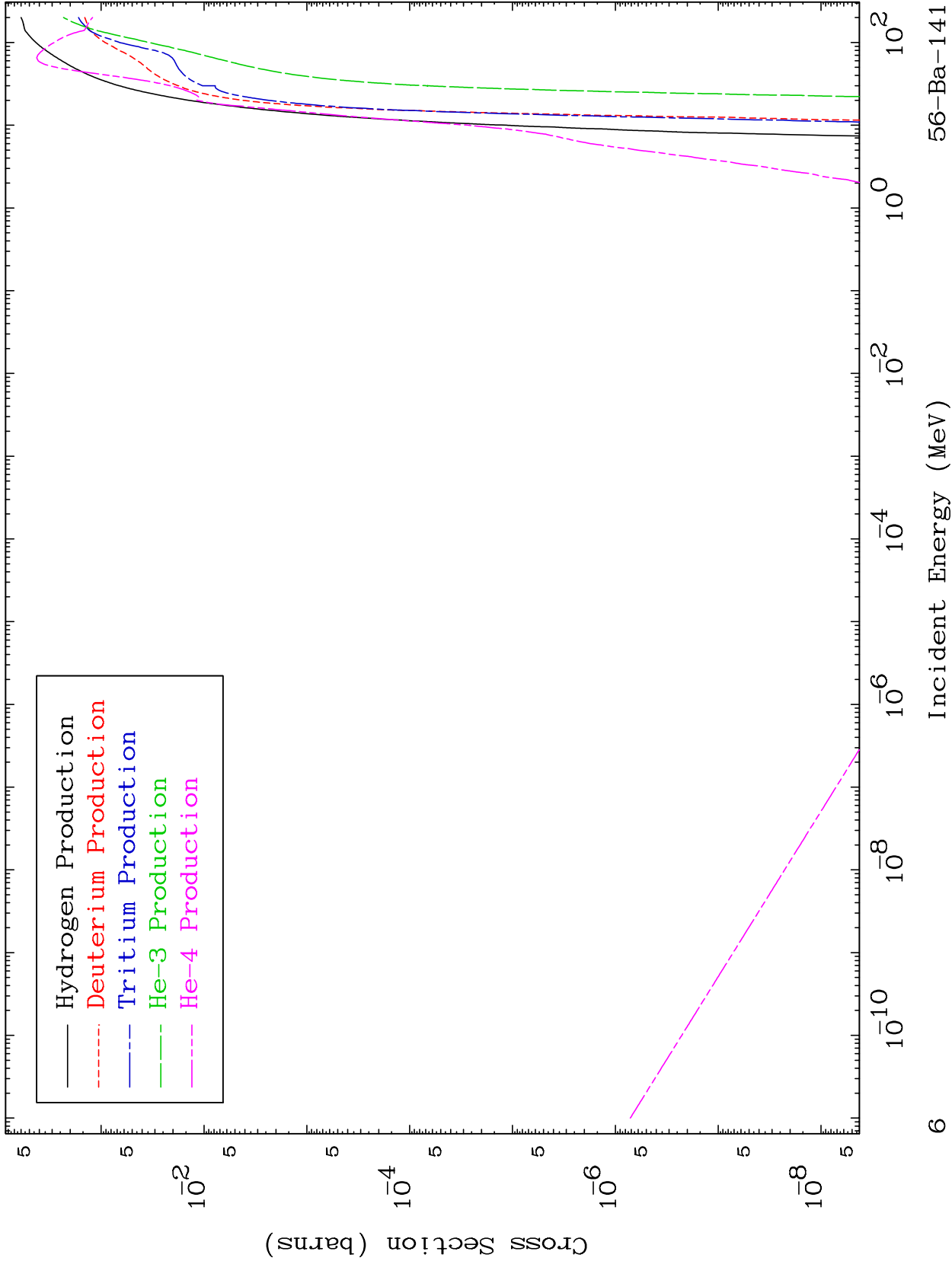

MAT 5658

(n,n') Level

56-Ba-141

293 Kelvin Cross Sections

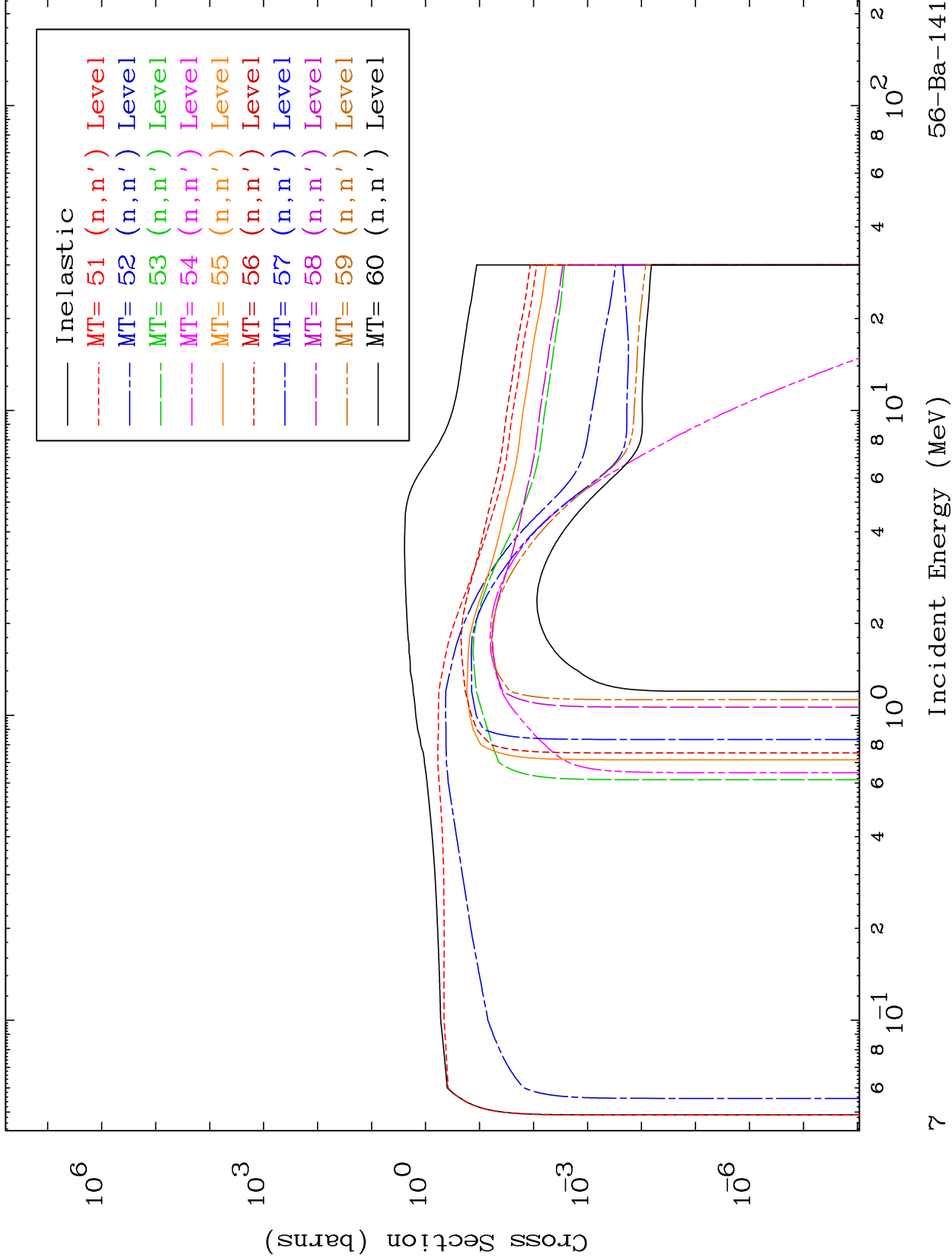

MAT 5658

(n,n') Level

56-Ba-141

293 Kelvin Cross Sections

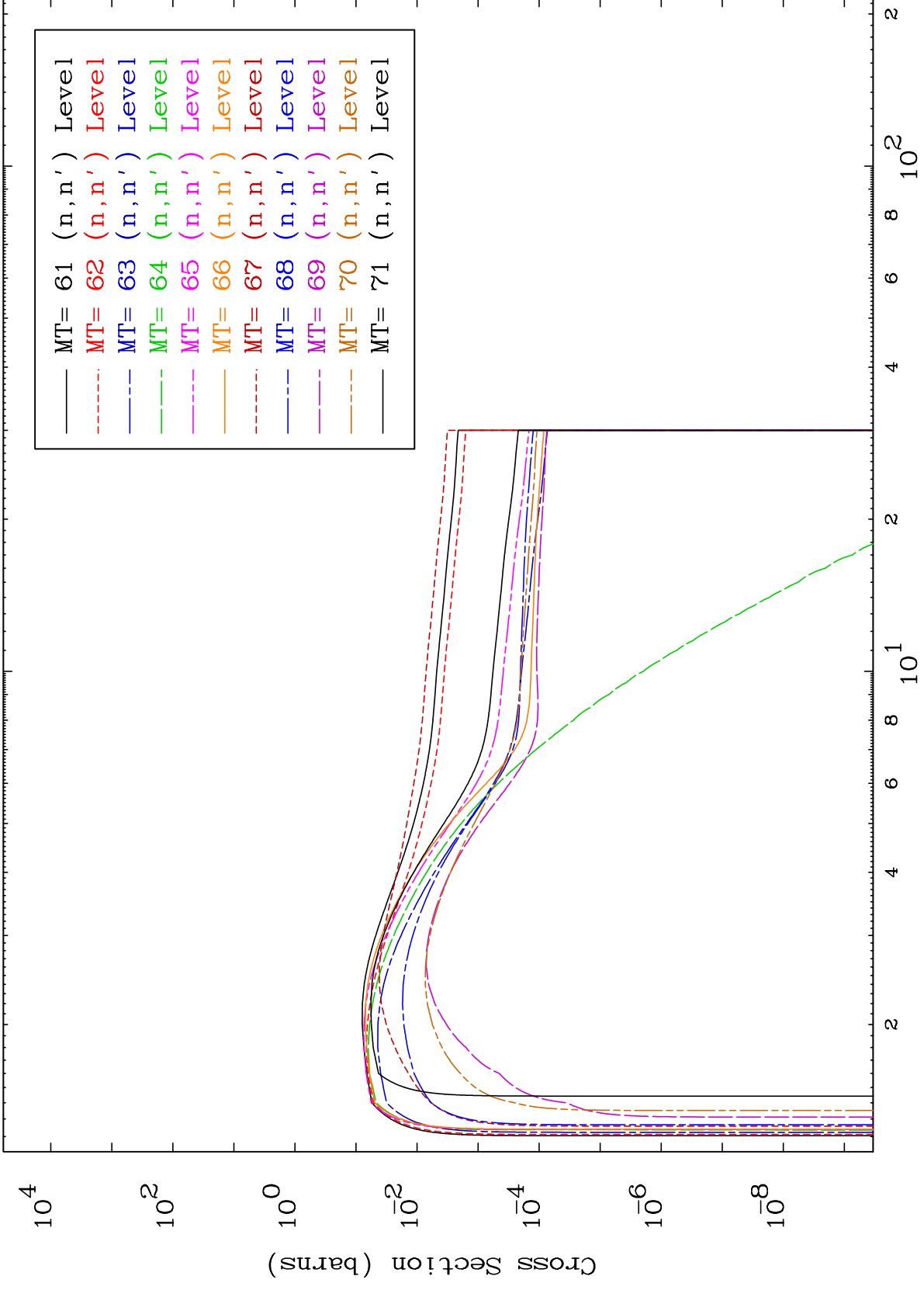

8

Incident Energy (MeV)

56-Ba-141

MAT 5658

(n,n') Level

56-Ba-141

293 Kelvin Cross Sections

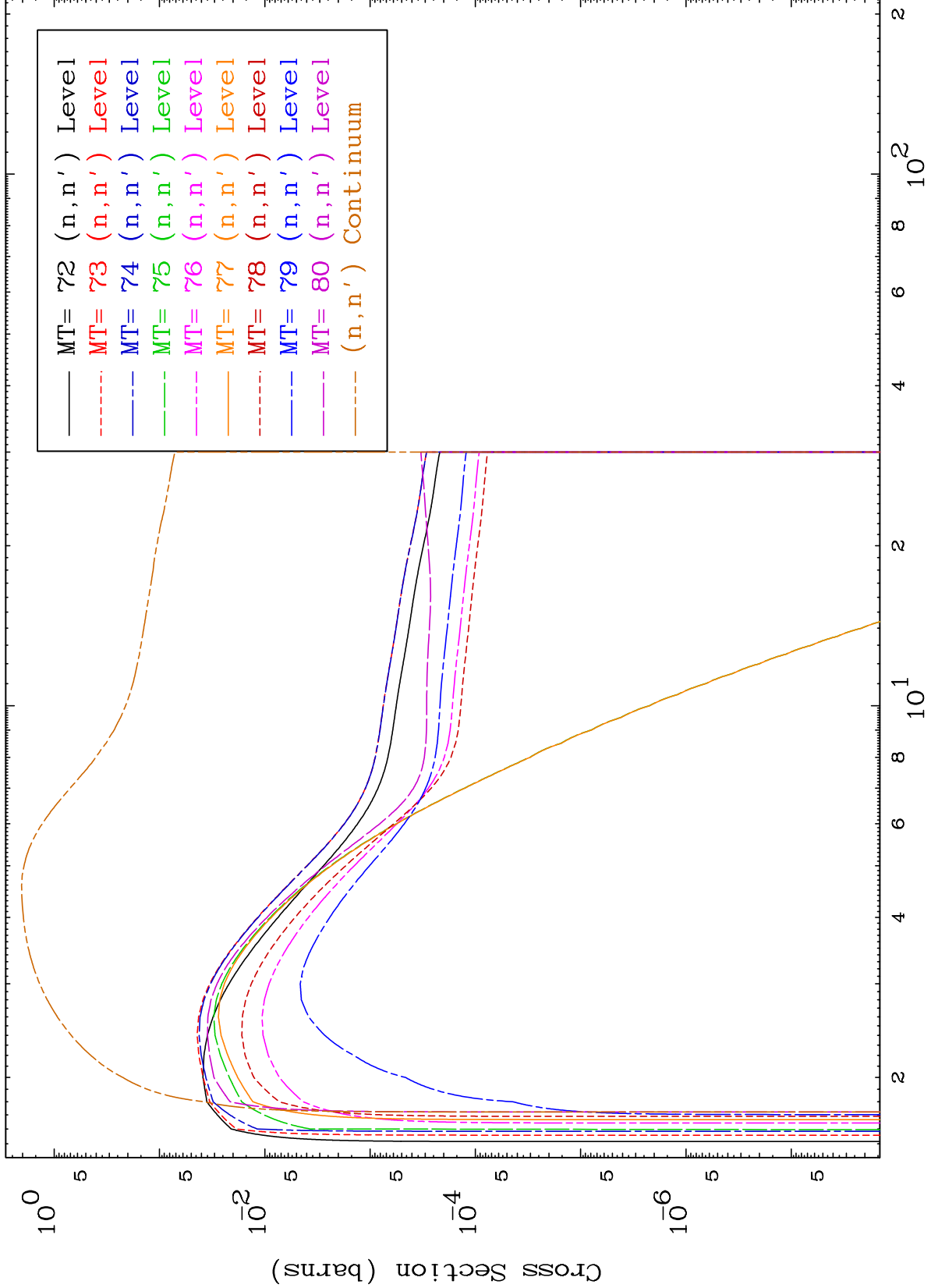

9

Incident Energy (MeV)

56-Ba-141

MAT 5658

(n,p) Levels  
293 Kelvin Cross Sections

56-Ba-141

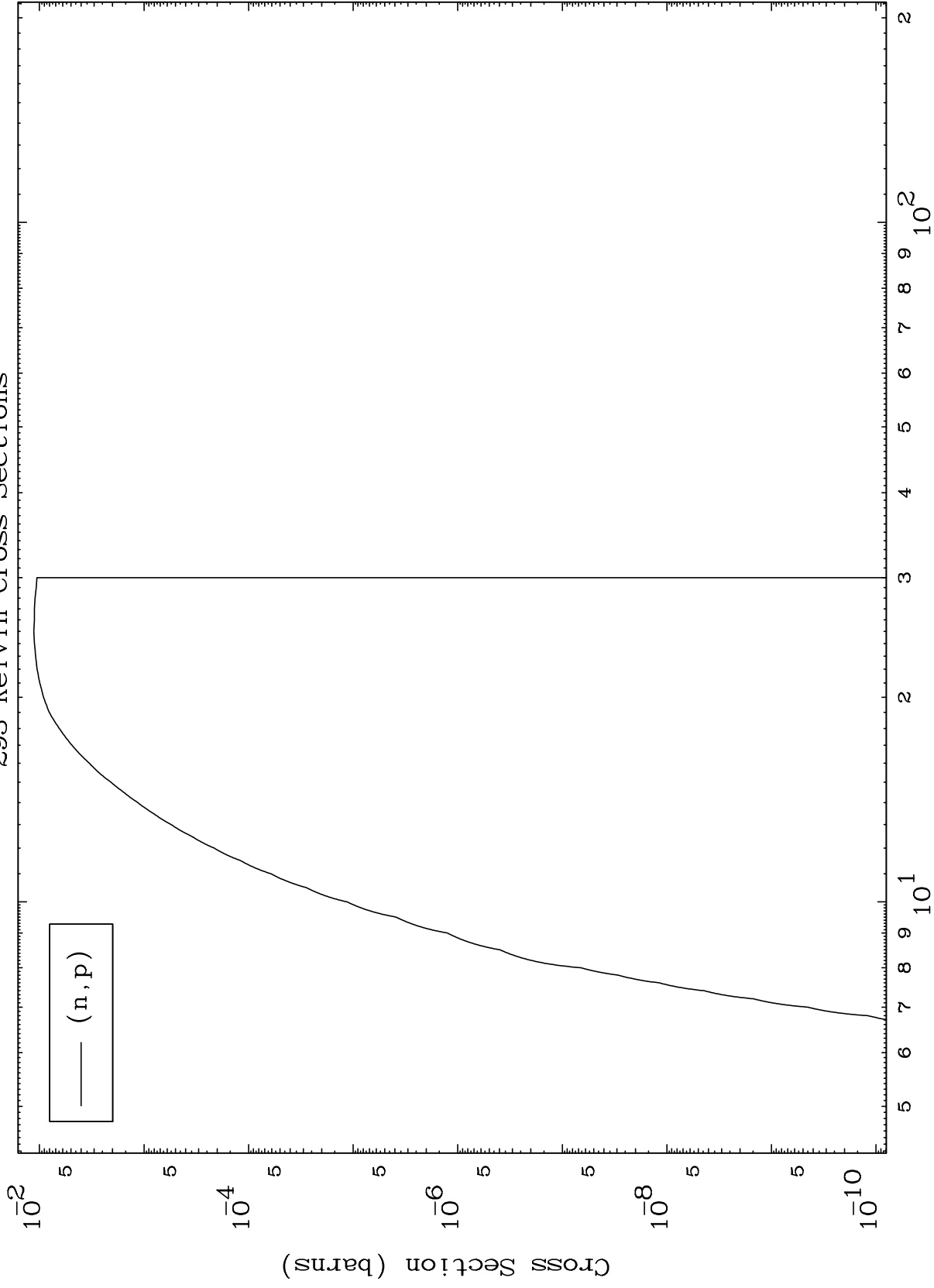

10

Incident Energy (MeV)

56-Ba-141

MAT 5658

(n,d) Levels  
293 Kelvin Cross Sections

56-Ba-141

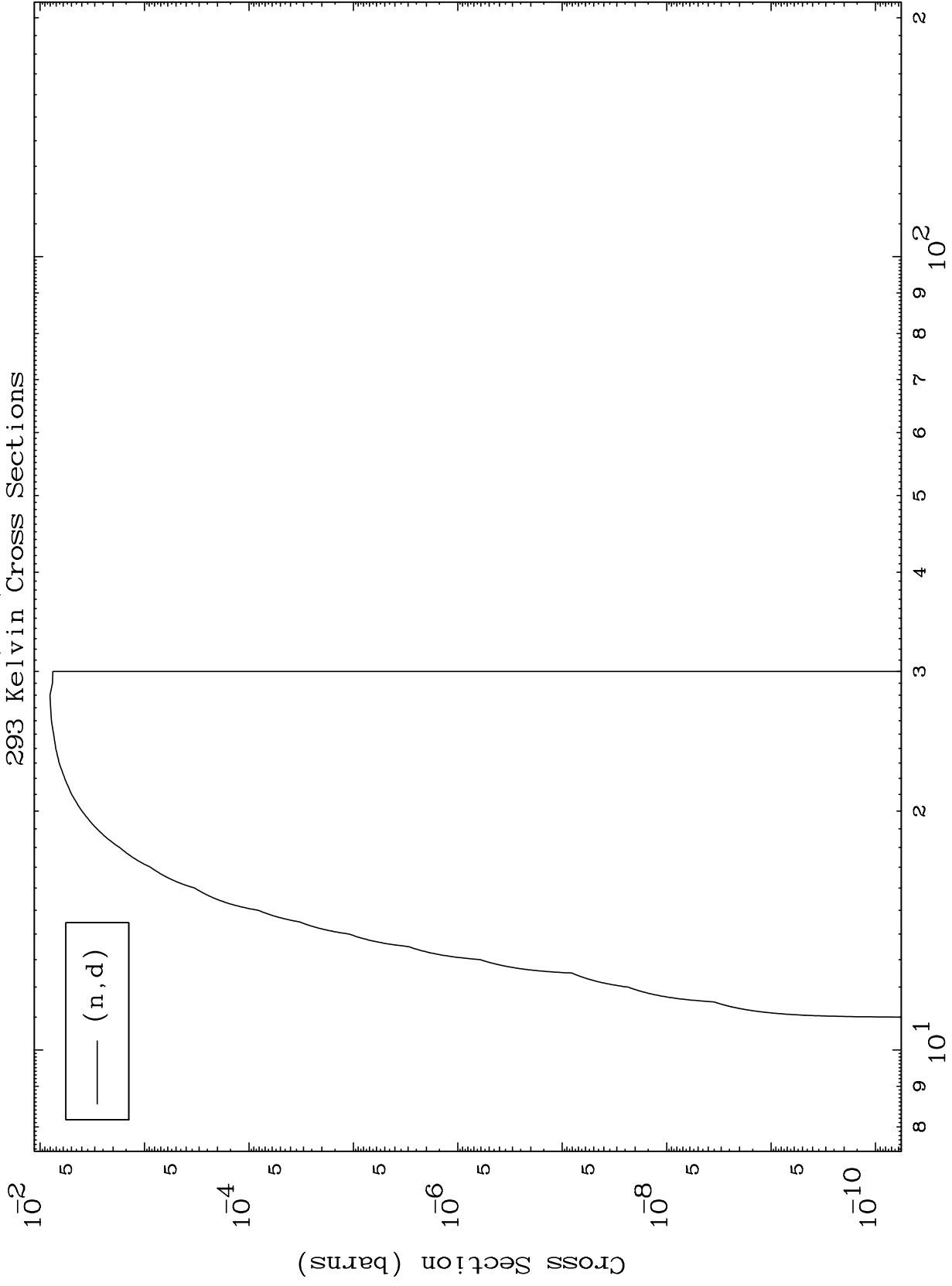

11

Incident Energy (MeV)

56-Ba-141

MAT 5658

(n,t) Levels  
293 Kelvin Cross Sections

56-Ba-141

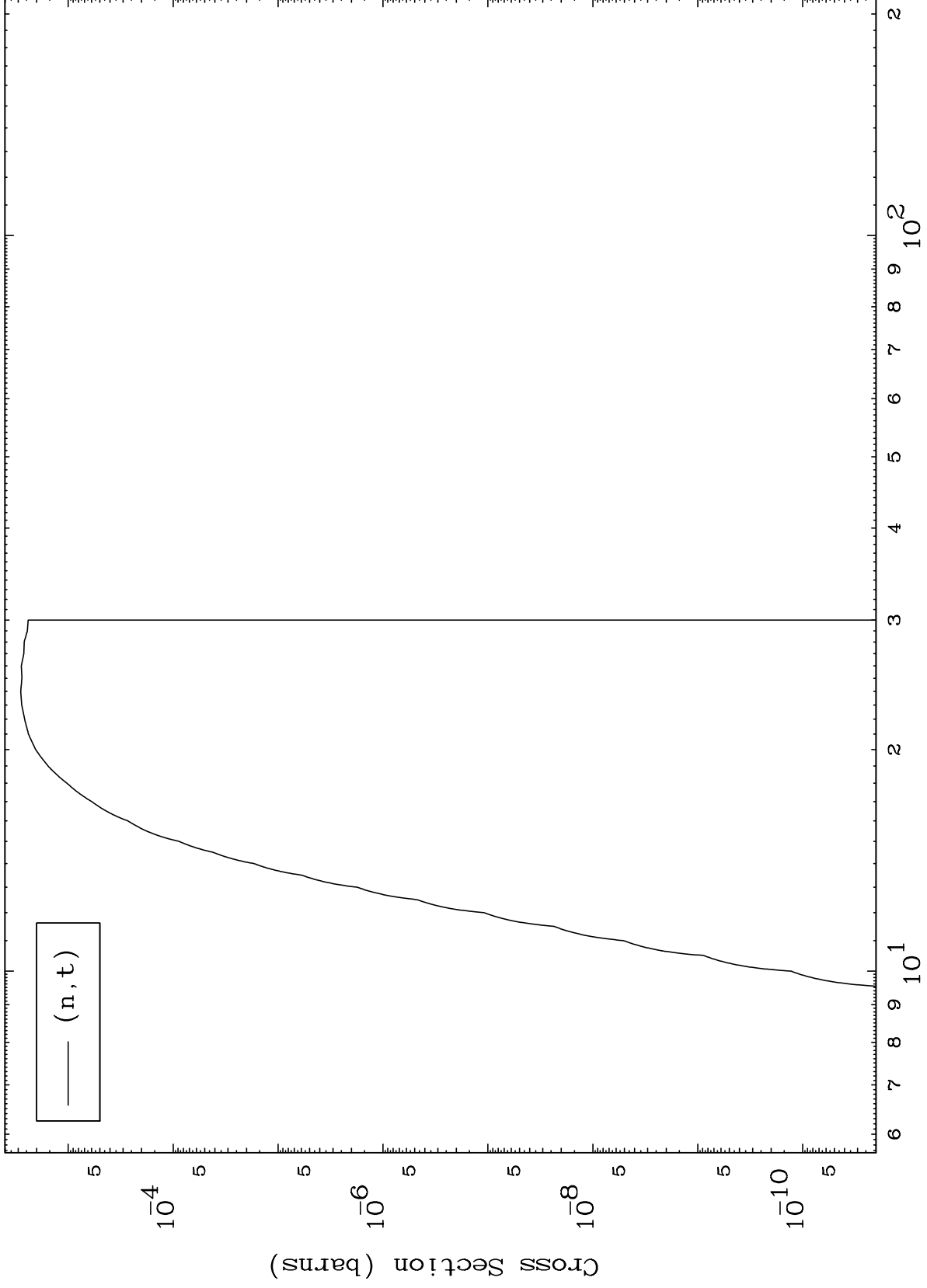

12

Incident Energy (MeV)

56-Ba-141

MAT 5658

(n,He3) Levels  
293 Kelvin Cross Sections

56-Ba-141

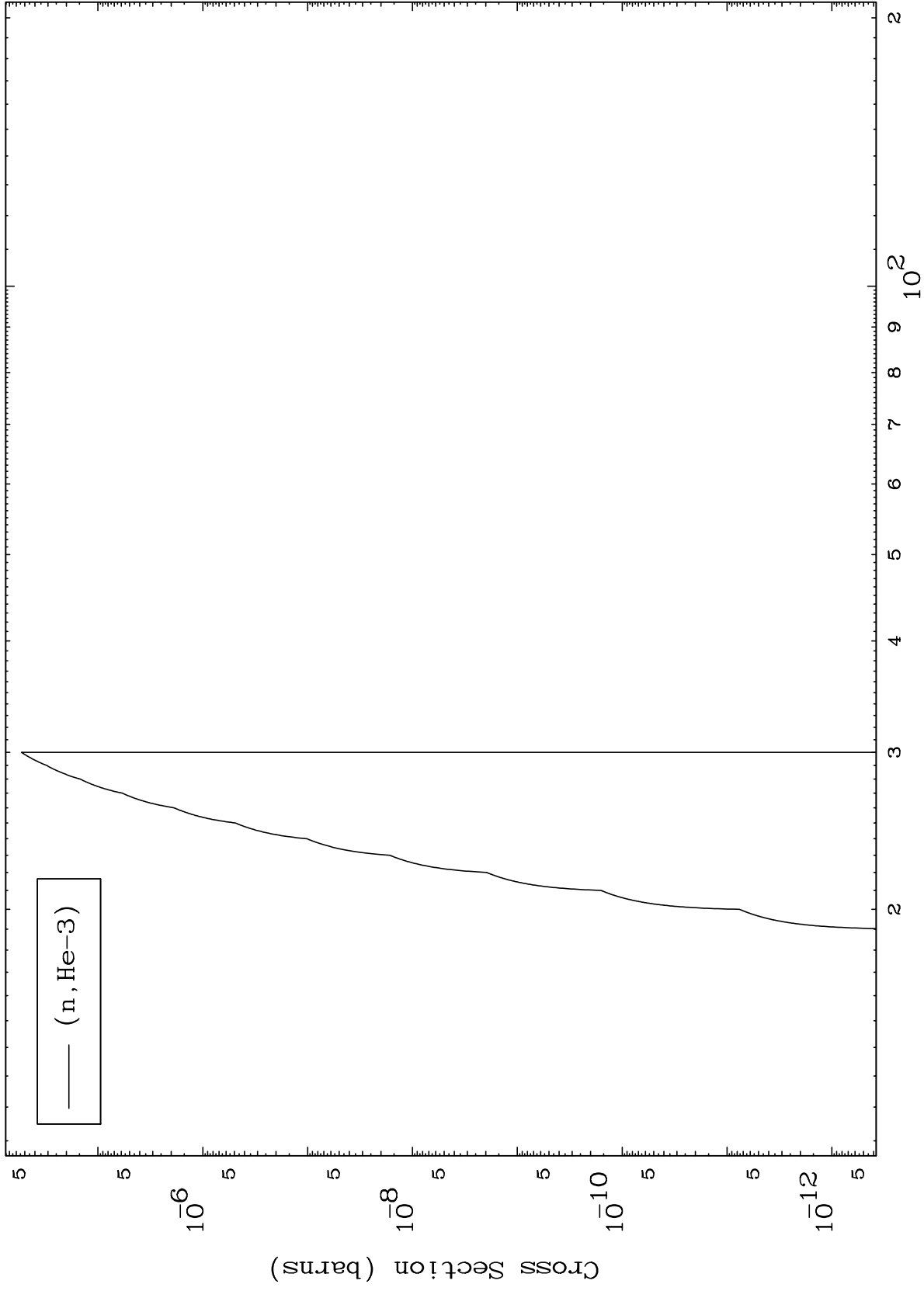

13

Incident Energy (MeV)

56-Ba-141

MAT 5658

(n,  $\alpha$ ) Levels  
293 Kelvin Cross Sections

56-Ba-141

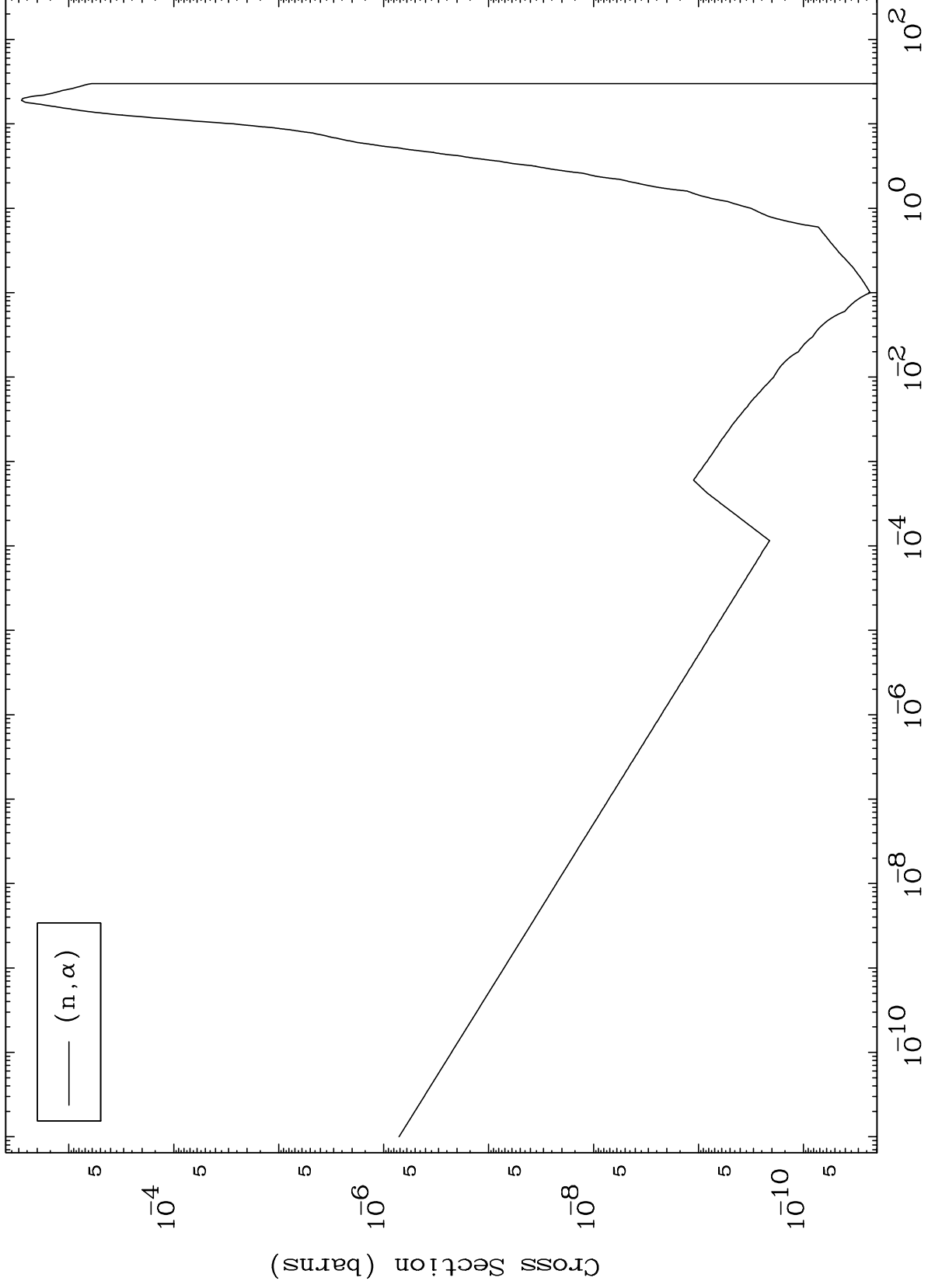

14

Incident Energy (MeV)

56-Ba-141

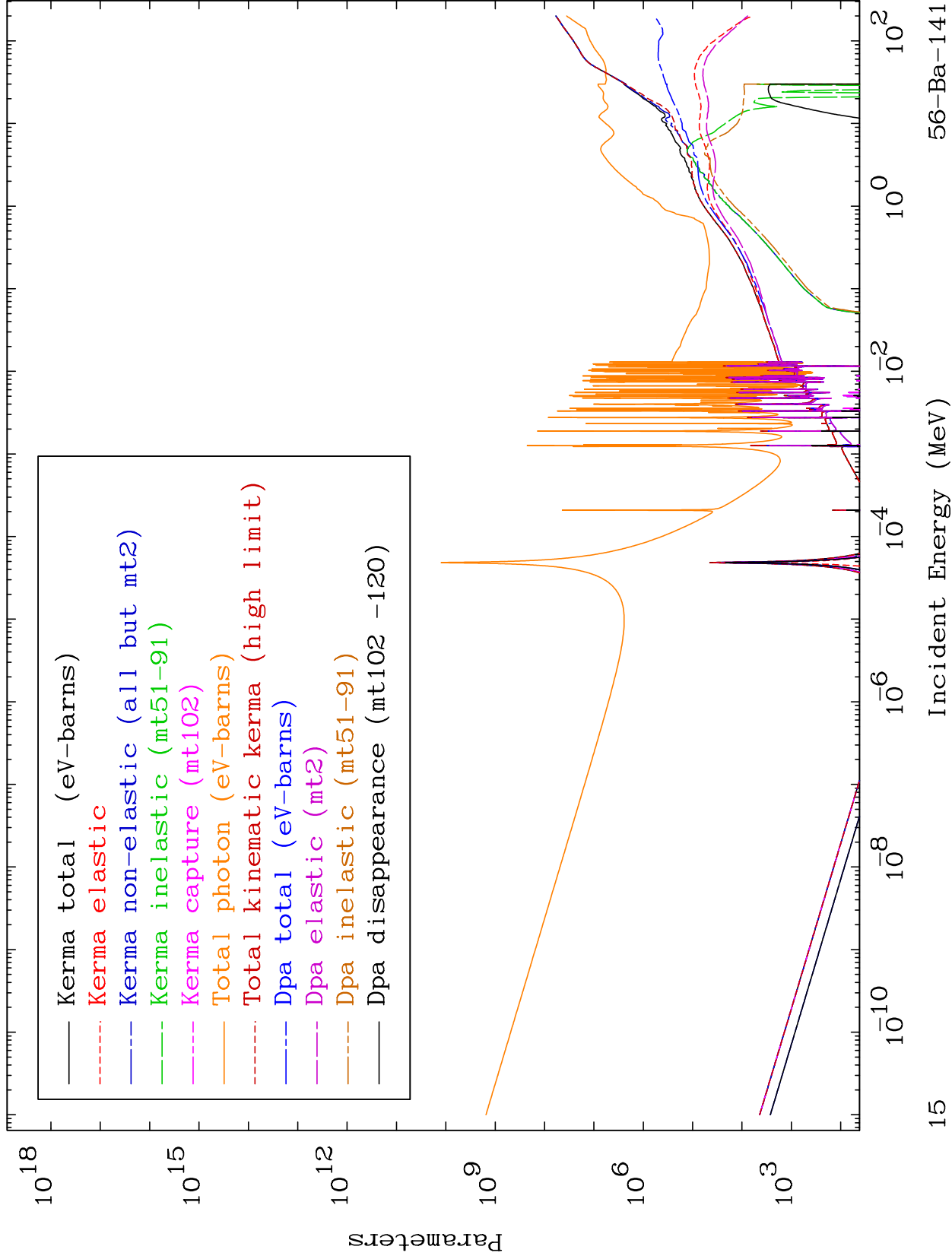

MAT 5658

Elastic Legendre Coefficients

56-Ba-141

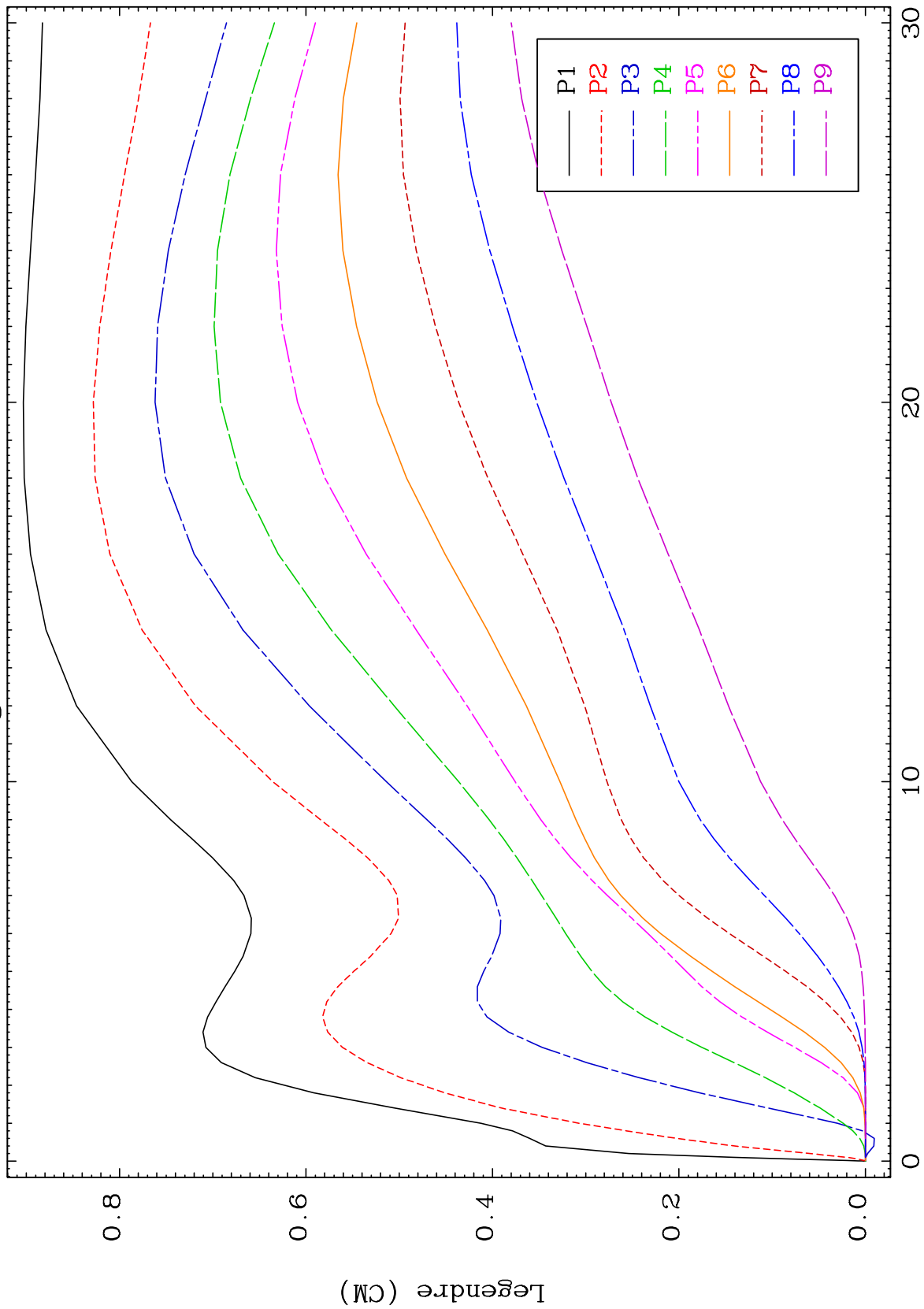

16

Incident Energy (MeV)

56-Ba-141

MAT 5658

Elastic Legendre Coefficients

56-Ba-141

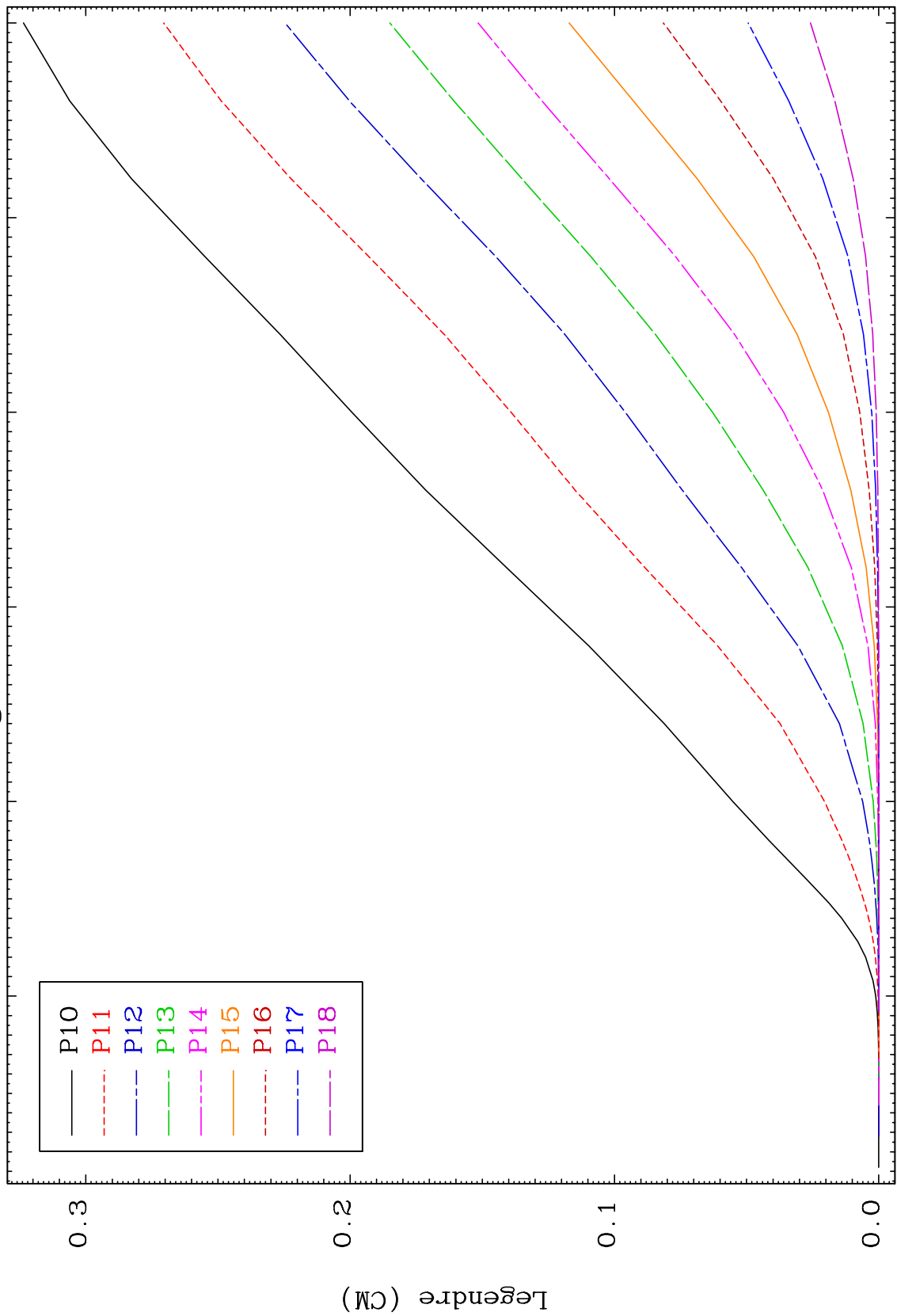

17

56-Ba-141

Incident Energy (MeV)

MAT 5658

Elastic  
Legendre Coefficients

56-Ba-141

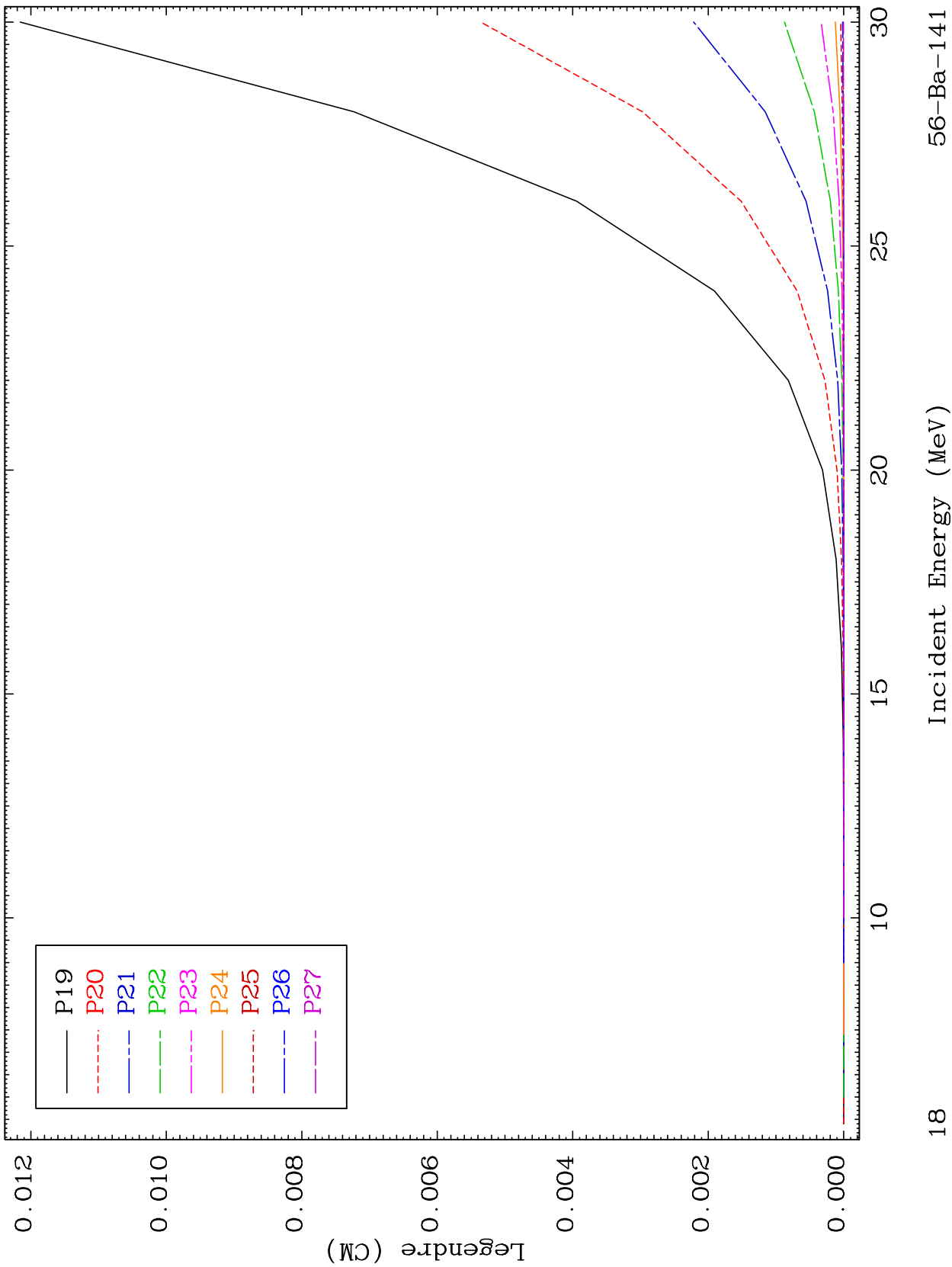

18

Incident Energy (MeV)

56-Ba-141

10 15 20 25 30

MAT 5658

Elastic Legendre Coefficients

56-Ba-141

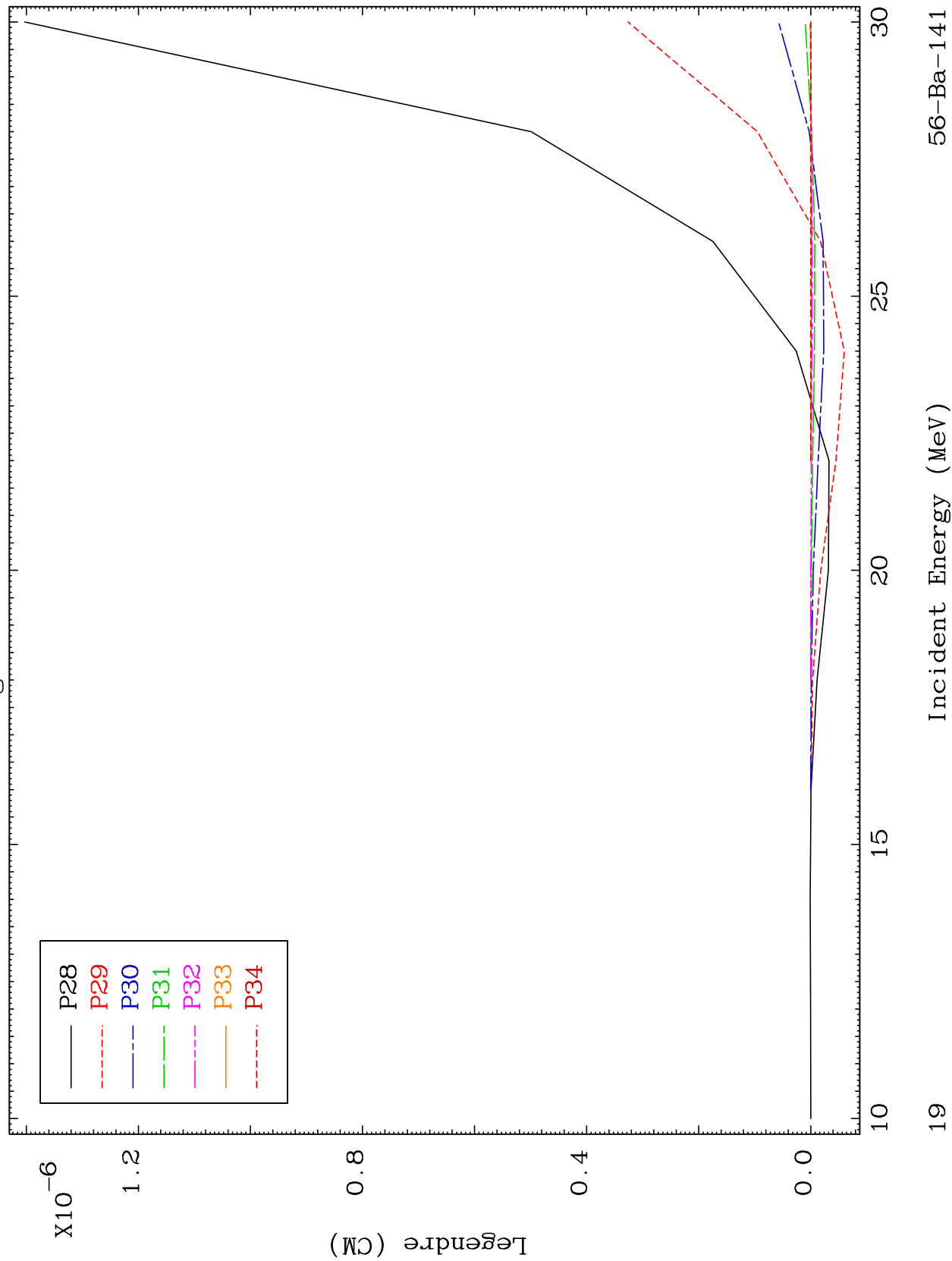

56-Ba-141

Incident Energy (MeV)

19

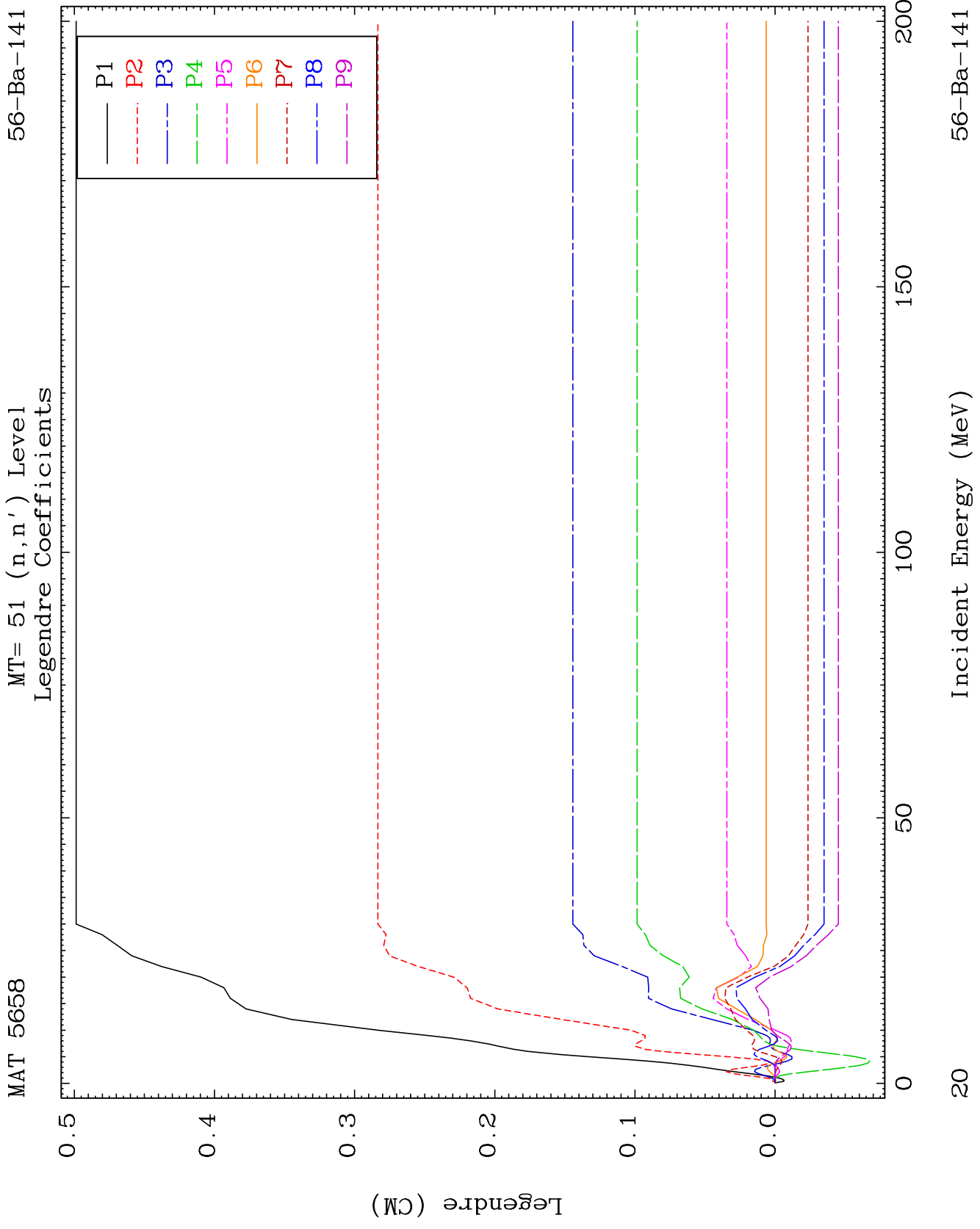



MAT 5658

MT= 51 (n,n') Level  
Legendre Coefficients

56-Ba-141

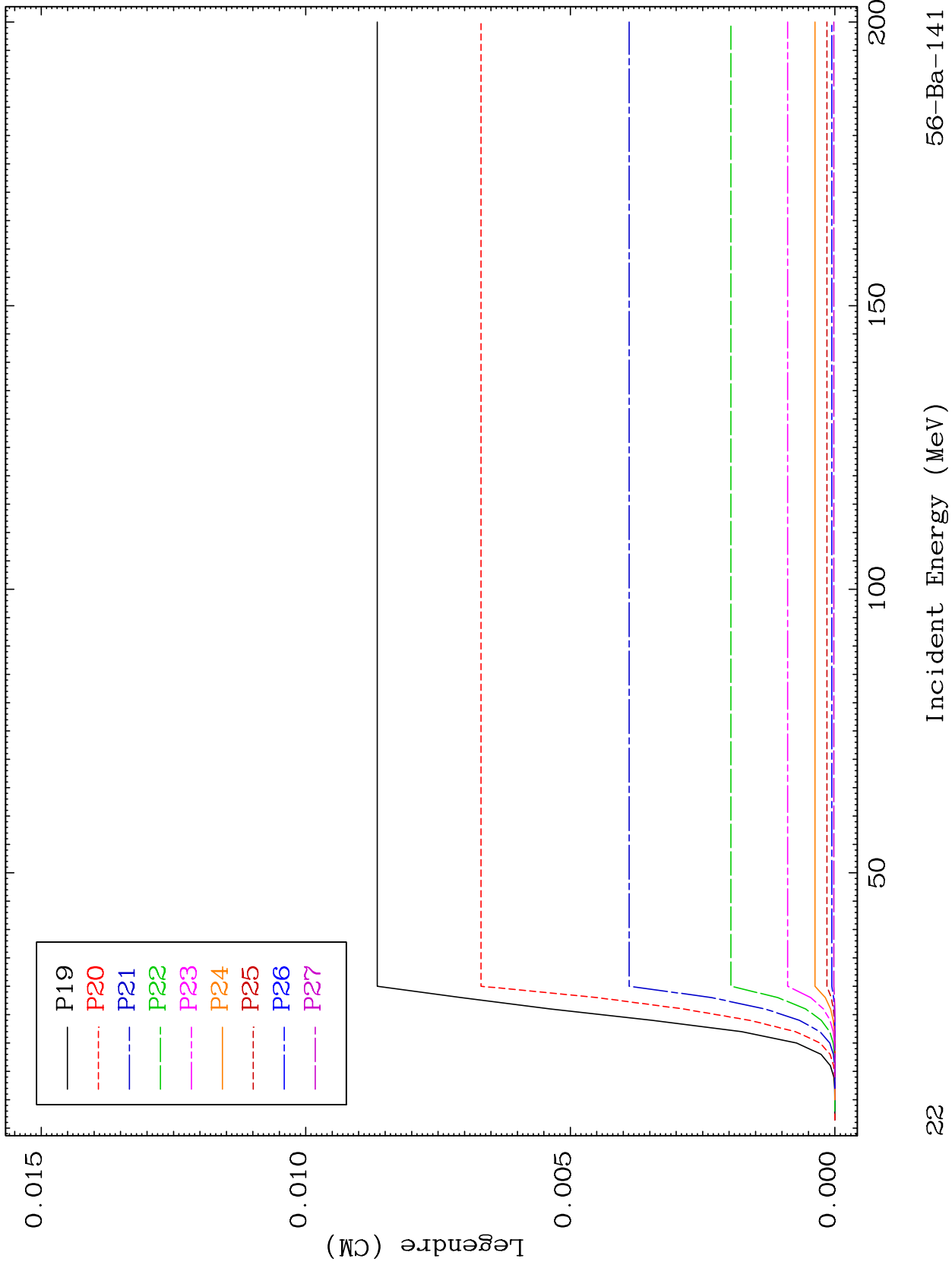

22

56-Ba-141

Incident Energy (MeV)

MAT 5658

MT= 51 (n,n') Level  
Legendre Coefficients

56-Ba-141

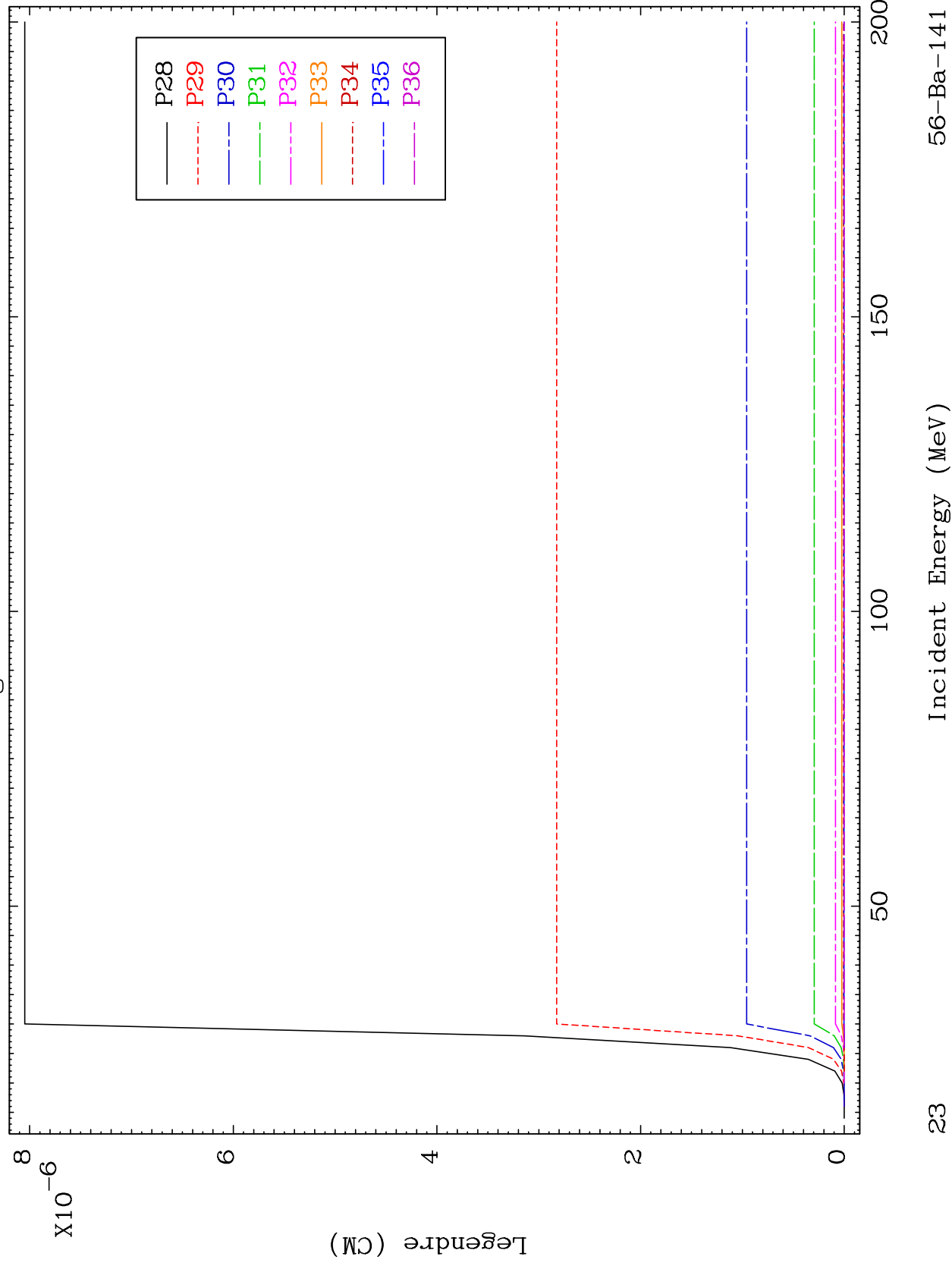

23

Incident Energy (MeV)

56-Ba-141

MAT 5658

MT= 52 (n,n') Level

56-Ba-141

Legendre Coefficients

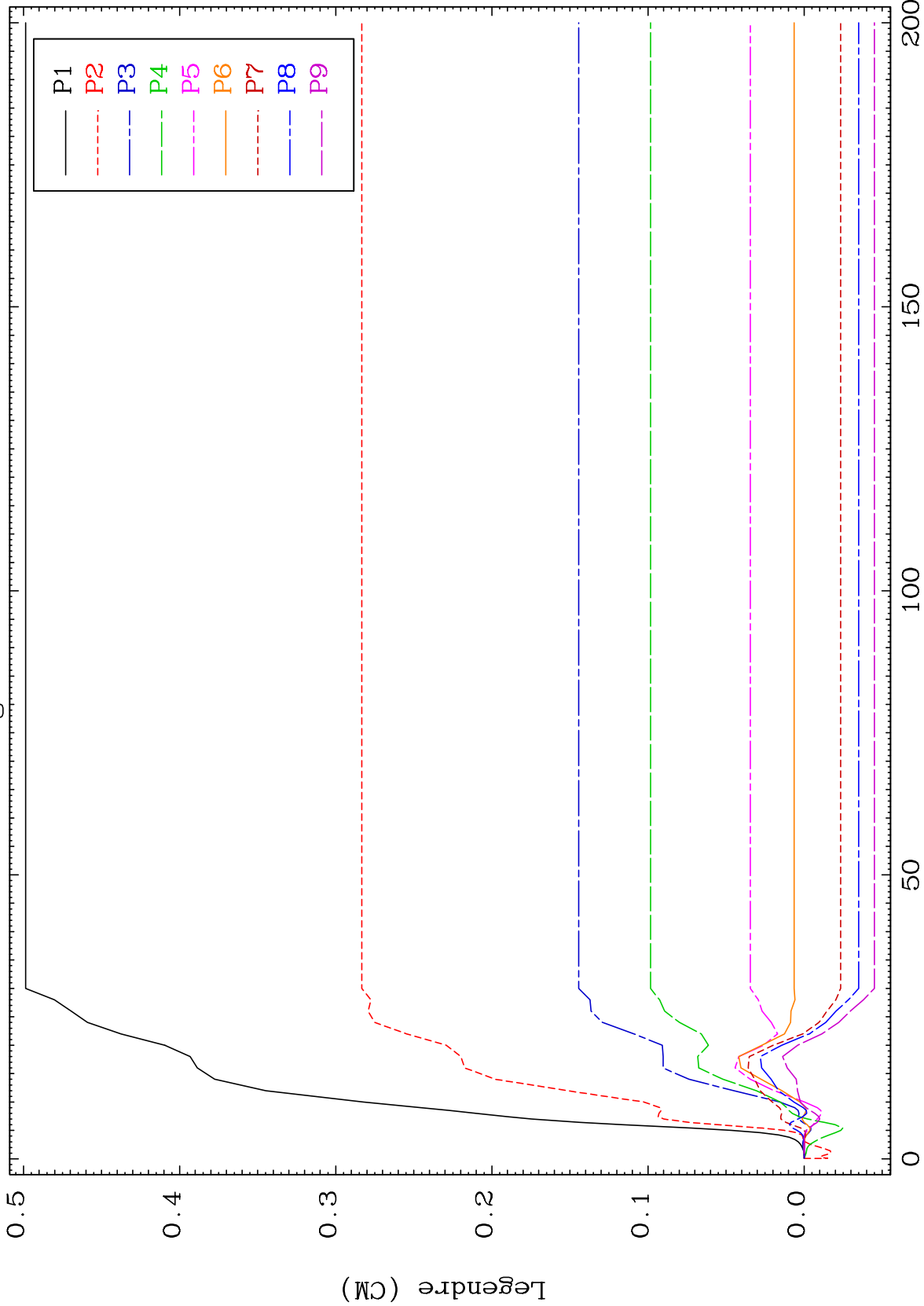

24

Incident Energy (MeV)

56-Ba-141

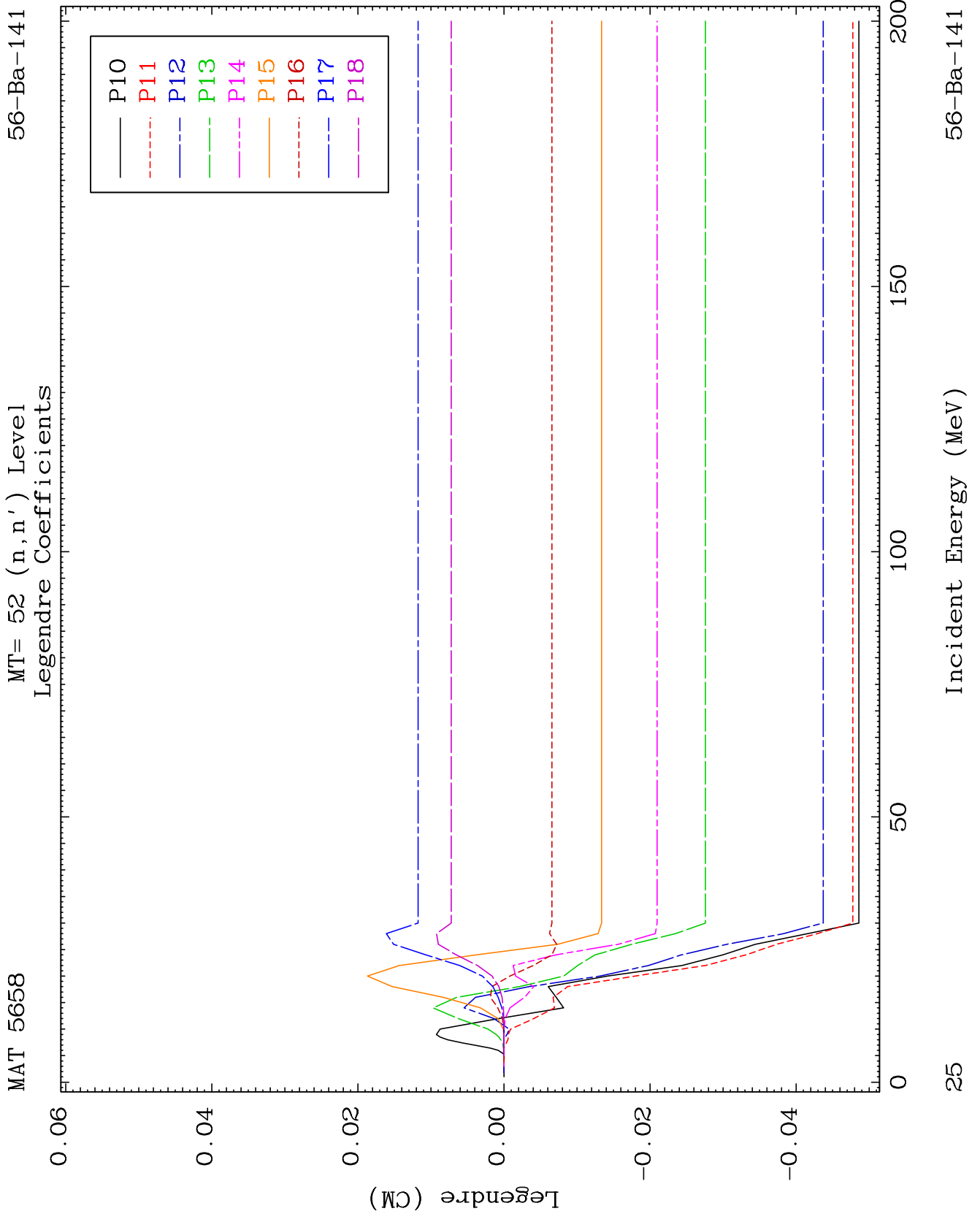

MAT 5658

MT= 52 (n,n') Level  
Legendre Coefficients

56-Ba-141

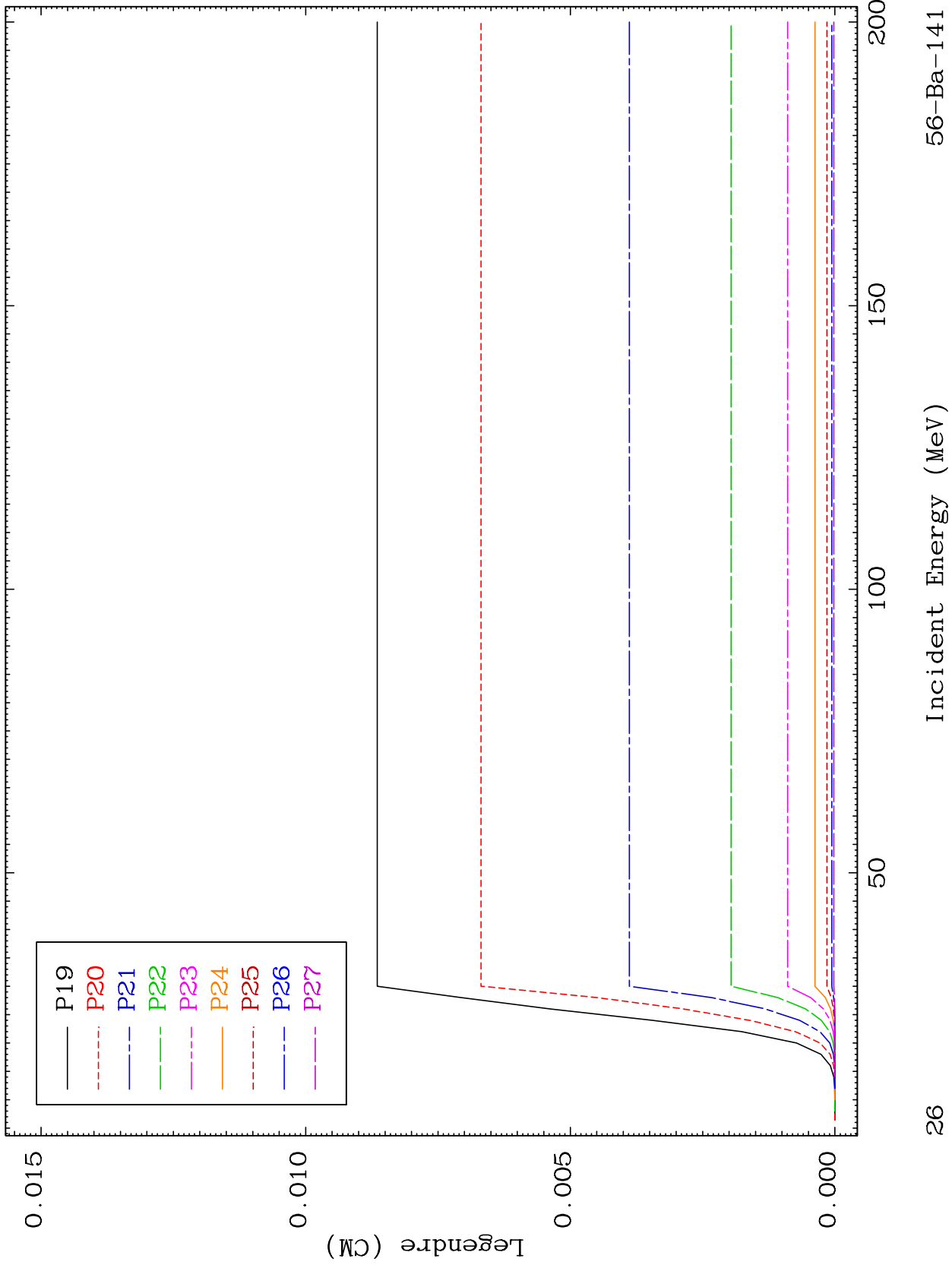

26

56-Ba-141

MAT 5658

MT= 52 (n,n') Level  
Legendre Coefficients

56-Ba-141

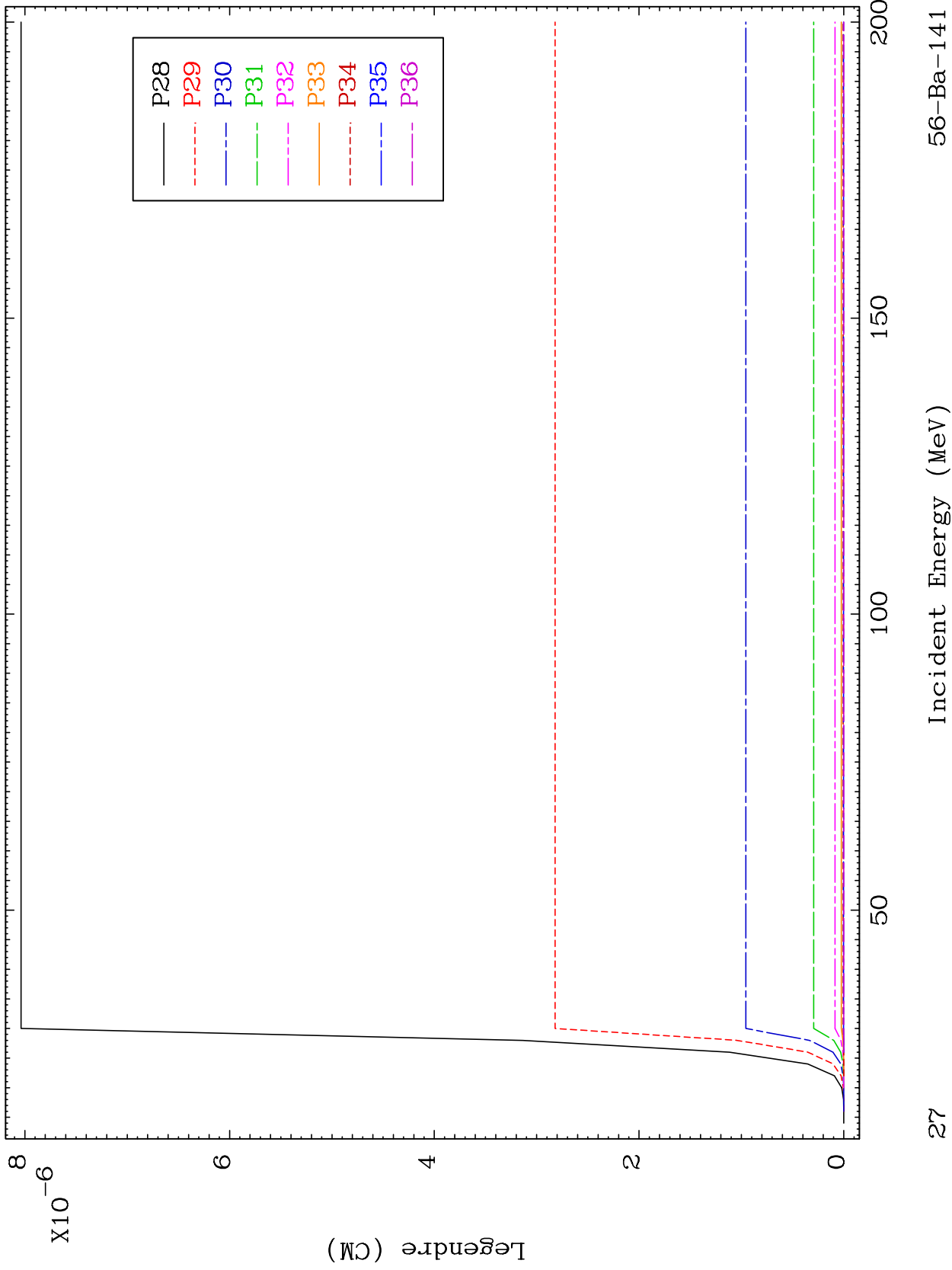

MAT 5658

MT= 53 (n,n') Level  
Legendre Coefficients

56-Ba-141

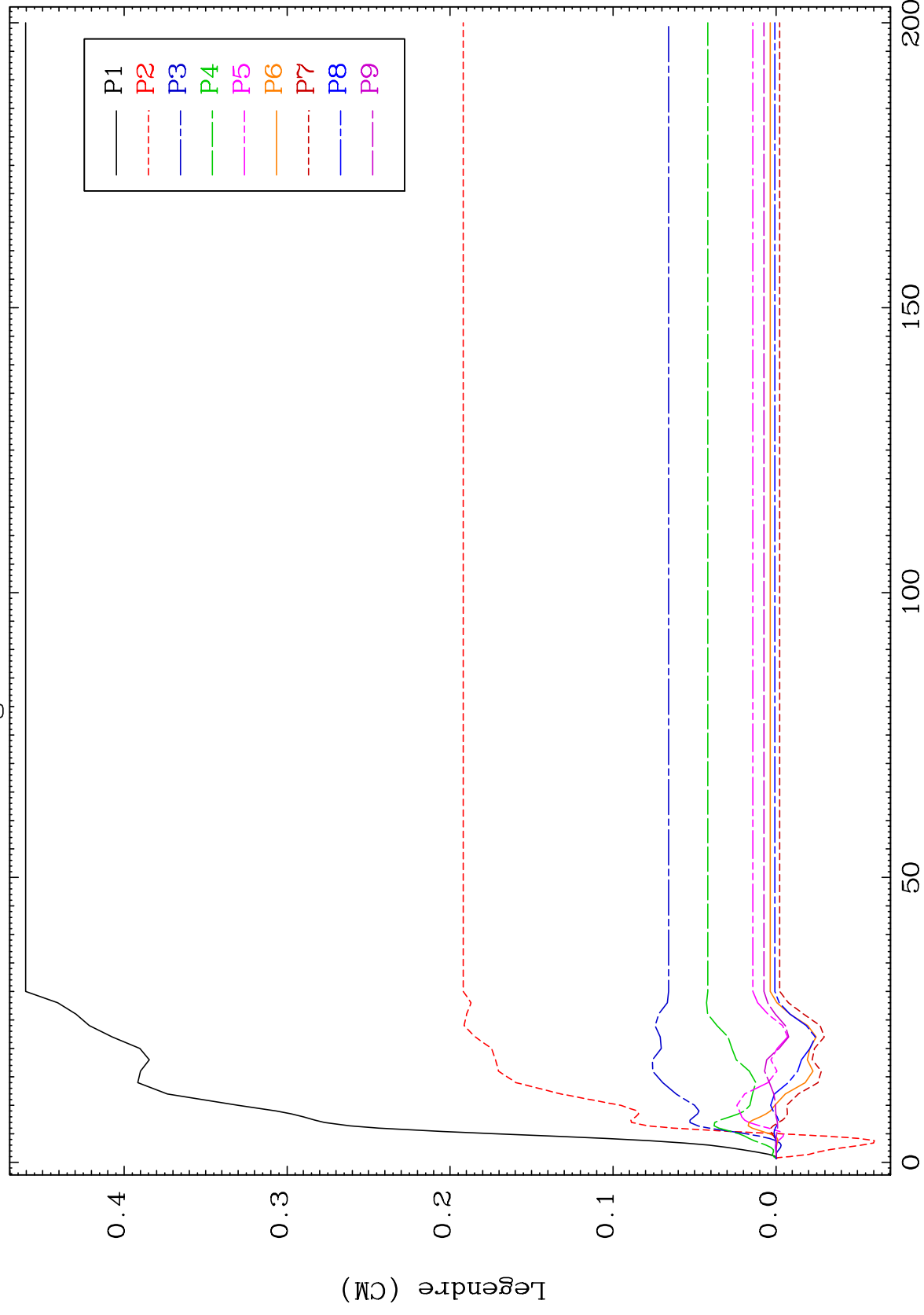

56-Ba-141

Incident Energy (MeV)

28

MAT 5658

MT= 53 (n,n') Level  
Legendre Coefficients

56-Ba-141

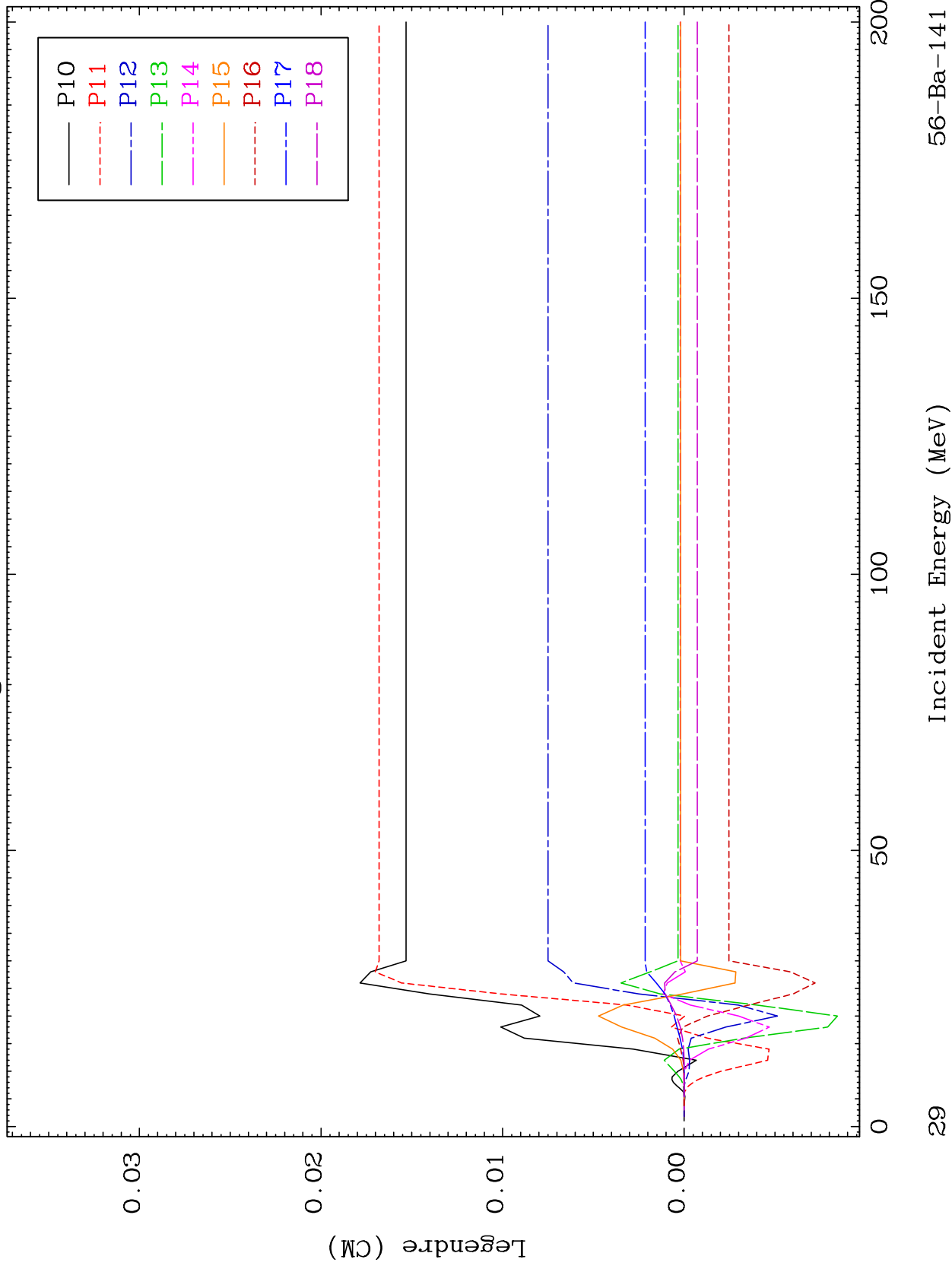

56-Ba-141

Incident Energy (MeV)

29

MAT 5658

MT= 53 (n,n') Level  
Legendre Coefficients

56-Ba-141

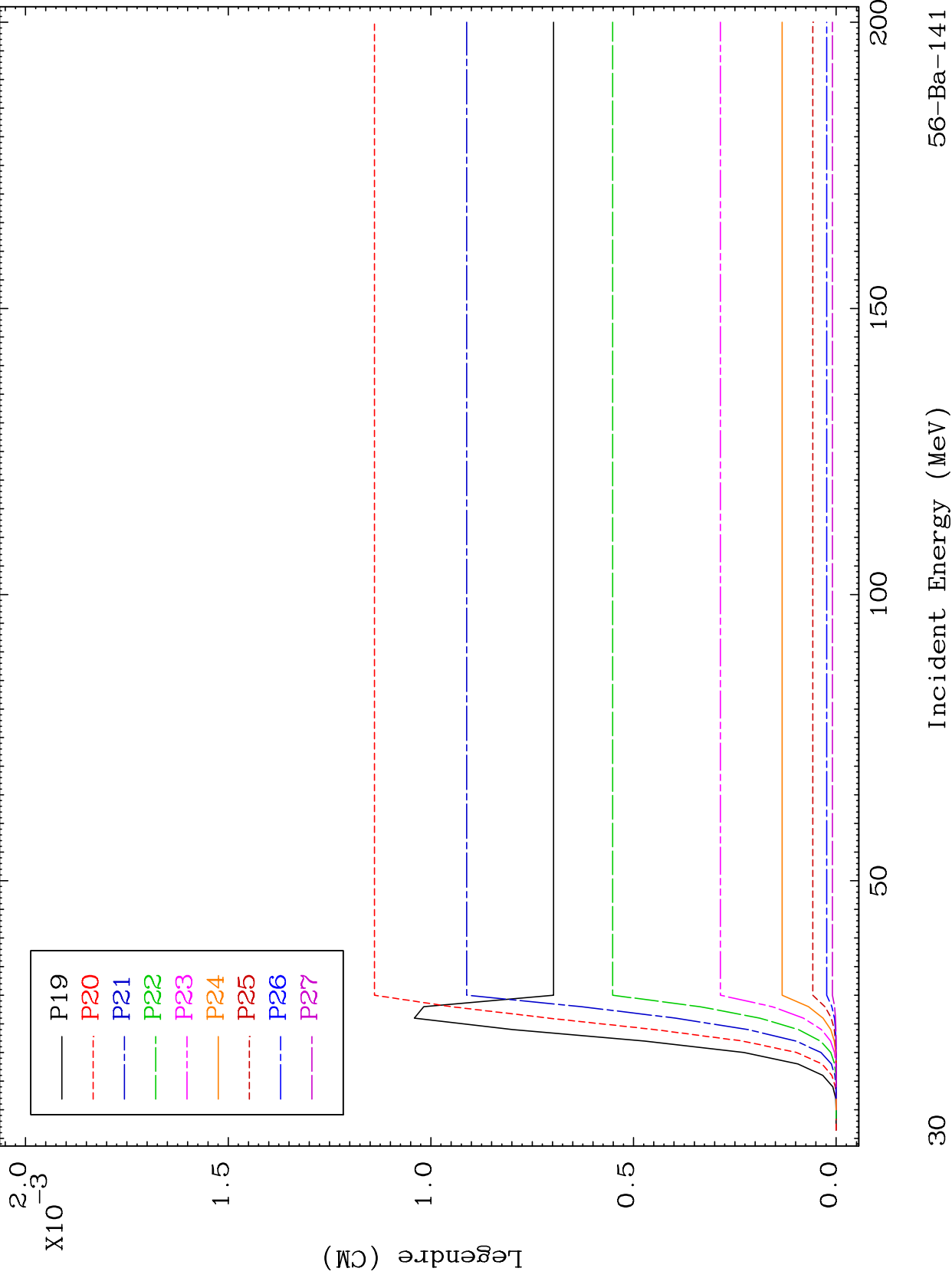

MAT 5658

MT= 53 (n,n') Level  
Legendre Coefficients

56-Ba-141

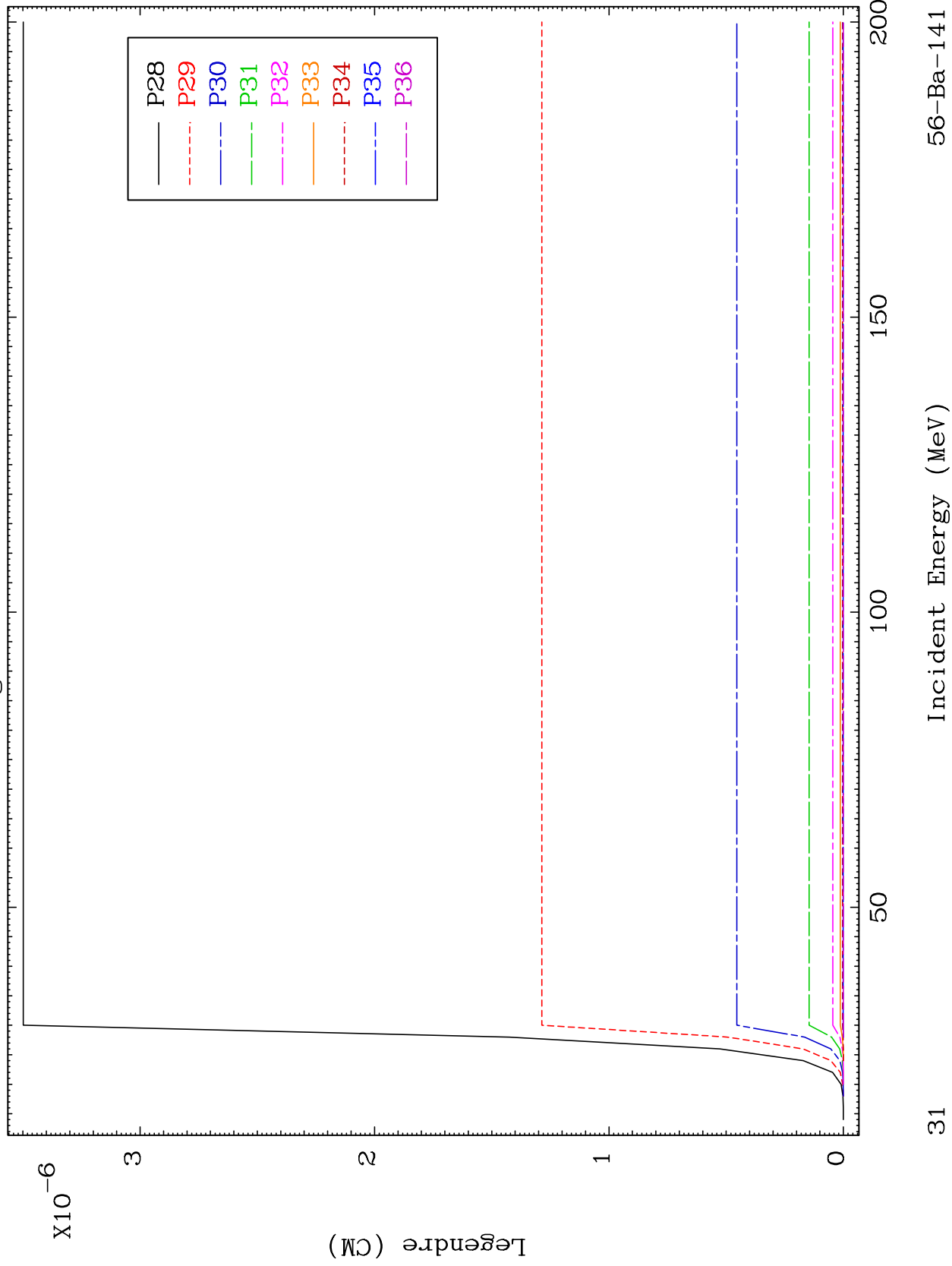

31

200

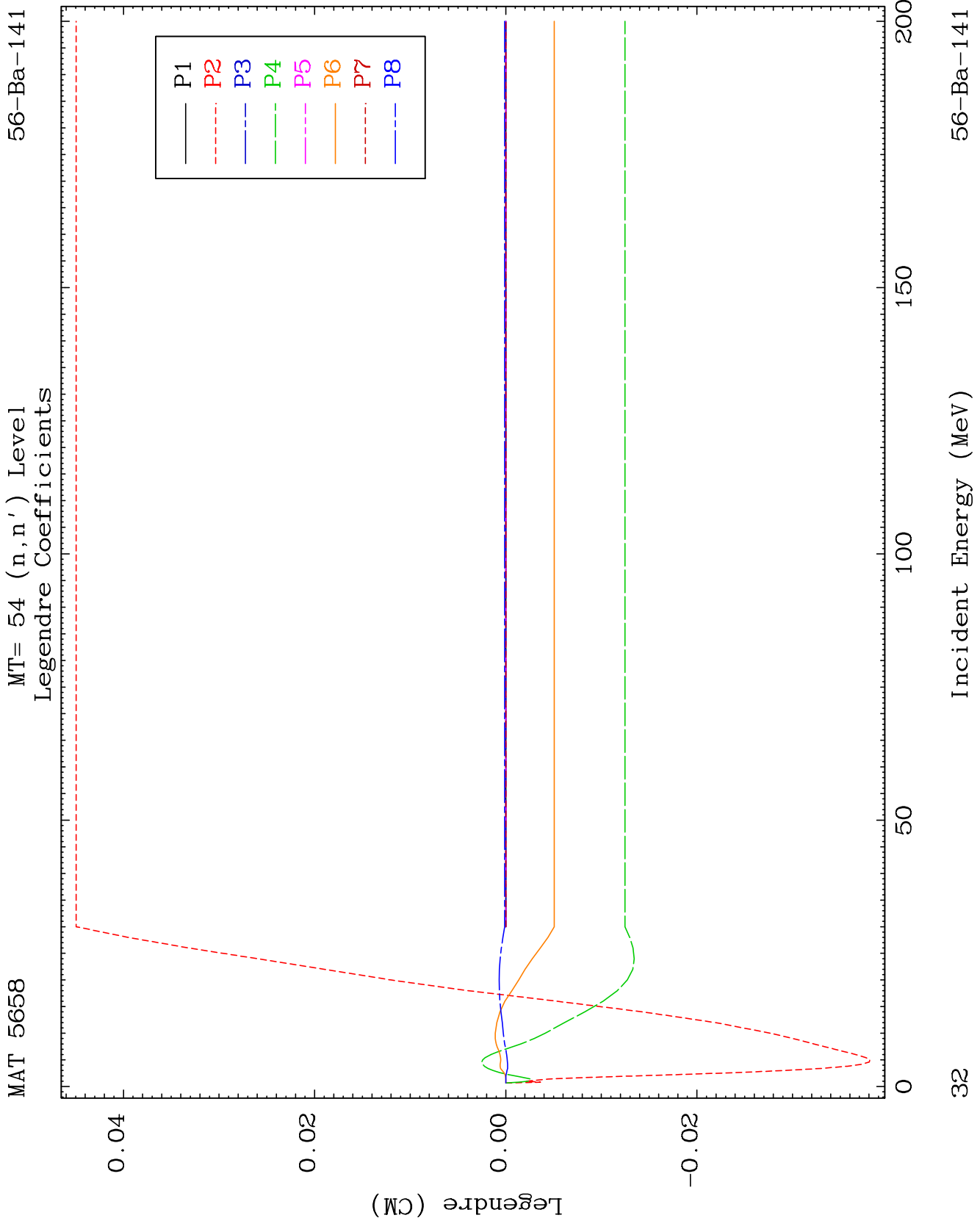

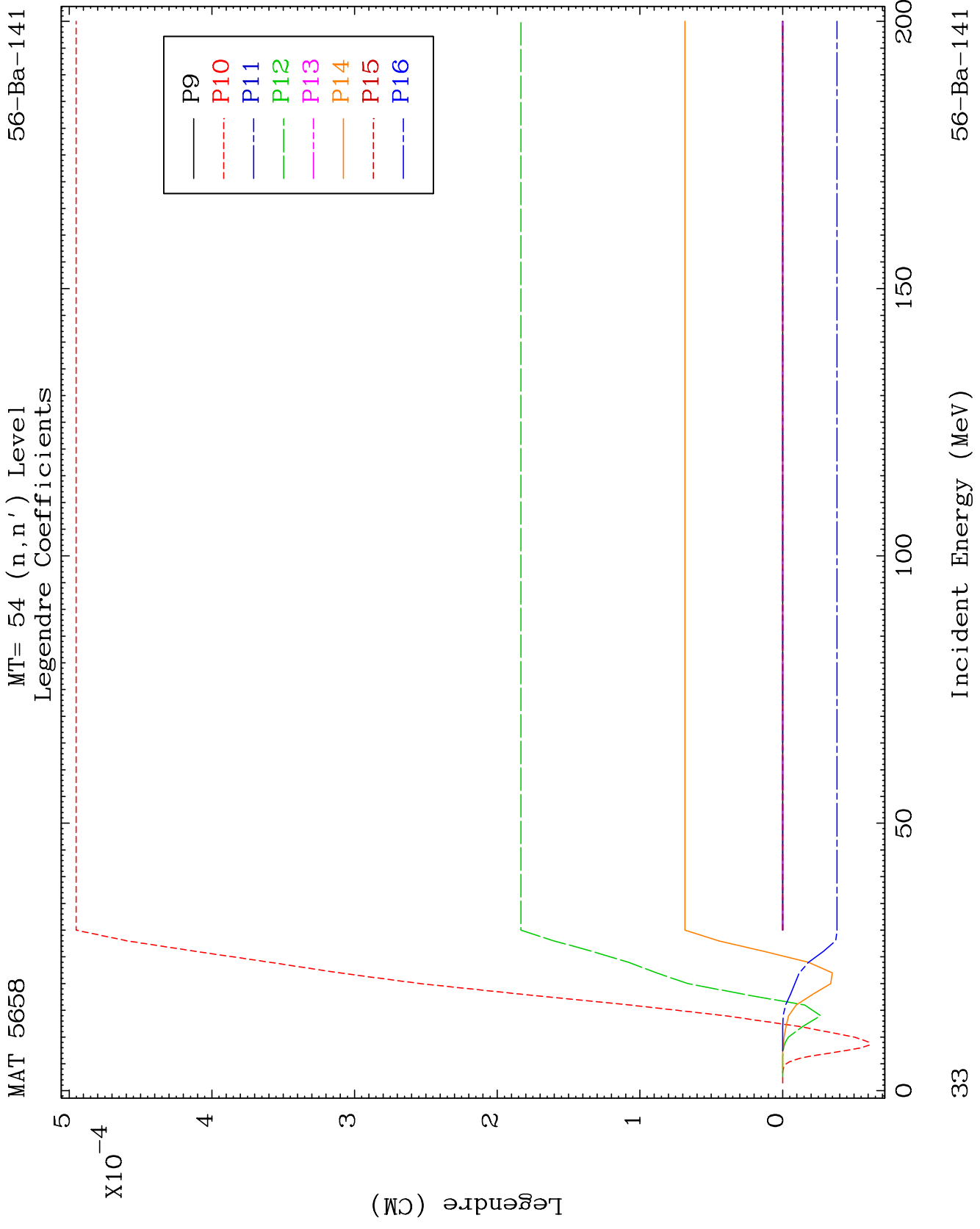

56-Ba-141

Incident Energy (MeV)

33

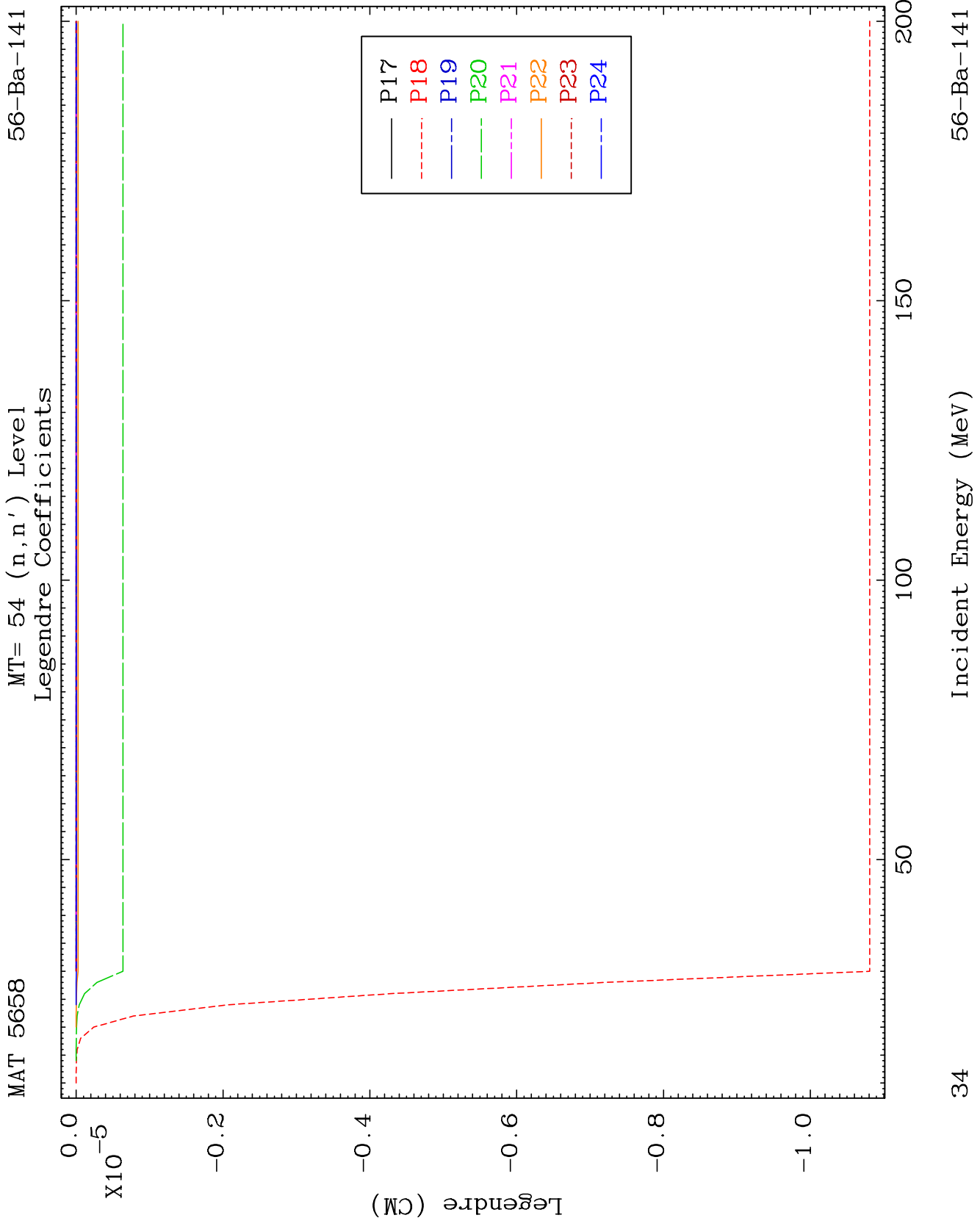

MAT 5658

MT= 55 (n,n') Level  
Legendre Coefficients

56-Ba-141

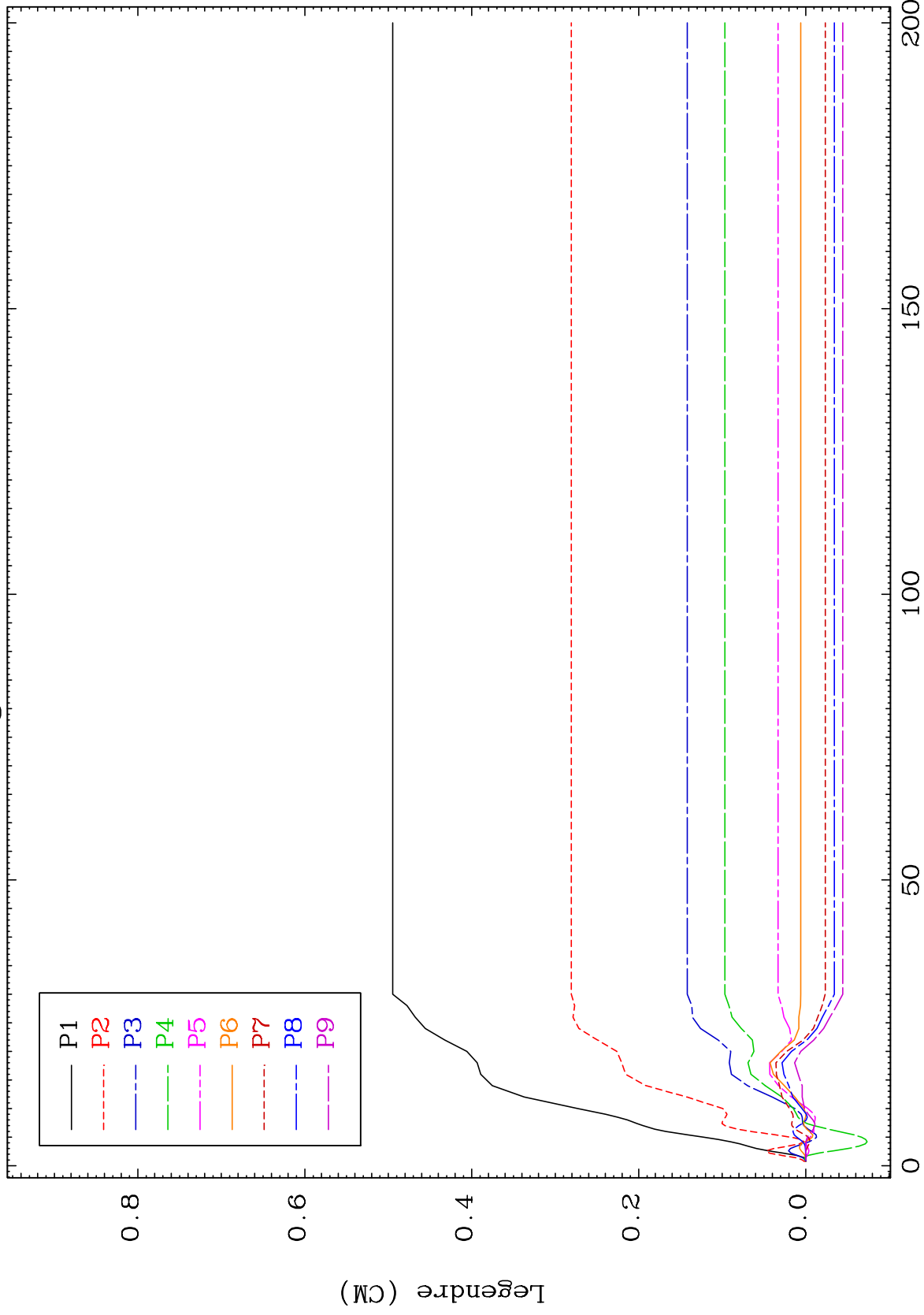

35

Incident Energy (MeV)

56-Ba-141

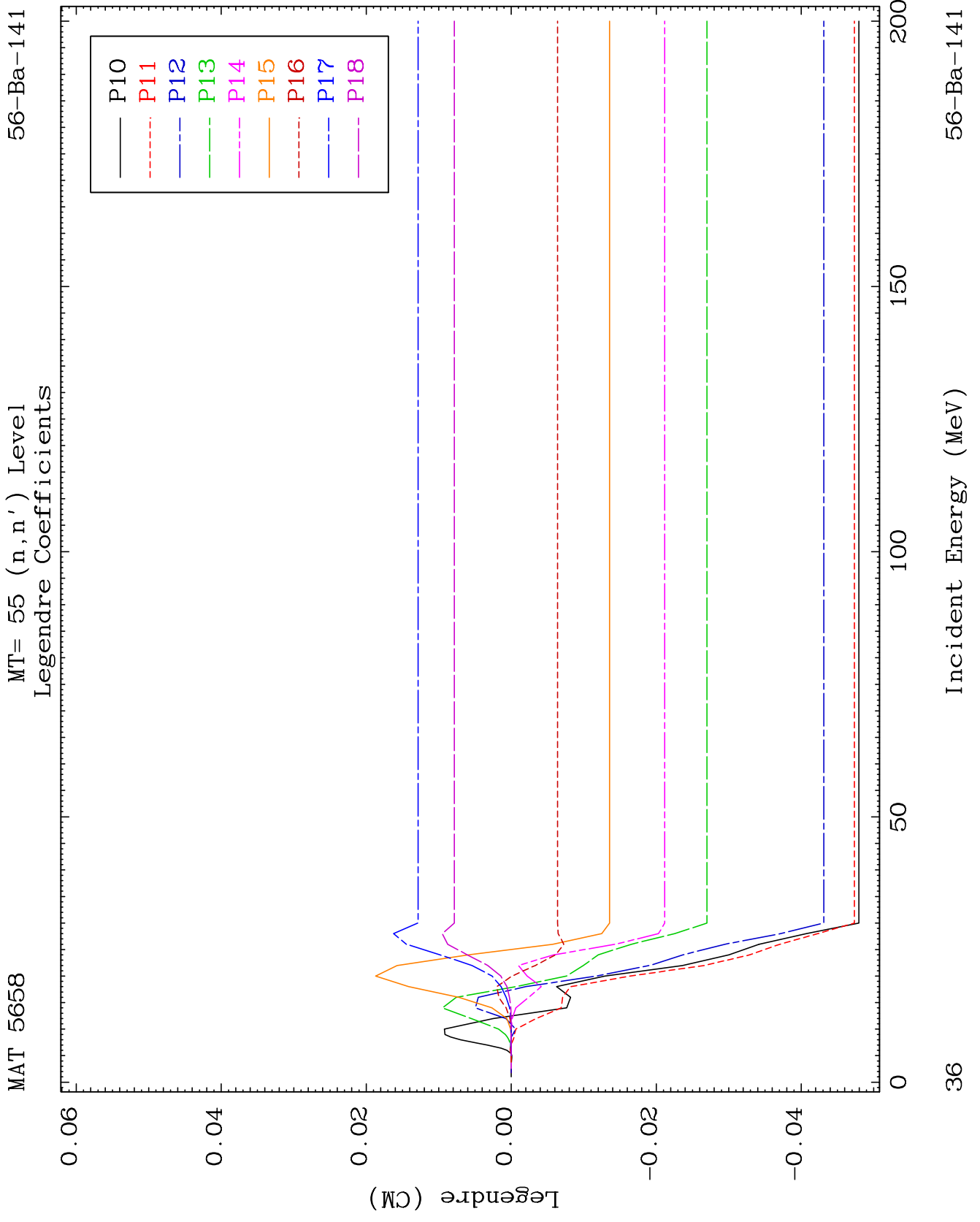

MAT 5658

MT= 55 (n,n') Level  
Legendre Coefficients

56-Ba-141

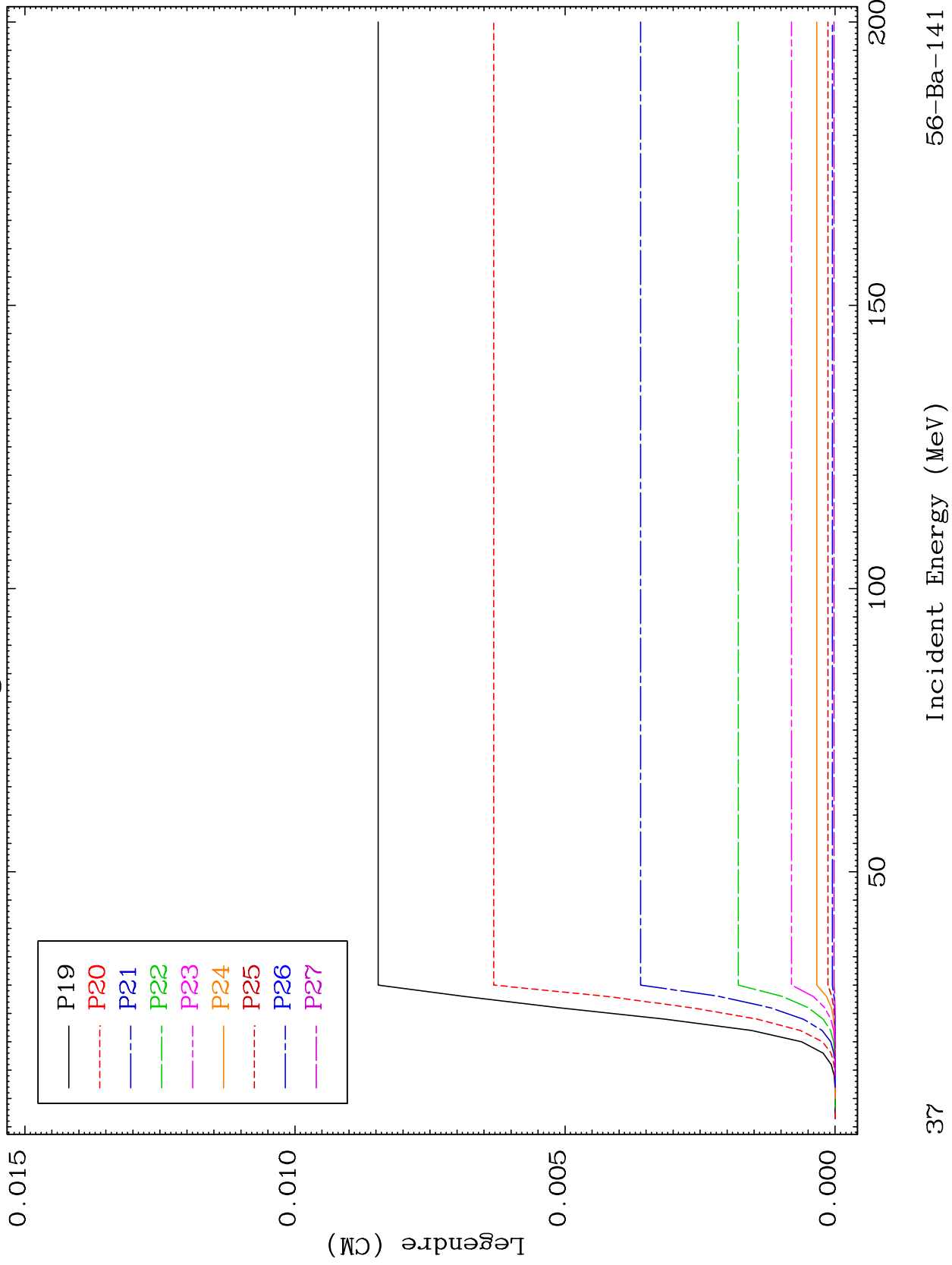

MAT 5658

MT= 55 (n,n') Level  
Legendre Coefficients

56-Ba-141

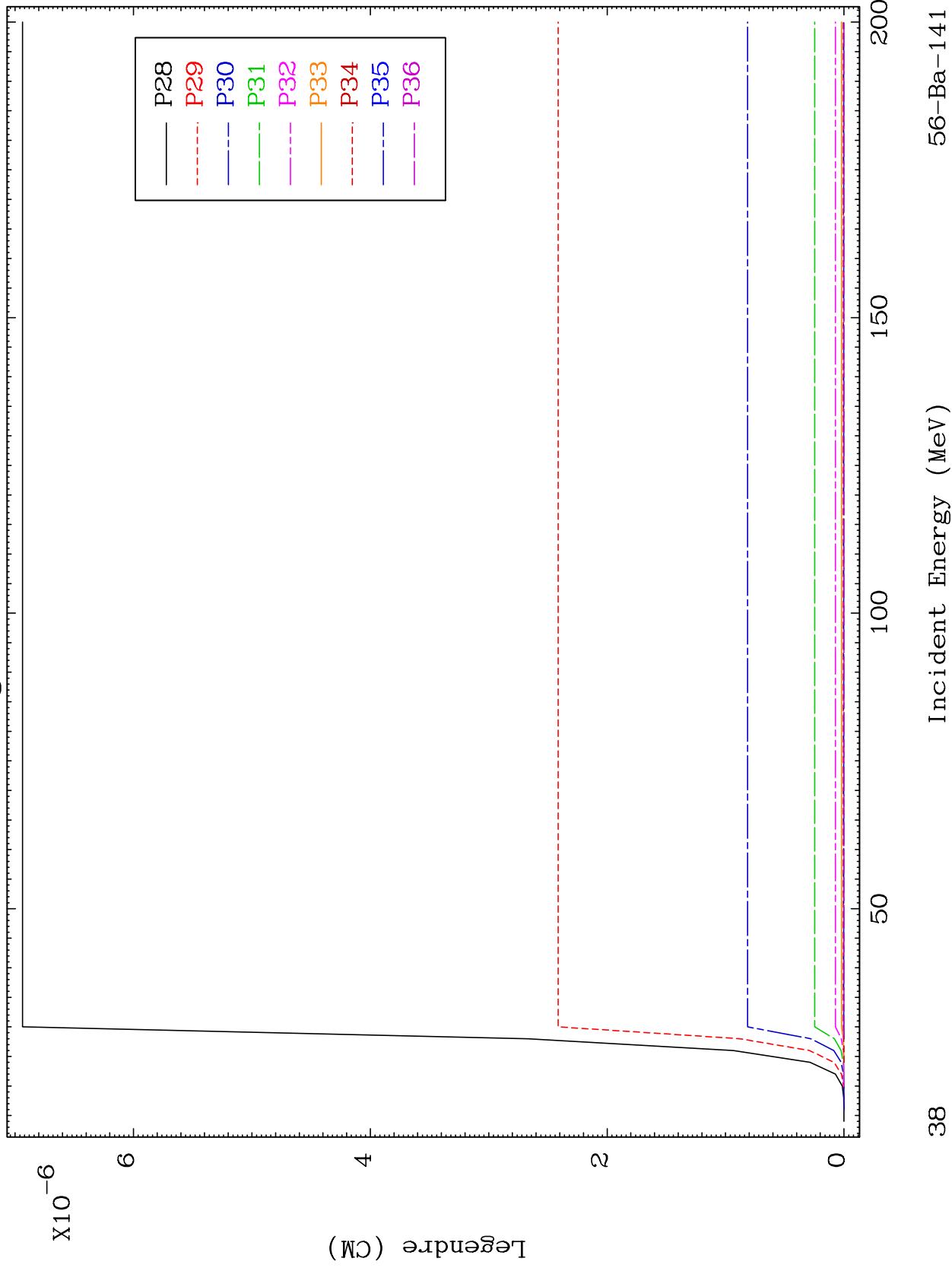

38

Incident Energy (MeV)

56-Ba-141

MAT 5658

MT= 56 (n,n') Level  
Legendre Coefficients

56-Ba-141

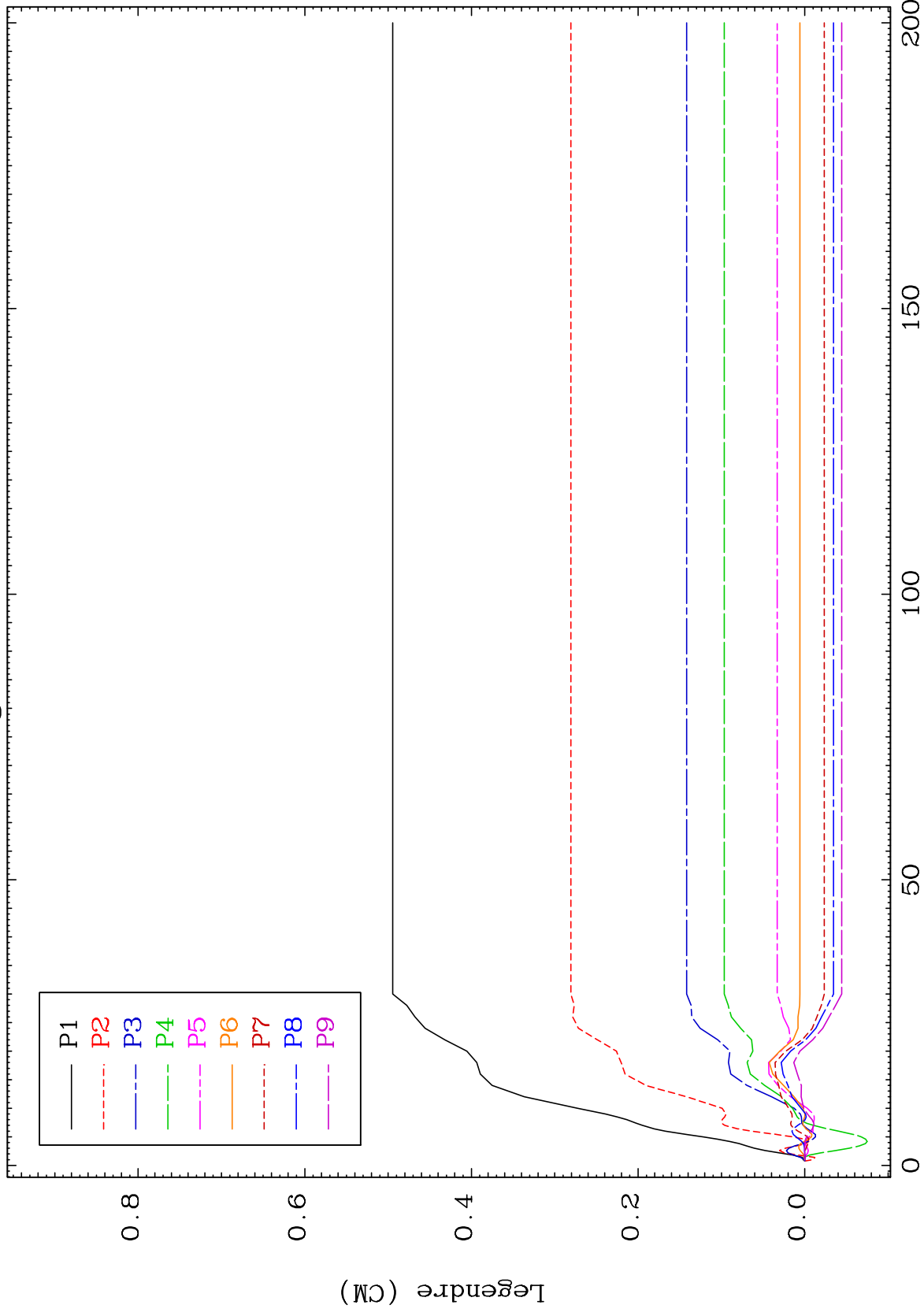

39

Incident Energy (MeV)

56-Ba-141



MAT 5658

MT= 56 (n,n') Level  
Legendre Coefficients

56-Ba-141

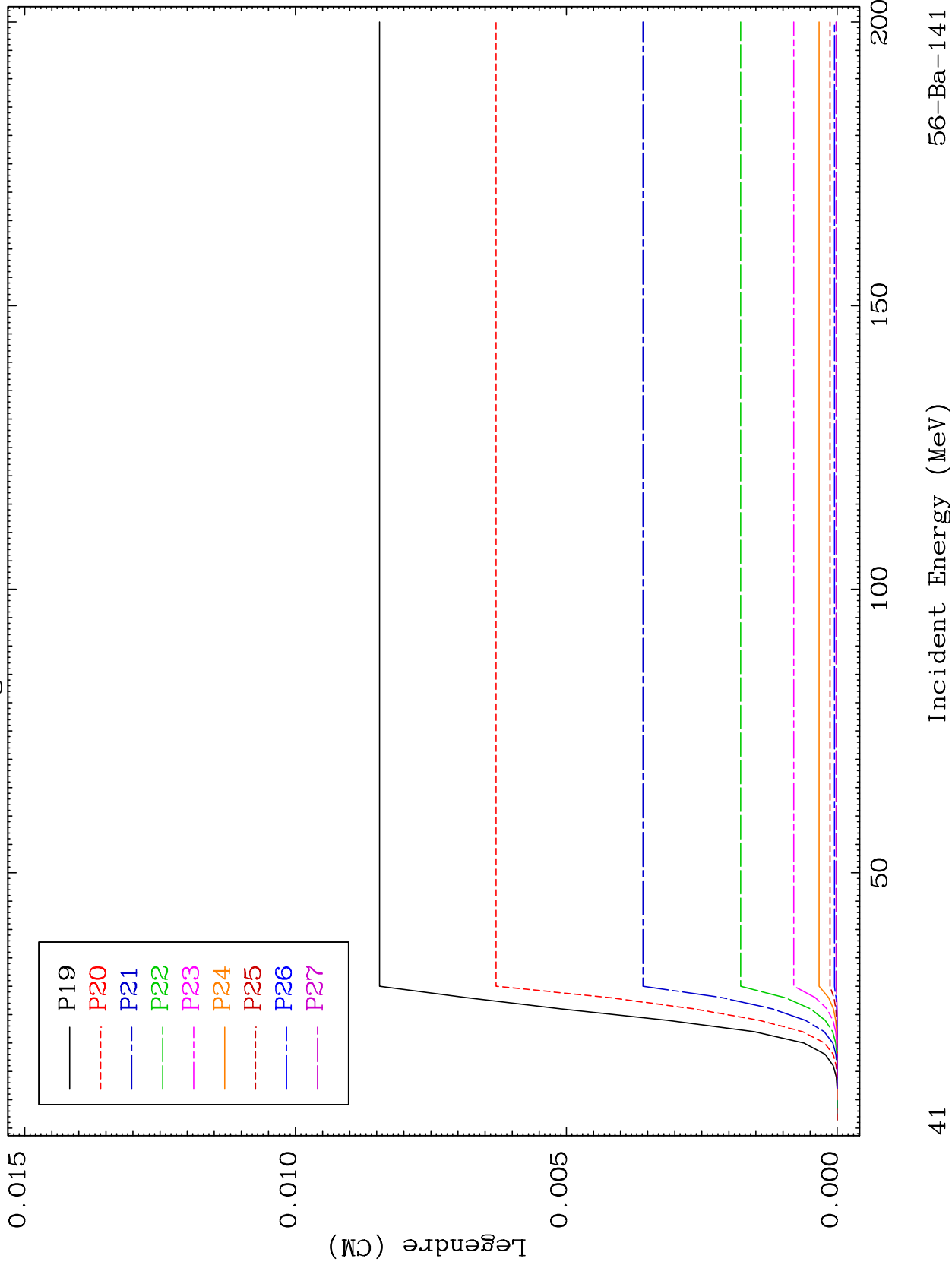

41

Incident Energy (MeV)

56-Ba-141

MAT 5658

MT= 56 (n,n') Level  
Legendre Coefficients

56-Ba-141

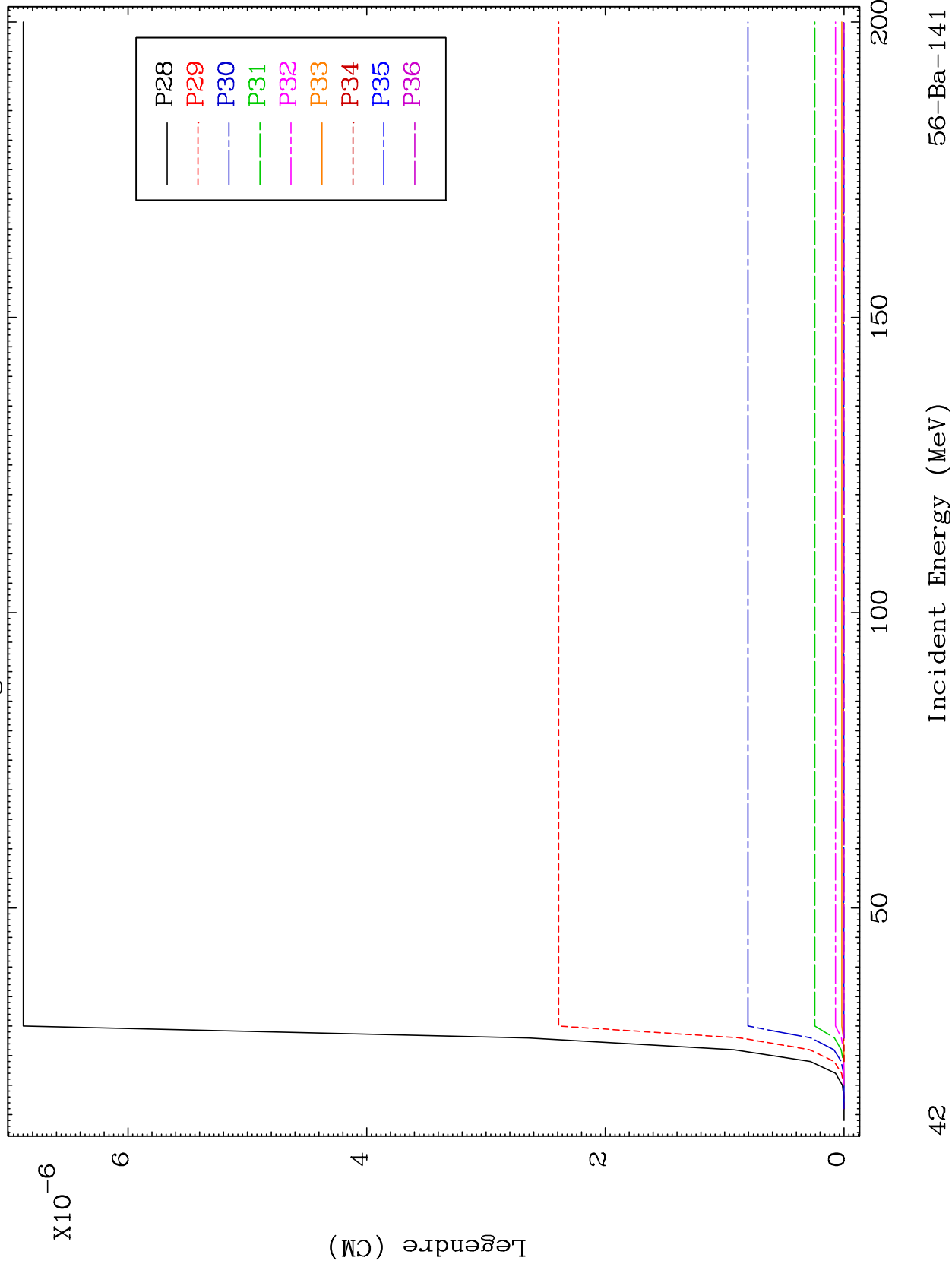

42

Incident Energy (MeV)

56-Ba-141

MAT 5658

MT= 57 (n,n') Level  
Legendre Coefficients

56-Ba-141

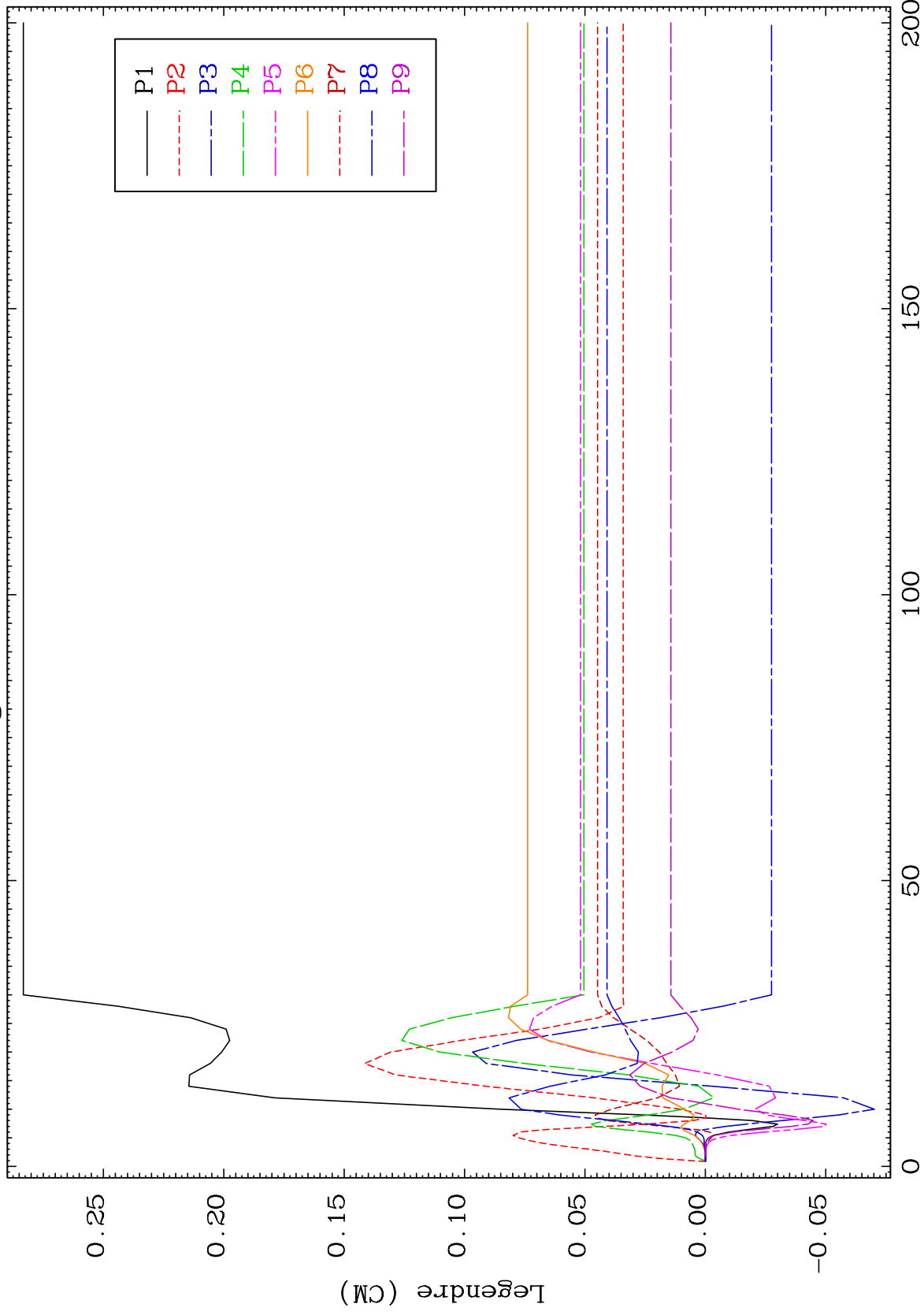

43

Incident Energy (MeV)

56-Ba-141

MAT 5658

56-Ba-141

MT= 57 (n,n') Level  
Legendre Coefficients

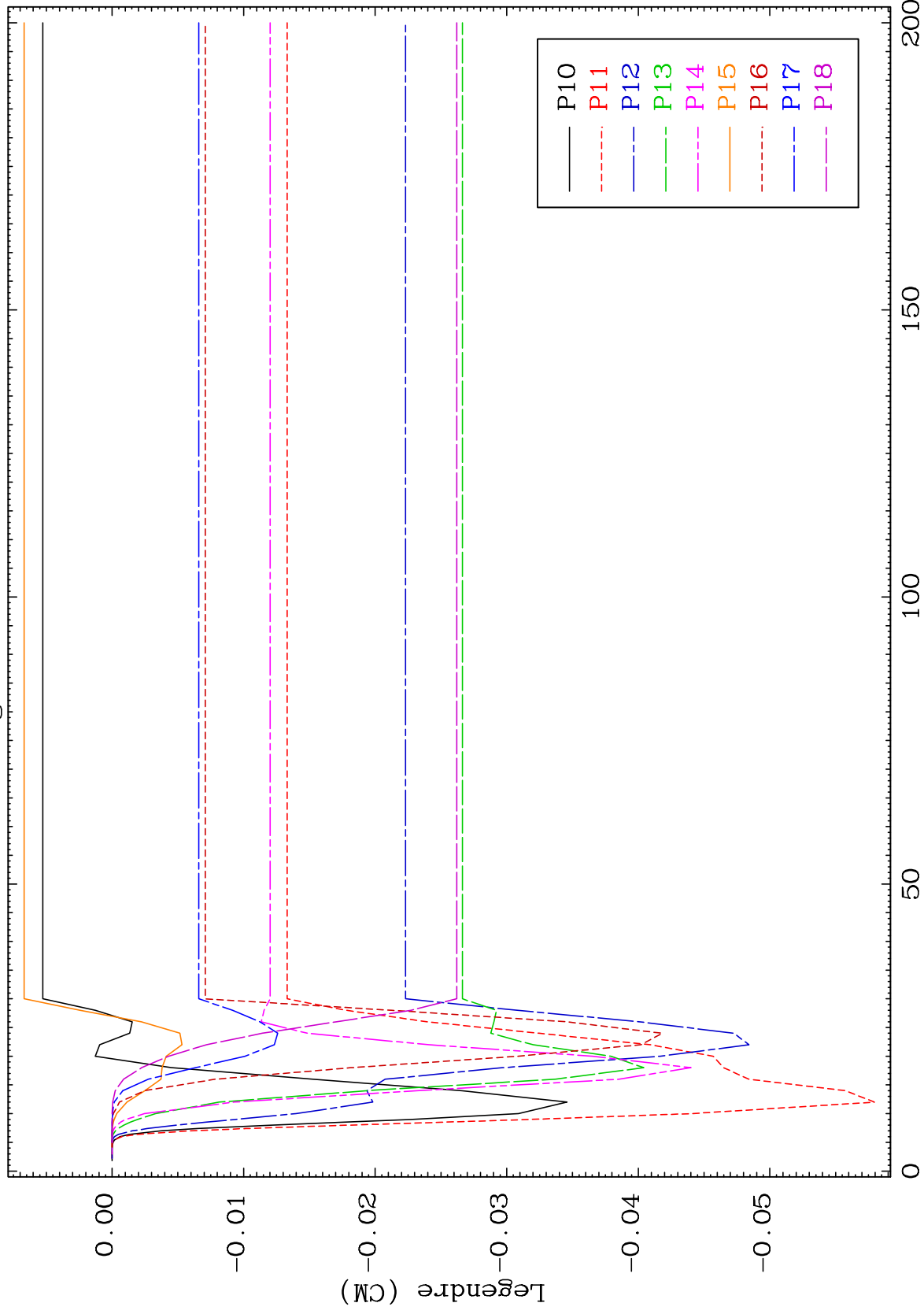

56-Ba-141

Incident Energy (MeV)

44

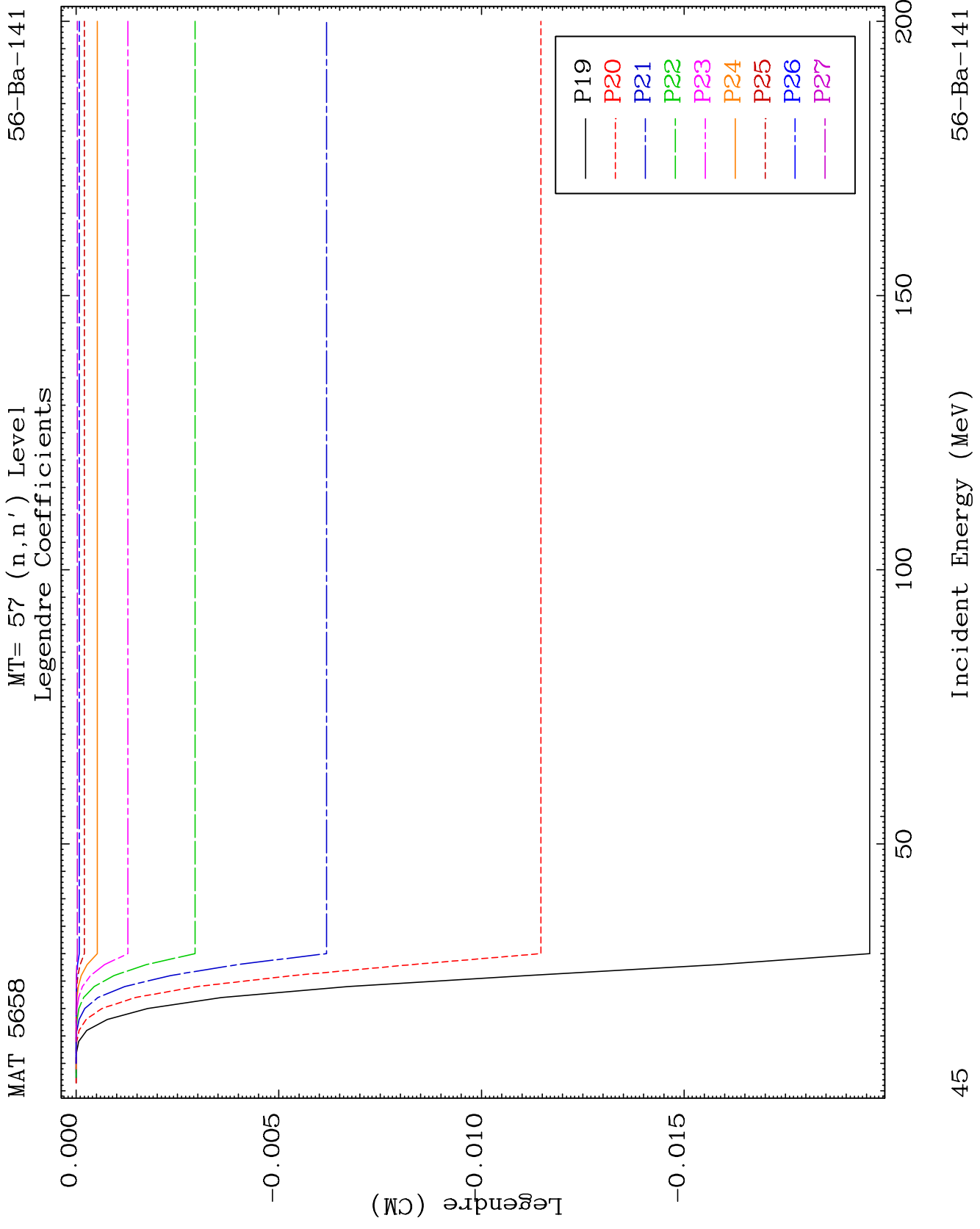

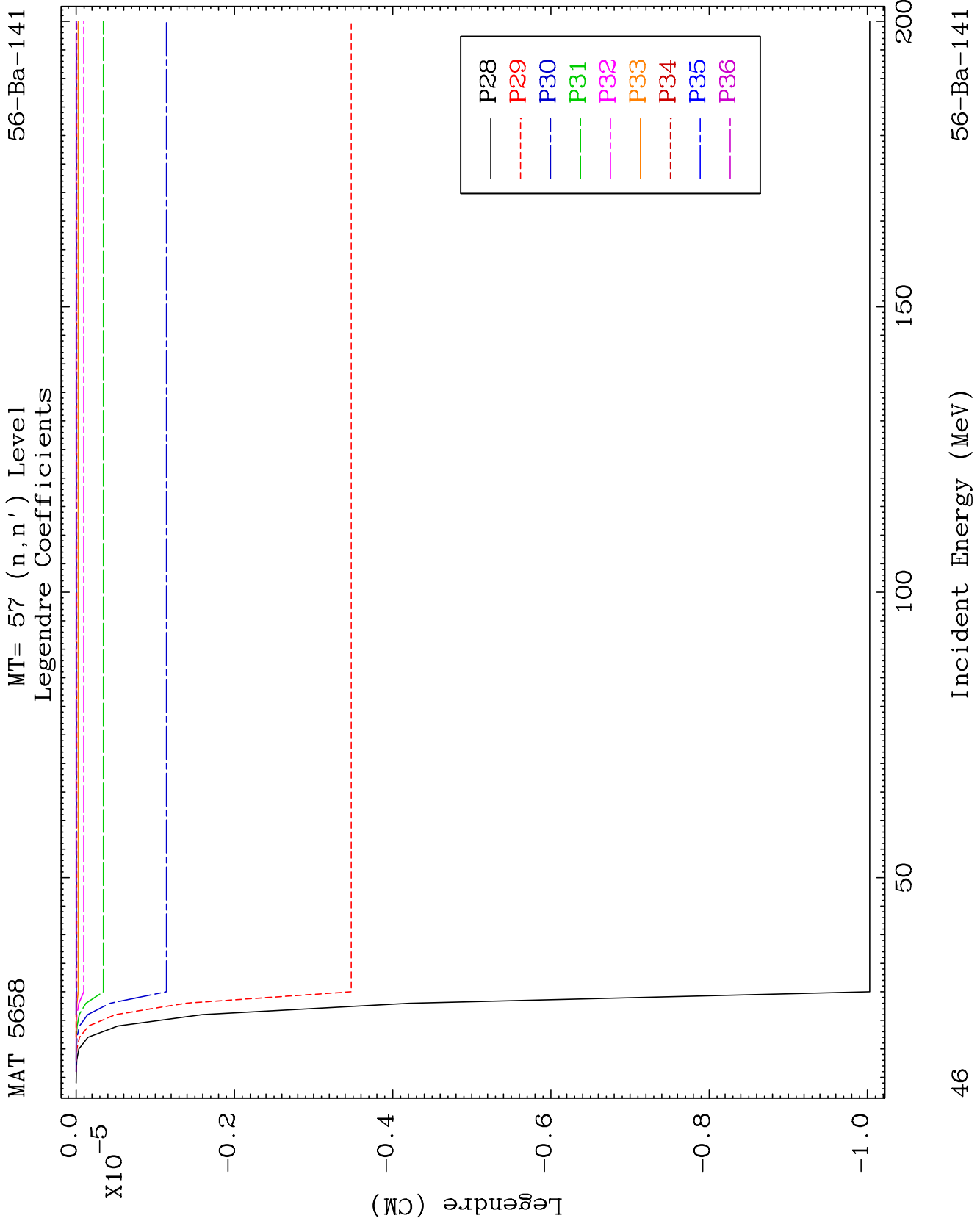

MAT 5658

MT= 58 (n,n') Level  
Legendre Coefficients

56-Ba-141

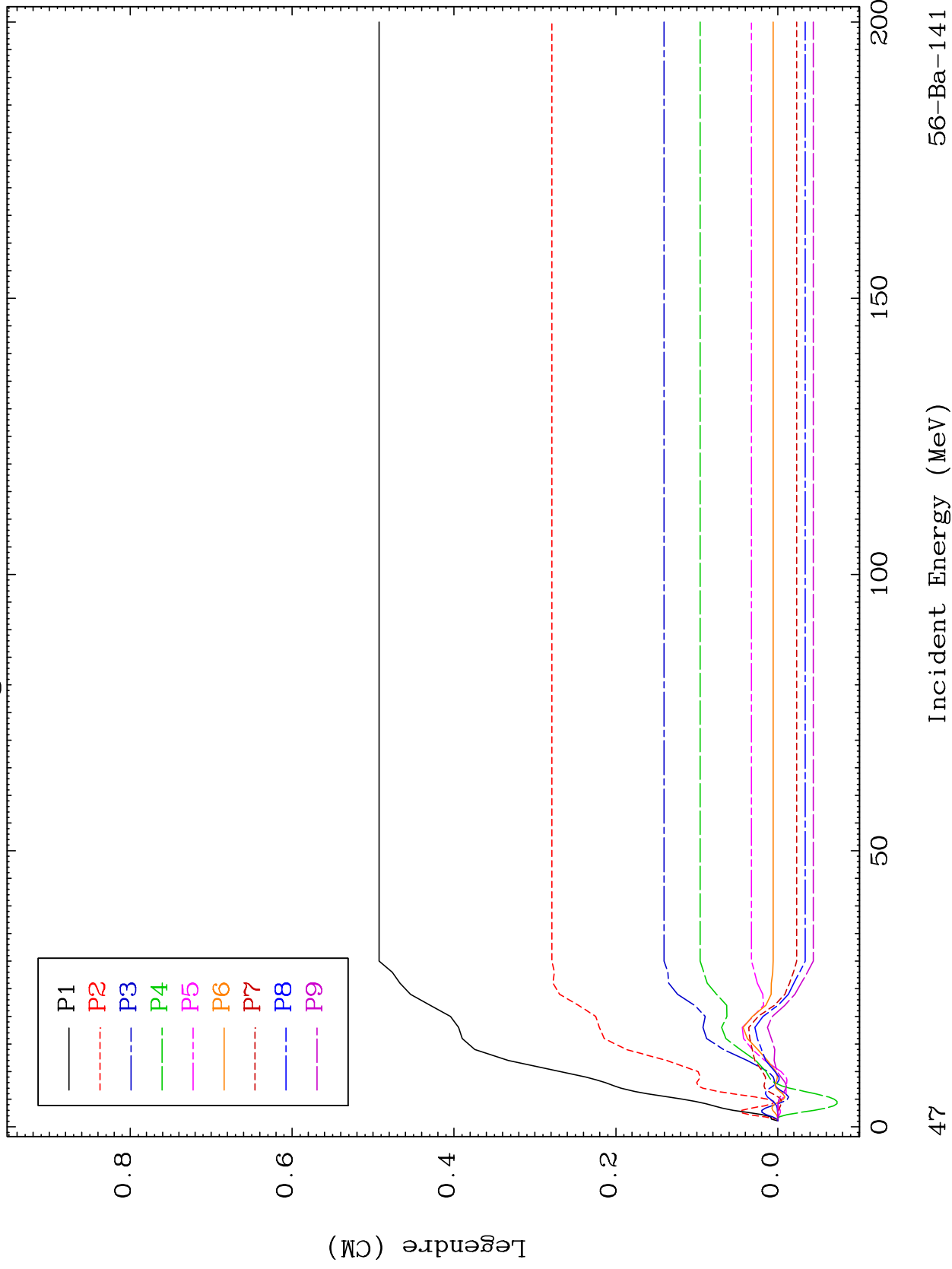

56-Ba-141

Incident Energy (MeV)

47

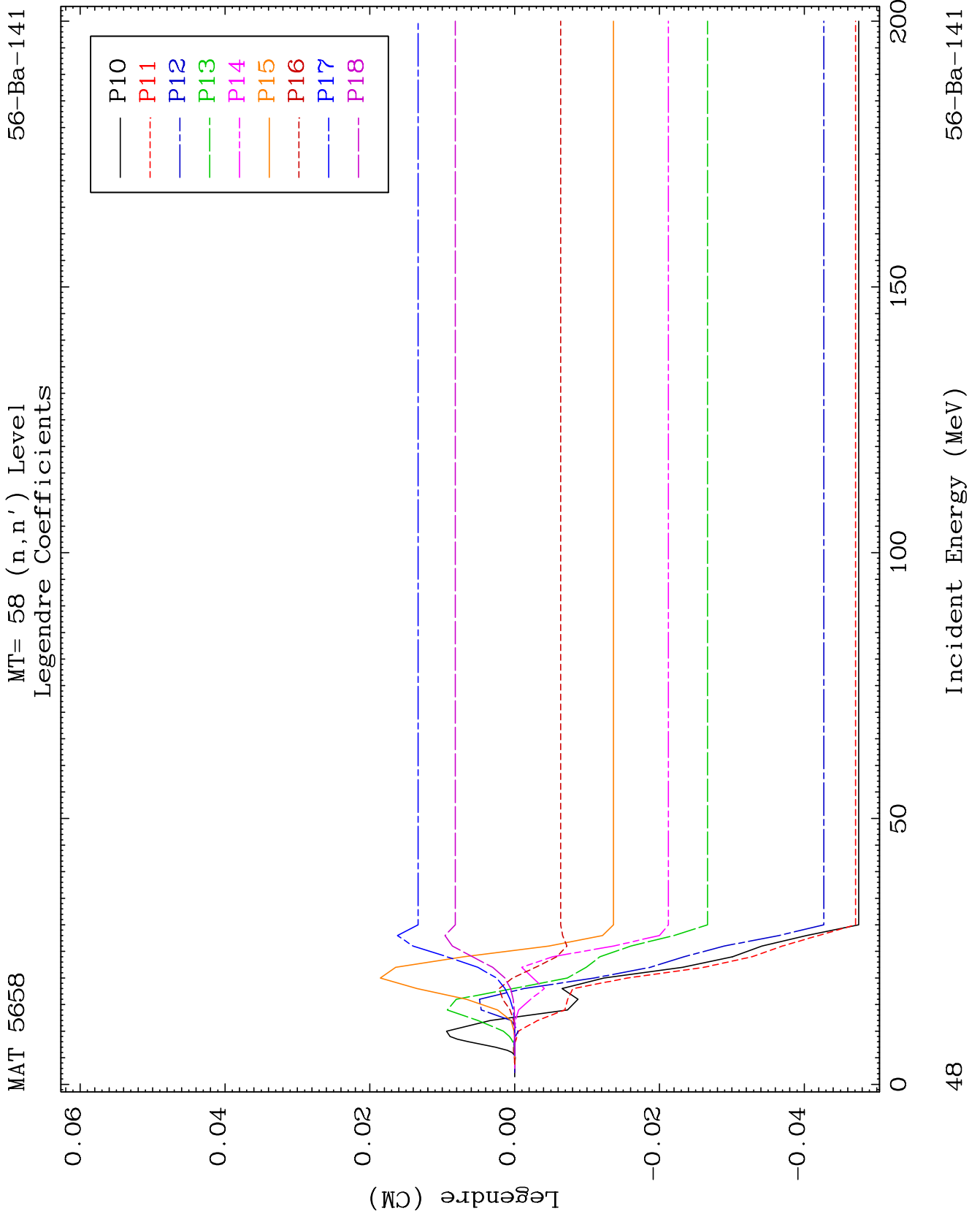

MAT 5658

MT= 58 (n,n') Level  
Legendre Coefficients

56-Ba-141

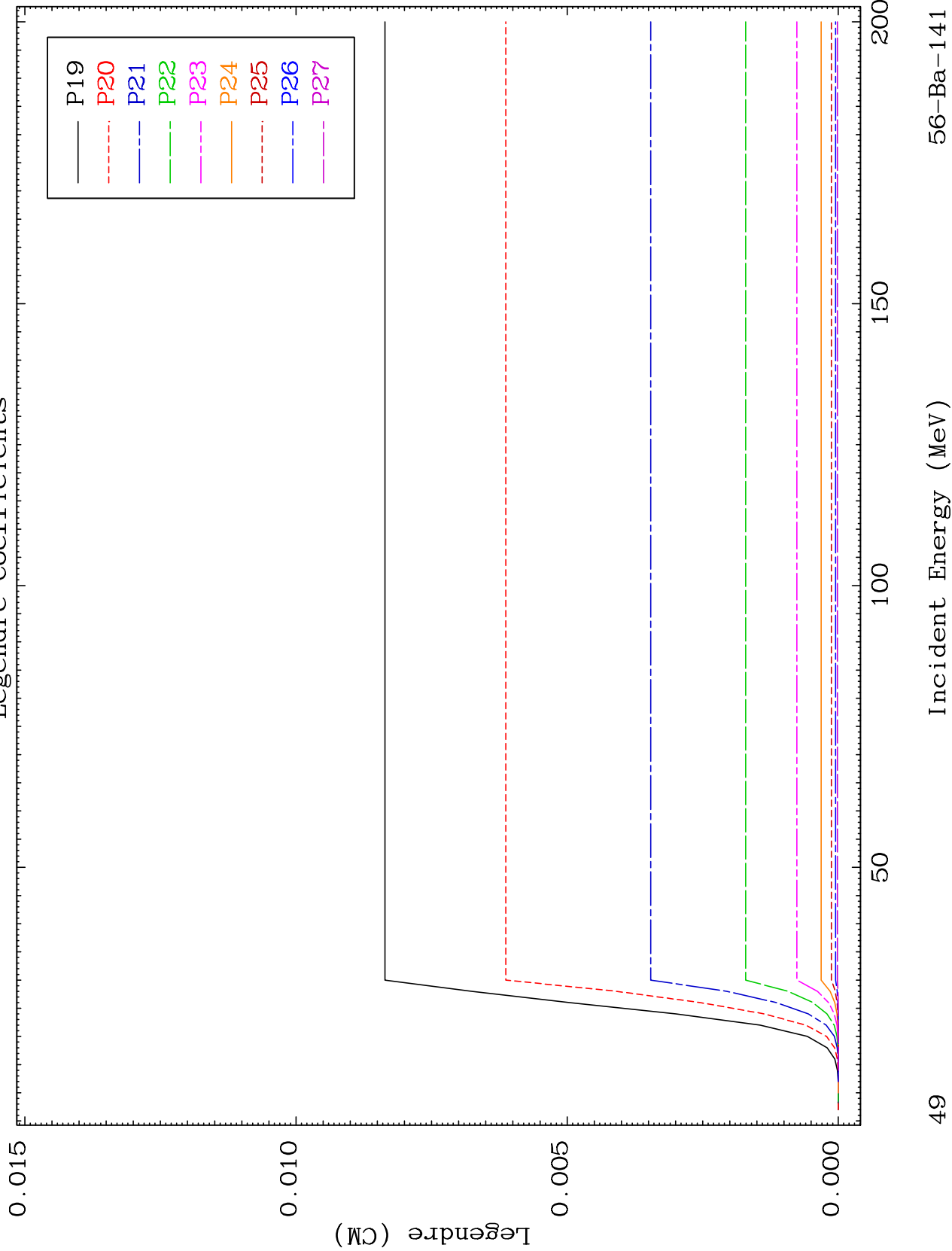

49

Incident Energy (MeV)

56-Ba-141

MAT 5658

MT= 58 (n,n') Level  
Legendre Coefficients

56-Ba-141

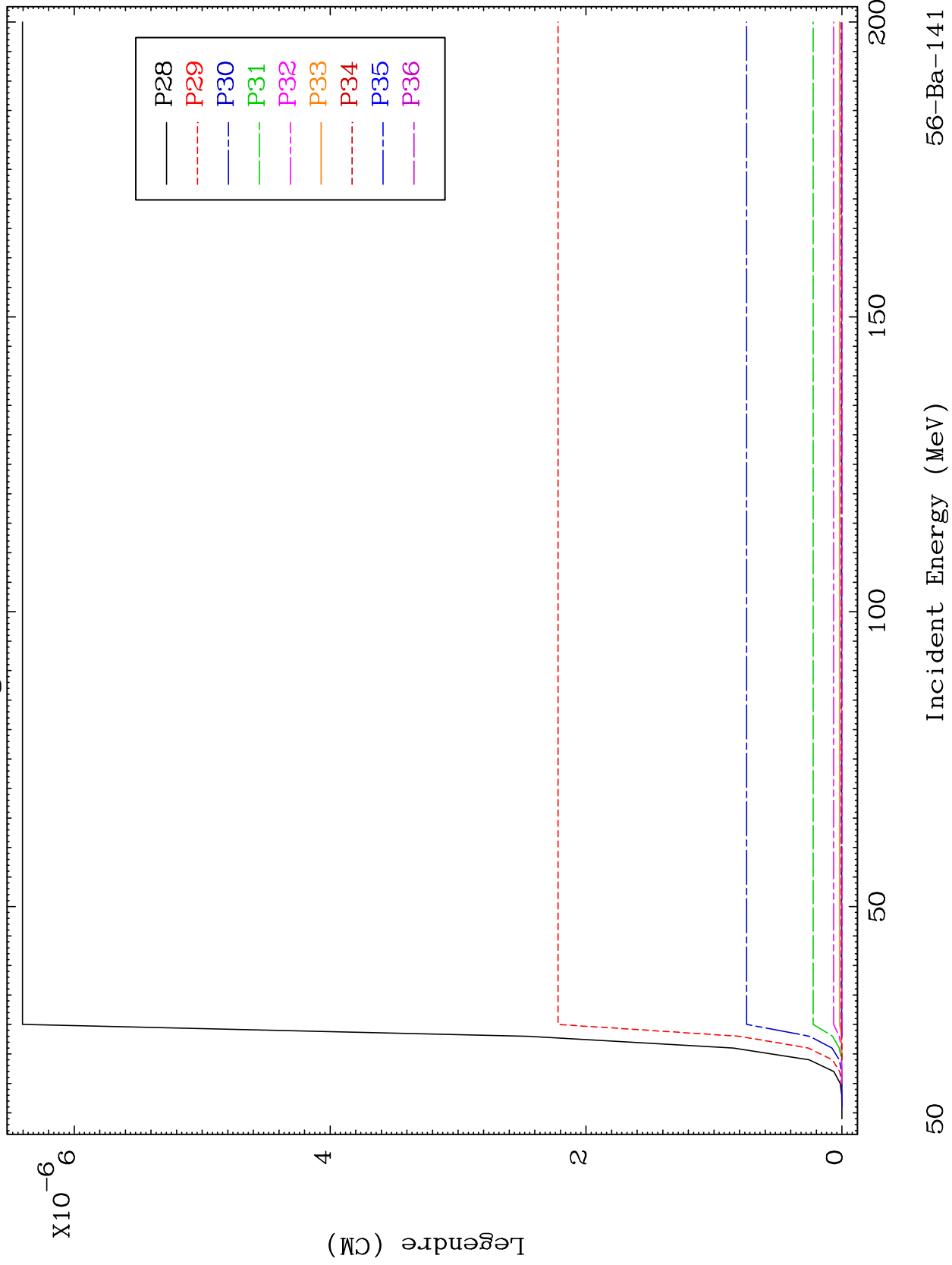

MAT 5658

MT= 59 (n,n') Level  
Legendre Coefficients

56-Ba-141

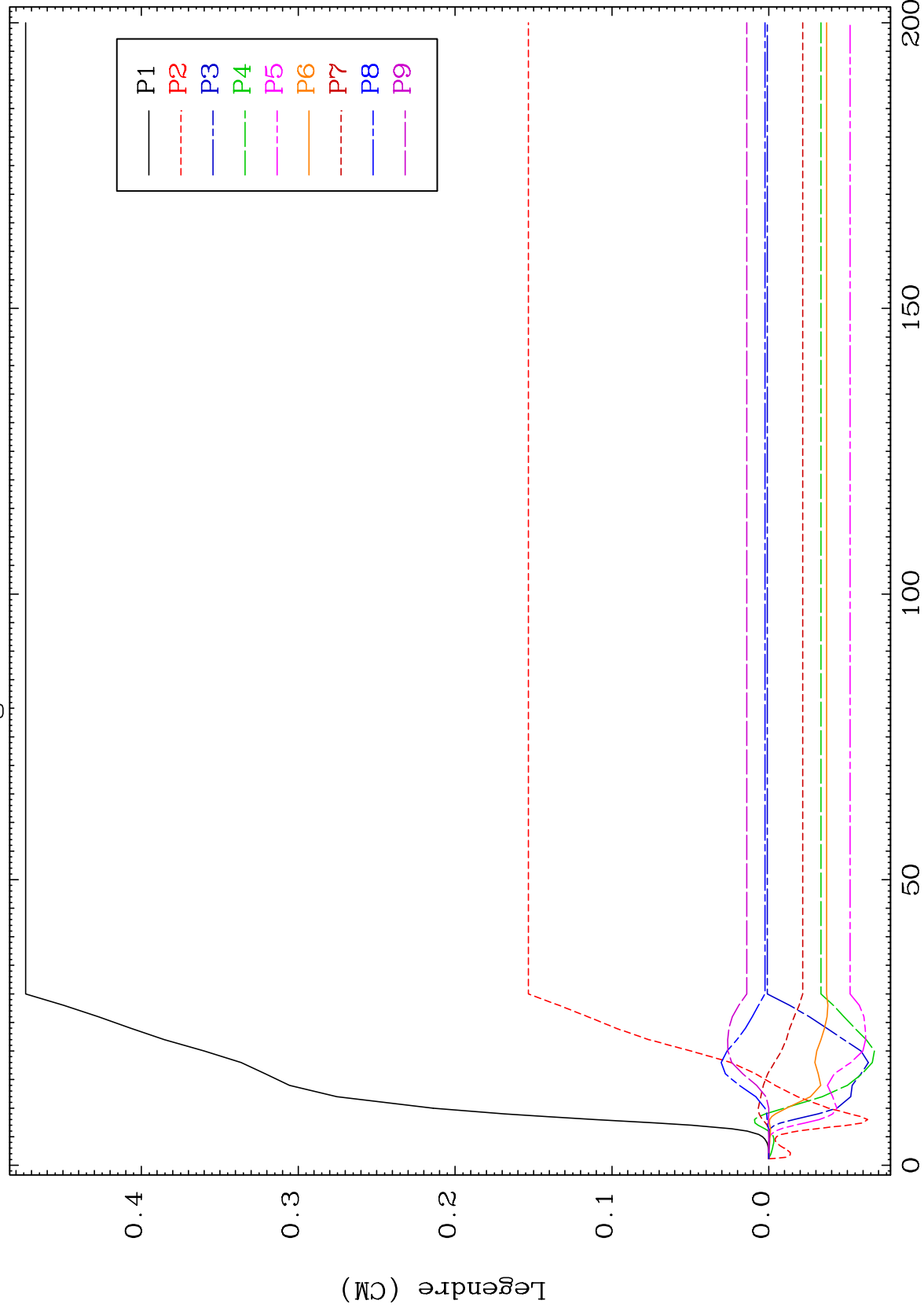

56-Ba-141

Incident Energy (MeV)

51

MAT 5658

MT= 59 (n,n') Level  
Legendre Coefficients

56-Ba-141

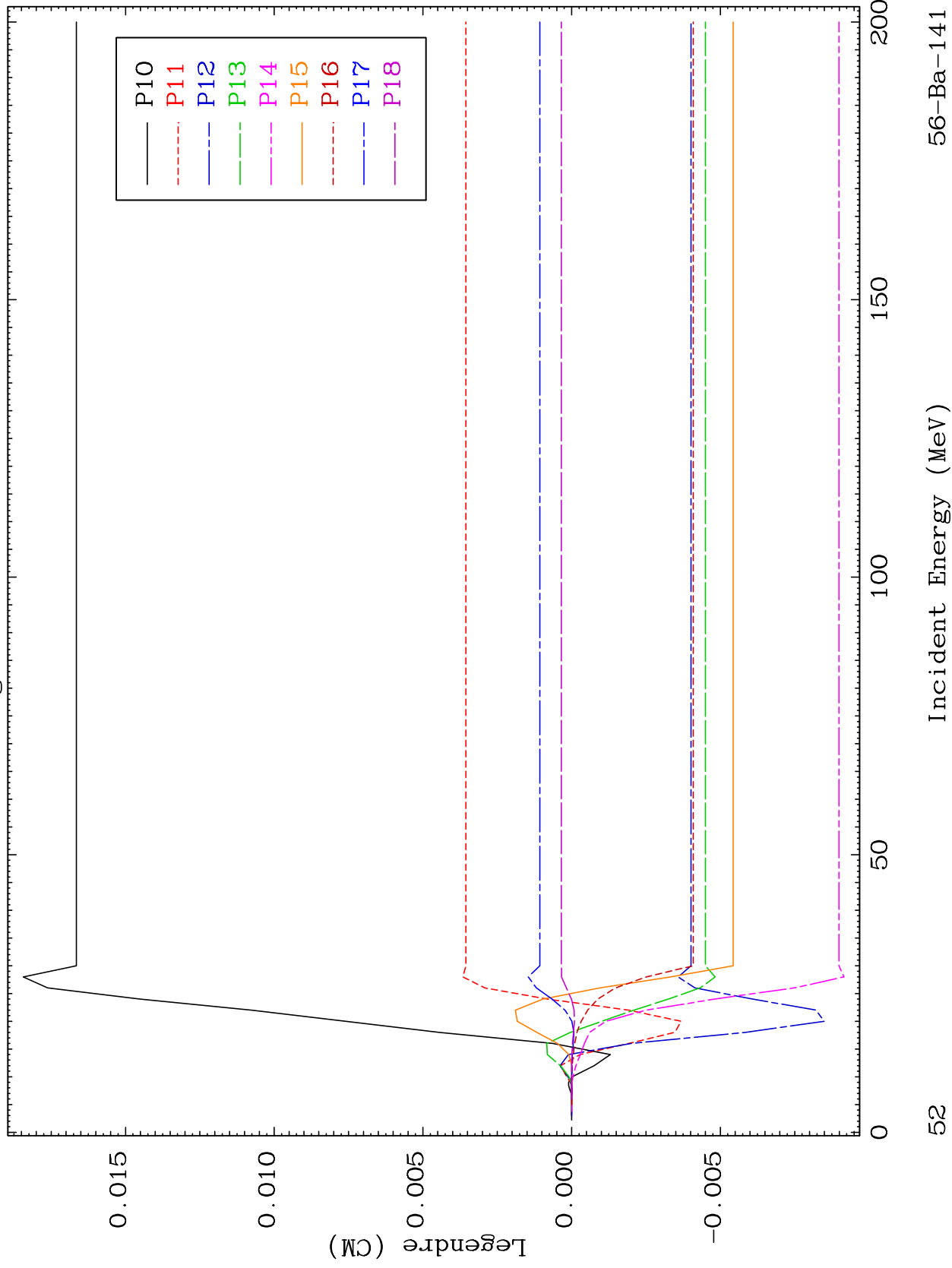

52

Incident Energy (MeV)

56-Ba-141

MAT 5658

MT= 59 (n,n') Level  
Legendre Coefficients

56-Ba-141

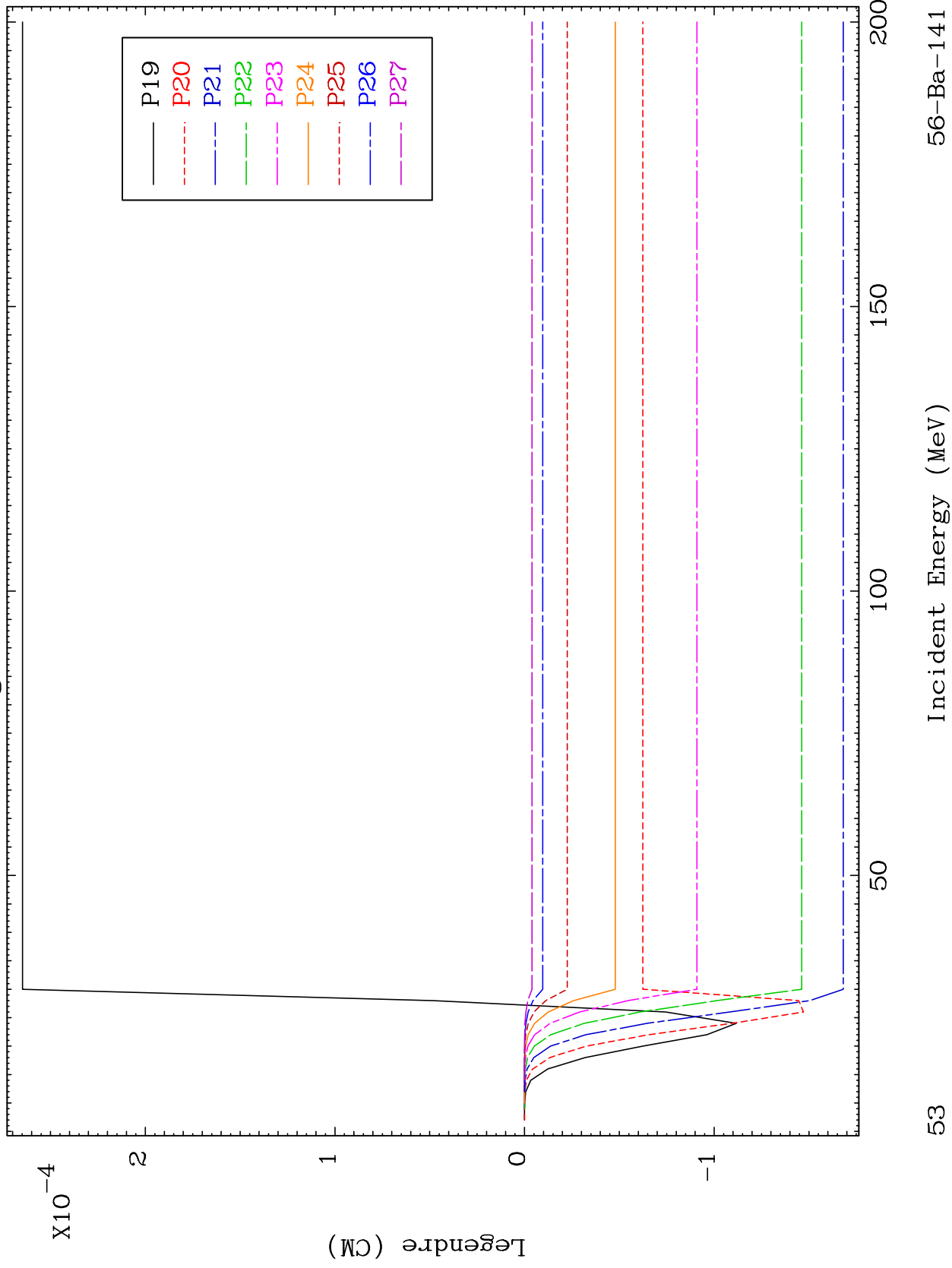

53

56-Ba-141

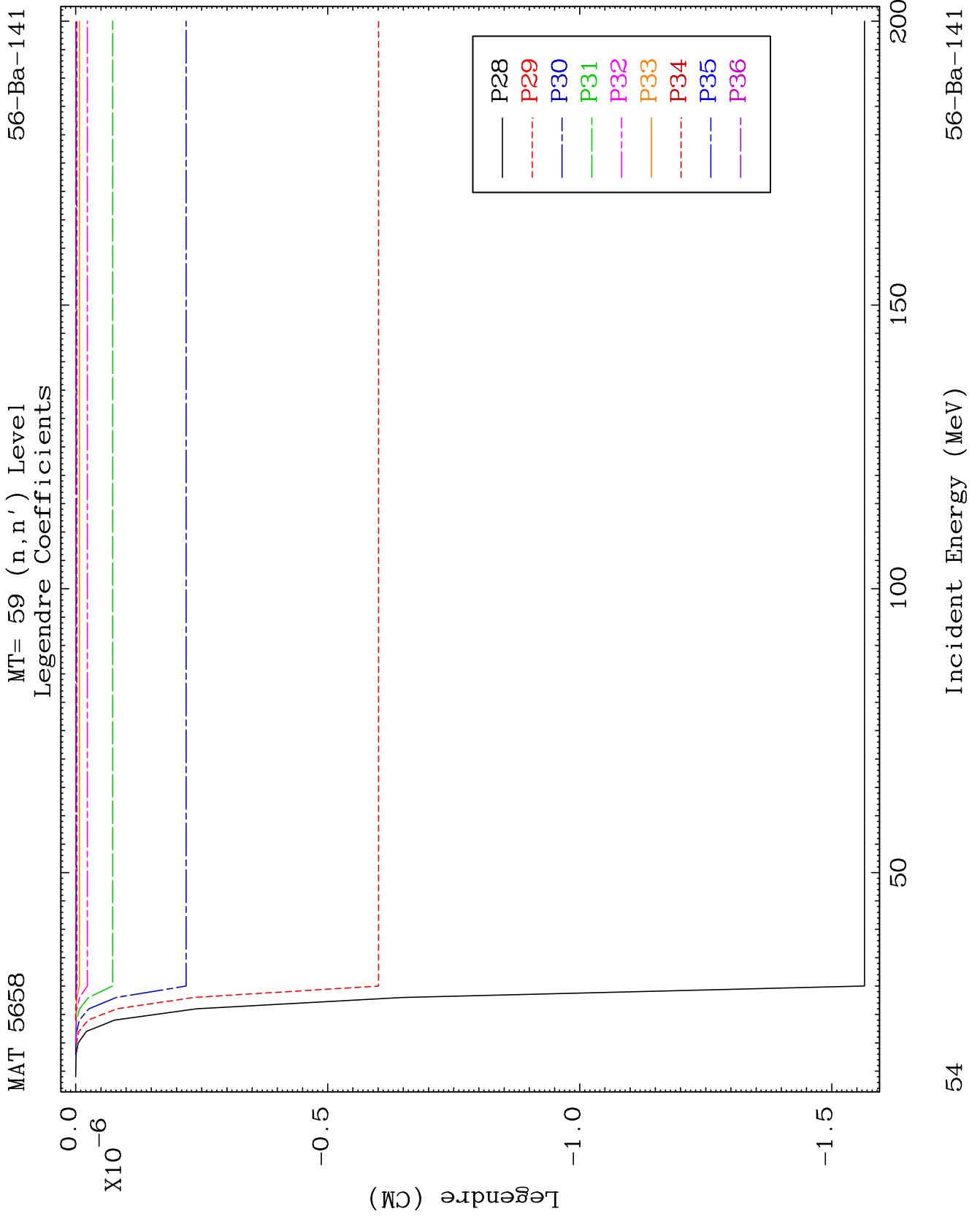



MAT 5658

MT= 60 (n,n') Level  
Legendre Coefficients

56-Ba-141

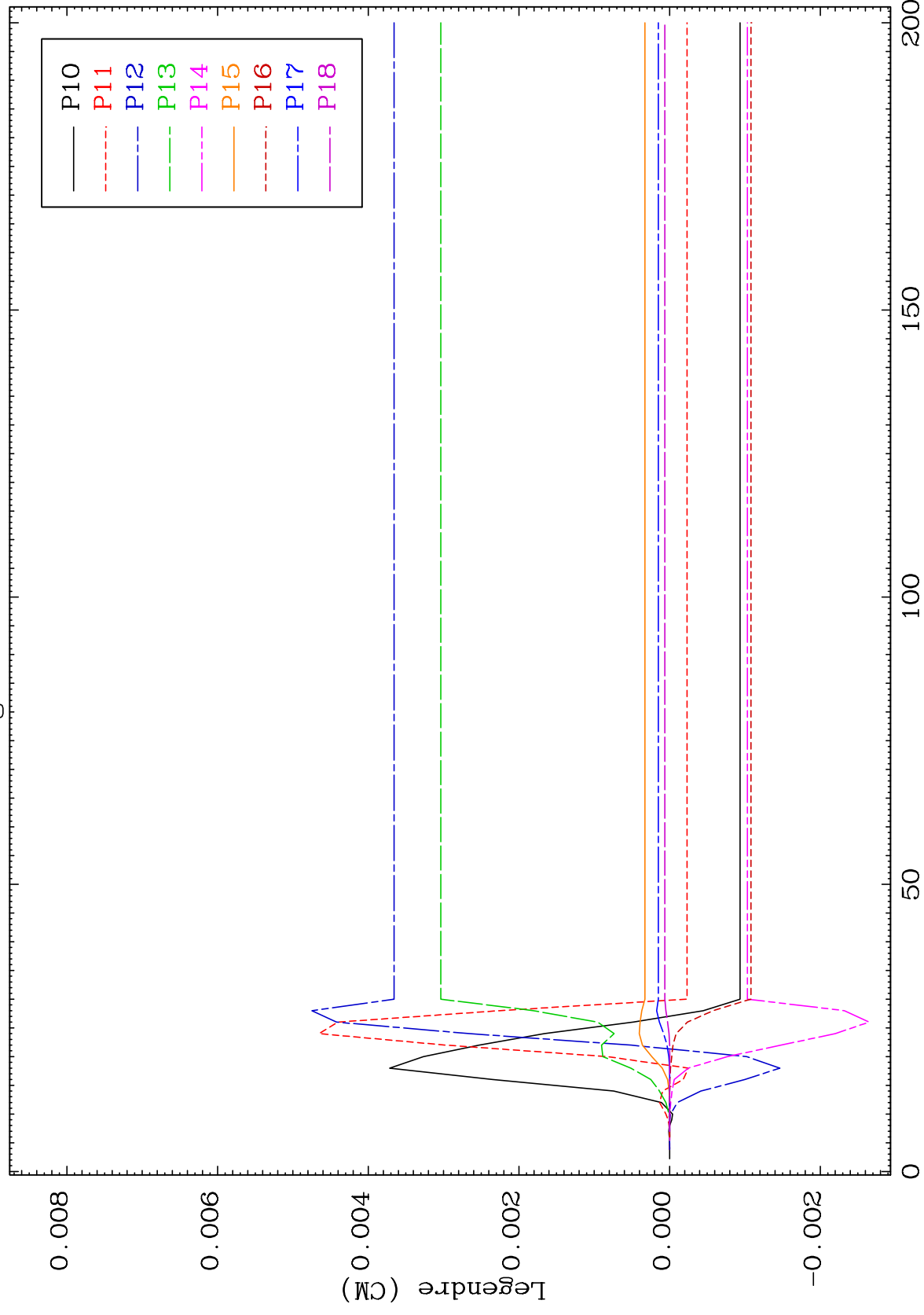

56

Incident Energy (MeV)

56-Ba-141

MAT 5658

MT= 60 (n,n') Level  
Legendre Coefficients

56-Ba-141

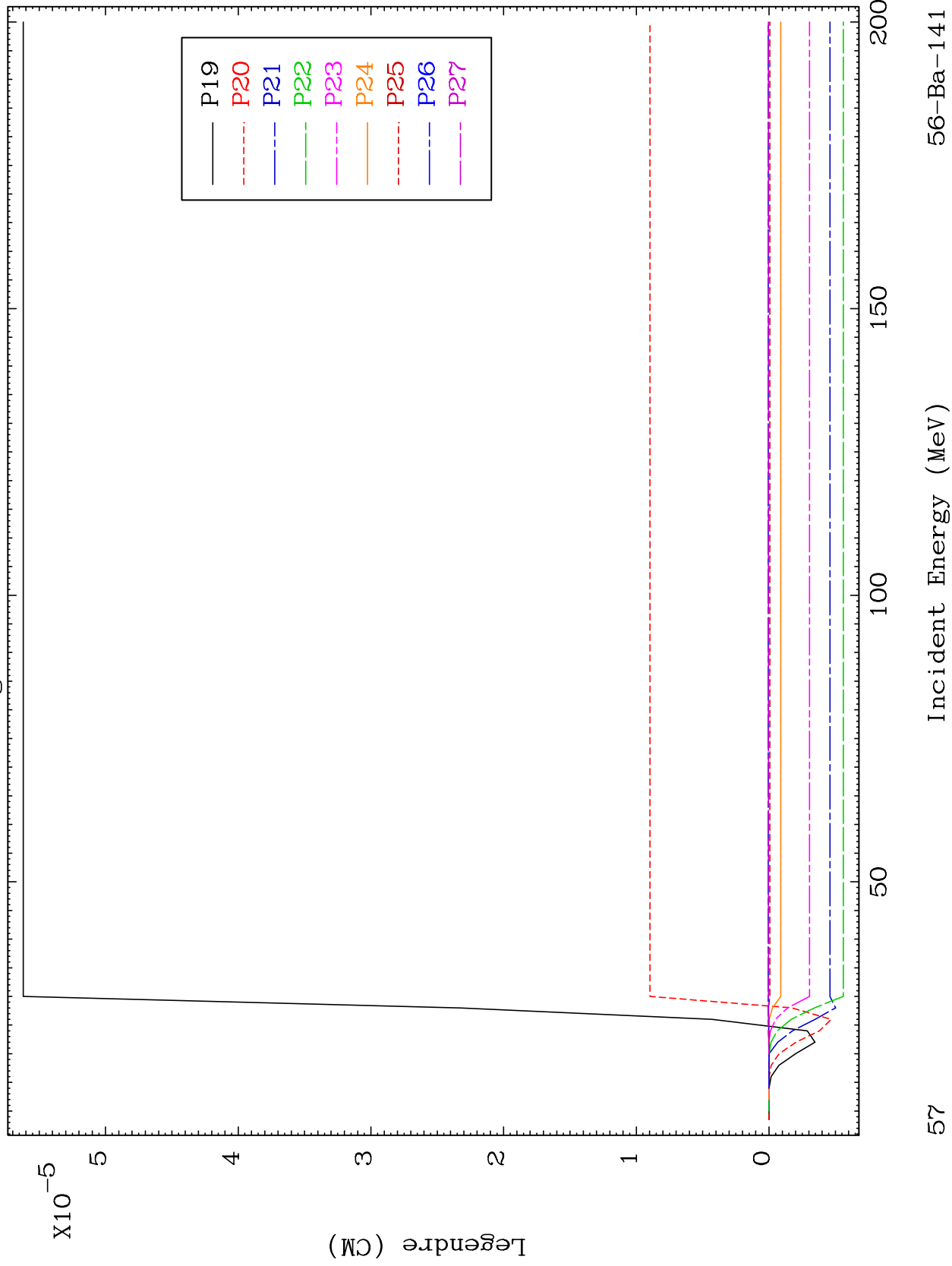

57



MAT 5658

MT= 61 (n,n') Level  
Legendre Coefficients

56-Ba-141

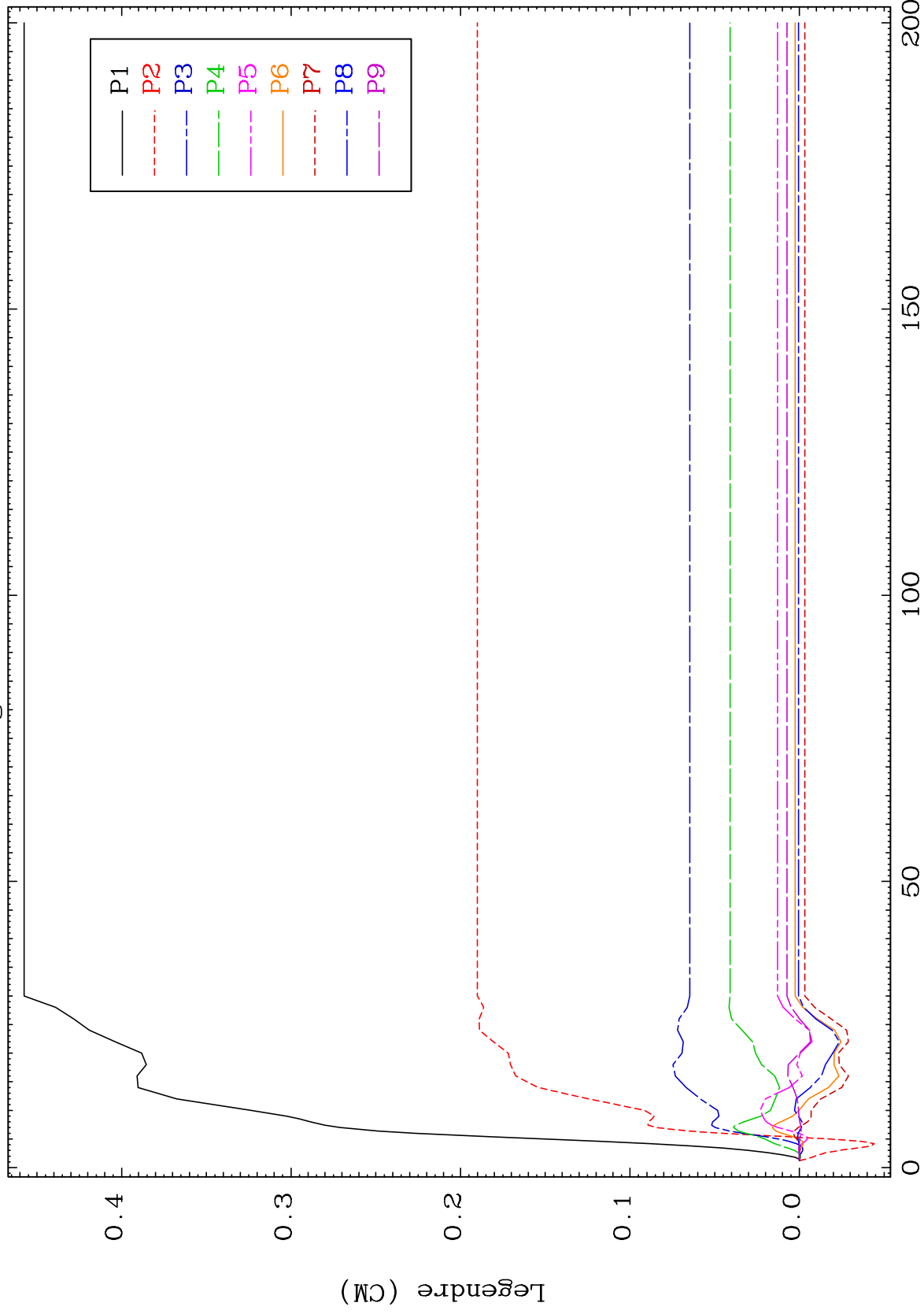

59

Incident Energy (MeV)

56-Ba-141

MAT 5658

MT= 61 (n,n') Level  
Legendre Coefficients

56-Ba-141

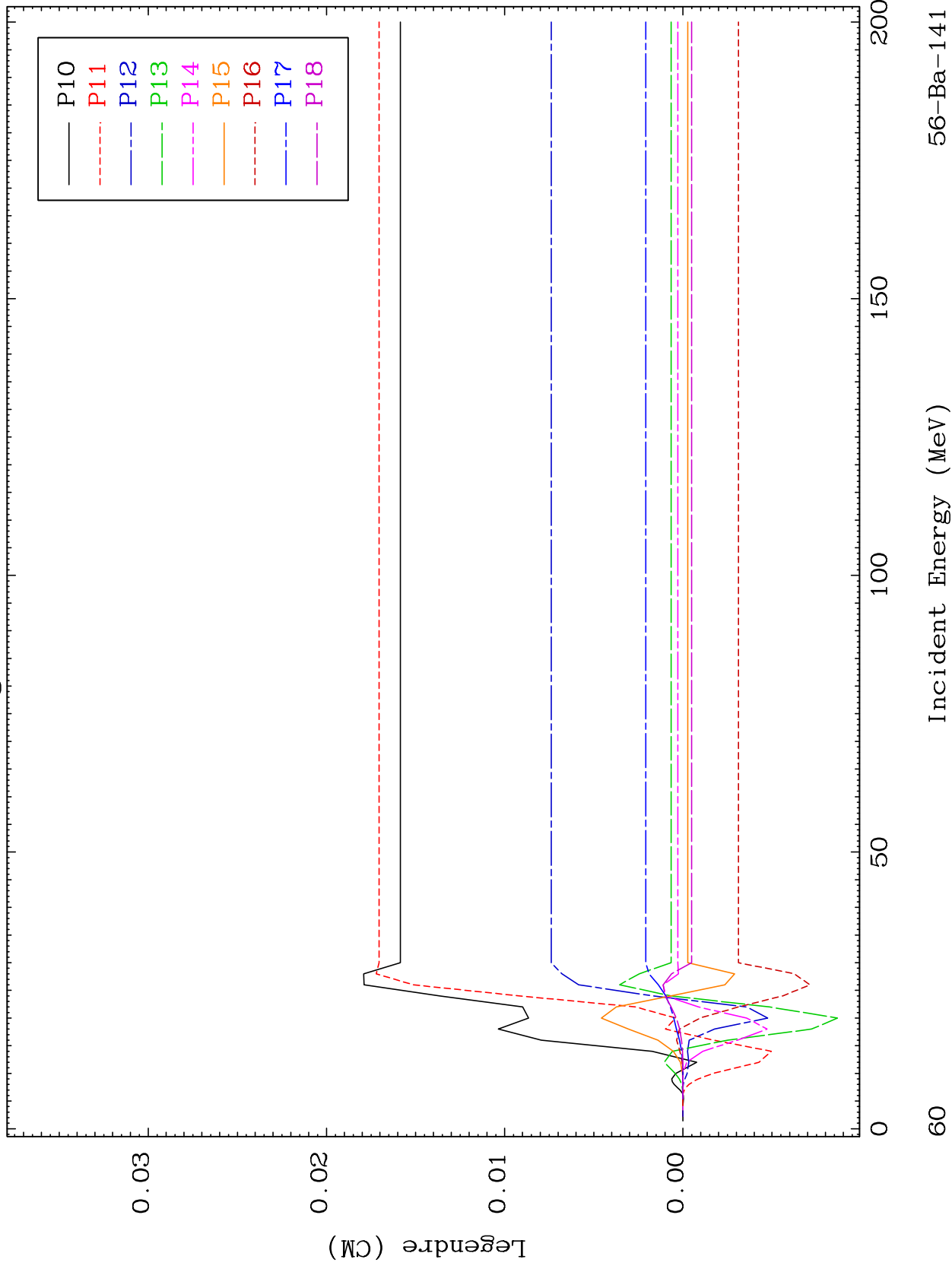

MAT 5658

MT= 61 (n,n') Level  
Legendre Coefficients

56-Ba-141

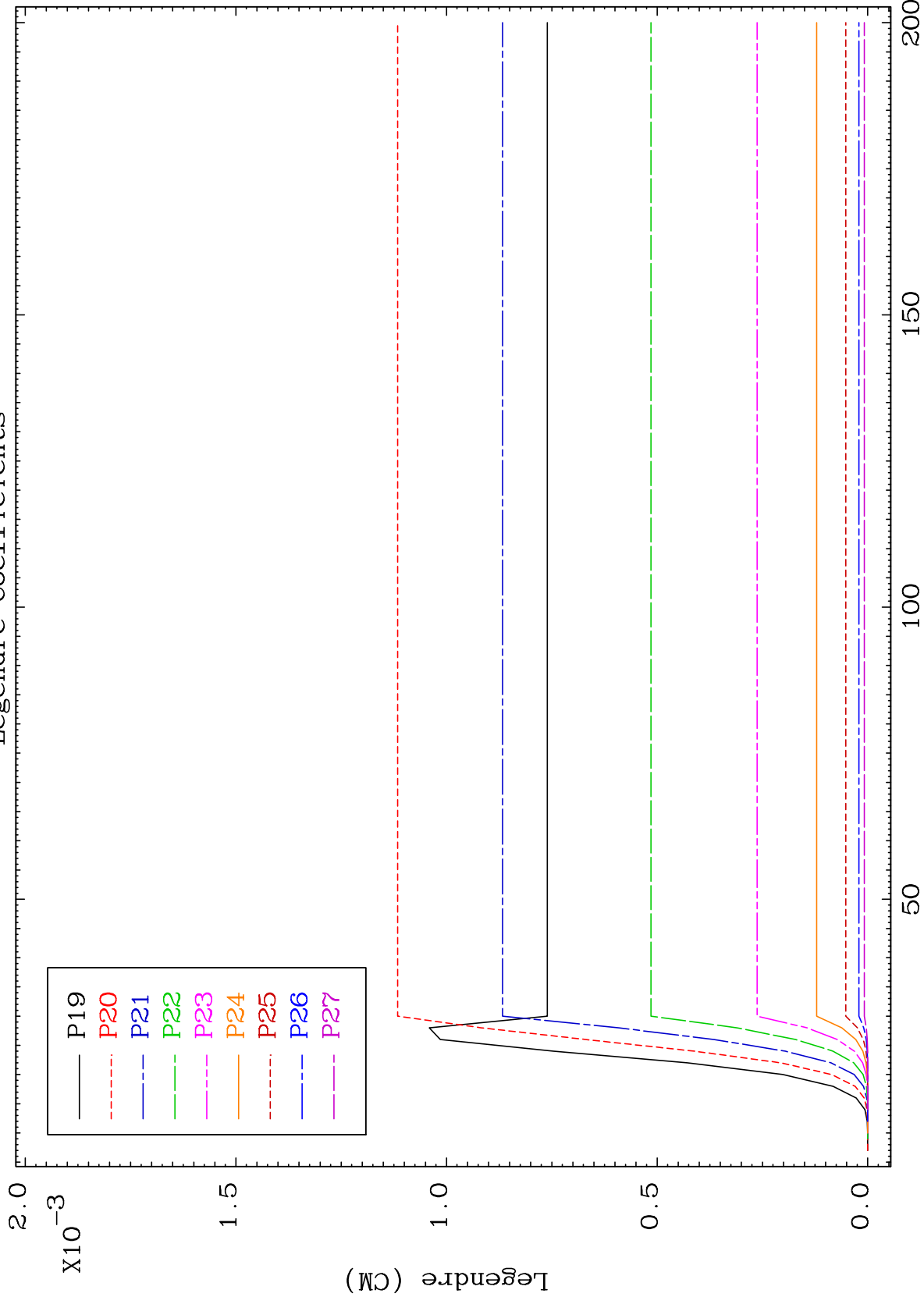

61

Incident Energy (MeV)

56-Ba-141

MAT 5658

MT= 61 (n,n') Level  
Legendre Coefficients

56-Ba-141

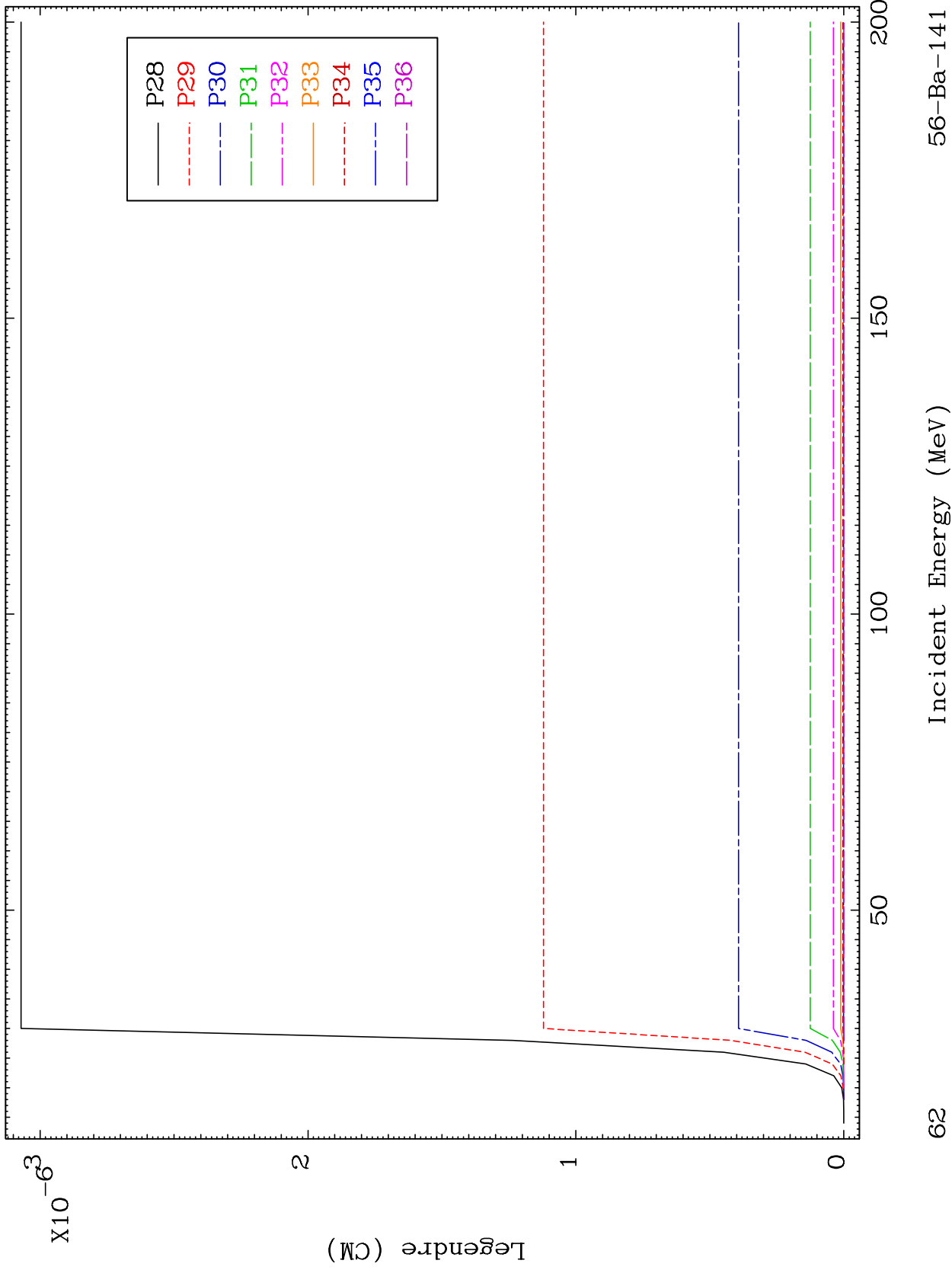

62

56-Ba-141

MAT 5658

MT= 62 (n,n') Level  
Legendre Coefficients

56-Ba-141

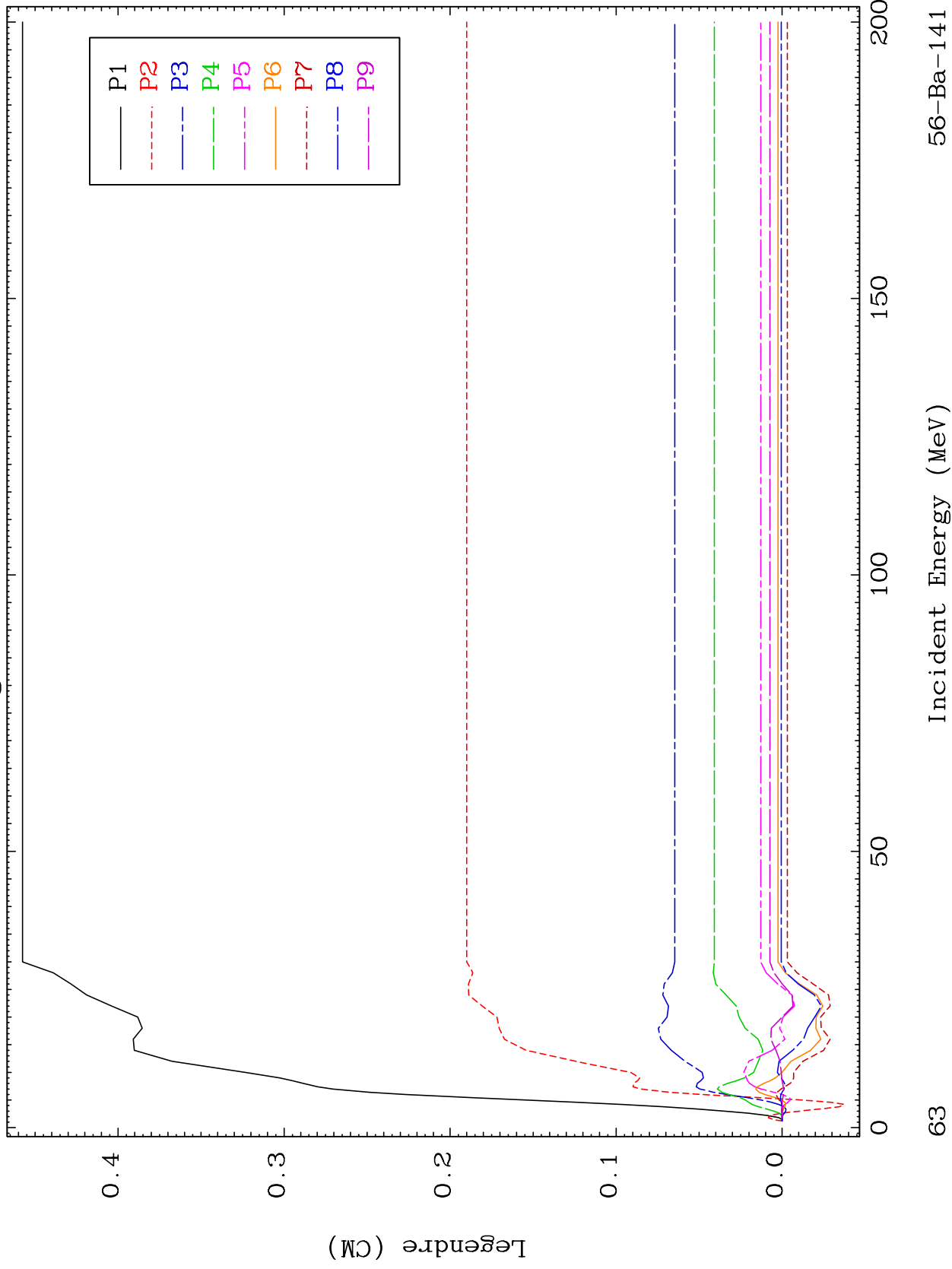

56-Ba-141

Incident Energy (MeV)

63

MAT 5658

MT= 62 (n,n') Level  
Legendre Coefficients

56-Ba-141

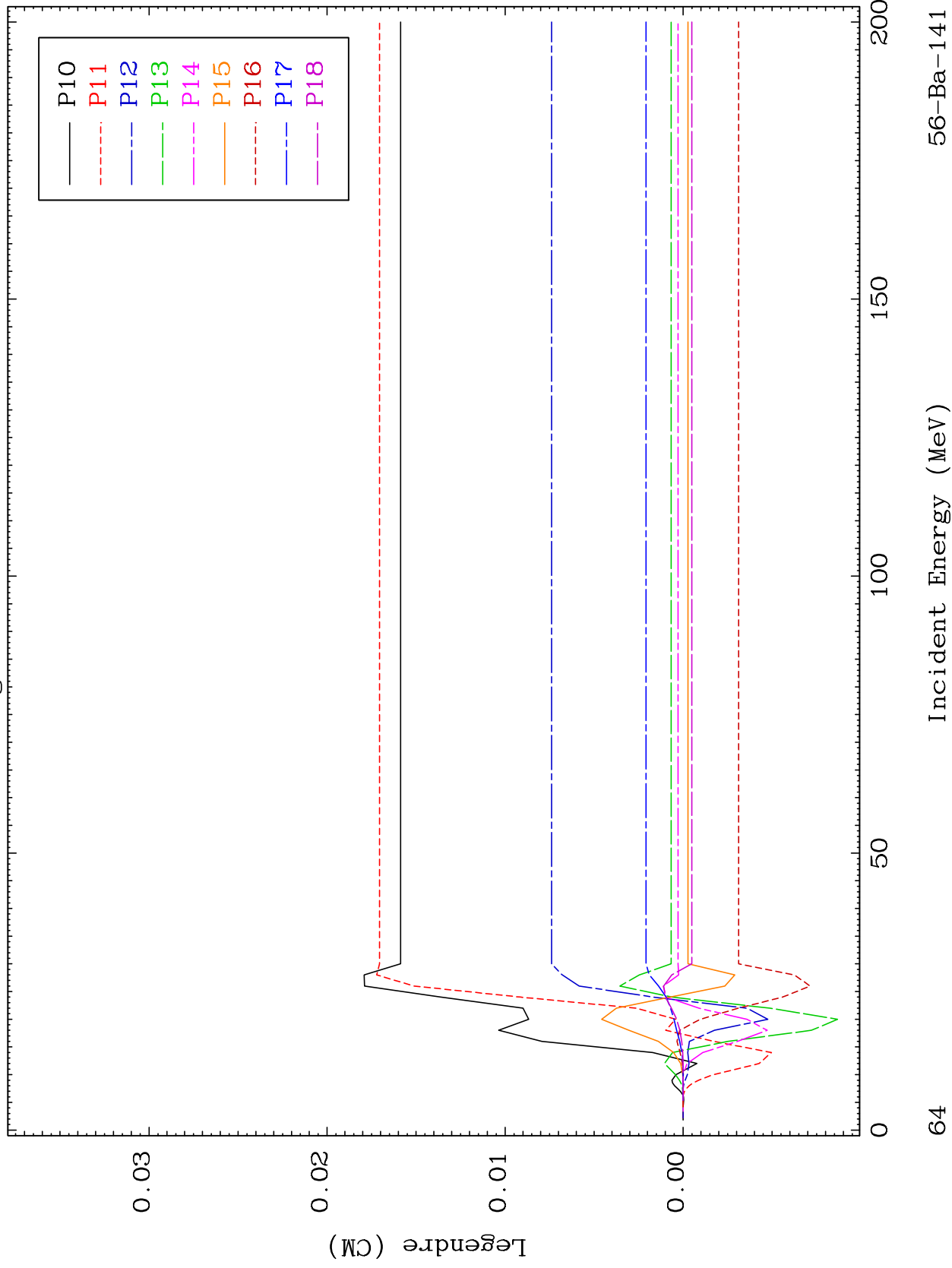

56-Ba-141

Incident Energy (MeV)

64

MAT 5658

MT= 62 (n,n') Level  
Legendre Coefficients

56-Ba-141

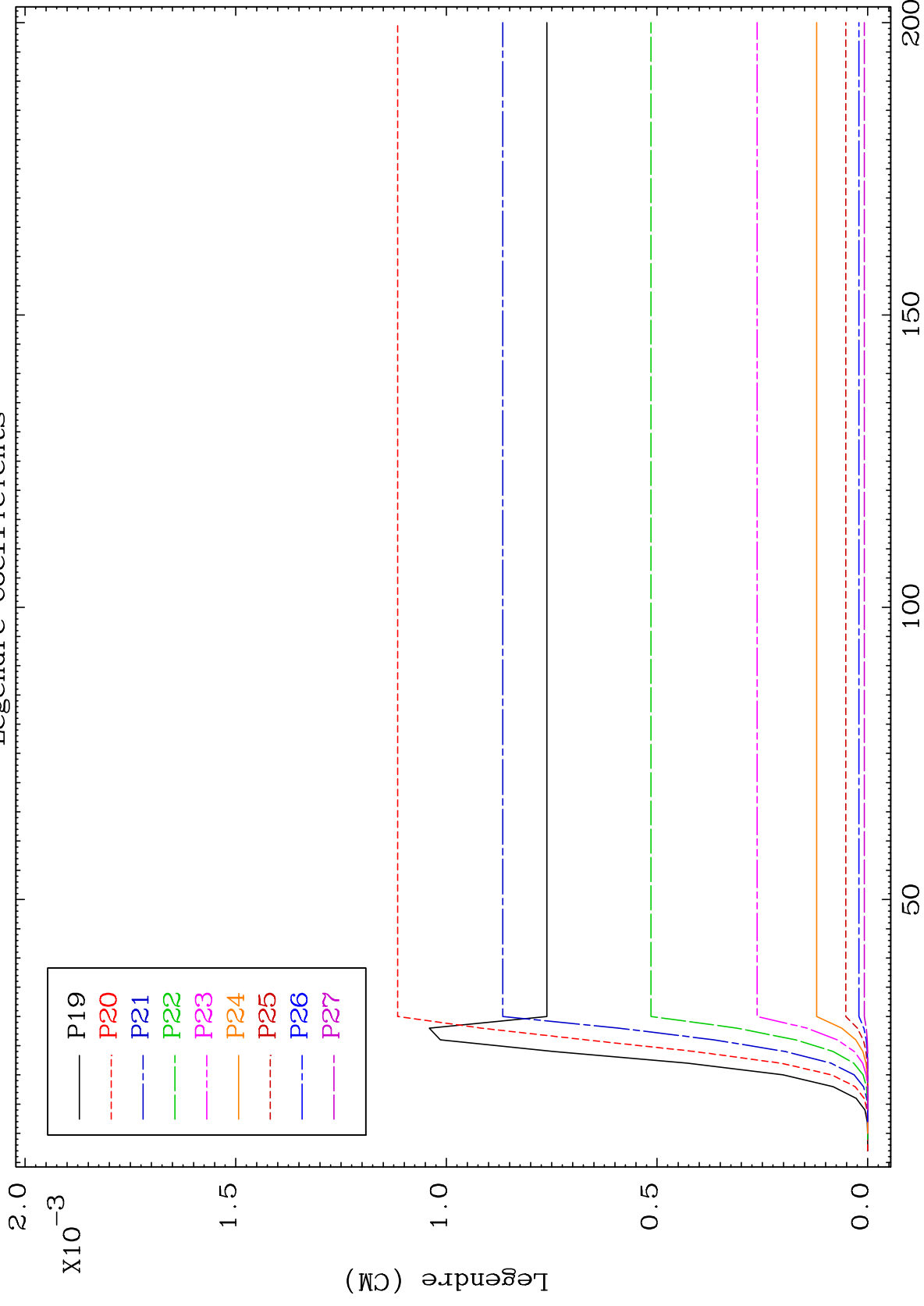

65

Incident Energy (MeV)

56-Ba-141

MAT 5658

MT= 62 (n,n') Level  
Legendre Coefficients

56-Ba-141

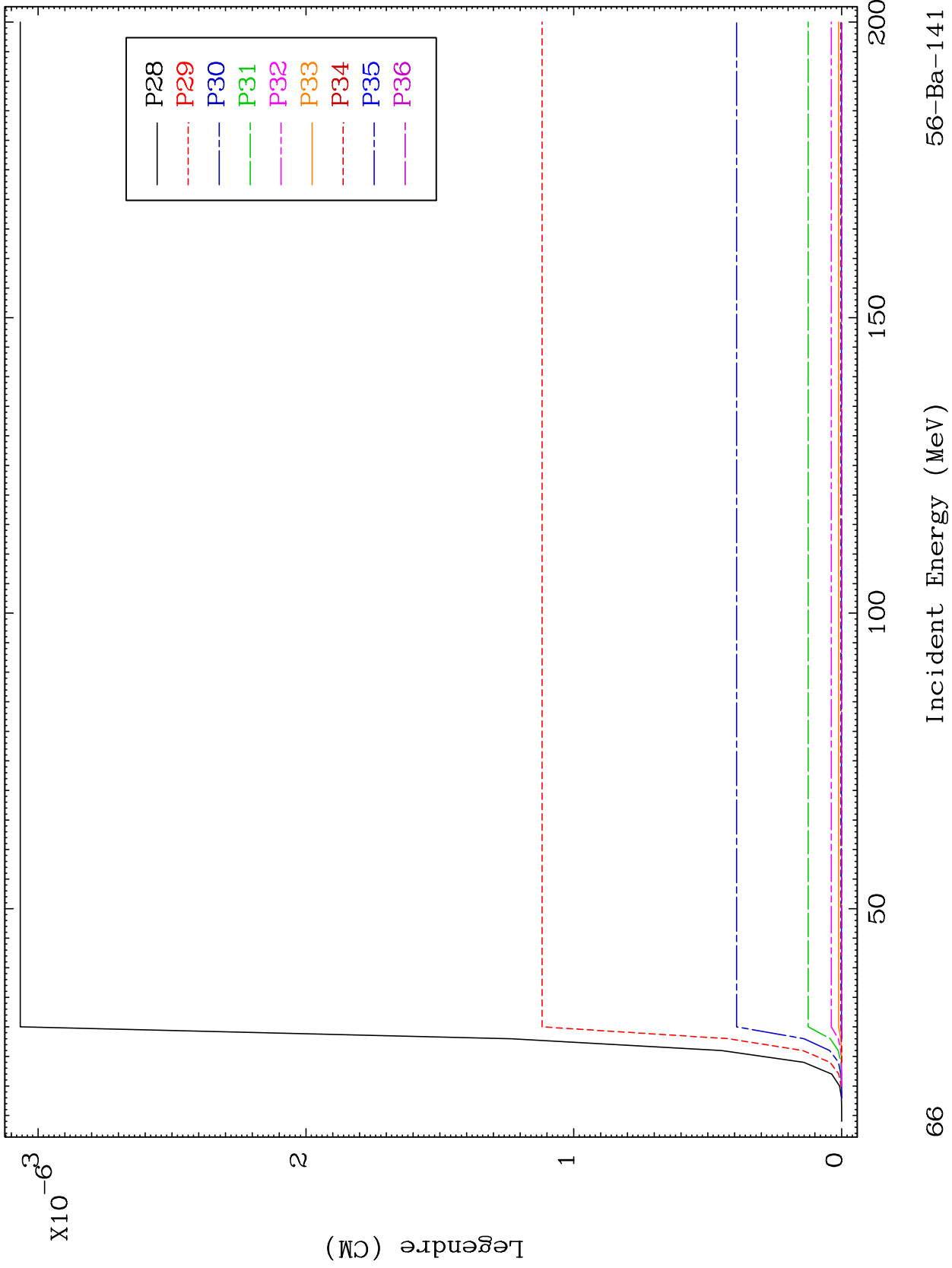

66

Incident Energy (MeV)

56-Ba-141

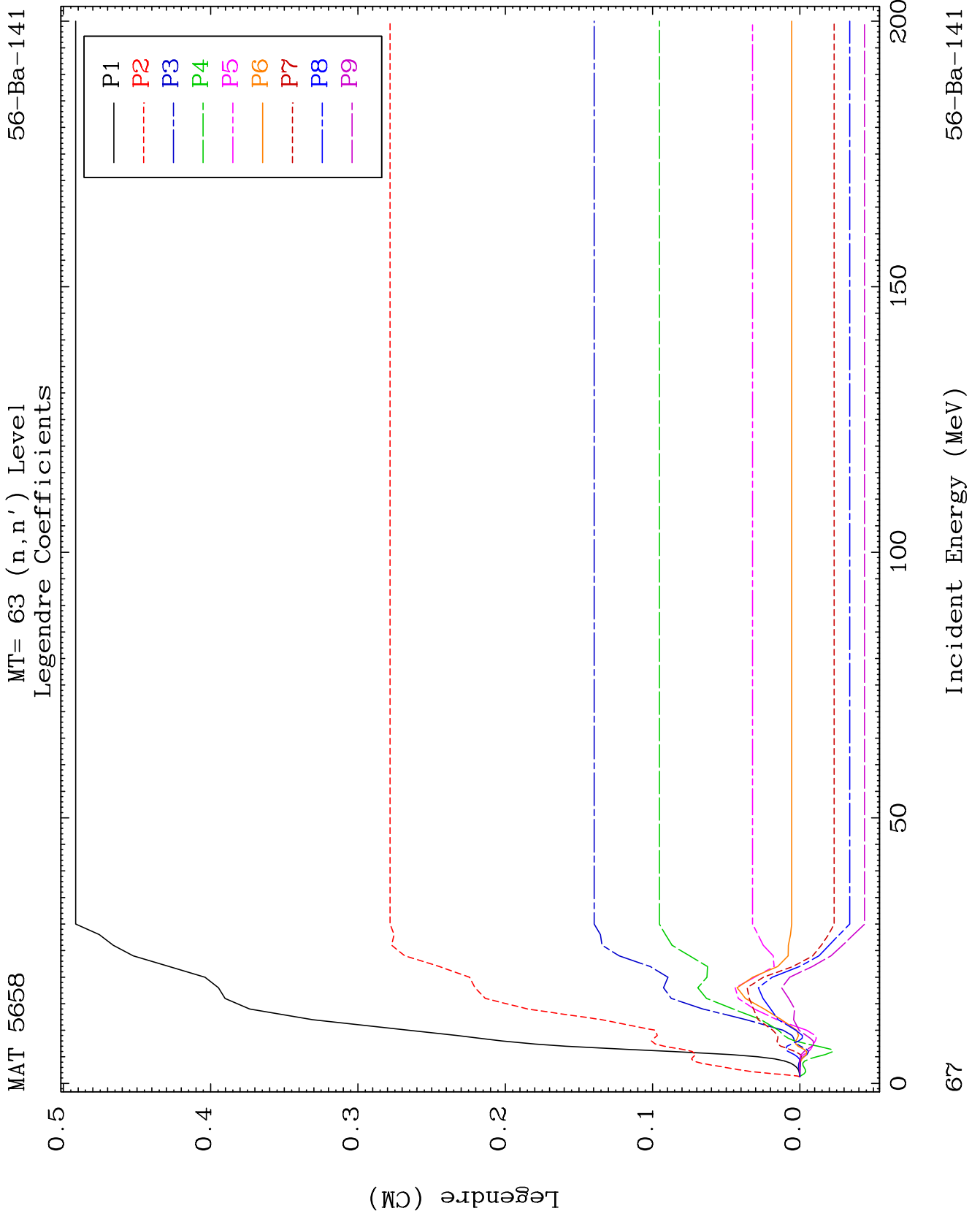

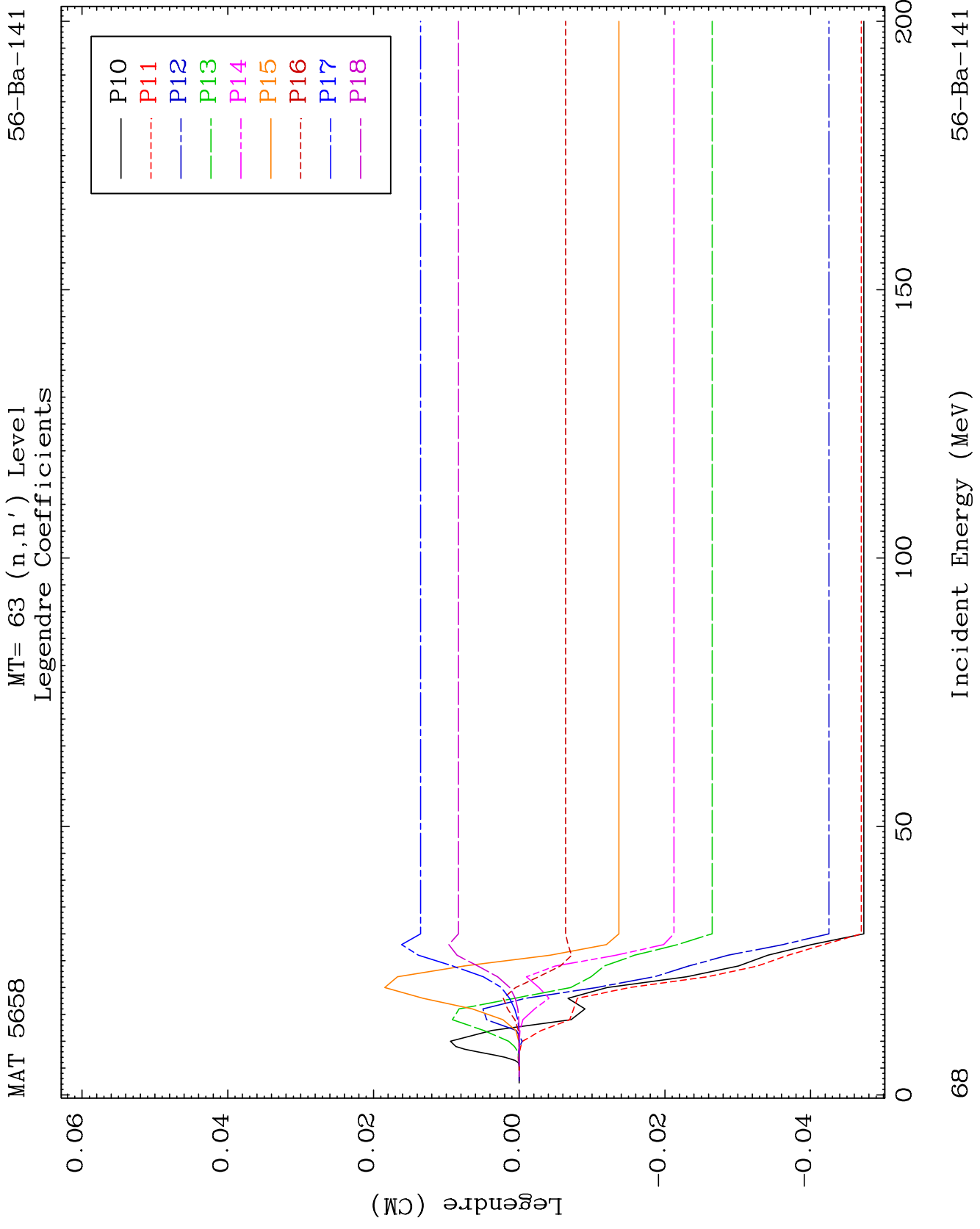

MAT 5658

MT= 63 (n,n') Level  
Legendre Coefficients

56-Ba-141

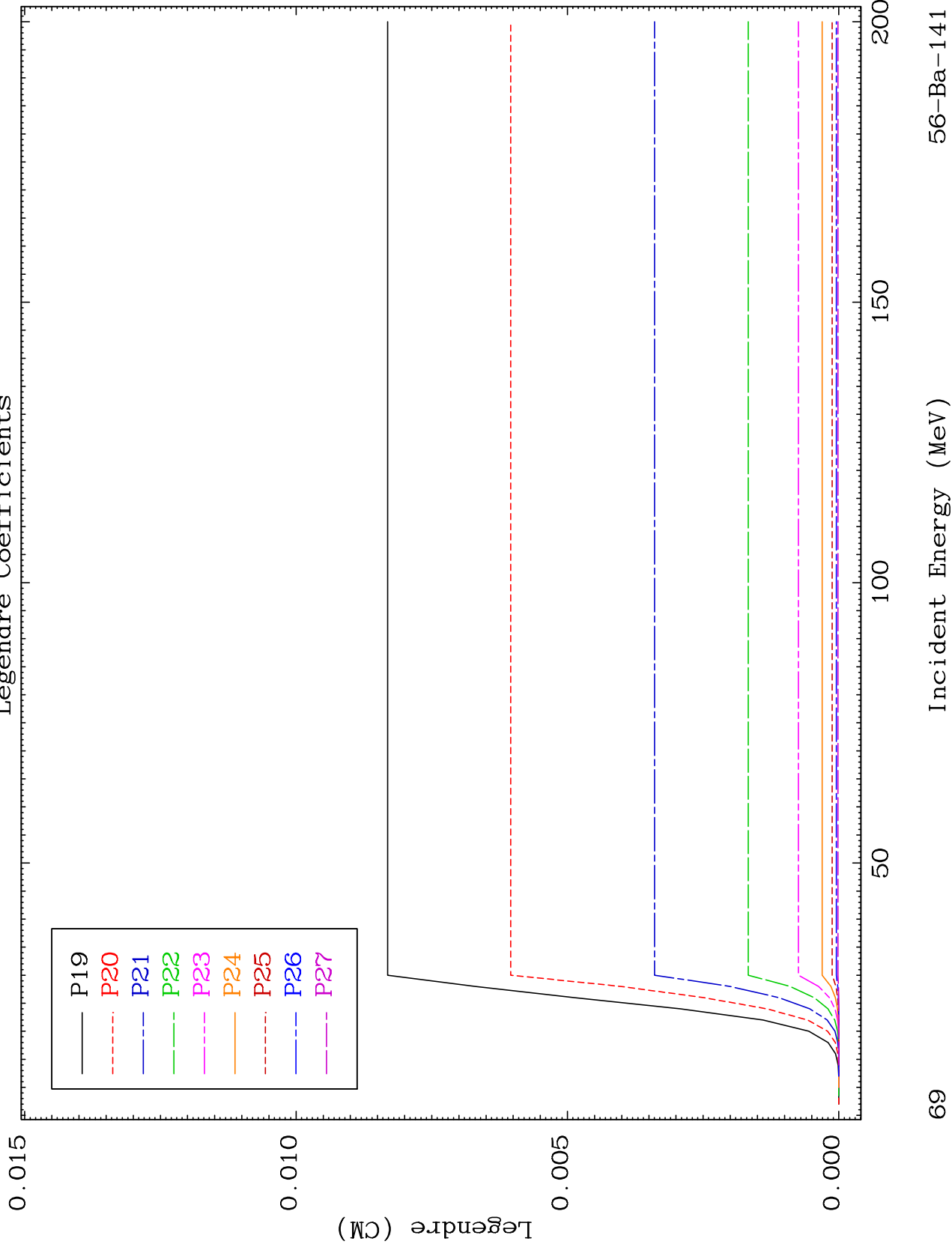

69

56-Ba-141

MAT 5658

MT= 63 (n,n') Level  
Legendre Coefficients

56-Ba-141

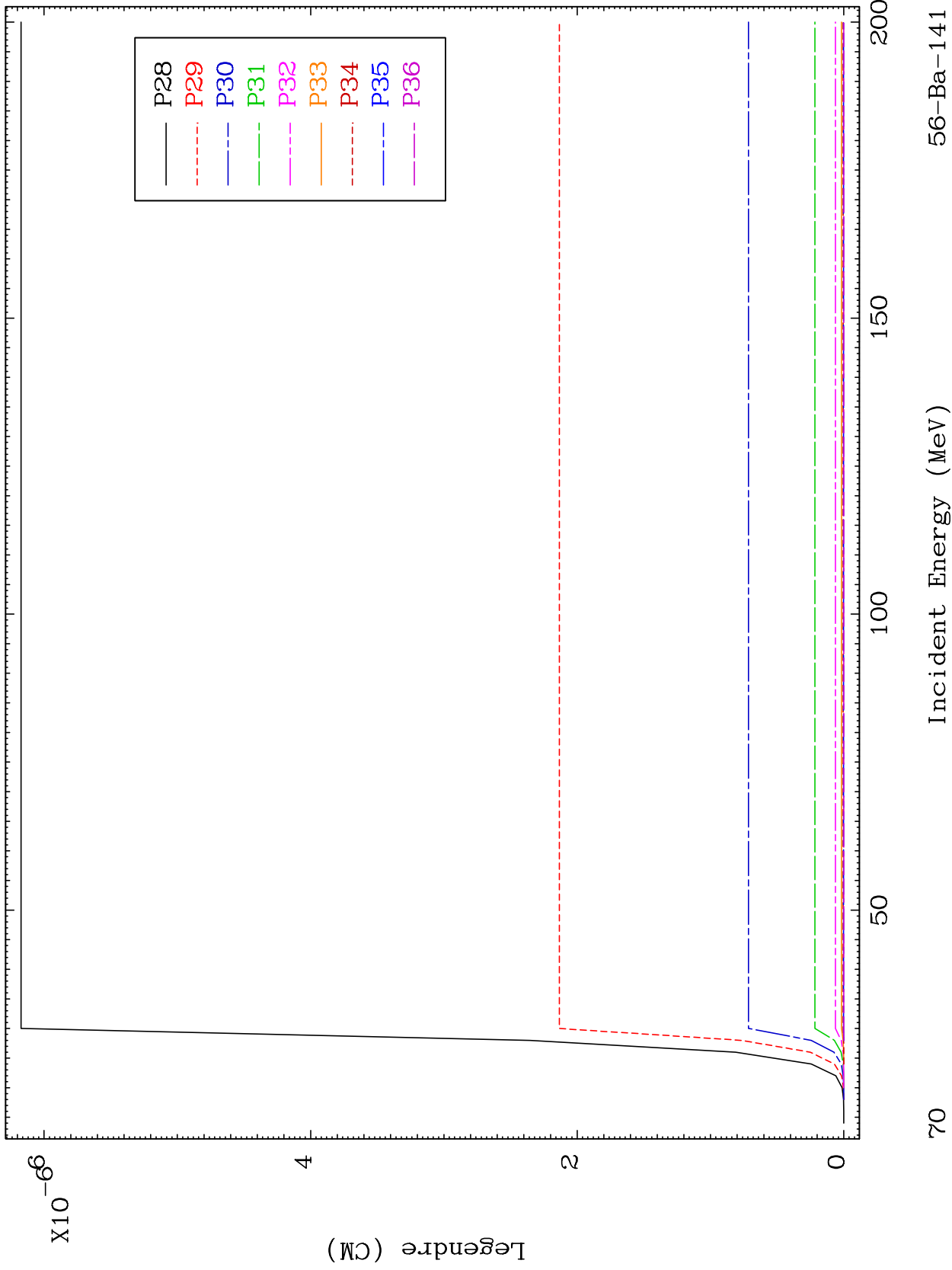

70

Incident Energy (MeV)

56-Ba-141



MAT 5658

MT= 64 (n,n') Level  
Legendre Coefficients

56-Ba-141

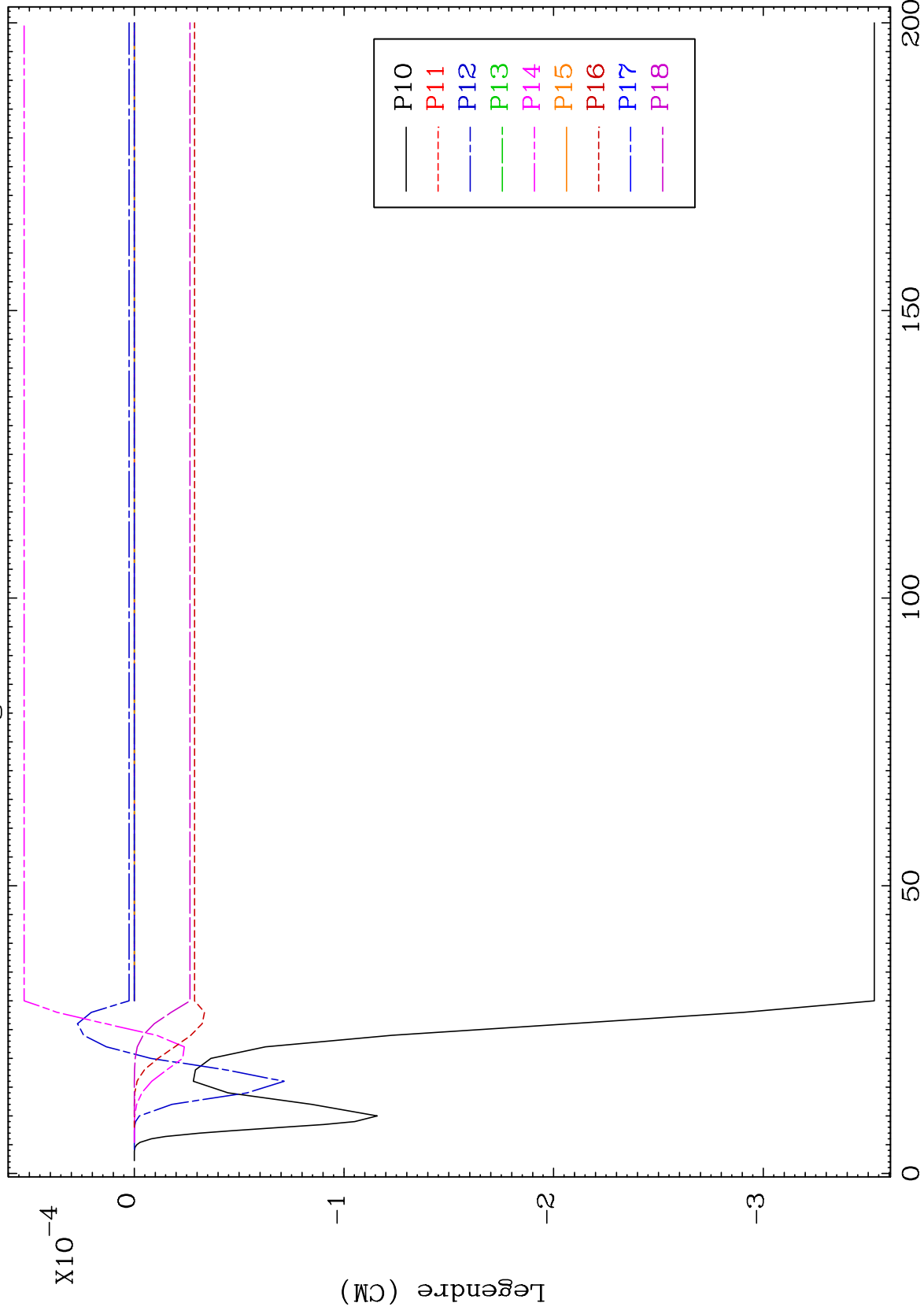

72

Incident Energy (MeV)

56-Ba-141

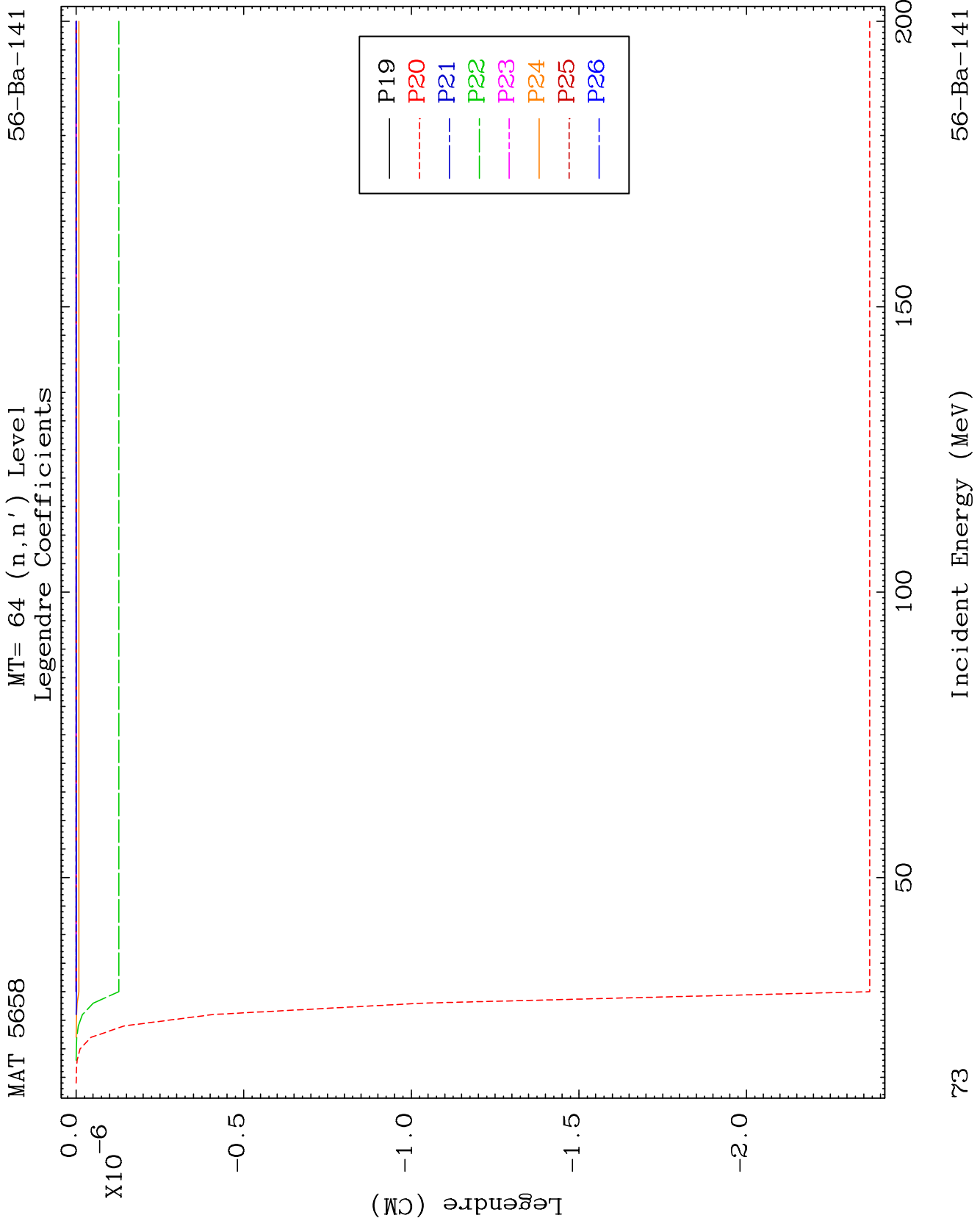



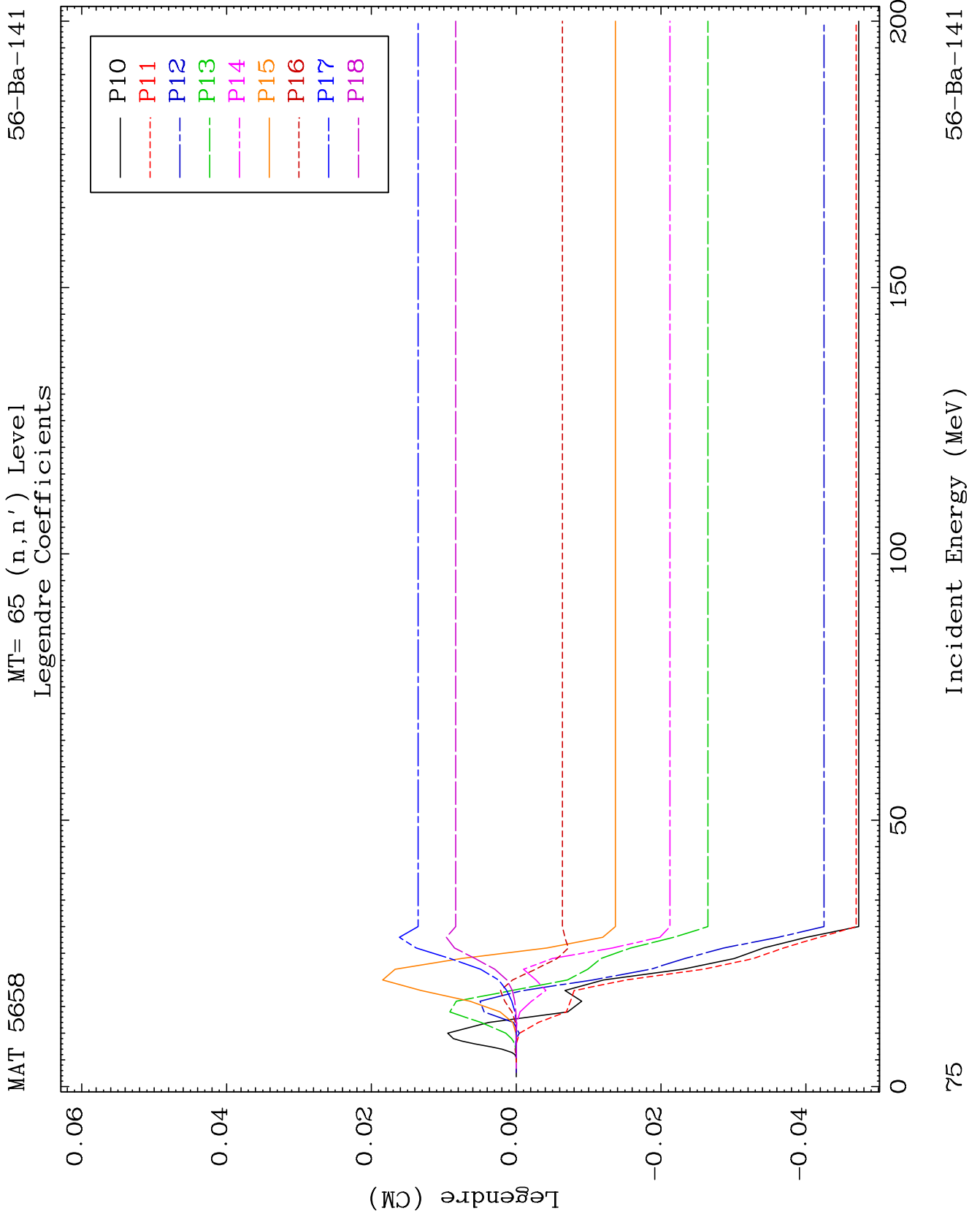

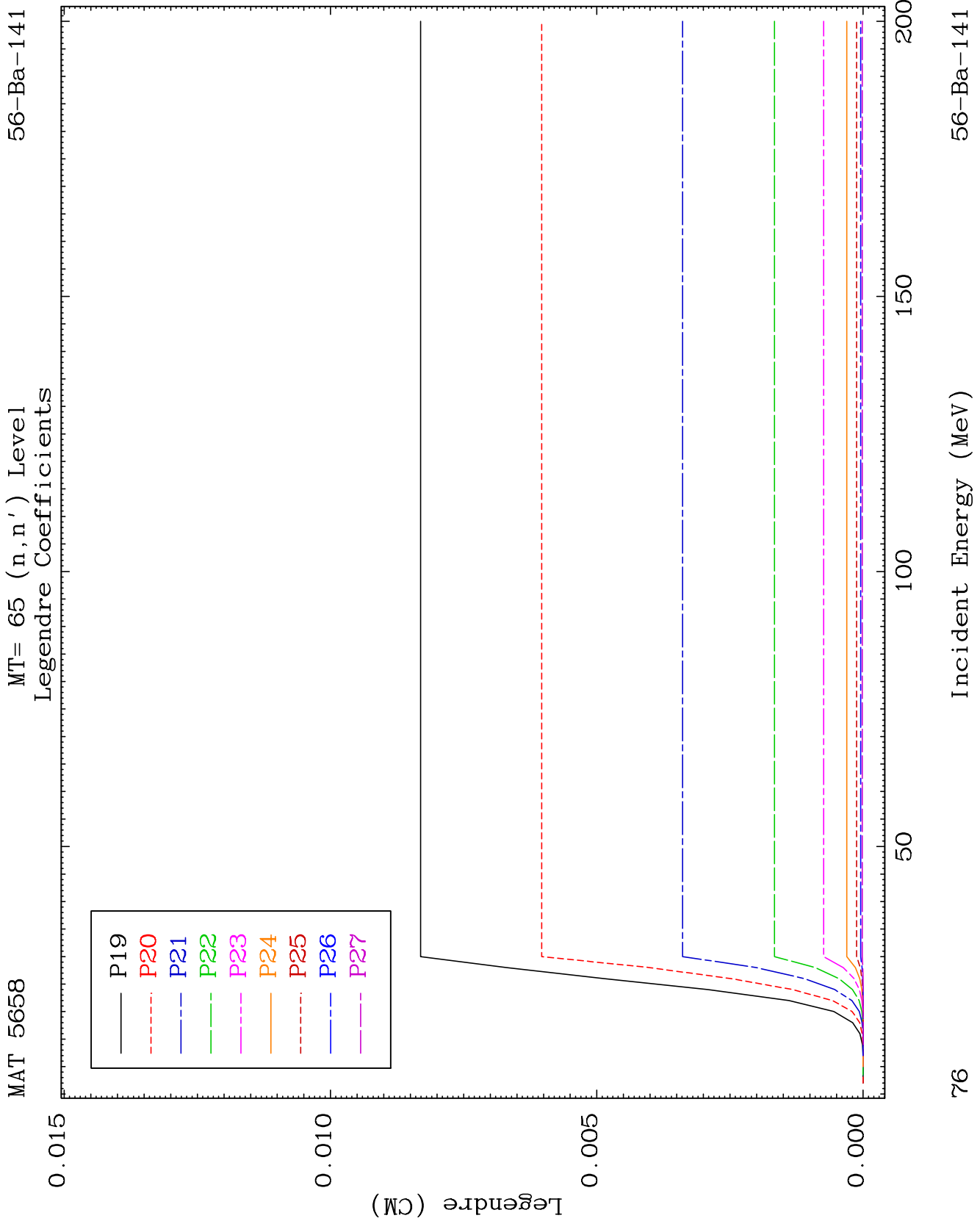

MAT 5658

MT= 65 (n,n') Level  
Legendre Coefficients

56-Ba-141

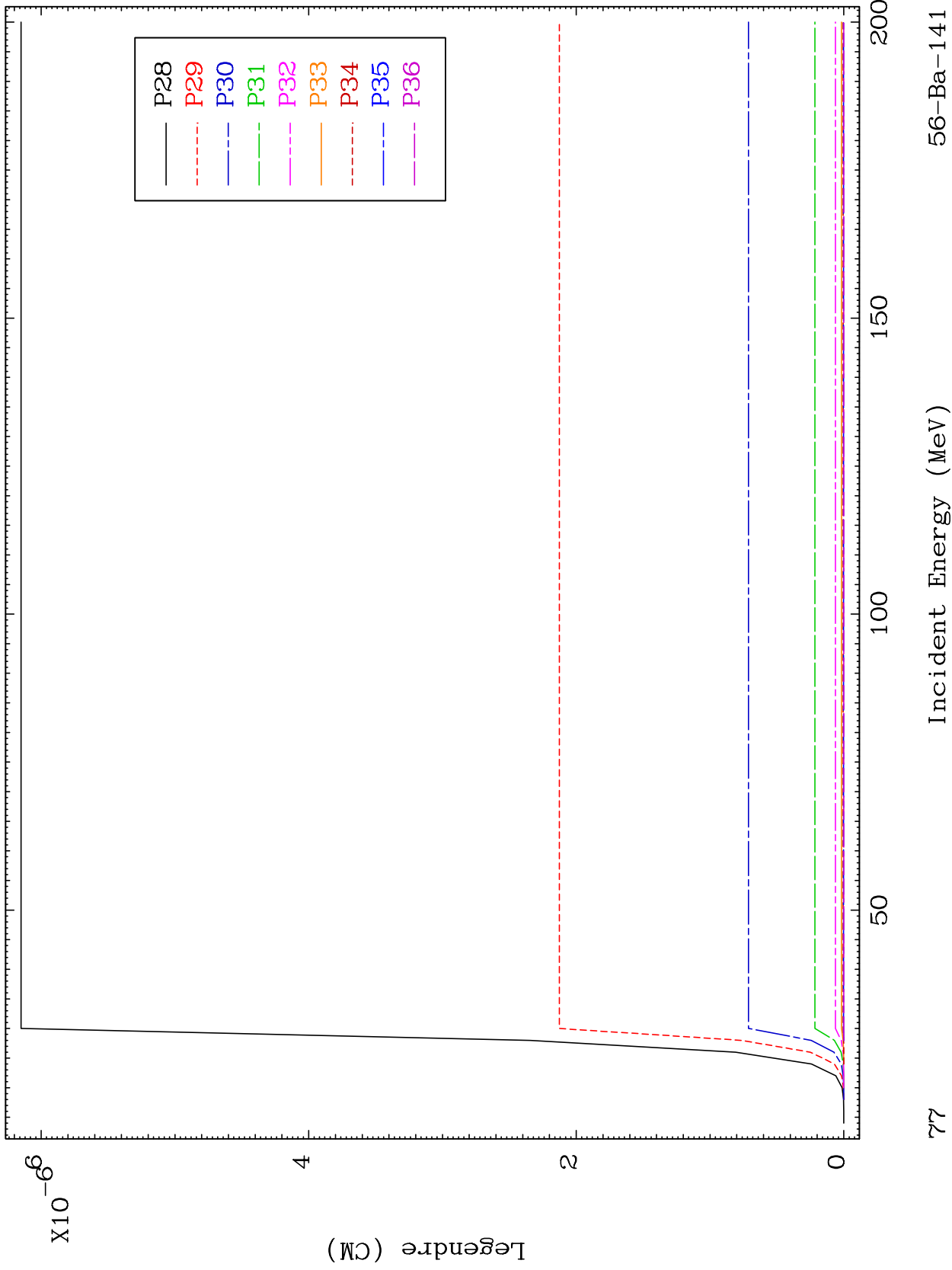

MAT 5658

MT= 66 (n,n') Level  
Legendre Coefficients

56-Ba-141

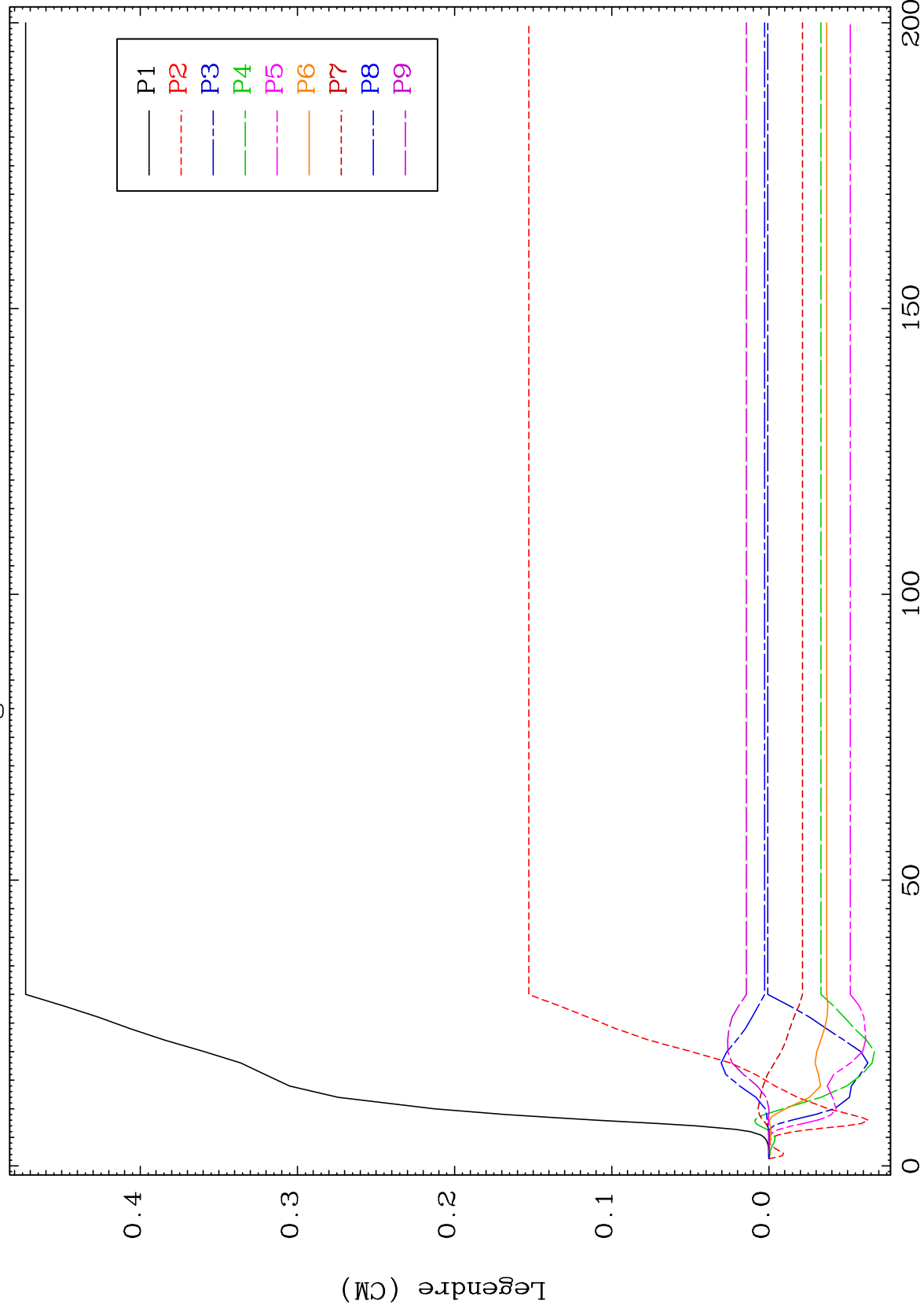

78

Incident Energy (MeV)

56-Ba-141

MAT 5658

MT= 66 (n,n') Level  
Legendre Coefficients

56-Ba-141

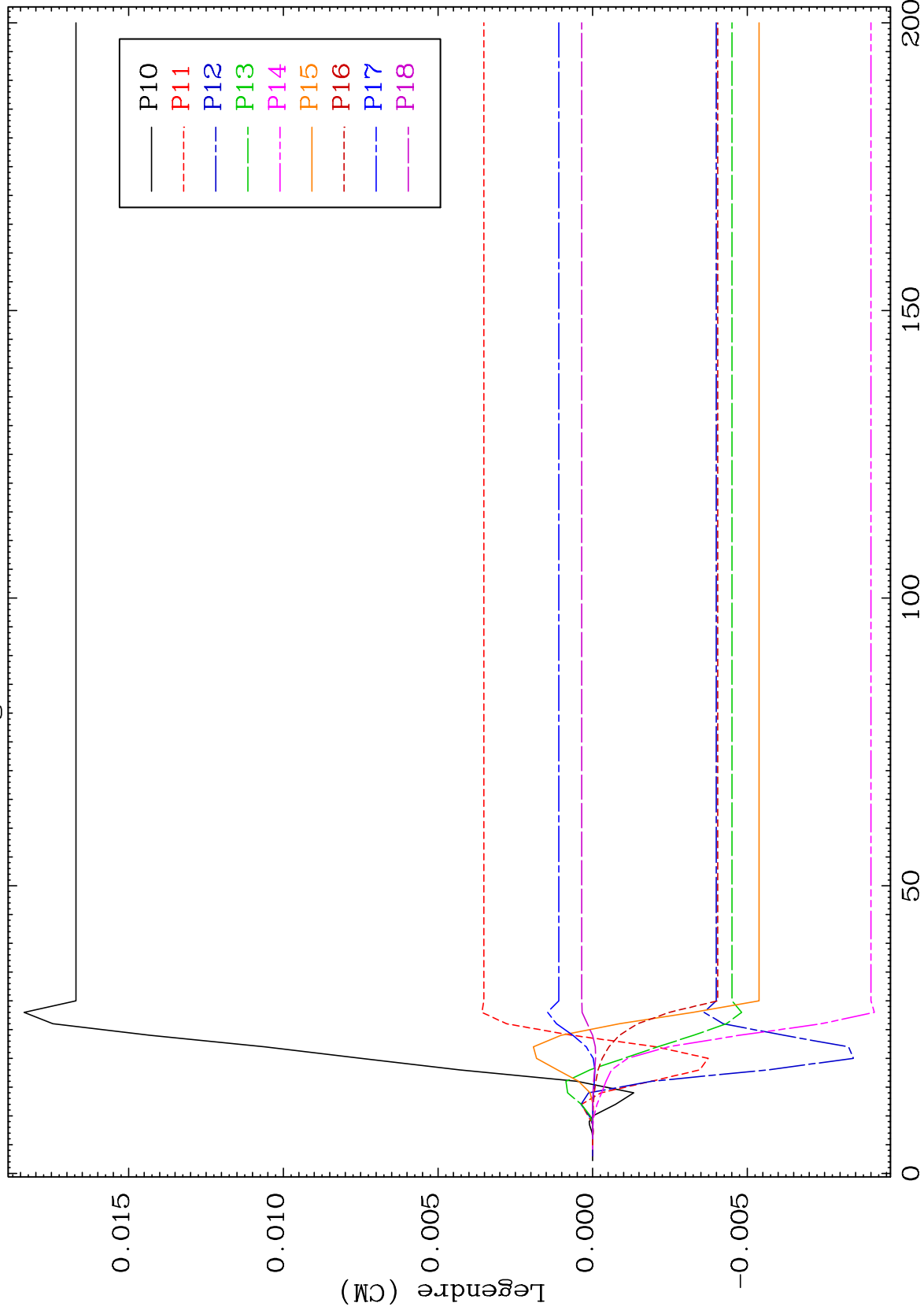

79

Incident Energy (MeV)

56-Ba-141

MAT 5658

MT= 66 (n,n') Level  
Legendre Coefficients

56-Ba-141

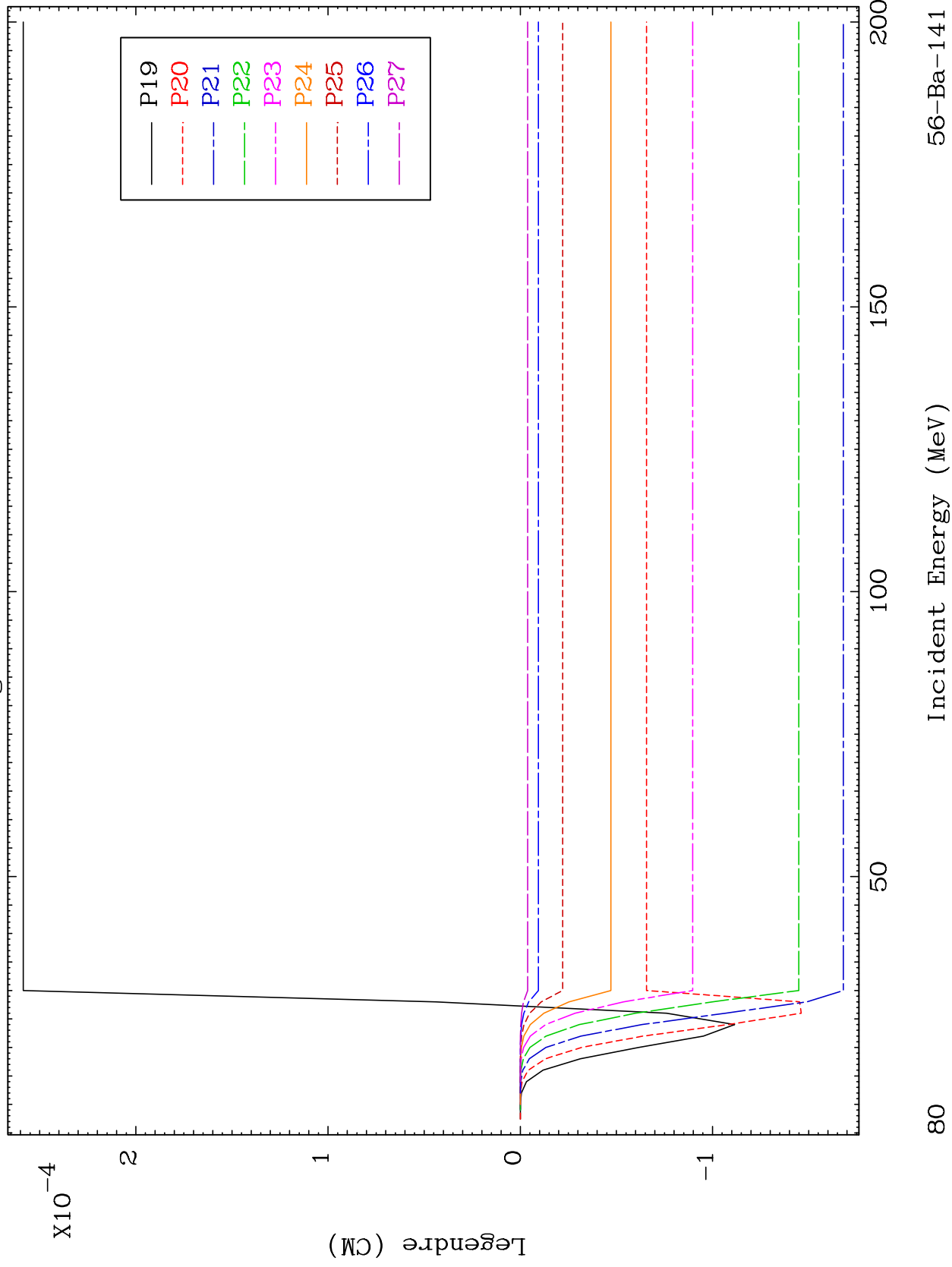

80

Incident Energy (MeV)

56-Ba-141

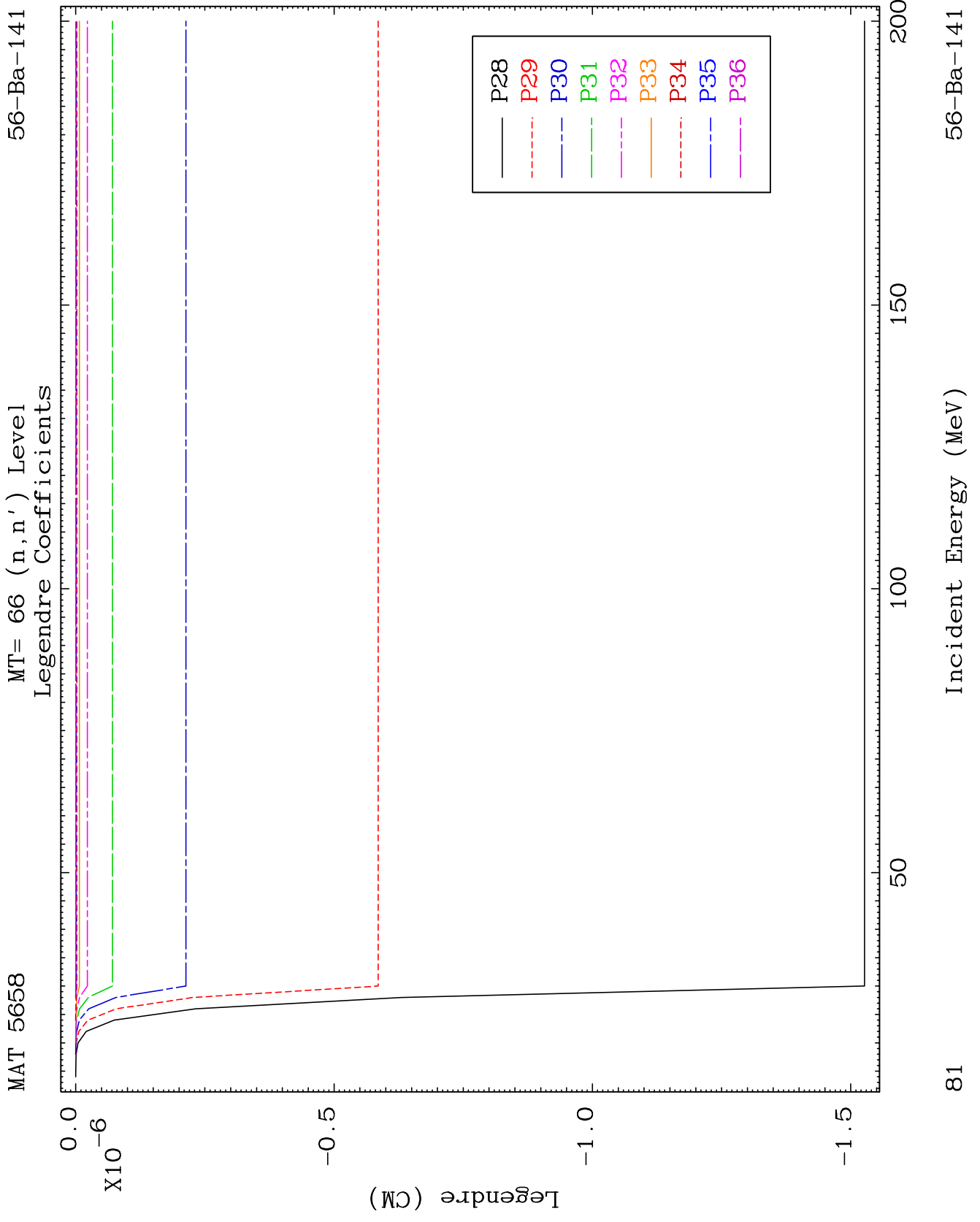

MAT 5658

MT= 67 (n,n') Level  
Legendre Coefficients

56-Ba-141

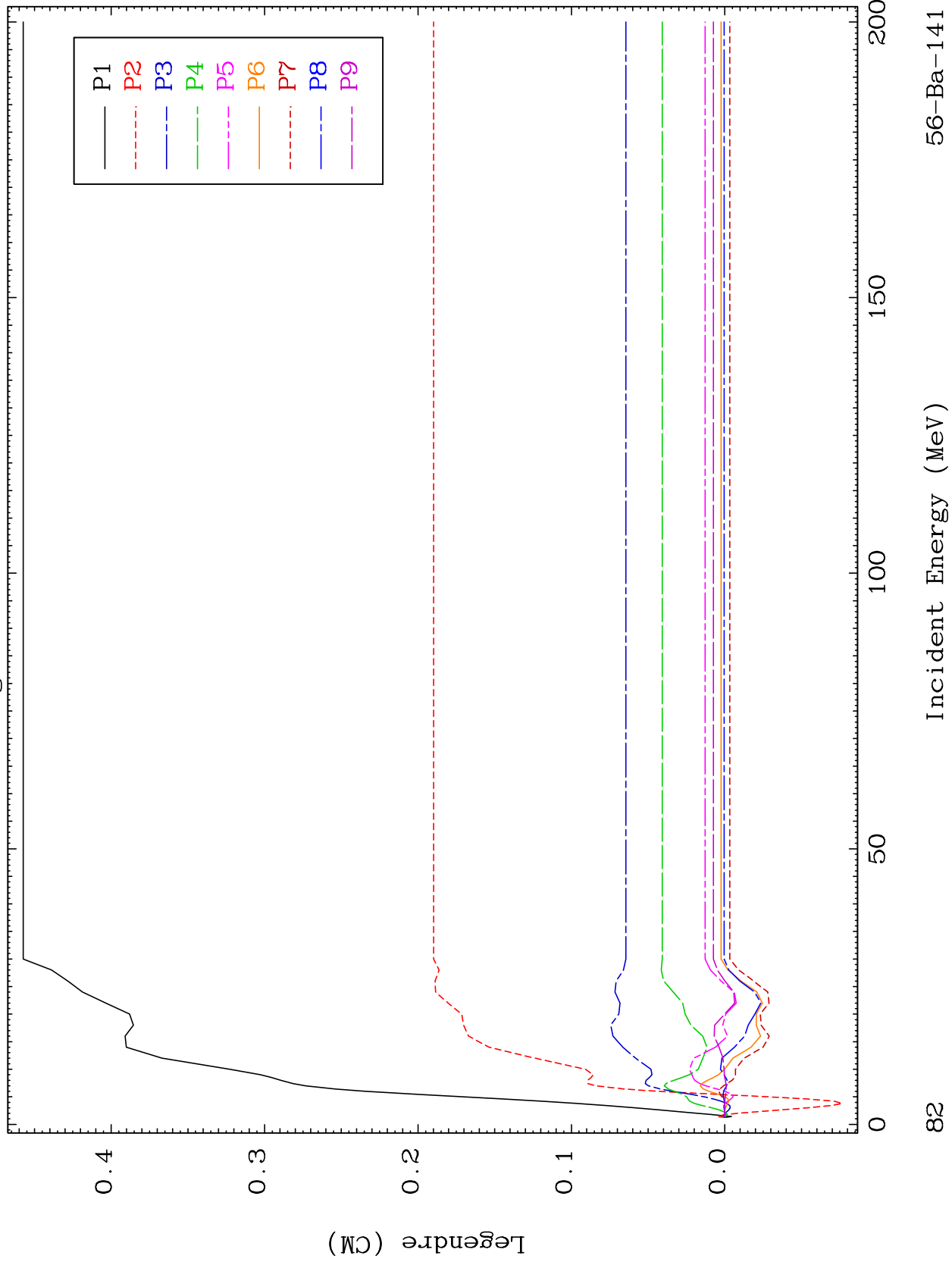

56-Ba-141

Incident Energy (MeV)

82

MAT 5658

MT= 67 (n,n') Level  
Legendre Coefficients

56-Ba-141

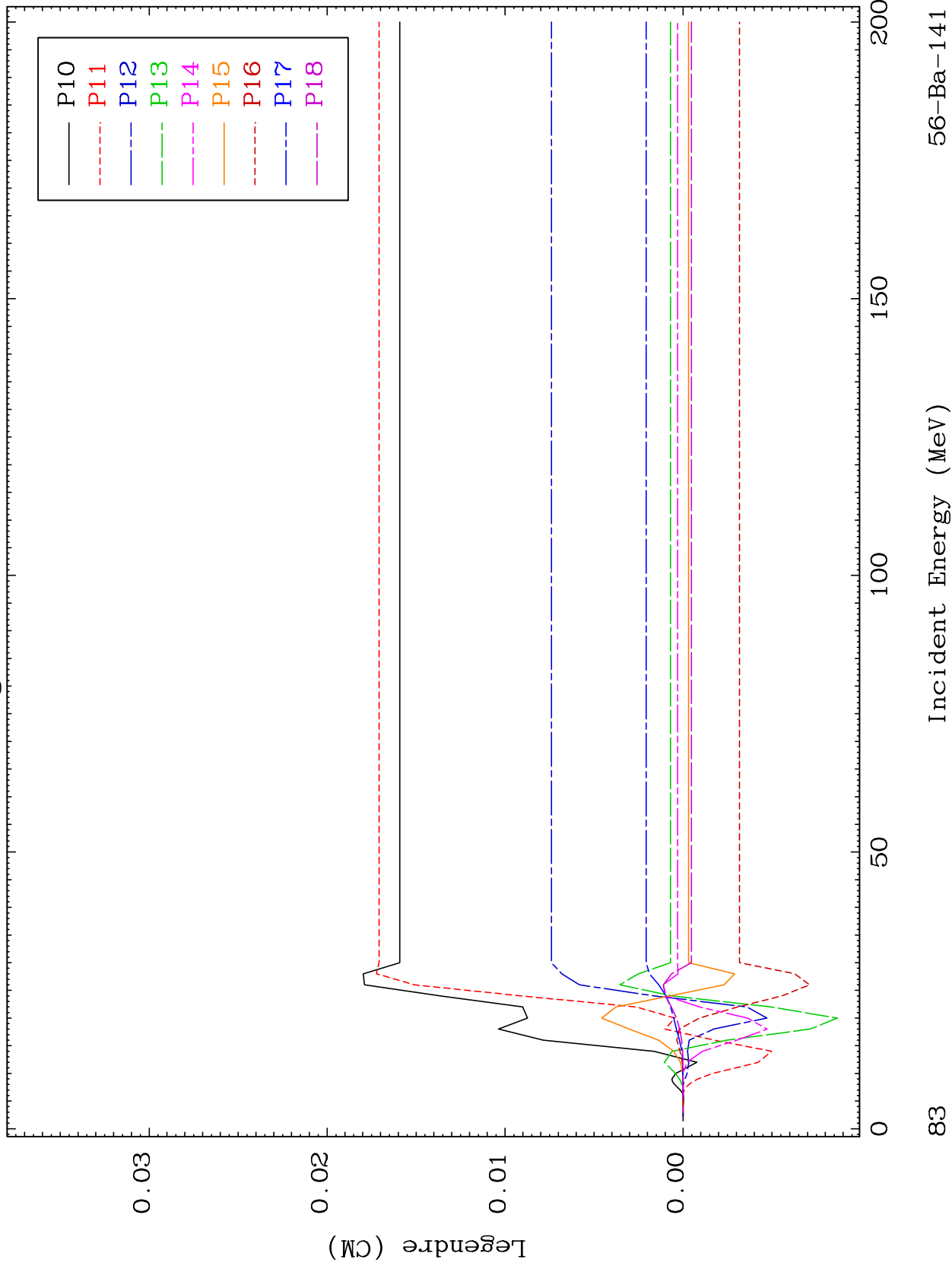

56-Ba-141

Incident Energy (MeV)

83

MAT 5658

MT= 67 (n,n') Level  
Legendre Coefficients

56-Ba-141

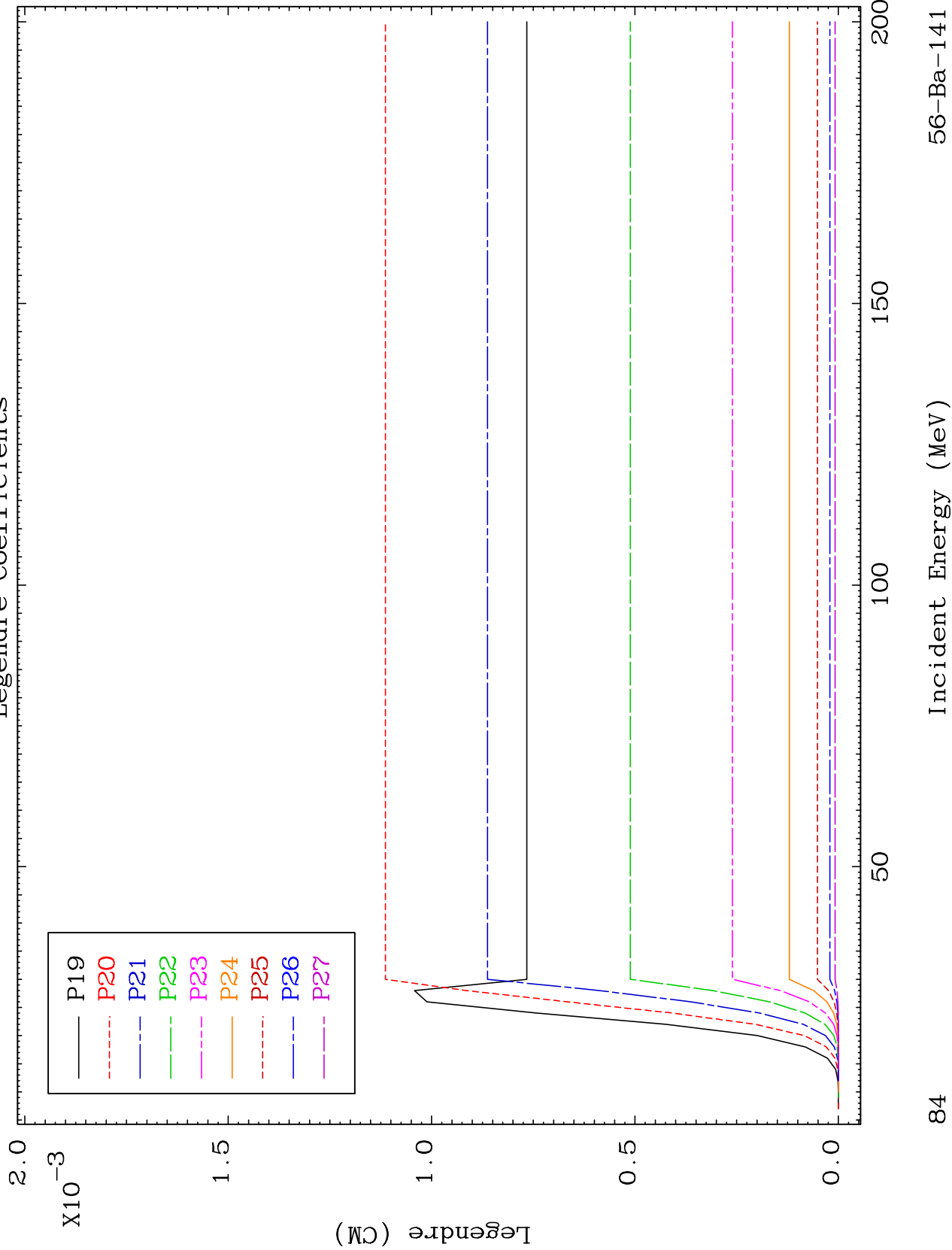

84

Incident Energy (MeV)

56-Ba-141

MAT 5658

MT= 67 (n,n') Level  
Legendre Coefficients

56-Ba-141

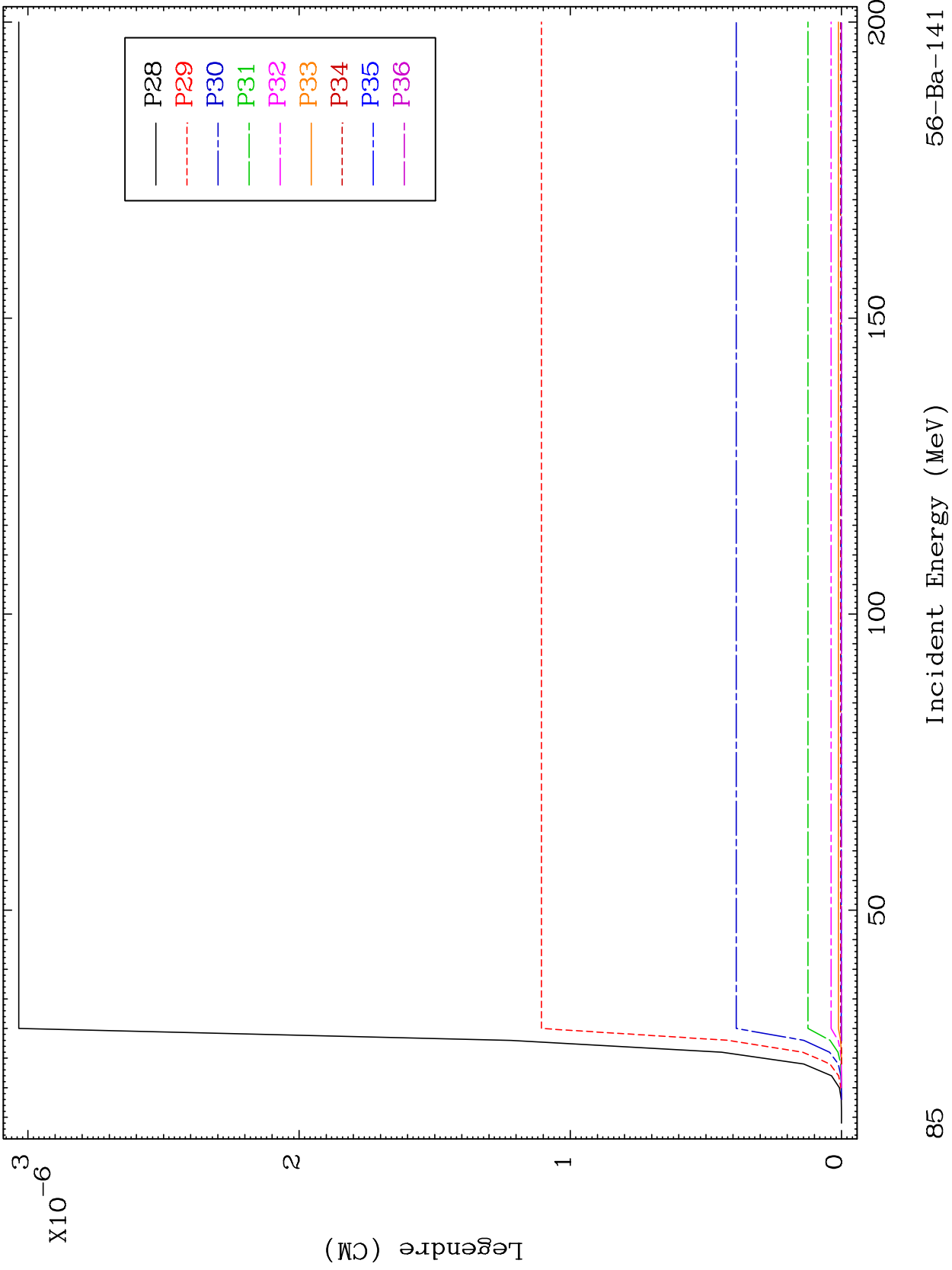

85

Incident Energy (MeV)

56-Ba-141

MAT 5658

MT= 68 (n,n') Level  
Legendre Coefficients

56-Ba-141

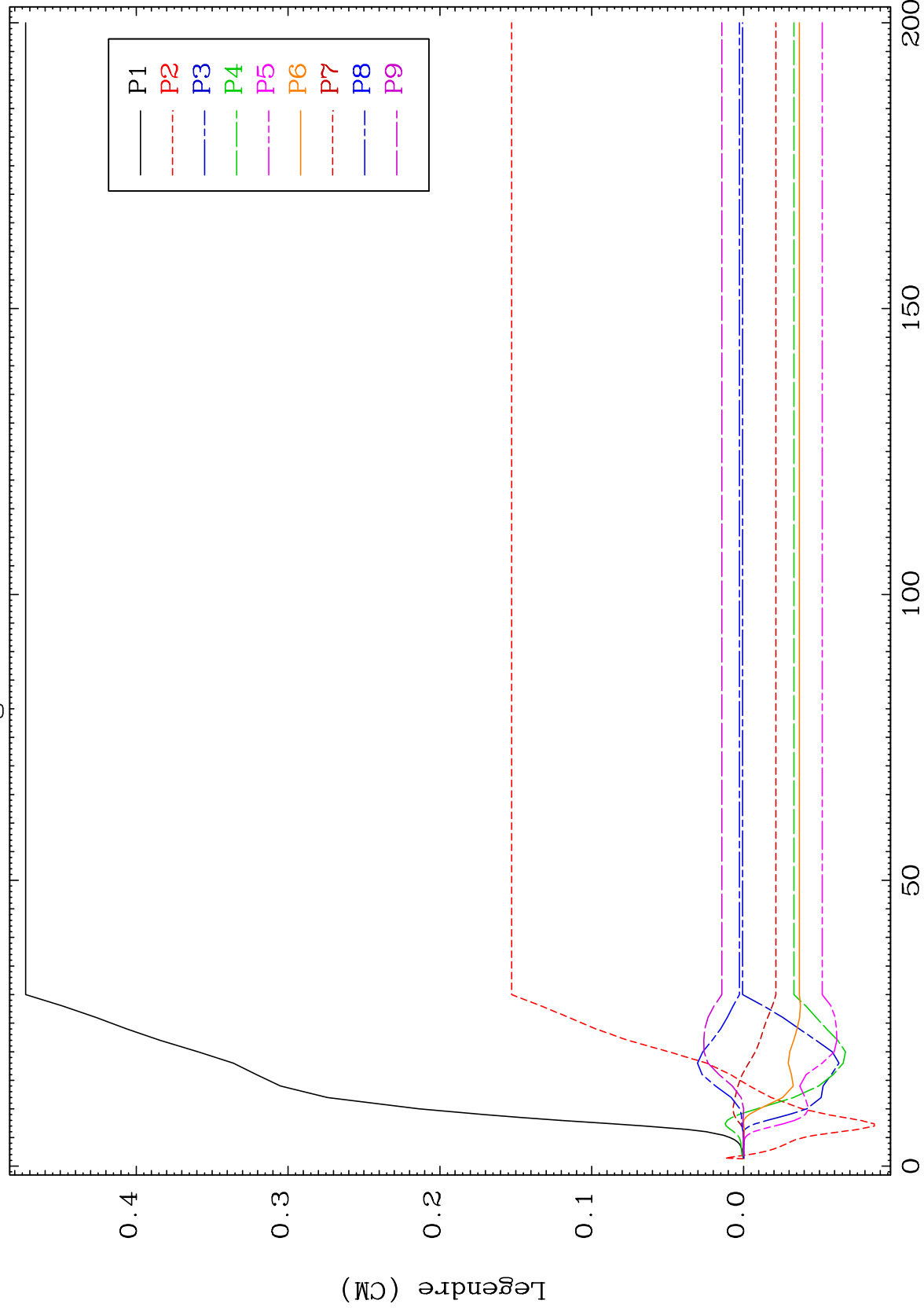

86

Incident Energy (MeV)

56-Ba-141

MAT 5658

MT= 68 (n,n') Level  
Legendre Coefficients

56-Ba-141

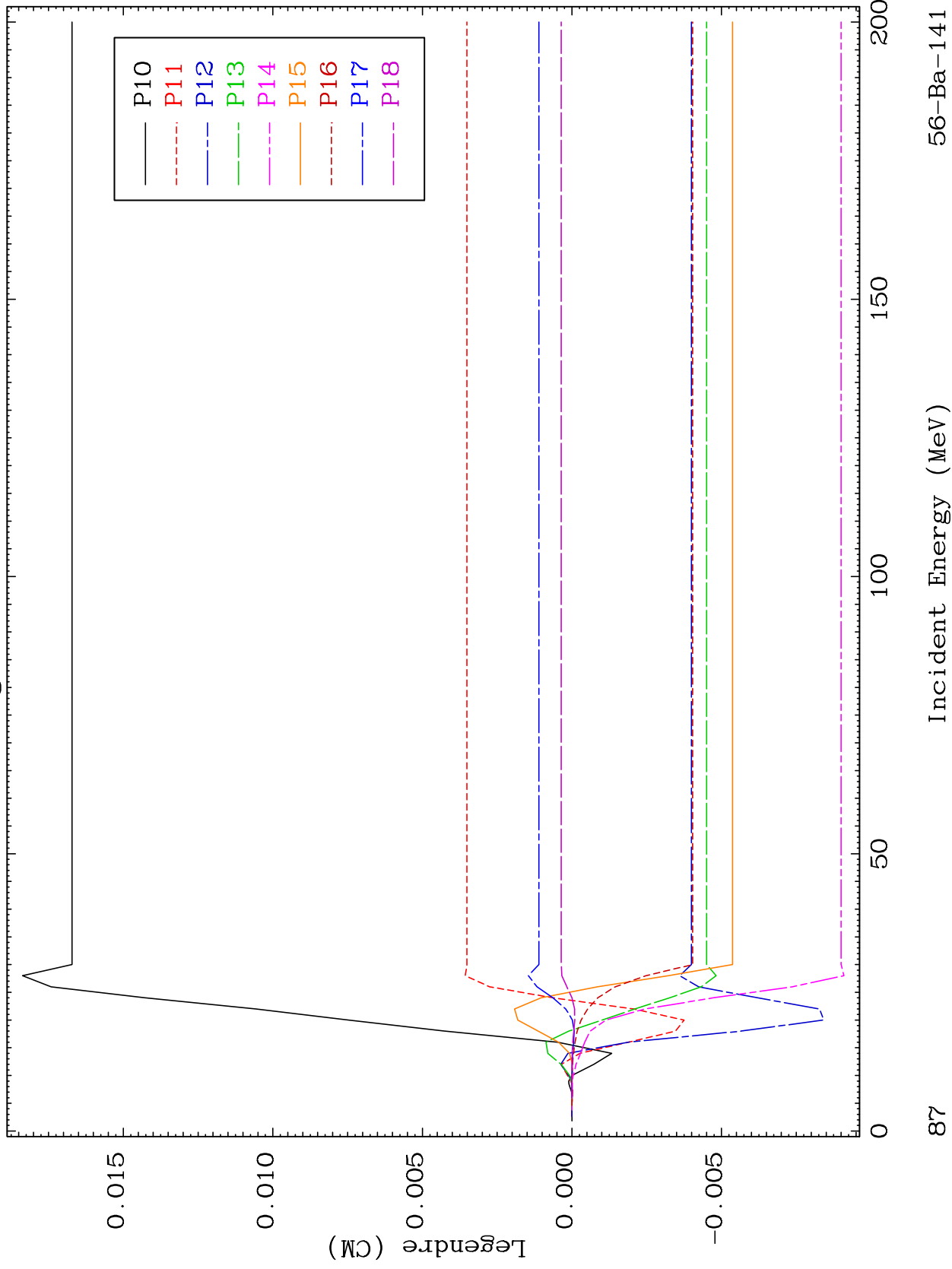

87

Incident Energy (MeV)

56-Ba-141

MAT 5658

MT= 68 (n,n') Level  
Legendre Coefficients

56-Ba-141

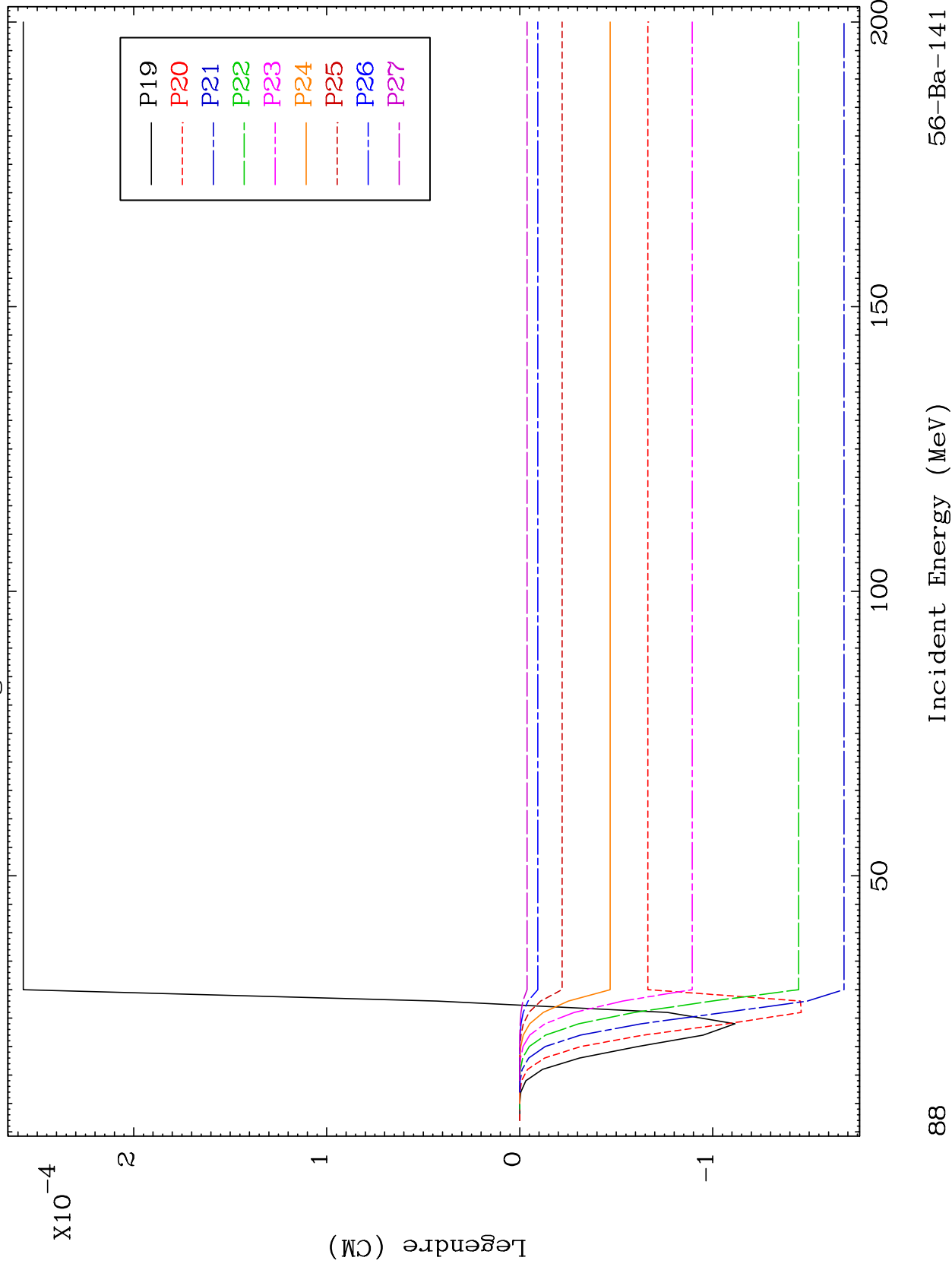

88

Incident Energy (MeV)

56-Ba-141



MAT 5658

MT= 69 (n,n') Level  
Legendre Coefficients

56-Ba-141

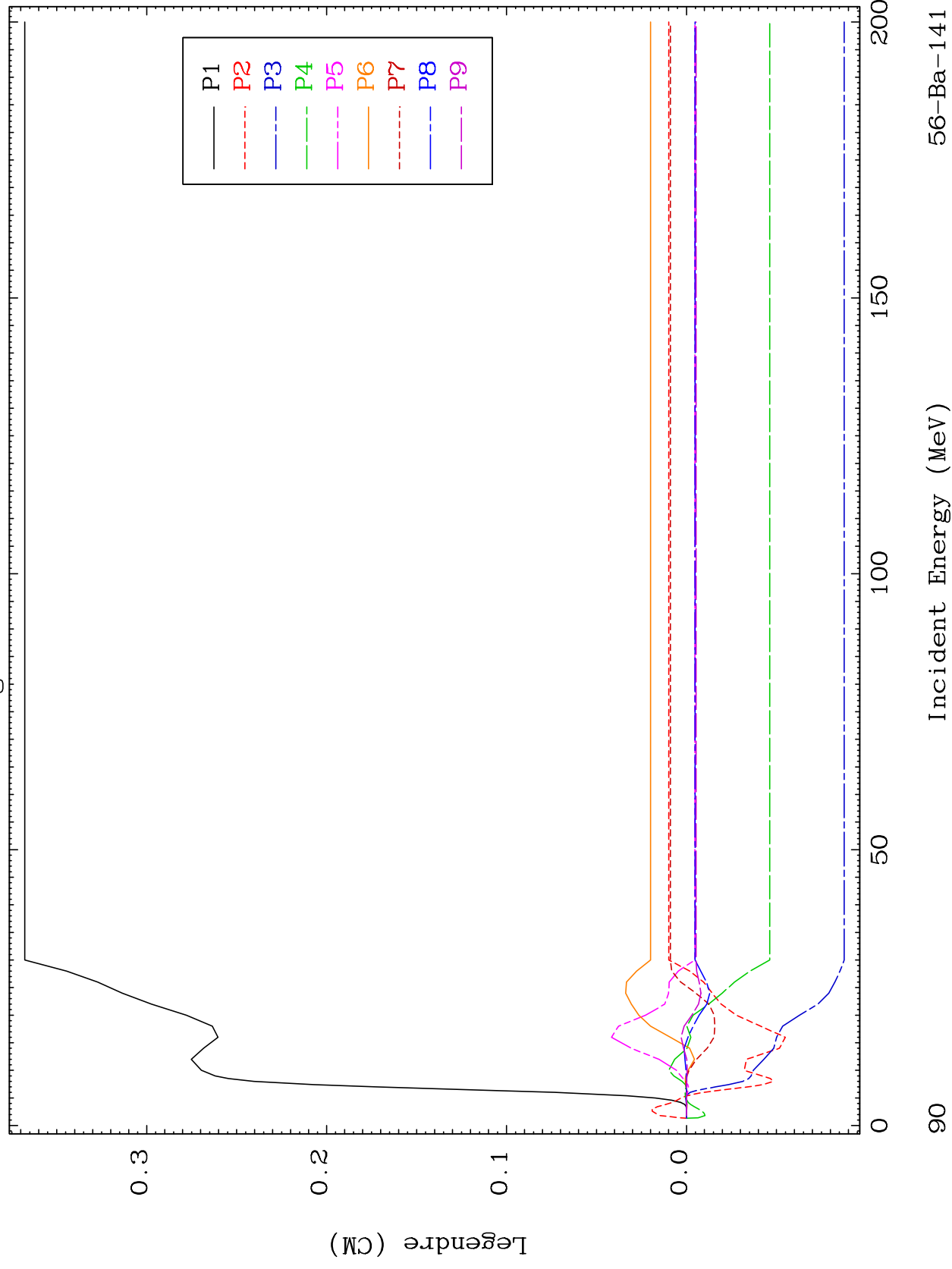

56-Ba-141

Incident Energy (MeV)

90

MAT 5658

MT= 69 (n,n') Level  
Legendre Coefficients

56-Ba-141

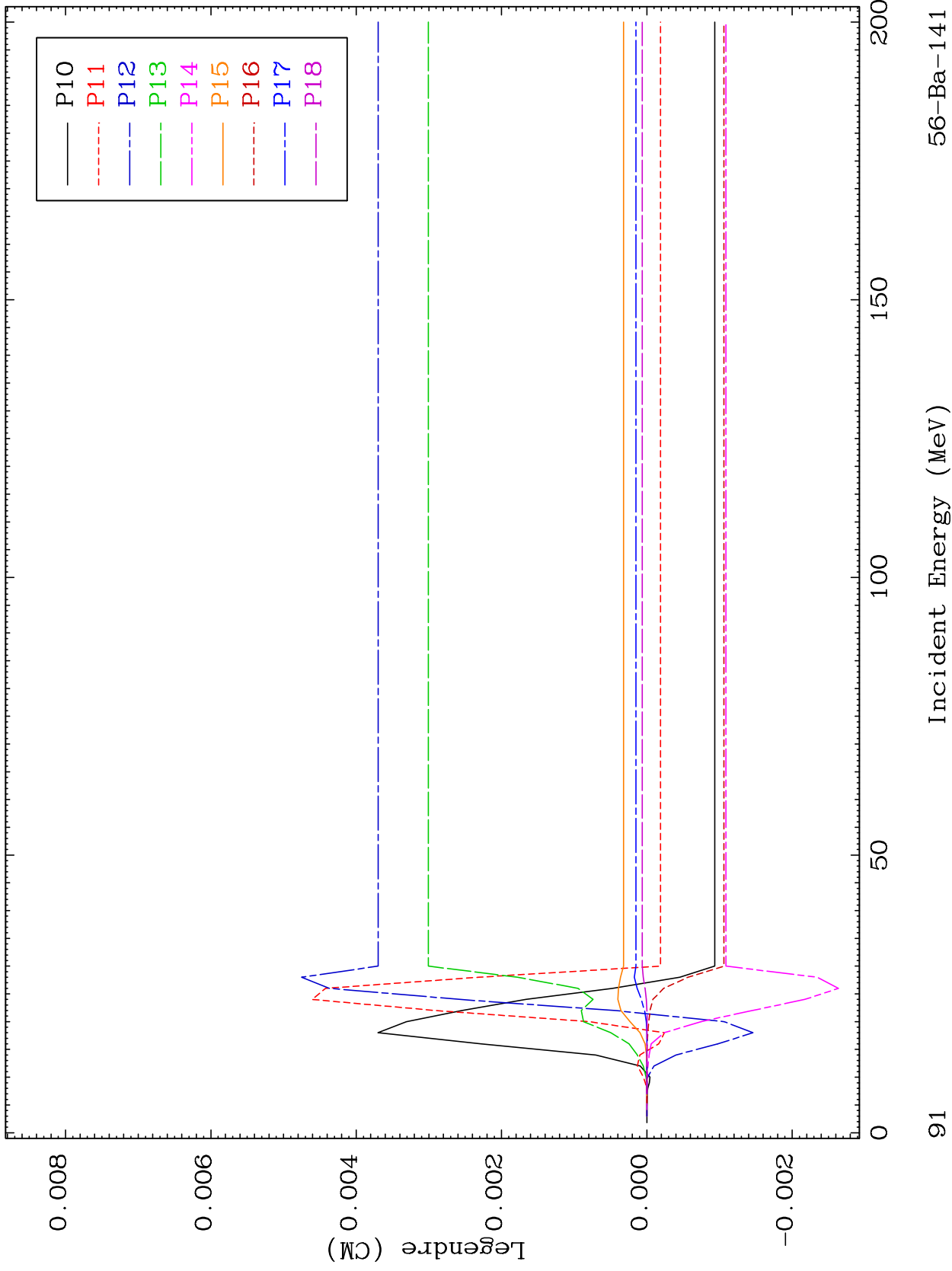

91

Incident Energy (MeV)

56-Ba-141

MAT 5658

MT= 69 (n,n') Level  
Legendre Coefficients

56-Ba-141

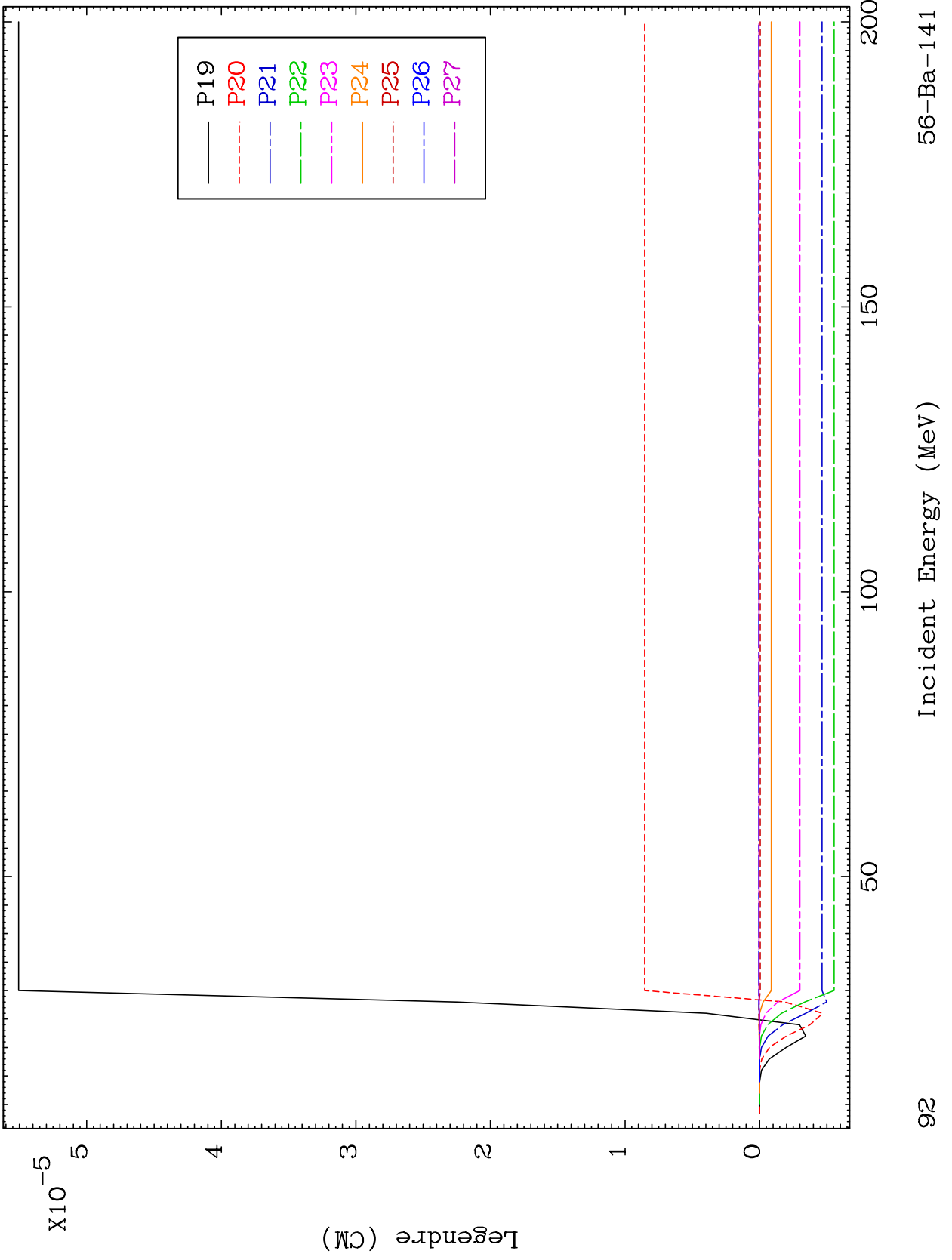

92

Incident Energy (MeV)

56-Ba-141

MAT 5658

MT= 69 (n,n') Level  
Legendre Coefficients

56-Ba-141

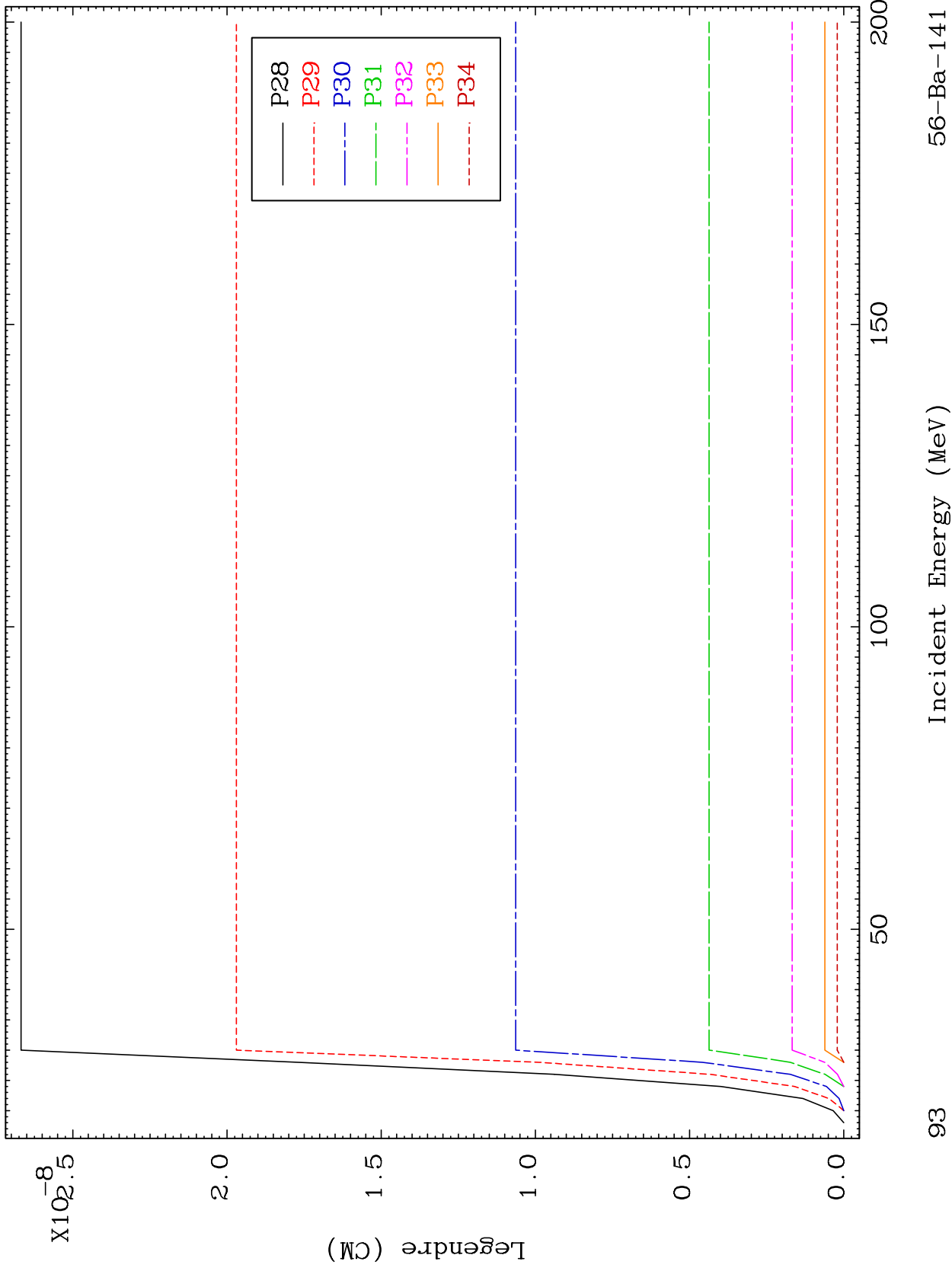

MAT 5658

MT= 70 (n,n') Level  
Legendre Coefficients

56-Ba-141

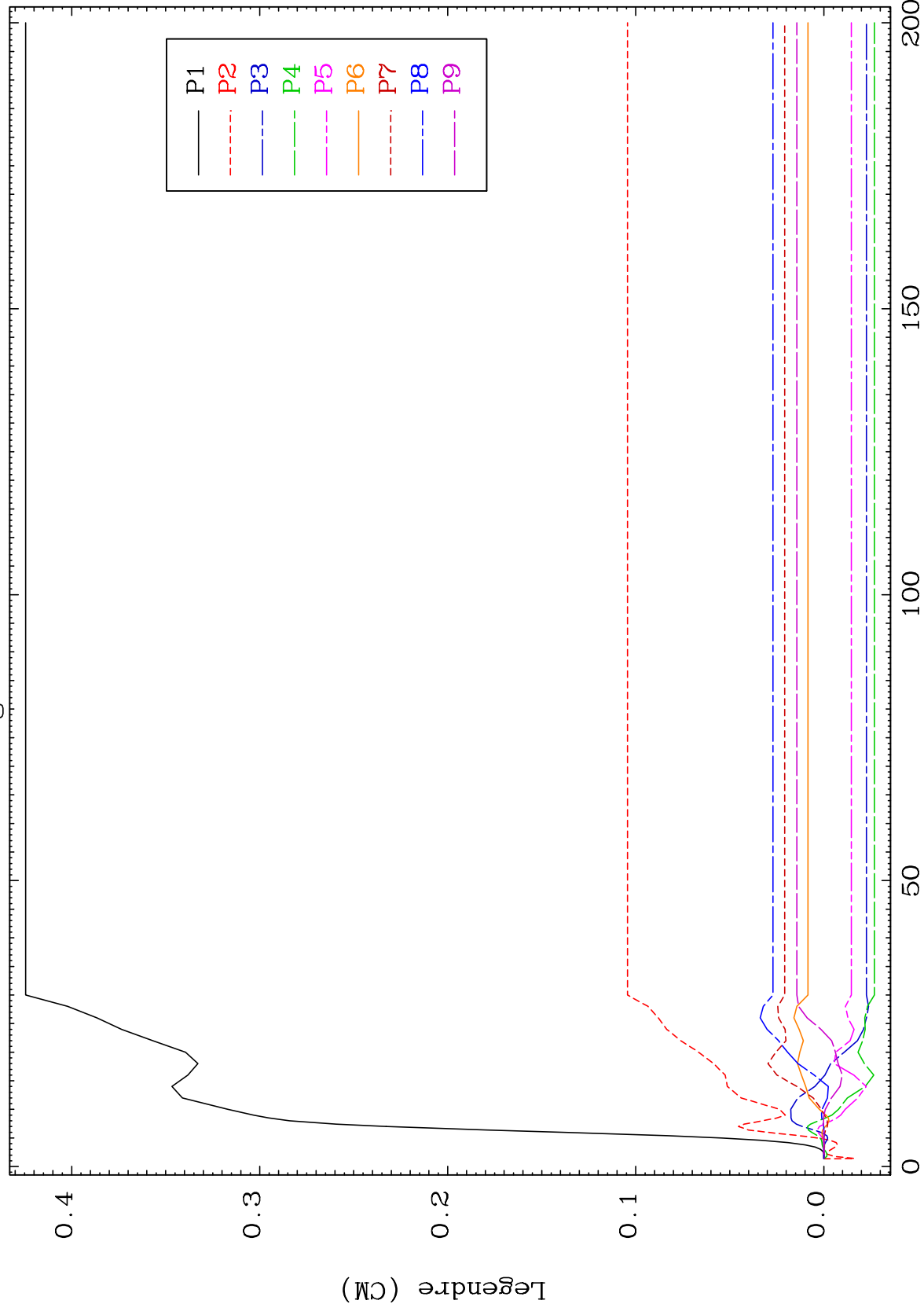

94

Incident Energy (MeV)

56-Ba-141

MAT 5658

MT= 70 (n,n') Level  
Legendre Coefficients

56-Ba-141

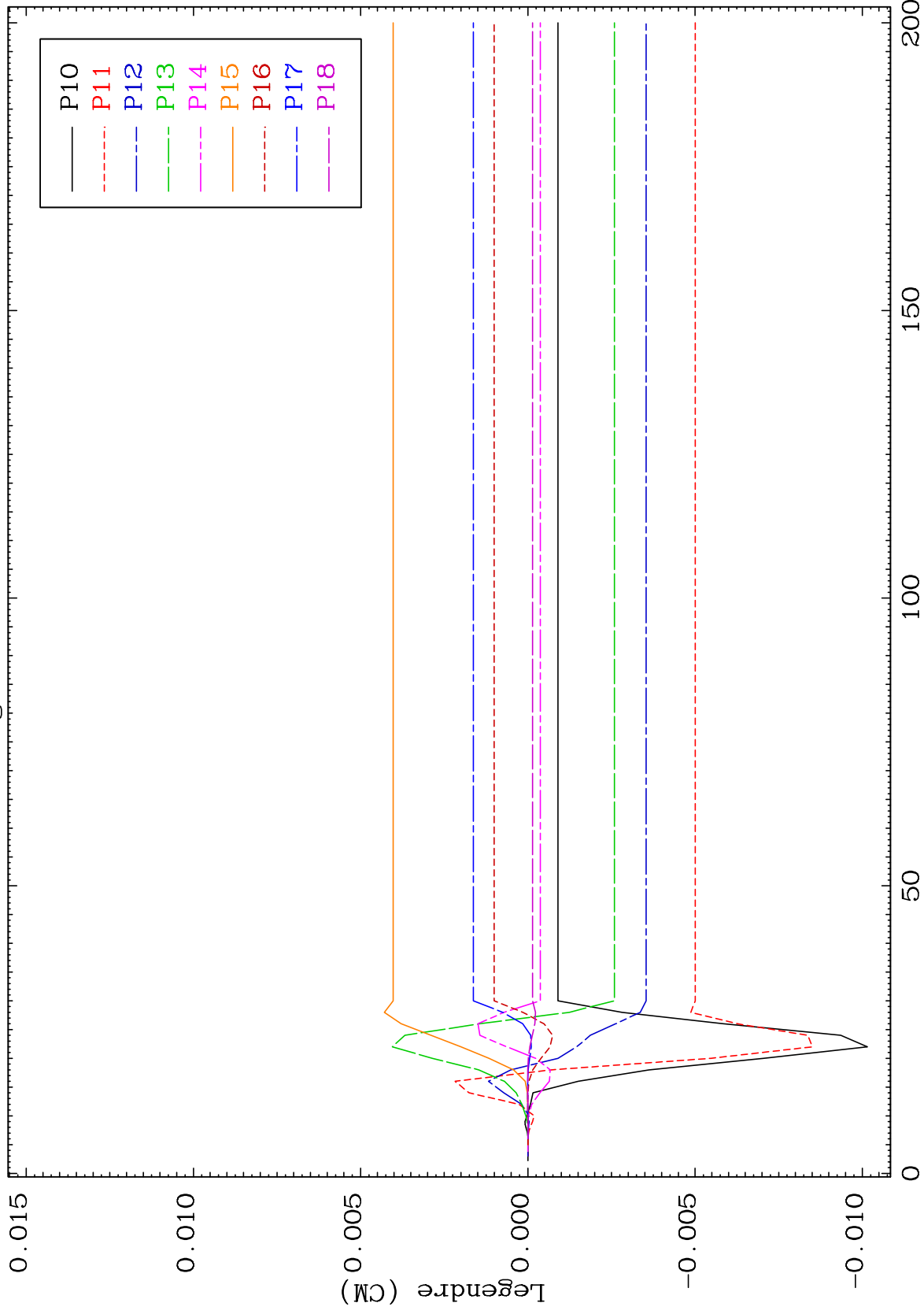

95

Incident Energy (MeV)

56-Ba-141

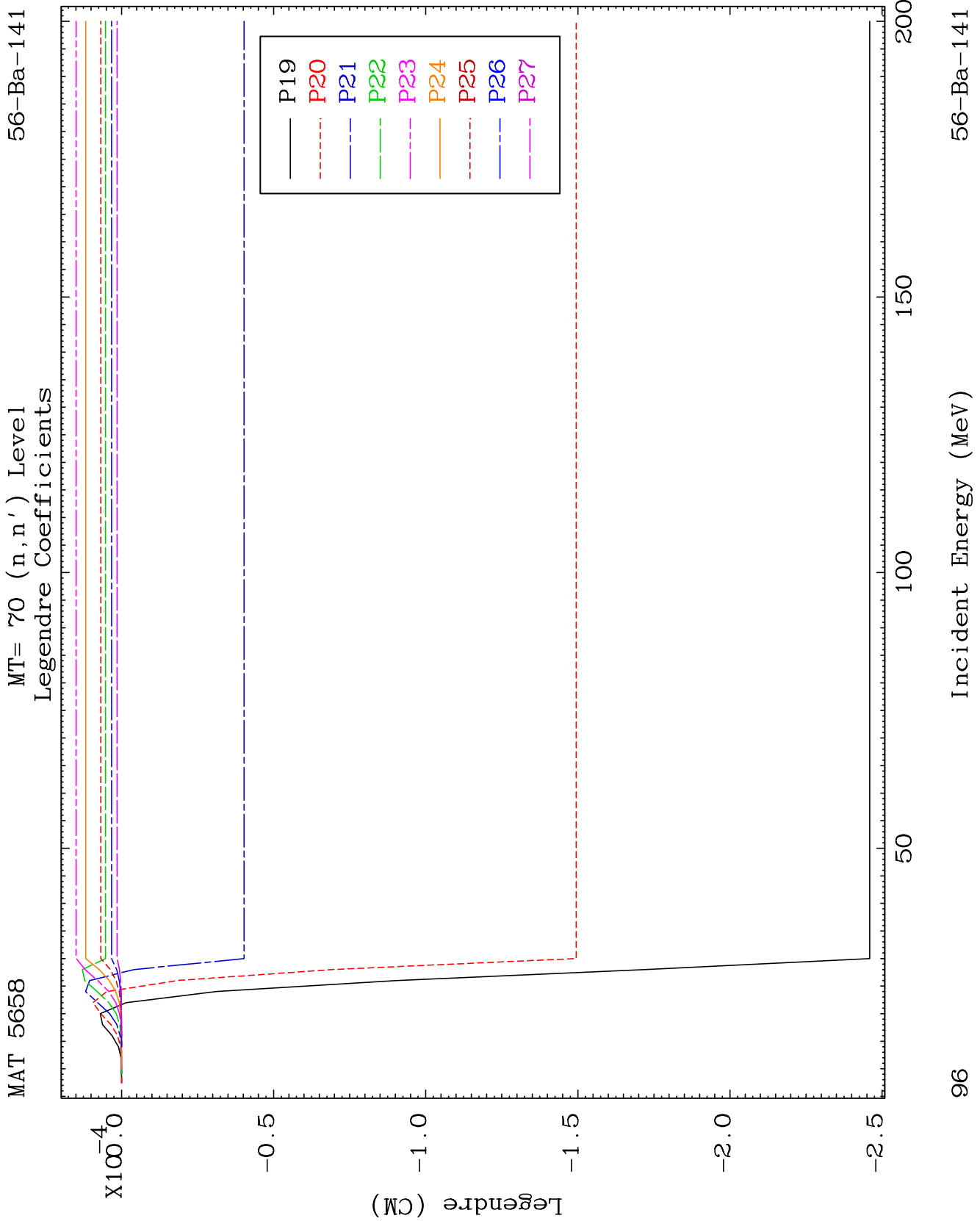

MAT 5658

MT= 70 (n,n') Level  
Legendre Coefficients

56-Ba-141

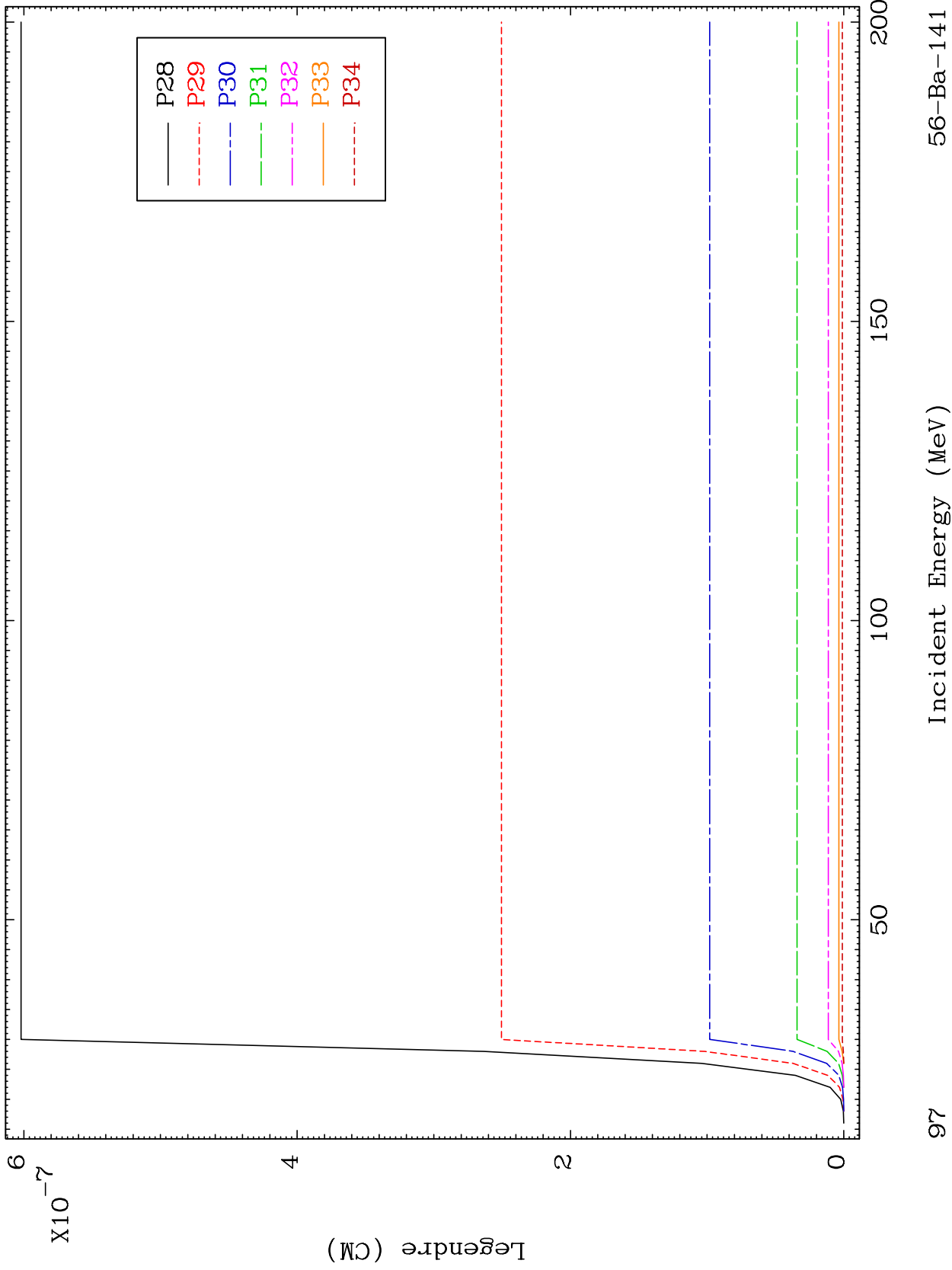

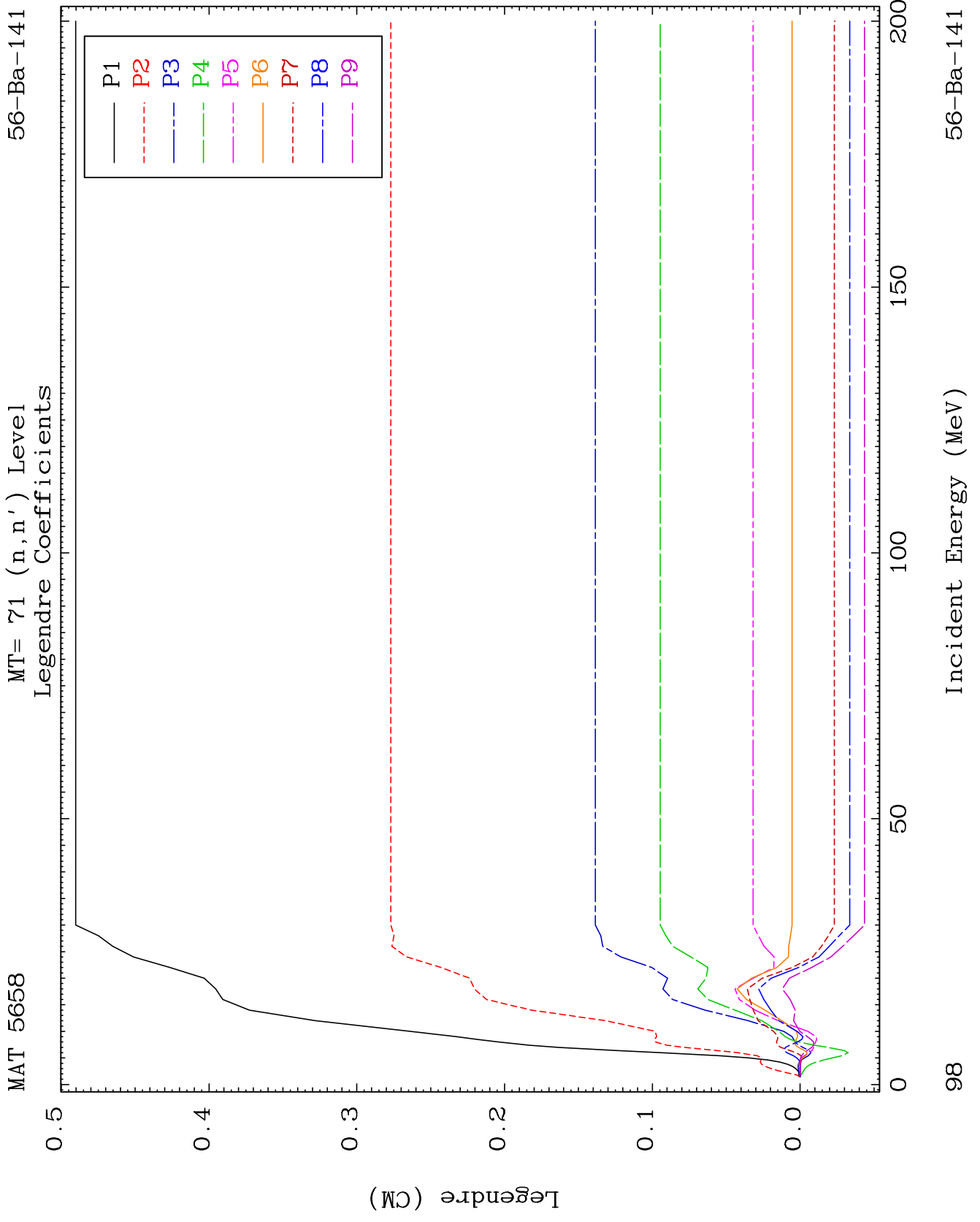

MAT 5658

MT= 71 (n,n') Level  
Legendre Coefficients

56-Ba-141

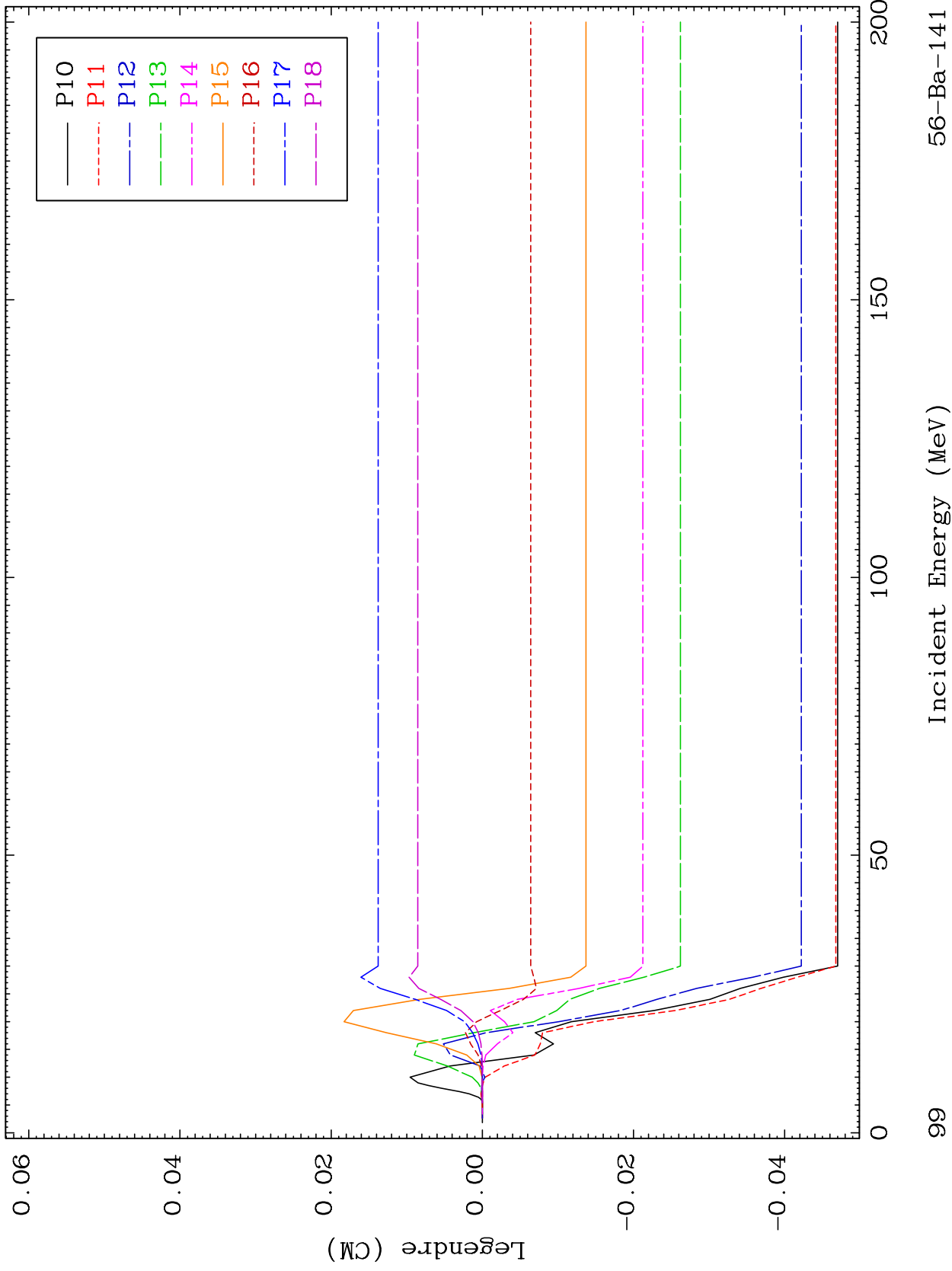

56-Ba-141

Incident Energy (MeV)

99

MAT 5658

MT= 71 (n,n') Level  
Legendre Coefficients

56-Ba-141

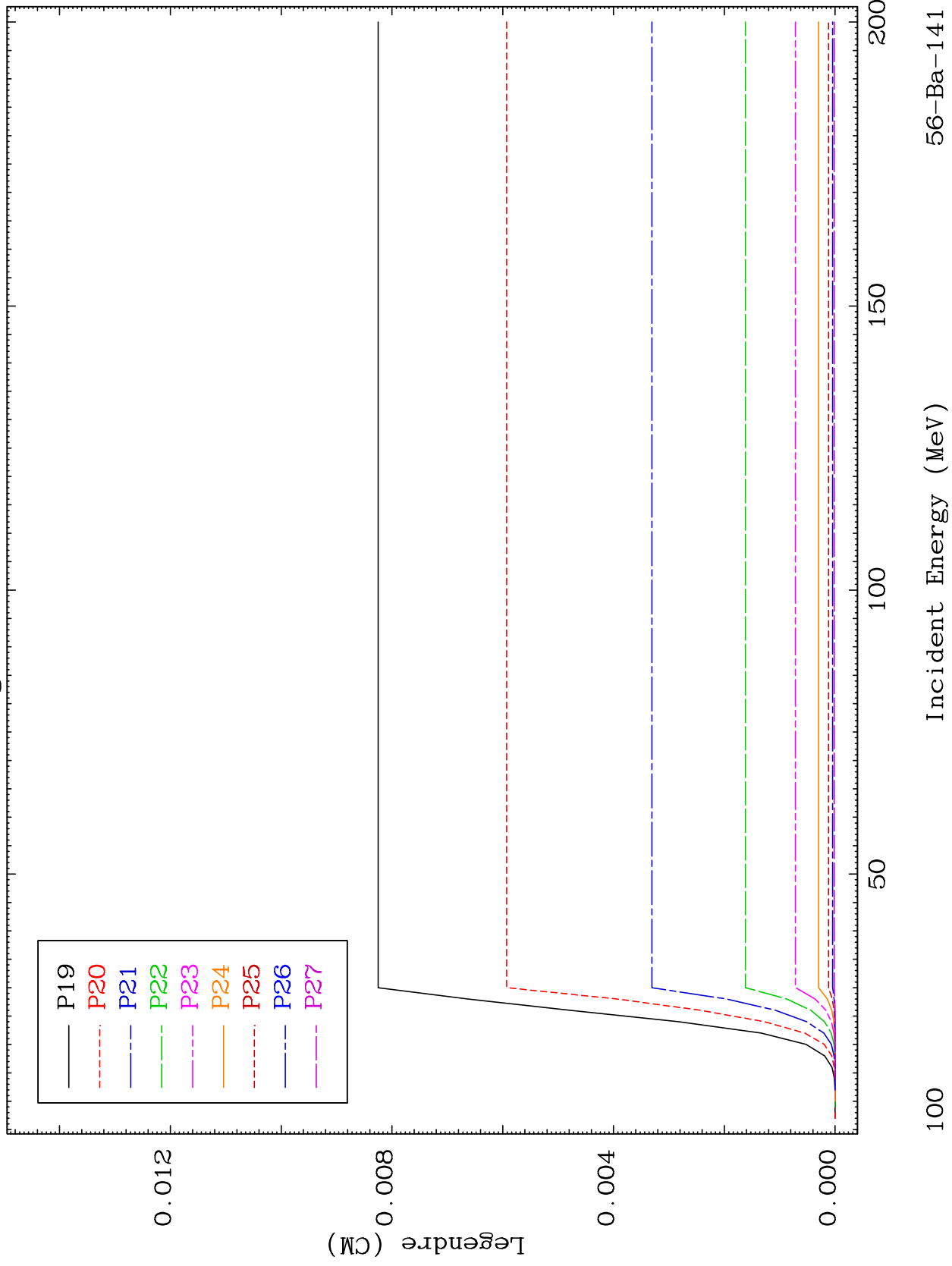

56-Ba-141

MAT 5658

MT= 71 (n,n') Level  
Legendre Coefficients

56-Ba-141

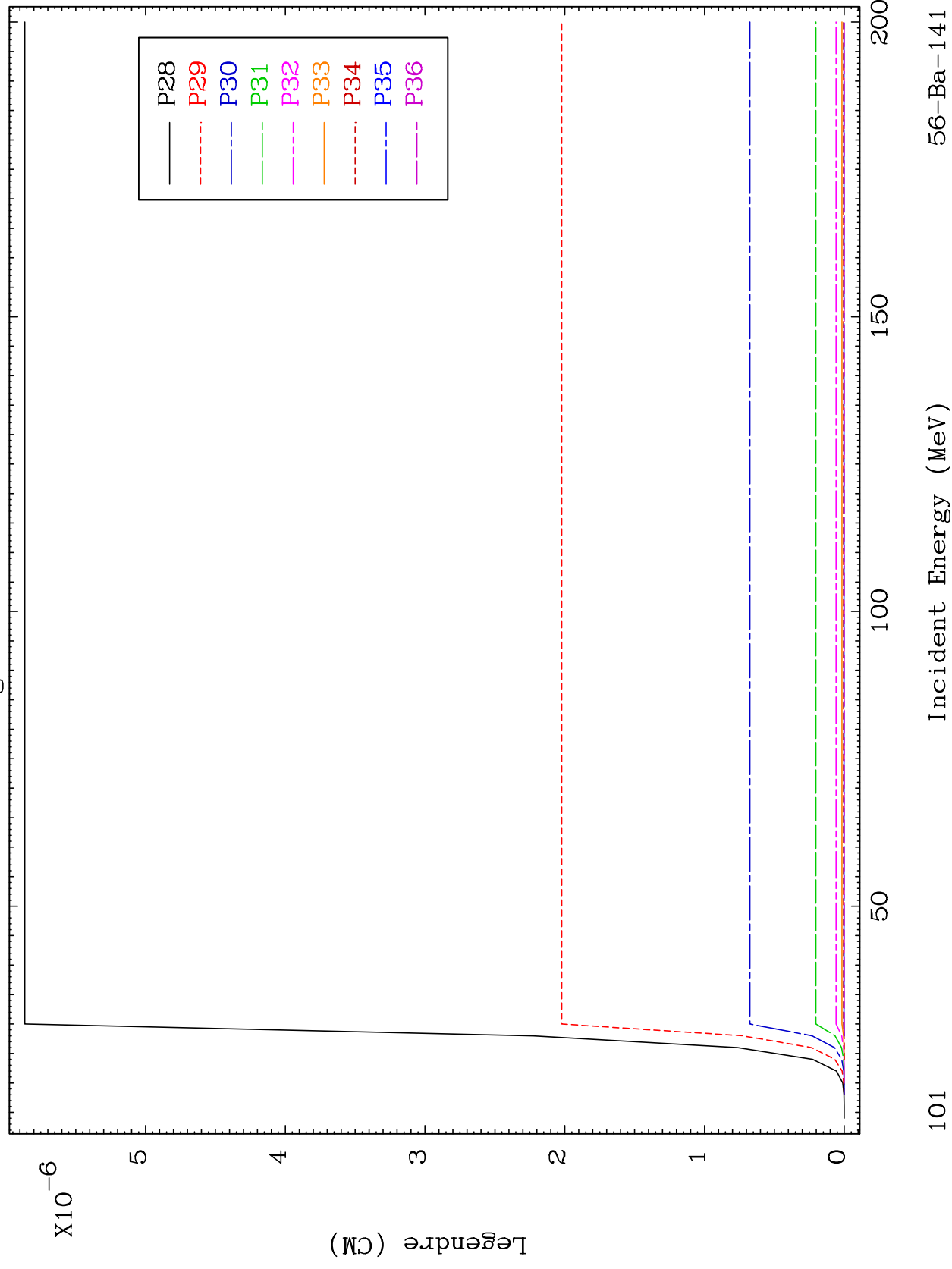

101

56-Ba-141

MAT 5658

MT= 72 (n,n') Level  
Legendre Coefficients

56-Ba-141

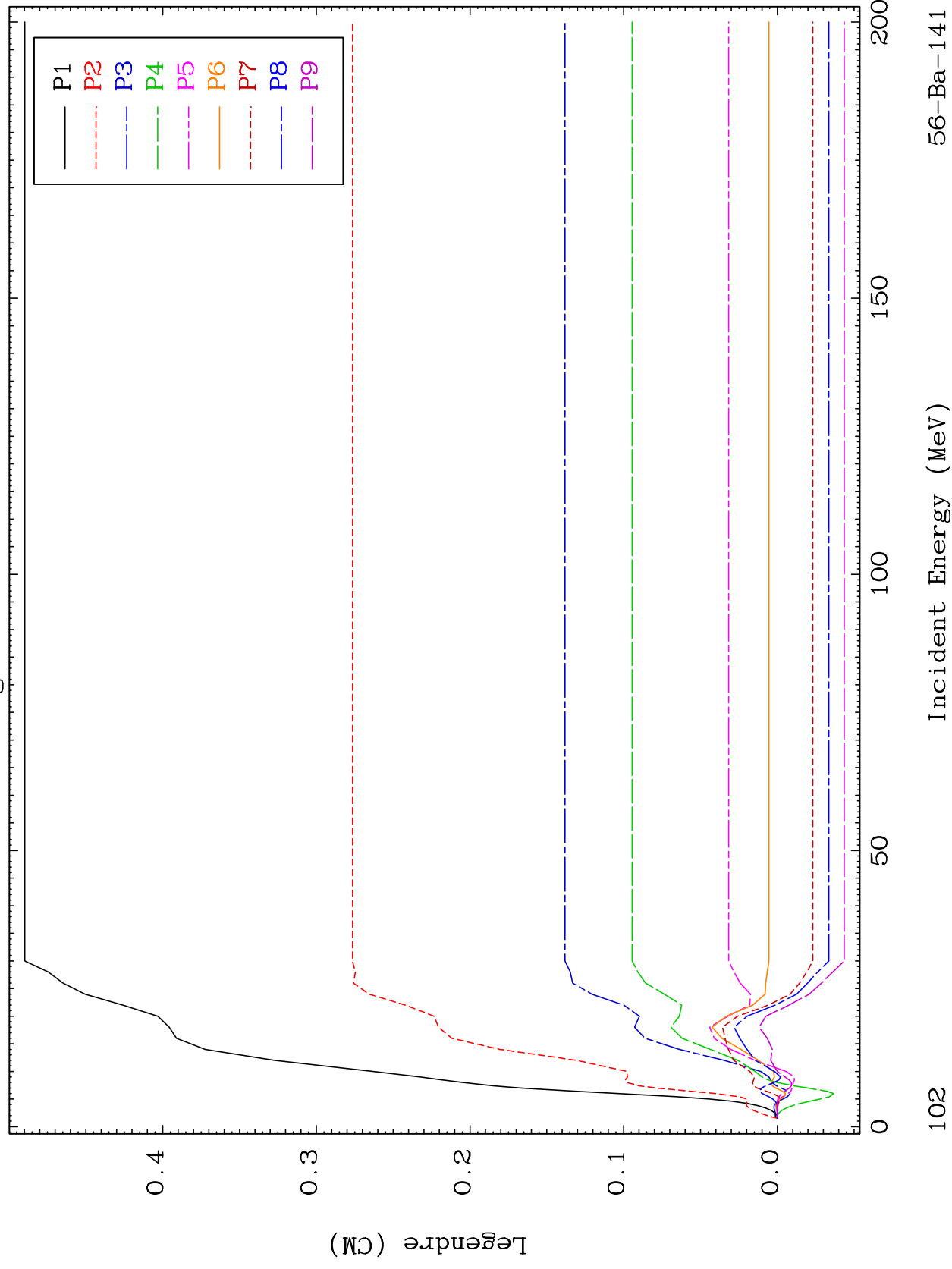

56-Ba-141

Incident Energy (MeV)

102

MAT 5658

MT= 72 (n,n') Level  
Legendre Coefficients

56-Ba-141

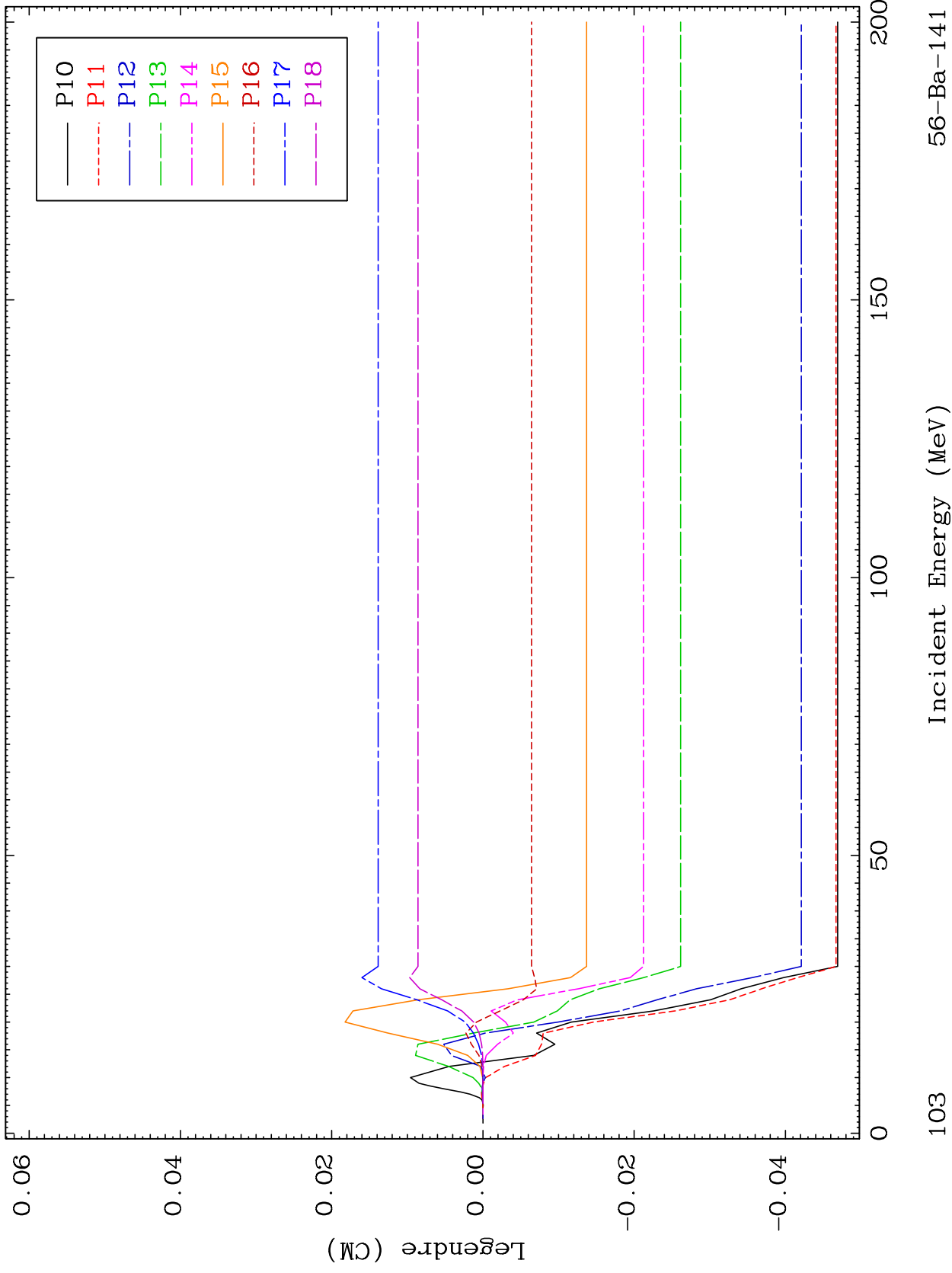

56-Ba-141

Incident Energy (MeV)

103

MAT 5658

MT= 72 (n,n') Level  
Legendre Coefficients

56-Ba-141

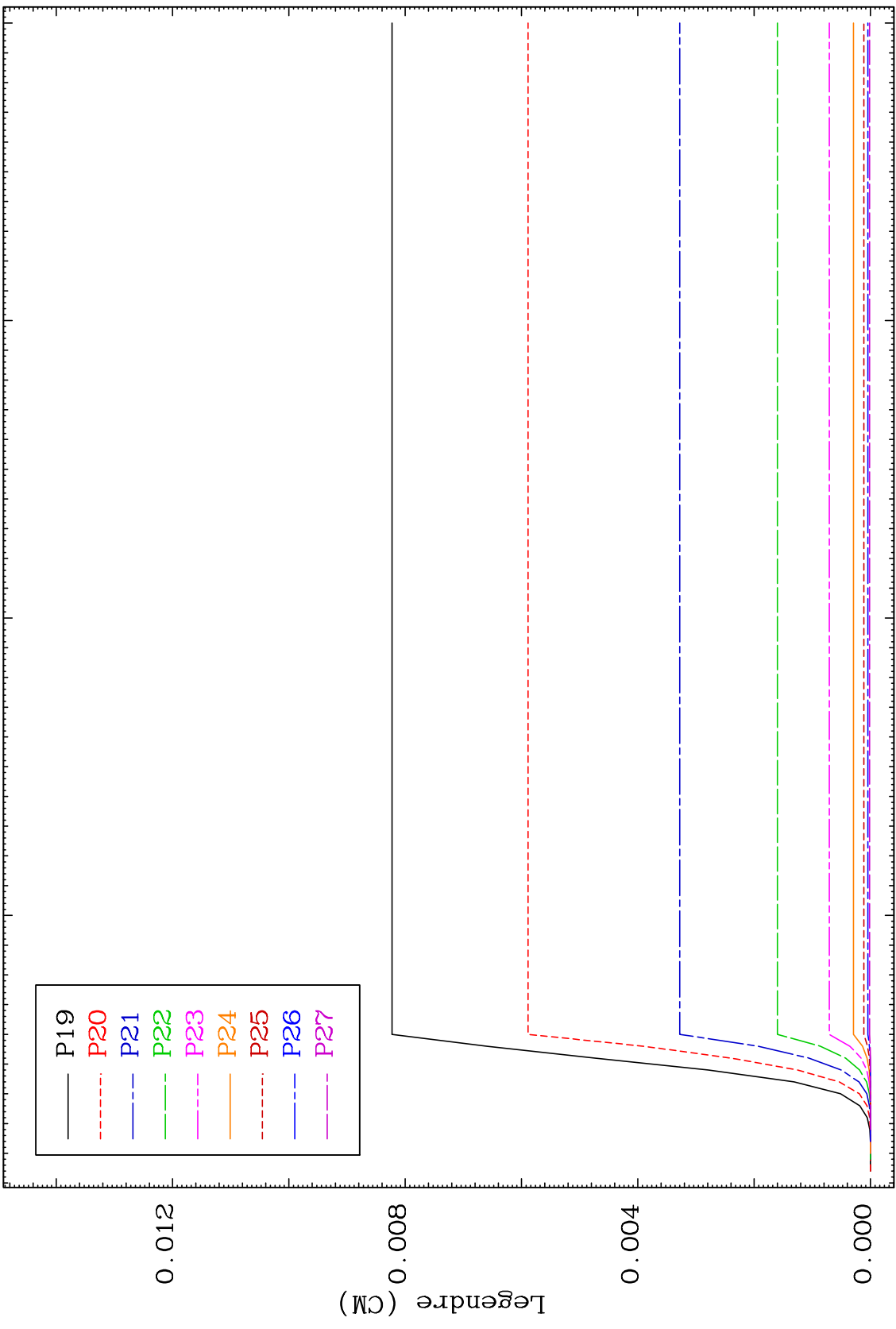

104

Incident Energy (MeV)

56-Ba-141

MAT 5658

MT= 72 (n,n') Level  
Legendre Coefficients

56-Ba-141

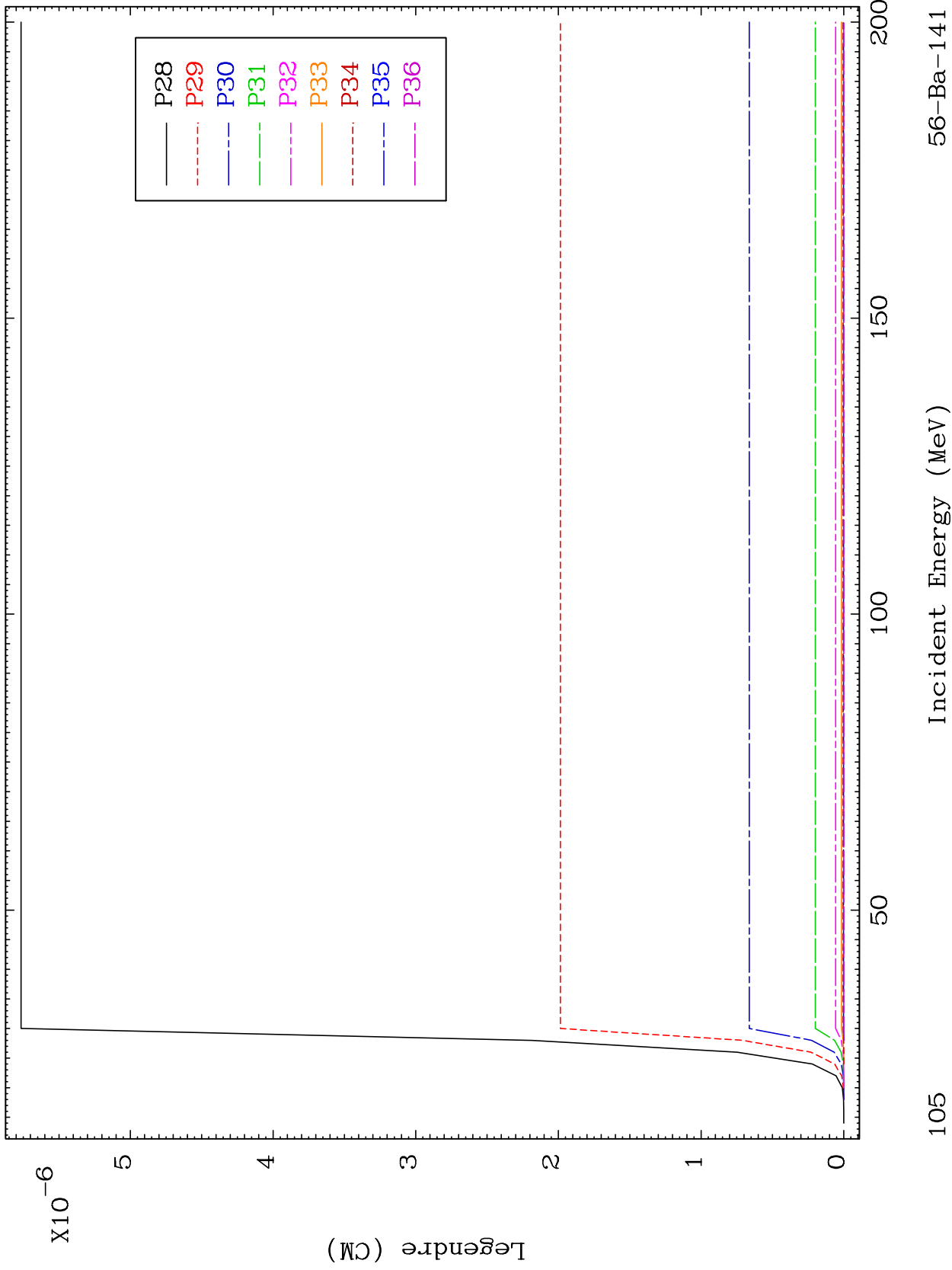

MAT 5658

MT= 73 (n,n') Level  
Legendre Coefficients

56-Ba-141

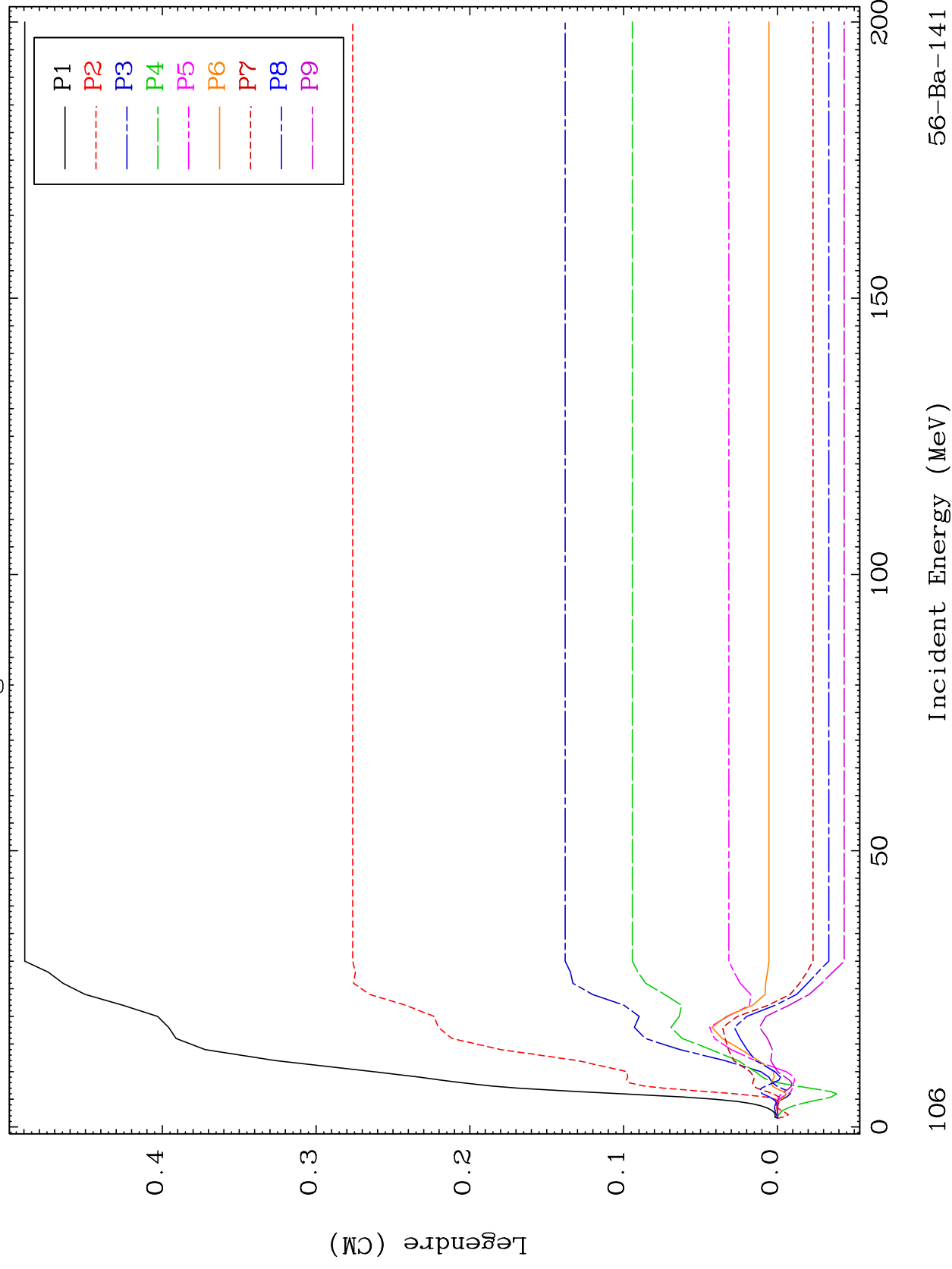

56-Ba-141

Incident Energy (MeV)

106

MAT 5658

MT= 73 (n,n') Level  
Legendre Coefficients

56-Ba-141

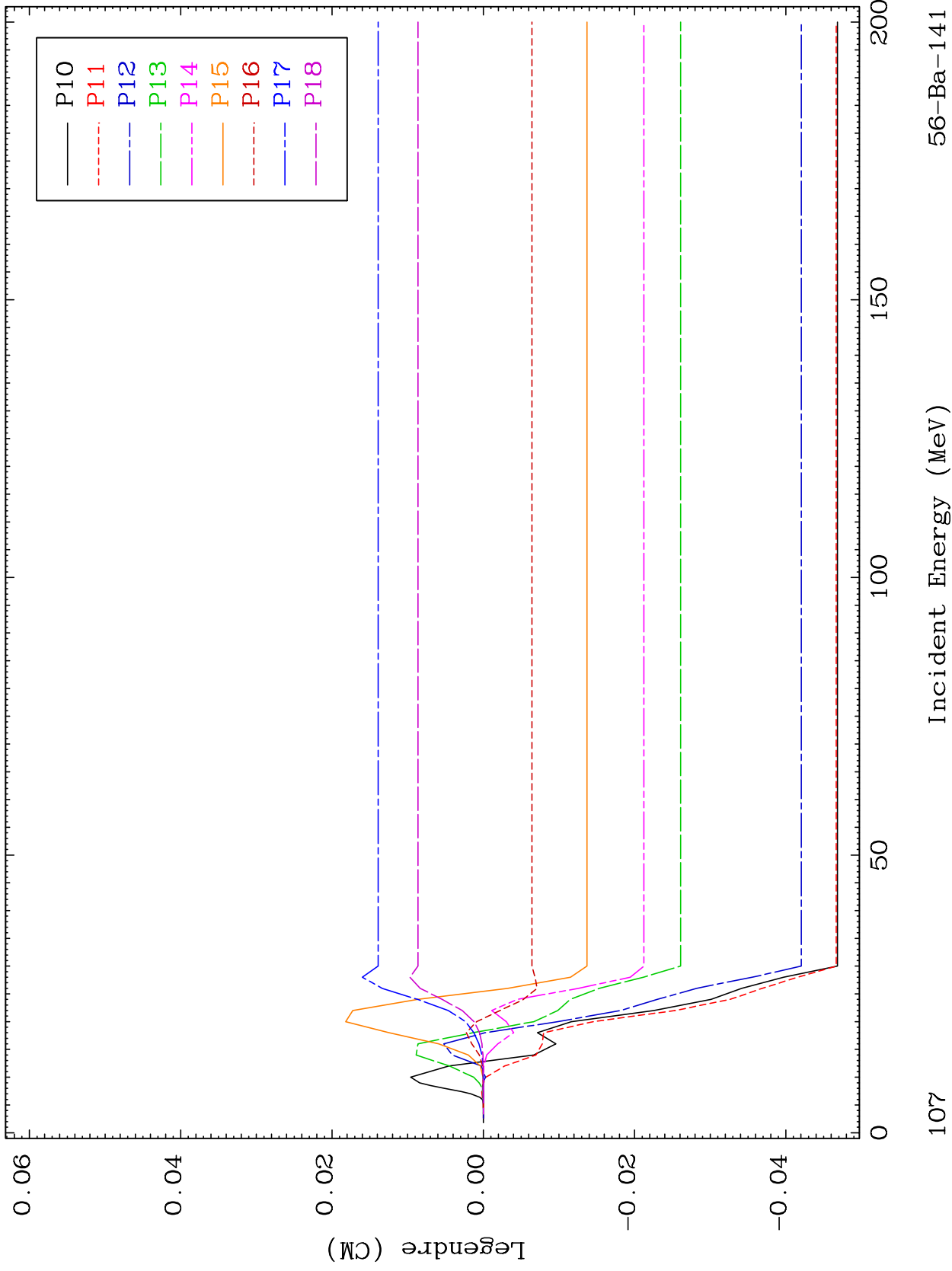

56-Ba-141

Incident Energy (MeV)

107

MAT 5658

MT= 73 (n,n') Level  
Legendre Coefficients

56-Ba-141

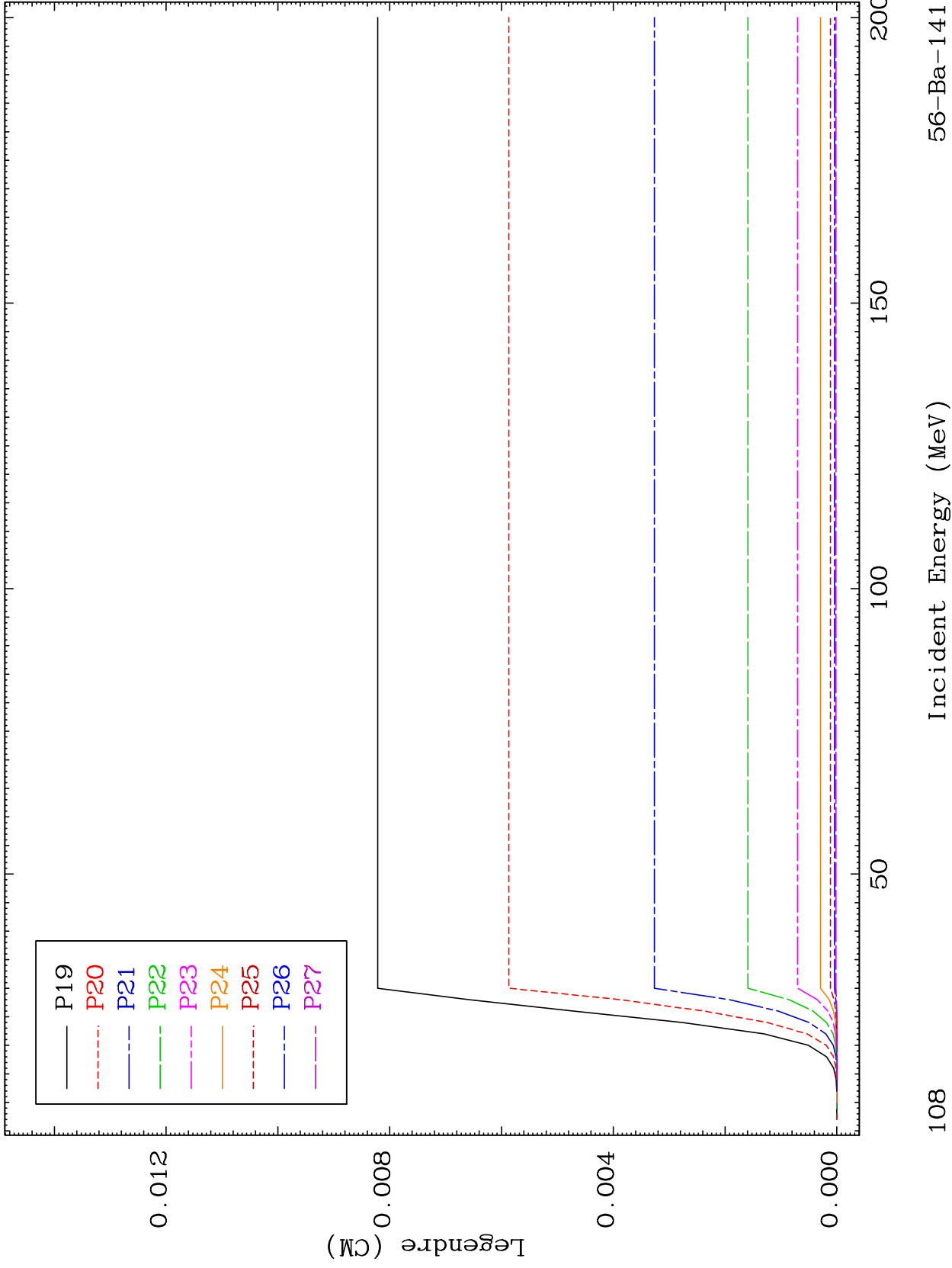

108

56-Ba-141

MAT 5658

MT= 73 (n,n') Level  
Legendre Coefficients

56-Ba-141

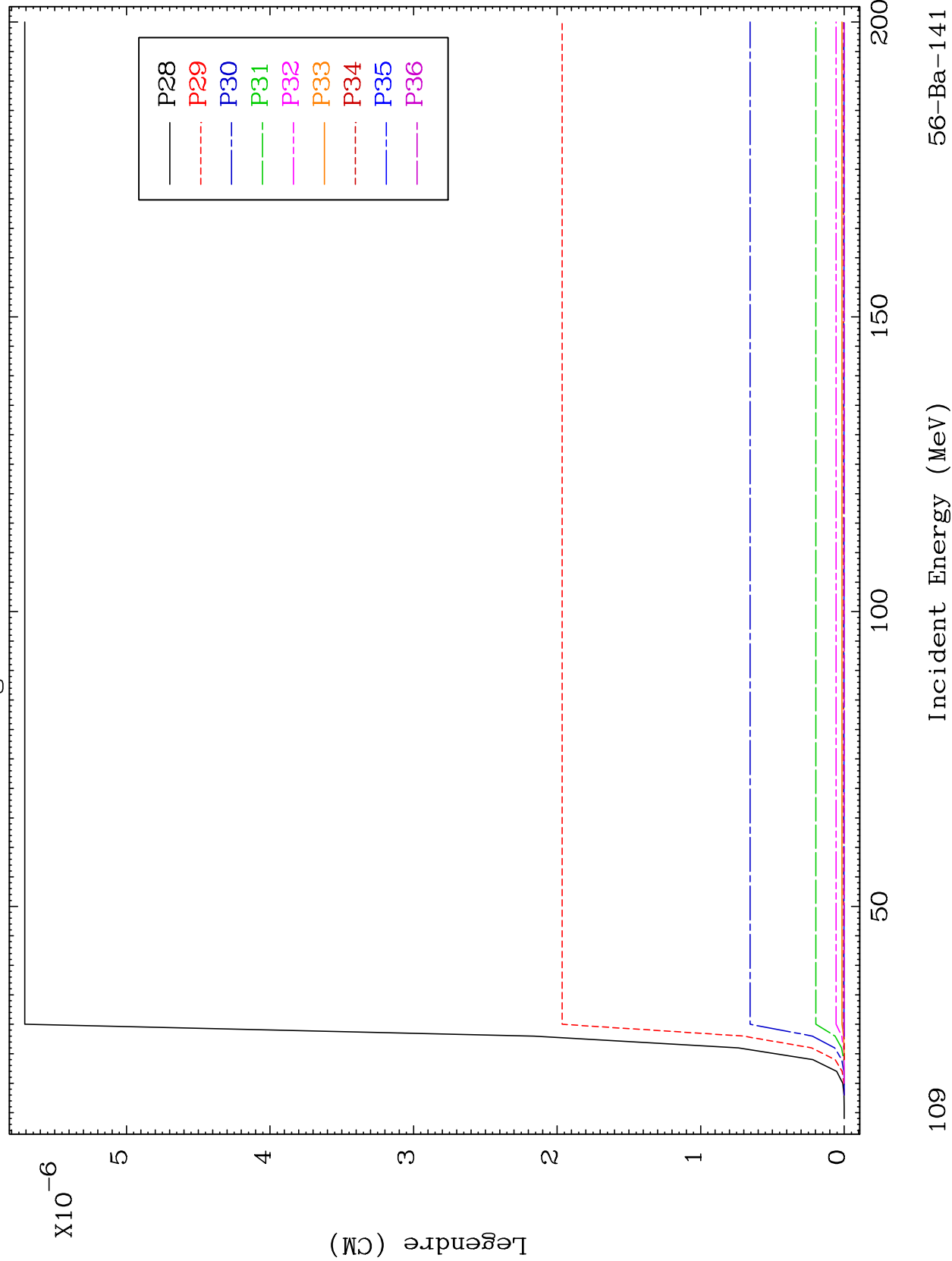

109

Incident Energy (MeV)

56-Ba-141



MAT 5658

MT= 74 (n,n') Level  
Legendre Coefficients

56-Ba-141

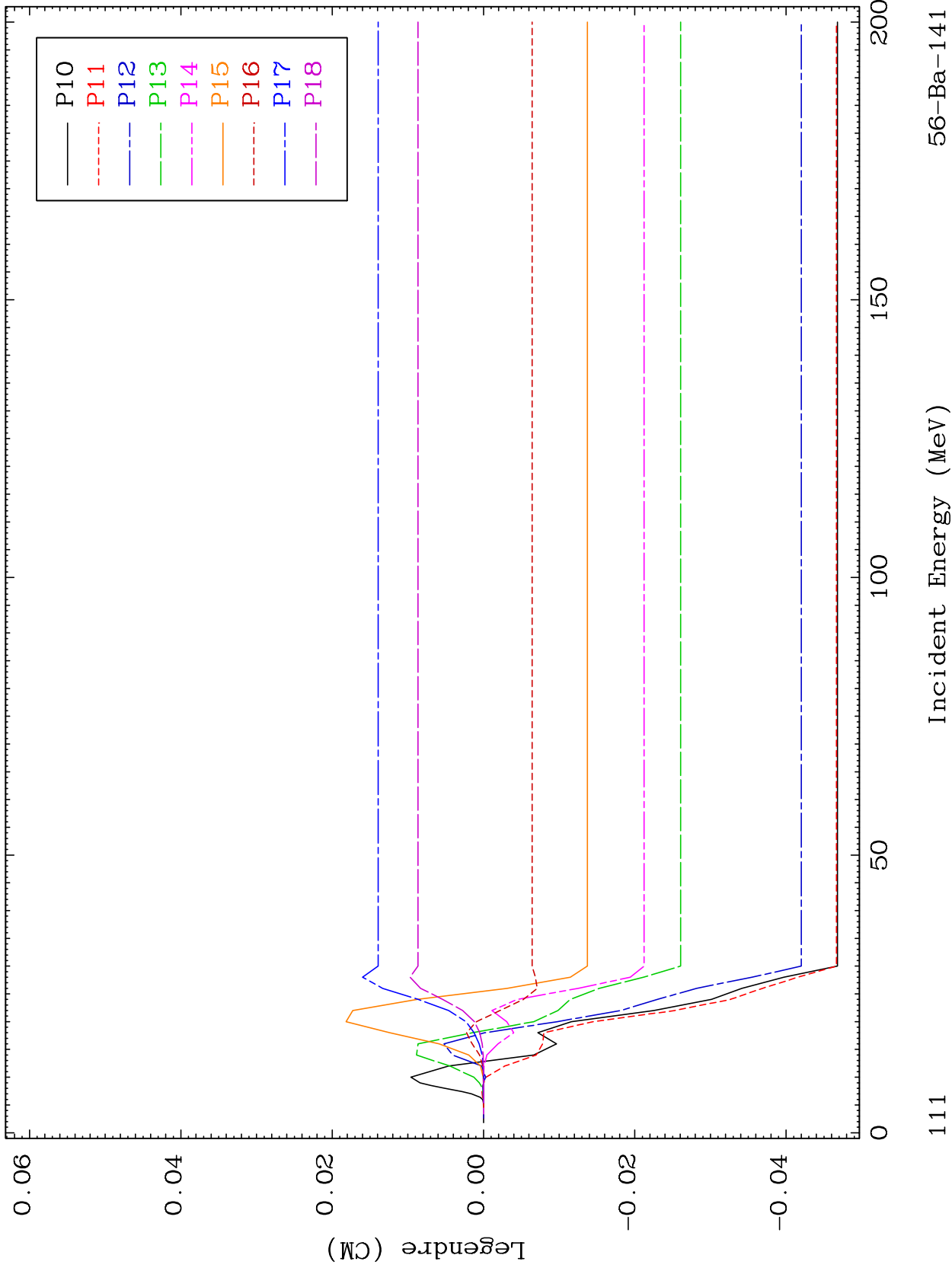

111

Incident Energy (MeV)

56-Ba-141

MAT 5658

MT= 74 (n,n') Level  
Legendre Coefficients

56-Ba-141

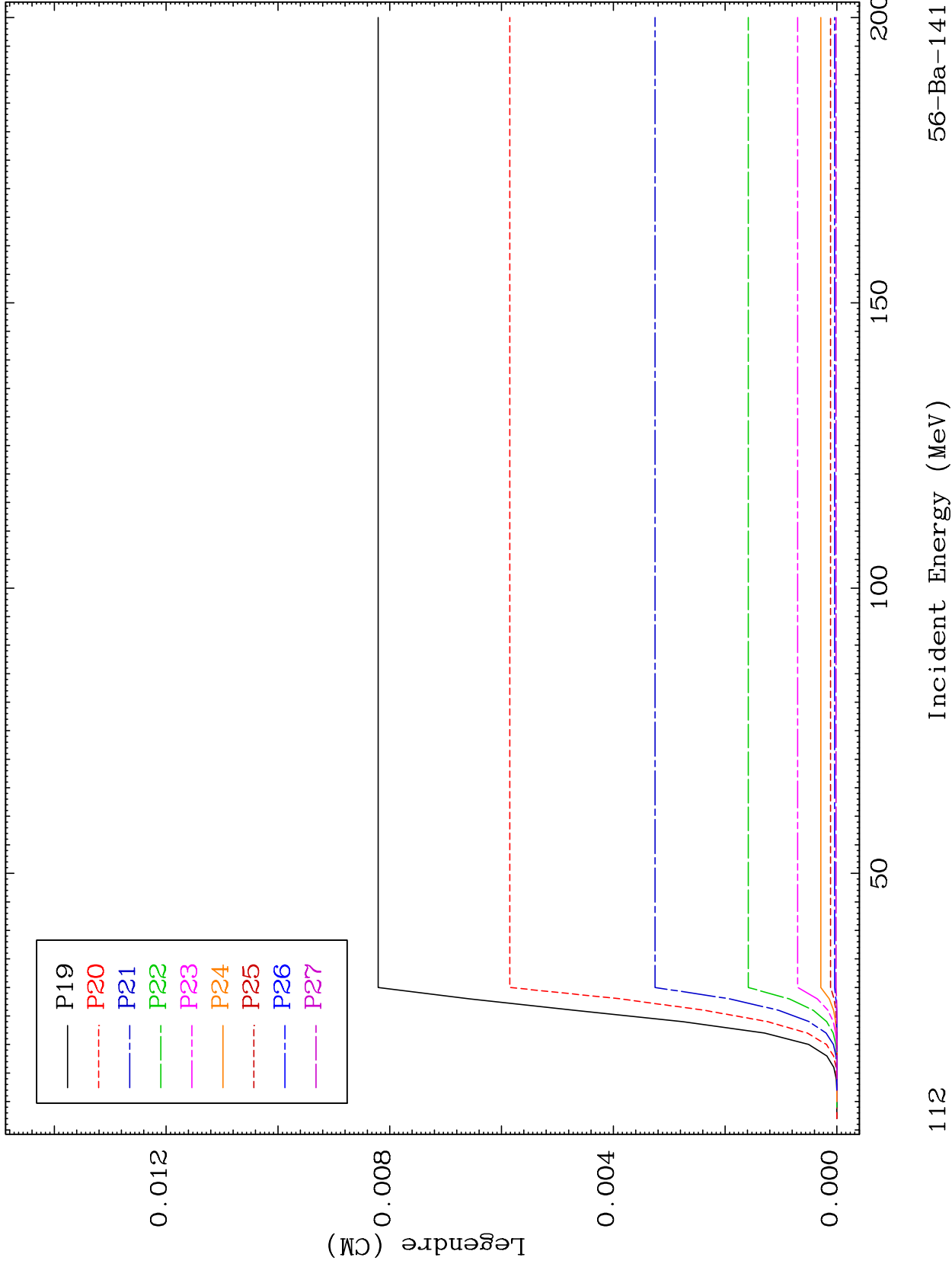

112

Incident Energy (MeV)

56-Ba-141

MAT 5658

MT= 74 (n,n') Level  
Legendre Coefficients

56-Ba-141

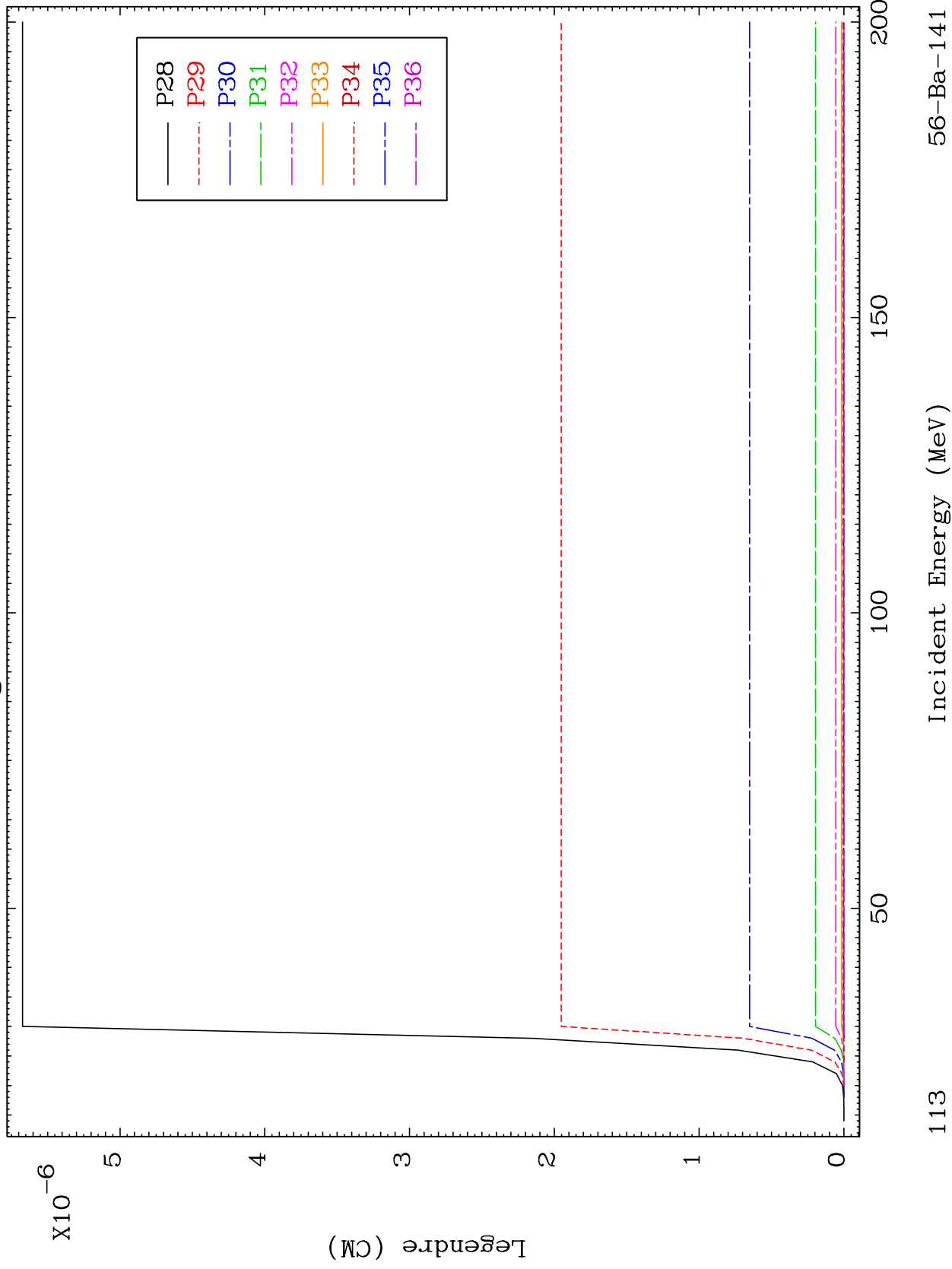

113

56-Ba-141

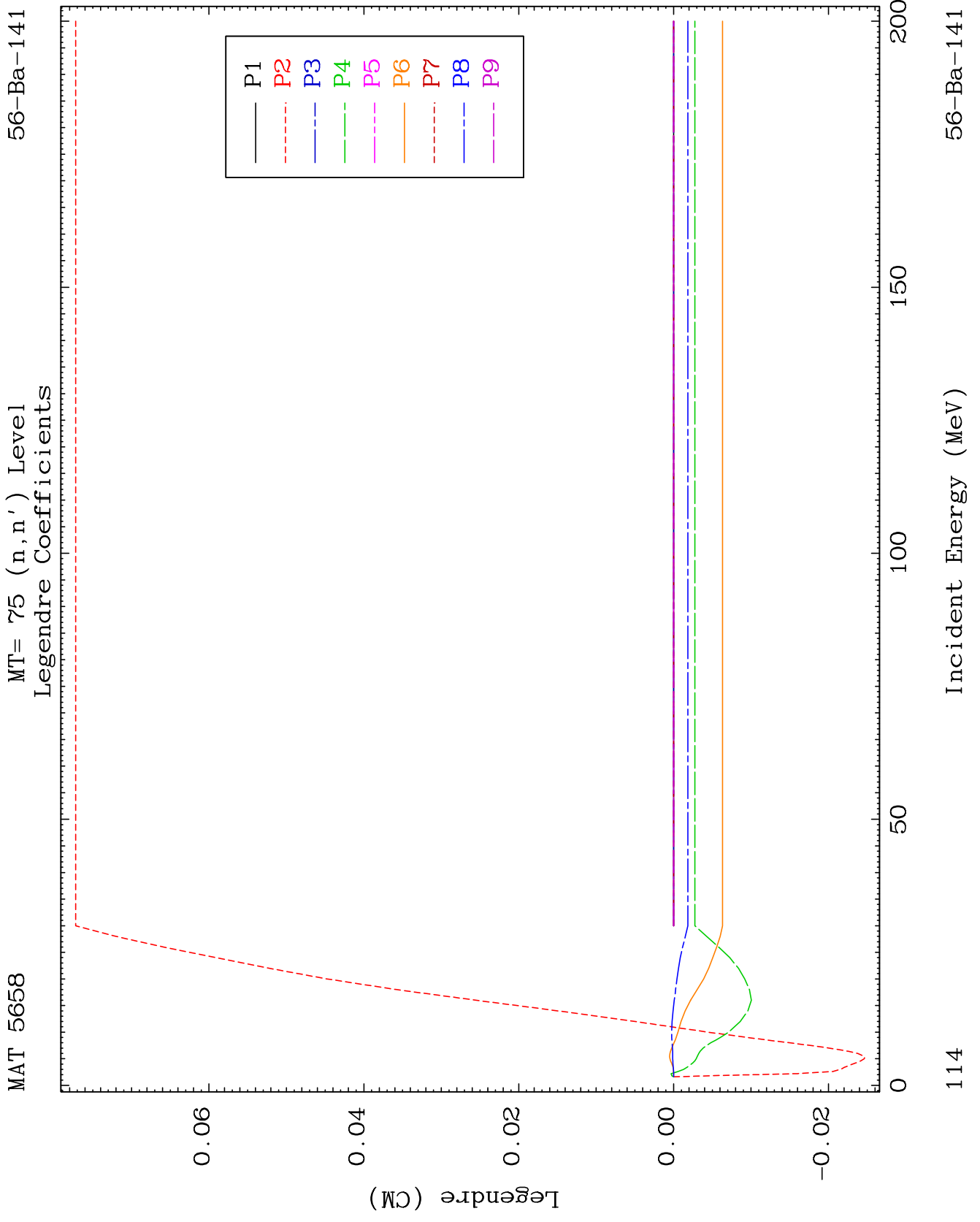

MAT 5658

MT= 75 (n,n') Level  
Legendre Coefficients

56-Ba-141

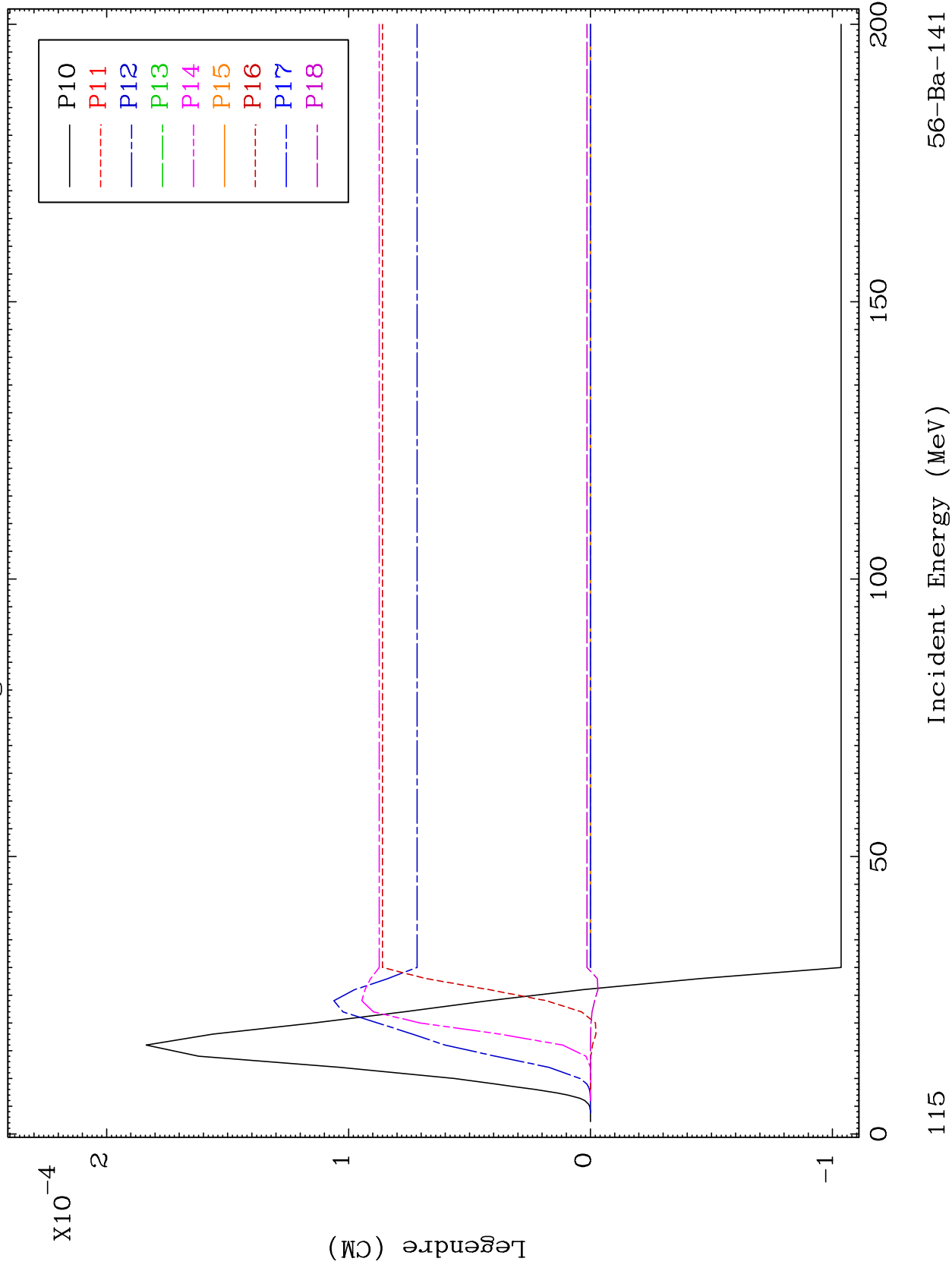

56-Ba-141

Incident Energy (MeV)

115

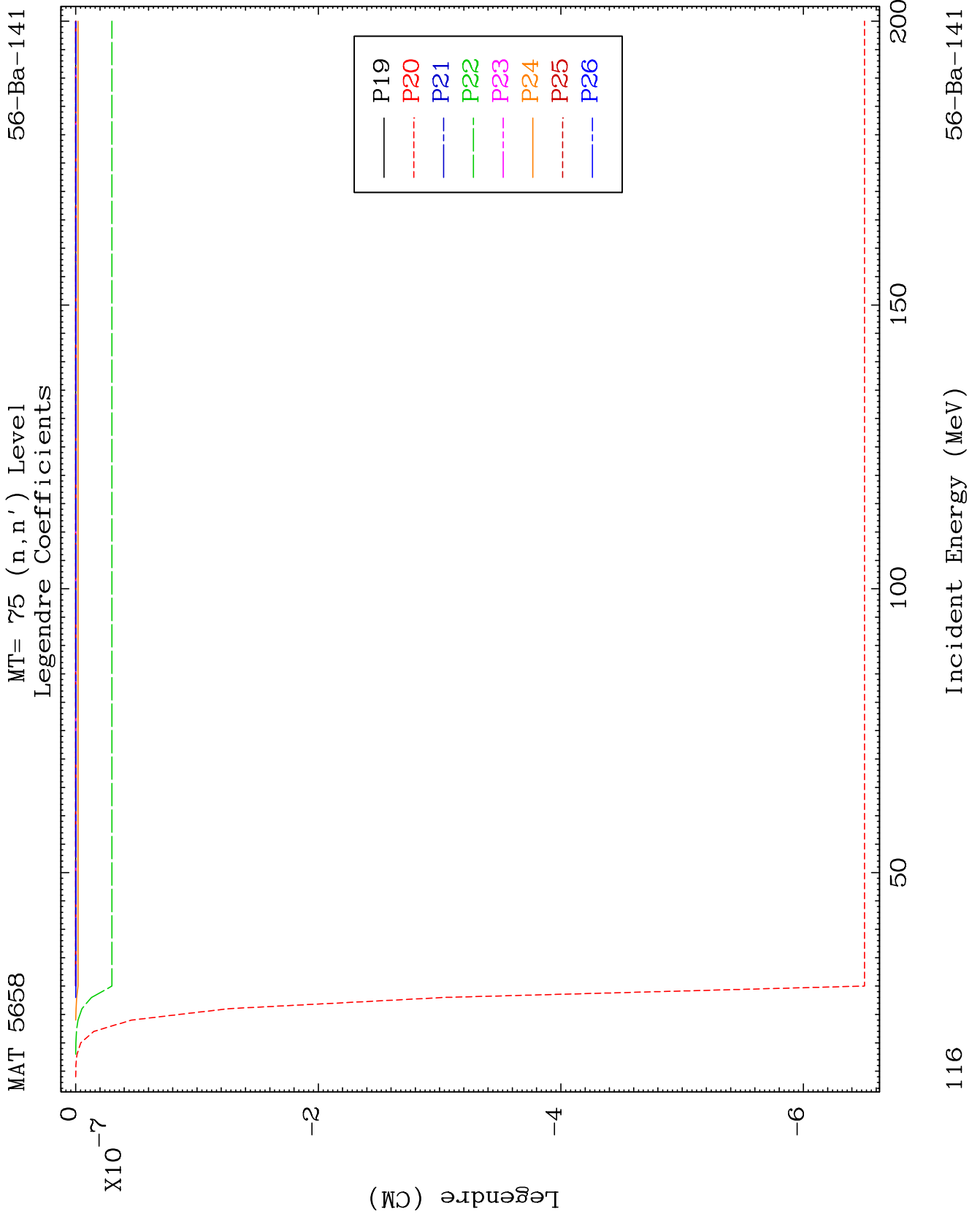

MAT 5658

MT= 76 (n,n') Level  
Legendre Coefficients

56-Ba-141

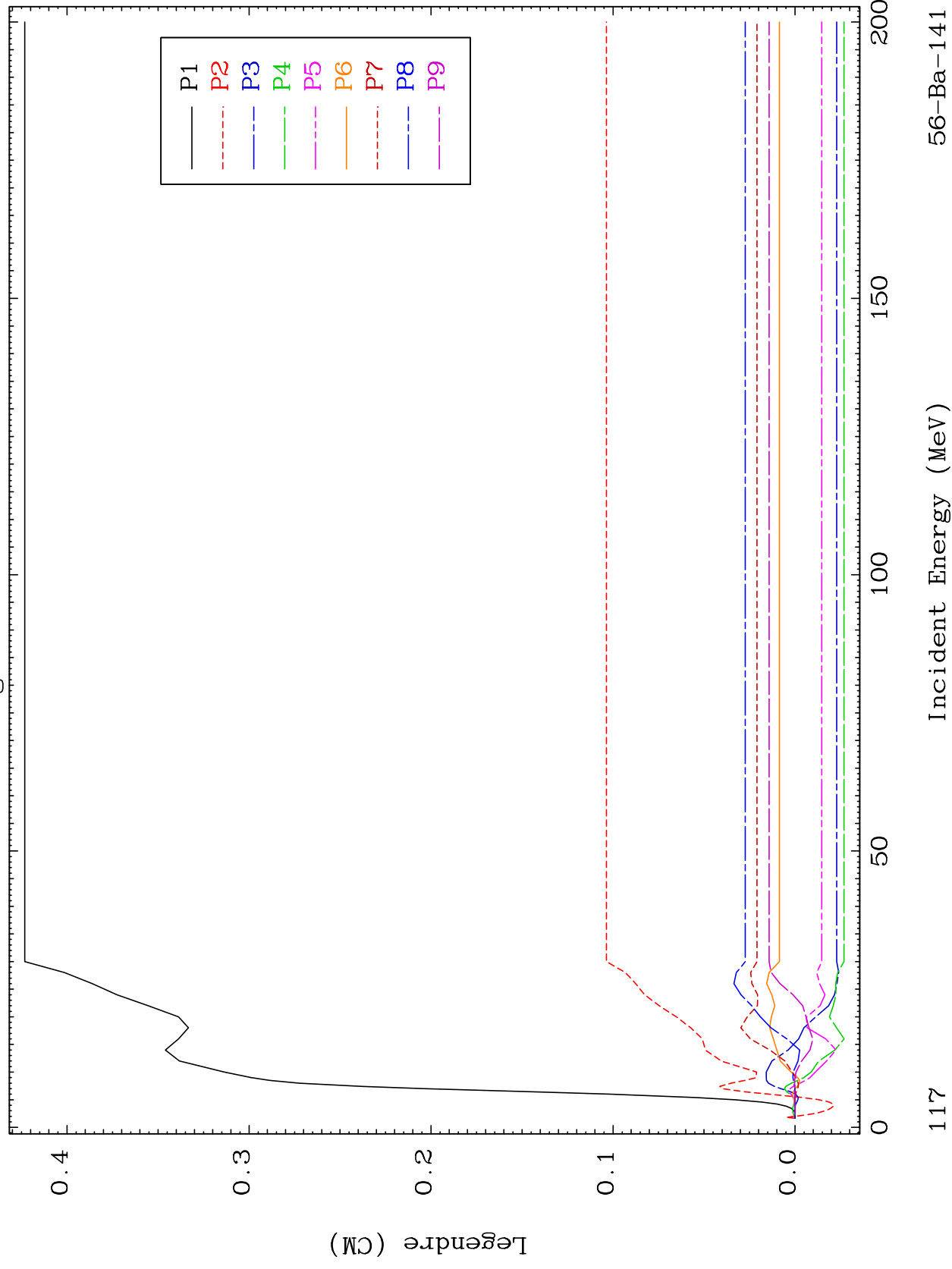

56-Ba-141

Incident Energy (MeV)

117

MAT 5658

MT= 76 (n,n') Level  
Legendre Coefficients

56-Ba-141

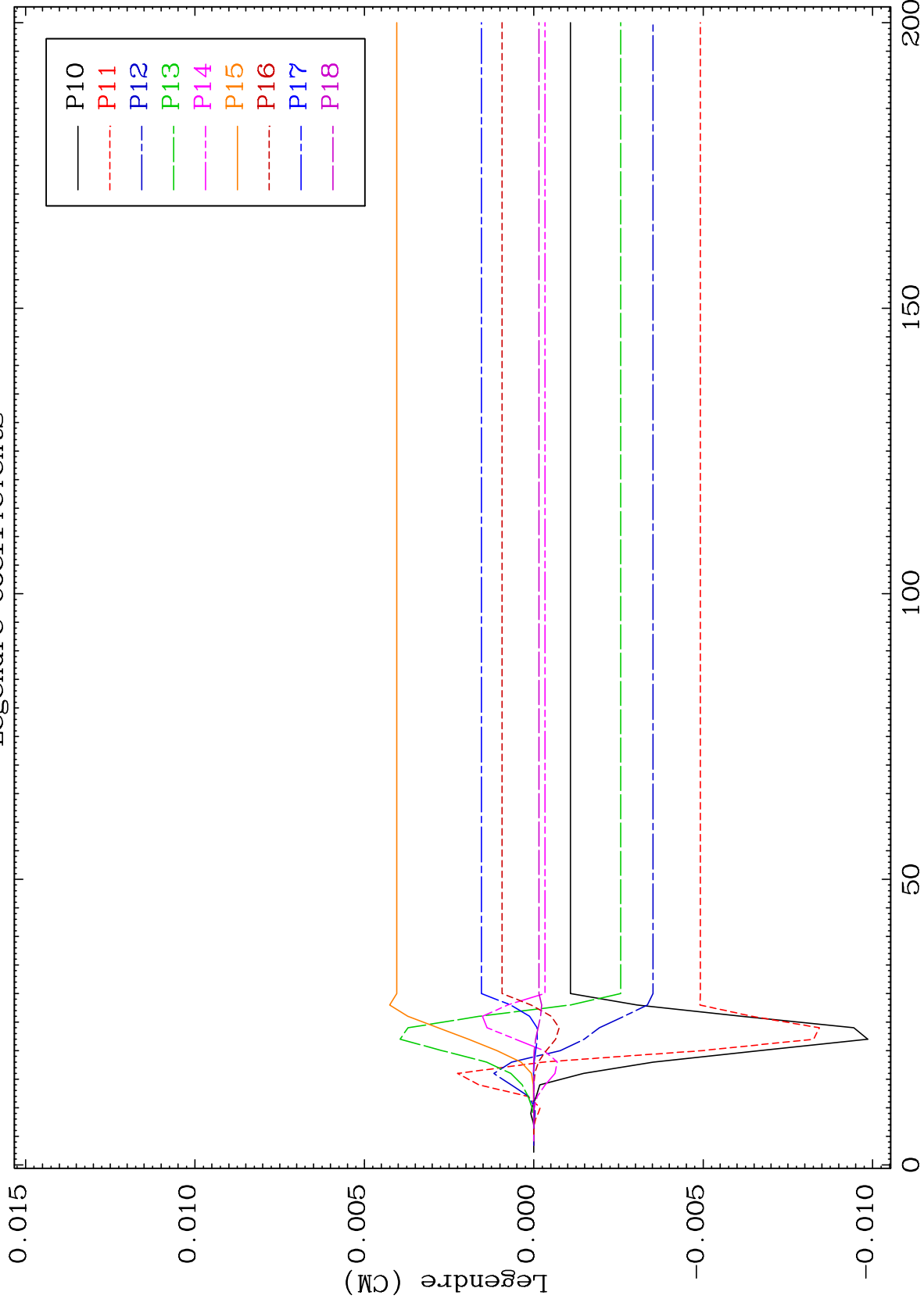

118

Incident Energy (MeV)

56-Ba-141

MAT 5658

MT= 76 (n,n') Level  
Legendre Coefficients

56-Ba-141

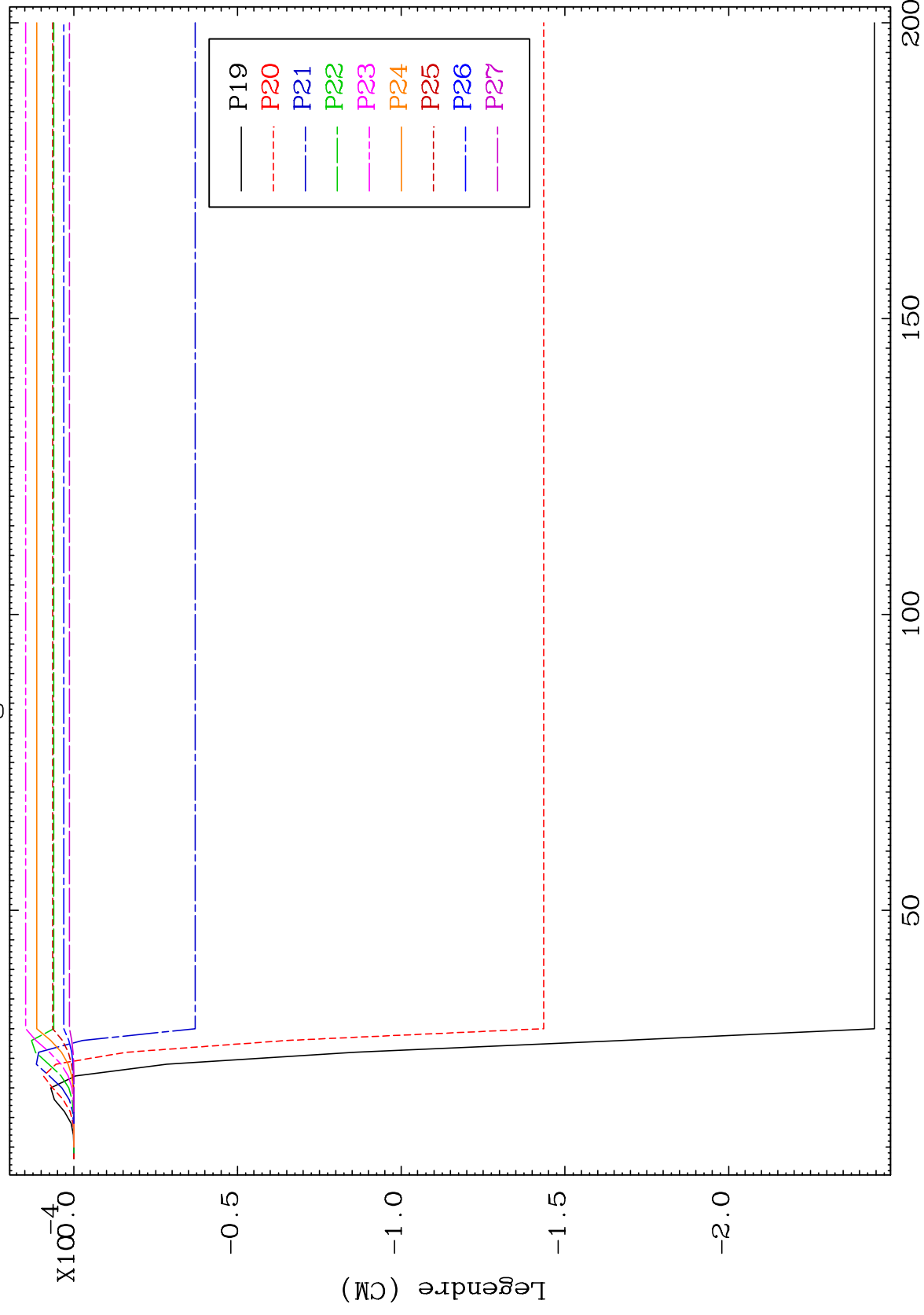

119

Incident Energy (MeV)

56-Ba-141

MAT 5658

MT= 76 (n,n') Level  
Legendre Coefficients

56-Ba-141

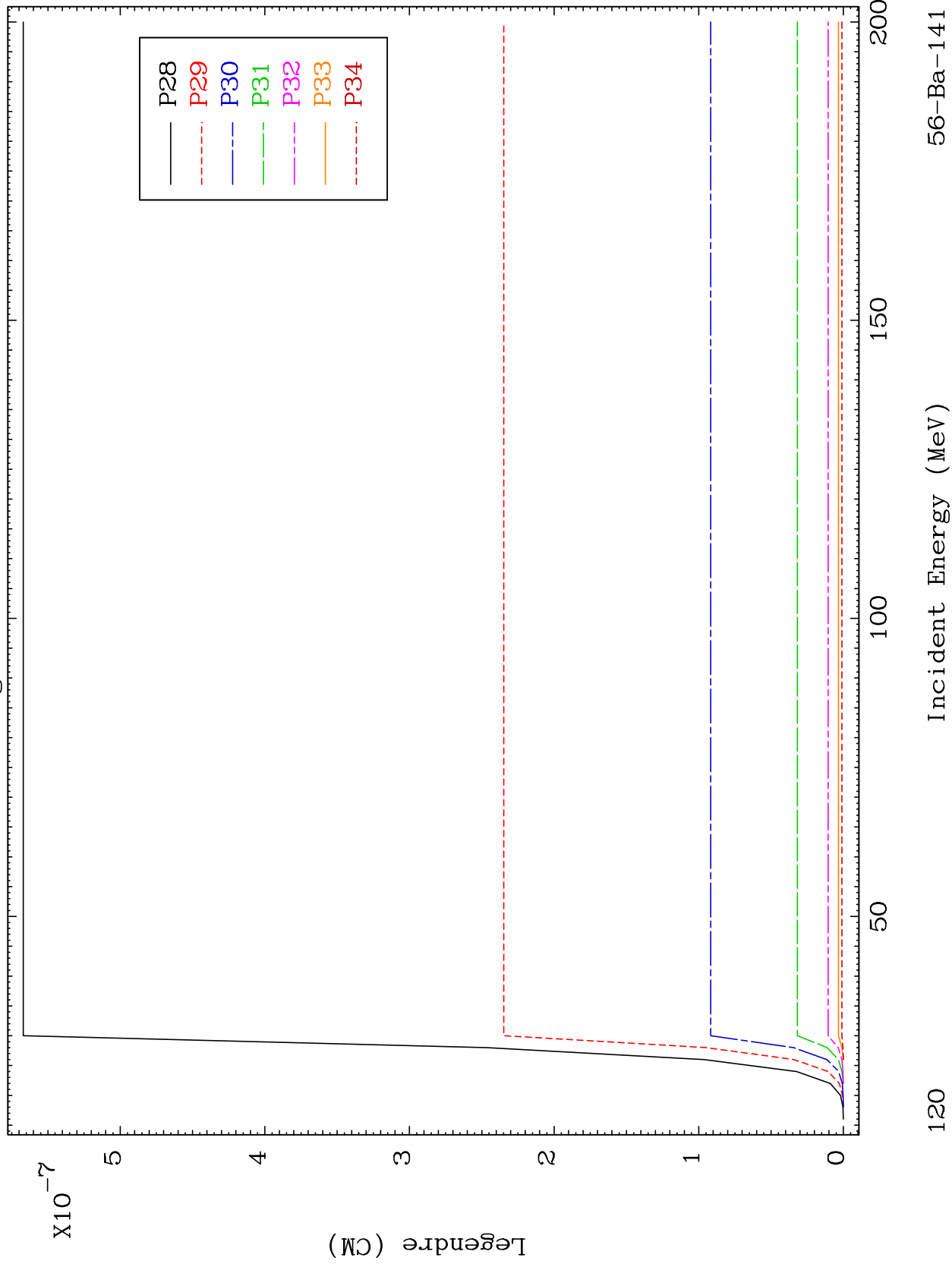

MAT 5658

MT= 77 (n,n') Level  
Legendre Coefficients

56-Ba-141

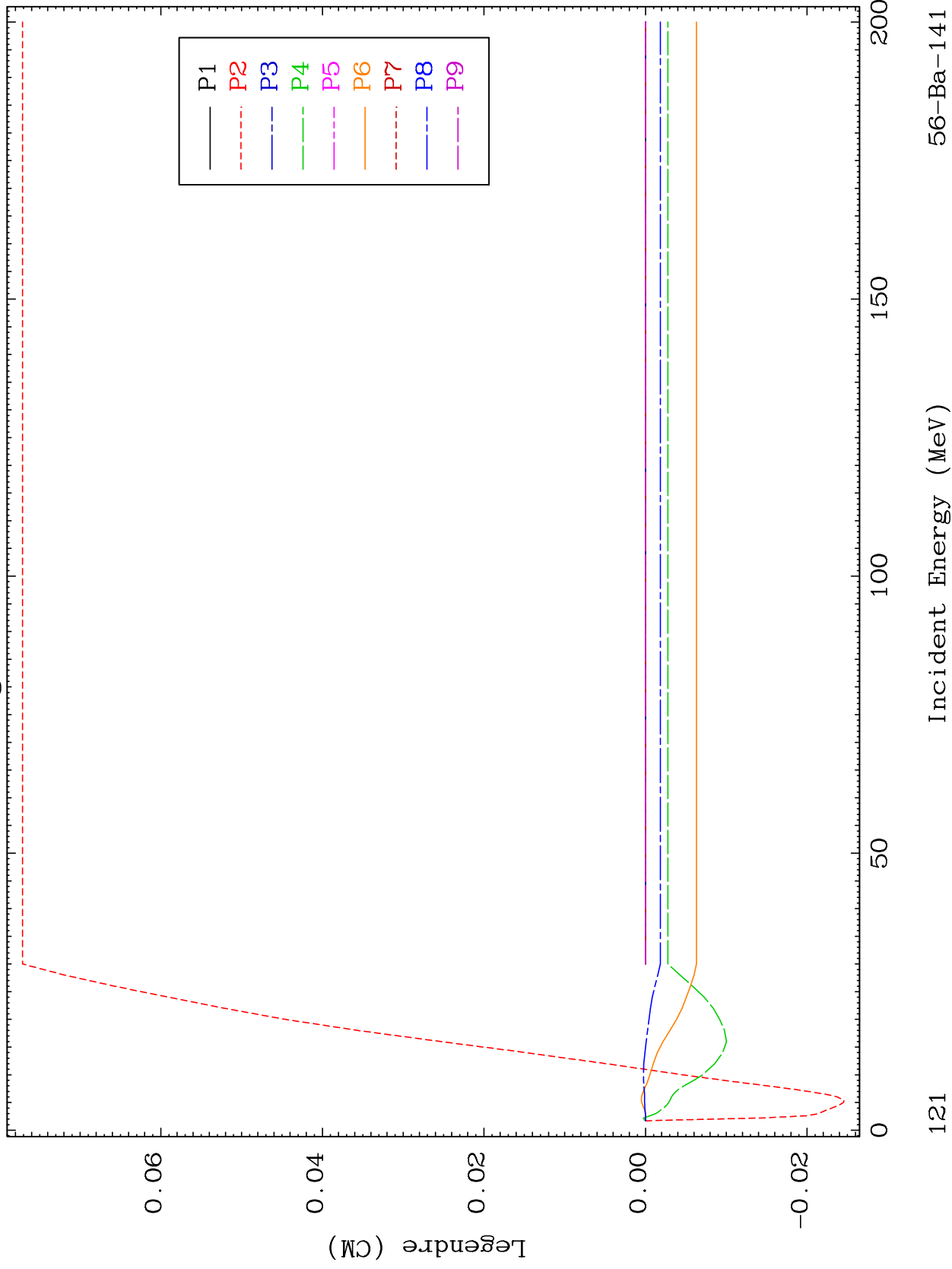

56-Ba-141

Incident Energy (MeV)

121

MAT 5658

MT= 77 (n,n') Level  
Legendre Coefficients

56-Ba-141

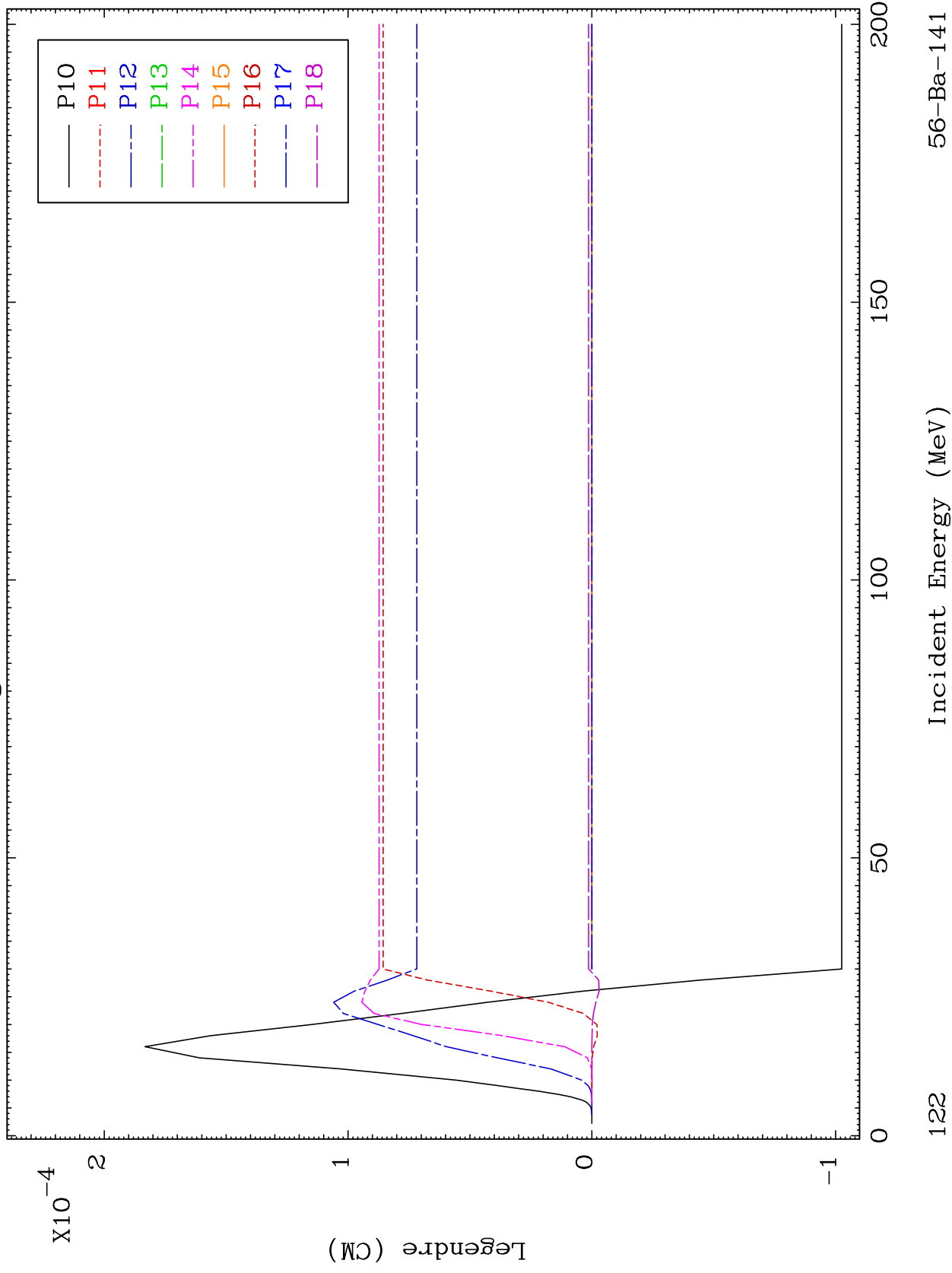

122

Incident Energy (MeV)

56-Ba-141

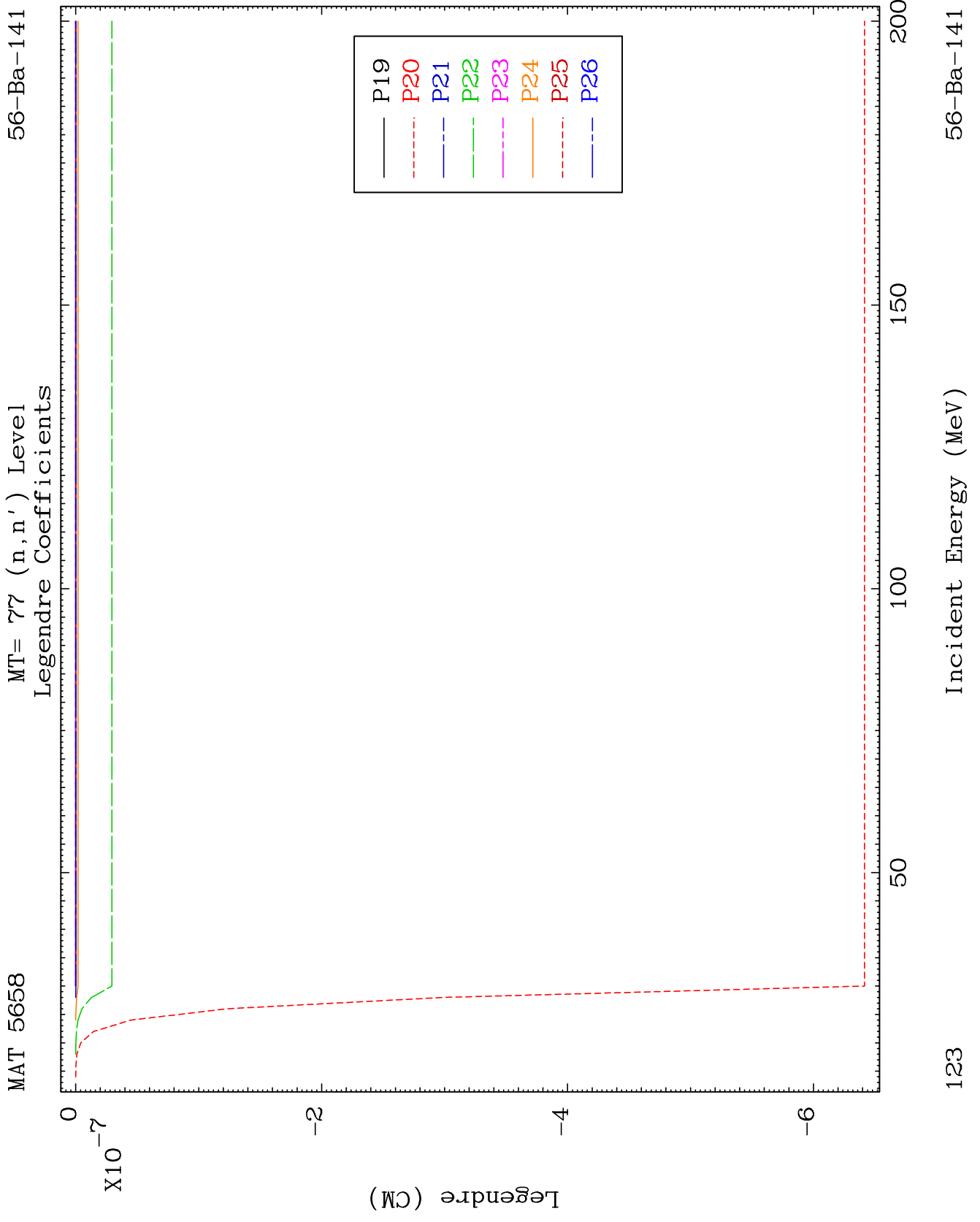

MAT 5658

MT= 78 (n,n') Level  
Legendre Coefficients

56-Ba-141

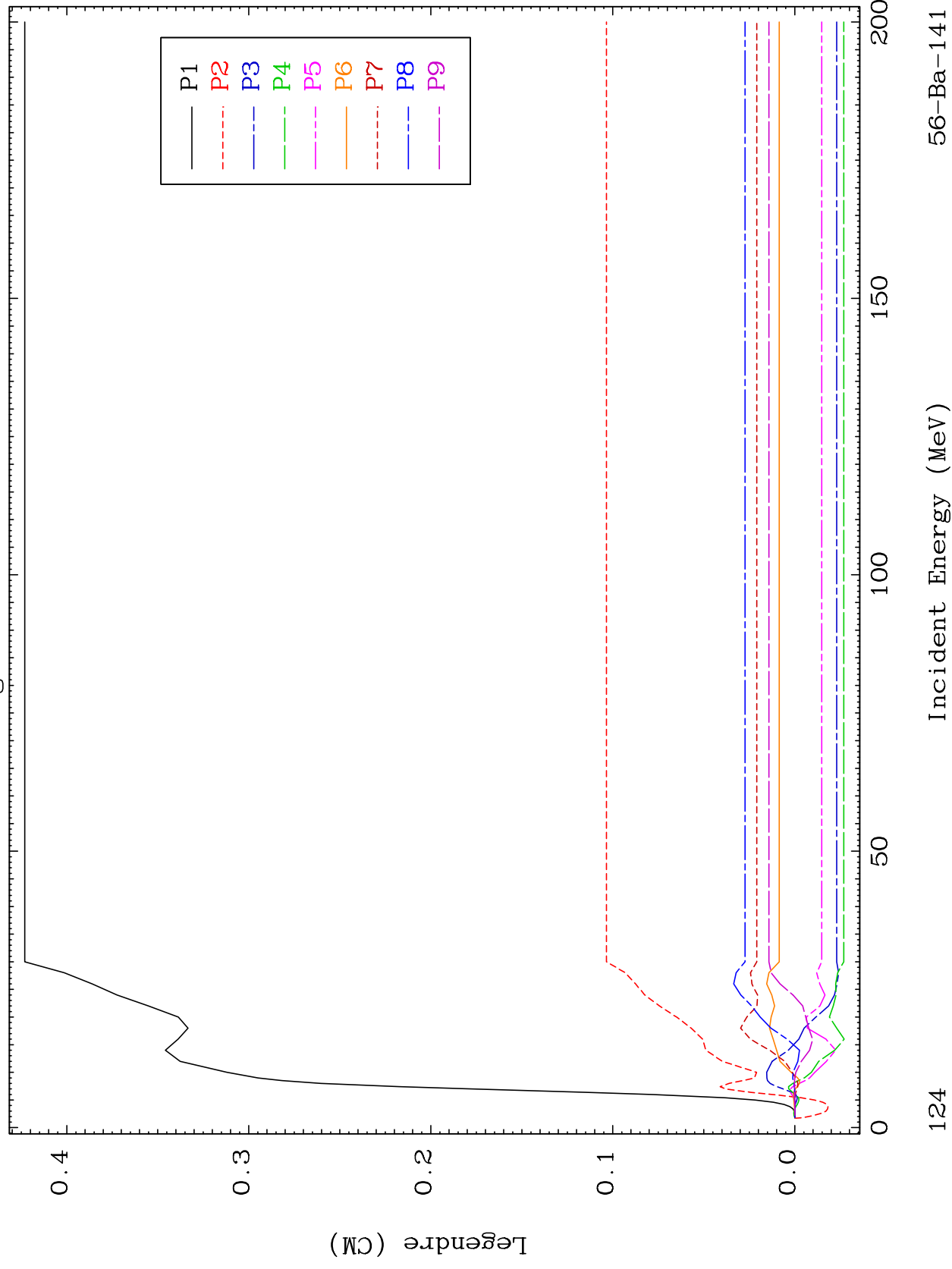

124

56-Ba-141

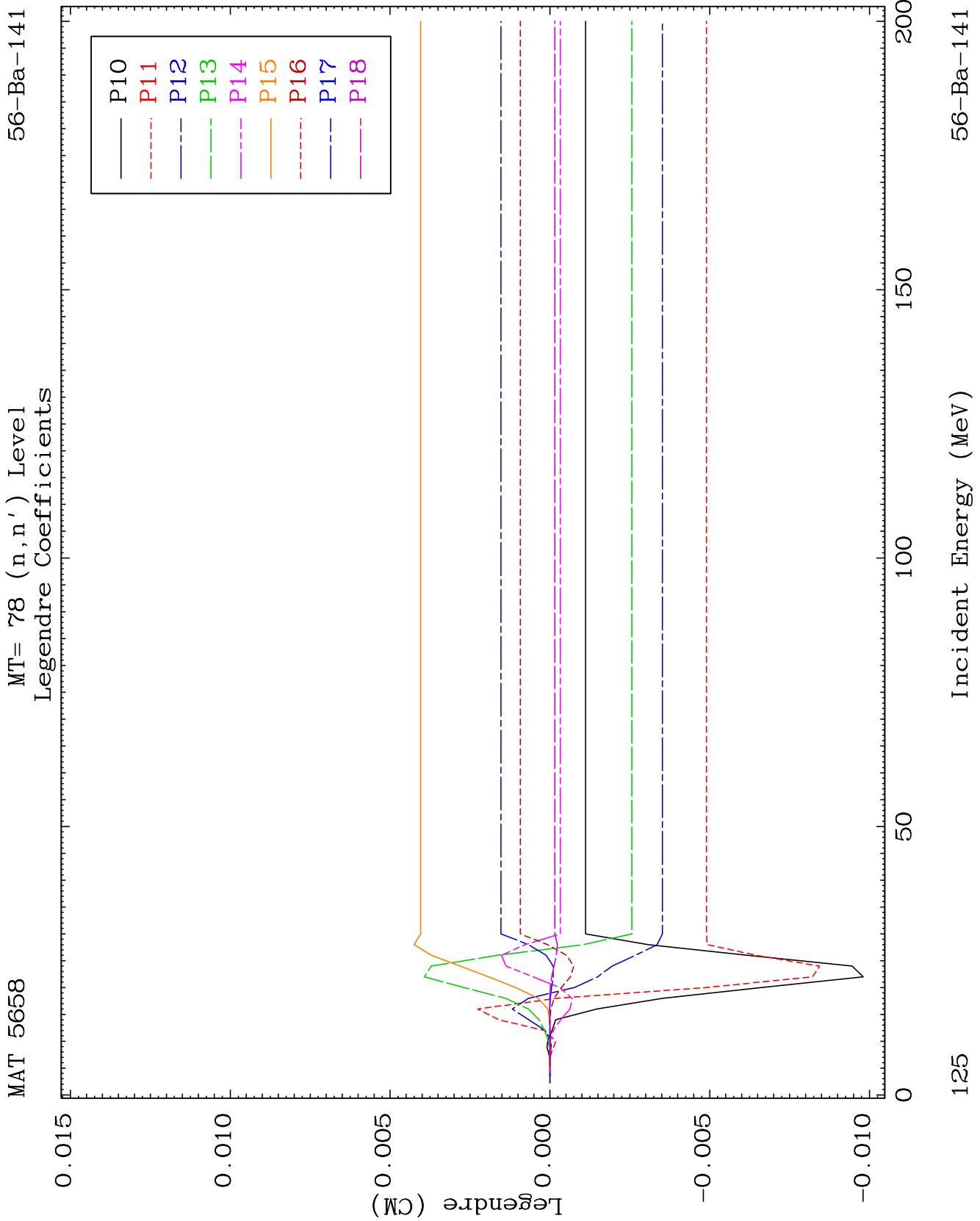

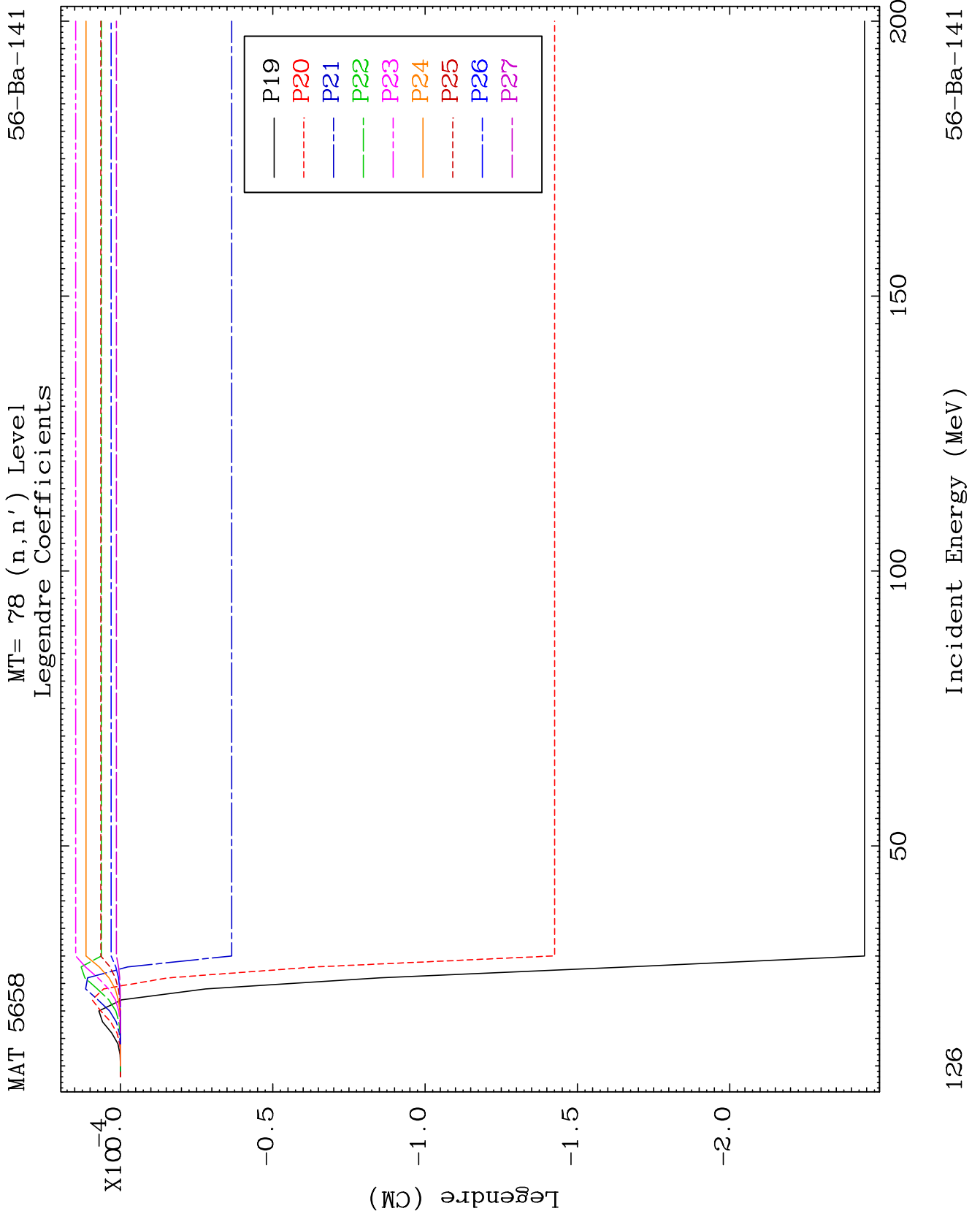

MAT 5658

MT= 78 (n,n') Level  
Legendre Coefficients

56-Ba-141

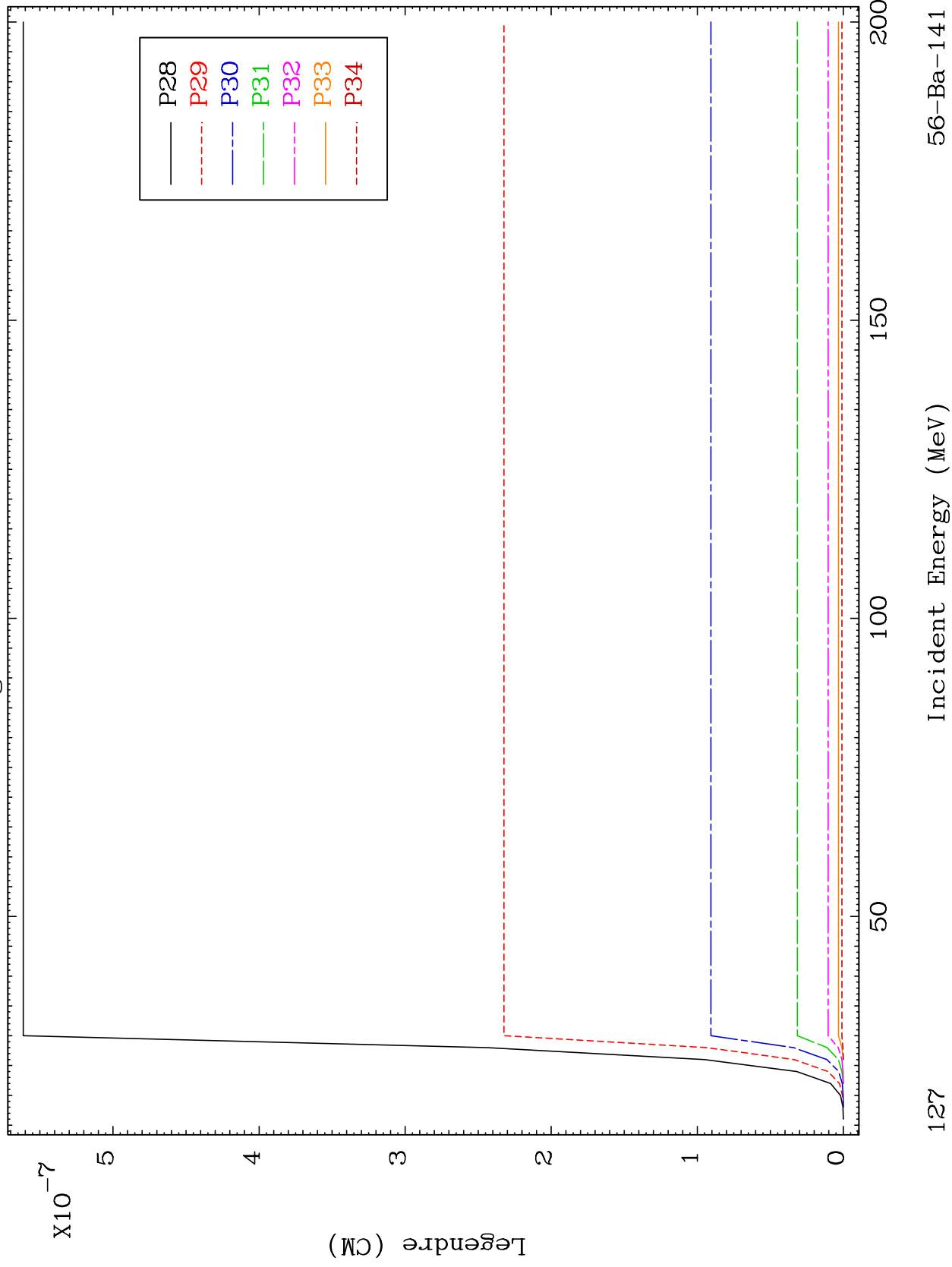

127

MAT 5658

MT= 79 (n,n') Level  
Legendre Coefficients

56-Ba-141

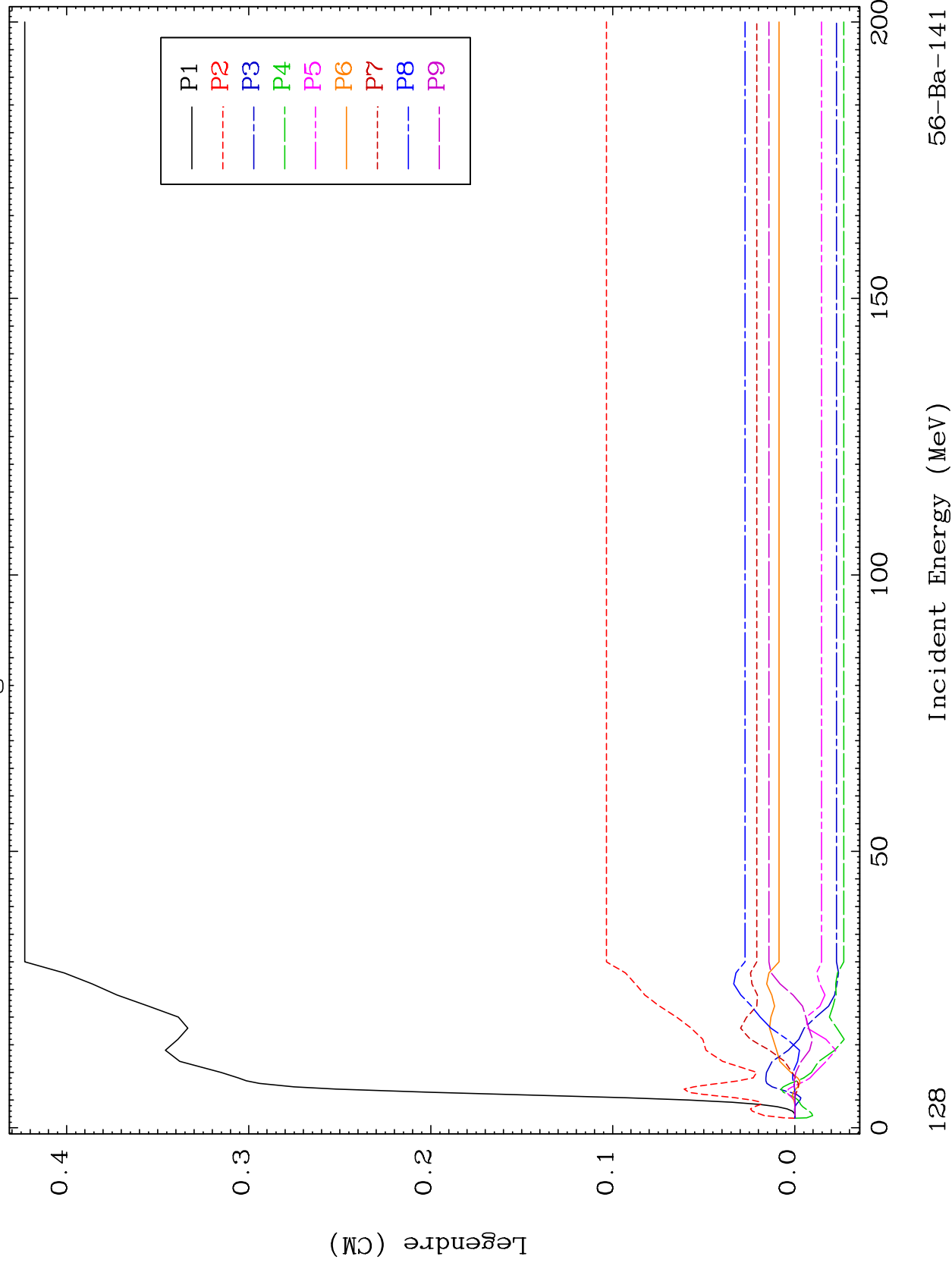

56-Ba-141

Incident Energy (MeV)

128

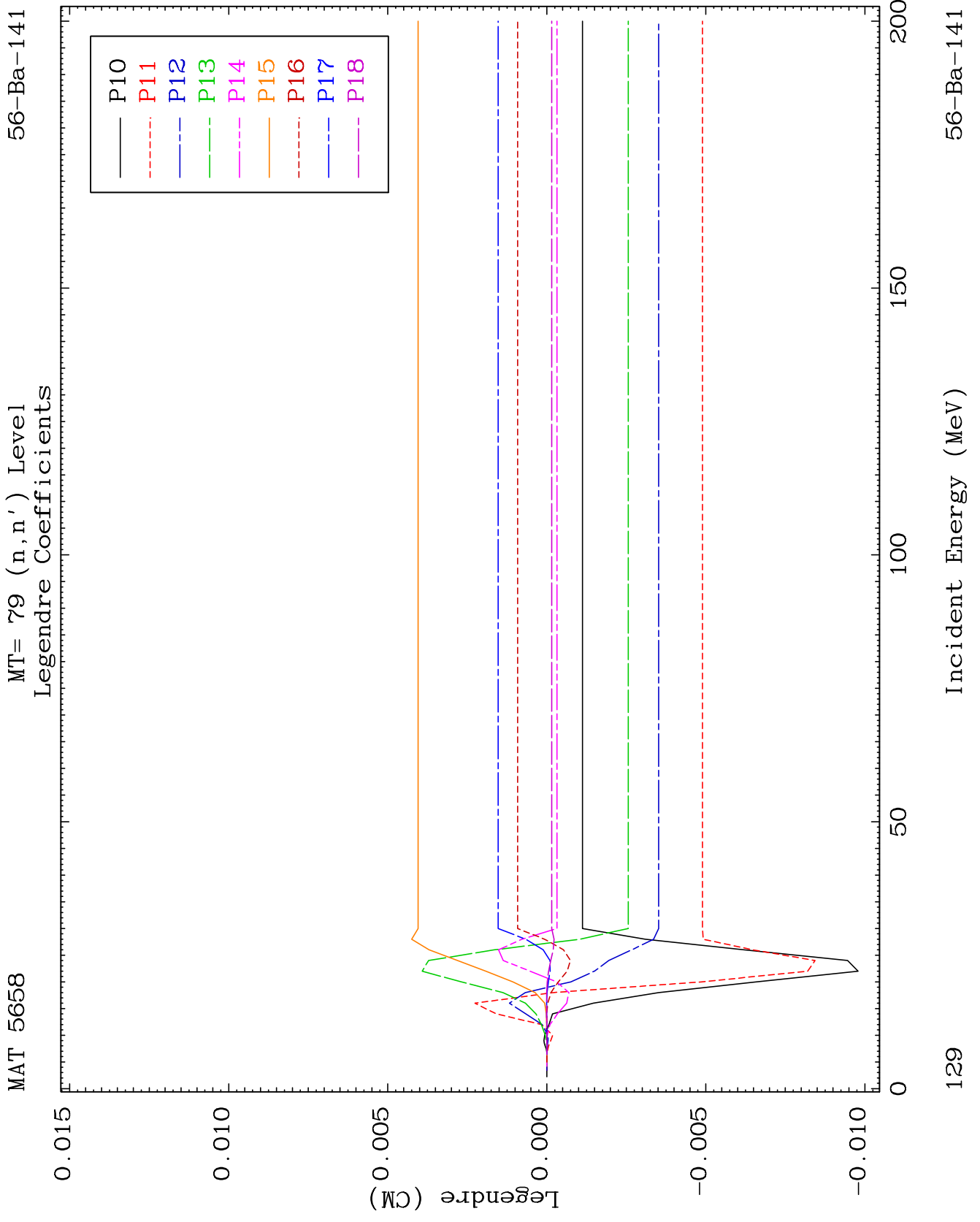

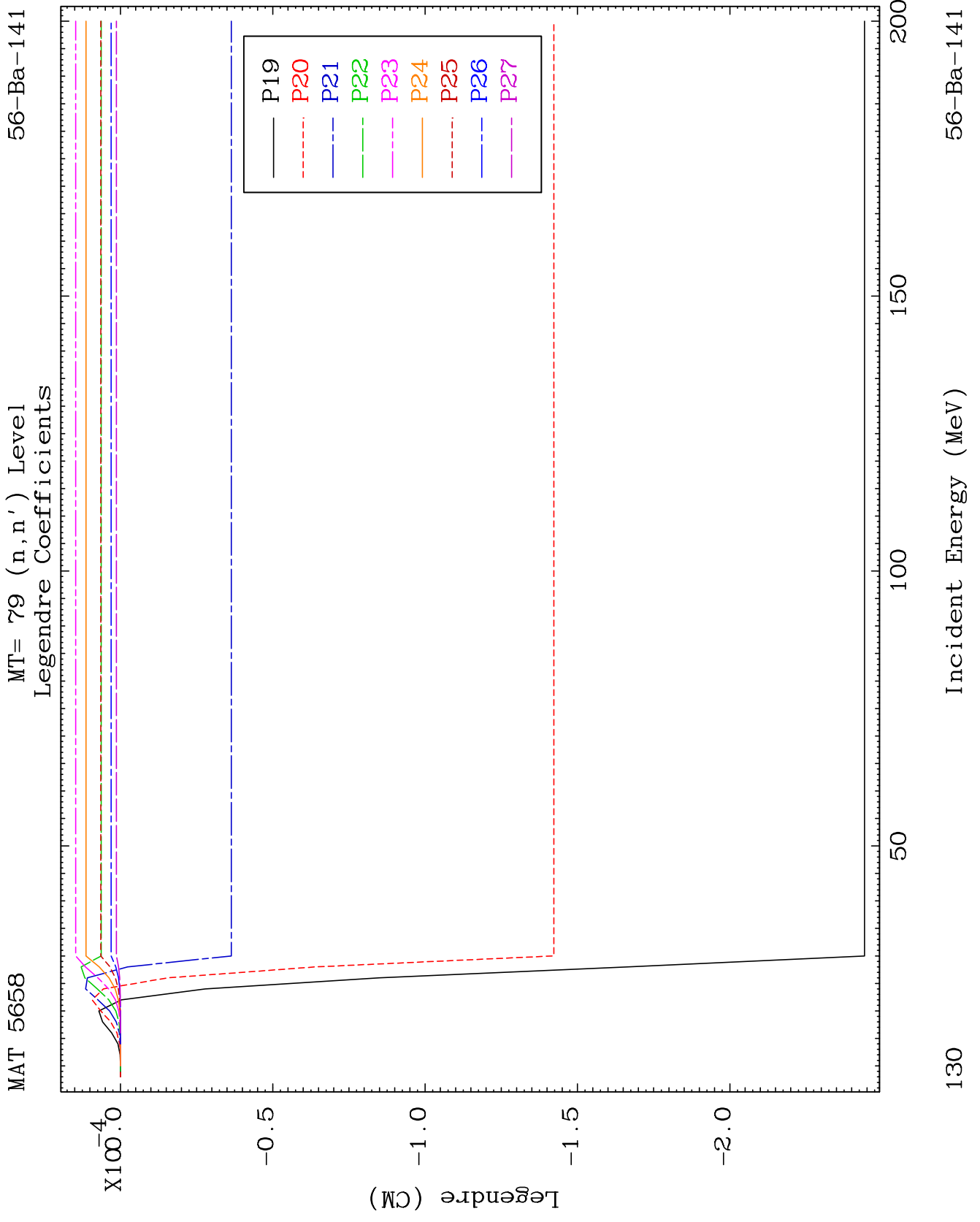

MAT 5658

MT= 79 (n,n') Level  
Legendre Coefficients

56-Ba-141

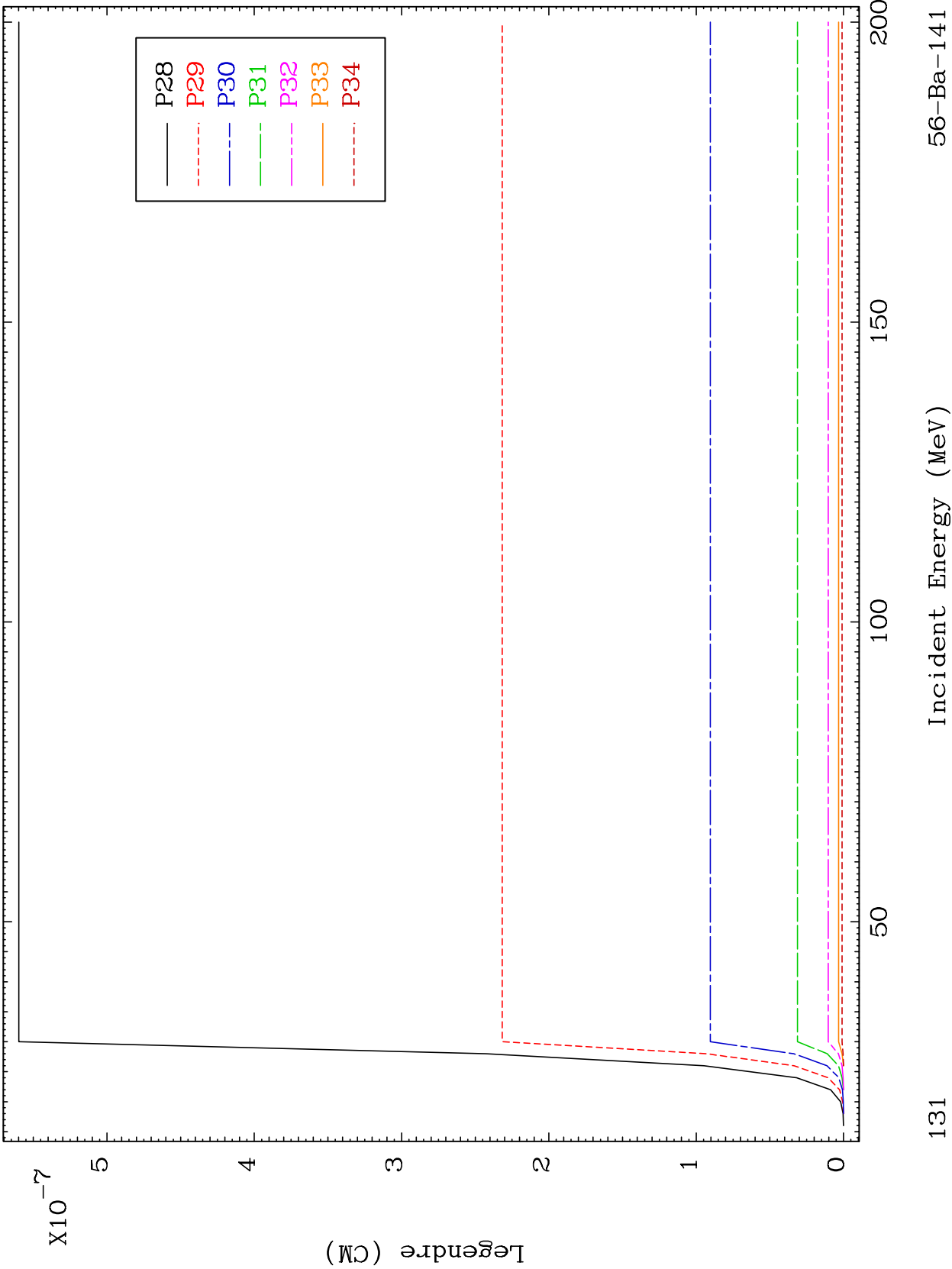

131

Incident Energy (MeV)

56-Ba-141

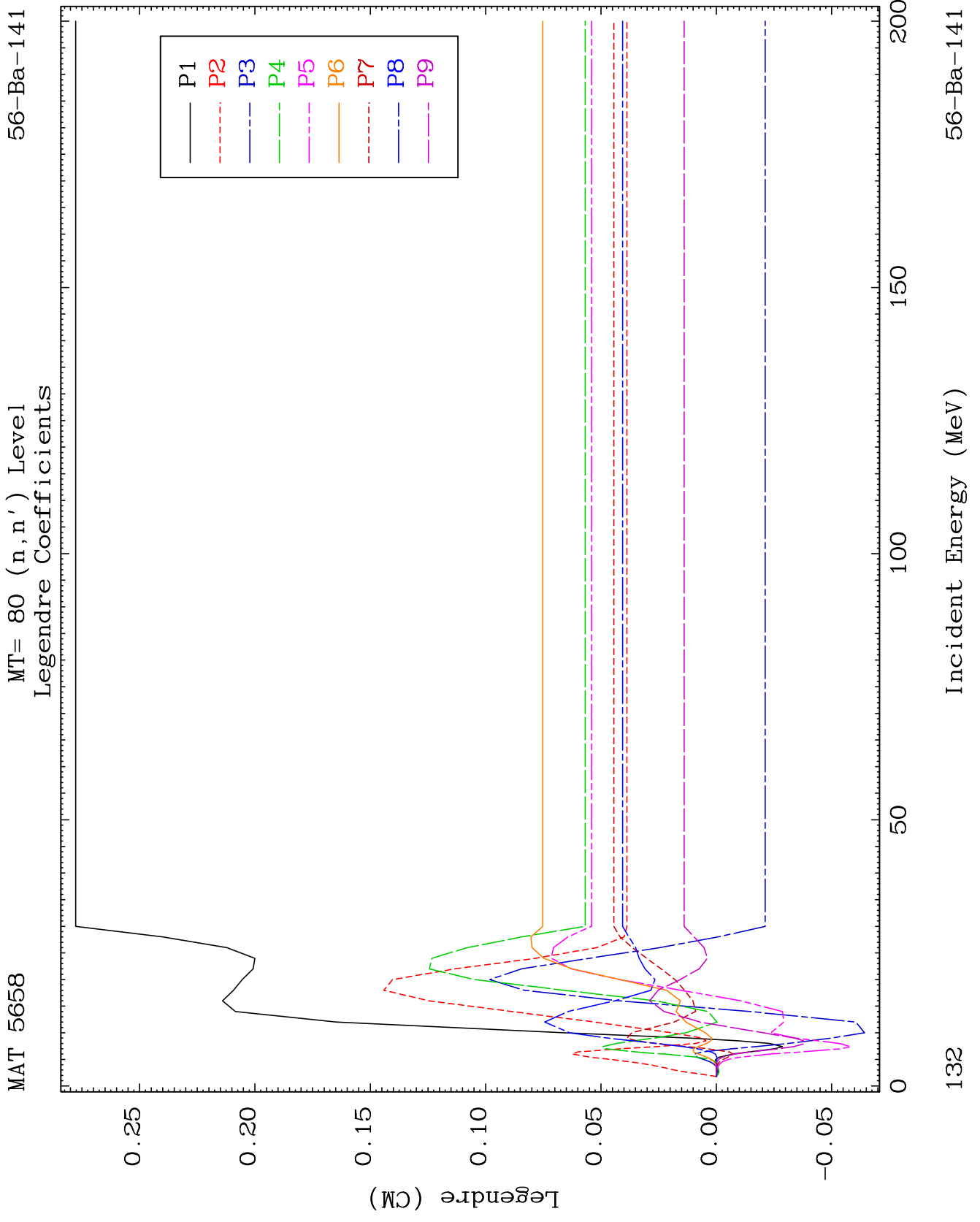

MAT 5658

MT= 80 (n,n') Level  
Legendre Coefficients

56-Ba-141

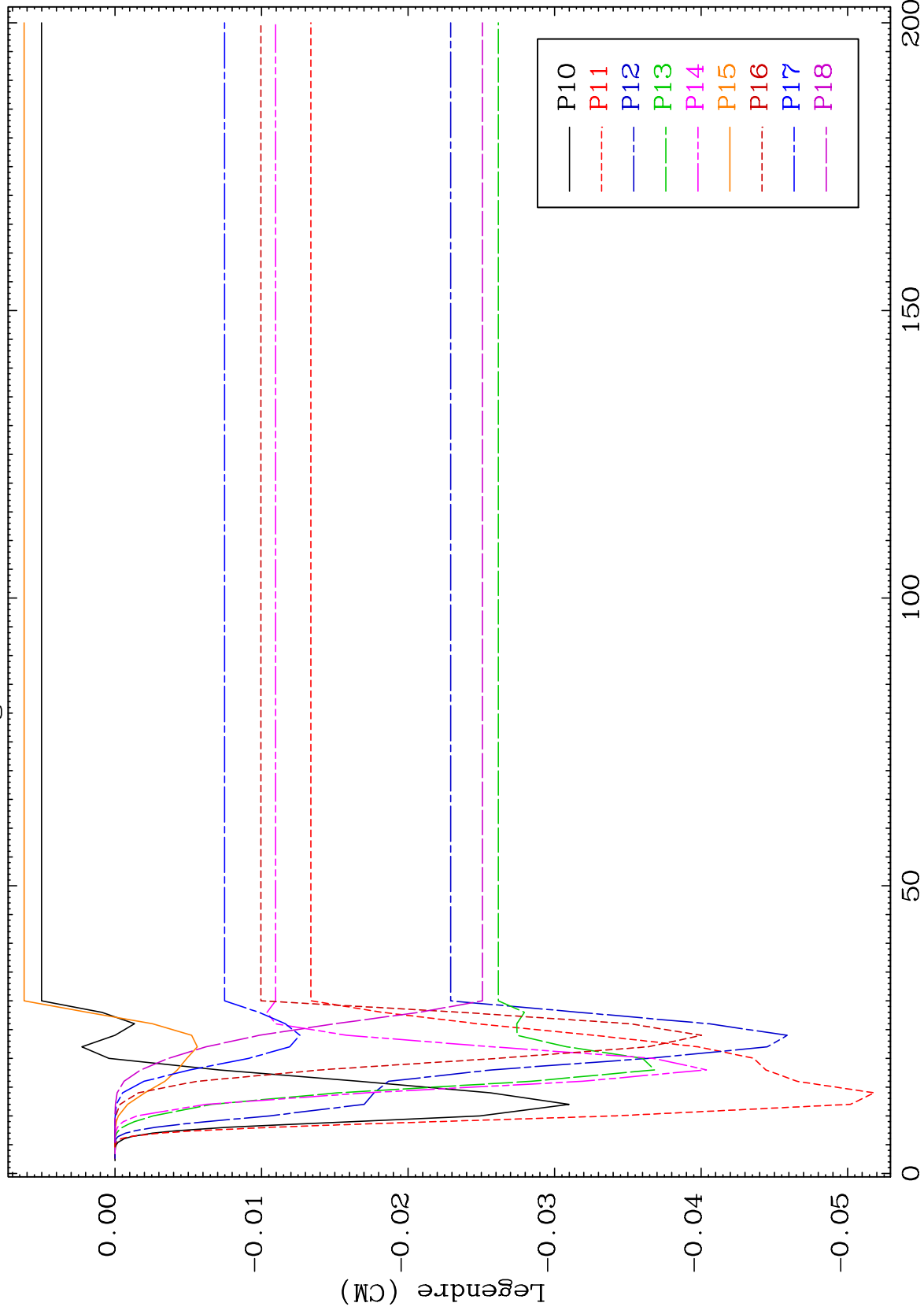

133

Incident Energy (MeV)

56-Ba-141

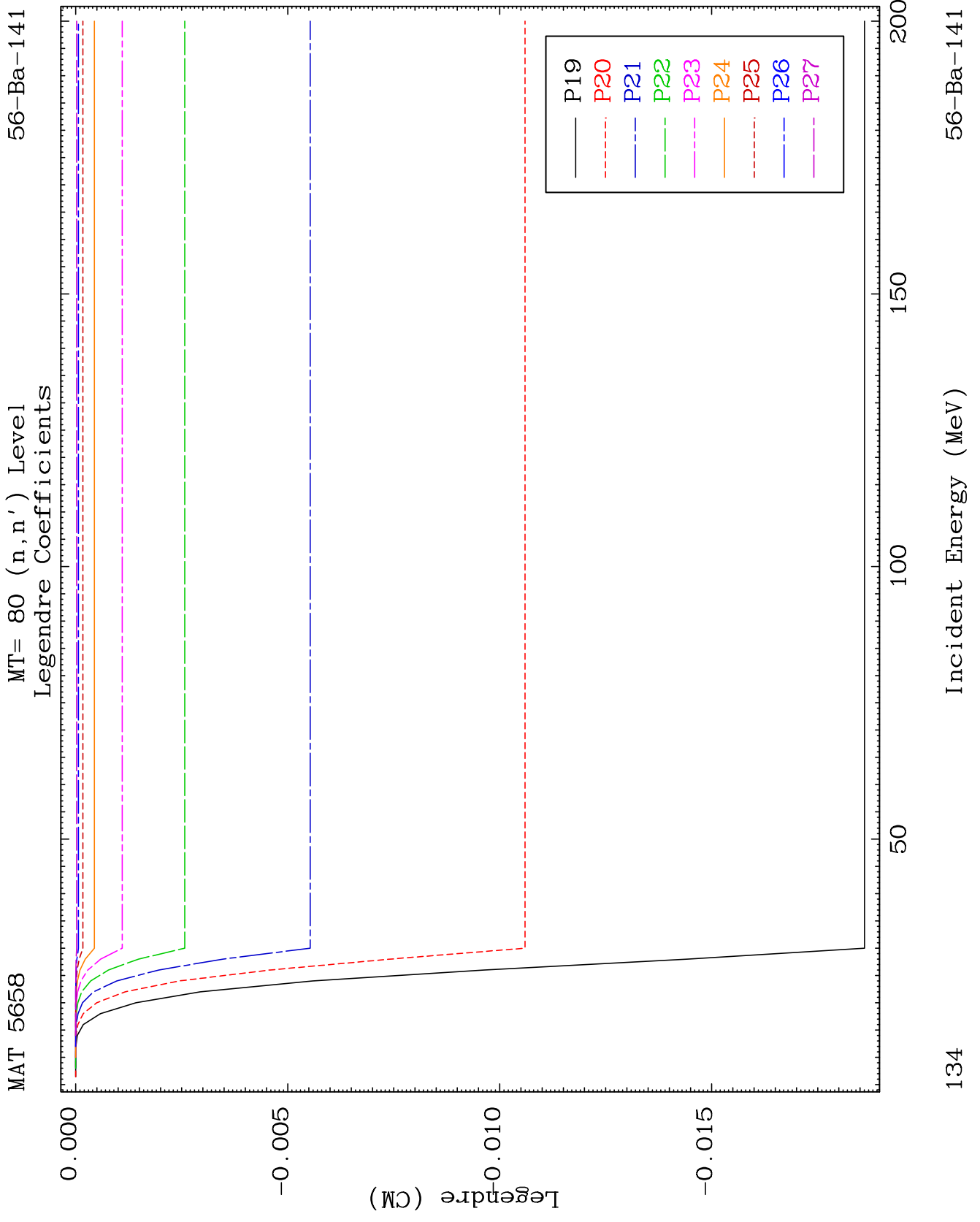

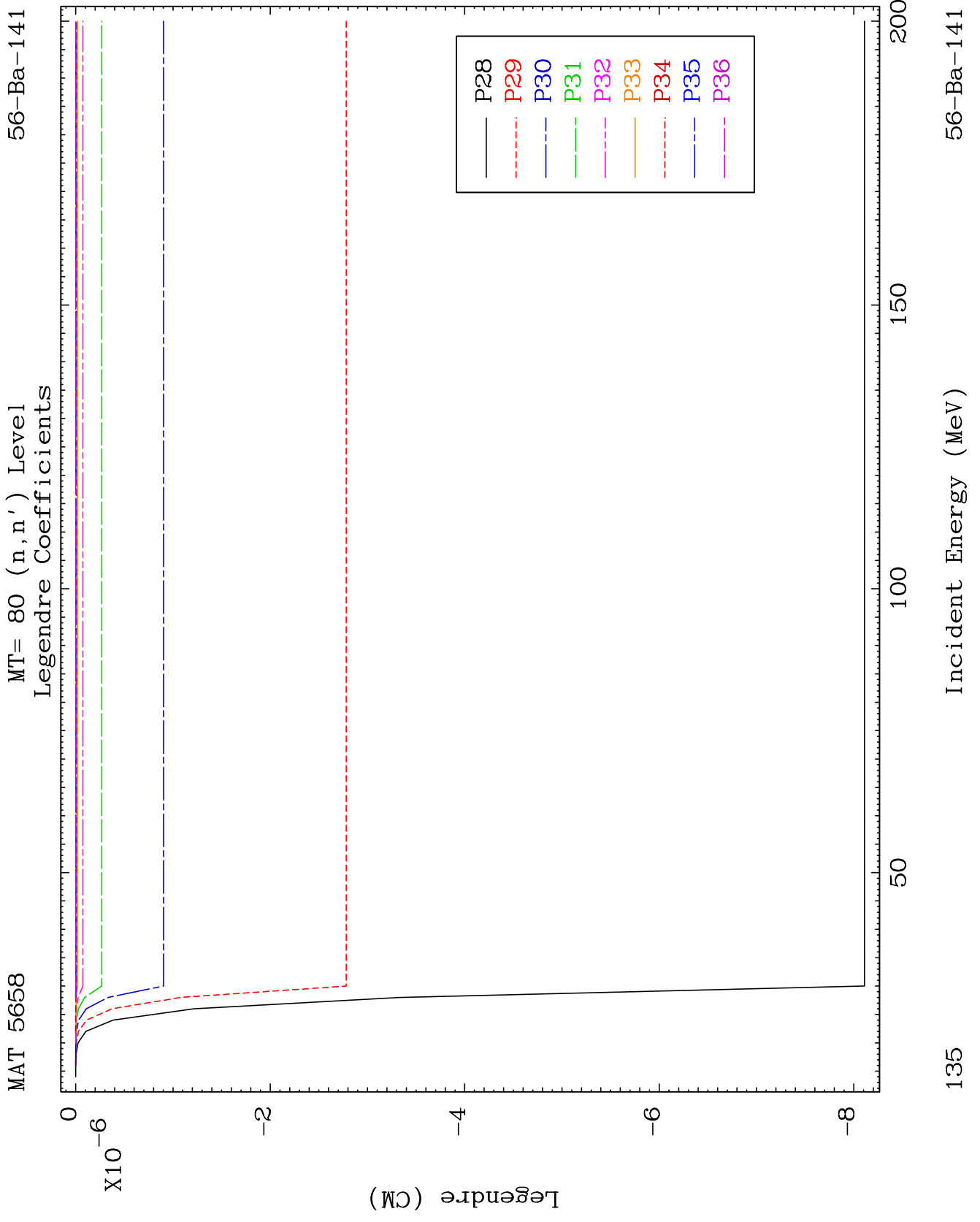

MAT 5658

56-Ba-141

(n,2n) d  
Radionuclide Production Cross Section

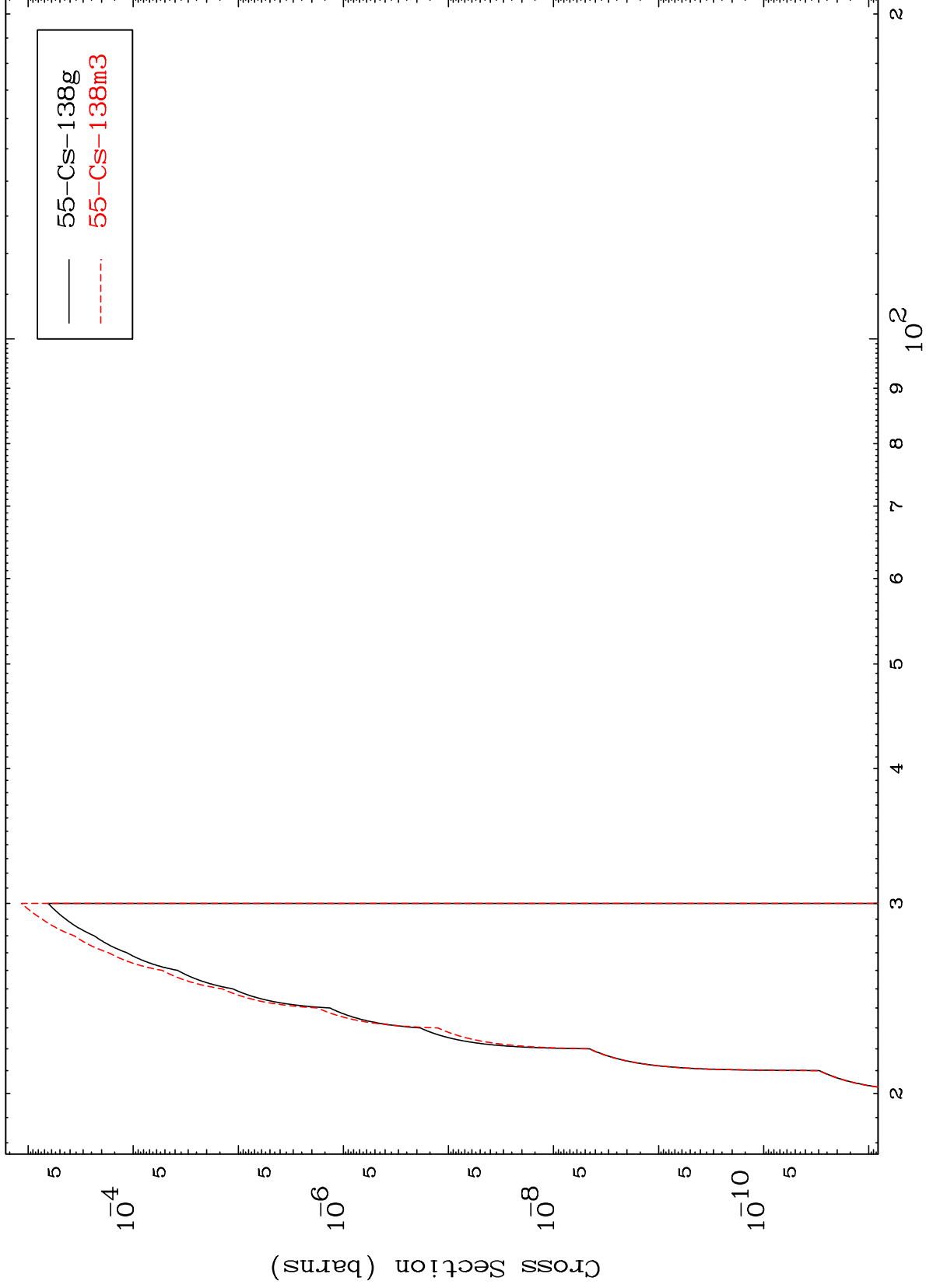

136

Incident Energy (MeV)

56-Ba-141

MAT 5658

(n,3n)  $\alpha$

56-Ba-141

Radionuclide Production Cross Section

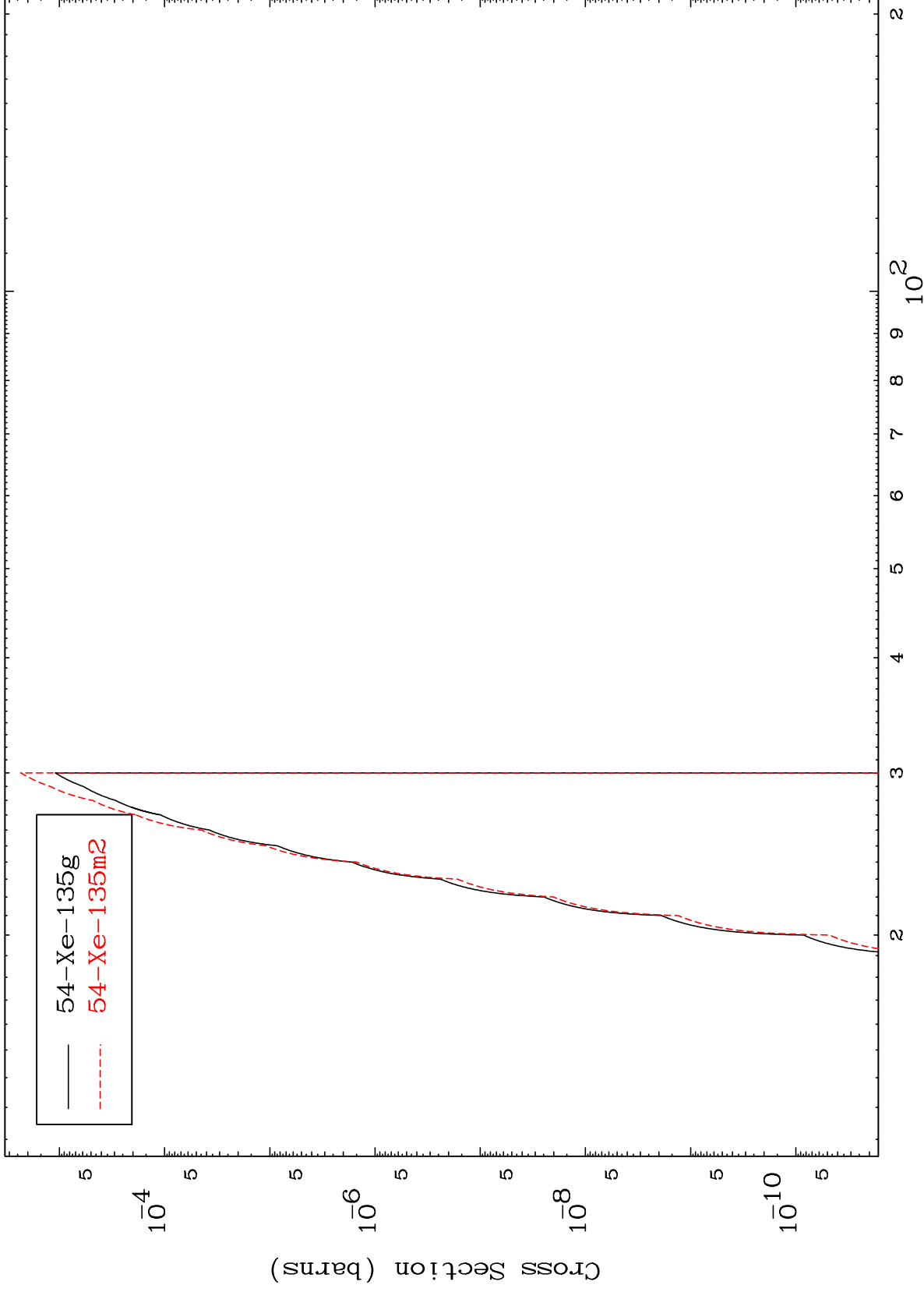

137

Incident Energy (MeV)

56-Ba-141

MAT 5658

(n,n') 2 $\alpha$

56-Ba-141

Radionuclide Production Cross Section

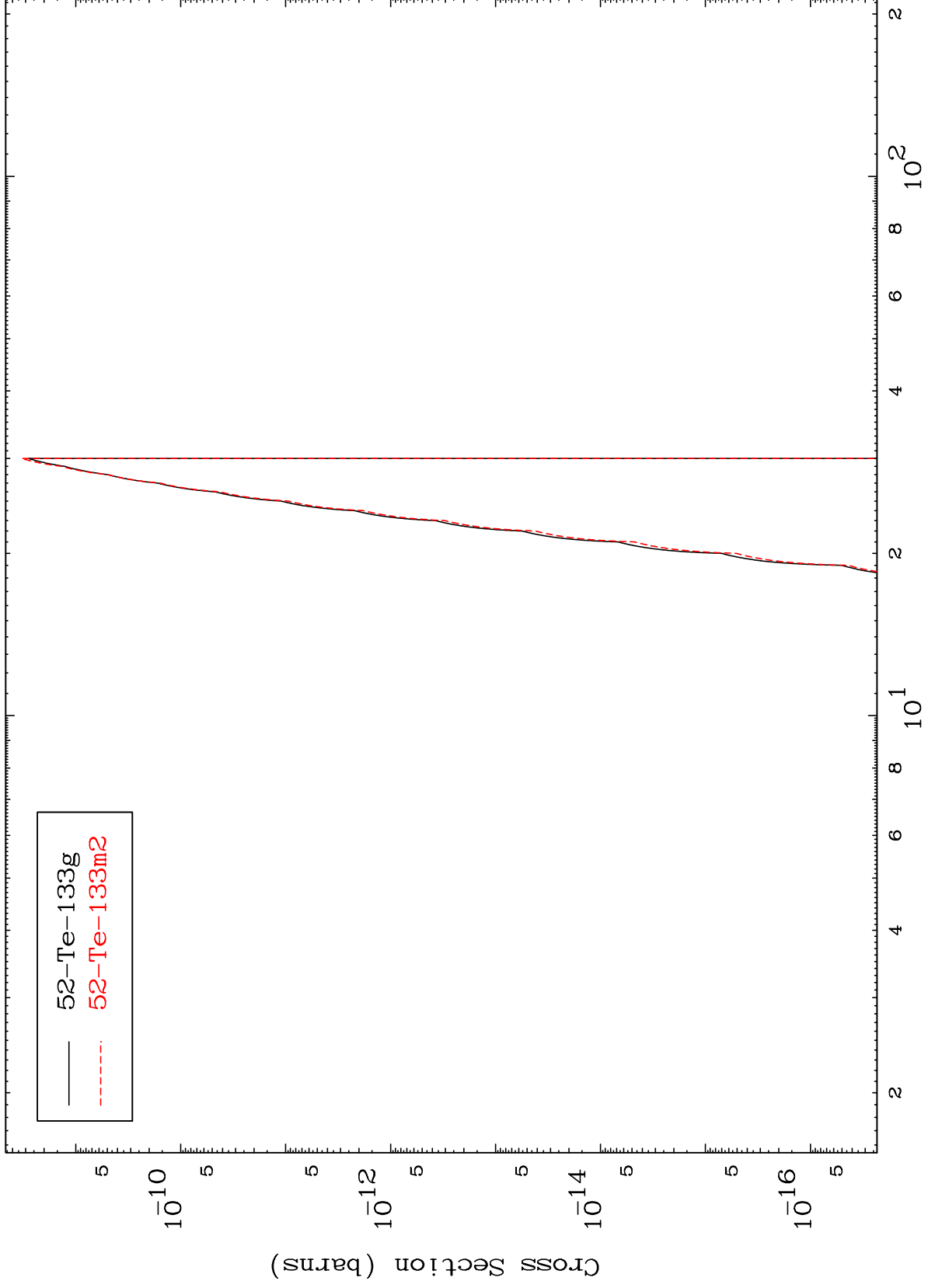

138

Incident Energy (MeV)

56-Ba-141

MAT 5658

(n,n') t

56-Ba-141

Radionuclide Production Cross Section

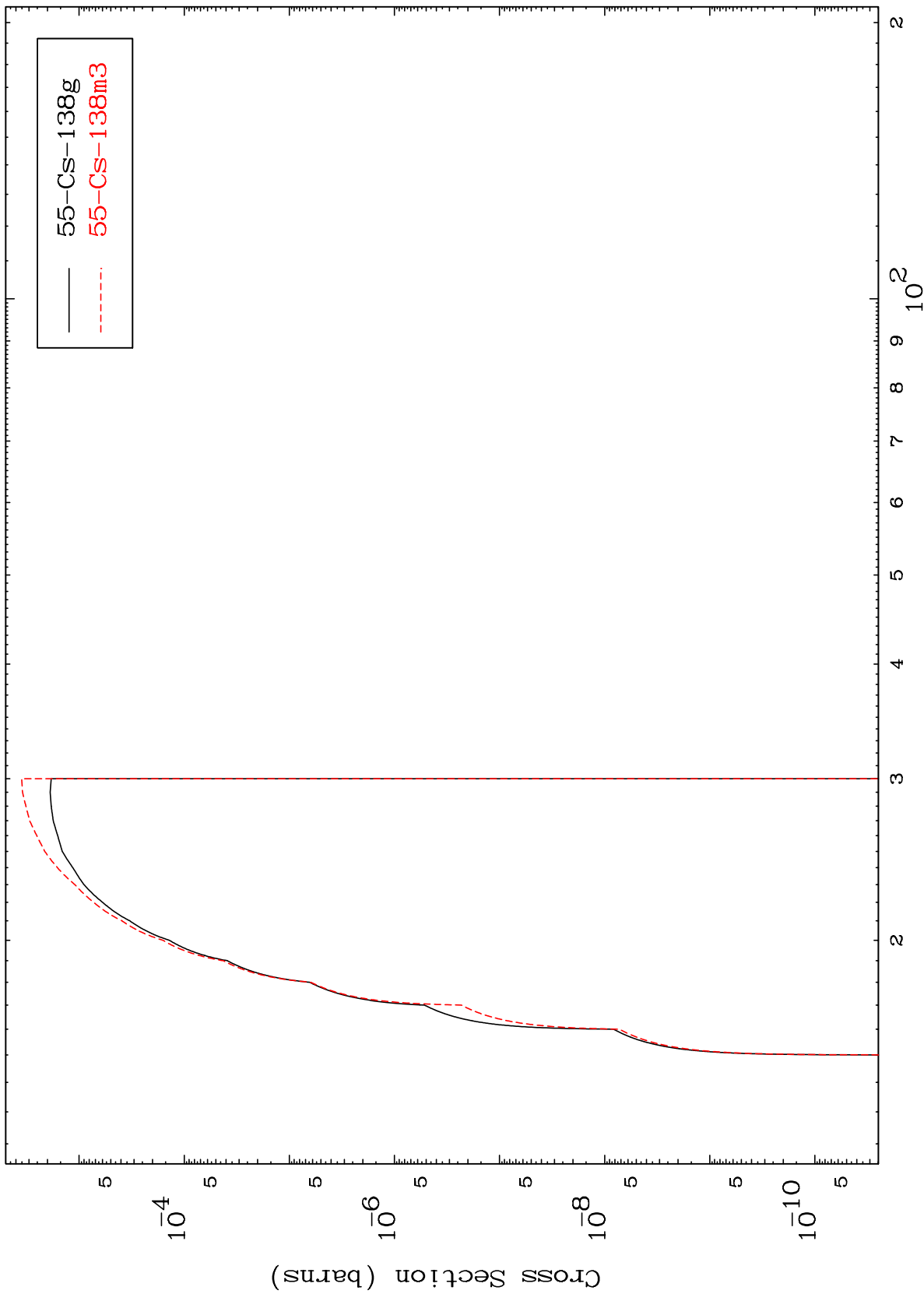

139

Incident Energy (MeV)

56-Ba-141

MAT 5658

(n,3n) p

56-Ba-141

Radionuclide Production Cross Section

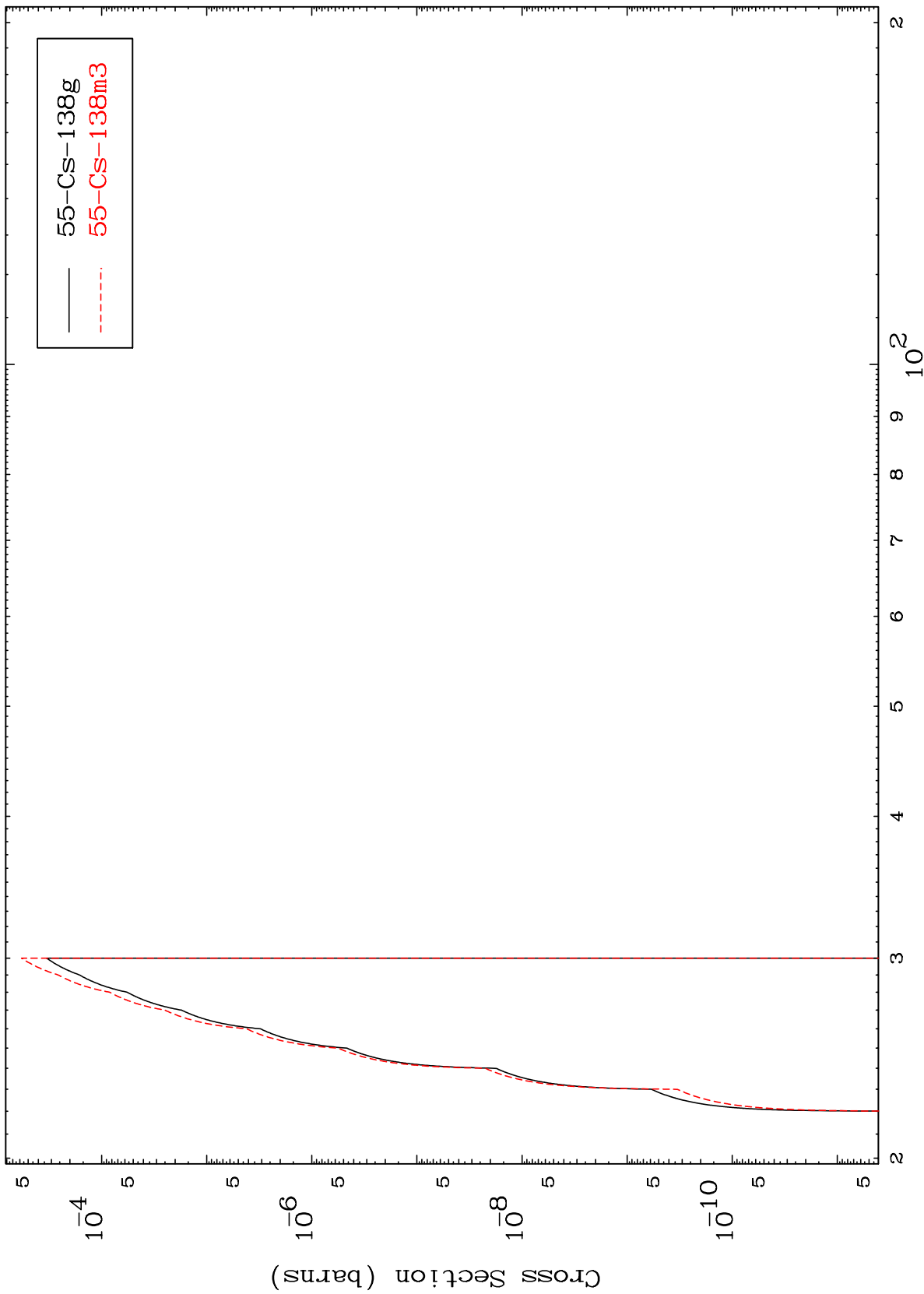

140

Incident Energy (MeV)

56-Ba-141

MAT 5658

(n,n') p  $\alpha$

56-Ba-141

Radionuclide Production Cross Section

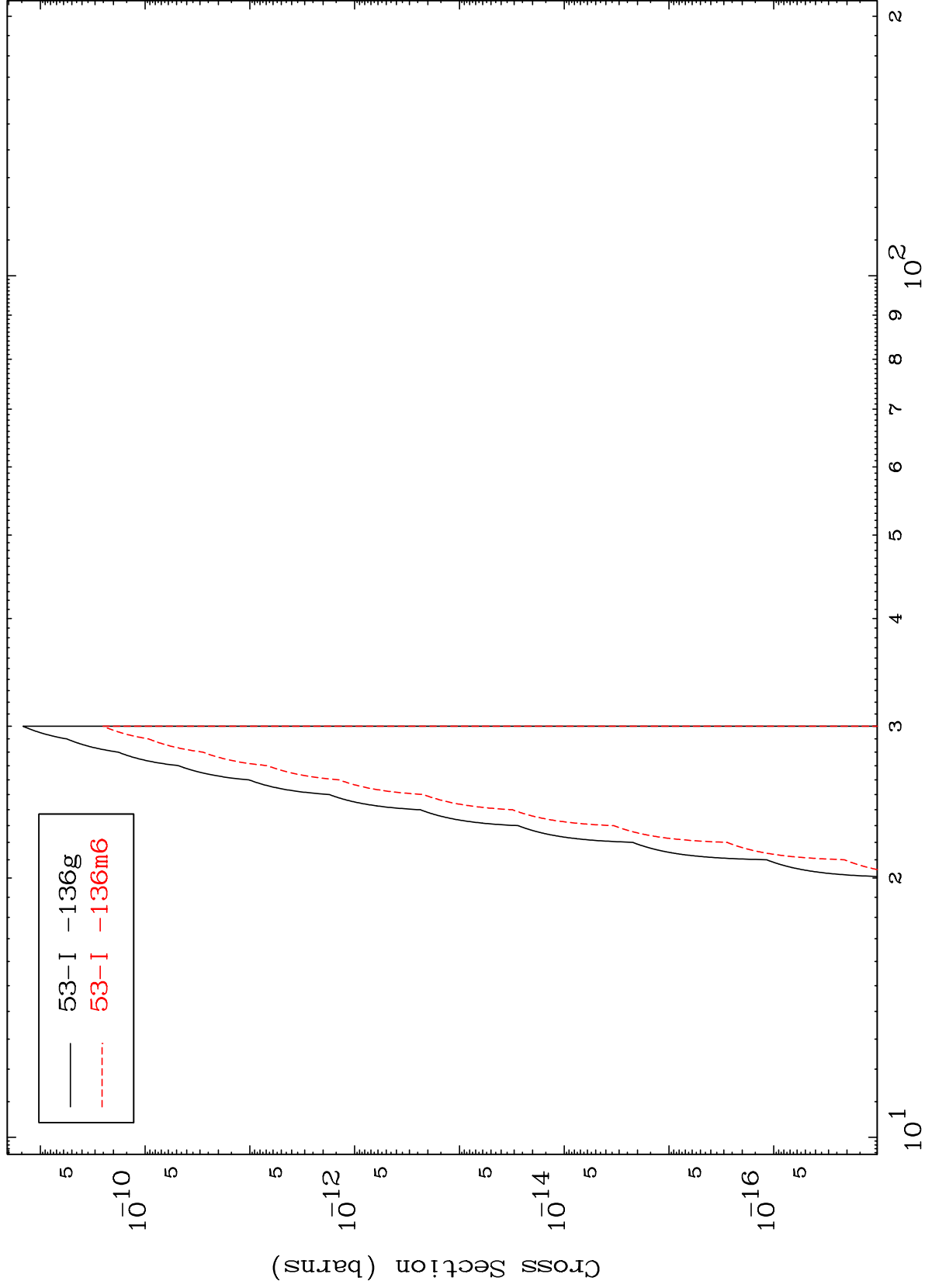

141

Incident Energy (MeV)

56-Ba-141

MAT 5658

(n,d)  $\alpha$

56-Ba-141

Radionuclide Production Cross Section

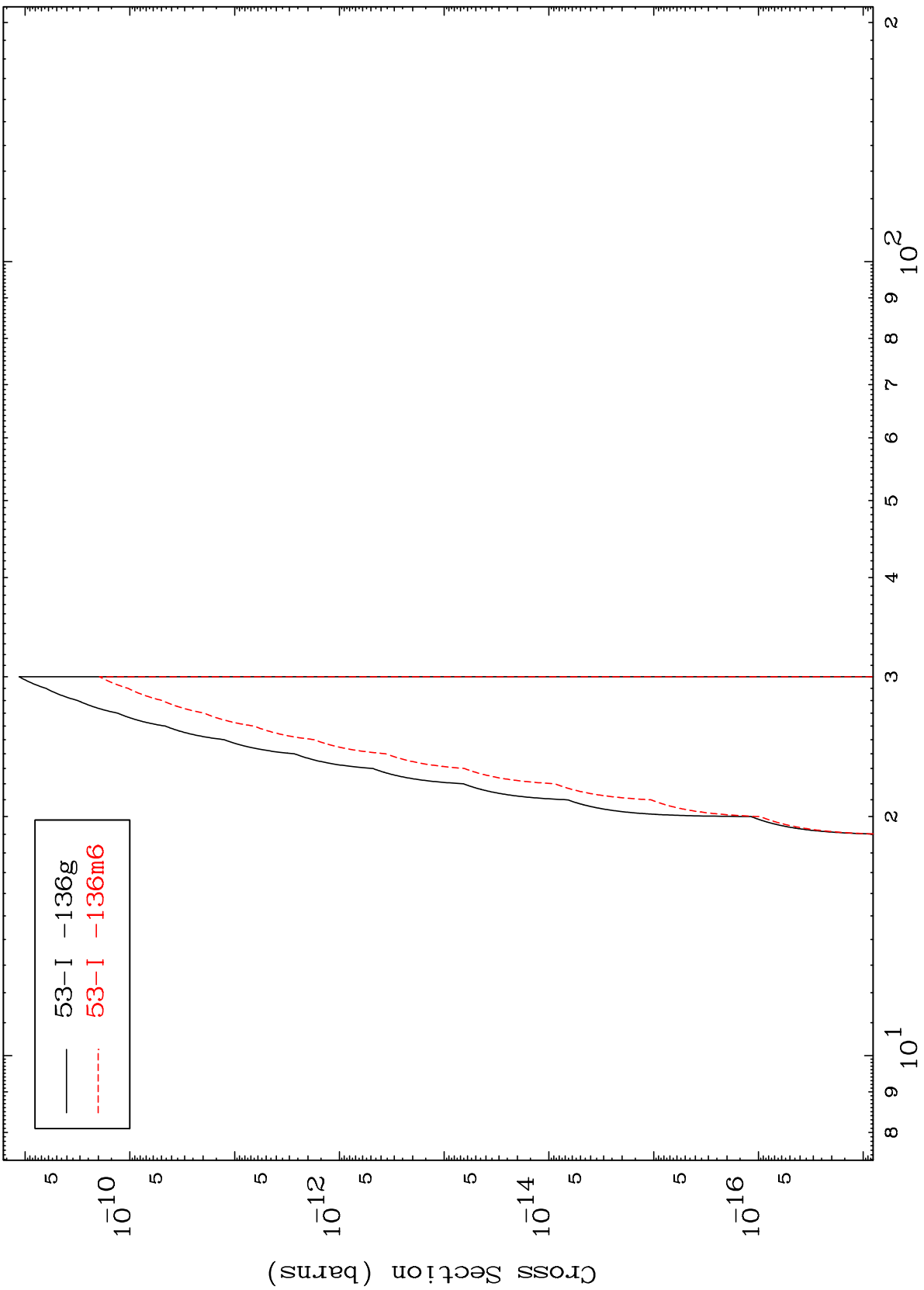

142

Incident Energy (MeV)

56-Ba-141