

AS080 NEUTRON ACER TENDL-2019 LIBRARY; T=293.16K
Principal cross sections

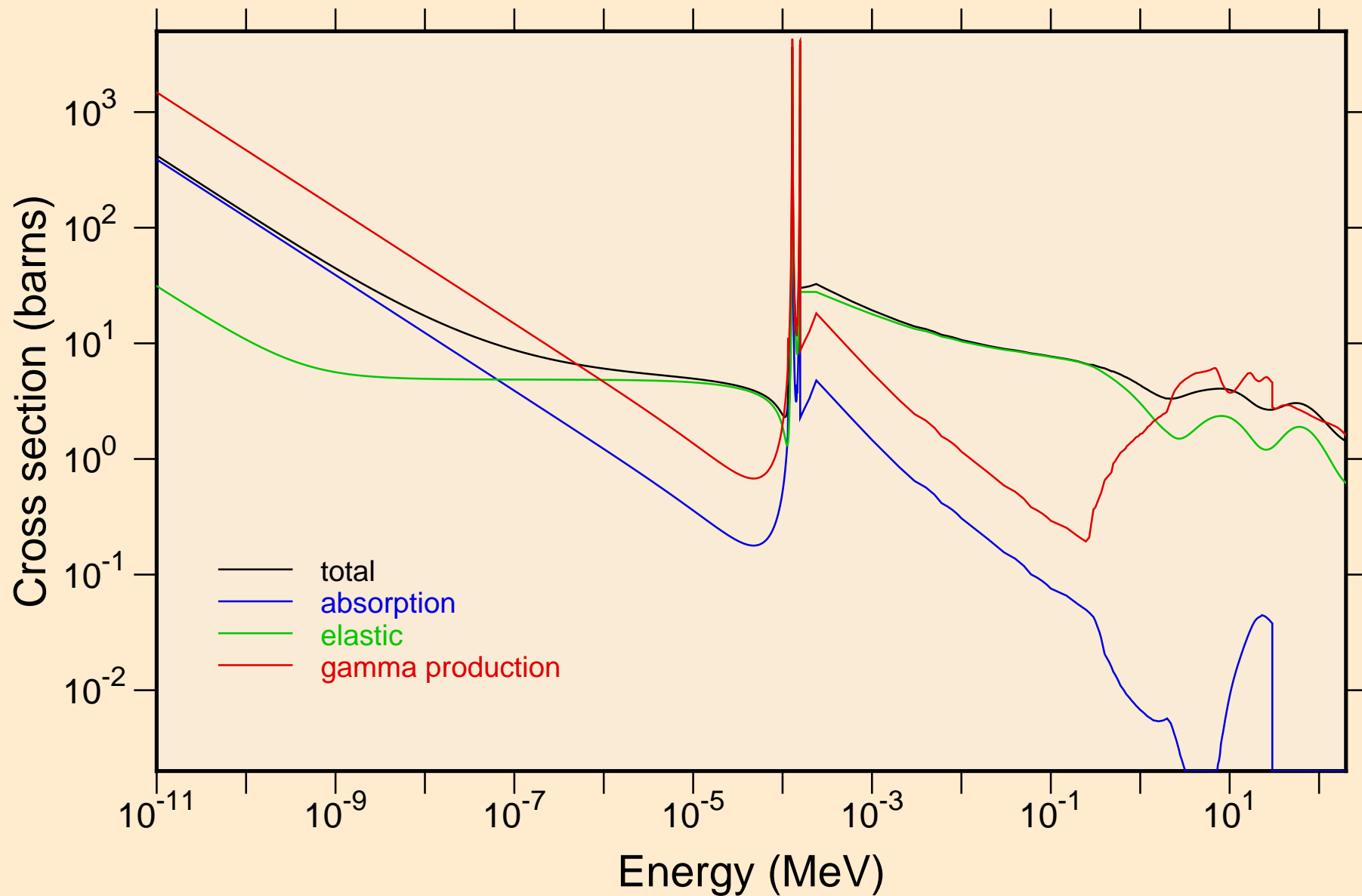

AS080 NEUTRON ACER TENDL-2019 LIBRARY; T=293.16K
Heating

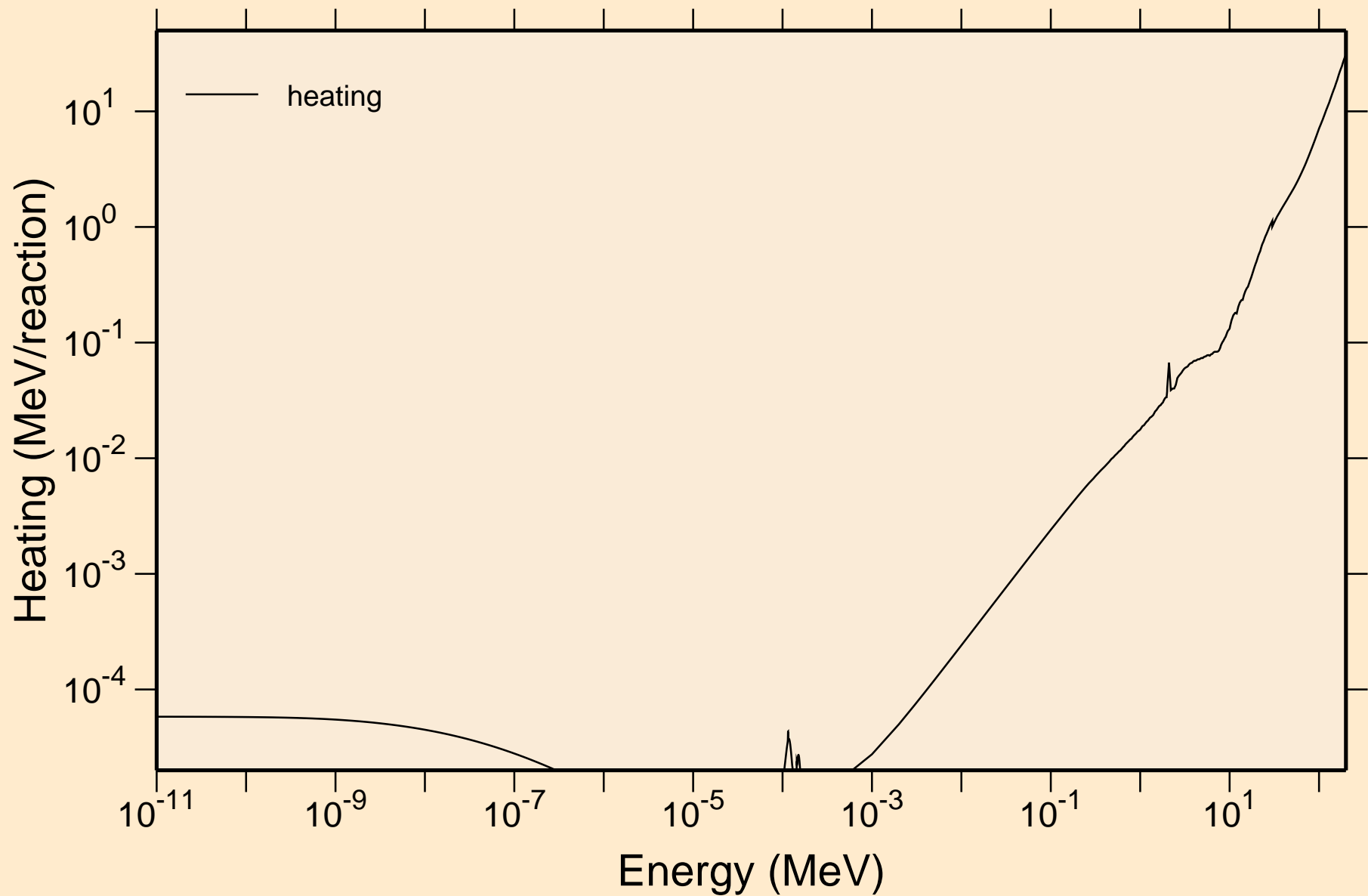

AS080 NEUTRON ACER TENDL-2019 LIBRARY; T=293.16K
Damage

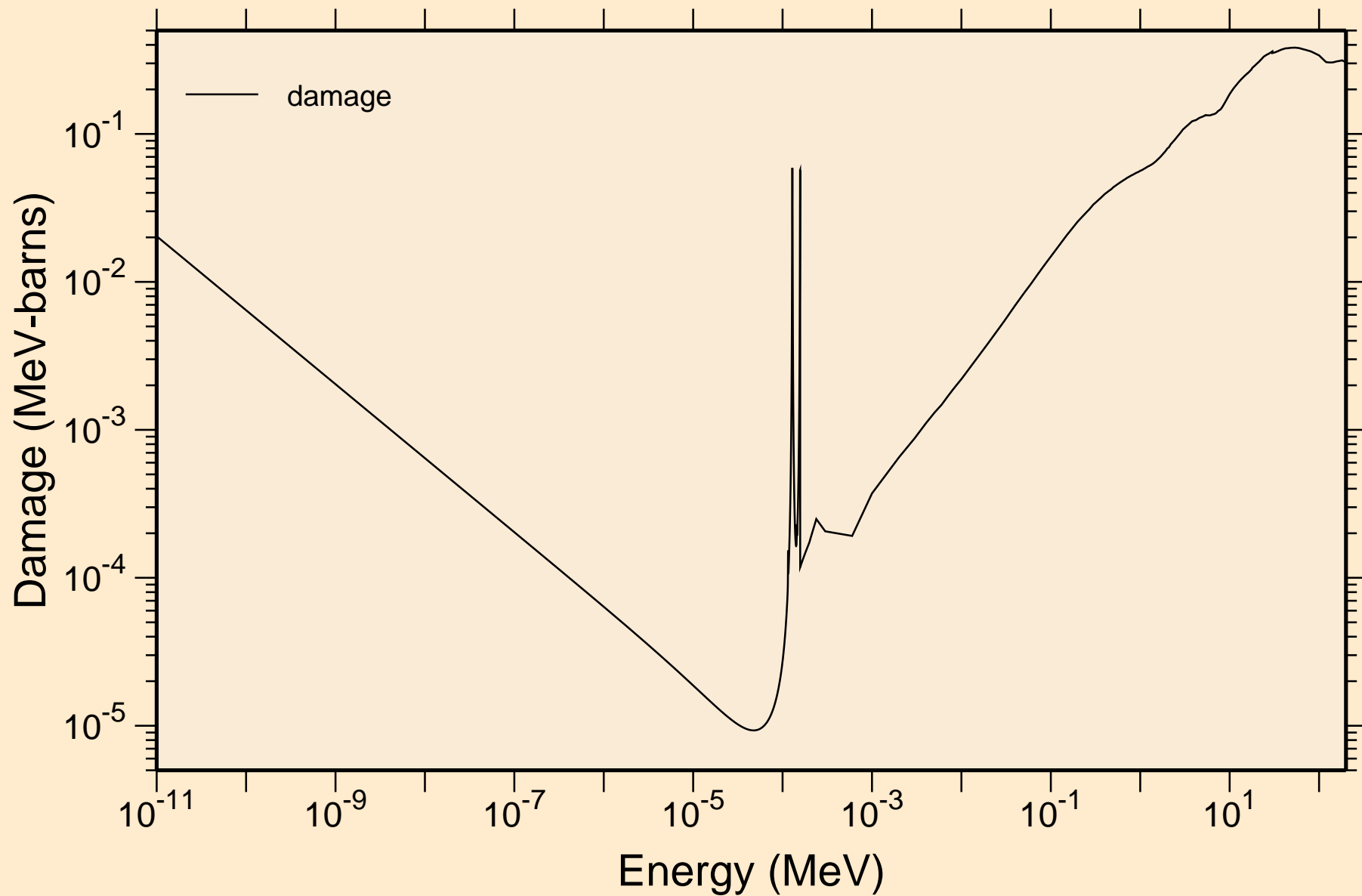

AS080 NEUTRON ACER TENDL-2019 LIBRARY; T=293.16K
Non-threshold reactions

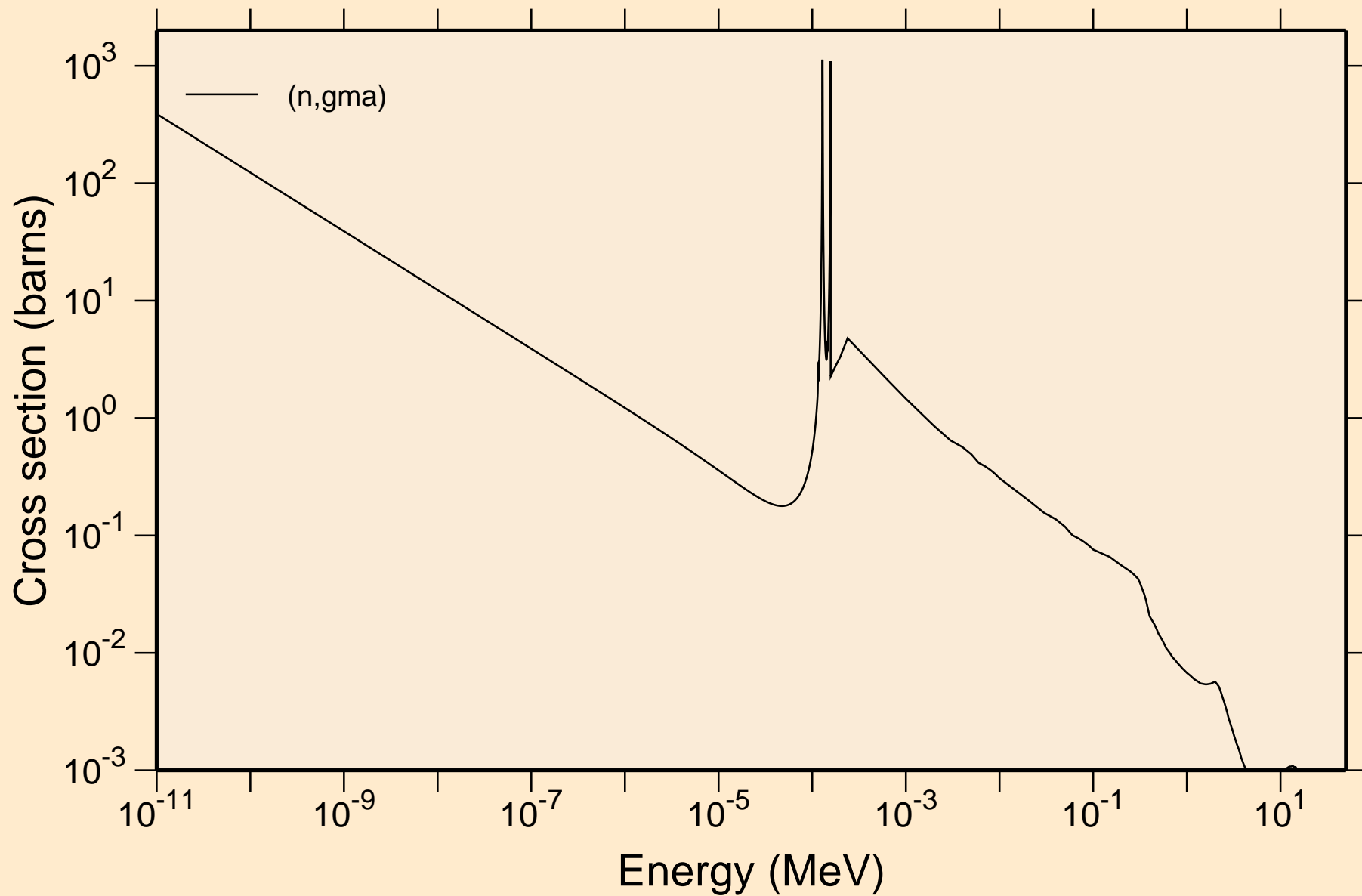

AS080 NEUTRON ACER TENDL-2019 LIBRARY; T=293.16K
Principal cross sections

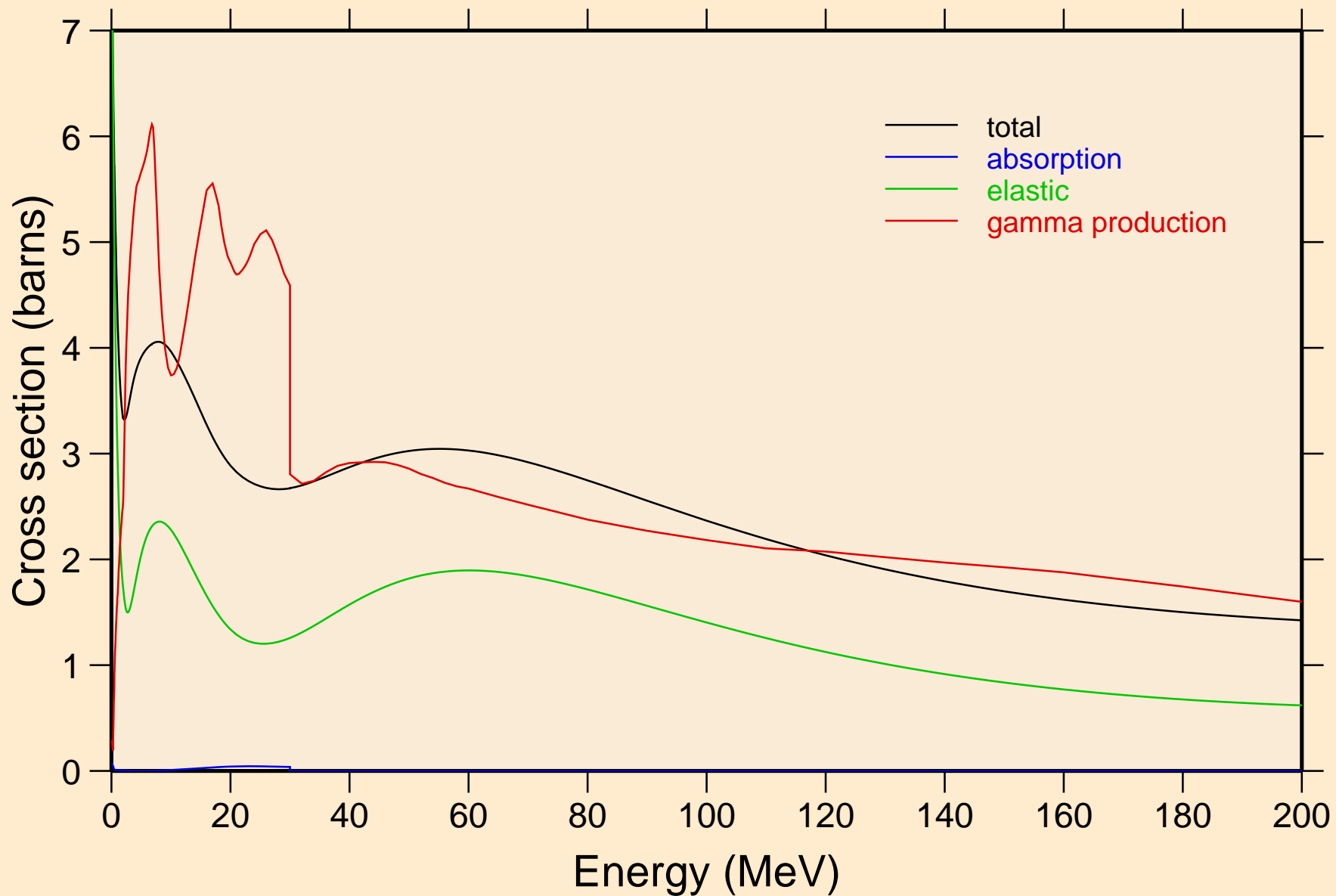

AS080 NEUTRON ACER TENDL-2019 LIBRARY; T=293.16K
Heating

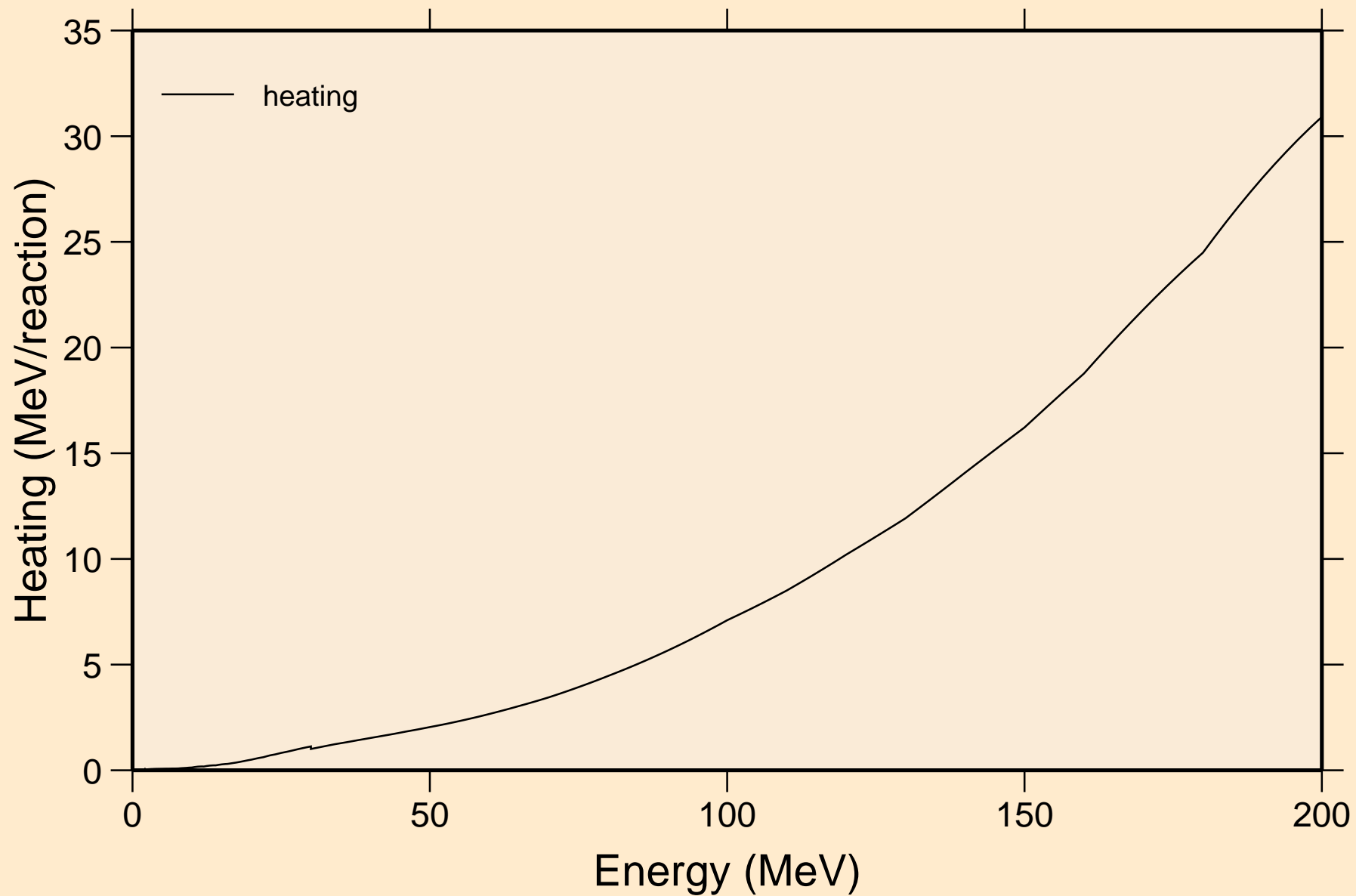

AS080 NEUTRON ACER TENDL-2019 LIBRARY; T=293.16K
Damage

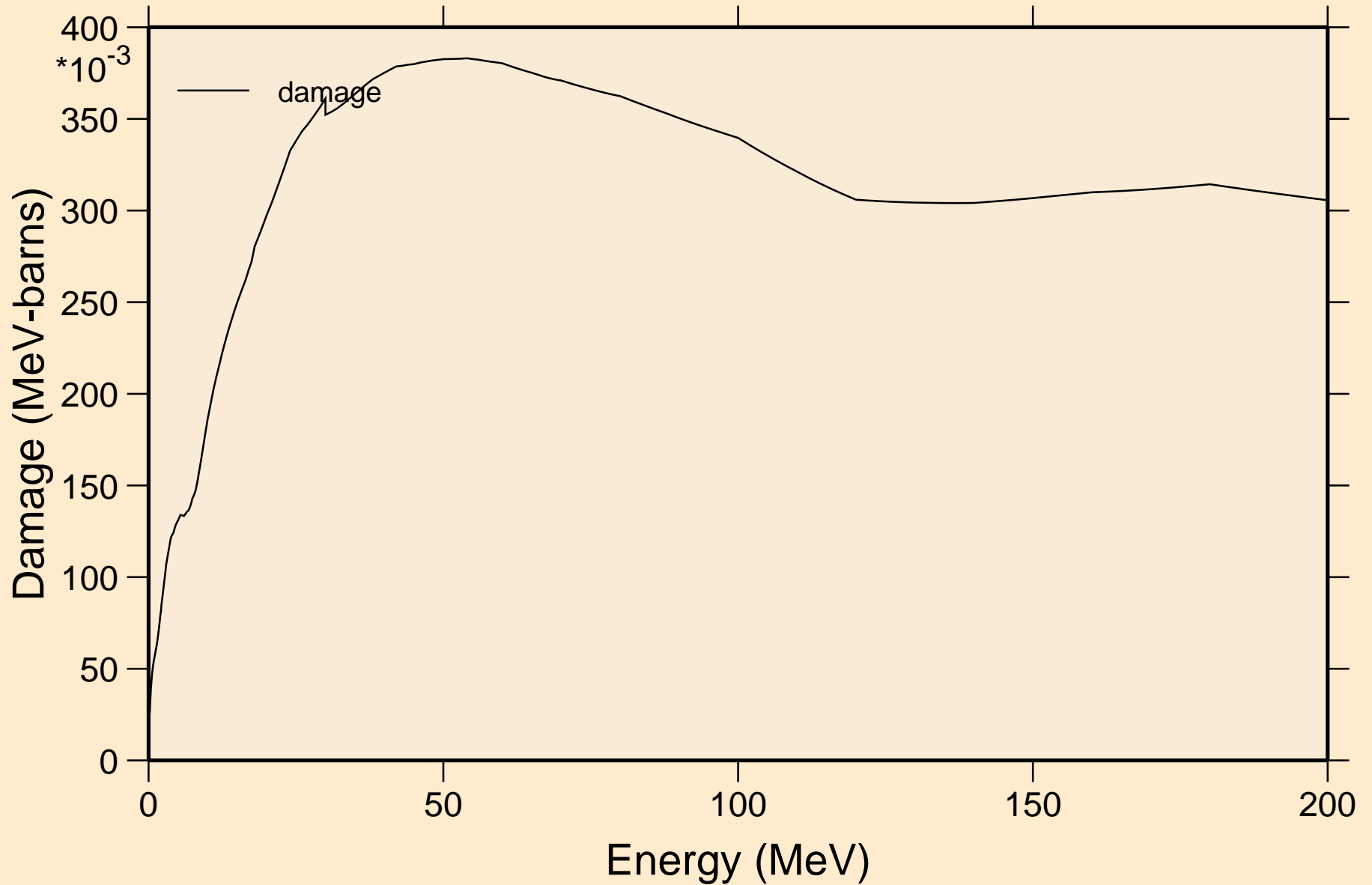

AS080 NEUTRON ACER TENDL-2019 LIBRARY; T=293.16K
Non-threshold reactions

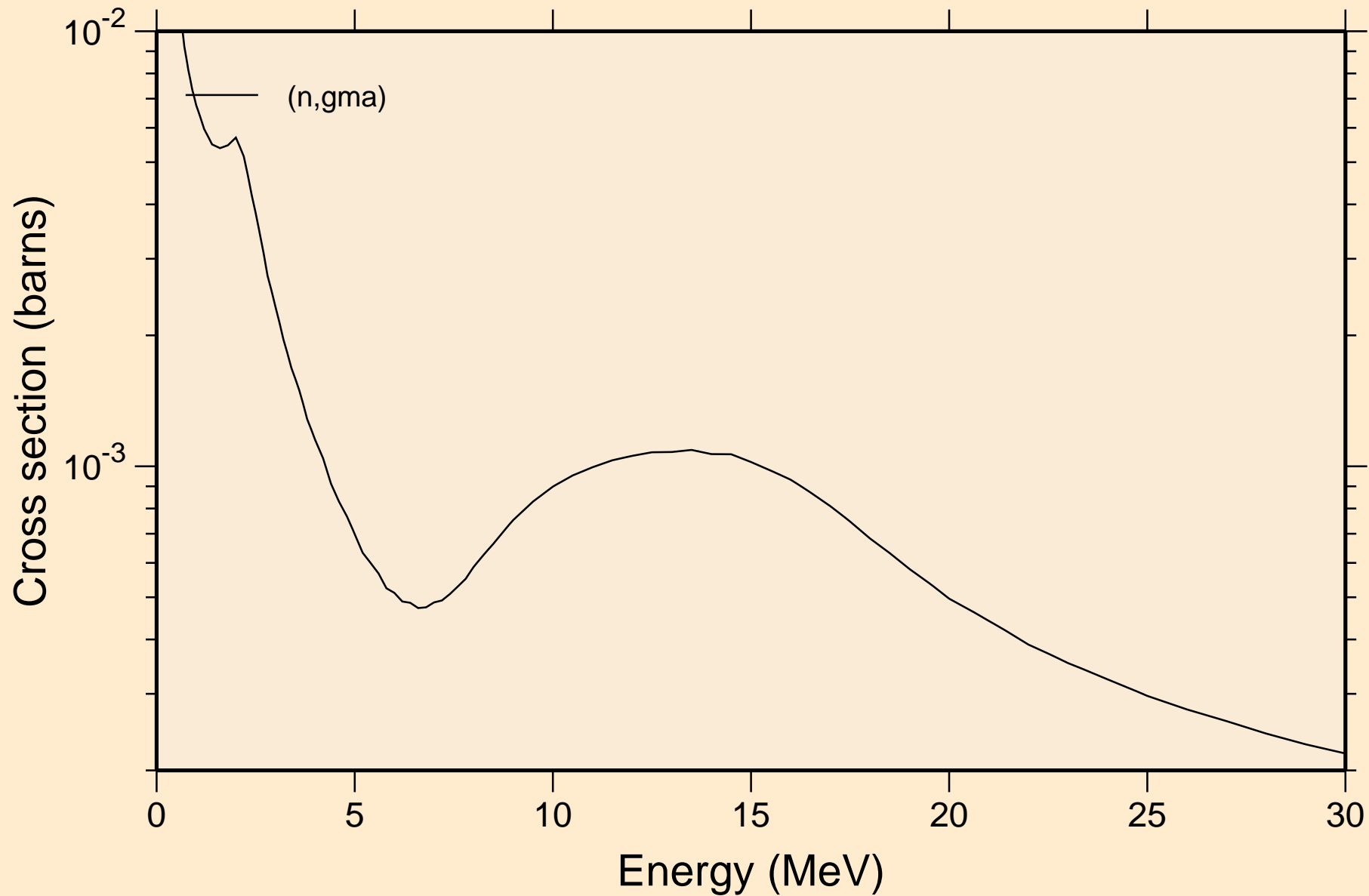

AS080 NEUTRON ACER TENDL-2019 LIBRARY; T=293.16K
Inelastic levels

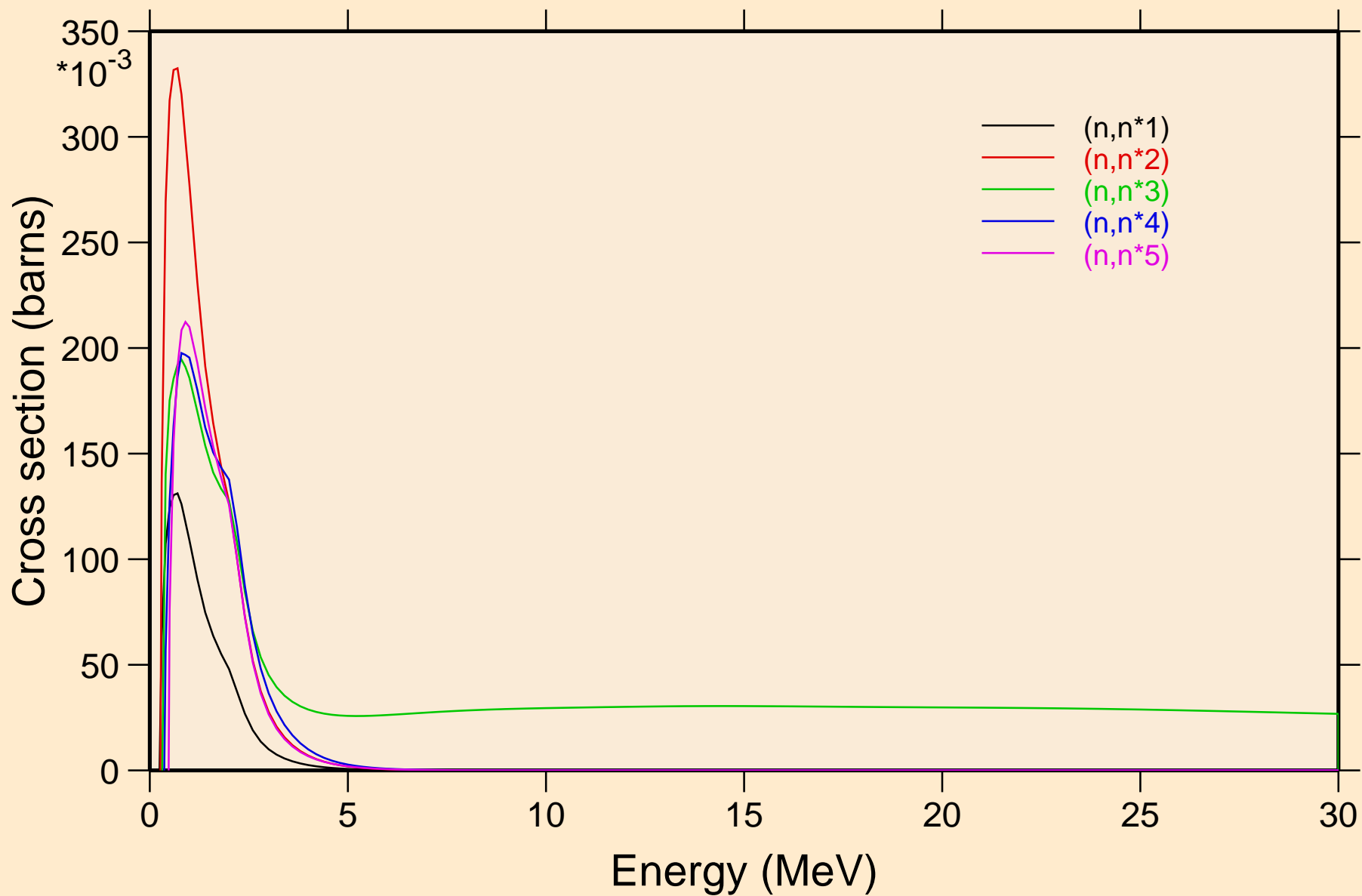

AS080 NEUTRON ACER TENDL-2019 LIBRARY; T=293.16K
Inelastic levels

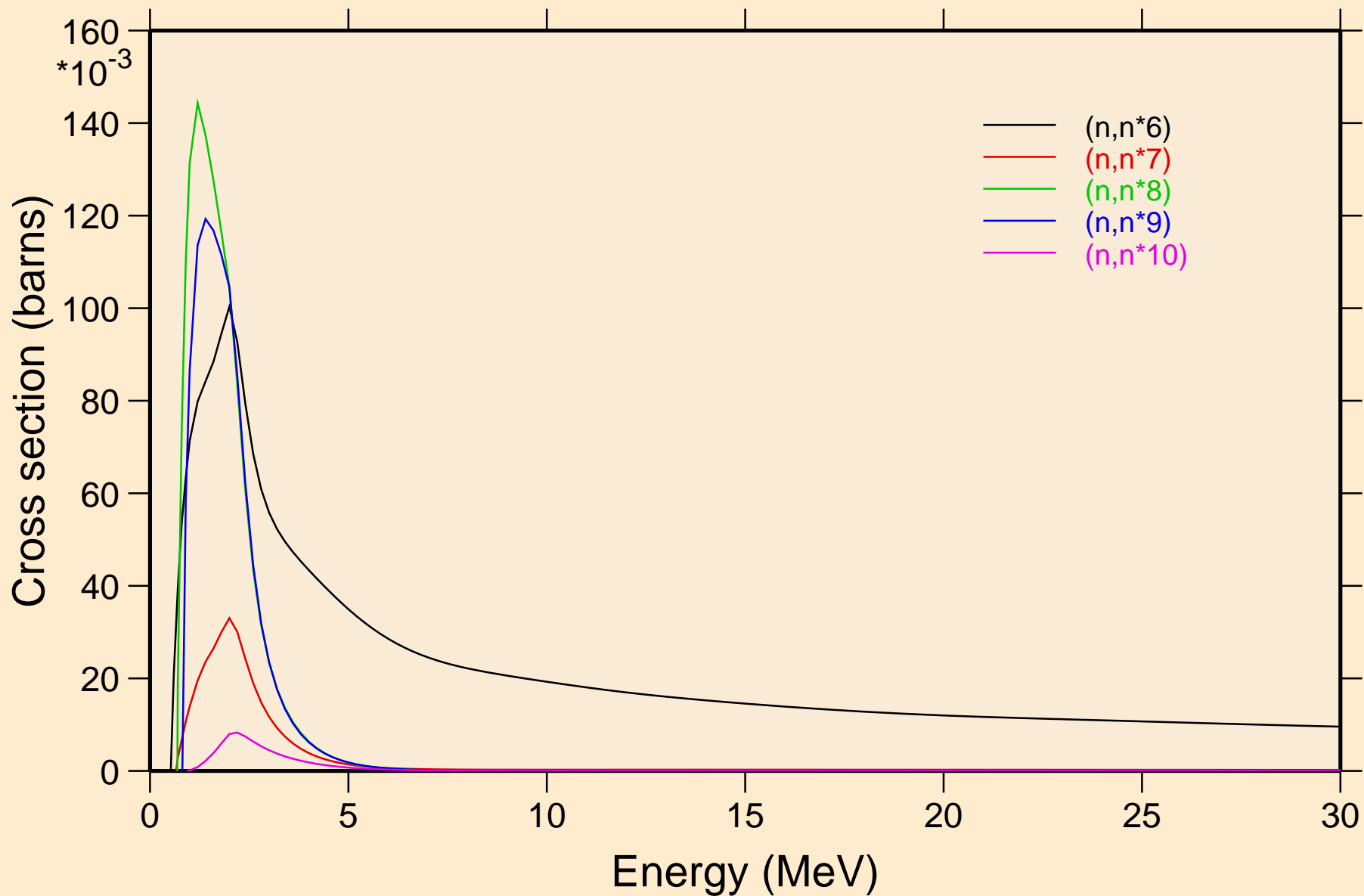

AS080 NEUTRON ACER TENDL-2019 LIBRARY; T=293.16K
Inelastic levels

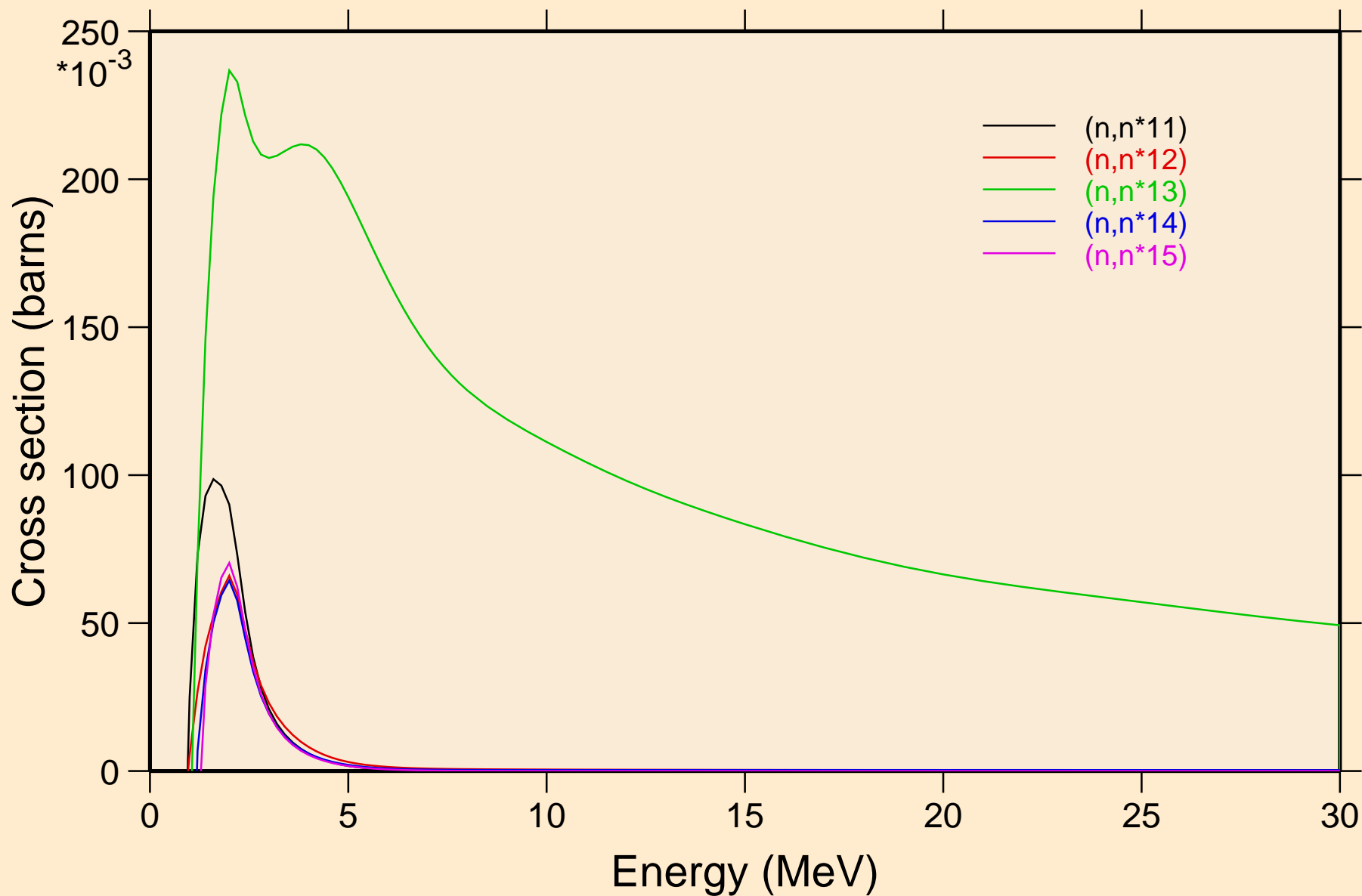

AS080 NEUTRON ACER TENDL-2019 LIBRARY; T=293.16K
Inelastic levels

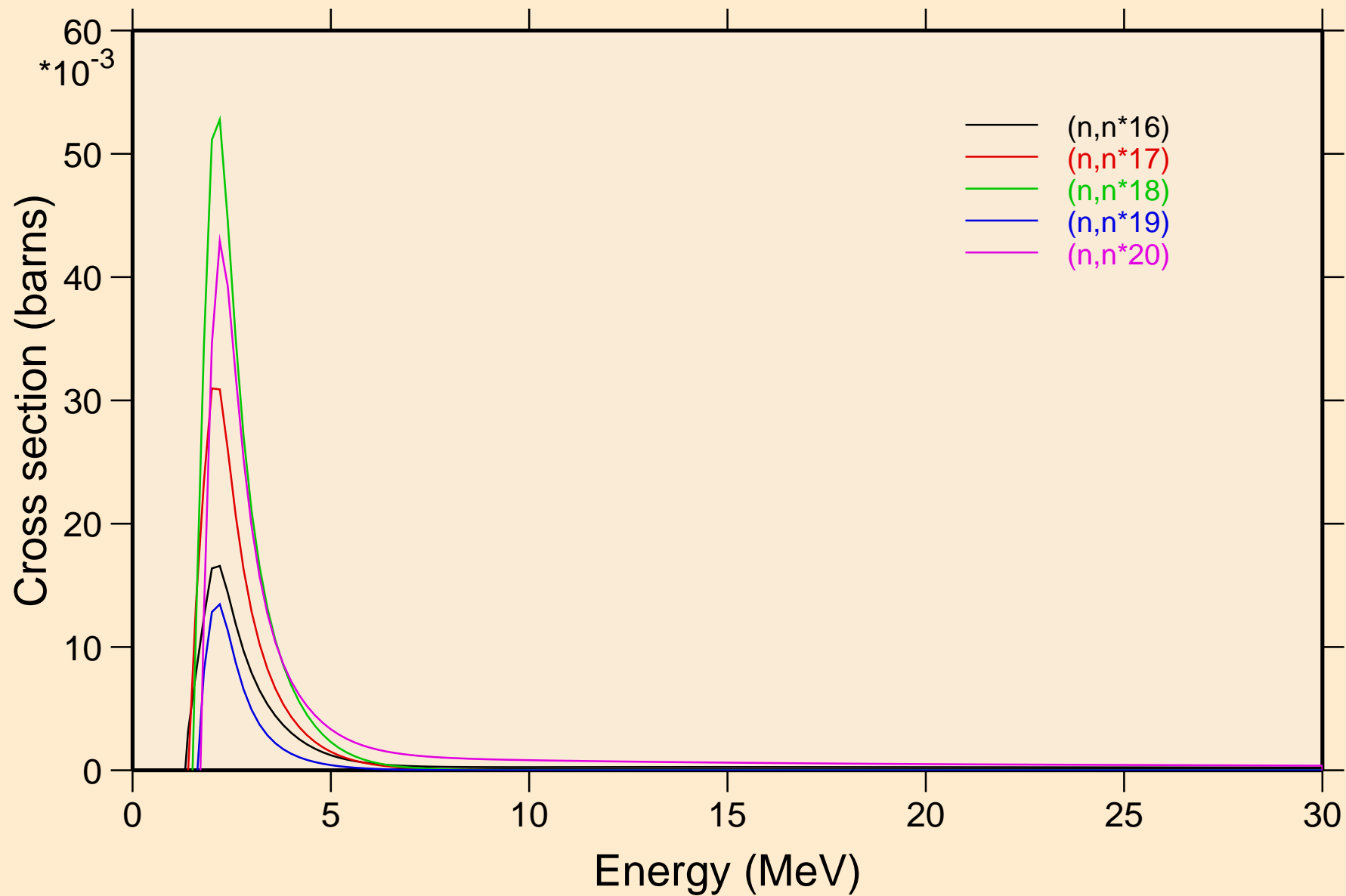

AS080 NEUTRON ACER TENDL-2019 LIBRARY; T=293.16K
Inelastic levels

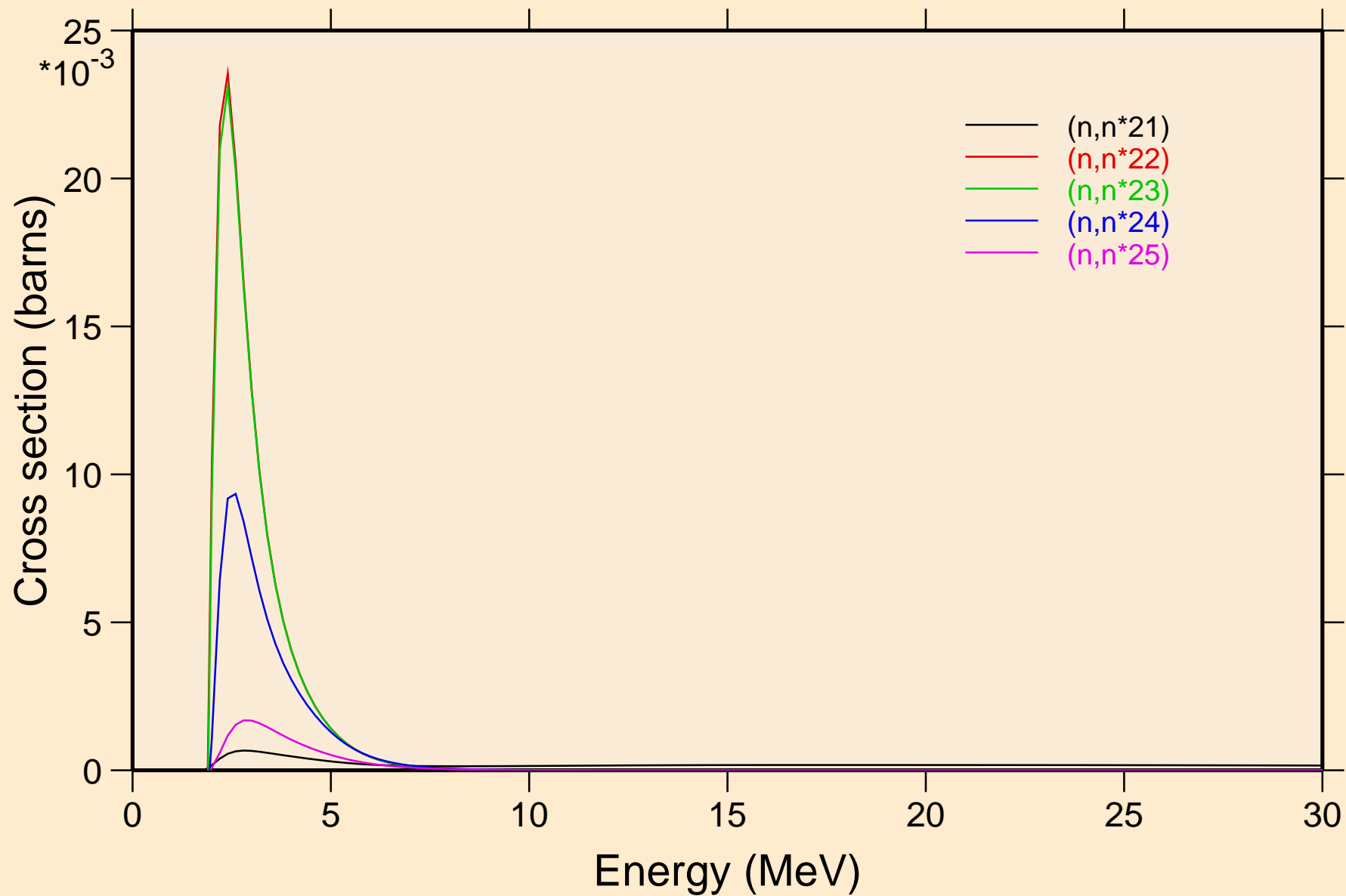

AS080 NEUTRON ACER TENDL-2019 LIBRARY; T=293.16K
Inelastic levels

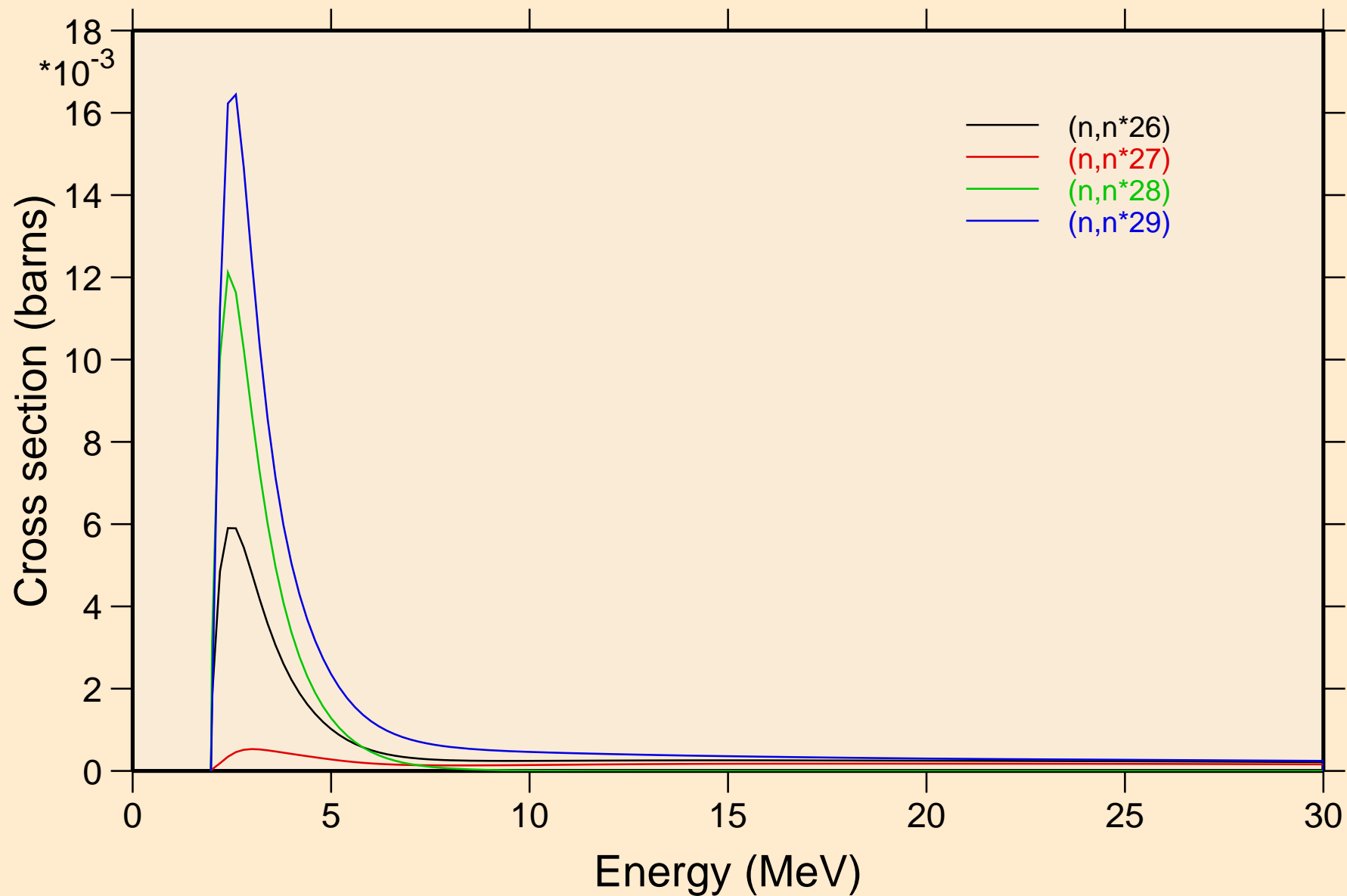

AS080 NEUTRON ACER TENDL-2019 LIBRARY; T=293.16K
Threshold reactions

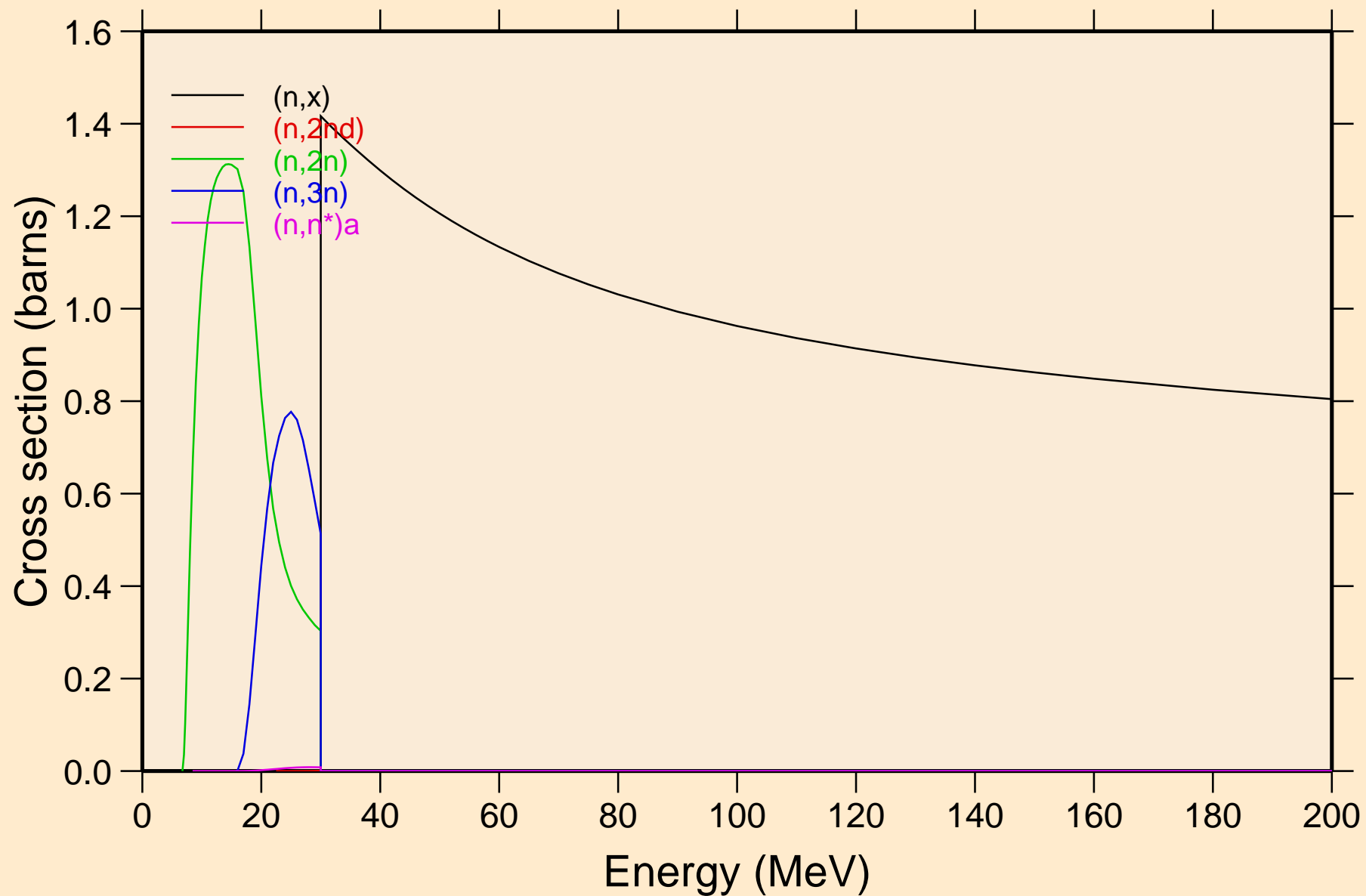

AS080 NEUTRON ACER TENDL-2019 LIBRARY; T=293.16K
Threshold reactions

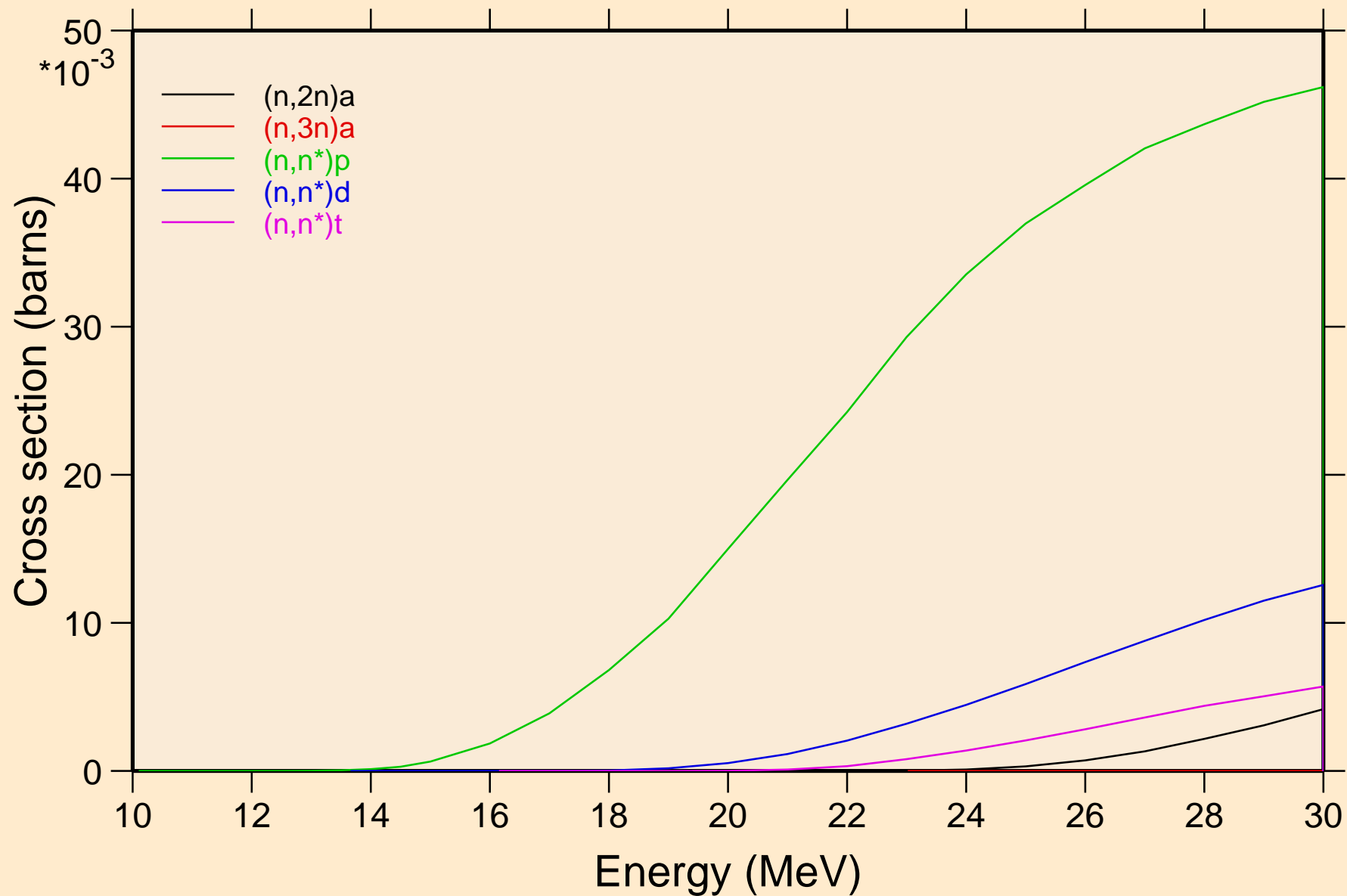

AS080 NEUTRON ACER TENDL-2019 LIBRARY; T=293.16K
Threshold reactions

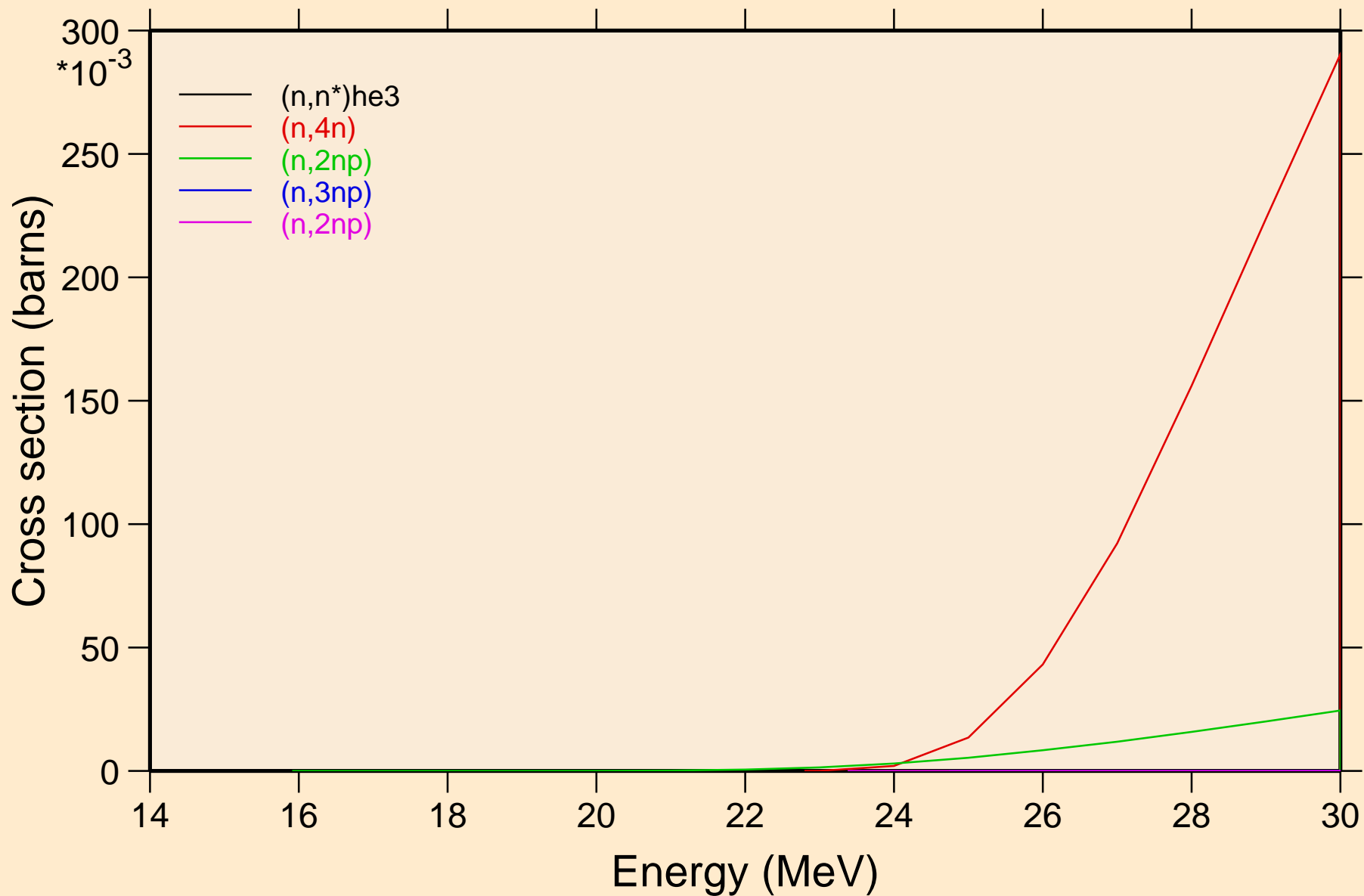

AS080 NEUTRON ACER TENDL-2019 LIBRARY; T=293.16K
Threshold reactions

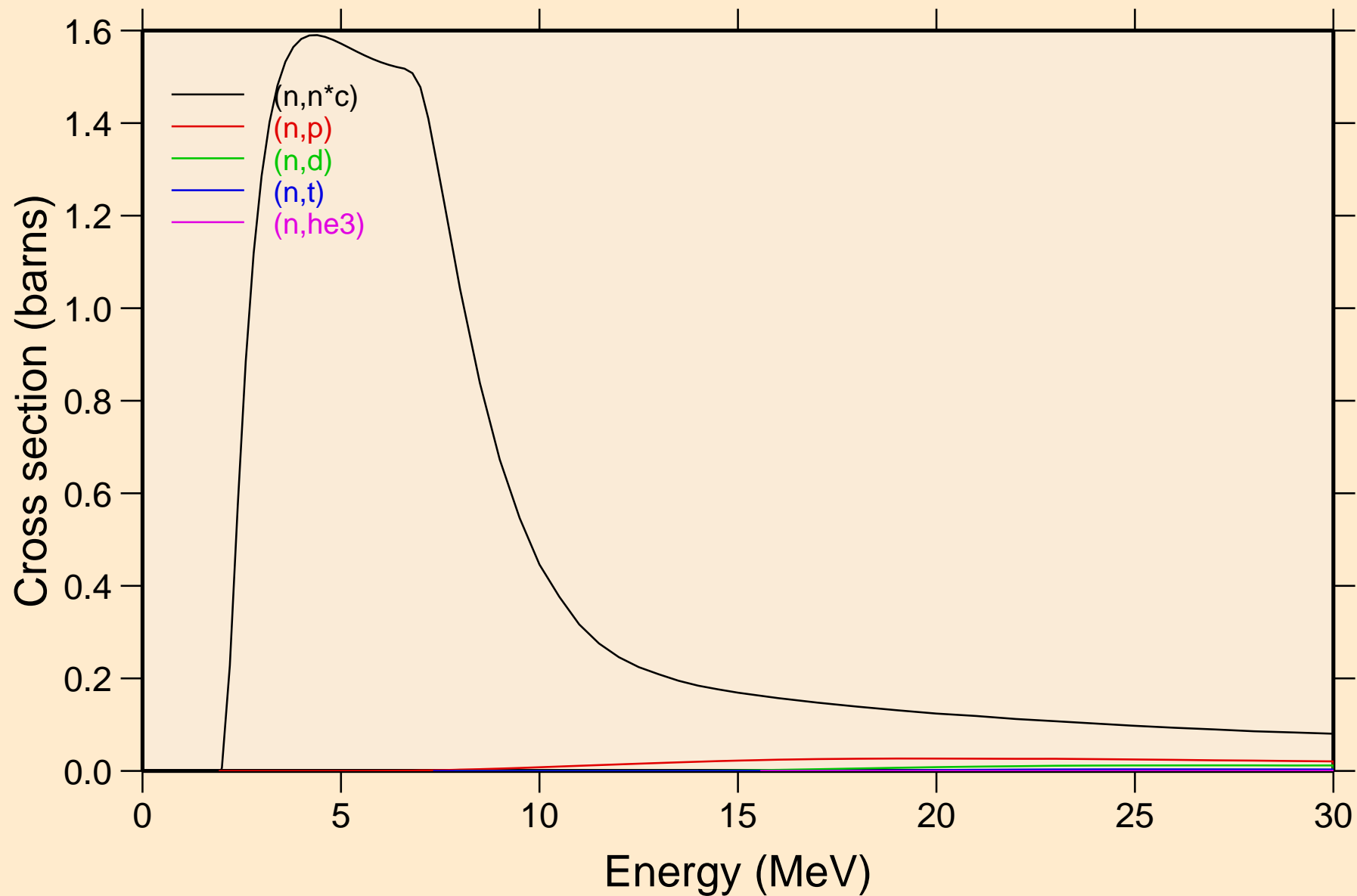

AS080 NEUTRON ACER TENDL-2019 LIBRARY; T=293.16K
Threshold reactions

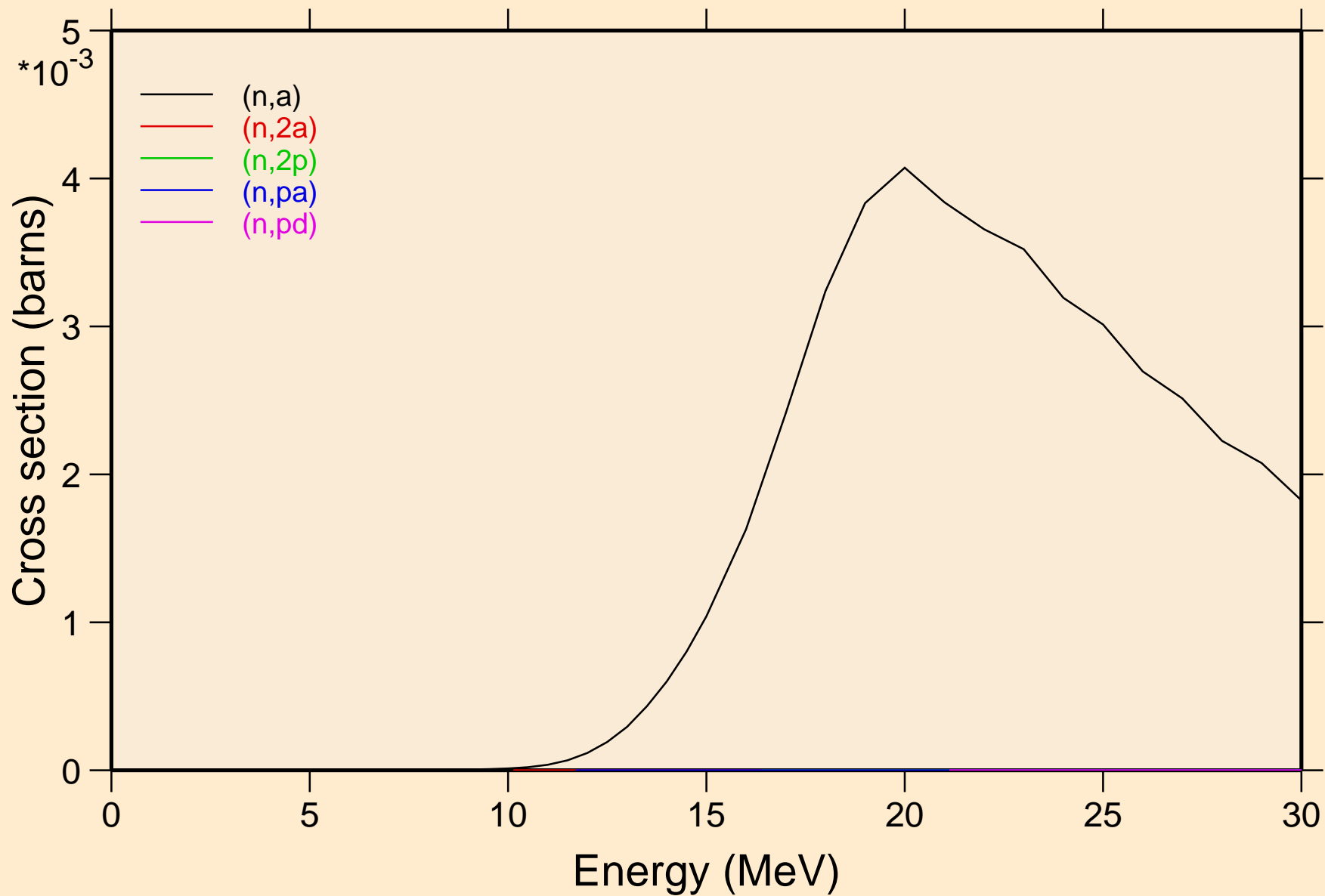

AS080 NEUTRON ACER TENDL-2019 LIBRARY; T=293.16K
Threshold reactions

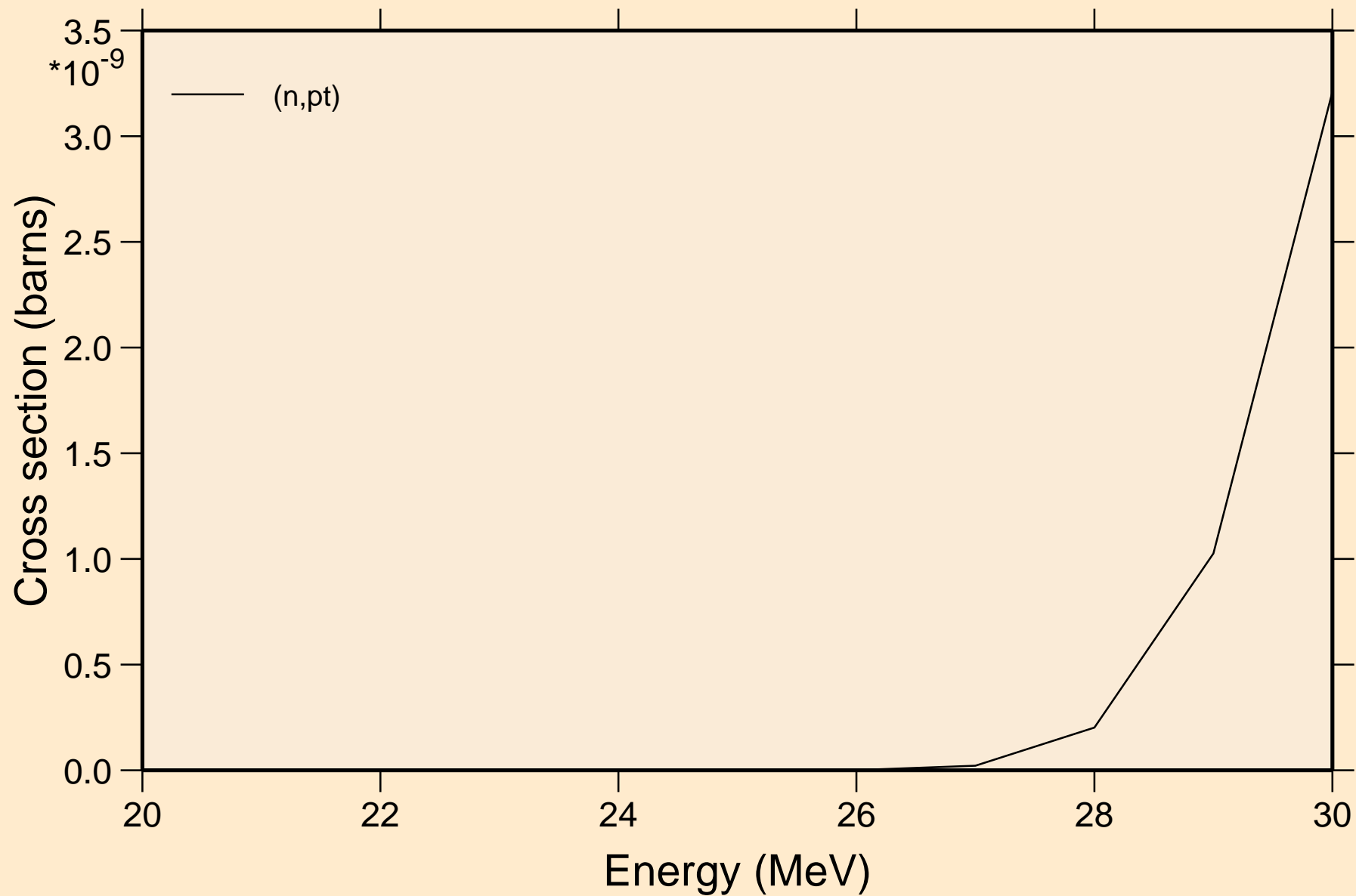

AS080 NEUTRON ACER TENDL-2019 LIBRARY; T=293.16K
Threshold reactions

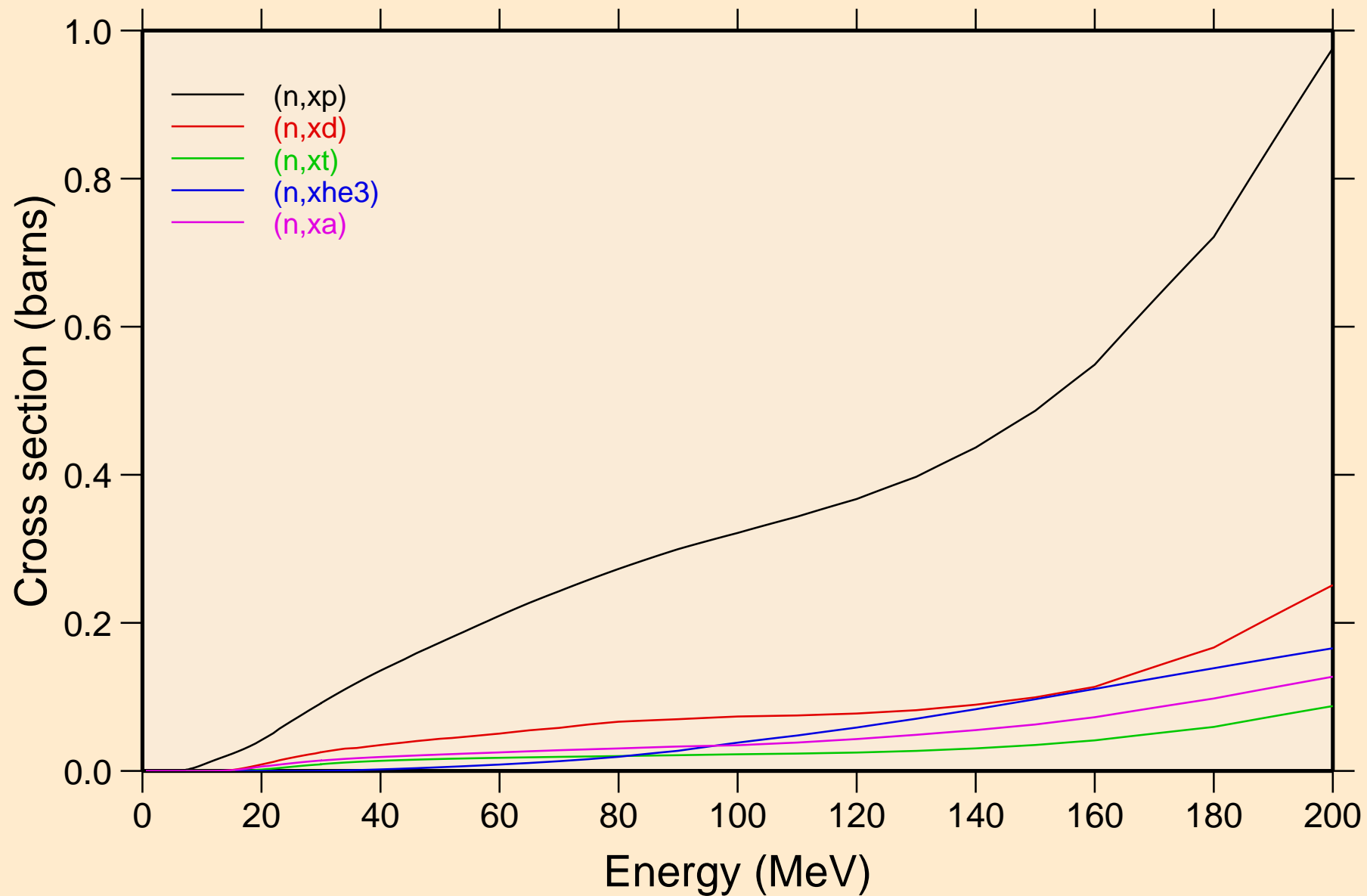

AS080 NEUTRON ACER TENDL-2019 LIBRARY; T=293.16K
angular distribution for elastic

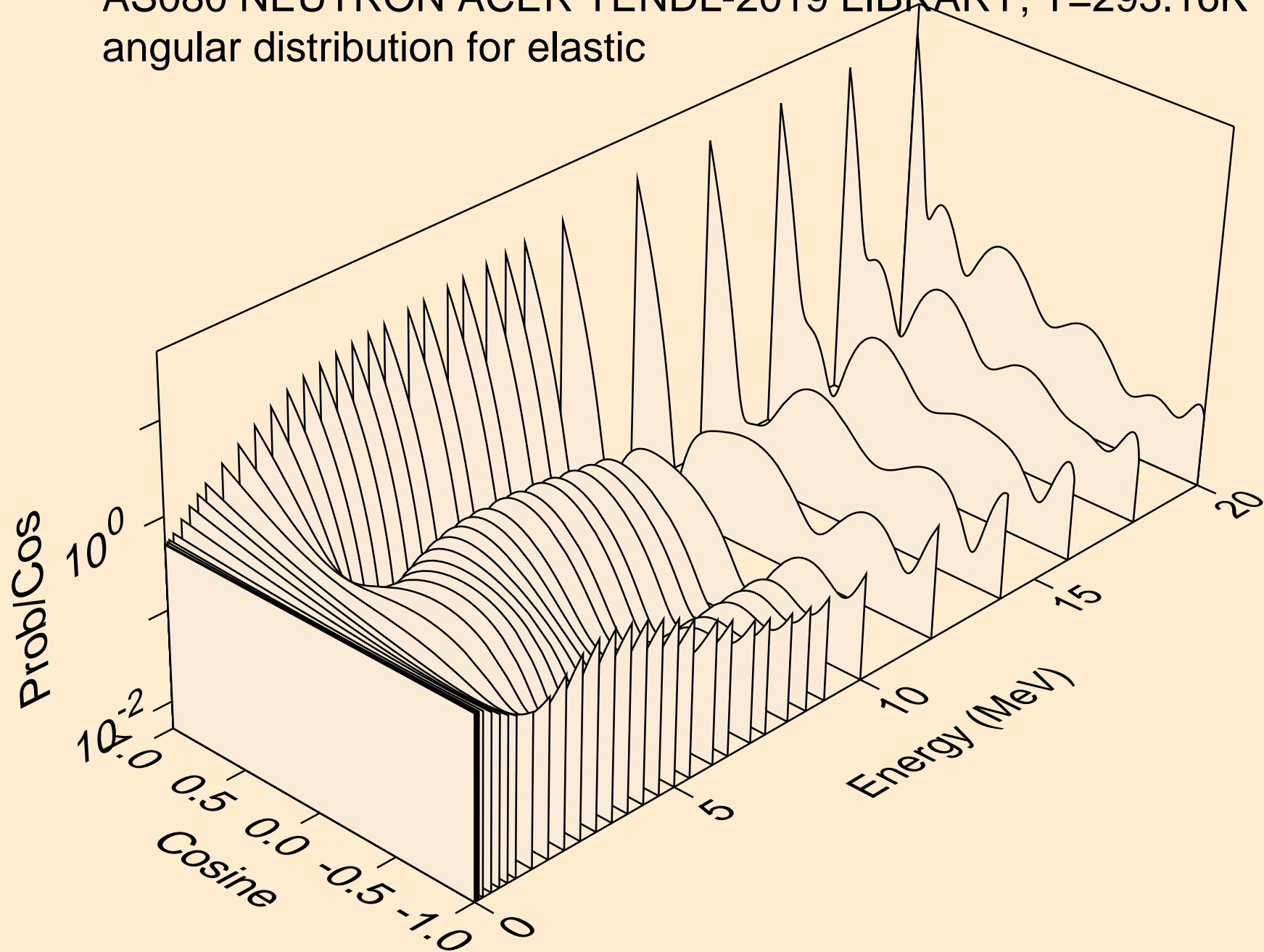

AS080 NEUTRON ACER TENDL-2019 LIBRARY; T=293.16K
angular distribution for elastic

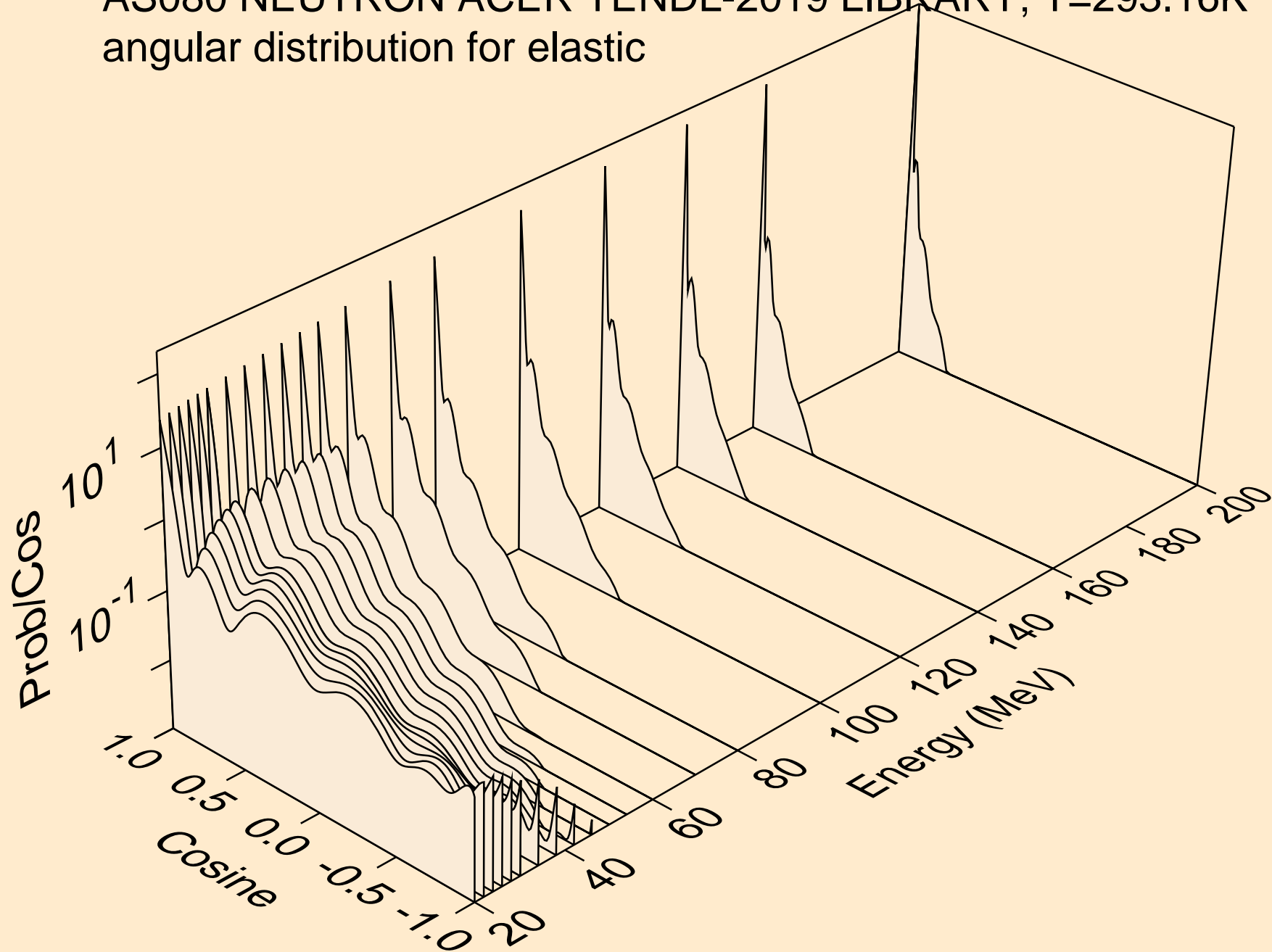

AS080 NEUTRON ACER TENDL-2019 LIBRARY; T=293.16K
angular distribution for (n,n*1)

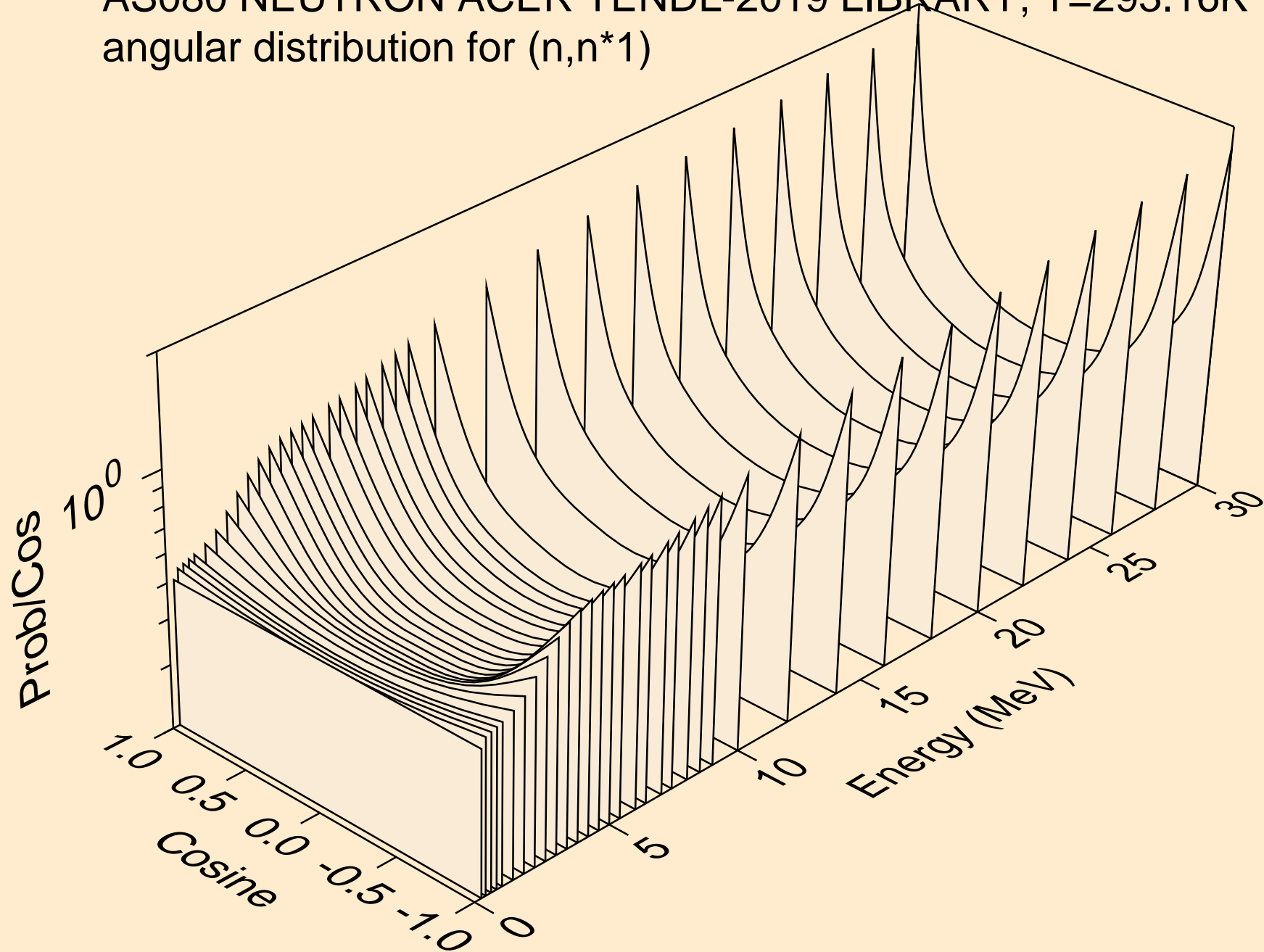

AS080 NEUTRON ACER TENDL-2019 LIBRARY; T=293.16K
angular distribution for (n,n*2)

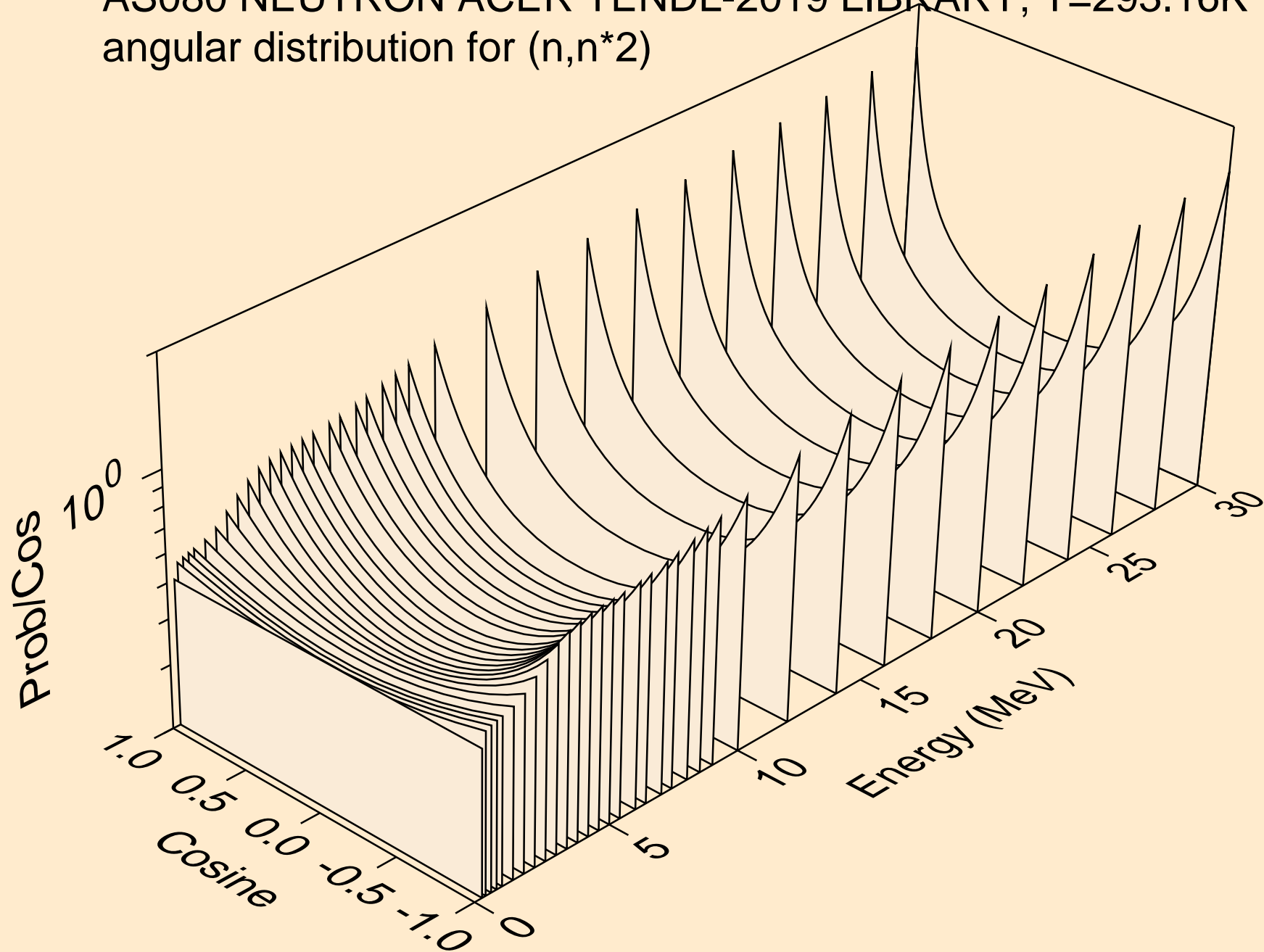

AS080 NEUTRON ACER TENDL-2019 LIBRARY; T=293.16K
angular distribution for (n,n*3)

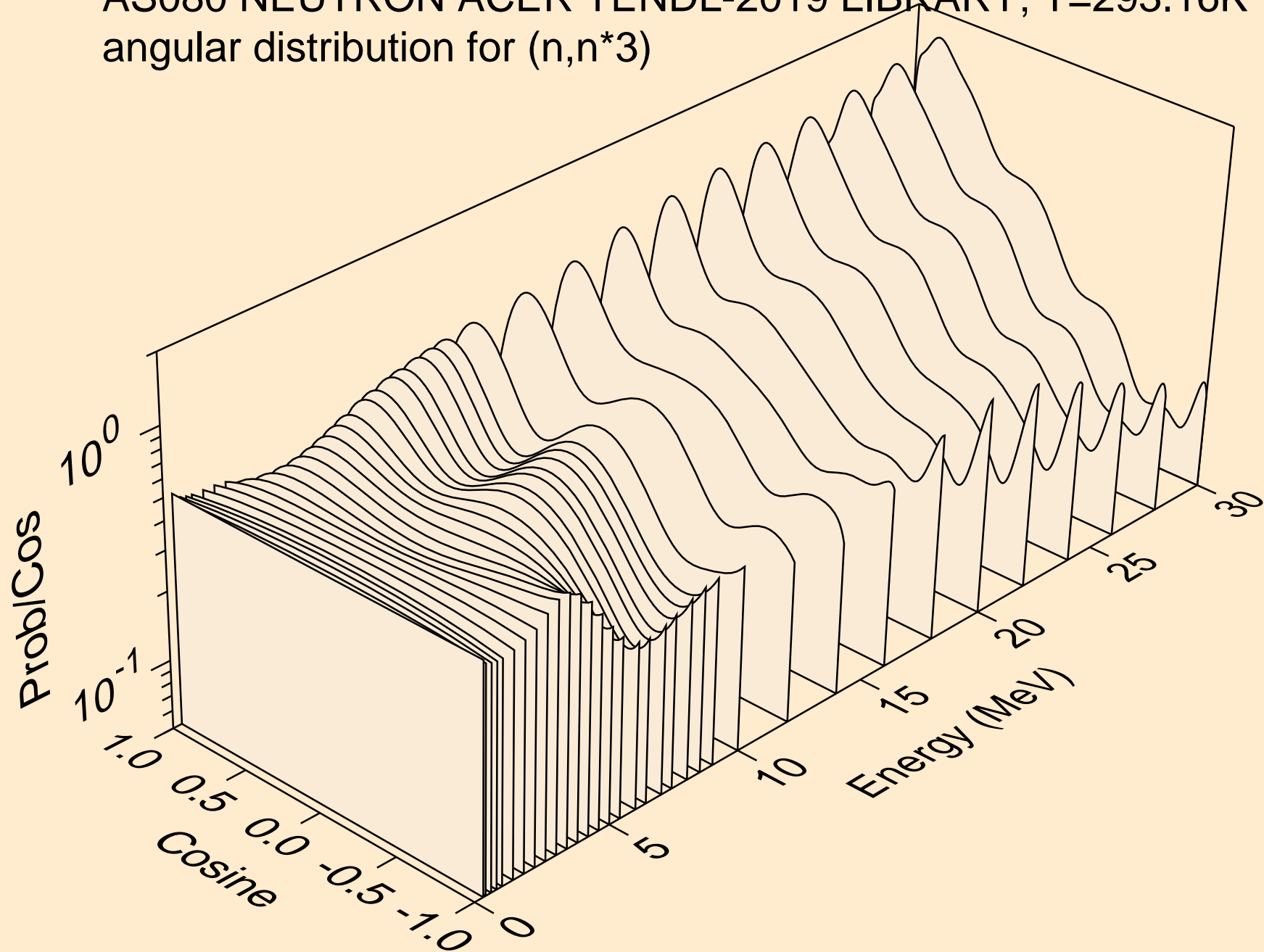

AS080 NEUTRON ACER TENDL-2019 LIBRARY; T=293.16K
angular distribution for (n,n*4)

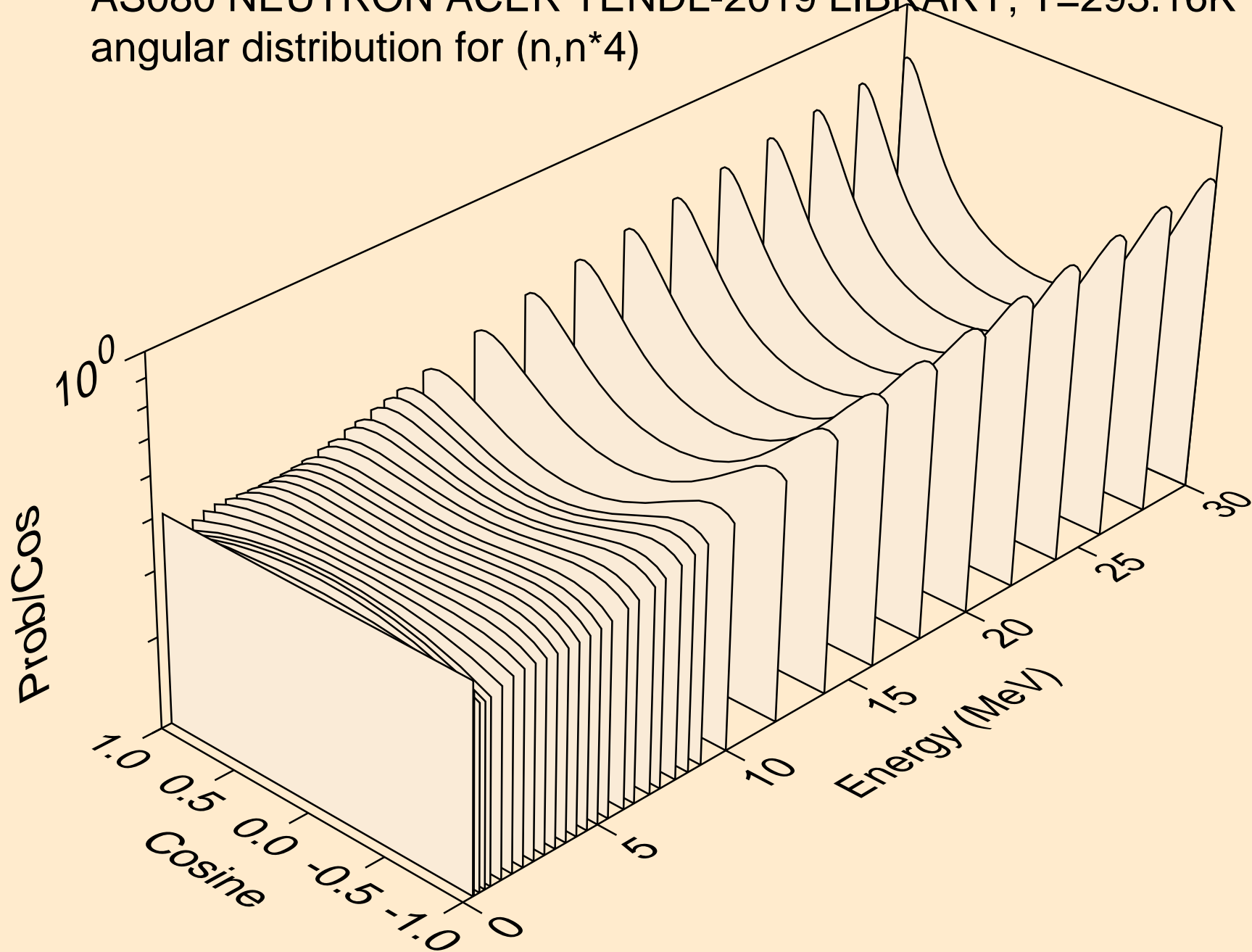

AS080 NEUTRON ACER TENDL-2019 LIBRARY; T=293.16K
angular distribution for (n,n*5)

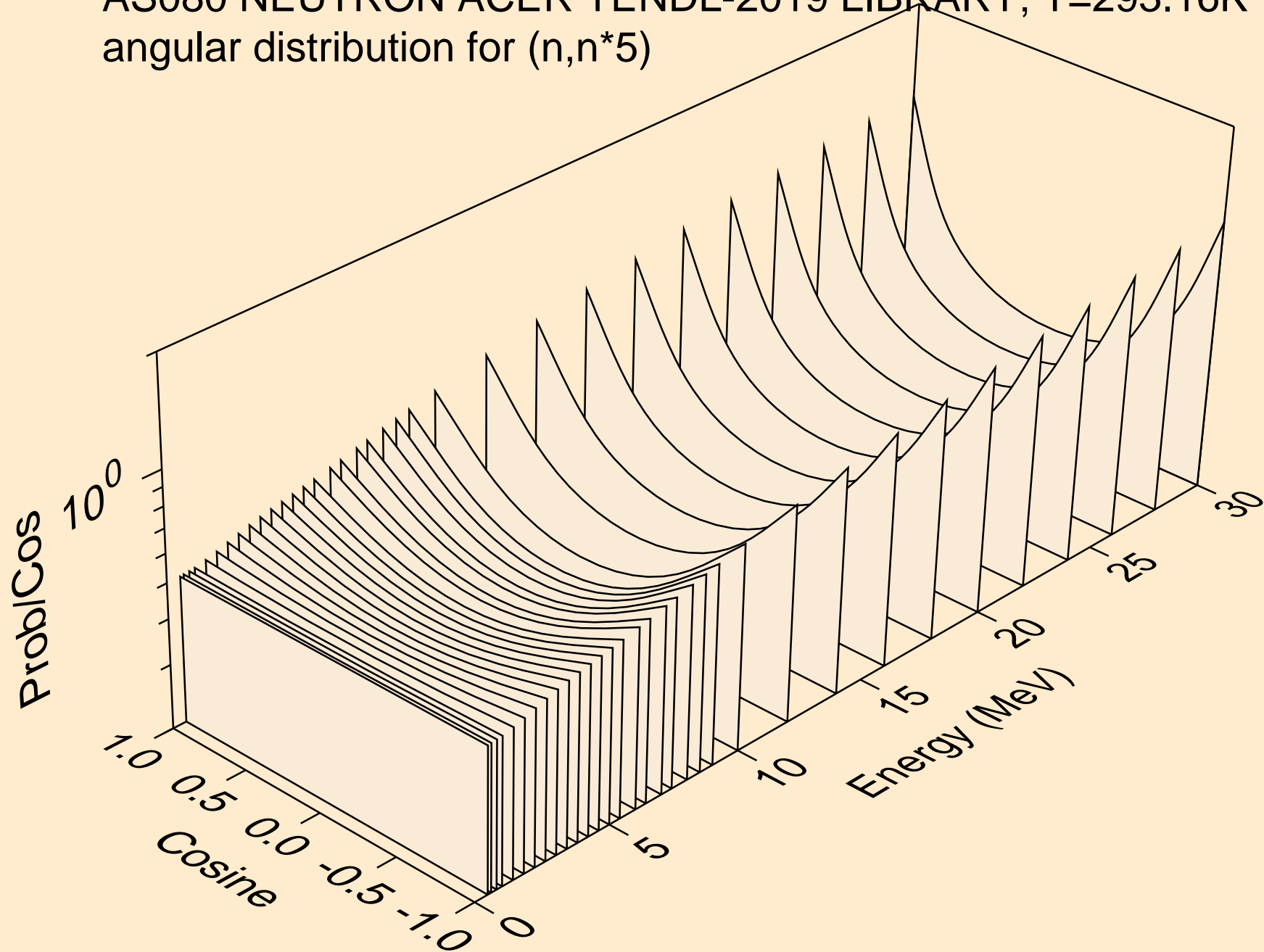

AS080 NEUTRON ACER TENDL-2019 LIBRARY; T=293.16K
angular distribution for (n,n*6)

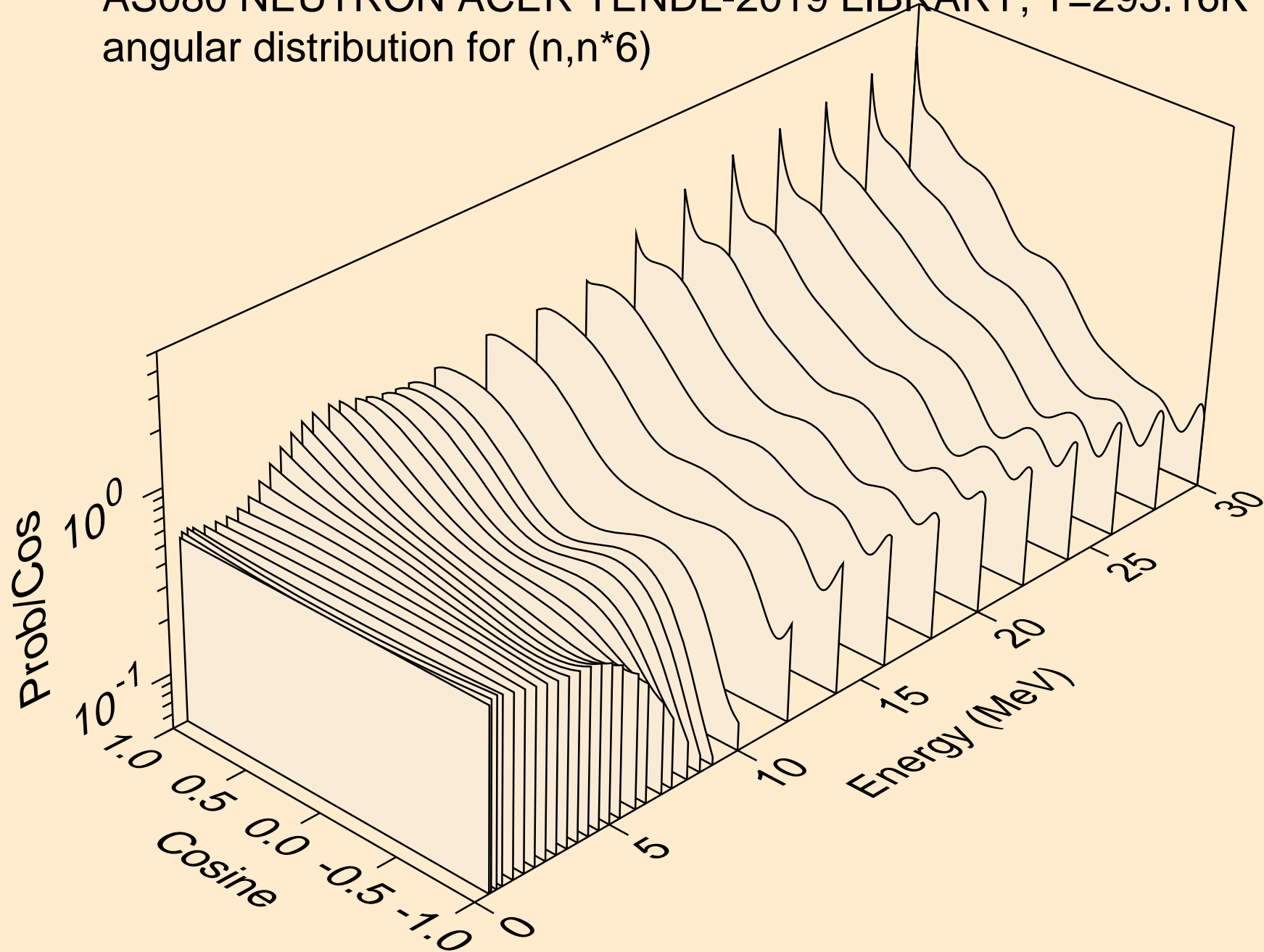

AS080 NEUTRON ACER TENDL-2019 LIBRARY; T=293.16K
angular distribution for (n,n*7)

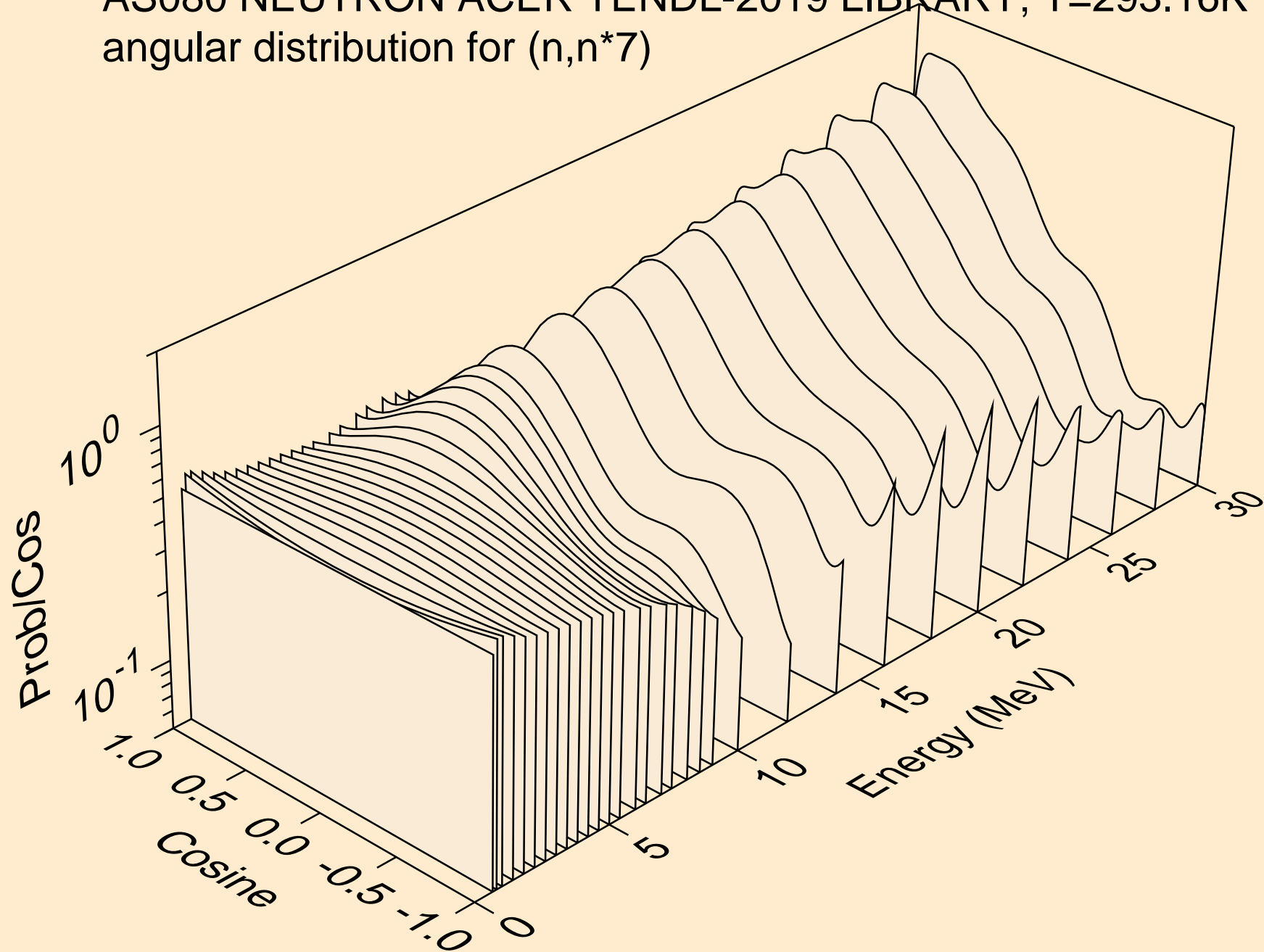

AS080 NEUTRON ACER TENDL-2019 LIBRARY; T=293.16K
angular distribution for (n,n*8)

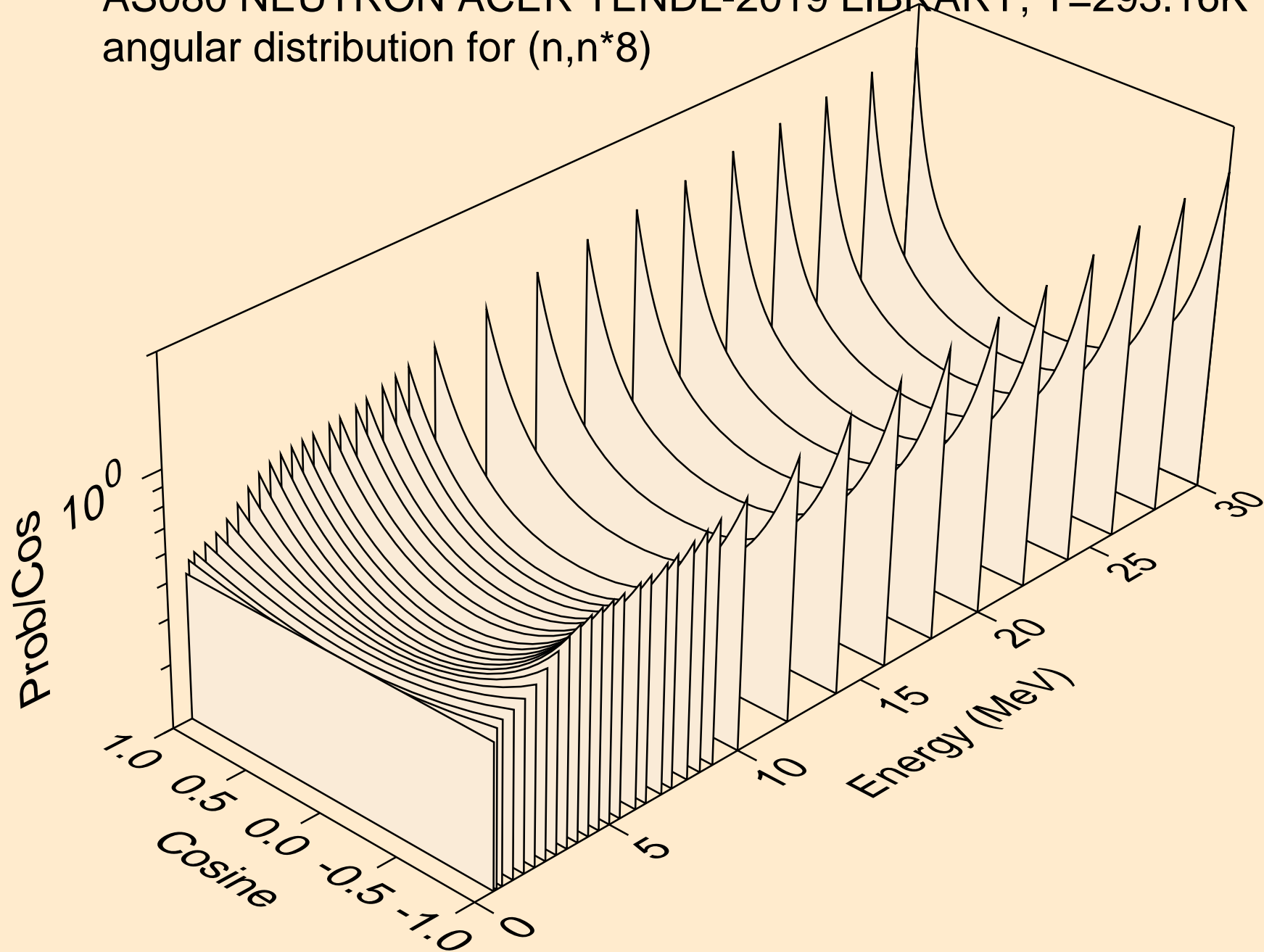

AS080 NEUTRON ACER TENDL-2019 LIBRARY; T=293.16K
angular distribution for (n,n*9)

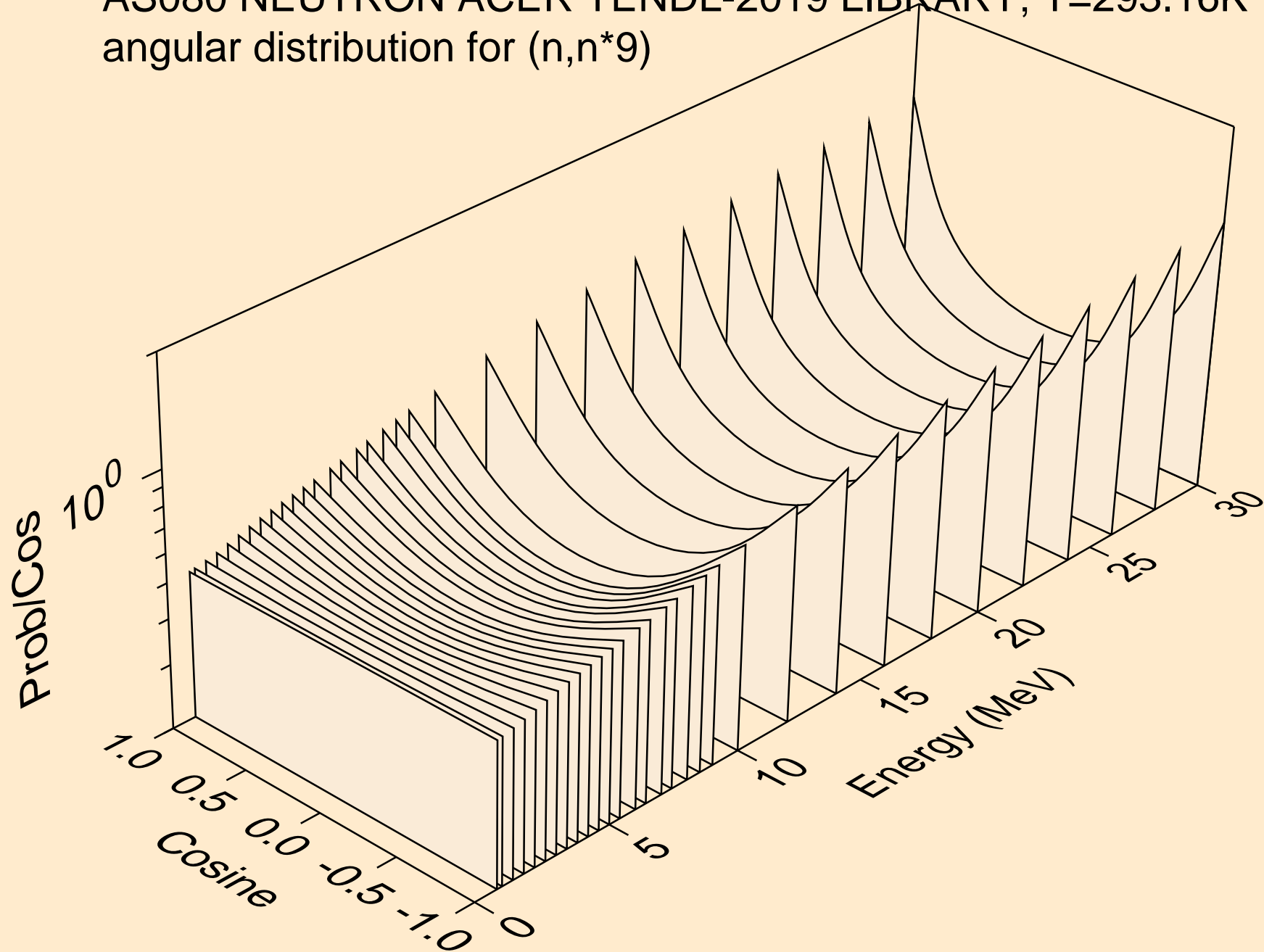

AS080 NEUTRON ACER TENDL-2019 LIBRARY; T=293.16K
angular distribution for (n,n*10)

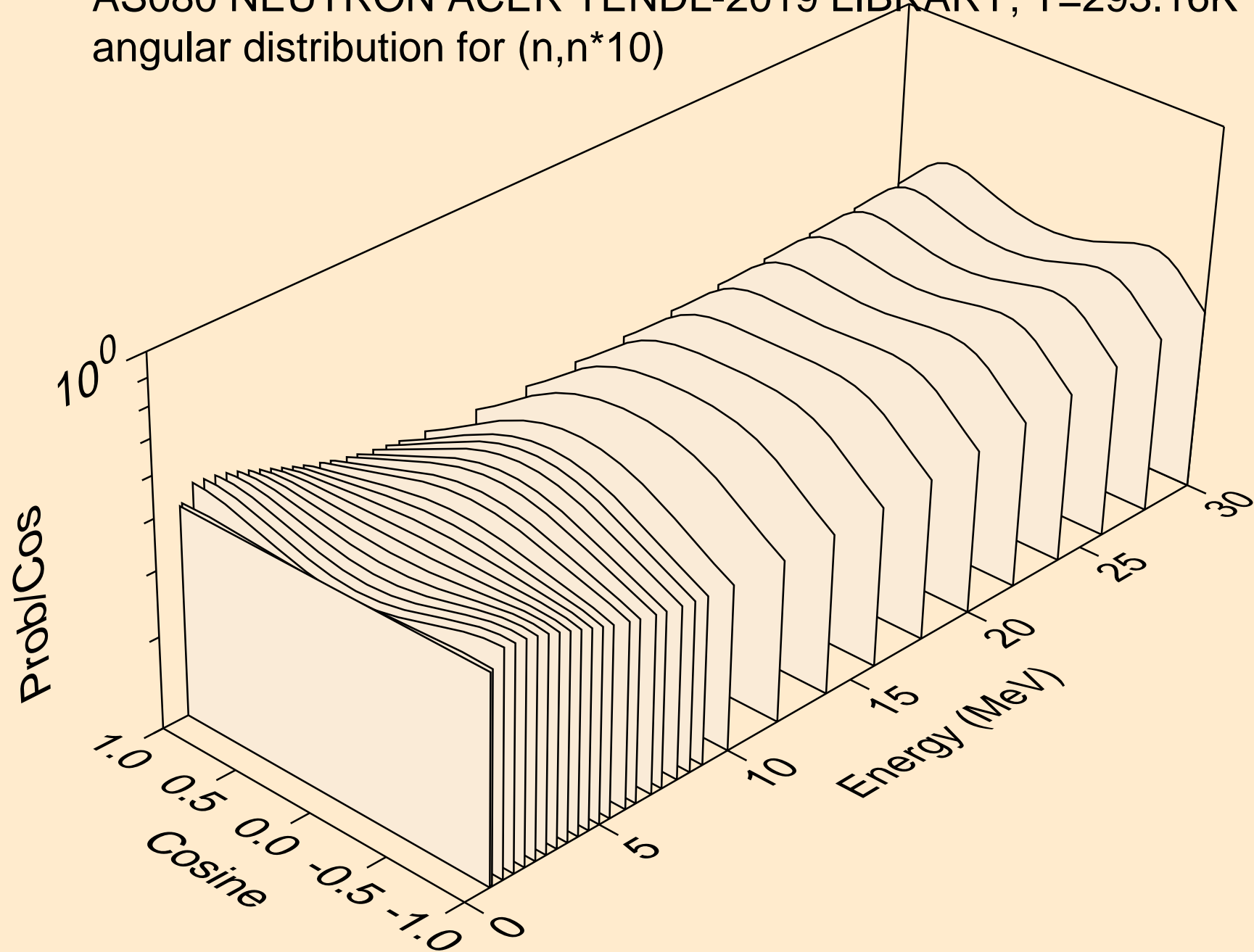

AS080 NEUTRON ACER TENDL-2019 LIBRARY; T=293.16K
angular distribution for (n,n*11)

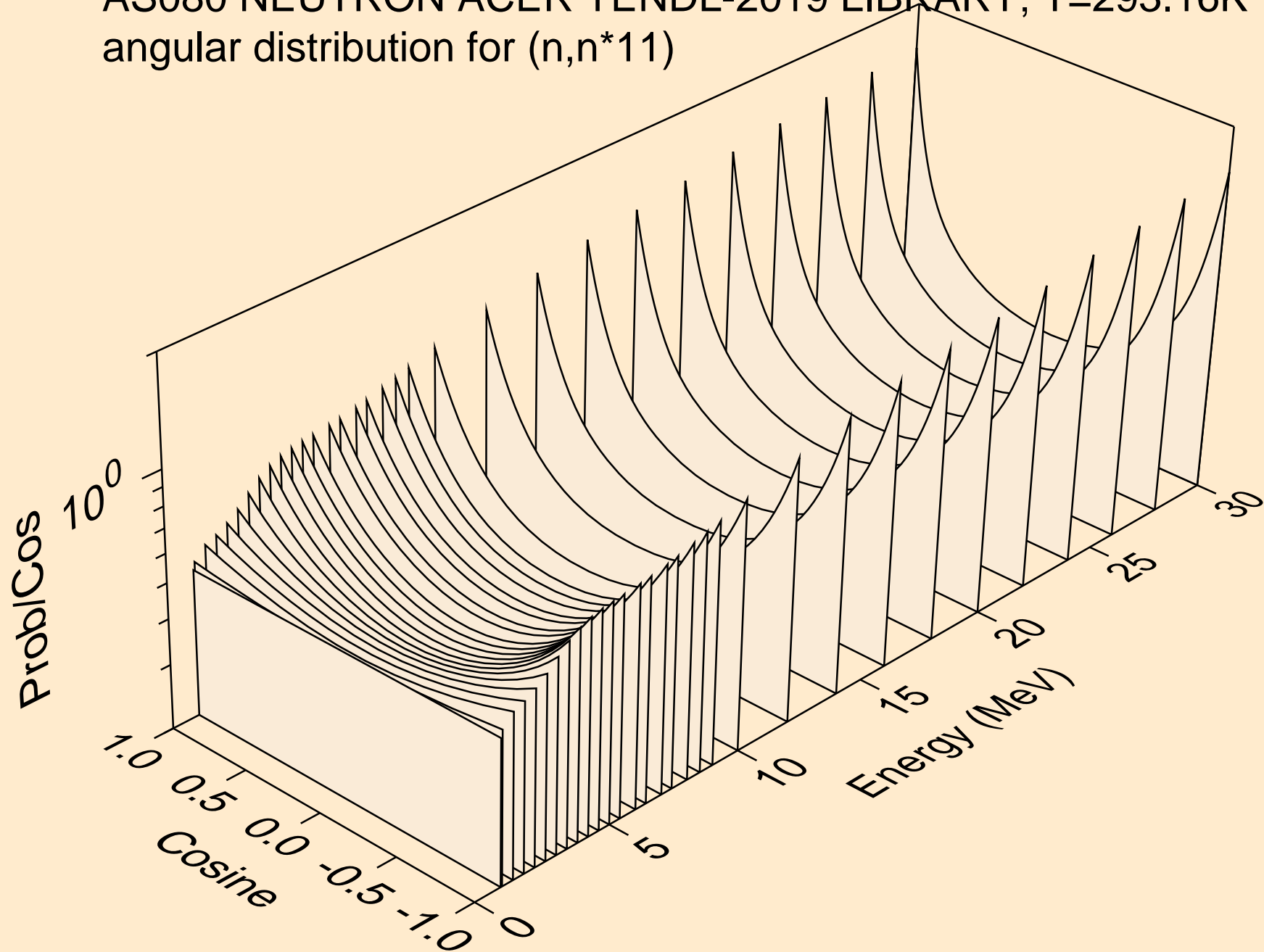

AS080 NEUTRON ACER TENDL-2019 LIBRARY; T=293.16K
angular distribution for (n,n*12)

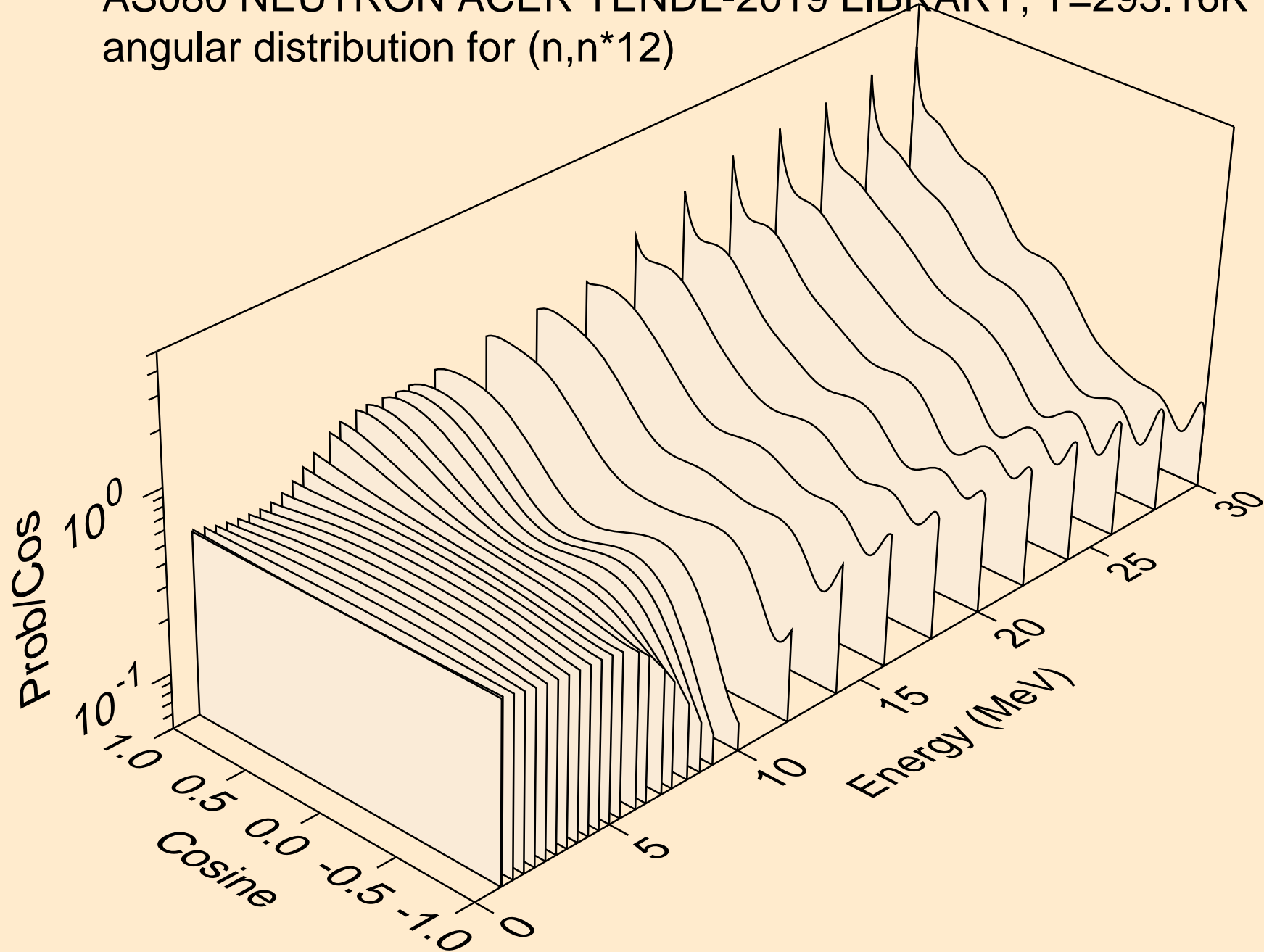

AS080 NEUTRON ACER TENDL-2019 LIBRARY; T=293.16K
angular distribution for (n,n*13)

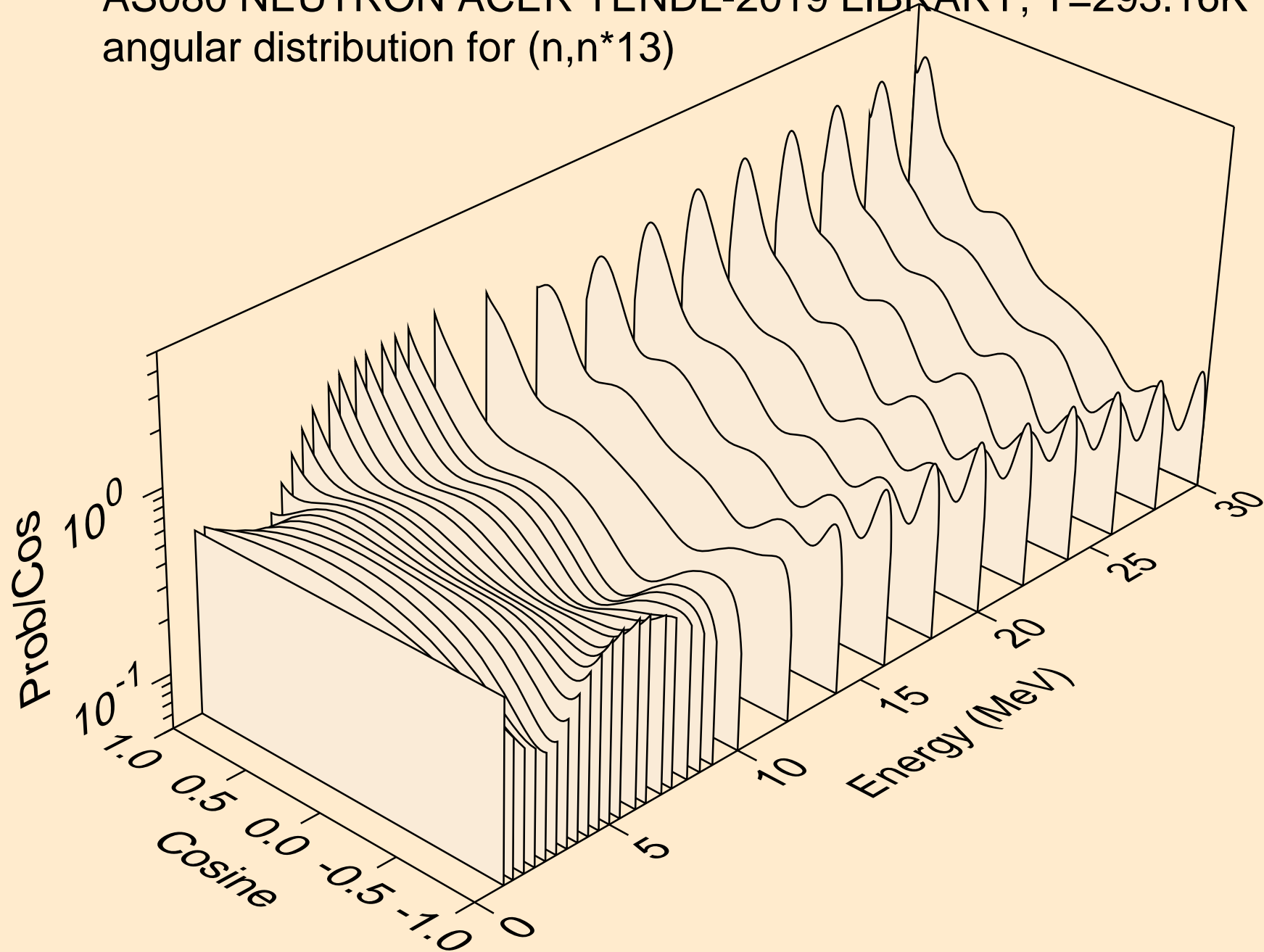

AS080 NEUTRON ACER TENDL-2019 LIBRARY; T=293.16K
angular distribution for (n,n*14)

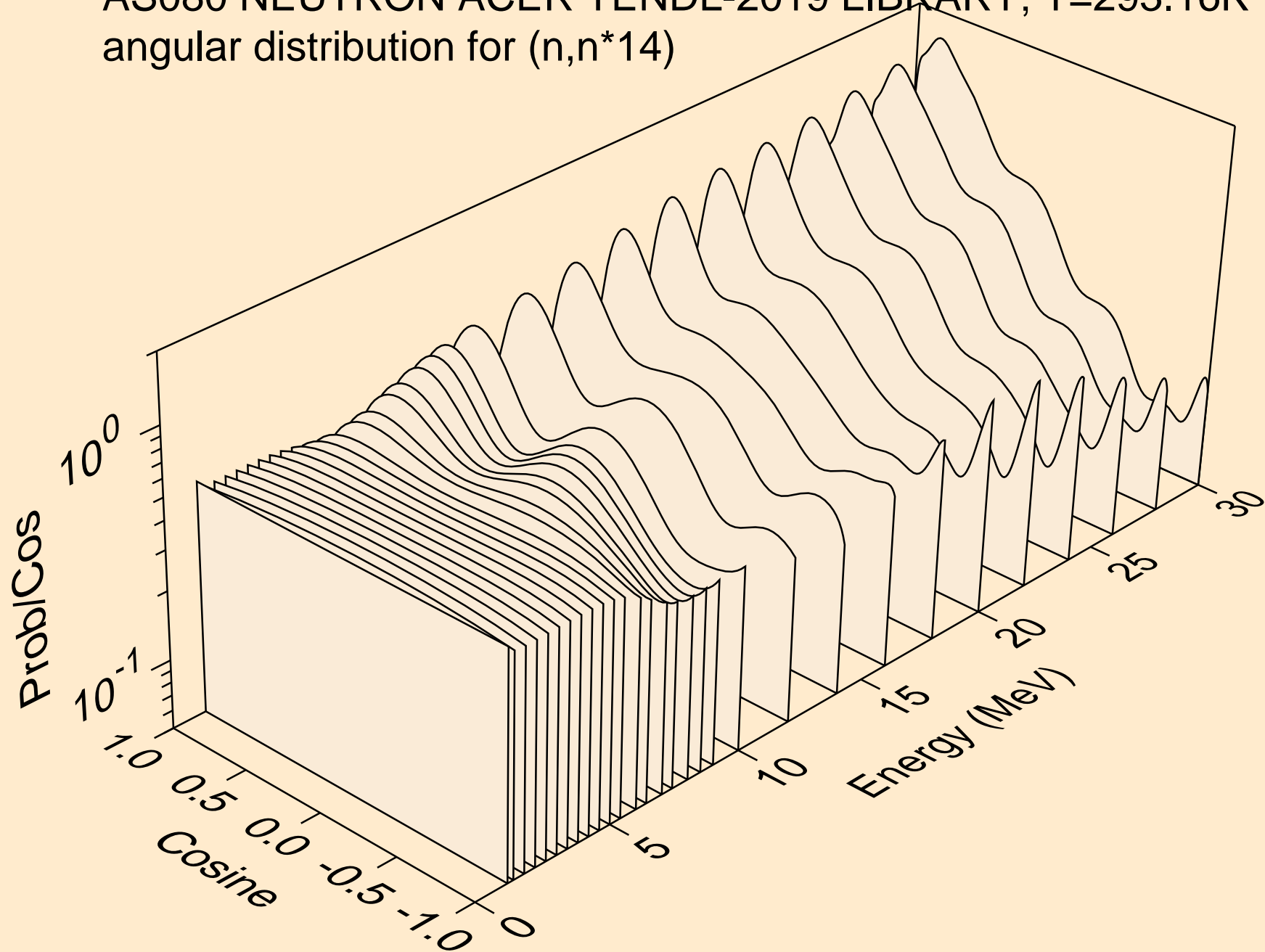

AS080 NEUTRON ACER TENDL-2019 LIBRARY; T=293.16K
angular distribution for (n,n*15)

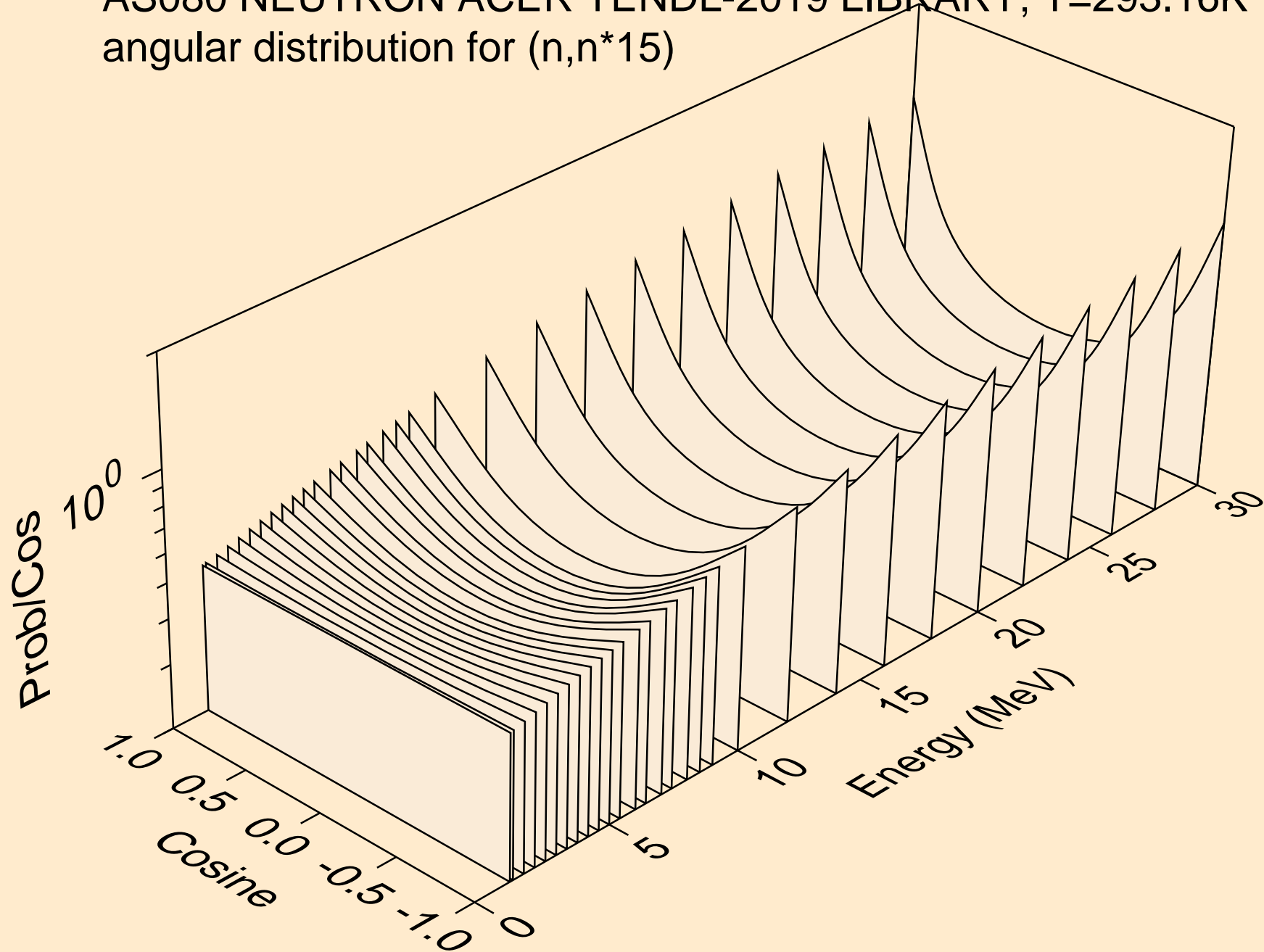

AS080 NEUTRON ACER TENDL-2019 LIBRARY; T=293.16K
angular distribution for (n,n*16)

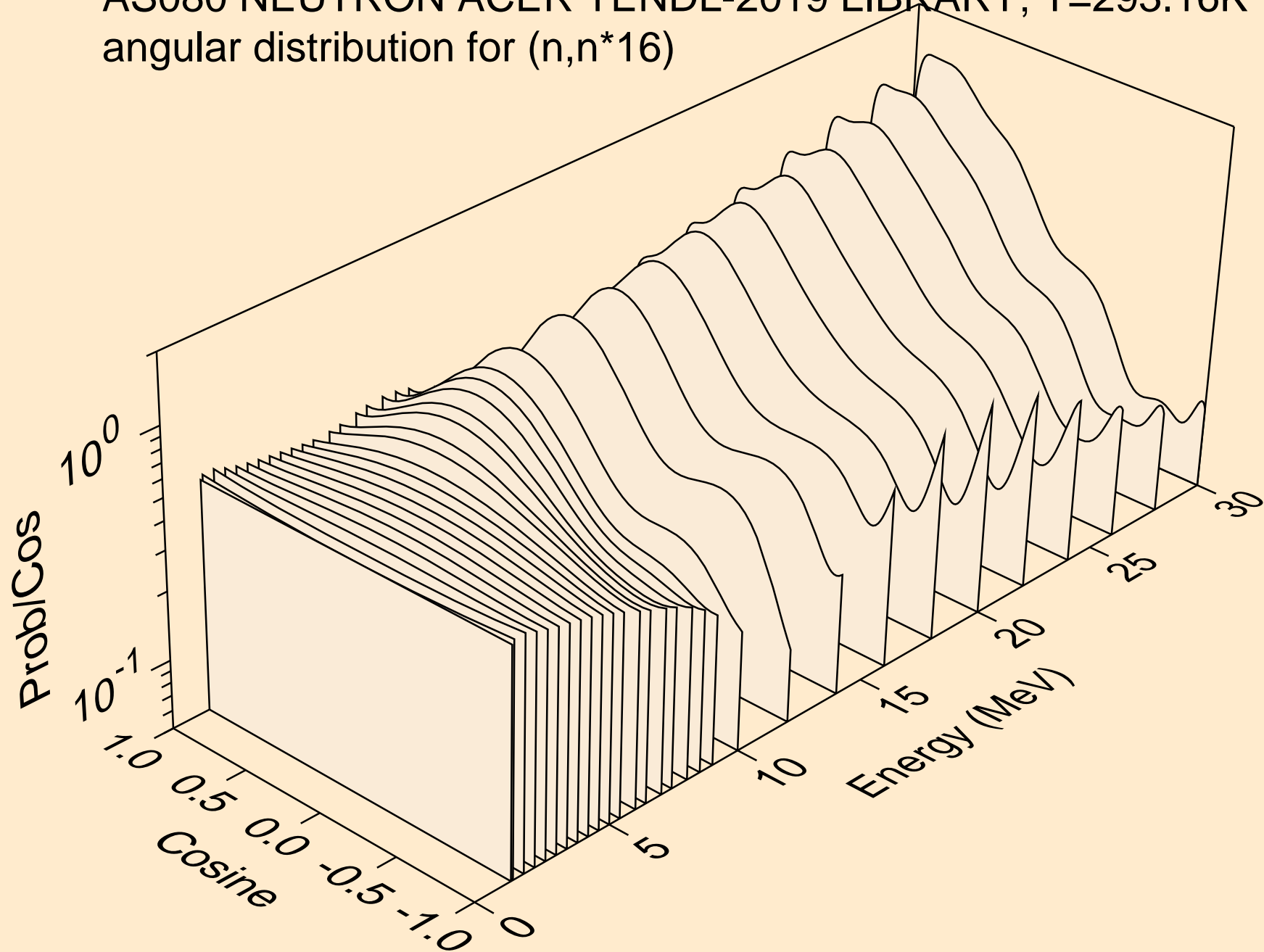

AS080 NEUTRON ACER TENDL-2019 LIBRARY; T=293.16K
angular distribution for (n,n*17)

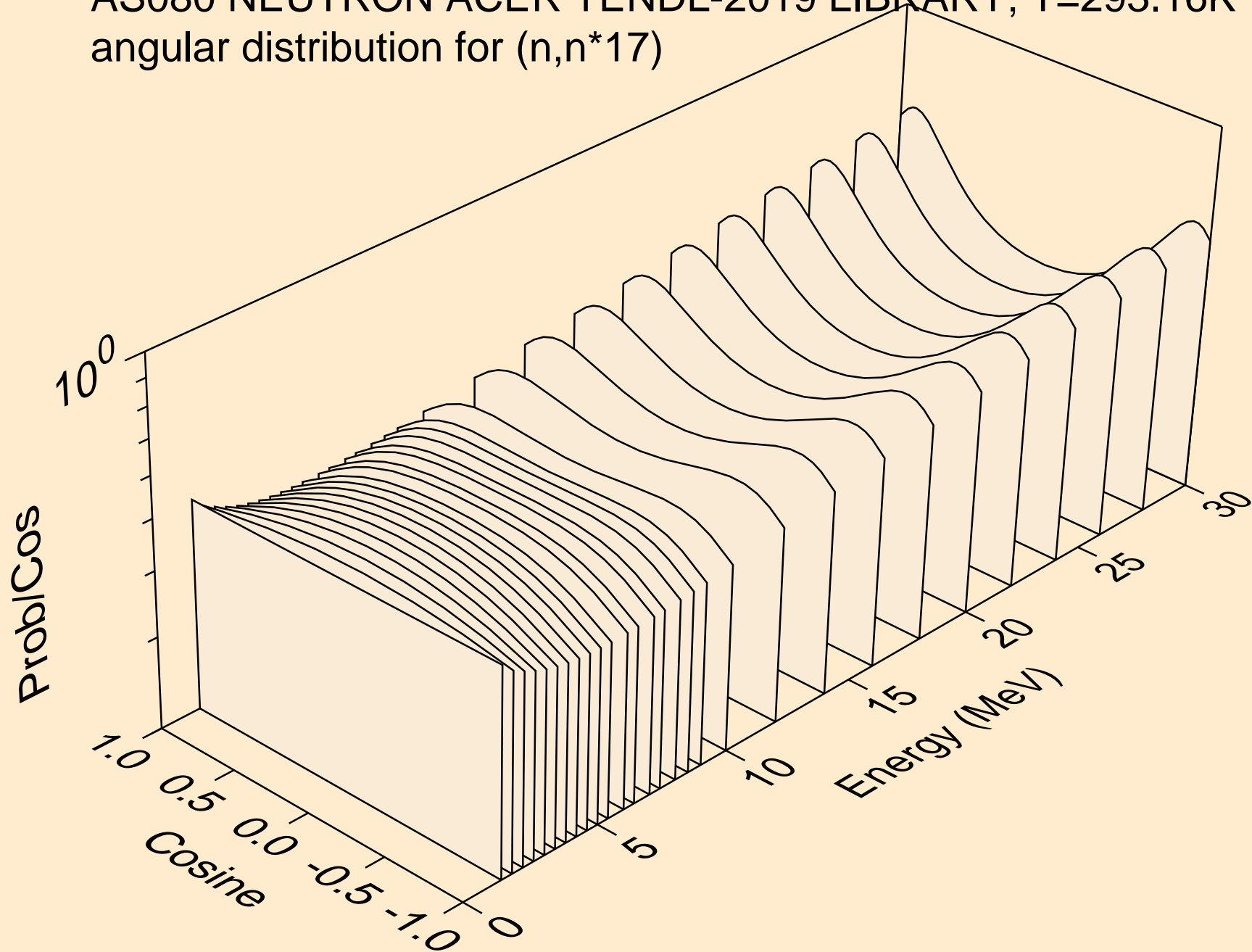

AS080 NEUTRON ACER TENDL-2019 LIBRARY; T=293.16K
angular distribution for (n,n*18)

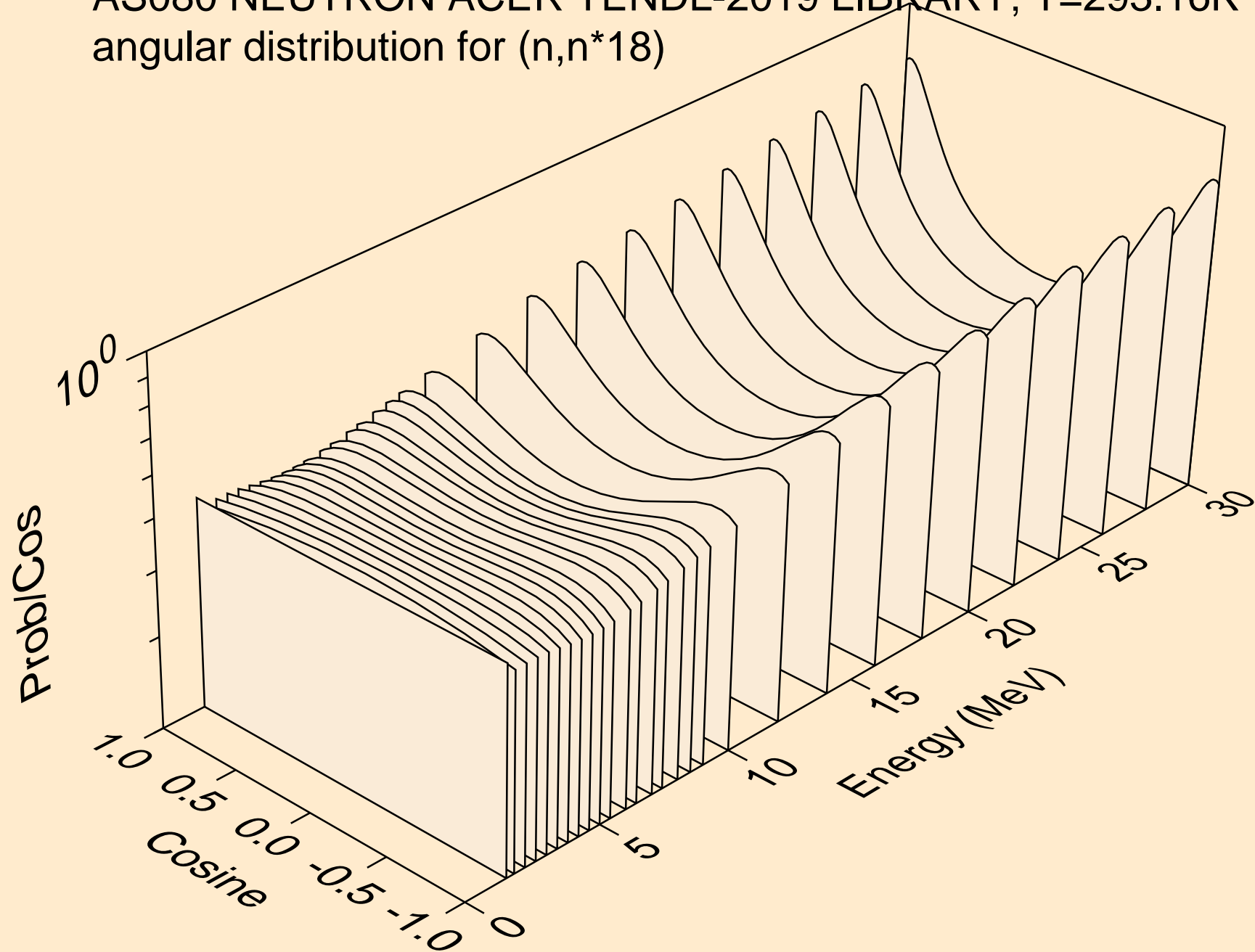

AS080 NEUTRON ACER TENDL-2019 LIBRARY; T=293.16K
angular distribution for (n,n*19)

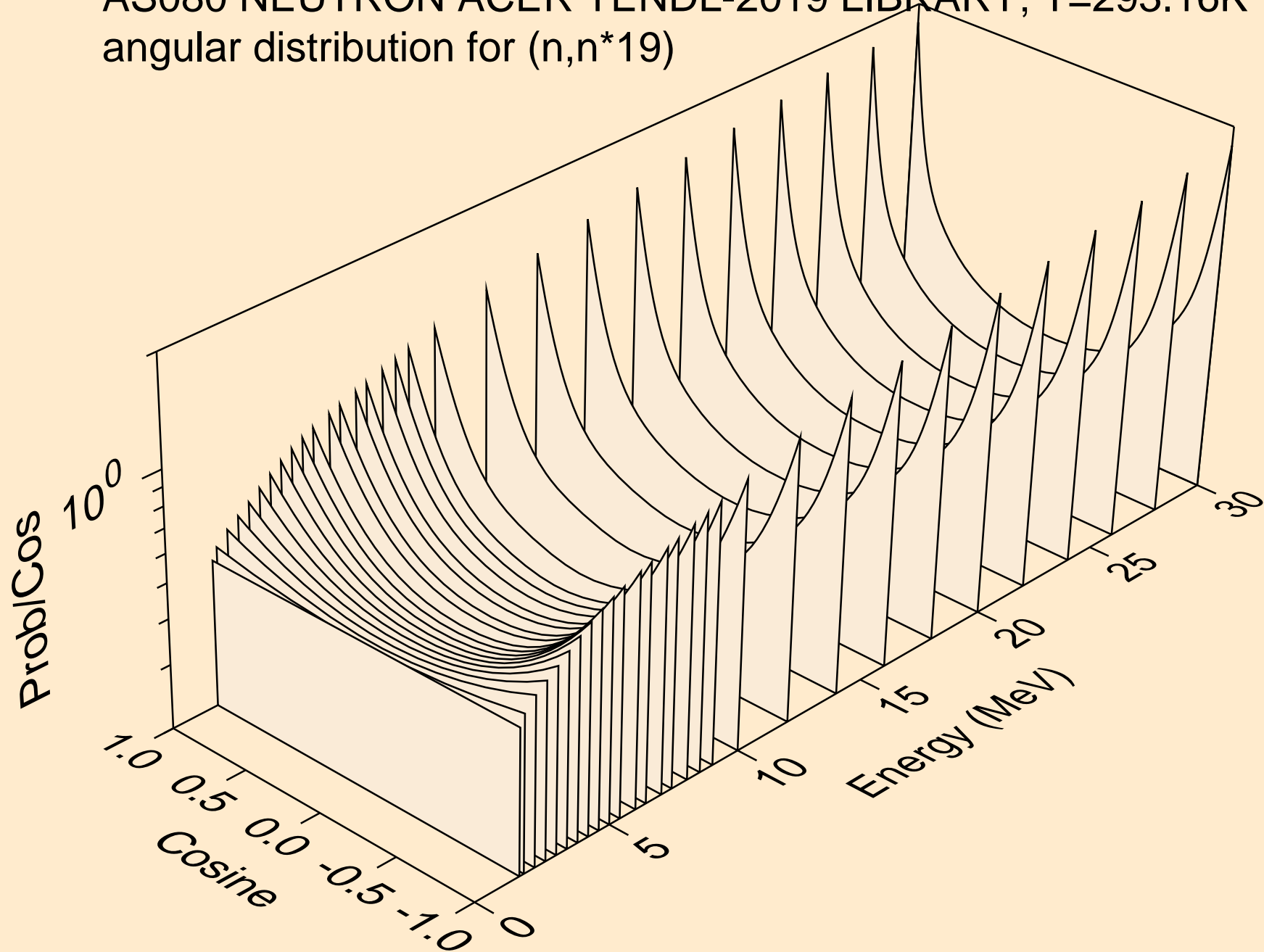

AS080 NEUTRON ACER TENDL-2019 LIBRARY; T=293.16K
angular distribution for (n,n*20)

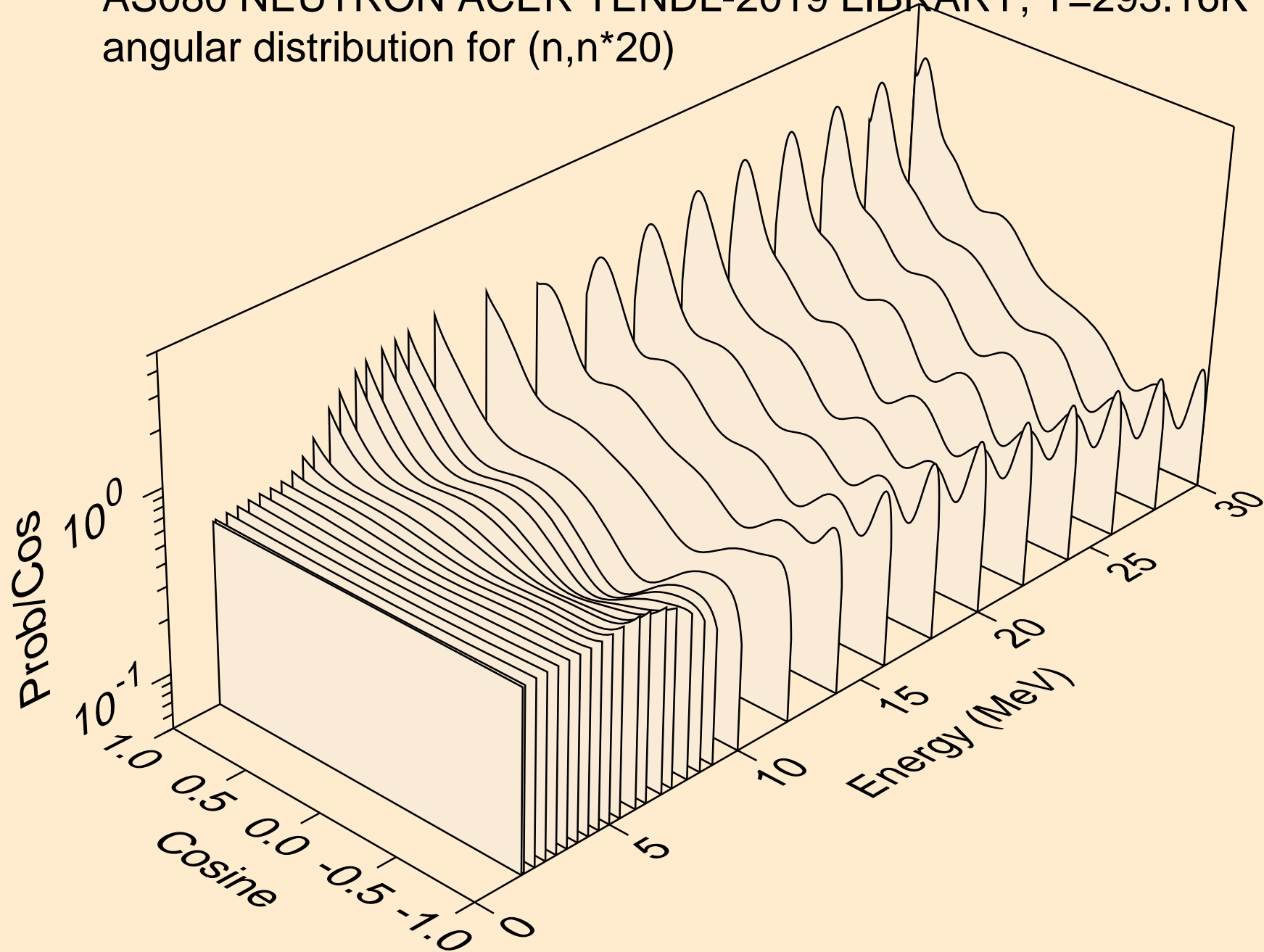

AS080 NEUTRON ACER TENDL-2019 LIBRARY; T=293.16K
angular distribution for (n,n*21)

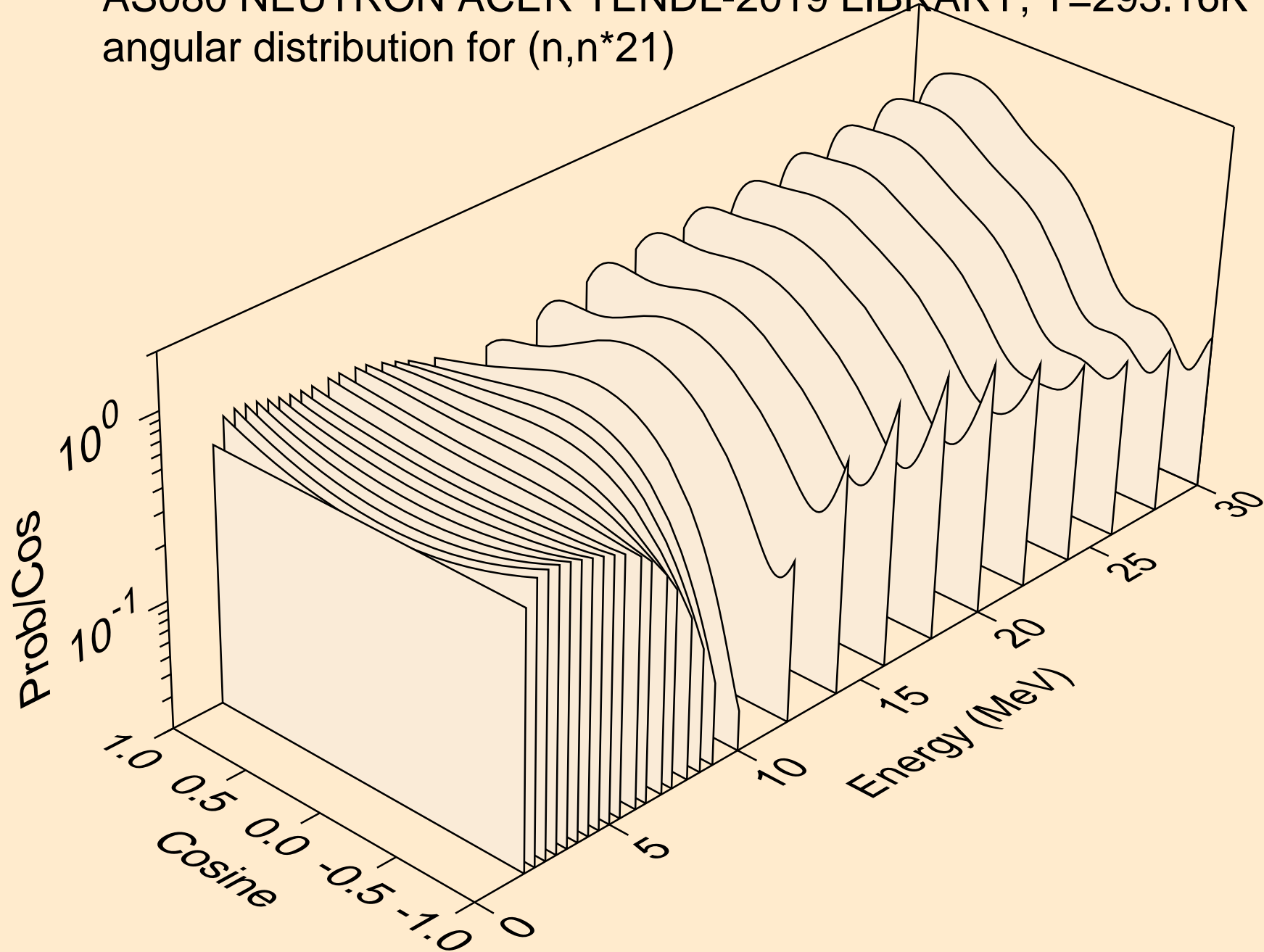

AS080 NEUTRON ACER TENDL-2019 LIBRARY; T=293.16K
angular distribution for (n,n*22)

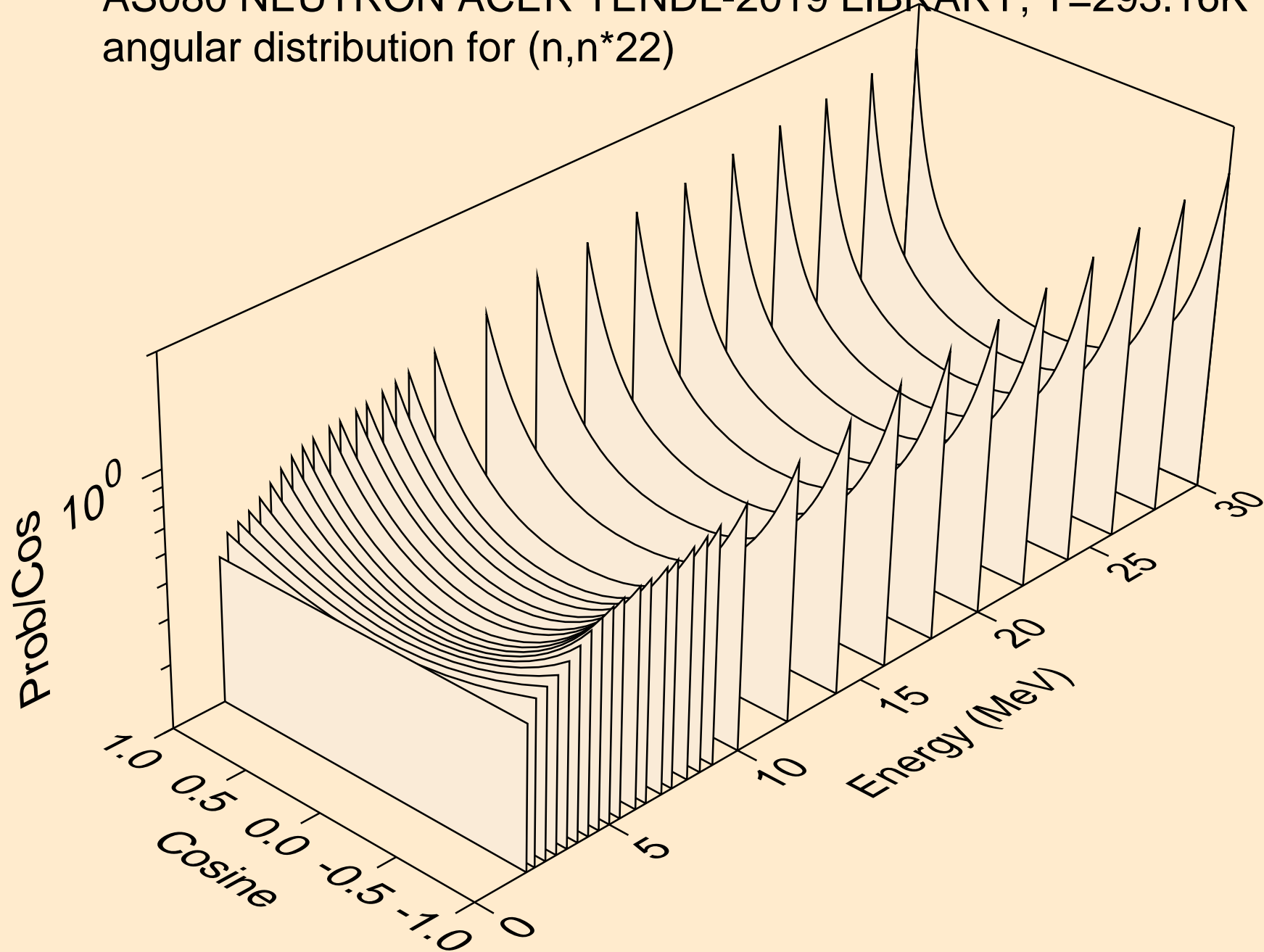

AS080 NEUTRON ACER TENDL-2019 LIBRARY; T=293.16K
angular distribution for (n,n*23)

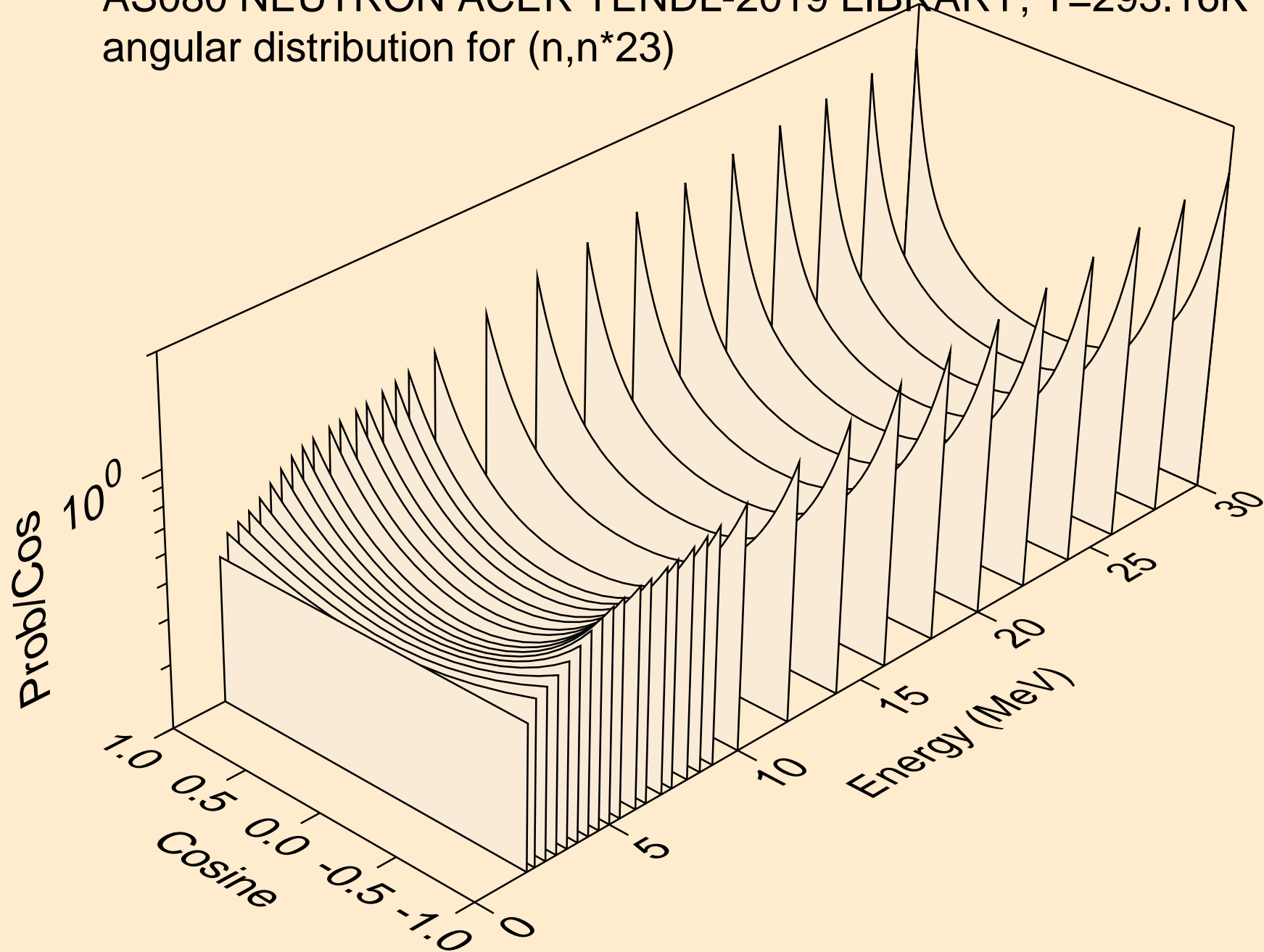

AS080 NEUTRON ACER TENDL-2019 LIBRARY; T=293.16K
angular distribution for (n,n*24)

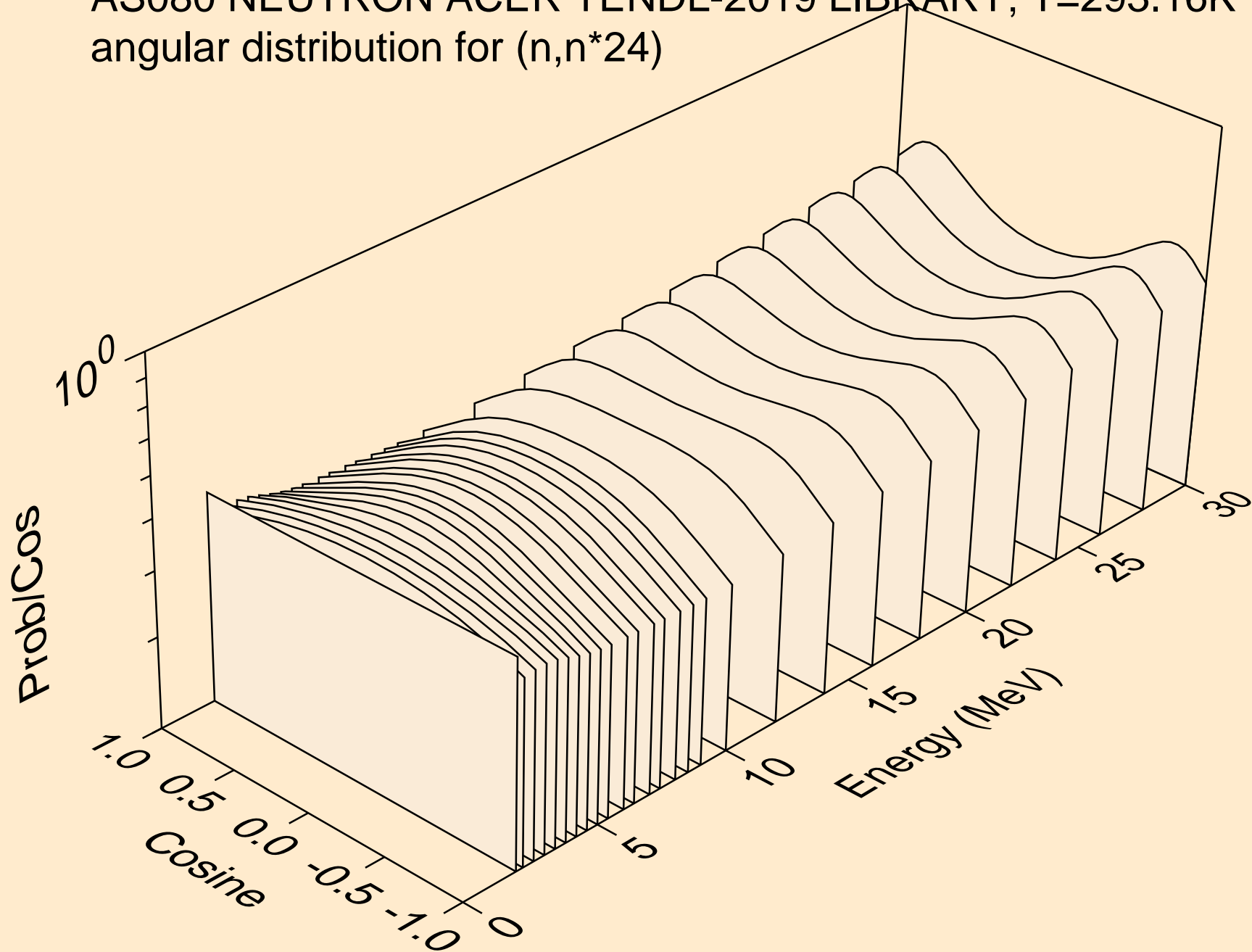

AS080 NEUTRON ACER TENDL-2019 LIBRARY; T=293.16K
angular distribution for (n,n*25)

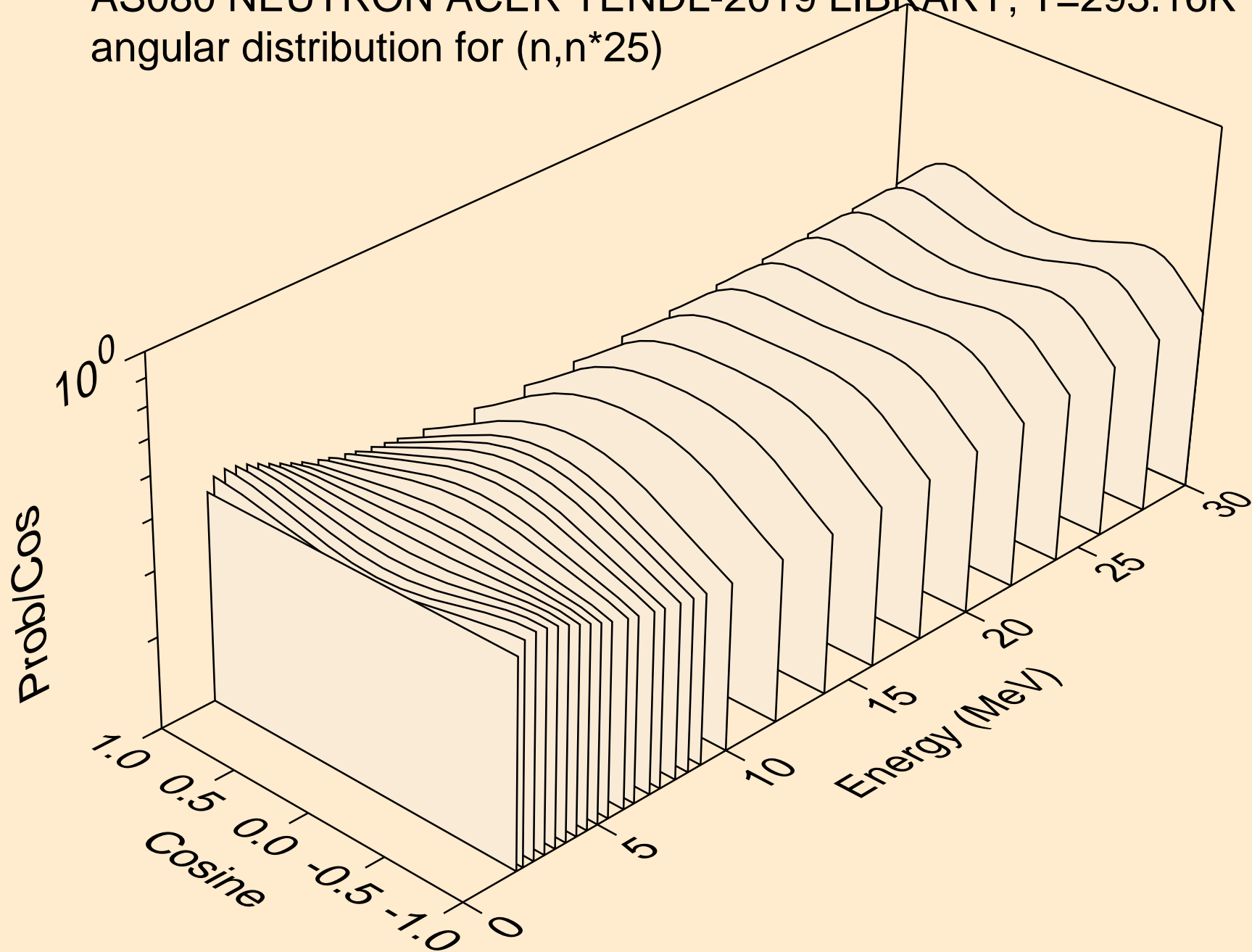

AS080 NEUTRON ACER TENDL-2019 LIBRARY; T=293.16K
angular distribution for (n,n*26)

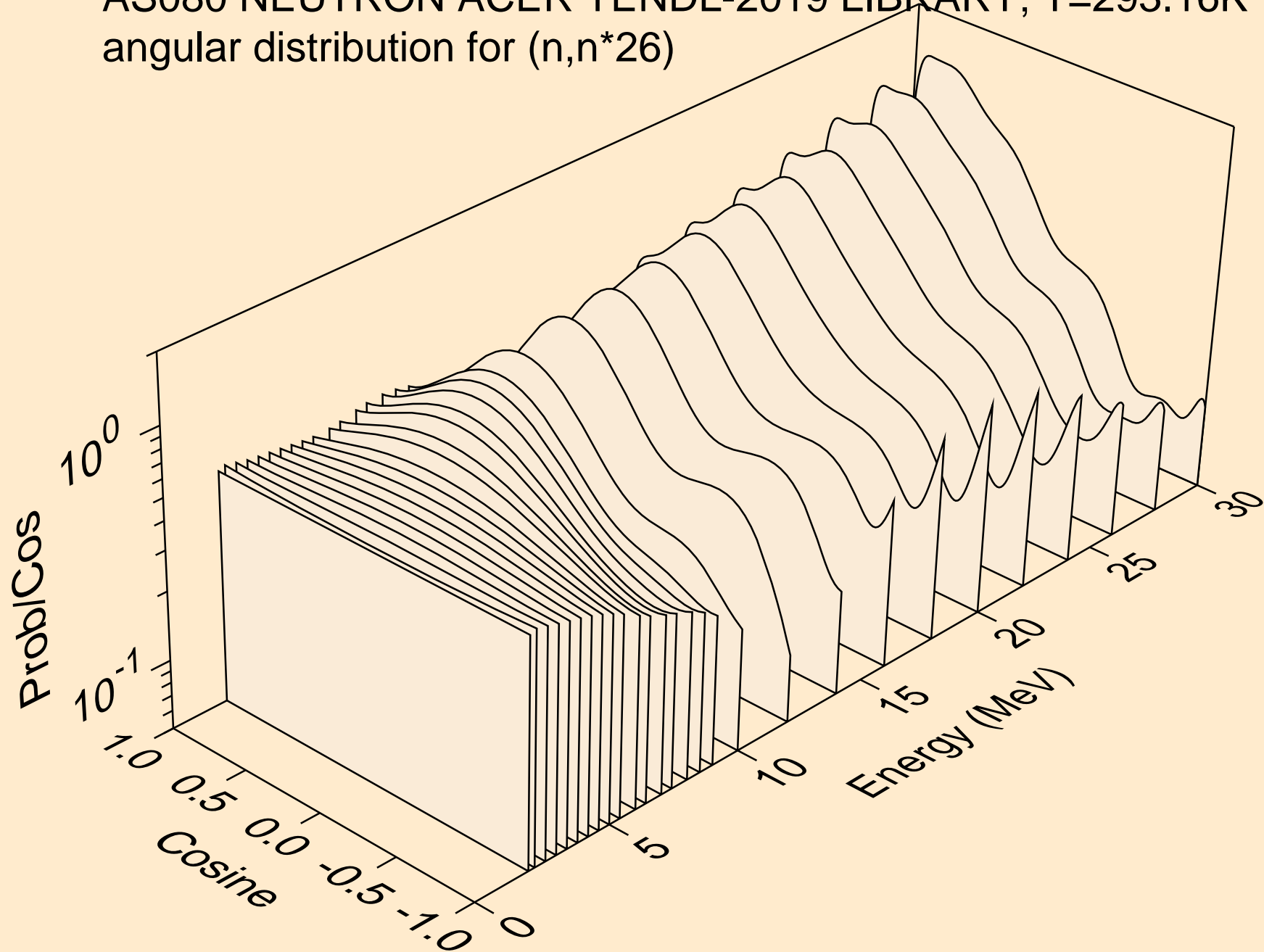

AS080 NEUTRON ACER TENDL-2019 LIBRARY; T=293.16K
angular distribution for (n,n*27)

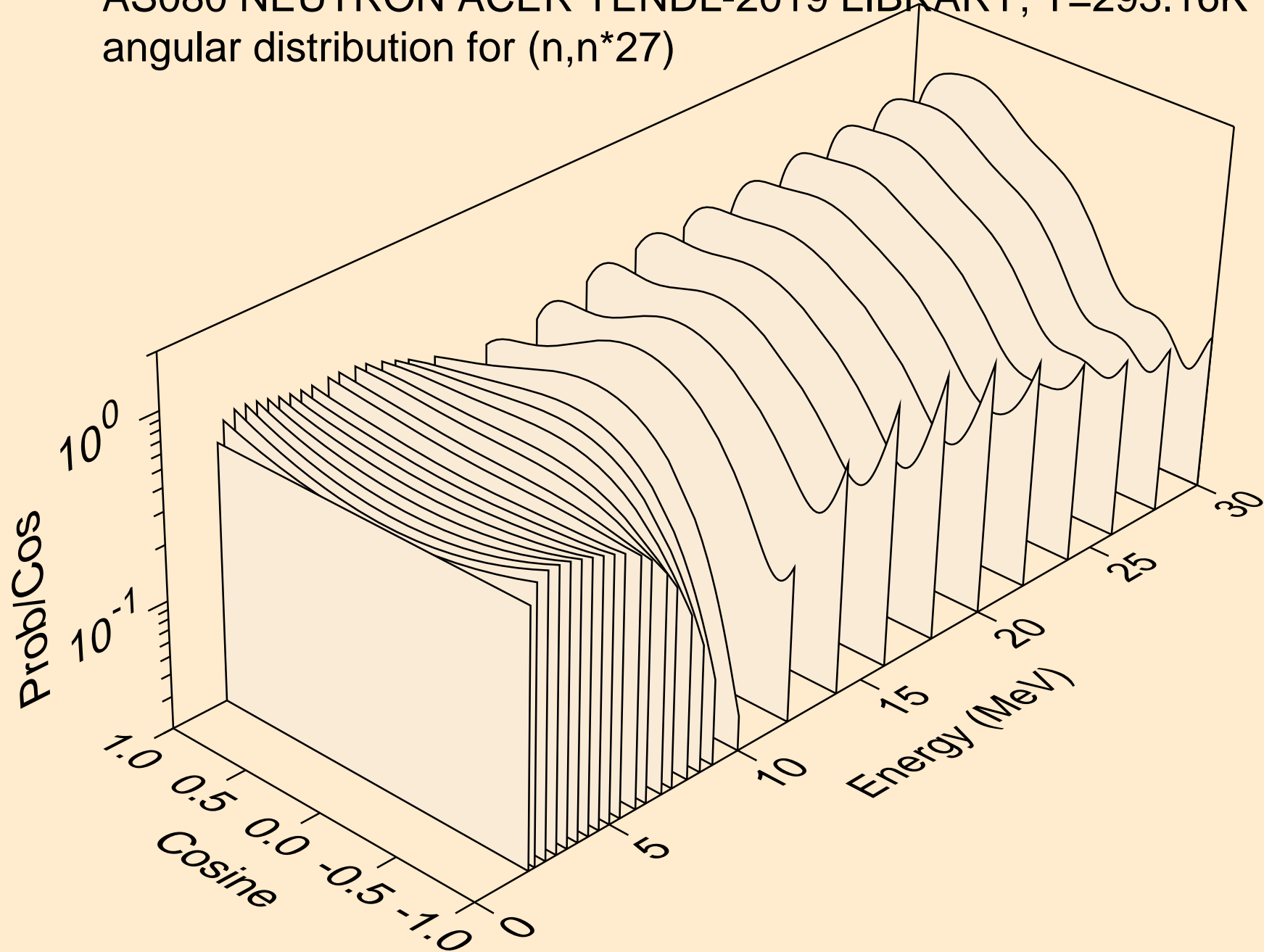

AS080 NEUTRON ACER TENDL-2019 LIBRARY; T=293.16K
angular distribution for (n,n*28)

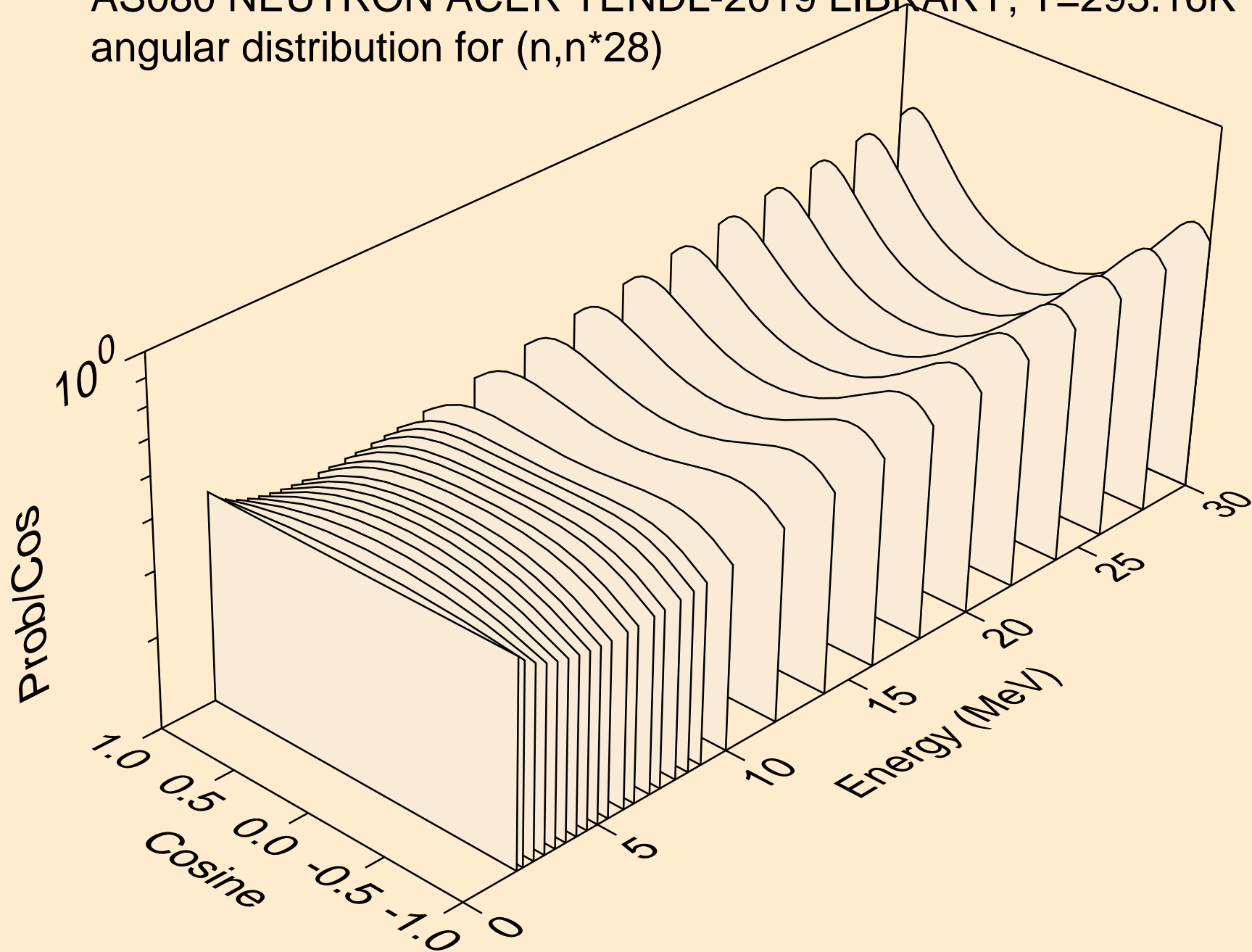

AS080 NEUTRON ACER TENDL-2019 LIBRARY; T=293.16K
angular distribution for (n,n*29)

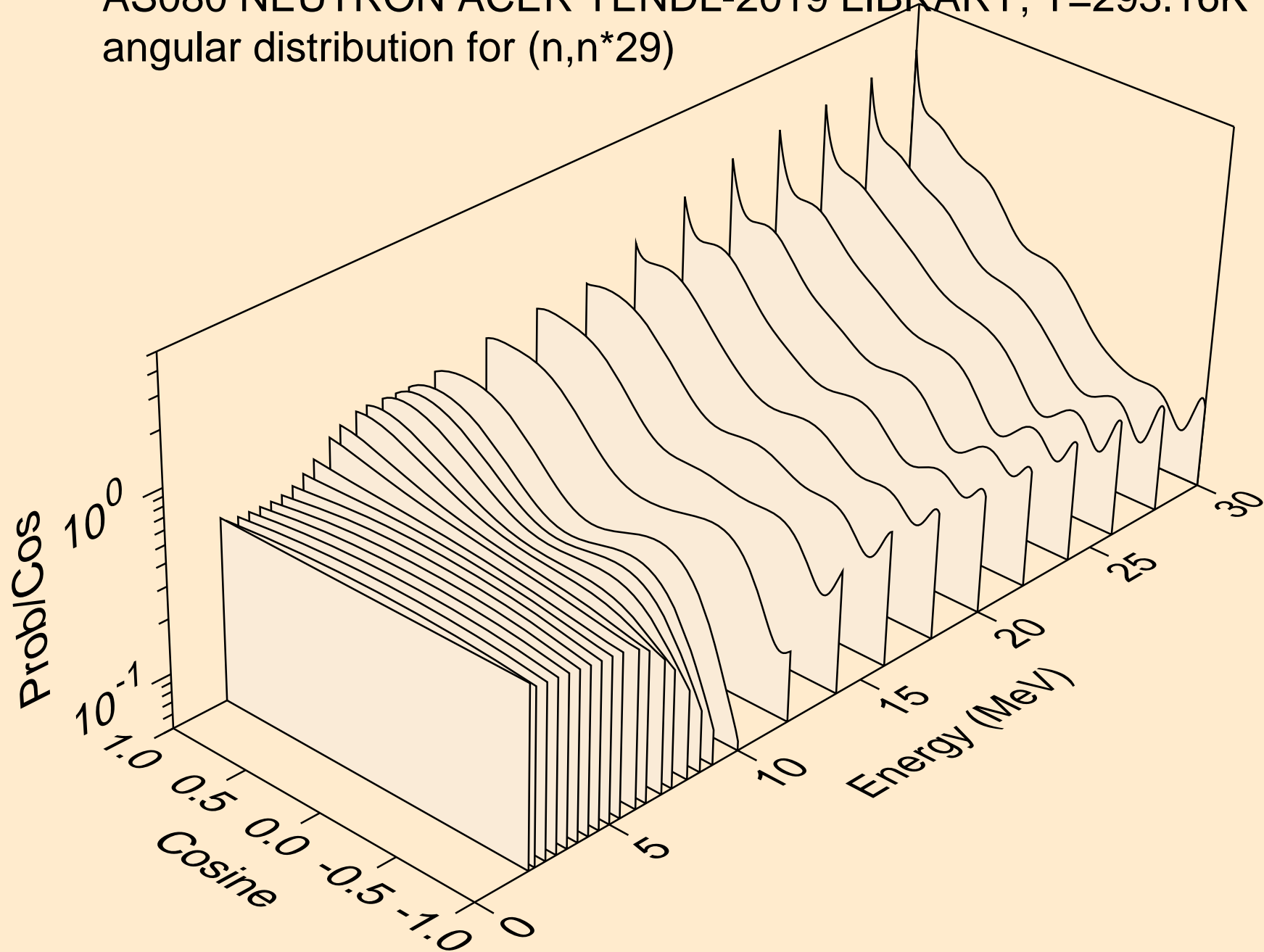

AS080 NEUTRON ACER TENDL-2019 LIBRARY; T=293.16K
Neutron emission for (n,x)

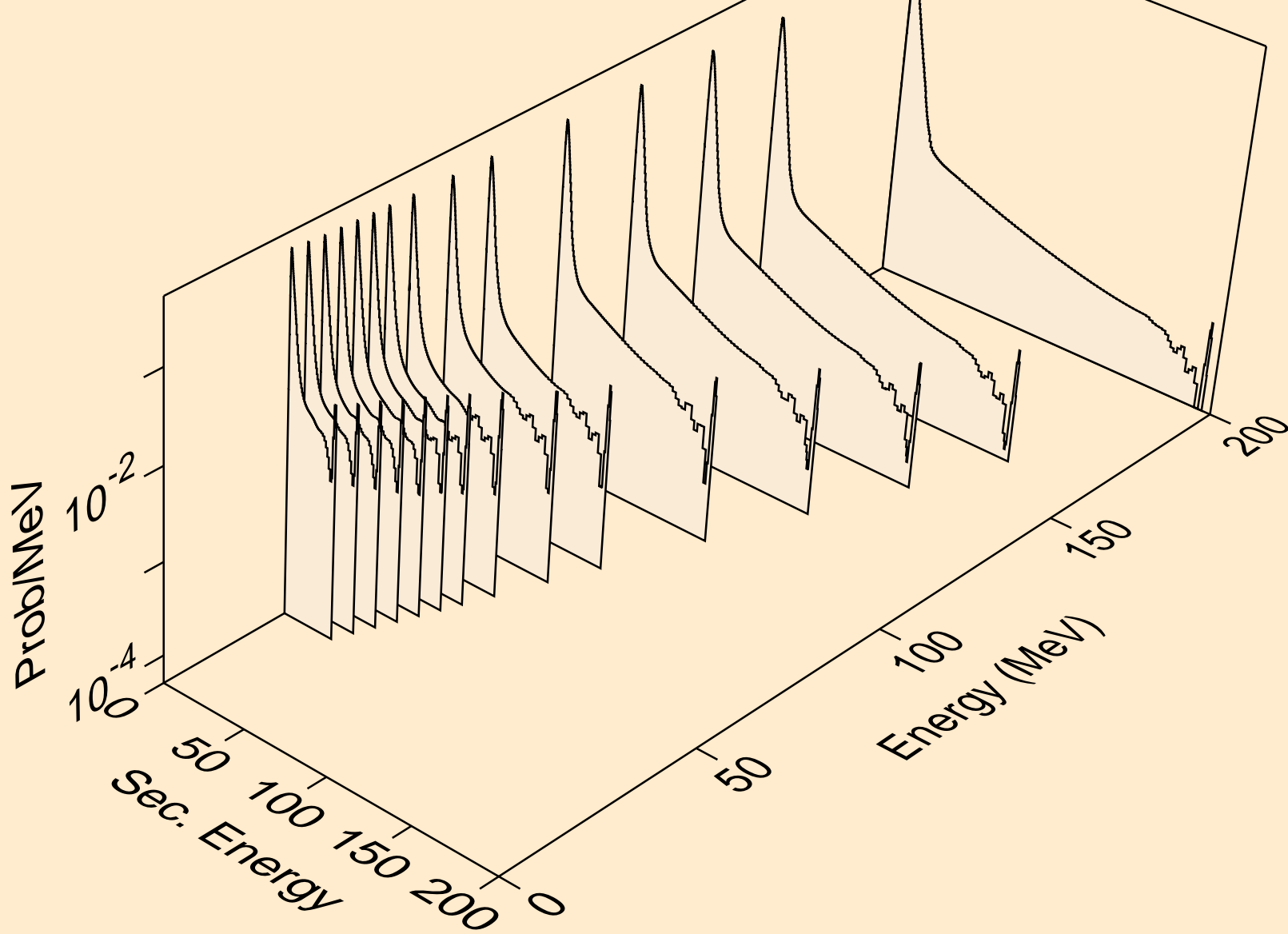

AS080 NEUTRON ACER TENDL-2019 LIBRARY; T=293.16K
Neutron emission for (n,2nd)

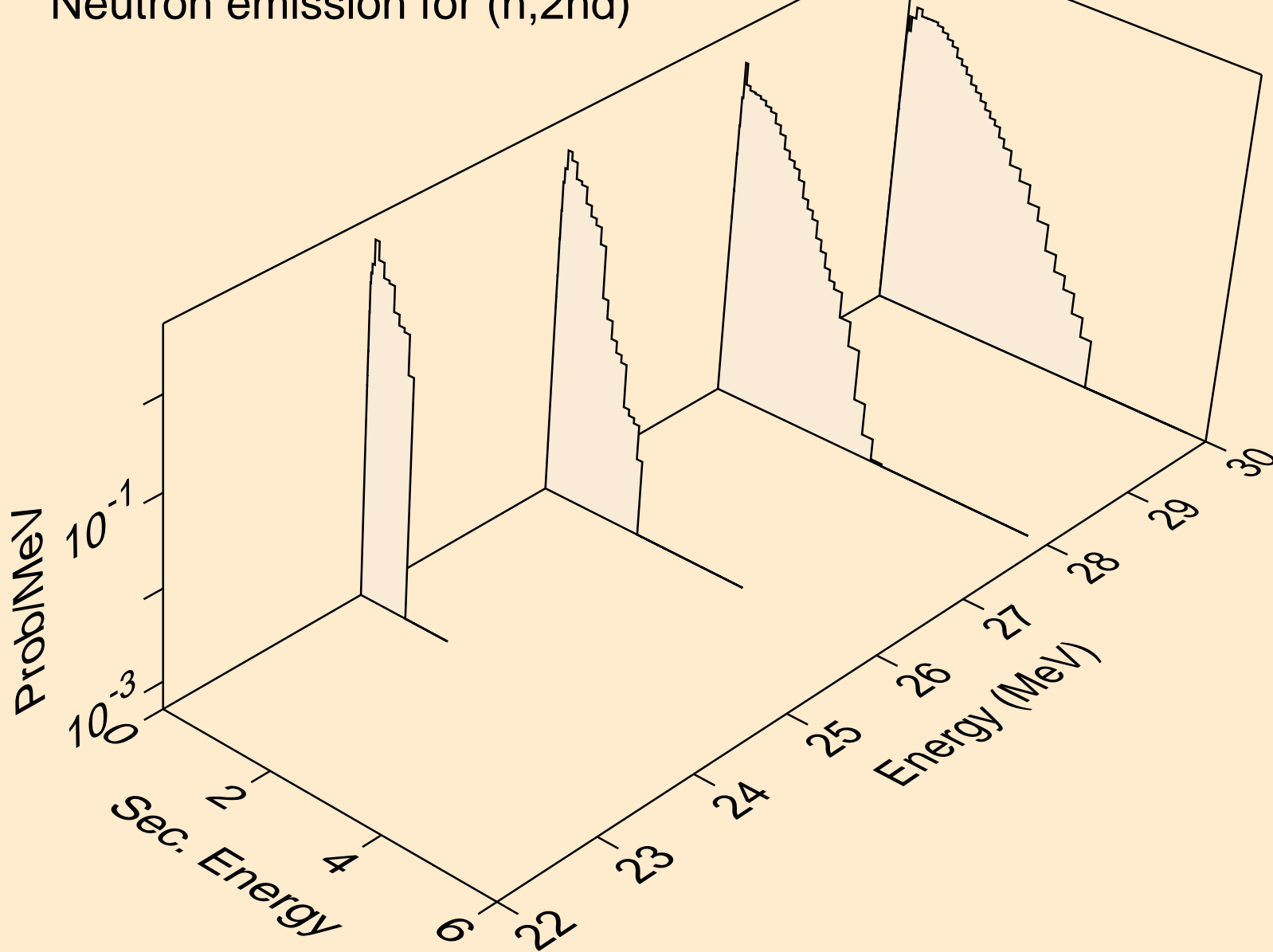

AS080 NEUTRON ACER TENDL-2019 LIBRARY; T=293.16K
Neutron emission for (n,2n)

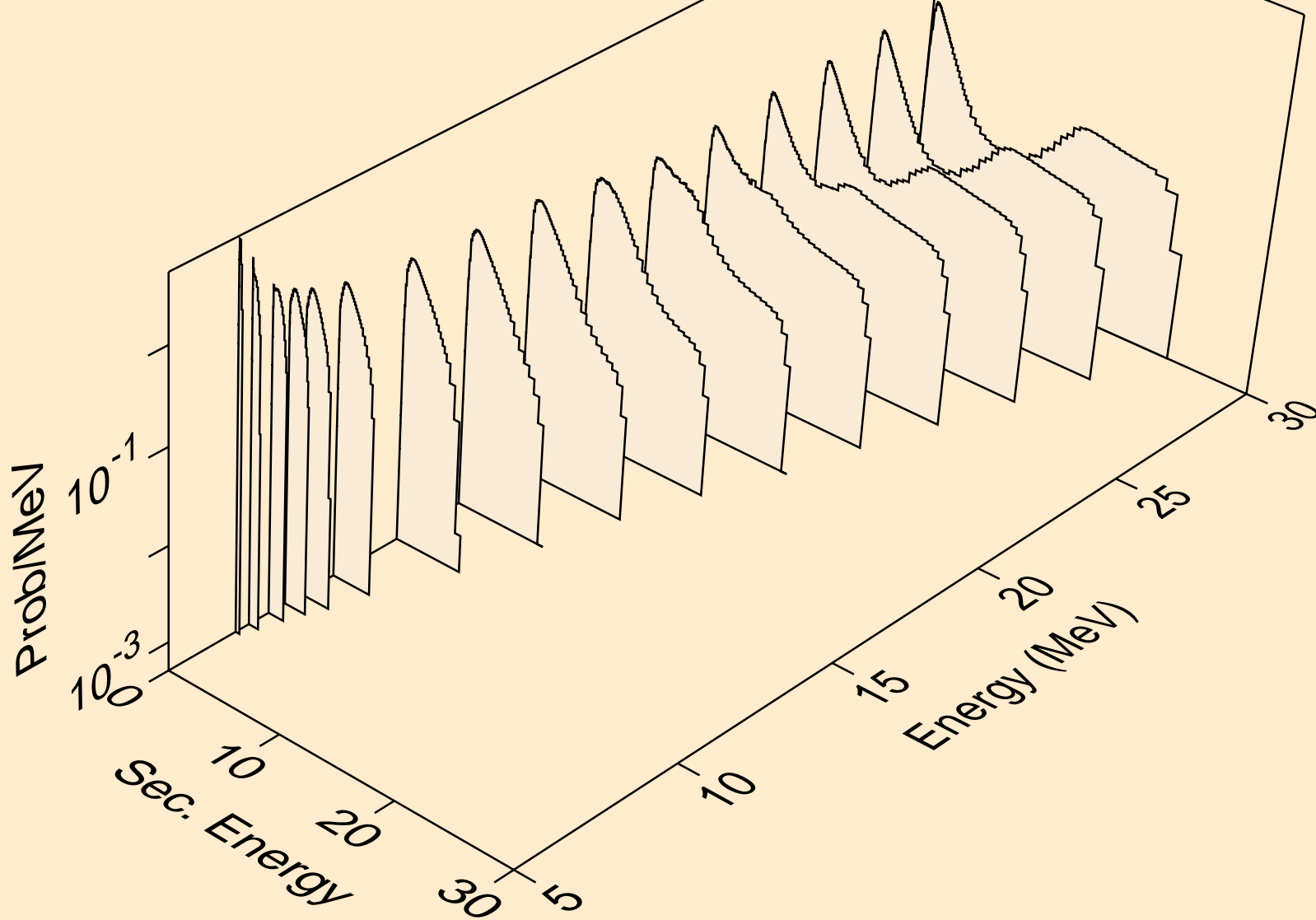

AS080 NEUTRON ACER TENDL-2019 LIBRARY; T=293.16K
Neutron emission for (n,3n)

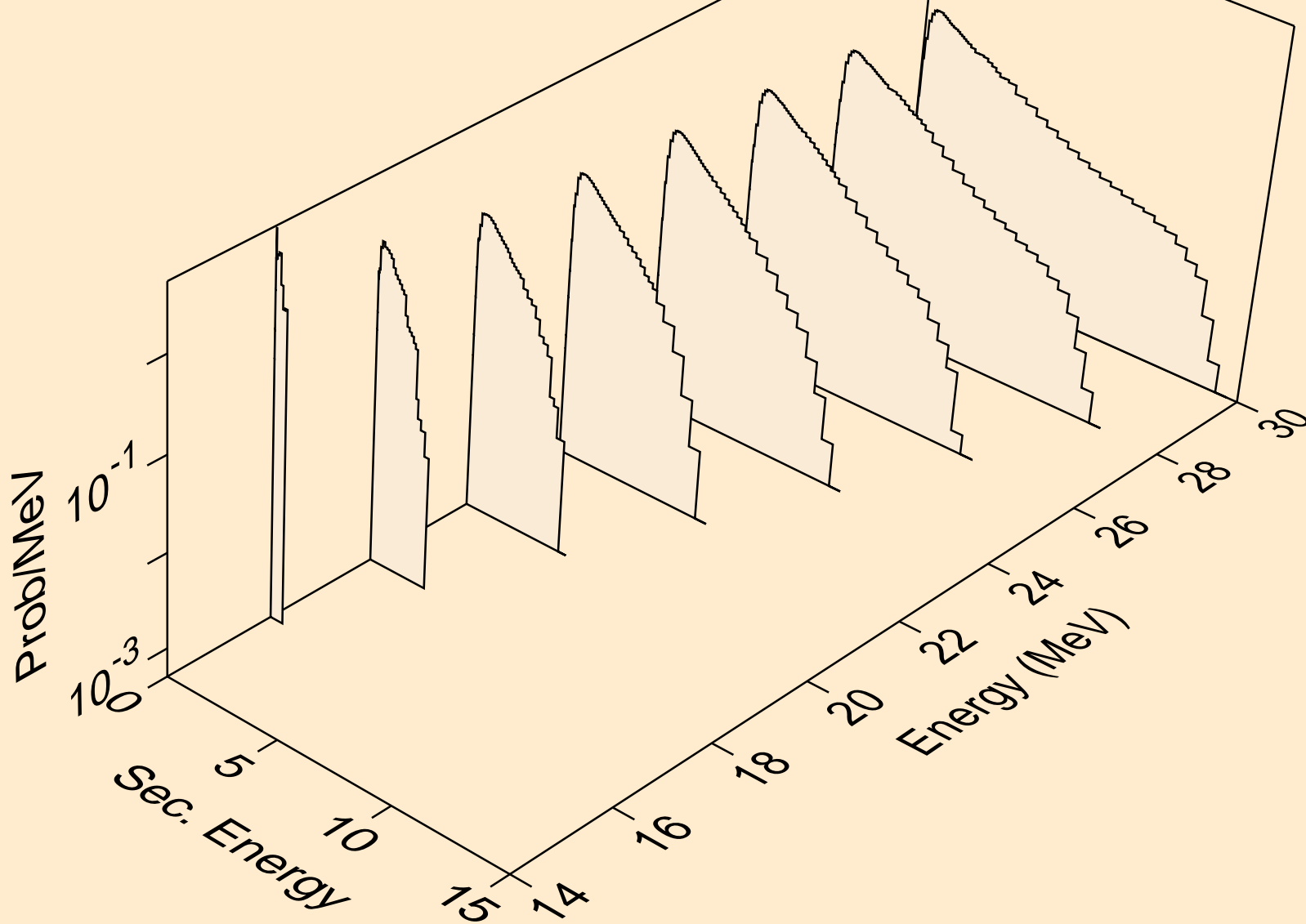

AS080 NEUTRON ACER TENDL-2019 LIBRARY; T=293.16K
Neutron emission for (n,n*)a

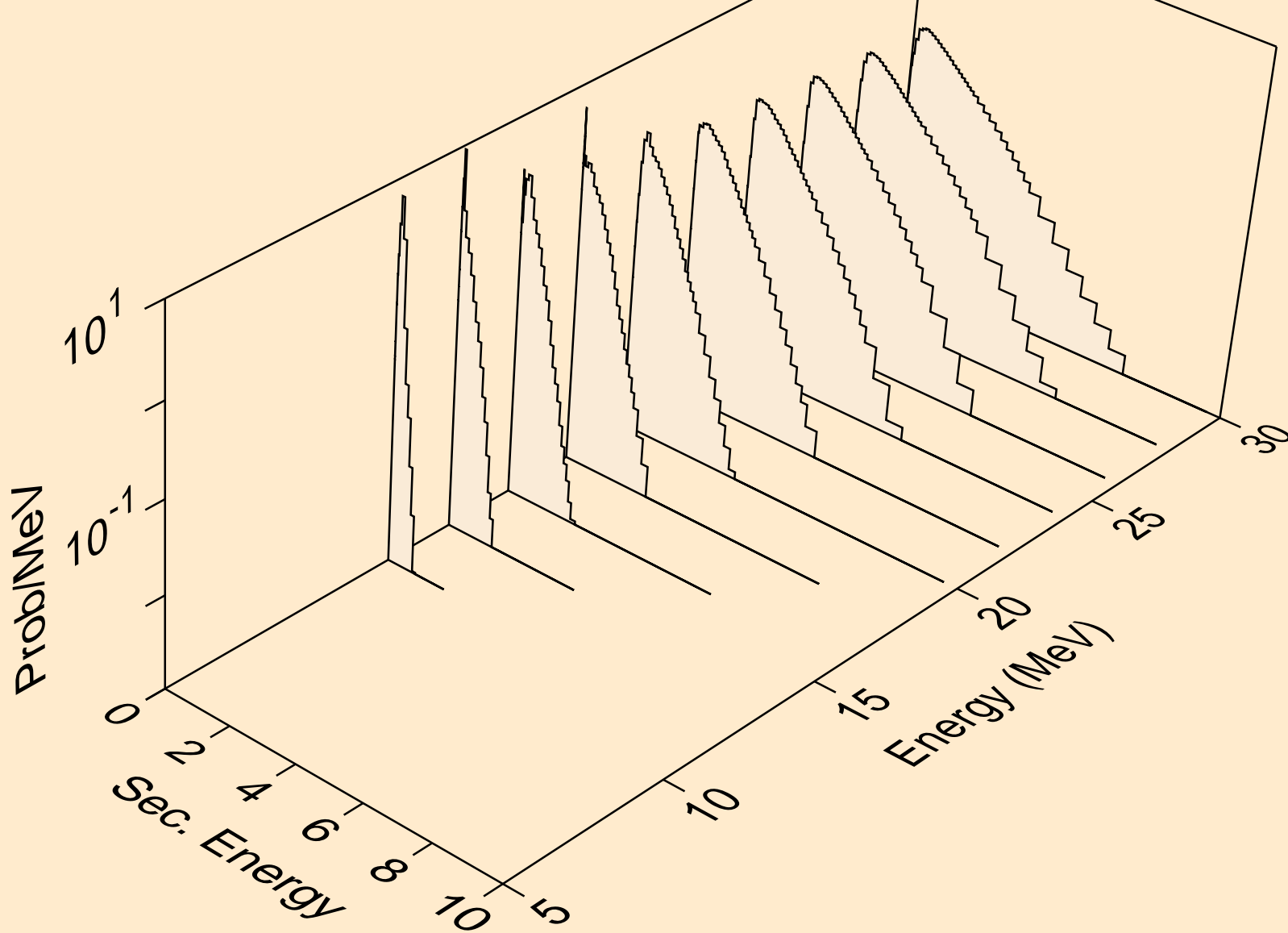

AS080 NEUTRON ACER TENDL-2019 LIBRARY; T=293.16K
Neutron emission for (n,2n)a

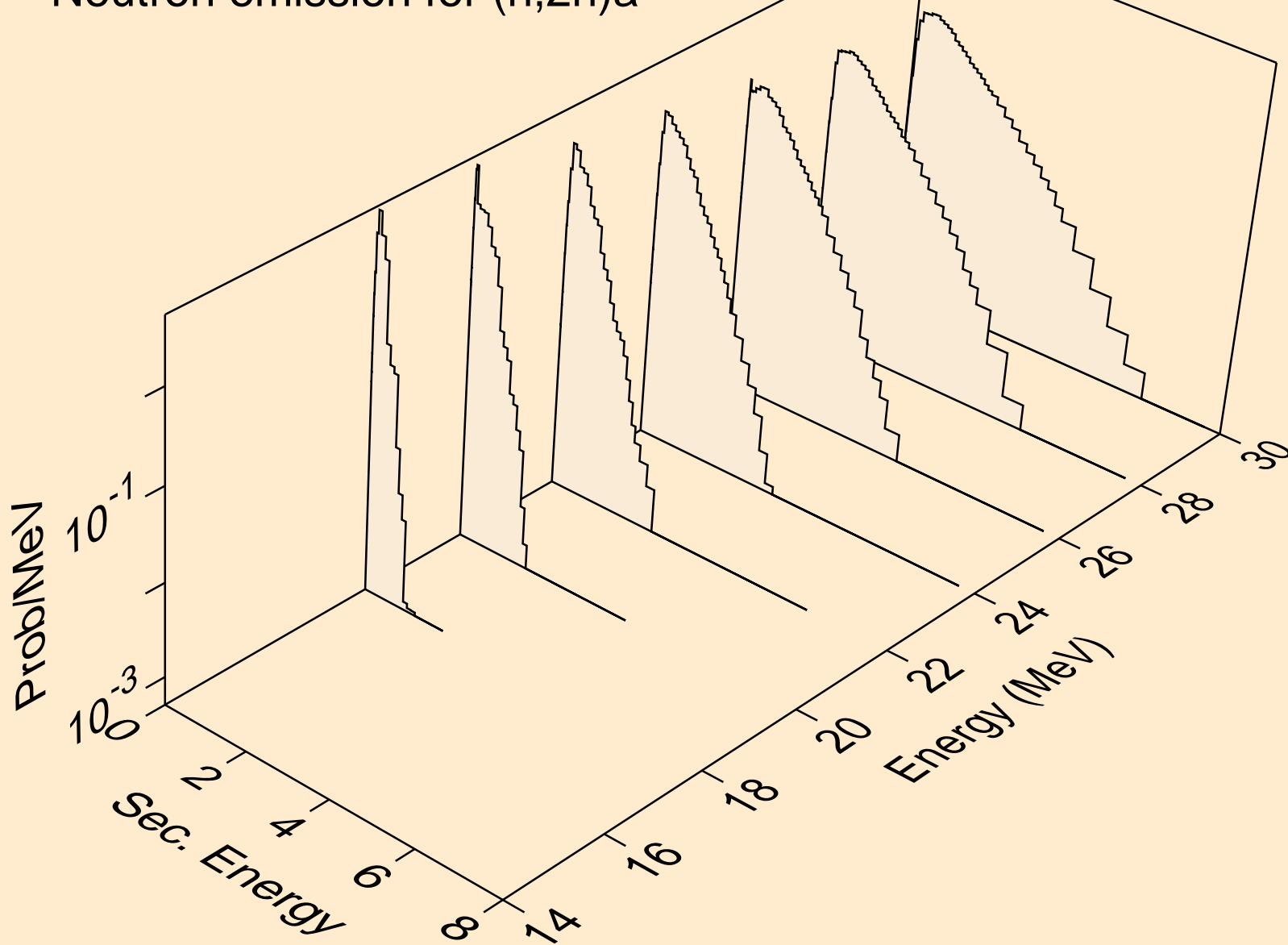

AS080 NEUTRON ACER TENDL-2019 LIBRARY; T=293.16K
Neutron emission for (n,3n)a

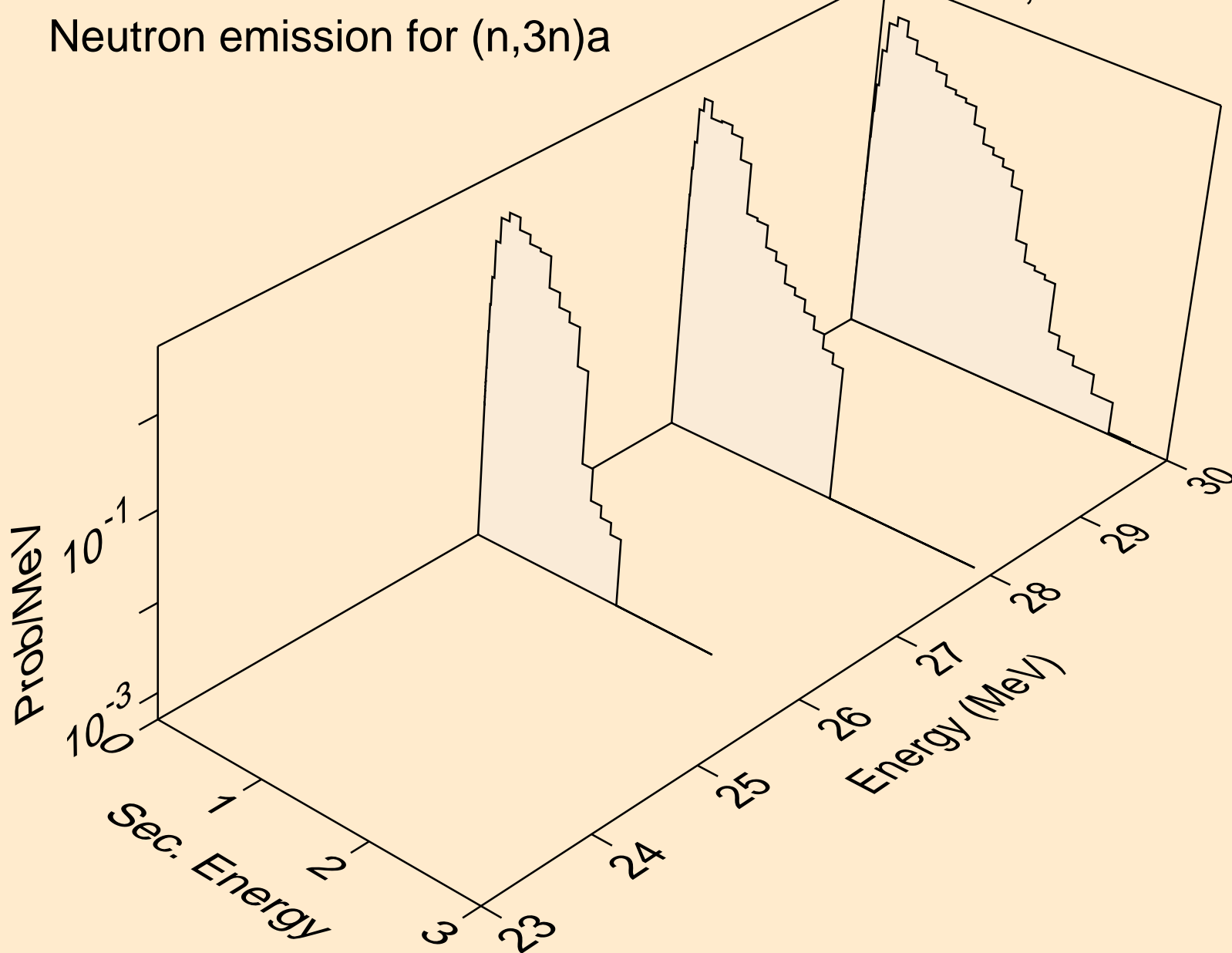

AS080 NEUTRON ACER TENDL-2019 LIBRARY; T=293.16K
Neutron emission for (n,n*)p

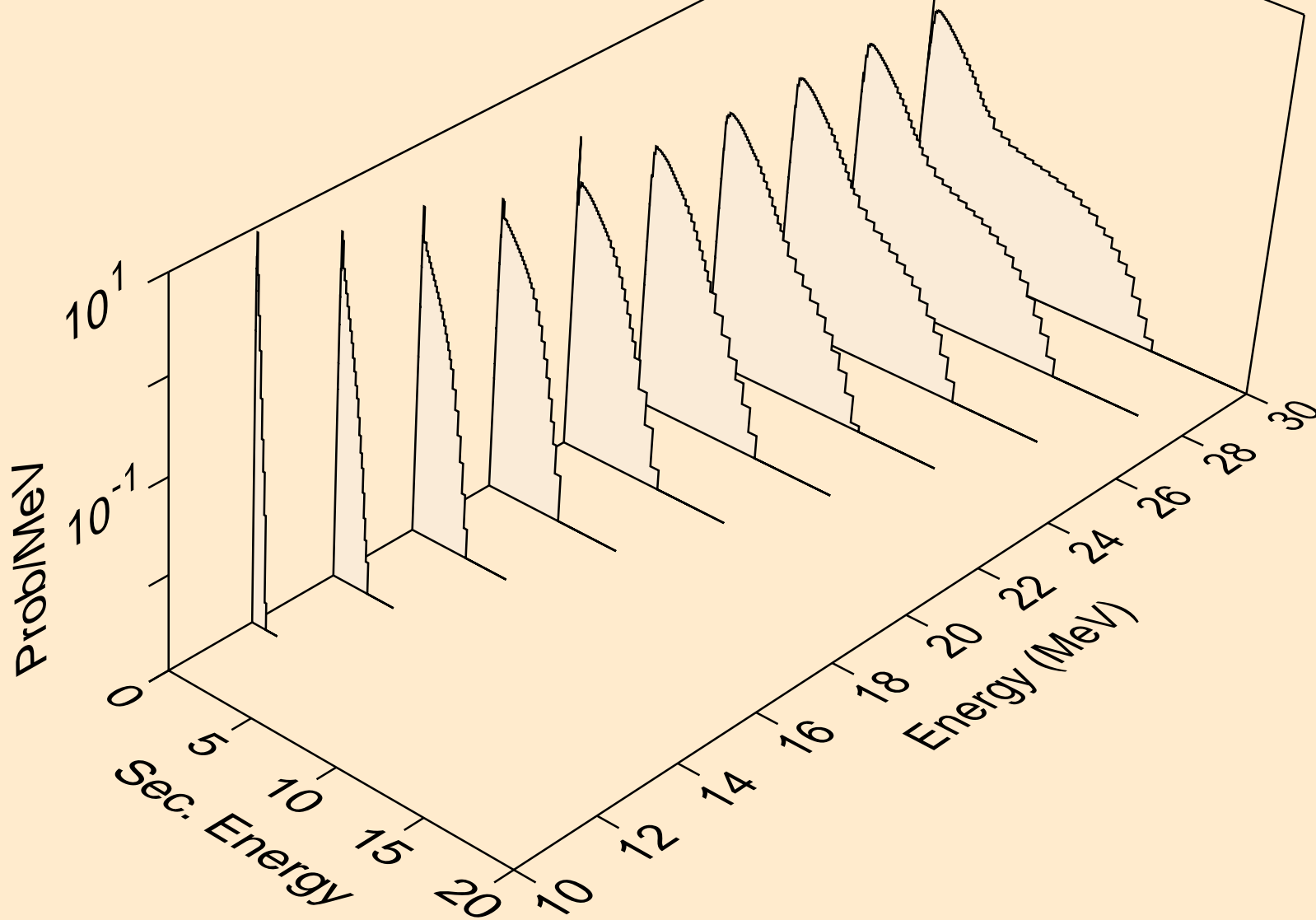

AS080 NEUTRON ACER TENDL-2019 LIBRARY; T=293.16K
Neutron emission for (n,n*)d

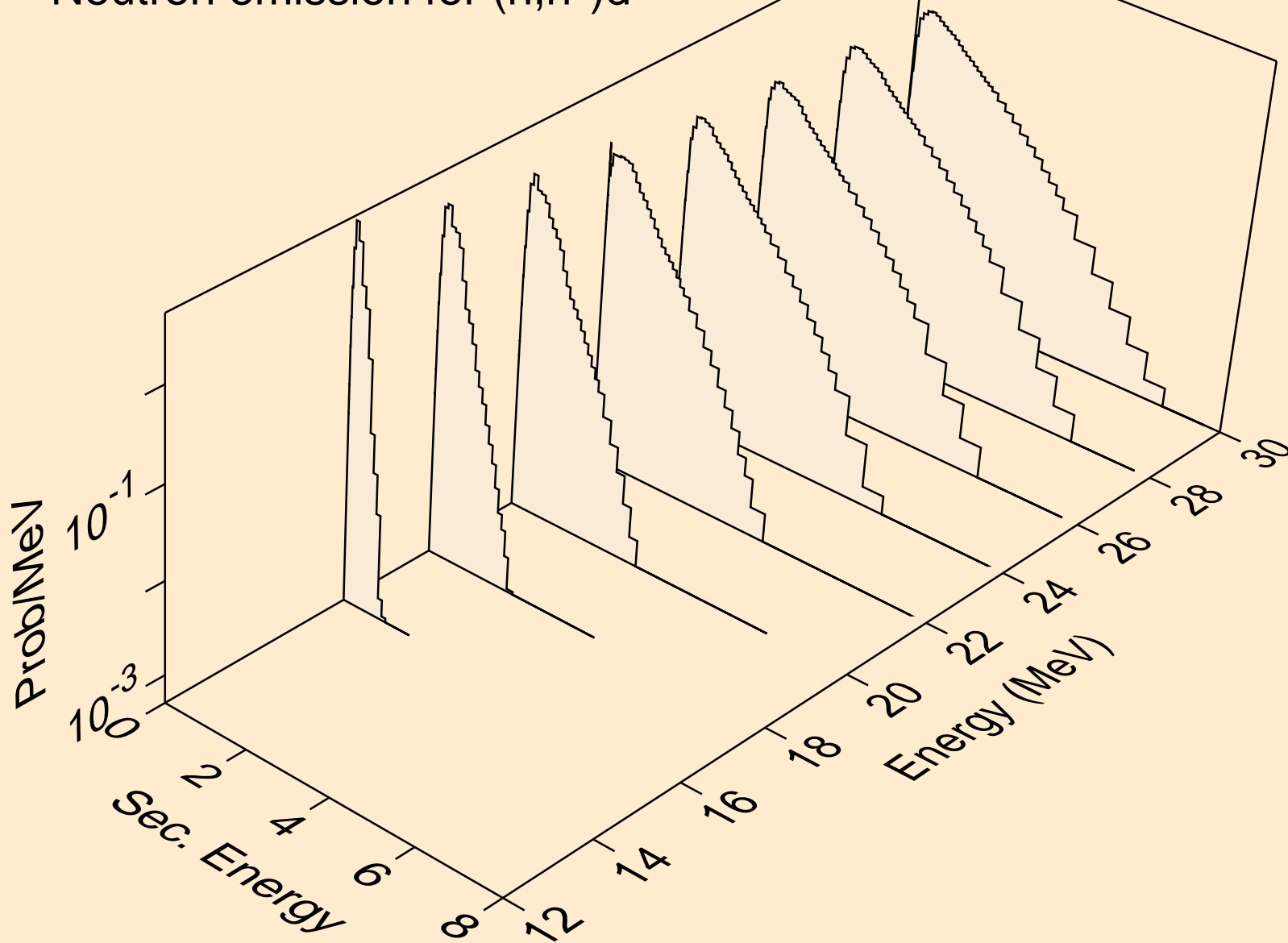

AS080 NEUTRON ACER TENDL-2019 LIBRARY; T=293.16K
Neutron emission for (n,n*)t

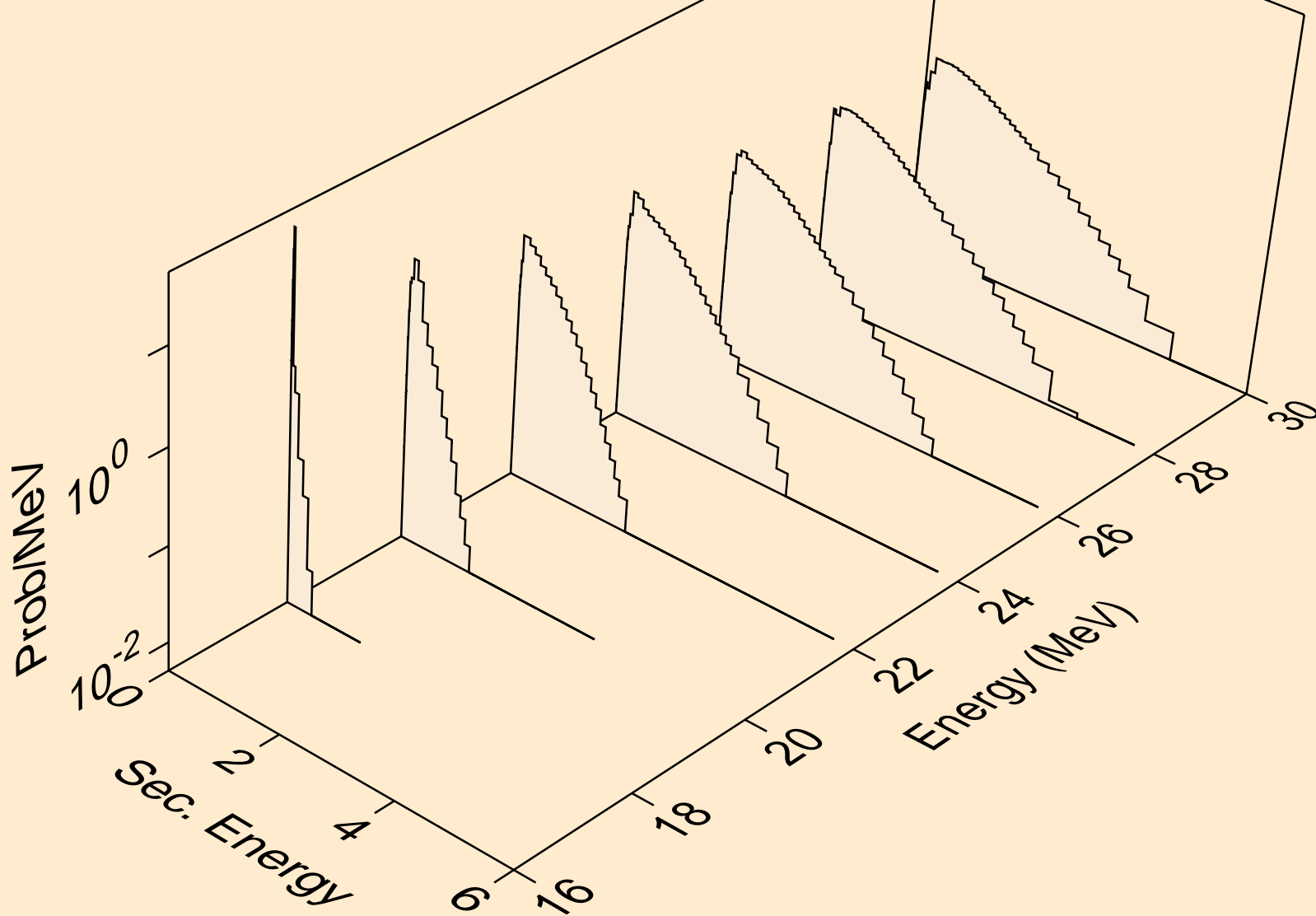

AS080 NEUTRON ACER TENDL-2019 LIBRARY; T=293.16K
Neutron emission for (n,n*)he3

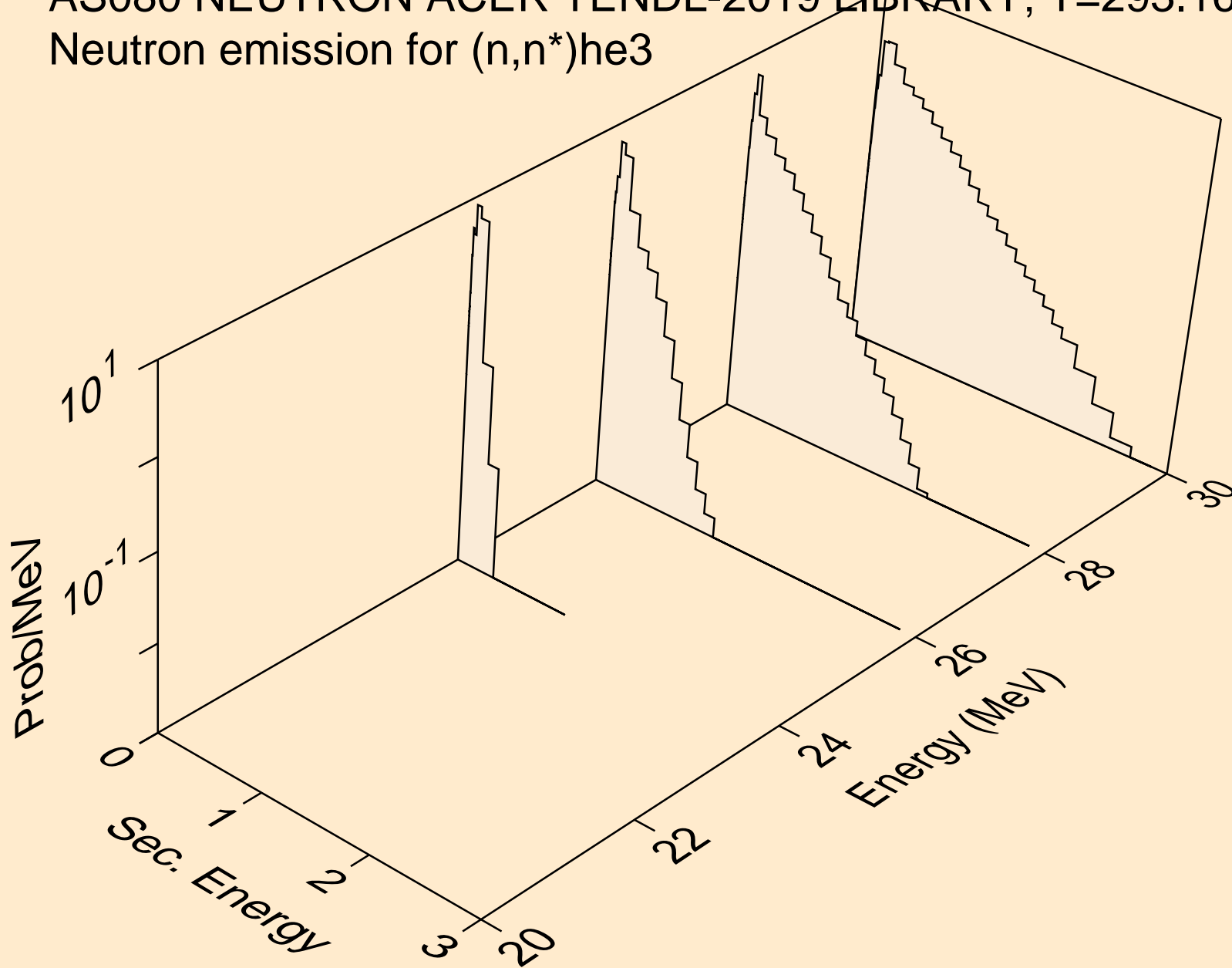

AS080 NEUTRON ACER TENDL-2019 LIBRARY; T=293.16K
Neutron emission for (n,4n)

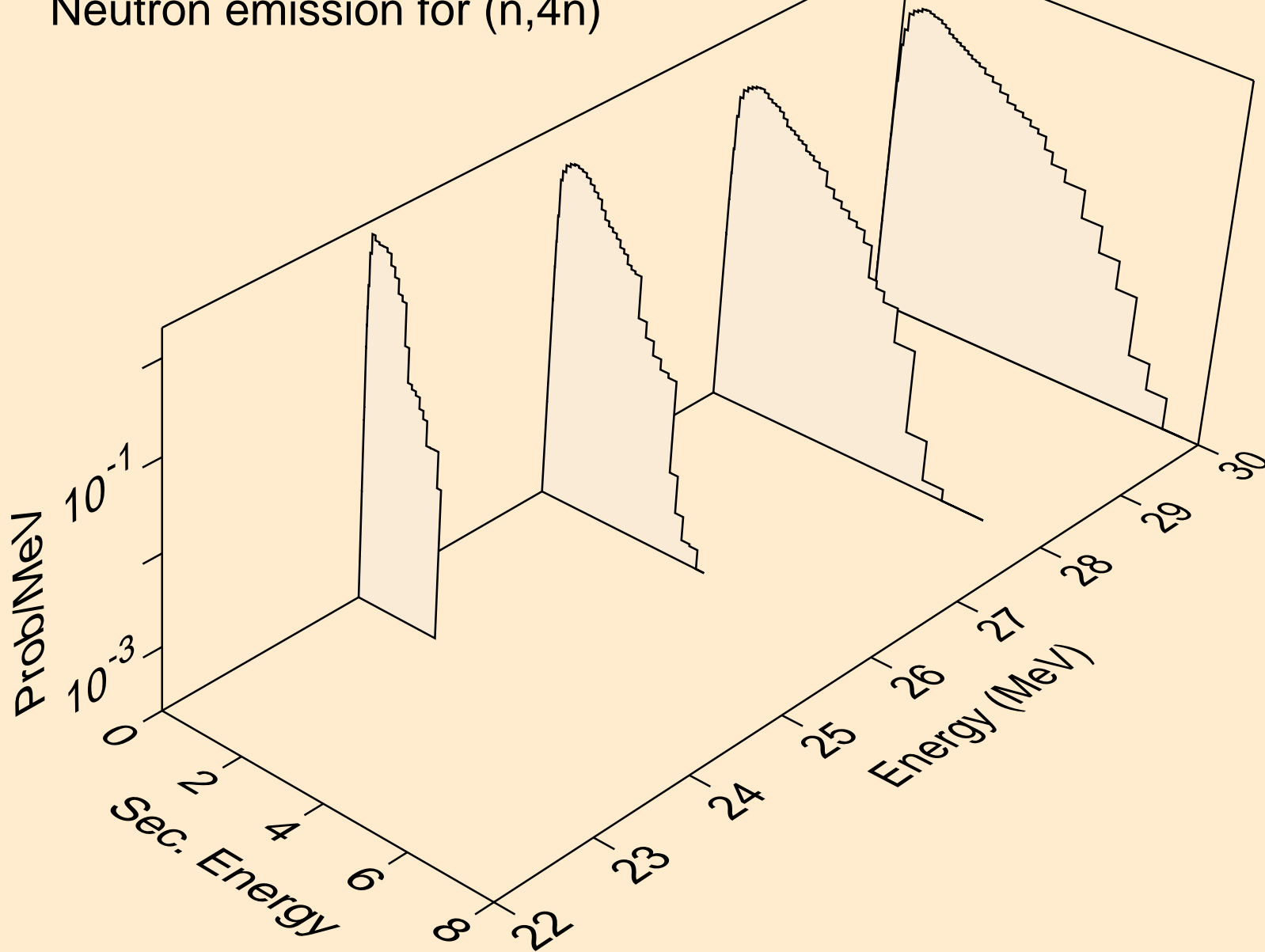

AS080 NEUTRON ACER TENDL-2019 LIBRARY; T=293.16K
Neutron emission for (n,2np)

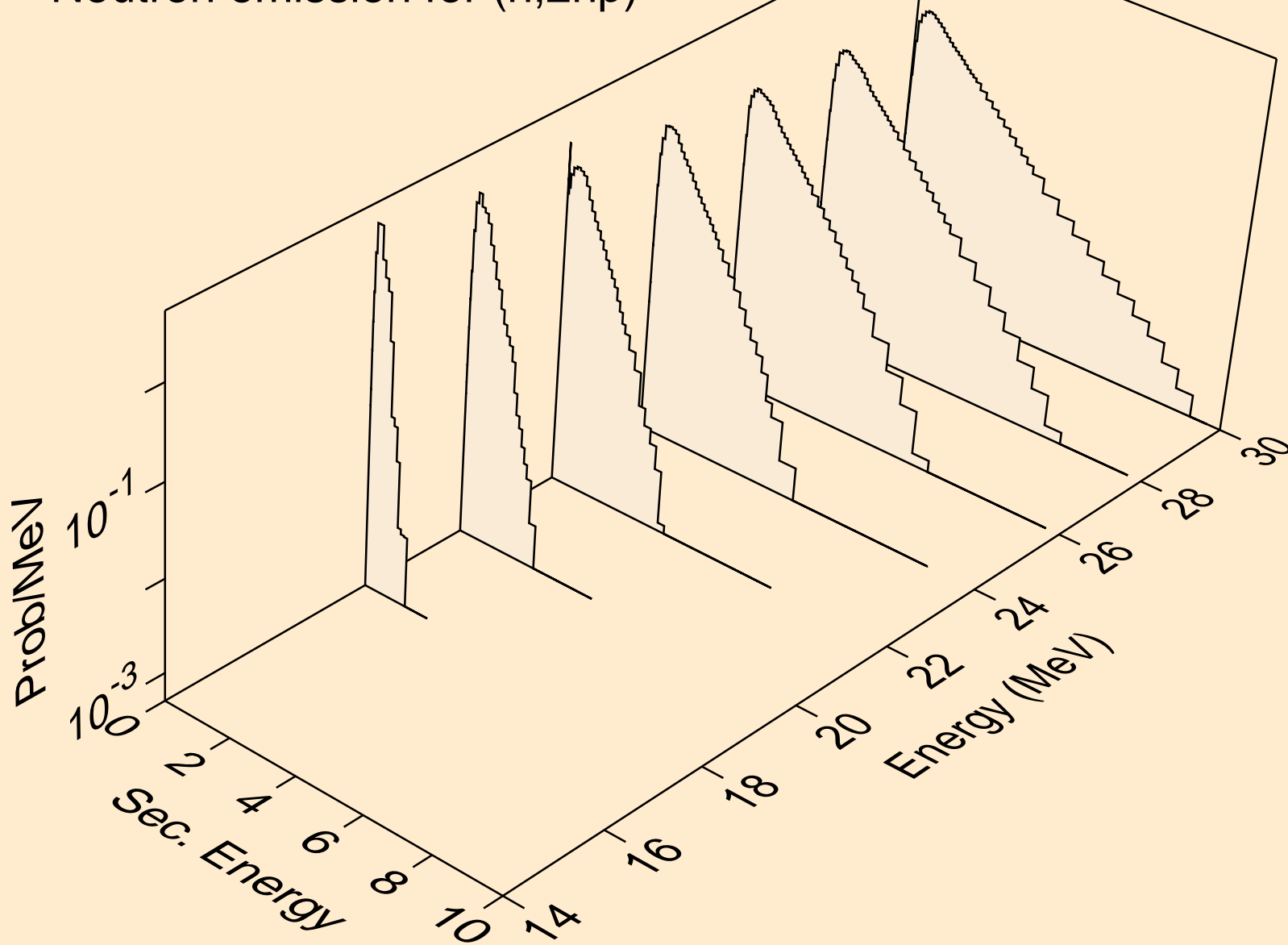

AS080 NEUTRON ACER TENDL-2019 LIBRARY; T=293.16K
Neutron emission for (n,3np)

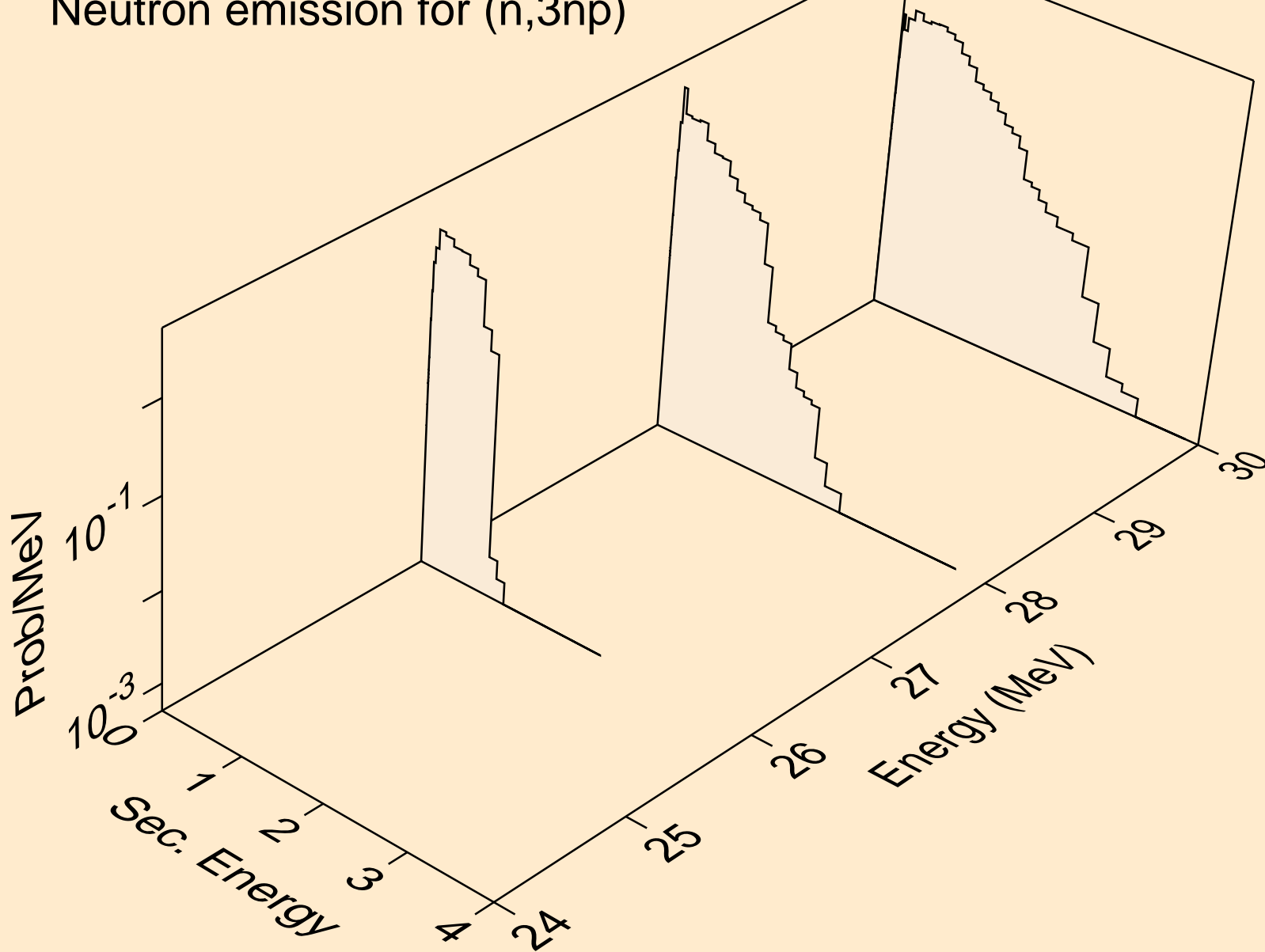

AS080 NEUTRON ACER TENDL-2019 LIBRARY; T=293.16K
Neutron emission for (n,2np)

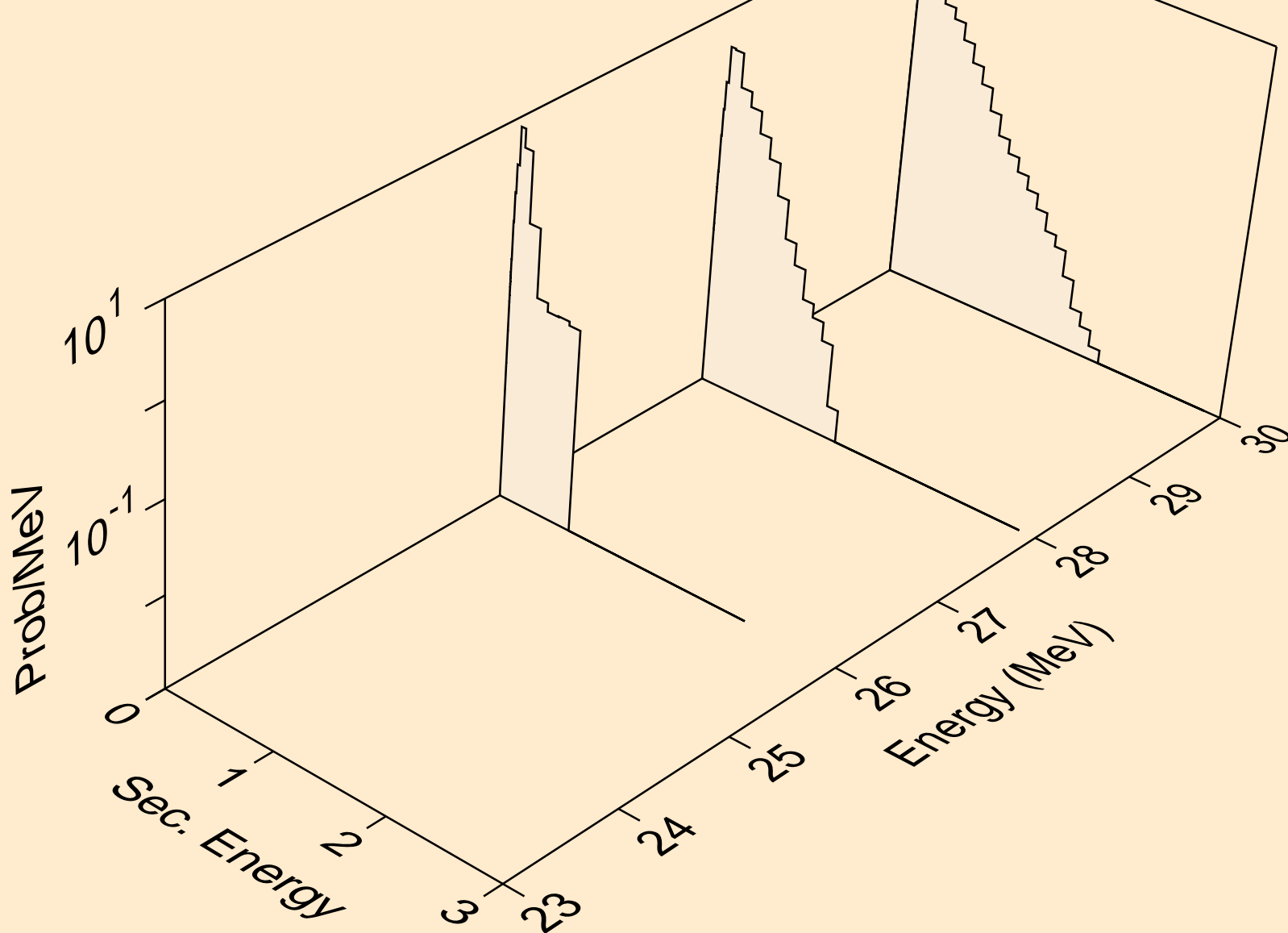

AS080 NEUTRON ACER TENDL-2019 LIBRARY; T=293.16K
Neutron emission for (n,n*c)

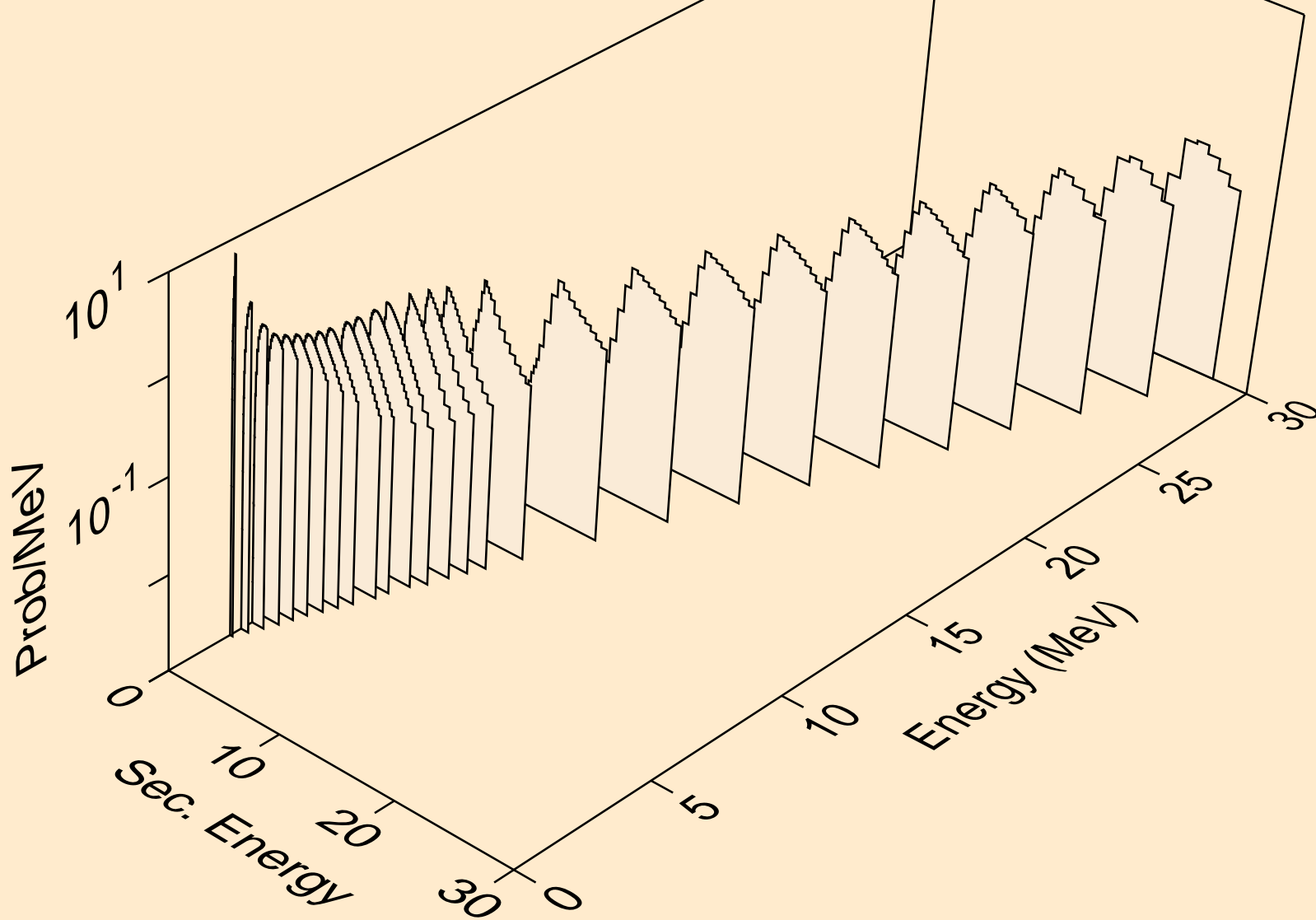

AS080 NEUTRON ACER TENDL-2019 LIBRARY; T=293.16K
Photon emission for (n,x)

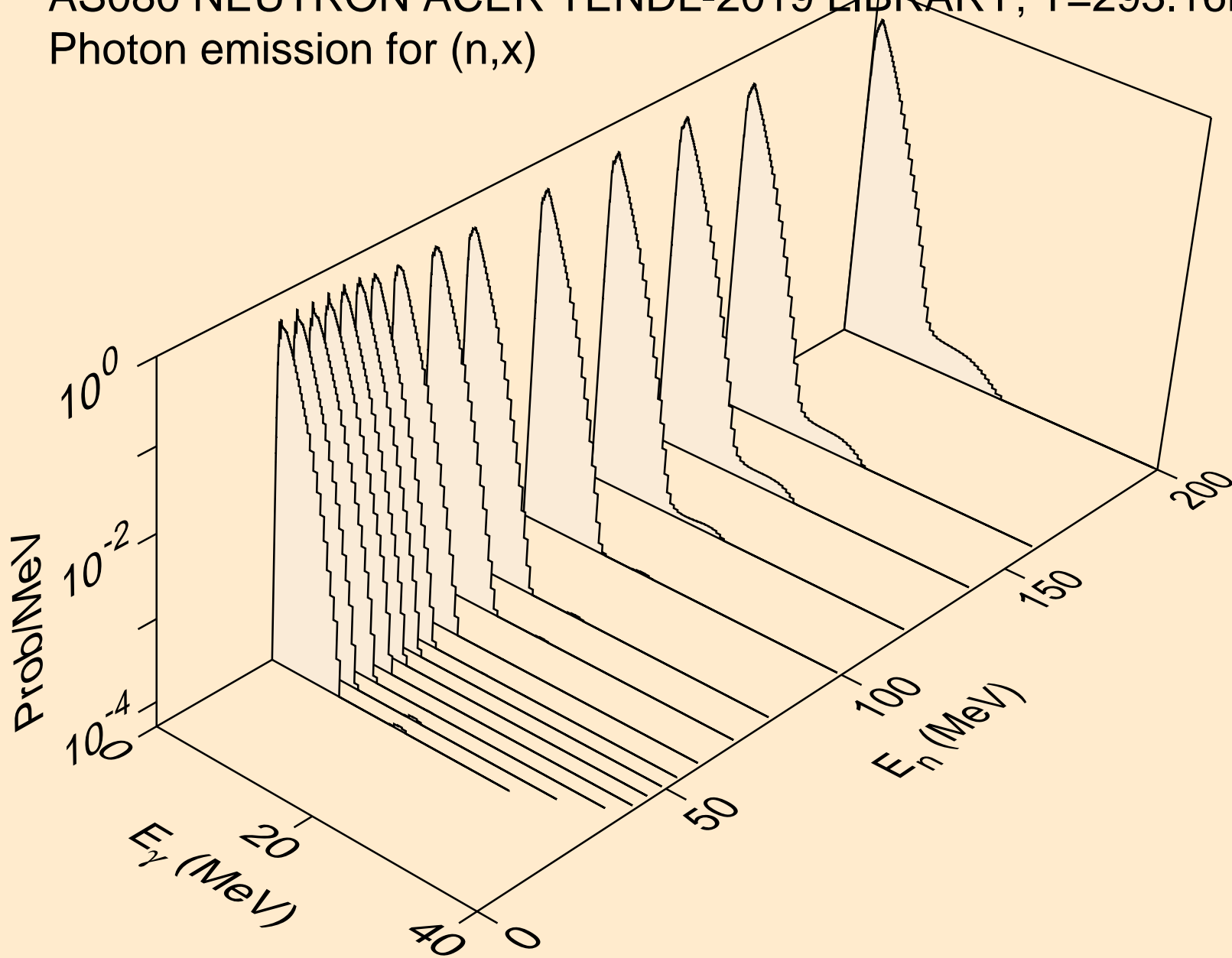

AS080 NEUTRON ACER TENDL-2019 LIBRARY; T=293.16K
Photon emission for (n,2nd)

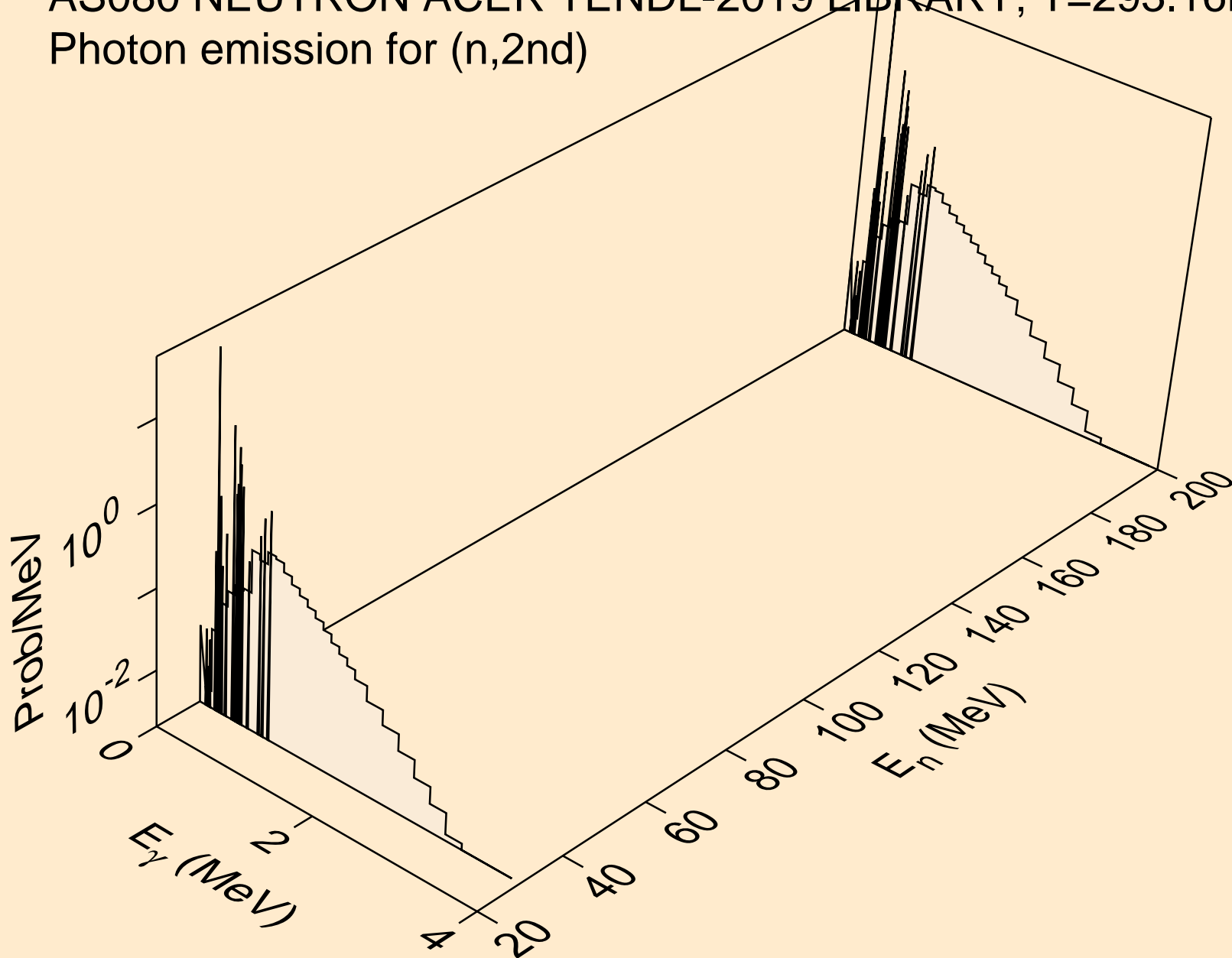

AS080 NEUTRON ACER TENDL-2019 LIBRARY; T=293.16K
Photon emission for (n,2n)

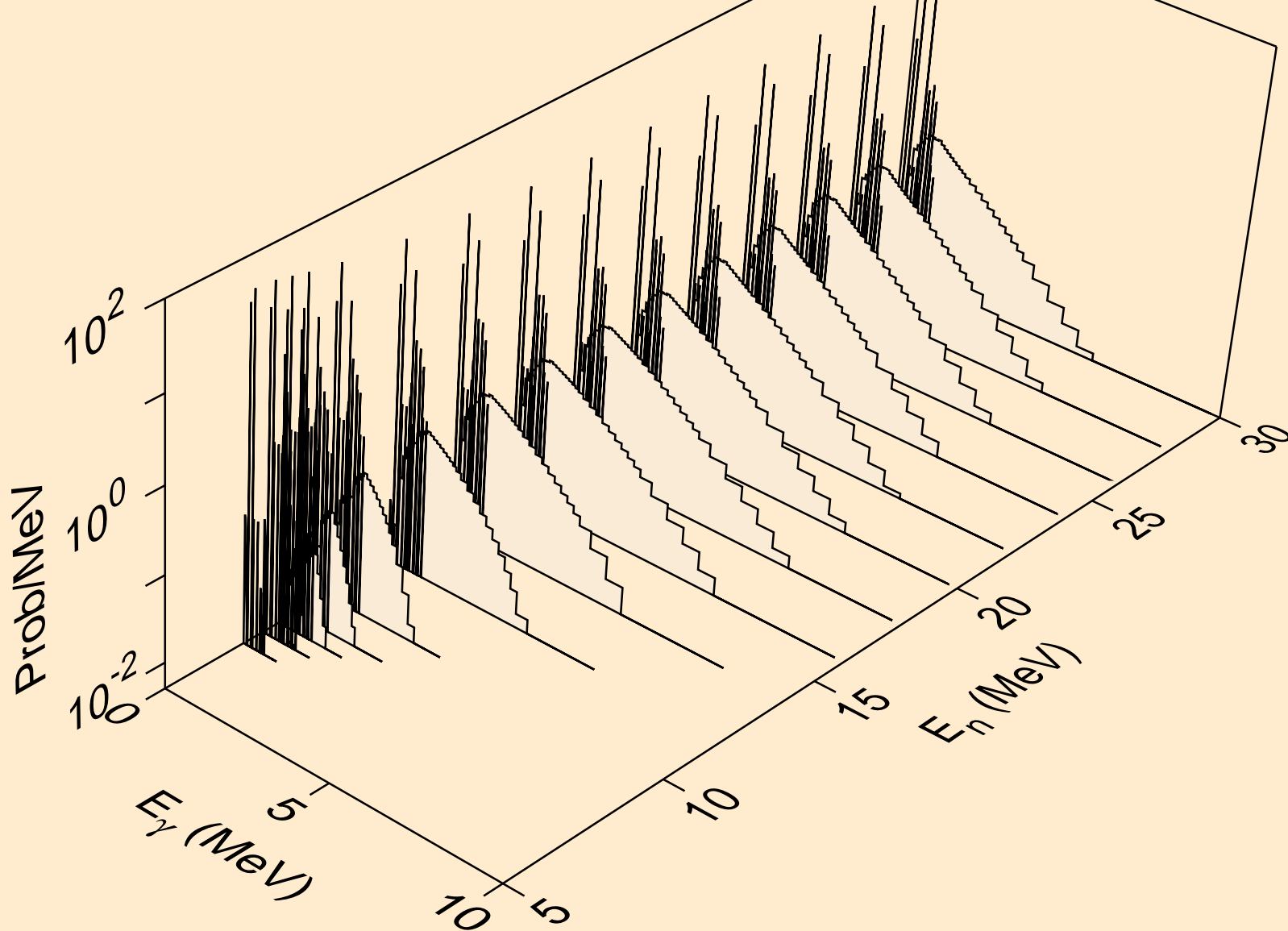

AS080 NEUTRON ACER TENDL-2019 LIBRARY; T=293.16K
Photon emission for (n,3n)

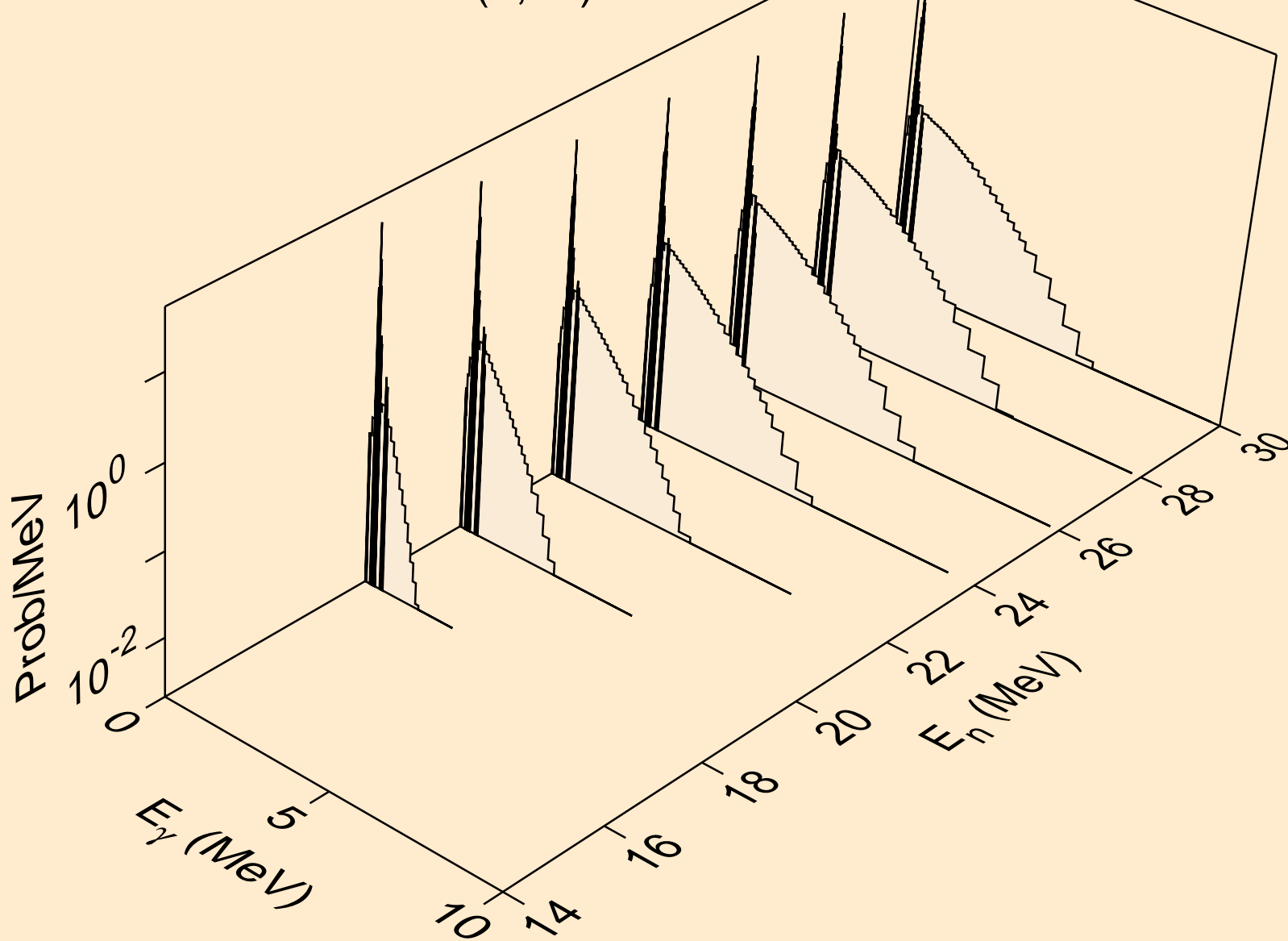

AS080 NEUTRON ACER TENDL-2019 LIBRARY; T=293.16K
Photon emission for (n,n*)a

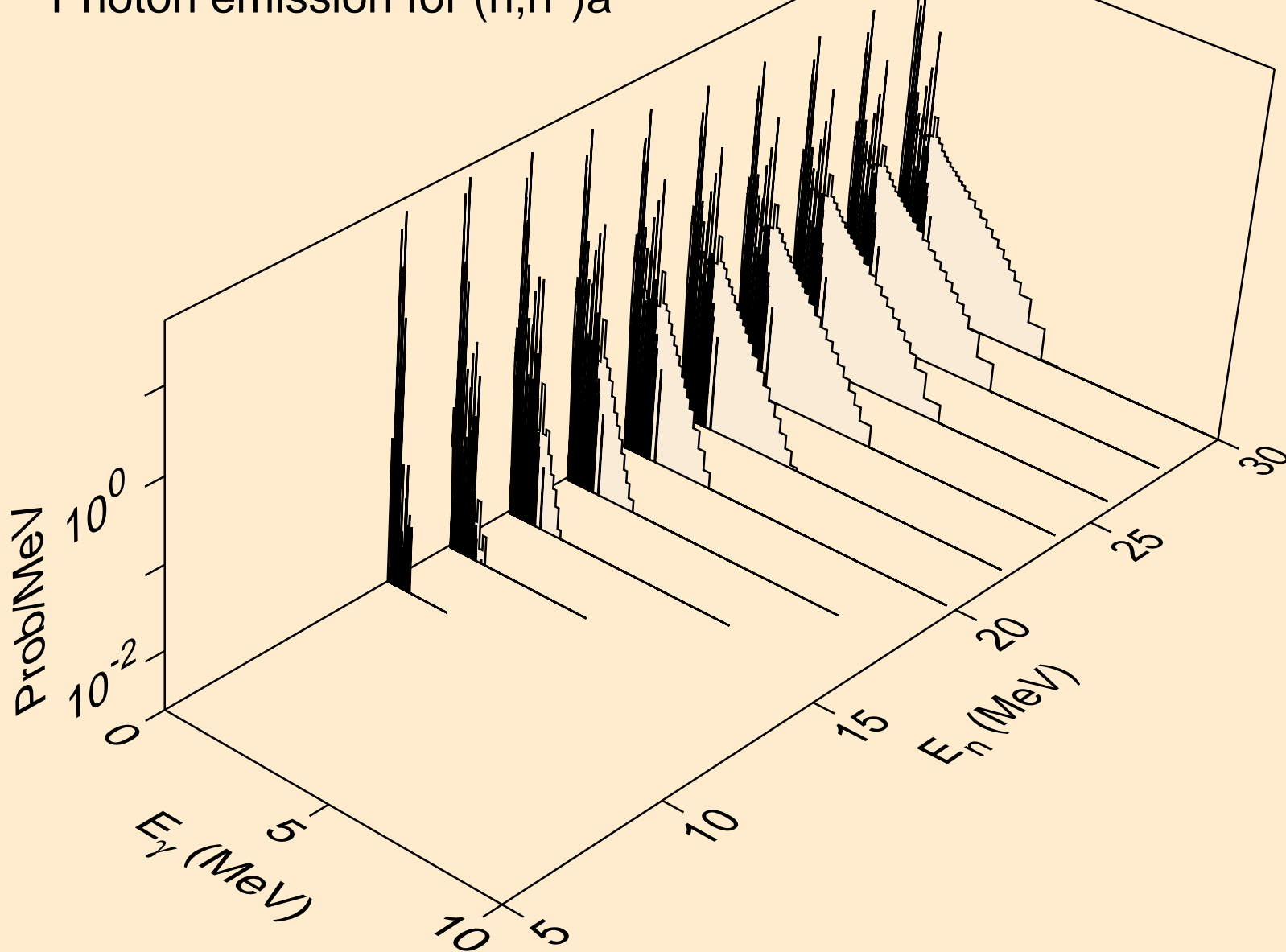

AS080 NEUTRON ACER TENDL-2019 LIBRARY; T=293.16K
Photon emission for (n,2n)a

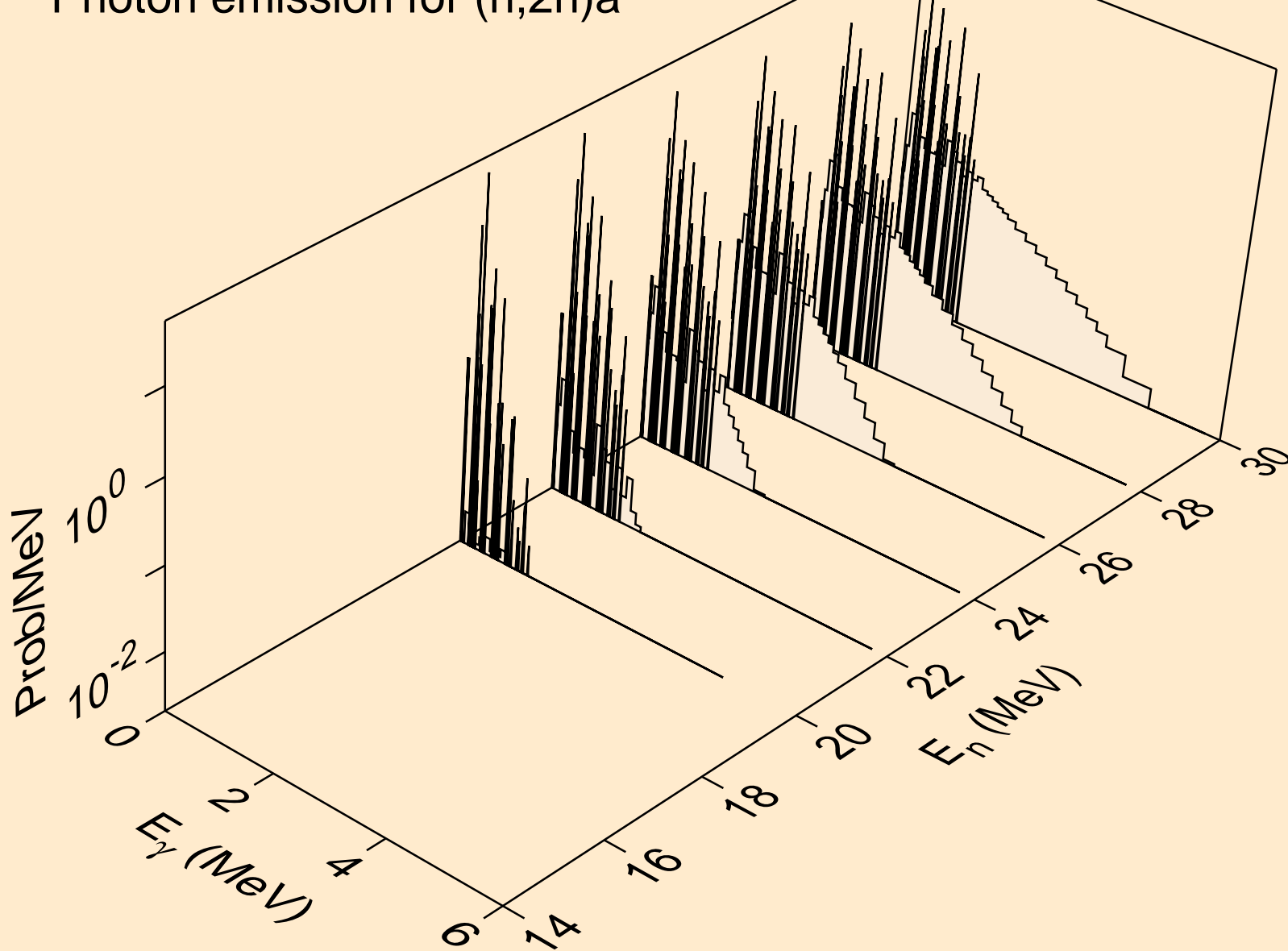

AS080 NEUTRON ACER TENDL-2019 LIBRARY; T=293.16K
Photon emission for (n,3n)a

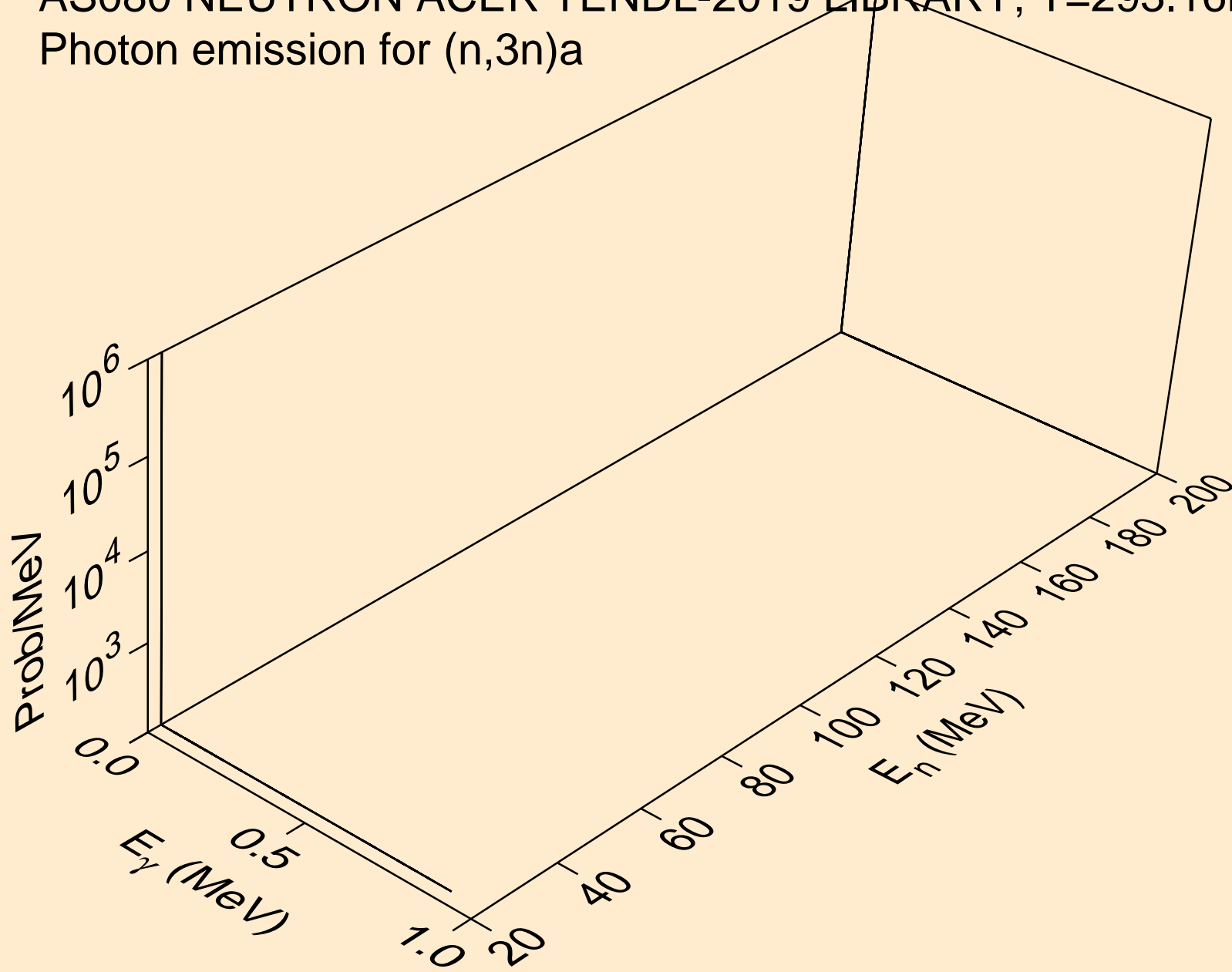

AS080 NEUTRON ACER TENDL-2019 LIBRARY; T=293.16K
Photon emission for (n,n*)p

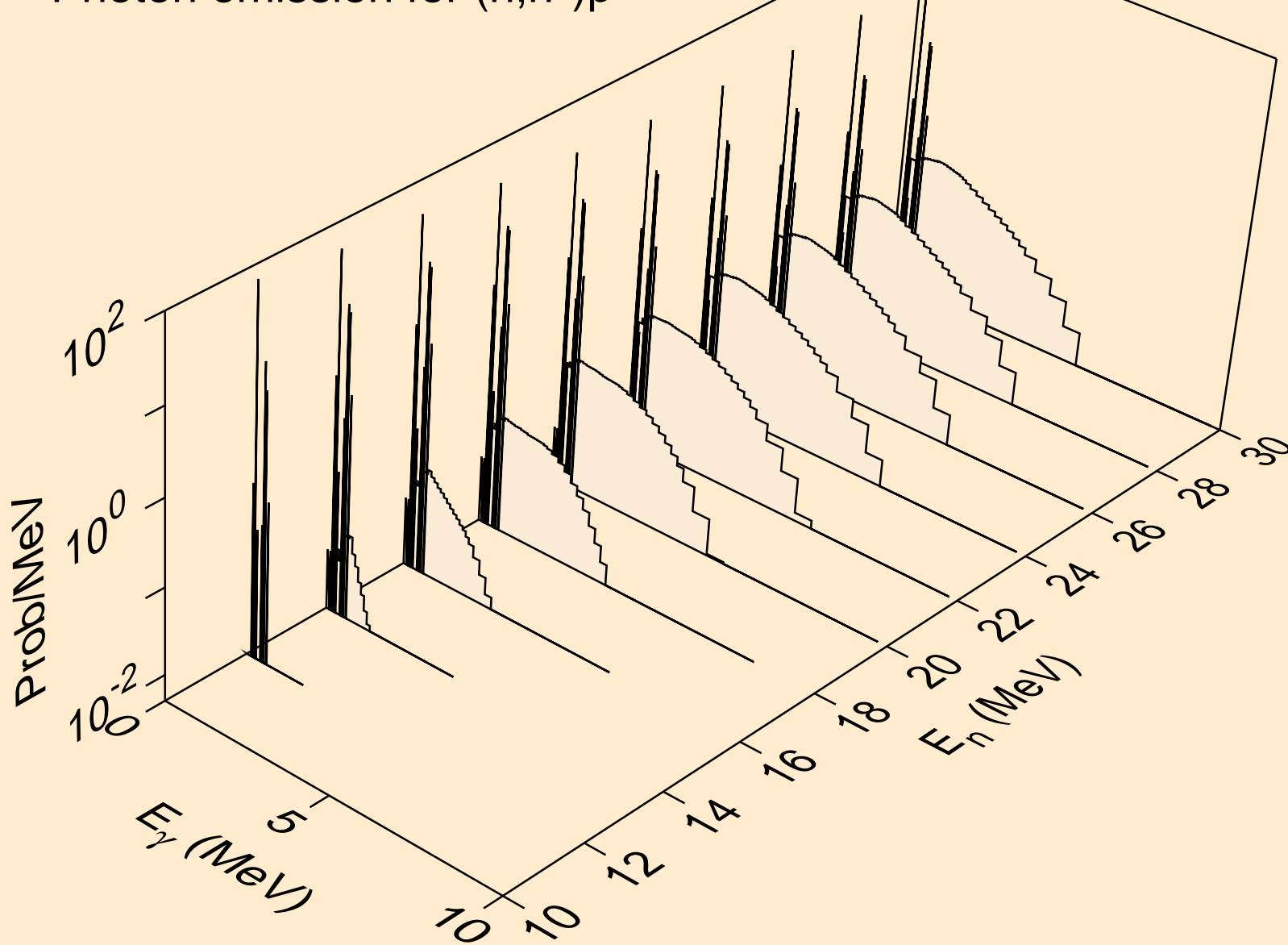

AS080 NEUTRON ACER TENDL-2019 LIBRARY; T=293.16K
Photon emission for (n,n*)d

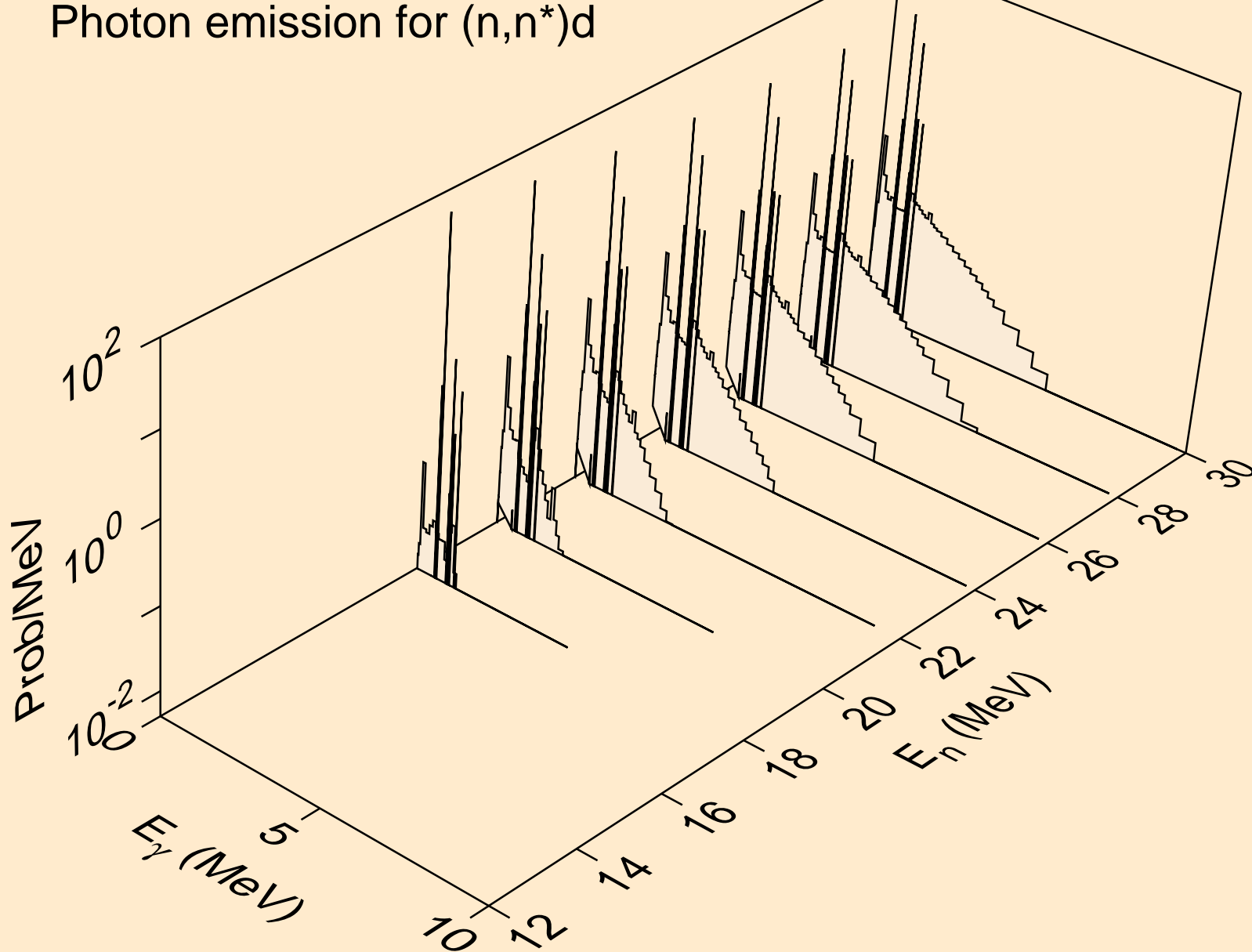

AS080 NEUTRON ACER TENDL-2019 LIBRARY; T=293.16K
Photon emission for (n,n*)t

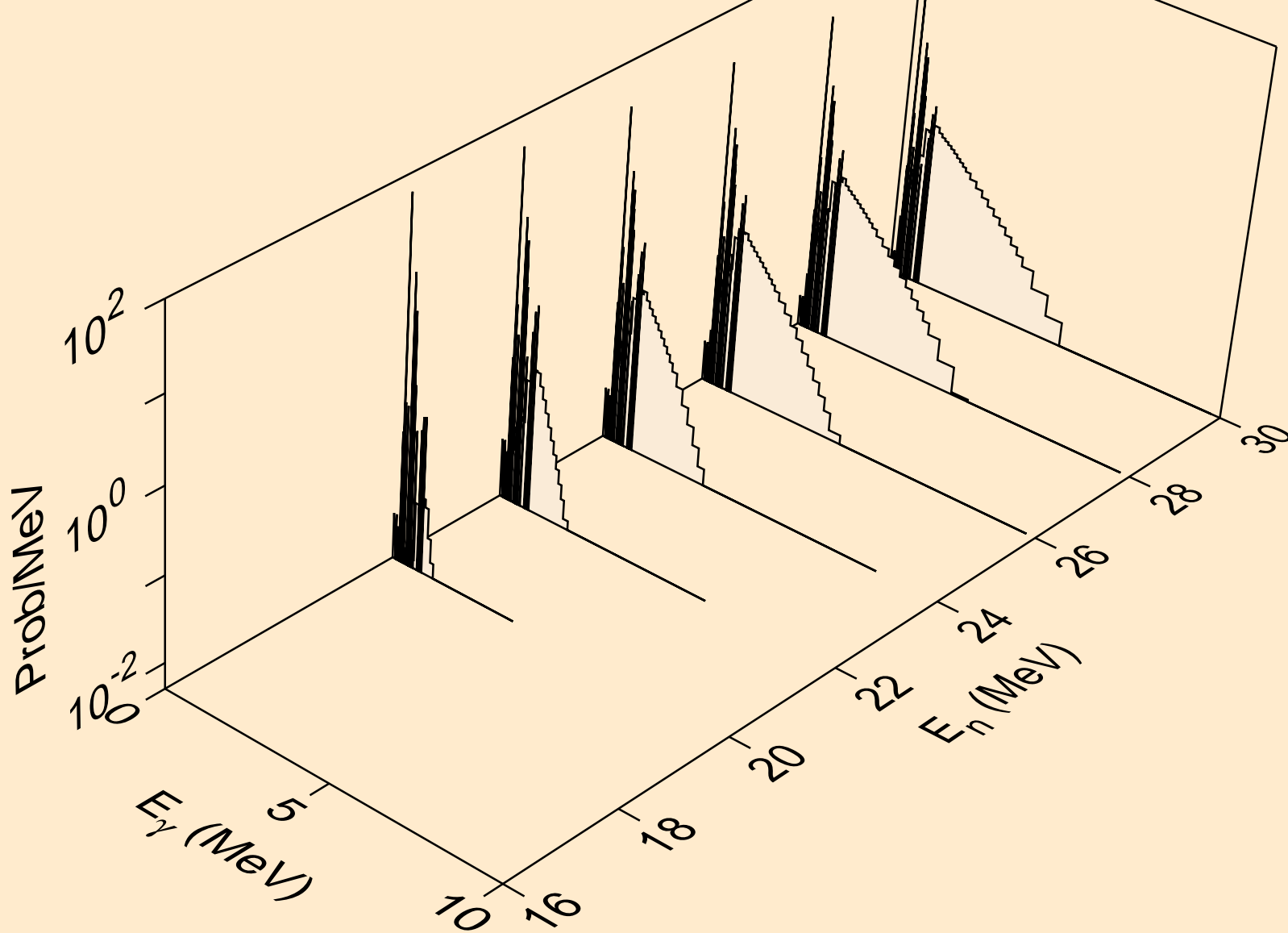

AS080 NEUTRON ACER TENDL-2019 LIBRARY; T=293.16K
Photon emission for (n,n*)he3

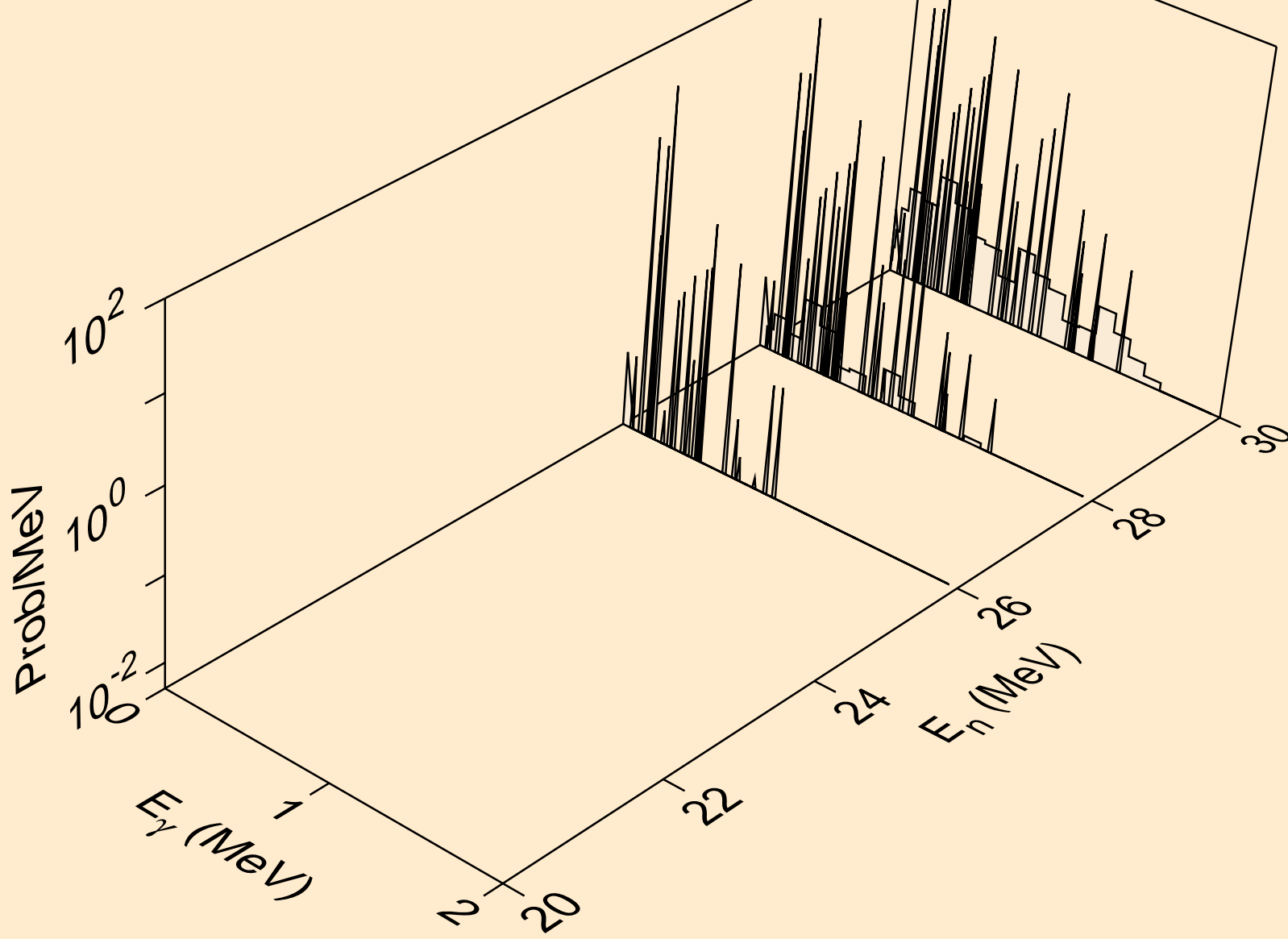

AS080 NEUTRON ACER TENDL-2019 LIBRARY; T=293.16K
Photon emission for (n,4n)

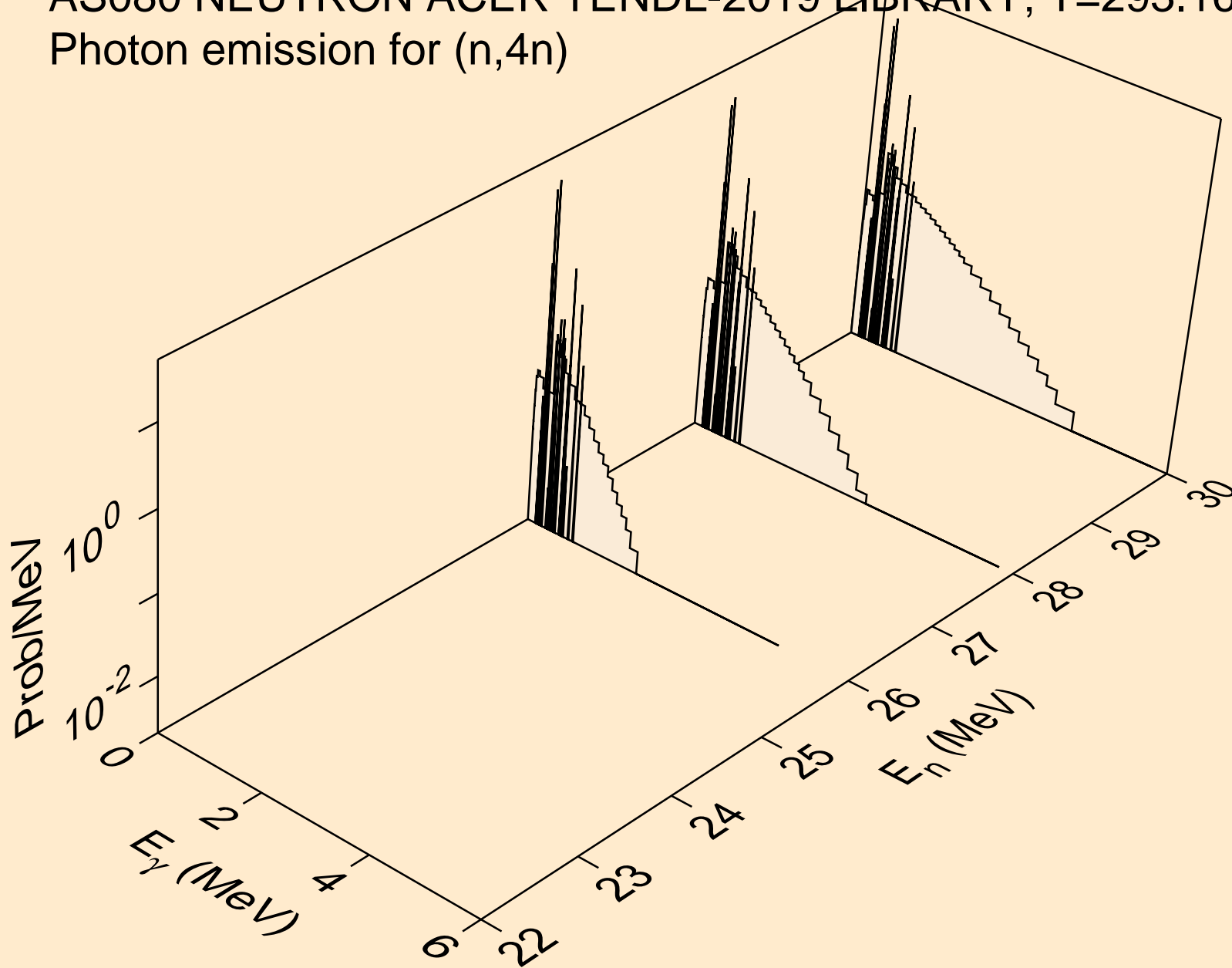

AS080 NEUTRON ACER TENDL-2019 LIBRARY; T=293.16K
Photon emission for (n,2np)

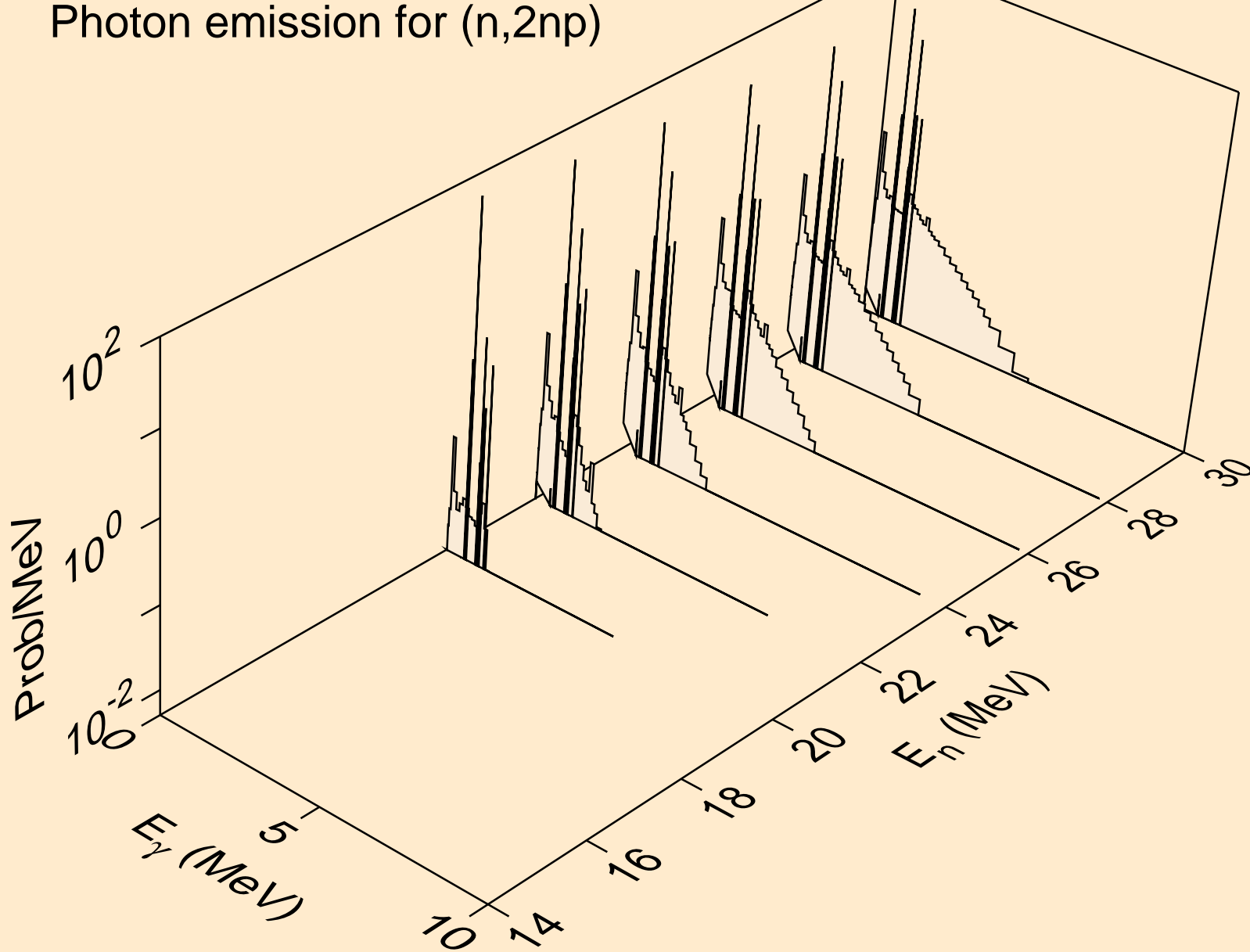

AS080 NEUTRON ACER TENDL-2019 LIBRARY; T=293.16K
Photon emission for (n,3np)

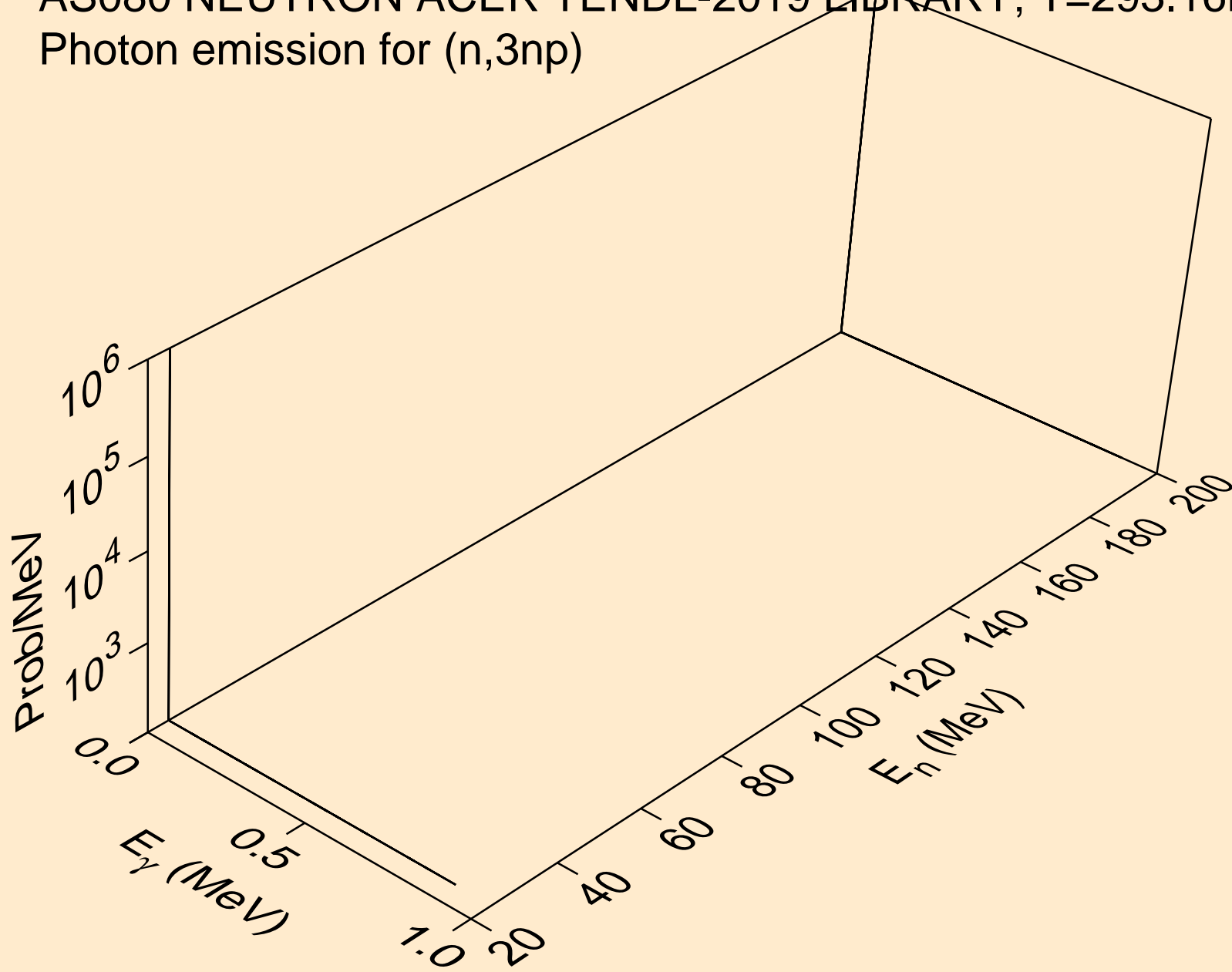

AS080 NEUTRON ACER TENDL-2019 LIBRARY; T=293.16K
Photon emission for (n,2np)

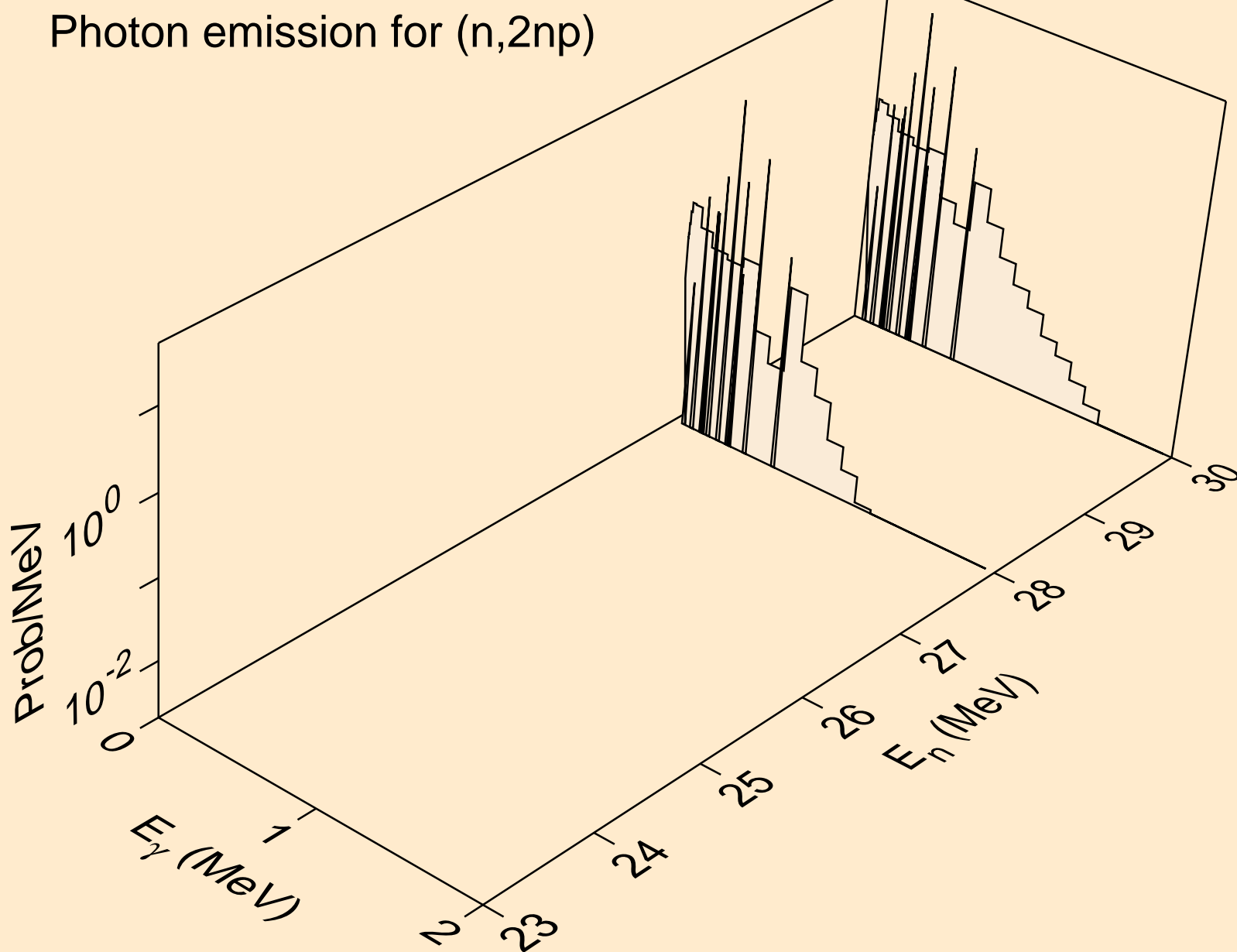

AS080 NEUTRON ACER TENDL-2019 LIBRARY; T=293.16K
Photon emission for (n,n*c)

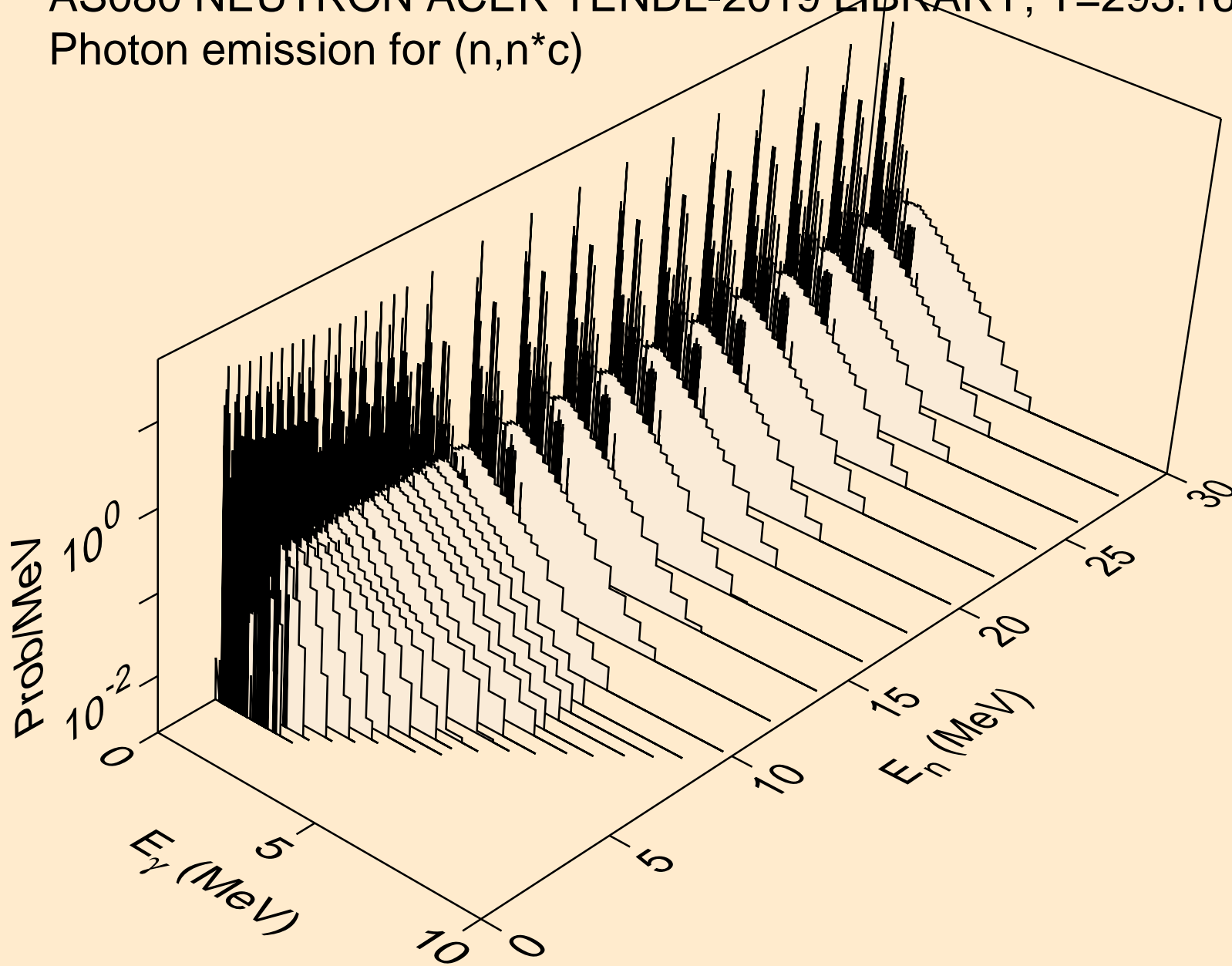

AS080 NEUTRON ACER TENDL-2019 LIBRARY; T=293.16K
Photon emission for (n,gma)

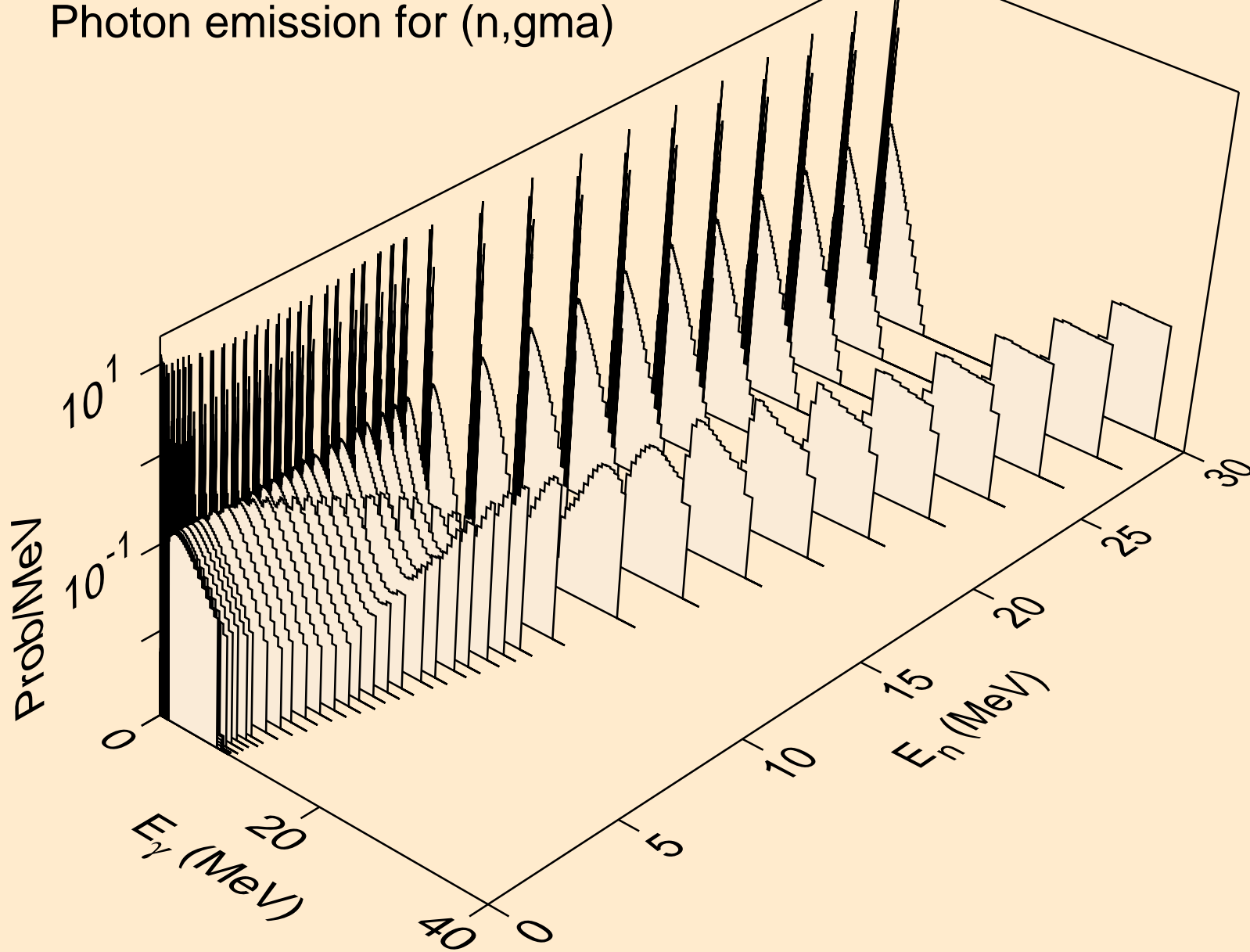

AS080 NEUTRON ACER TENDL-2019 LIBRARY; T=293.16K
Photon emission for (n,p)

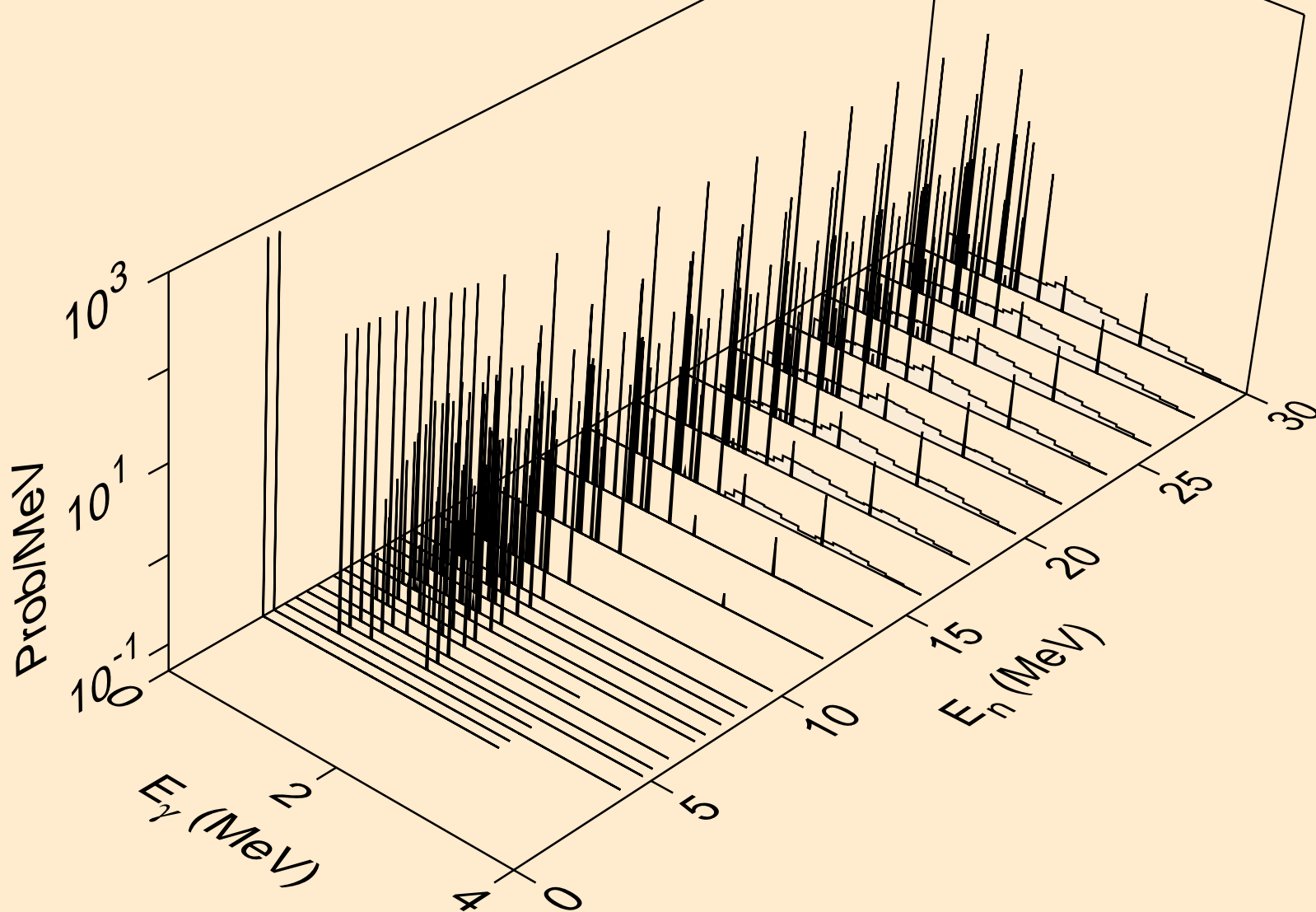

AS080 NEUTRON ACER TENDL-2019 LIBRARY; T=293.16K
Photon emission for (n,d)

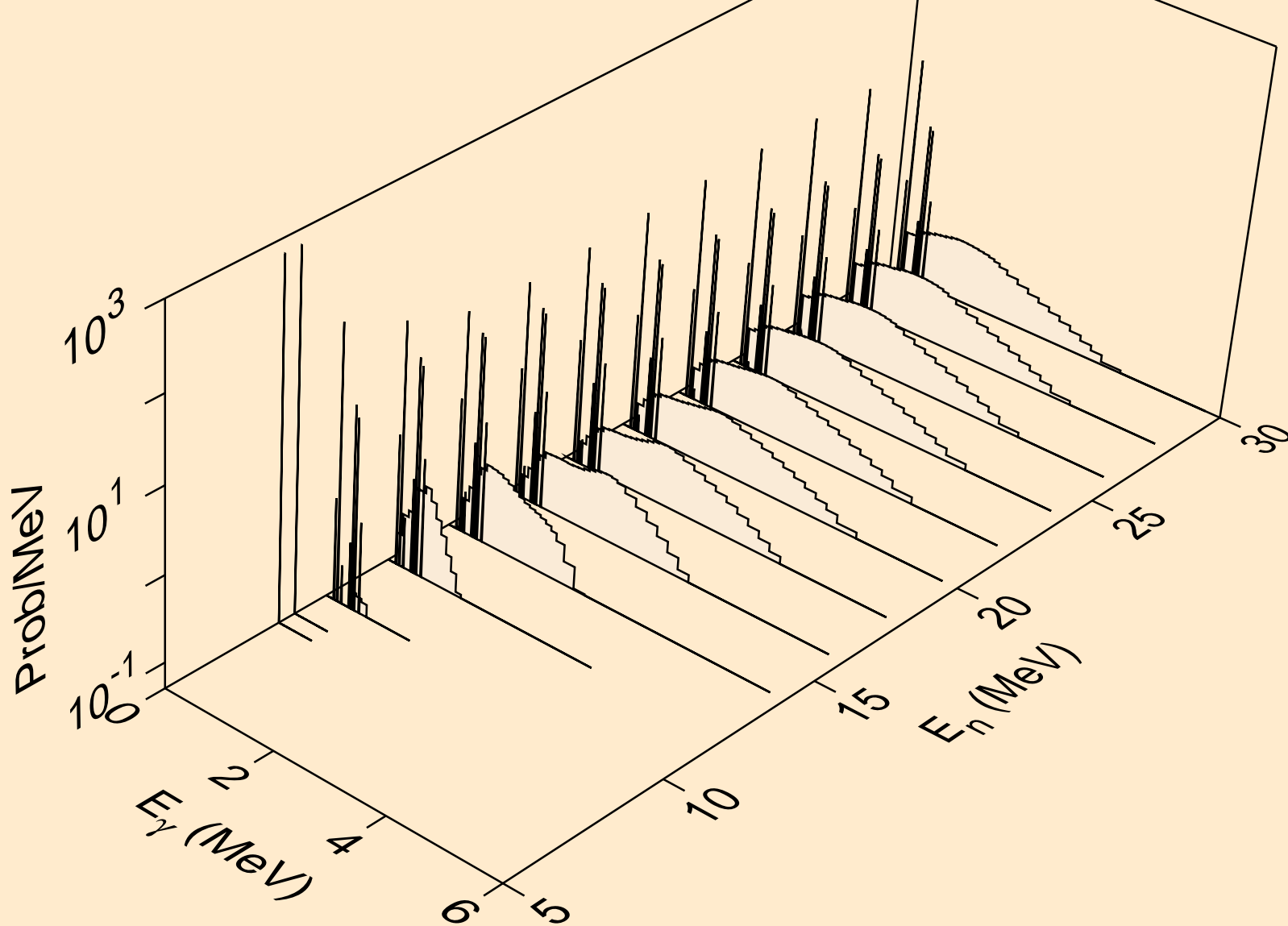

AS080 NEUTRON ACER TENDL-2019 LIBRARY; T=293.16K
Photon emission for (n,t)

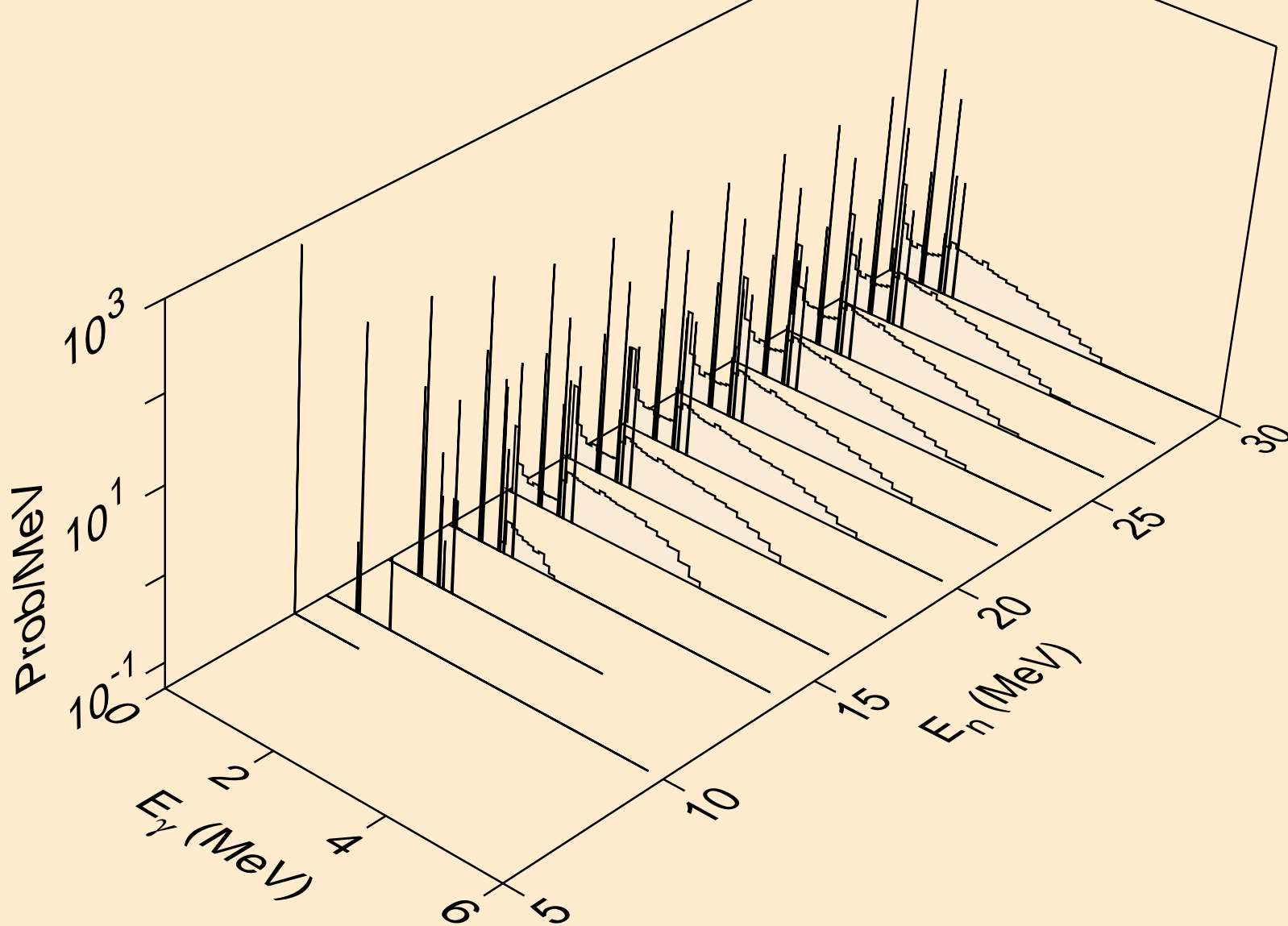

AS080 NEUTRON ACER TENDL-2019 LIBRARY; T=293.16K
Photon emission for (n,he3)

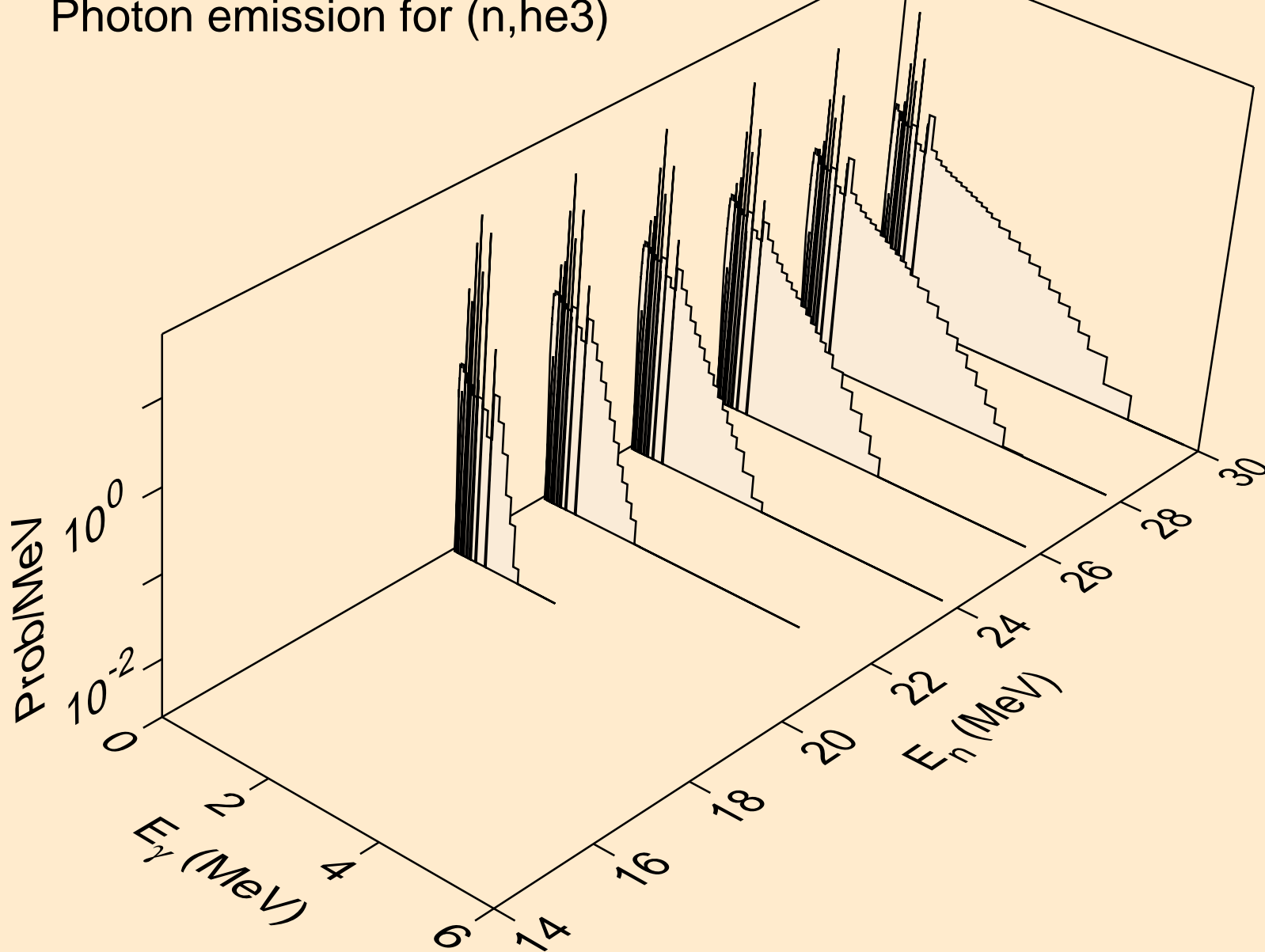

AS080 NEUTRON ACER TENDL-2019 LIBRARY; T=293.16K
Photon emission for (n,a)

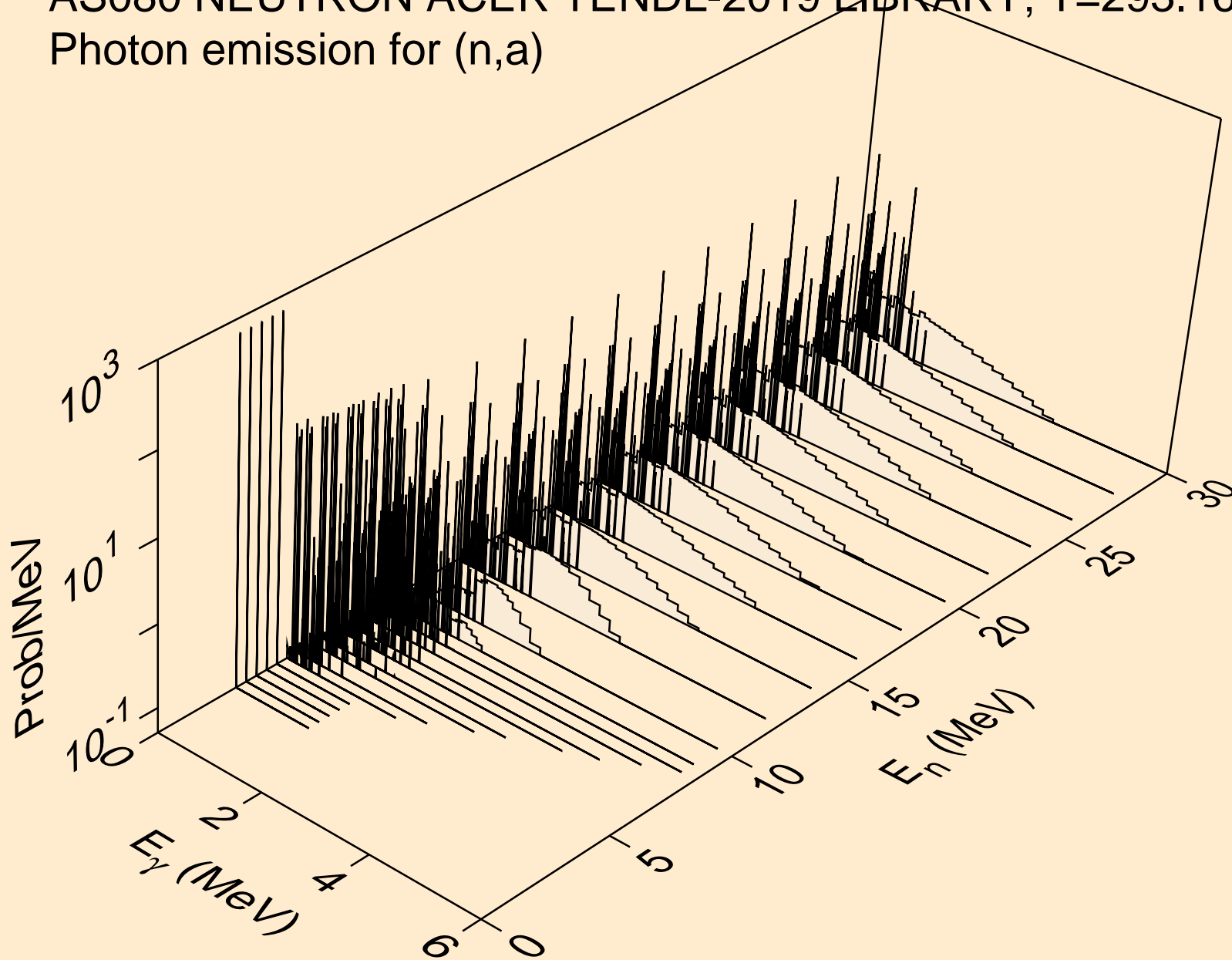

AS080 NEUTRON ACER TENDL-2019 LIBRARY; T=293.16K
Photon emission for (n,2a)

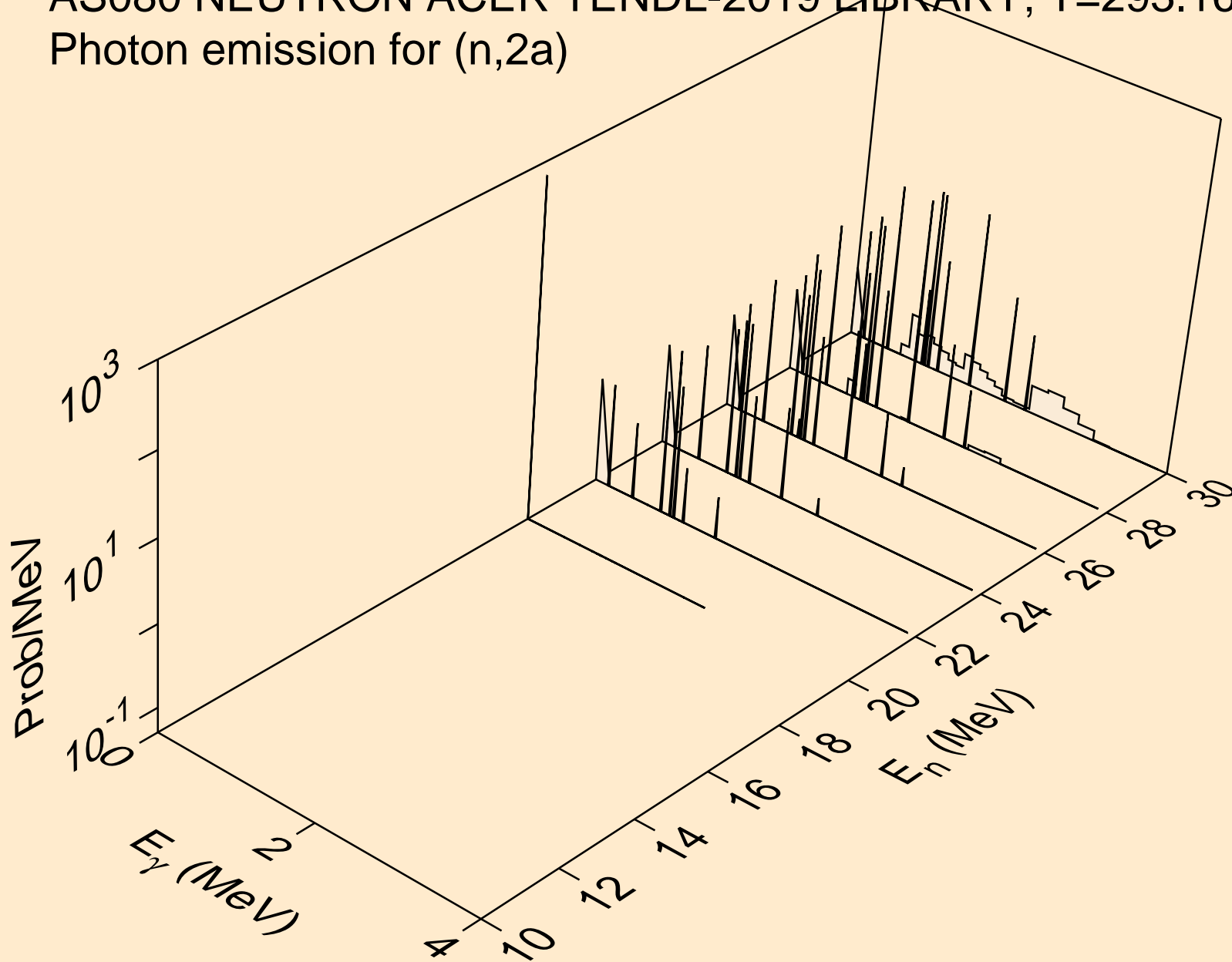

AS080 NEUTRON ACER TENDL-2019 LIBRARY; T=293.16K
Photon emission for (n,2p)

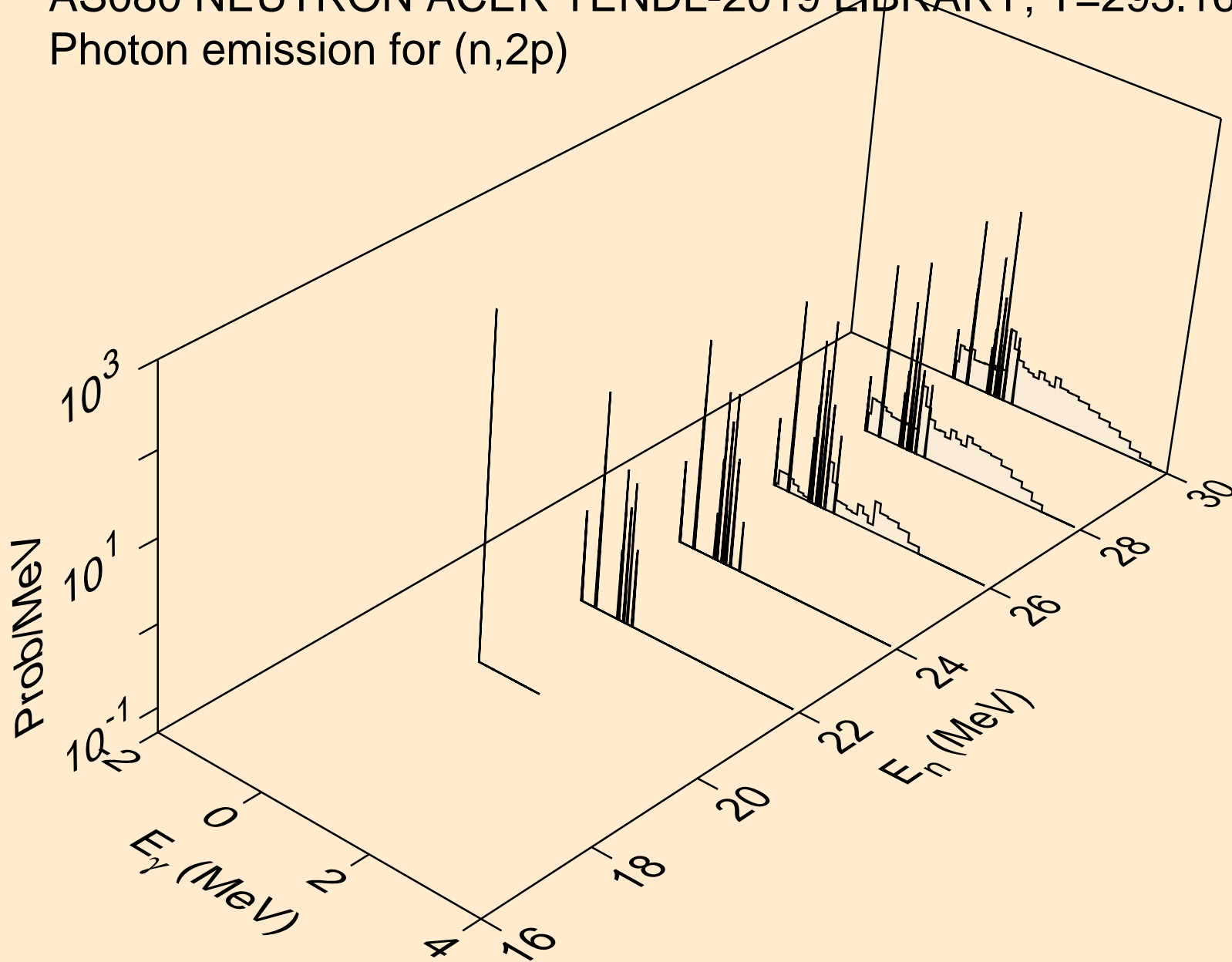

AS080 NEUTRON ACER TENDL-2019 LIBRARY; T=293.16K
Photon emission for (n,p)

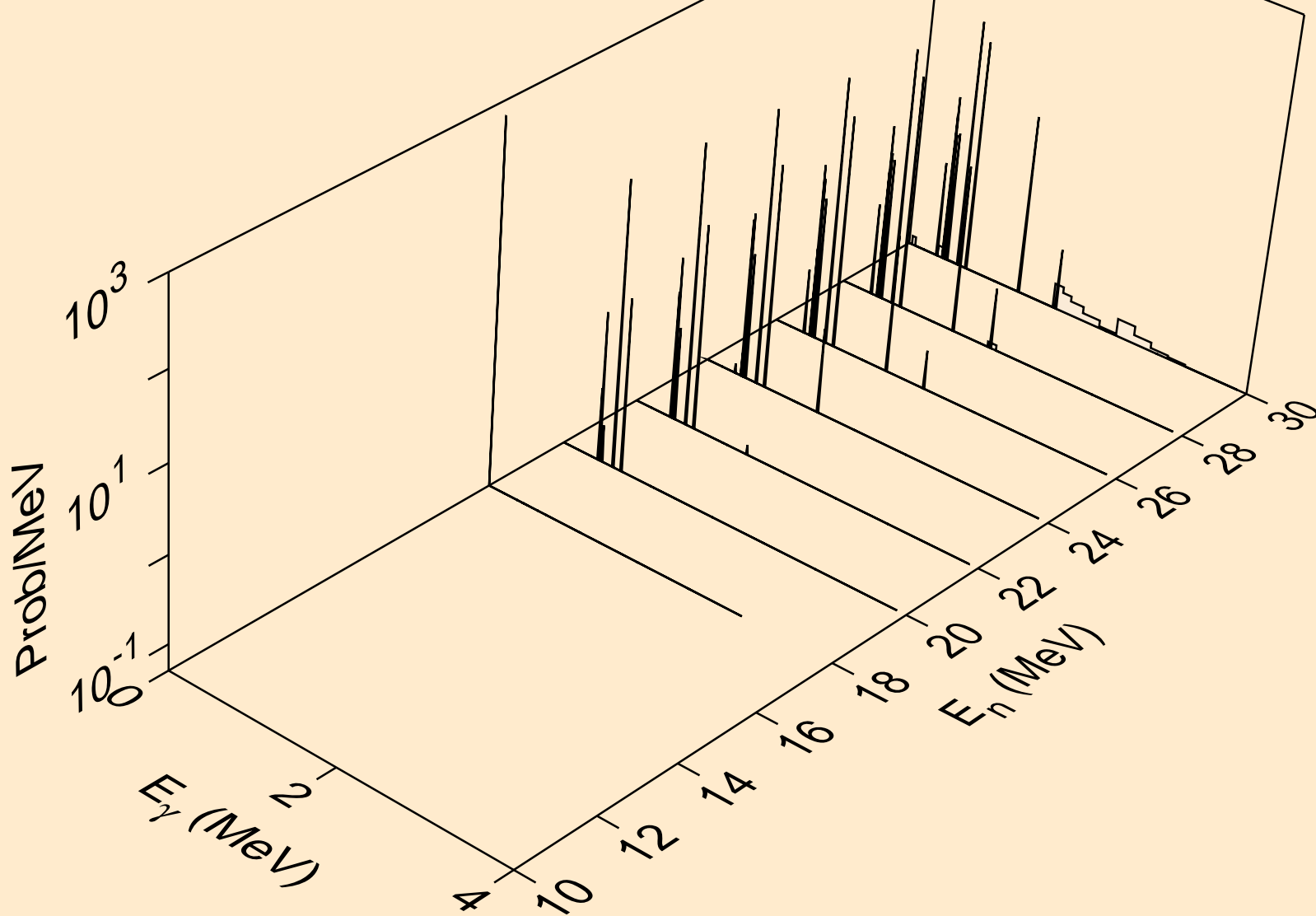

AS080 NEUTRON ACER TENDL-2019 LIBRARY; T=293.16K
Photon emission for (n,pd)

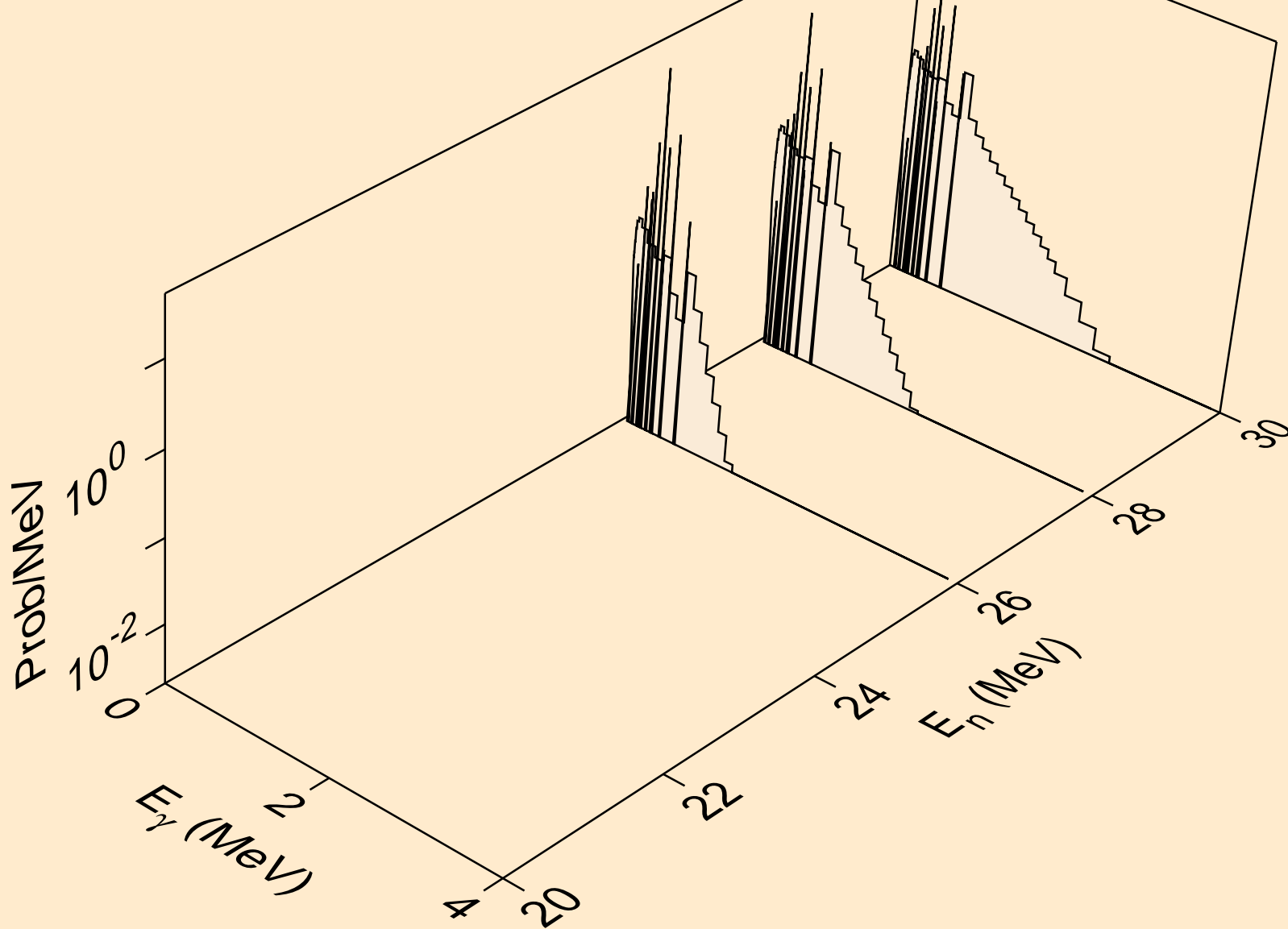

AS080 NEUTRON ACER TENDL-2019 LIBRARY; T=293.16K
Photon emission for (n,pt)

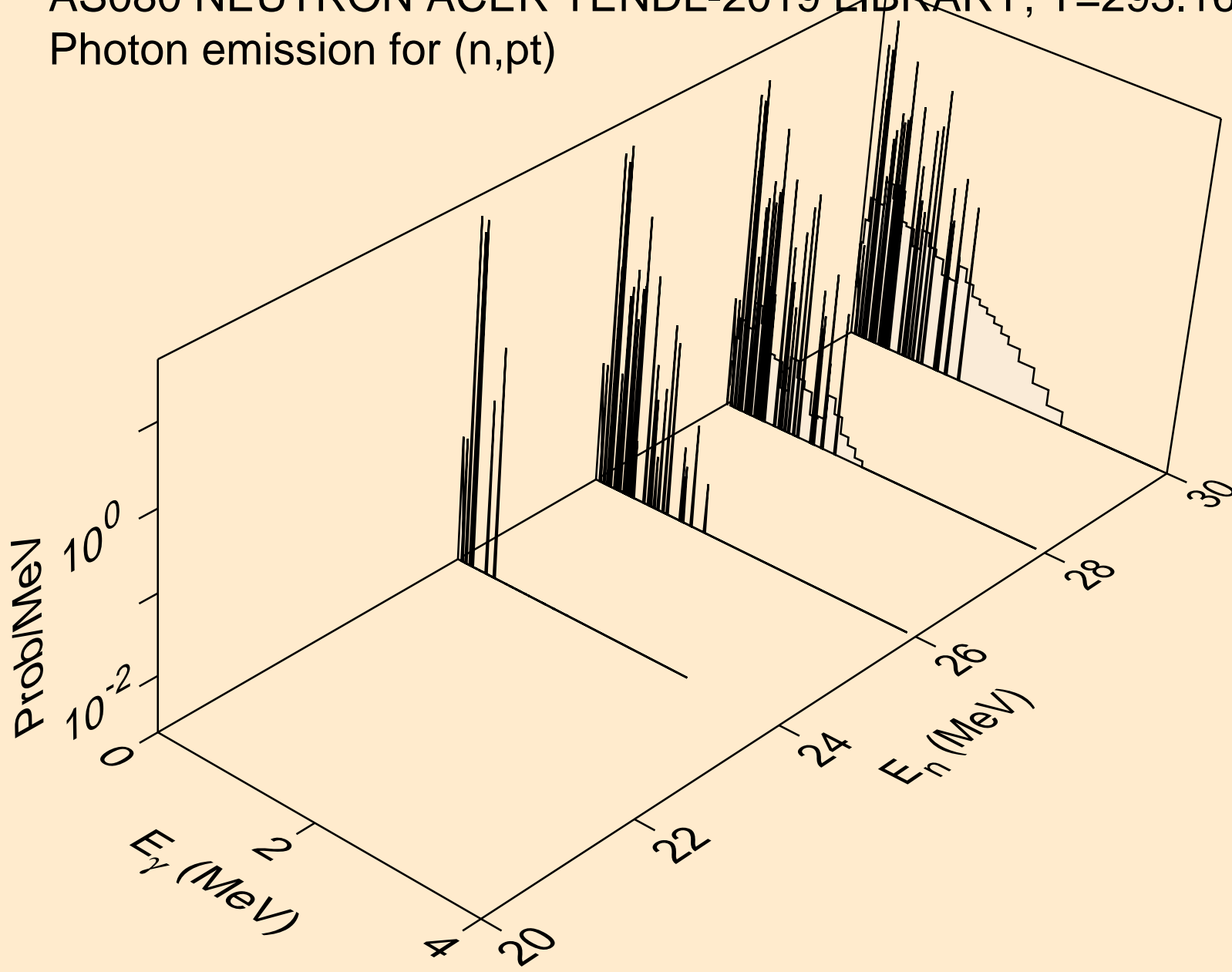

AS080 NEUTRON ACER TENDL-2019 LIBRARY; T=293.16K
thermal capture photon spectrum

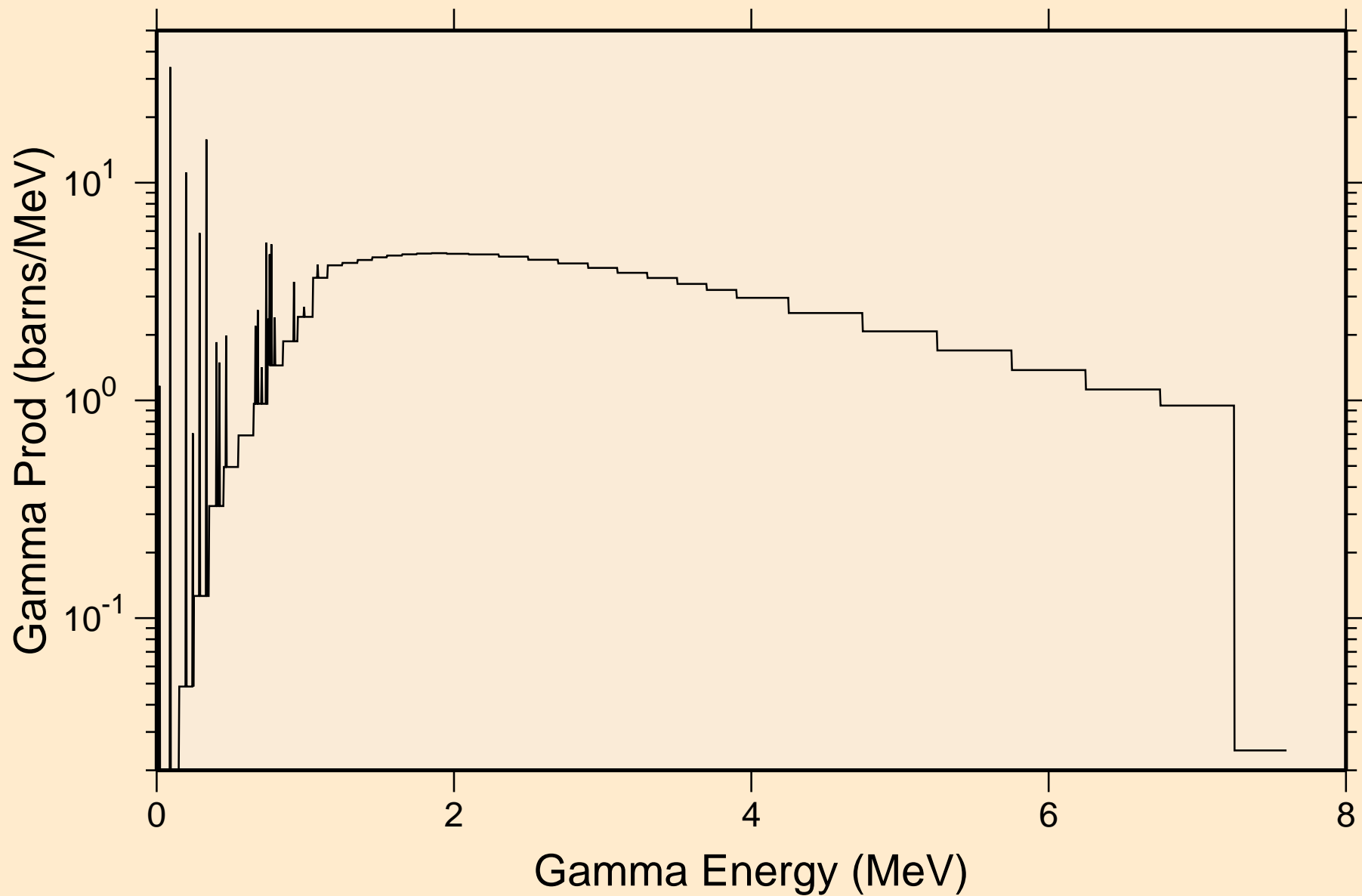

AS080 NEUTRON ACER TENDL-2019 LIBRARY; T=293.16K
14 MeV photon spectrum

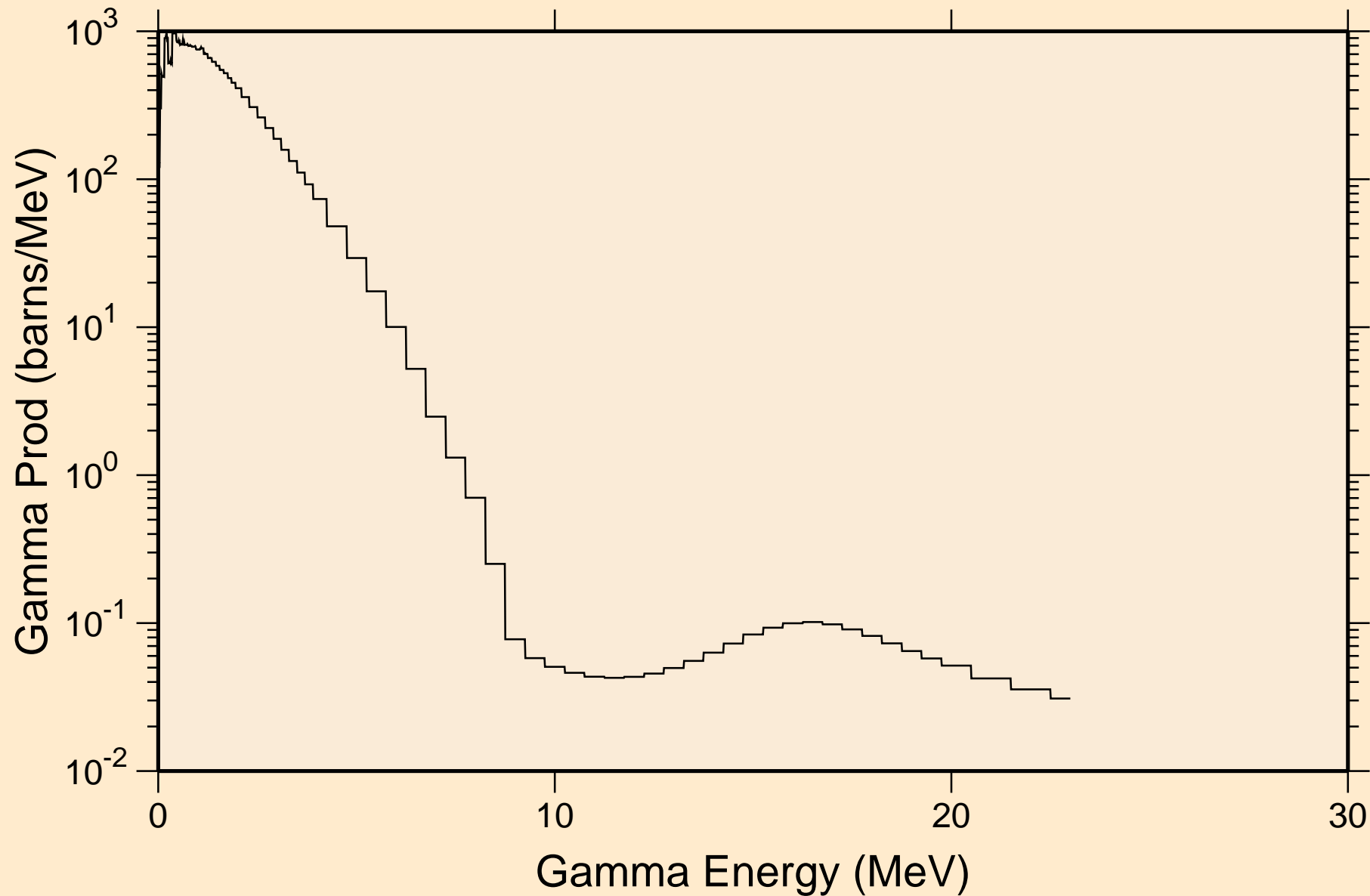

AS080 NEUTRON ACER TENDL-2019 LIBRARY; T=293.16K
Particle heating contributions

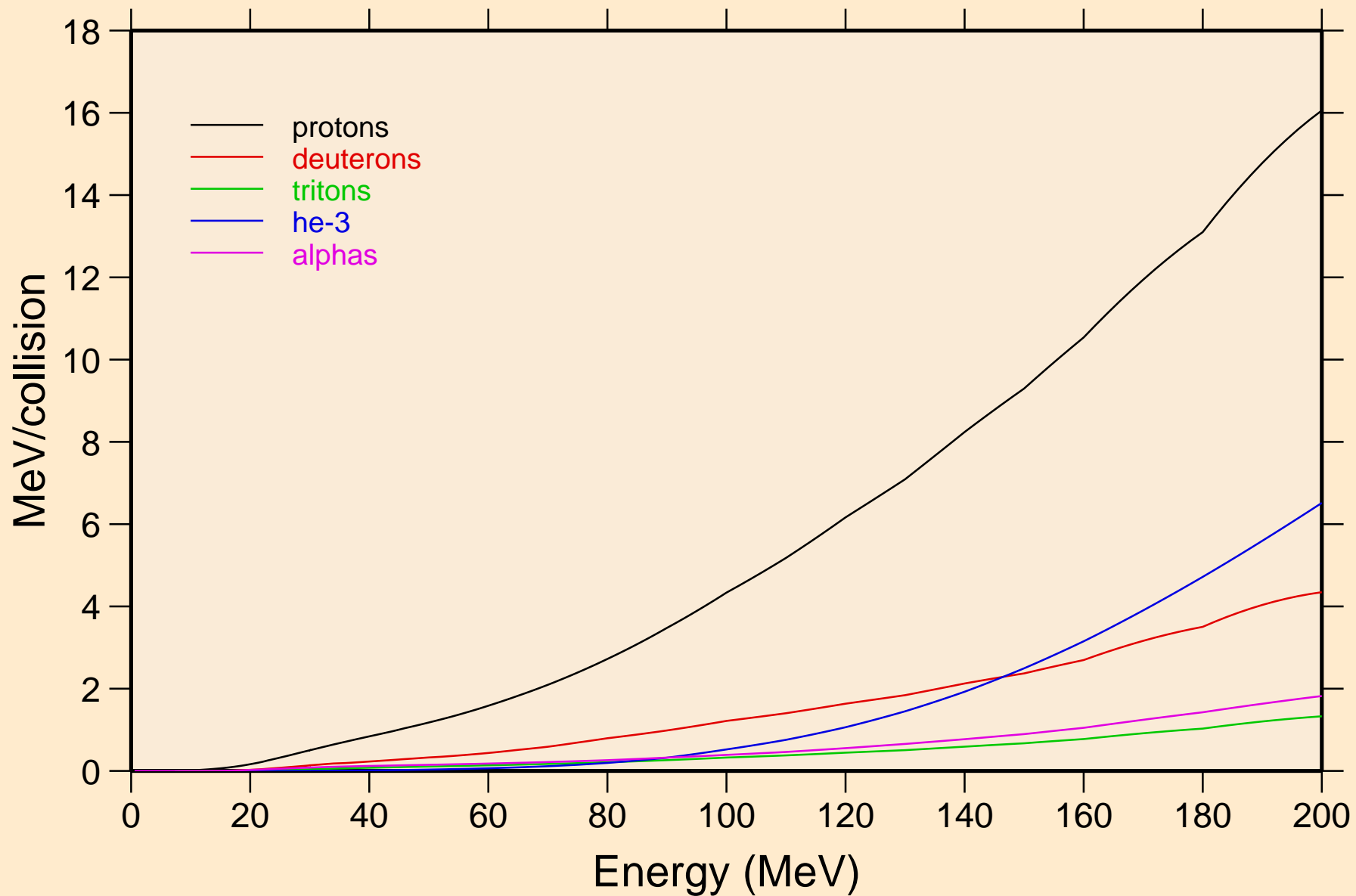

AS080 NEUTRON ACER TENDL-2019 LIBRARY; T=293.16K
Recoil Heating

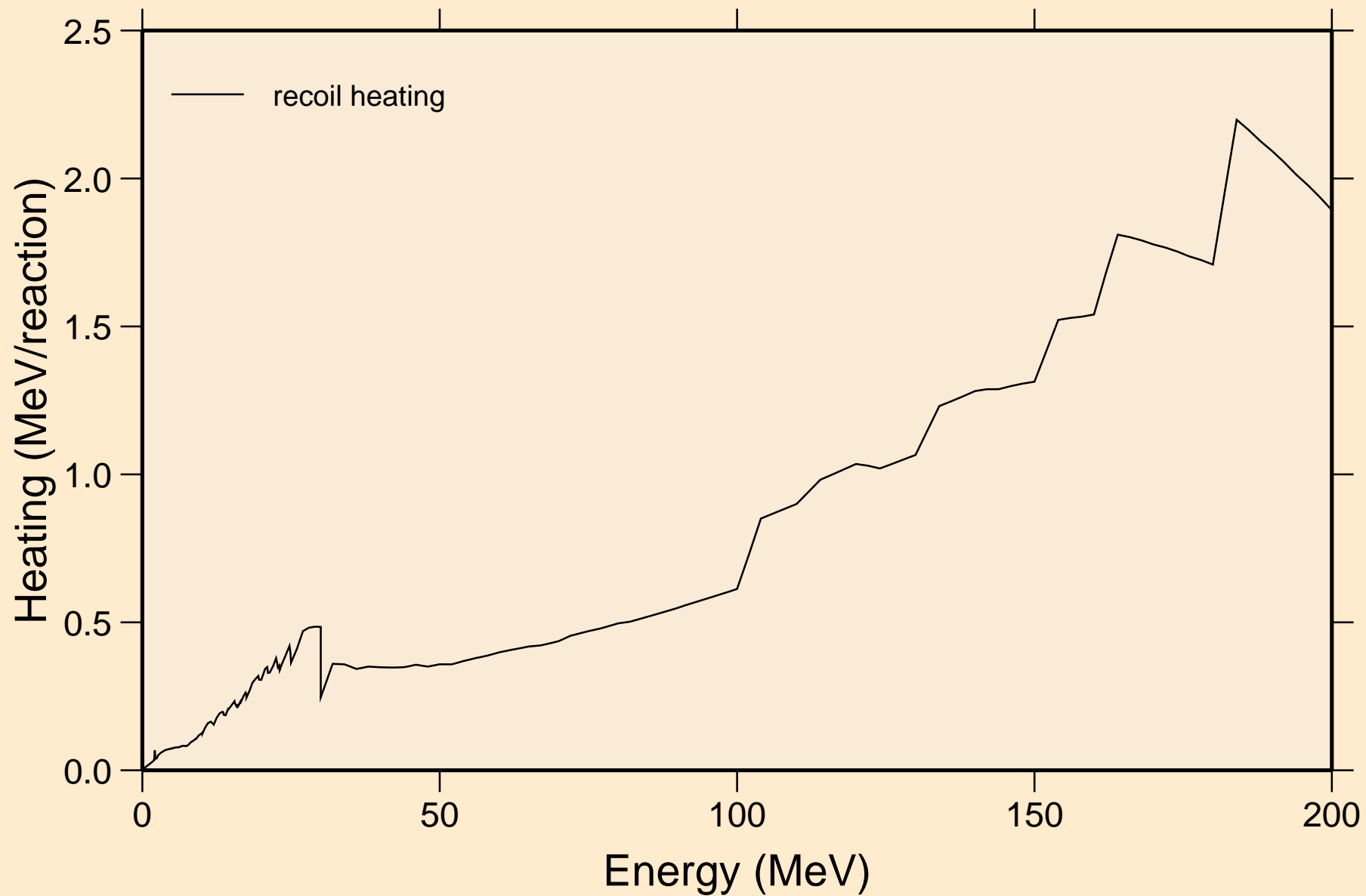

AS080 NEUTRON ACER TENDL-2019 LIBRARY; T=293.16K
Particle production cross sections

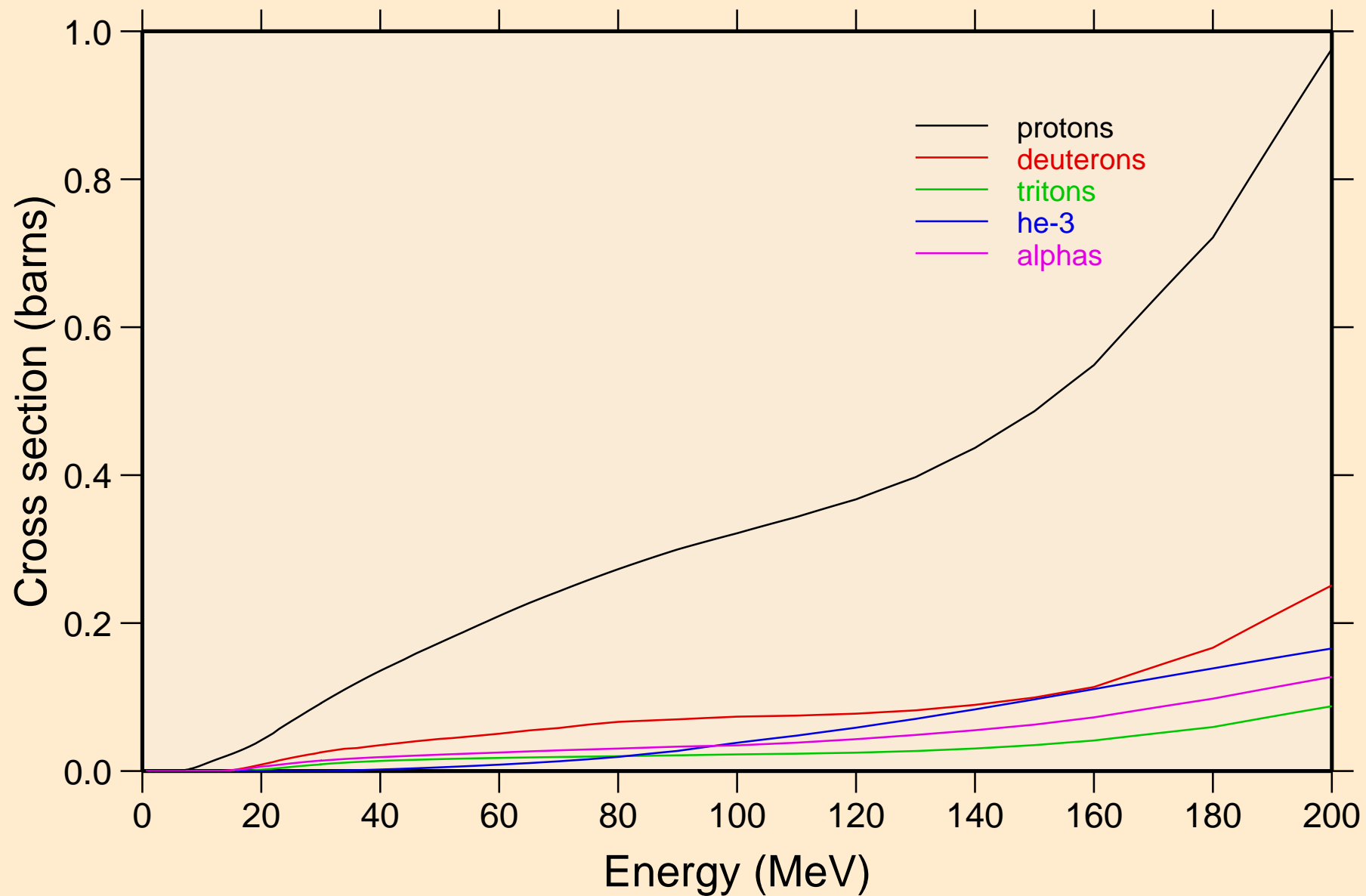

AS080 NEUTRON ACER TENDL-2019 LIBRARY; T=293.16K
protons from (n,x)

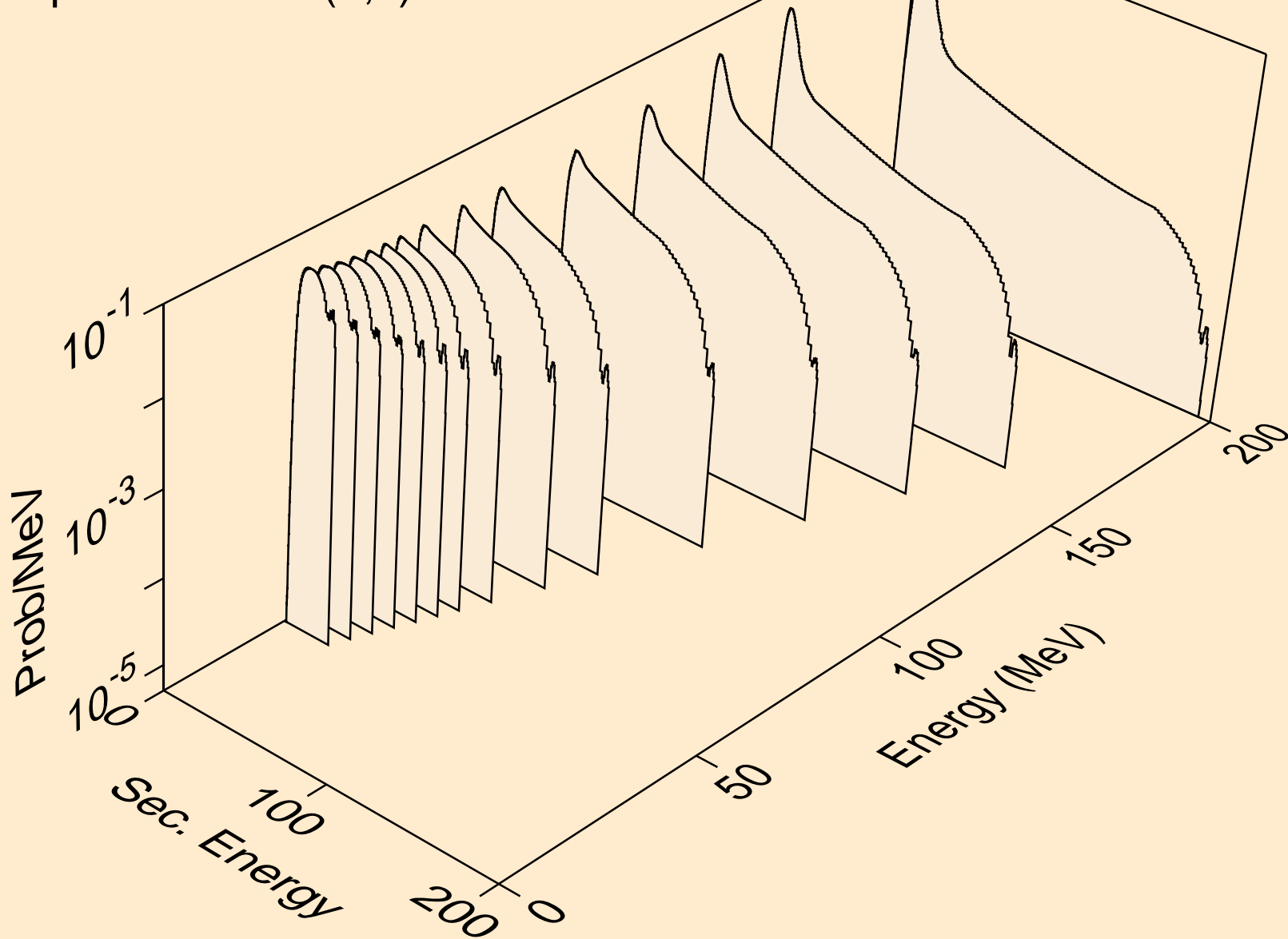

AS080 NEUTRON ACER TENDL-2019 LIBRARY; T=293.16K
protons from (n,n*)p

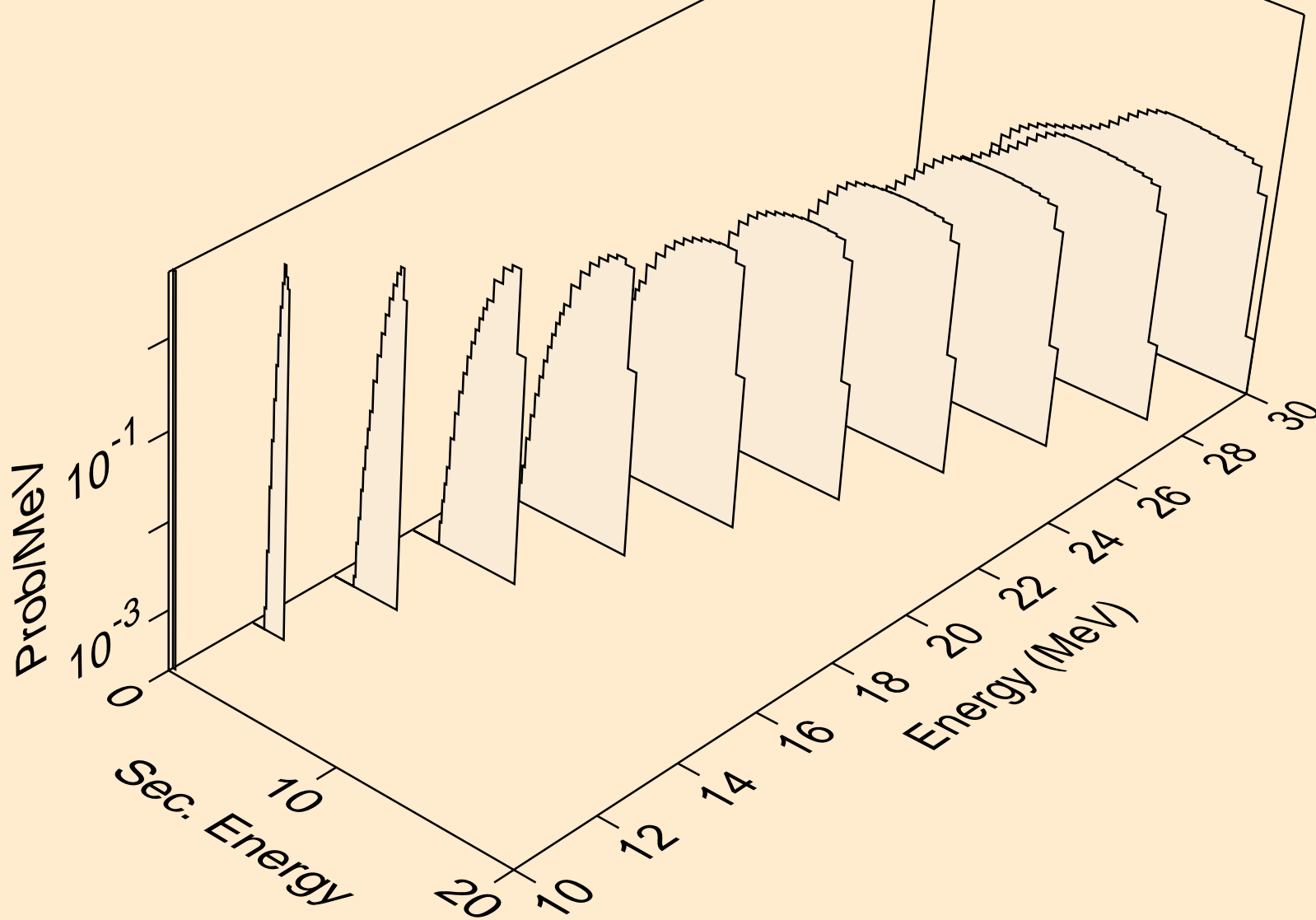

AS080 NEUTRON ACER TENDL-2019 LIBRARY; T=293.16K
protons from (n,2np)

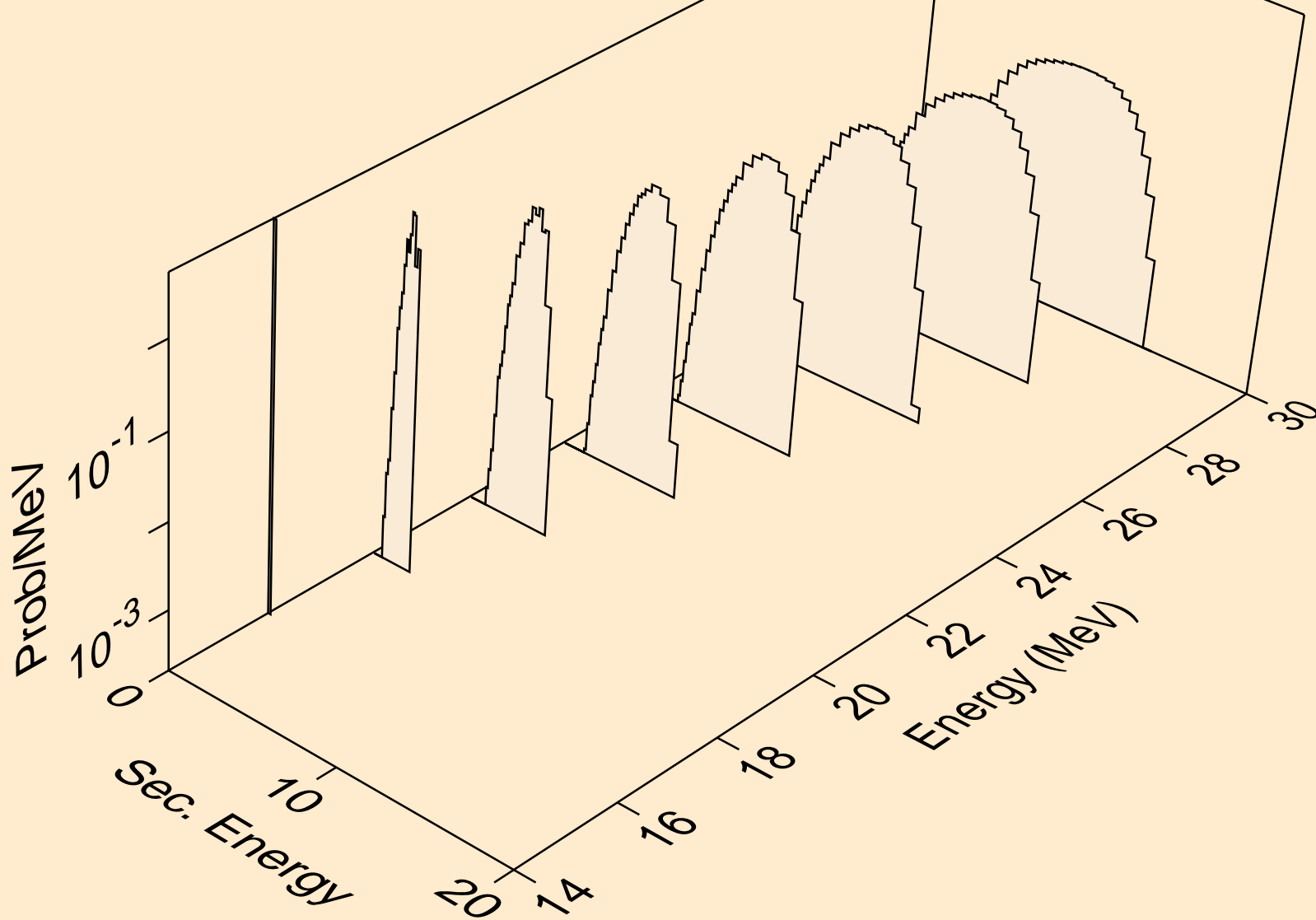

AS080 NEUTRON ACER TENDL-2019 LIBRARY; T=293.16K
protons from (n,3np)

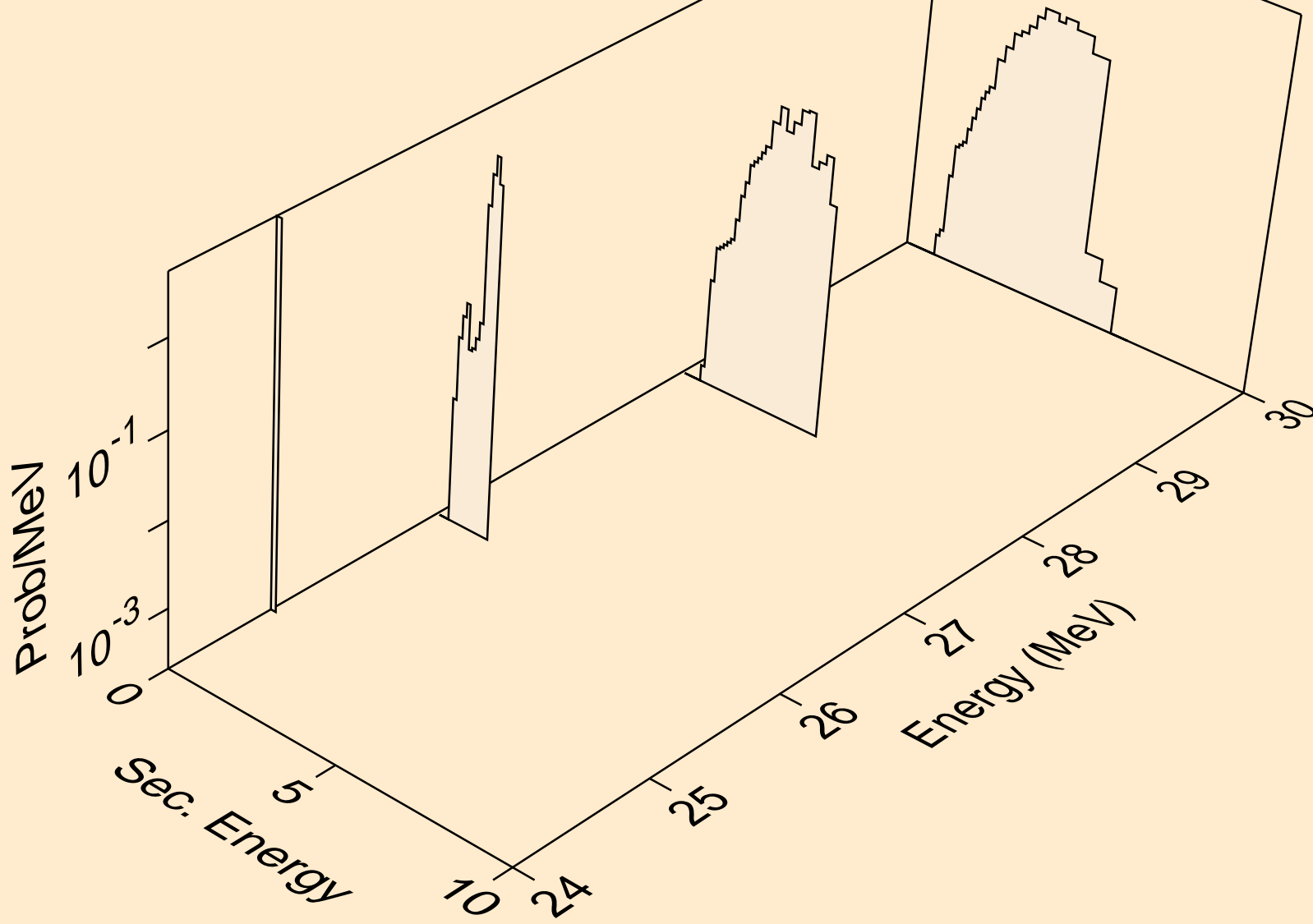

AS080 NEUTRON ACER TENDL-2019 LIBRARY; T=293.16K
protons from (n,2np)

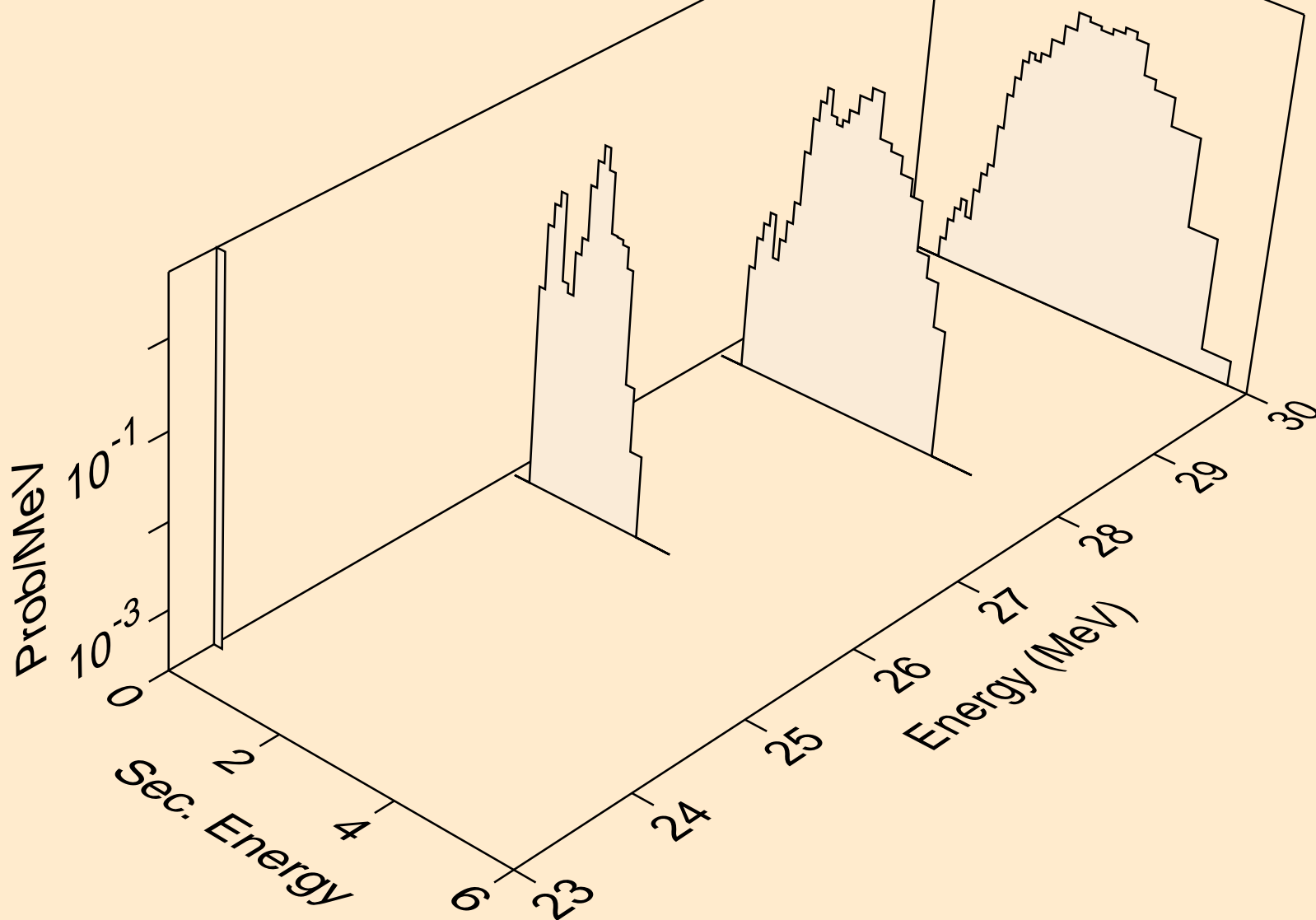

AS080 NEUTRON ACER TENDL-2019 LIBRARY; T=293.16K
protons from (n,p)

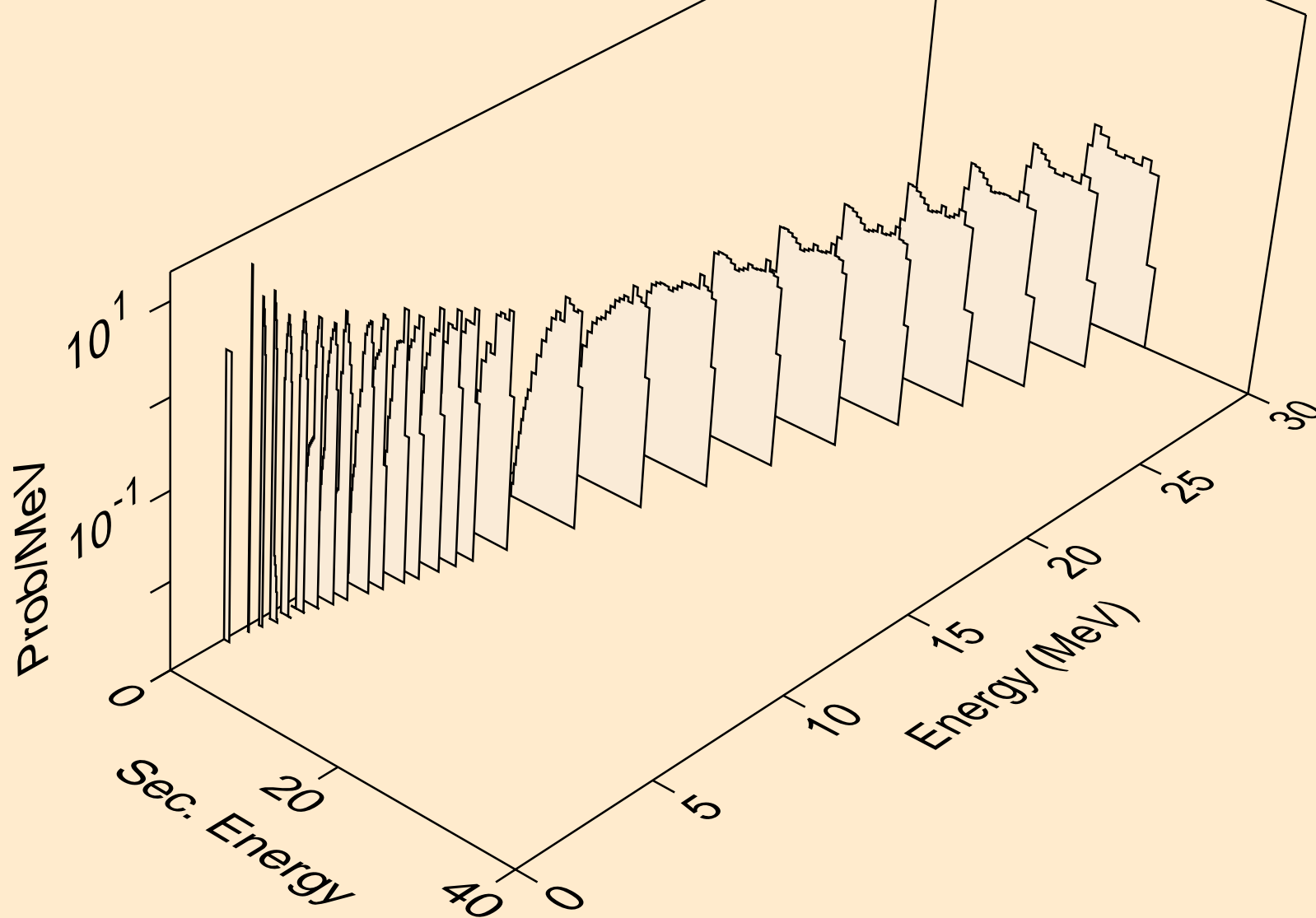

AS080 NEUTRON ACER TENDL-2019 LIBRARY; T=293.16K
protons from (n,2p)

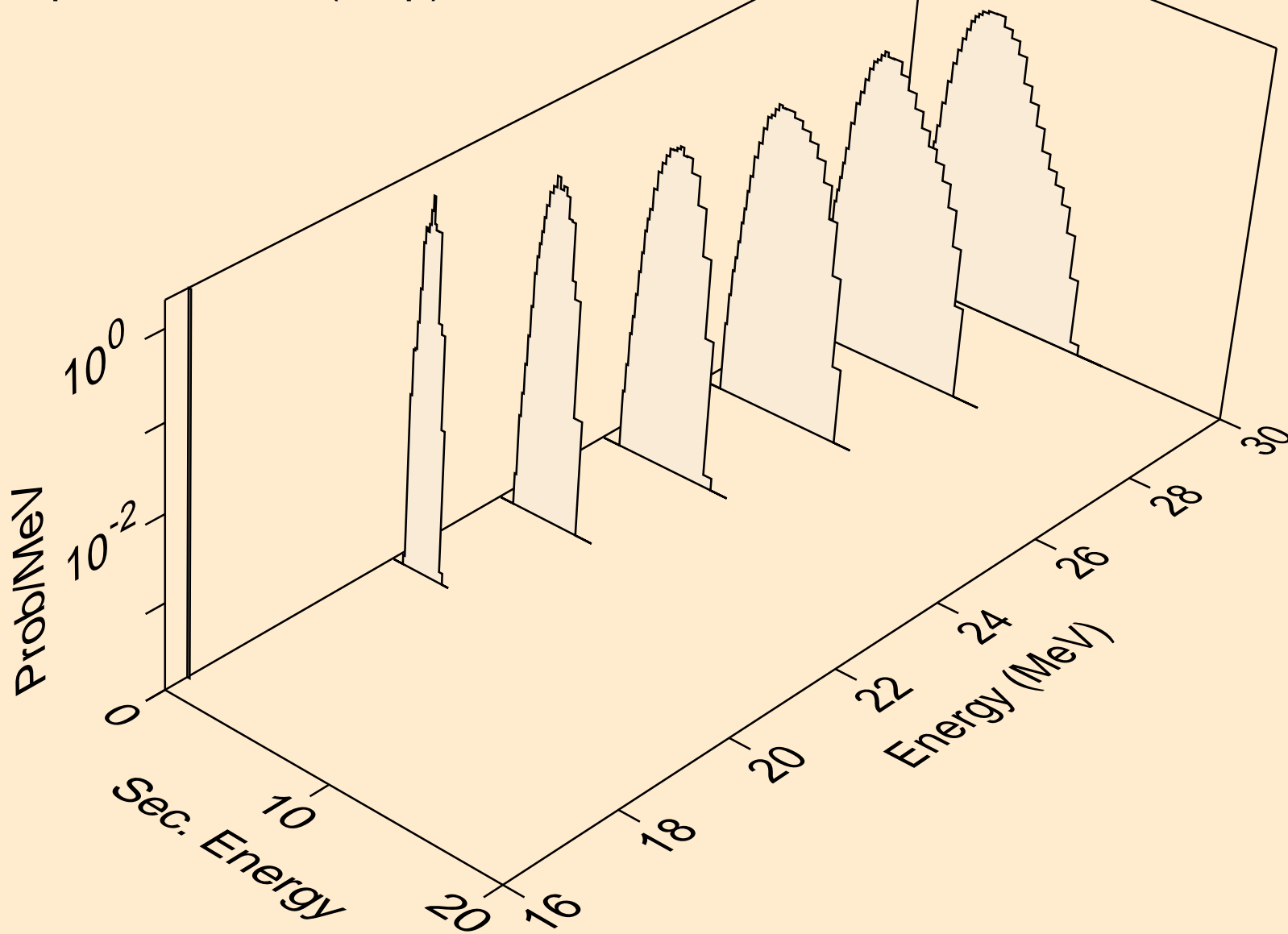

AS080 NEUTRON ACER TENDL-2019 LIBRARY; T=293.16K
protons from (n,p)

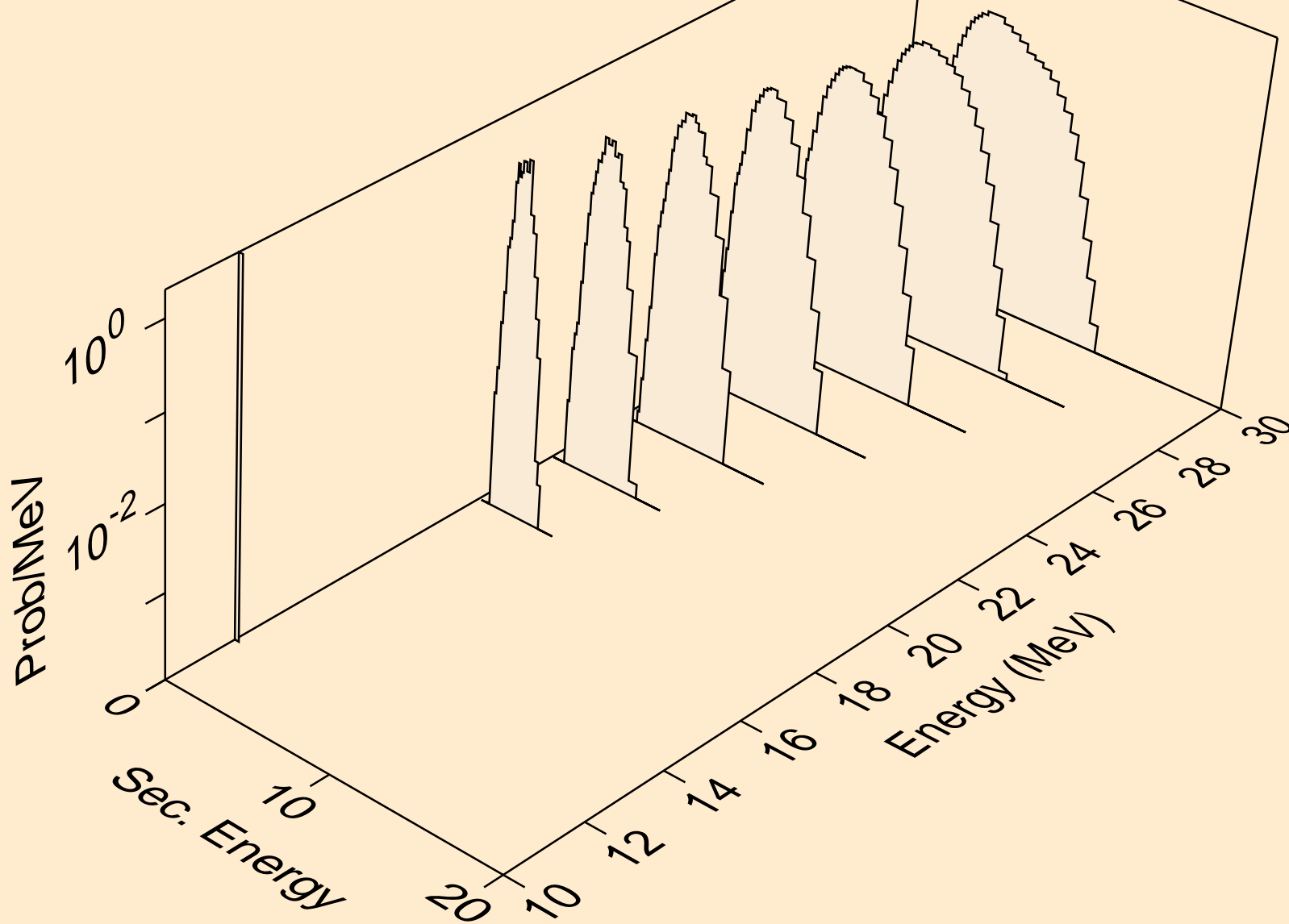

AS080 NEUTRON ACER TENDL-2019 LIBRARY; T=293.16K
protons from (n,pd)

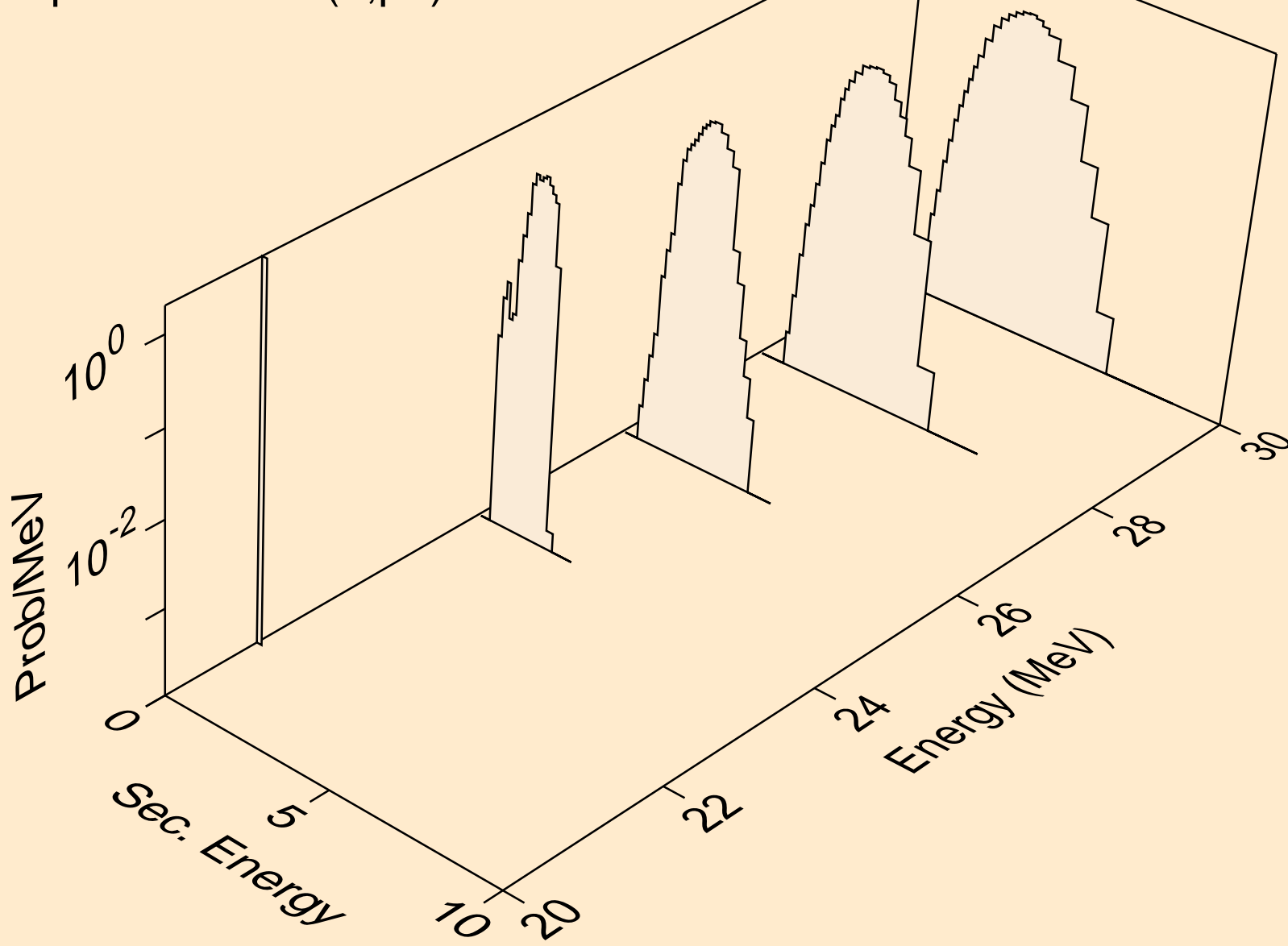

AS080 NEUTRON ACER TENDL-2019 LIBRARY; T=293.16K
protons from (n,pt)

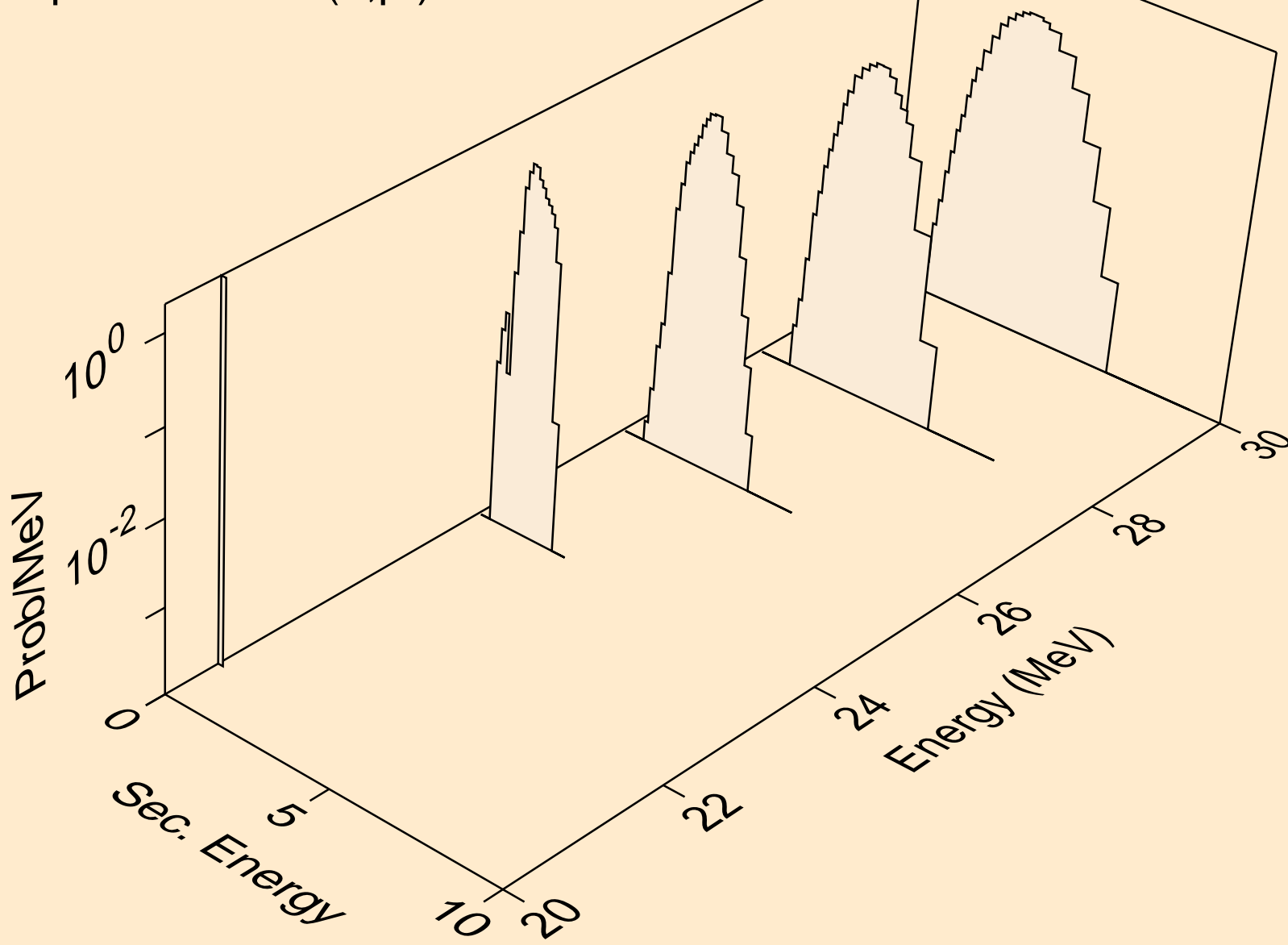

AS080 NEUTRON ACER TENDL-2019 LIBRARY; T=293.16K
deuterons from (n,x)

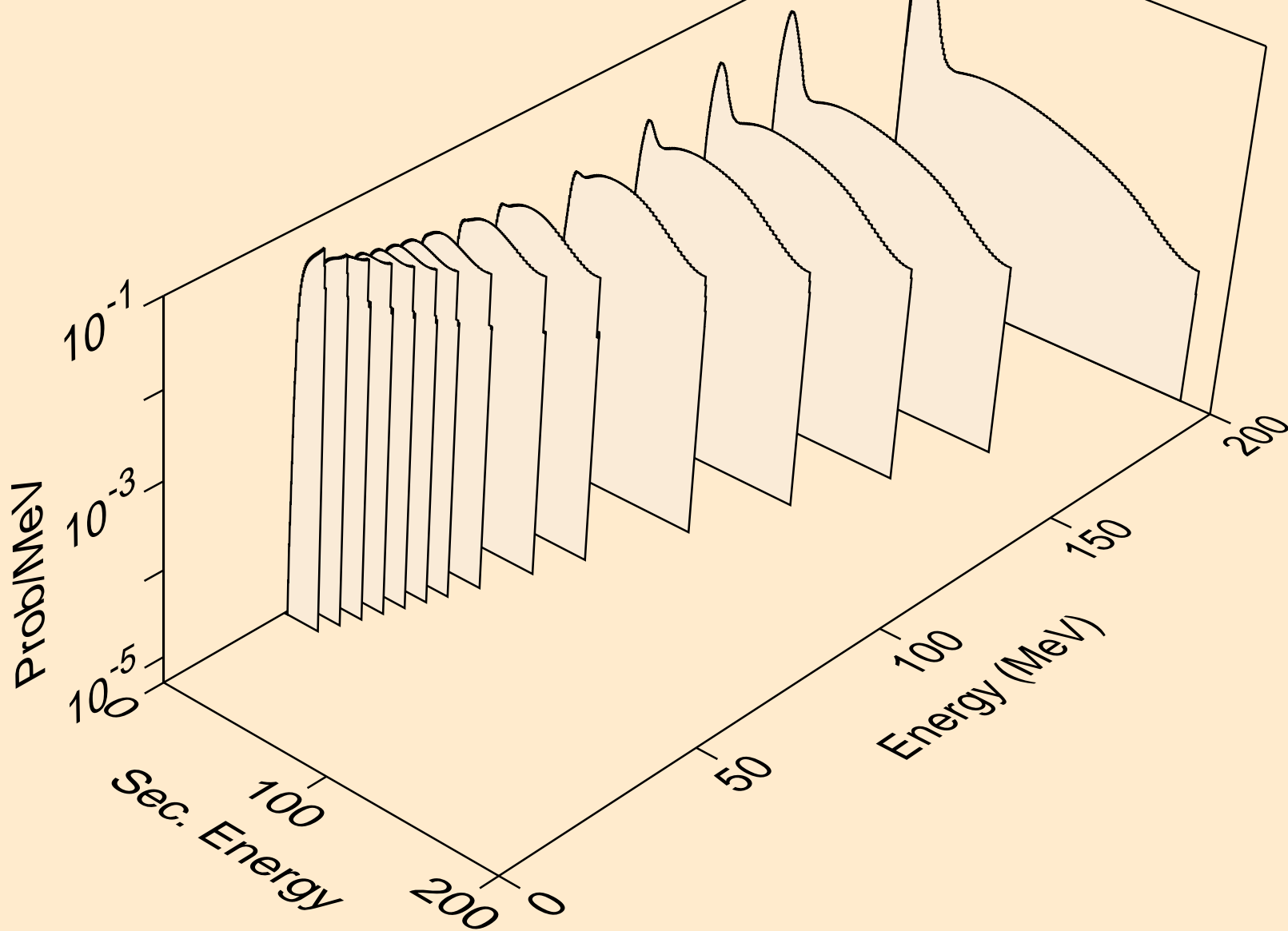

AS080 NEUTRON ACER TENDL-2019 LIBRARY; T=293.16K
deuterons from (n,2nd)

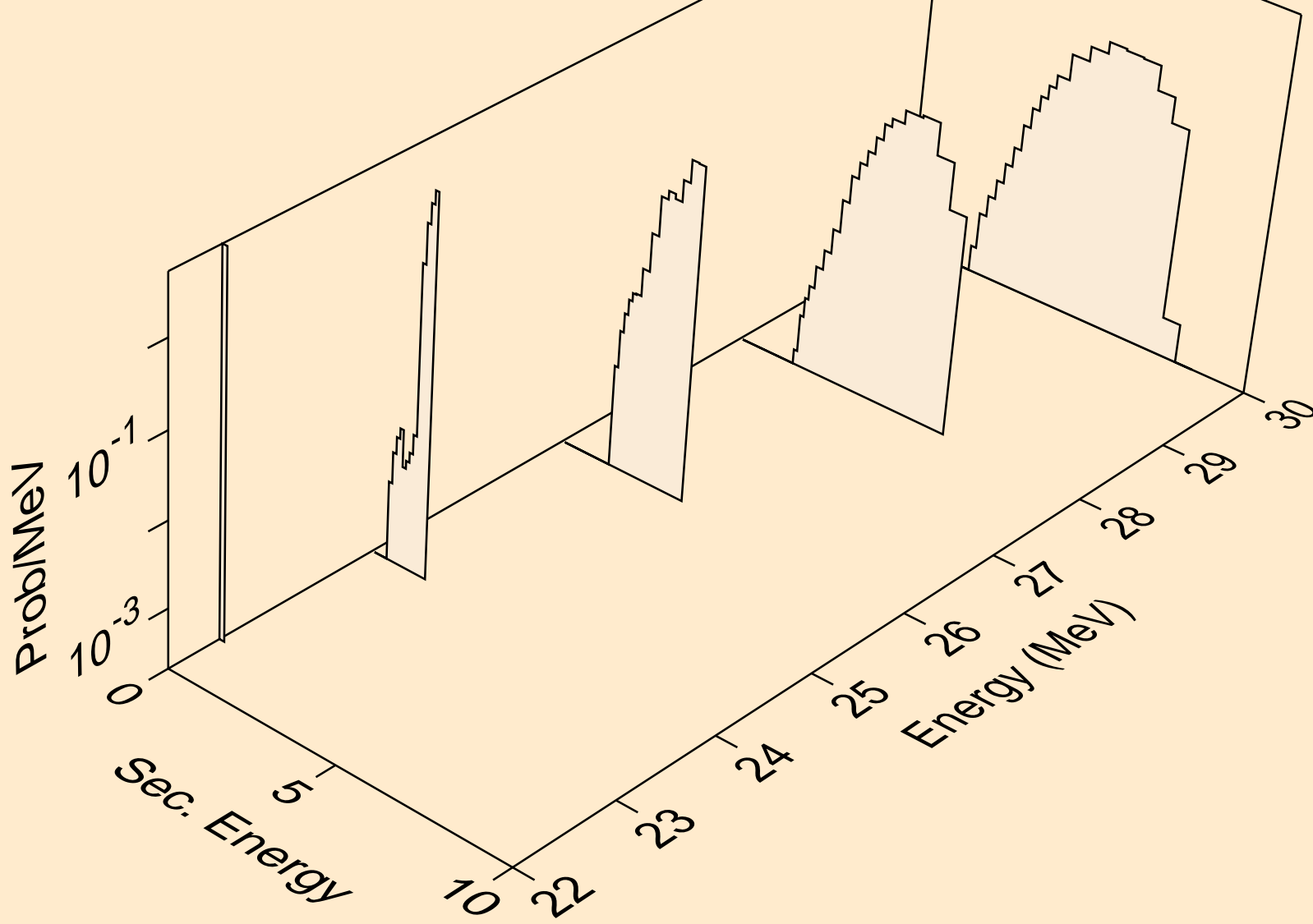

AS080 NEUTRON ACER TENDL-2019 LIBRARY; T=293.16K
deuterons from (n,n*)d

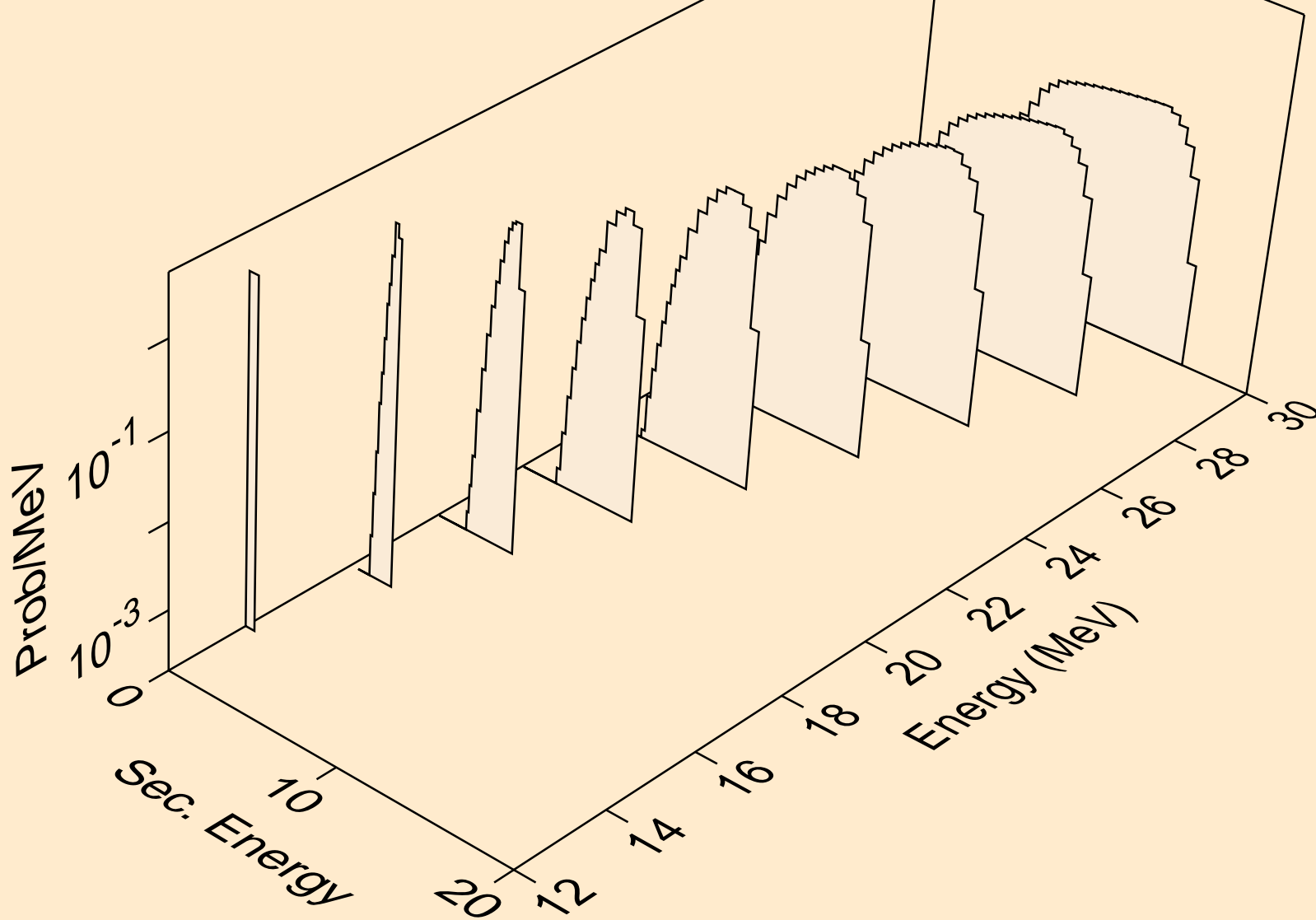

AS080 NEUTRON ACER TENDL-2019 LIBRARY; T=293.16K
deuterons from (n,d)

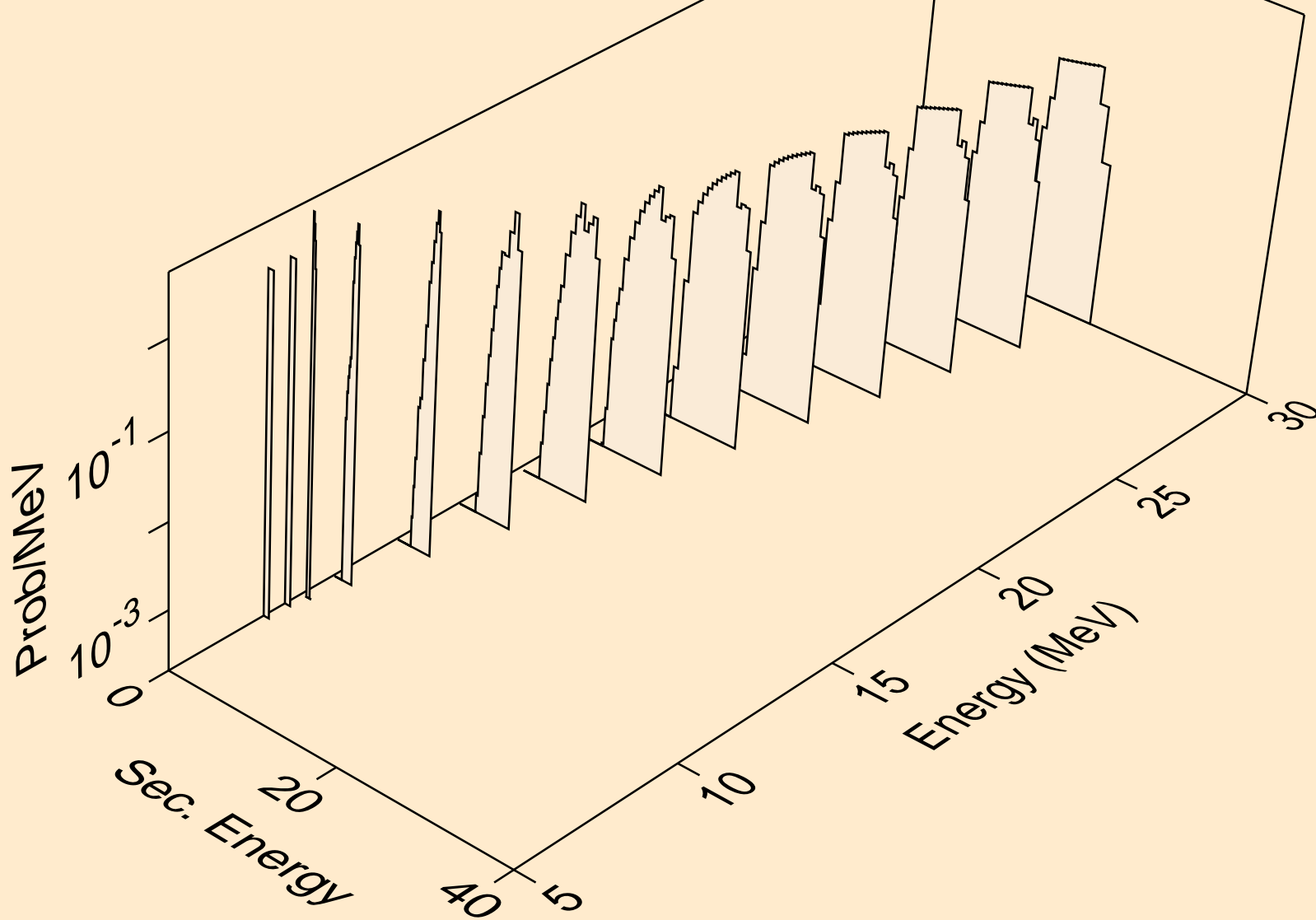

AS080 NEUTRON ACER TENDL-2019 LIBRARY; T=293.16K
deuterons from (n,pd)

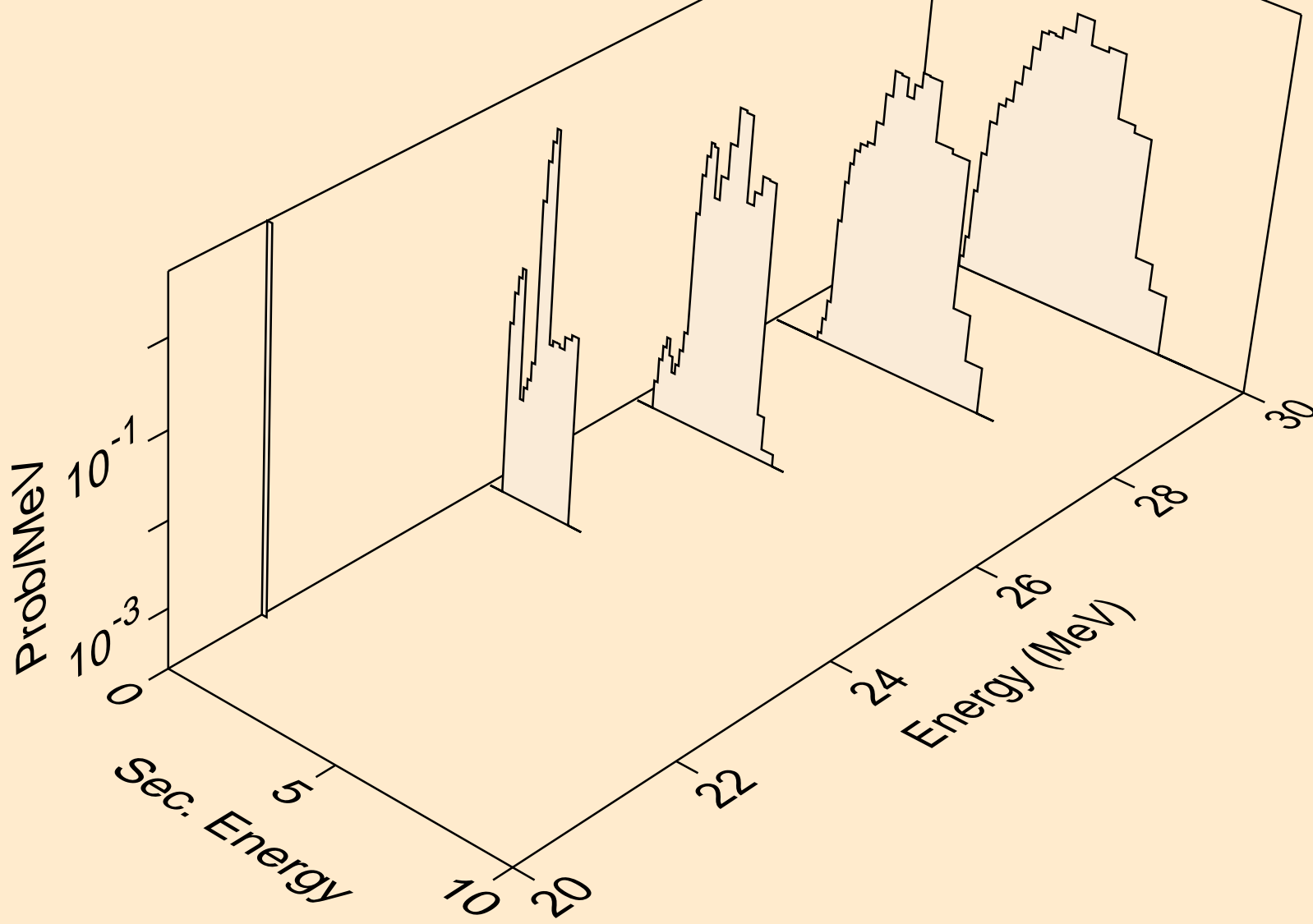

AS080 NEUTRON ACER TENDL-2019 LIBRARY; T=293.16K
tritons from (n,x)

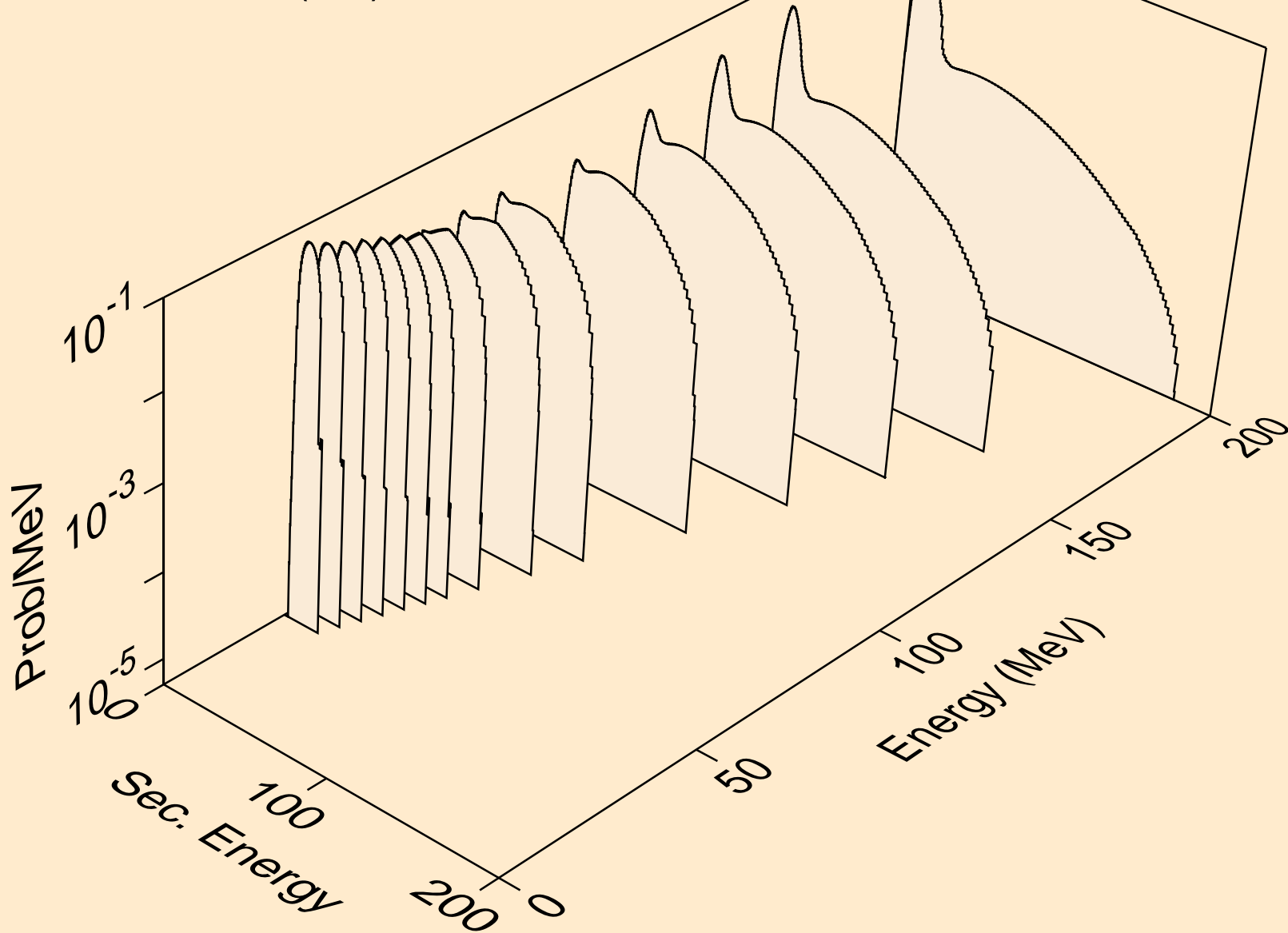

AS080 NEUTRON ACER TENDL-2019 LIBRARY; T=293.16K
tritons from (n,n*)t

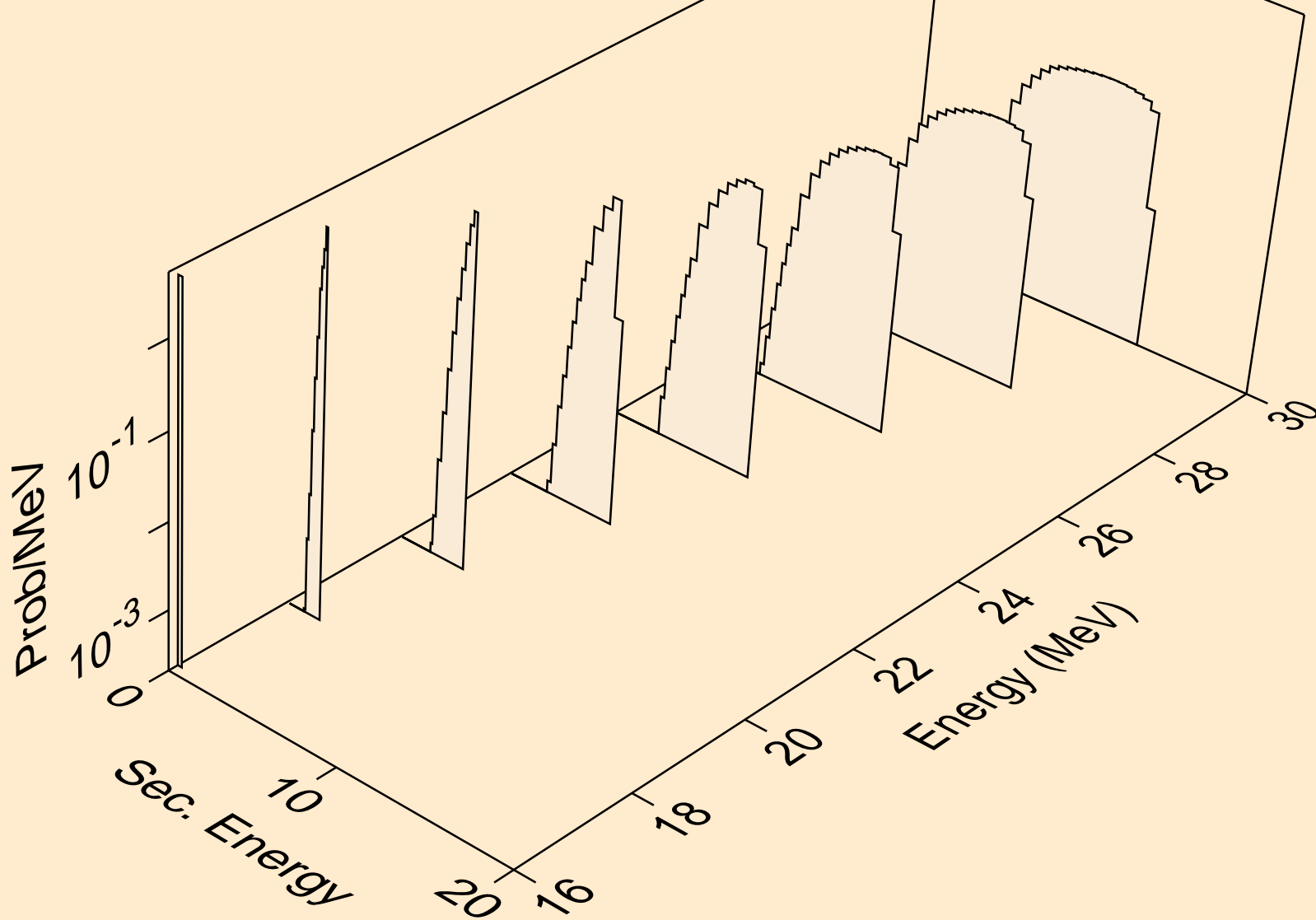

AS080 NEUTRON ACER TENDL-2019 LIBRARY; T=293.16K
tritons from (n,t)

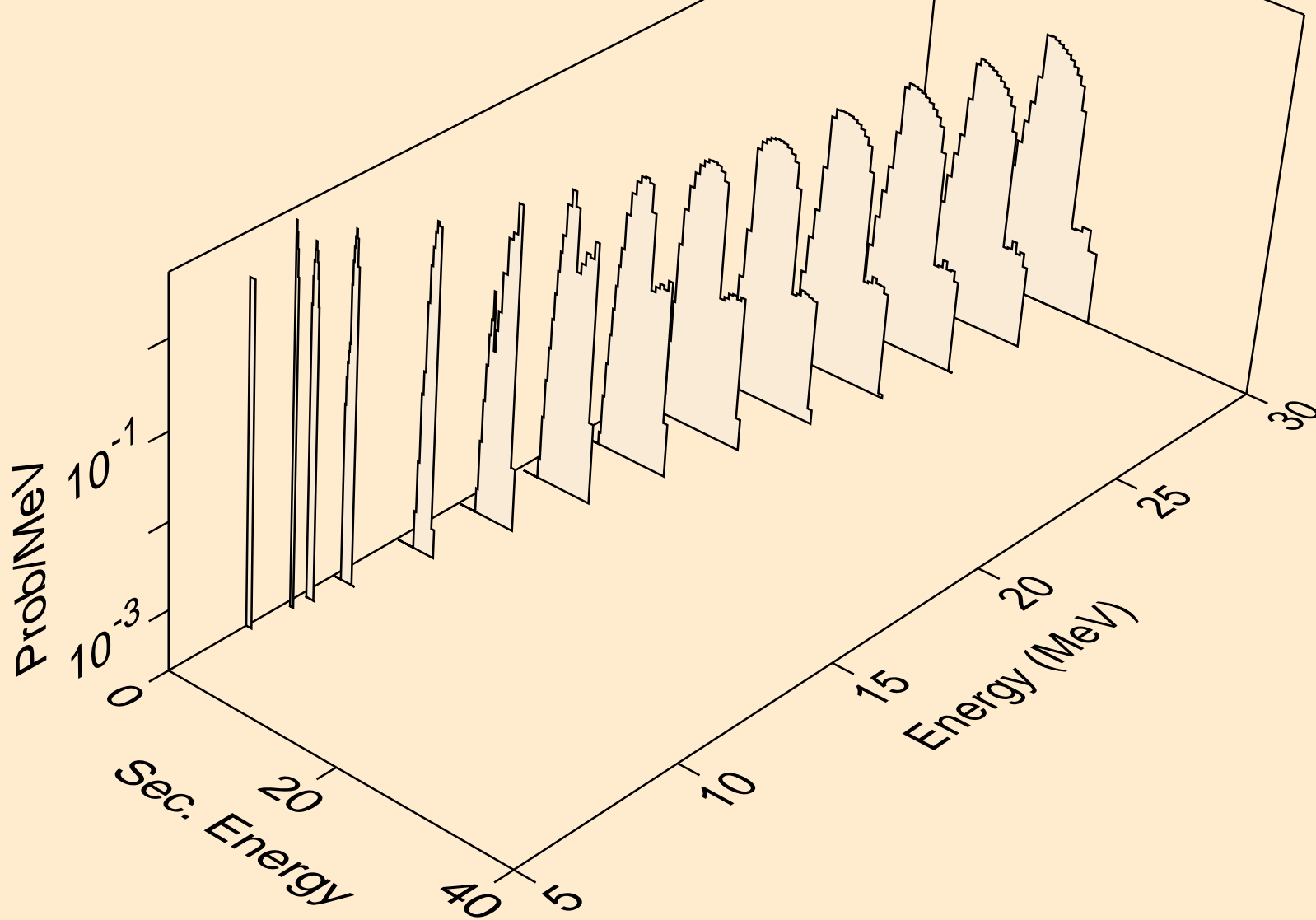

AS080 NEUTRON ACER TENDL-2019 LIBRARY; T=293.16K
tritons from (n,pt)

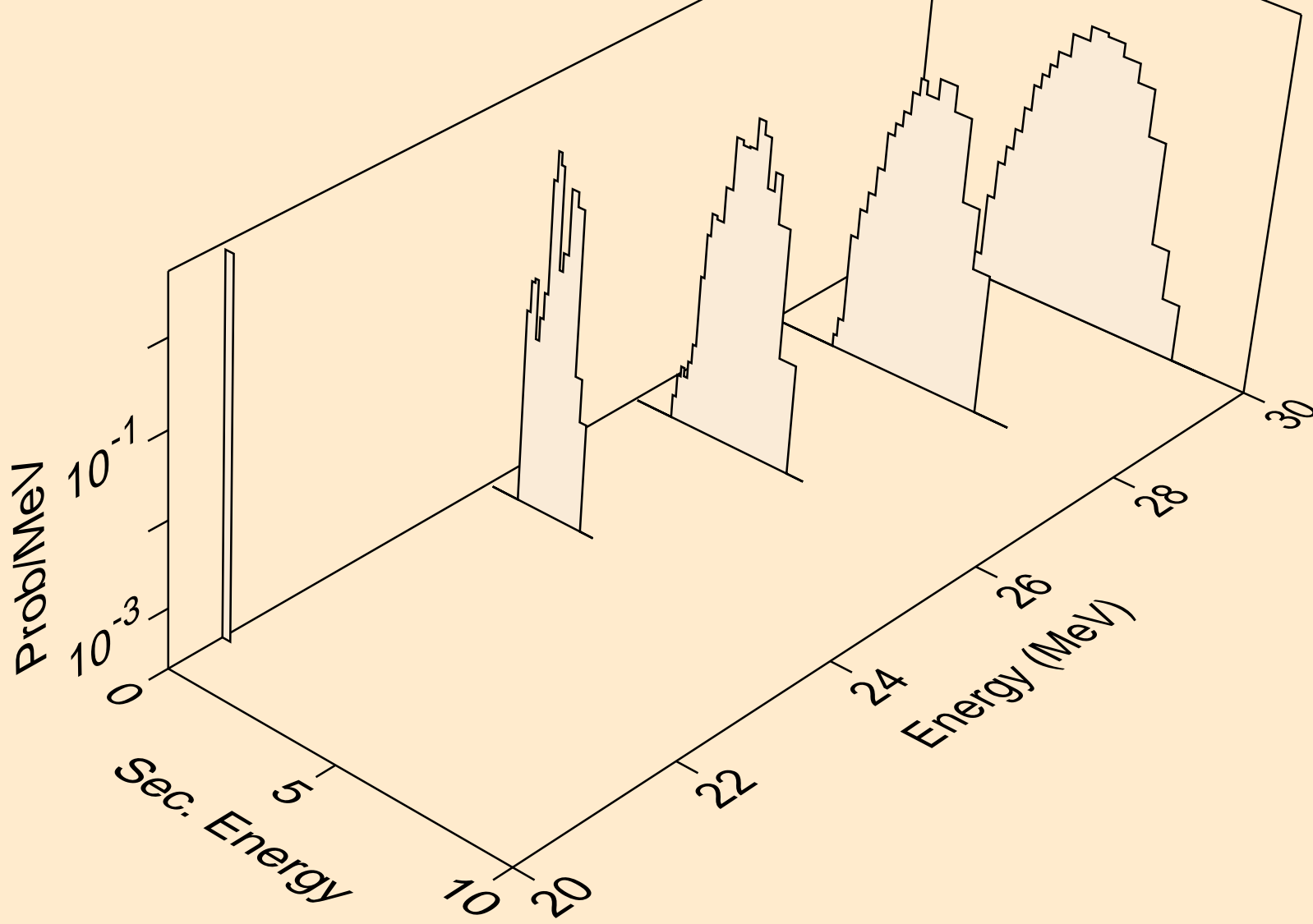

AS080 NEUTRON ACER TENDL-2019 LIBRARY; T=293.16K
he3s from (n,x)

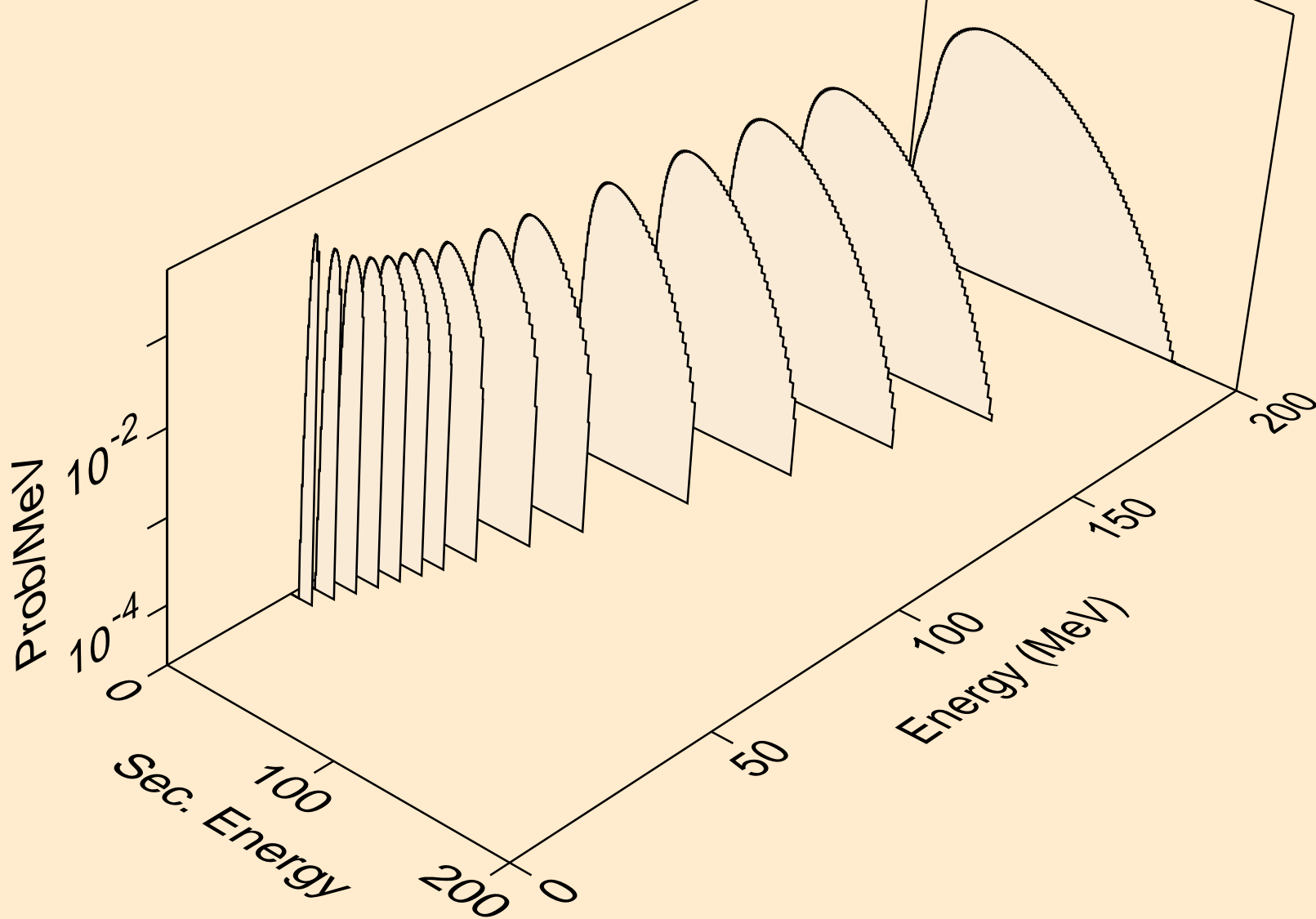

AS080 NEUTRON ACER TENDL-2019 LIBRARY; T=293.16K
he3s from (n,n*)he3

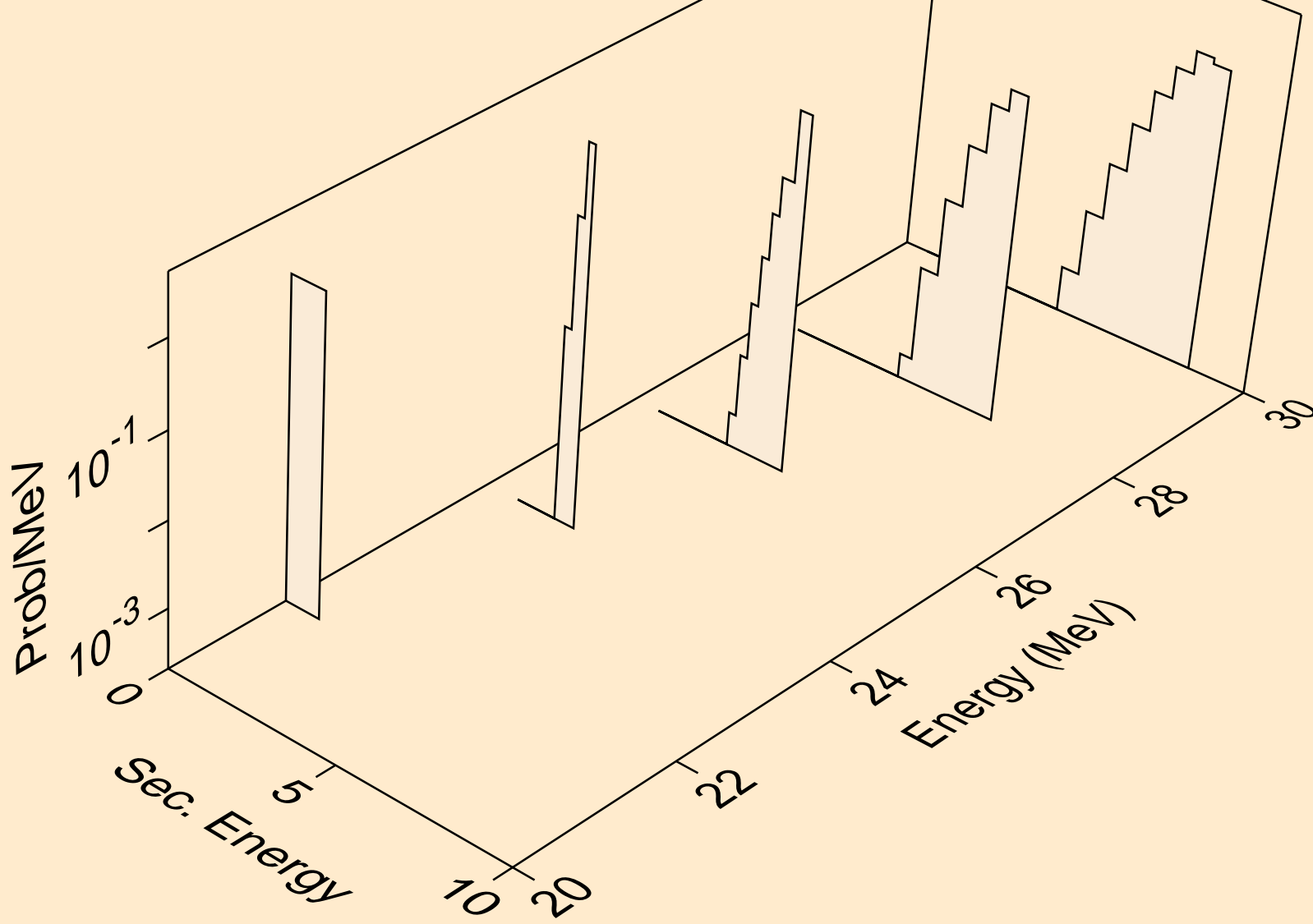

AS080 NEUTRON ACER TENDL-2019 LIBRARY; T=293.16K
he3s from (n,he3)

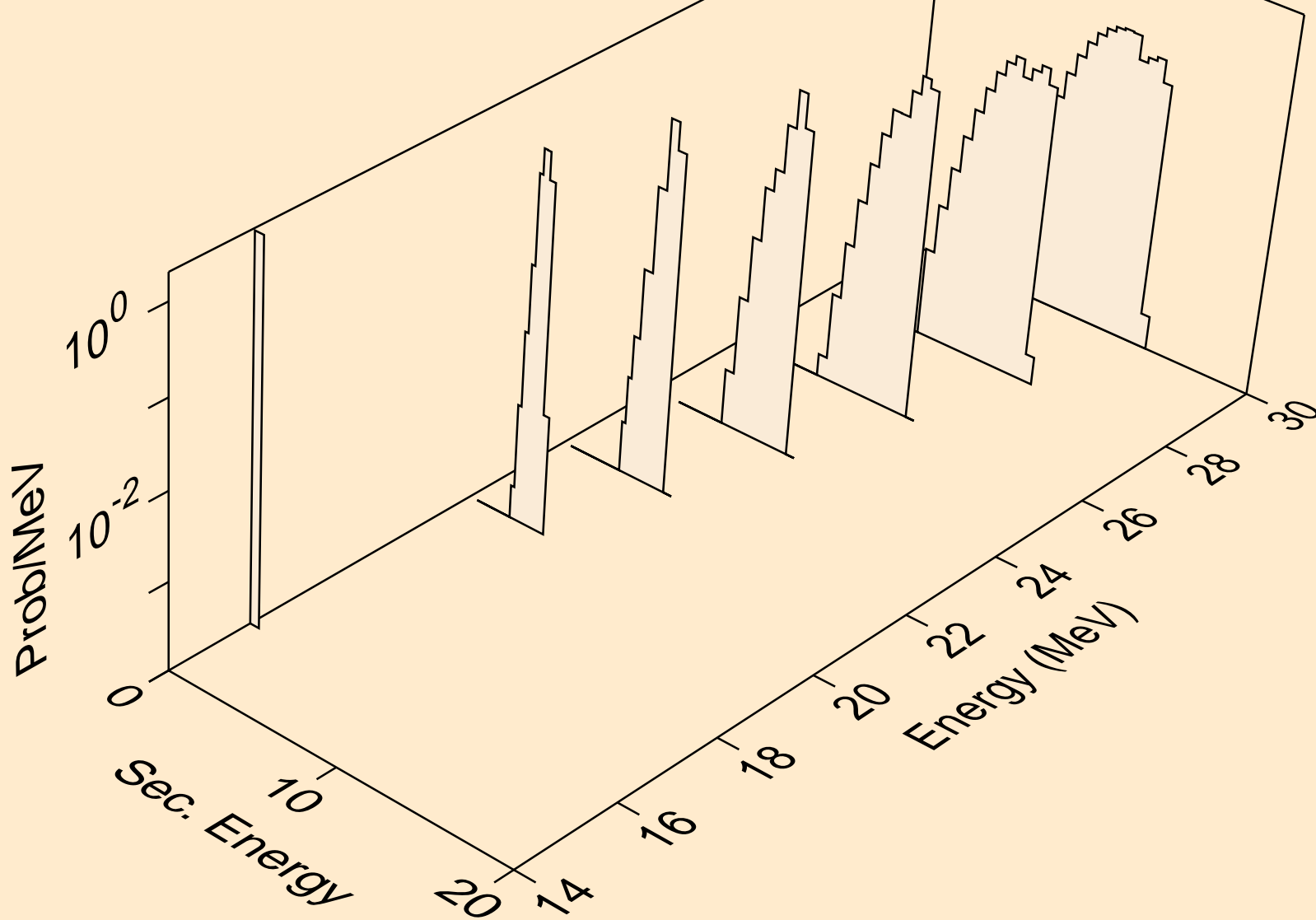

AS080 NEUTRON ACER TENDL-2019 LIBRARY; T=293.16K
alphas from (n,x)

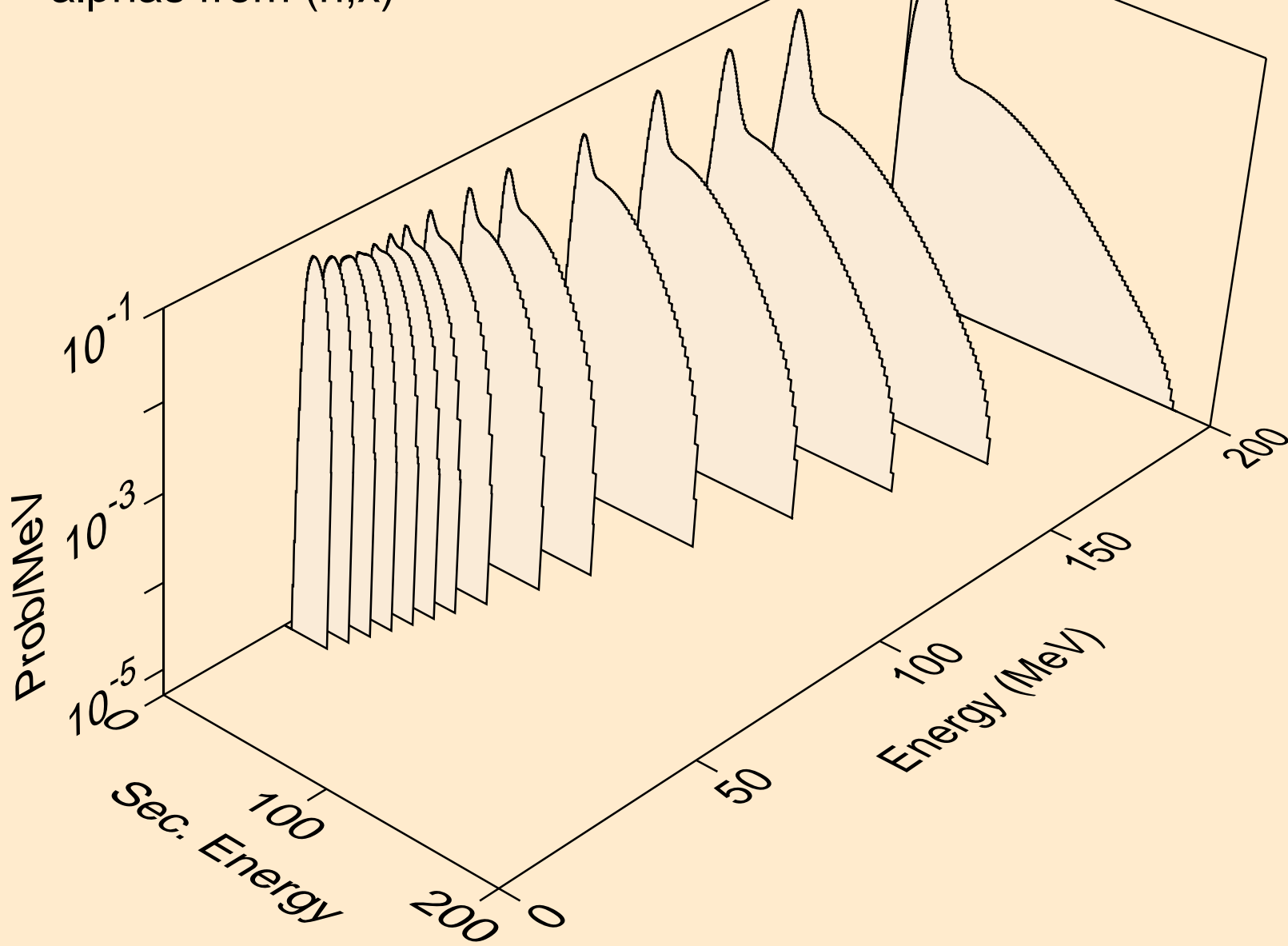

AS080 NEUTRON ACER TENDL-2019 LIBRARY; T=293.16K
alphas from (n,n*)a

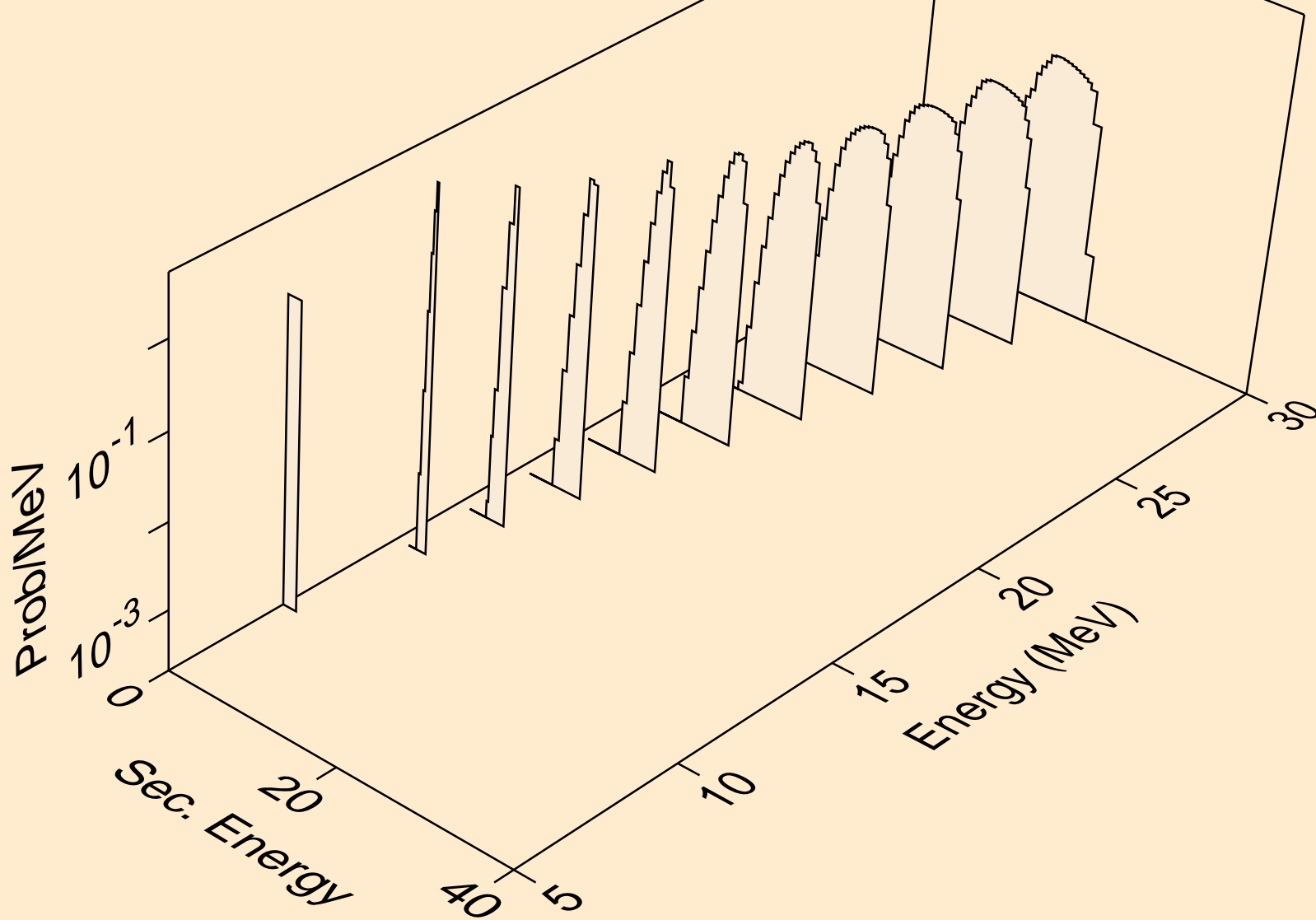

AS080 NEUTRON ACER TENDL-2019 LIBRARY; T=293.16K
alphas from (n,2n)a

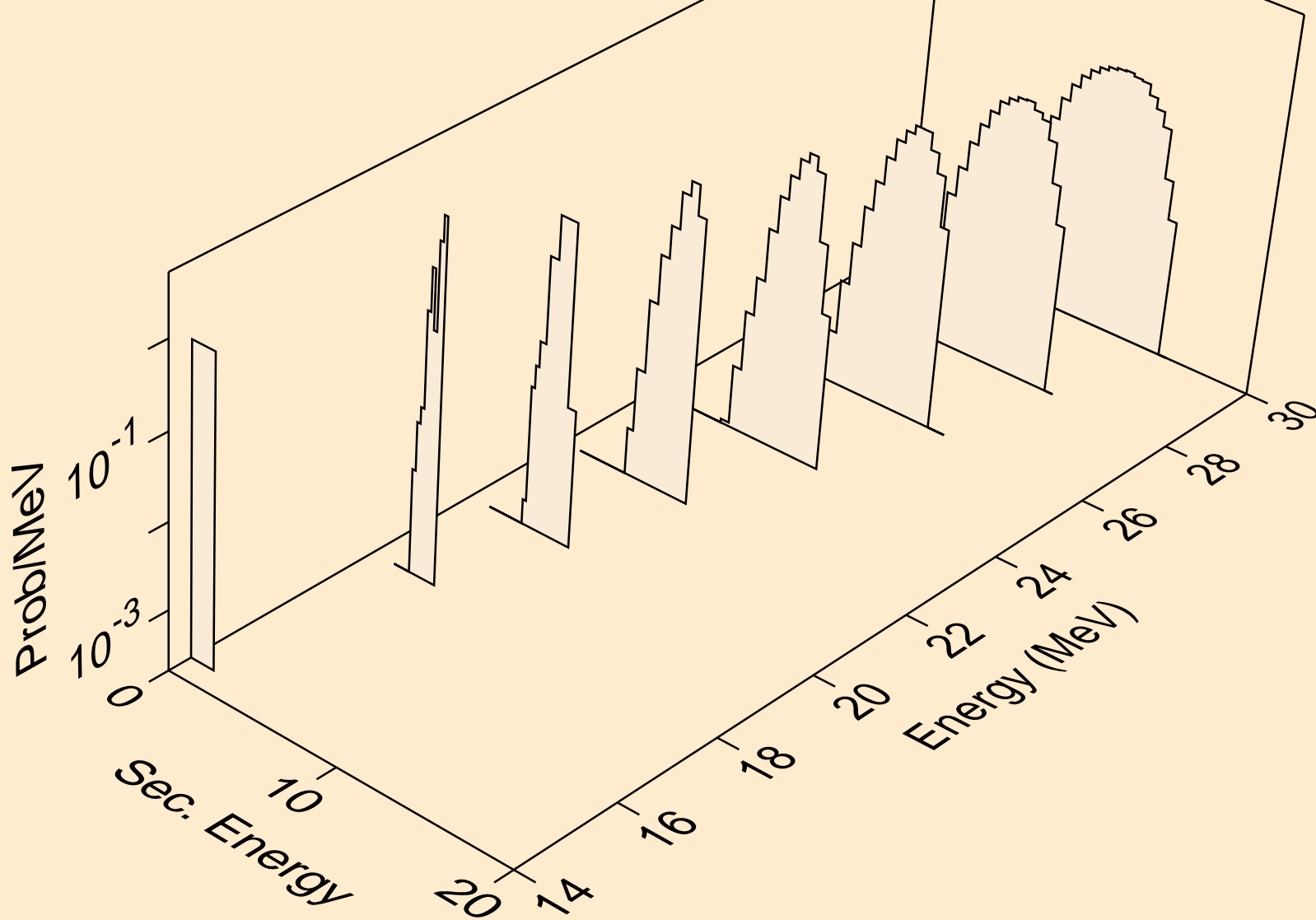

AS080 NEUTRON ACER TENDL-2019 LIBRARY; T=293.16K
alphas from (n,3n)a

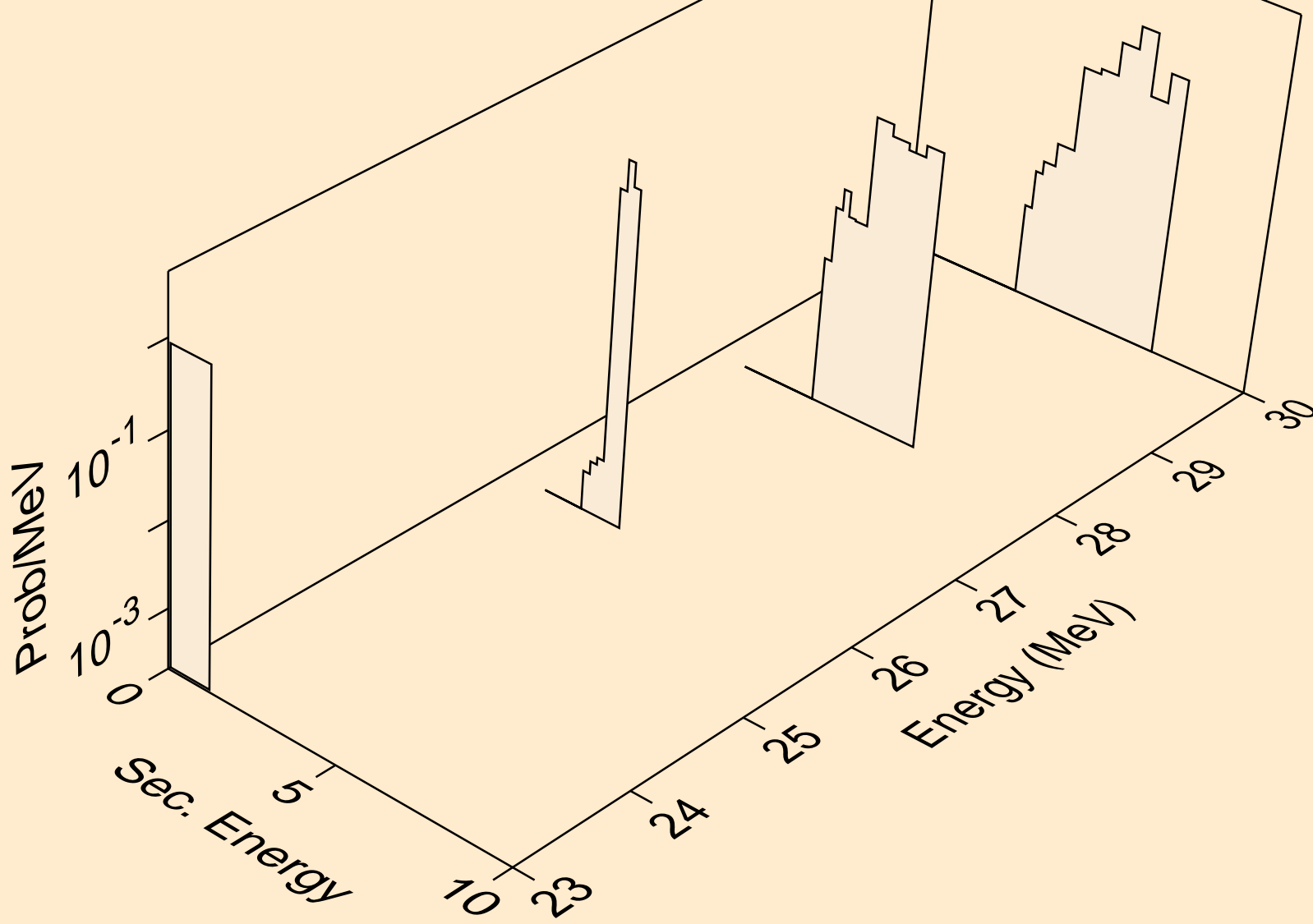

AS080 NEUTRON ACER TENDL-2019 LIBRARY; T=293.16K
alphas from (n,a)

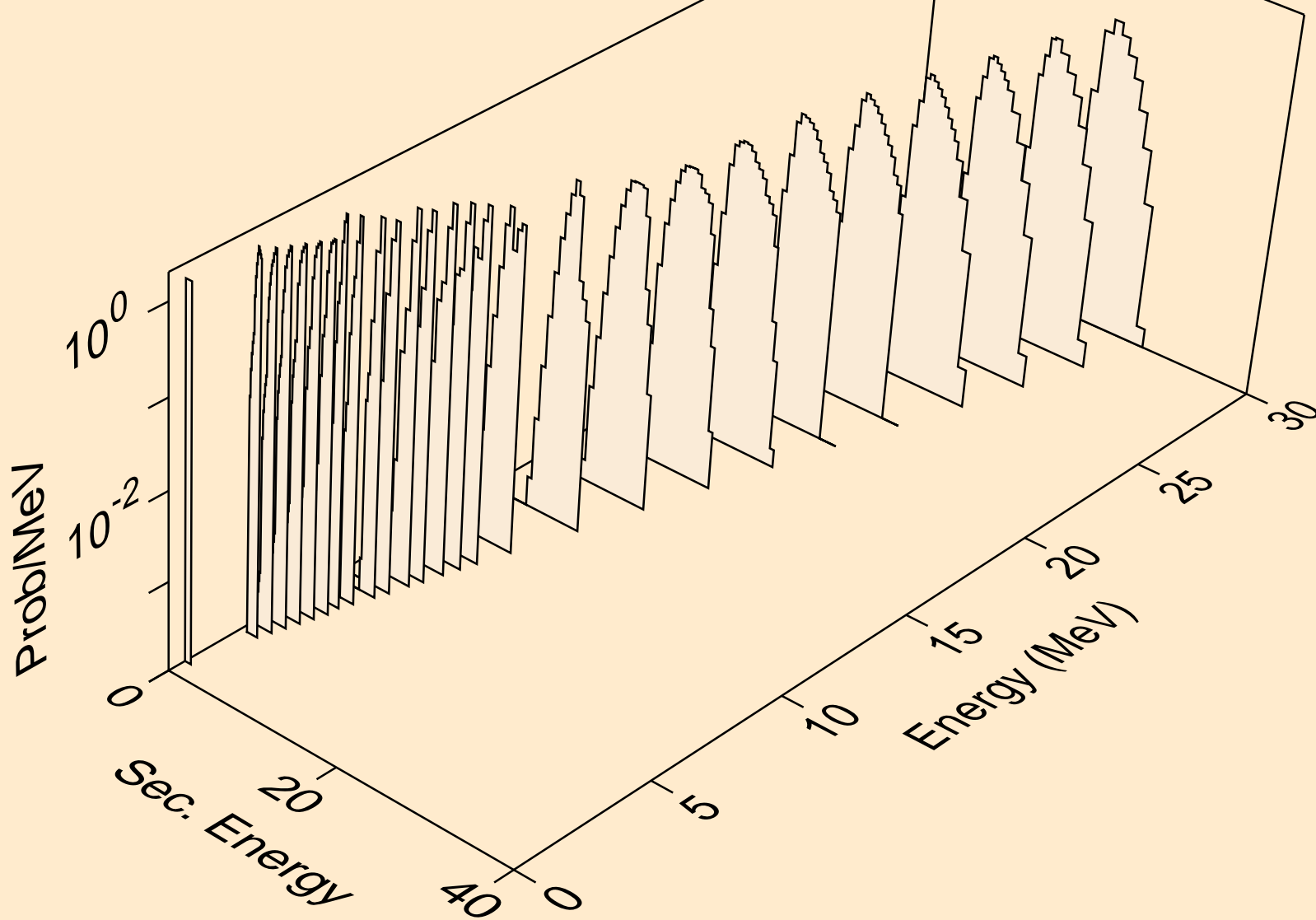

AS080 NEUTRON ACER TENDL-2019 LIBRARY; T=293.16K
alphas from (n,2a)

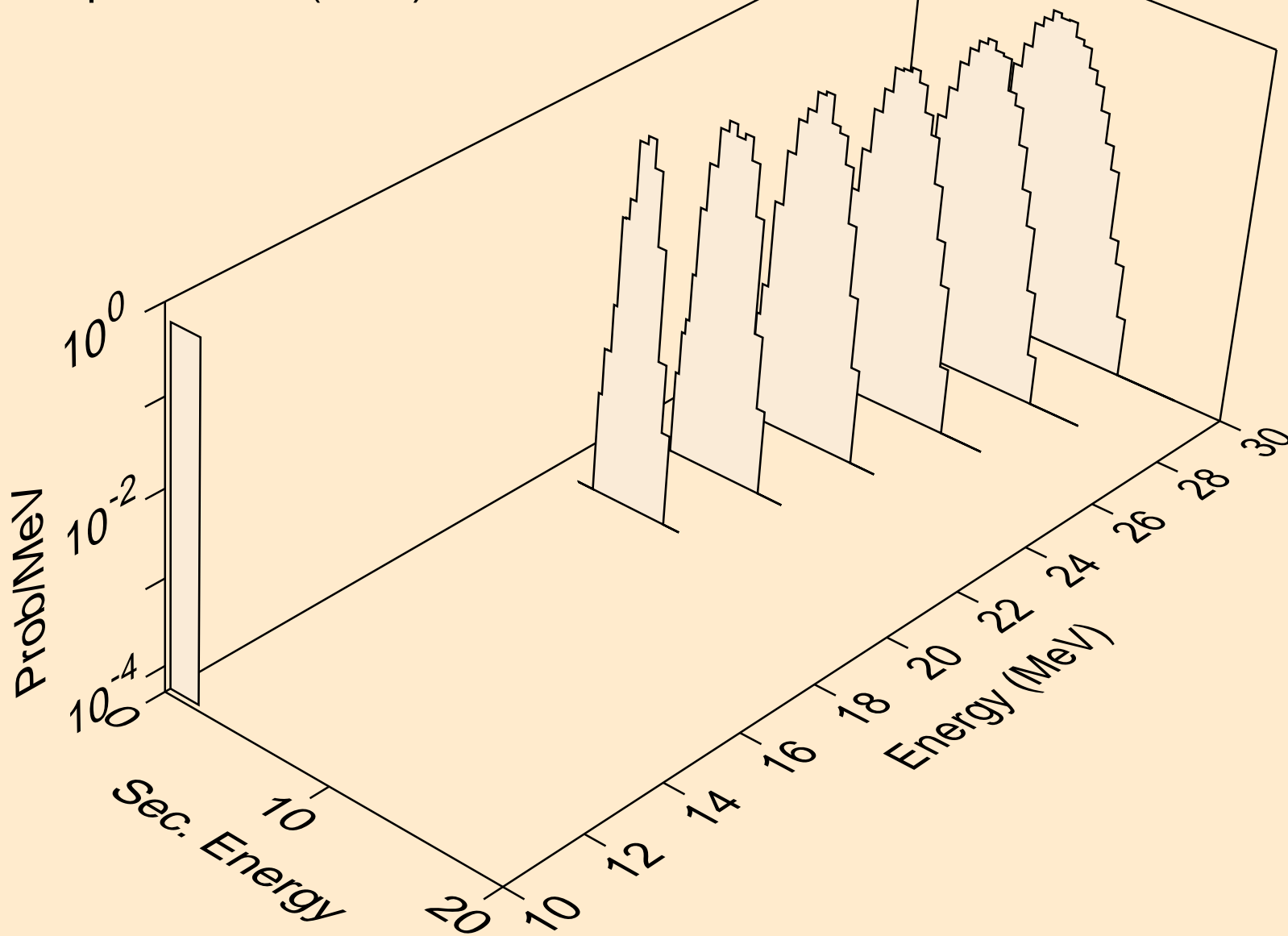

AS080 NEUTRON ACER TENDL-2019 LIBRARY; T=293.16K
alphas from (n,pa)

