

BI198M NEUTRON ACER TENDL-2019 LIBRARY; T=293.16K  
Principal cross sections

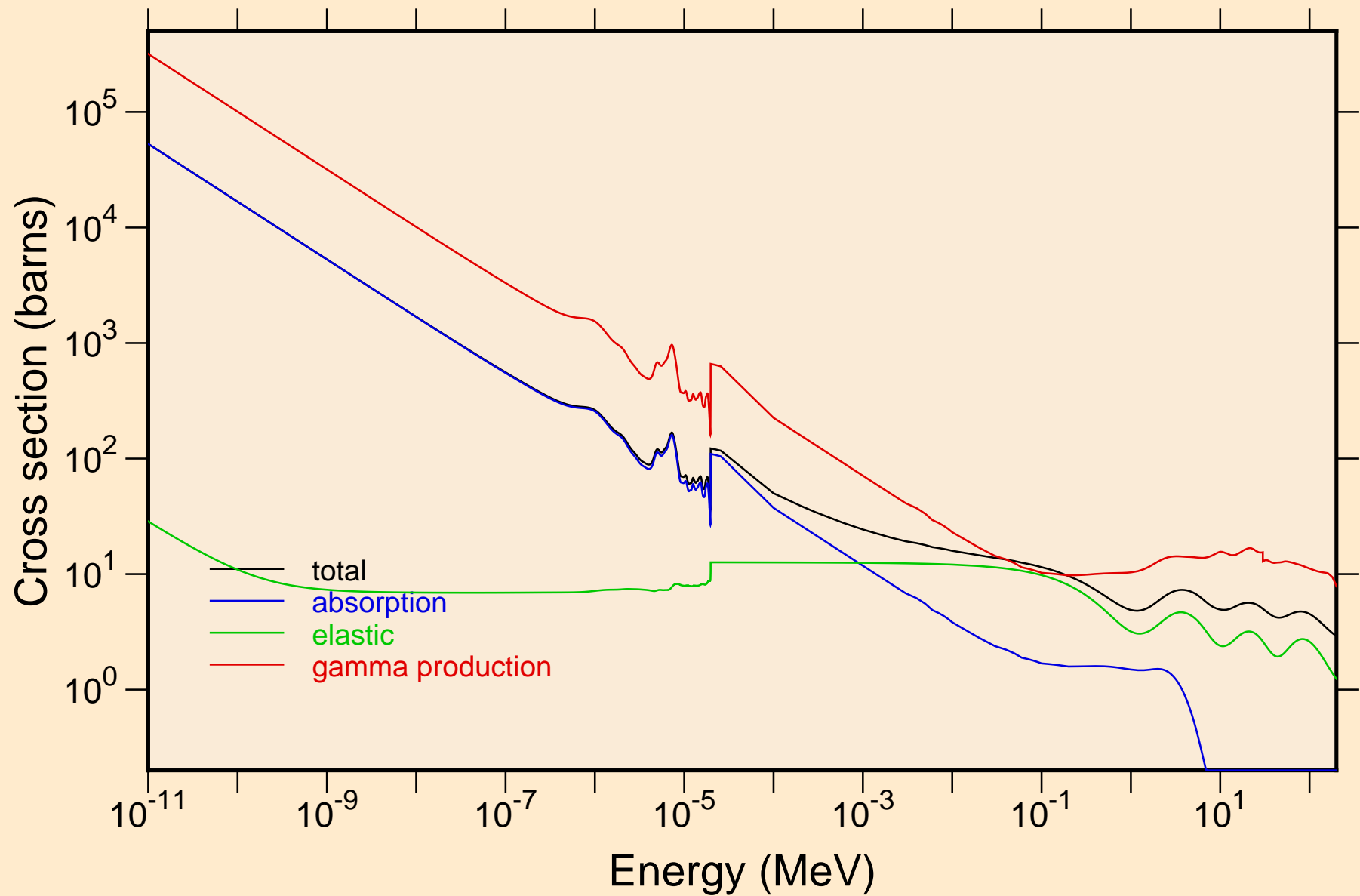

BI198M NEUTRON ACER TENDL-2019 LIBRARY; T=293.16K  
resonance total cross section

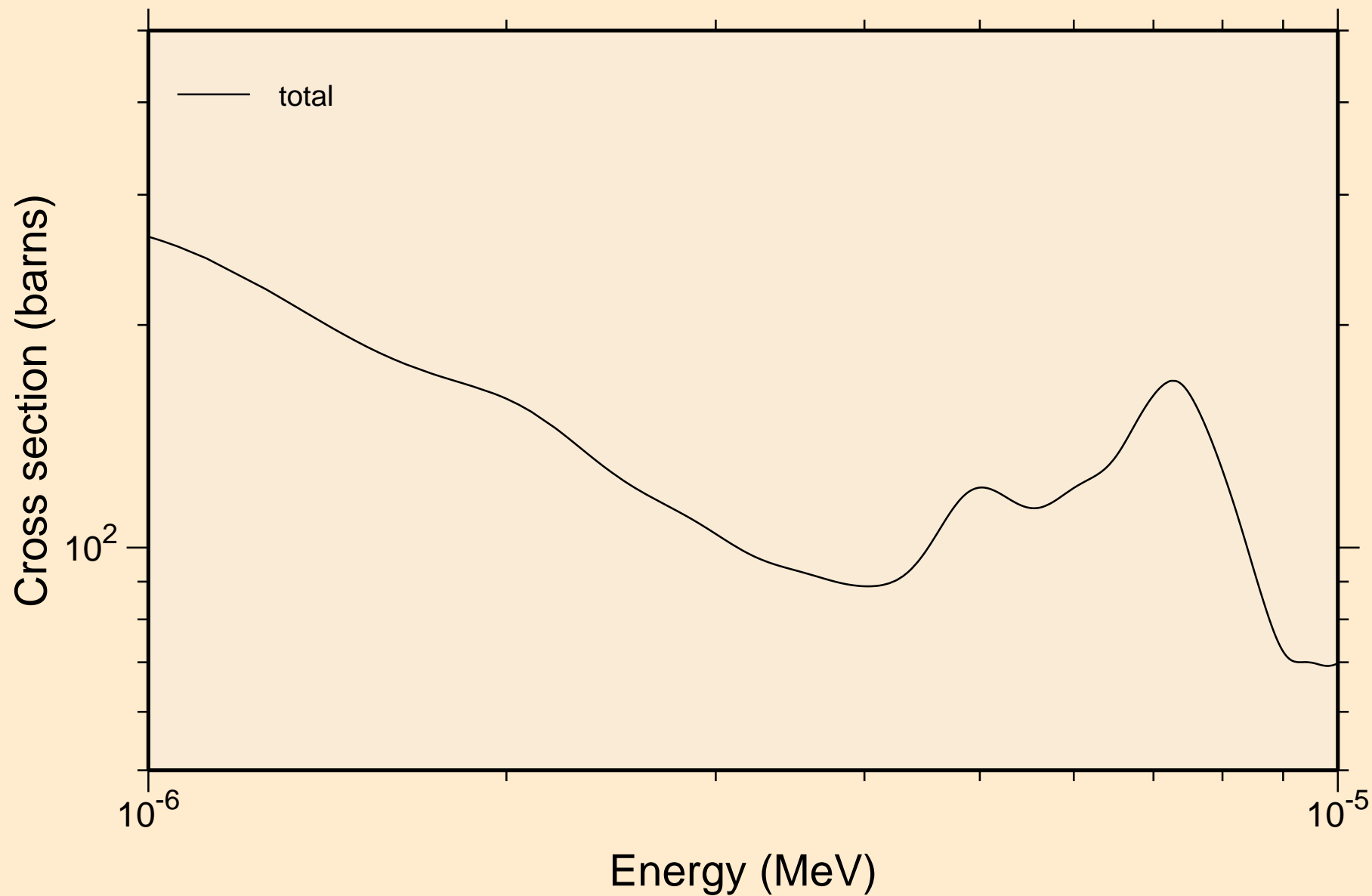

BI198M NEUTRON ACER TENDL-2019 LIBRARY; T=293.16K  
resonance total cross section

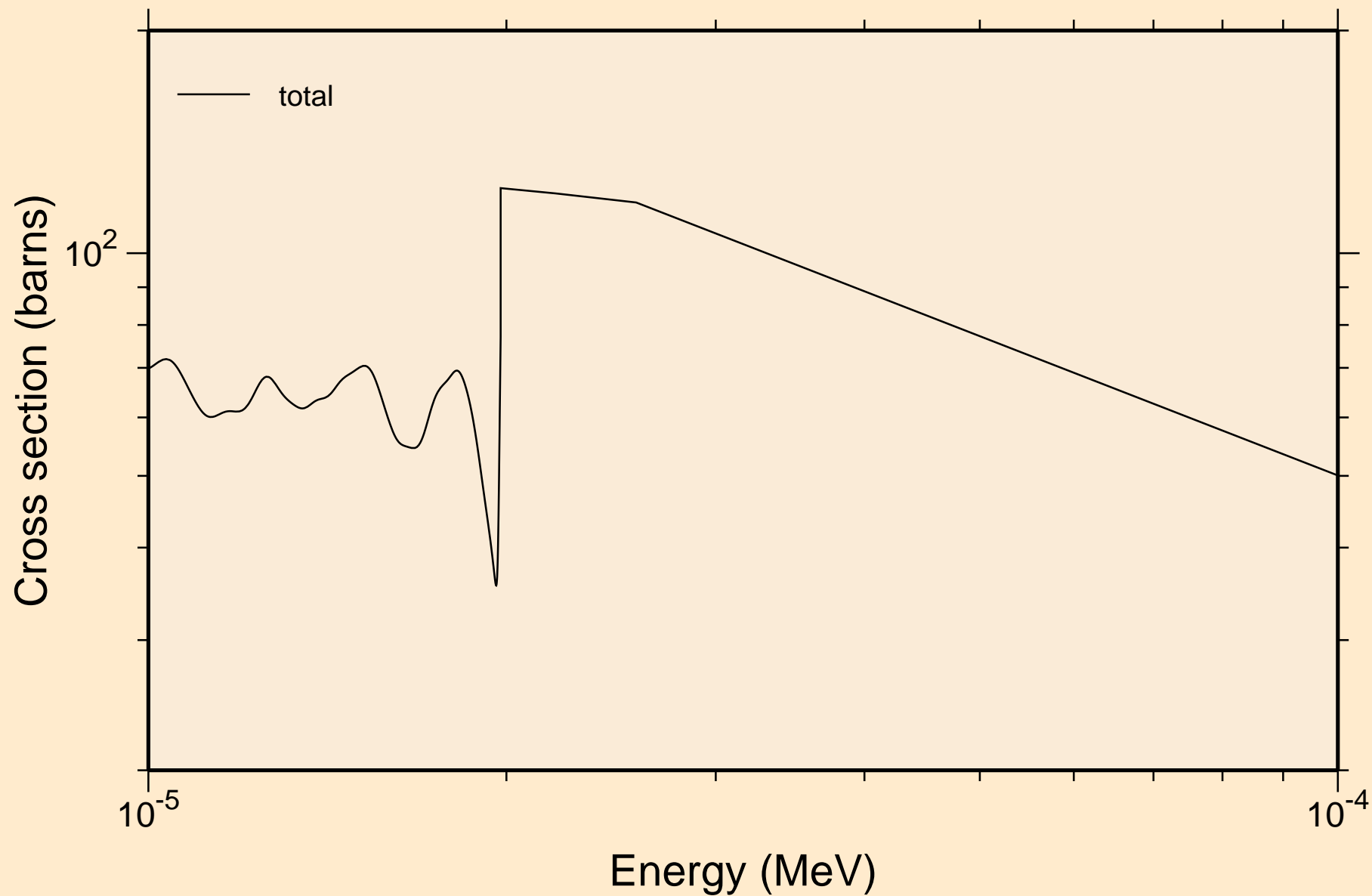

BI198M NEUTRON ACER TENDL-2019 LIBRARY; T=293.16K  
resonance total cross section

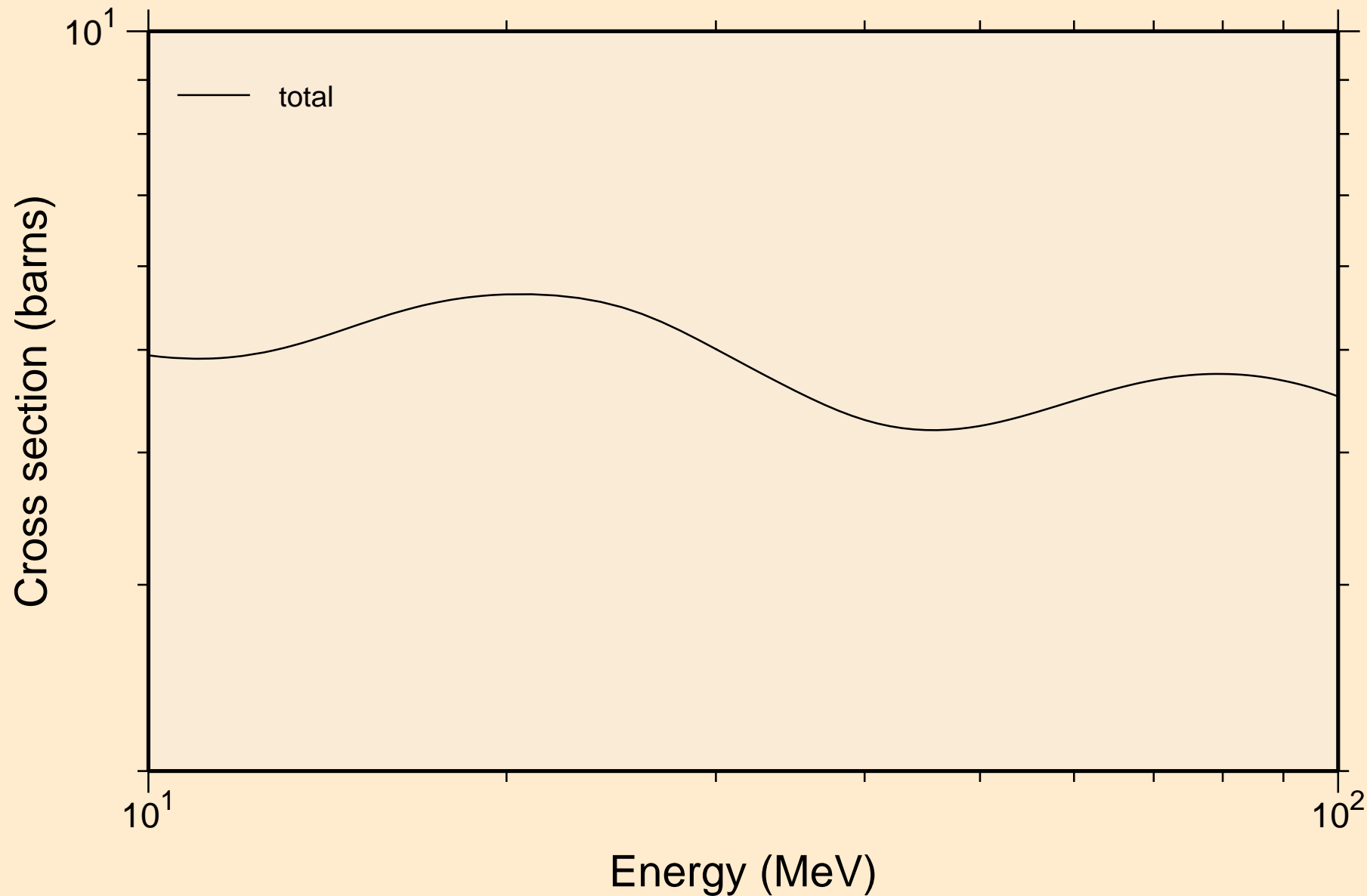

BI198M NEUTRON ACER TENDL-2019 LIBRARY; T=293.16K  
resonance absorption cross sections

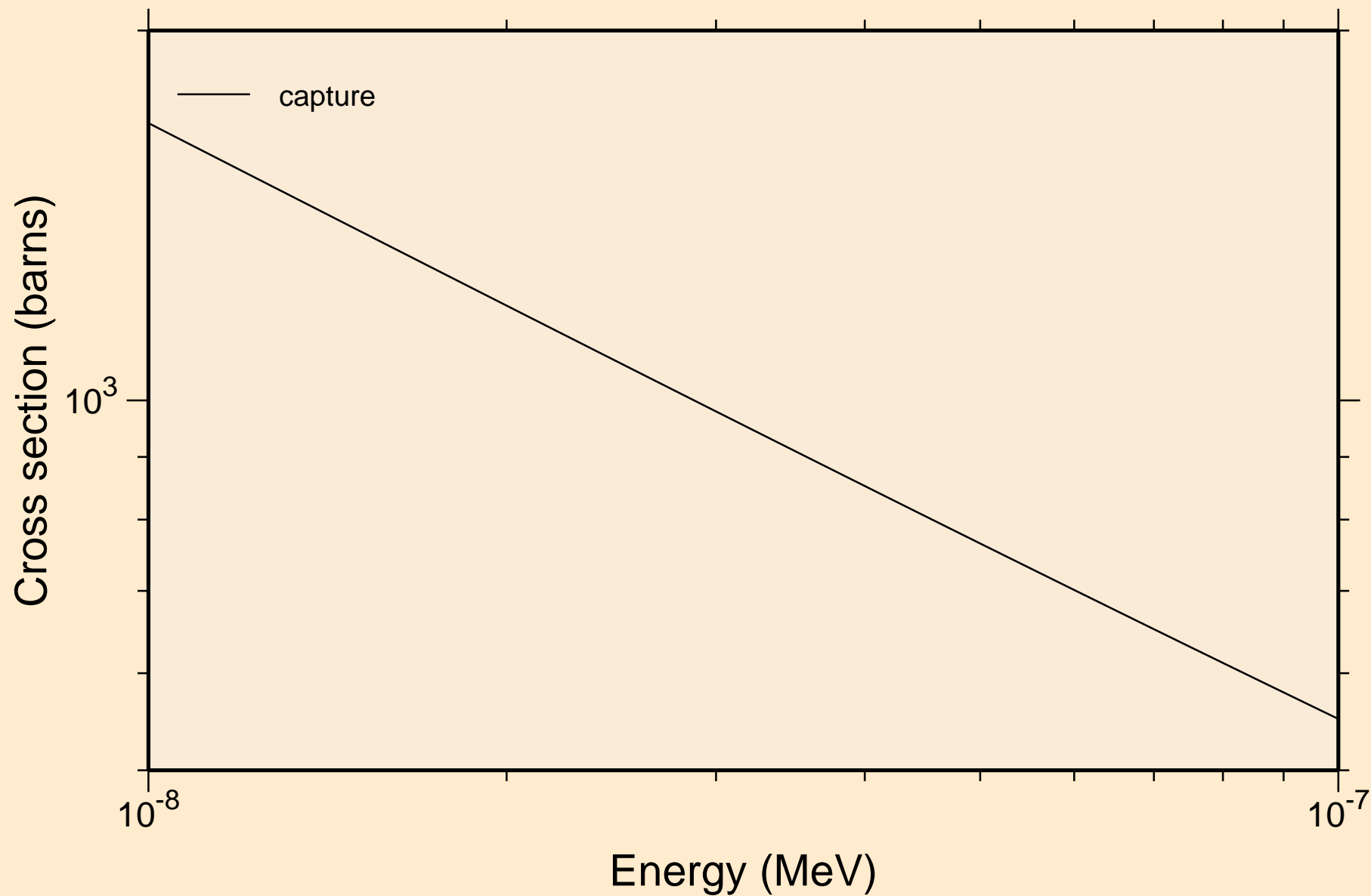

BI198M NEUTRON ACER TENDL-2019 LIBRARY; T=293.16K  
resonance absorption cross sections

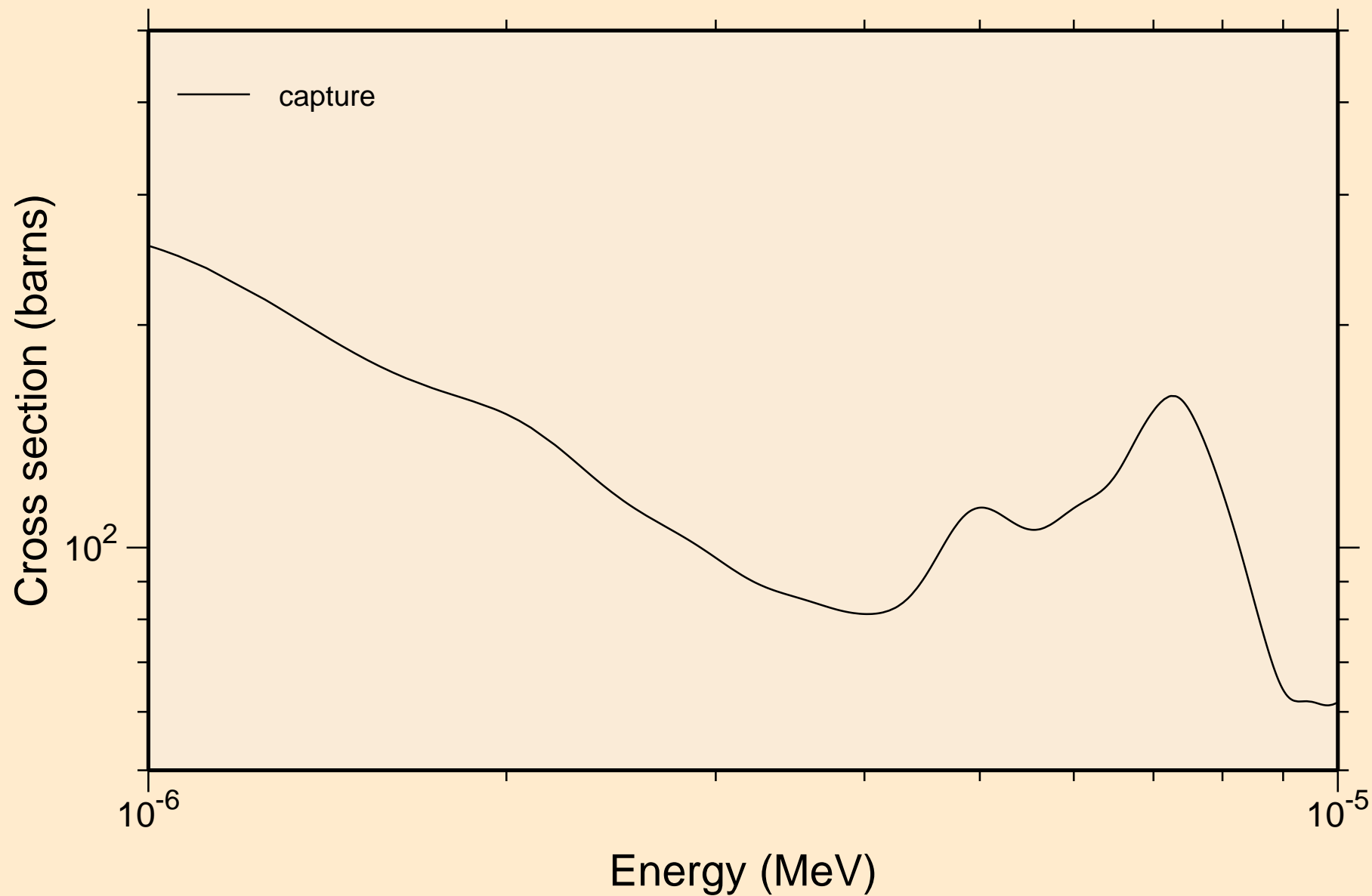

BI198M NEUTRON ACER TENDL-2019 LIBRARY; T=293.16K  
resonance absorption cross sections

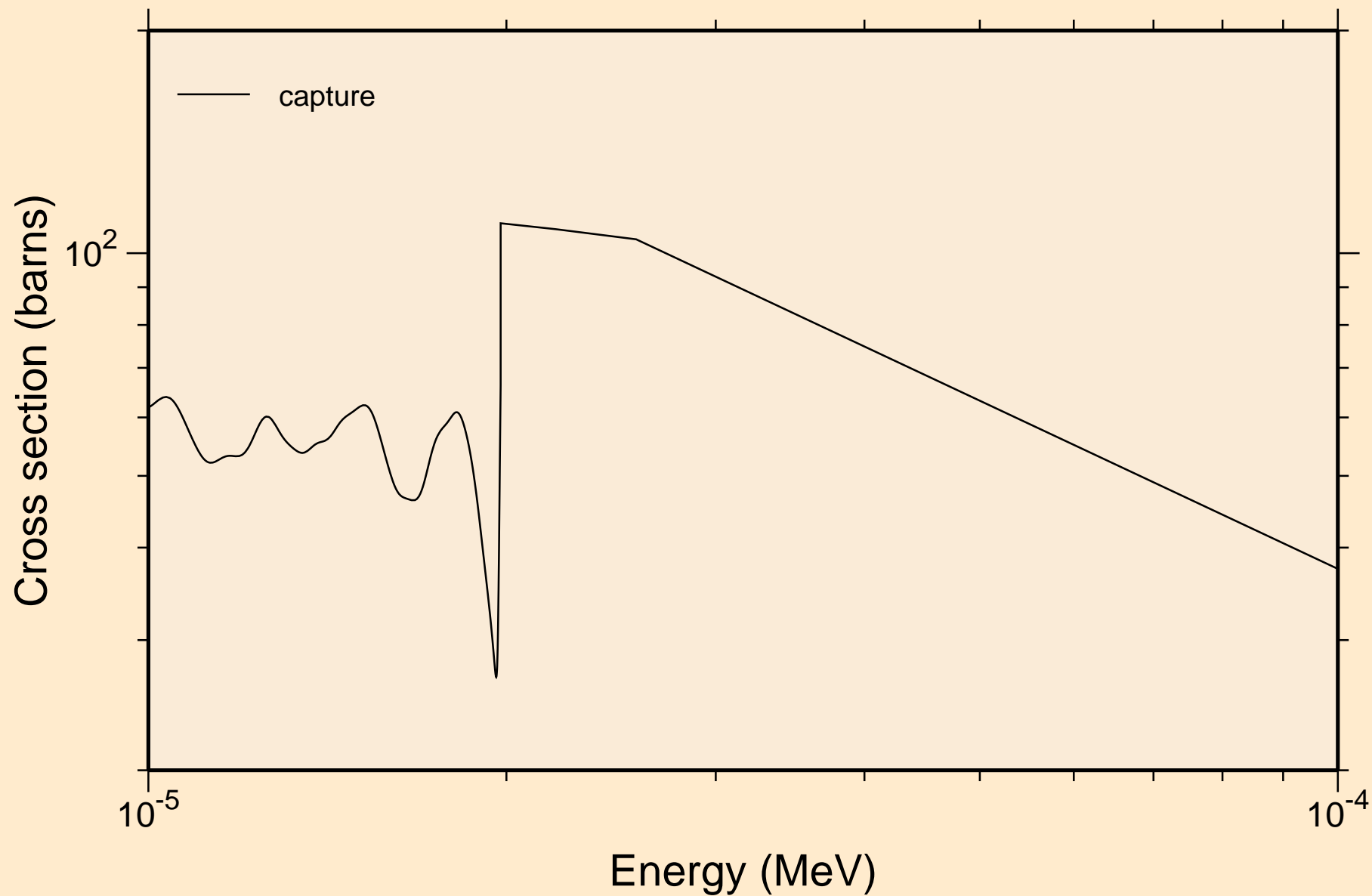

BI198M NEUTRON ACER TENDL-2019 LIBRARY; T=293.16K  
resonance absorption cross sections

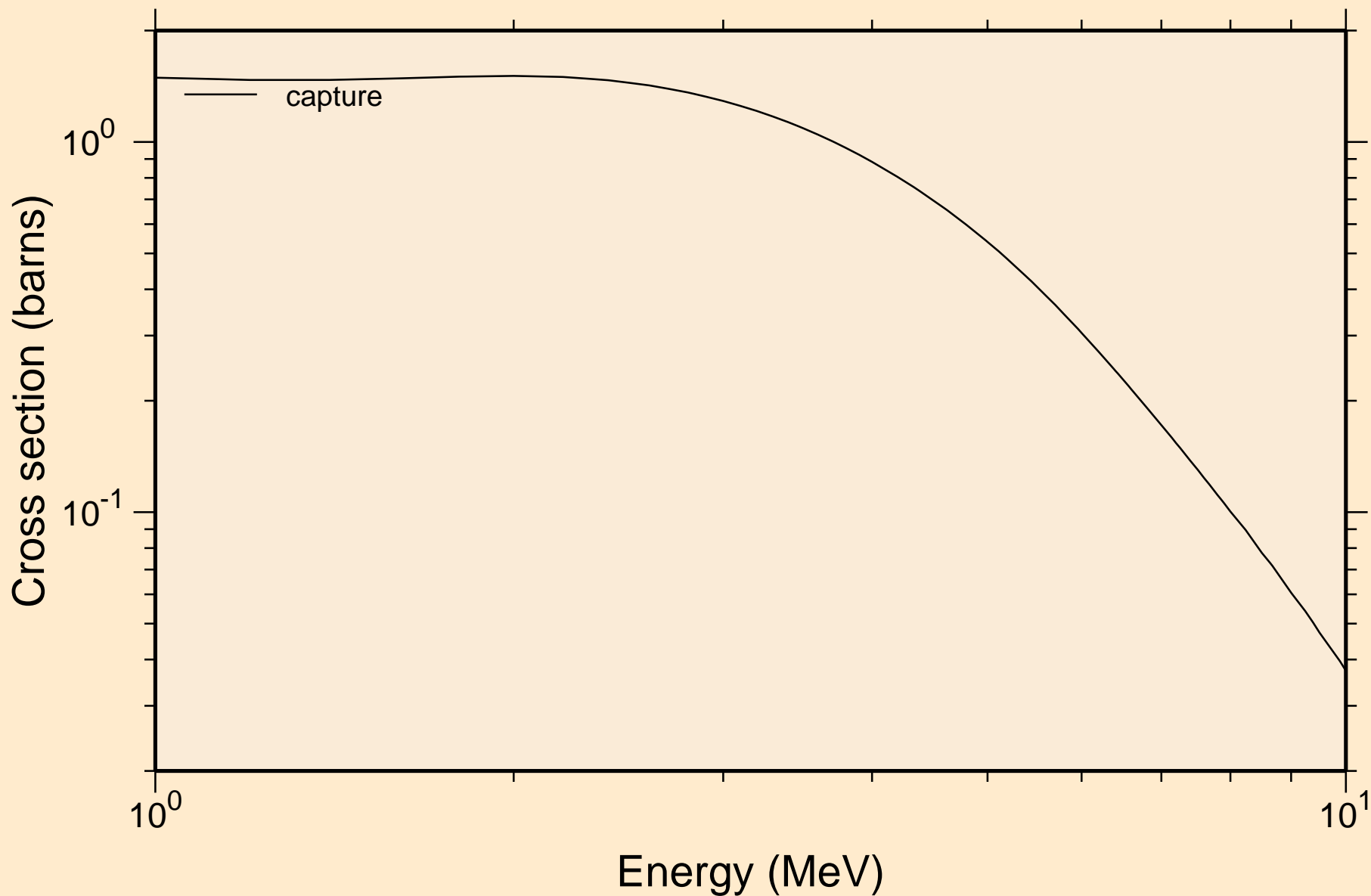

BI198M NEUTRON ACER TENDL-2019 LIBRARY; T=293.16K  
Heating

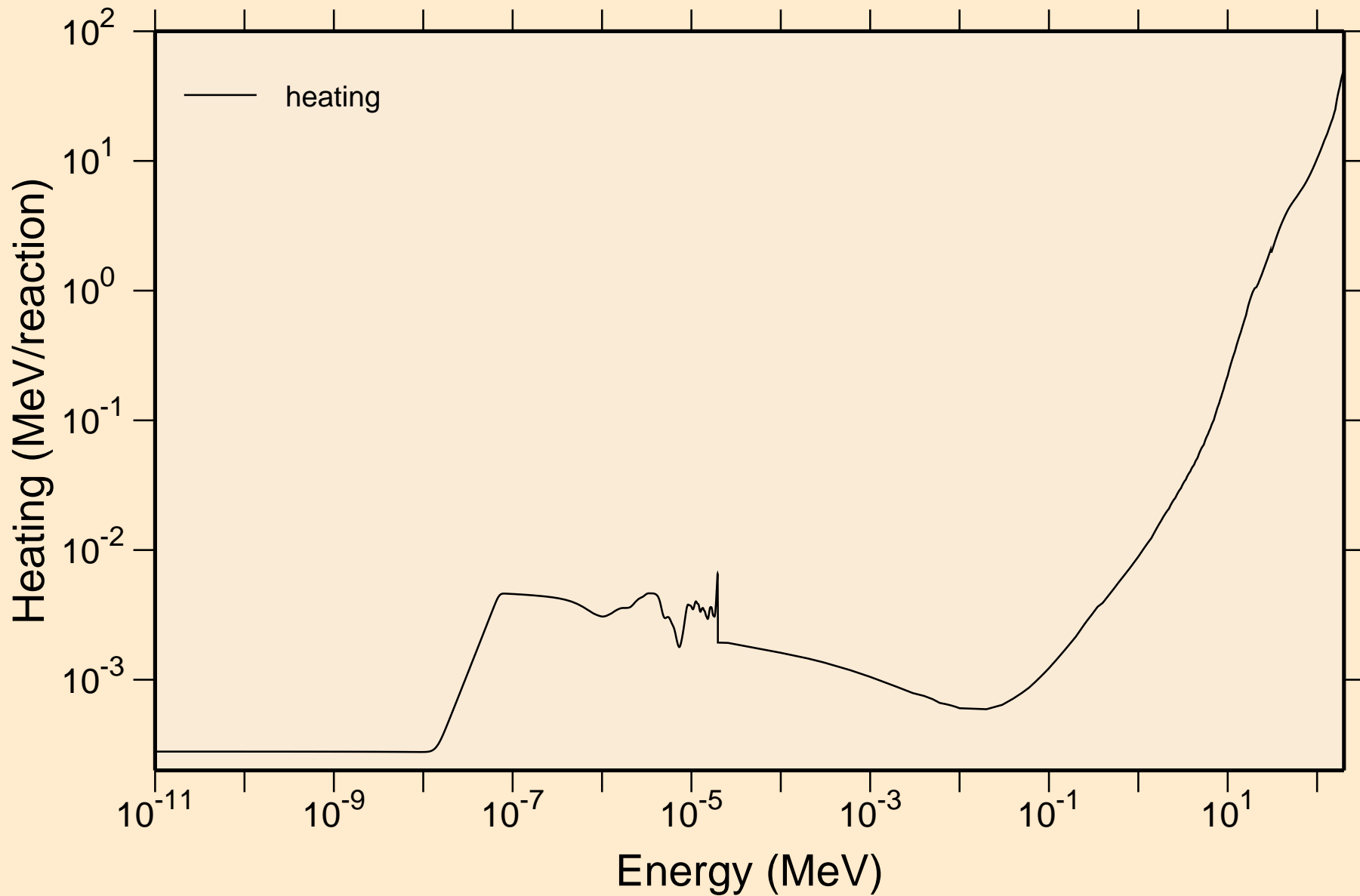

BI198M NEUTRON ACER TENDL-2019 LIBRARY; T=293.16K  
Damage

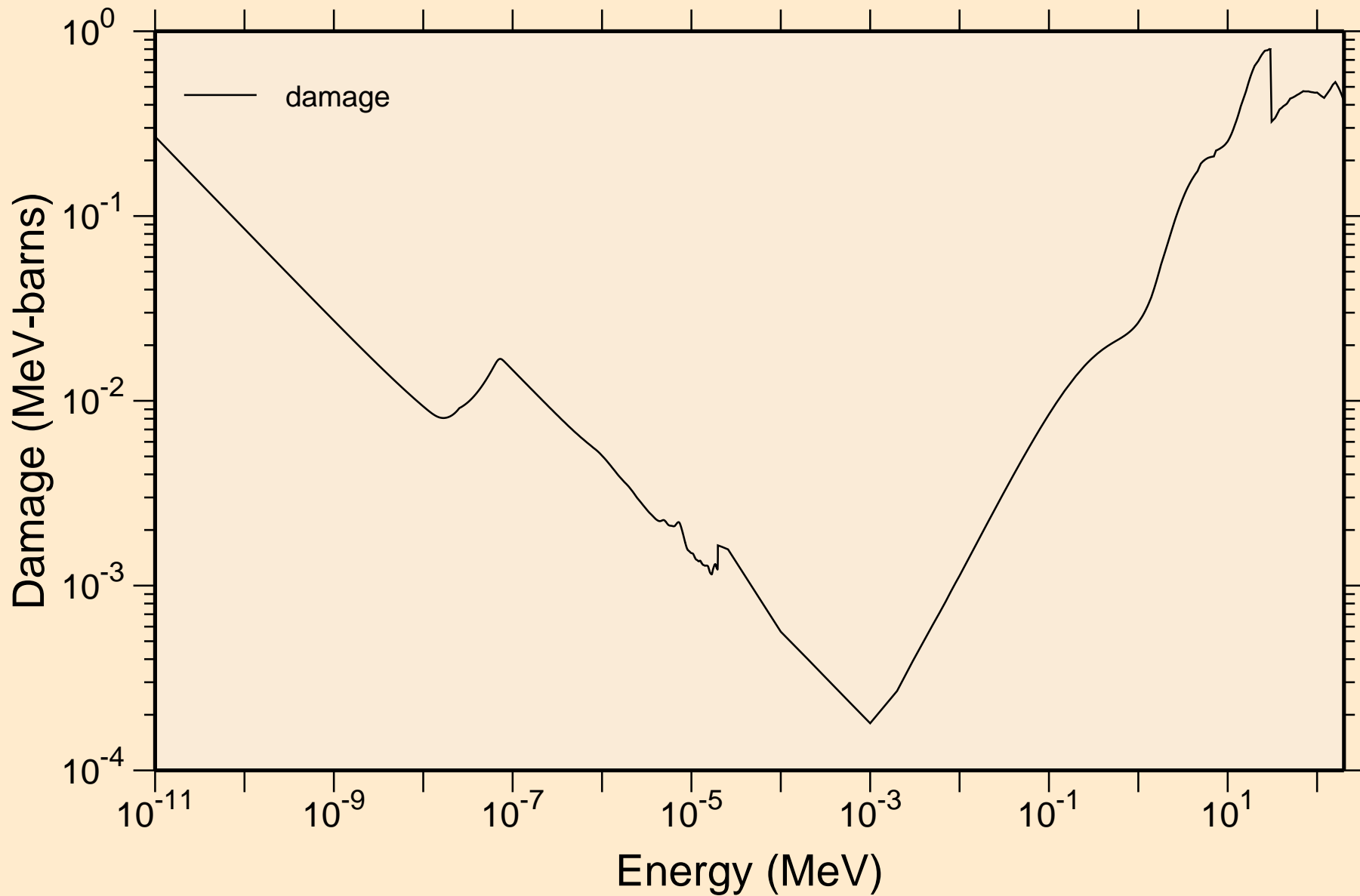

BI198M NEUTRON ACER TENDL-2019 LIBRARY; T=293.16K  
Non-threshold reactions

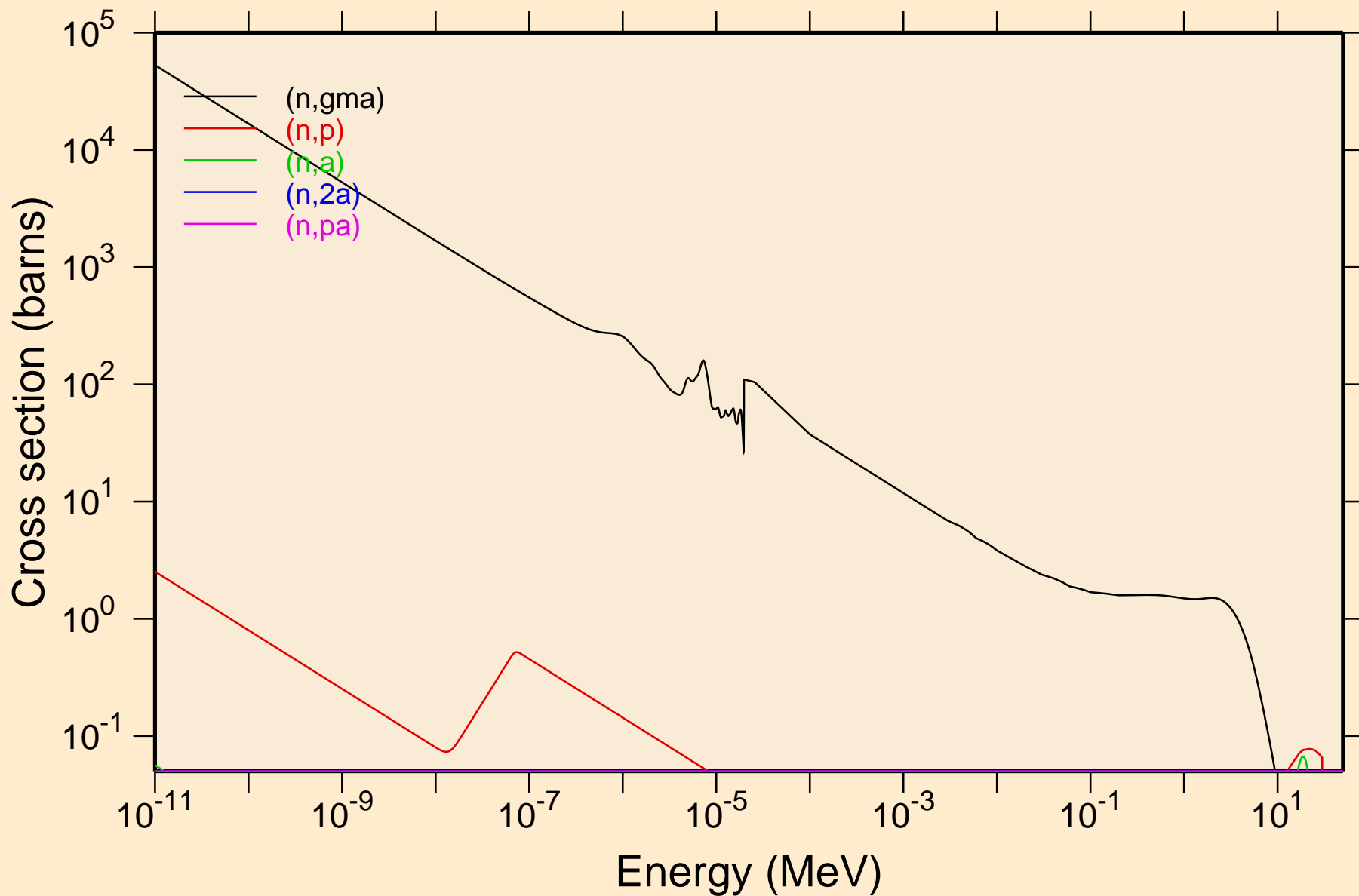

BI198M NEUTRON ACER TENDL-2019 LIBRARY; T=293.16K  
Non-threshold reactions

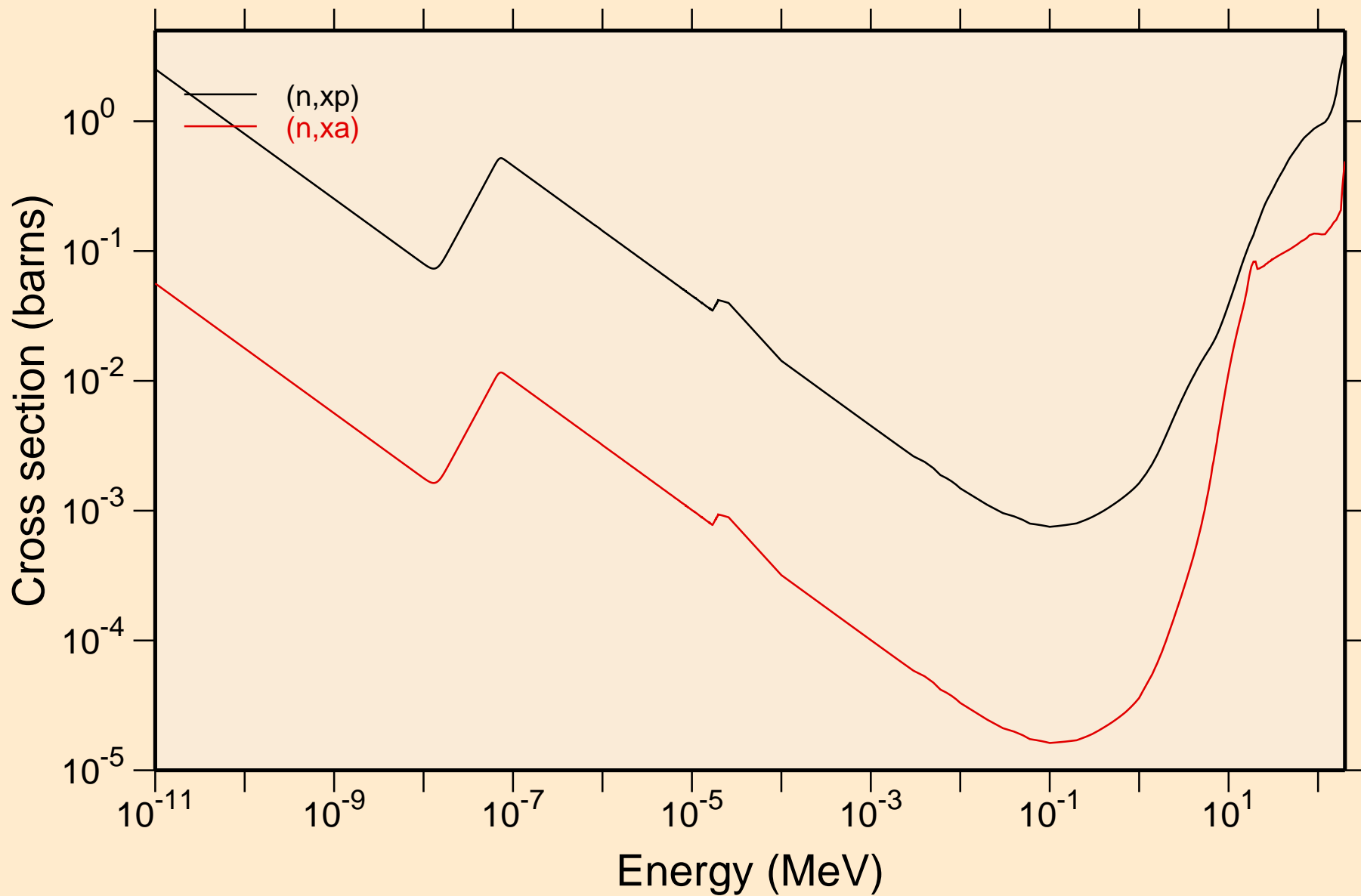

BI198M NEUTRON ACER TENDL-2019 LIBRARY; T=293.16K  
Principal cross sections

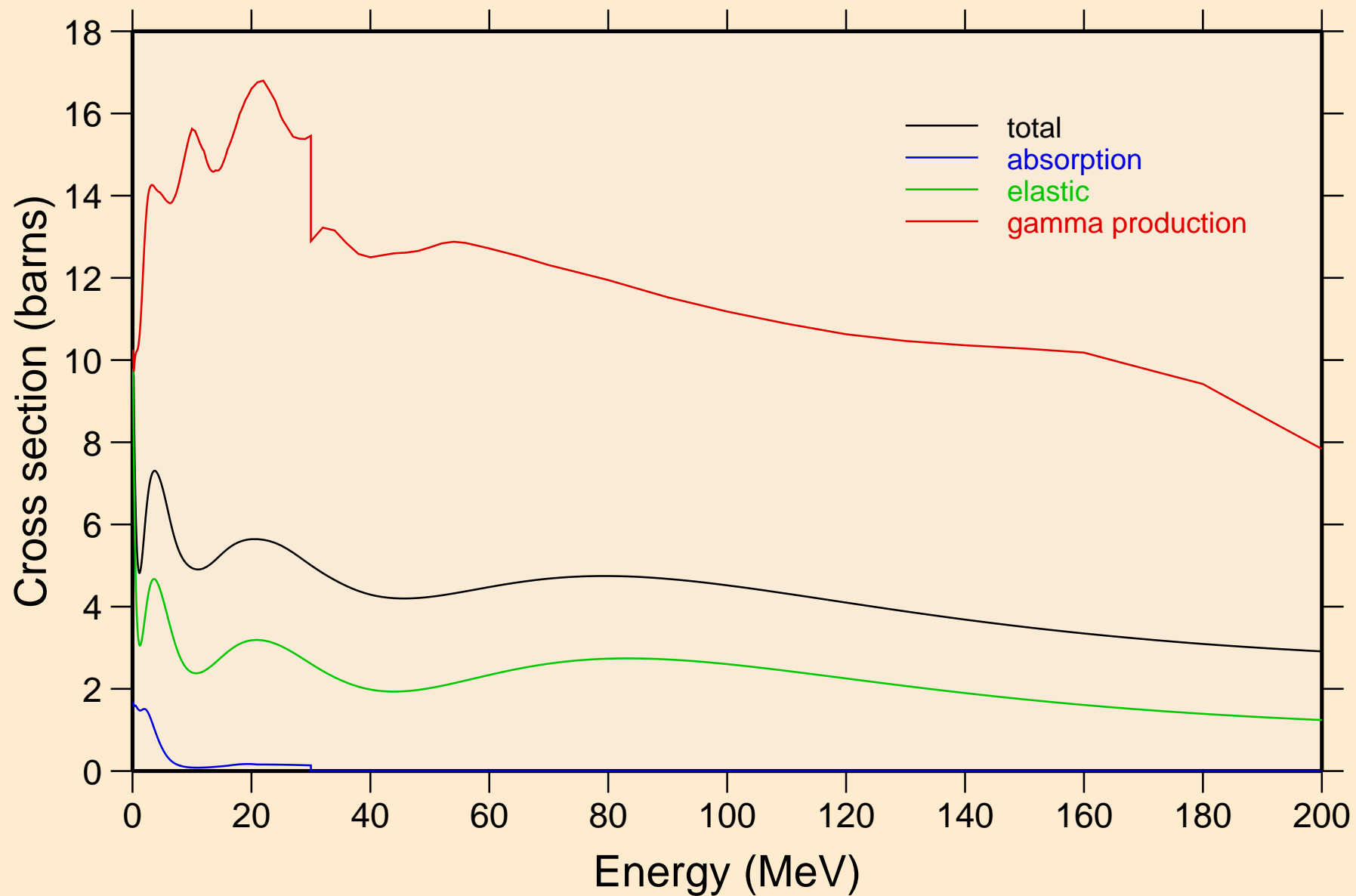

BI198M NEUTRON ACER TENDL-2019 LIBRARY; T=293.16K  
Heating

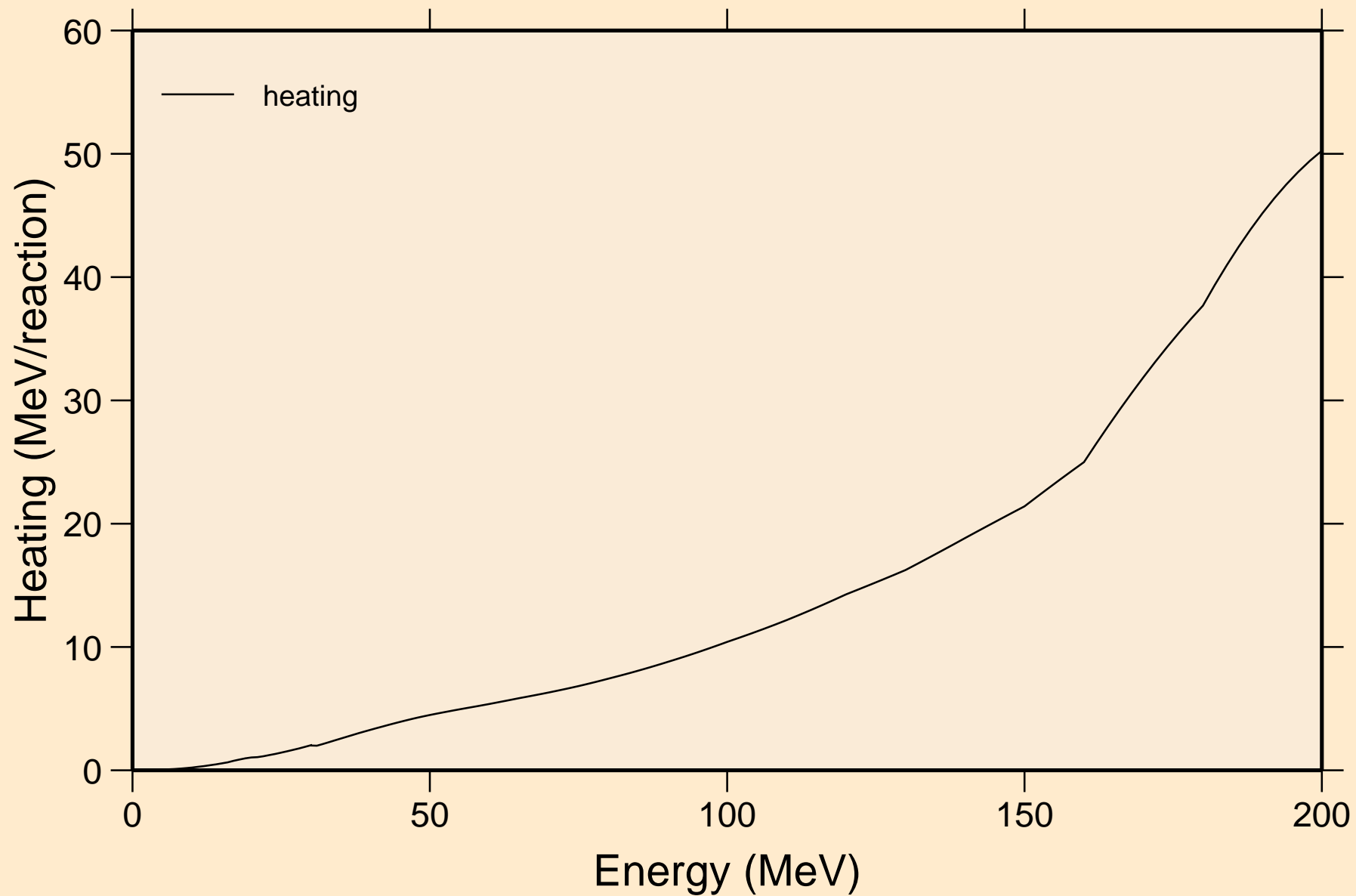

BI198M NEUTRON ACER TENDL-2019 LIBRARY; T=293.16K  
Damage

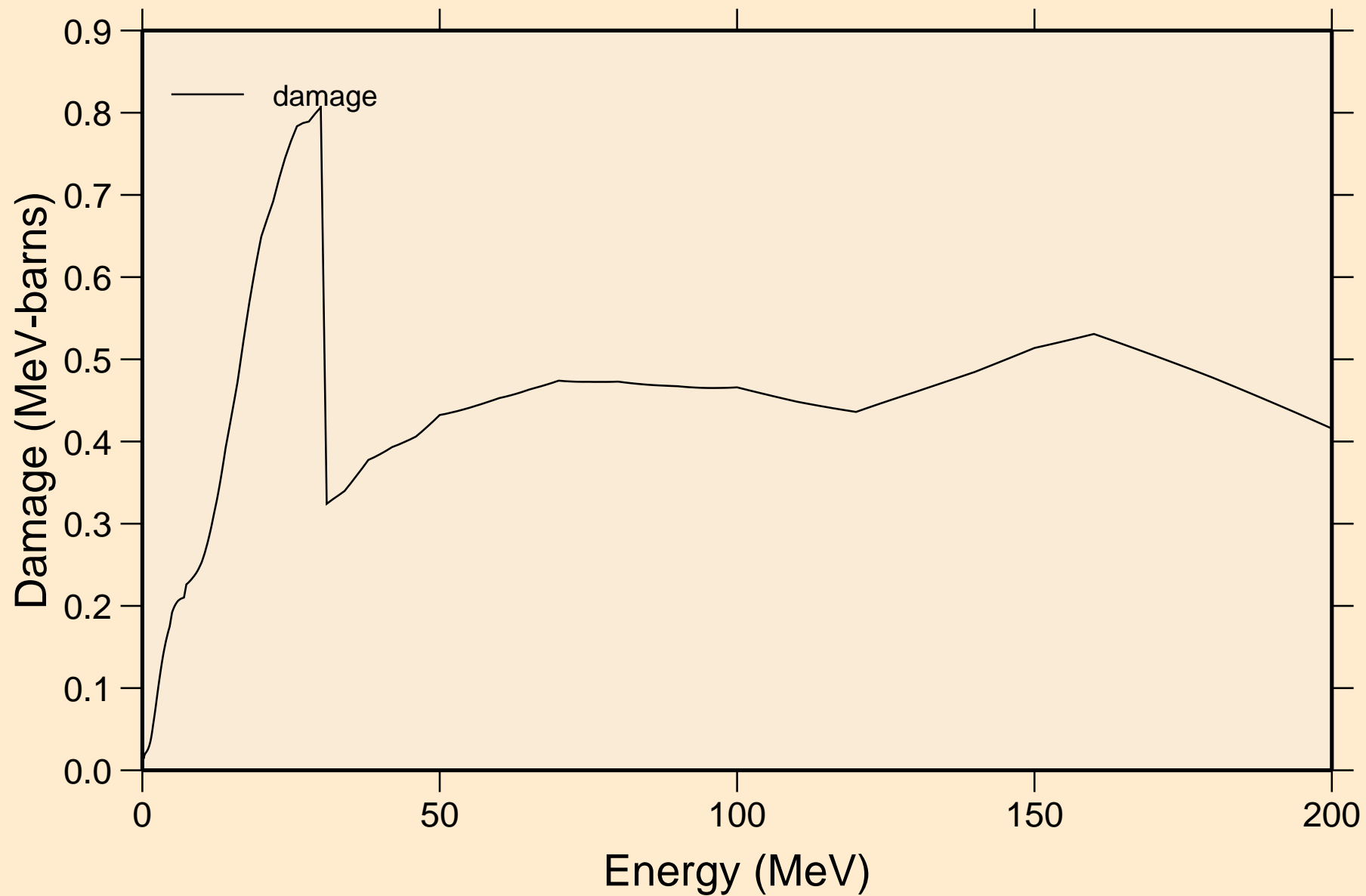

BI198M NEUTRON ACER TENDL-2019 LIBRARY; T=293.16K  
Non-threshold reactions

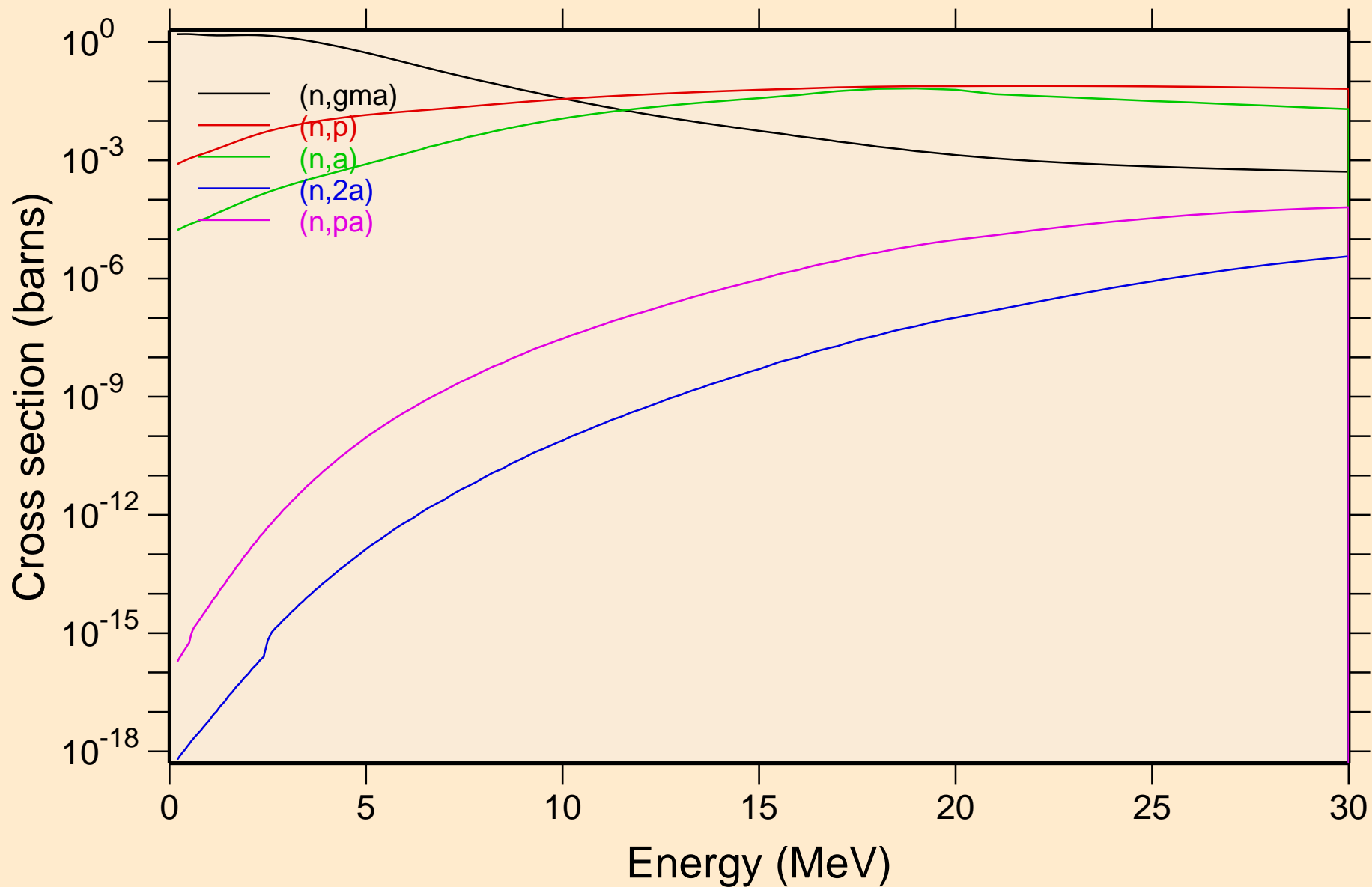

BI198M NEUTRON ACER TENDL-2019 LIBRARY; T=293.16K  
Non-threshold reactions

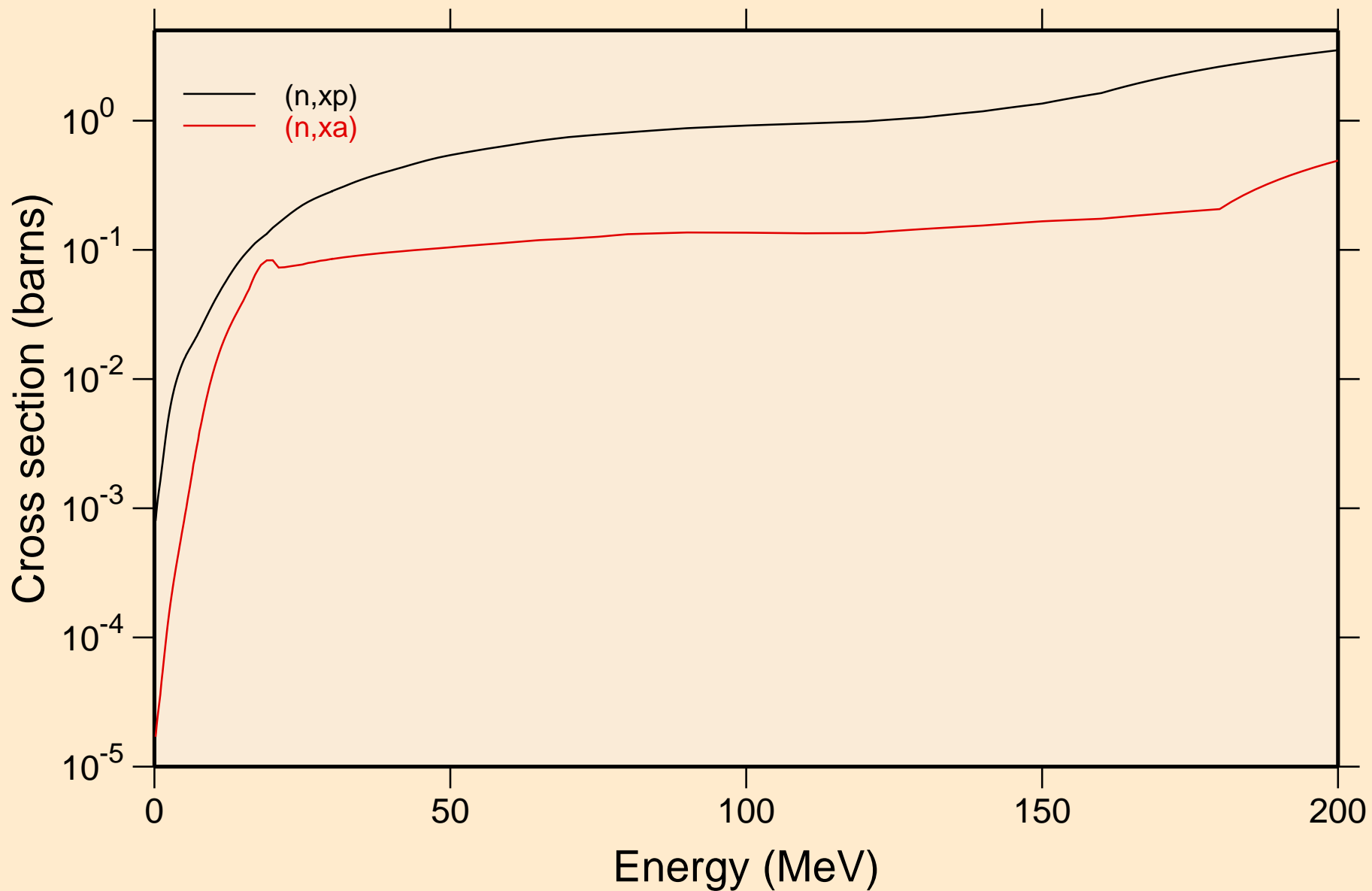

BI198M NEUTRON ACER TENDL-2019 LIBRARY; T=293.16K  
Inelastic levels

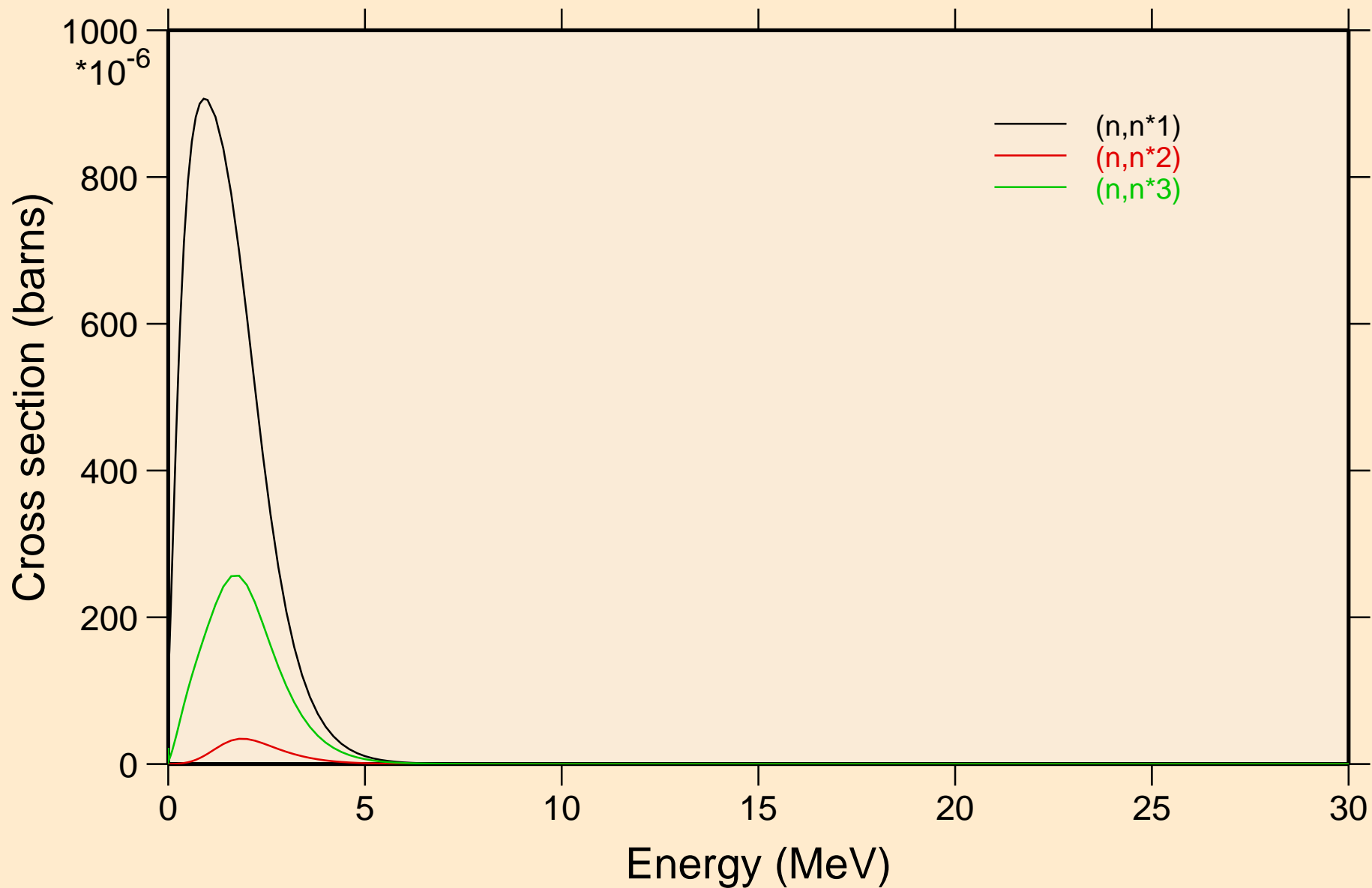

BI198M NEUTRON ACER TENDL-2019 LIBRARY; T=293.16K  
Threshold reactions

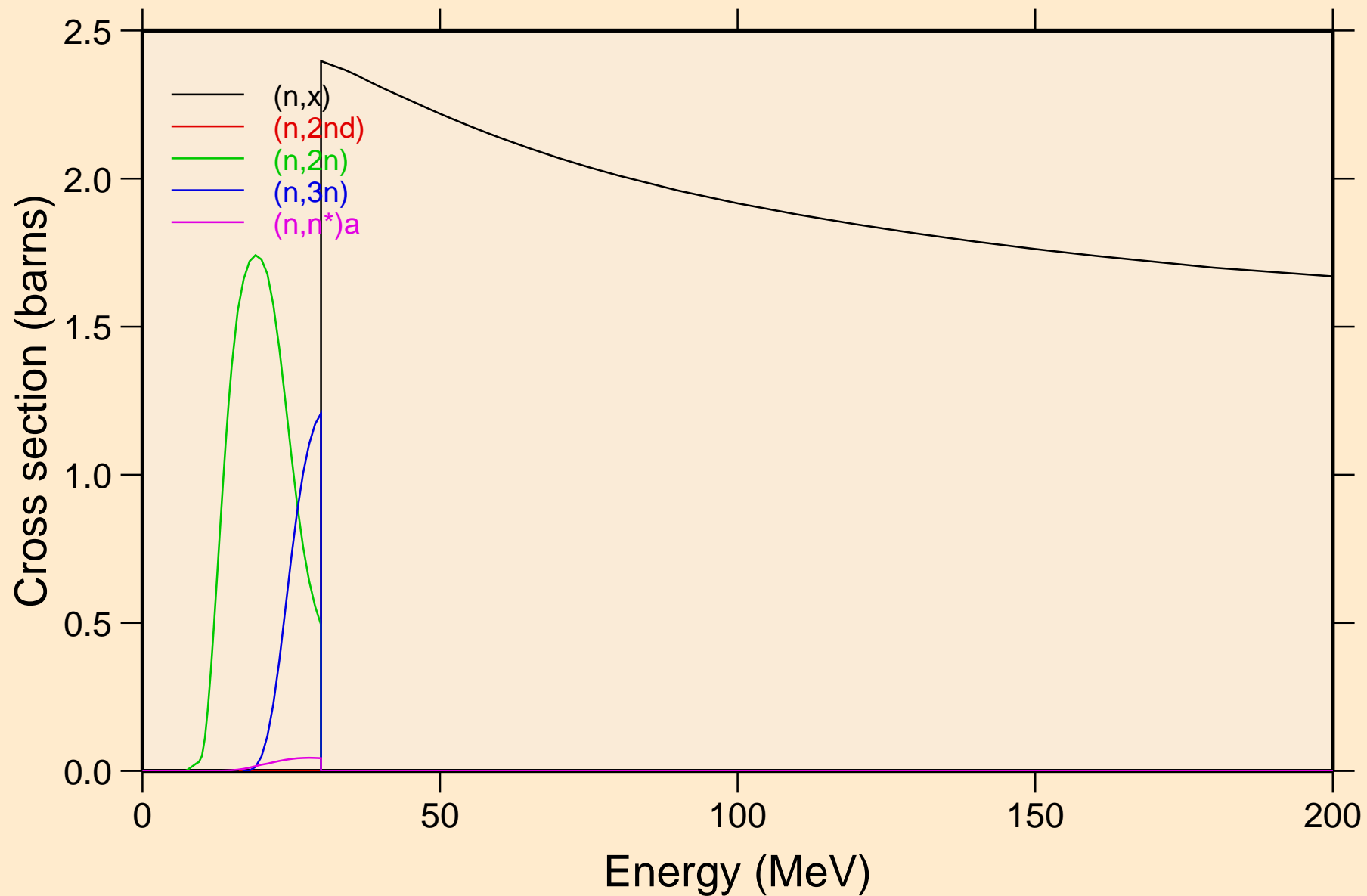

BI198M NEUTRON ACER TENDL-2019 LIBRARY; T=293.16K  
Threshold reactions

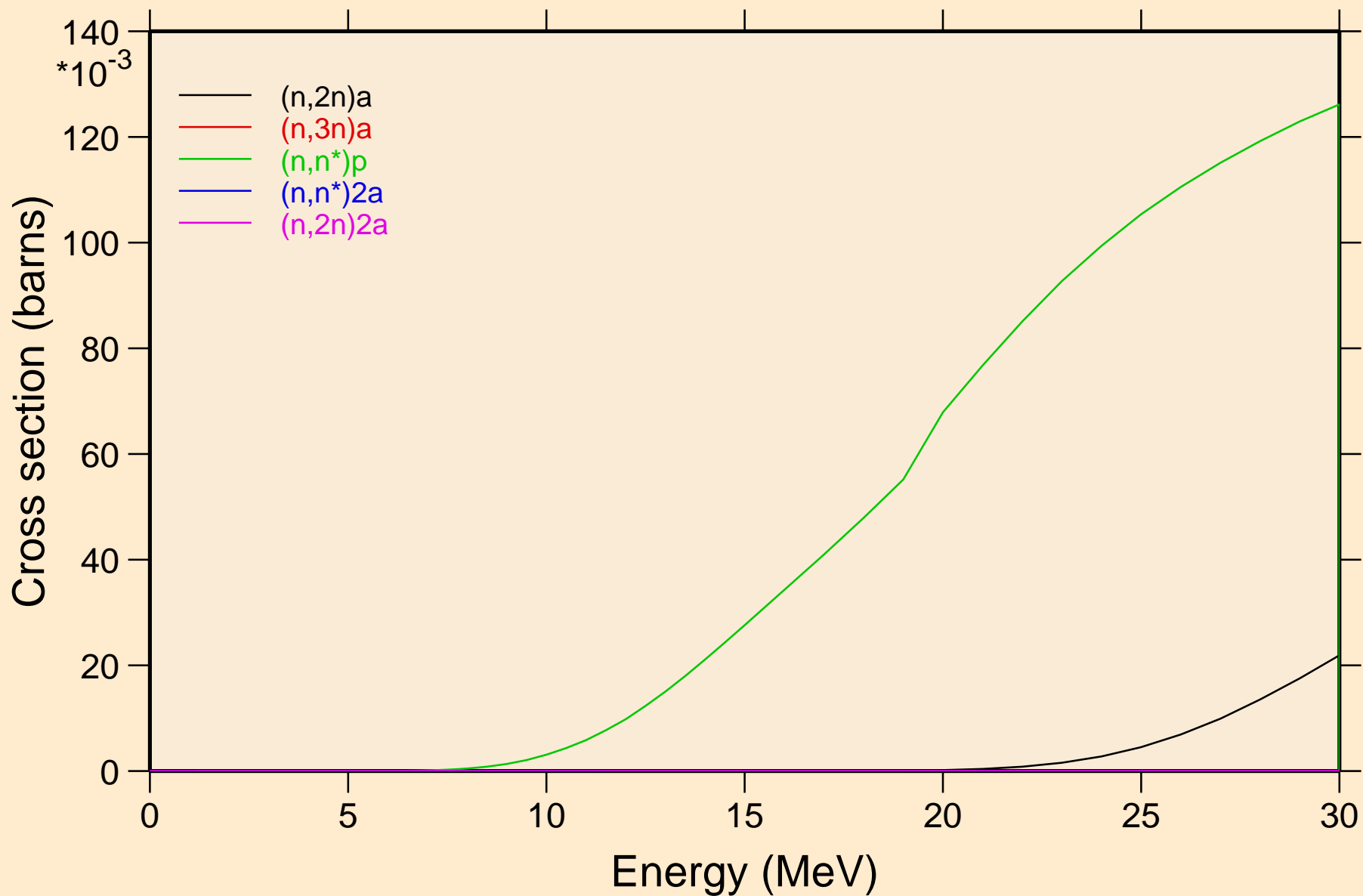

BI198M NEUTRON ACER TENDL-2019 LIBRARY; T=293.16K  
Threshold reactions

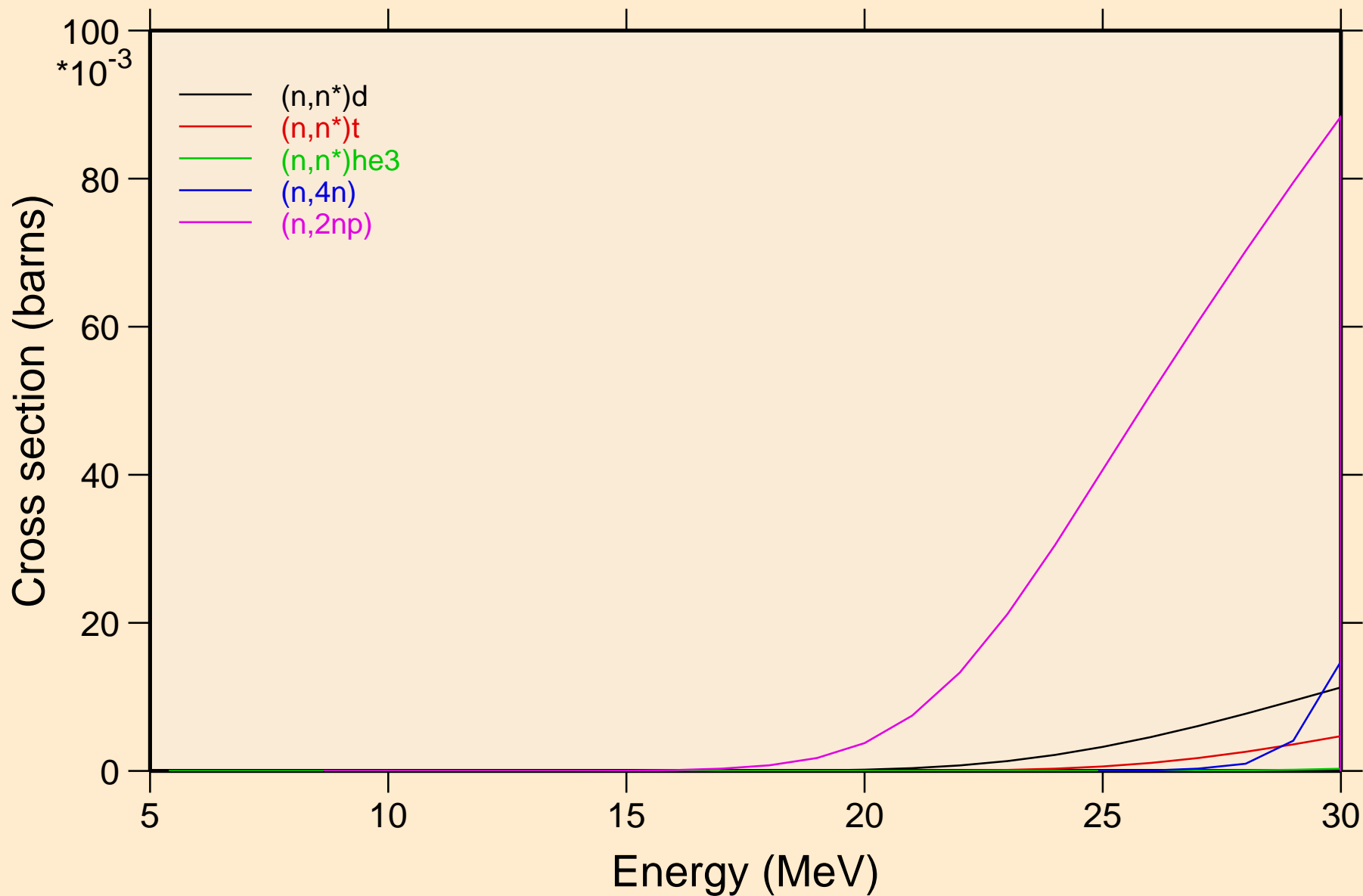

BI198M NEUTRON ACER TENDL-2019 LIBRARY; T=293.16K  
Threshold reactions

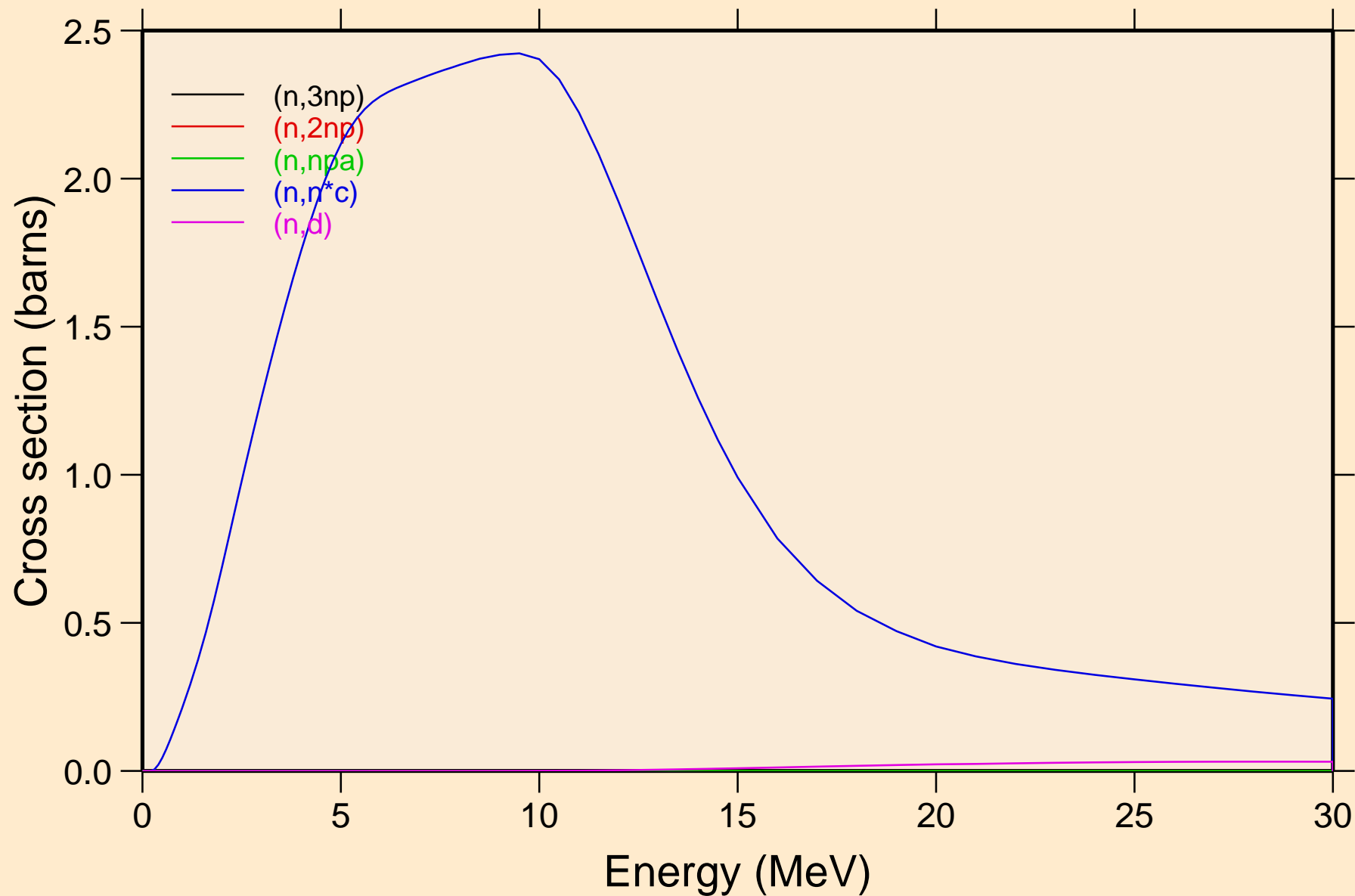

BI198M NEUTRON ACER TENDL-2019 LIBRARY; T=293.16K  
Threshold reactions

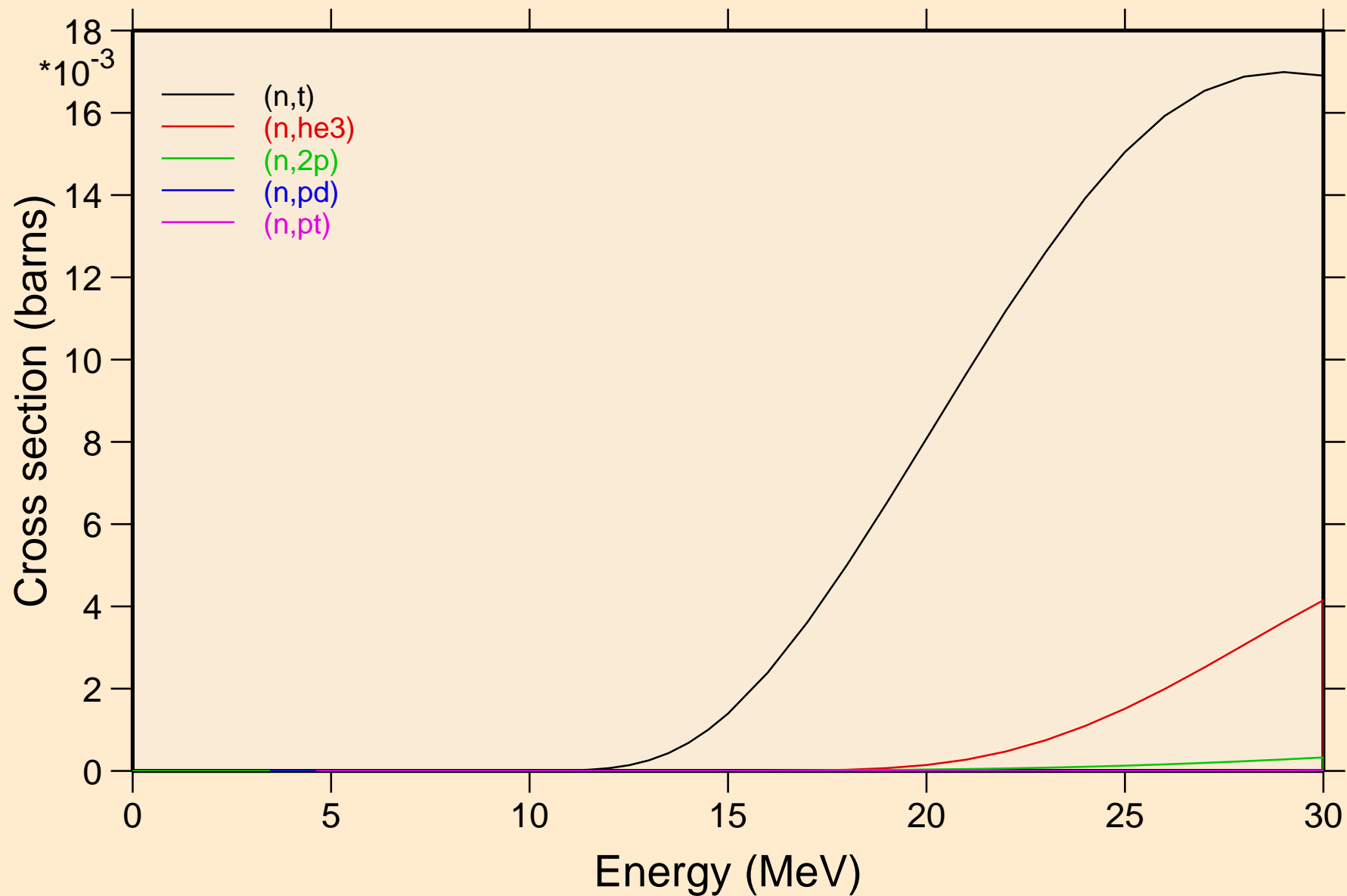

BI198M NEUTRON ACER TENDL-2019 LIBRARY; T=293.16K  
Threshold reactions

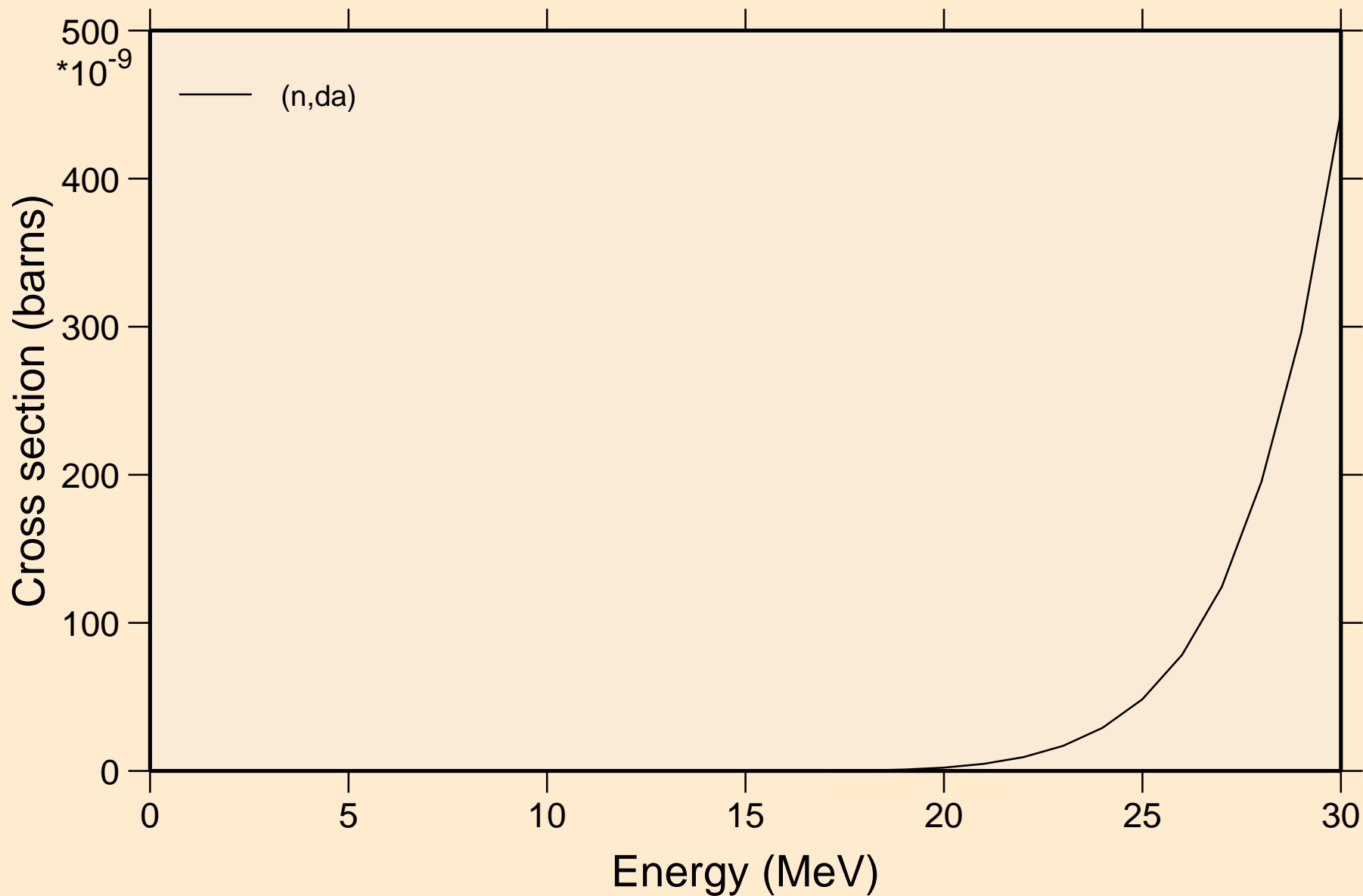

BI198M NEUTRON ACER TENDL-2019 LIBRARY; T=293.16K  
Threshold reactions

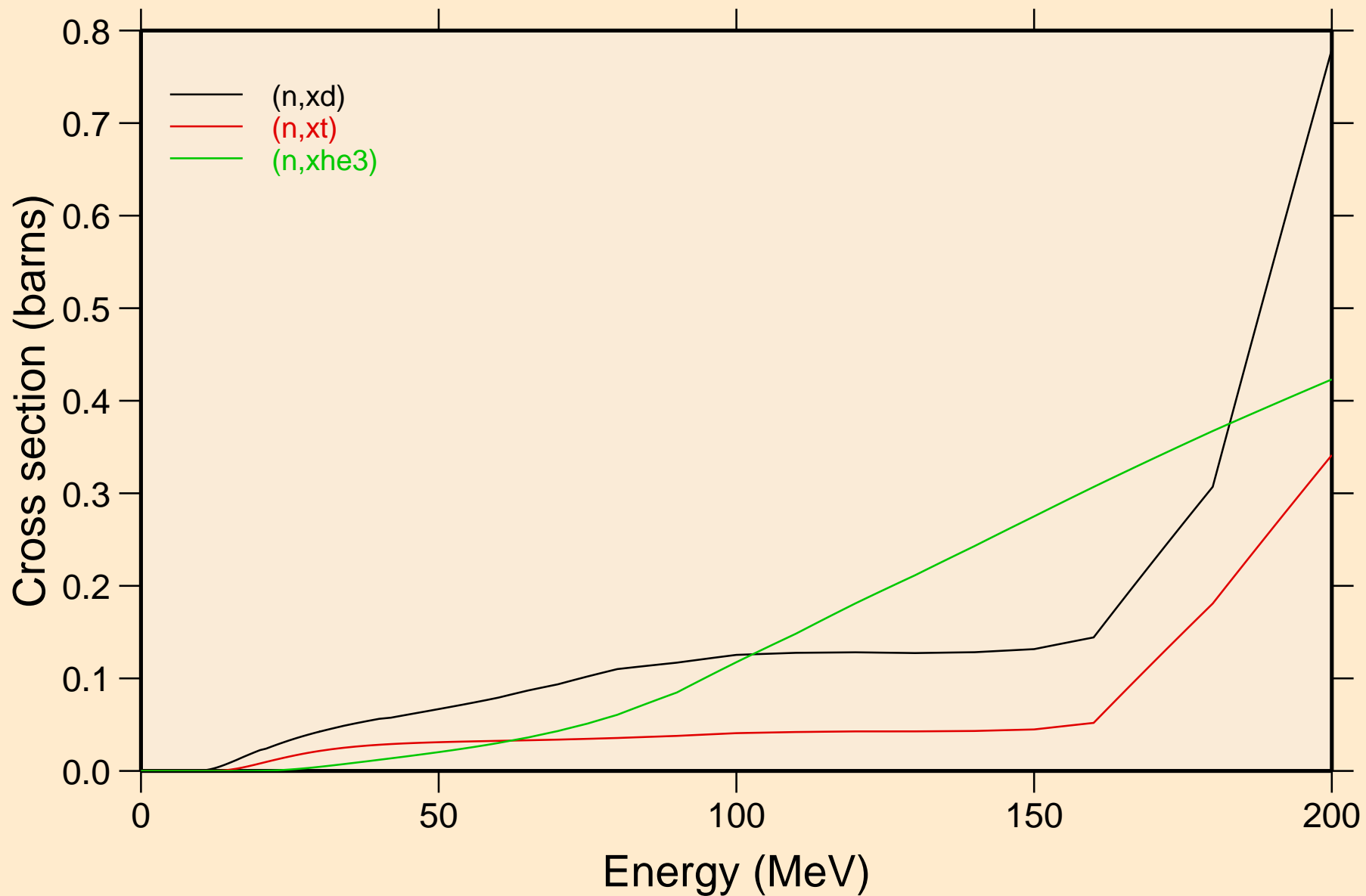

BI198M NEUTRON ACER TENDL-2019 LIBRARY; T=293.16K  
angular distribution for elastic

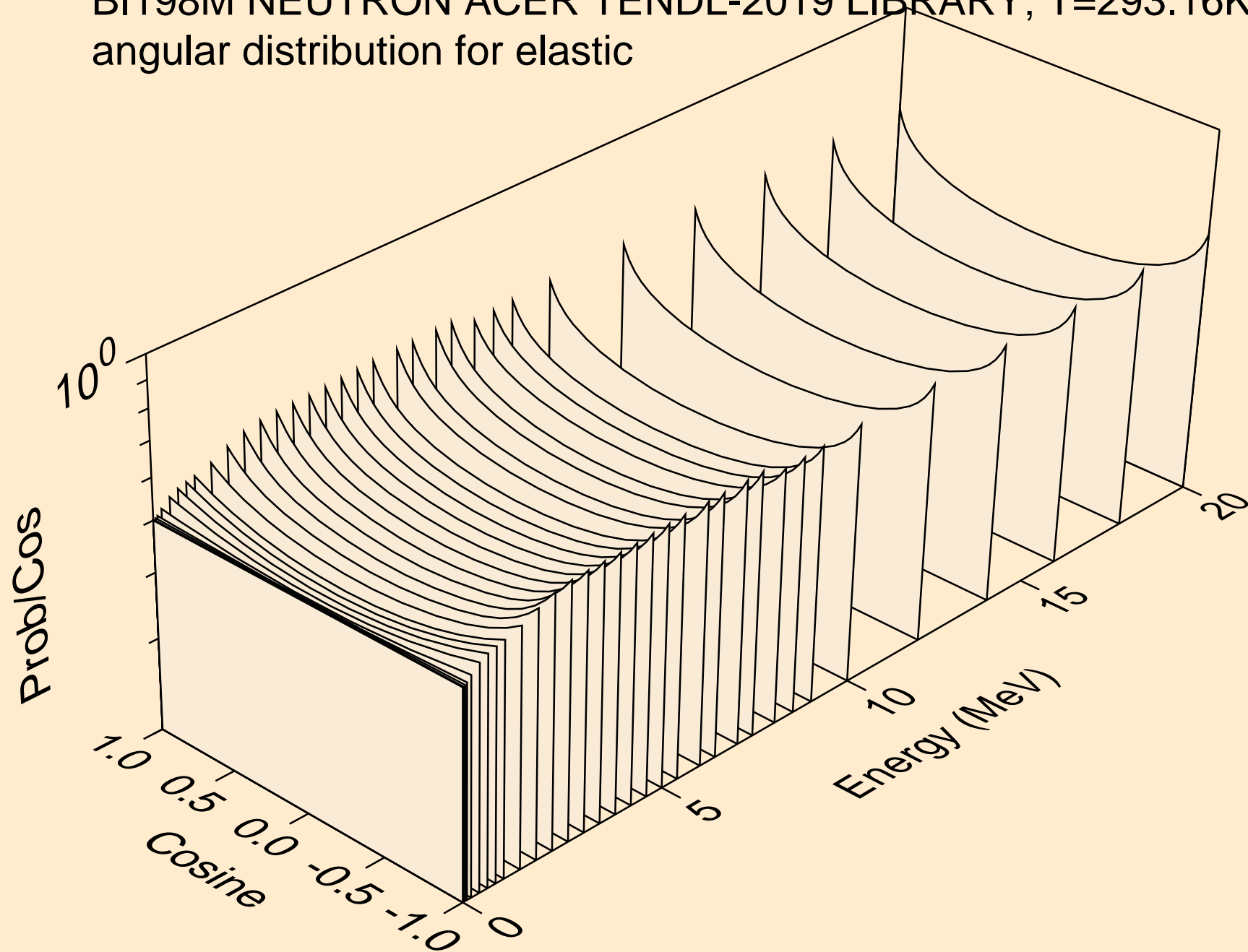

BI198M NEUTRON ACER TENDL-2019 LIBRARY; T=293.16K  
angular distribution for elastic

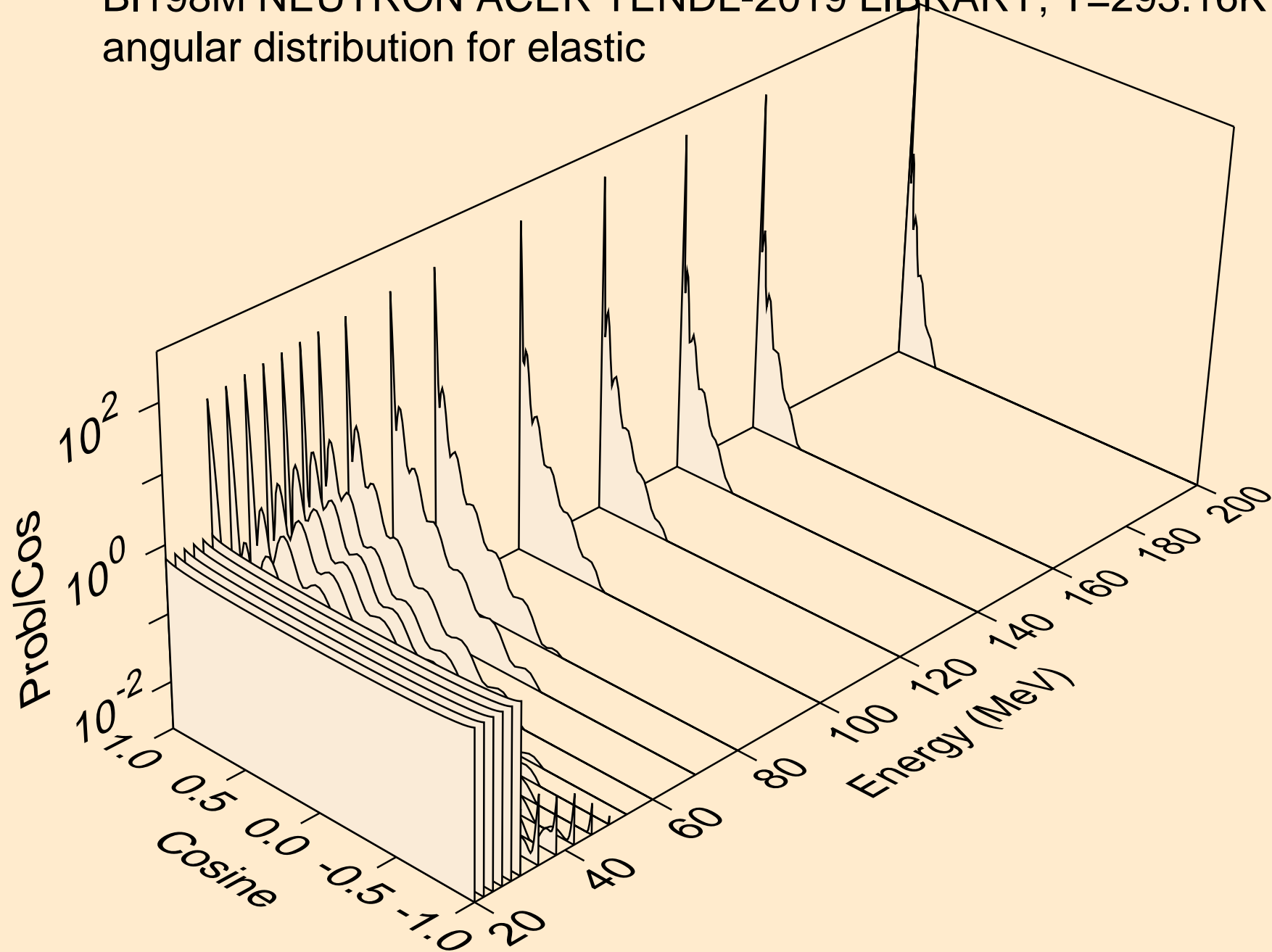

BI198M NEUTRON ACER TENDL-2019 LIBRARY; T=293.16K  
angular distribution for (n,n\*1)

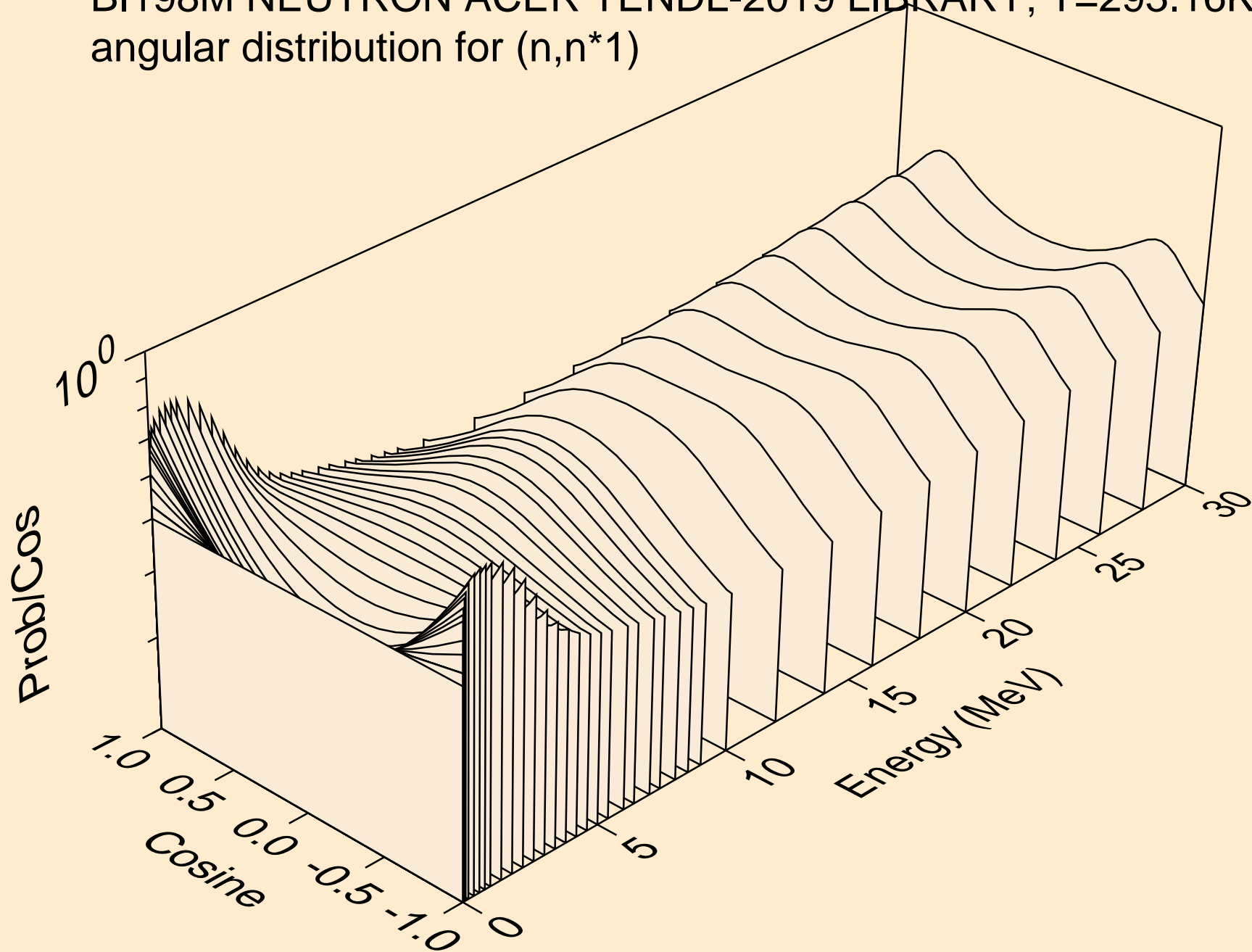

BI198M NEUTRON ACER TENDL-2019 LIBRARY; T=293.16K  
angular distribution for (n,n\*2)

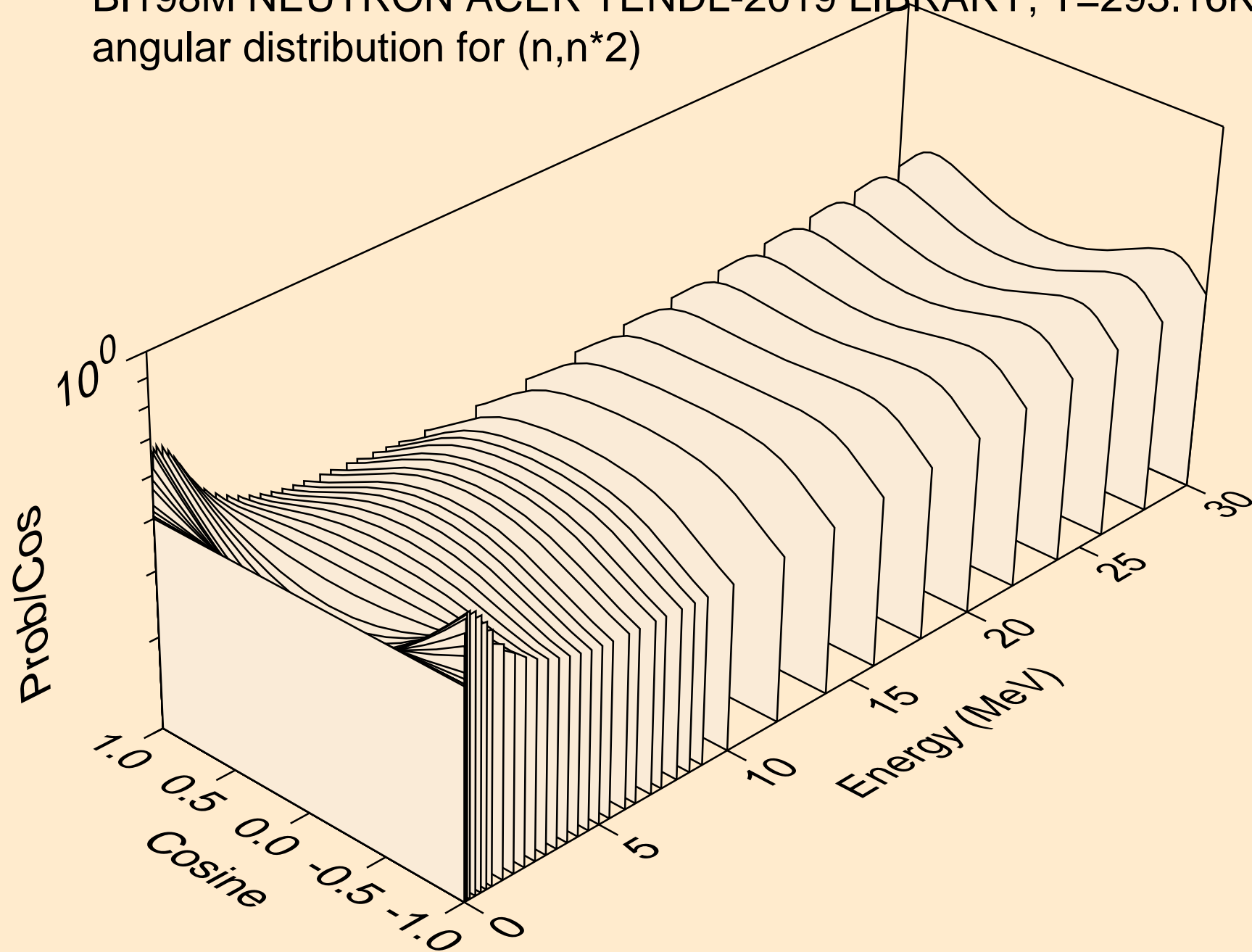

BI198M NEUTRON ACER TENDL-2019 LIBRARY; T=293.16K  
angular distribution for (n,n\*3)

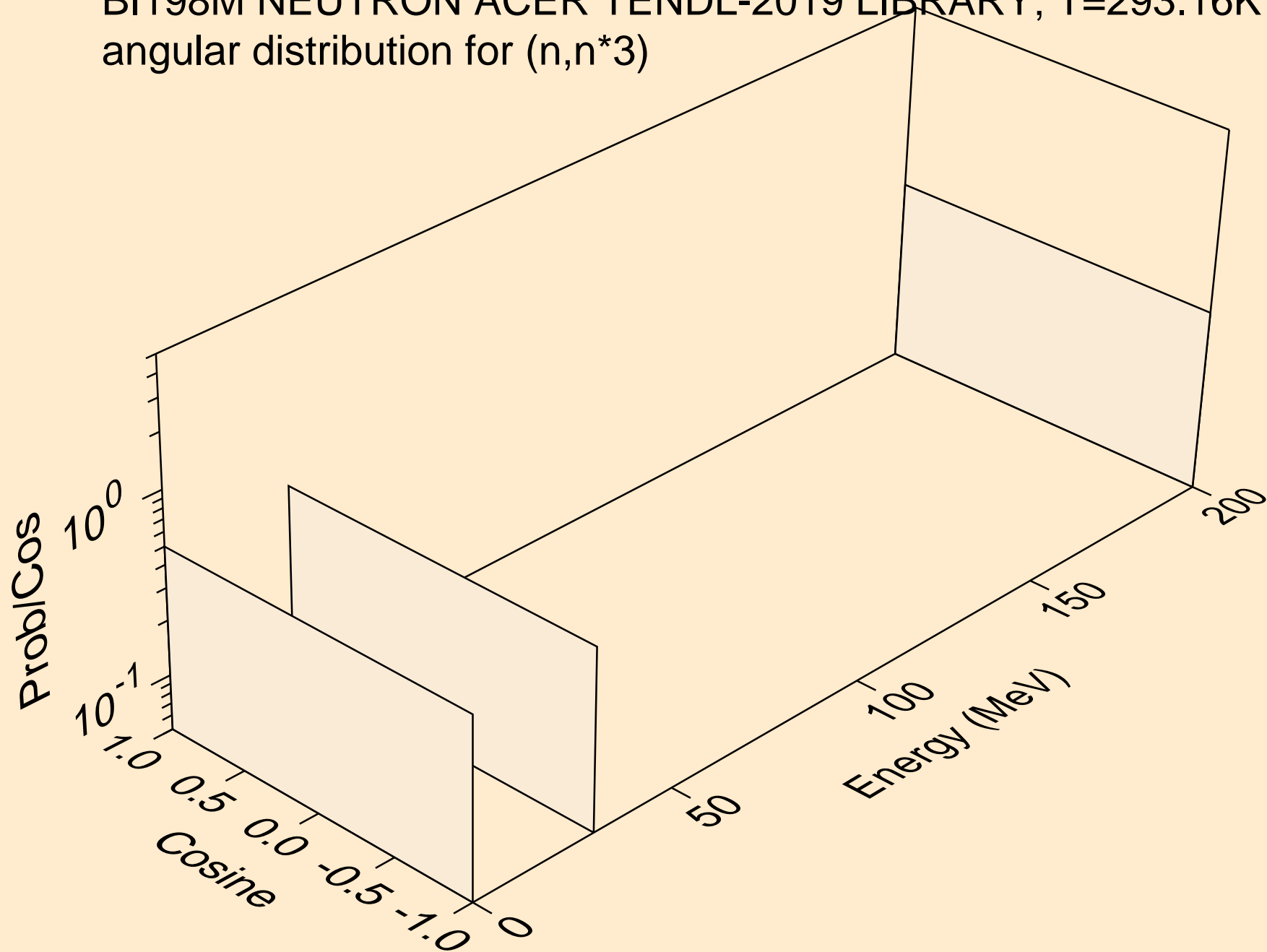

BI198M NEUTRON ACER TENDL-2019 LIBRARY; T=293.16K  
Neutron emission for (n,x)

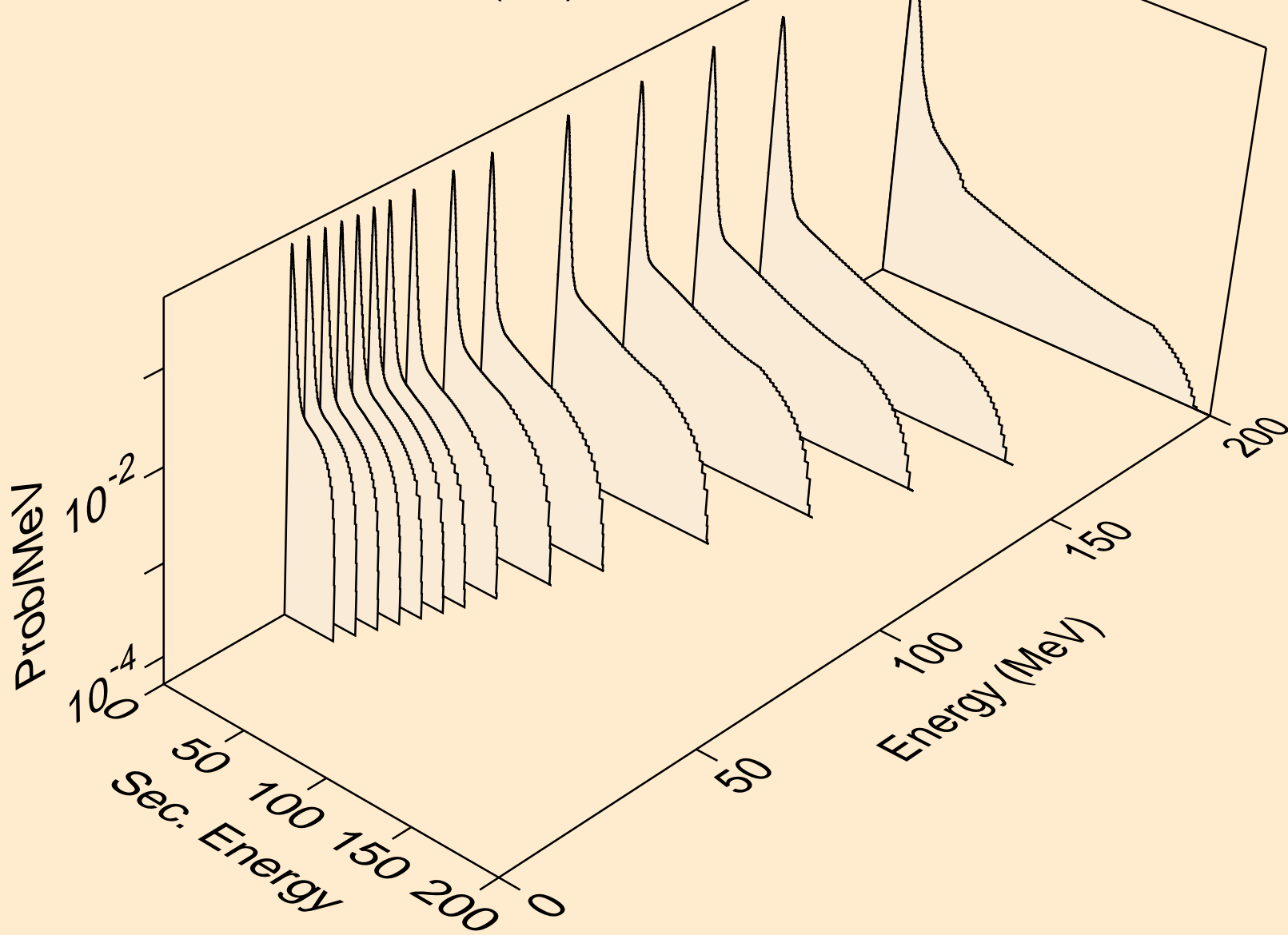

BI198M NEUTRON ACER TENDL-2019 LIBRARY; T=293.16K  
Neutron emission for (n,2nd)

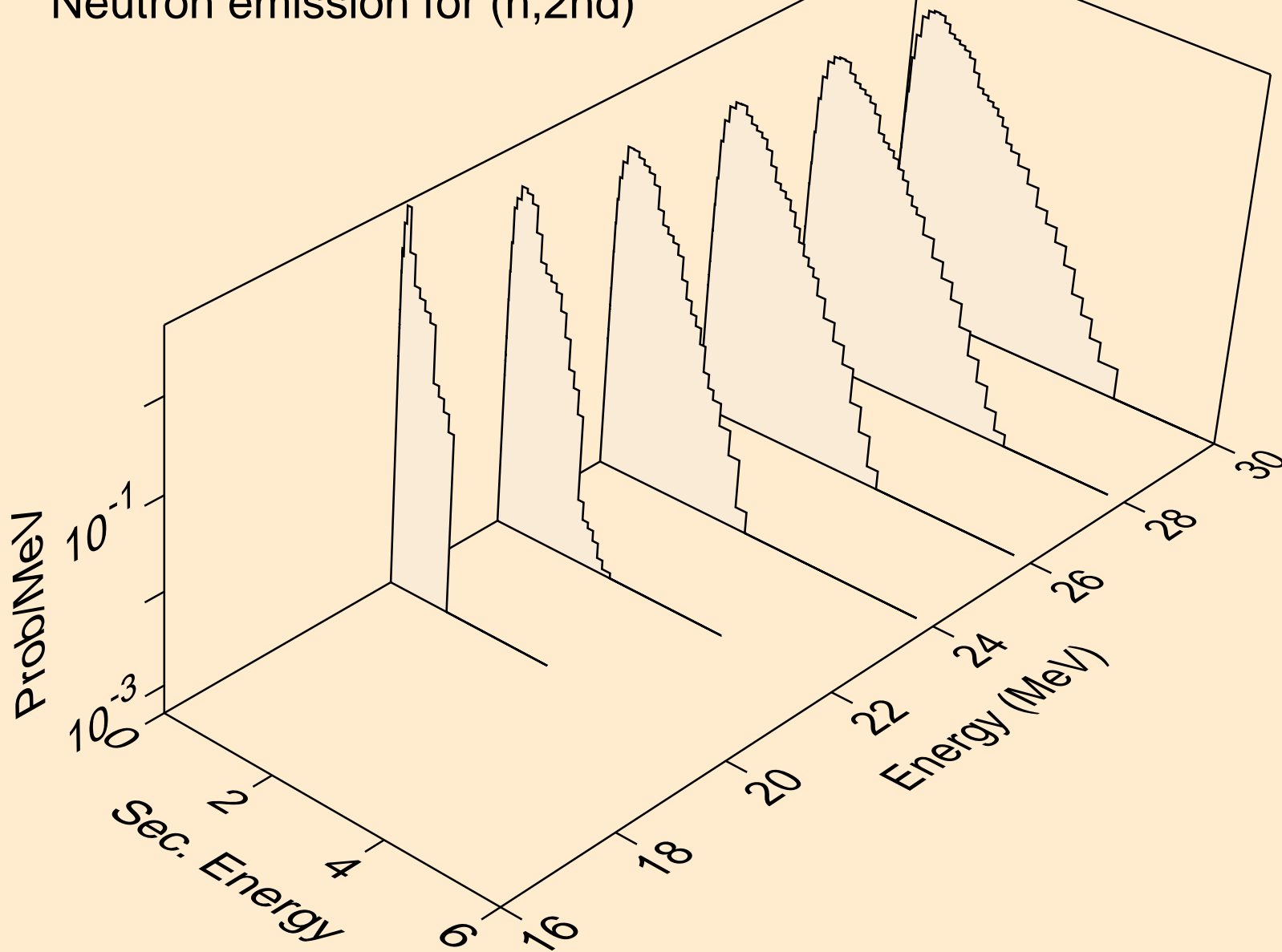

BI198M NEUTRON ACER TENDL-2019 LIBRARY; T=293.16K  
Neutron emission for (n,2n)

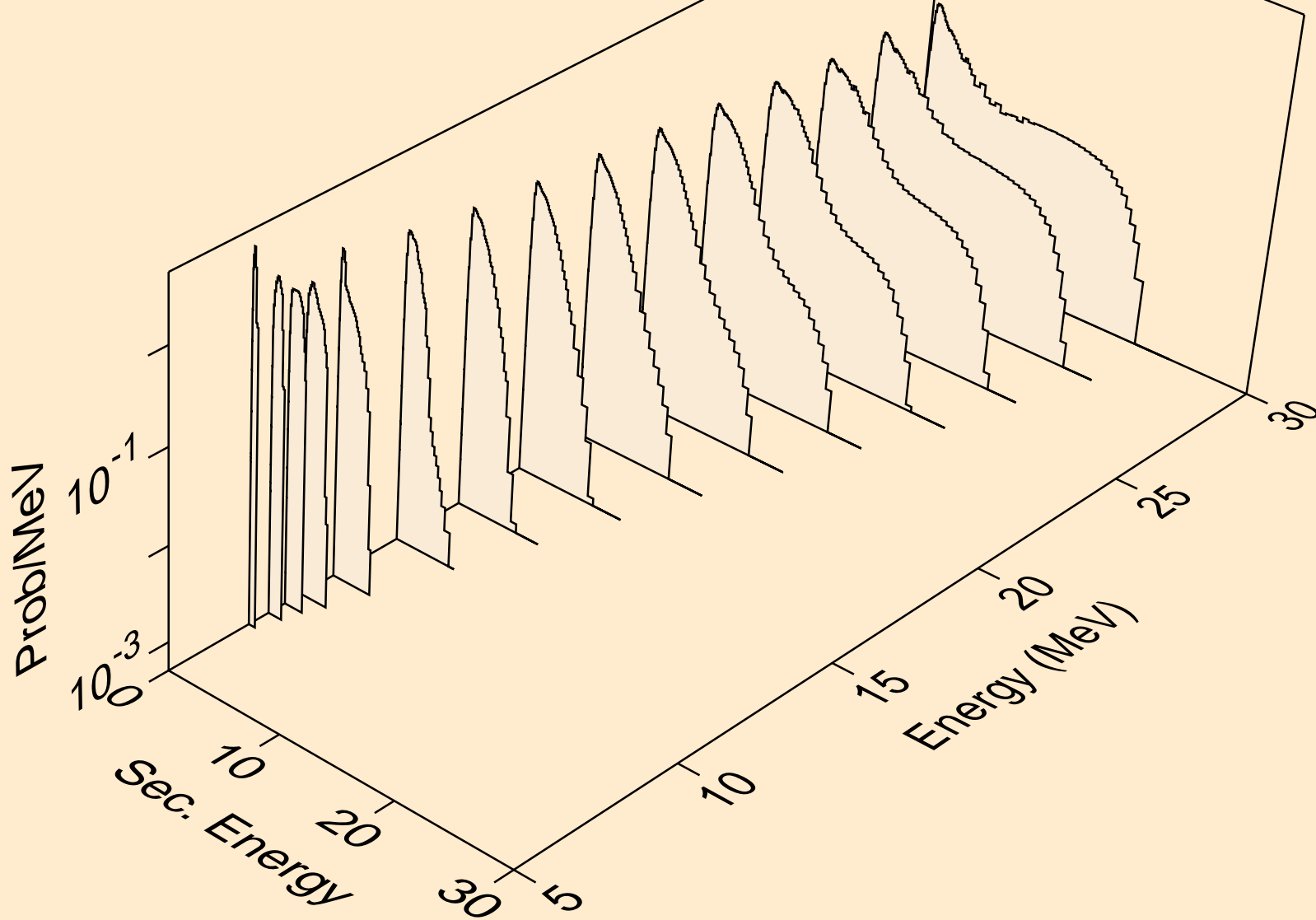

BI198M NEUTRON ACER TENDL-2019 LIBRARY; T=293.16K  
Neutron emission for (n,3n)

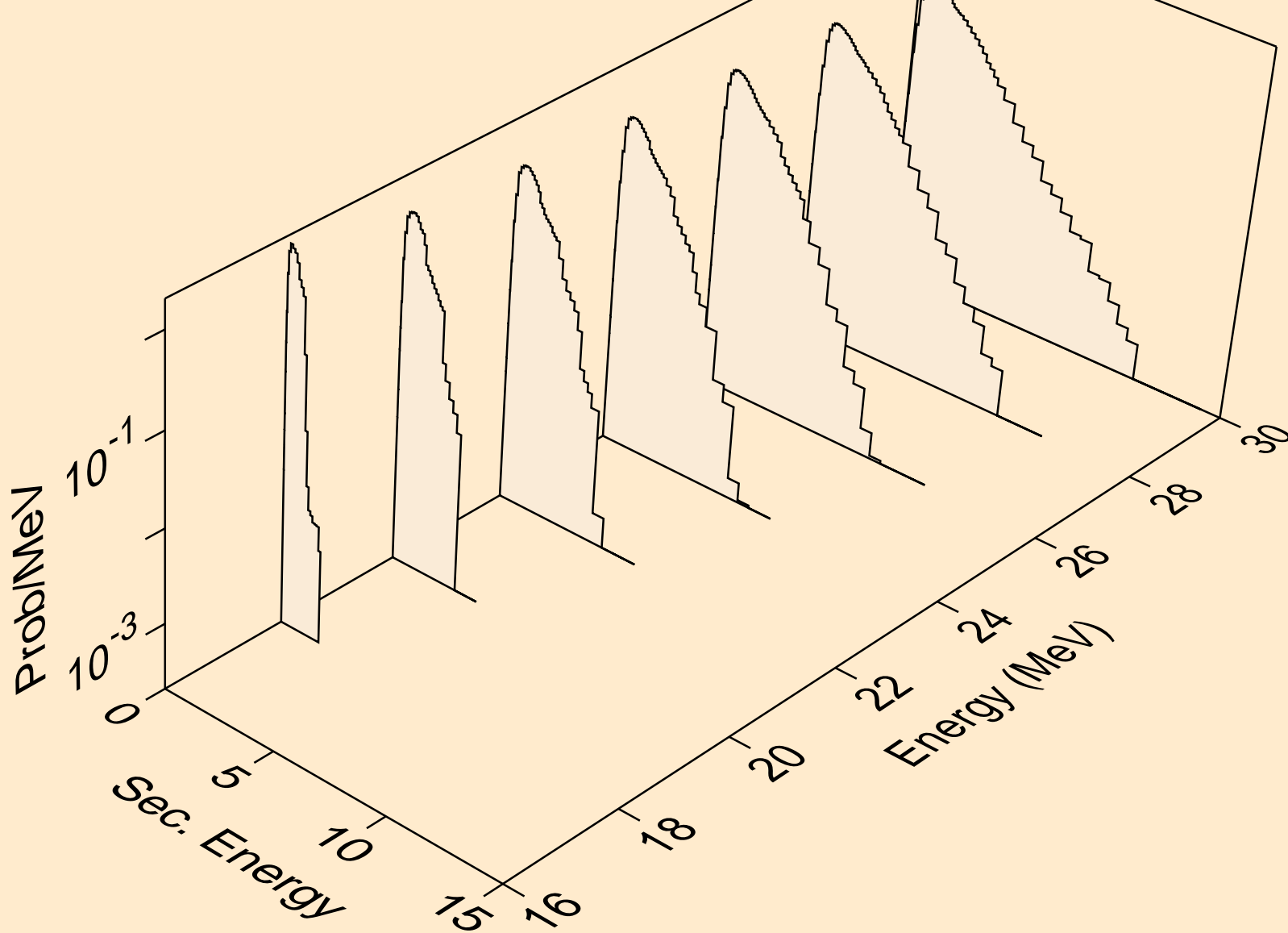

BI198M NEUTRON ACER TENDL-2019 LIBRARY; T=293.16K  
Neutron emission for (n,n\*)a

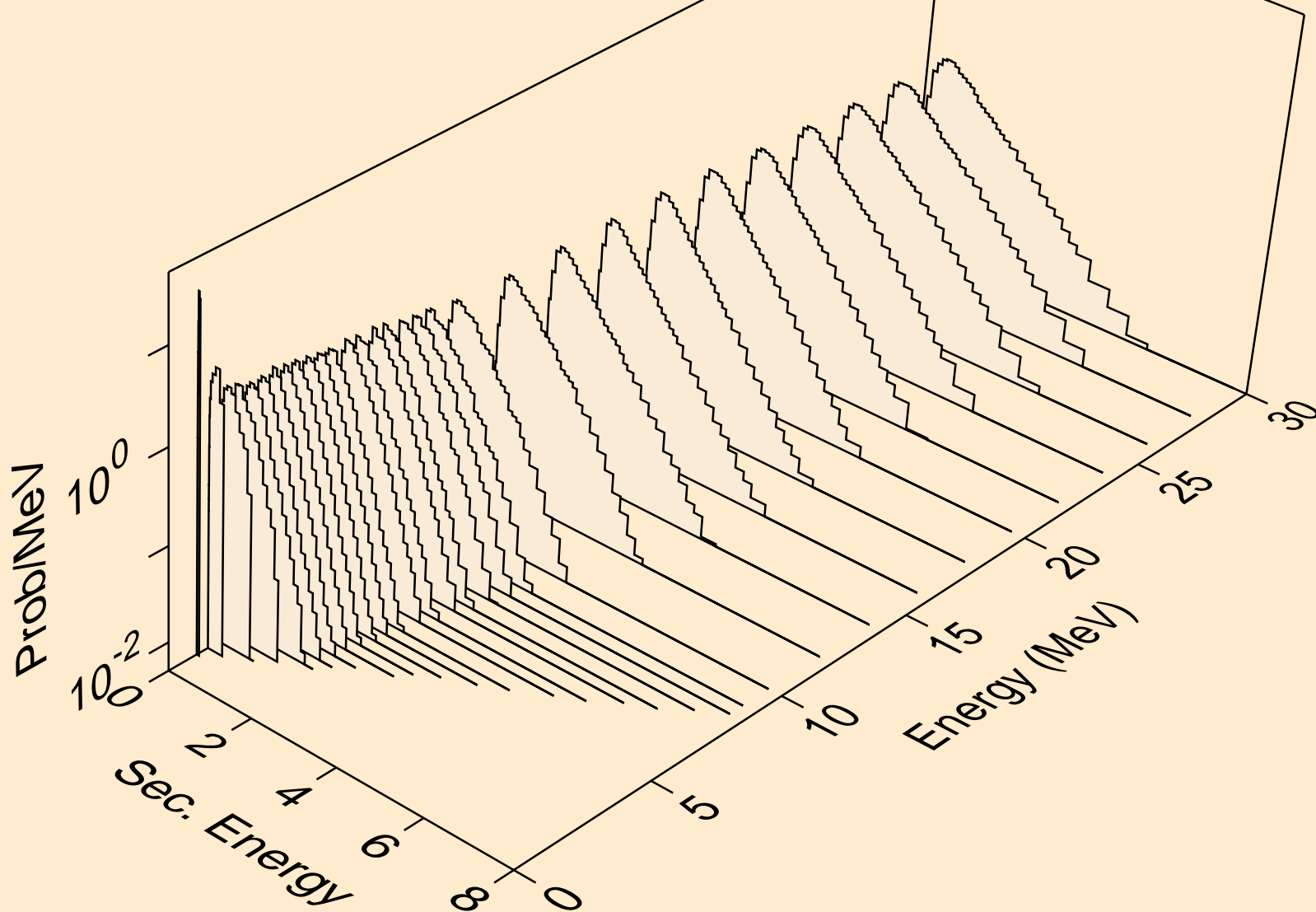

BI198M NEUTRON ACER TENDL-2019 LIBRARY; T=293.16K  
Neutron emission for (n,2n)<sub>a</sub>

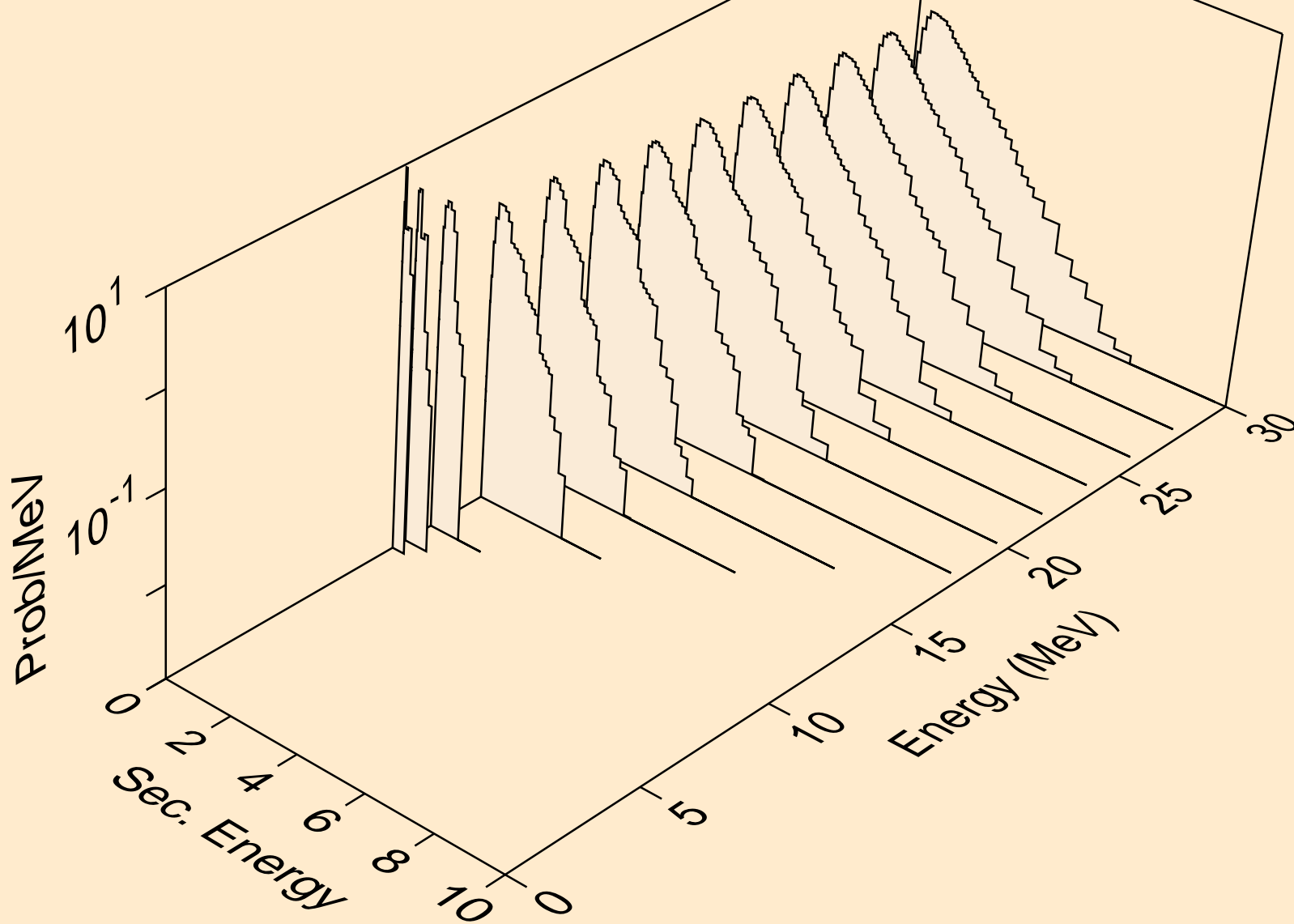

BI198M NEUTRON ACER TENDL-2019 LIBRARY; T=293.16K  
Neutron emission for (n,3n)a

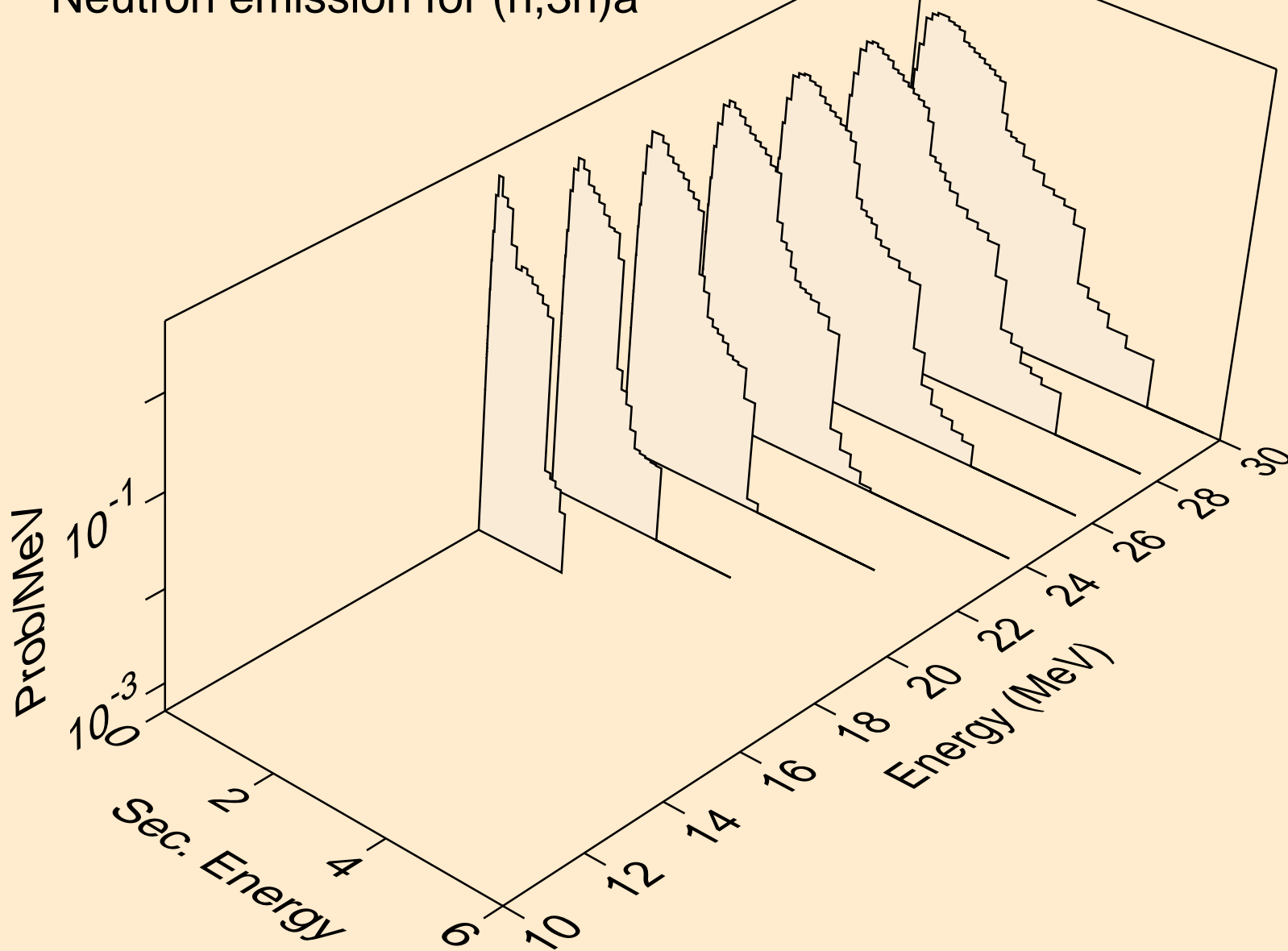

BI198M NEUTRON ACER TENDL-2019 LIBRARY; T=293.16K  
Neutron emission for (n,n\*)p

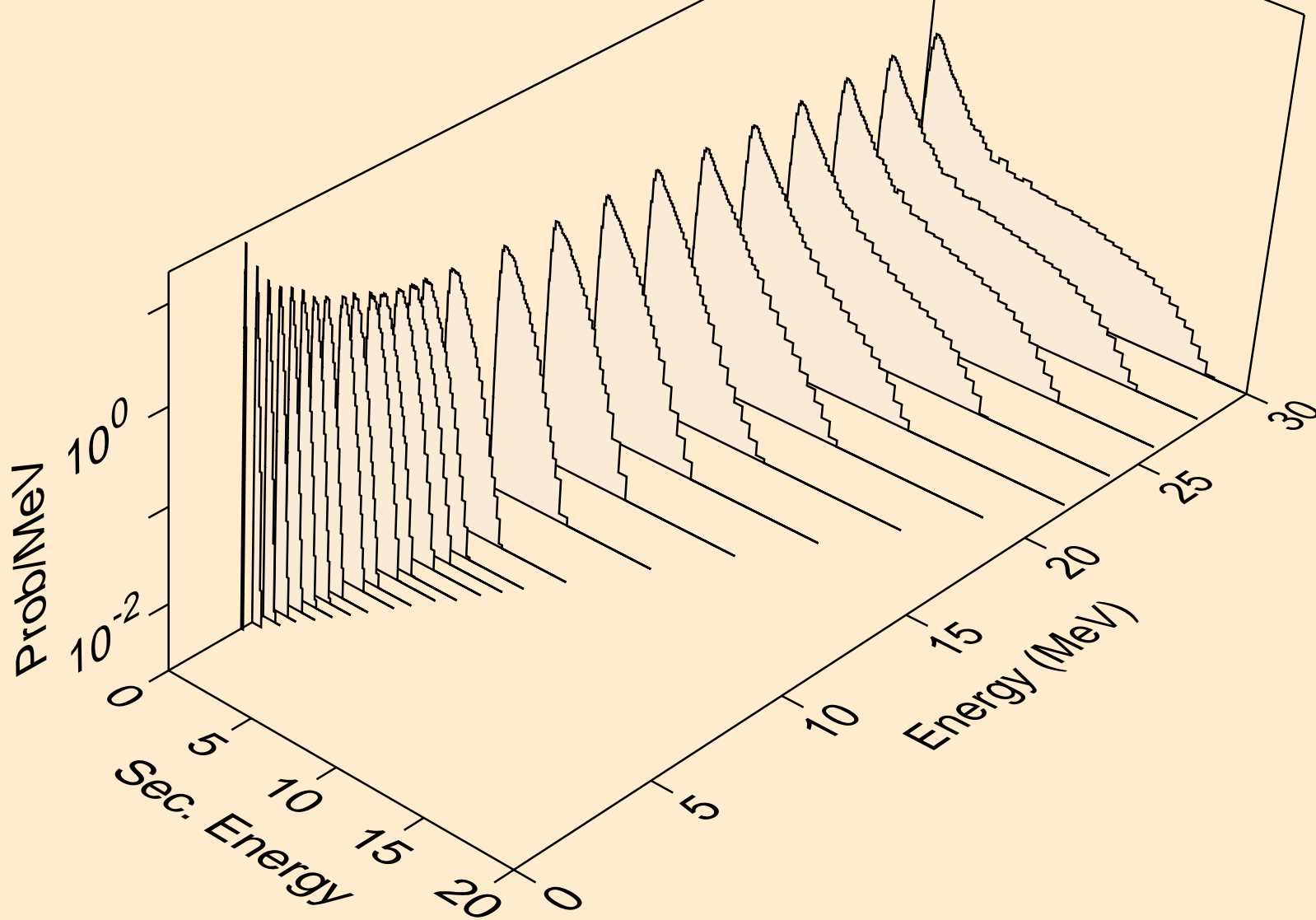

BI198M NEUTRON ACER TENDL-2019 LIBRARY; T=293.16K  
Neutron emission for (n,n\*)2a

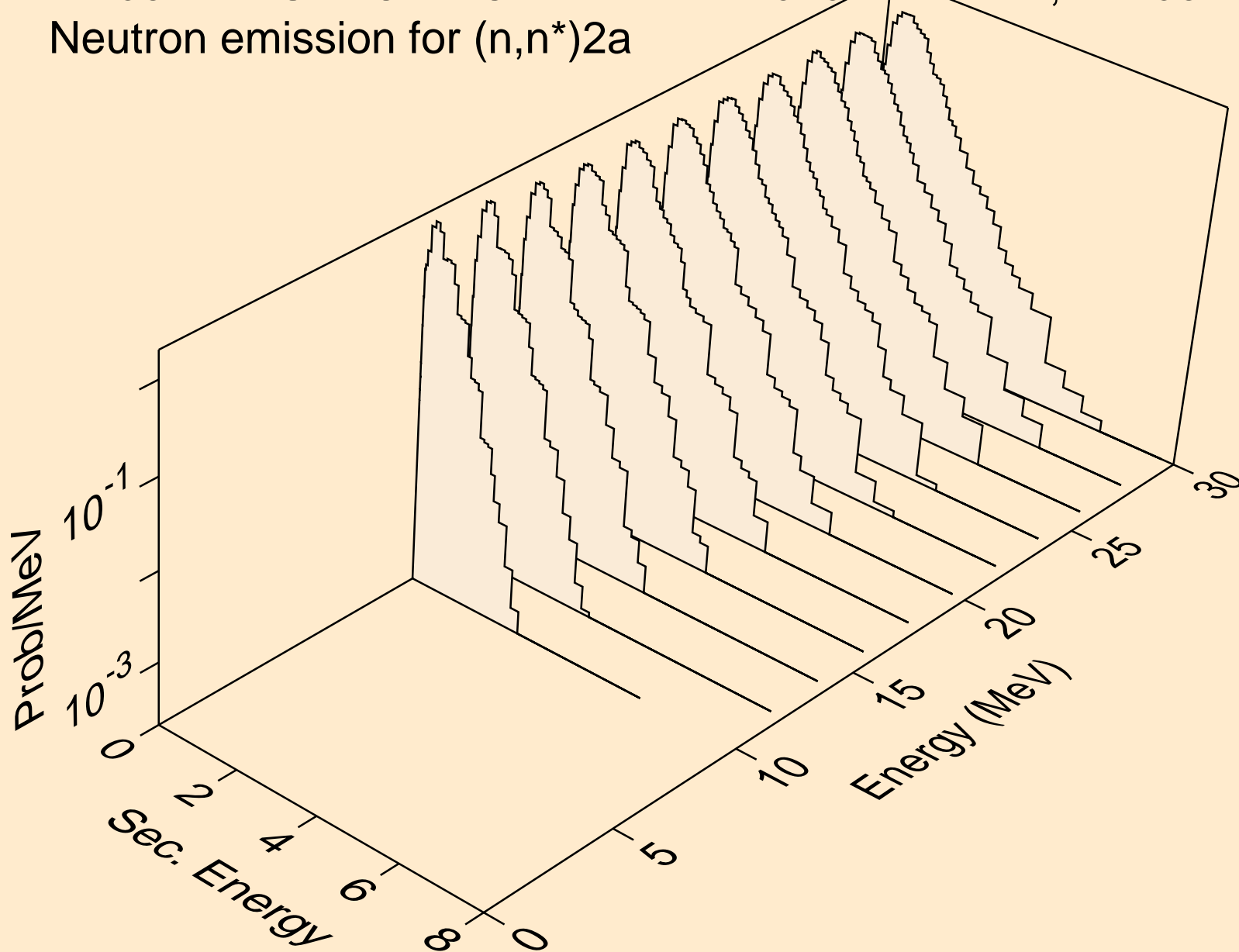

BI198M NEUTRON ACER TENDL-2019 LIBRARY; T=293.16K  
Neutron emission for (n,2n)2a

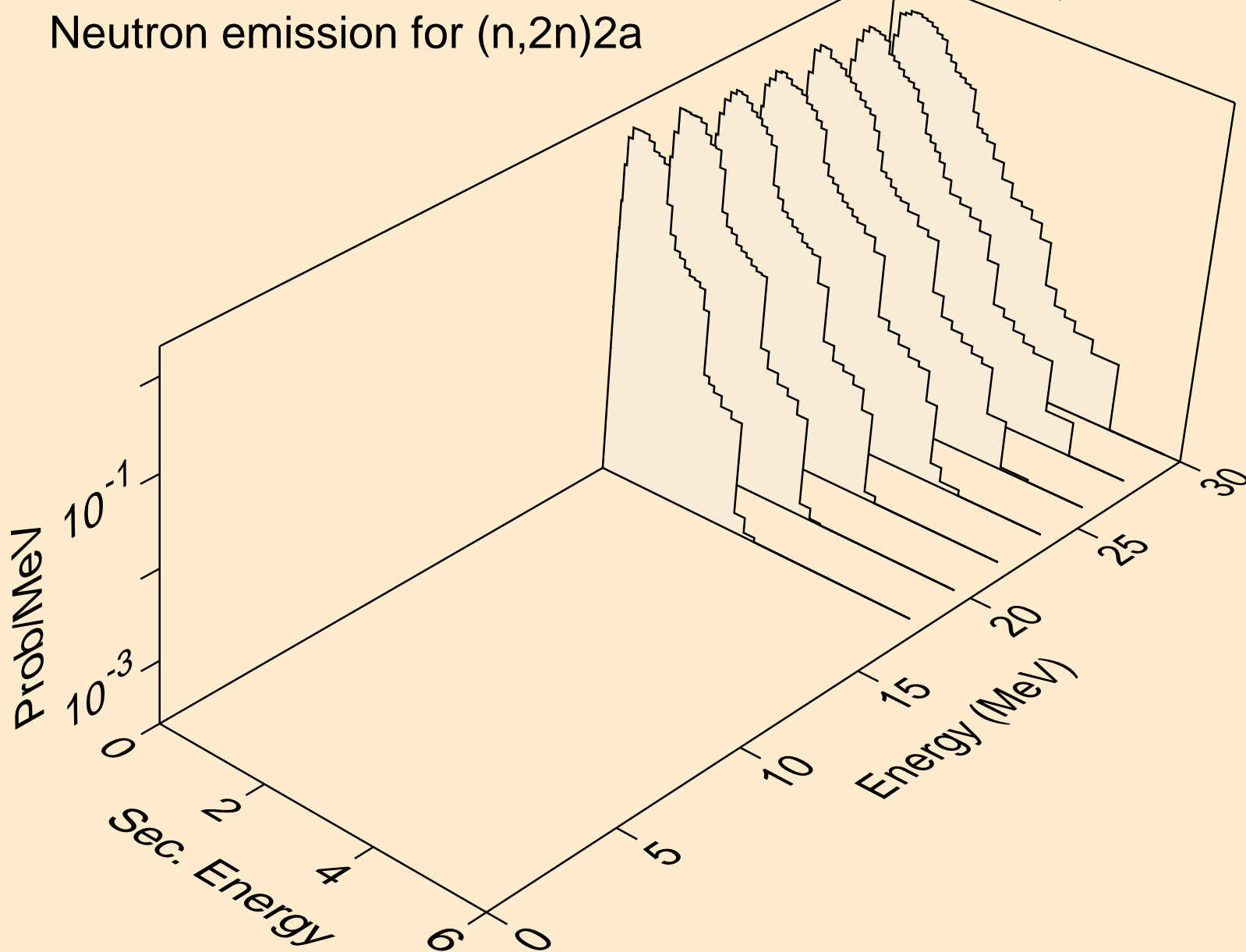

BI198M NEUTRON ACER TENDL-2019 LIBRARY; T=293.16K  
Neutron emission for (n,n\*)d

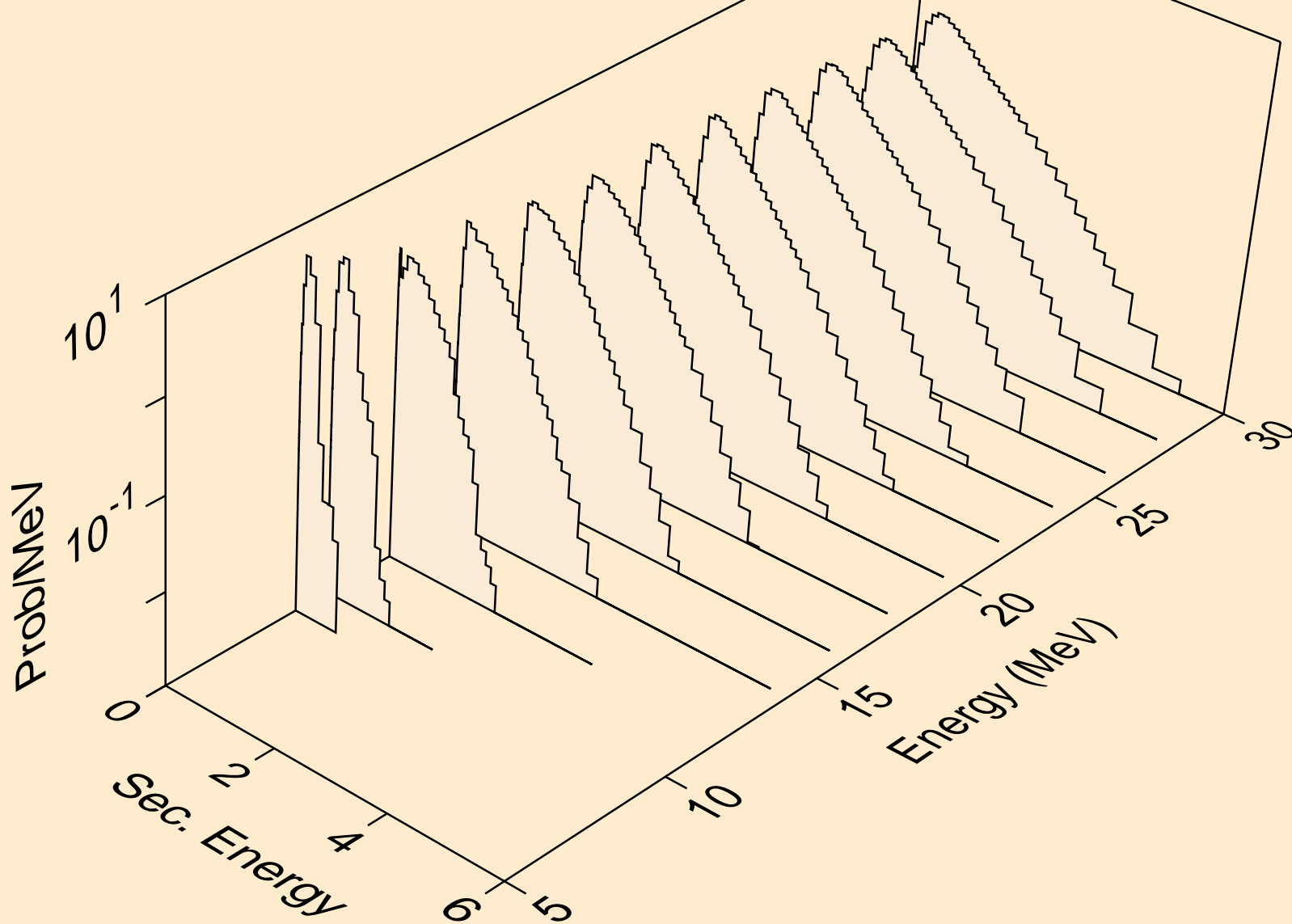

BI198M NEUTRON ACER TENDL-2019 LIBRARY; T=293.16K  
Neutron emission for (n,n\*)t

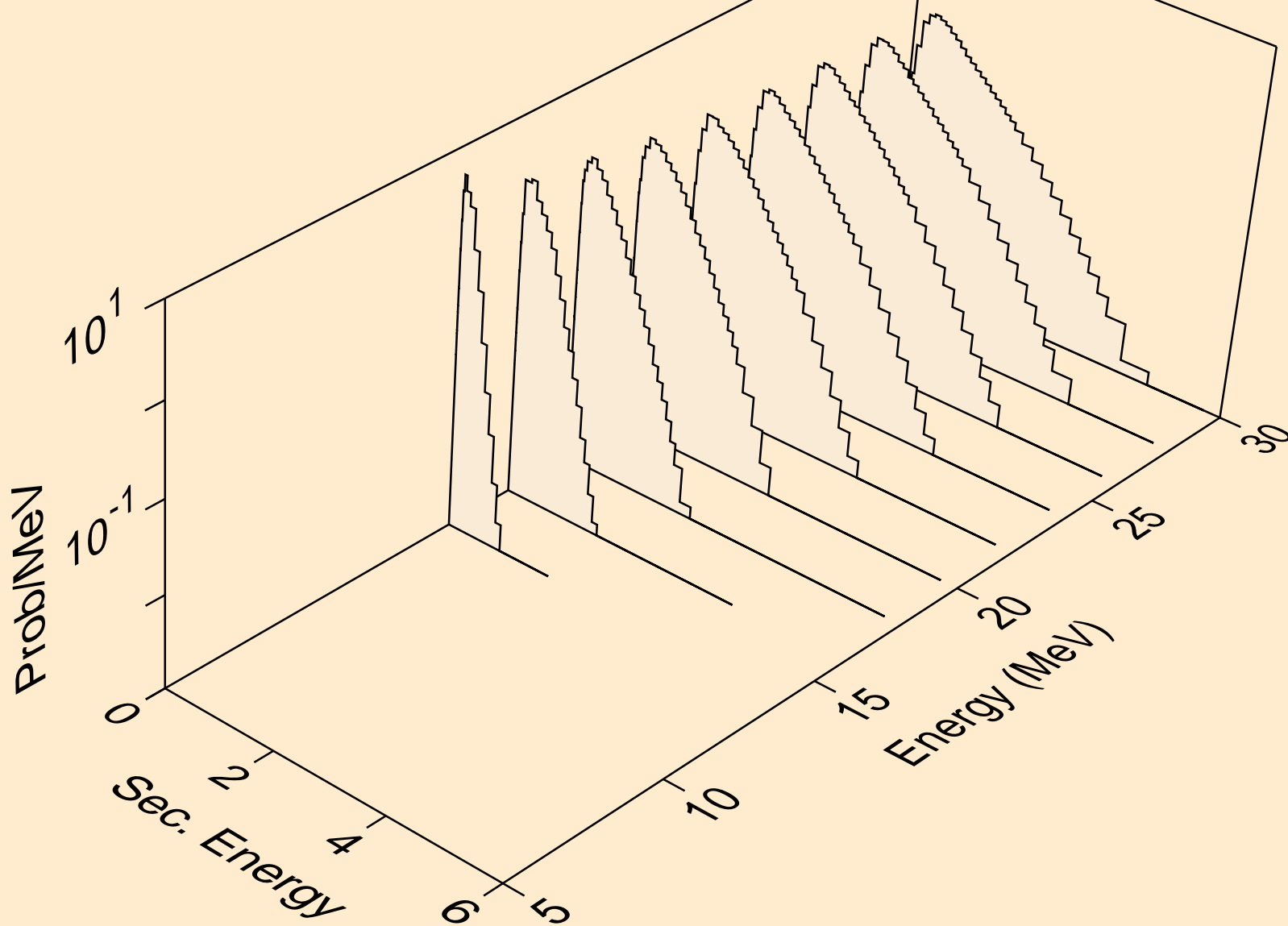

BI198M NEUTRON ACER TENDL-2019 LIBRARY; T=293.16K  
Neutron emission for (n,n\*)he3

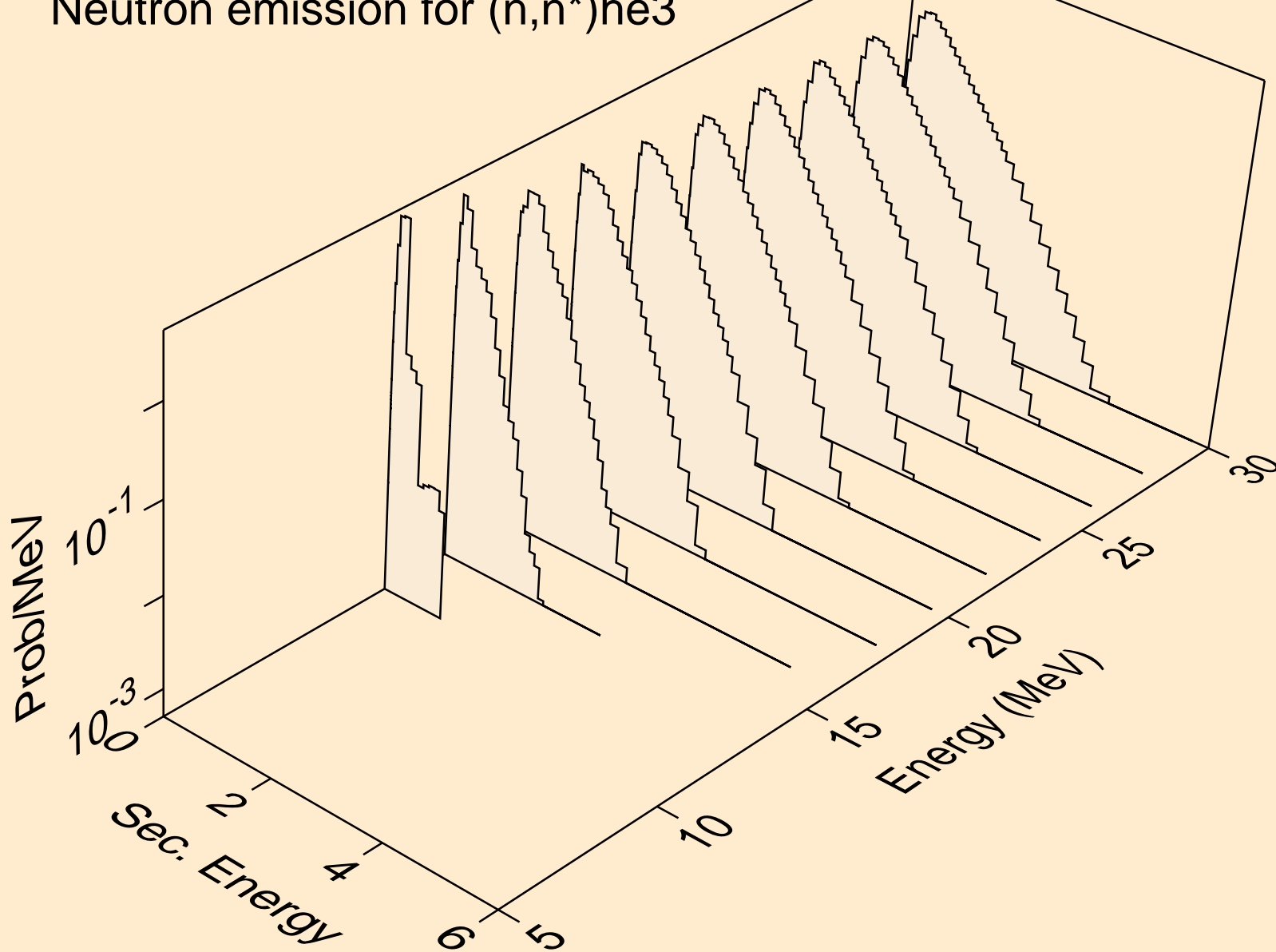

BI198M NEUTRON ACER TENDL-2019 LIBRARY; T=293.16K  
Neutron emission for (n,4n)

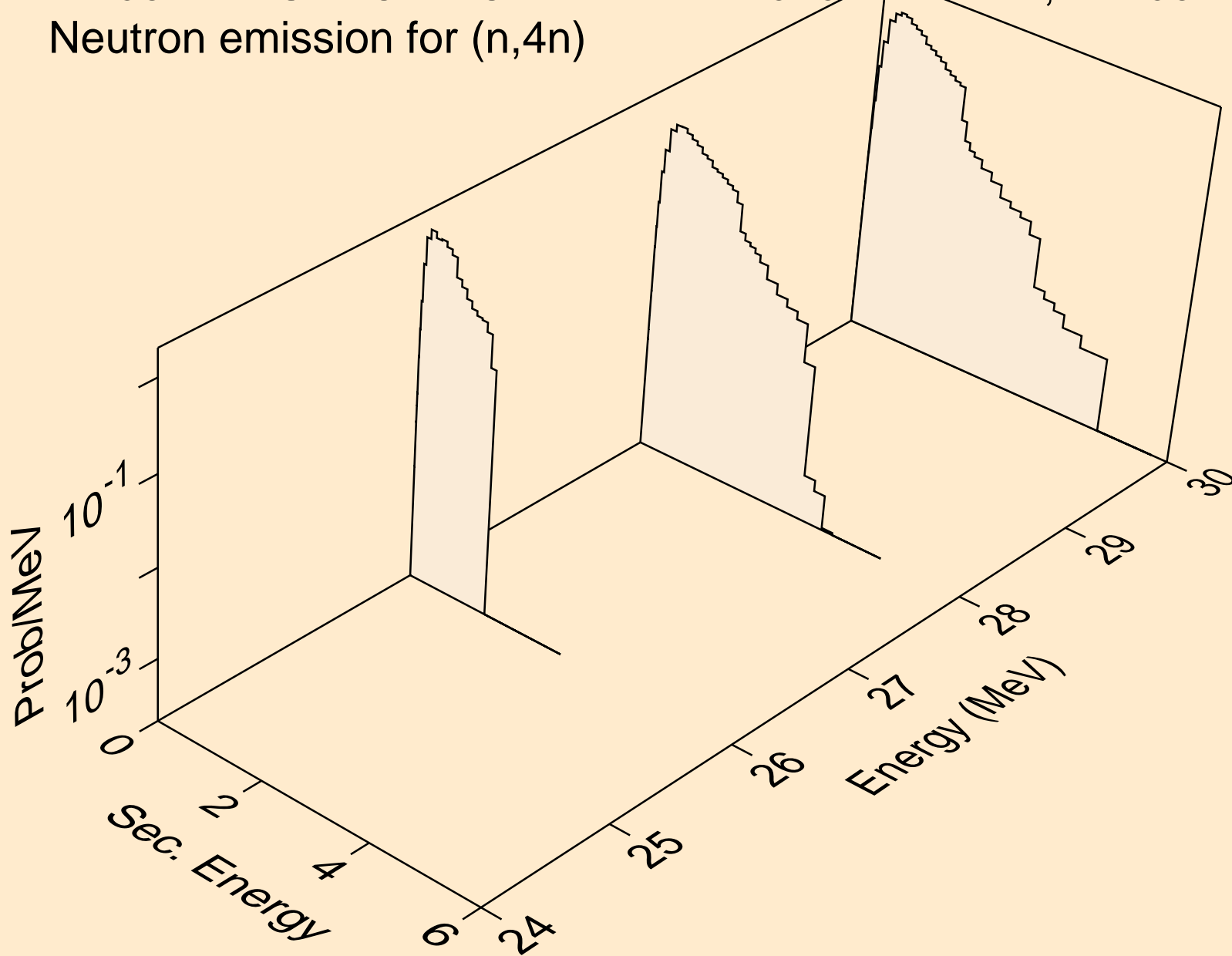

BI198M NEUTRON ACER TENDL-2019 LIBRARY; T=293.16K  
Neutron emission for (n,2np)

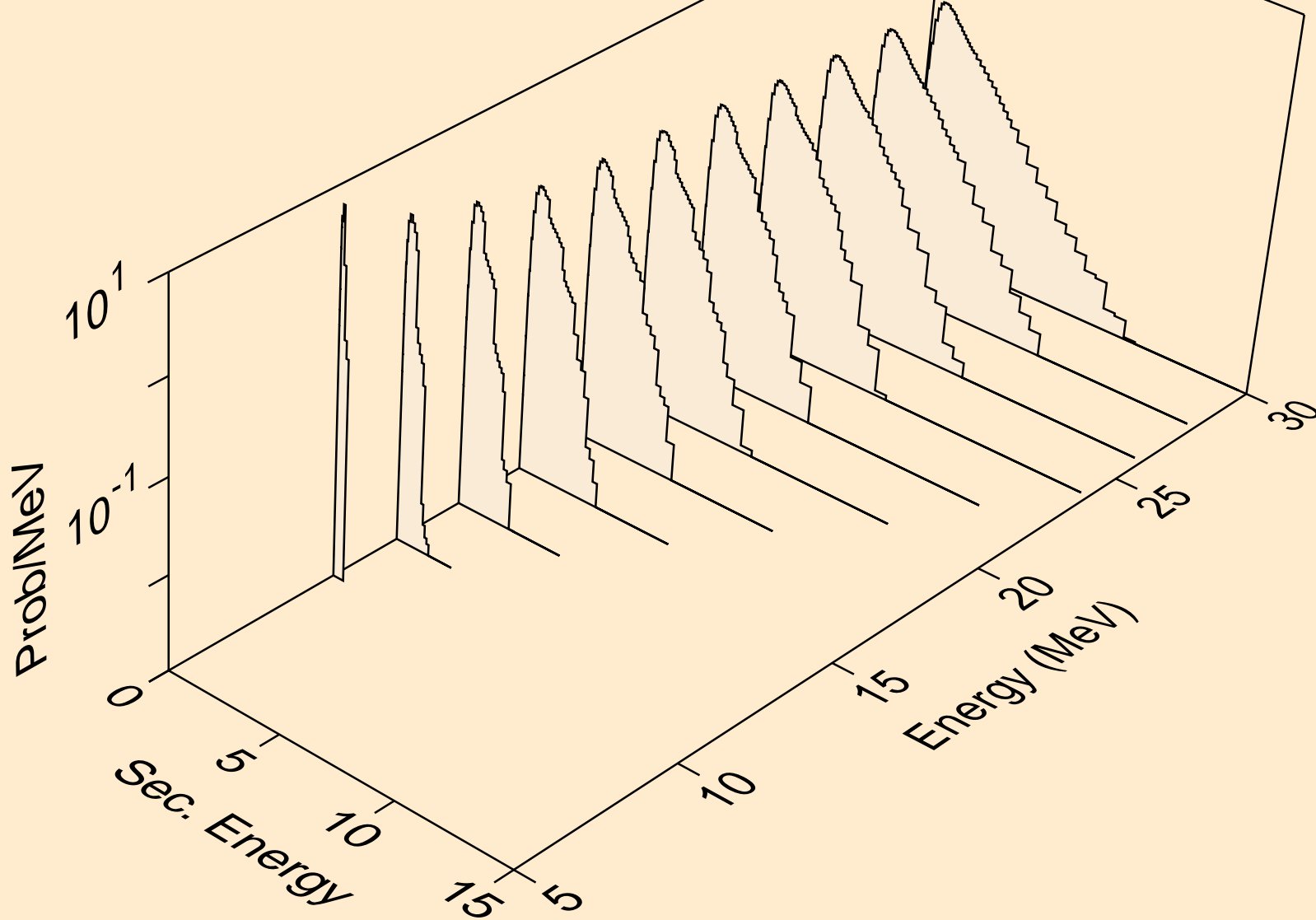

BI198M NEUTRON ACER TENDL-2019 LIBRARY; T=293.16K  
Neutron emission for (n,3np)

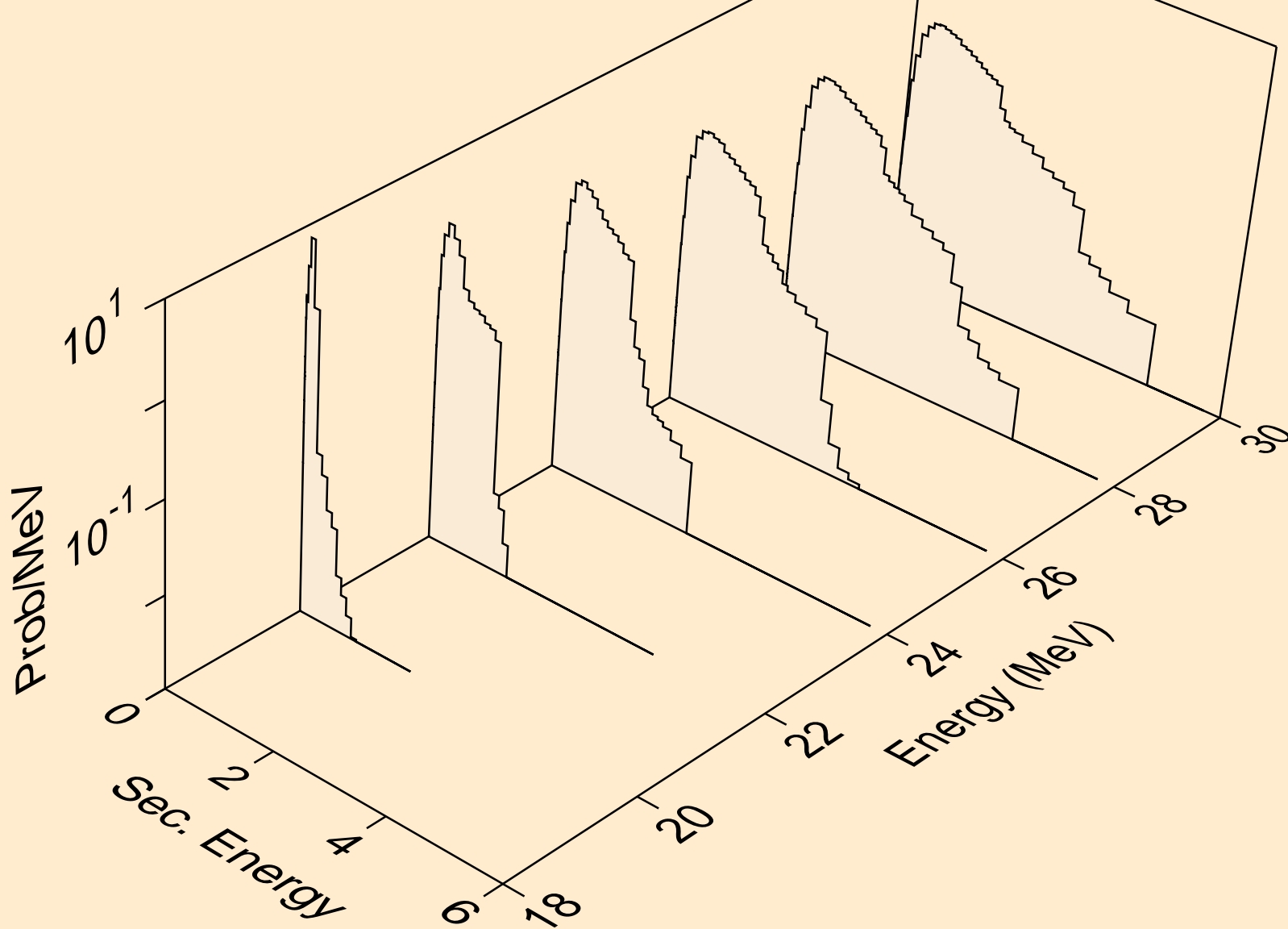

BI198M NEUTRON ACER TENDL-2019 LIBRARY; T=293.16K  
Neutron emission for (n,2np)

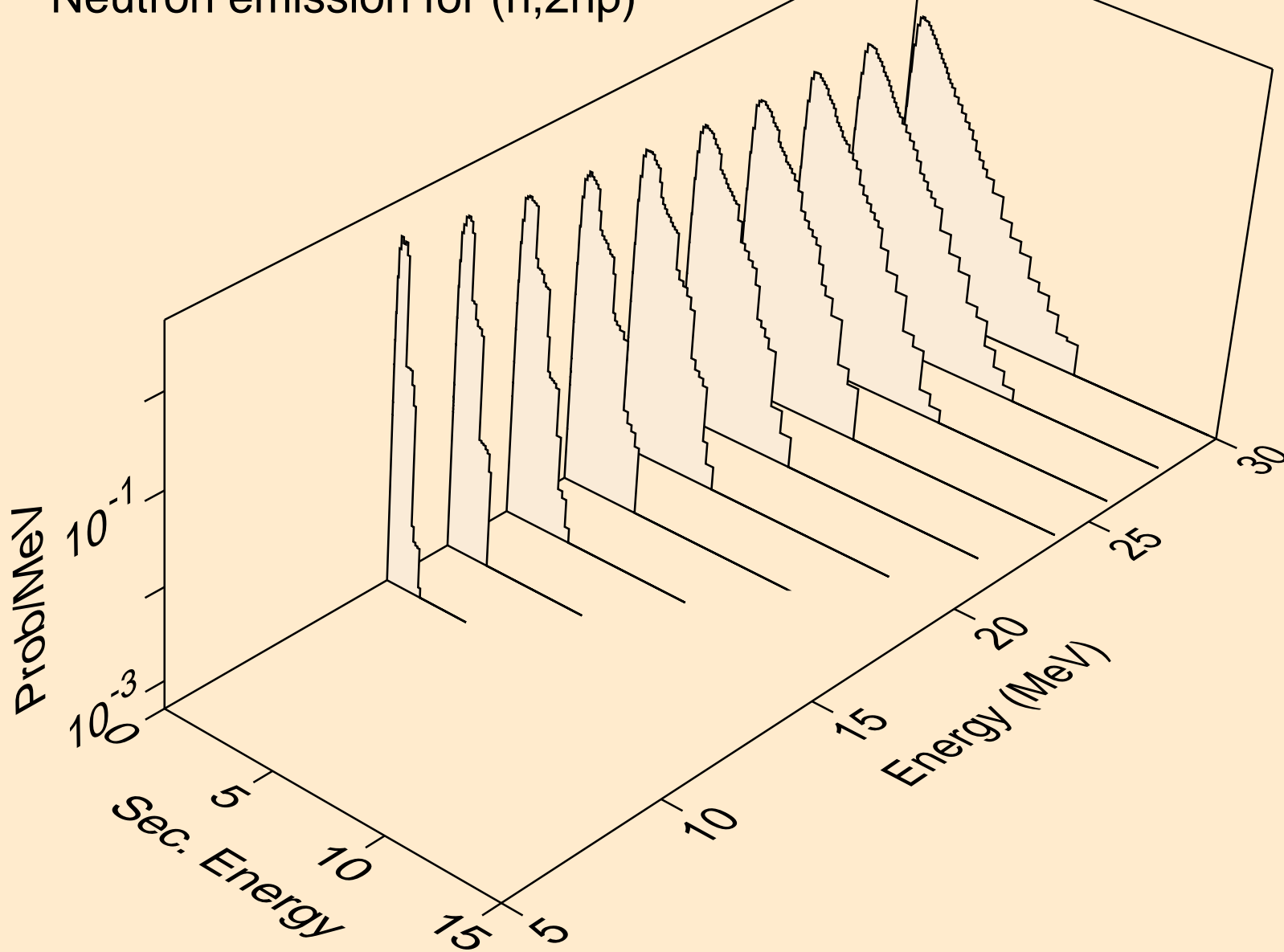

BI198M NEUTRON ACER TENDL-2019 LIBRARY; T=293.16K  
Neutron emission for (n,npa)

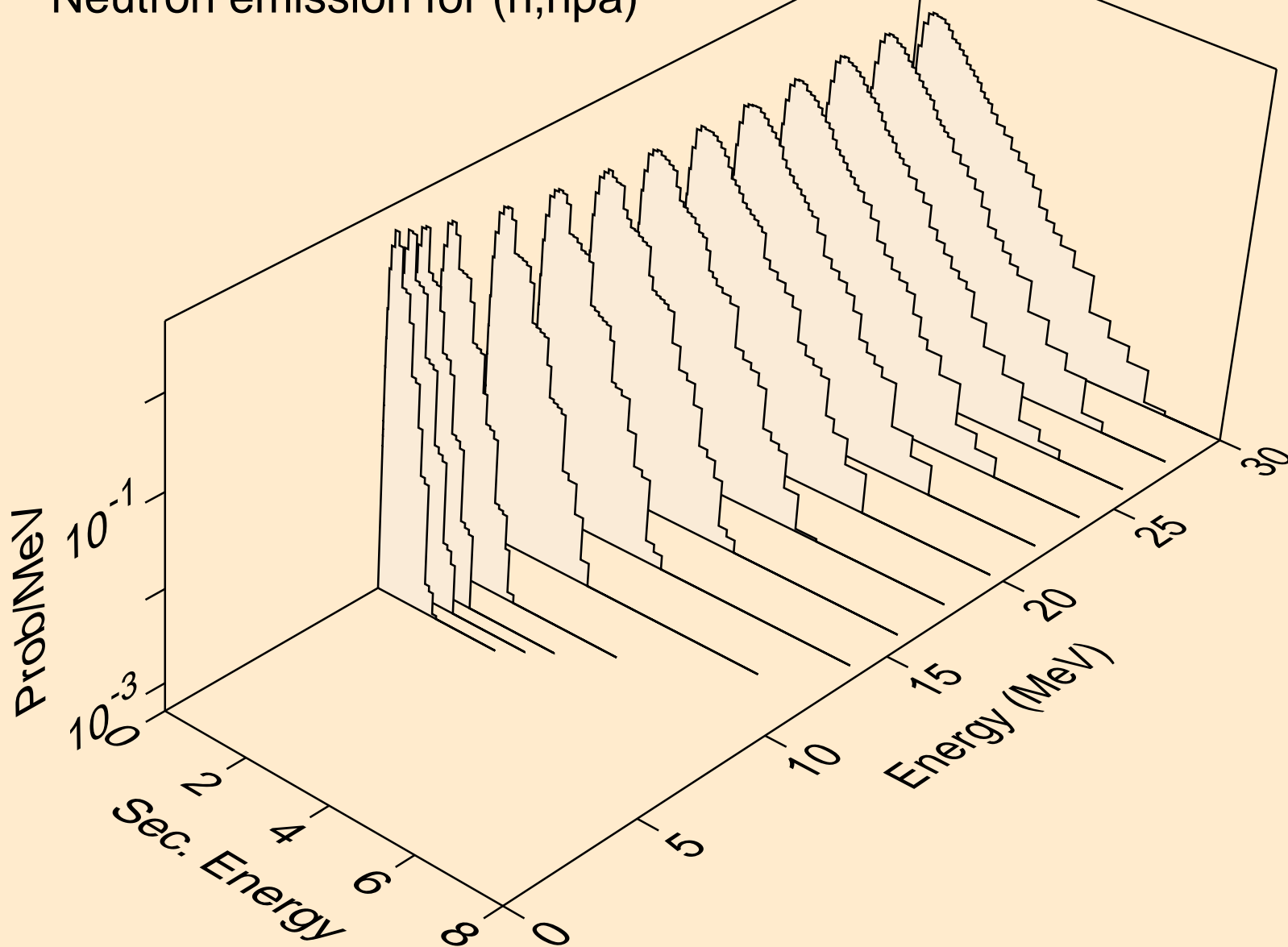

BI198M NEUTRON ACER TENDL-2019 LIBRARY; T=293.16K  
Neutron emission for (n,n\*c)

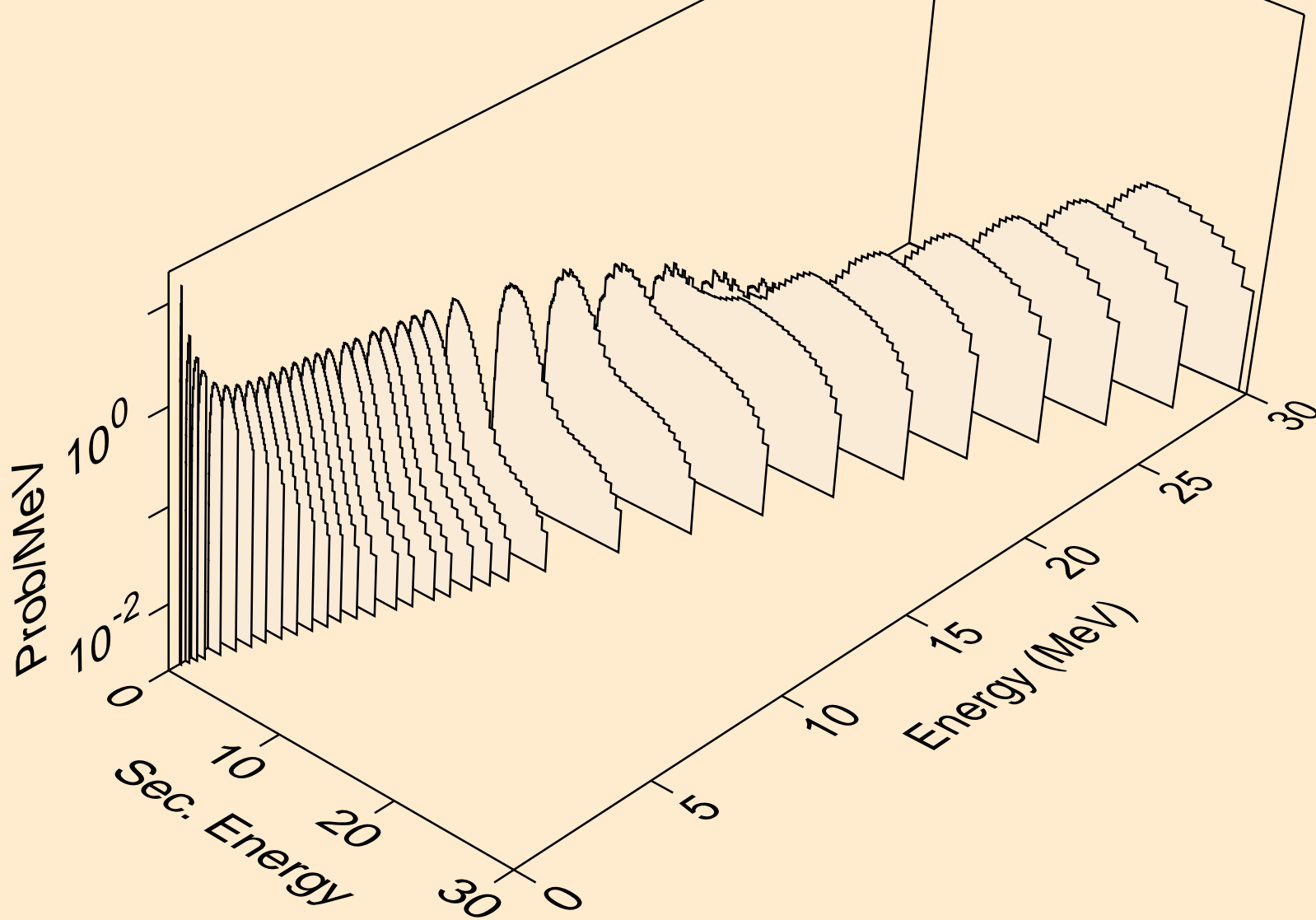

BI198M NEUTRON ACER TENDL-2019 LIBRARY; T=293.16K  
Photon emission for (n,x)

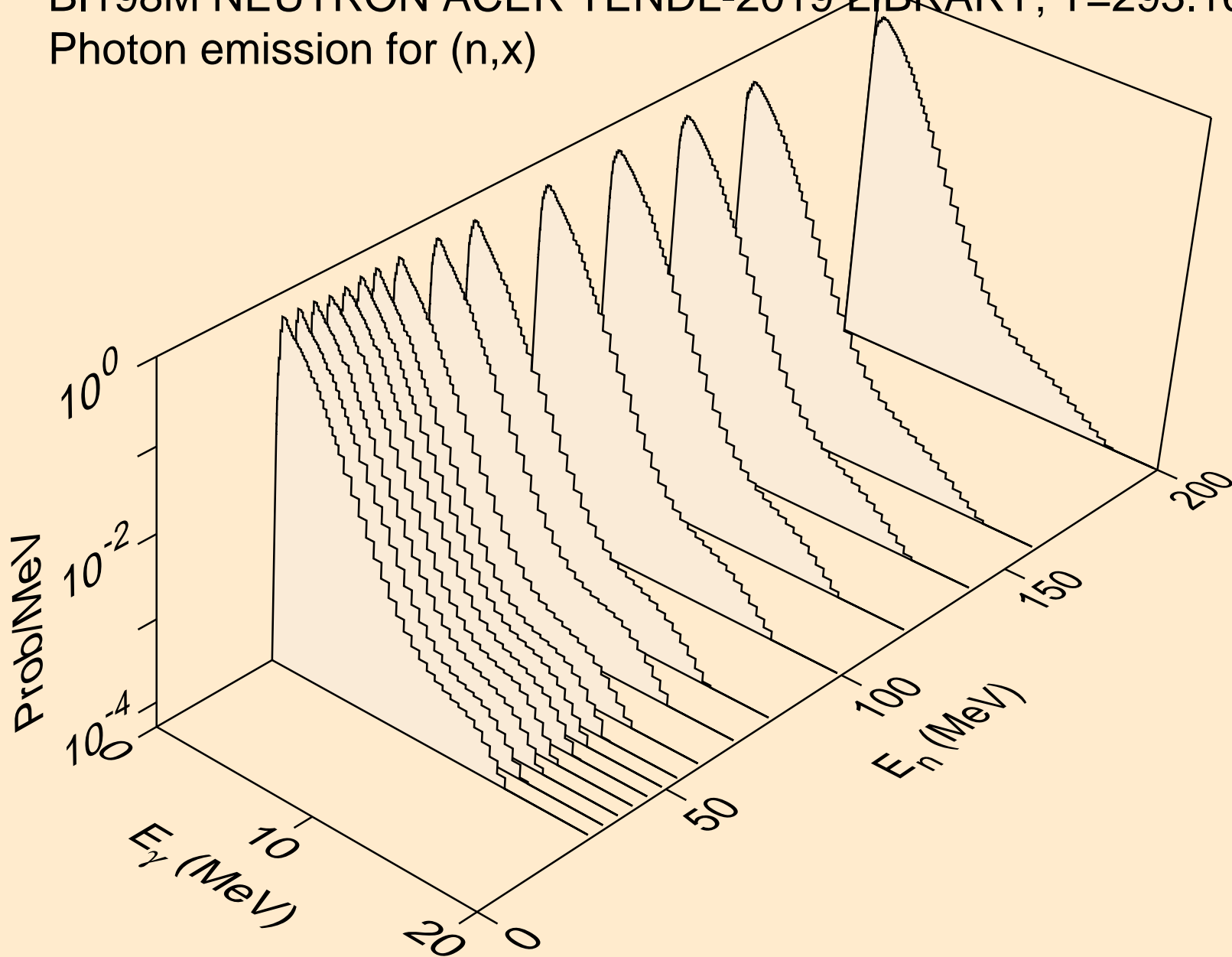

BI198M NEUTRON ACER TENDL-2019 LIBRARY; T=293.16K  
Photon emission for (n,2nd)

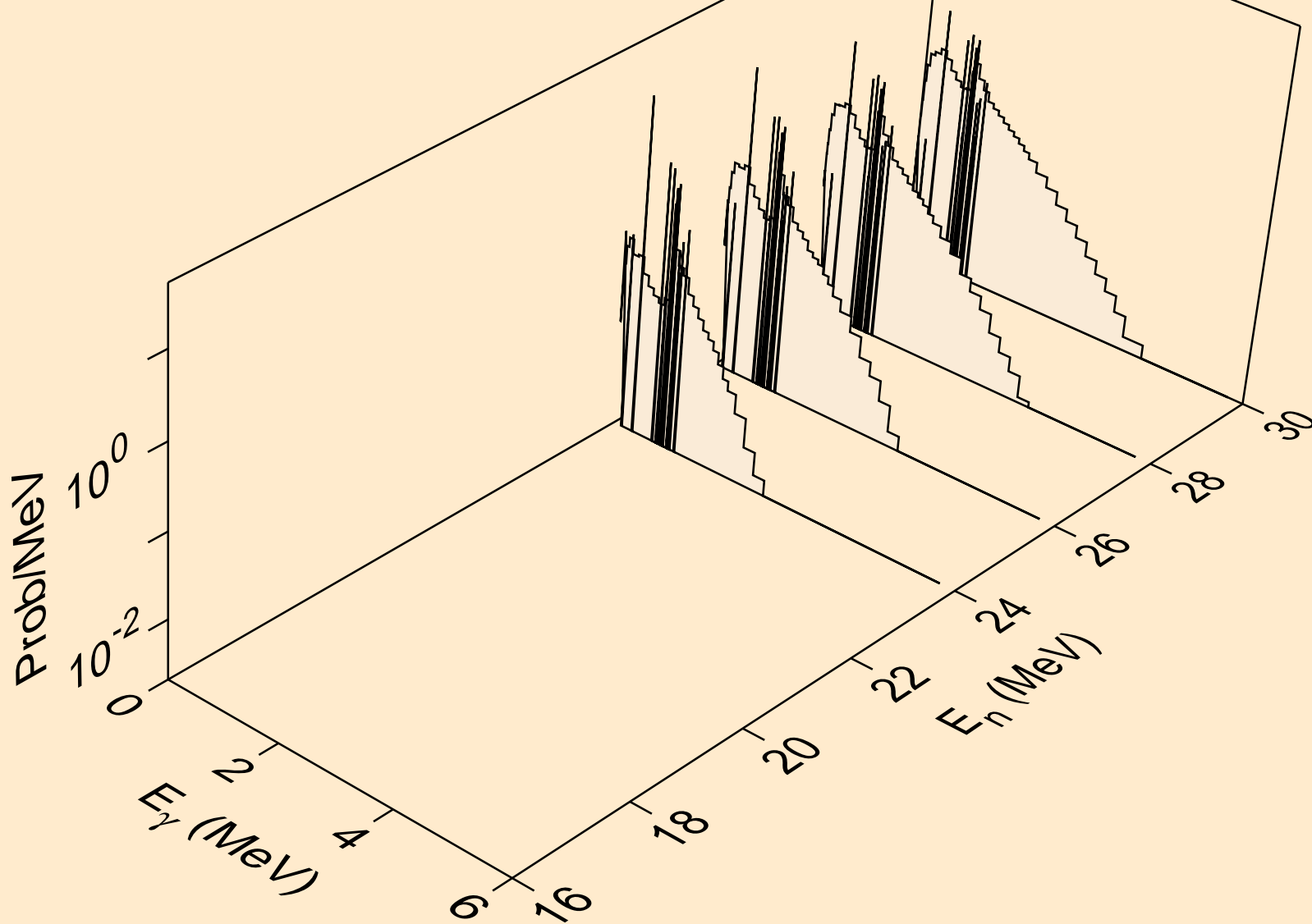

BI198M NEUTRON ACER TENDL-2019 LIBRARY; T=293.16K  
Photon emission for (n,2n)

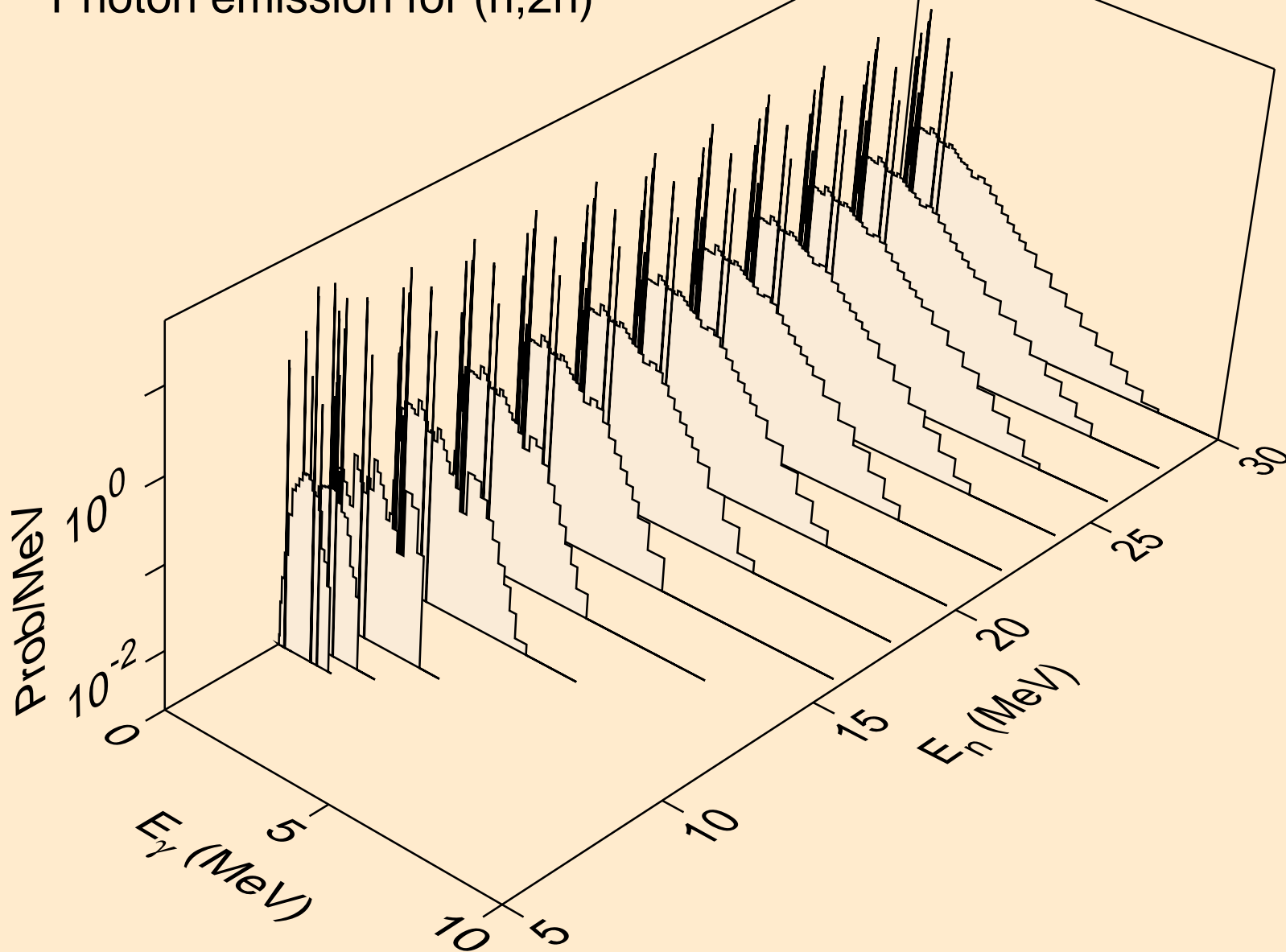

BI198M NEUTRON ACER TENDL-2019 LIBRARY; T=293.16K  
Photon emission for (n,3n)

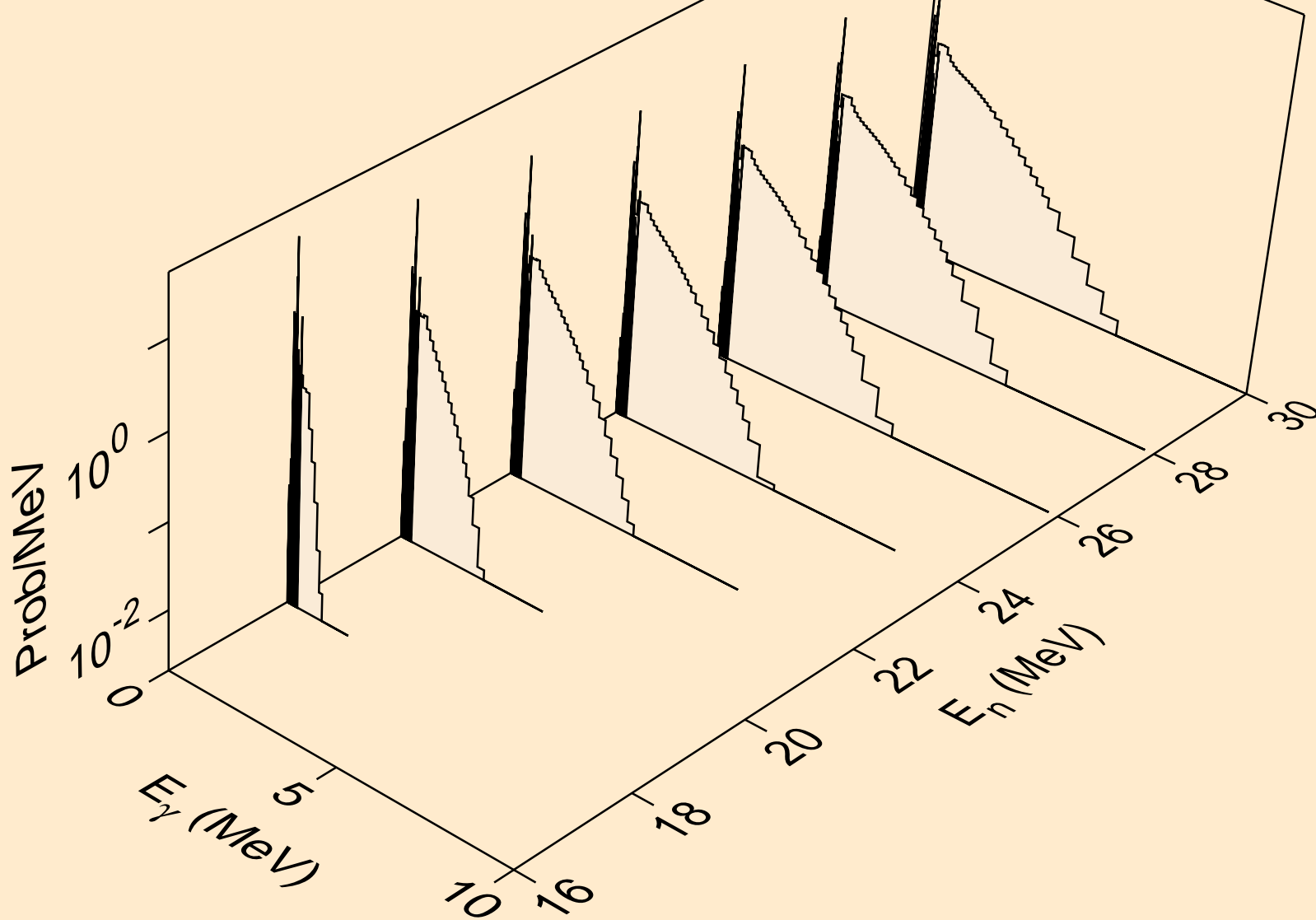

BI198M NEUTRON ACER TENDL-2019 LIBRARY; T=293.16K  
Photon emission for (n,n\*)a

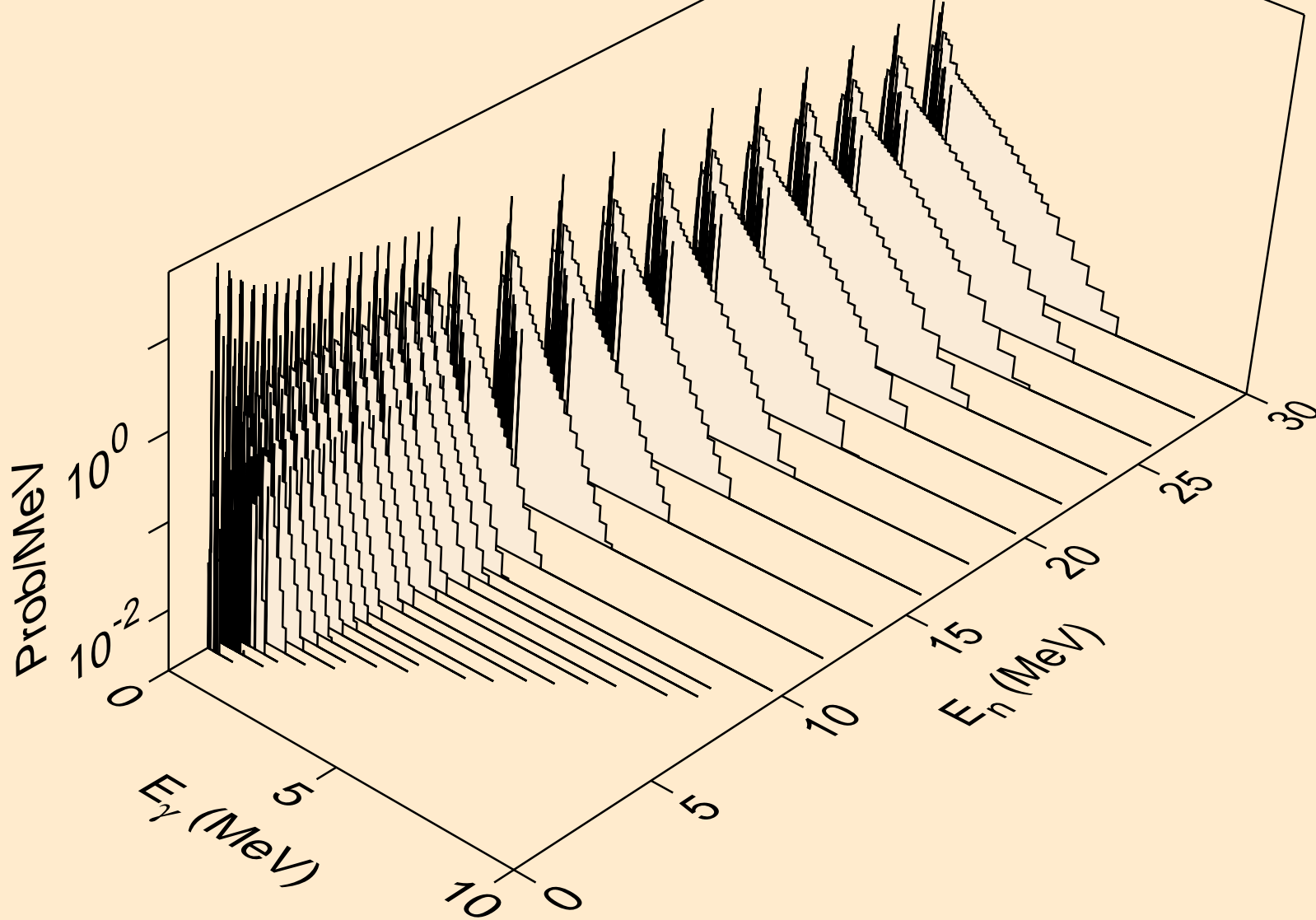

BI198M NEUTRON ACER TENDL-2019 LIBRARY; T=293.16K  
Photon emission for (n,2n)a

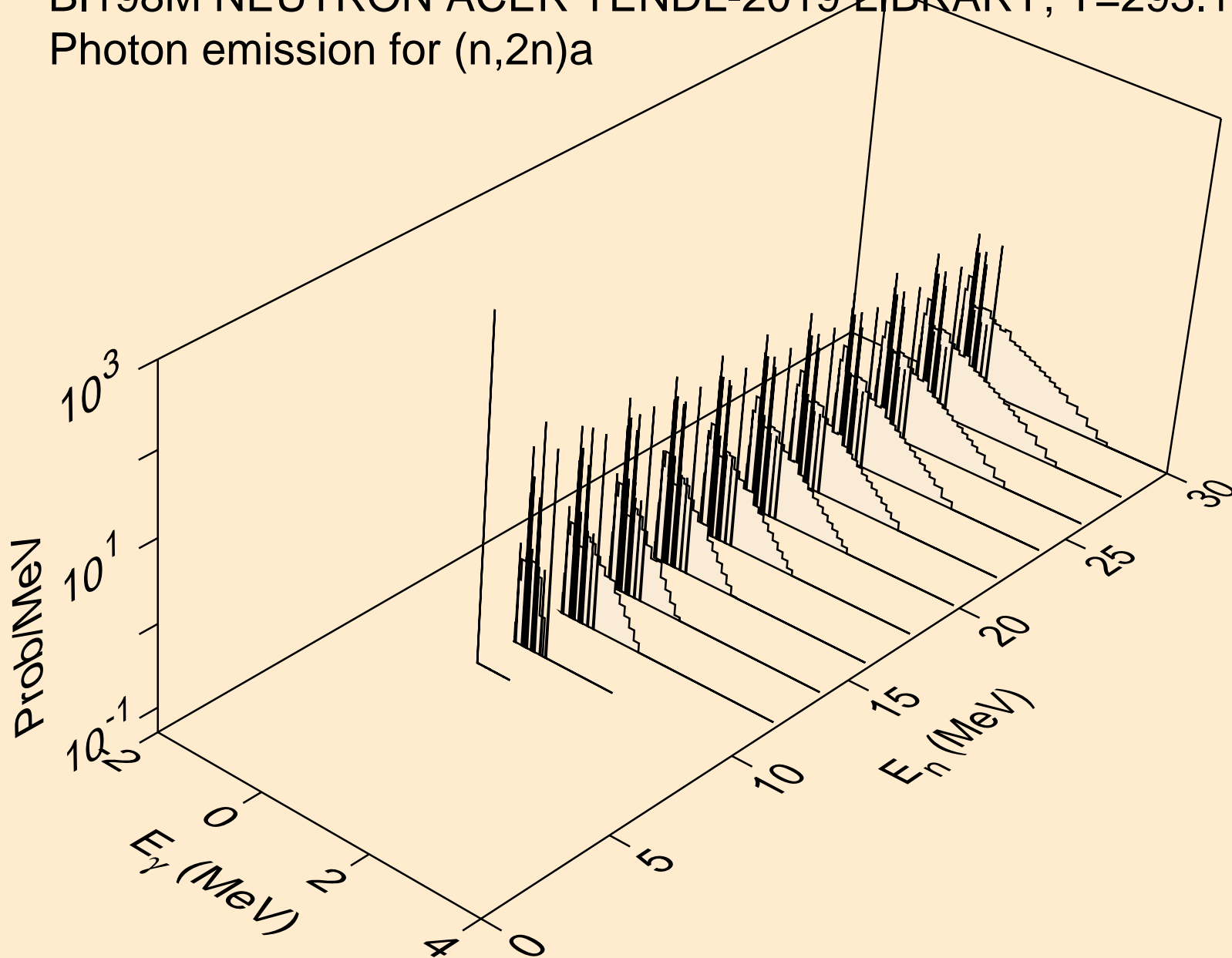

BI198M NEUTRON ACER TENDL-2019 LIBRARY; T=293.16K  
Photon emission for (n,3n)a

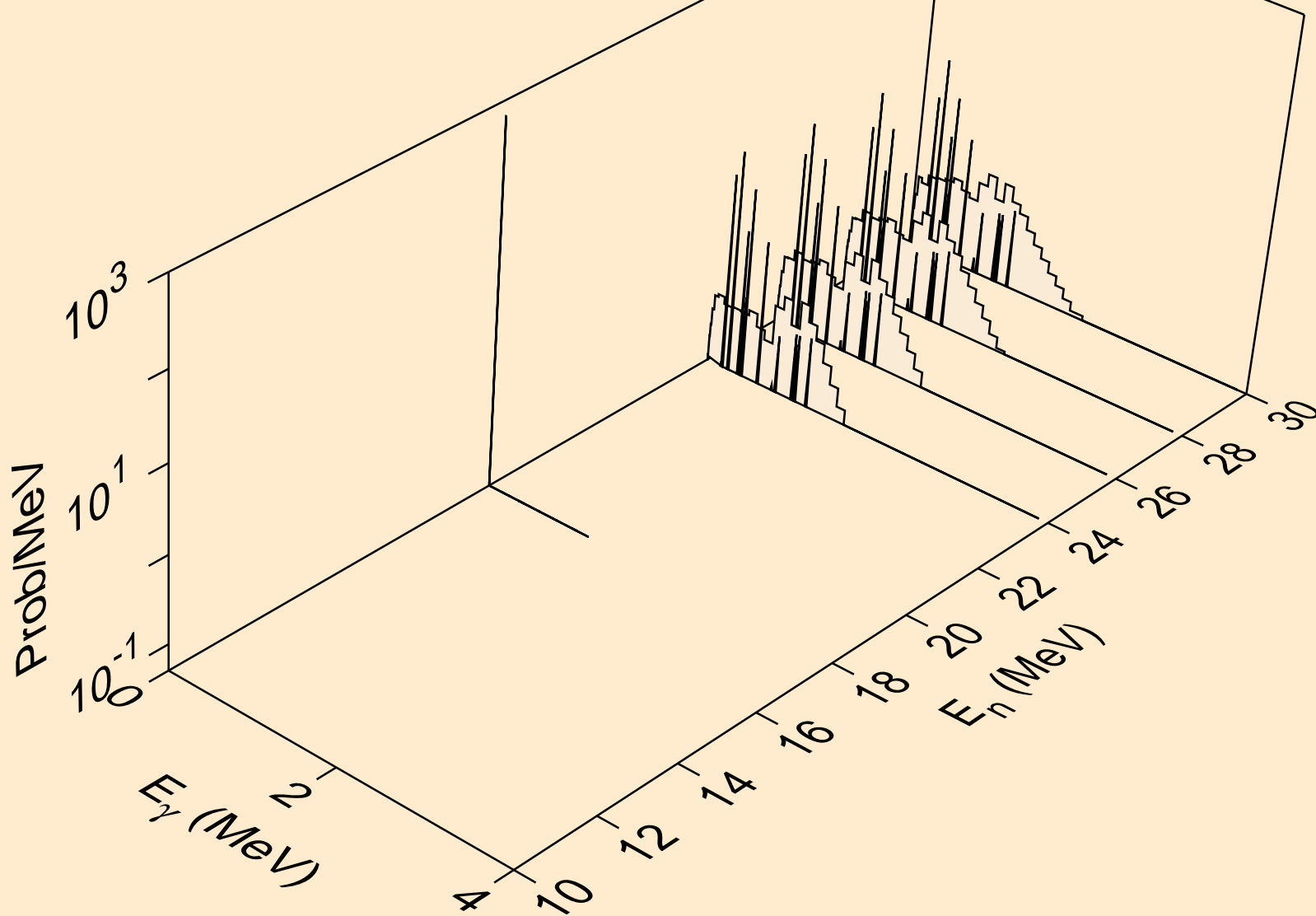

BI198M NEUTRON ACER TENDL-2019 LIBRARY; T=293.16K  
Photon emission for (n,n\*)p

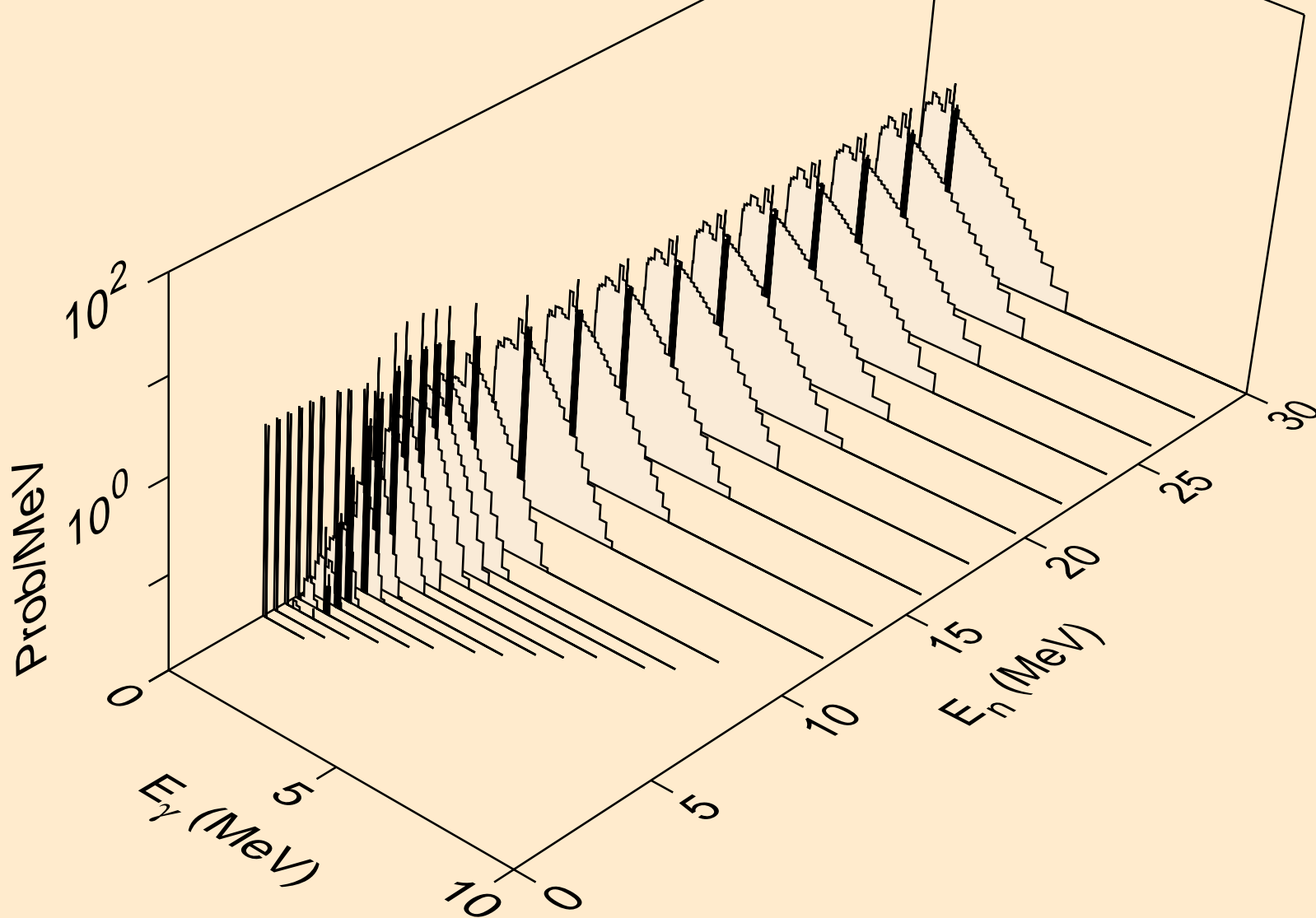

BI198M NEUTRON ACER TENDL-2019 LIBRARY; T=293.16K  
Photon emission for (n,n\*)2a

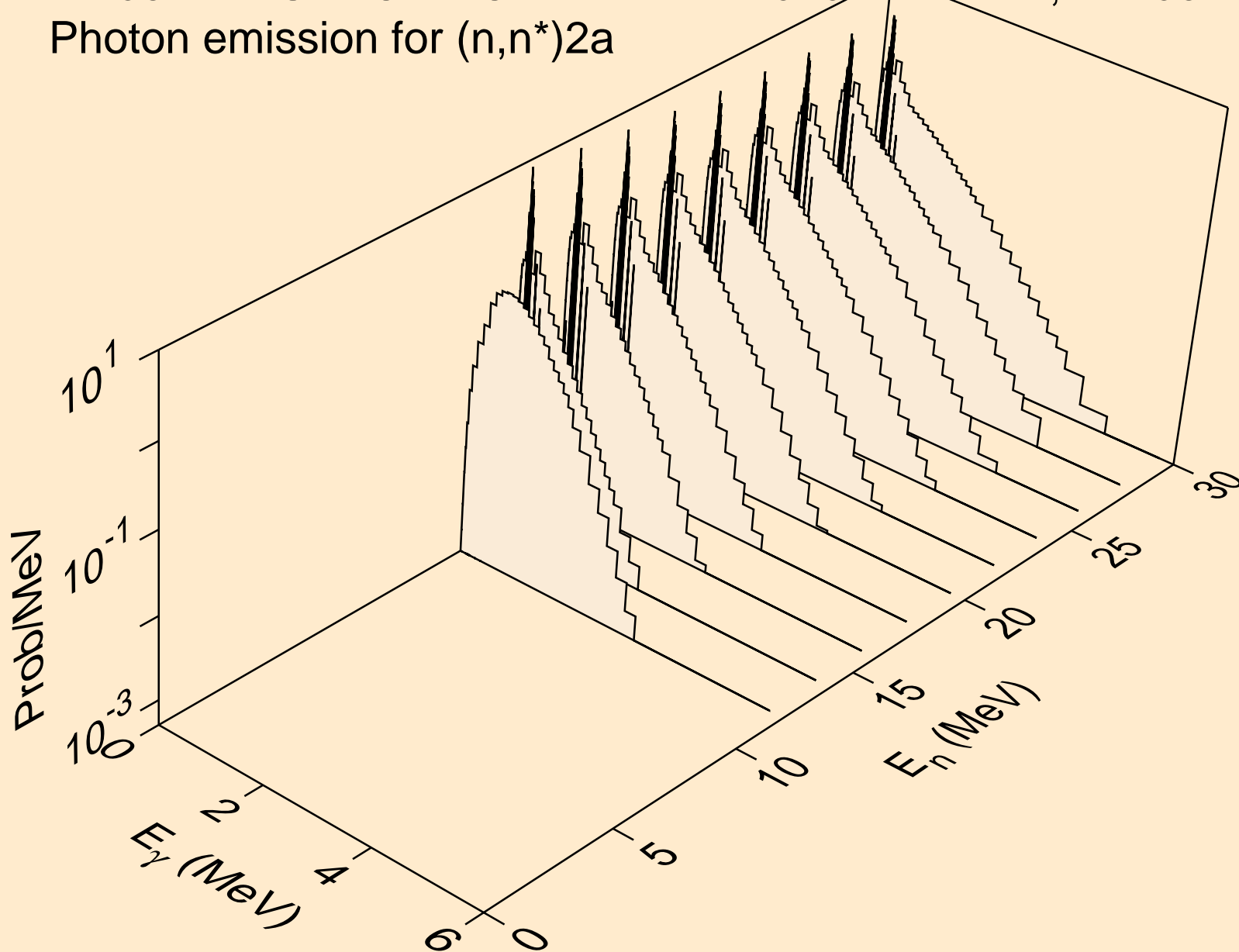

BI198M NEUTRON ACER TENDL-2019 LIBRARY; T=293.16K  
Photon emission for (n,2n)2a

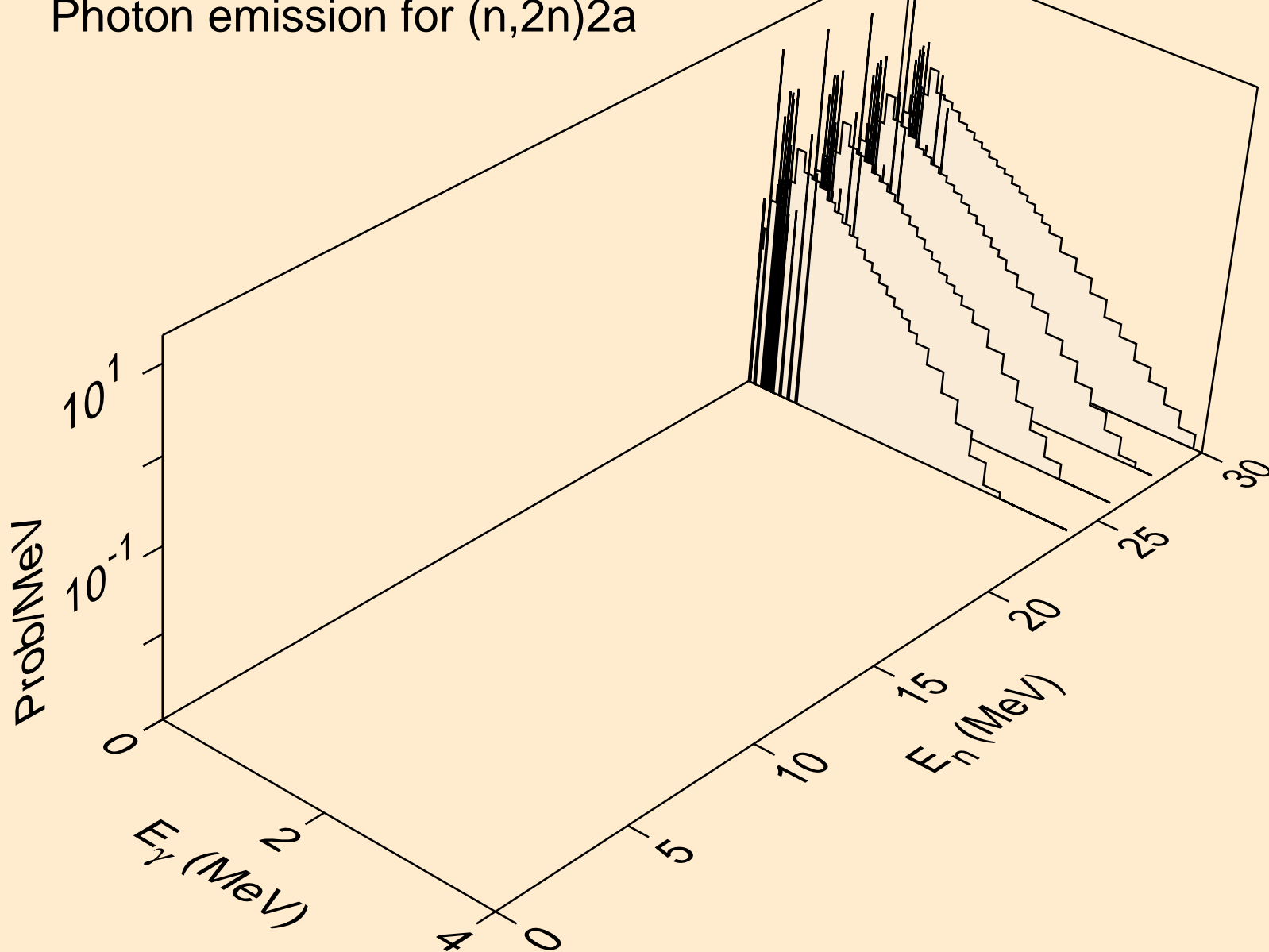

BI198M NEUTRON ACER TENDL-2019 LIBRARY; T=293.16K  
Photon emission for (n,n\*)d

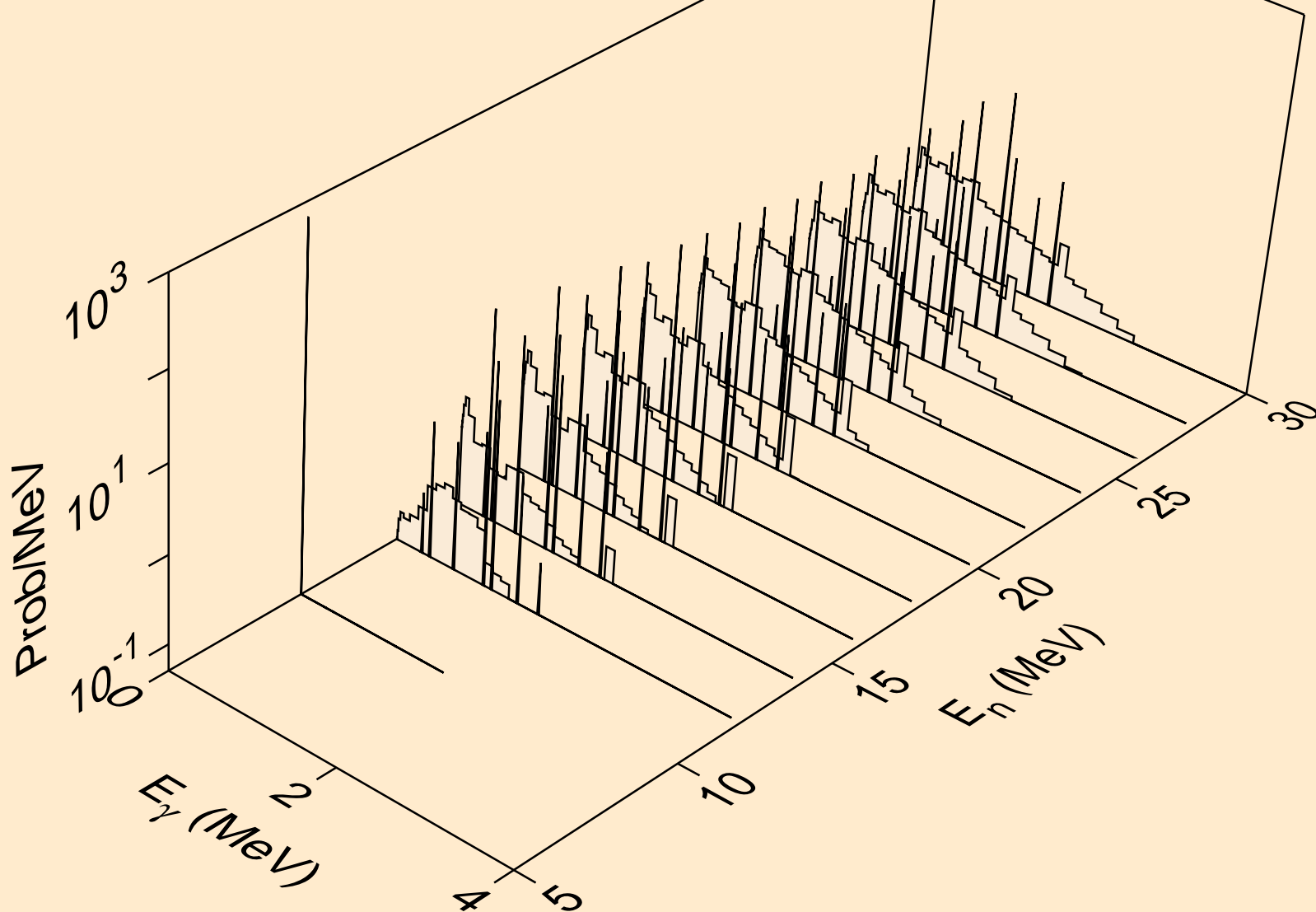

BI198M NEUTRON ACER TENDL-2019 LIBRARY; T=293.16K  
Photon emission for (n,n\*)t

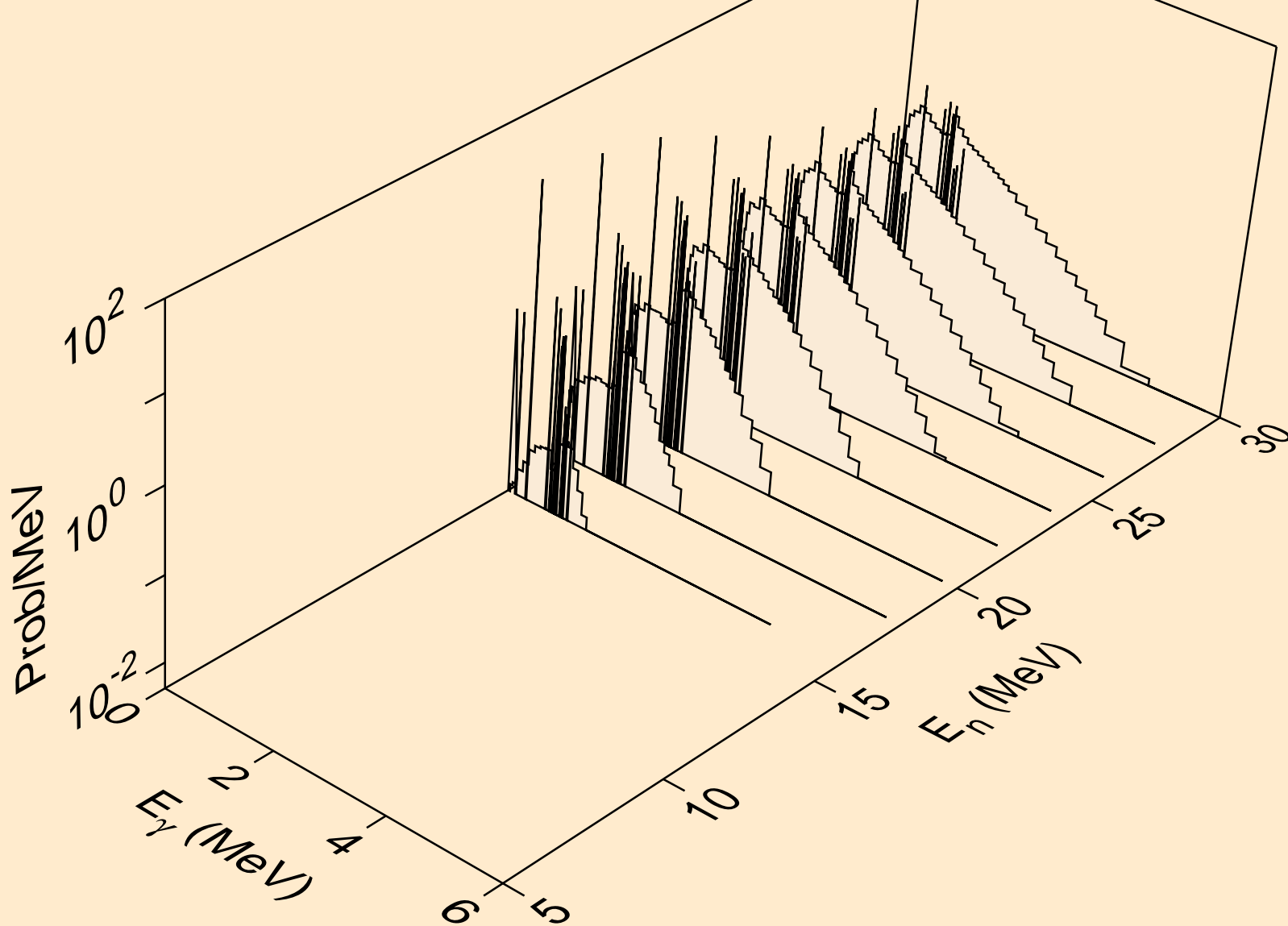

BI198M NEUTRON ACER TENDL-2019 LIBRARY; T=293.16K  
Photon emission for (n,n\*)he3

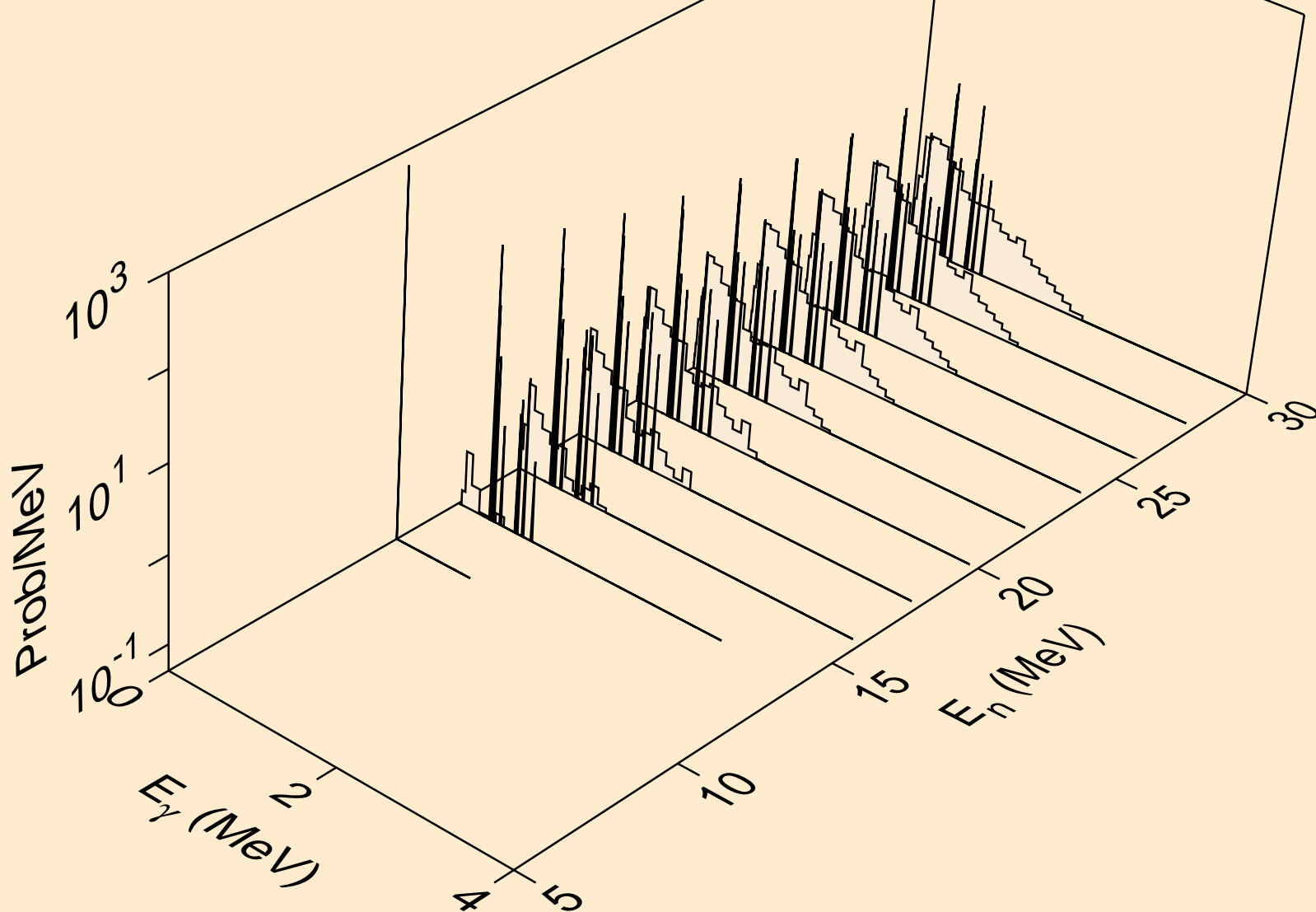

BI198M NEUTRON ACER TENDL-2019 LIBRARY; T=293.16K  
Photon emission for (n,4n)

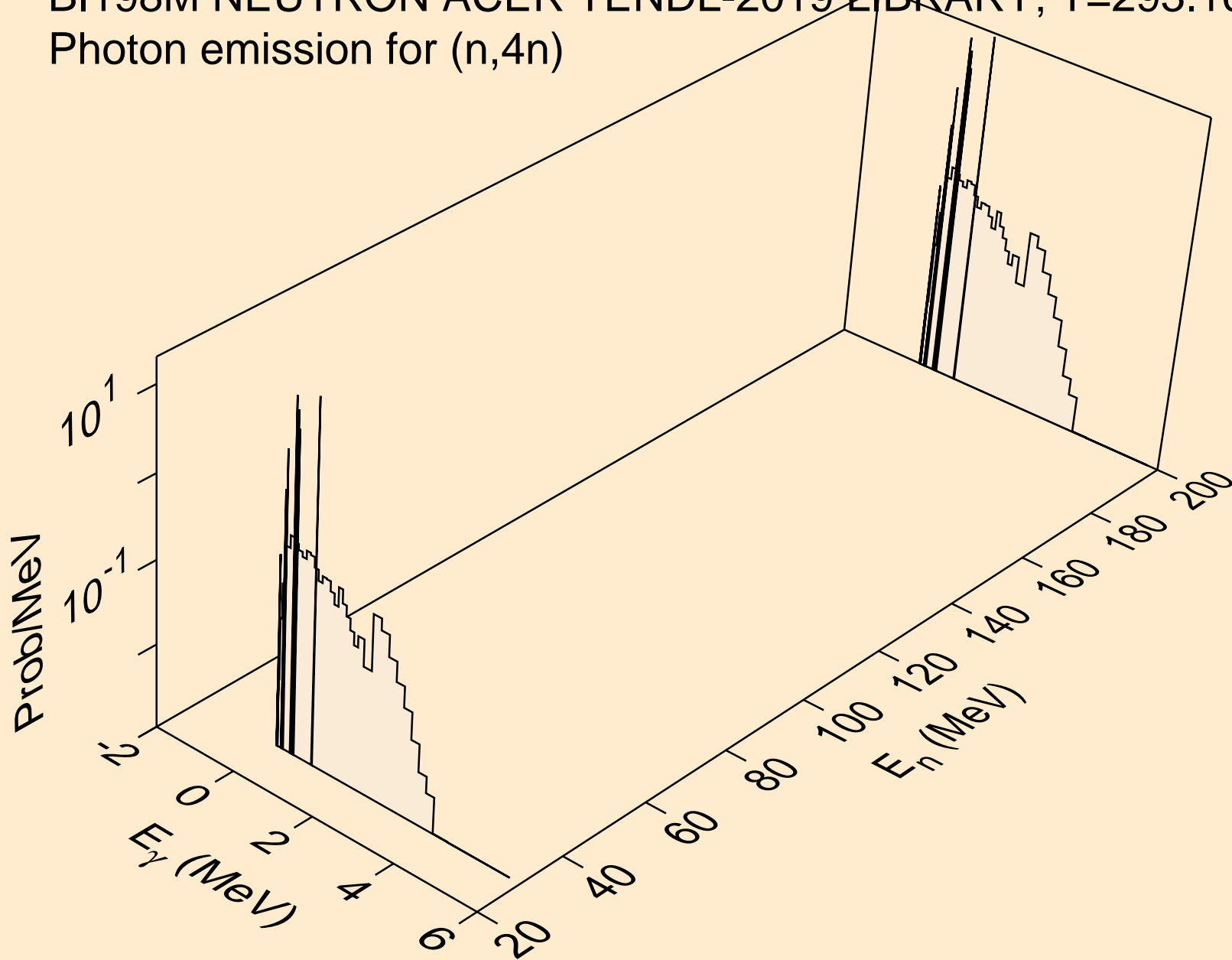

BI198M NEUTRON ACER TENDL-2019 LIBRARY; T=293.16K  
Photon emission for (n,2np)

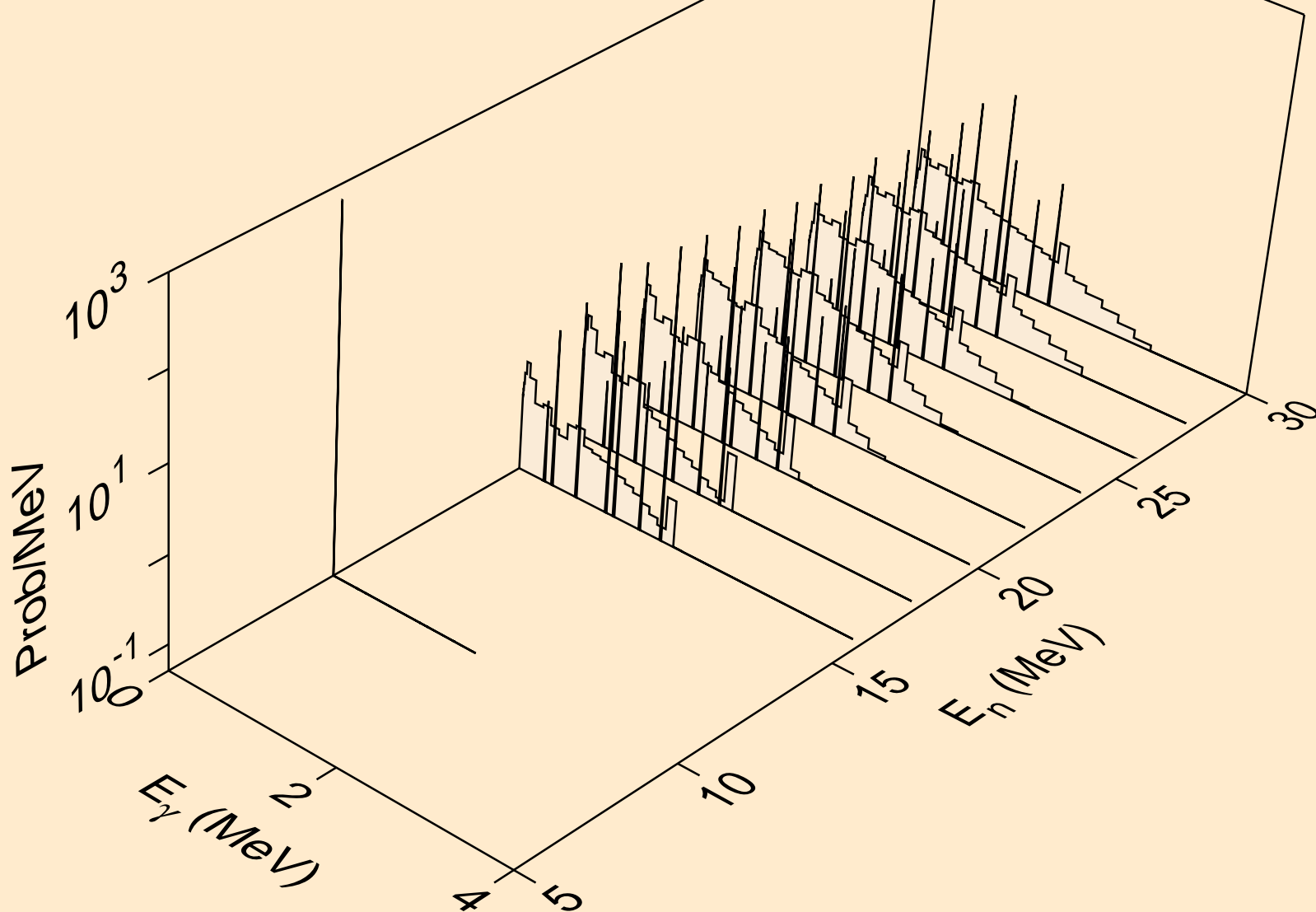

BI198M NEUTRON ACER TENDL-2019 LIBRARY; T=293.16K  
Photon emission for (n,3np)

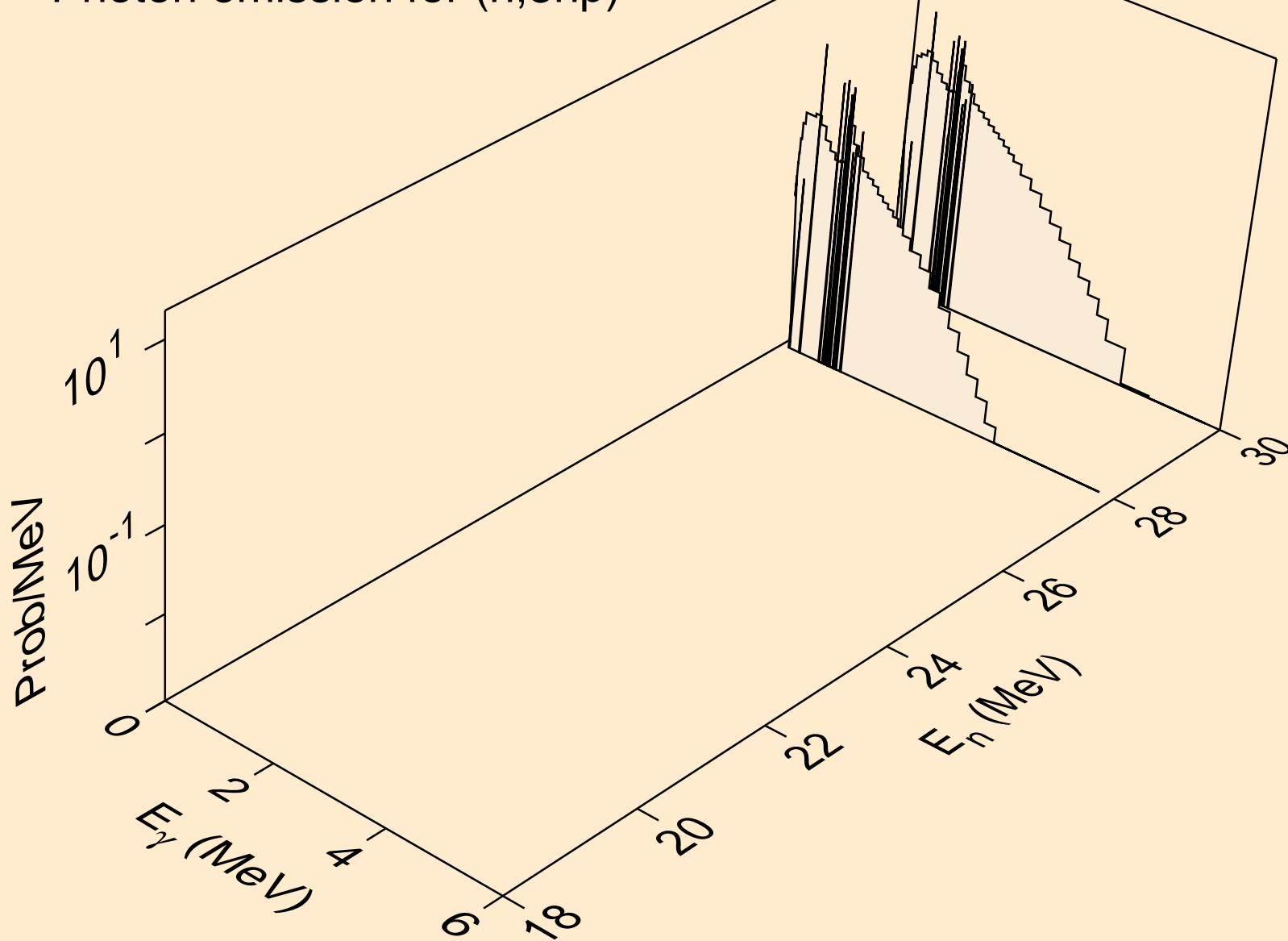

BI198M NEUTRON ACER TENDL-2019 LIBRARY; T=293.16K  
Photon emission for (n,2np)

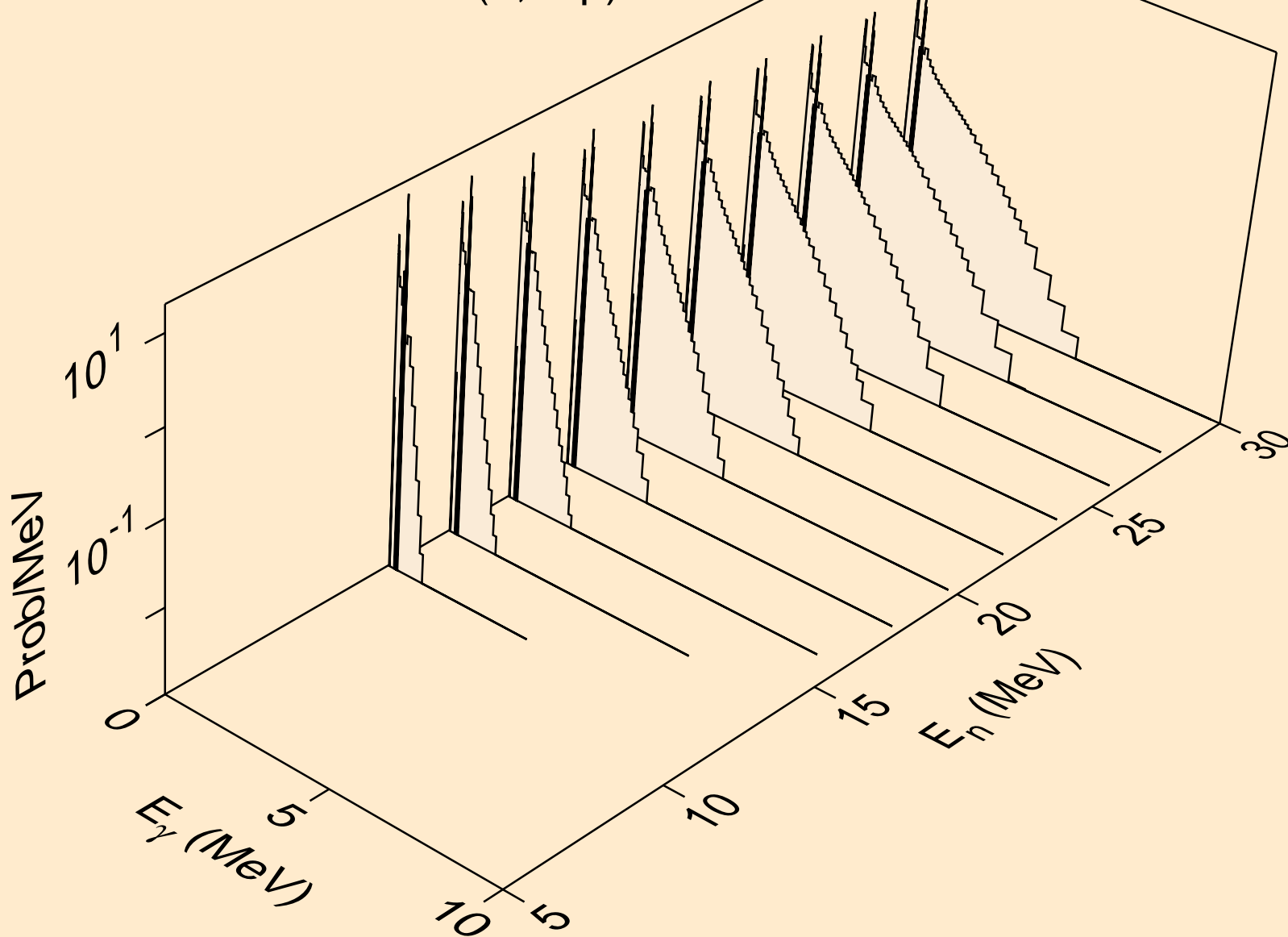

BI198M NEUTRON ACER TENDL-2019 LIBRARY; T=293.16K  
Photon emission for (n,npa)

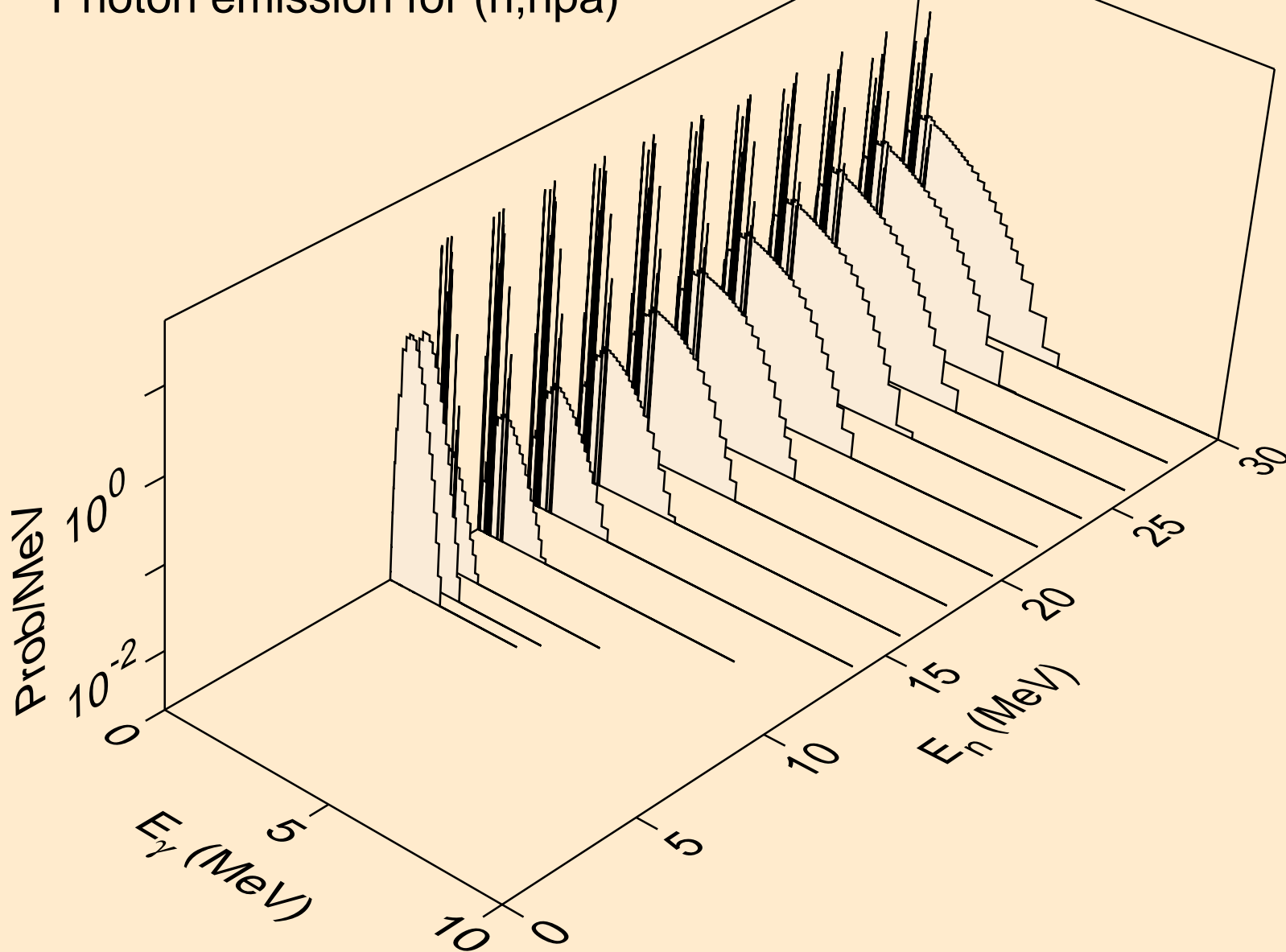

BI198M NEUTRON ACER TENDL-2019 LIBRARY; T=293.16K  
Photon emission for (n,n\*1)

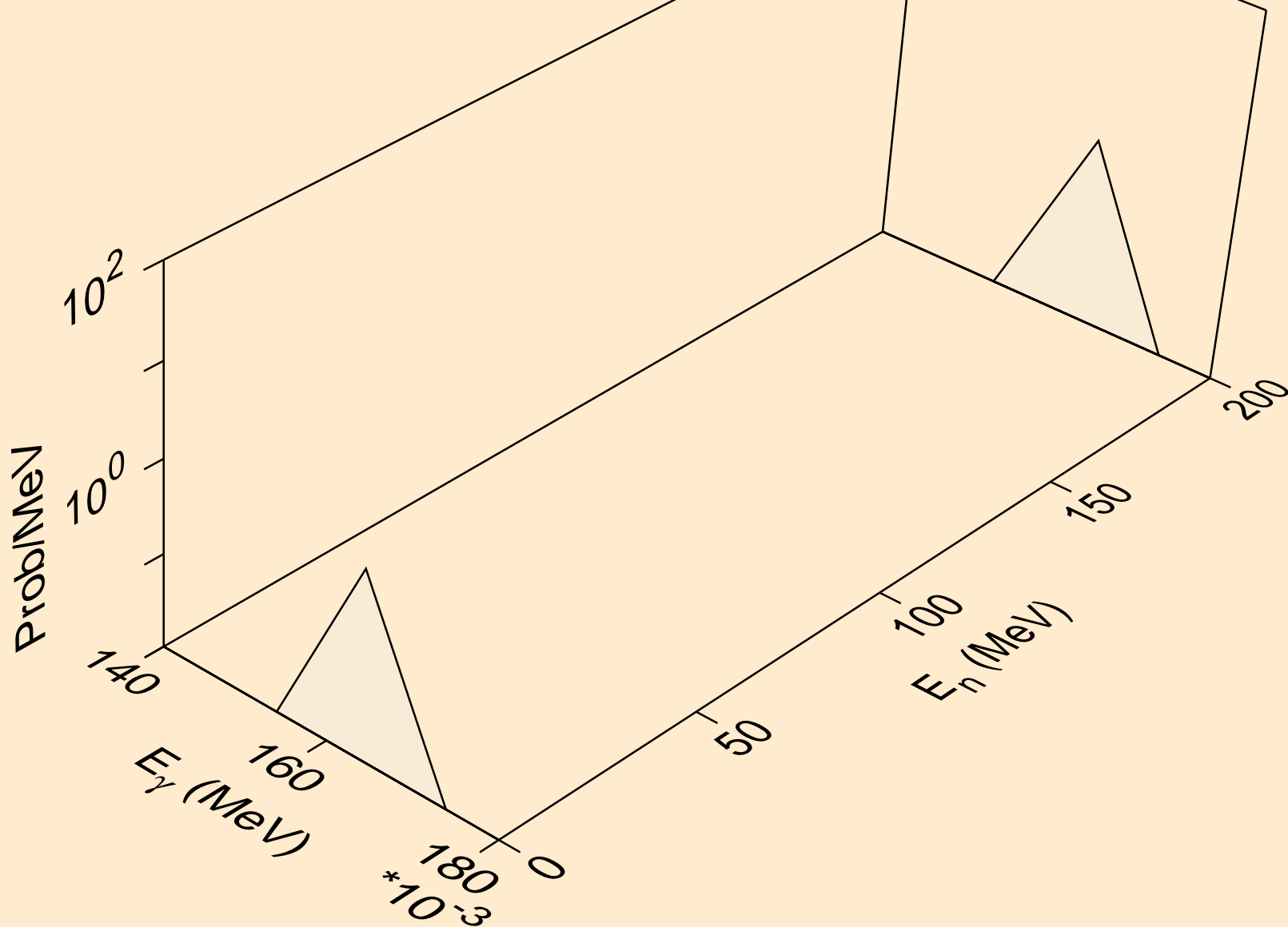

BI198M NEUTRON ACER TENDL-2019 LIBRARY; T=293.16K  
Photon emission for (n,n\*2)

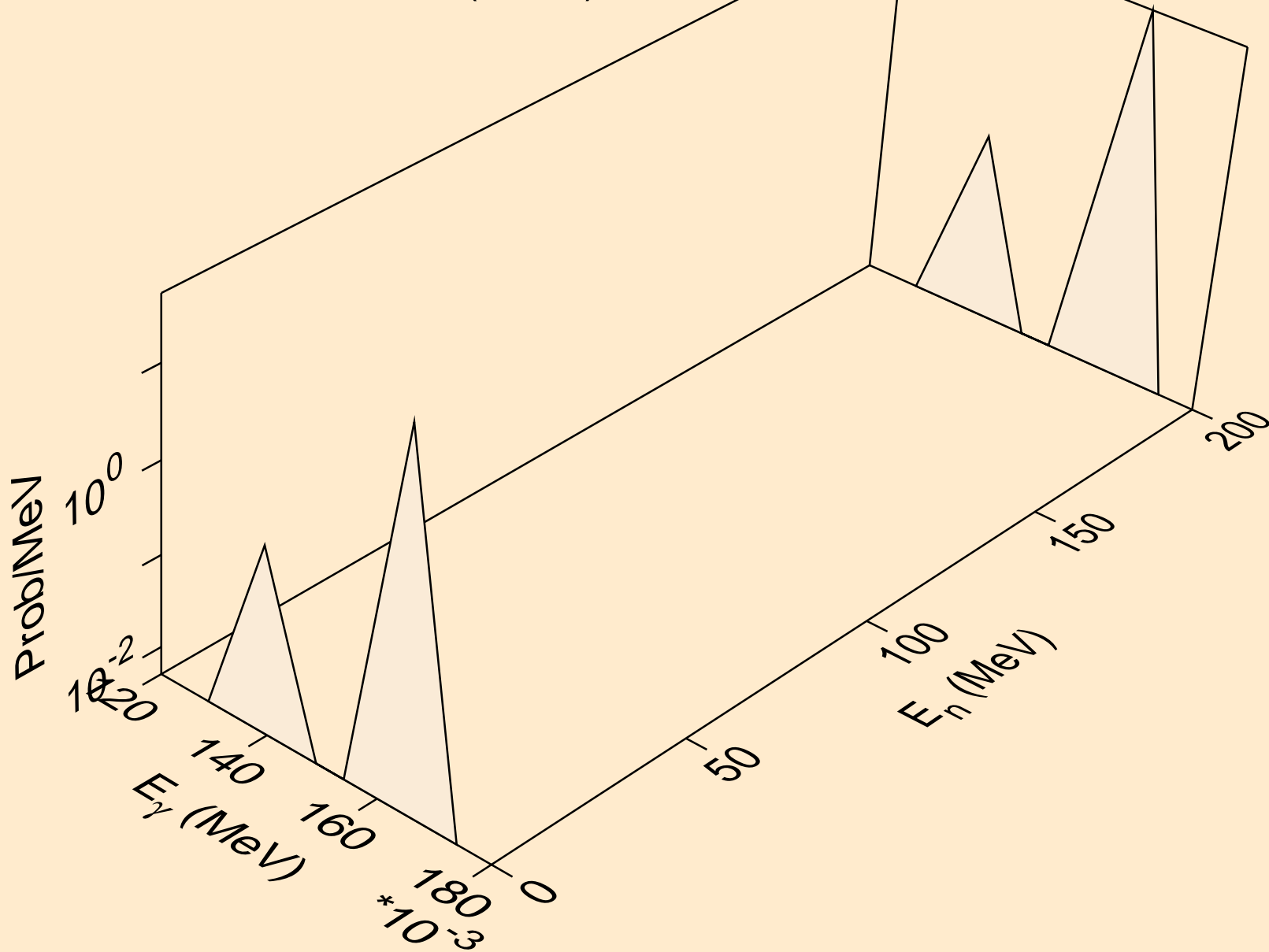

BI198M NEUTRON ACER TENDL-2019 LIBRARY; T=293.16K  
Photon emission for (n,n\*c)

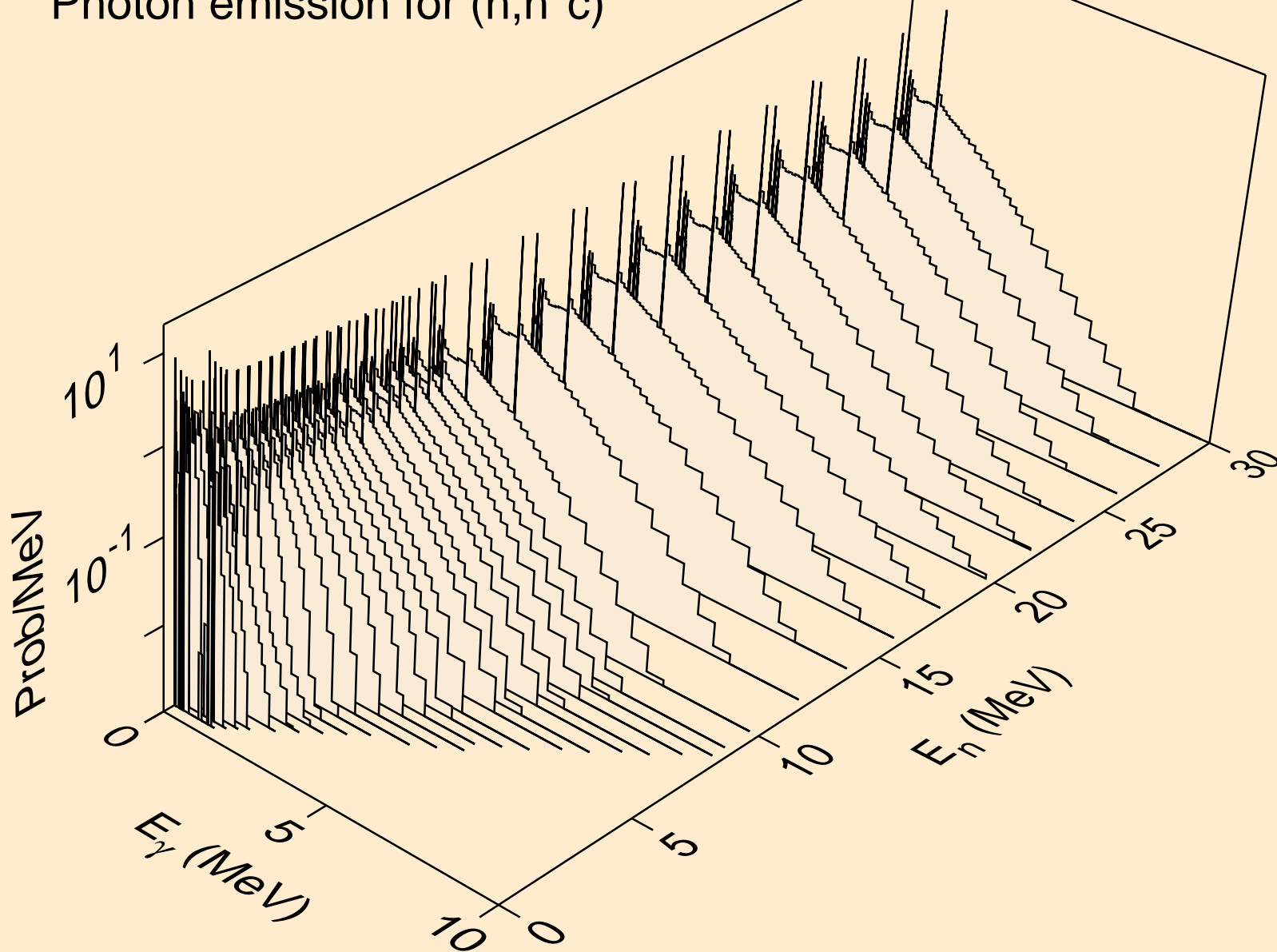

BI198M NEUTRON ACER TENDL-2019 LIBRARY; T=293.16K  
Photon emission for (n,gma)

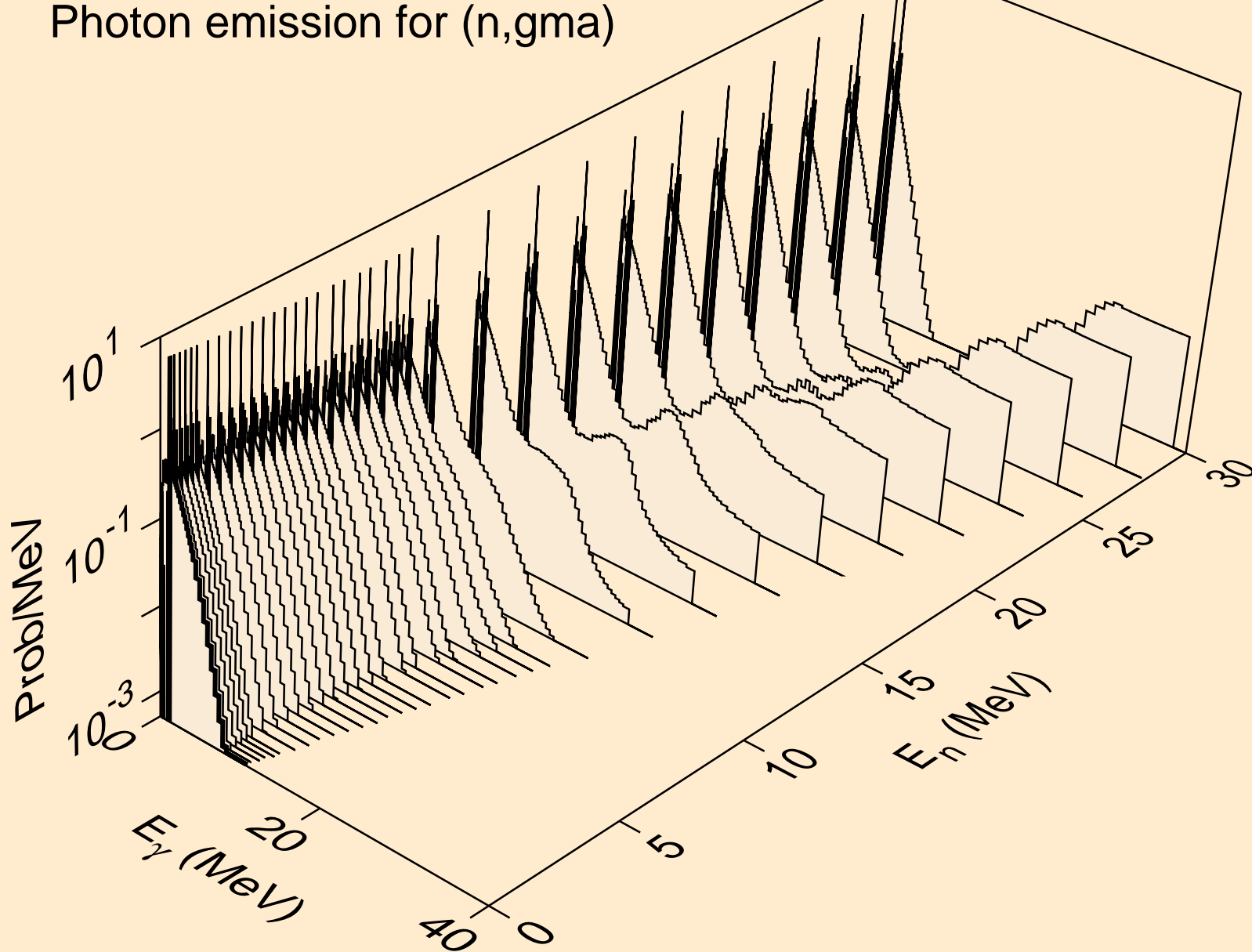

BI198M NEUTRON ACER TENDL-2019 LIBRARY; T=293.16K  
Photon emission for (n,p)

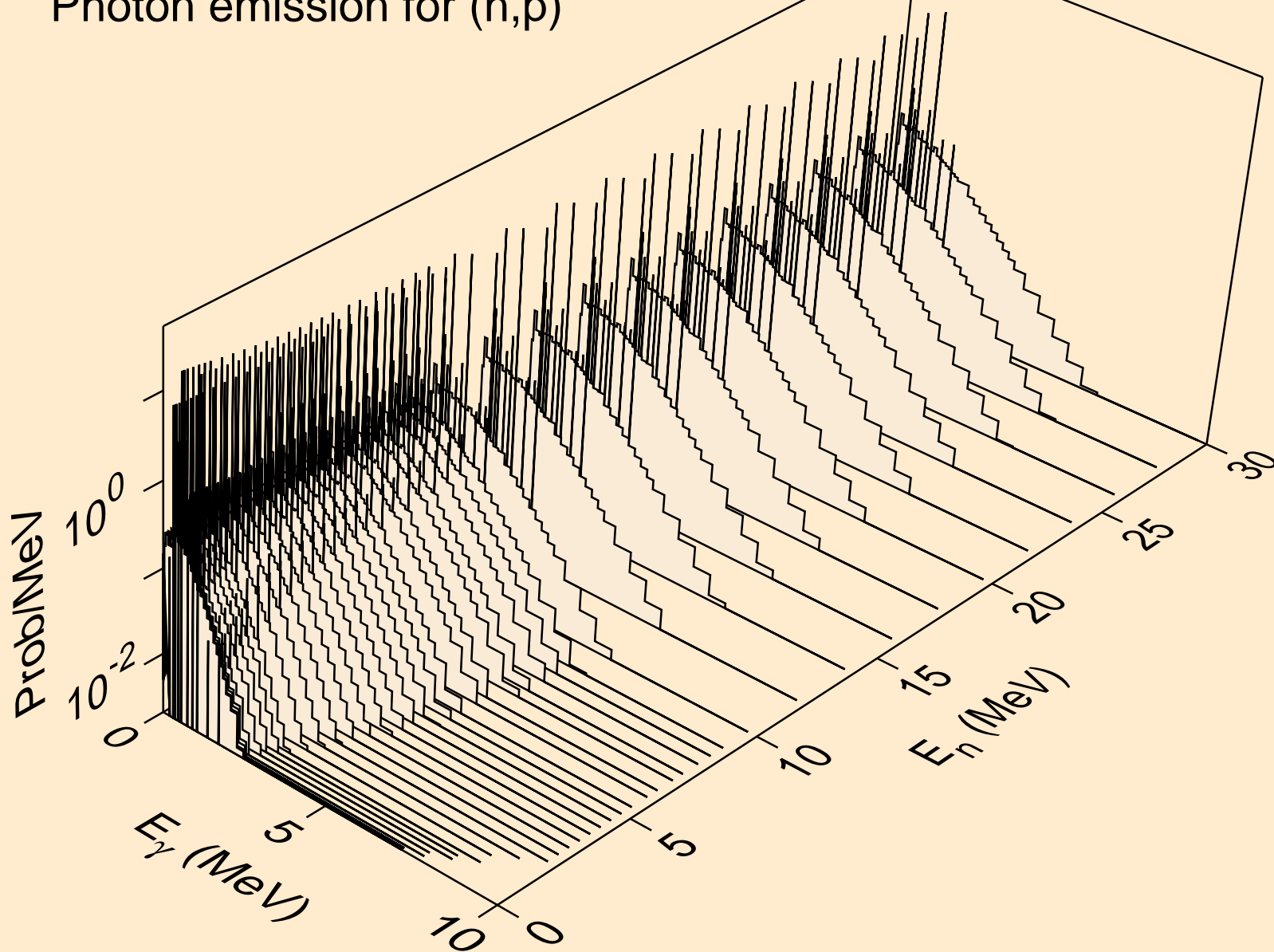

BI198M NEUTRON ACER TENDL-2019 LIBRARY; T=293.16K  
Photon emission for (n,d)

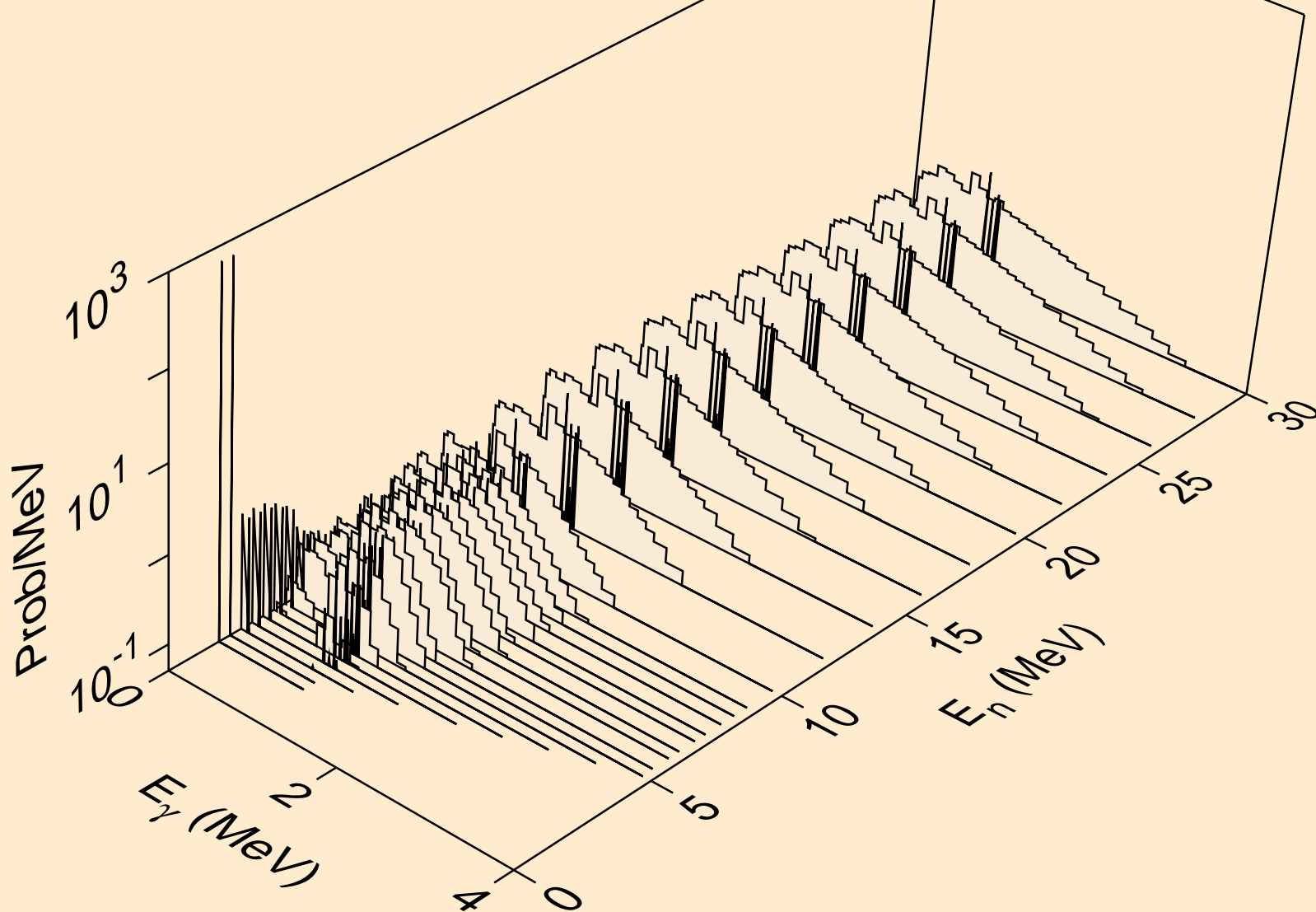

BI198M NEUTRON ACER TENDL-2019 LIBRARY; T=293.16K  
Photon emission for (n,t)

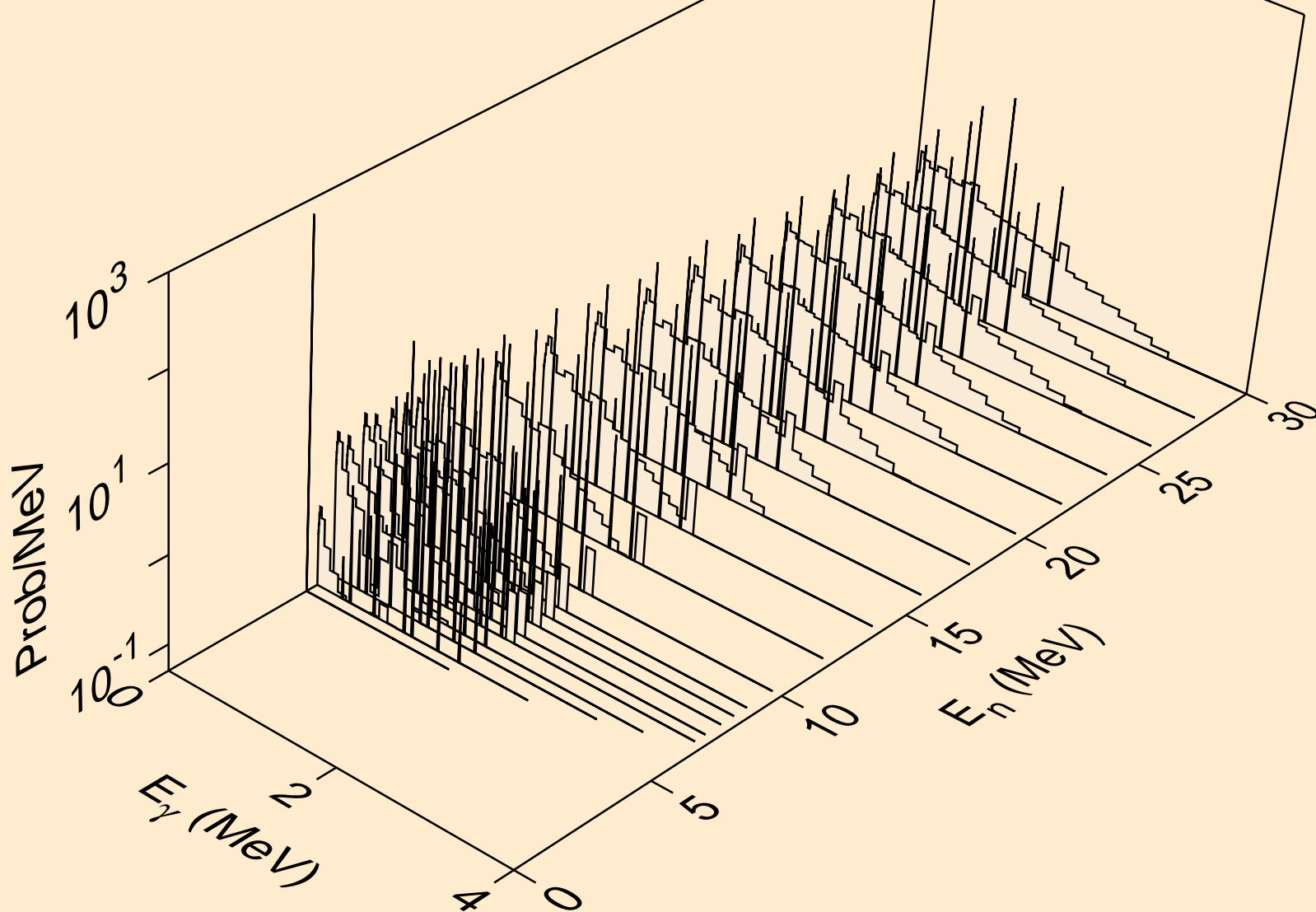

BI198M NEUTRON ACER TENDL-2019 LIBRARY; T=293.16K  
Photon emission for (n,he3)

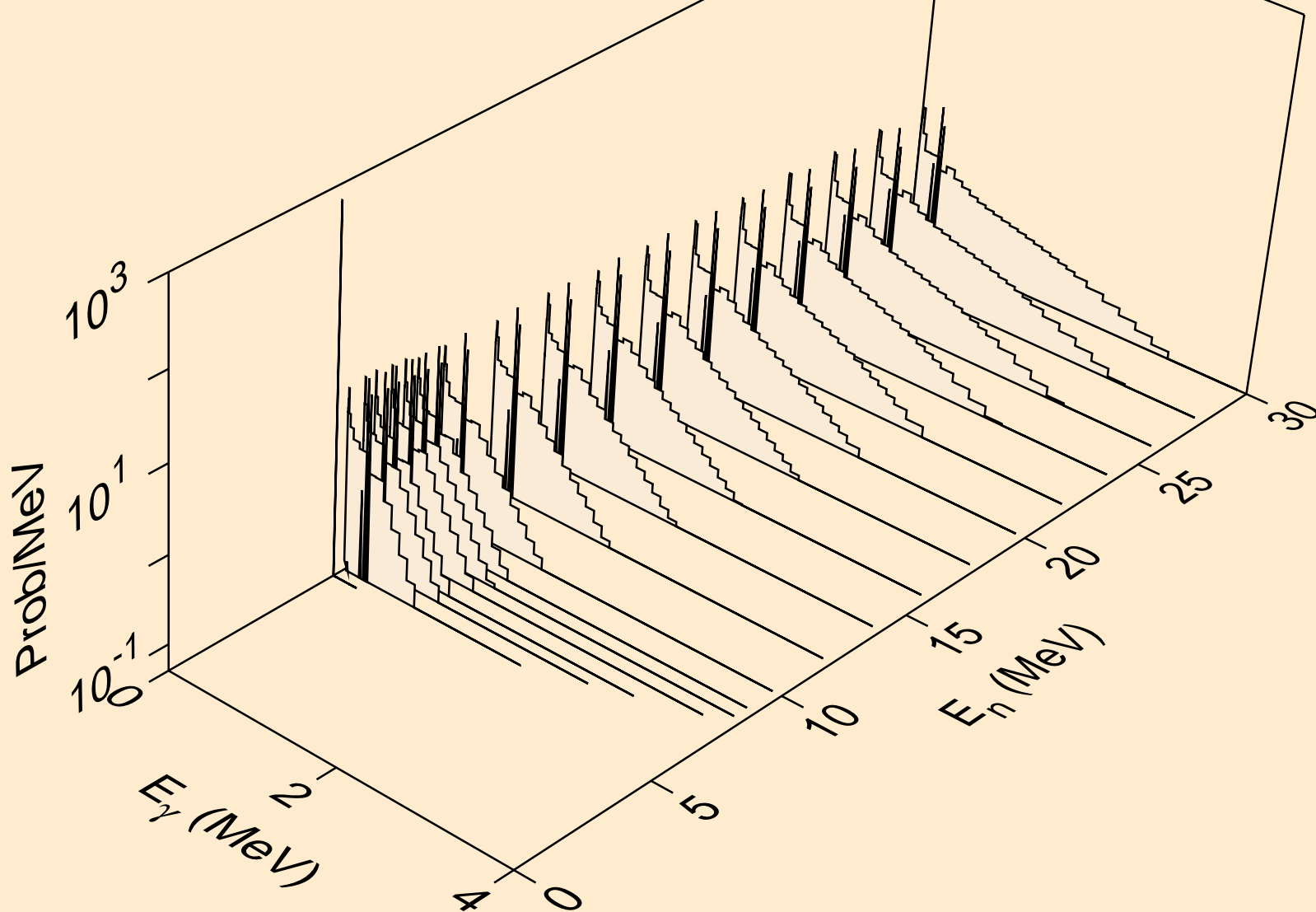

BI198M NEUTRON ACER TENDL-2019 LIBRARY; T=293.16K  
Photon emission for (n,a)

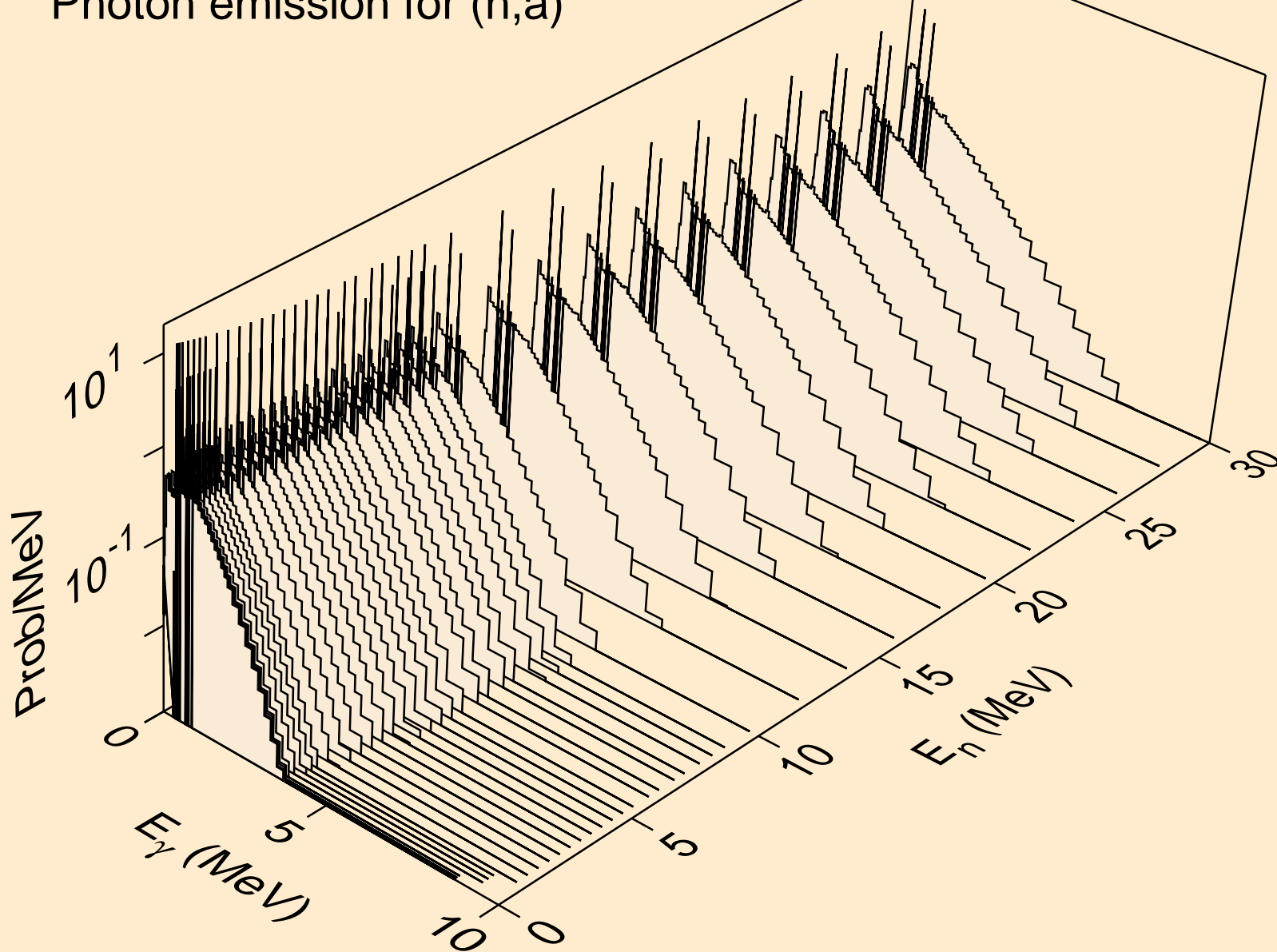

BI198M NEUTRON ACER TENDL-2019 LIBRARY; T=293.16K  
Photon emission for (n,2a)

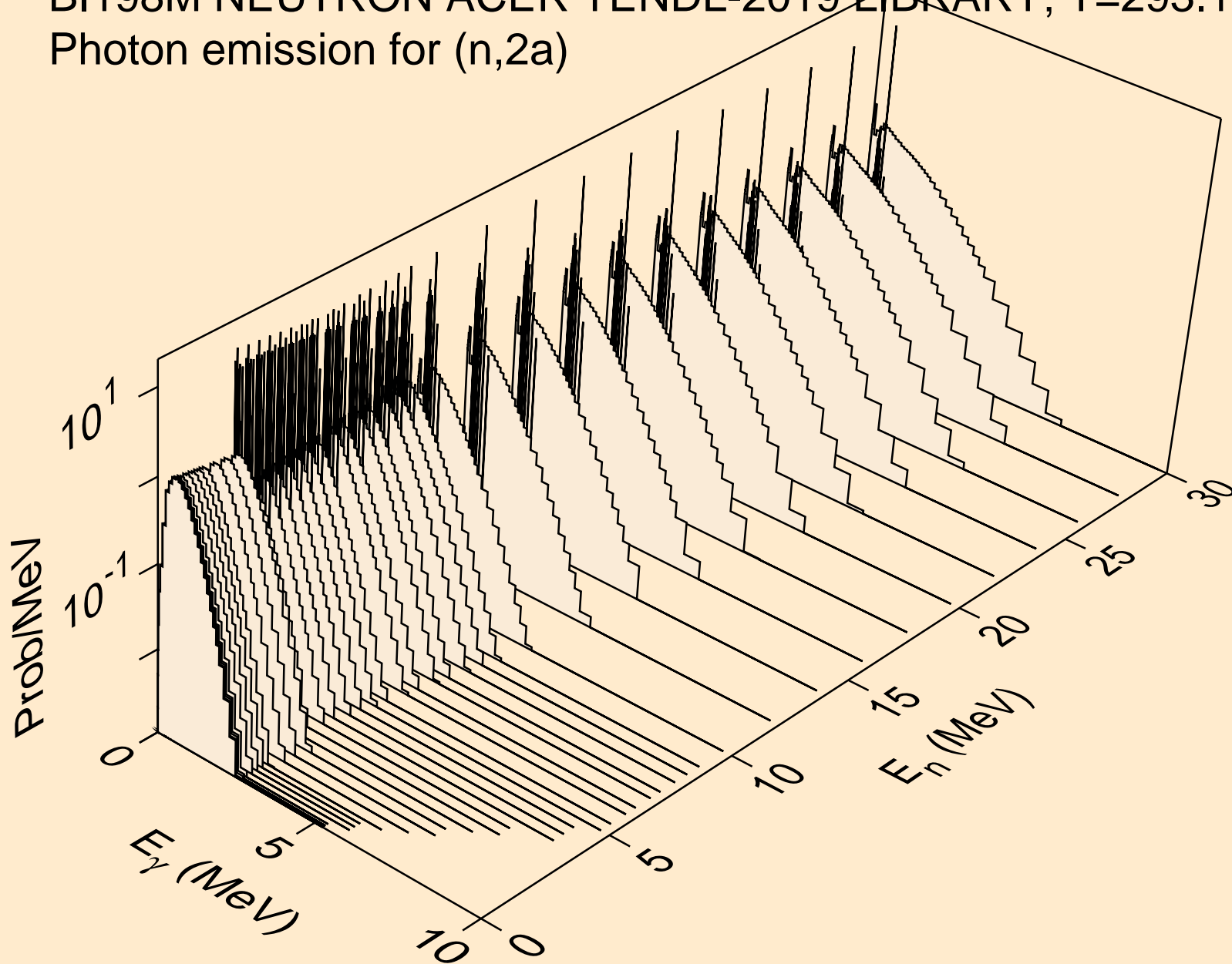

BI198M NEUTRON ACER TENDL-2019 LIBRARY; T=293.16K  
Photon emission for (n,2p)

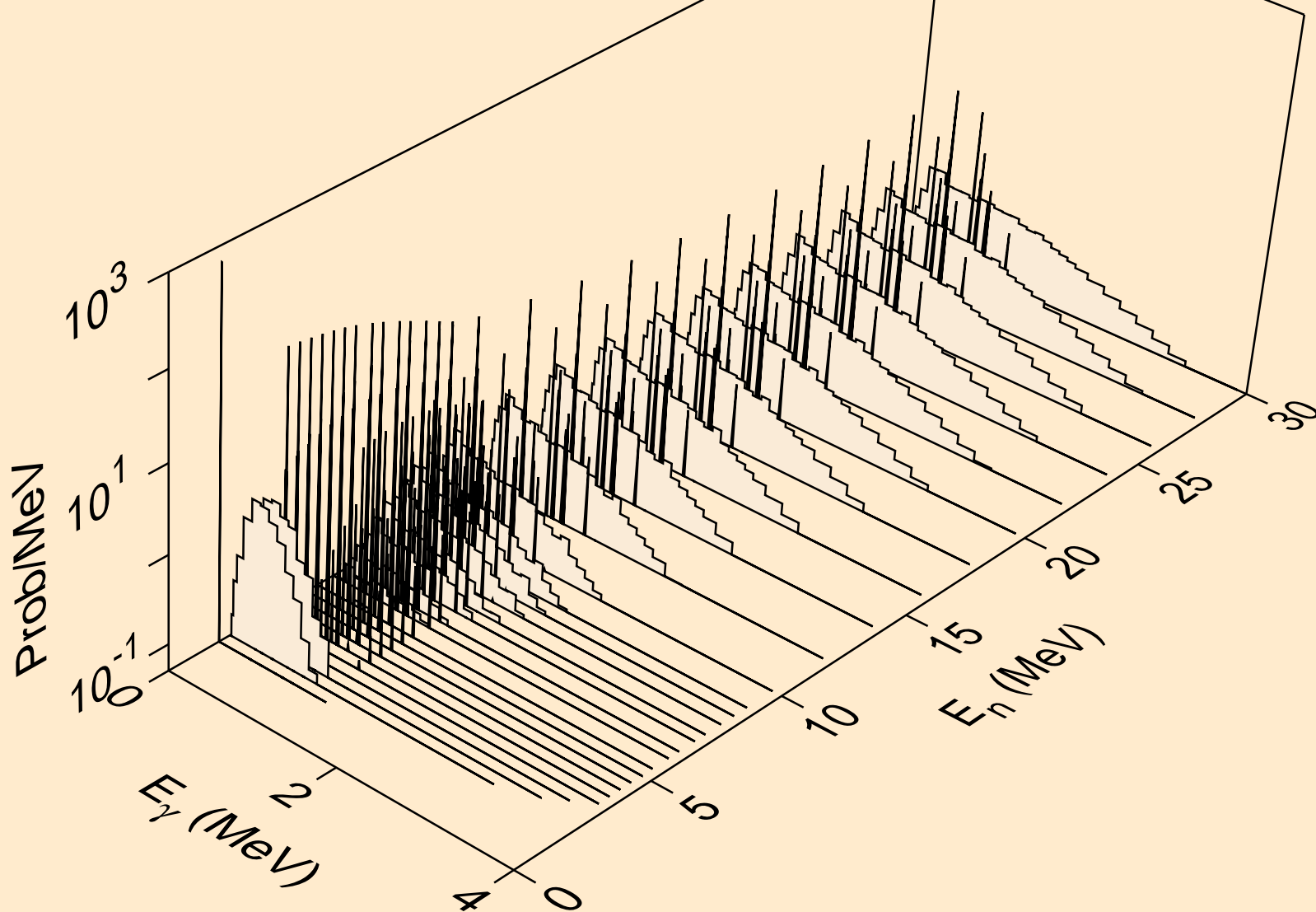

BI198M NEUTRON ACER TENDL-2019 LIBRARY; T=293.16K  
Photon emission for (n,p $\alpha$ )

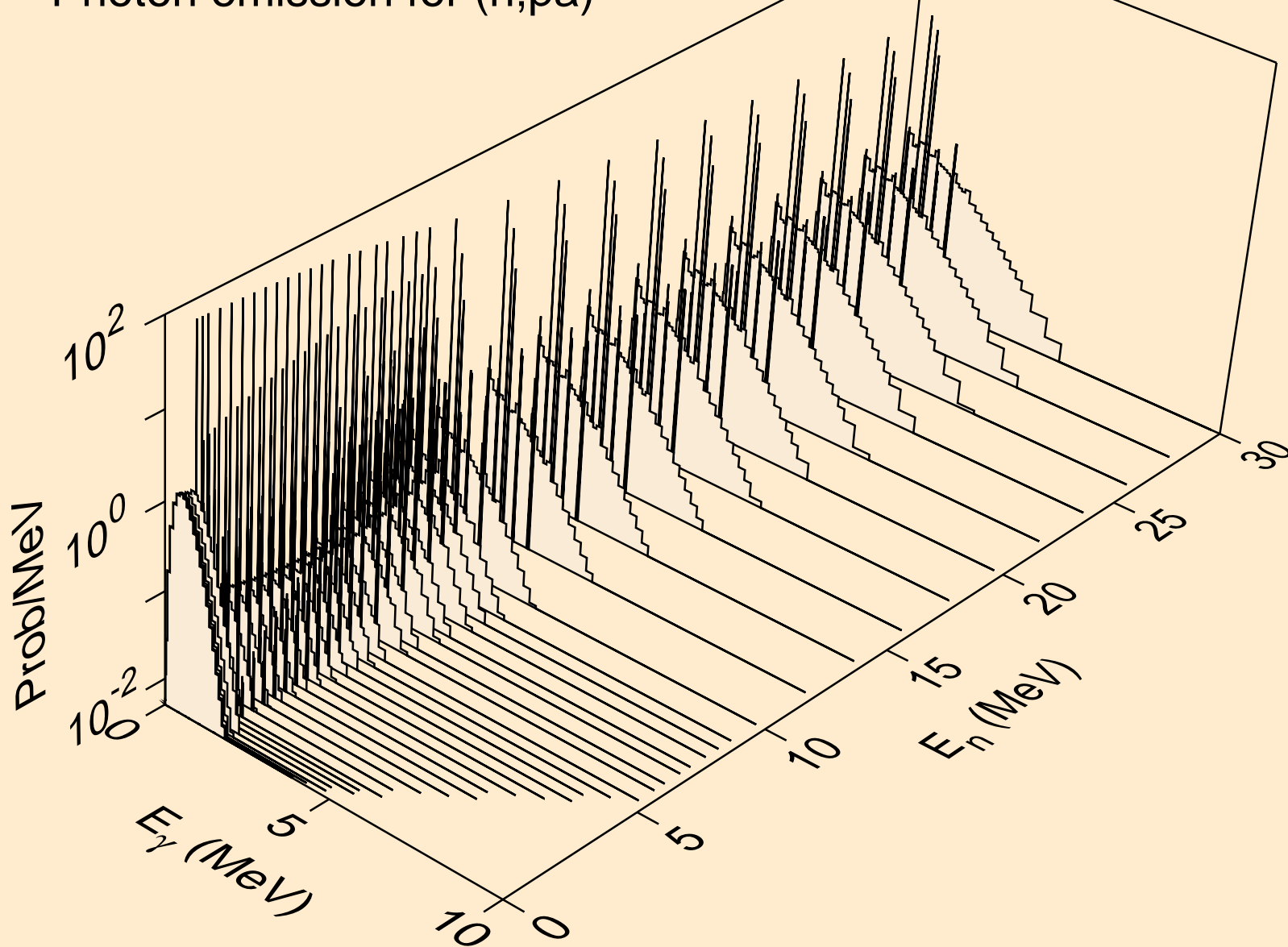

BI198M NEUTRON ACER TENDL-2019 LIBRARY; T=293.16K  
Photon emission for (n,pd)

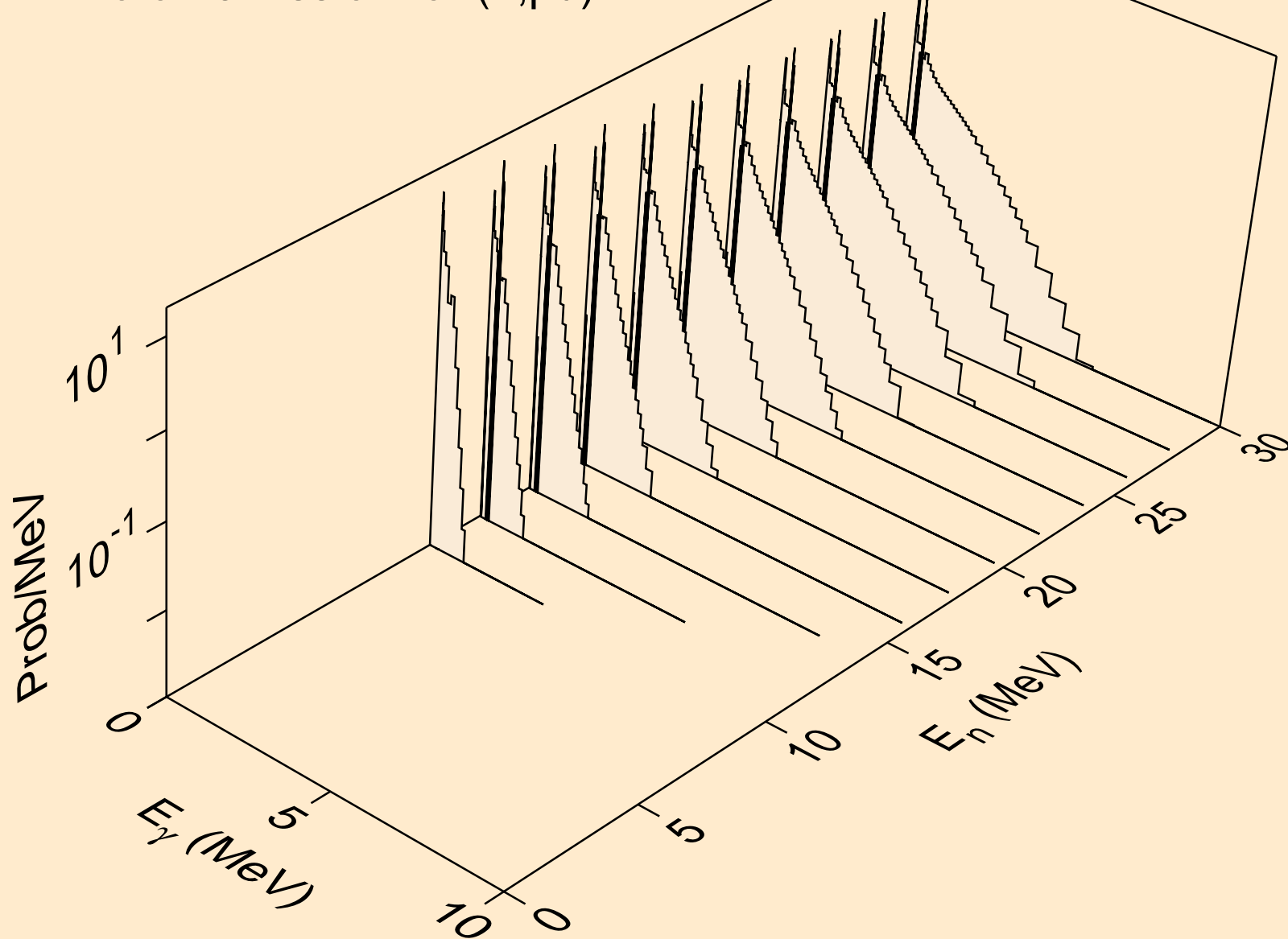

BI198M NEUTRON ACER TENDL-2019 LIBRARY; T=293.16K  
Photon emission for (n,pt)

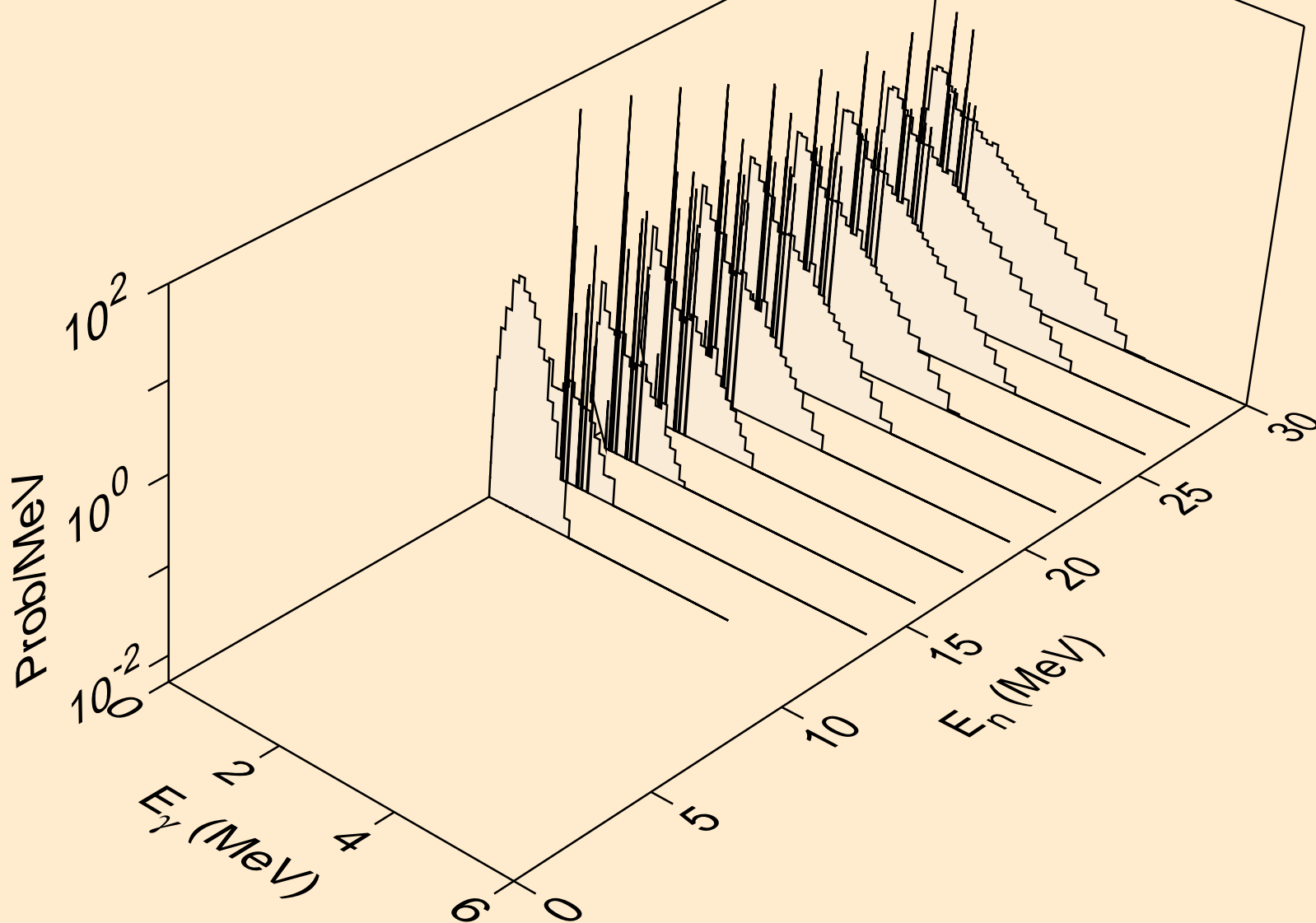

BI198M NEUTRON ACER TENDL-2019 LIBRARY; T=293.16K  
Photon emission for (n,da)

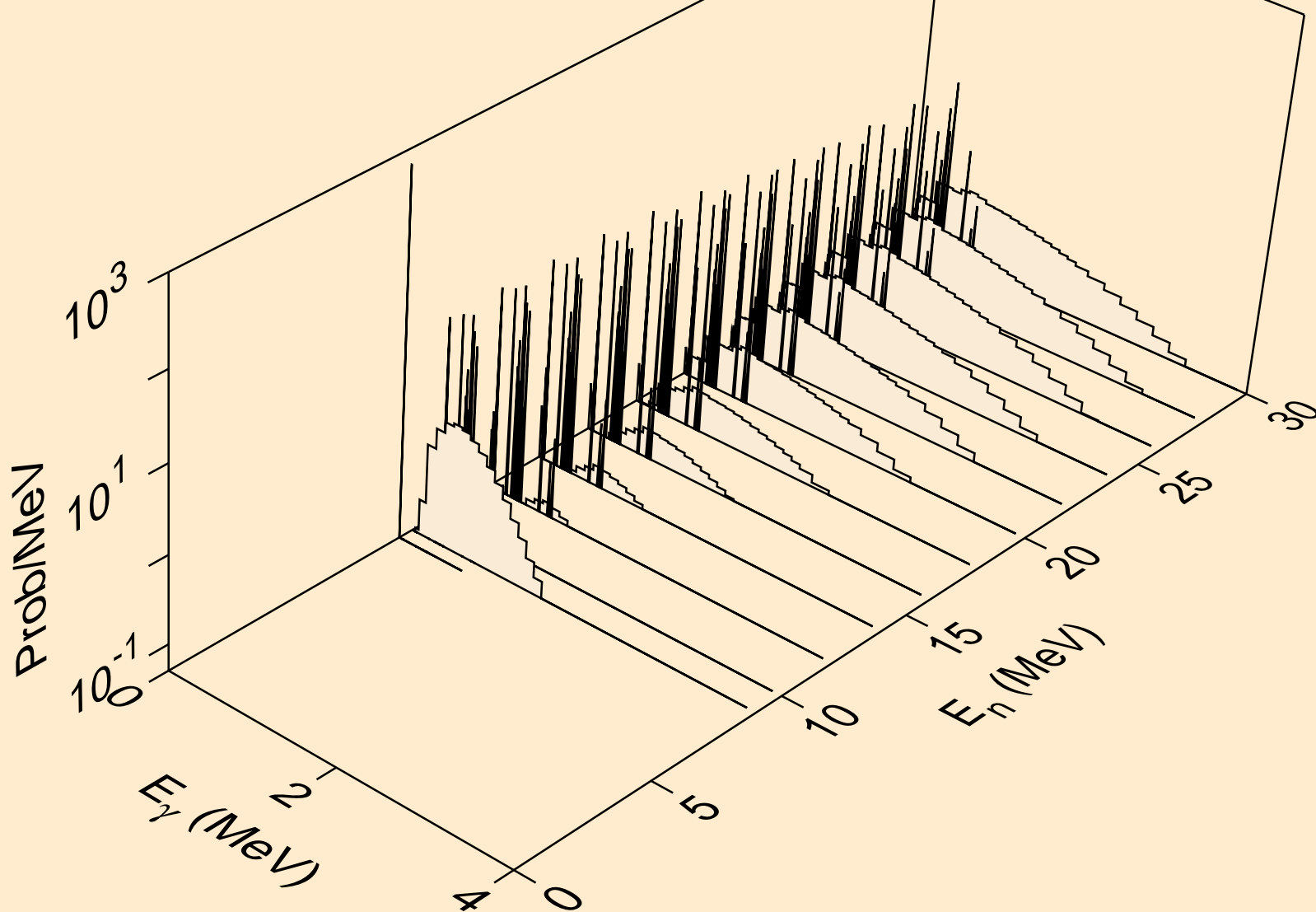

BI198M NEUTRON ACER TENDL-2019 LIBRARY; T=293.16K  
thermal capture photon spectrum

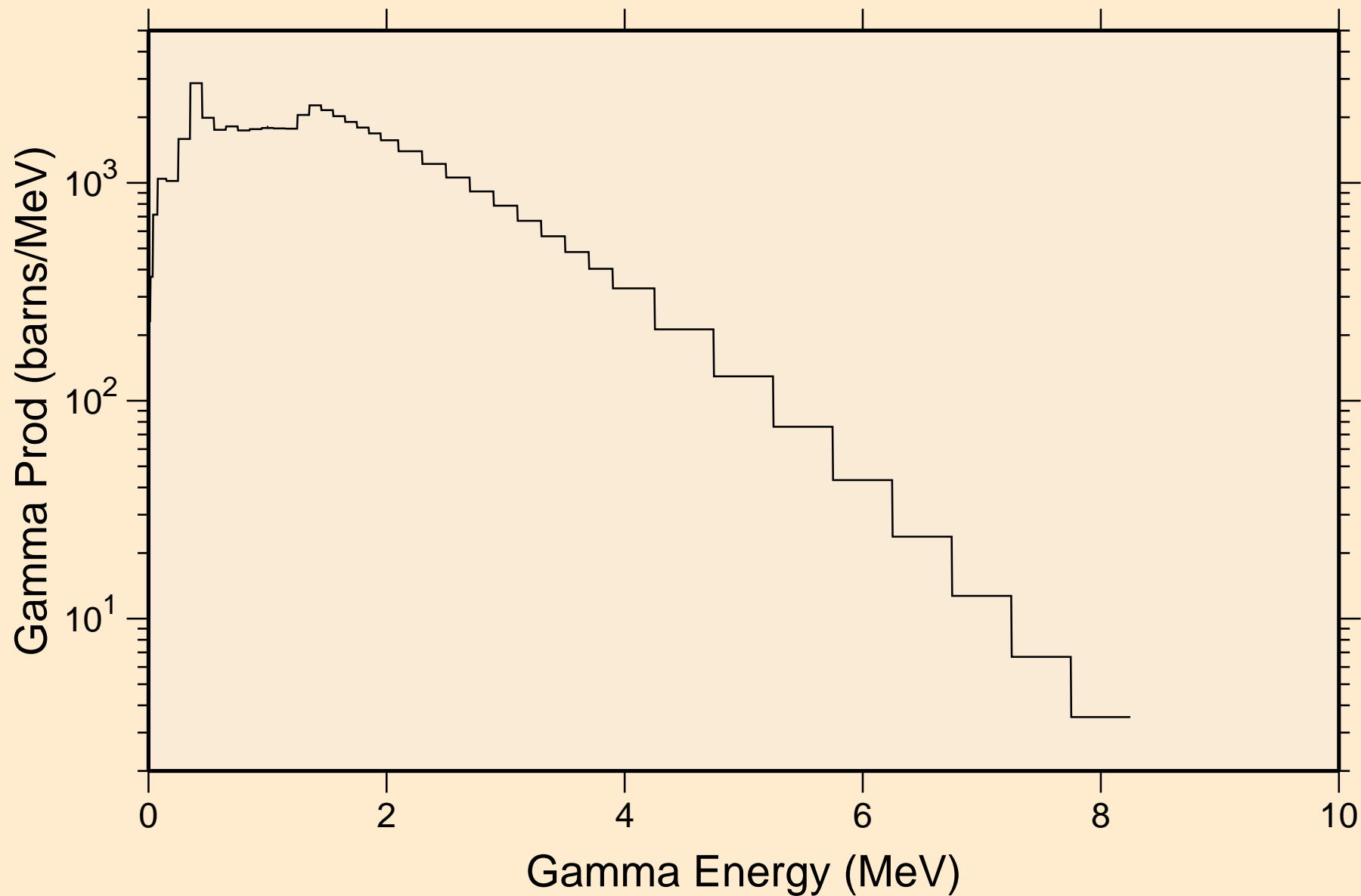

BI198M NEUTRON ACER TENDL-2019 LIBRARY; T=293.16K  
14 MeV photon spectrum

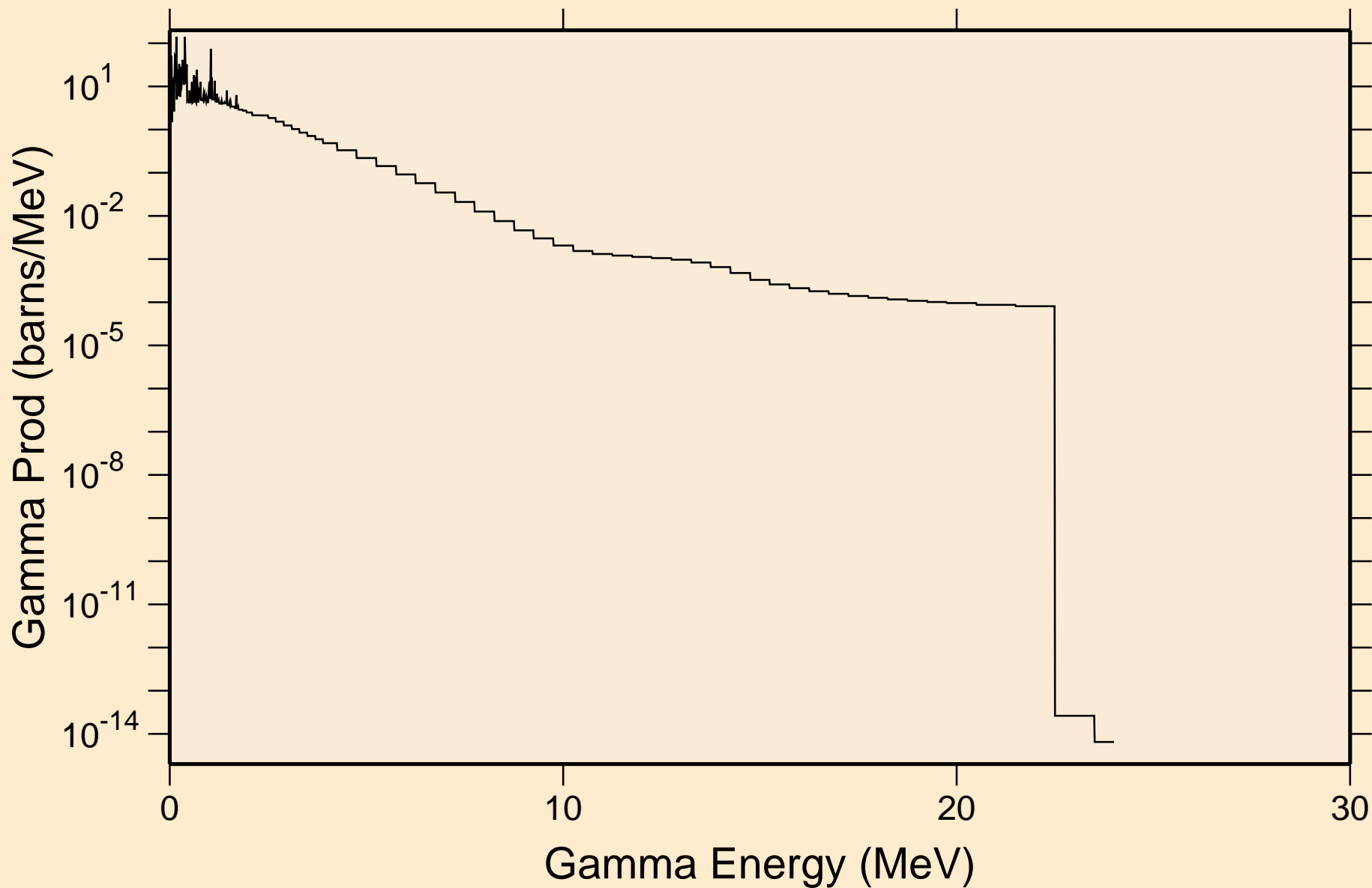

# BI198M NEUTRON ACER TENDL-2019 LIBRARY; T=293.16K

## Particle heating contributions

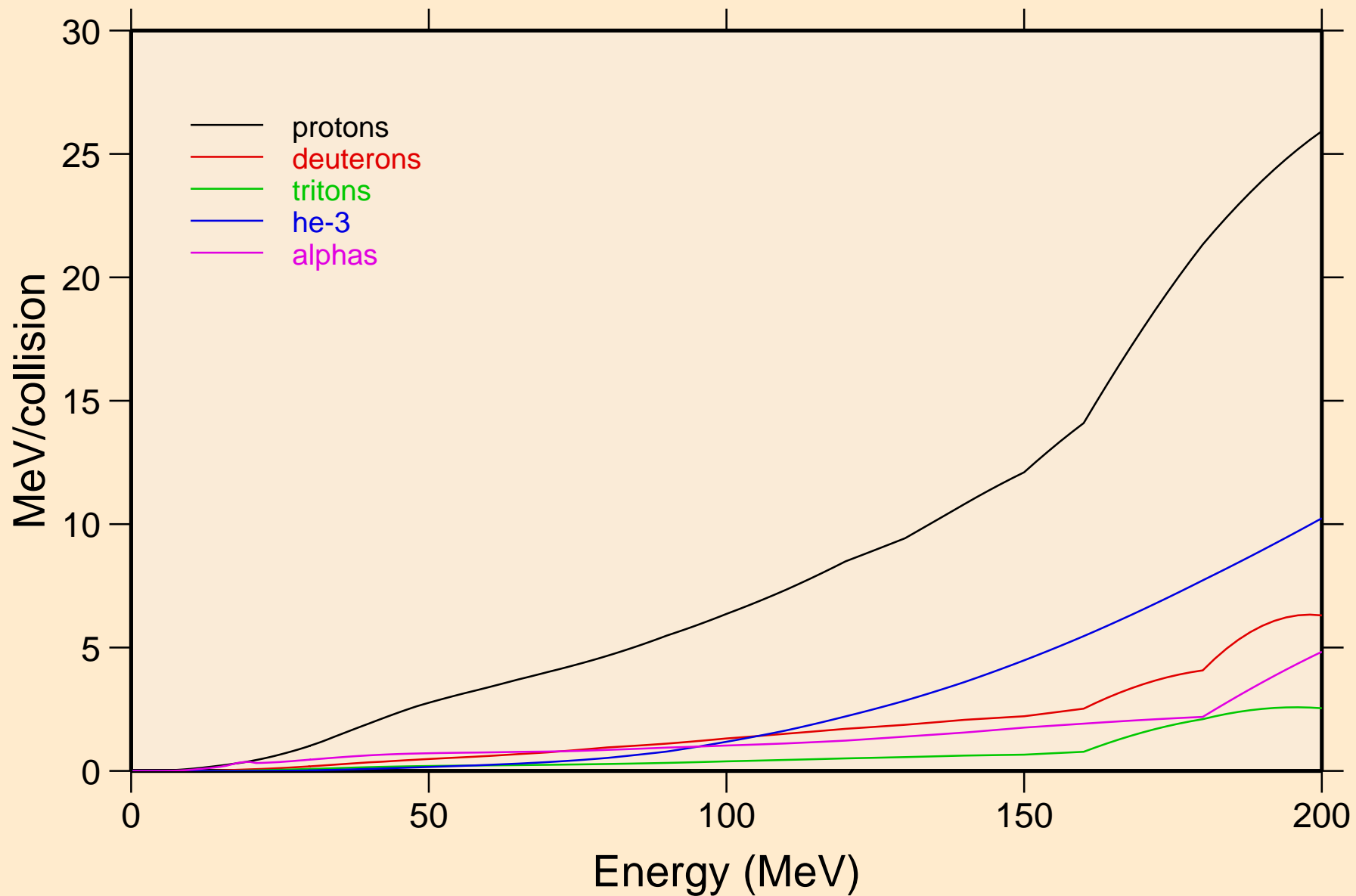

BI198M NEUTRON ACER TENDL-2019 LIBRARY; T=293.16K  
Recoil Heating

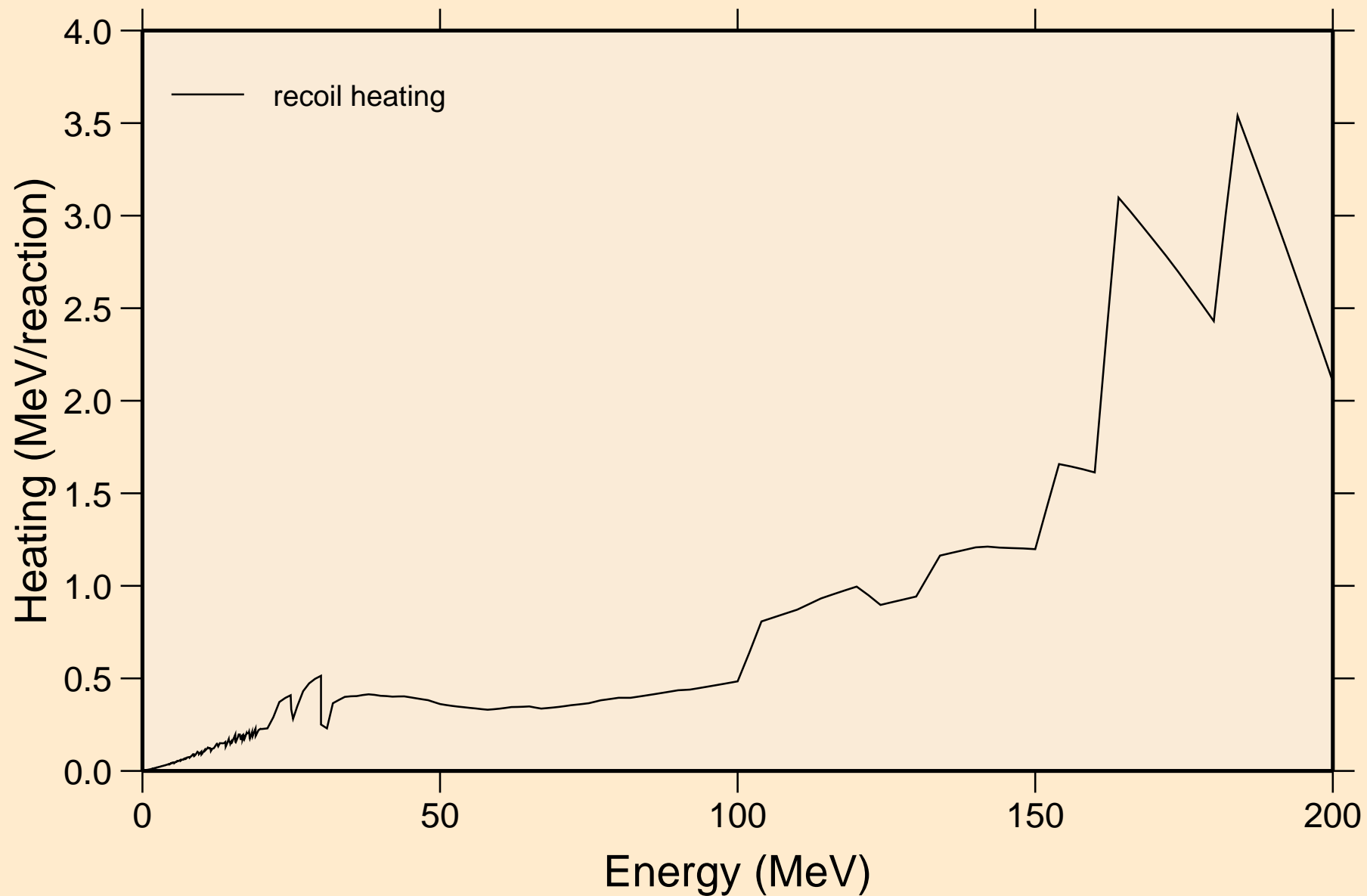

BI198M NEUTRON ACER TENDL-2019 LIBRARY; T=293.16K  
Particle production cross sections

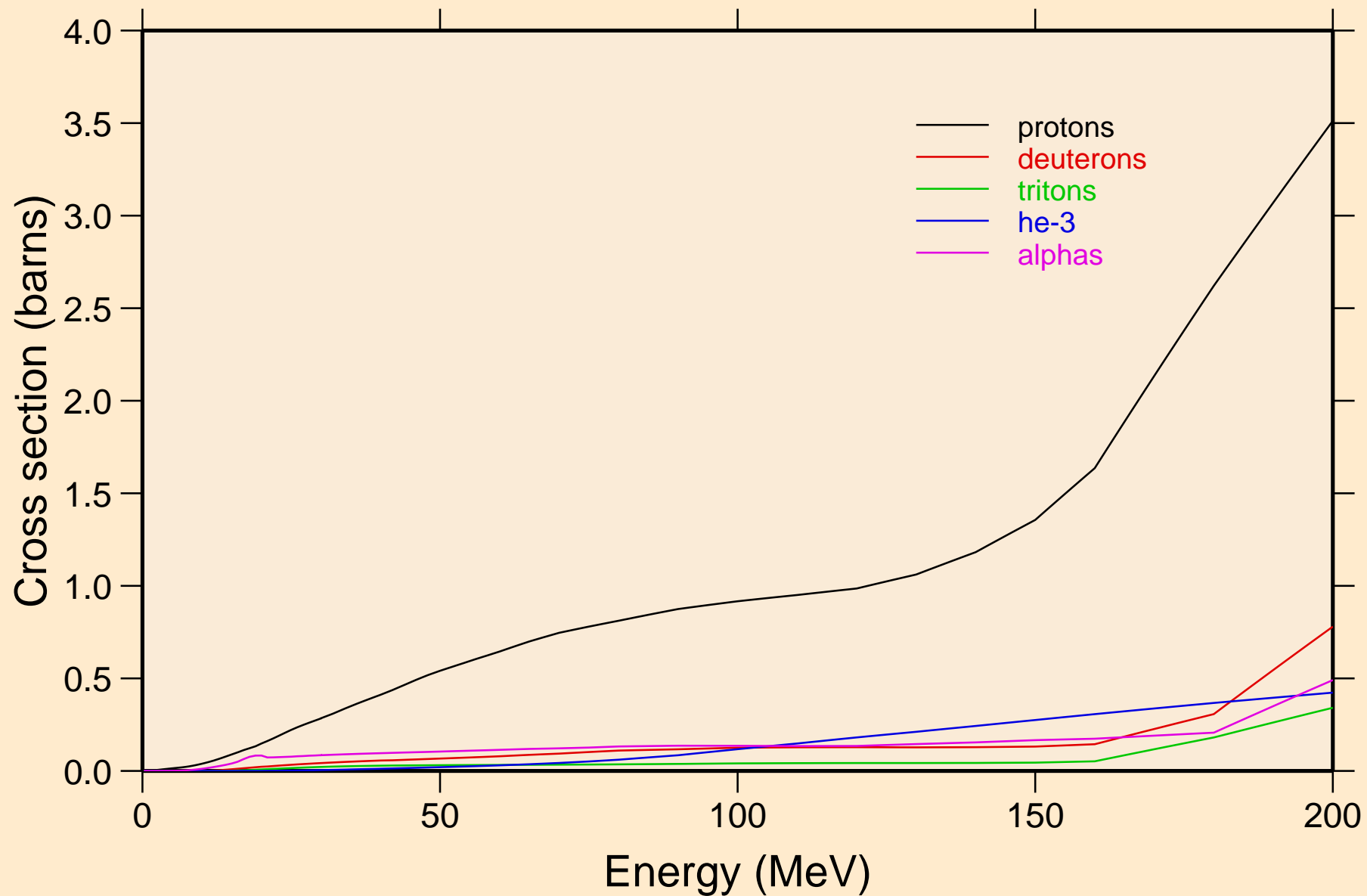

BI198M NEUTRON ACER TENDL-2019 LIBRARY; T=293.16K  
protons from (n,x)

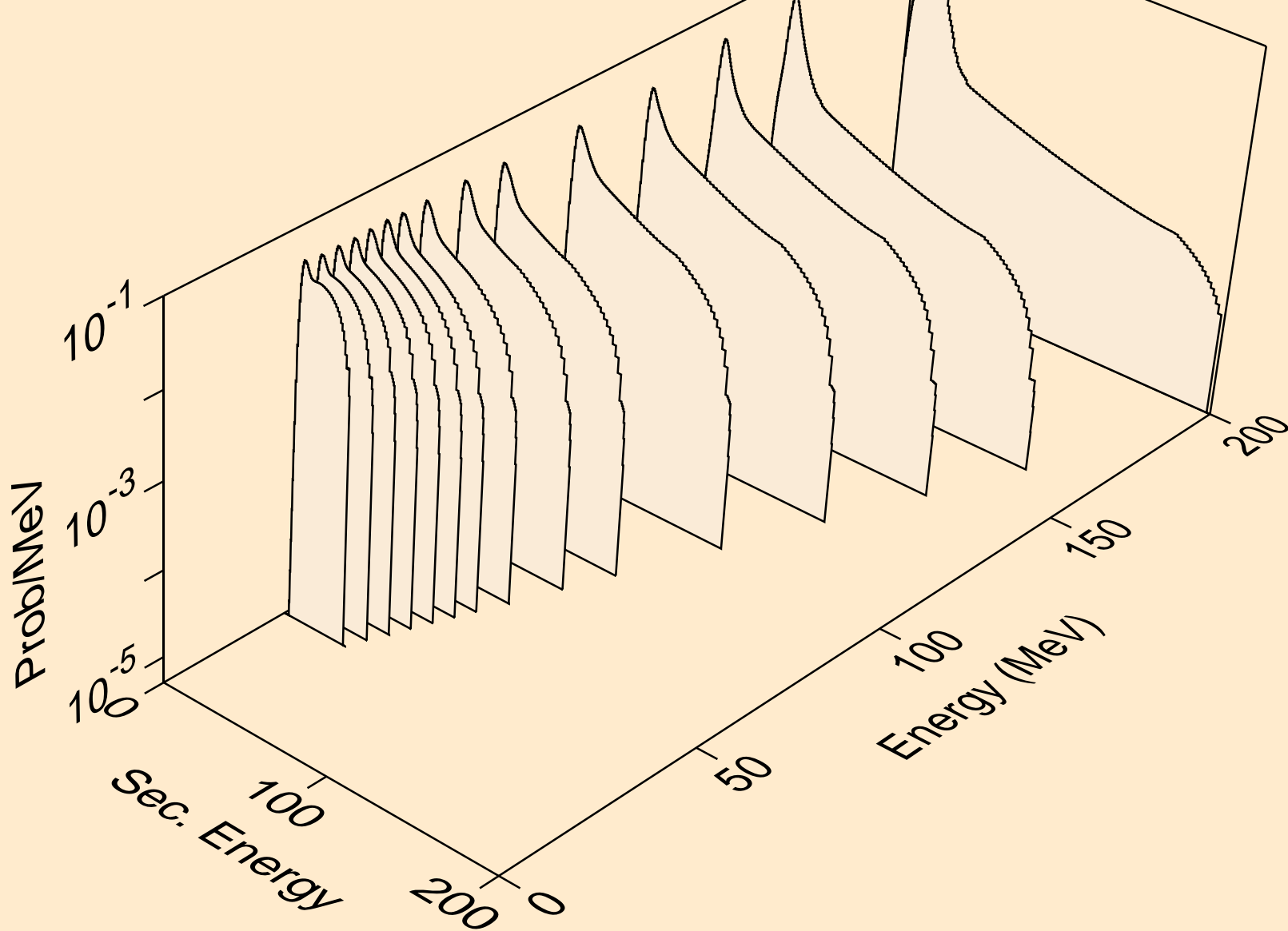

BI198M NEUTRON ACER TENDL-2019 LIBRARY; T=293.16K  
protons from (n,n\*)p

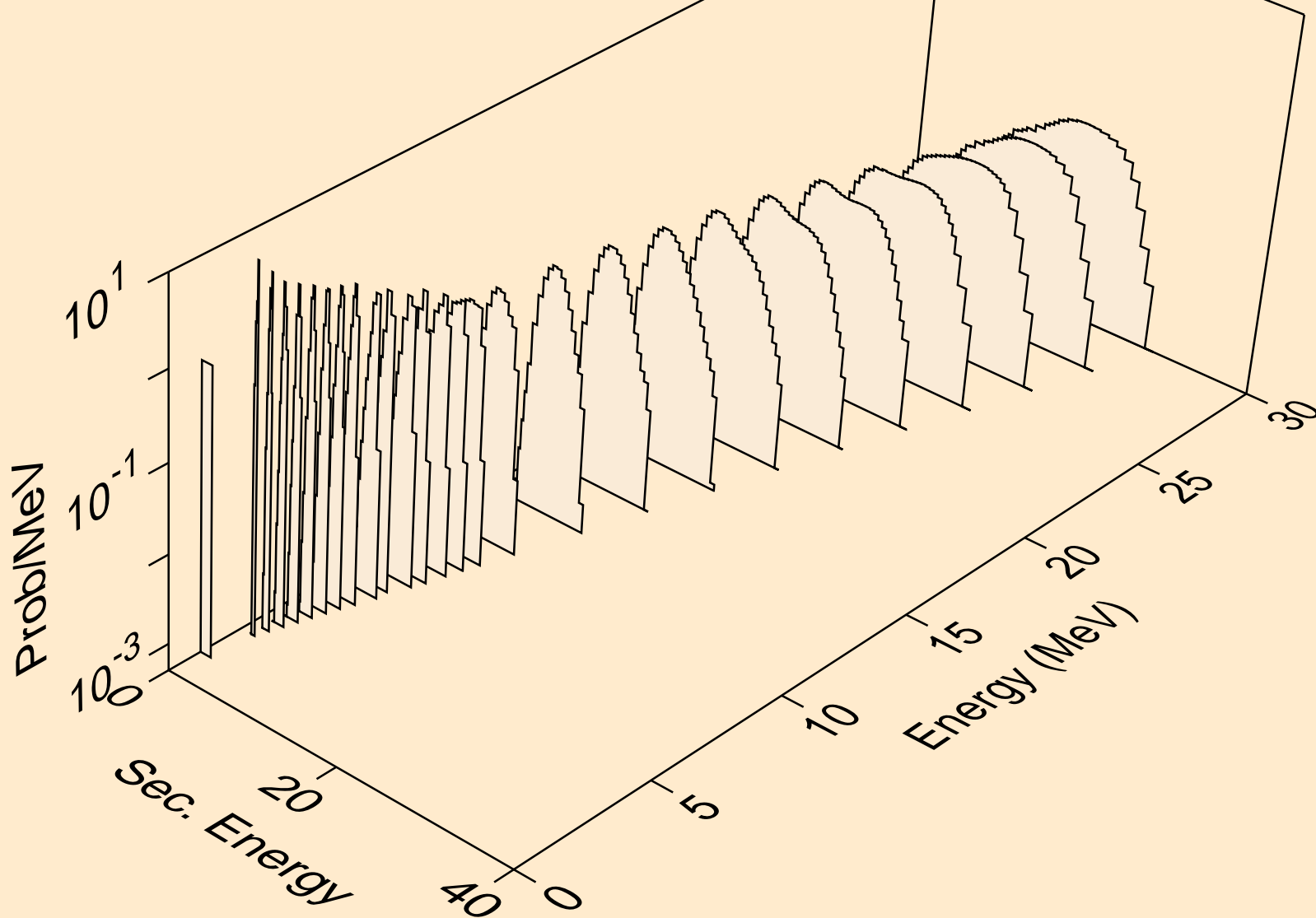

BI198M NEUTRON ACER TENDL-2019 LIBRARY; T=293.16K  
protons from (n,2np)

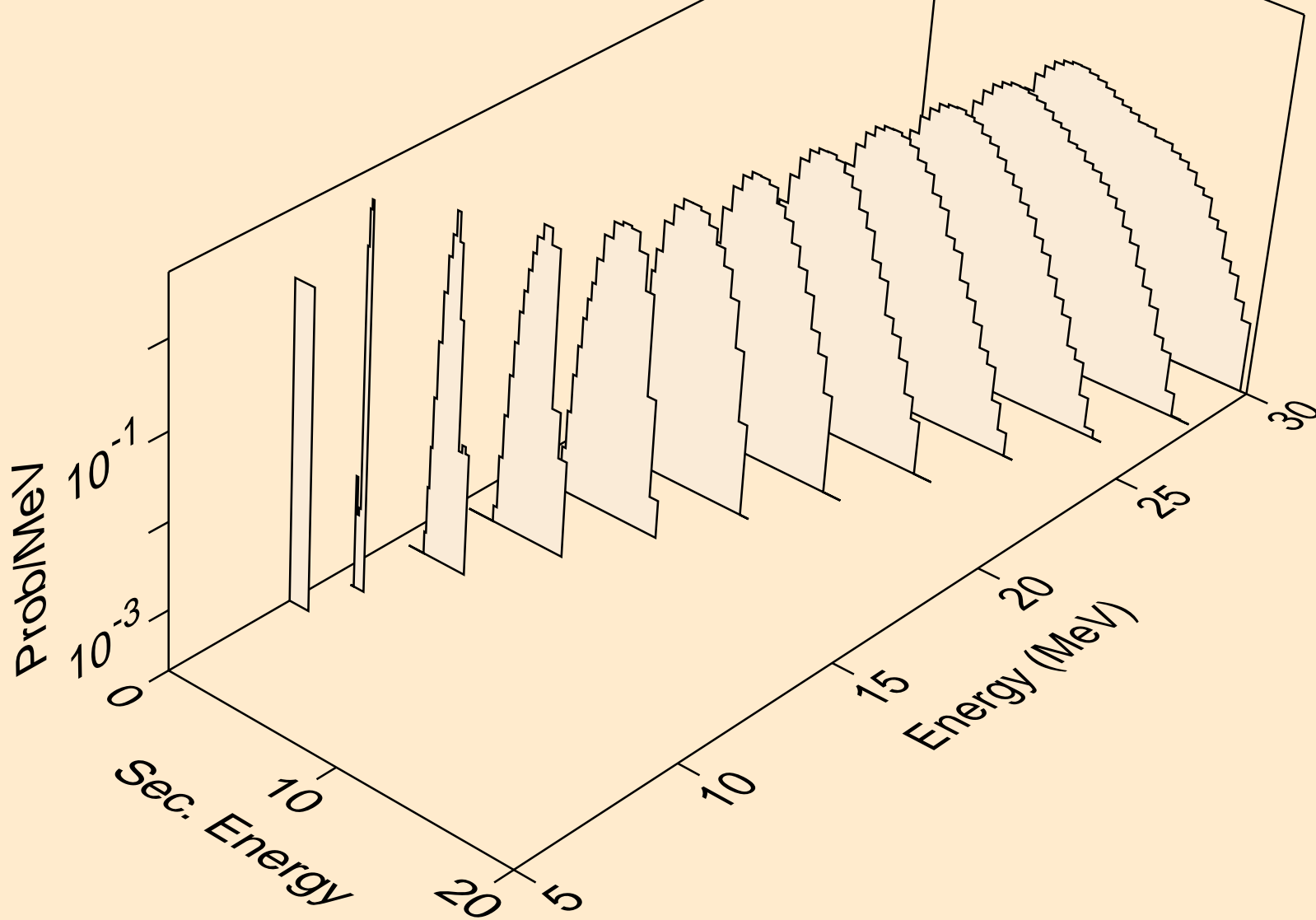

BI198M NEUTRON ACER TENDL-2019 LIBRARY; T=293.16K  
protons from (n,3np)

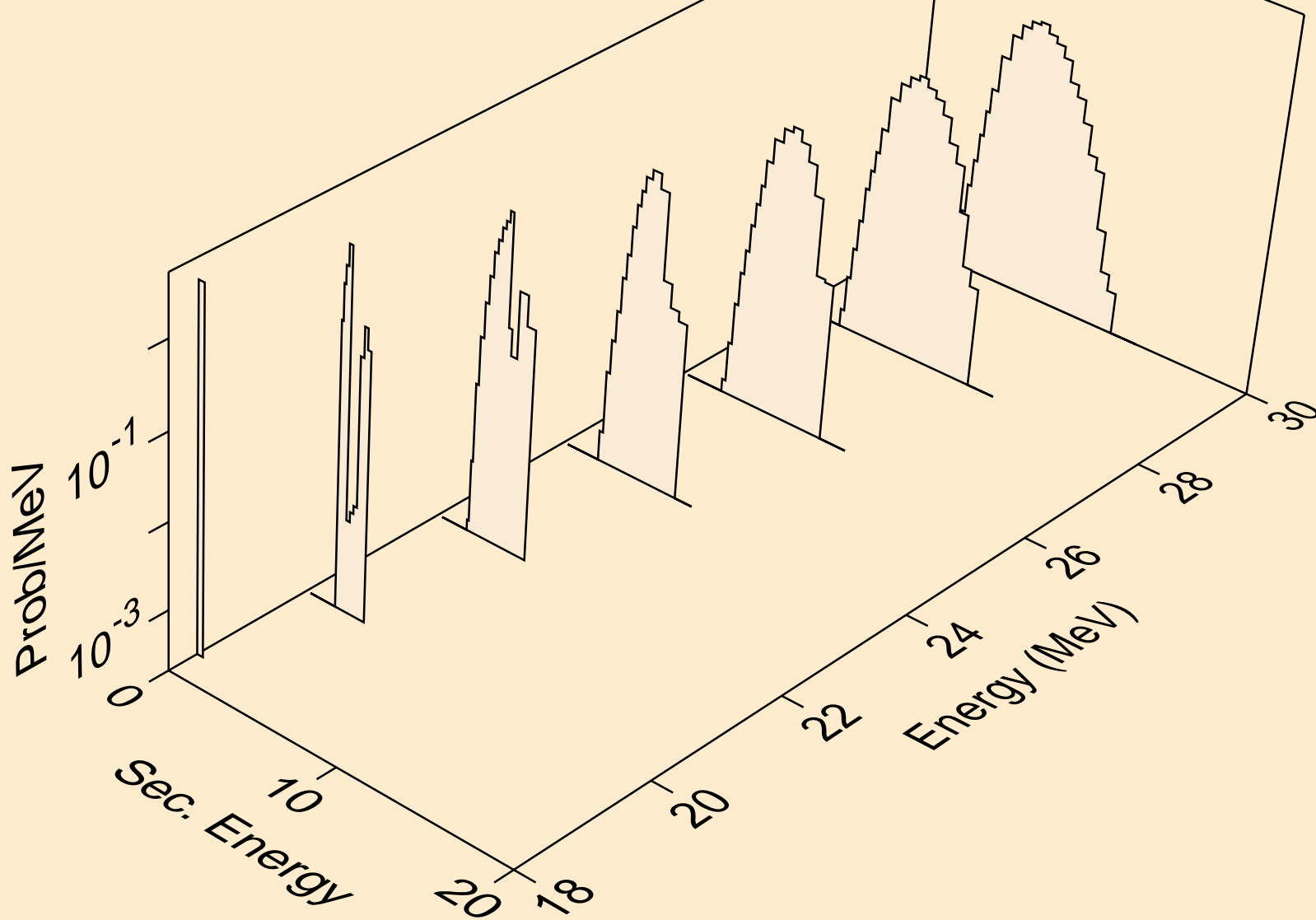

BI198M NEUTRON ACER TENDL-2019 LIBRARY; T=293.16K  
protons from (n,2np)

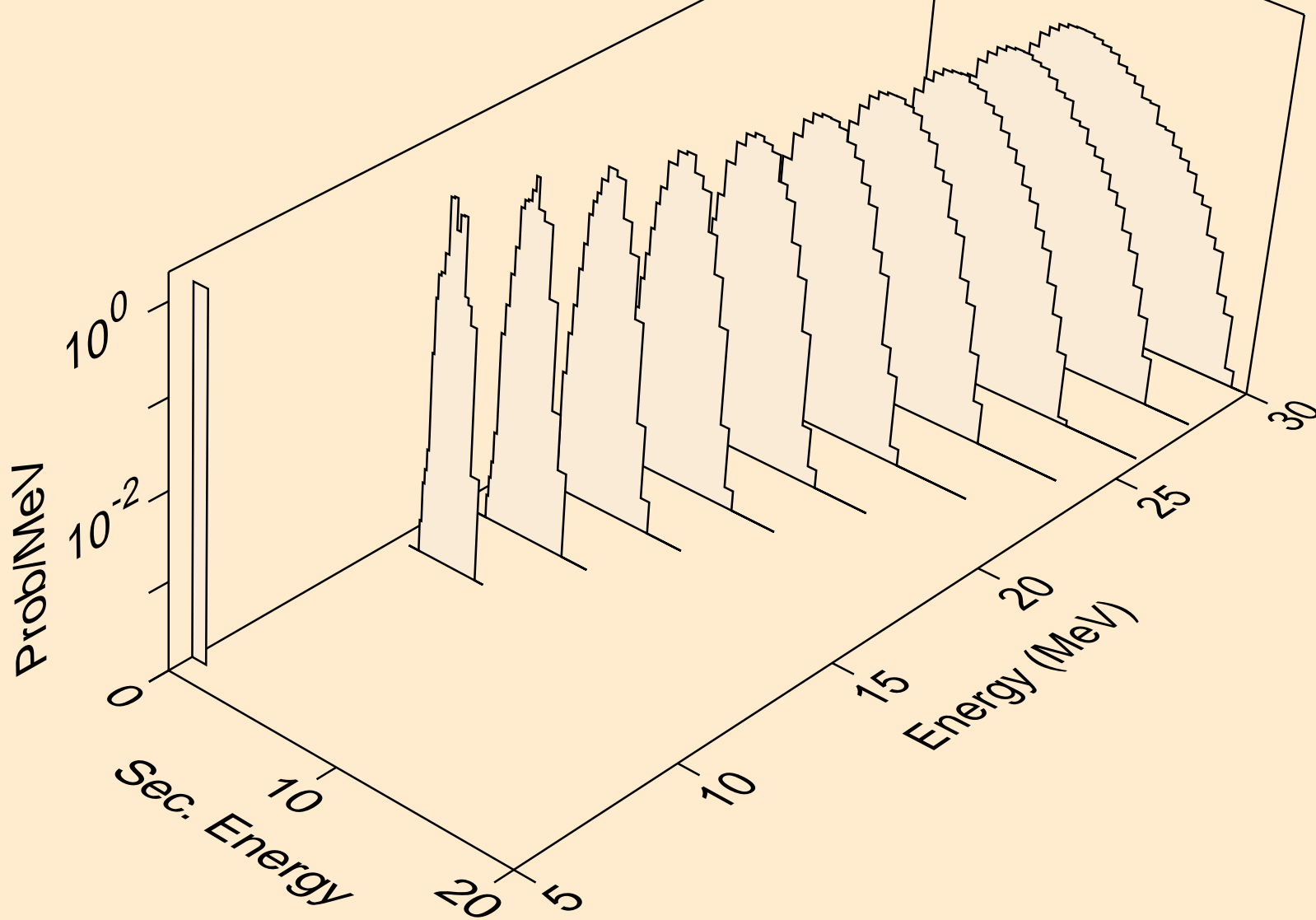

BI198M NEUTRON ACER TENDL-2019 LIBRARY; T=293.16K  
protons from (n,npa)

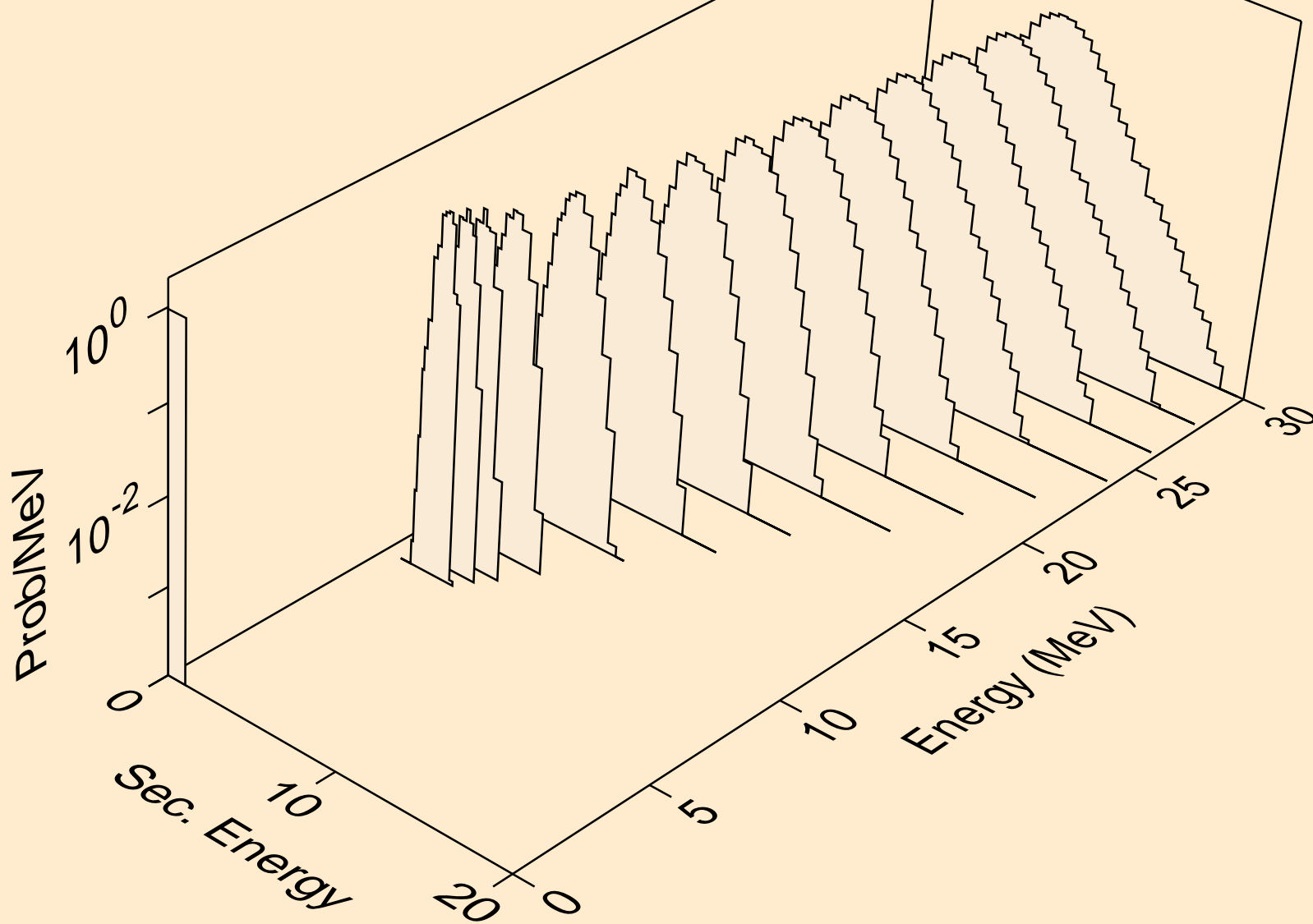

BI198M NEUTRON ACER TENDL-2019 LIBRARY; T=293.16K  
protons from (n,p)

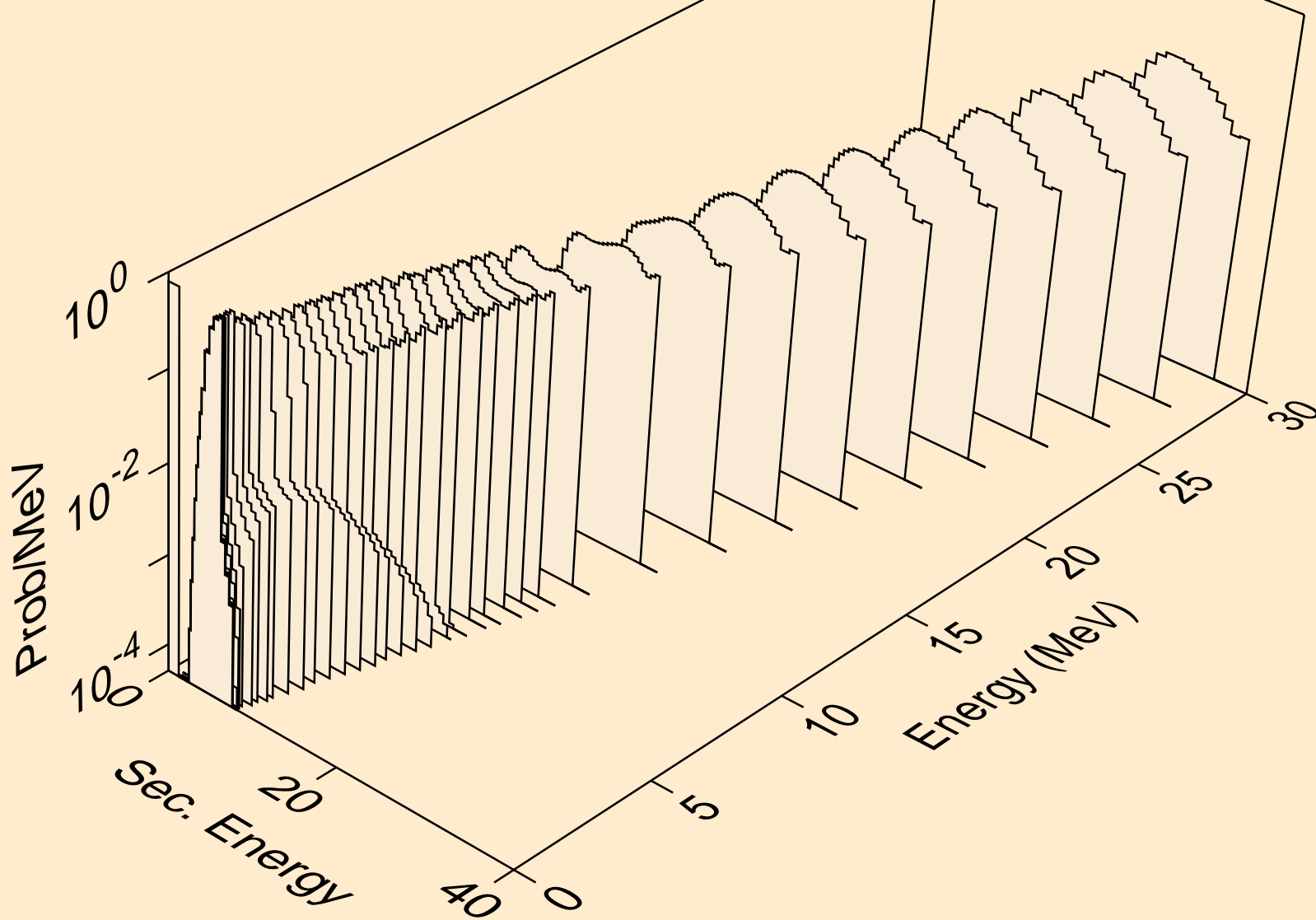

BI198M NEUTRON ACER TENDL-2019 LIBRARY; T=293.16K  
protons from (n,2p)

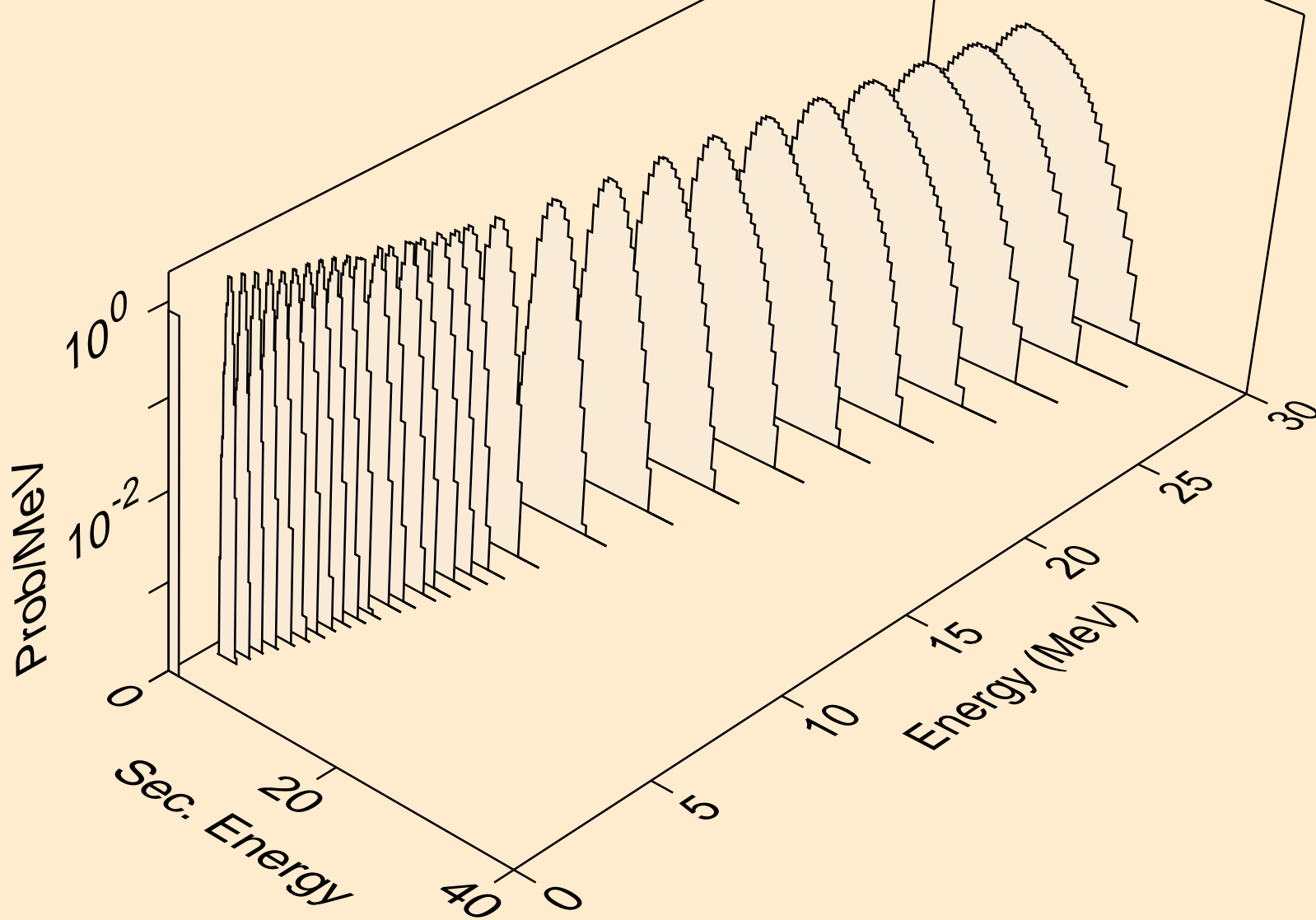

BI198M NEUTRON ACER TENDL-2019 LIBRARY; T=293.16K  
protons from (n,p)

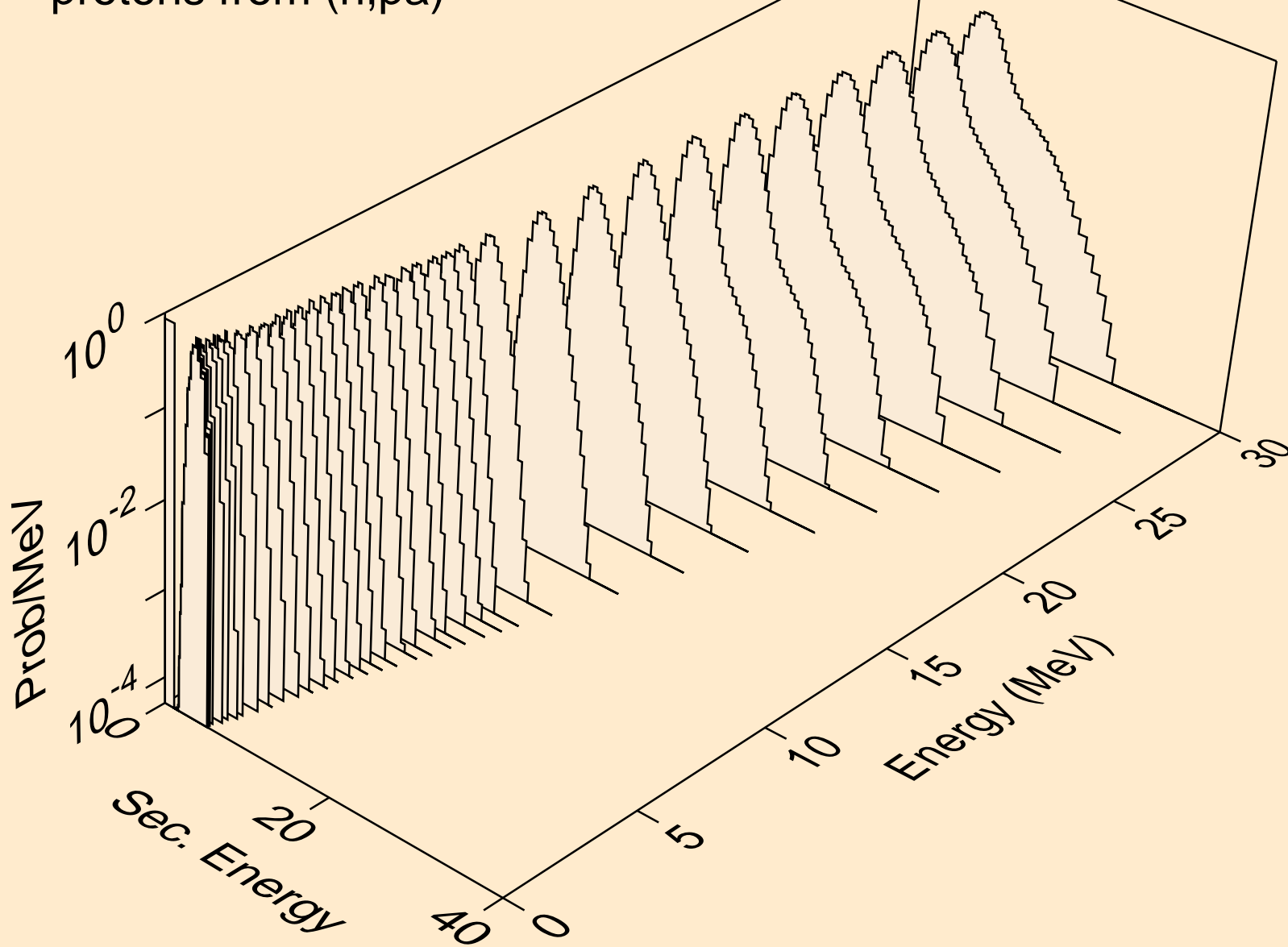

BI198M NEUTRON ACER TENDL-2019 LIBRARY; T=293.16K  
protons from (n,pd)

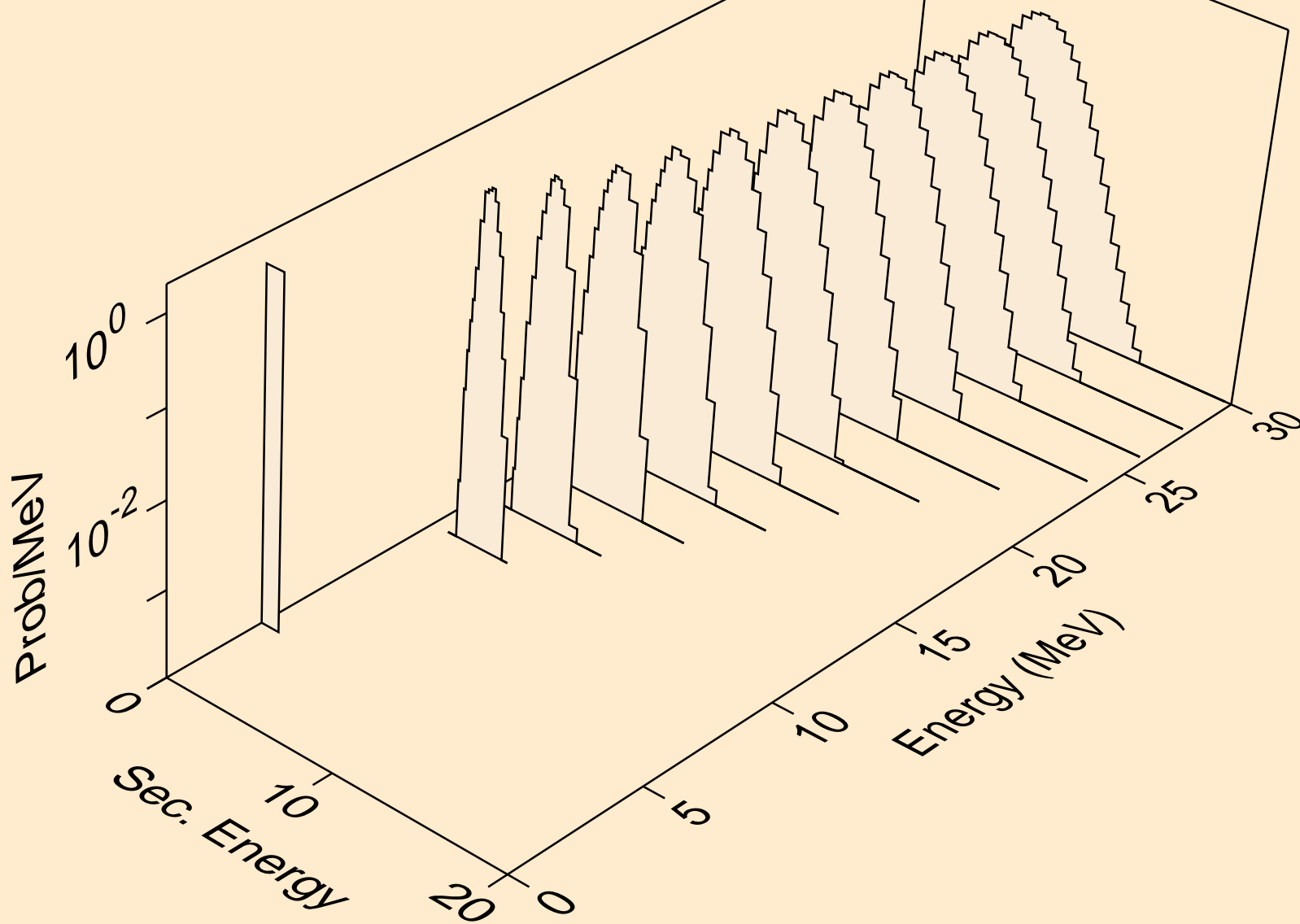

BI198M NEUTRON ACER TENDL-2019 LIBRARY; T=293.16K  
protons from (n,pt)

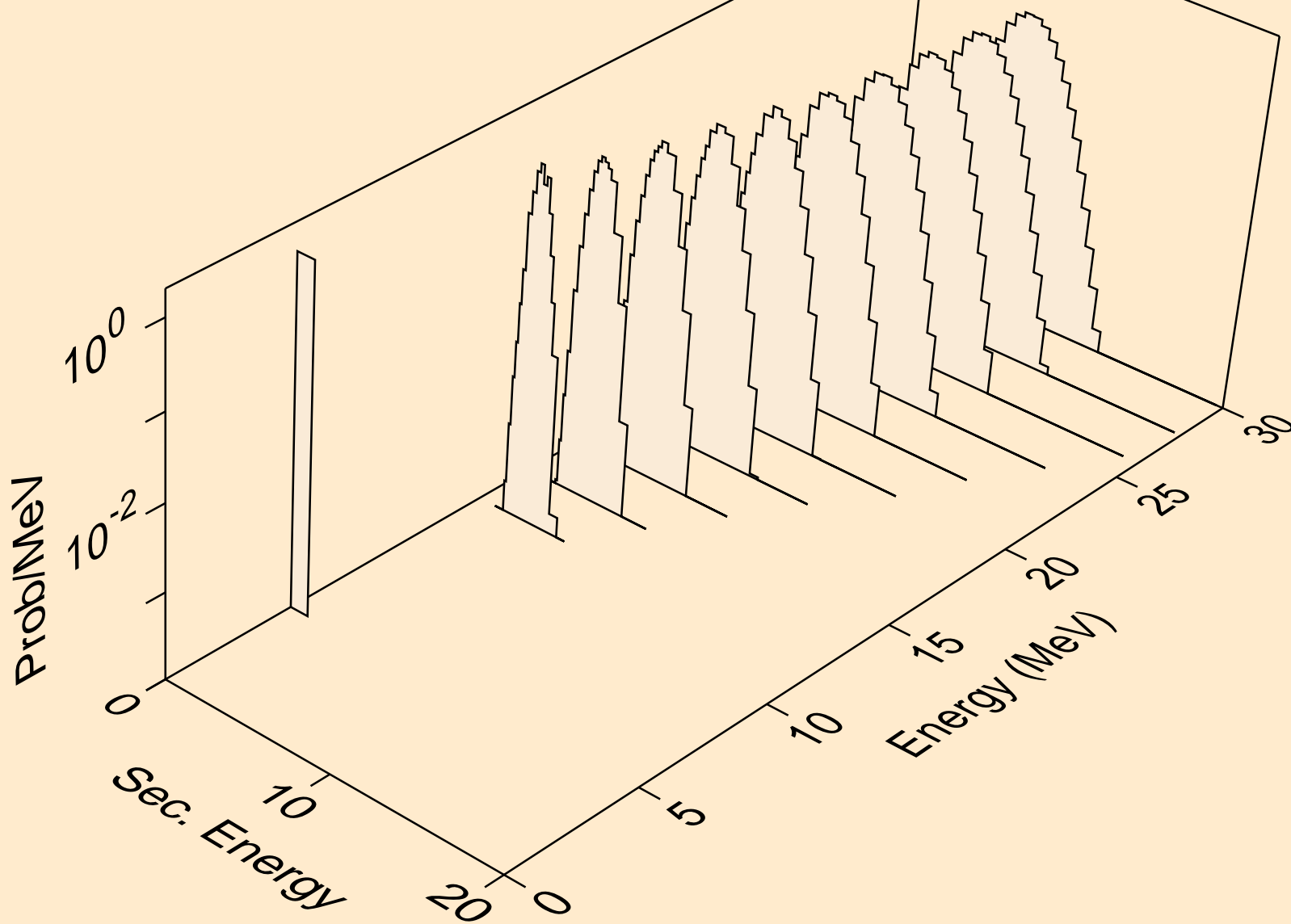

BI198M NEUTRON ACER TENDL-2019 LIBRARY; T=293.16K  
deuterons from (n,x)

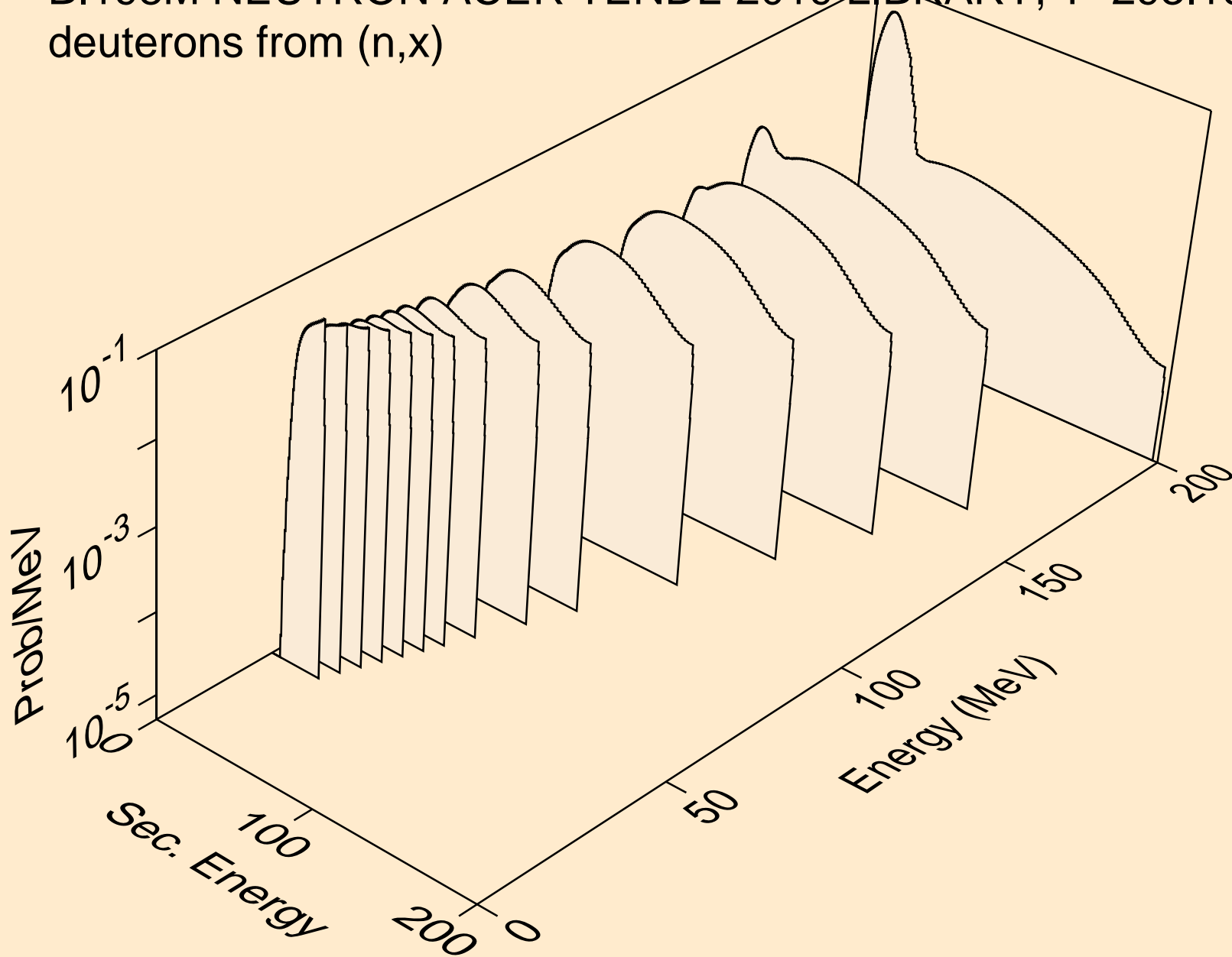

BI198M NEUTRON ACER TENDL-2019 LIBRARY; T=293.16K  
deuterons from (n,2nd)

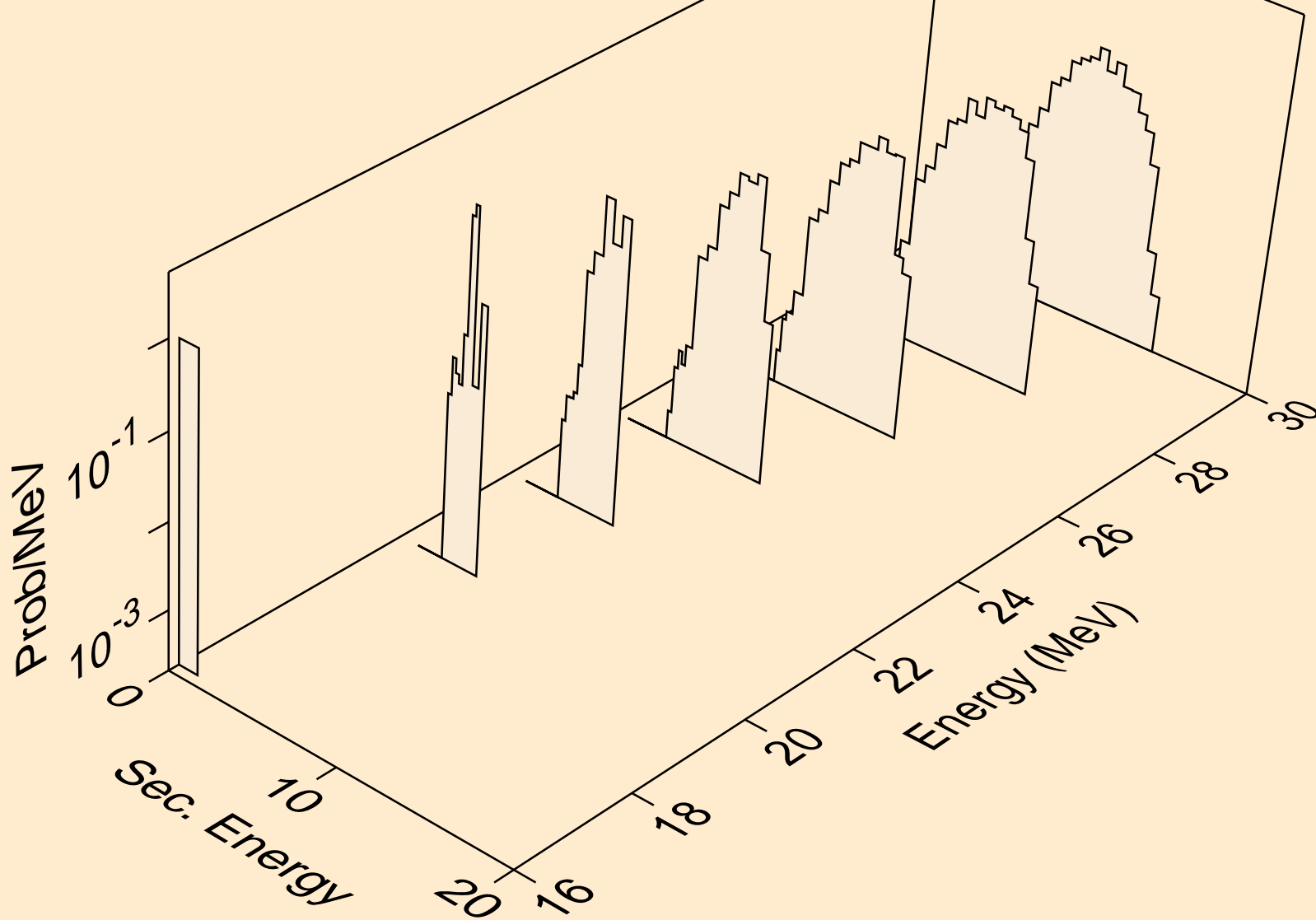

BI198M NEUTRON ACER TENDL-2019 LIBRARY; T=293.16K  
deuterons from (n,n\*)d

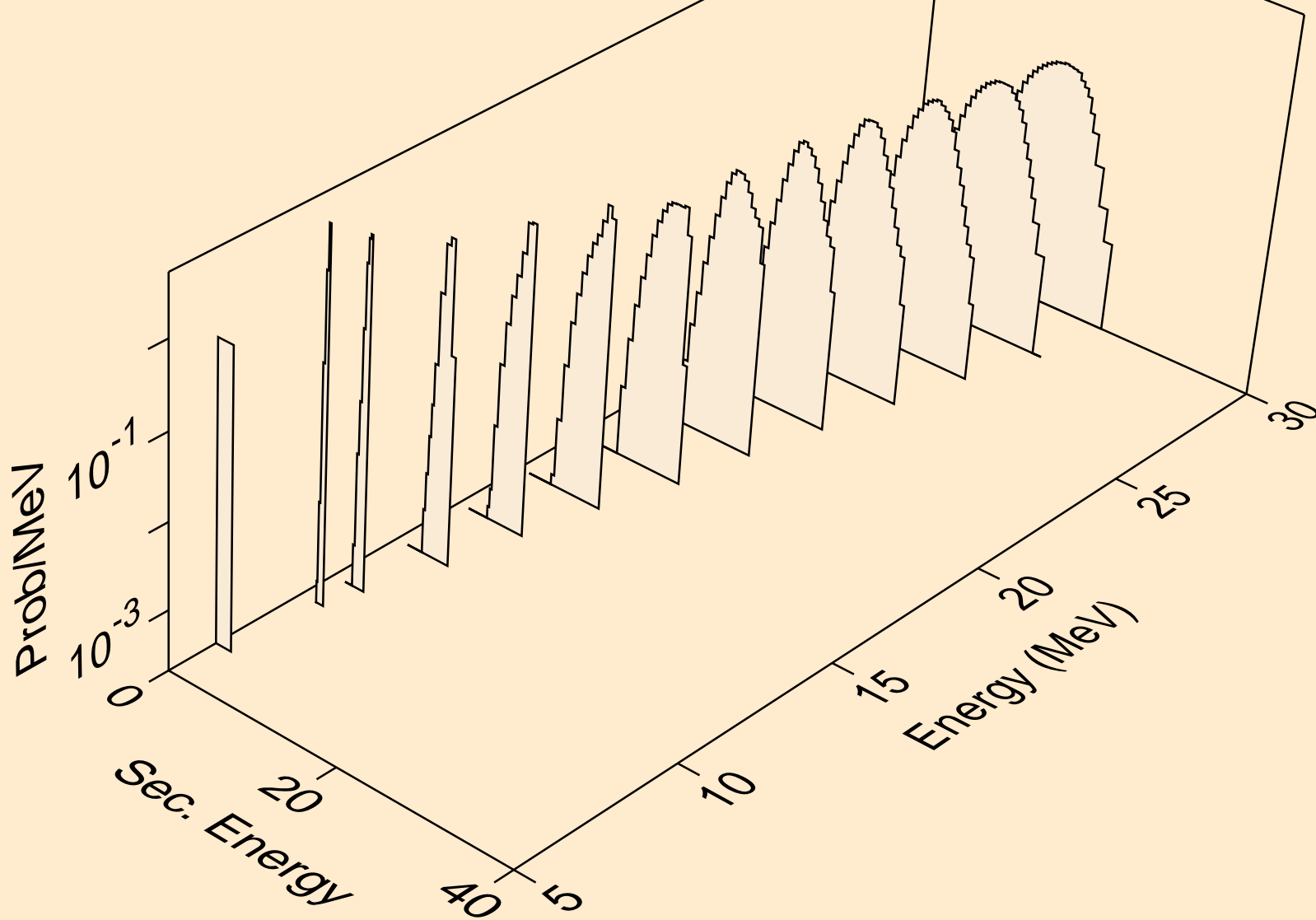

BI198M NEUTRON ACER TENDL-2019 LIBRARY; T=293.16K  
deuterons from (n,d)

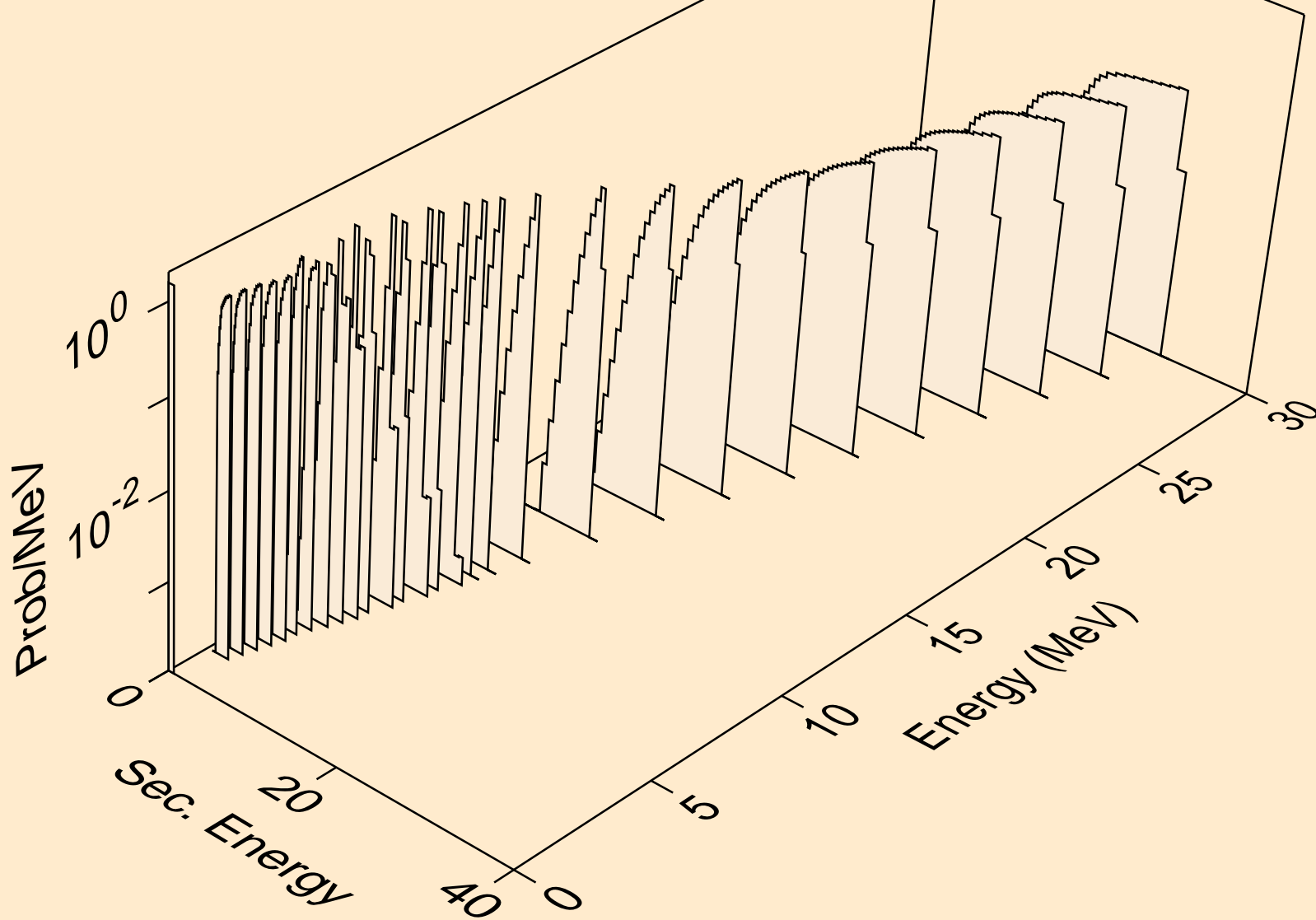

BI198M NEUTRON ACER TENDL-2019 LIBRARY; T=293.16K  
deuterons from (n,pd)

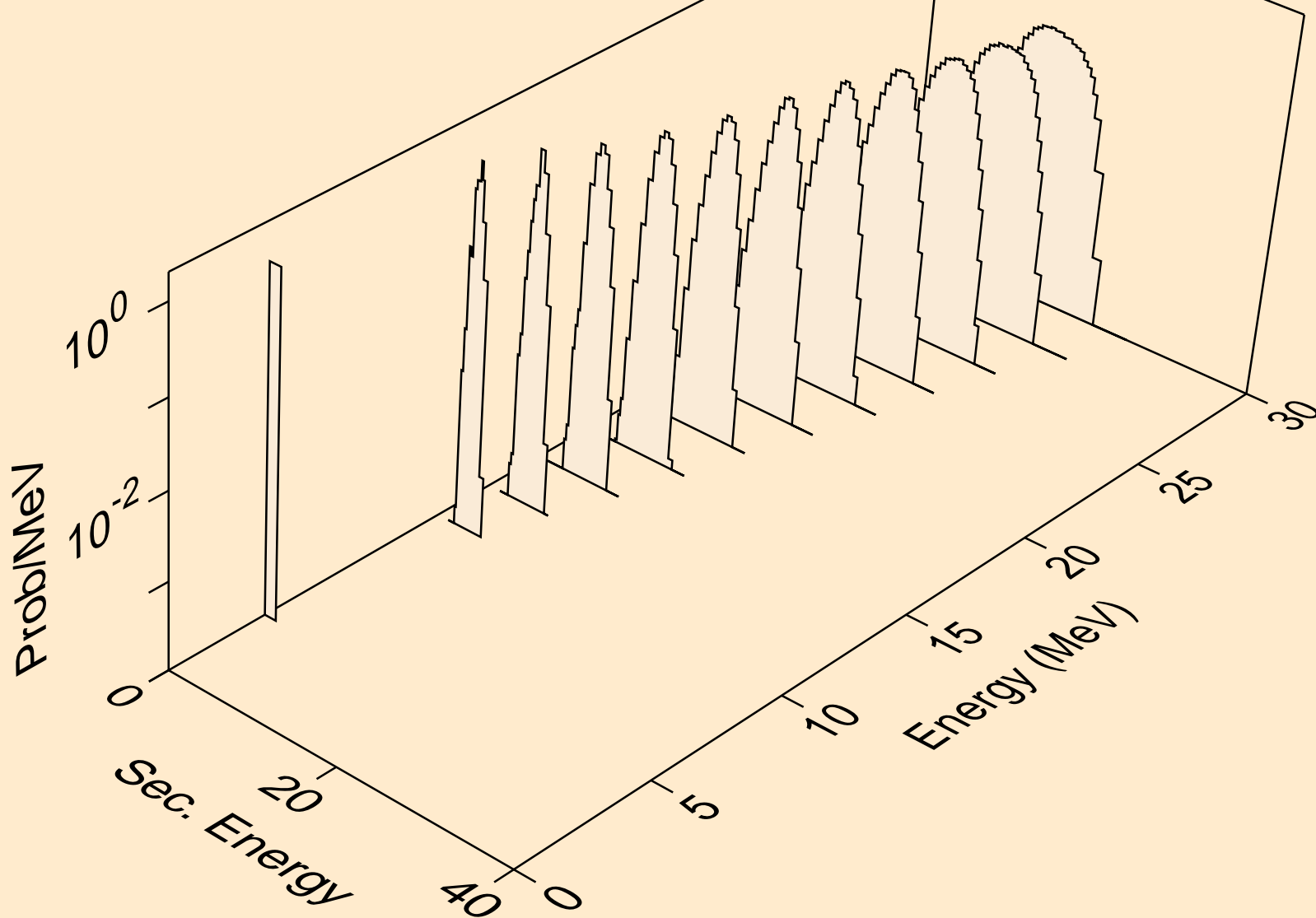

BI198M NEUTRON ACER TENDL-2019 LIBRARY; T=293.16K  
deuterons from (n,da)

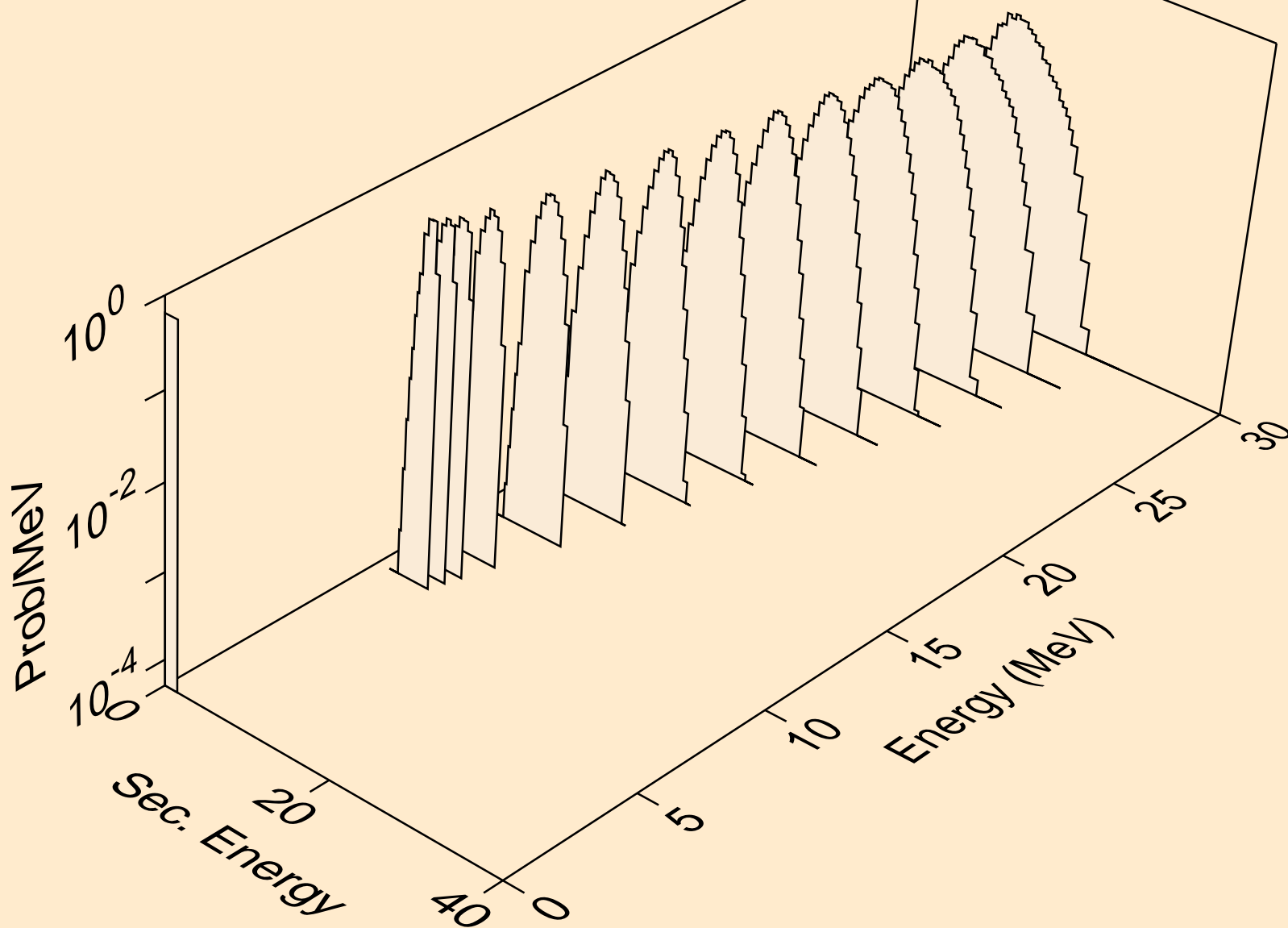

BI198M NEUTRON ACER TENDL-2019 LIBRARY; T=293.16K  
tritons from (n,x)

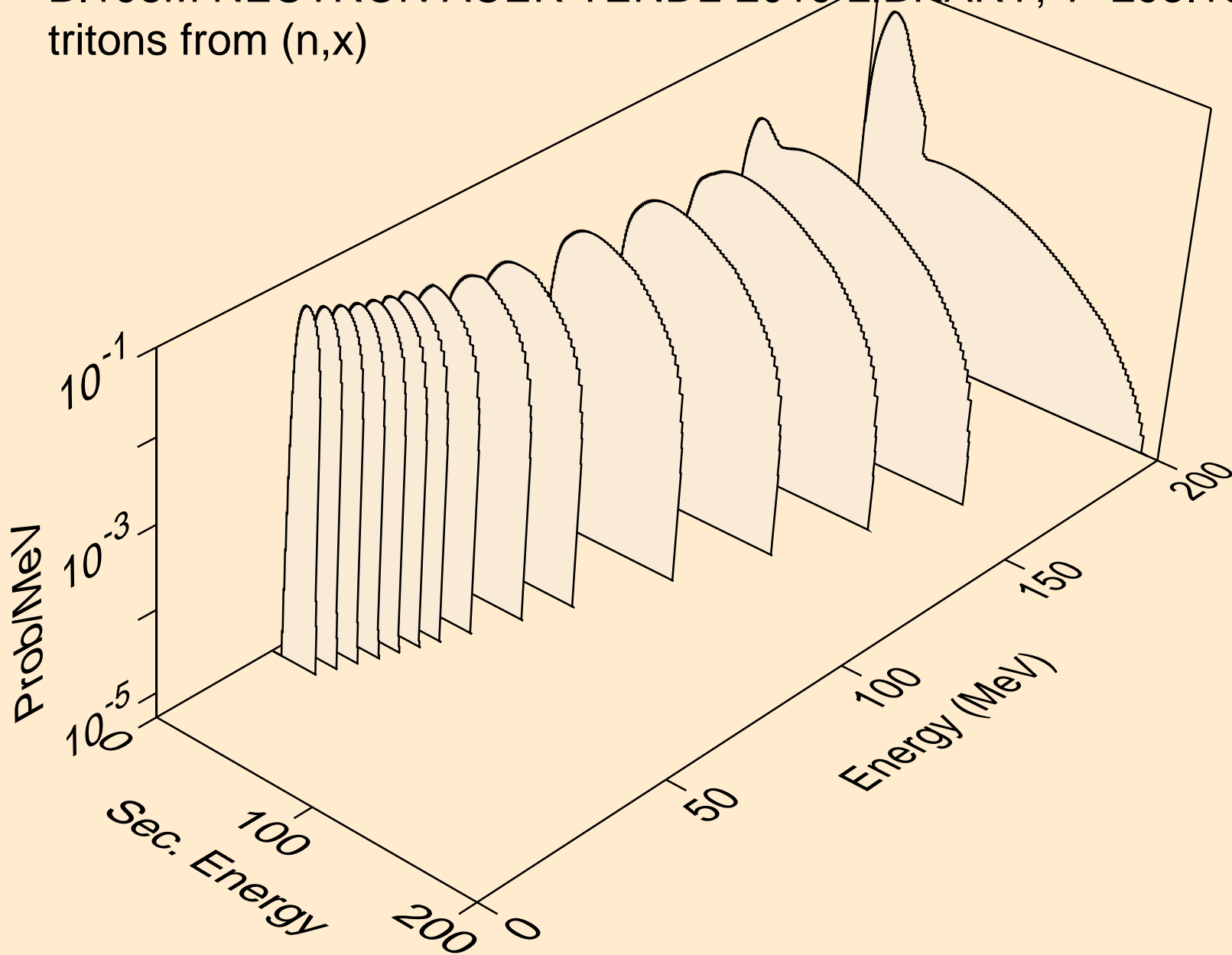

BI198M NEUTRON ACER TENDL-2019 LIBRARY; T=293.16K  
tritons from (n,n\*)t

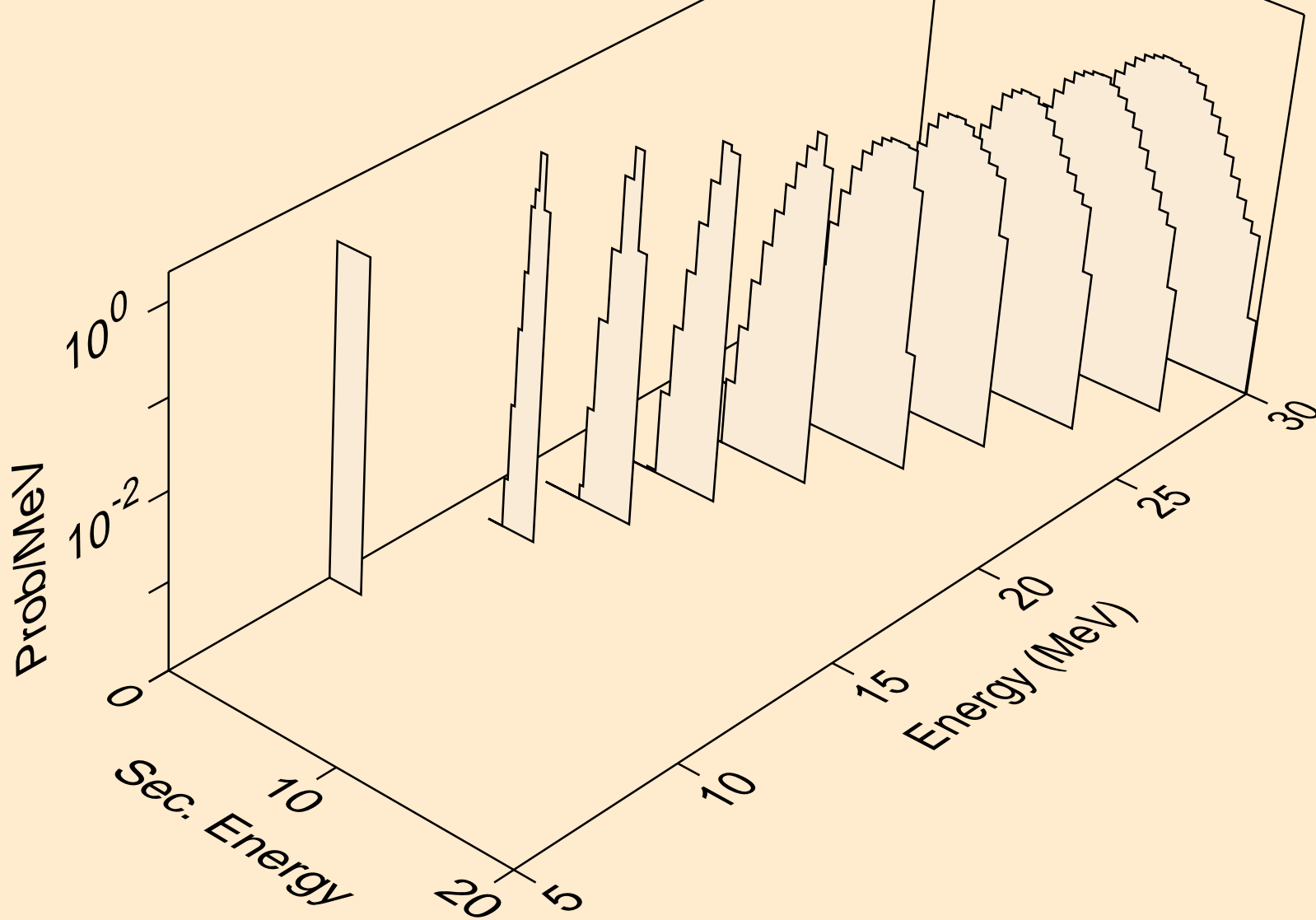

BI198M NEUTRON ACER TENDL-2019 LIBRARY; T=293.16K  
tritons from (n,t)

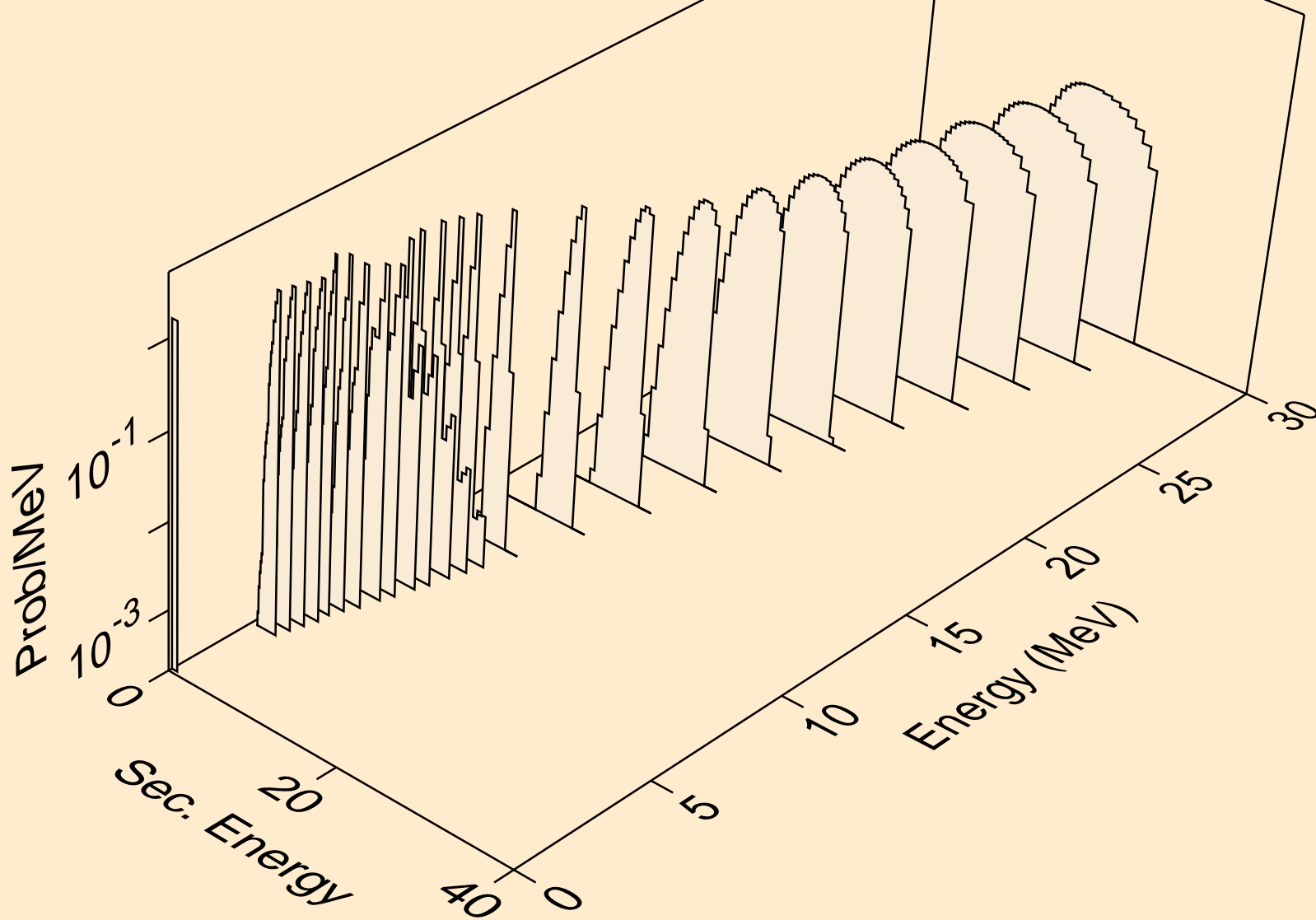

BI198M NEUTRON ACER TENDL-2019 LIBRARY; T=293.16K  
tritons from (n,pt)

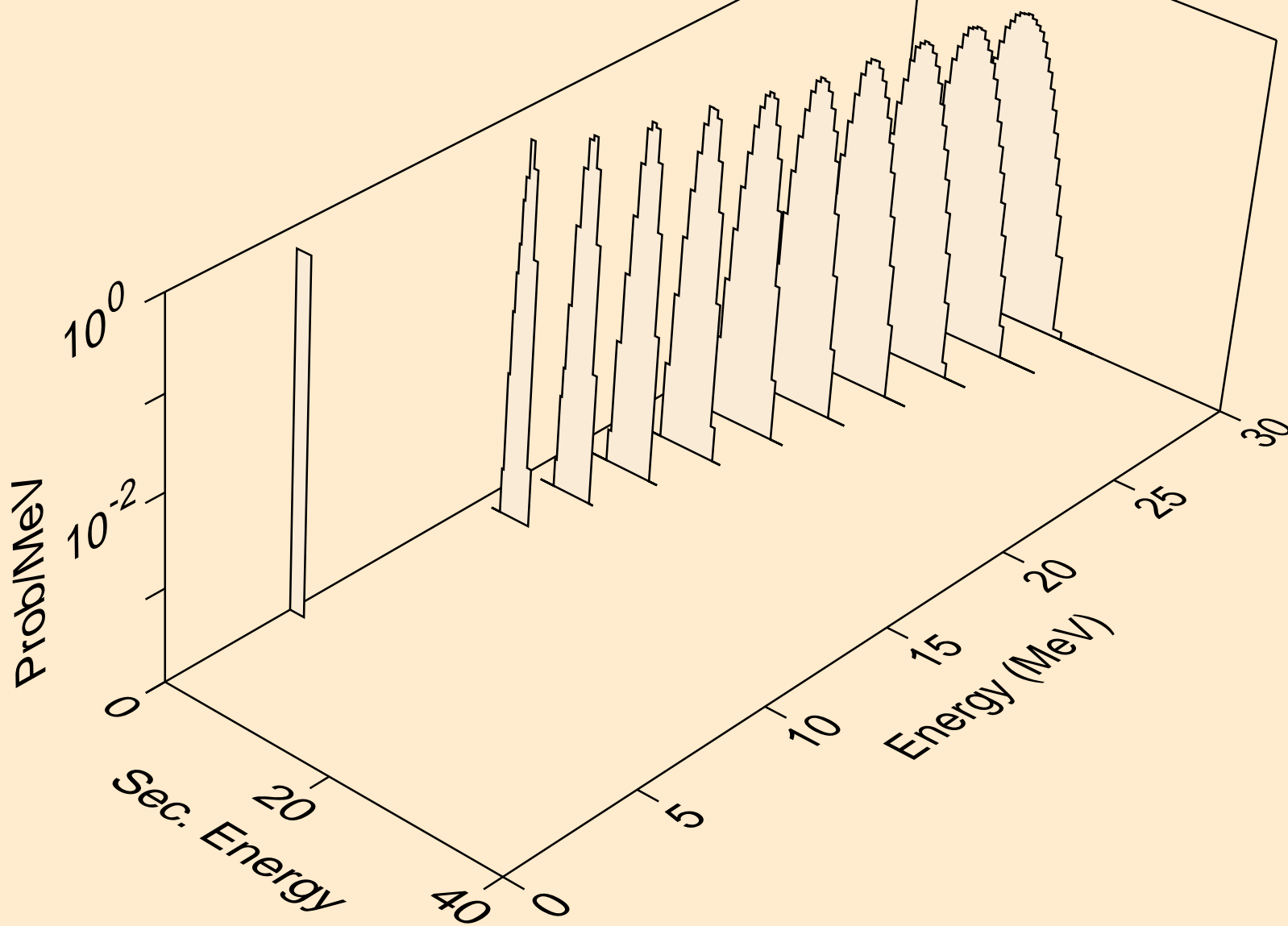

BI198M NEUTRON ACER TENDL-2019 LIBRARY; T=293.16K  
he3s from (n,x)

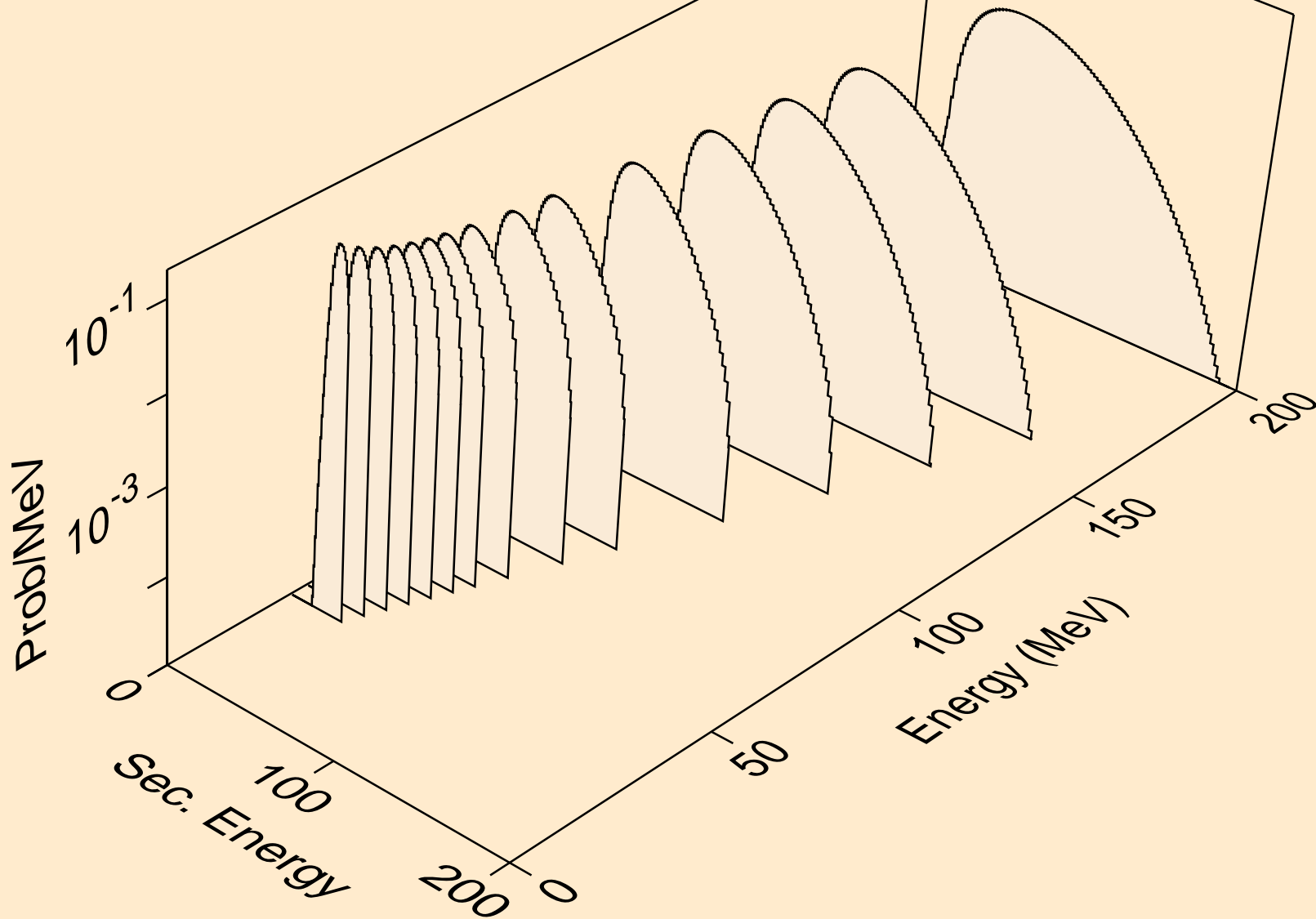

BI198M NEUTRON ACER TENDL-2019 LIBRARY; T=293.16K  
he3s from (n,n\*)he3

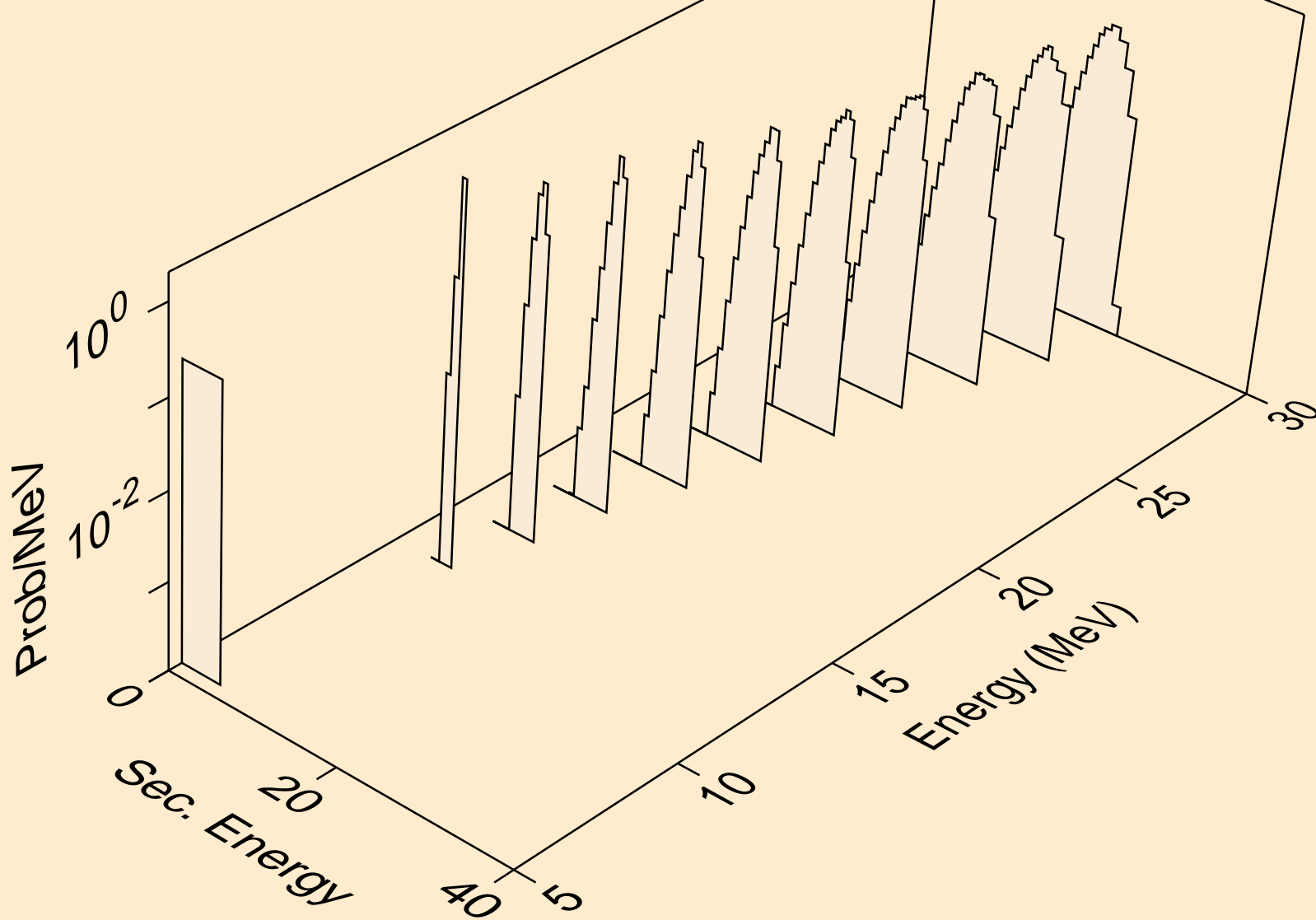

BI198M NEUTRON ACER TENDL-2019 LIBRARY; T=293.16K  
he3s from (n,he3)

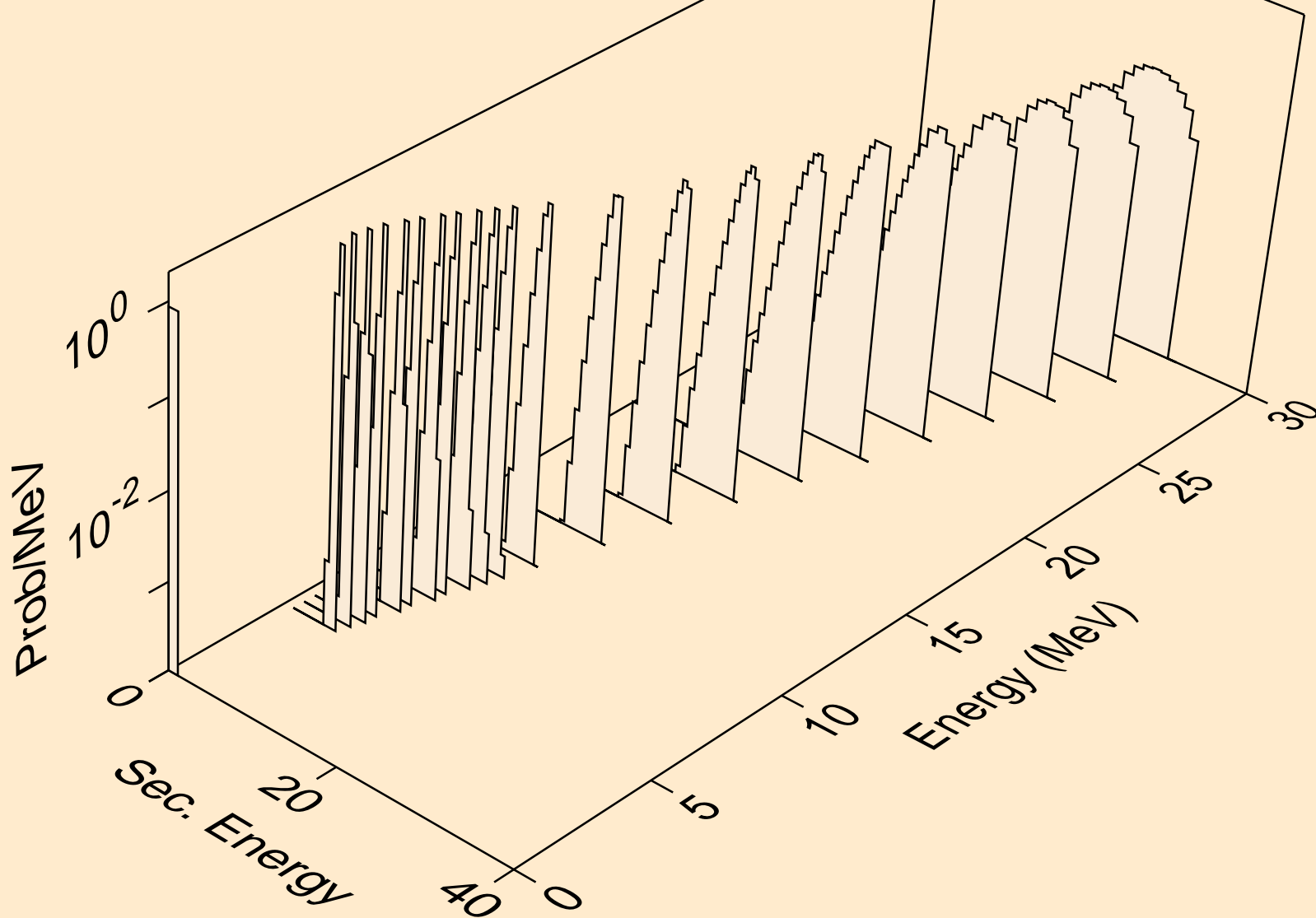

BI198M NEUTRON ACER TENDL-2019 LIBRARY; T=293.16K  
alphas from (n,x)

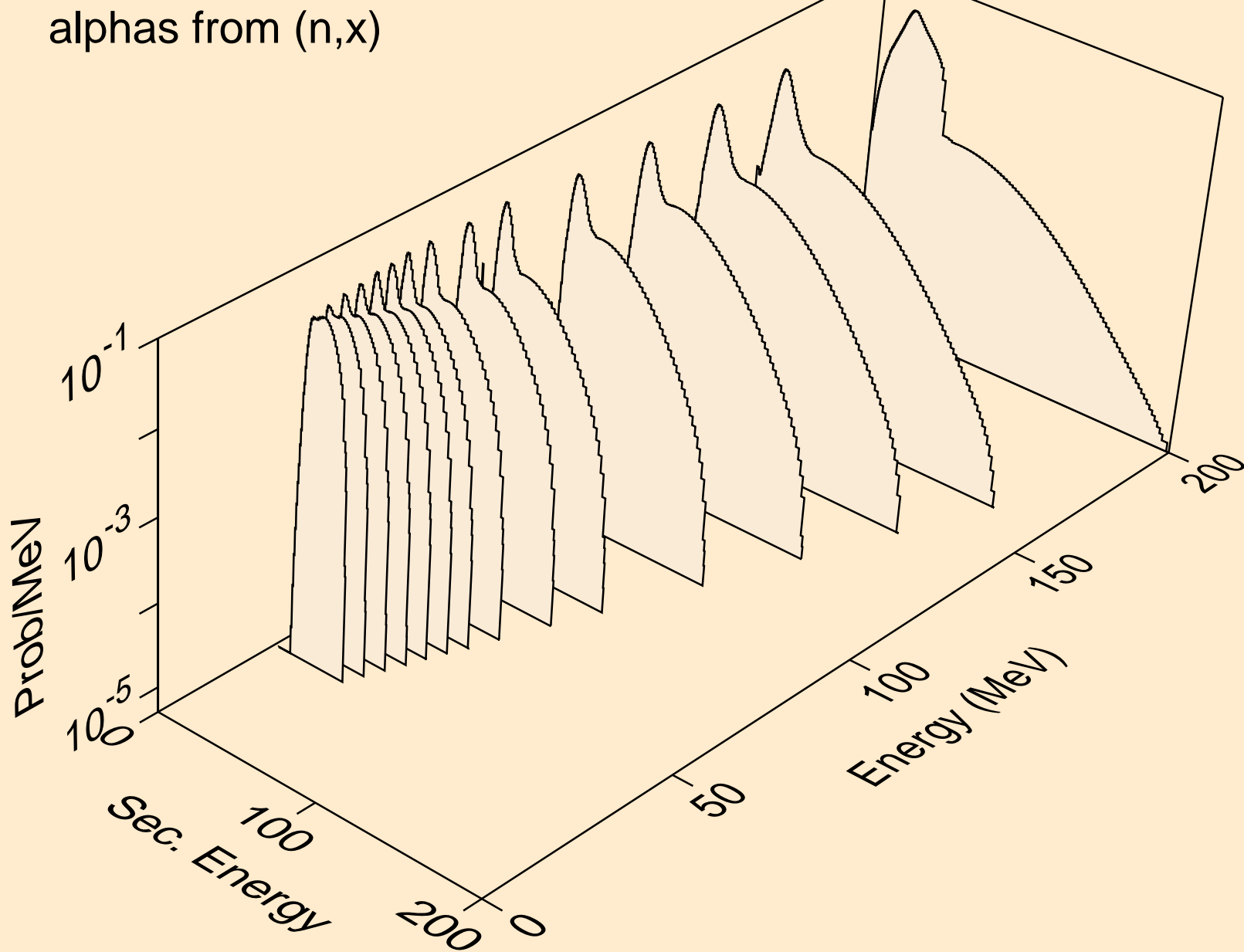

BI198M NEUTRON ACER TENDL-2019 LIBRARY; T=293.16K  
alphas from (n,n\*)a

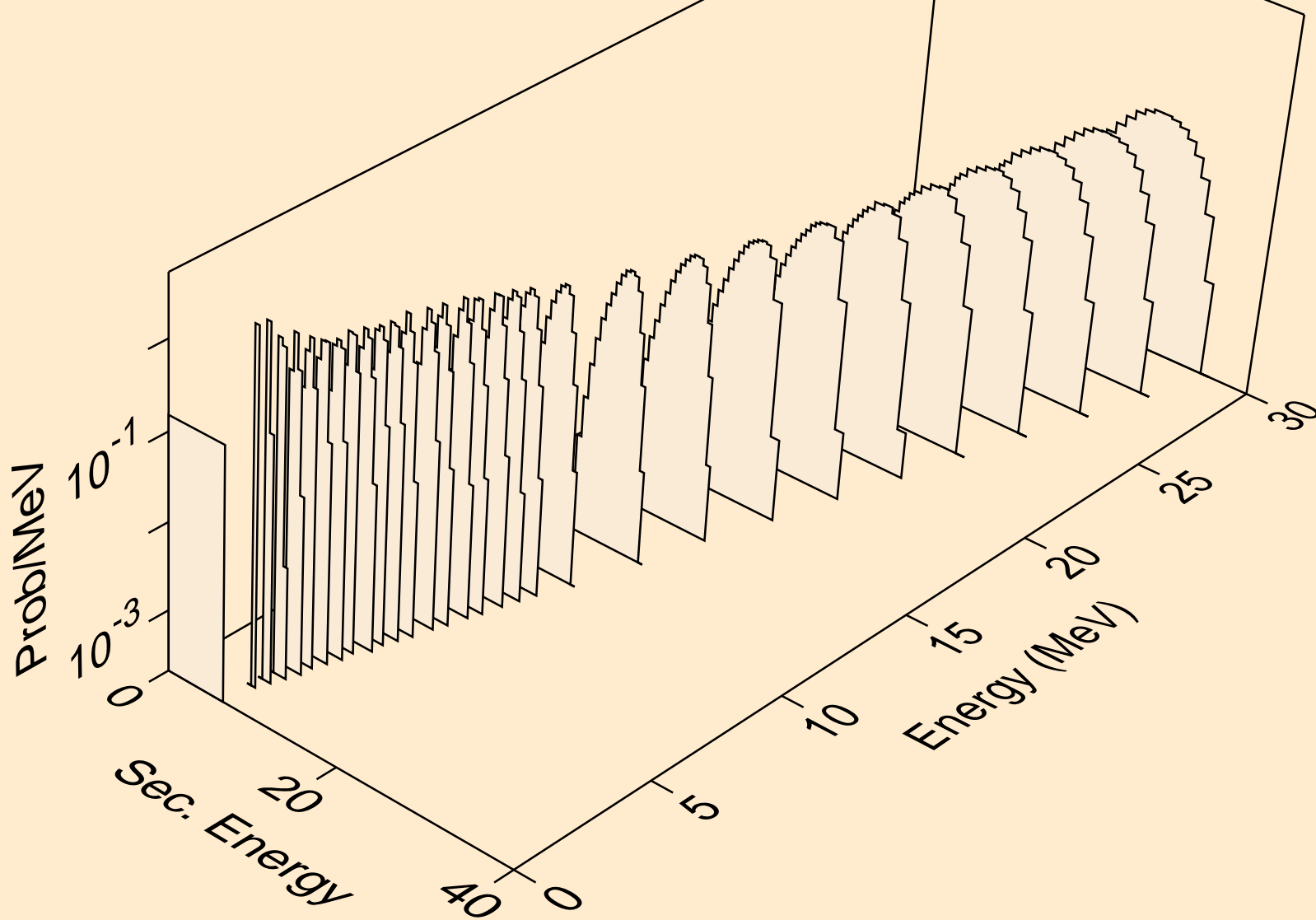

BI198M NEUTRON ACER TENDL-2019 LIBRARY; T=293.16K  
alphas from (n,2n)a

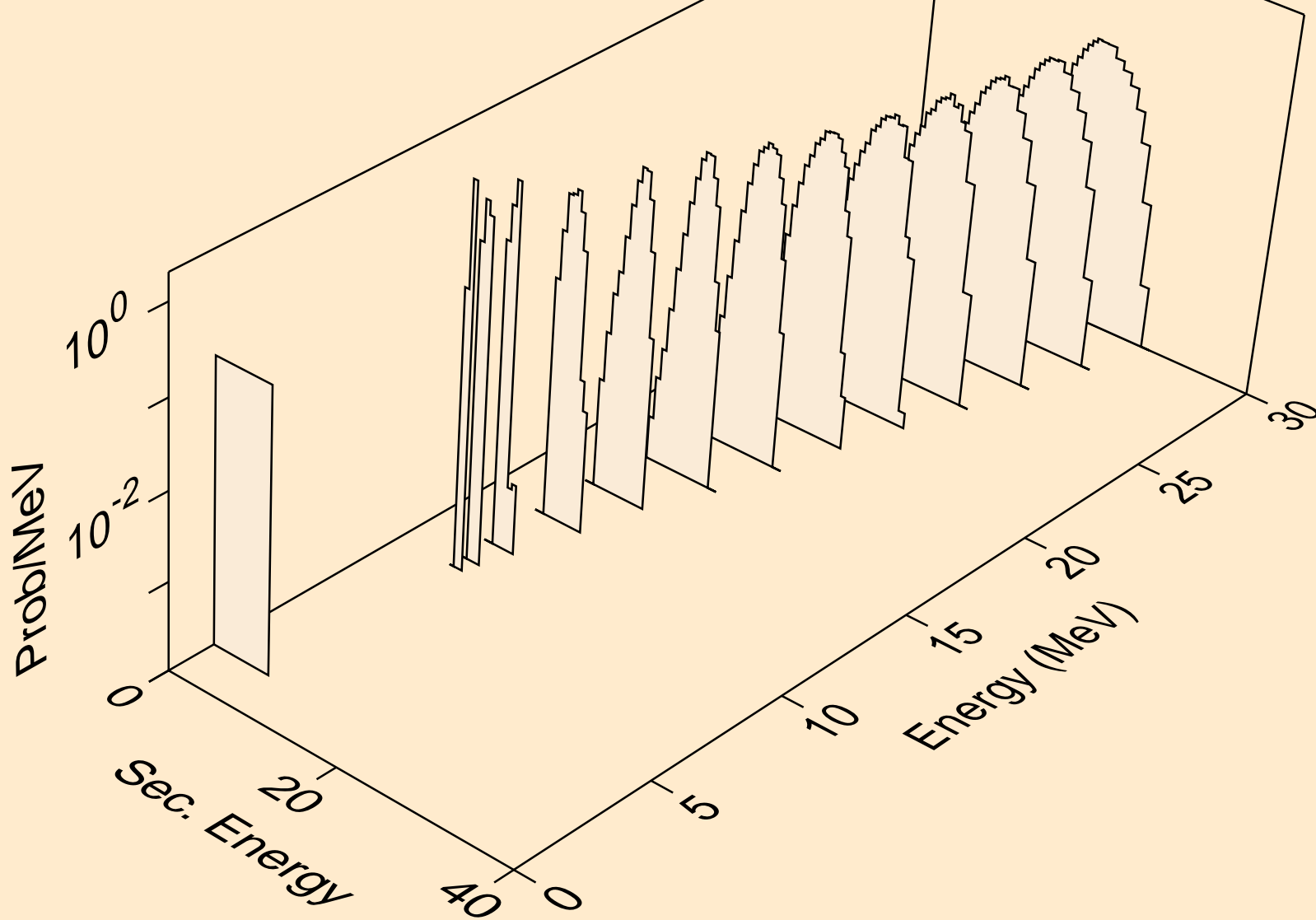

BI198M NEUTRON ACER TENDL-2019 LIBRARY; T=293.16K  
alphas from (n,3n)a

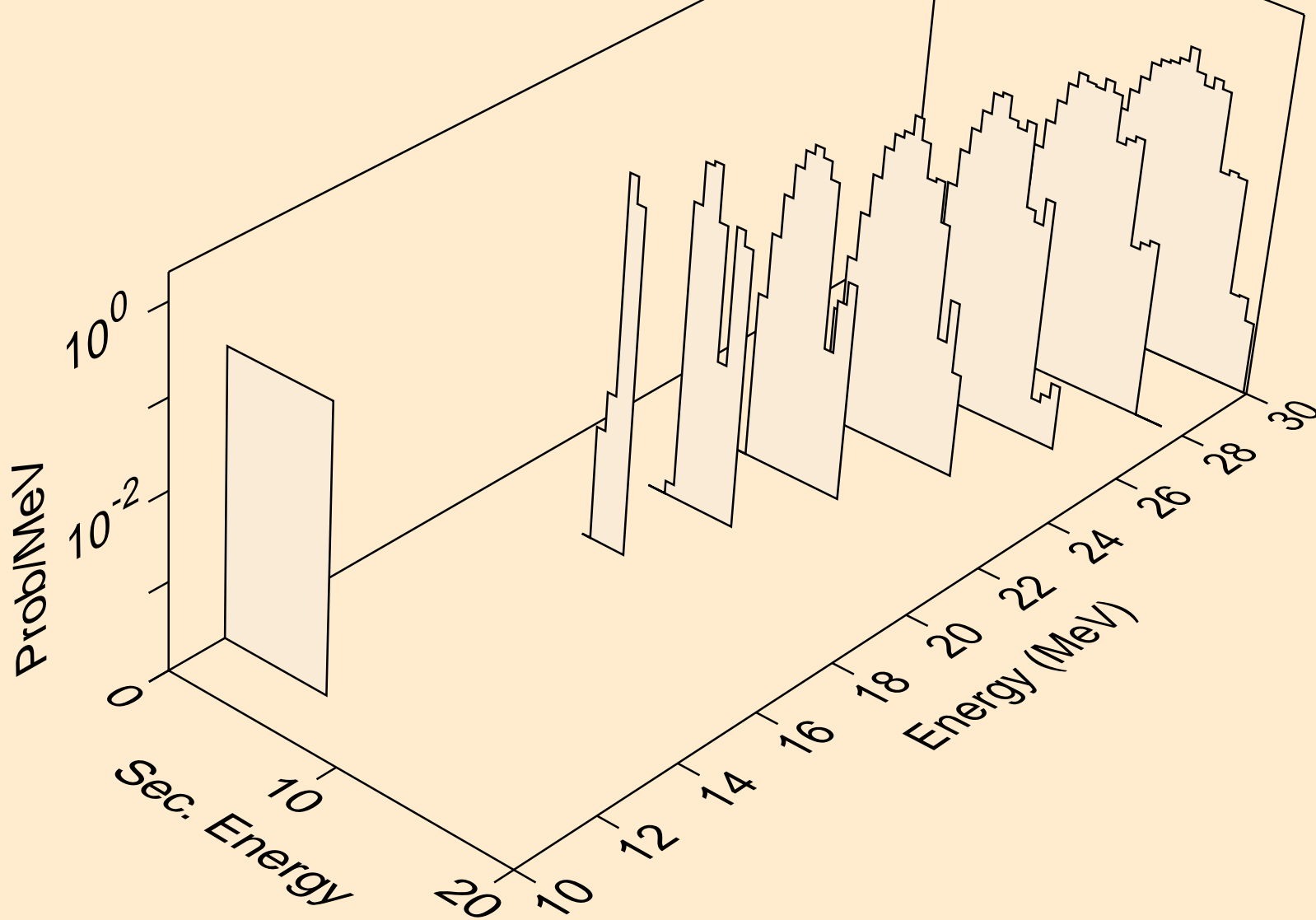

BI198M NEUTRON ACER TENDL-2019 LIBRARY; T=293.16K  
alphas from (n,n\*)2a

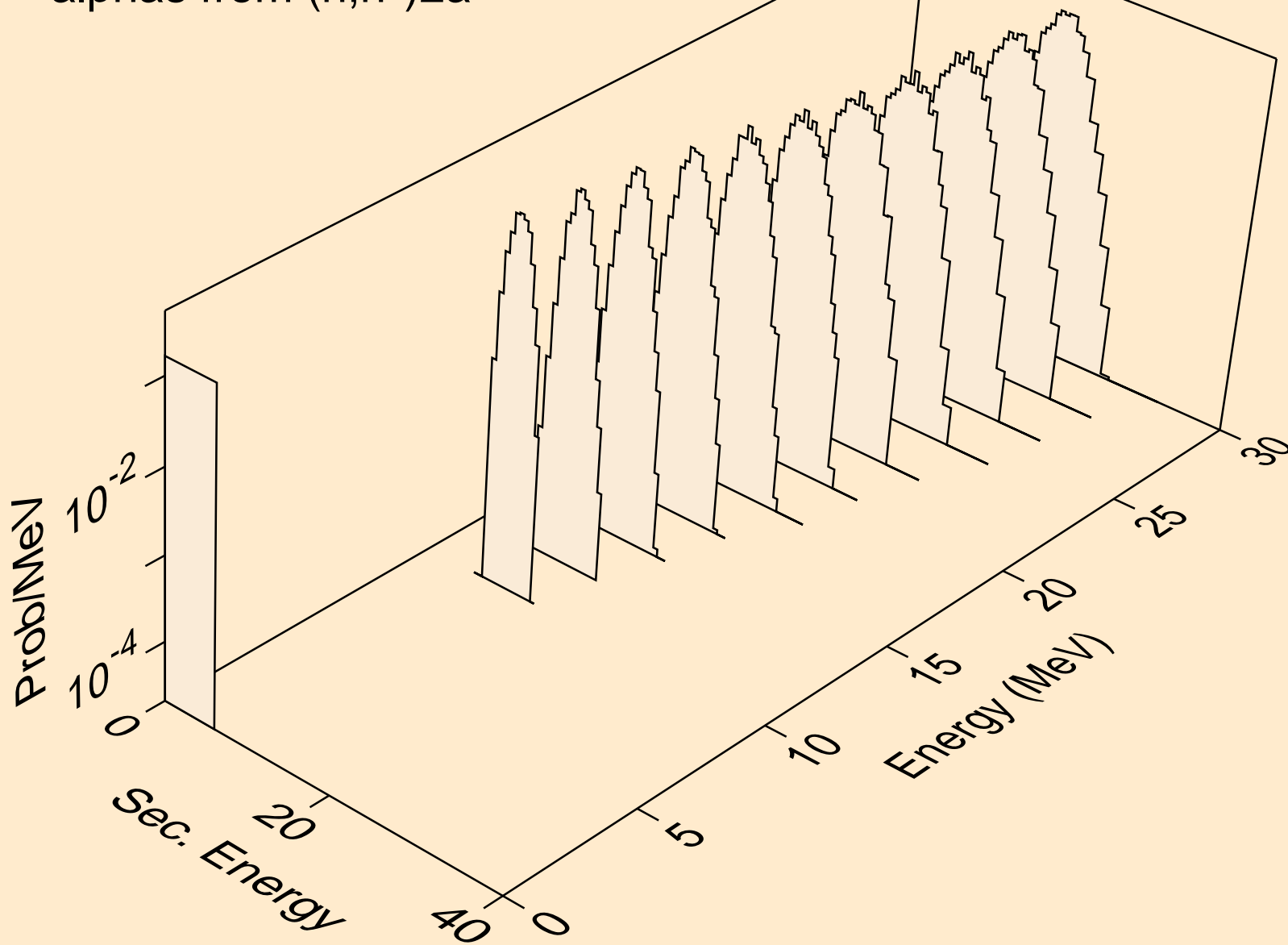

BI198M NEUTRON ACER TENDL-2019 LIBRARY; T=293.16K  
alphas from (n,2n)2a

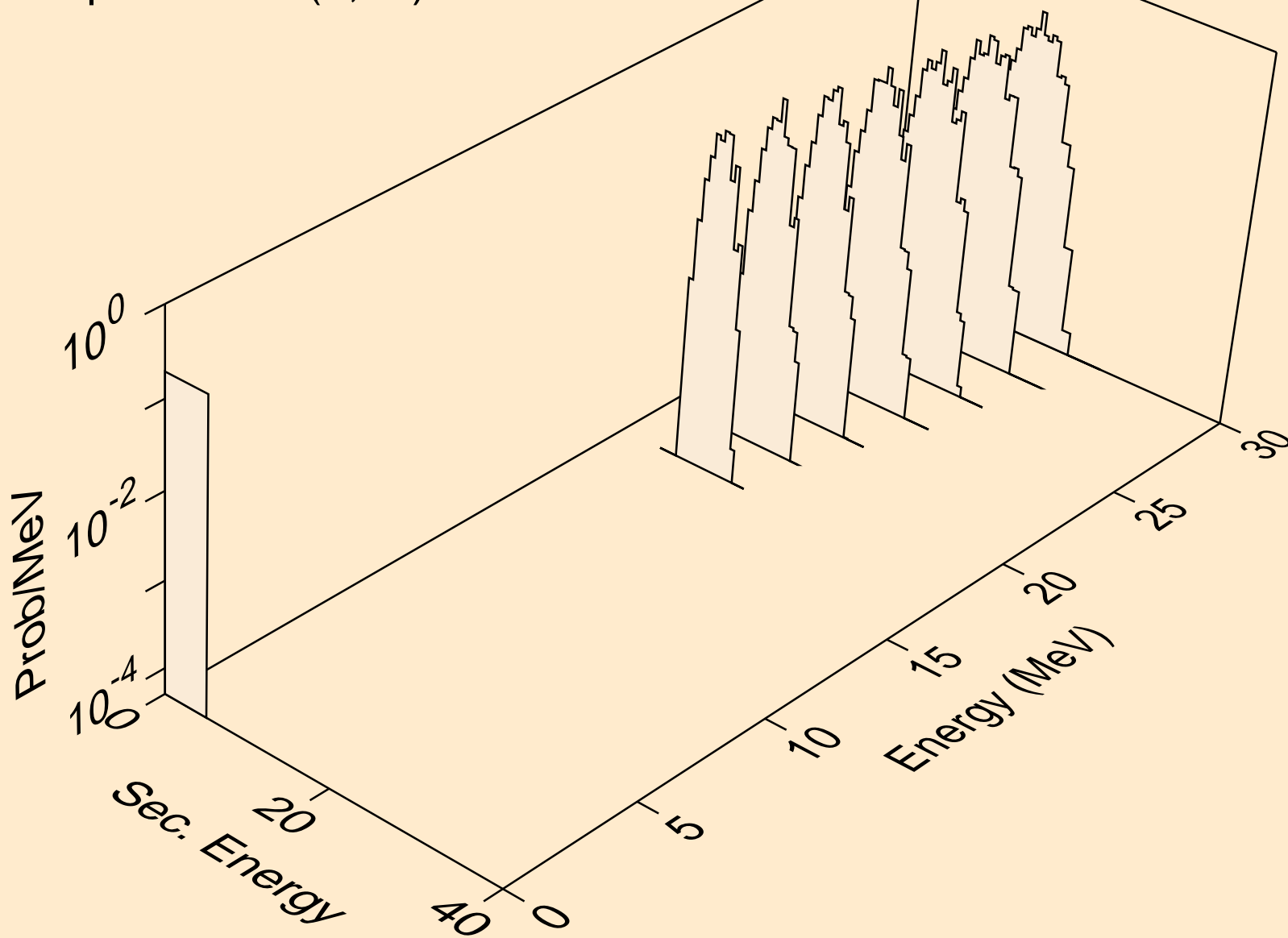

BI198M NEUTRON ACER TENDL-2019 LIBRARY; T=293.16K  
alphas from (n,npa)

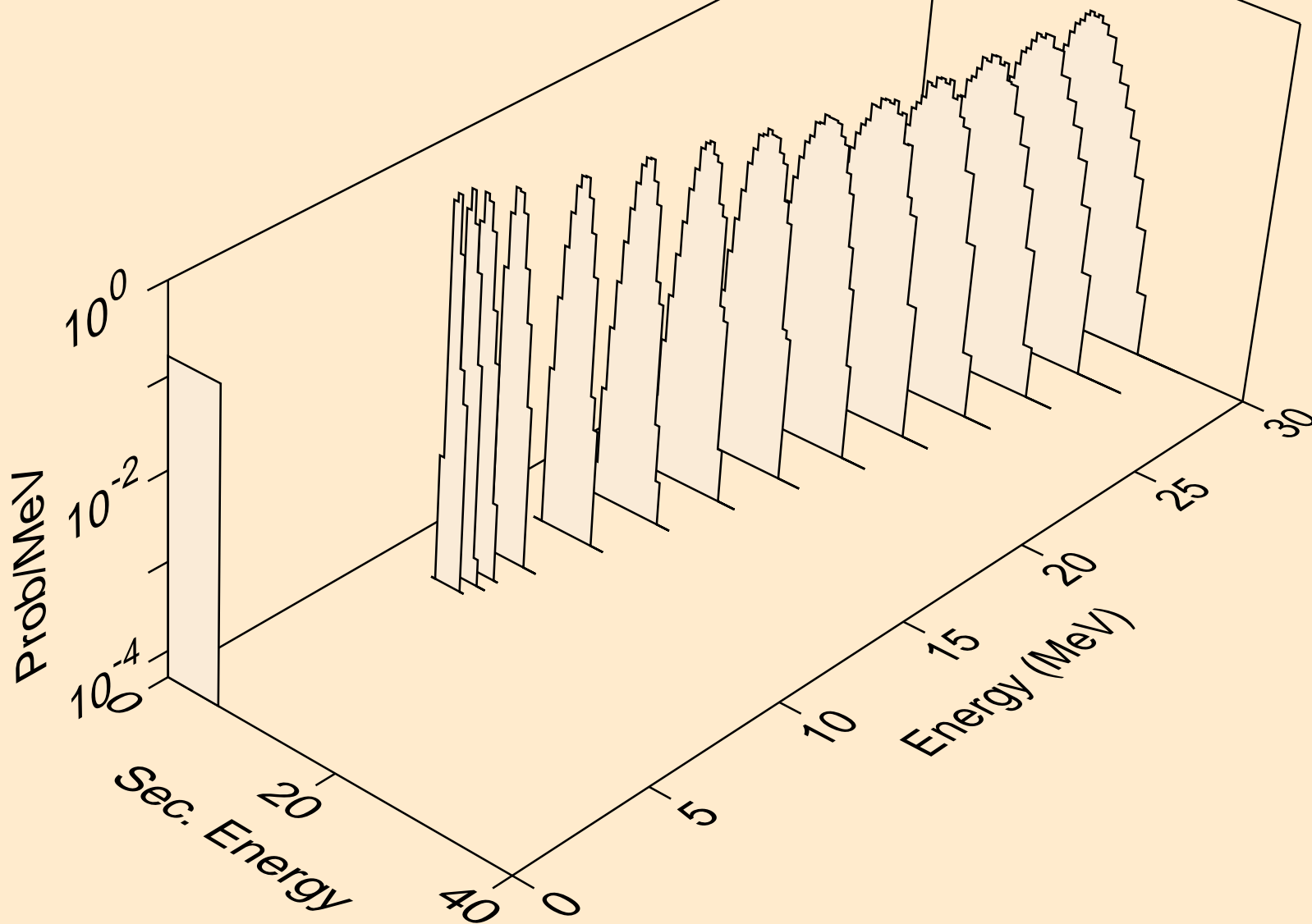

BI198M NEUTRON ACER TENDL-2019 LIBRARY; T=293.16K  
alphas from (n,a)

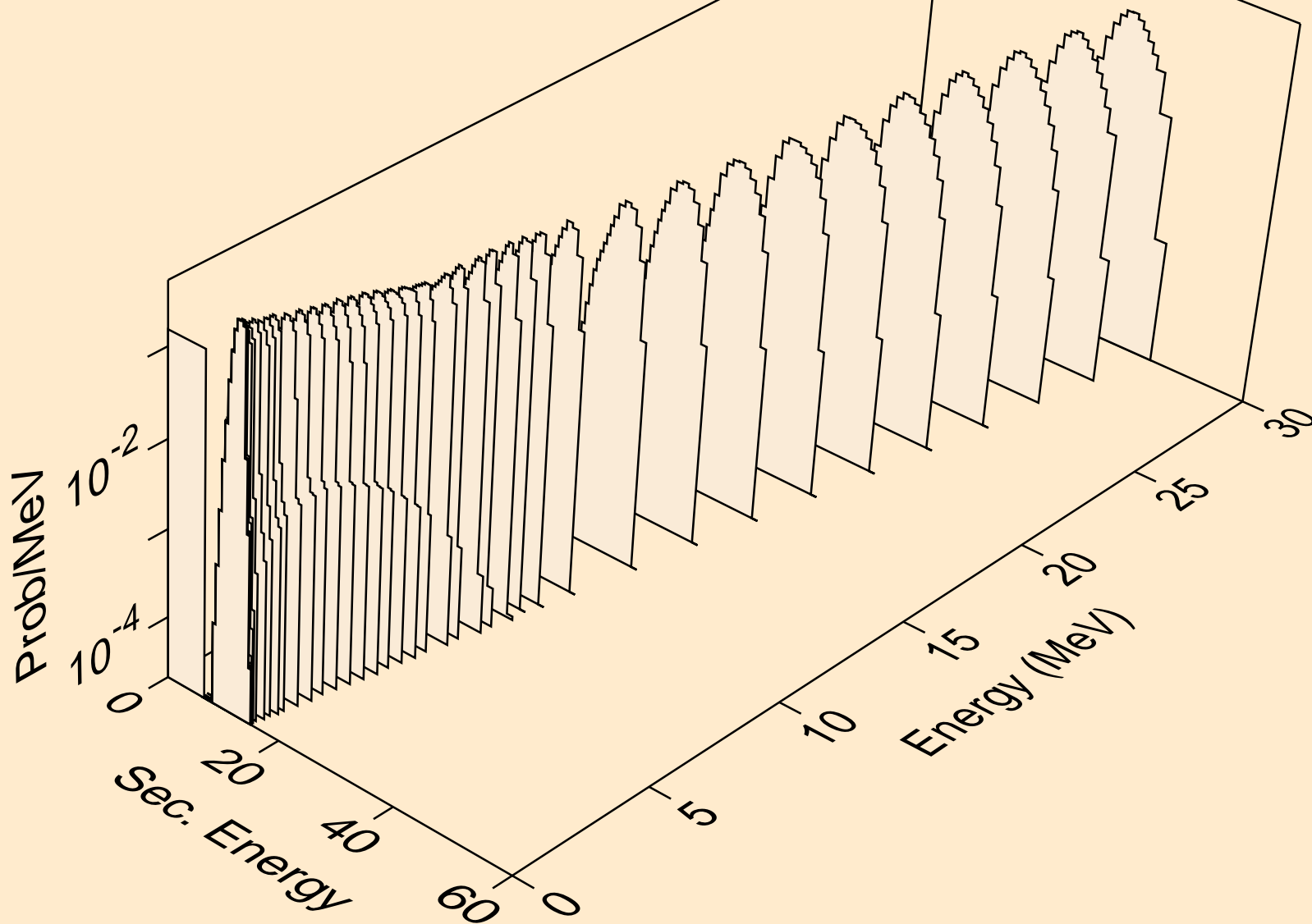

BI198M NEUTRON ACER TENDL-2019 LIBRARY; T=293.16K  
alphas from (n,2a)

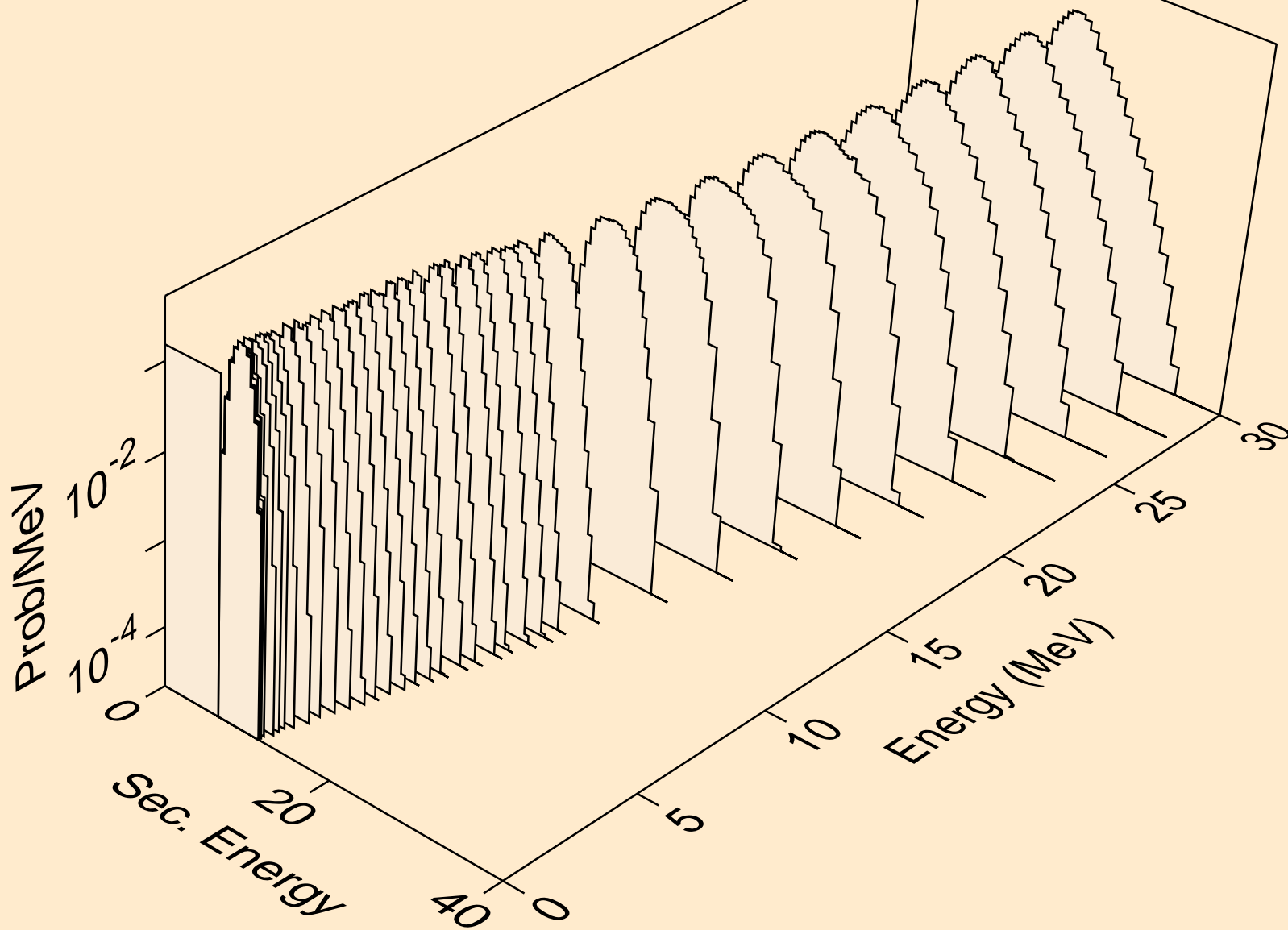

BI198M NEUTRON ACER TENDL-2019 LIBRARY; T=293.16K  
alphas from (n,pa)

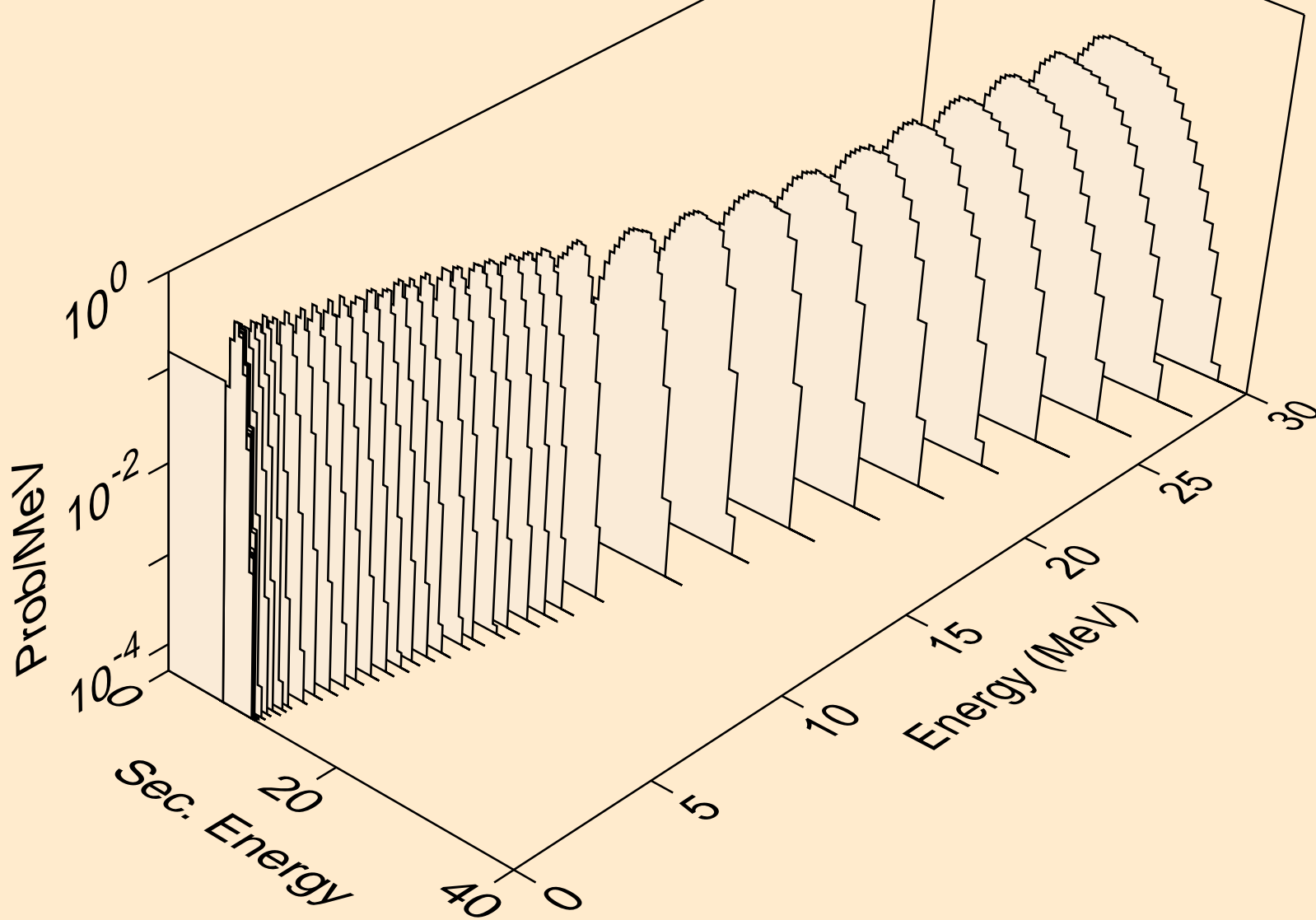

BI198M NEUTRON ACER TENDL-2019 LIBRARY; T=293.16K  
alphas from (n,da)

