

BR080 NEUTRON ACER TENDL-2019 LIBRARY; T=293.16K
Principal cross sections

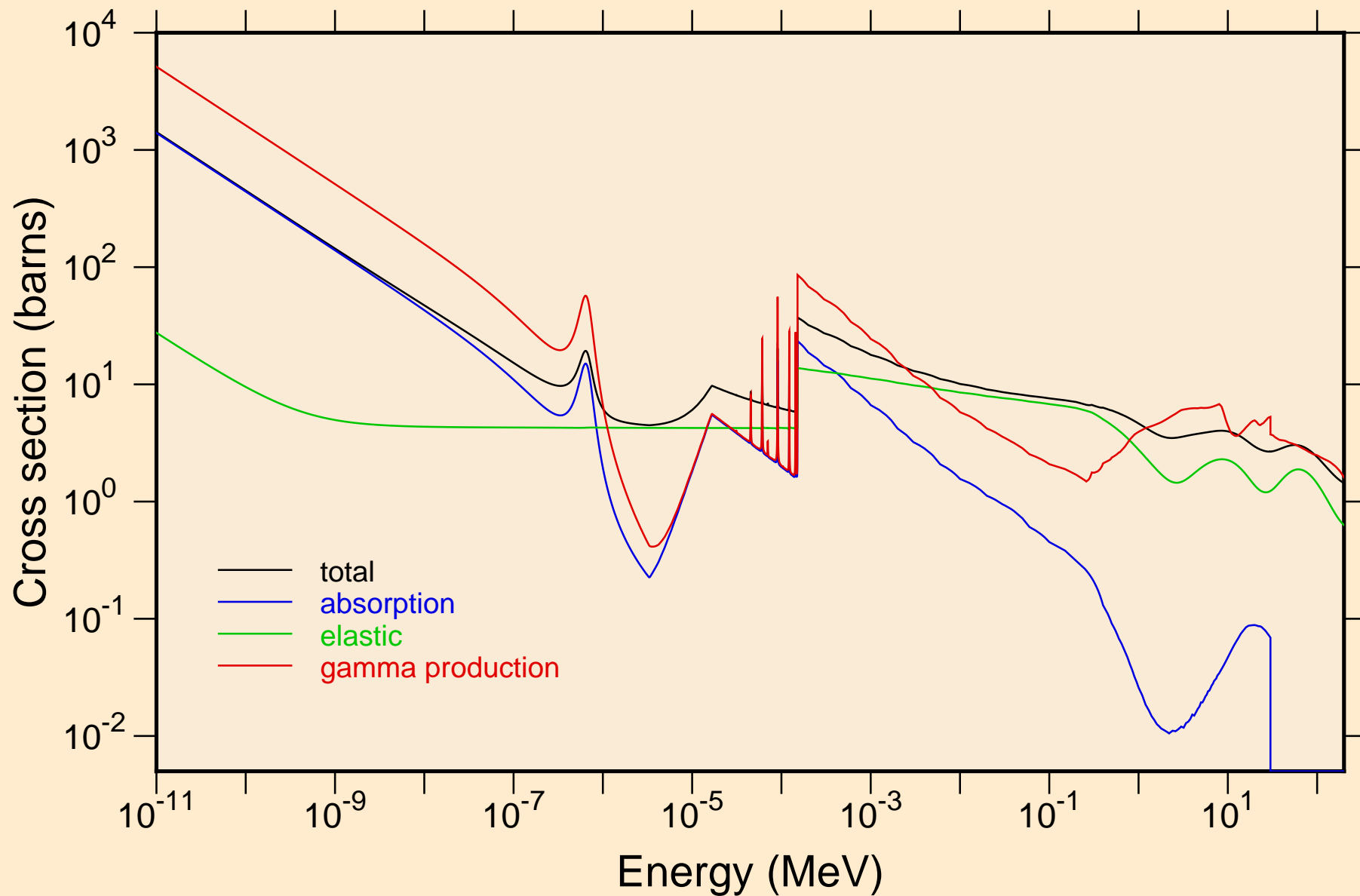

BR080 NEUTRON ACER TENDL-2019 LIBRARY; T=293.16K
resonance total cross section

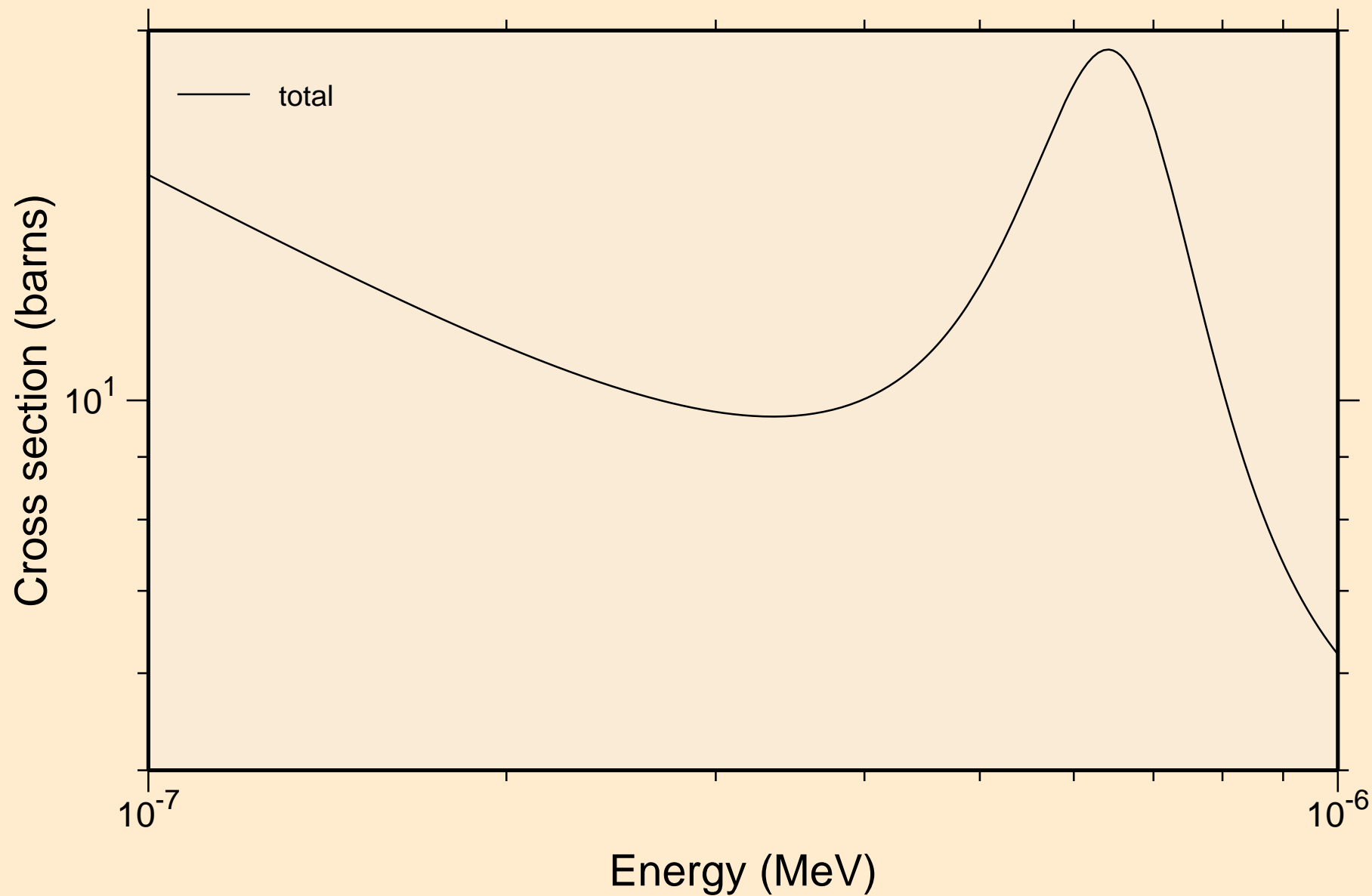

BR080 NEUTRON ACER TENDL-2019 LIBRARY; T=293.16K
resonance total cross section

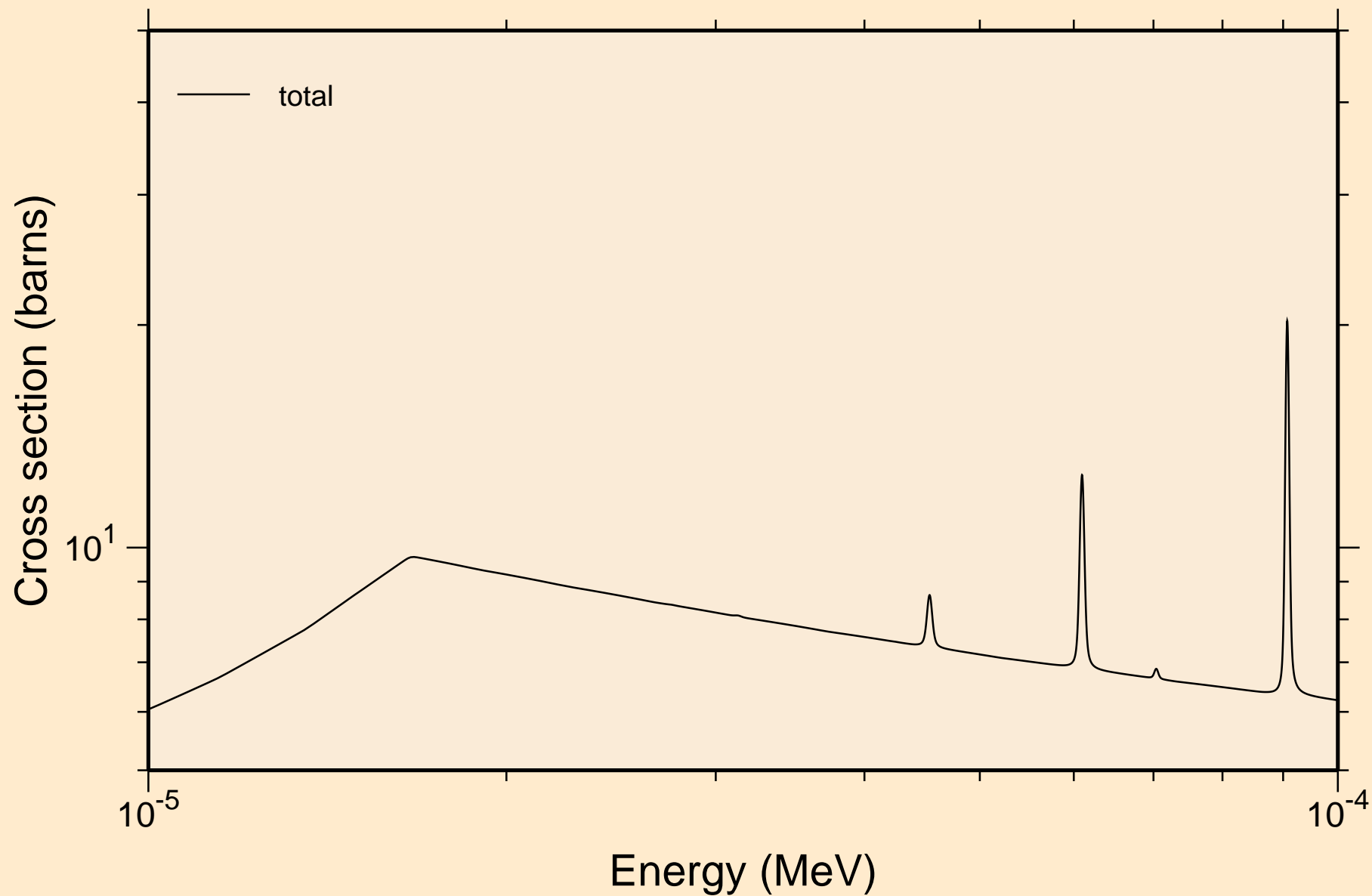

BR080 NEUTRON ACER TENDL-2019 LIBRARY; T=293.16K
resonance total cross section

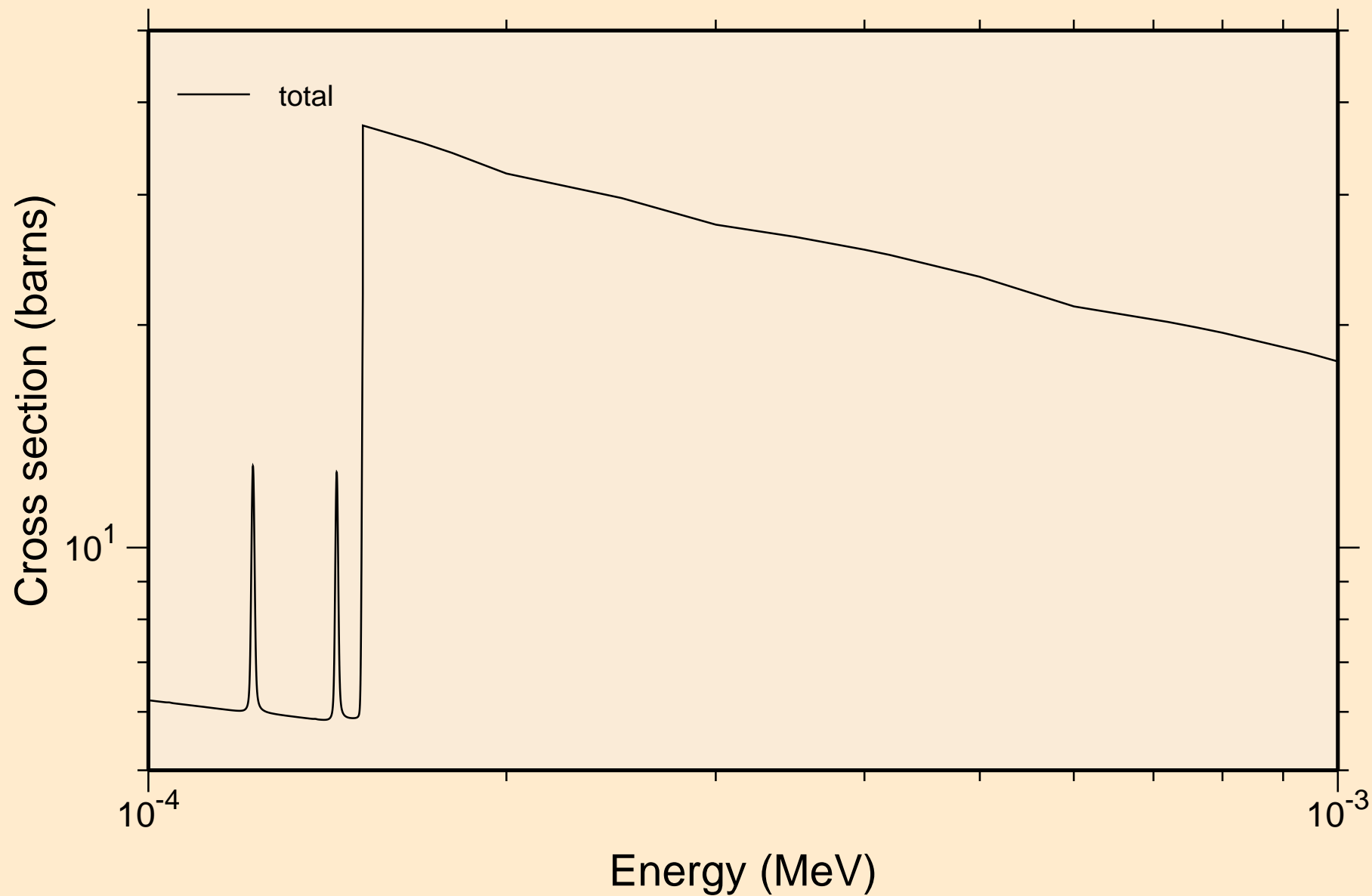

B̄R080 NEUTRON ACER TENDL-2019 LIBRARY; T=293.16K
resonance total cross section

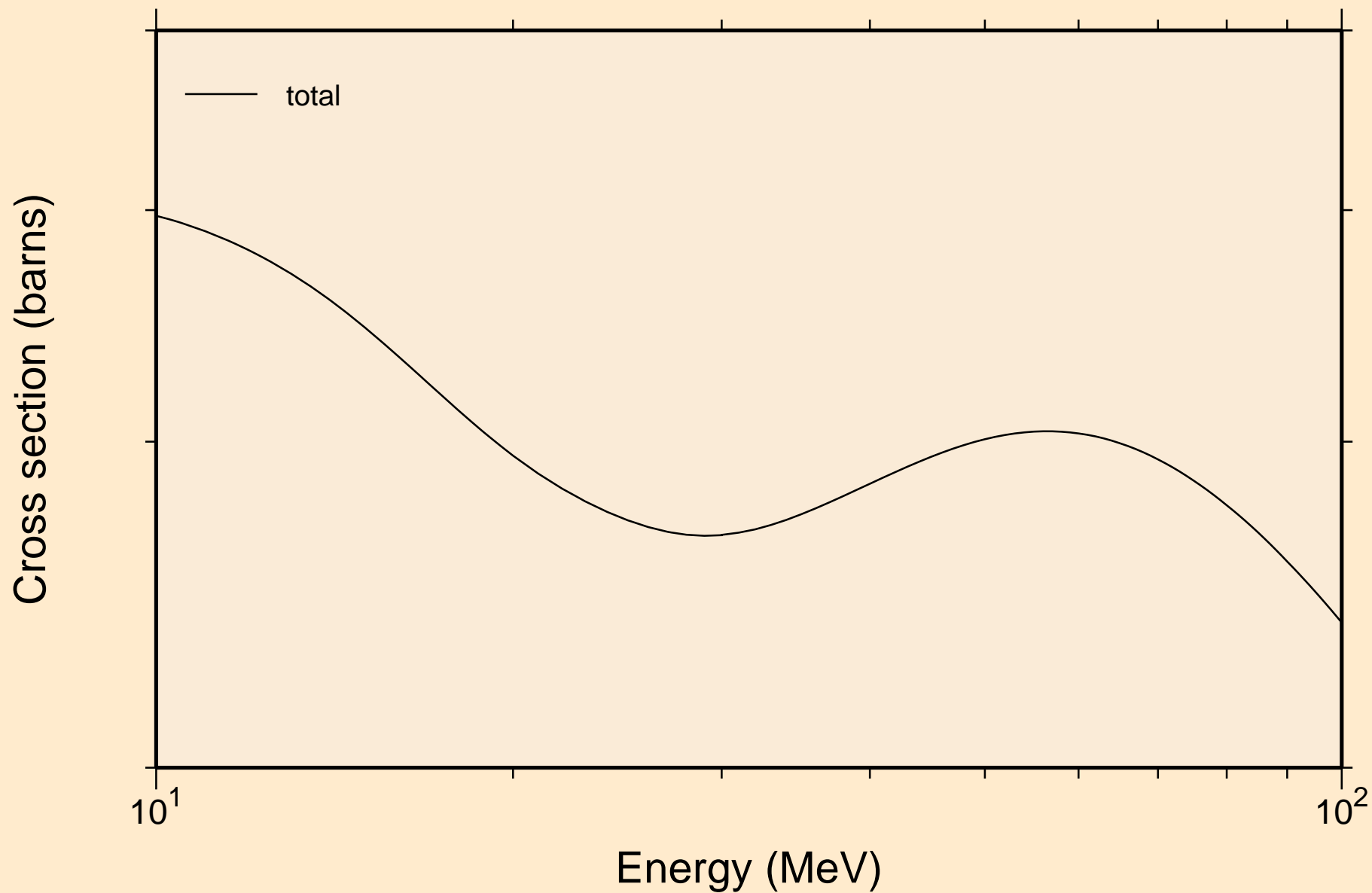

BR080 NEUTRON ACER TENDL-2019 LIBRARY; T=293.16K
resonance absorption cross sections

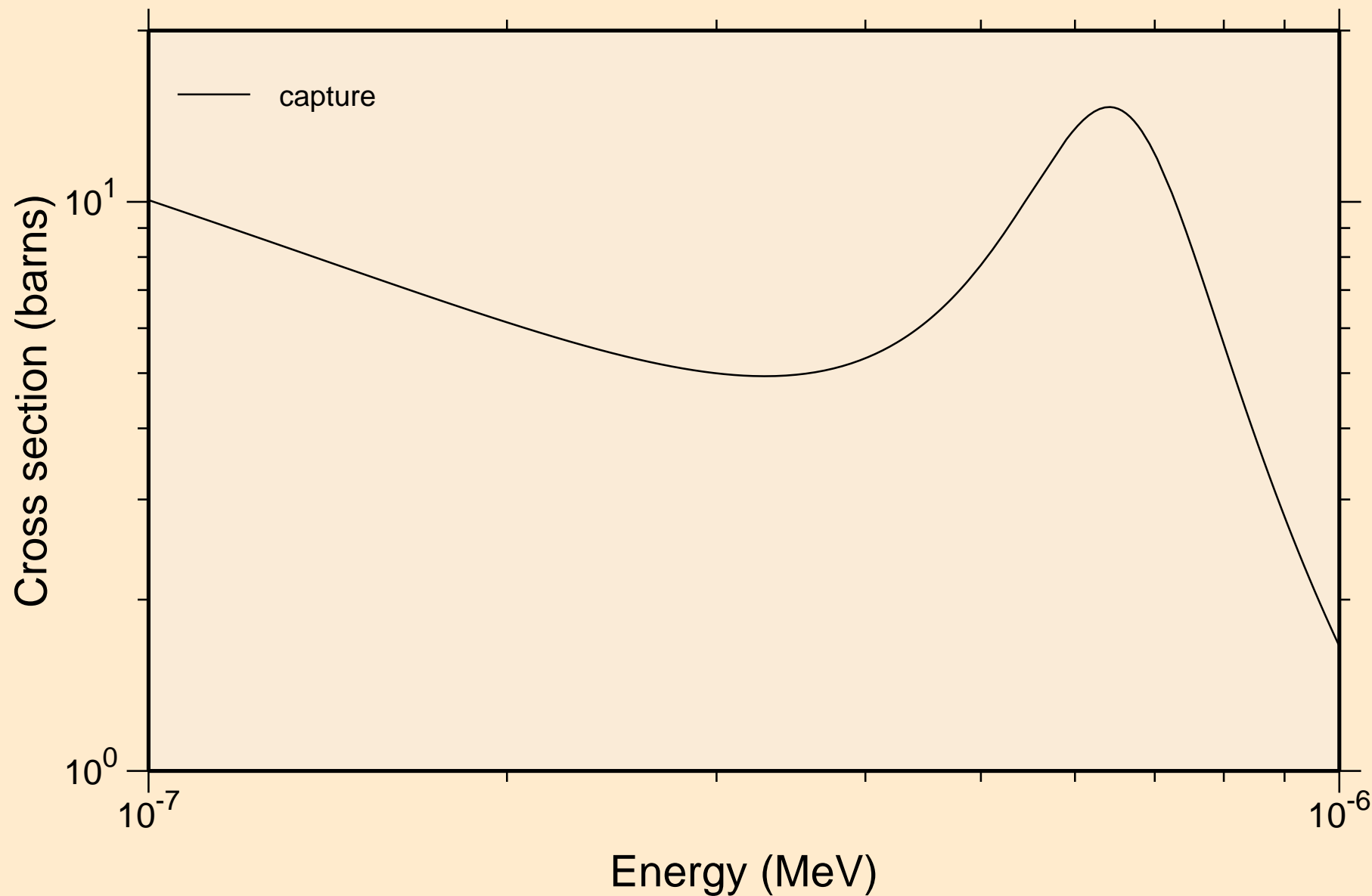

BR080 NEUTRON ACER TENDL-2019 LIBRARY; T=293.16K
resonance absorption cross sections

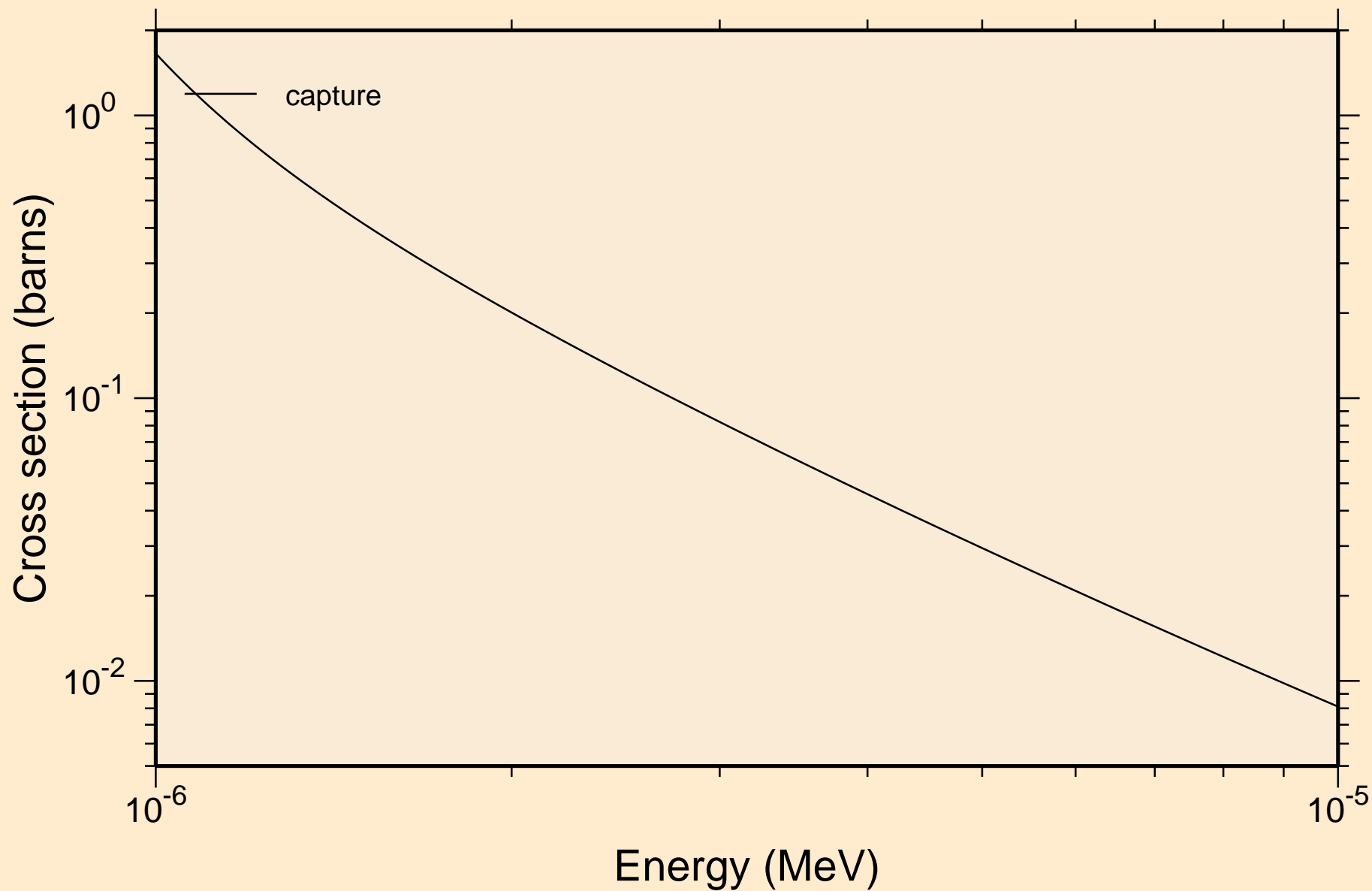

BR080 NEUTRON ACER TENDL-2019 LIBRARY; T=293.16K
resonance absorption cross sections

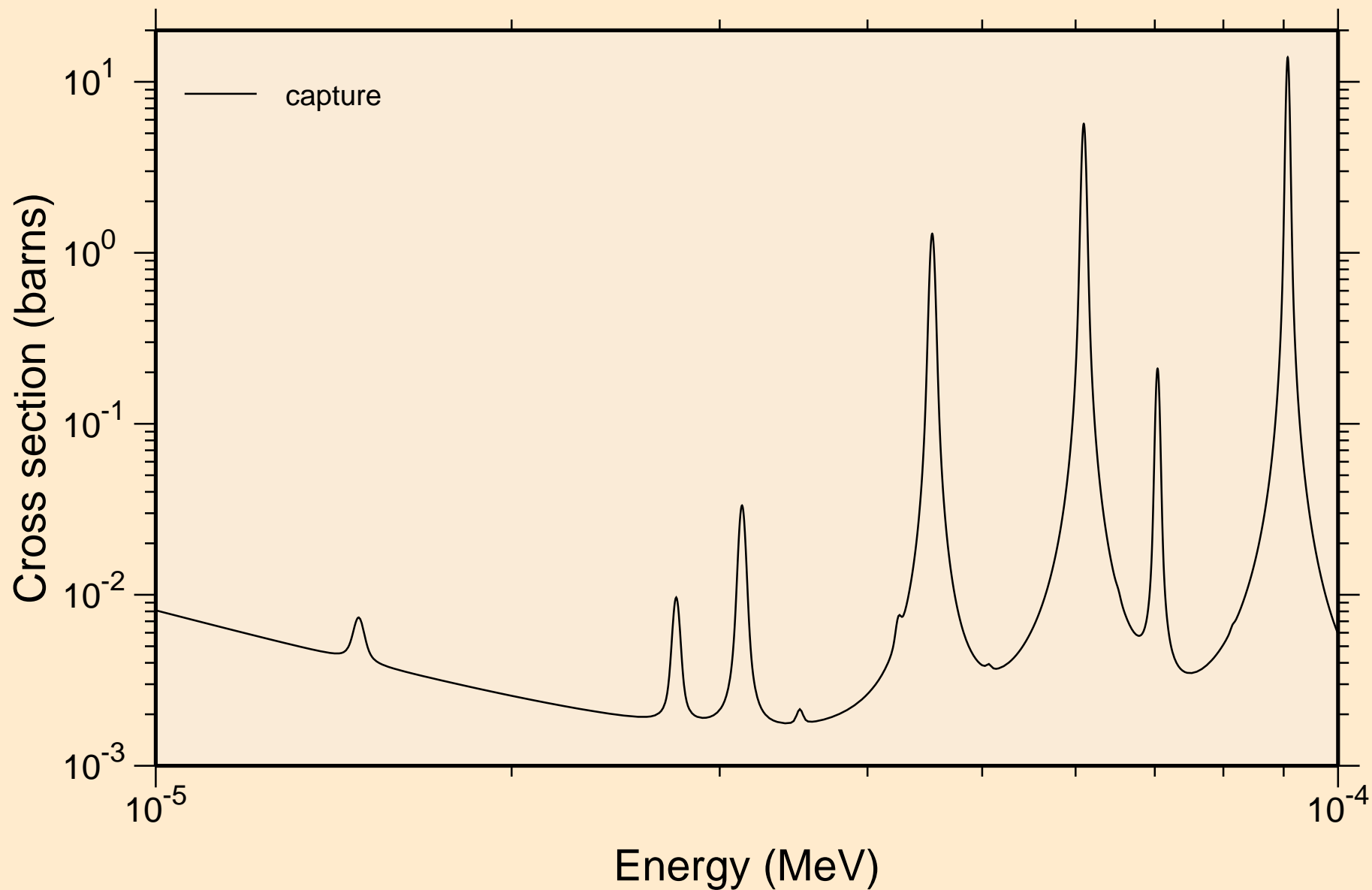

BR080 NEUTRON ACER TENDL-2019 LIBRARY; T=293.16K
resonance absorption cross sections

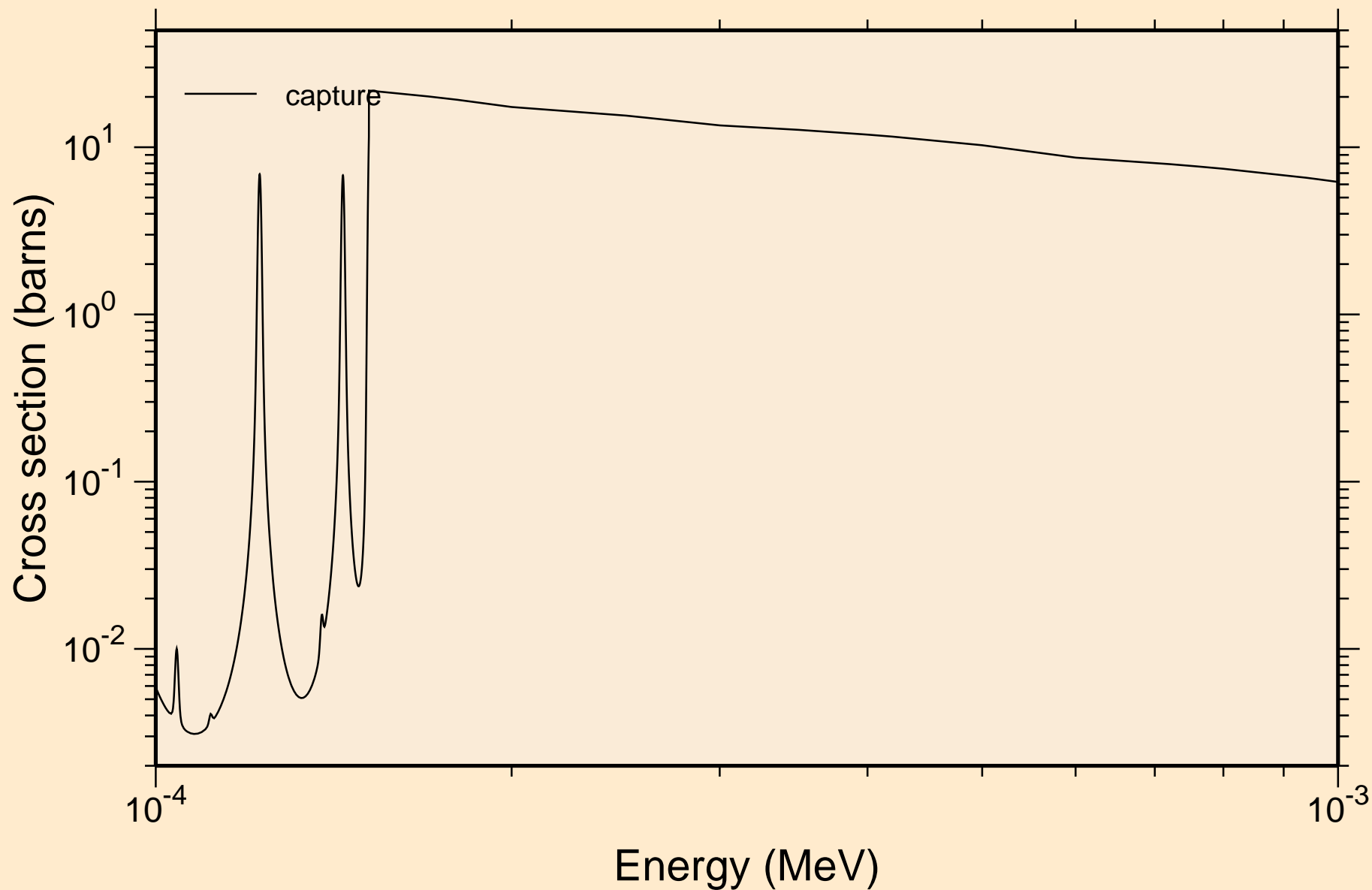

BR080 NEUTRON ACER TENDL-2019 LIBRARY; T=293.16K
resonance absorption cross sections

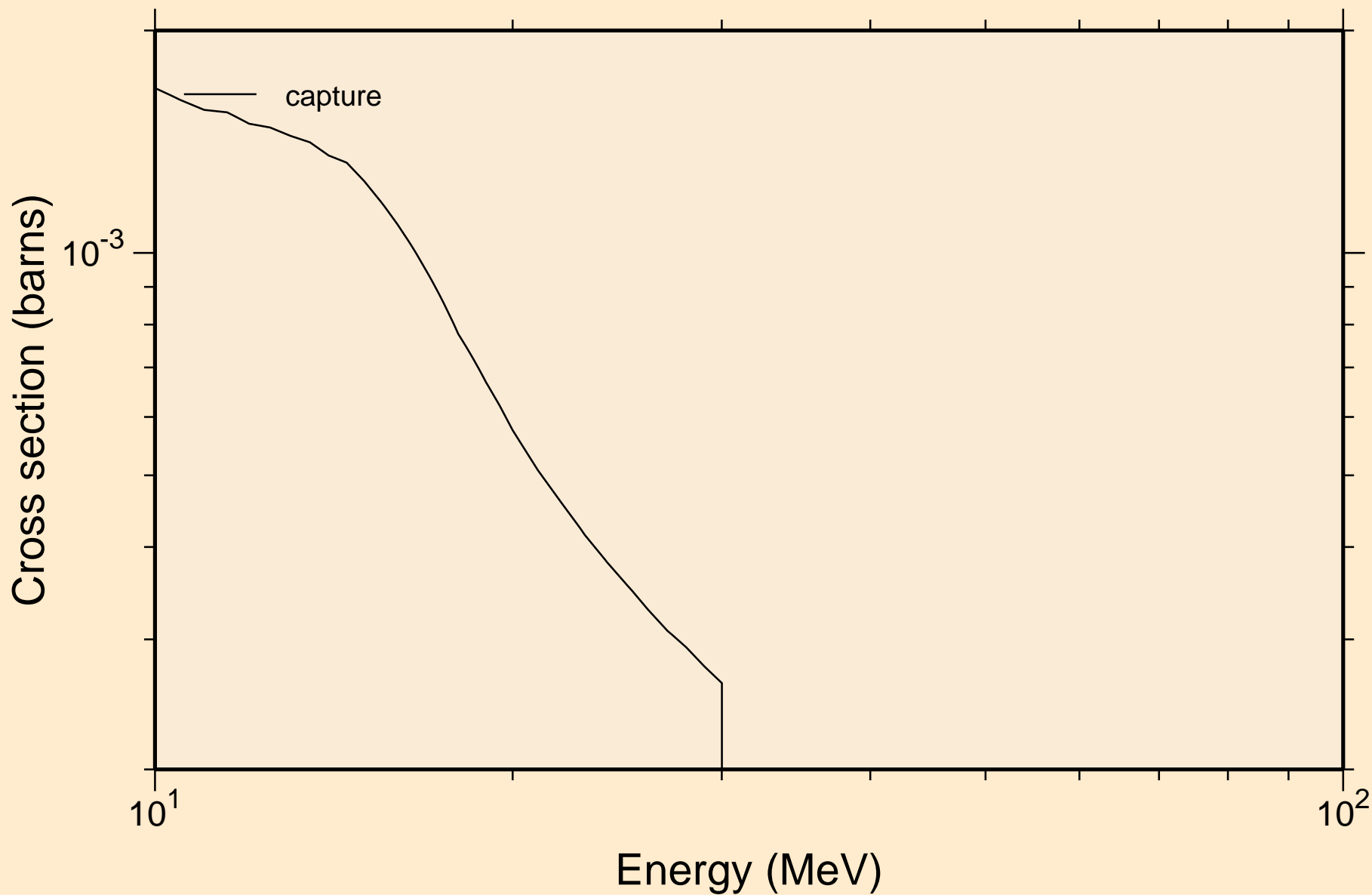

BR080 NEUTRON ACER TENDL-2019 LIBRARY; T=293.16K
Heating

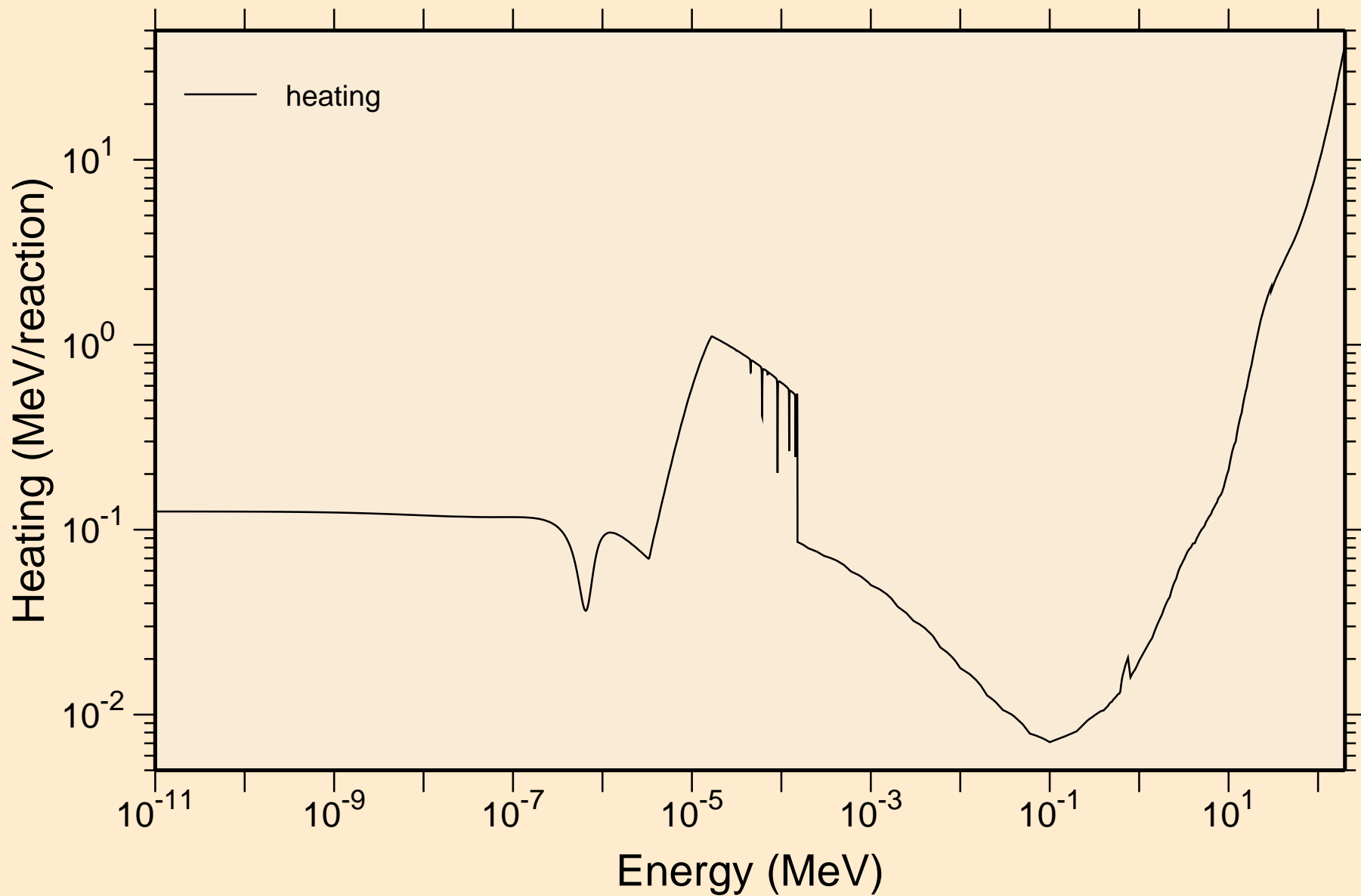

BR080 NEUTRON ACER TENDL-2019 LIBRARY; T=293.16K
Damage

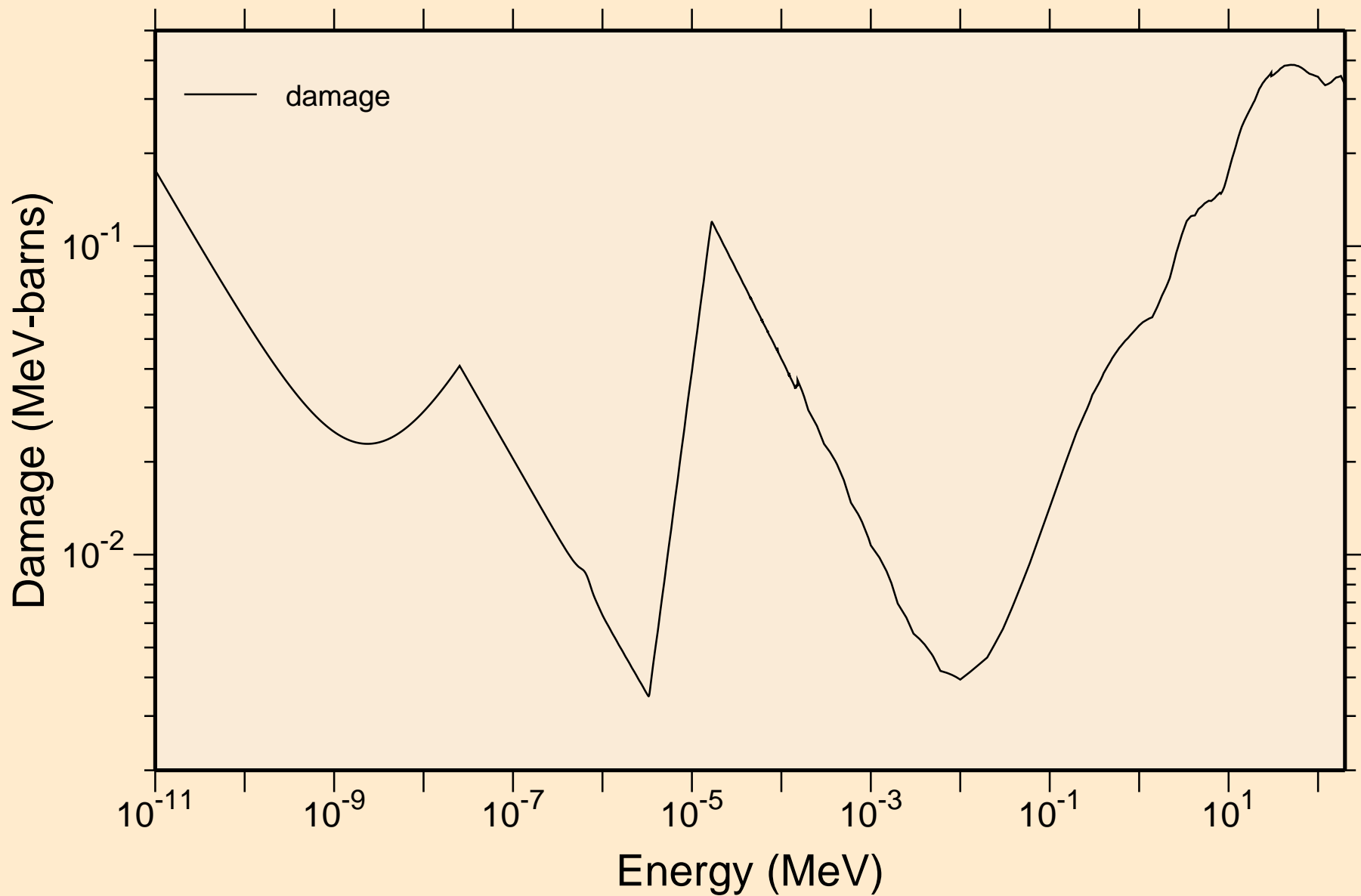

BR080 NEUTRON ACER TENDL-2019 LIBRARY; T=293.16K
Non-threshold reactions

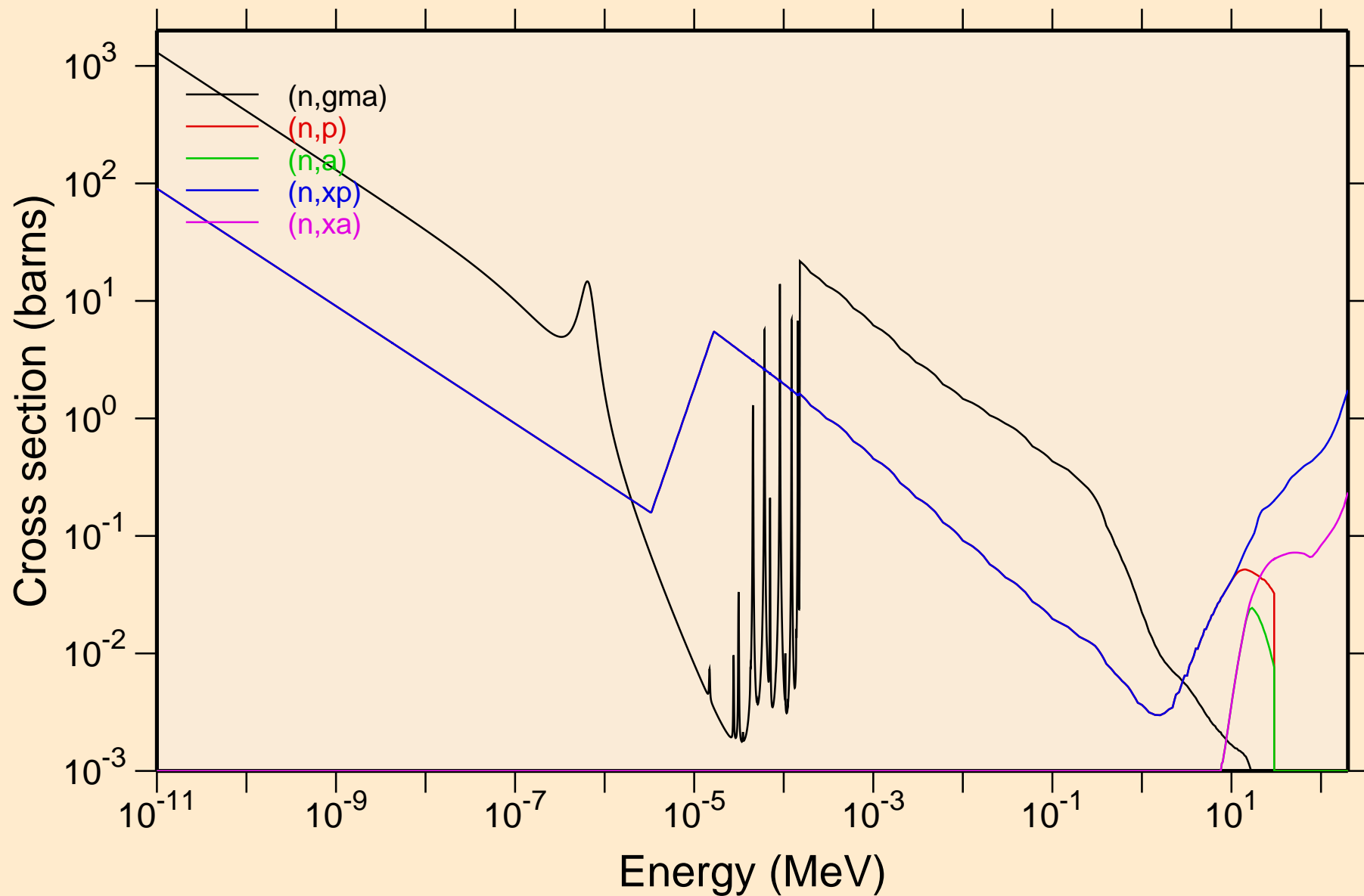

BR080 NEUTRON ACER TENDL-2019 LIBRARY; T=293.16K
Principal cross sections

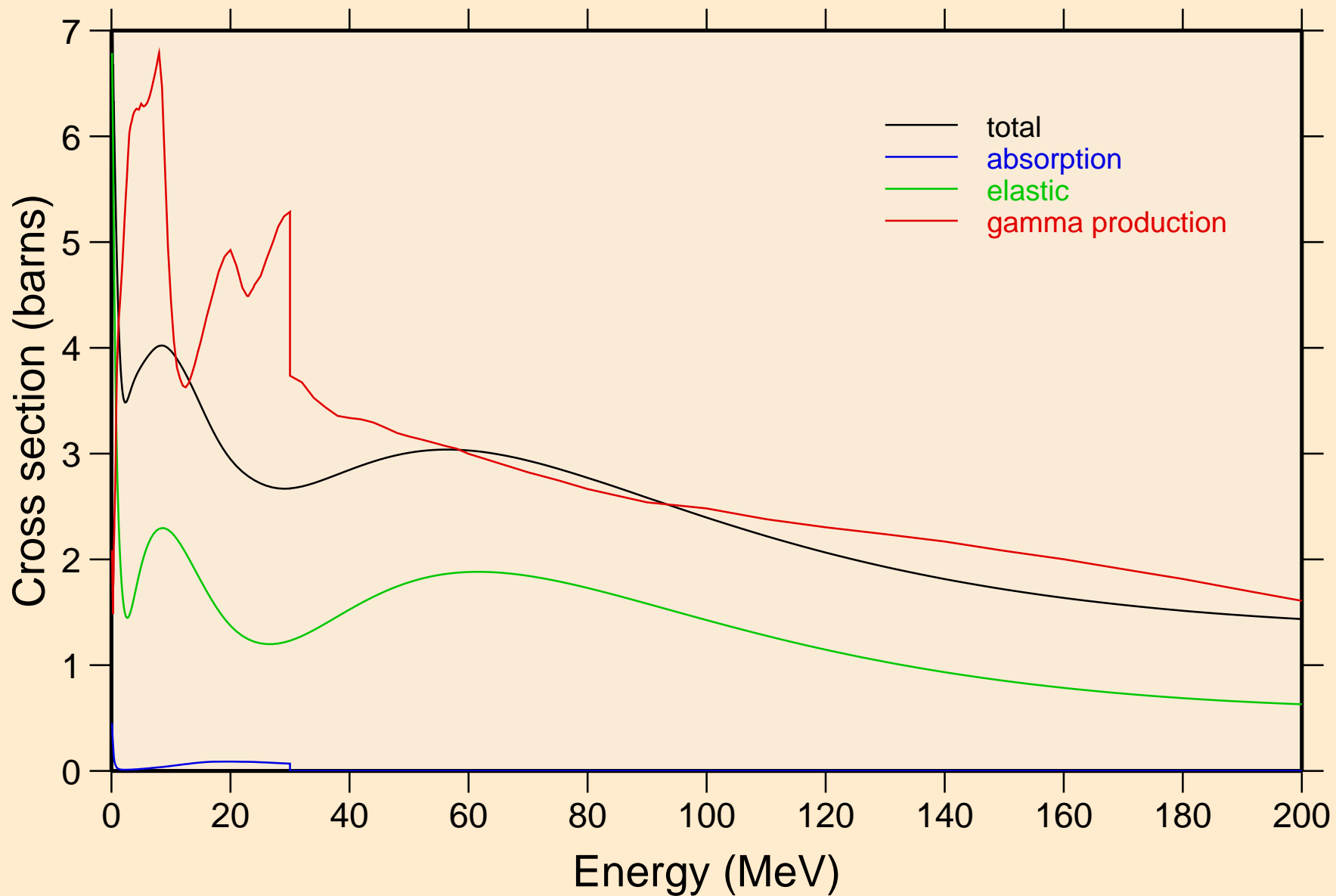

BR080 NEUTRON ACER TENDL-2019 LIBRARY; T=293.16K
Heating

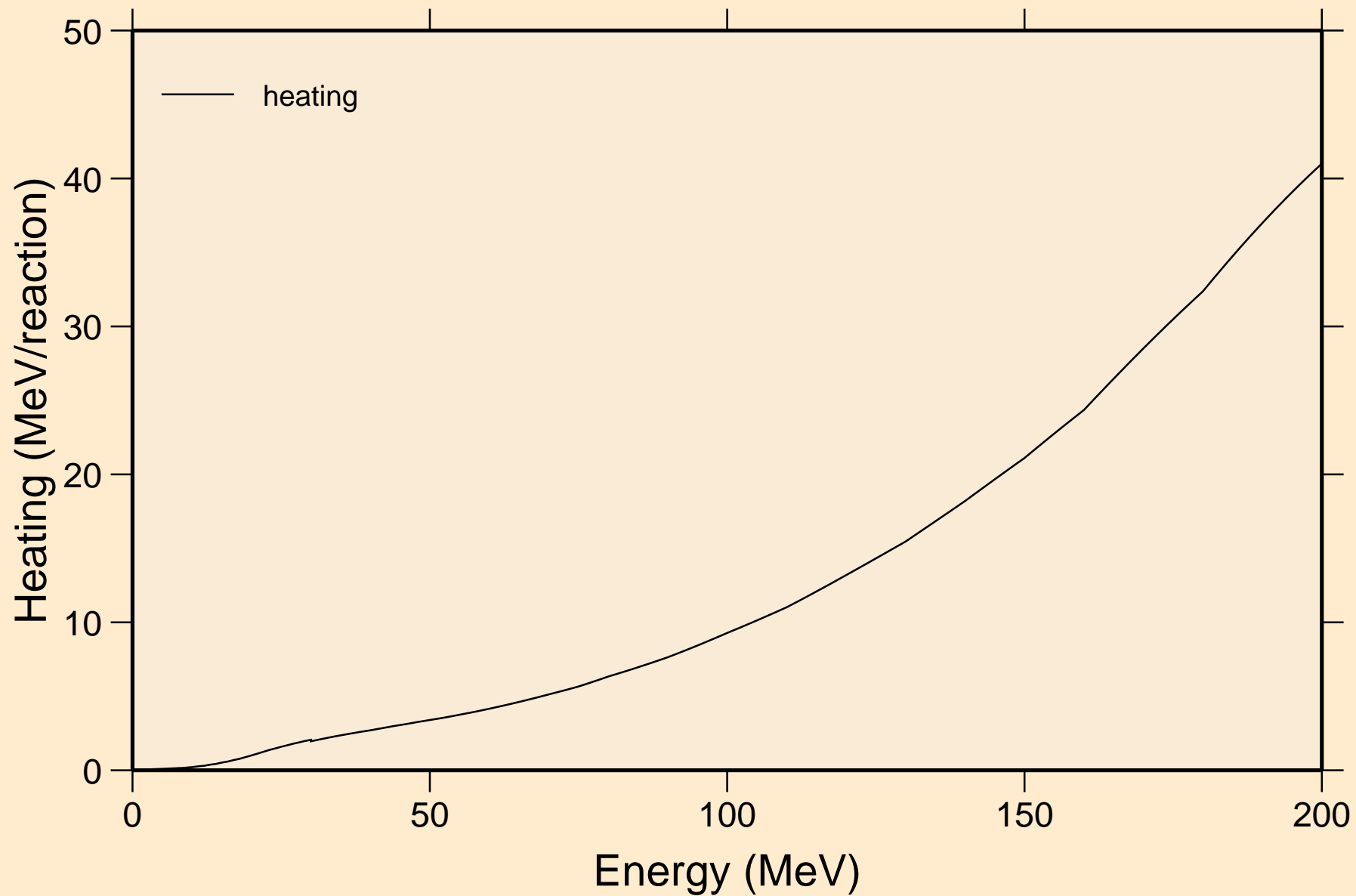

BR080 NEUTRON ACER TENDL-2019 LIBRARY; T=293.16K
Damage

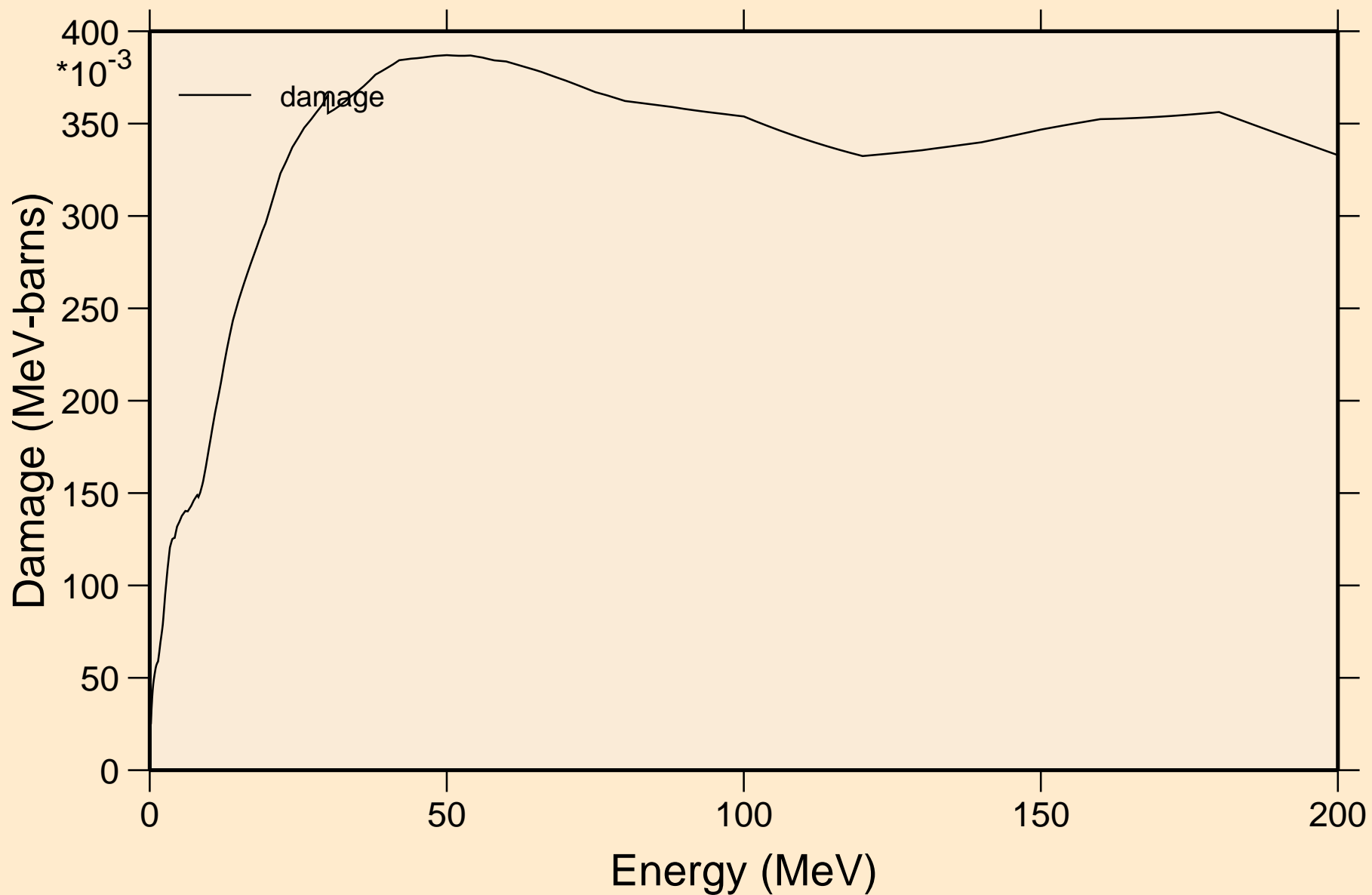

BR080 NEUTRON ACER TENDL-2019 LIBRARY; T=293.16K
Non-threshold reactions

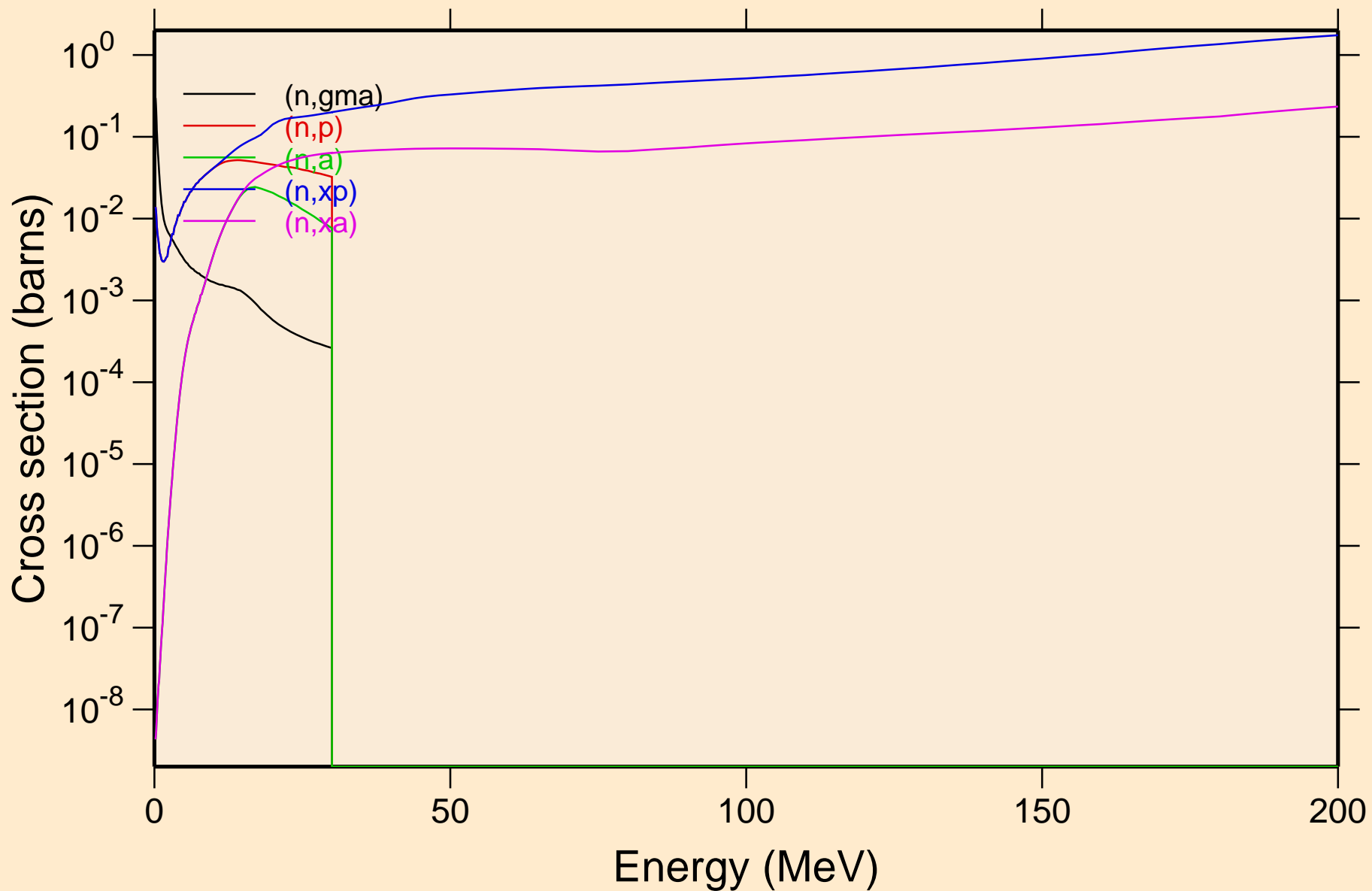

BR080 NEUTRON ACER TENDL-2019 LIBRARY; T=293.16K
Inelastic levels

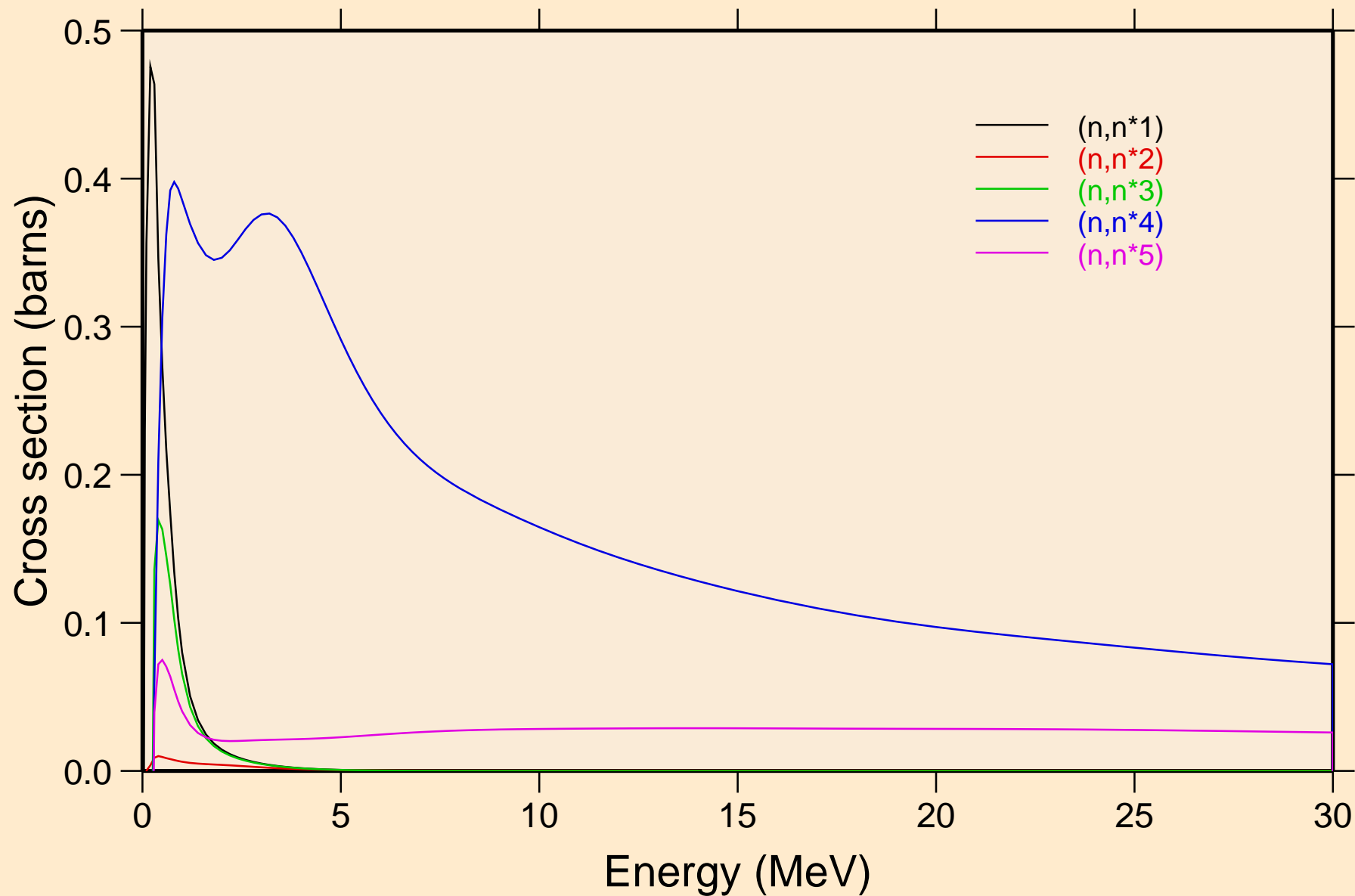

BR080 NEUTRON ACER TENDL-2019 LIBRARY; T=293.16K
Inelastic levels

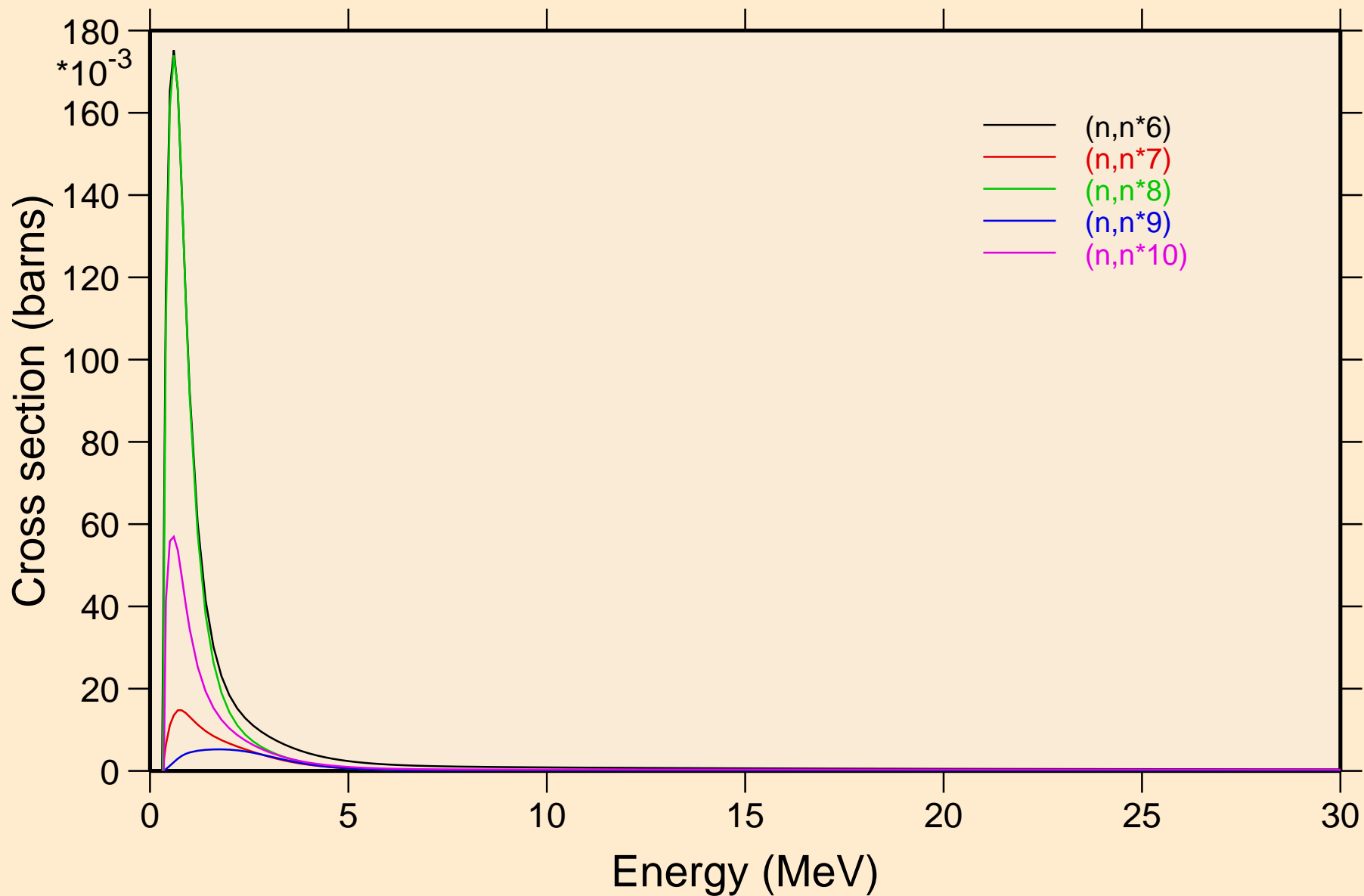

BR080 NEUTRON ACER TENDL-2019 LIBRARY; T=293.16K
Inelastic levels

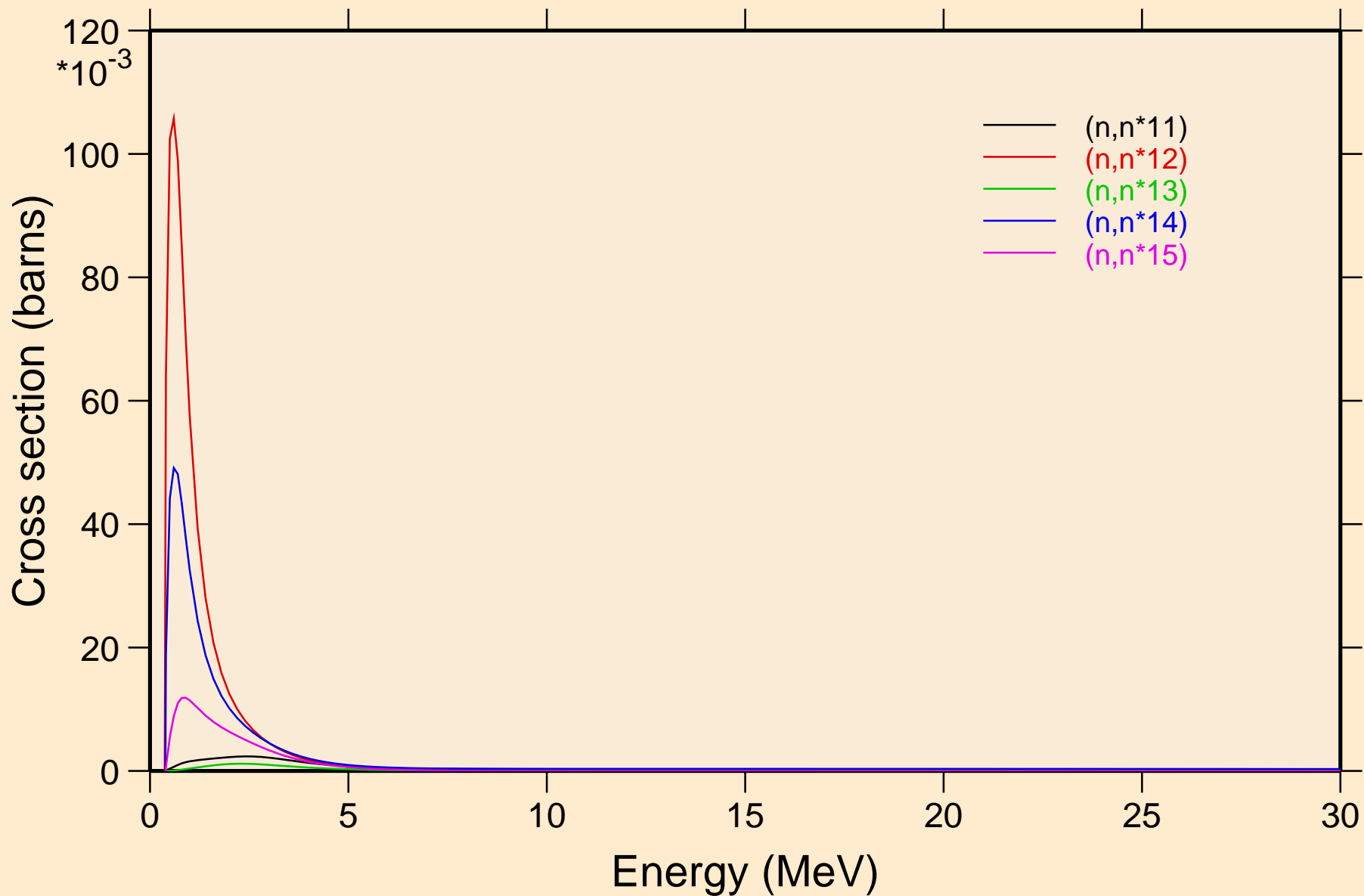

BR080 NEUTRON ACER TENDL-2019 LIBRARY; T=293.16K
Inelastic levels

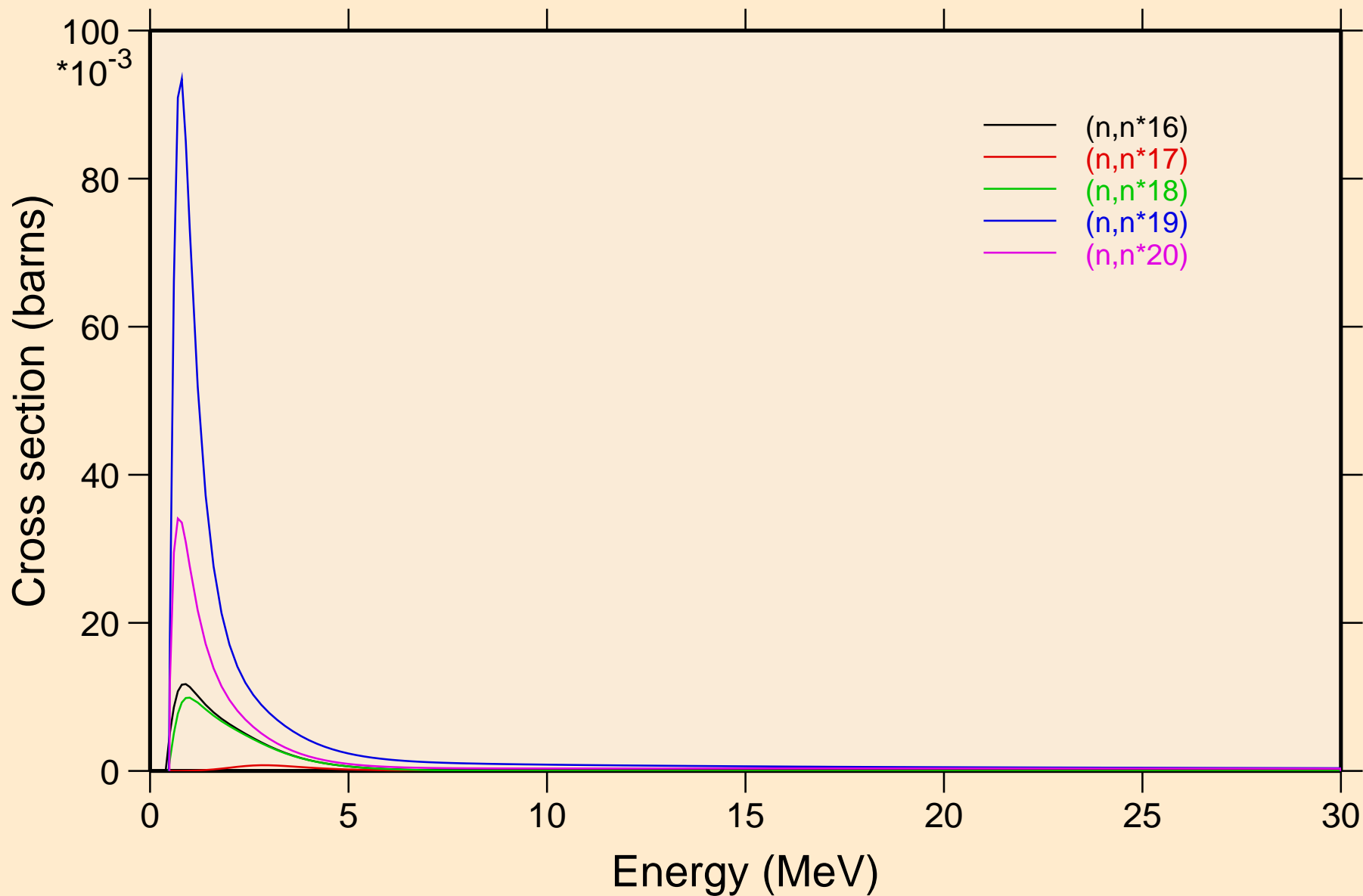

BR080 NEUTRON ACER TENDL-2019 LIBRARY; T=293.16K
Inelastic levels

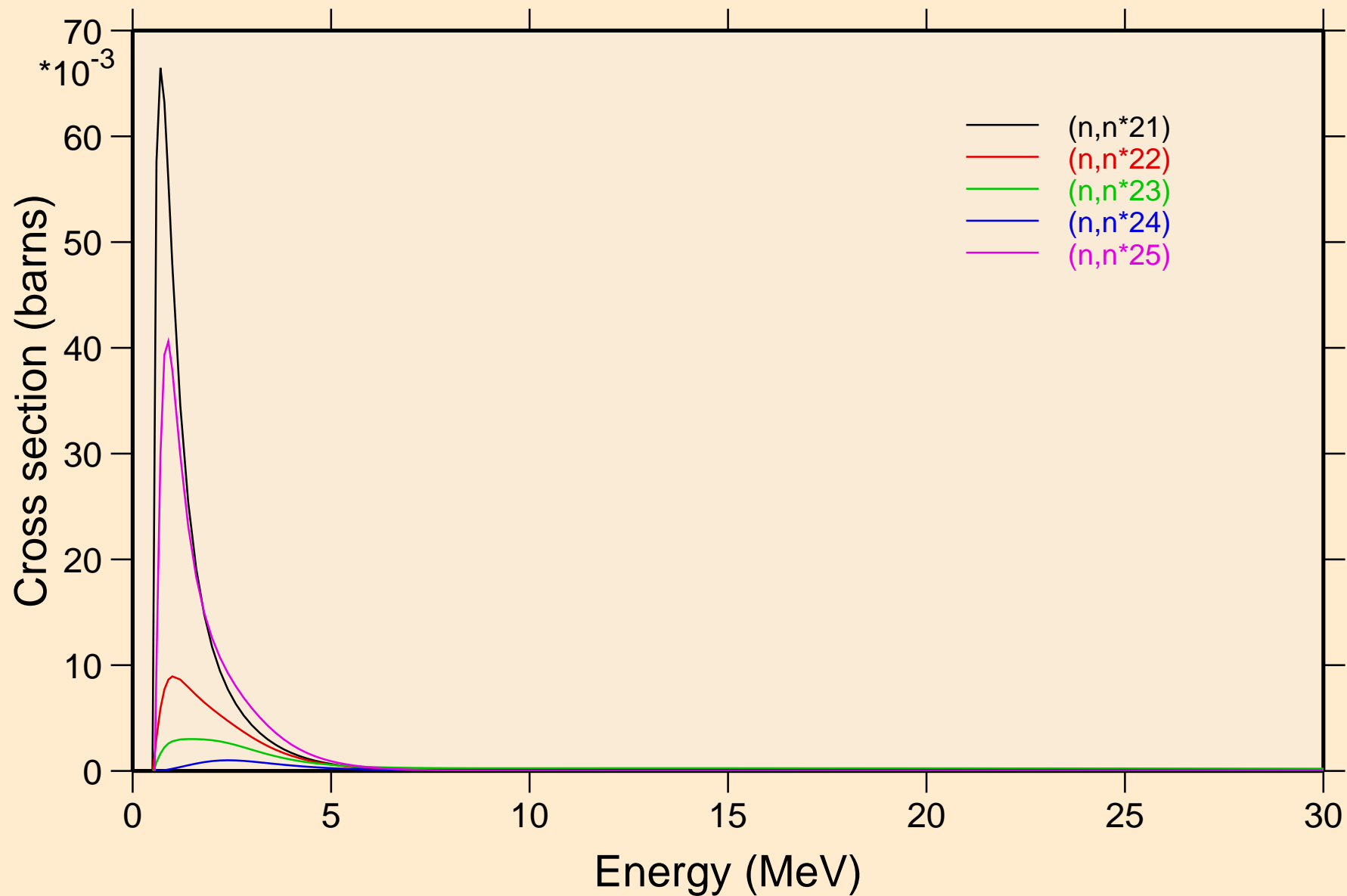

BR080 NEUTRON ACER TENDL-2019 LIBRARY; T=293.16K
Inelastic levels

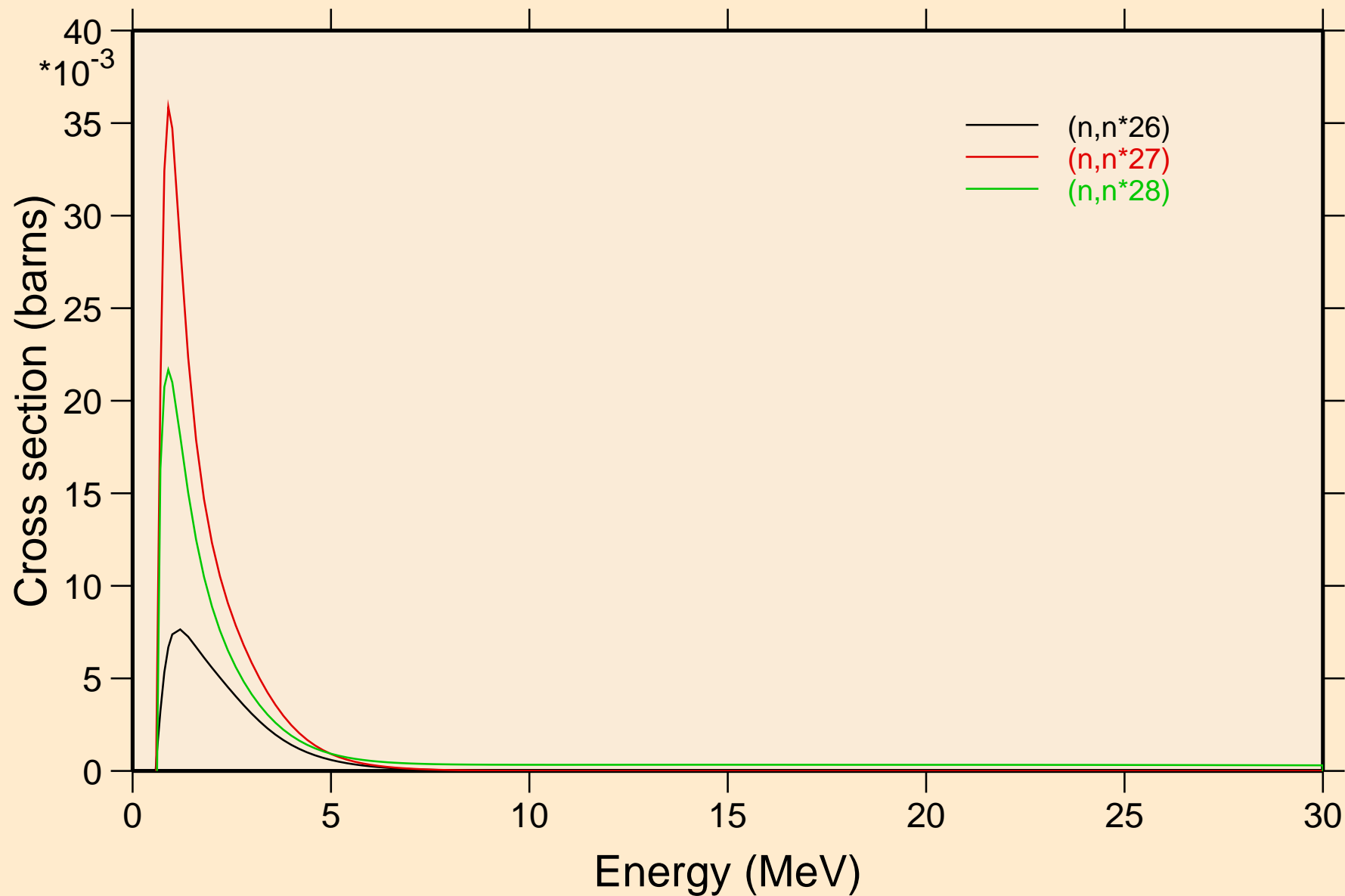

BR080 NEUTRON ACER TENDL-2019 LIBRARY; T=293.16K
Threshold reactions

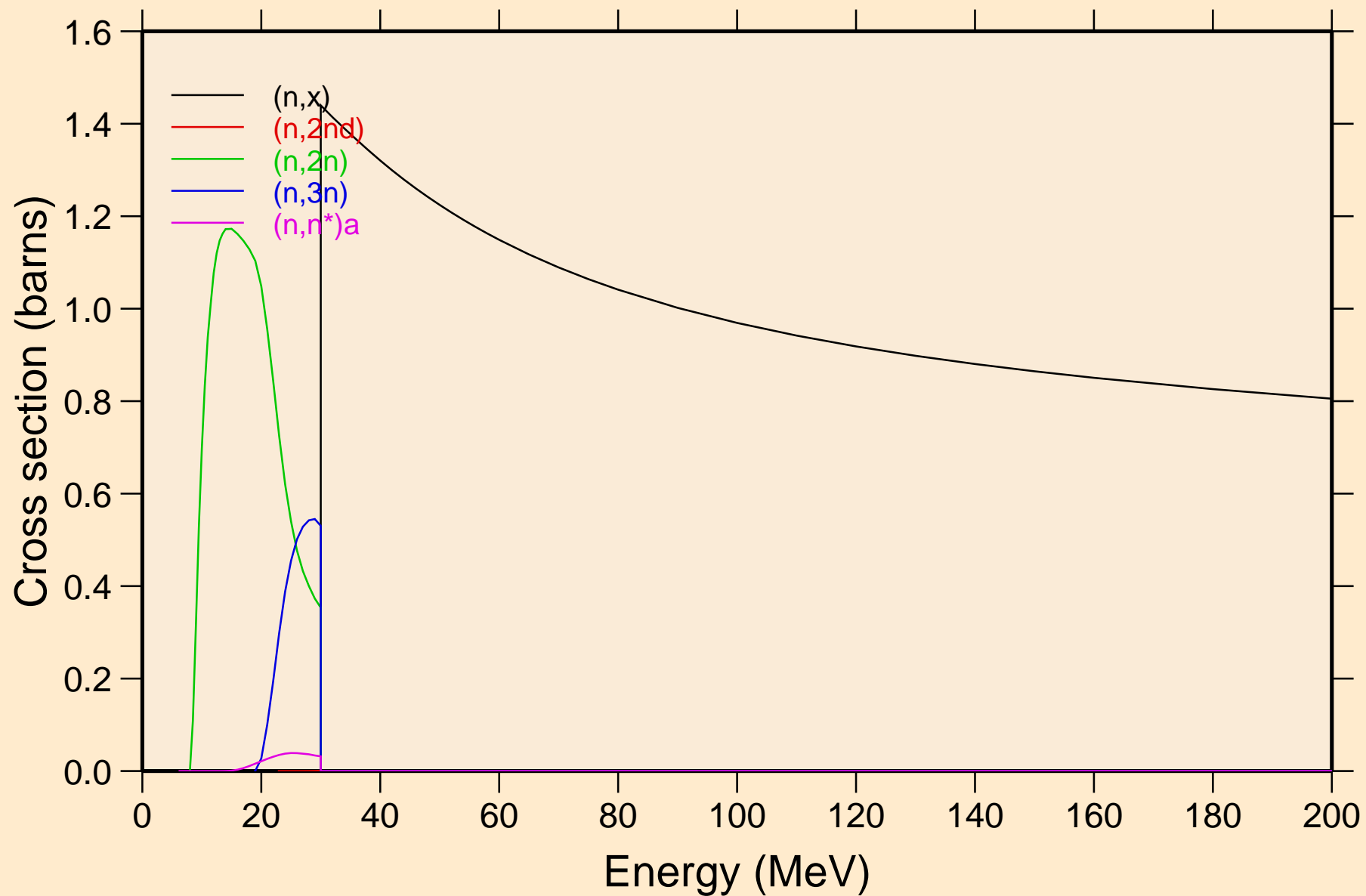

BR080 NEUTRON ACER TENDL-2019 LIBRARY; T=293.16K
Threshold reactions

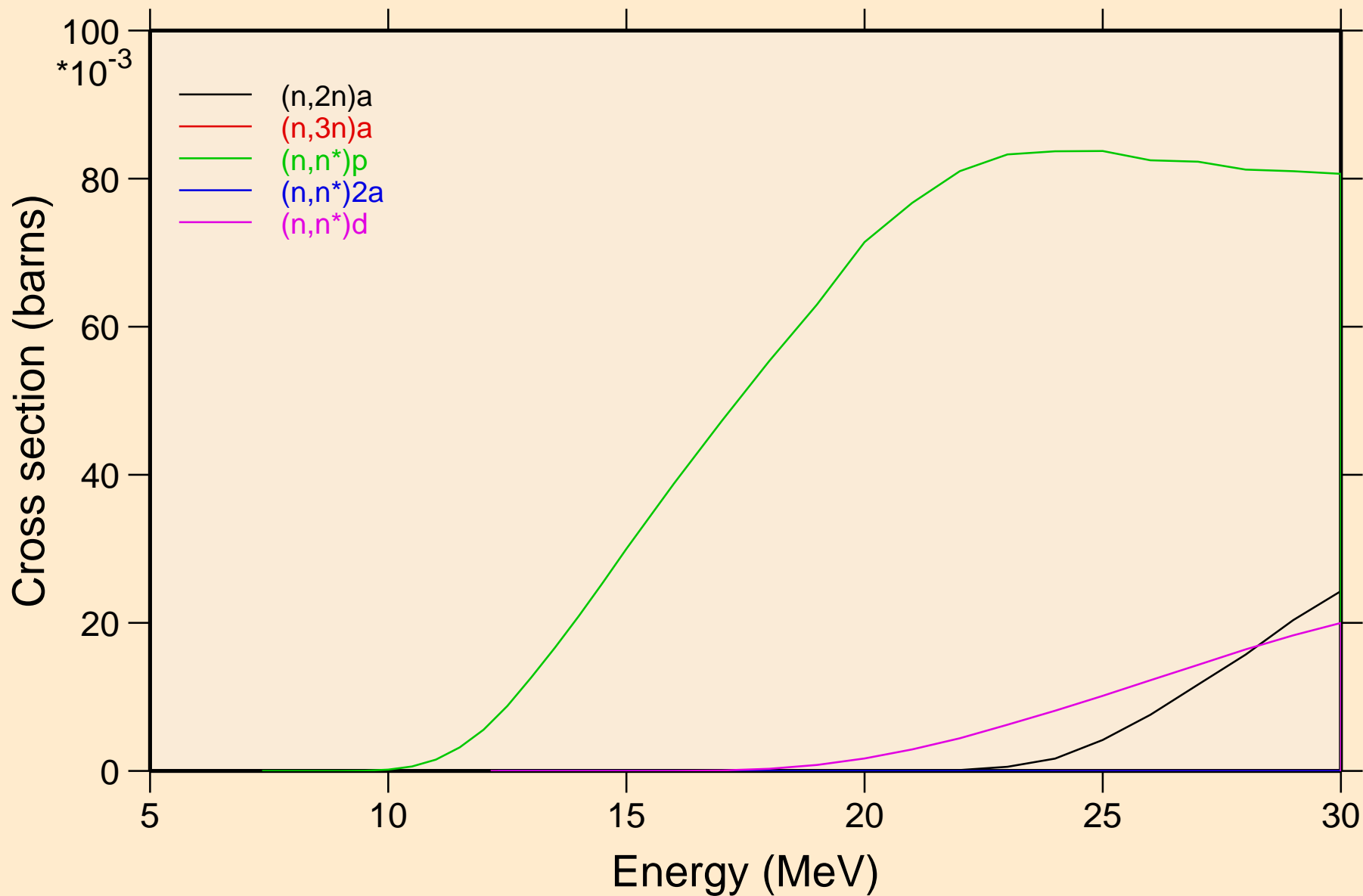

BR080 NEUTRON ACER TENDL-2019 LIBRARY; T=293.16K
Threshold reactions

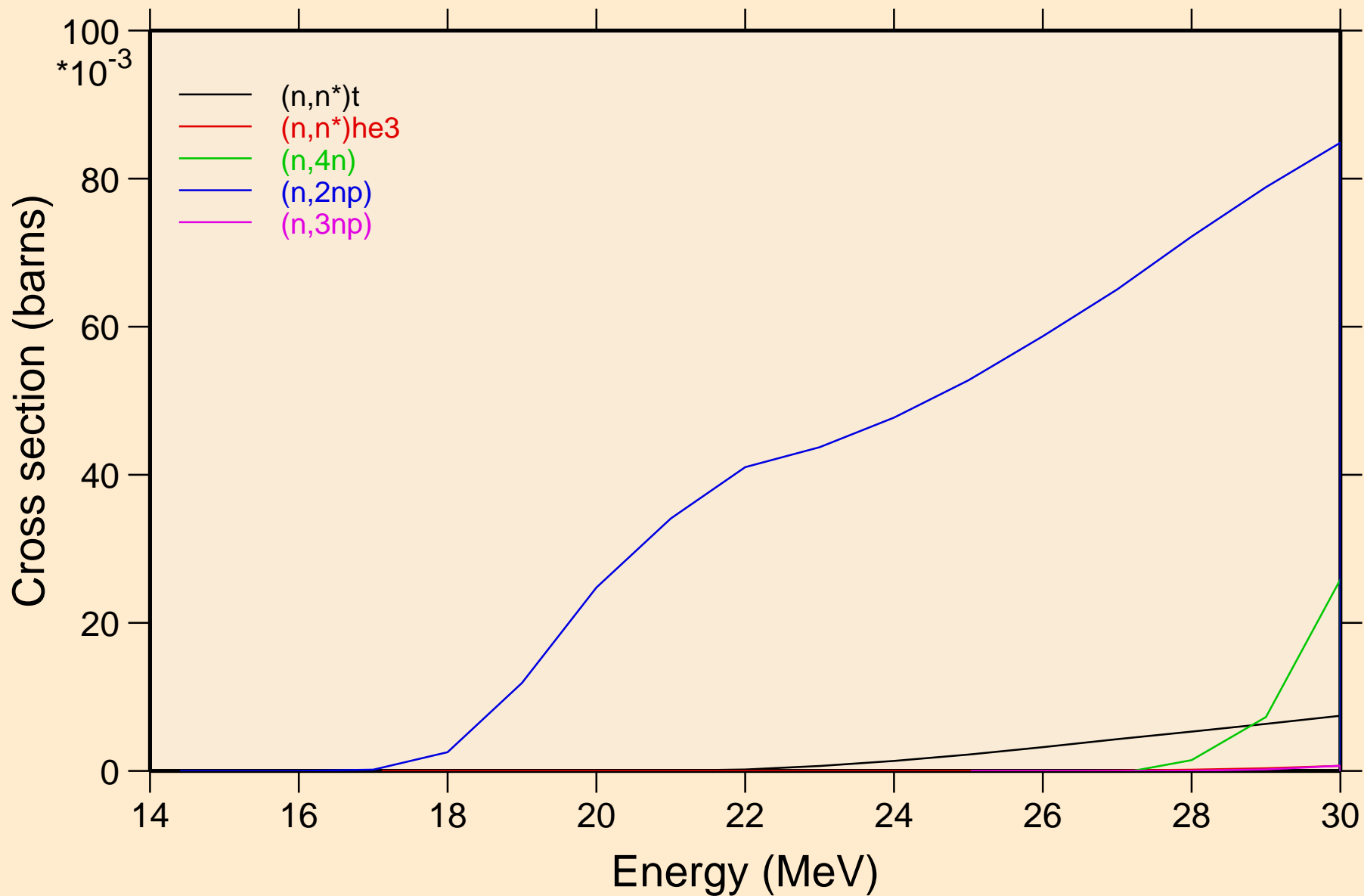

BR080 NEUTRON ACER TENDL-2019 LIBRARY; T=293.16K
Threshold reactions

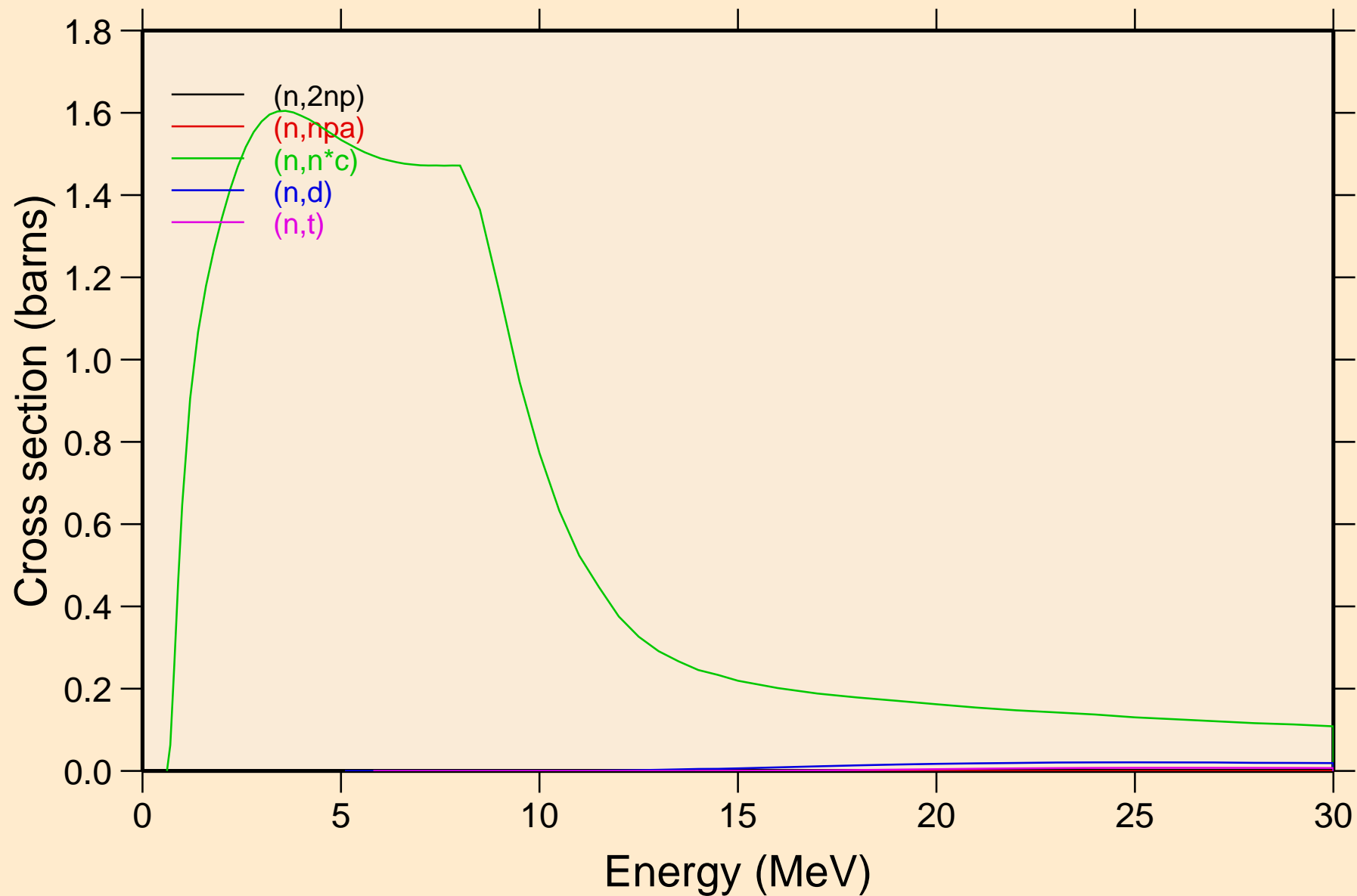

BR080 NEUTRON ACER TENDL-2019 LIBRARY; T=293.16K
Threshold reactions

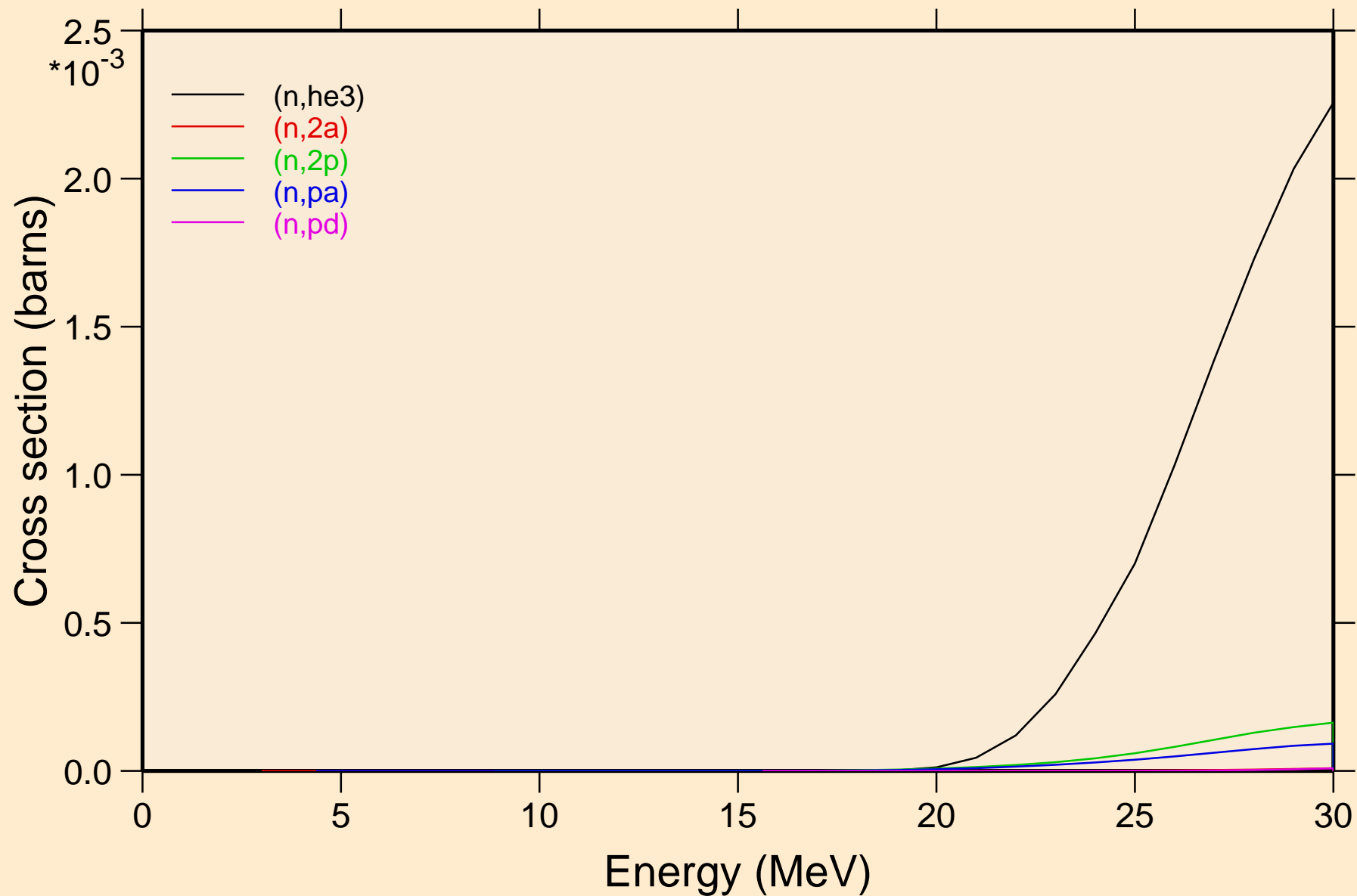

BR080 NEUTRON ACER TENDL-2019 LIBRARY; T=293.16K
Threshold reactions

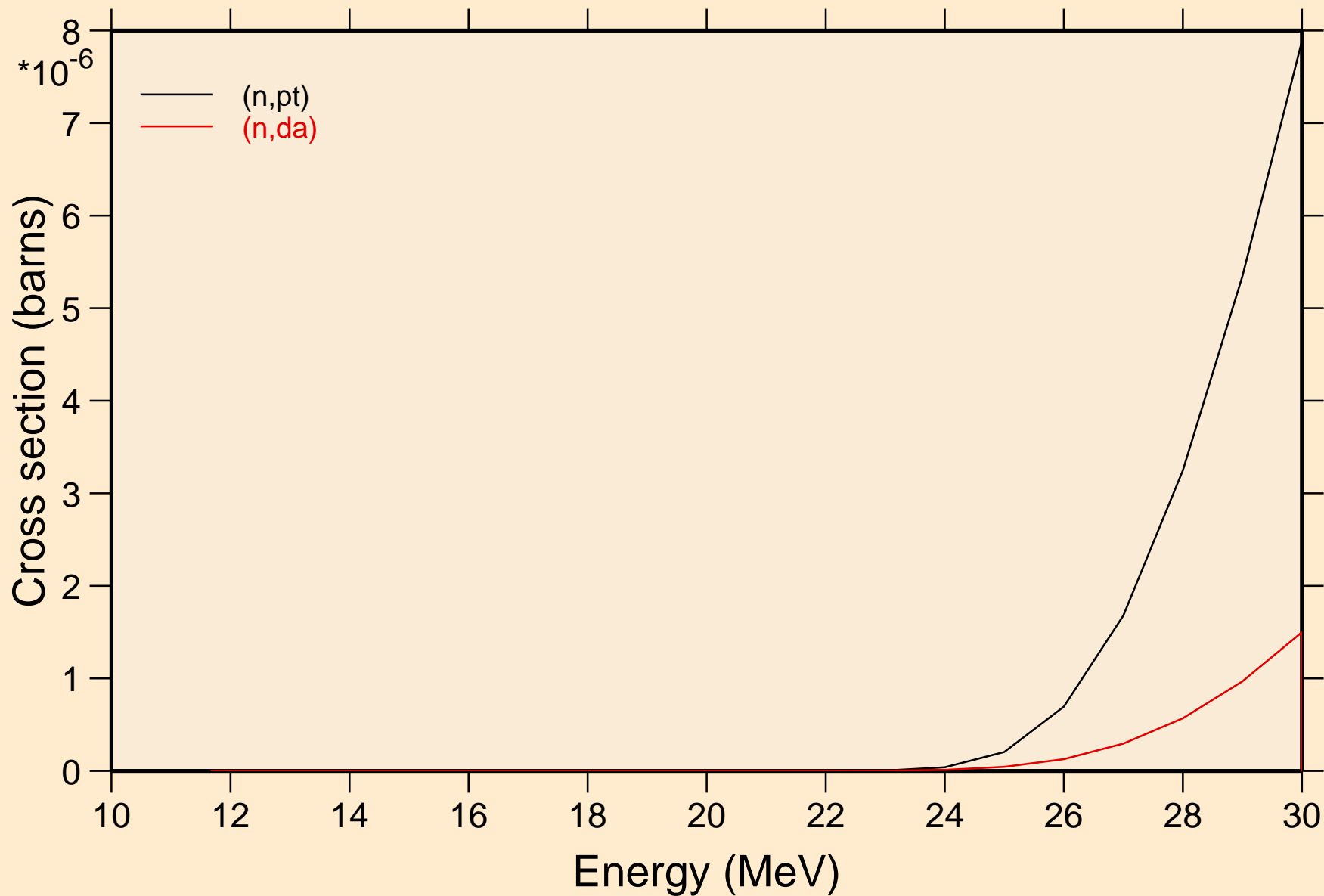

BR080 NEUTRON ACER TENDL-2019 LIBRARY; T=293.16K
Threshold reactions

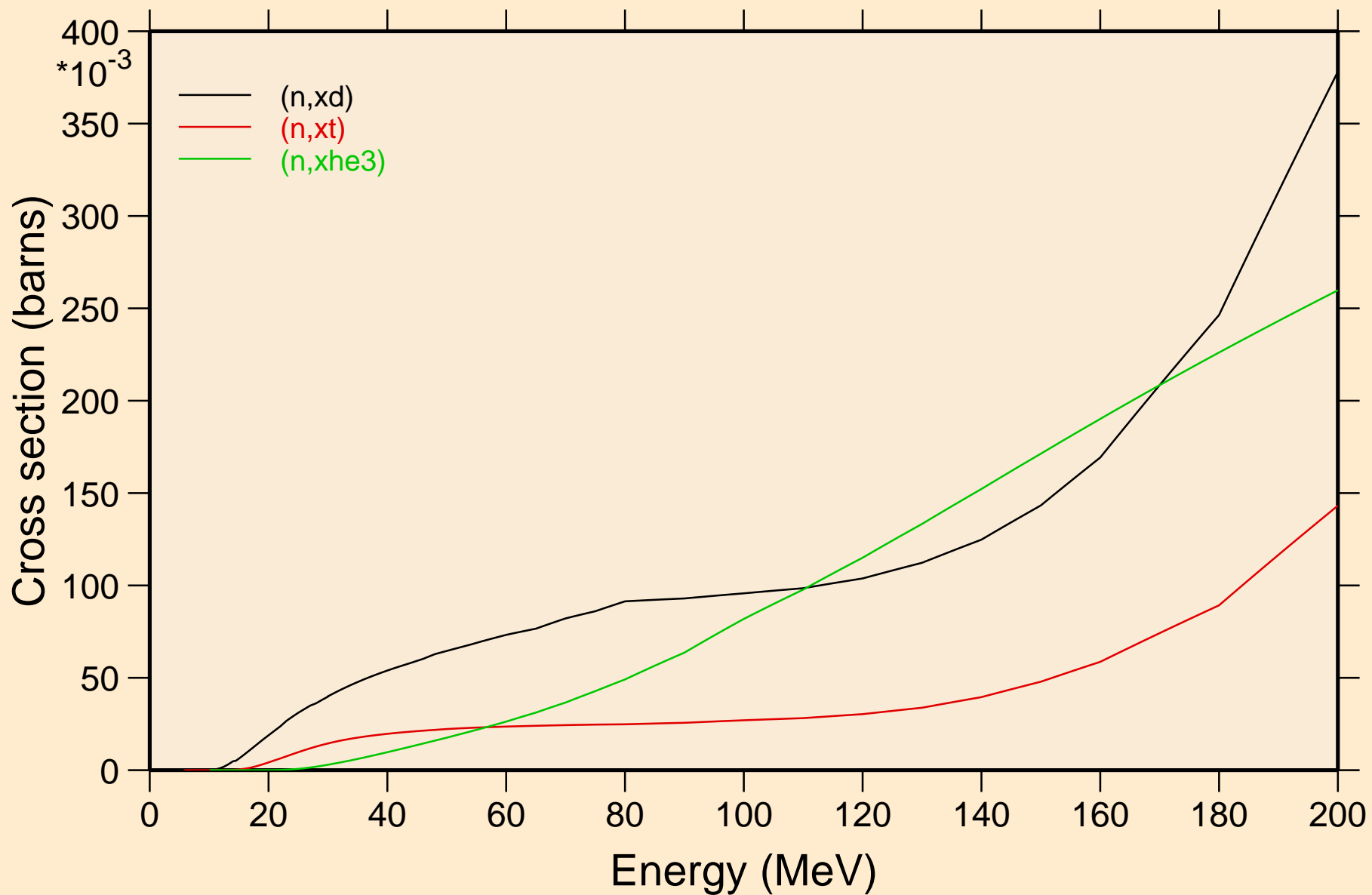

BR080 NEUTRON ACER TENDL-2019 LIBRARY; T=293.16K
angular distribution for elastic

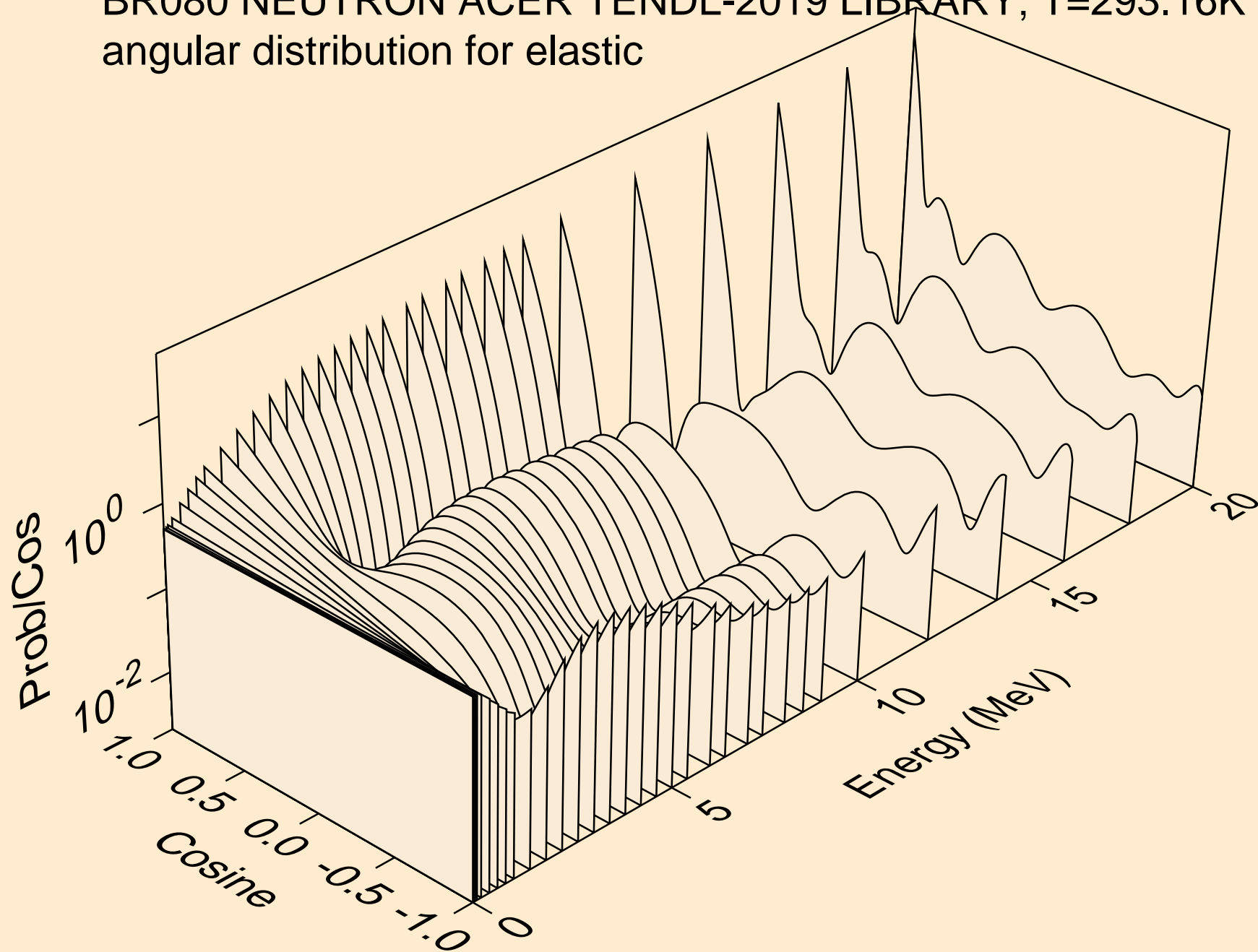

BR080 NEUTRON ACER TENDL-2019 LIBRARY; T=293.16K
angular distribution for elastic

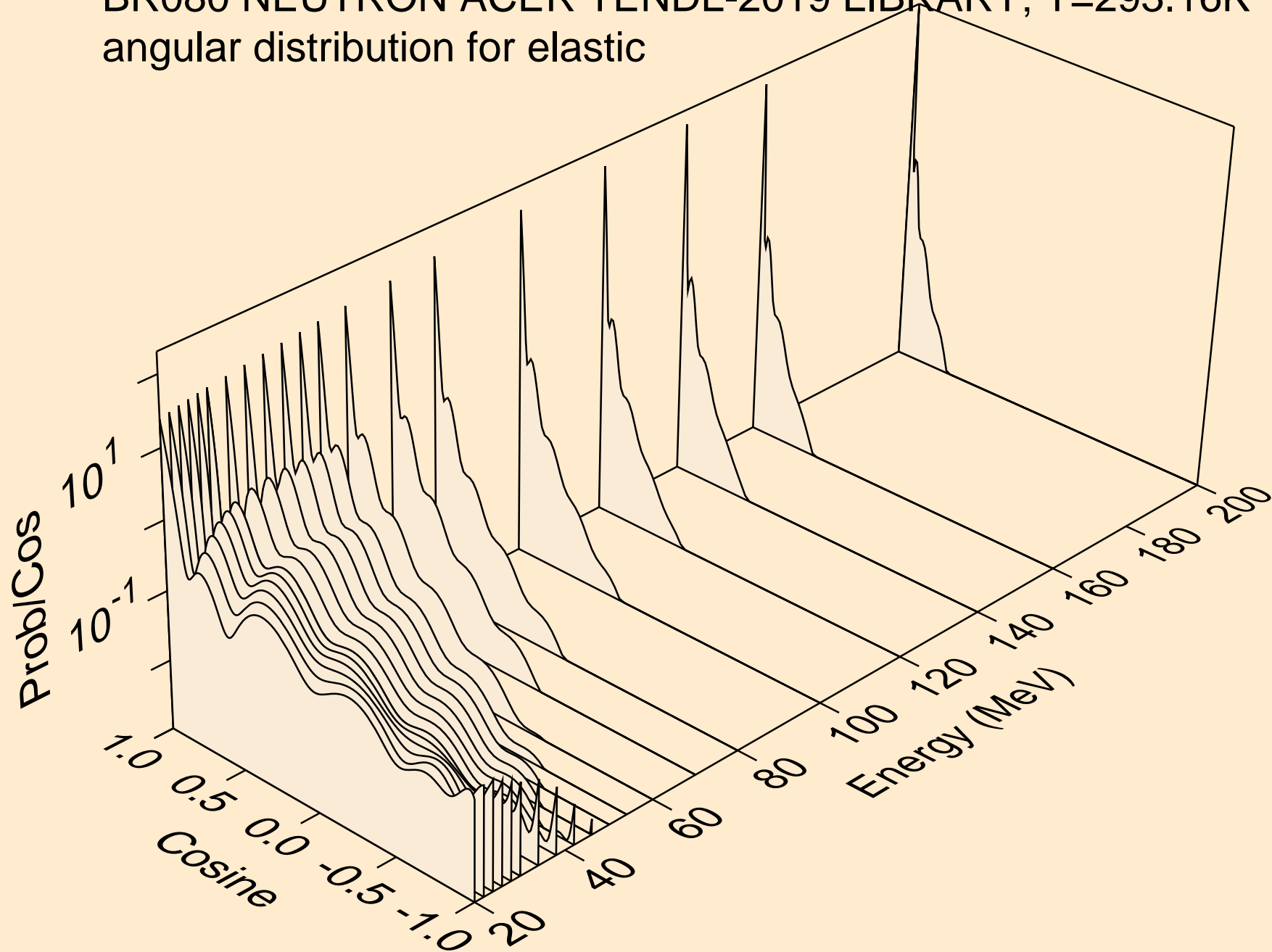

BR080 NEUTRON ACER TENDL-2019 LIBRARY; T=293.16K
angular distribution for (n,n*1)

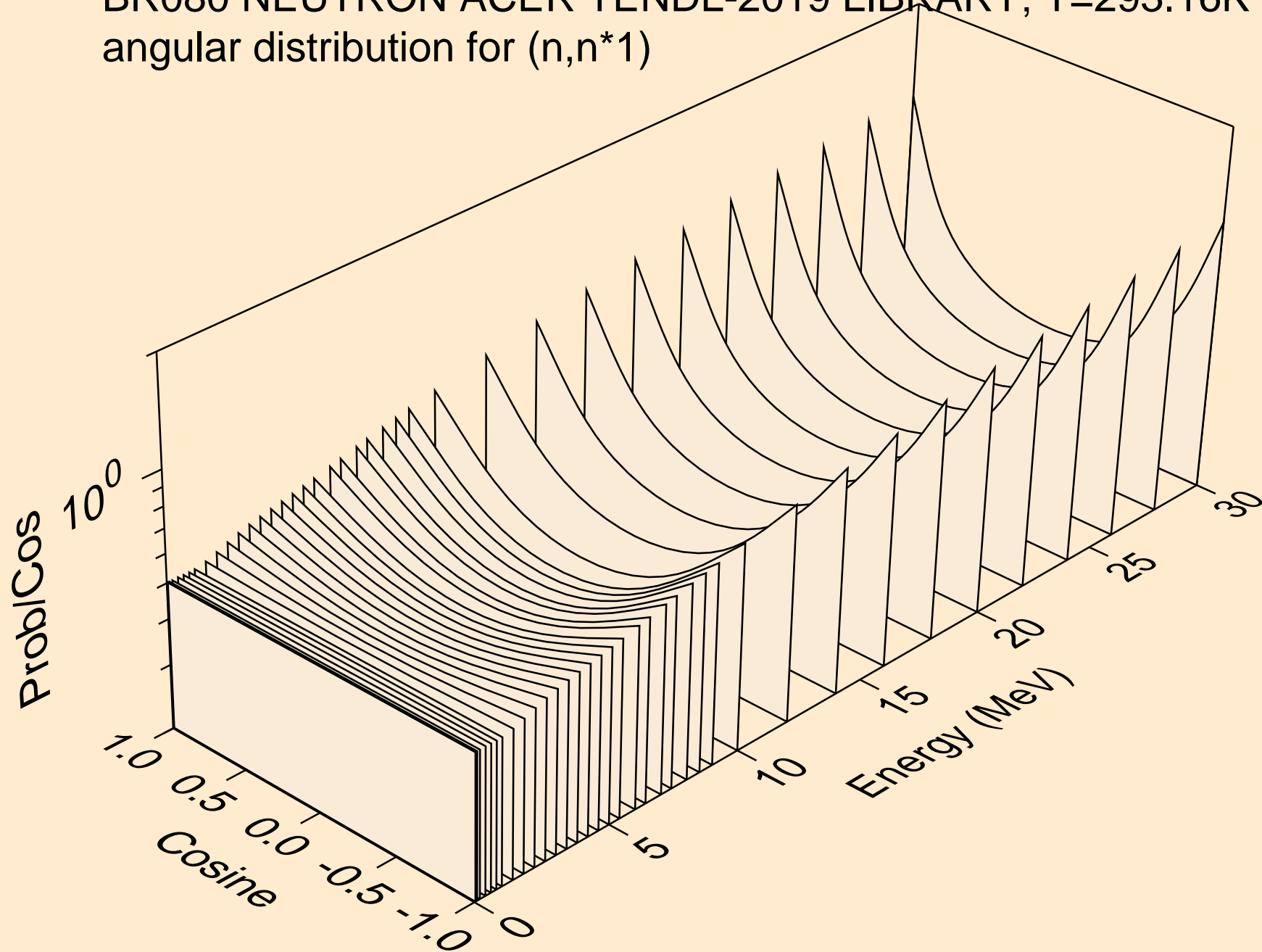

BR080 NEUTRON ACER TENDL-2019 LIBRARY; T=293.16K
angular distribution for (n,n*2)

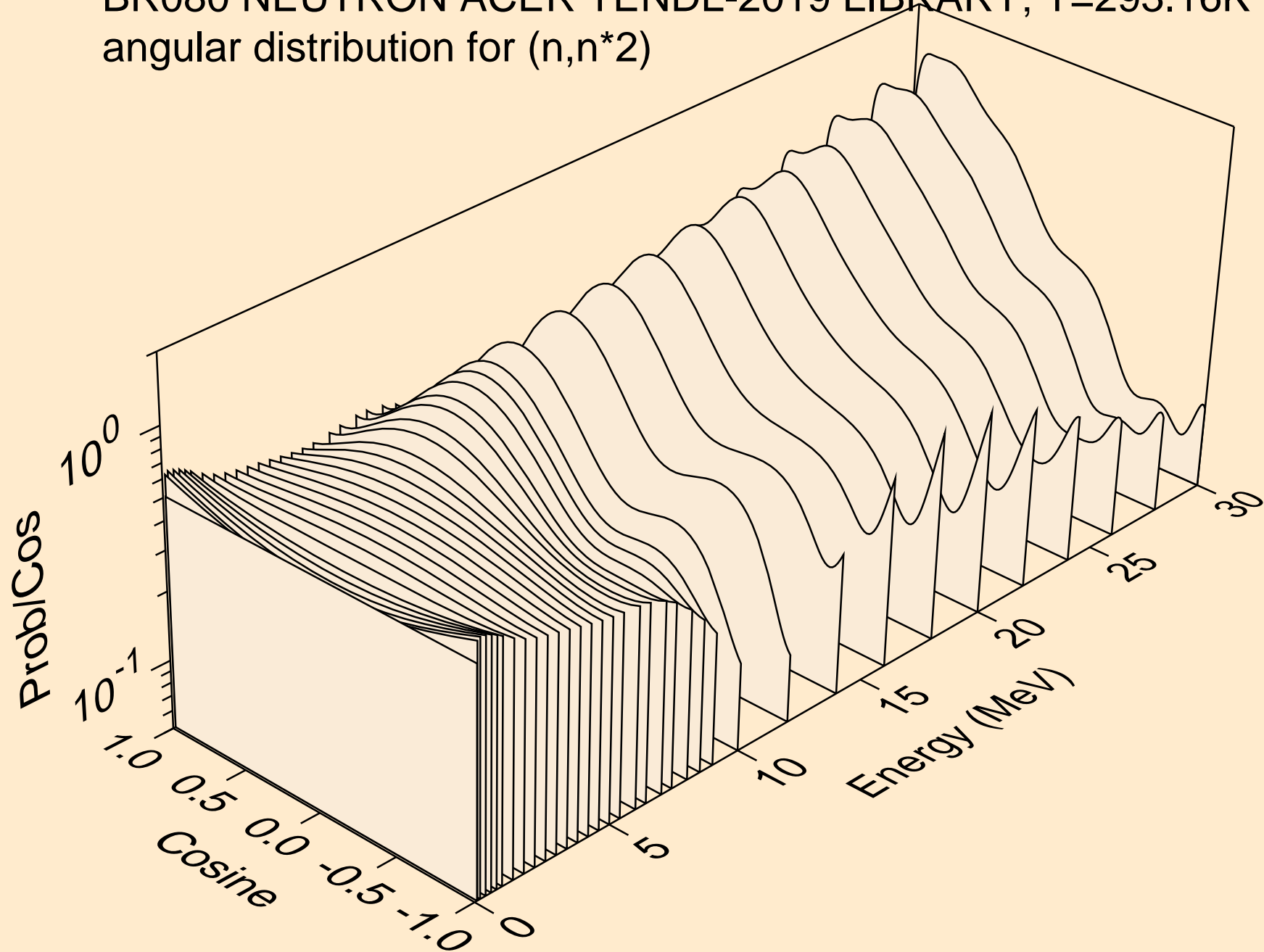

BR080 NEUTRON ACER TENDL-2019 LIBRARY; T=293.16K
angular distribution for (n,n*3)

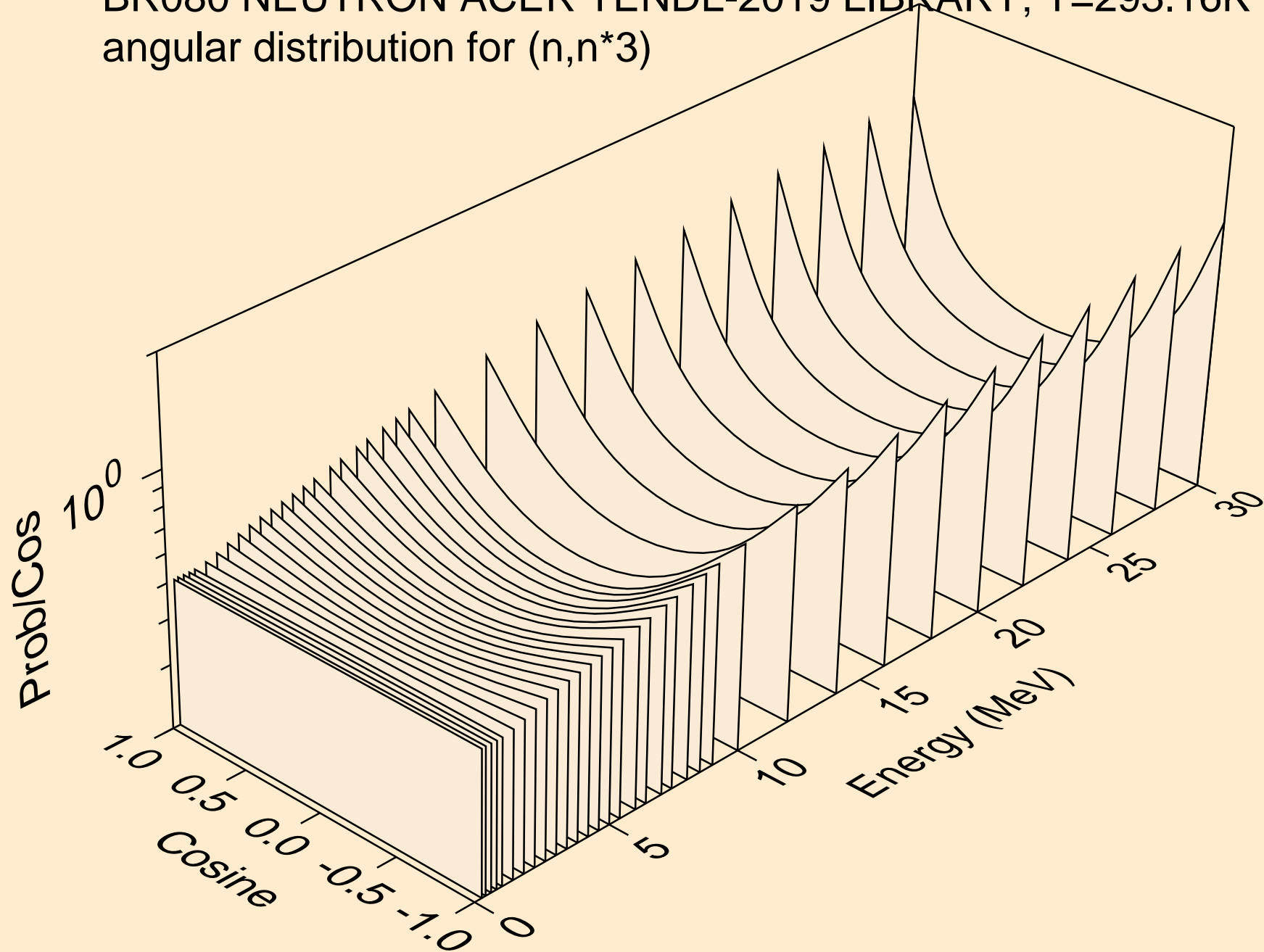

BR080 NEUTRON ACER TENDL-2019 LIBRARY; T=293.16K
angular distribution for (n,n*4)

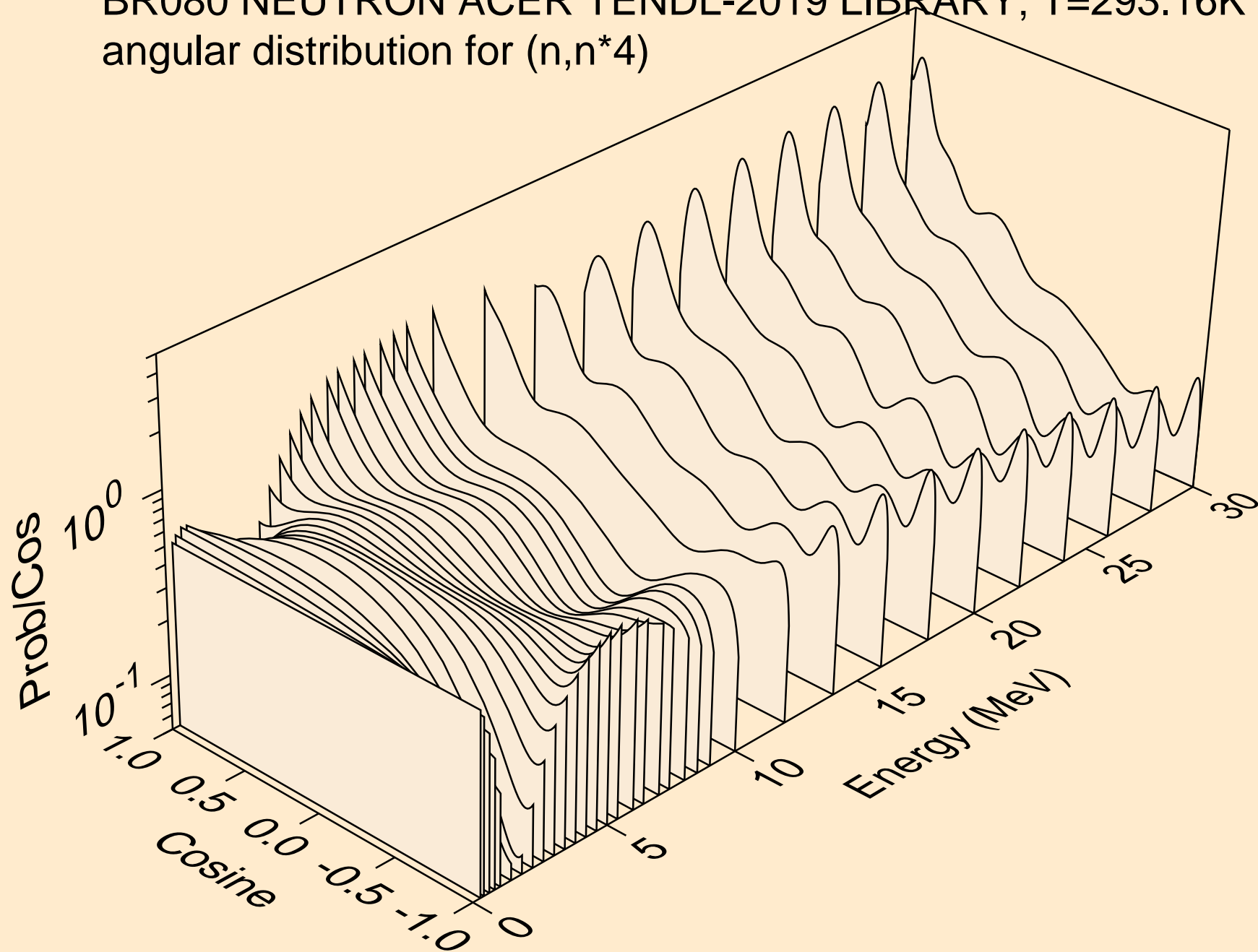

BR080 NEUTRON ACER TENDL-2019 LIBRARY; T=293.16K
angular distribution for (n,n*5)

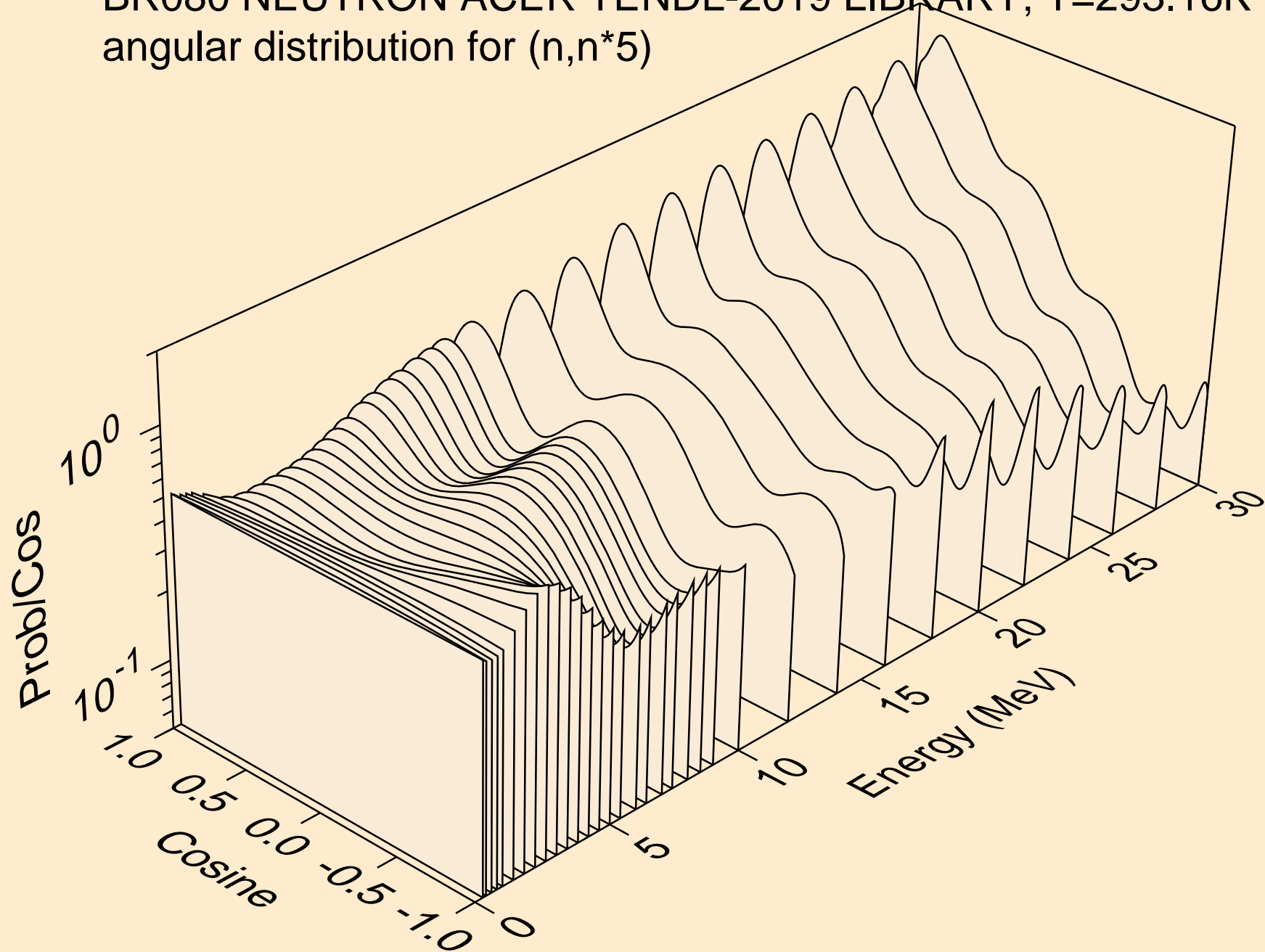

BR080 NEUTRON ACER TENDL-2019 LIBRARY; T=293.16K
angular distribution for (n,n*6)

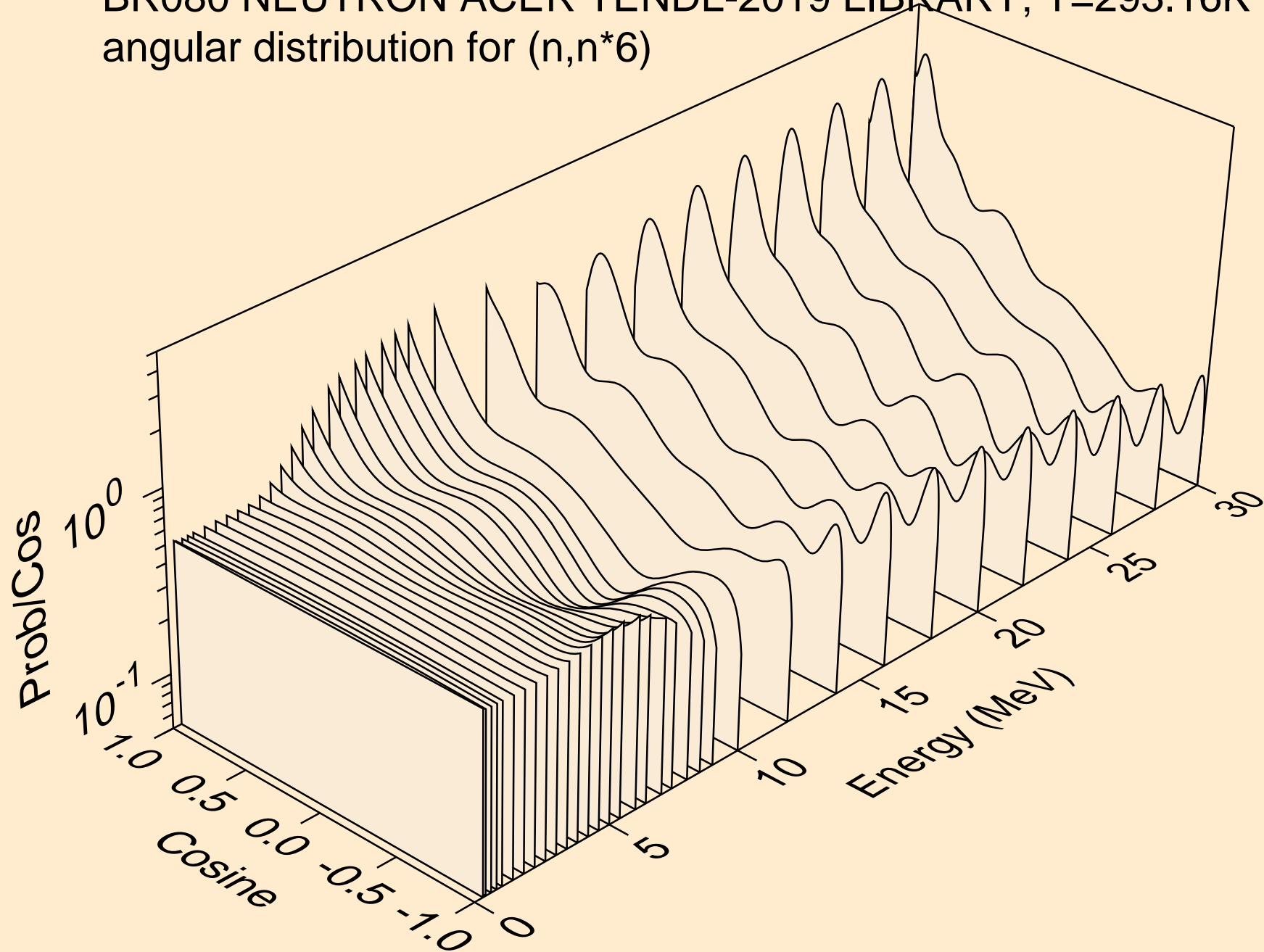

BR080 NEUTRON ACER TENDL-2019 LIBRARY; T=293.16K
angular distribution for (n,n*7)

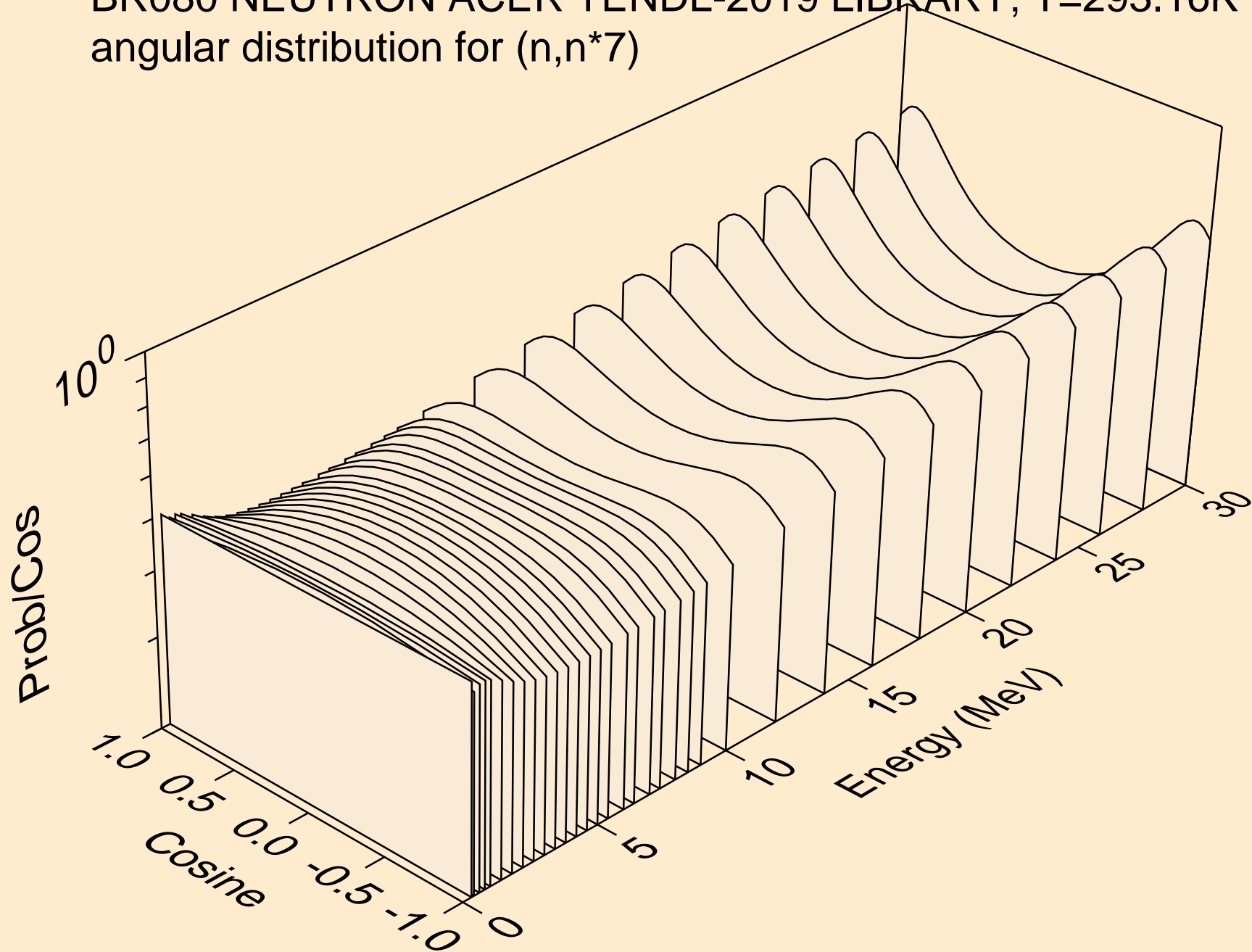

BR080 NEUTRON ACER TENDL-2019 LIBRARY; T=293.16K
angular distribution for (n,n*8)

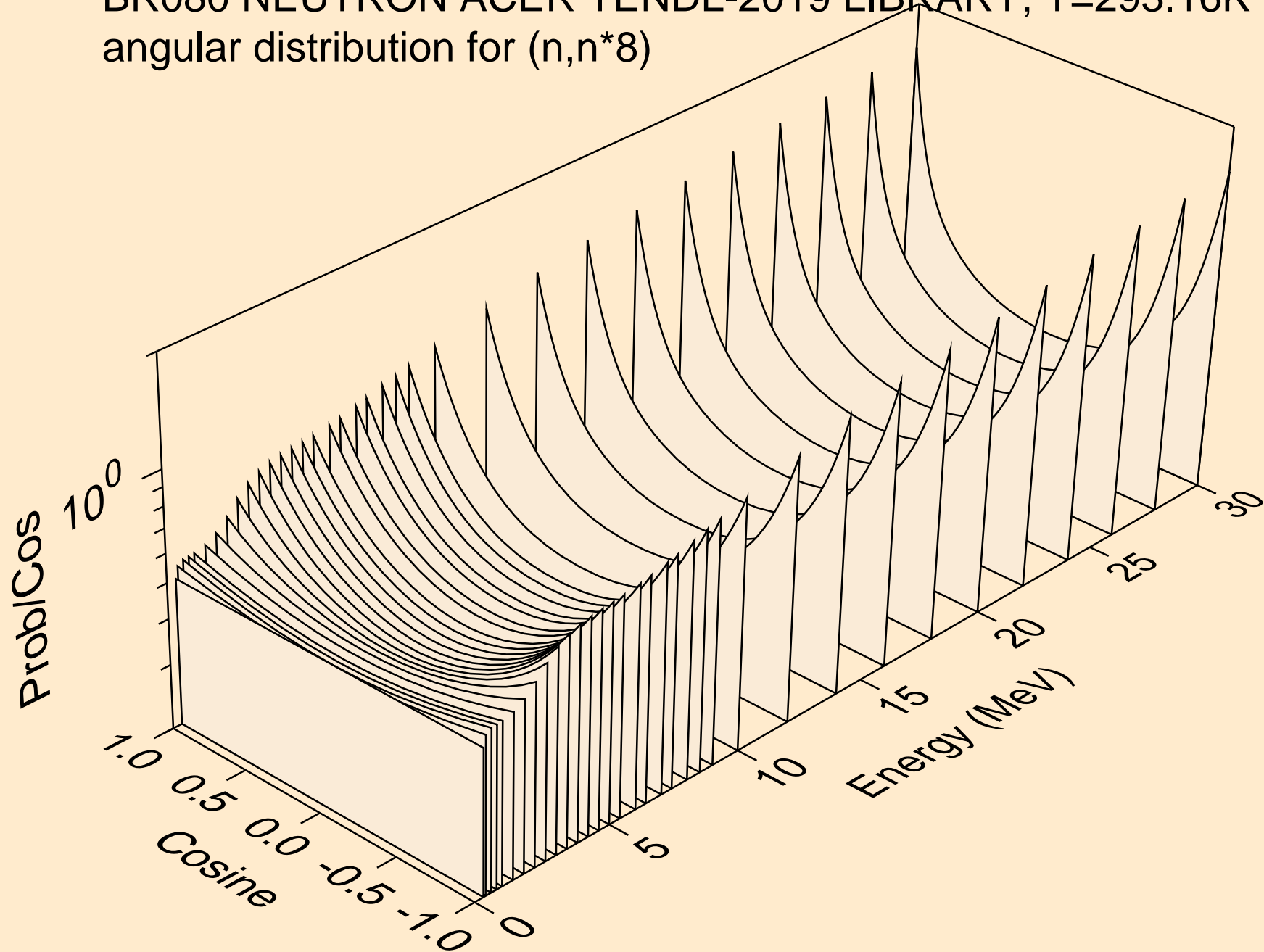

BR080 NEUTRON ACER TENDL-2019 LIBRARY; T=293.16K
angular distribution for (n,n*9)

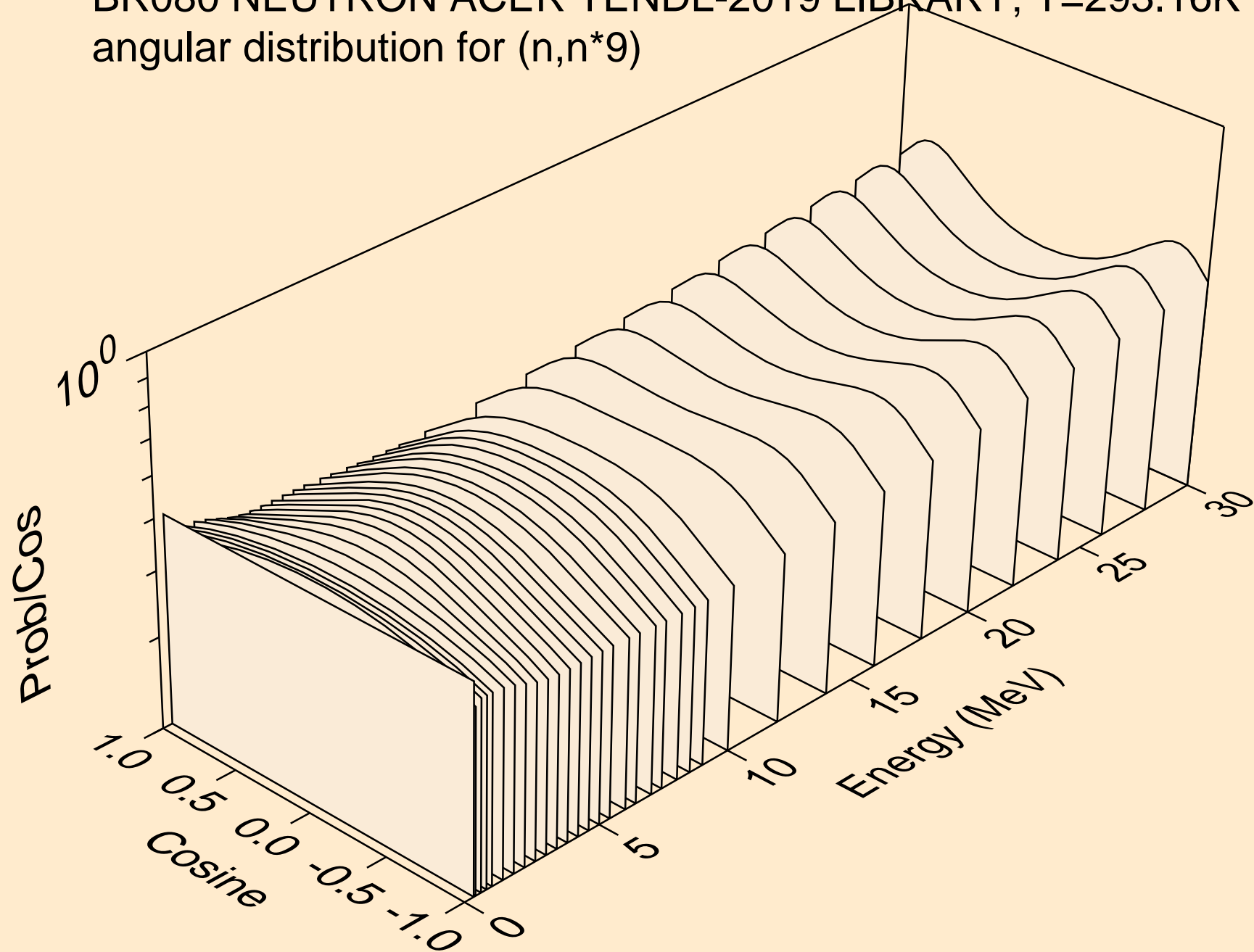

BR080 NEUTRON ACER TENDL-2019 LIBRARY; T=293.16K
angular distribution for (n,n*10)

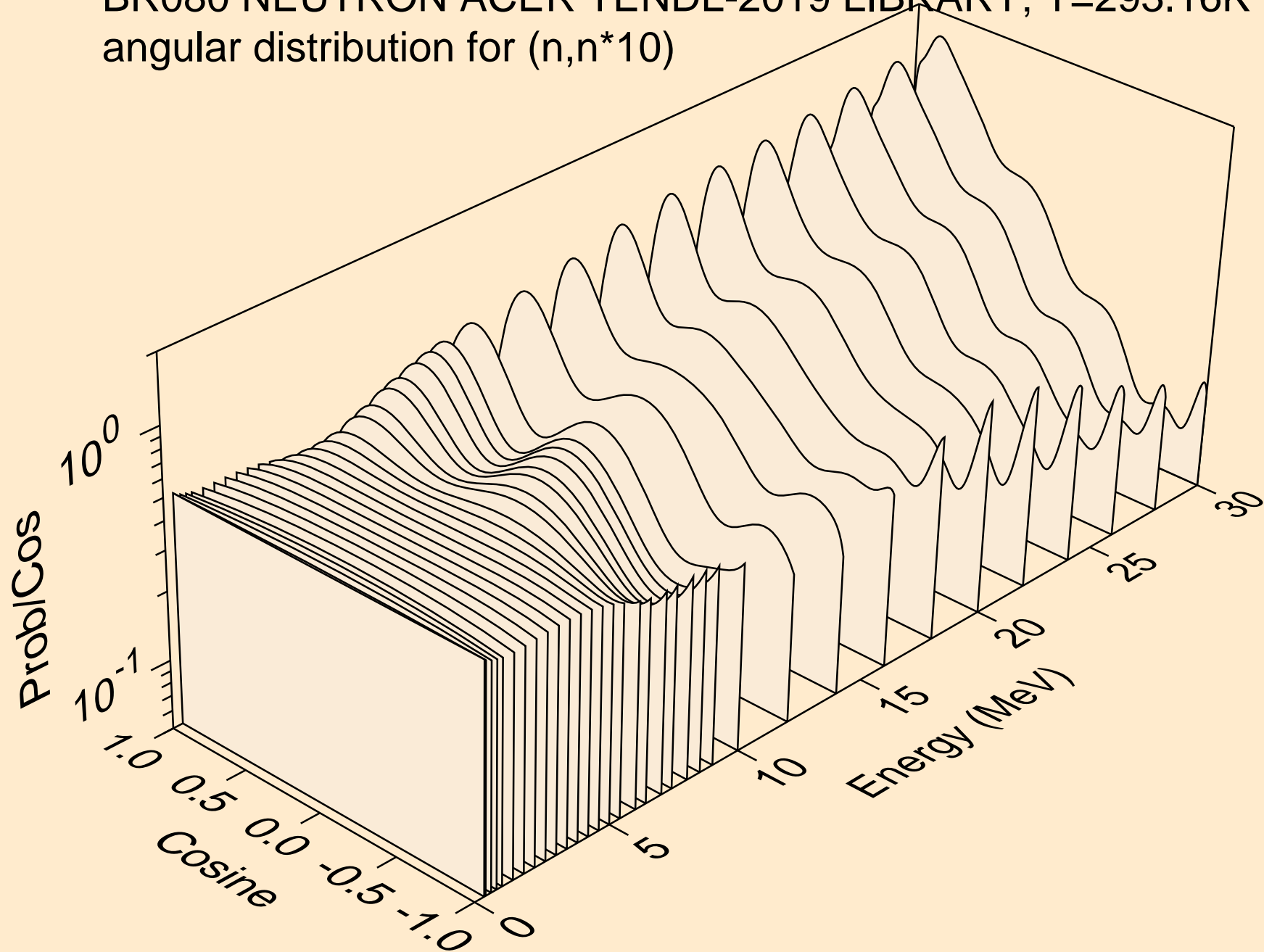

BR080 NEUTRON ACER TENDL-2019 LIBRARY; T=293.16K
angular distribution for (n,n*11)

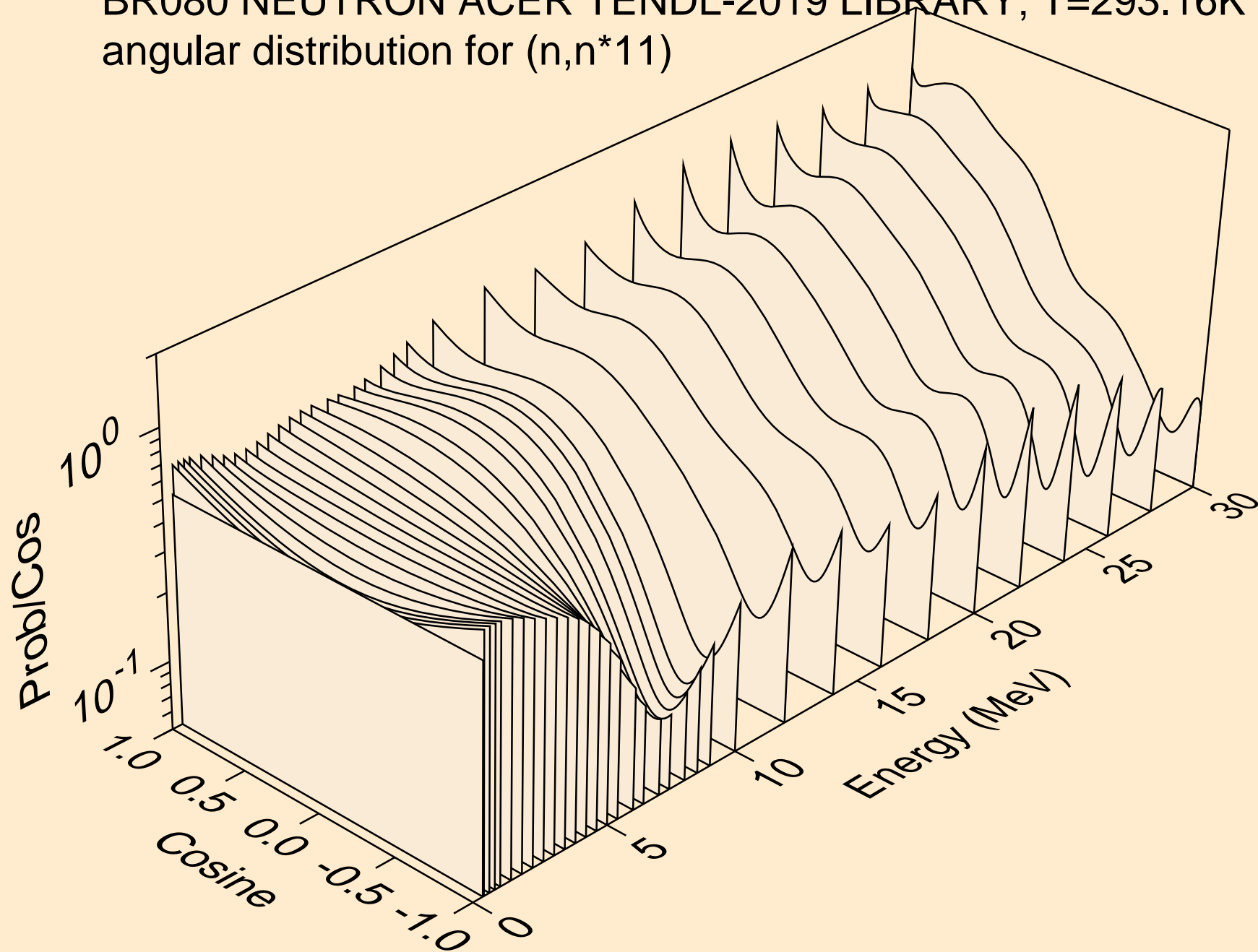

BR080 NEUTRON ACER TENDL-2019 LIBRARY; T=293.16K
angular distribution for (n,n*12)

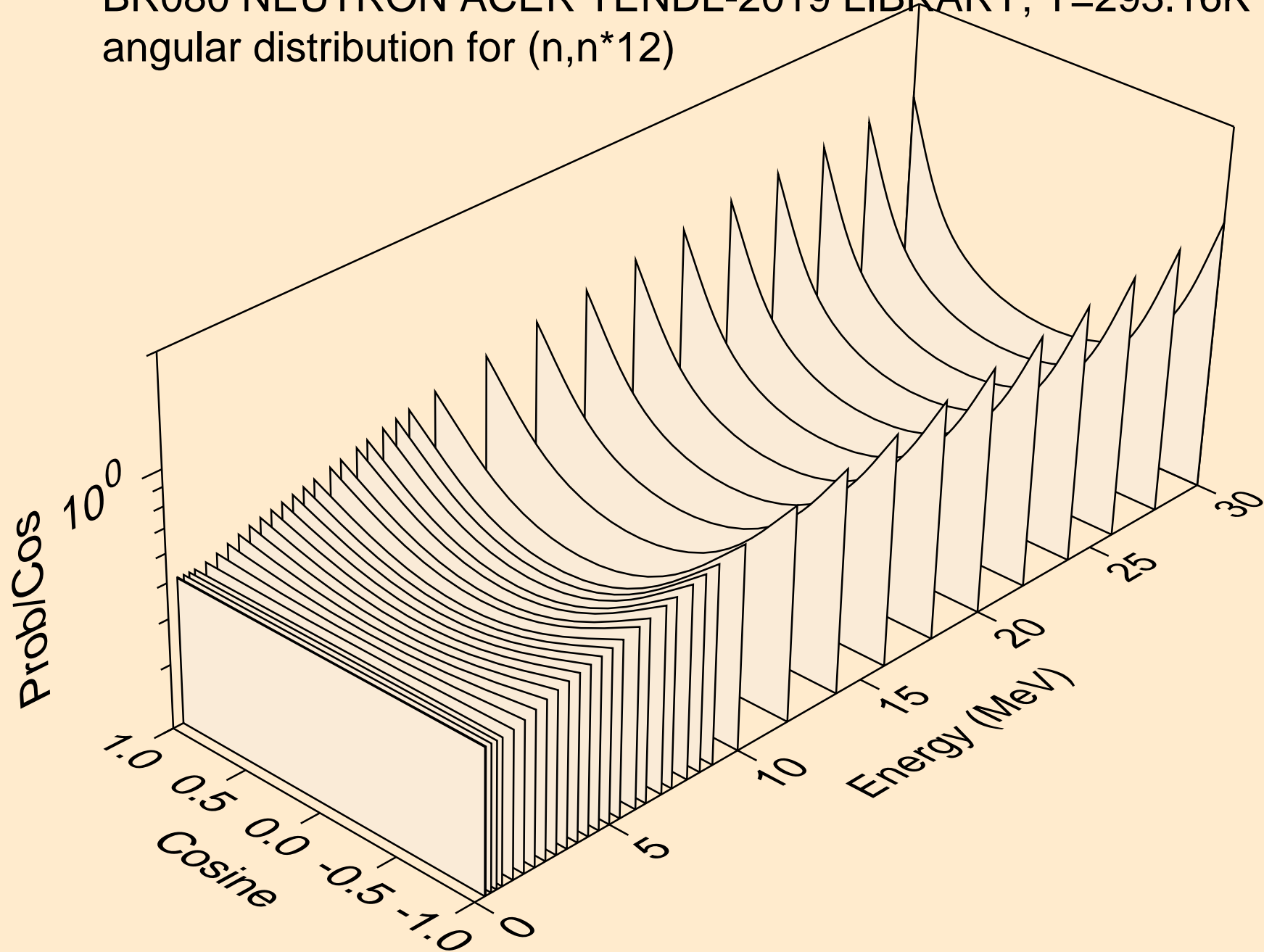

BR080 NEUTRON ACER TENDL-2019 LIBRARY; T=293.16K
angular distribution for (n,n*13)

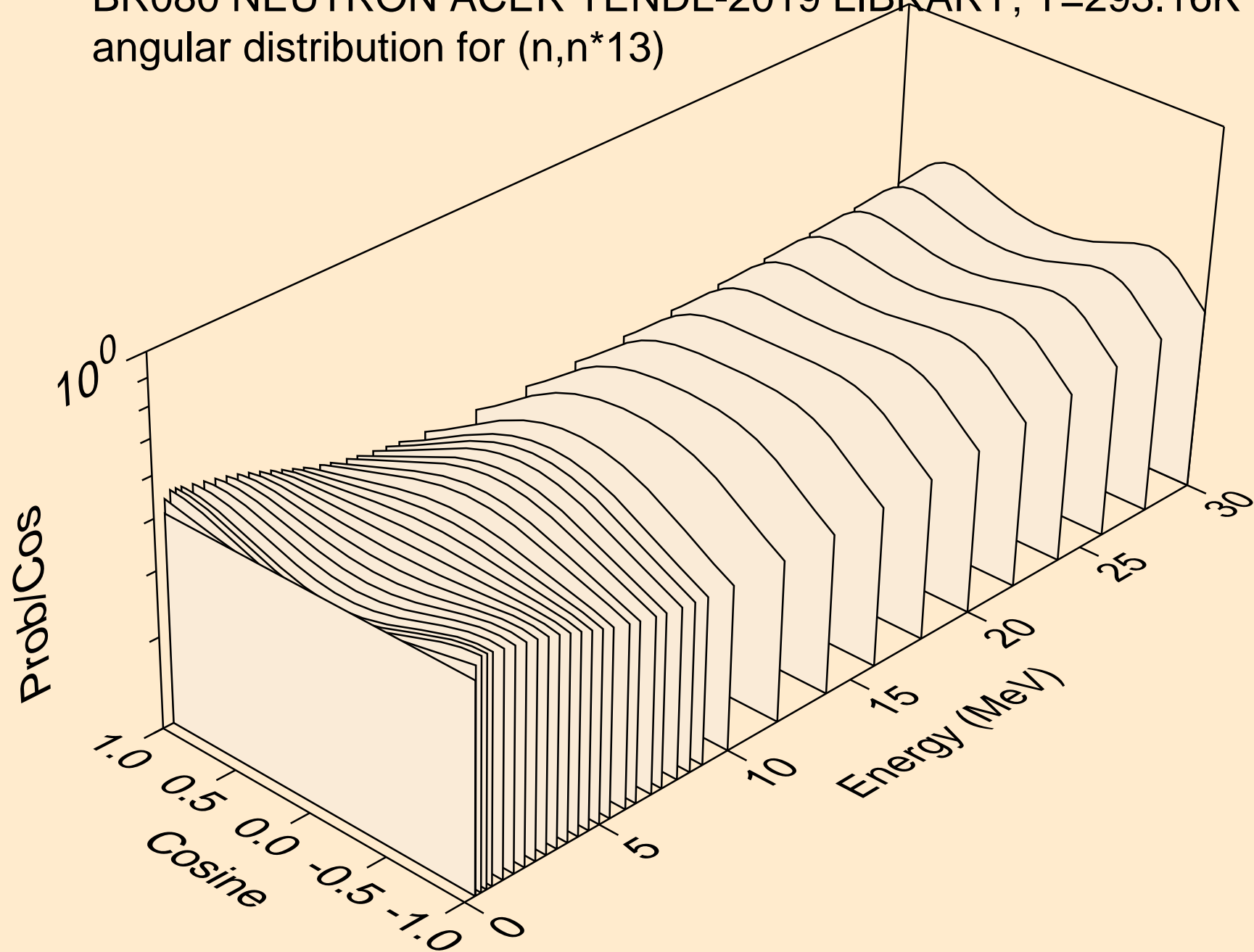

BR080 NEUTRON ACER TENDL-2019 LIBRARY; T=293.16K
angular distribution for (n,n*14)

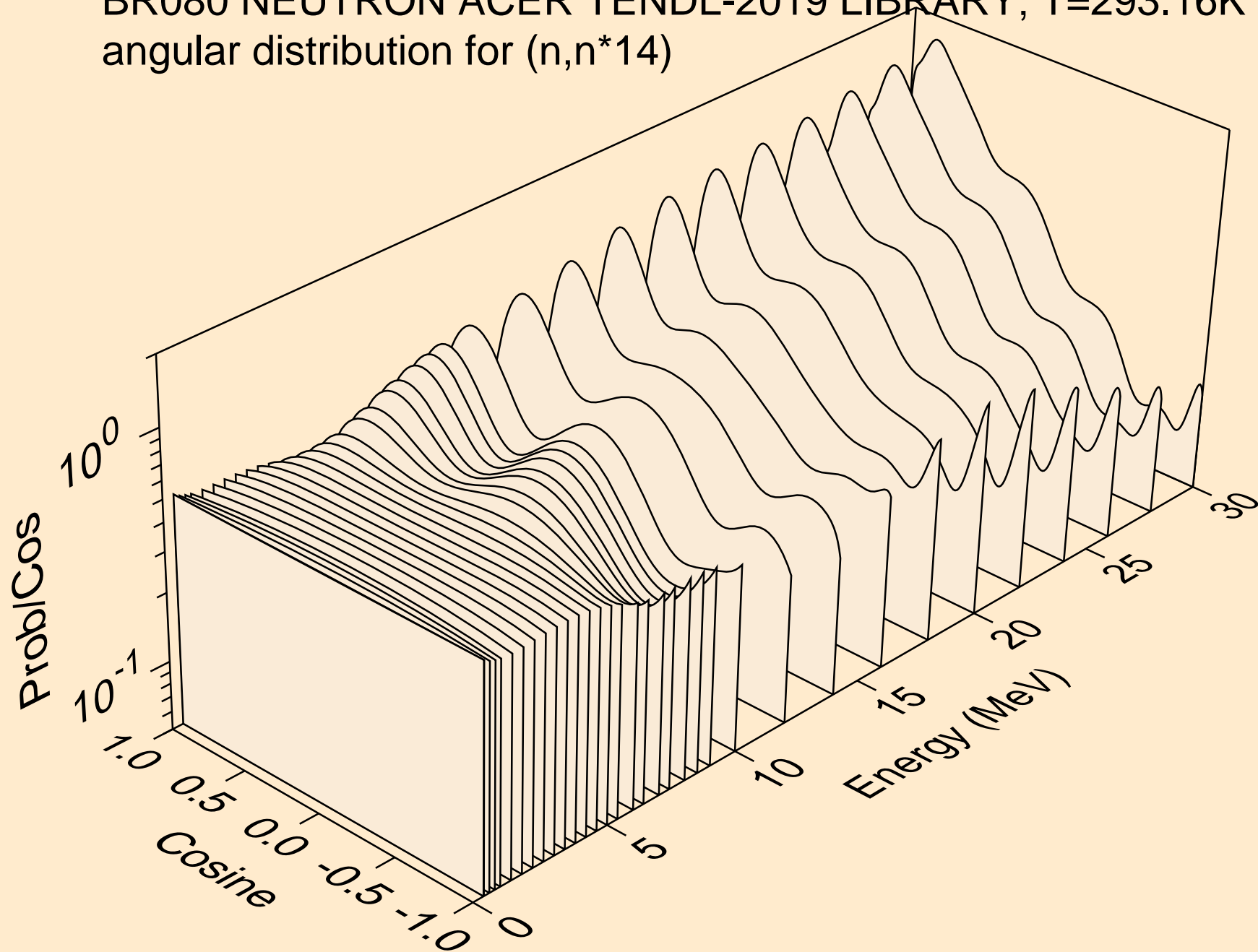

BR080 NEUTRON ACER TENDL-2019 LIBRARY; T=293.16K
angular distribution for (n,n*15)

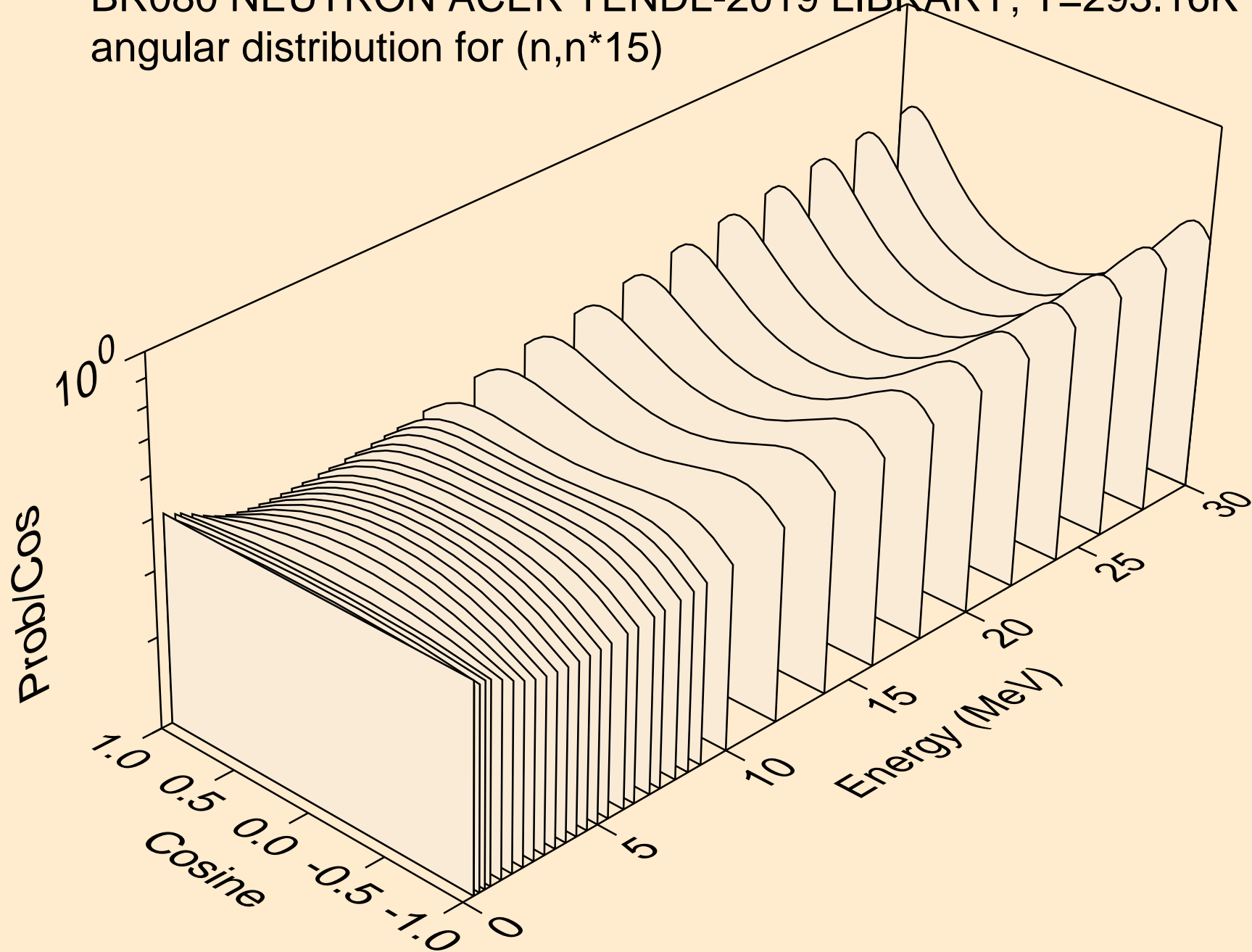

BR080 NEUTRON ACER TENDL-2019 LIBRARY; T=293.16K
angular distribution for (n,n*16)

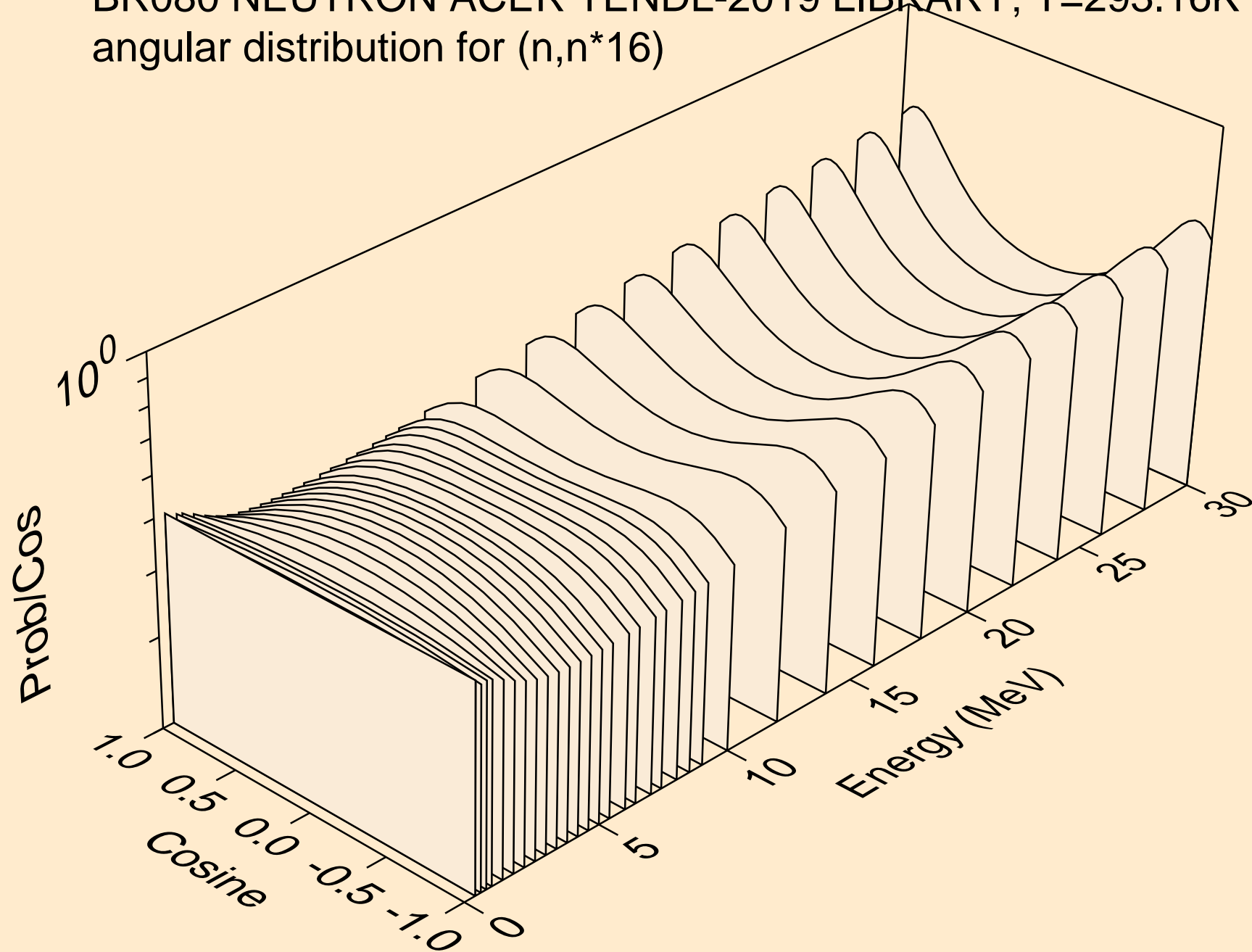

BR080 NEUTRON ACER TENDL-2019 LIBRARY; T=293.16K
angular distribution for (n,n*17)

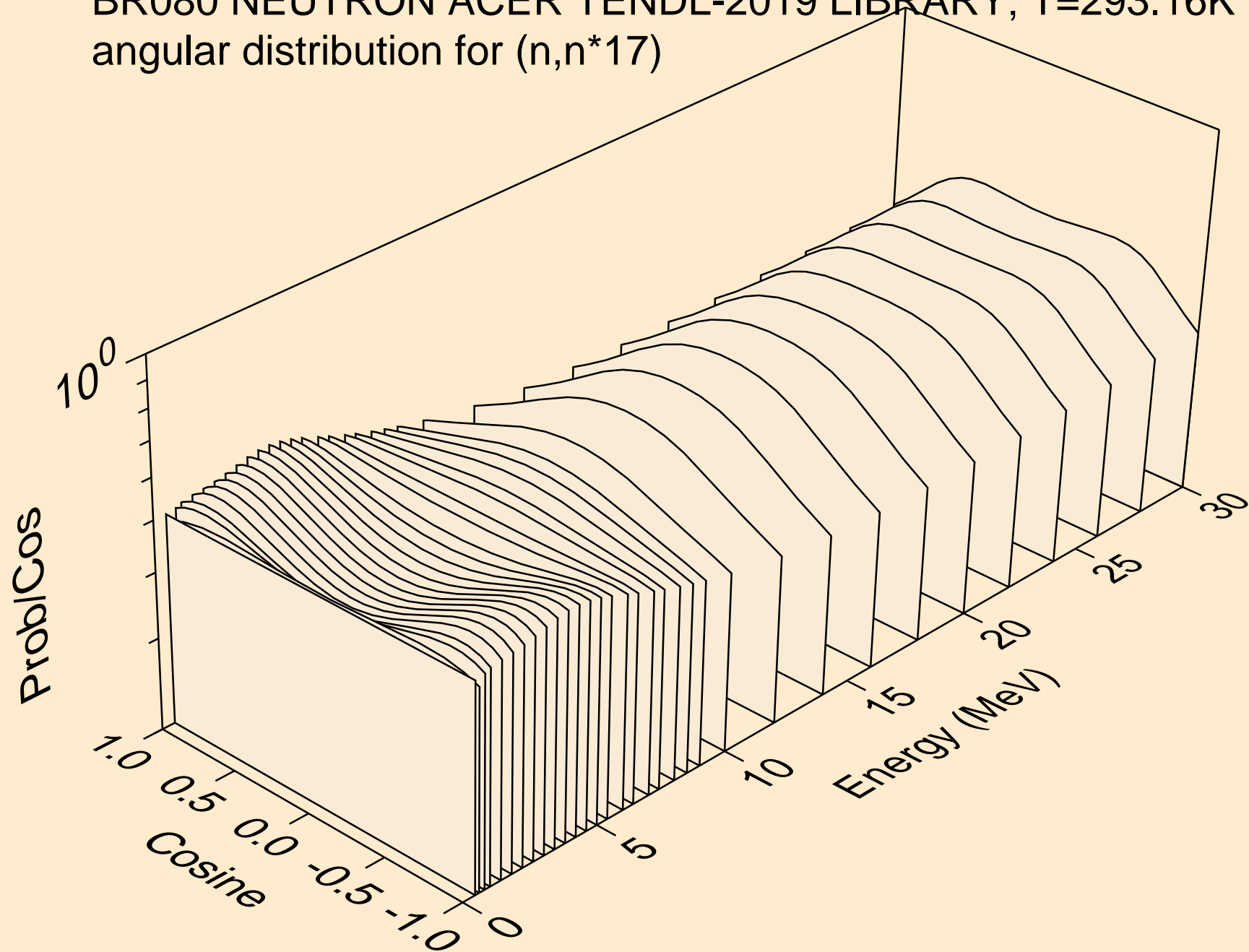

BR080 NEUTRON ACER TENDL-2019 LIBRARY; T=293.16K
angular distribution for (n,n*18)

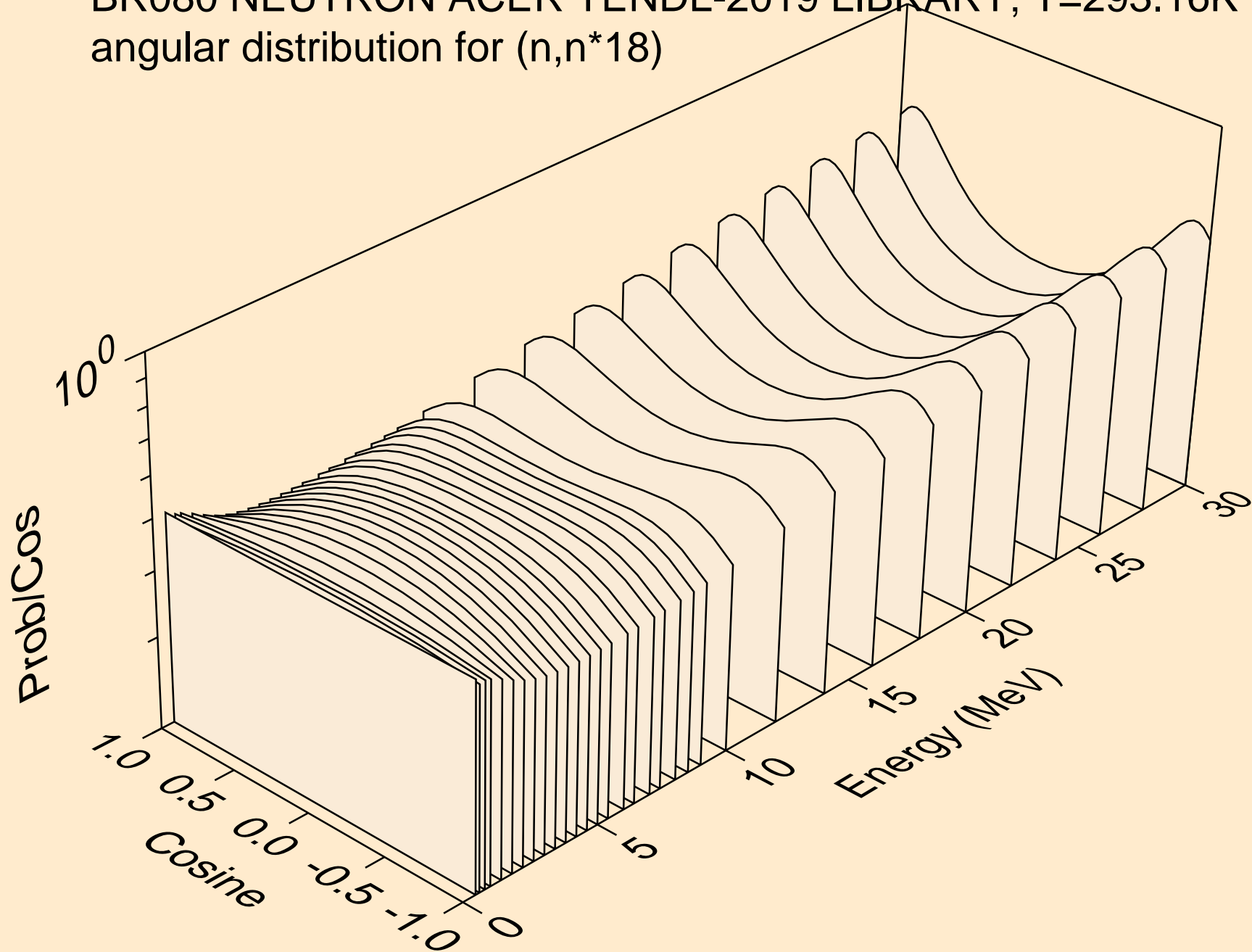

BR080 NEUTRON ACER TENDL-2019 LIBRARY; T=293.16K
angular distribution for (n,n*19)

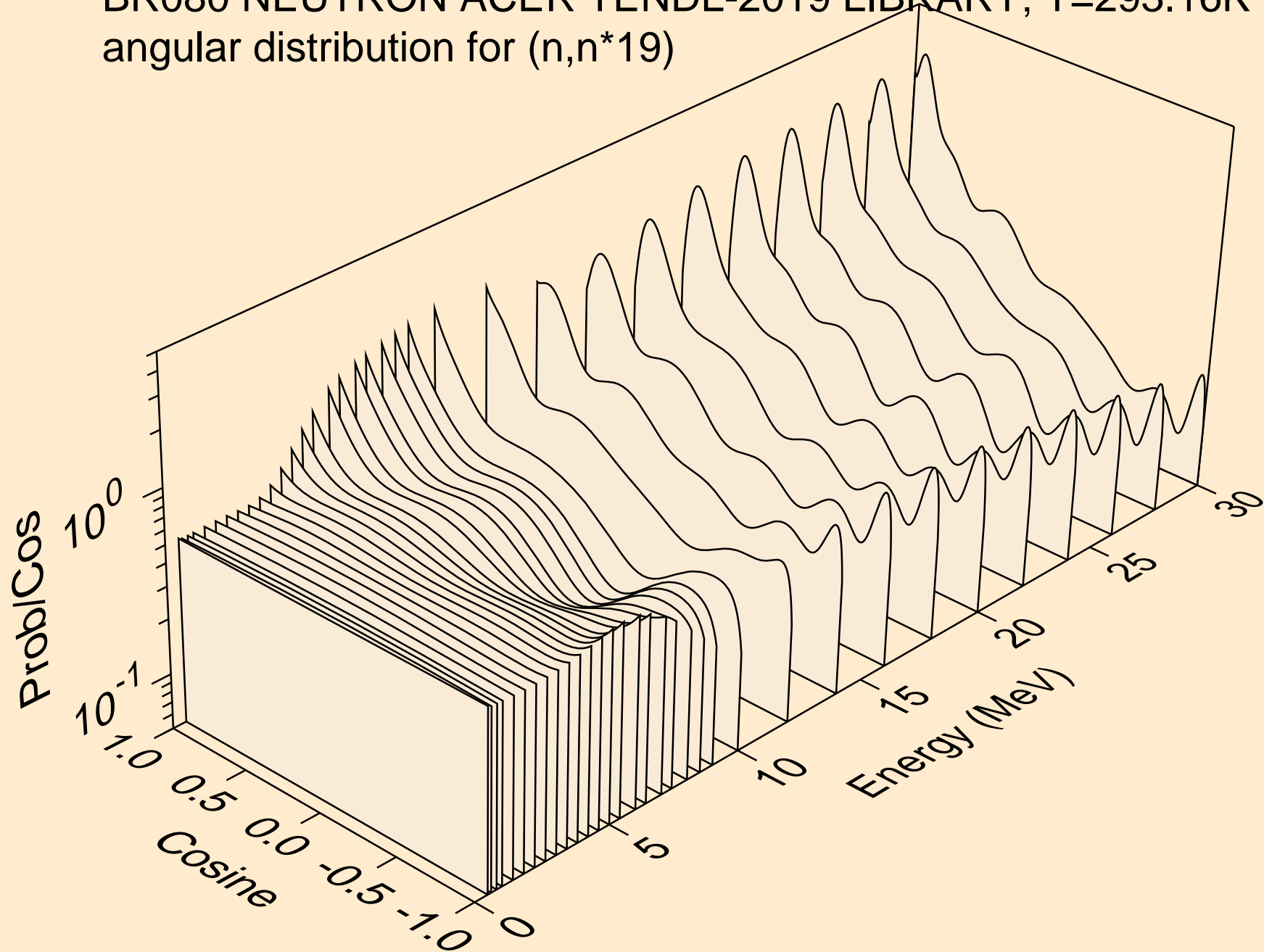

BR080 NEUTRON ACER TENDL-2019 LIBRARY; T=293.16K
angular distribution for (n,n*20)

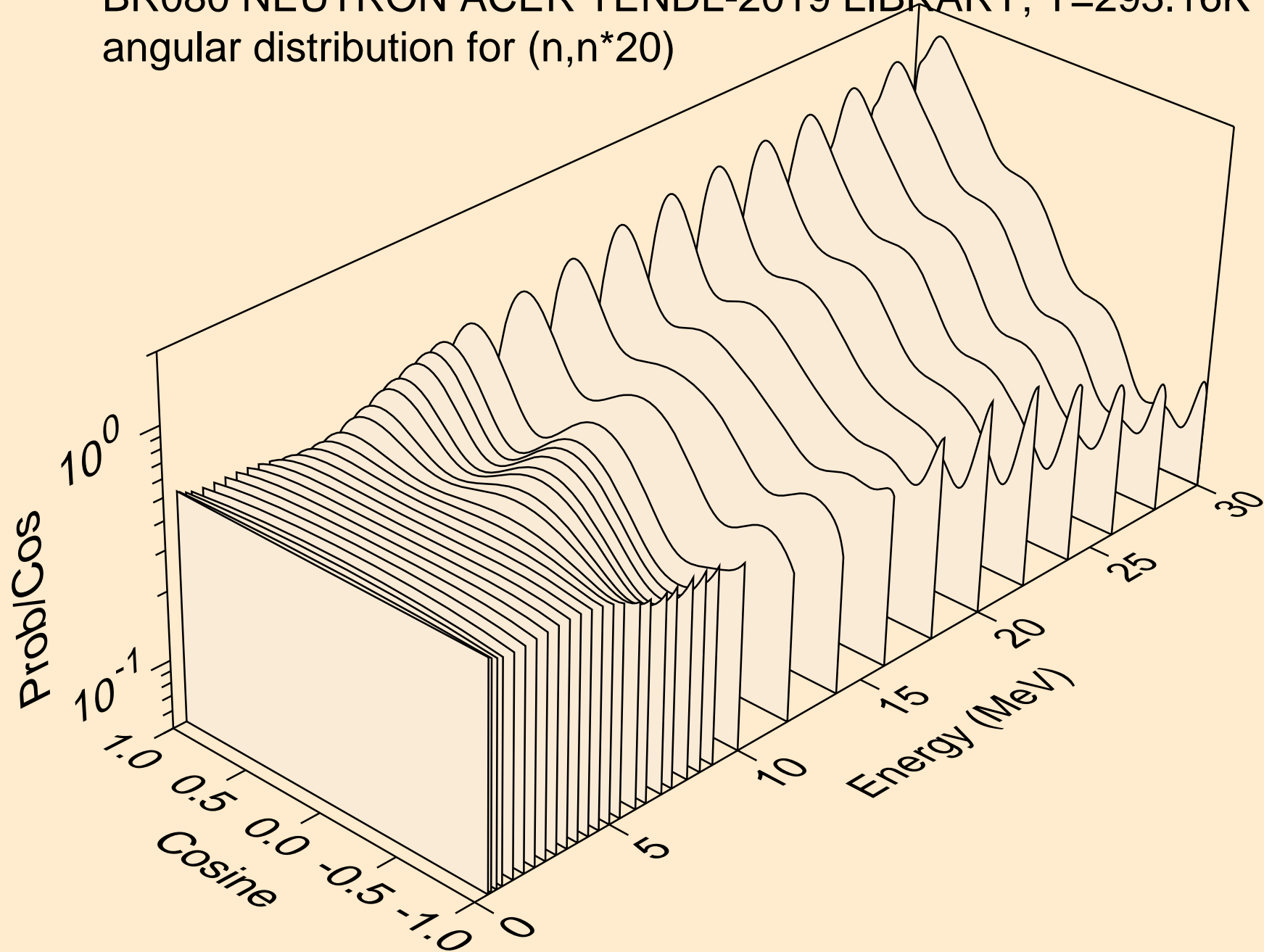

BR080 NEUTRON ACER TENDL-2019 LIBRARY; T=293.16K
angular distribution for (n,n*21)

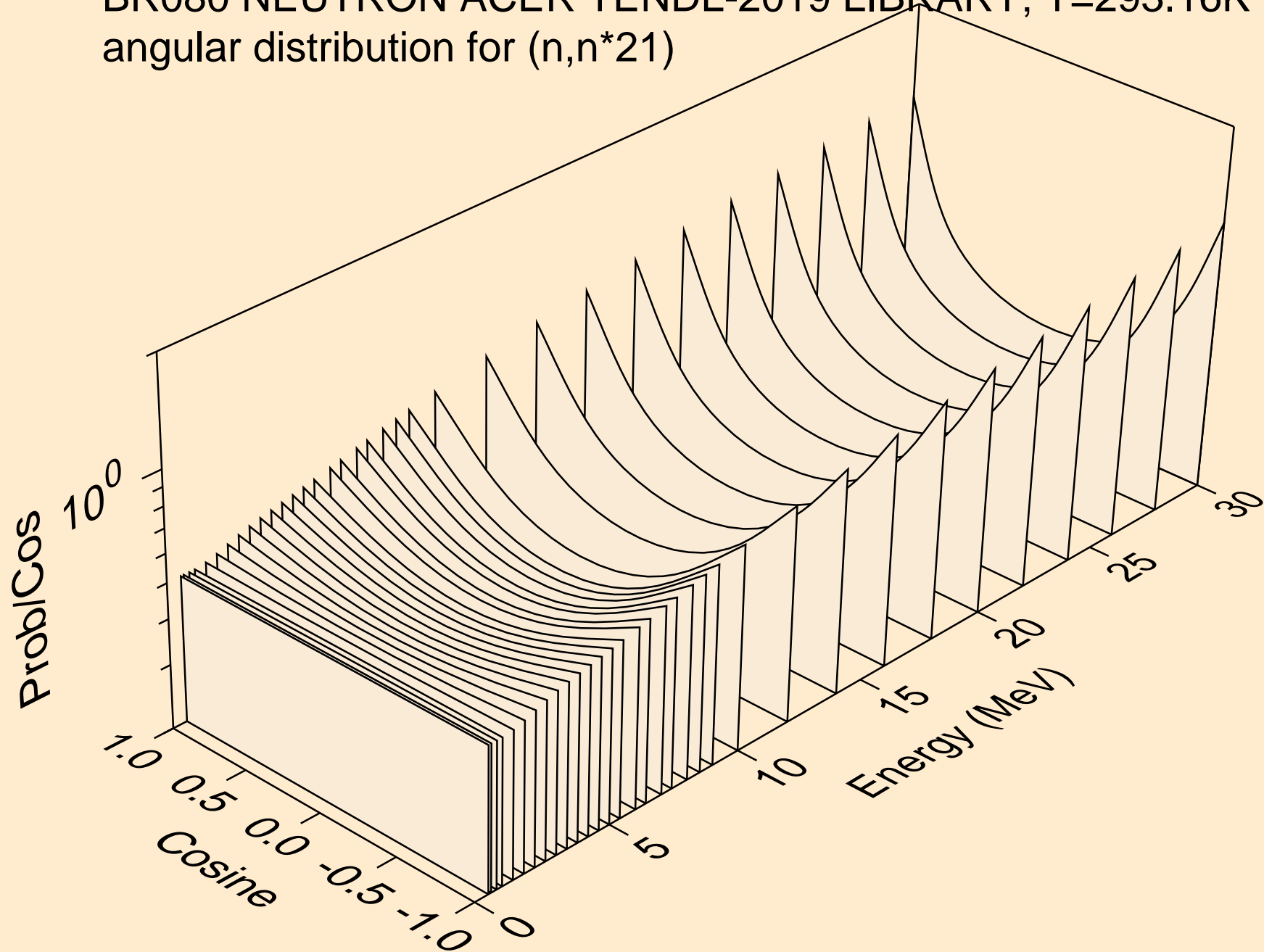

BR080 NEUTRON ACER TENDL-2019 LIBRARY; T=293.16K
angular distribution for (n,n*22)

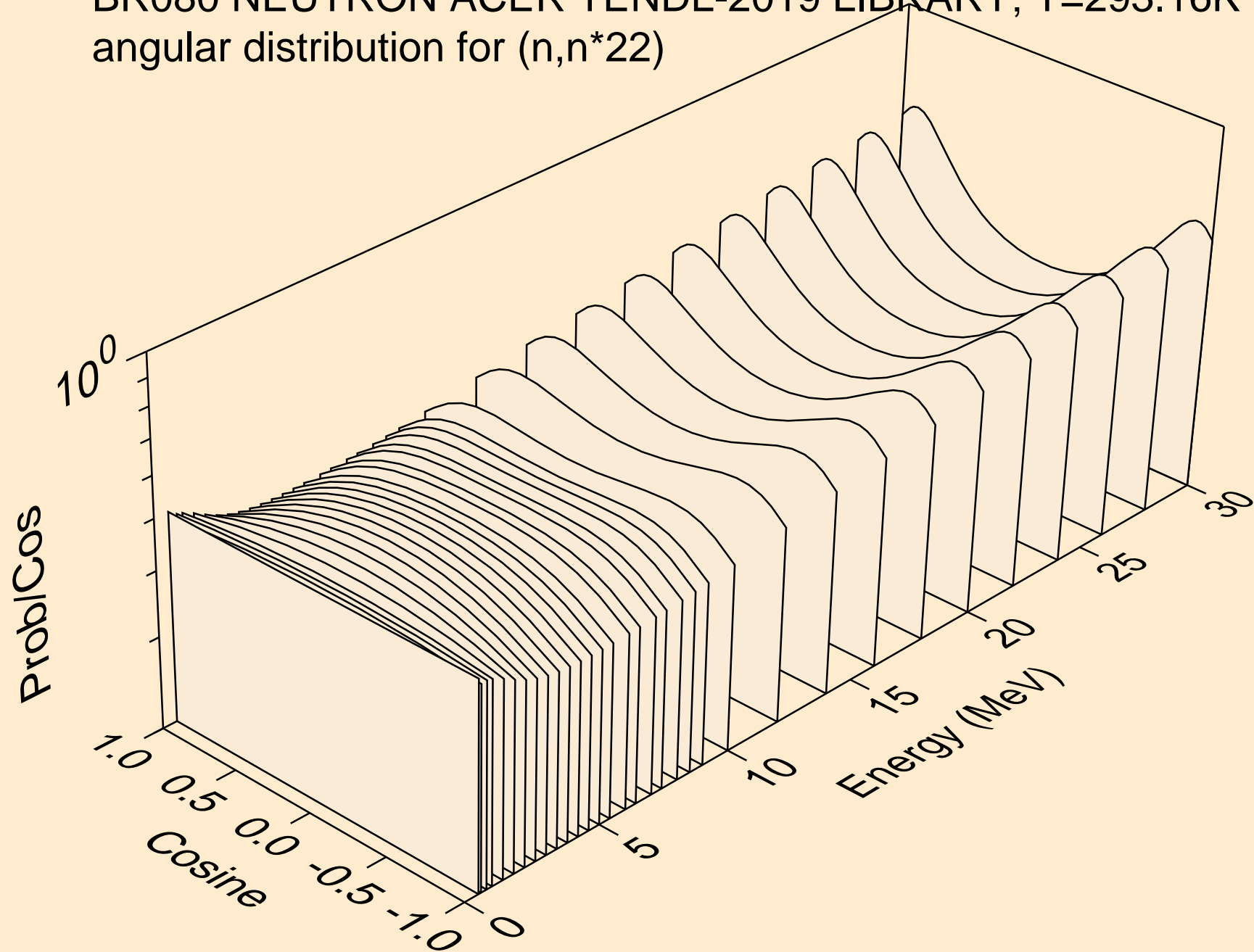

BR080 NEUTRON ACER TENDL-2019 LIBRARY; T=293.16K
angular distribution for (n,n*23)

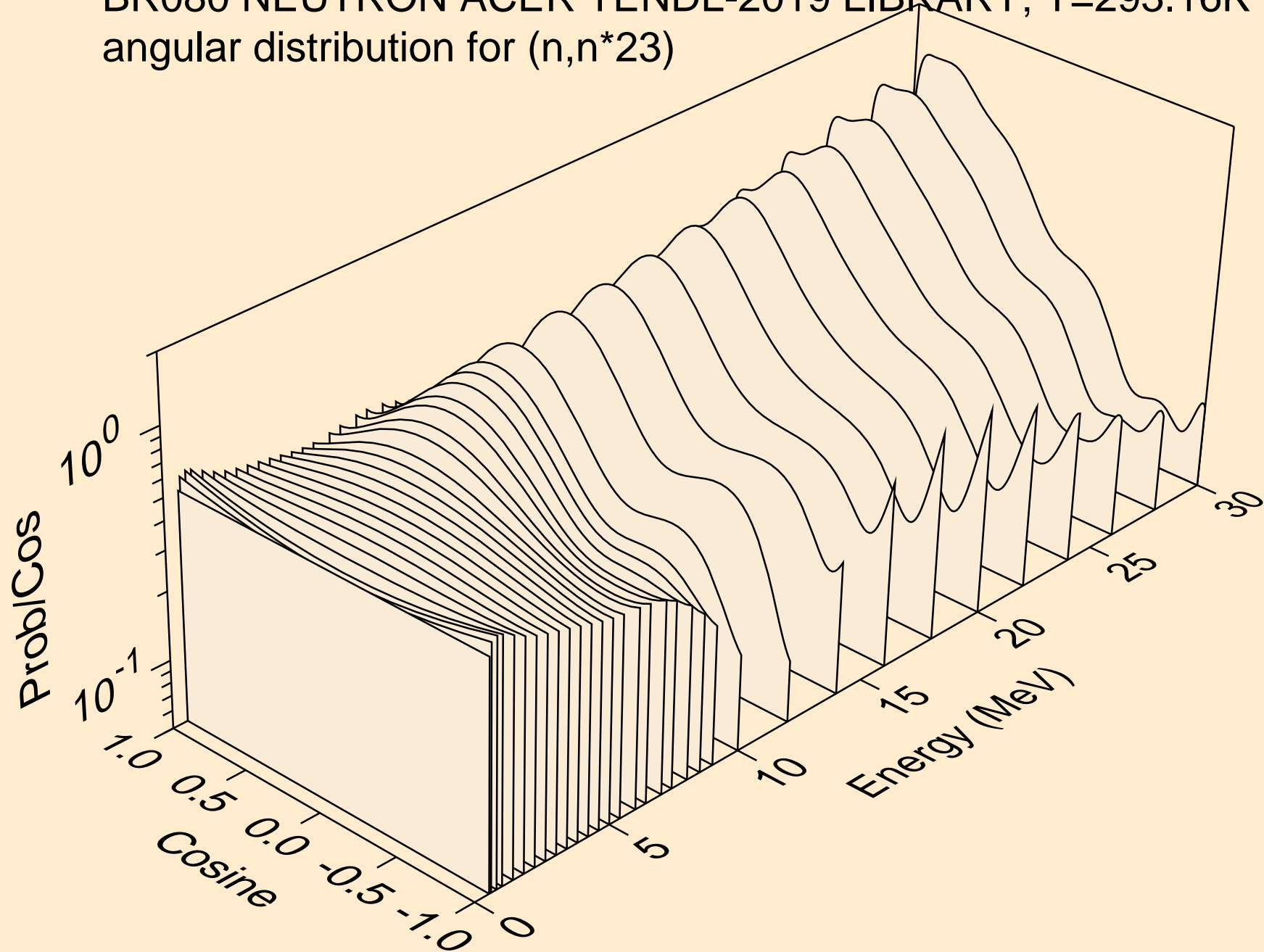

BR080 NEUTRON ACER TENDL-2019 LIBRARY; T=293.16K
angular distribution for (n,n*24)

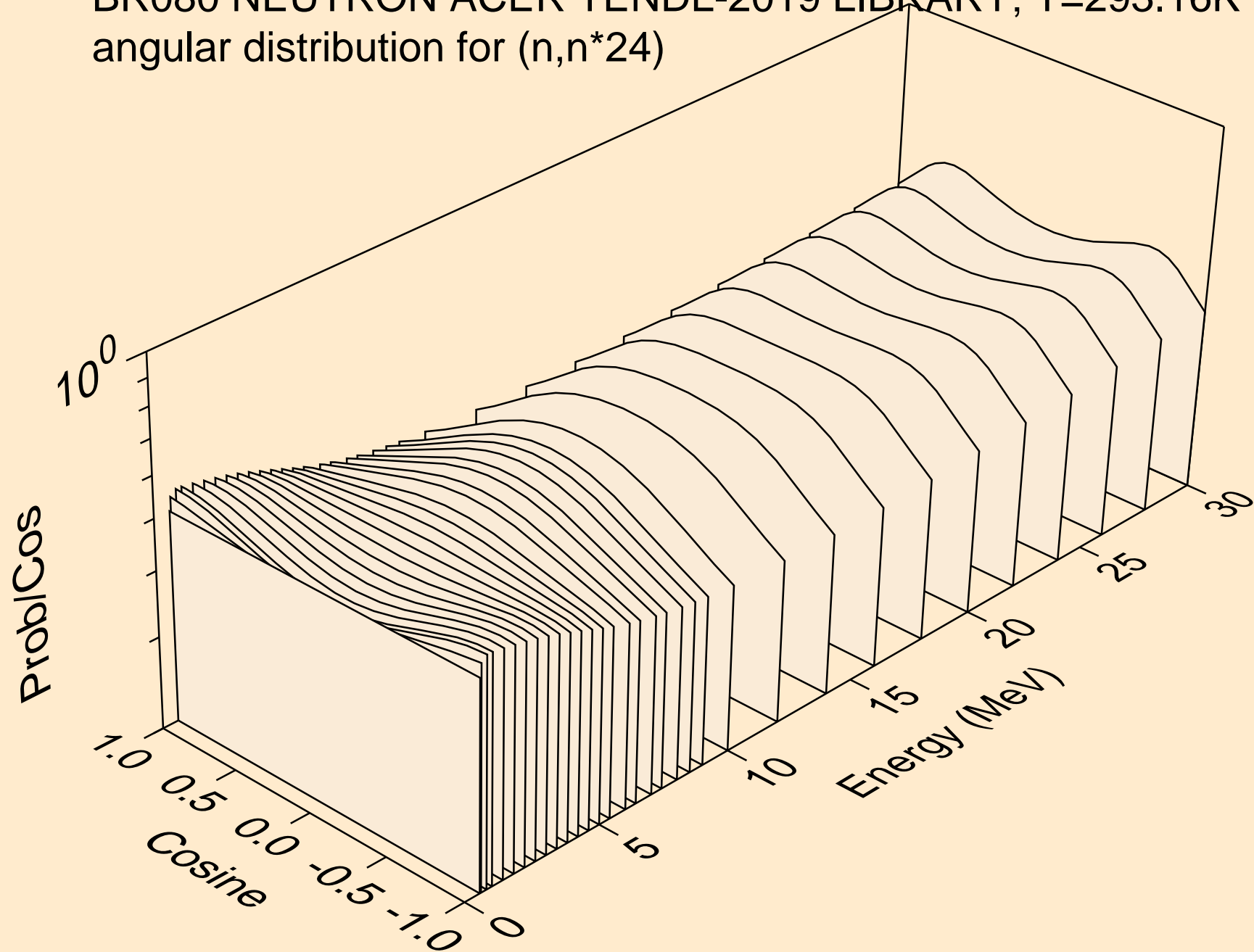

BR080 NEUTRON ACER TENDL-2019 LIBRARY; T=293.16K
angular distribution for (n,n*25)

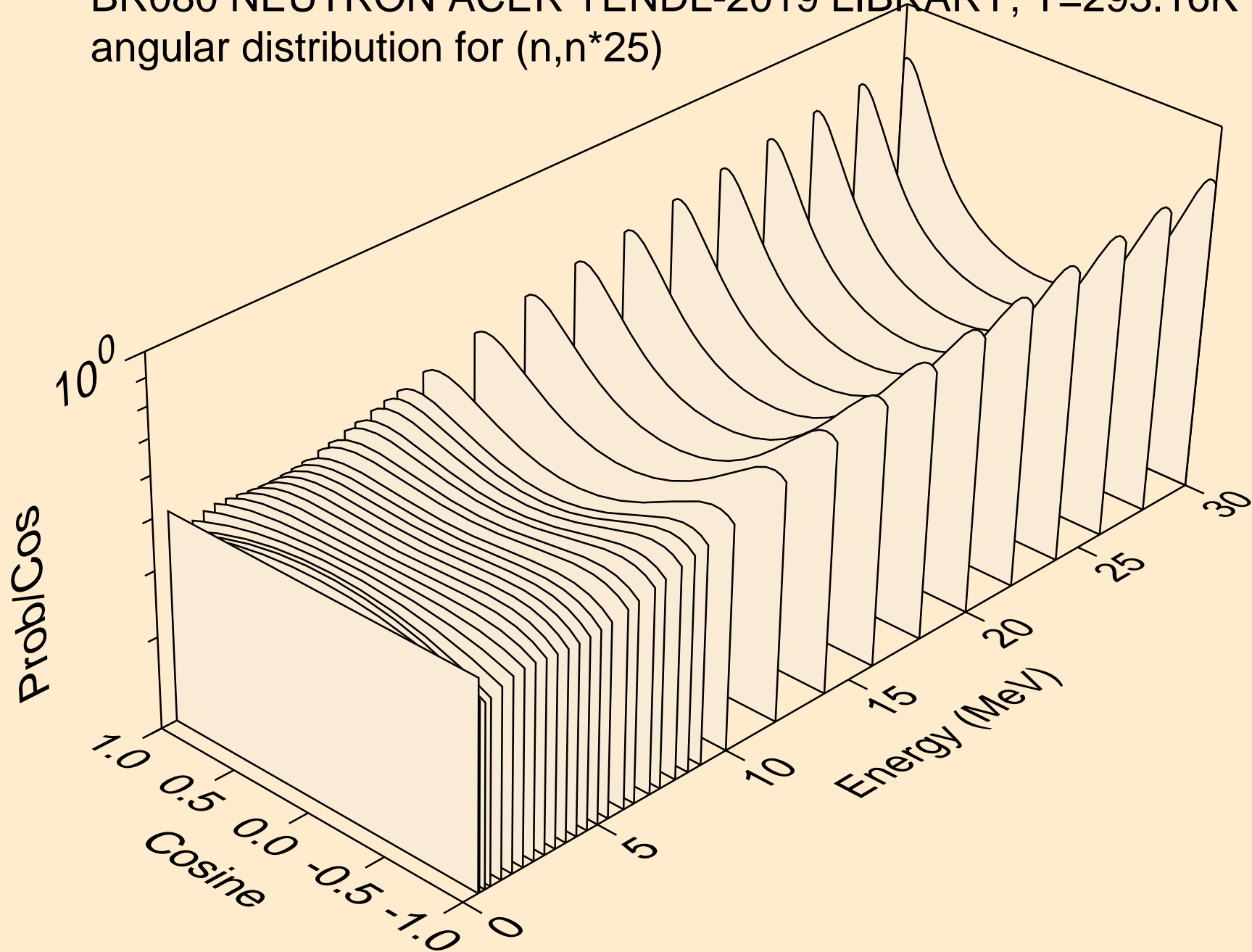

BR080 NEUTRON ACER TENDL-2019 LIBRARY; T=293.16K
angular distribution for (n,n*26)

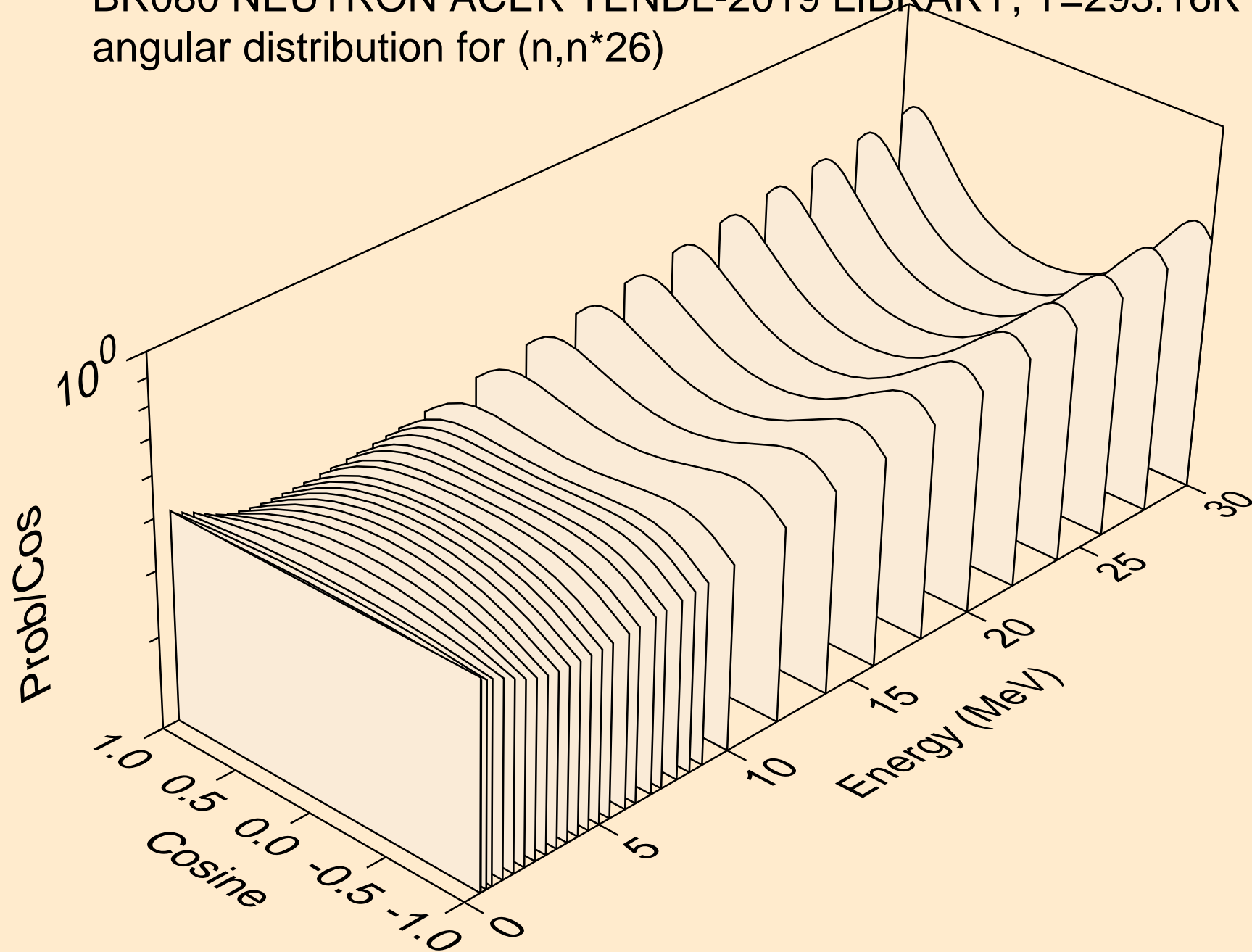

BR080 NEUTRON ACER TENDL-2019 LIBRARY; T=293.16K
angular distribution for (n,n*27)

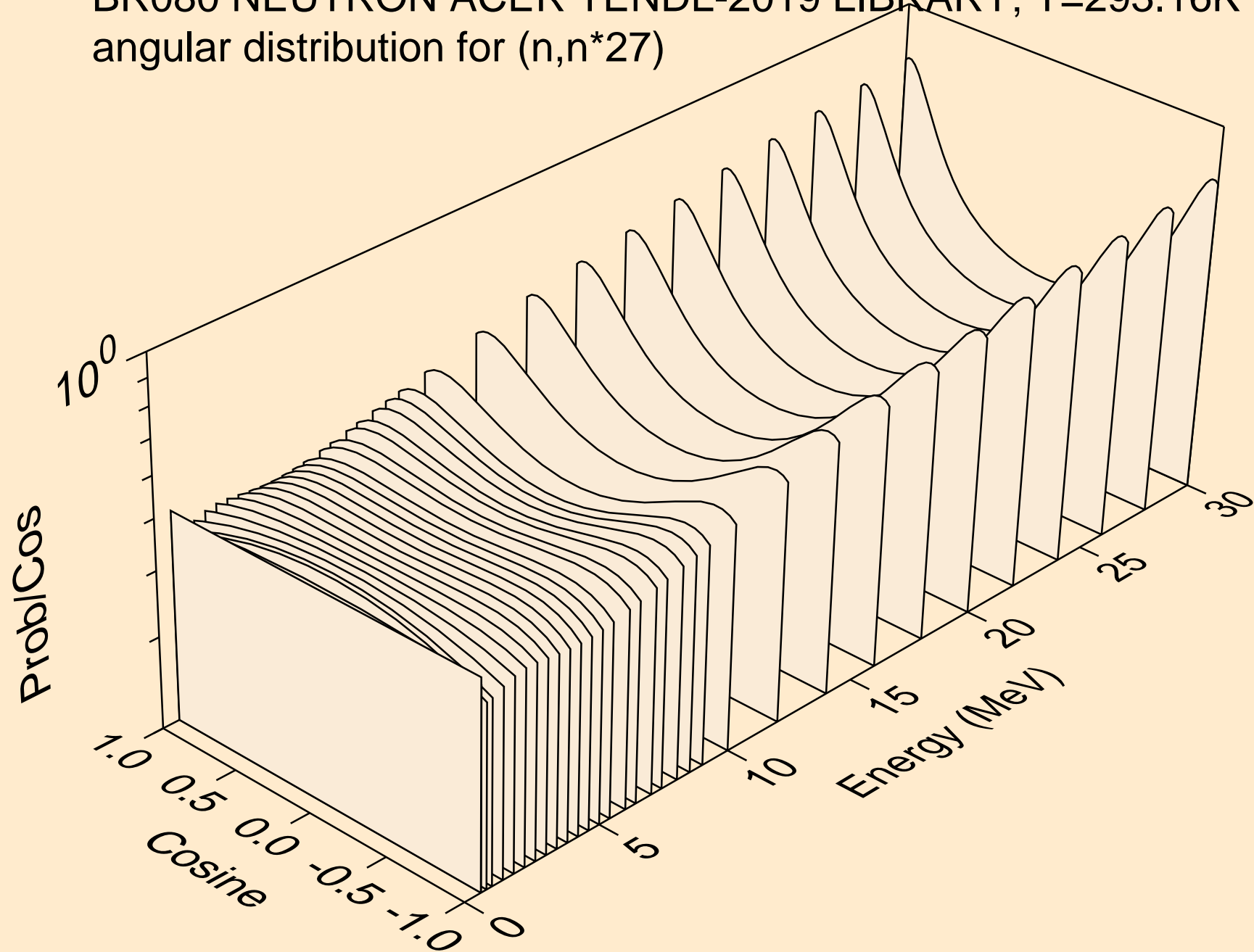

BR080 NEUTRON ACER TENDL-2019 LIBRARY; T=293.16K
angular distribution for (n,n*28)

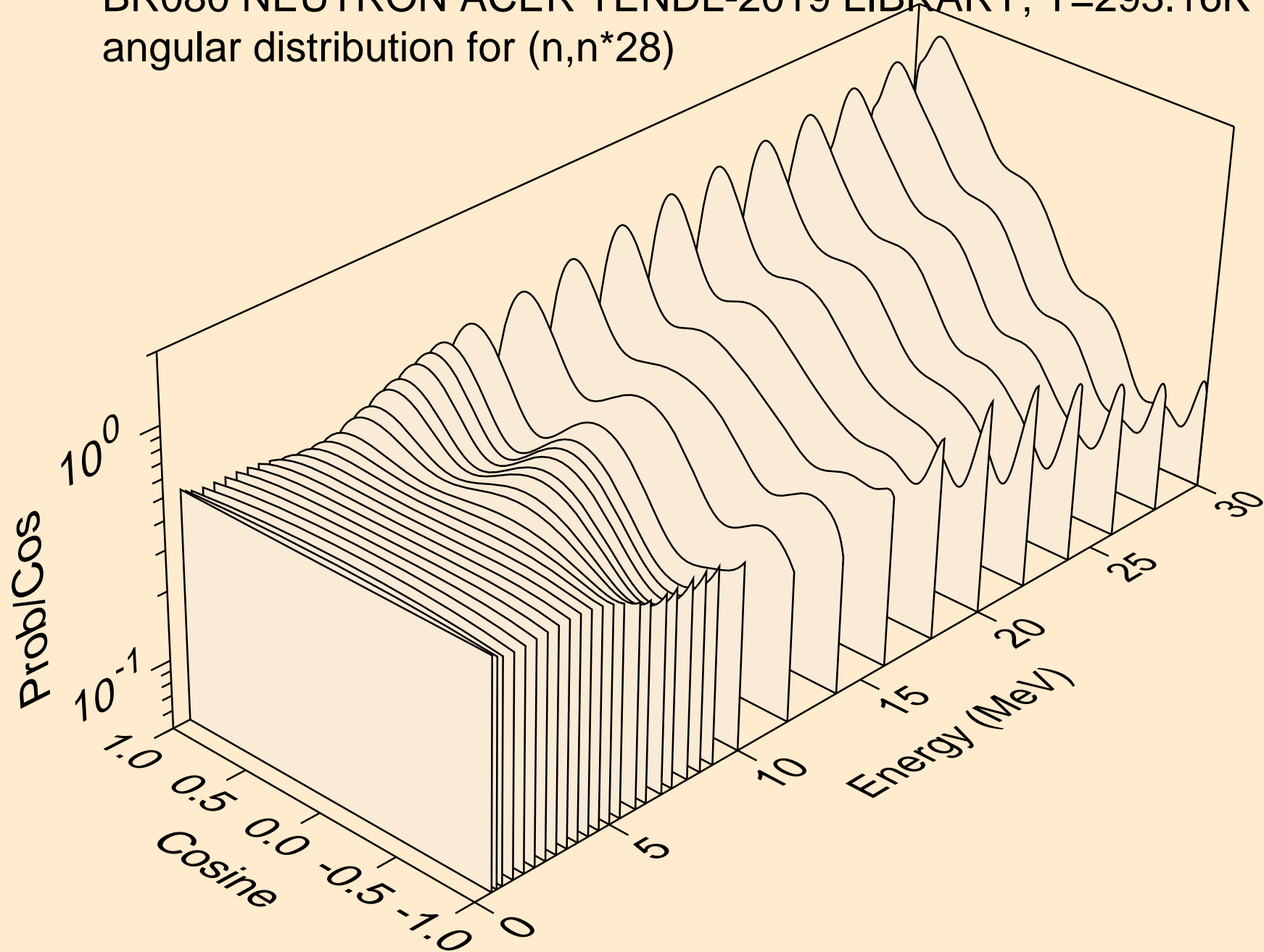

BR080 NEUTRON ACER TENDL-2019 LIBRARY; T=293.16K
Neutron emission for (n,x)

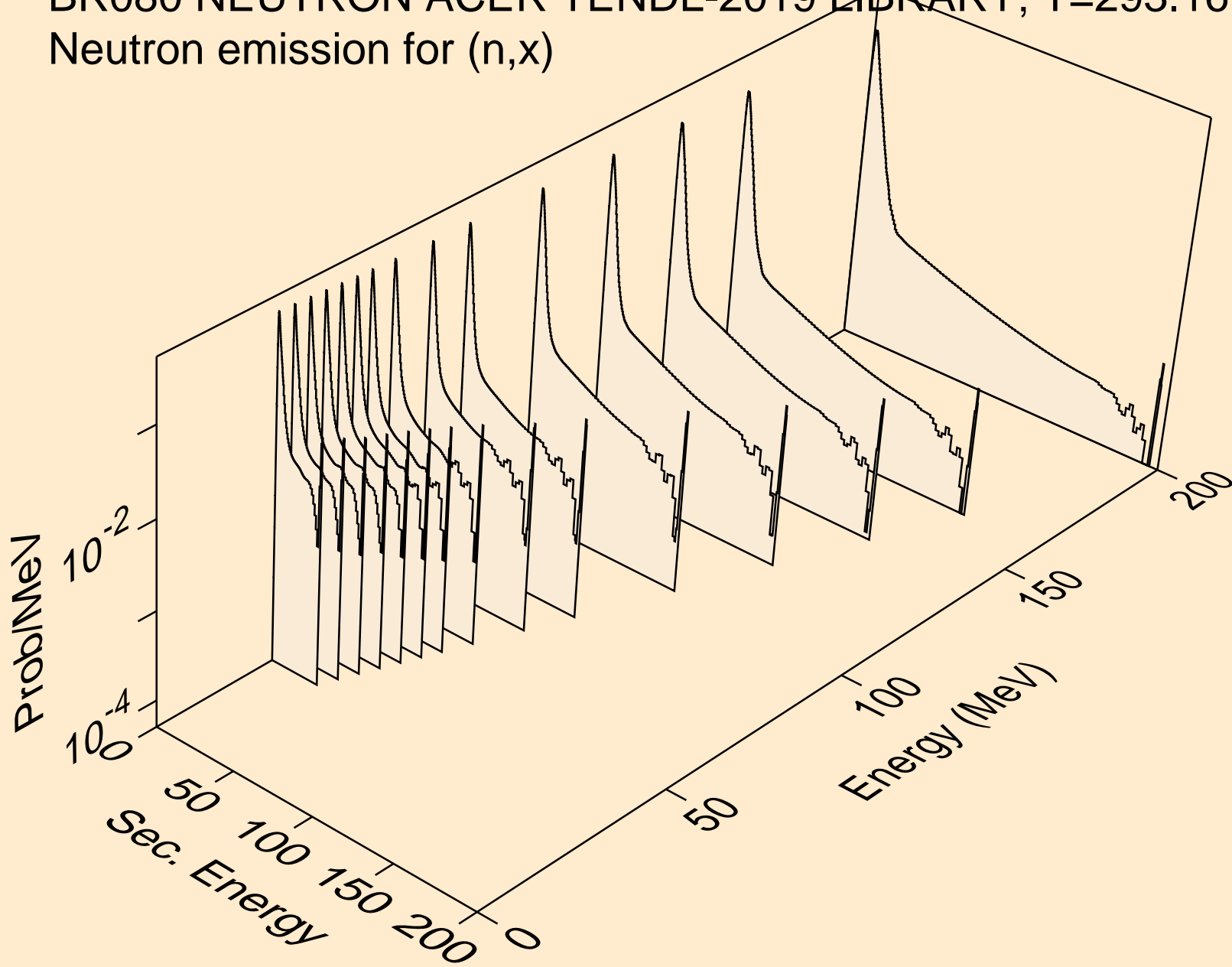

BR080 NEUTRON ACER TENDL-2019 LIBRARY; T=293.16K
Neutron emission for (n,2nd)

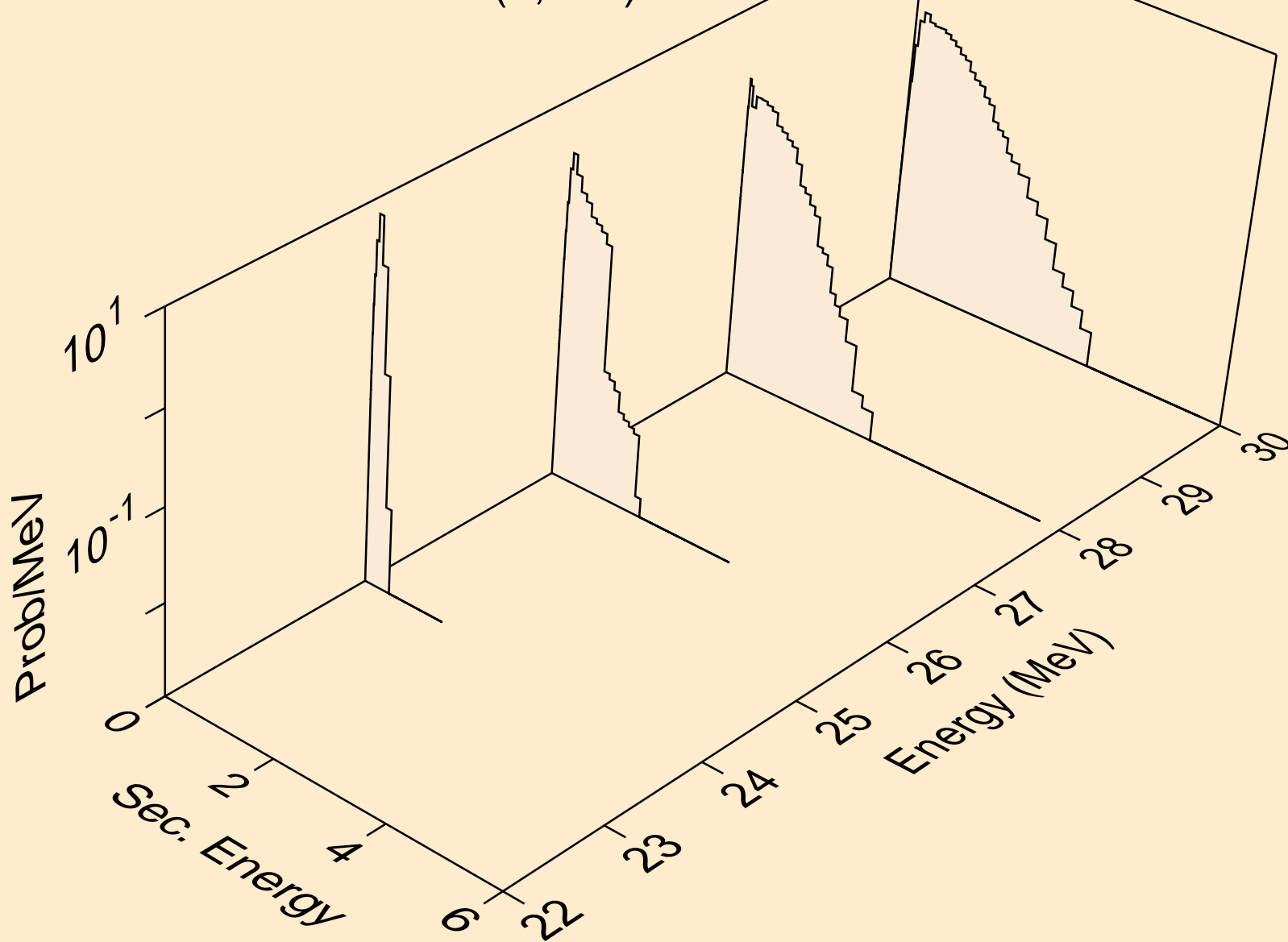

BR080 NEUTRON ACER TENDL-2019 LIBRARY; T=293.16K
Neutron emission for (n,2n)

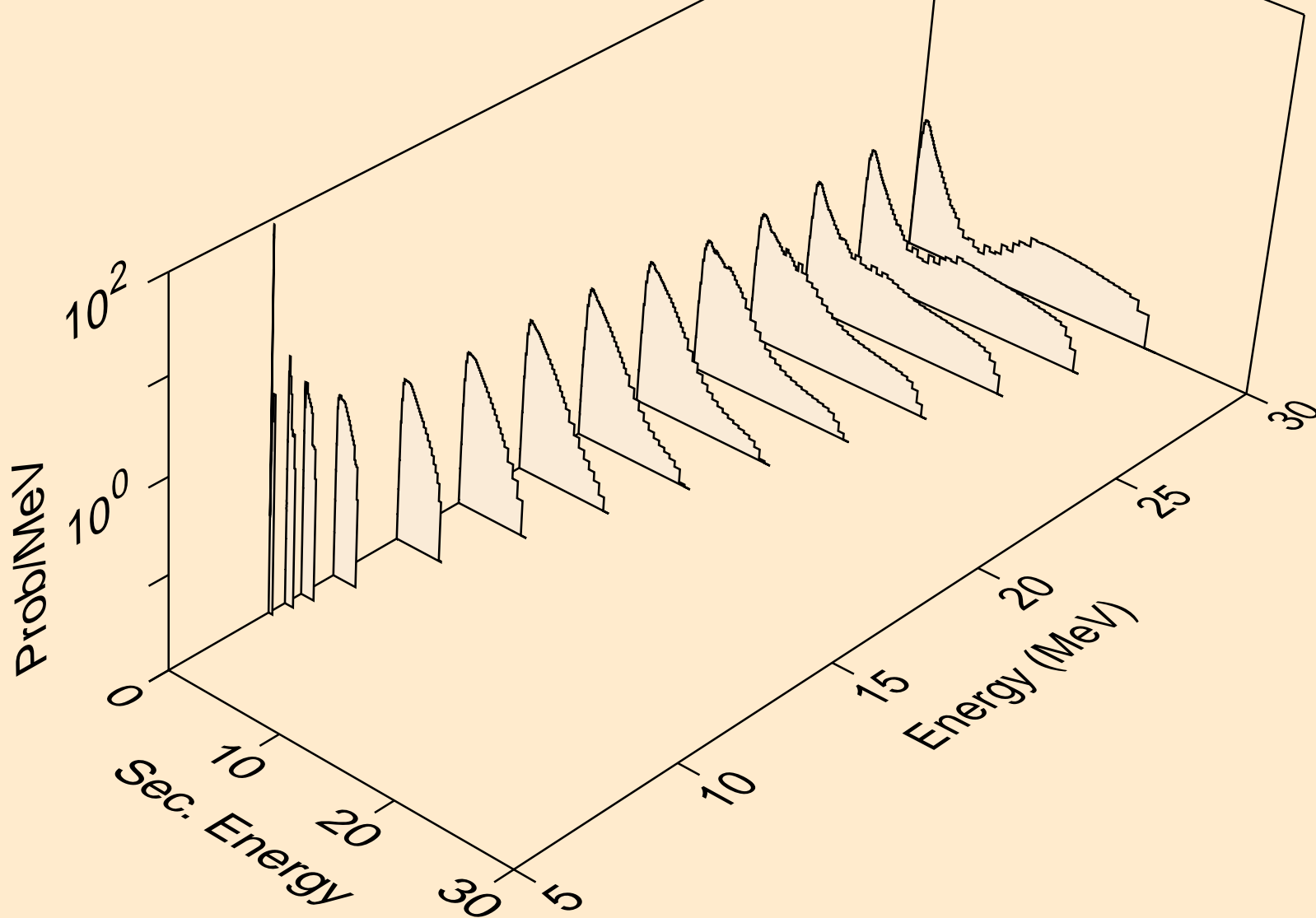

BR080 NEUTRON ACER TENDL-2019 LIBRARY; T=293.16K
Neutron emission for (n,3n)

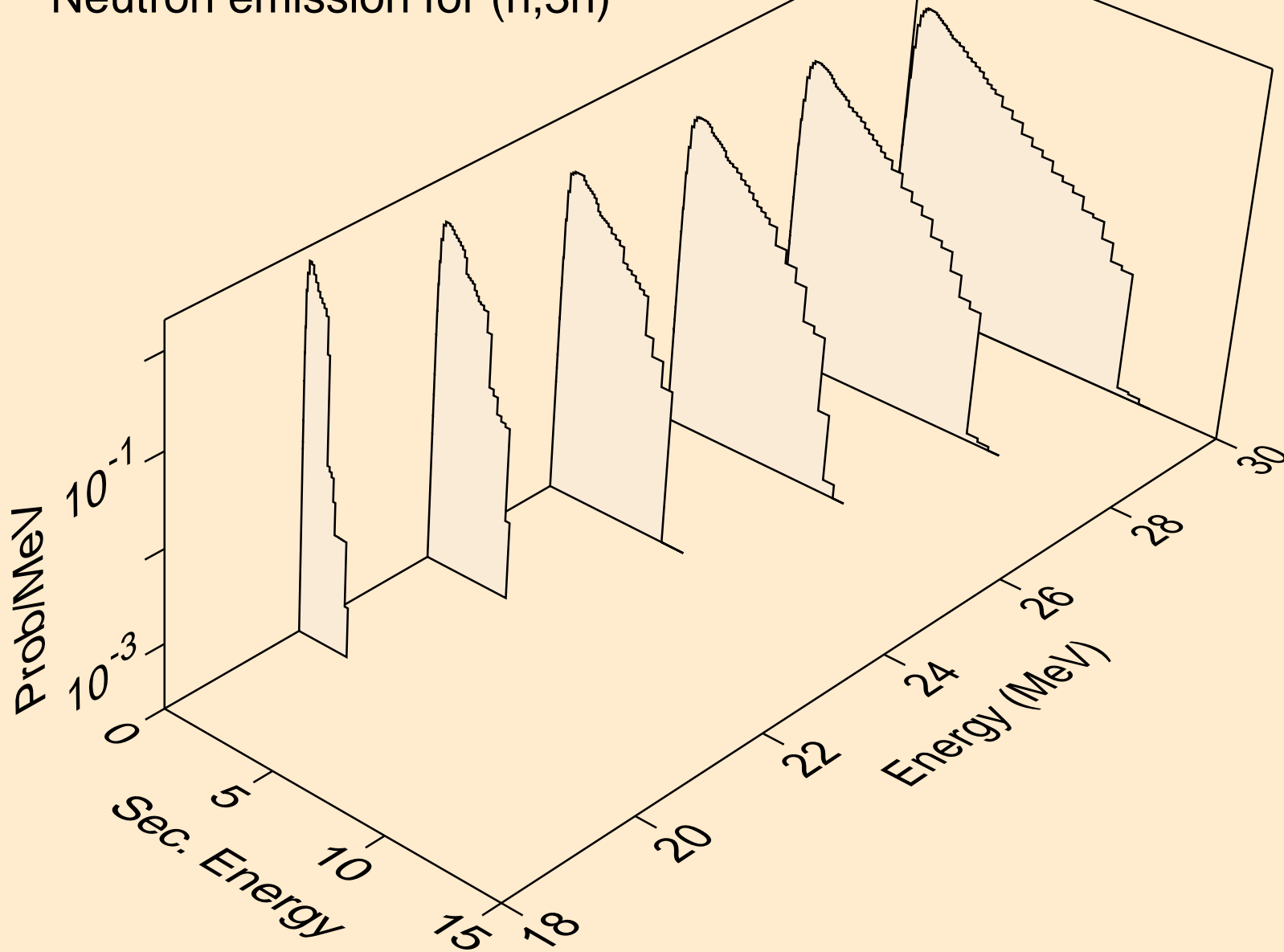

BR080 NEUTRON ACER TENDL-2019 LIBRARY; T=293.16K
Neutron emission for (n,n*)a

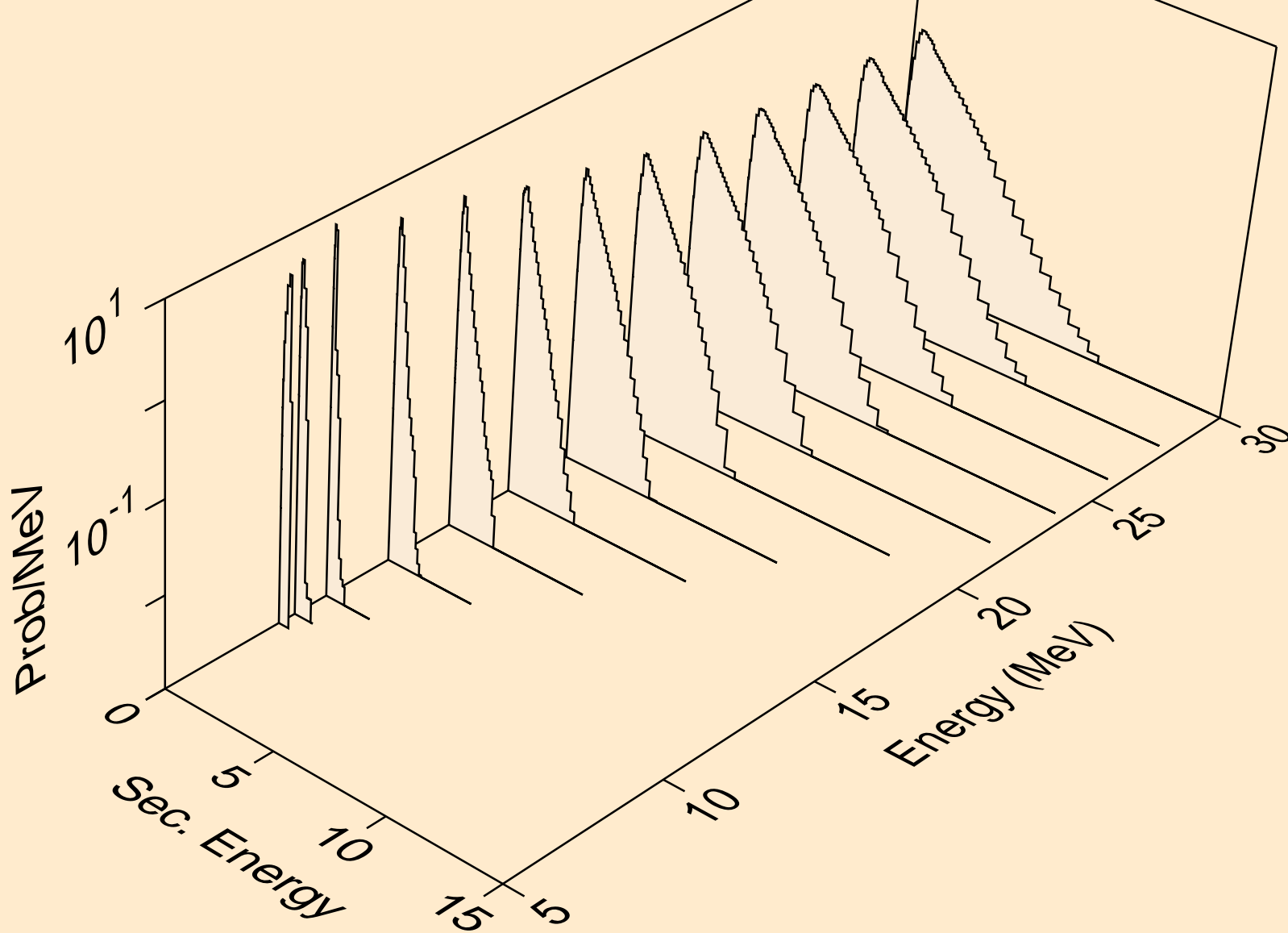

BR080 NEUTRON ACER TENDL-2019 LIBRARY; T=293.16K
Neutron emission for (n,2n)a

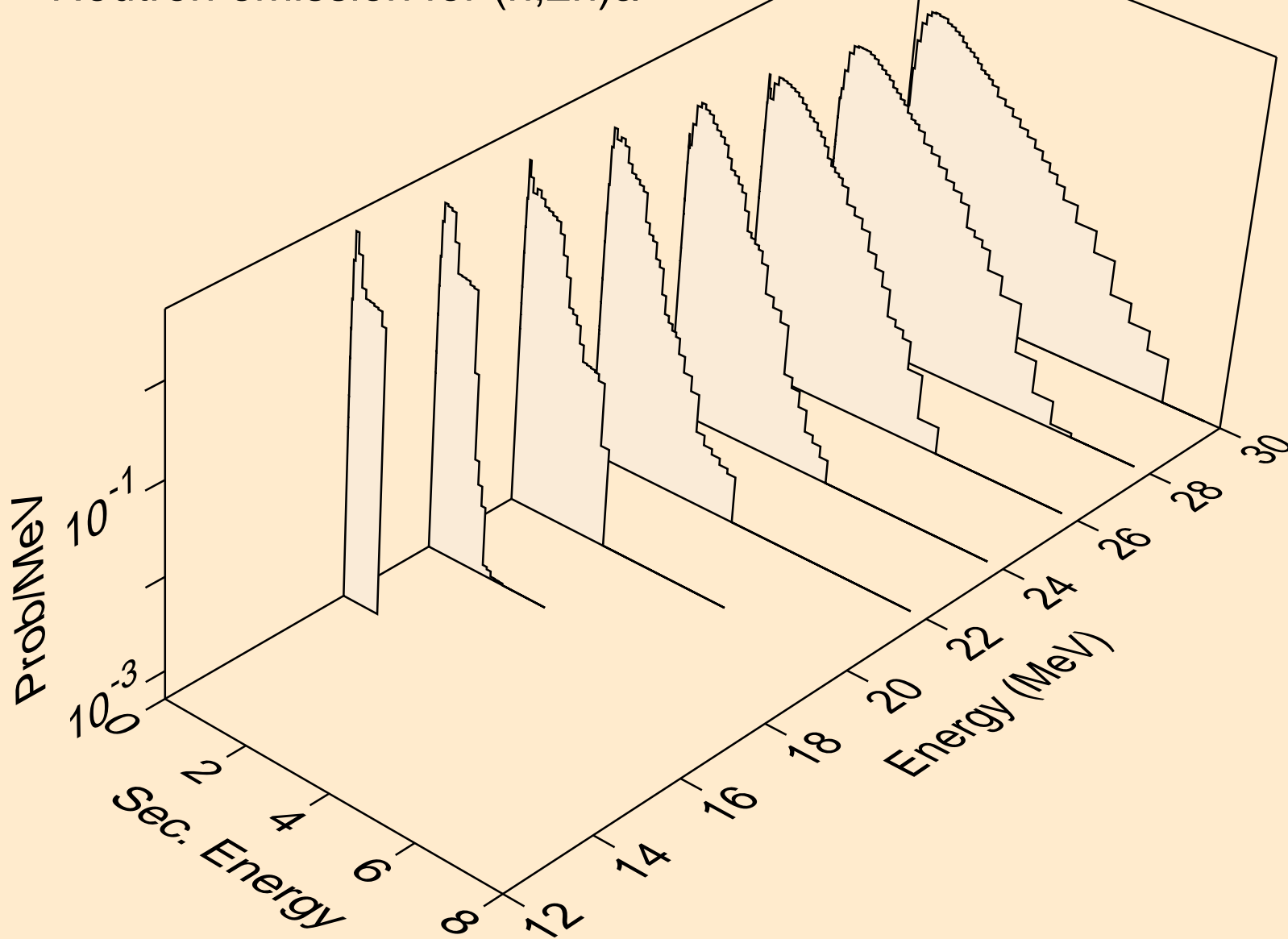

BR080 NEUTRON ACER TENDL-2019 LIBRARY; T=293.16K
Neutron emission for (n,3n)a

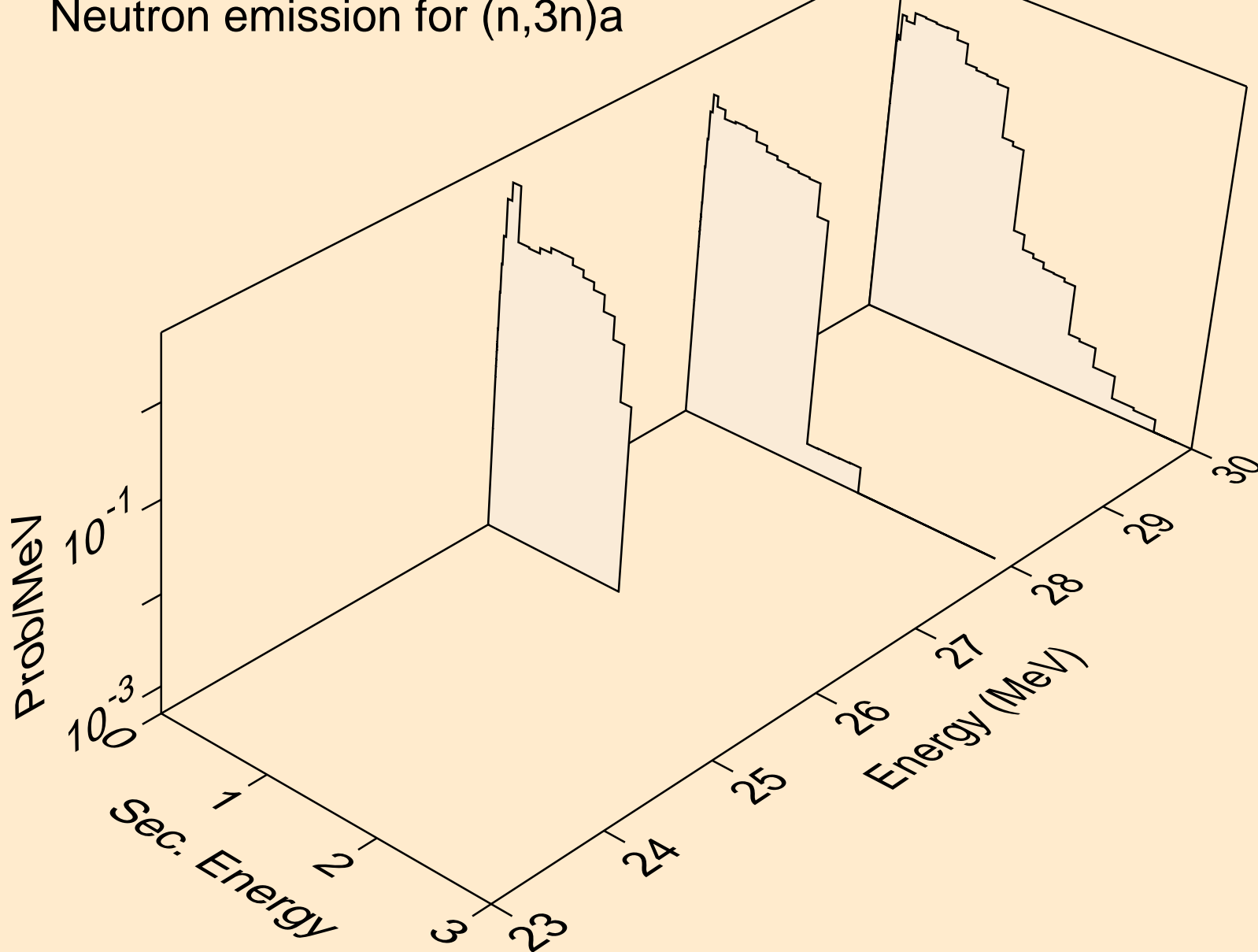

BR080 NEUTRON ACER TENDL-2019 LIBRARY; T=293.16K
Neutron emission for (n,n*)p

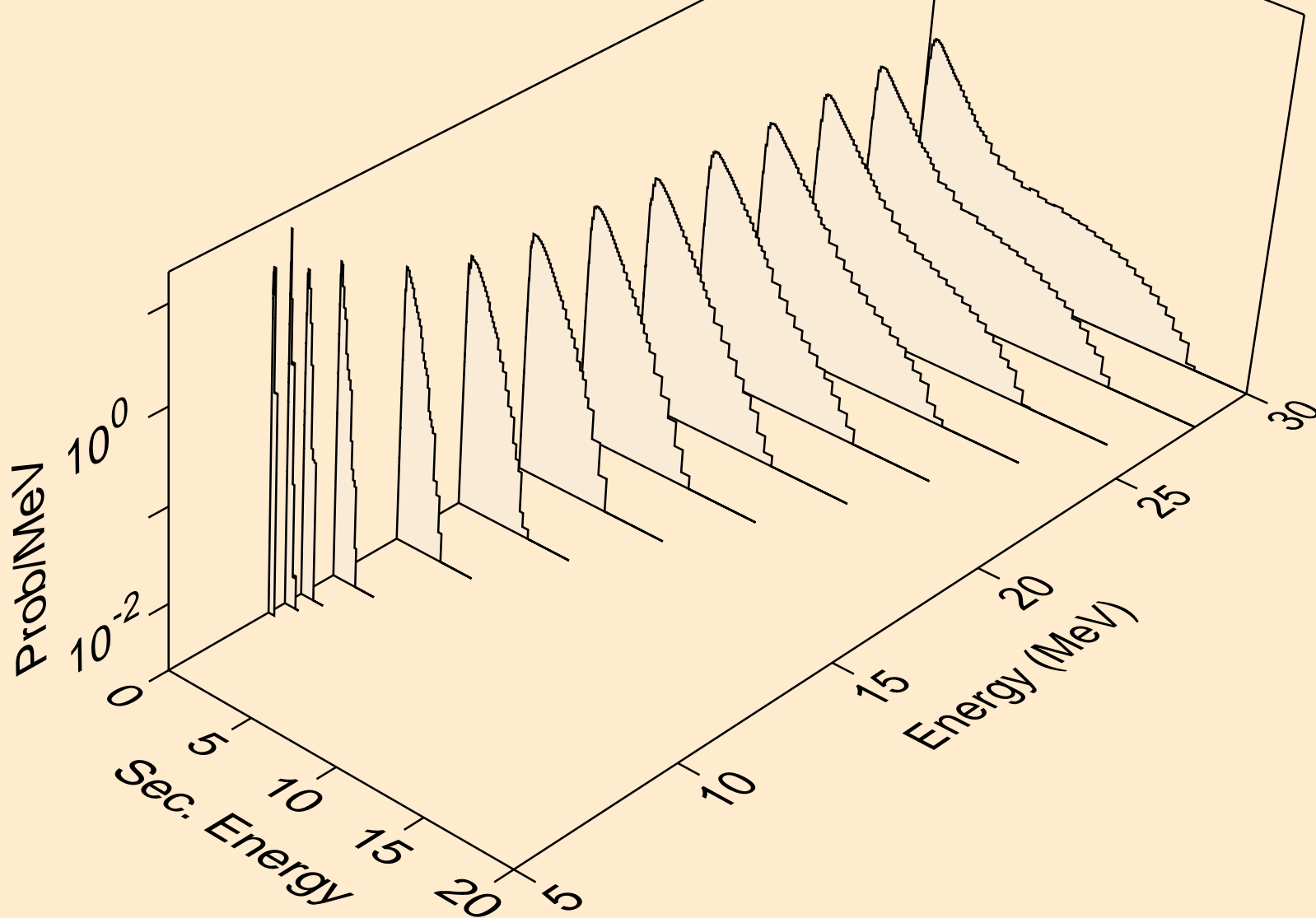

BR080 NEUTRON ACER TENDL-2019 LIBRARY; T=293.16K
Neutron emission for (n,n*)2a

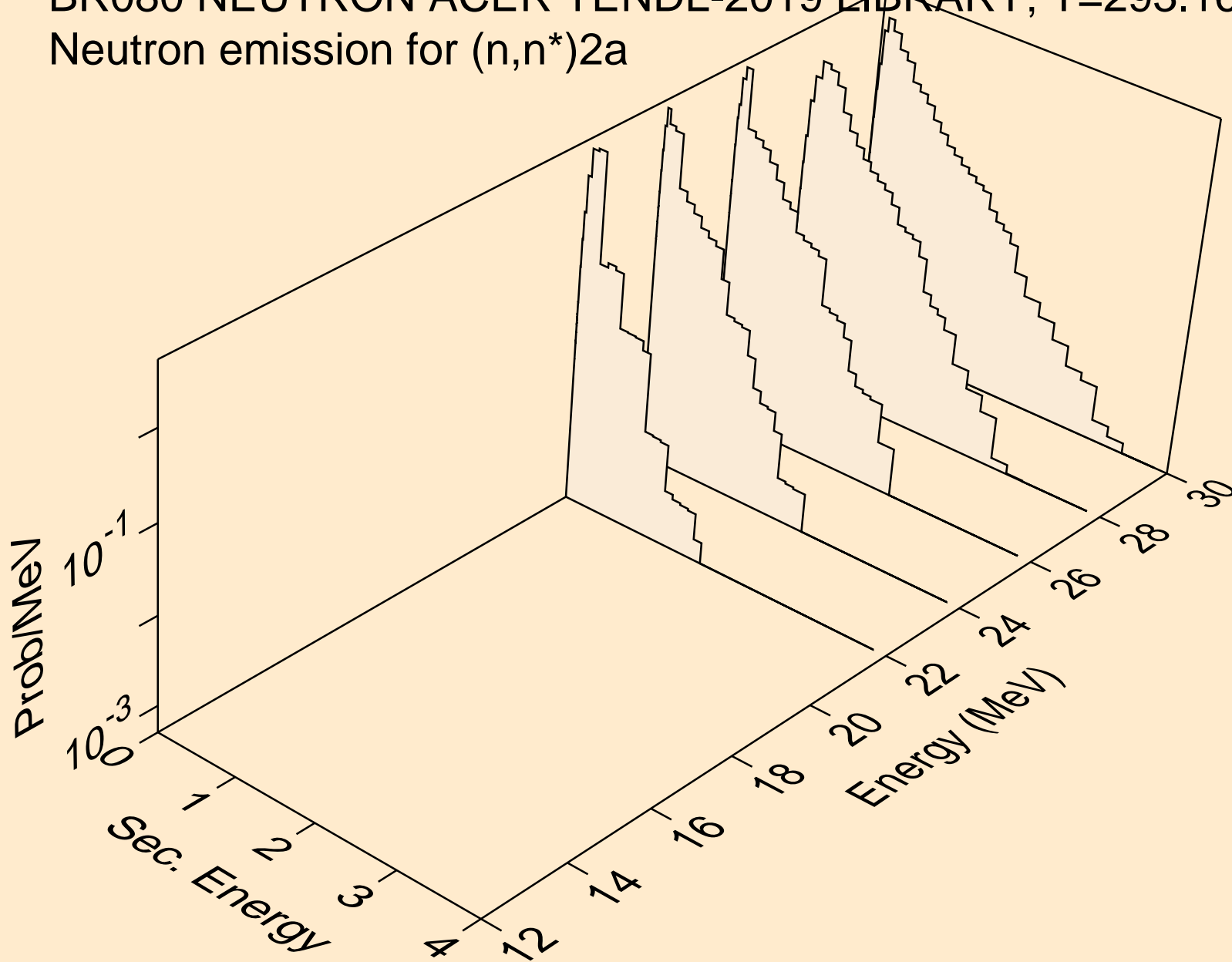

BR080 NEUTRON ACER TENDL-2019 LIBRARY; T=293.16K
Neutron emission for (n,n*)d

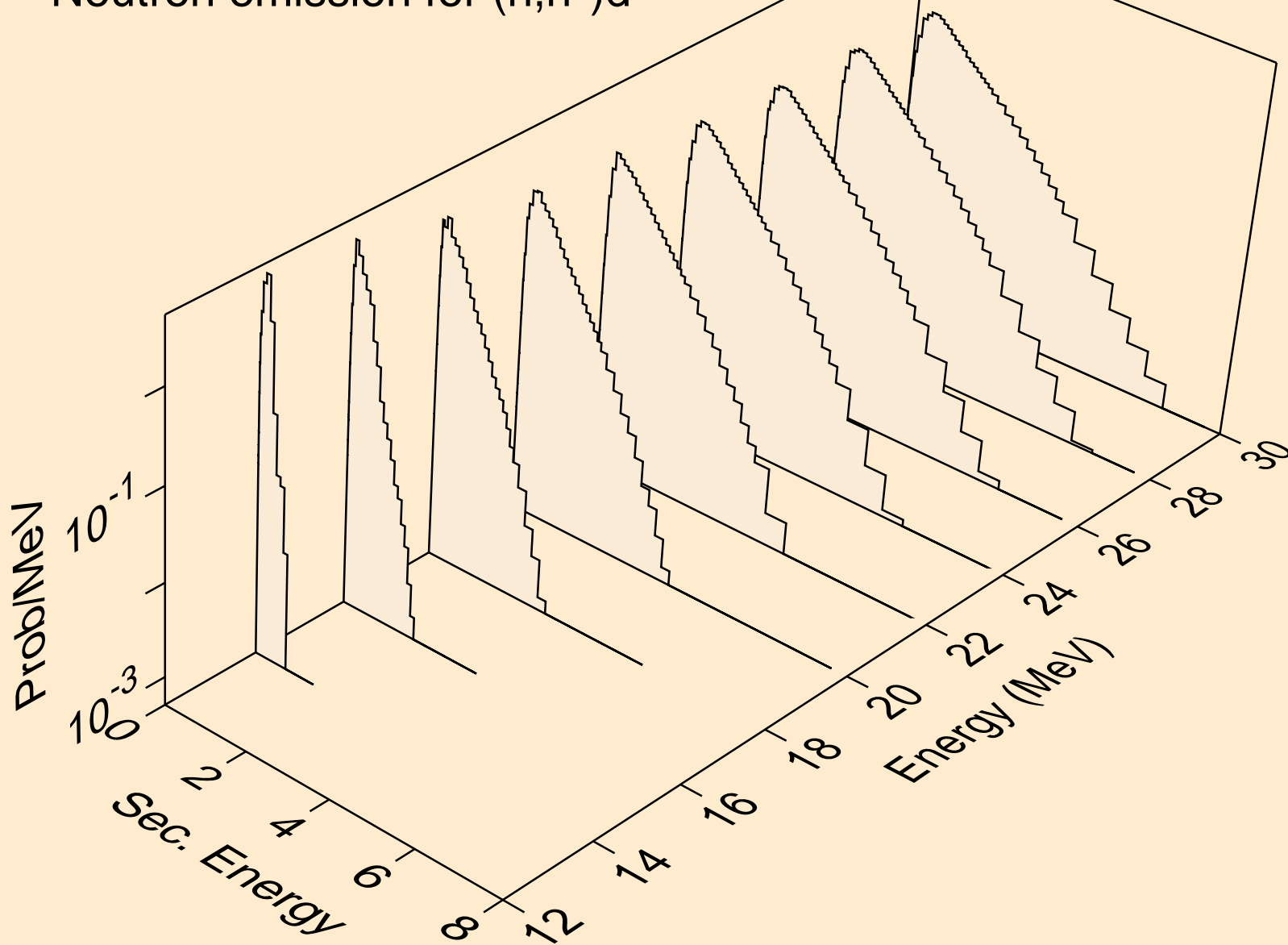

BR080 NEUTRON ACER TENDL-2019 LIBRARY; T=293.16K
Neutron emission for (n,n*)t

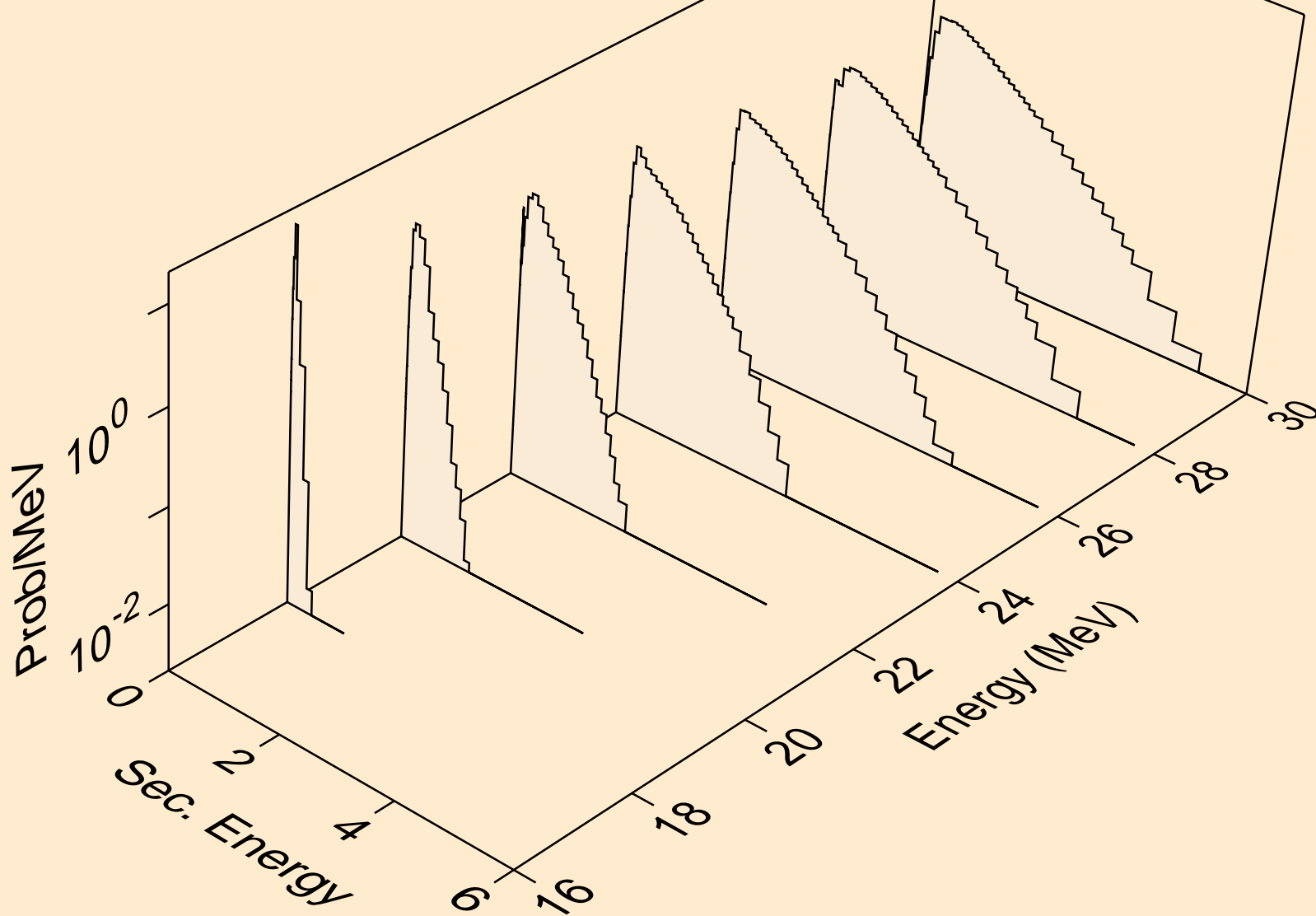

BR080 NEUTRON ACER TENDL-2019 LIBRARY; T=293.16K
Neutron emission for (n,n*)he3

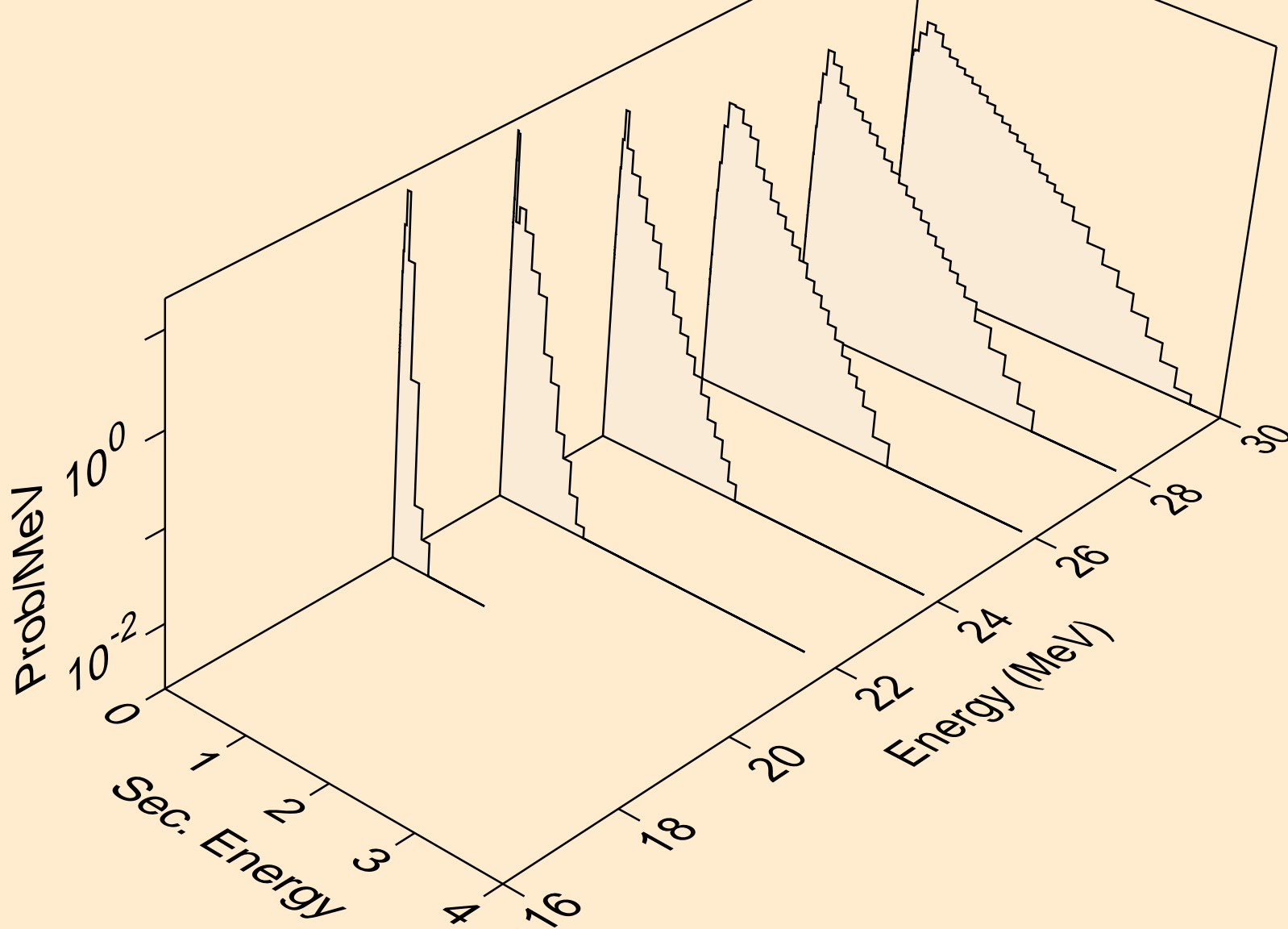

BR080 NEUTRON ACER TENDL-2019 LIBRARY; T=293.16K
Neutron emission for (n,4n)

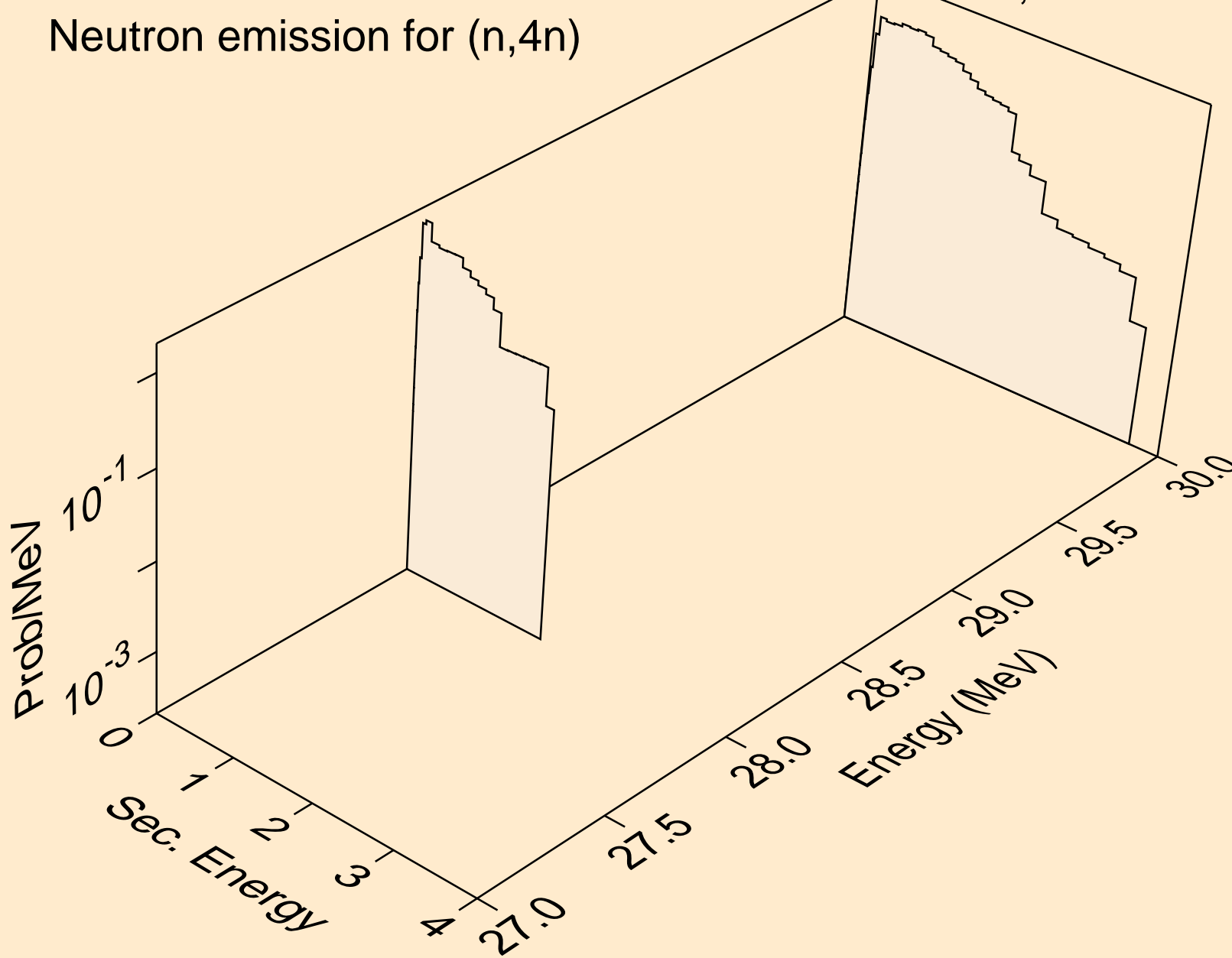

BR080 NEUTRON ACER TENDL-2019 LIBRARY; T=293.16K
Neutron emission for (n,2np)

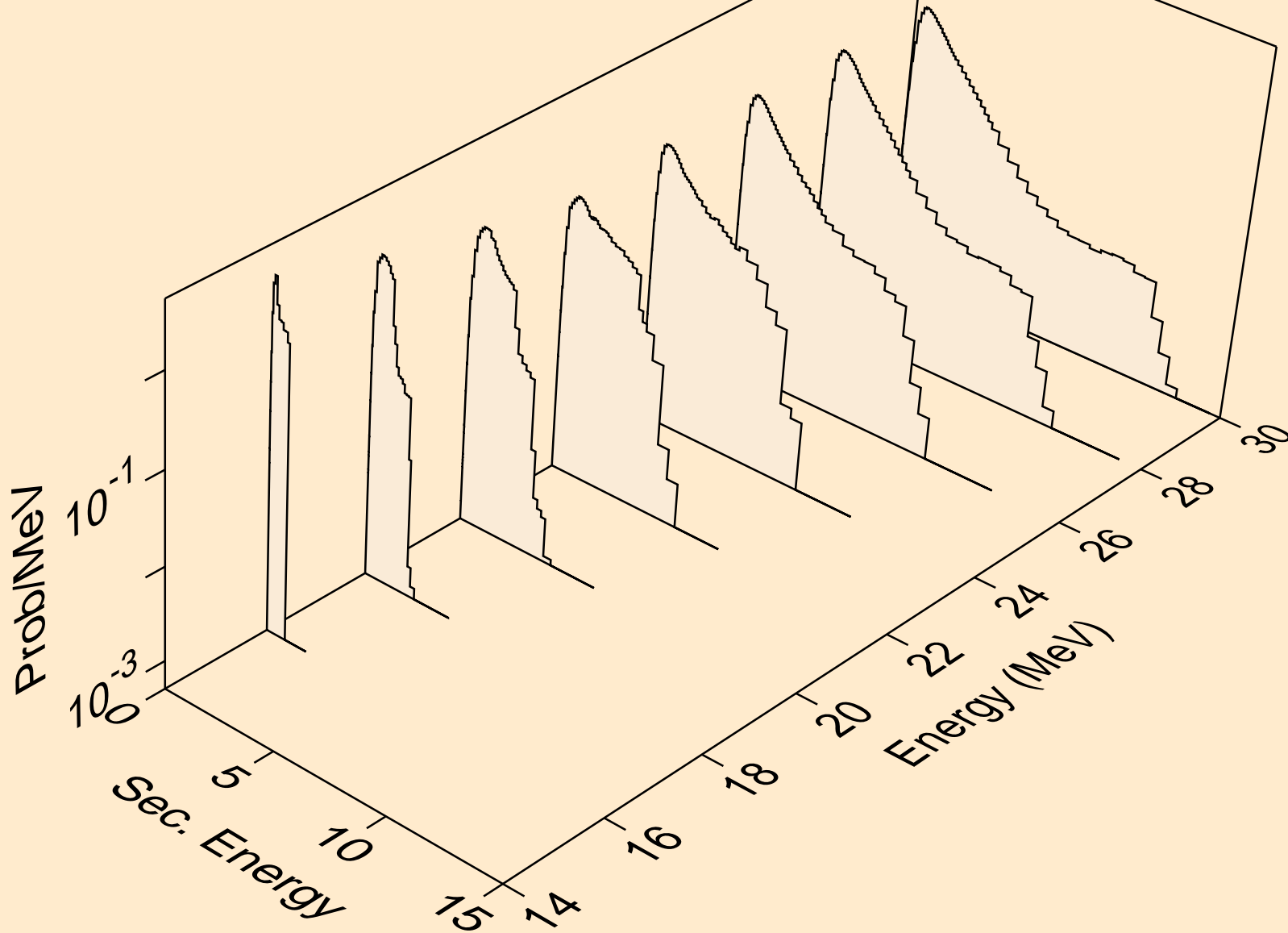

BR080 NEUTRON ACER TENDL-2019 LIBRARY; T=293.16K
Neutron emission for (n,3np)

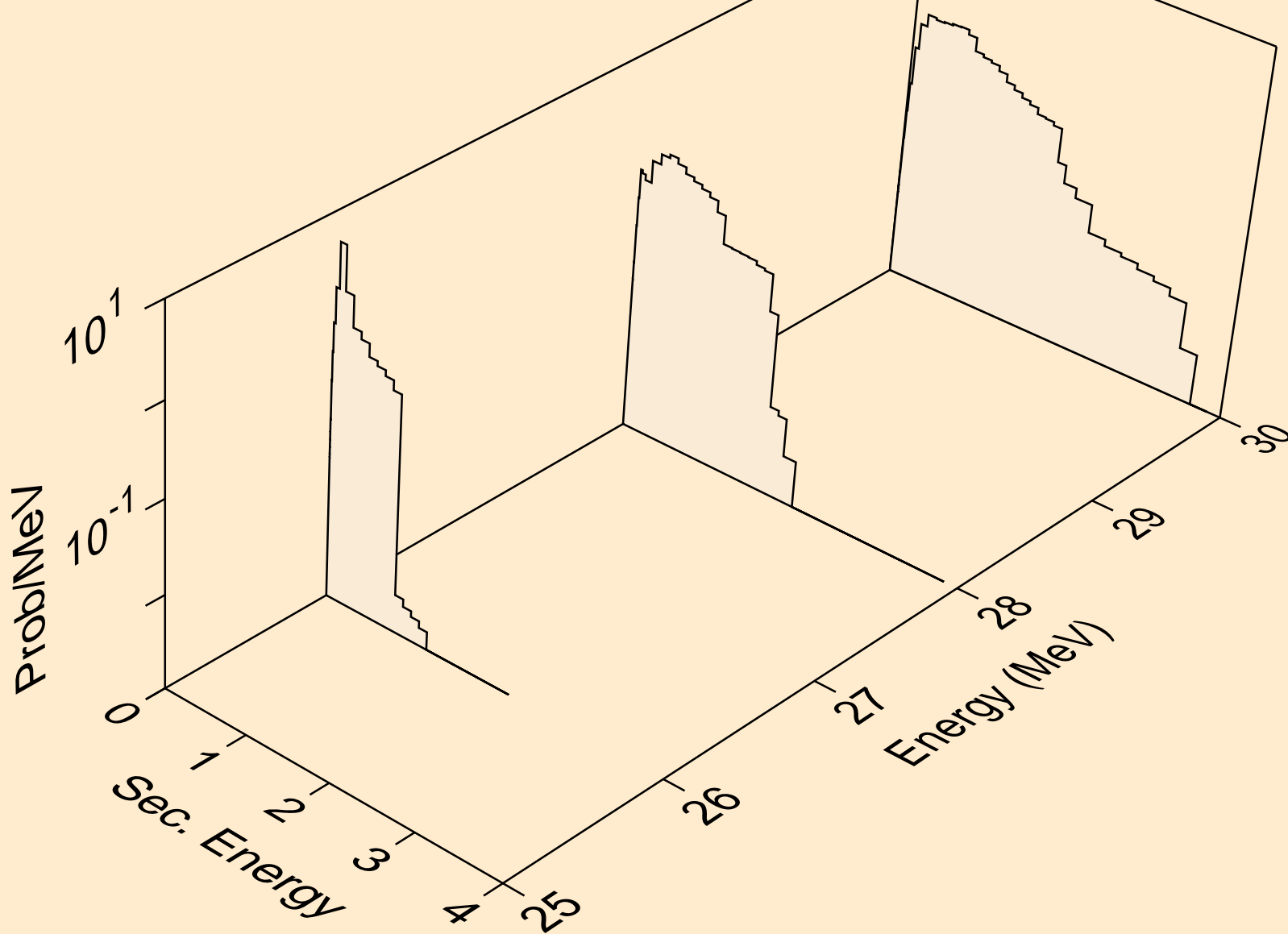

BR080 NEUTRON ACER TENDL-2019 LIBRARY; T=293.16K
Neutron emission for (n,2np)

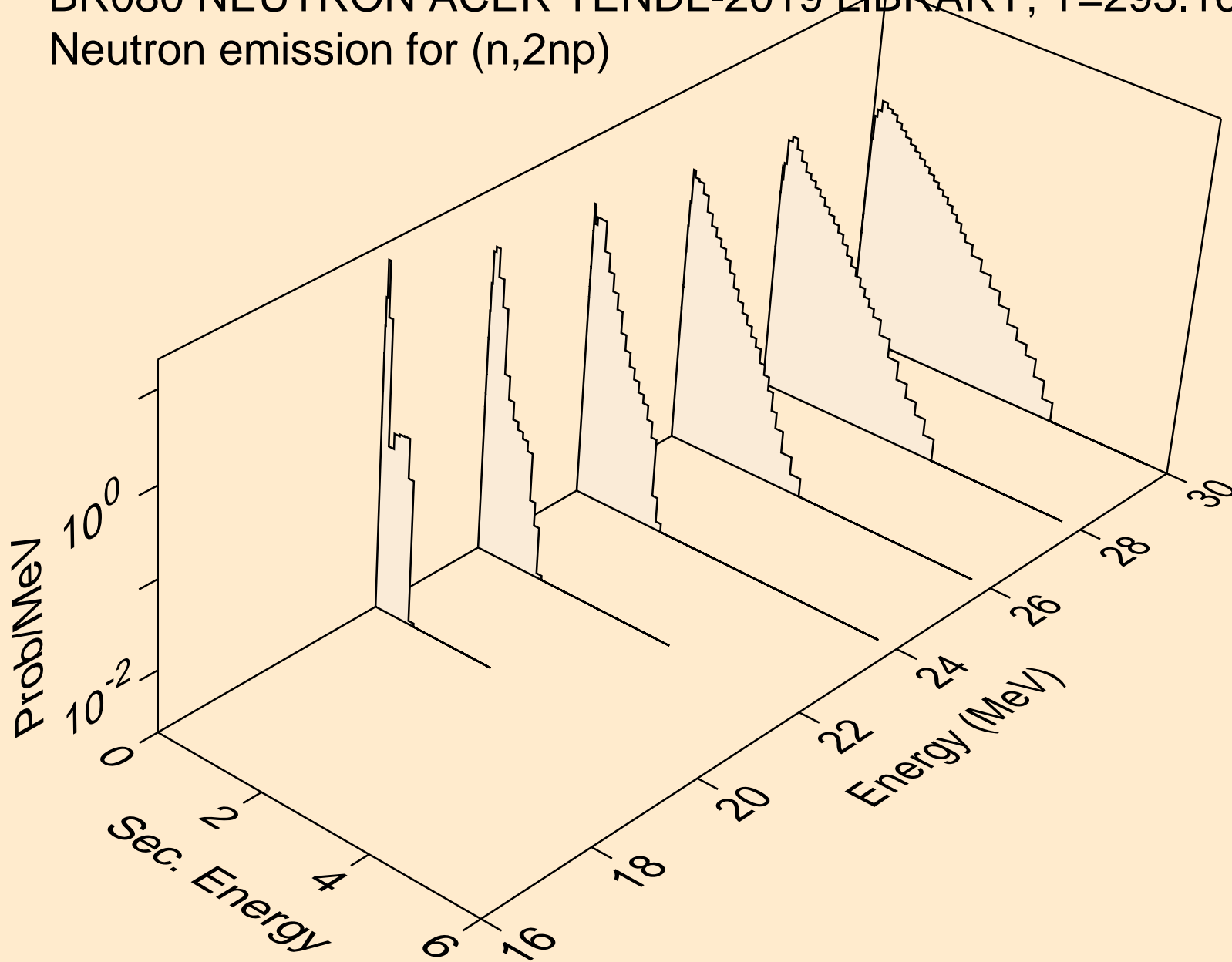

BR080 NEUTRON ACER TENDL-2019 LIBRARY; T=293.16K
Neutron emission for (n,npa)

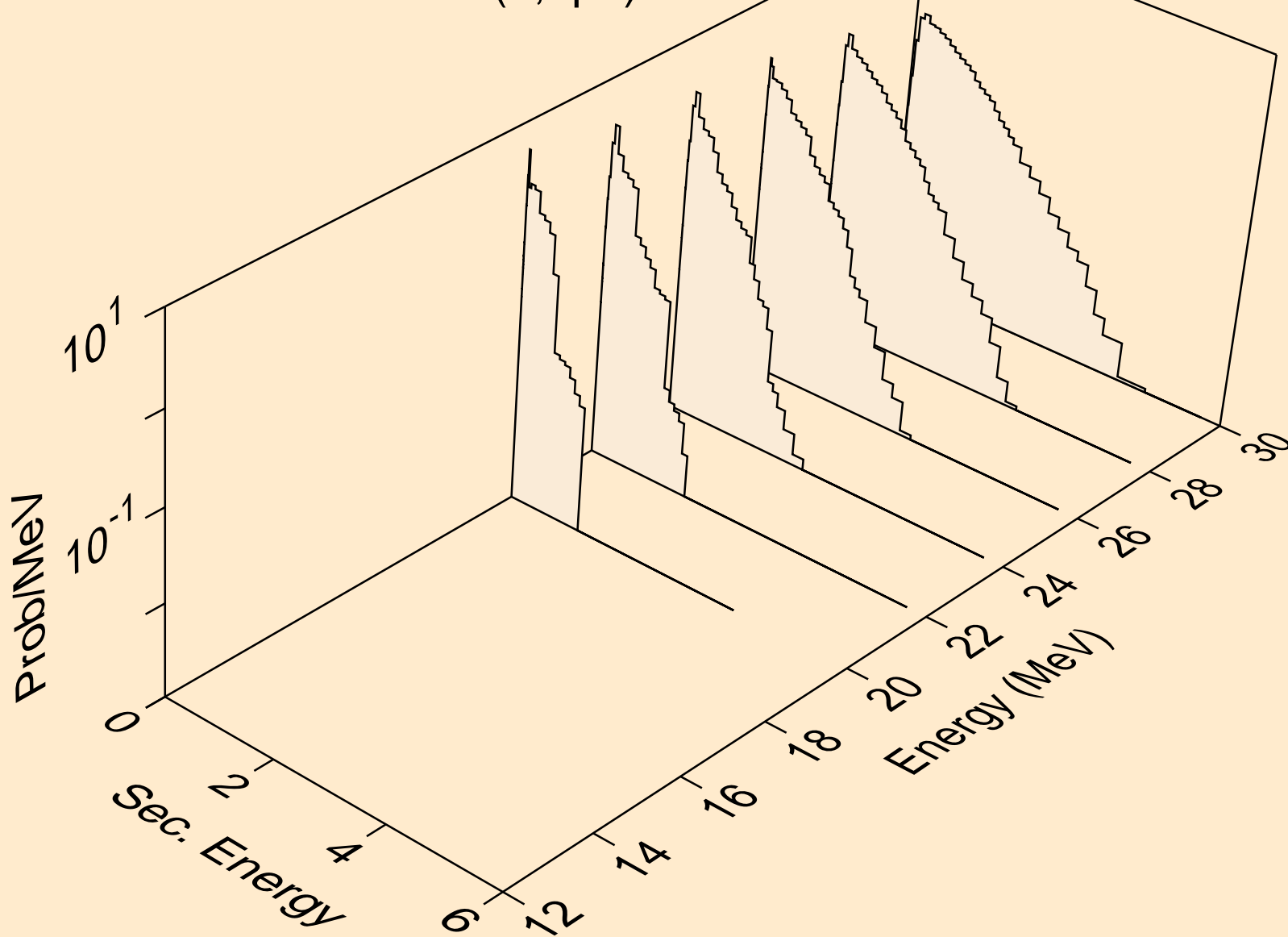

BR080 NEUTRON ACER TENDL-2019 LIBRARY; T=293.16K
Neutron emission for (n,n*c)

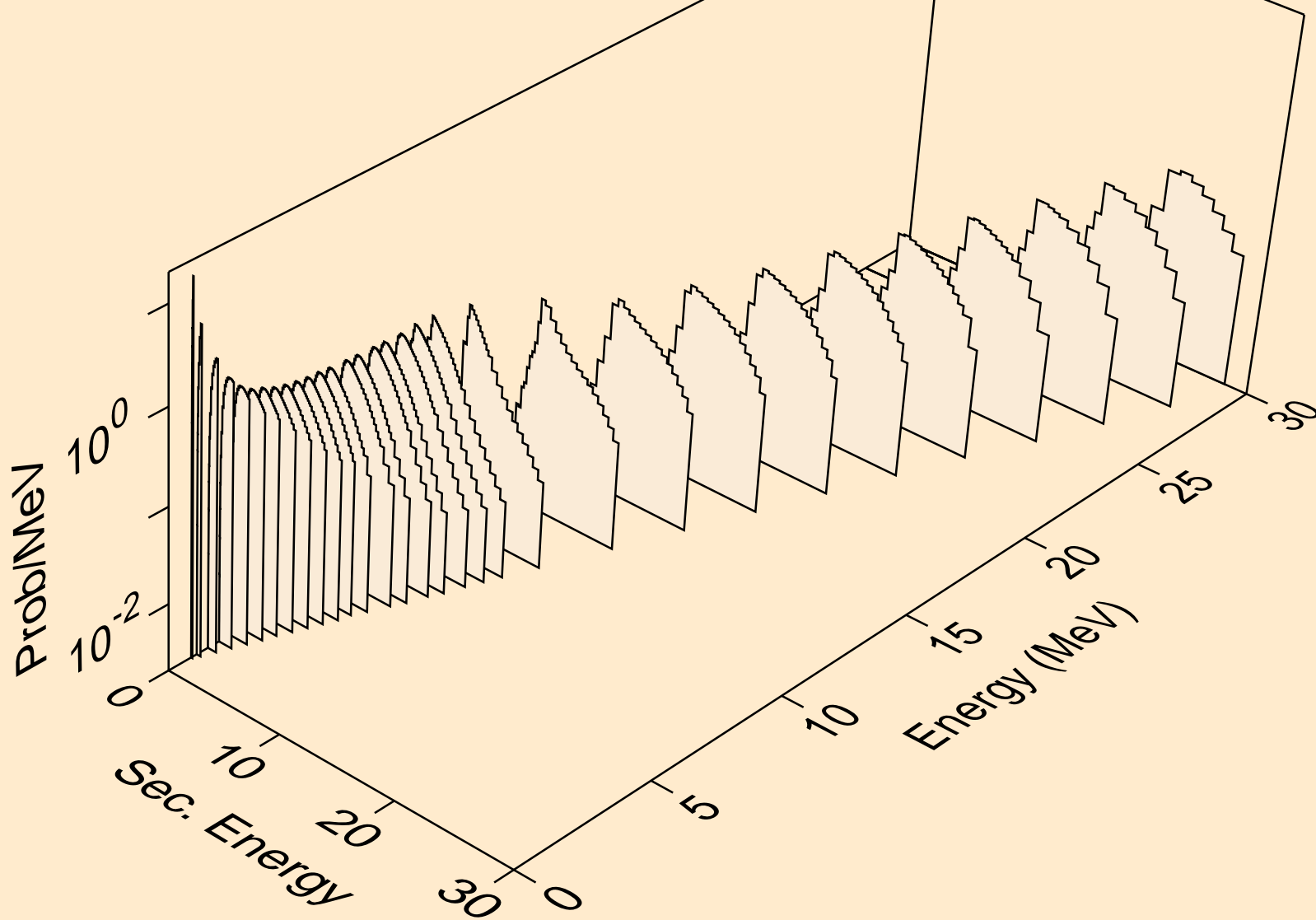

BR080 NEUTRON ACER TENDL-2019 LIBRARY; T=293.16K
Photon emission for (n,x)

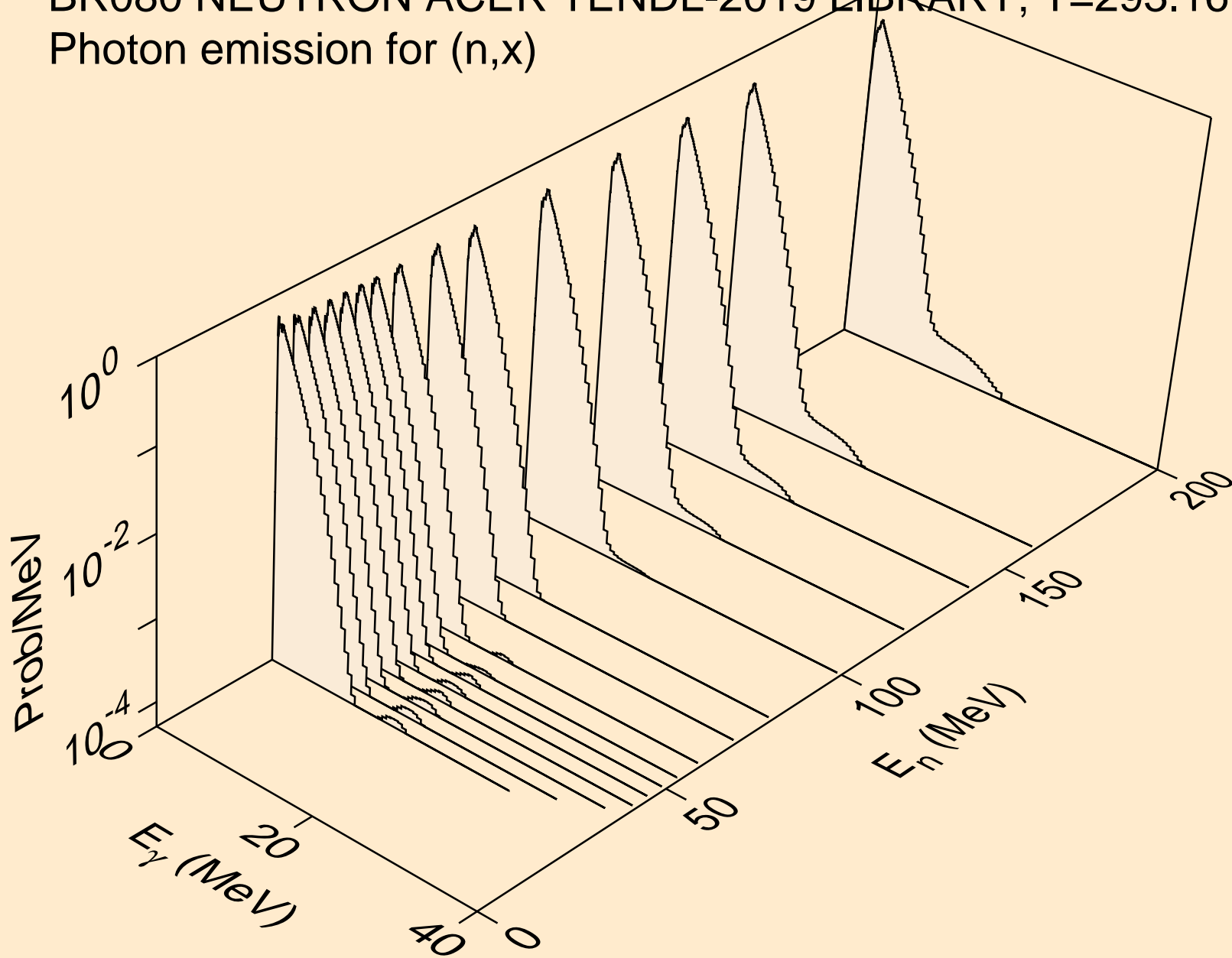

BR080 NEUTRON ACER TENDL-2019 LIBRARY; T=293.16K
Photon emission for (n,2nd)

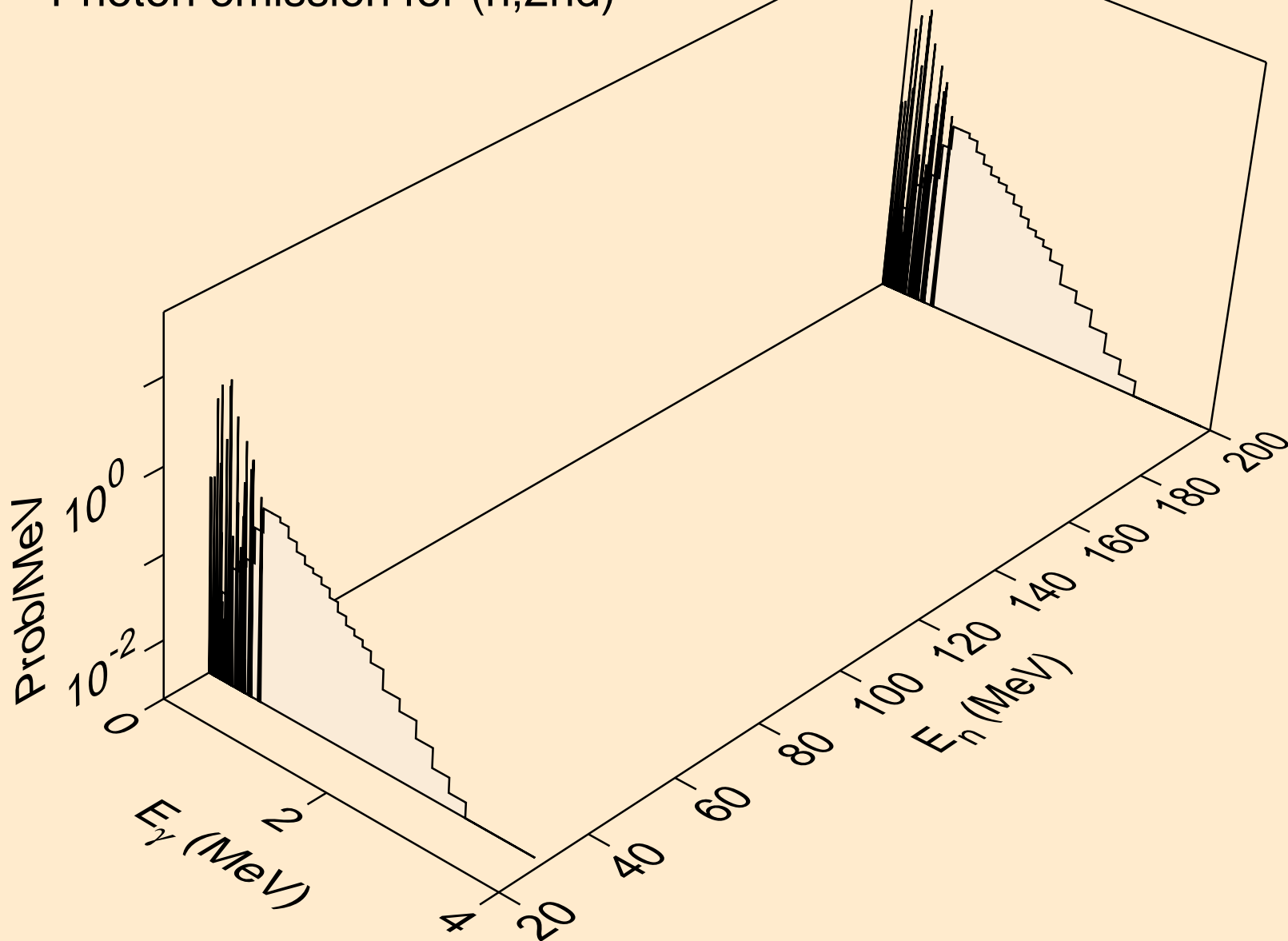

BR080 NEUTRON ACER TENDL-2019 LIBRARY; T=293.16K
Photon emission for (n,2n)

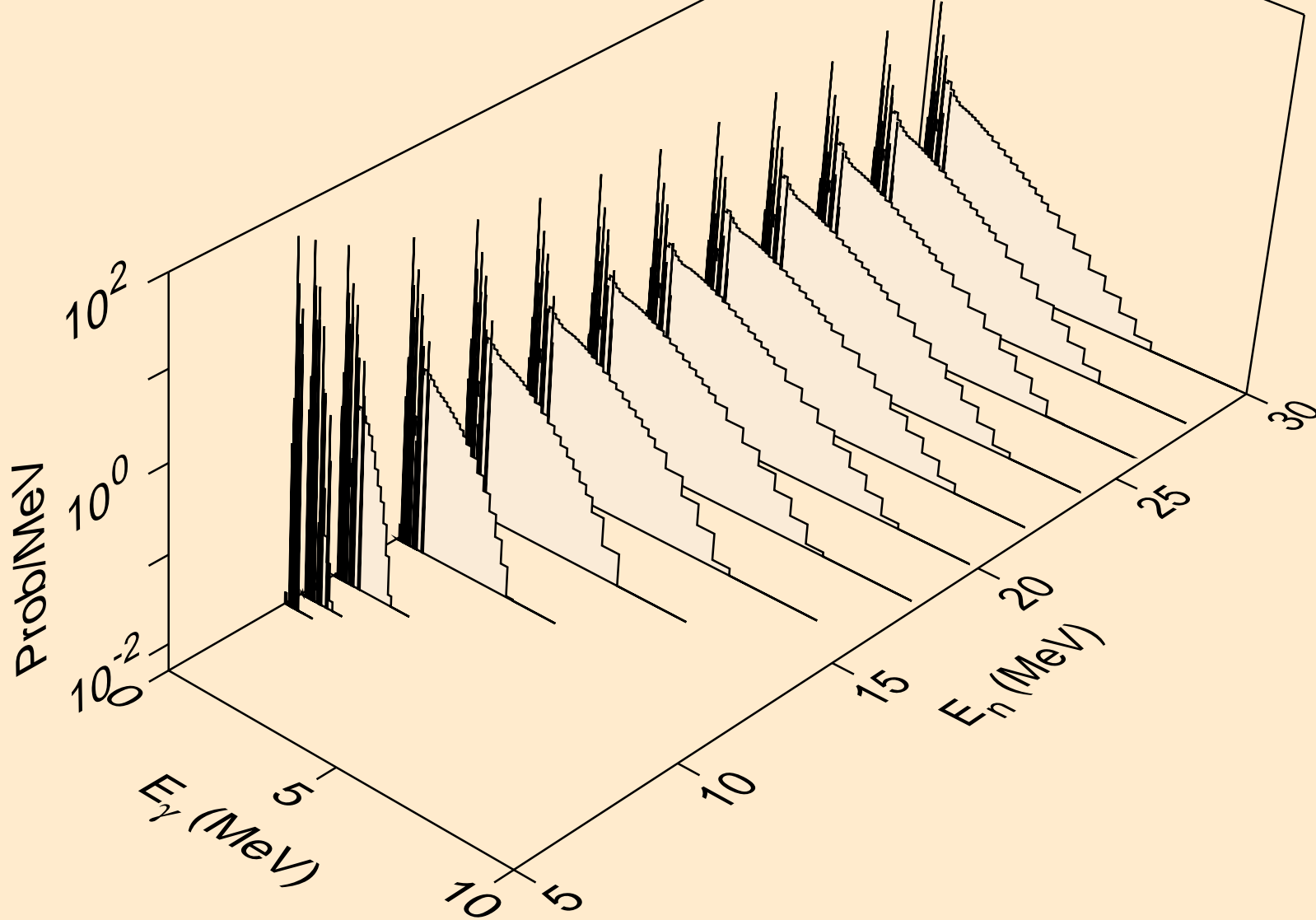

BR080 NEUTRON ACER TENDL-2019 LIBRARY; T=293.16K
Photon emission for (n,3n)

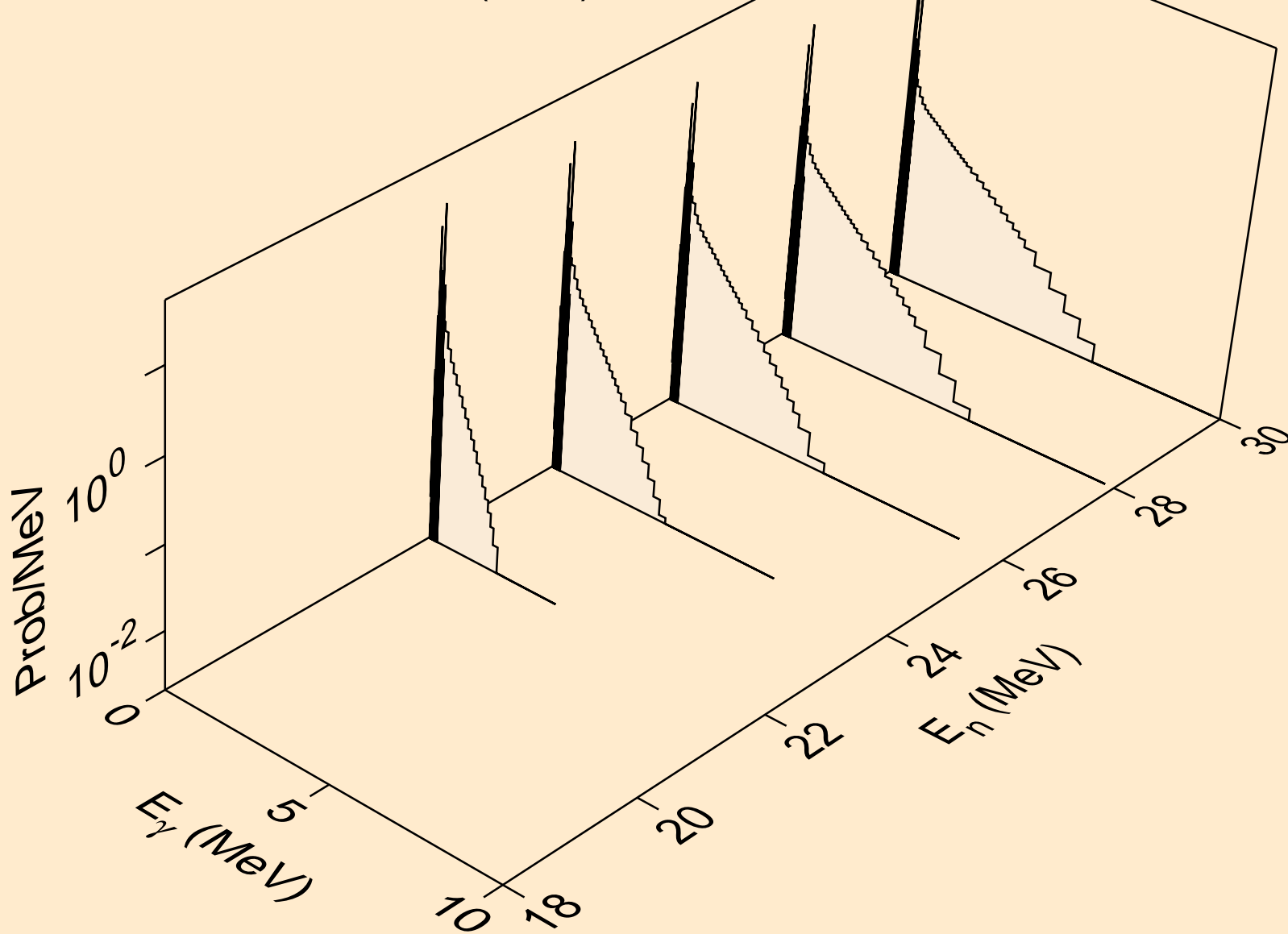

BR080 NEUTRON ACER TENDL-2019 LIBRARY; T=293.16K
Photon emission for (n,n*)a

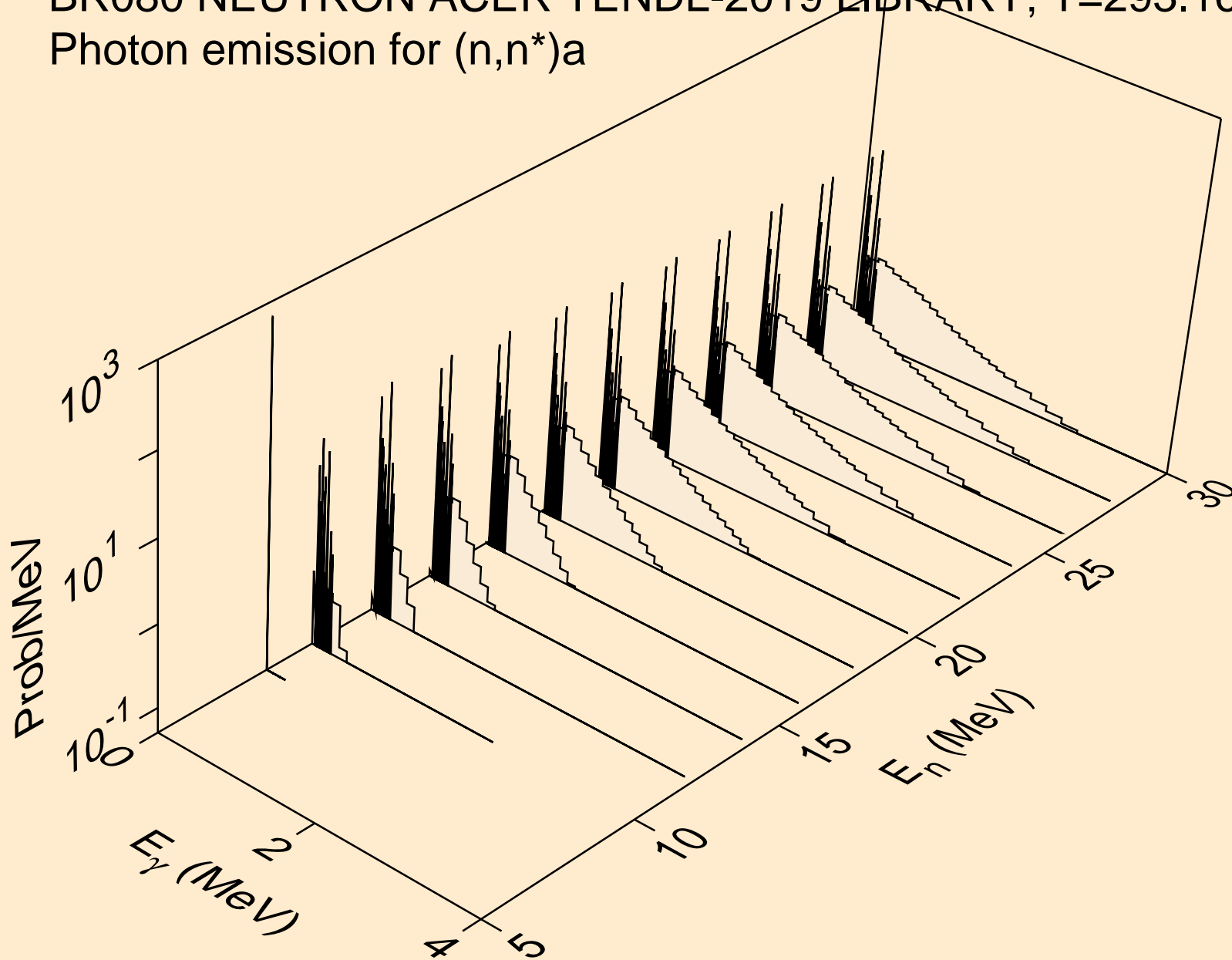

BR080 NEUTRON ACER TENDL-2019 LIBRARY; T=293.16K
Photon emission for (n,2n)a

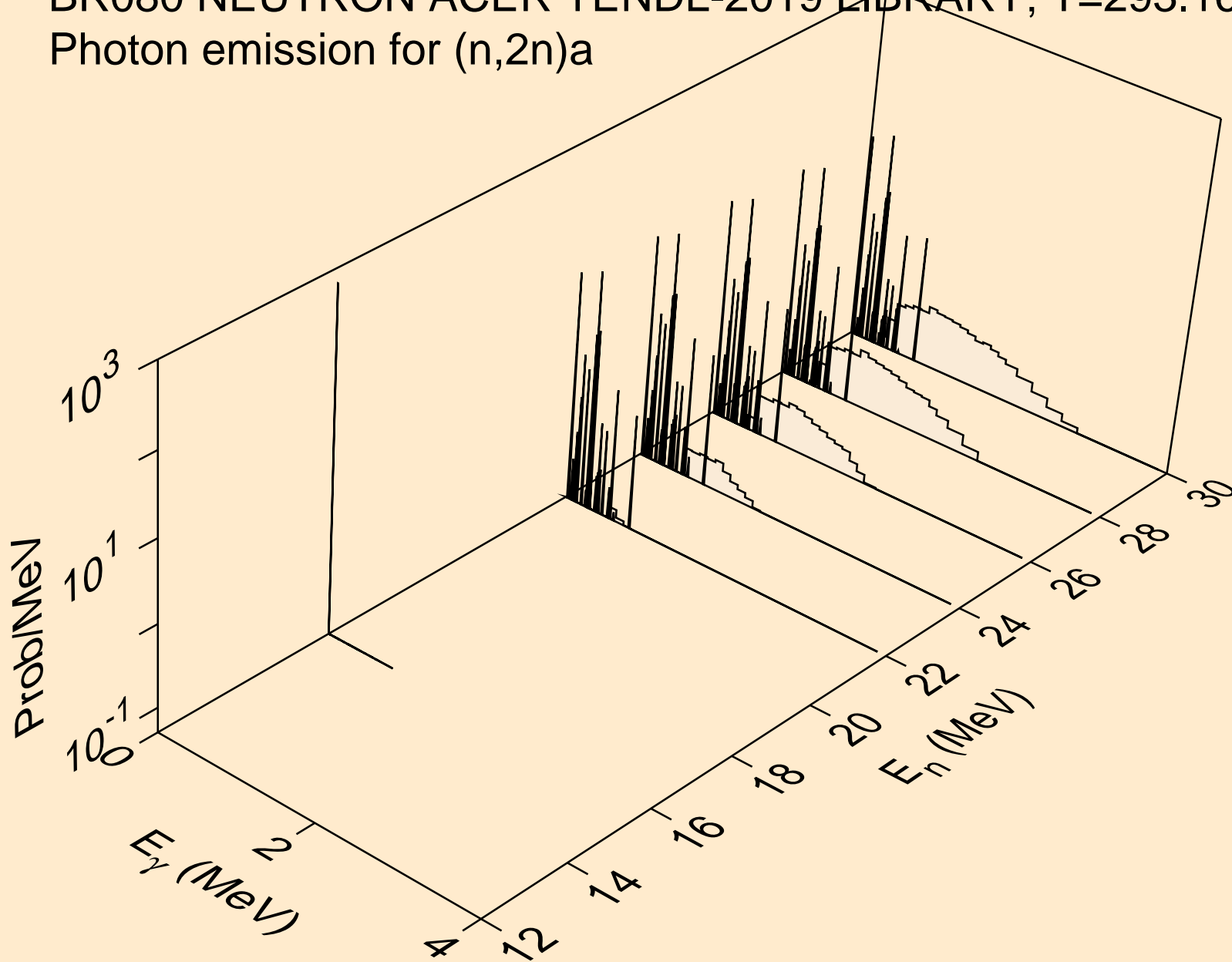

BR080 NEUTRON ACER TENDL-2019 LIBRARY; T=293.16K
Photon emission for (n,3n)a

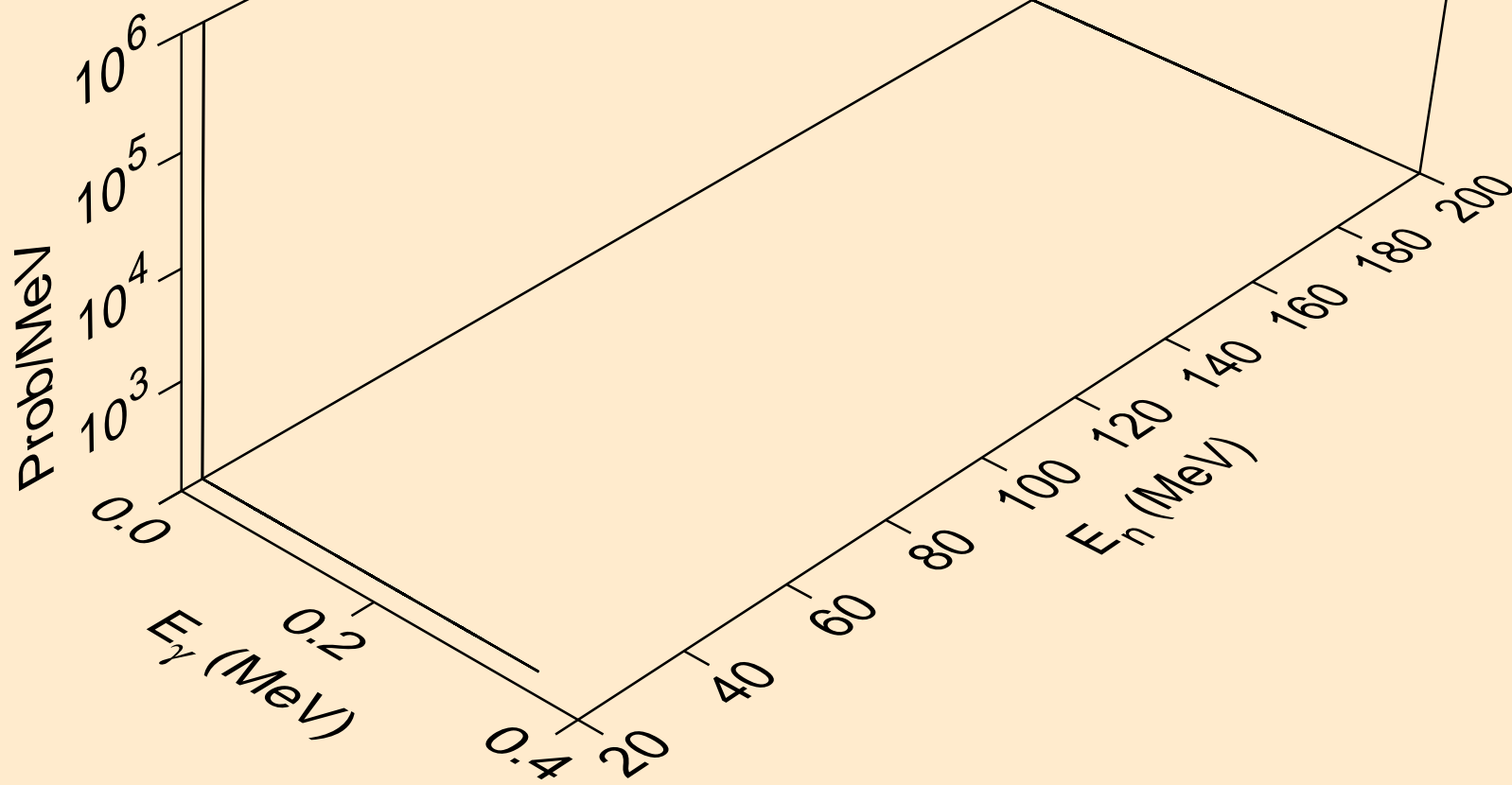

BR080 NEUTRON ACER TENDL-2019 LIBRARY; T=293.16K
Photon emission for (n,n*)p

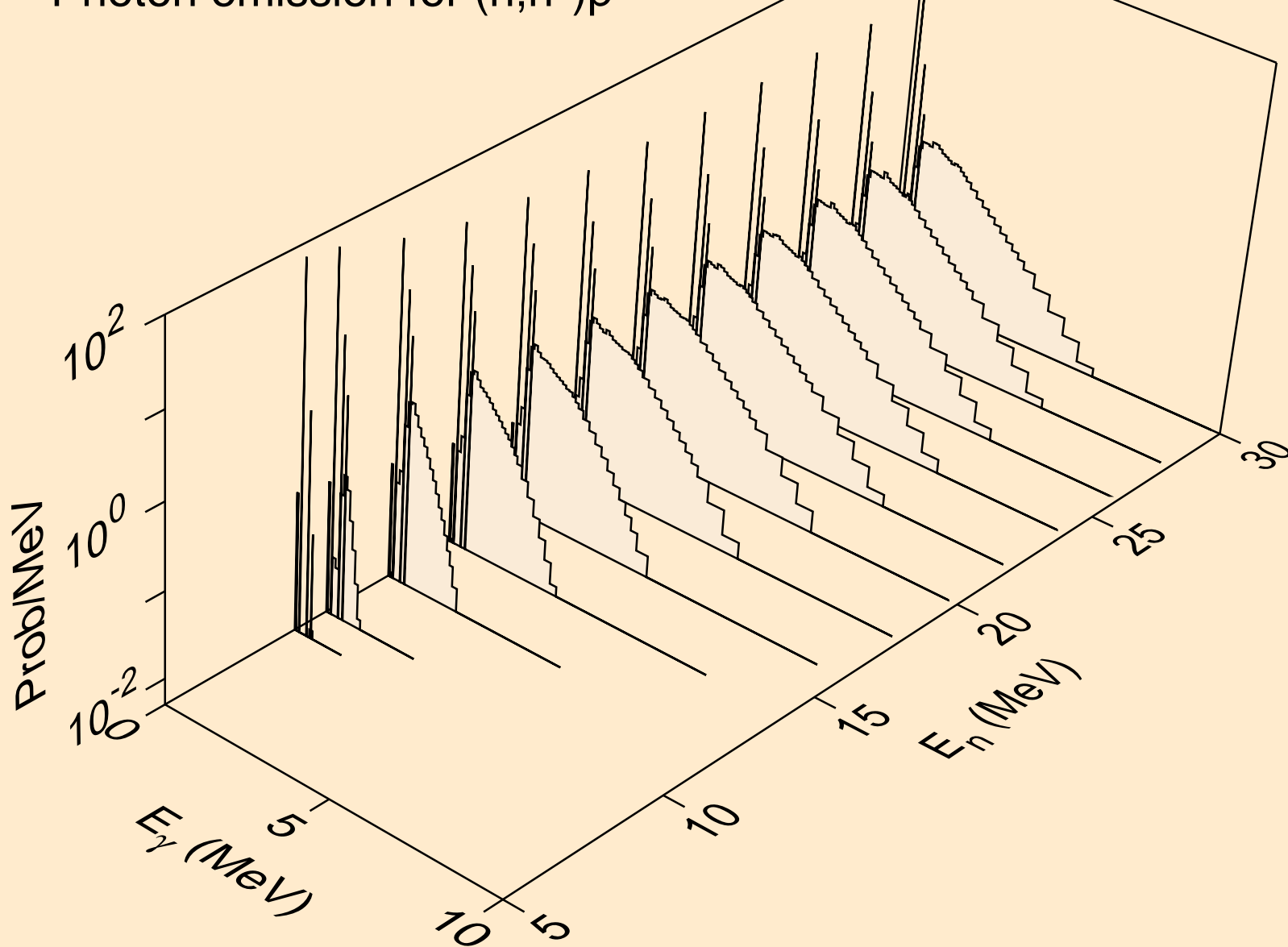

BR080 NEUTRON ACER TENDL-2019 LIBRARY; T=293.16K
Photon emission for (n,n*)2a

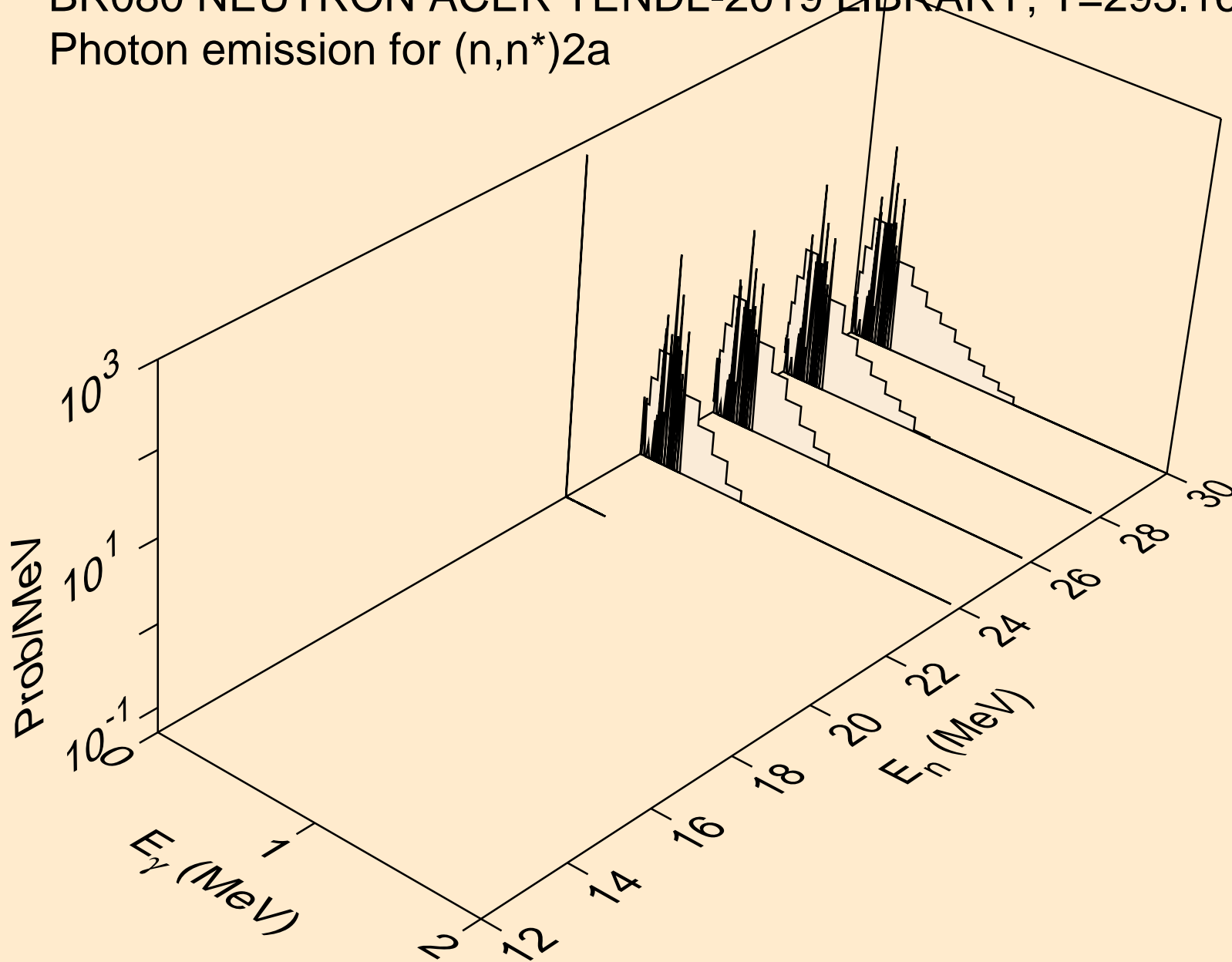

BR080 NEUTRON ACER TENDL-2019 LIBRARY; T=293.16K
Photon emission for (n,n*)d

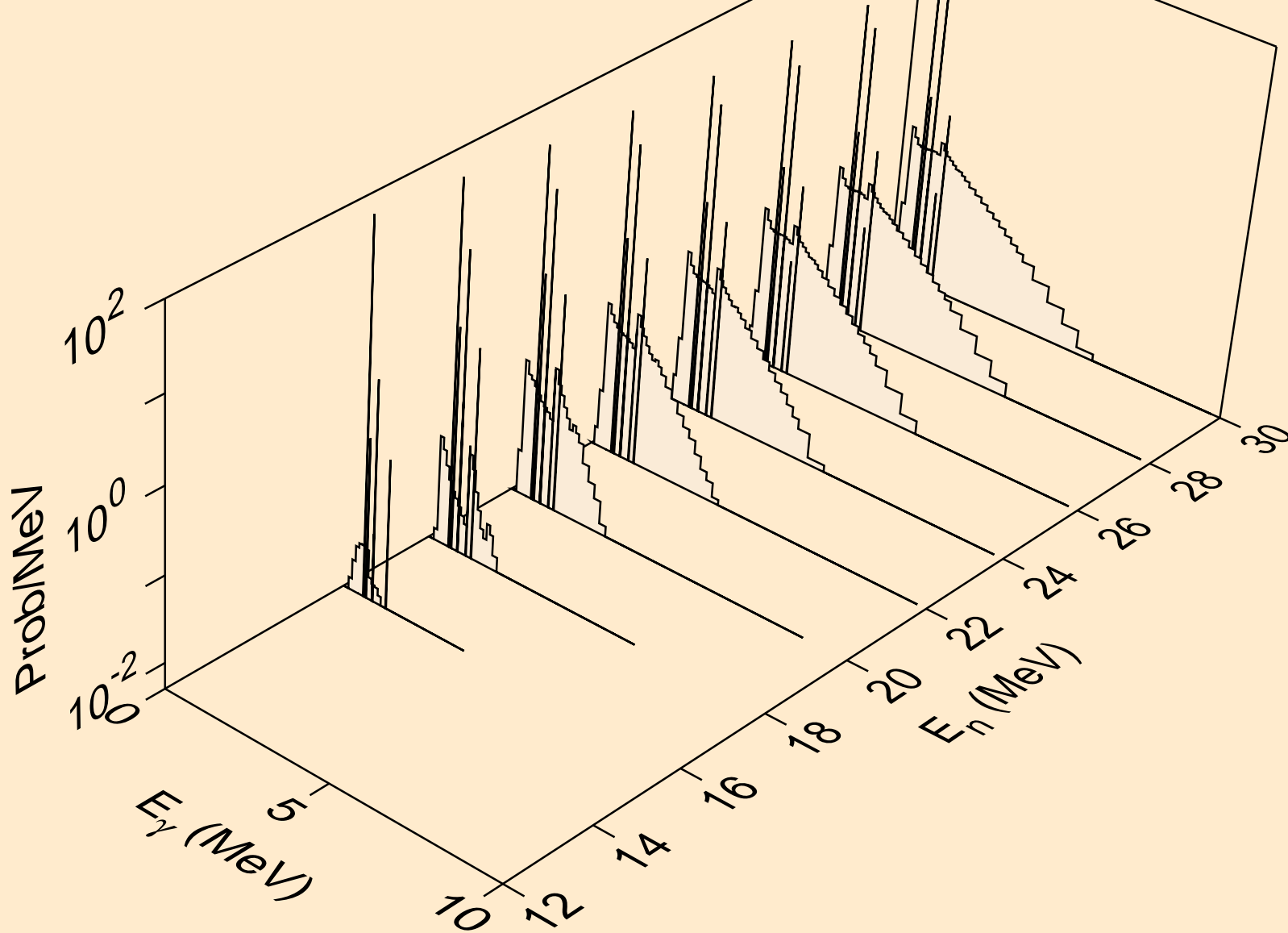

BR080 NEUTRON ACER TENDL-2019 LIBRARY; T=293.16K
Photon emission for (n,n*)t

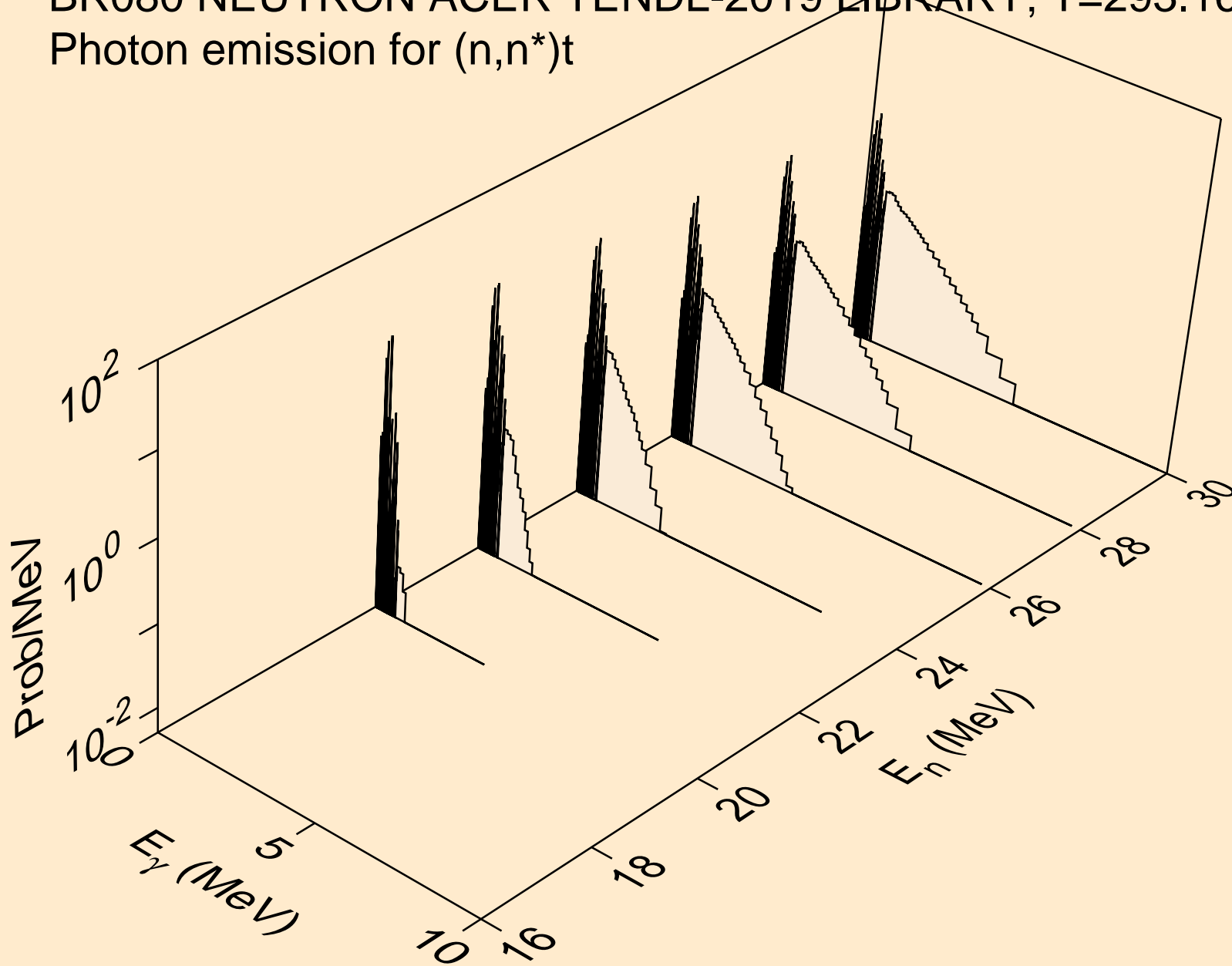

BR080 NEUTRON ACER TENDL-2019 LIBRARY; T=293.16K
Photon emission for (n,n*)he3

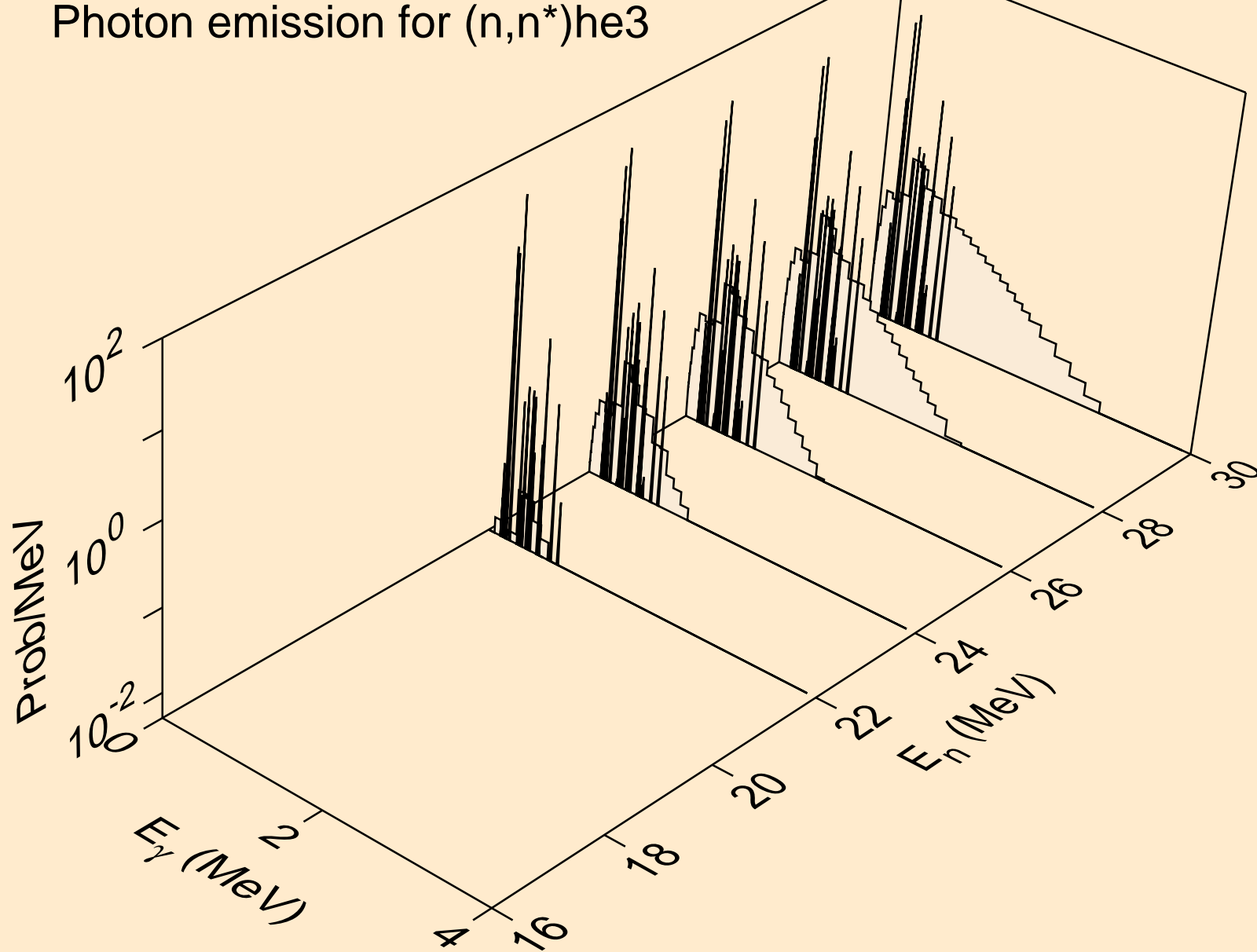

BR080 NEUTRON ACER TENDL-2019 LIBRARY; T=293.16K
Photon emission for (n,4n)

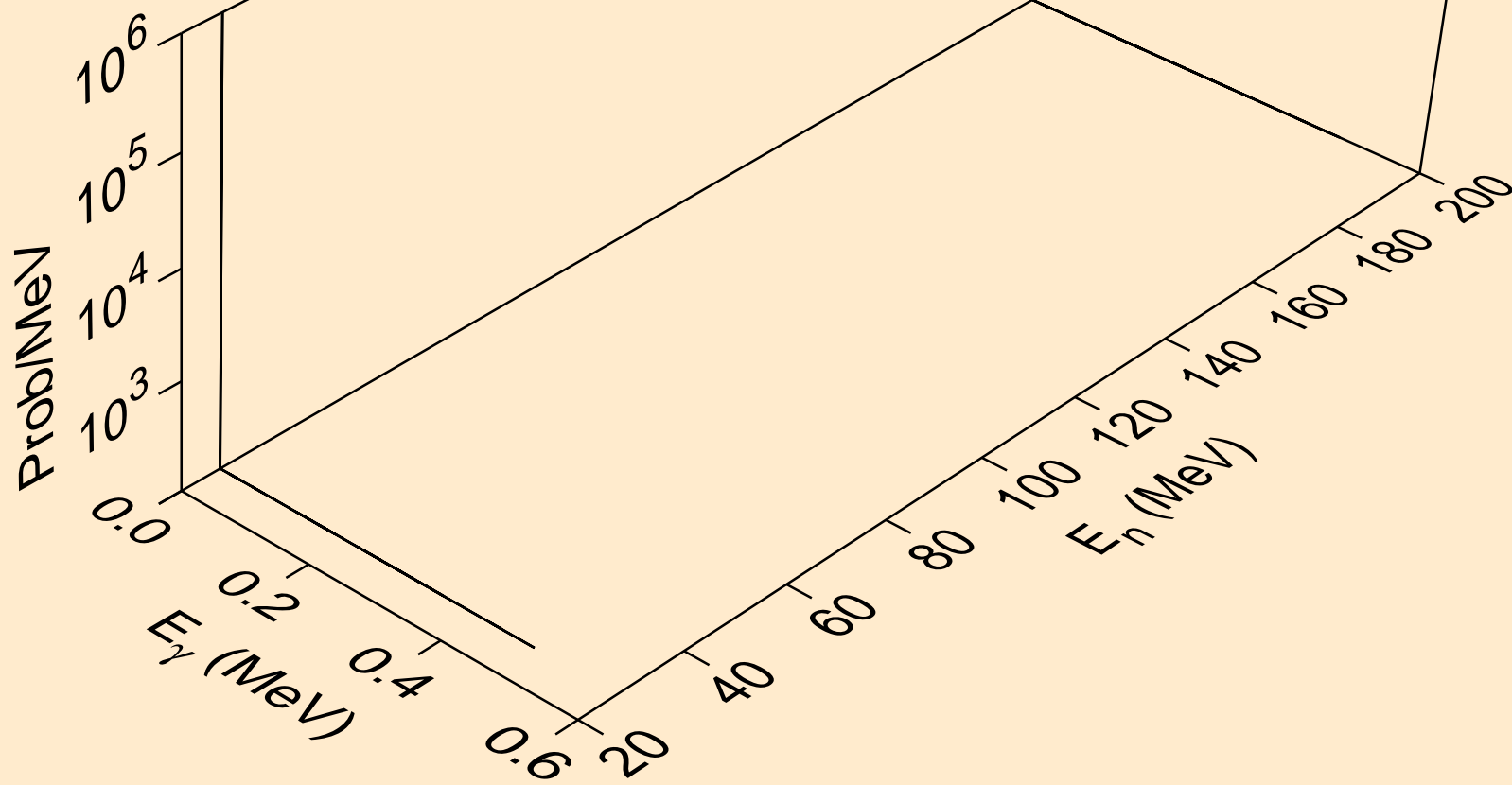

BR080 NEUTRON ACER TENDL-2019 LIBRARY; T=293.16K
Photon emission for (n,2np)

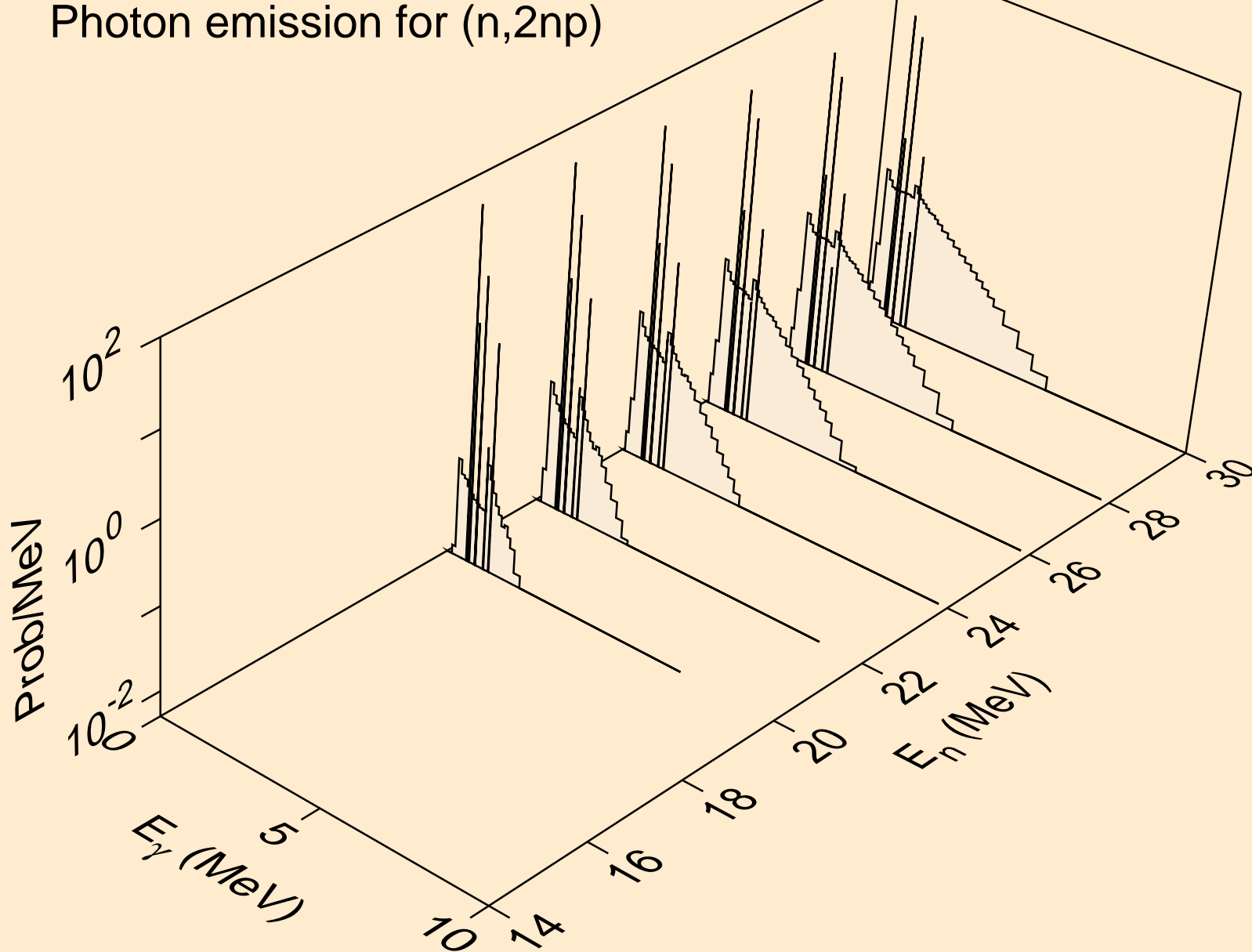

BR080 NEUTRON ACER TENDL-2019 LIBRARY; T=293.16K
Photon emission for (n,3np)

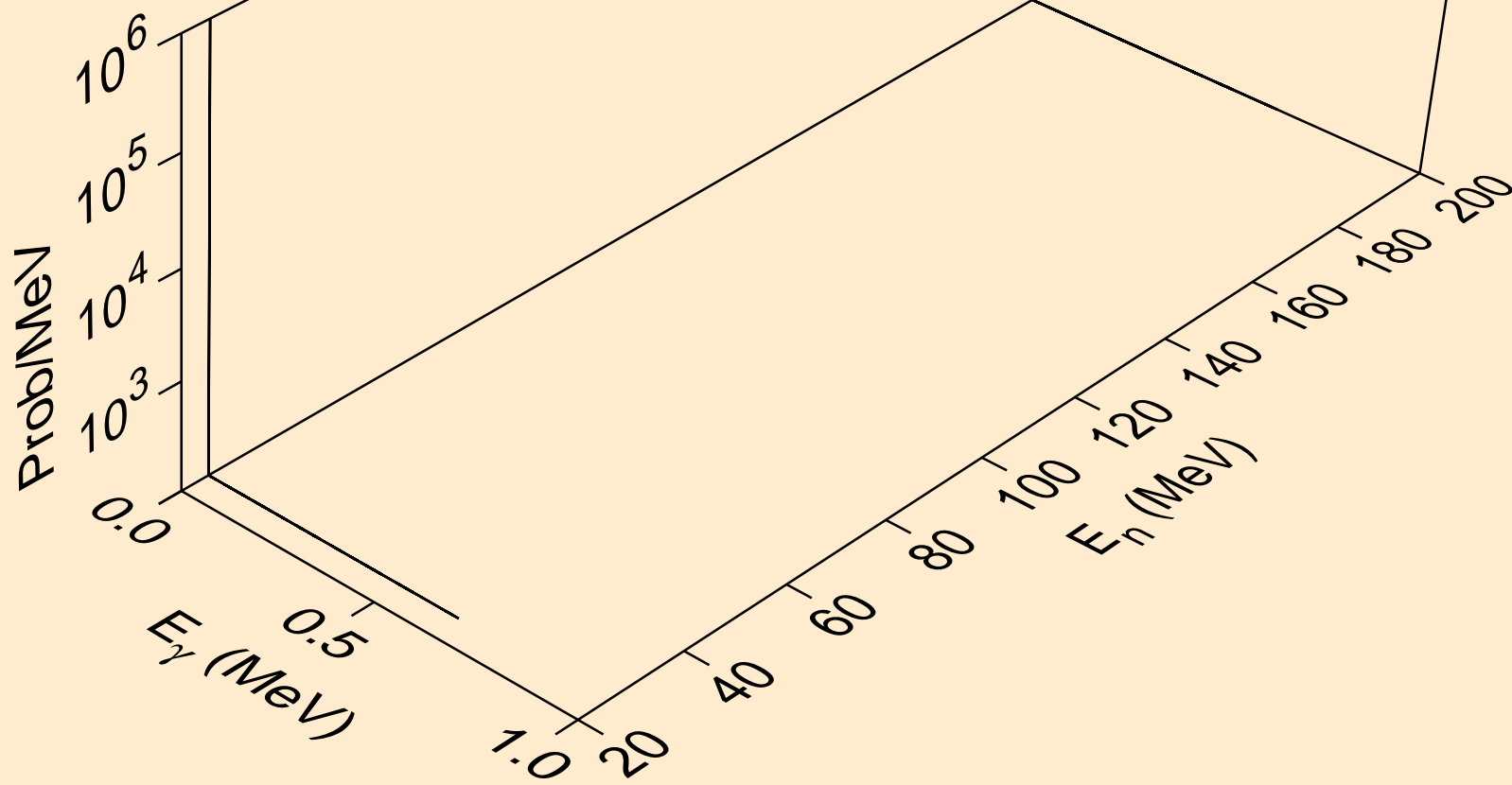

BR080 NEUTRON ACER TENDL-2019 LIBRARY; T=293.16K
Photon emission for (n,2np)

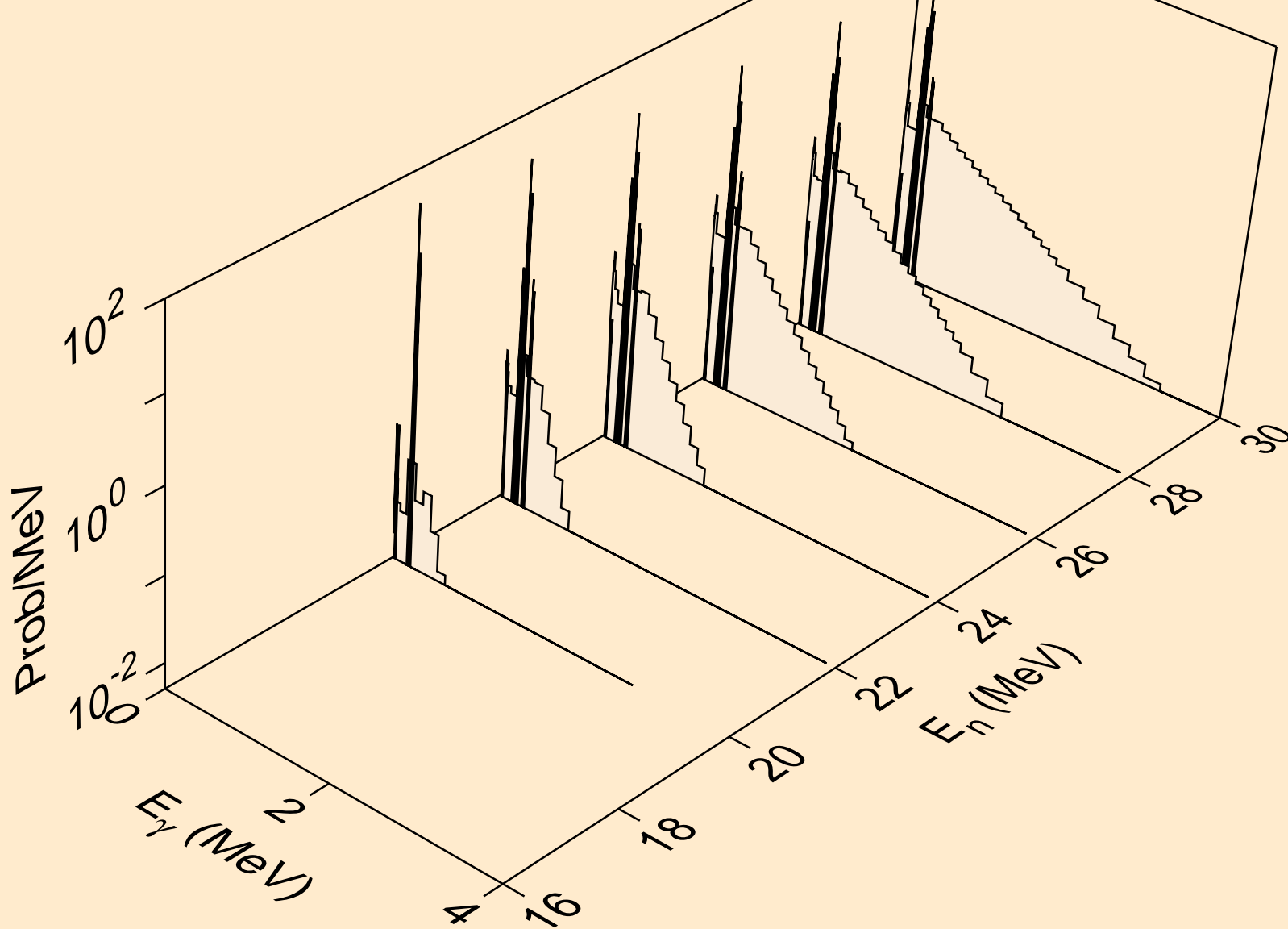

BR080 NEUTRON ACER TENDL-2019 LIBRARY; T=293.16K
Photon emission for (n,npa)

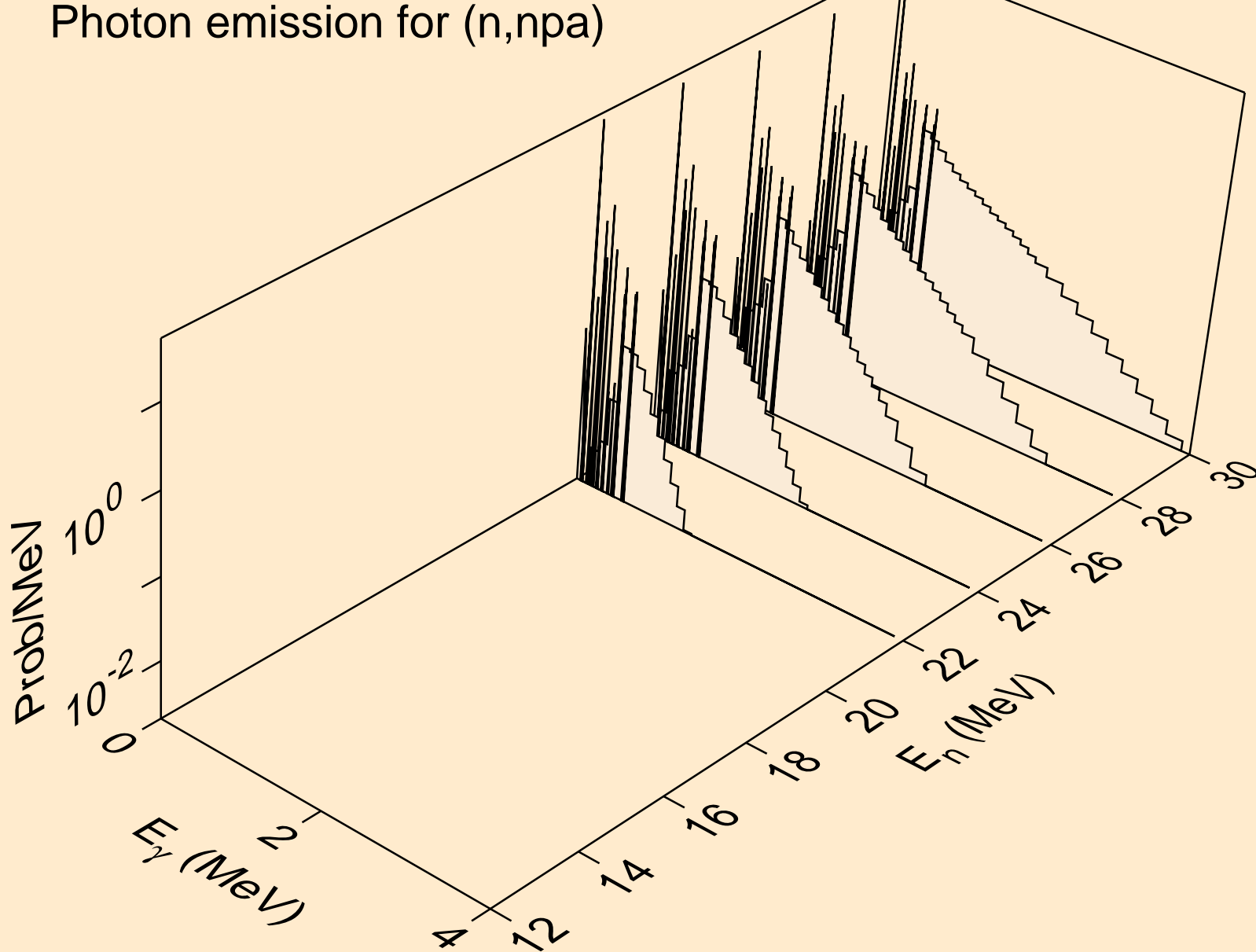

BR080 NEUTRON ACER TENDL-2019 LIBRARY; T=293.16K
Photon emission for (n,n*c)

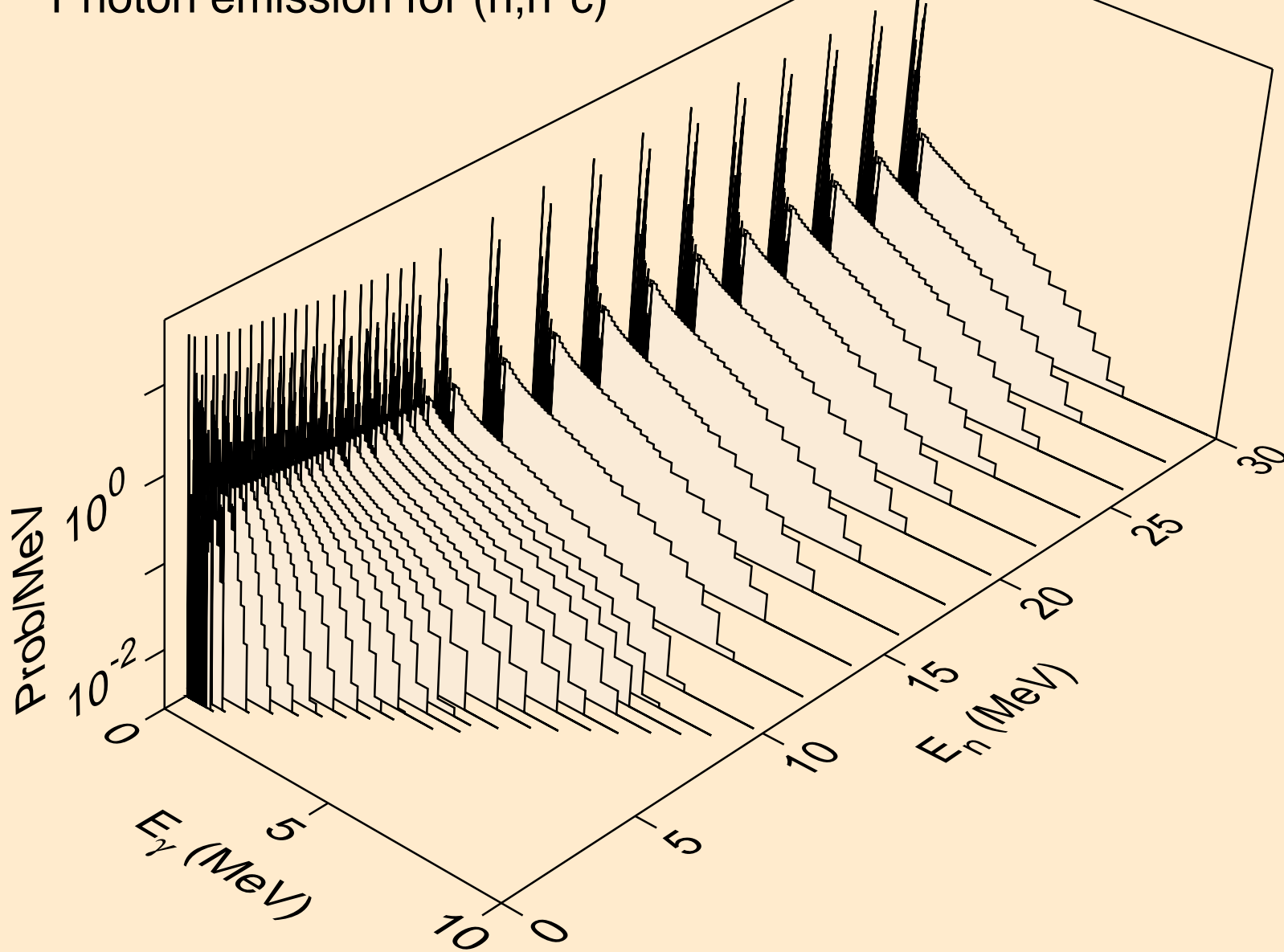

BR080 NEUTRON ACER TENDL-2019 LIBRARY; T=293.16K
Photon emission for (n,gma)

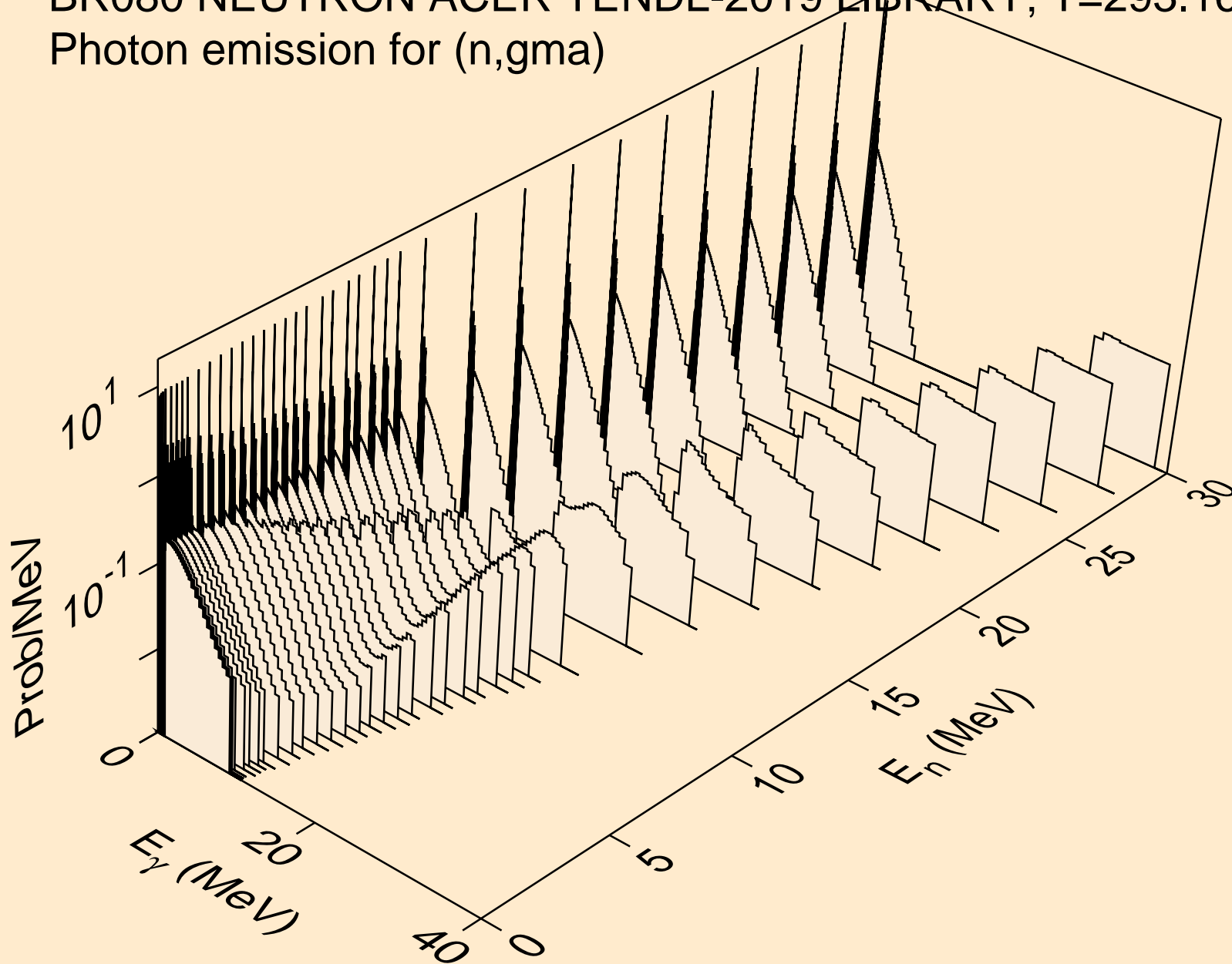

BR080 NEUTRON ACER TENDL-2019 LIBRARY; T=293.16K
Photon emission for (n,p)

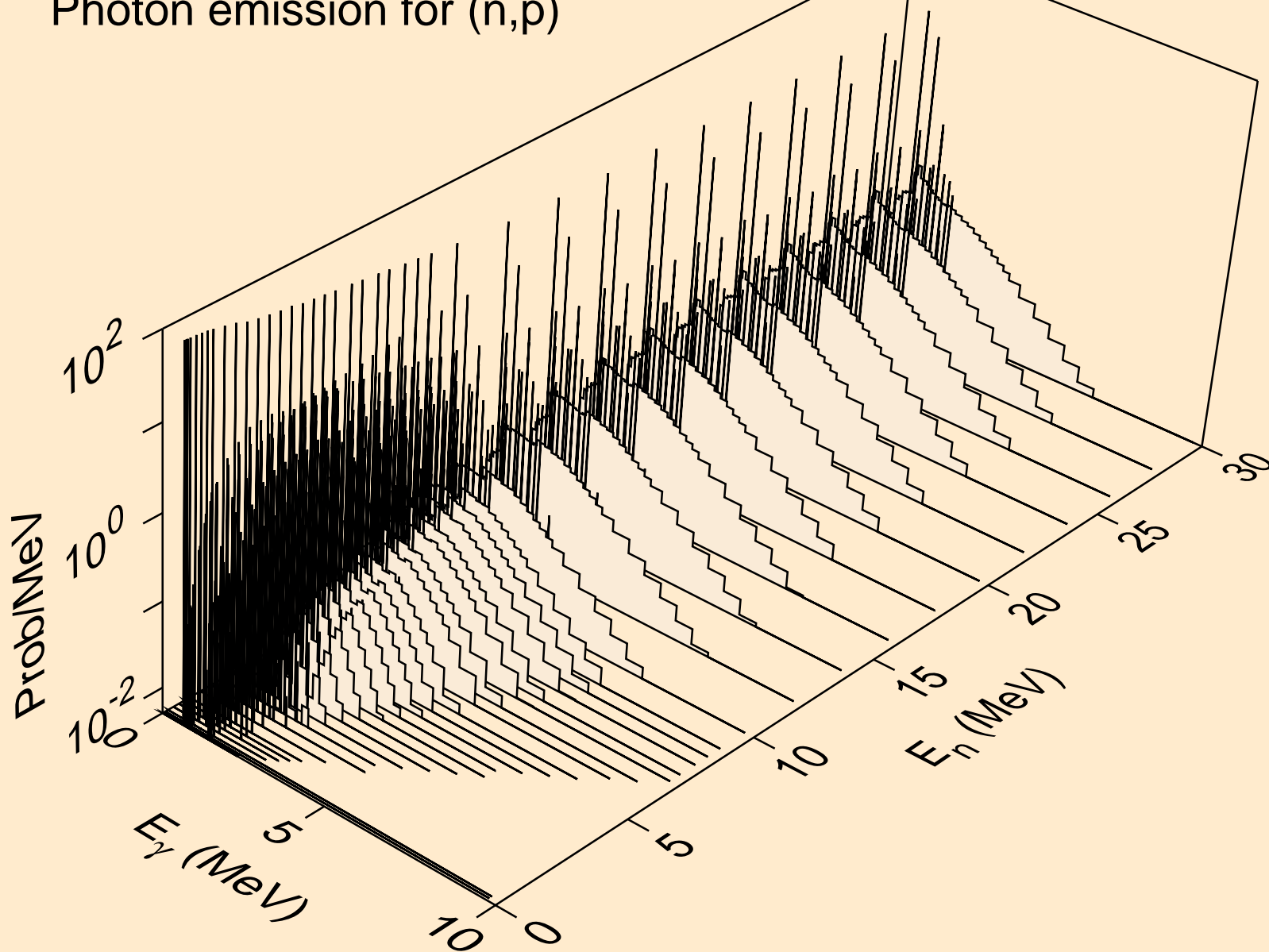

BR080 NEUTRON ACER TENDL-2019 LIBRARY; T=293.16K
Photon emission for (n,d)

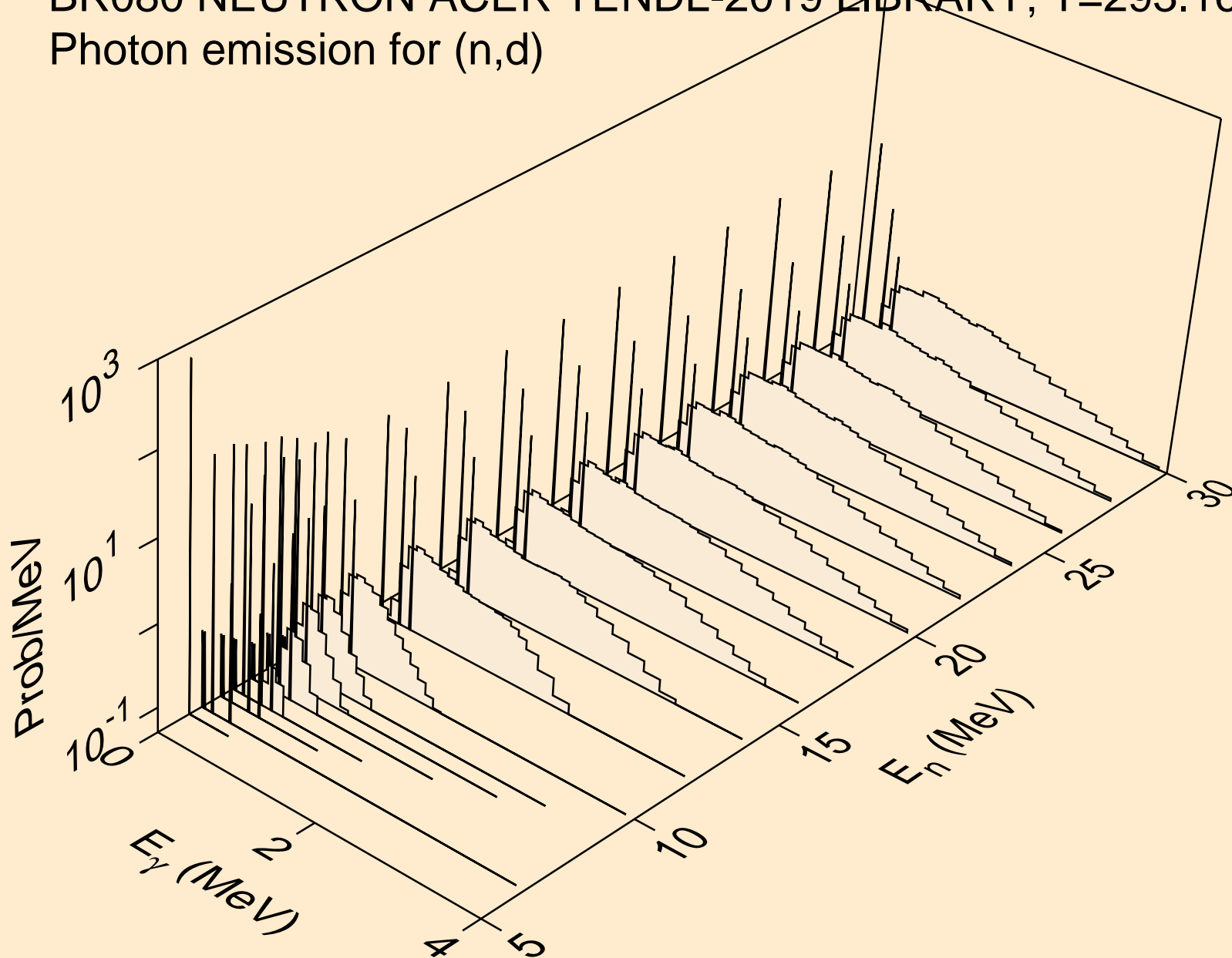

BR080 NEUTRON ACER TENDL-2019 LIBRARY; T=293.16K
Photon emission for (n,t)

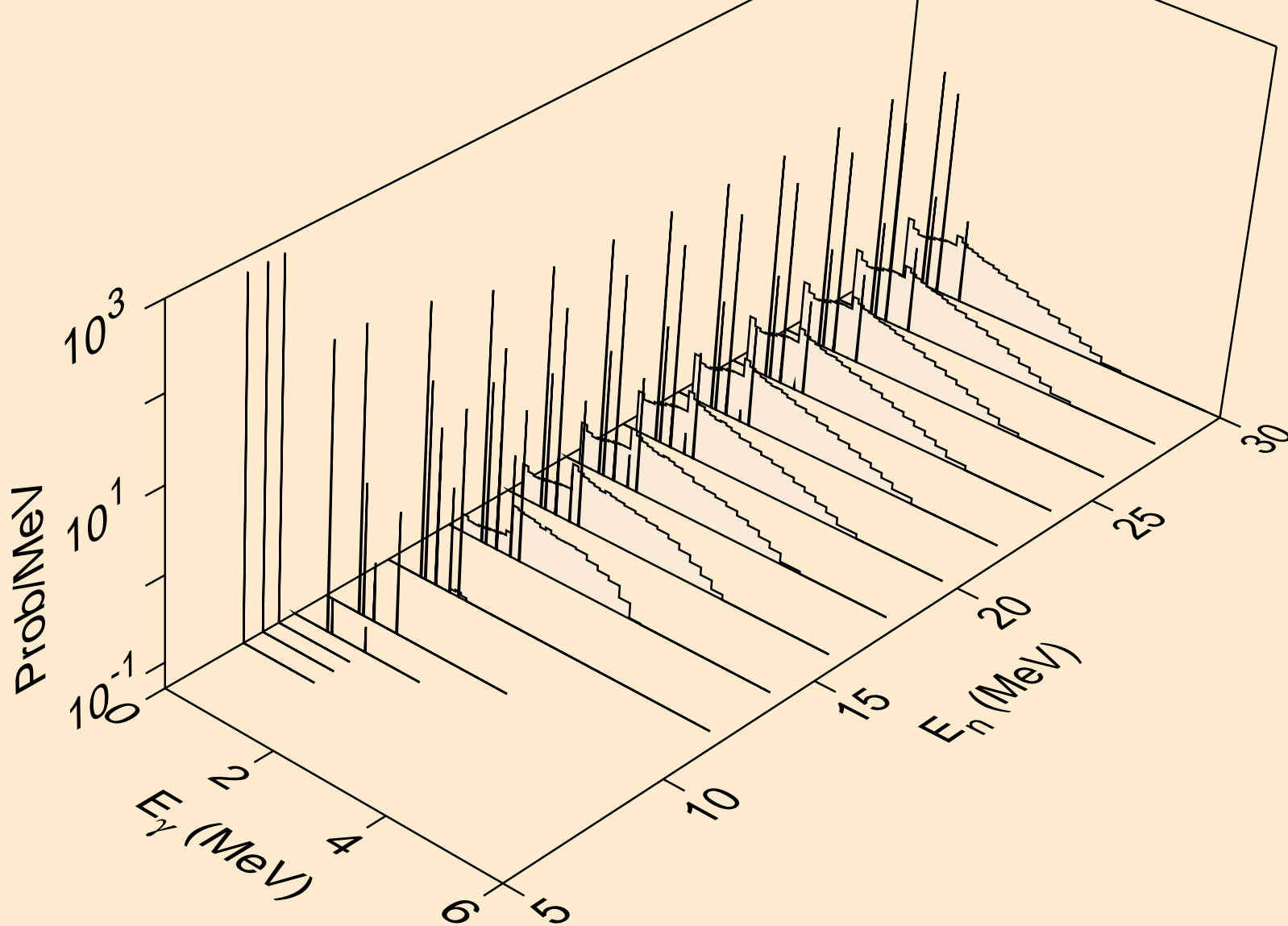

BR080 NEUTRON ACER TENDL-2019 LIBRARY; T=293.16K
Photon emission for (n,he3)

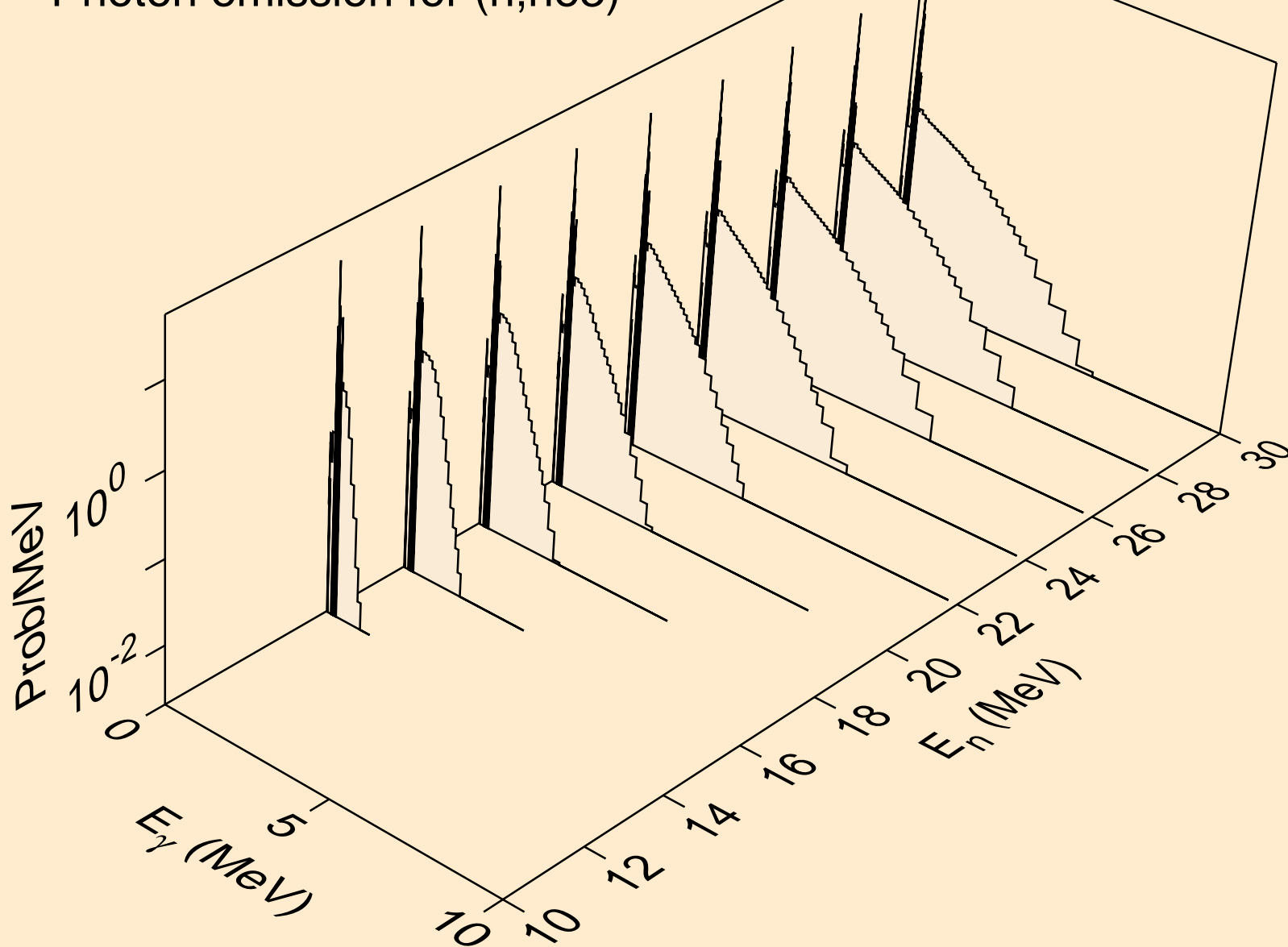

BR080 NEUTRON ACER TENDL-2019 LIBRARY; T=293.16K
Photon emission for (n,a)

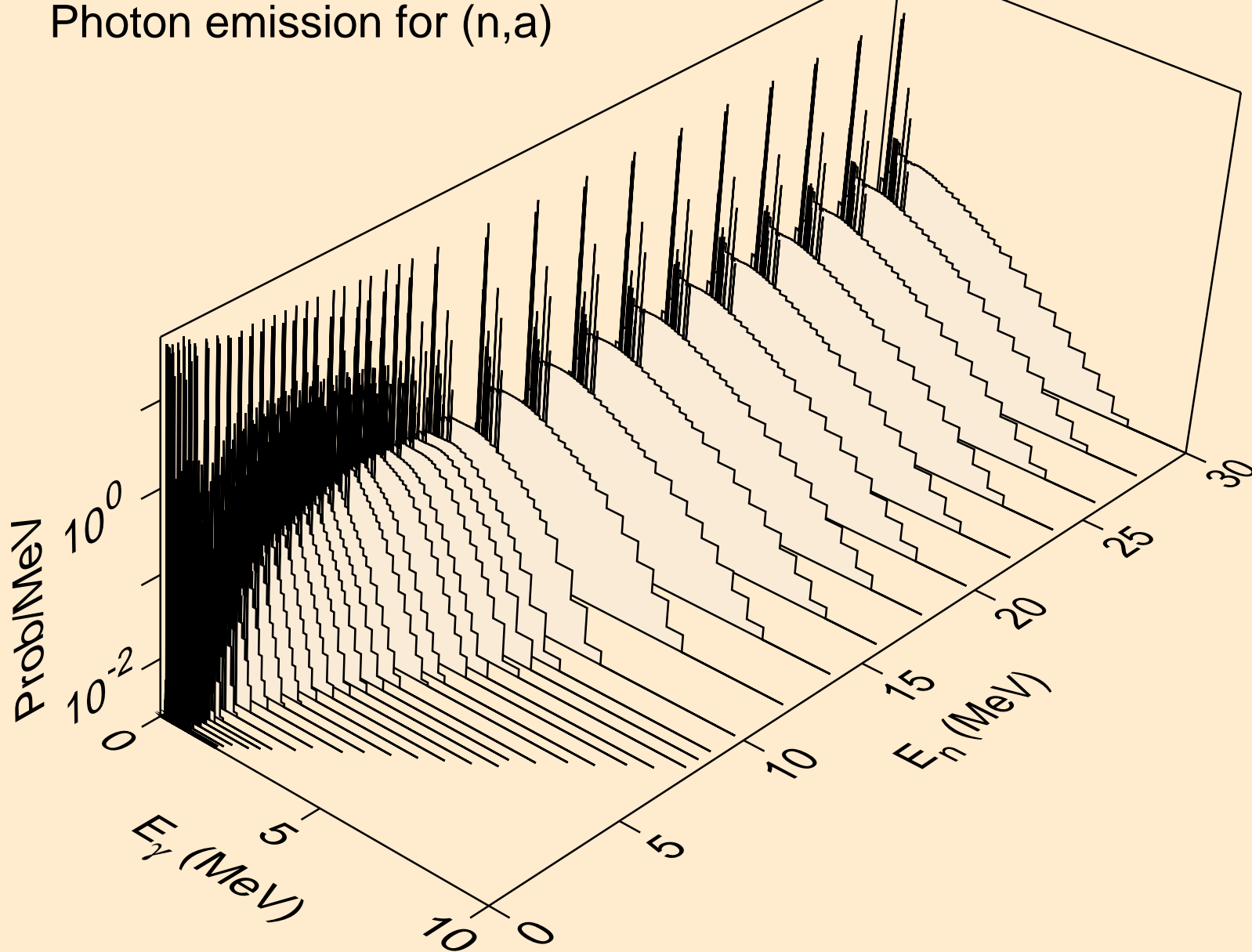

BR080 NEUTRON ACER TENDL-2019 LIBRARY; T=293.16K
Photon emission for (n,2a)

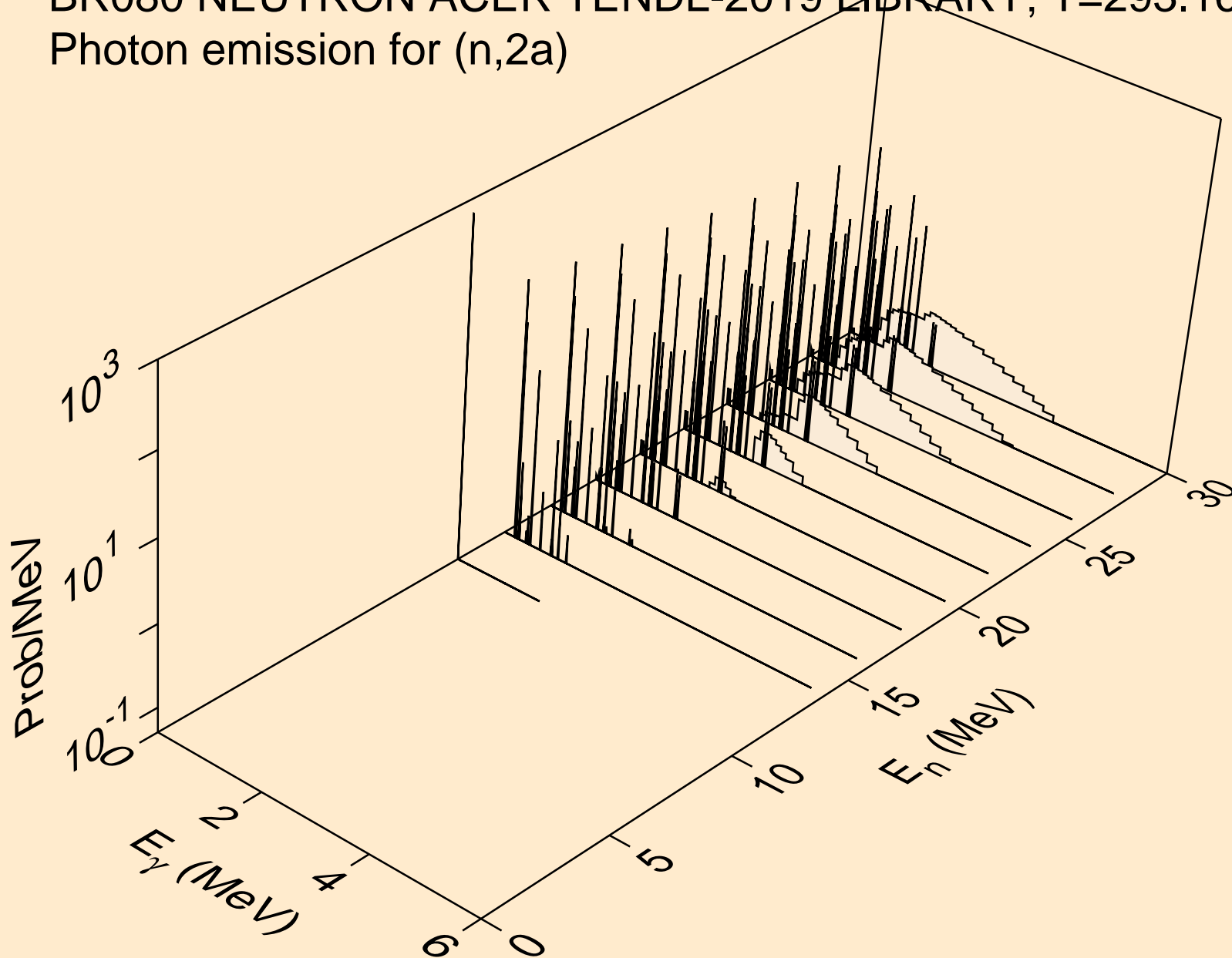

BR080 NEUTRON ACER TENDL-2019 LIBRARY; T=293.16K
Photon emission for (n,2p)

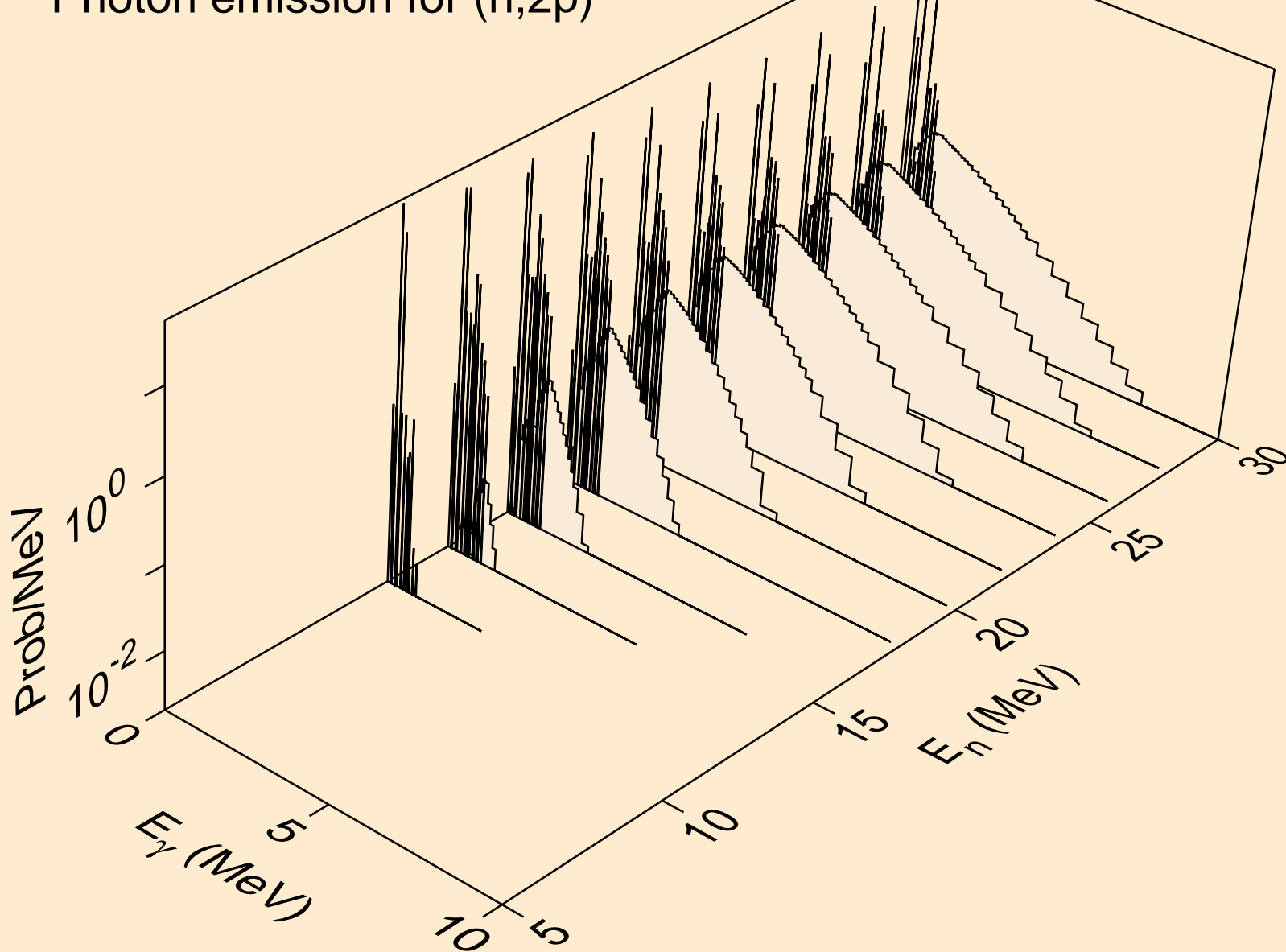

BR080 NEUTRON ACER TENDL-2019 LIBRARY; T=293.16K
Photon emission for (n,p α)

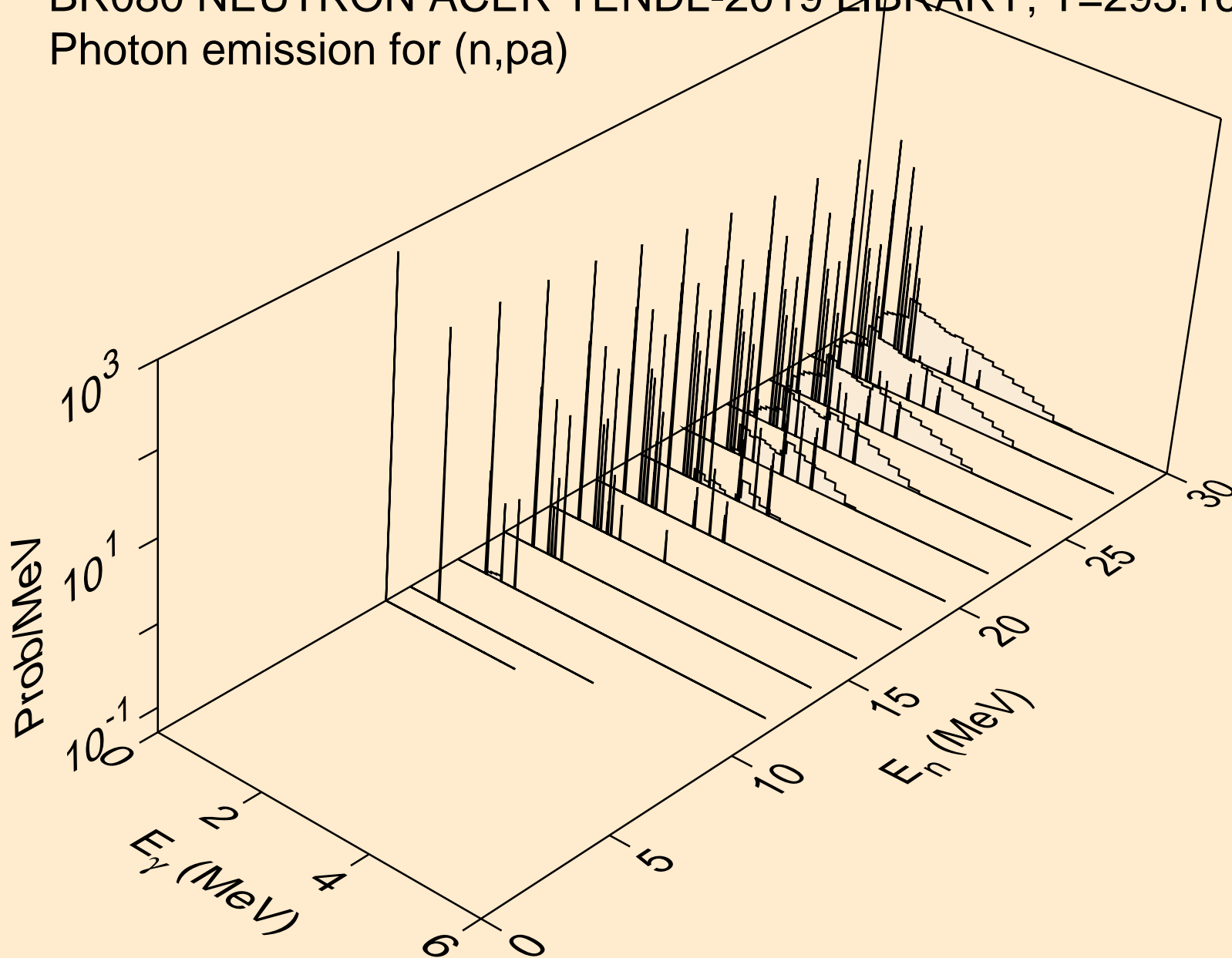

BR080 NEUTRON ACER TENDL-2019 LIBRARY; T=293.16K
Photon emission for (n,pd)

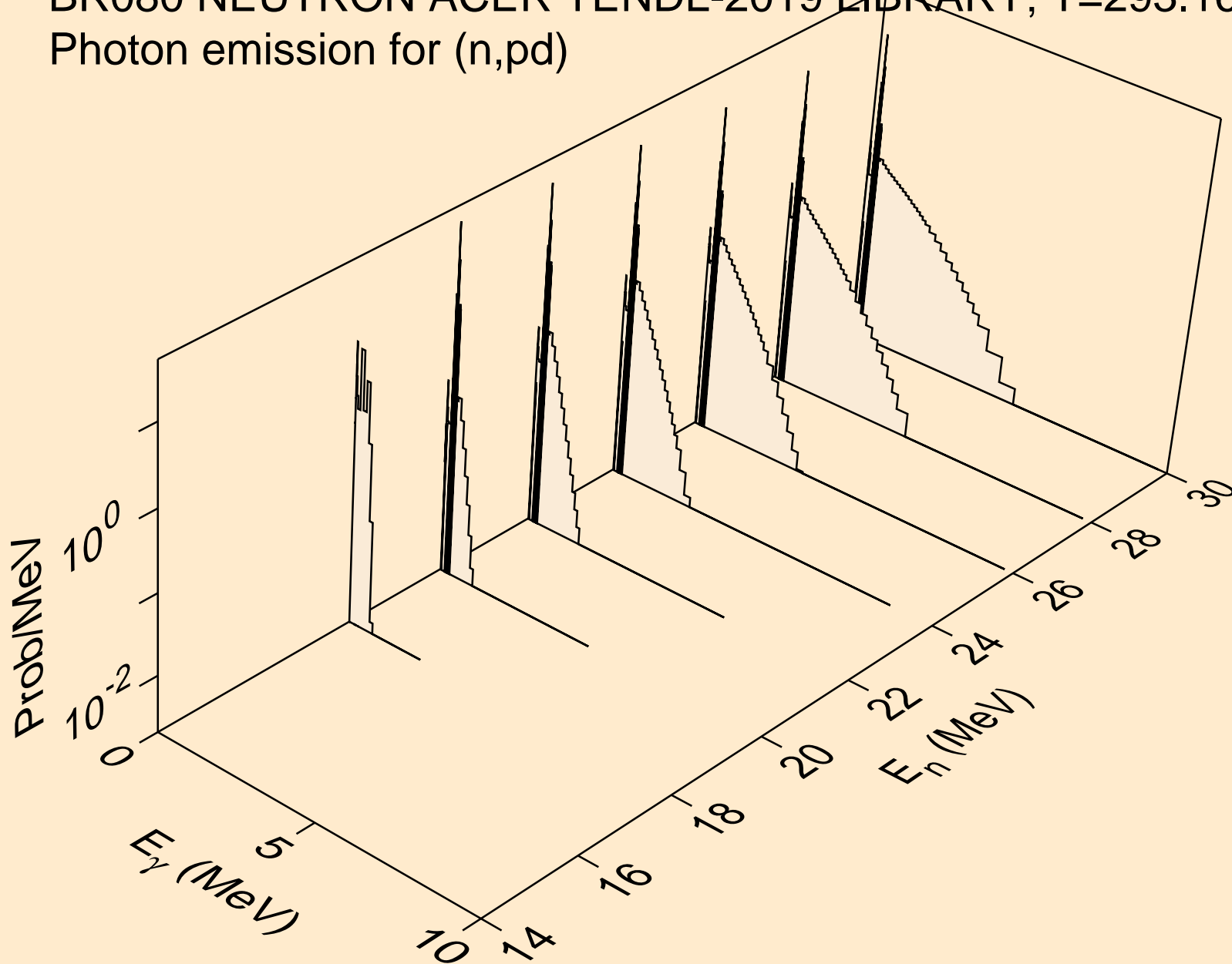

BR080 NEUTRON ACER TENDL-2019 LIBRARY; T=293.16K
Photon emission for (n,pt)

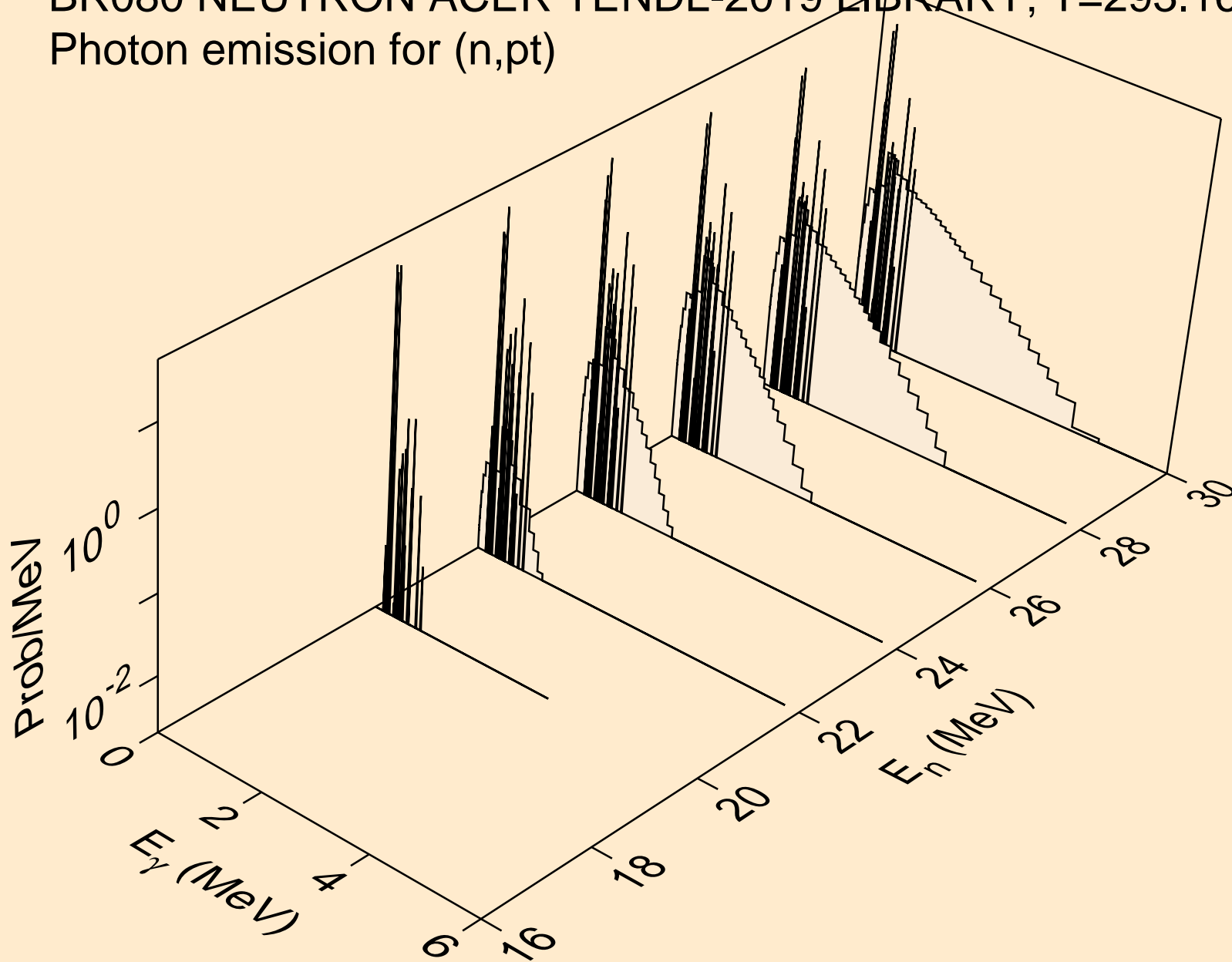

BR080 NEUTRON ACER TENDL-2019 LIBRARY; T=293.16K
Photon emission for (n,da)

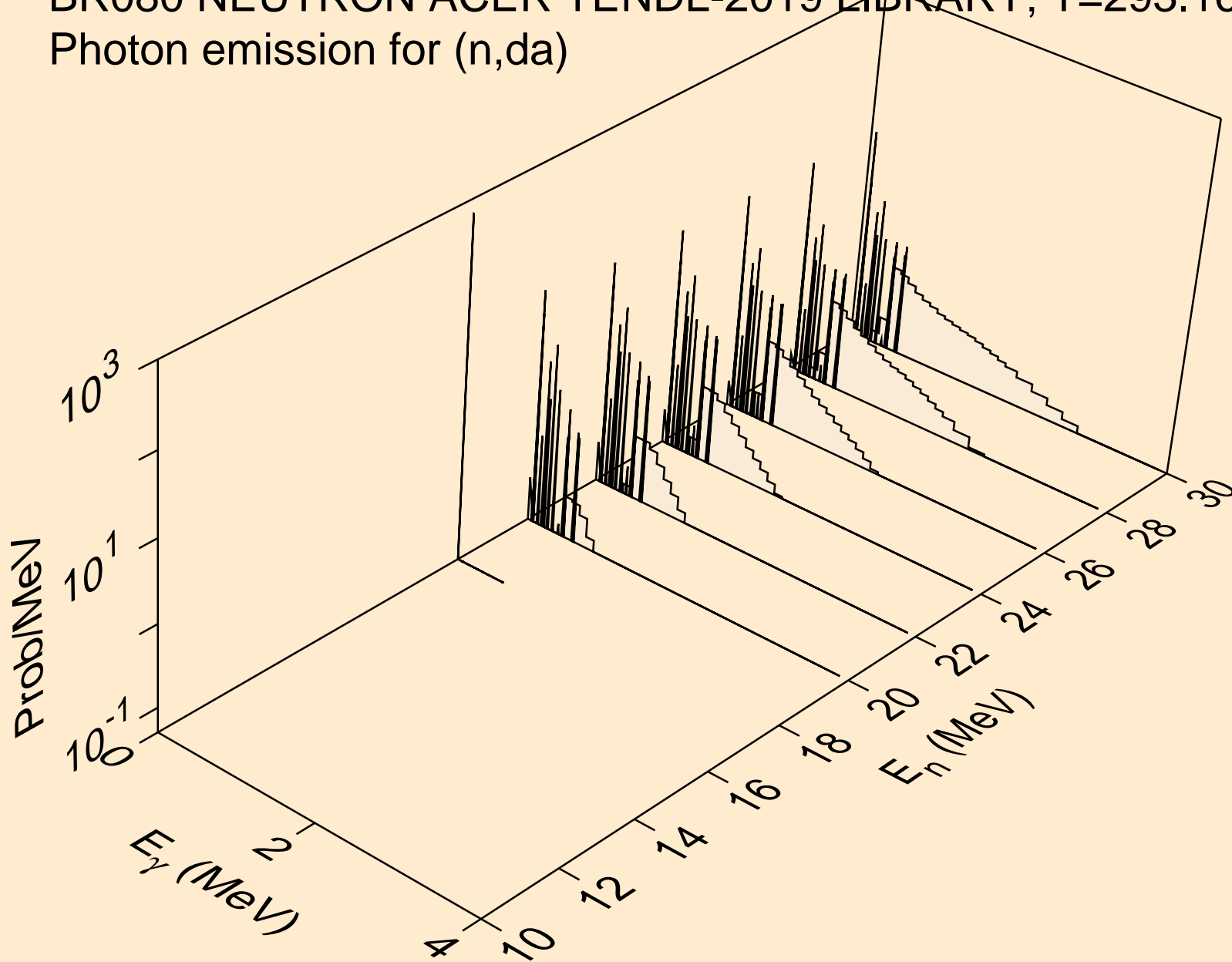

BR080 NEUTRON ACER TENDL-2019 LIBRARY; T=293.16K
thermal capture photon spectrum

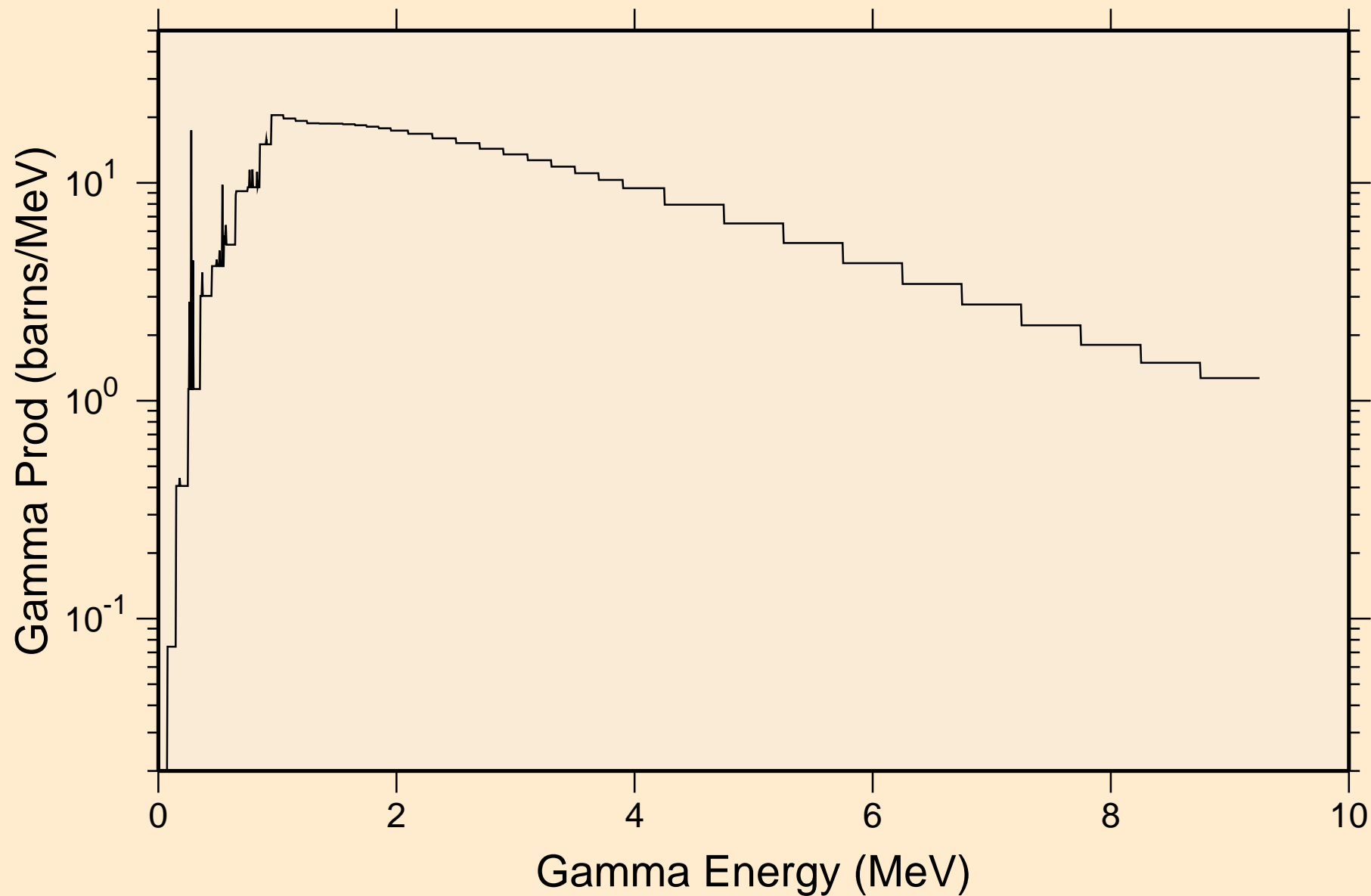

BR080 NEUTRON ACER TENDL-2019 LIBRARY; T=293.16K
14 MeV photon spectrum

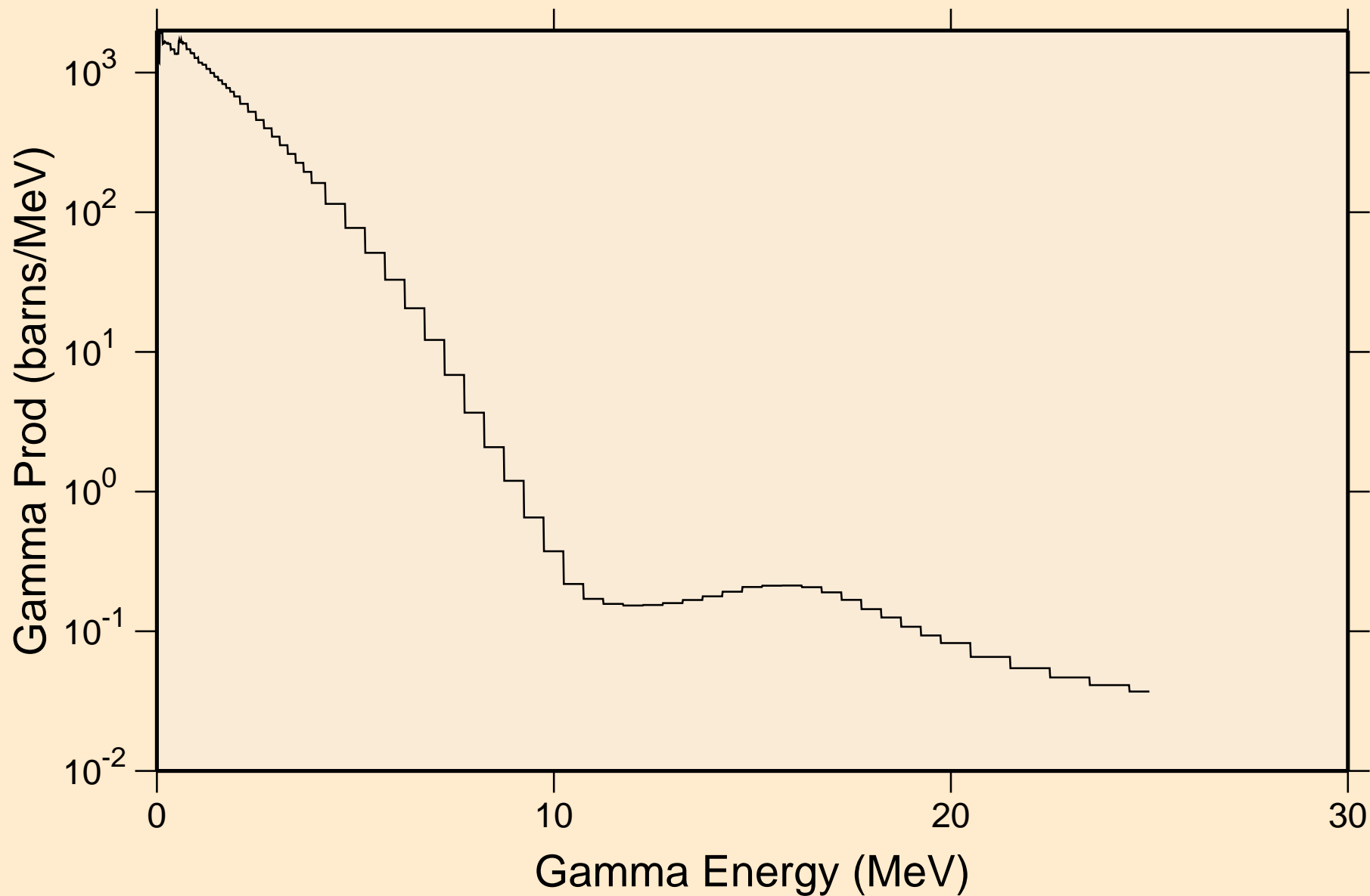

BR080 NEUTRON ACER TENDL-2019 LIBRARY; T=293.16K
Particle heating contributions

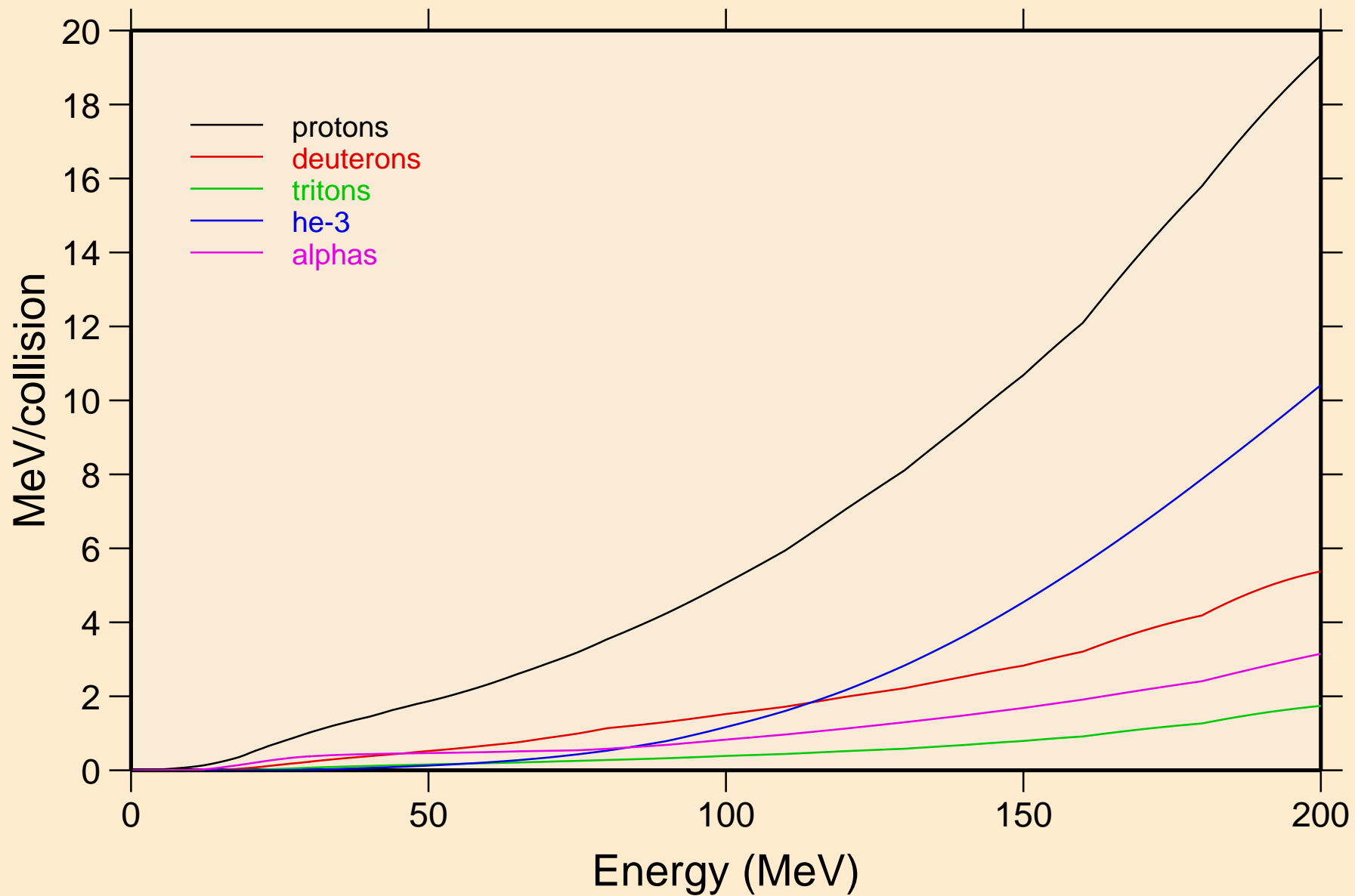

BR080 NEUTRON ACER TENDL-2019 LIBRARY; T=293.16K
Recoil Heating

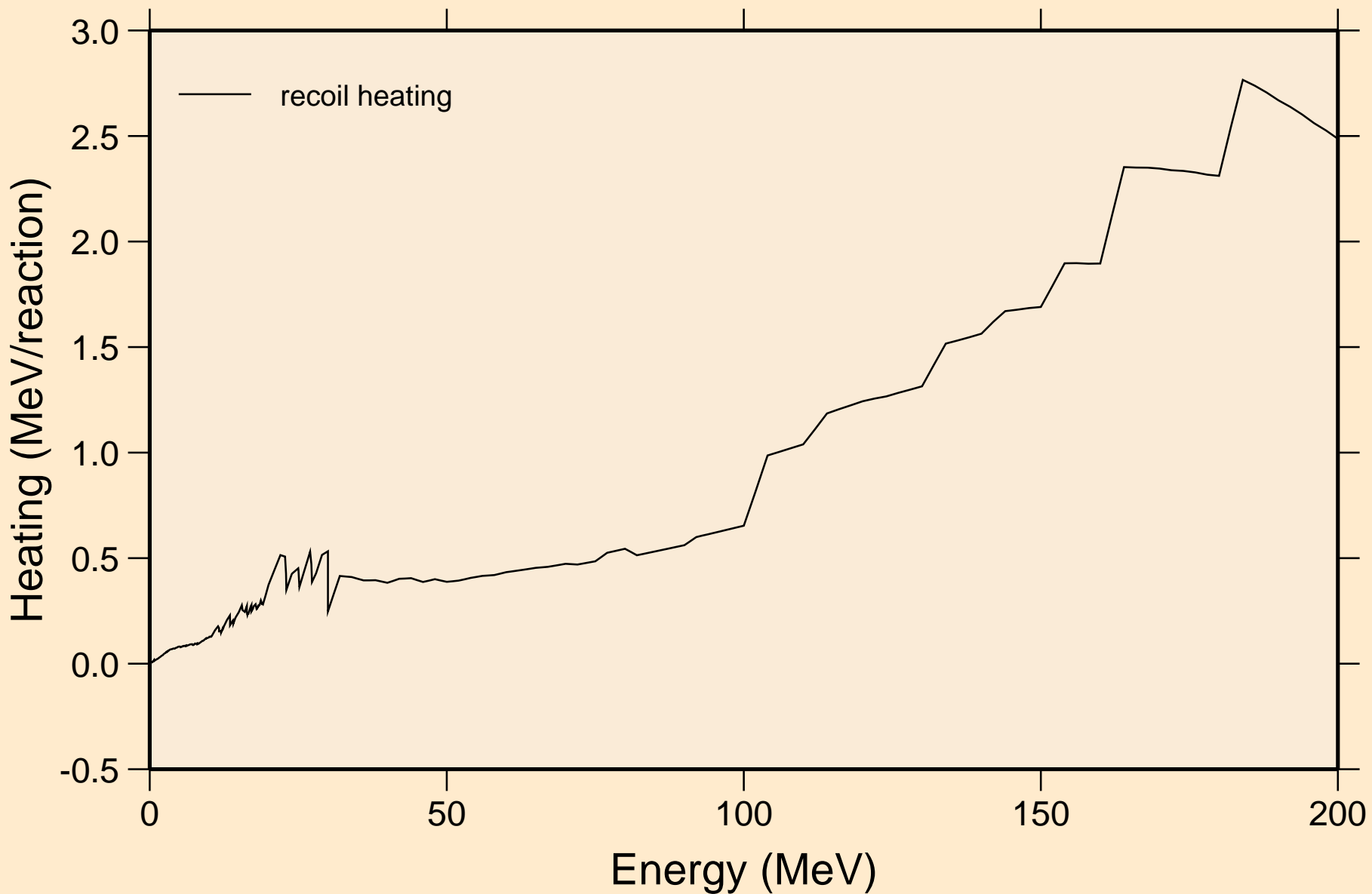

BR080 NEUTRON ACER TENDL-2019 LIBRARY; T=293.16K
Particle production cross sections

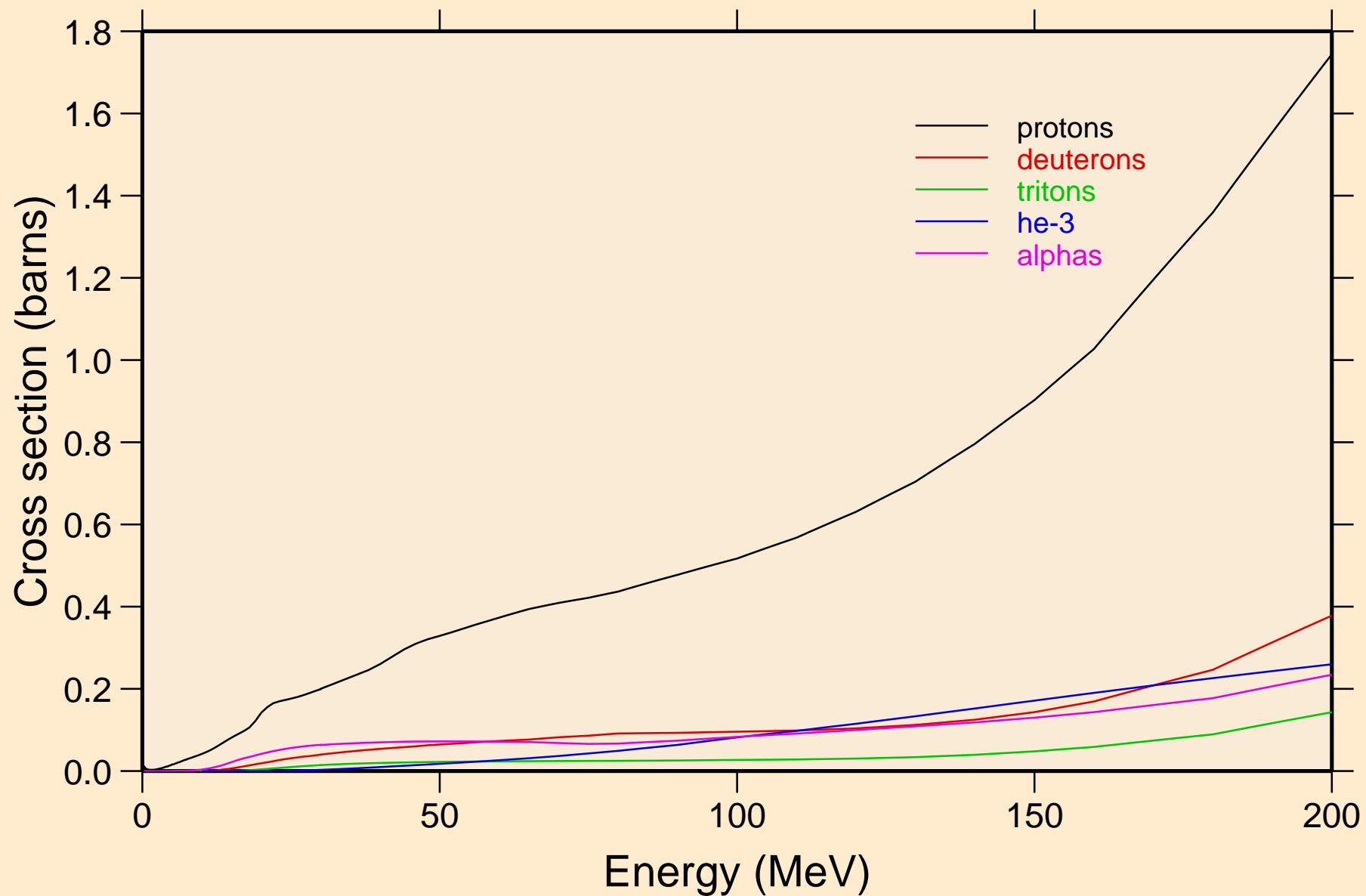

BR080 NEUTRON ACER TENDL-2019 LIBRARY; T=293.16K
protons from (n,x)

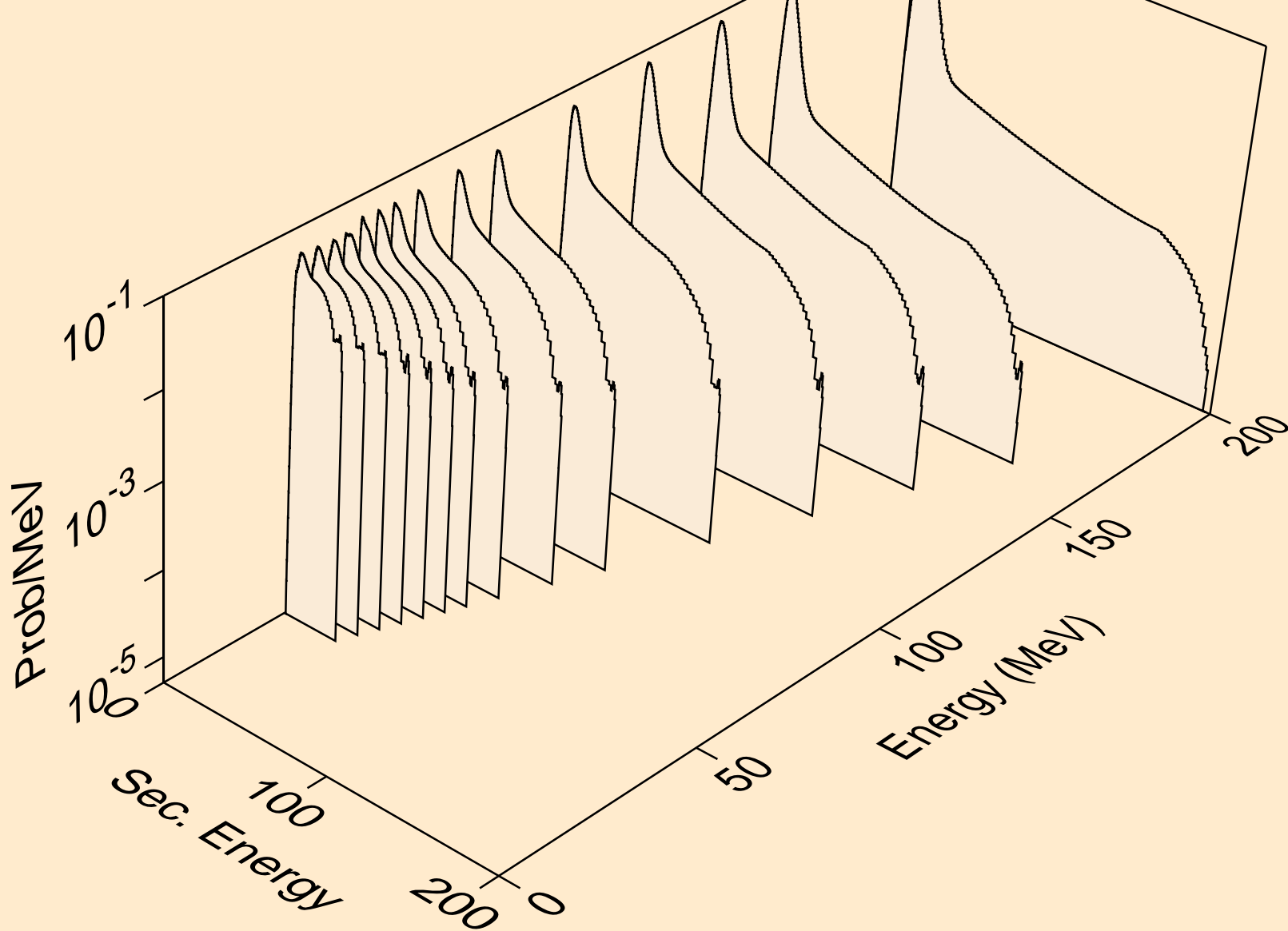

BR080 NEUTRON ACER TENDL-2019 LIBRARY; T=293.16K
protons from (n,n*)p

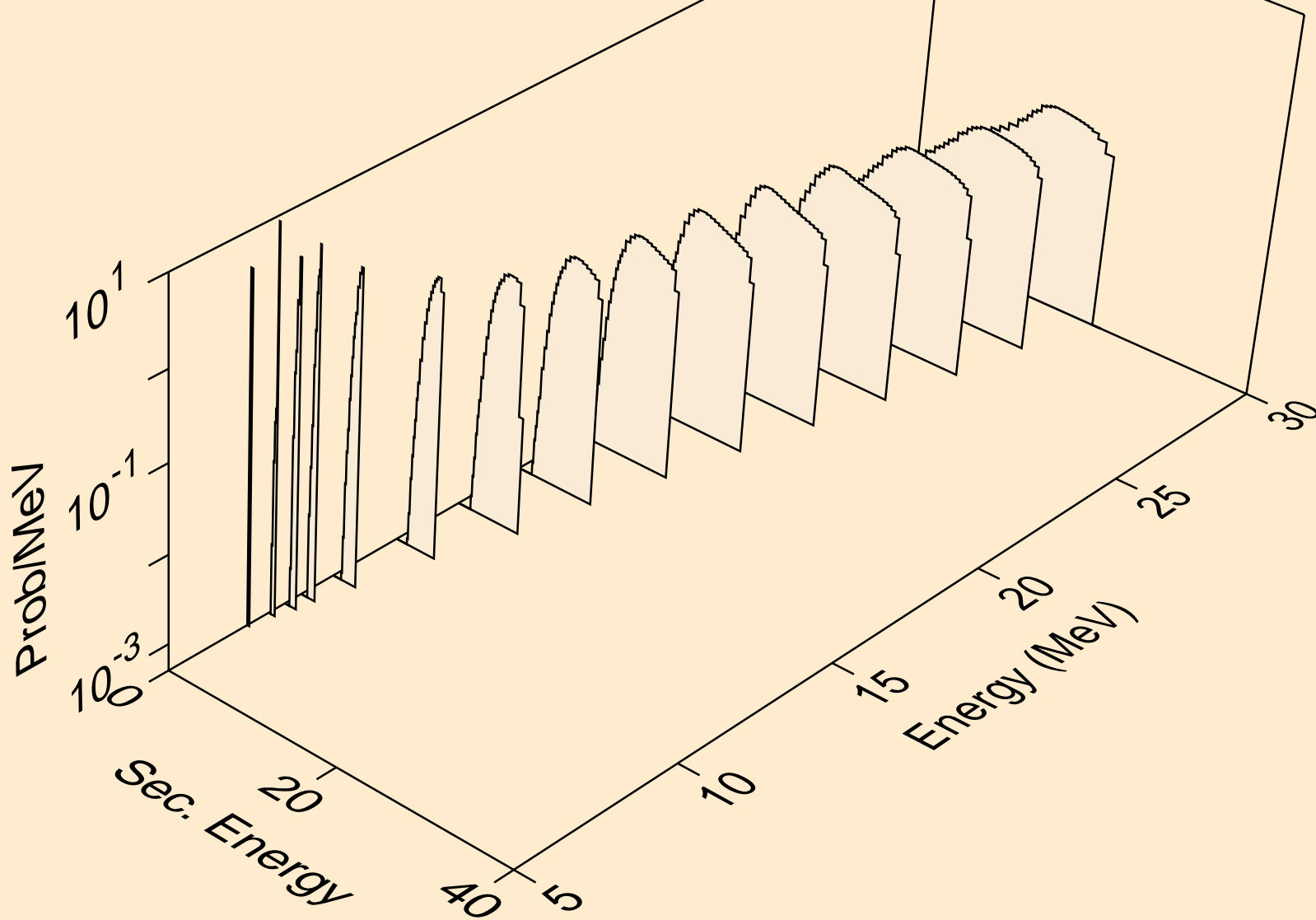

BR080 NEUTRON ACER TENDL-2019 LIBRARY; T=293.16K
protons from (n,2np)

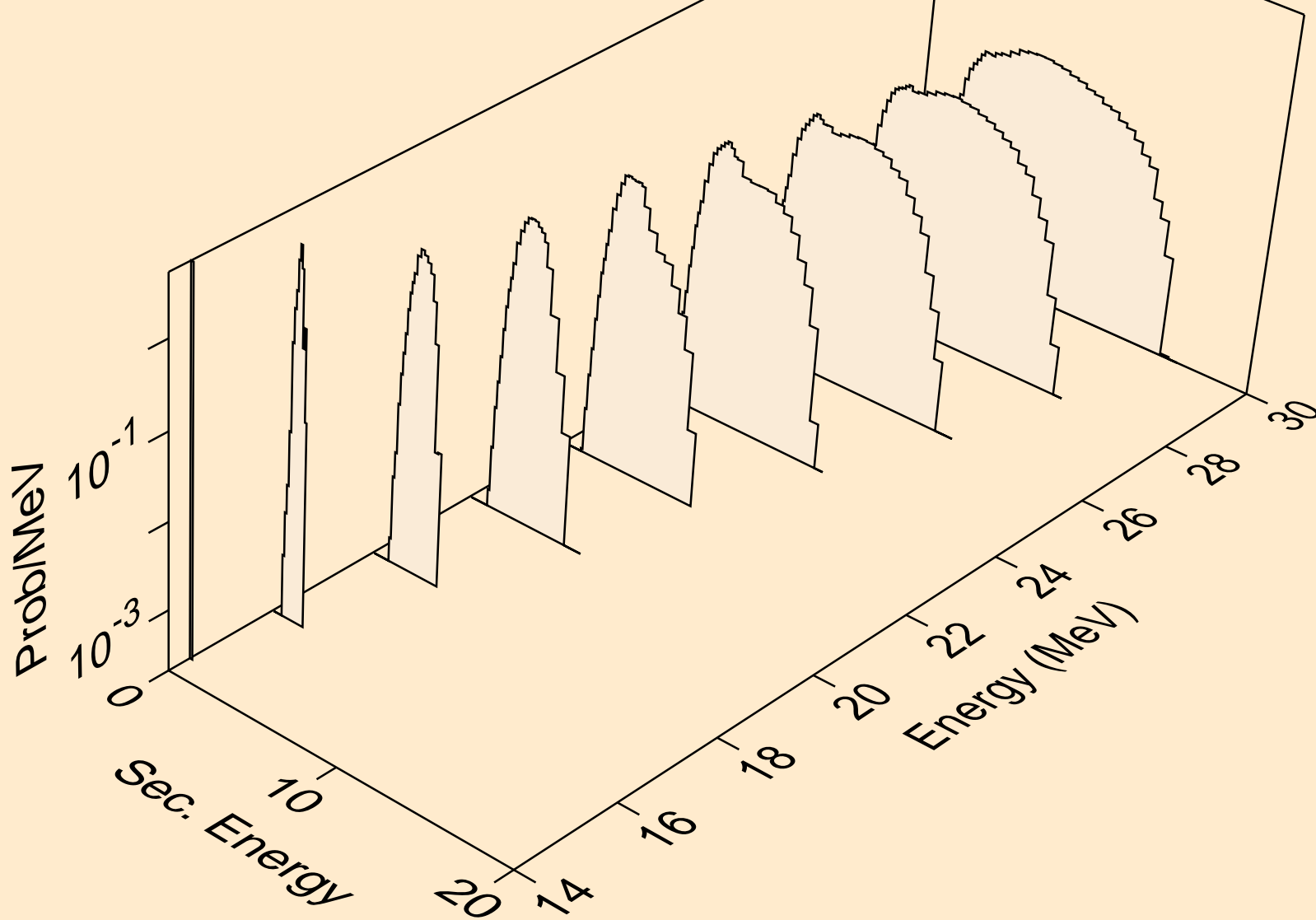

BR080 NEUTRON ACER TENDL-2019 LIBRARY; T=293.16K
protons from (n,3np)

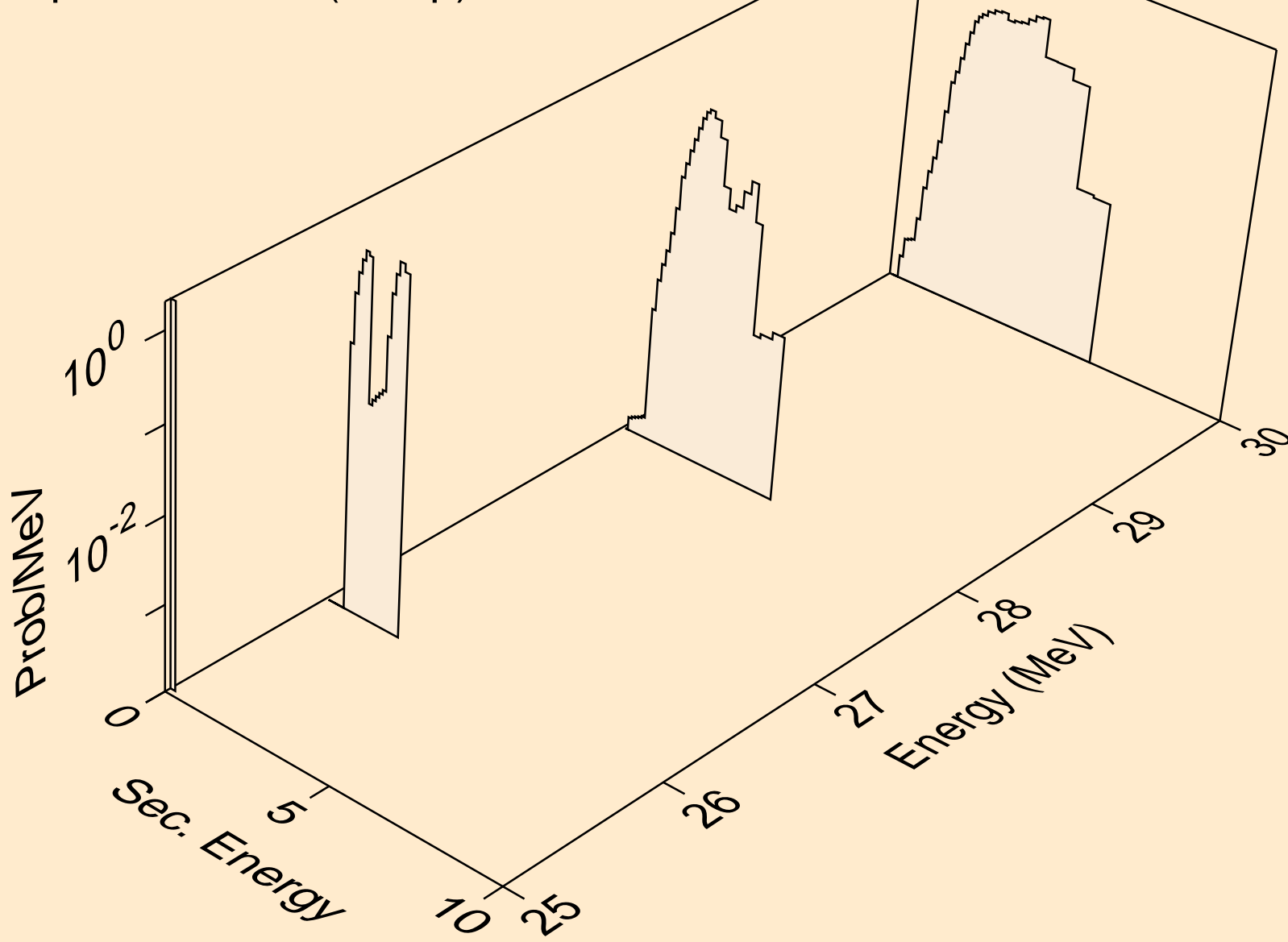

BR080 NEUTRON ACER TENDL-2019 LIBRARY; T=293.16K
protons from (n,2np)

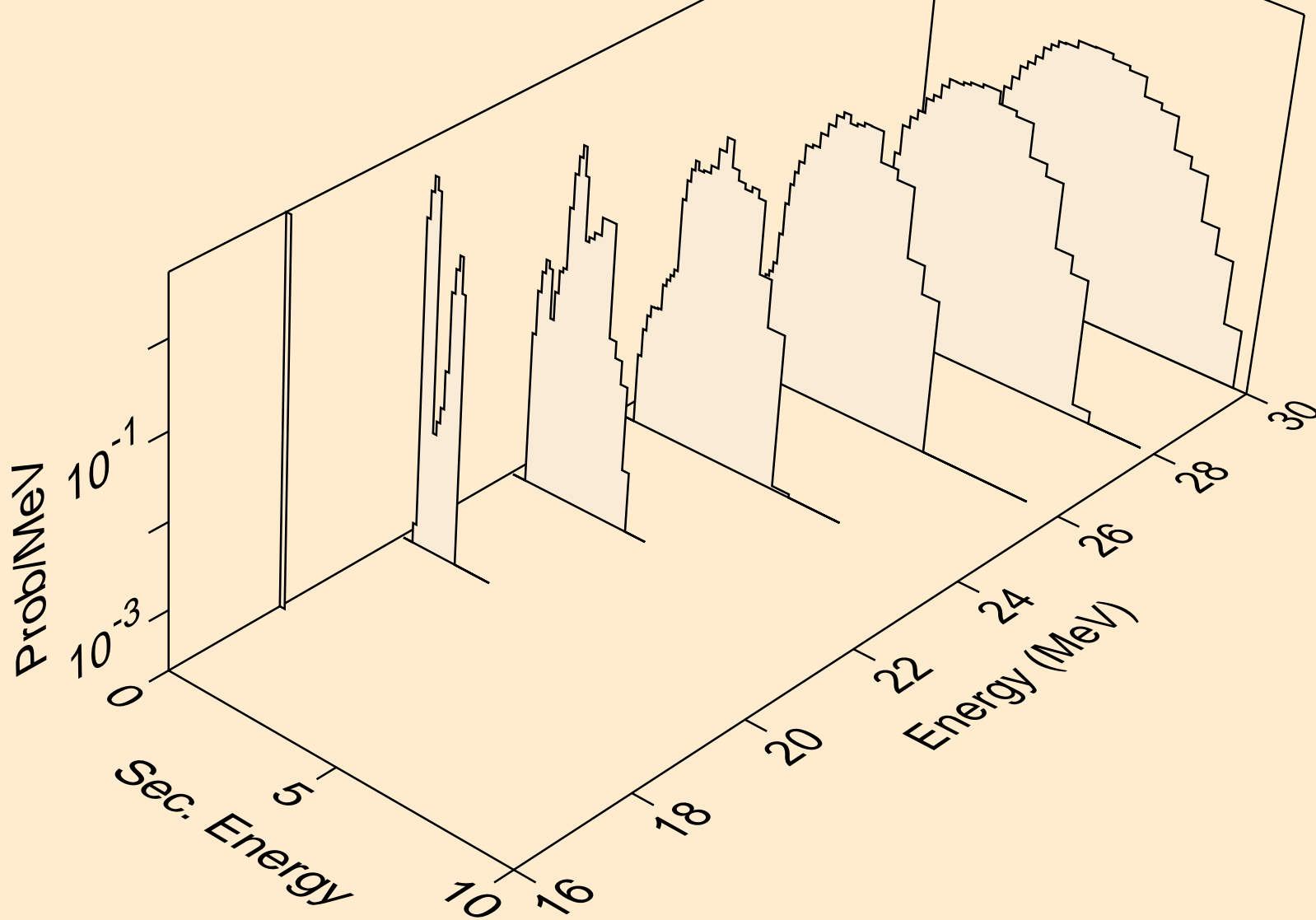

BR080 NEUTRON ACER TENDL-2019 LIBRARY; T=293.16K
protons from (n,npa)

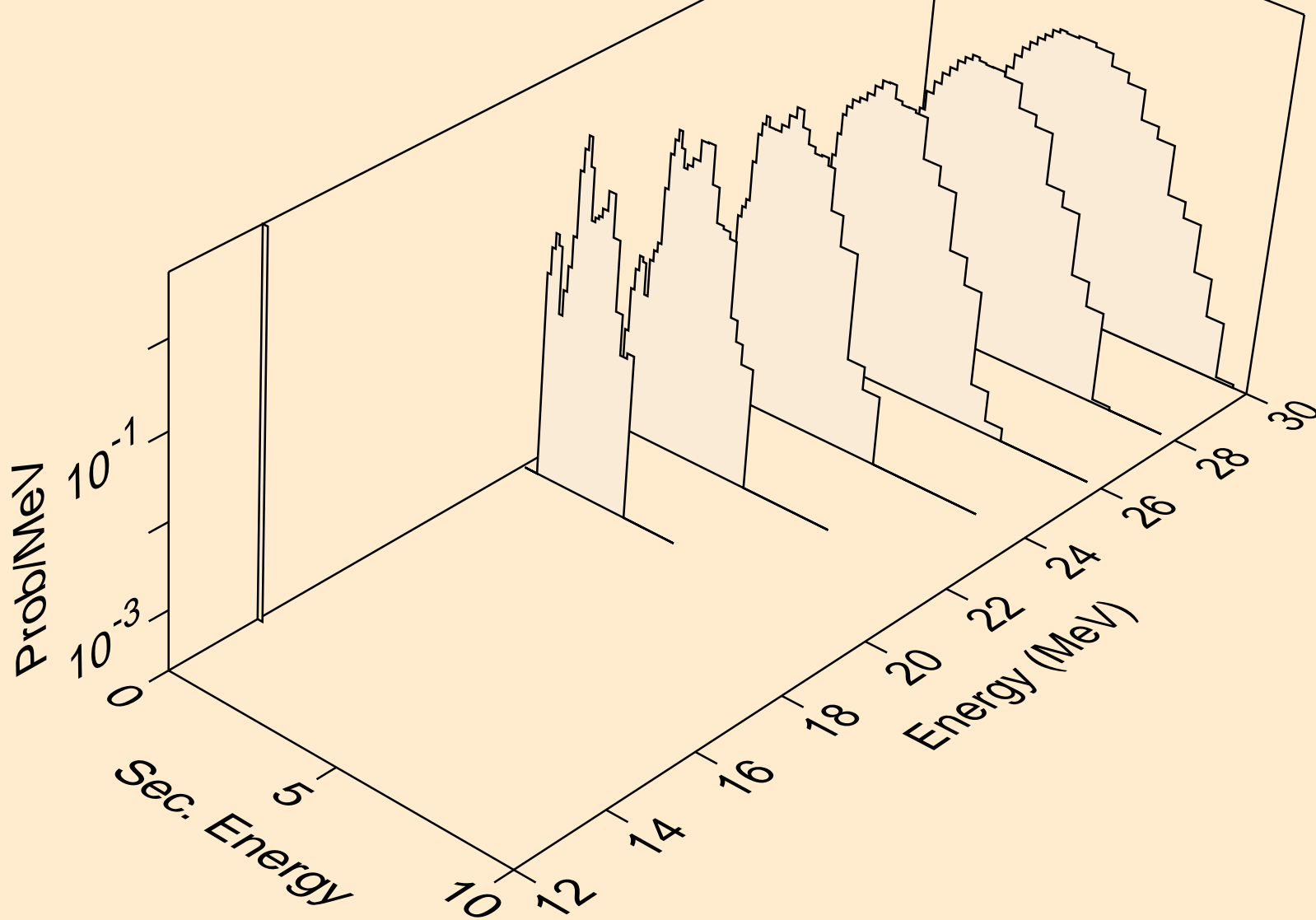

BR080 NEUTRON ACER TENDL-2019 LIBRARY; T=293.16K
protons from (n,p)

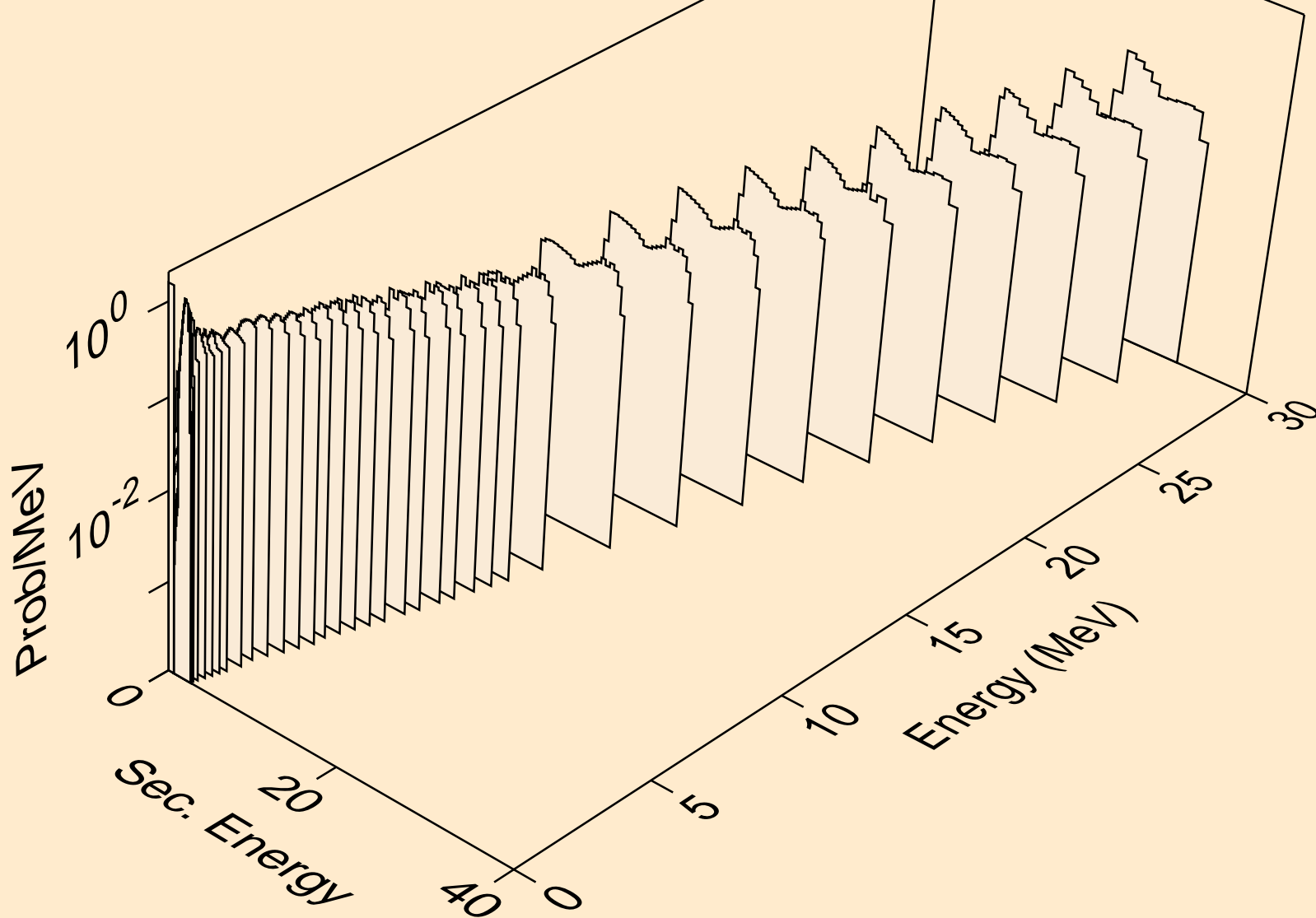

BR080 NEUTRON ACER TENDL-2019 LIBRARY; T=293.16K
protons from (n,2p)

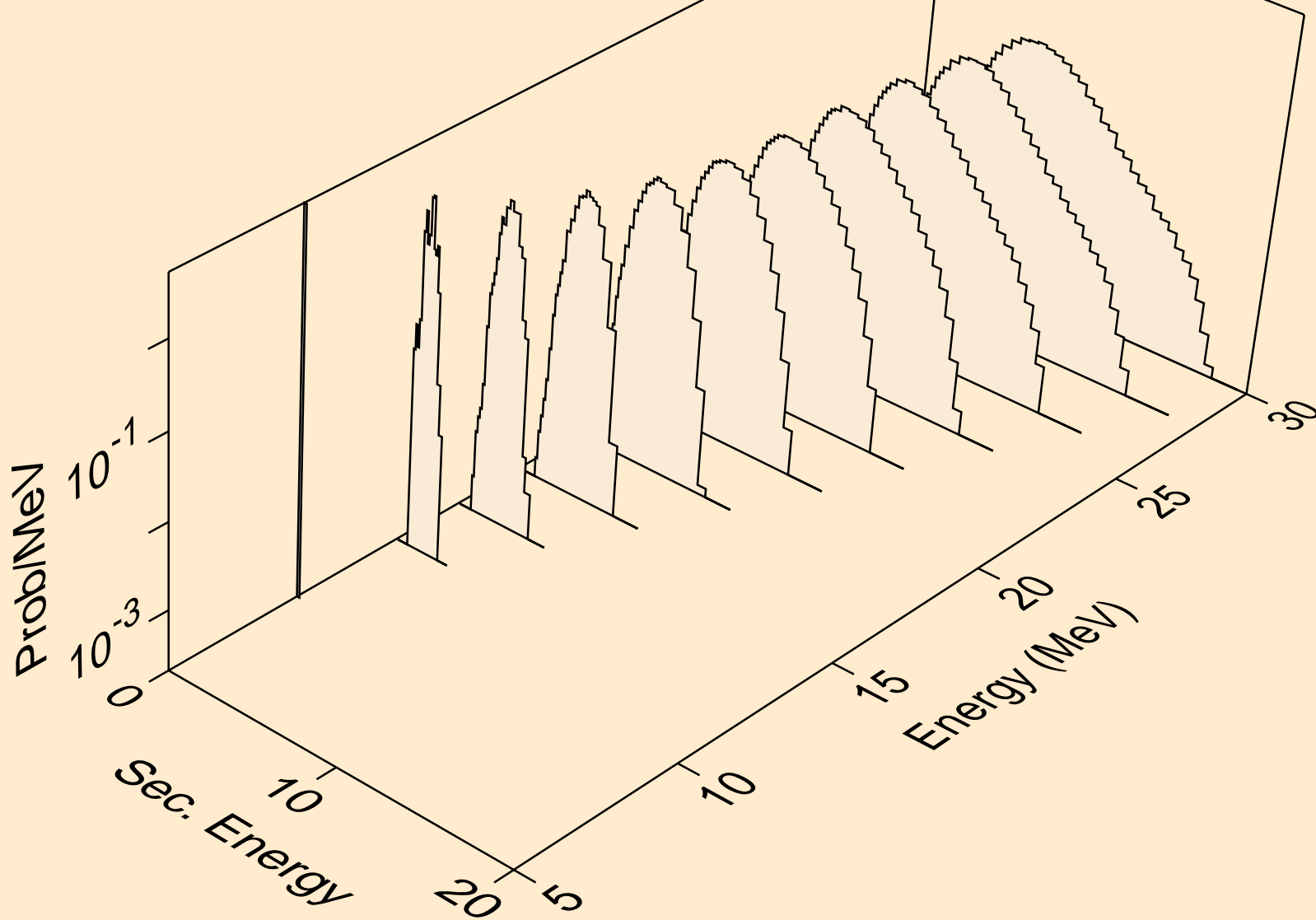

BR080 NEUTRON ACER TENDL-2019 LIBRARY; T=293.16K
protons from (n,p)

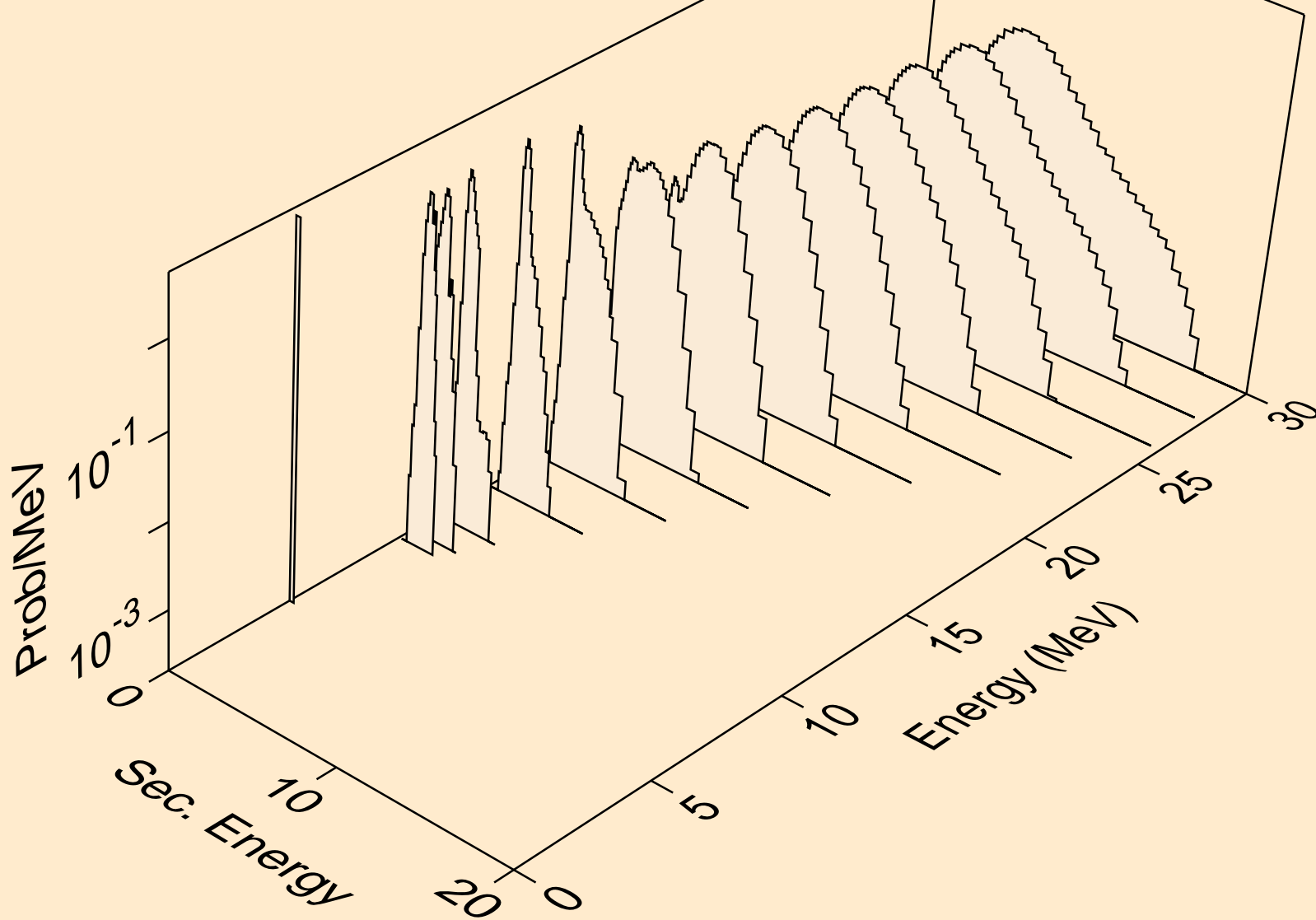

BR080 NEUTRON ACER TENDL-2019 LIBRARY; T=293.16K
protons from (n,pd)

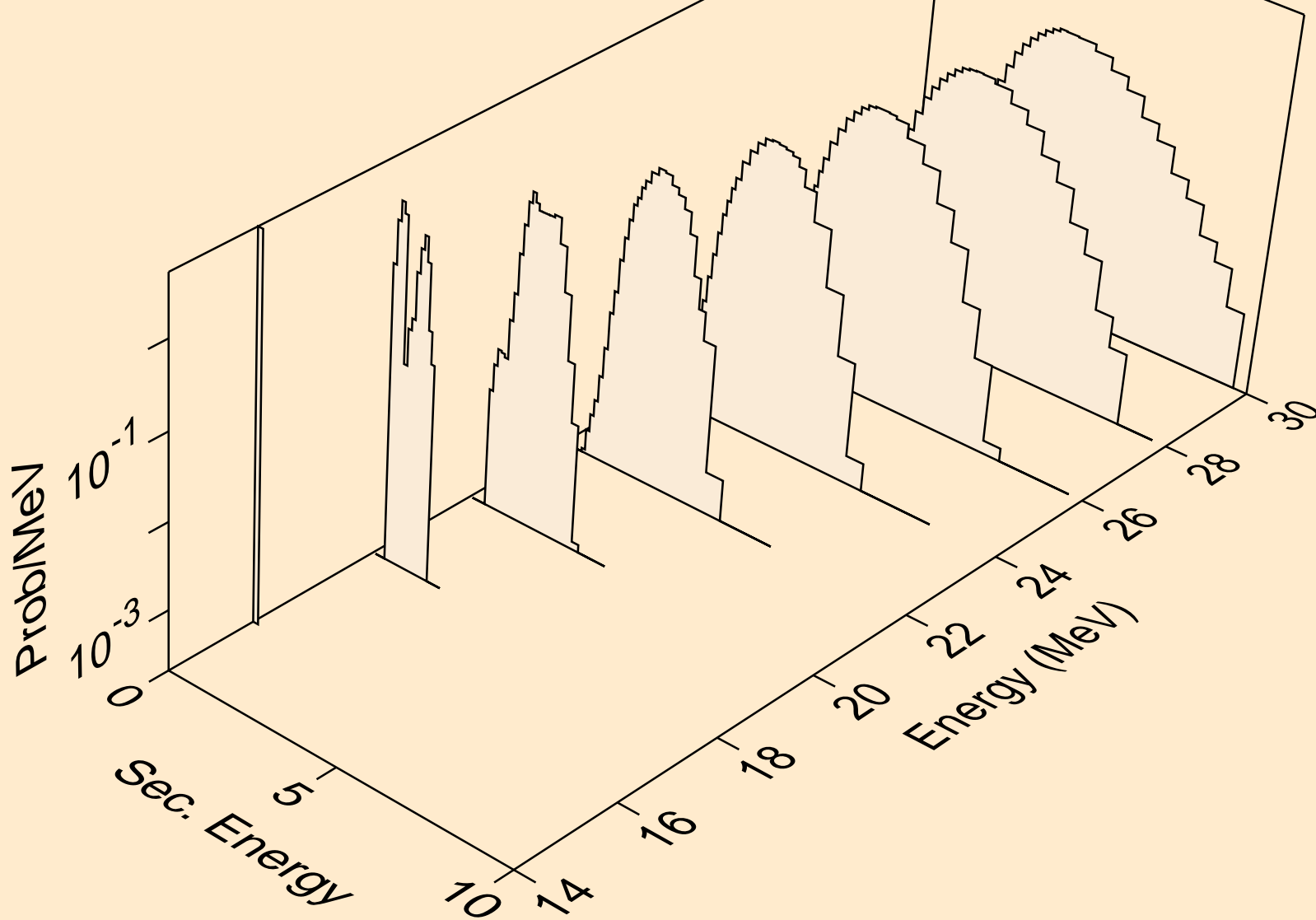

BR080 NEUTRON ACER TENDL-2019 LIBRARY; T=293.16K
protons from (n,pt)

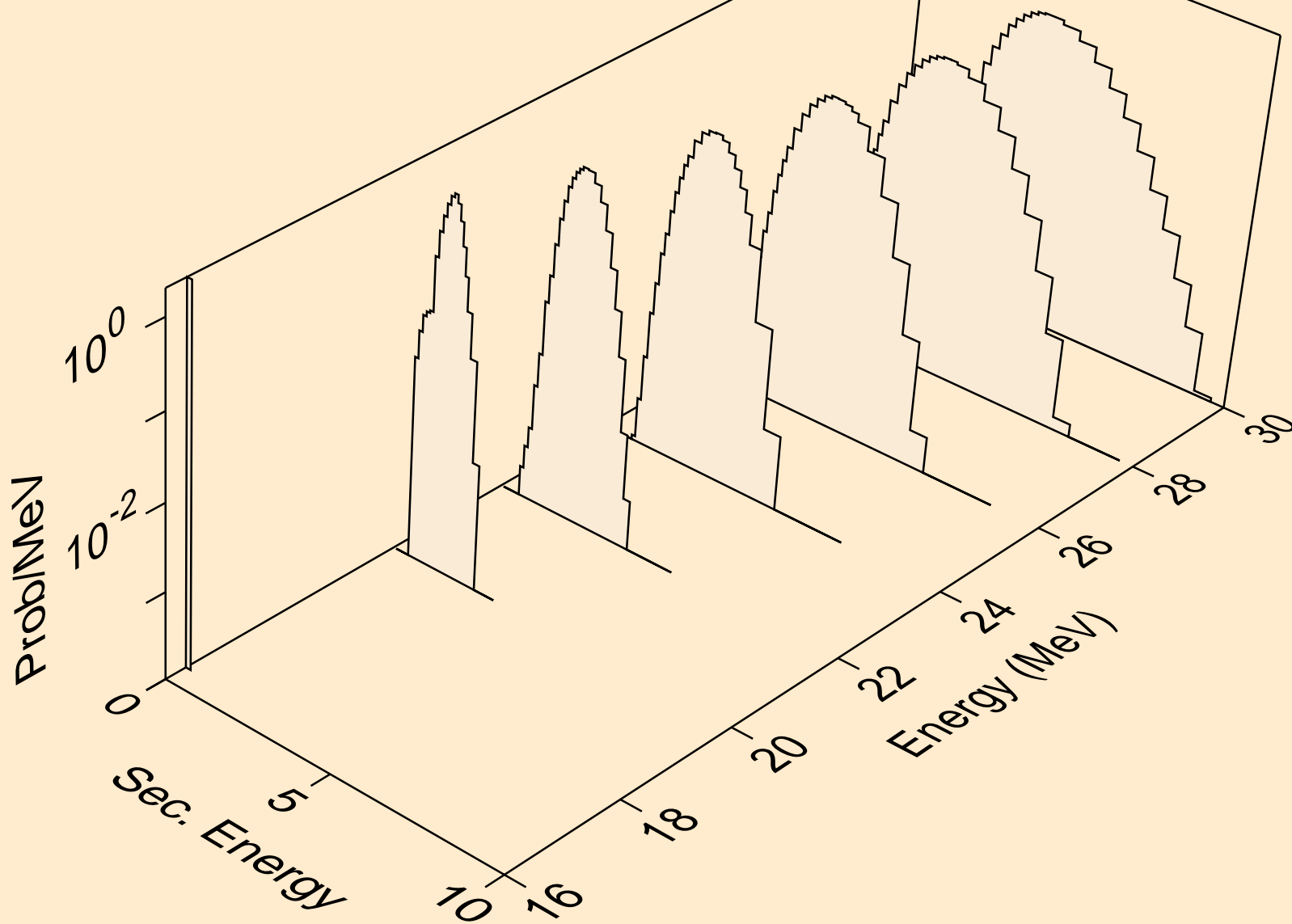

BR080 NEUTRON ACER TENDL-2019 LIBRARY; T=293.16K
deuterons from (n,x)

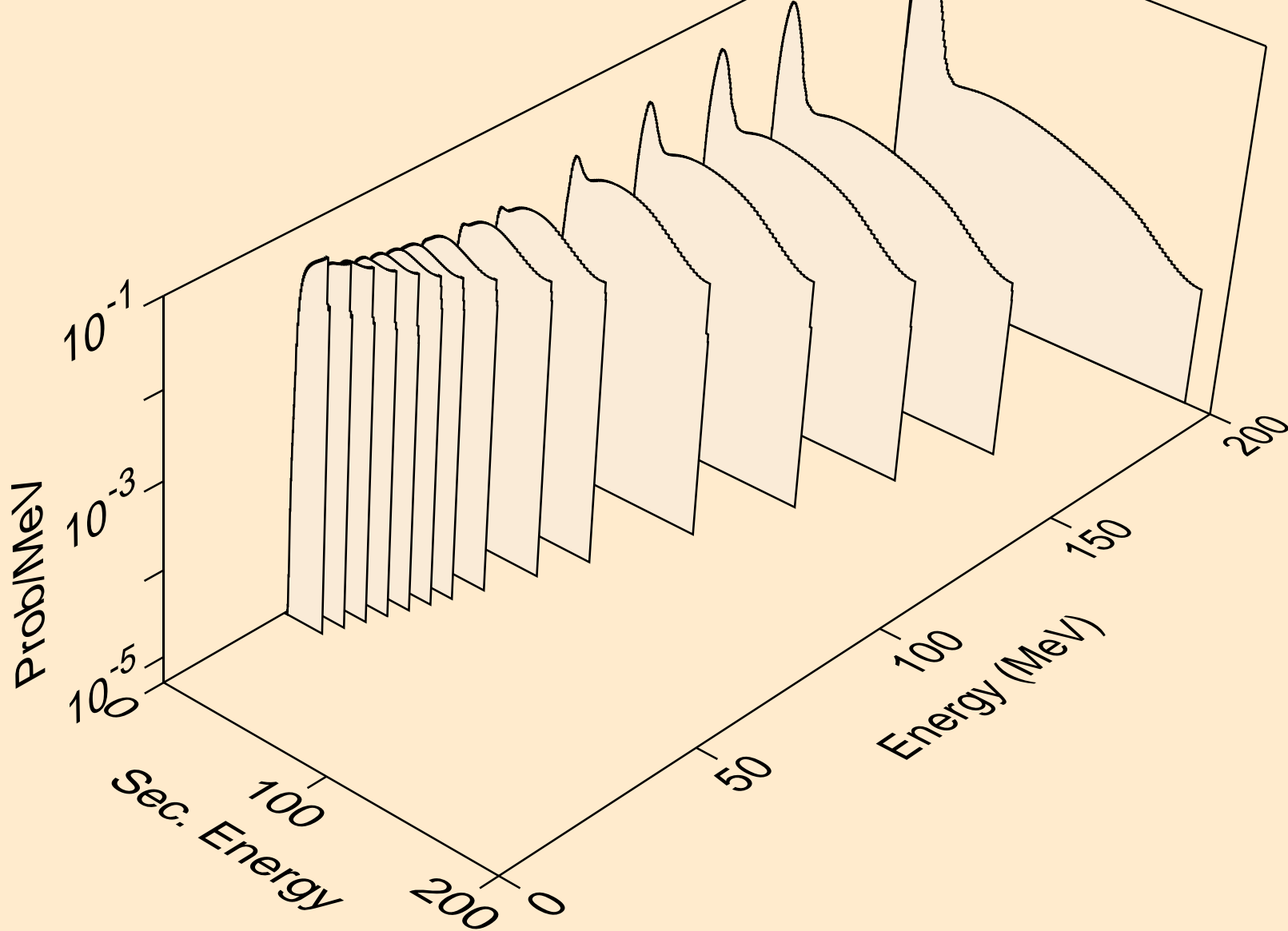

BR080 NEUTRON ACER TENDL-2019 LIBRARY; T=293.16K
deuterons from (n,2nd)

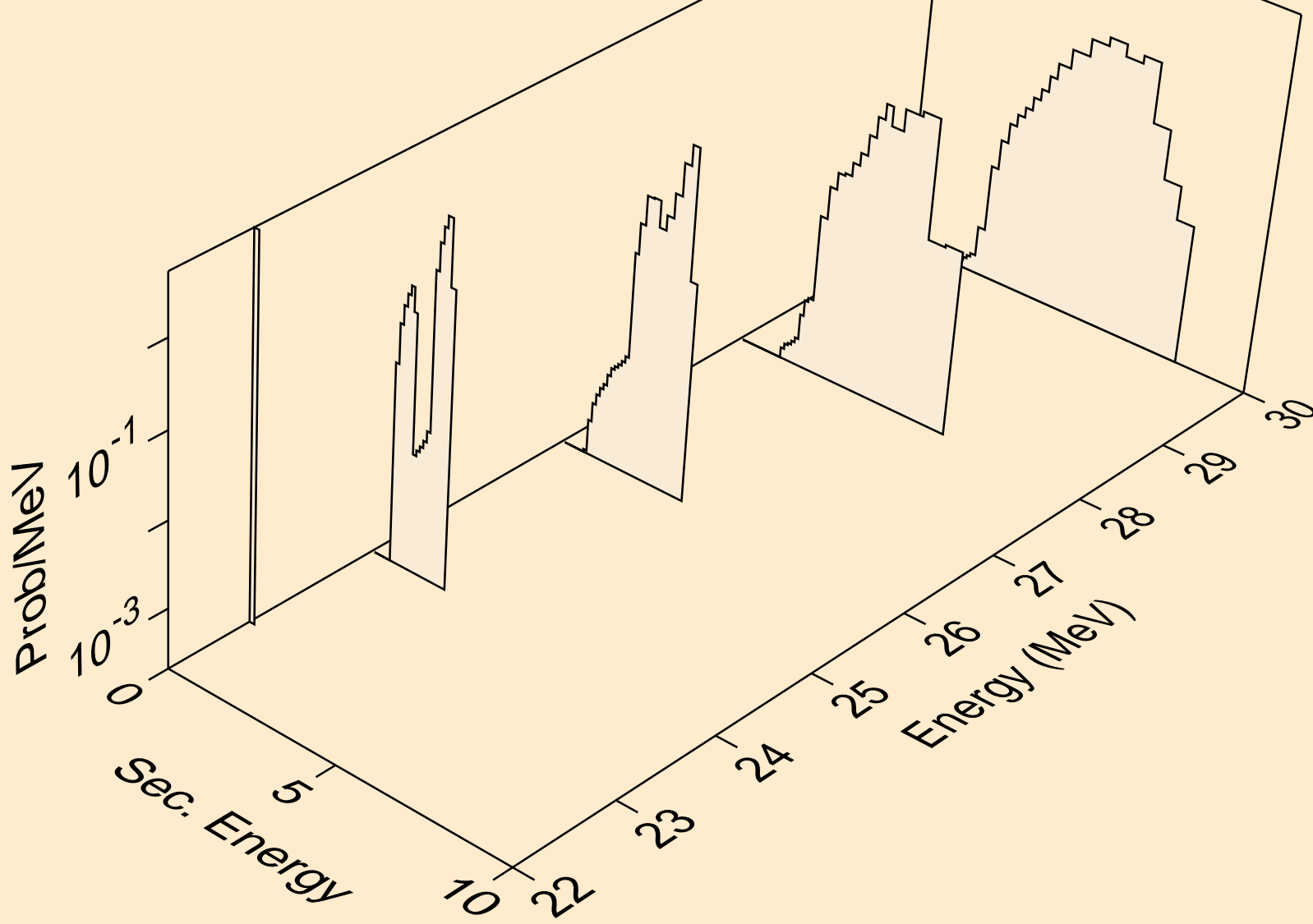

BR080 NEUTRON ACER TENDL-2019 LIBRARY; T=293.16K
deuterons from (n,n*)d

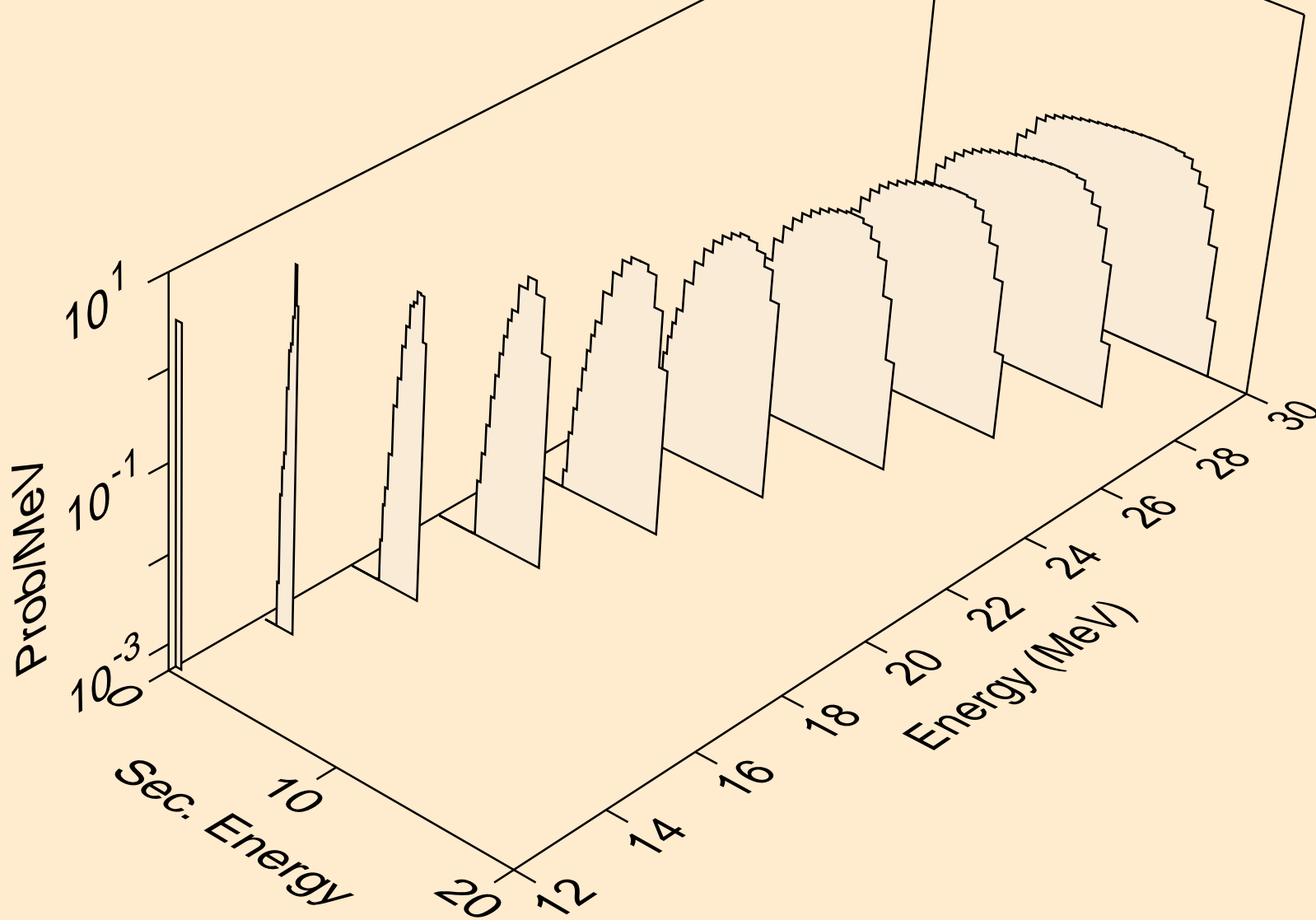

BR080 NEUTRON ACER TENDL-2019 LIBRARY; T=293.16K
deuterons from (n,d)

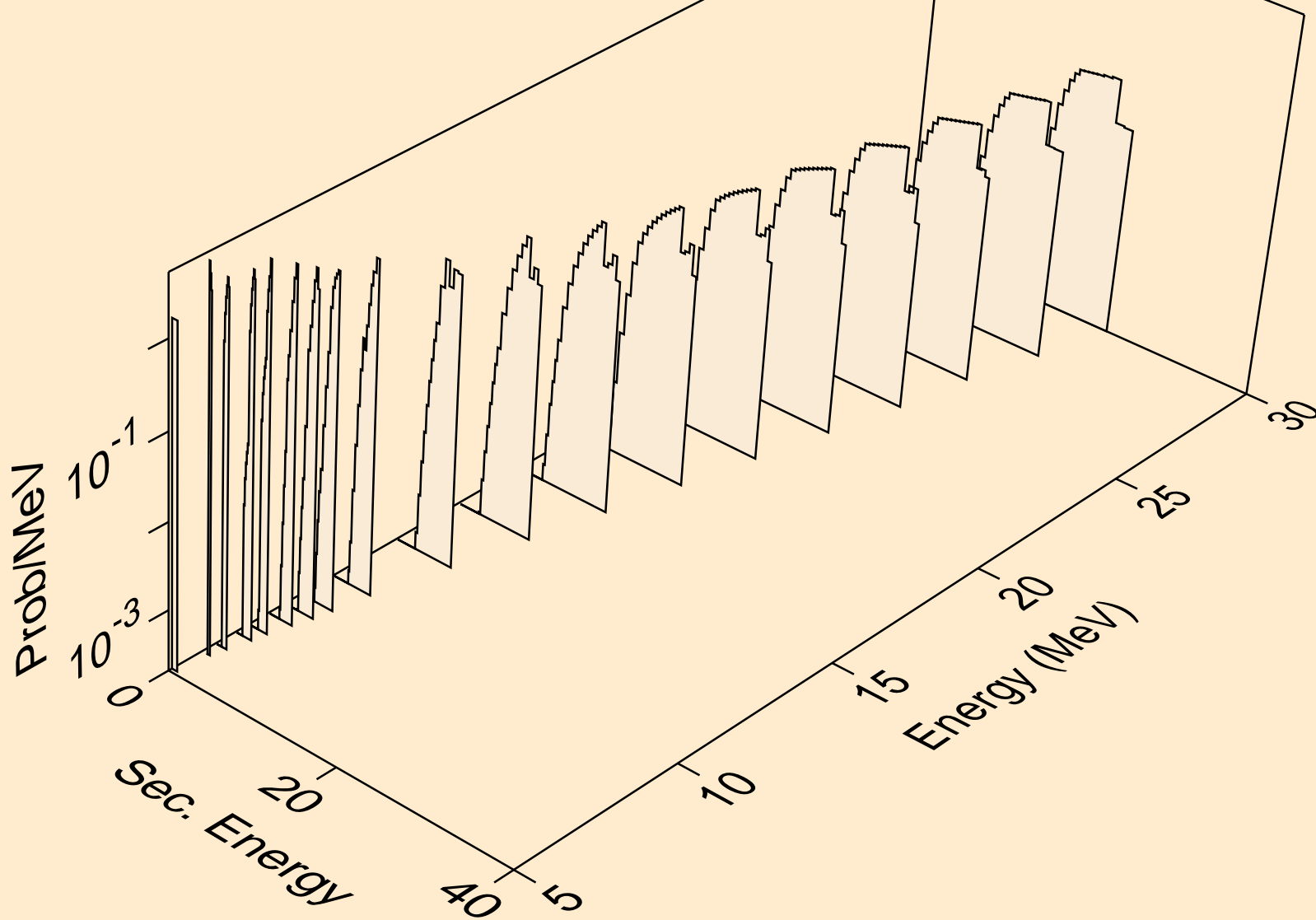

BR080 NEUTRON ACER TENDL-2019 LIBRARY; T=293.16K
deuterons from (n,pd)

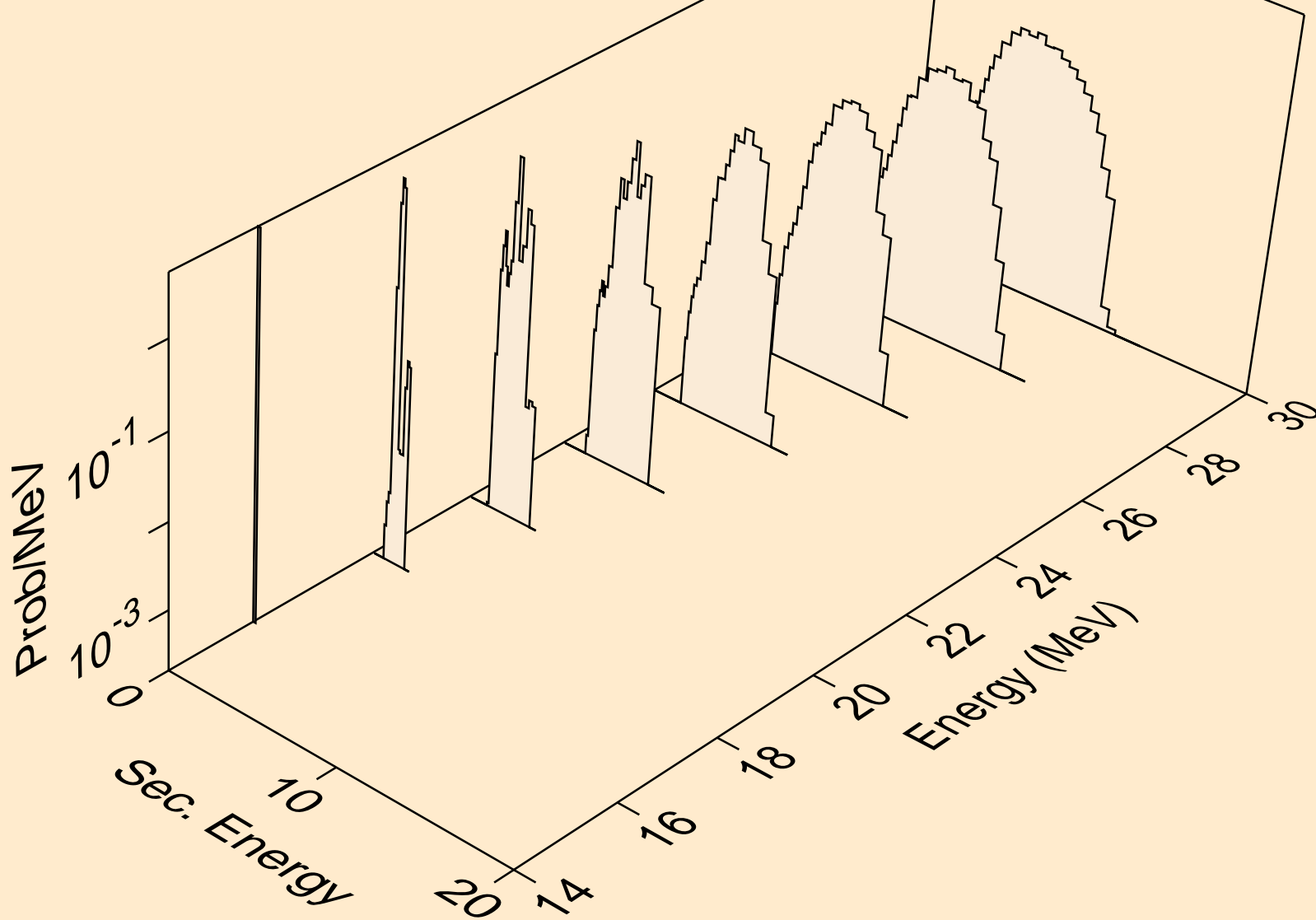

BR080 NEUTRON ACER TENDL-2019 LIBRARY; T=293.16K
deuterons from (n,da)

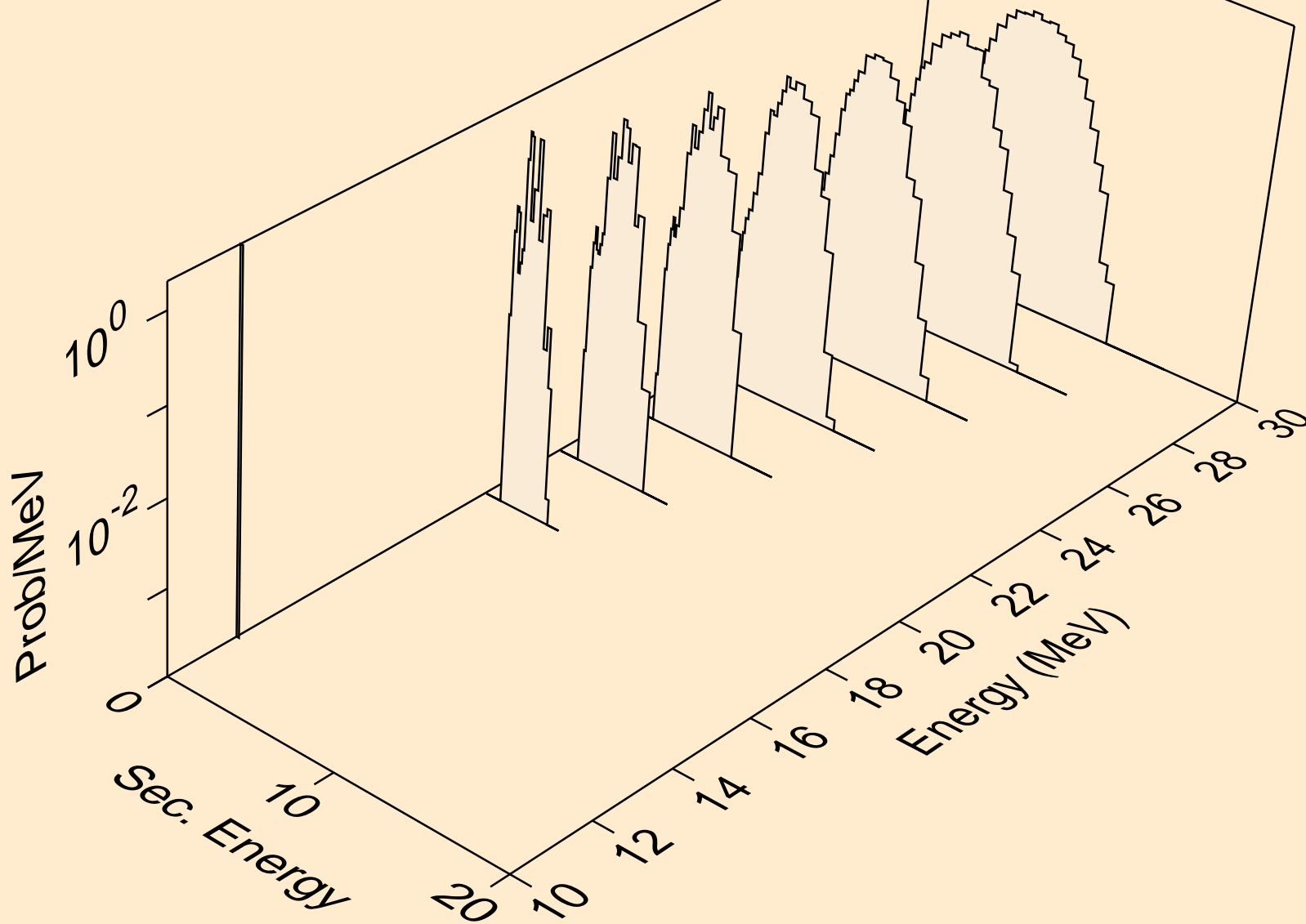

BR080 NEUTRON ACER TENDL-2019 LIBRARY; T=293.16K
tritons from (n,x)

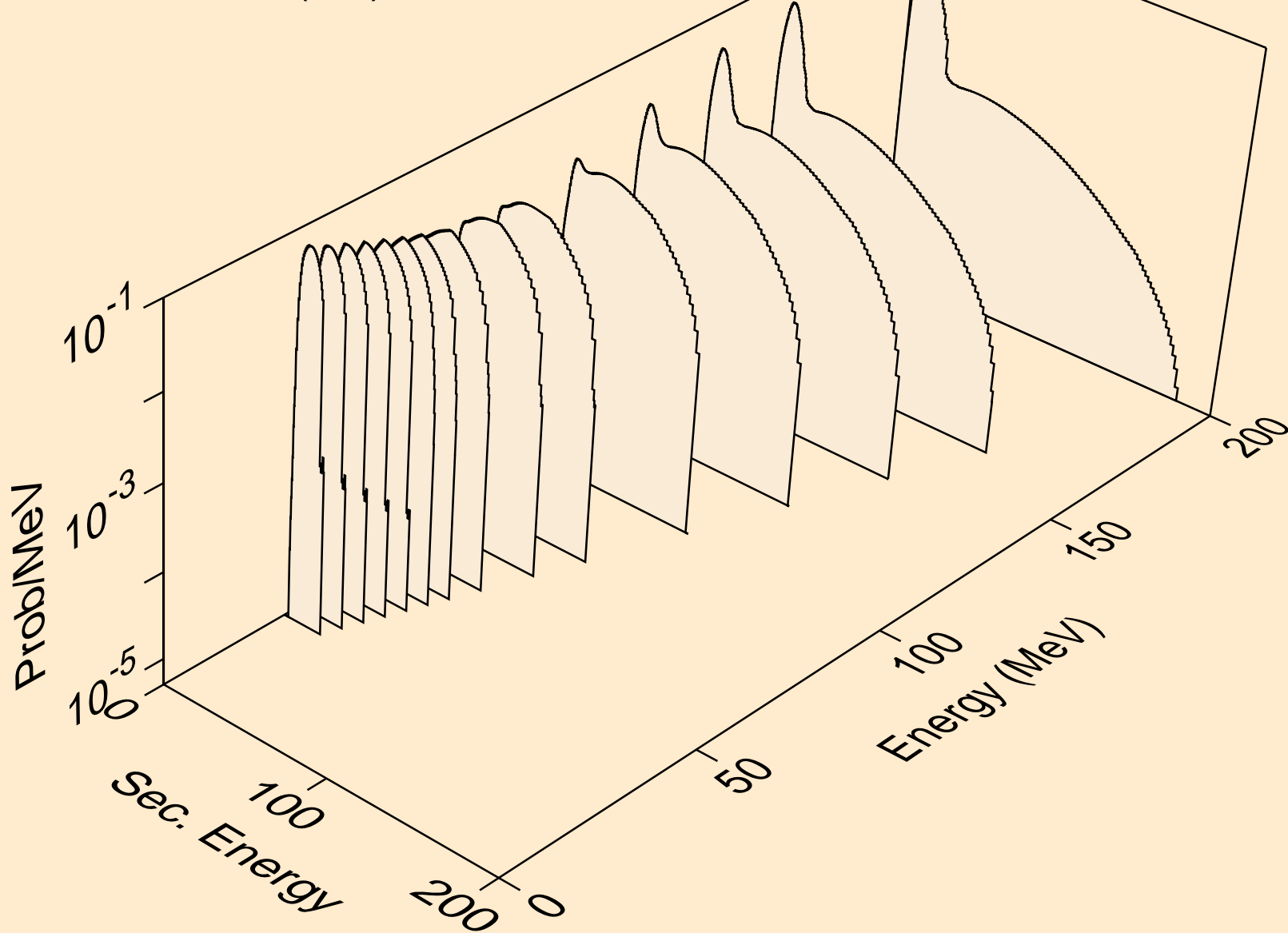

BR080 NEUTRON ACER TENDL-2019 LIBRARY; T=293.16K
tritons from (n,n*)t

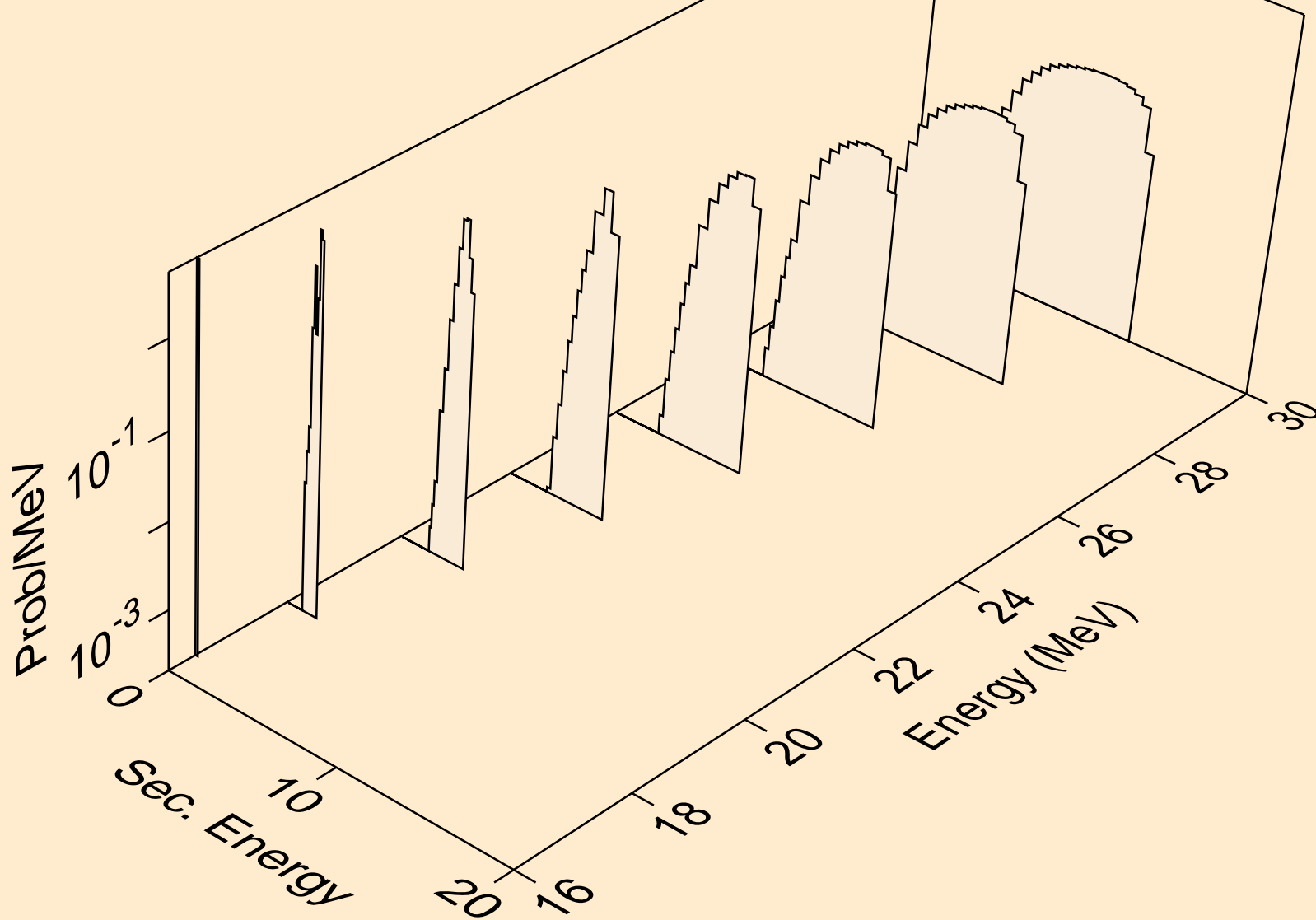

BR080 NEUTRON ACER TENDL-2019 LIBRARY; T=293.16K
tritons from (n,t)

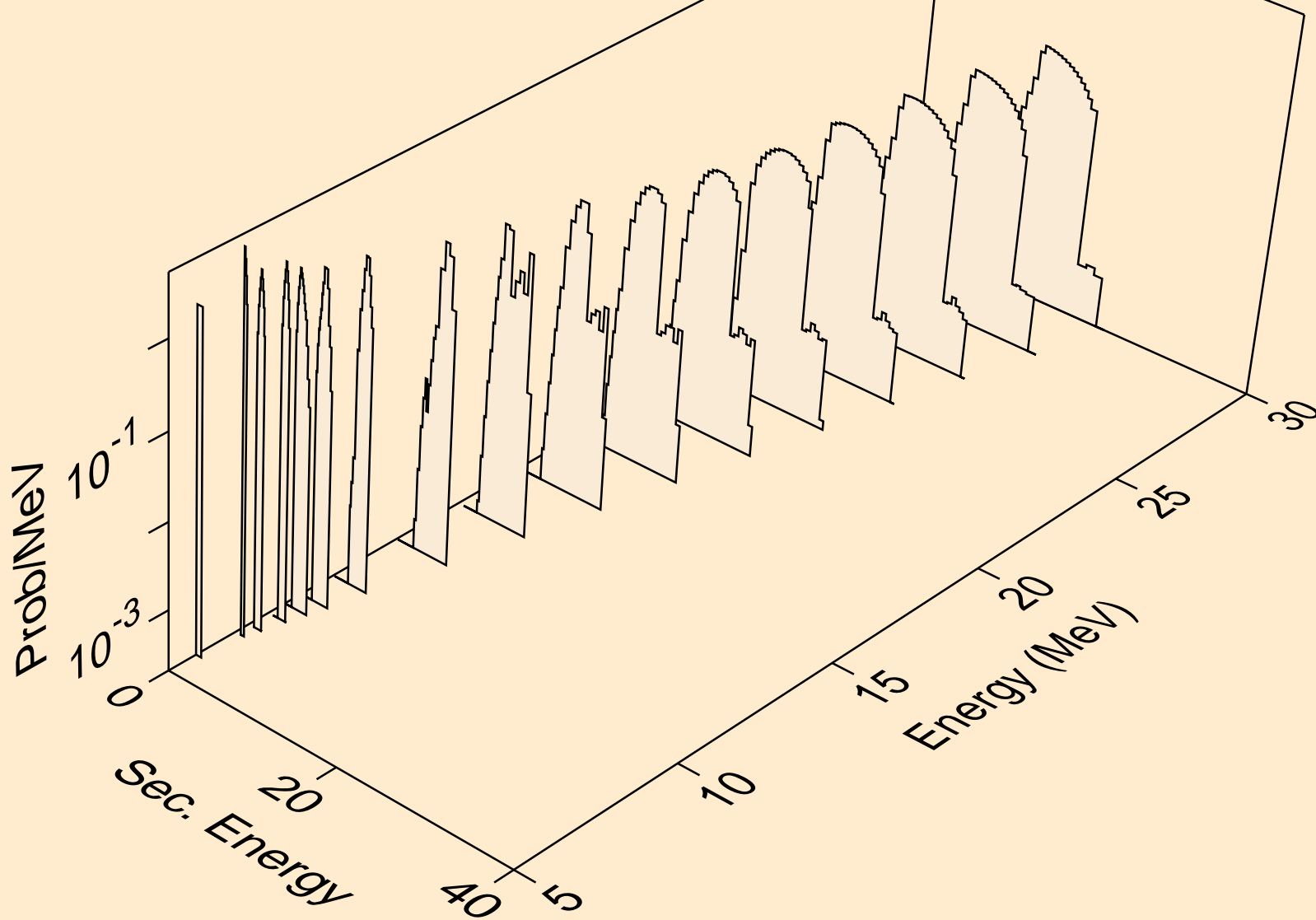

BR080 NEUTRON ACER TENDL-2019 LIBRARY; T=293.16K
tritons from (n,pt)

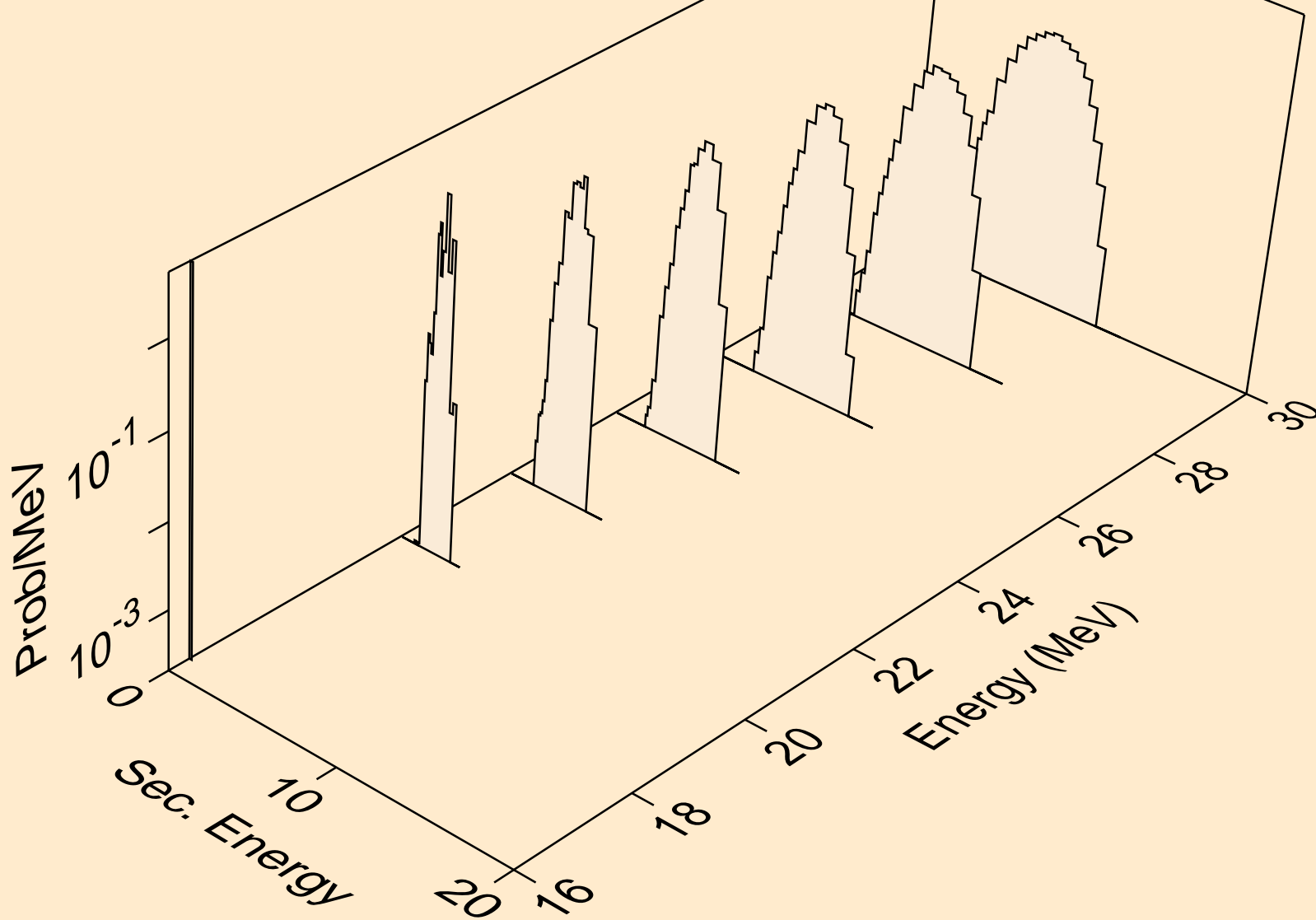

BR080 NEUTRON ACER TENDL-2019 LIBRARY; T=293.16K
he3s from (n,x)

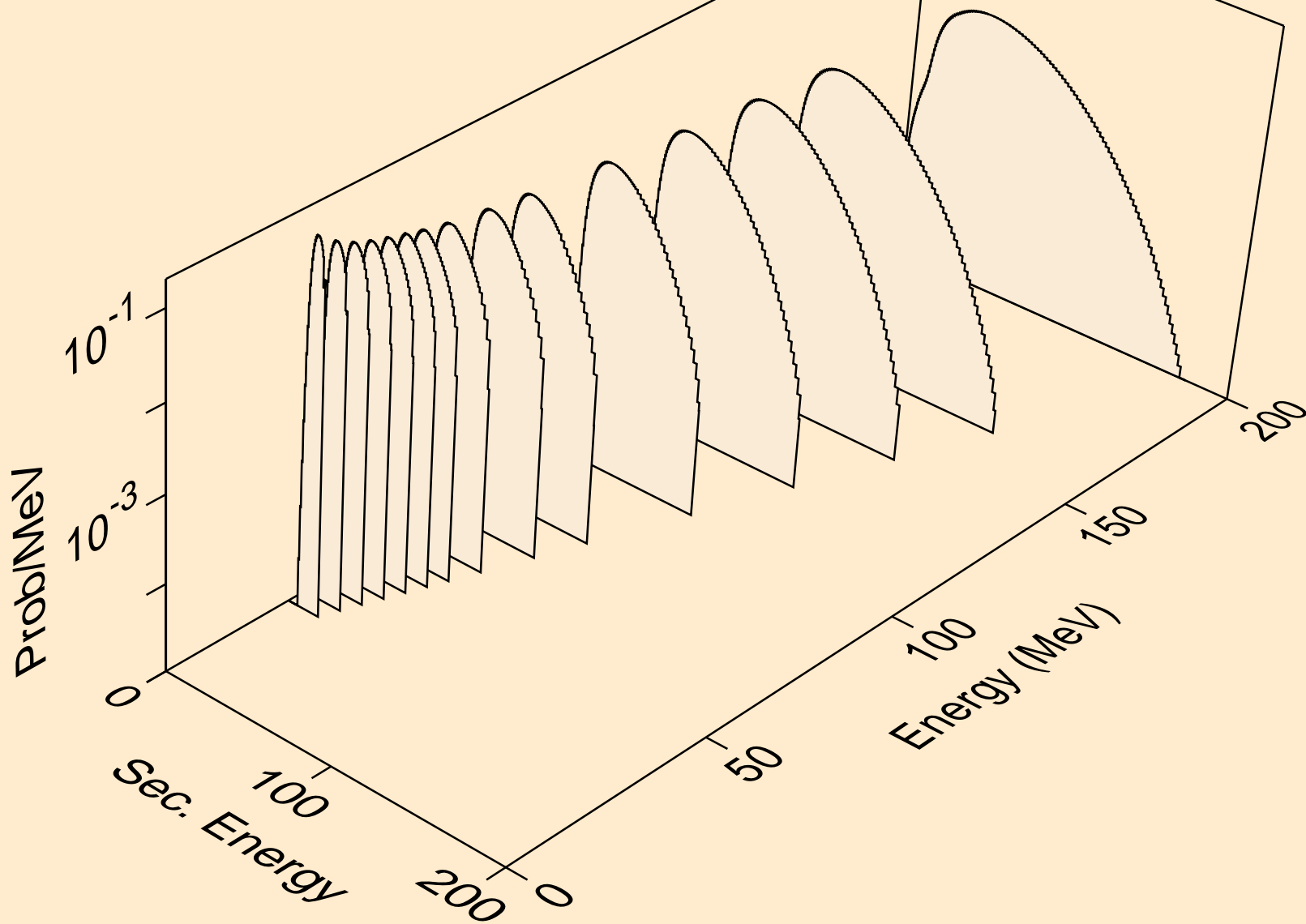

BR080 NEUTRON ACER TENDL-2019 LIBRARY; T=293.16K
he3s from (n,n*)he3

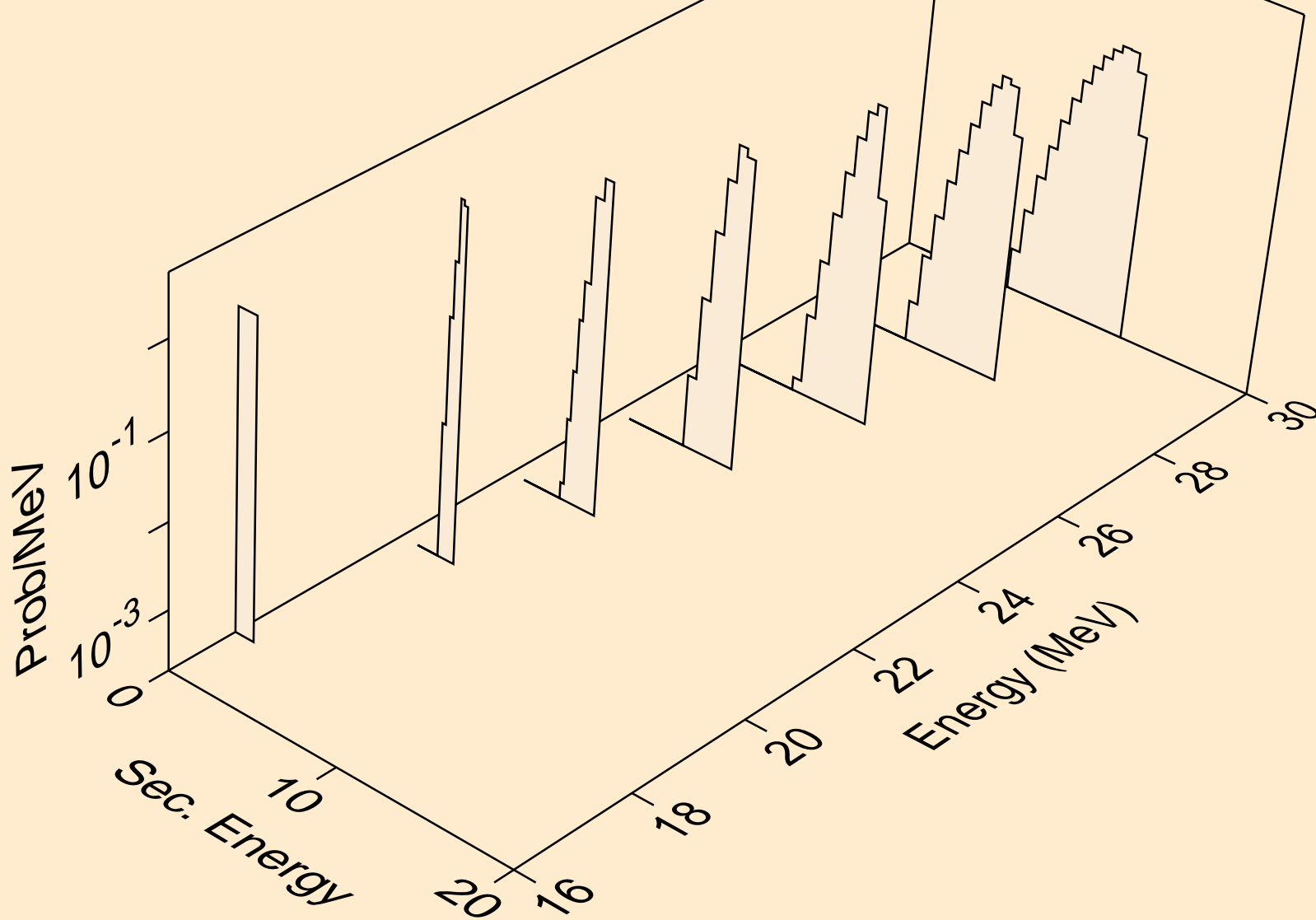

BR080 NEUTRON ACER TENDL-2019 LIBRARY; T=293.16K
he3s from (n,he3)

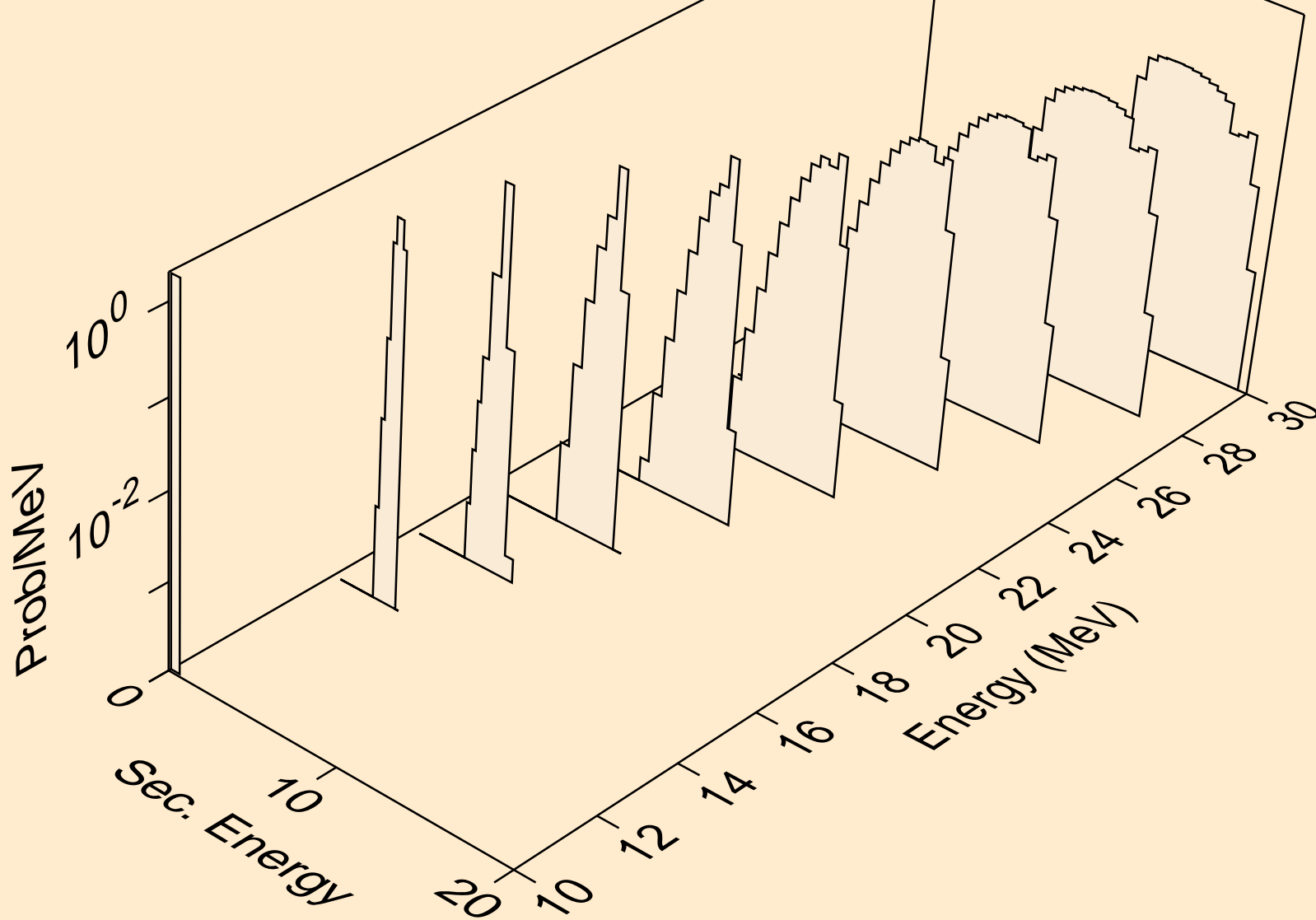

BR080 NEUTRON ACER TENDL-2019 LIBRARY; T=293.16K
alphas from (n,x)

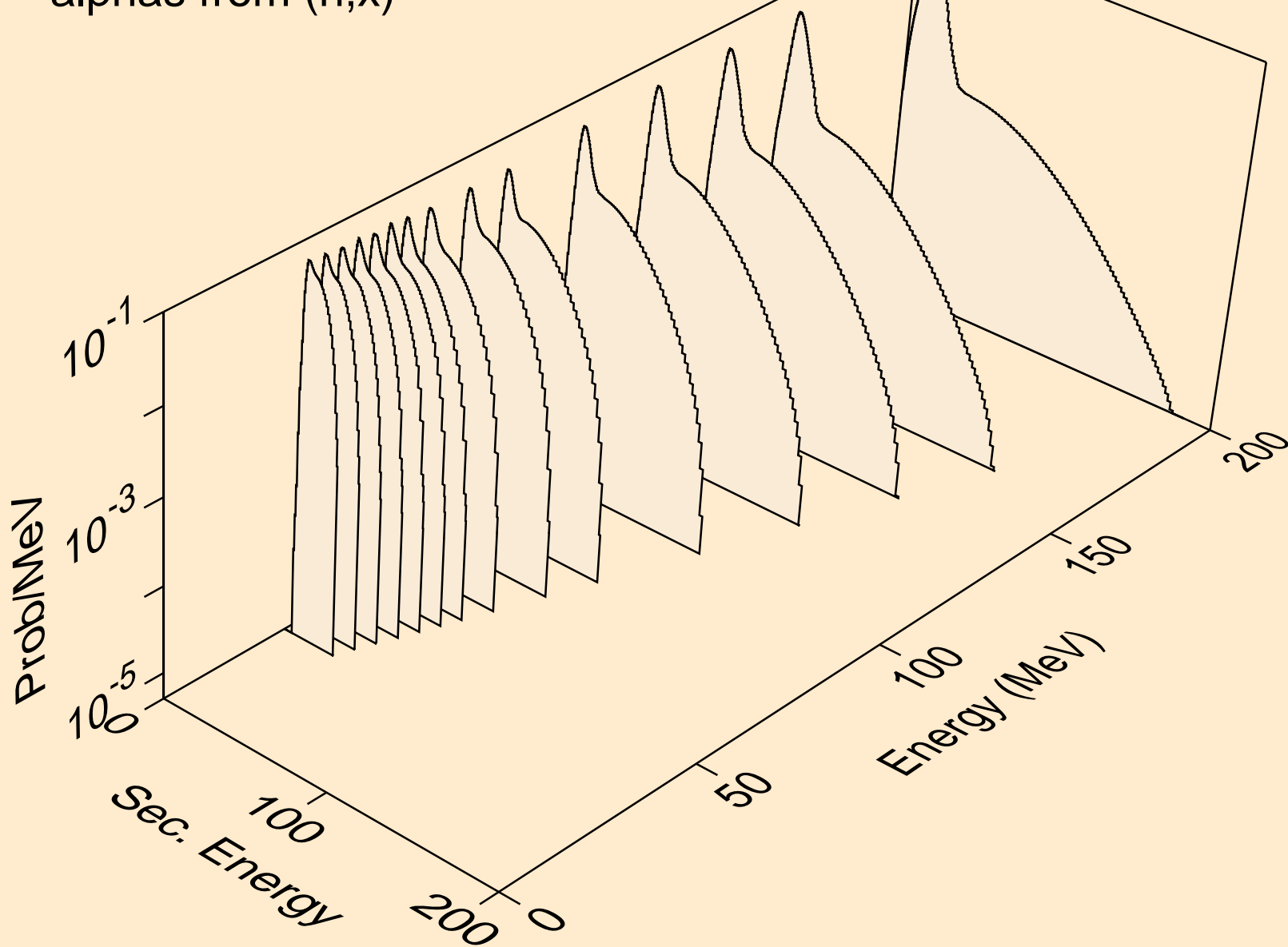

BR080 NEUTRON ACER TENDL-2019 LIBRARY; T=293.16K
alphas from (n,n*)a

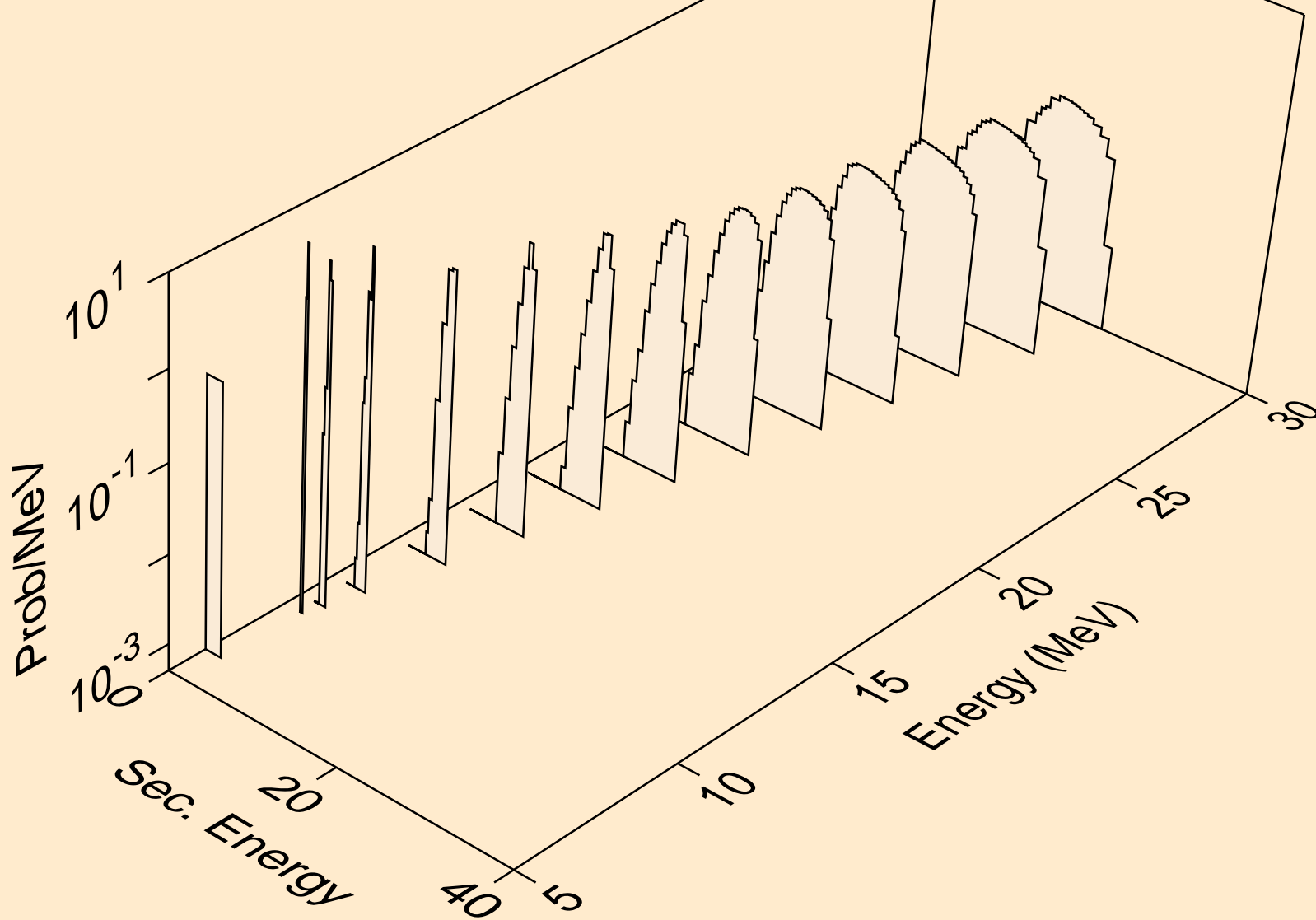

BR080 NEUTRON ACER TENDL-2019 LIBRARY; T=293.16K
alphas from (n,2n)a

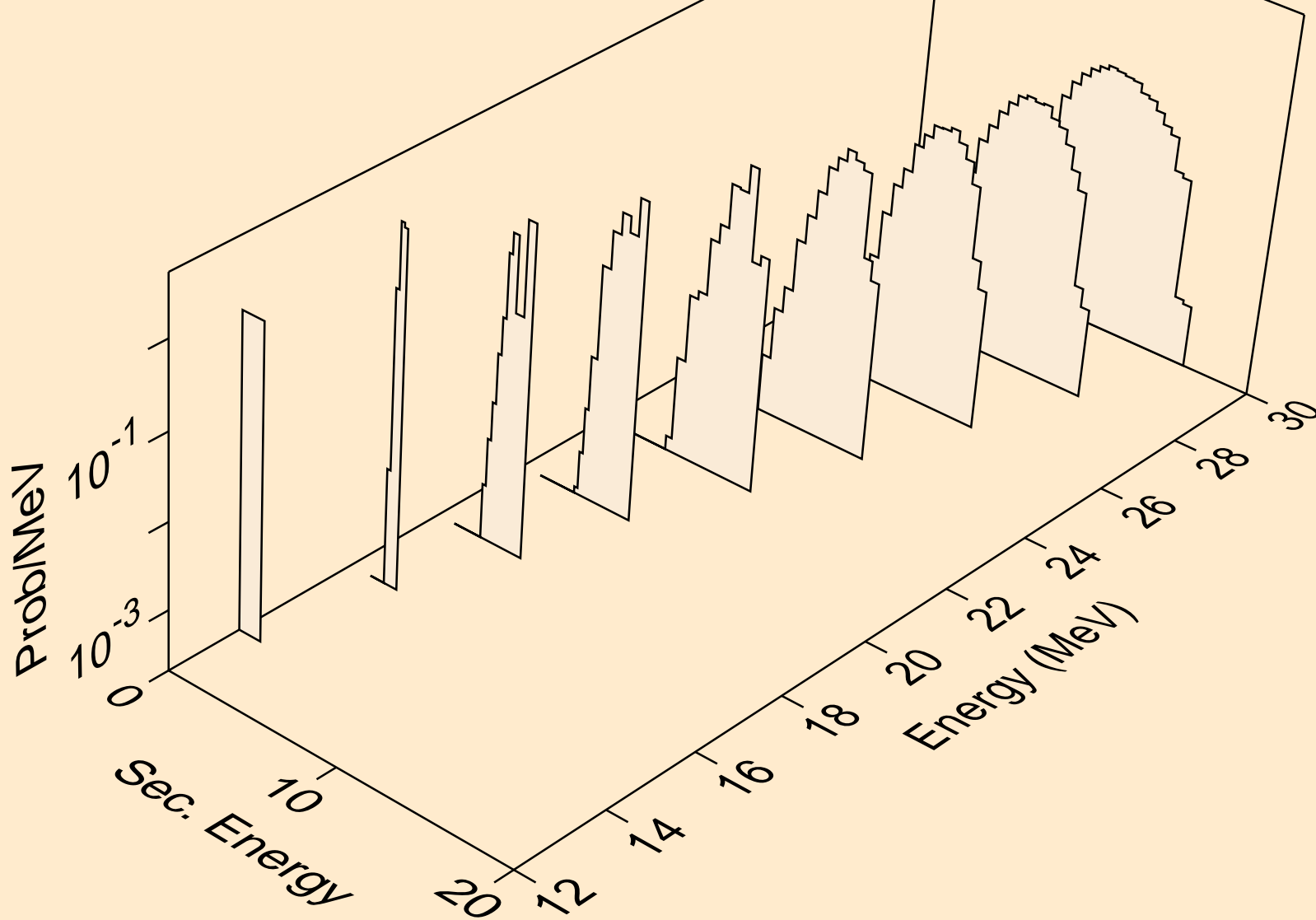

BR080 NEUTRON ACER TENDL-2019 LIBRARY; T=293.16K
alphas from (n,3n)a

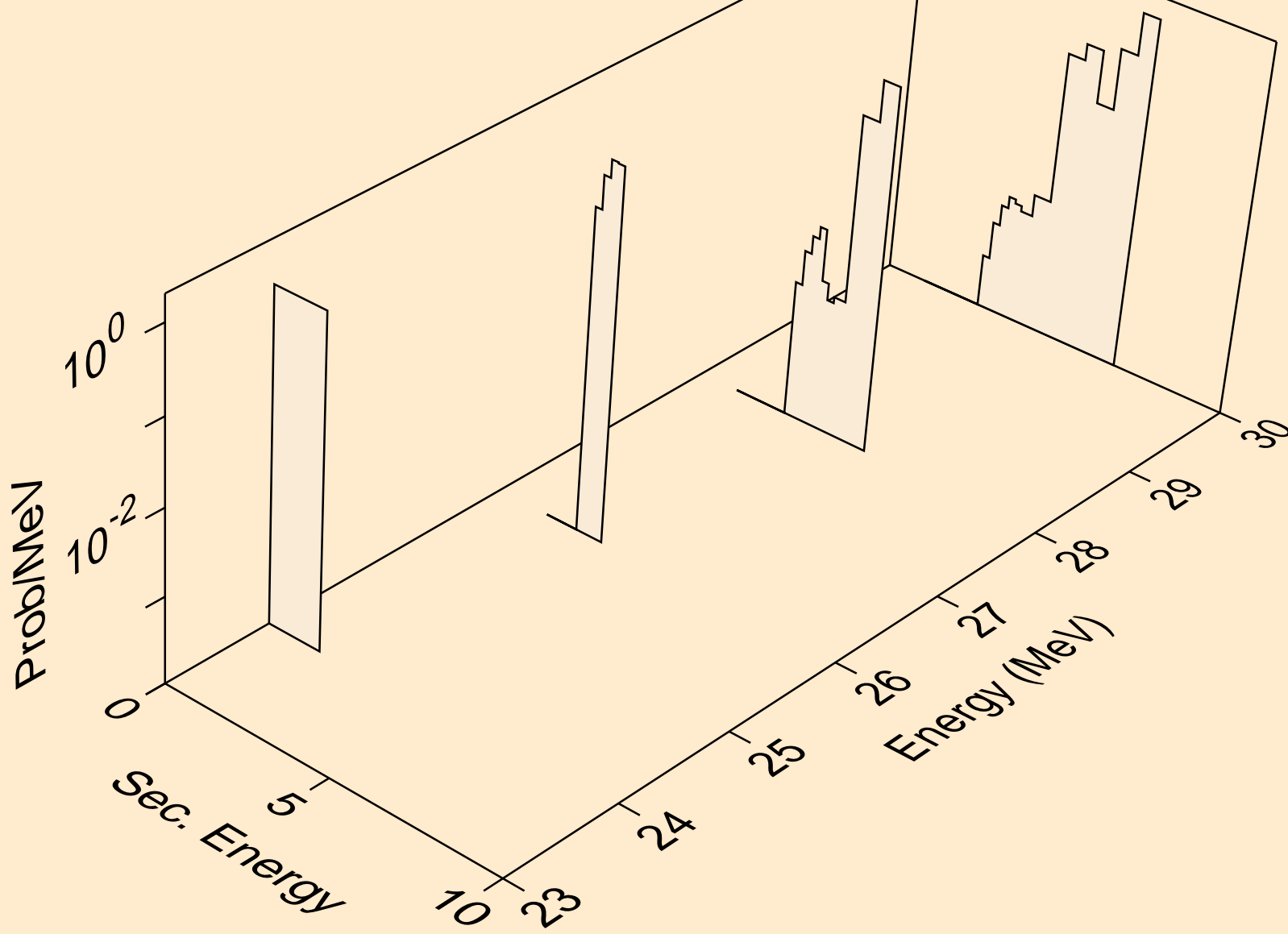

BR080 NEUTRON ACER TENDL-2019 LIBRARY; T=293.16K
alphas from (n,n*)2a

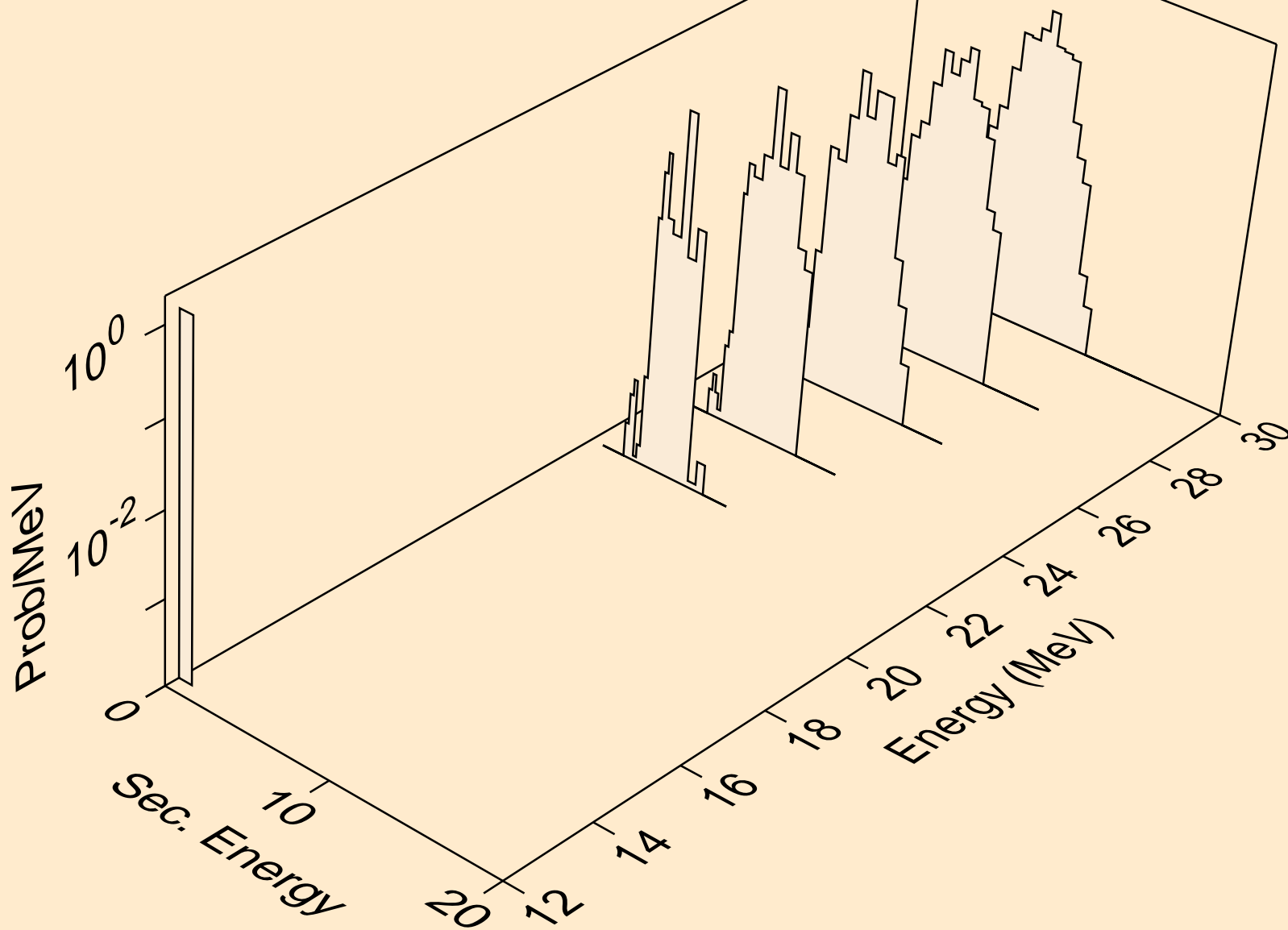

BR080 NEUTRON ACER TENDL-2019 LIBRARY; T=293.16K
alphas from (n,npa)

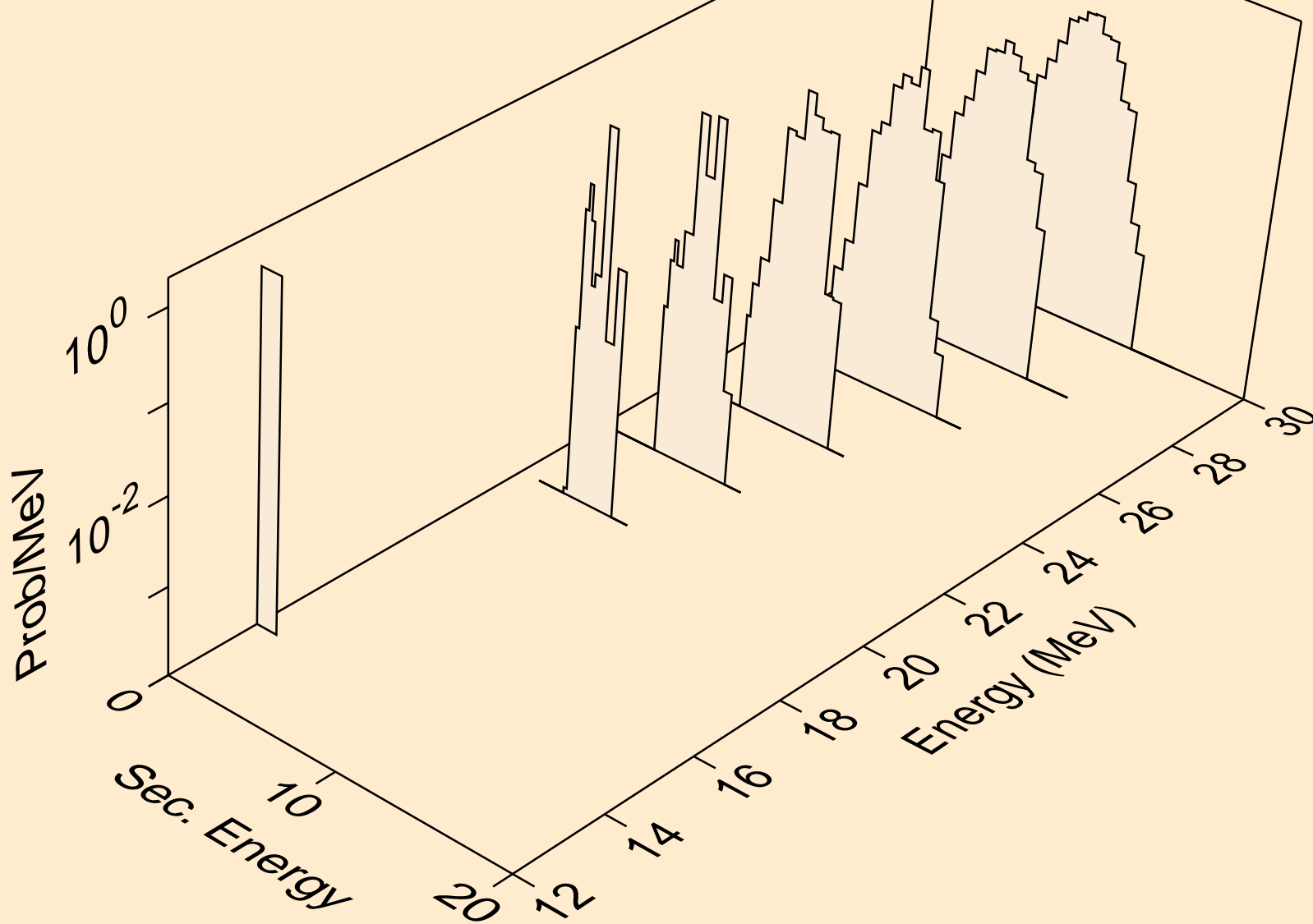

BR080 NEUTRON ACER TENDL-2019 LIBRARY; T=293.16K
alphas from (n,a)

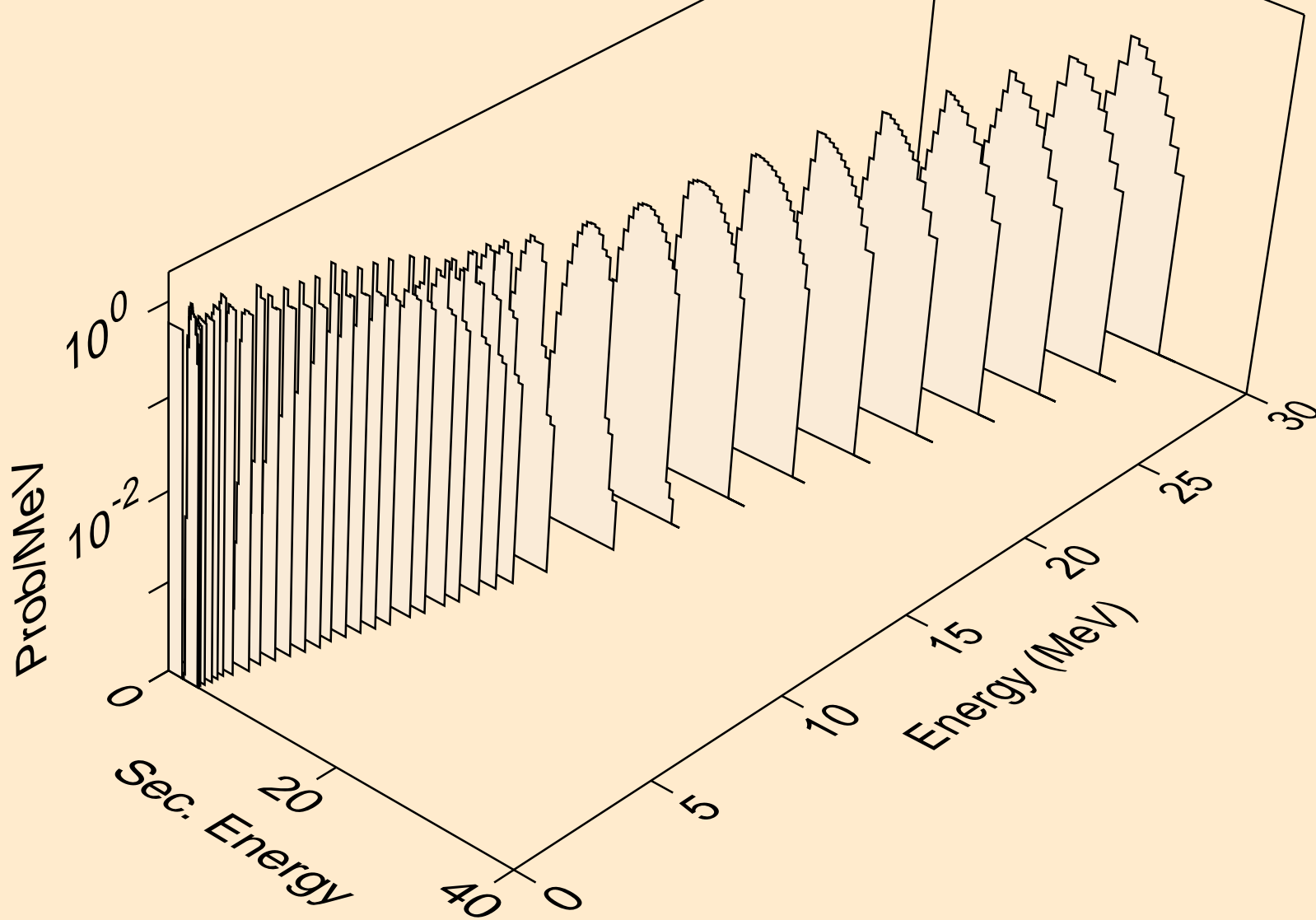

BR080 NEUTRON ACER TENDL-2019 LIBRARY; T=293.16K
alphas from (n,2a)

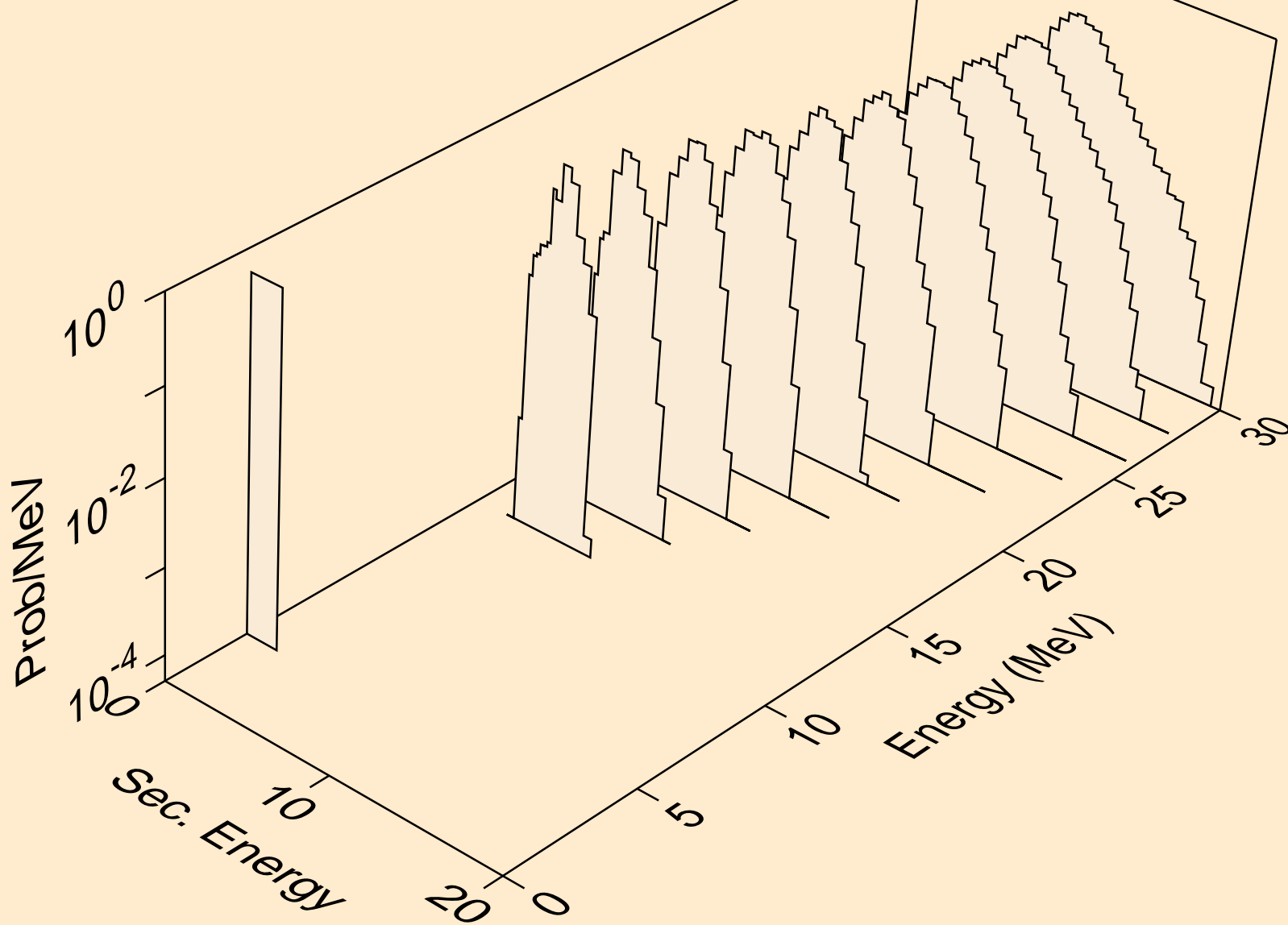

BR080 NEUTRON ACER TENDL-2019 LIBRARY; T=293.16K
alphas from (n,pa)

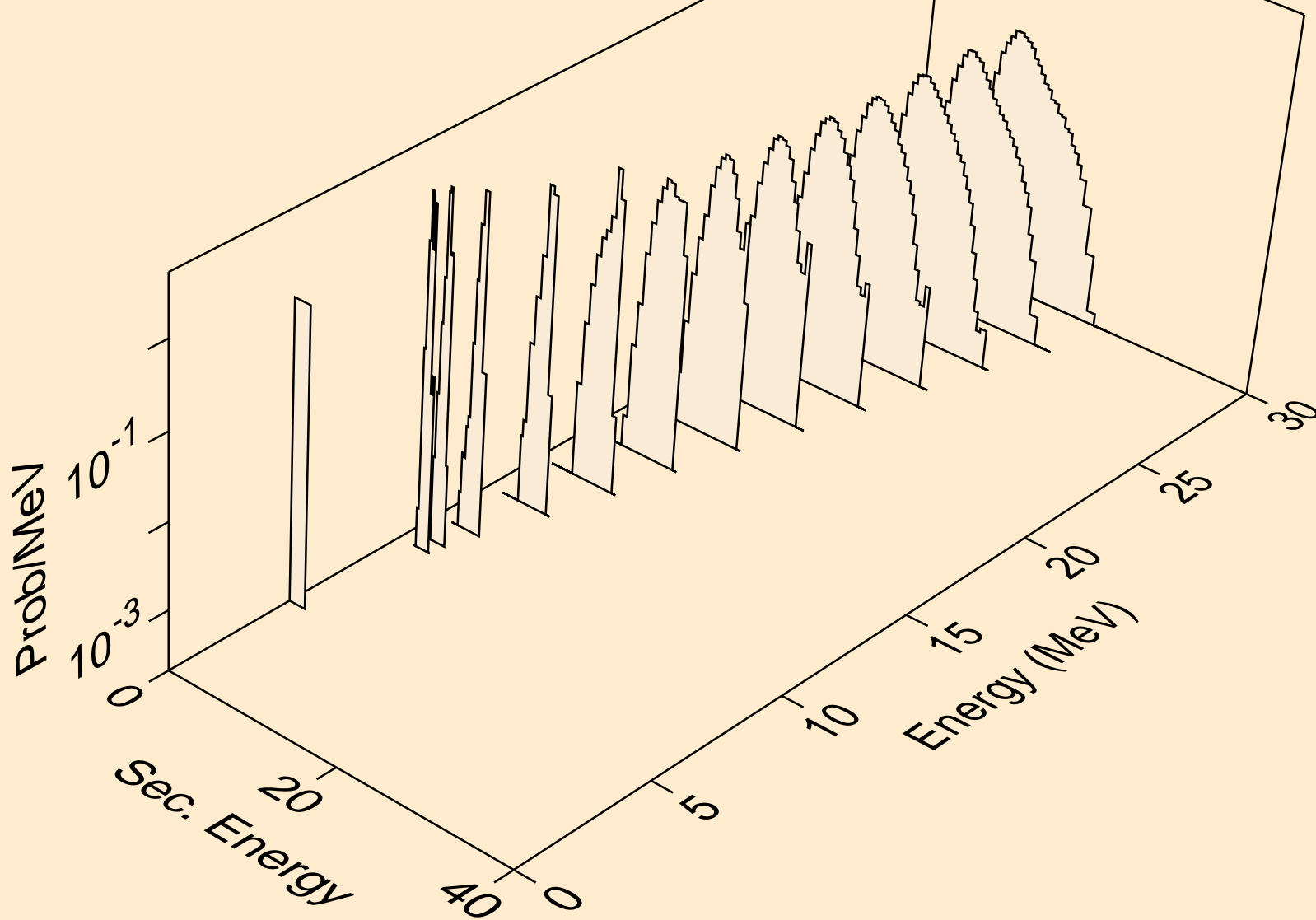

BR080 NEUTRON ACER TENDL-2019 LIBRARY; T=293.16K
alphas from (n,da)

