

CA041 NEUTRON ACER TENDL-2019 LIBRARY; T=293.16K
Principal cross sections

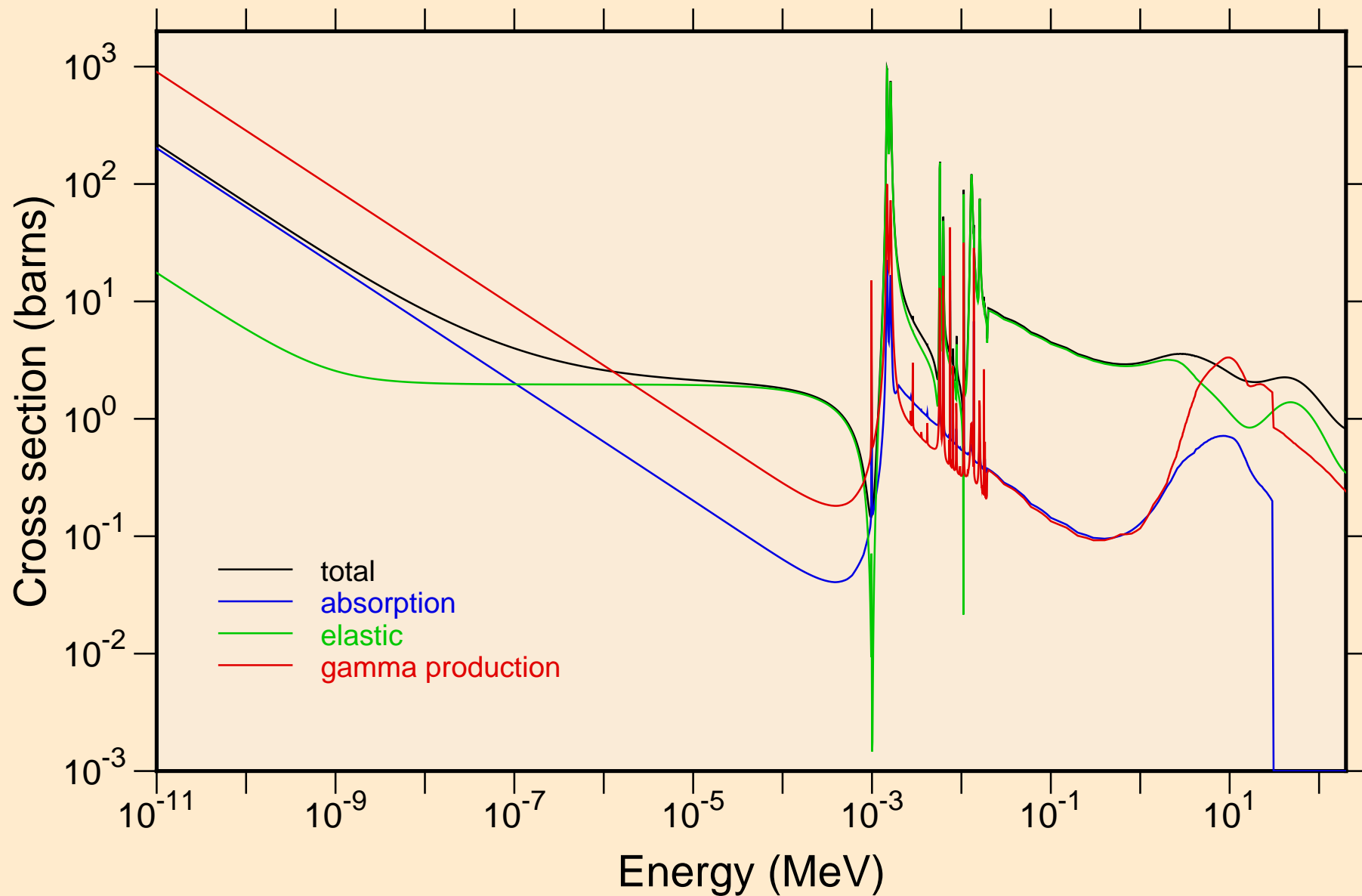

CA041 NEUTRON ACER TENDL-2019 LIBRARY; T=293.16K
resonance total cross section

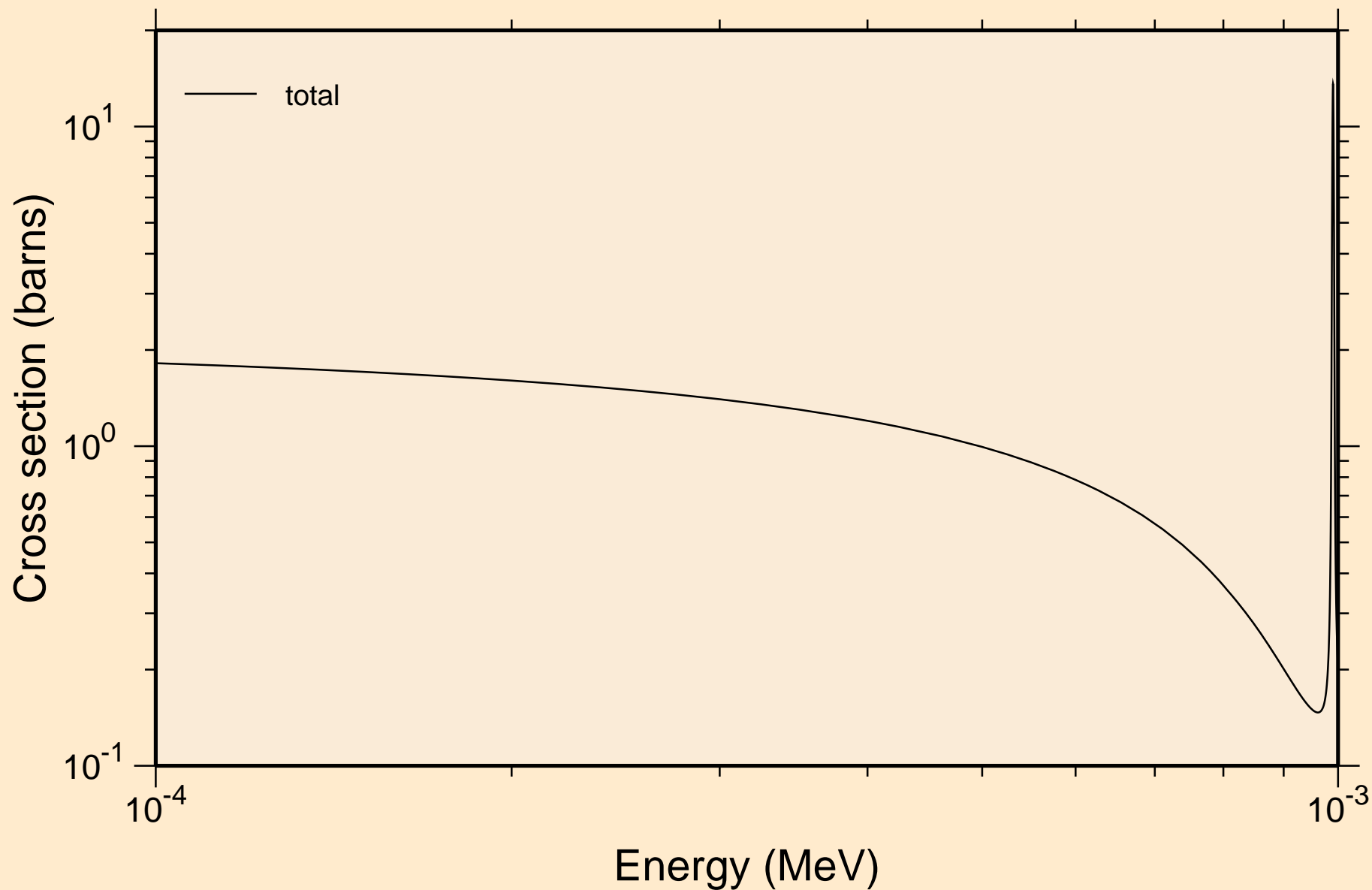

CA041 NEUTRON ACER TENDL-2019 LIBRARY; T=293.16K
resonance total cross section

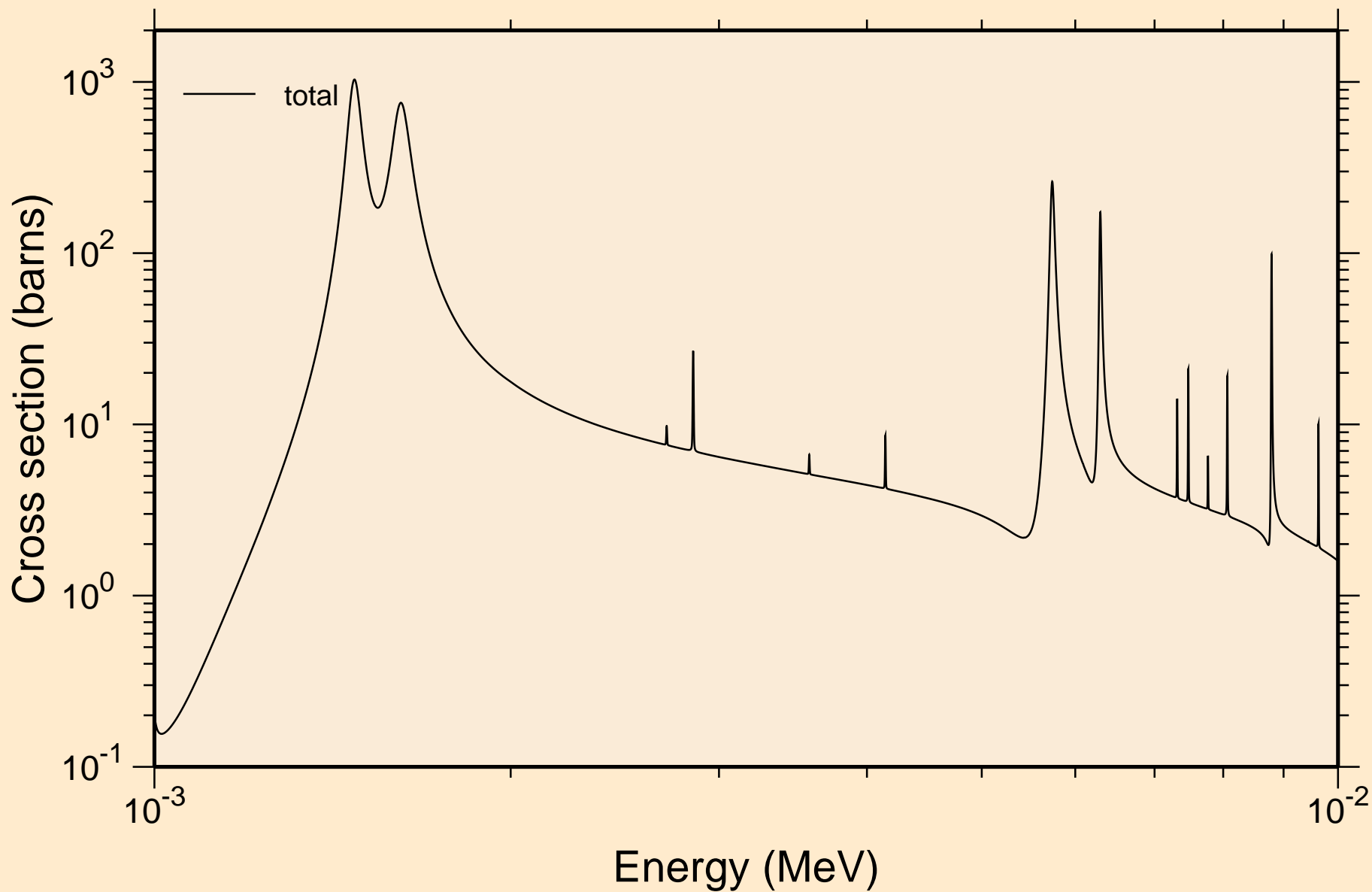

CA041 NEUTRON ACER TENDL-2019 LIBRARY; T=293.16K
resonance total cross section

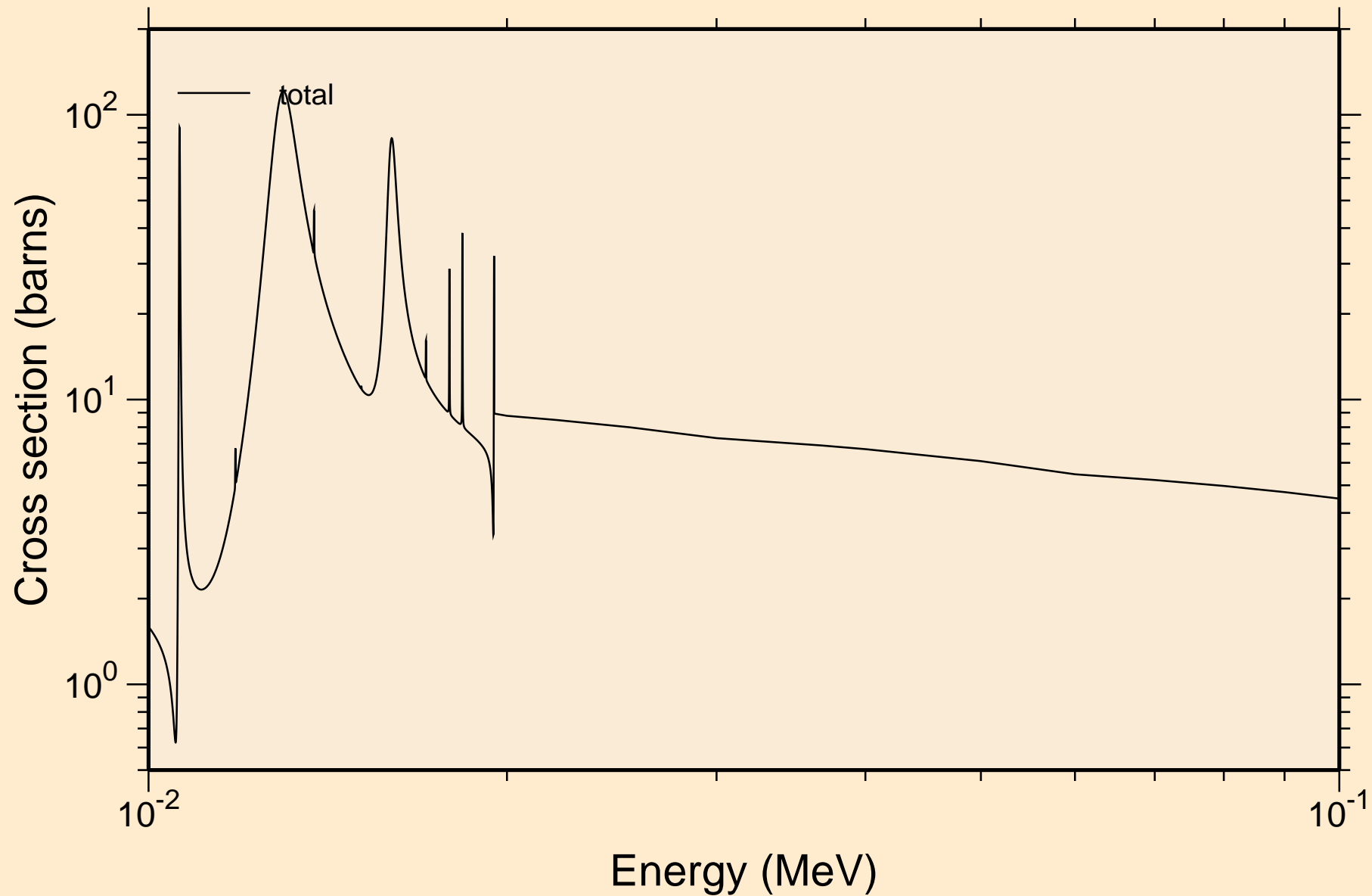

C̄A041 NEUTRON ACER TENDL-2019 LIBRARY; T=293.16K
resonance total cross section

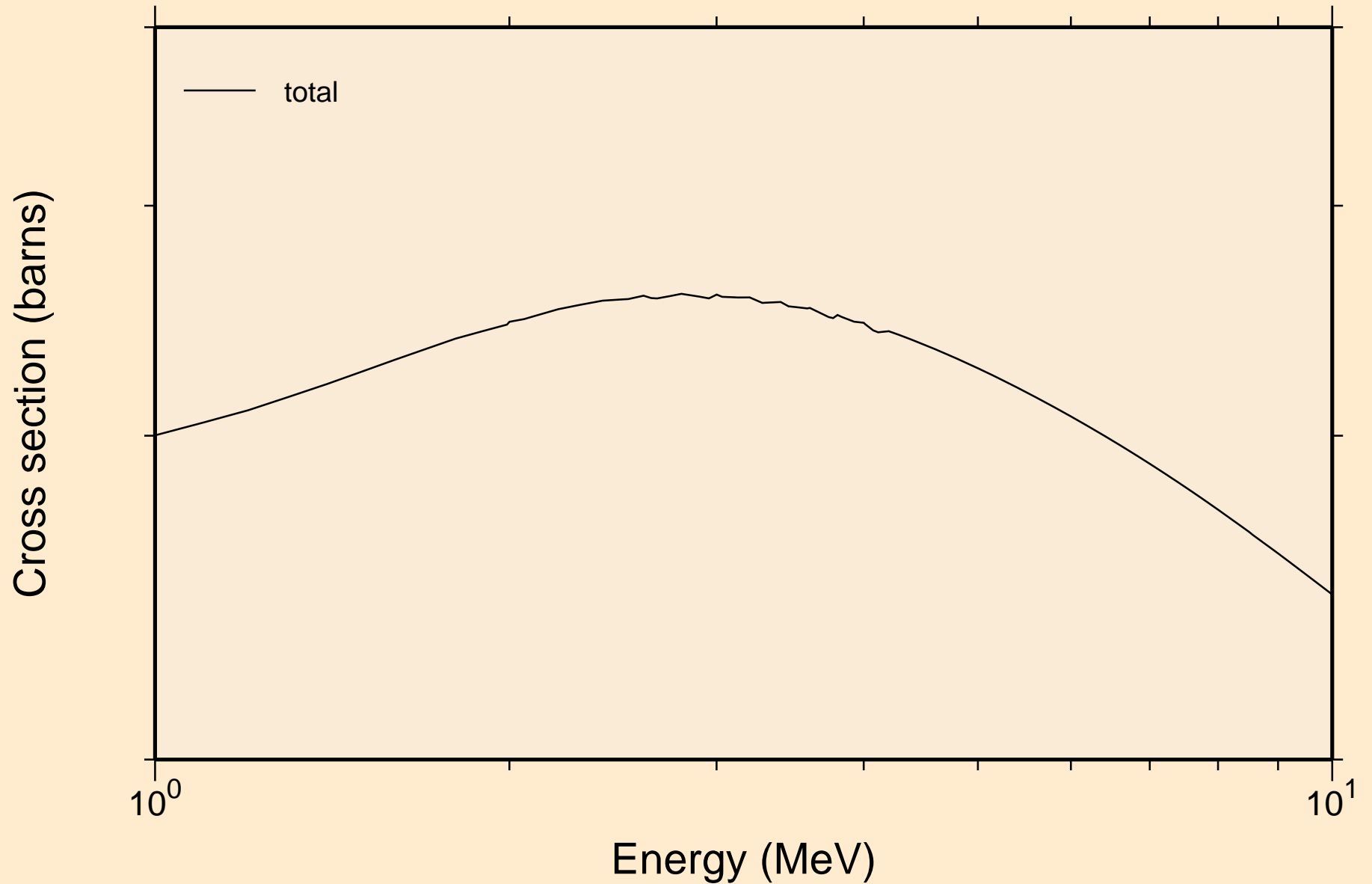

CA041 NEUTRON ACER TENDL-2019 LIBRARY; T=293.16K
resonance absorption cross sections

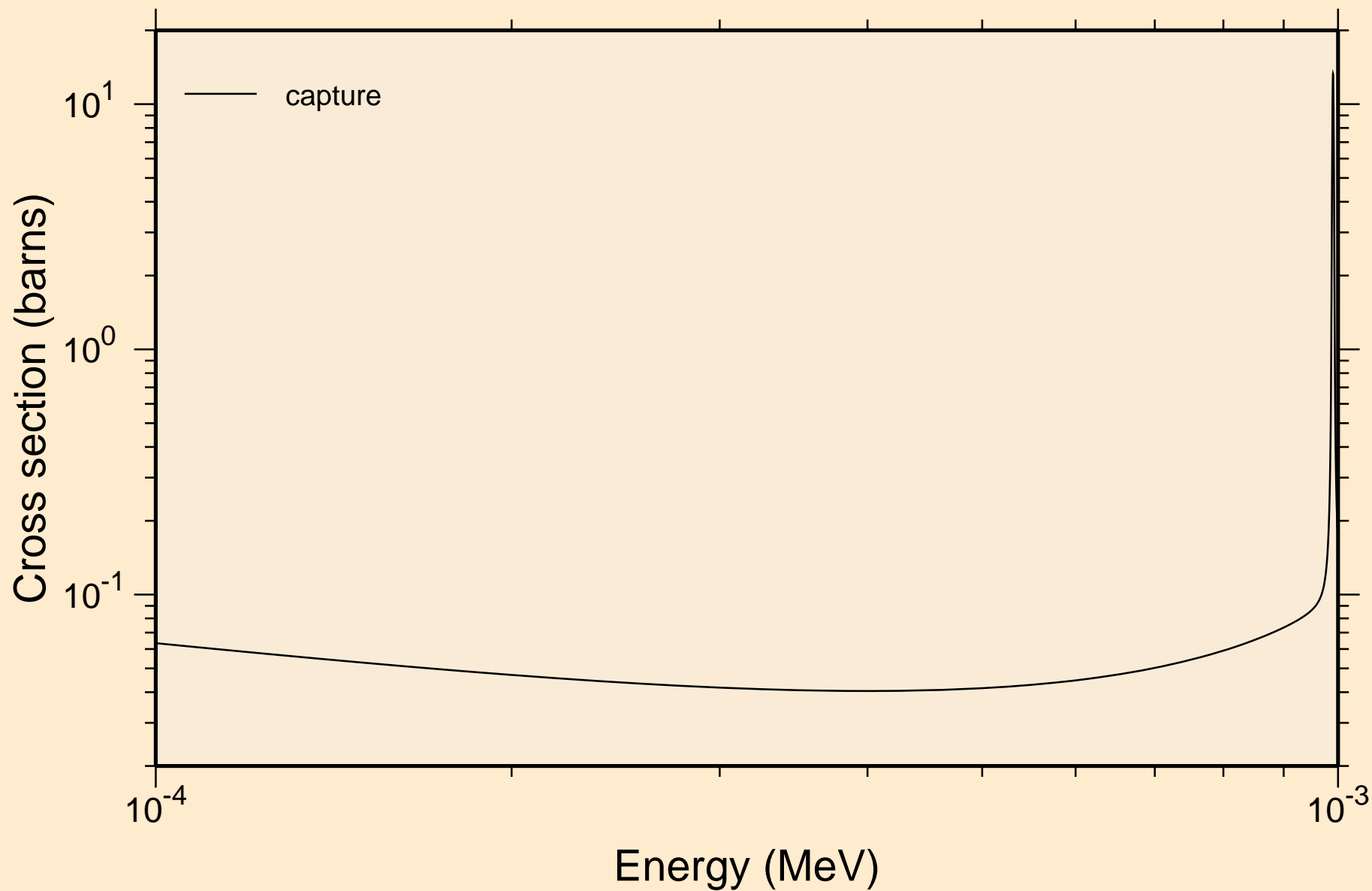

CA041 NEUTRON ACER TENDL-2019 LIBRARY; T=293.16K
resonance absorption cross sections

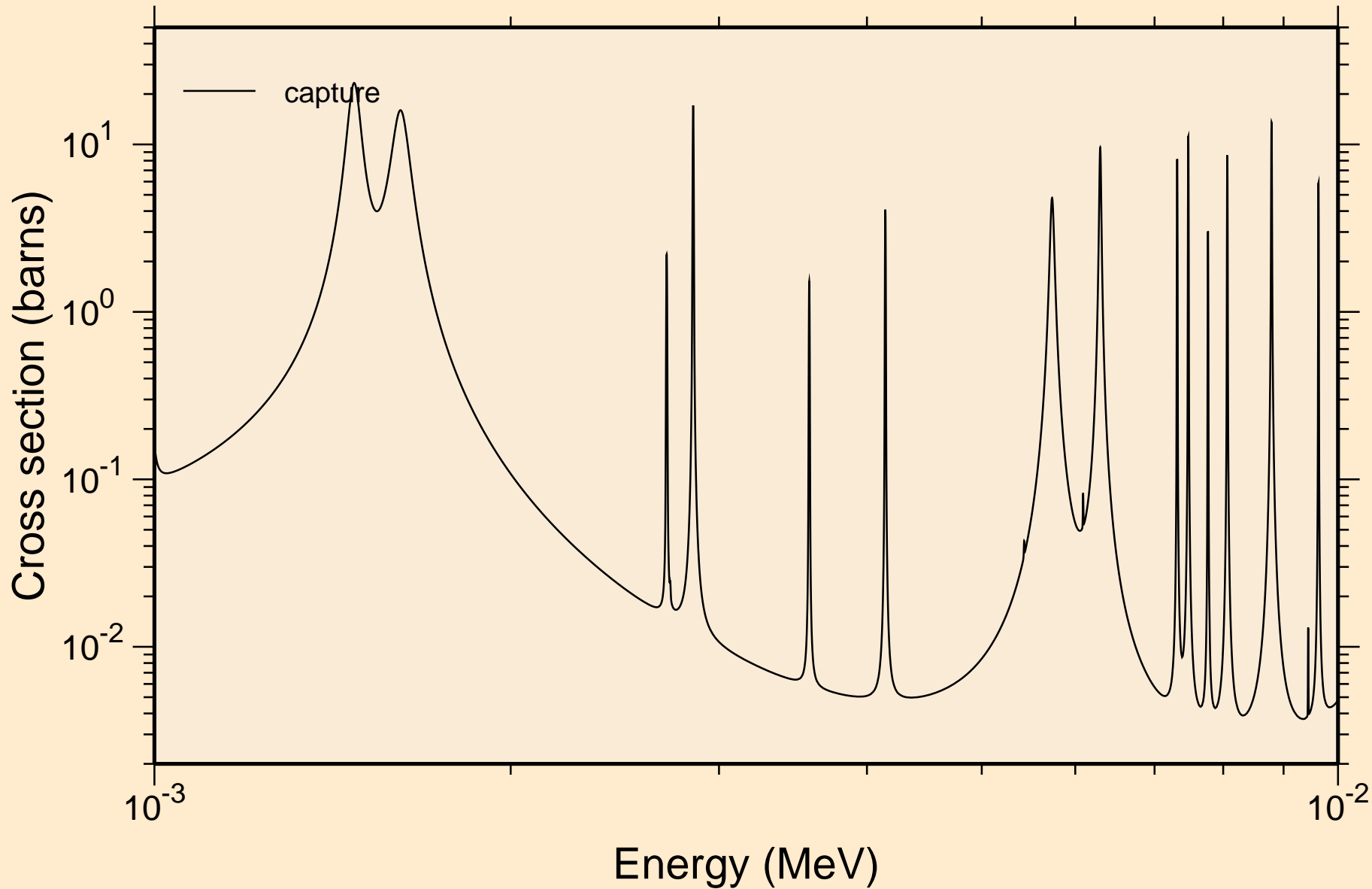

CA041 NEUTRON ACER TENDL-2019 LIBRARY; T=293.16K
resonance absorption cross sections

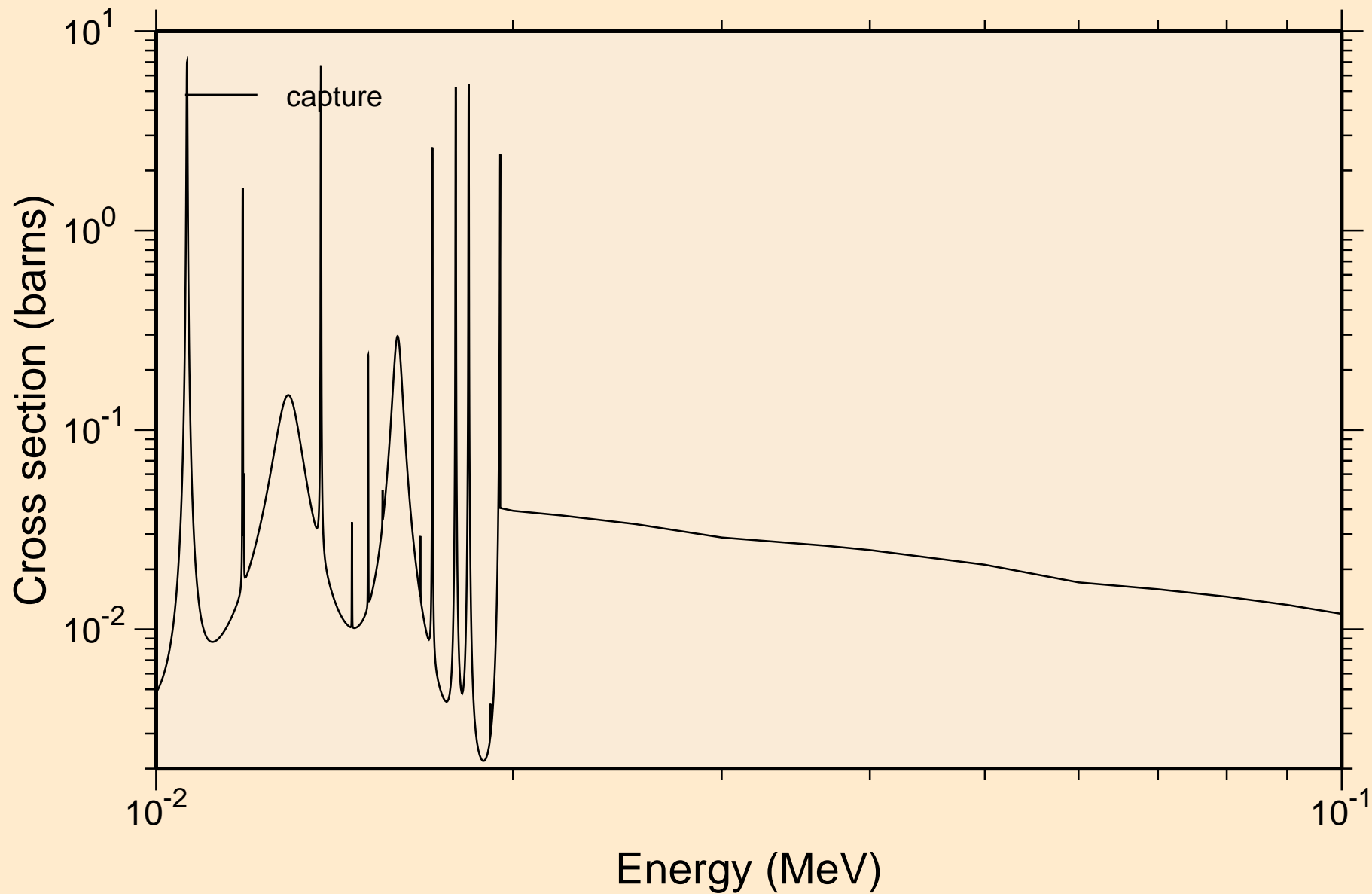

CA041 NEUTRON ACER TENDL-2019 LIBRARY; T=293.16K
resonance absorption cross sections

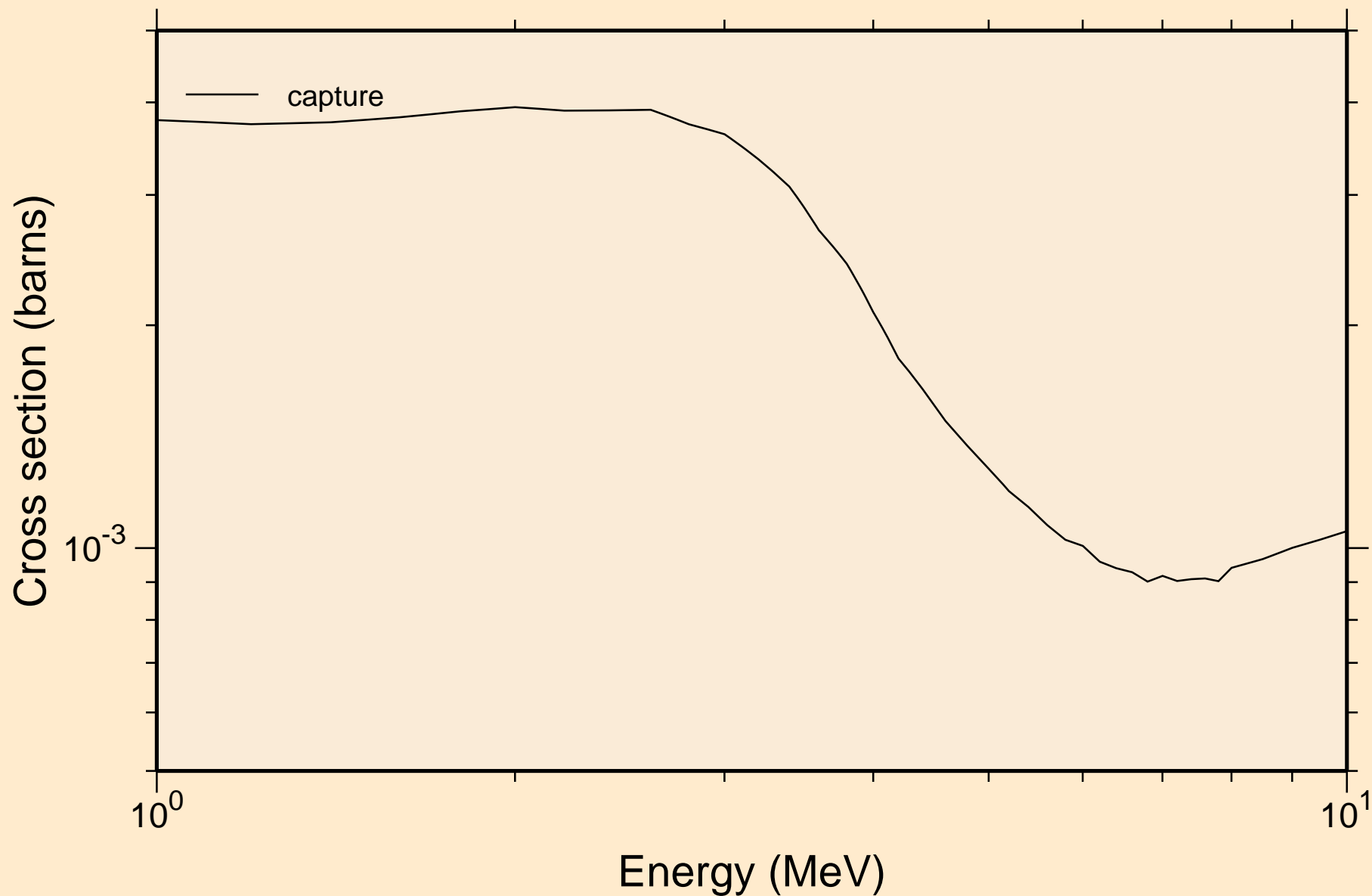

CA041 NEUTRON ACER TENDL-2019 LIBRARY; T=293.16K
Heating

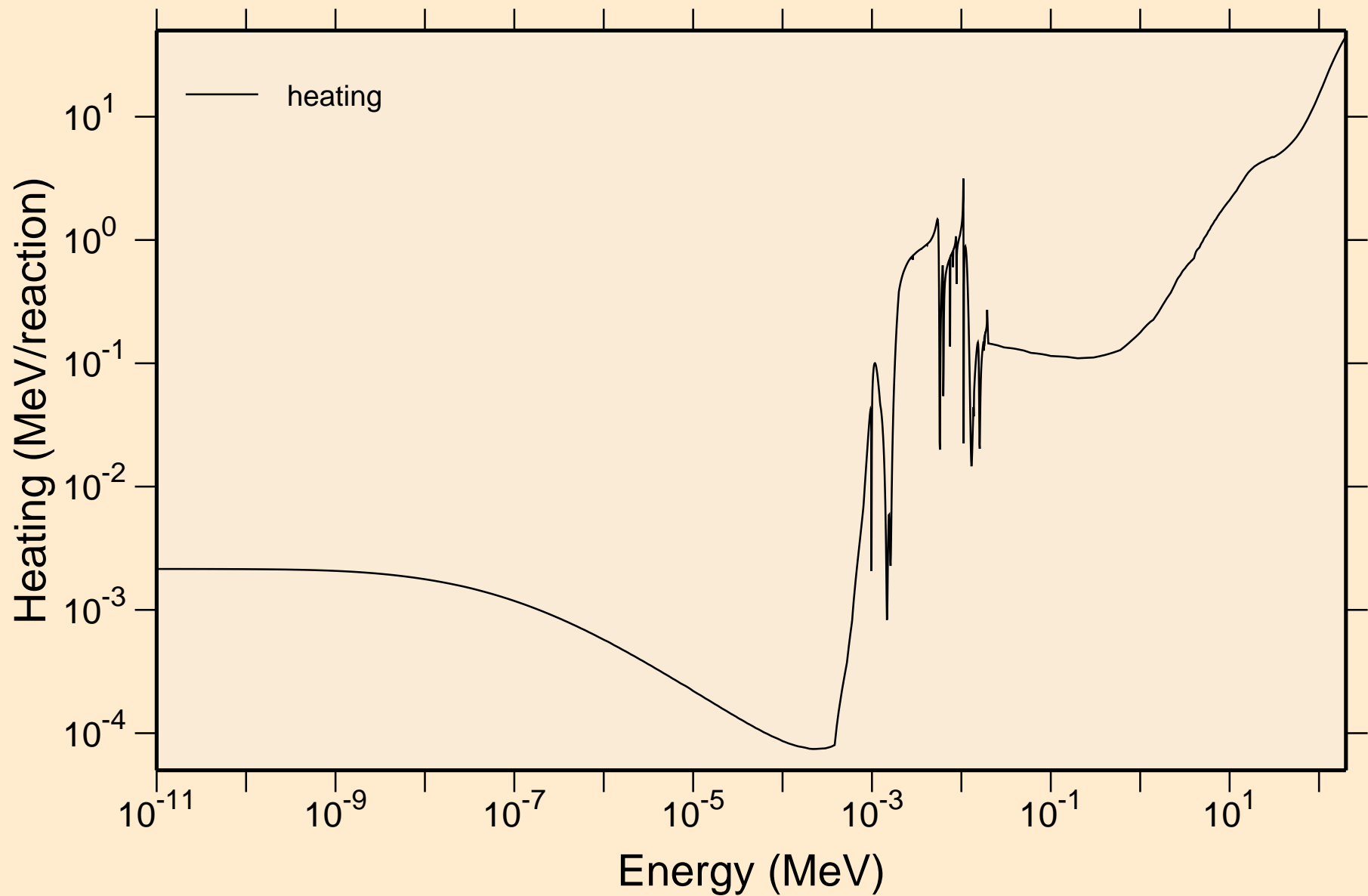

CA041 NEUTRON ACER TENDL-2019 LIBRARY; T=293.16K
Damage

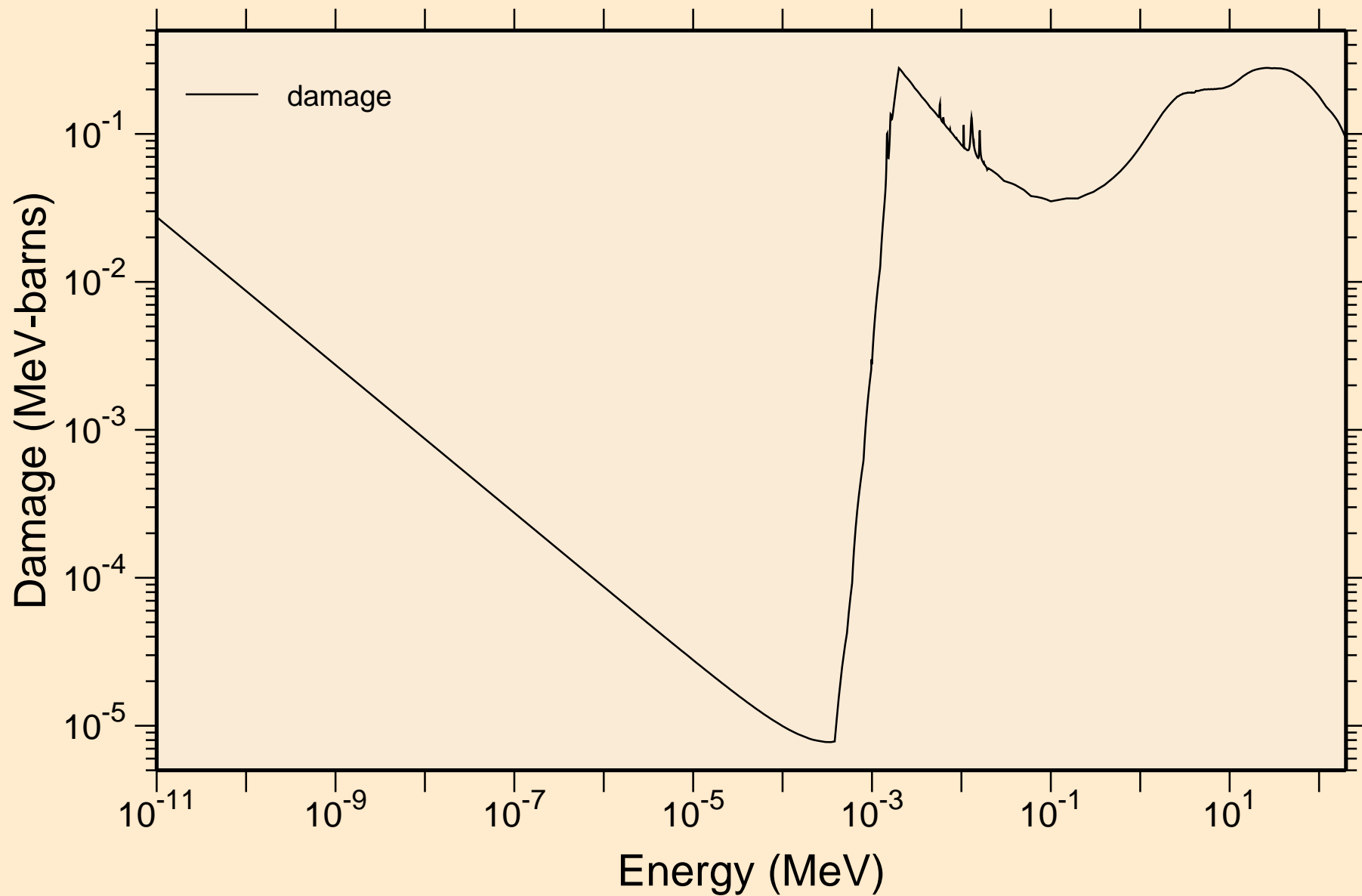

CA041 NEUTRON ACER TENDL-2019 LIBRARY; T=293.16K
Non-threshold reactions

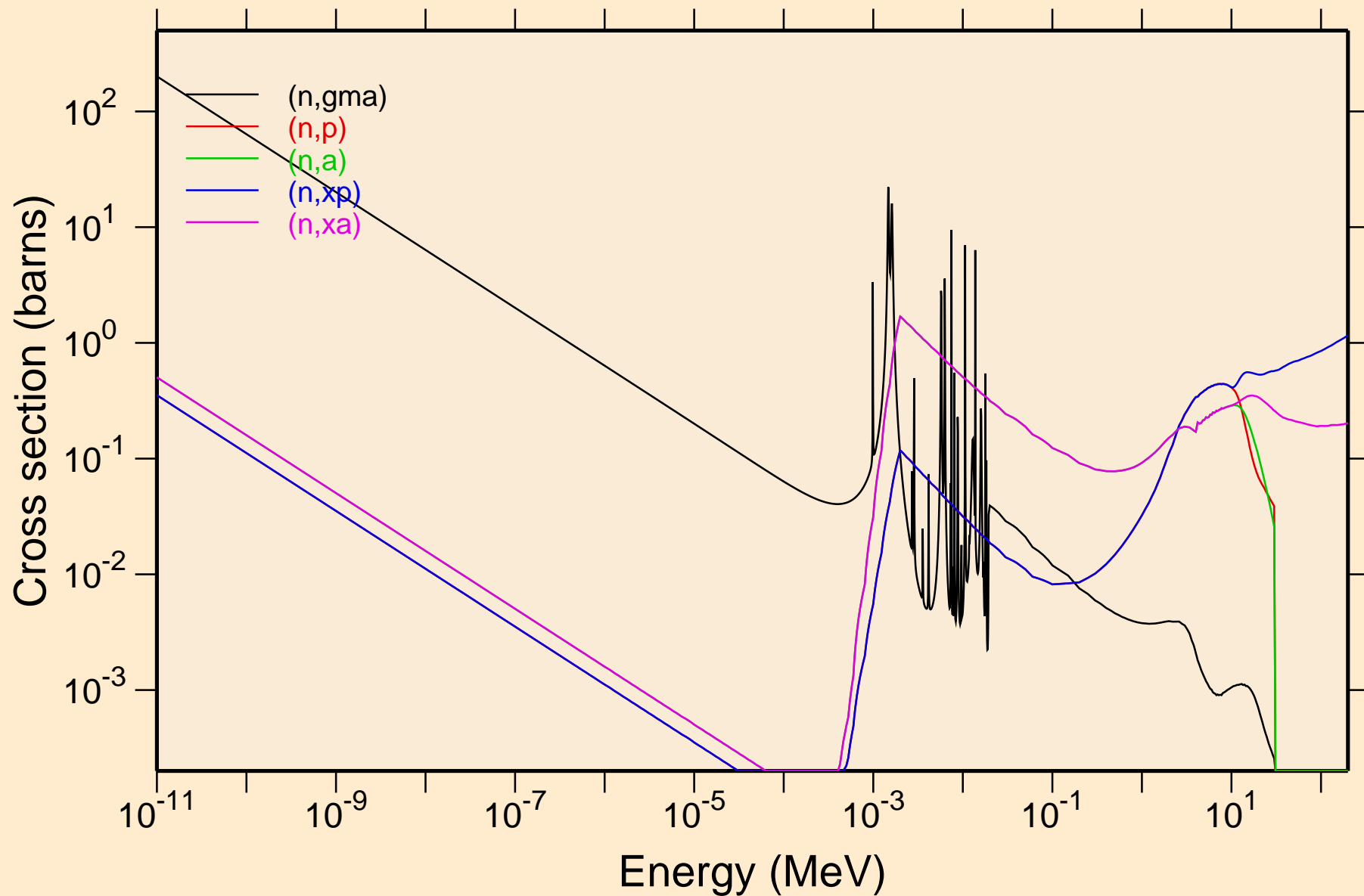

CA041 NEUTRON ACER TENDL-2019 LIBRARY; T=293.16K
Principal cross sections

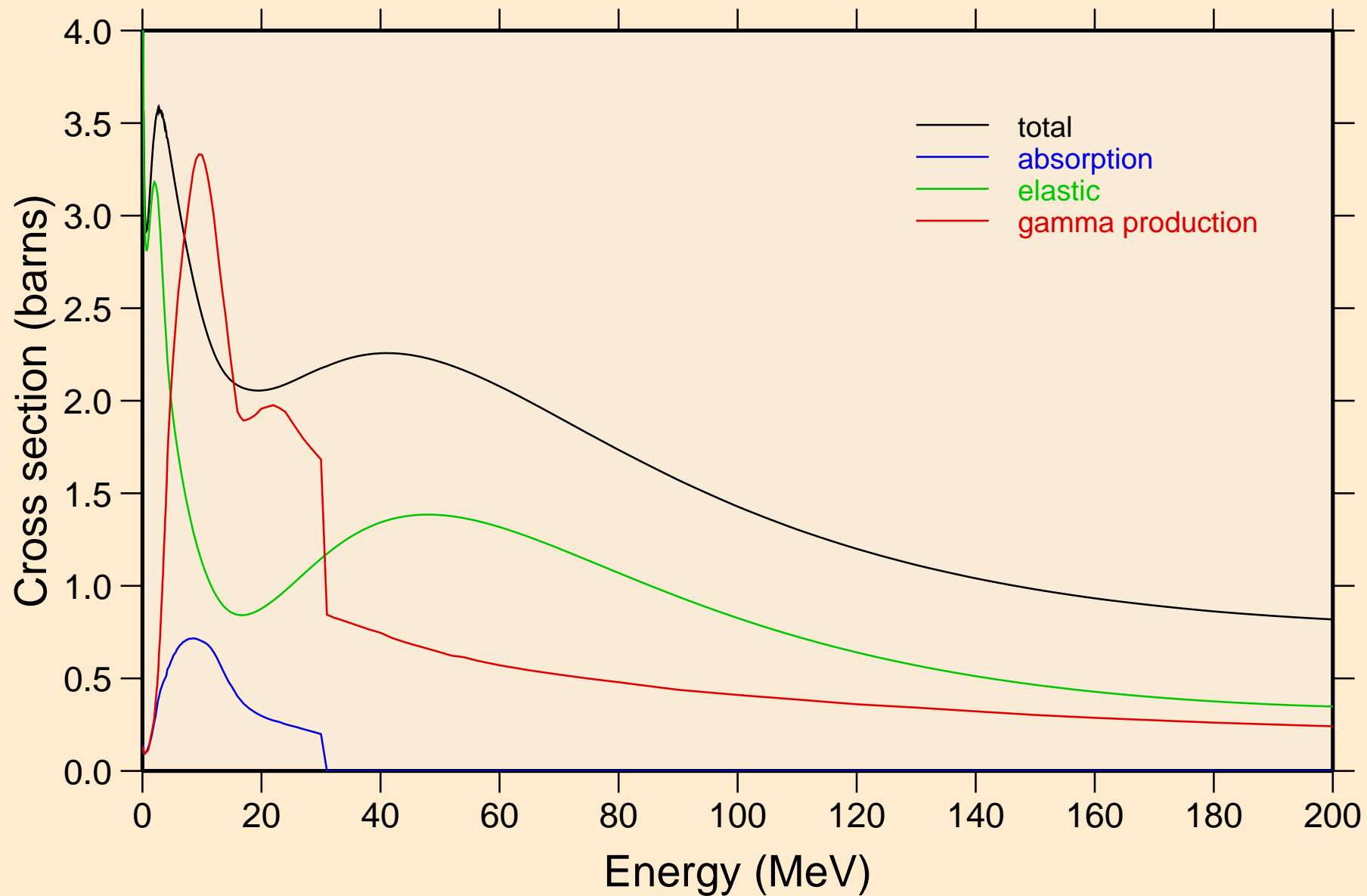

CA041 NEUTRON ACER TENDL-2019 LIBRARY; T=293.16K
Heating

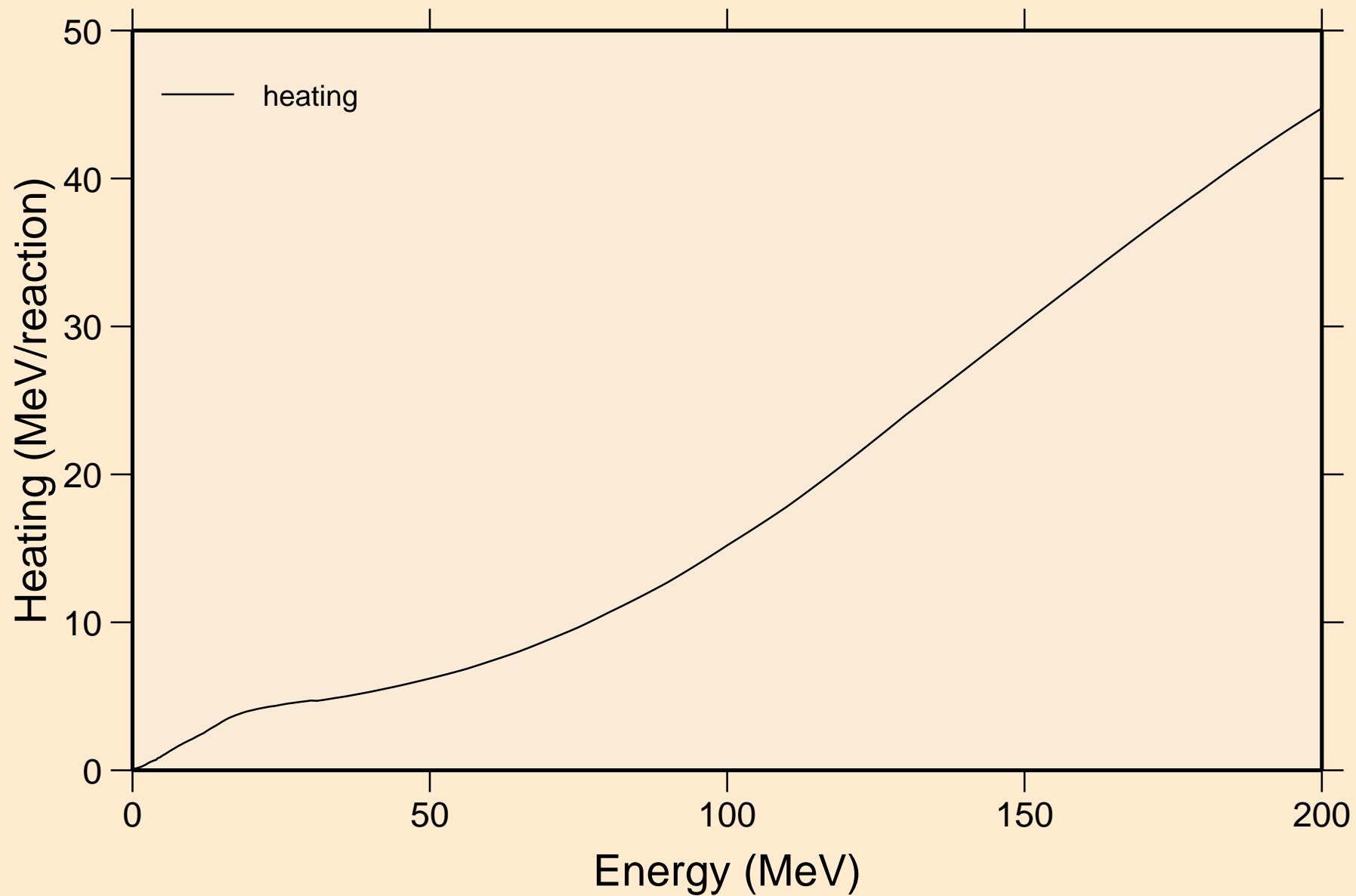

CA041 NEUTRON ACER TENDL-2019 LIBRARY; T=293.16K
Damage

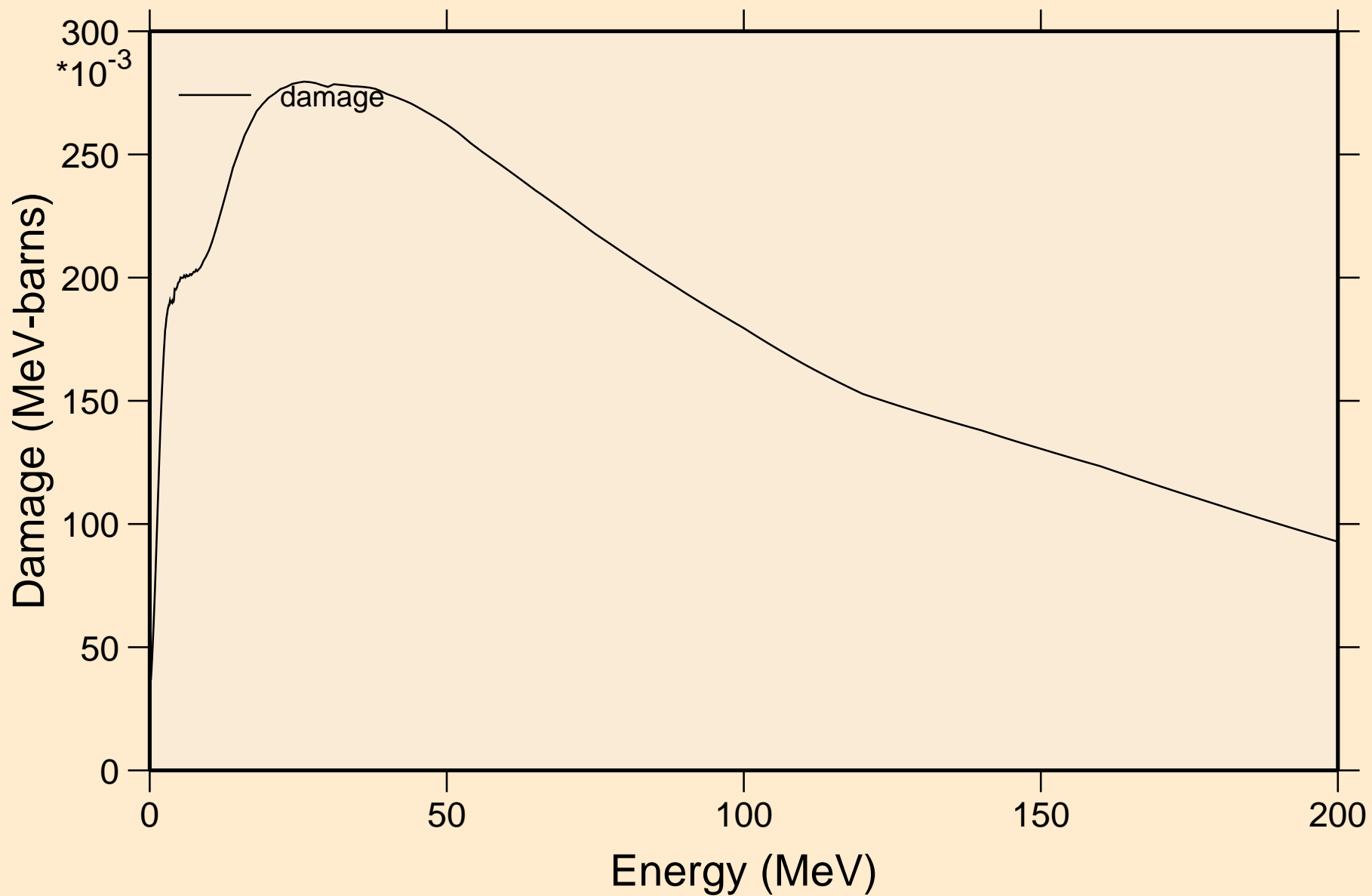

CA041 NEUTRON ACER TENDL-2019 LIBRARY; T=293.16K
Non-threshold reactions

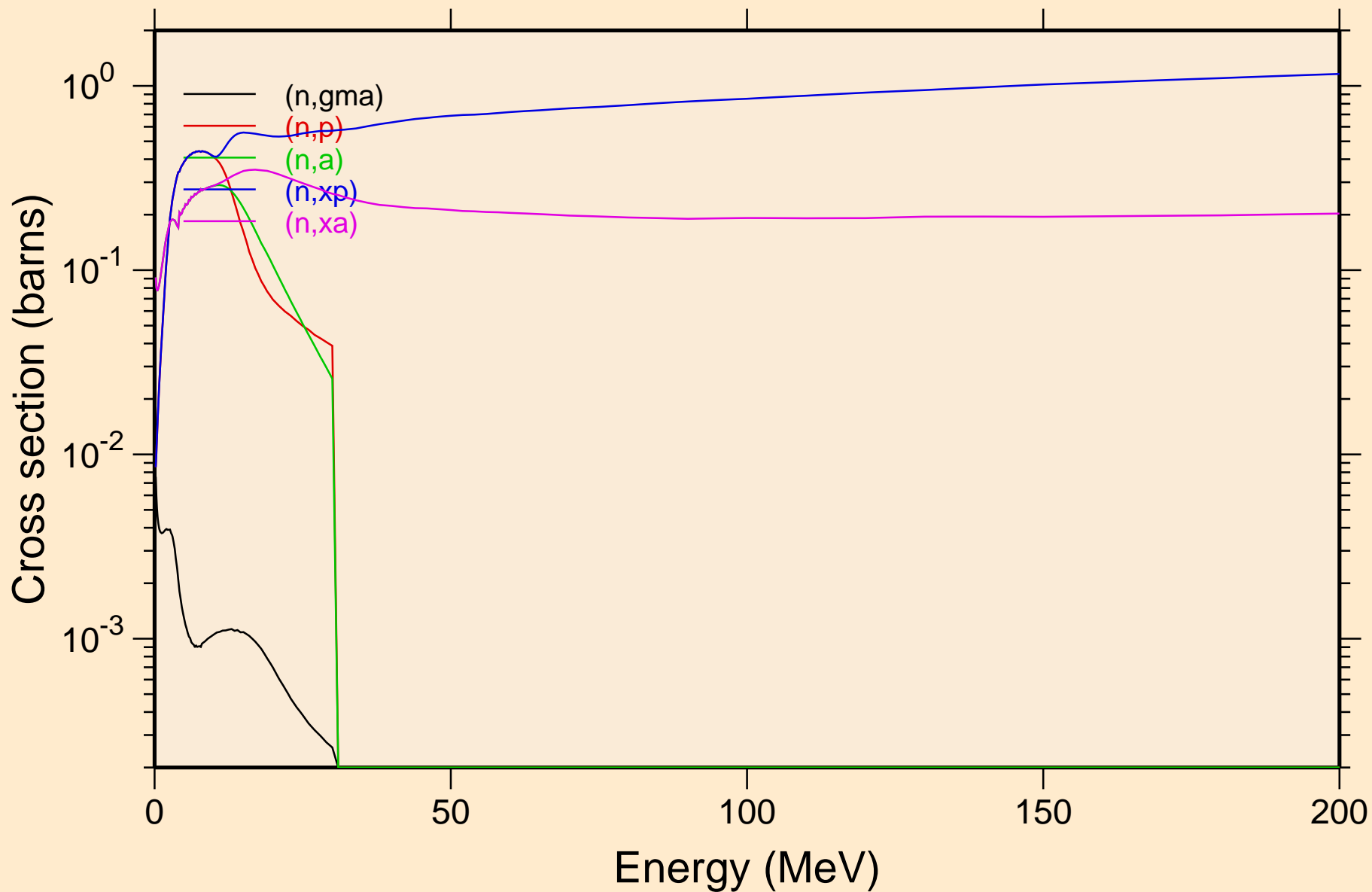

CA041 NEUTRON ACER TENDL-2019 LIBRARY; T=293.16K
Inelastic levels

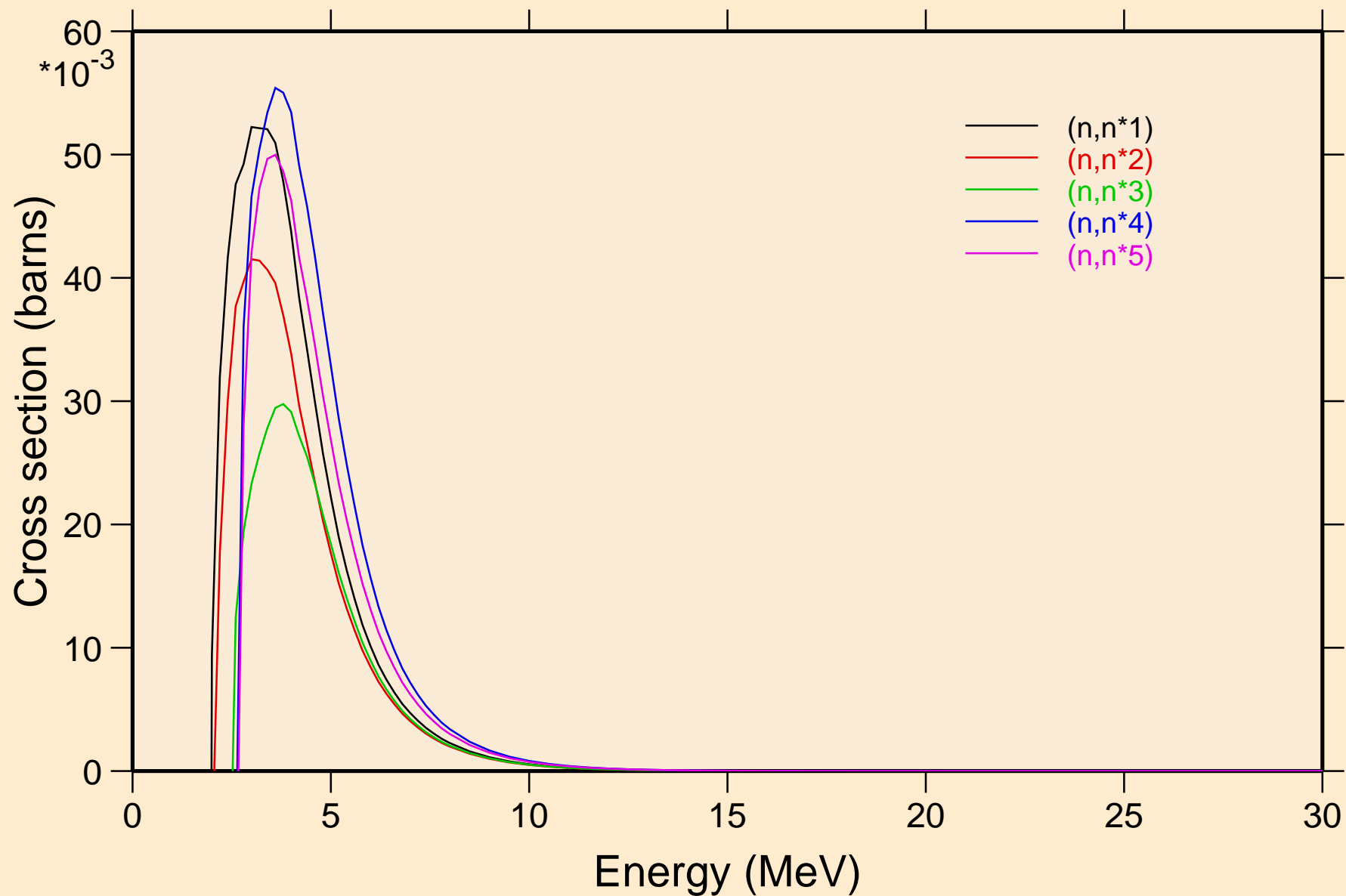

CA041 NEUTRON ACER TENDL-2019 LIBRARY; T=293.16K
Inelastic levels

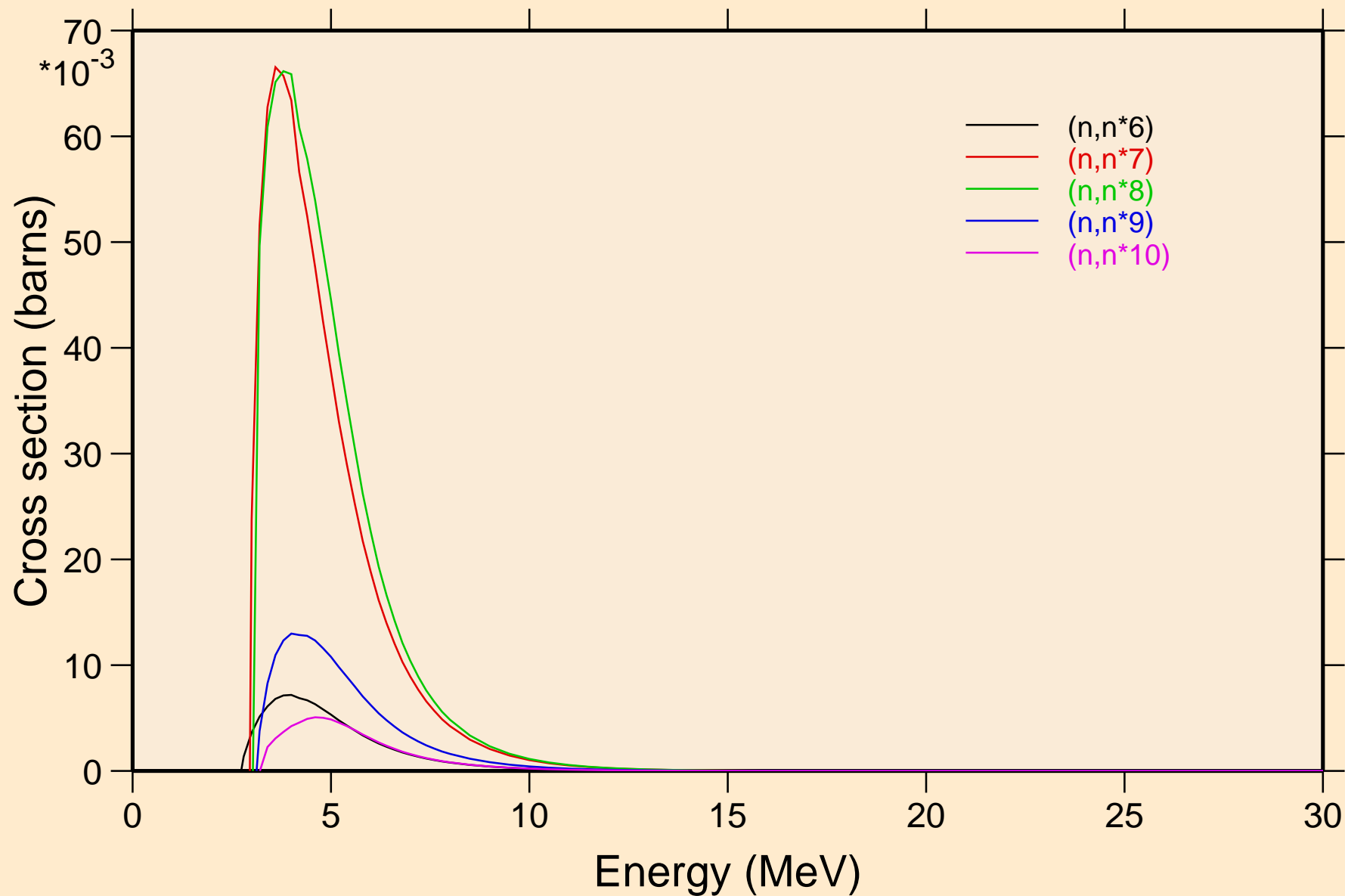

CA041 NEUTRON ACER TENDL-2019 LIBRARY; T=293.16K
Inelastic levels

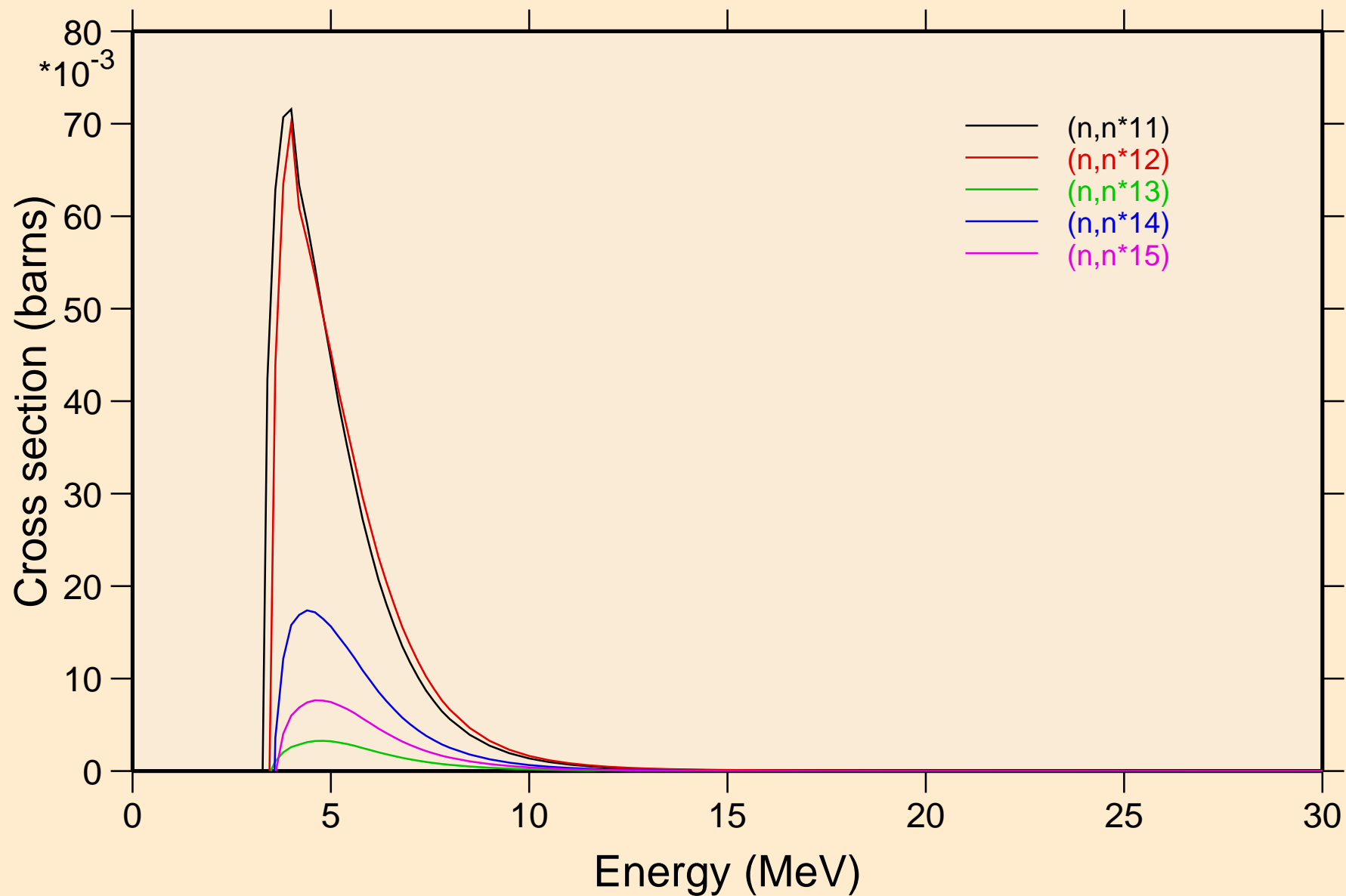

CA041 NEUTRON ACER TENDL-2019 LIBRARY; T=293.16K
Inelastic levels

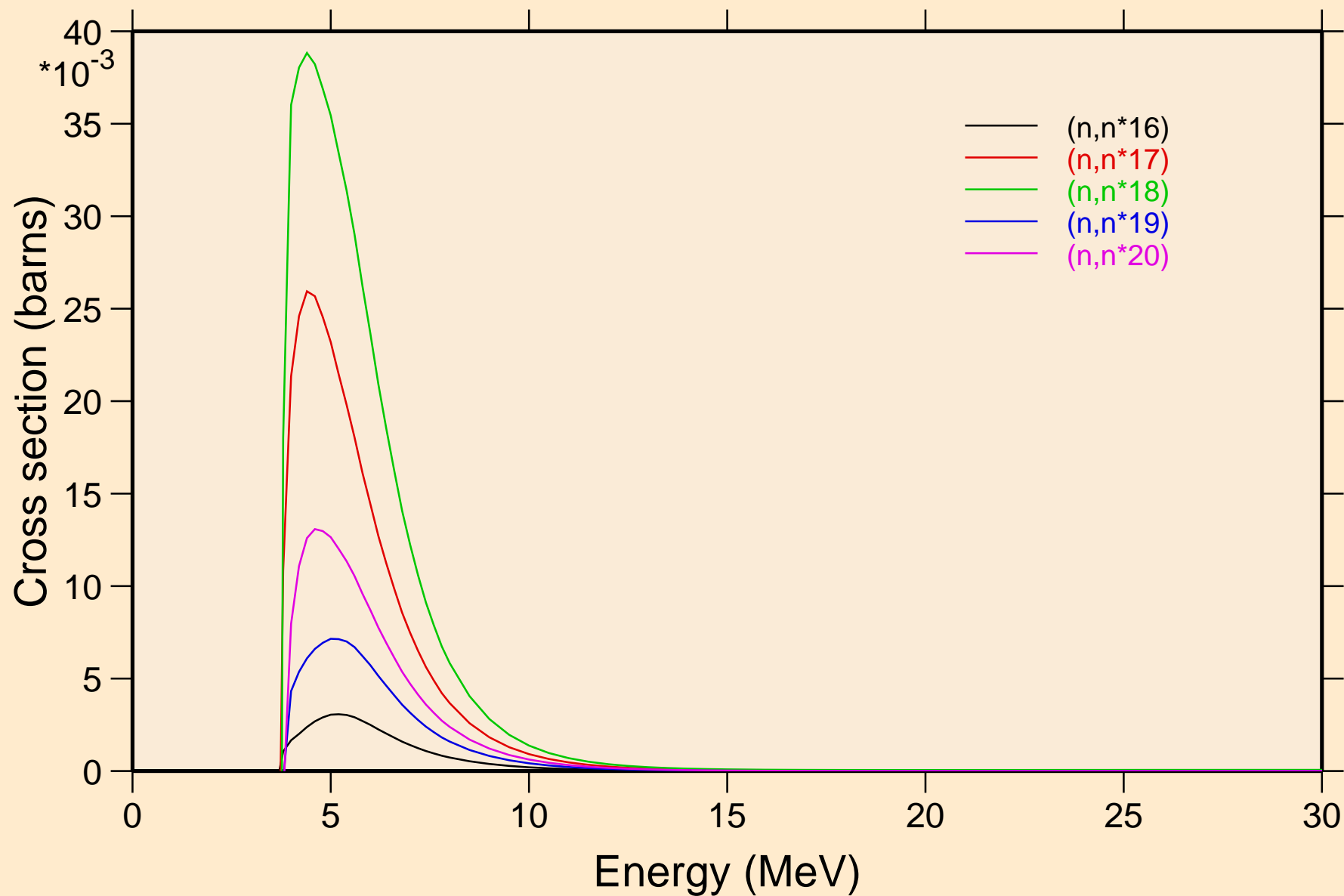

CA041 NEUTRON ACER TENDL-2019 LIBRARY; T=293.16K
Inelastic levels

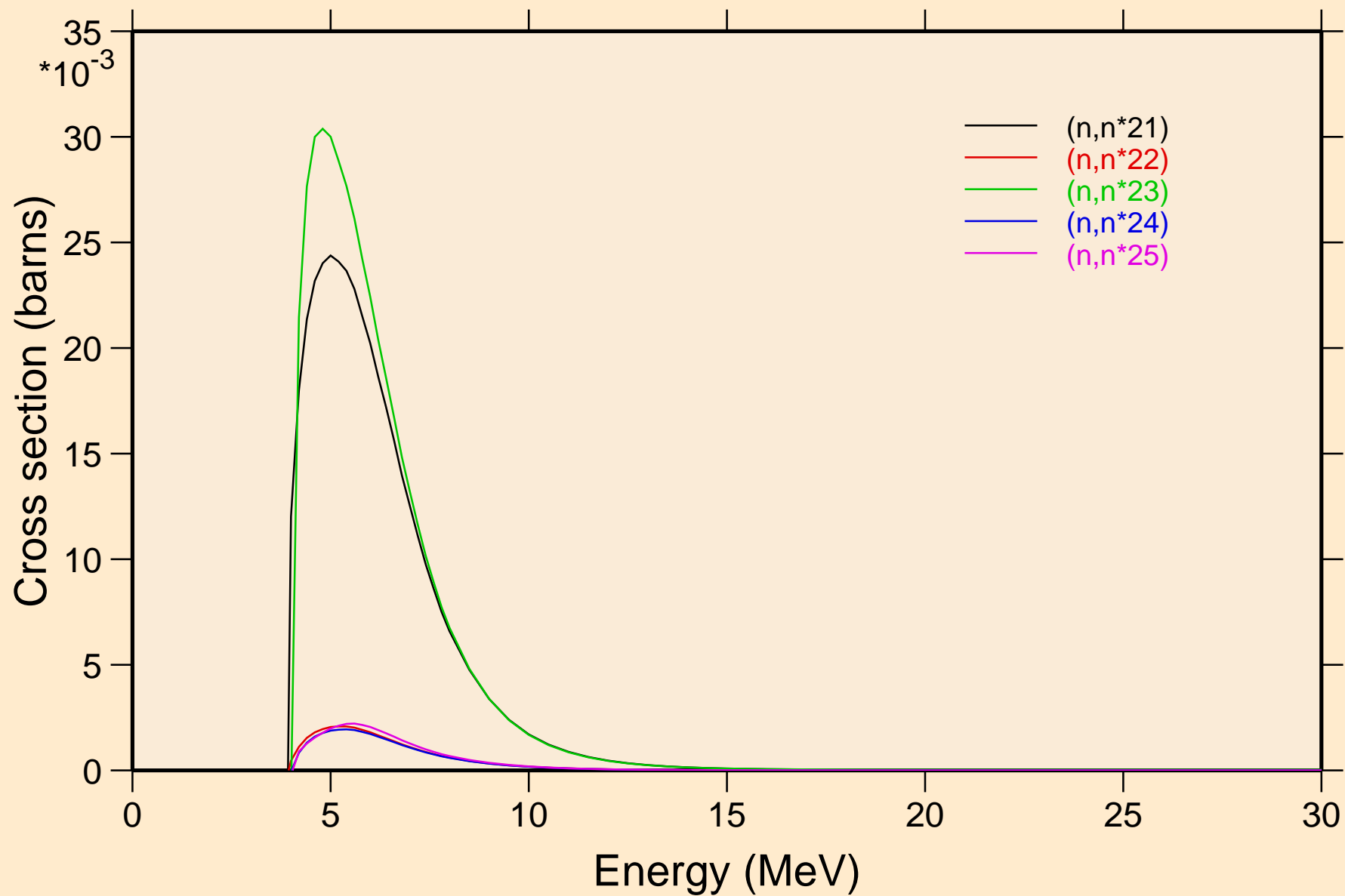

CA041 NEUTRON ACER TENDL-2019 LIBRARY; T=293.16K
Inelastic levels

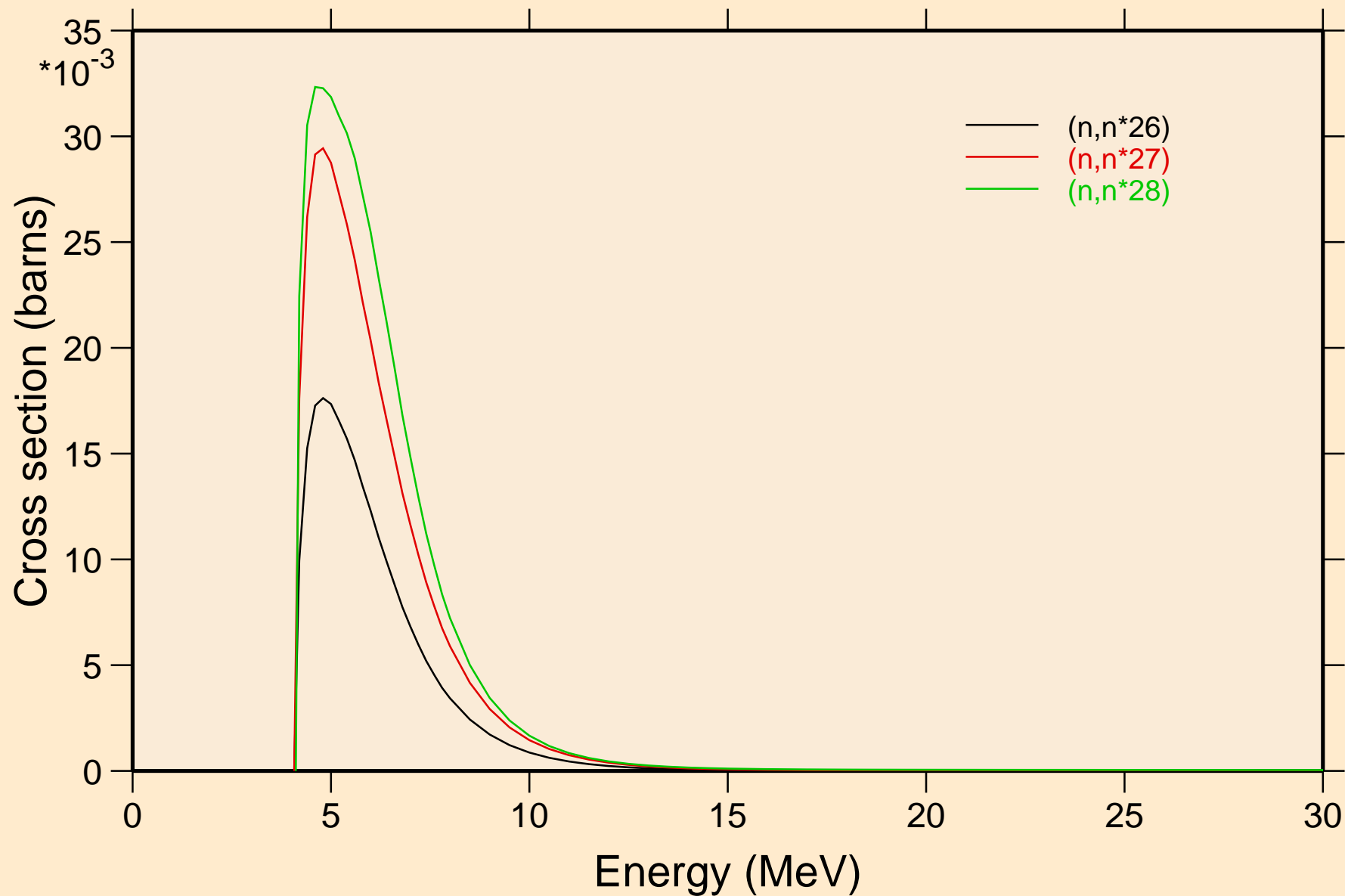

CA041 NEUTRON ACER TENDL-2019 LIBRARY; T=293.16K
Threshold reactions

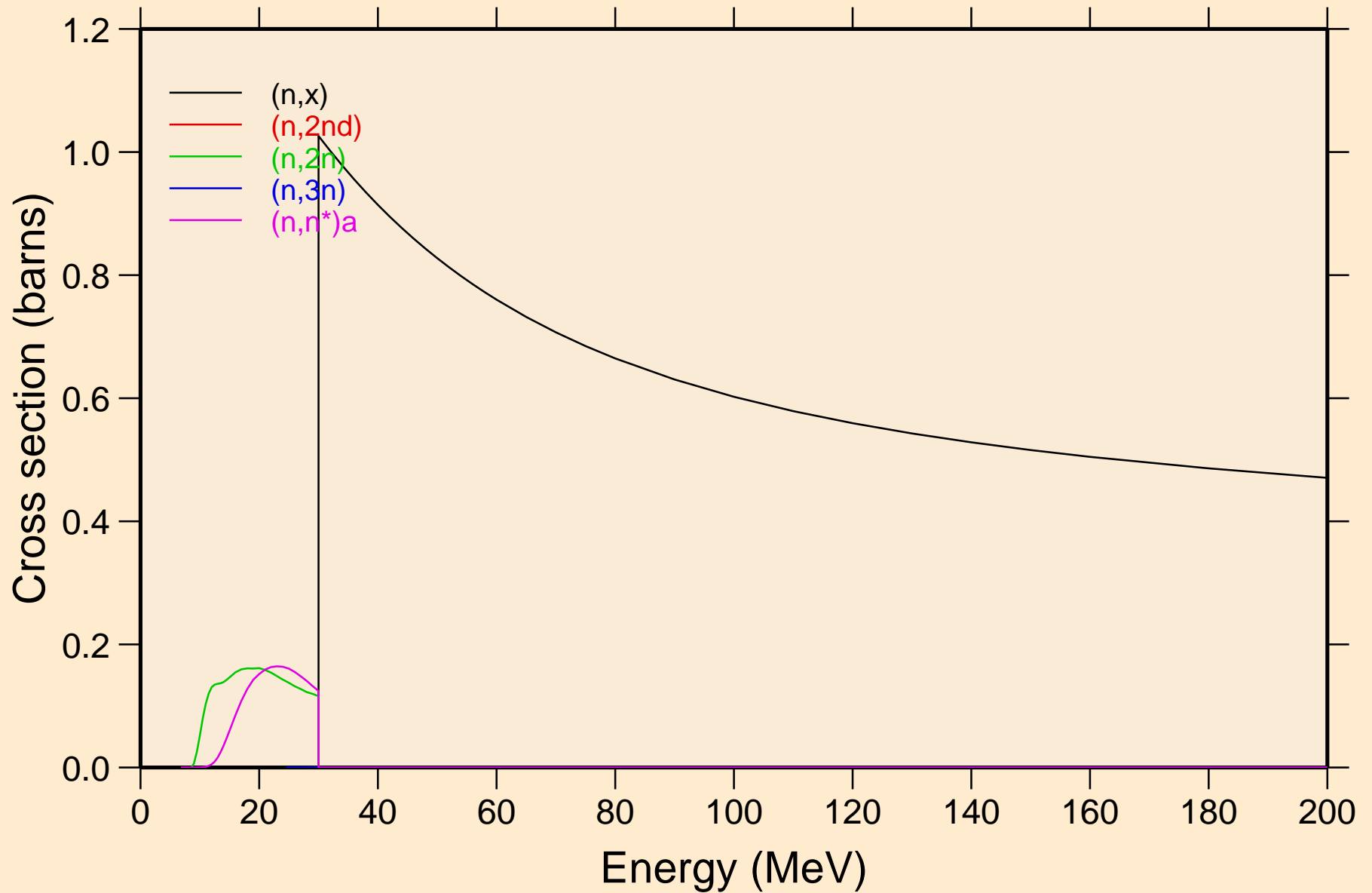

CA041 NEUTRON ACER TENDL-2019 LIBRARY; T=293.16K
Threshold reactions

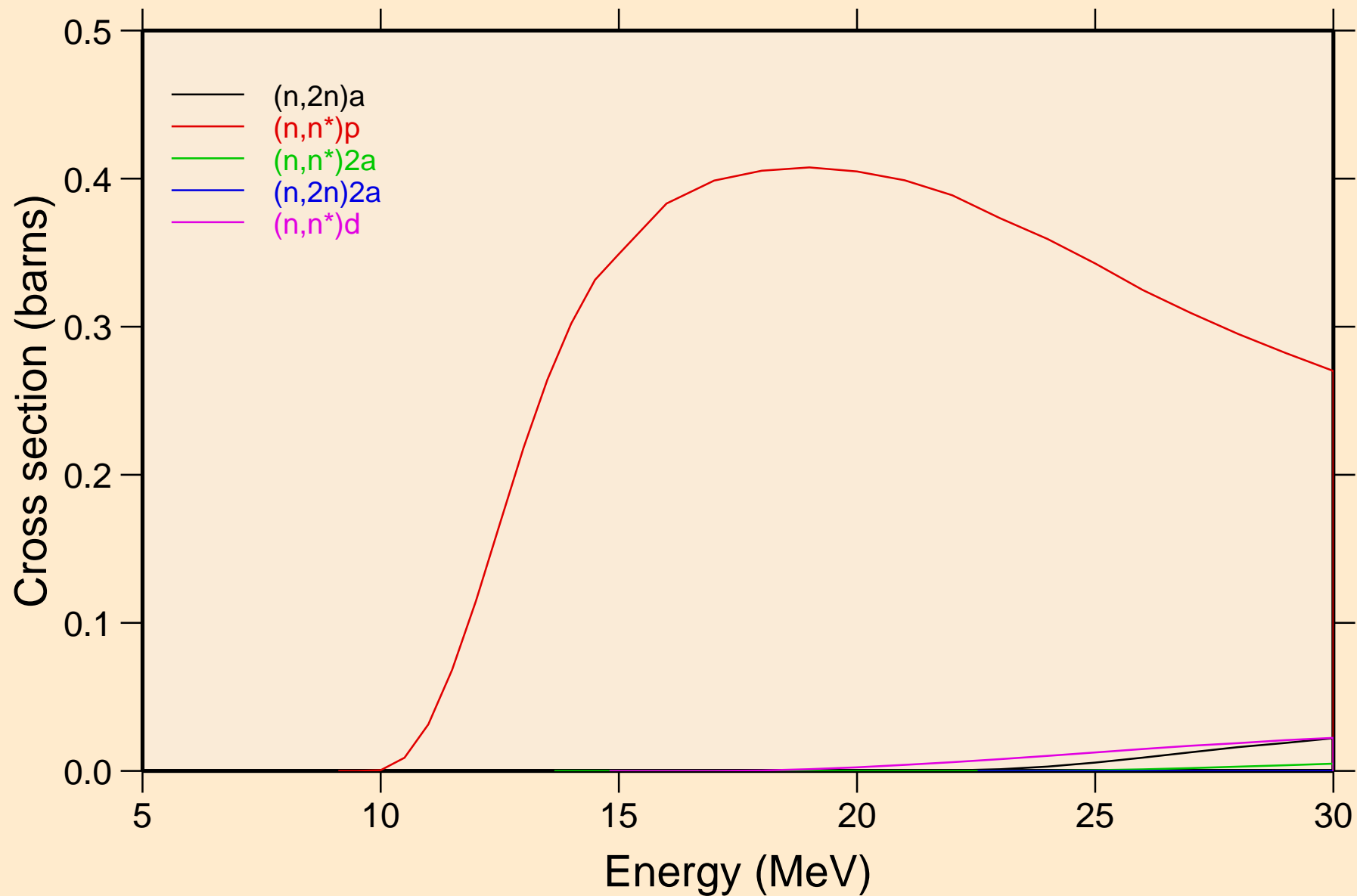

CA041 NEUTRON ACER TENDL-2019 LIBRARY; T=293.16K
Threshold reactions

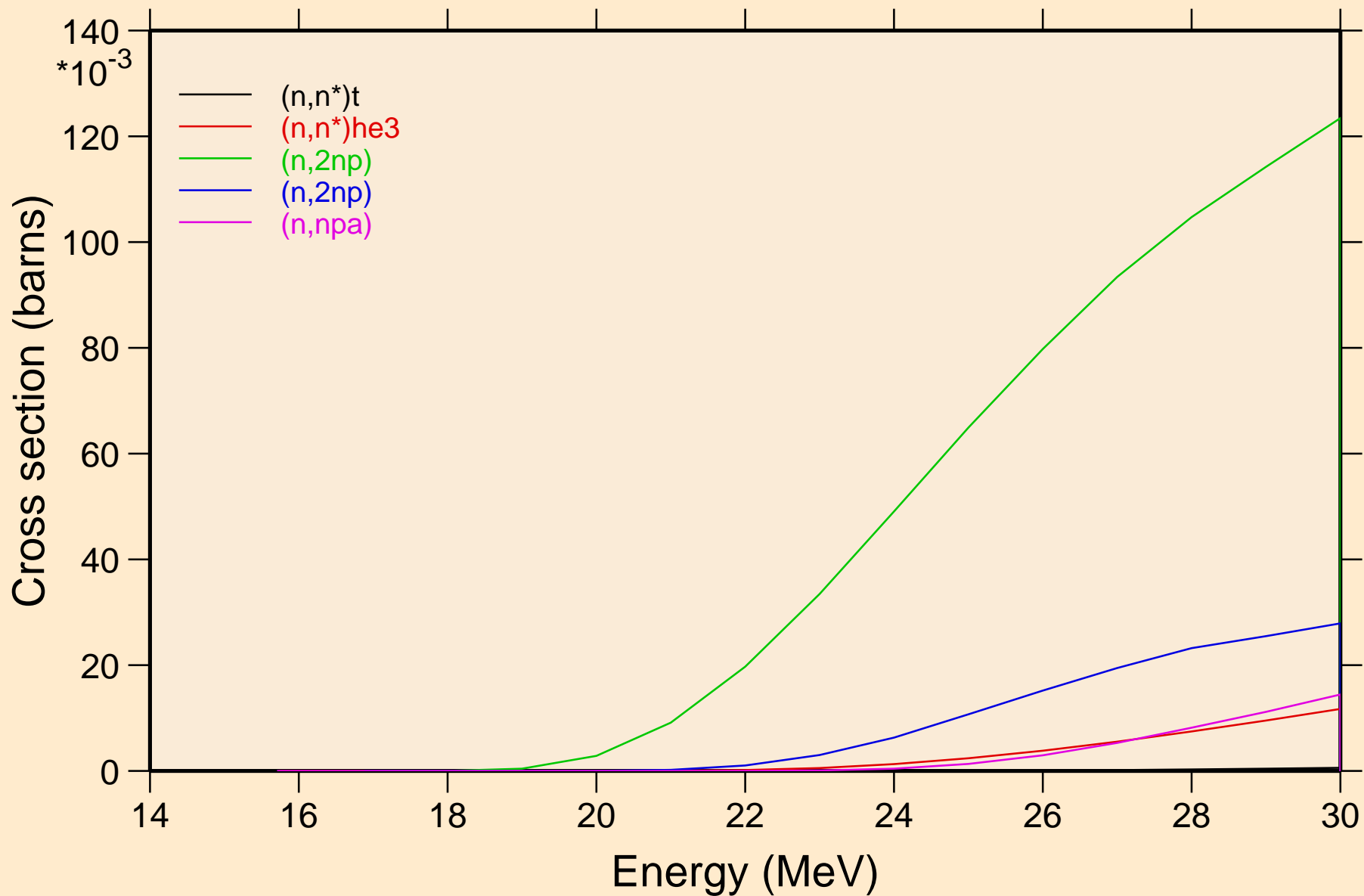

CA041 NEUTRON ACER TENDL-2019 LIBRARY; T=293.16K
Threshold reactions

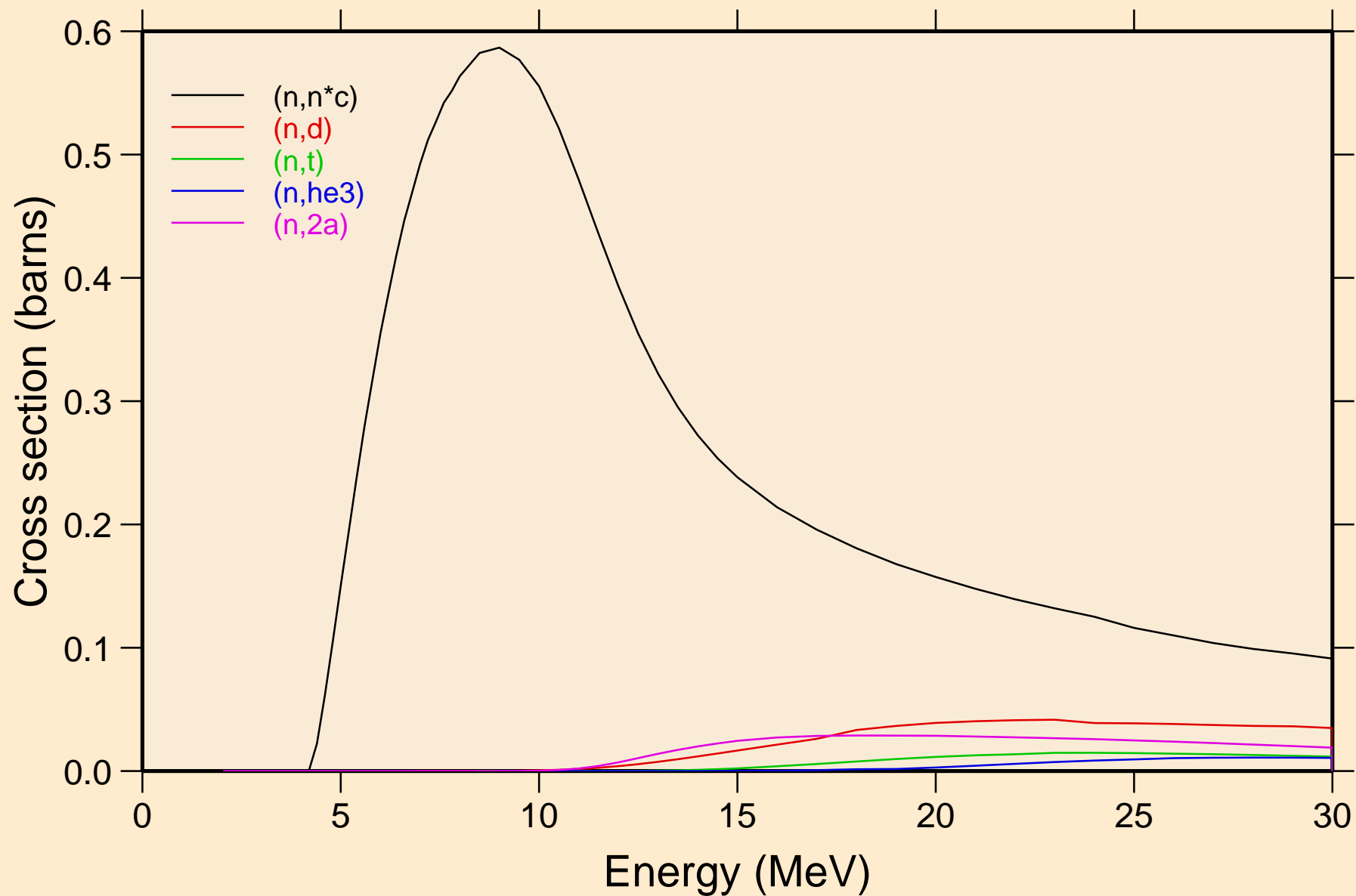

CA041 NEUTRON ACER TENDL-2019 LIBRARY; T=293.16K
Threshold reactions

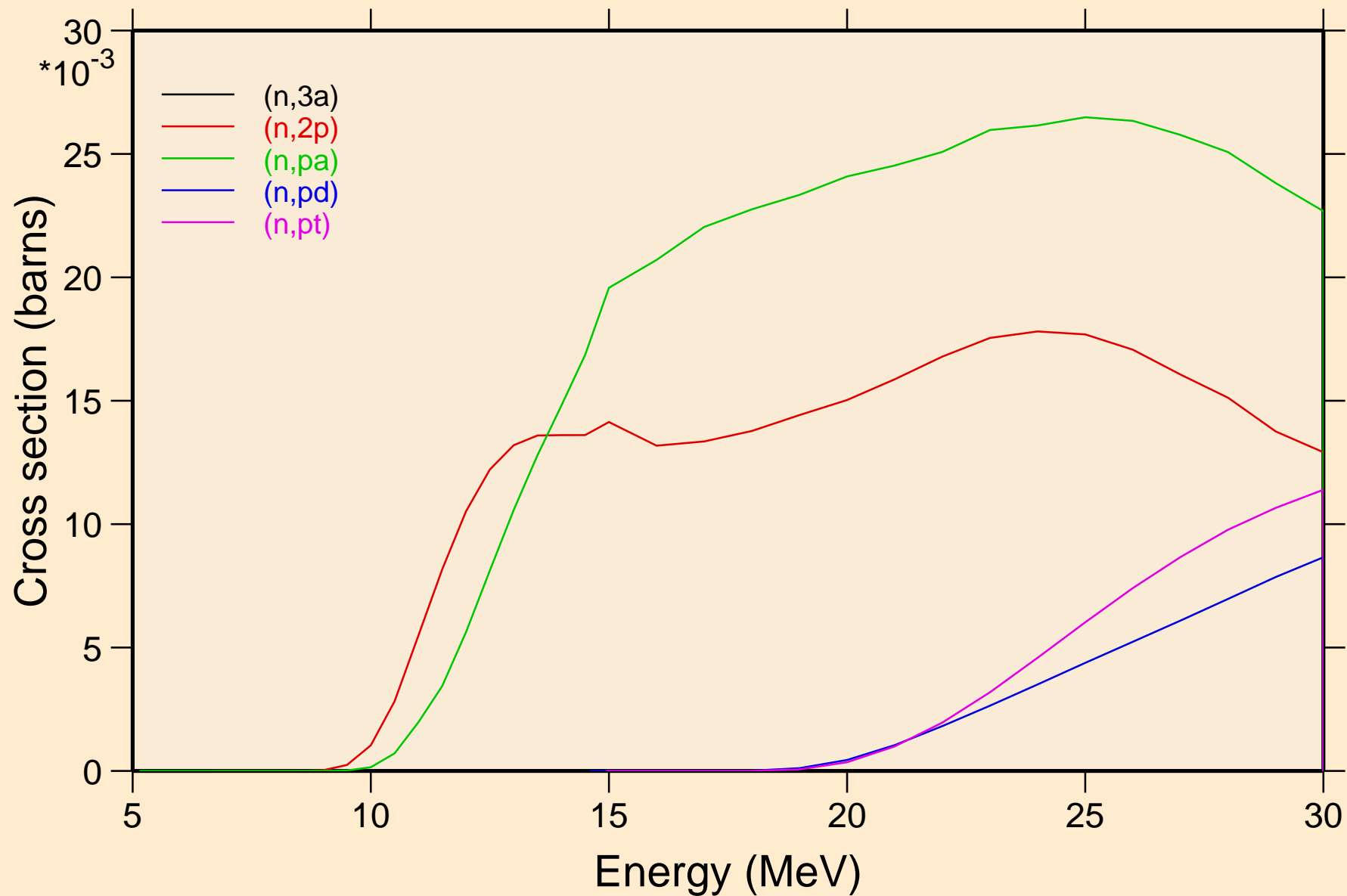

CA041 NEUTRON ACER TENDL-2019 LIBRARY; T=293.16K
Threshold reactions

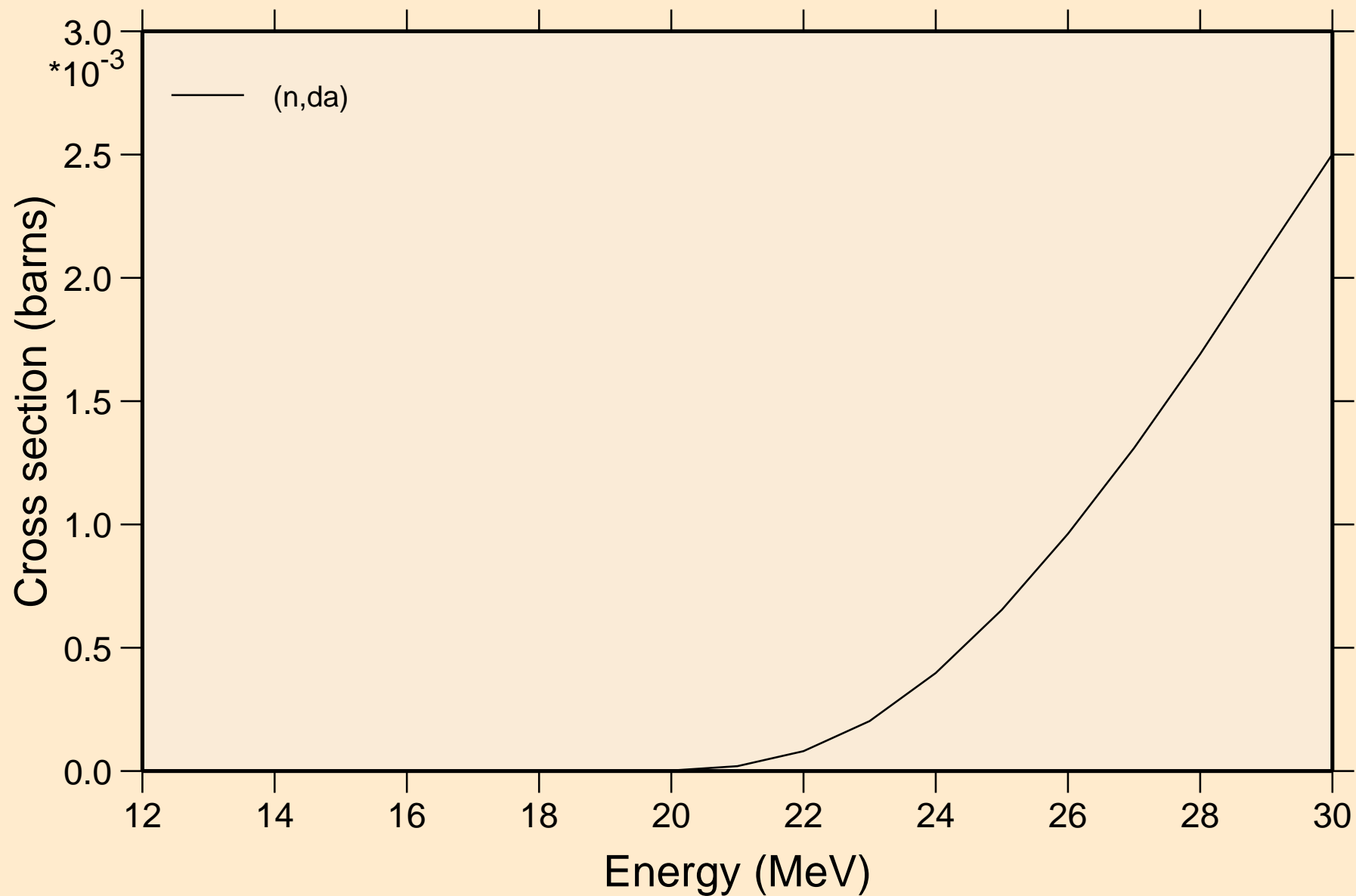

CA041 NEUTRON ACER TENDL-2019 LIBRARY; T=293.16K
Threshold reactions

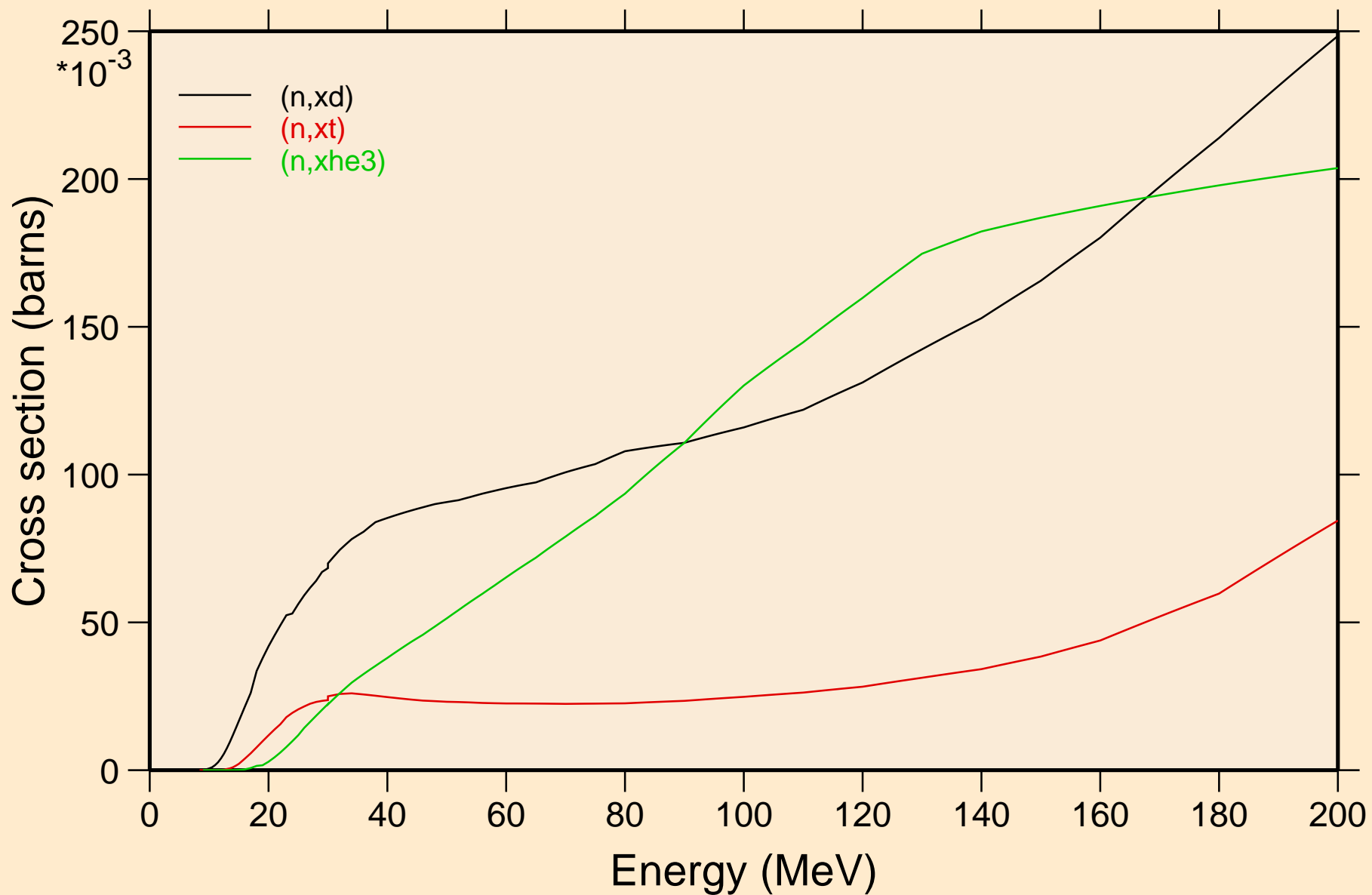

CA041 NEUTRON ACER TENDL-2019 LIBRARY; T=293.16K
angular distribution for elastic

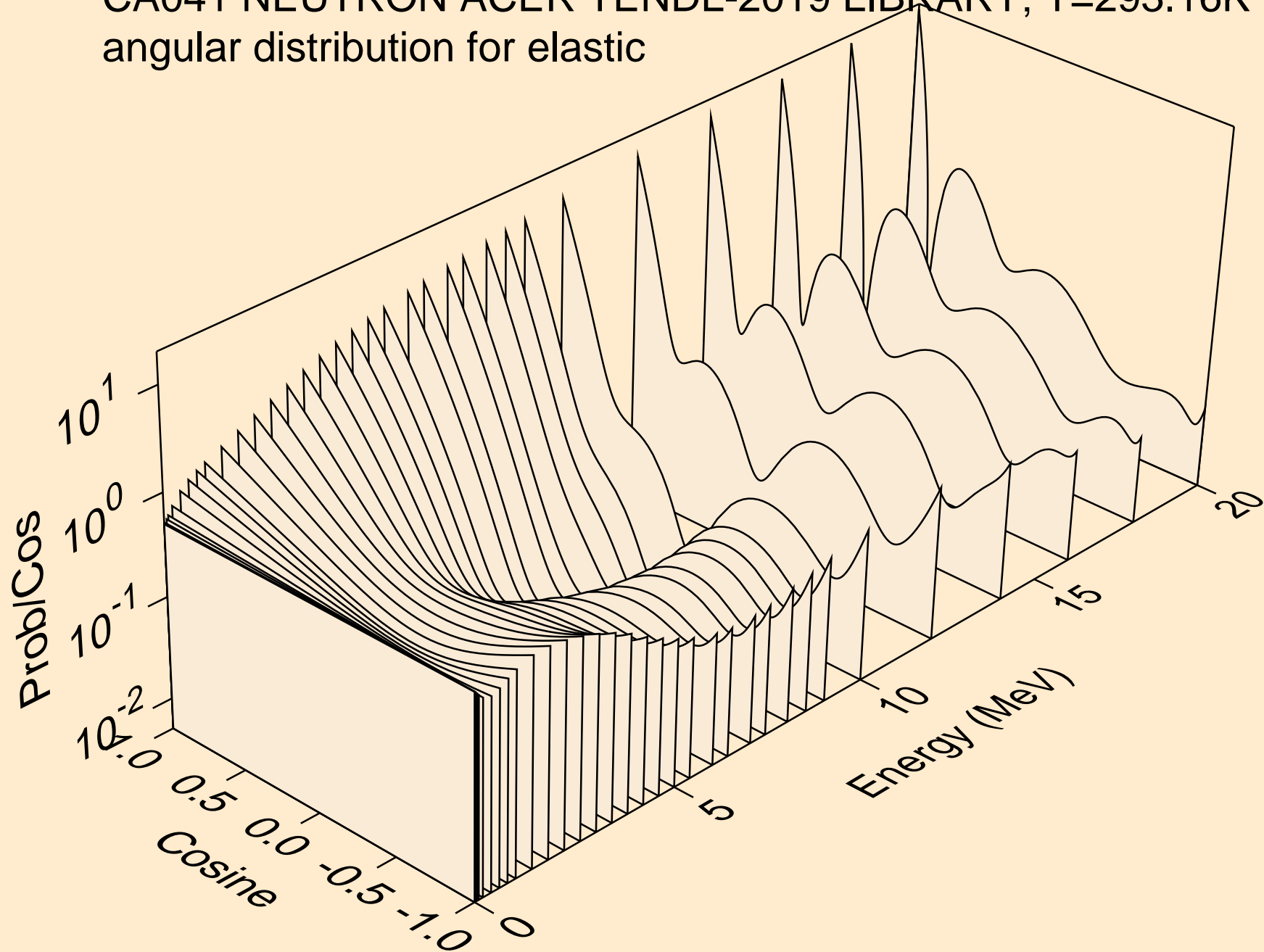

CA041 NEUTRON ACER TENDL-2019 LIBRARY; T=293.16K
angular distribution for elastic

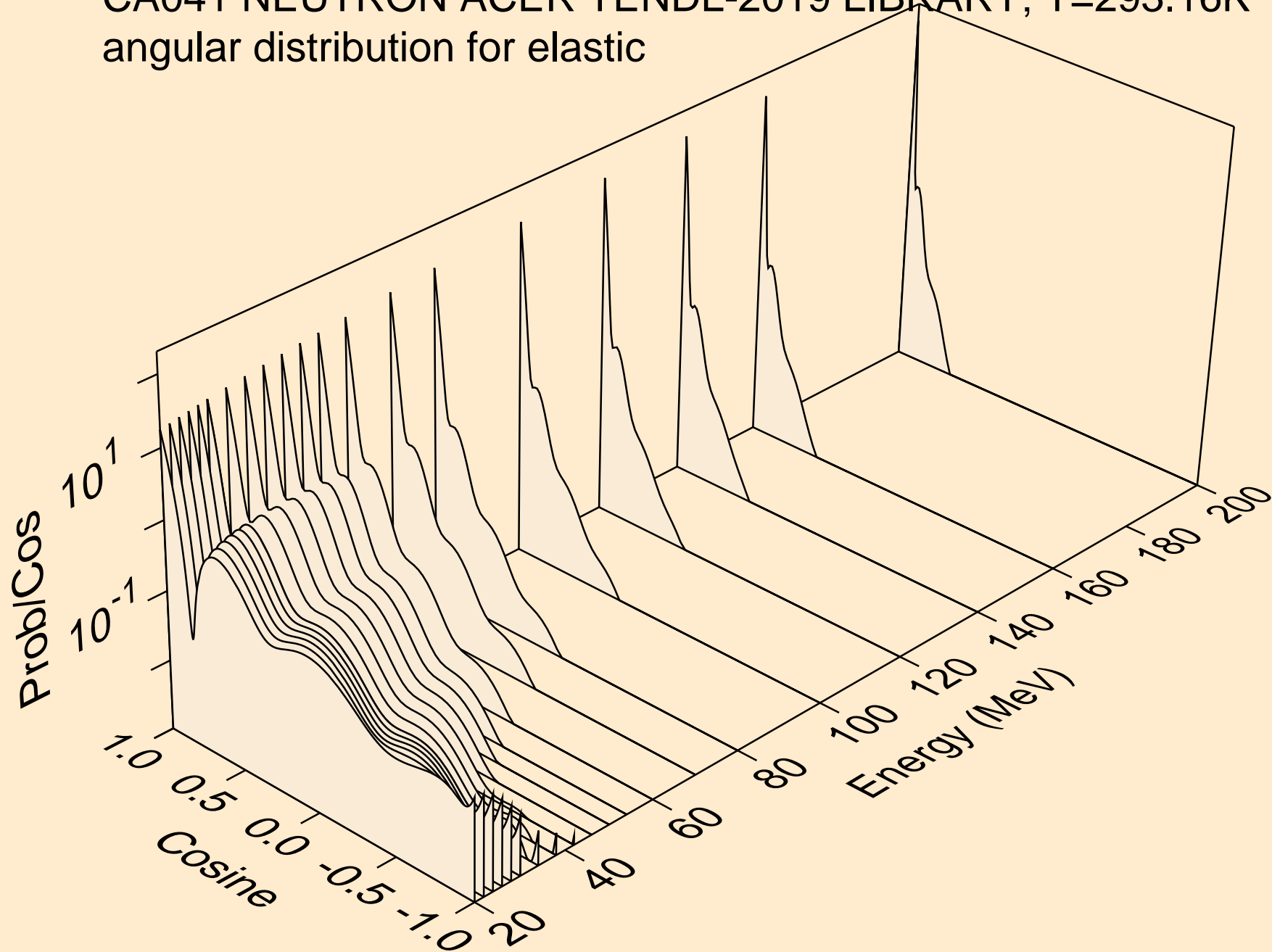

CA041 NEUTRON ACER TENDL-2019 LIBRARY; T=293.16K
angular distribution for (n,n*1)

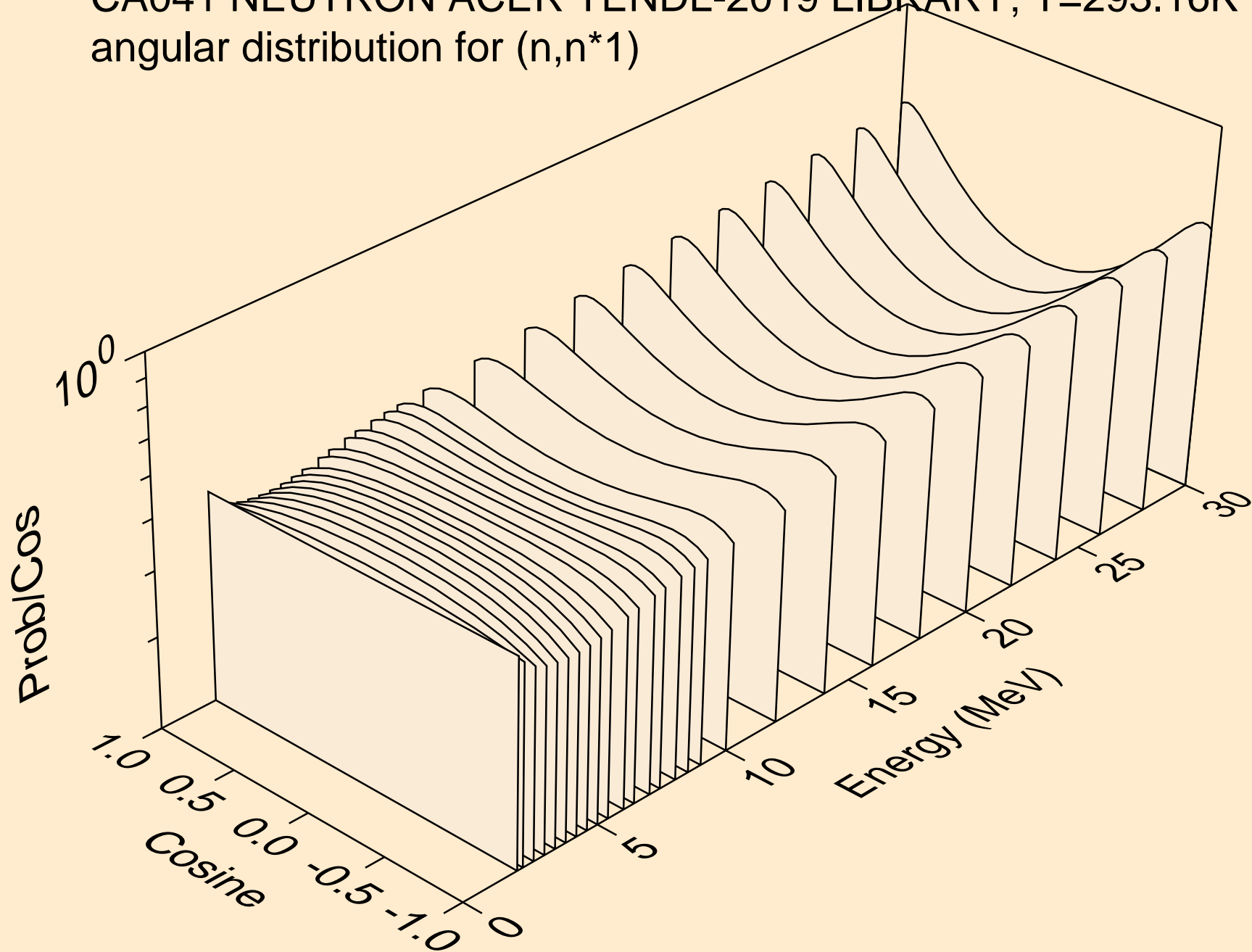

CA041 NEUTRON ACER TENDL-2019 LIBRARY; T=293.16K
angular distribution for (n,n*2)

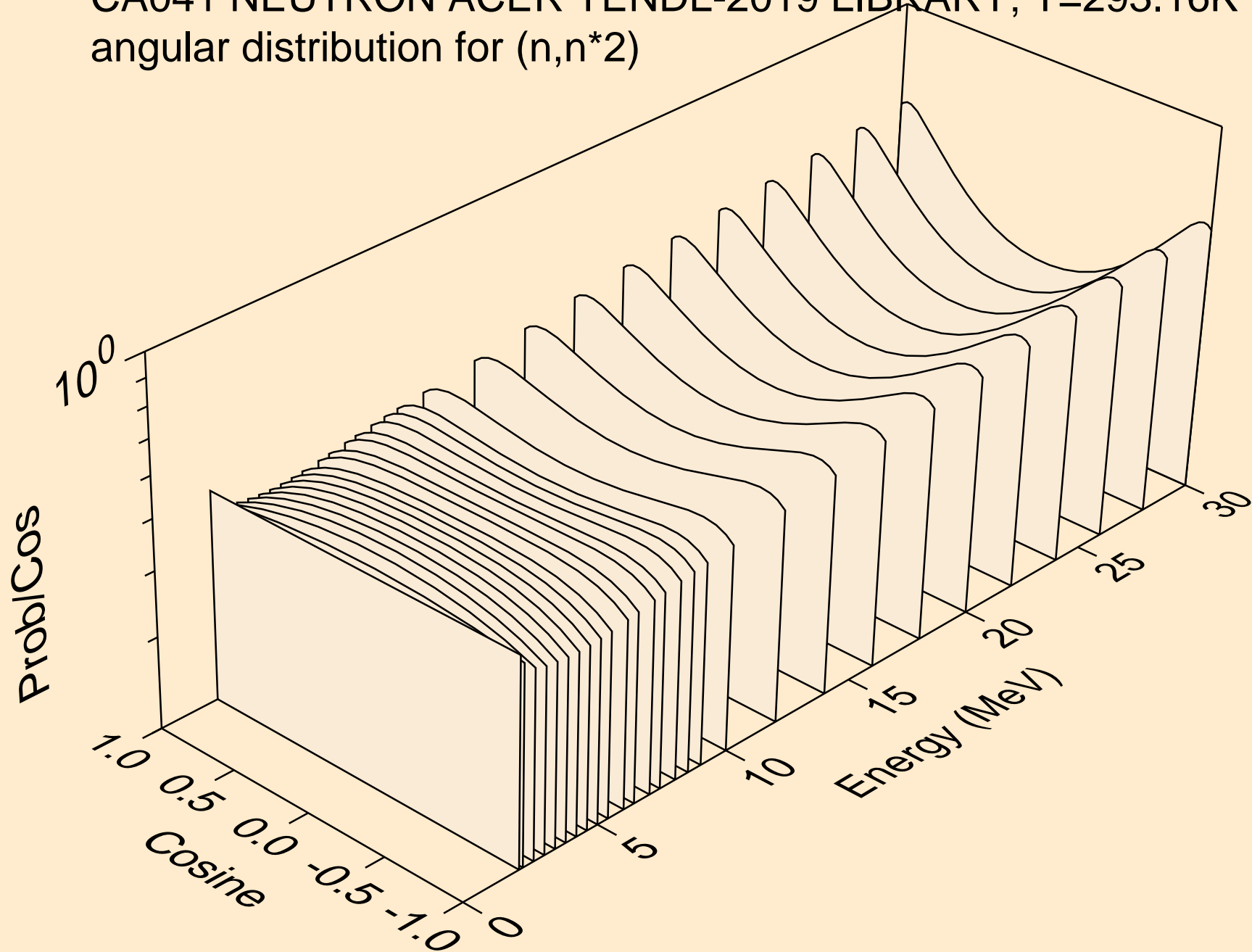

CA041 NEUTRON ACER TENDL-2019 LIBRARY; T=293.16K
angular distribution for (n,n*3)

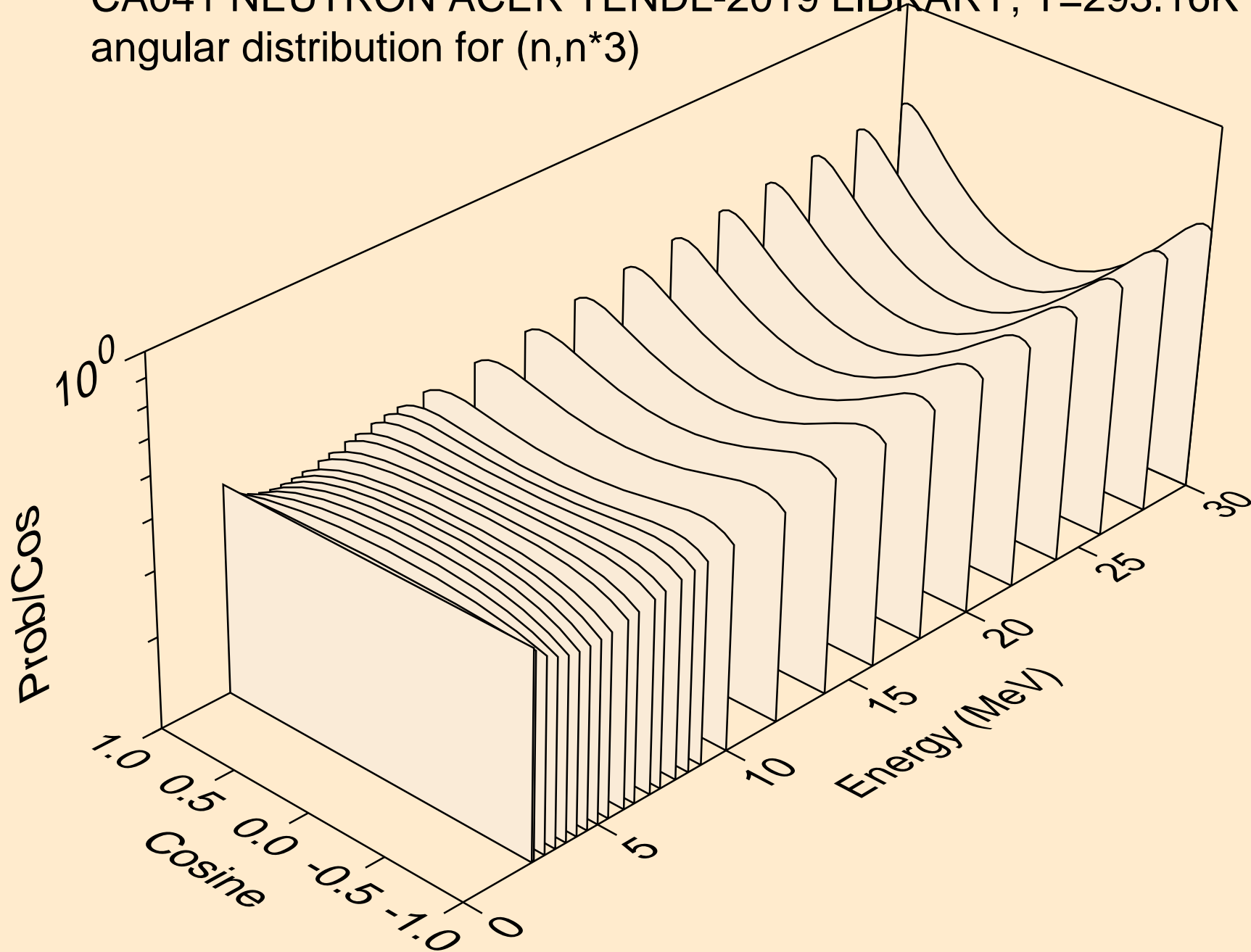

CA041 NEUTRON ACER TENDL-2019 LIBRARY; T=293.16K
angular distribution for (n,n*4)

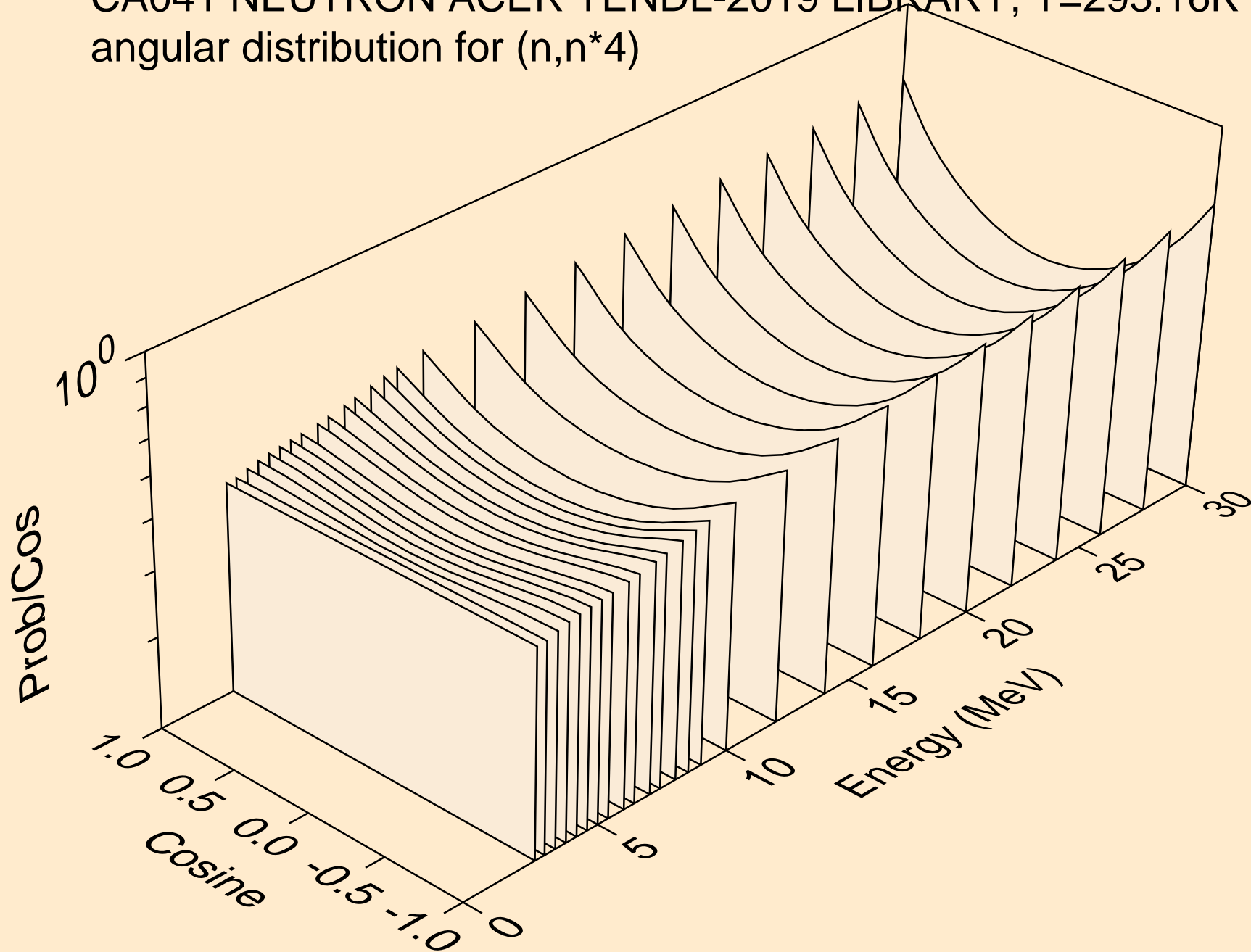

CA041 NEUTRON ACER TENDL-2019 LIBRARY; T=293.16K
angular distribution for (n,n*5)

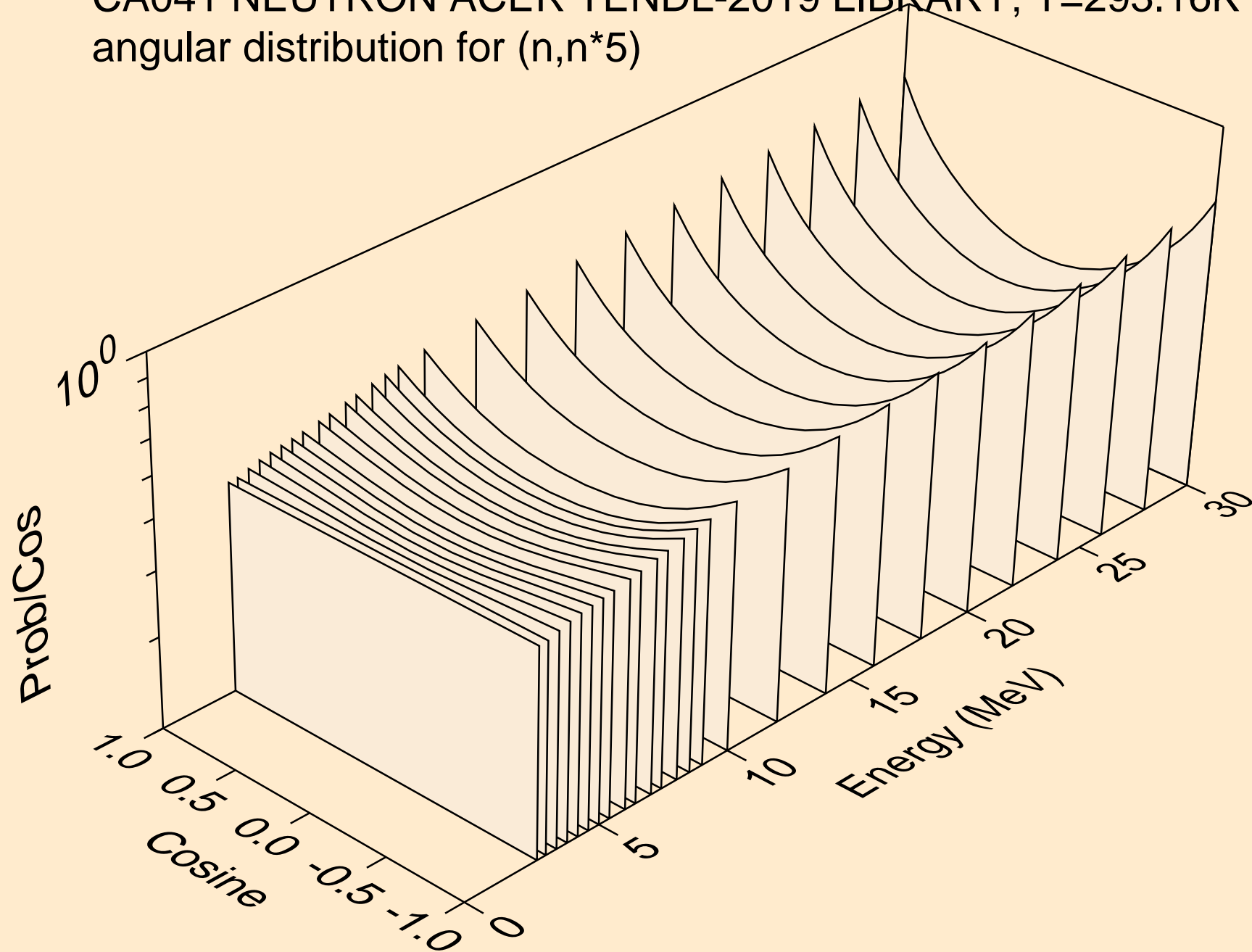

CA041 NEUTRON ACER TENDL-2019 LIBRARY; T=293.16K
angular distribution for (n,n*6)

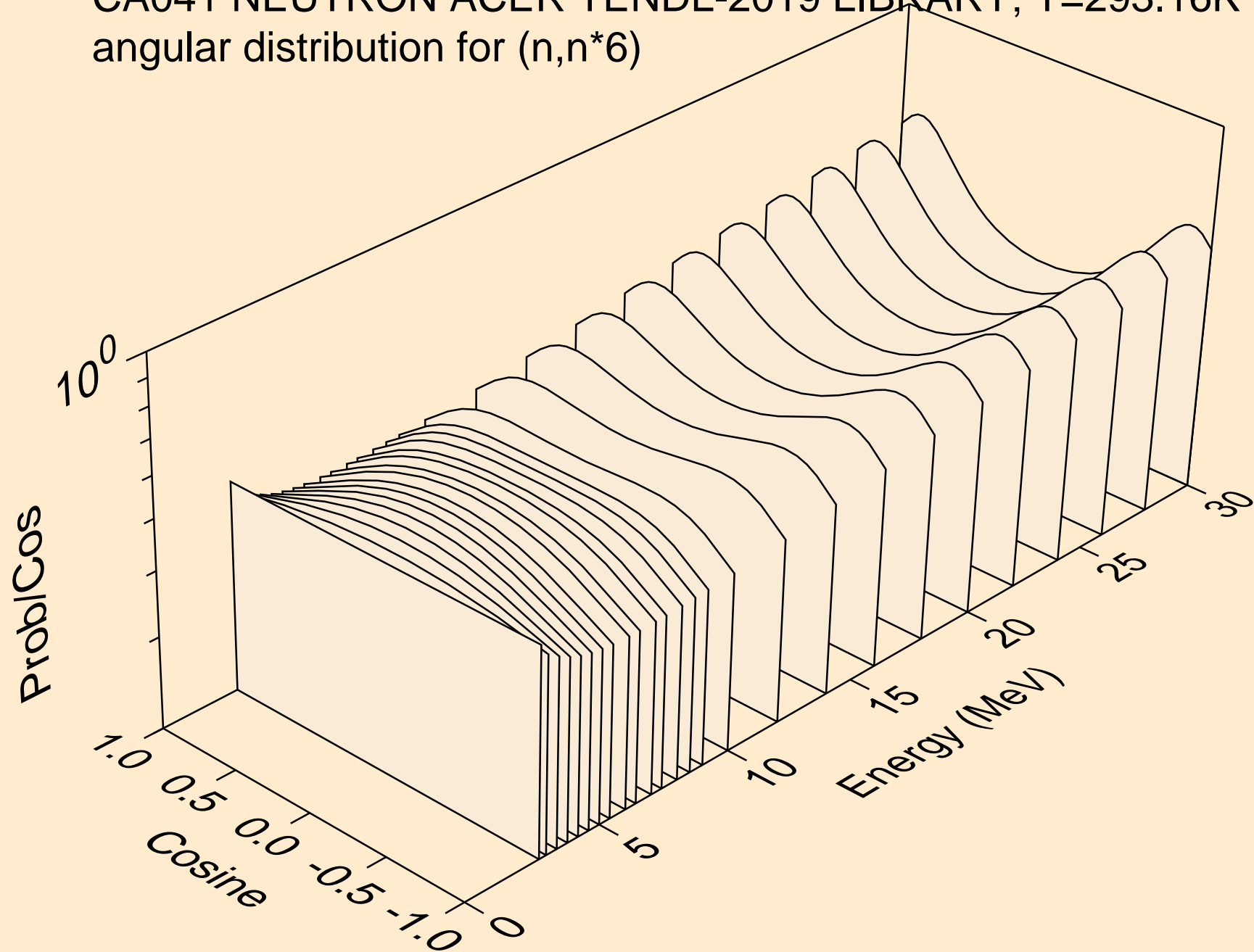

CA041 NEUTRON ACER TENDL-2019 LIBRARY; T=293.16K
angular distribution for (n,n*7)

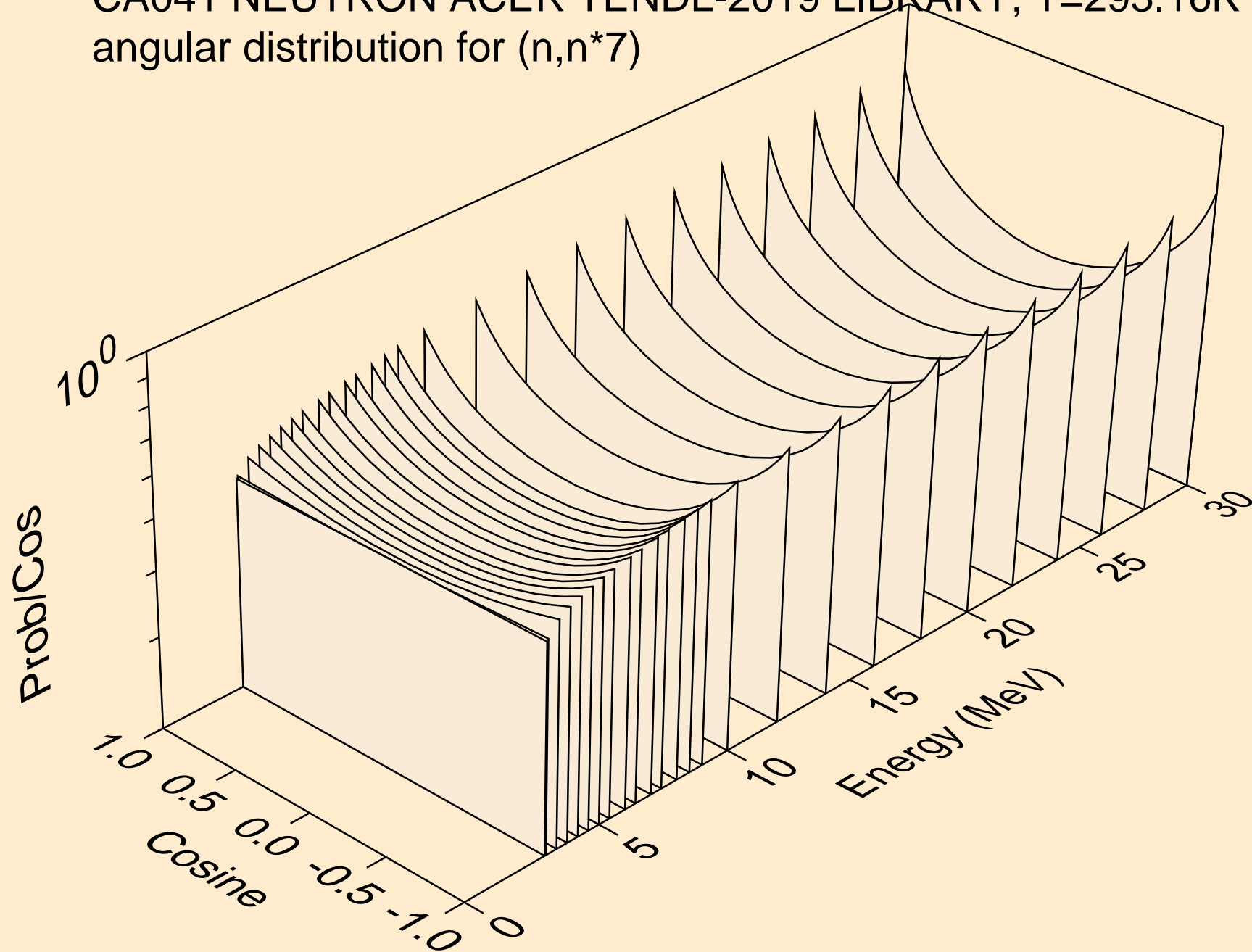

CA041 NEUTRON ACER TENDL-2019 LIBRARY; T=293.16K
angular distribution for (n,n*8)

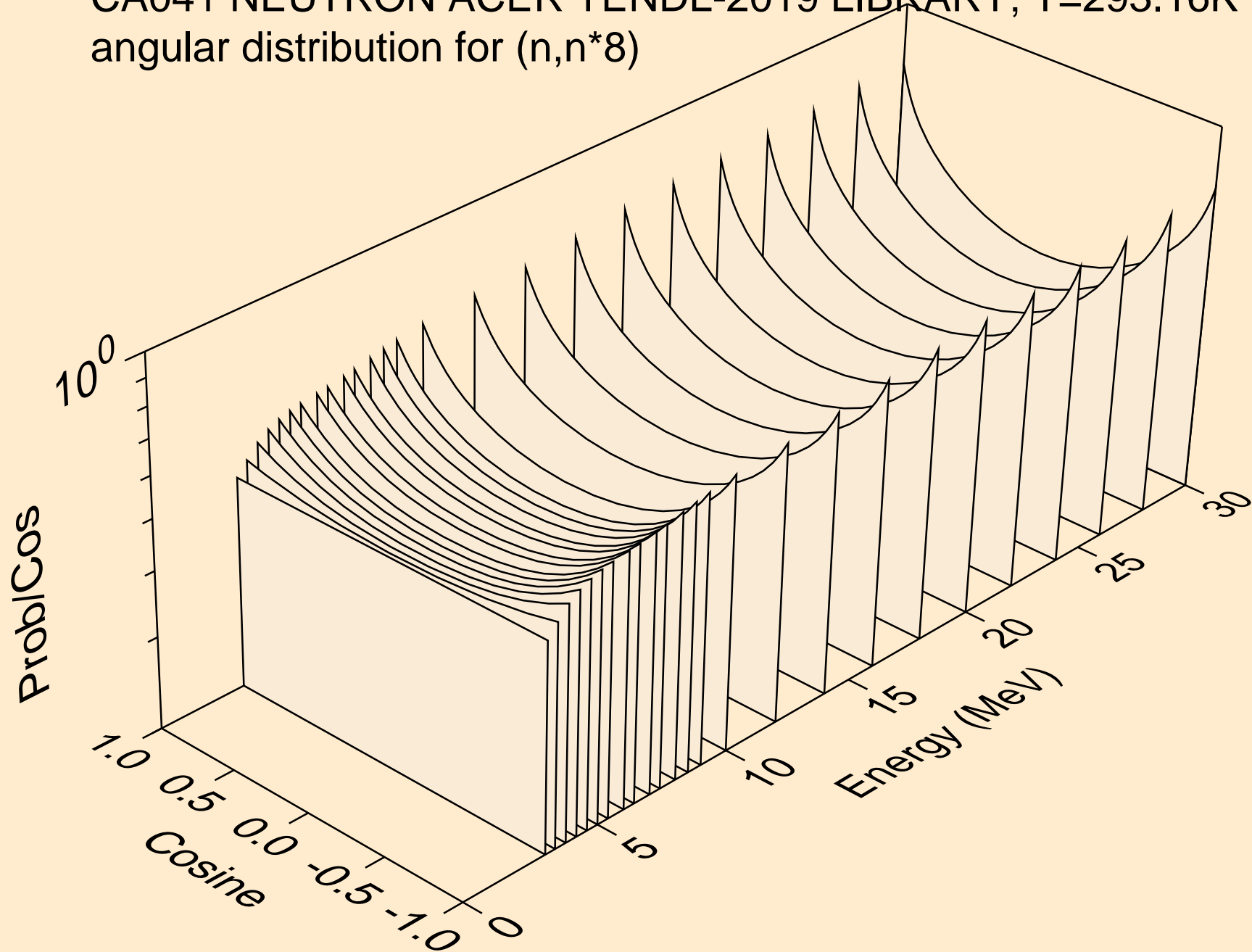

CA041 NEUTRON ACER TENDL-2019 LIBRARY; T=293.16K
angular distribution for (n,n*9)

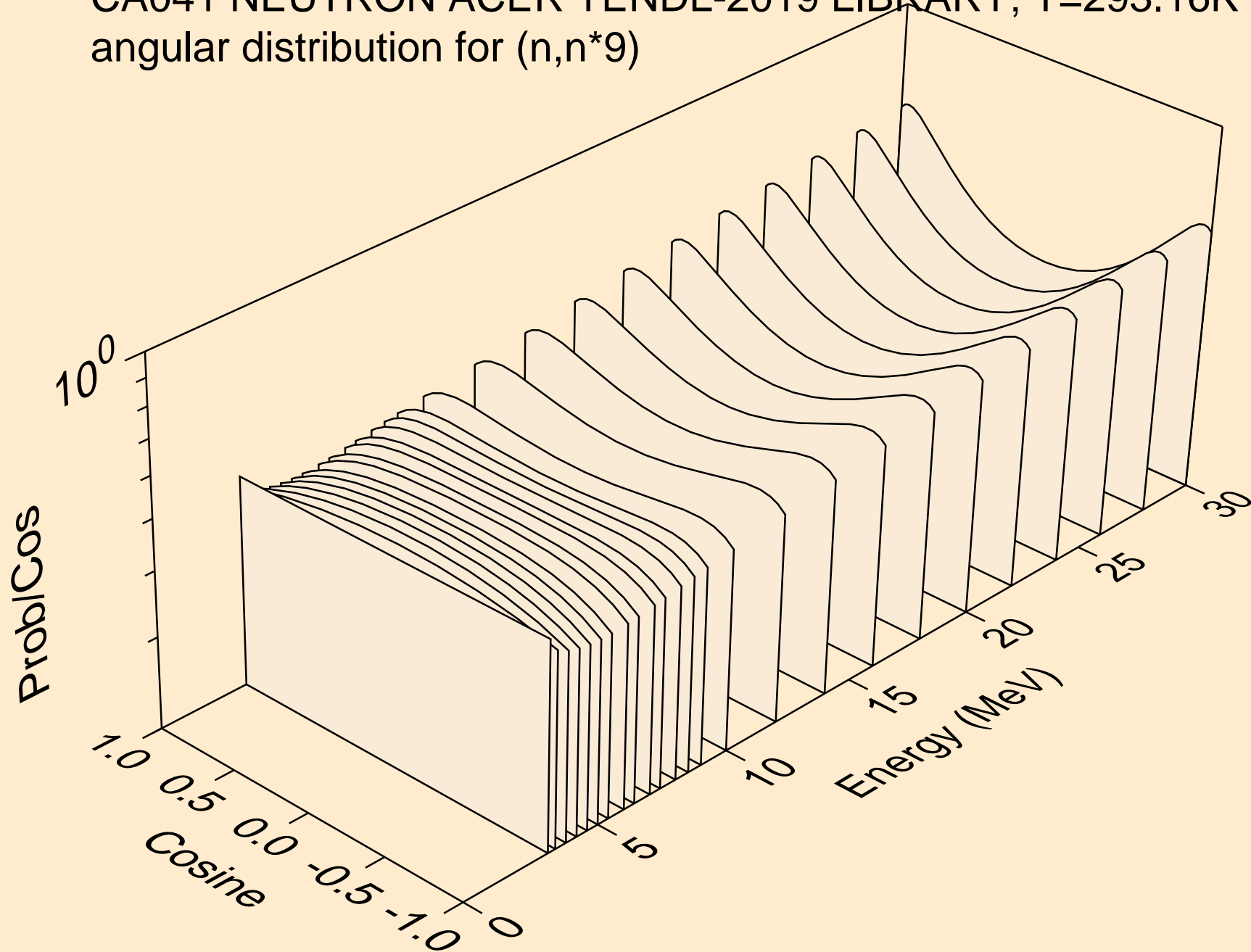

CA041 NEUTRON ACER TENDL-2019 LIBRARY; T=293.16K
angular distribution for (n,n*10)

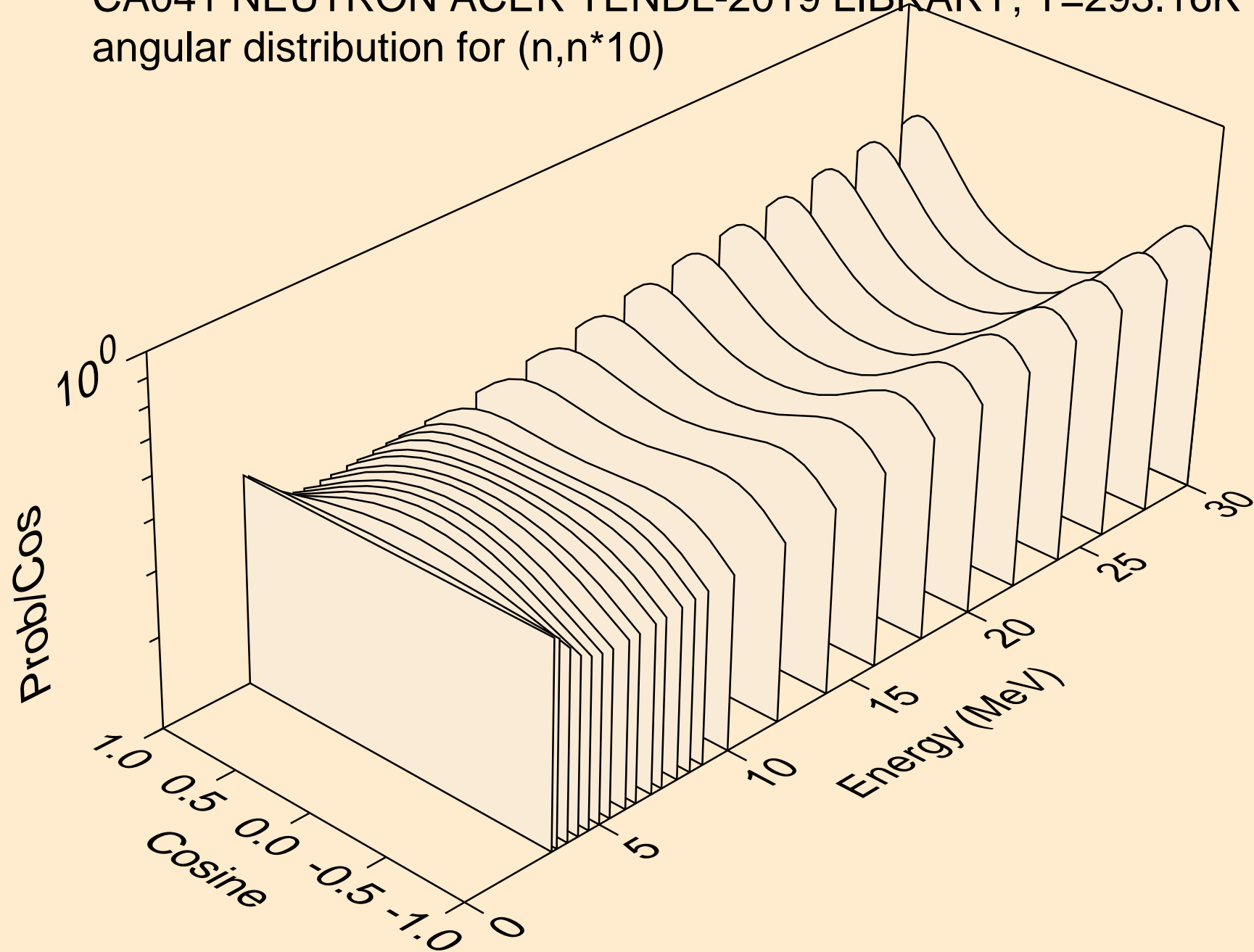

CA041 NEUTRON ACER TENDL-2019 LIBRARY; T=293.16K
angular distribution for (n,n*11)

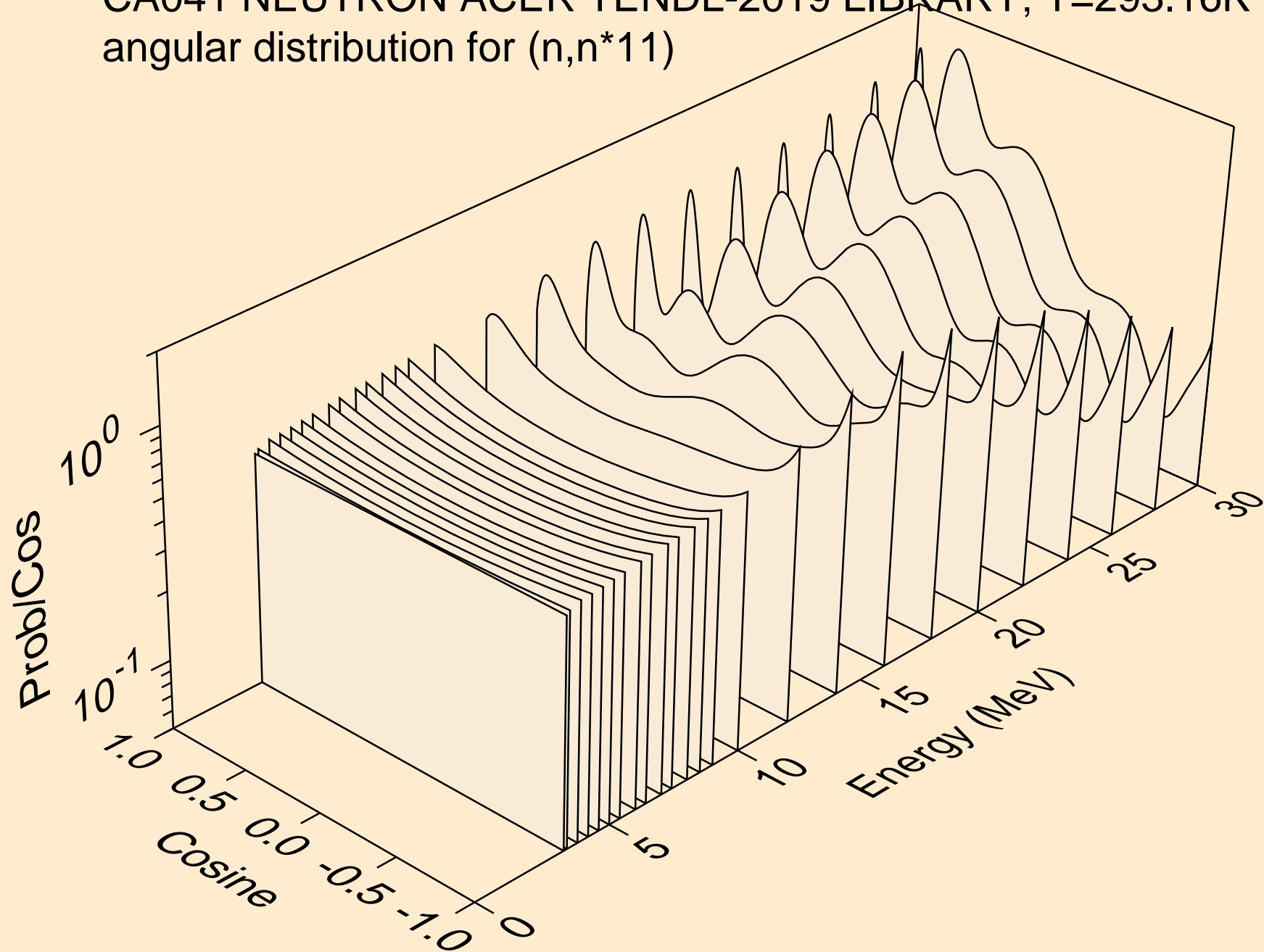

CA041 NEUTRON ACER TENDL-2019 LIBRARY; T=293.16K
angular distribution for (n,n*12)

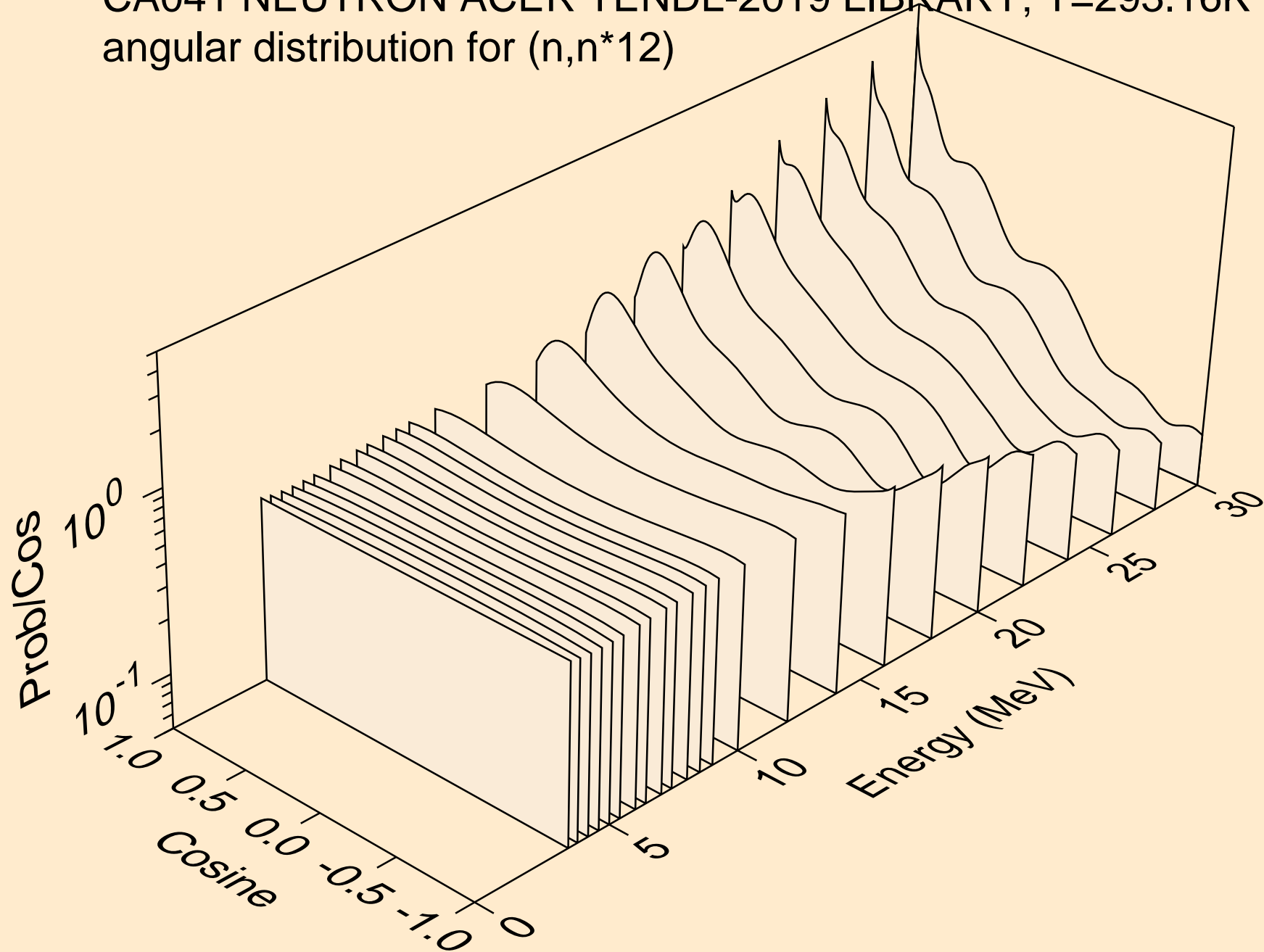

CA041 NEUTRON ACER TENDL-2019 LIBRARY; T=293.16K
angular distribution for (n,n*13)

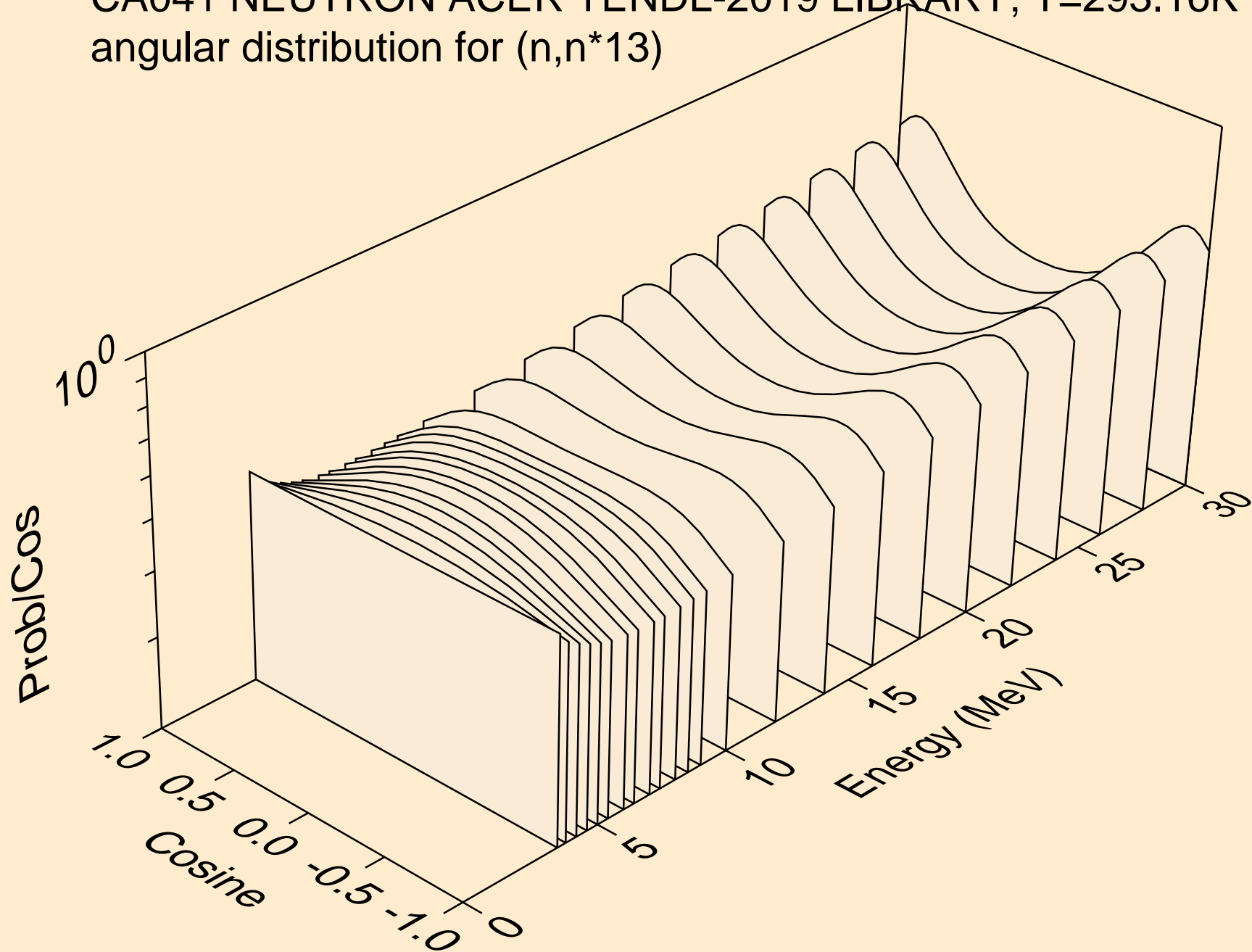

CA041 NEUTRON ACER TENDL-2019 LIBRARY; T=293.16K
angular distribution for (n,n*14)

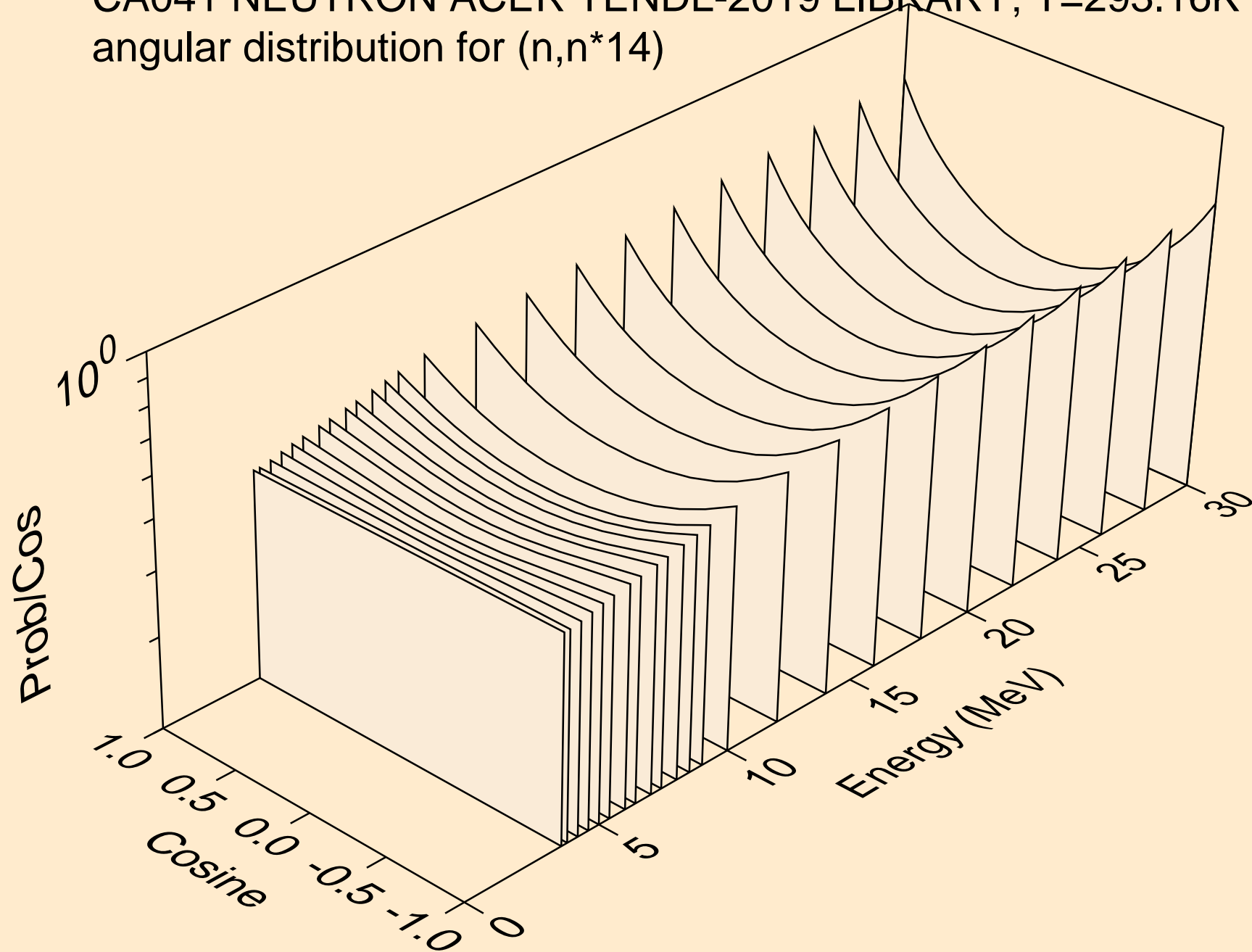

CA041 NEUTRON ACER TENDL-2019 LIBRARY; T=293.16K
angular distribution for (n,n*15)

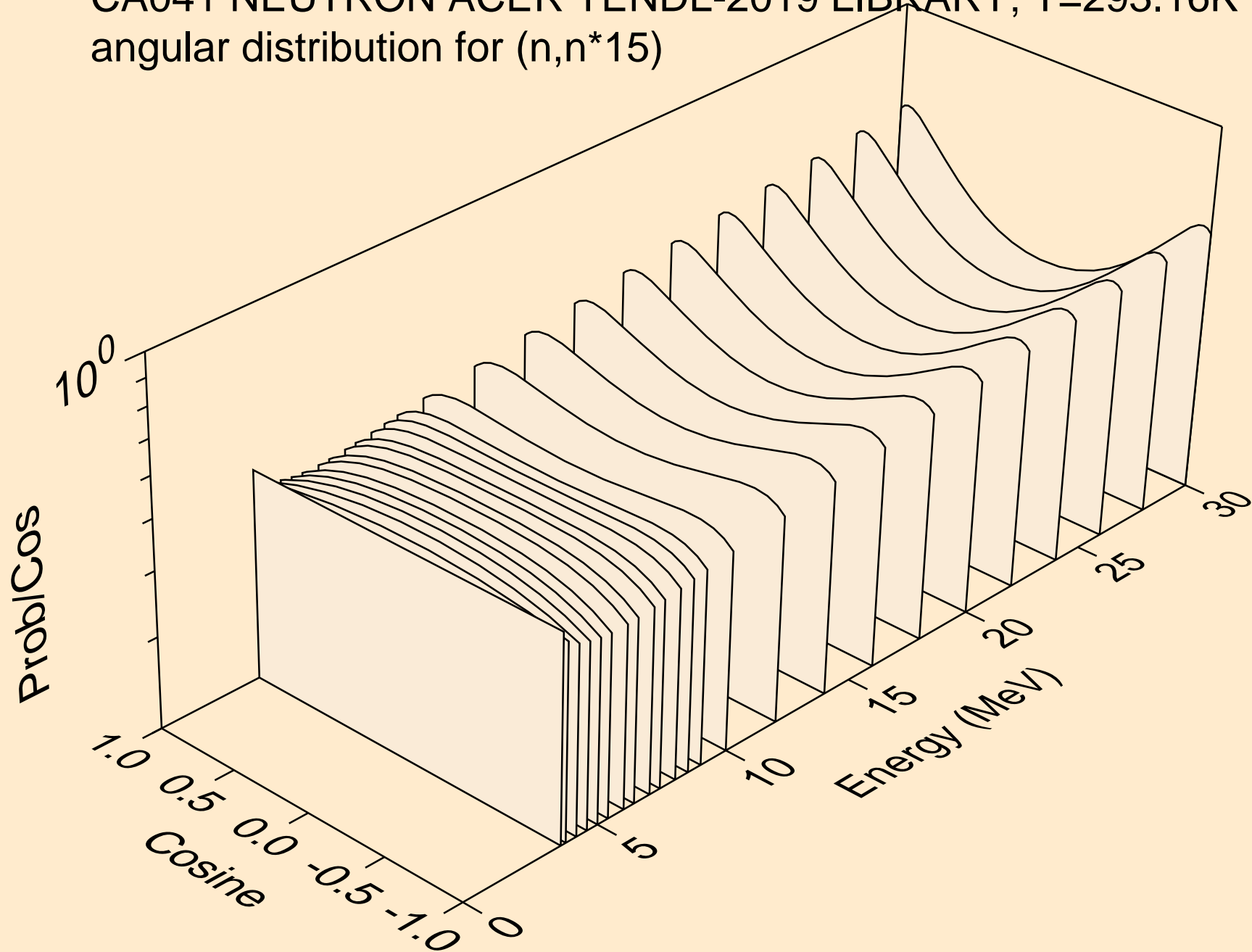

CA041 NEUTRON ACER TENDL-2019 LIBRARY; T=293.16K
angular distribution for (n,n*16)

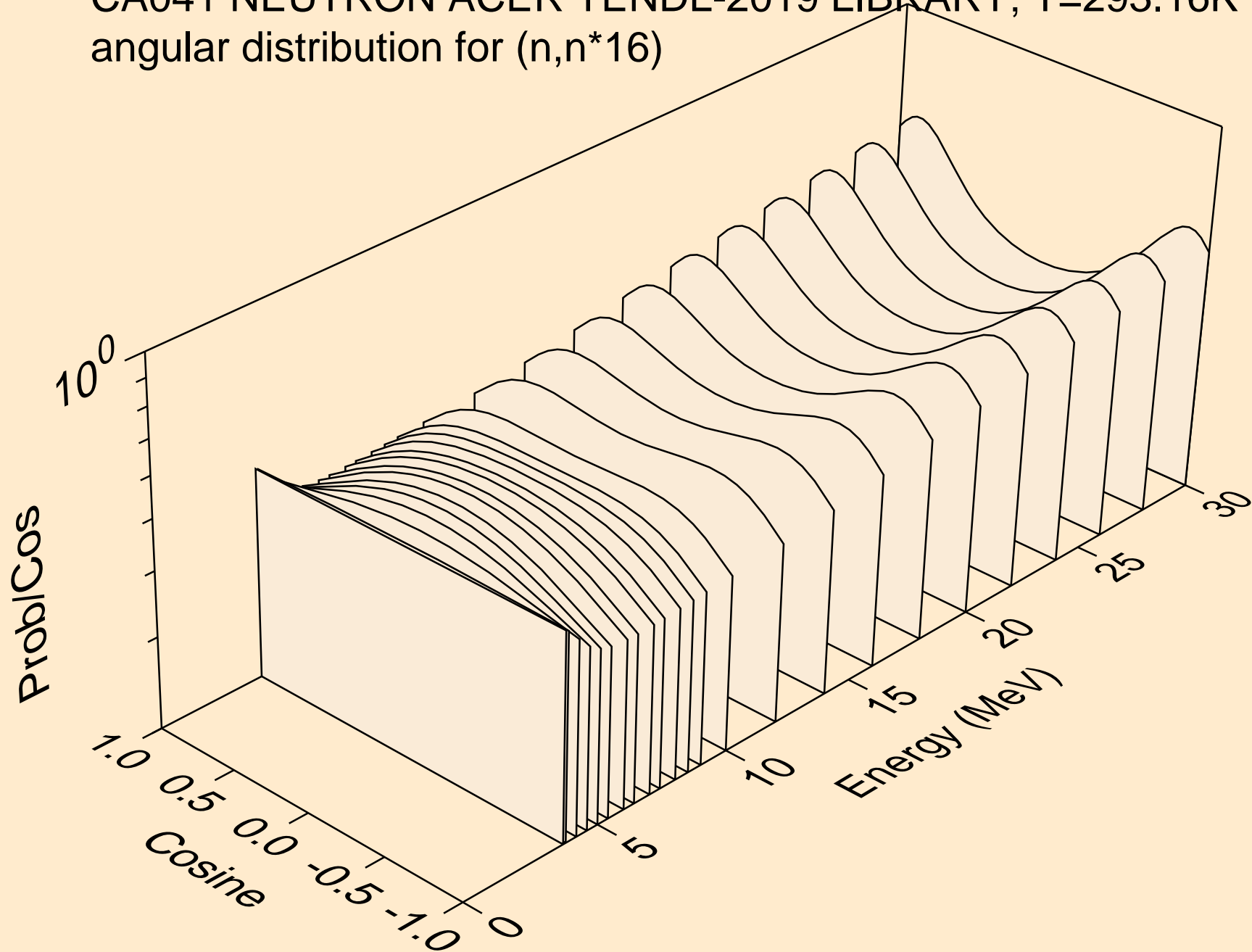

CA041 NEUTRON ACER TENDL-2019 LIBRARY; T=293.16K
angular distribution for (n,n*17)

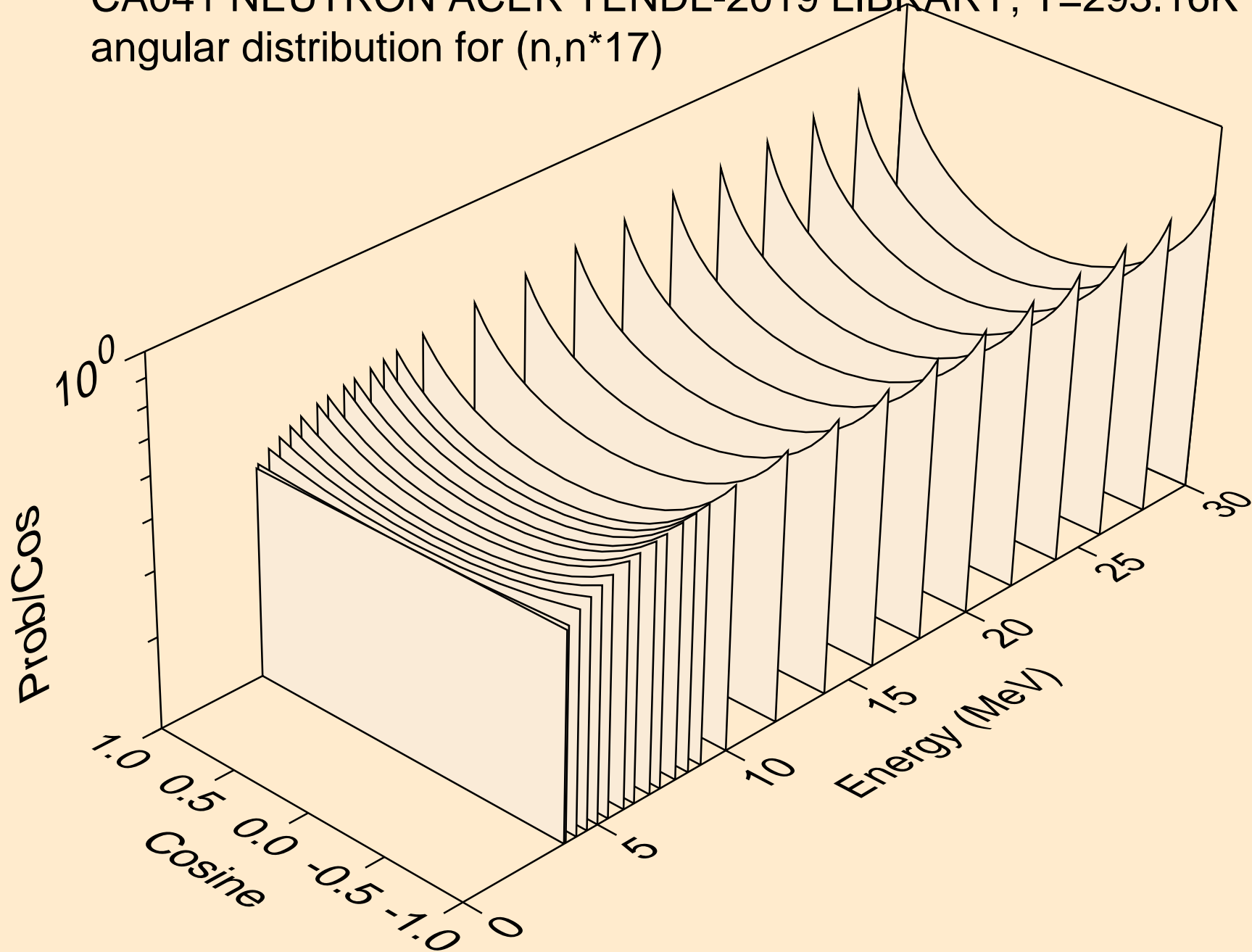

CA041 NEUTRON ACER TENDL-2019 LIBRARY; T=293.16K
angular distribution for (n,n*18)

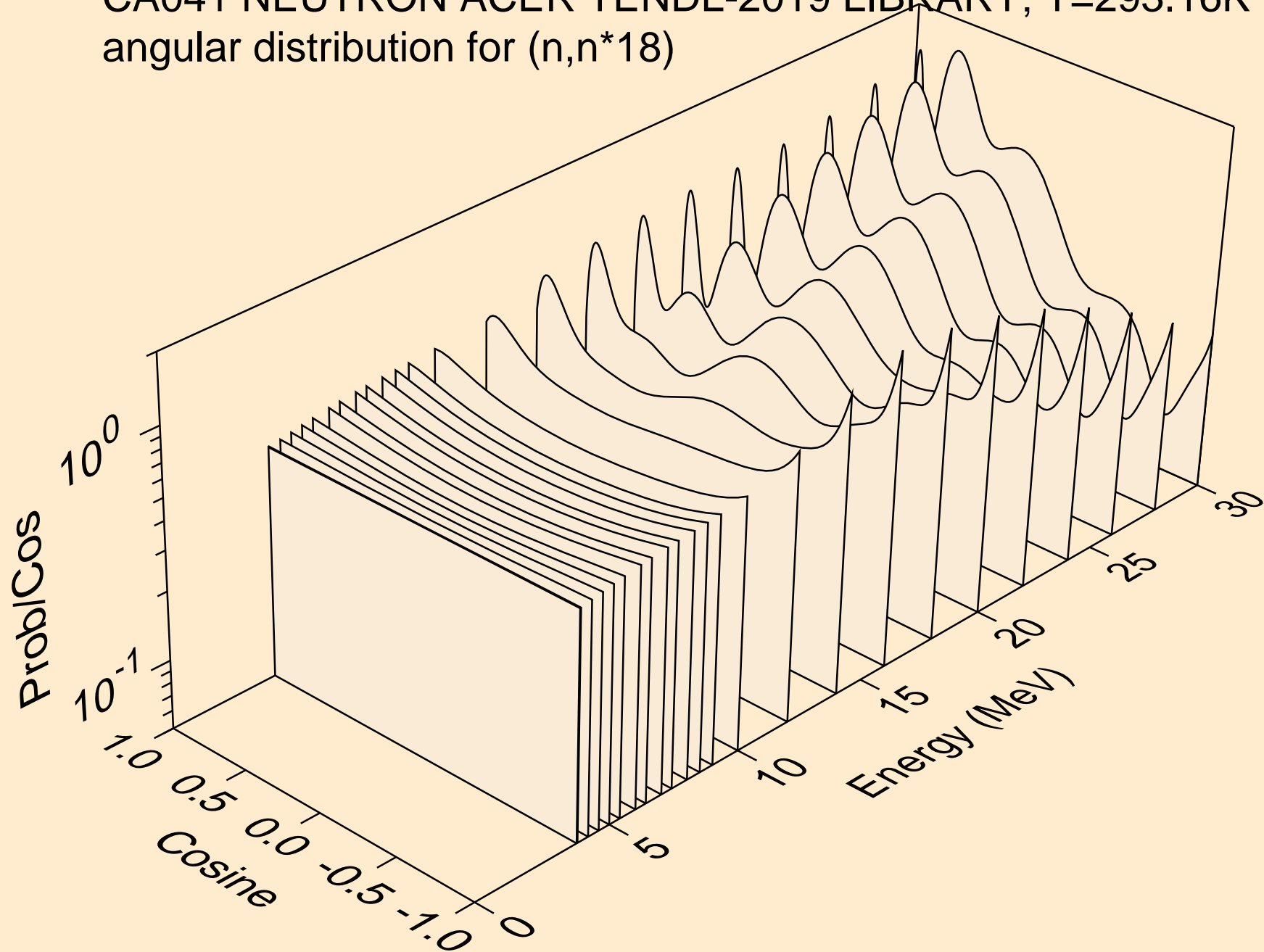

CA041 NEUTRON ACER TENDL-2019 LIBRARY; T=293.16K
angular distribution for (n,n*19)

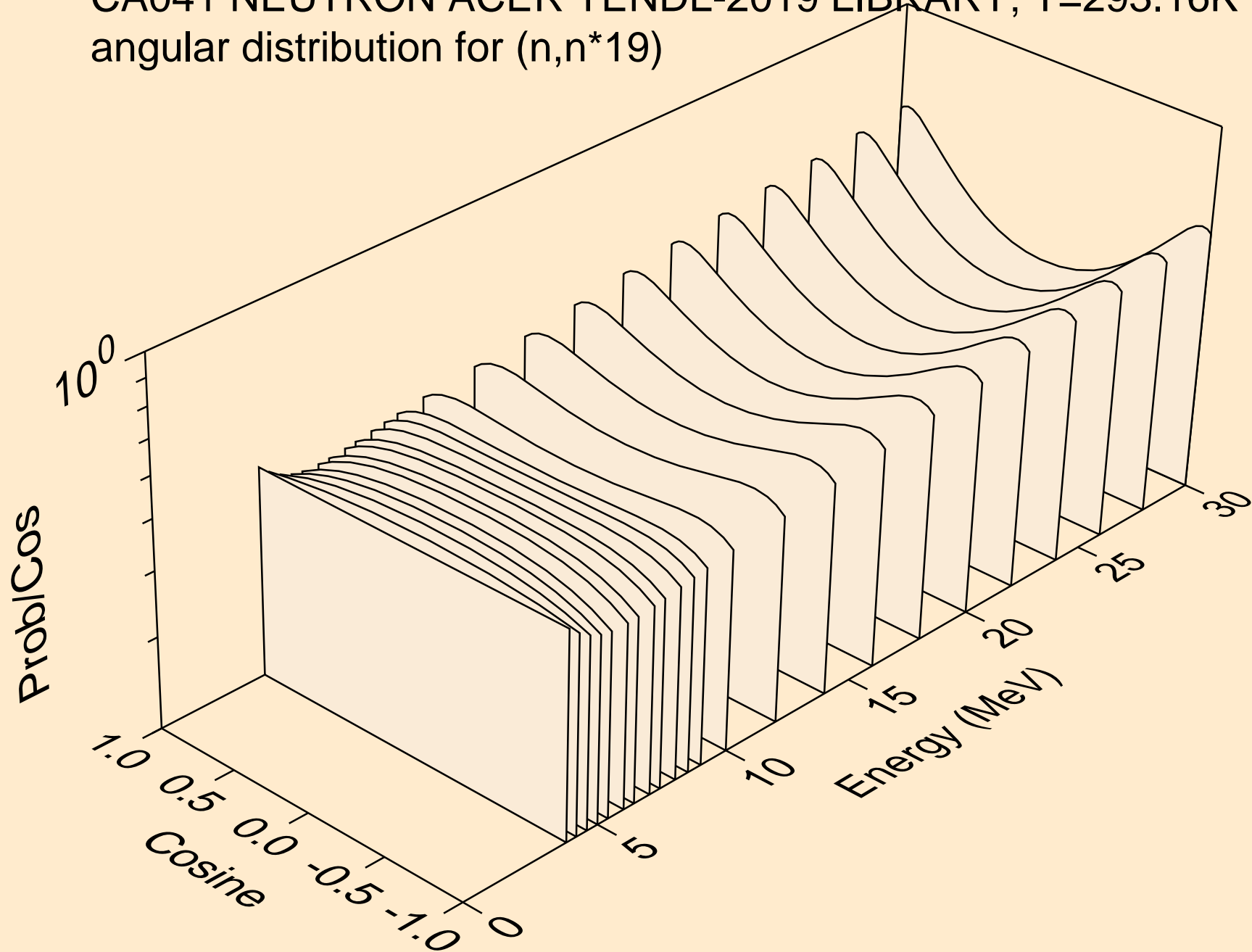

CA041 NEUTRON ACER TENDL-2019 LIBRARY; T=293.16K
angular distribution for (n,n*20)

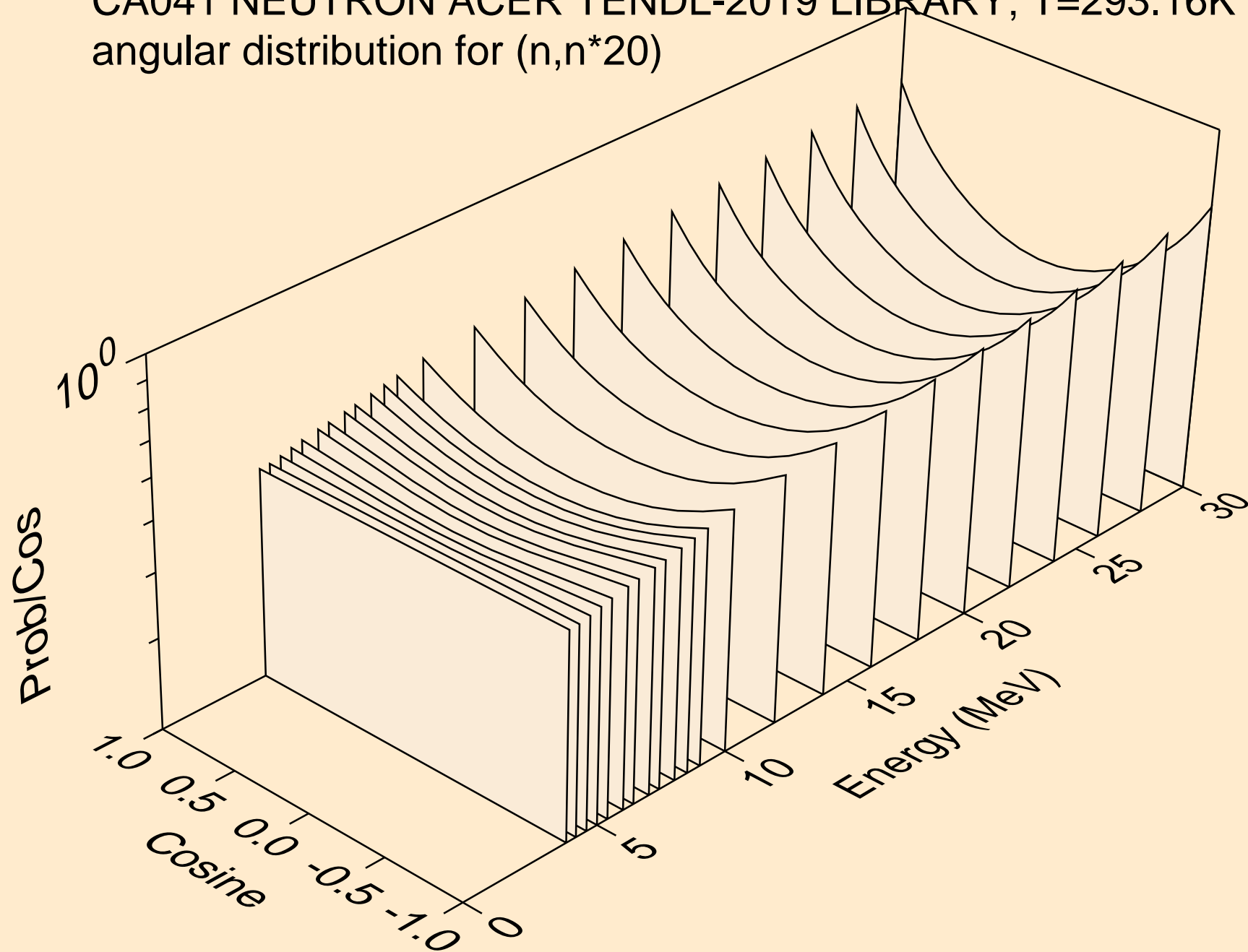

CA041 NEUTRON ACER TENDL-2019 LIBRARY; T=293.16K
angular distribution for (n,n*21)

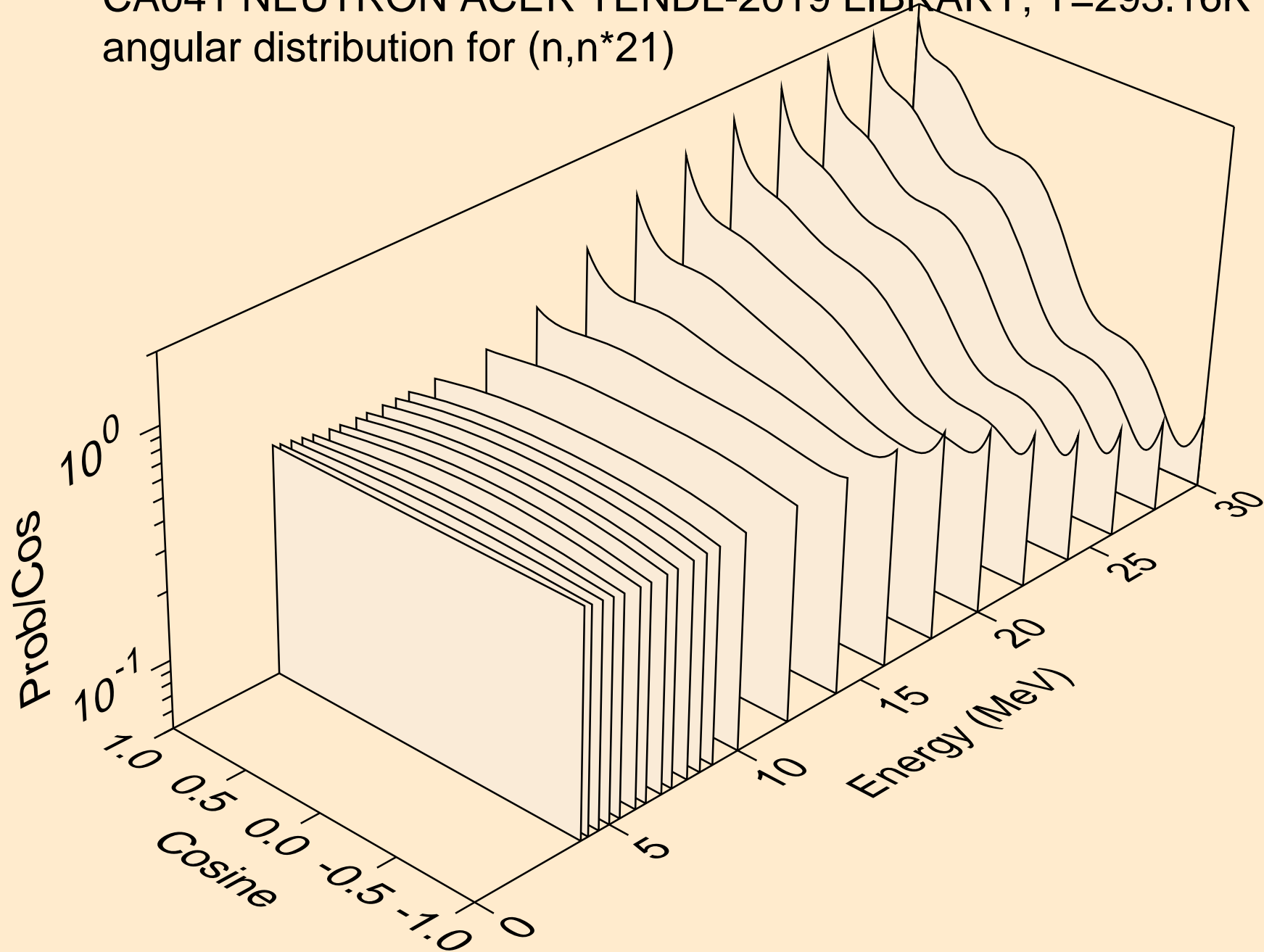

CA041 NEUTRON ACER TENDL-2019 LIBRARY; T=293.16K
angular distribution for (n,n*22)

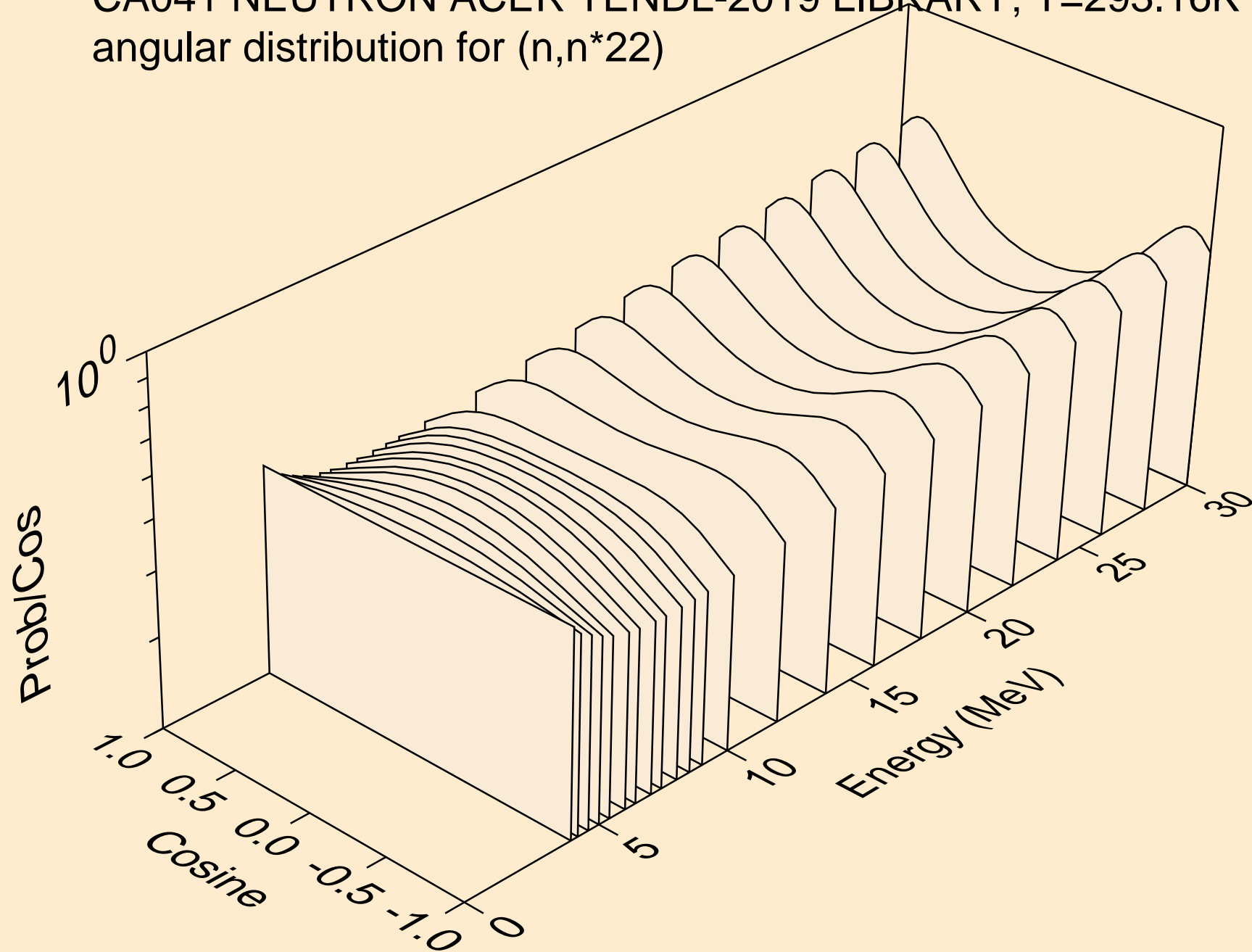

CA041 NEUTRON ACER TENDL-2019 LIBRARY; T=293.16K
angular distribution for (n,n*23)

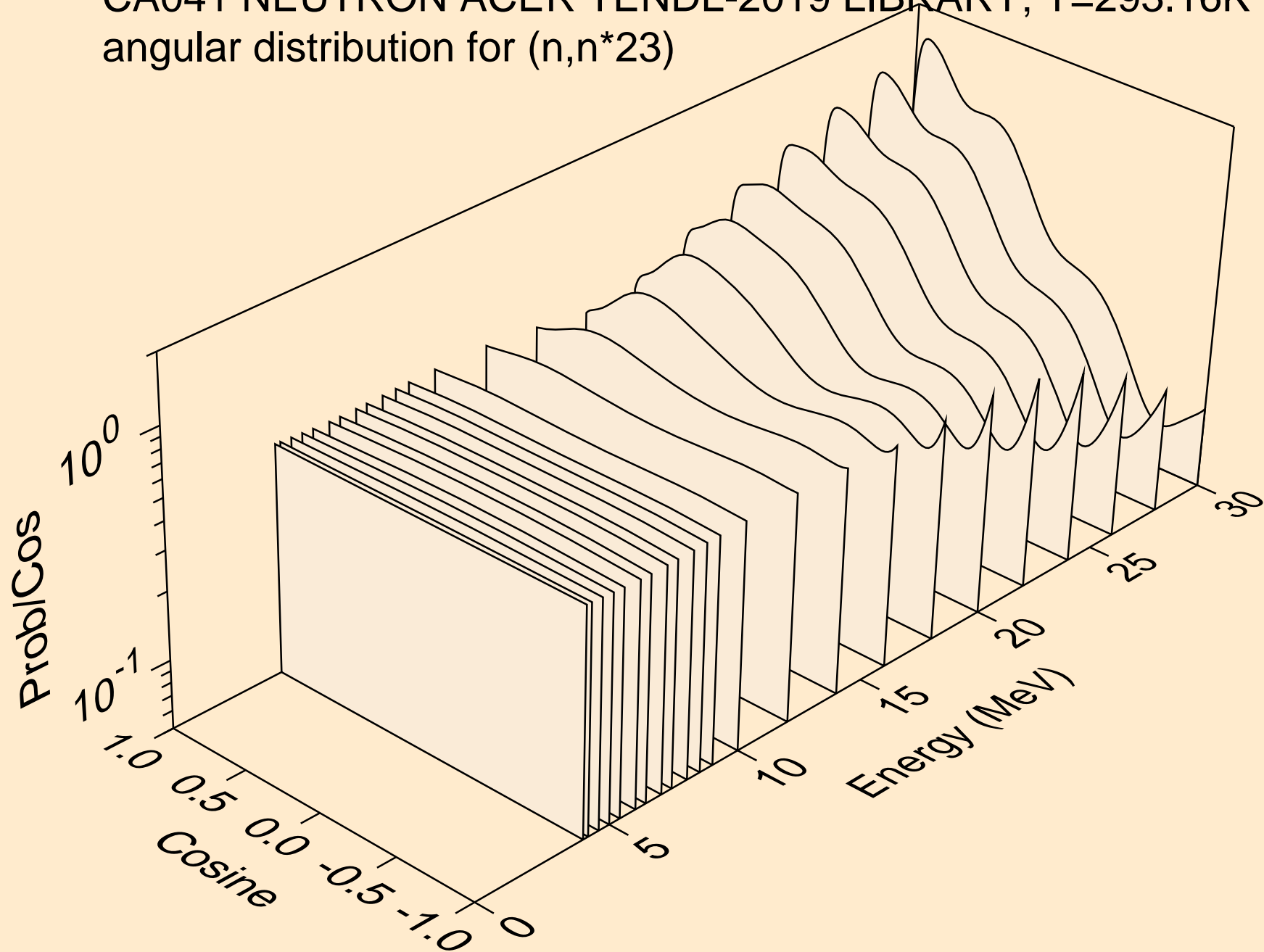

CA041 NEUTRON ACER TENDL-2019 LIBRARY; T=293.16K
angular distribution for (n,n*24)

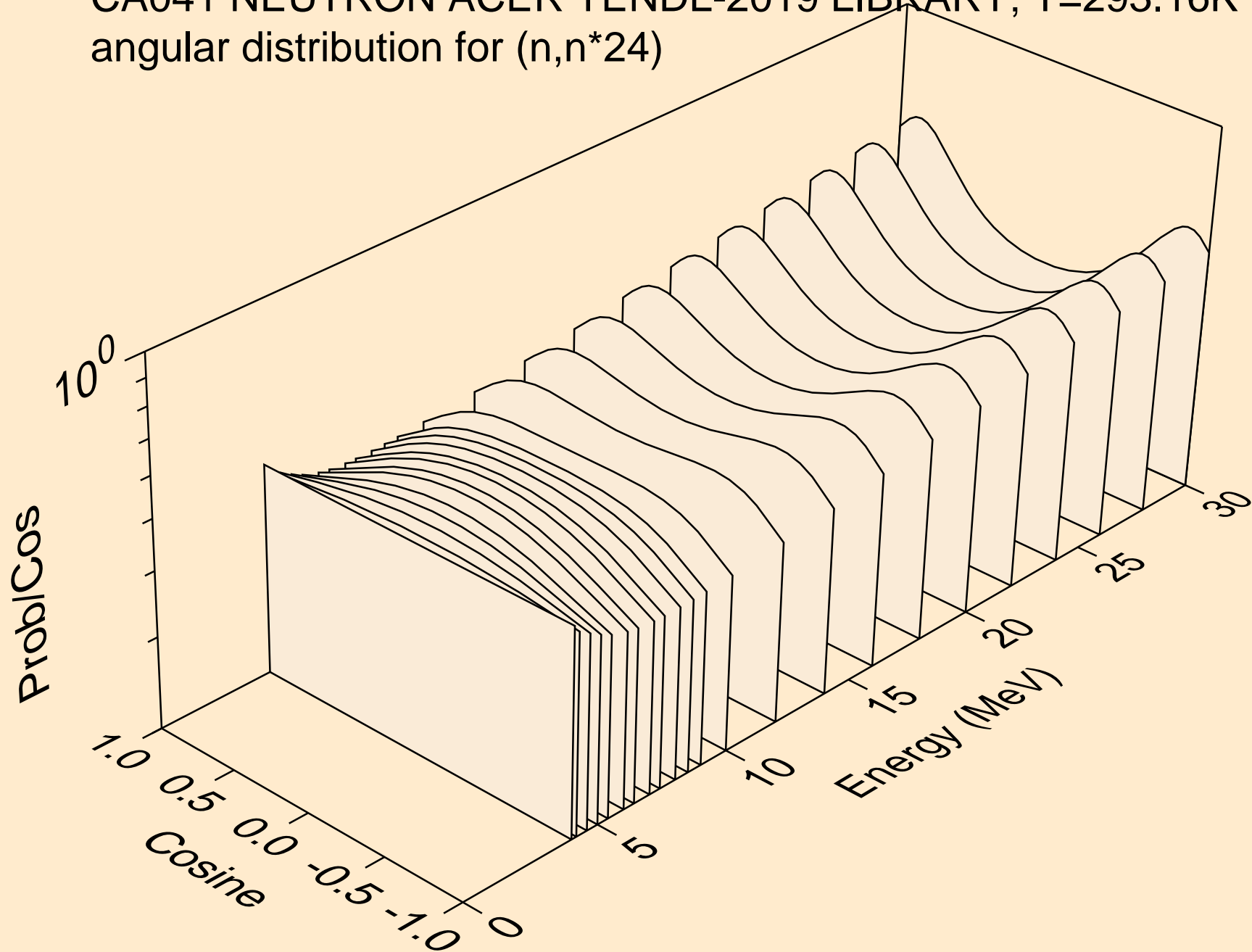

CA041 NEUTRON ACER TENDL-2019 LIBRARY; T=293.16K
angular distribution for (n,n*25)

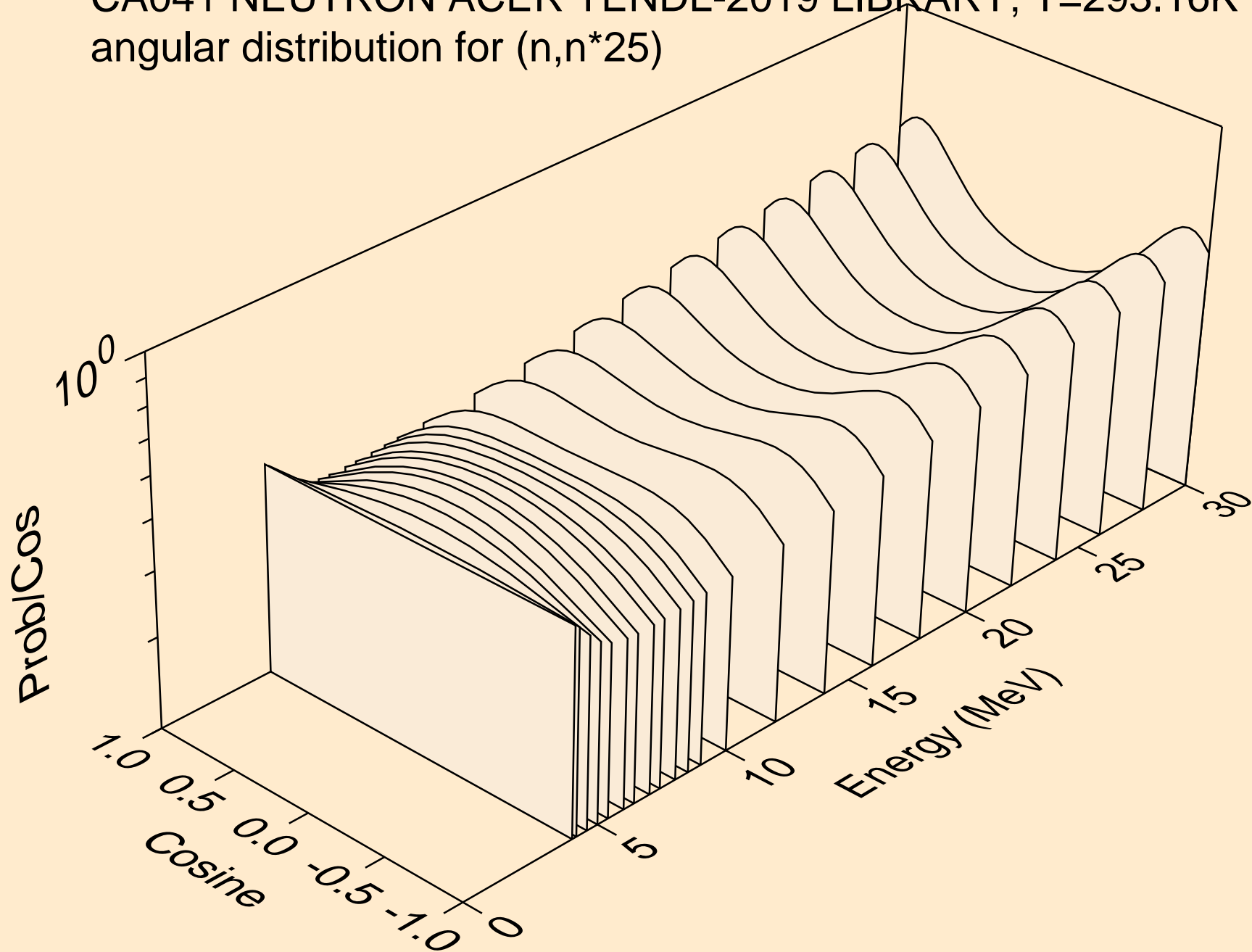

CA041 NEUTRON ACER TENDL-2019 LIBRARY; T=293.16K
angular distribution for (n,n*26)

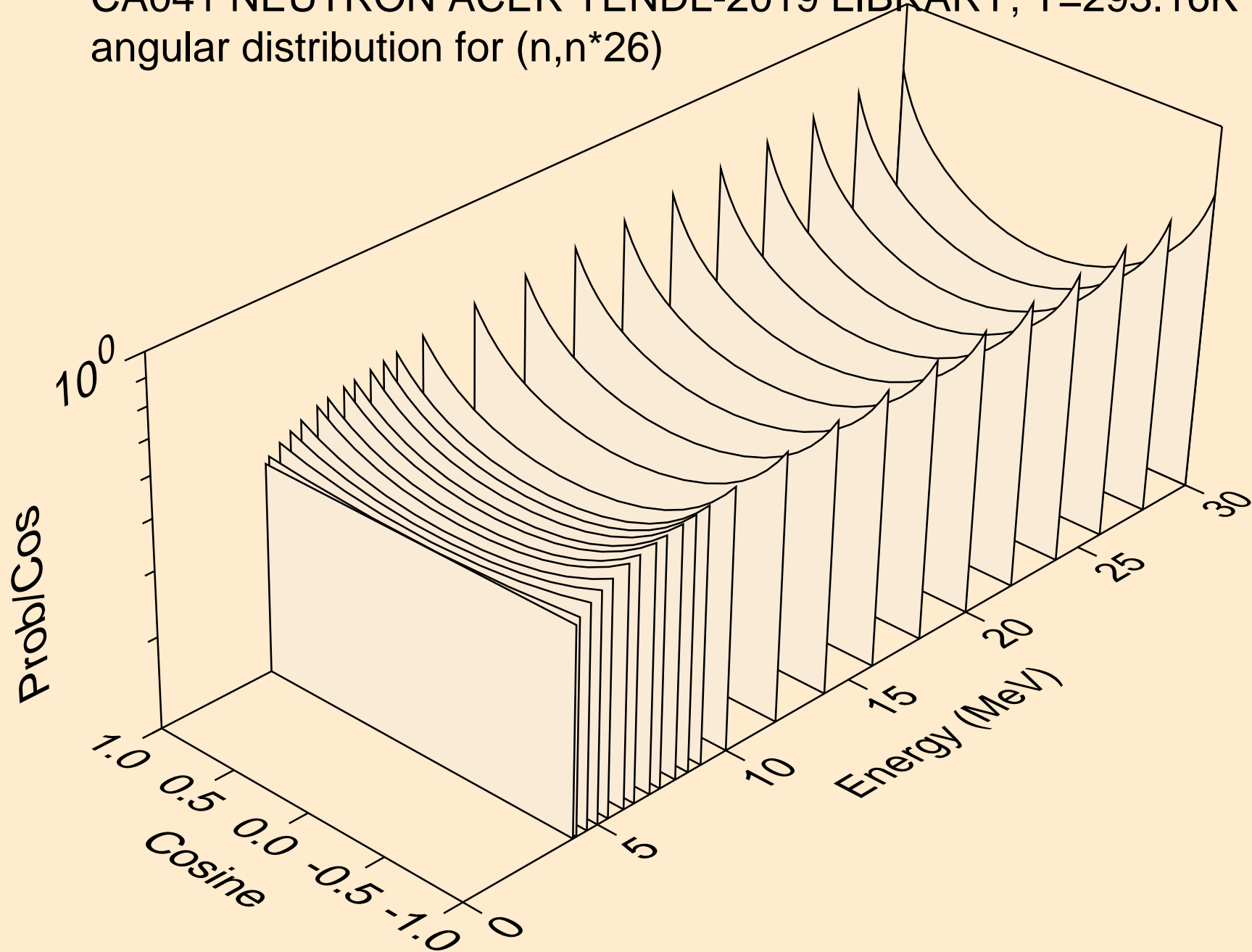

CA041 NEUTRON ACER TENDL-2019 LIBRARY; T=293.16K
angular distribution for (n,n*27)

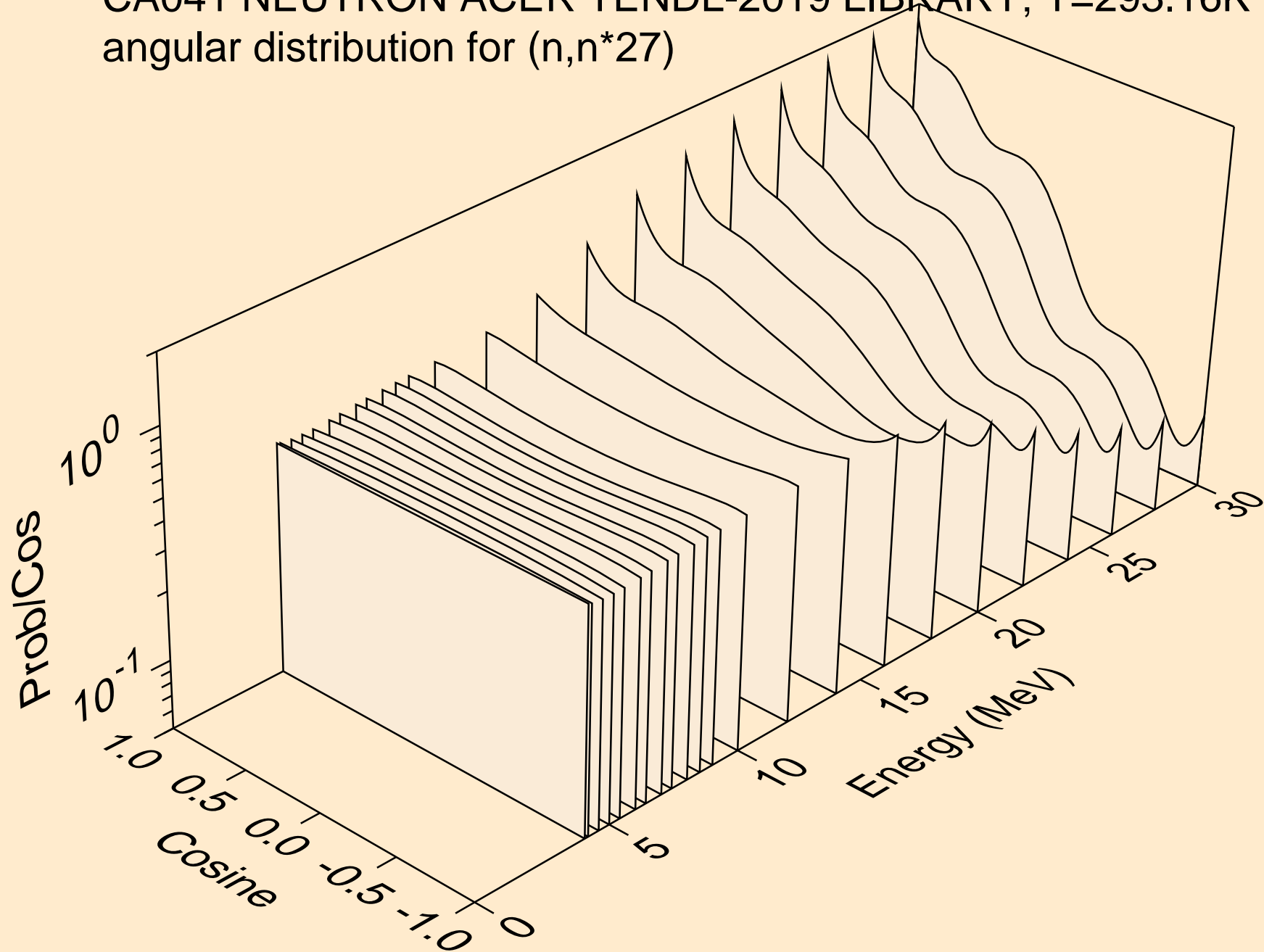

CA041 NEUTRON ACER TENDL-2019 LIBRARY; T=293.16K
angular distribution for (n,n*28)

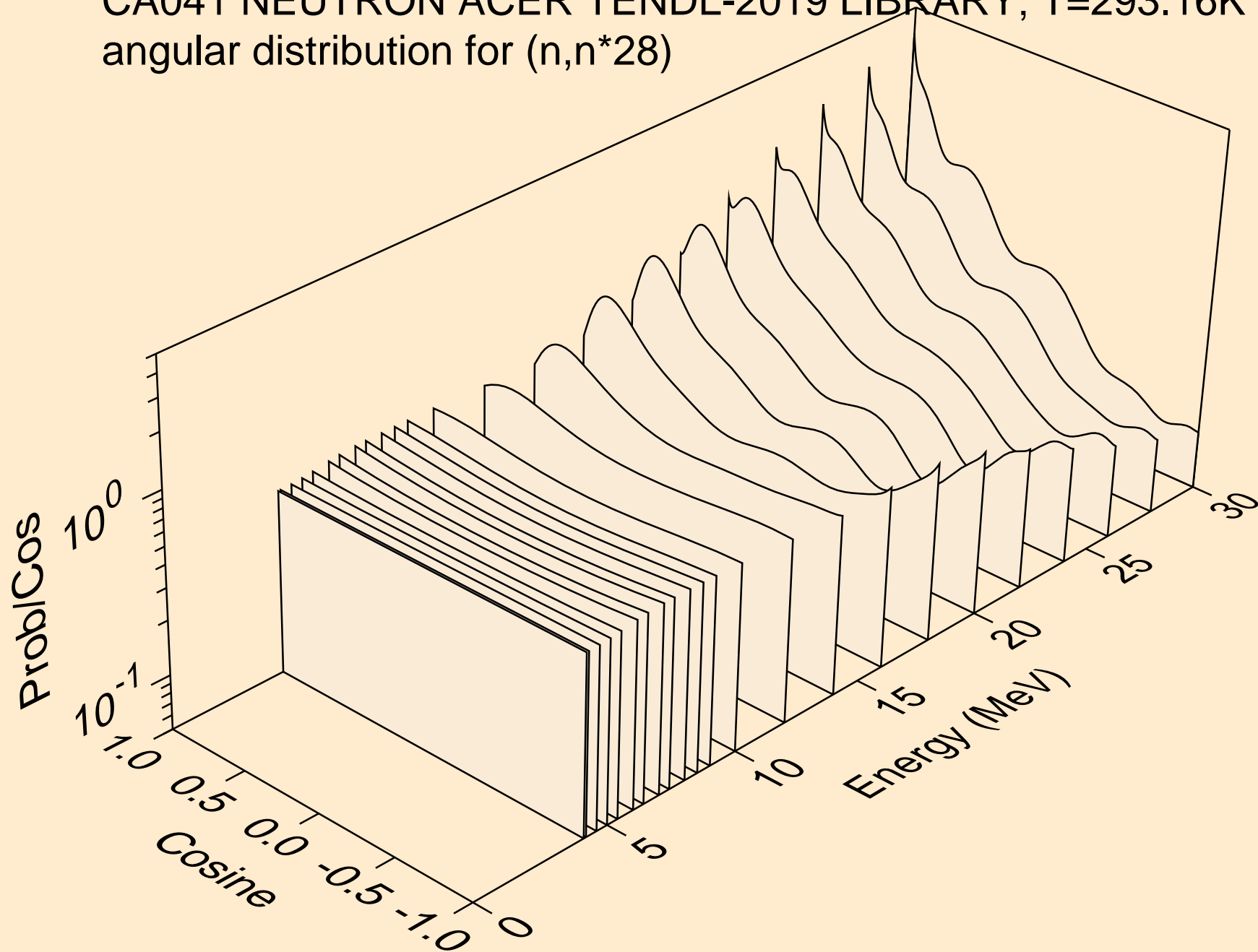

CA041 NEUTRON ACER TENDL-2019 LIBRARY; T=293.16K
Neutron emission for (n,x)

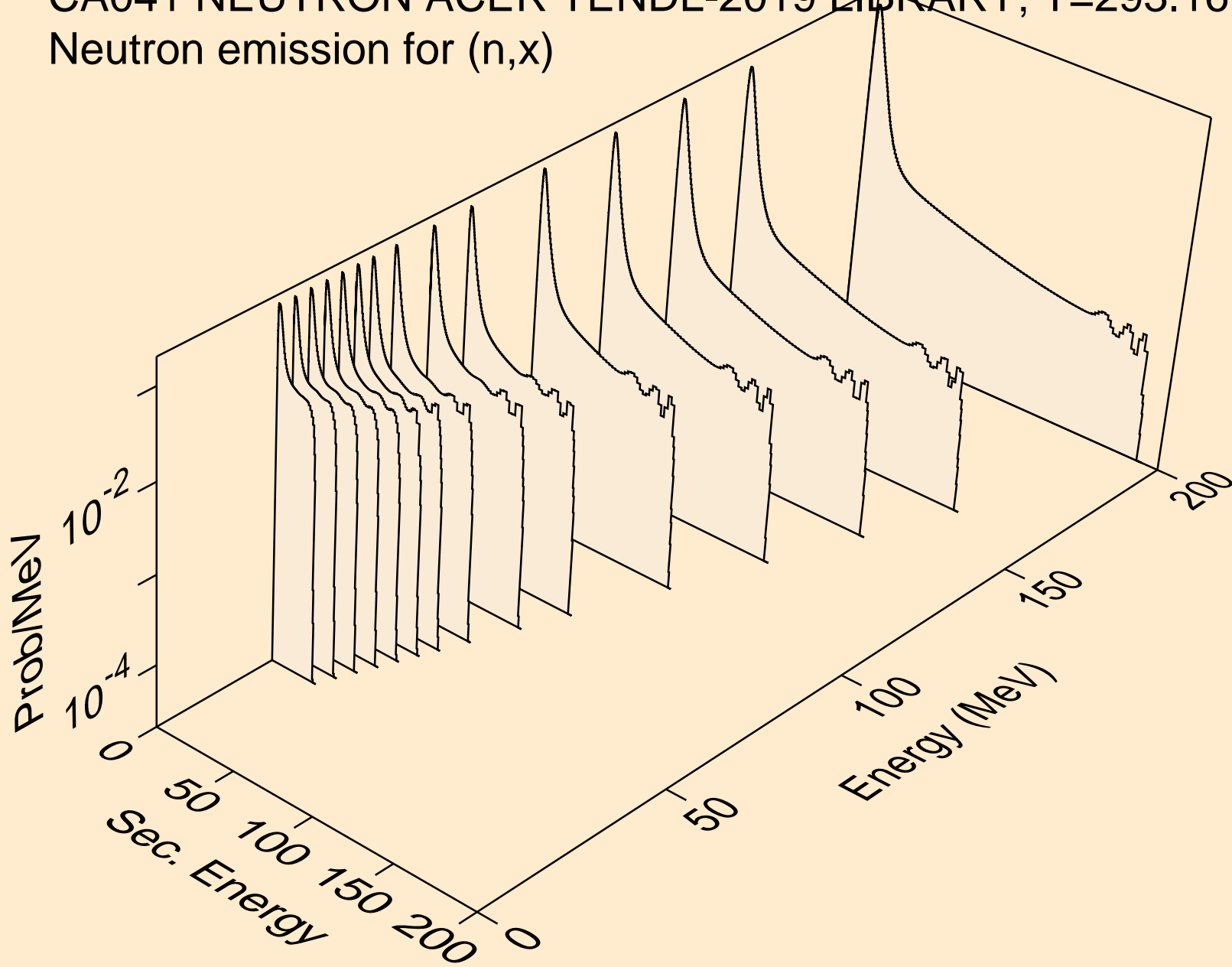

CA041 NEUTRON ACER TENDL-2019 LIBRARY; T=293.16K
Neutron emission for (n,2nd)

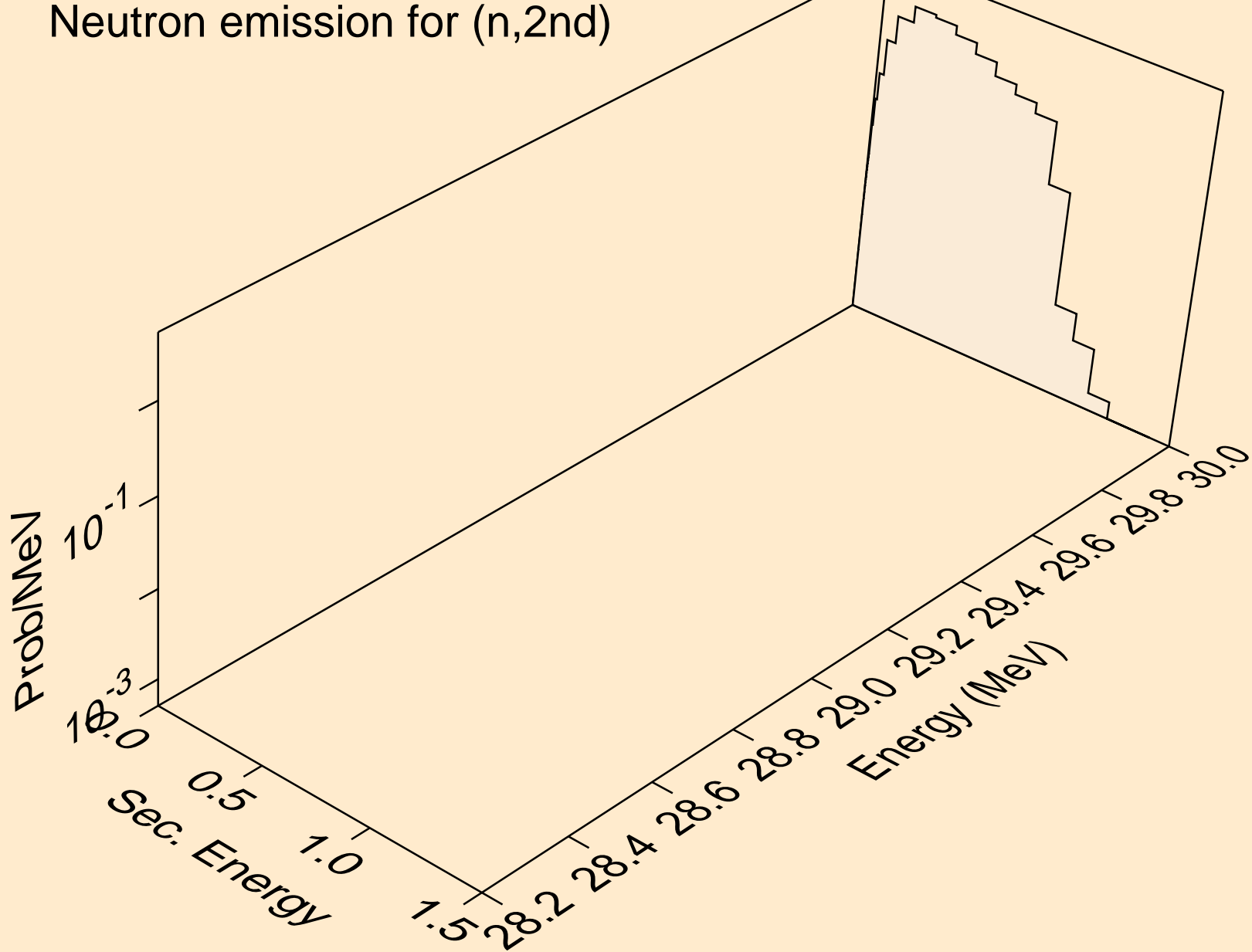

CA041 NEUTRON ACER TENDL-2019 LIBRARY; T=293.16K
Neutron emission for (n,2n)

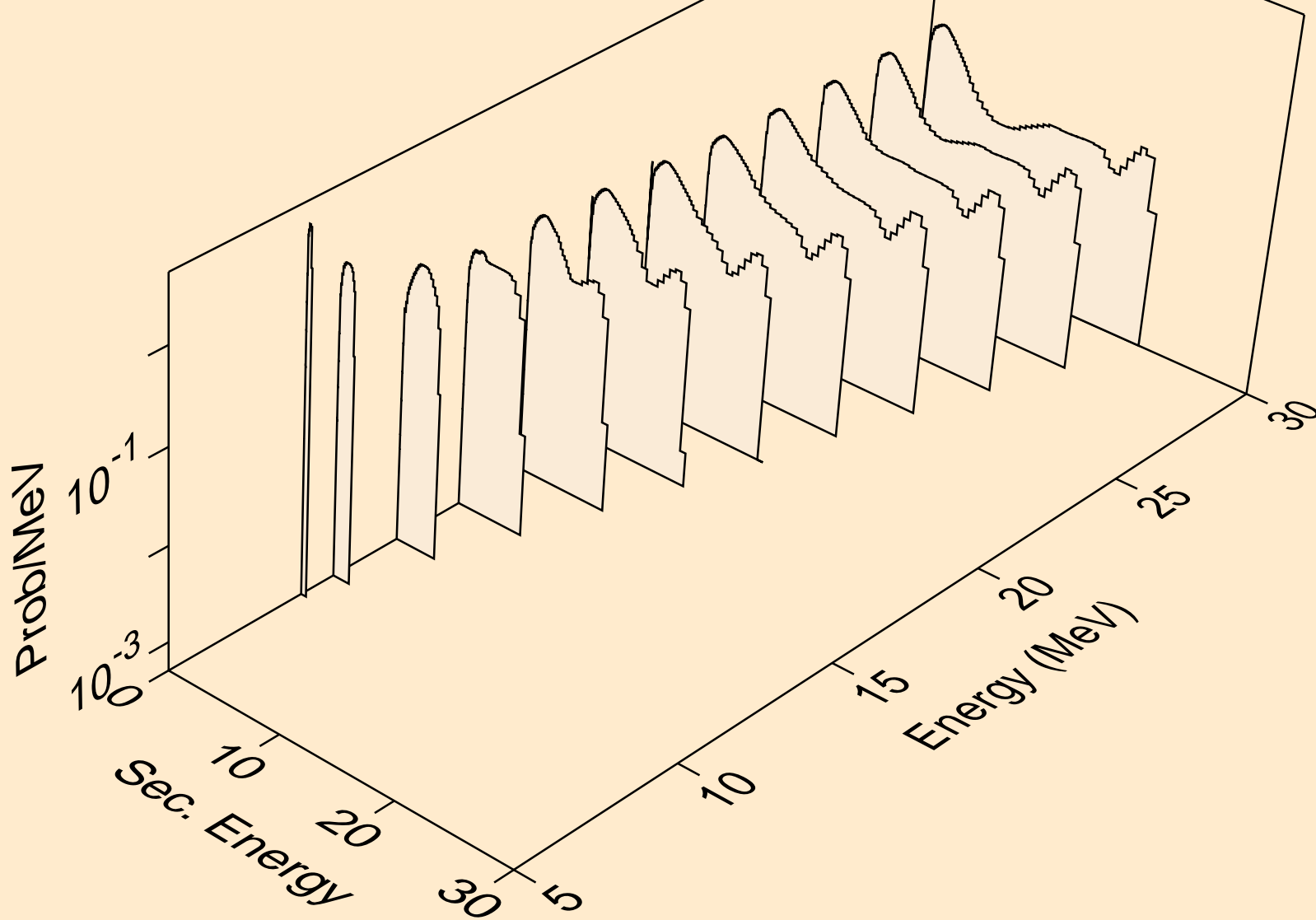

CA041 NEUTRON ACER TENDL-2019 LIBRARY; T=293.16K
Neutron emission for (n,3n)

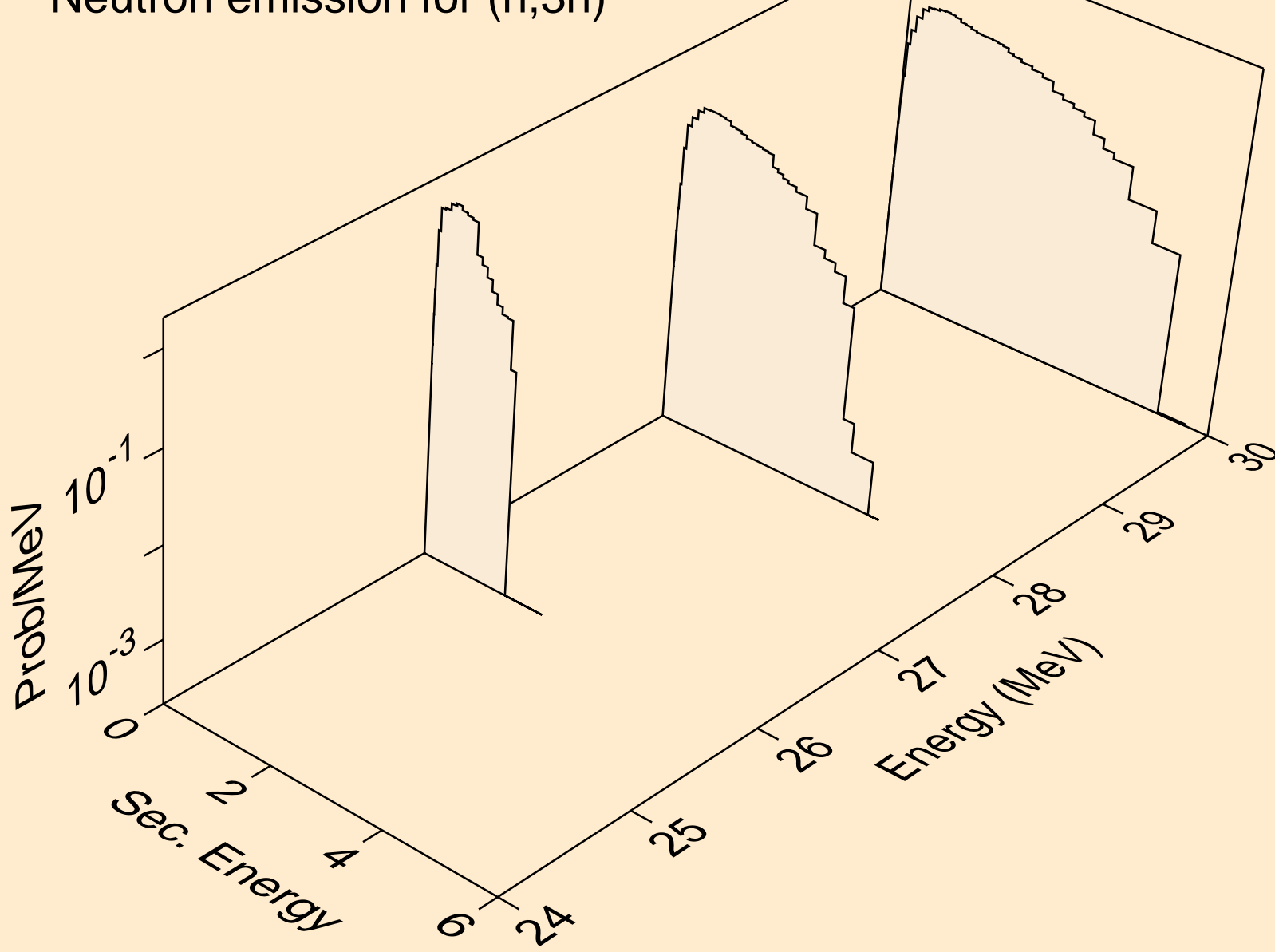

CA041 NEUTRON ACER TENDL-2019 LIBRARY; T=293.16K
Neutron emission for (n,n*)a

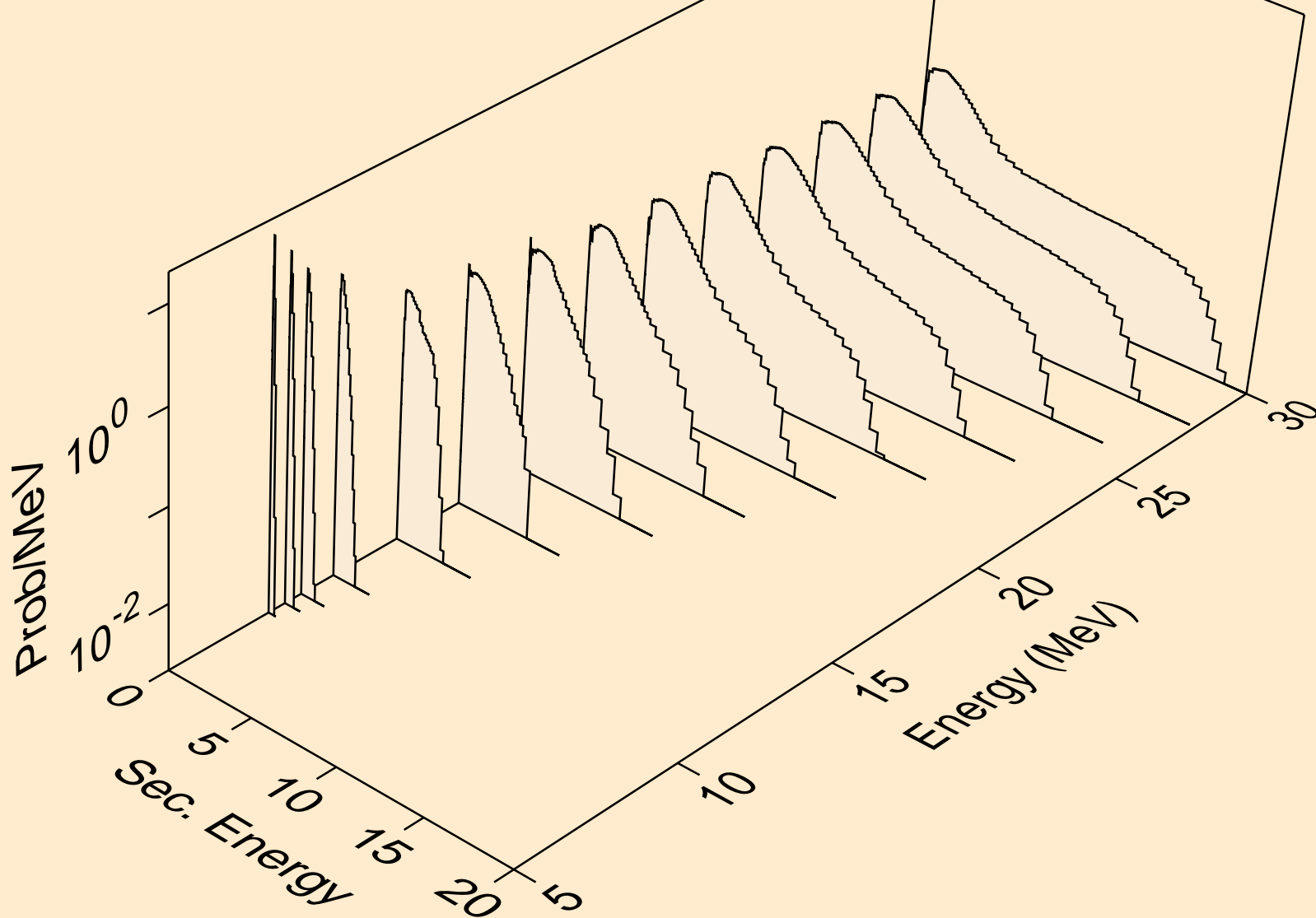

CA041 NEUTRON ACER TENDL-2019 LIBRARY; T=293.16K
Neutron emission for (n,2n)a

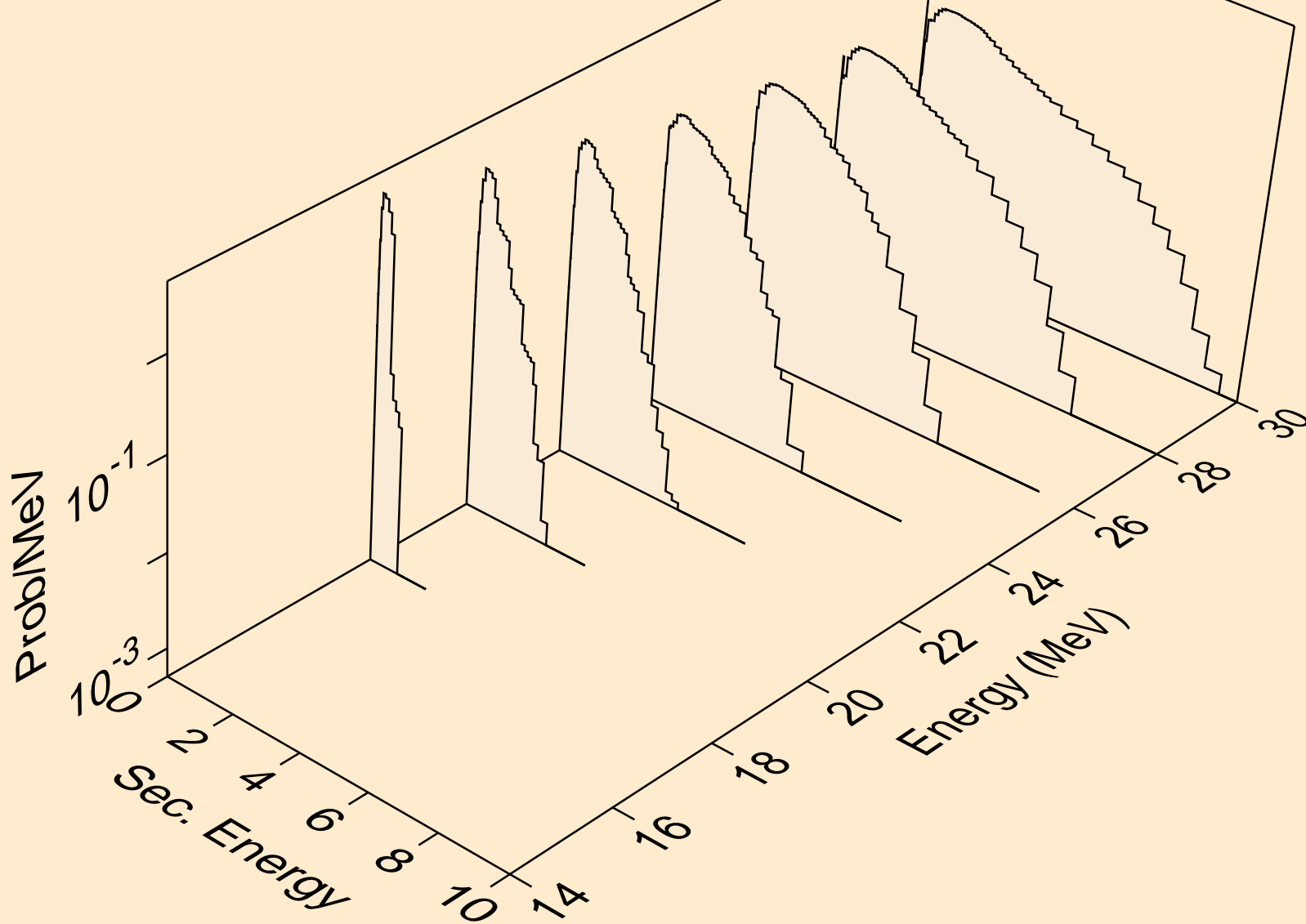

CA041 NEUTRON ACER TENDL-2019 LIBRARY; T=293.16K
Neutron emission for (n,n*)p

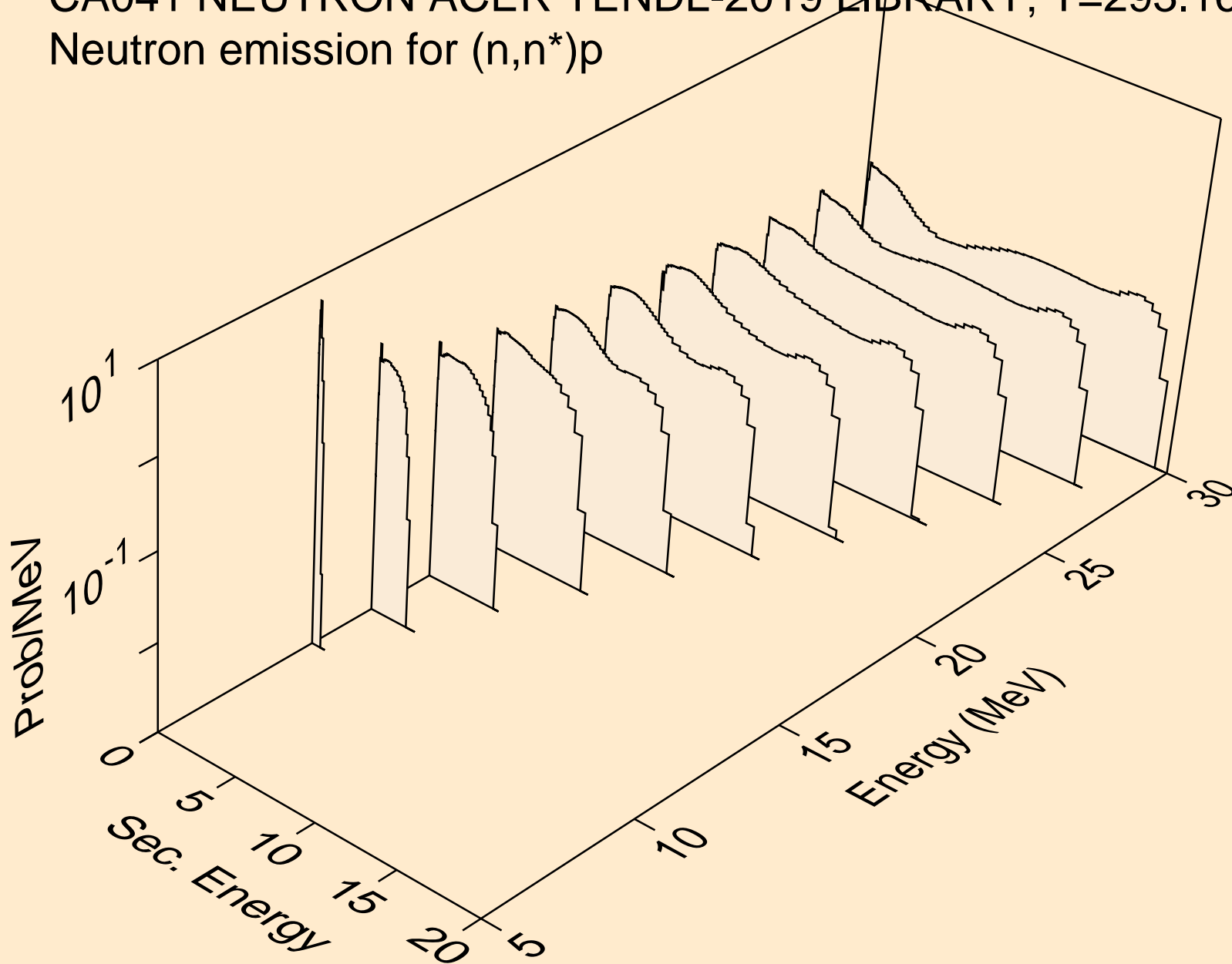

CA041 NEUTRON ACER TENDL-2019 LIBRARY; T=293.16K
Neutron emission for (n,n*)2a

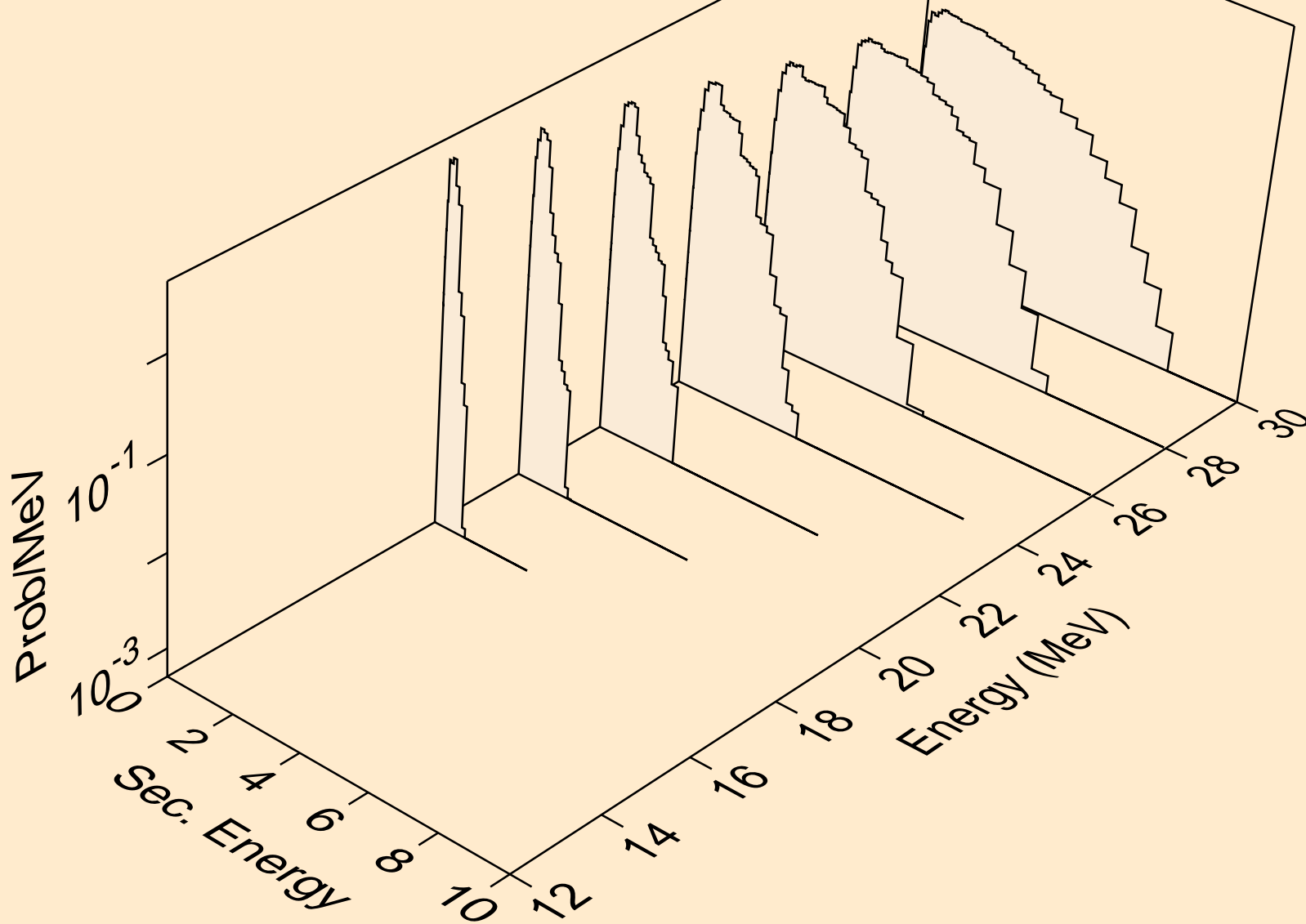

CA041 NEUTRON ACER TENDL-2019 LIBRARY; T=293.16K
Neutron emission for (n,2n)2a

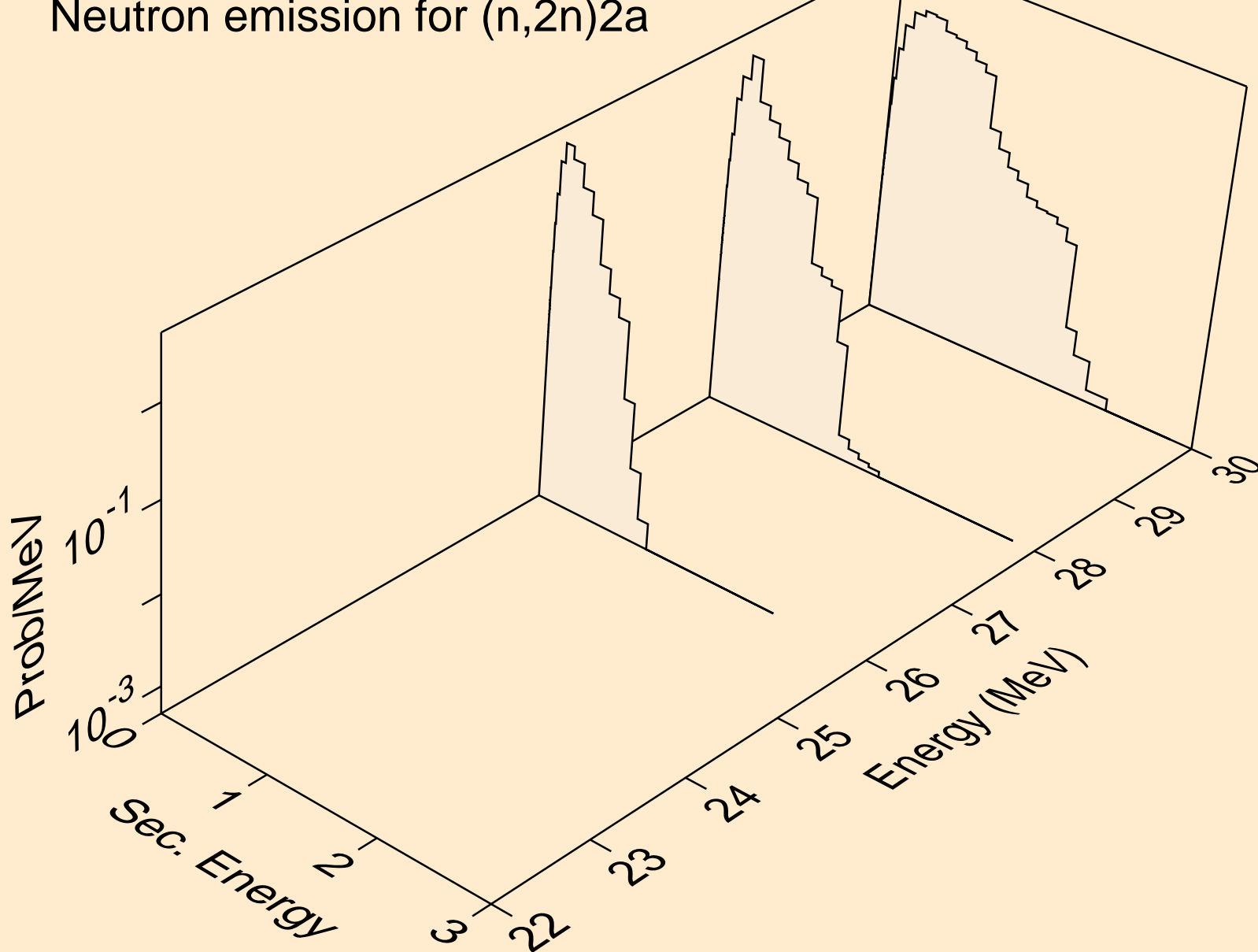

CA041 NEUTRON ACER TENDL-2019 LIBRARY; T=293.16K
Neutron emission for (n,n*)d

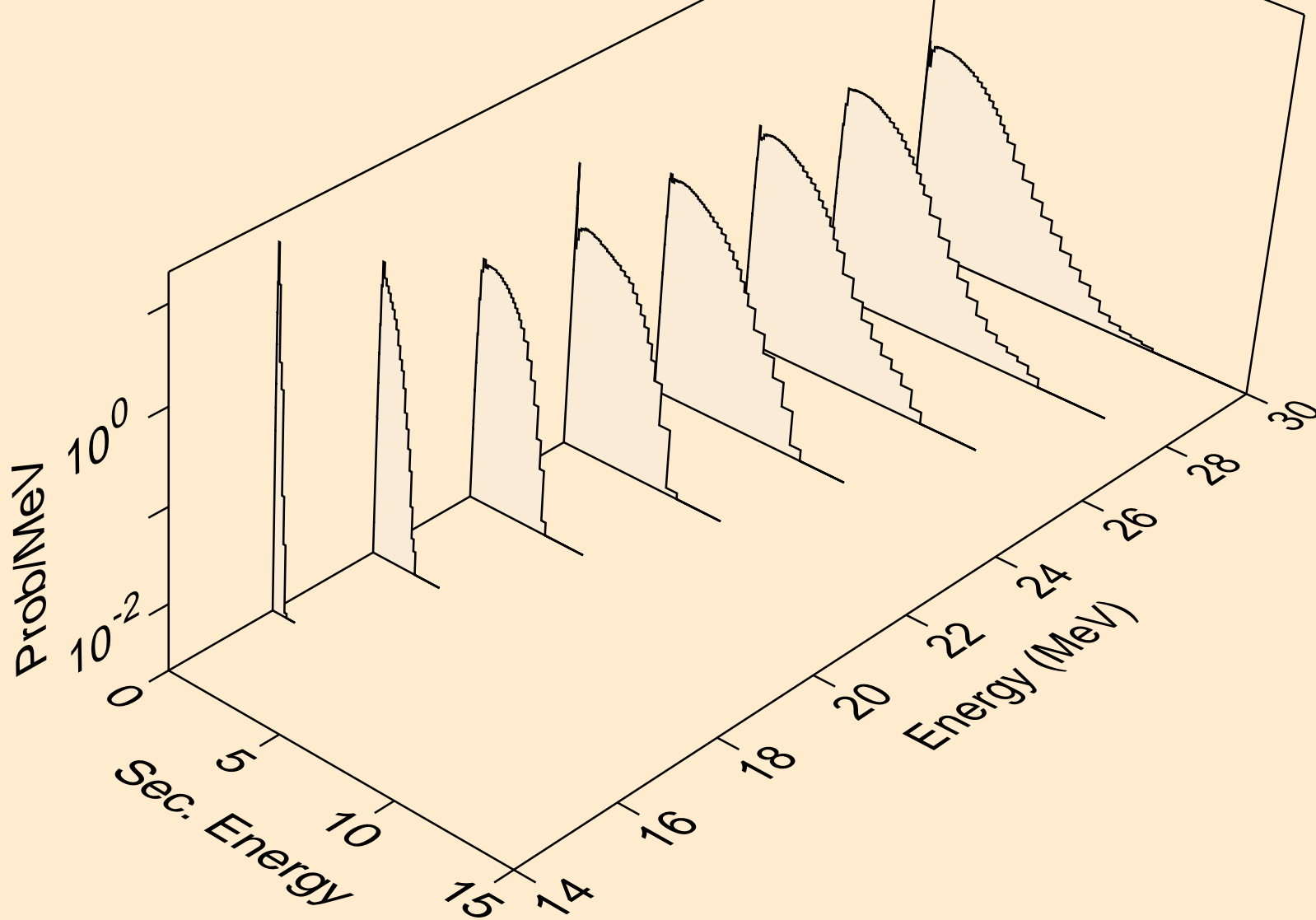

CA041 NEUTRON ACER TENDL-2019 LIBRARY; T=293.16K
Neutron emission for (n,n*)t

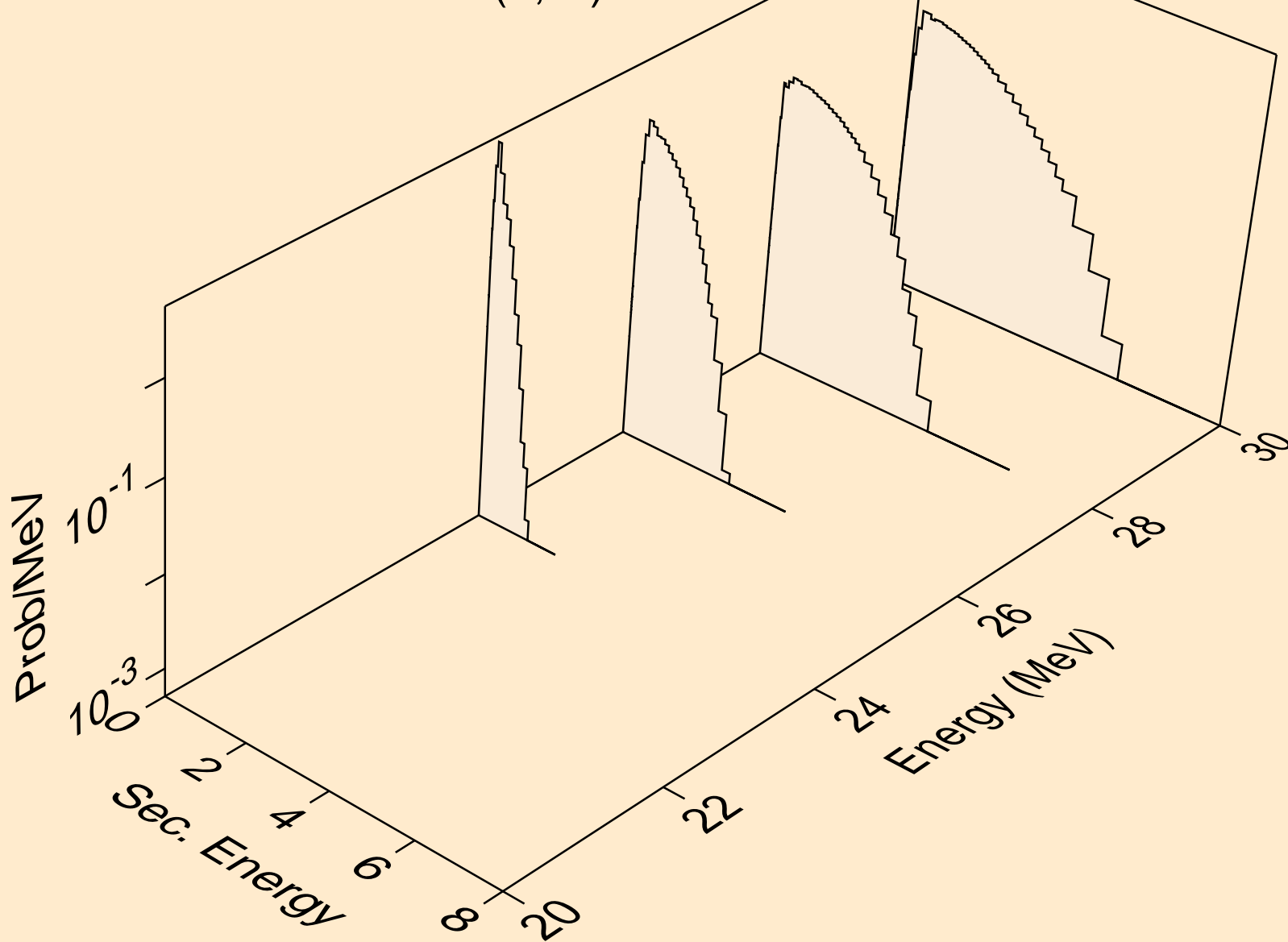

CA041 NEUTRON ACER TENDL-2019 LIBRARY; T=293.16K
Neutron emission for (n,n*)he3

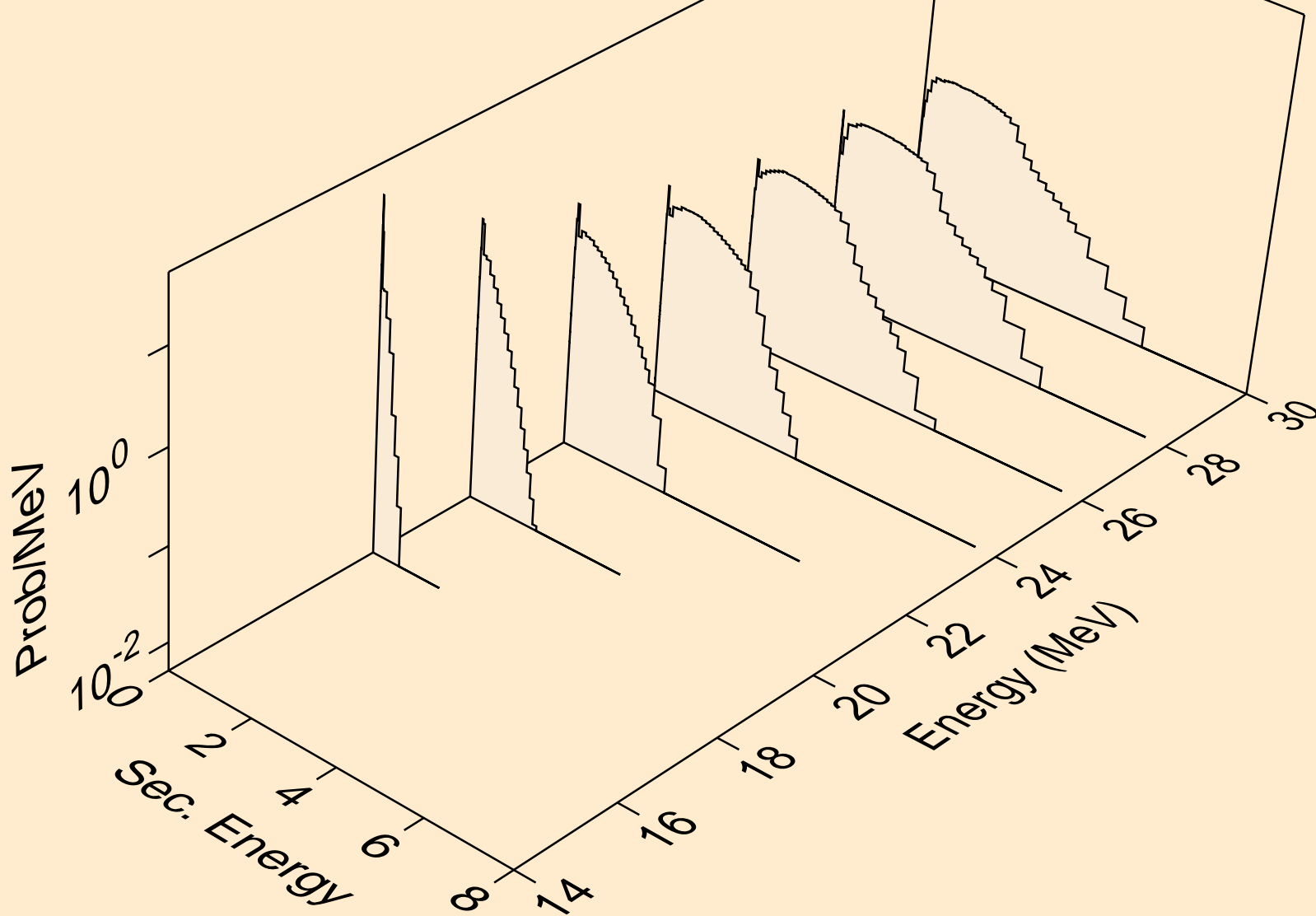

CA041 NEUTRON ACER TENDL-2019 LIBRARY; T=293.16K
Neutron emission for (n,2np)

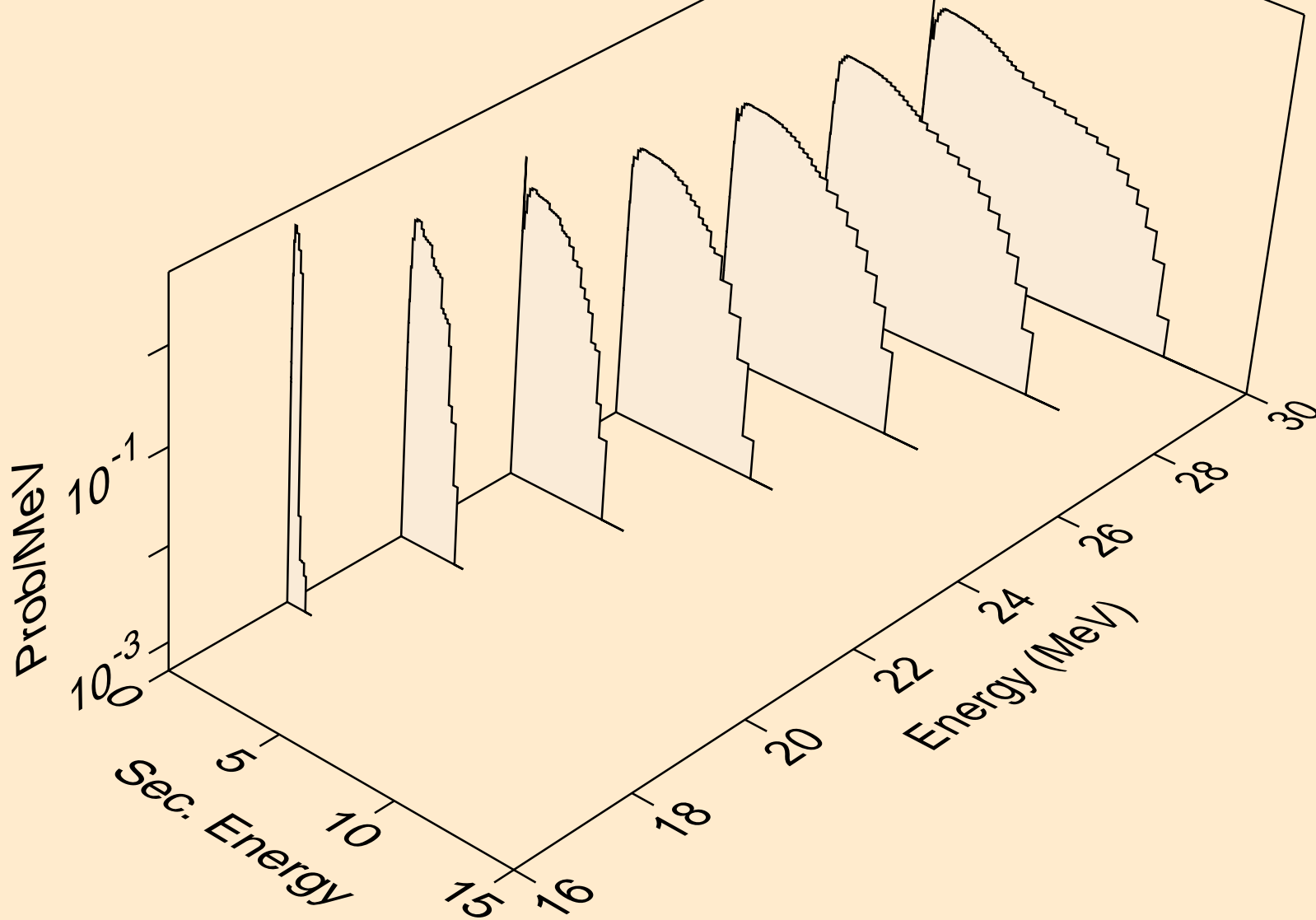

CA041 NEUTRON ACER TENDL-2019 LIBRARY; T=293.16K
Neutron emission for (n,2np)

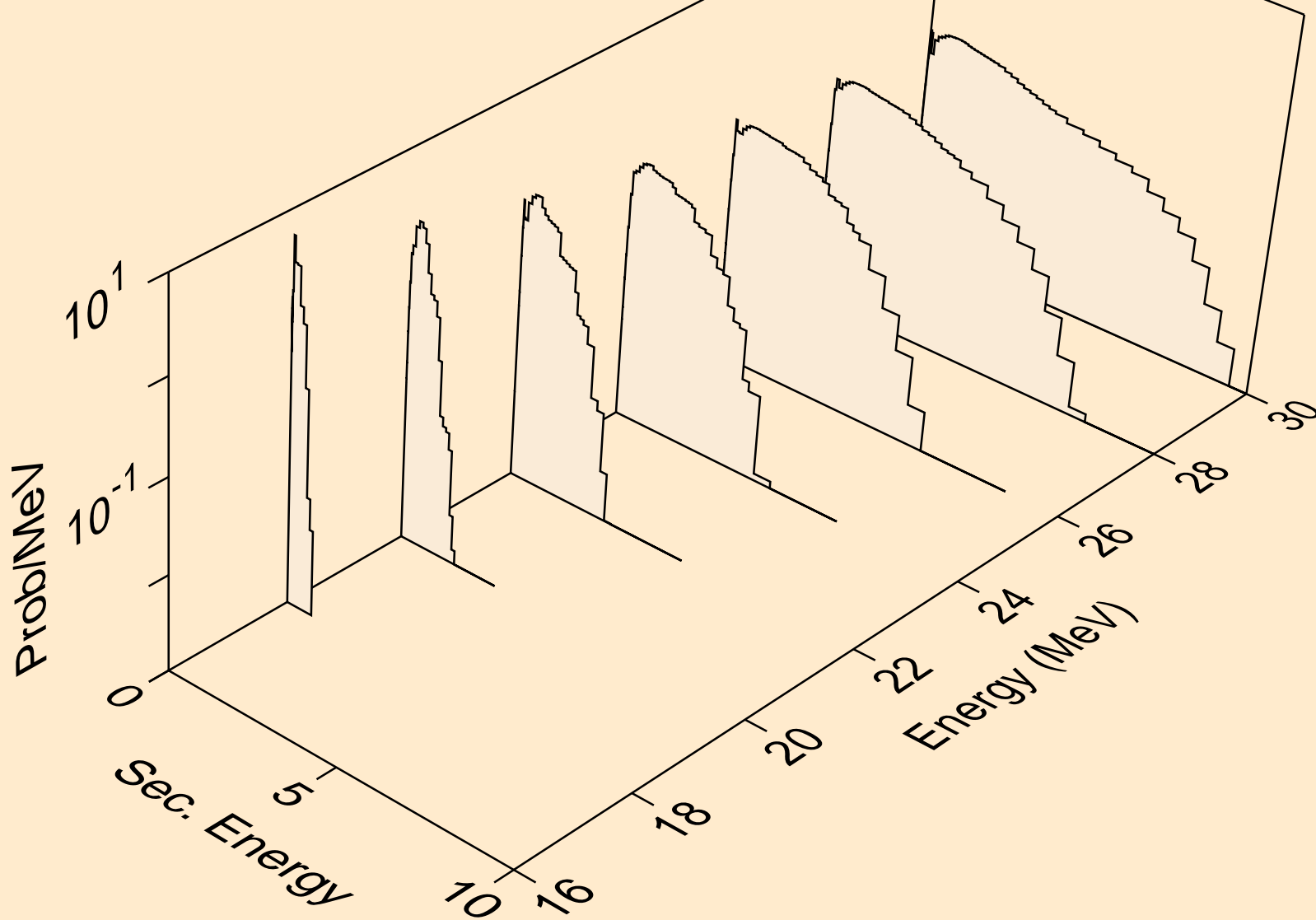

CA041 NEUTRON ACER TENDL-2019 LIBRARY; T=293.16K
Neutron emission for (n,npa)

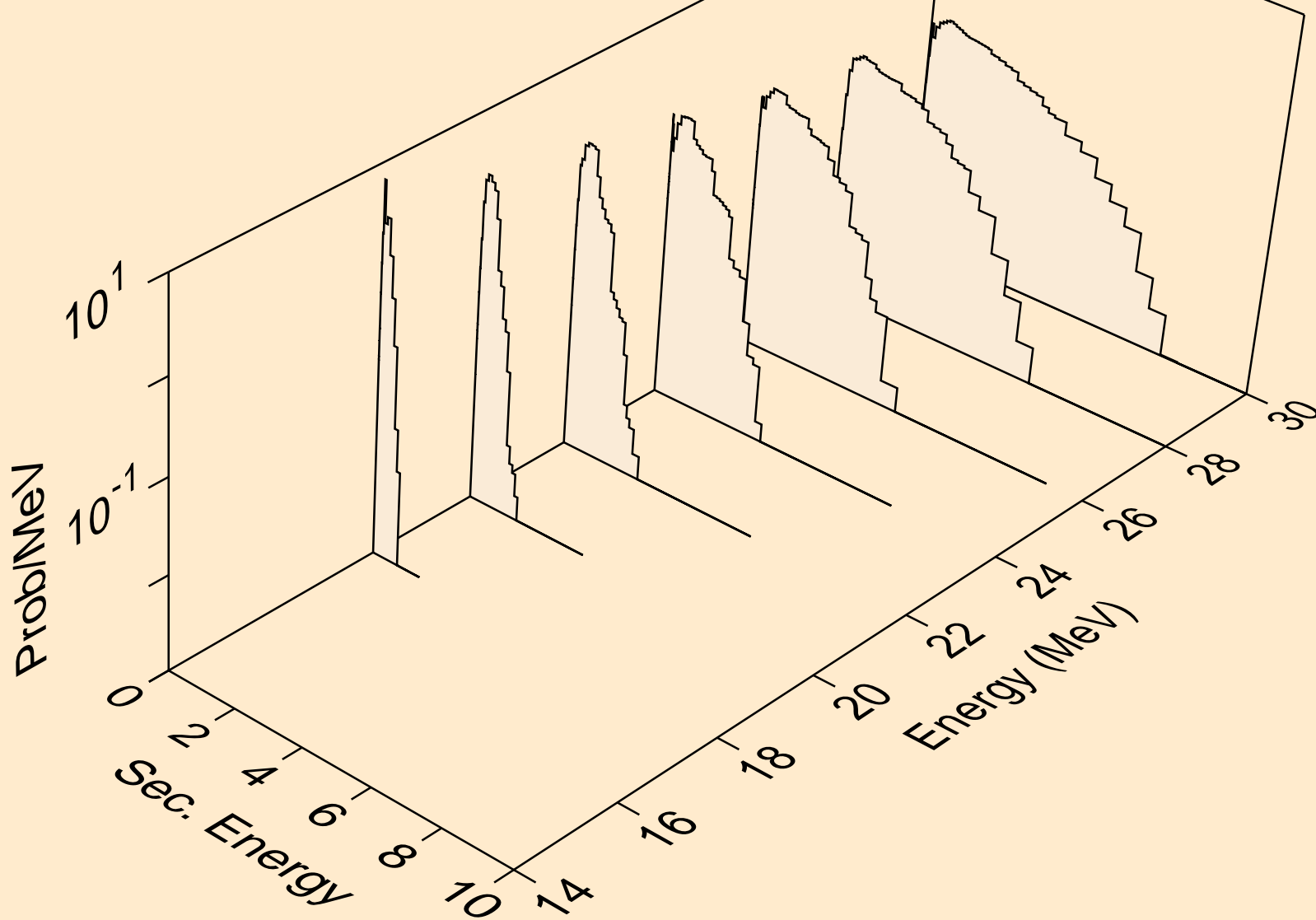

CA041 NEUTRON ACER TENDL-2019 LIBRARY; T=293.16K
Neutron emission for (n,n*c)

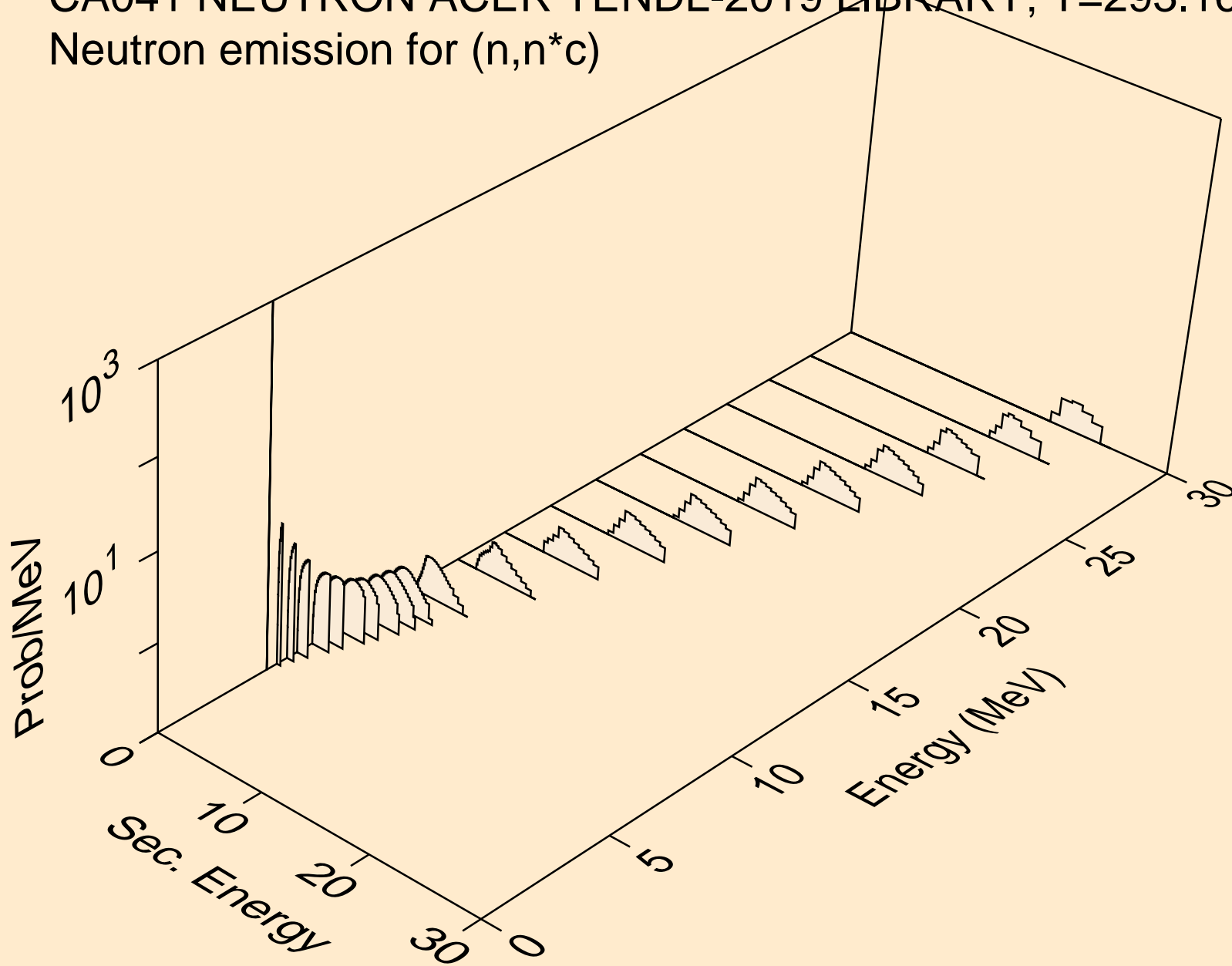

CA041 NEUTRON ACER TENDL-2019 LIBRARY; T=293.16K
Photon emission for (n,x)

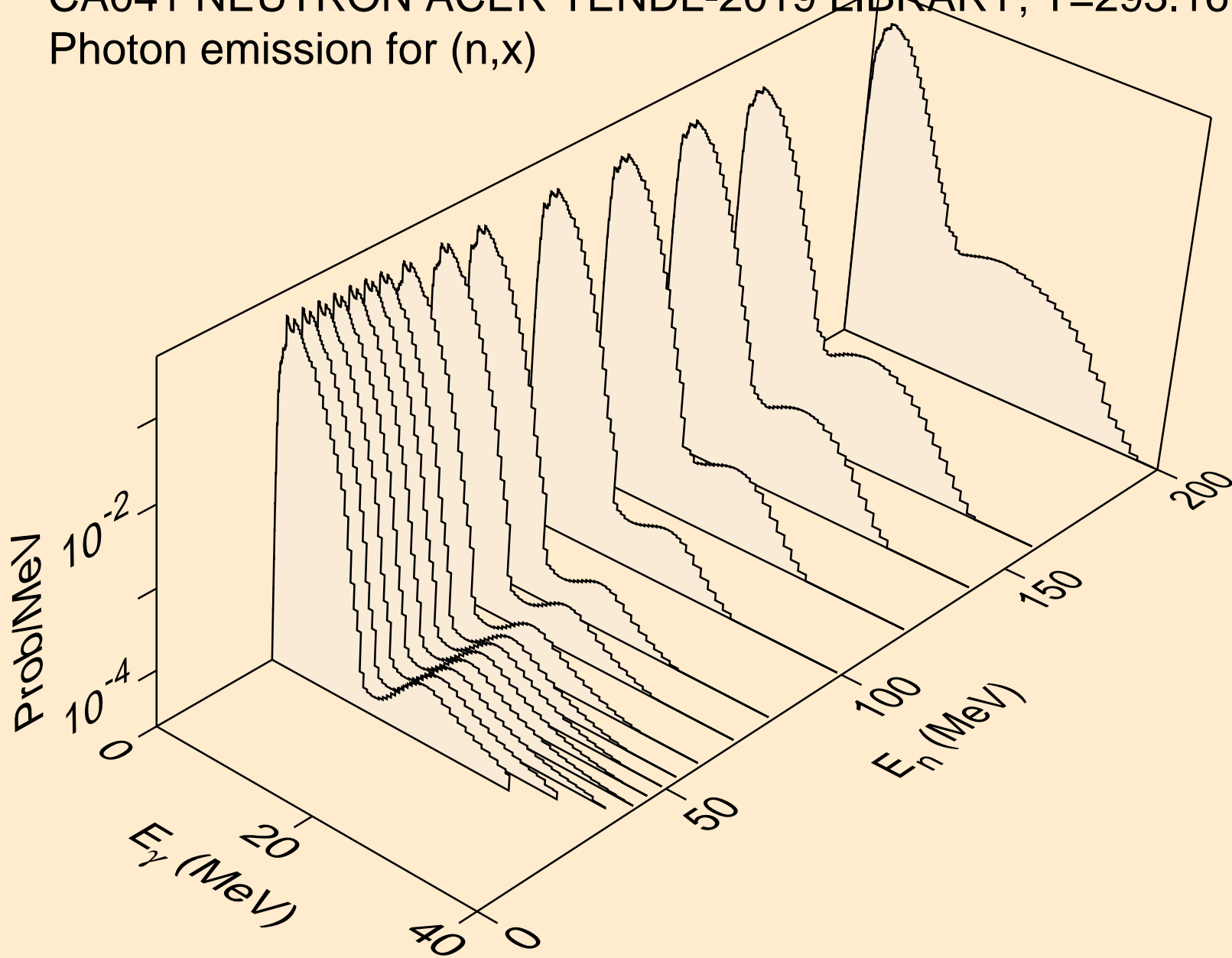

CA041 NEUTRON ACER TENDL-2019 LIBRARY; T=293.16K
Photon emission for (n,2nd)

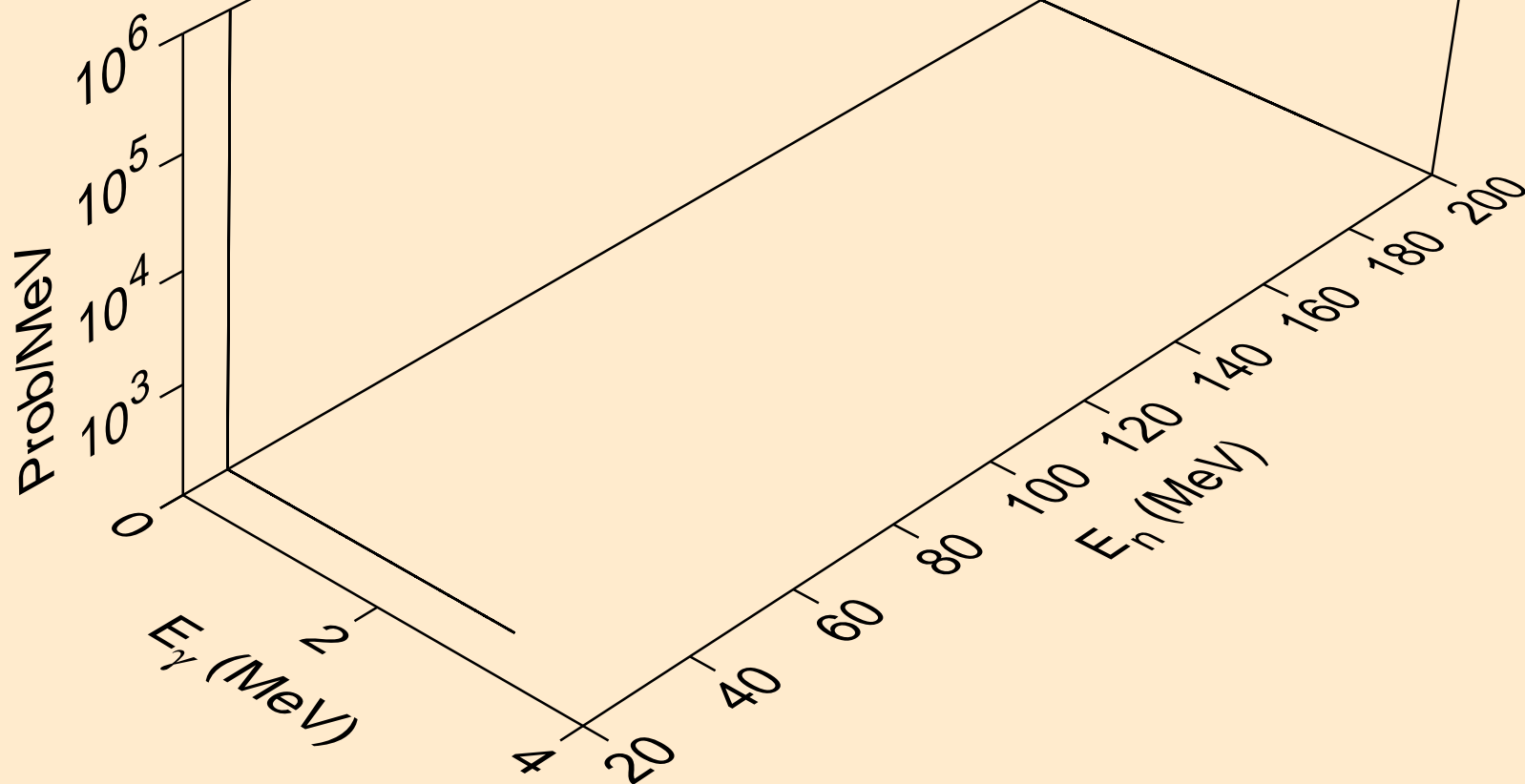

CA041 NEUTRON ACER TENDL-2019 LIBRARY; T=293.16K
Photon emission for (n,2n)

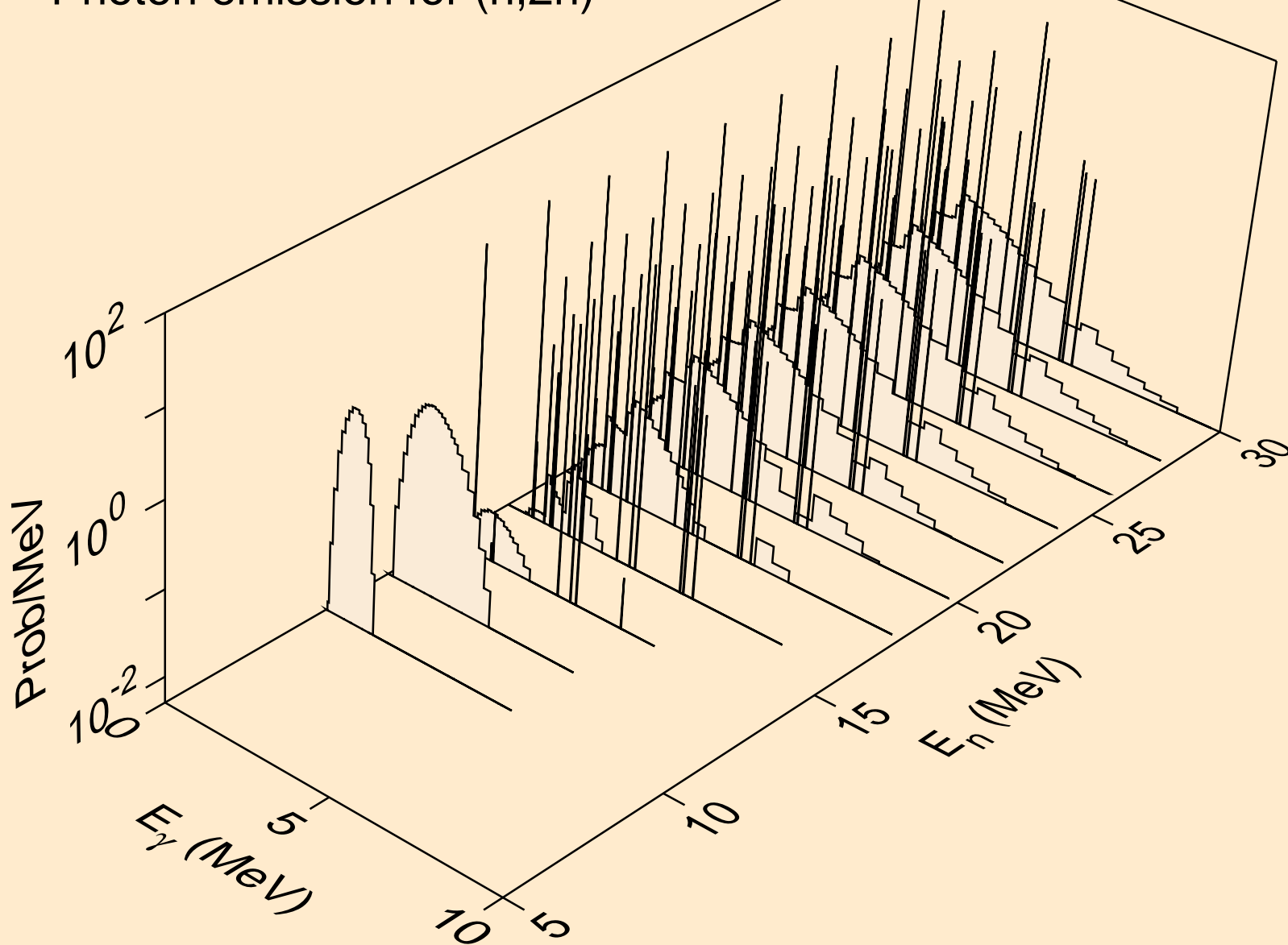

CA041 NEUTRON ACER TENDL-2019 LIBRARY; T=293.16K
Photon emission for (n,3n)

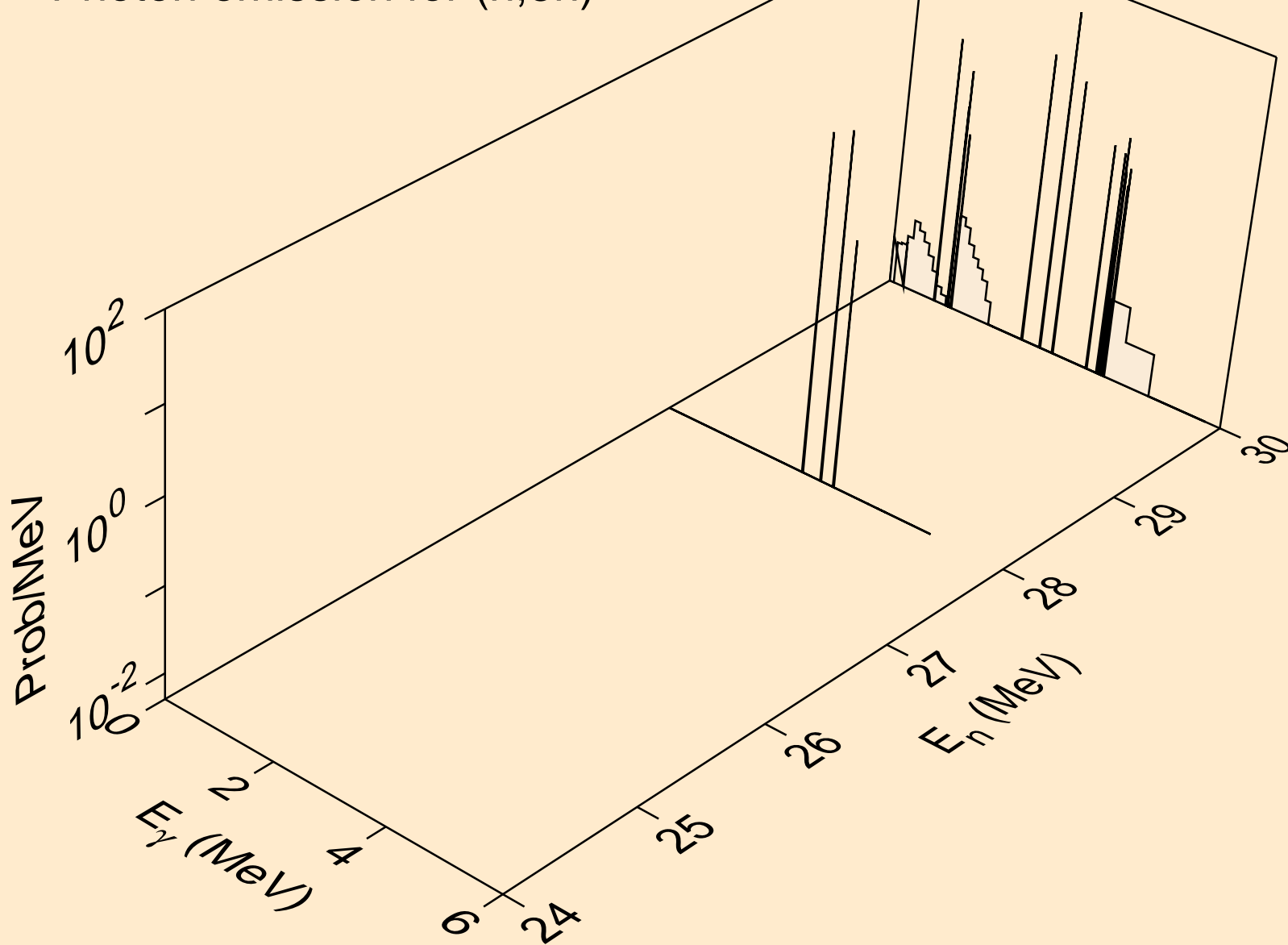

CA041 NEUTRON ACER TENDL-2019 LIBRARY; T=293.16K
Photon emission for (n,n*)a

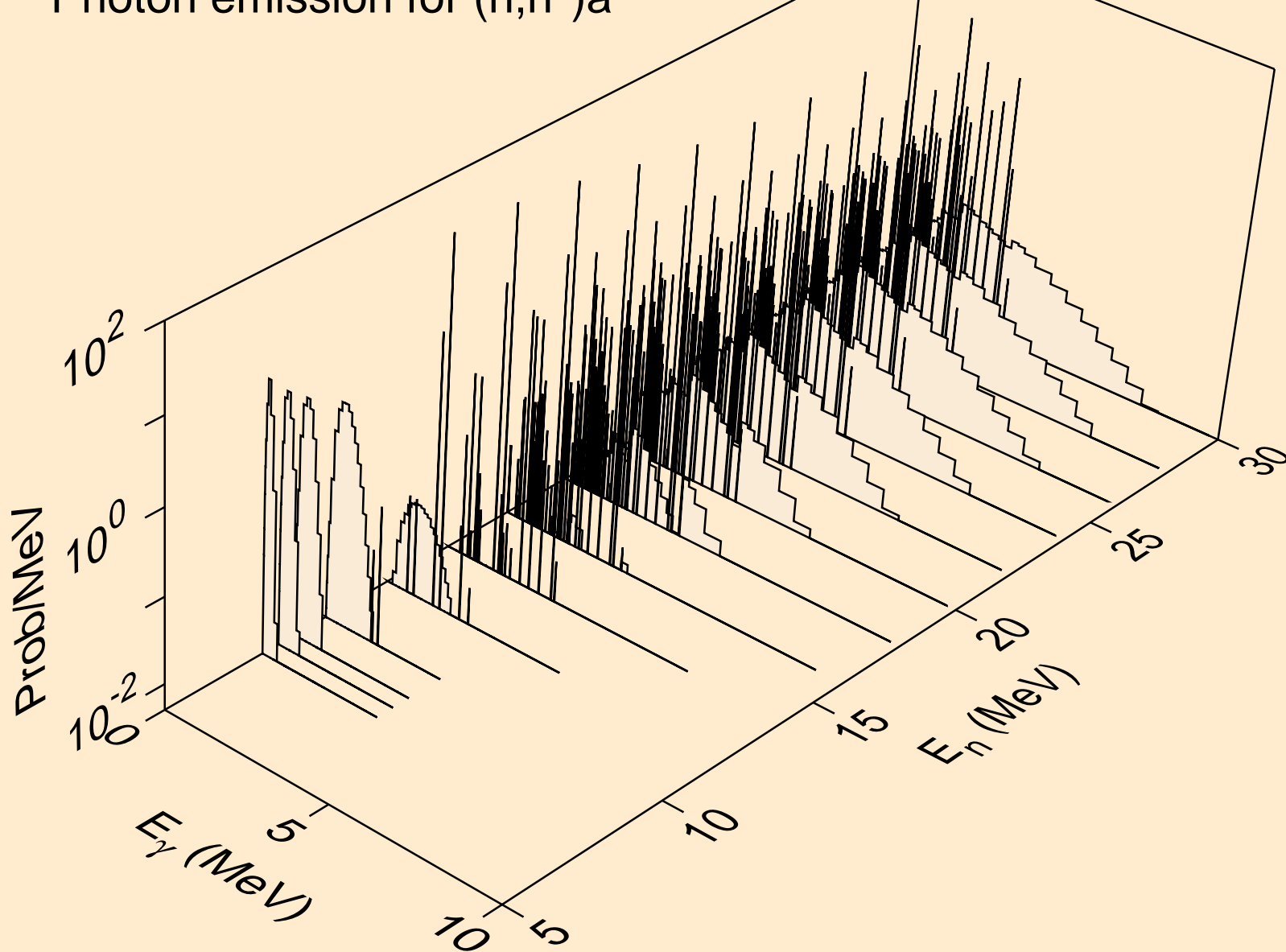

CA041 NEUTRON ACER TENDL-2019 LIBRARY; T=293.16K
Photon emission for (n,2n)a

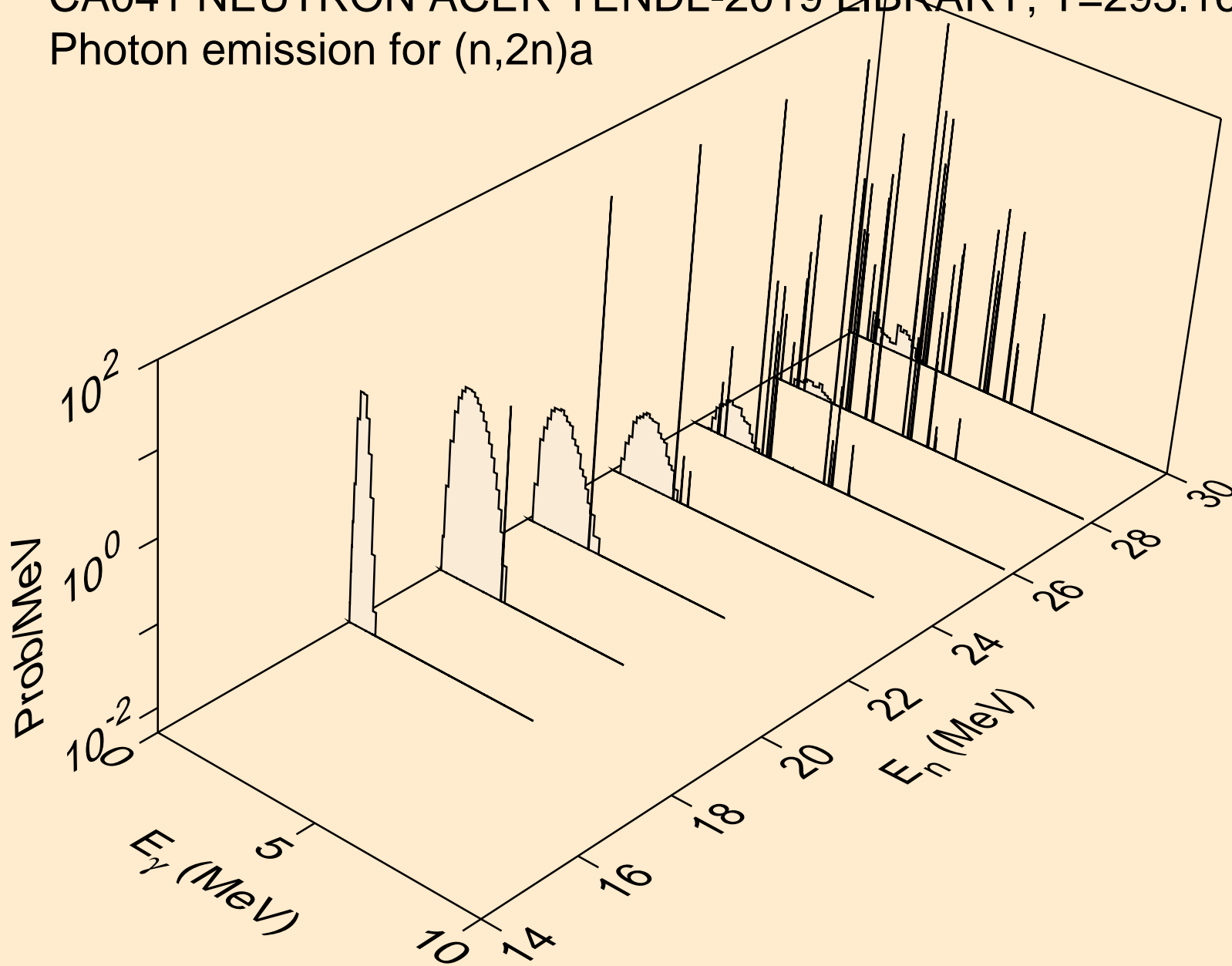

CA041 NEUTRON ACER TENDL-2019 LIBRARY; T=293.16K
Photon emission for (n,n*)p

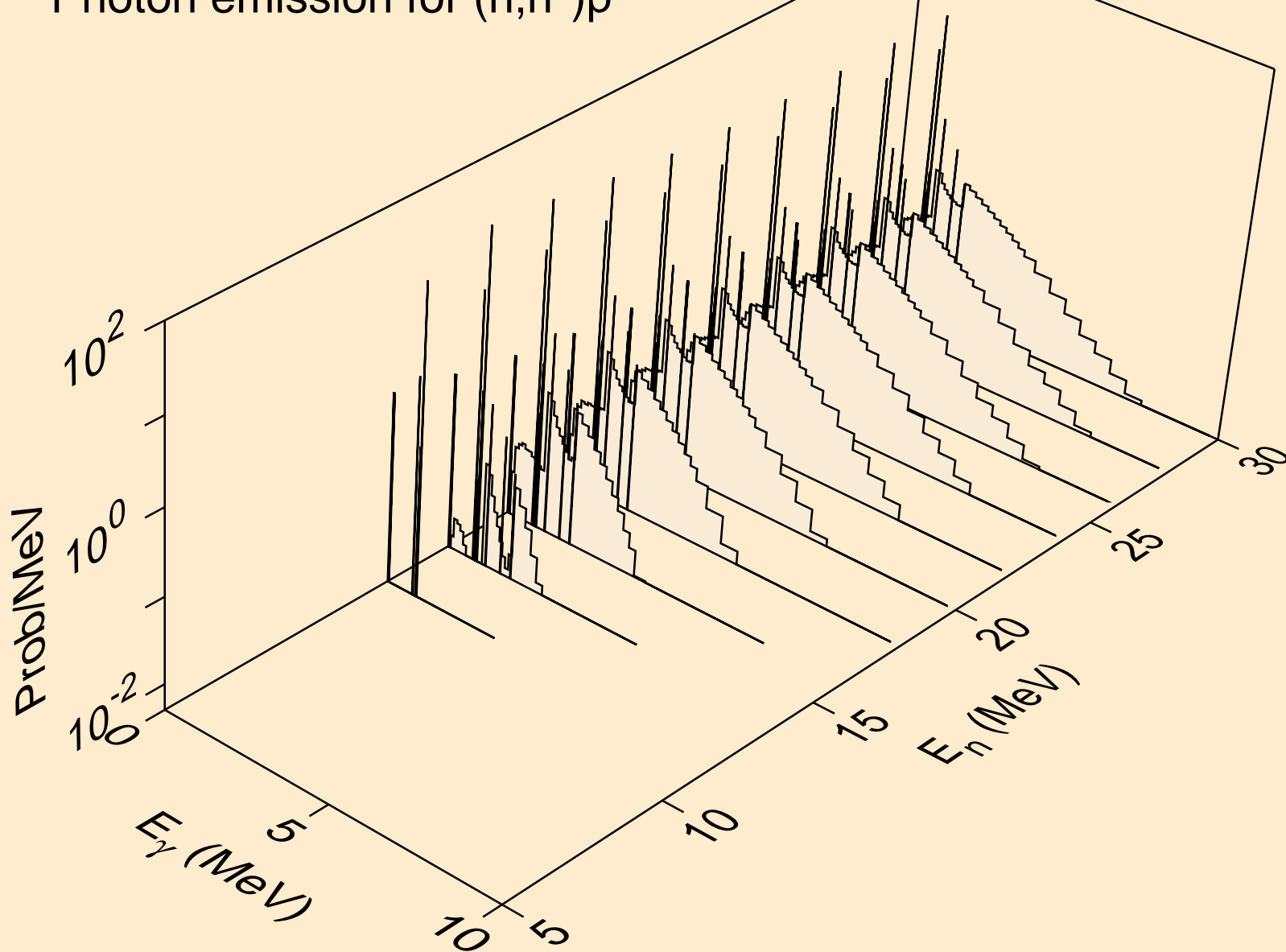

CA041 NEUTRON ACER TENDL-2019 LIBRARY; T=293.16K
Photon emission for (n,n*)2a

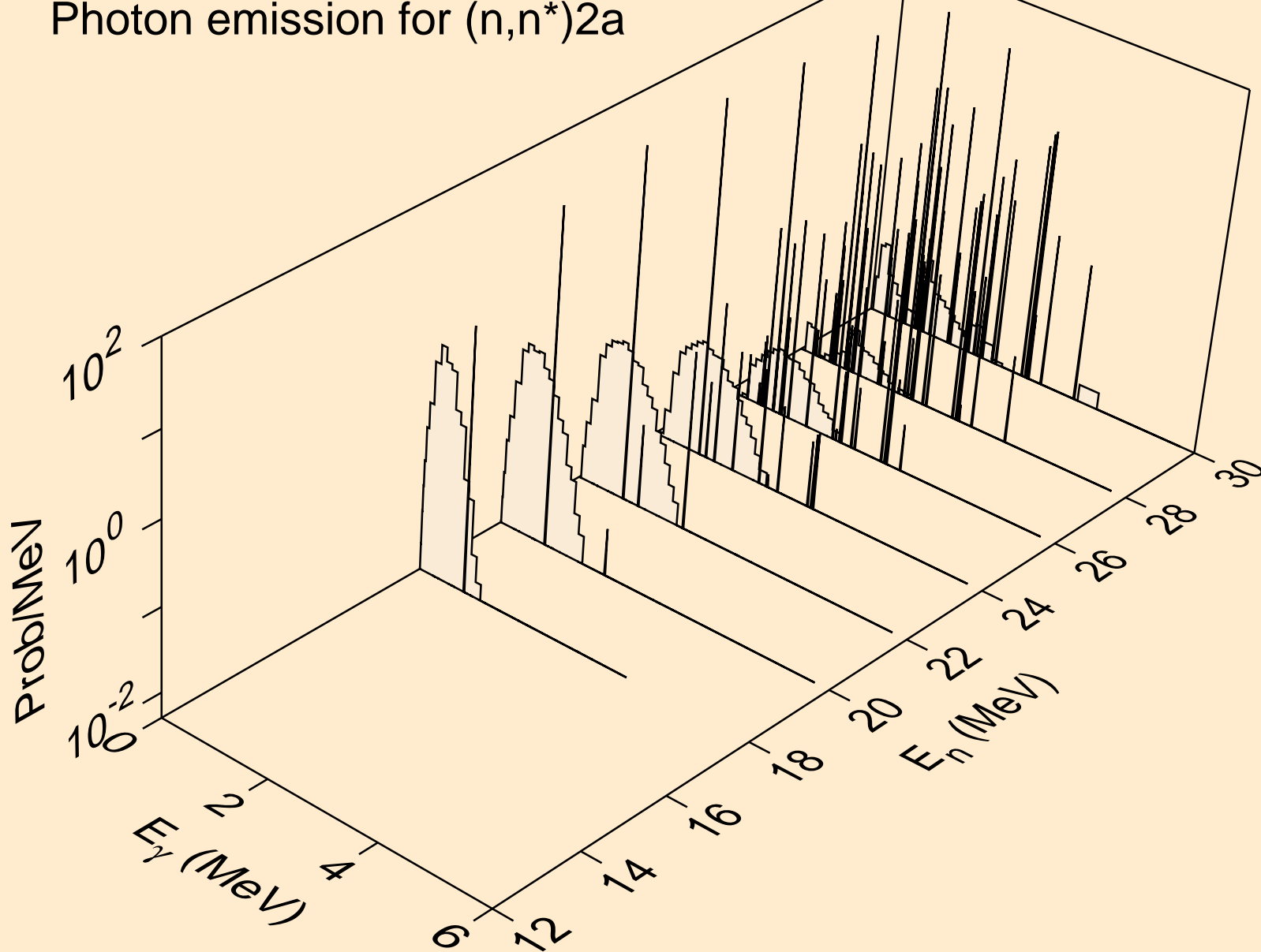

CA041 NEUTRON ACER TENDL-2019 LIBRARY; T=293.16K
Photon emission for (n,2n)2a

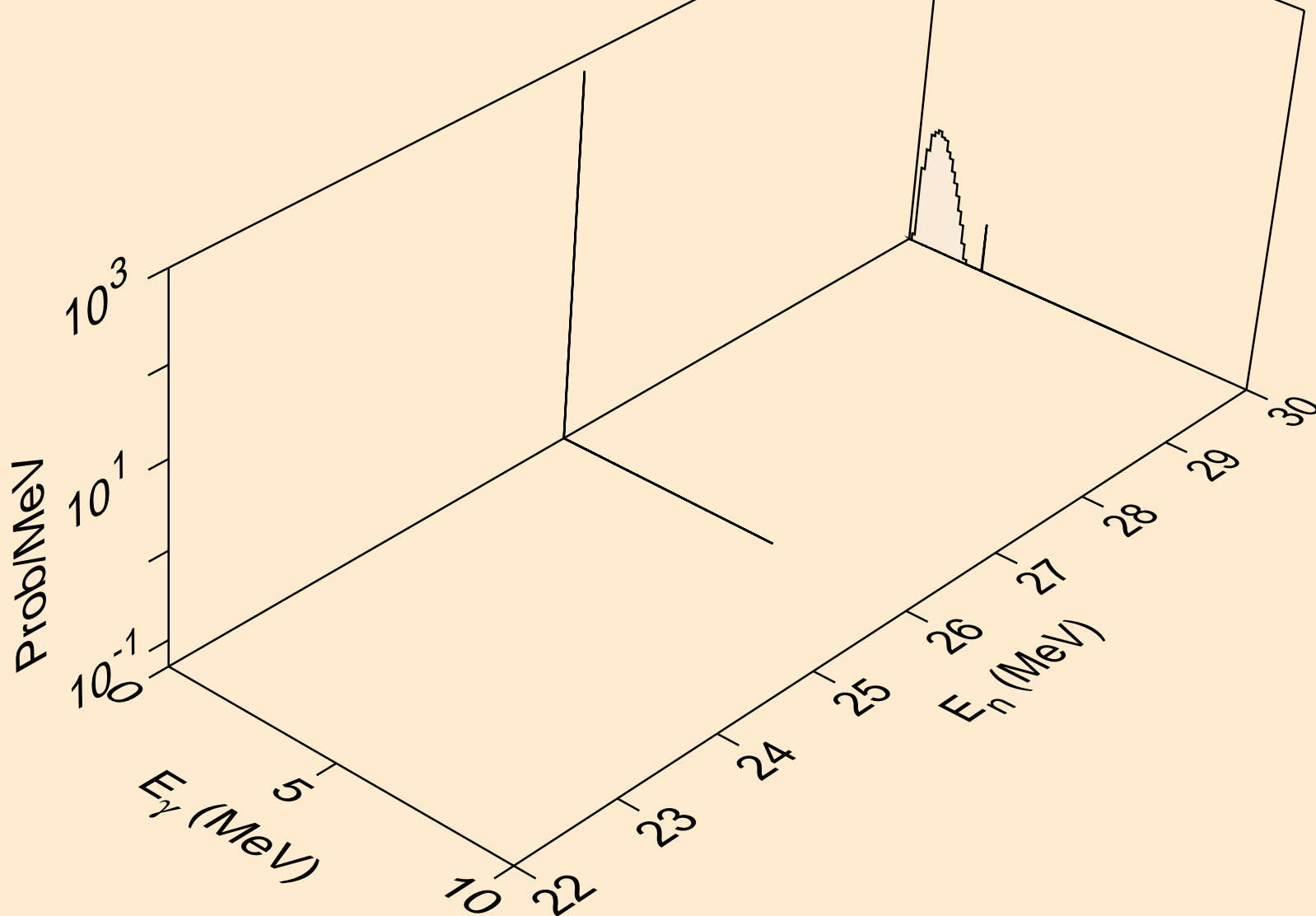

CA041 NEUTRON ACER TENDL-2019 LIBRARY; T=293.16K
Photon emission for (n,n*)d

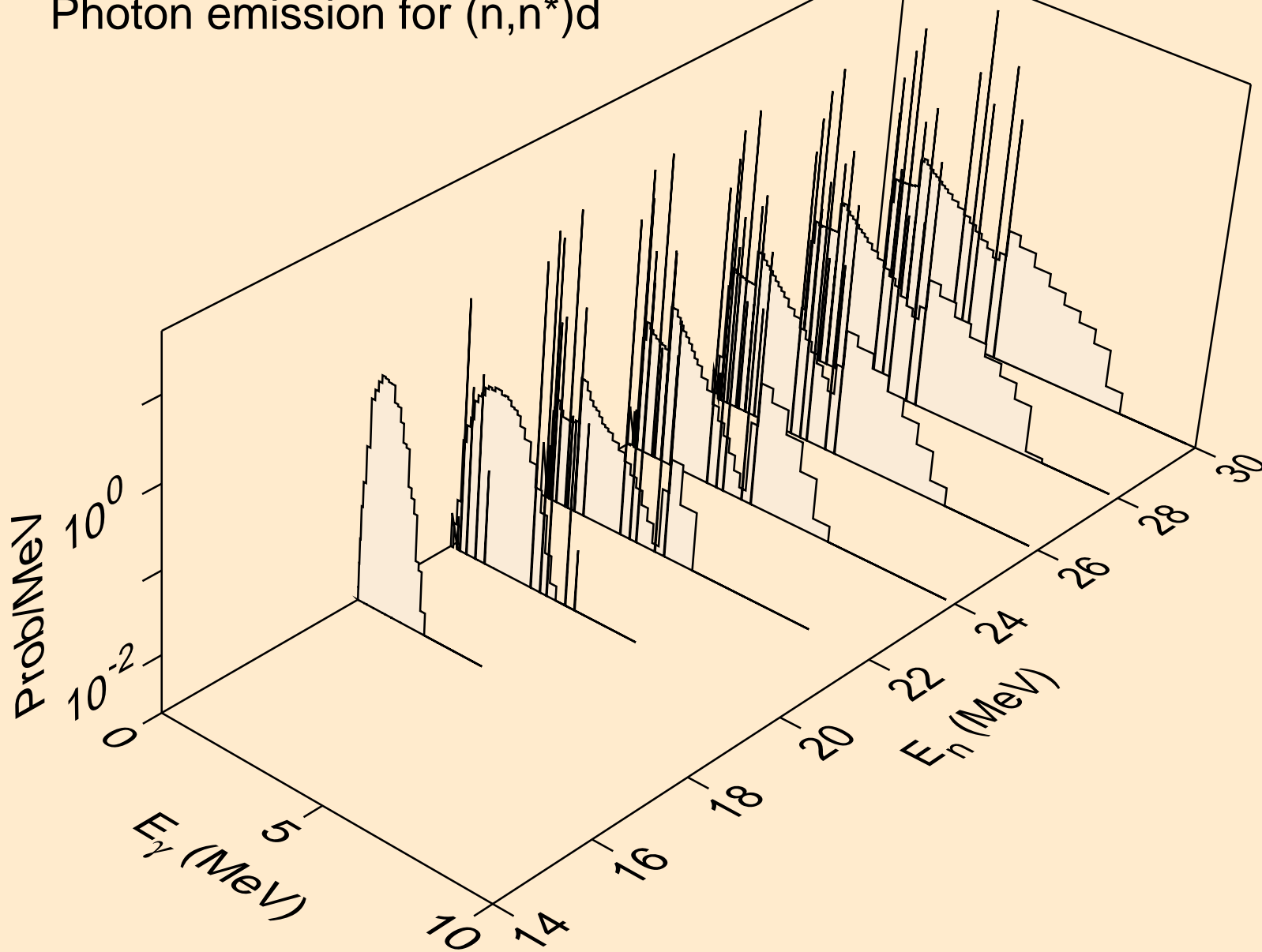

CA041 NEUTRON ACER TENDL-2019 LIBRARY; T=293.16K
Photon emission for (n,n*)t

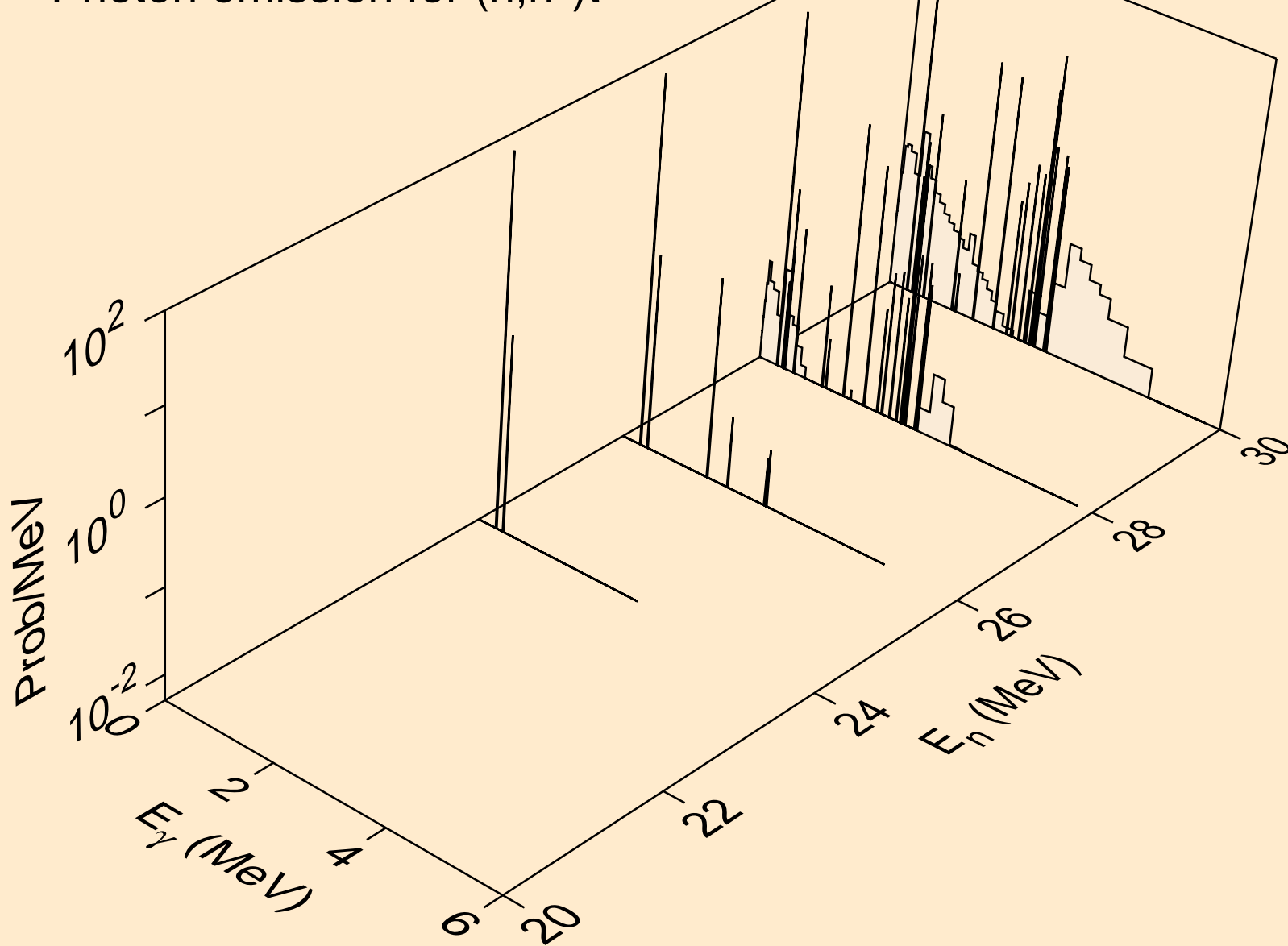

CA041 NEUTRON ACER TENDL-2019 LIBRARY; T=293.16K
Photon emission for (n,n*)he3

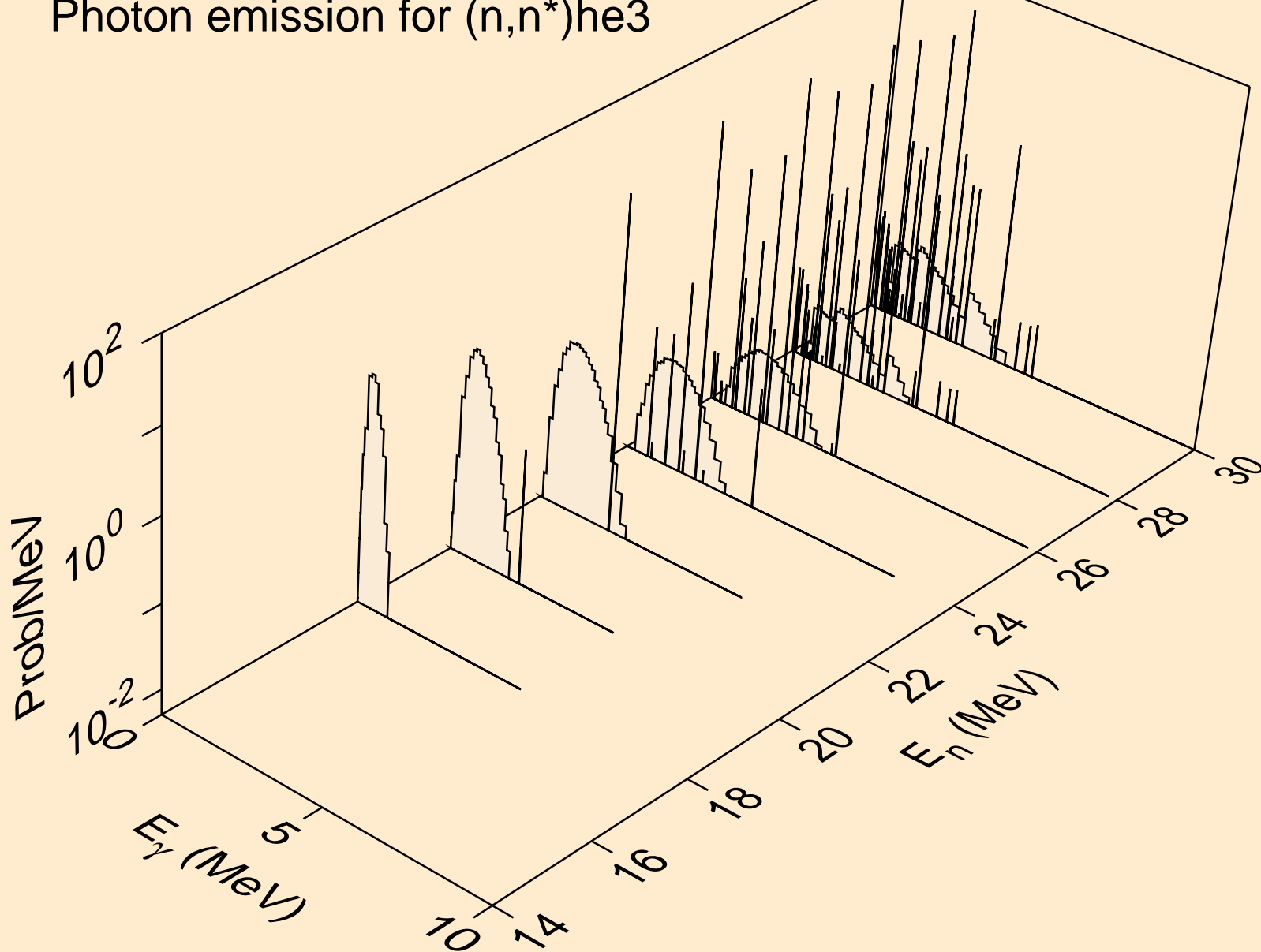

CA041 NEUTRON ACER TENDL-2019 LIBRARY; T=293.16K
Photon emission for (n,2np)

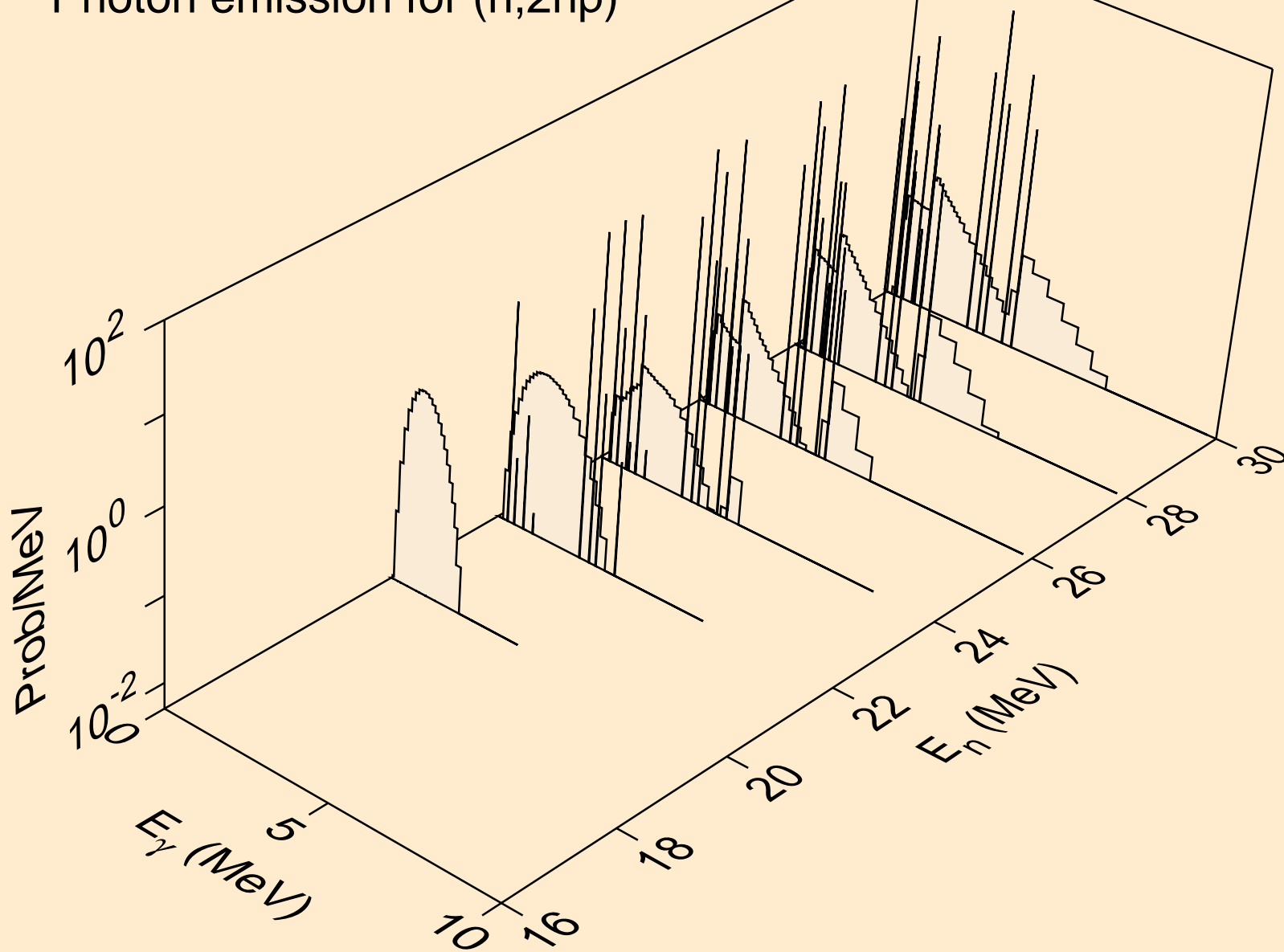

CA041 NEUTRON ACER TENDL-2019 LIBRARY; T=293.16K
Photon emission for (n,2np)

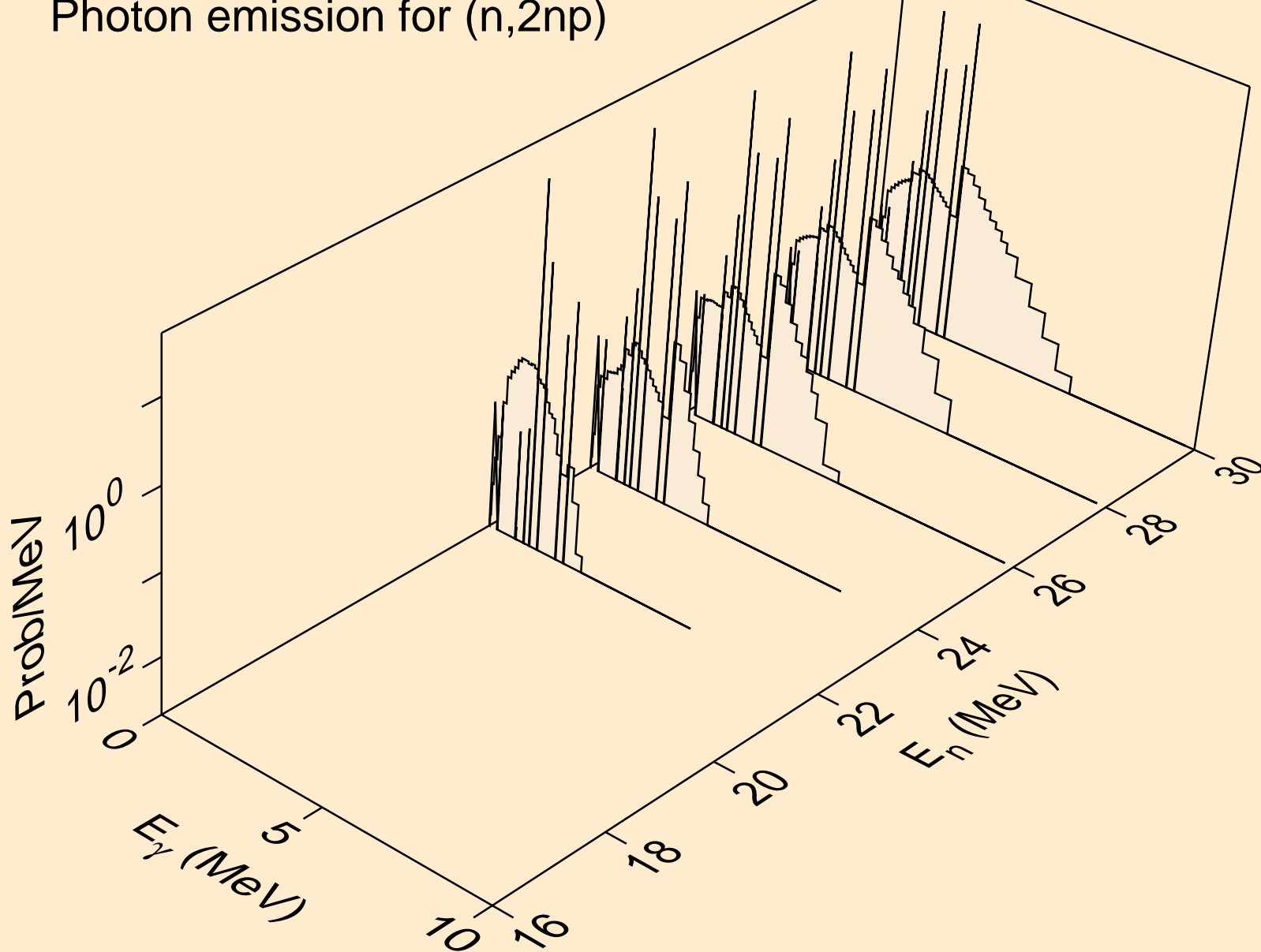

CA041 NEUTRON ACER TENDL-2019 LIBRARY; T=293.16K
Photon emission for (n,npa)

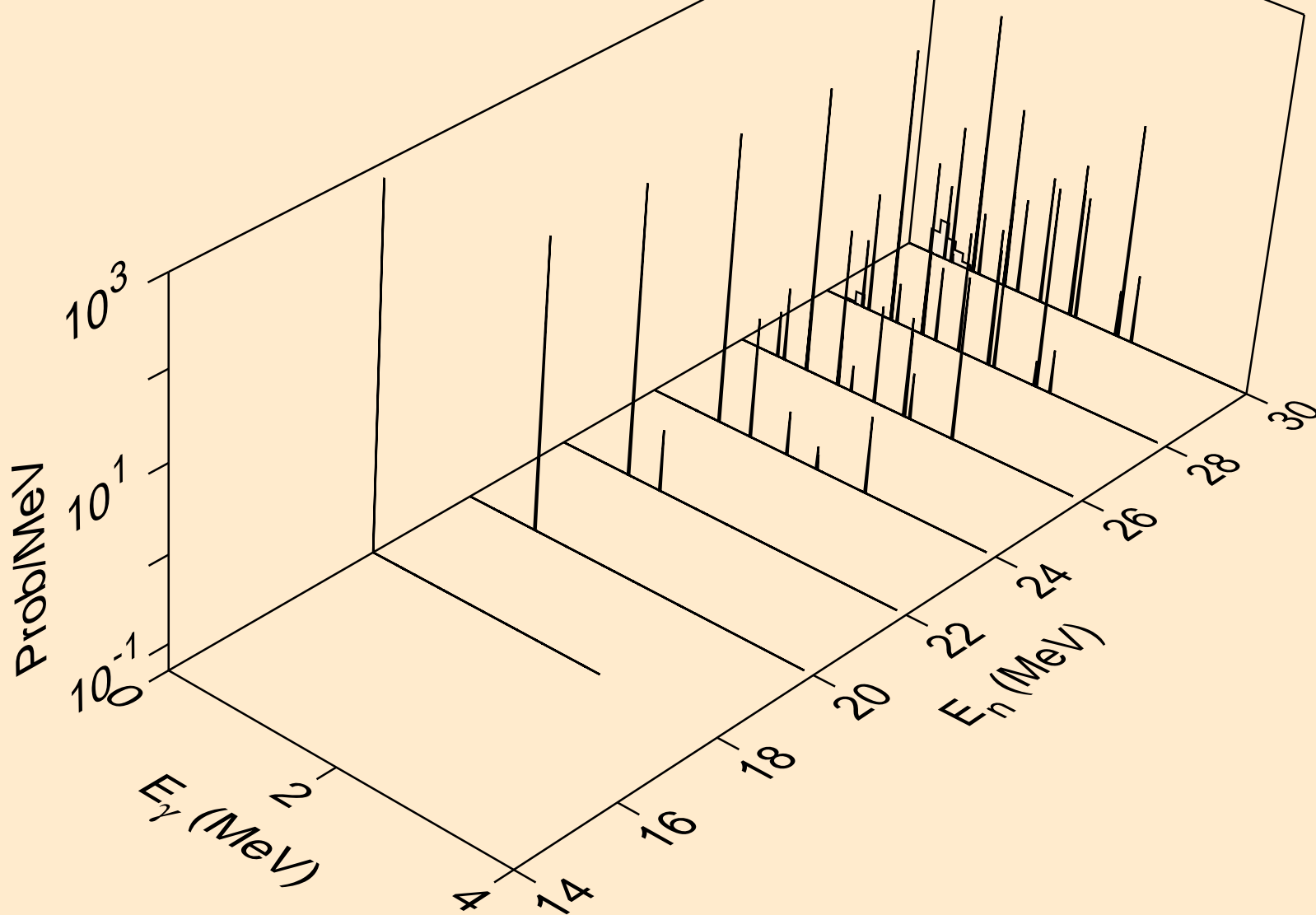

CA041 NEUTRON ACER TENDL-2019 LIBRARY; T=293.16K
Photon emission for (n,n*c)

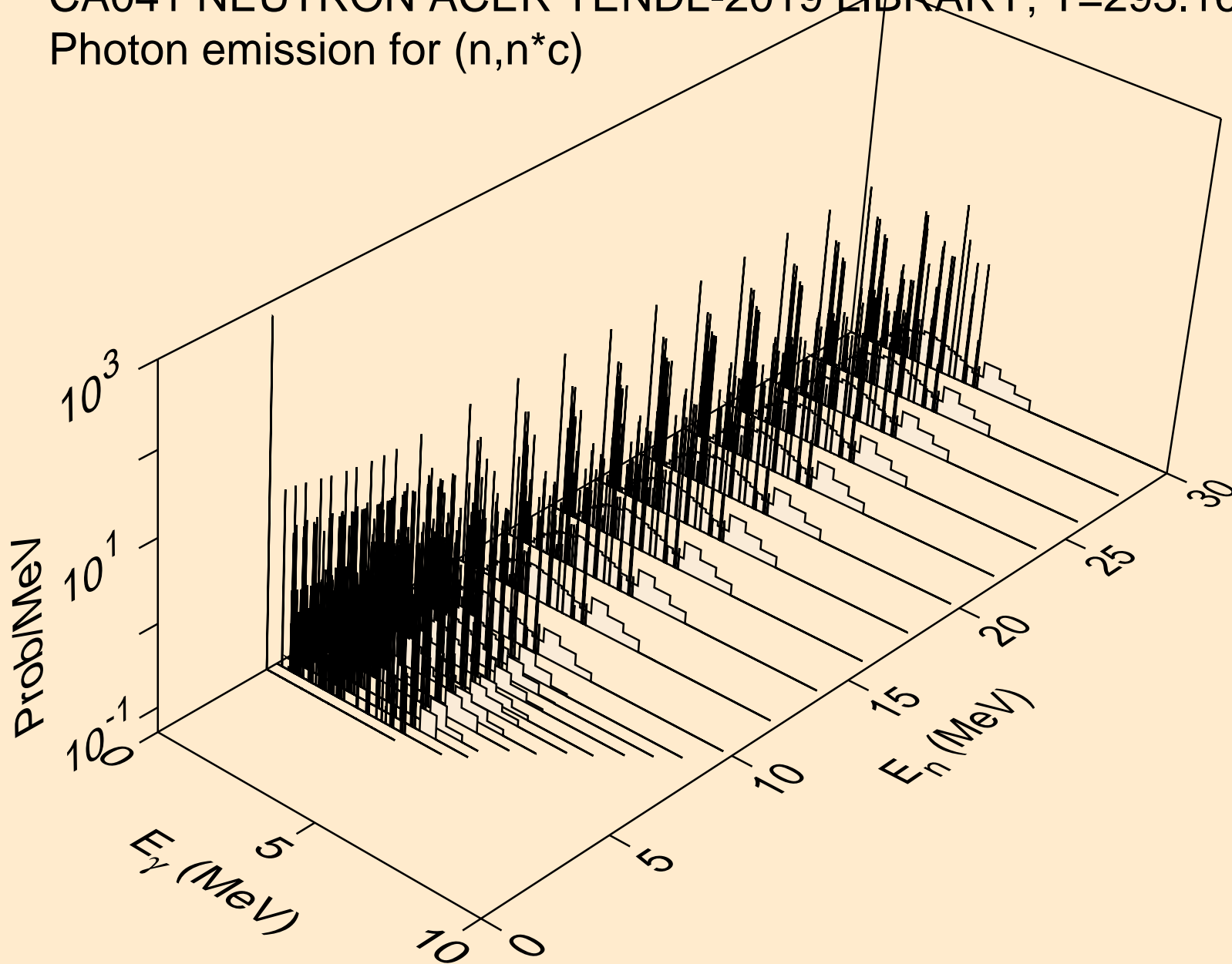

CA041 NEUTRON ACER TENDL-2019 LIBRARY; T=293.16K
Photon emission for (n,gma)

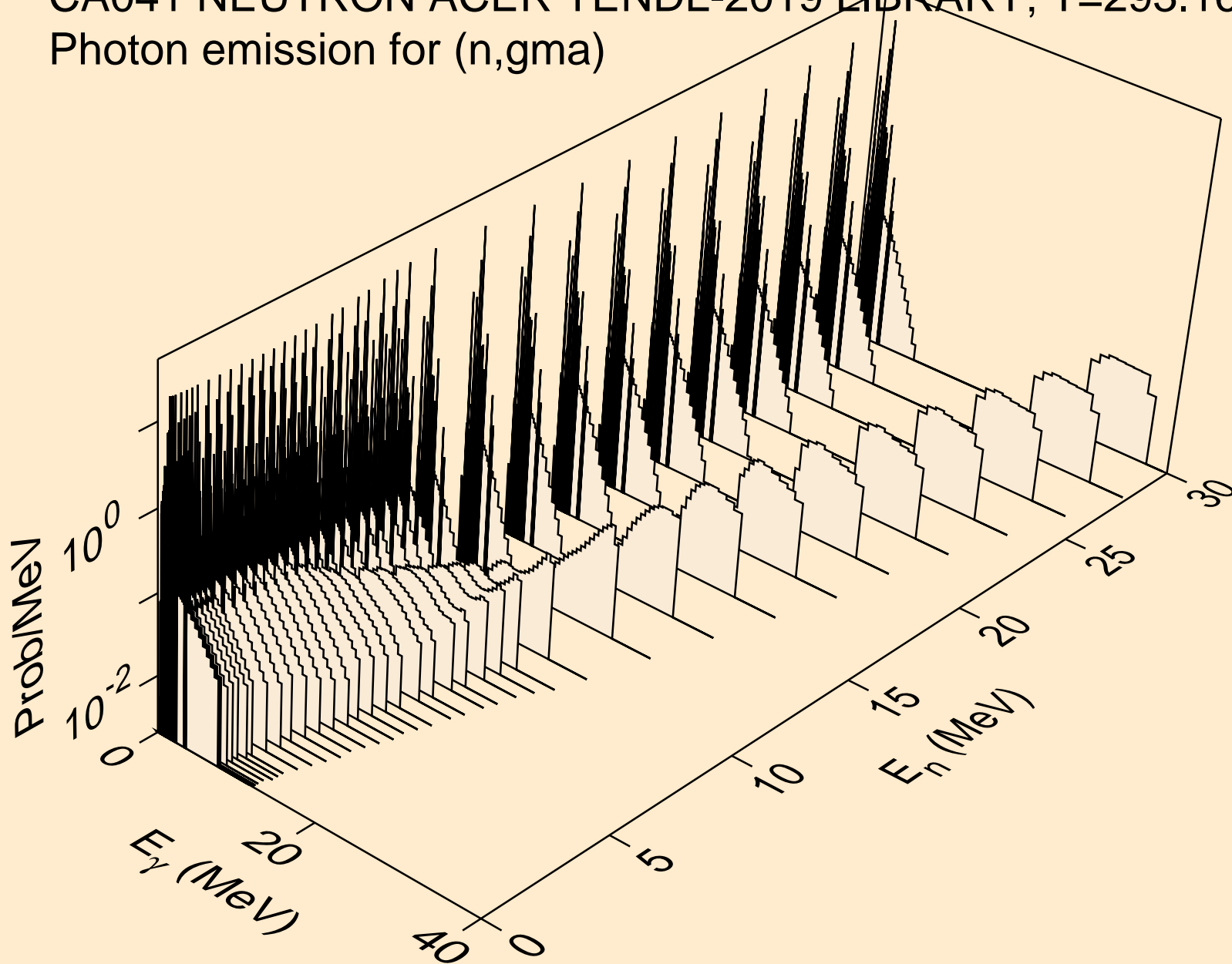

CA041 NEUTRON ACER TENDL-2019 LIBRARY; T=293.16K
Photon emission for (n,p)

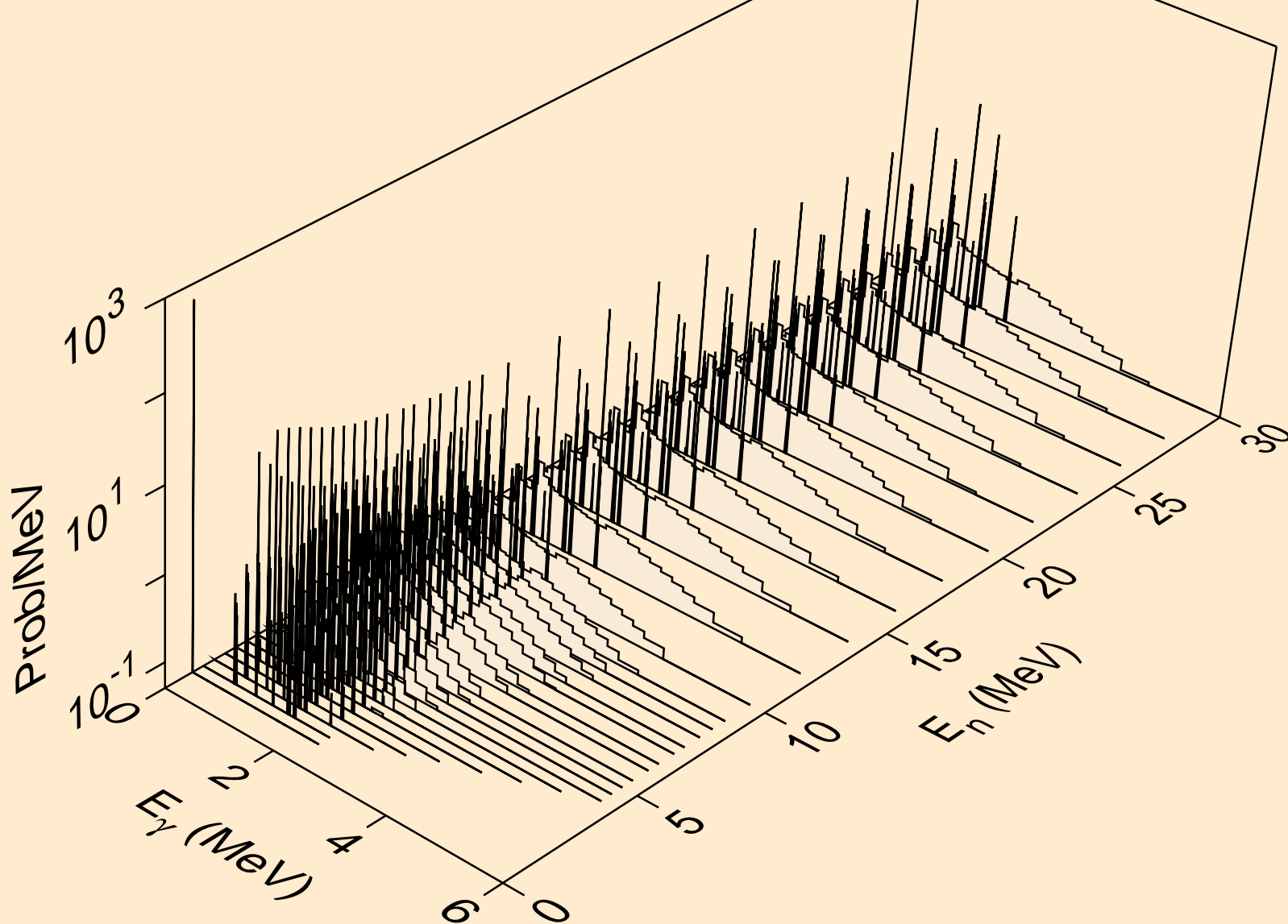

CA041 NEUTRON ACER TENDL-2019 LIBRARY; T=293.16K
Photon emission for (n,d)

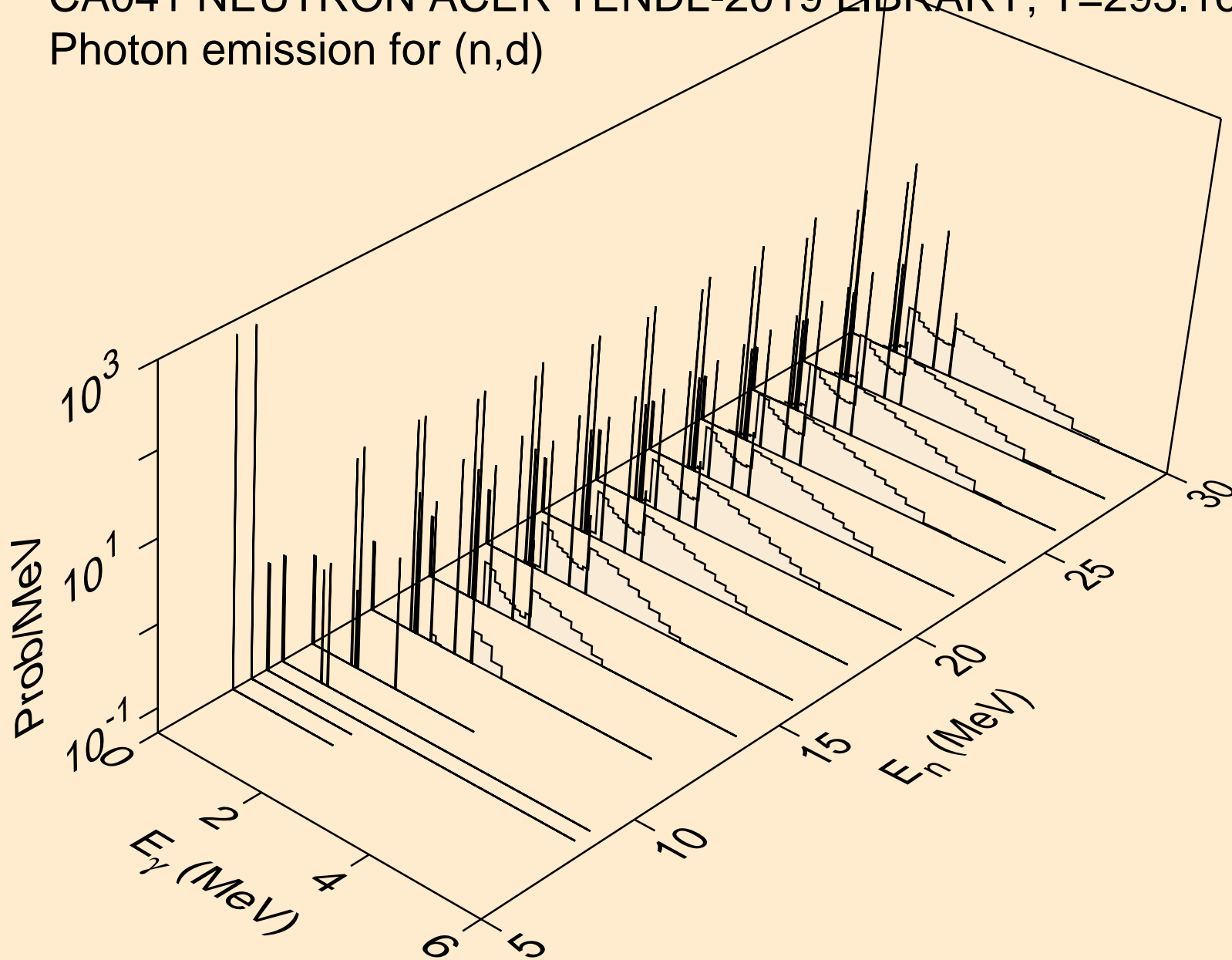

CA041 NEUTRON ACER TENDL-2019 LIBRARY; T=293.16K
Photon emission for (n,t)

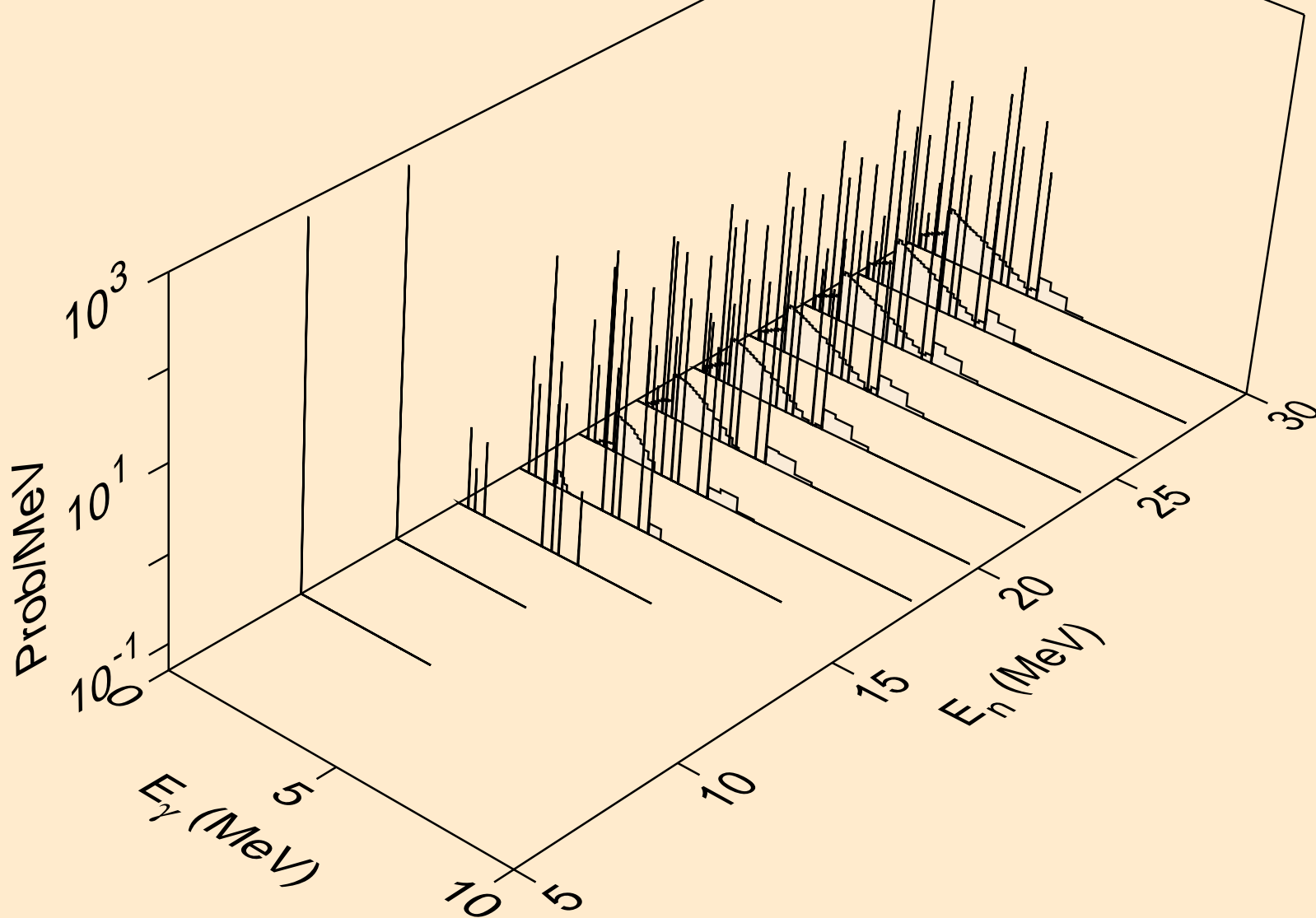

CA041 NEUTRON ACER TENDL-2019 LIBRARY; T=293.16K
Photon emission for (n,he3)

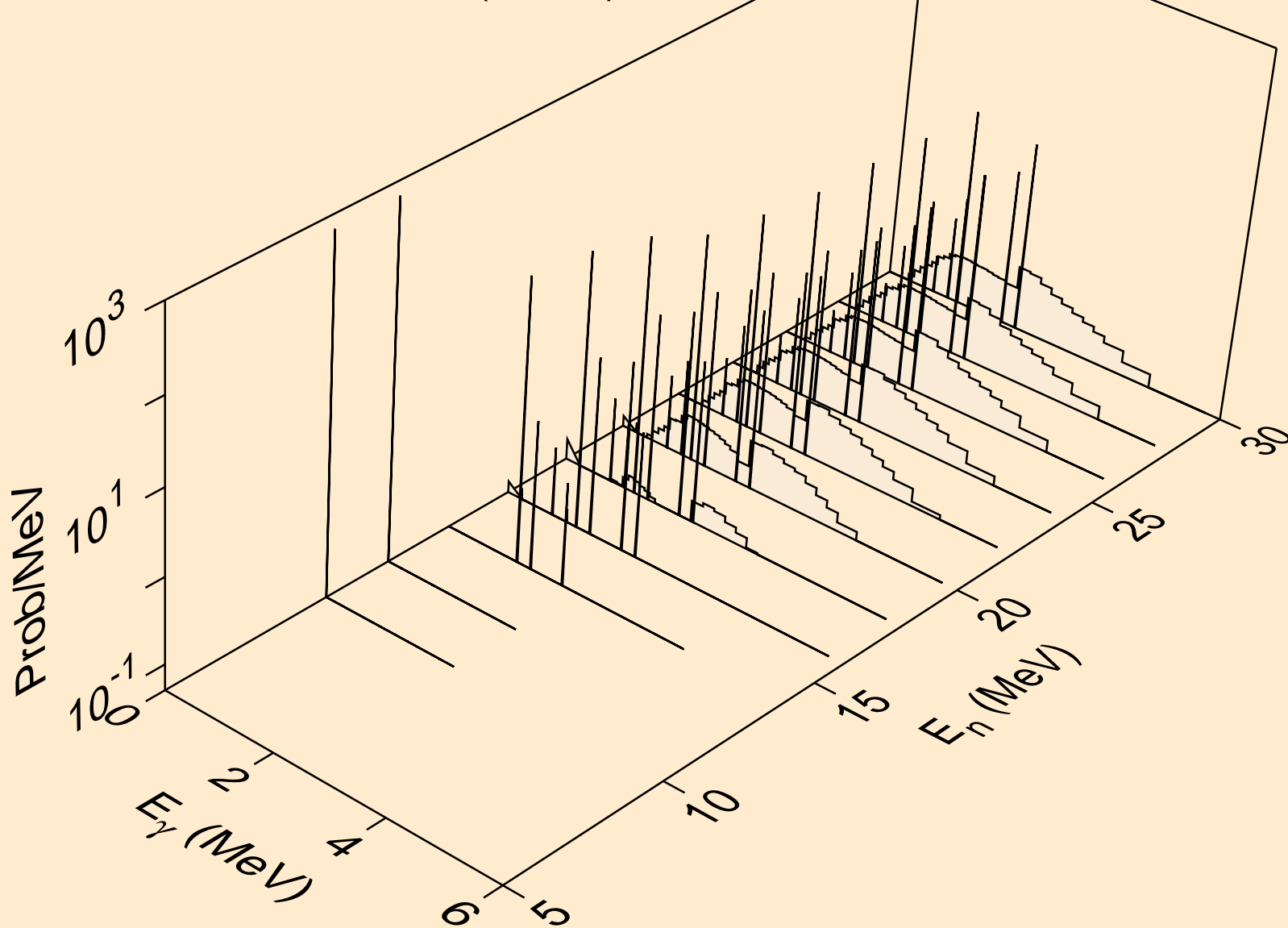

CA041 NEUTRON ACER TENDL-2019 LIBRARY; T=293.16K
Photon emission for (n,a)

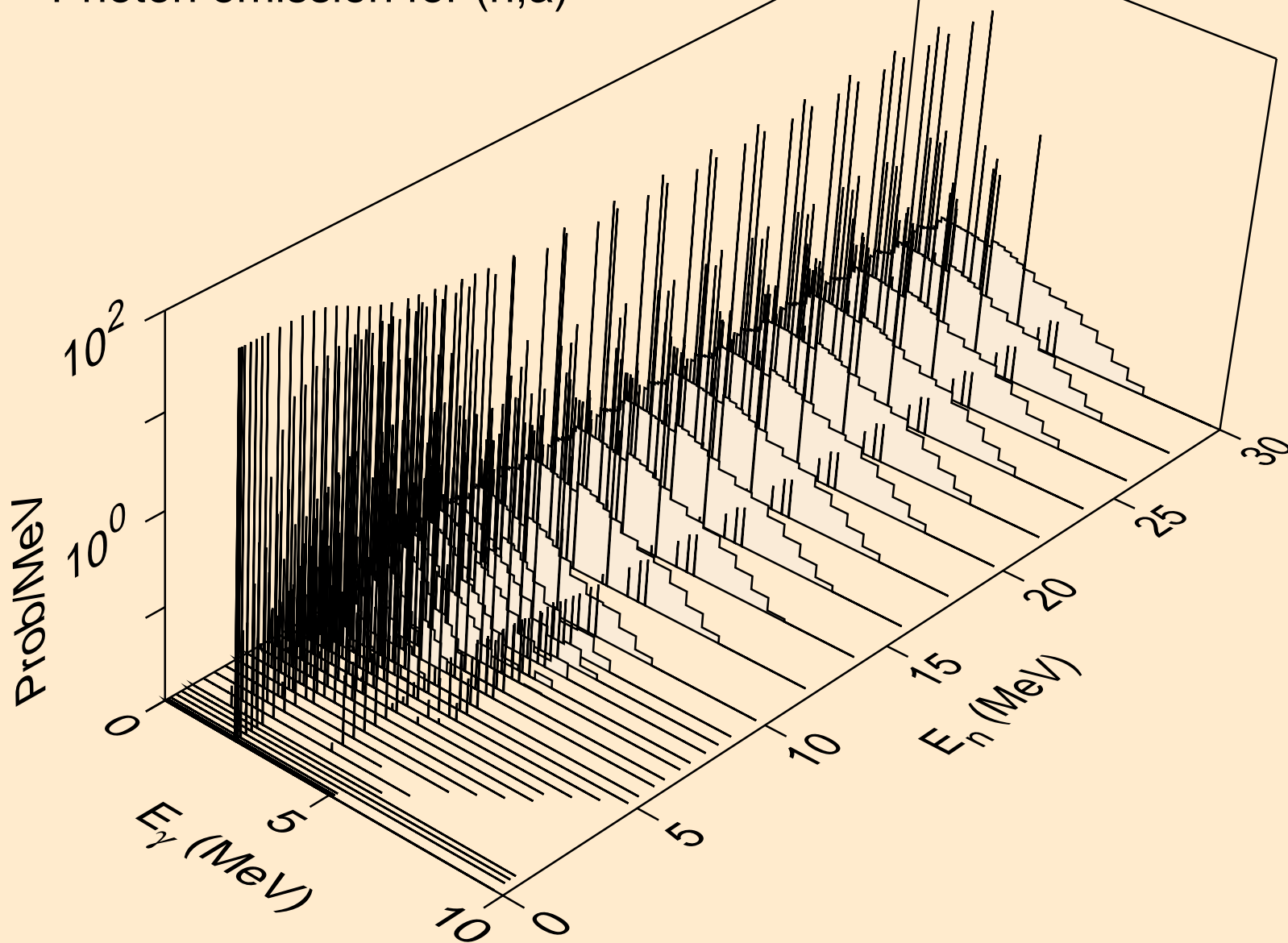

CA041 NEUTRON ACER TENDL-2019 LIBRARY; T=293.16K
Photon emission for (n,2a)

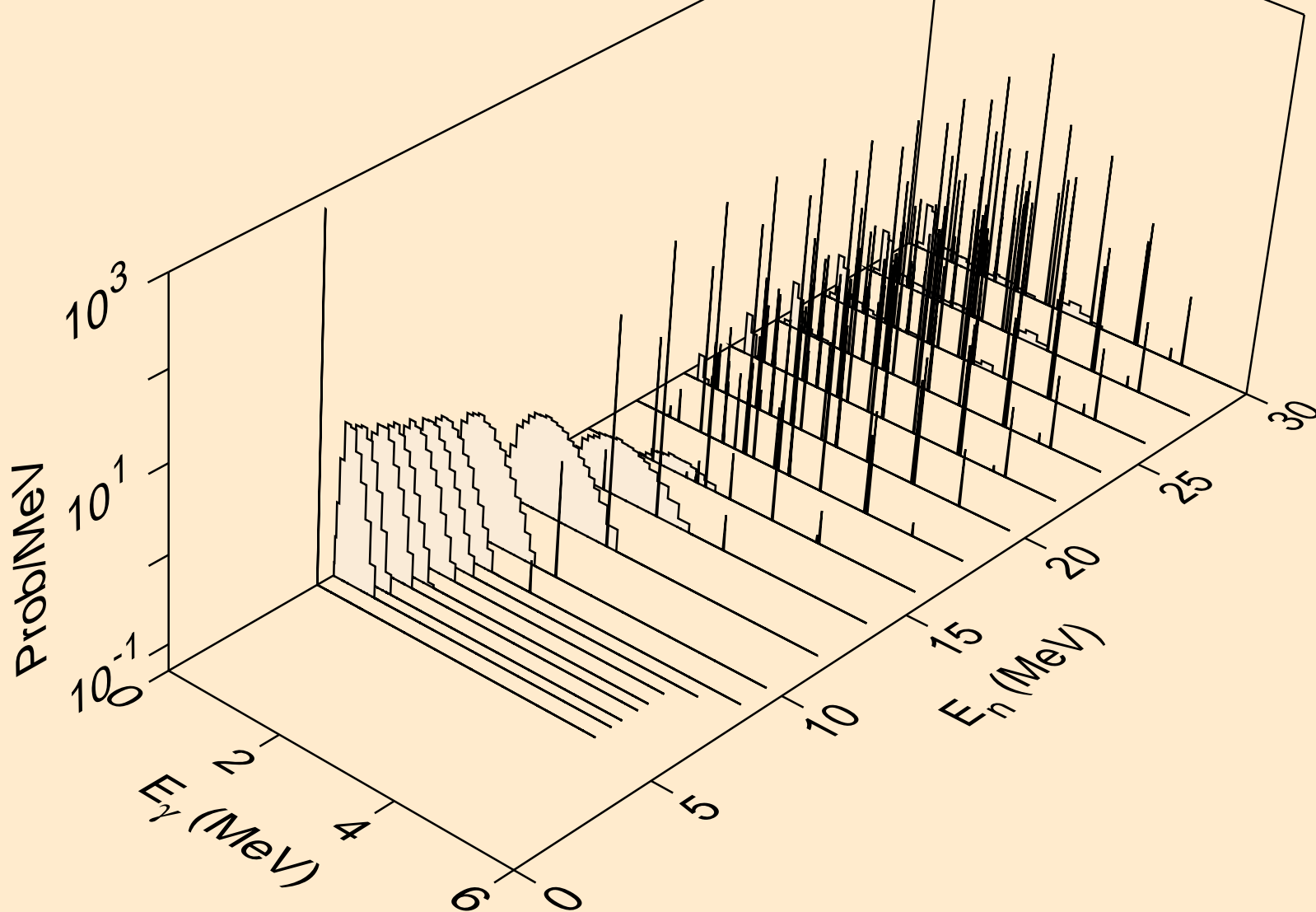

CA041 NEUTRON ACER TENDL-2019 LIBRARY; T=293.16K
Photon emission for (n,3a)

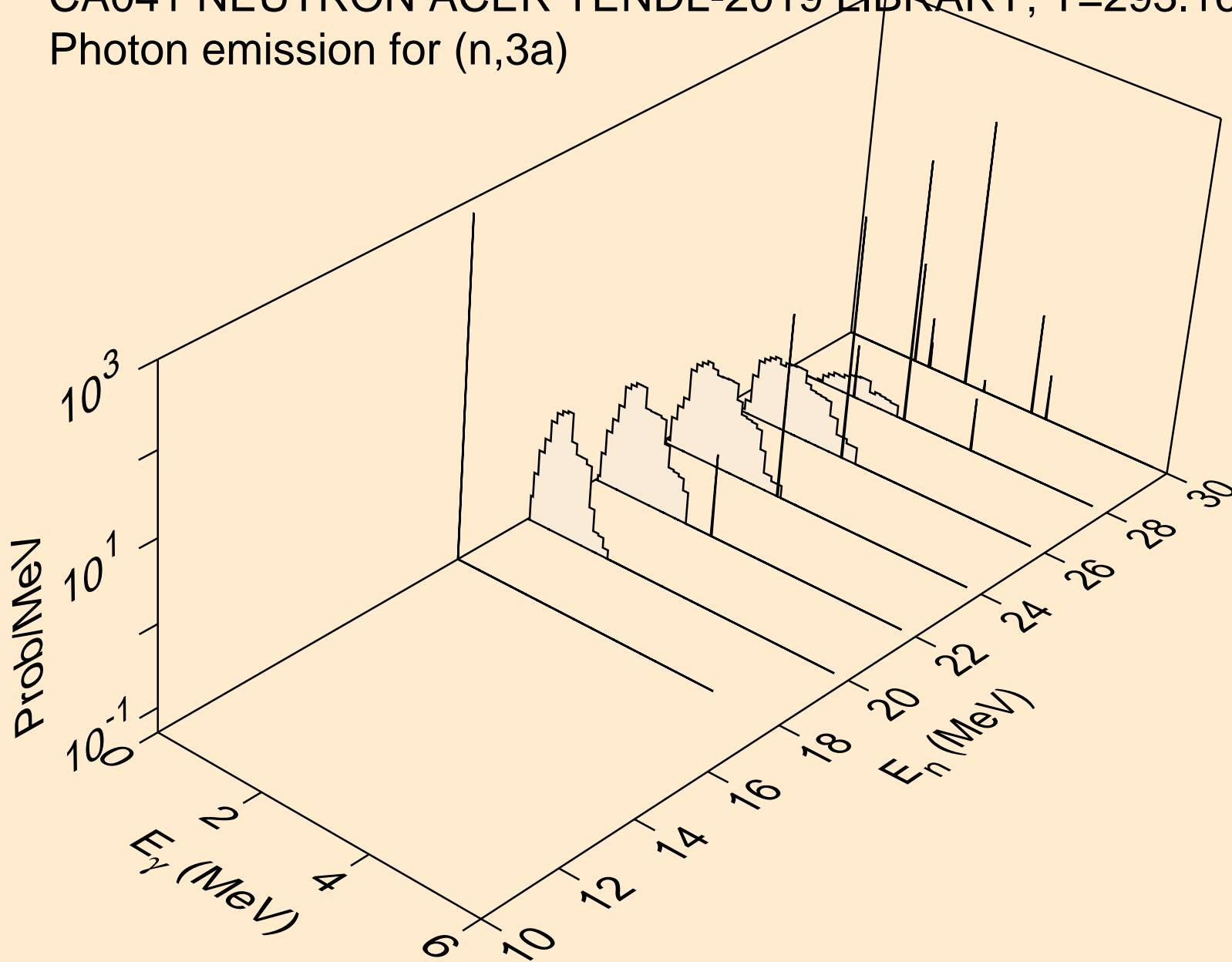

CA041 NEUTRON ACER TENDL-2019 LIBRARY; T=293.16K
Photon emission for (n,2p)

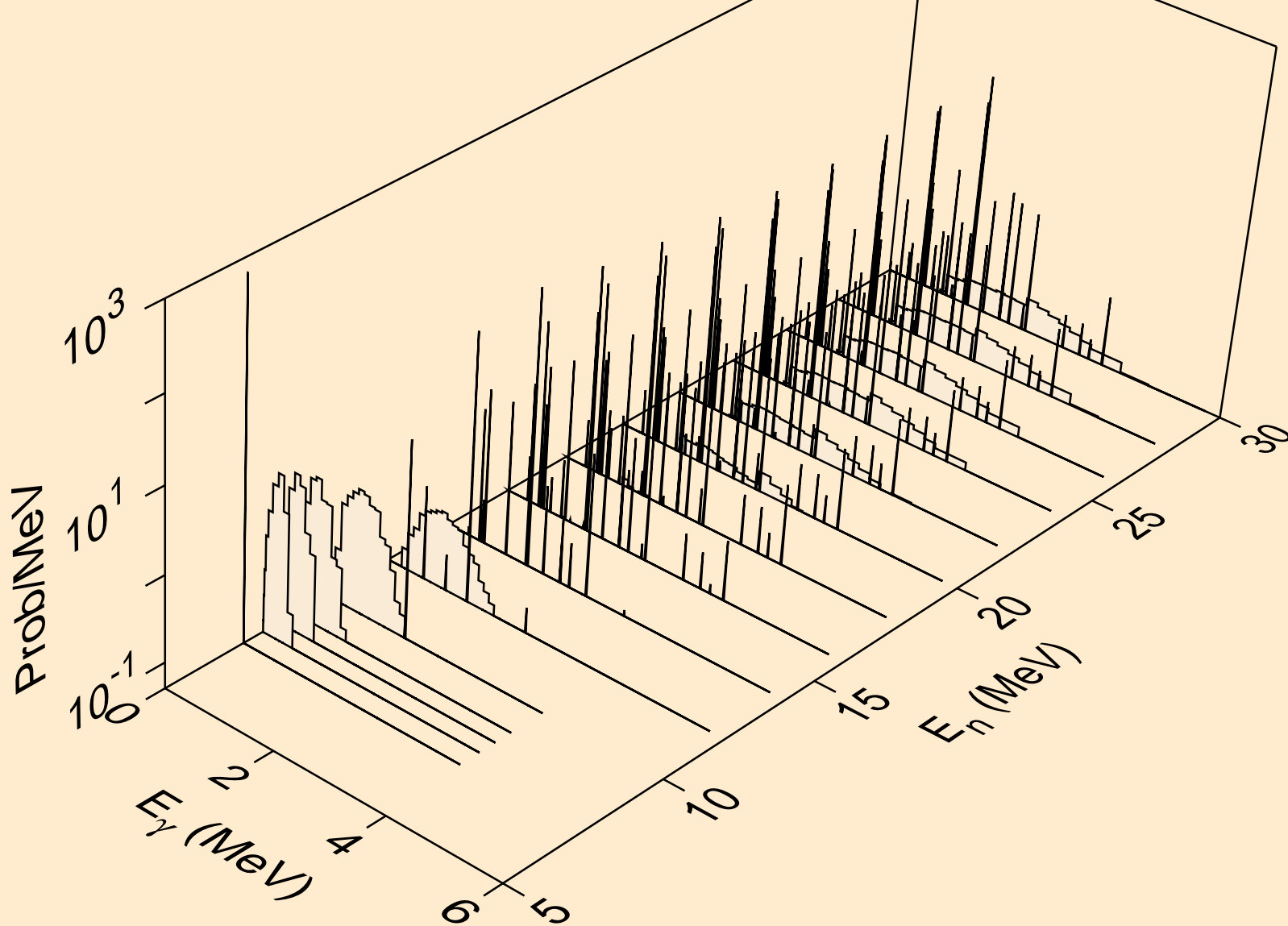

CA041 NEUTRON ACER TENDL-2019 LIBRARY; T=293.16K
Photon emission for (n,p)

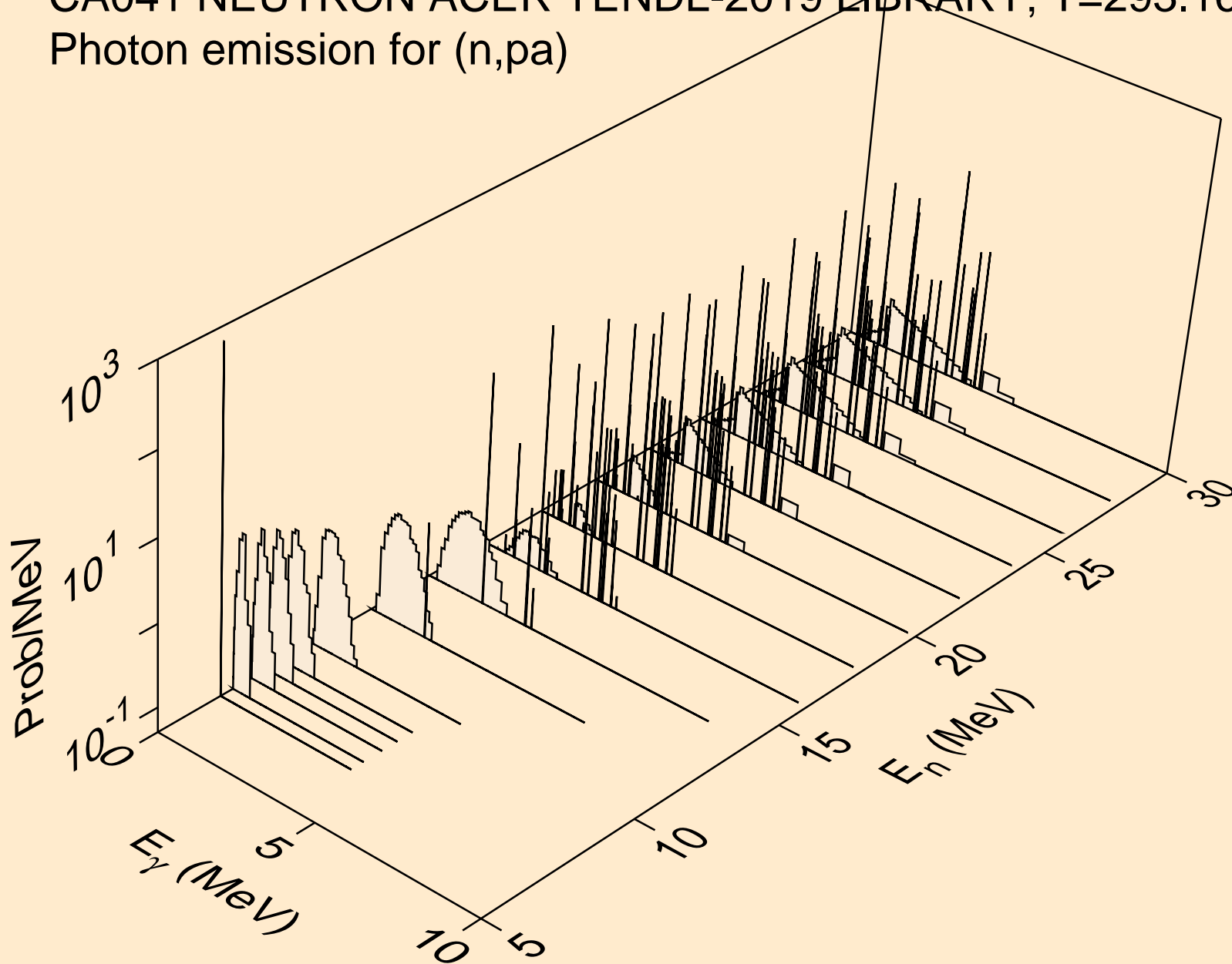

CA041 NEUTRON ACER TENDL-2019 LIBRARY; T=293.16K
Photon emission for (n,pd)

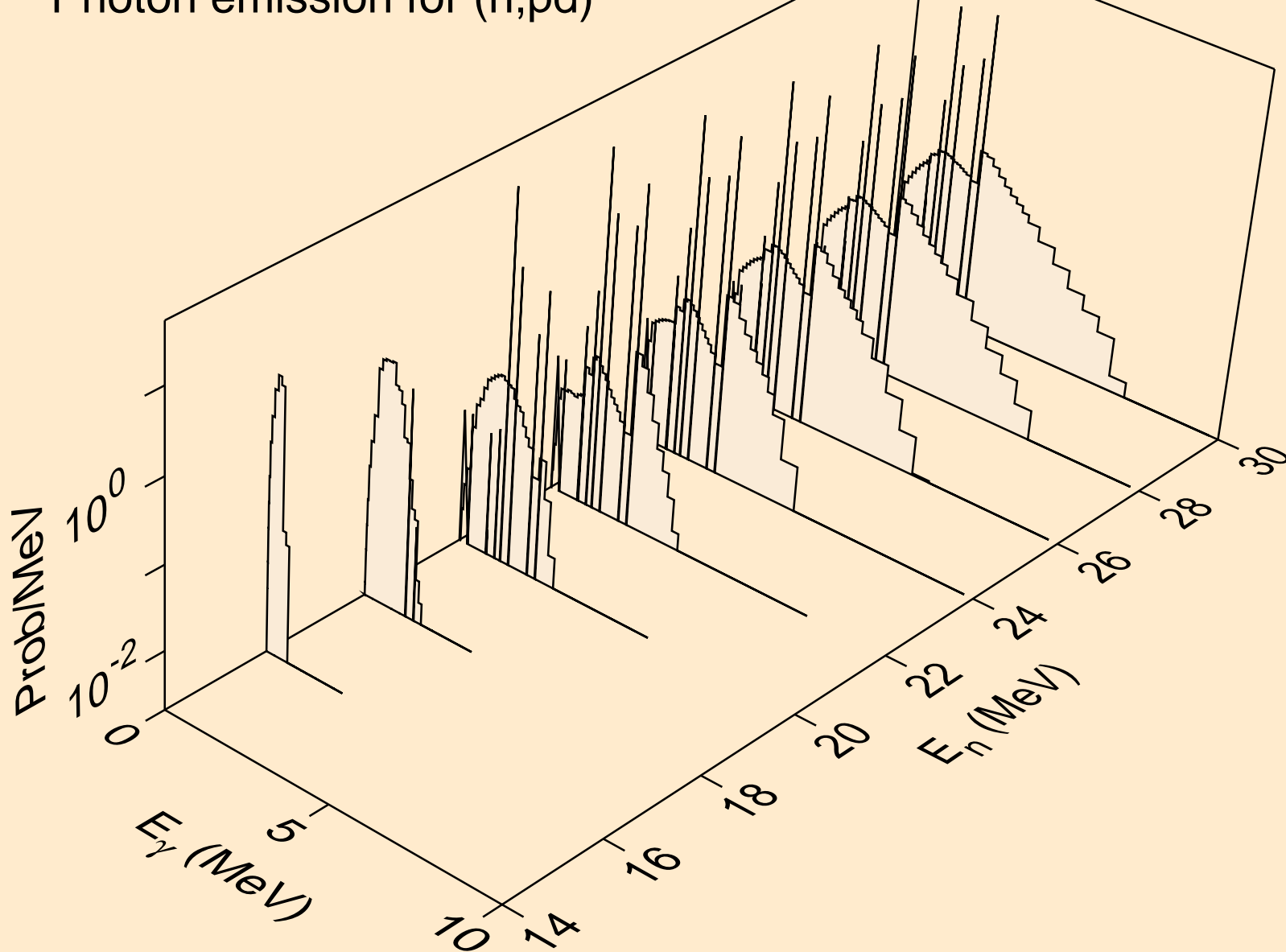

CA041 NEUTRON ACER TENDL-2019 LIBRARY; T=293.16K
Photon emission for (n,pt)

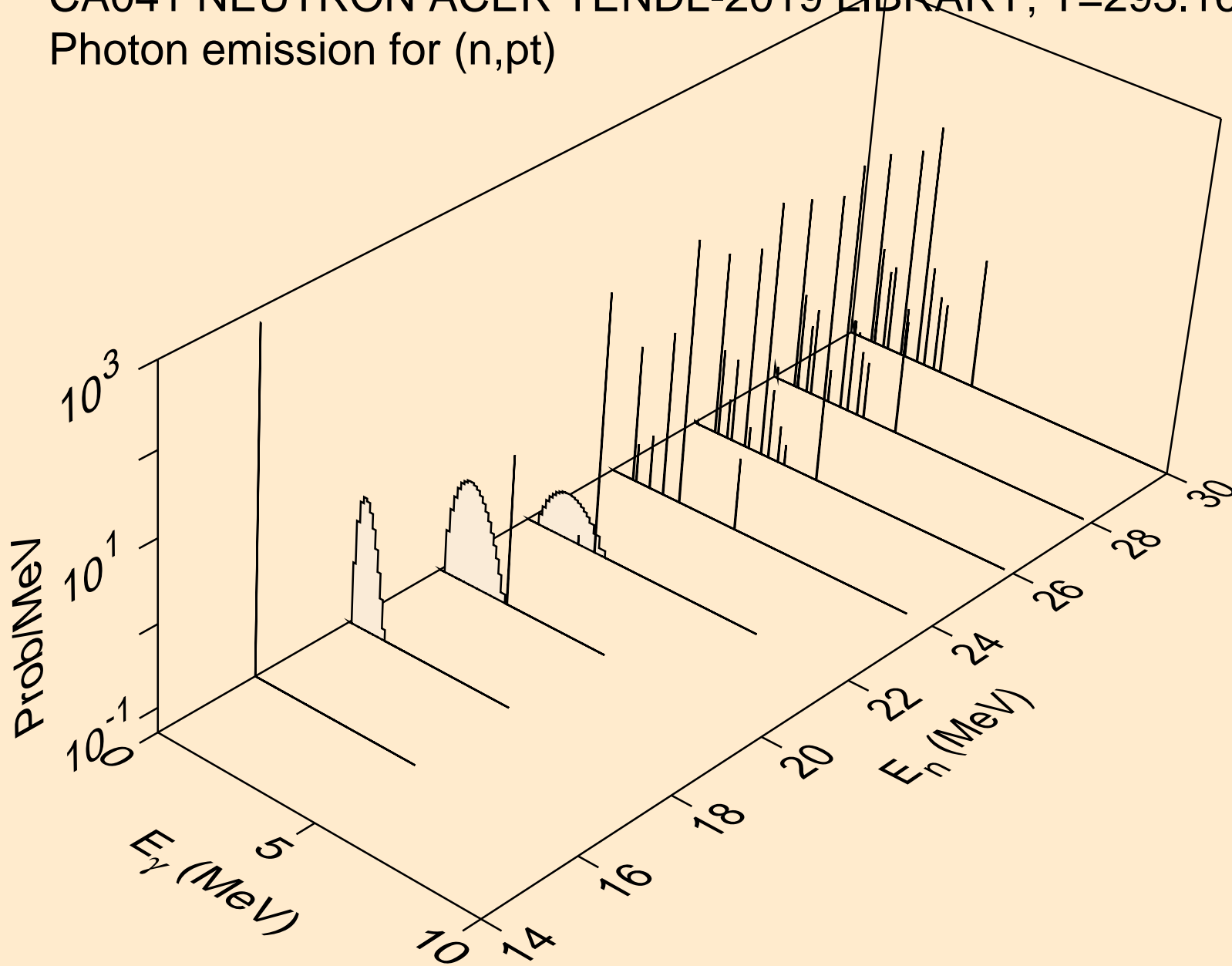

CA041 NEUTRON ACER TENDL-2019 LIBRARY; T=293.16K
Photon emission for (n,da)

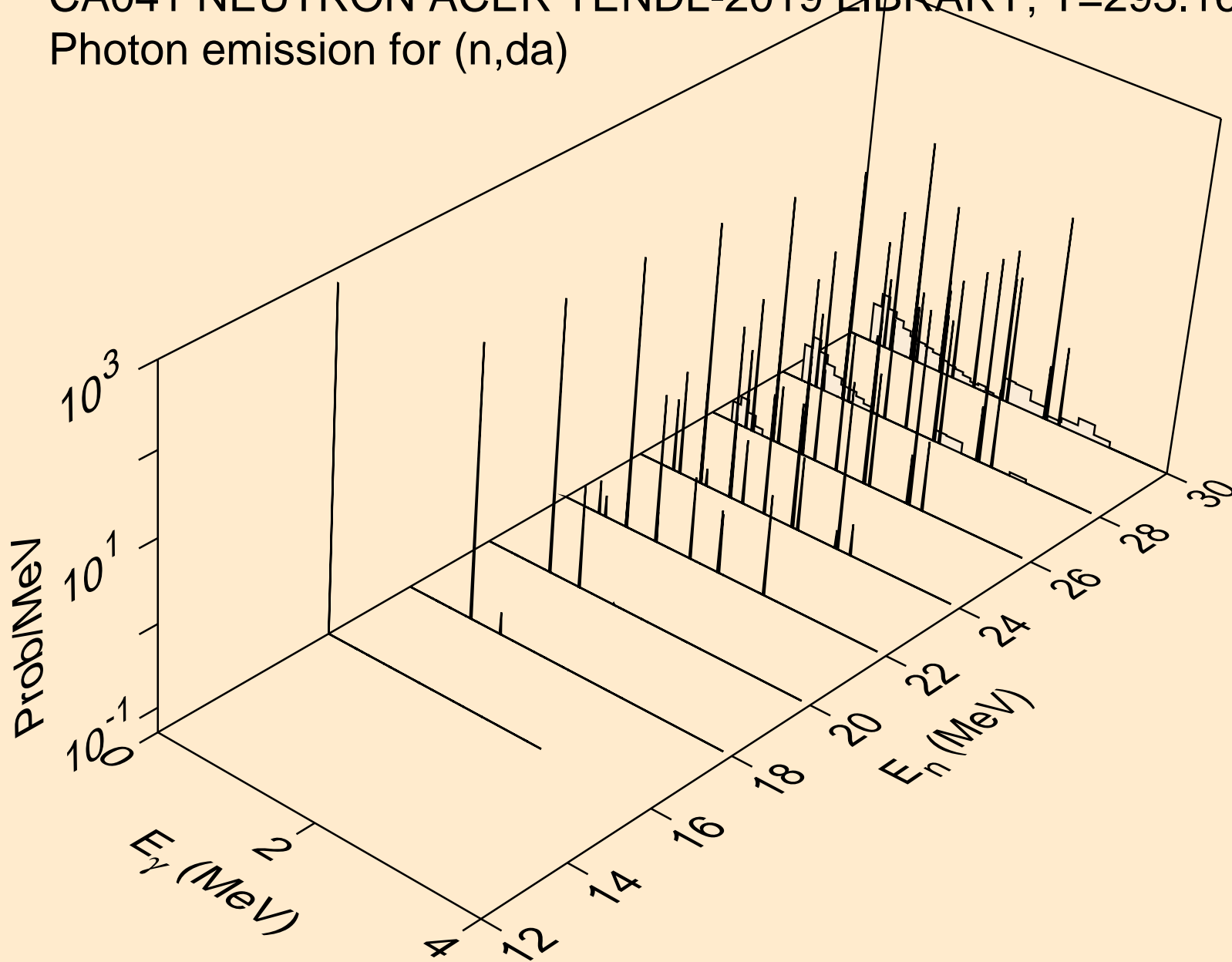

CA041 NEUTRON ACER TENDL-2019 LIBRARY; T=293.16K
thermal capture photon spectrum

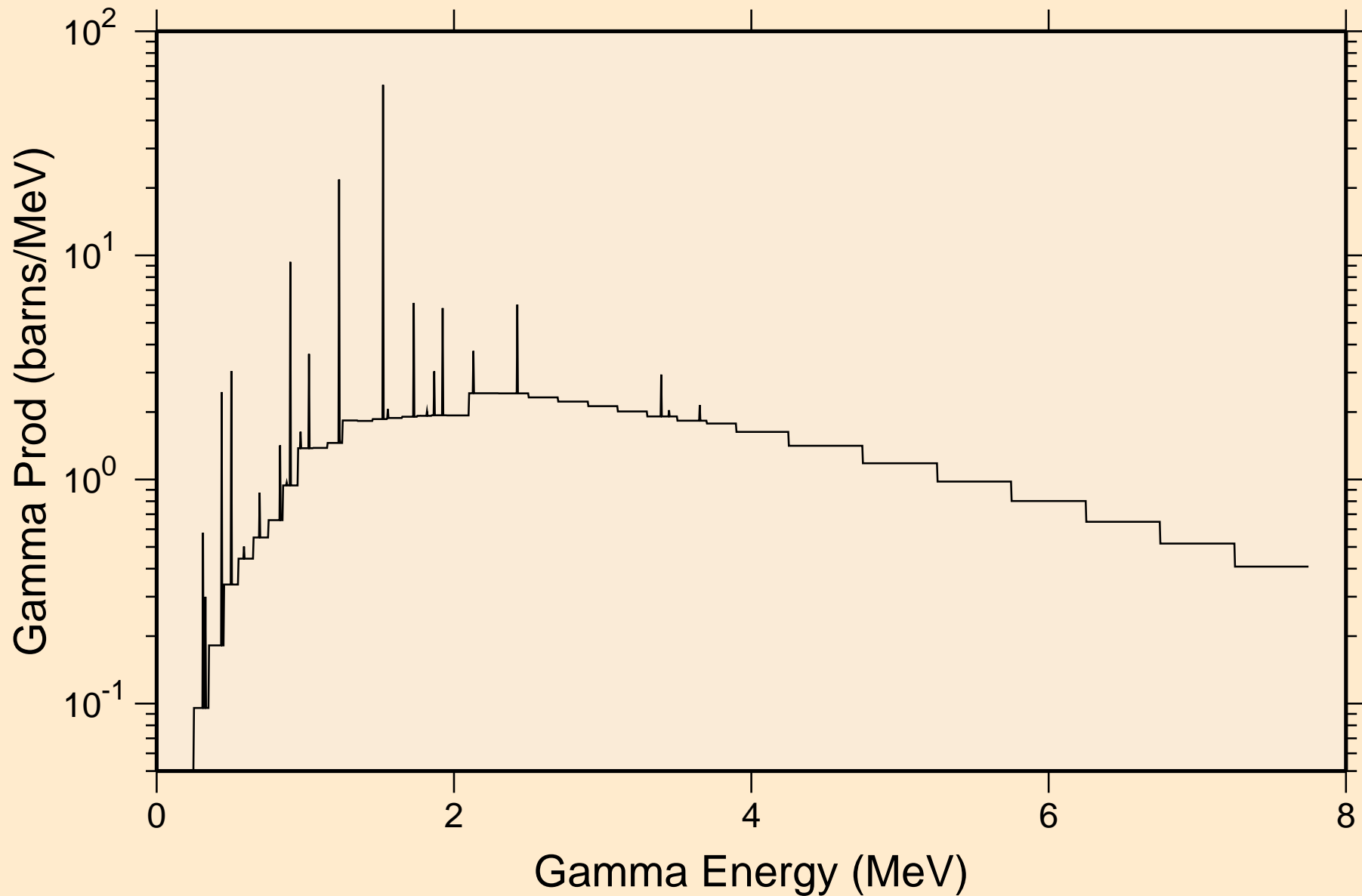

CA041 NEUTRON ACER TENDL-2019 LIBRARY; T=293.16K
14 MeV photon spectrum

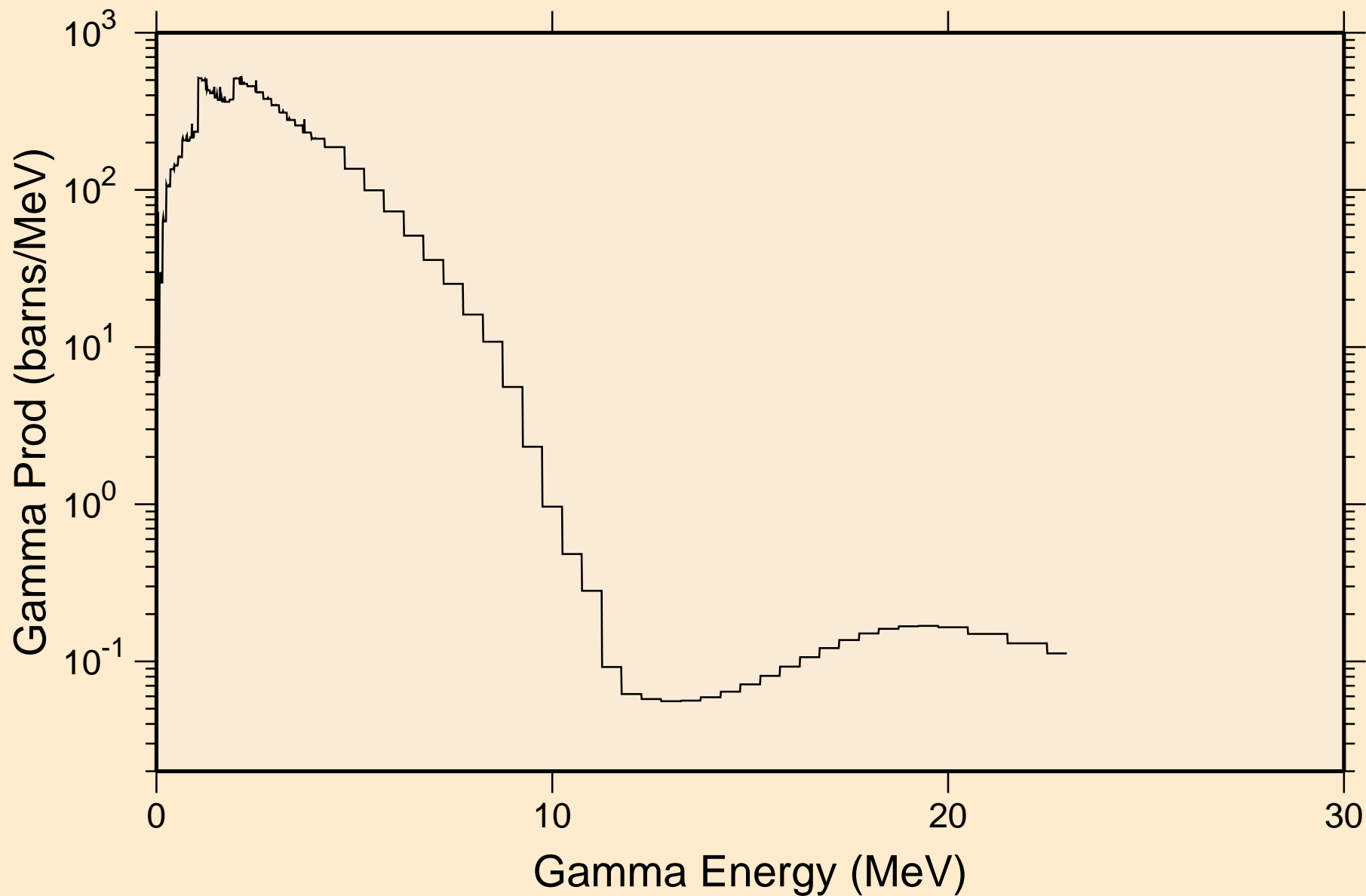

CA041 NEUTRON ACER TENDL-2019 LIBRARY; T=293.16K
Particle heating contributions

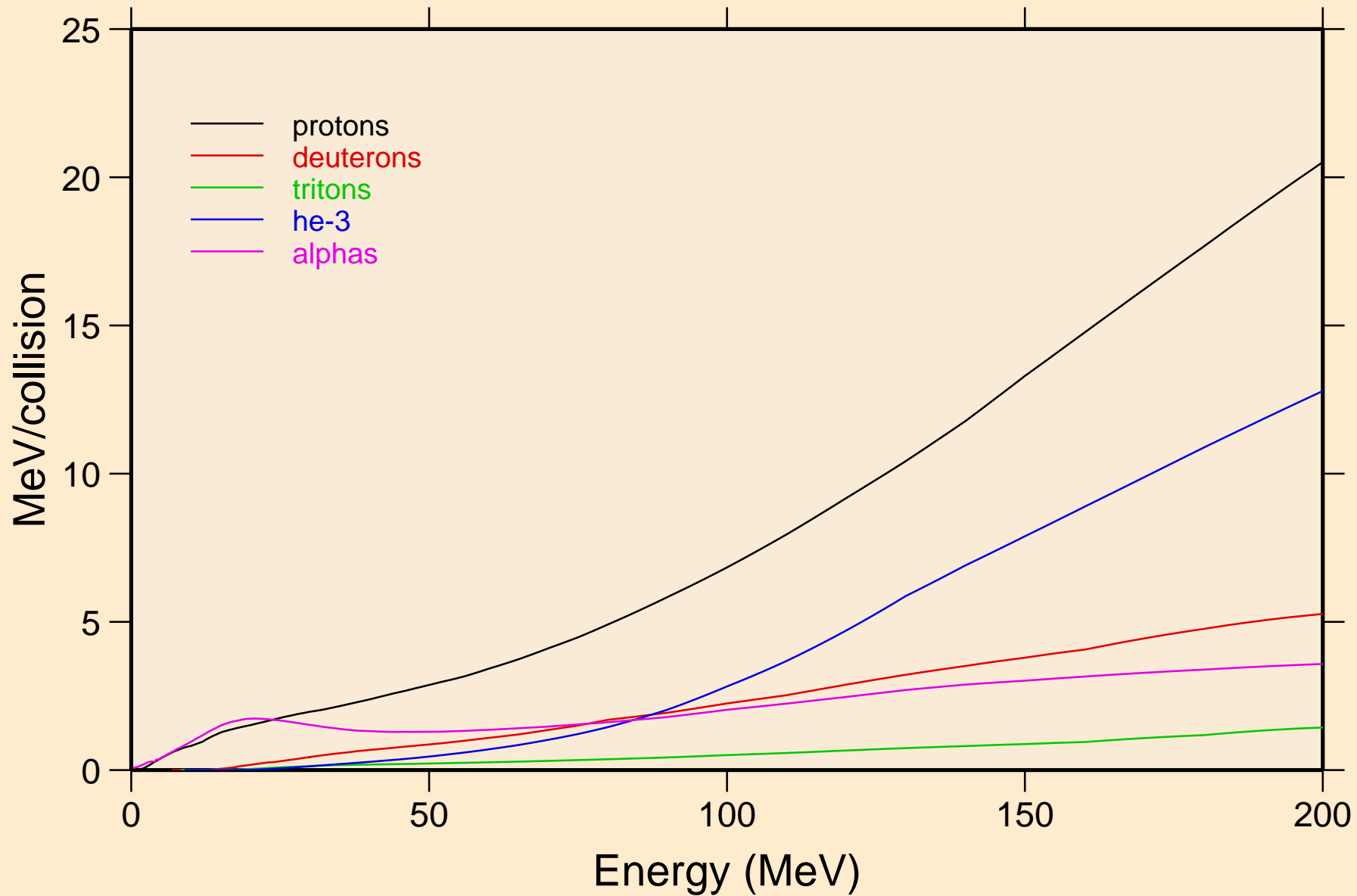

CA041 NEUTRON ACER TENDL-2019 LIBRARY; T=293.16K
Recoil Heating

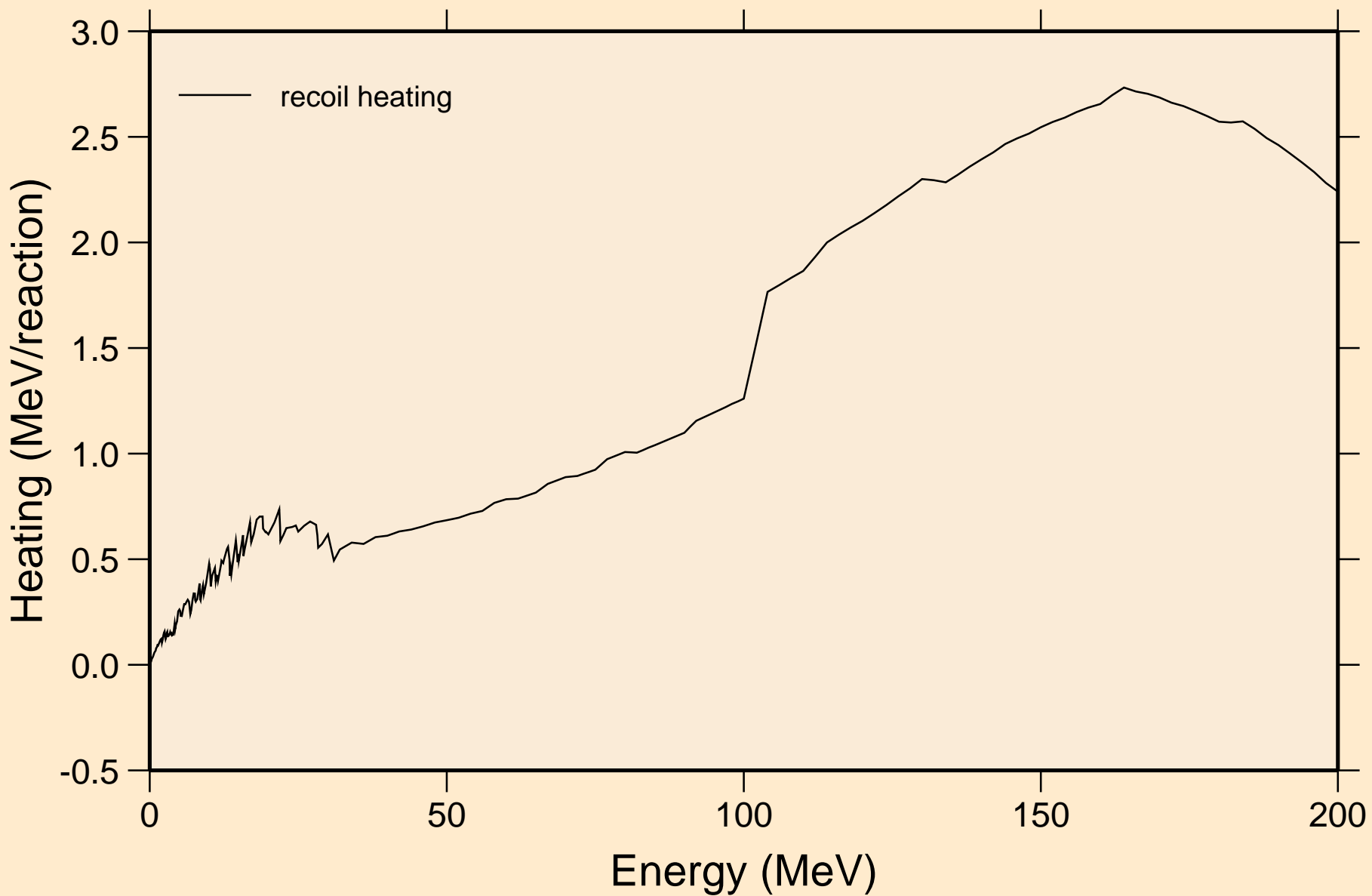

CA041 NEUTRON ACER TENDL-2019 LIBRARY; T=293.16K

Particle production cross sections

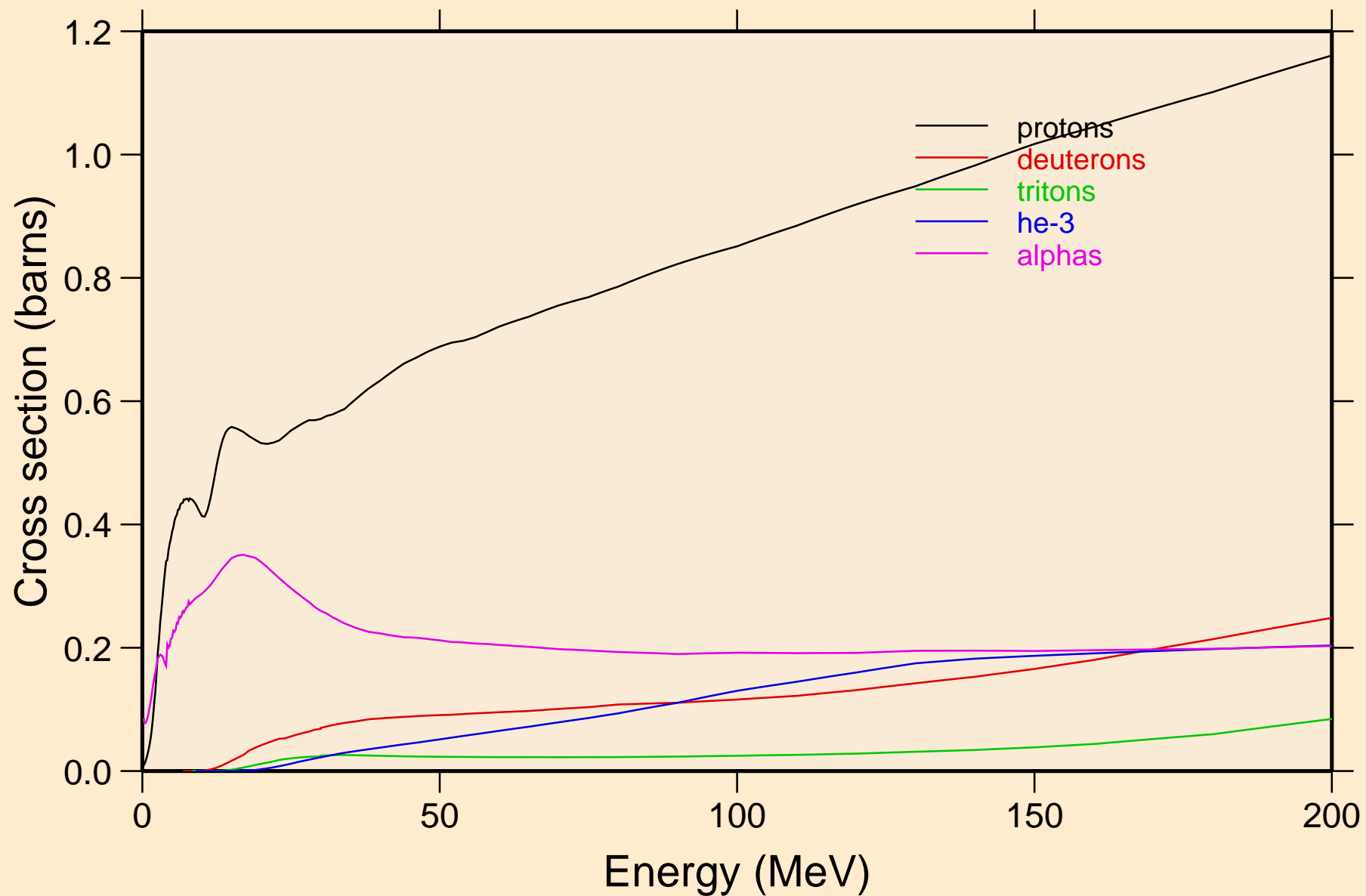

CA041 NEUTRON ACER TENDL-2019 LIBRARY; T=293.16K
protons from (n,x)

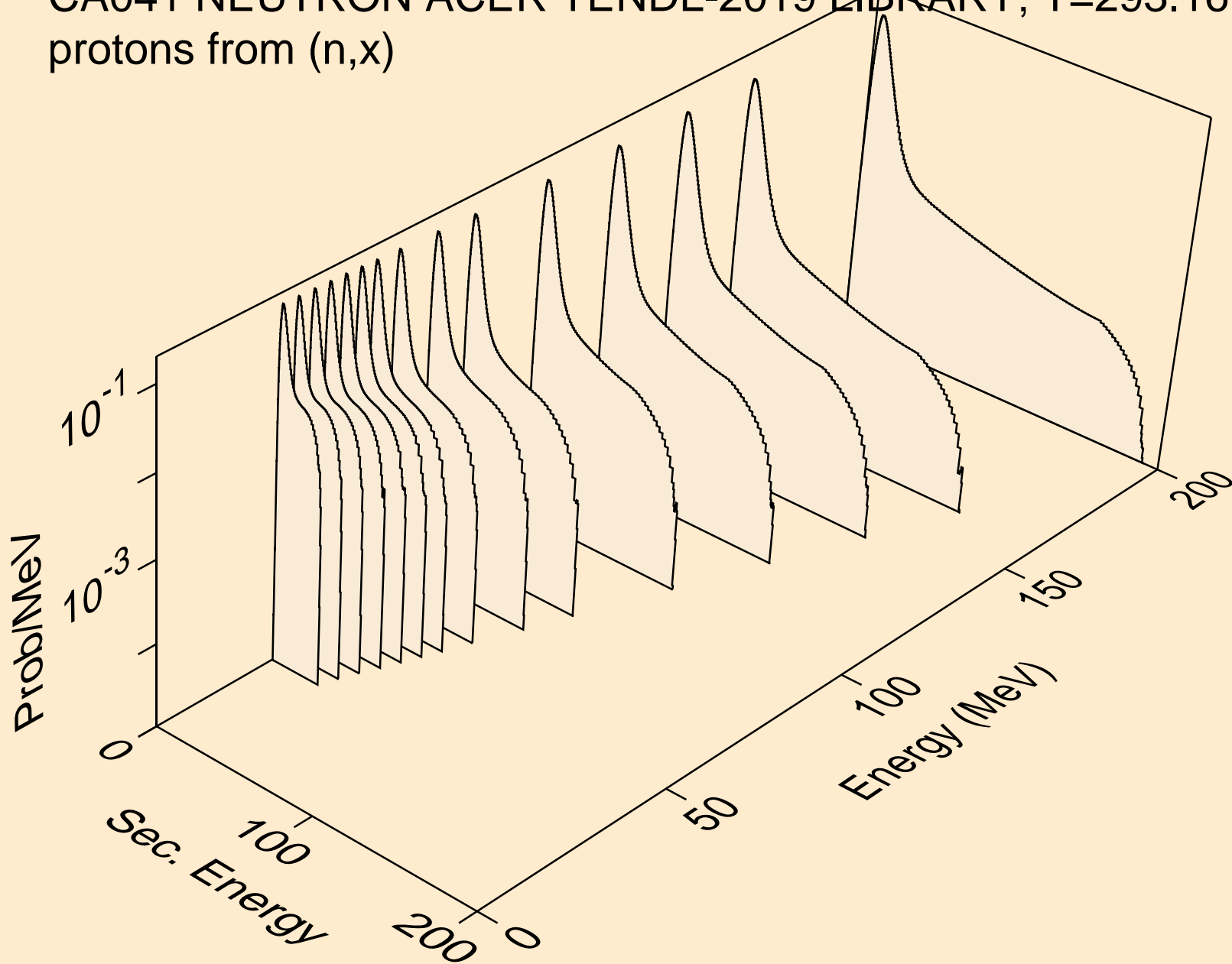

CA041 NEUTRON ACER TENDL-2019 LIBRARY; T=293.16K
protons from (n,n*)p

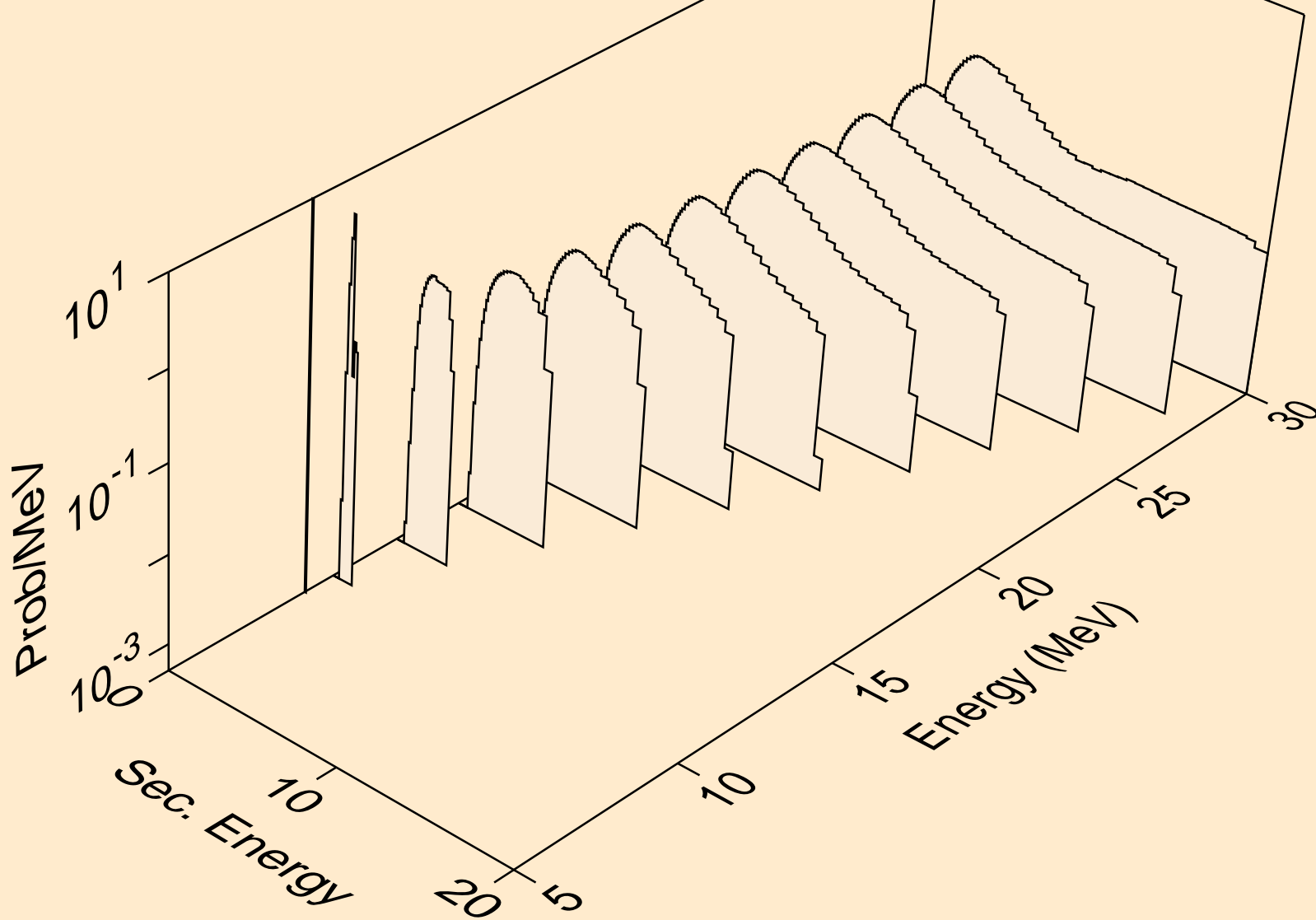

CA041 NEUTRON ACER TENDL-2019 LIBRARY; T=293.16K
protons from (n,2np)

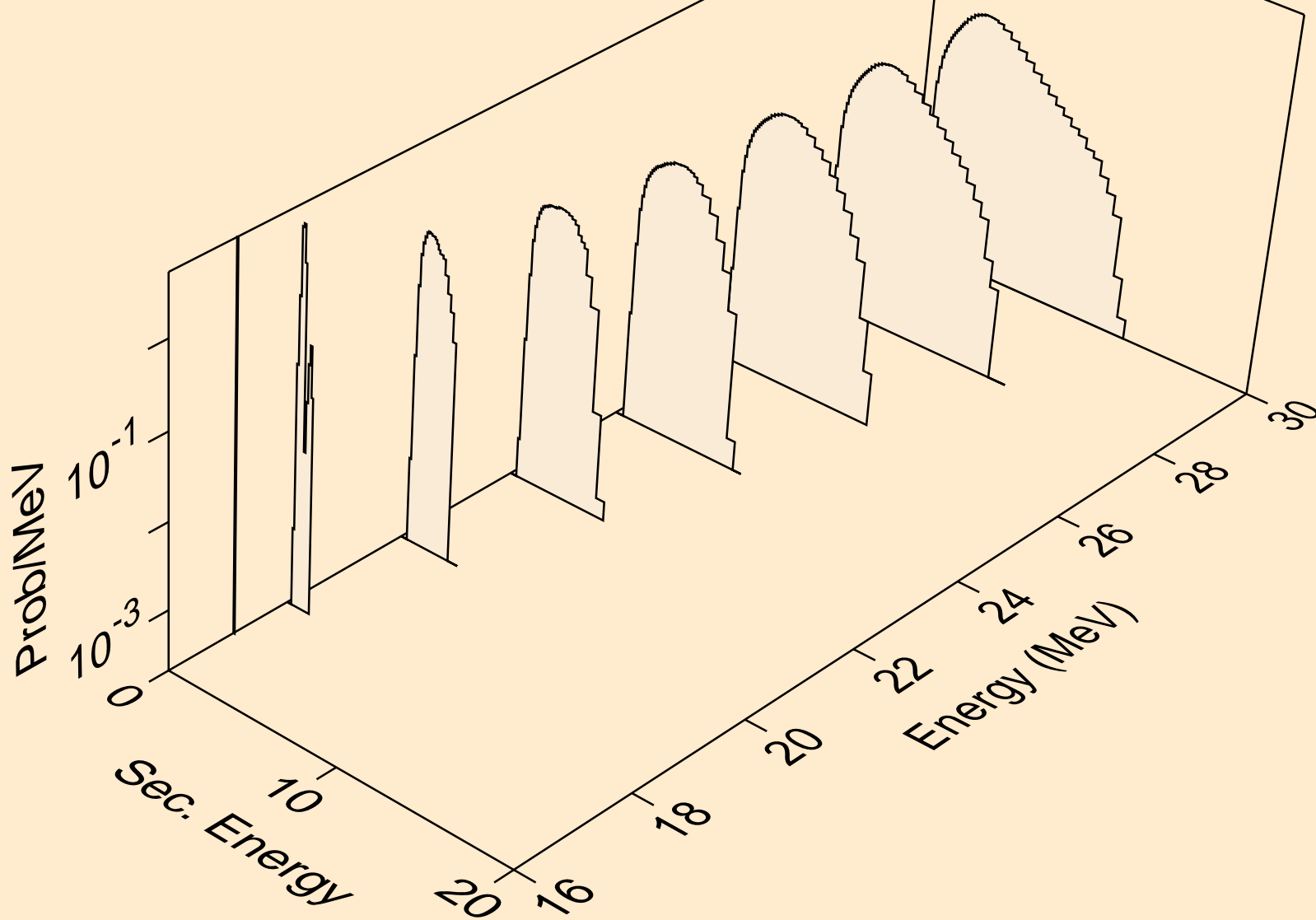

CA041 NEUTRON ACER TENDL-2019 LIBRARY; T=293.16K
protons from (n,2np)

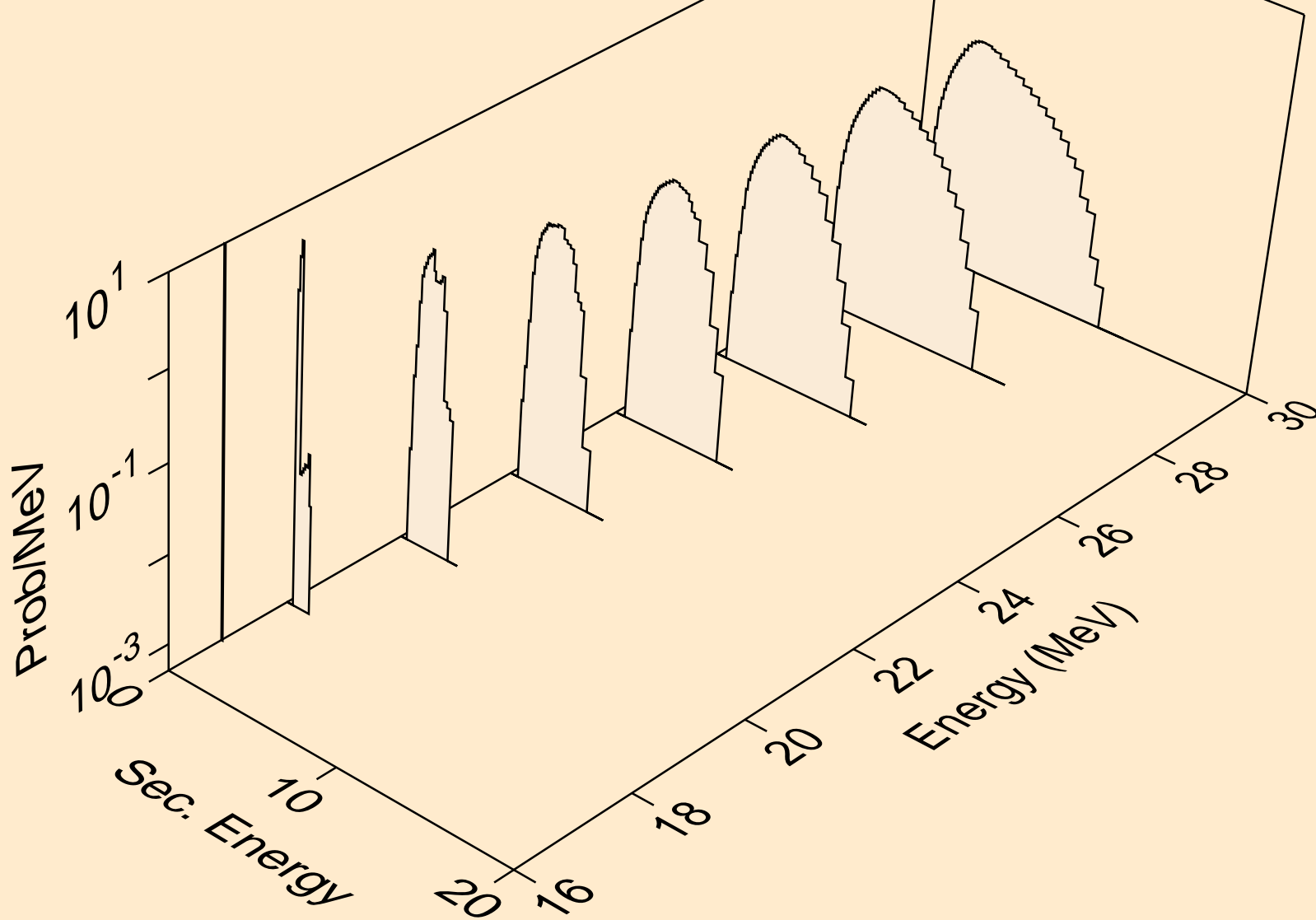

CA041 NEUTRON ACER TENDL-2019 LIBRARY; T=293.16K
protons from (n,npa)

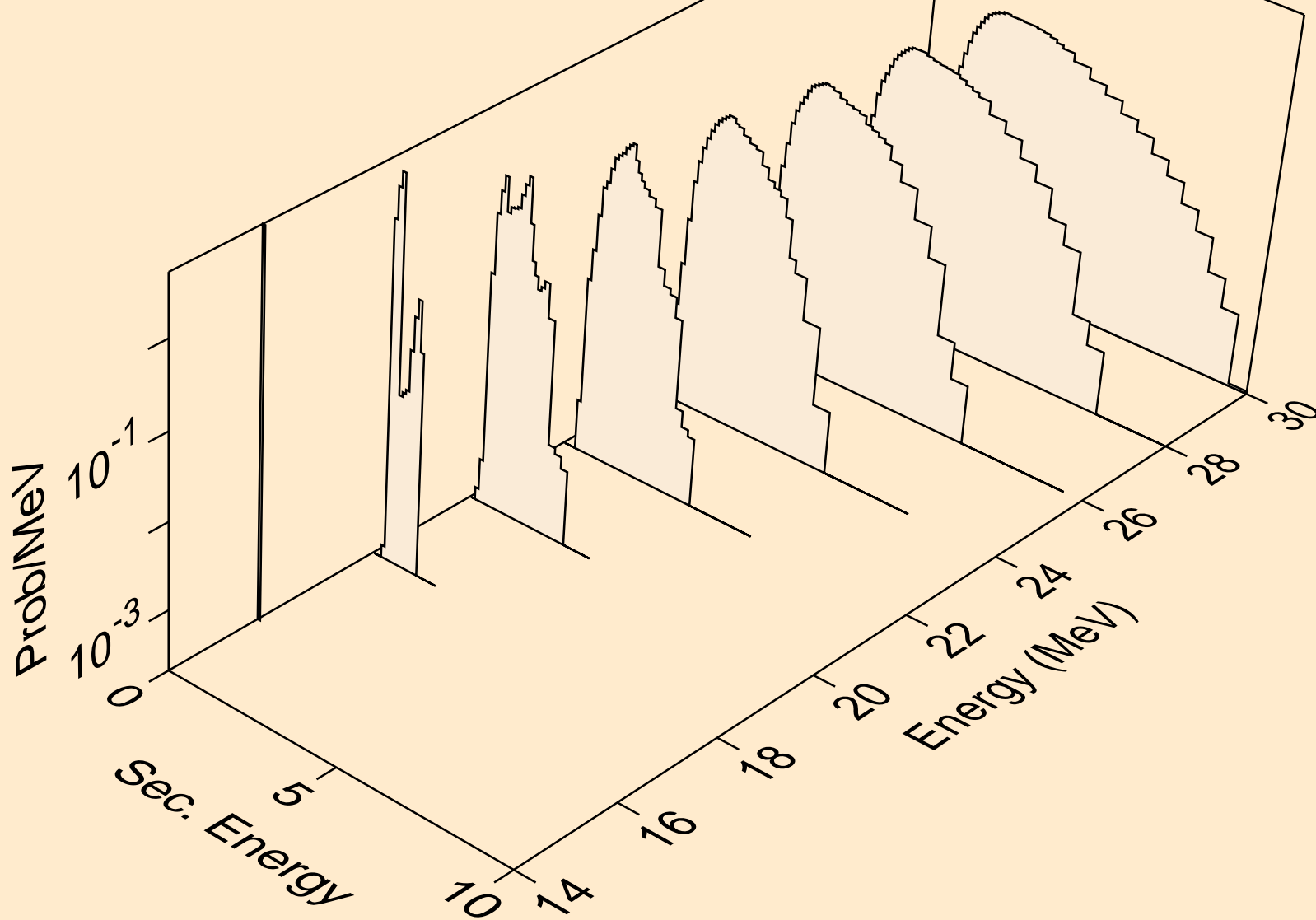

CA041 NEUTRON ACER TENDL-2019 LIBRARY; T=293.16K
protons from (n,p)

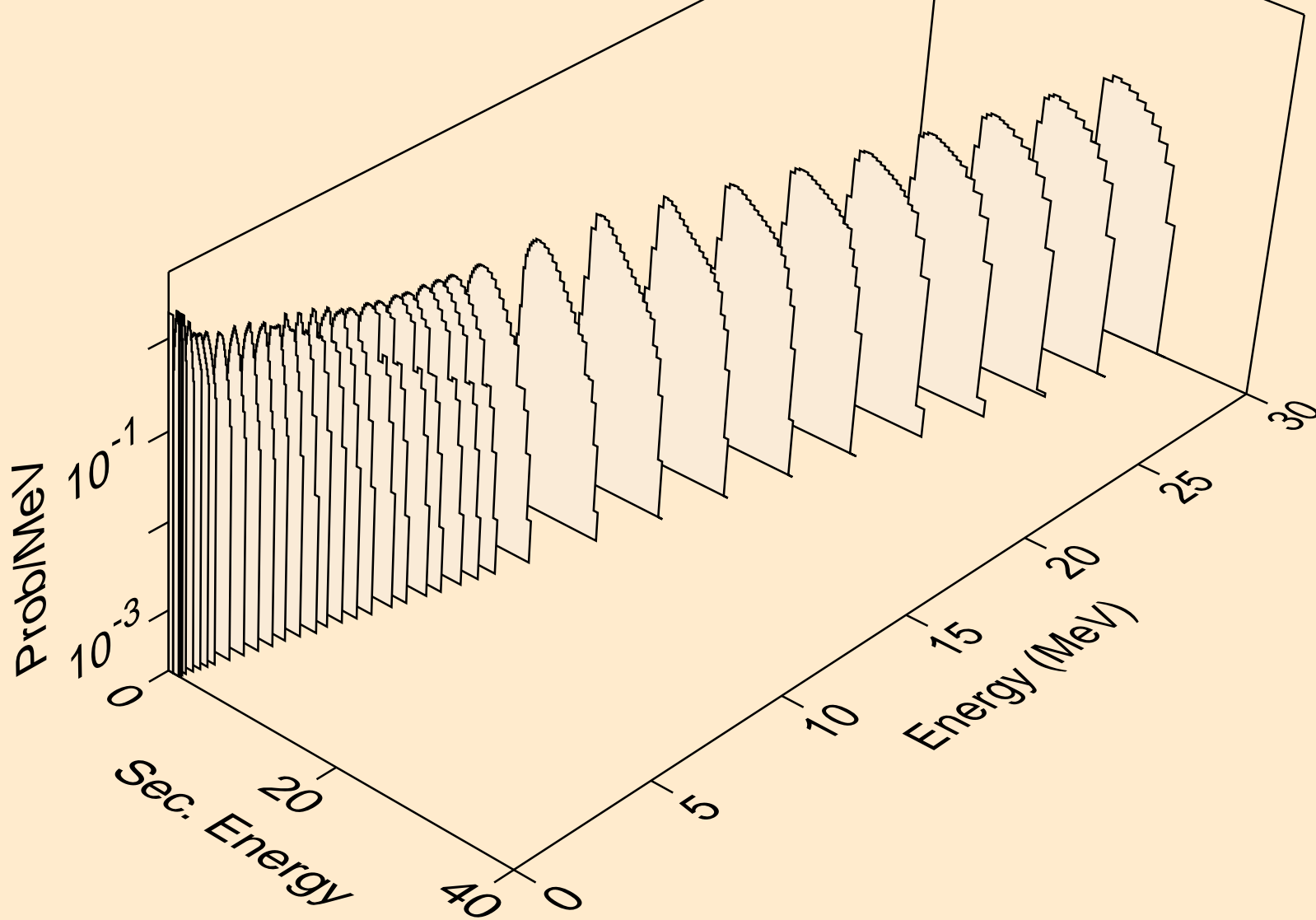

CA041 NEUTRON ACER TENDL-2019 LIBRARY; T=293.16K
protons from (n,2p)

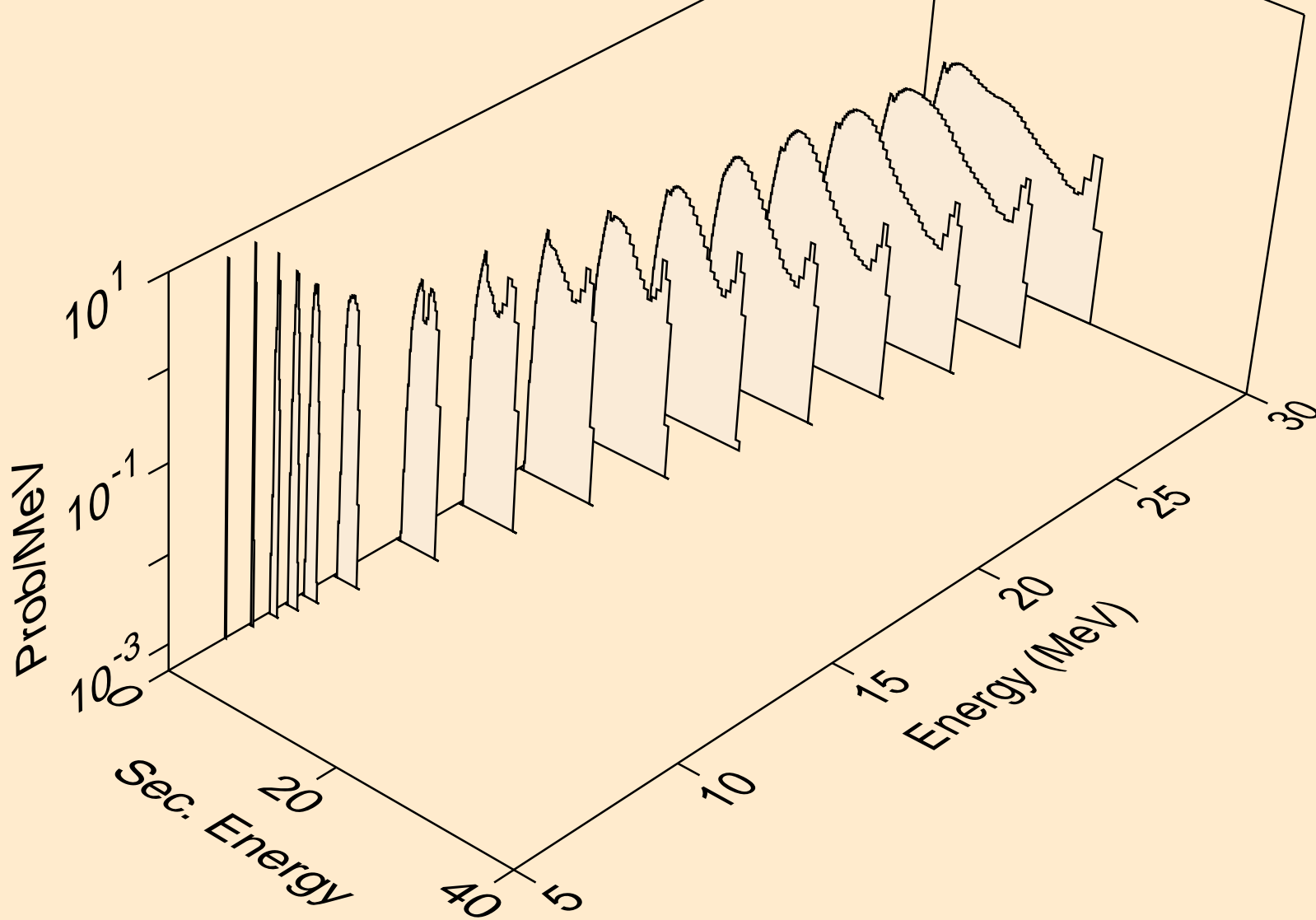

CA041 NEUTRON ACER TENDL-2019 LIBRARY; T=293.16K
protons from (n,p)

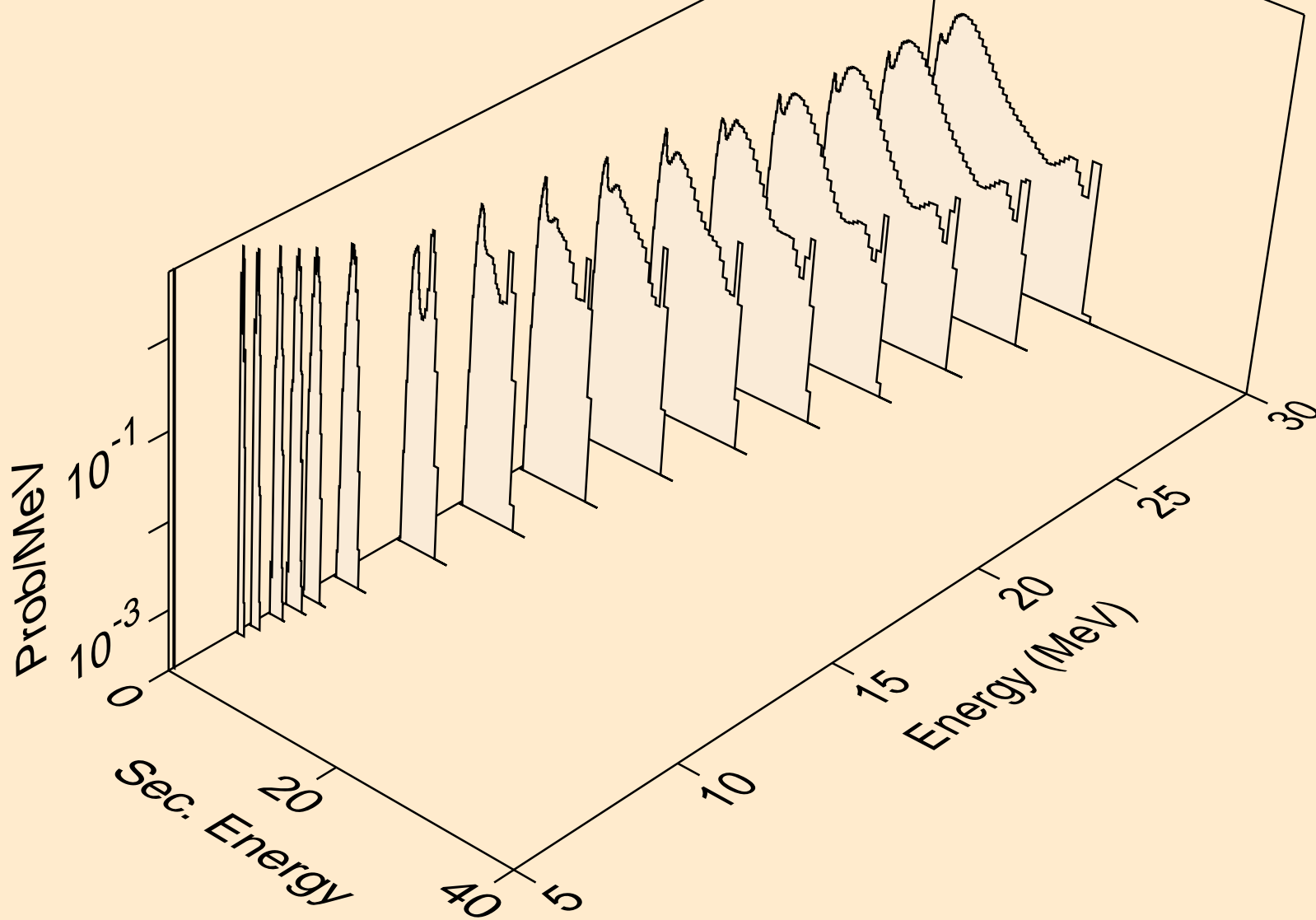

CA041 NEUTRON ACER TENDL-2019 LIBRARY; T=293.16K
protons from (n,pd)

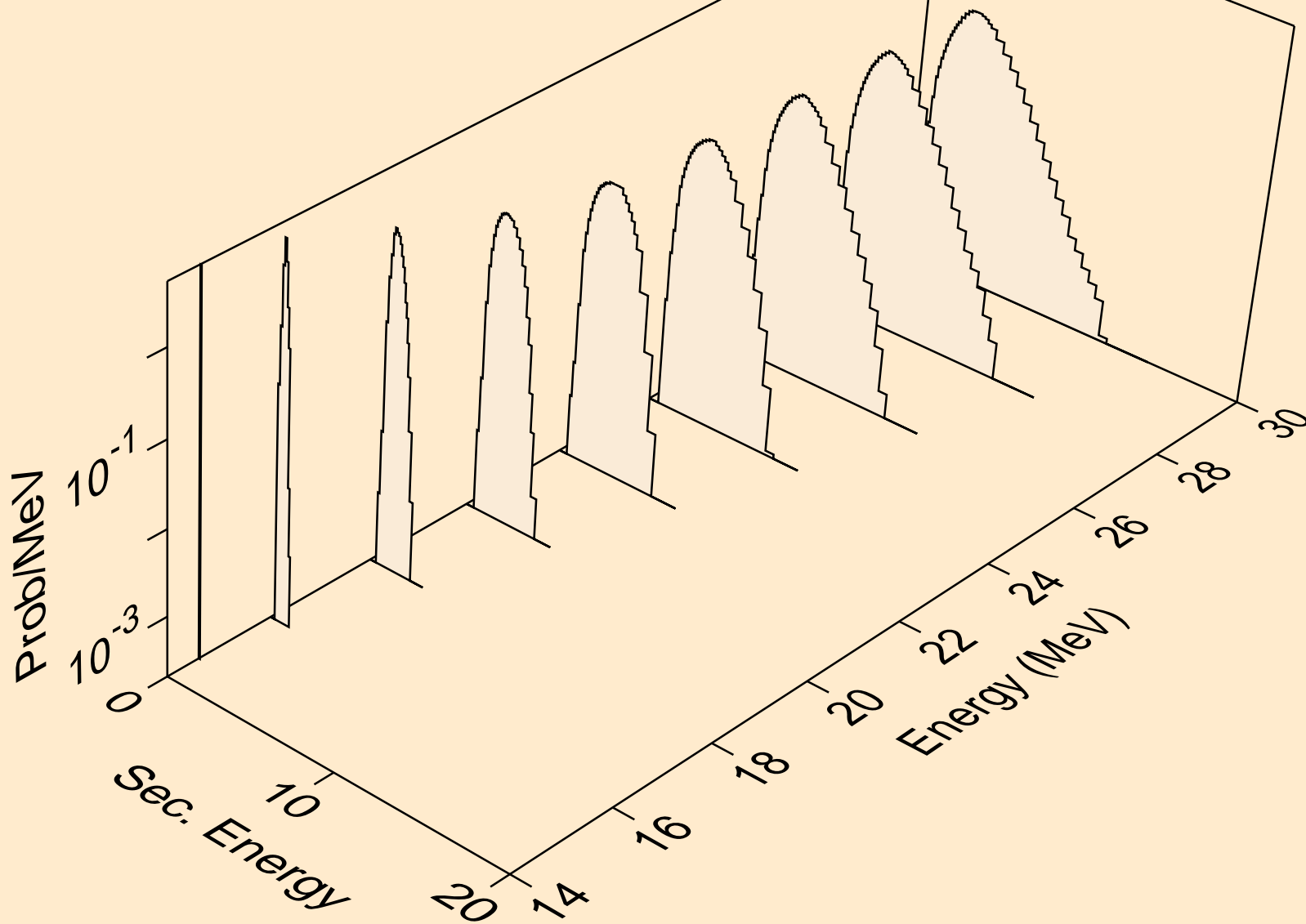

CA041 NEUTRON ACER TENDL-2019 LIBRARY; T=293.16K
protons from (n,pt)

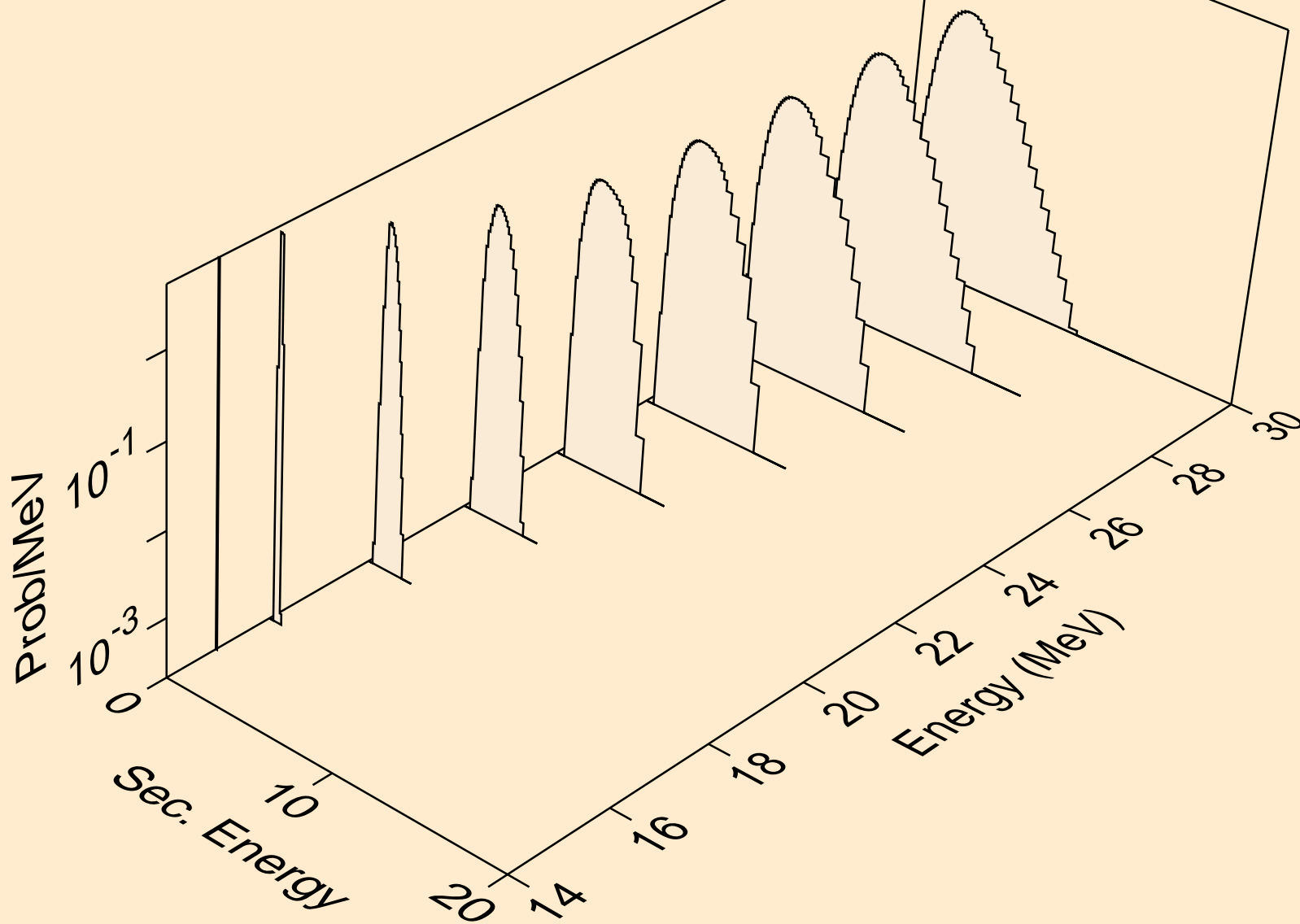

CA041 NEUTRON ACER TENDL-2019 LIBRARY; T=293.16K
deuterons from (n,x)

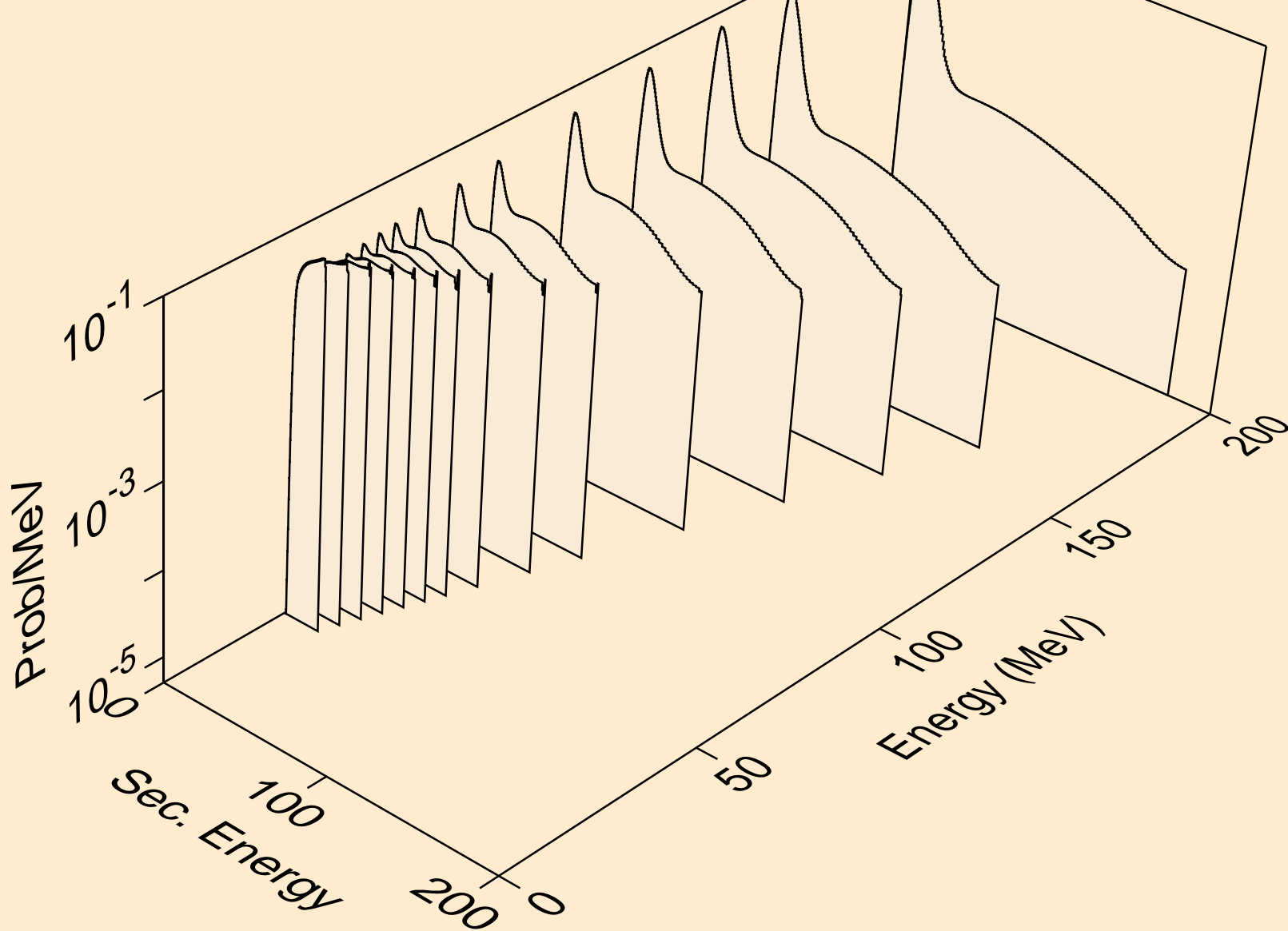

CA041 NEUTRON ACER TENDL-2019 LIBRARY; T=293.16K
deuterons from (n,2nd)

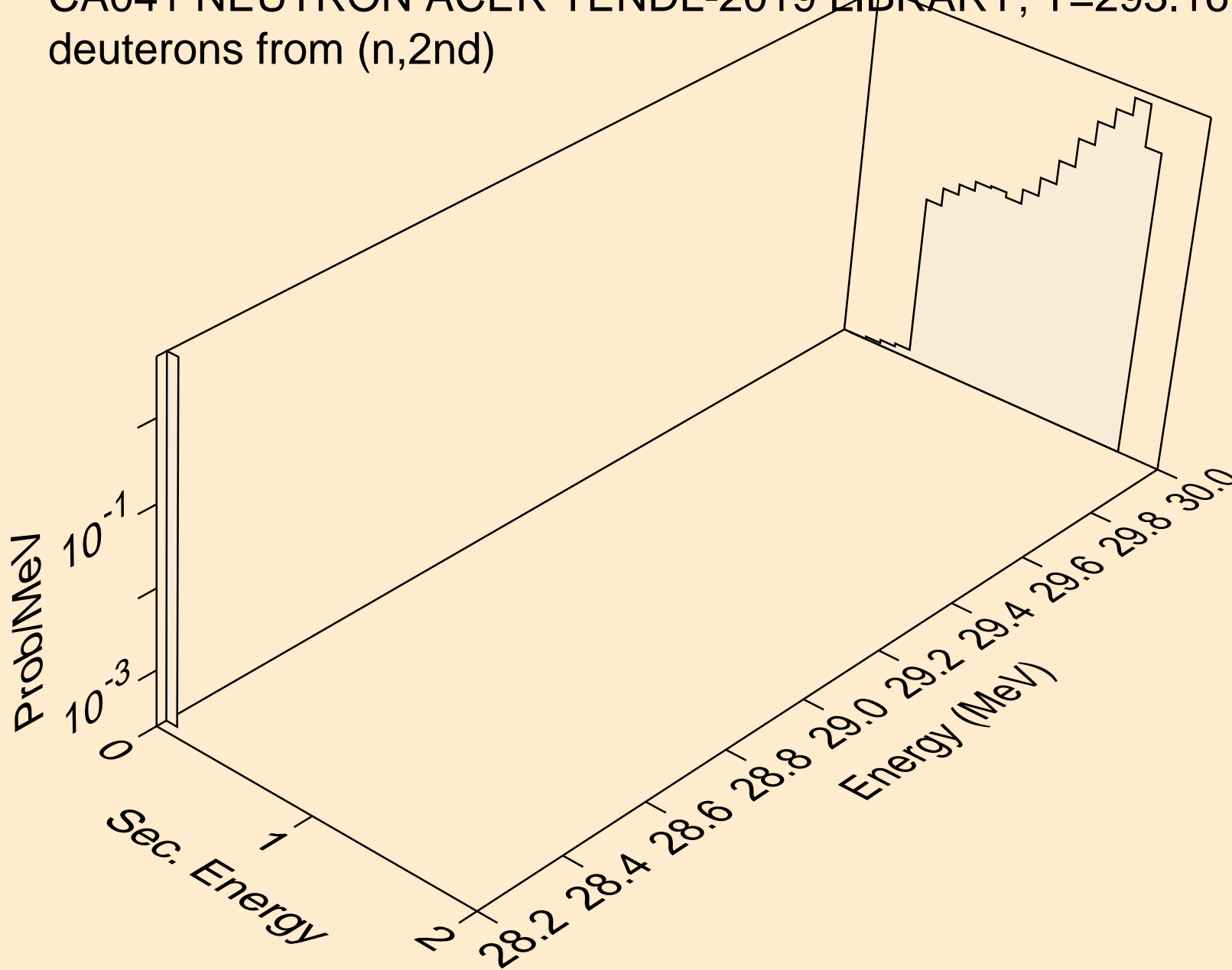

CA041 NEUTRON ACER TENDL-2019 LIBRARY; T=293.16K
deuterons from (n,n*)d

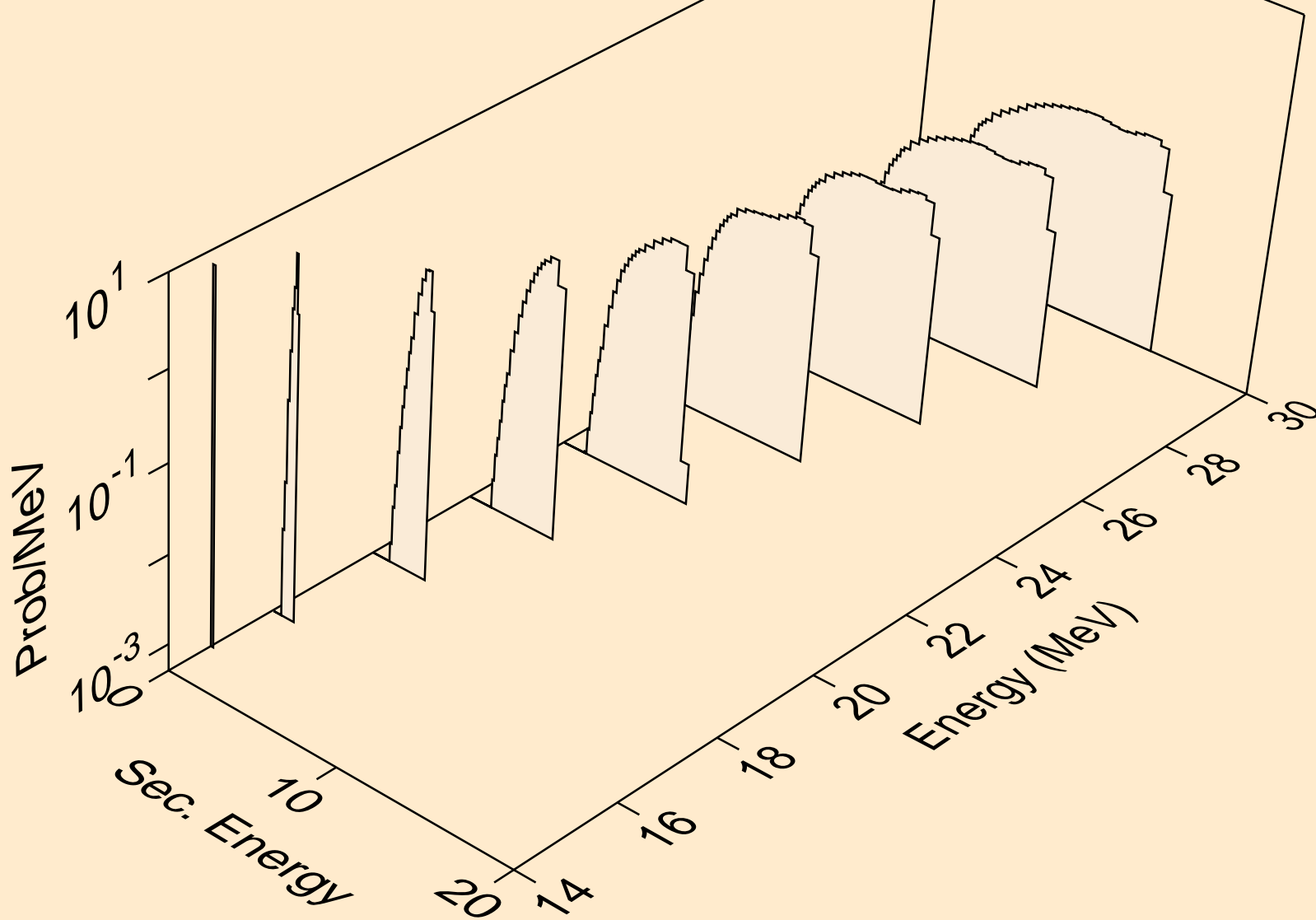

CA041 NEUTRON ACER TENDL-2019 LIBRARY; T=293.16K
deuterons from (n,d)

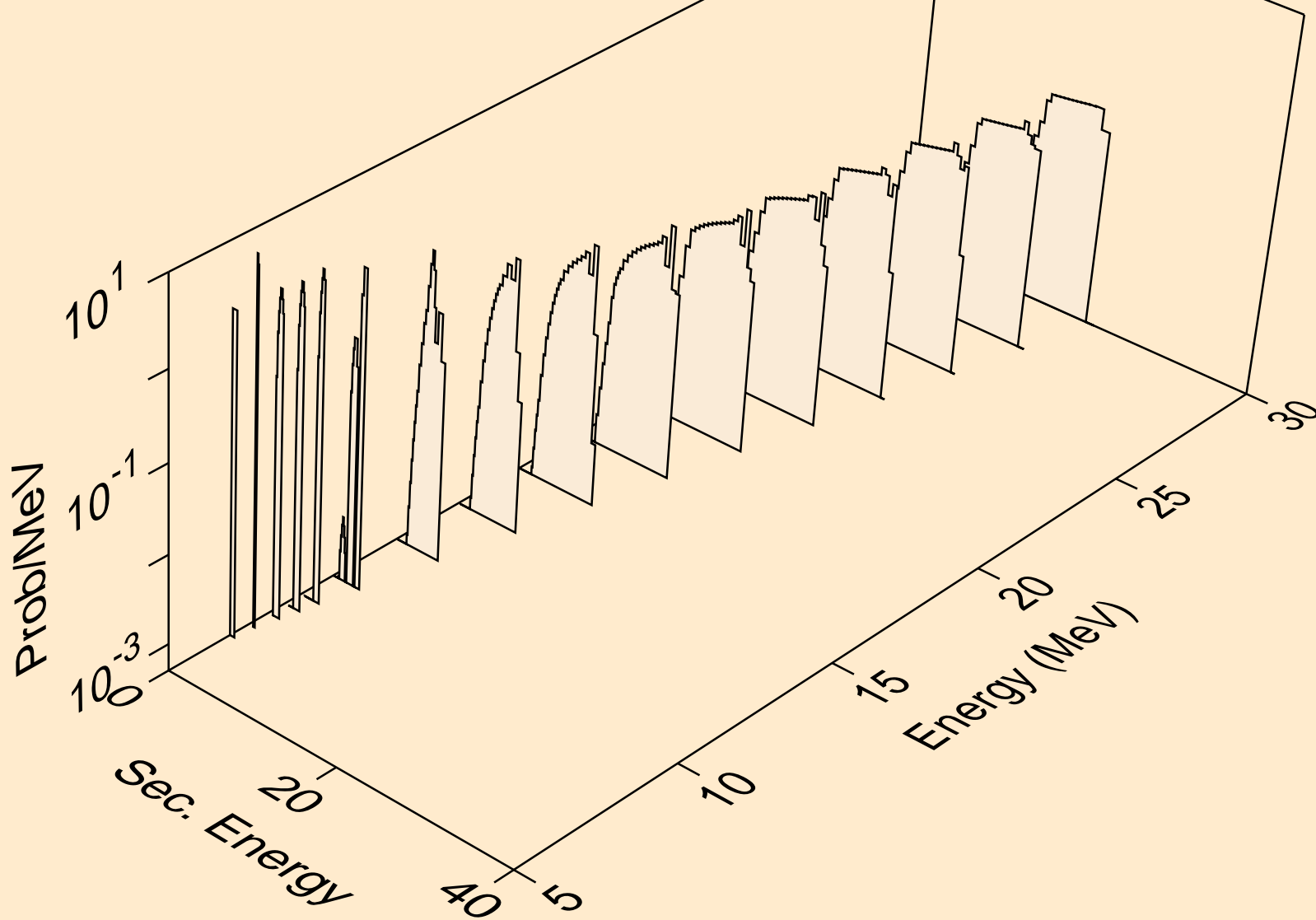

CA041 NEUTRON ACER TENDL-2019 LIBRARY; T=293.16K
deuterons from (n,pd)

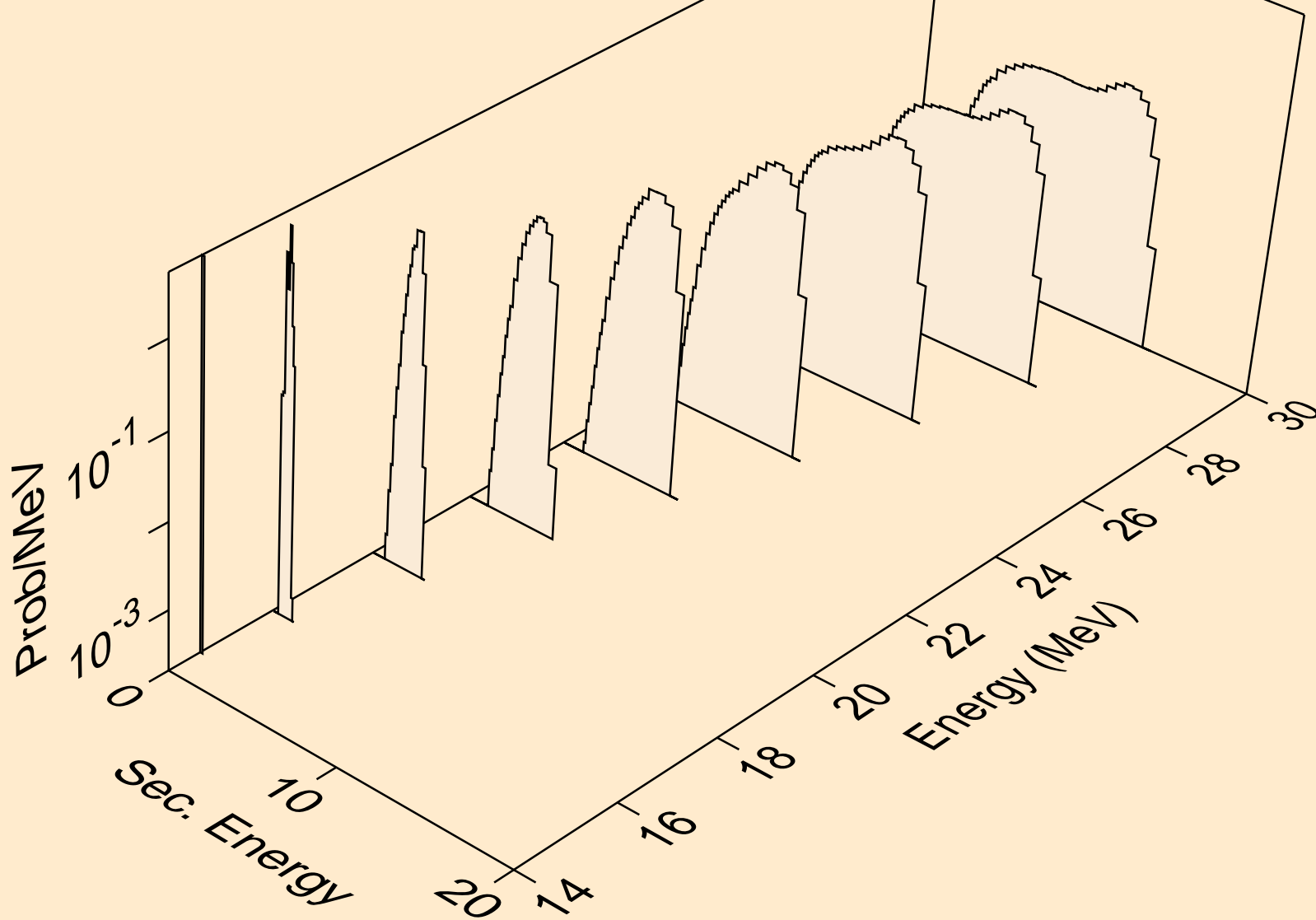

CA041 NEUTRON ACER TENDL-2019 LIBRARY; T=293.16K
deuterons from (n,da)

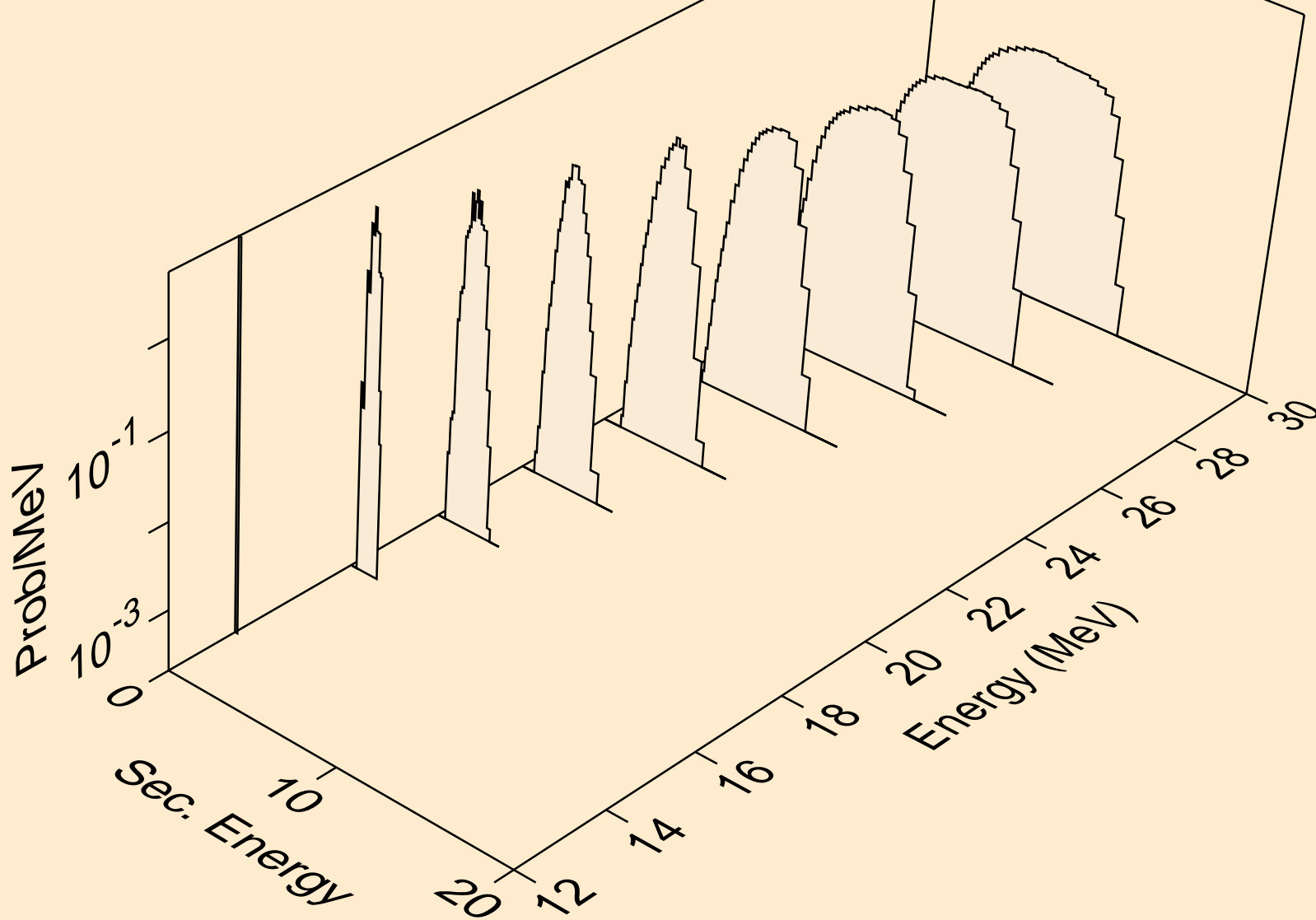

CA041 NEUTRON ACER TENDL-2019 LIBRARY; T=293.16K
tritons from (n,x)

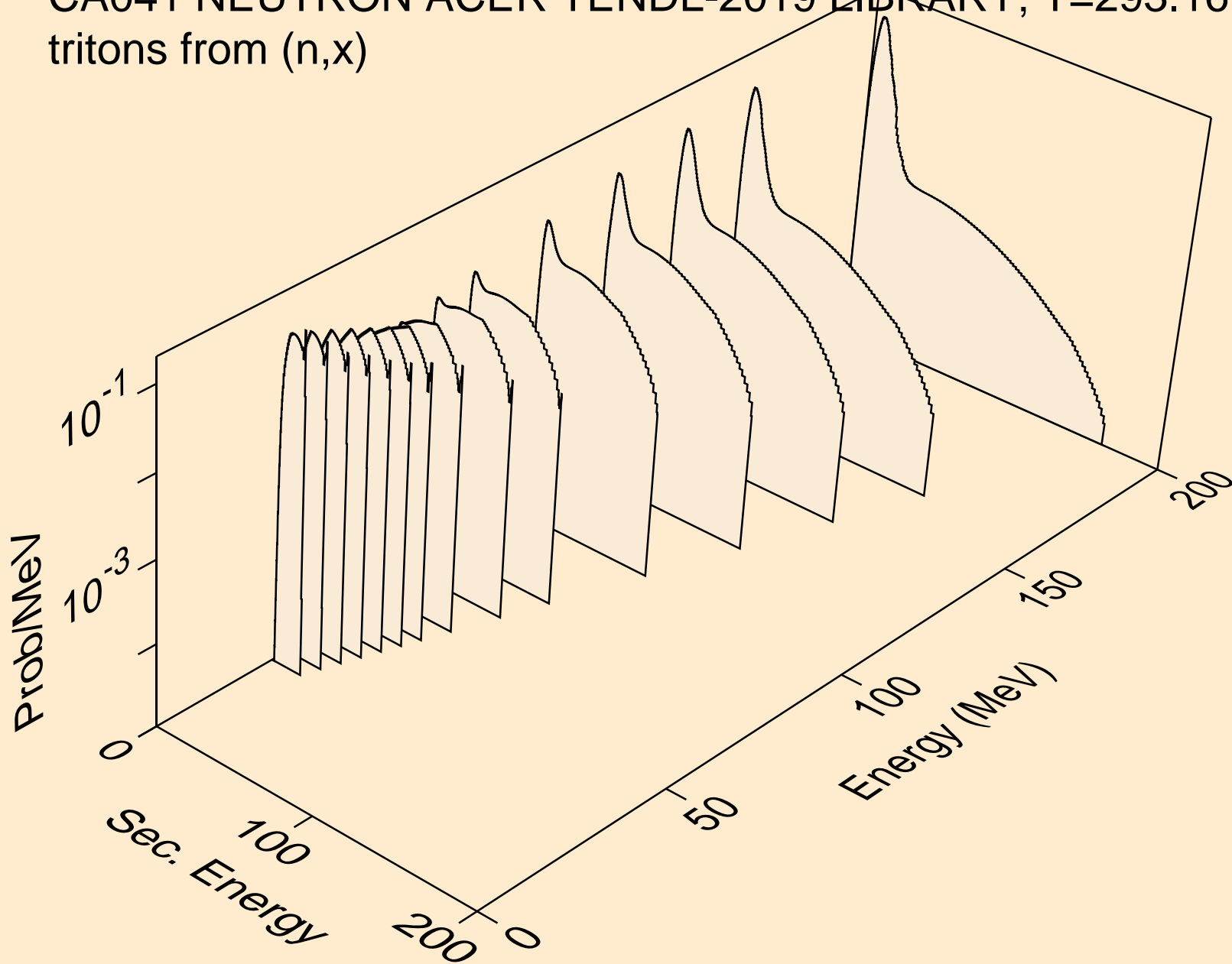

CA041 NEUTRON ACER TENDL-2019 LIBRARY; T=293.16K
tritons from (n,n*)t

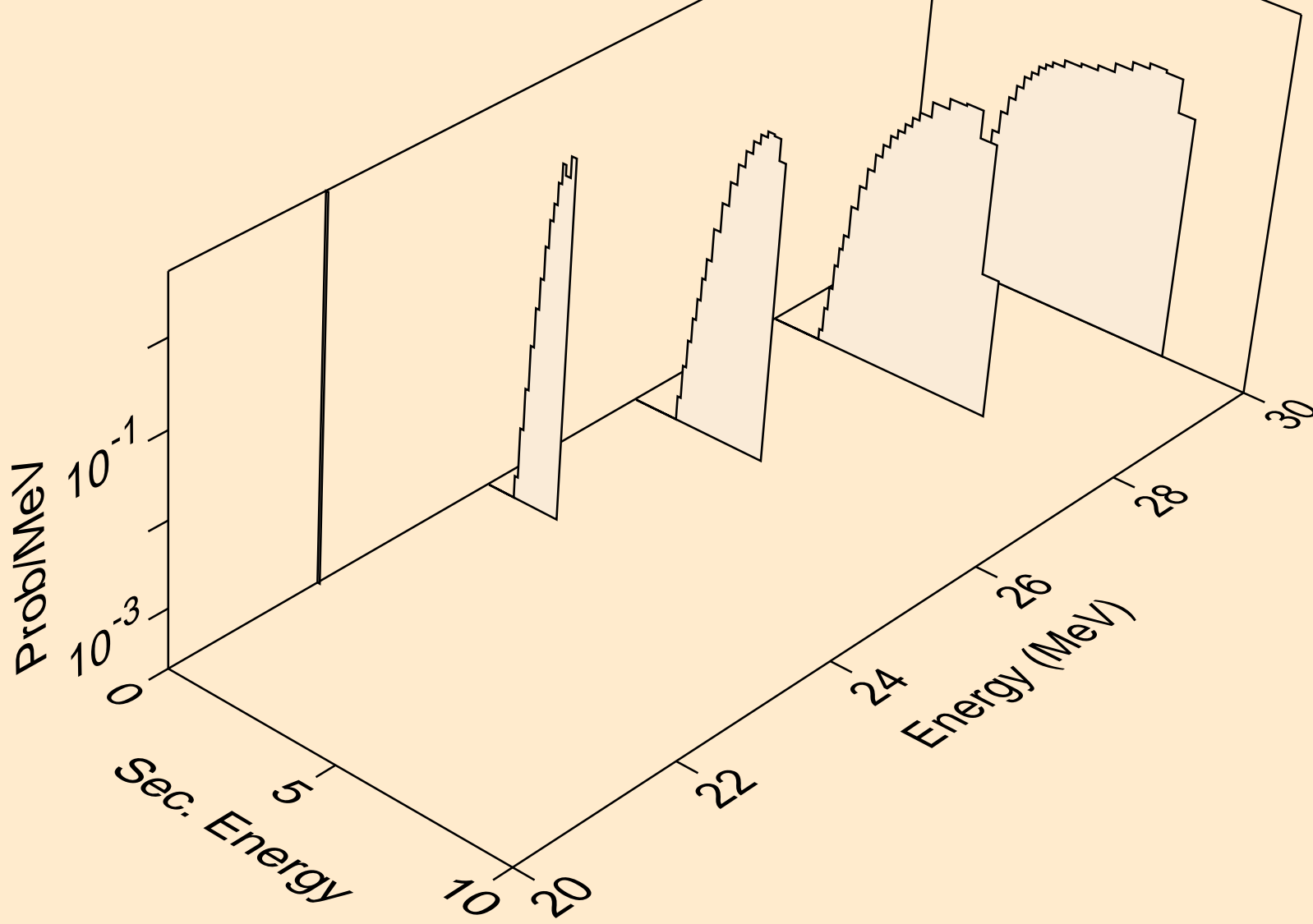

CA041 NEUTRON ACER TENDL-2019 LIBRARY; T=293.16K
tritons from (n,t)

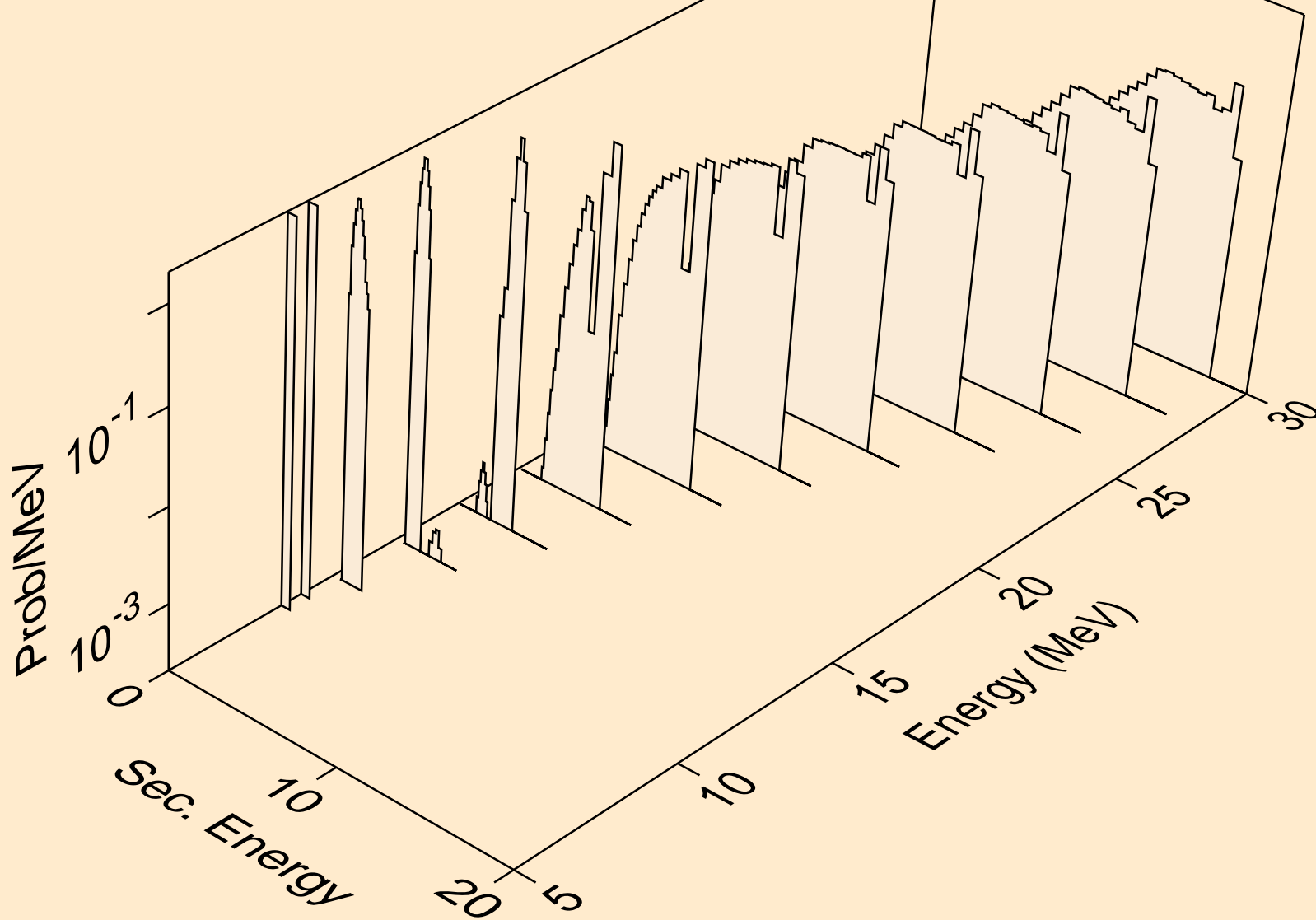

CA041 NEUTRON ACER TENDL-2019 LIBRARY; T=293.16K
tritons from (n,pt)

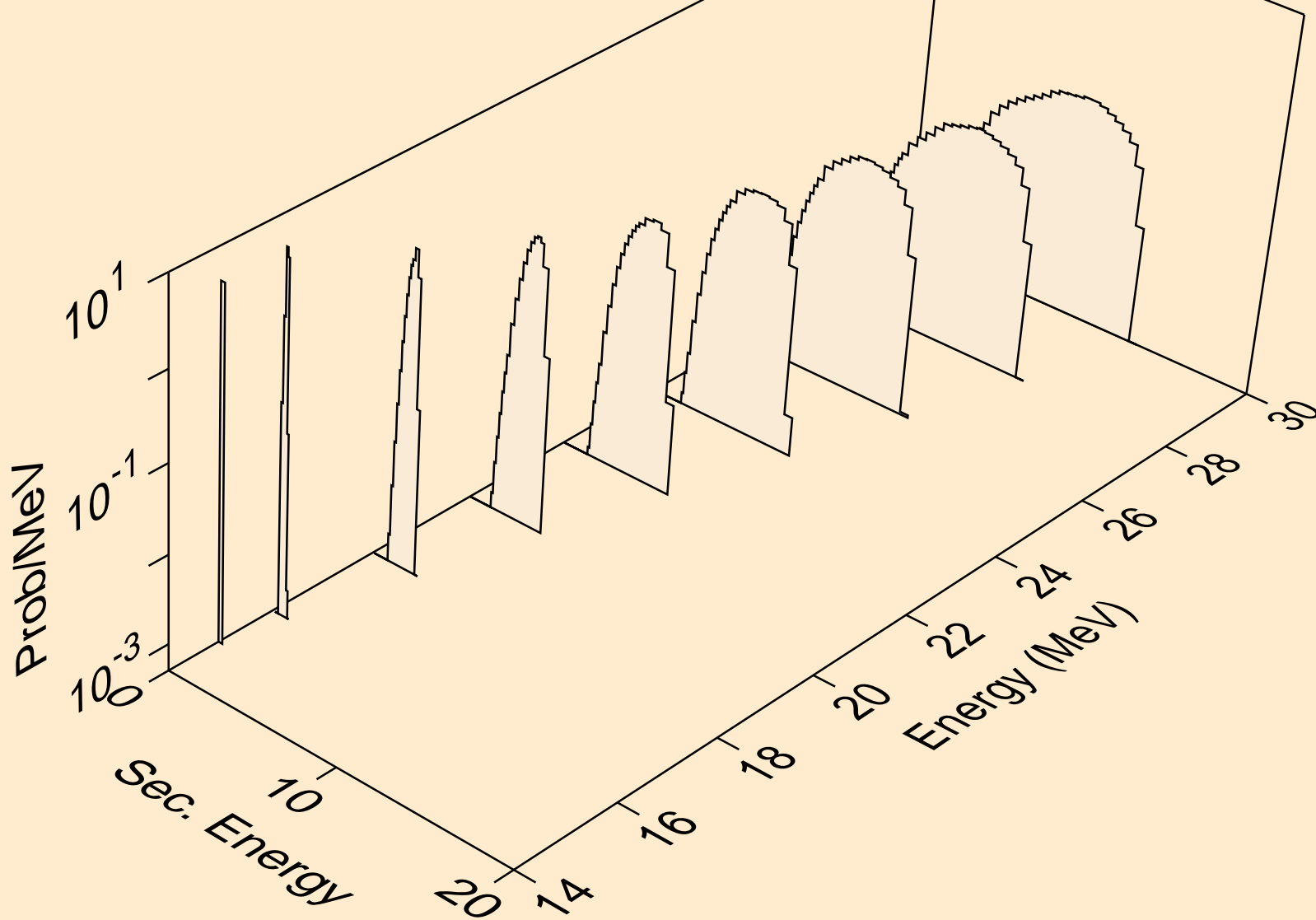

CA041 NEUTRON ACER TENDL-2019 LIBRARY; T=293.16K
he3s from (n,x)

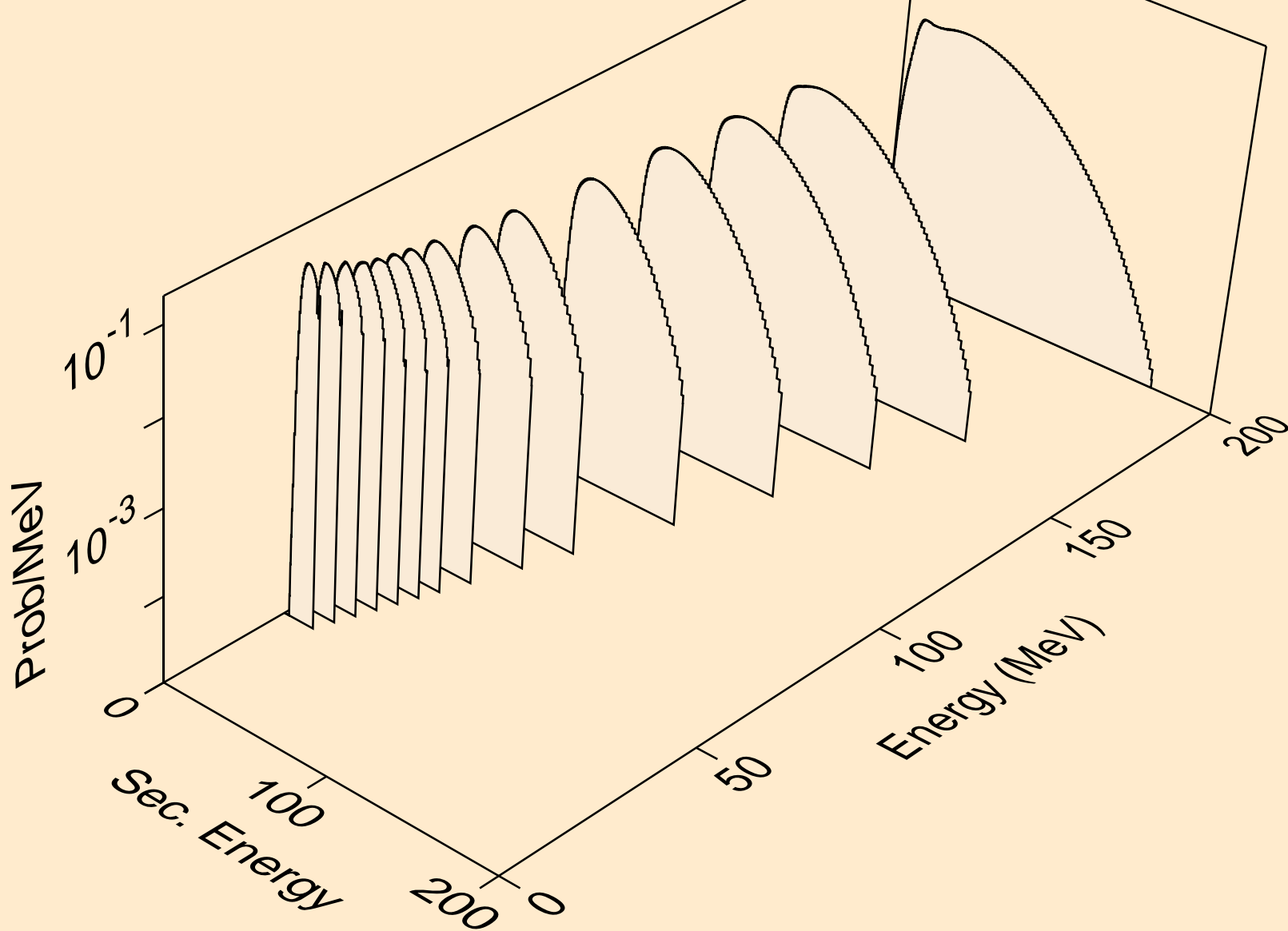

CA041 NEUTRON ACER TENDL-2019 LIBRARY; T=293.16K
he3s from (n,n*)he3

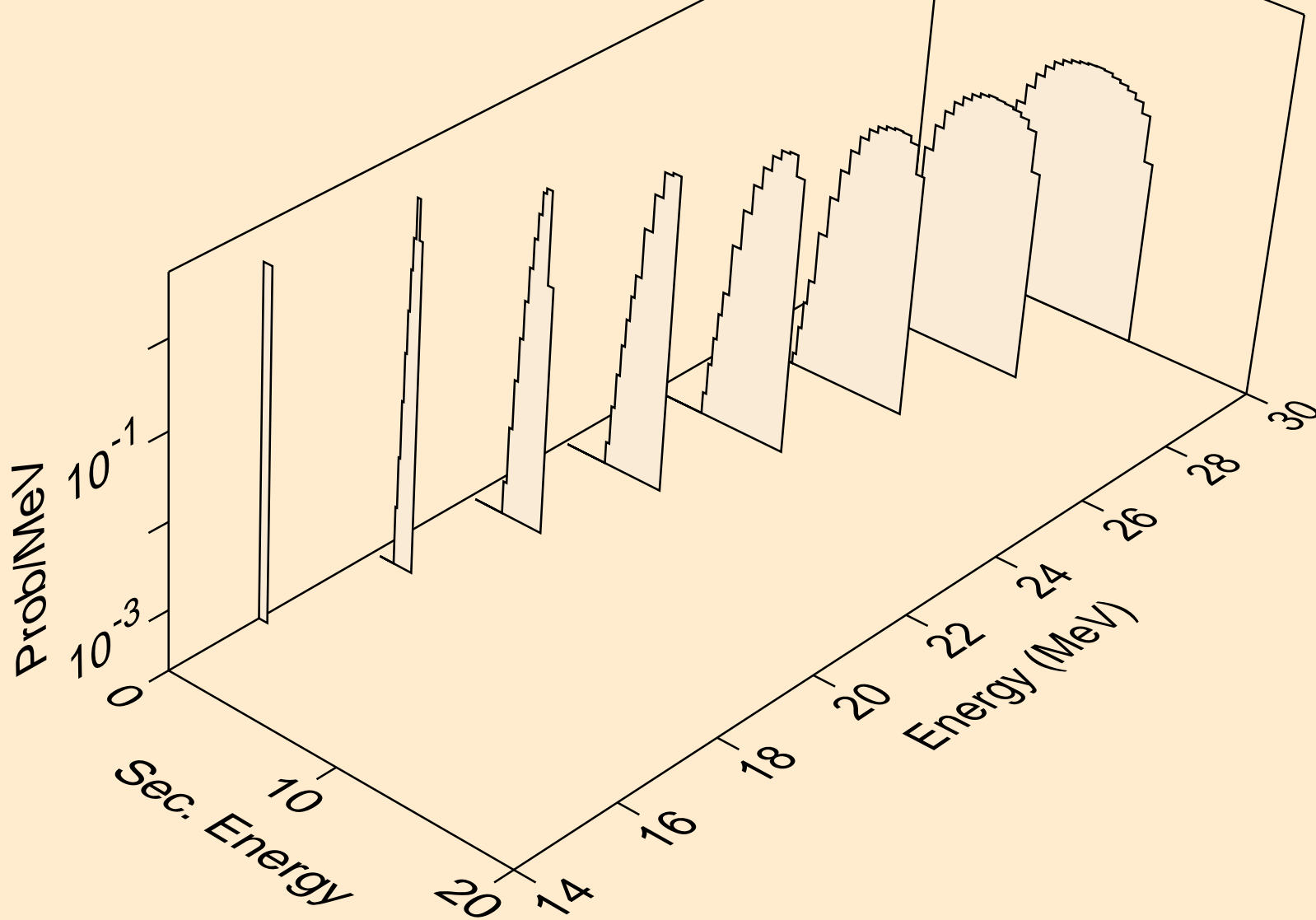

CA041 NEUTRON ACER TENDL-2019 LIBRARY; T=293.16K
he3s from (n,he3)

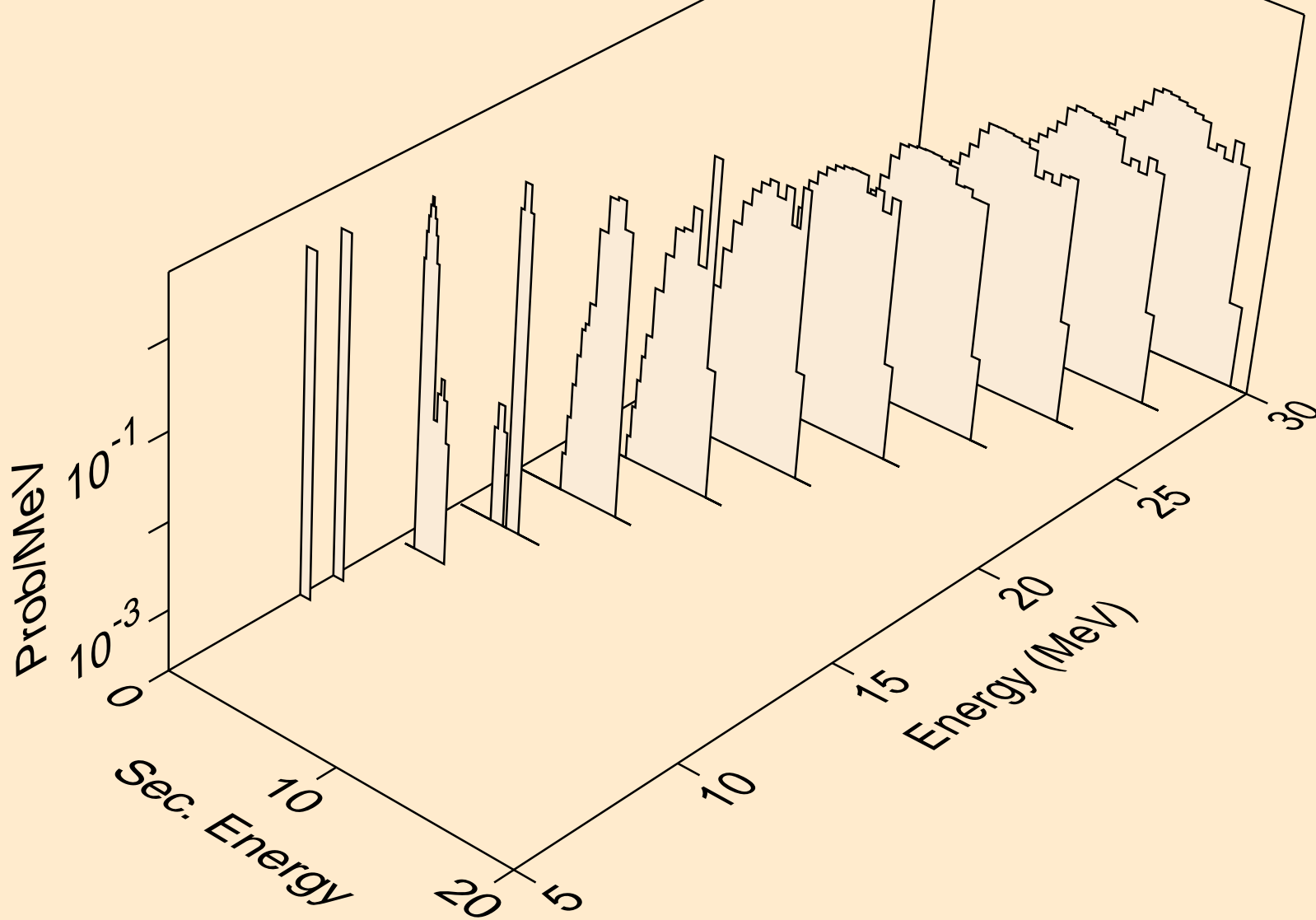

CA041 NEUTRON ACER TENDL-2019 LIBRARY; T=293.16K
alphas from (n,x)

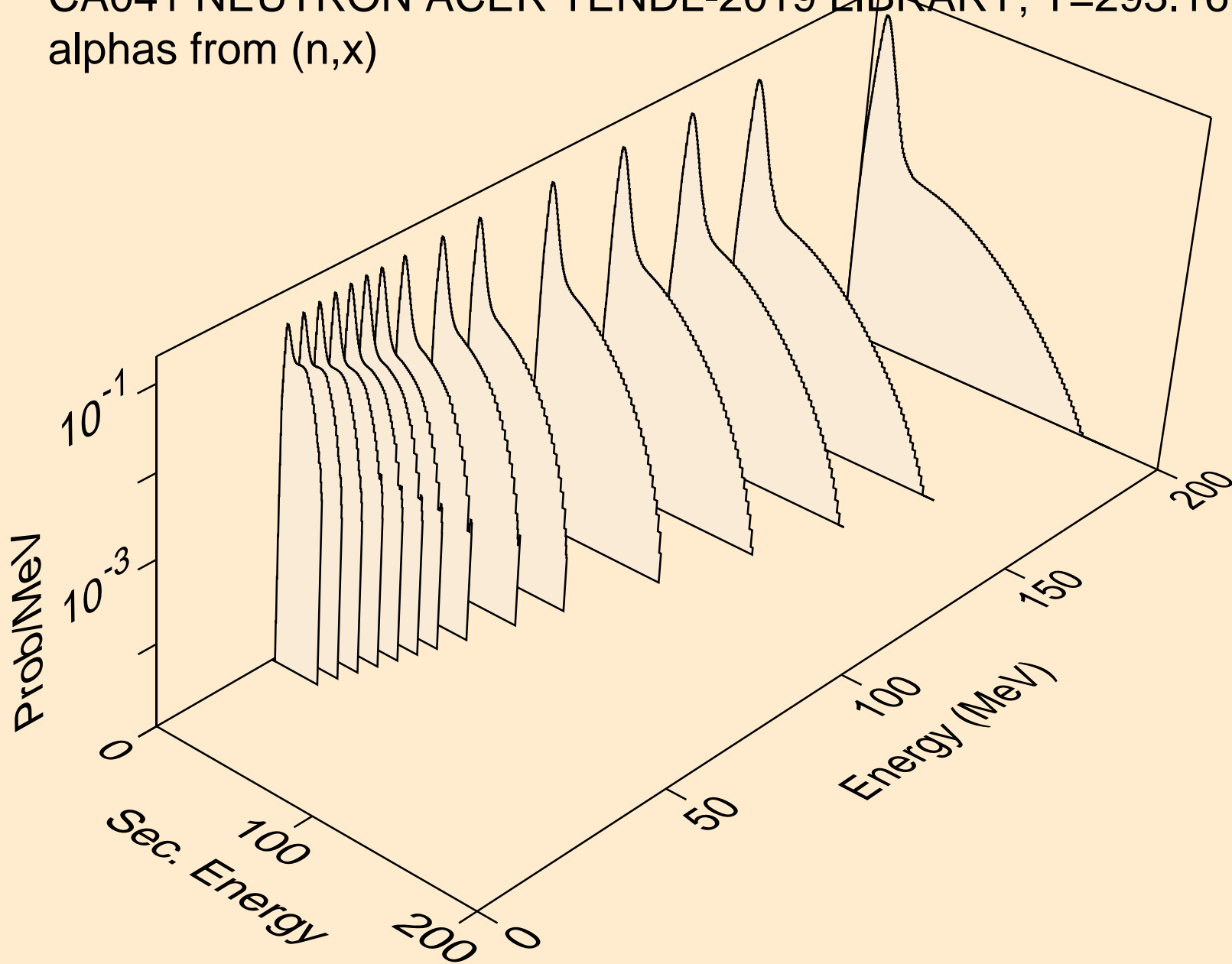

CA041 NEUTRON ACER TENDL-2019 LIBRARY; T=293.16K
alphas from (n,n*)a

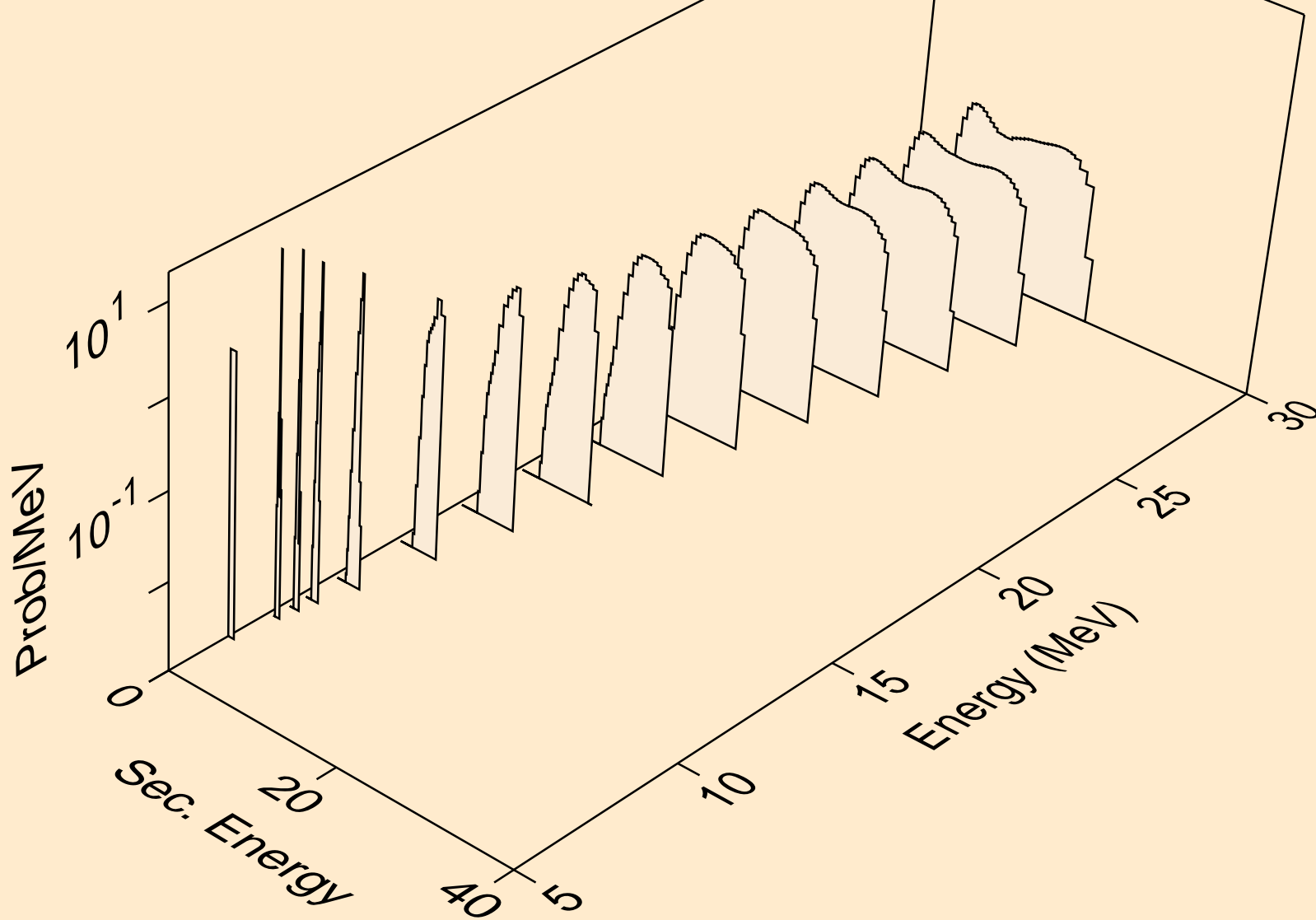

CA041 NEUTRON ACER TENDL-2019 LIBRARY; T=293.16K
alphas from (n,2n)a

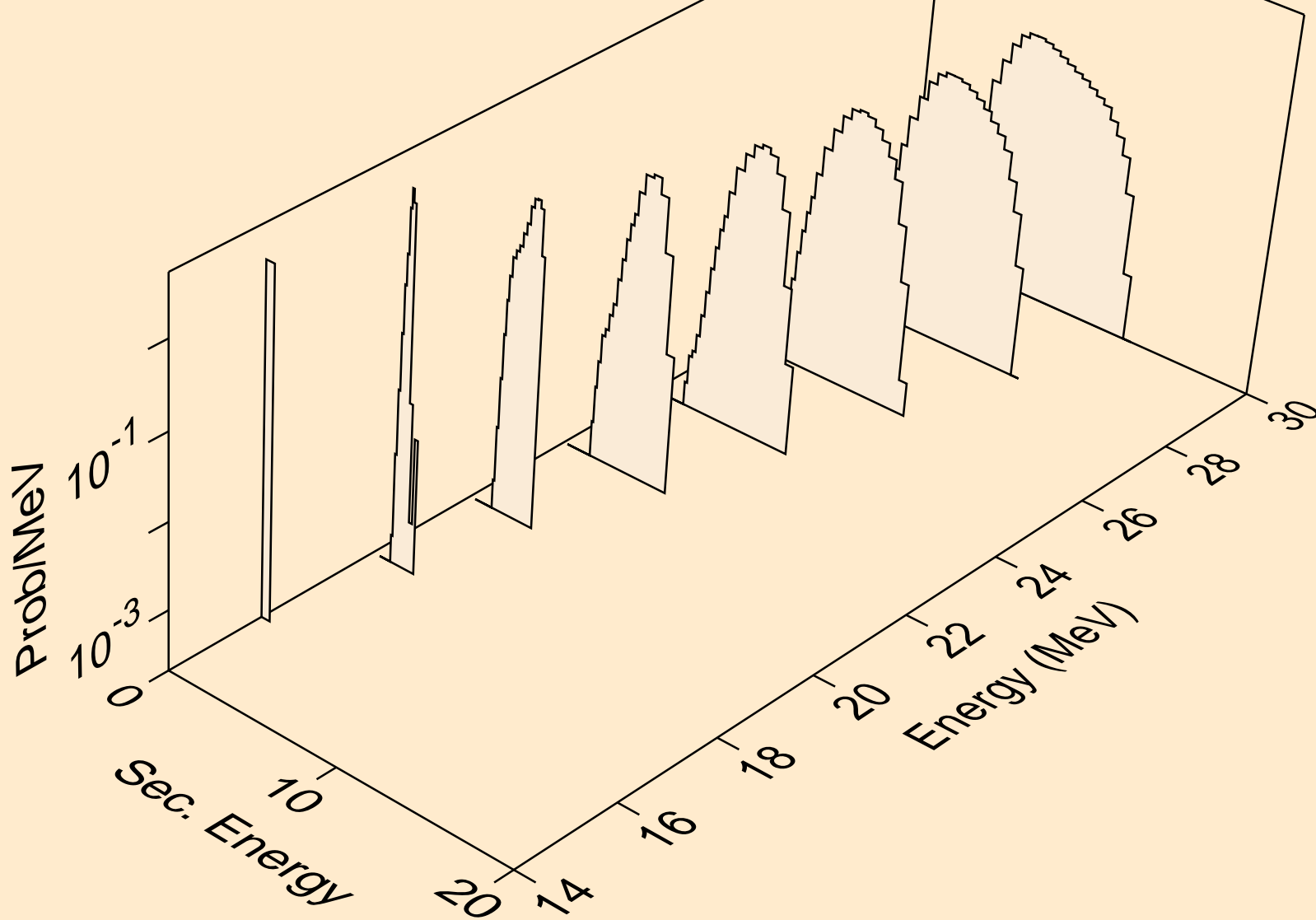

CA041 NEUTRON ACER TENDL-2019 LIBRARY; T=293.16K
alphas from (n,n*)2a

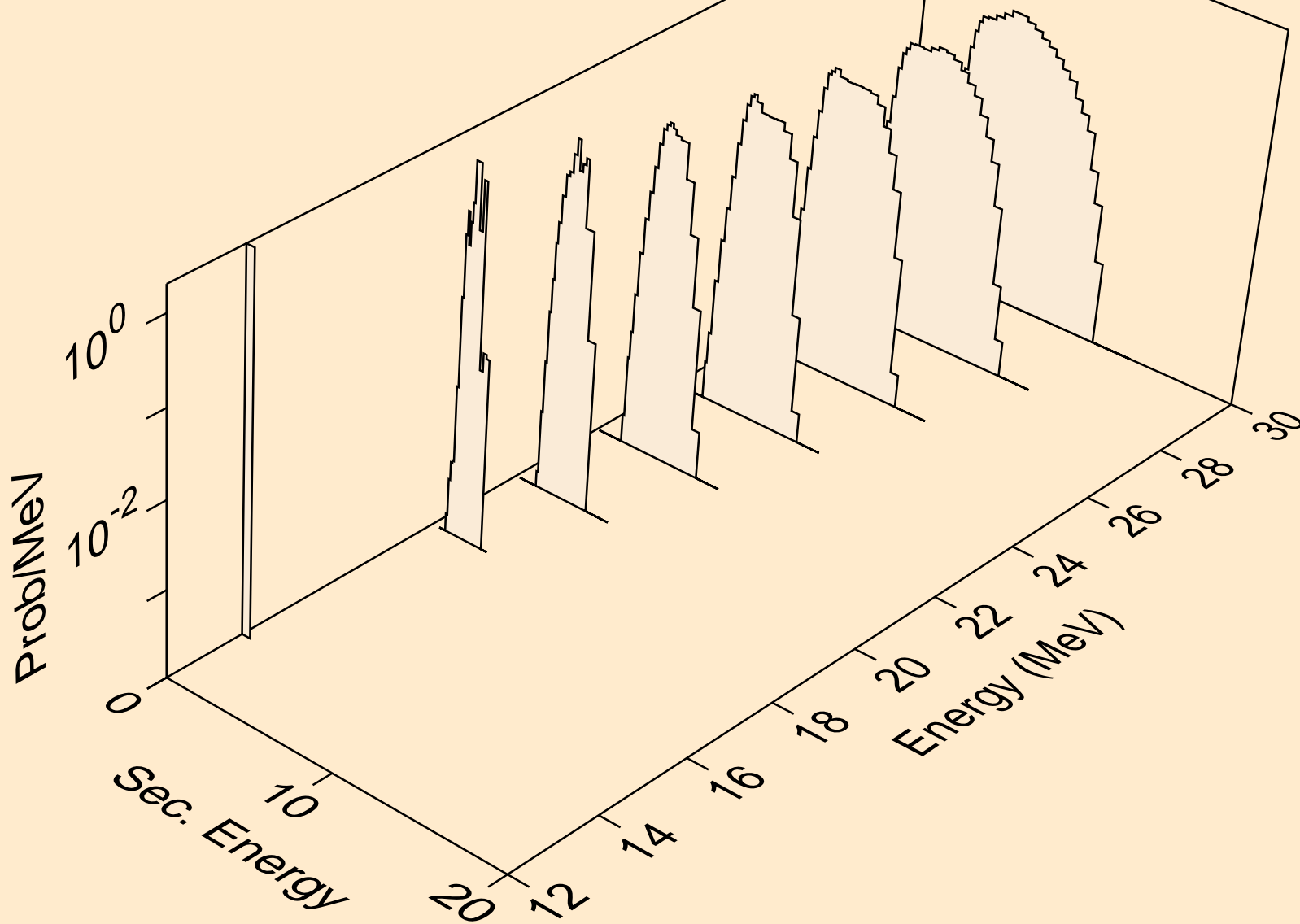

CA041 NEUTRON ACER TENDL-2019 LIBRARY; T=293.16K
alphas from (n,2n)2a

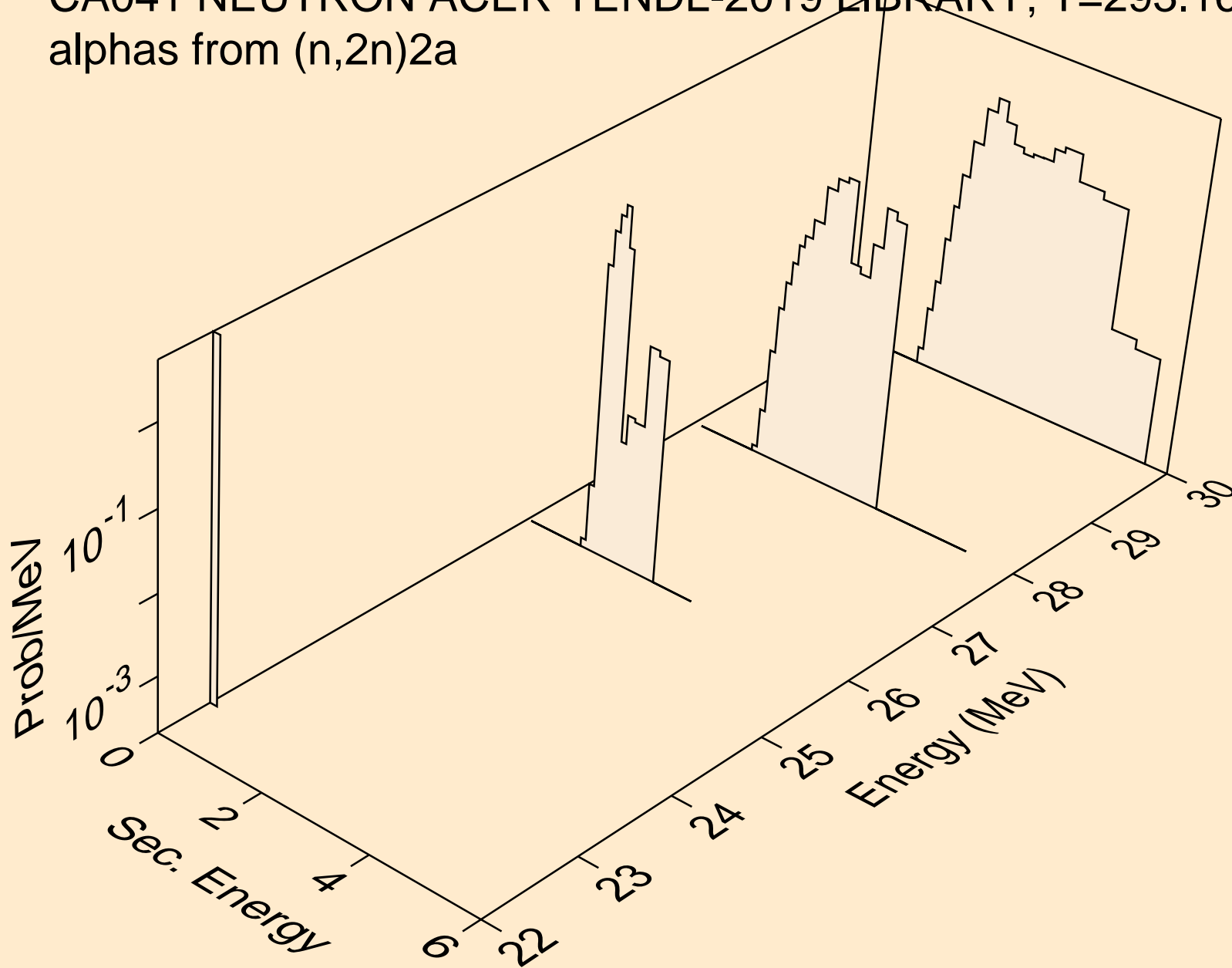

CA041 NEUTRON ACER TENDL-2019 LIBRARY; T=293.16K
alphas from (n,npa)

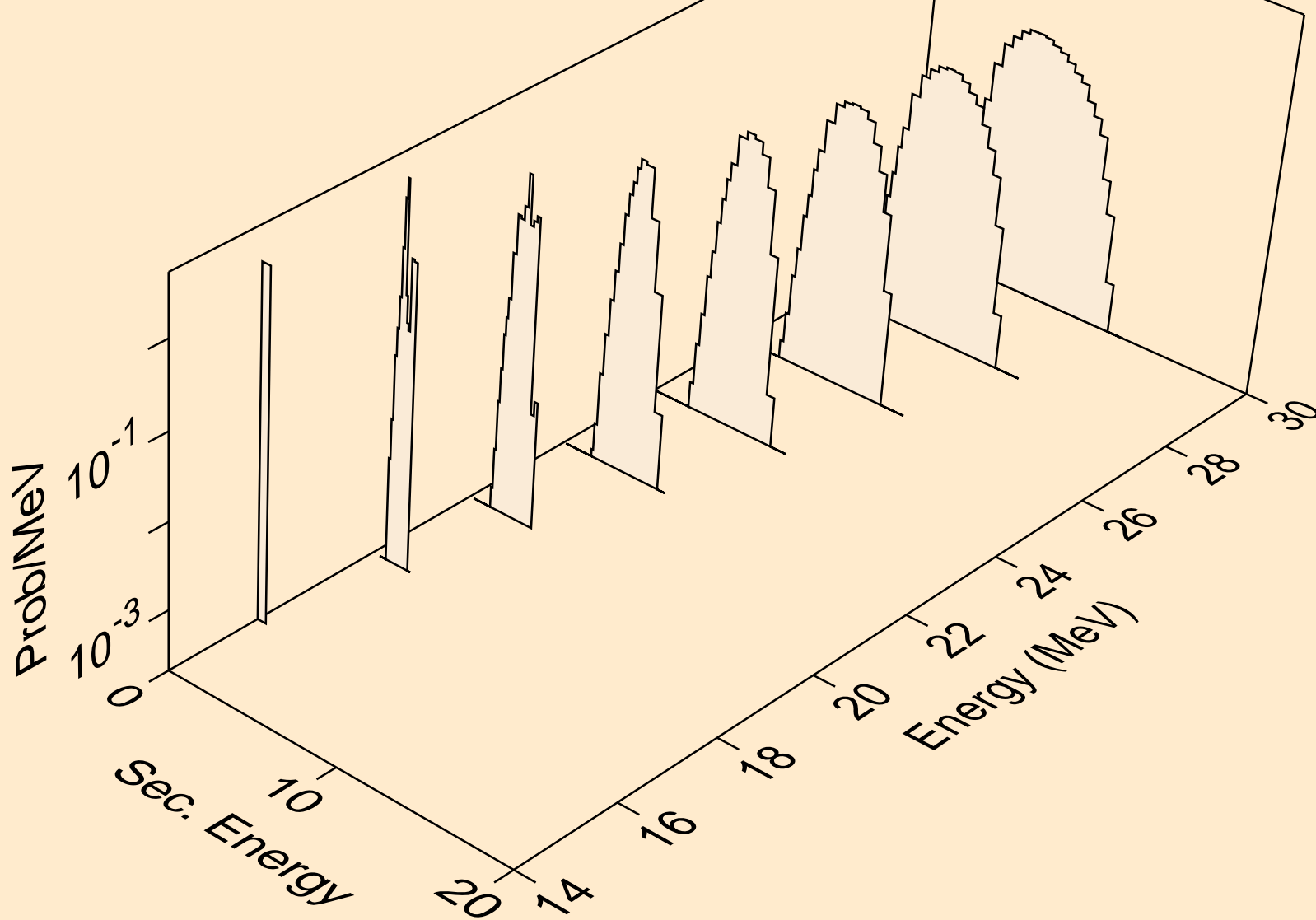

CA041 NEUTRON ACER TENDL-2019 LIBRARY; T=293.16K
alphas from (n,a)

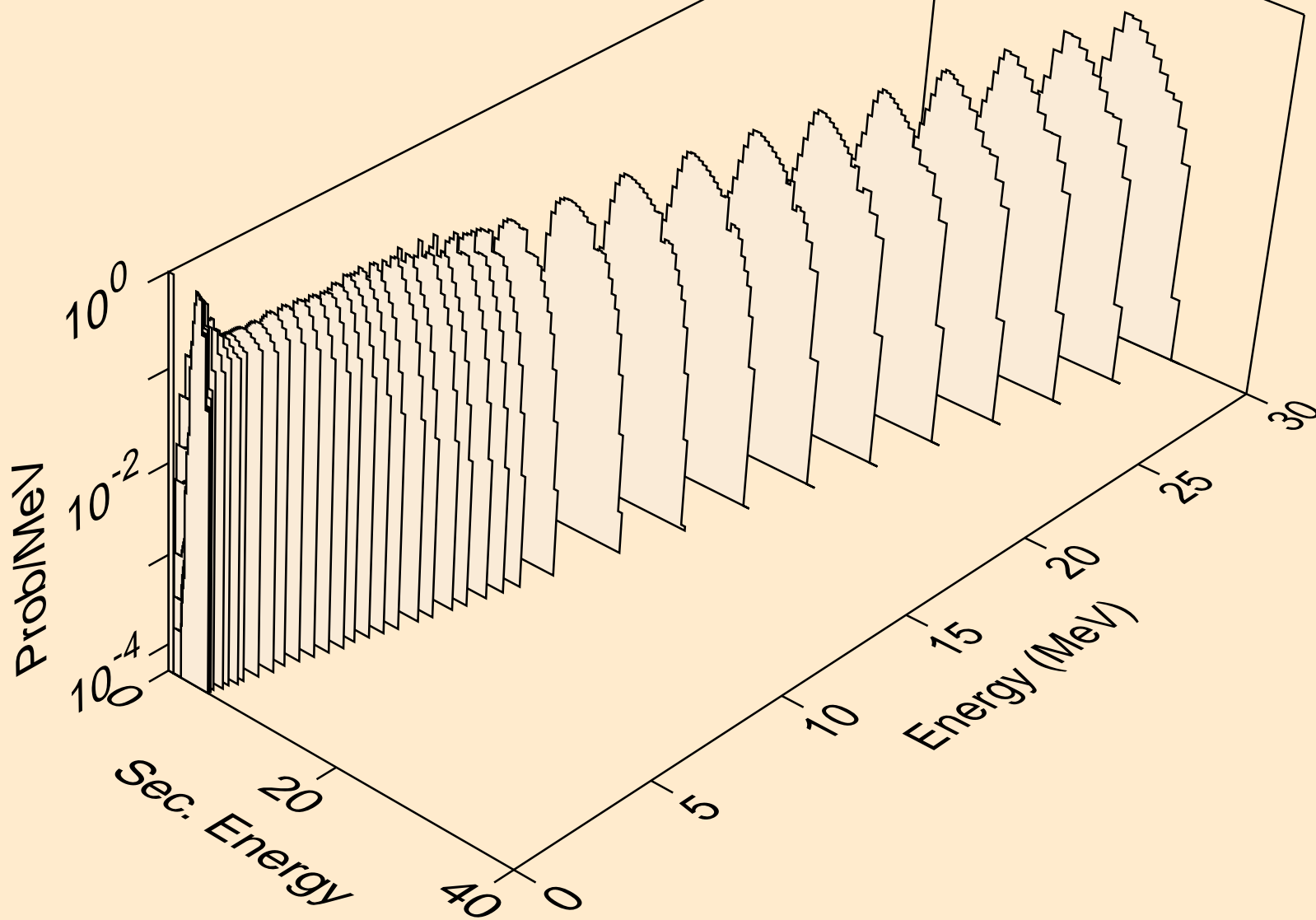

CA041 NEUTRON ACER TENDL-2019 LIBRARY; T=293.16K
alphas from (n,2a)

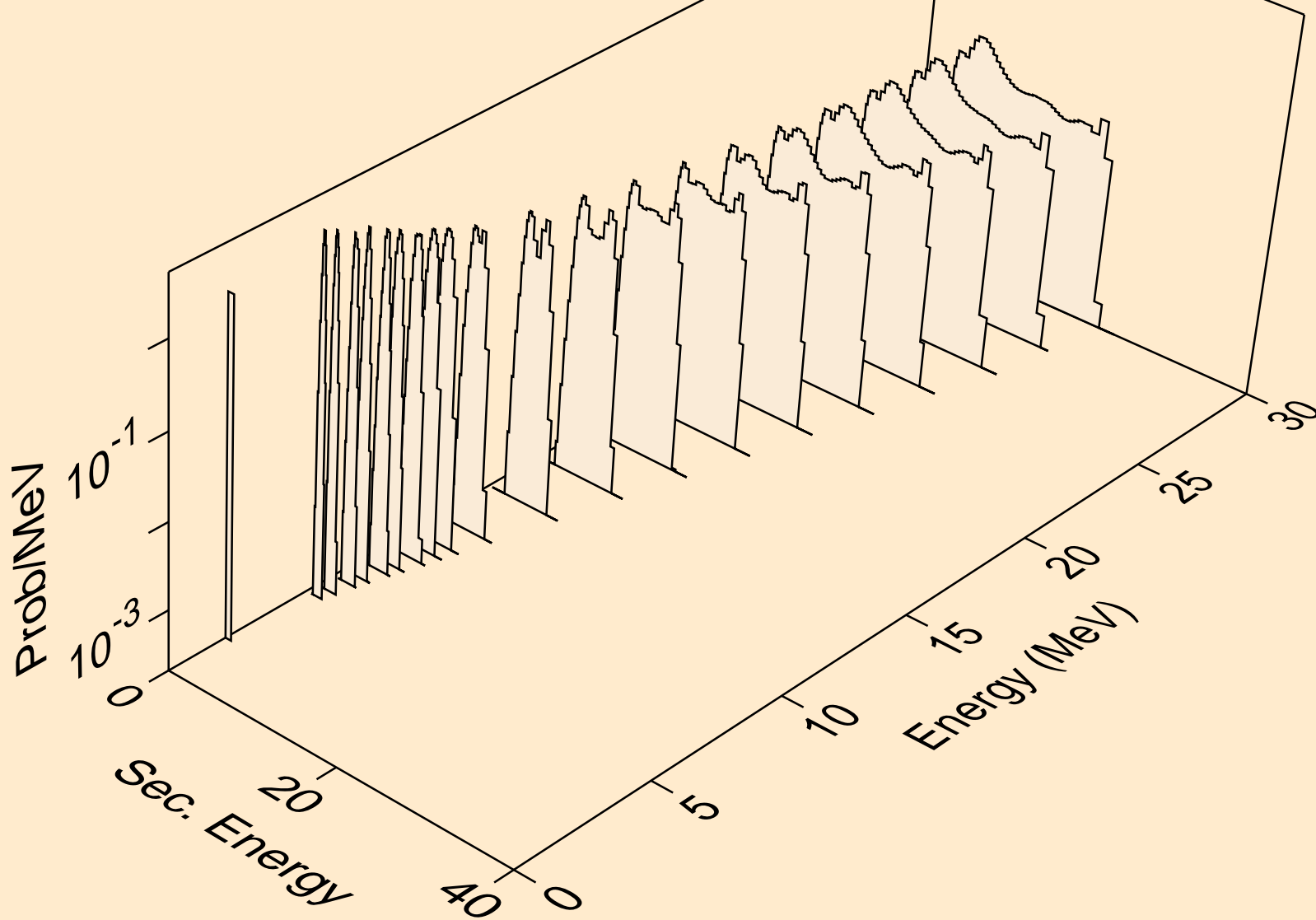

CA041 NEUTRON ACER TENDL-2019 LIBRARY; T=293.16K
alphas from (n,3a)

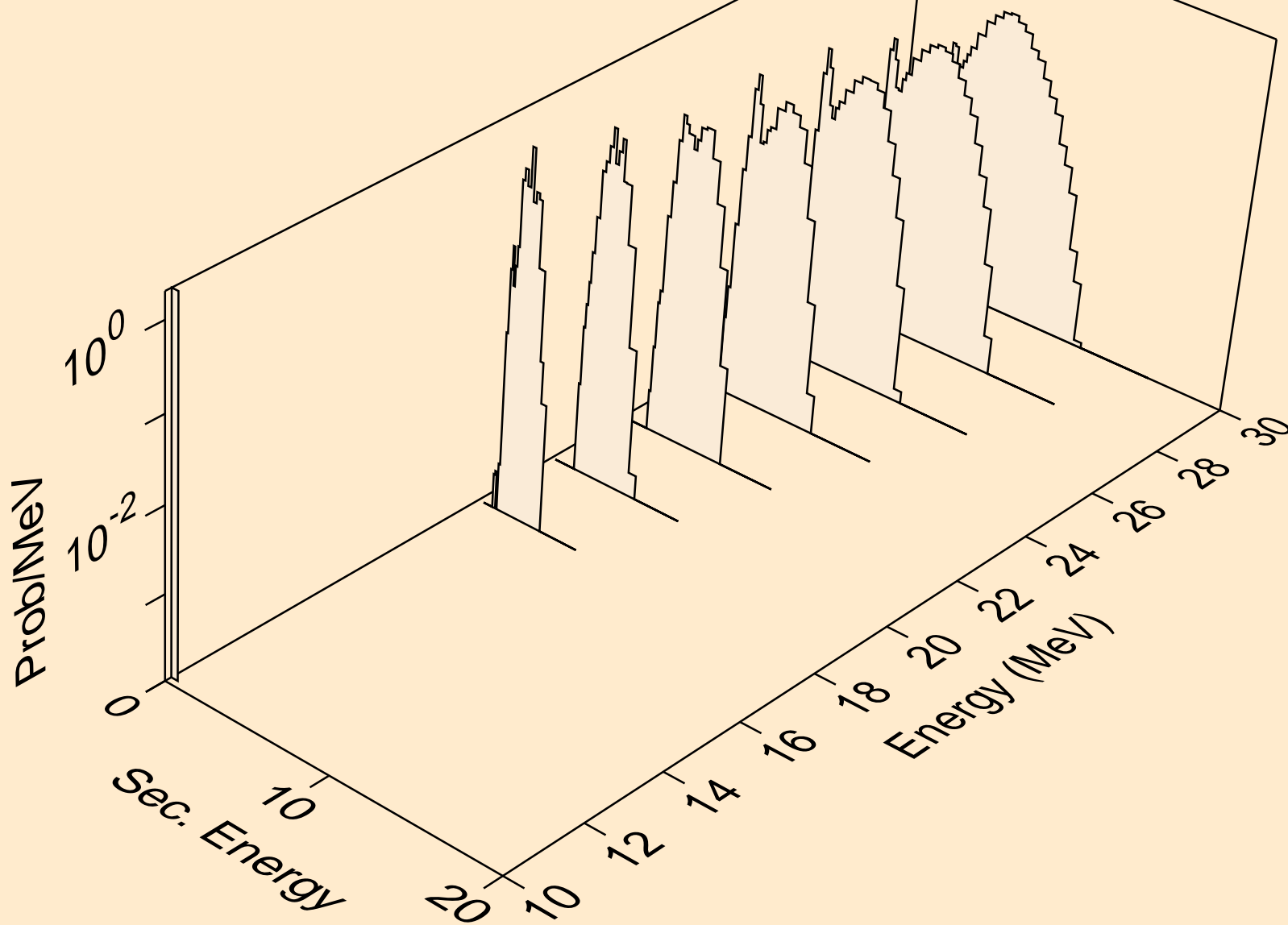

CA041 NEUTRON ACER TENDL-2019 LIBRARY; T=293.16K
alphas from (n,pa)

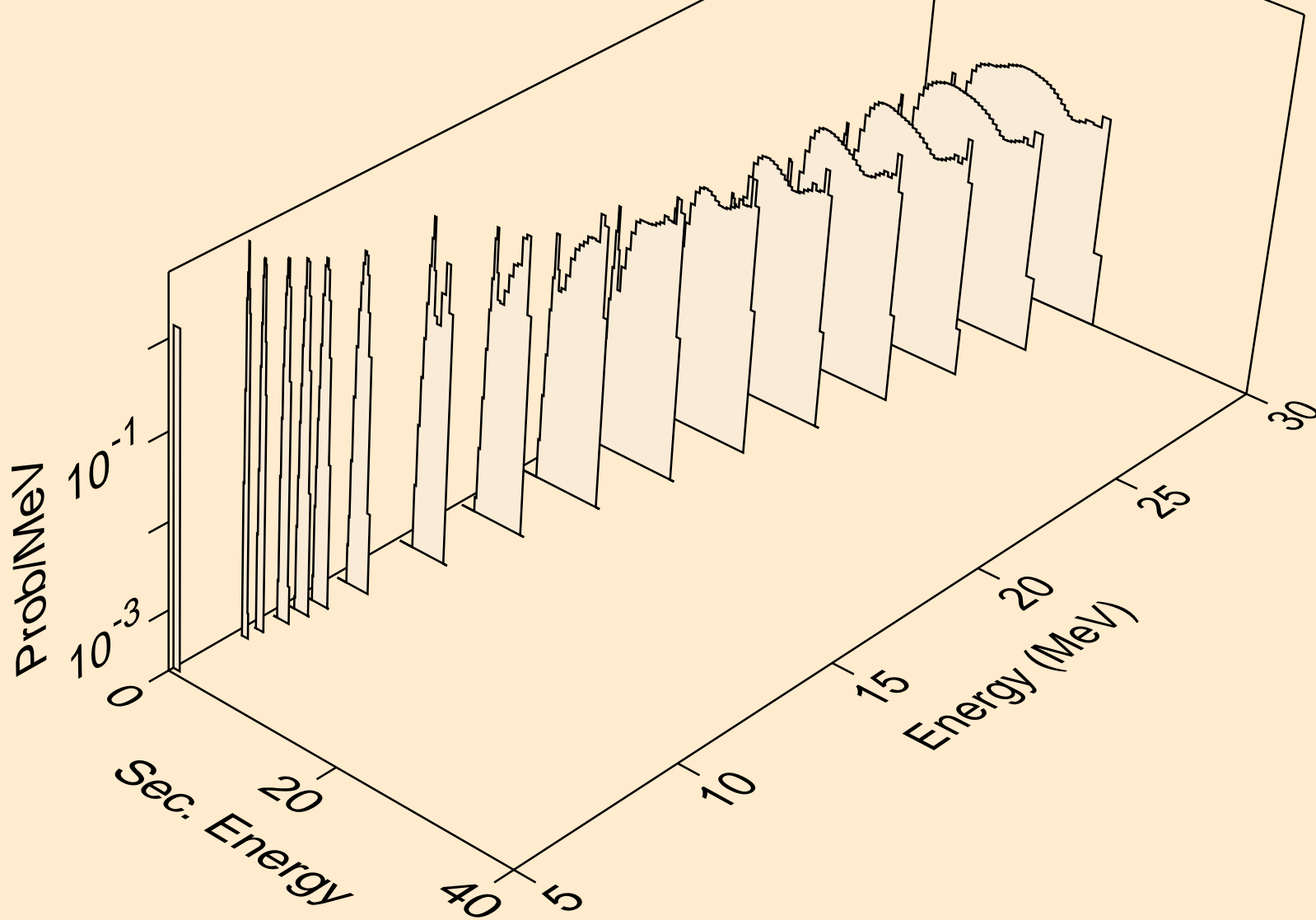

CA041 NEUTRON ACER TENDL-2019 LIBRARY; T=293.16K
alphas from (n,da)

