

CA050 NEUTRON ACER TENDL-2019 LIBRARY; T=293.16K
Principal cross sections

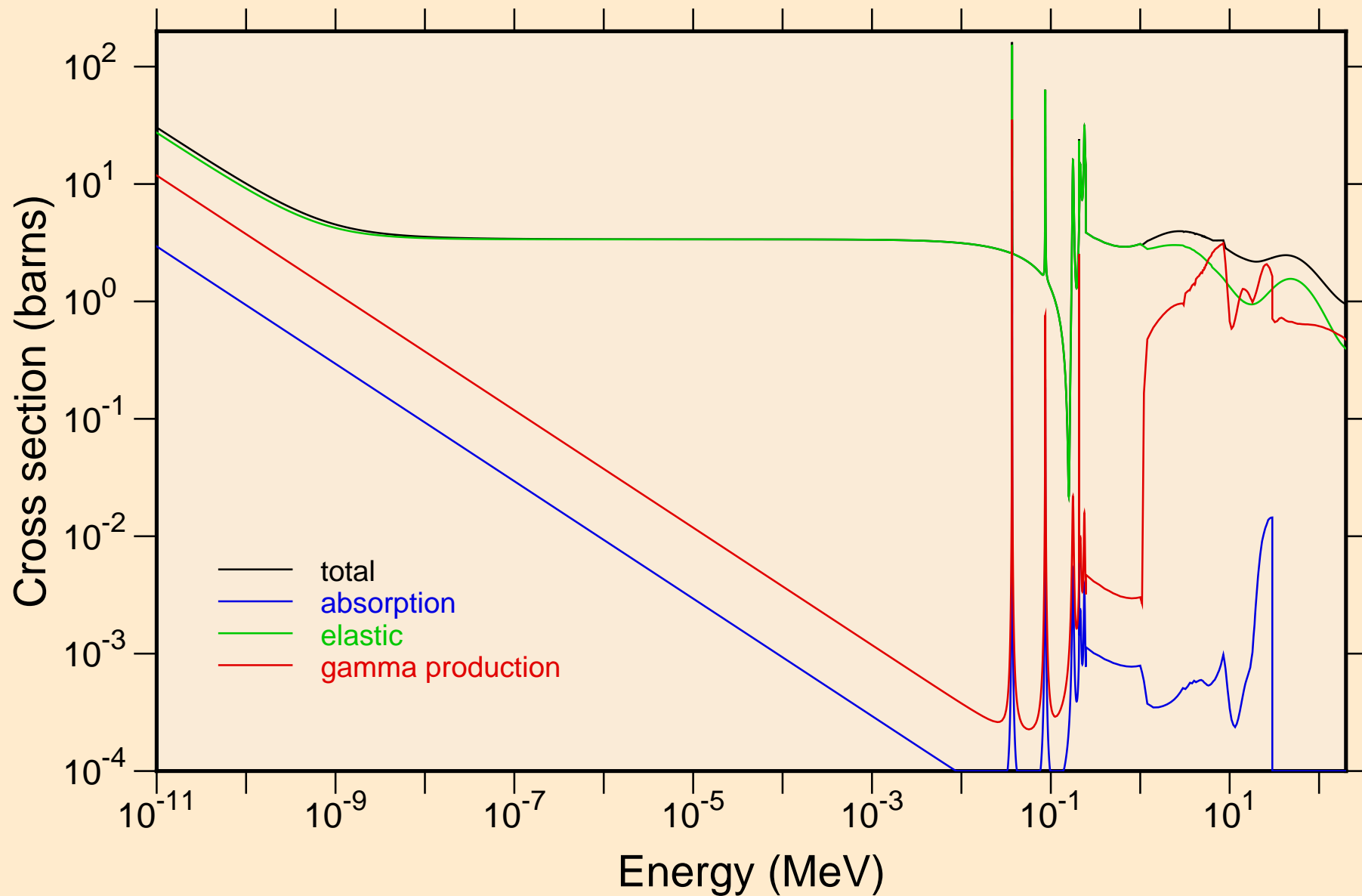

CA050 NEUTRON ACER TENDL-2019 LIBRARY; T=293.16K
resonance total cross section

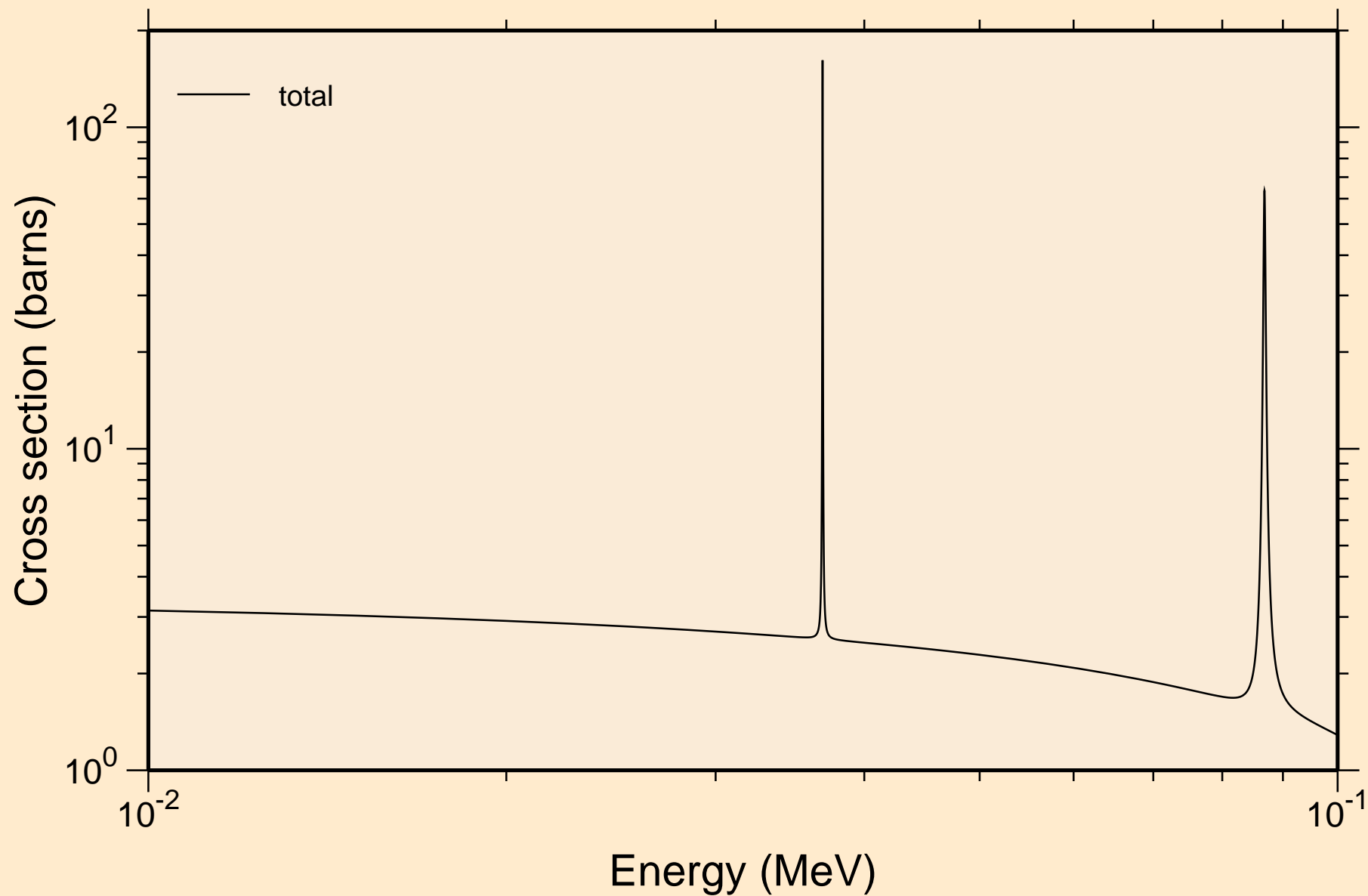

CA050 NEUTRON ACER TENDL-2019 LIBRARY; T=293.16K
resonance total cross section

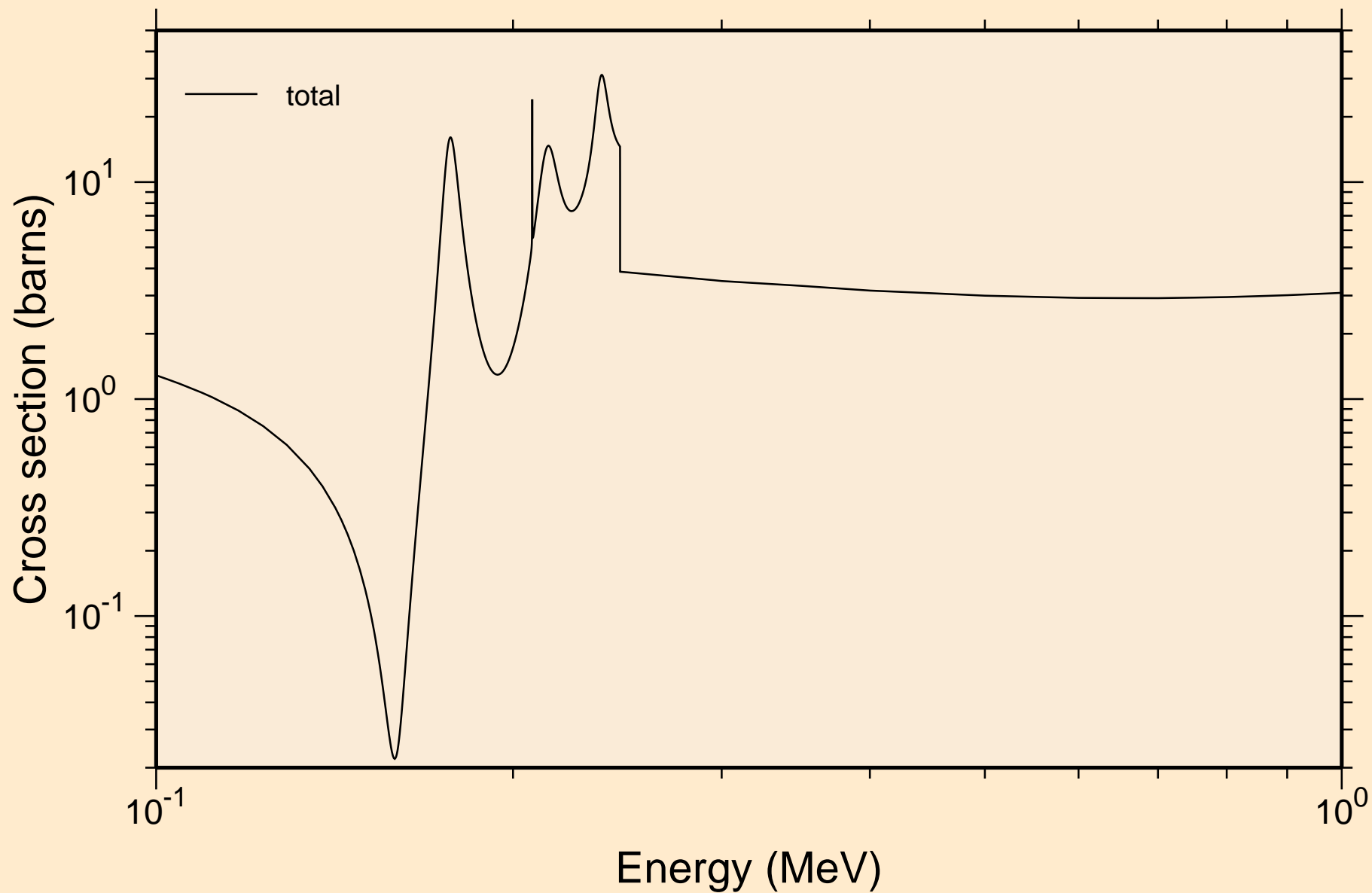

CA050 NEUTRON ACER TENDL-2019 LIBRARY; T=293.16K
resonance total cross section

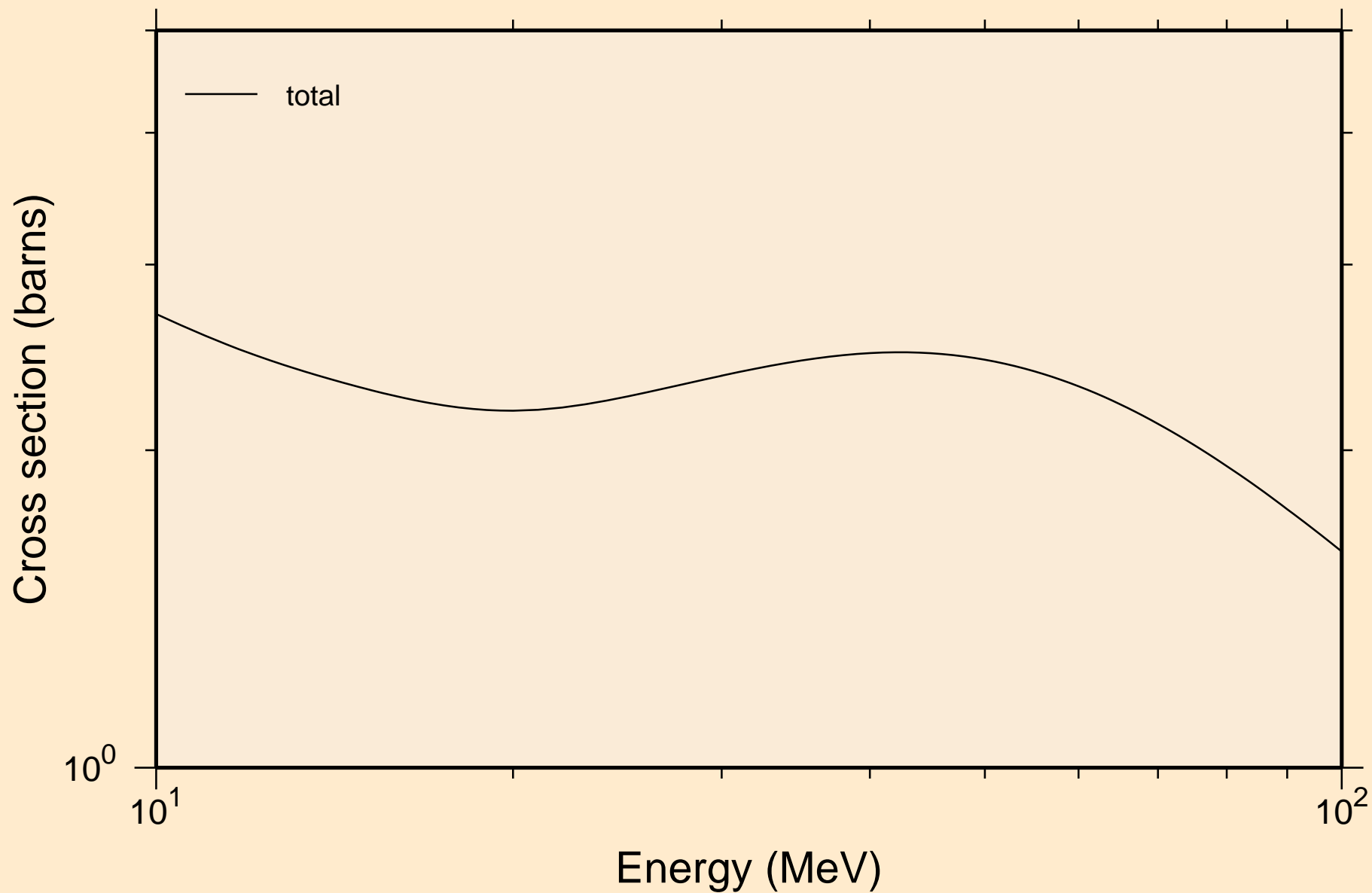

CA050 NEUTRON ACER TENDL-2019 LIBRARY; T=293.16K
resonance absorption cross sections

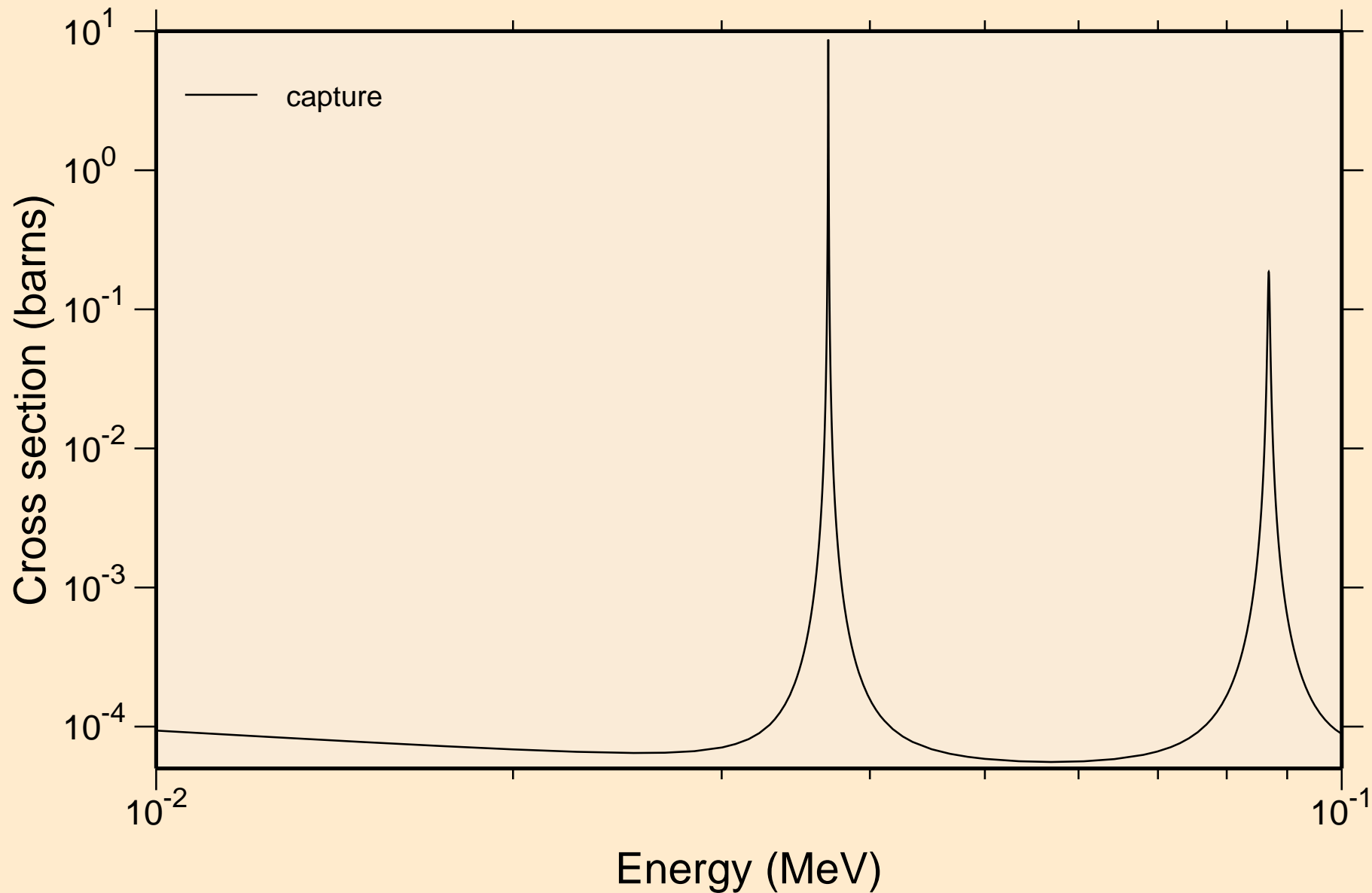

CA050 NEUTRON ACER TENDL-2019 LIBRARY; T=293.16K
resonance absorption cross sections

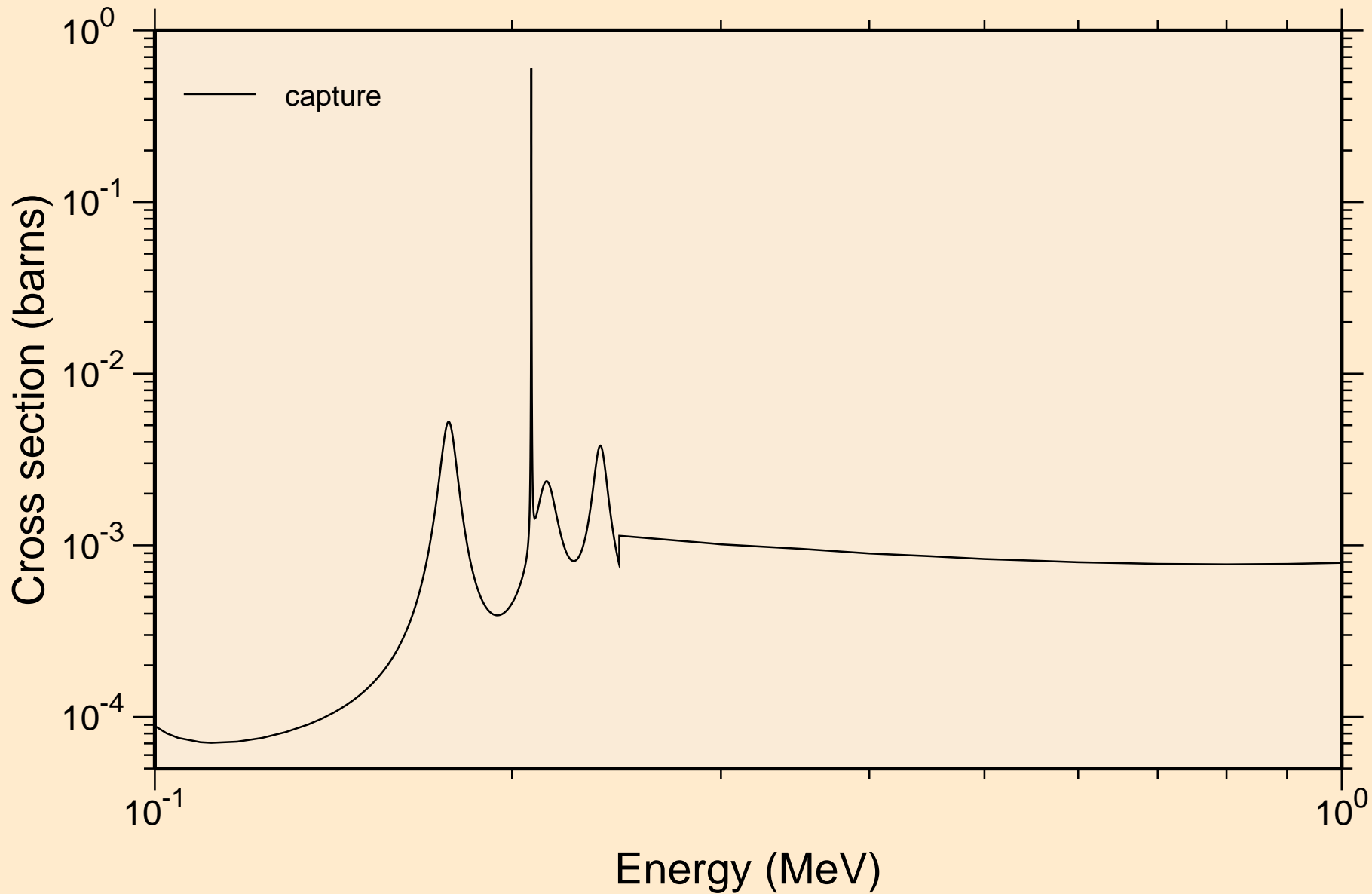

CA050 NEUTRON ACER TENDL-2019 LIBRARY; T=293.16K
resonance absorption cross sections

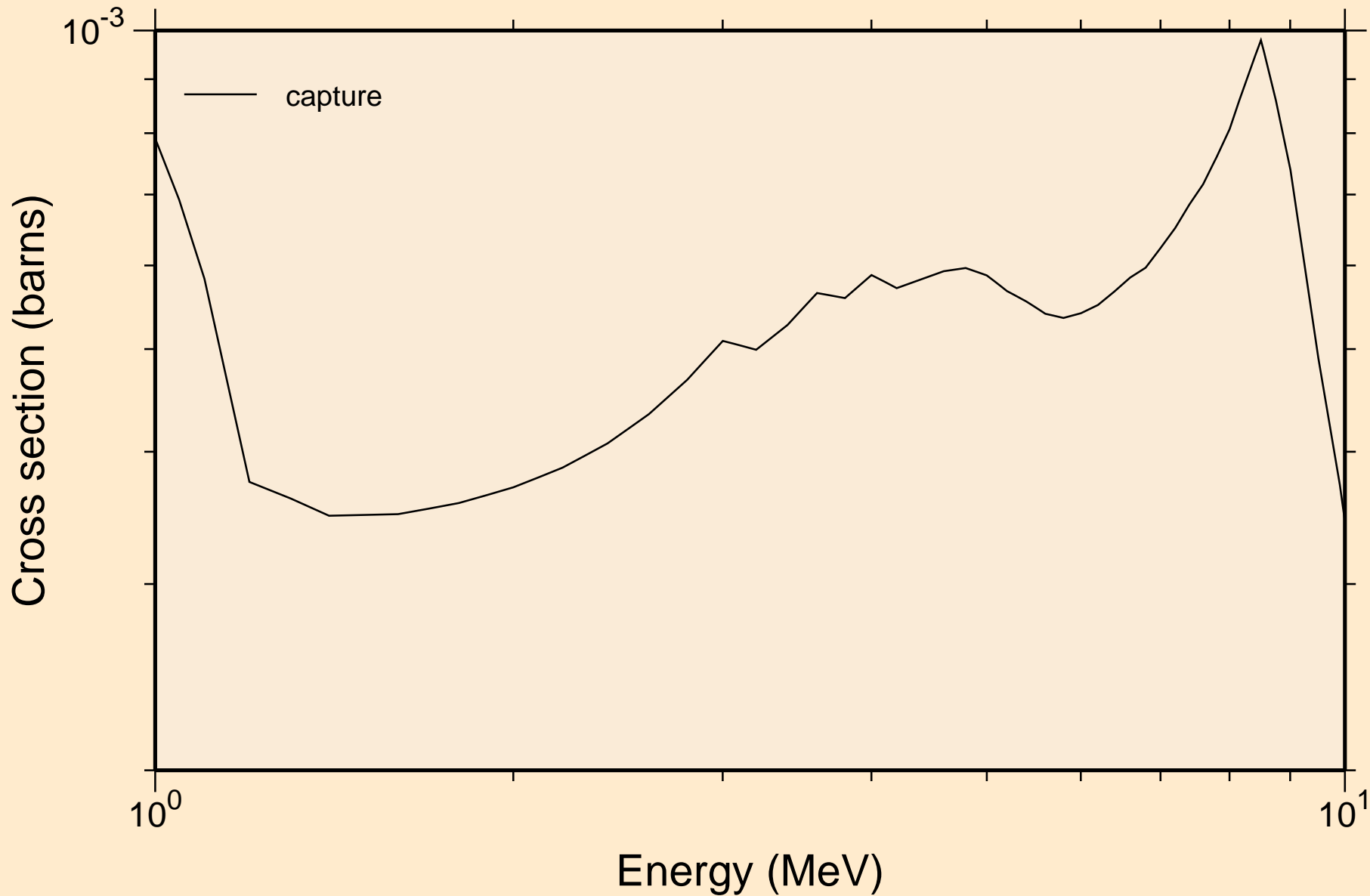

CA050 NEUTRON ACER TENDL-2019 LIBRARY; T=293.16K
Heating

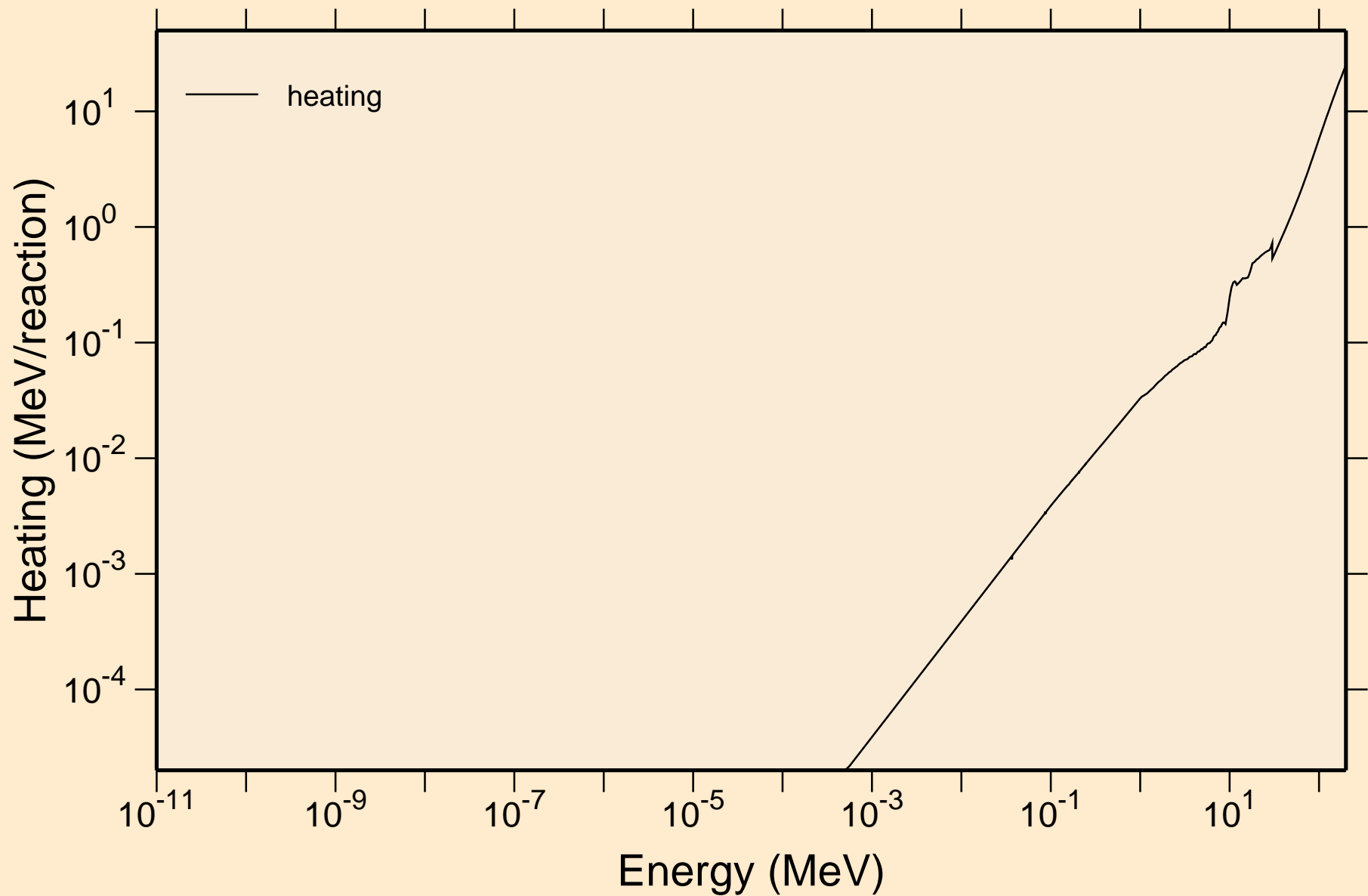

CA050 NEUTRON ACER TENDL-2019 LIBRARY; T=293.16K
Damage

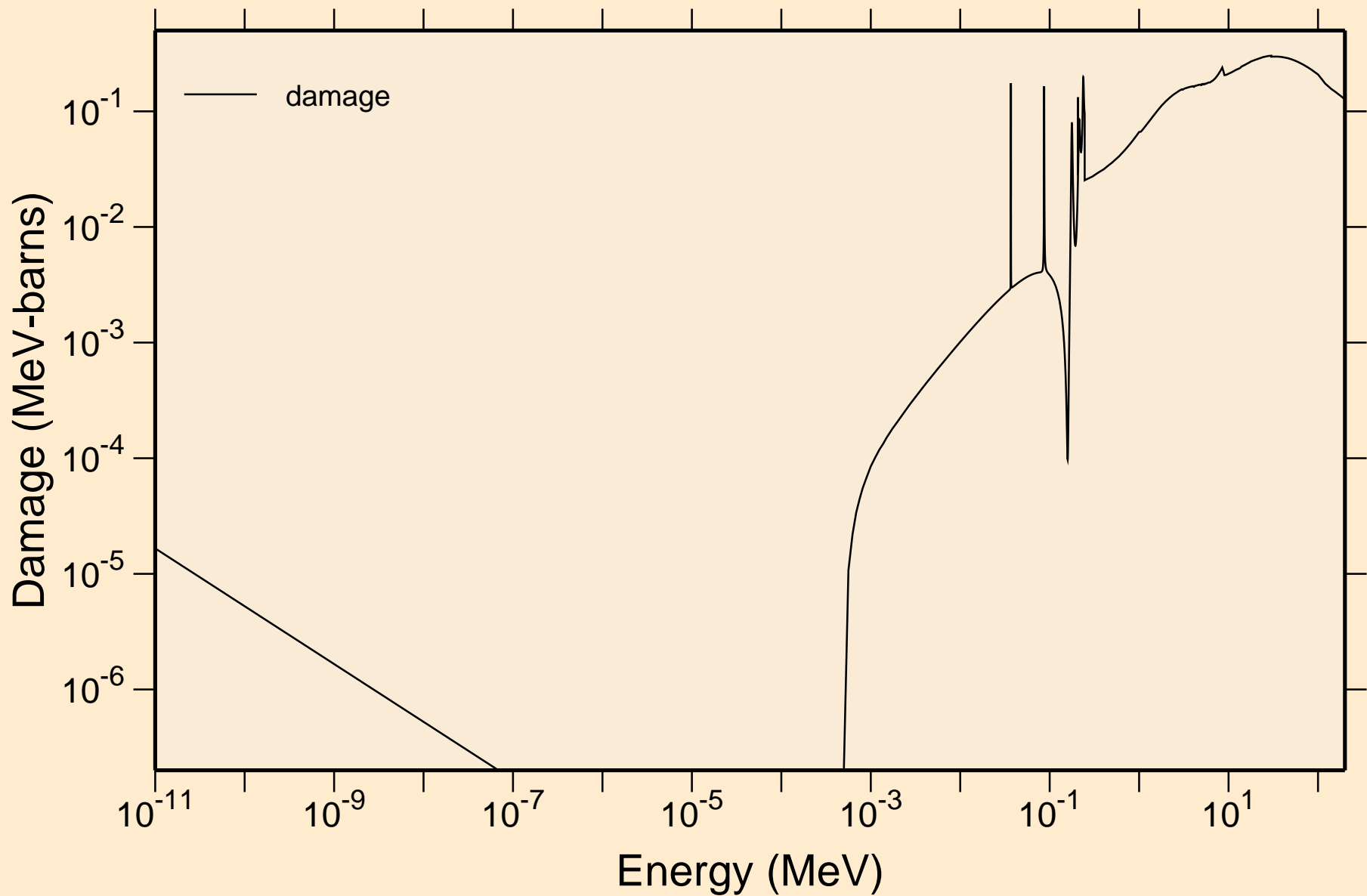

CA050 NEUTRON ACER TENDL-2019 LIBRARY; T=293.16K
Non-threshold reactions

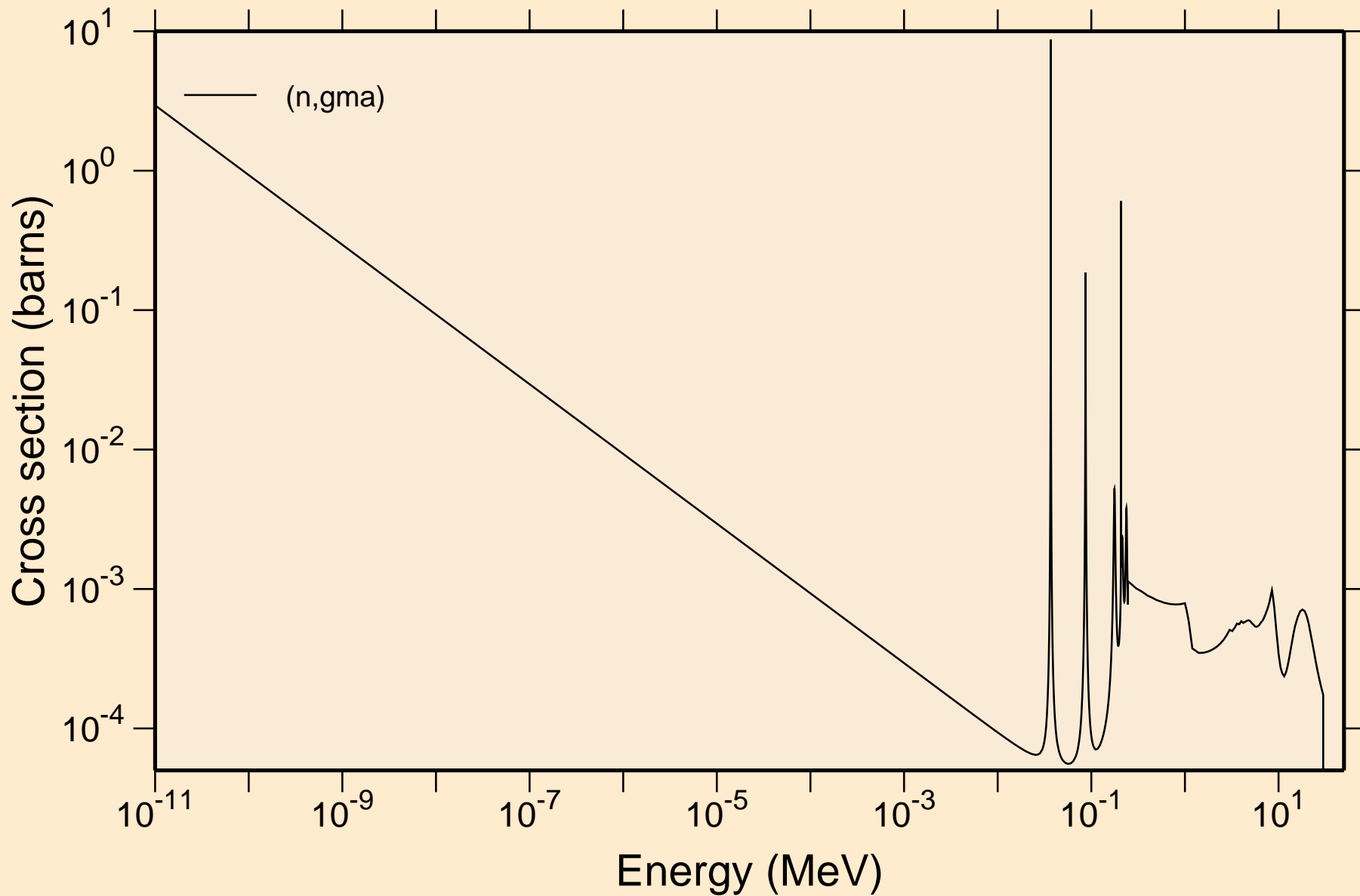

CA050 NEUTRON ACER TENDL-2019 LIBRARY; T=293.16K
Principal cross sections

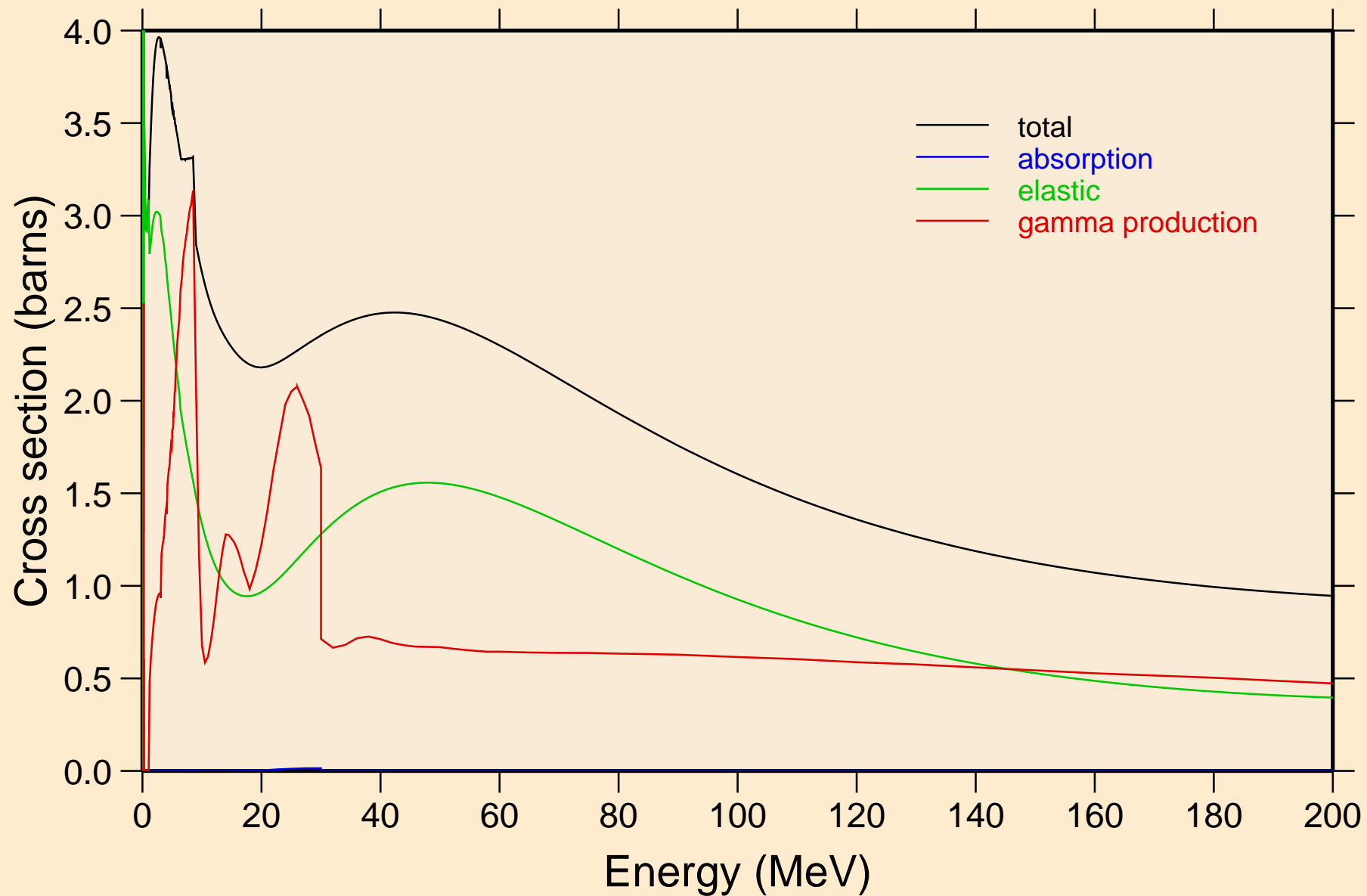

CA050 NEUTRON ACER TENDL-2019 LIBRARY; T=293.16K
Heating

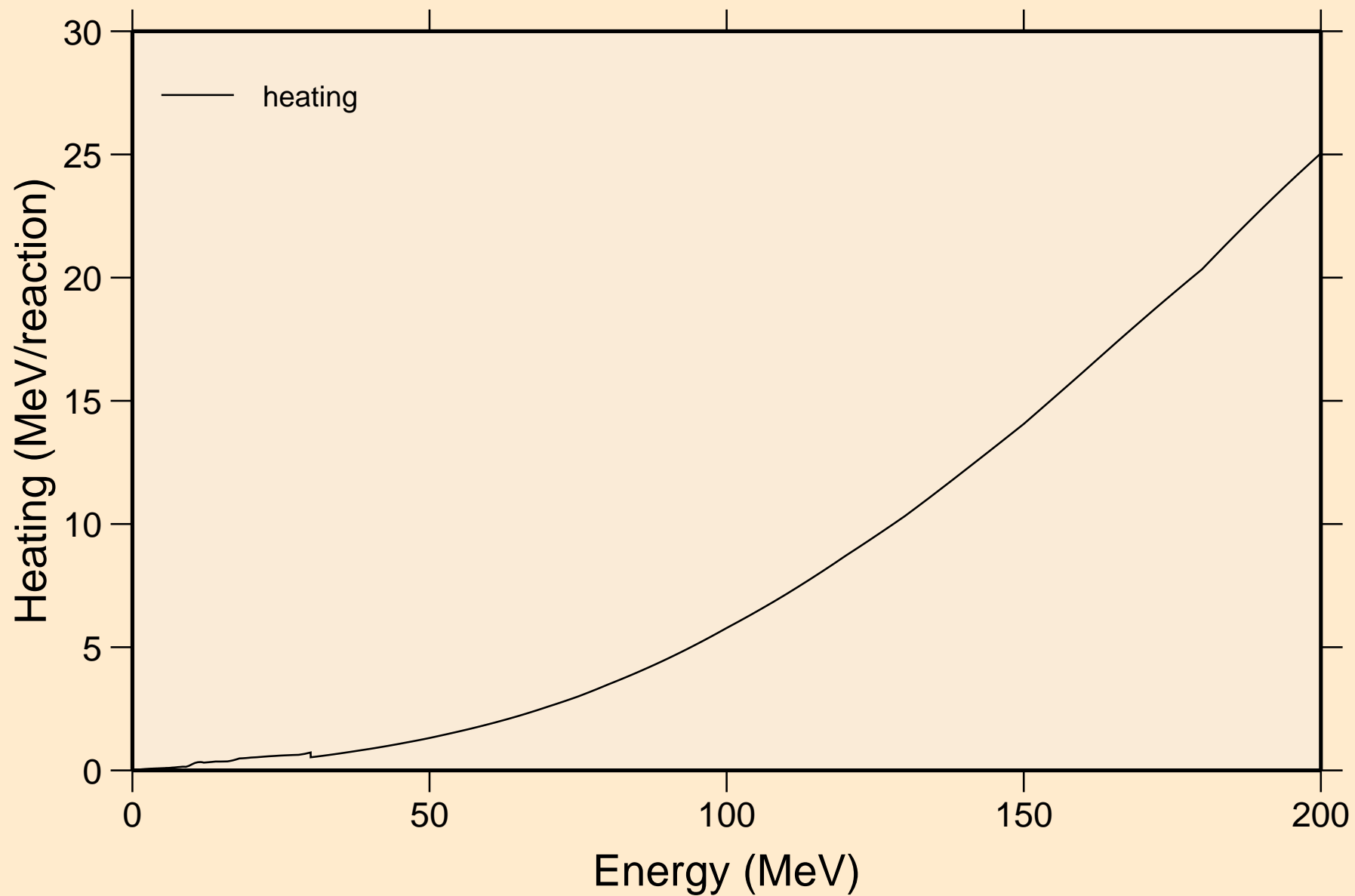

CA050 NEUTRON ACER TENDL-2019 LIBRARY; T=293.16K
Damage

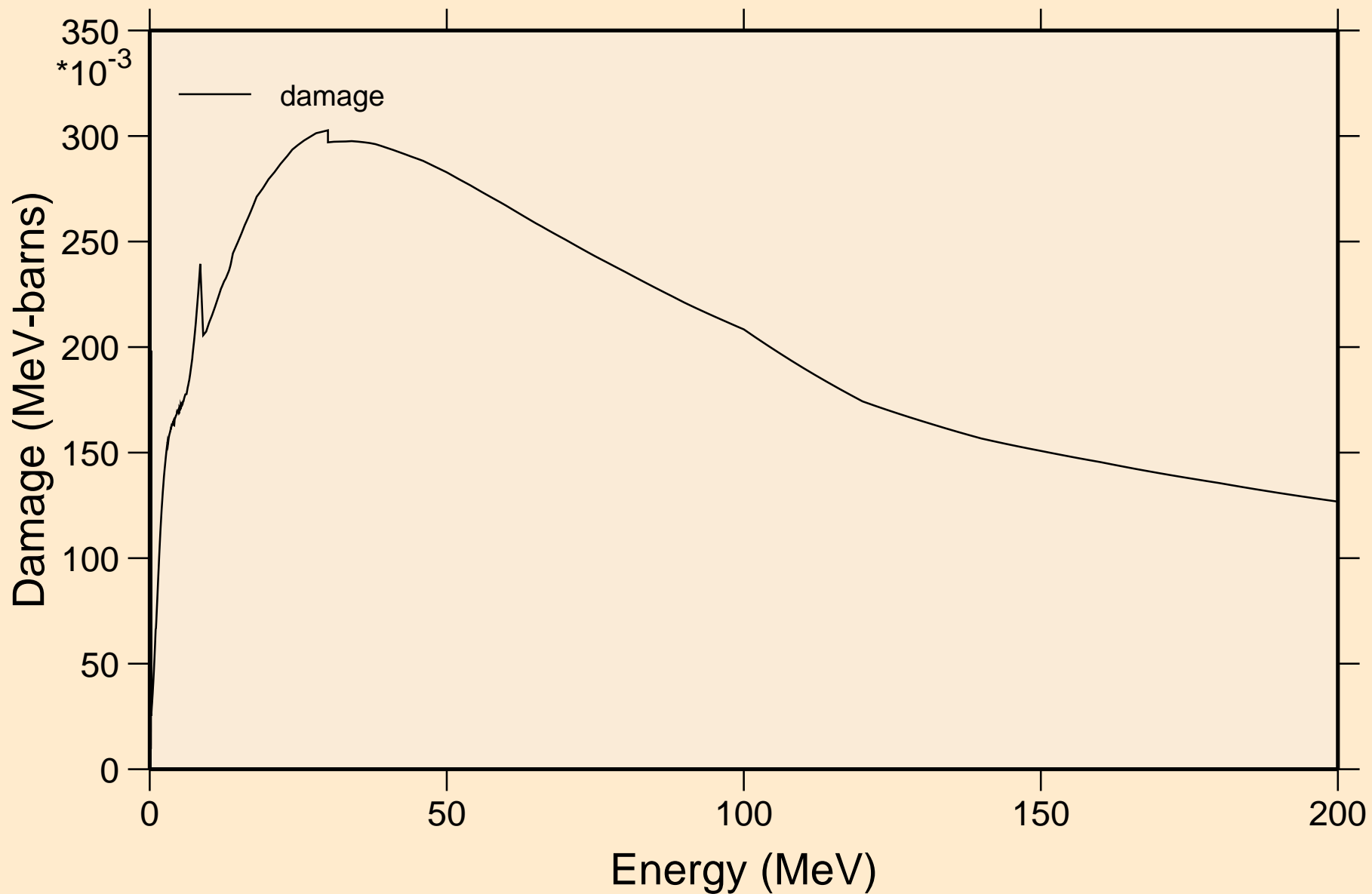

CA050 NEUTRON ACER TENDL-2019 LIBRARY; T=293.16K
Non-threshold reactions

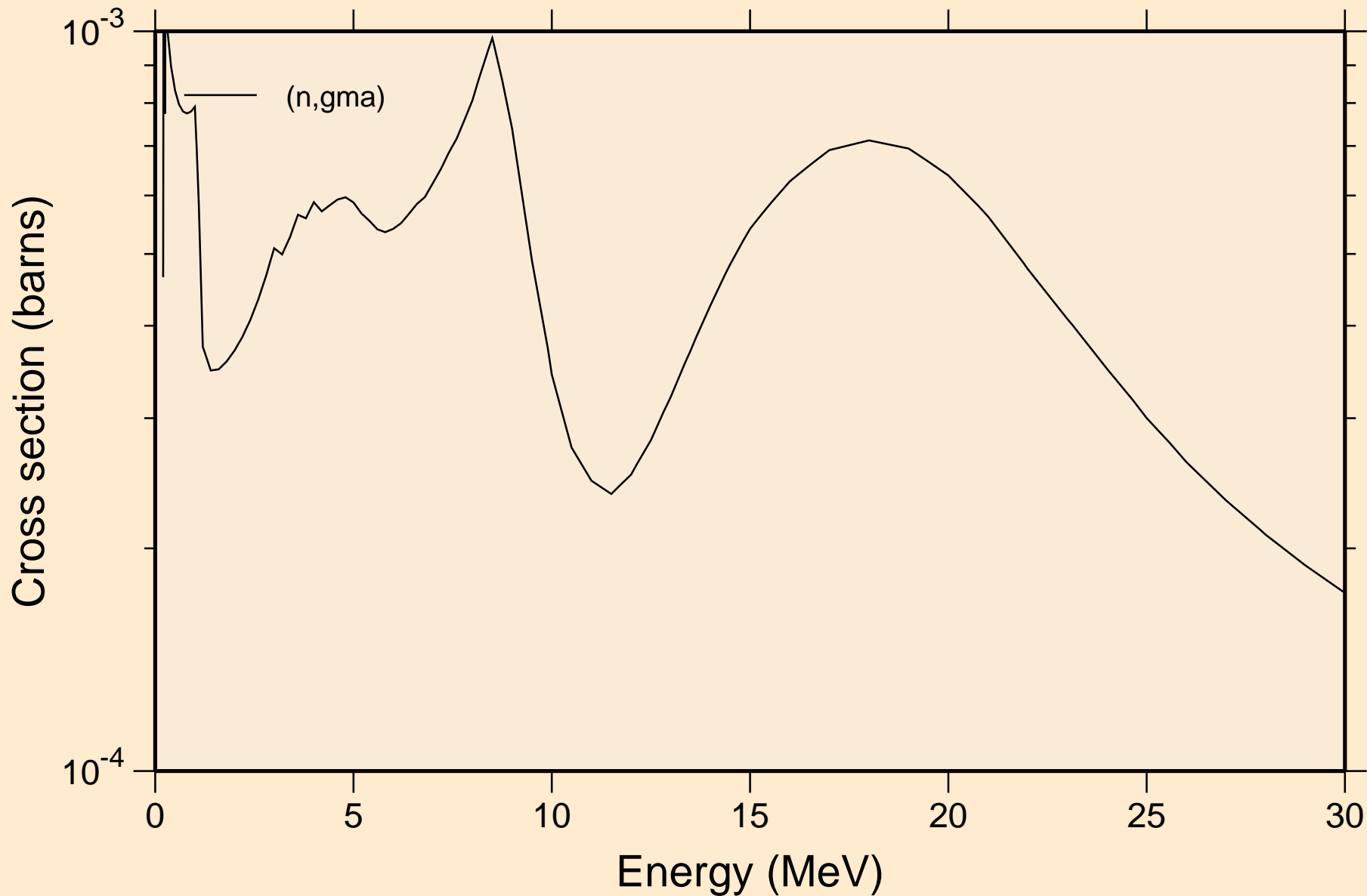

CA050 NEUTRON ACER TENDL-2019 LIBRARY; T=293.16K
Inelastic levels

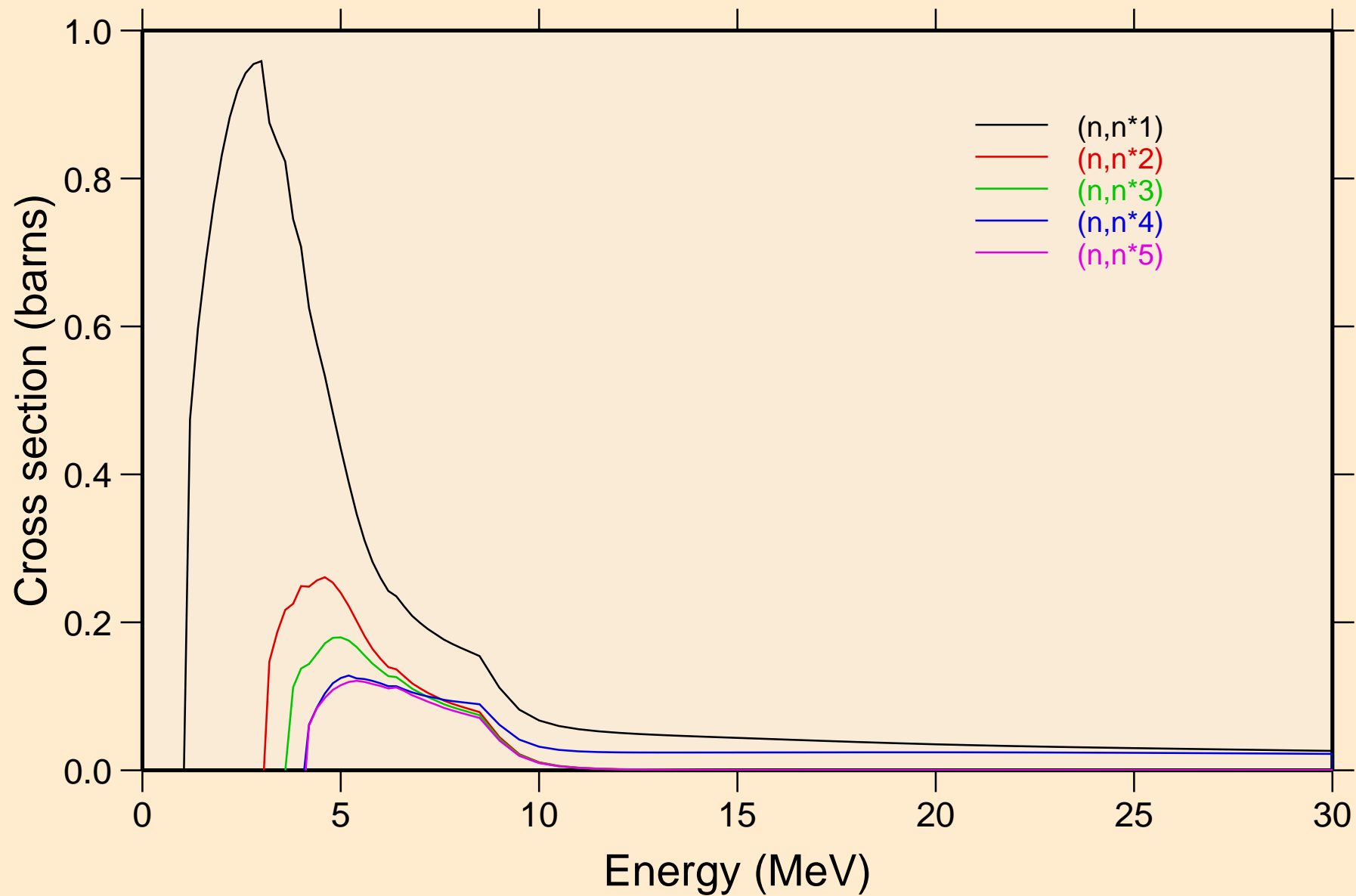

CA050 NEUTRON ACER TENDL-2019 LIBRARY; T=293.16K
Inelastic levels

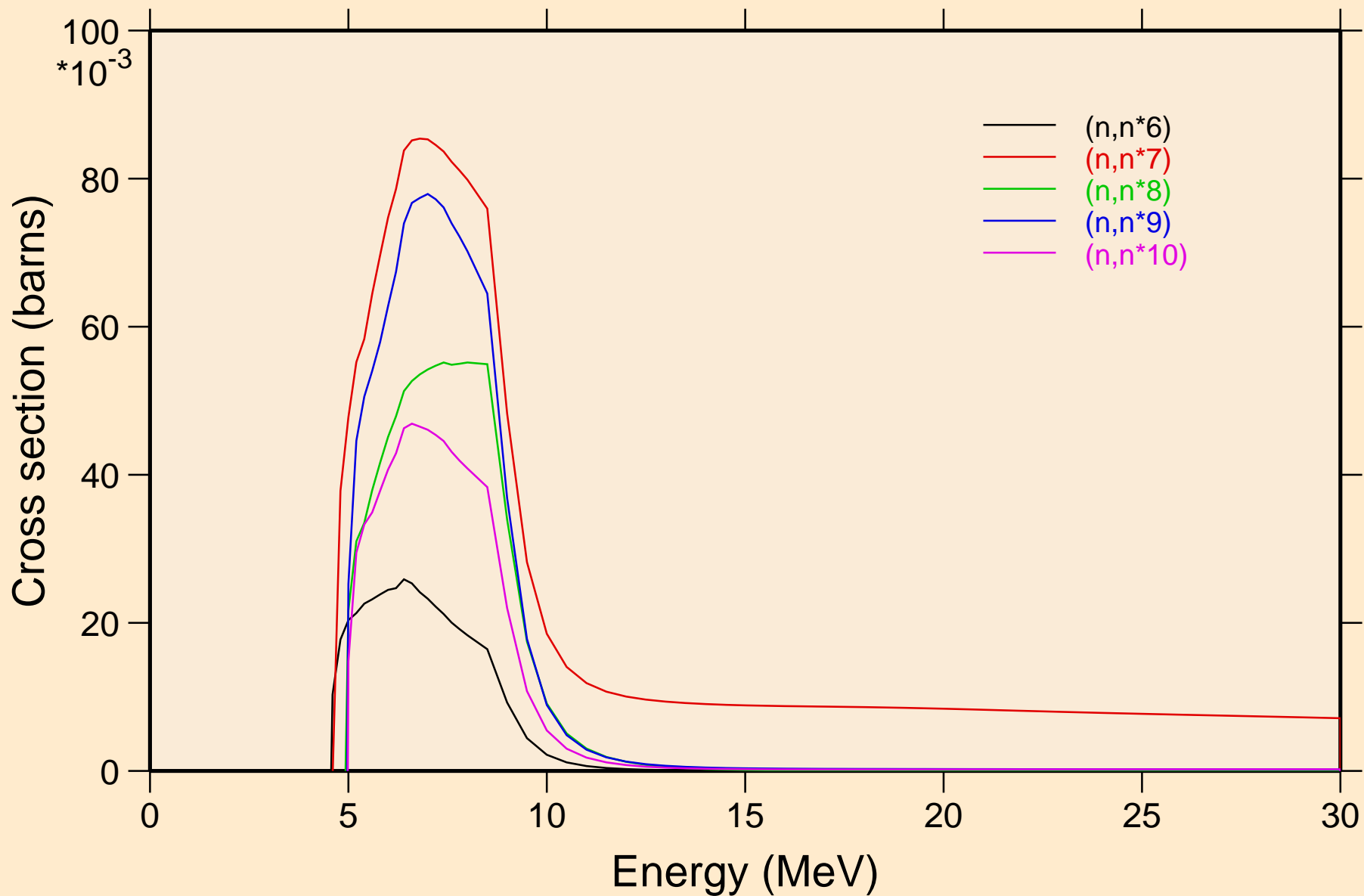

CA050 NEUTRON ACER TENDL-2019 LIBRARY; T=293.16K
Inelastic levels

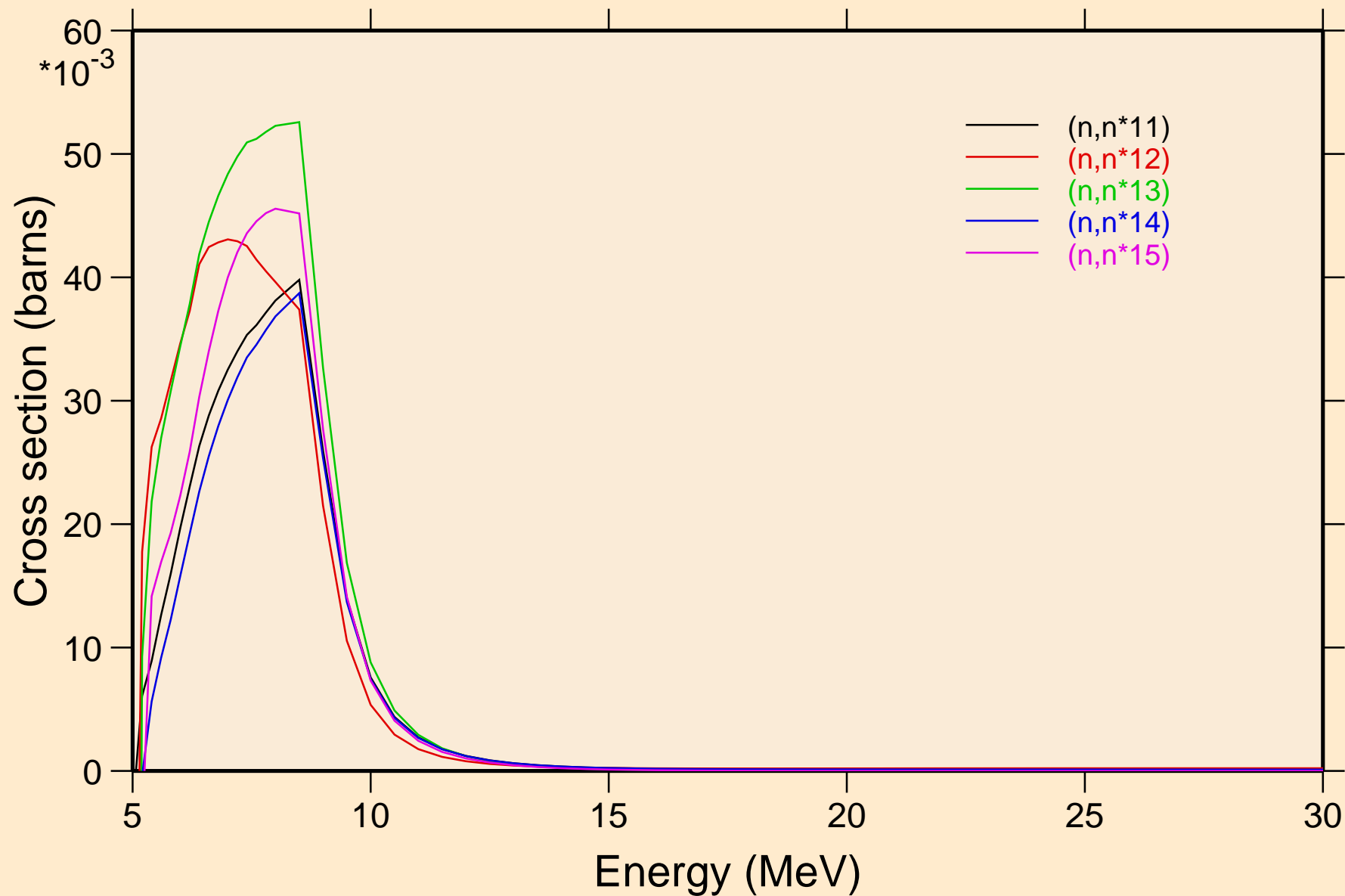

CA050 NEUTRON ACER TENDL-2019 LIBRARY; T=293.16K
Inelastic levels

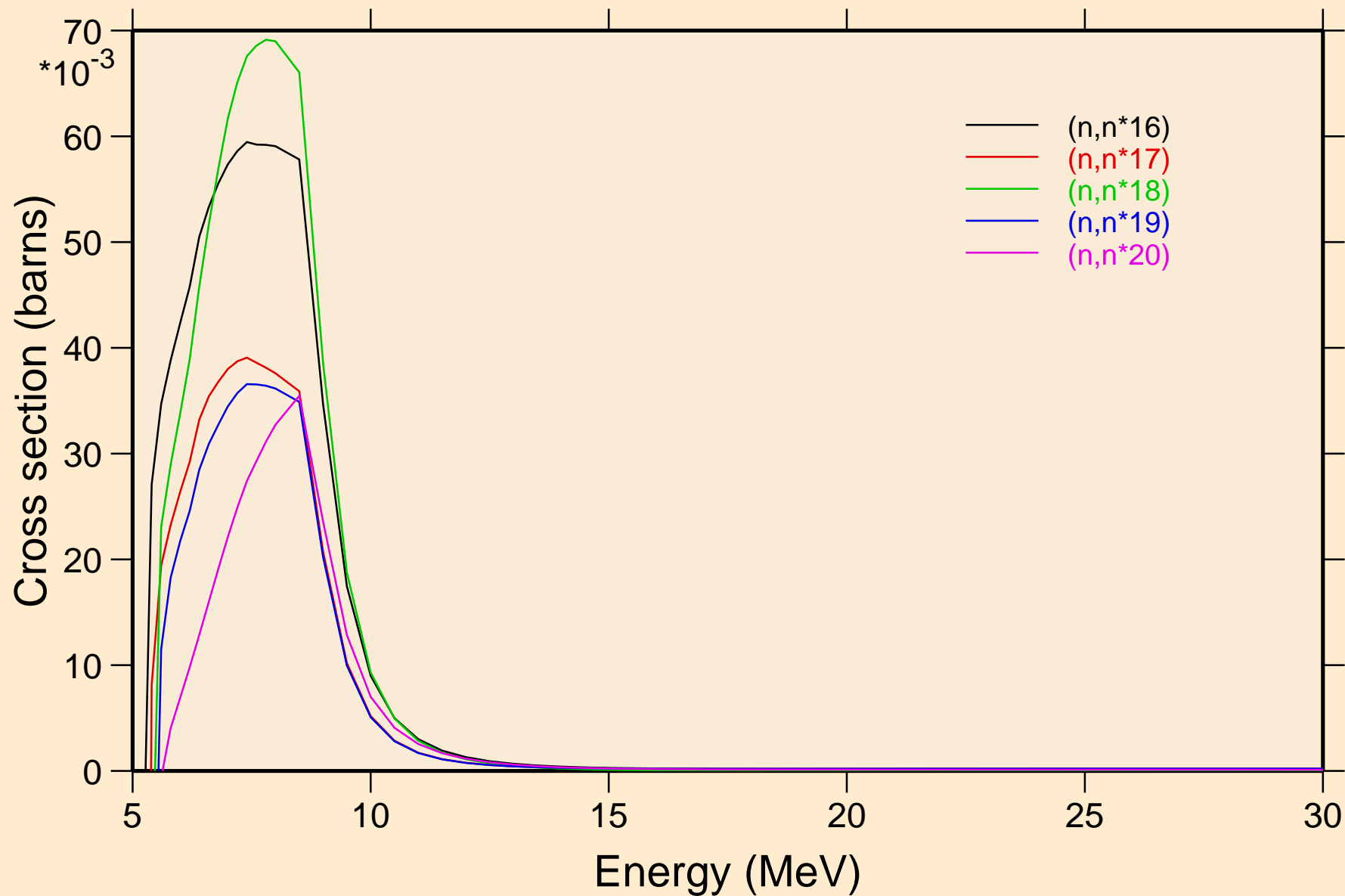

CA050 NEUTRON ACER TENDL-2019 LIBRARY; T=293.16K
Inelastic levels

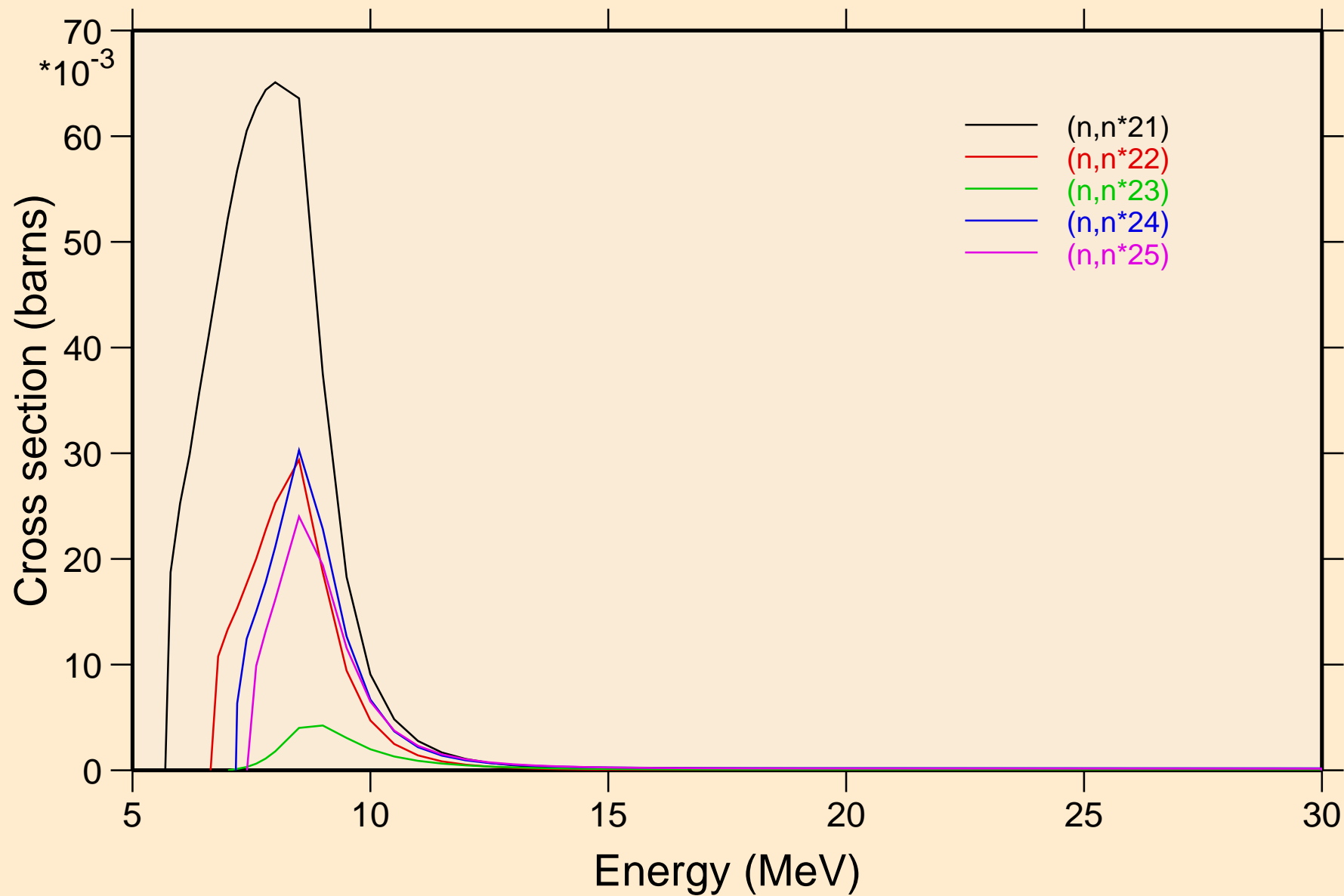

CA050 NEUTRON ACER TENDL-2019 LIBRARY; T=293.16K
Inelastic levels

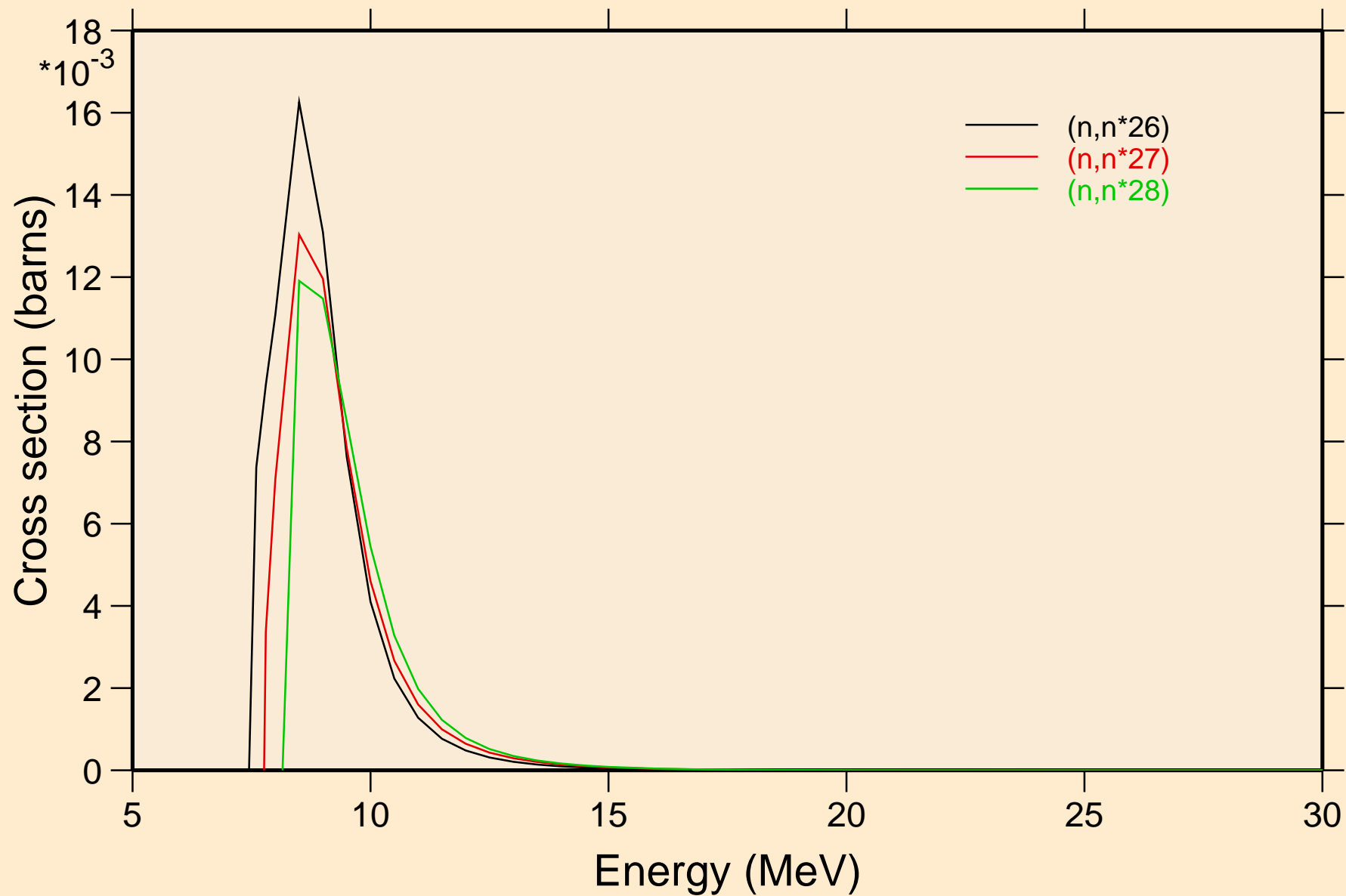

CA050 NEUTRON ACER TENDL-2019 LIBRARY; T=293.16K
Threshold reactions

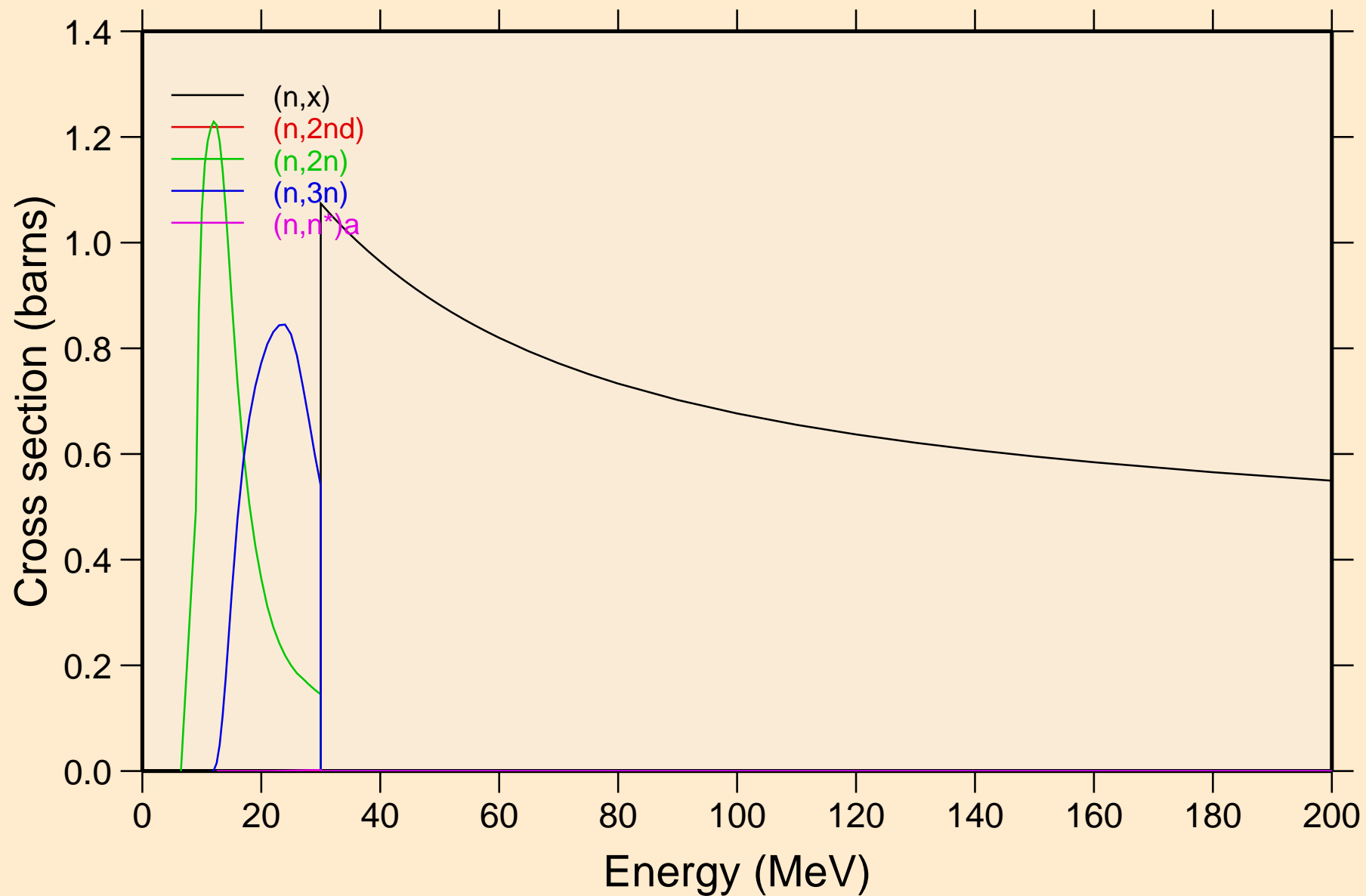

CA050 NEUTRON ACER TENDL-2019 LIBRARY; T=293.16K
Threshold reactions

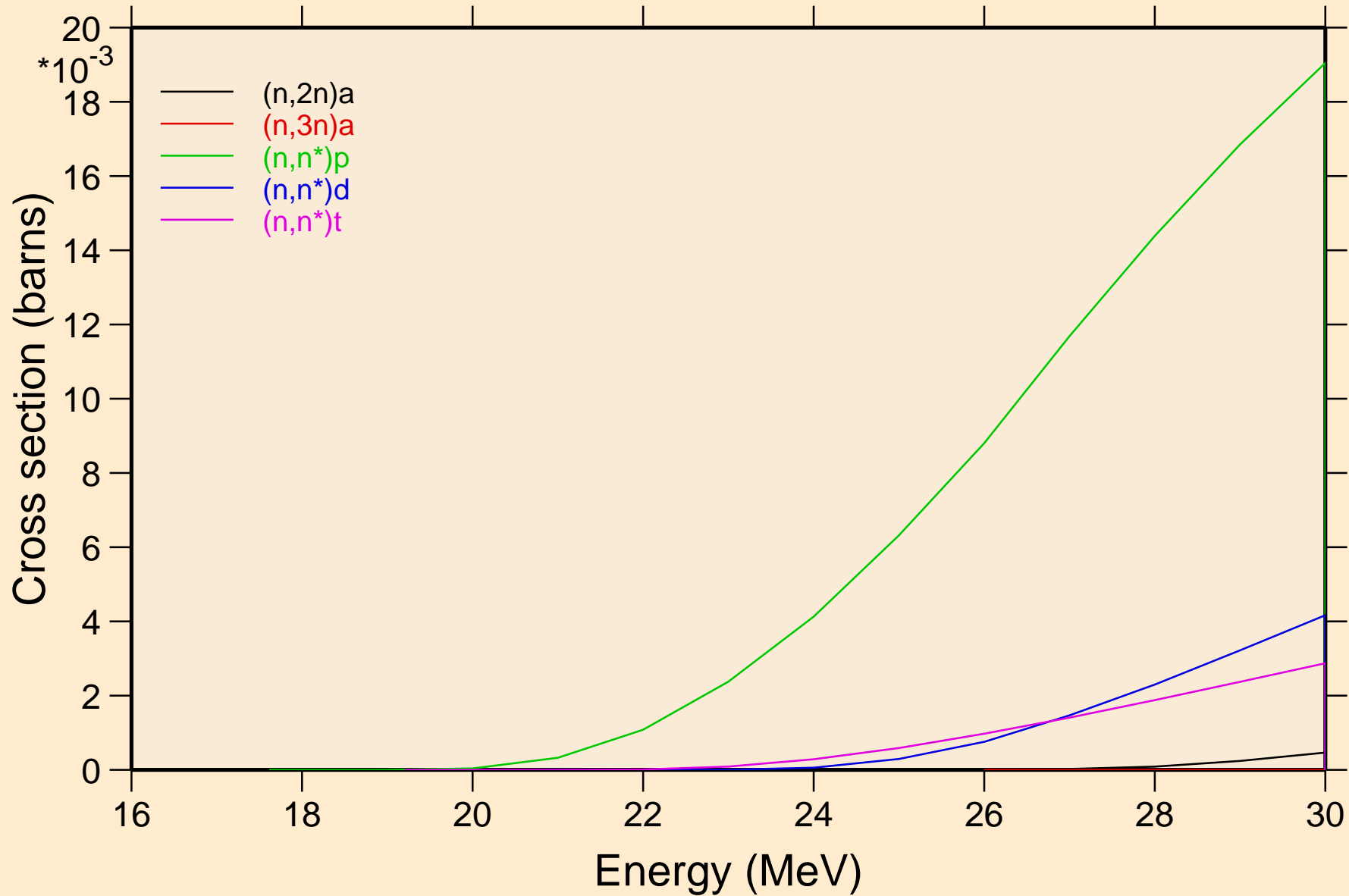

CA050 NEUTRON ACER TENDL-2019 LIBRARY; T=293.16K
Threshold reactions

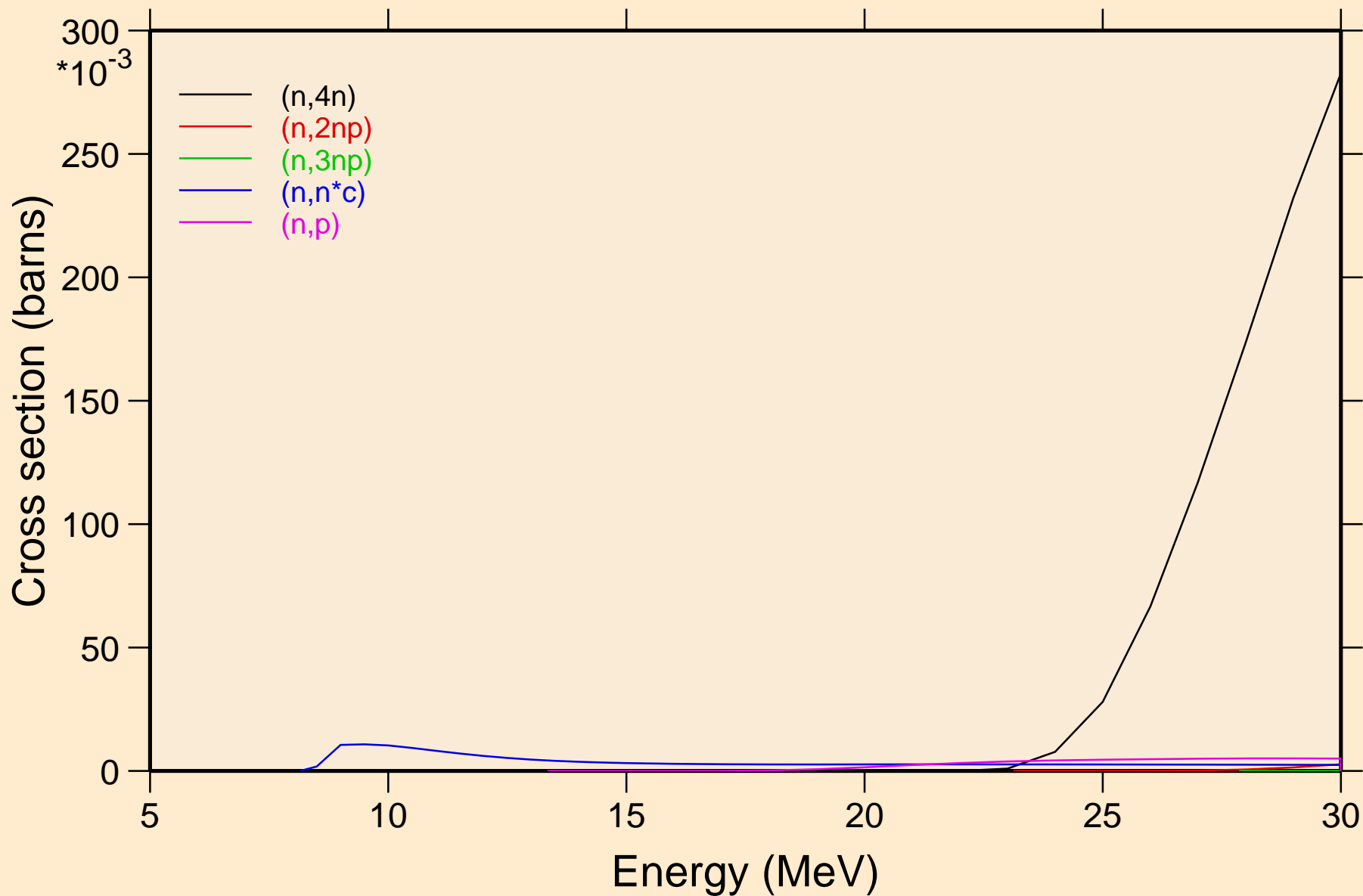

CA050 NEUTRON ACER TENDL-2019 LIBRARY; T=293.16K
Threshold reactions

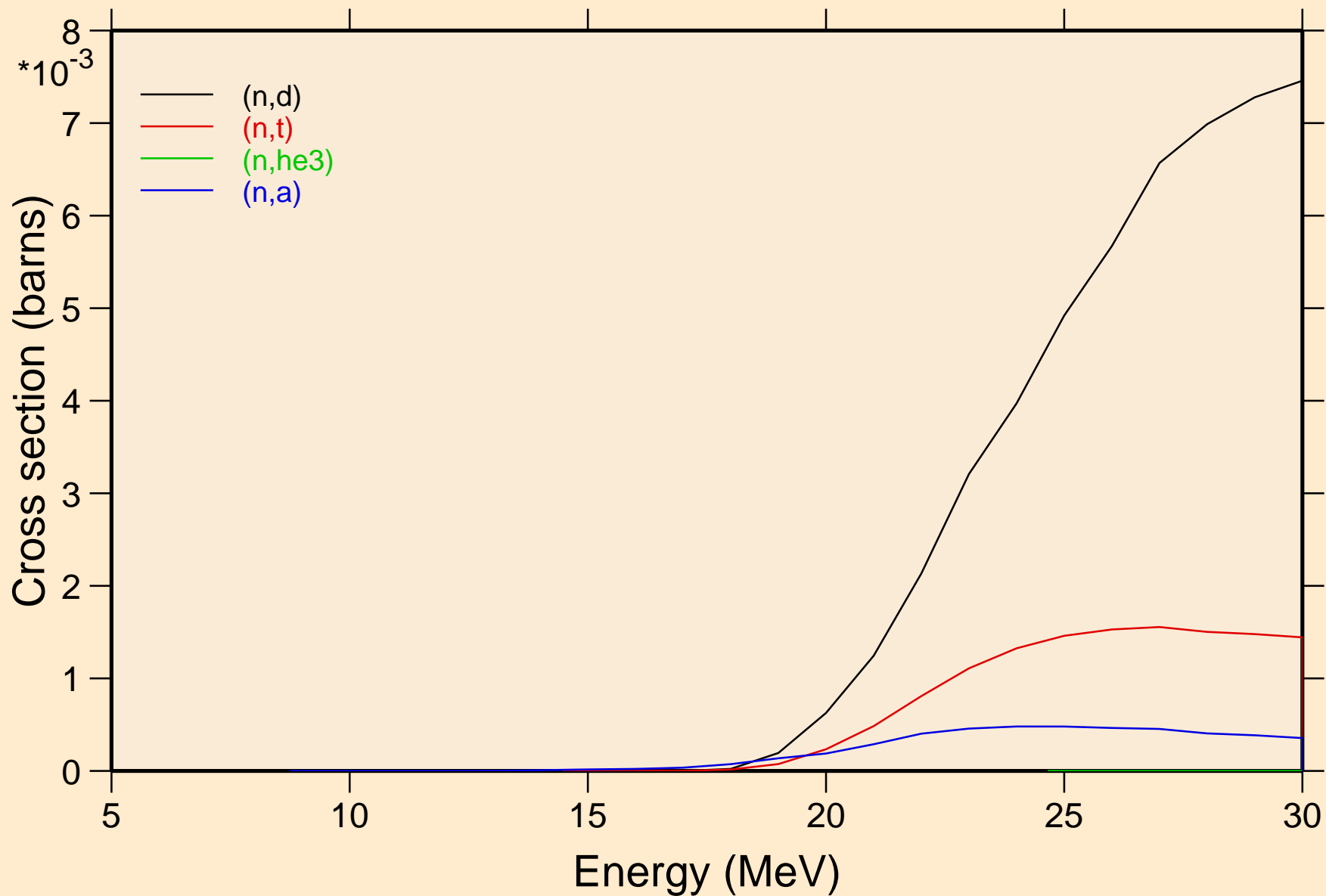

CA050 NEUTRON ACER TENDL-2019 LIBRARY; T=293.16K
Threshold reactions

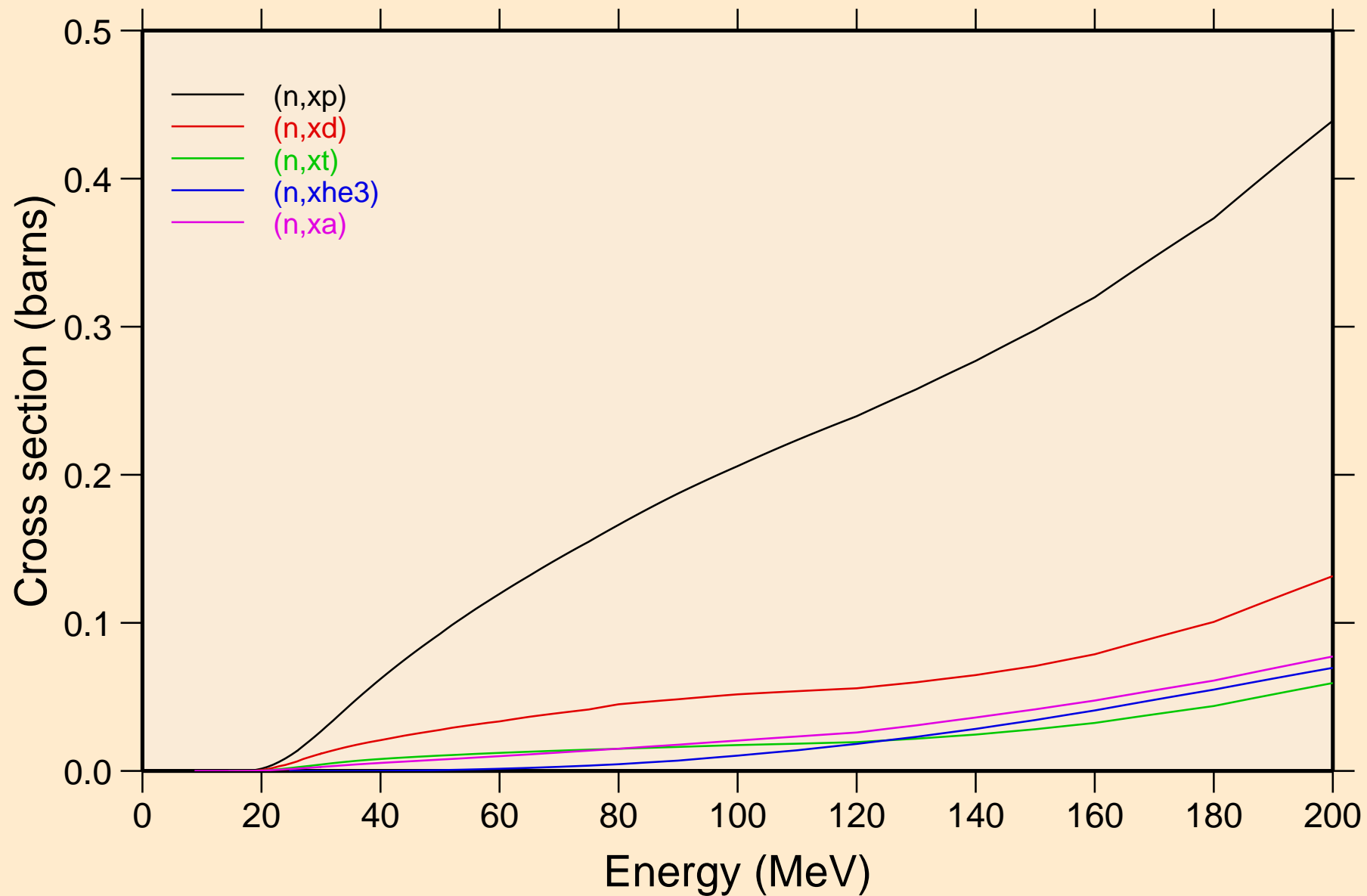

CA050 NEUTRON ACER TENDL-2019 LIBRARY; T=293.16K
angular distribution for elastic

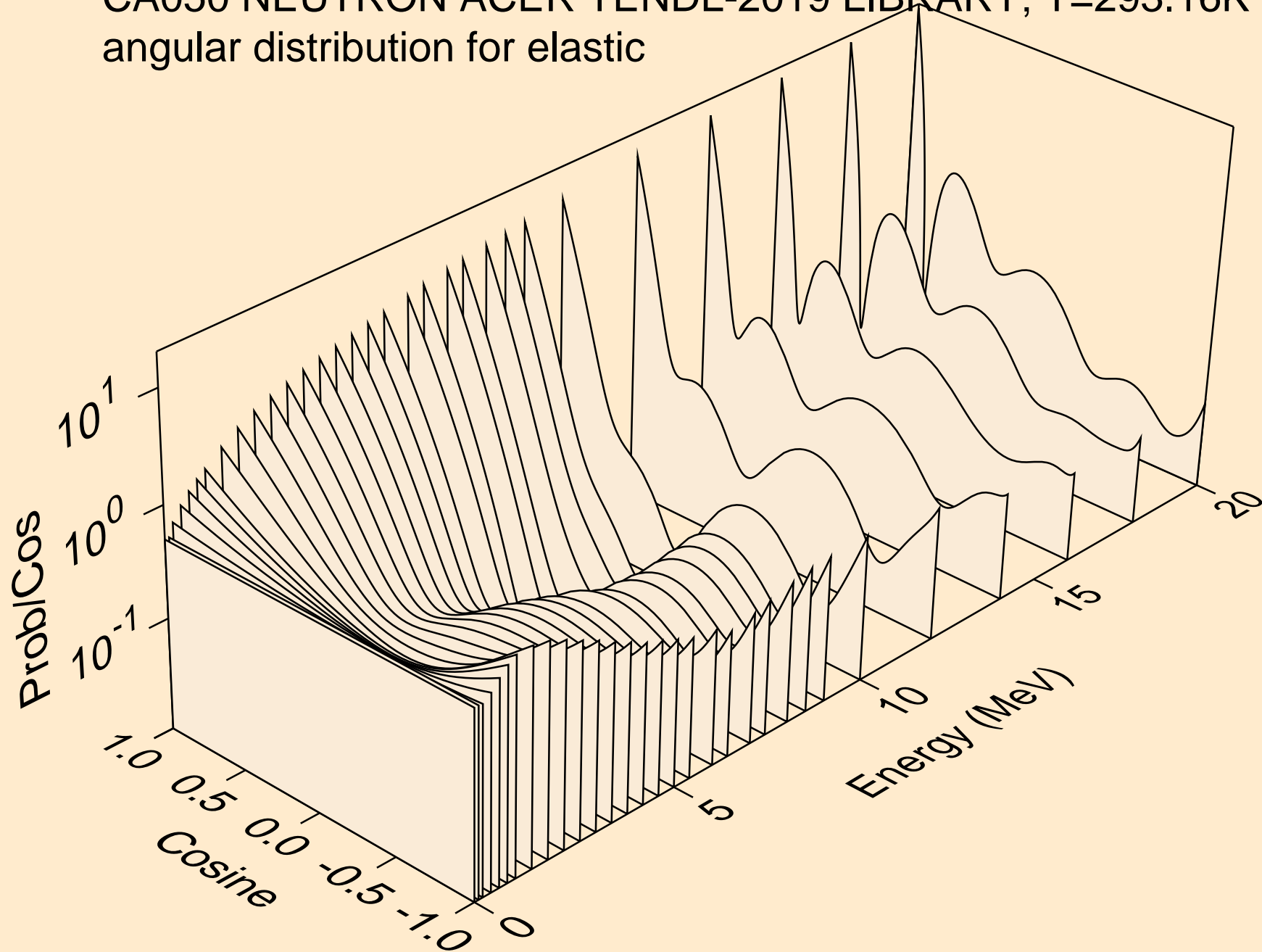

CA050 NEUTRON ACER TENDL-2019 LIBRARY; T=293.16K
angular distribution for elastic

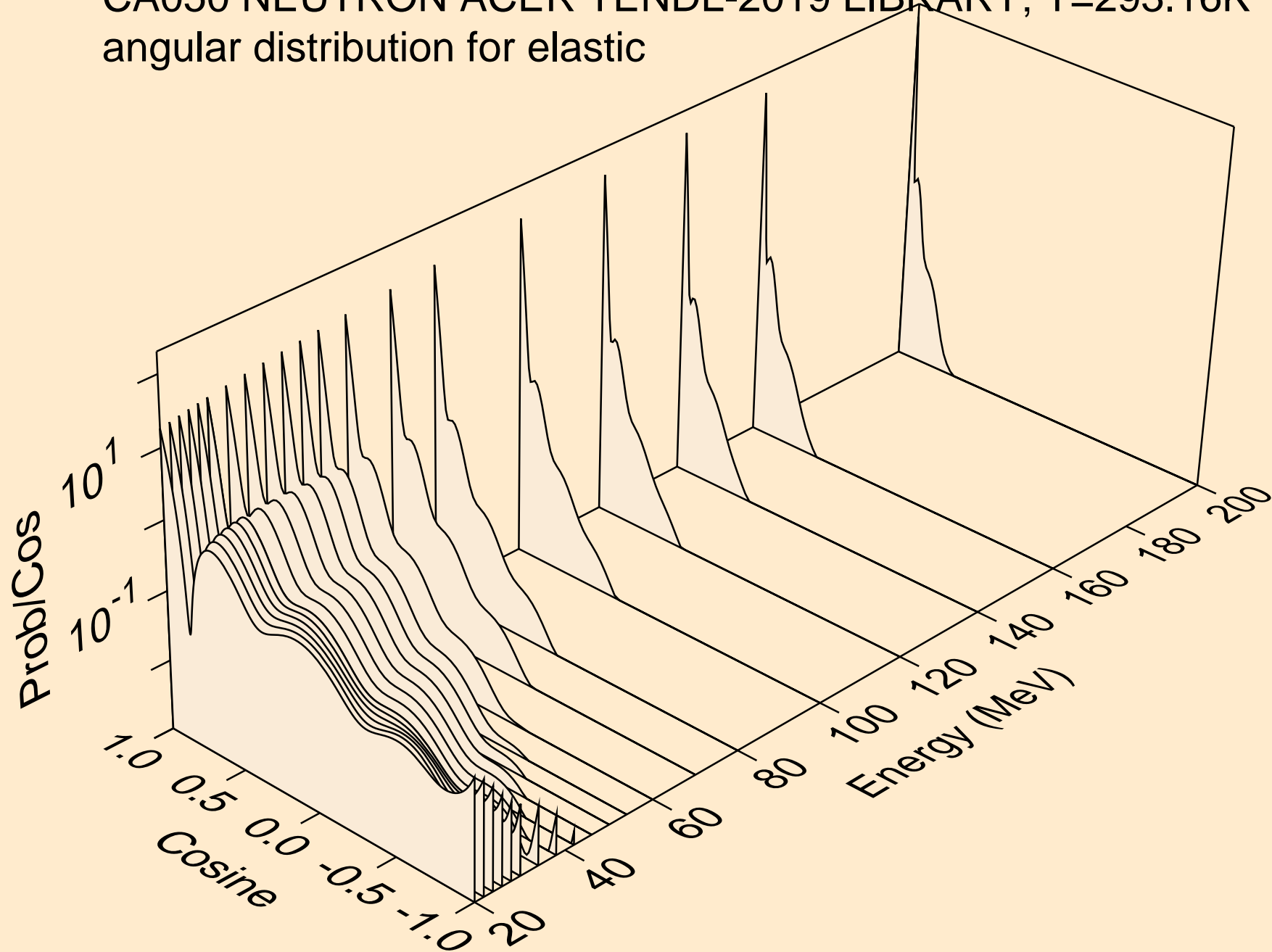

CA050 NEUTRON ACER TENDL-2019 LIBRARY; T=293.16K
angular distribution for (n,n*1)

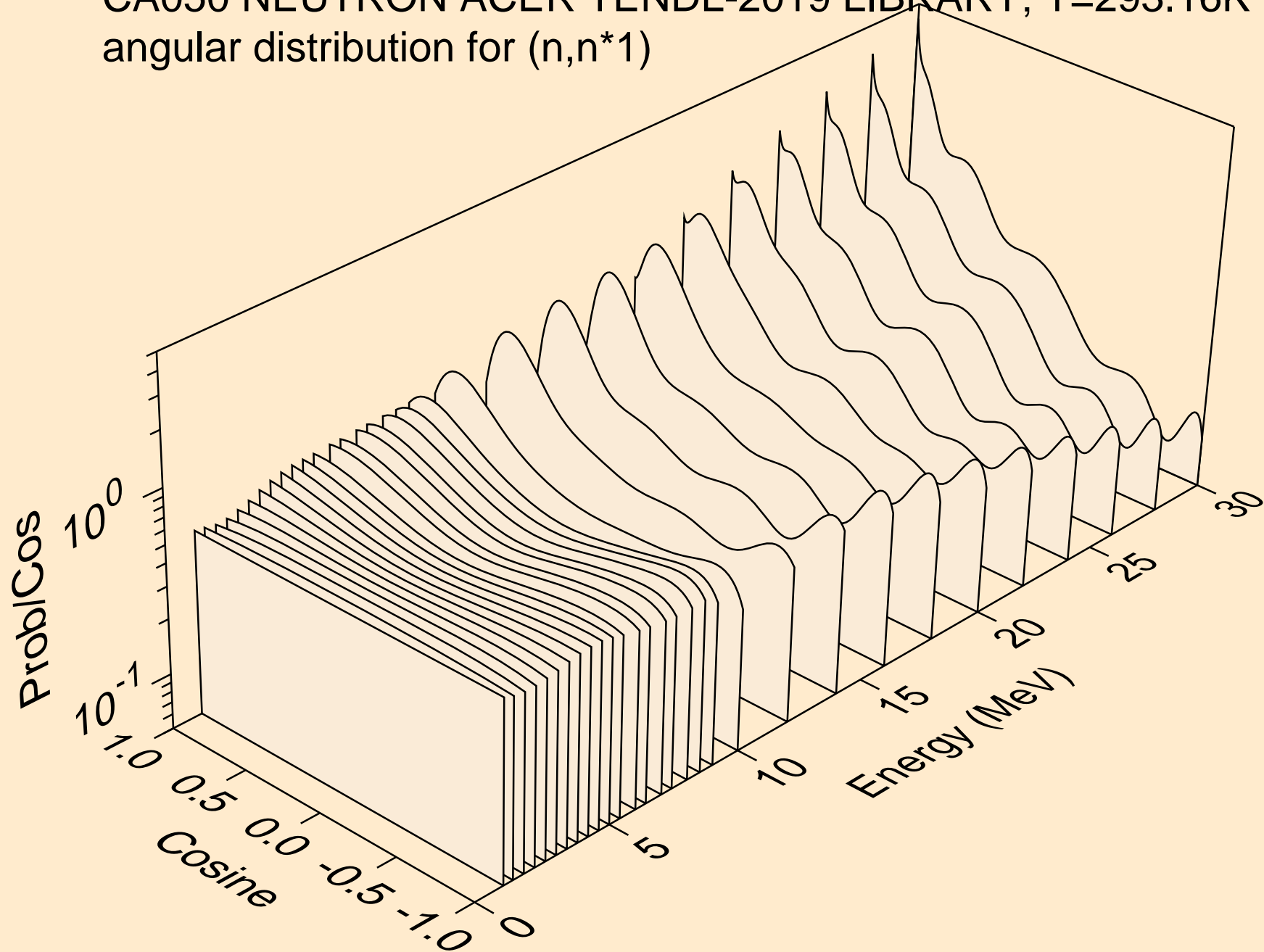

CA050 NEUTRON ACER TENDL-2019 LIBRARY; T=293.16K
angular distribution for (n,n*2)

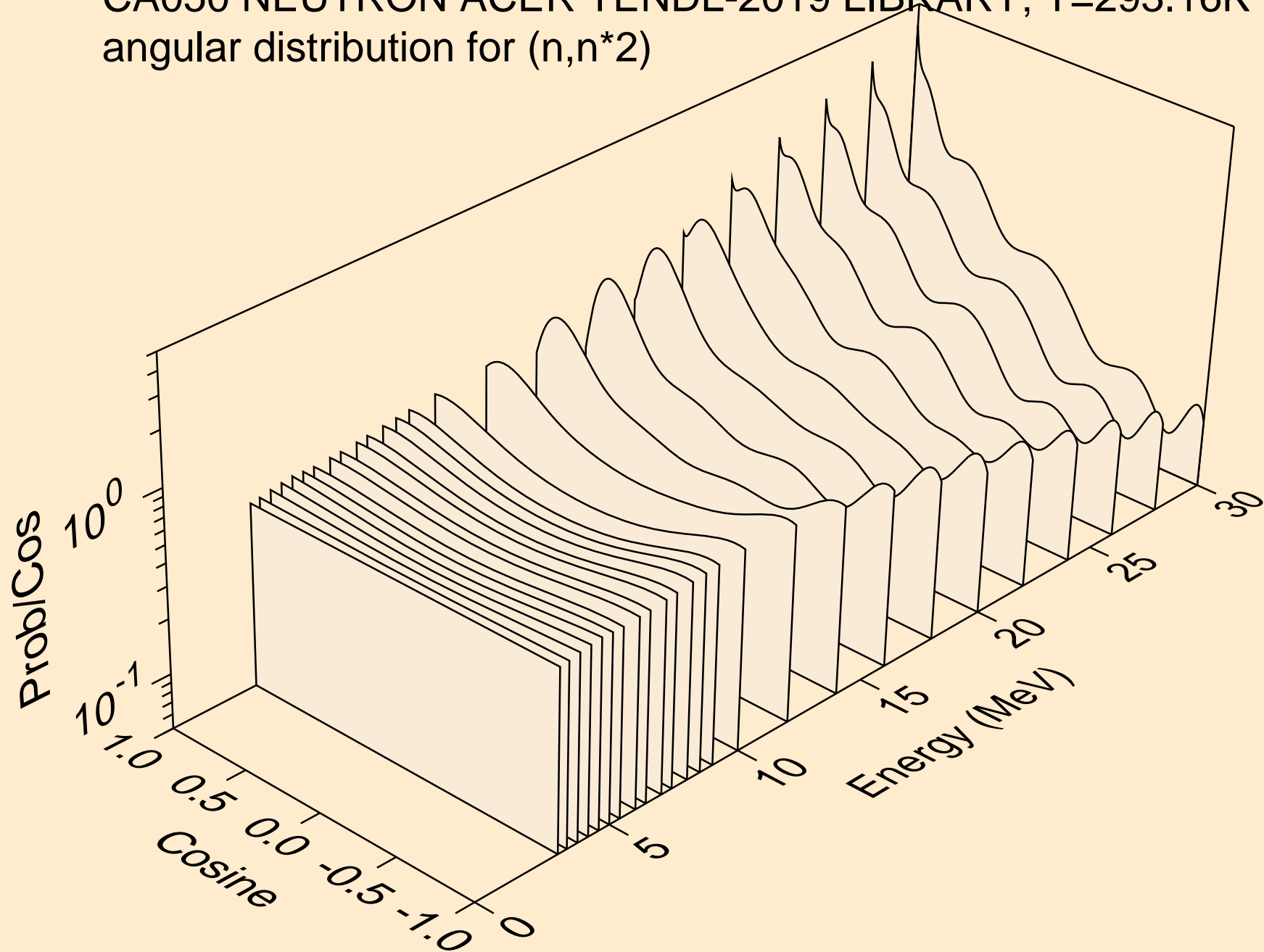

CA050 NEUTRON ACER TENDL-2019 LIBRARY; T=293.16K
angular distribution for (n,n*3)

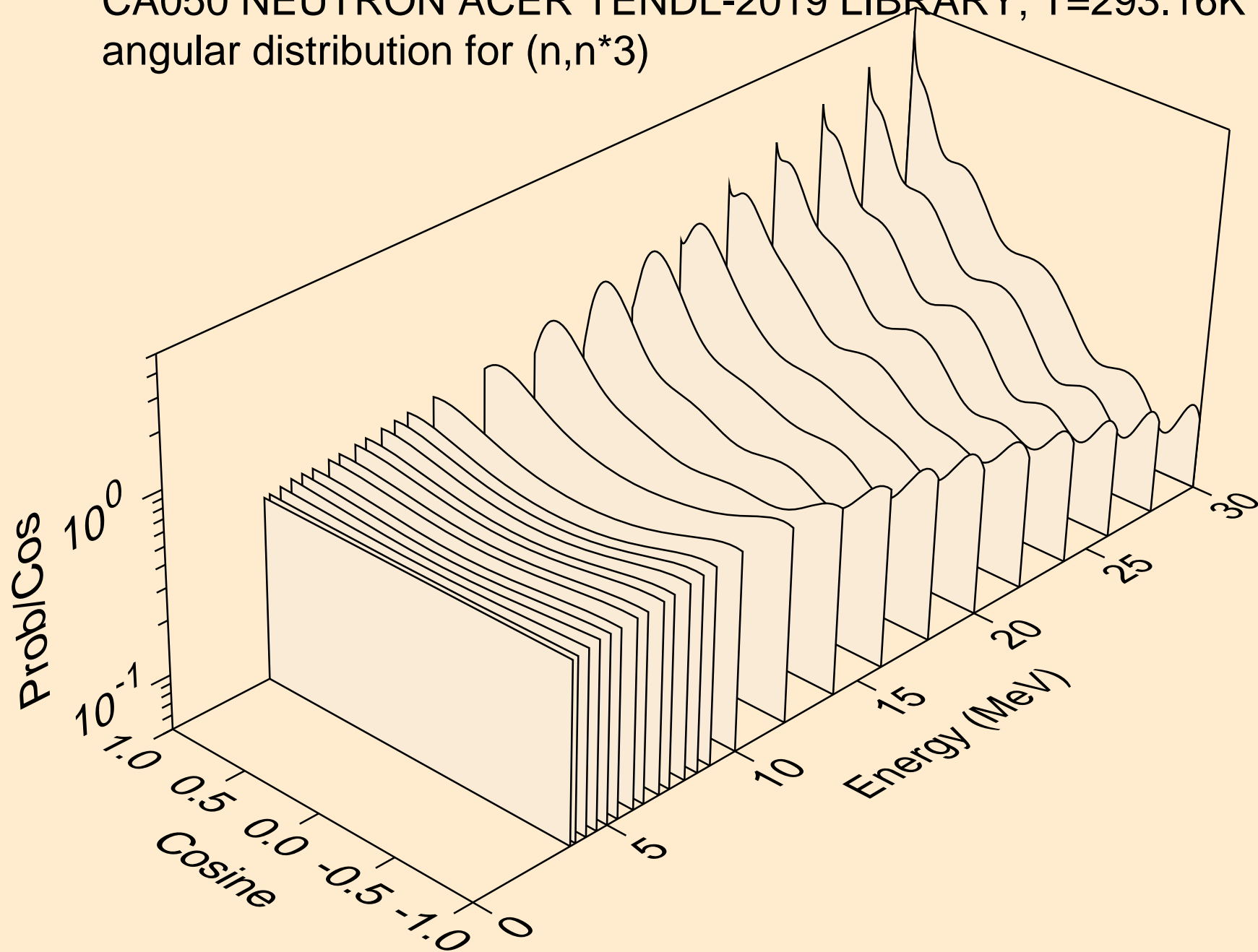

CA050 NEUTRON ACER TENDL-2019 LIBRARY; T=293.16K
angular distribution for (n,n*4)

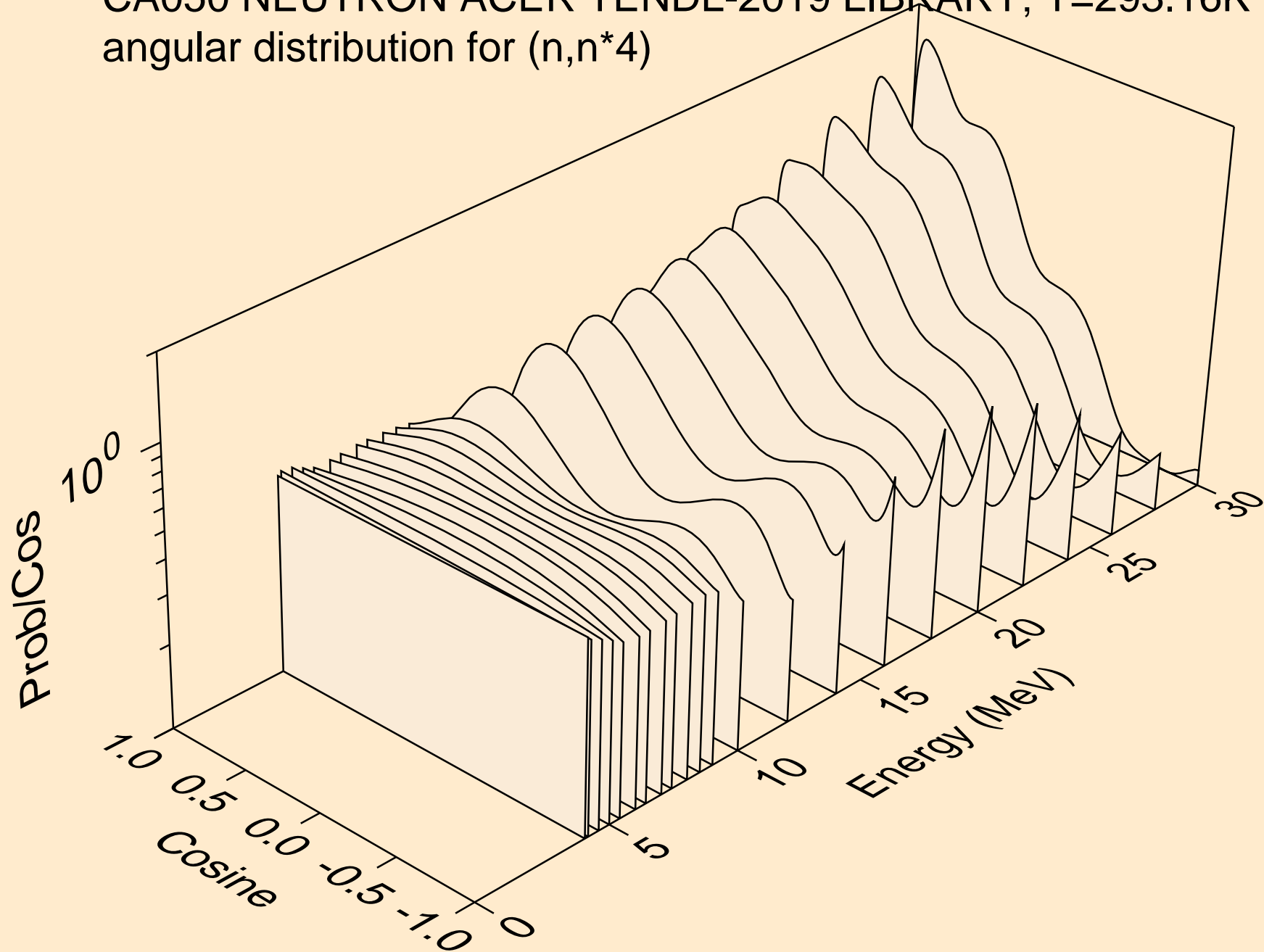

CA050 NEUTRON ACER TENDL-2019 LIBRARY; T=293.16K
angular distribution for (n,n*5)

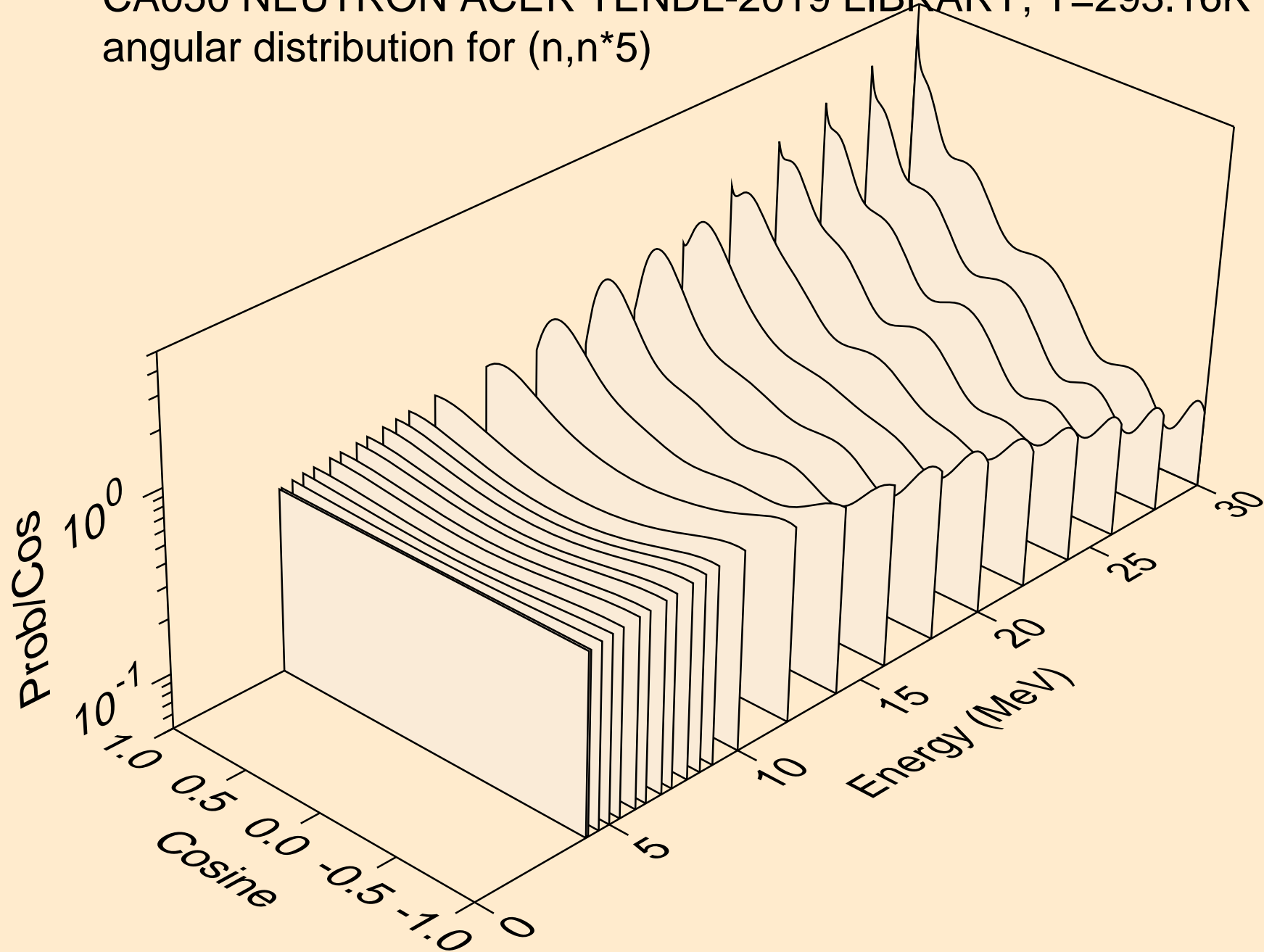

CA050 NEUTRON ACER TENDL-2019 LIBRARY; T=293.16K
angular distribution for (n,n*6)

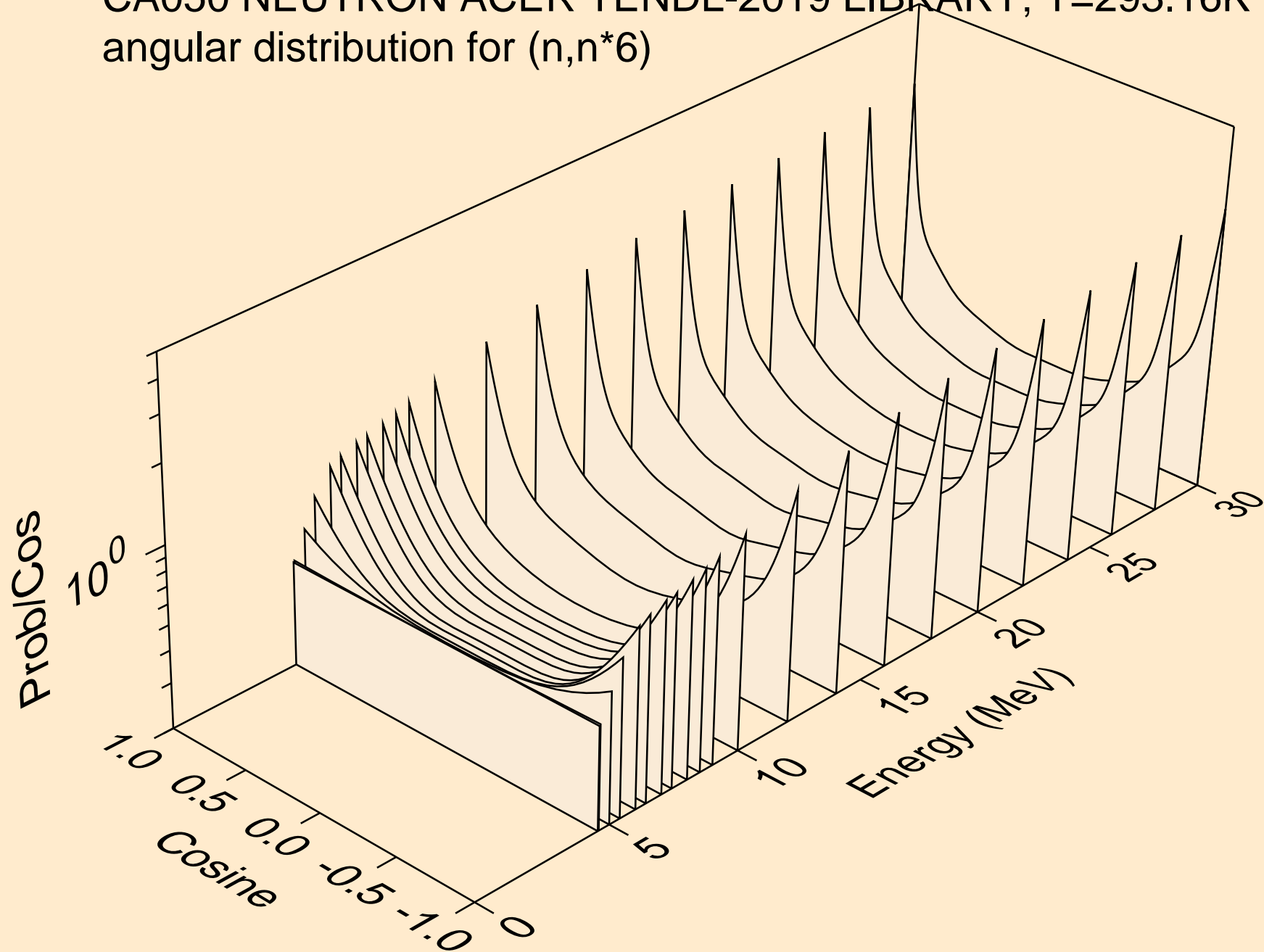

CA050 NEUTRON ACER TENDL-2019 LIBRARY; T=293.16K
angular distribution for (n,n*7)

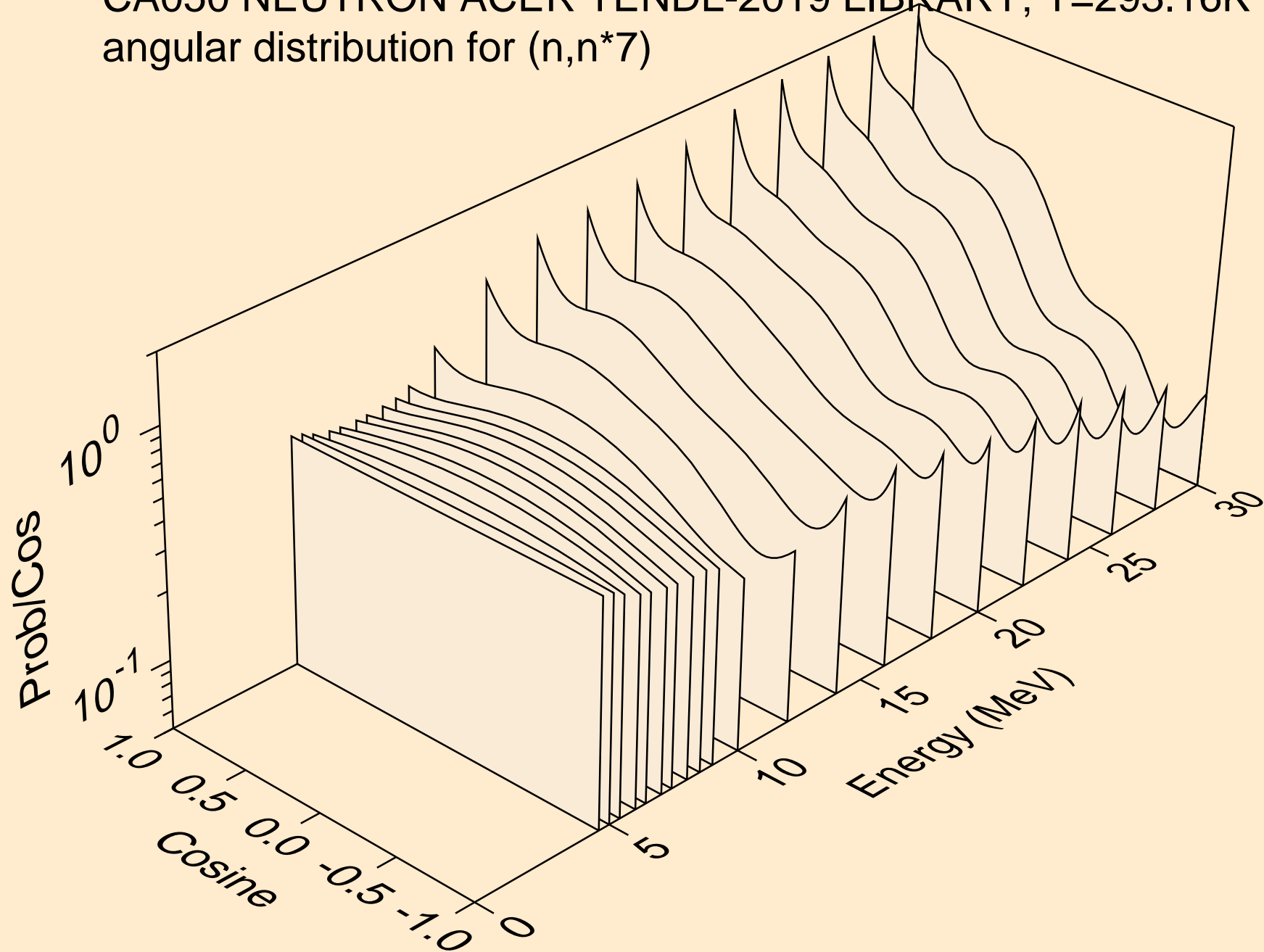

CA050 NEUTRON ACER TENDL-2019 LIBRARY; T=293.16K
angular distribution for (n,n*8)

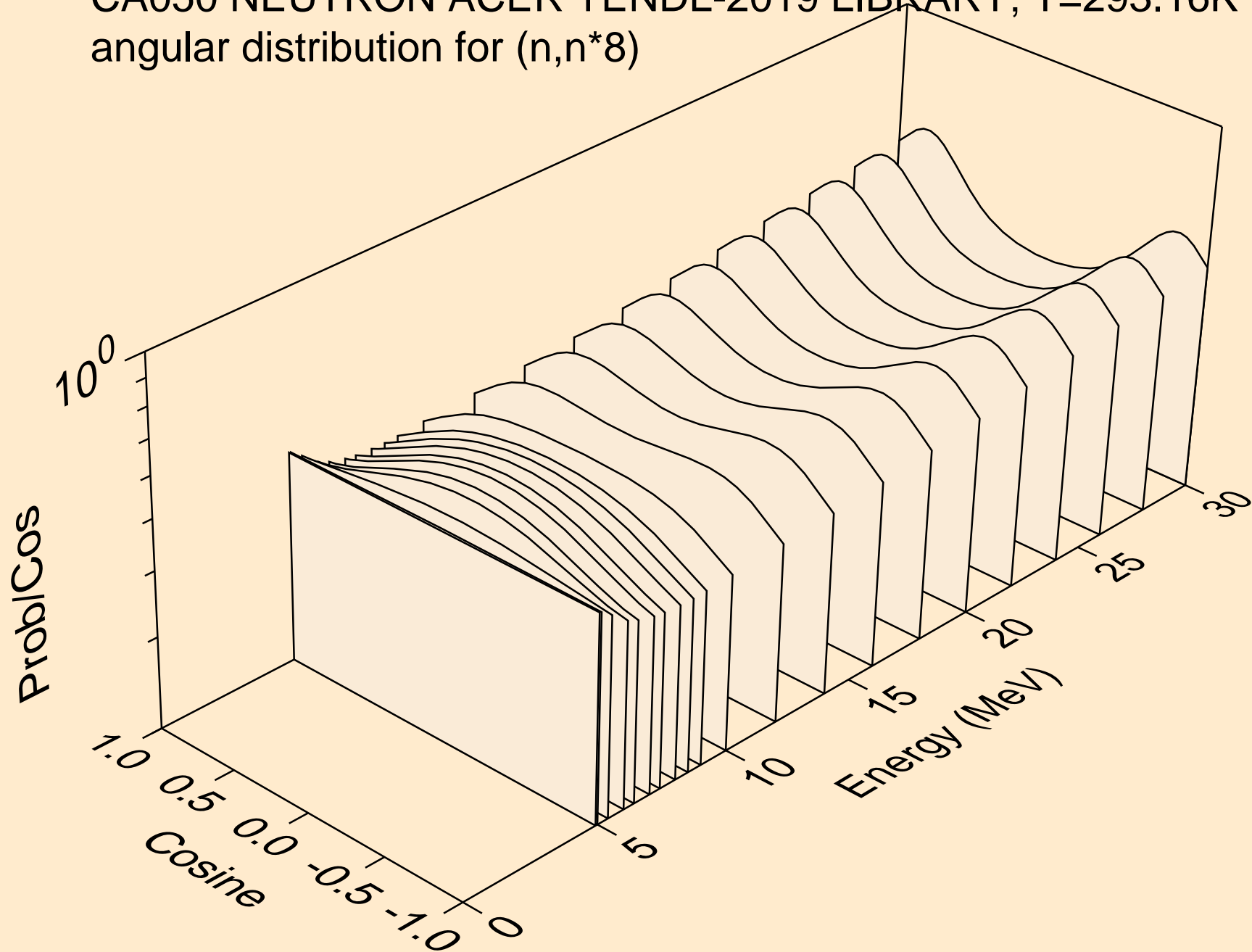

CA050 NEUTRON ACER TENDL-2019 LIBRARY; T=293.16K
angular distribution for (n,n*9)

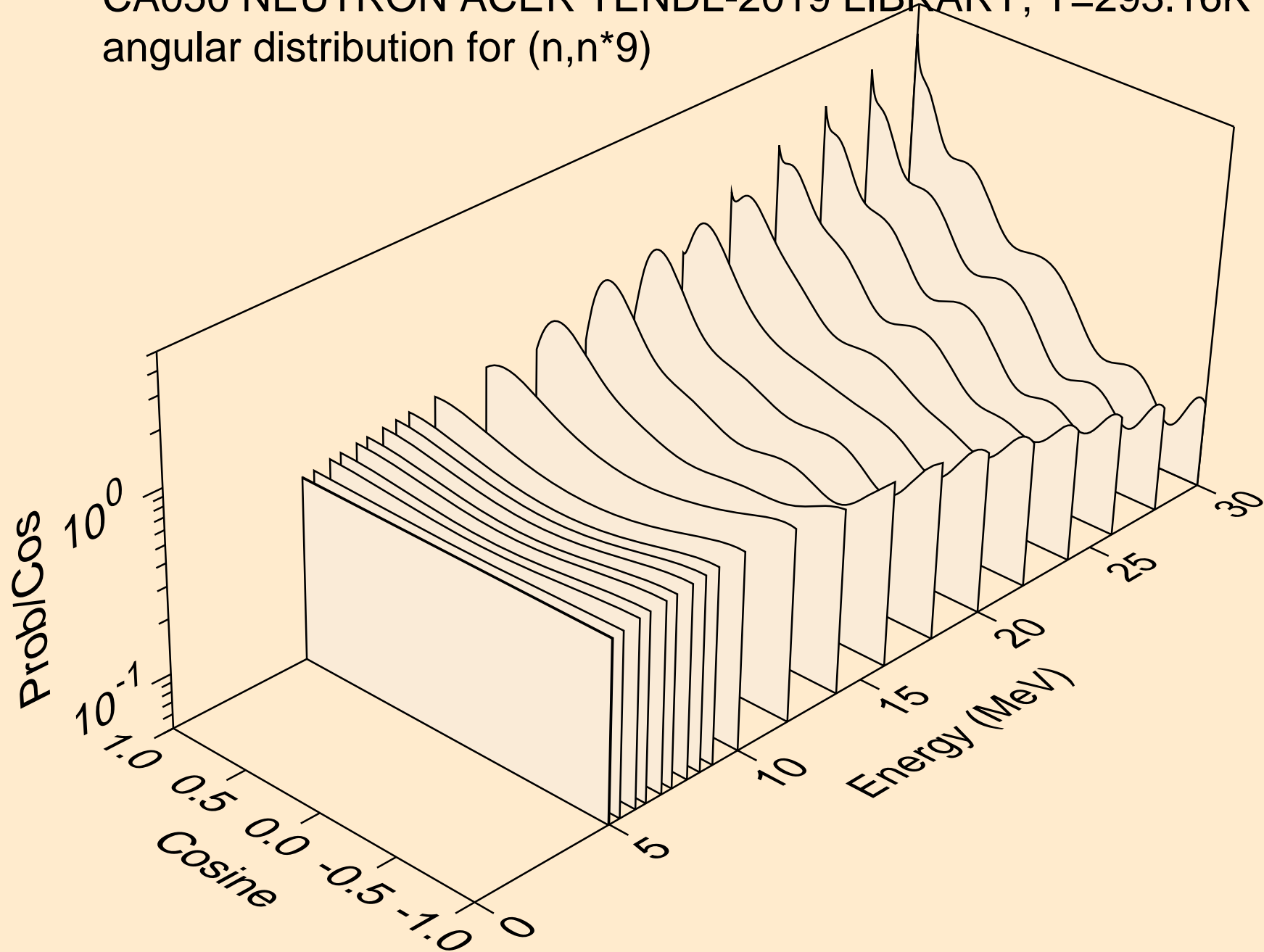

CA050 NEUTRON ACER TENDL-2019 LIBRARY; T=293.16K
angular distribution for (n,n*10)

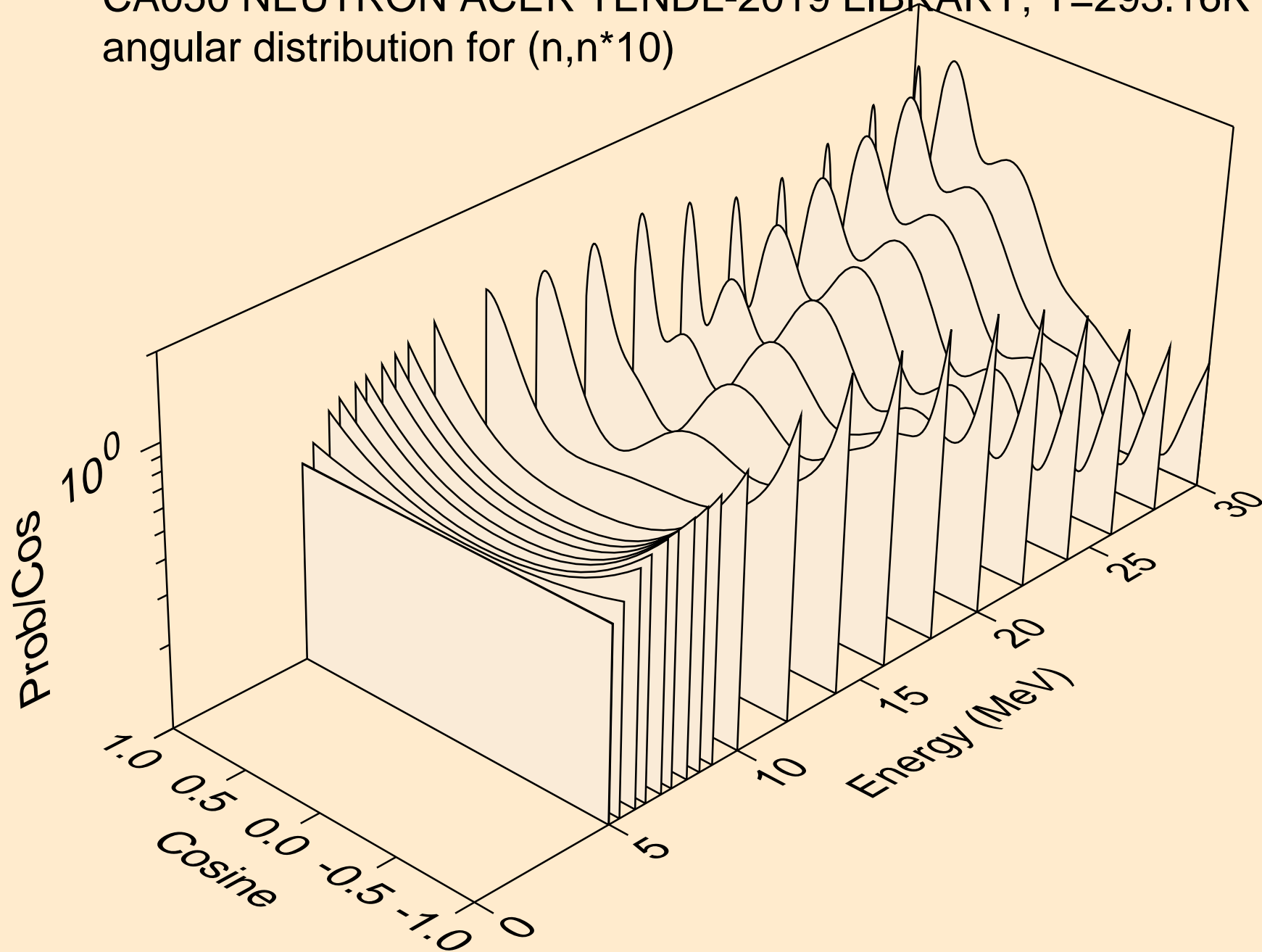

CA050 NEUTRON ACER TENDL-2019 LIBRARY; T=293.16K
angular distribution for (n,n*11)

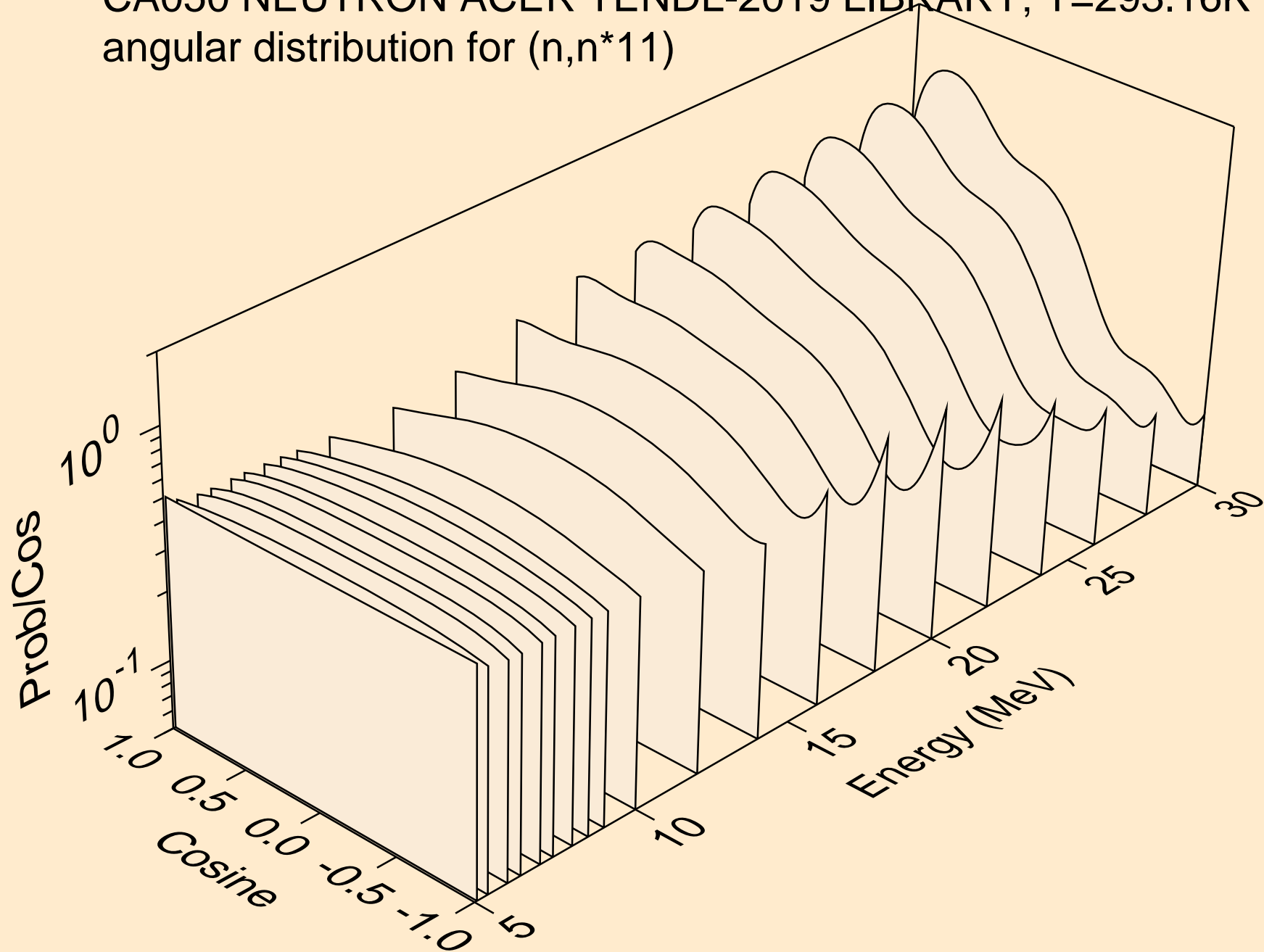

CA050 NEUTRON ACER TENDL-2019 LIBRARY; T=293.16K
angular distribution for (n,n*12)

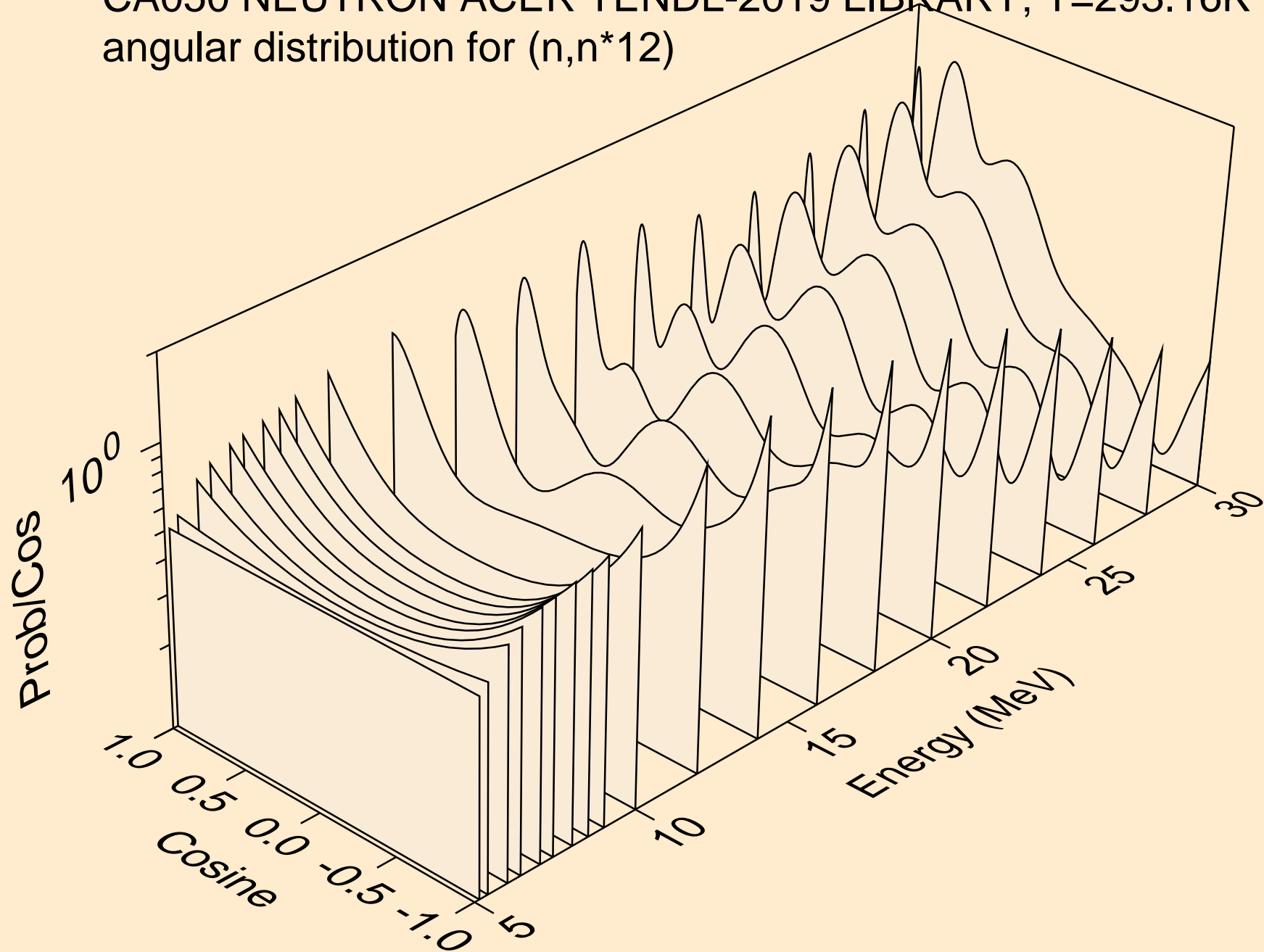

CA050 NEUTRON ACER TENDL-2019 LIBRARY; T=293.16K
angular distribution for (n,n*13)

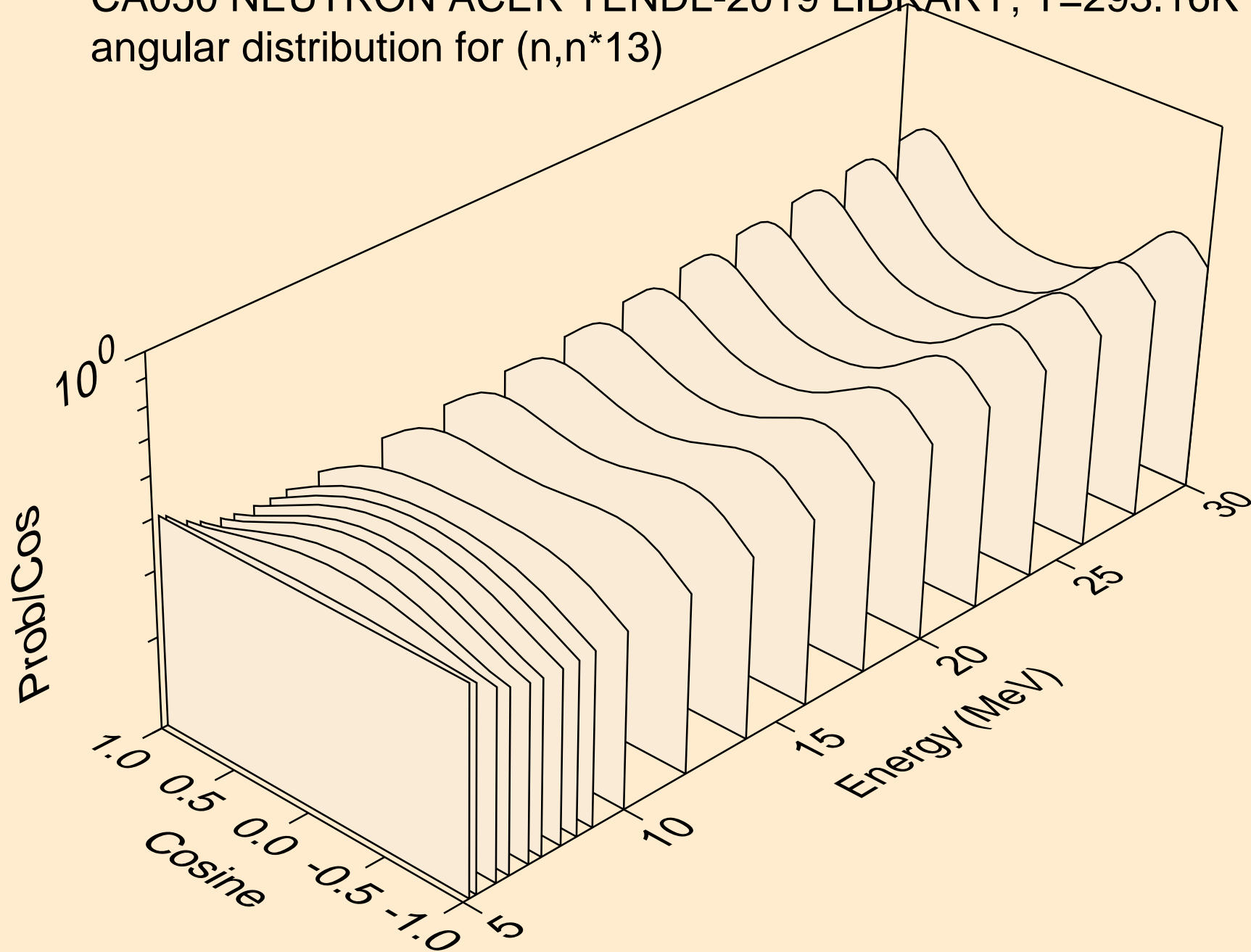

CA050 NEUTRON ACER TENDL-2019 LIBRARY; T=293.16K
angular distribution for (n,n*14)

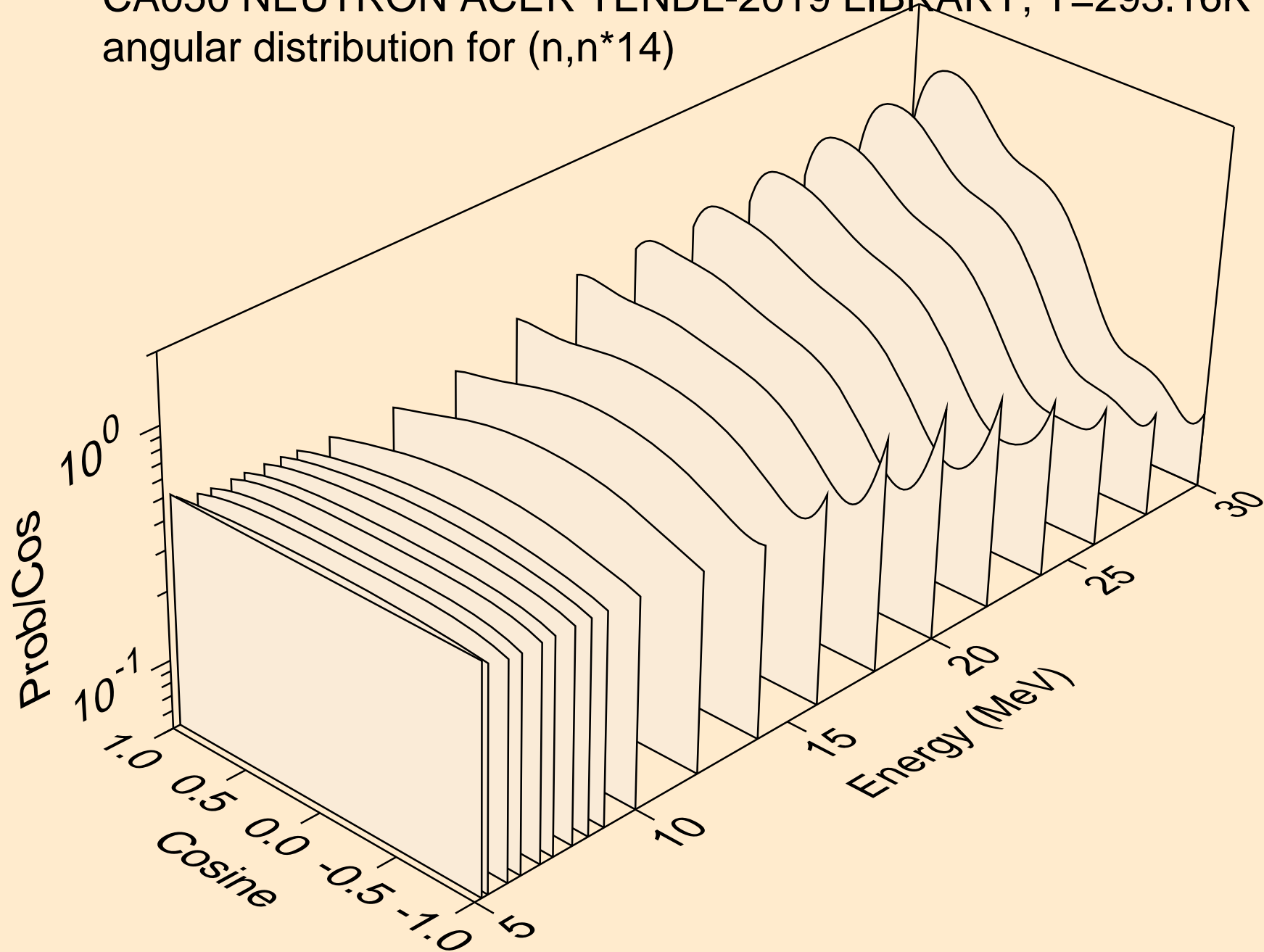

CA050 NEUTRON ACER TENDL-2019 LIBRARY; T=293.16K
angular distribution for (n,n*15)

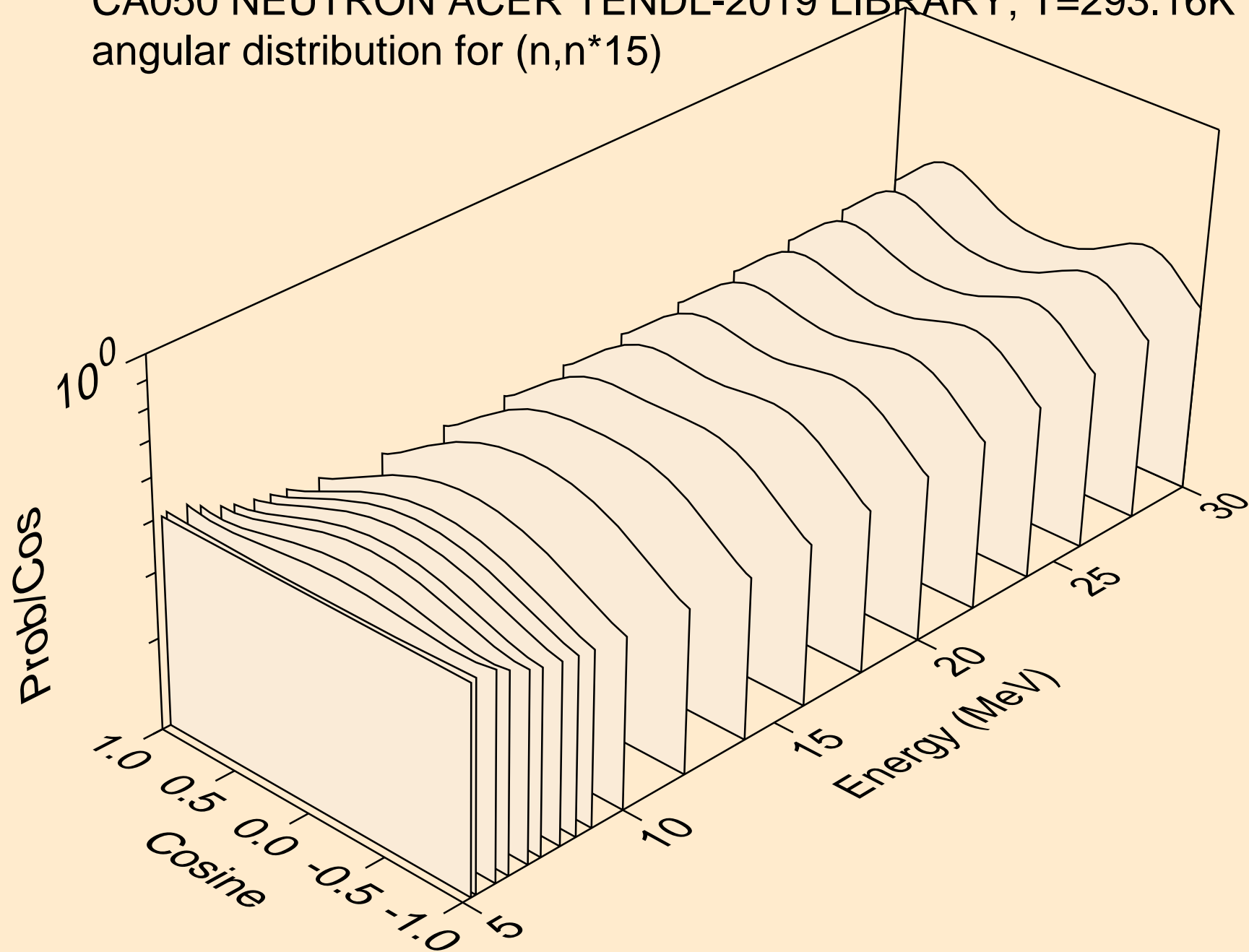

CA050 NEUTRON ACER TENDL-2019 LIBRARY; T=293.16K
angular distribution for (n,n*16)

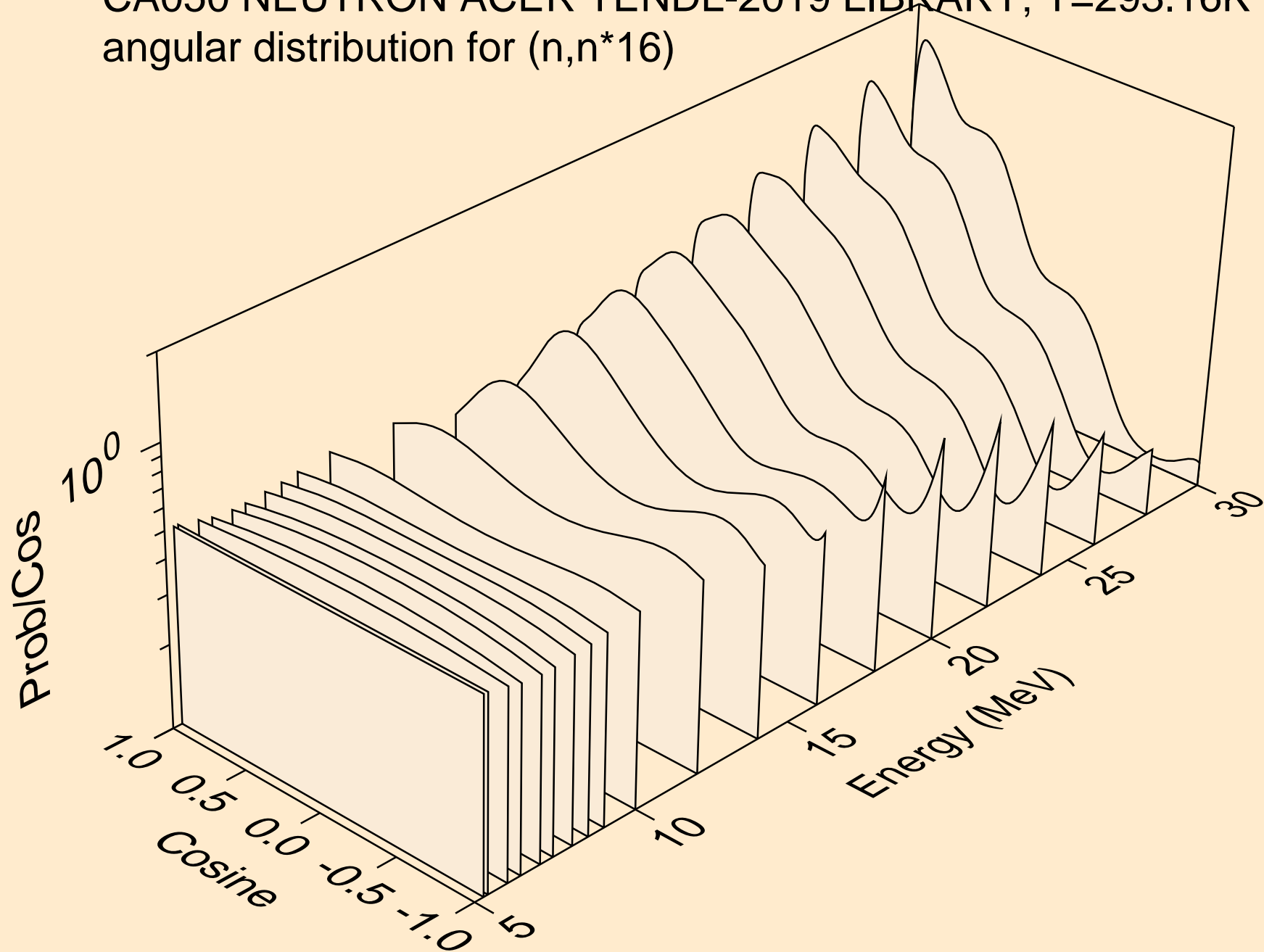

CA050 NEUTRON ACER TENDL-2019 LIBRARY; T=293.16K
angular distribution for (n,n*17)

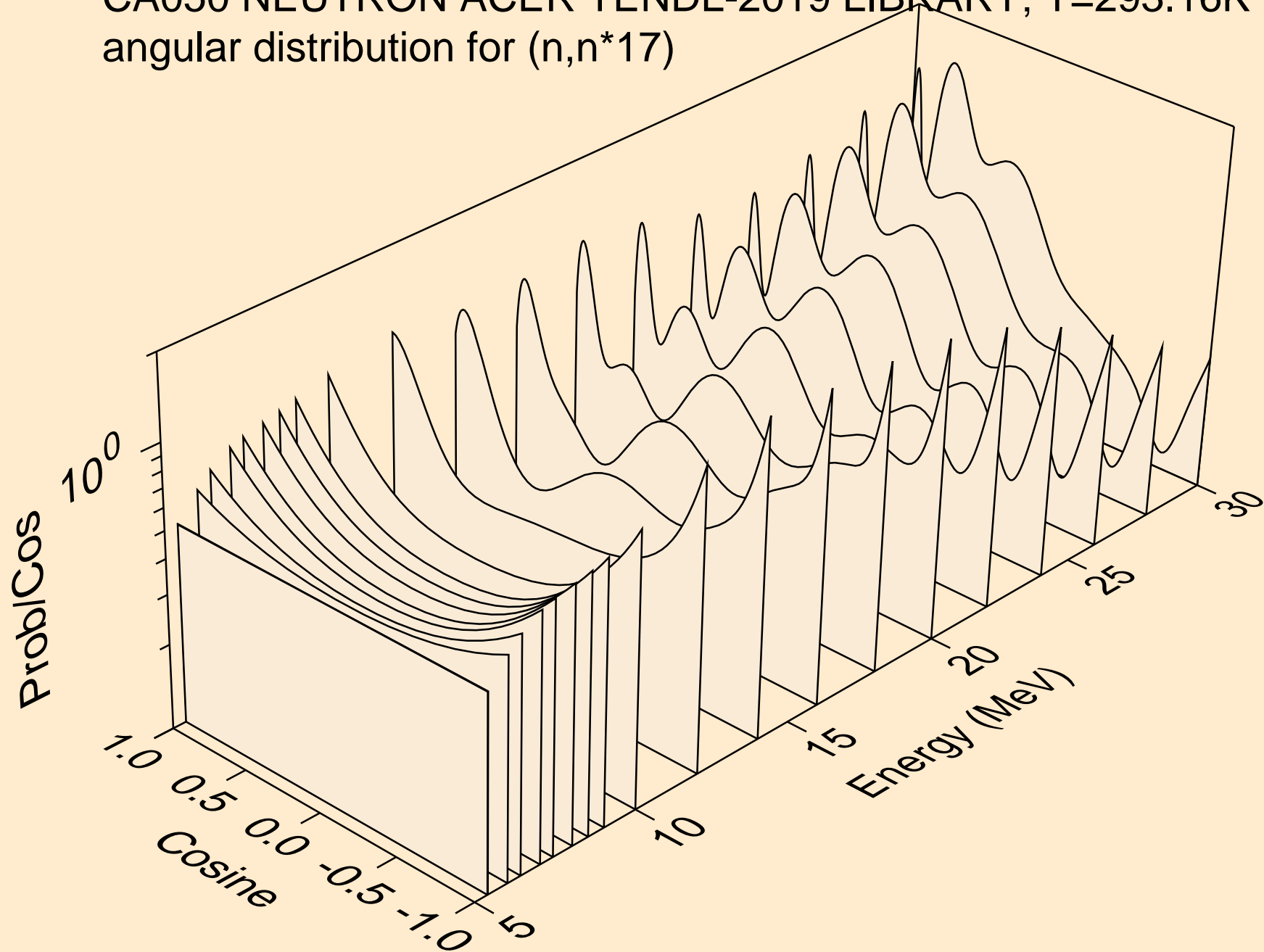

CA050 NEUTRON ACER TENDL-2019 LIBRARY; T=293.16K
angular distribution for (n,n*18)

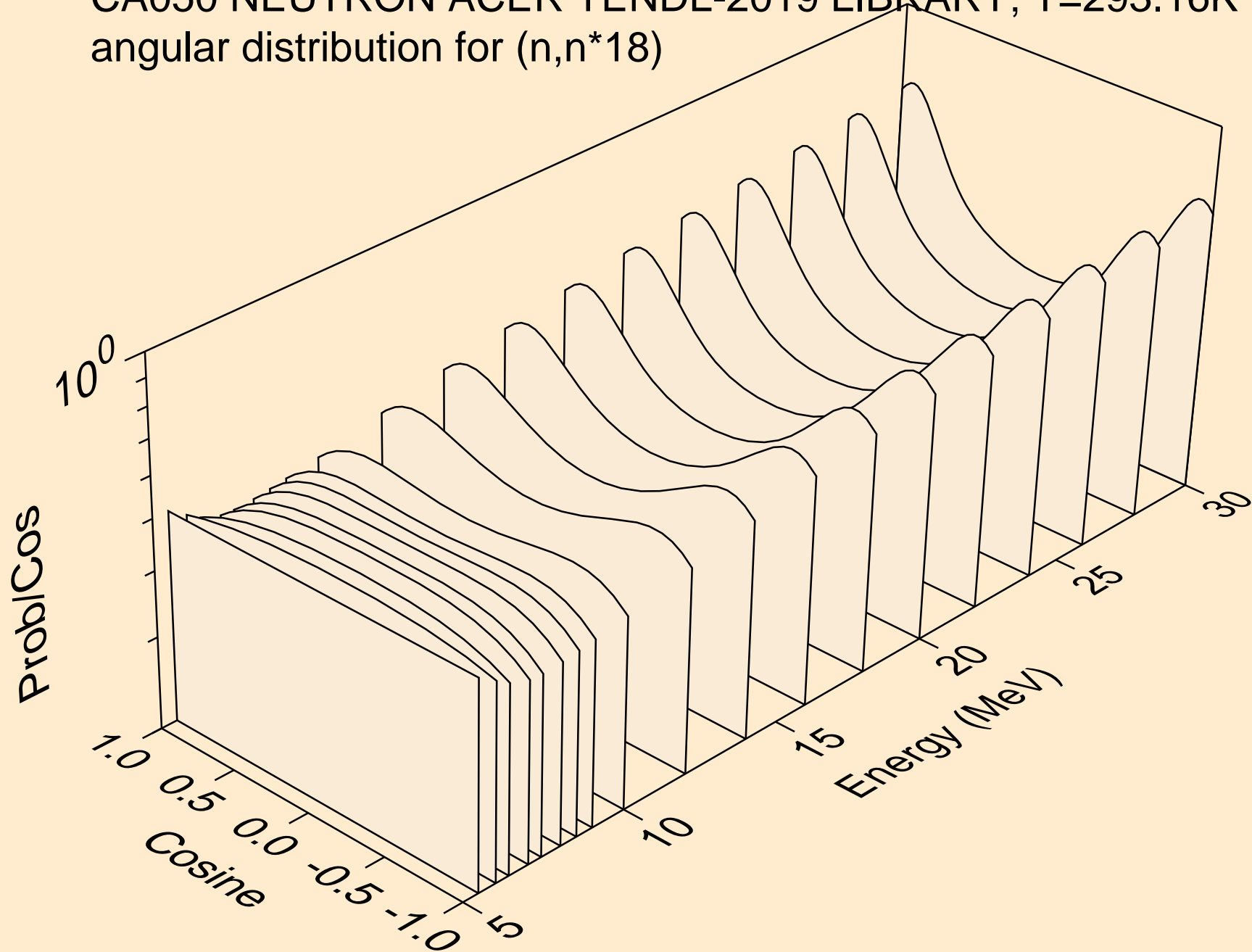

CA050 NEUTRON ACER TENDL-2019 LIBRARY; T=293.16K
angular distribution for (n,n*19)

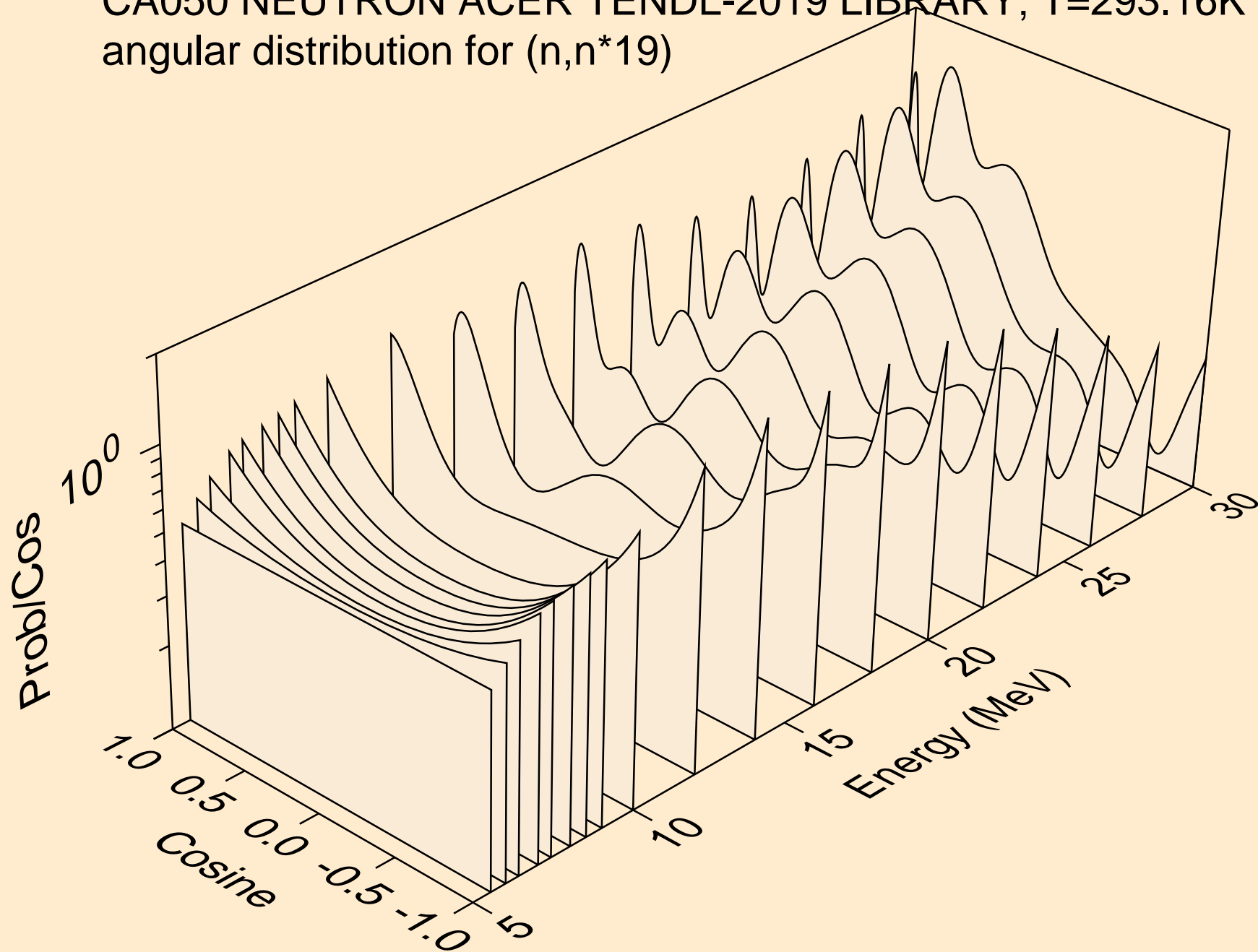

CA050 NEUTRON ACER TENDL-2019 LIBRARY; T=293.16K
angular distribution for (n,n*20)

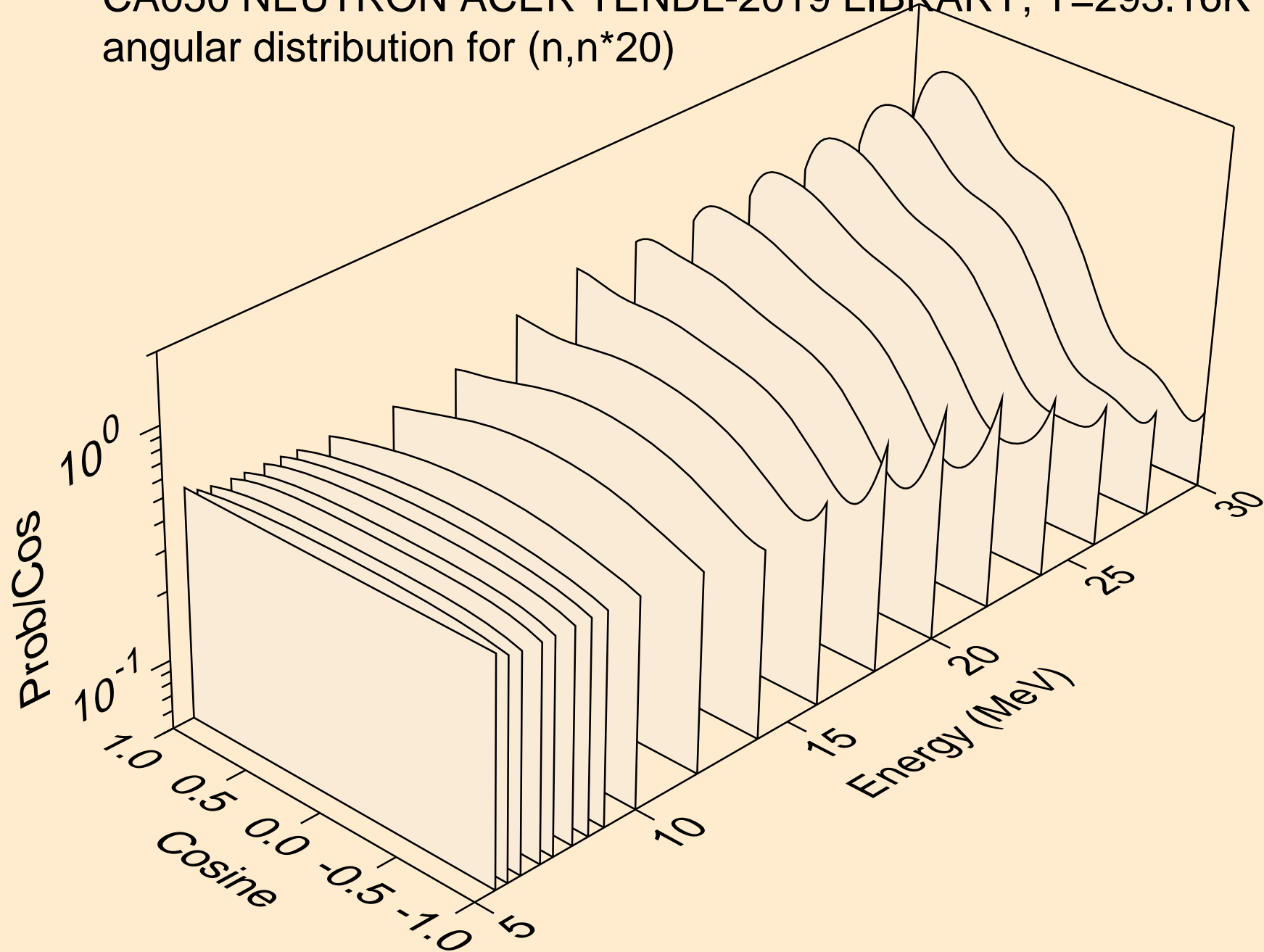

CA050 NEUTRON ACER TENDL-2019 LIBRARY; T=293.16K
angular distribution for (n,n*21)

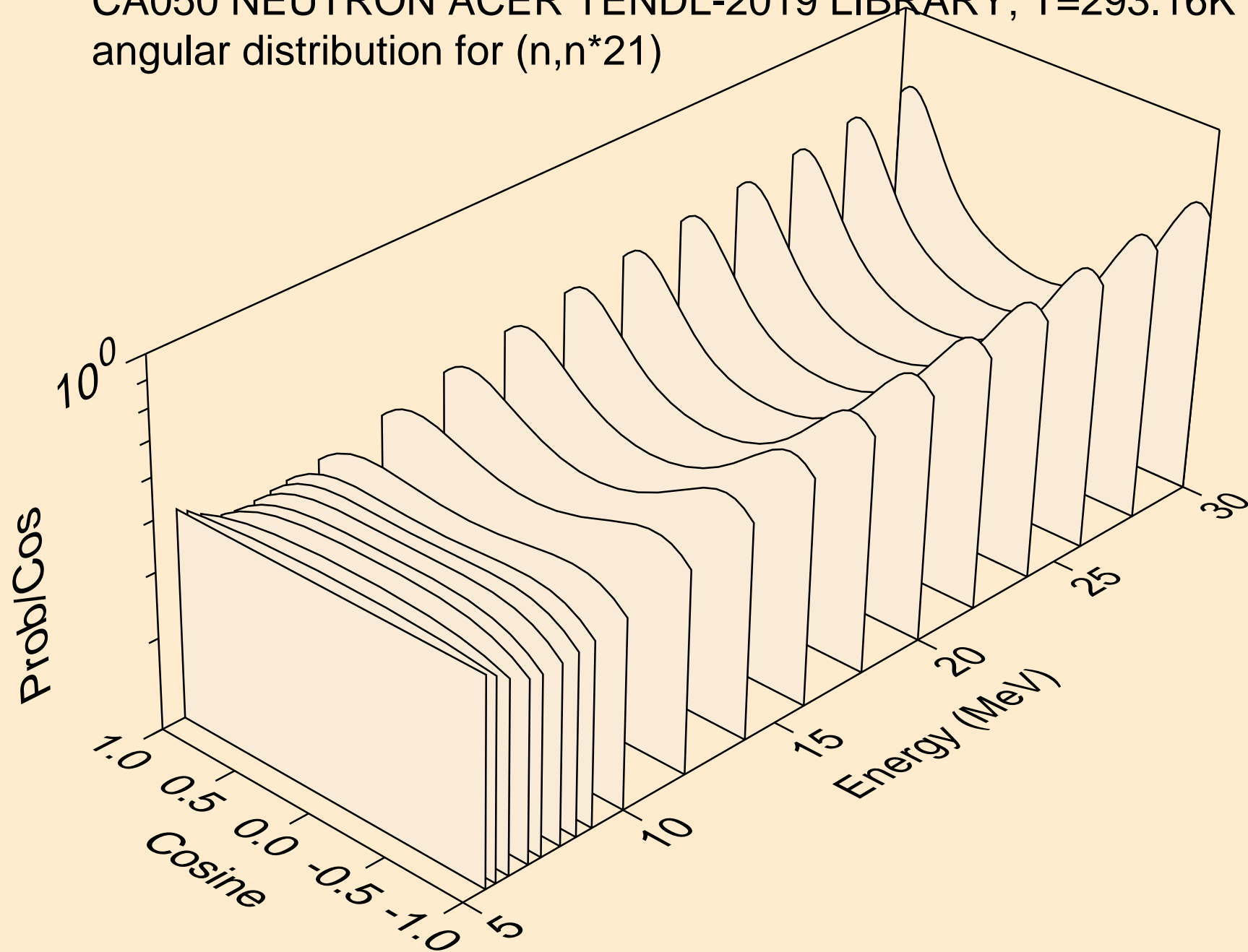

CA050 NEUTRON ACER TENDL-2019 LIBRARY; T=293.16K
angular distribution for (n,n*22)

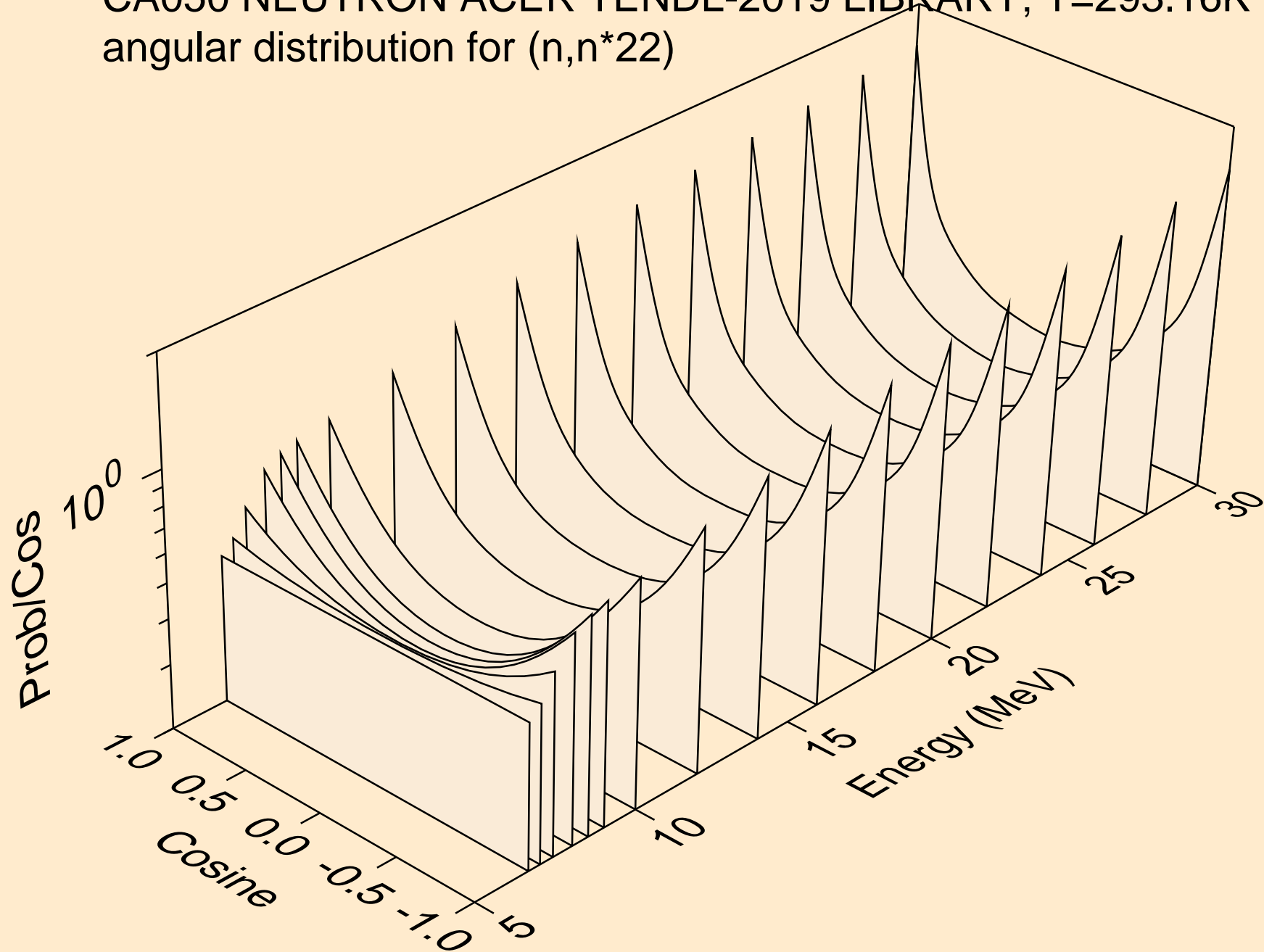

CA050 NEUTRON ACER TENDL-2019 LIBRARY; T=293.16K
angular distribution for (n,n*23)

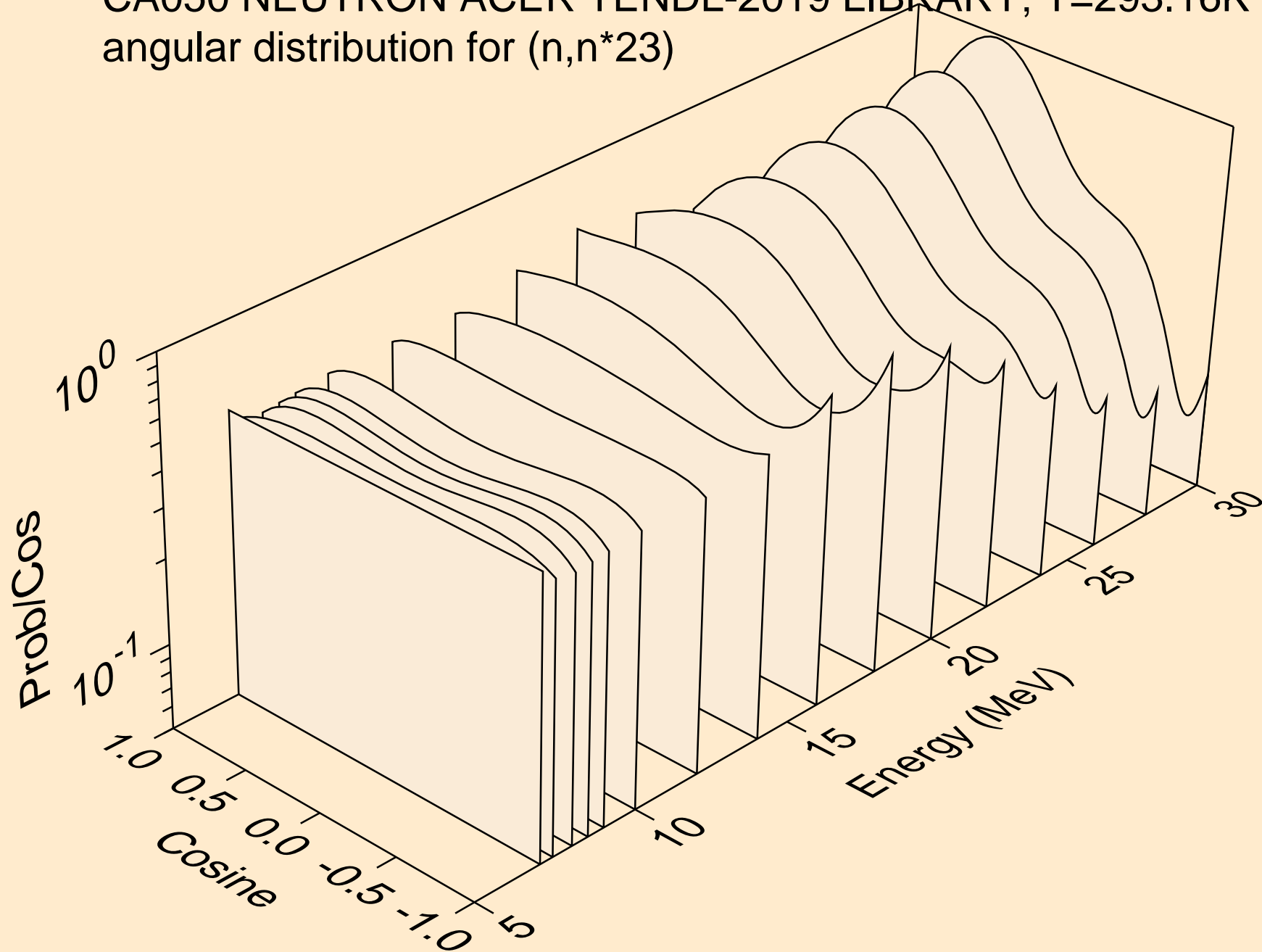

CA050 NEUTRON ACER TENDL-2019 LIBRARY; T=293.16K
angular distribution for (n,n*24)

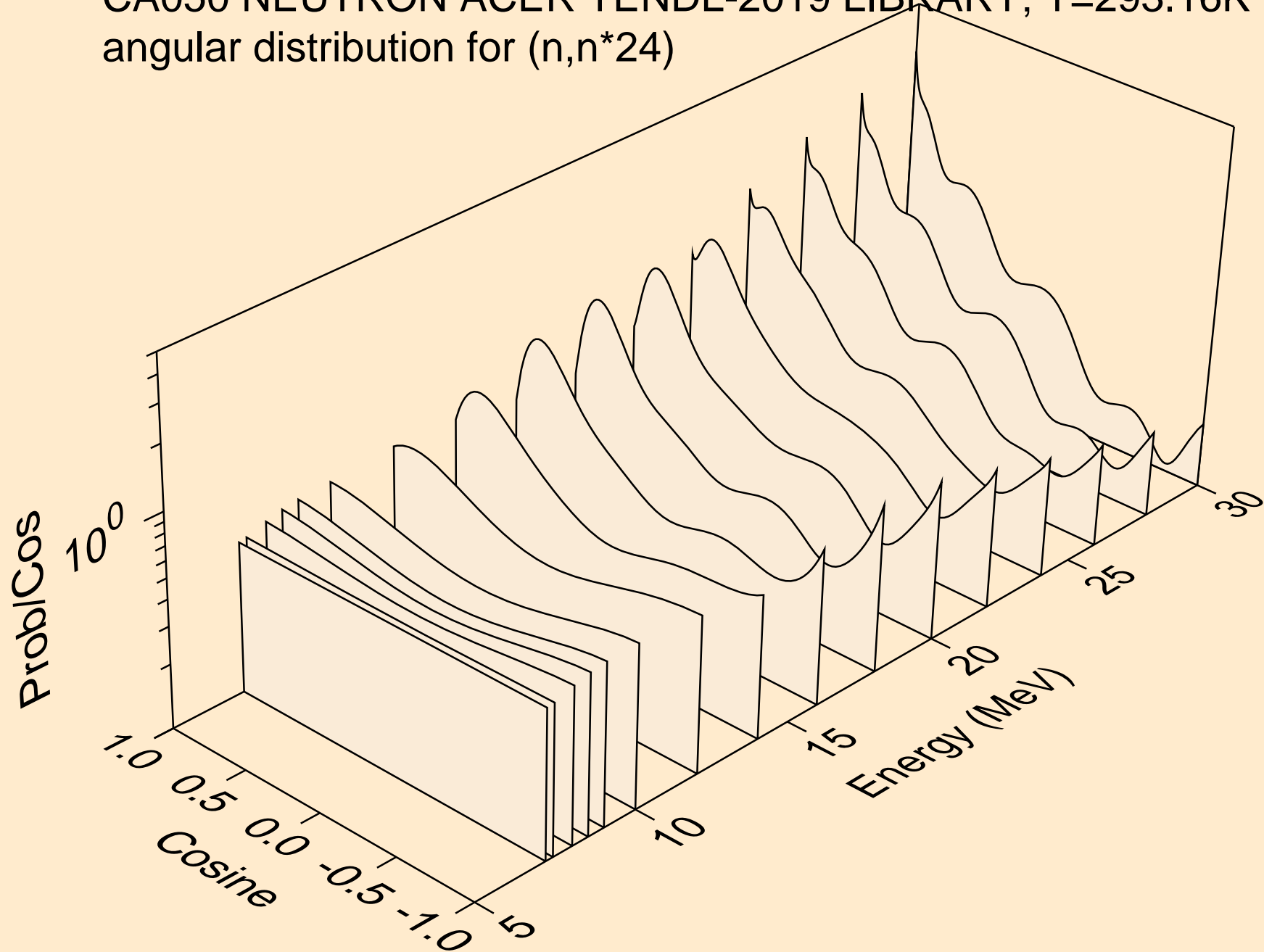

CA050 NEUTRON ACER TENDL-2019 LIBRARY; T=293.16K
angular distribution for (n,n*25)

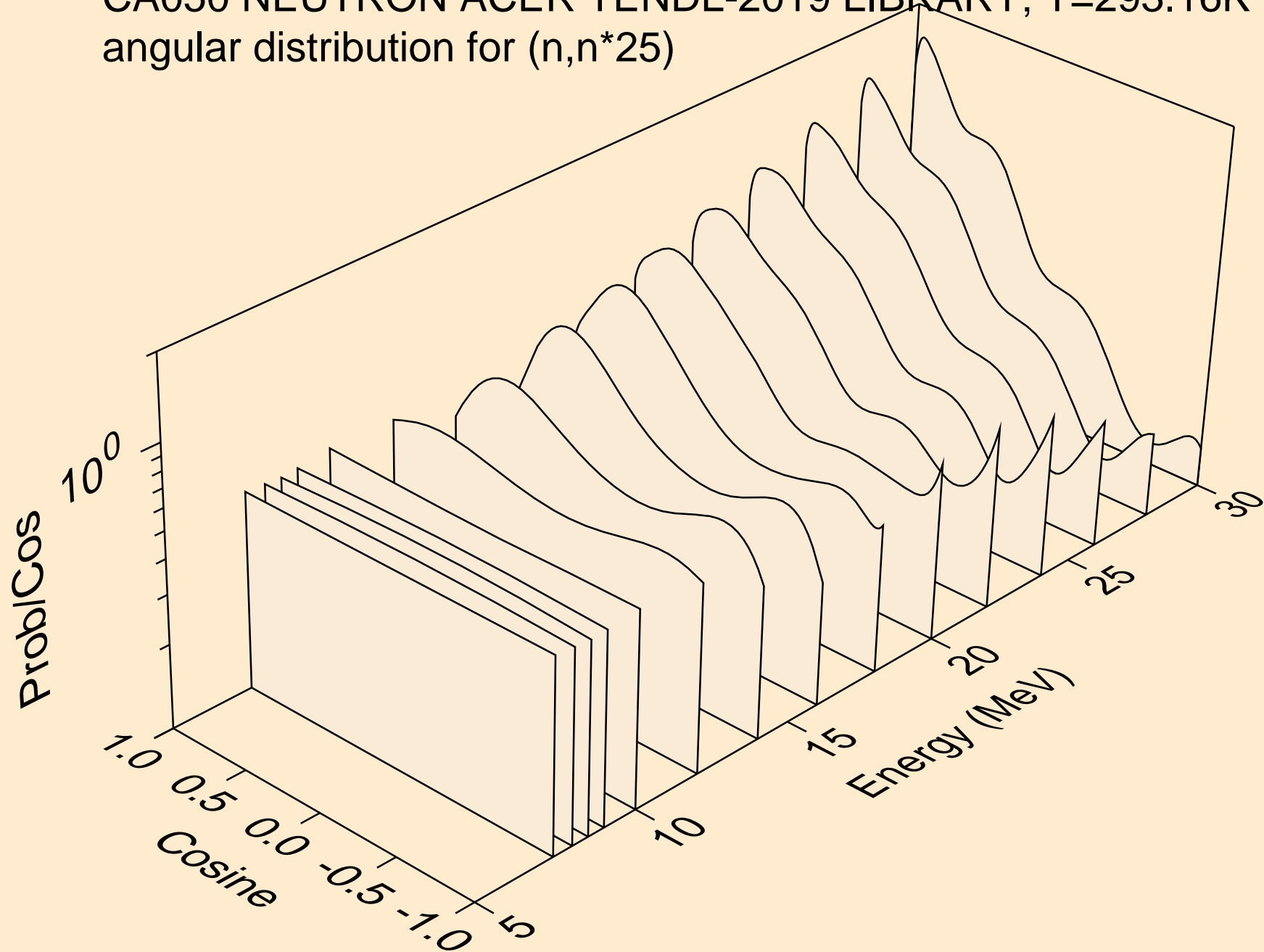

CA050 NEUTRON ACER TENDL-2019 LIBRARY; T=293.16K
angular distribution for (n,n*26)

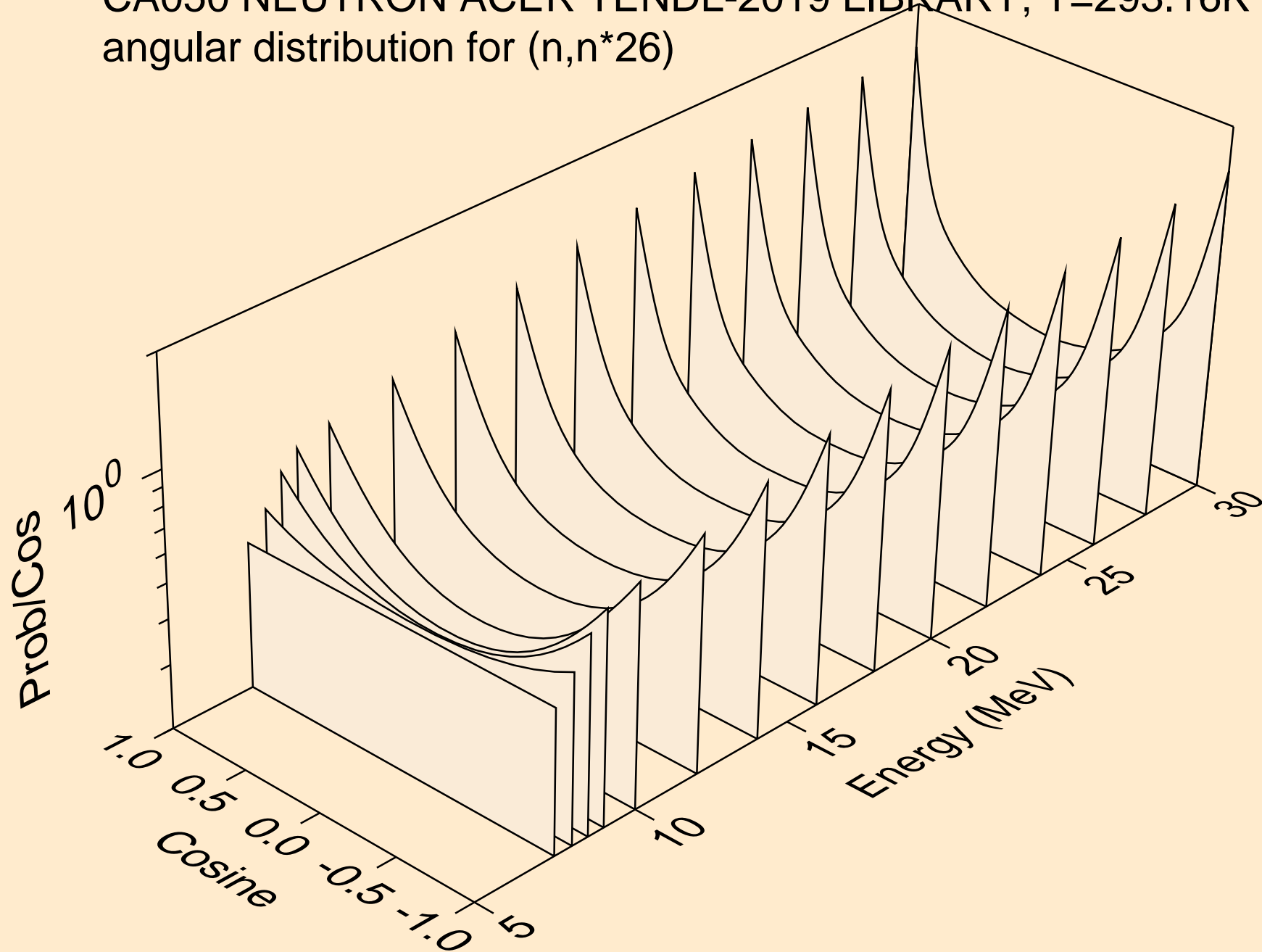

CA050 NEUTRON ACER TENDL-2019 LIBRARY; T=293.16K
angular distribution for (n,n*27)

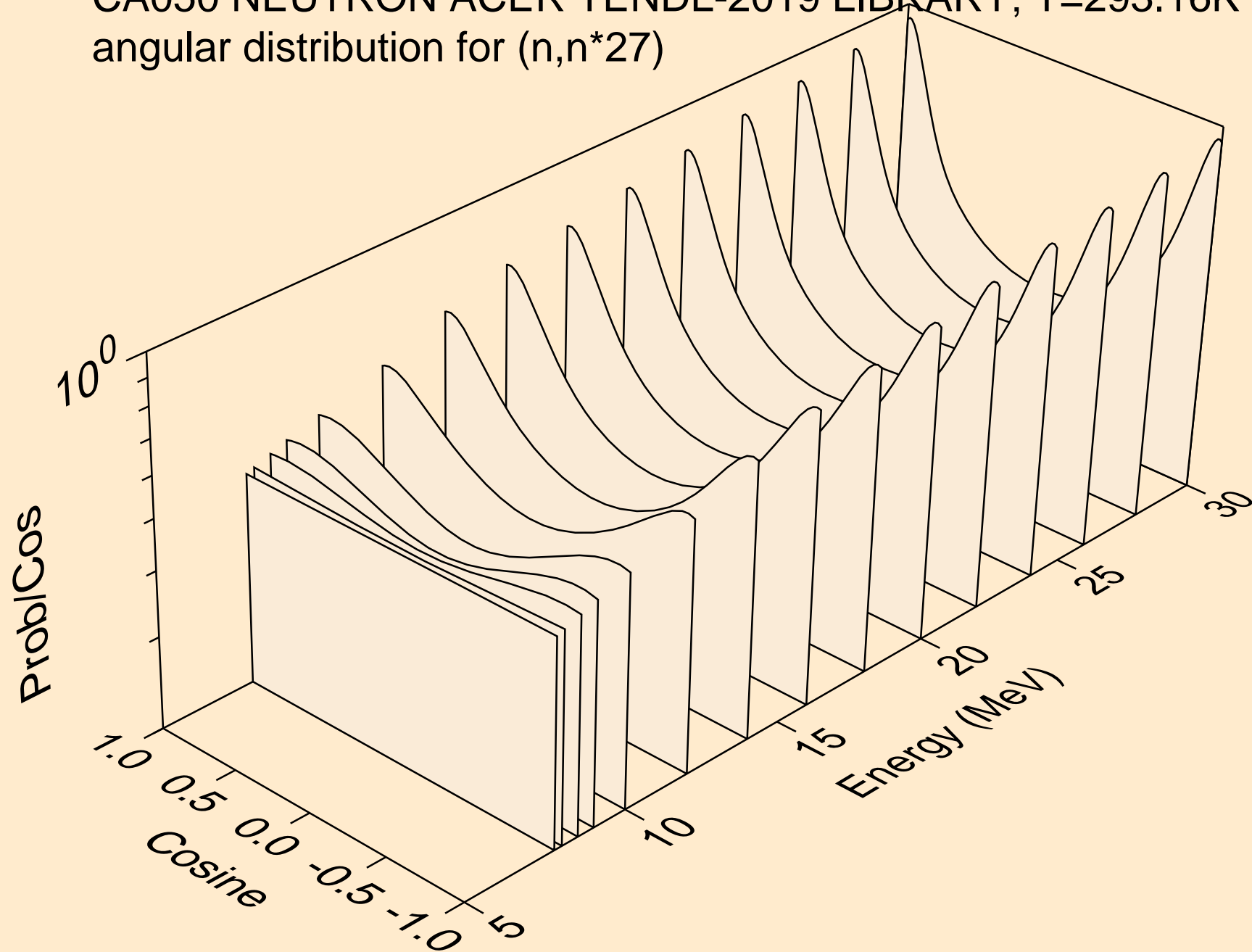

CA050 NEUTRON ACER TENDL-2019 LIBRARY; T=293.16K
angular distribution for (n,n*28)

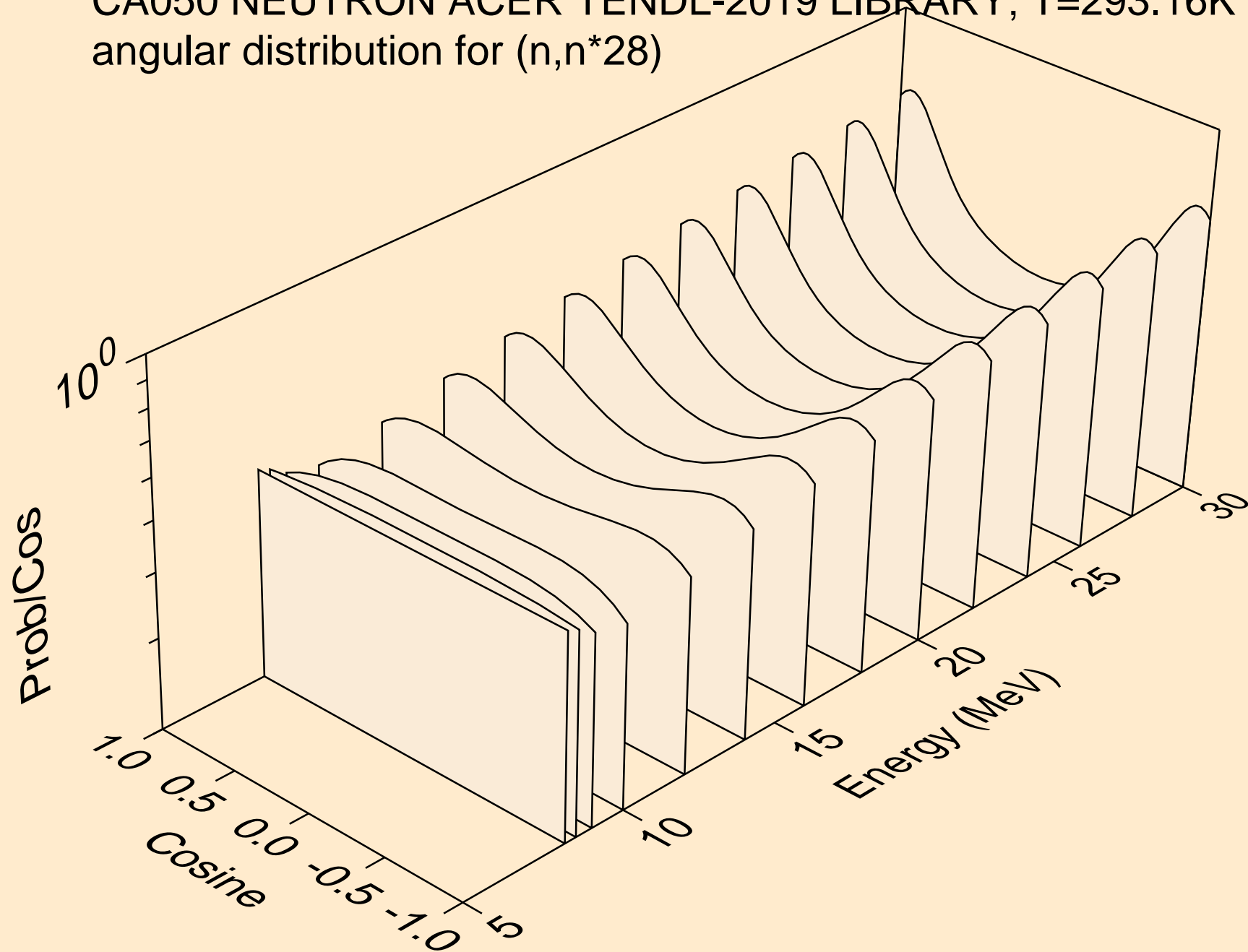

CA050 NEUTRON ACER TENDL-2019 LIBRARY; T=293.16K
Neutron emission for (n,x)

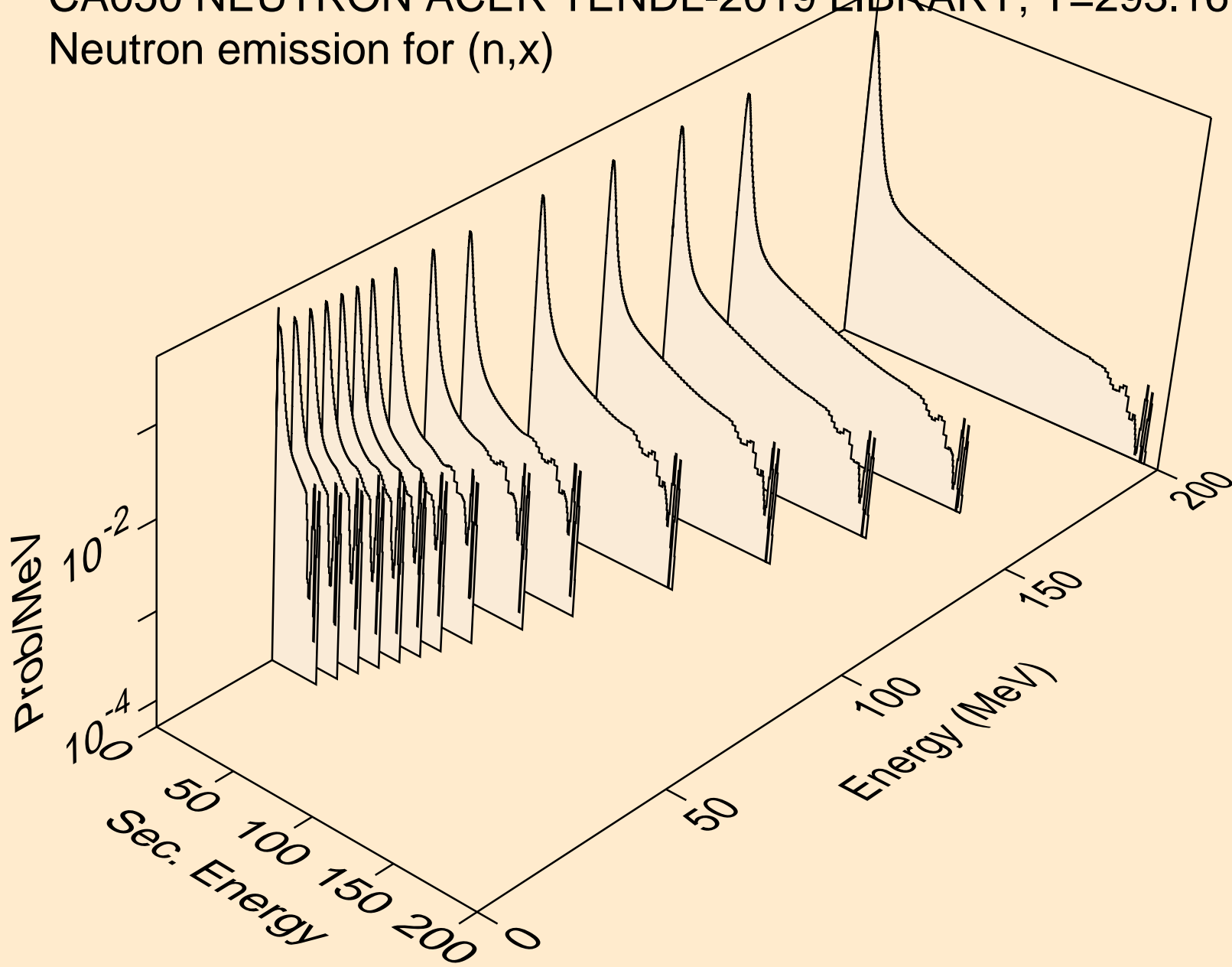

CA050 NEUTRON ACER TENDL-2019 LIBRARY; T=293.16K
Neutron emission for (n,2nd)

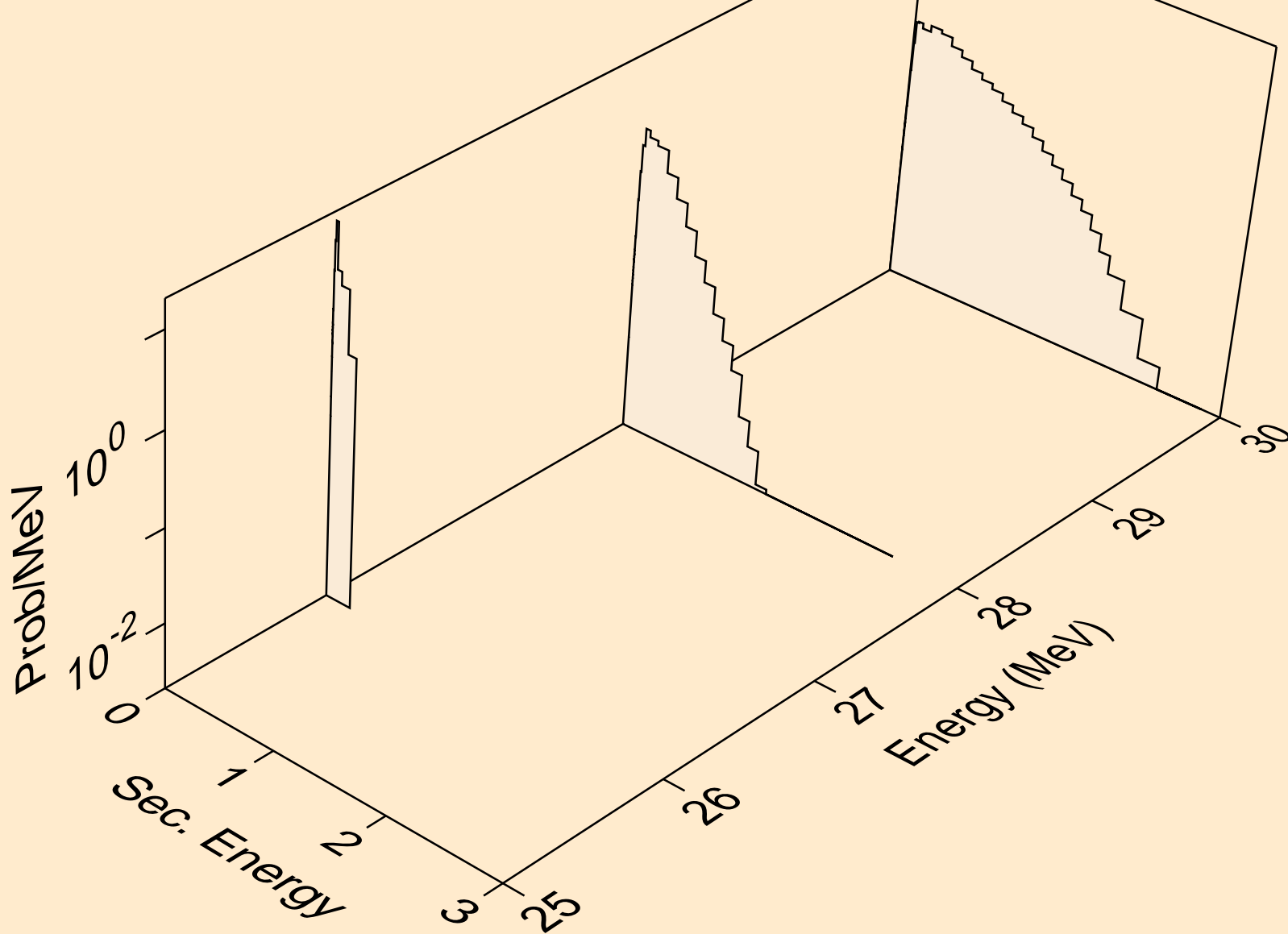

CA050 NEUTRON ACER TENDL-2019 LIBRARY; T=293.16K
Neutron emission for (n,2n)

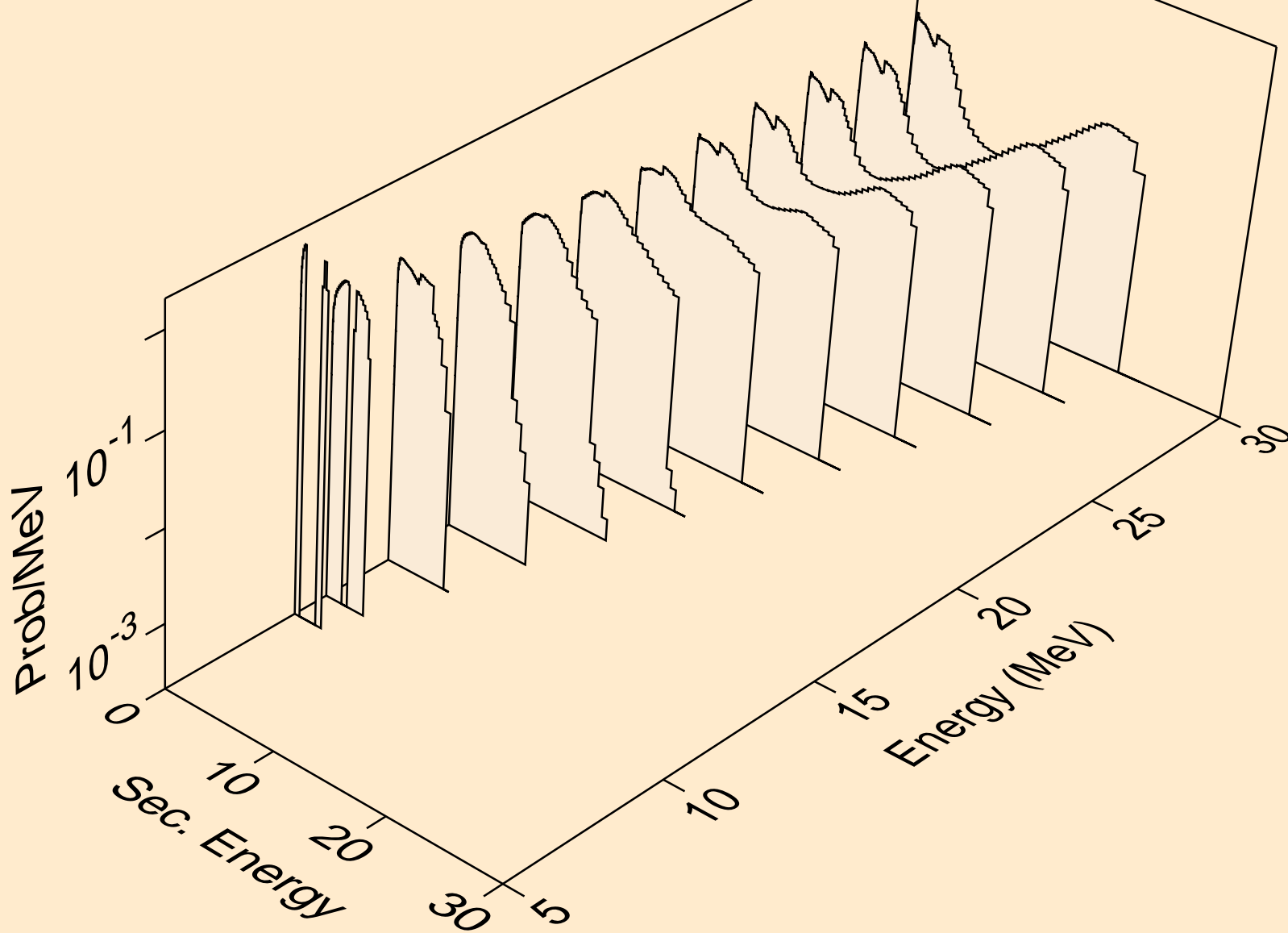

CA050 NEUTRON ACER TENDL-2019 LIBRARY; T=293.16K
Neutron emission for (n,3n)

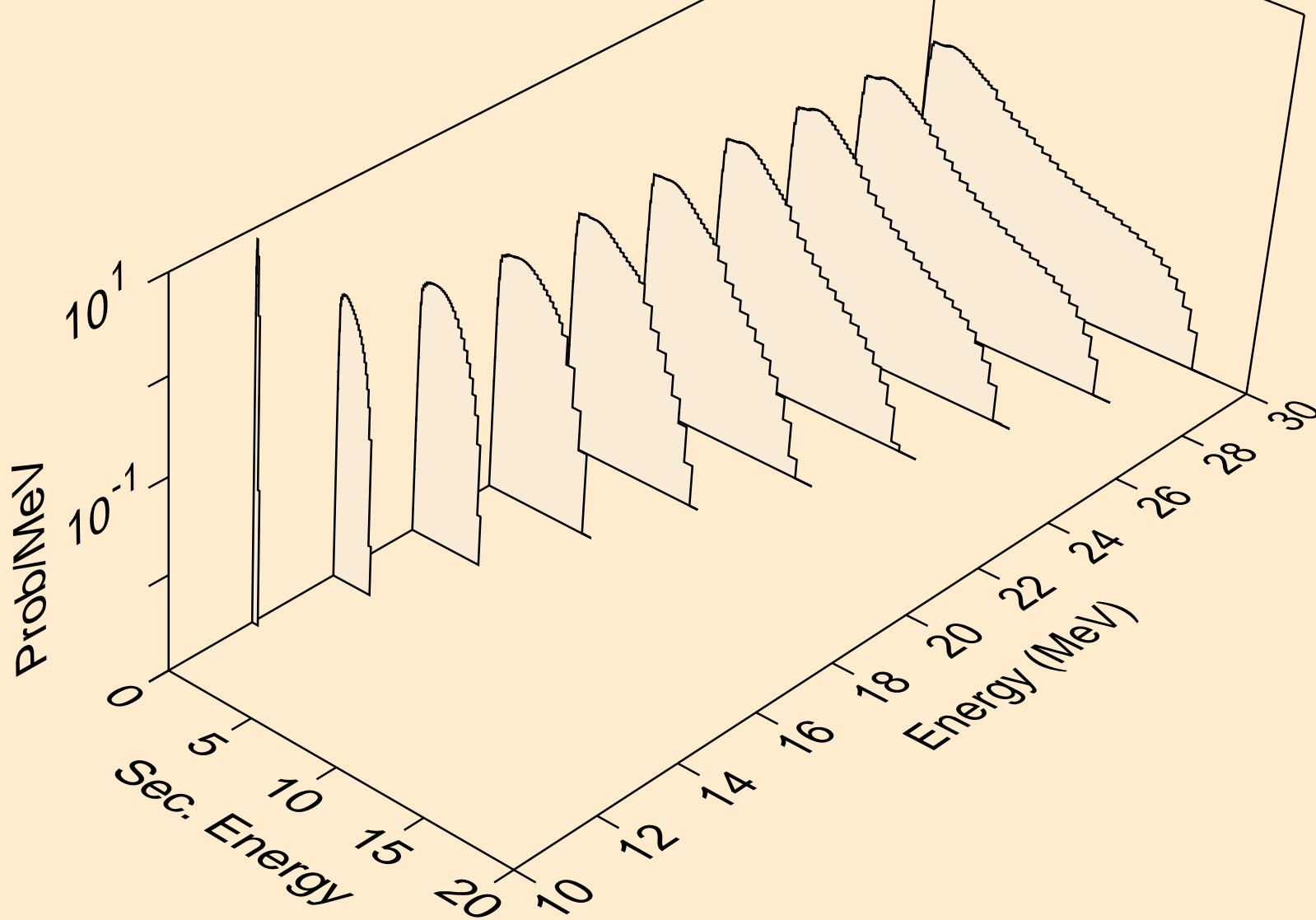

CA050 NEUTRON ACER TENDL-2019 LIBRARY; T=293.16K
Neutron emission for (n,n*)a

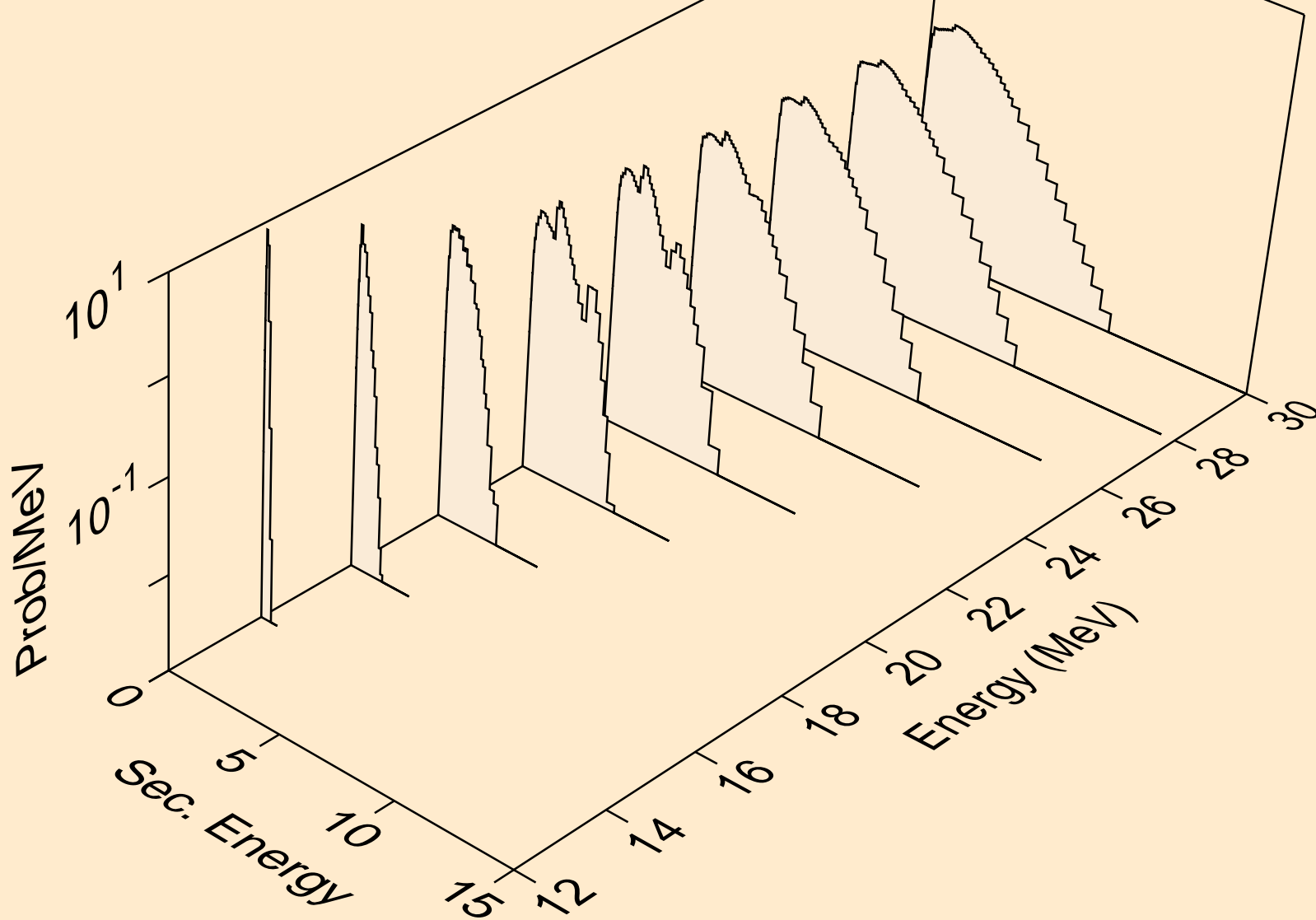

CA050 NEUTRON ACER TENDL-2019 LIBRARY; T=293.16K
Neutron emission for (n,2n)a

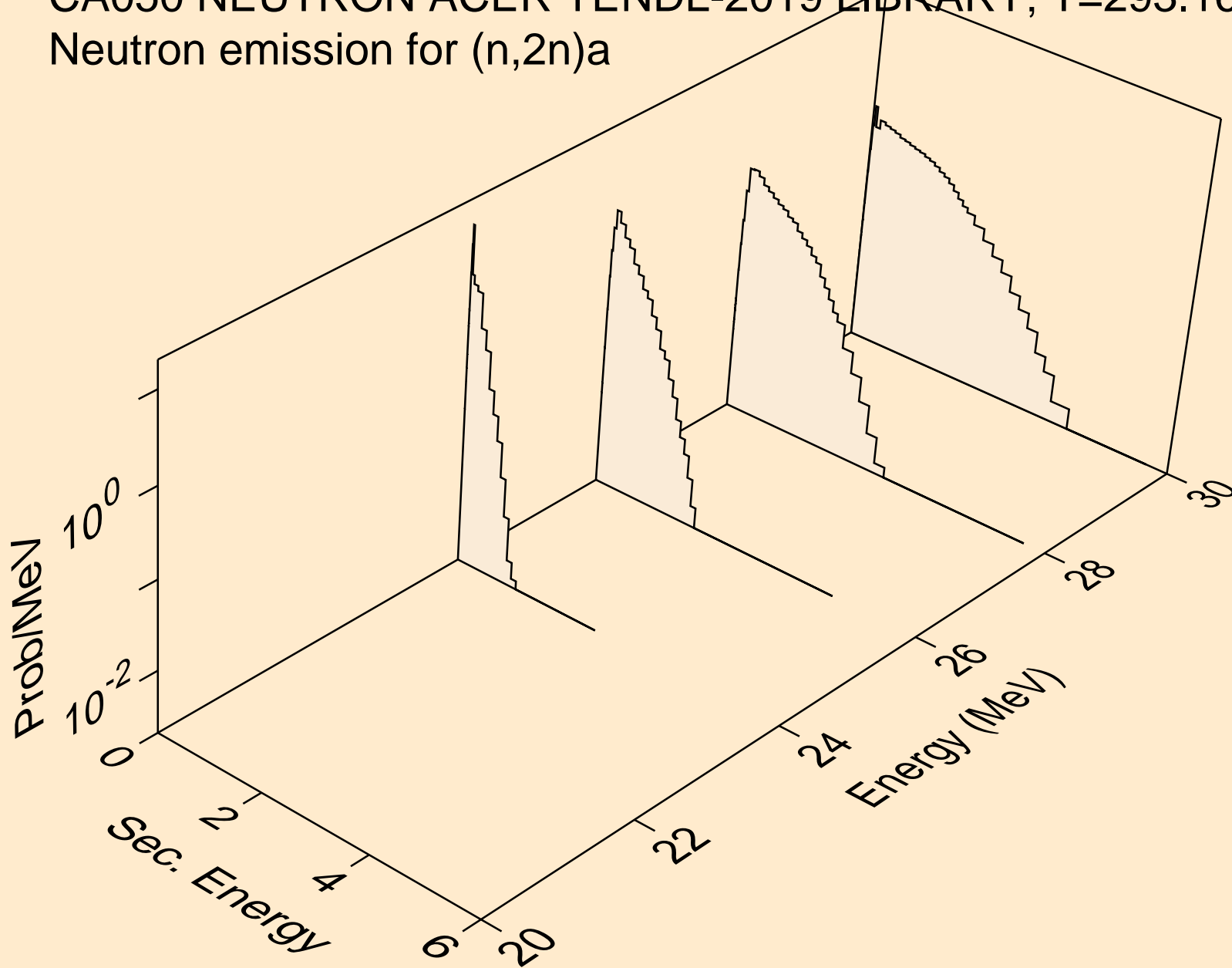

CA050 NEUTRON ACER TENDL-2019 LIBRARY; T=293.16K
Neutron emission for (n,3n)a

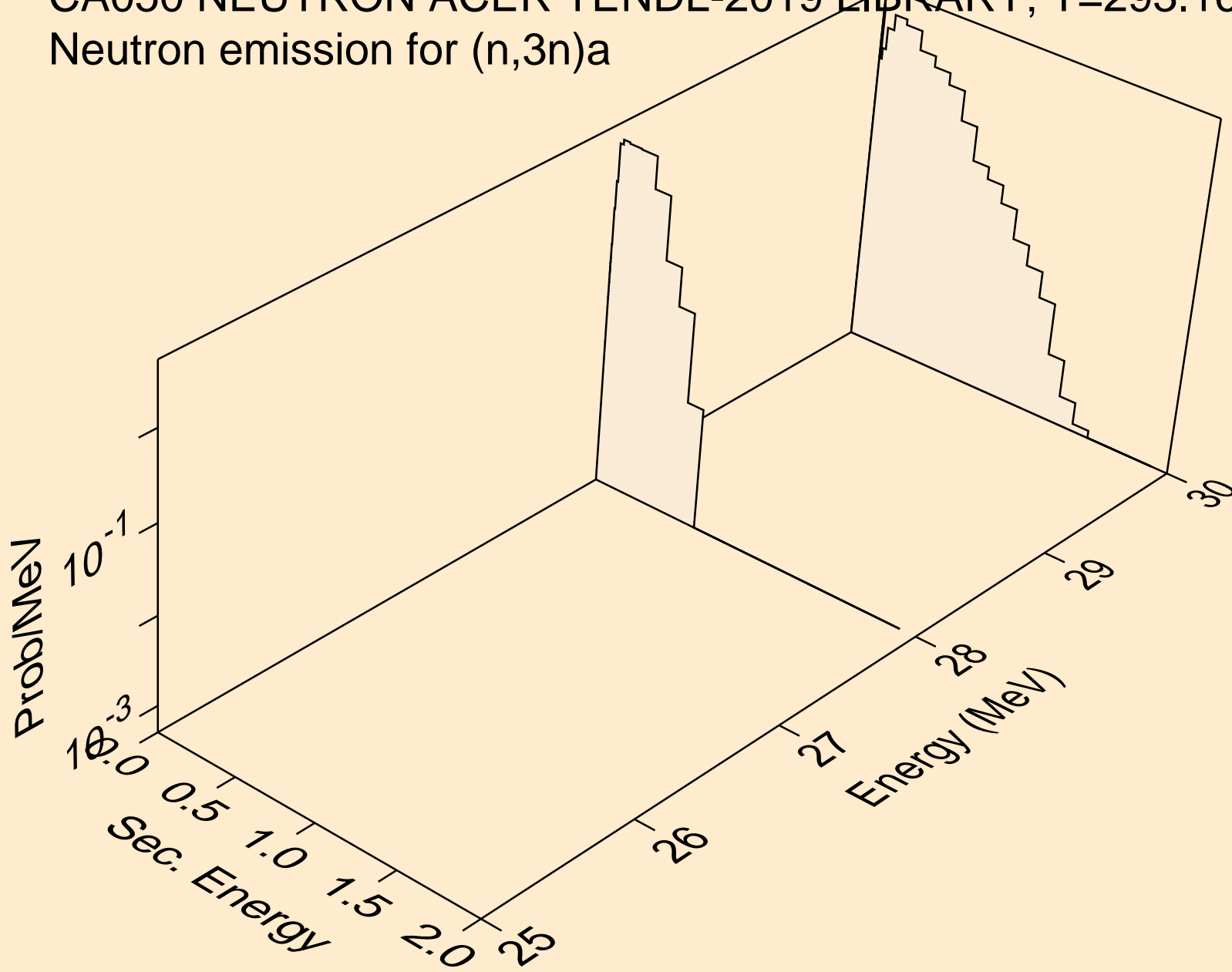

CA050 NEUTRON ACER TENDL-2019 LIBRARY; T=293.16K
Neutron emission for (n,n*)p

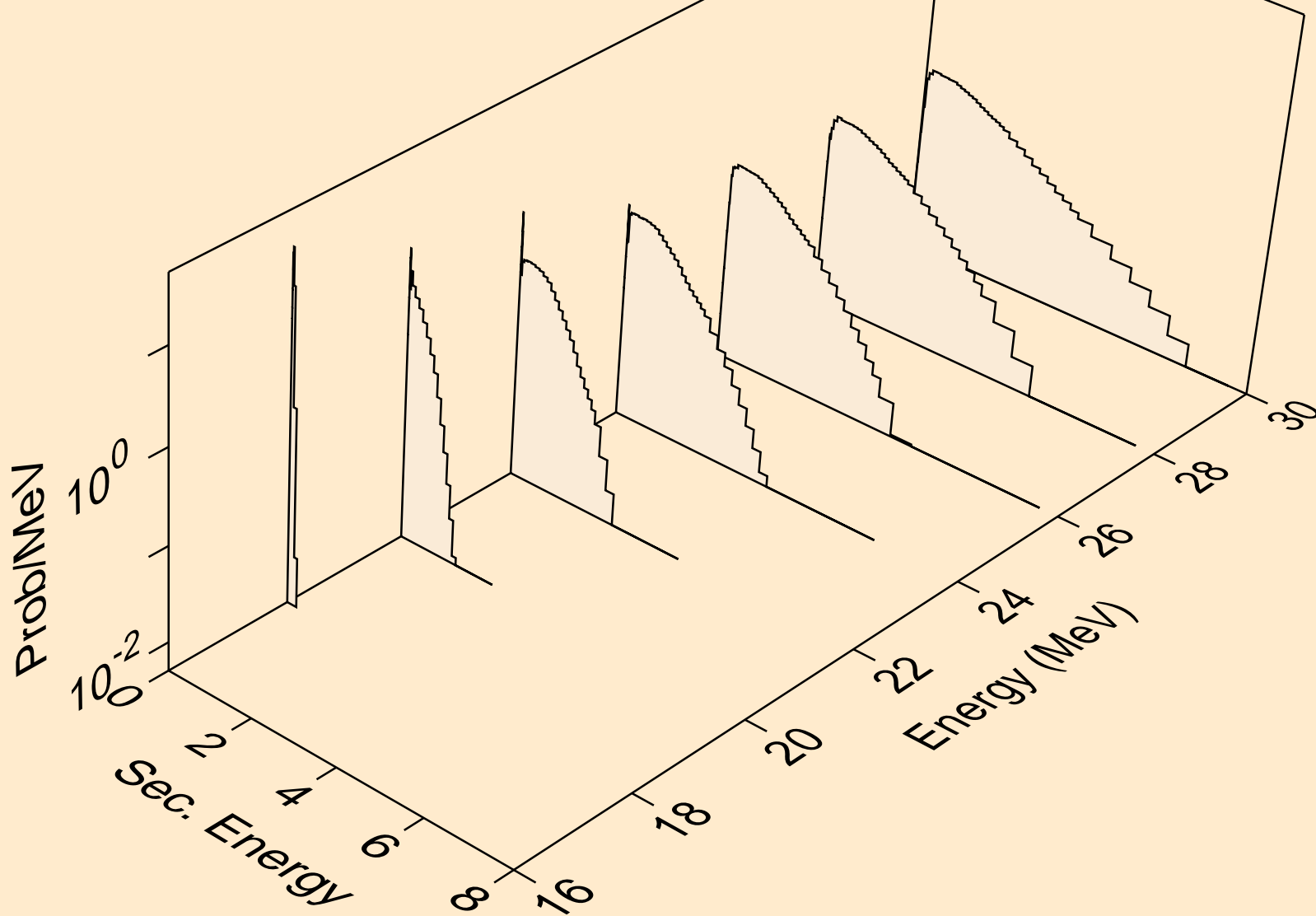

CA050 NEUTRON ACER TENDL-2019 LIBRARY; T=293.16K
Neutron emission for (n,n*)d

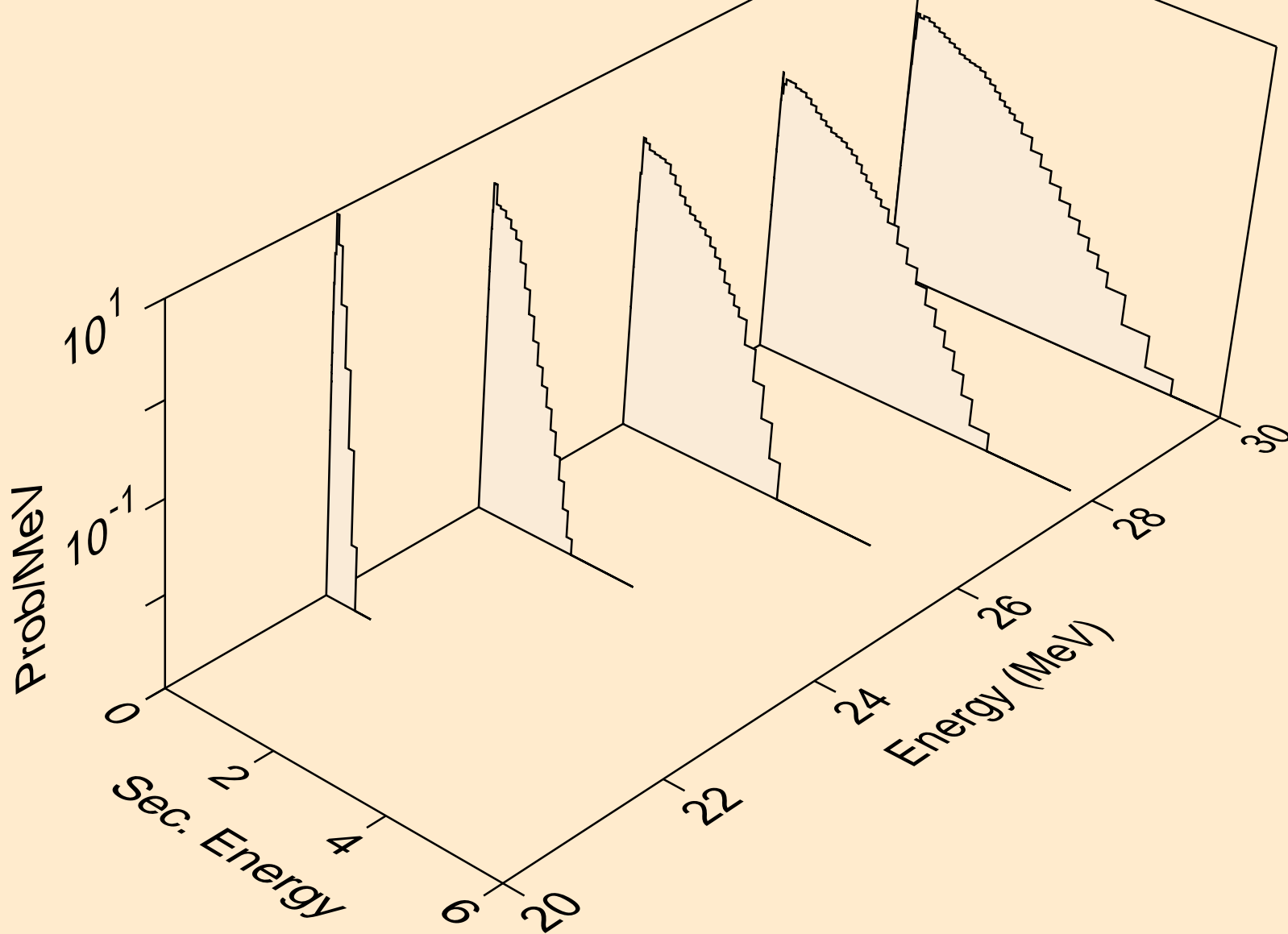

CA050 NEUTRON ACER TENDL-2019 LIBRARY; T=293.16K
Neutron emission for (n,n*)t

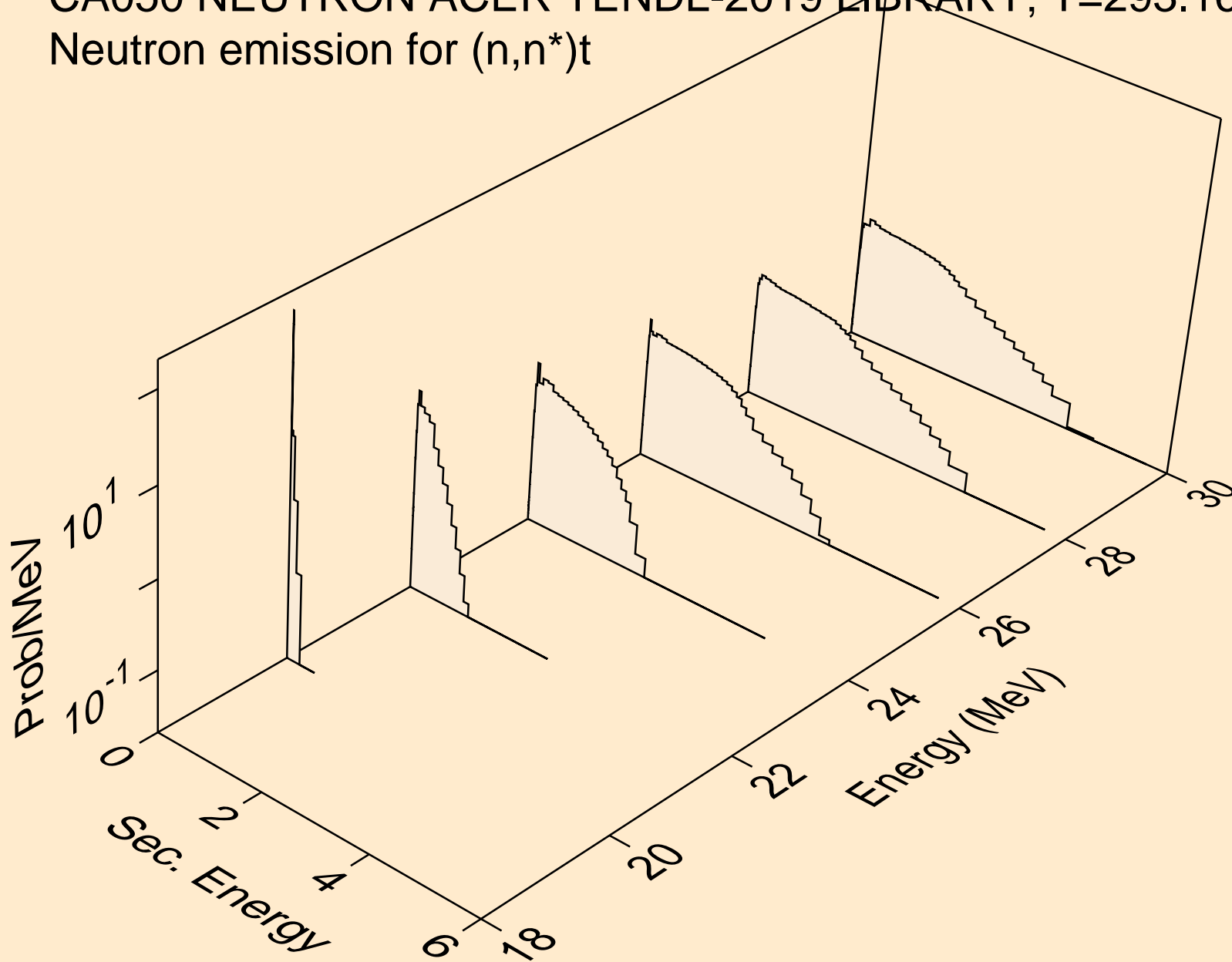

CA050 NEUTRON ACER TENDL-2019 LIBRARY; T=293.16K
Neutron emission for (n,4n)

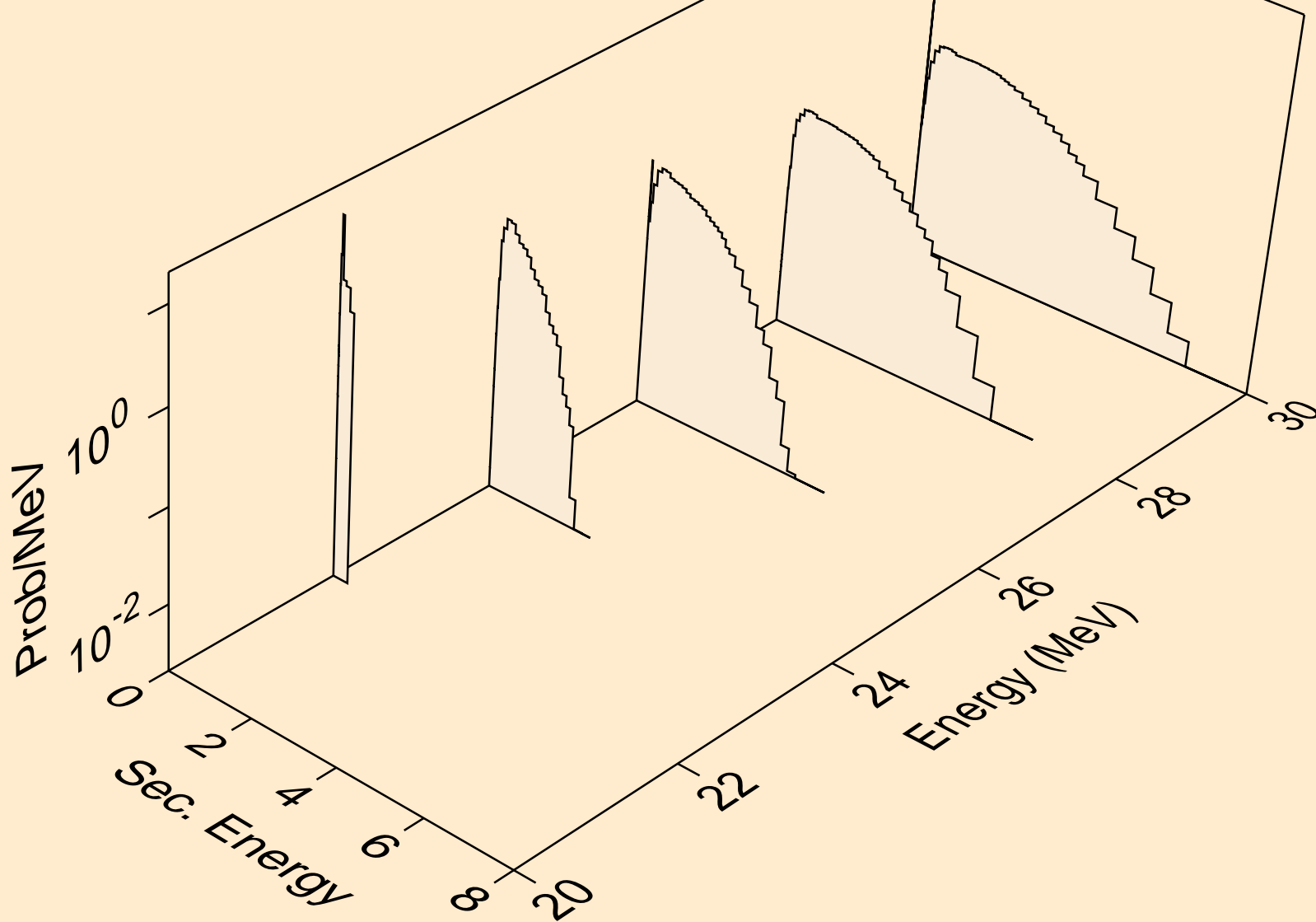

CA050 NEUTRON ACER TENDL-2019 LIBRARY; T=293.16K
Neutron emission for (n,2np)

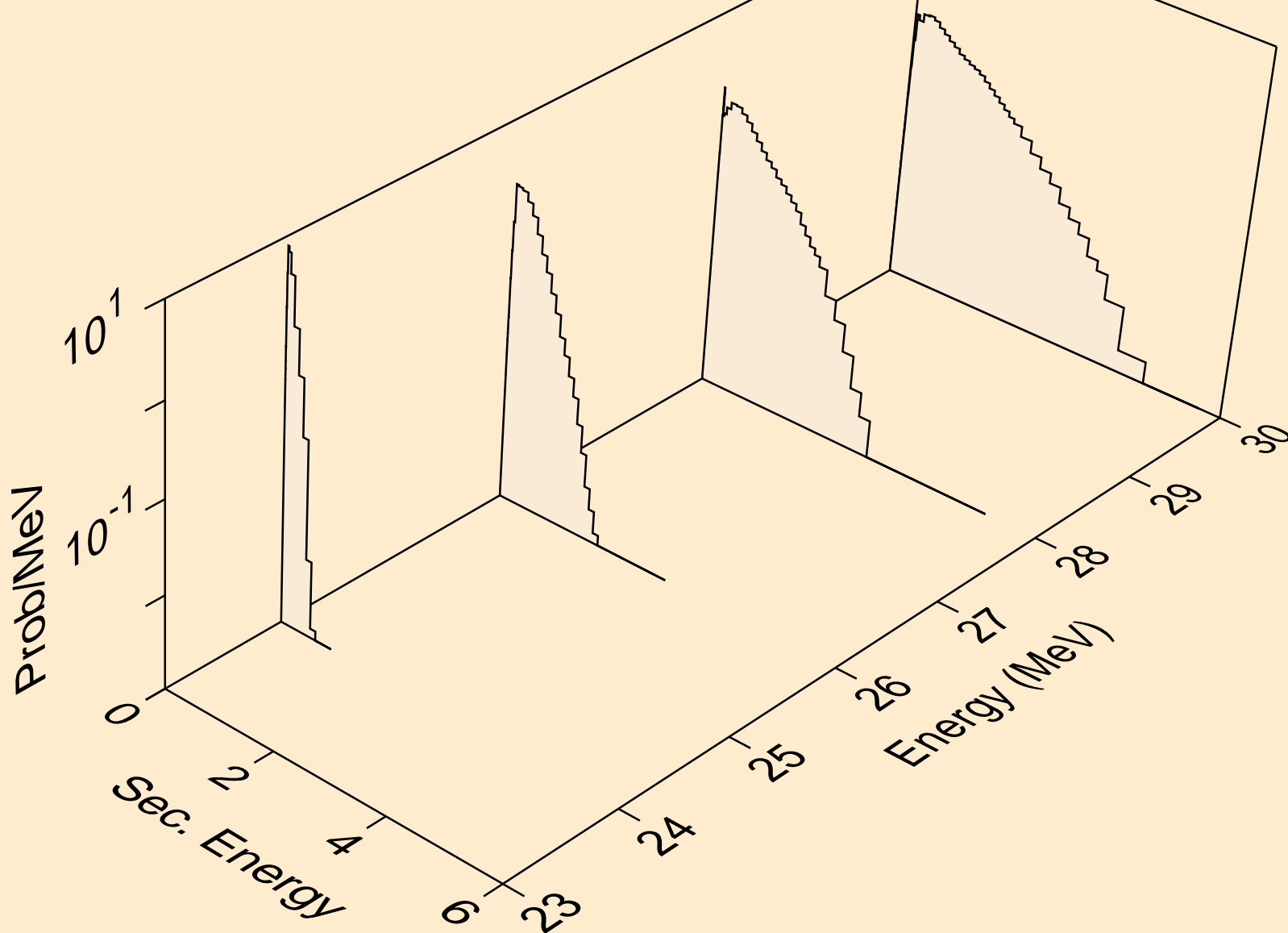

CA050 NEUTRON ACER TENDL-2019 LIBRARY; T=293.16K
Neutron emission for (n,3np)

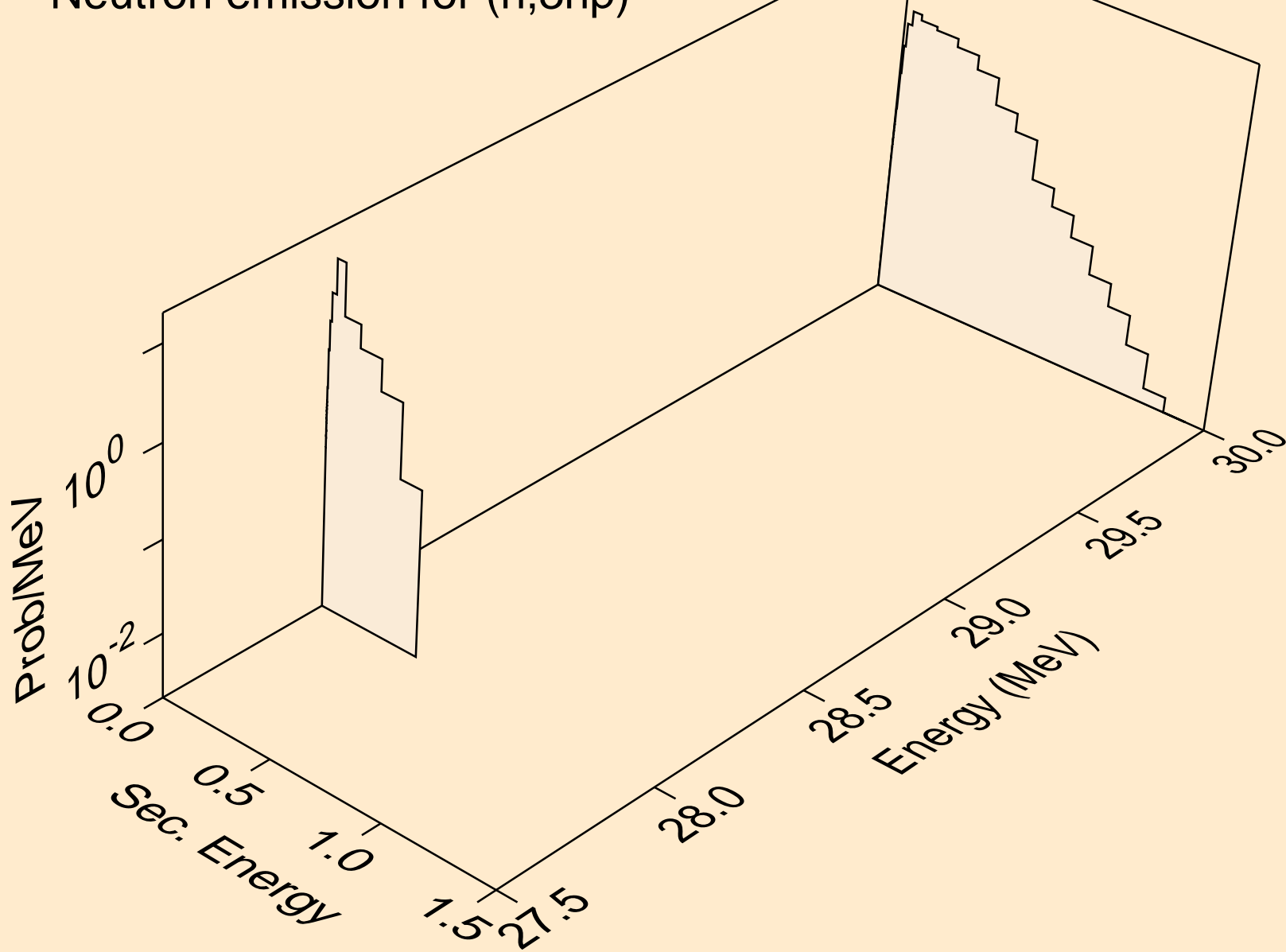

CA050 NEUTRON ACER TENDL-2019 LIBRARY; T=293.16K
Neutron emission for (n,n*c)

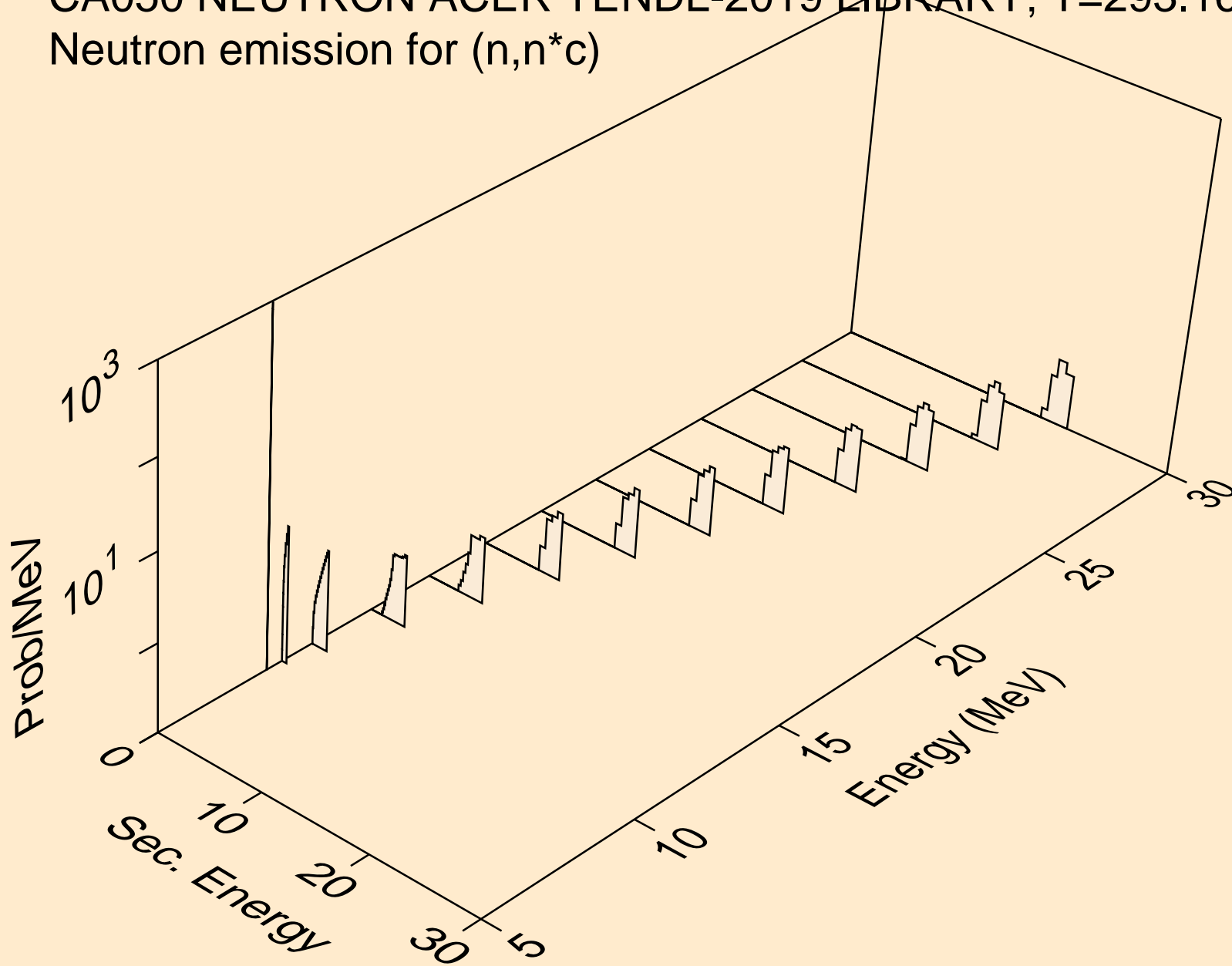

CA050 NEUTRON ACER TENDL-2019 LIBRARY; T=293.16K
Photon emission for (n,x)

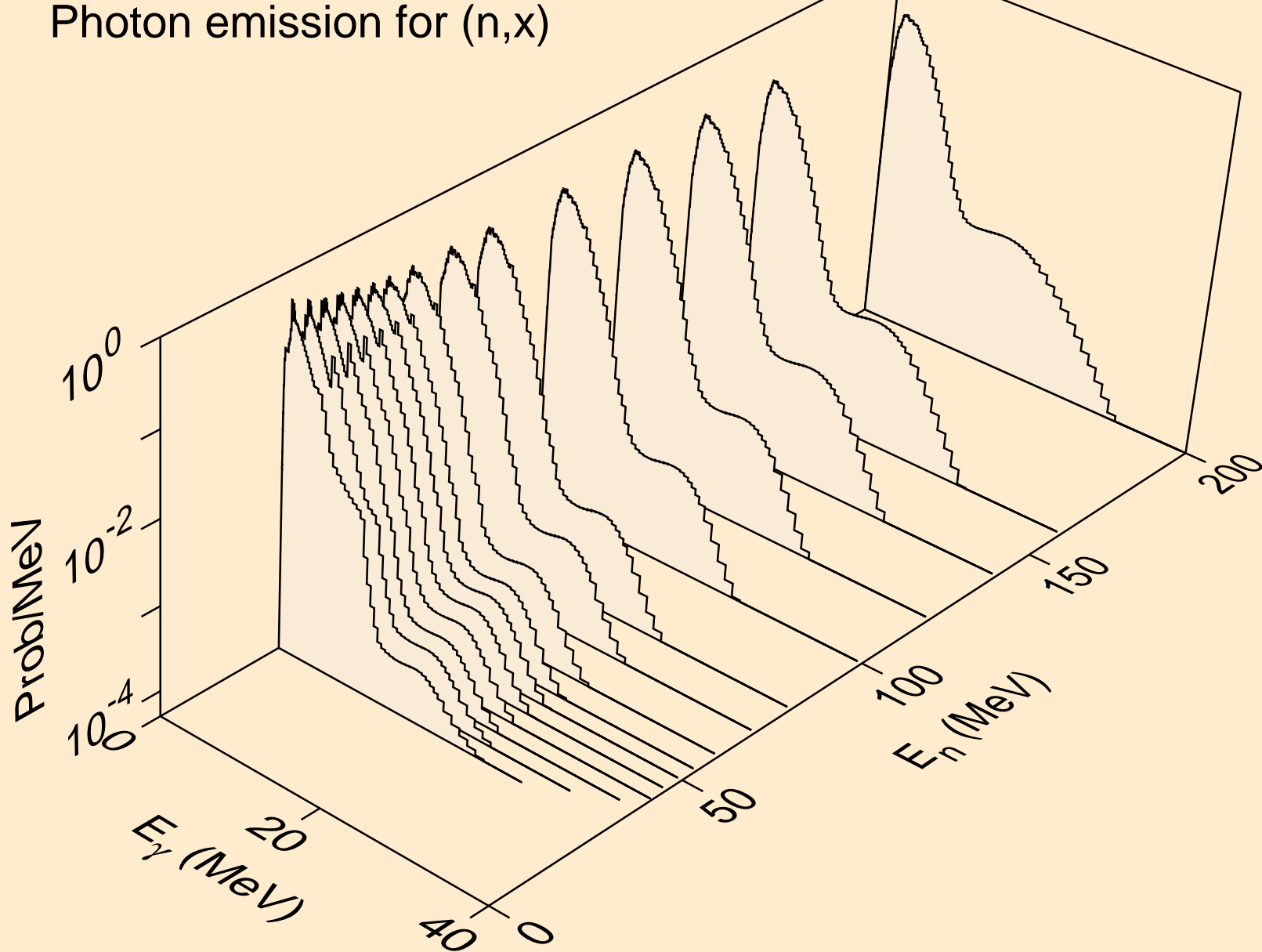

CA050 NEUTRON ACER TENDL-2019 LIBRARY; T=293.16K
Photon emission for (n,2nd)

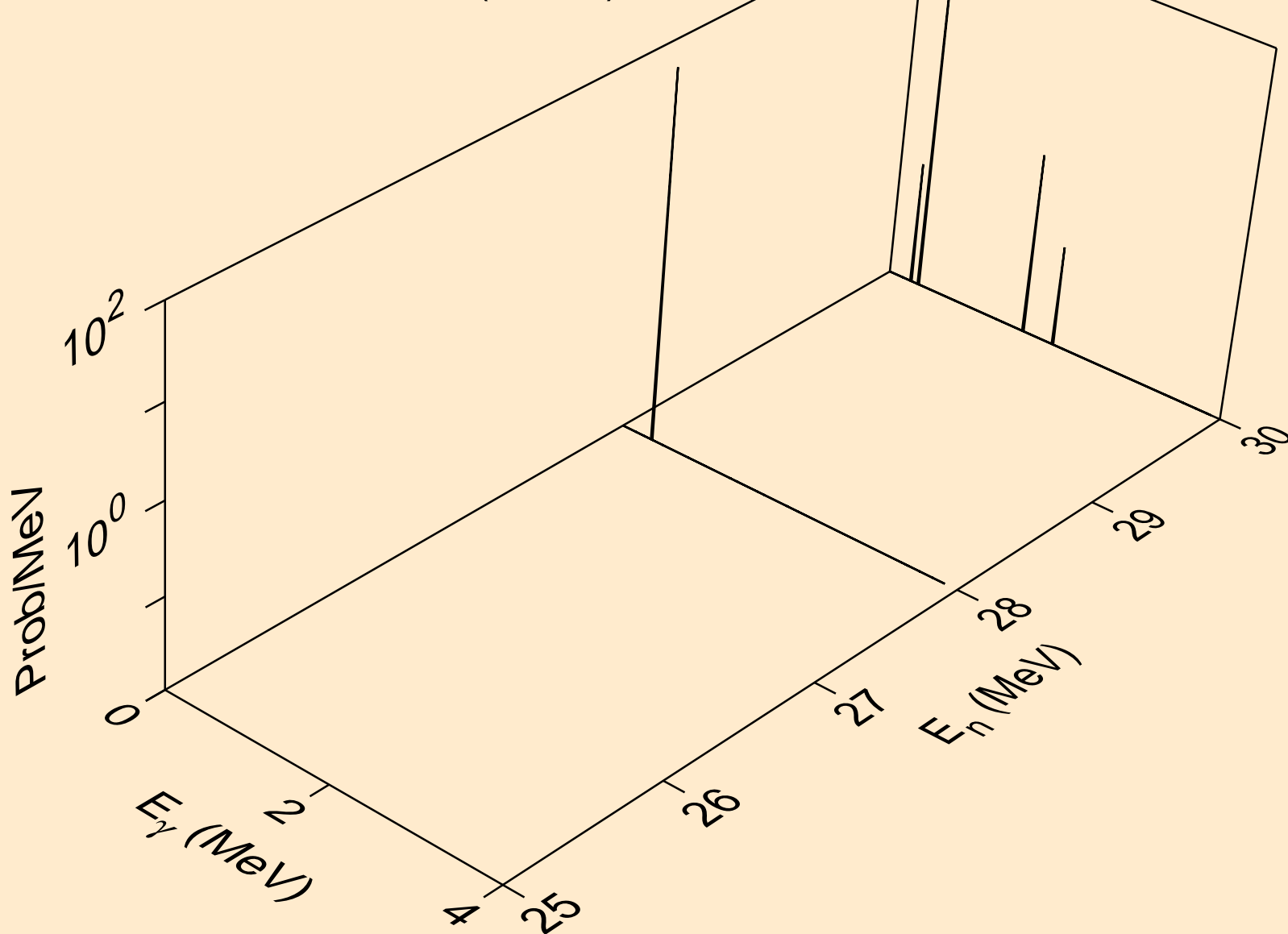

CA050 NEUTRON ACER TENDL-2019 LIBRARY; T=293.16K
Photon emission for (n,2n)

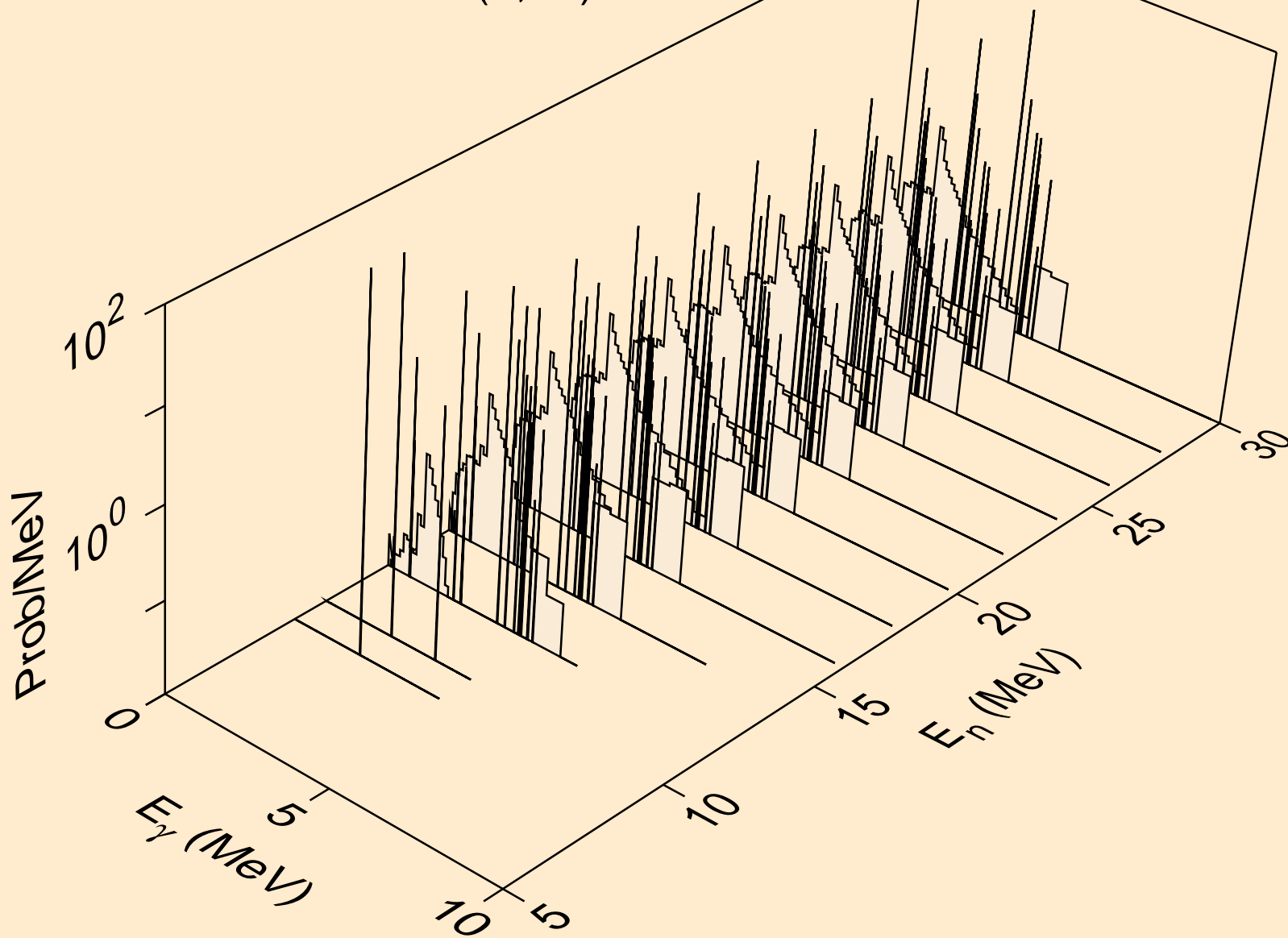

CA050 NEUTRON ACER TENDL-2019 LIBRARY; T=293.16K
Photon emission for (n,3n)

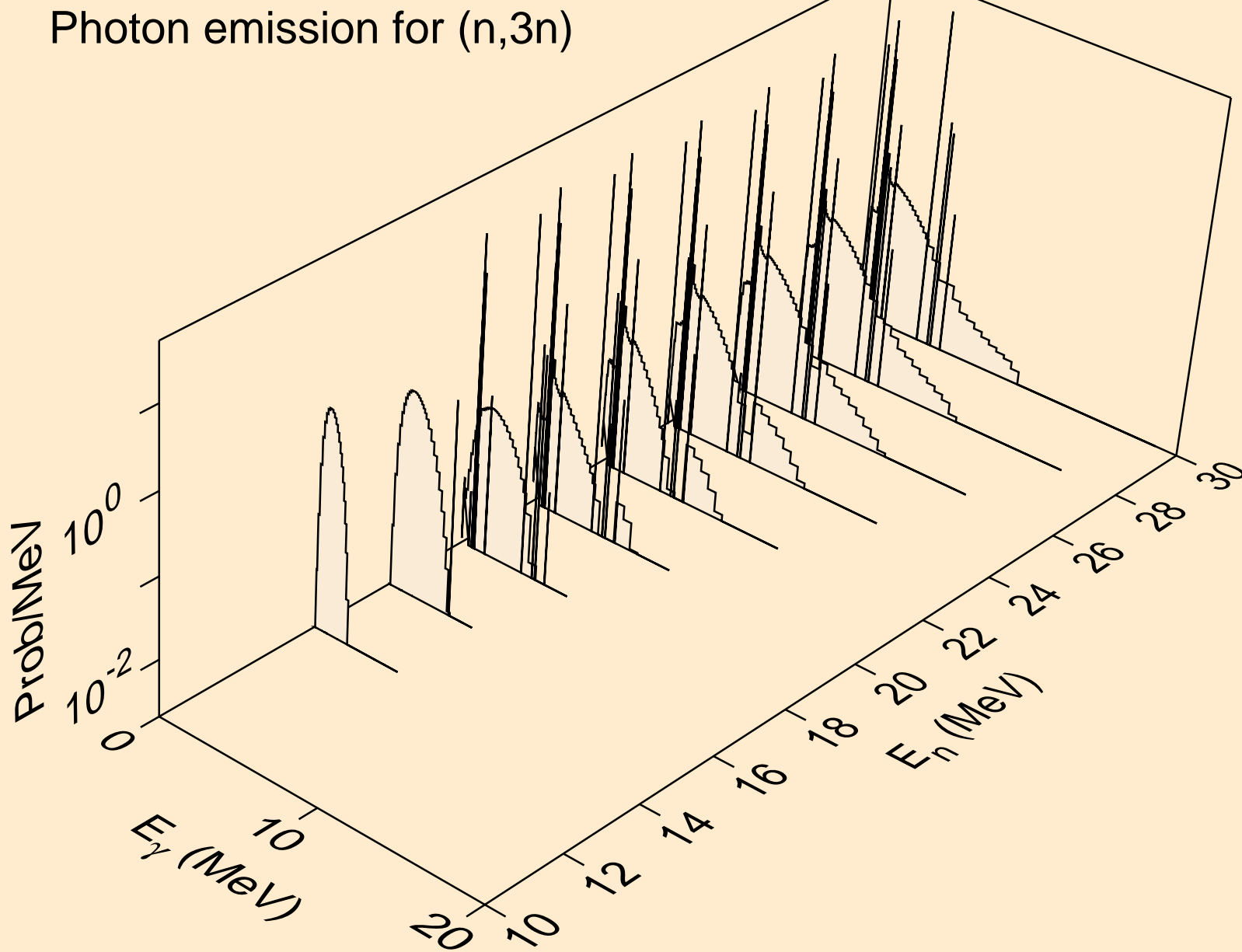

CA050 NEUTRON ACER TENDL-2019 LIBRARY; T=293.16K
Photon emission for (n,n*)a

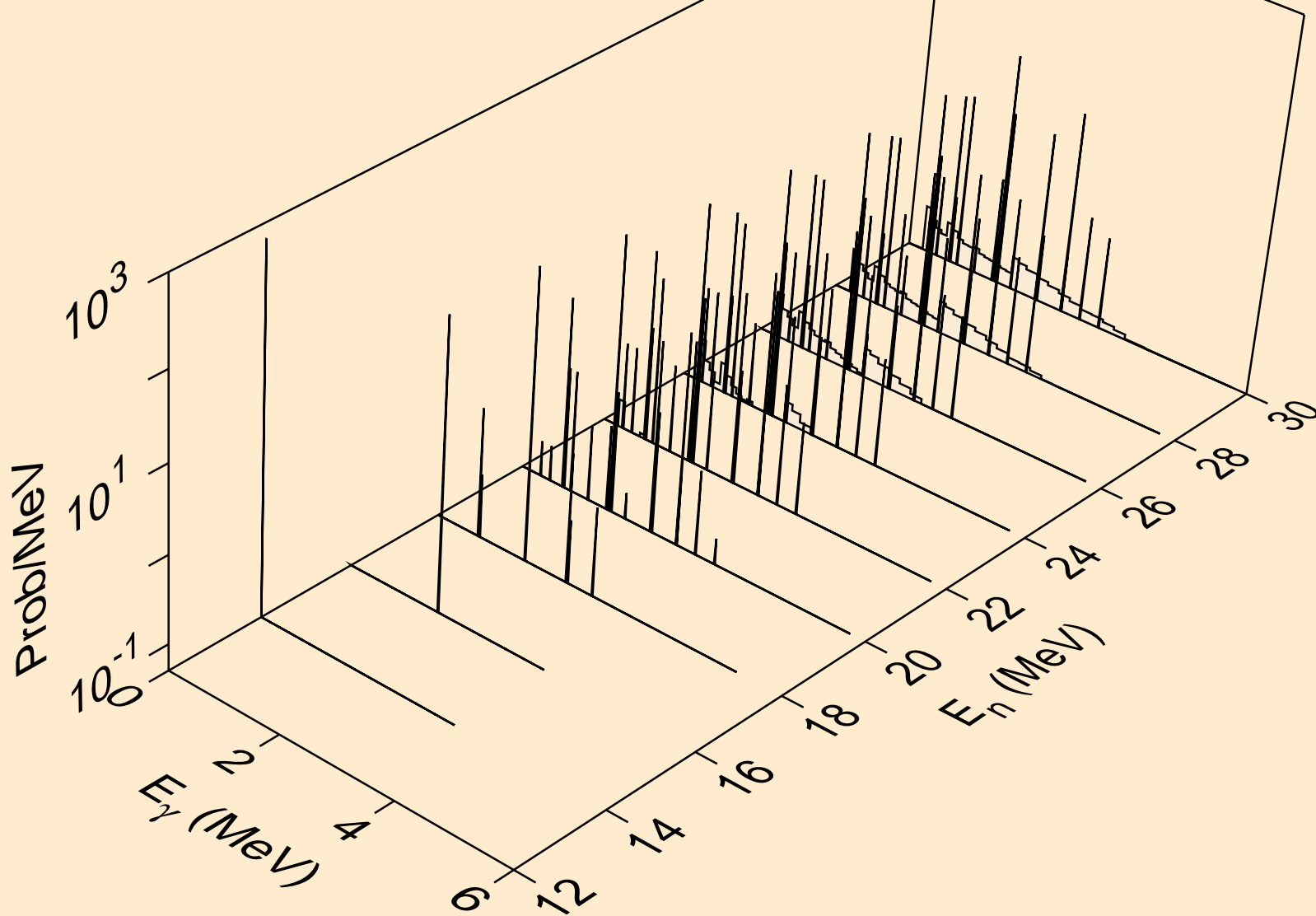

CA050 NEUTRON ACER TENDL-2019 LIBRARY; T=293.16K
Photon emission for (n,2n)a

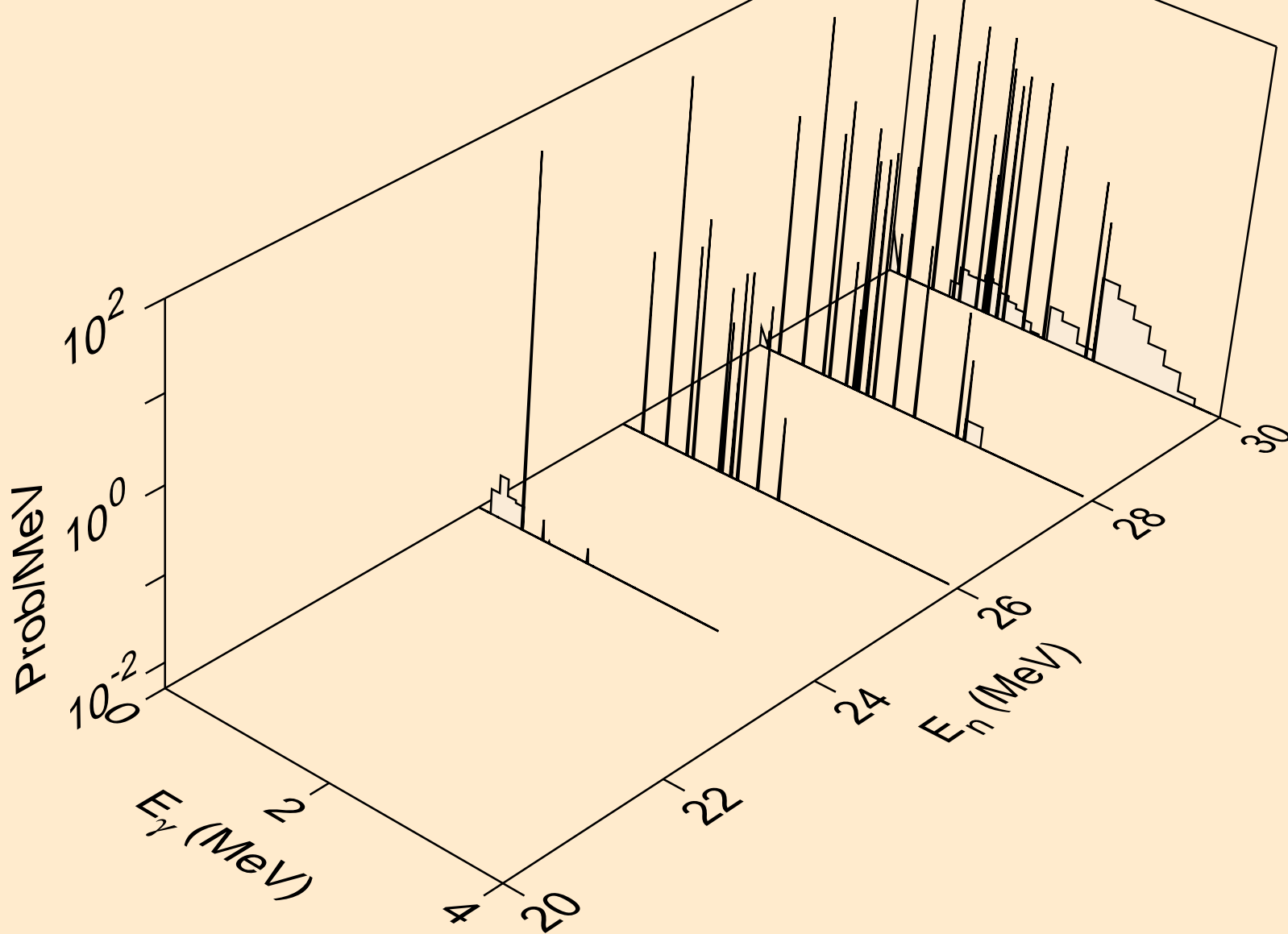

CA050 NEUTRON ACER TENDL-2019 LIBRARY; T=293.16K
Photon emission for (n,3n)a

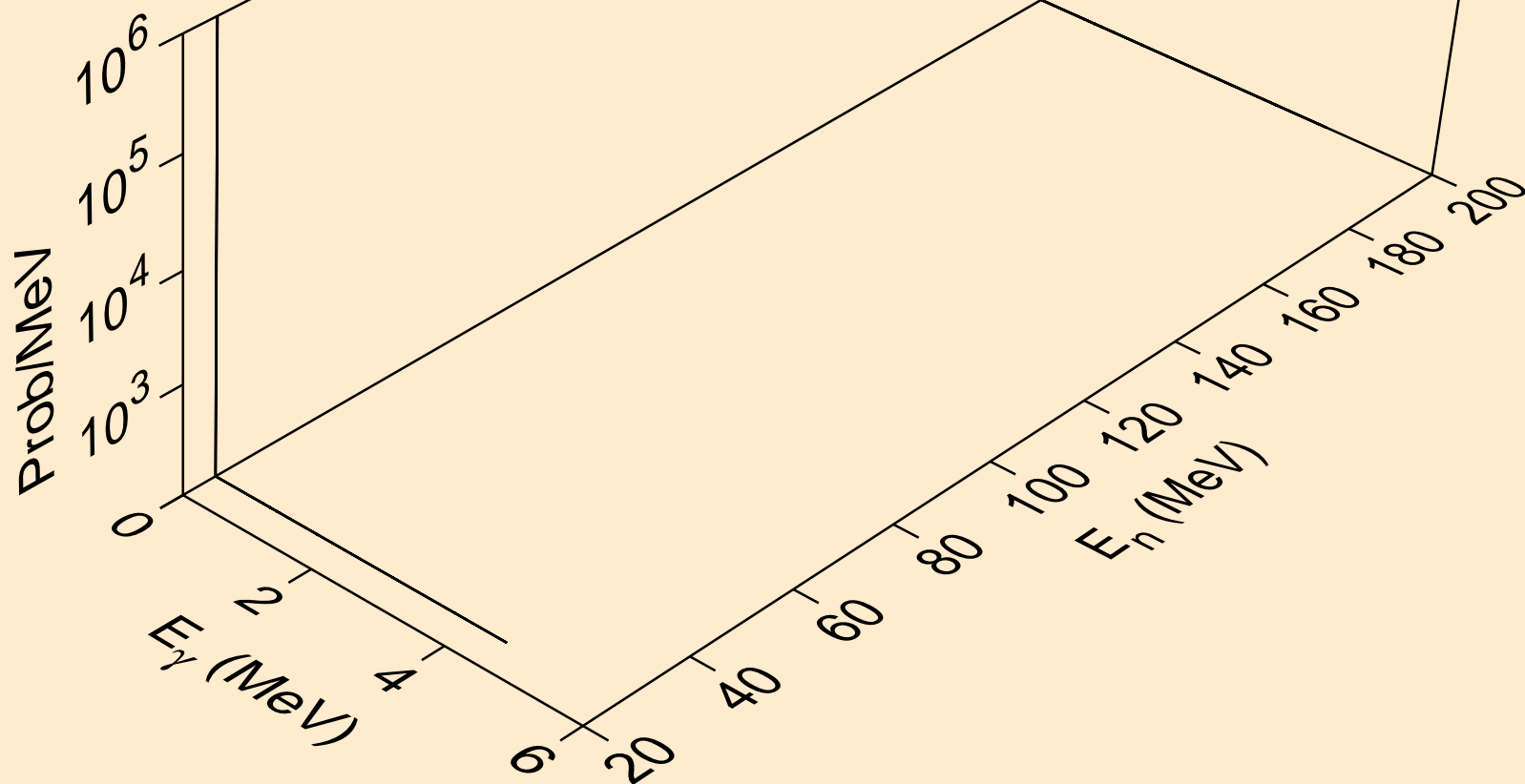

CA050 NEUTRON ACER TENDL-2019 LIBRARY; T=293.16K
Photon emission for (n,n*)p

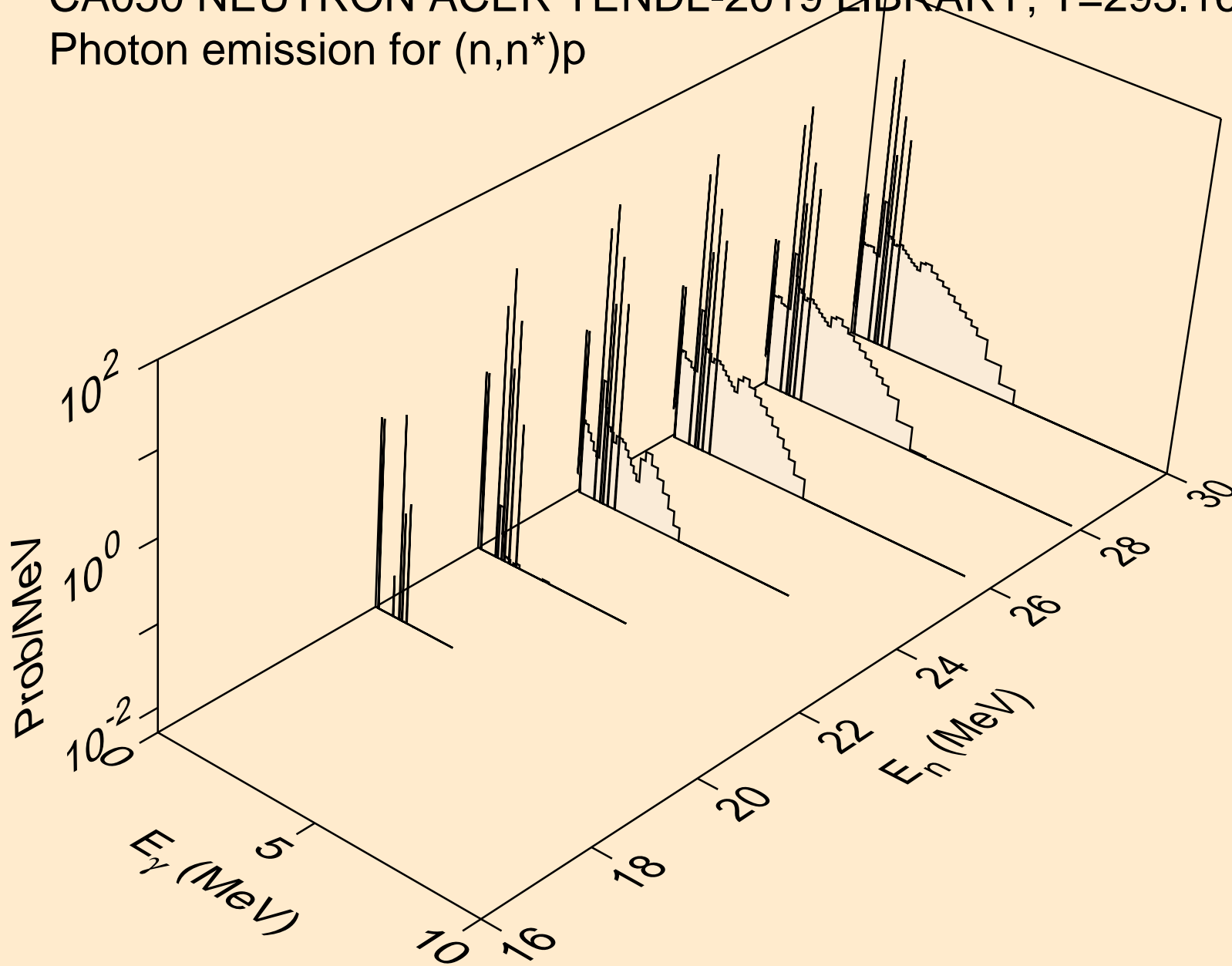

CA050 NEUTRON ACER TENDL-2019 LIBRARY; T=293.16K
Photon emission for (n,n*)d

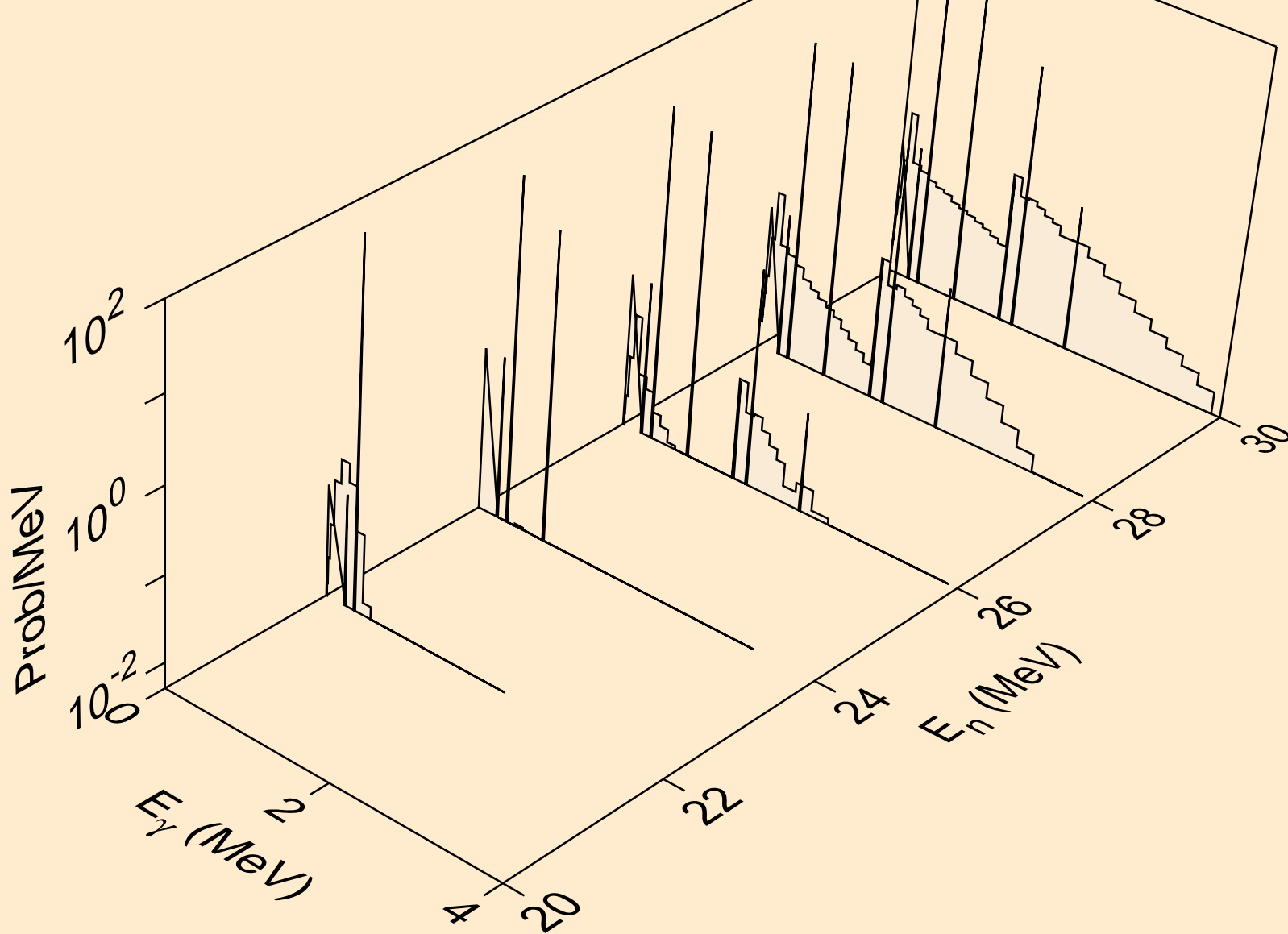

CA050 NEUTRON ACER TENDL-2019 LIBRARY; T=293.16K
Photon emission for (n,n*)t

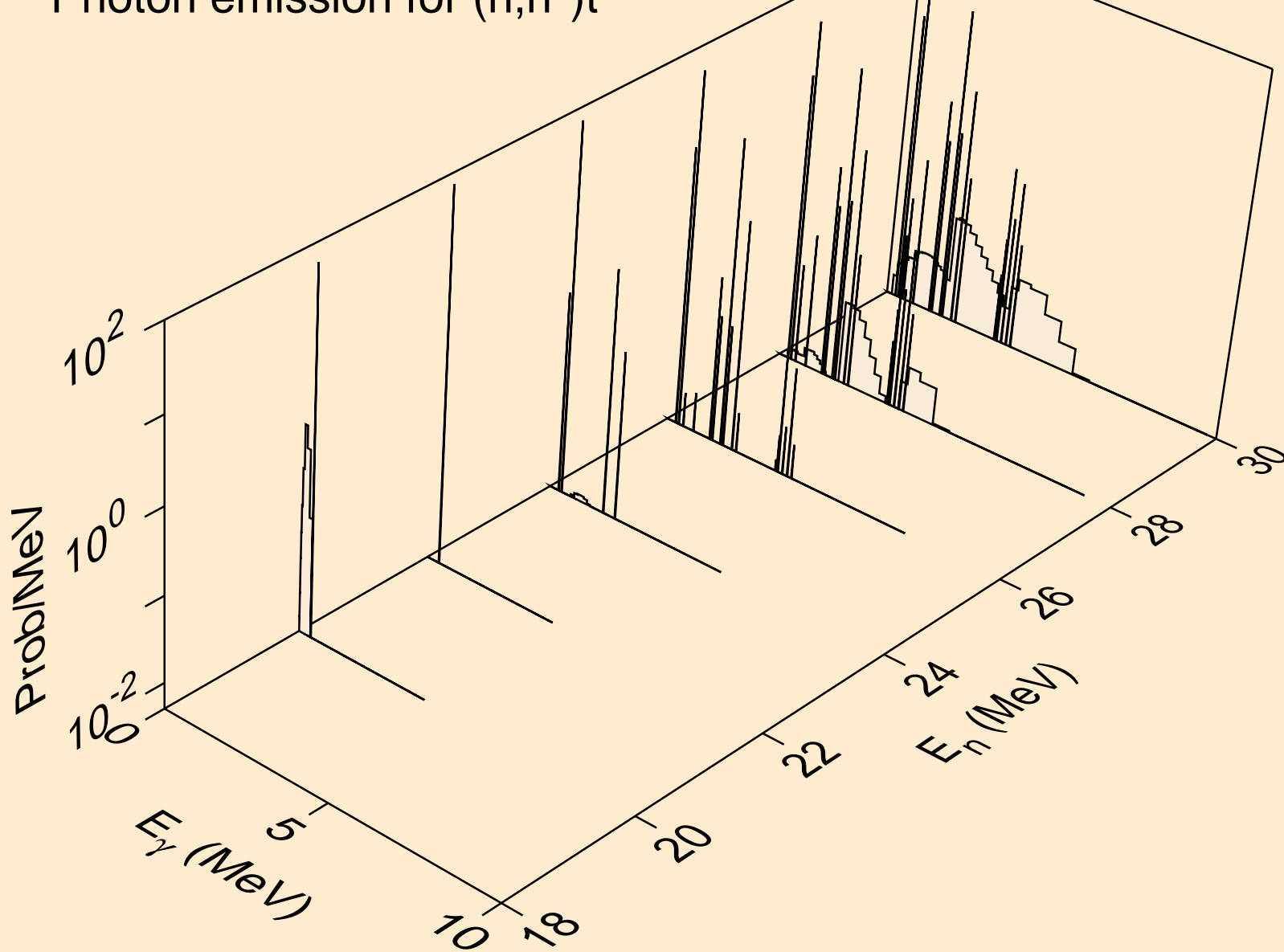

CA050 NEUTRON ACER TENDL-2019 LIBRARY; T=293.16K
Photon emission for (n,4n)

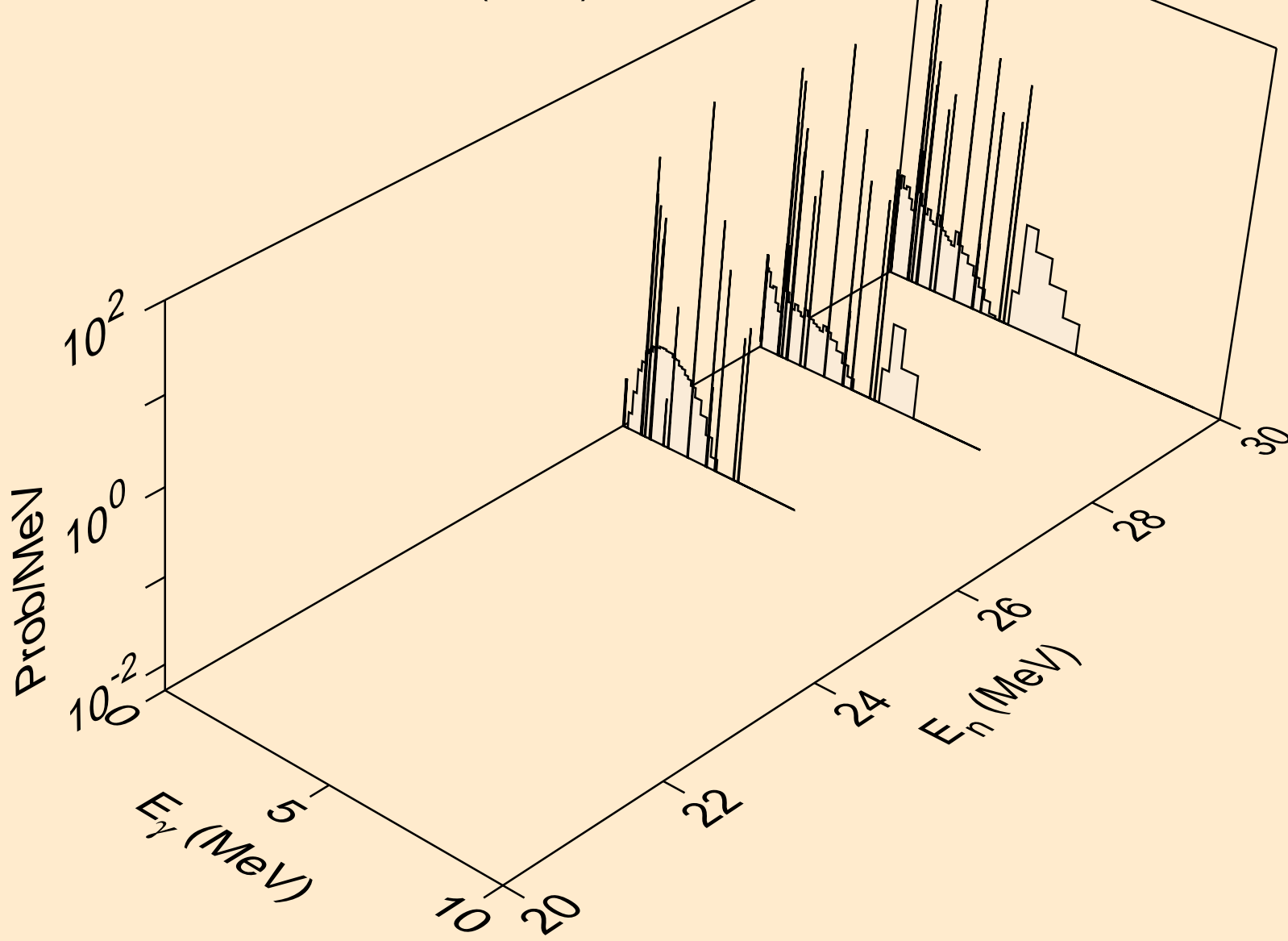

CA050 NEUTRON ACER TENDL-2019 LIBRARY; T=293.16K
Photon emission for (n,2np)

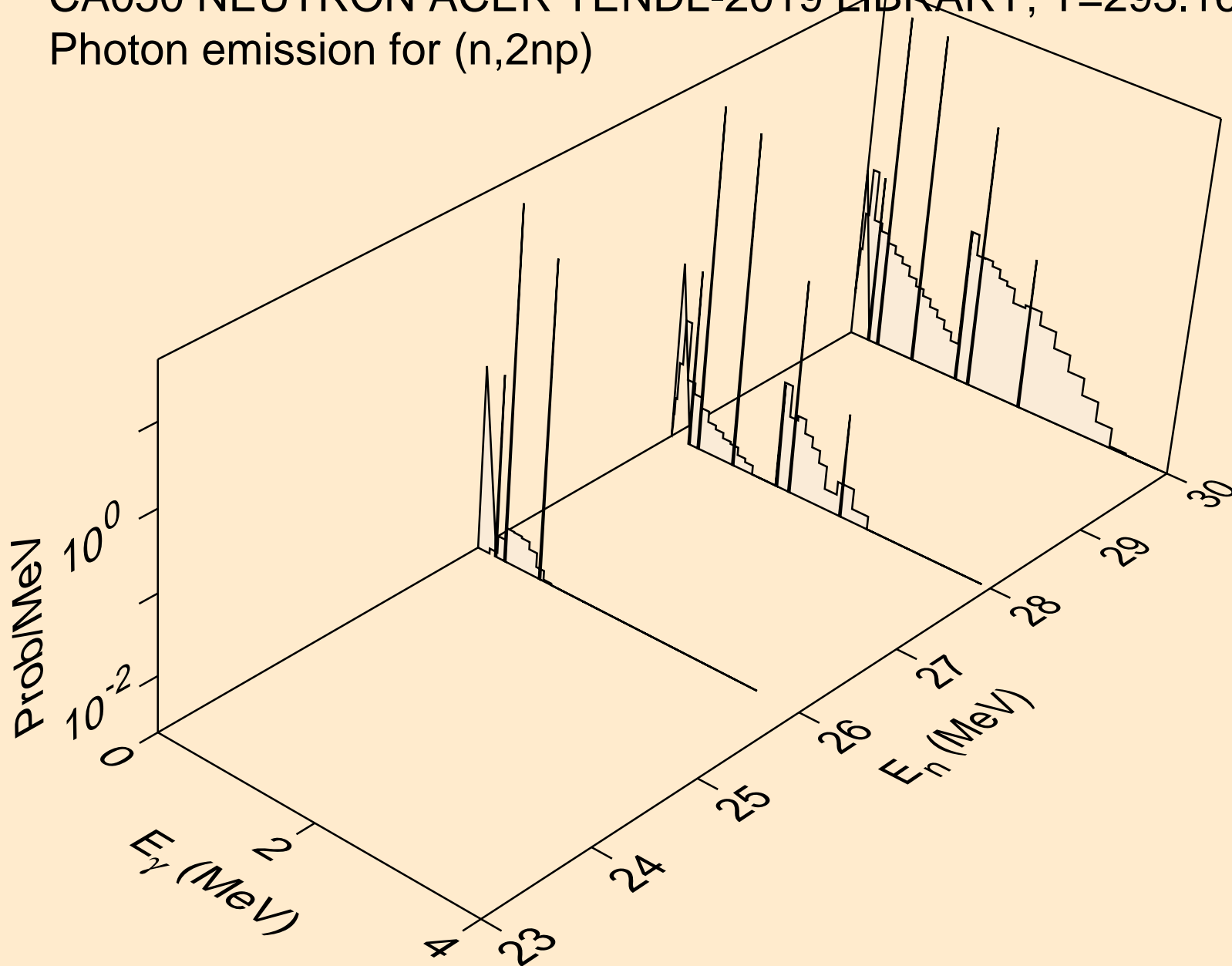

CA050 NEUTRON ACER TENDL-2019 LIBRARY; T=293.16K
Photon emission for (n,3np)

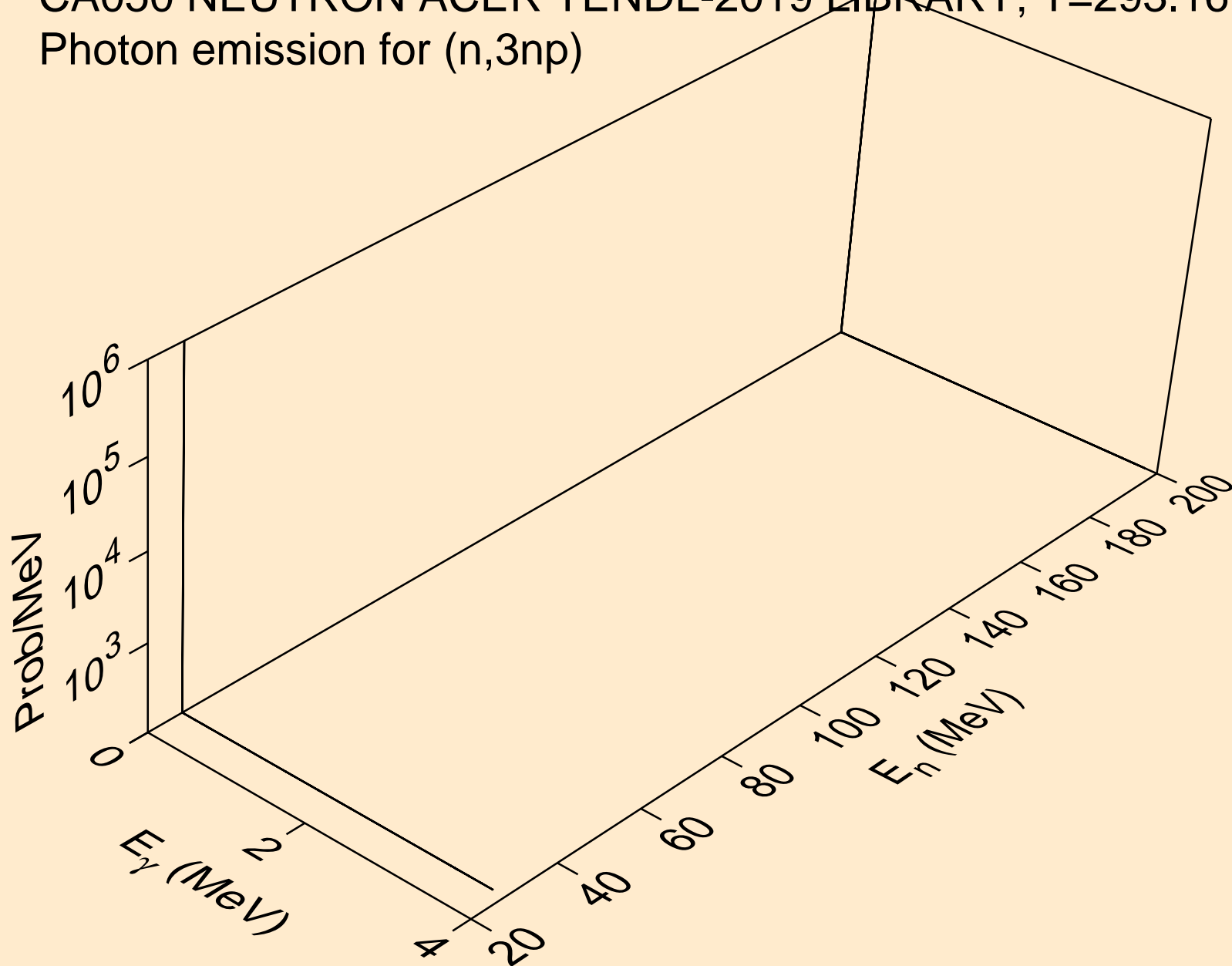

CA050 NEUTRON ACER TENDL-2019 LIBRARY; T=293.16K
Photon emission for (n,n*c)

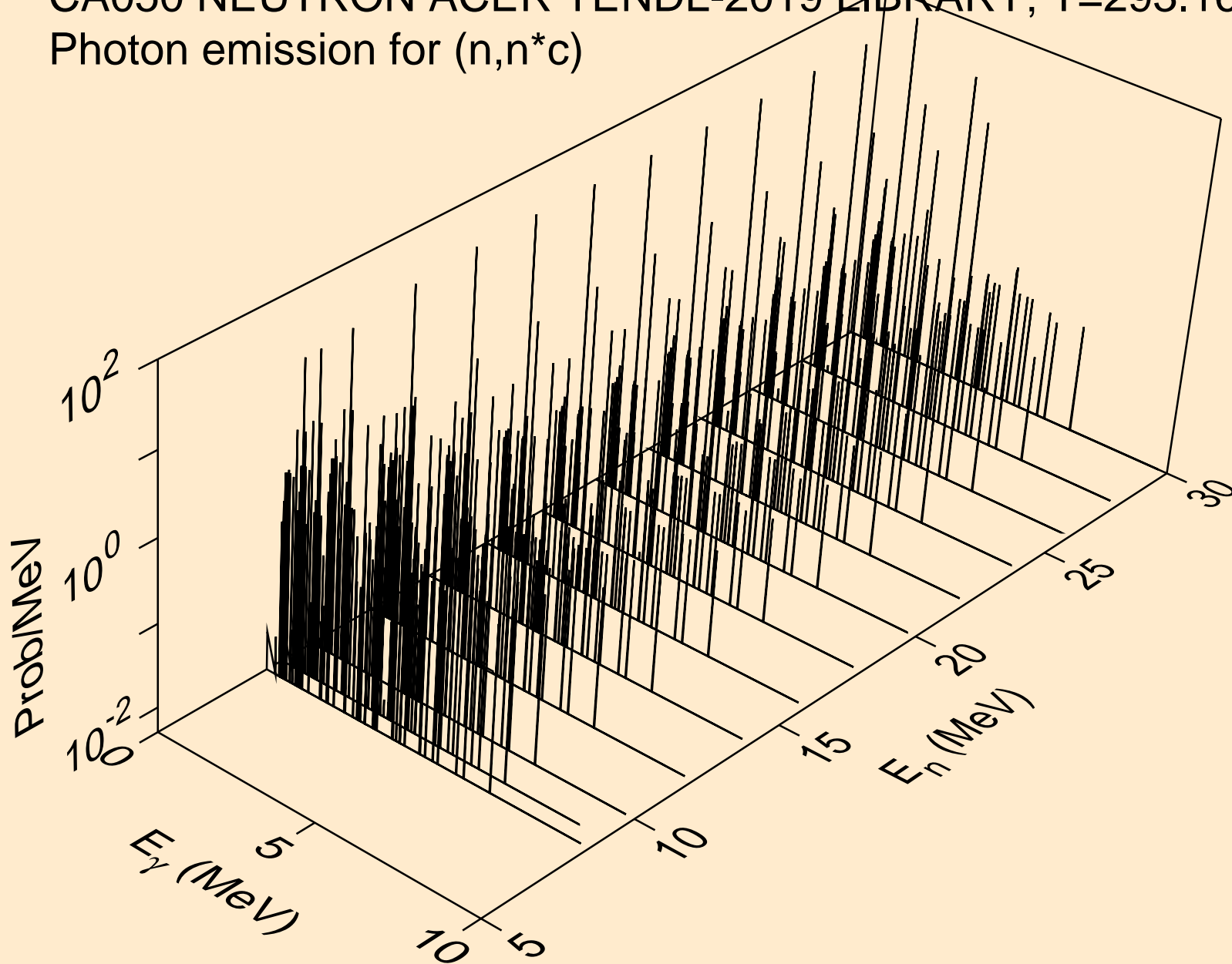

CA050 NEUTRON ACER TENDL-2019 LIBRARY; T=293.16K
Photon emission for (n,gma)

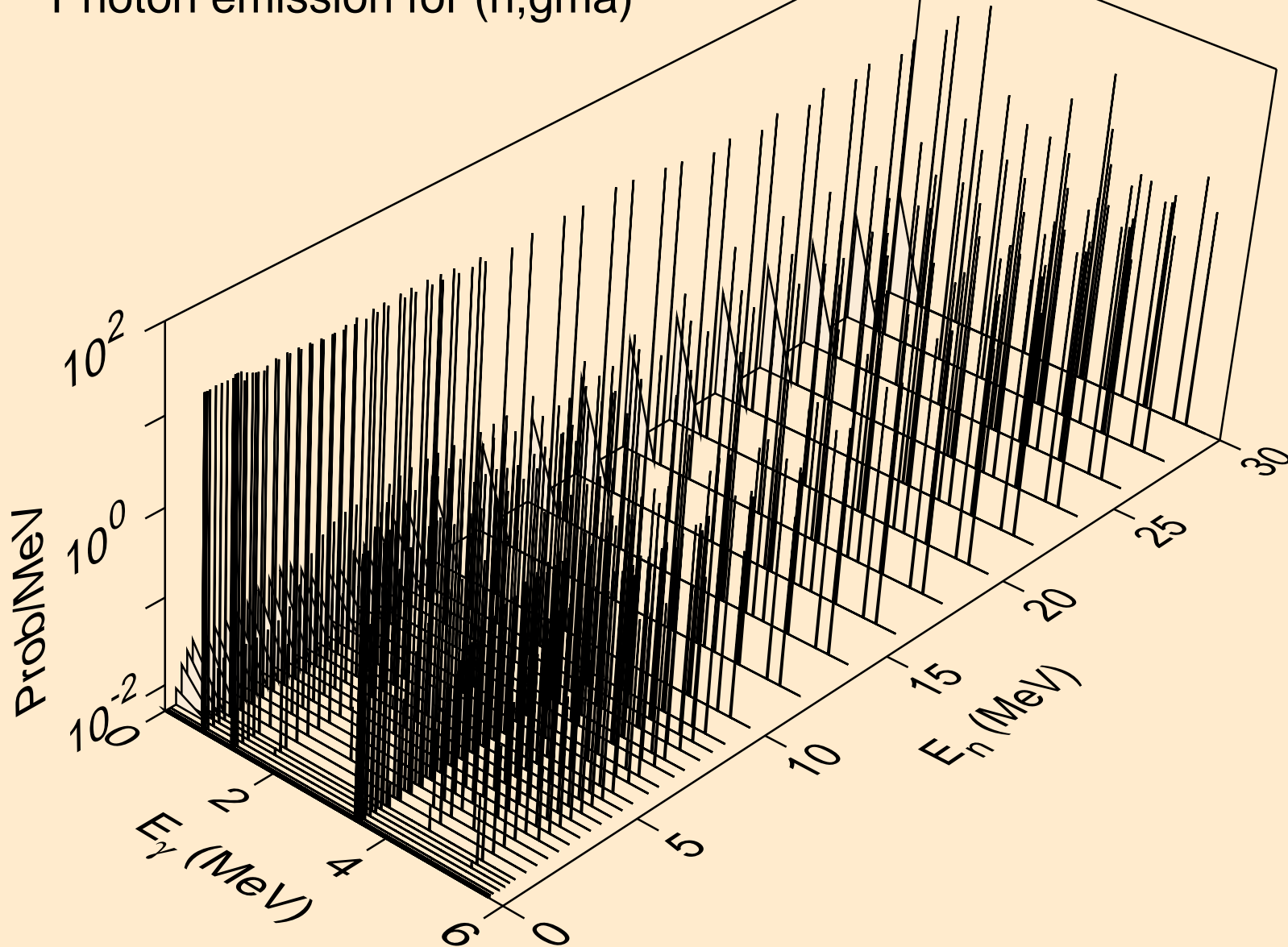

CA050 NEUTRON ACER TENDL-2019 LIBRARY; T=293.16K
Photon emission for (n,p)

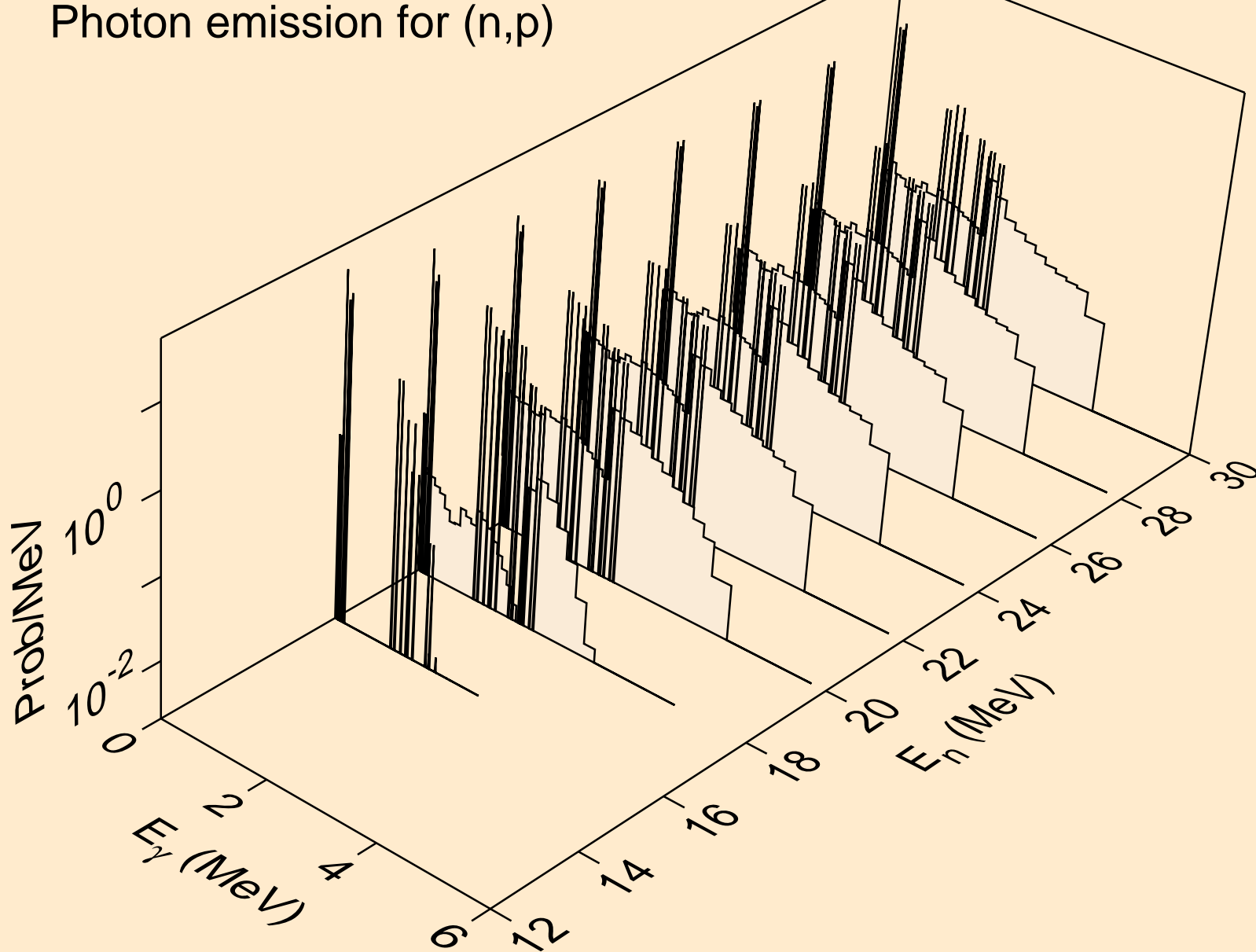

CA050 NEUTRON ACER TENDL-2019 LIBRARY; T=293.16K
Photon emission for (n,d)

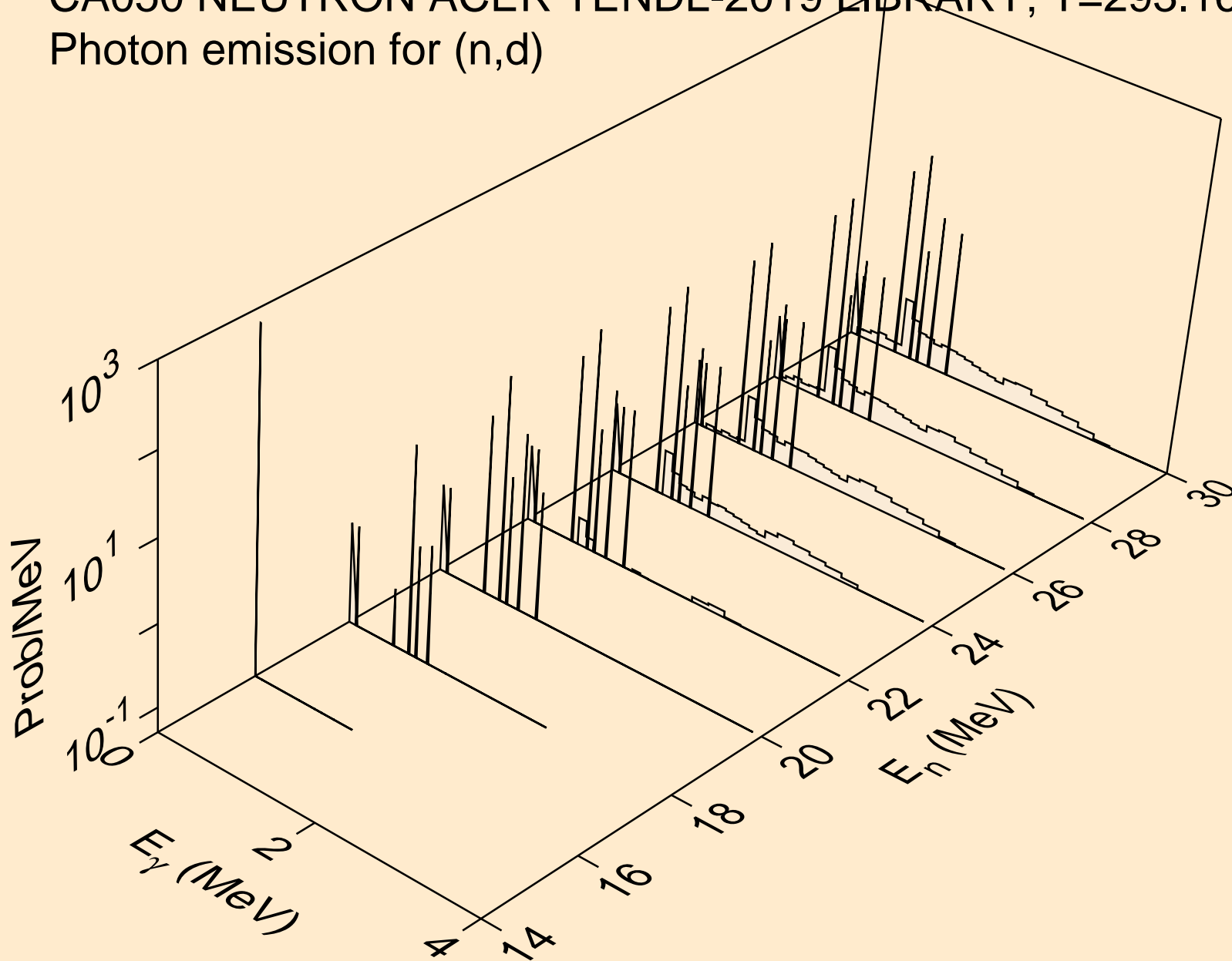

CA050 NEUTRON ACER TENDL-2019 LIBRARY; T=293.16K
Photon emission for (n,t)

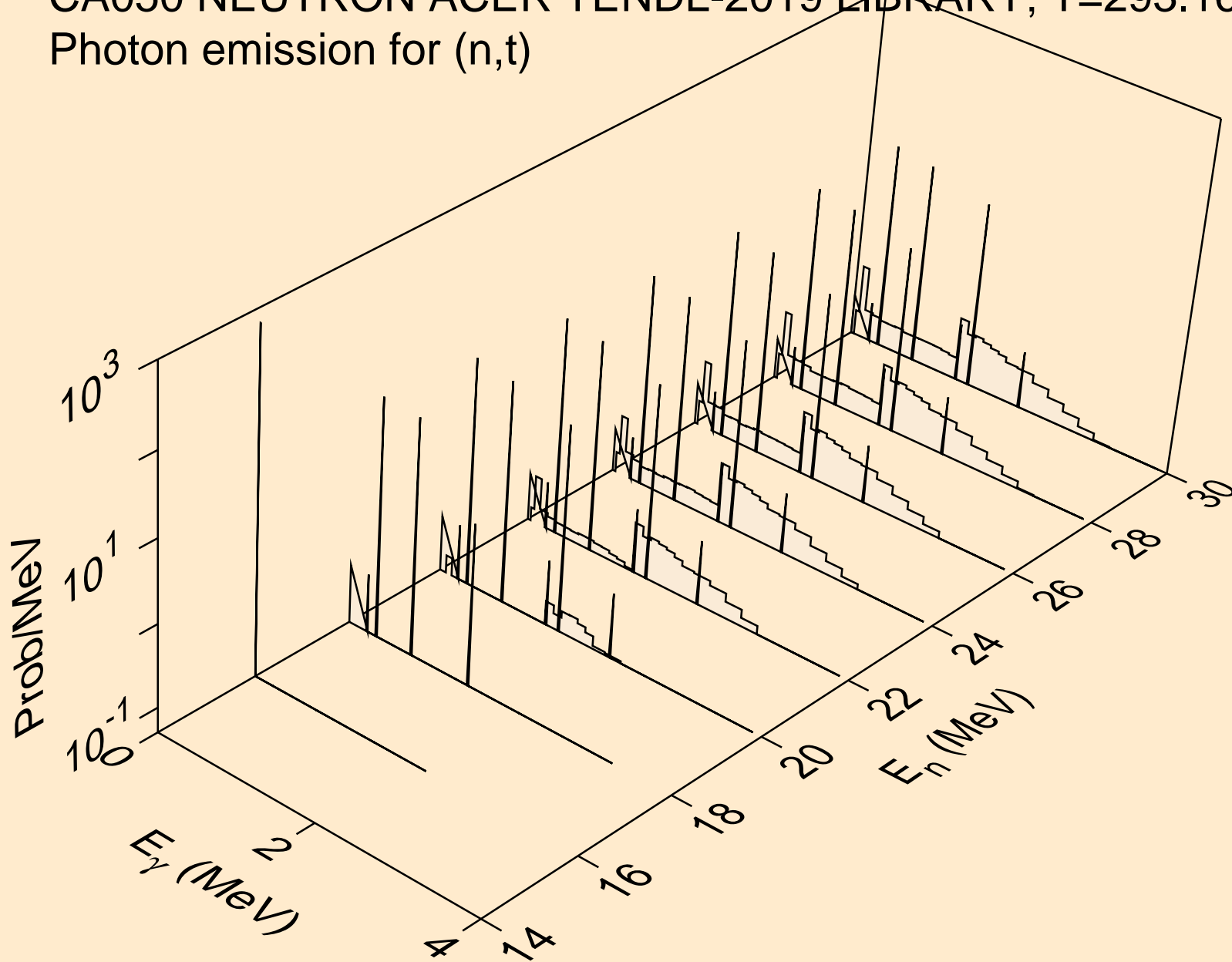

CA050 NEUTRON ACER TENDL-2019 LIBRARY; T=293.16K
Photon emission for (n,he3)

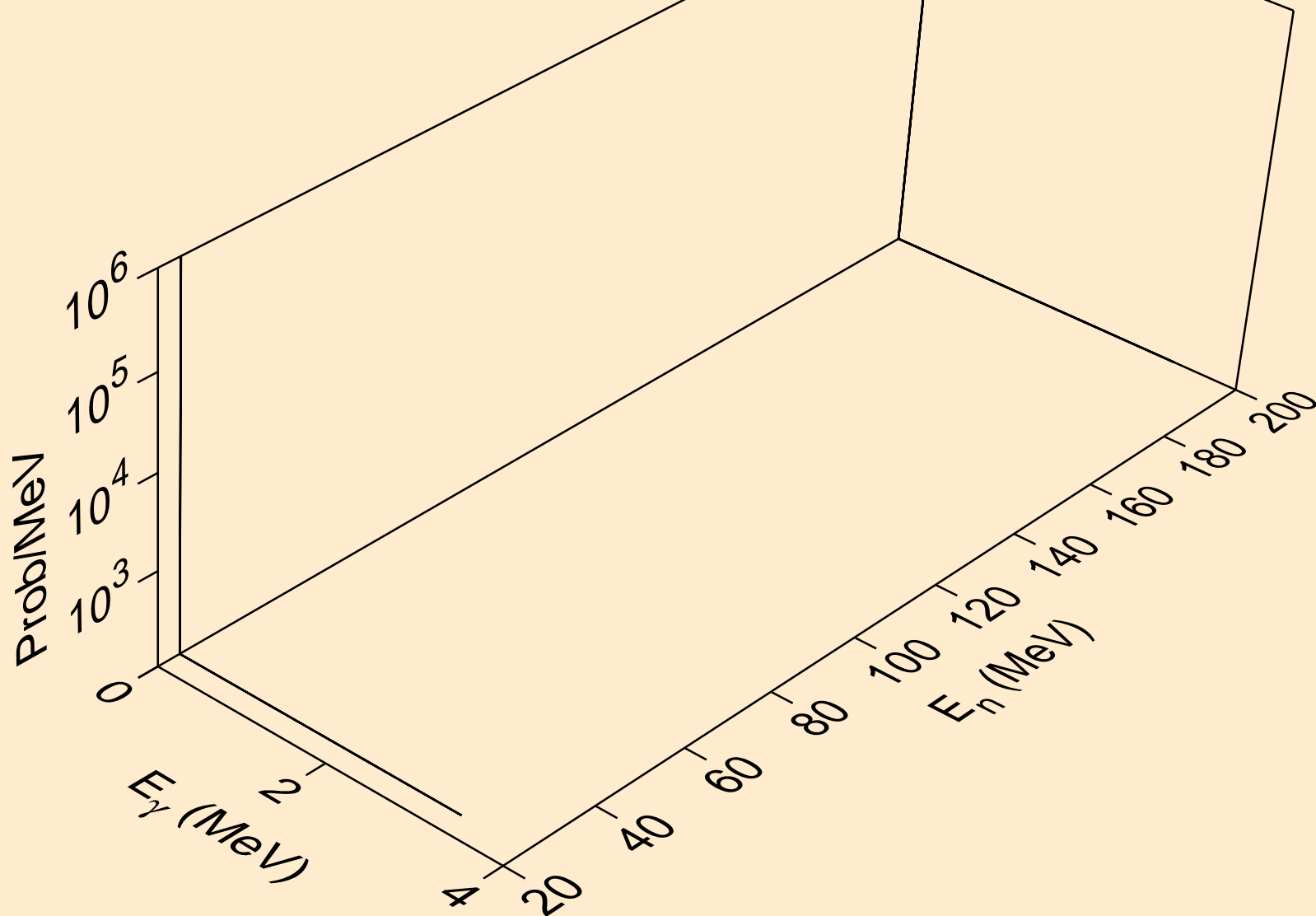

CA050 NEUTRON ACER TENDL-2019 LIBRARY; T=293.16K
Photon emission for (n,a)

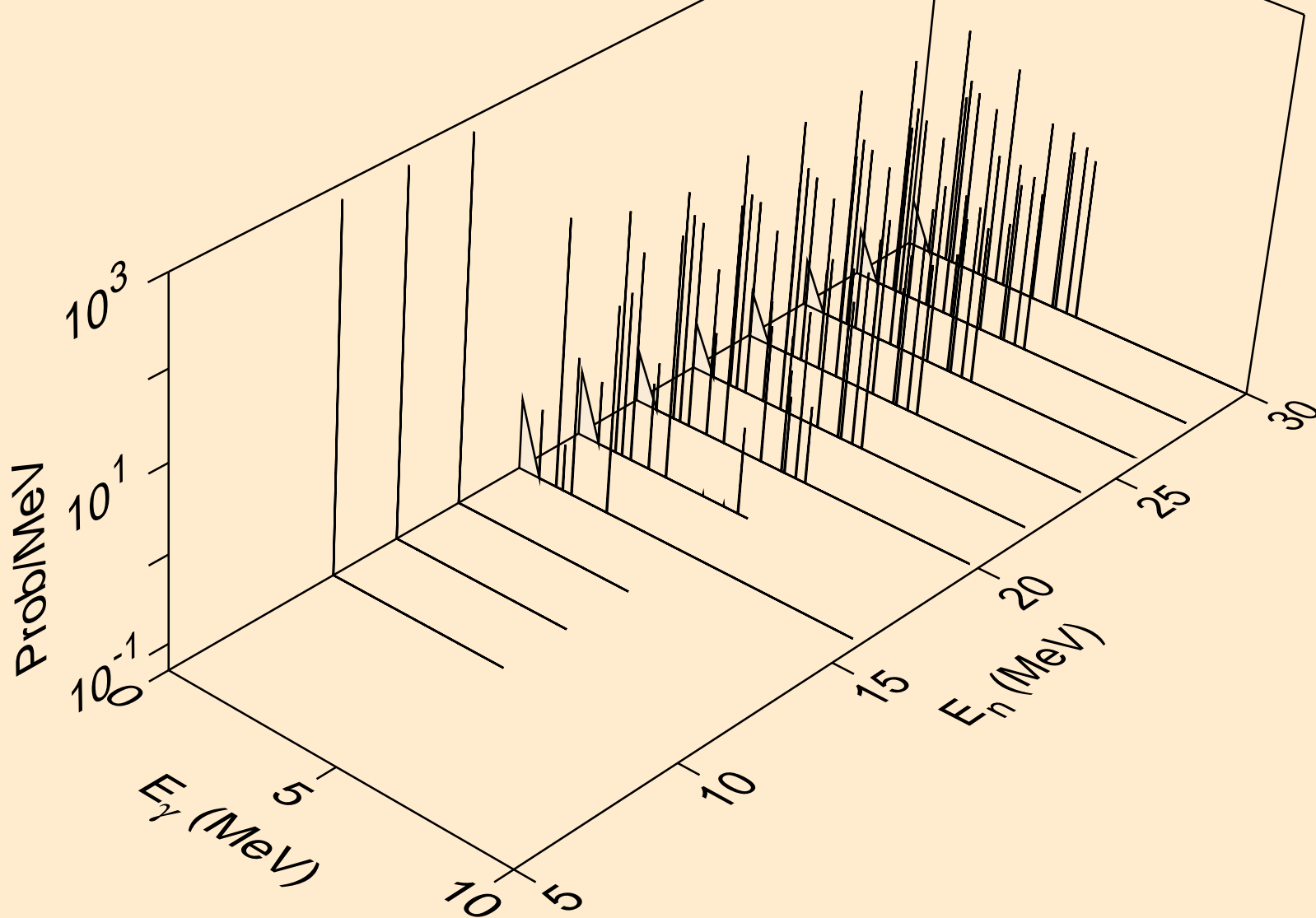

CA050 NEUTRON ACER TENDL-2019 LIBRARY; T=293.16K
thermal capture photon spectrum

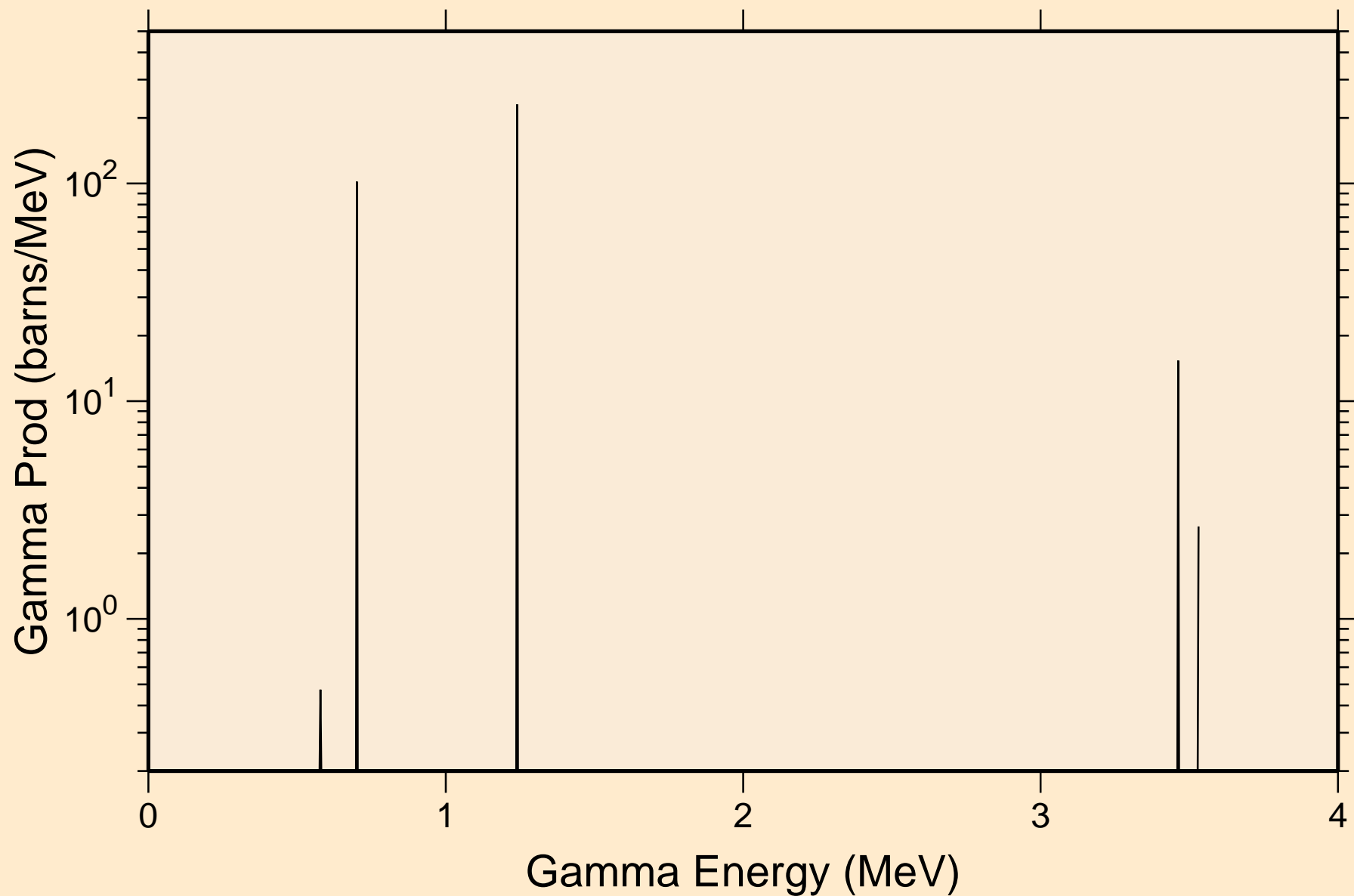

CA050 NEUTRON ACER TENDL-2019 LIBRARY; T=293.16K
14 MeV photon spectrum

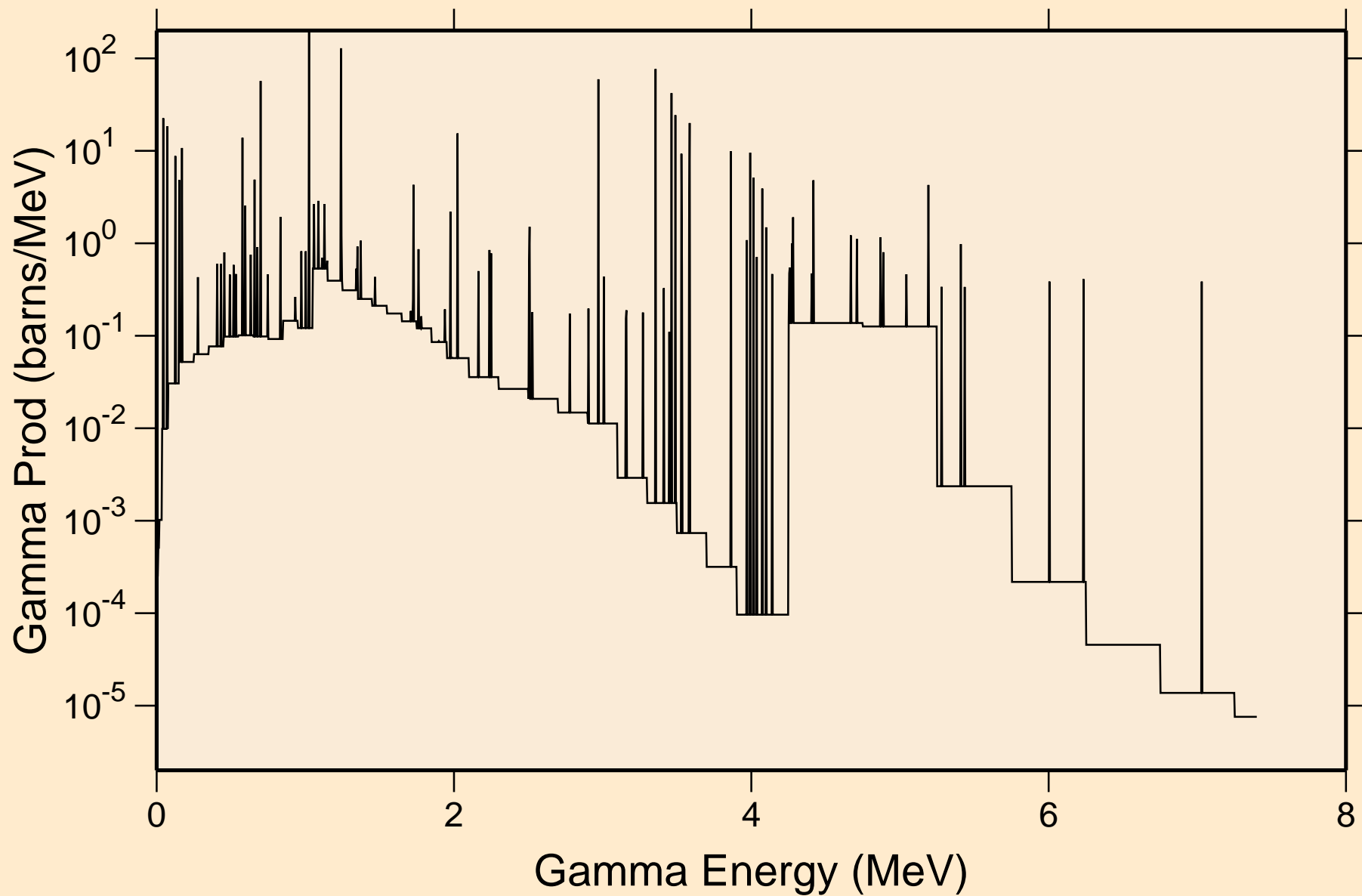

CA050 NEUTRON ACER TENDL-2019 LIBRARY; T=293.16K

Particle heating contributions

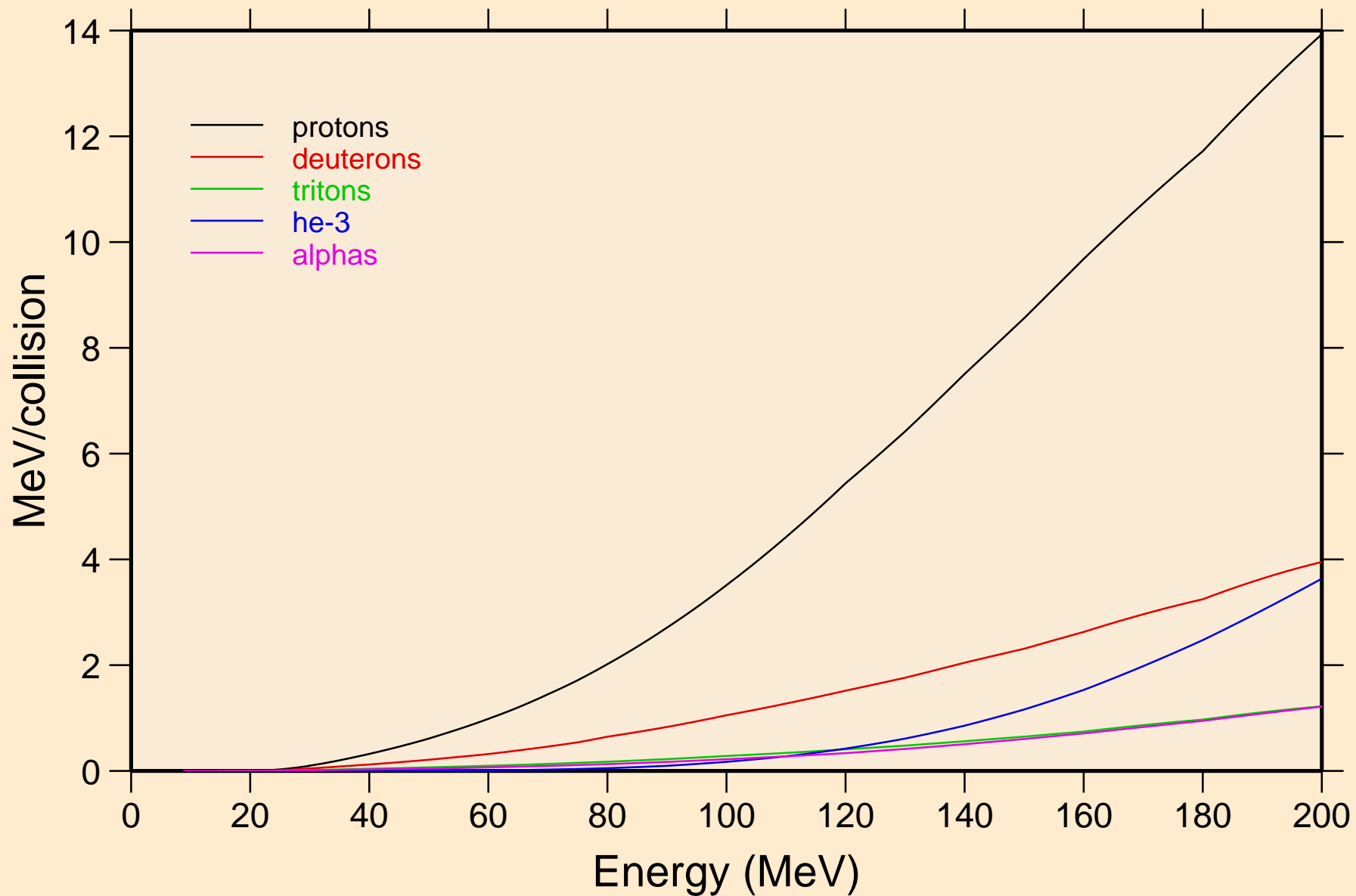

CA050 NEUTRON ACER TENDL-2019 LIBRARY; T=293.16K
Recoil Heating

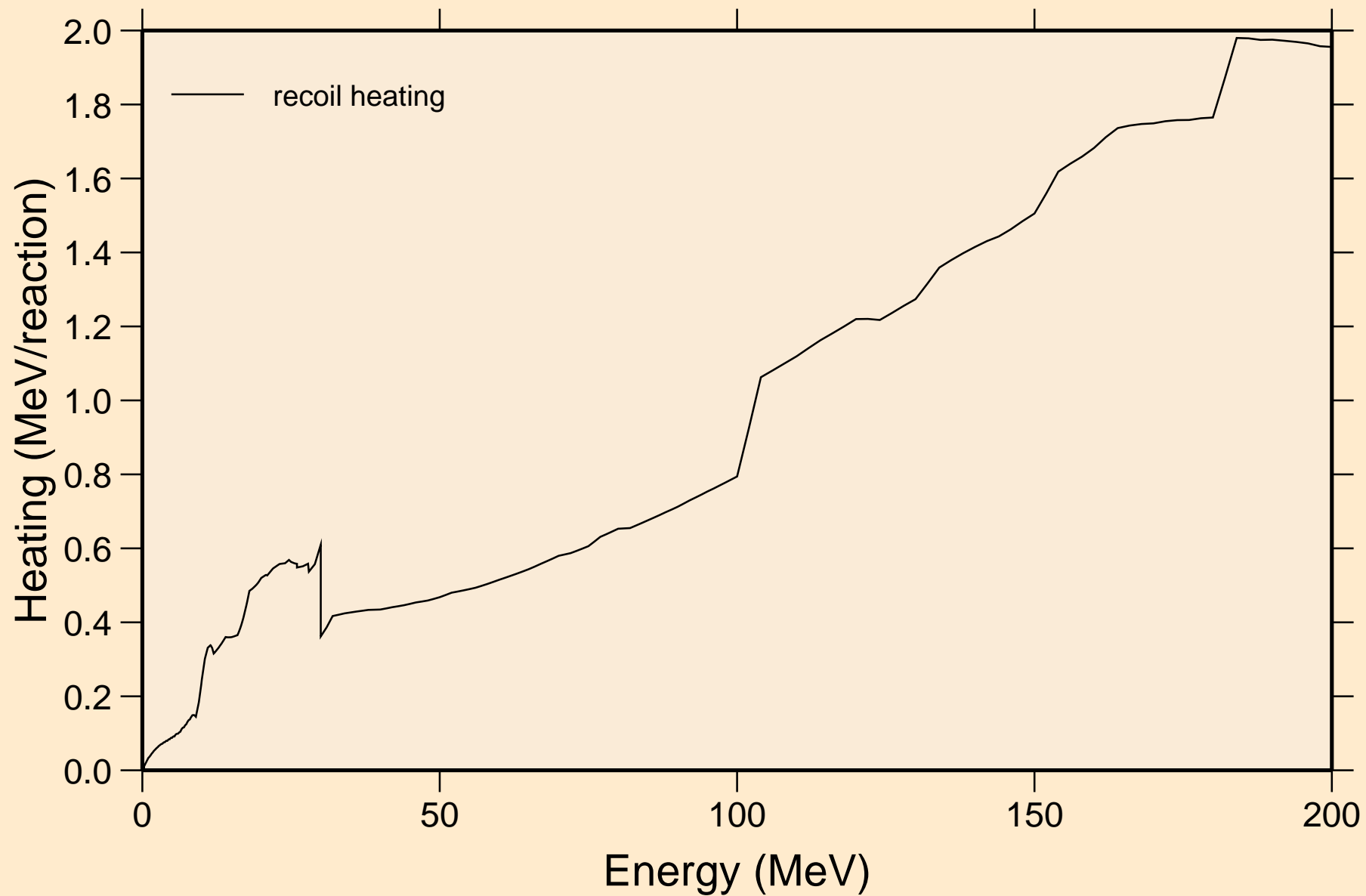

CA050 NEUTRON ACER TENDL-2019 LIBRARY; T=293.16K
Particle production cross sections

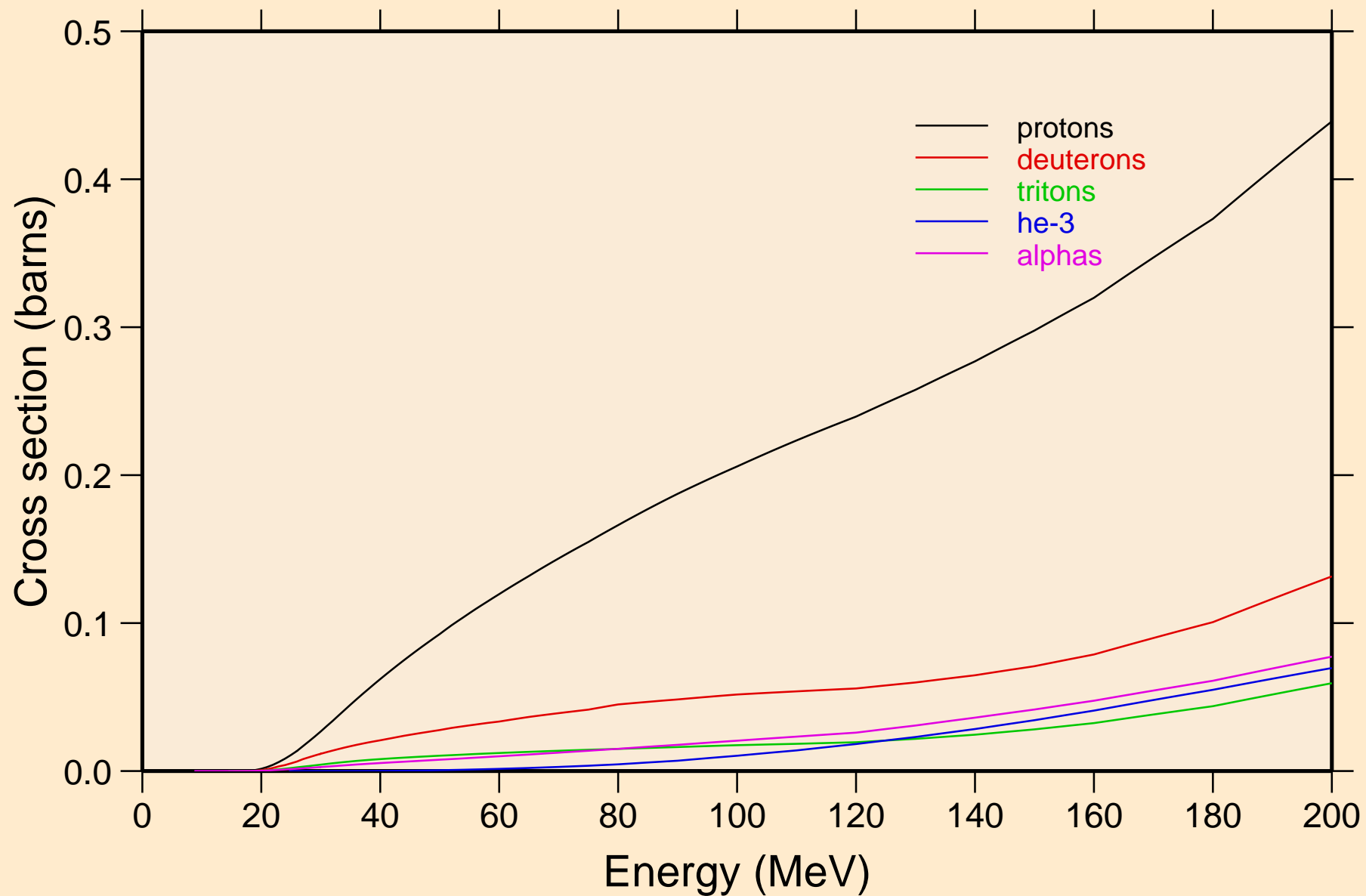

CA050 NEUTRON ACER TENDL-2019 LIBRARY; T=293.16K
protons from (n,x)

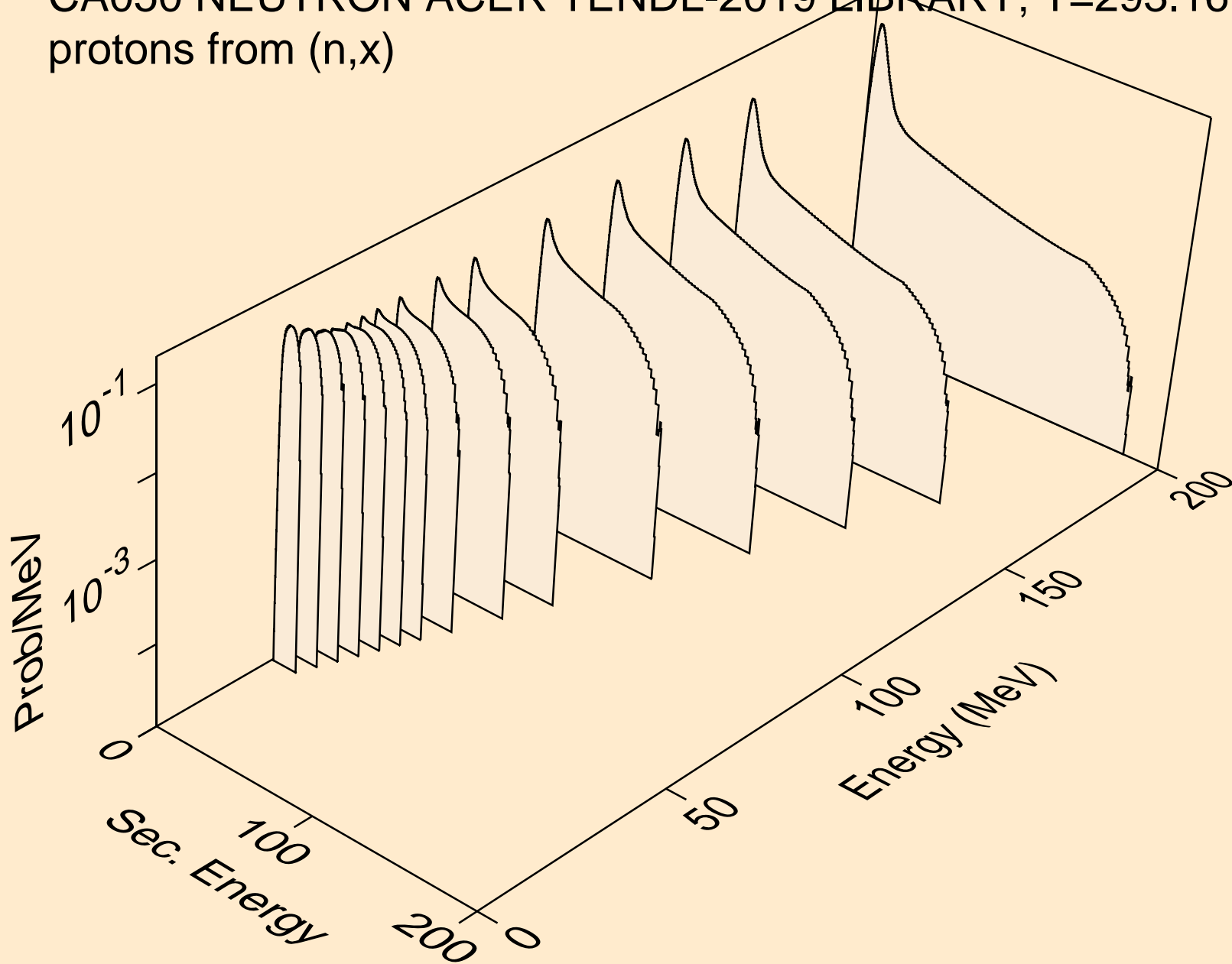

CA050 NEUTRON ACER TENDL-2019 LIBRARY; T=293.16K
protons from (n,n*)p

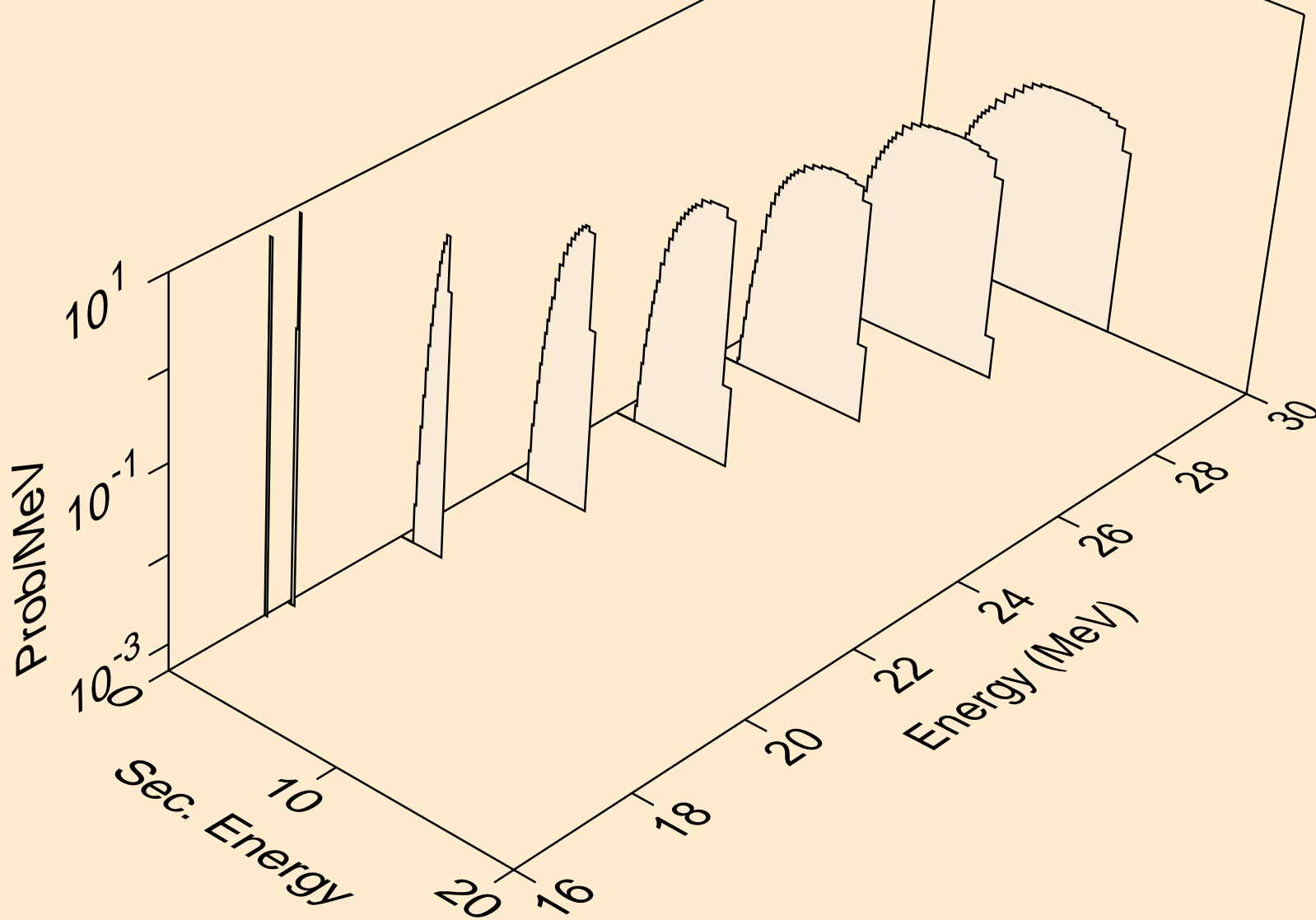

CA050 NEUTRON ACER TENDL-2019 LIBRARY; T=293.16K
protons from (n,2np)

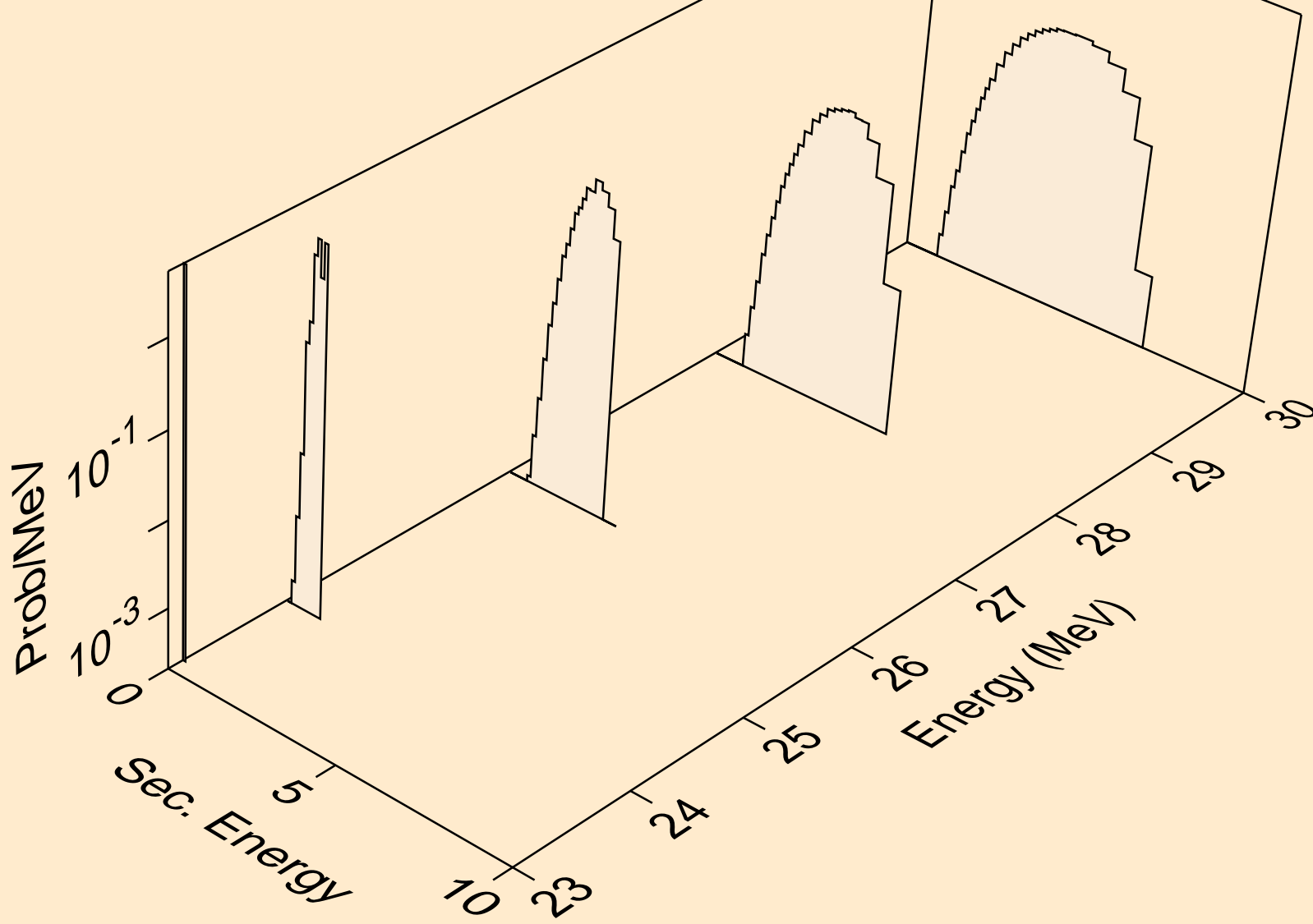

CA050 NEUTRON ACER TENDL-2019 LIBRARY; T=293.16K
protons from (n,3np)

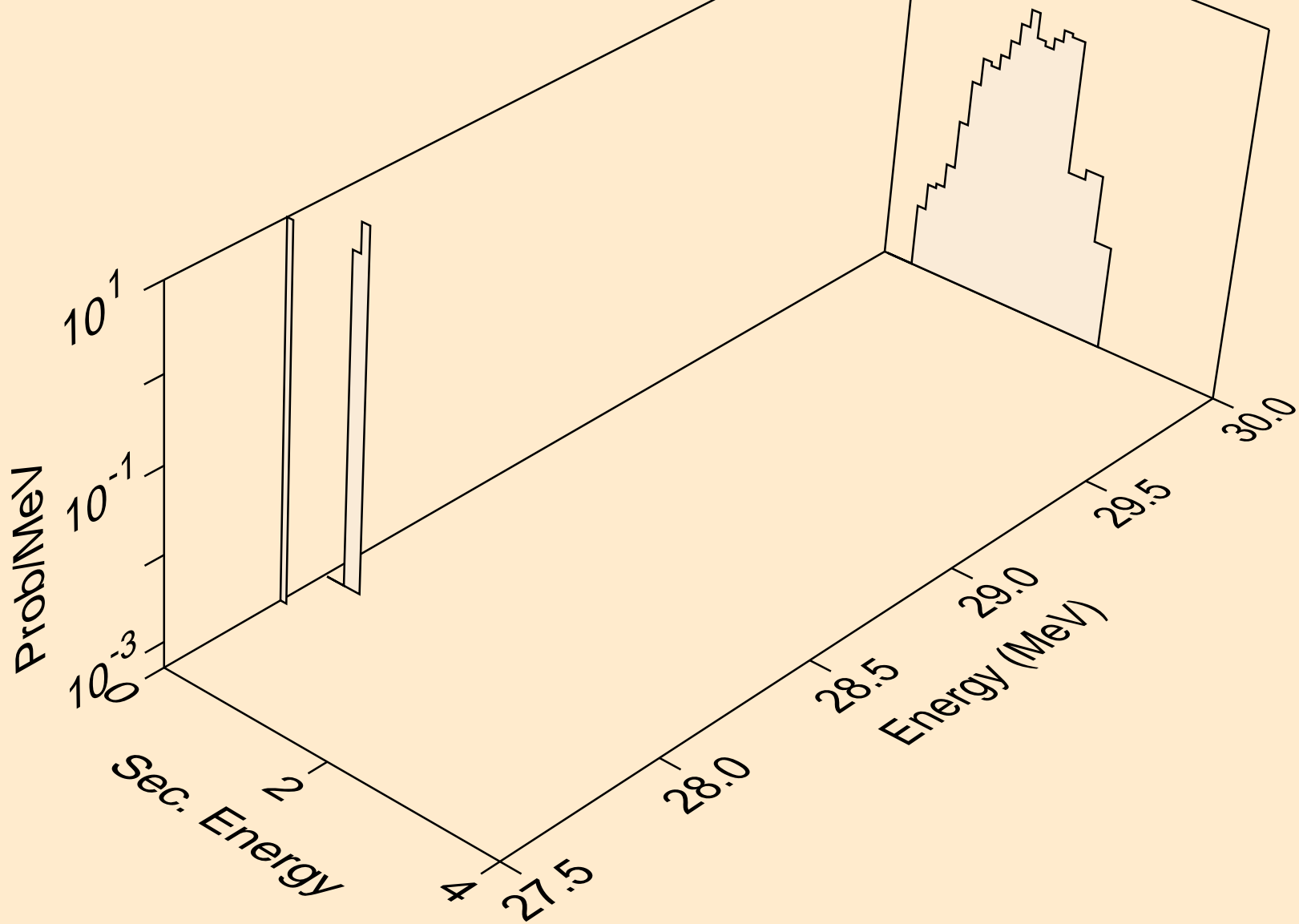

CA050 NEUTRON ACER TENDL-2019 LIBRARY; T=293.16K
protons from (n,p)

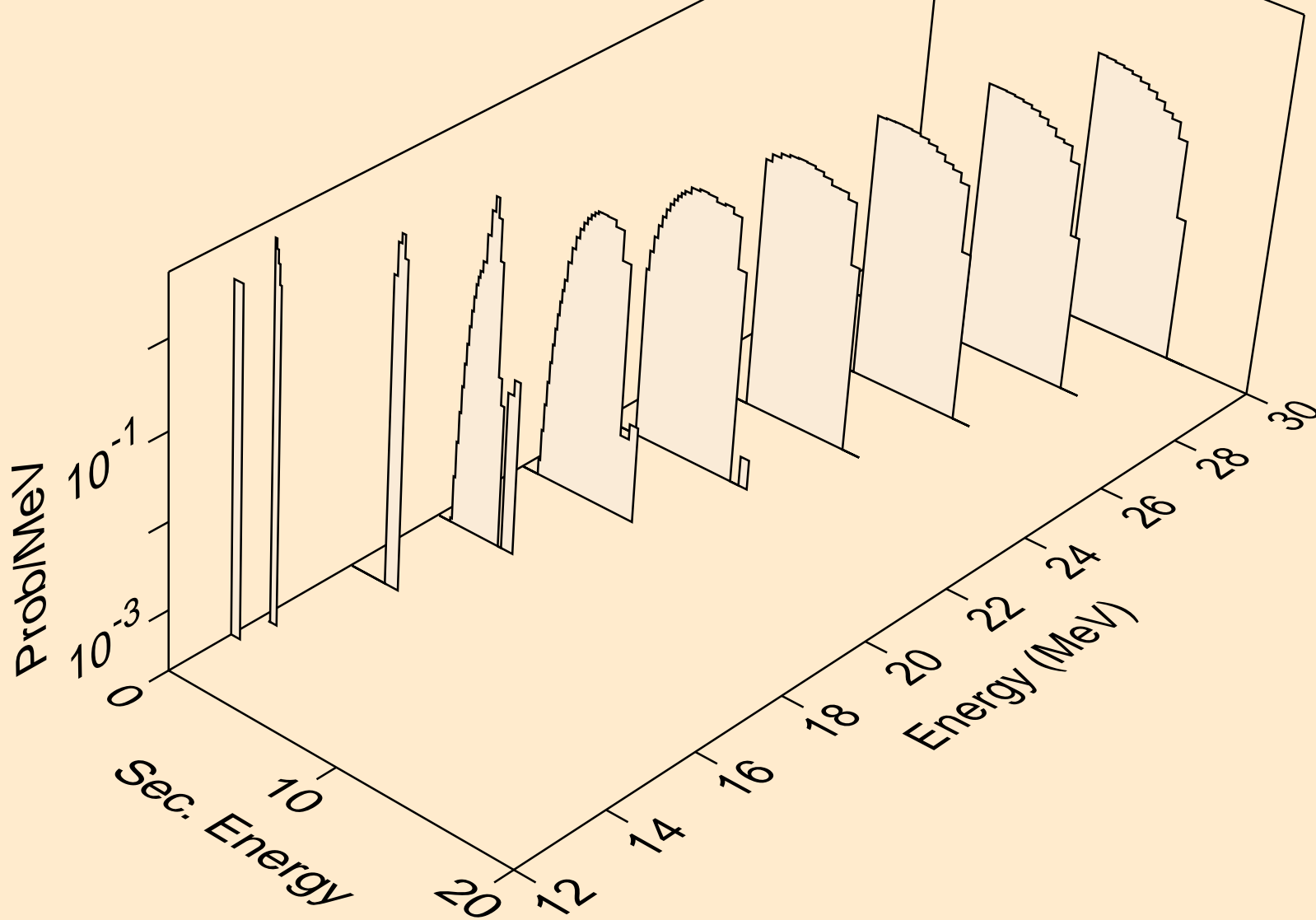

CA050 NEUTRON ACER TENDL-2019 LIBRARY; T=293.16K
deuterons from (n,x)

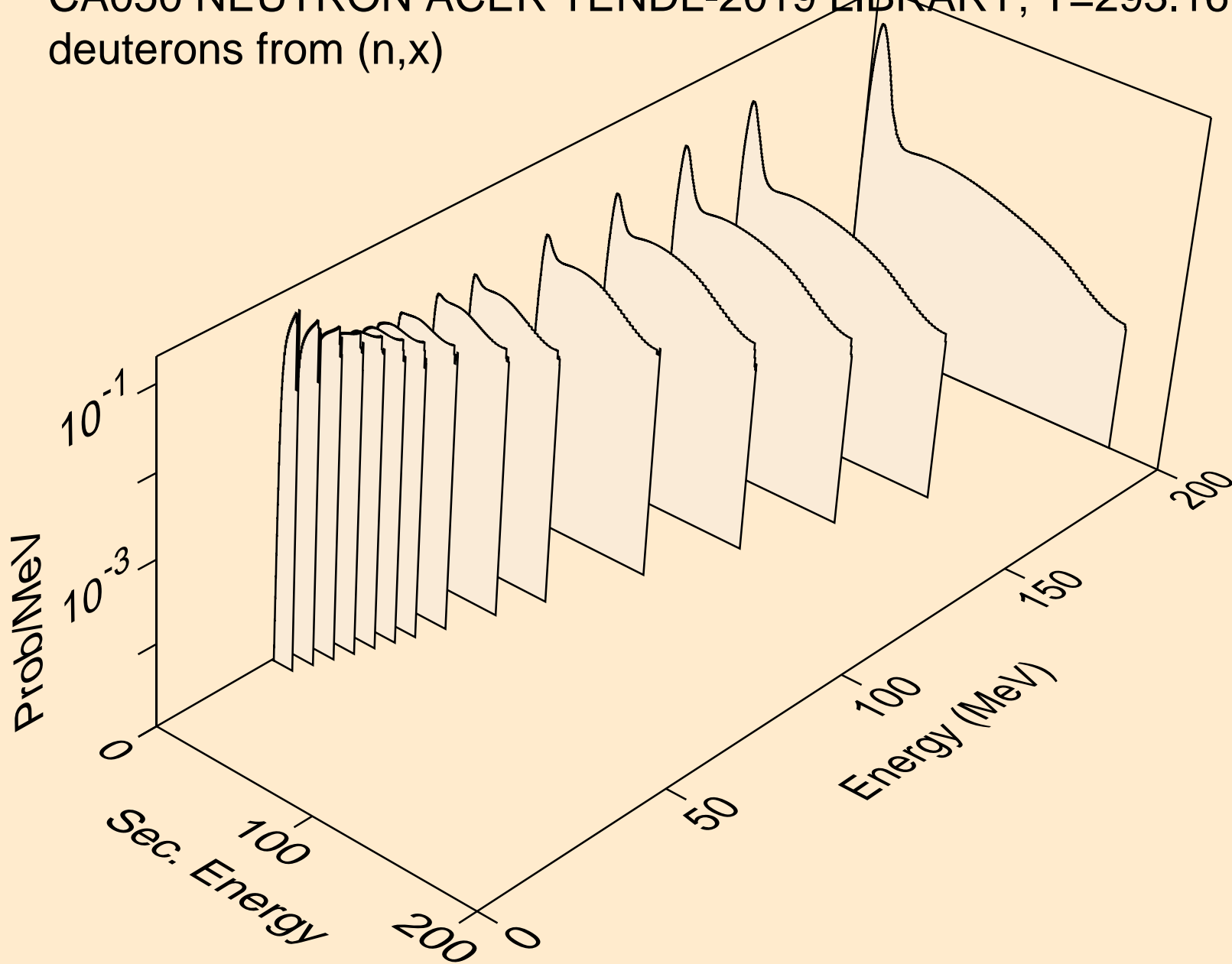

CA050 NEUTRON ACER TENDL-2019 LIBRARY; T=293.16K
deuterons from (n,2nd)

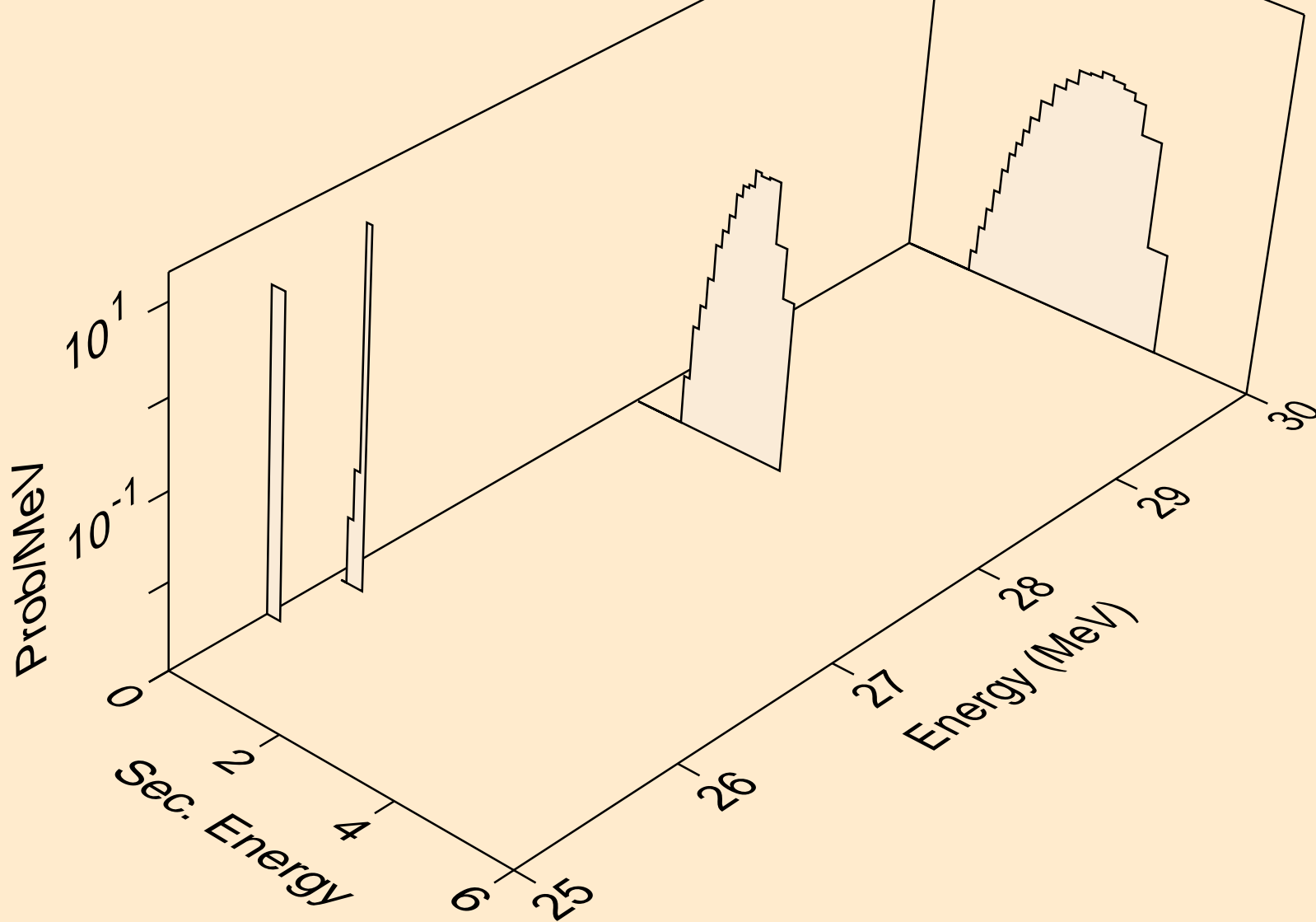

CA050 NEUTRON ACER TENDL-2019 LIBRARY; T=293.16K
deuterons from (n,n*)d

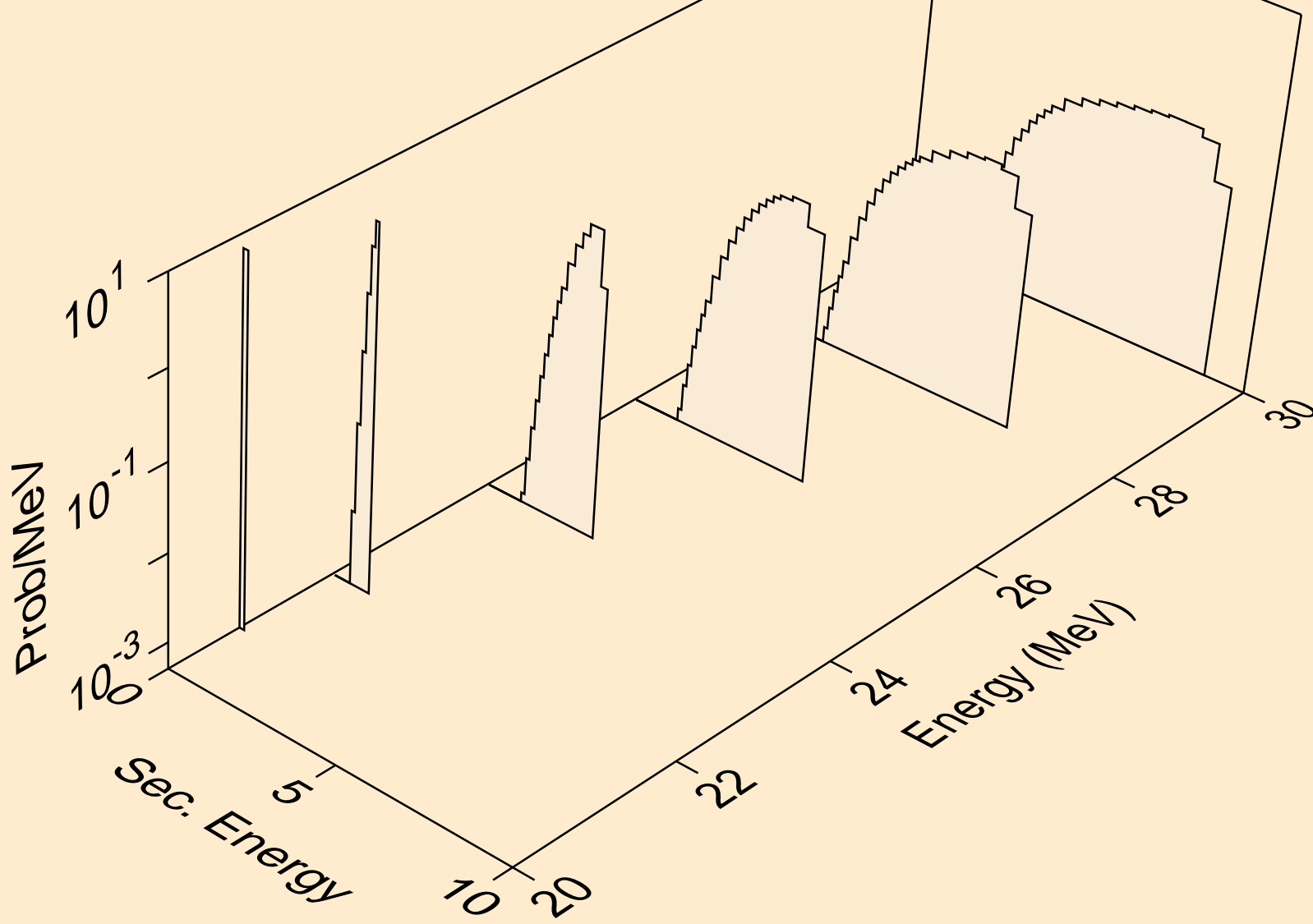

CA050 NEUTRON ACER TENDL-2019 LIBRARY; T=293.16K
deuterons from (n,d)

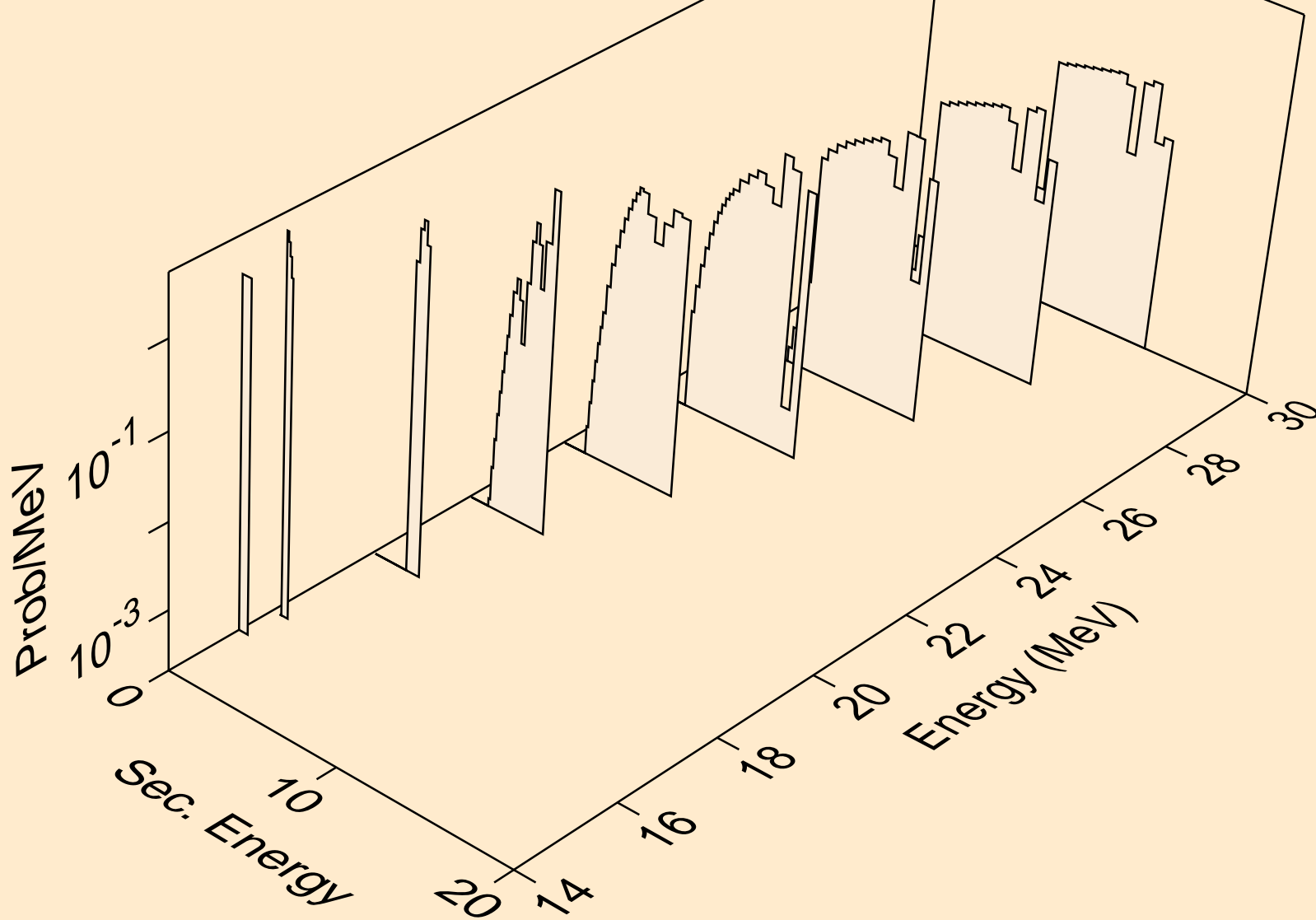

CA050 NEUTRON ACER TENDL-2019 LIBRARY; T=293.16K
tritons from (n,x)

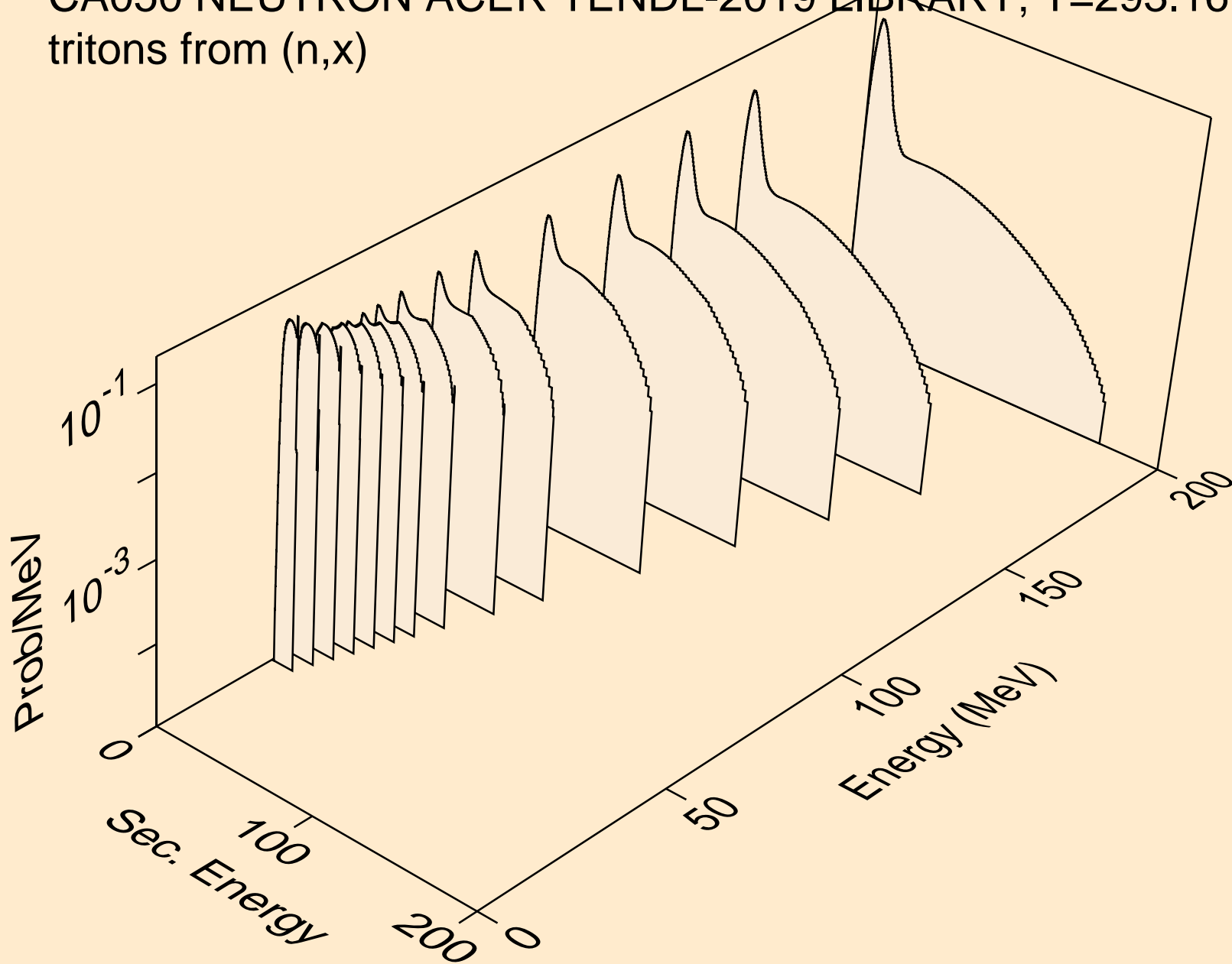

CA050 NEUTRON ACER TENDL-2019 LIBRARY; T=293.16K
tritons from (n,n*)t

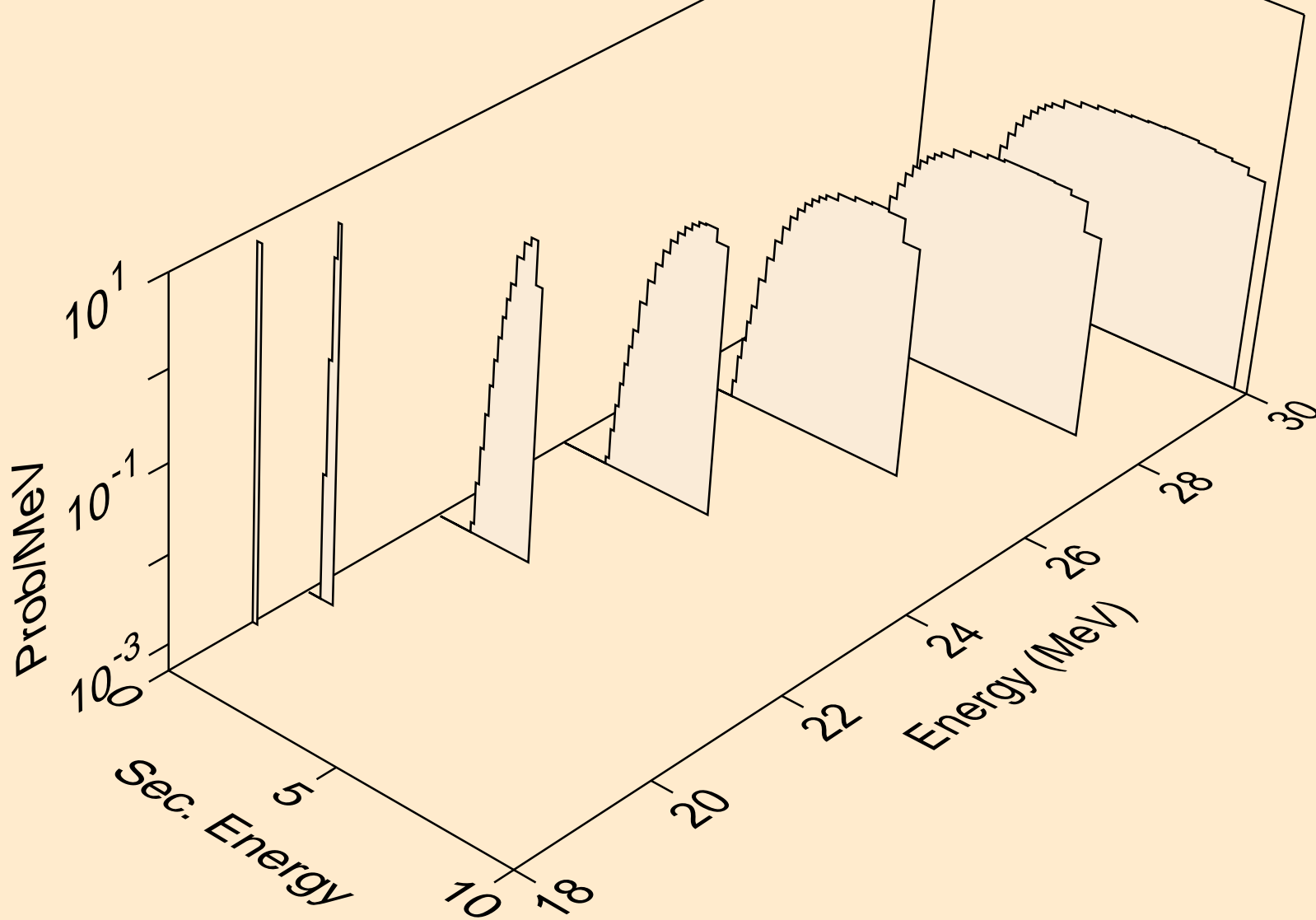

CA050 NEUTRON ACER TENDL-2019 LIBRARY; T=293.16K
tritons from (n,t)

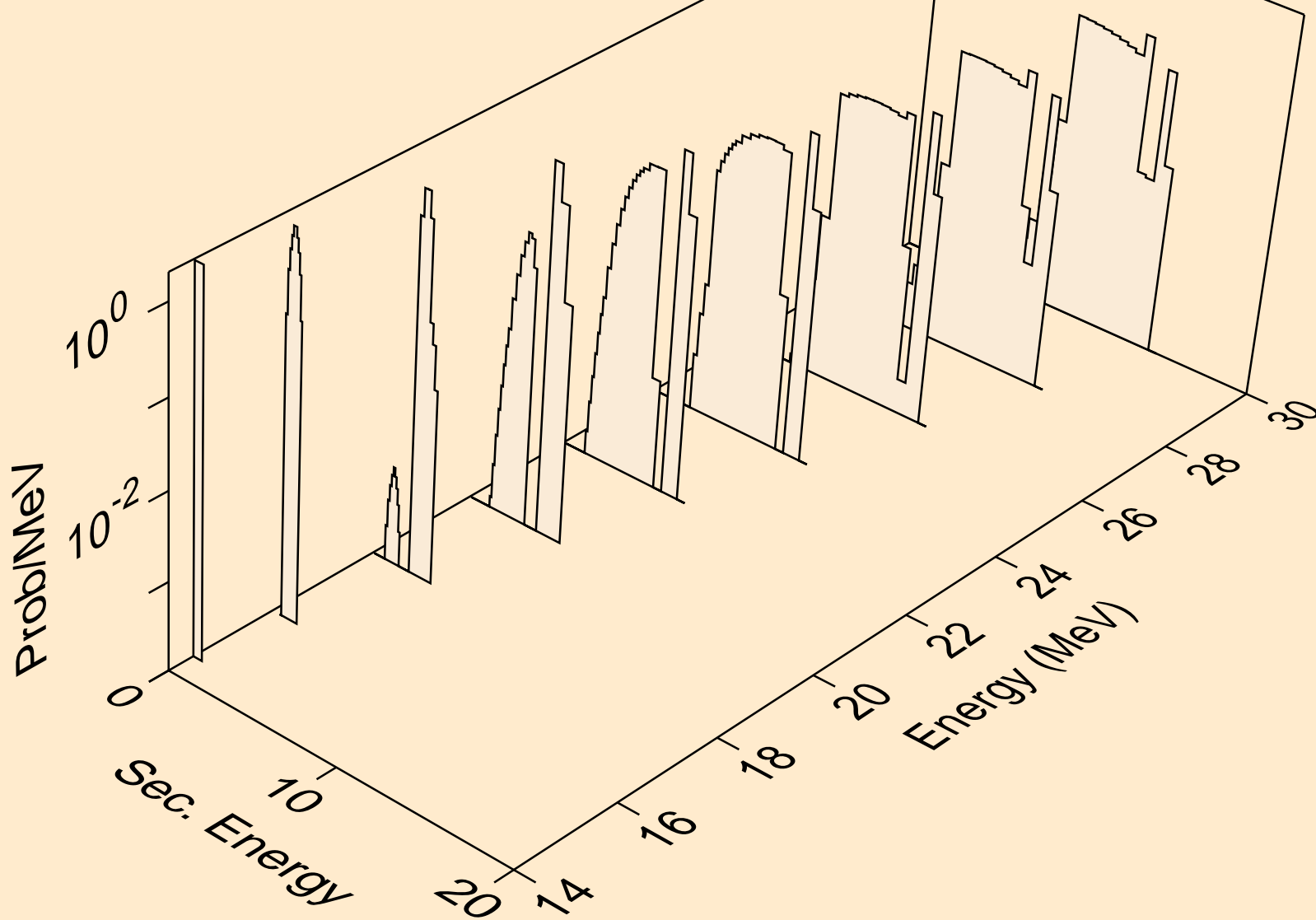

CA050 NEUTRON ACER TENDL-2019 LIBRARY; T=293.16K
he3s from (n,x)

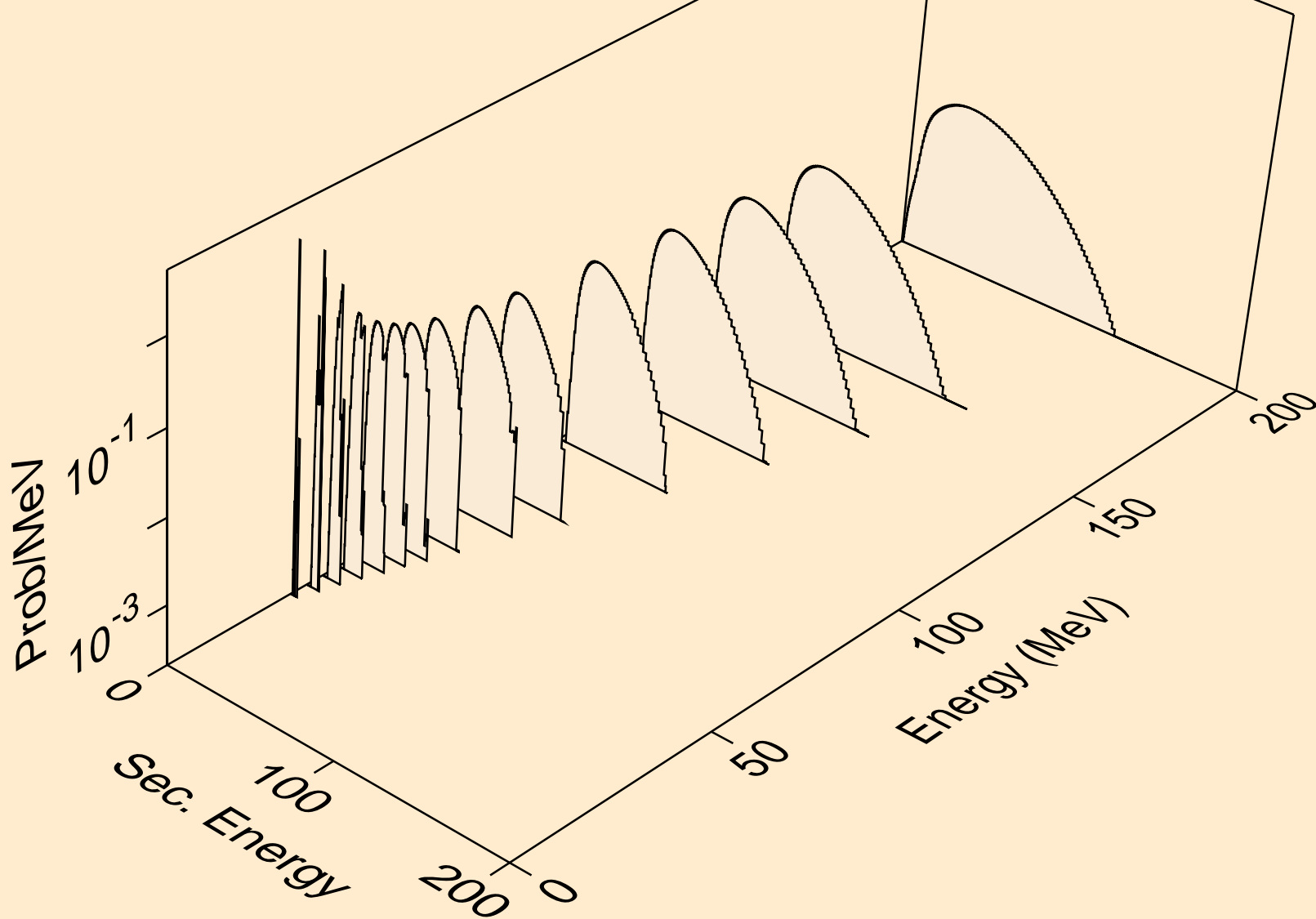

CA050 NEUTRON ACER TENDL-2019 LIBRARY; T=293.16K
he3s from (n,he3)

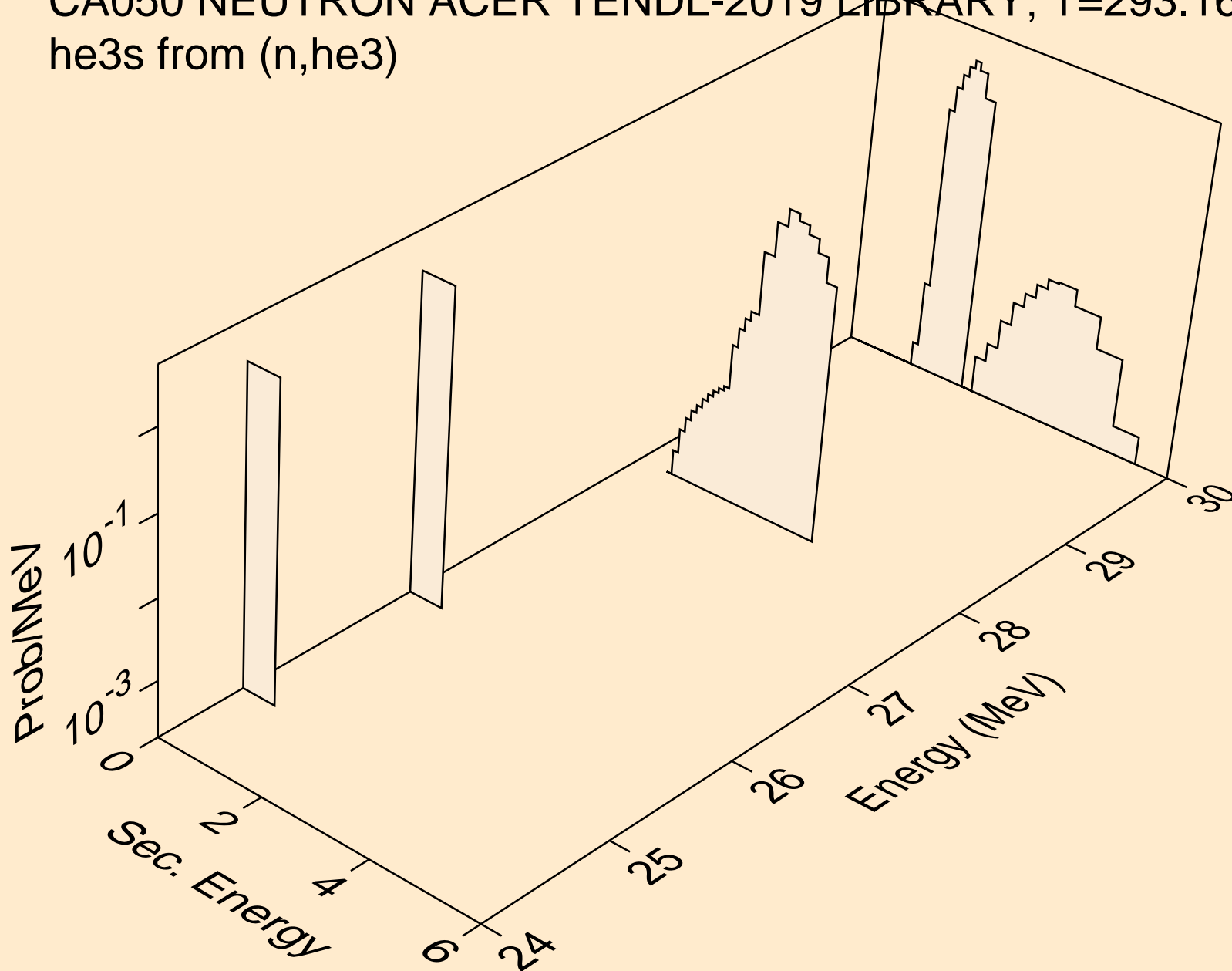

CA050 NEUTRON ACER TENDL-2019 LIBRARY; T=293.16K
alphas from (n,x)

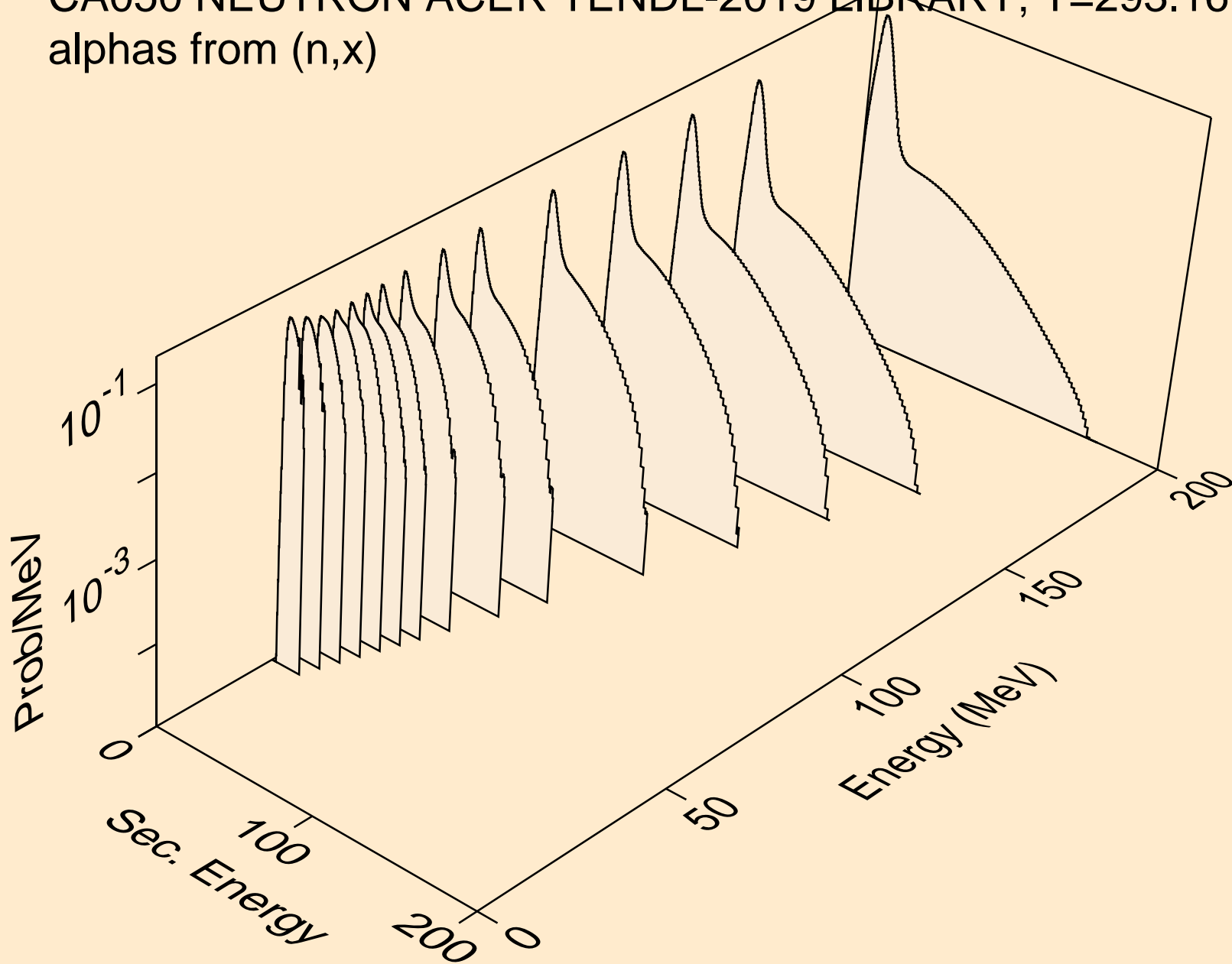

CA050 NEUTRON ACER TENDL-2019 LIBRARY; T=293.16K
alphas from (n,n*)a

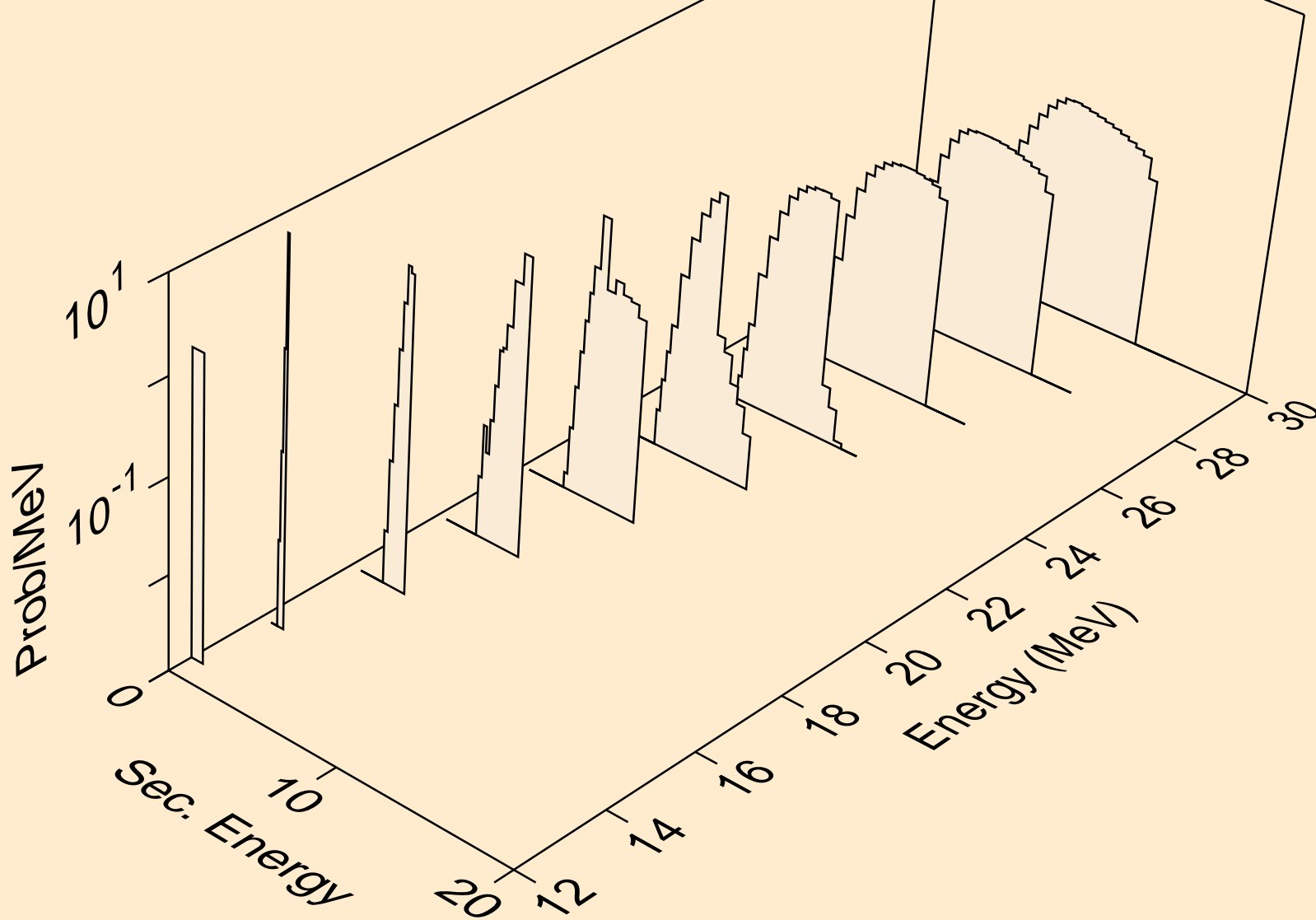

CA050 NEUTRON ACER TENDL-2019 LIBRARY; T=293.16K
alphas from (n,2n)a

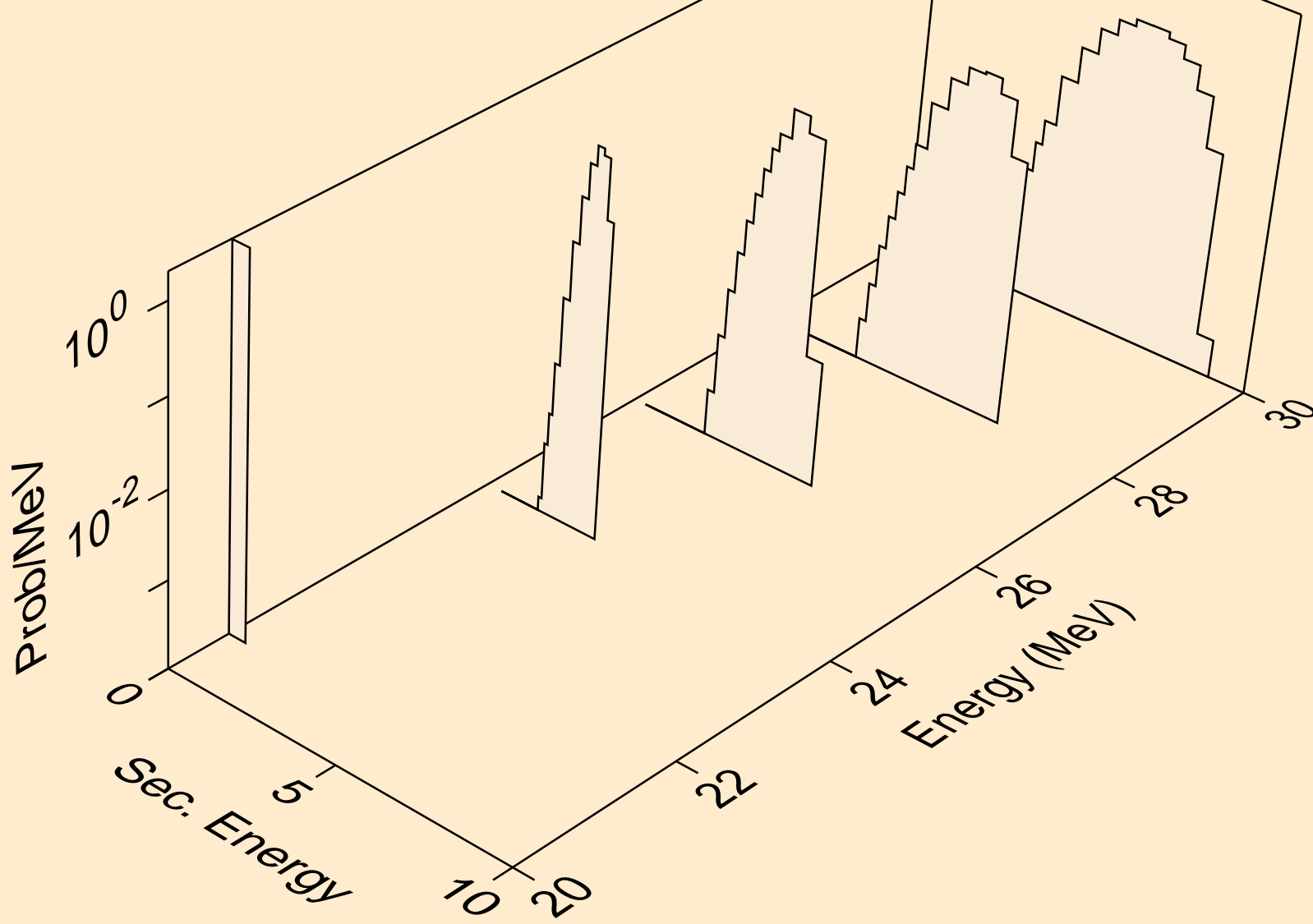

CA050 NEUTRON ACER TENDL-2019 LIBRARY; T=293.16K
alphas from (n,3n)a

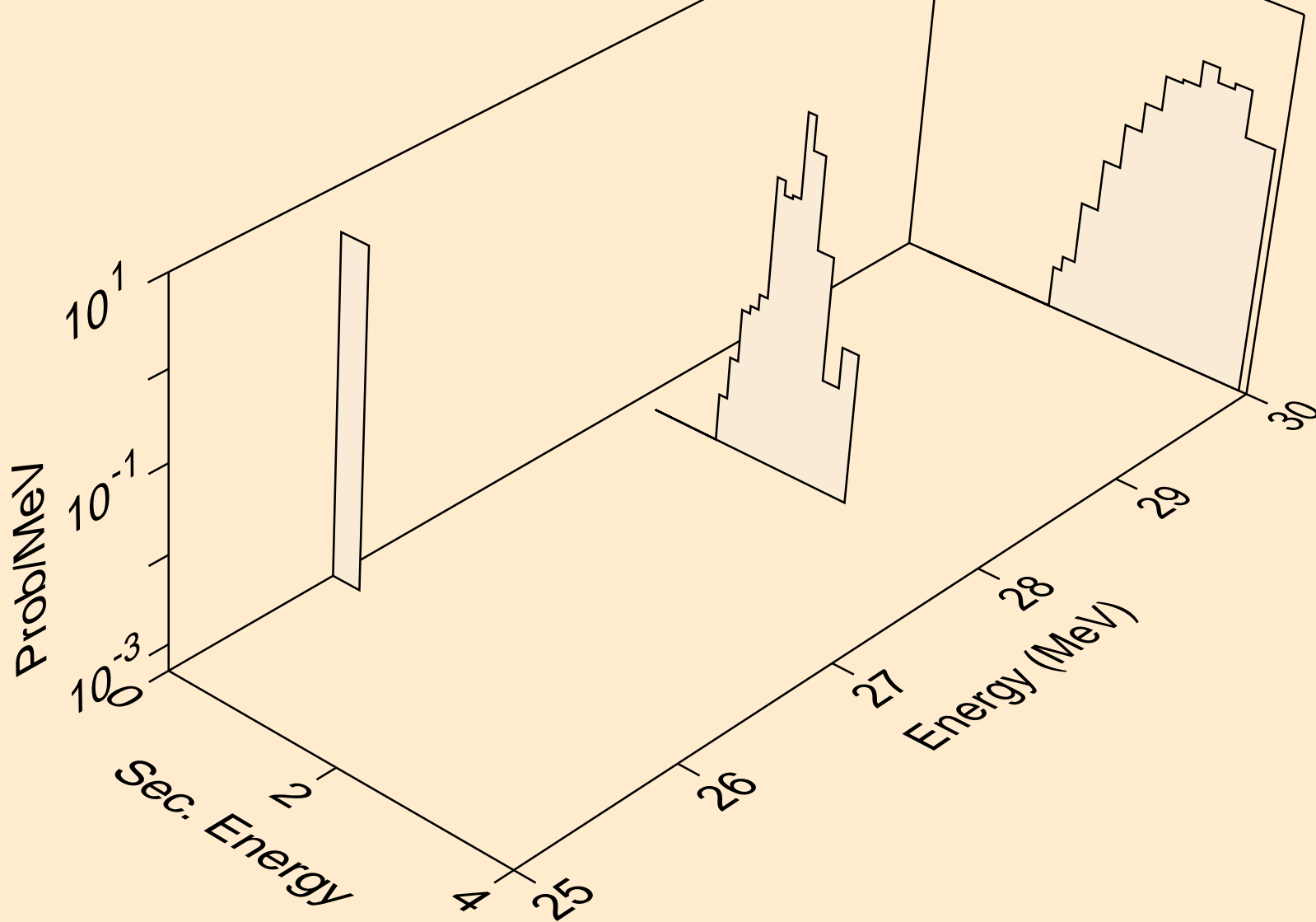

CA050 NEUTRON ACER TENDL-2019 LIBRARY; T=293.16K
alphas from (n,a)

