

# CD113 NEUTRON ACER TENDL-2019 LIBRARY; T=293.16K

## Principal cross sections

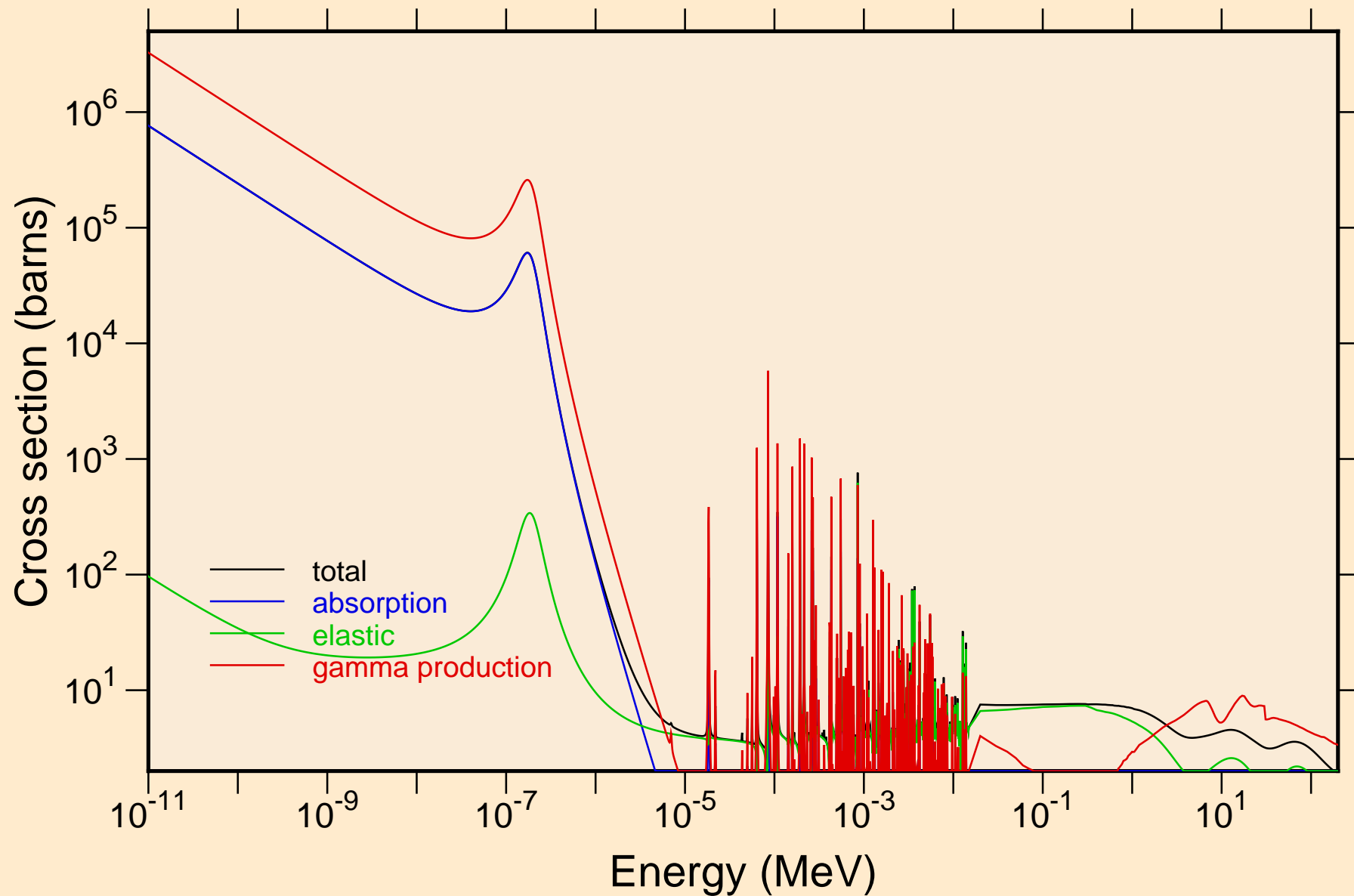

CD113 NEUTRON ACER TENDL-2019 LIBRARY; T=293.16K  
resonance total cross section

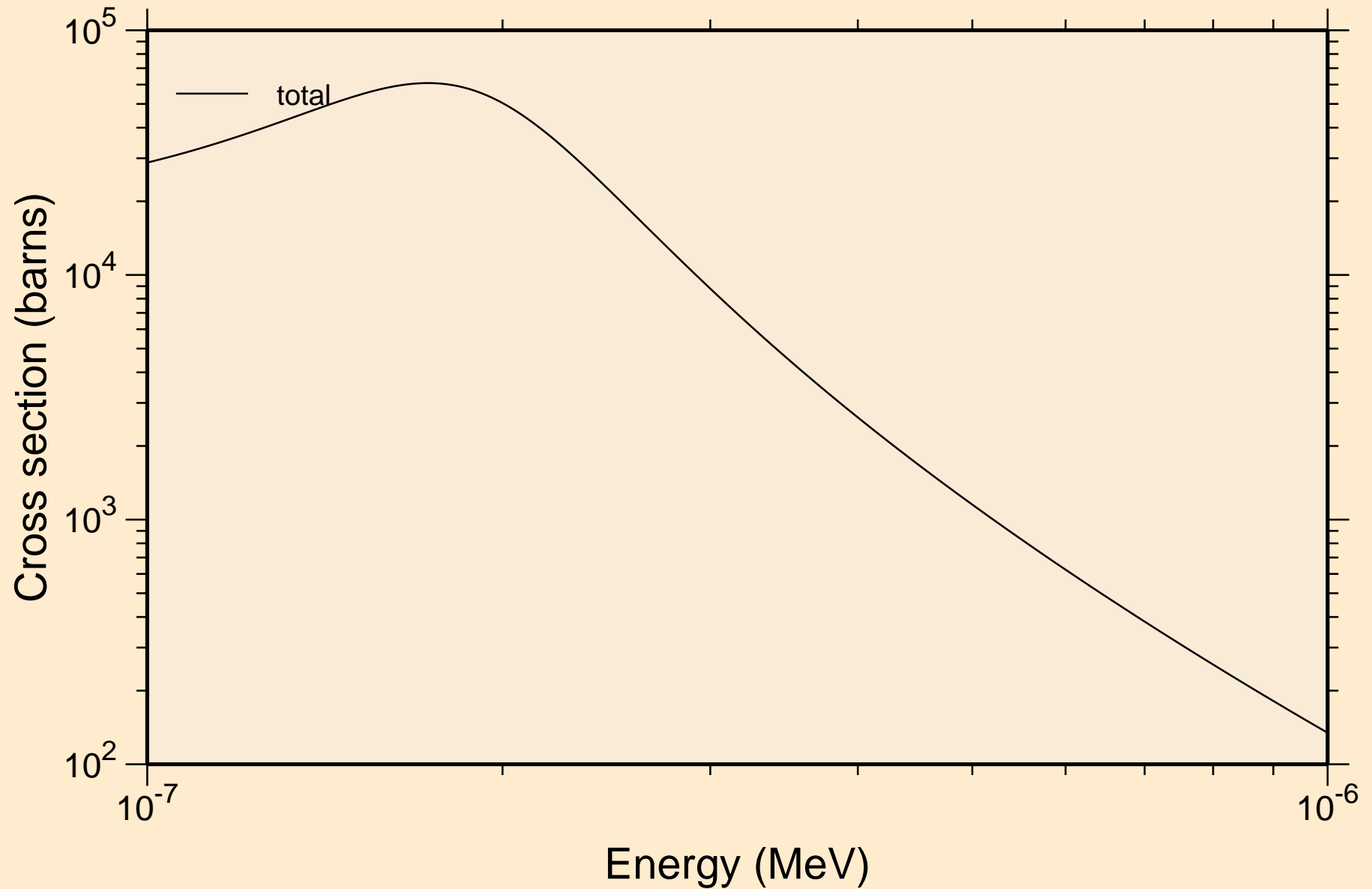

CD113 NEUTRON ACER TENDL-2019 LIBRARY; T=293.16K  
resonance total cross section

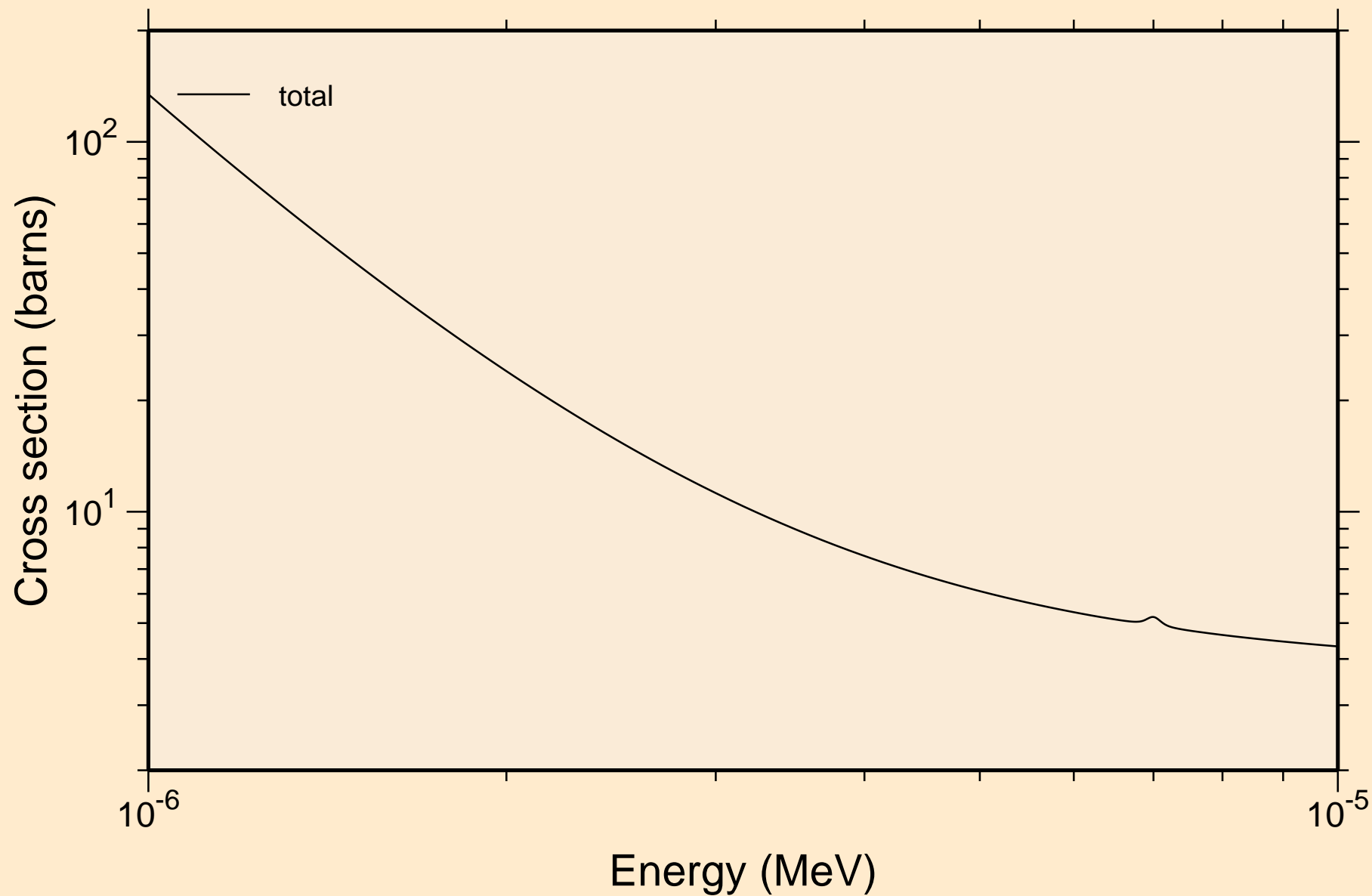

CD113 NEUTRON ACER TENDL-2019 LIBRARY; T=293.16K  
resonance total cross section

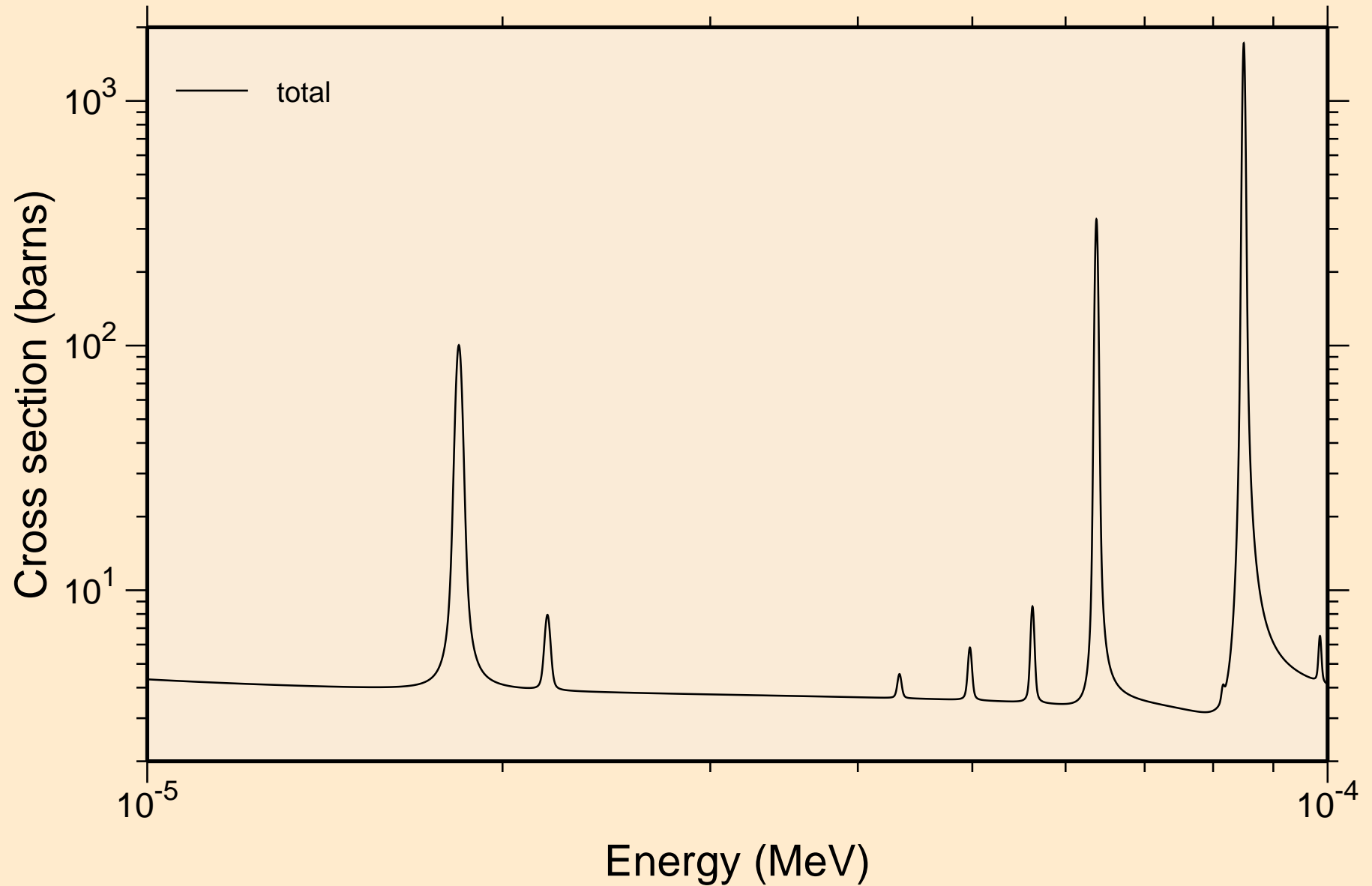

CD113 NEUTRON ACER TENDL-2019 LIBRARY; T=293.16K  
resonance total cross section

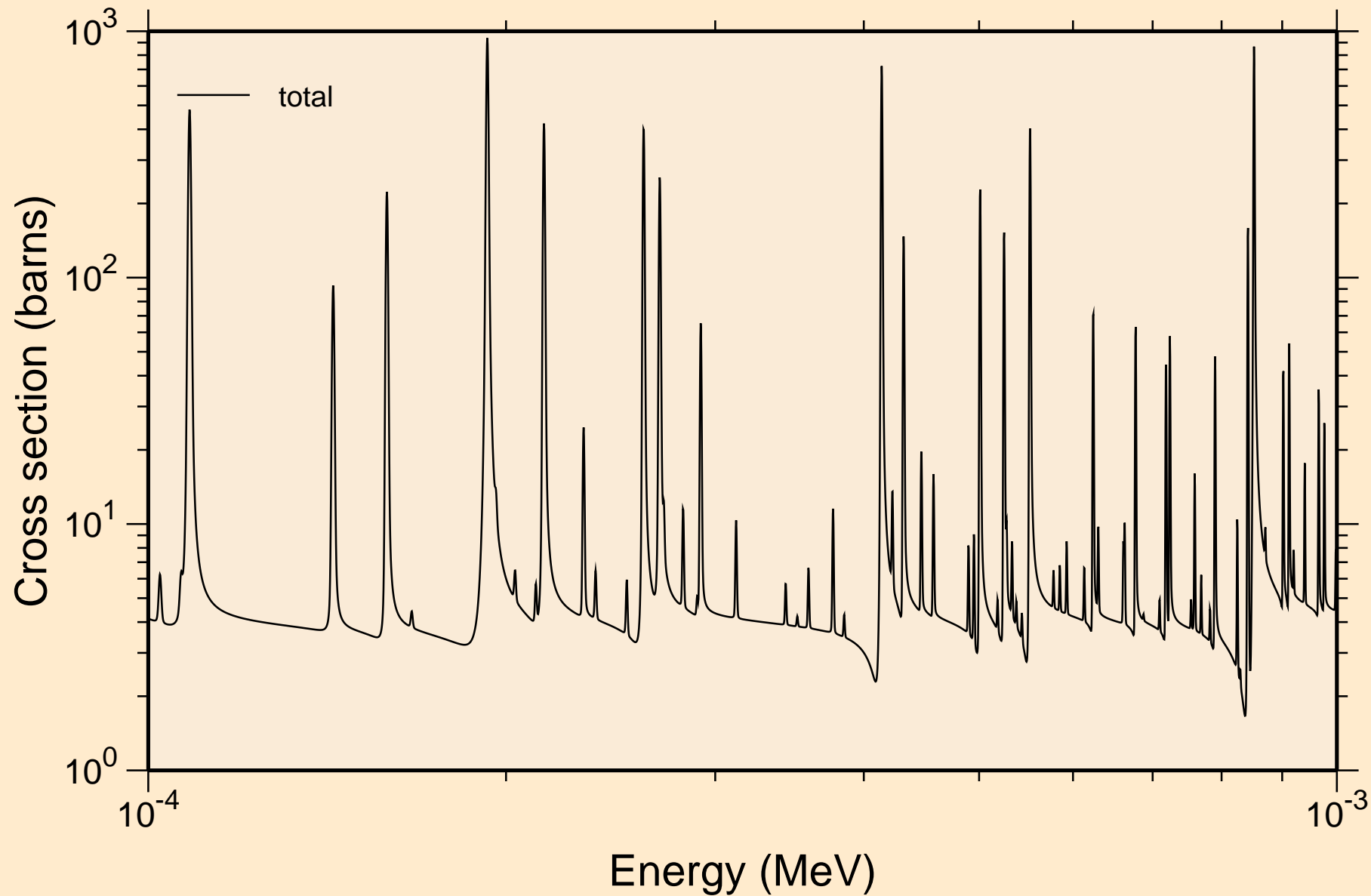

CD113 NEUTRON ACER TENDL-2019 LIBRARY; T=293.16K  
resonance total cross section

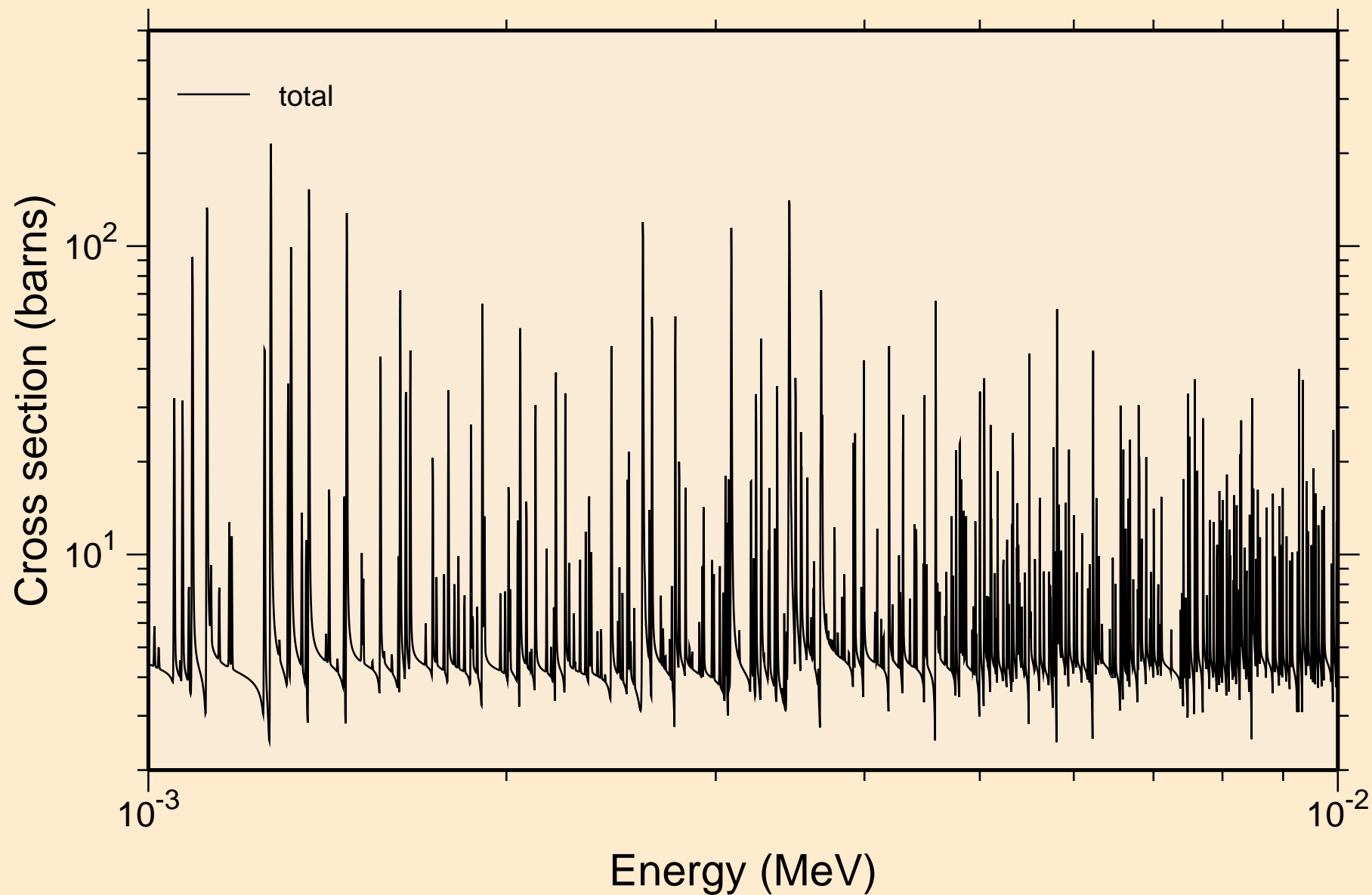

CD113 NEUTRON ACER TENDL-2019 LIBRARY; T=293.16K  
resonance total cross section

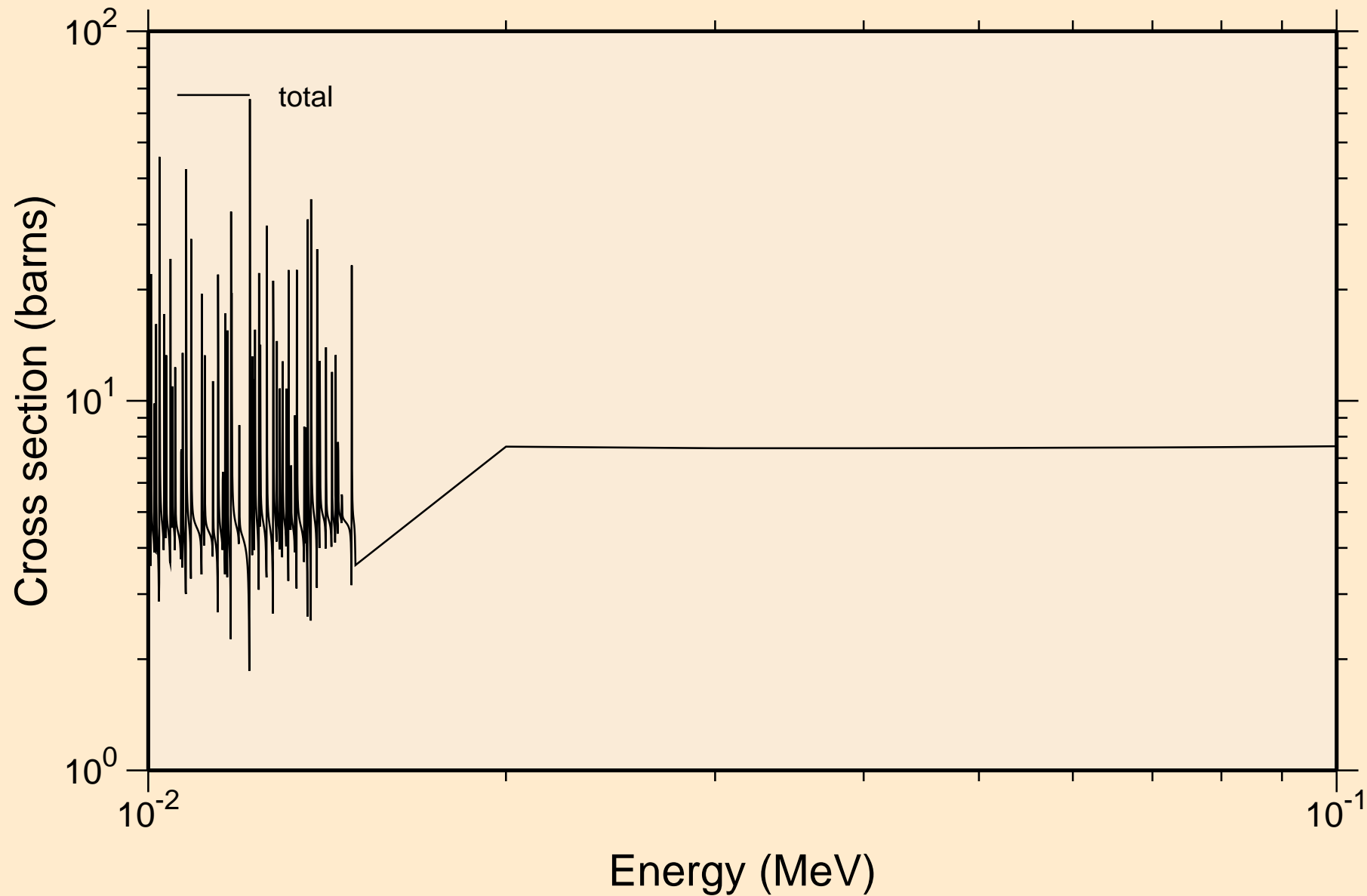

CD113 NEUTRON ACER TENDL-2019 LIBRARY; T=293.16K  
resonance total cross section

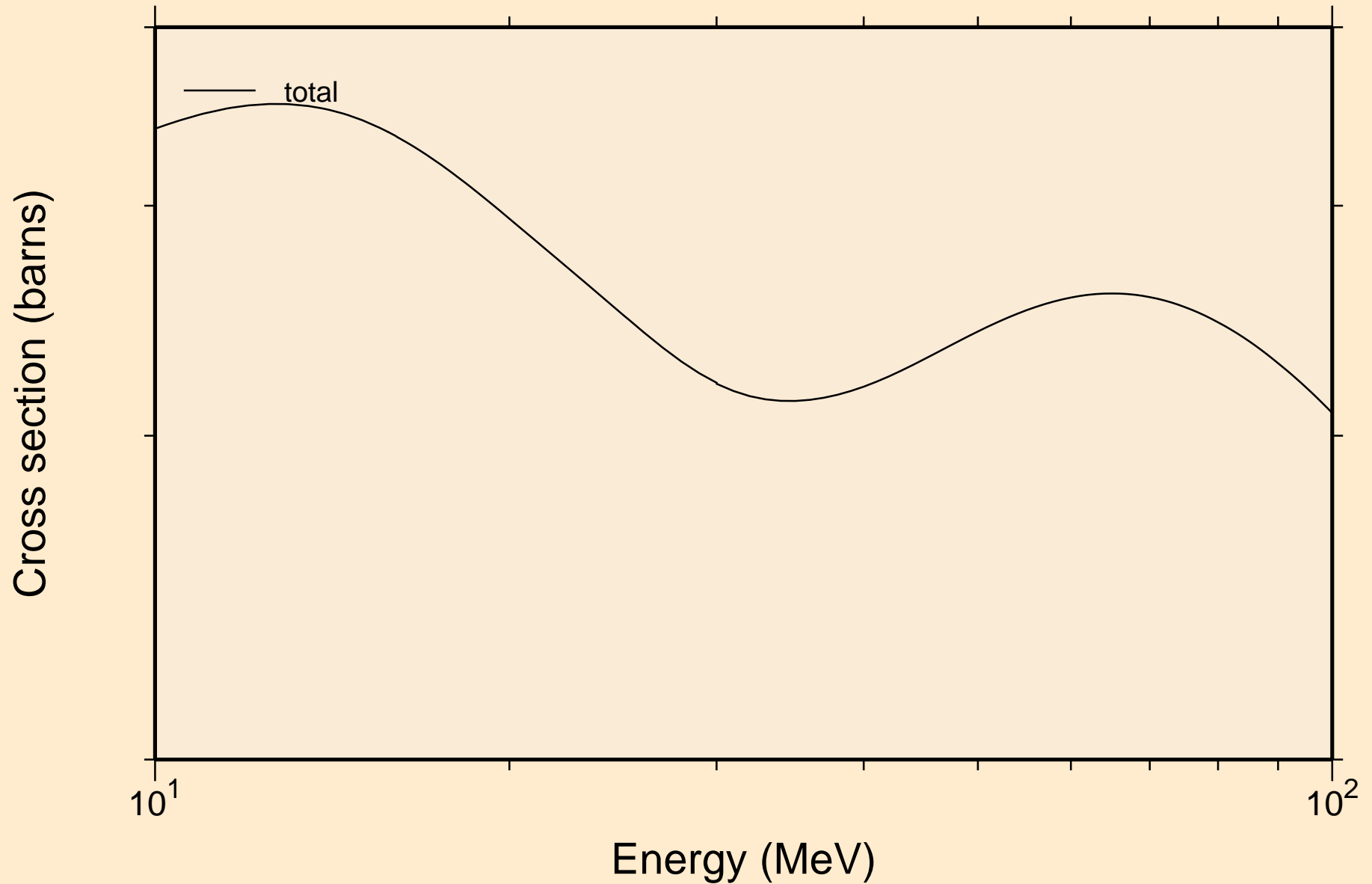

CD113 NEUTRON ACER TENDL-2019 LIBRARY; T=293.16K  
resonance absorption cross sections

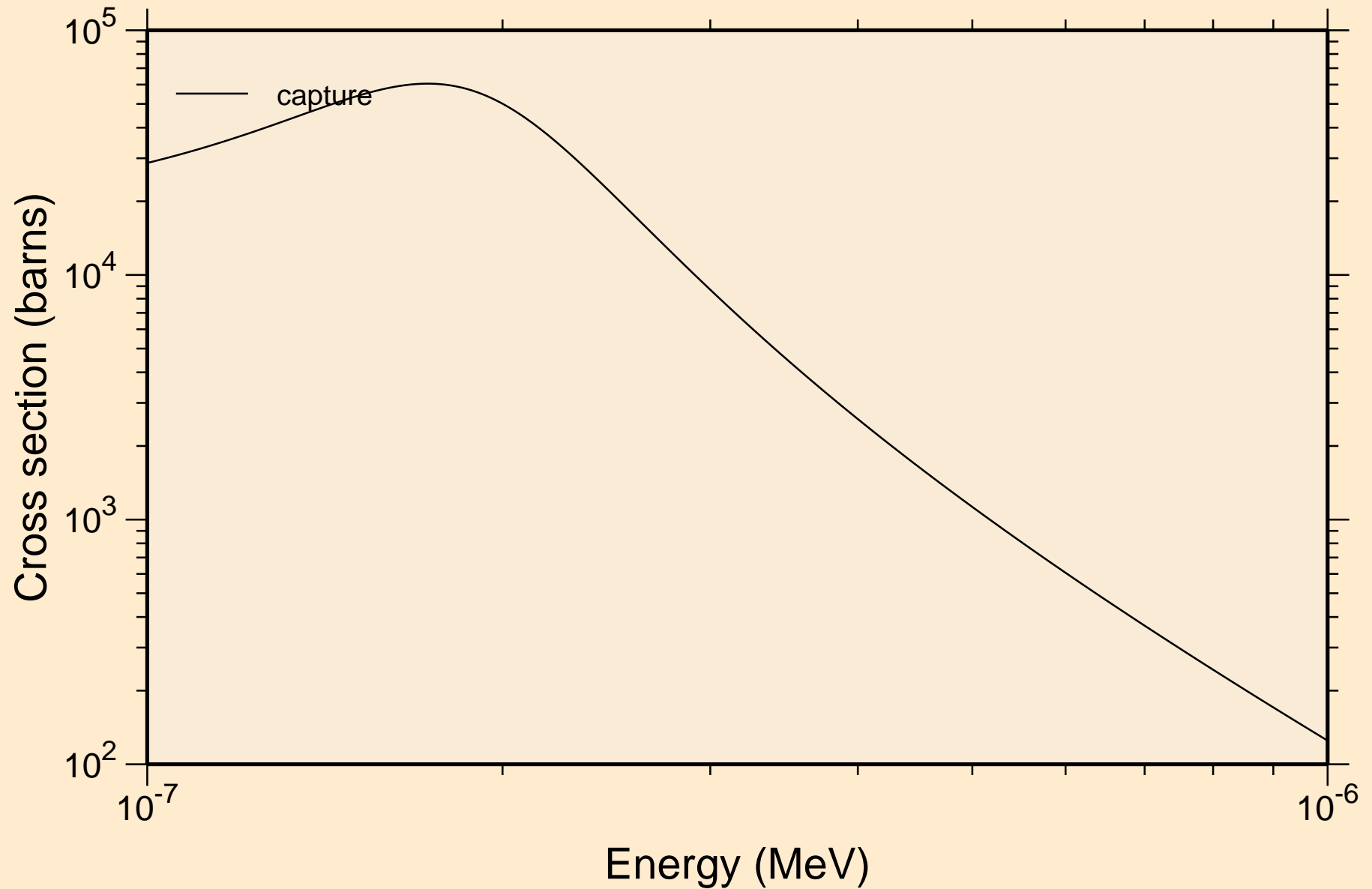

CD113 NEUTRON ACER TENDL-2019 LIBRARY; T=293.16K  
resonance absorption cross sections

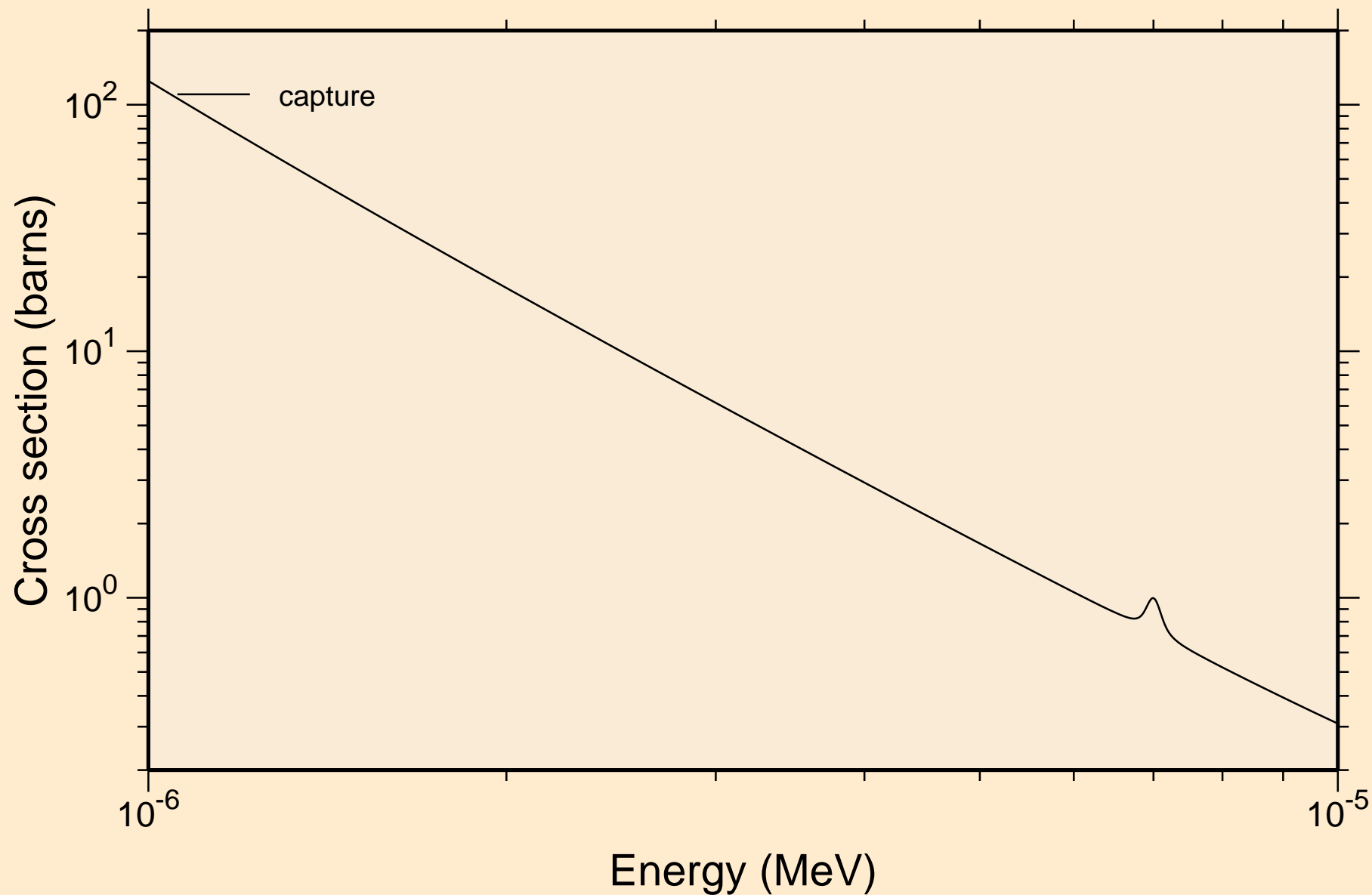

CD113 NEUTRON ACER TENDL-2019 LIBRARY; T=293.16K  
resonance absorption cross sections

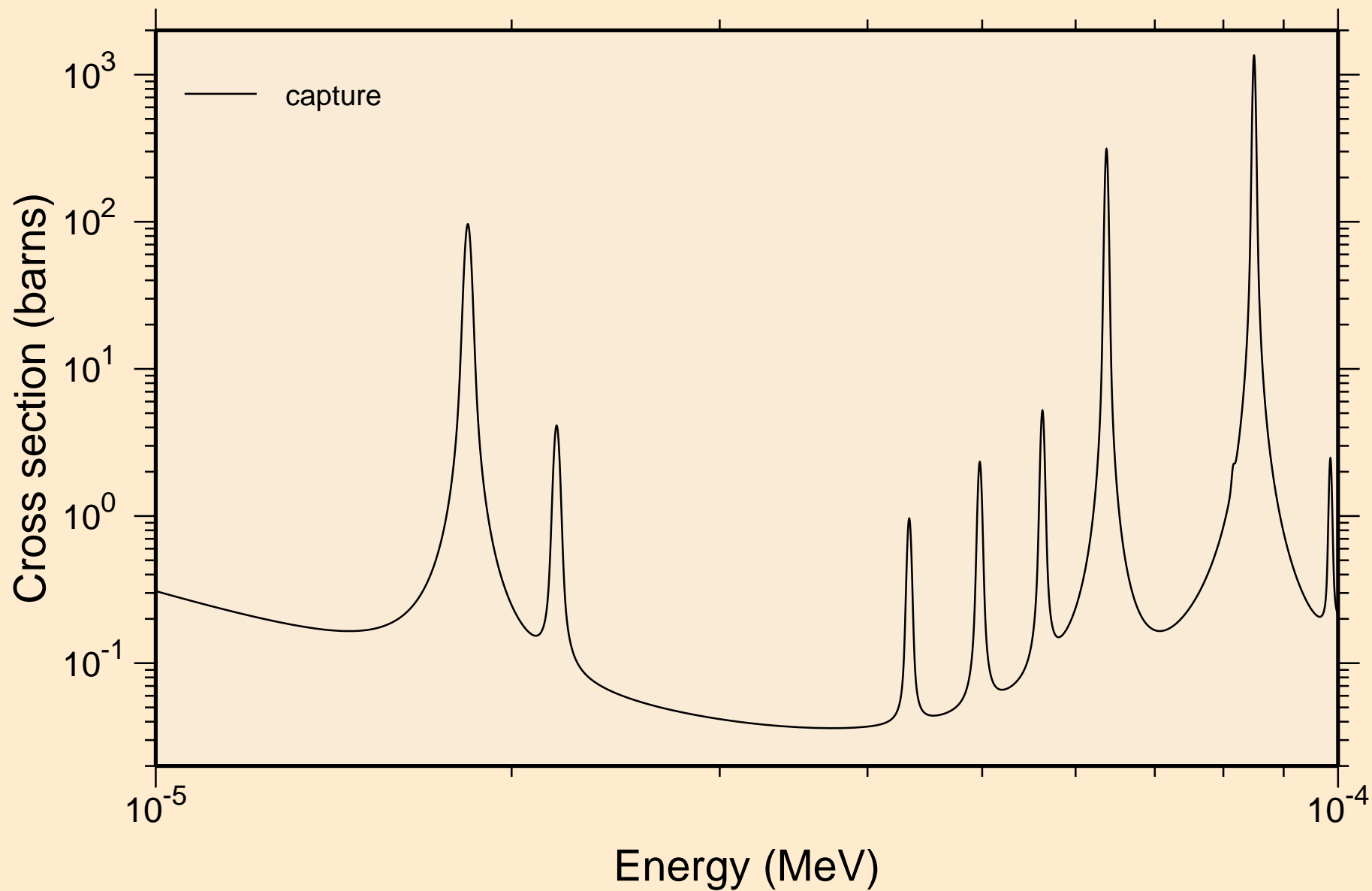

CD113 NEUTRON ACER TENDL-2019 LIBRARY; T=293.16K  
resonance absorption cross sections

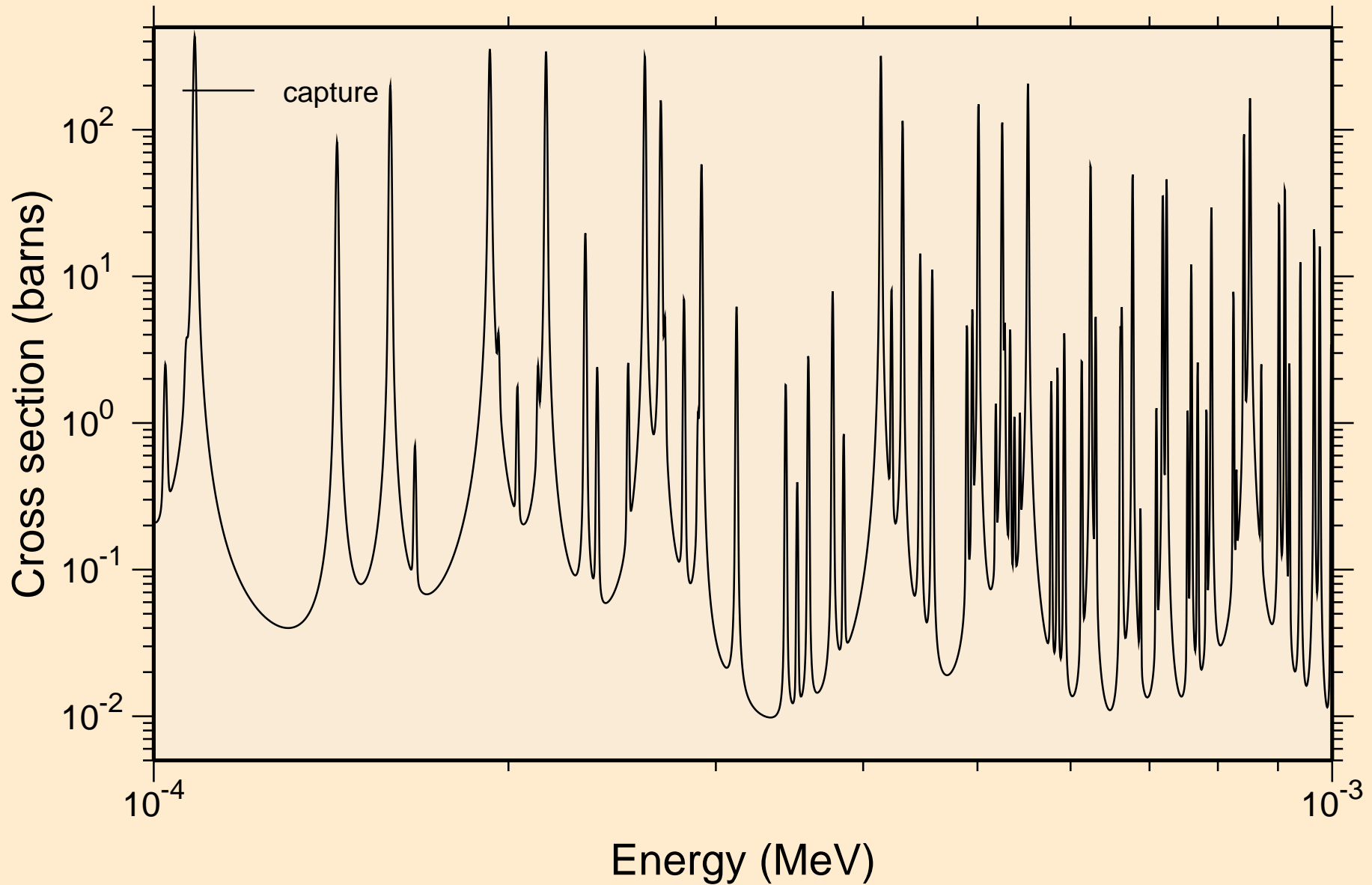

CD113 NEUTRON ACER TENDL-2019 LIBRARY; T=293.16K  
resonance absorption cross sections

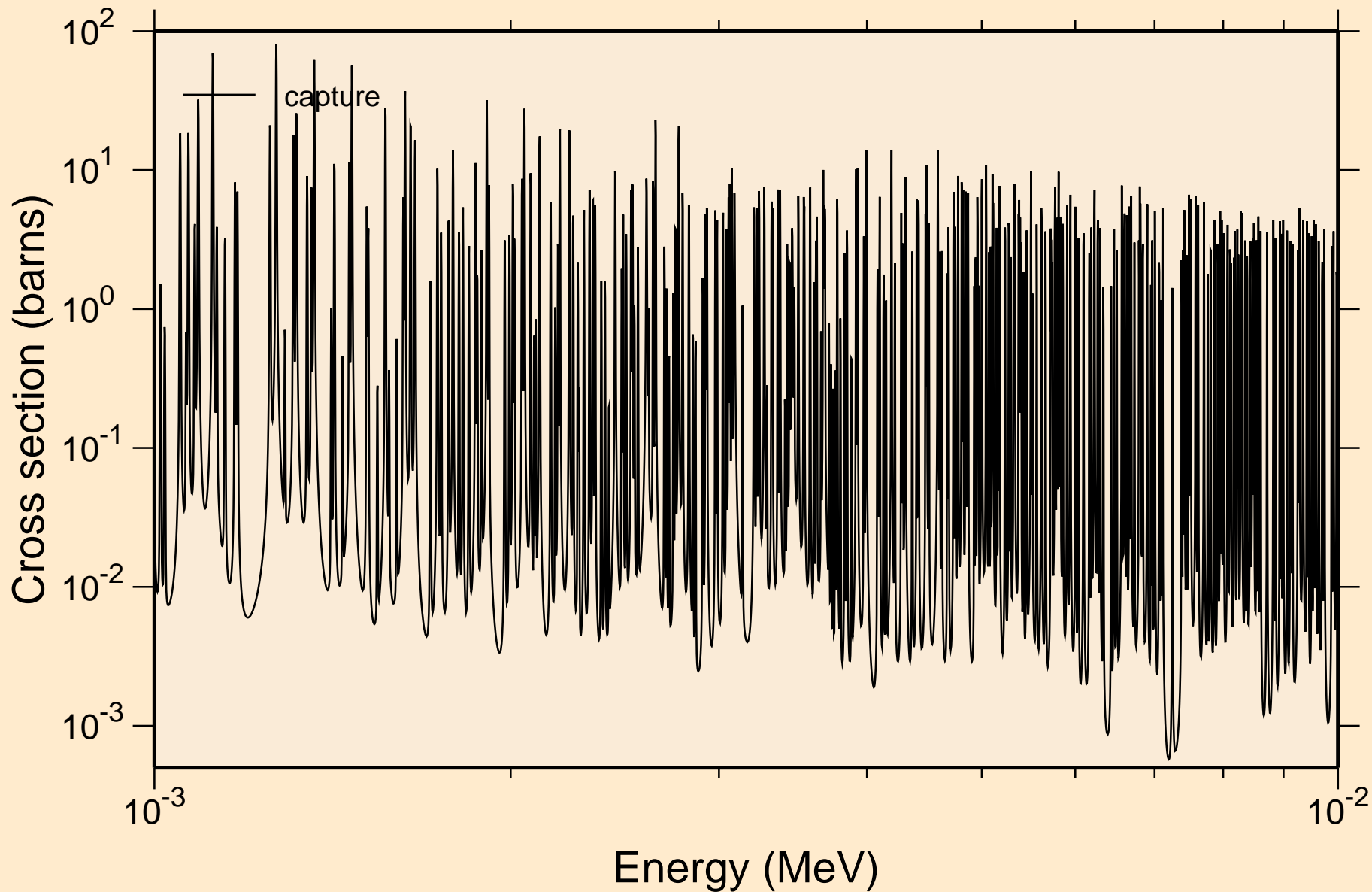

CD113 NEUTRON ACER TENDL-2019 LIBRARY; T=293.16K  
resonance absorption cross sections

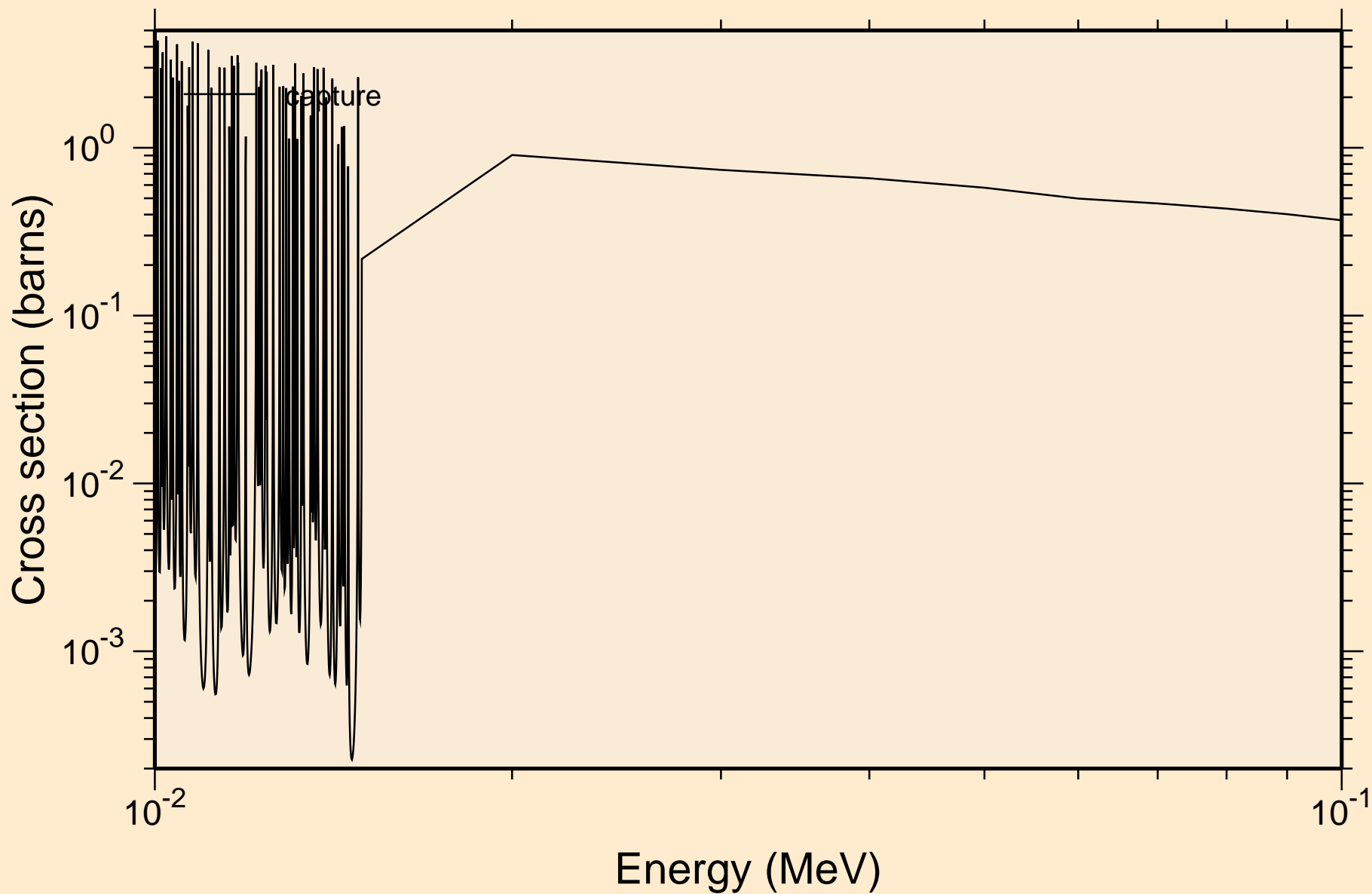

CD113 NEUTRON ACER TENDL-2019 LIBRARY; T=293.16K  
resonance absorption cross sections

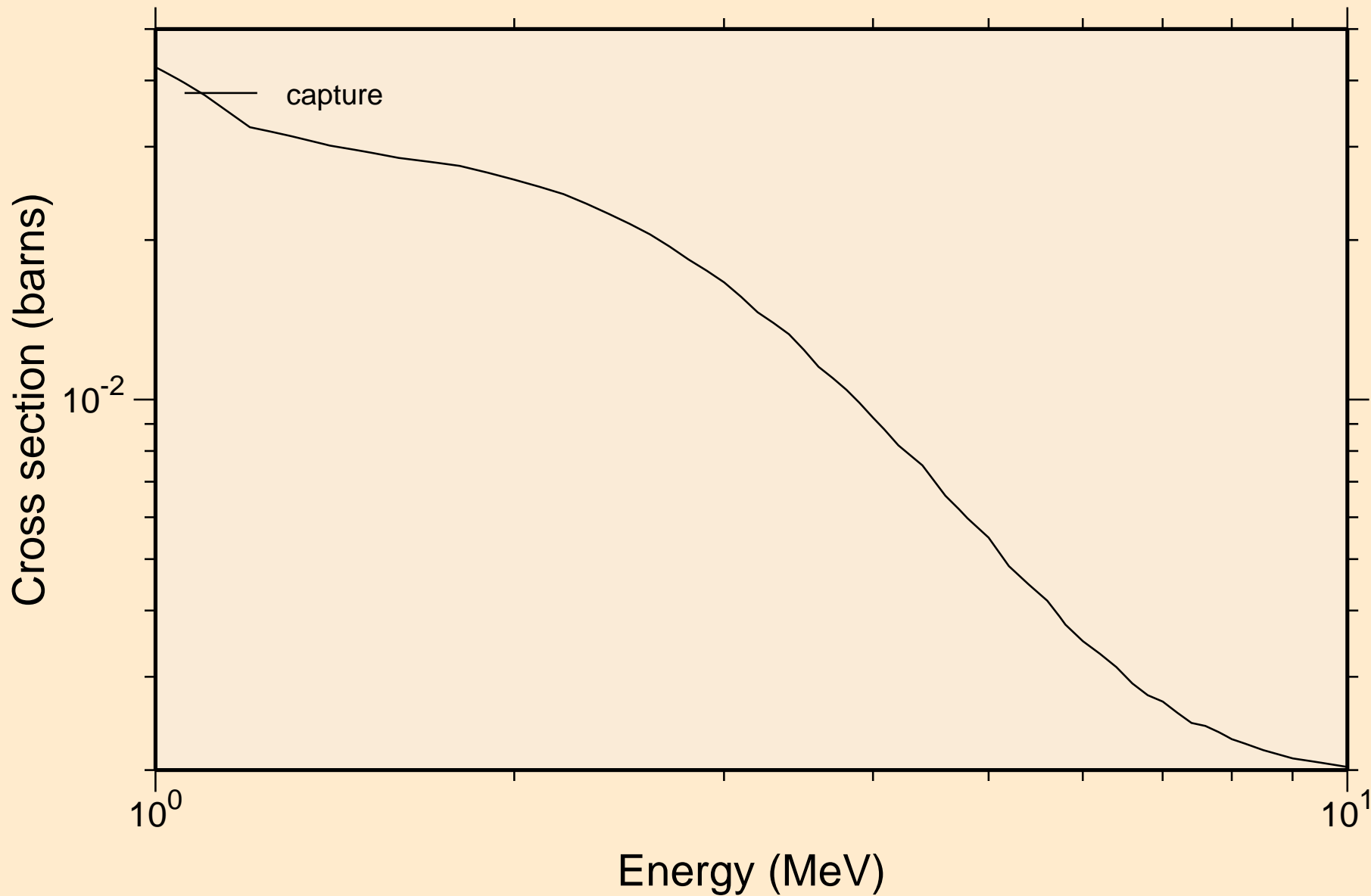

CD113 NEUTRON ACER TENDL-2019 LIBRARY; T=293.16K  
Heating

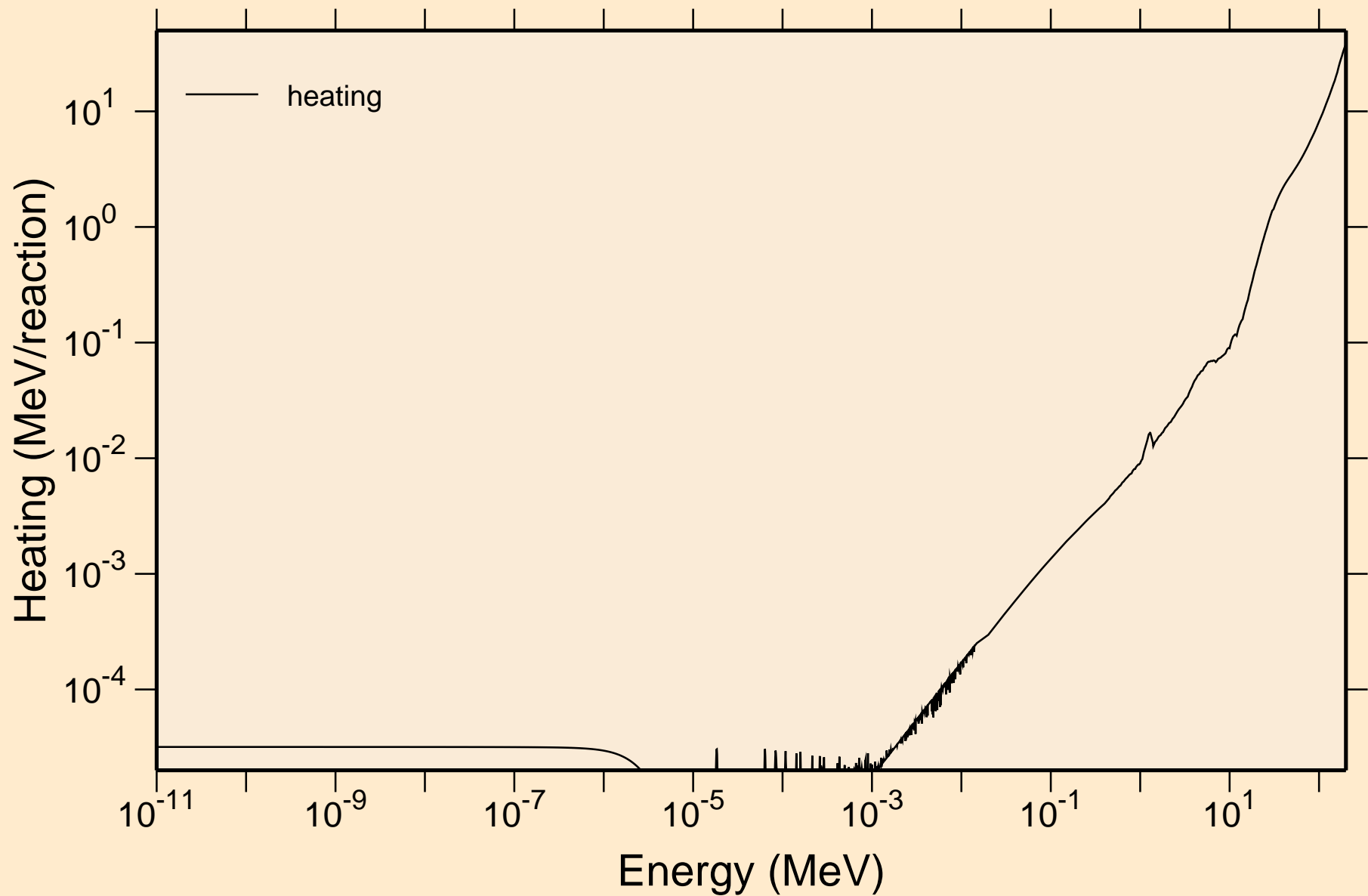

# CD113 NEUTRON ACER TENDL-2019 LIBRARY; T=293.16K Damage

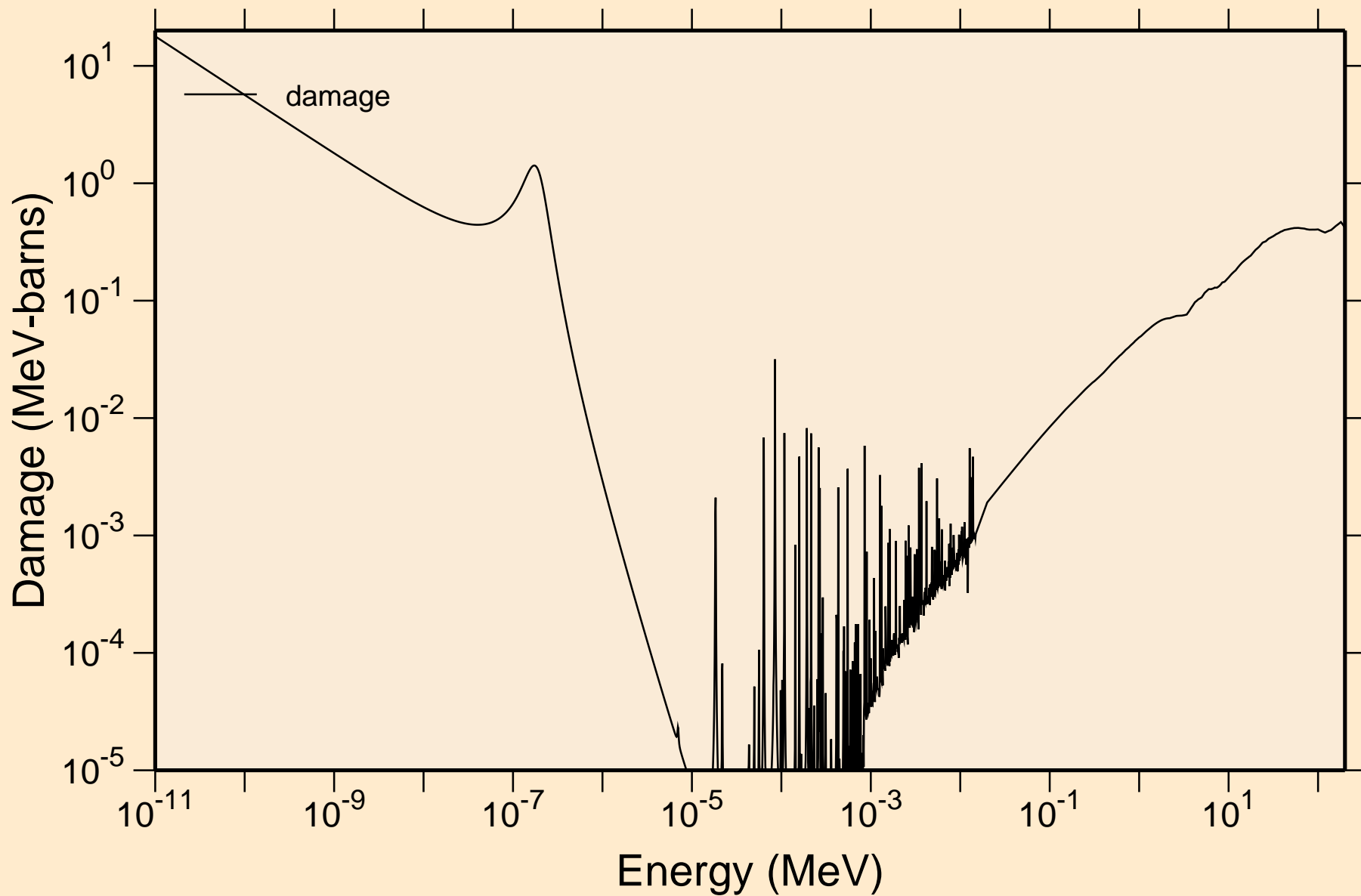

# CD113 NEUTRON ACER TENDL-2019 LIBRARY; T=293.16K

## Non-threshold reactions

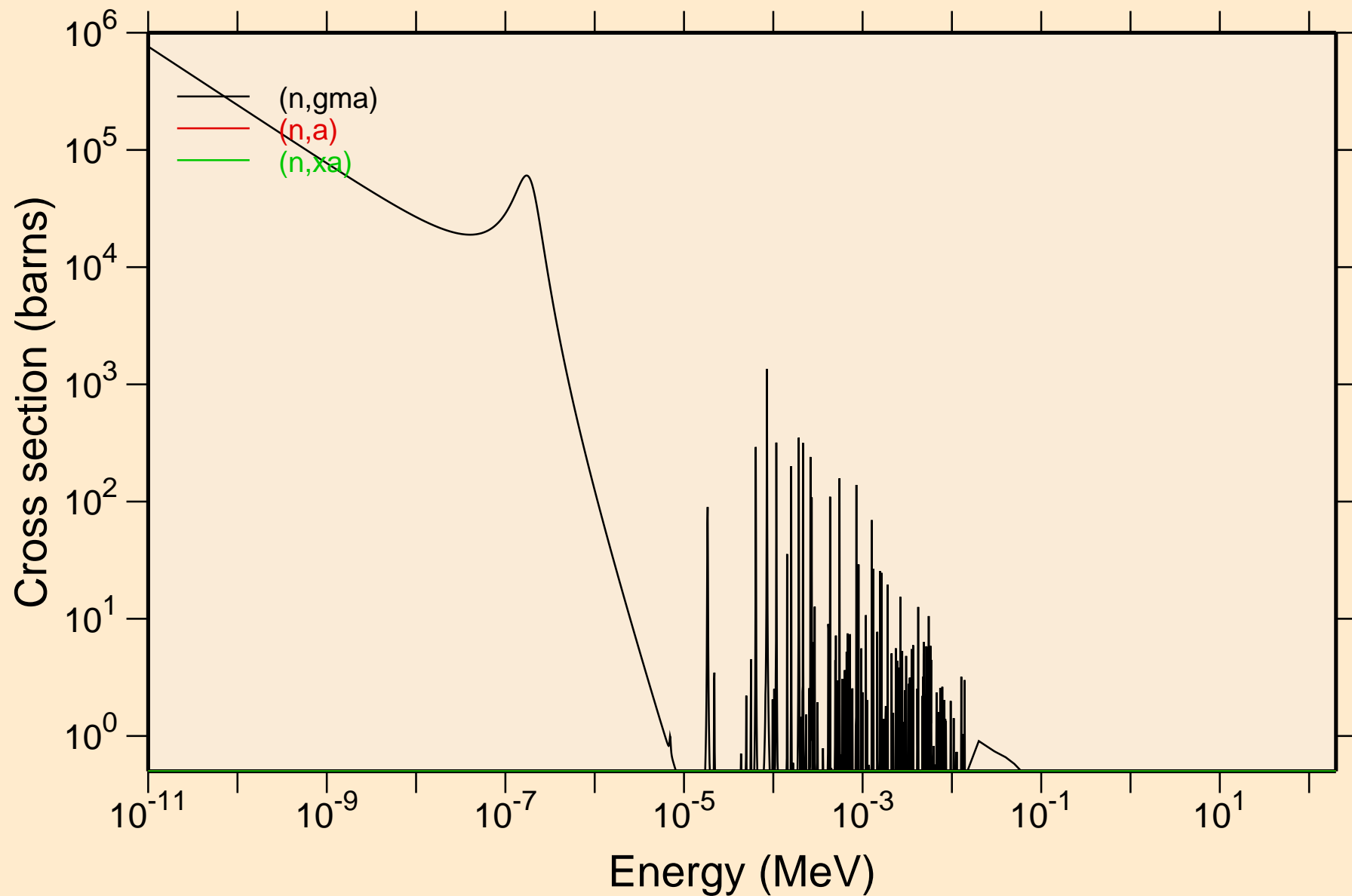

CD113 NEUTRON ACER TENDL-2019 LIBRARY; T=293.16K  
Principal cross sections

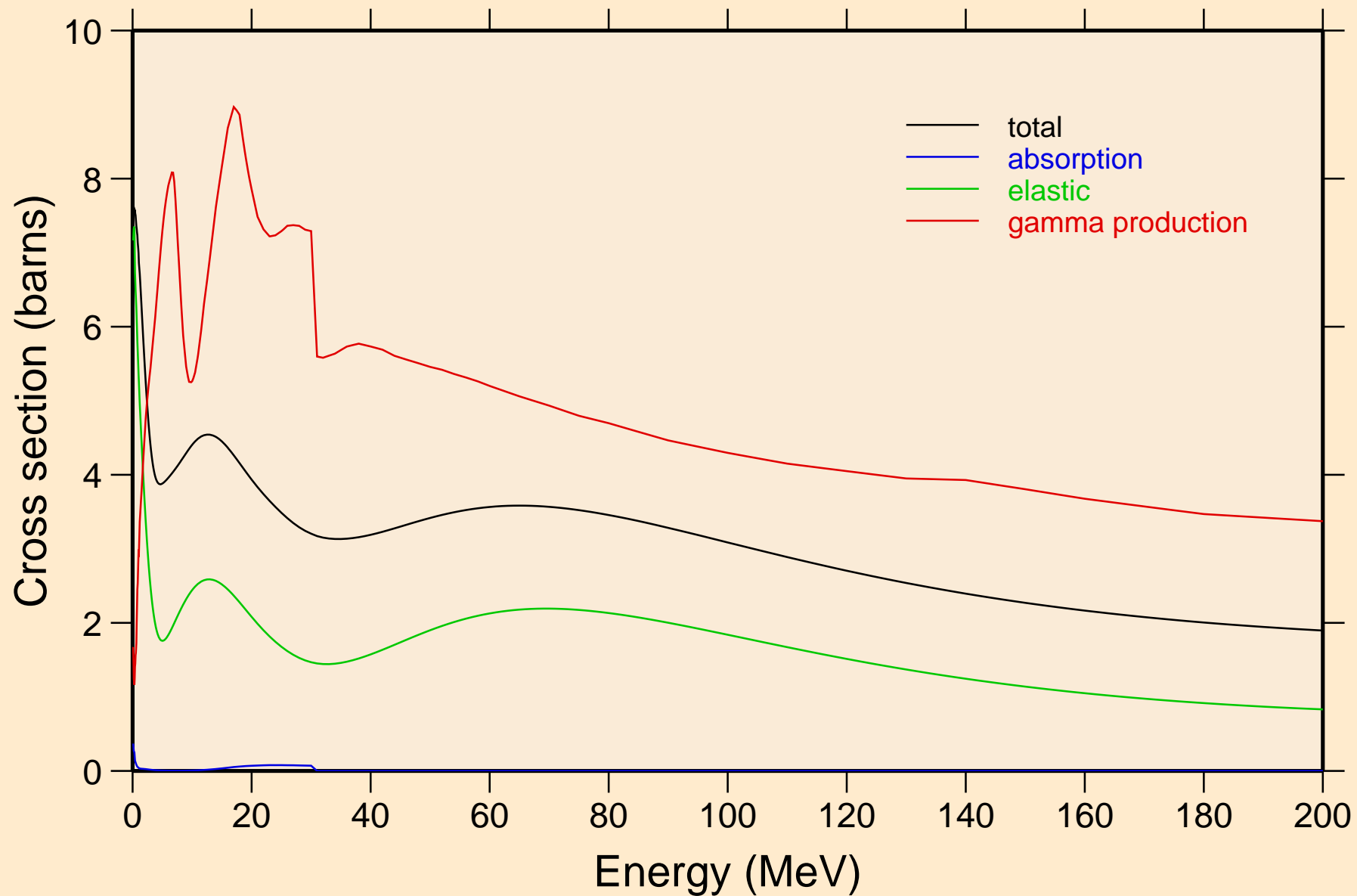

CD113 NEUTRON ACER TENDL-2019 LIBRARY; T=293.16K  
Heating

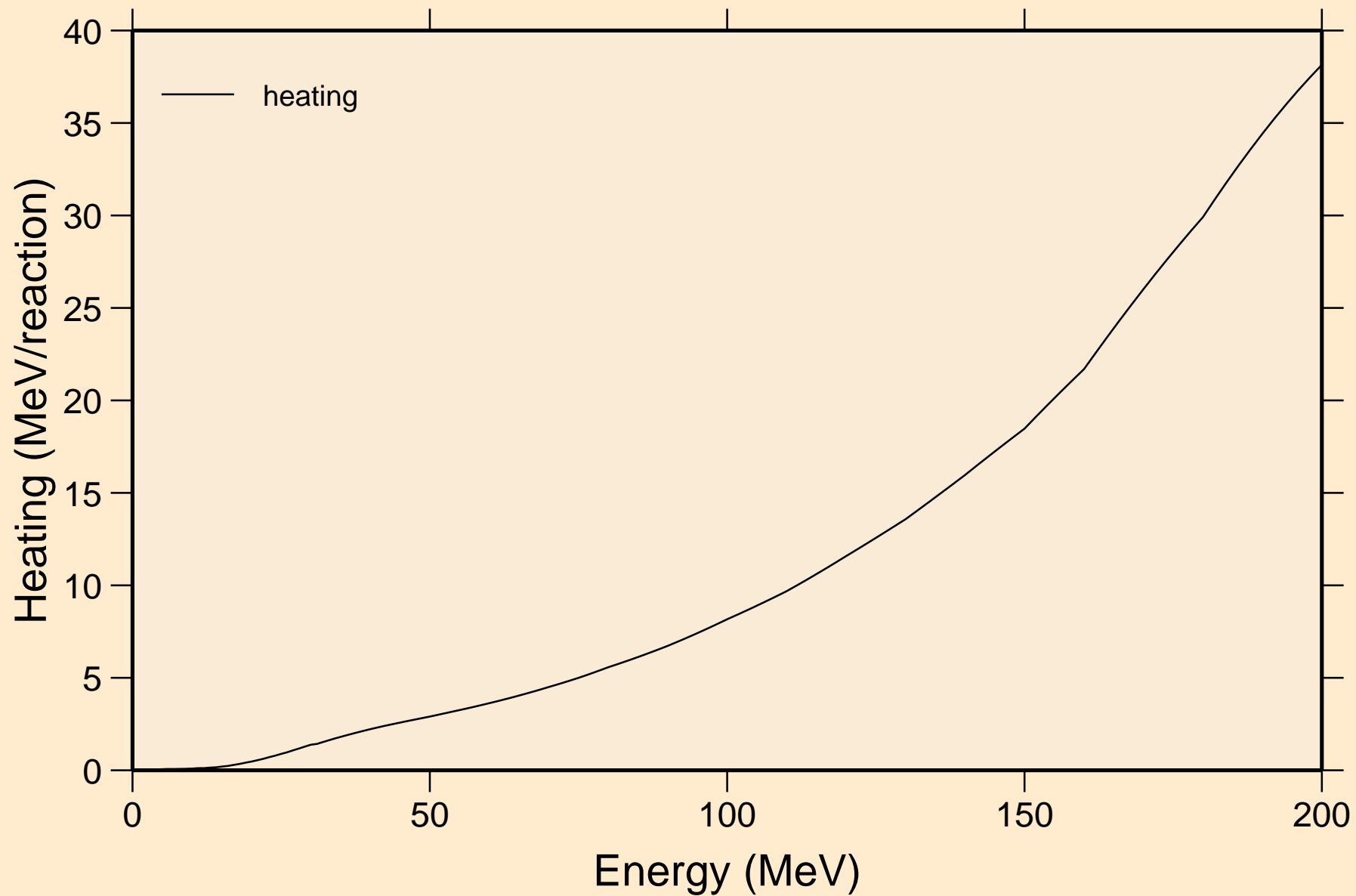

CD113 NEUTRON ACER TENDL-2019 LIBRARY; T=293.16K  
Damage

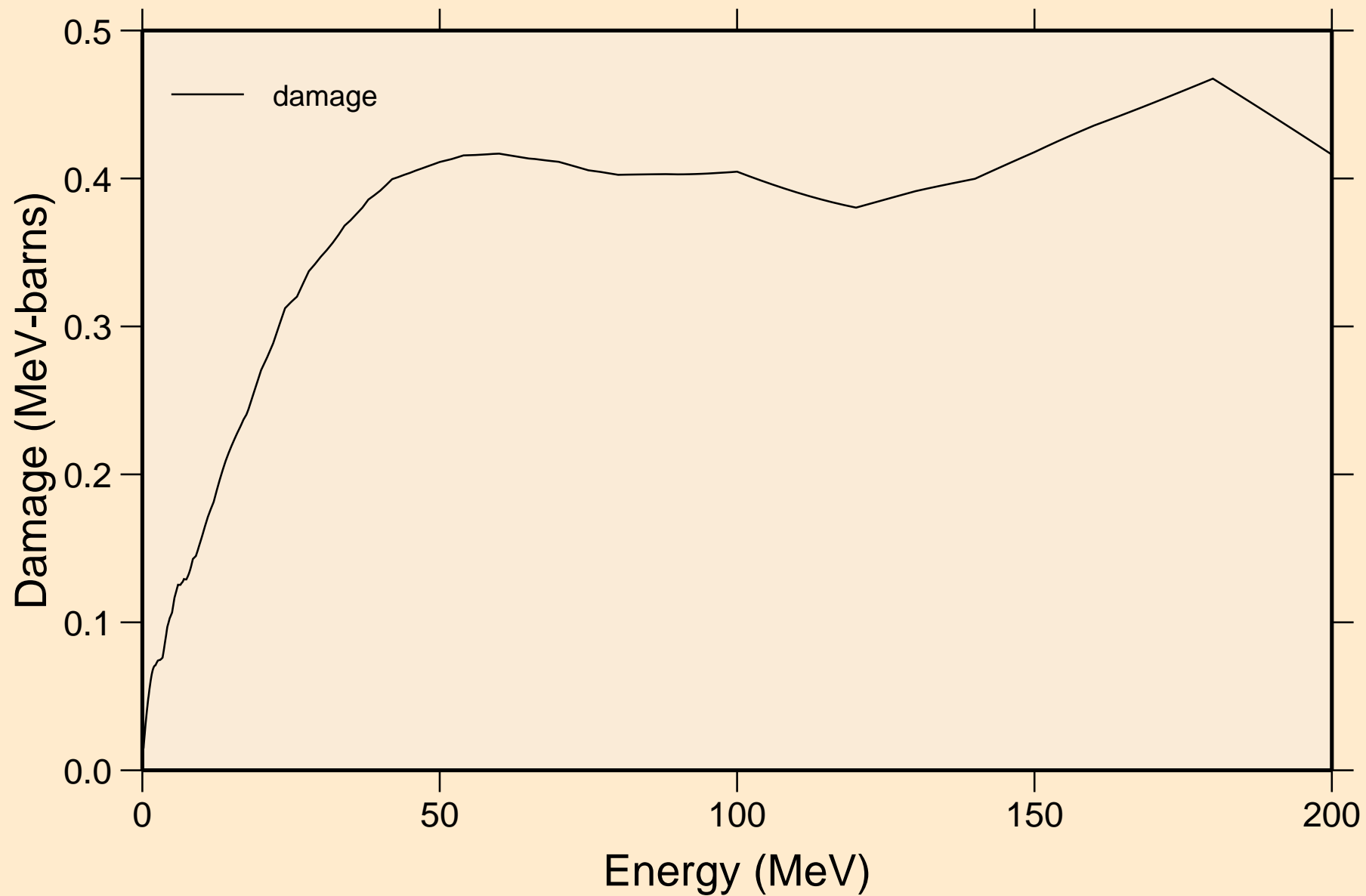

CD113 NEUTRON ACER TENDL-2019 LIBRARY; T=293.16K  
Non-threshold reactions

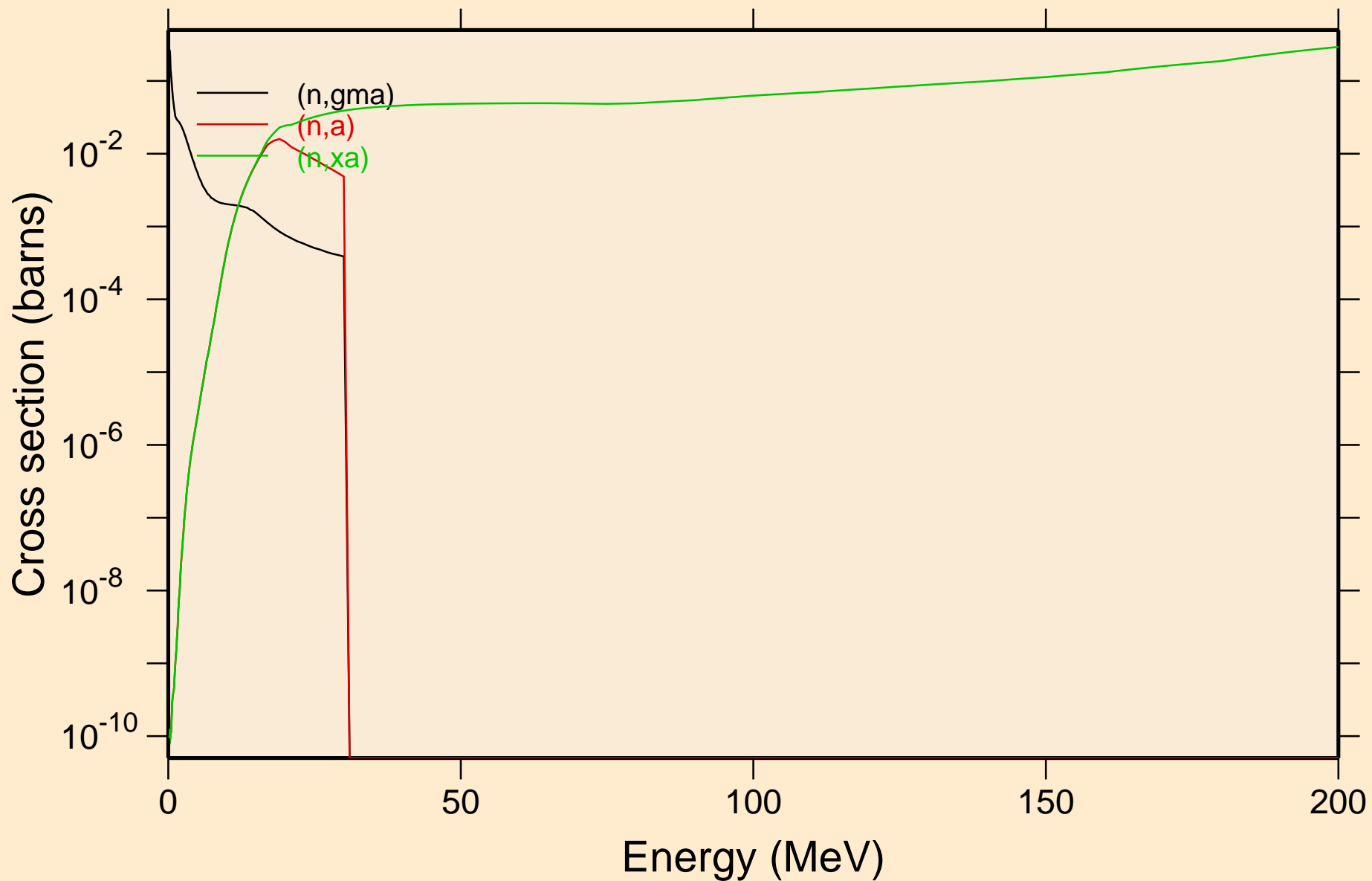

CD113 NEUTRON ACER TENDL-2019 LIBRARY; T=293.16K  
Inelastic levels

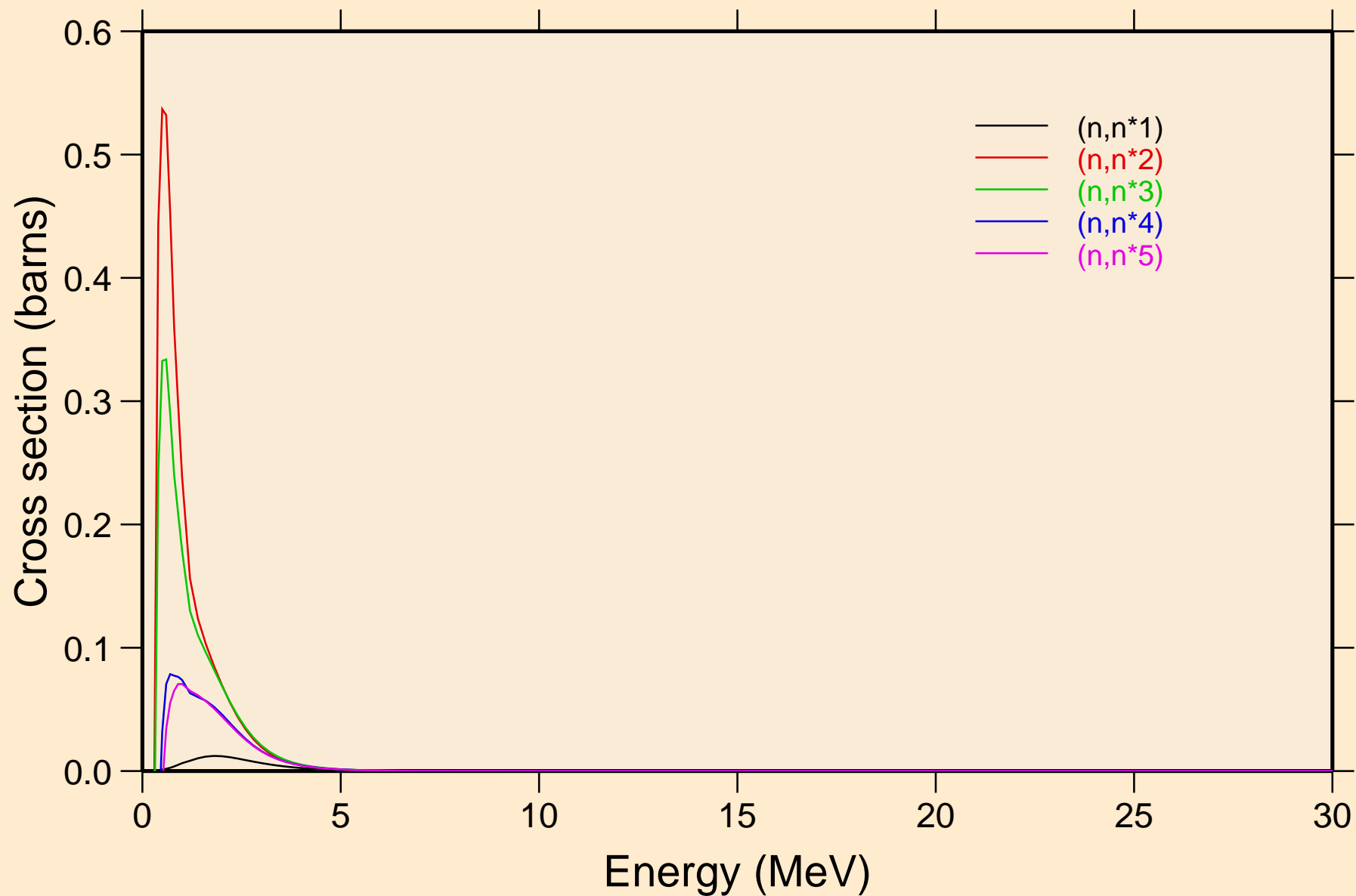

CD113 NEUTRON ACER TENDL-2019 LIBRARY; T=293.16K  
Inelastic levels

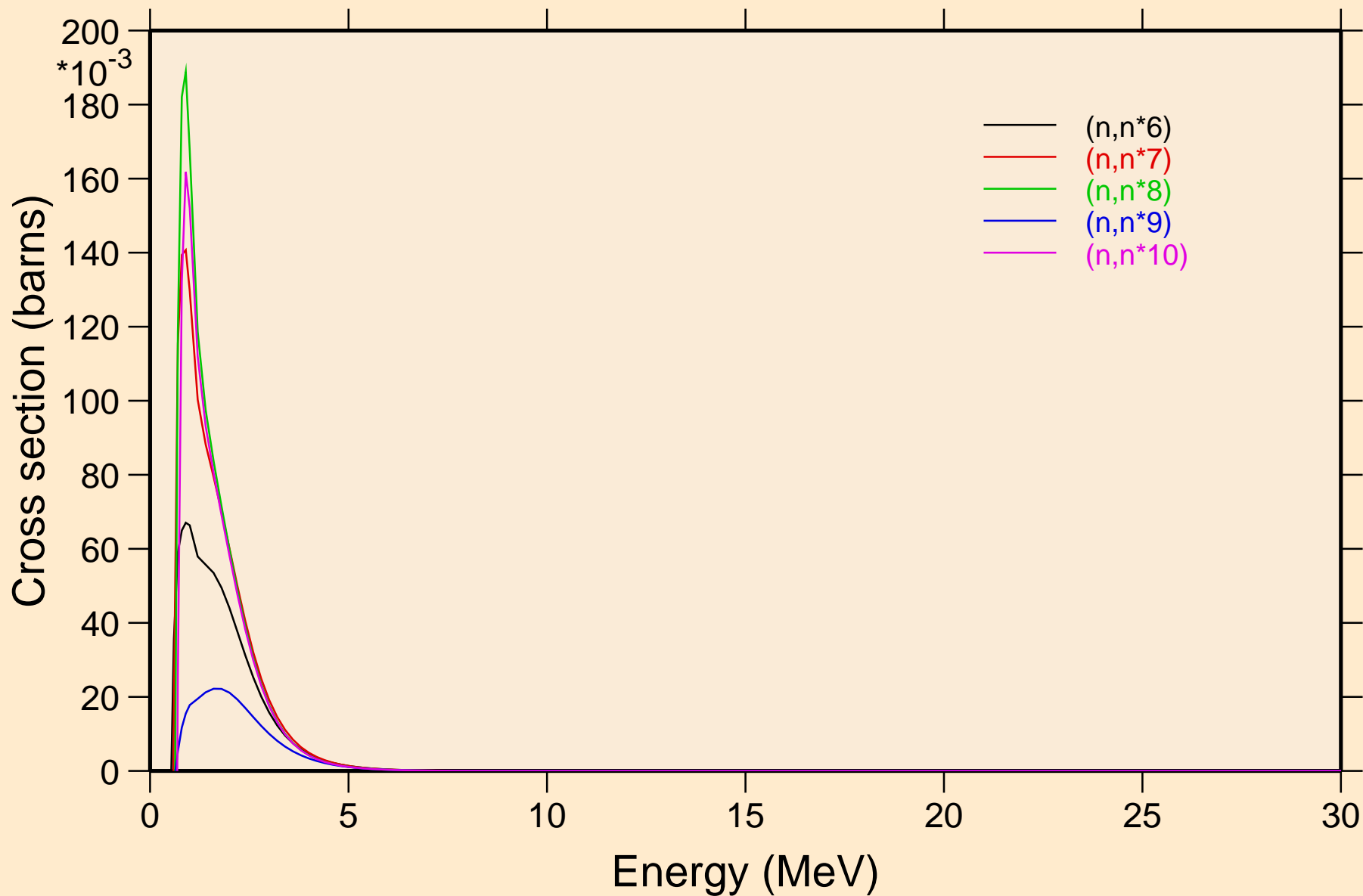

CD113 NEUTRON ACER TENDL-2019 LIBRARY; T=293.16K  
Inelastic levels

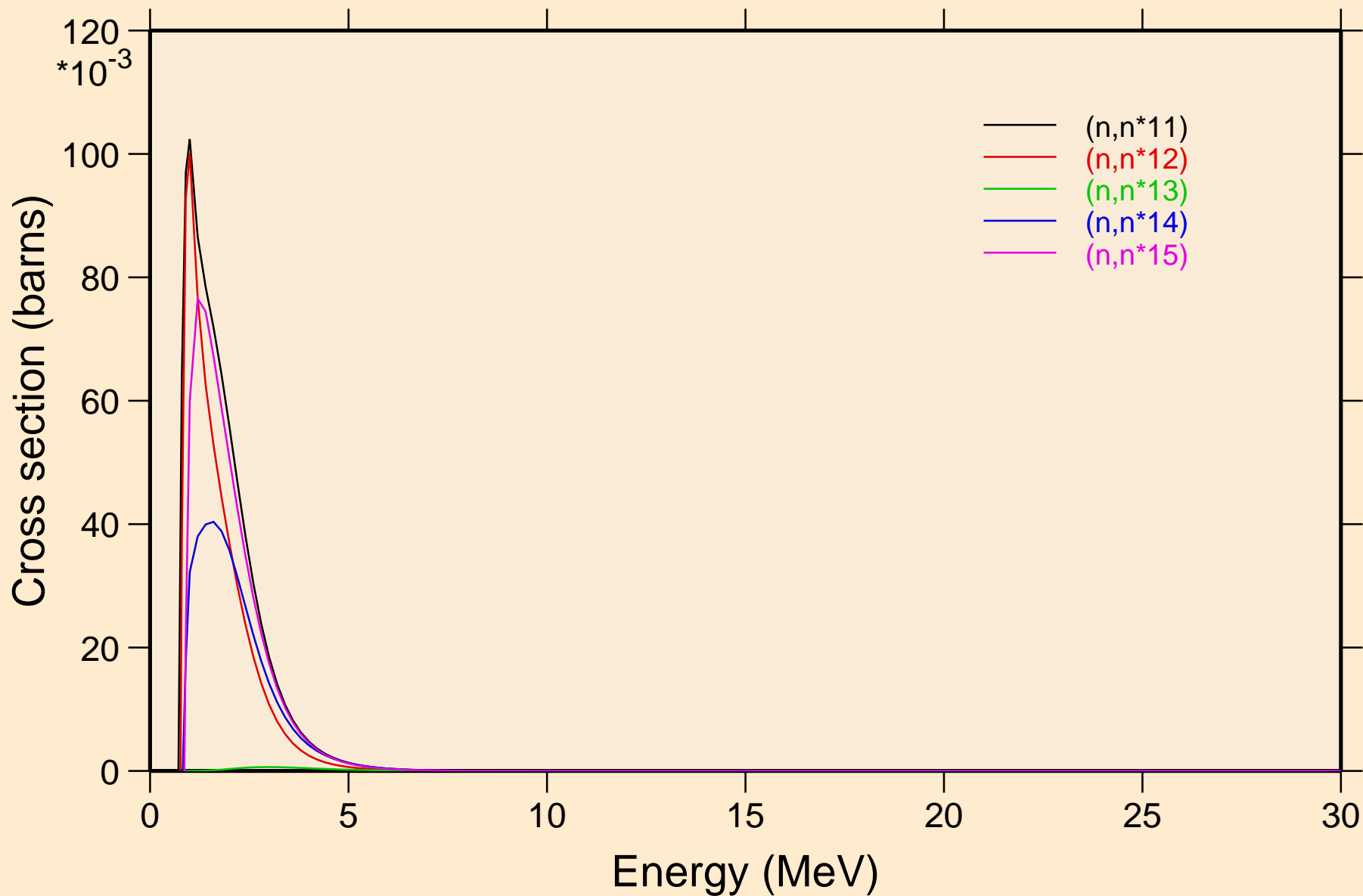

CD113 NEUTRON ACER TENDL-2019 LIBRARY; T=293.16K  
Inelastic levels

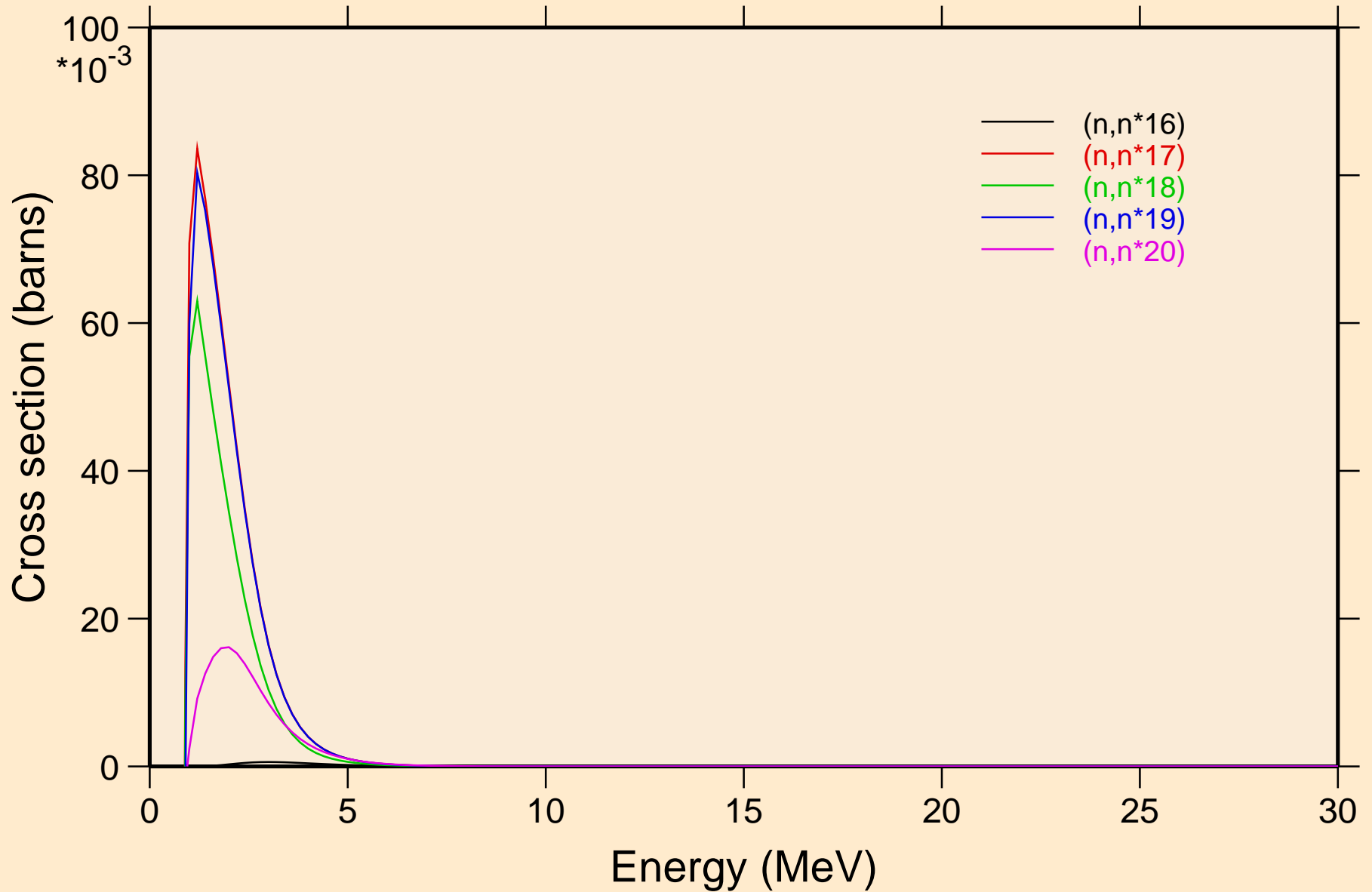

CD113 NEUTRON ACER TENDL-2019 LIBRARY; T=293.16K  
Inelastic levels

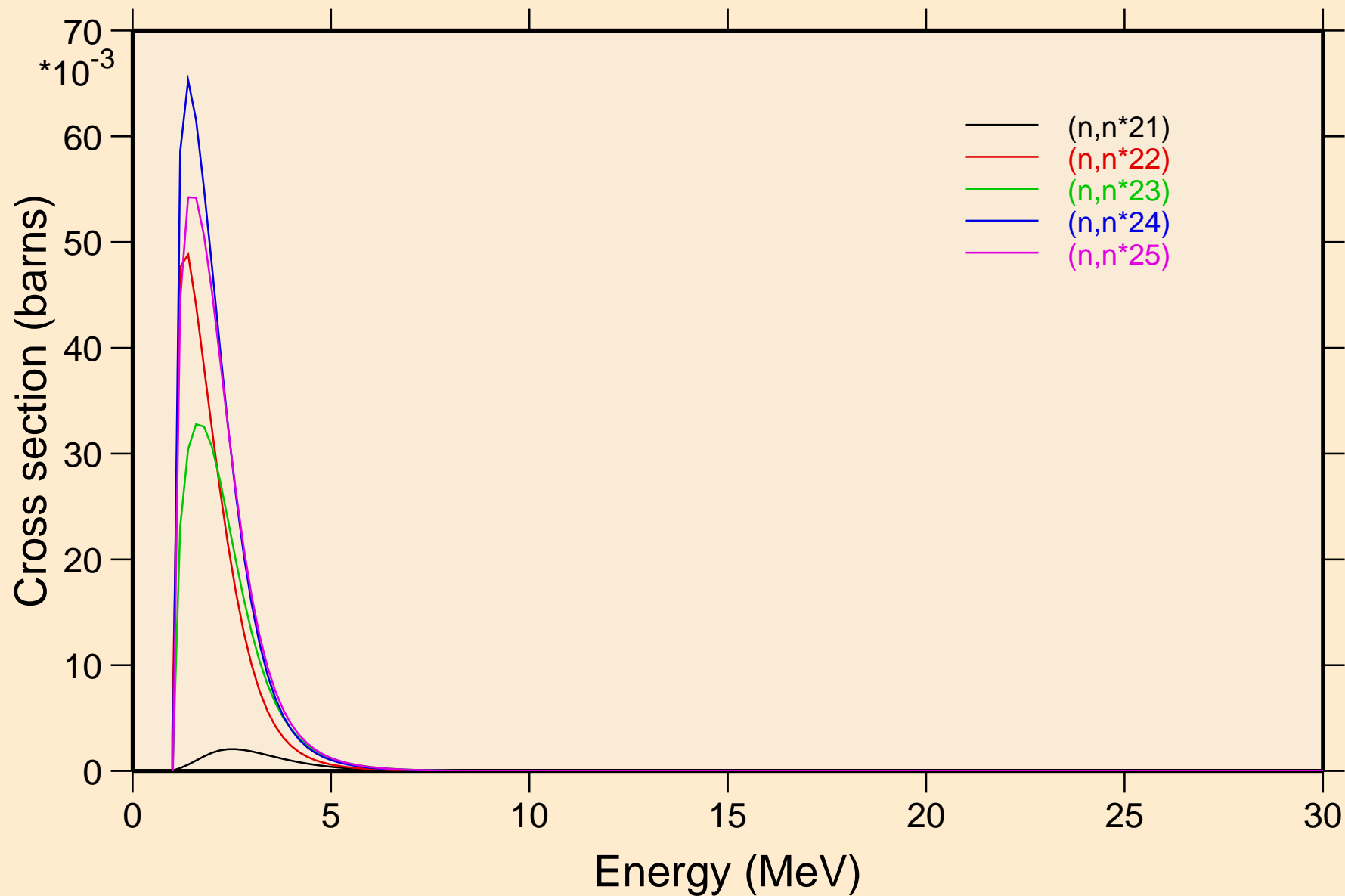

CD113 NEUTRON ACER TENDL-2019 LIBRARY; T=293.16K  
Inelastic levels

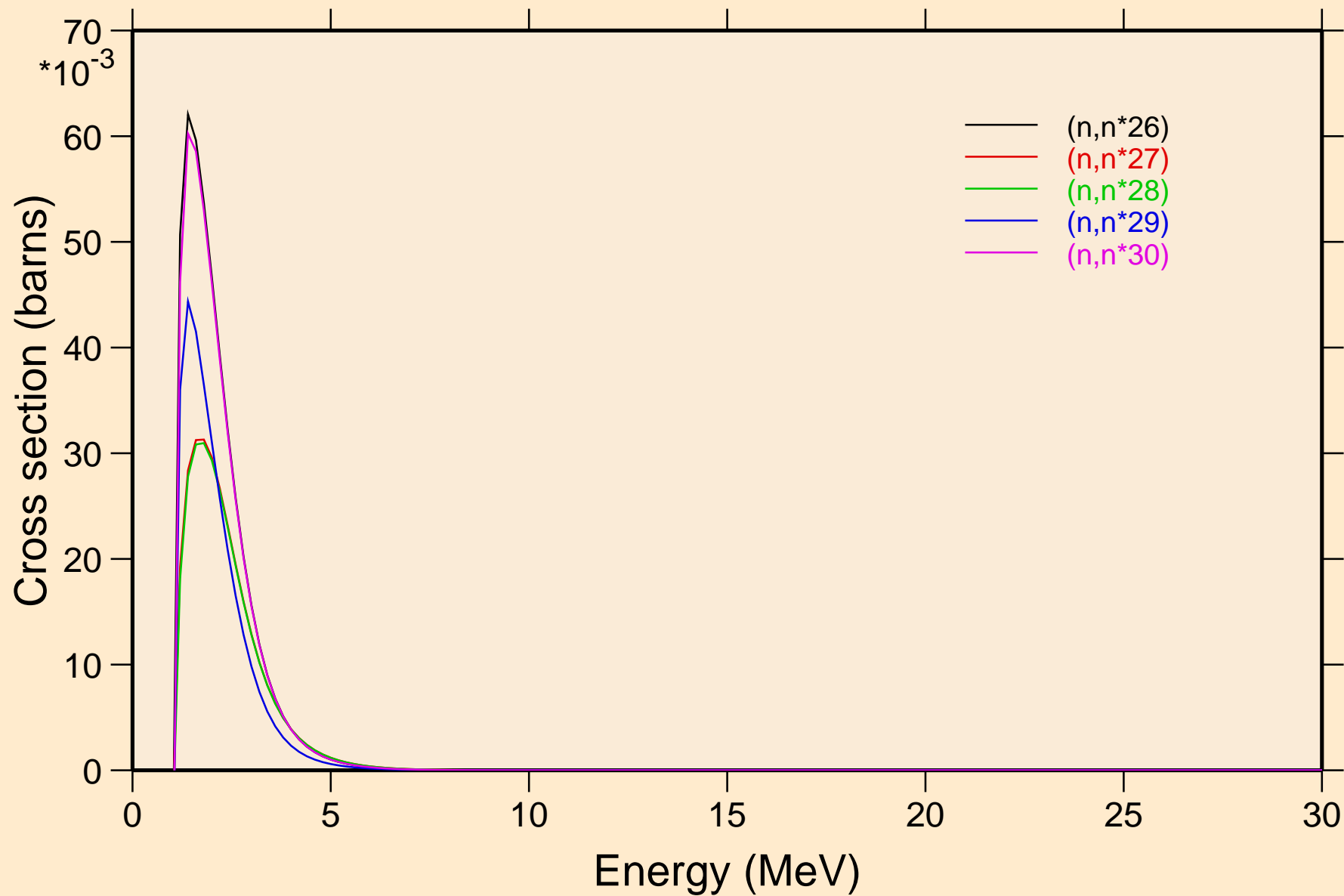

# CD113 NEUTRON ACER TENDL-2019 LIBRARY; T=293.16K

## Threshold reactions

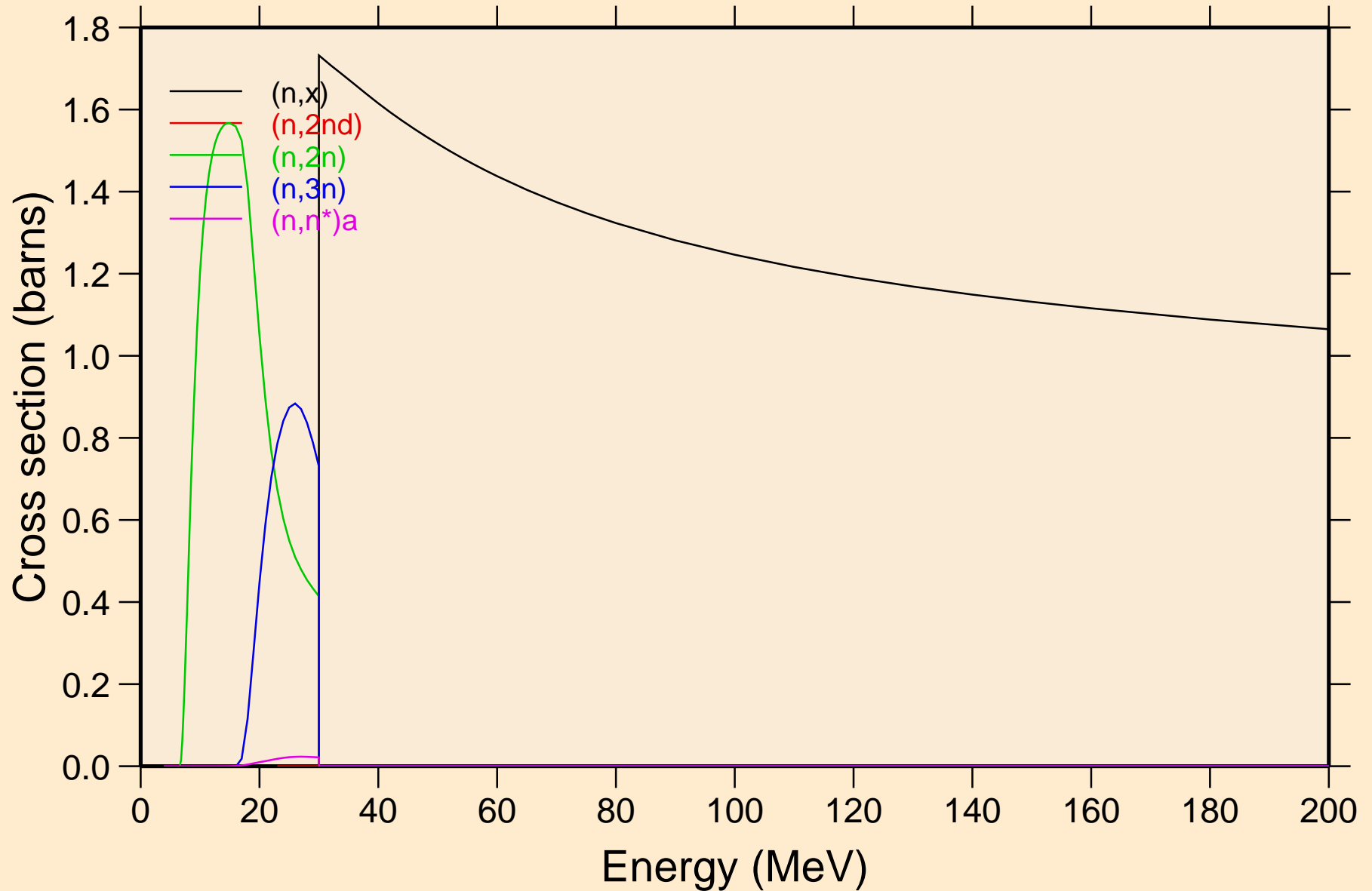

CD113 NEUTRON ACER TENDL-2019 LIBRARY; T=293.16K  
Threshold reactions

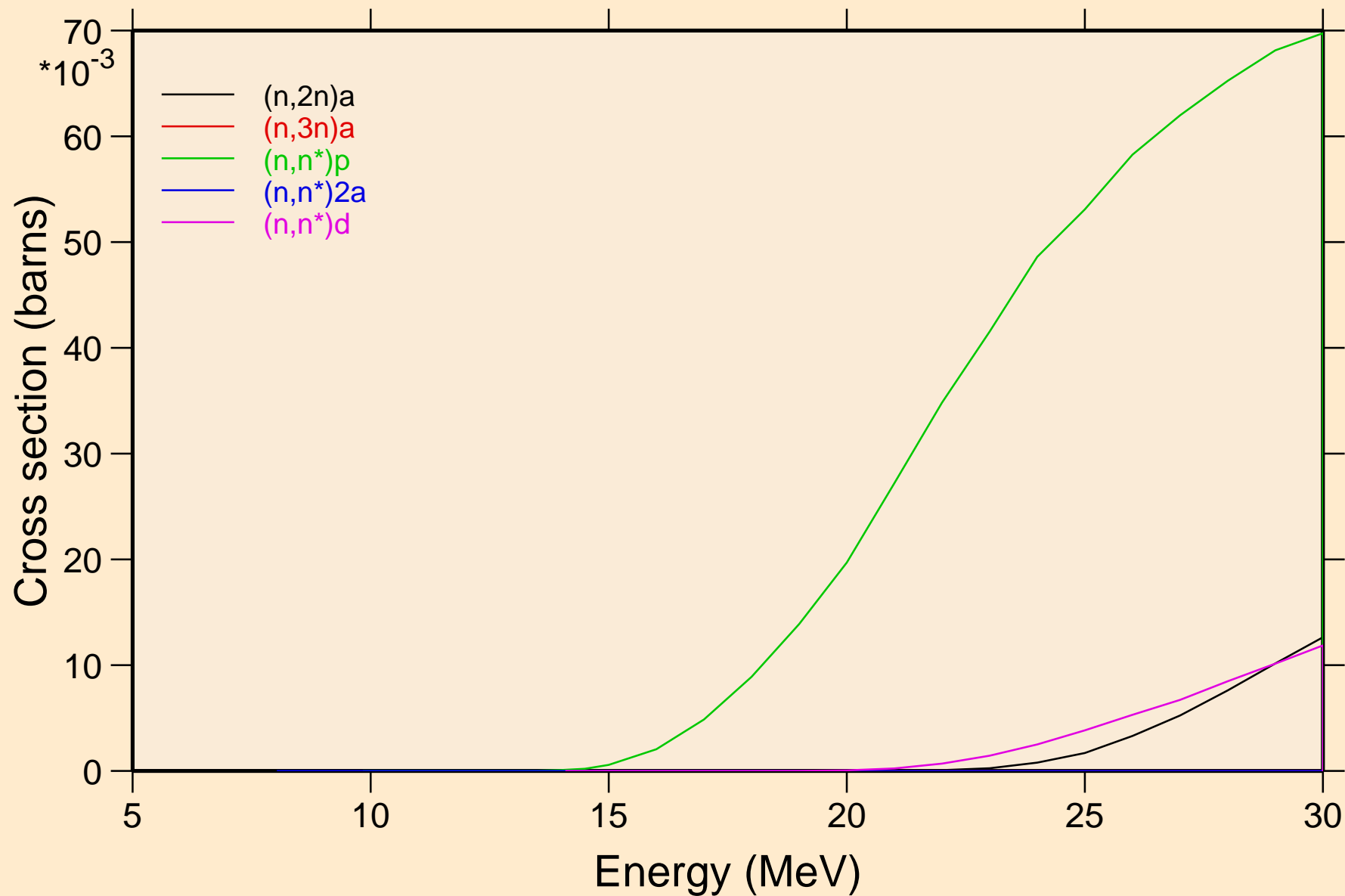

# CD113 NEUTRON ACER TENDL-2019 LIBRARY; T=293.16K

## Threshold reactions

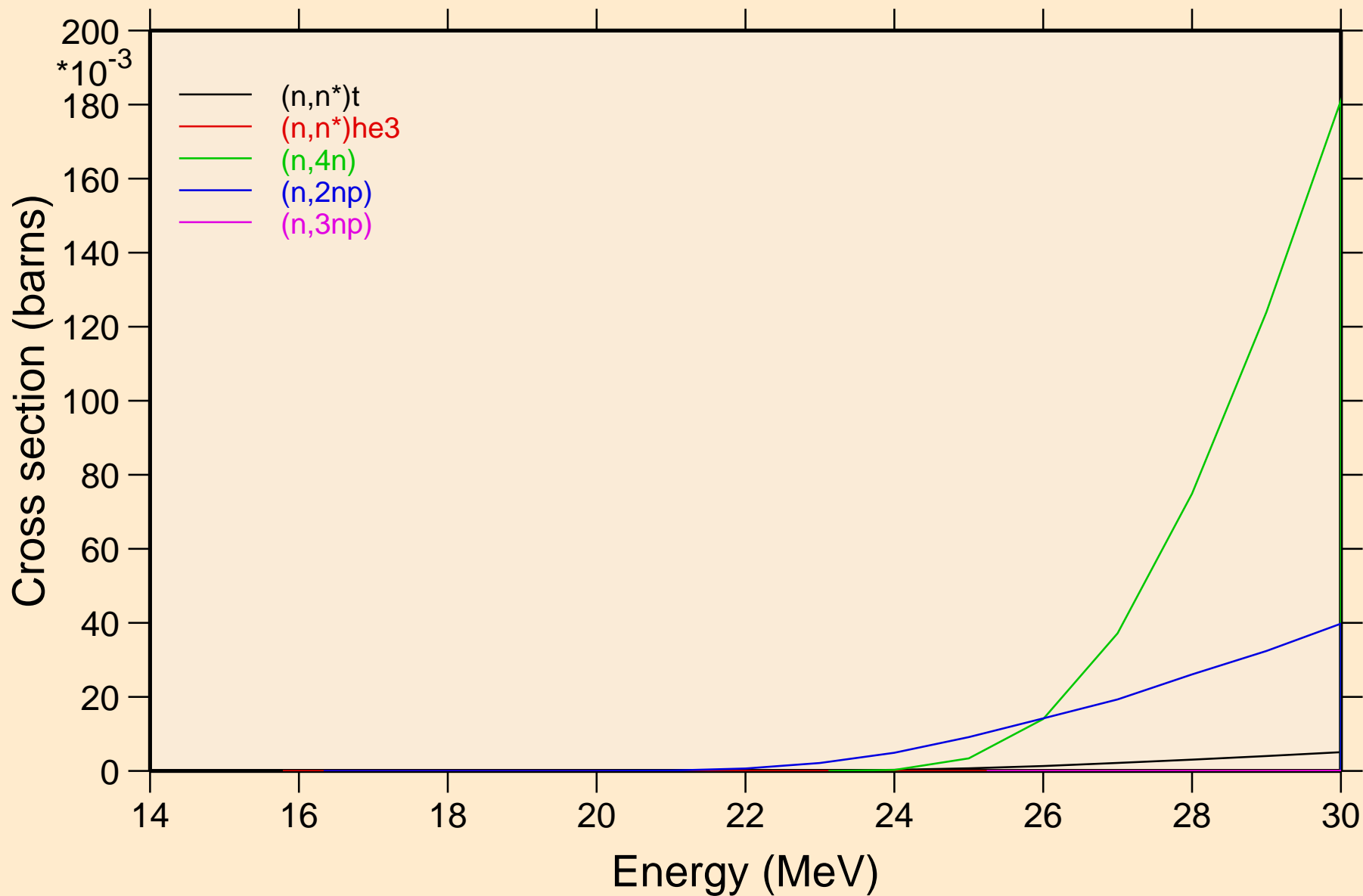

CD113 NEUTRON ACER TENDL-2019 LIBRARY; T=293.16K  
Threshold reactions

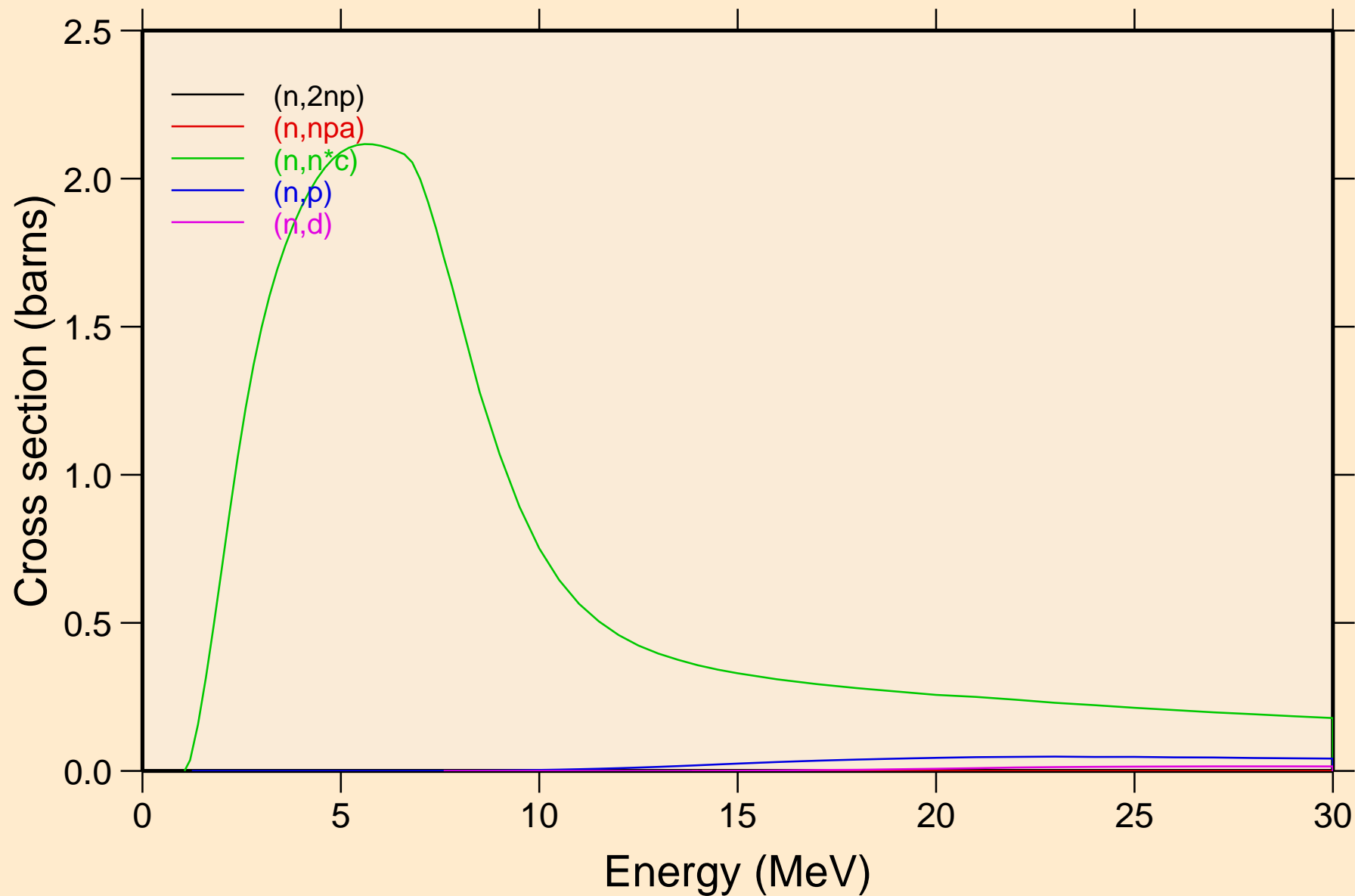

CD113 NEUTRON ACER TENDL-2019 LIBRARY; T=293.16K  
Threshold reactions

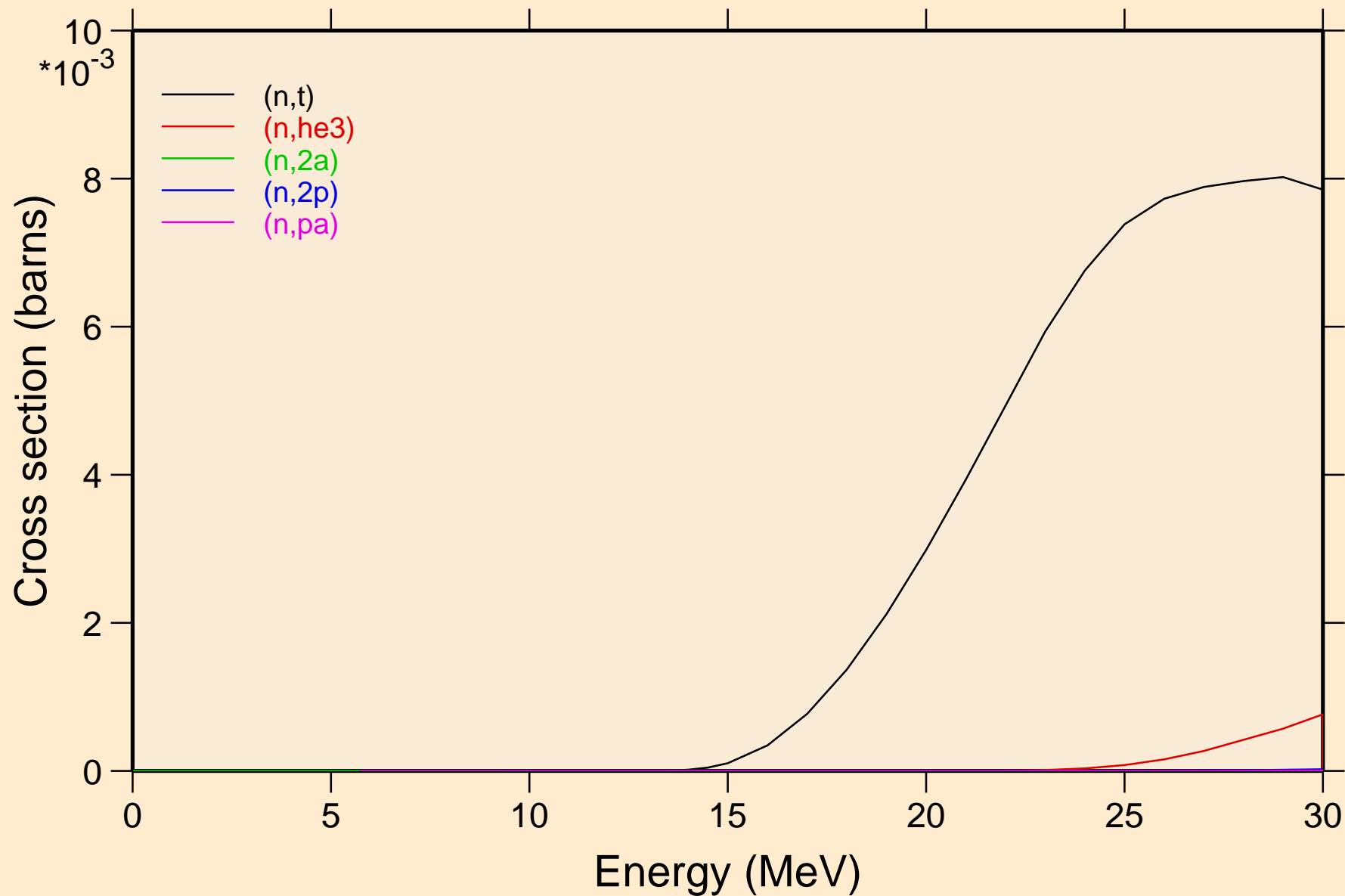

CD113 NEUTRON ACER TENDL-2019 LIBRARY; T=293.16K  
Threshold reactions

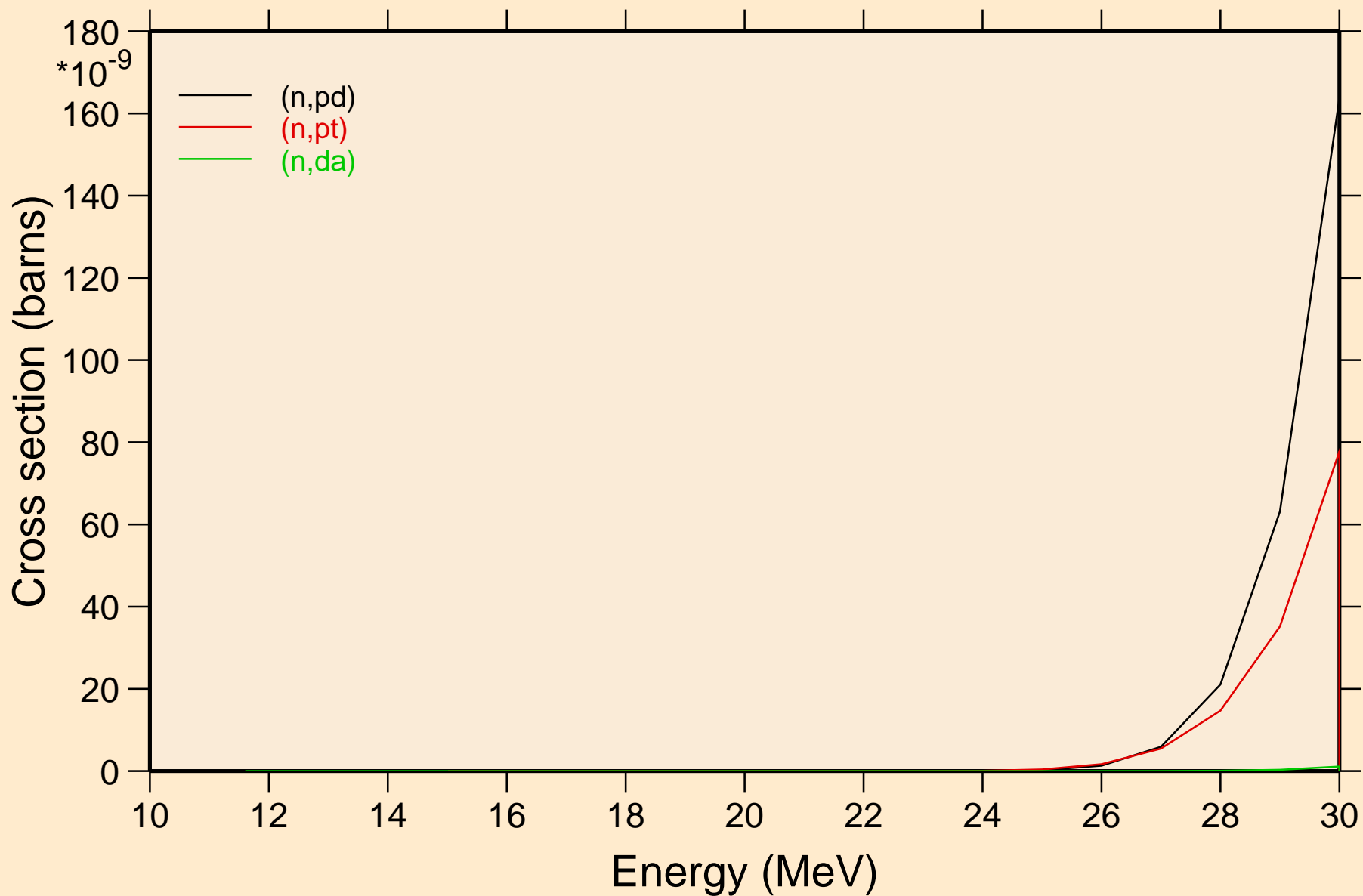

CD113 NEUTRON ACER TENDL-2019 LIBRARY; T=293.16K  
Threshold reactions

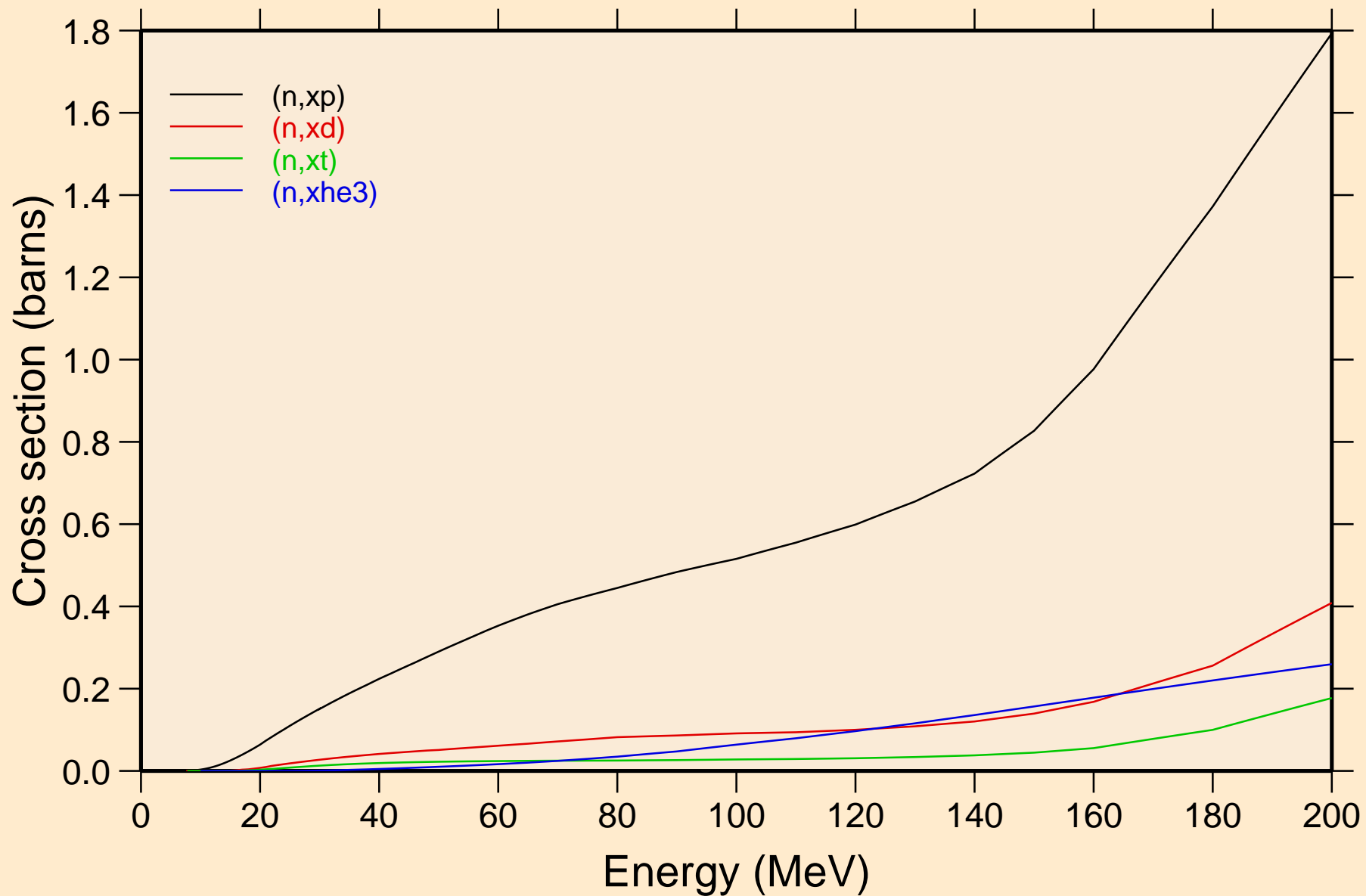

CD113 NEUTRON ACER TENDL-2019 LIBRARY; T=293.16K  
angular distribution for elastic

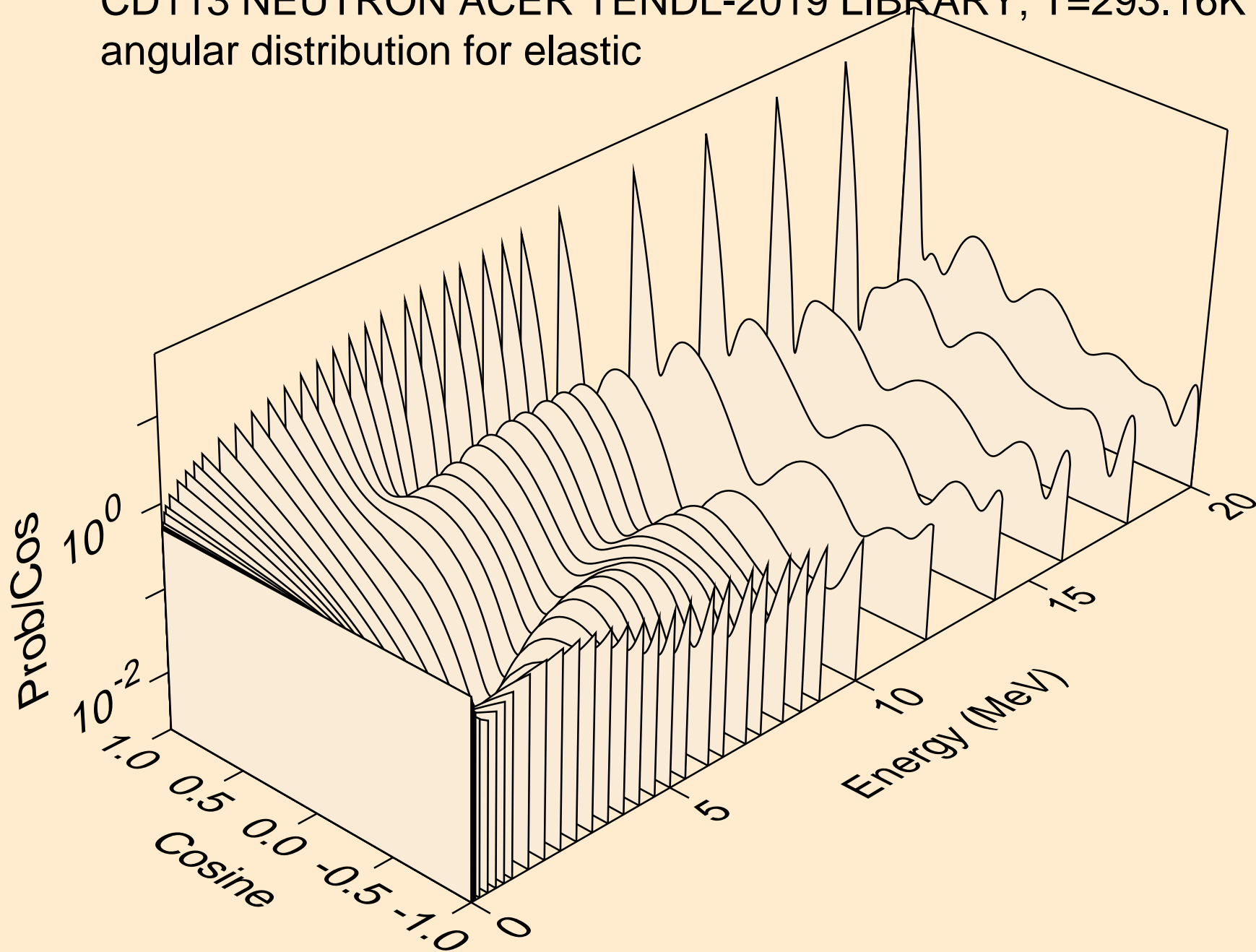

CD113 NEUTRON ACER TENDL-2019 LIBRARY; T=293.16K  
angular distribution for elastic

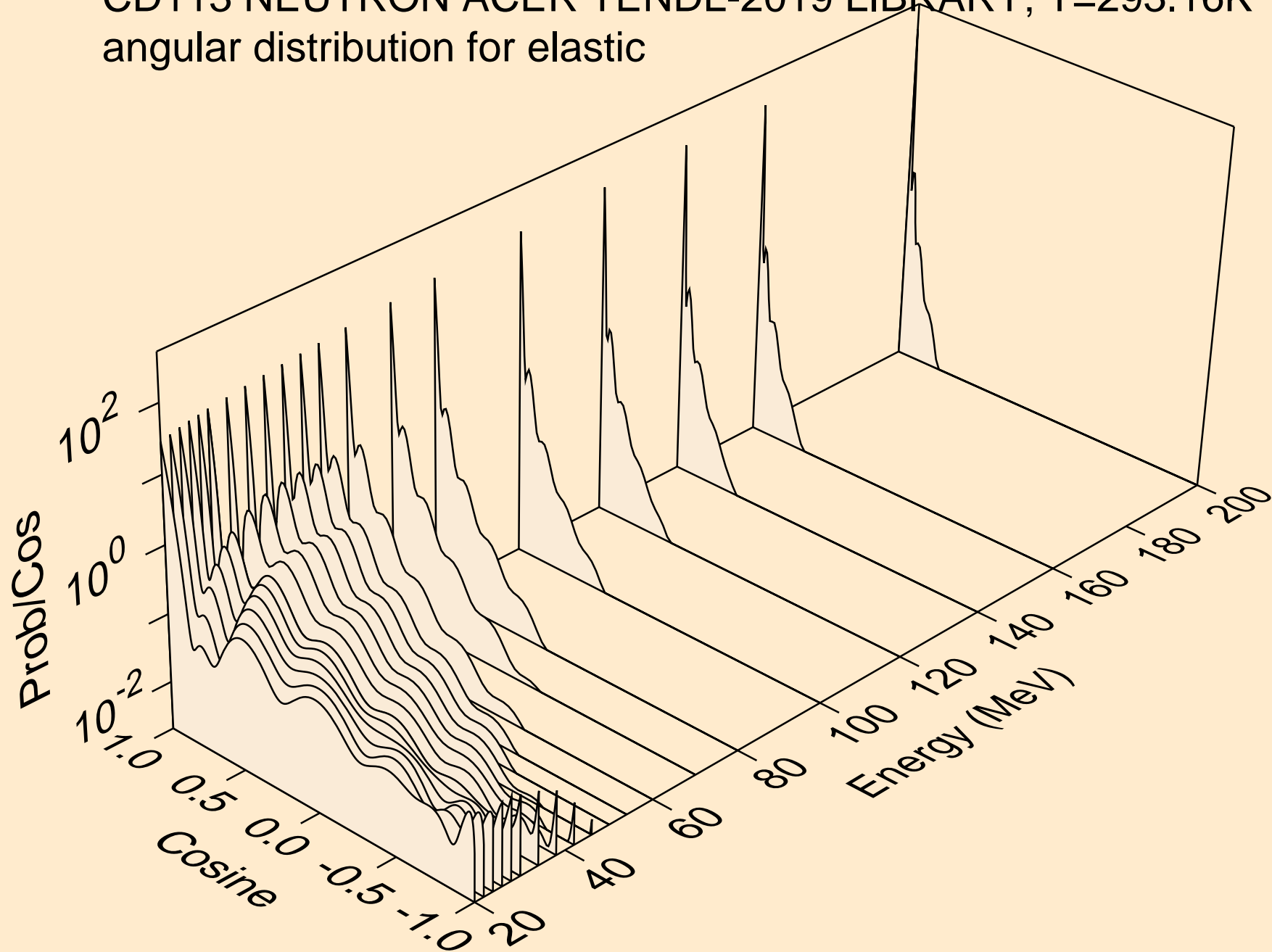

CD113 NEUTRON ACER TENDL-2019 LIBRARY; T=293.16K  
angular distribution for (n,n\*1)

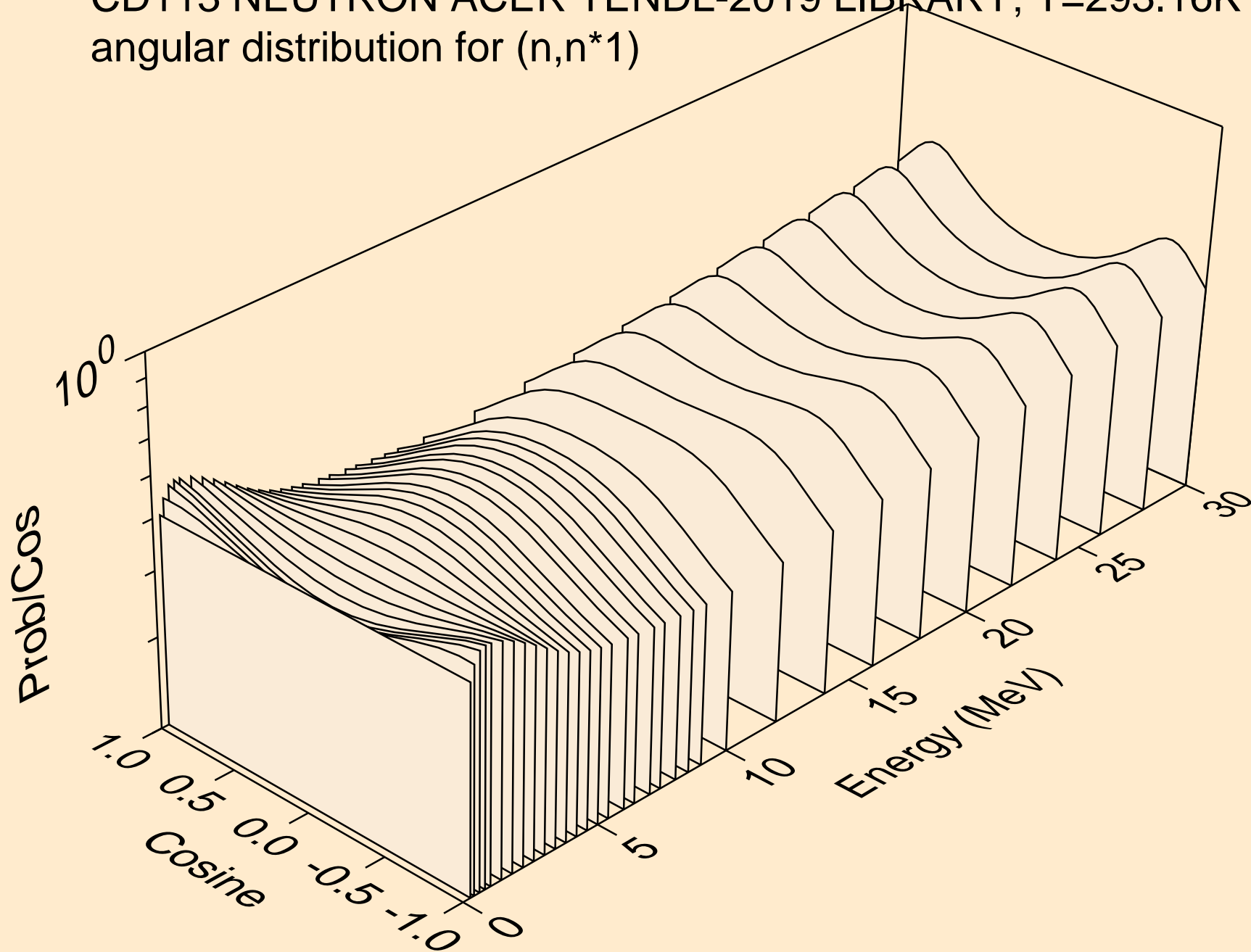

CD113 NEUTRON ACER TENDL-2019 LIBRARY; T=293.16K  
angular distribution for (n,n\*2)

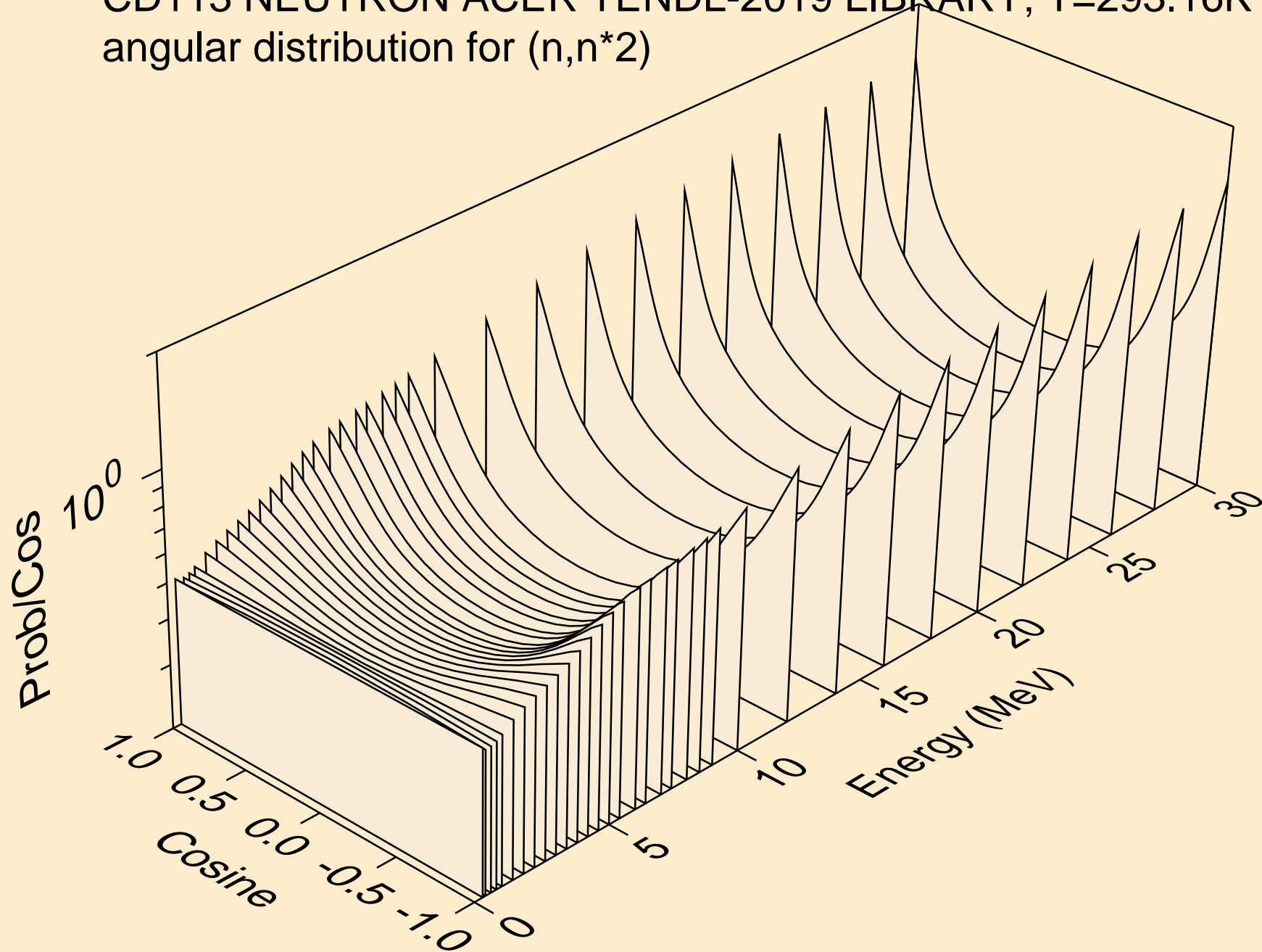

CD113 NEUTRON ACER TENDL-2019 LIBRARY; T=293.16K  
angular distribution for (n,n\*3)

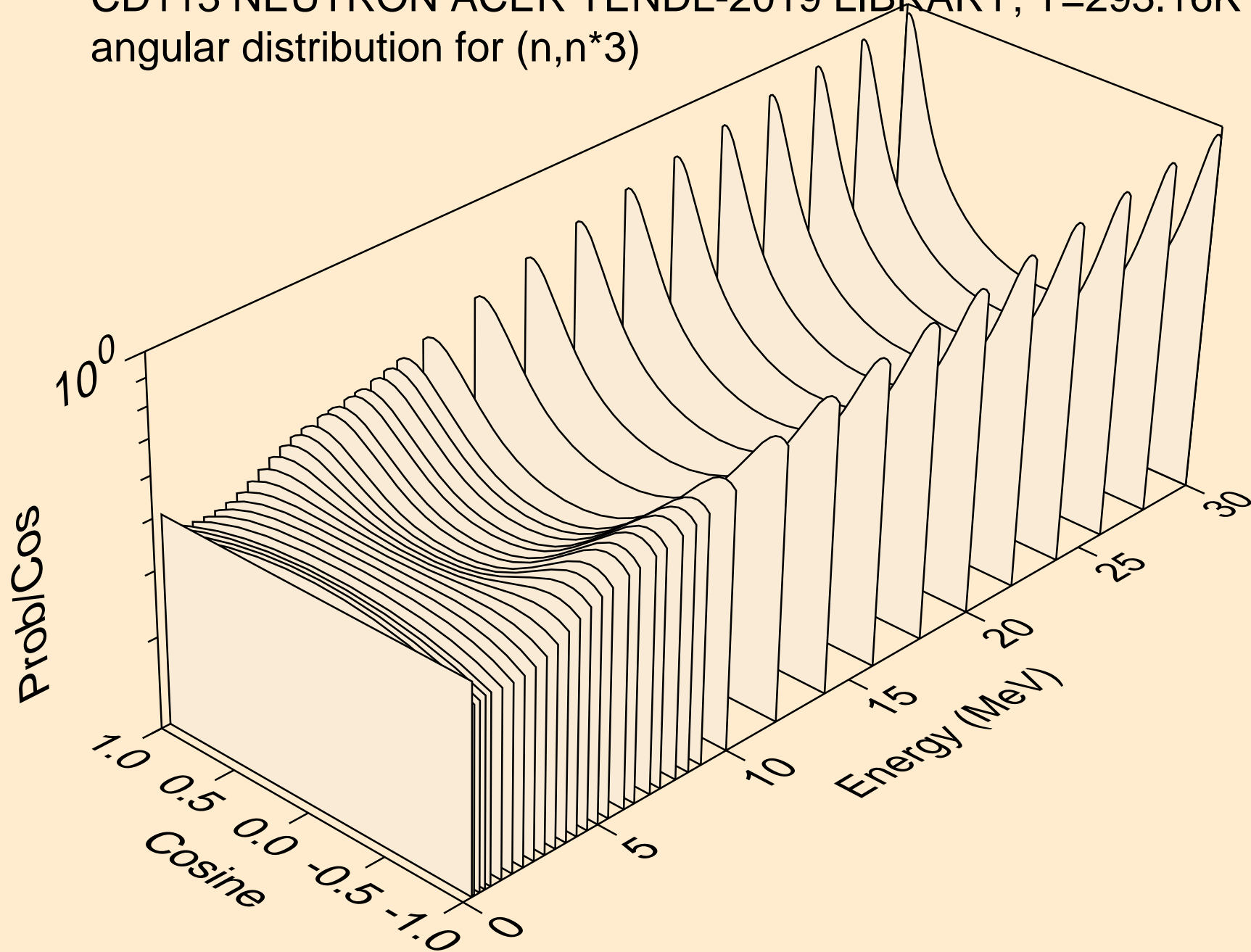

CD113 NEUTRON ACER TENDL-2019 LIBRARY; T=293.16K  
angular distribution for (n,n\*4)

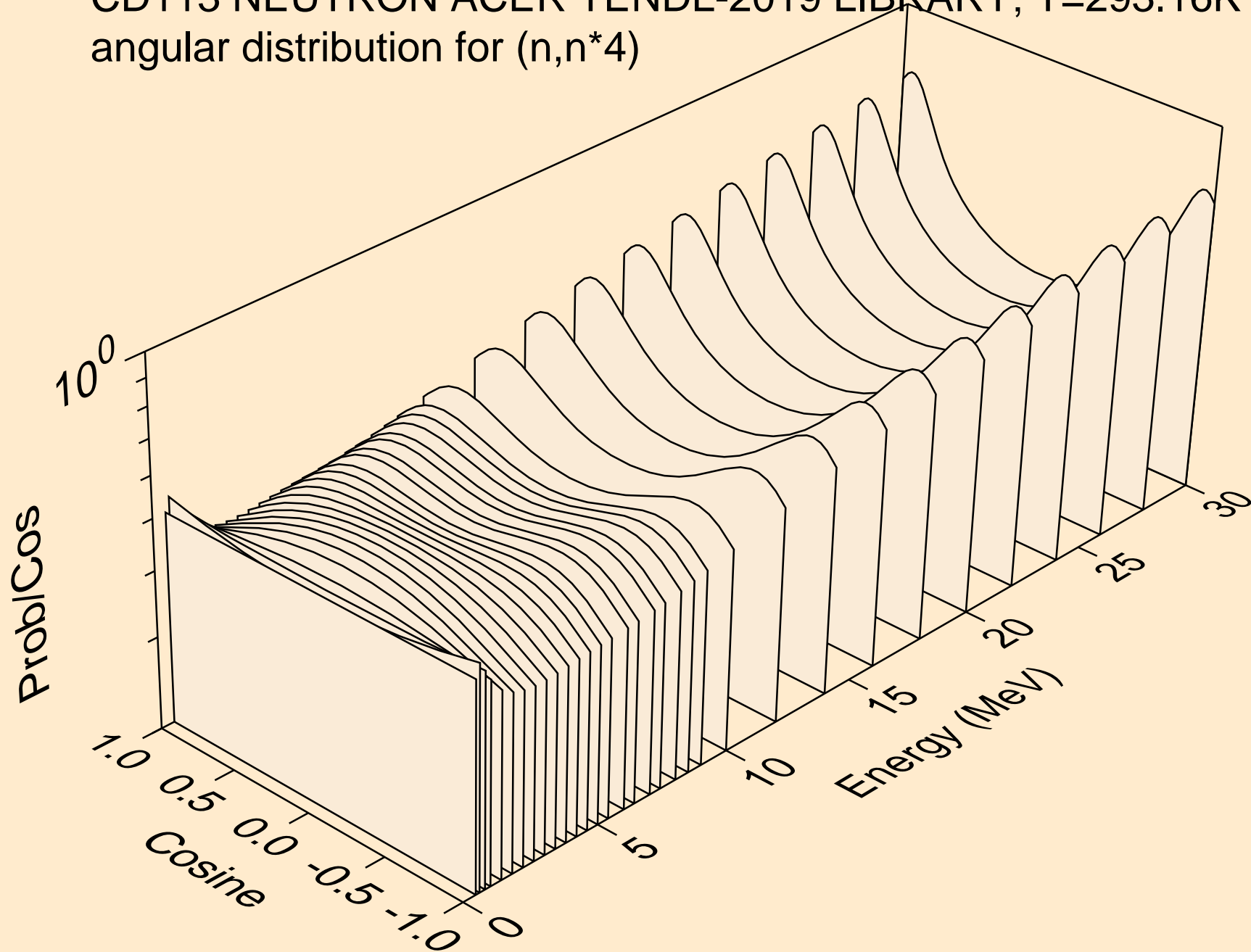

CD113 NEUTRON ACER TENDL-2019 LIBRARY; T=293.16K  
angular distribution for (n,n\*5)

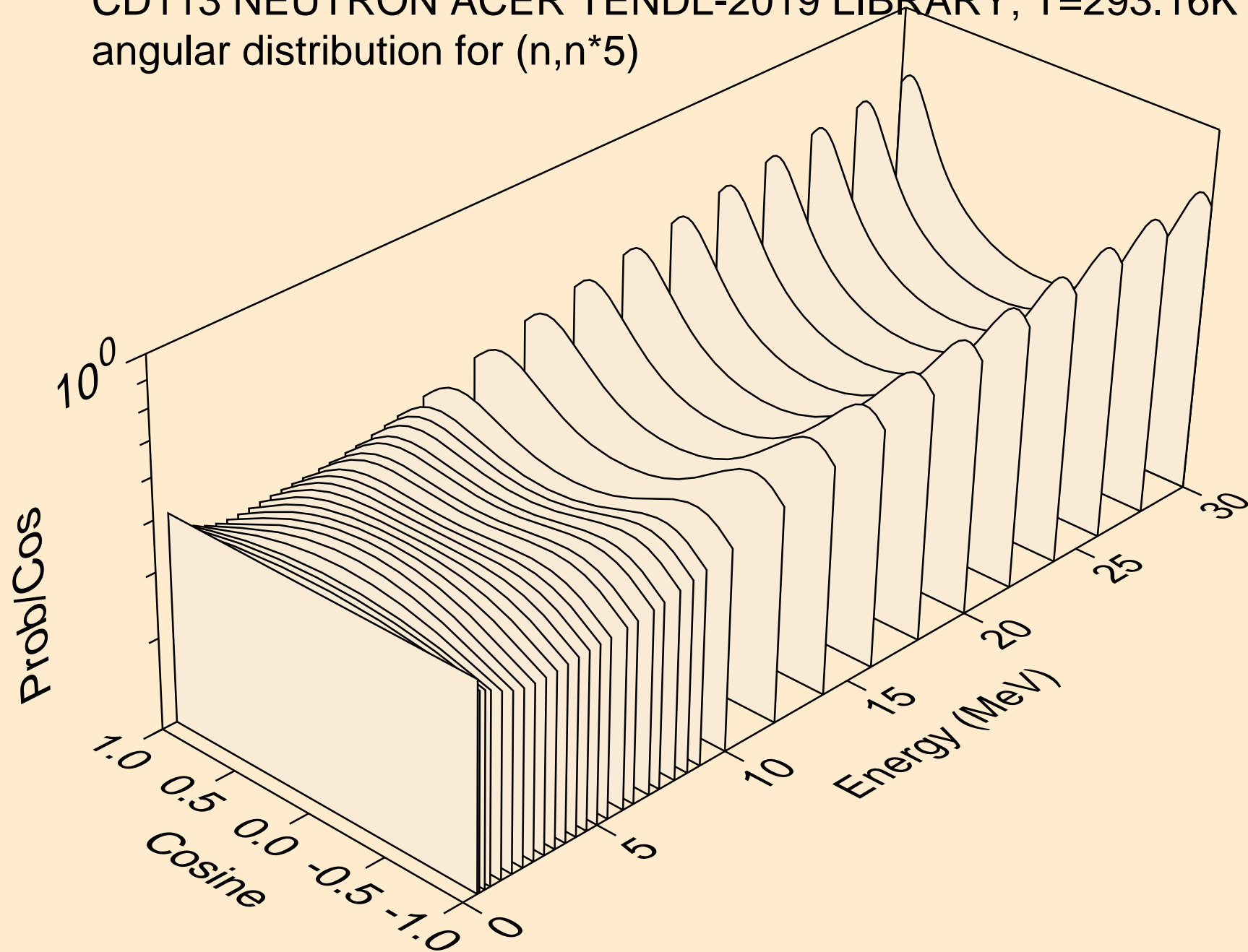

CD113 NEUTRON ACER TENDL-2019 LIBRARY; T=293.16K  
angular distribution for (n,n\*6)

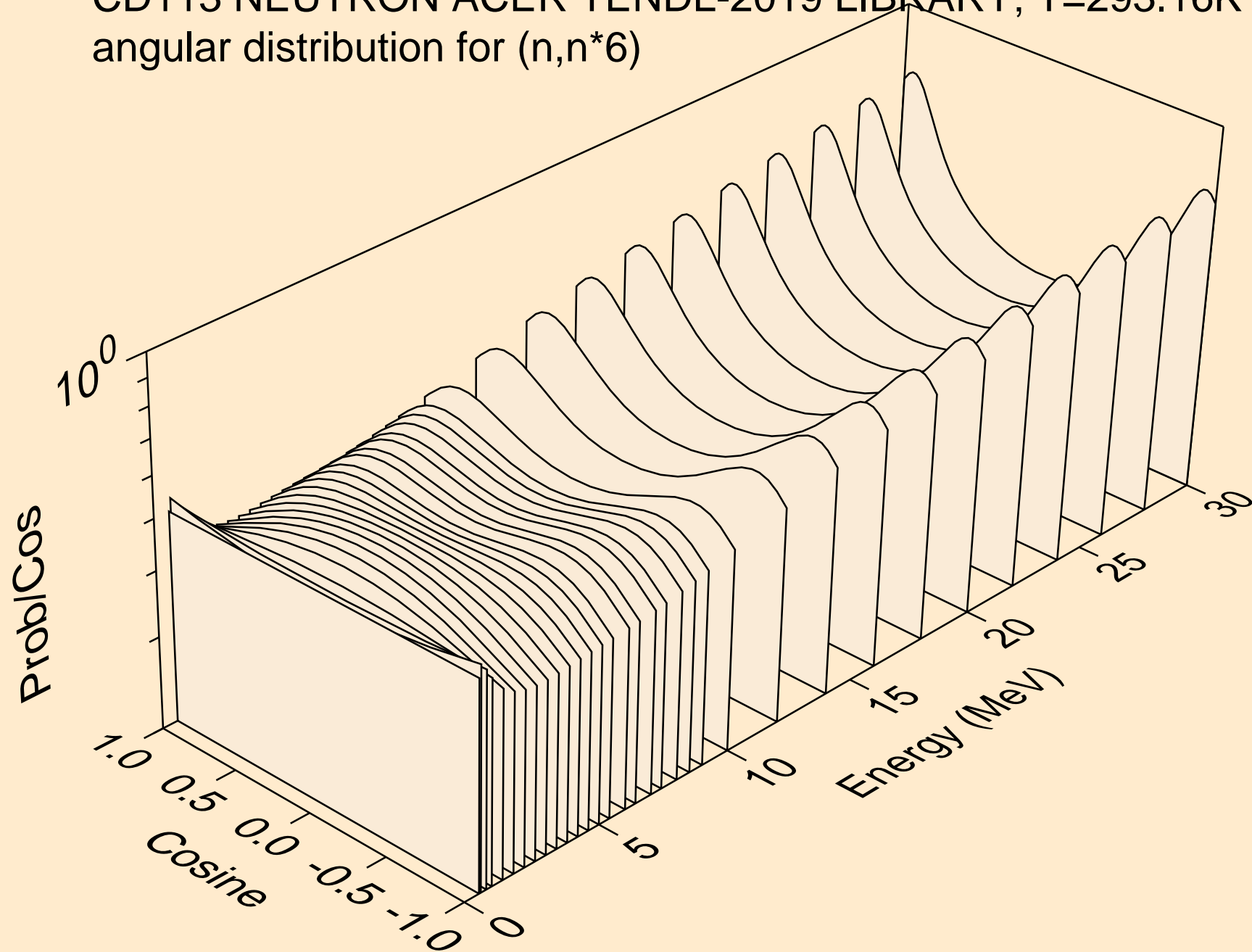

CD113 NEUTRON ACER TENDL-2019 LIBRARY; T=293.16K  
angular distribution for (n,n\*7)

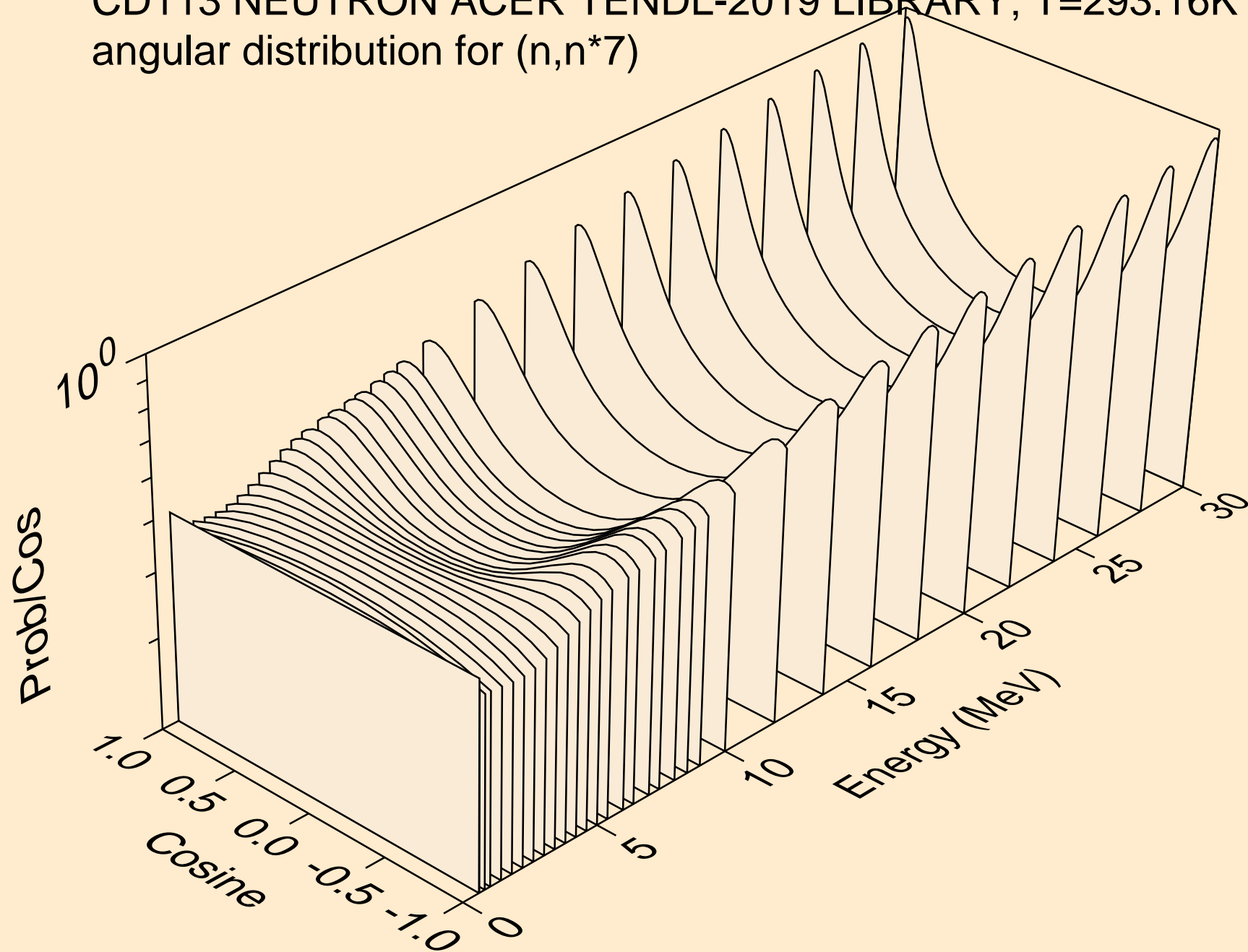

CD113 NEUTRON ACER TENDL-2019 LIBRARY; T=293.16K  
angular distribution for (n,n\*8)

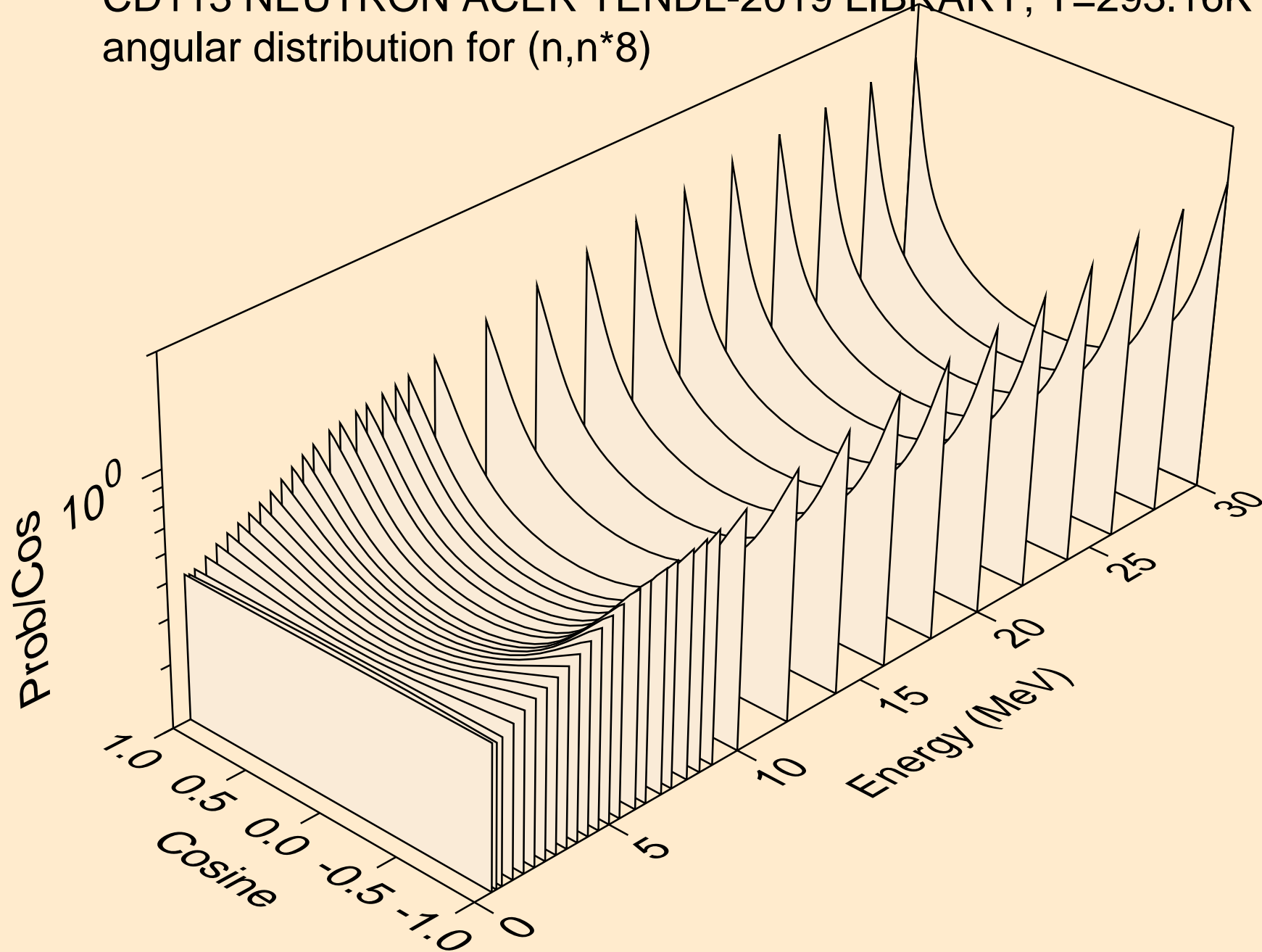

CD113 NEUTRON ACER TENDL-2019 LIBRARY; T=293.16K  
angular distribution for (n,n\*9)

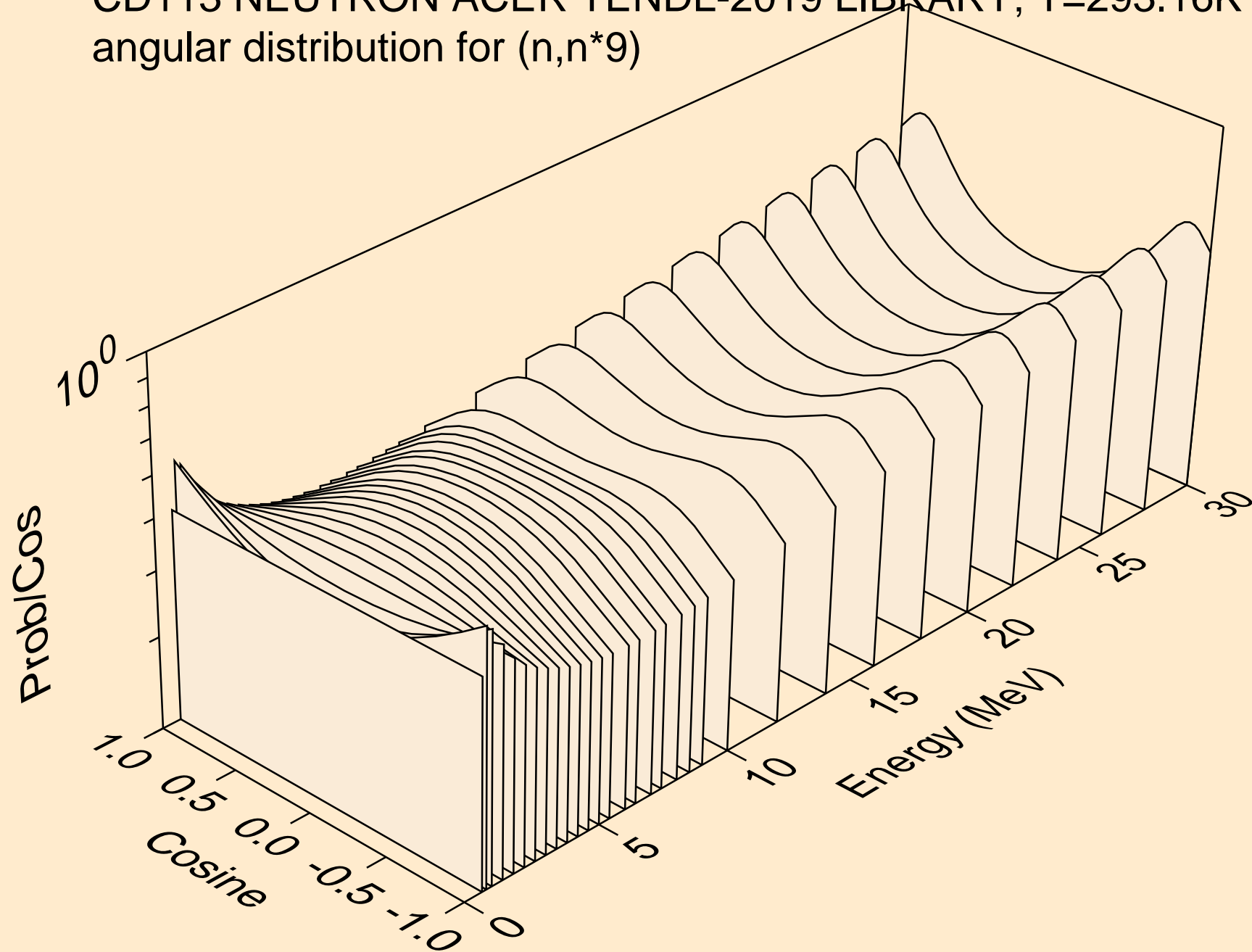

CD113 NEUTRON ACER TENDL-2019 LIBRARY; T=293.16K  
angular distribution for (n,n\*10)

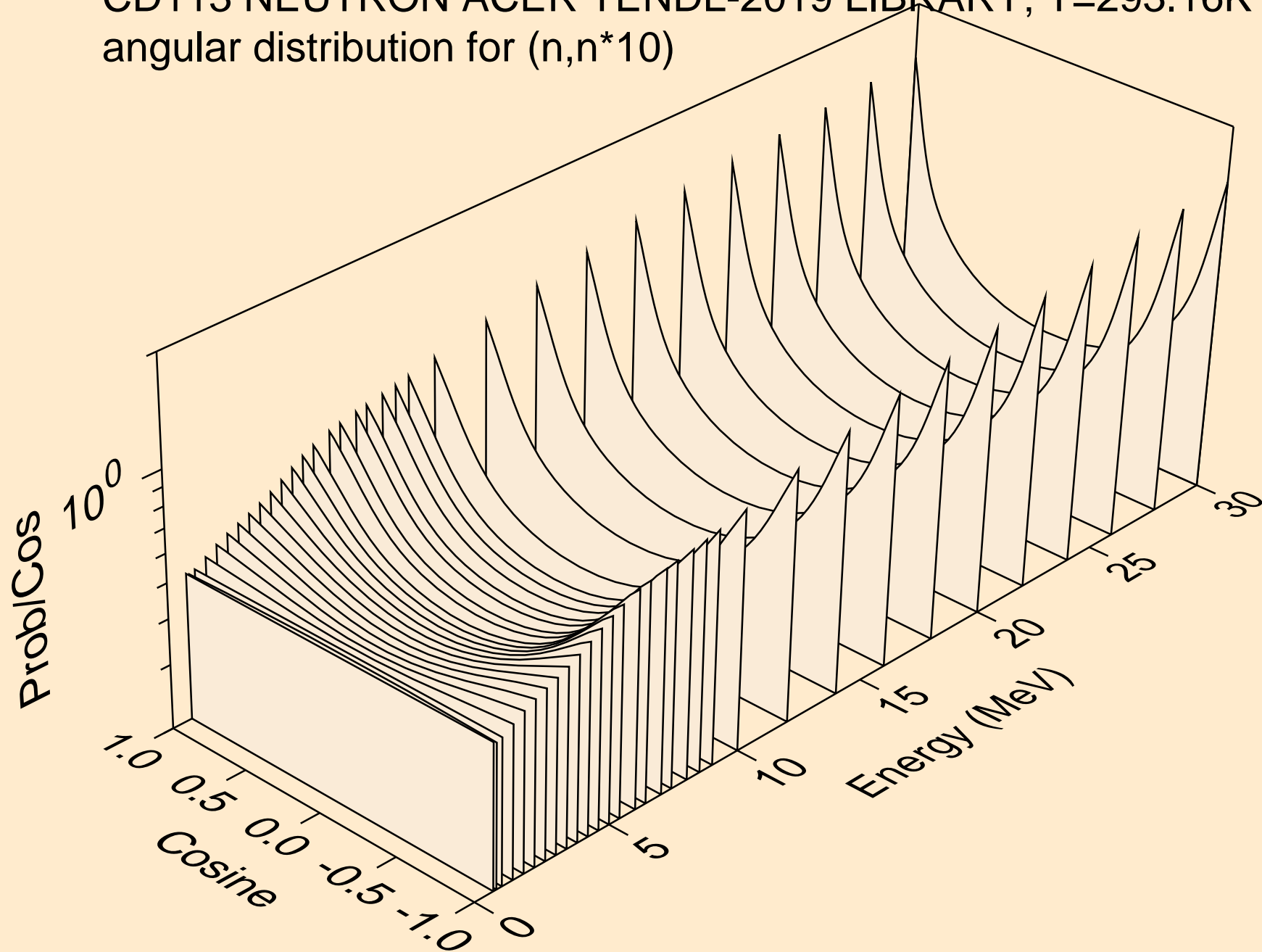

CD113 NEUTRON ACER TENDL-2019 LIBRARY; T=293.16K  
angular distribution for (n,n\*11)

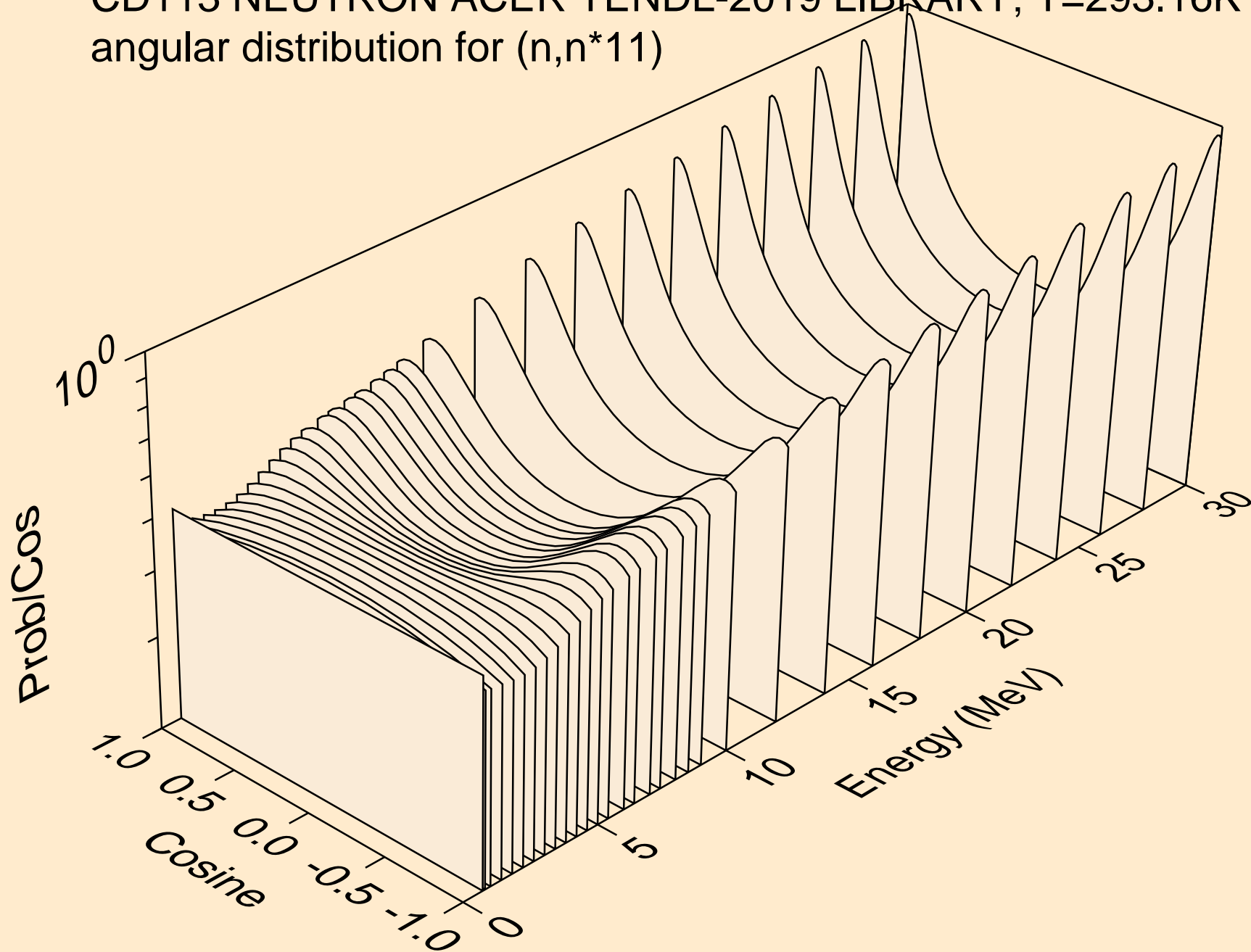

CD113 NEUTRON ACER TENDL-2019 LIBRARY; T=293.16K  
angular distribution for (n,n\*12)

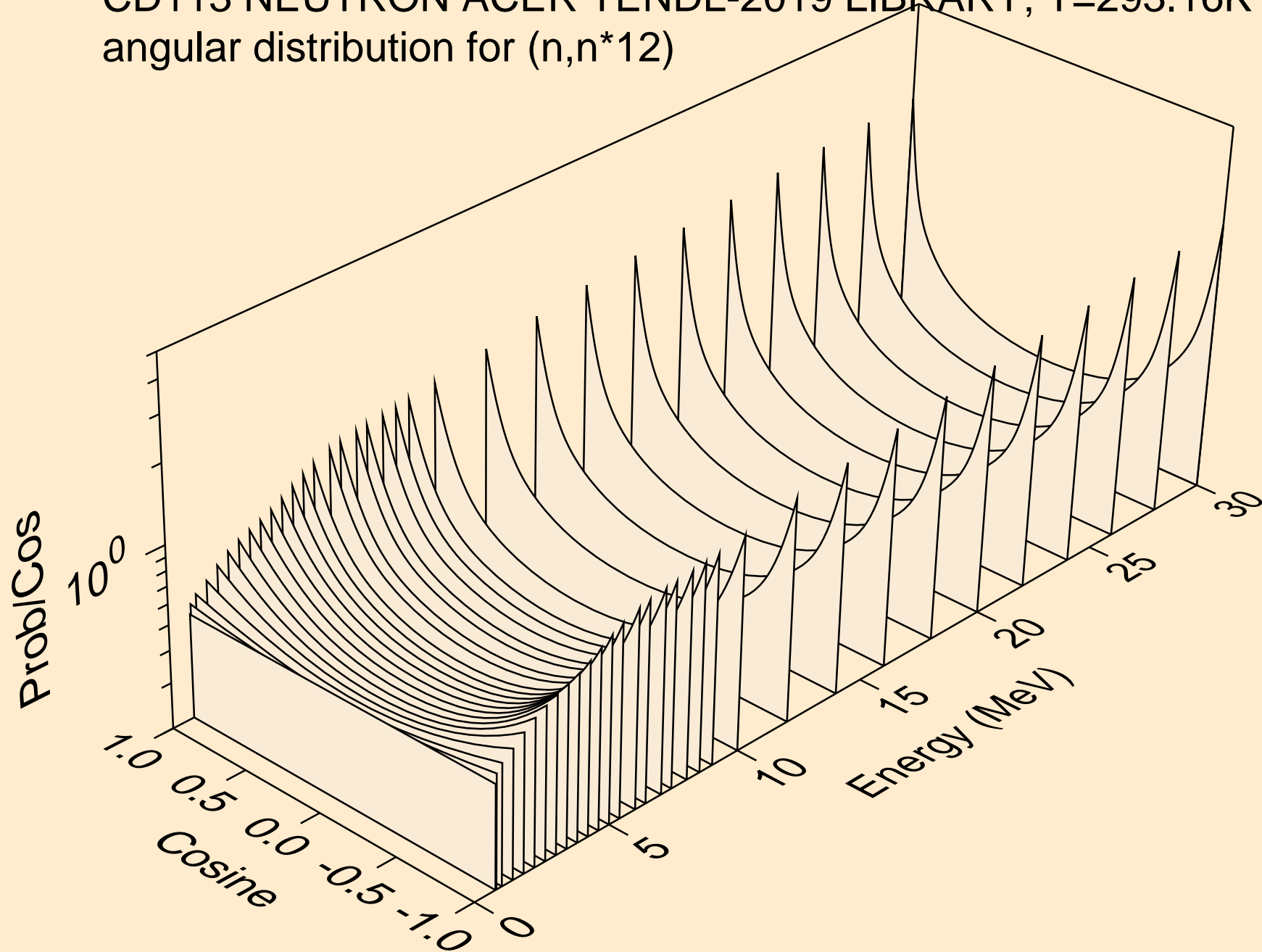

CD113 NEUTRON ACER TENDL-2019 LIBRARY; T=293.16K  
angular distribution for (n,n\*13)

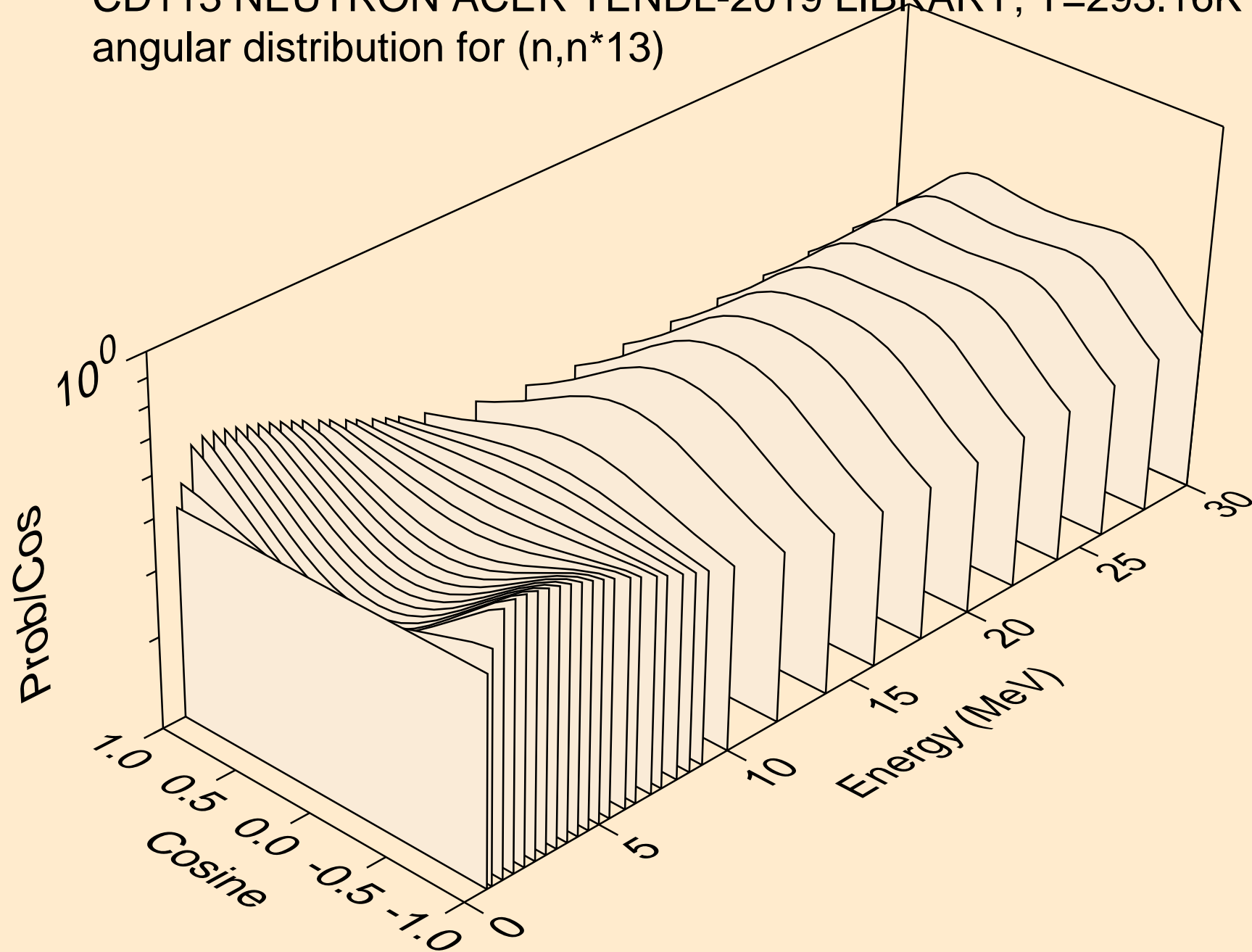

CD113 NEUTRON ACER TENDL-2019 LIBRARY; T=293.16K  
angular distribution for (n,n\*14)

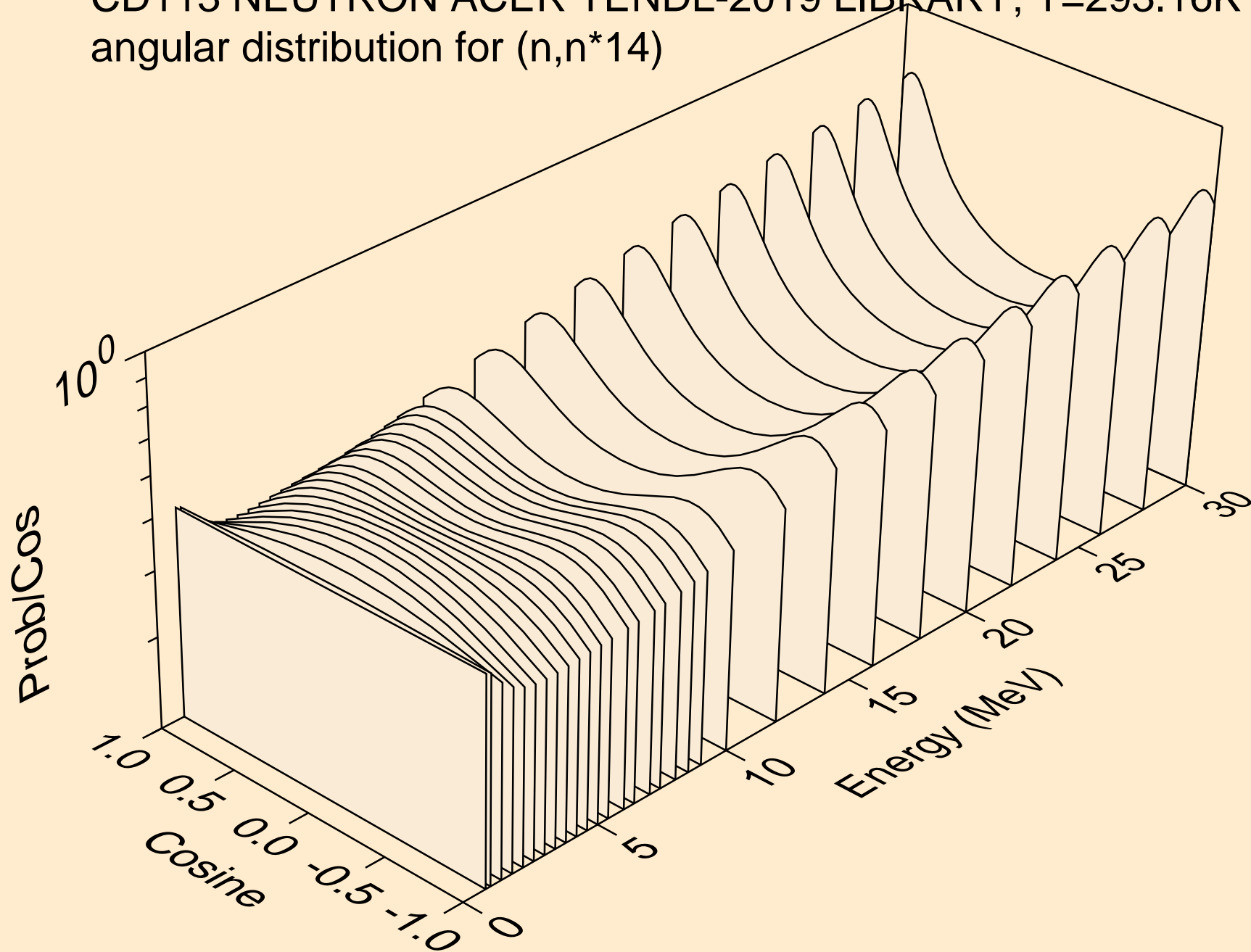

CD113 NEUTRON ACER TENDL-2019 LIBRARY; T=293.16K  
angular distribution for (n,n\*15)

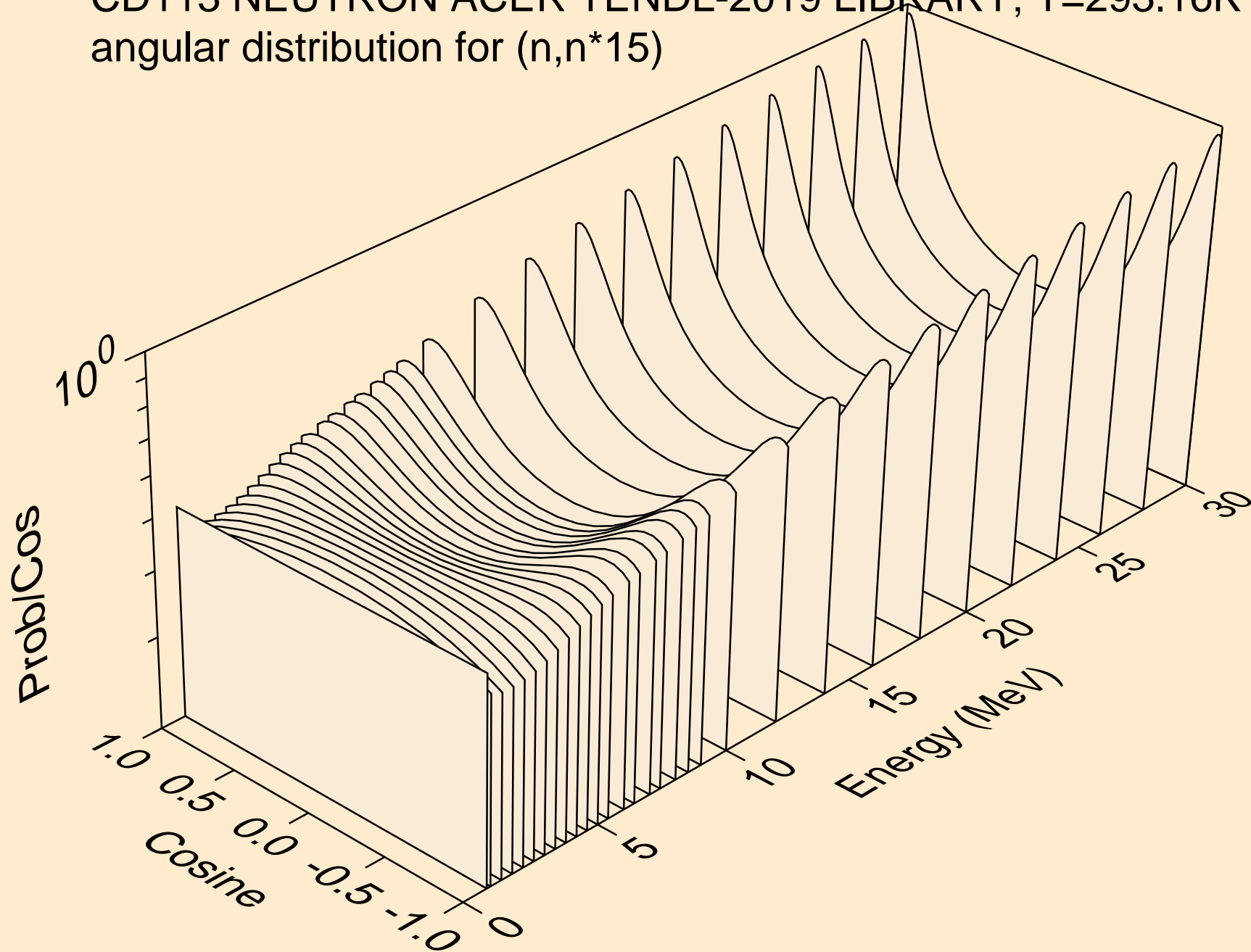

CD113 NEUTRON ACER TENDL-2019 LIBRARY; T=293.16K  
angular distribution for (n,n\*16)

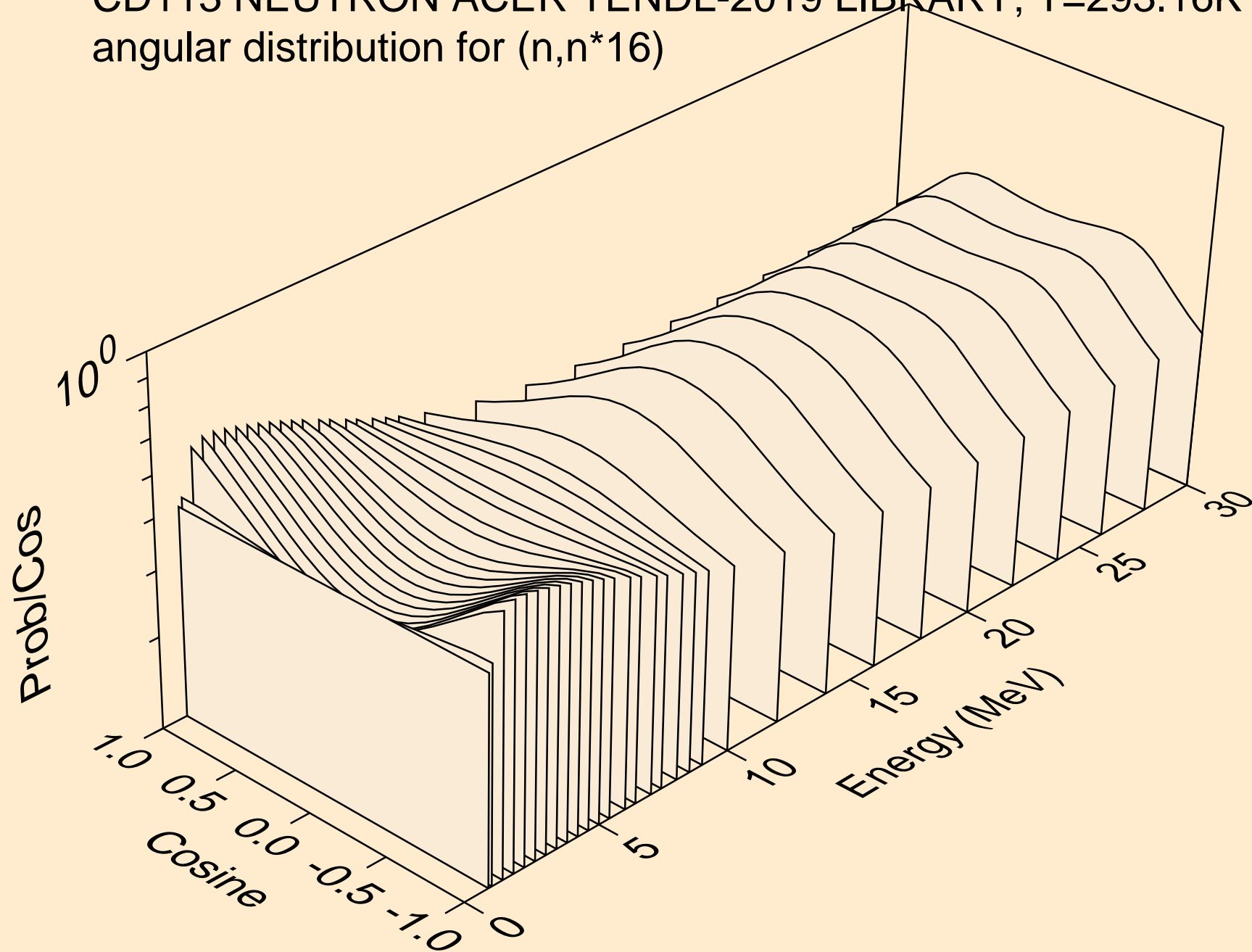

CD113 NEUTRON ACER TENDL-2019 LIBRARY; T=293.16K  
angular distribution for (n,n\*17)

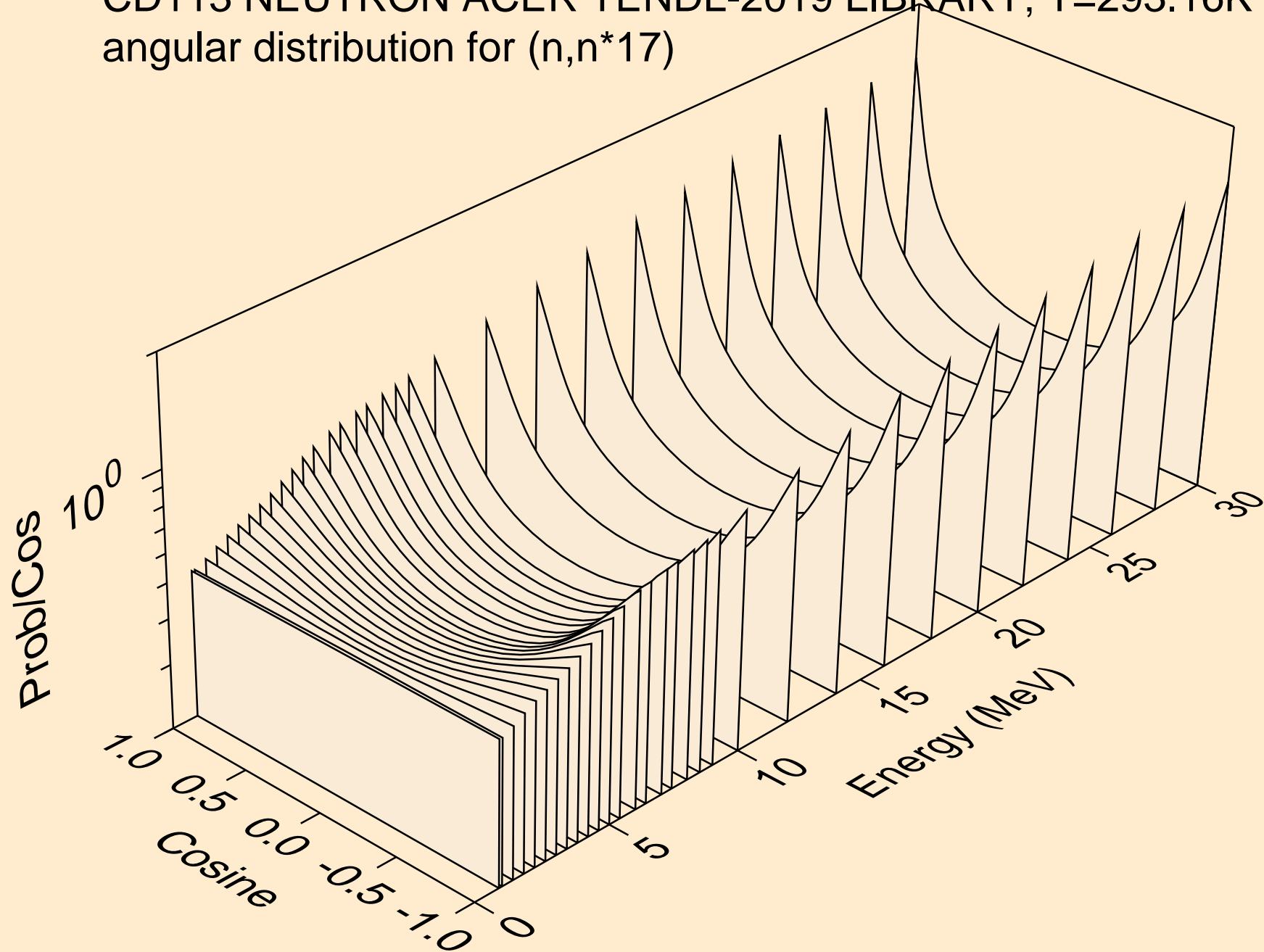

CD113 NEUTRON ACER TENDL-2019 LIBRARY; T=293.16K  
angular distribution for (n,n\*18)

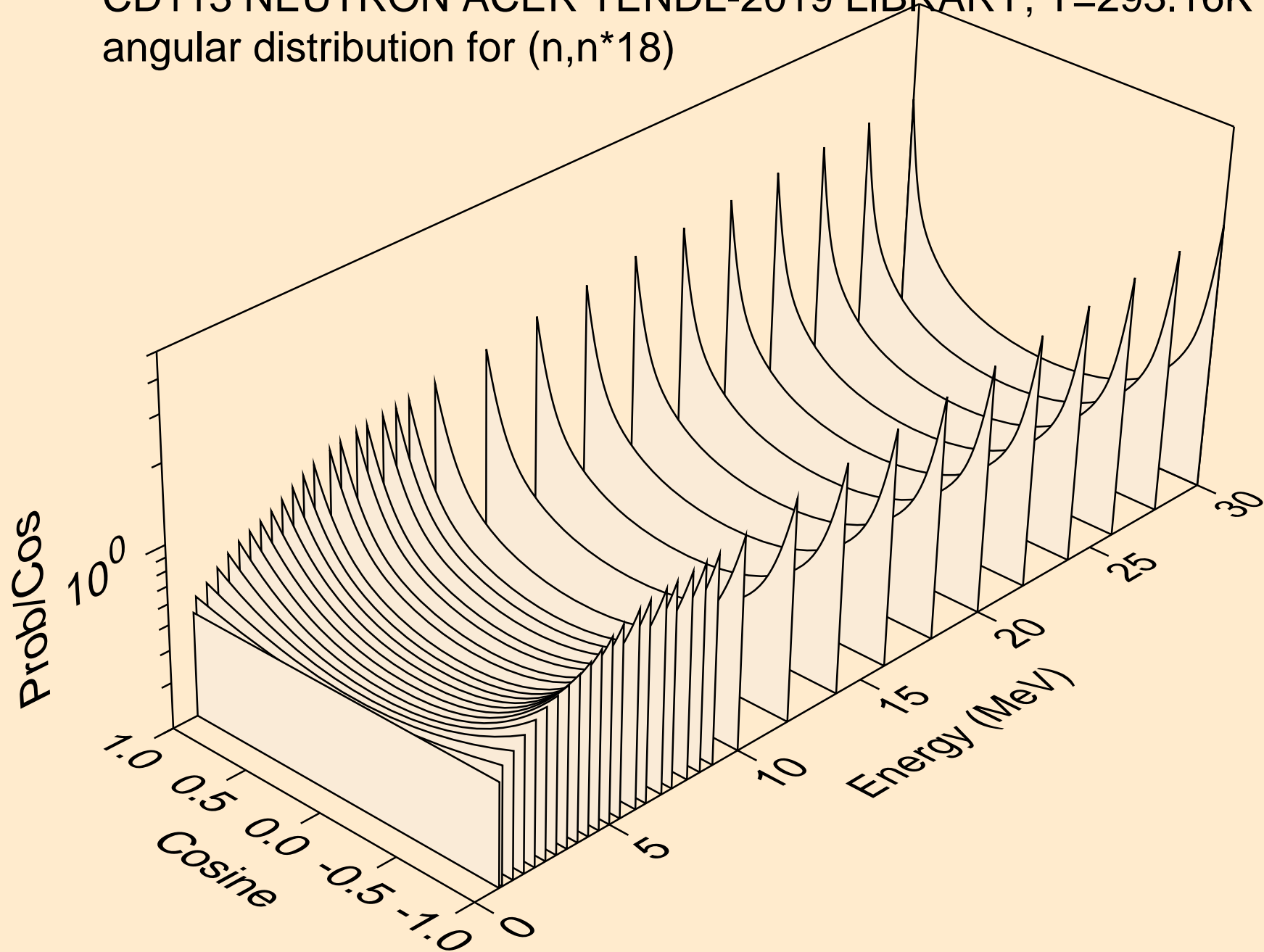

CD113 NEUTRON ACER TENDL-2019 LIBRARY; T=293.16K  
angular distribution for (n,n\*19)

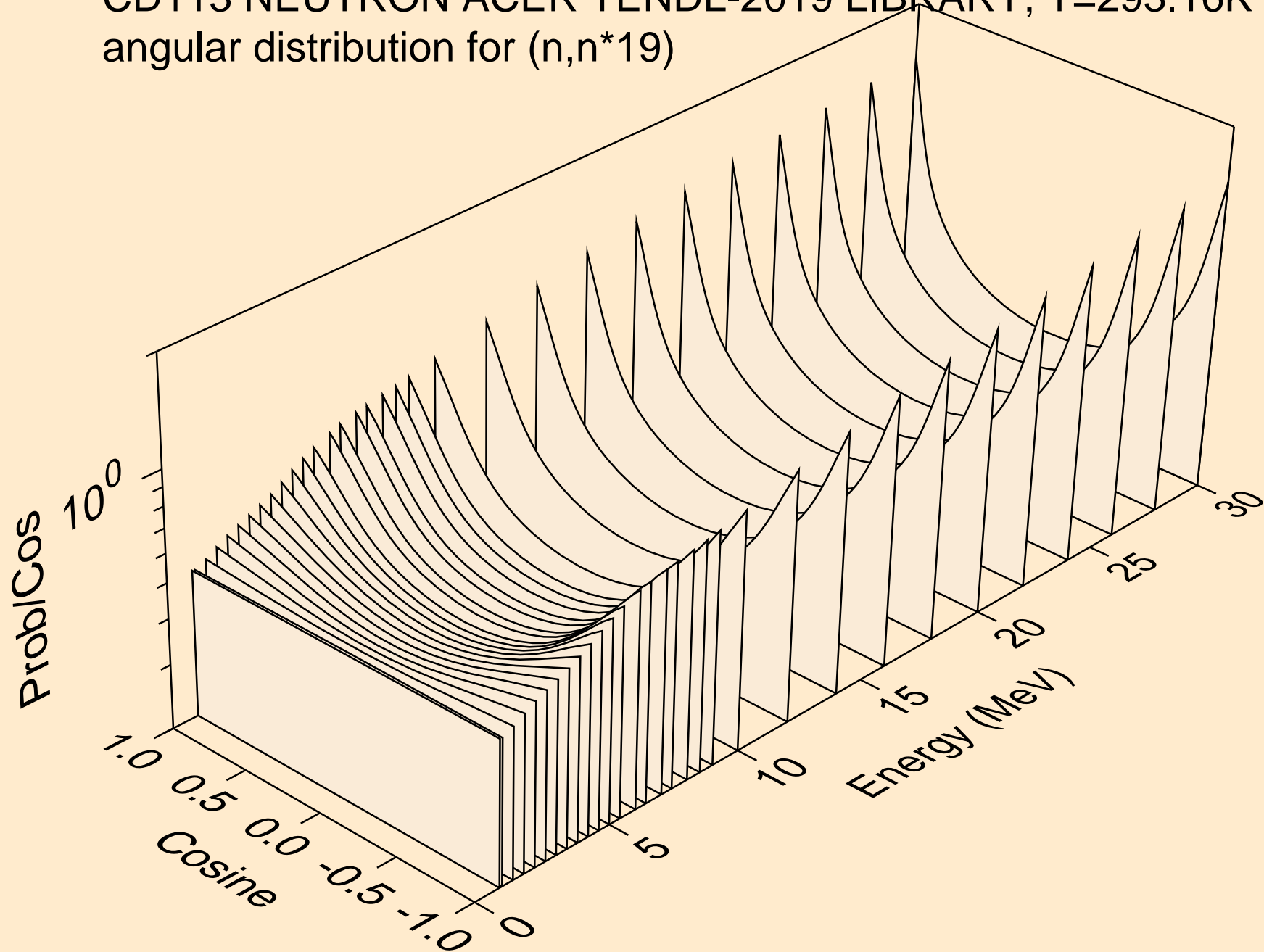

CD113 NEUTRON ACER TENDL-2019 LIBRARY; T=293.16K  
angular distribution for (n,n\*20)

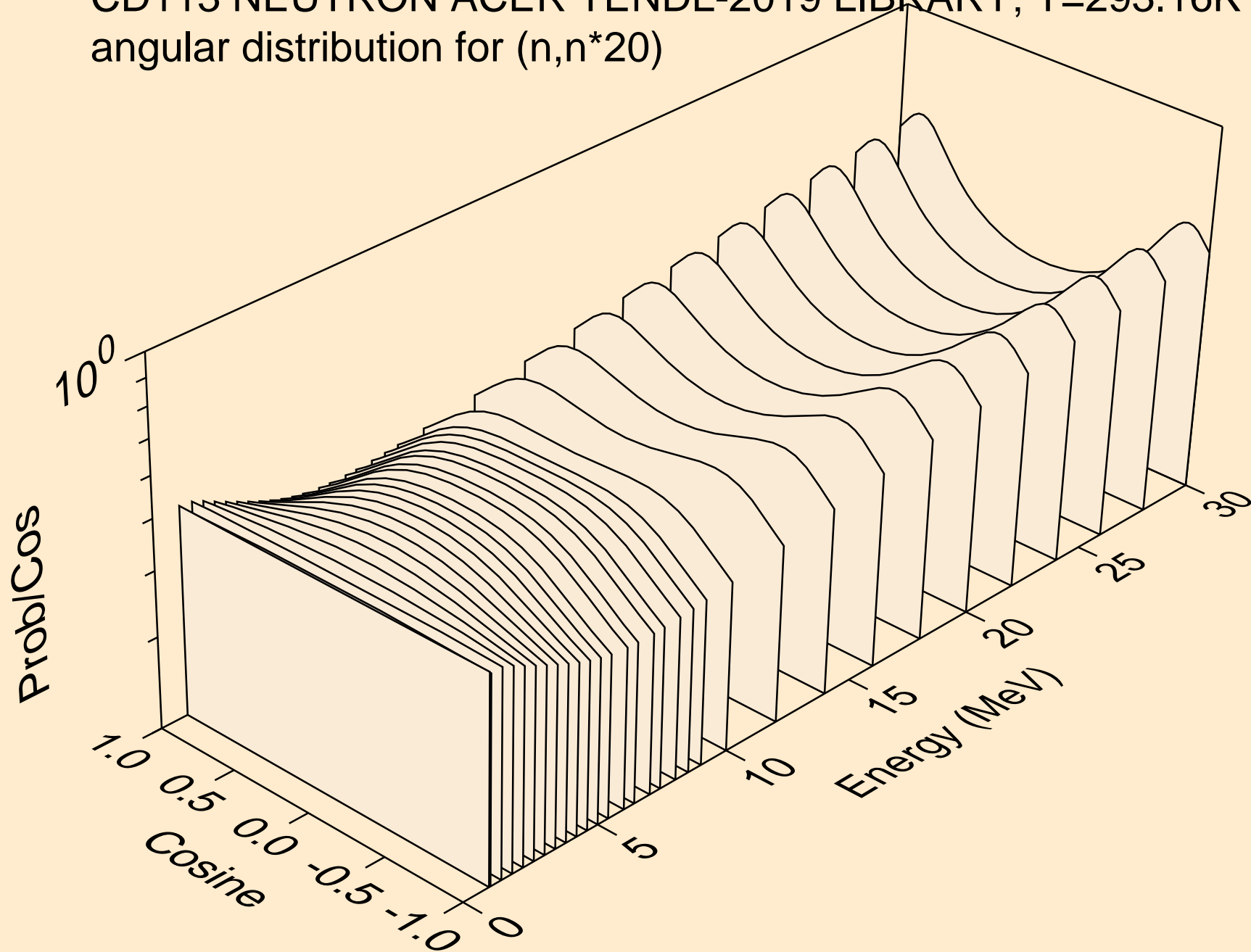

CD113 NEUTRON ACER TENDL-2019 LIBRARY; T=293.16K  
angular distribution for (n,n\*21)

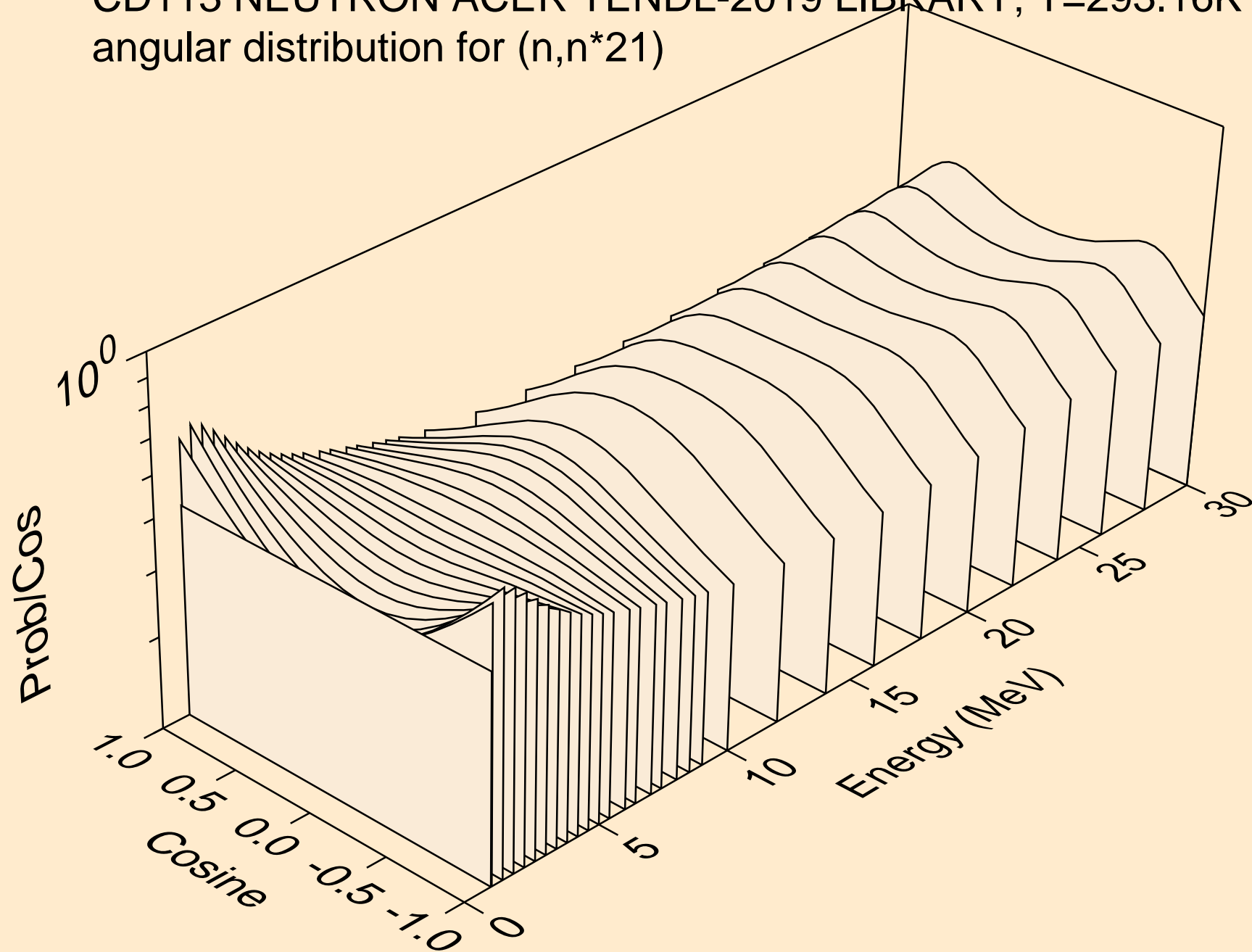

CD113 NEUTRON ACER TENDL-2019 LIBRARY; T=293.16K  
angular distribution for (n,n\*22)

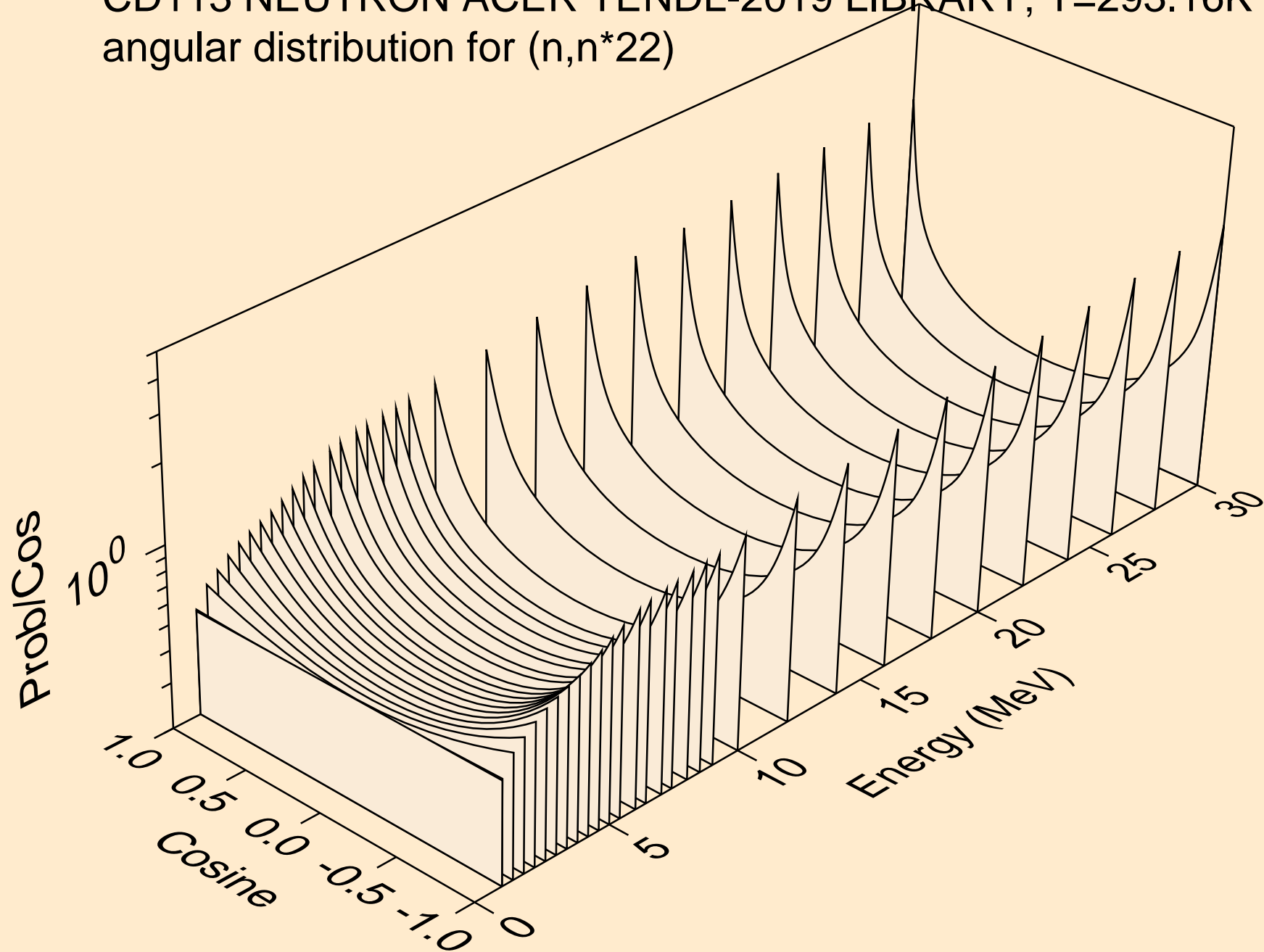

CD113 NEUTRON ACER TENDL-2019 LIBRARY; T=293.16K  
angular distribution for (n,n\*23)

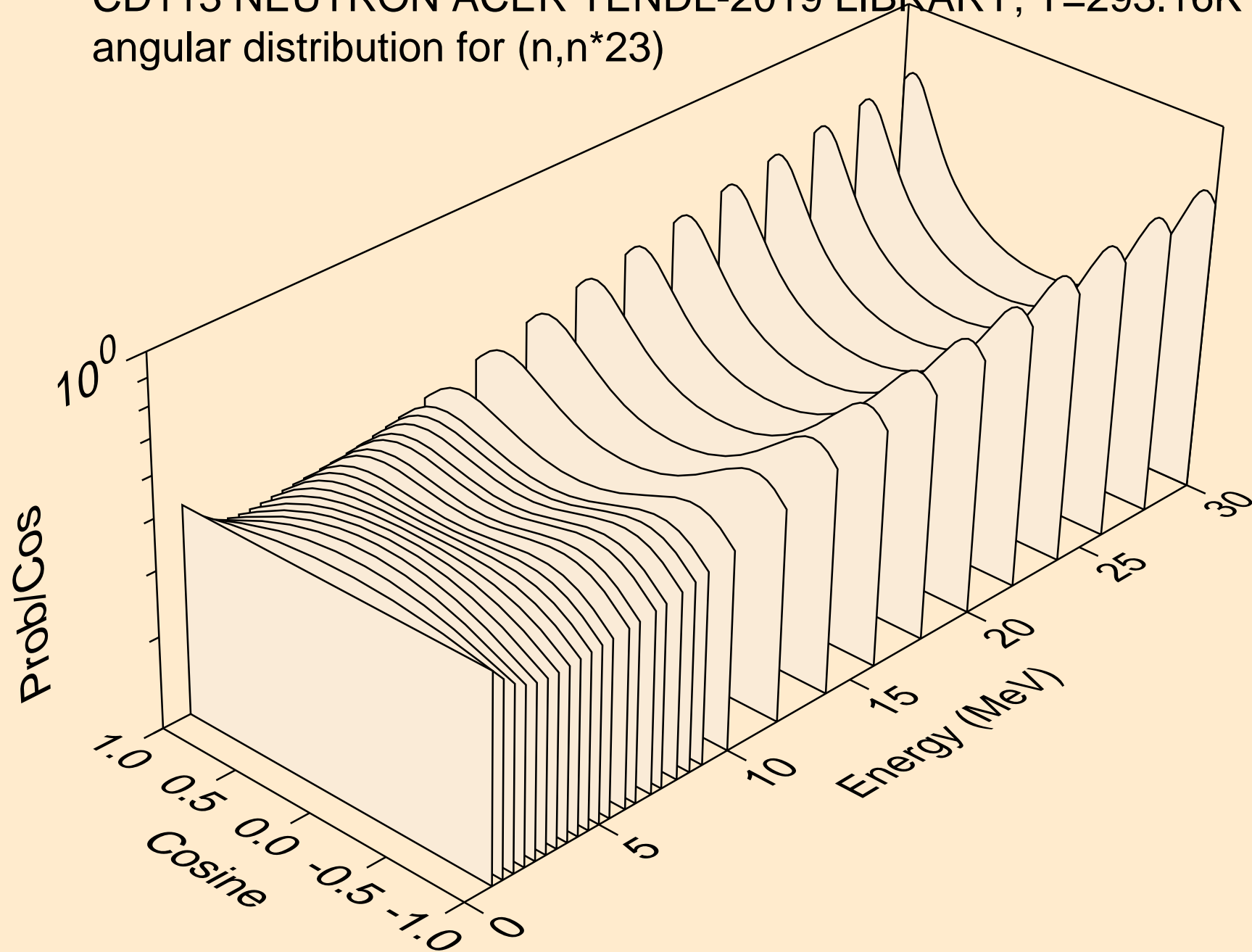

CD113 NEUTRON ACER TENDL-2019 LIBRARY; T=293.16K  
angular distribution for (n,n\*24)

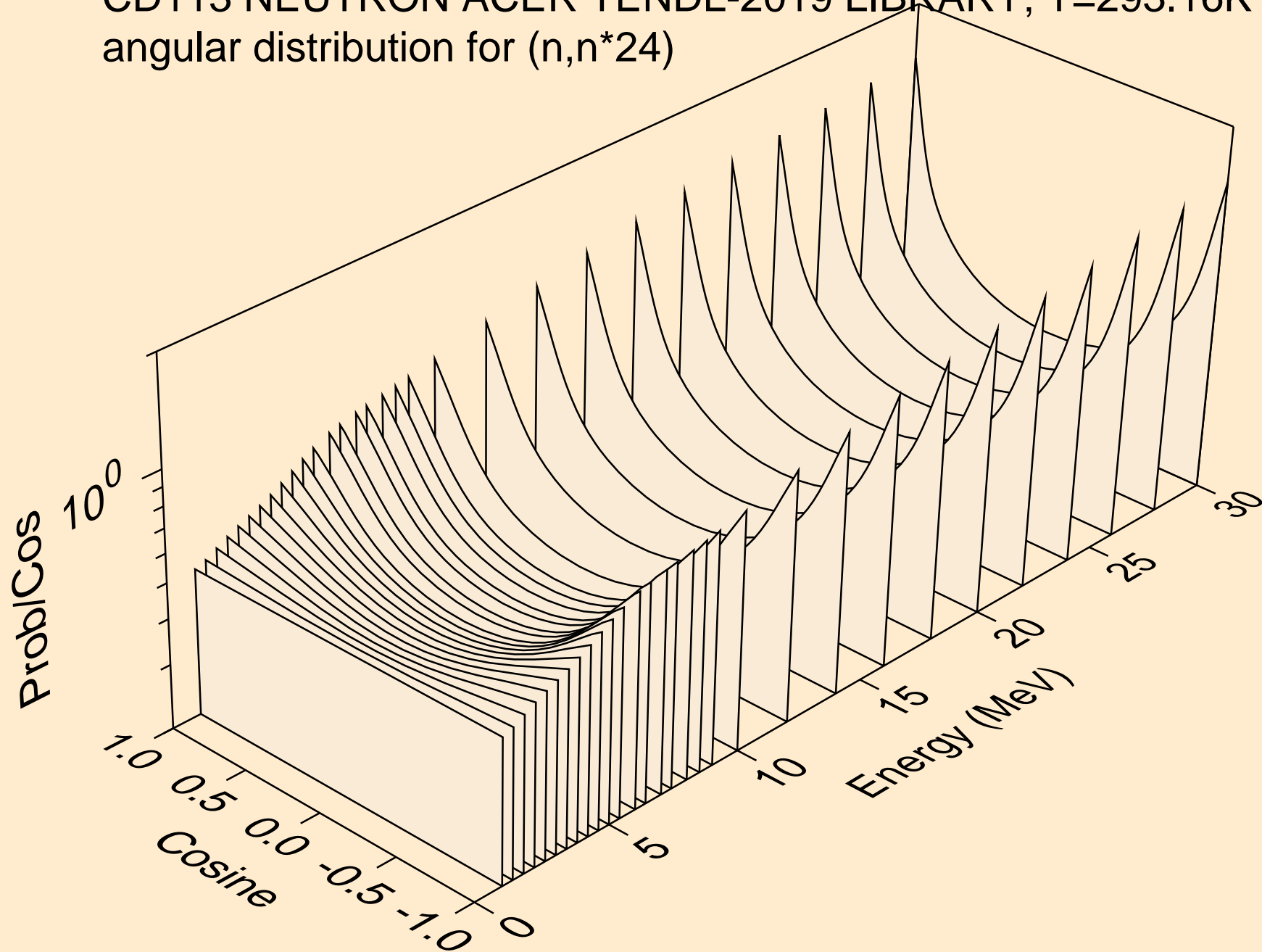

CD113 NEUTRON ACER TENDL-2019 LIBRARY; T=293.16K  
angular distribution for (n,n\*25)

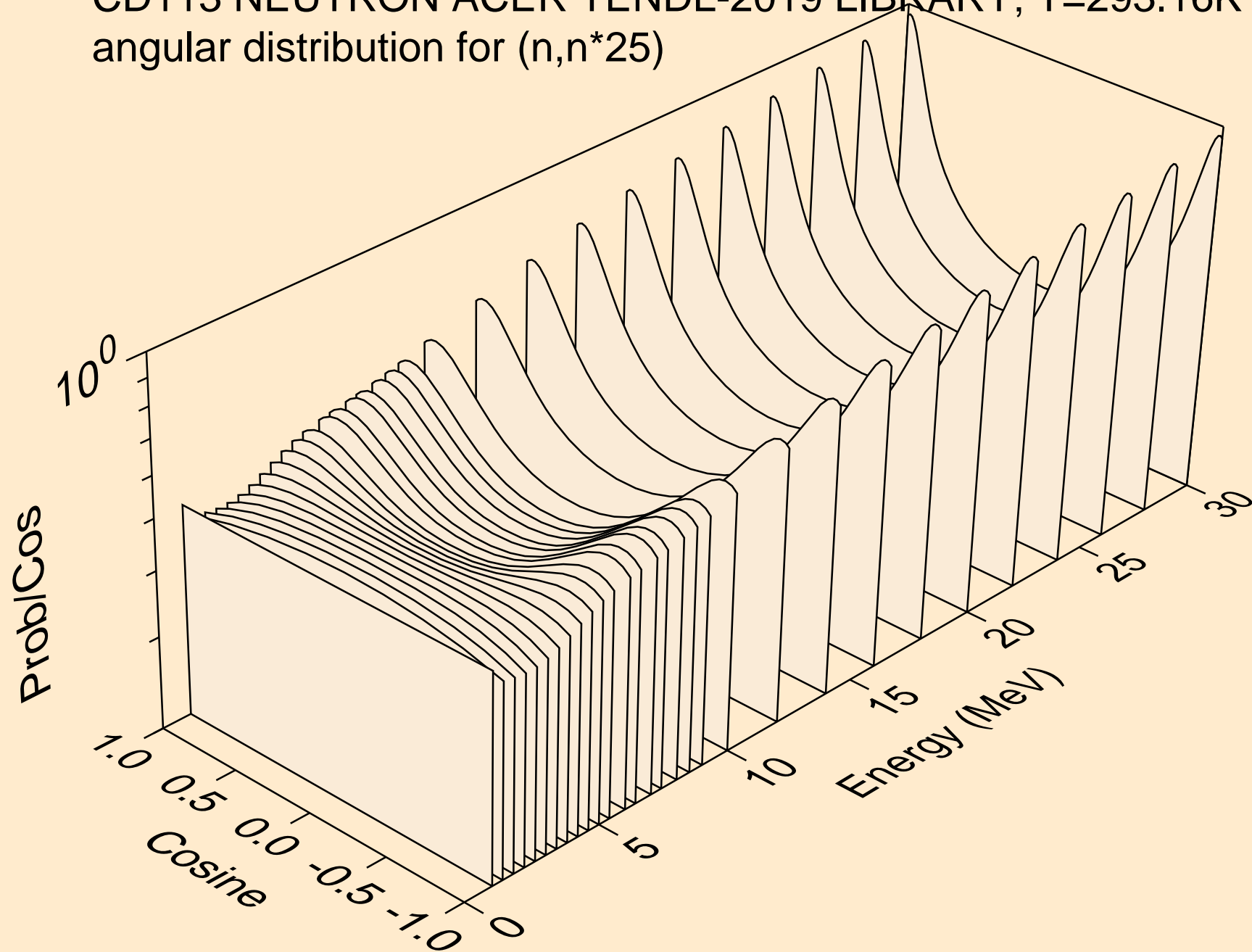

CD113 NEUTRON ACER TENDL-2019 LIBRARY; T=293.16K  
angular distribution for (n,n\*26)

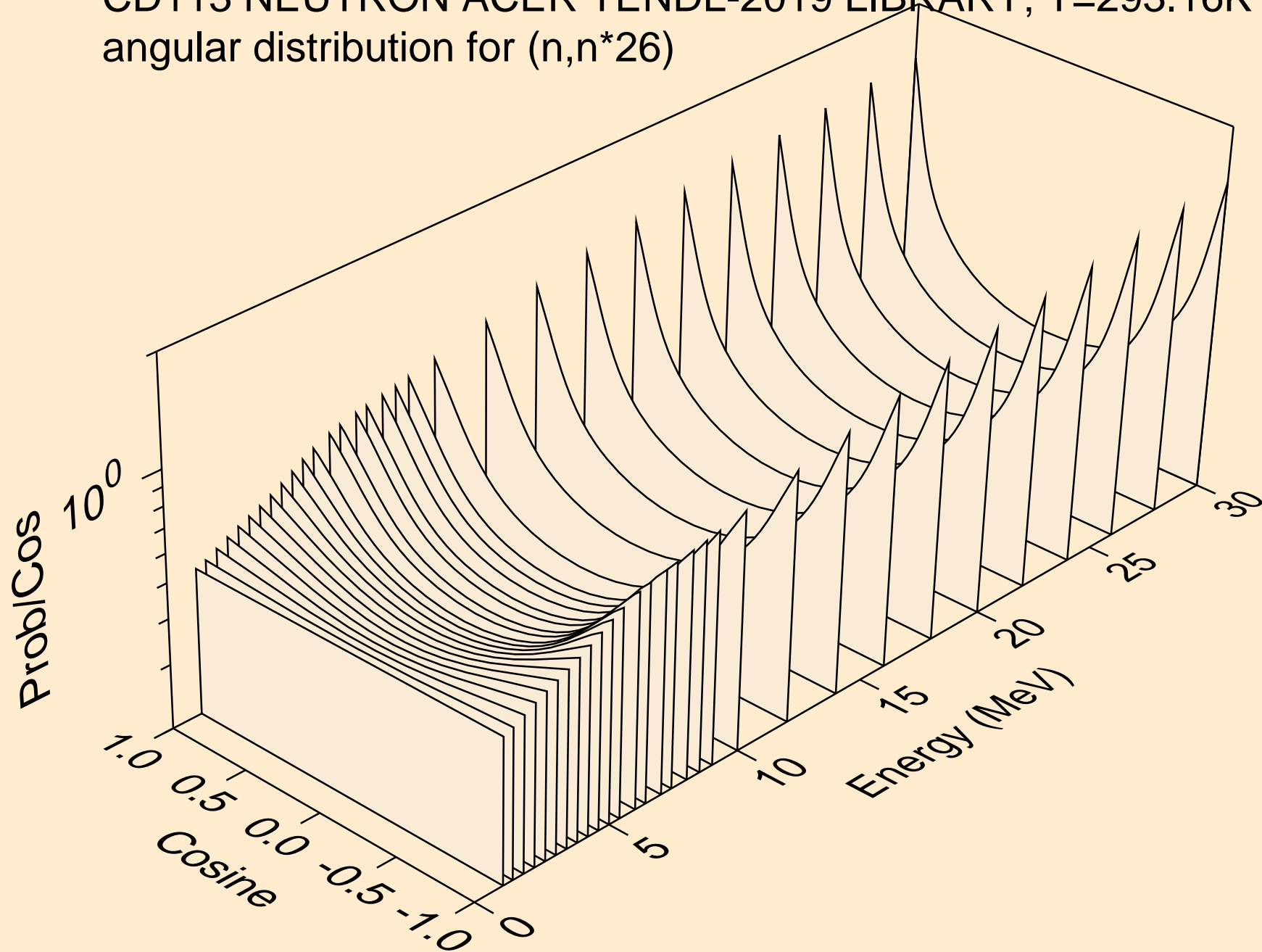

CD113 NEUTRON ACER TENDL-2019 LIBRARY; T=293.16K  
angular distribution for (n,n\*27)

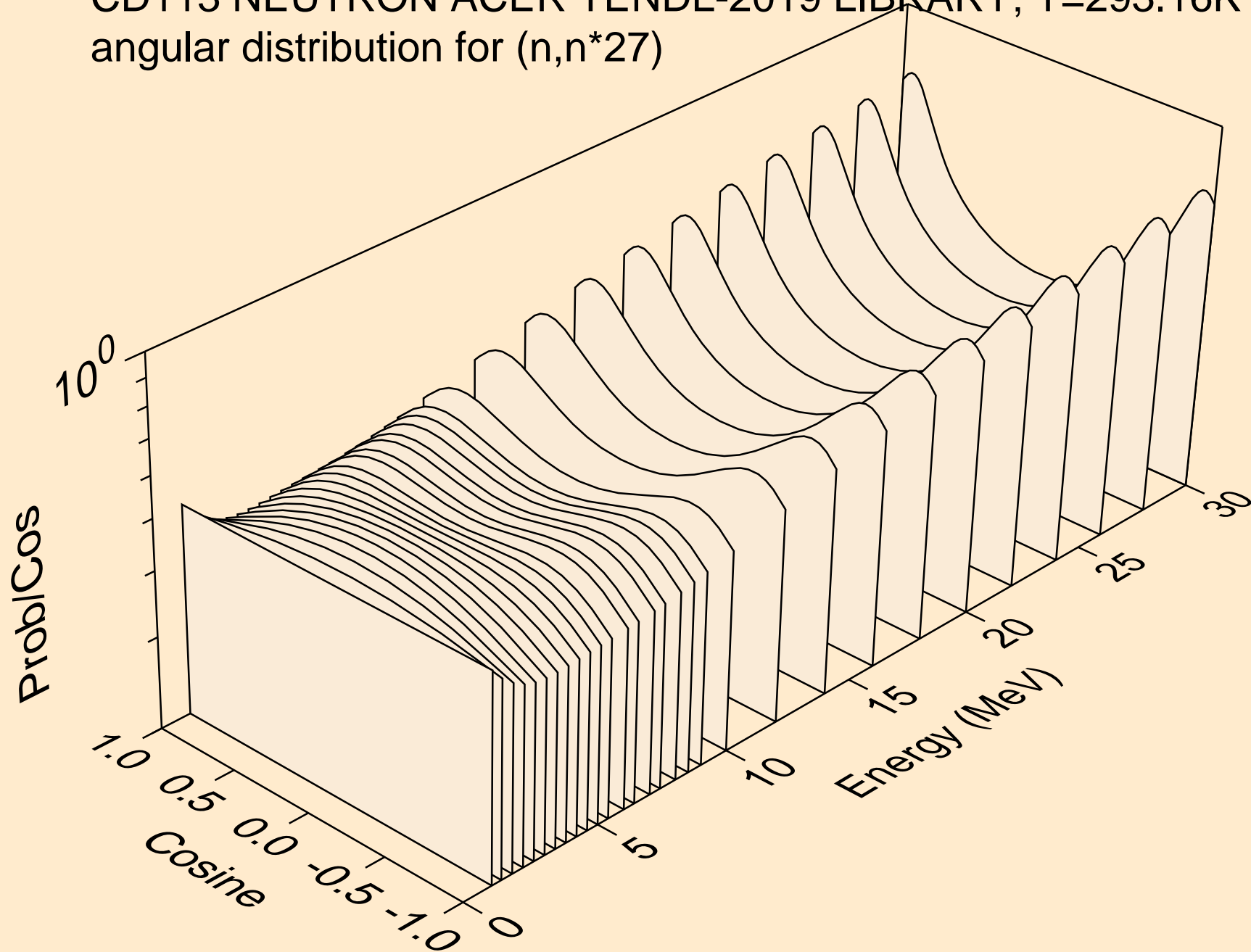

CD113 NEUTRON ACER TENDL-2019 LIBRARY; T=293.16K  
angular distribution for (n,n\*28)

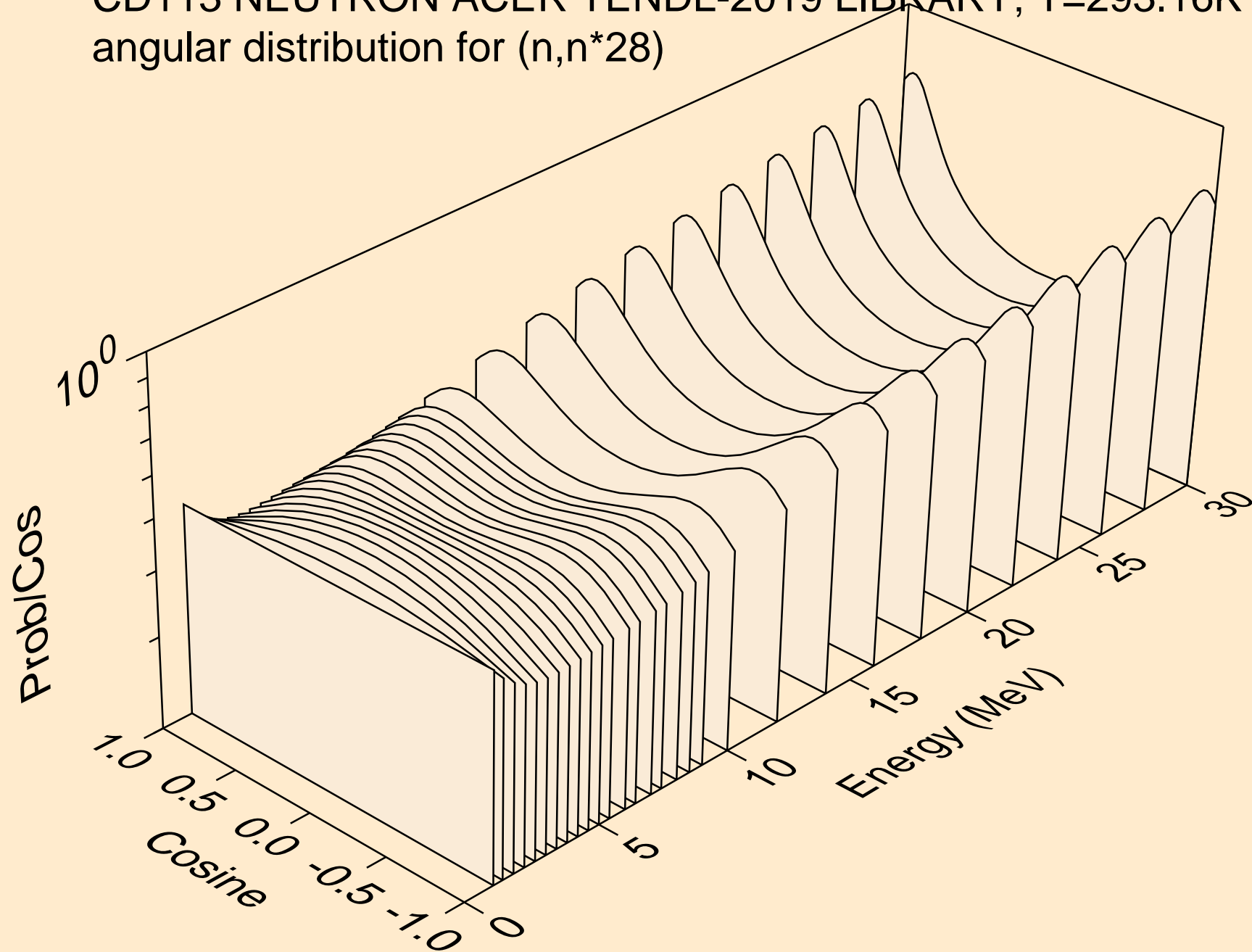

CD113 NEUTRON ACER TENDL-2019 LIBRARY; T=293.16K  
angular distribution for (n,n\*29)

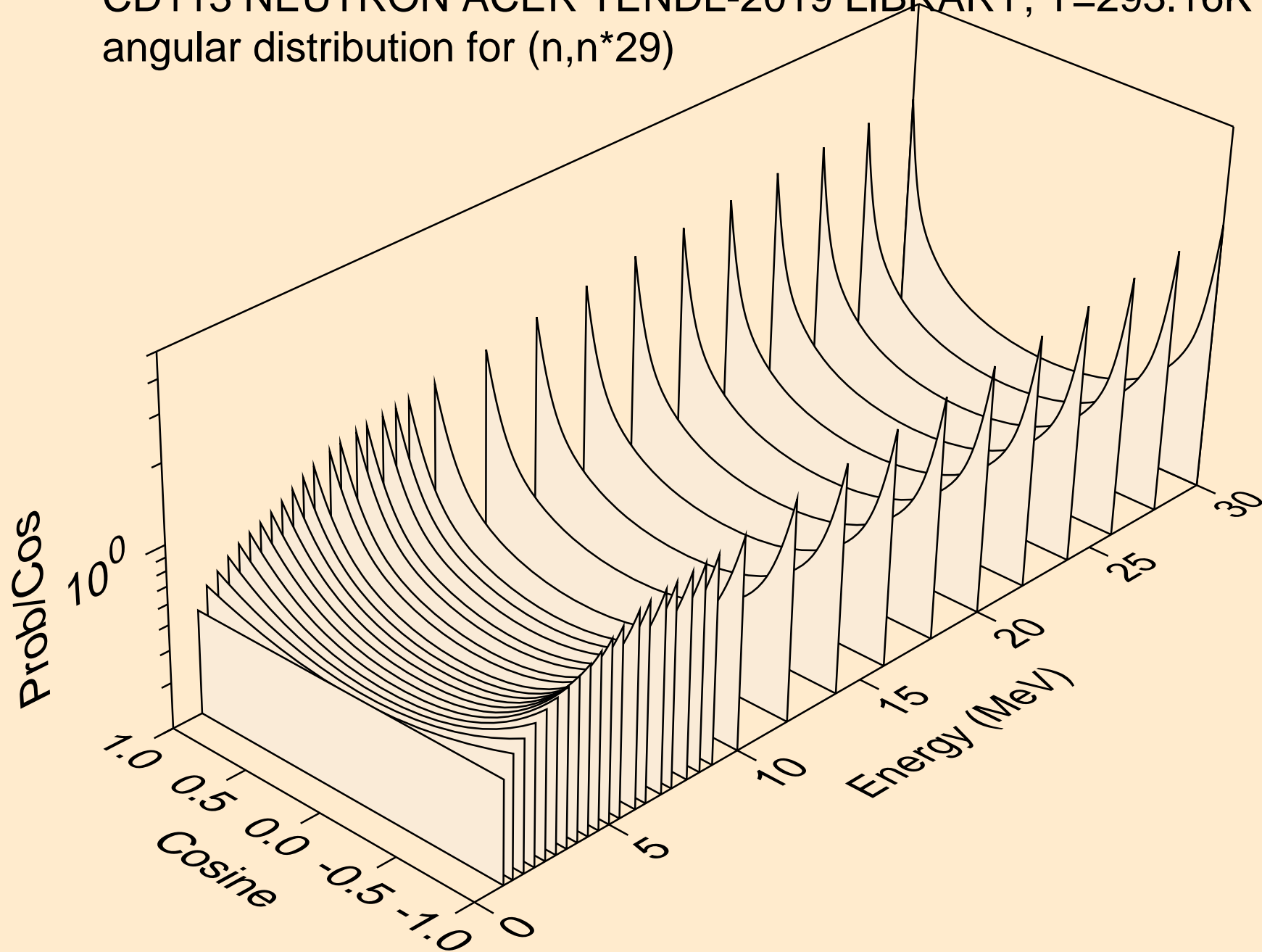

CD113 NEUTRON ACER TENDL-2019 LIBRARY; T=293.16K  
angular distribution for (n,n\*30)

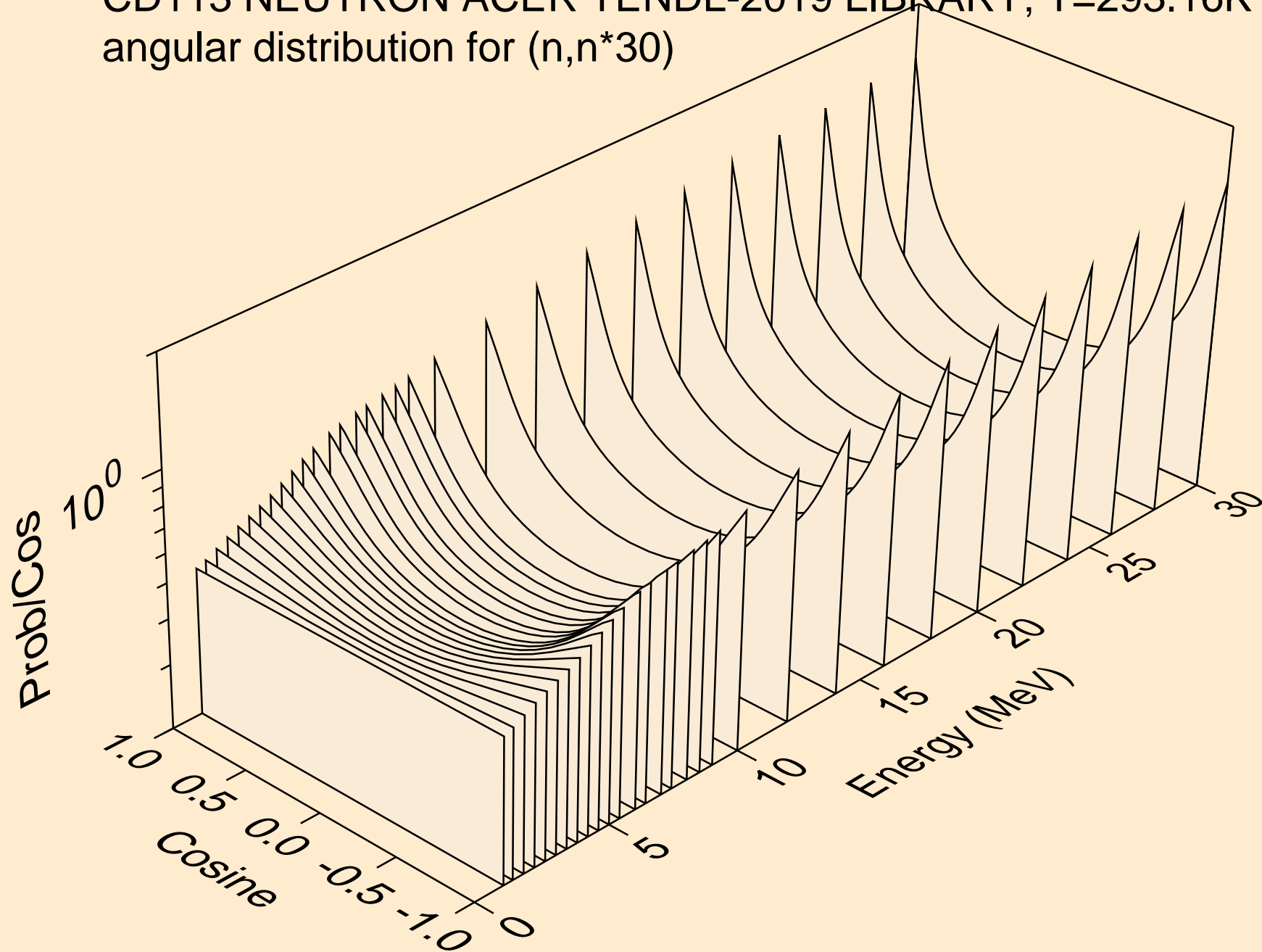

CD113 NEUTRON ACER TENDL-2019 LIBRARY; T=293.16K  
Neutron emission for (n,x)

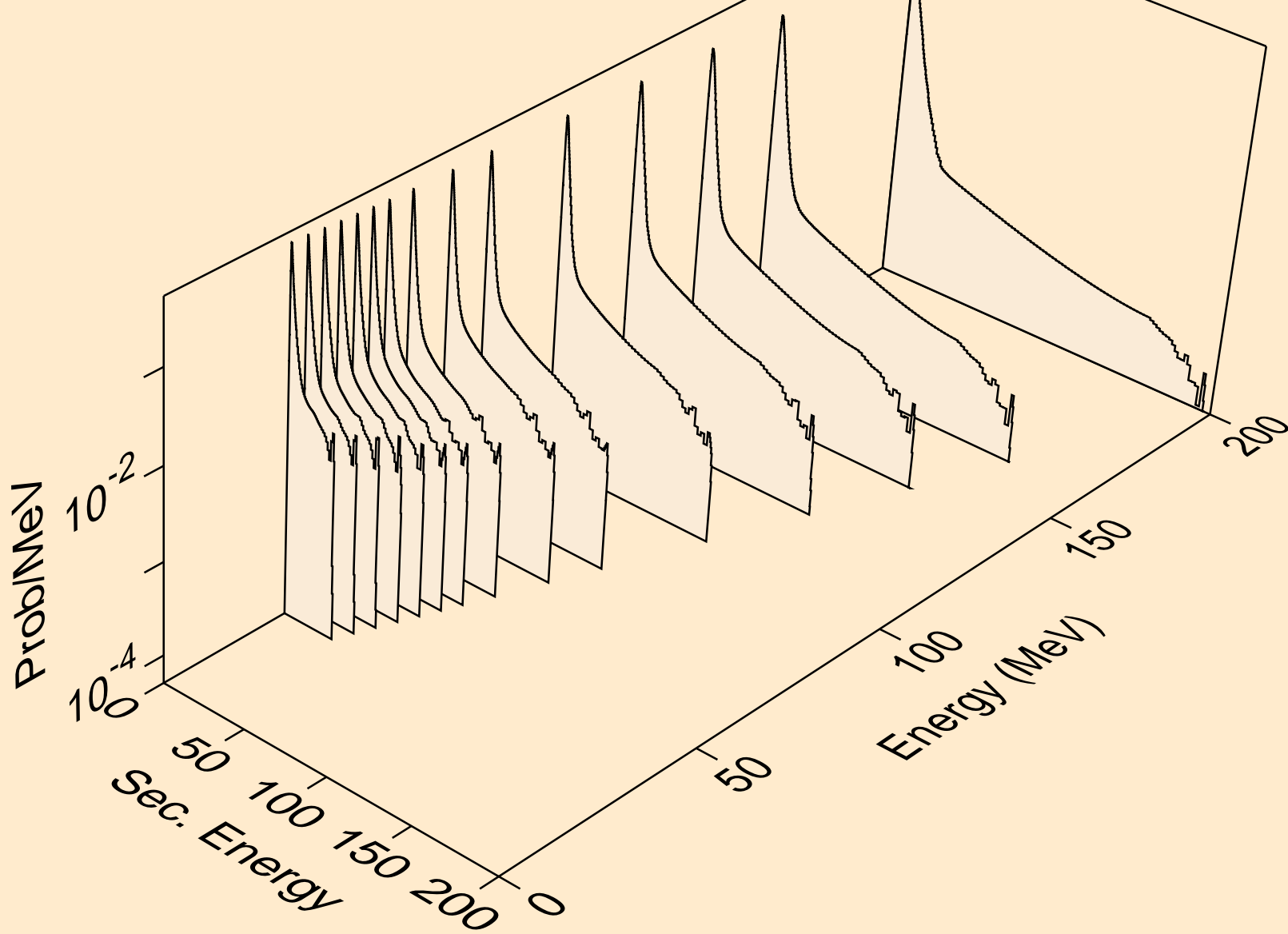

CD113 NEUTRON ACER TENDL-2019 LIBRARY; T=293.16K  
Neutron emission for (n,2nd)

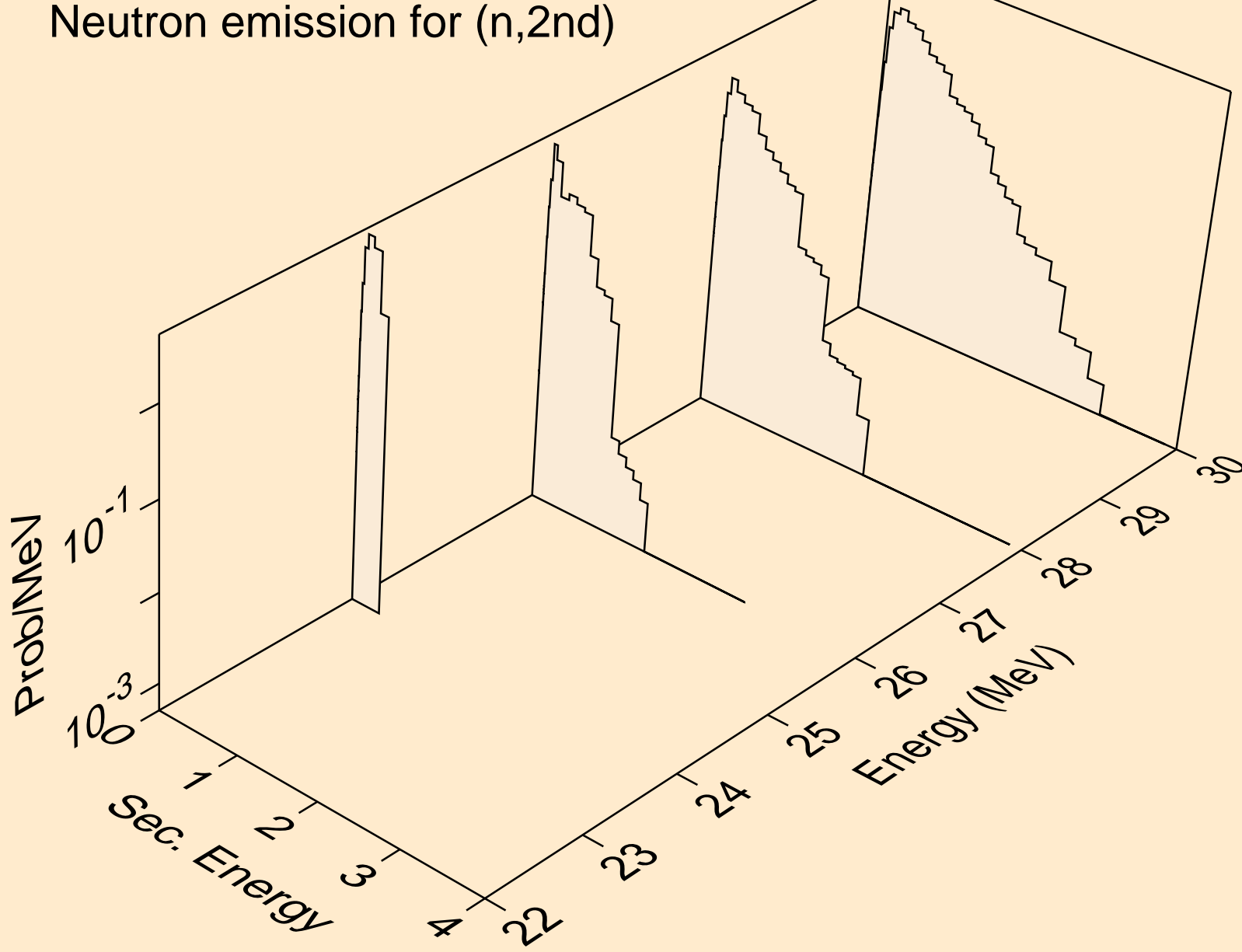

CD113 NEUTRON ACER TENDL-2019 LIBRARY; T=293.16K  
Neutron emission for (n,2n)

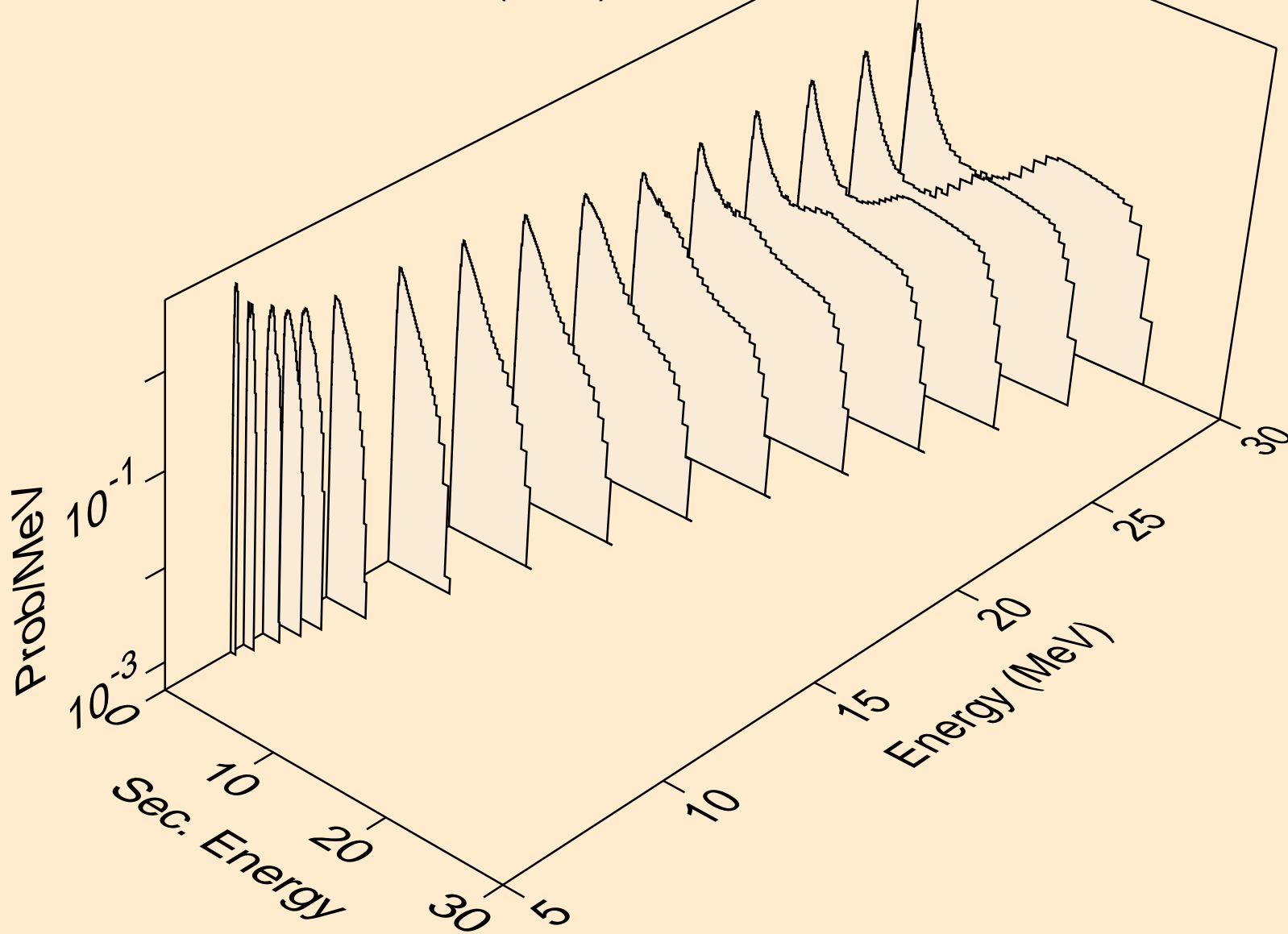

CD113 NEUTRON ACER TENDL-2019 LIBRARY; T=293.16K  
Neutron emission for (n,3n)

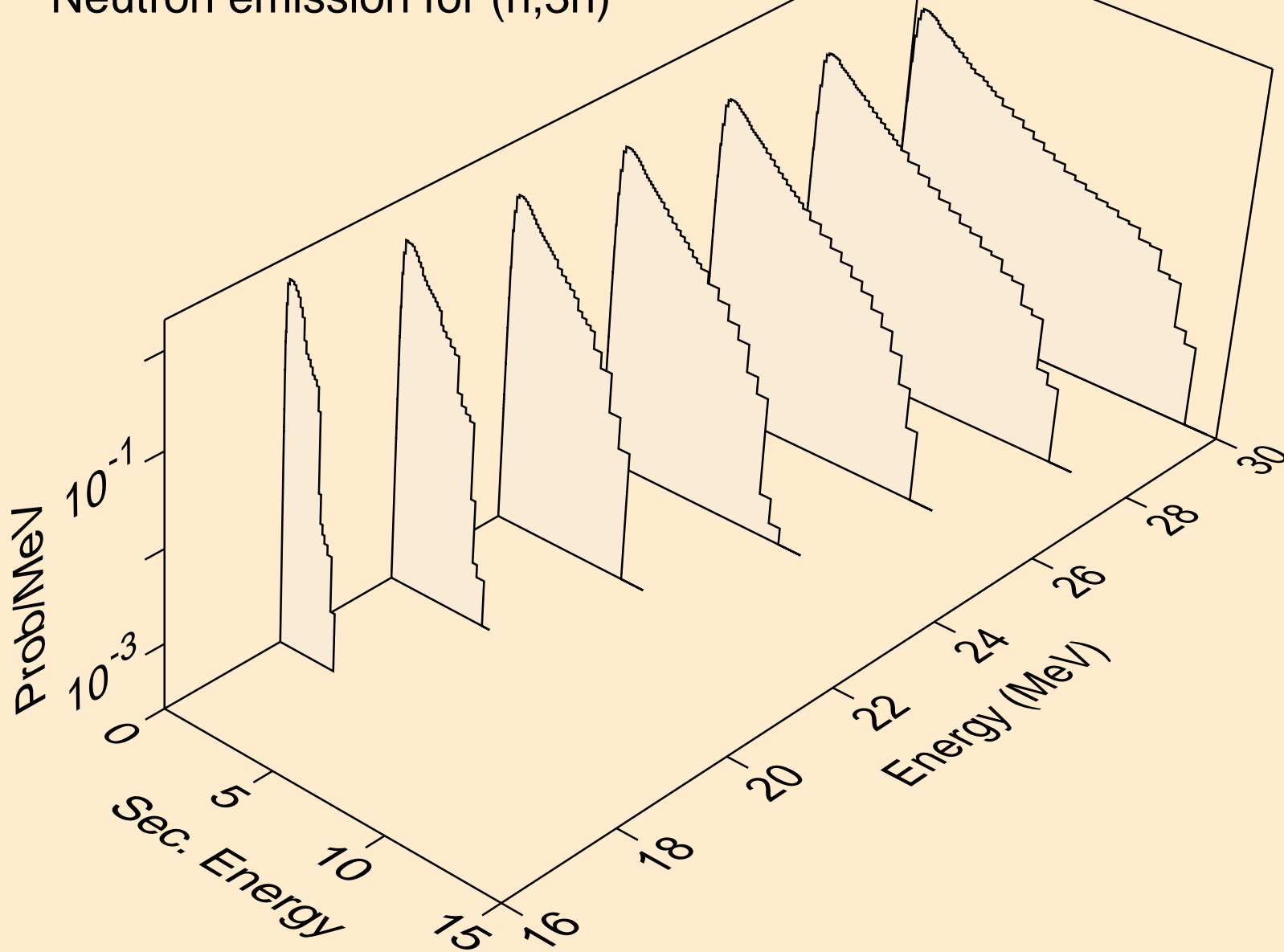

CD113 NEUTRON ACER TENDL-2019 LIBRARY; T=293.16K  
Neutron emission for (n,n\*)a

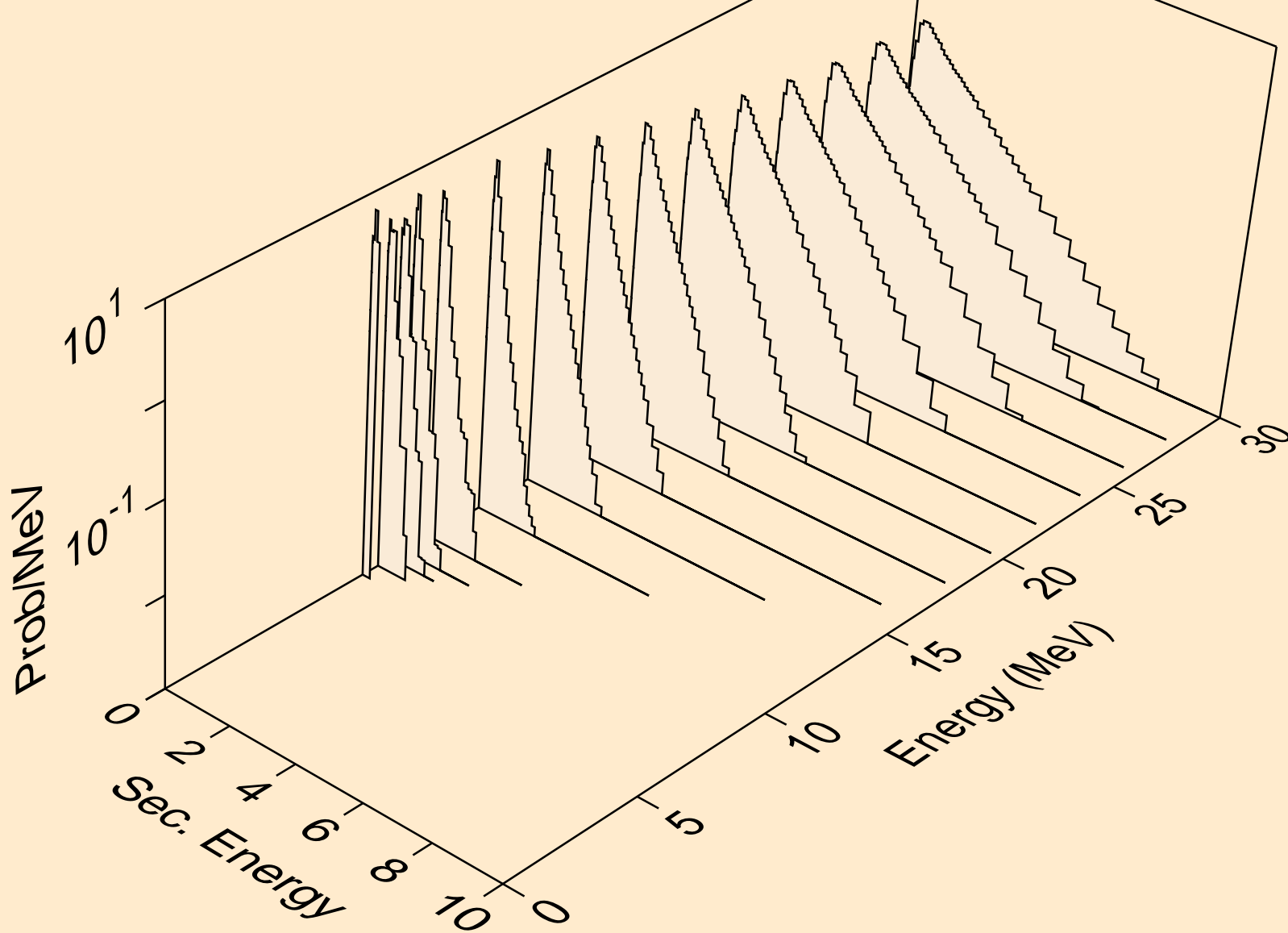

CD113 NEUTRON ACER TENDL-2019 LIBRARY; T=293.16K  
Neutron emission for (n,2n)a

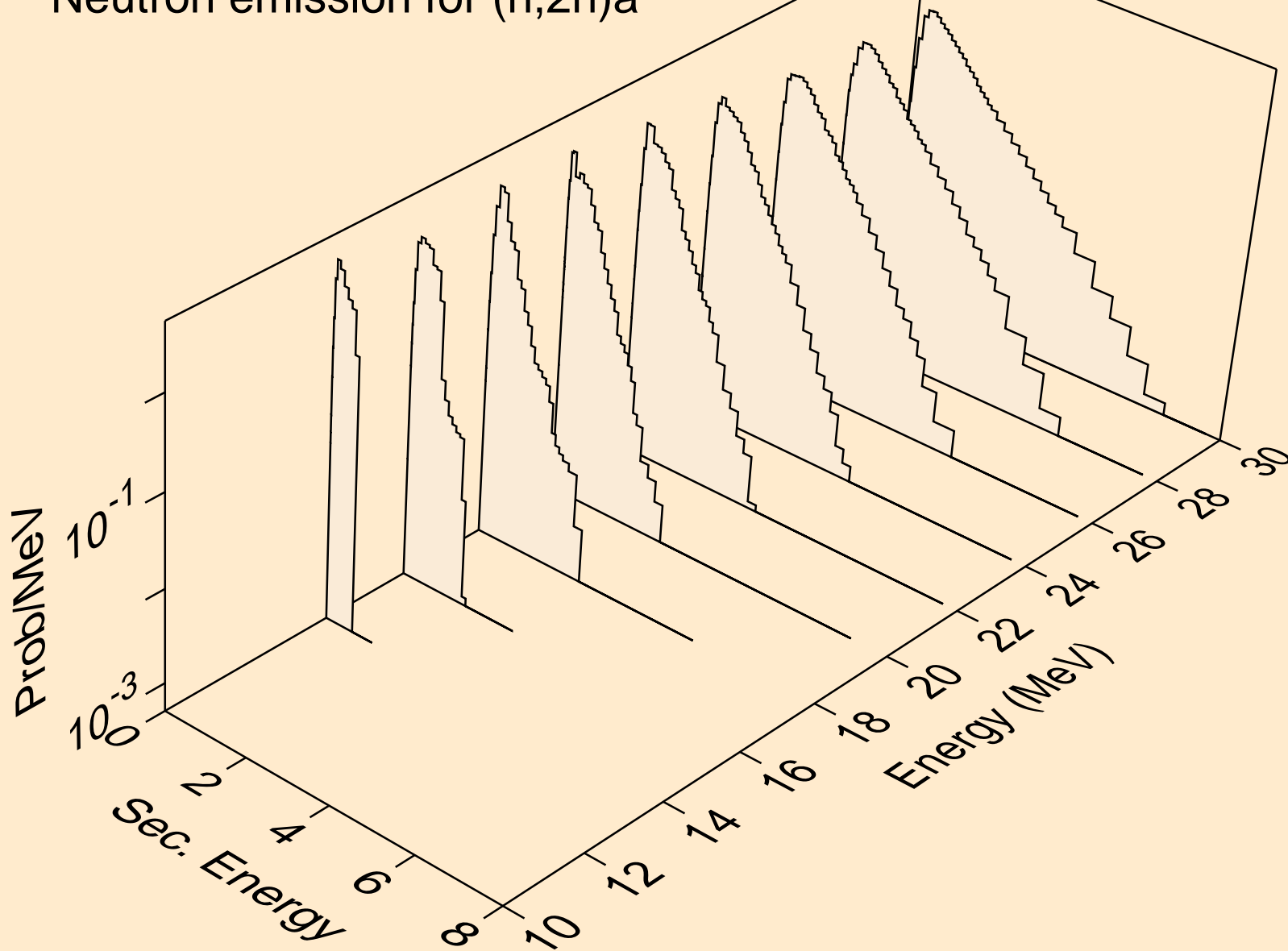

CD113 NEUTRON ACER TENDL-2019 LIBRARY; T=293.16K  
Neutron emission for (n,3n)a

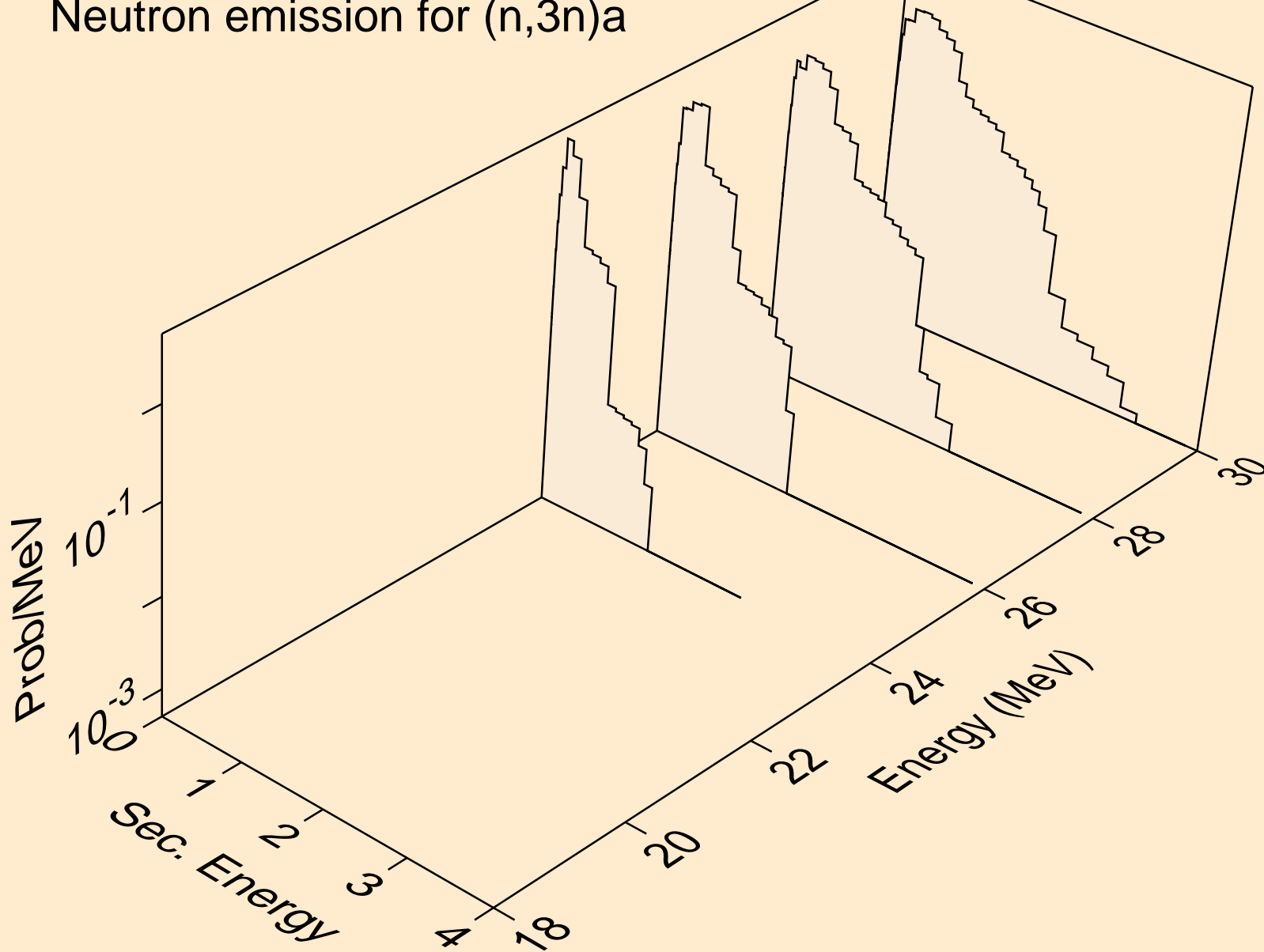

CD113 NEUTRON ACER TENDL-2019 LIBRARY; T=293.16K  
Neutron emission for (n,n\*)p

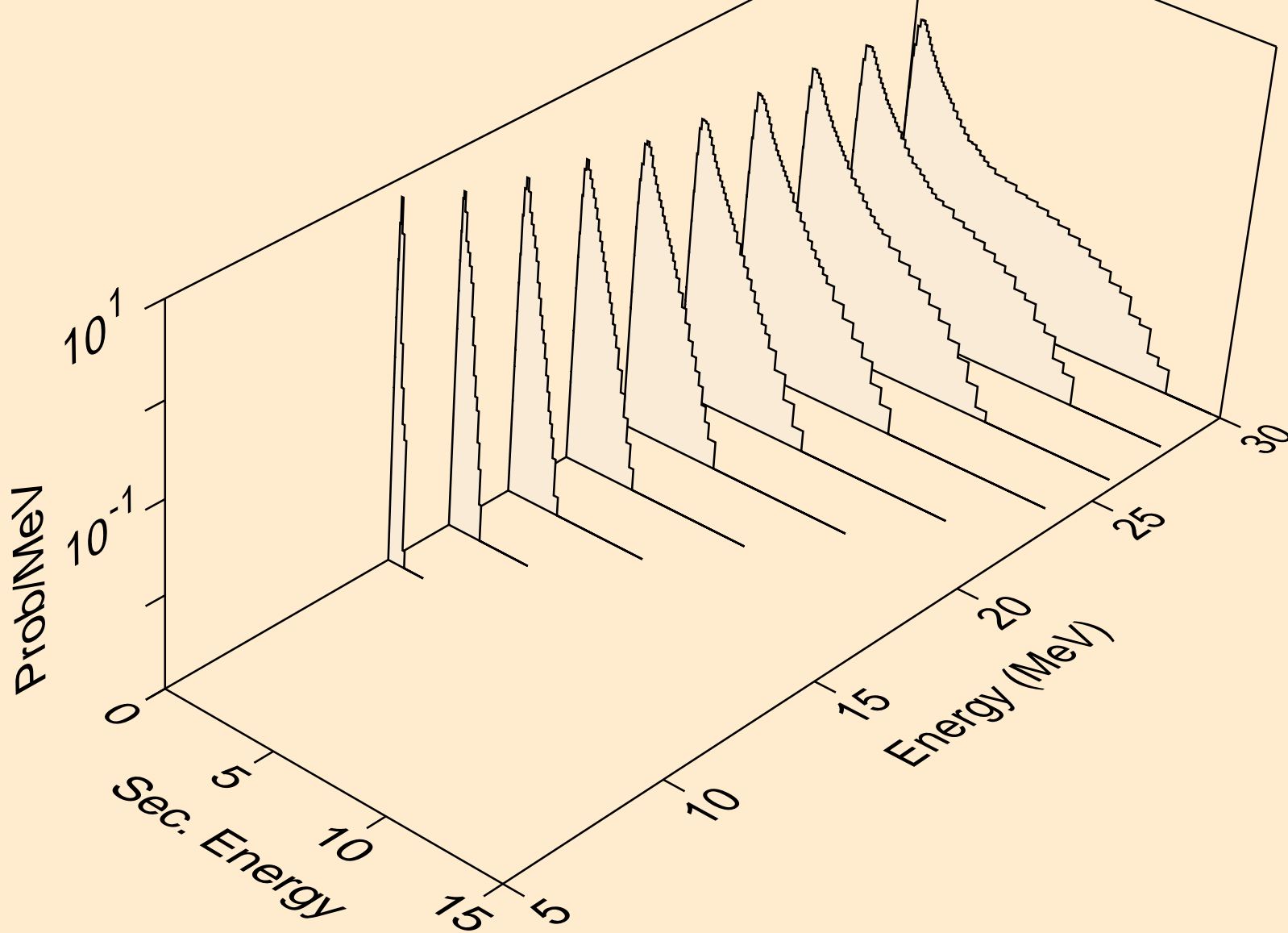

CD113 NEUTRON ACER TENDL-2019 LIBRARY; T=293.16K  
Neutron emission for (n,n\*)2a

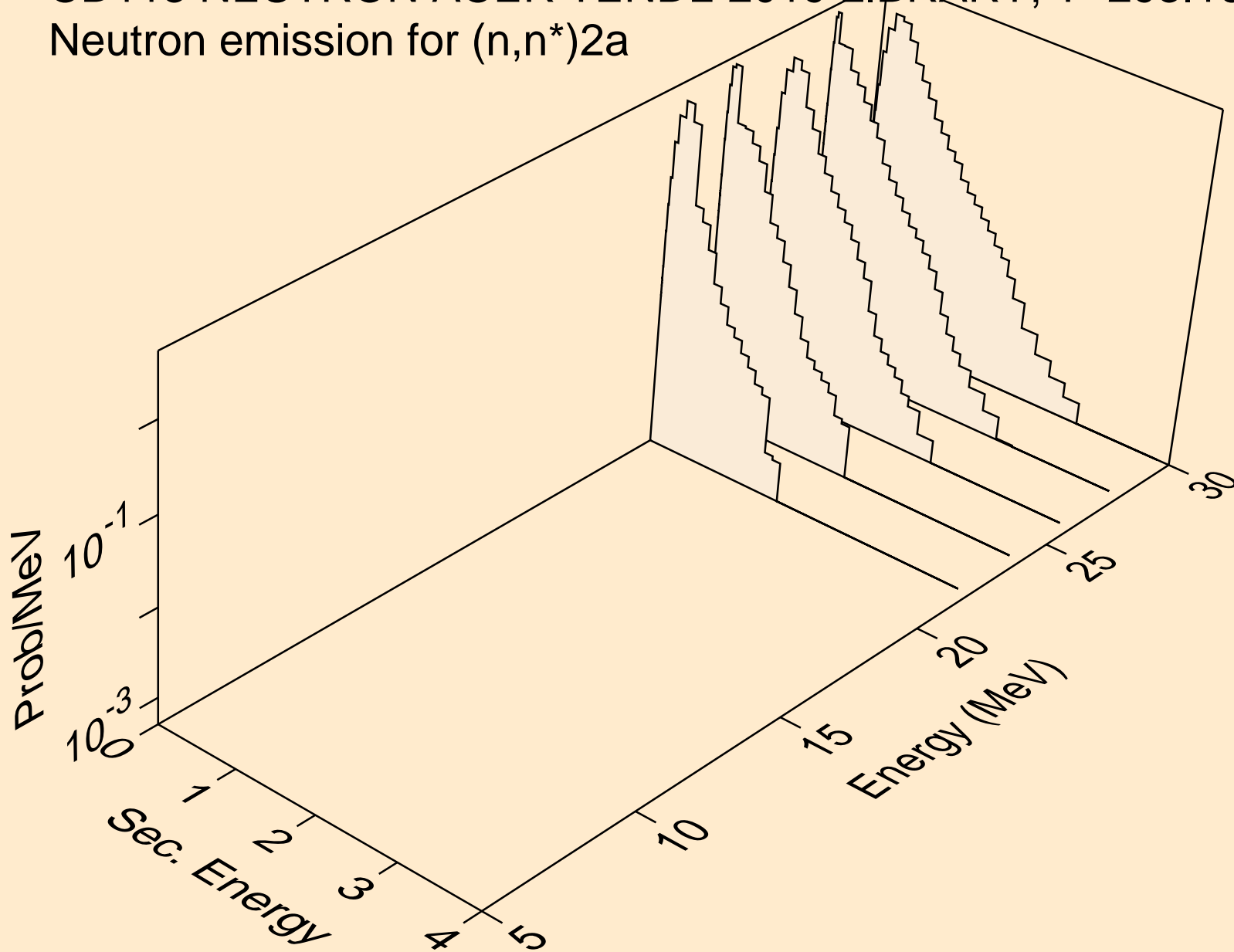

CD113 NEUTRON ACER TENDL-2019 LIBRARY; T=293.16K  
Neutron emission for (n,n\*)d

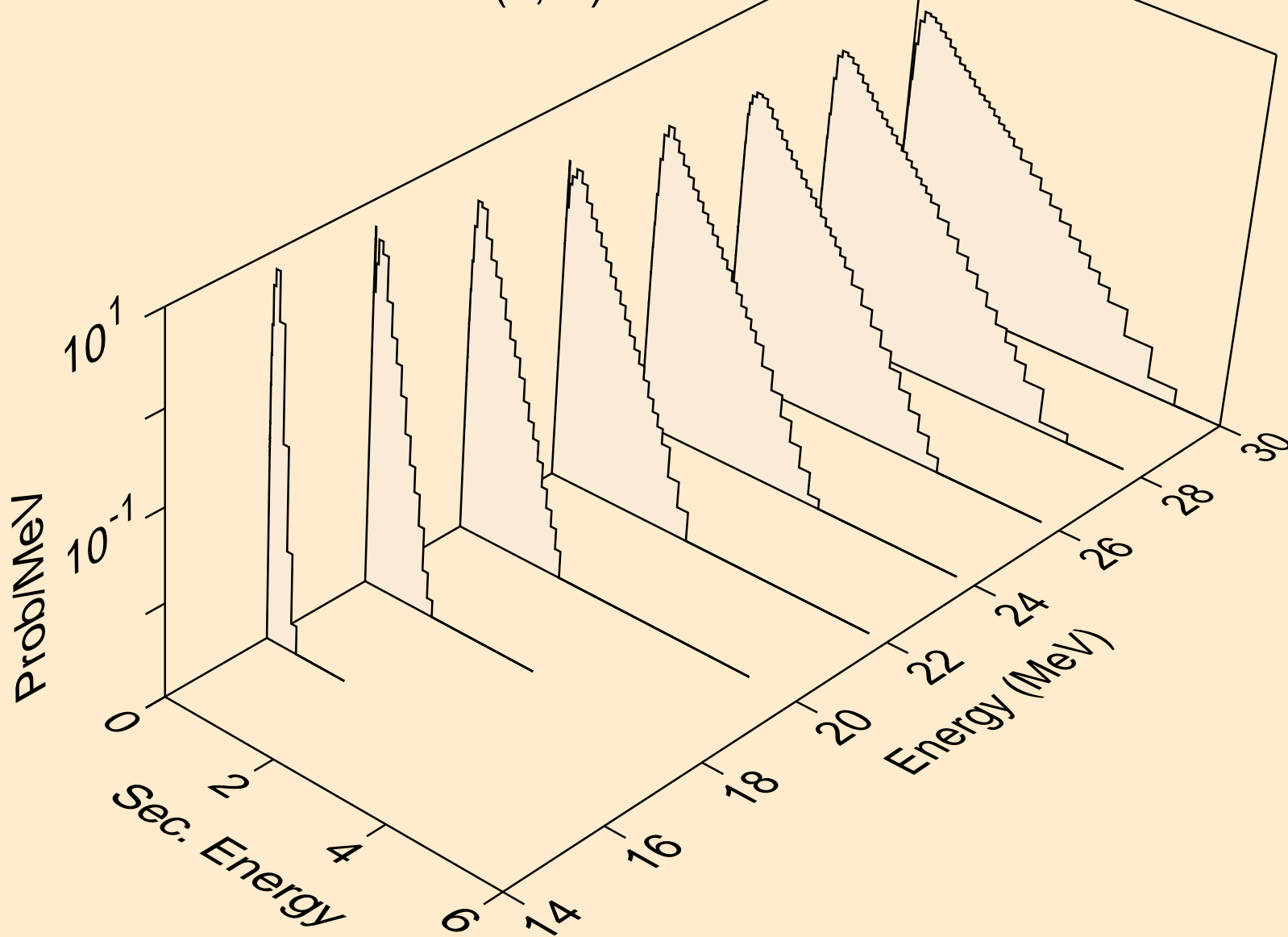

CD113 NEUTRON ACER TENDL-2019 LIBRARY; T=293.16K  
Neutron emission for (n,n\*)t

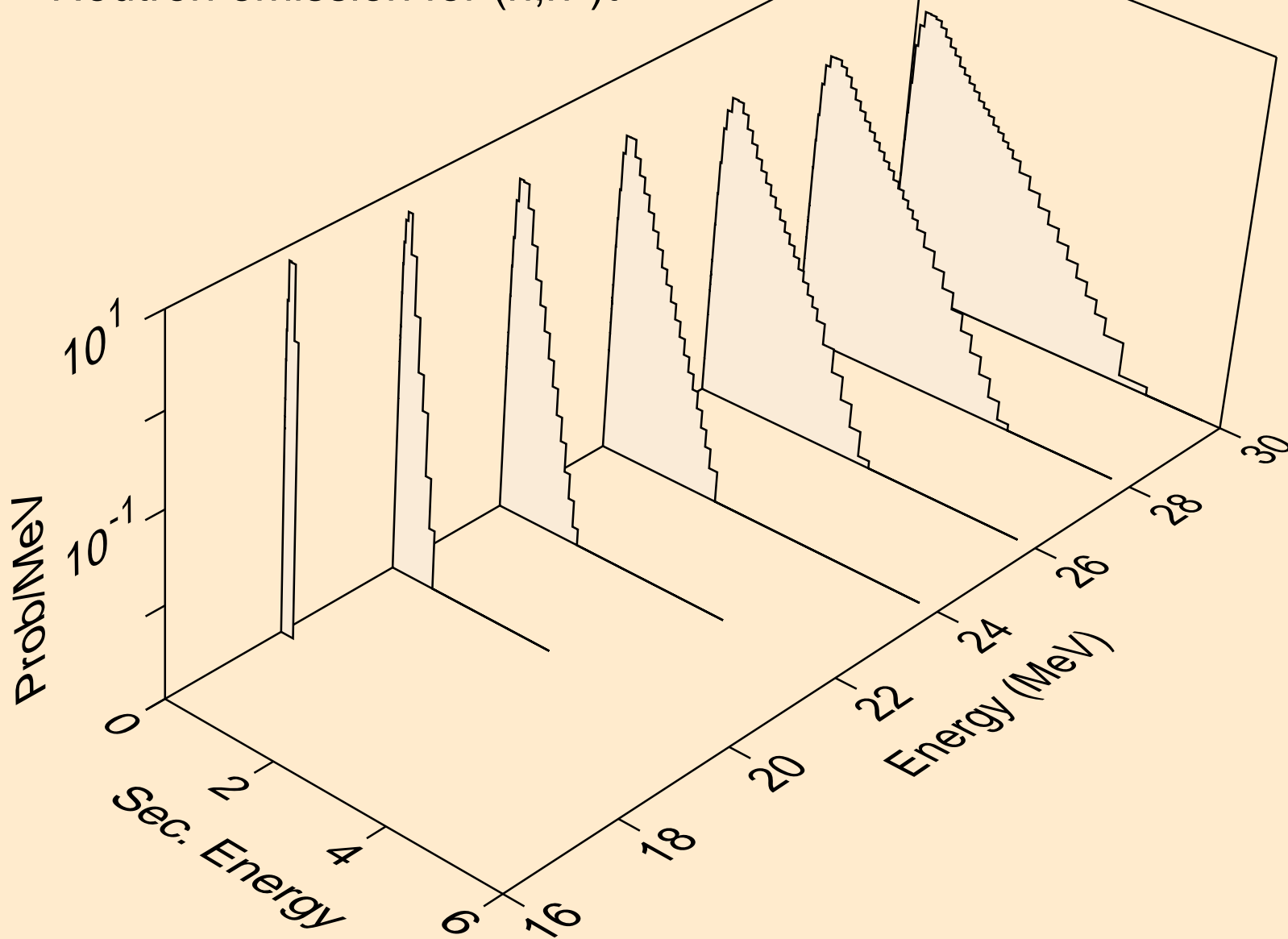

CD113 NEUTRON ACER TENDL-2019 LIBRARY; T=293.16K  
Neutron emission for (n,n\*)he3

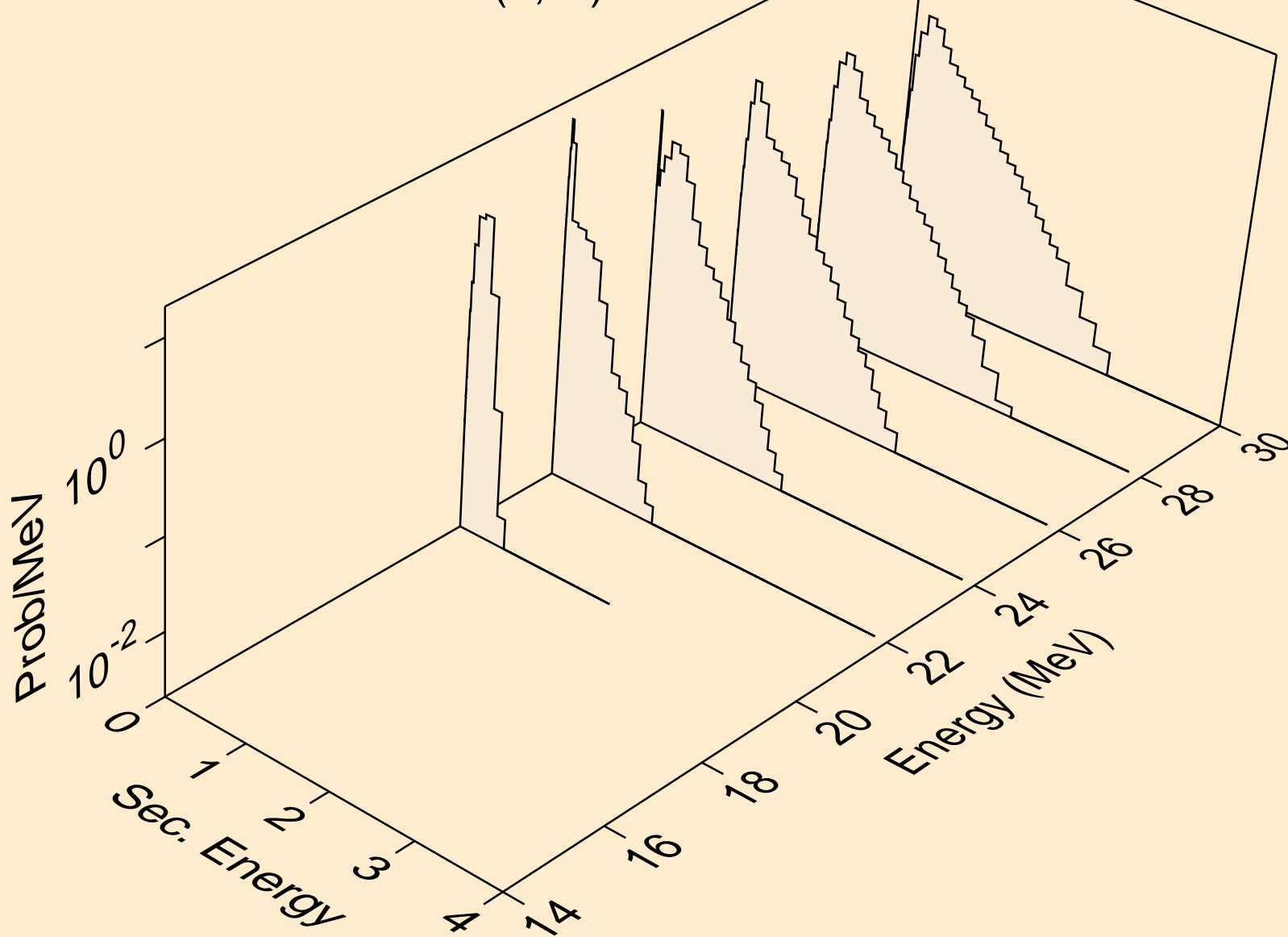

CD113 NEUTRON ACER TENDL-2019 LIBRARY; T=293.16K  
Neutron emission for (n,4n)

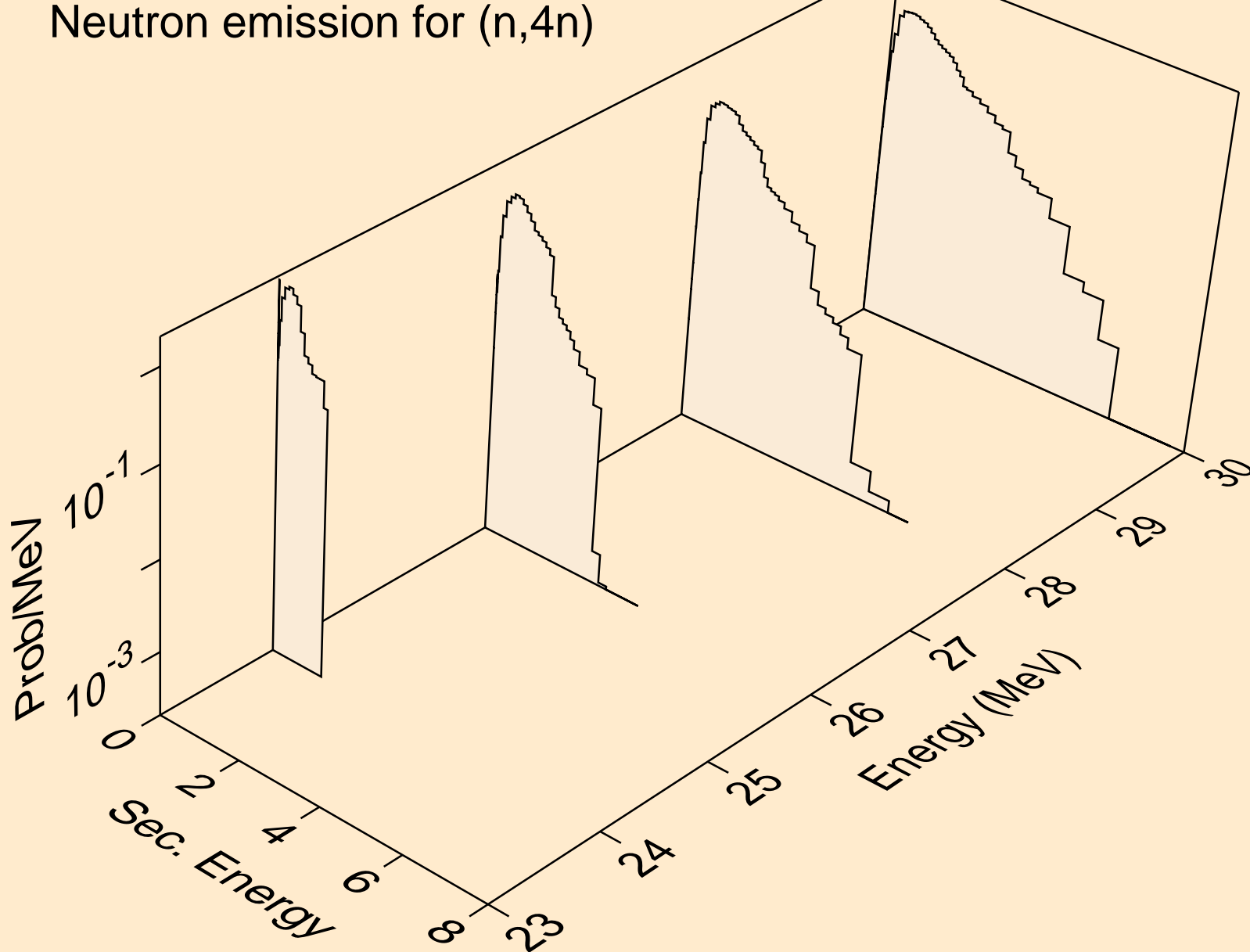

CD113 NEUTRON ACER TENDL-2019 LIBRARY; T=293.16K  
Neutron emission for (n,2np)

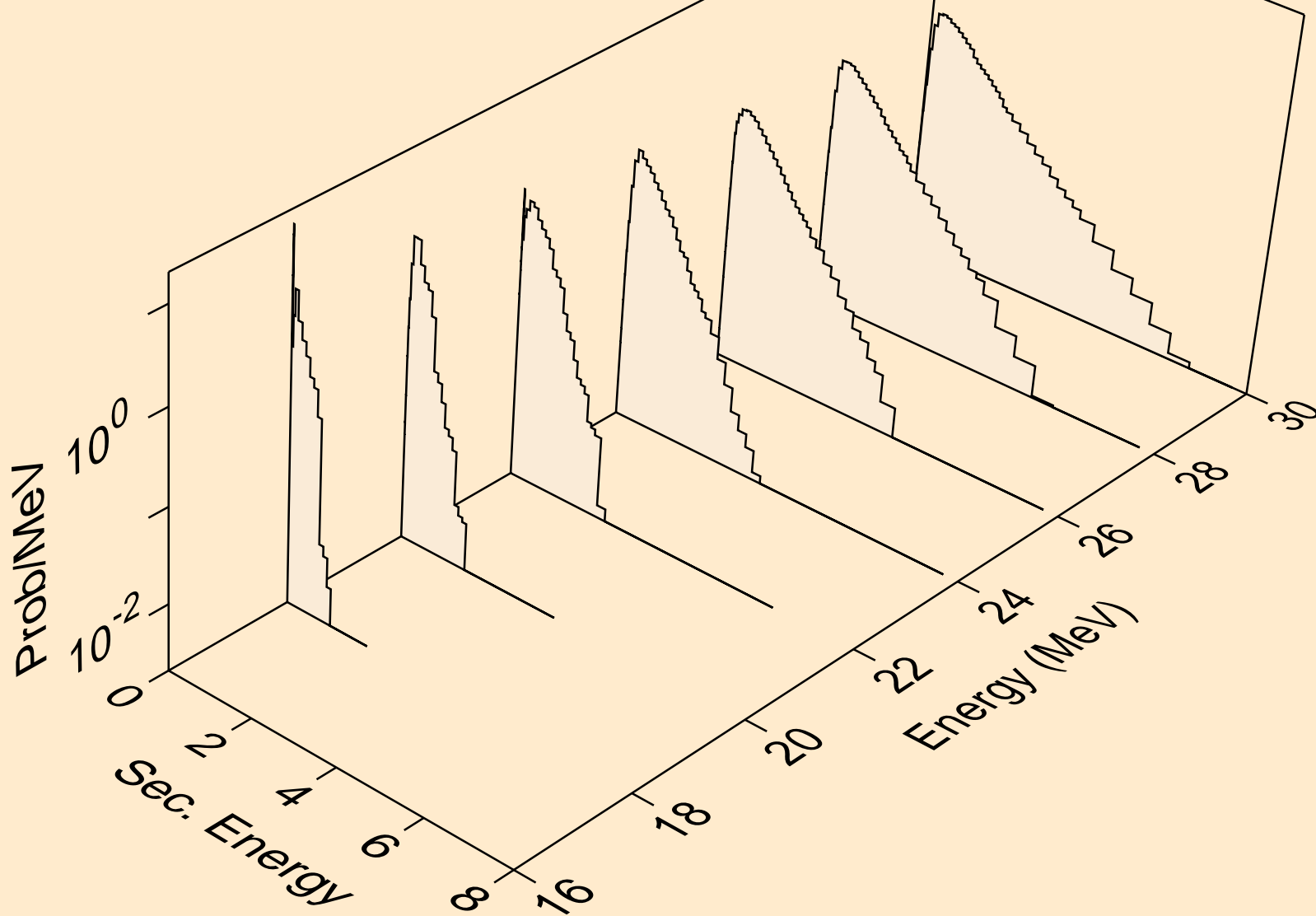

CD113 NEUTRON ACER TENDL-2019 LIBRARY; T=293.16K  
Neutron emission for (n,3np)

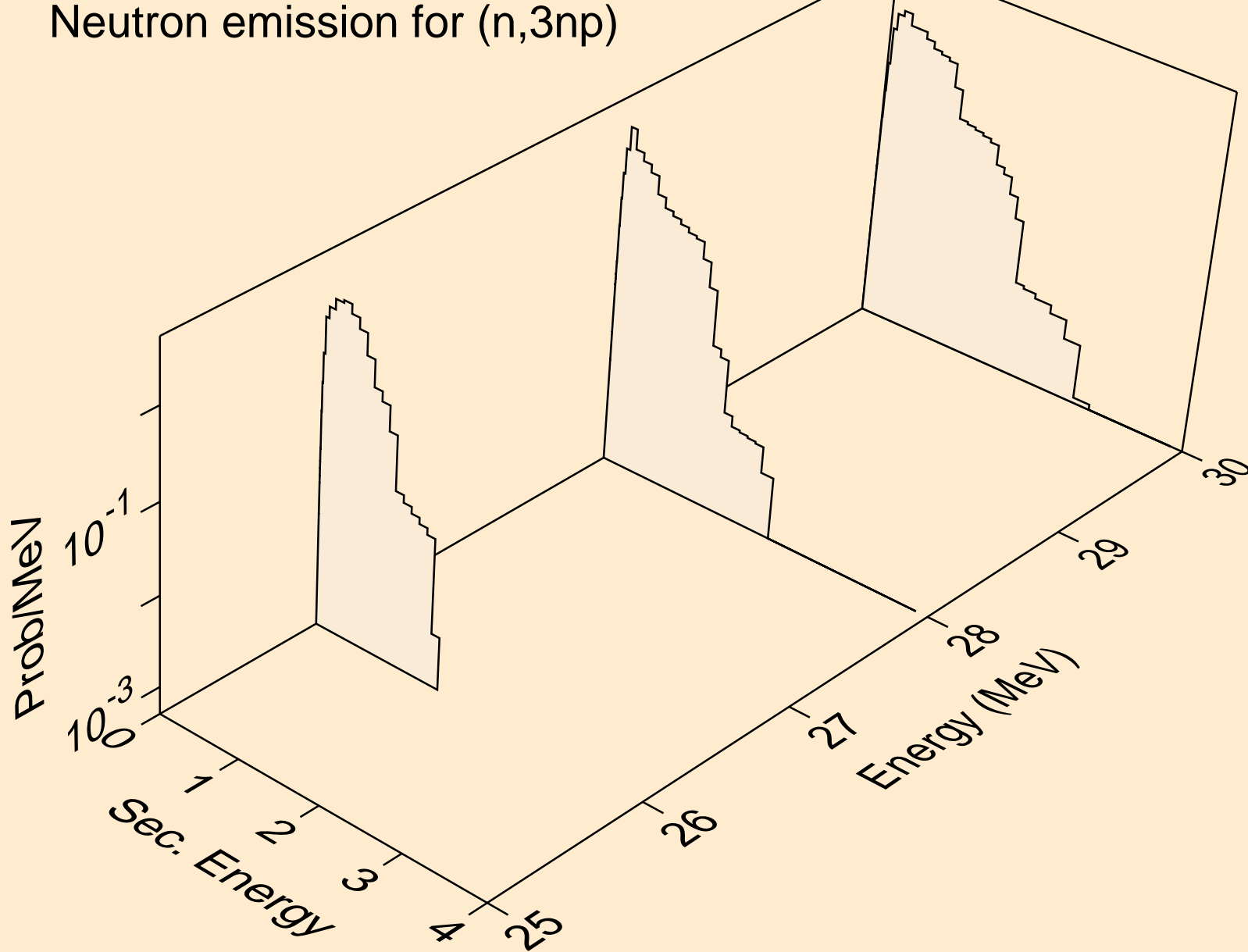

CD113 NEUTRON ACER TENDL-2019 LIBRARY; T=293.16K  
Neutron emission for (n,2np)

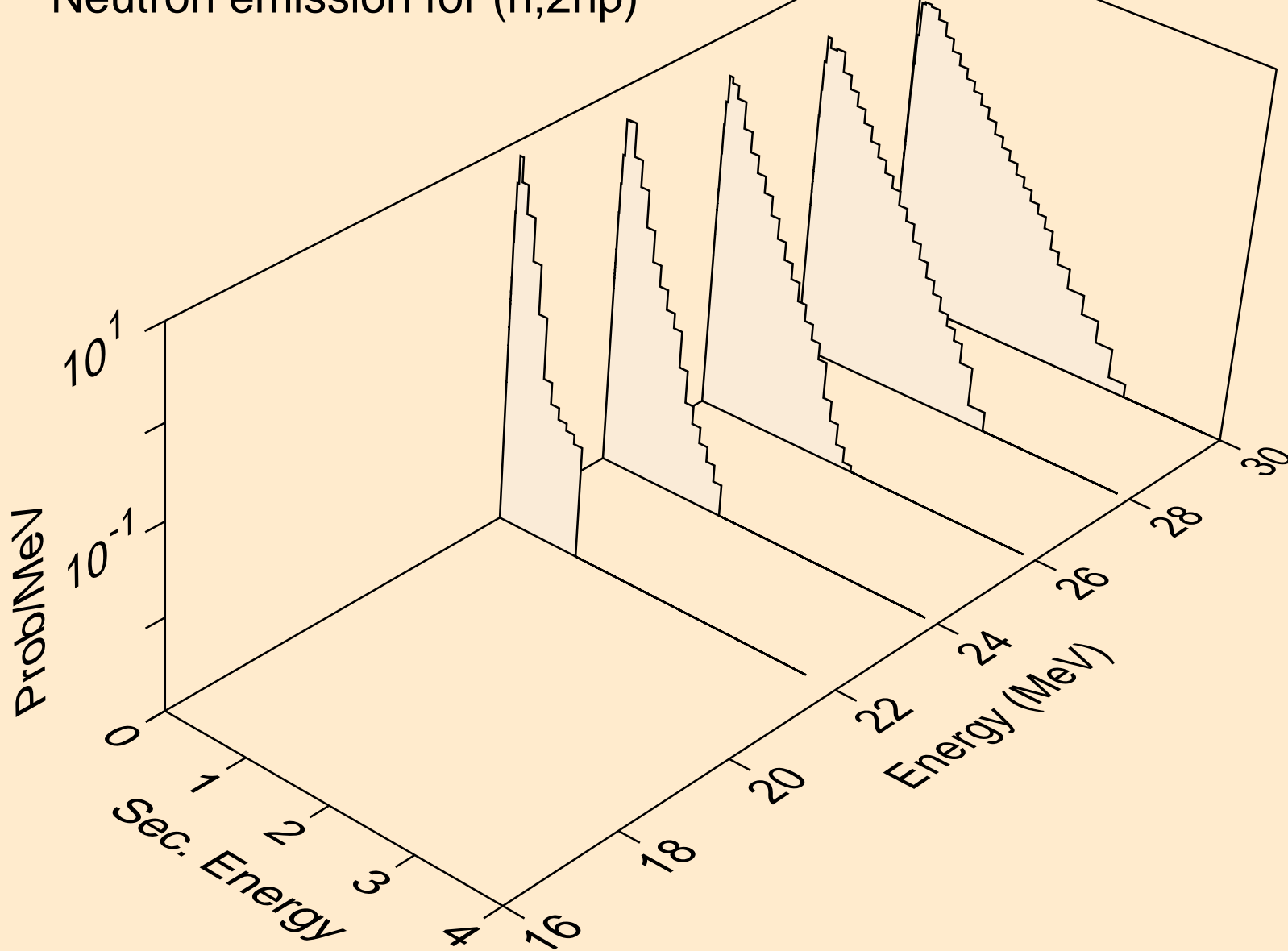

CD113 NEUTRON ACER TENDL-2019 LIBRARY; T=293.16K  
Neutron emission for (n,npa)

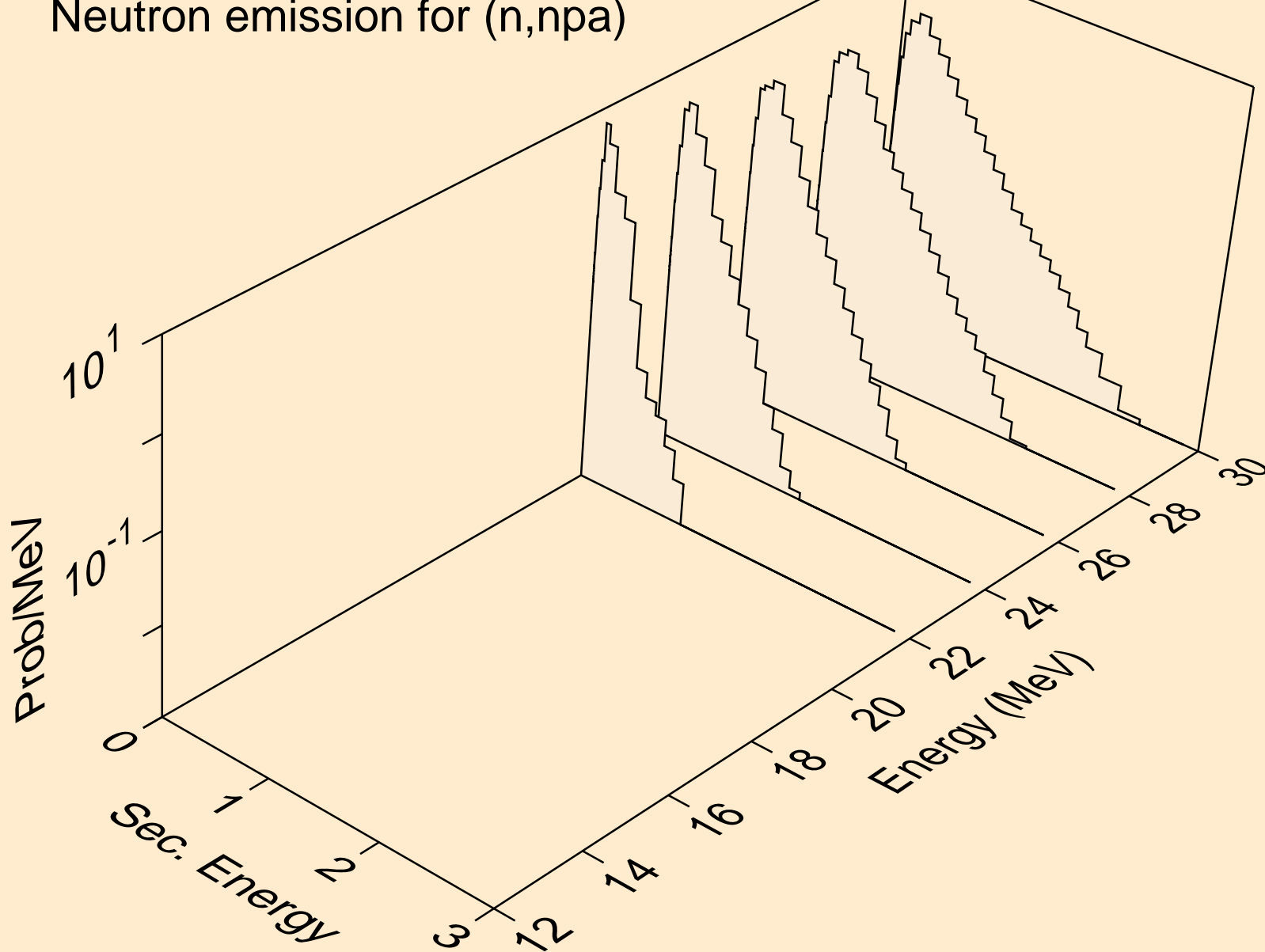

CD113 NEUTRON ACER TENDL-2019 LIBRARY; T=293.16K  
Neutron emission for (n,n\*c)

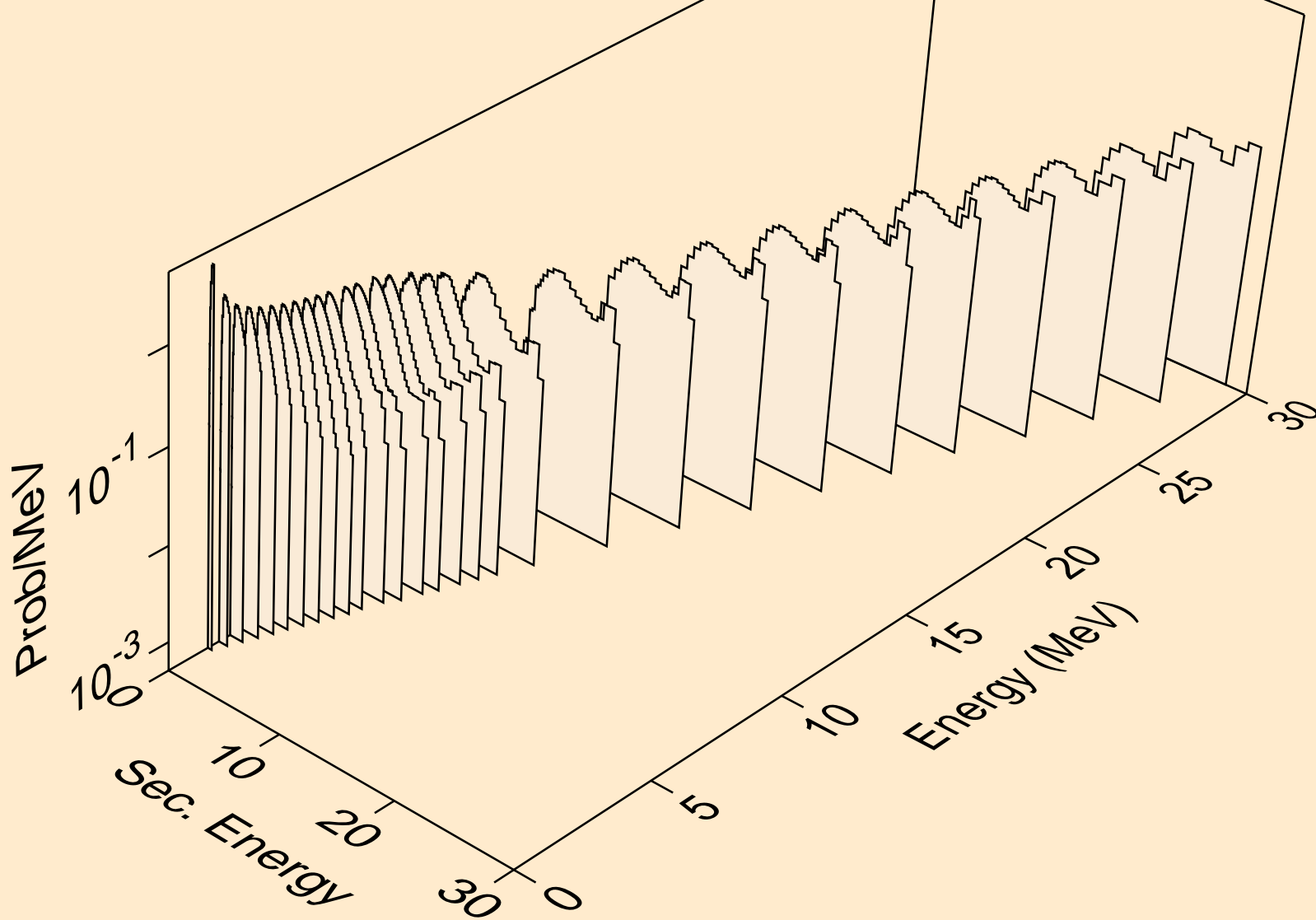

CD113 NEUTRON ACER TENDL-2019 LIBRARY; T=293.16K  
Photon emission for (n,x)

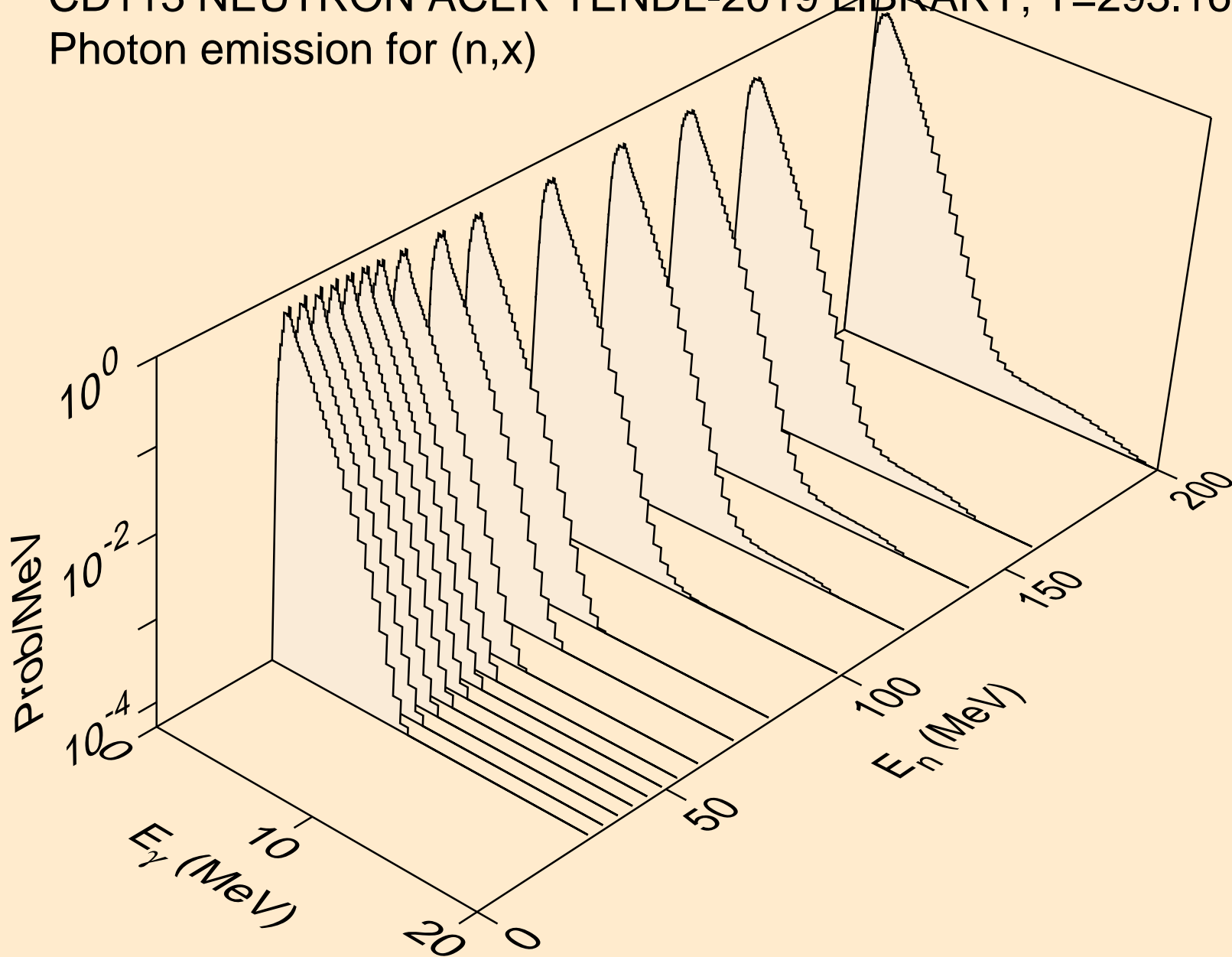

CD113 NEUTRON ACER TENDL-2019 LIBRARY; T=293.16K  
Photon emission for (n,2nd)

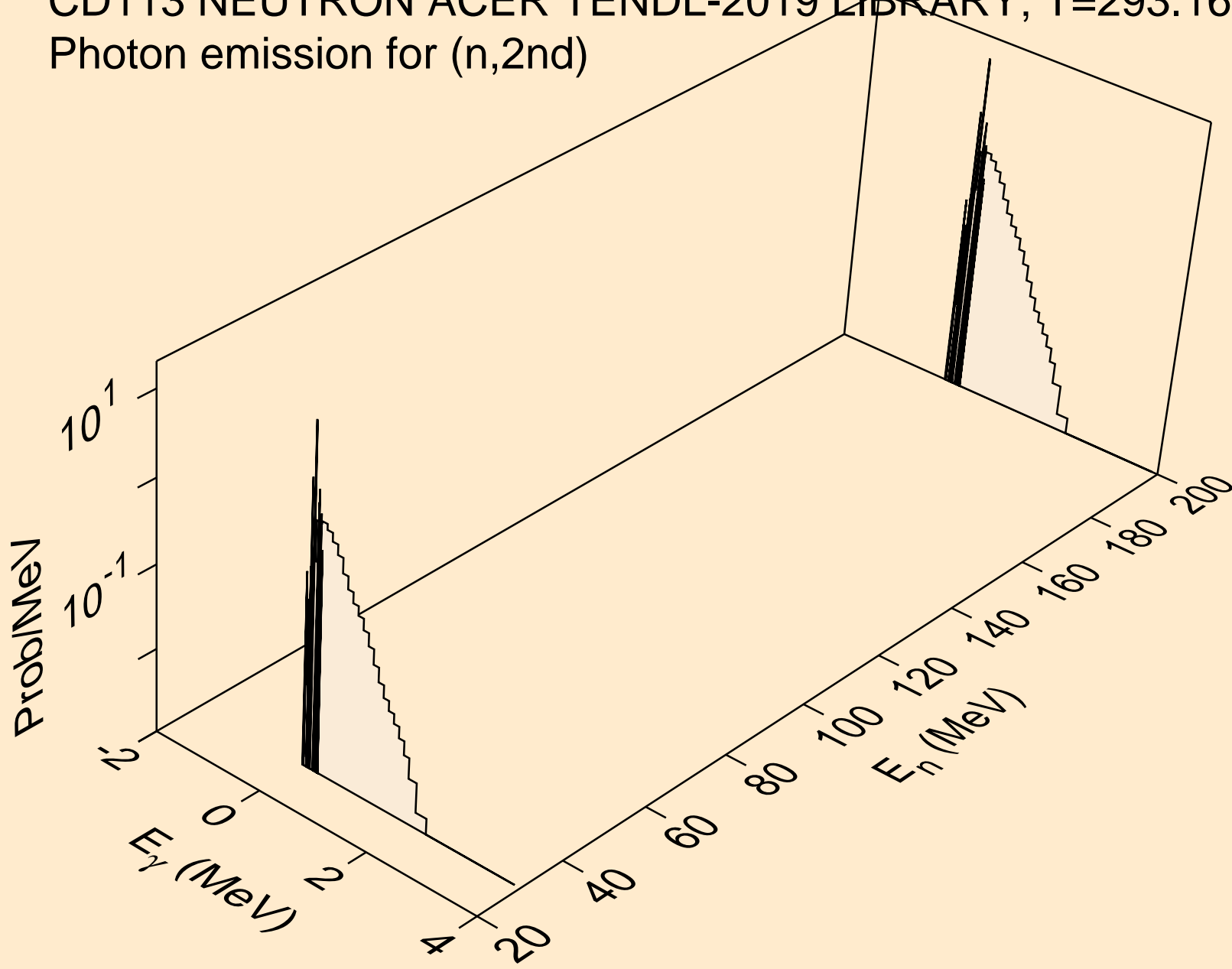

CD113 NEUTRON ACER TENDL-2019 LIBRARY; T=293.16K  
Photon emission for (n,2n)

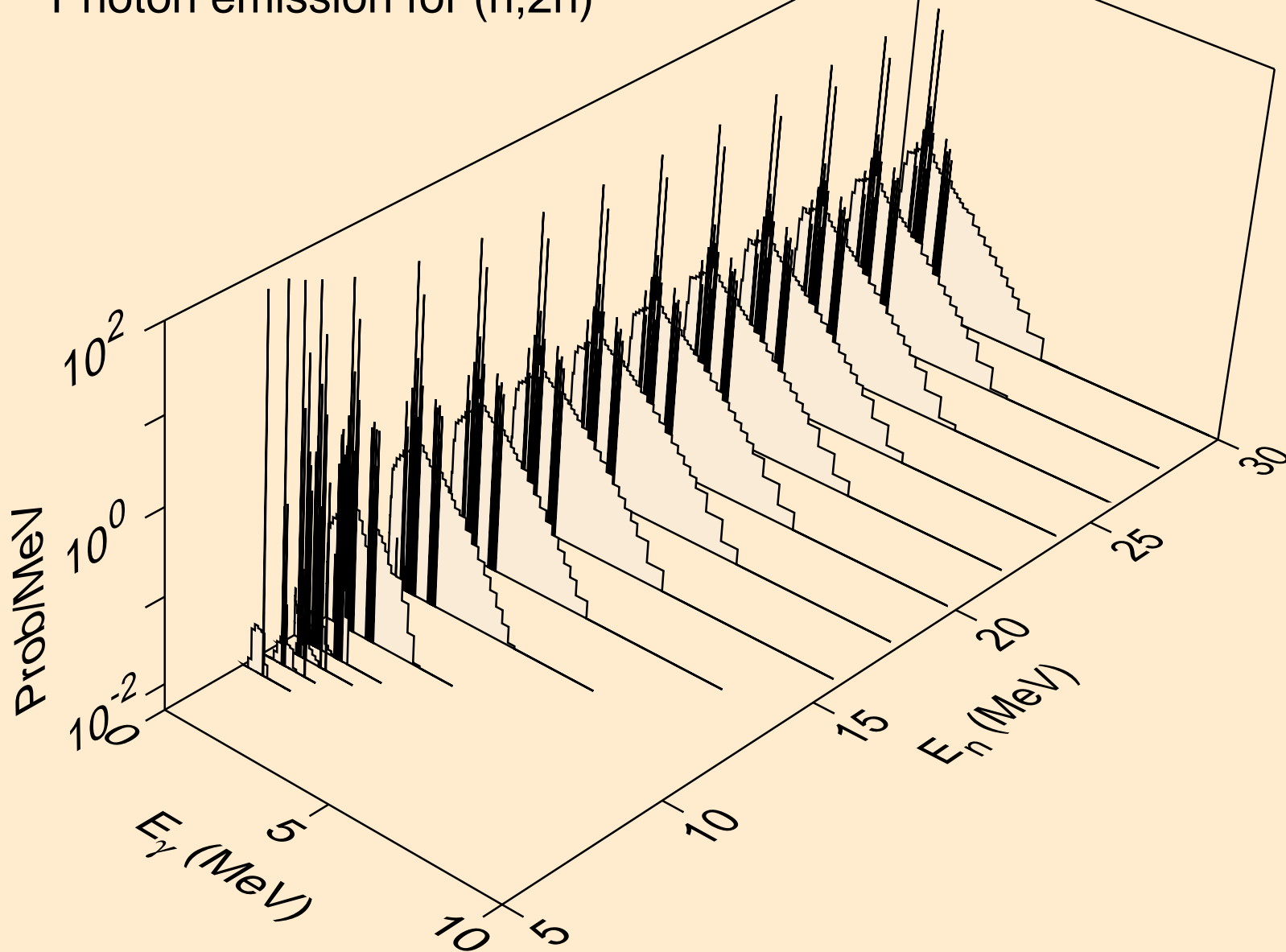

CD113 NEUTRON ACER TENDL-2019 LIBRARY; T=293.16K  
Photon emission for (n,3n)

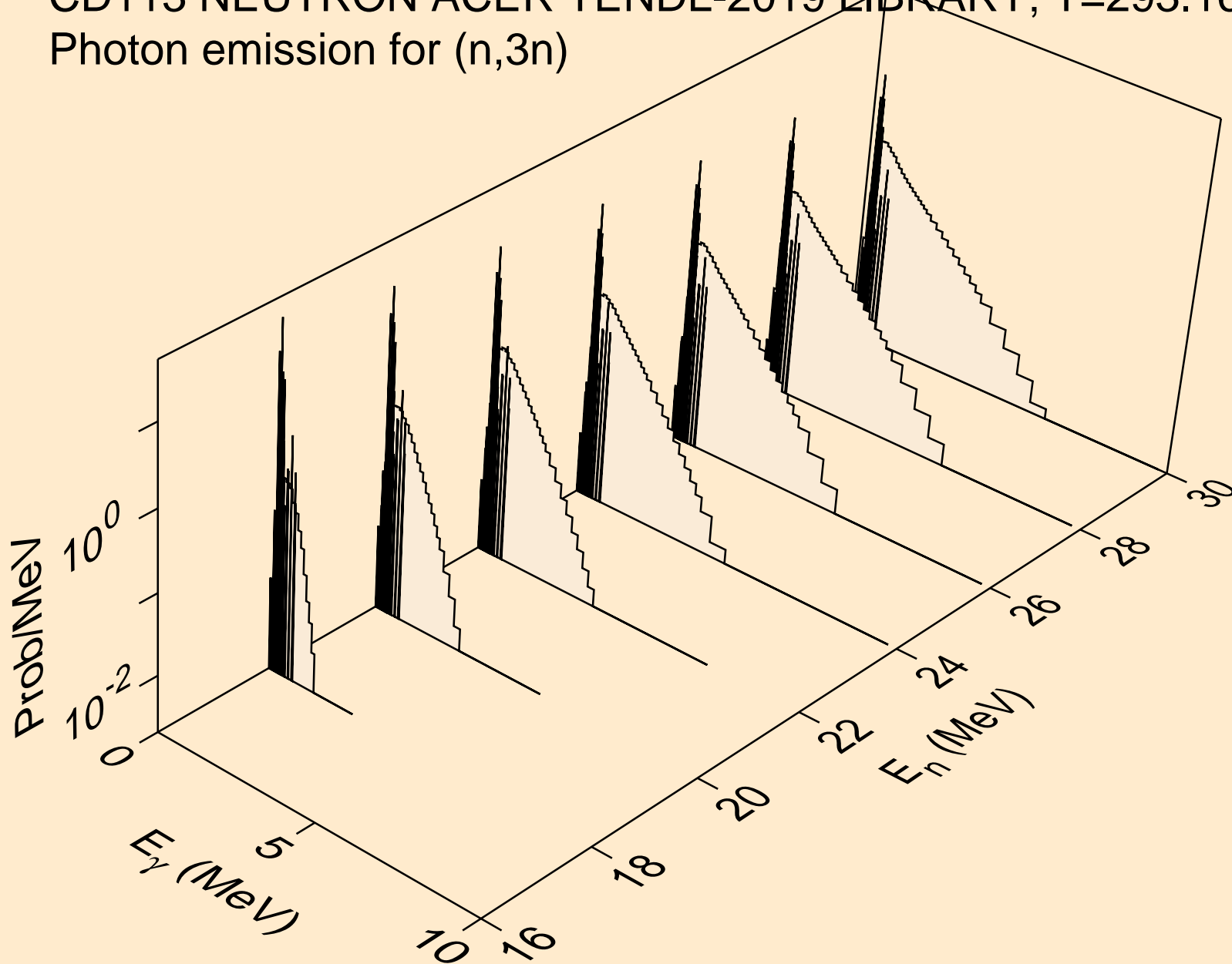

CD113 NEUTRON ACER TENDL-2019 LIBRARY; T=293.16K  
Photon emission for (n,n\*)a

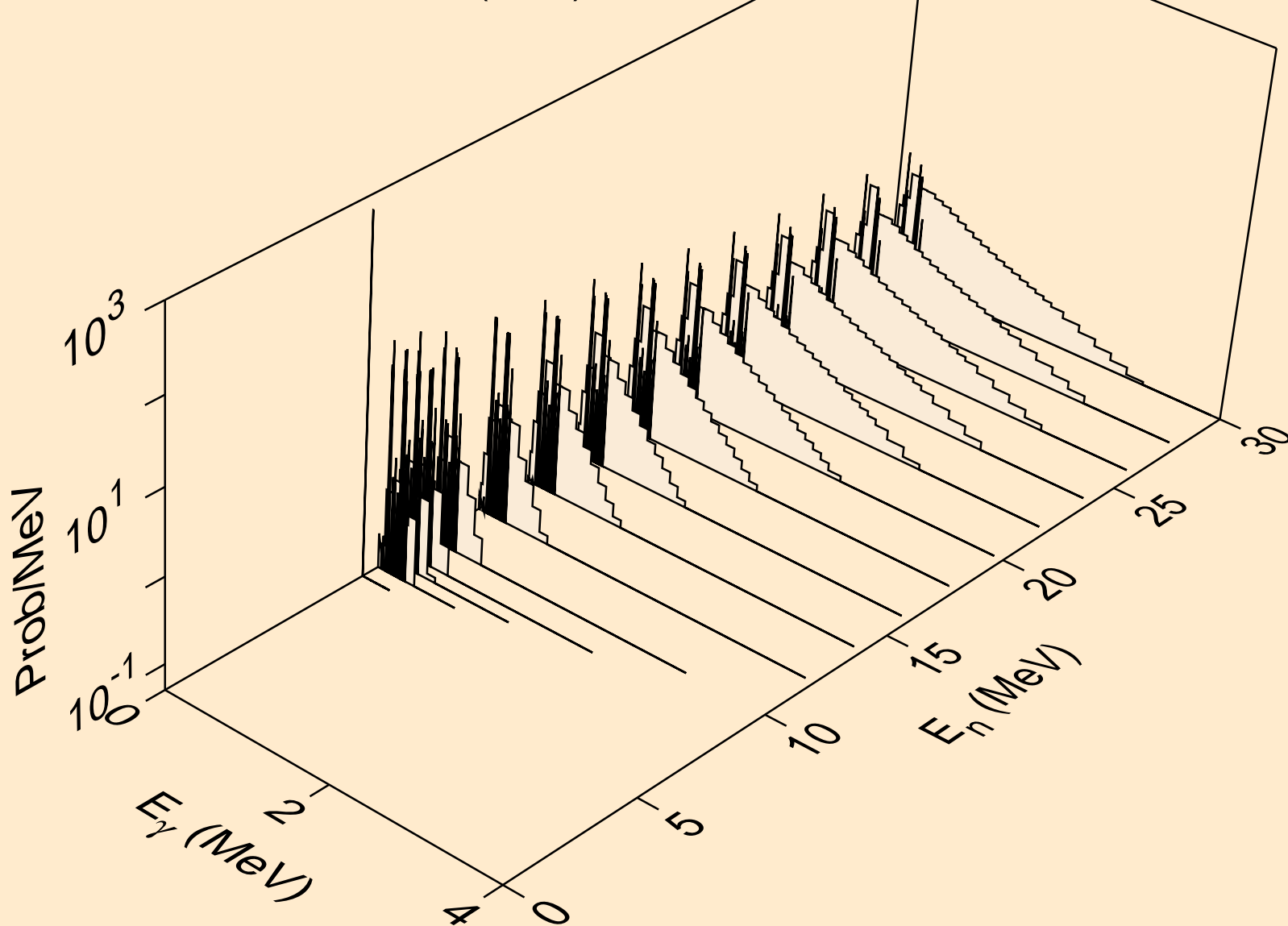

CD113 NEUTRON ACER TENDL-2019 LIBRARY; T=293.16K  
Photon emission for (n,2n)a

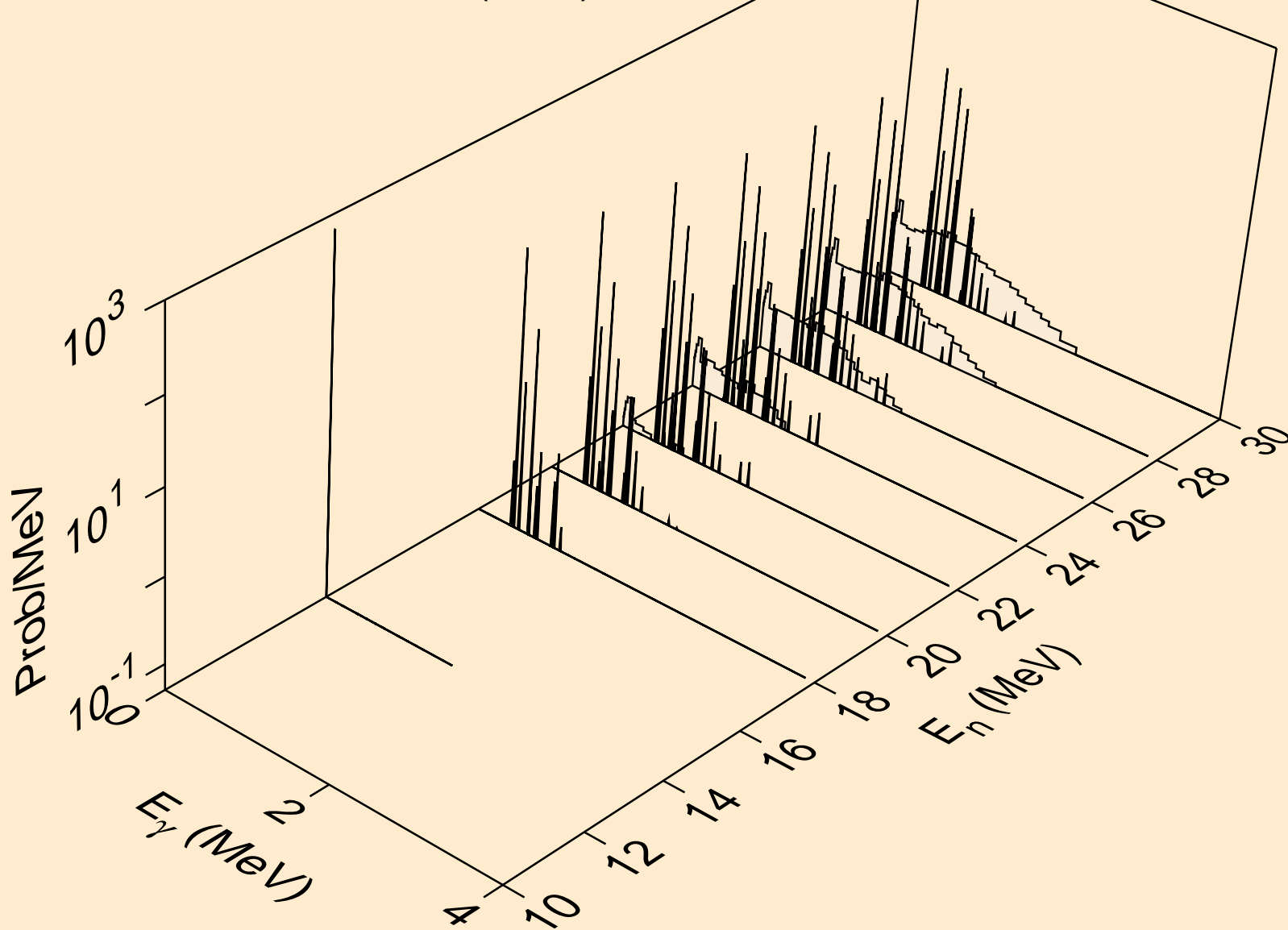

CD113 NEUTRON ACER TENDL-2019 LIBRARY; T=293.16K  
Photon emission for (n,3n)a

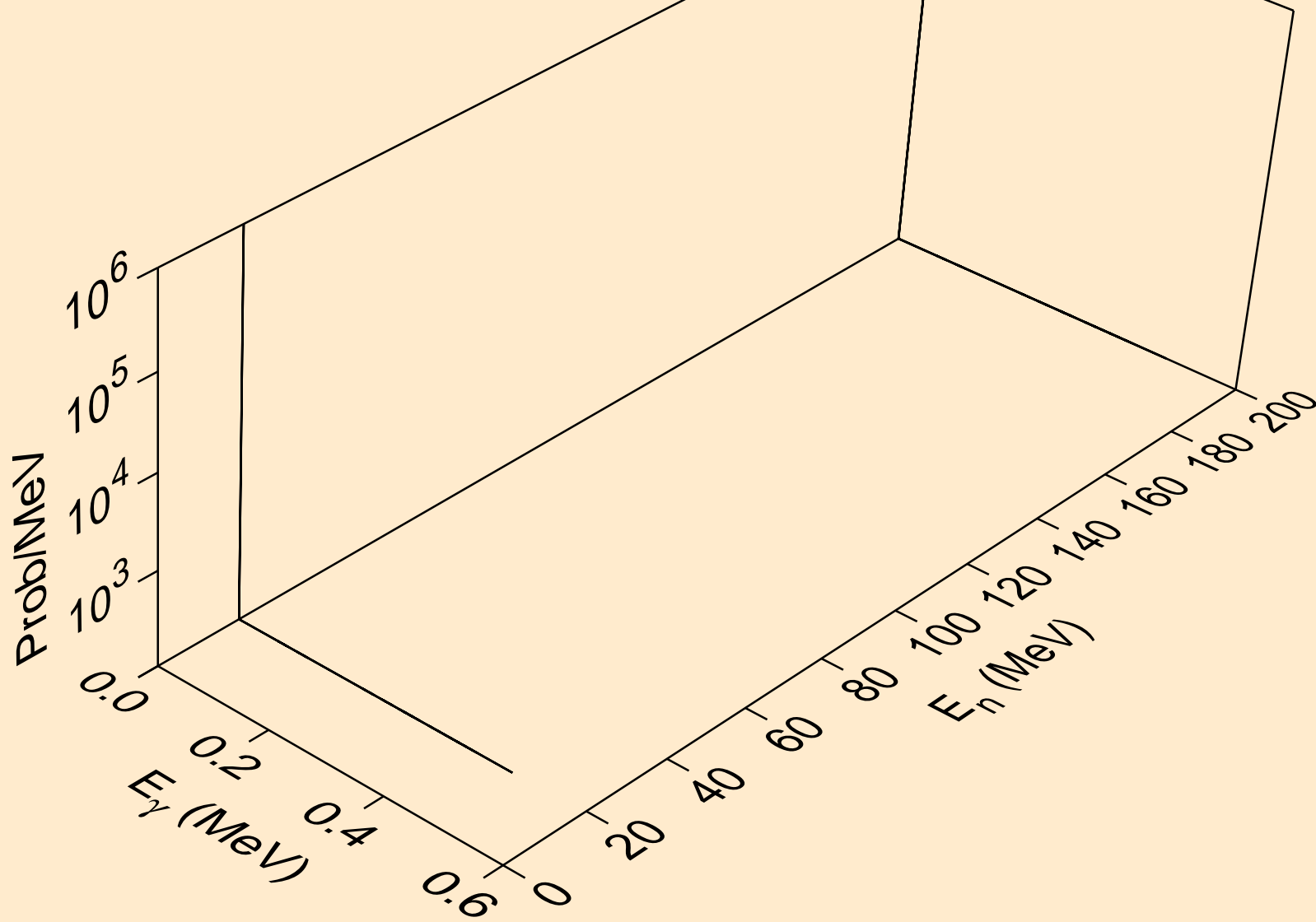

CD113 NEUTRON ACER TENDL-2019 LIBRARY; T=293.16K  
Photon emission for (n,n\*)p

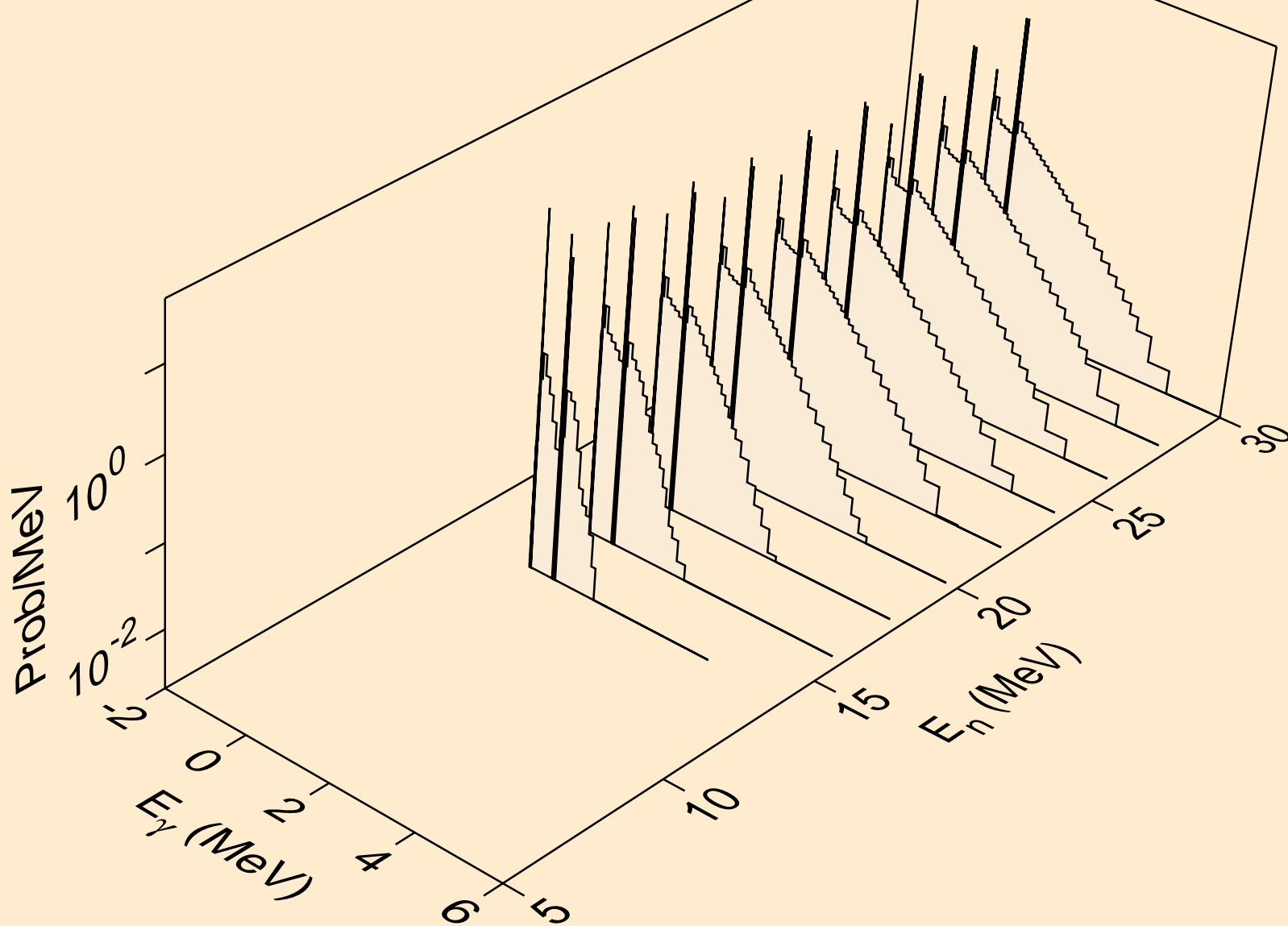

CD113 NEUTRON ACER TENDL-2019 LIBRARY; T=293.16K  
Photon emission for (n,n\*)2a

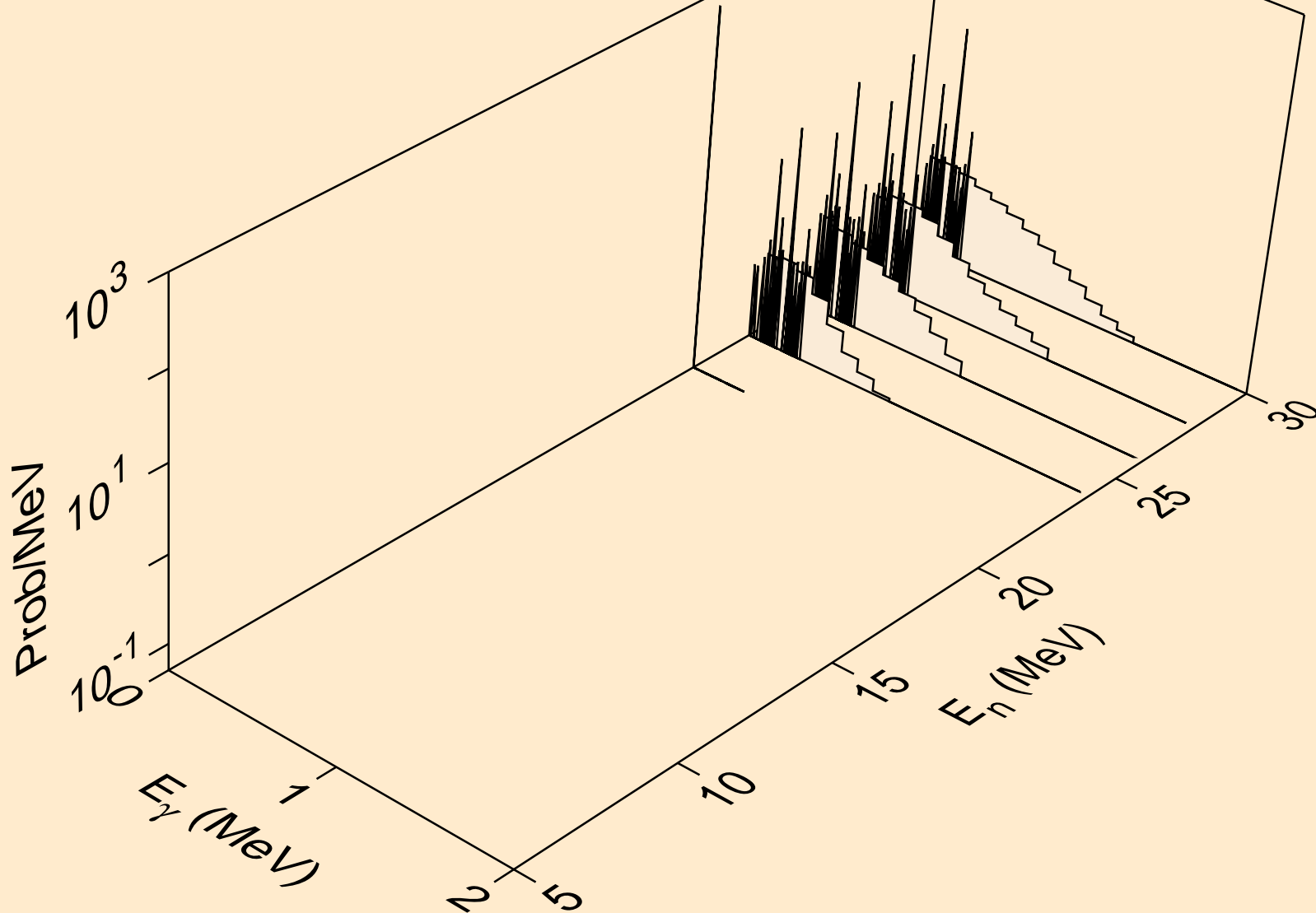

CD113 NEUTRON ACER TENDL-2019 LIBRARY; T=293.16K  
Photon emission for (n,n\*)d

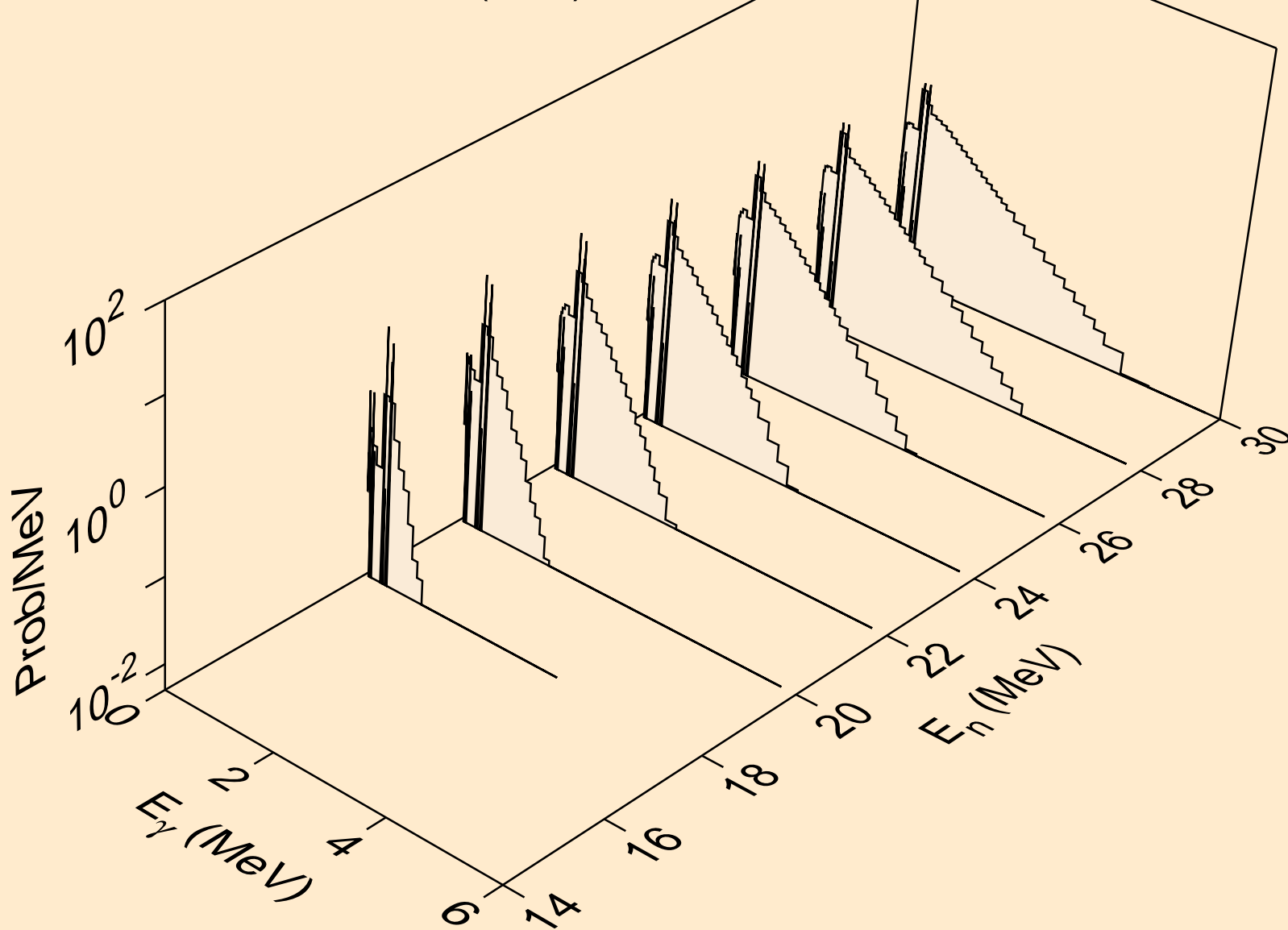

CD113 NEUTRON ACER TENDL-2019 LIBRARY; T=293.16K  
Photon emission for (n,n\*)t

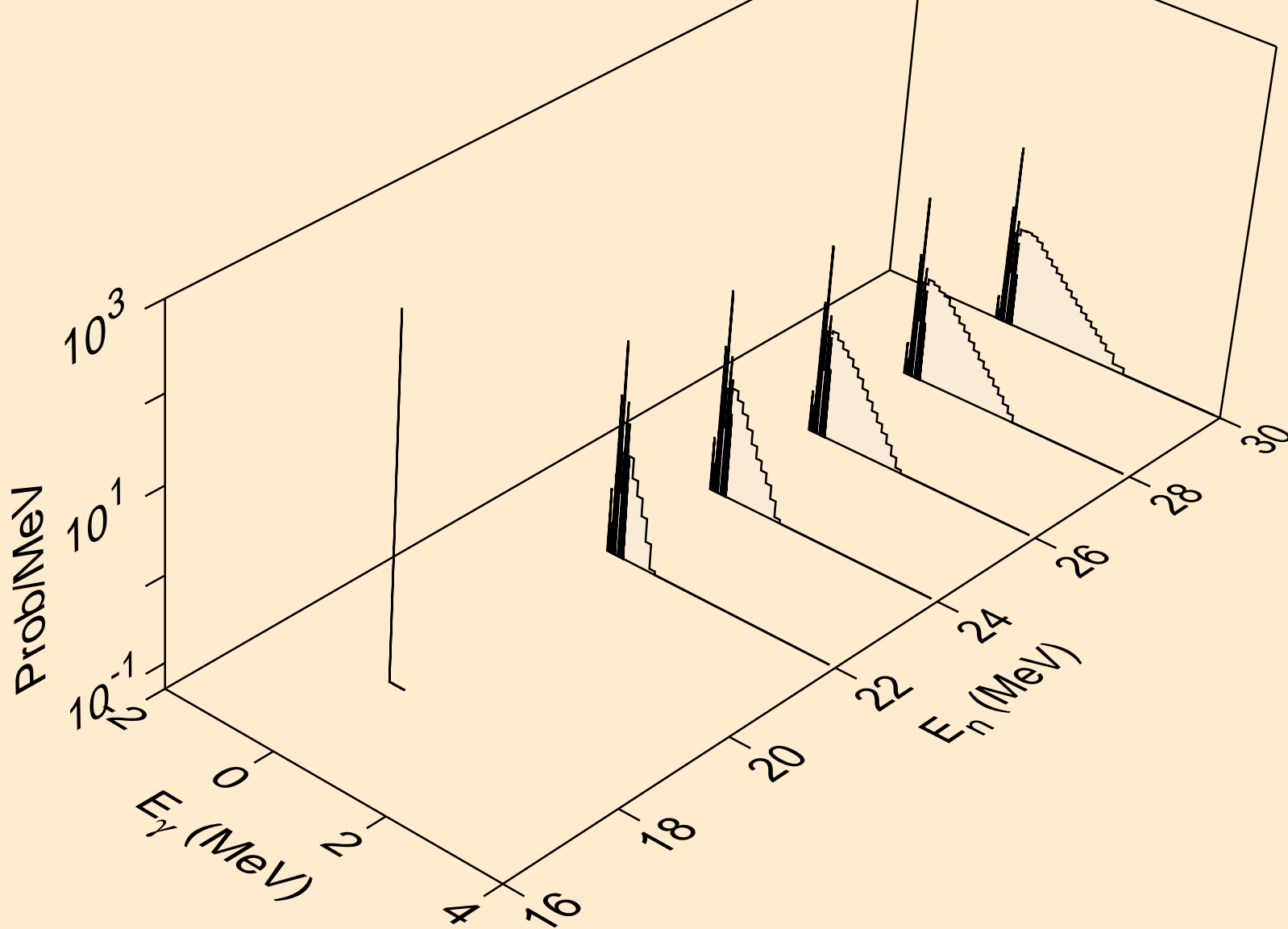

CD113 NEUTRON ACER TENDL-2019 LIBRARY; T=293.16K  
Photon emission for (n,n\*)he3

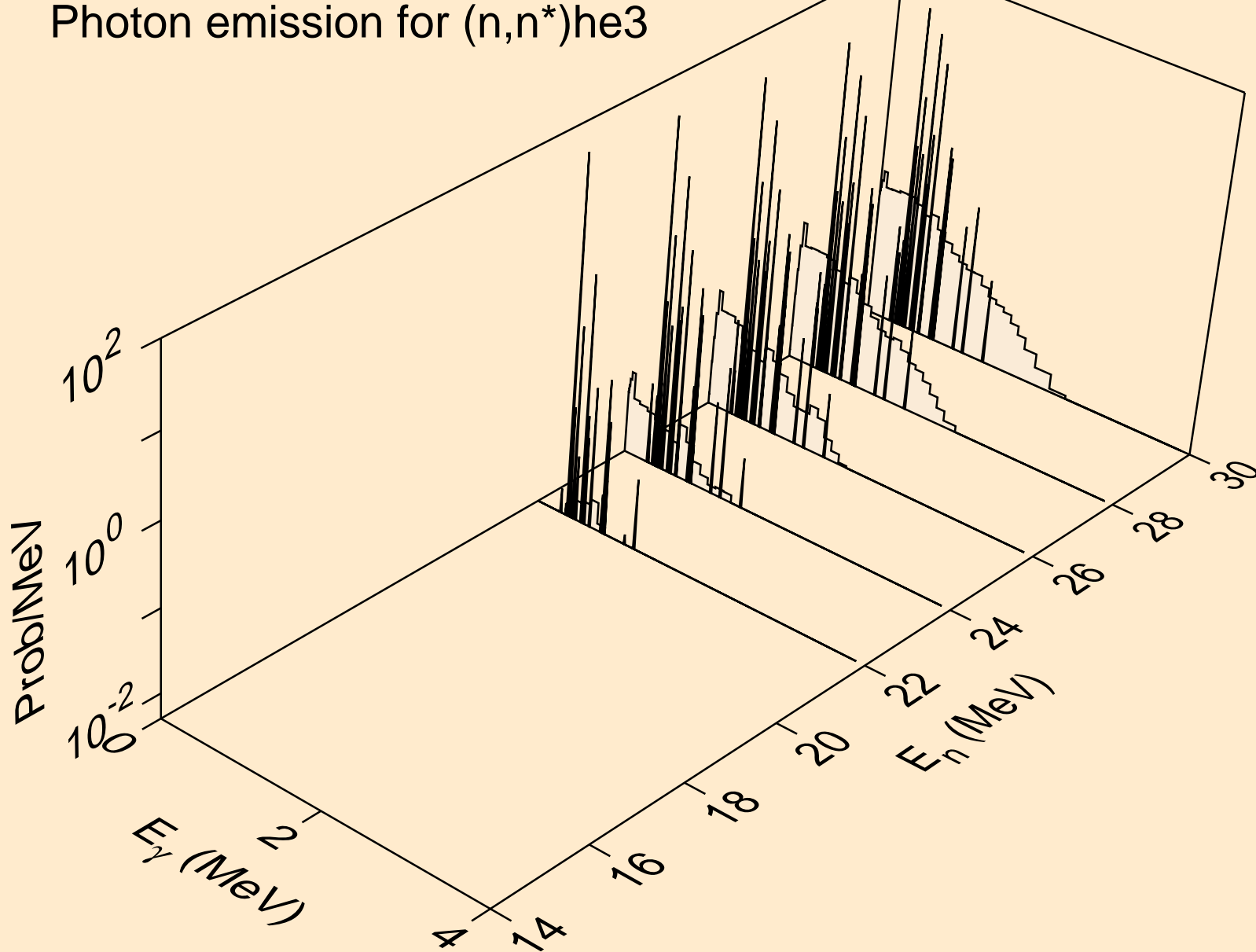

CD113 NEUTRON ACER TENDL-2019 LIBRARY; T=293.16K  
Photon emission for (n,4n)

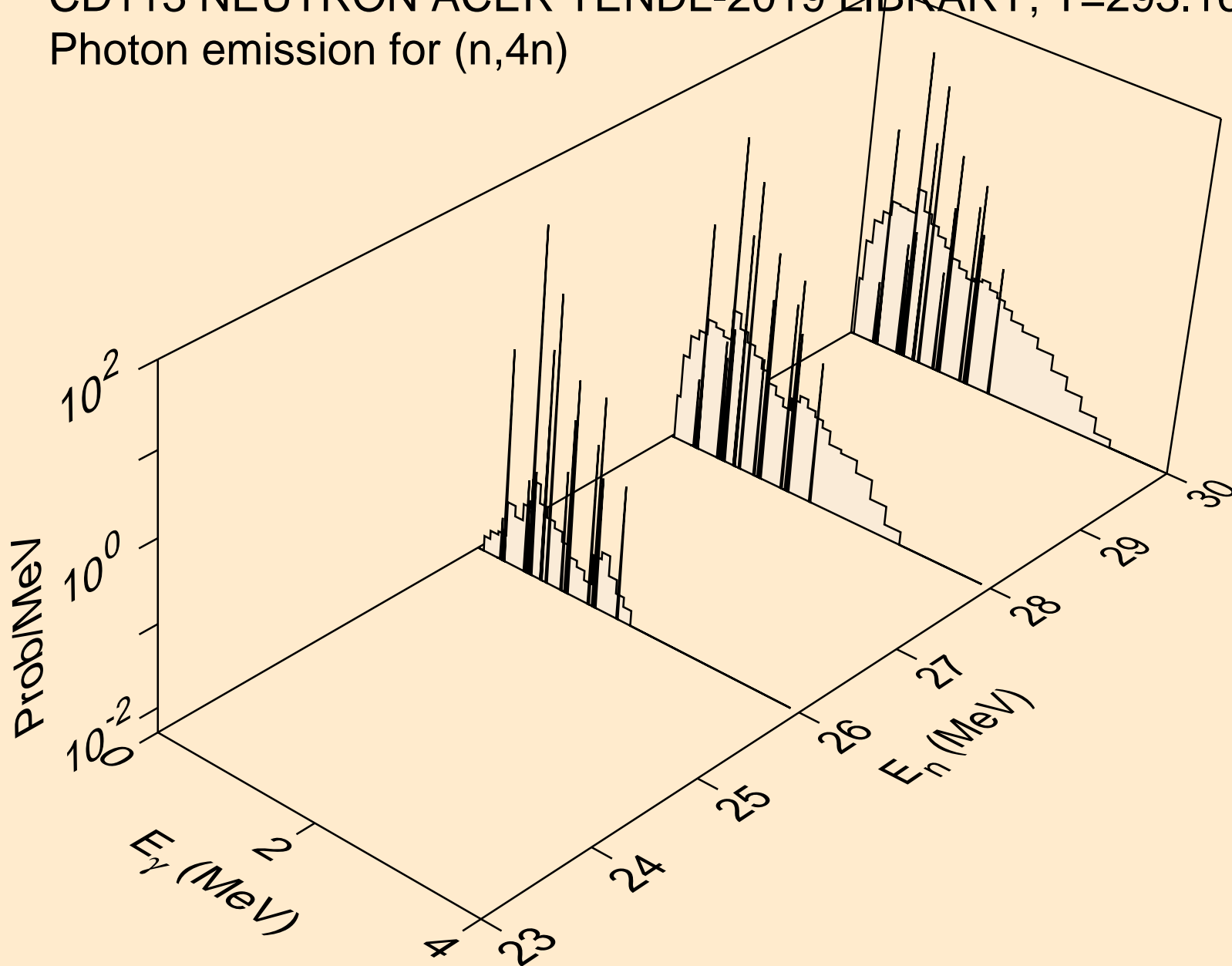

CD113 NEUTRON ACER TENDL-2019 LIBRARY; T=293.16K  
Photon emission for (n,2np)

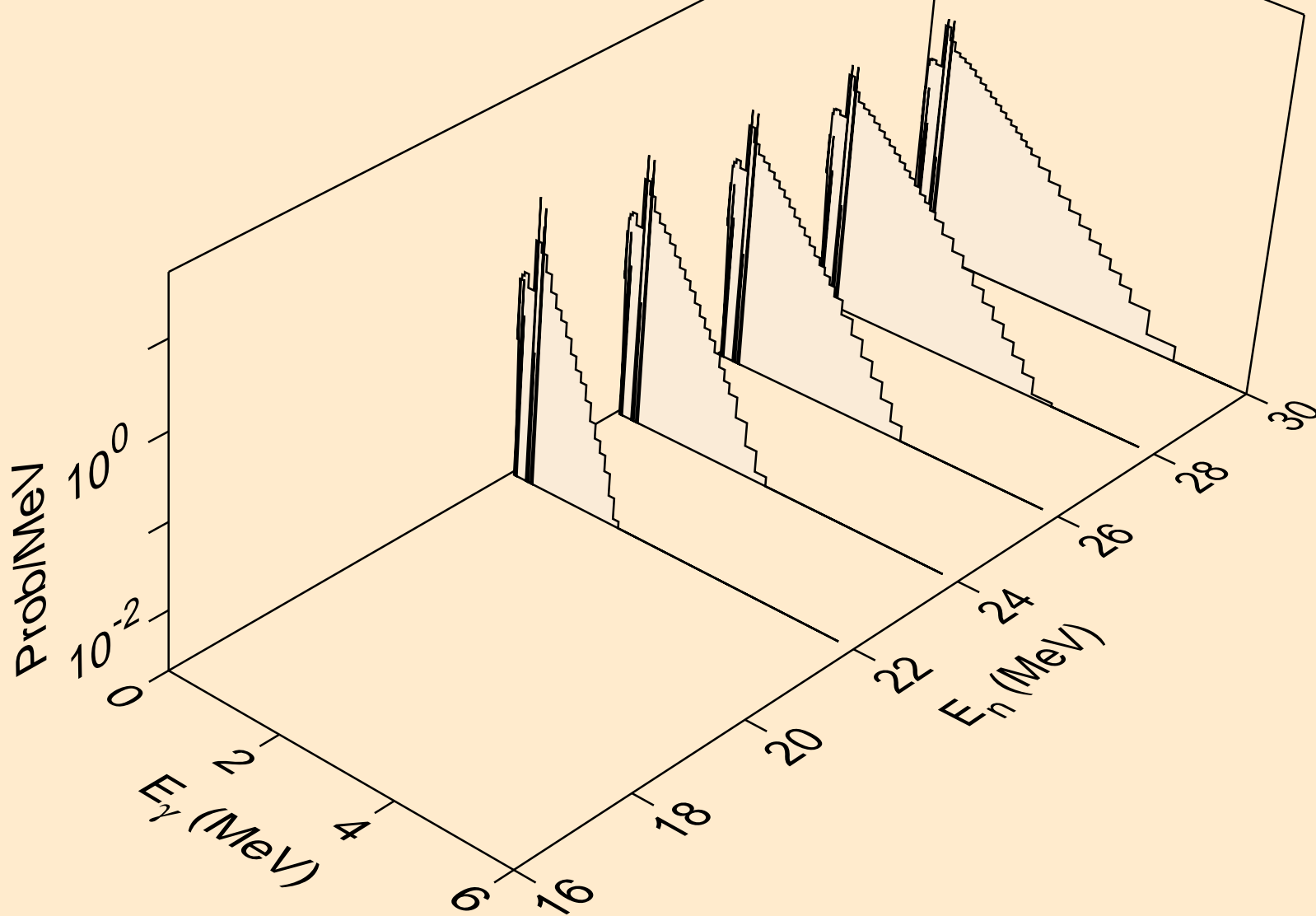

CD113 NEUTRON ACER TENDL-2019 LIBRARY; T=293.16K  
Photon emission for (n,3np)

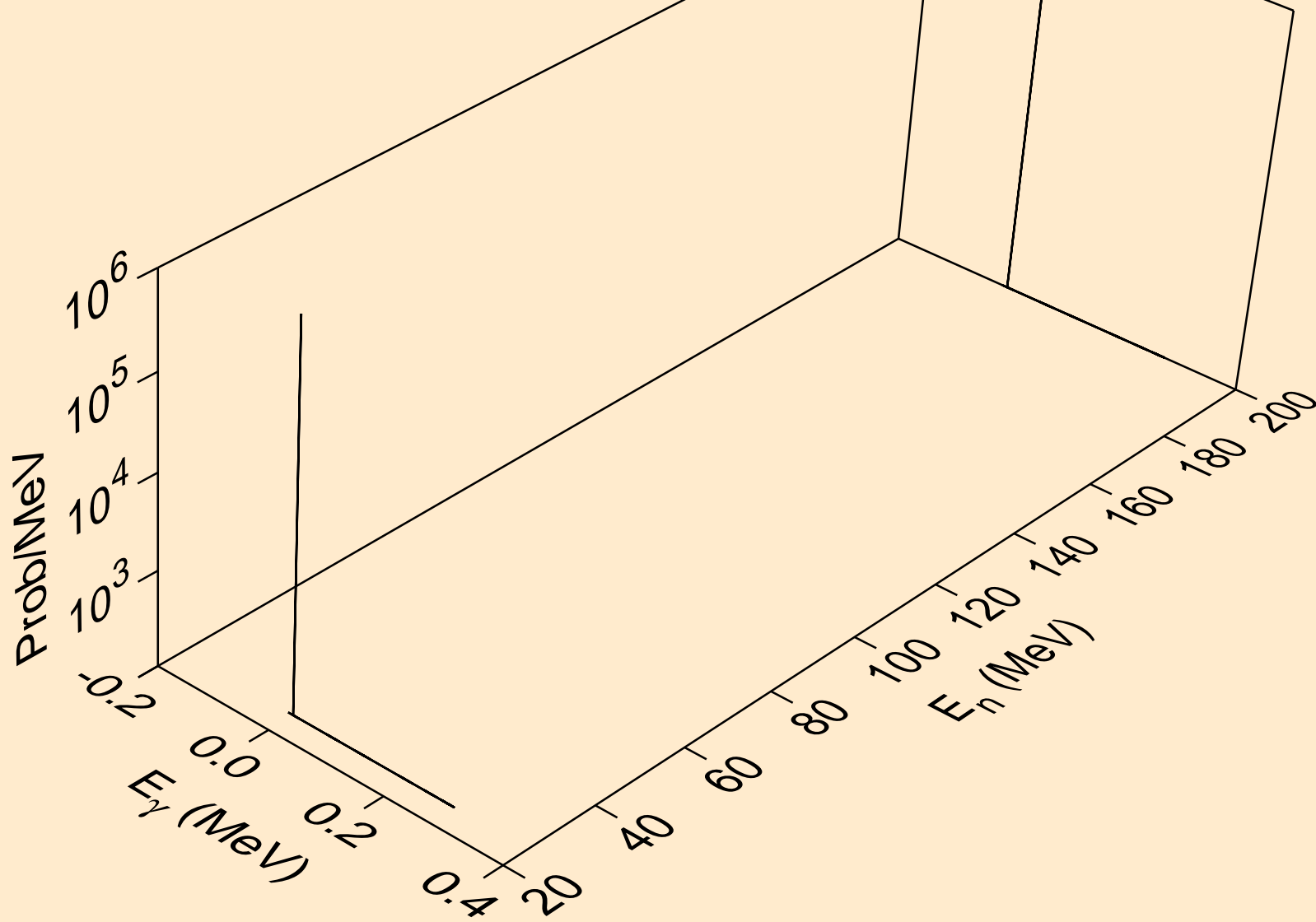

CD113 NEUTRON ACER TENDL-2019 LIBRARY; T=293.16K  
Photon emission for (n,2np)

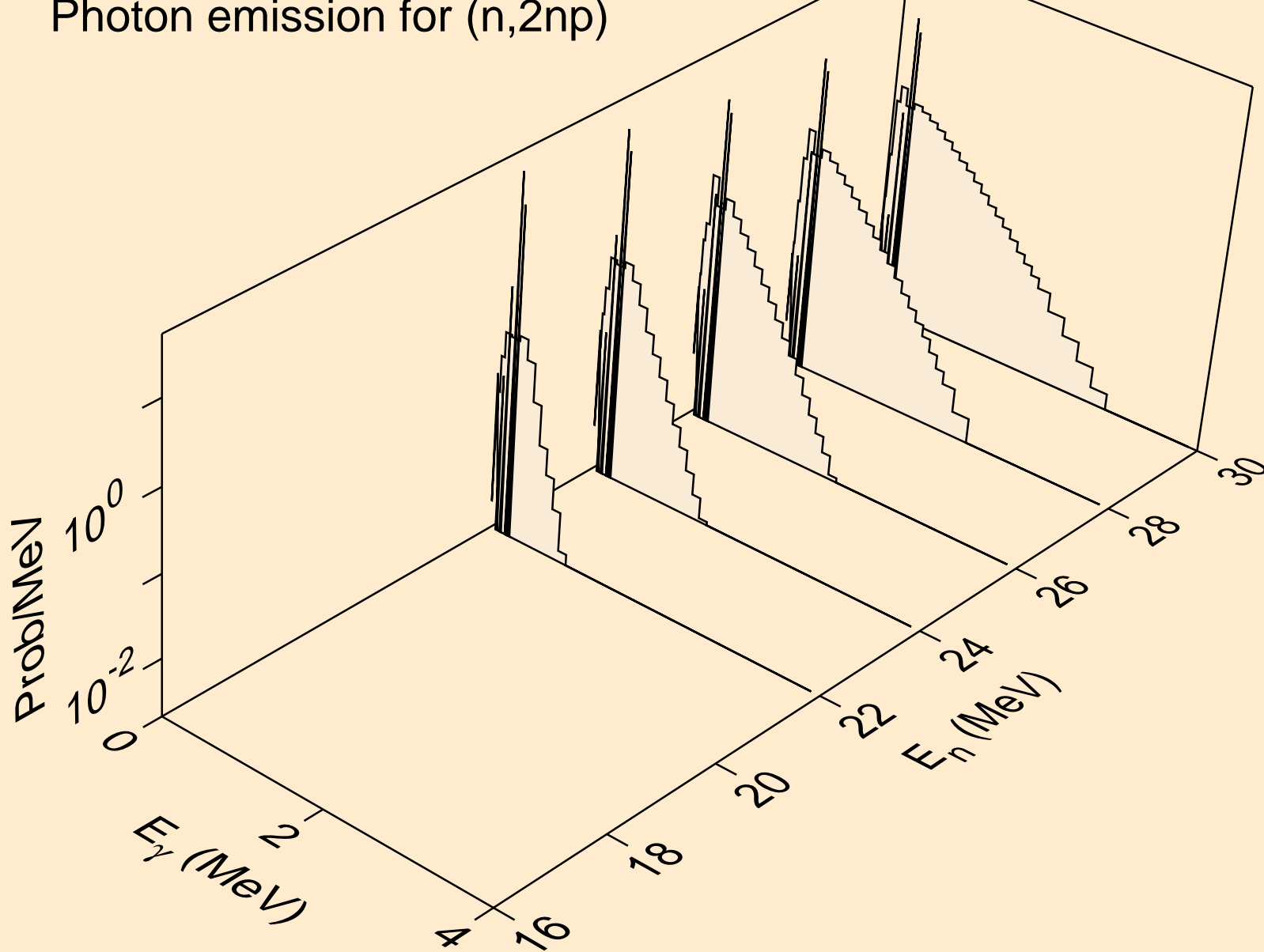

CD113 NEUTRON ACER TENDL-2019 LIBRARY; T=293.16K  
Photon emission for (n,npa)

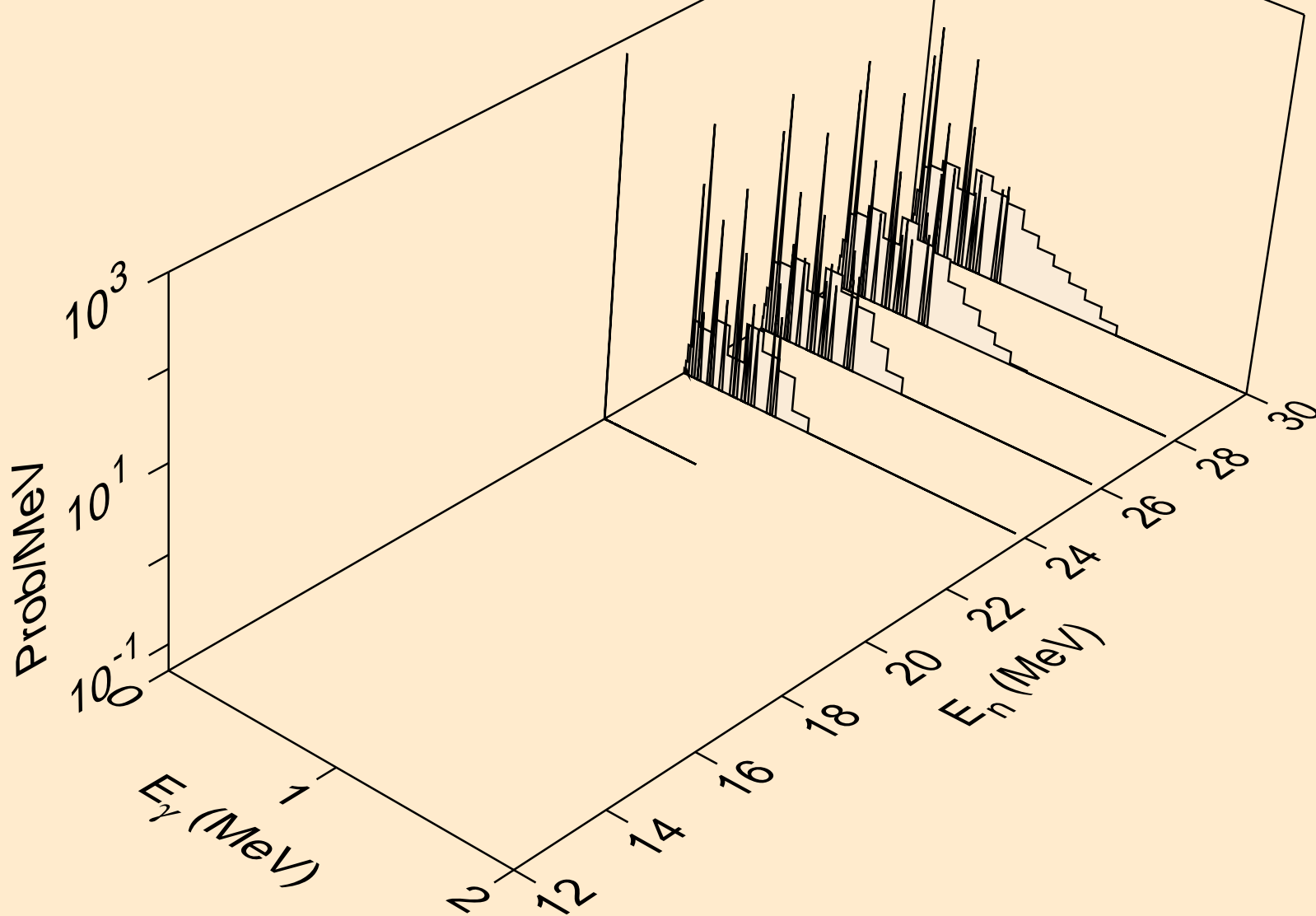

CD113 NEUTRON ACER TENDL-2019 LIBRARY; T=293.16K  
Photon emission for (n,n\*c)

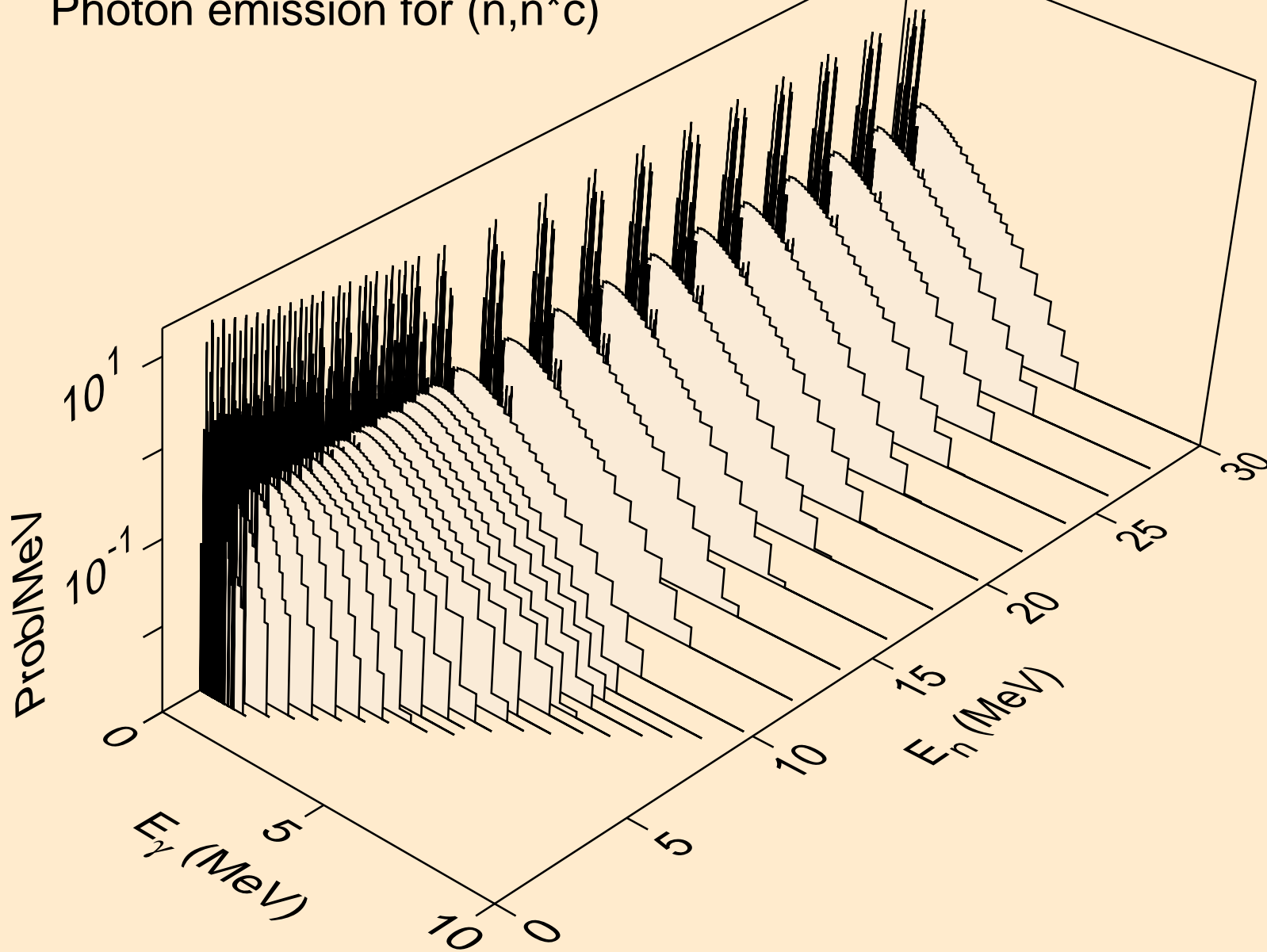

CD113 NEUTRON ACER TENDL-2019 LIBRARY; T=293.16K  
Photon emission for (n,gma)

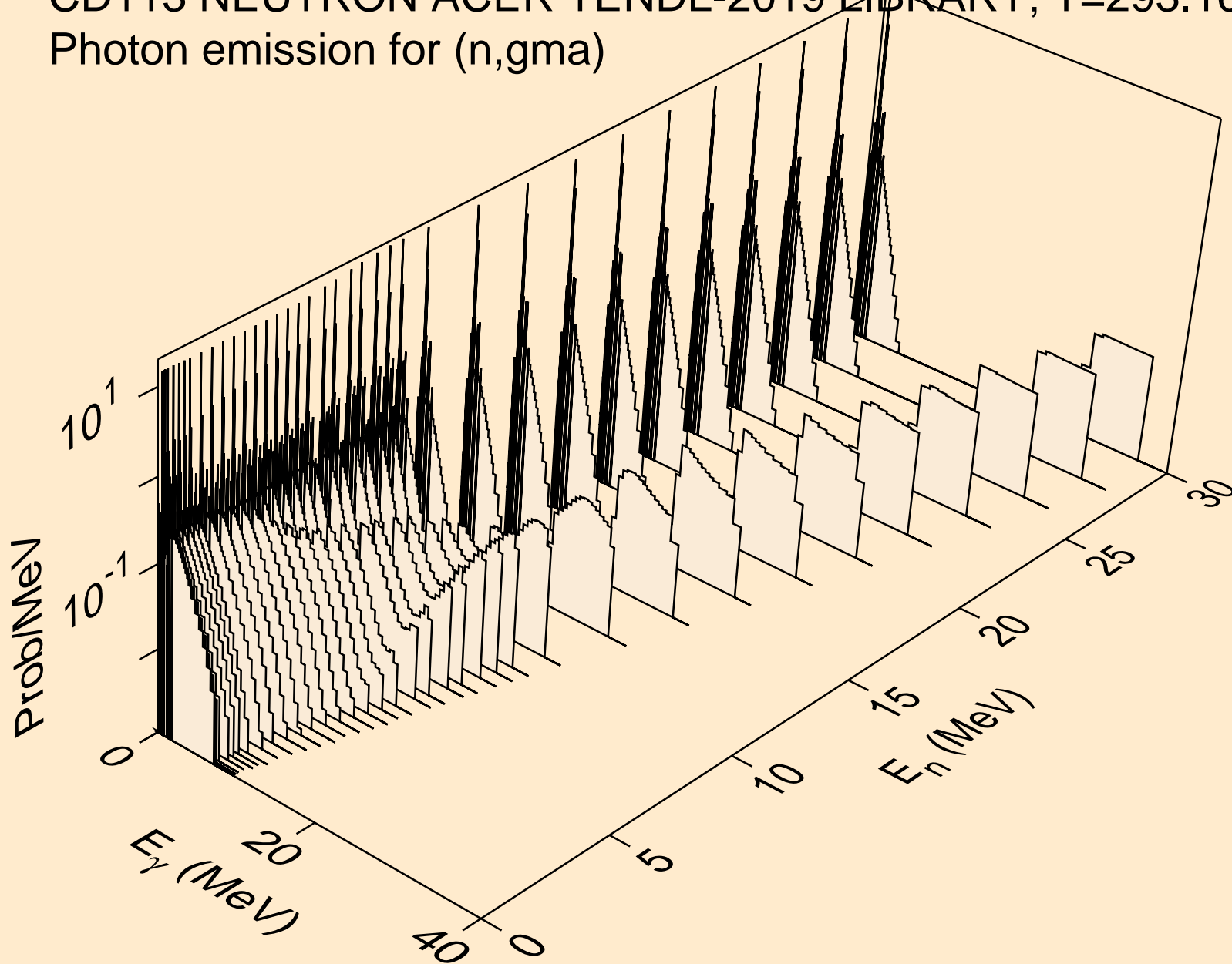

CD113 NEUTRON ACER TENDL-2019 LIBRARY; T=293.16K  
Photon emission for (n,p)

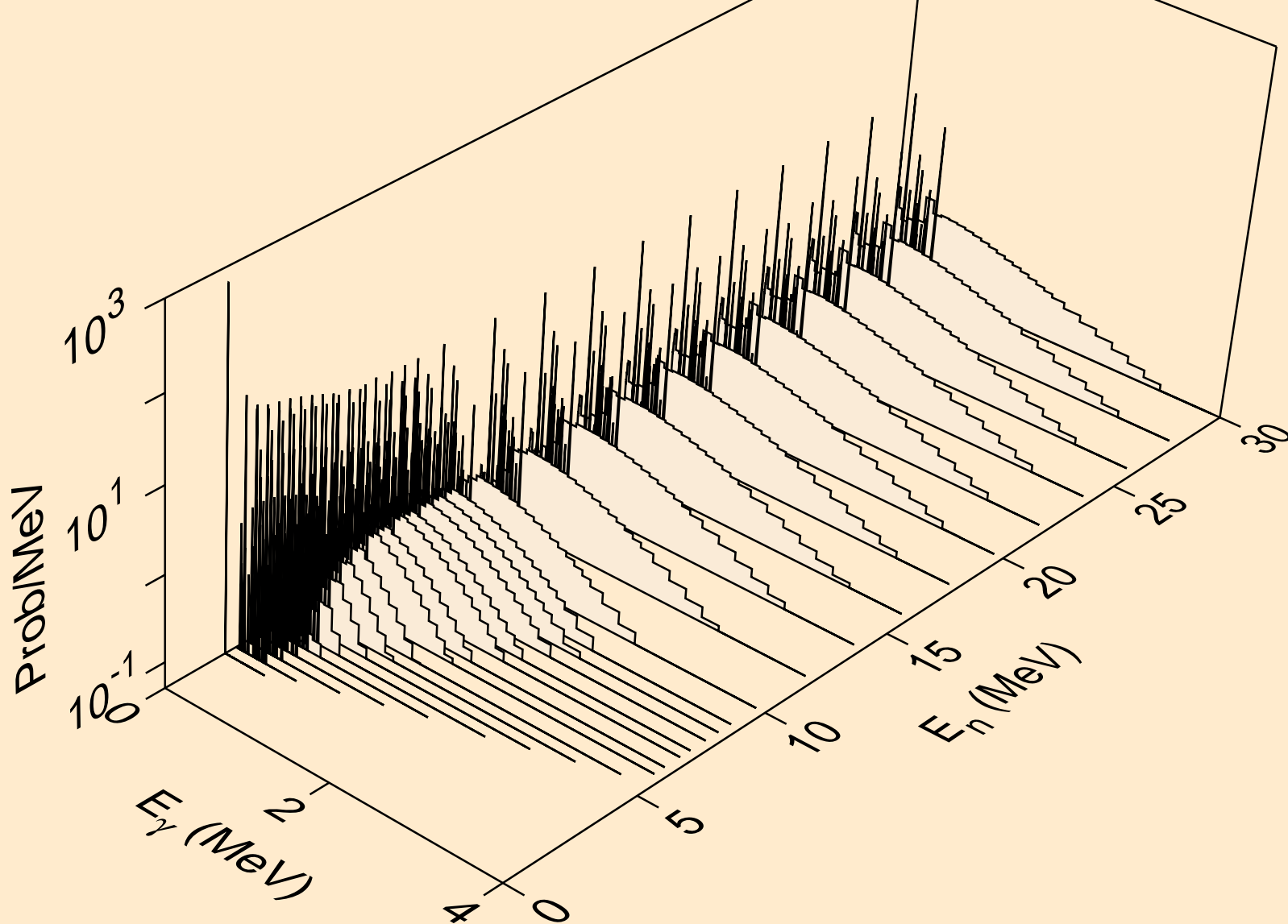

CD113 NEUTRON ACER TENDL-2019 LIBRARY; T=293.16K  
Photon emission for (n,d)

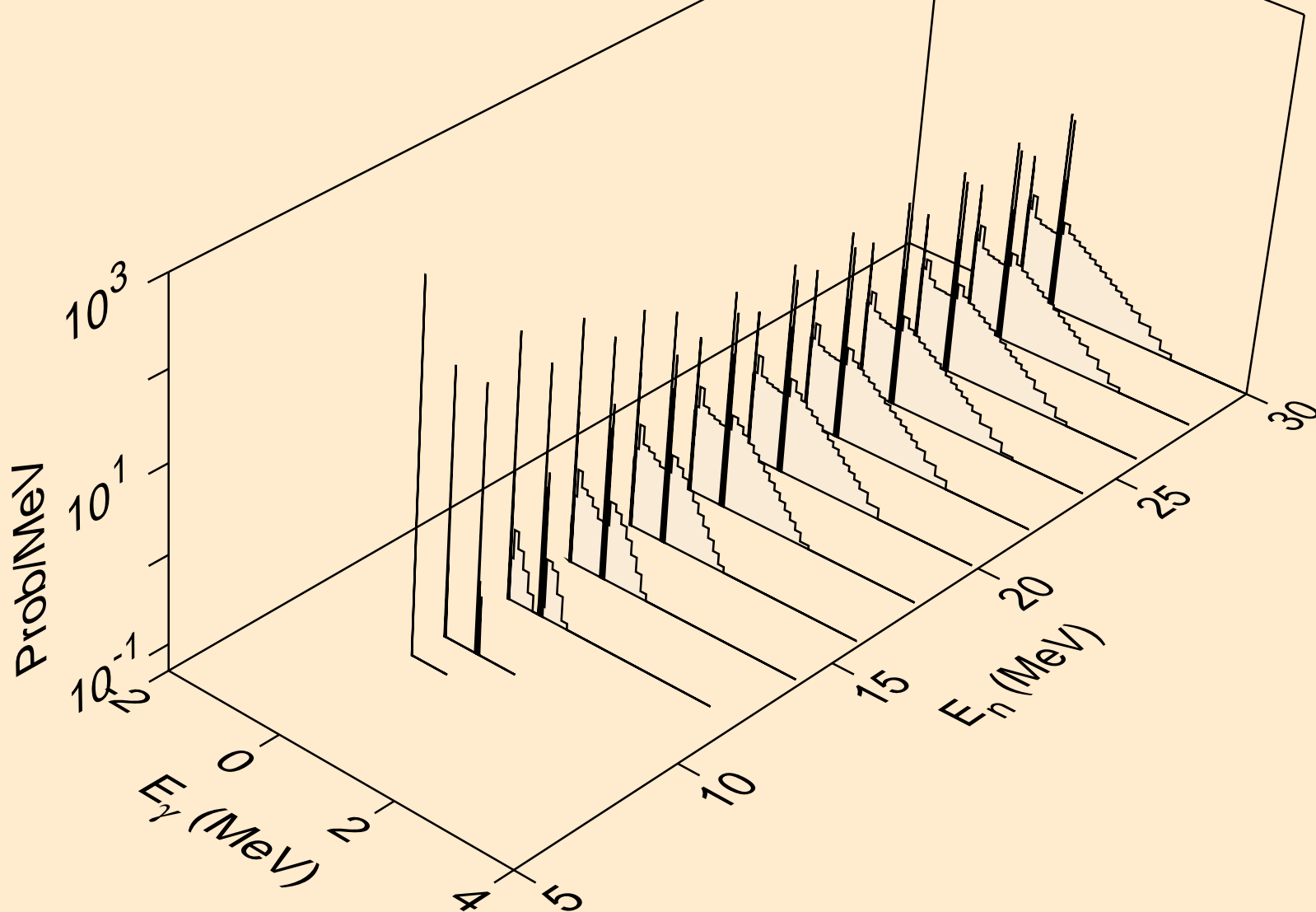

CD113 NEUTRON ACER TENDL-2019 LIBRARY; T=293.16K  
Photon emission for (n,t)

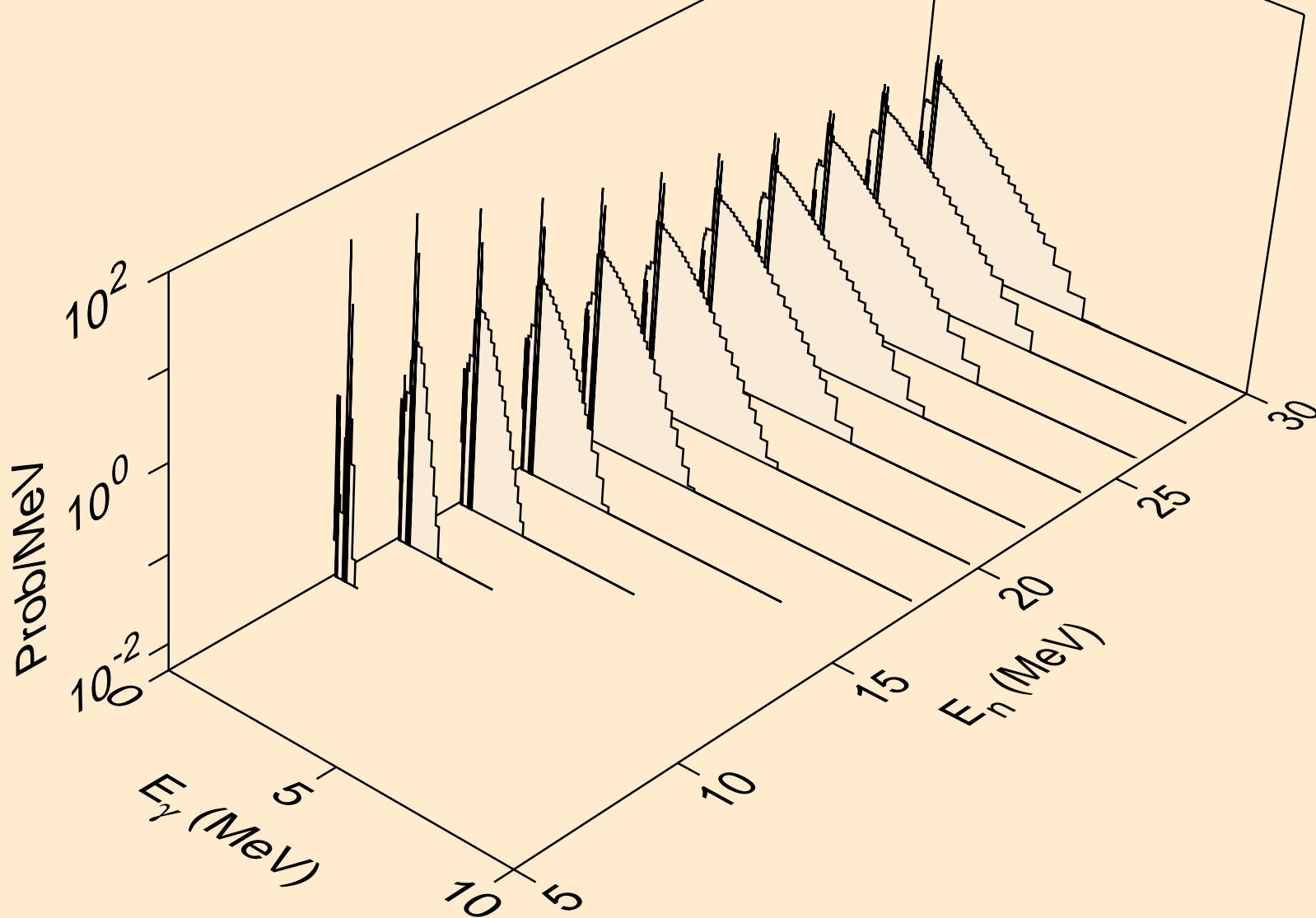

CD113 NEUTRON ACER TENDL-2019 LIBRARY; T=293.16K  
Photon emission for (n,he3)

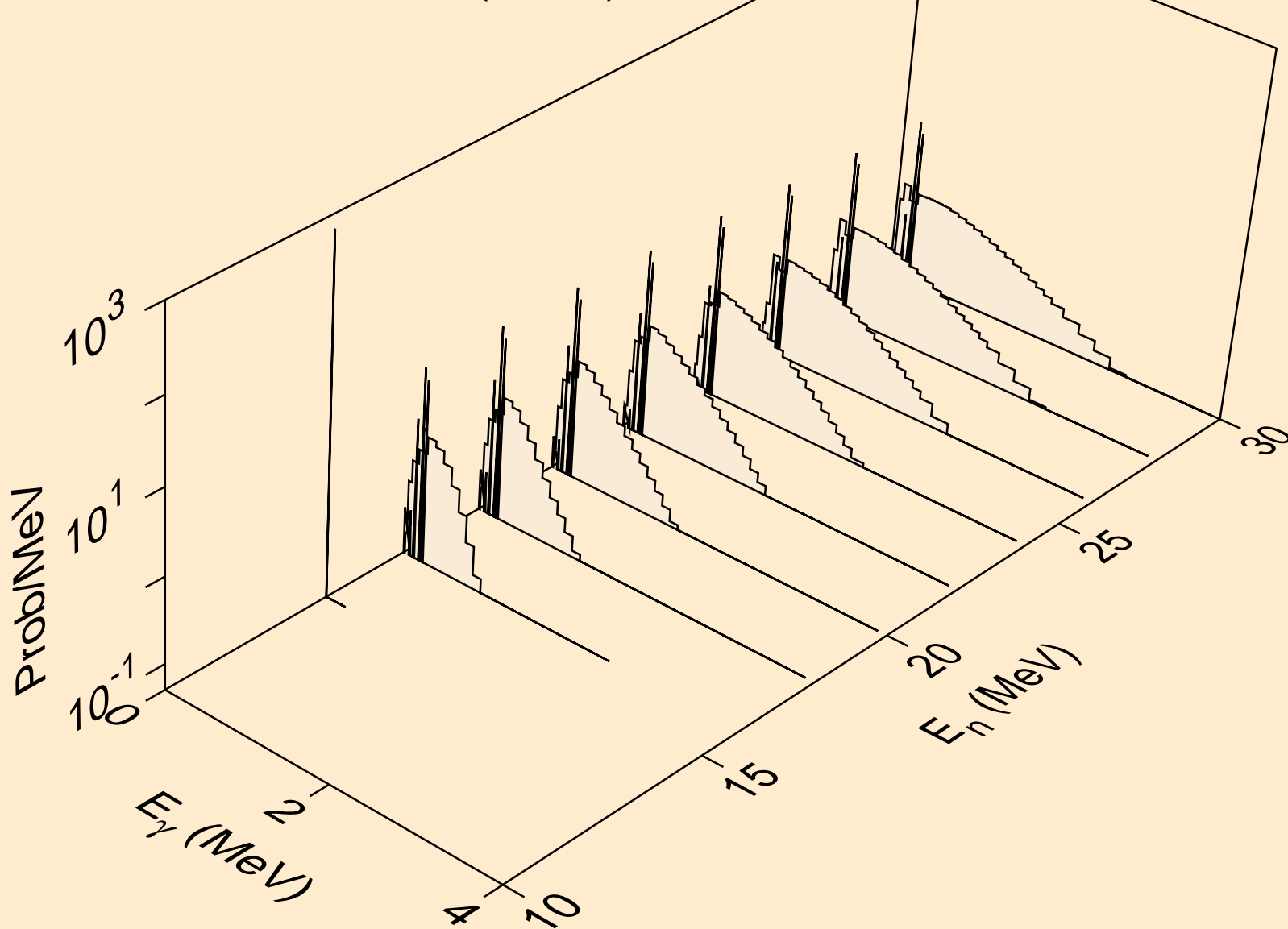

CD113 NEUTRON ACER TENDL-2019 LIBRARY; T=293.16K  
Photon emission for (n,a)

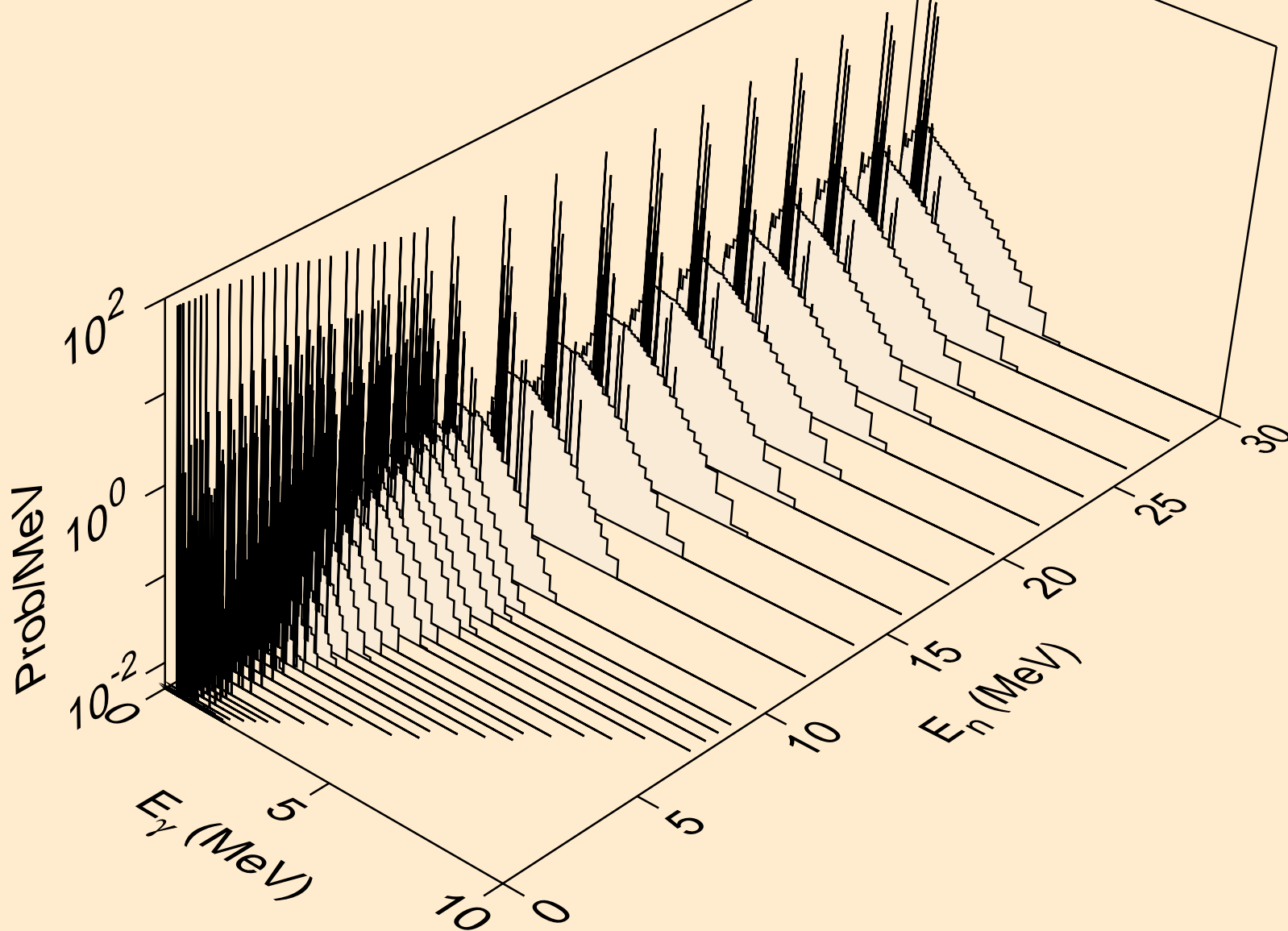

CD113 NEUTRON ACER TENDL-2019 LIBRARY; T=293.16K  
Photon emission for (n,2a)

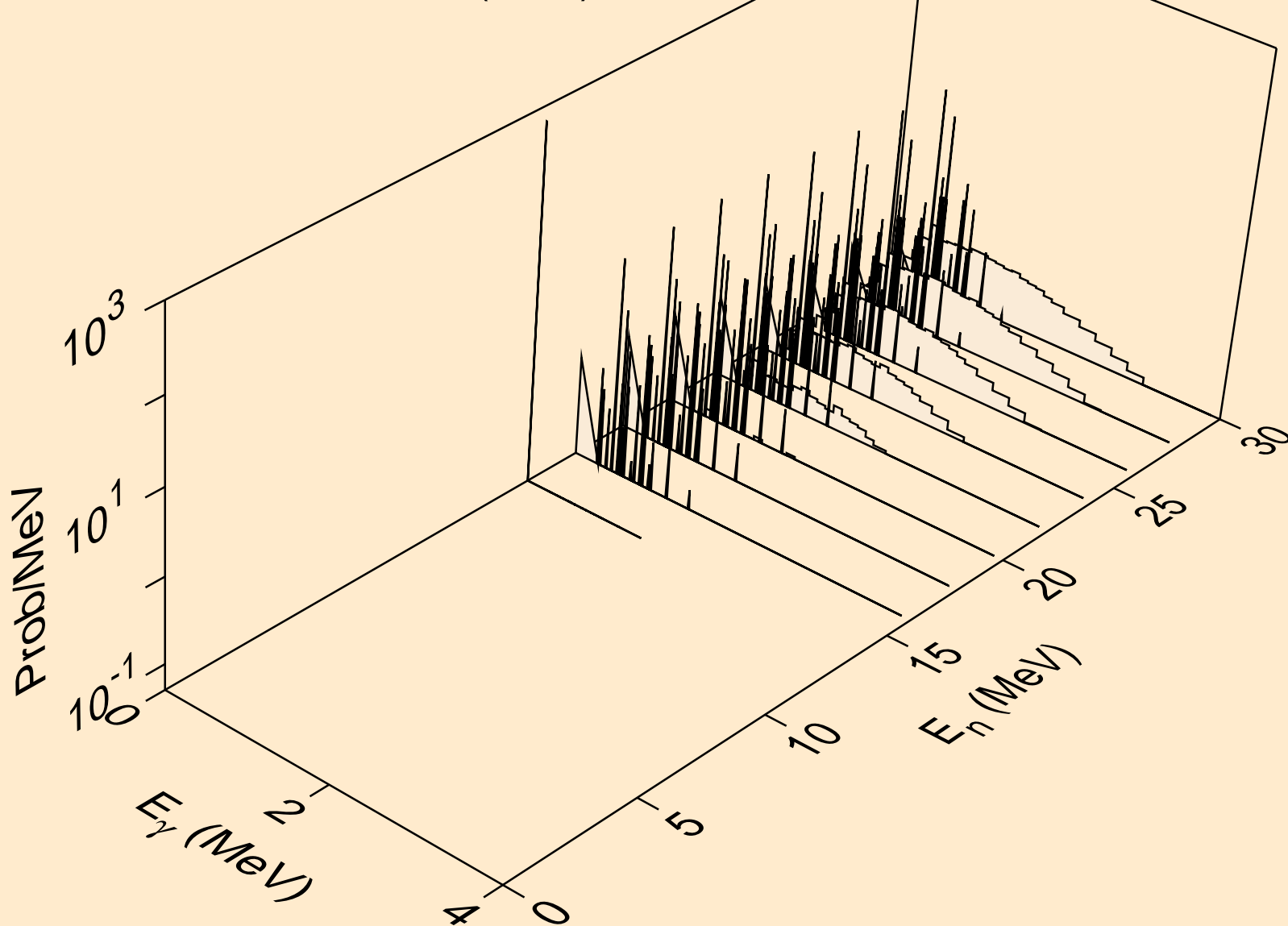

CD113 NEUTRON ACER TENDL-2019 LIBRARY; T=293.16K  
Photon emission for (n,2p)

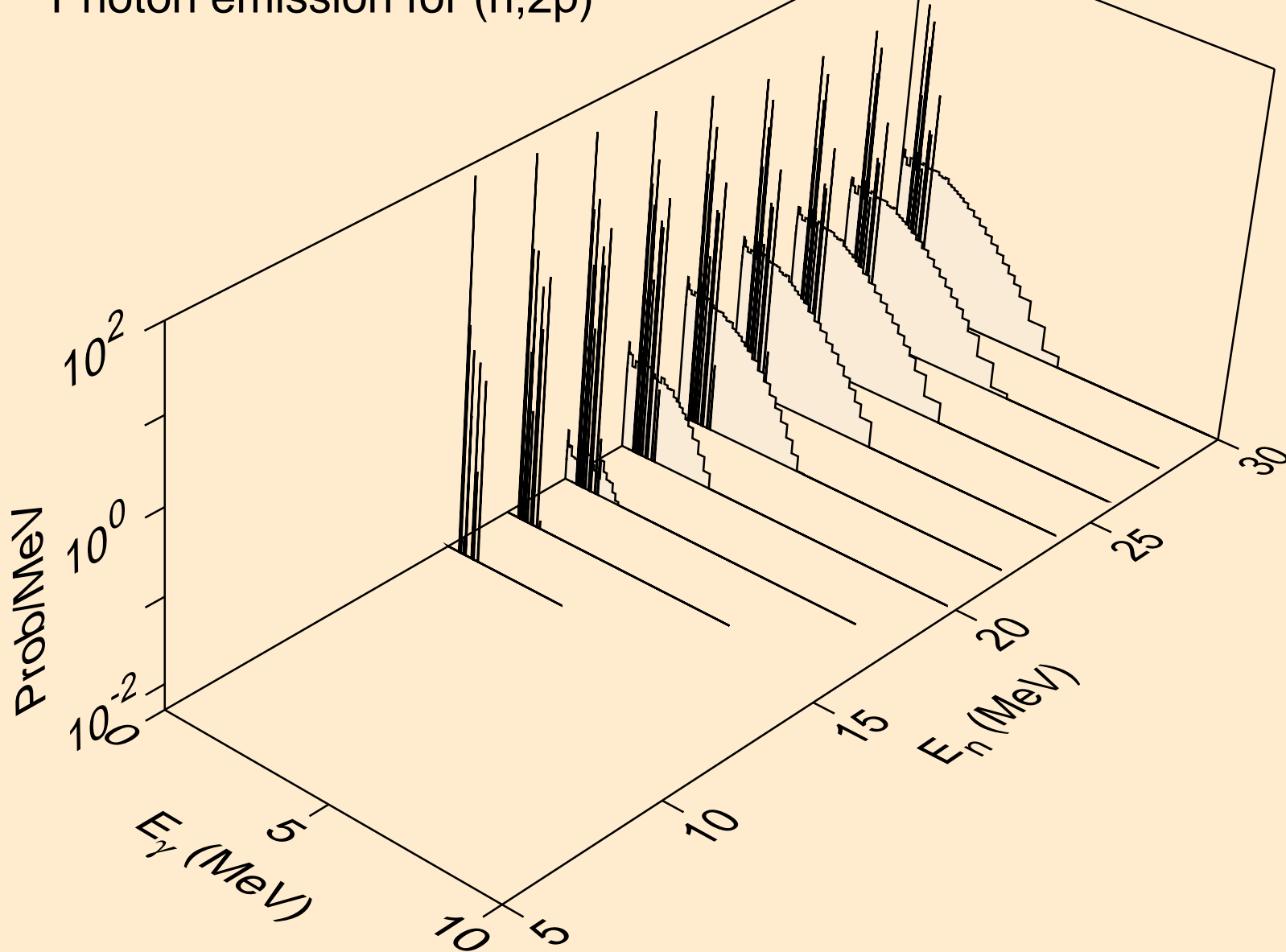

CD113 NEUTRON ACER TENDL-2019 LIBRARY; T=293.16K  
Photon emission for (n,p $\alpha$ )

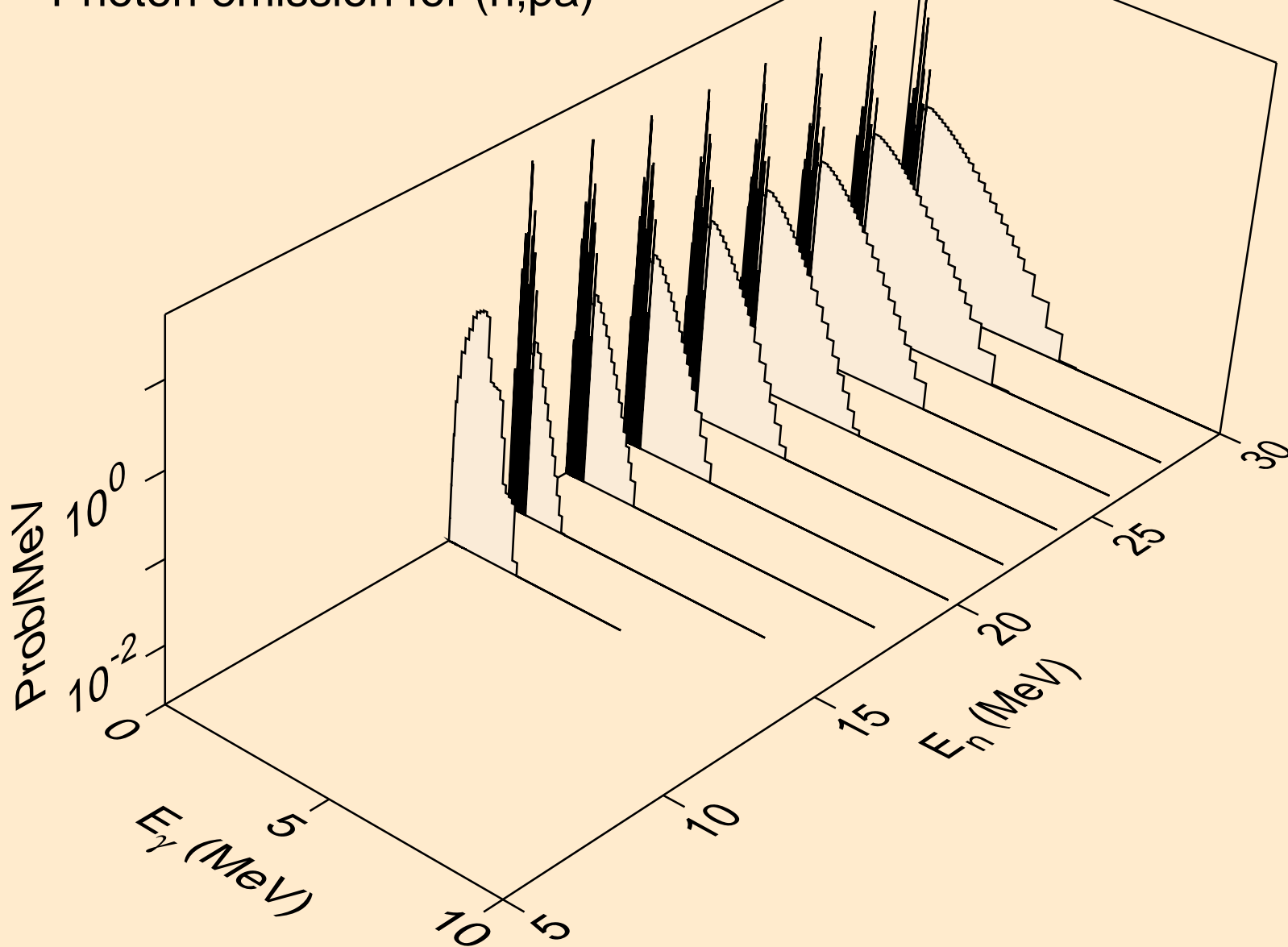

CD113 NEUTRON ACER TENDL-2019 LIBRARY; T=293.16K  
Photon emission for (n,pd)

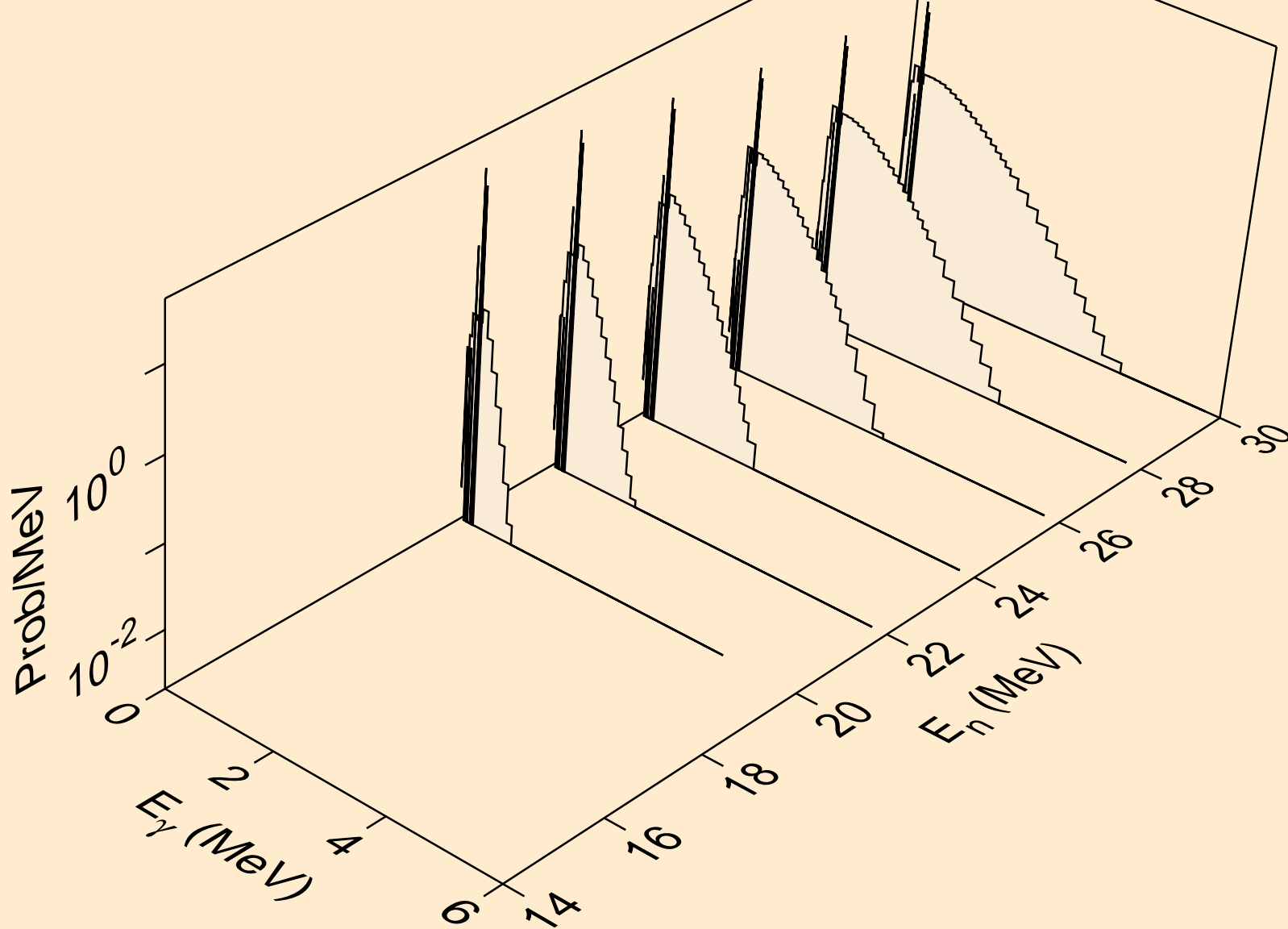

CD113 NEUTRON ACER TENDL-2019 LIBRARY; T=293.16K  
Photon emission for (n,pt)

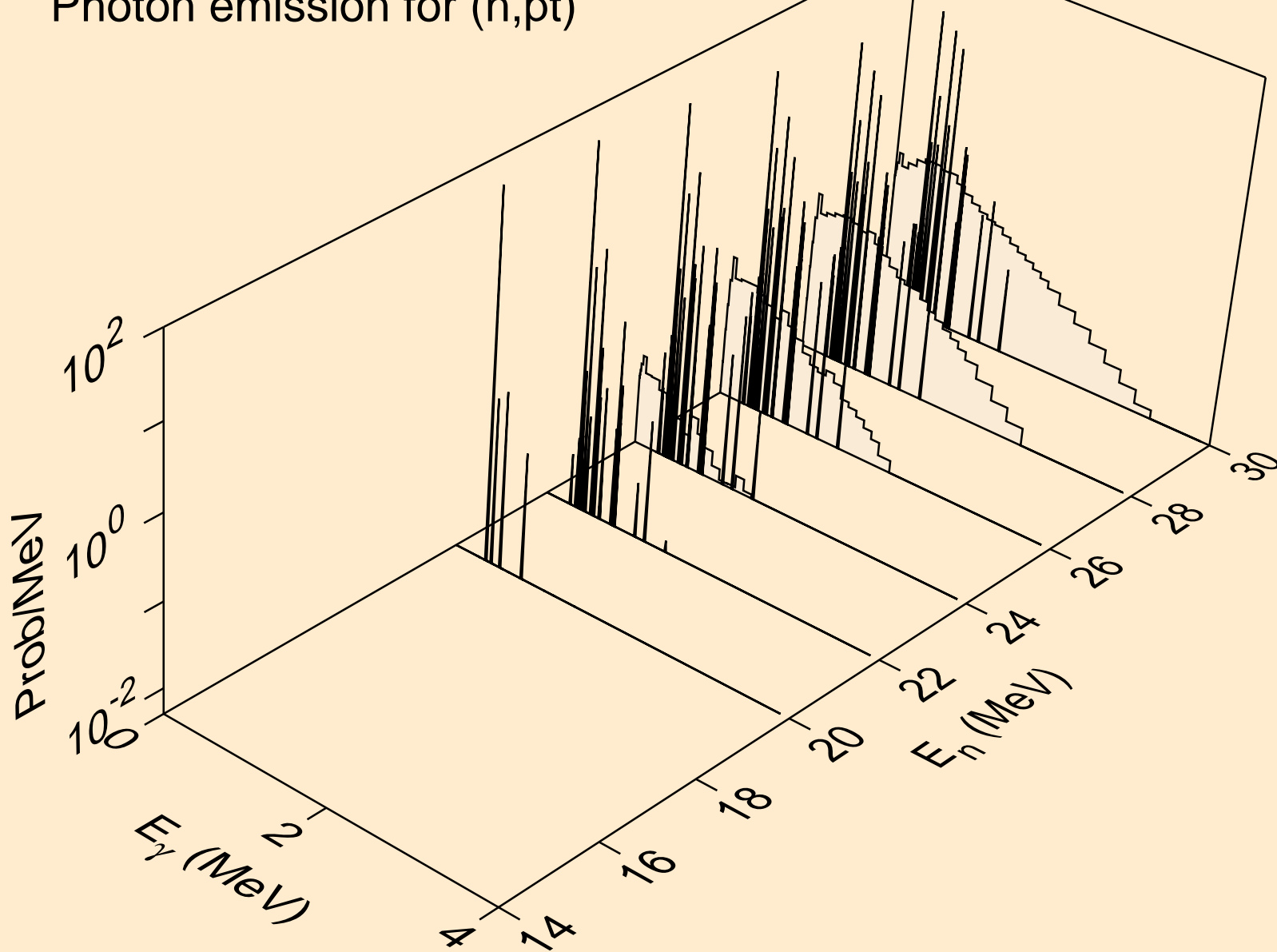

CD113 NEUTRON ACER TENDL-2019 LIBRARY; T=293.16K  
Photon emission for (n,da)

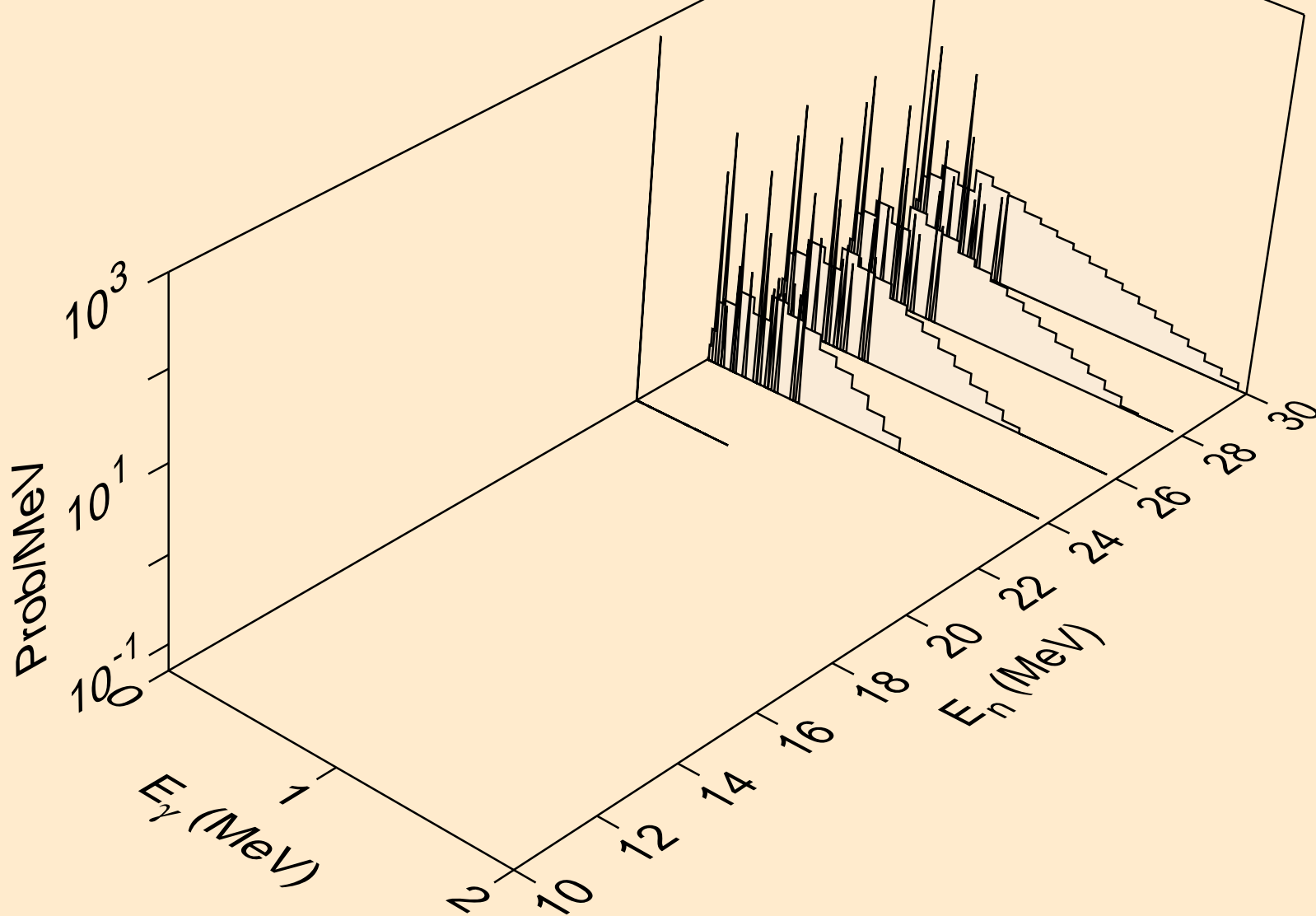

CD113 NEUTRON ACER TENDL-2019 LIBRARY; T=293.16K  
thermal capture photon spectrum

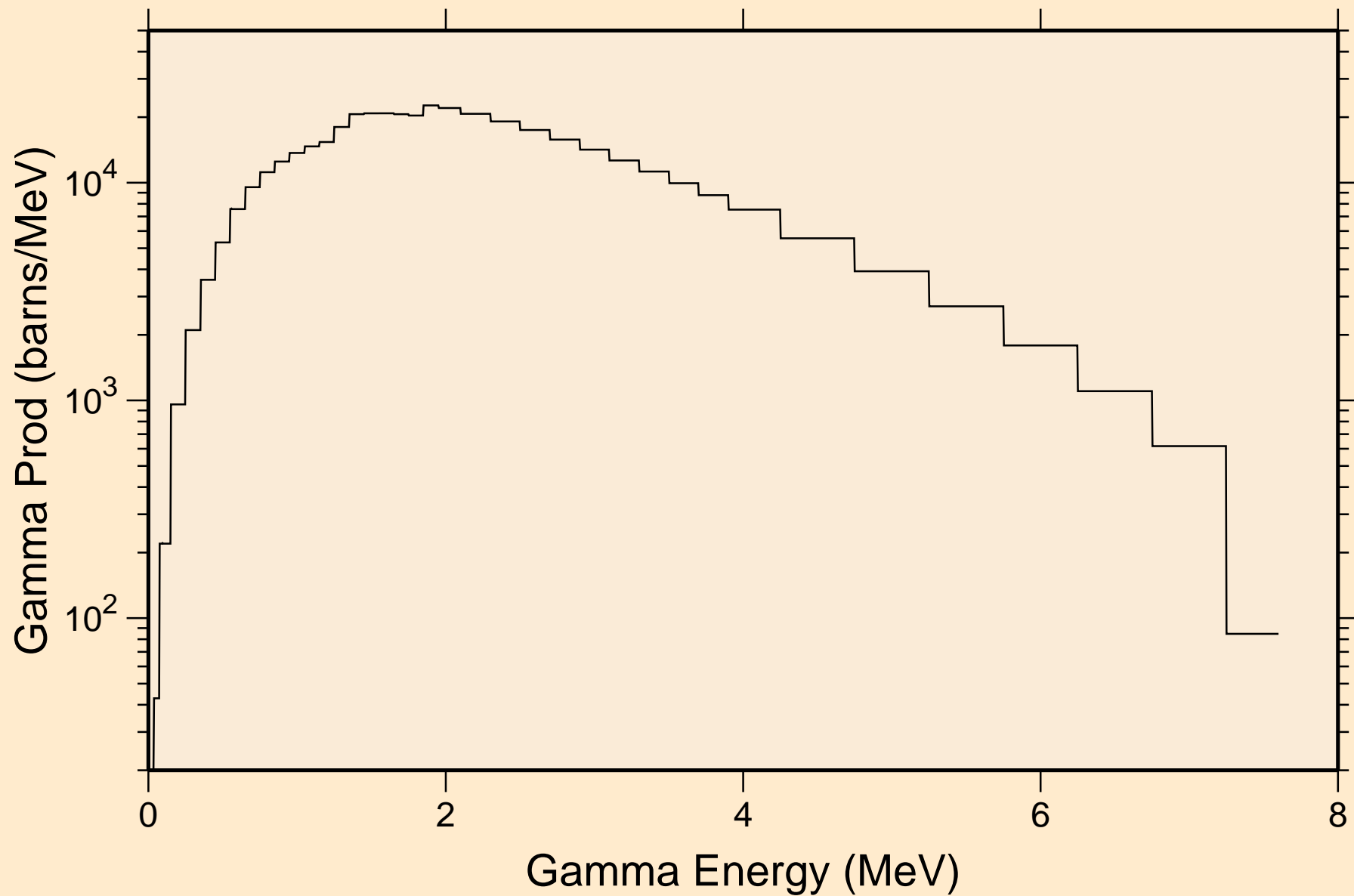

CD113 NEUTRON ACER TENDL-2019 LIBRARY; T=293.16K  
14 MeV photon spectrum

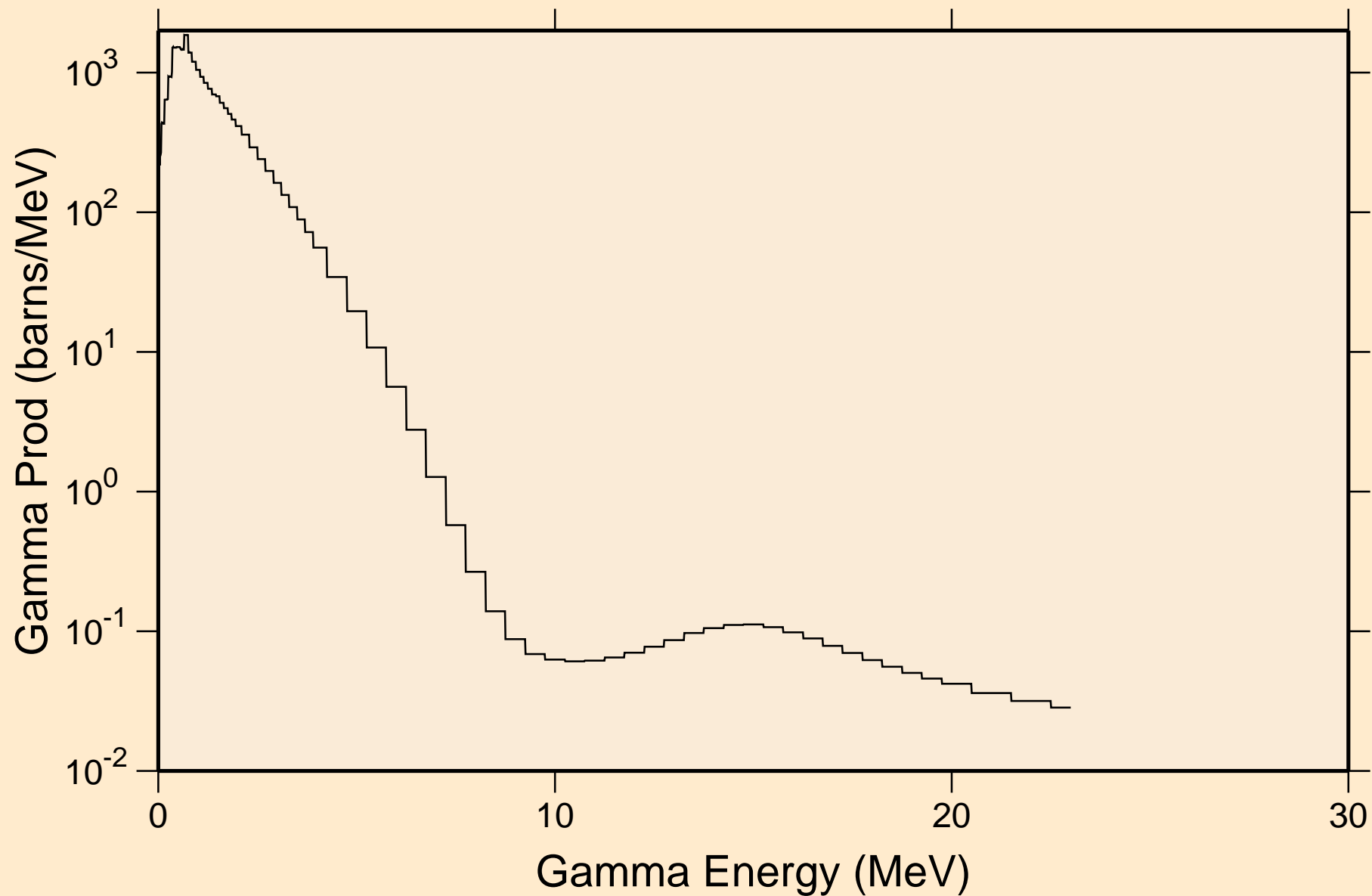

# CD113 NEUTRON ACER TENDL-2019 LIBRARY; T=293.16K

## Particle heating contributions

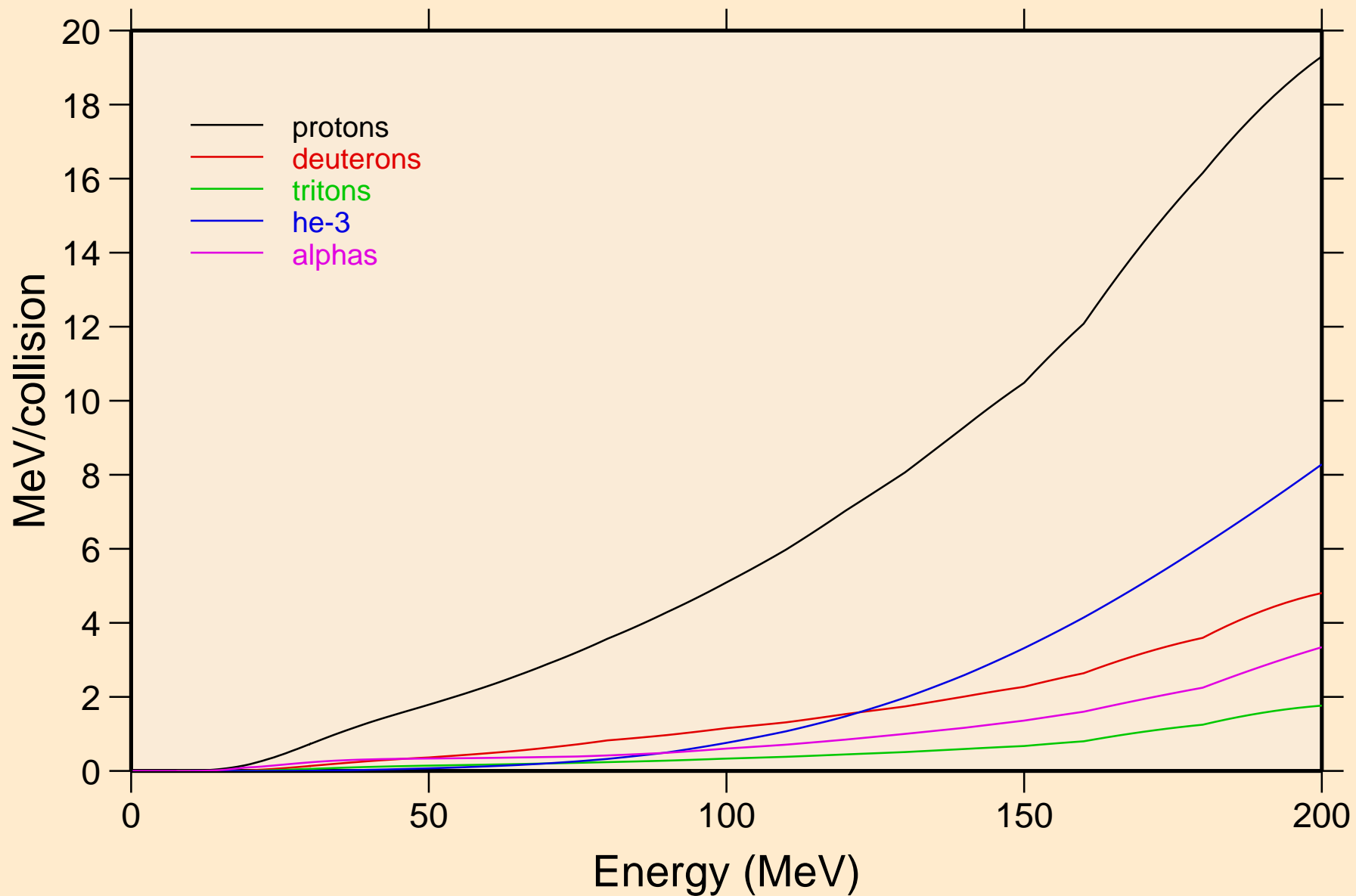

CD113 NEUTRON ACER TENDL-2019 LIBRARY; T=293.16K  
Recoil Heating

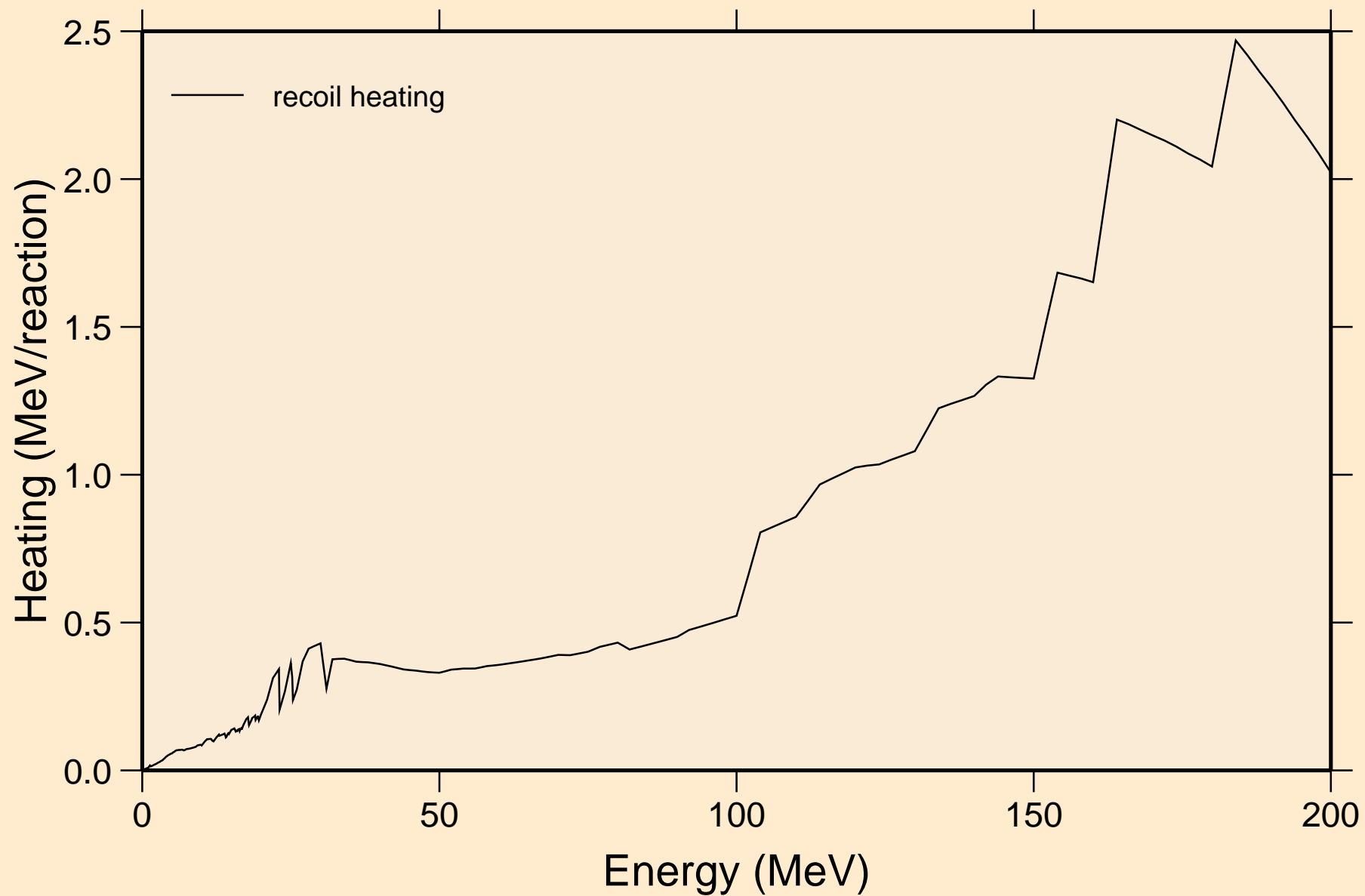

# CD113 NEUTRON ACER TENDL-2019 LIBRARY; T=293.16K

## Particle production cross sections

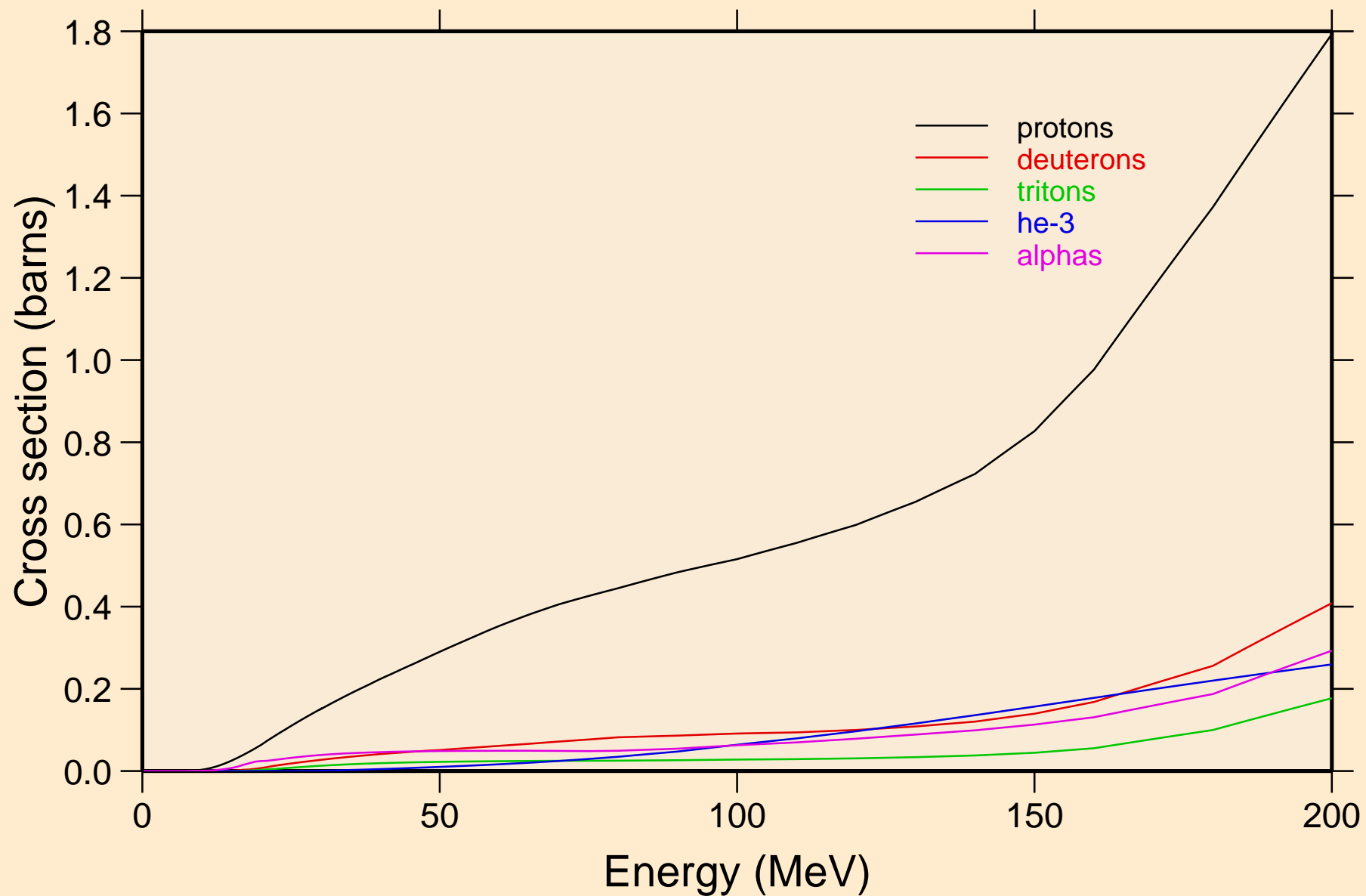

CD113 NEUTRON ACER TENDL-2019 LIBRARY; T=293.16K  
protons from (n,x)

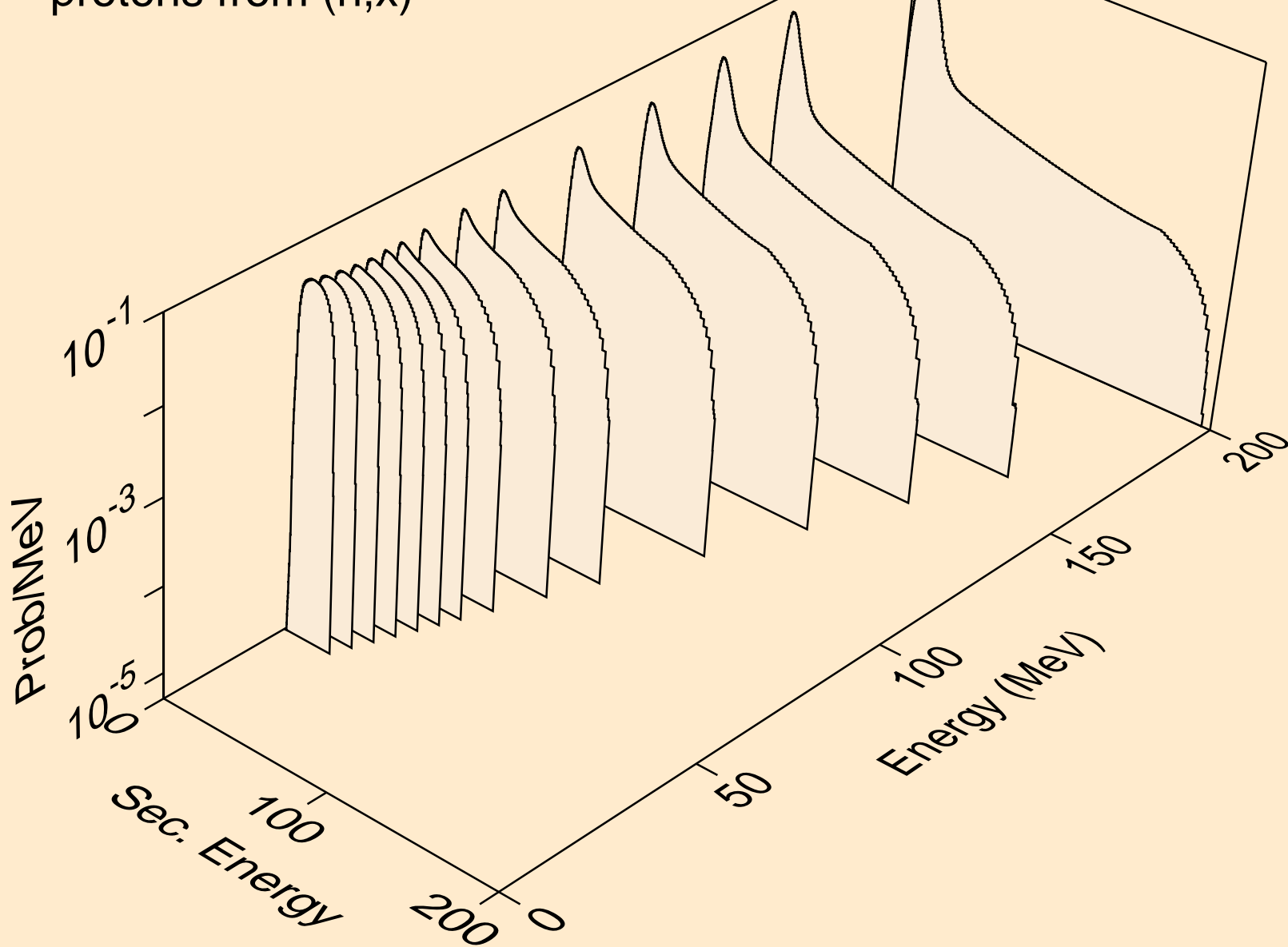

CD113 NEUTRON ACER TENDL-2019 LIBRARY; T=293.16K  
protons from (n,n\*)p

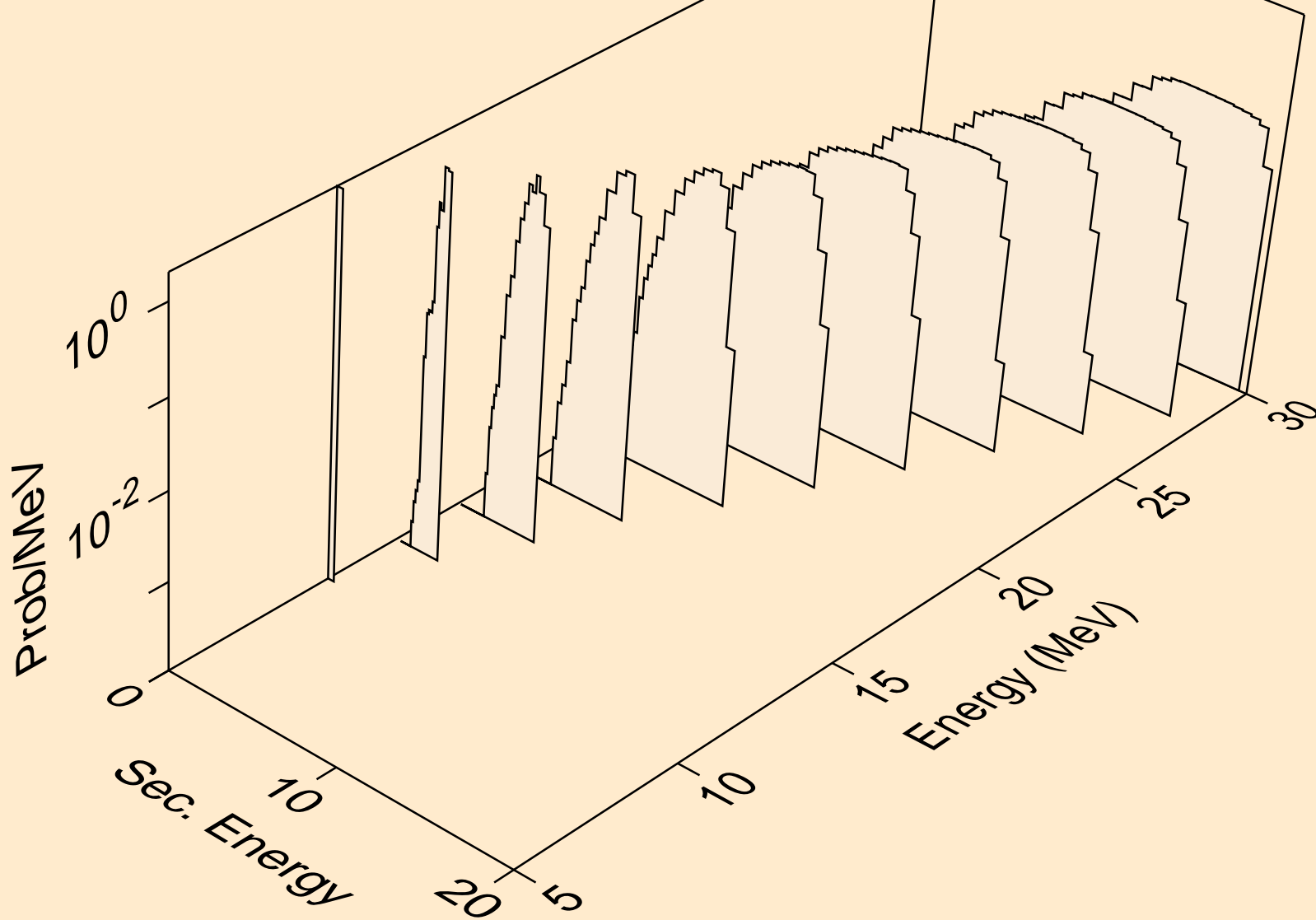

CD113 NEUTRON ACER TENDL-2019 LIBRARY; T=293.16K  
protons from (n,2np)

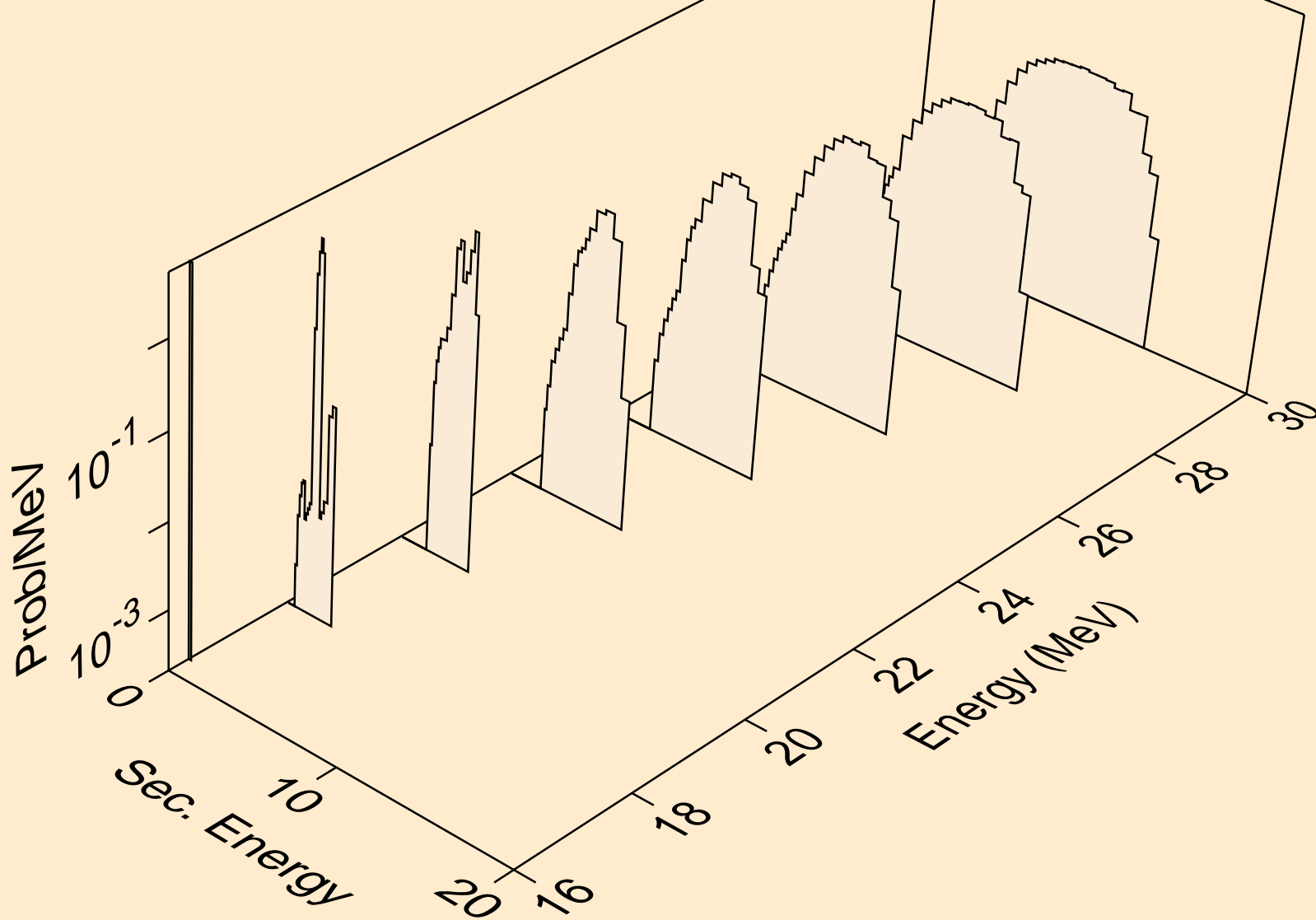

CD113 NEUTRON ACER TENDL-2019 LIBRARY; T=293.16K  
protons from (n,3np)

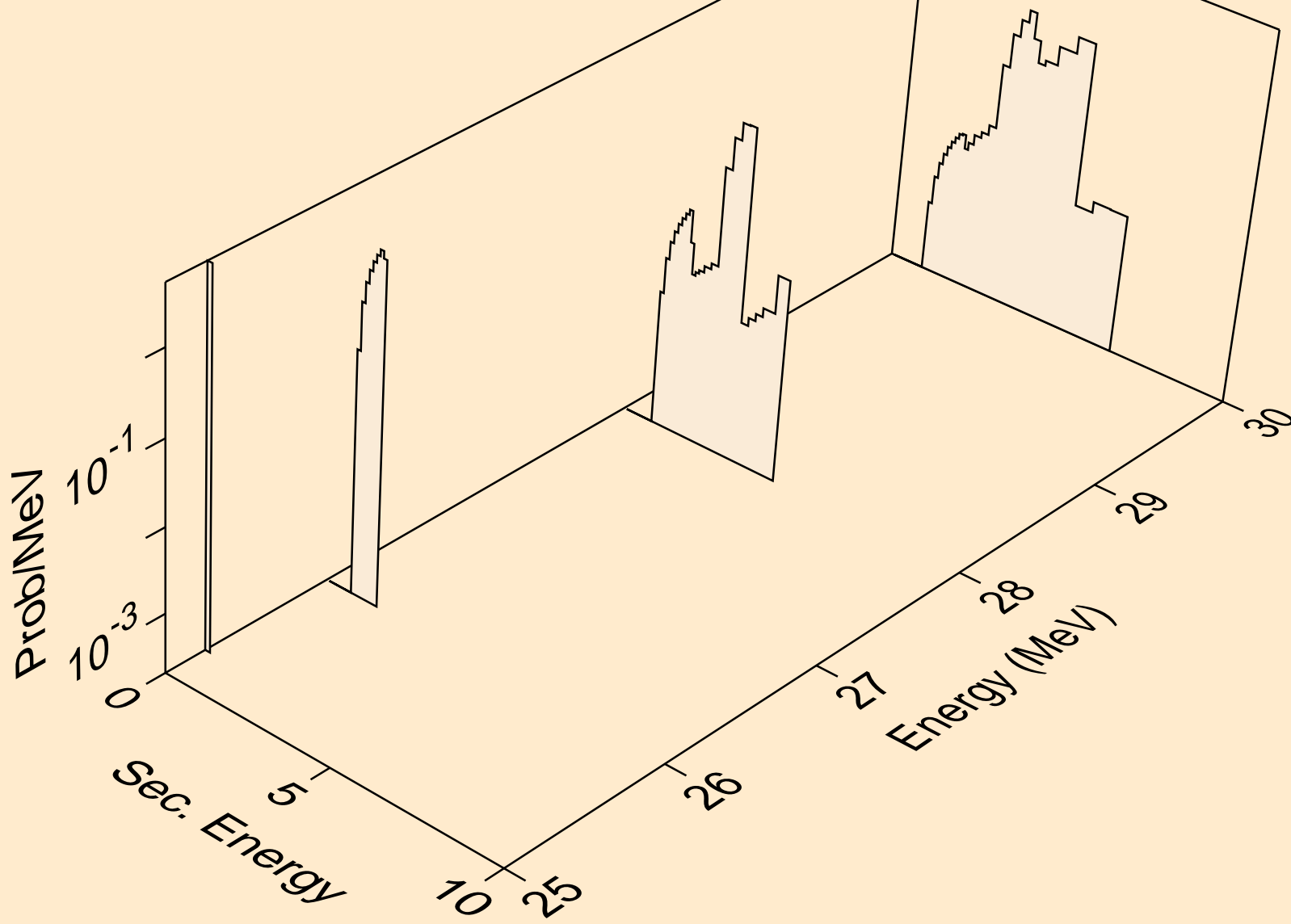

CD113 NEUTRON ACER TENDL-2019 LIBRARY; T=293.16K  
protons from (n,2np)

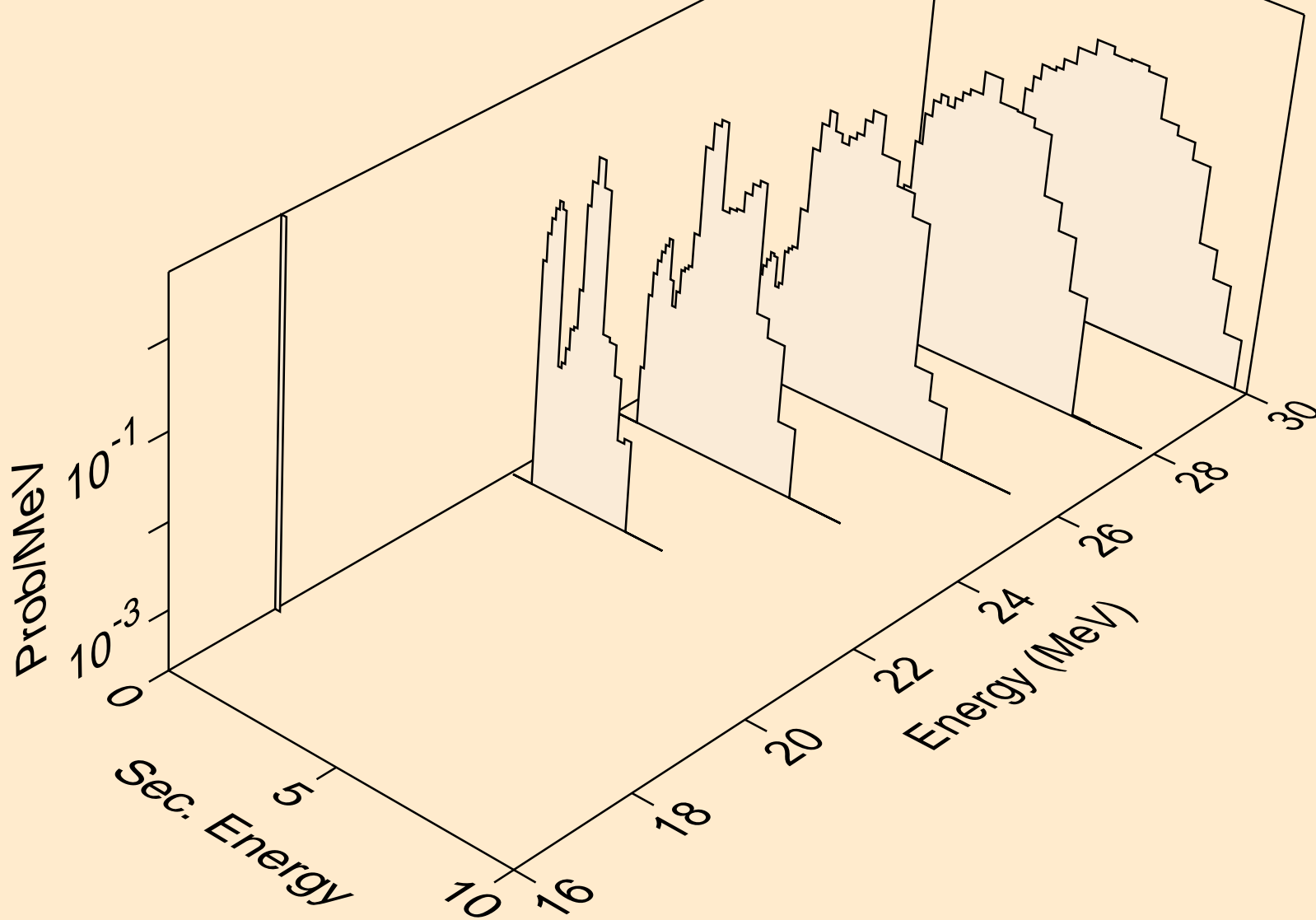

CD113 NEUTRON ACER TENDL-2019 LIBRARY; T=293.16K  
protons from (n,npa)

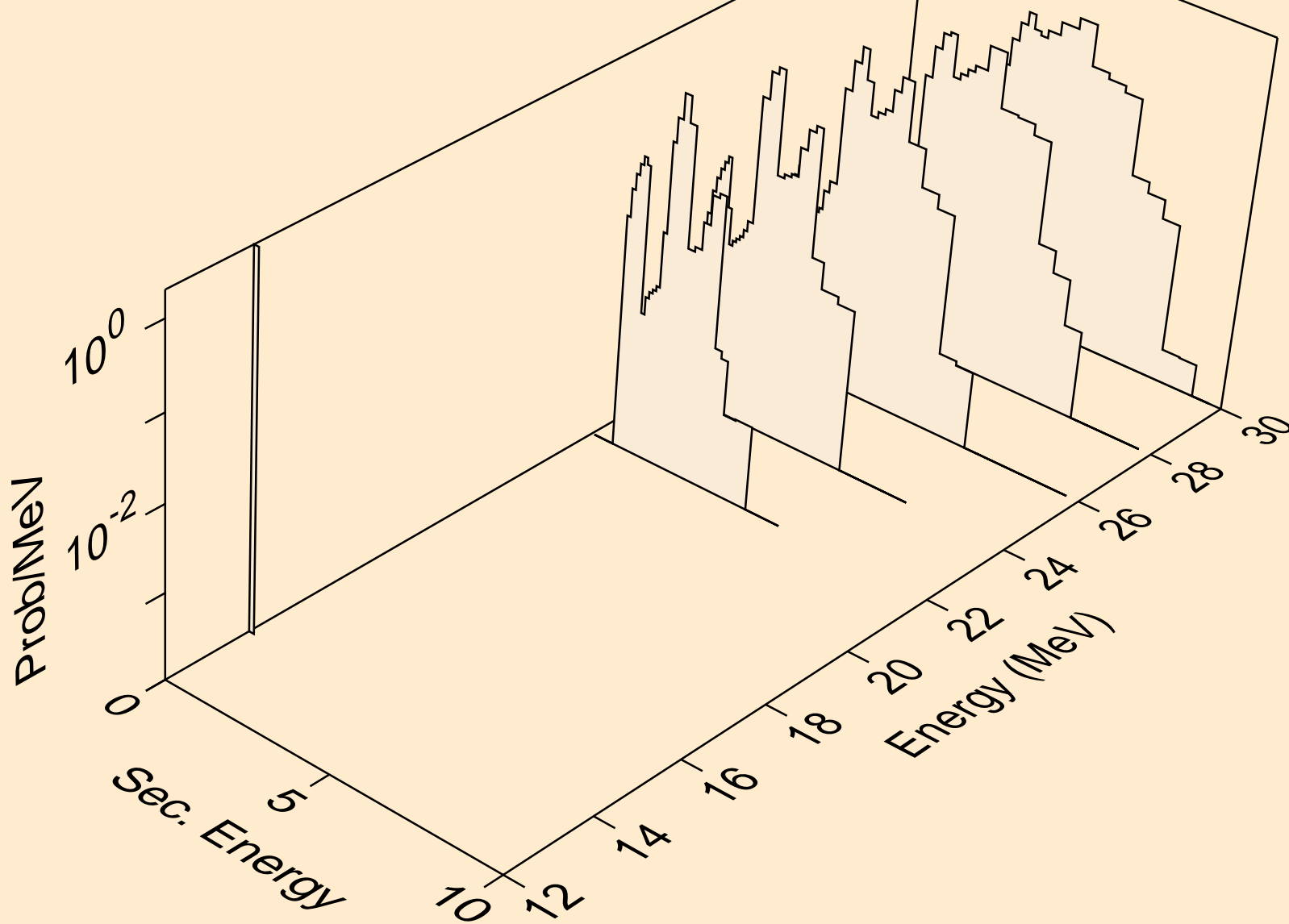

CD113 NEUTRON ACER TENDL-2019 LIBRARY; T=293.16K  
protons from (n,p)

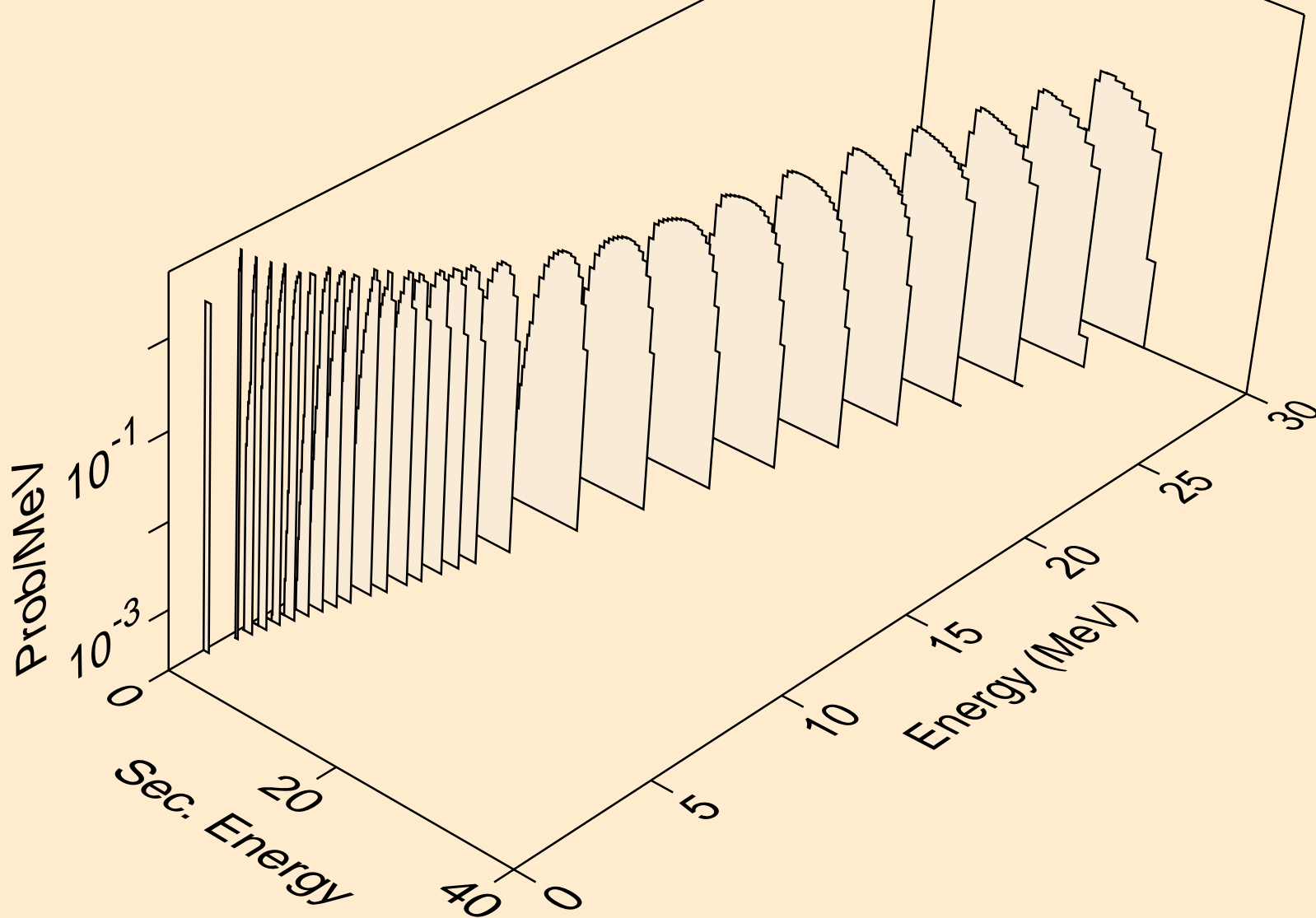

CD113 NEUTRON ACER TENDL-2019 LIBRARY; T=293.16K  
protons from (n,2p)

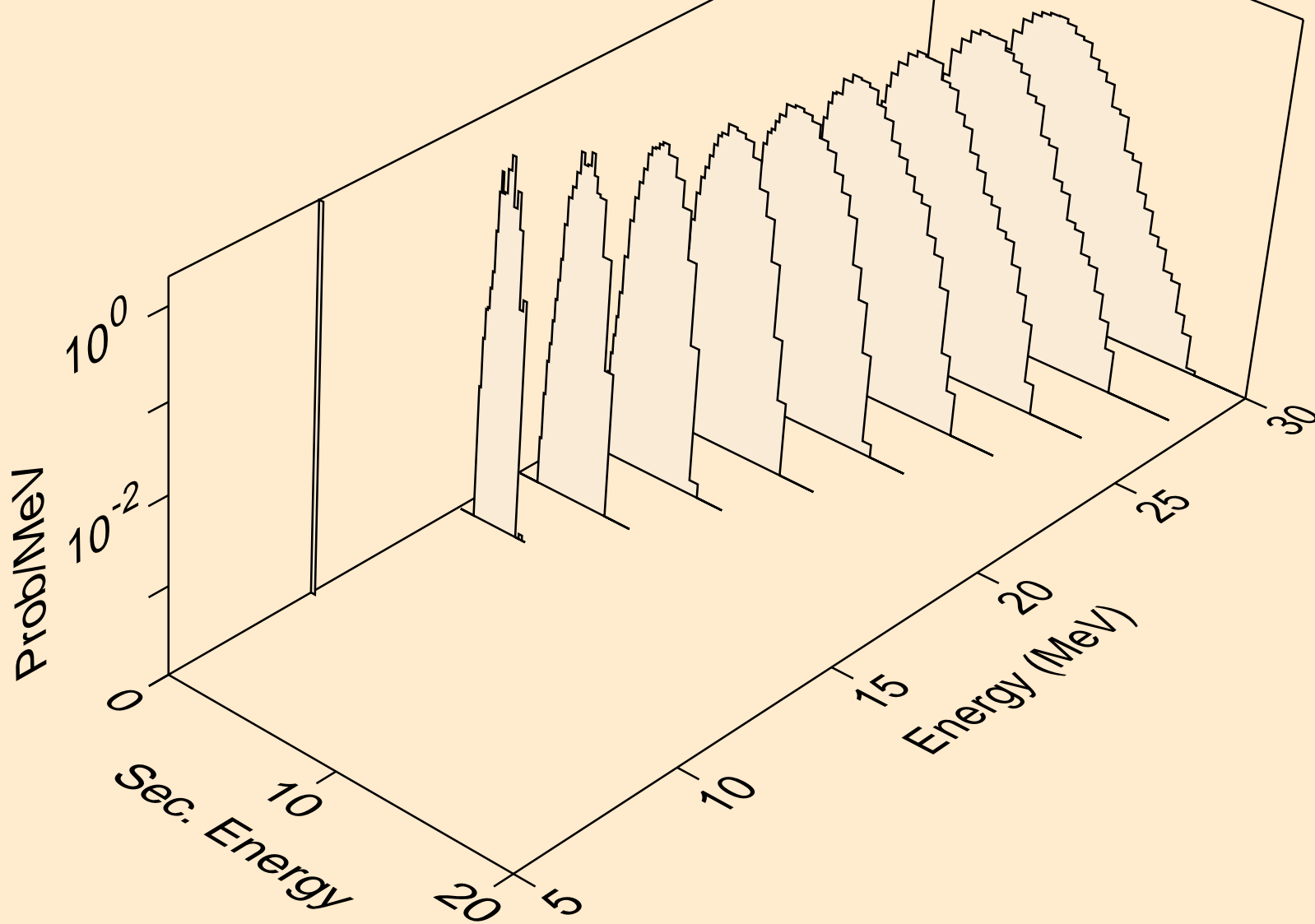

CD113 NEUTRON ACER TENDL-2019 LIBRARY; T=293.16K  
protons from (n,p)

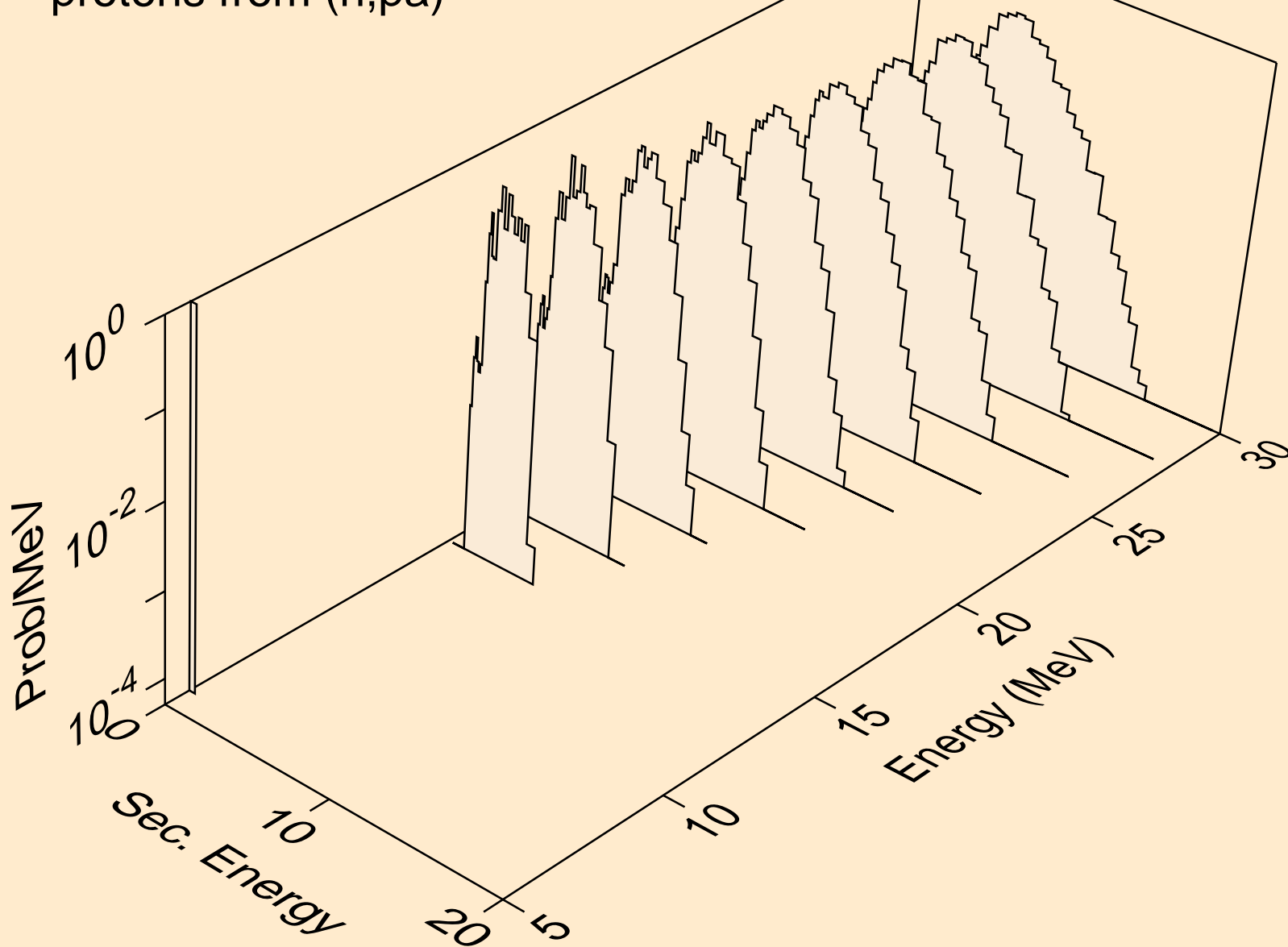

CD113 NEUTRON ACER TENDL-2019 LIBRARY; T=293.16K  
protons from (n,pd)

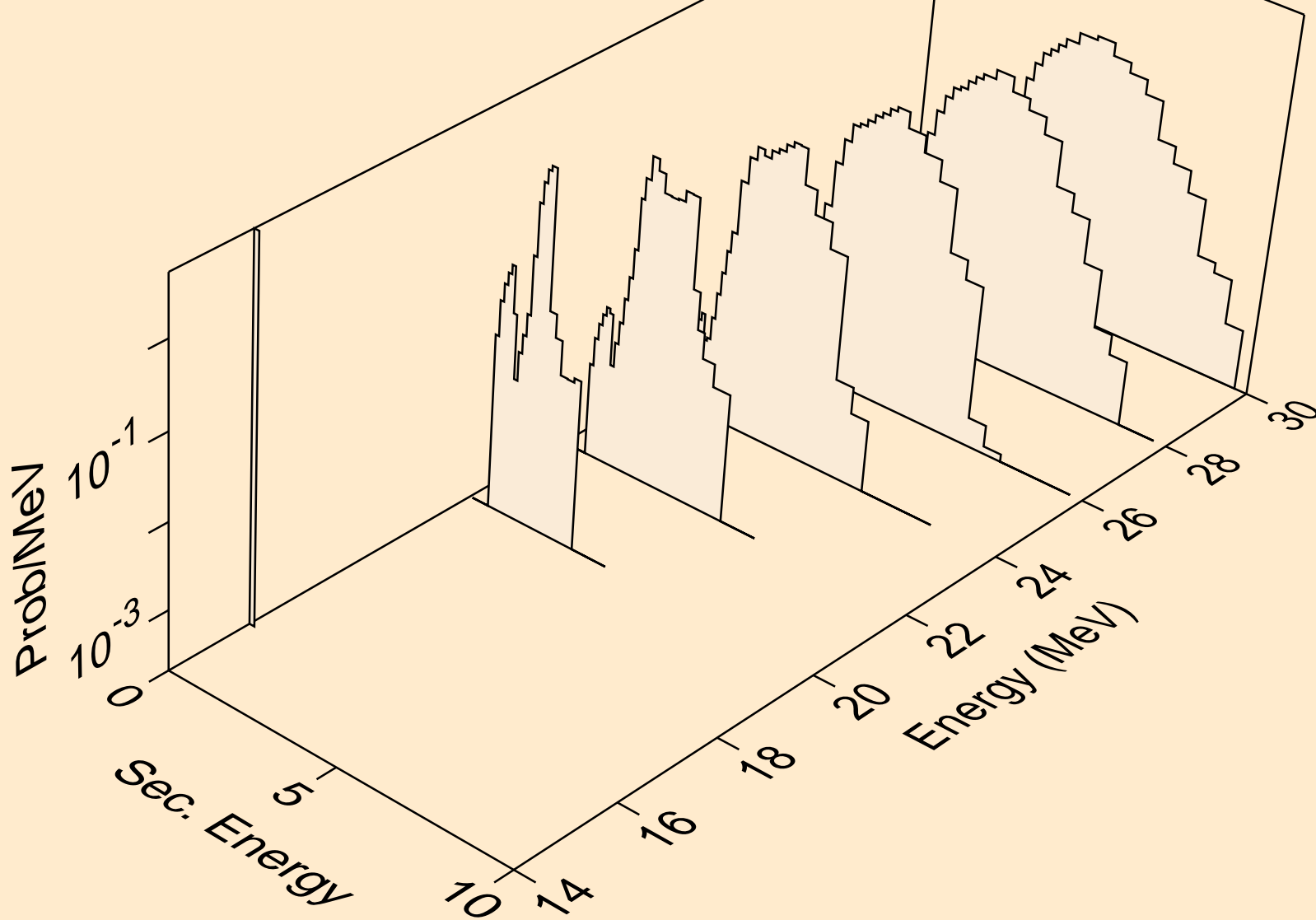

CD113 NEUTRON ACER TENDL-2019 LIBRARY; T=293.16K  
protons from (n,pt)

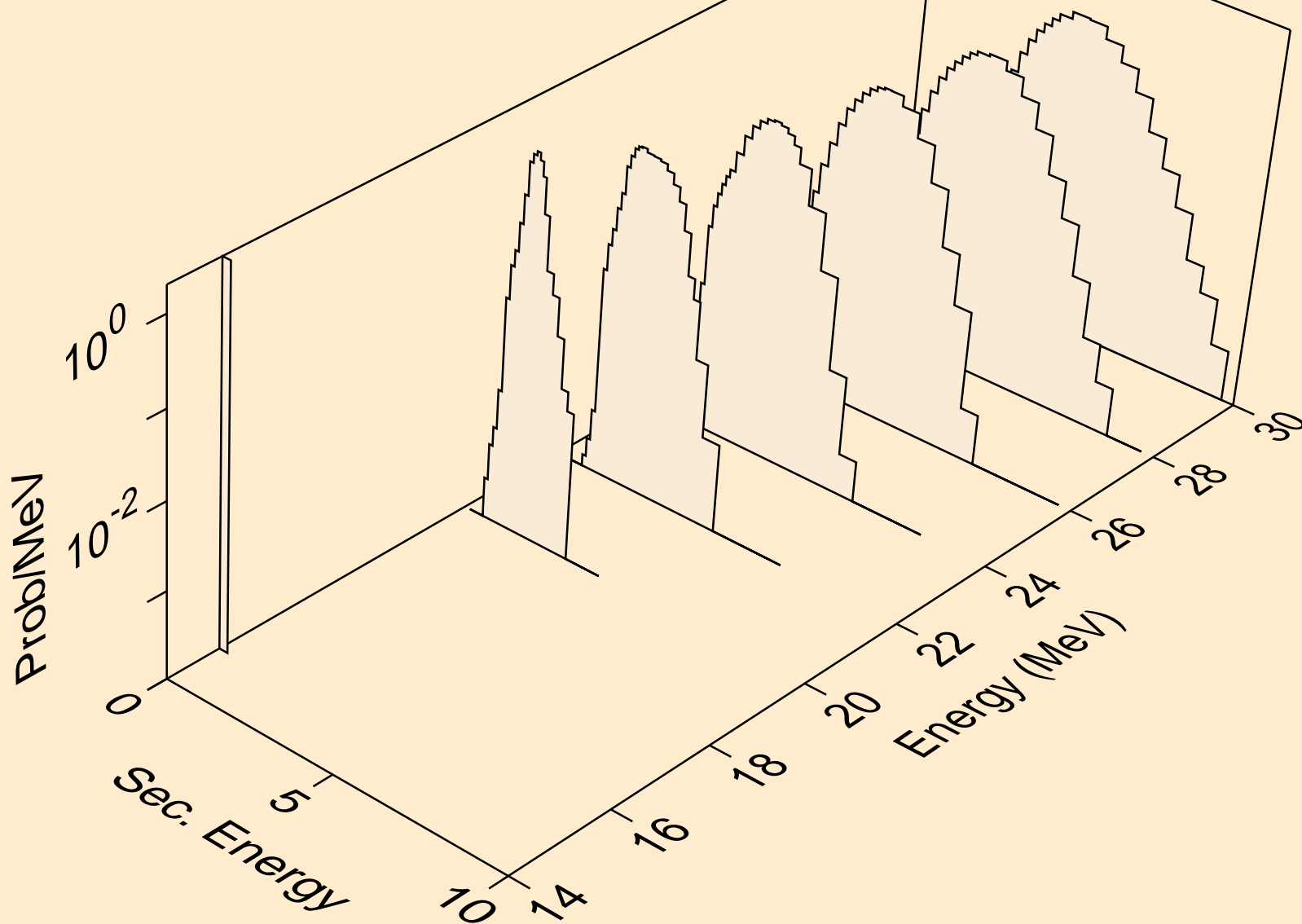

CD113 NEUTRON ACER TENDL-2019 LIBRARY; T=293.16K  
deuterons from (n,x)

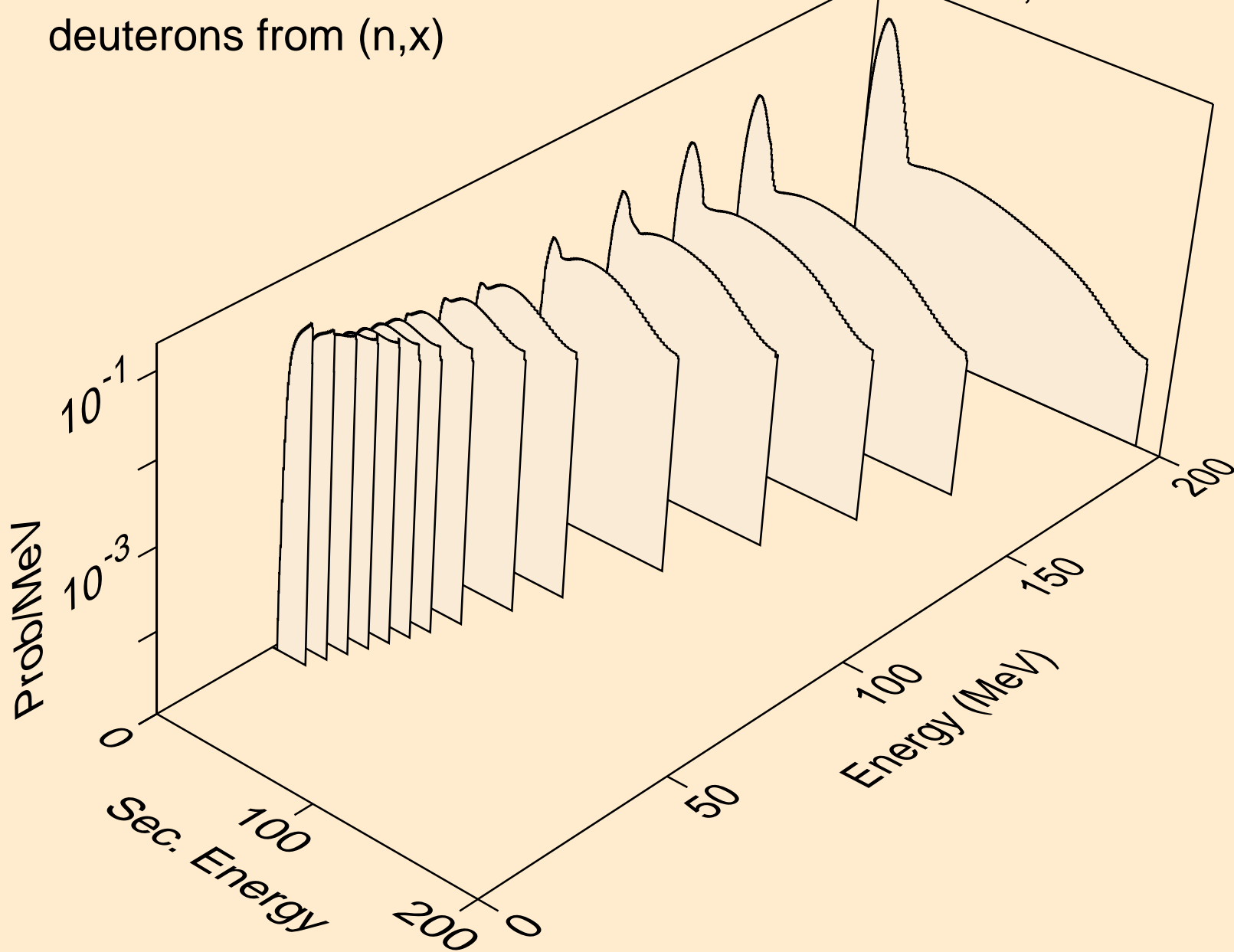

CD113 NEUTRON ACER TENDL-2019 LIBRARY; T=293.16K  
deuterons from (n,2nd)

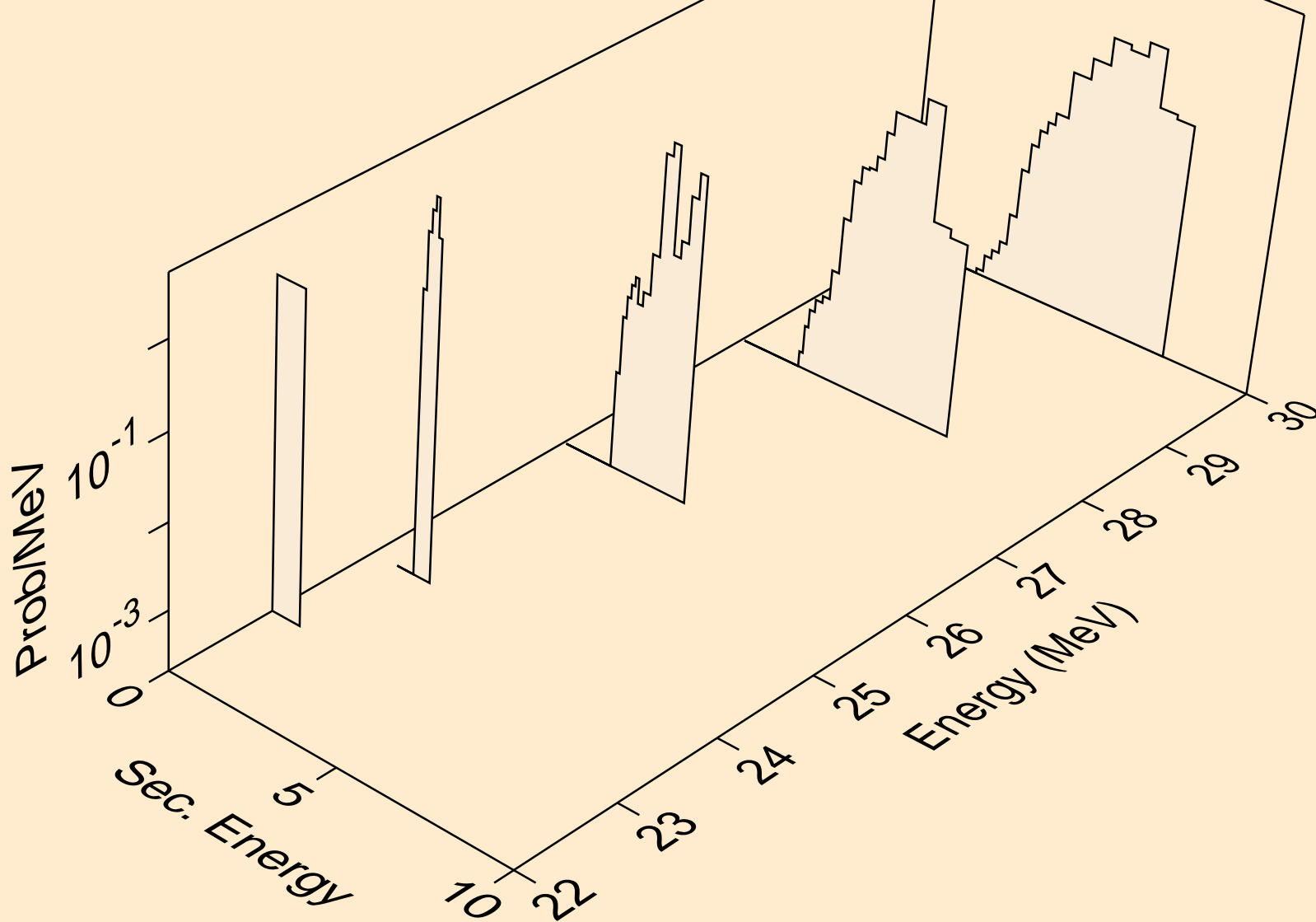

CD113 NEUTRON ACER TENDL-2019 LIBRARY; T=293.16K  
deuterons from (n,n\*)d

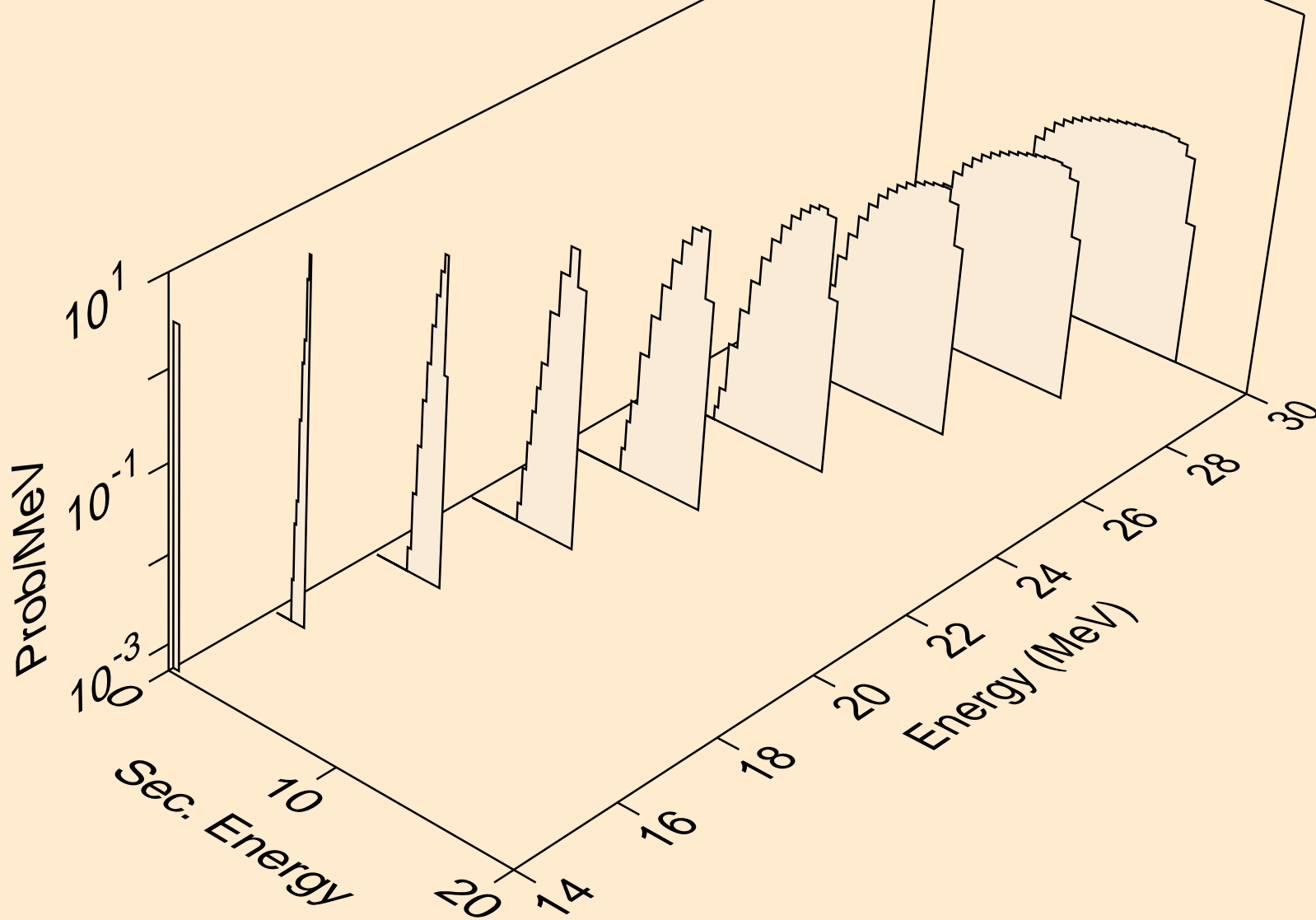

CD113 NEUTRON ACER TENDL-2019 LIBRARY; T=293.16K  
deuterons from (n,d)

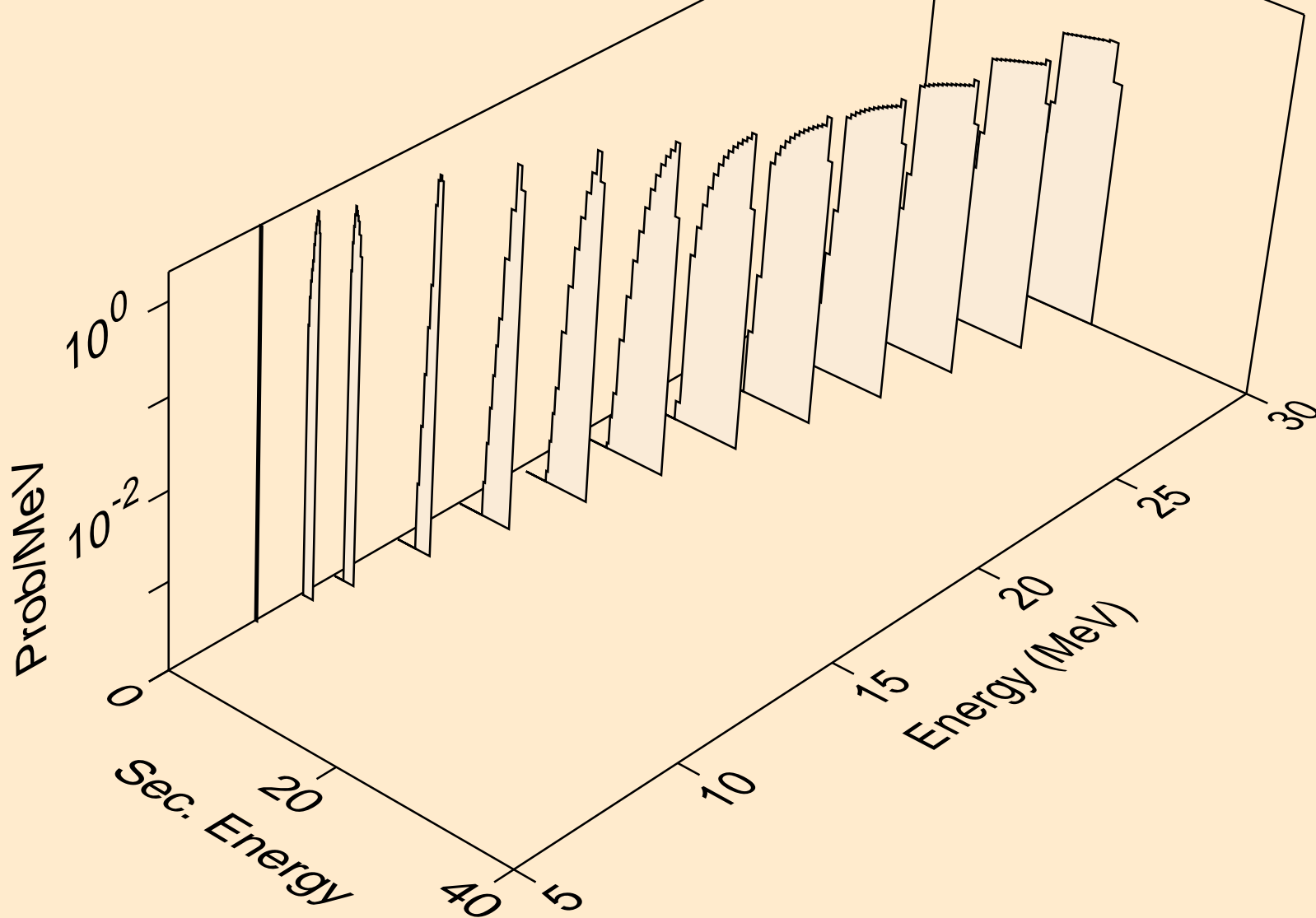

CD113 NEUTRON ACER TENDL-2019 LIBRARY; T=293.16K  
deuterons from (n,pd)

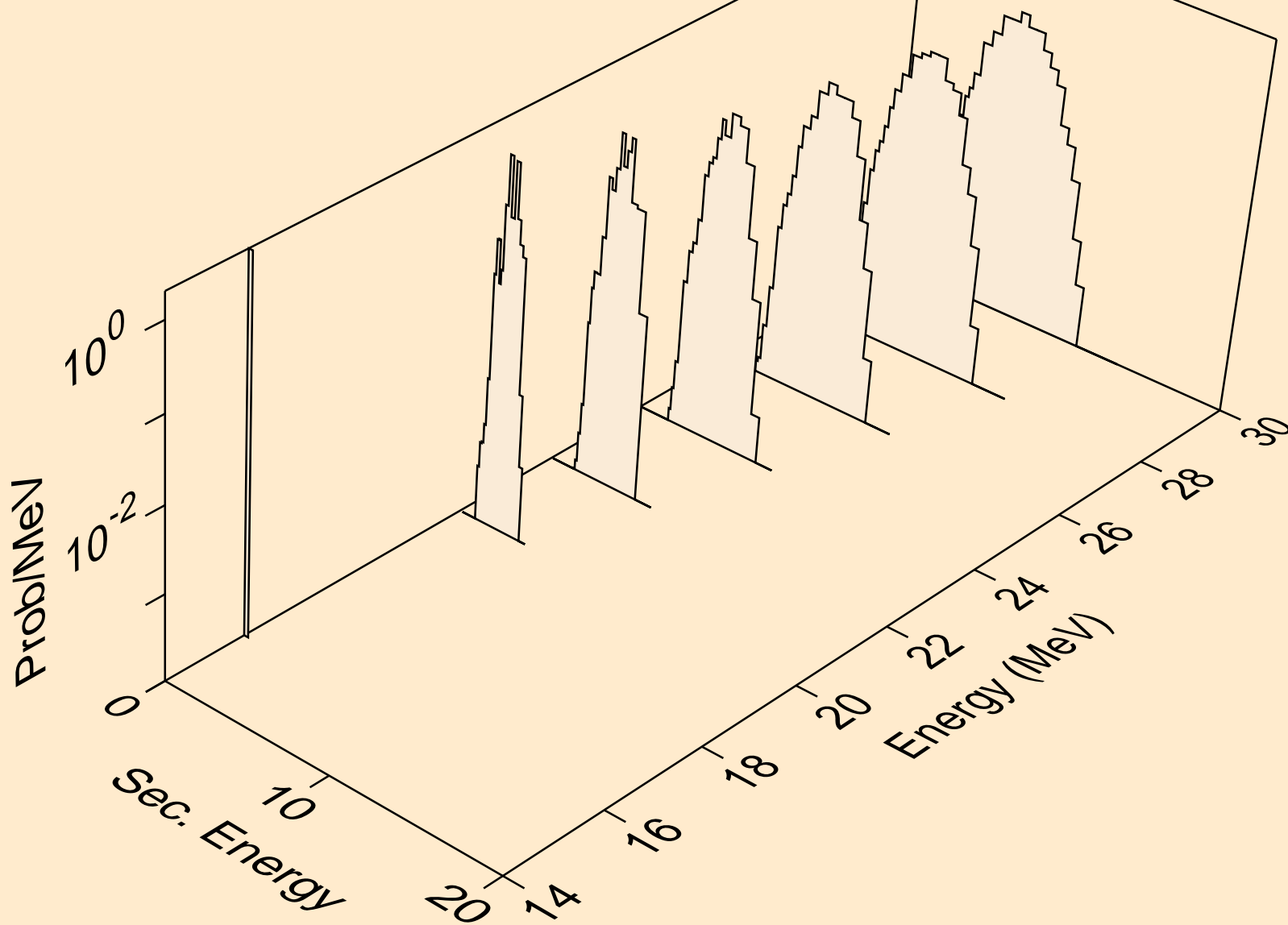

CD113 NEUTRON ACER TENDL-2019 LIBRARY; T=293.16K  
deuterons from (n,da)

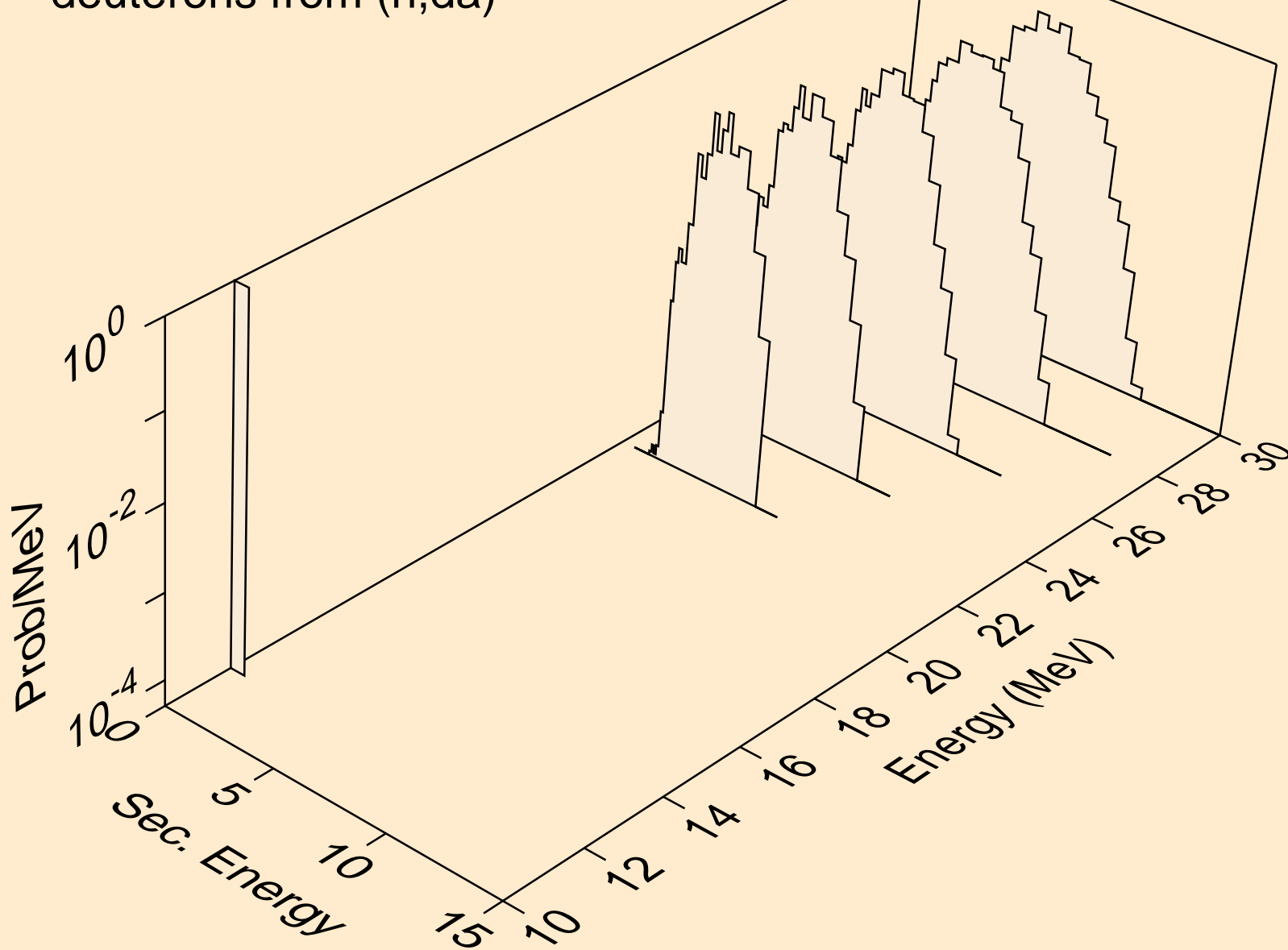

CD113 NEUTRON ACER TENDL-2019 LIBRARY; T=293.16K  
tritons from (n,x)

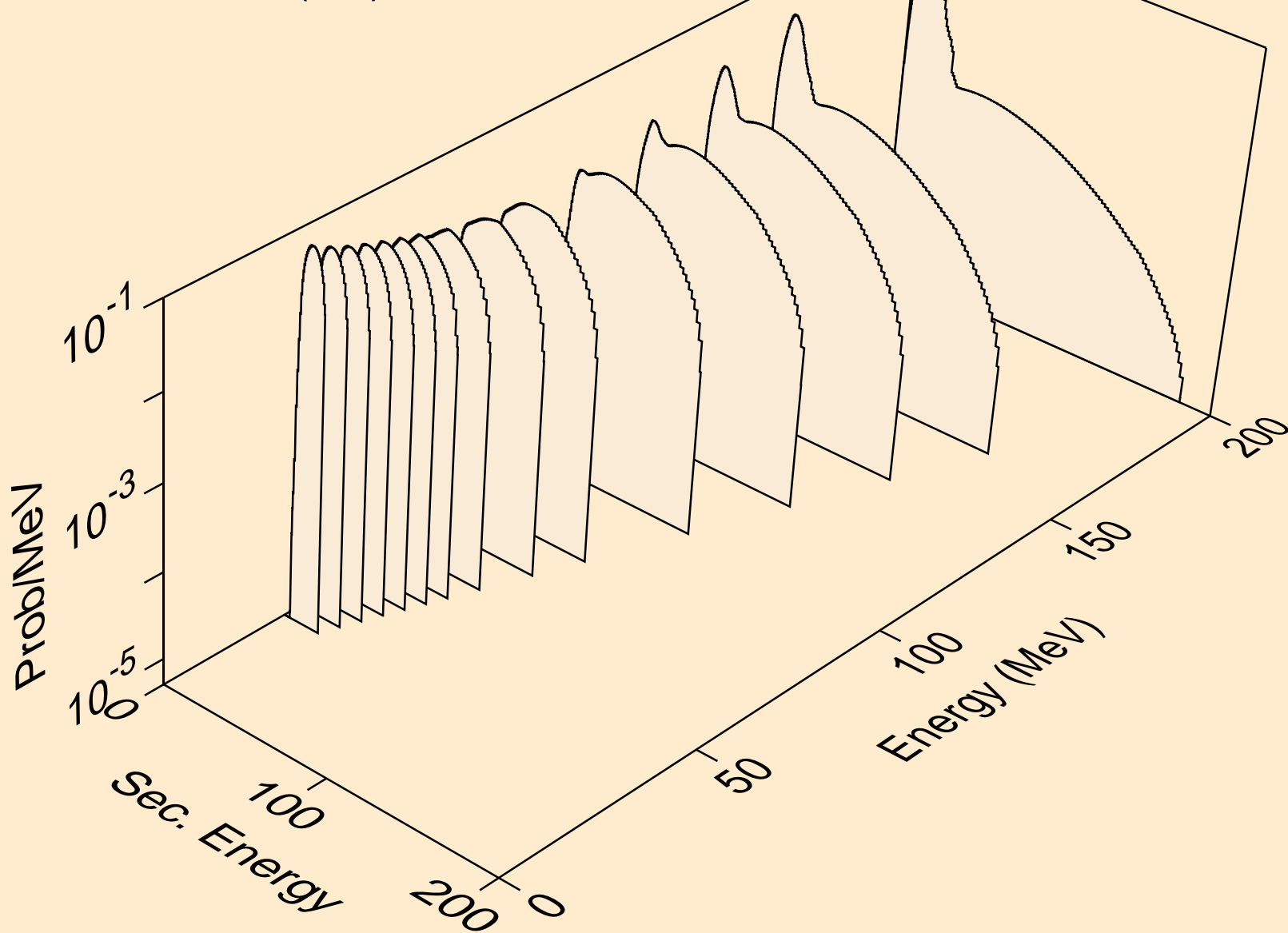

CD113 NEUTRON ACER TENDL-2019 LIBRARY; T=293.16K  
tritons from (n,n\*)t

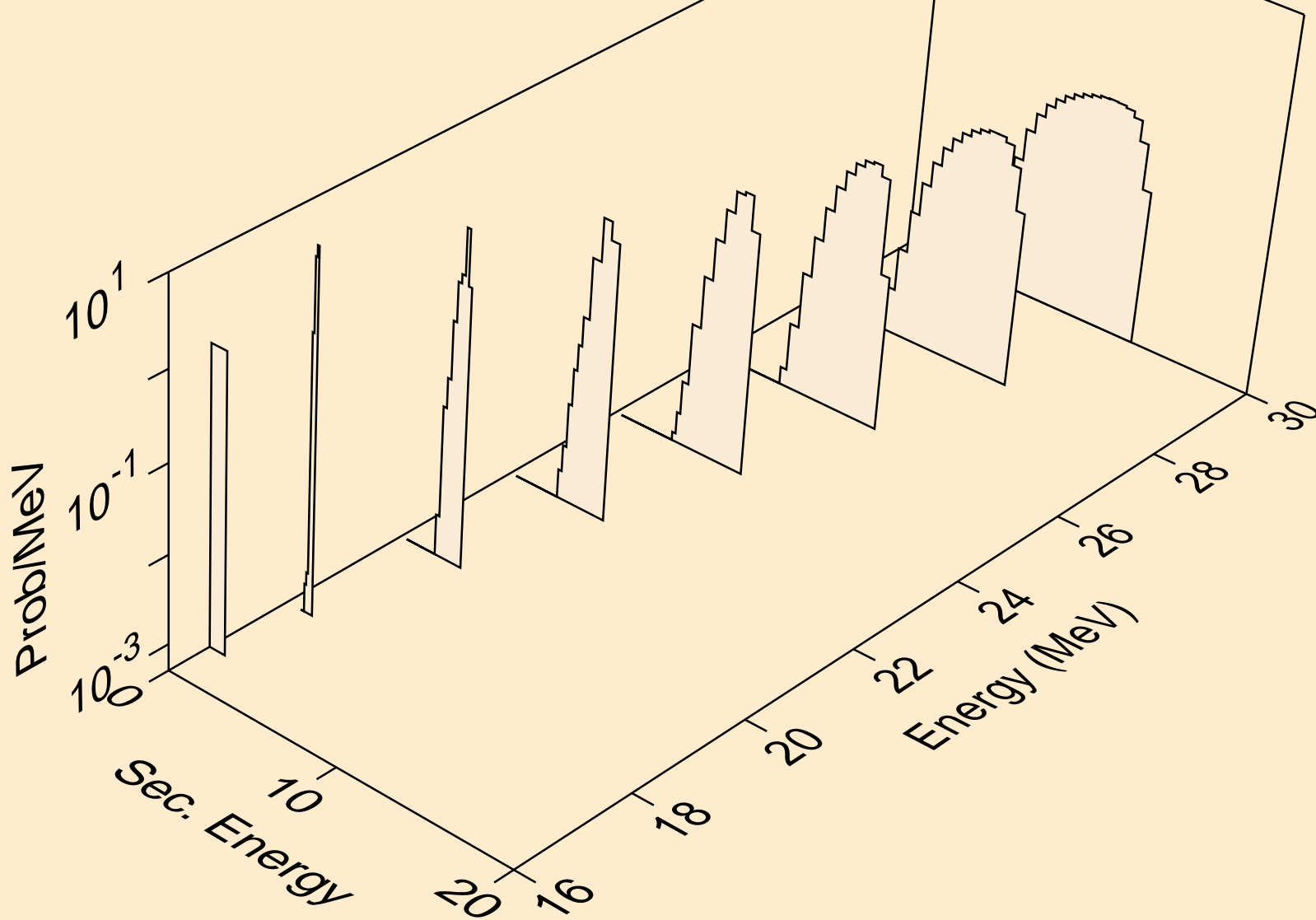

CD113 NEUTRON ACER TENDL-2019 LIBRARY; T=293.16K  
tritons from (n,t)

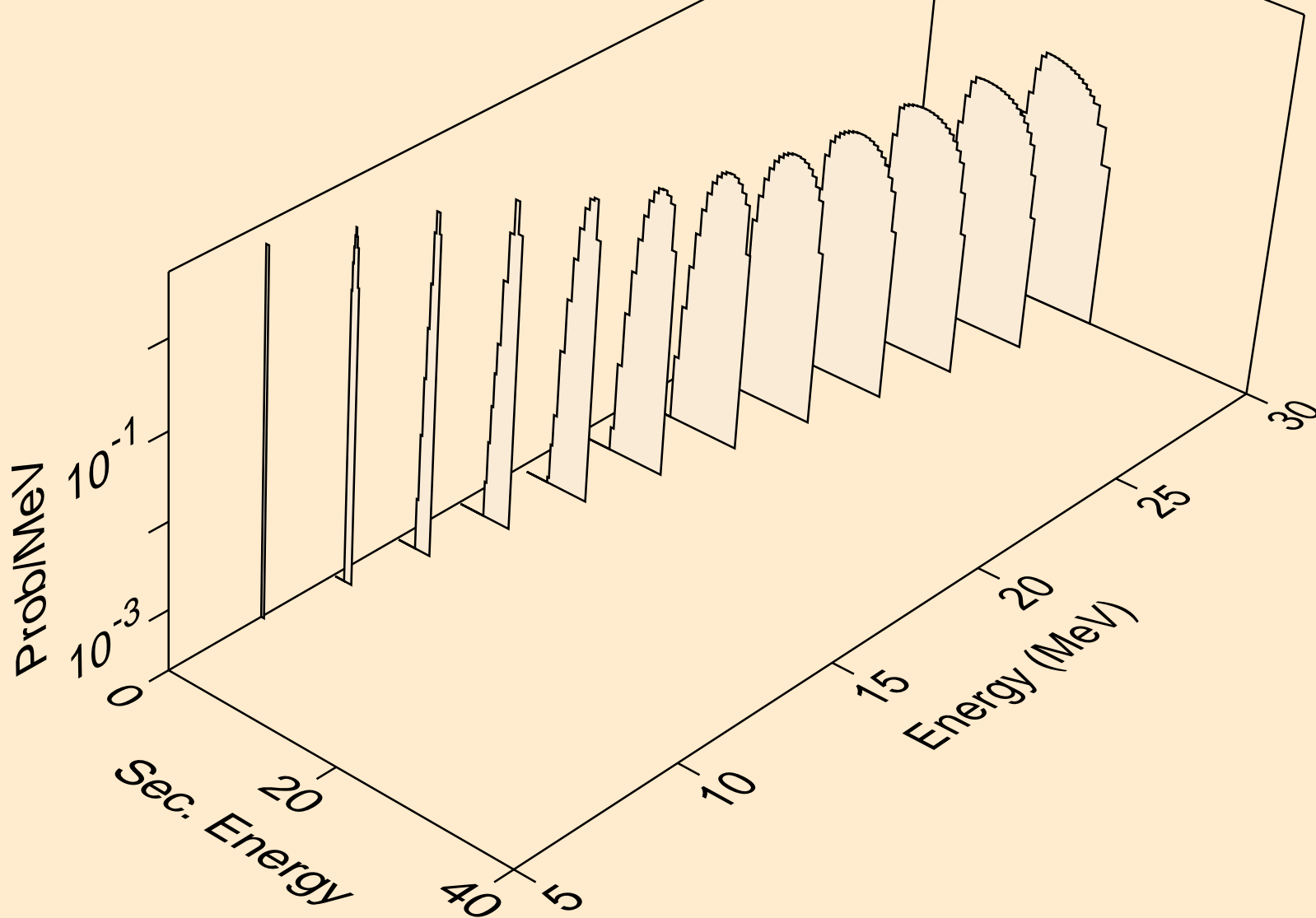

CD113 NEUTRON ACER TENDL-2019 LIBRARY; T=293.16K  
tritons from (n,pt)

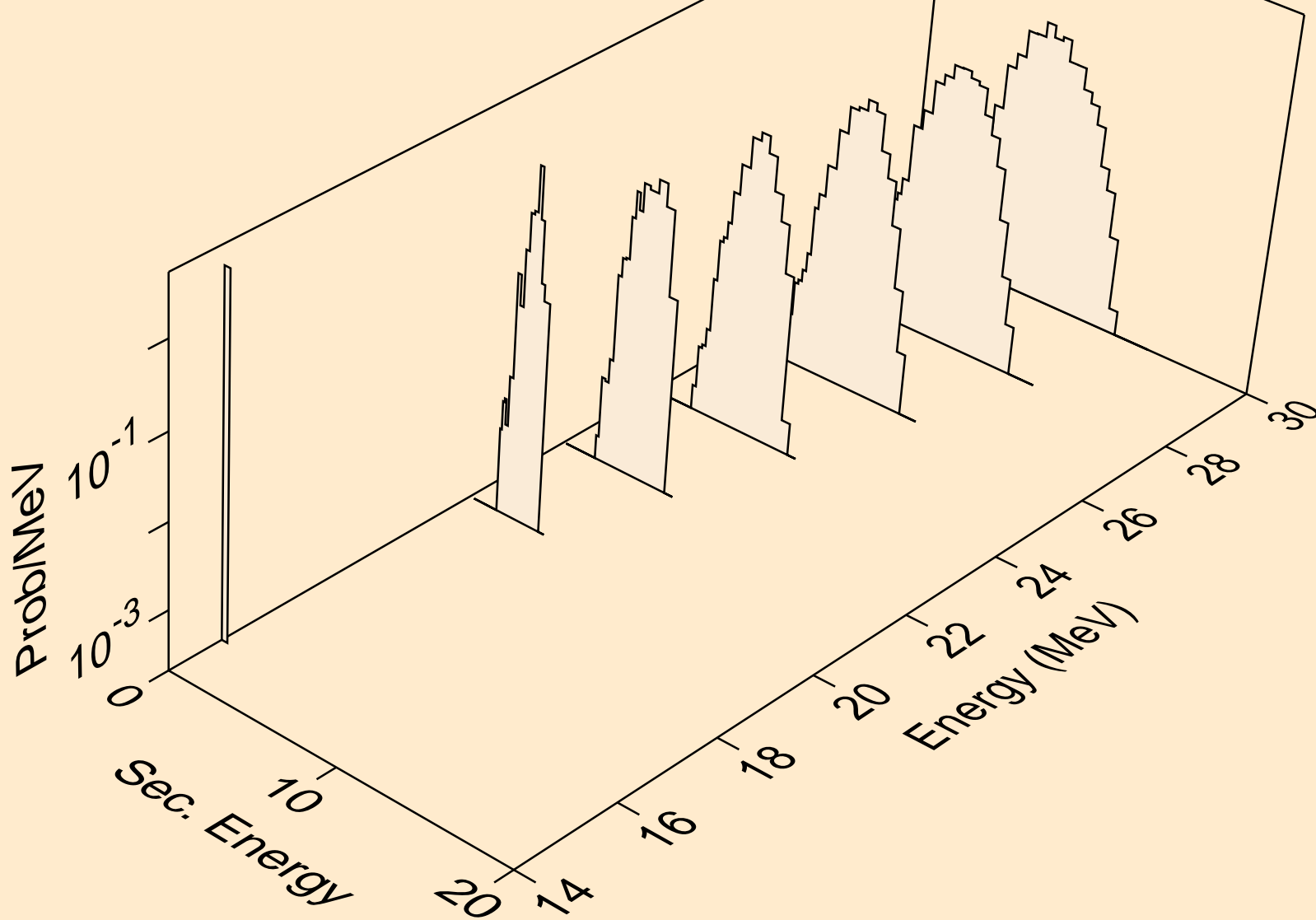

CD113 NEUTRON ACER TENDL-2019 LIBRARY; T=293.16K  
he3s from (n,x)

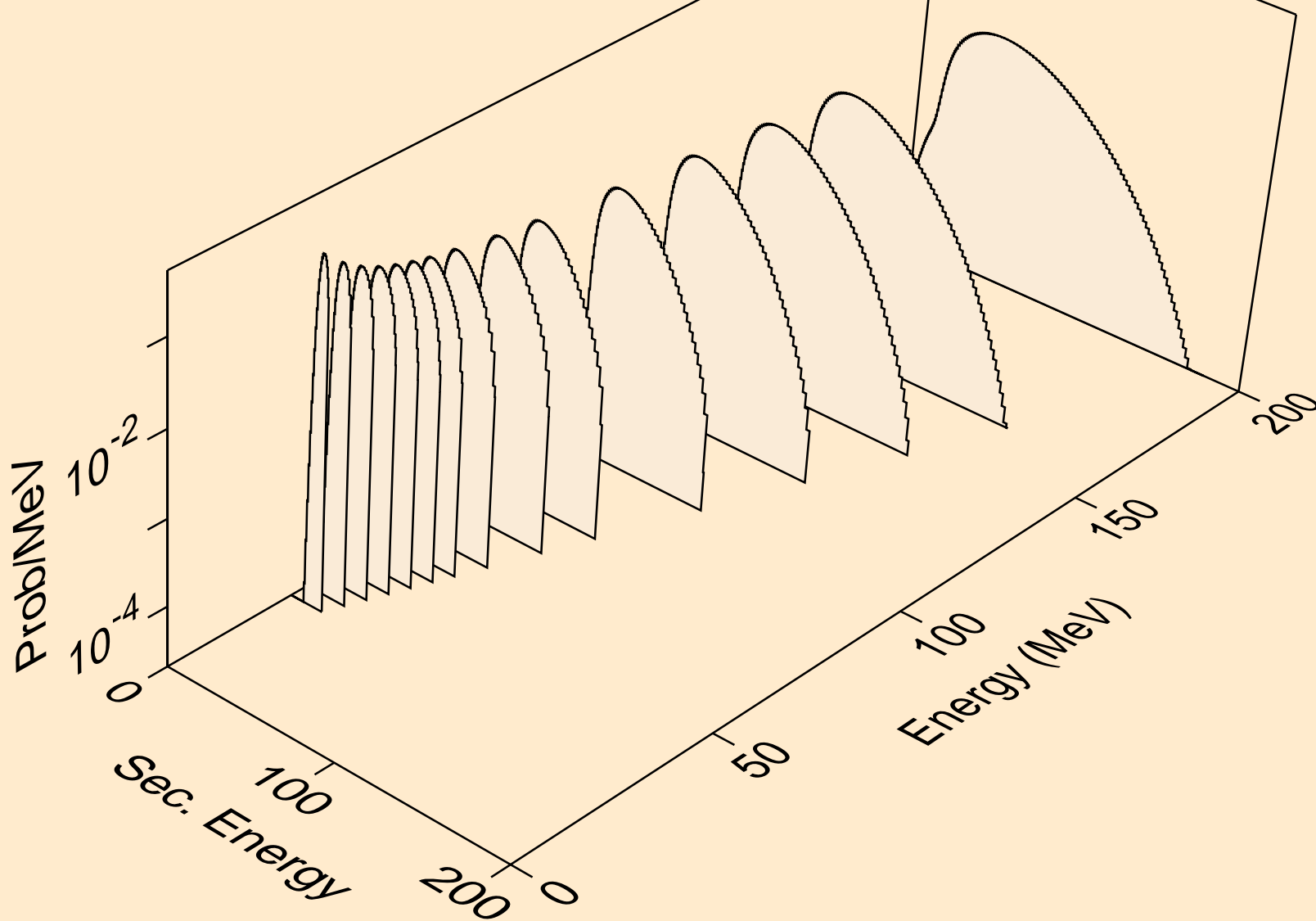

CD113 NEUTRON ACER TENDL-2019 LIBRARY; T=293.16K  
he3s from (n,n\*)he3

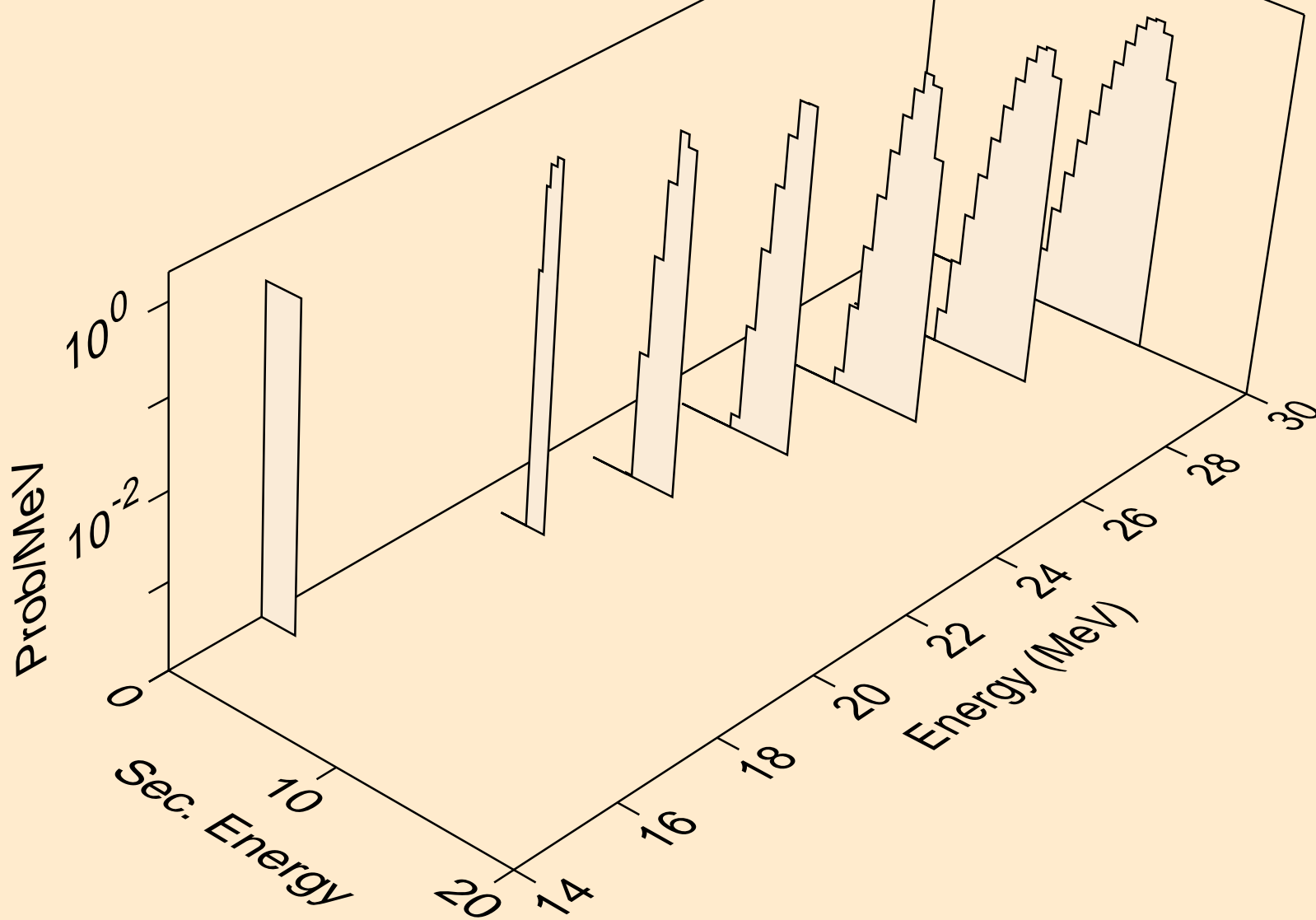

CD113 NEUTRON ACER TENDL-2019 LIBRARY; T=293.16K  
he3s from (n,he3)

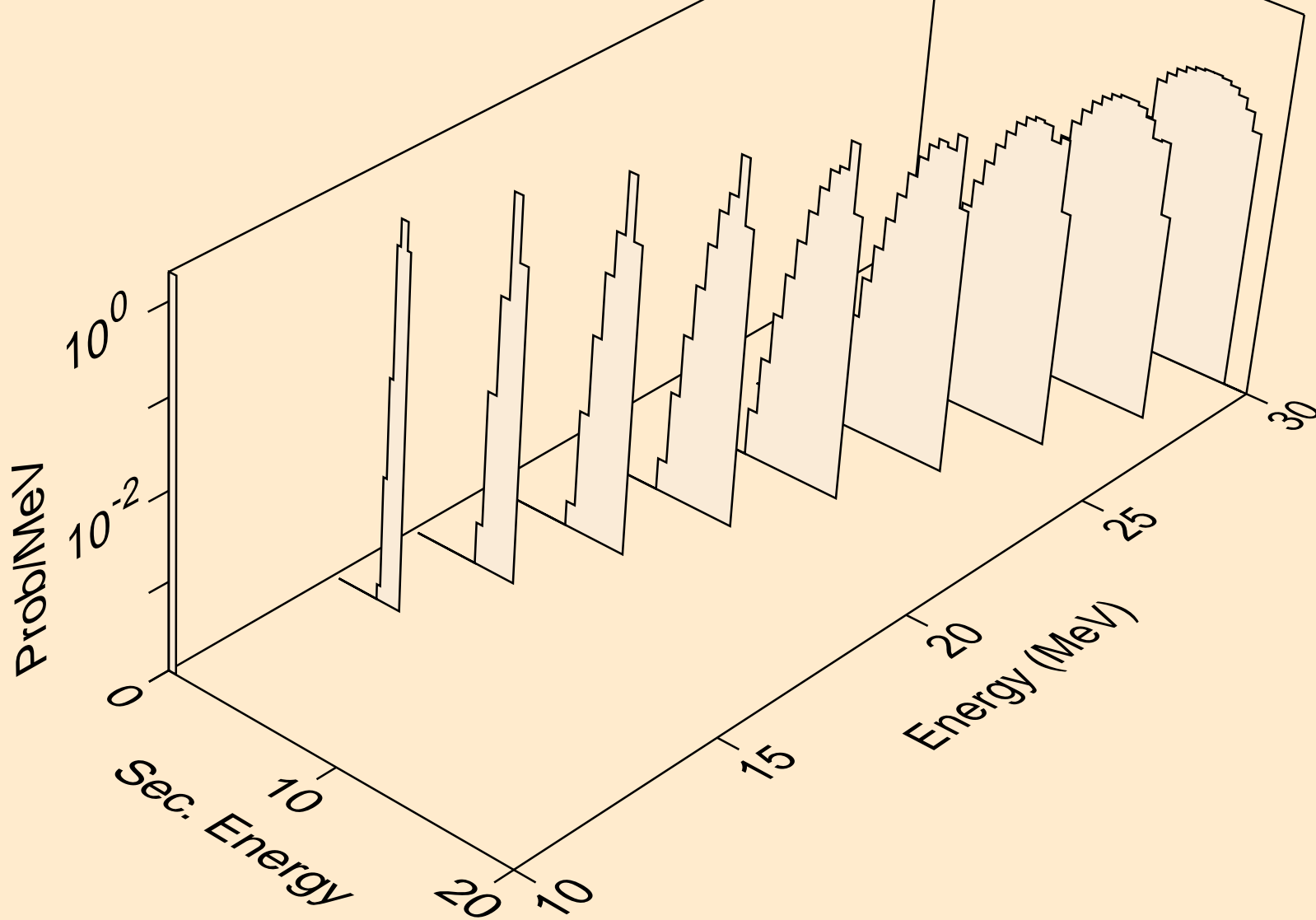

CD113 NEUTRON ACER TENDL-2019 LIBRARY; T=293.16K  
alphas from (n,x)

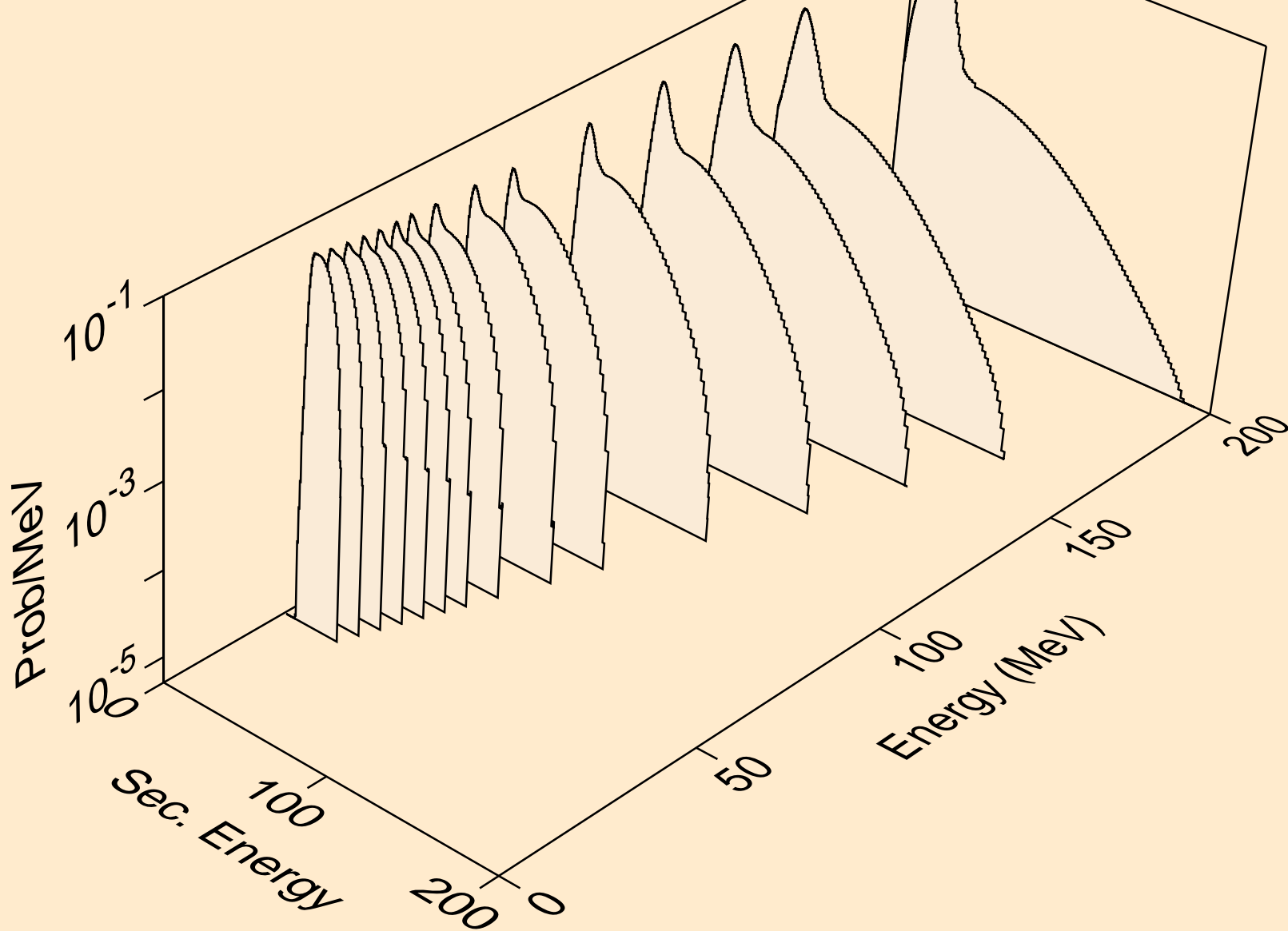

CD113 NEUTRON ACER TENDL-2019 LIBRARY; T=293.16K  
alphas from (n,n\*)a

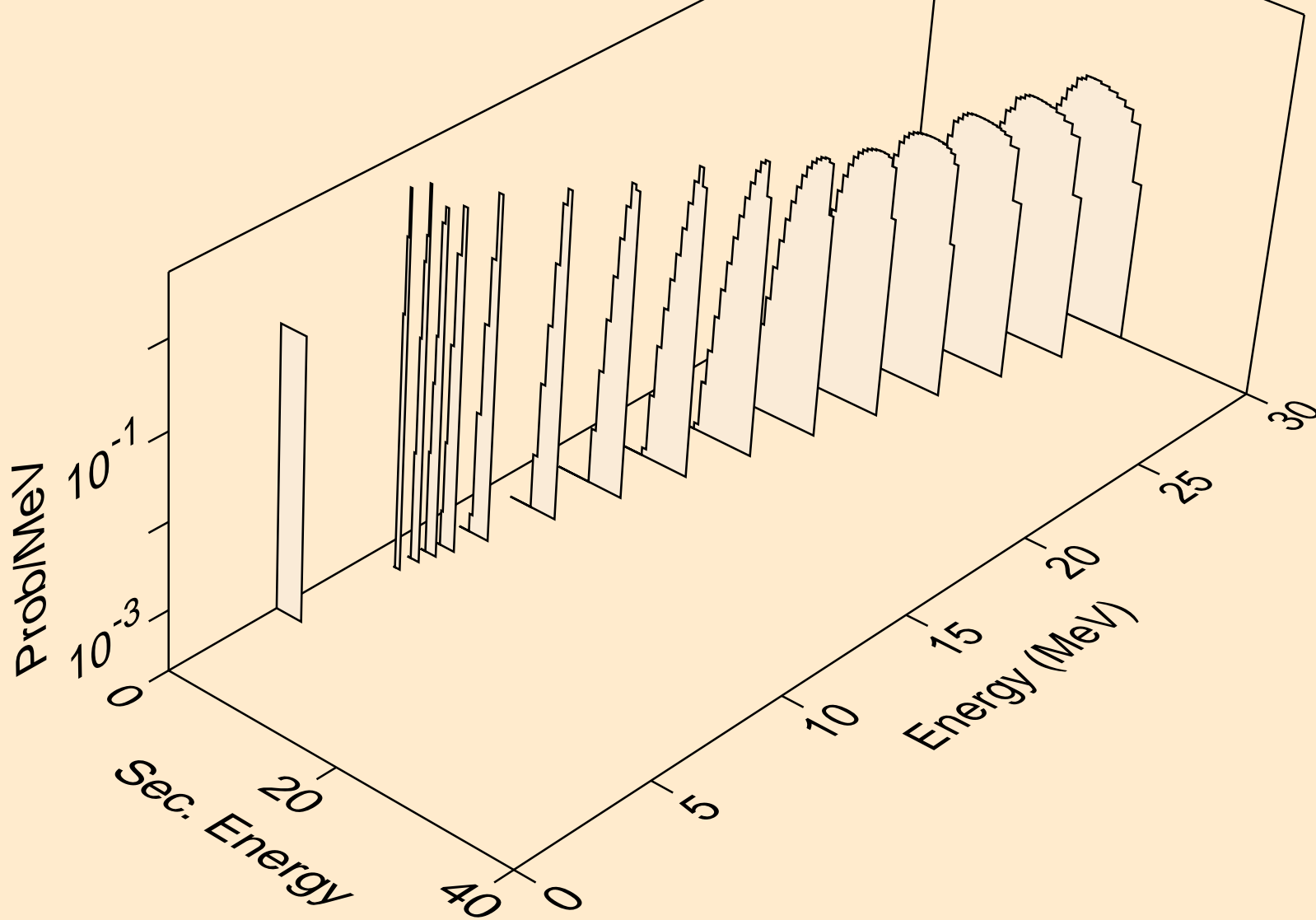

CD113 NEUTRON ACER TENDL-2019 LIBRARY; T=293.16K  
alphas from (n,2n)a

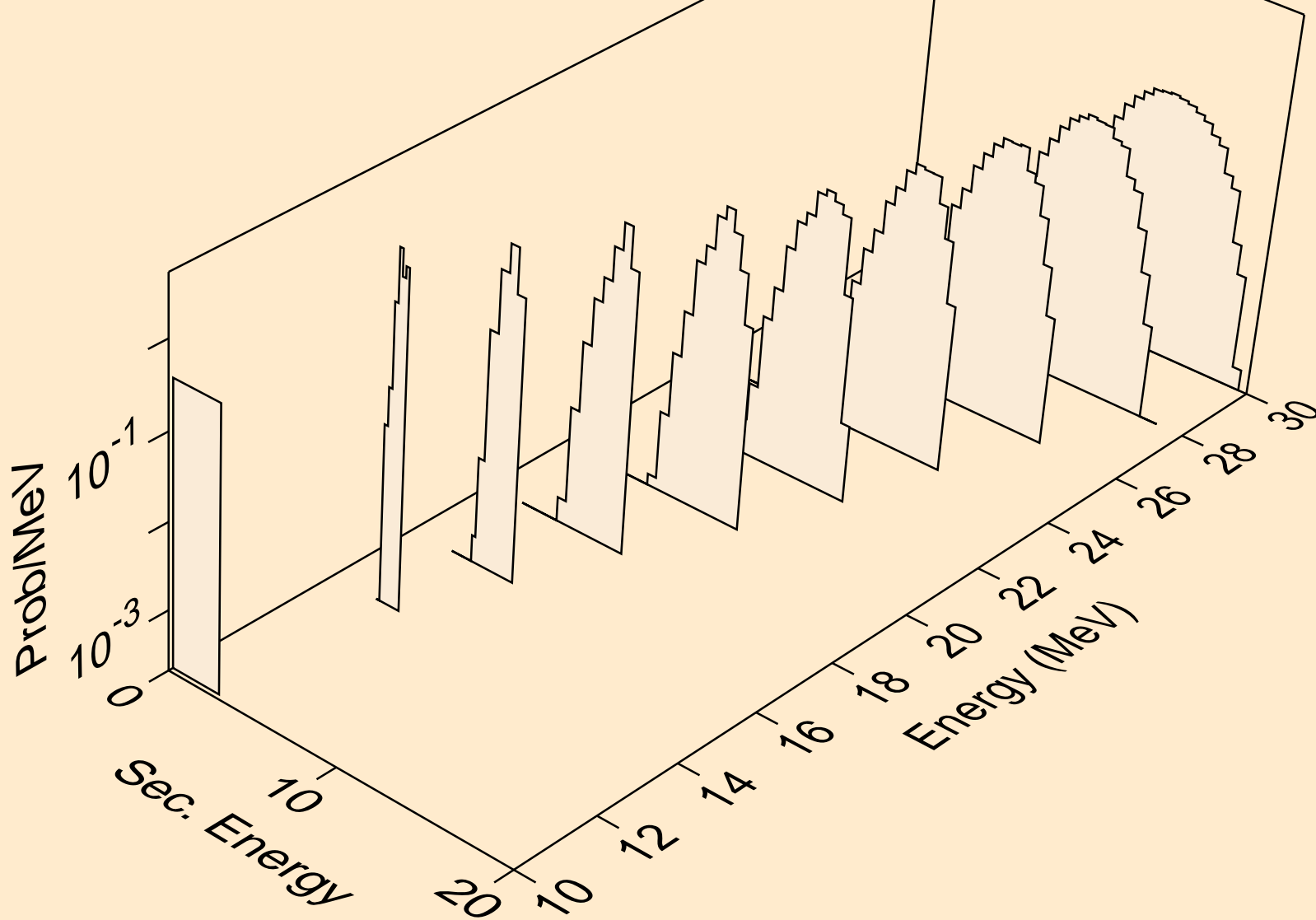

CD113 NEUTRON ACER TENDL-2019 LIBRARY; T=293.16K  
alphas from (n,3n)a

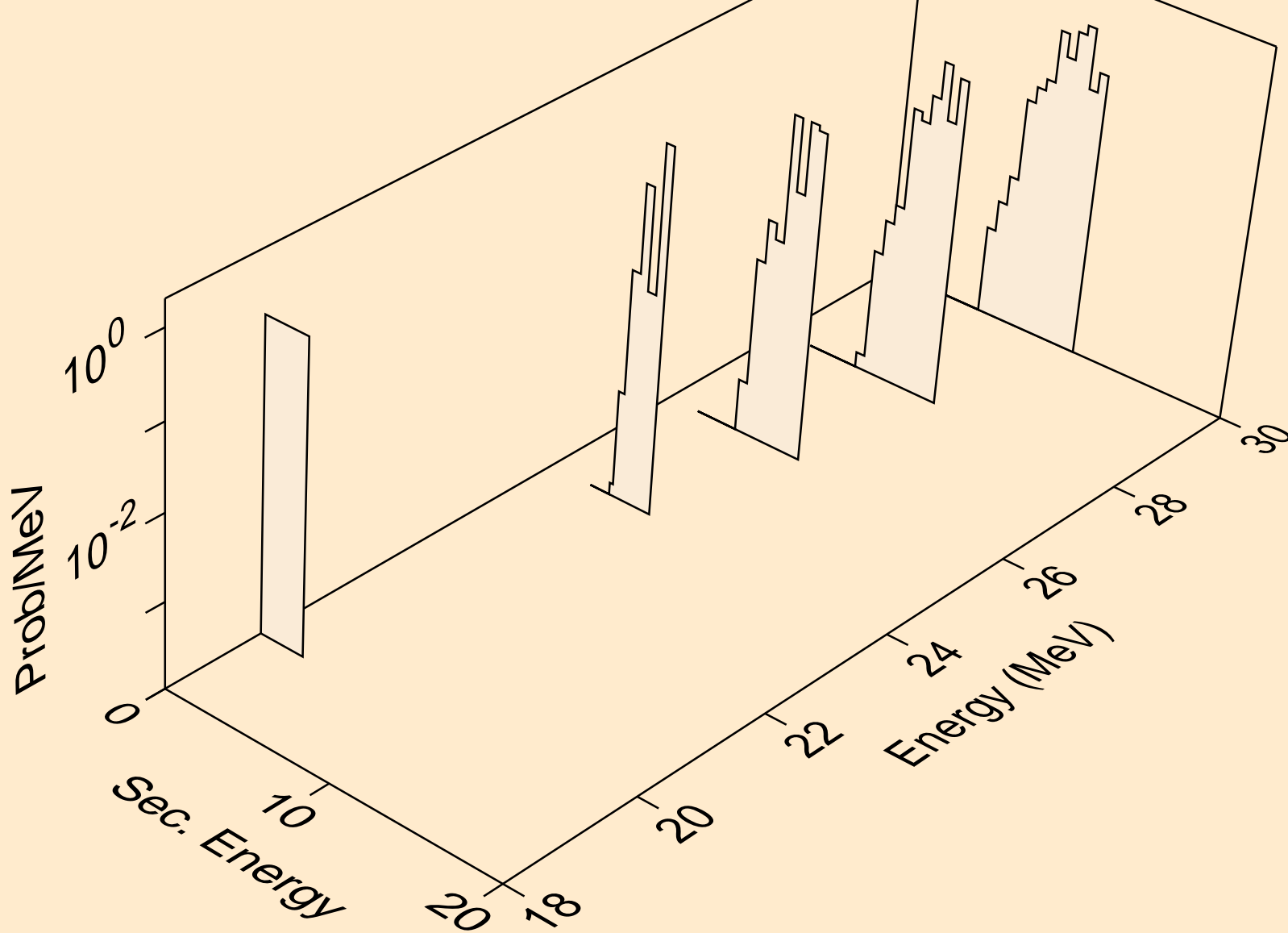

CD113 NEUTRON ACER TENDL-2019 LIBRARY; T=293.16K  
alphas from (n,n\*)2a

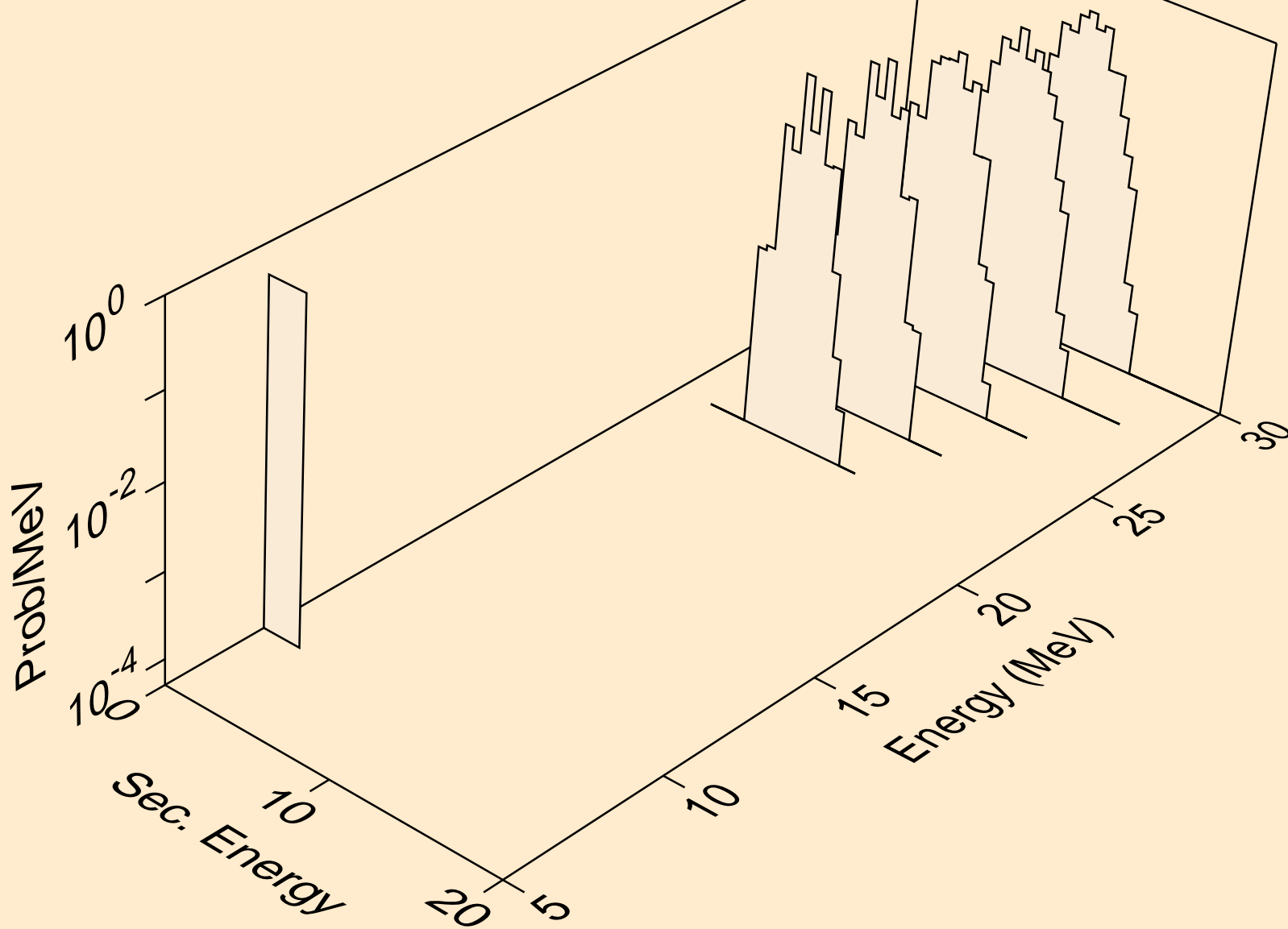

CD113 NEUTRON ACER TENDL-2019 LIBRARY; T=293.16K  
alphas from (n,npa)

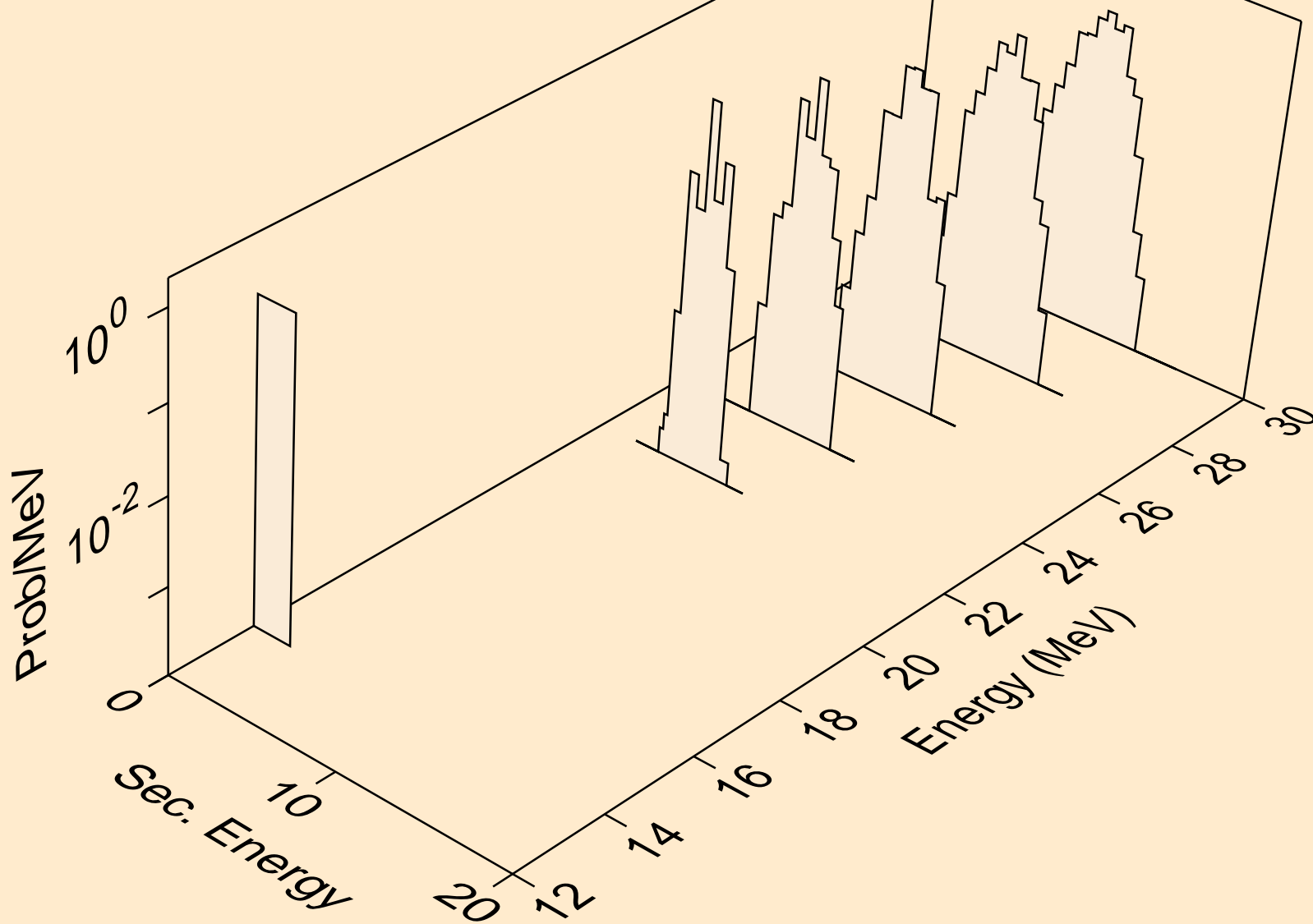

CD113 NEUTRON ACER TENDL-2019 LIBRARY; T=293.16K  
alphas from (n,a)

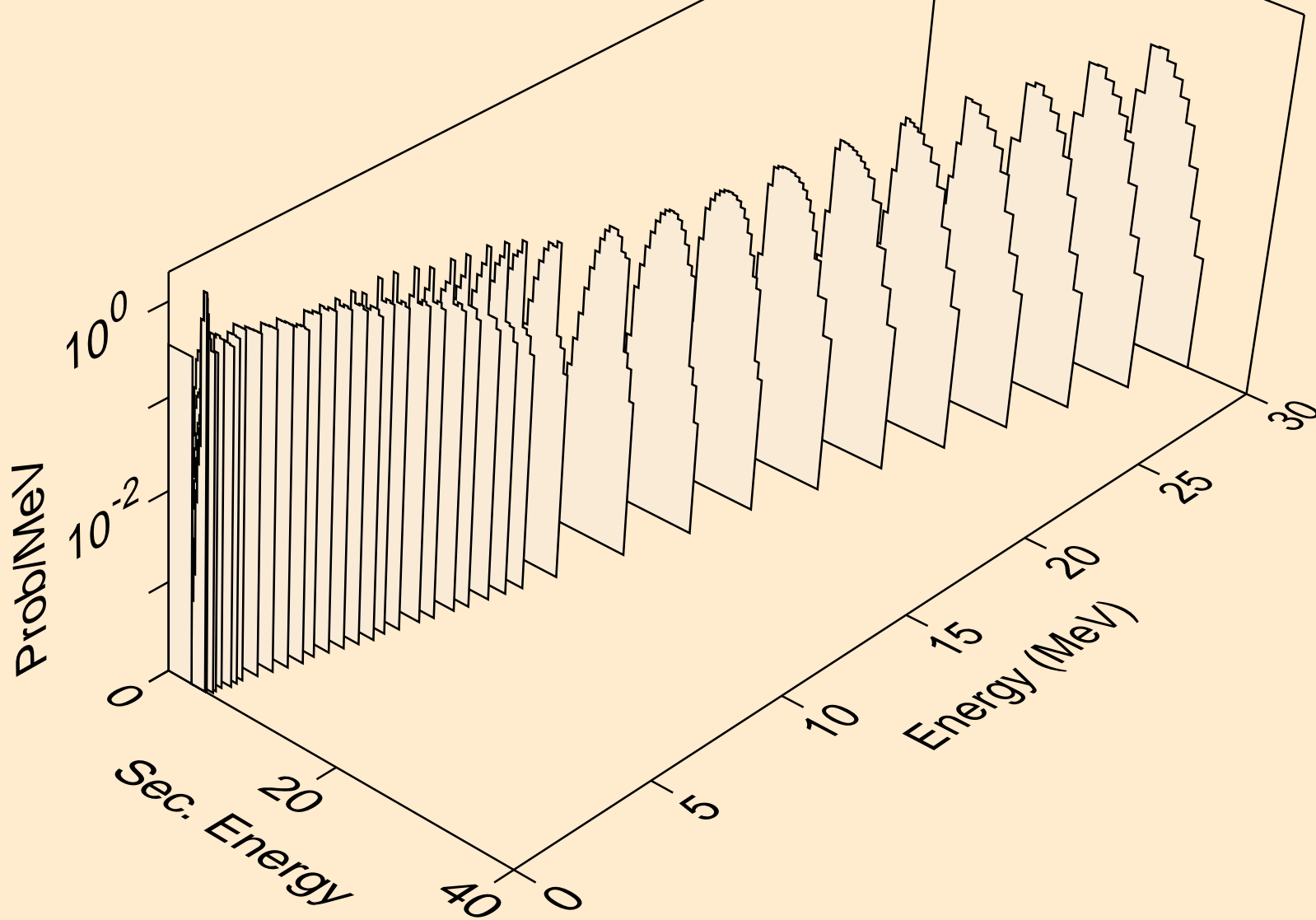

CD113 NEUTRON ACER TENDL-2019 LIBRARY; T=293.16K  
alphas from (n,2a)

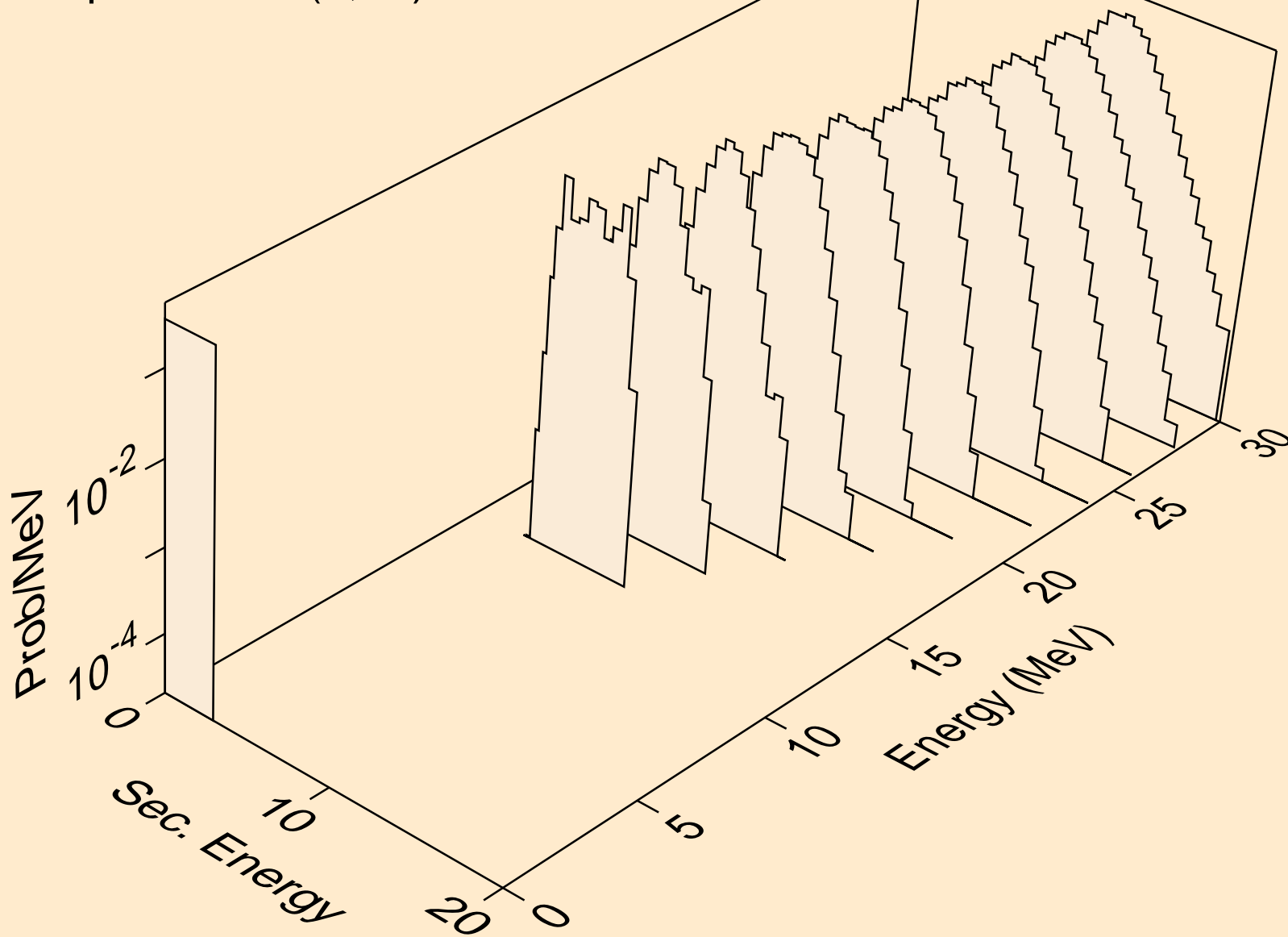

CD113 NEUTRON ACER TENDL-2019 LIBRARY; T=293.16K  
alphas from (n,pa)

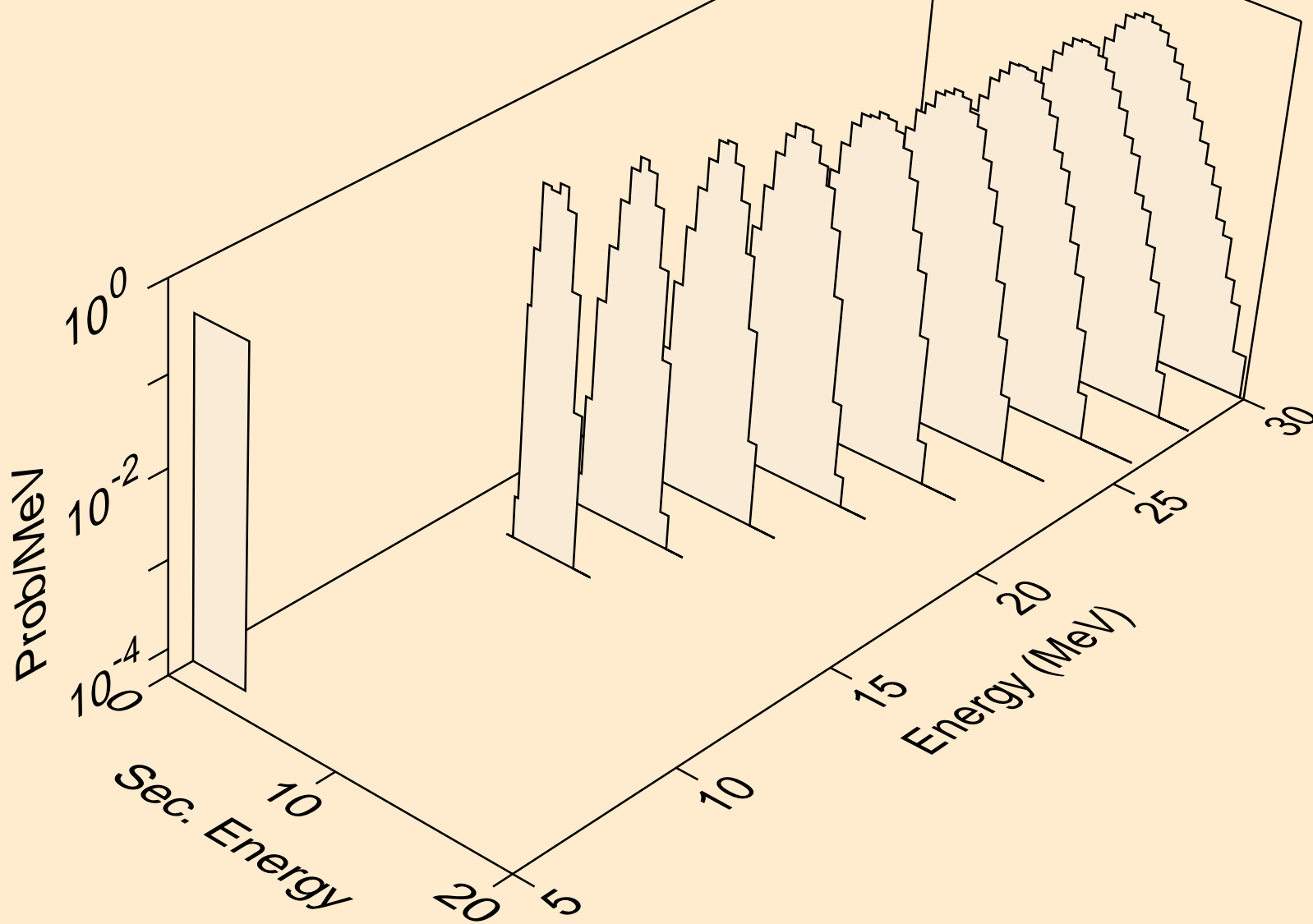

CD113 NEUTRON ACER TENDL-2019 LIBRARY; T=293.16K  
alphas from (n,da)

