

CD115 NEUTRON ACER TENDL-2019 LIBRARY; T=293.16K

Principal cross sections

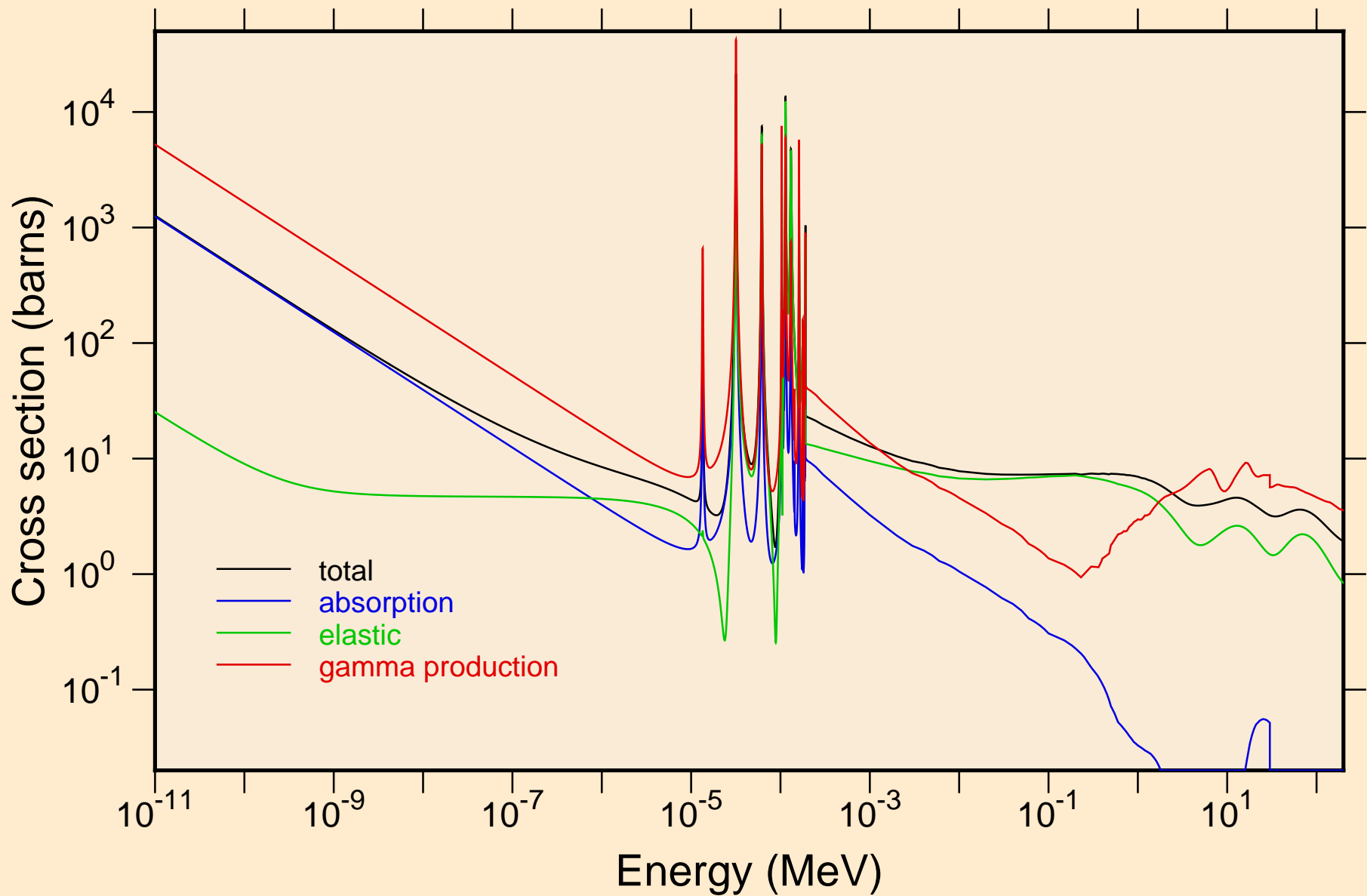

CD115 NEUTRON ACER TENDL-2019 LIBRARY; T=293.16K
resonance total cross section

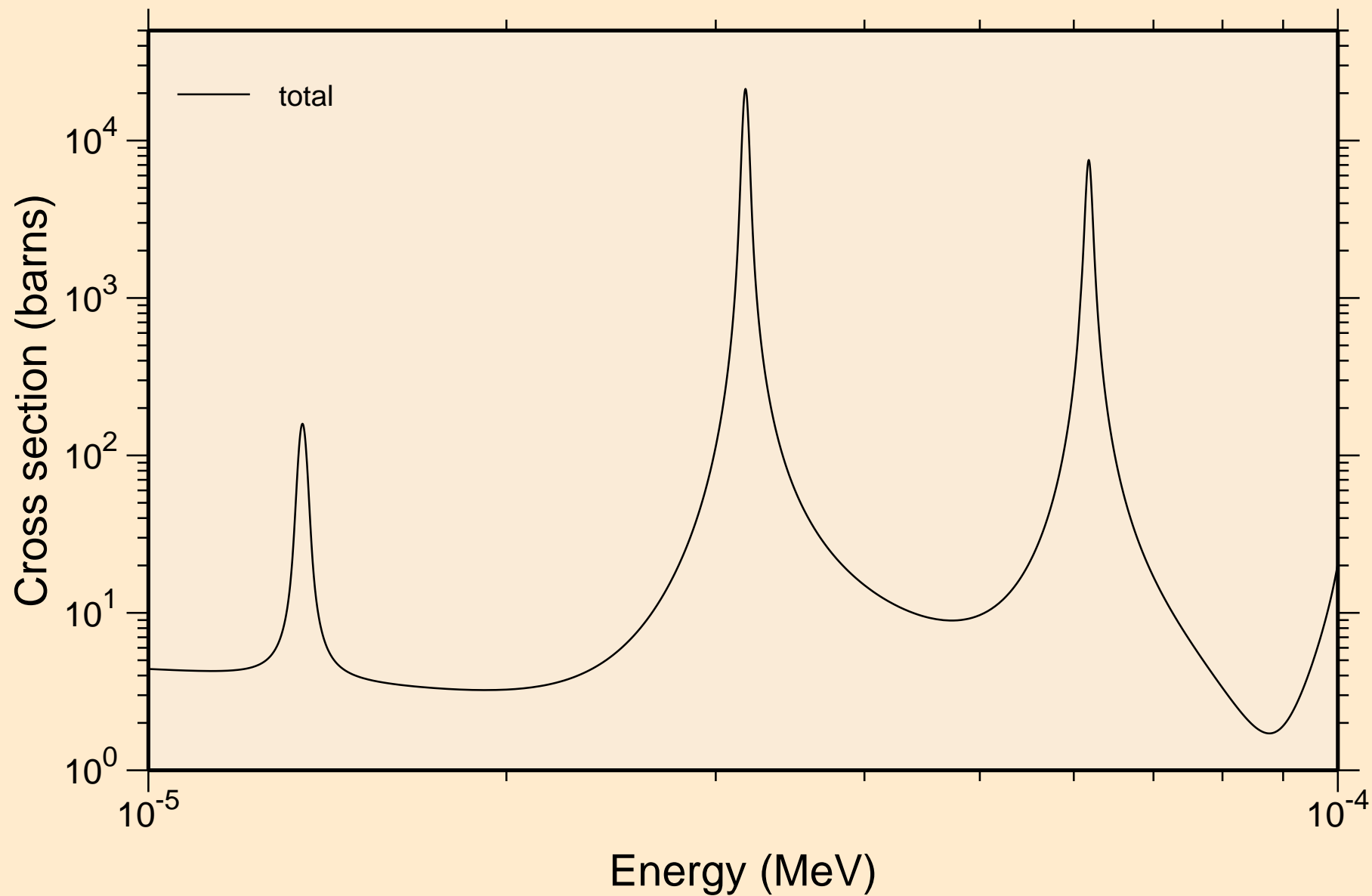

CD115 NEUTRON ACER TENDL-2019 LIBRARY; T=293.16K
resonance total cross section

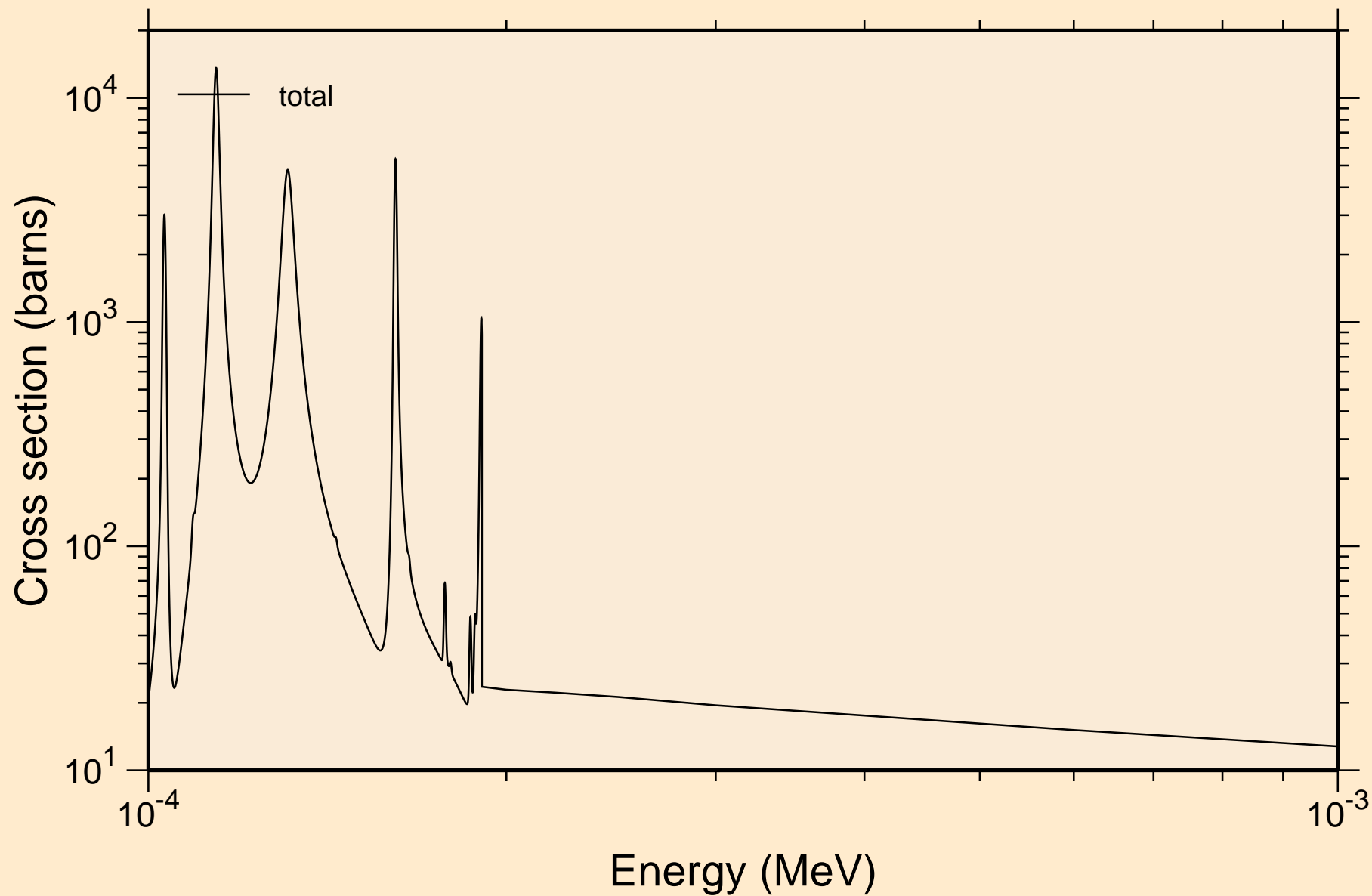

CD115 NEUTRON ACER TENDL-2019 LIBRARY; T=293.16K
resonance total cross section

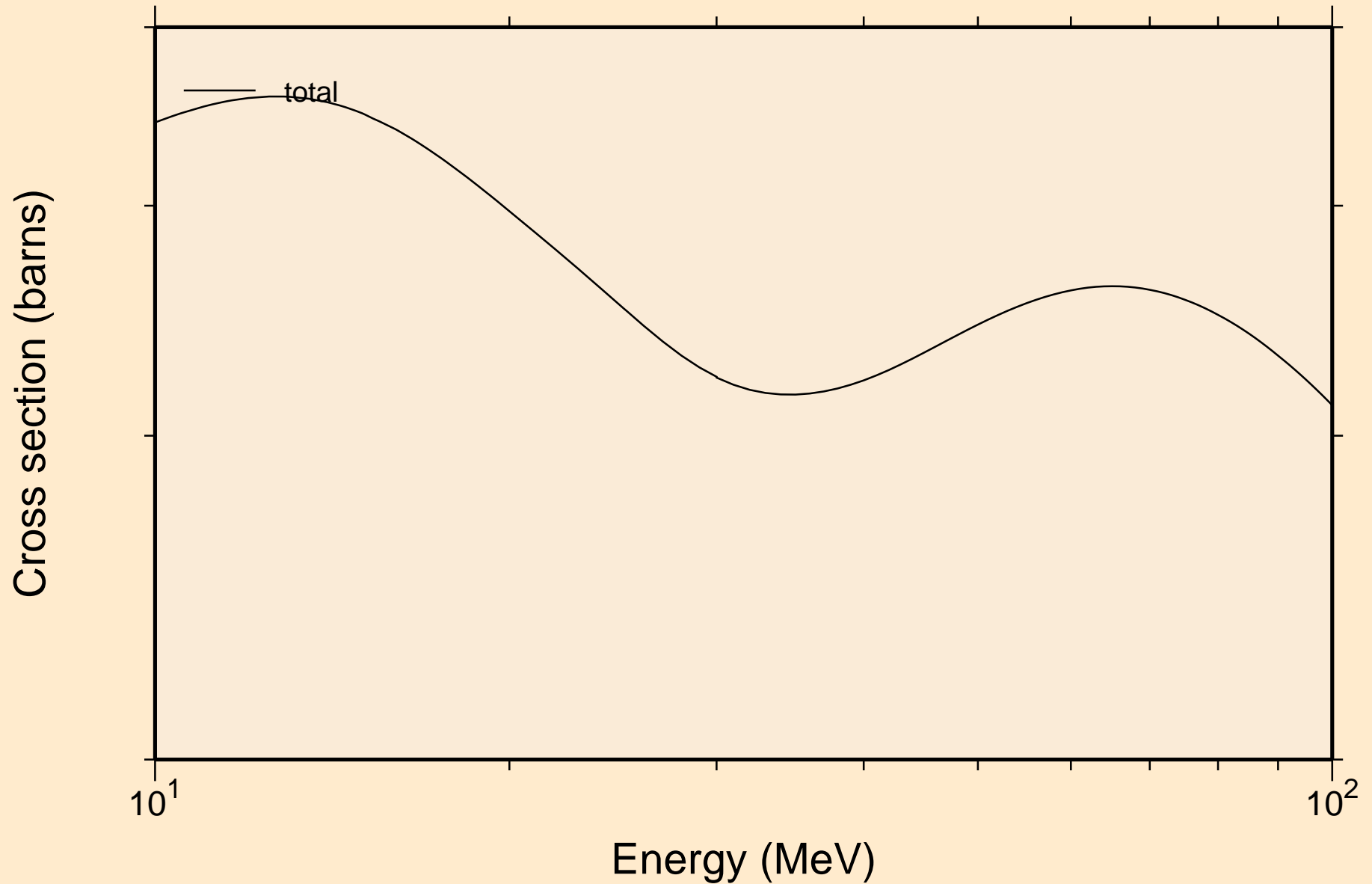

CD115 NEUTRON ACER TENDL-2019 LIBRARY; T=293.16K
resonance absorption cross sections

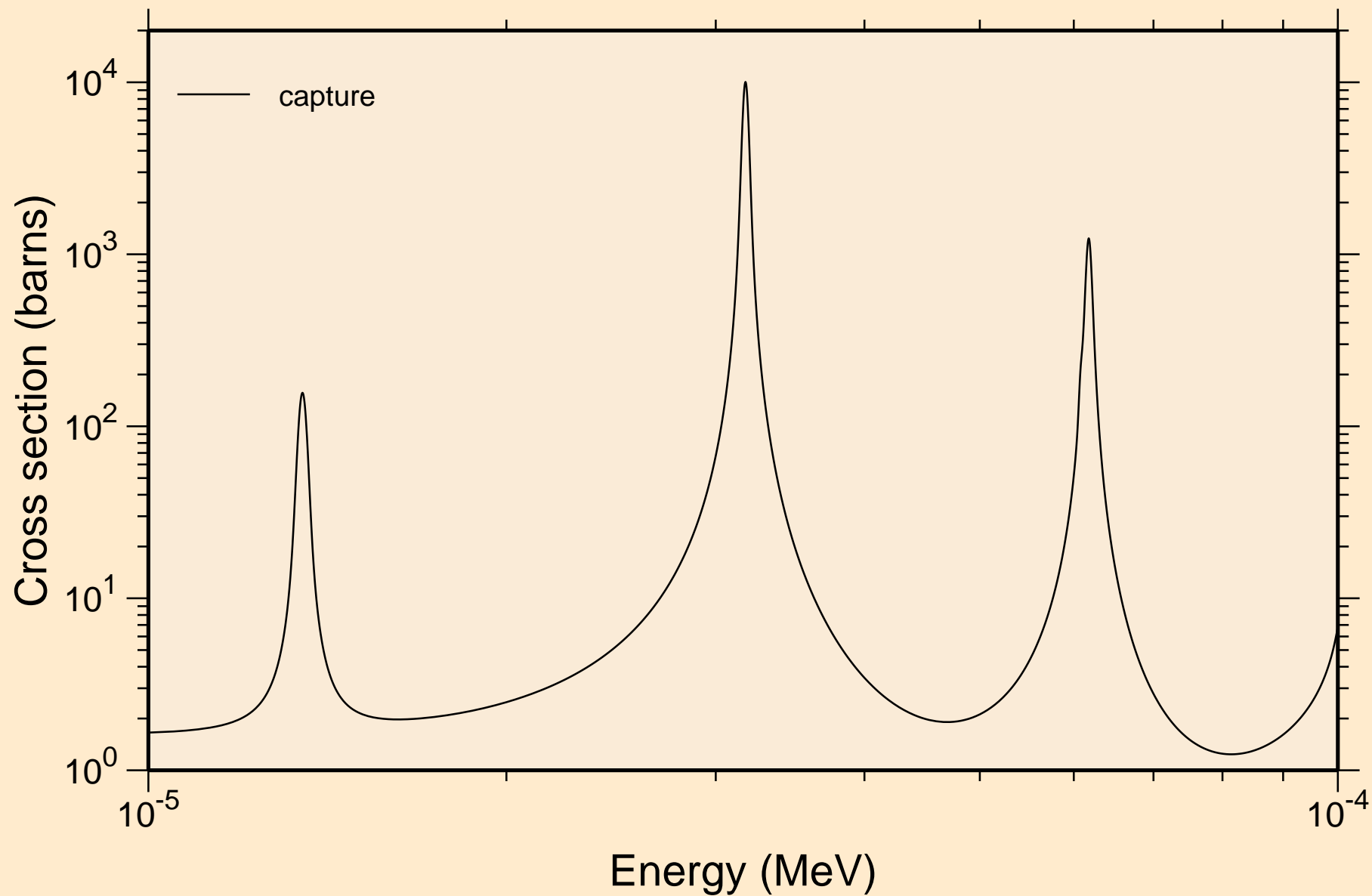

CD115 NEUTRON ACER TENDL-2019 LIBRARY; T=293.16K
resonance absorption cross sections

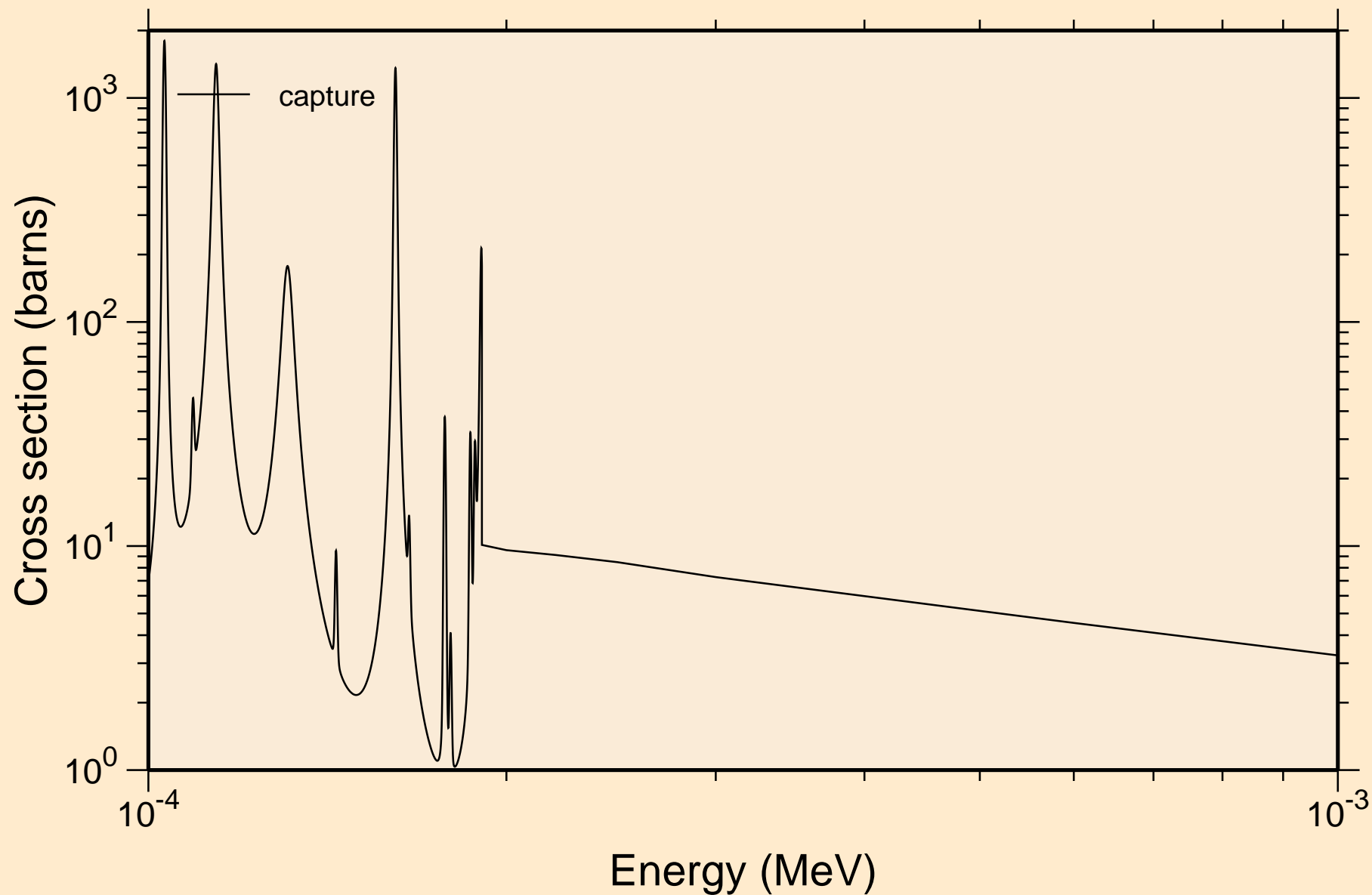

CD115 NEUTRON ACER TENDL-2019 LIBRARY; T=293.16K
resonance absorption cross sections

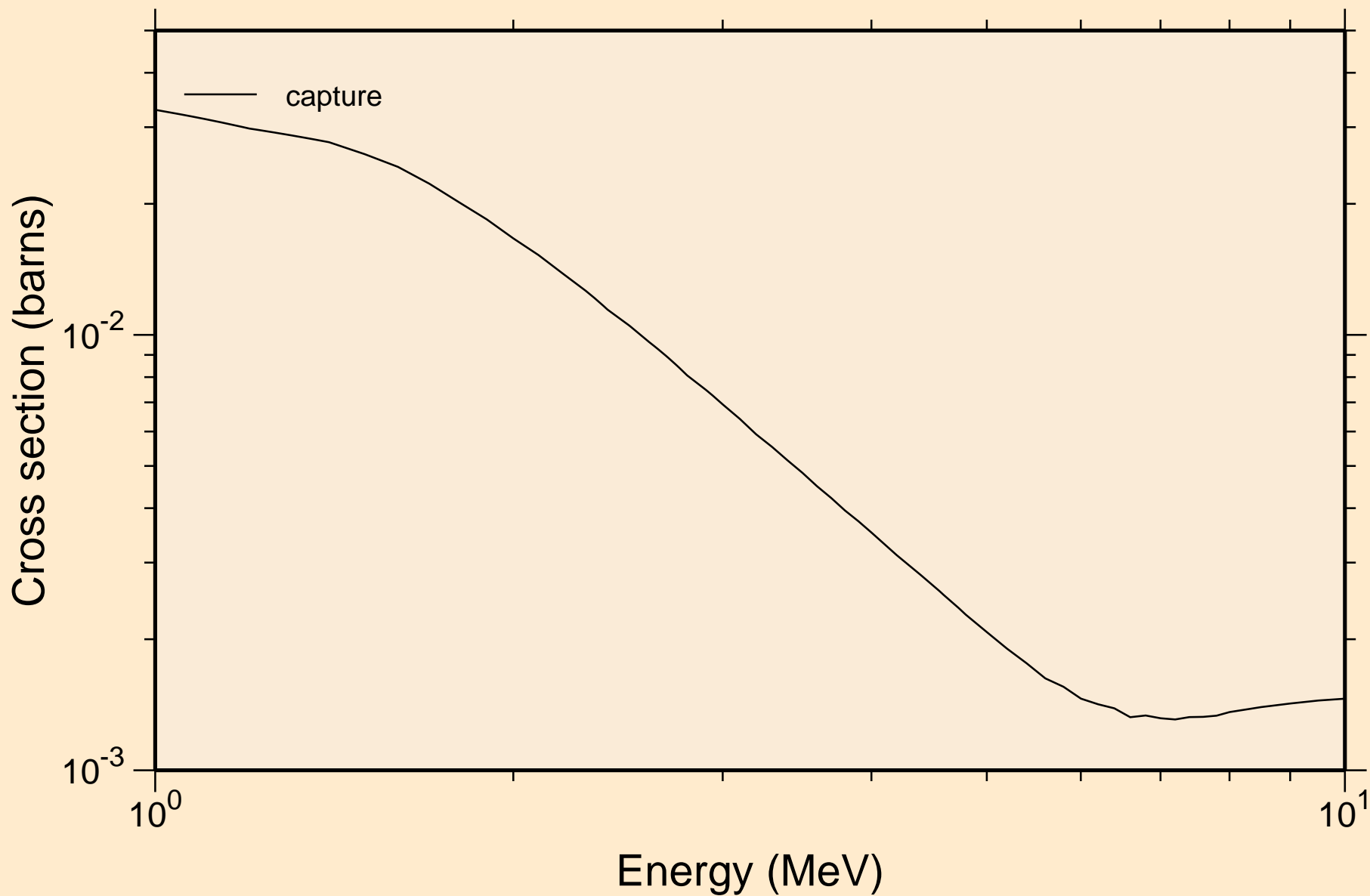

CD115 NEUTRON ACER TENDL-2019 LIBRARY; T=293.16K
Heating

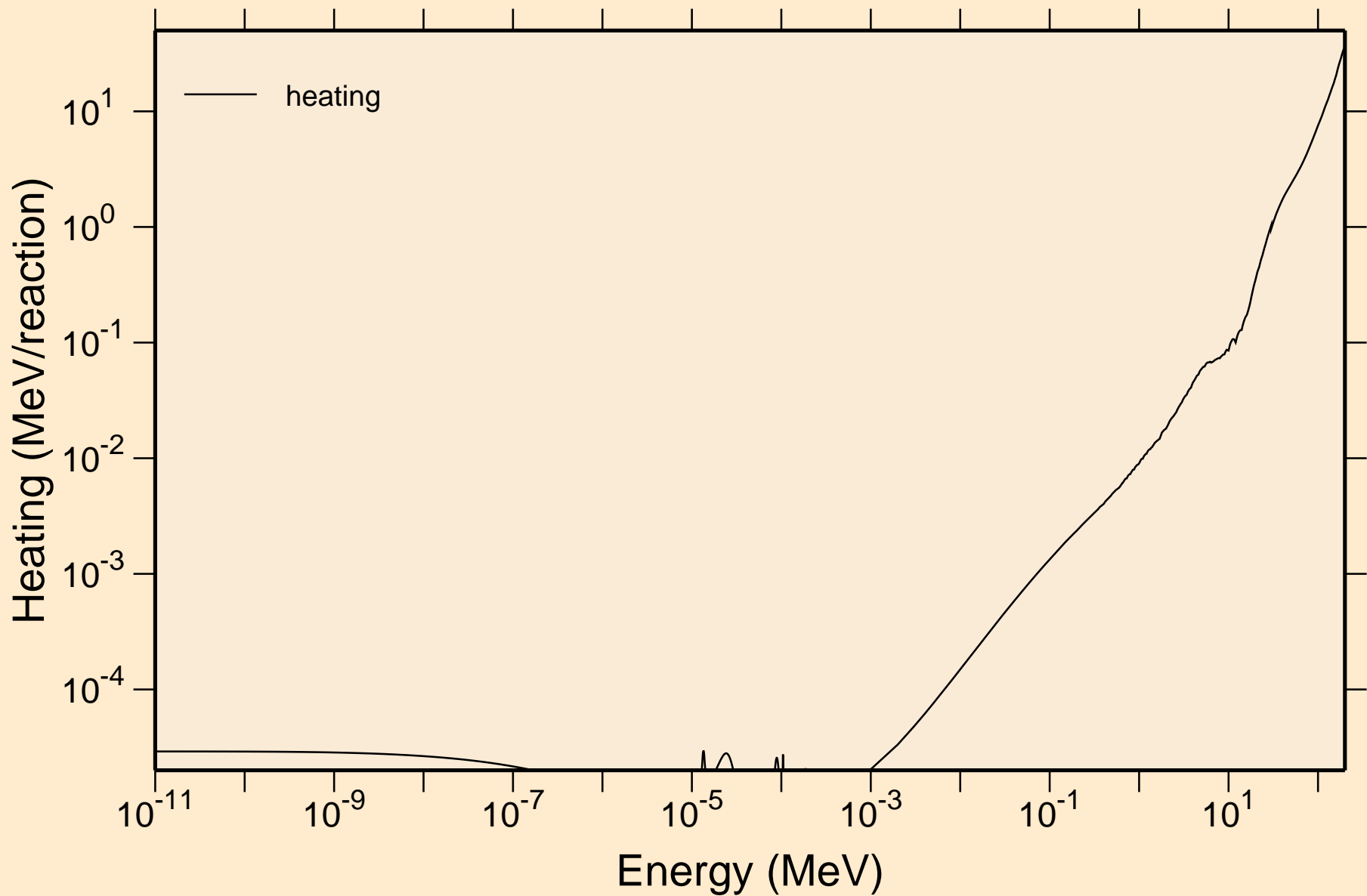

CD115 NEUTRON ACER TENDL-2019 LIBRARY; T=293.16K Damage

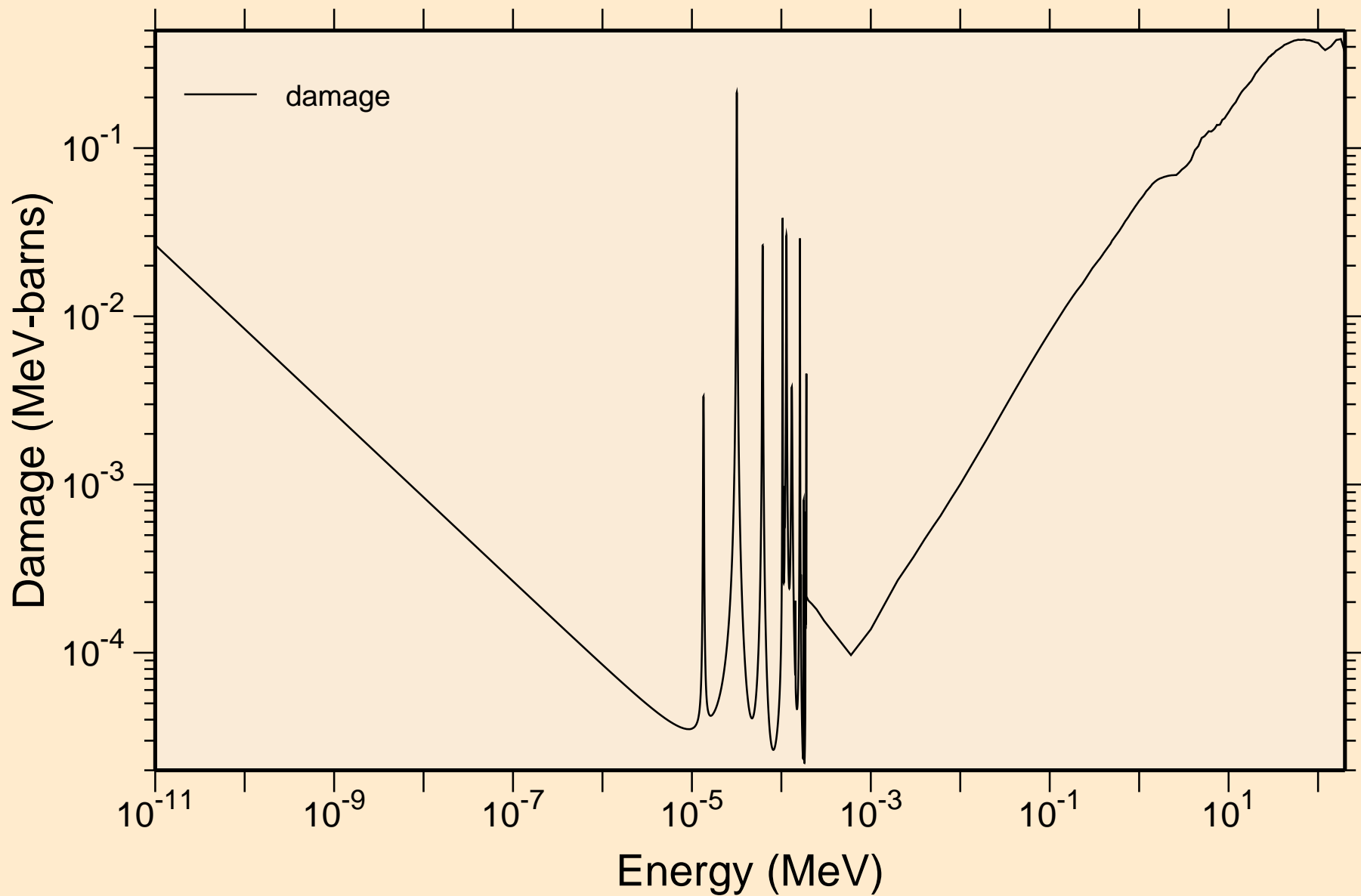

CD115 NEUTRON ACER TENDL-2019 LIBRARY; T=293.16K
Non-threshold reactions

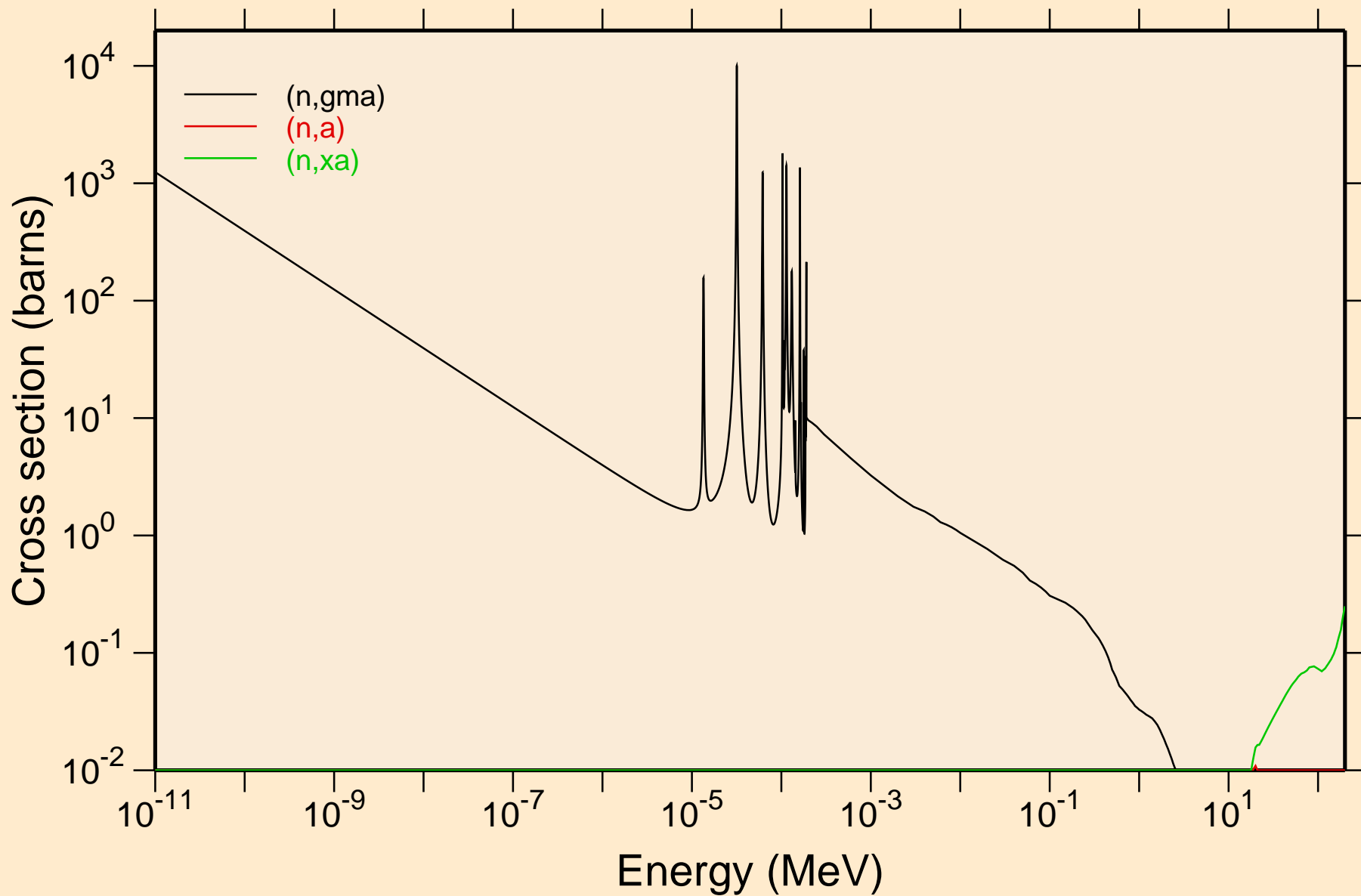

CD115 NEUTRON ACER TENDL-2019 LIBRARY; T=293.16K
Principal cross sections

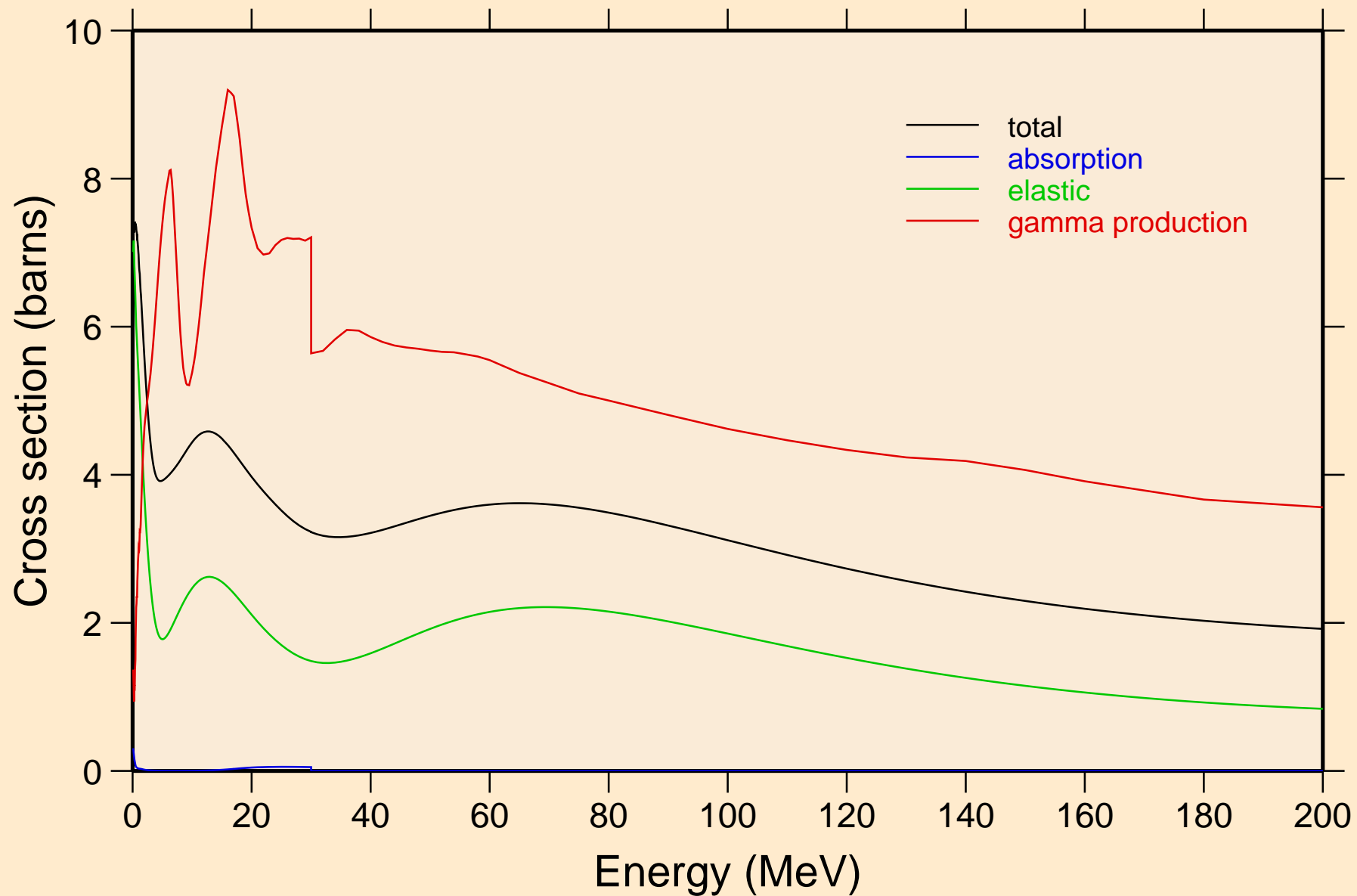

CD115 NEUTRON ACER TENDL-2019 LIBRARY; T=293.16K
Heating

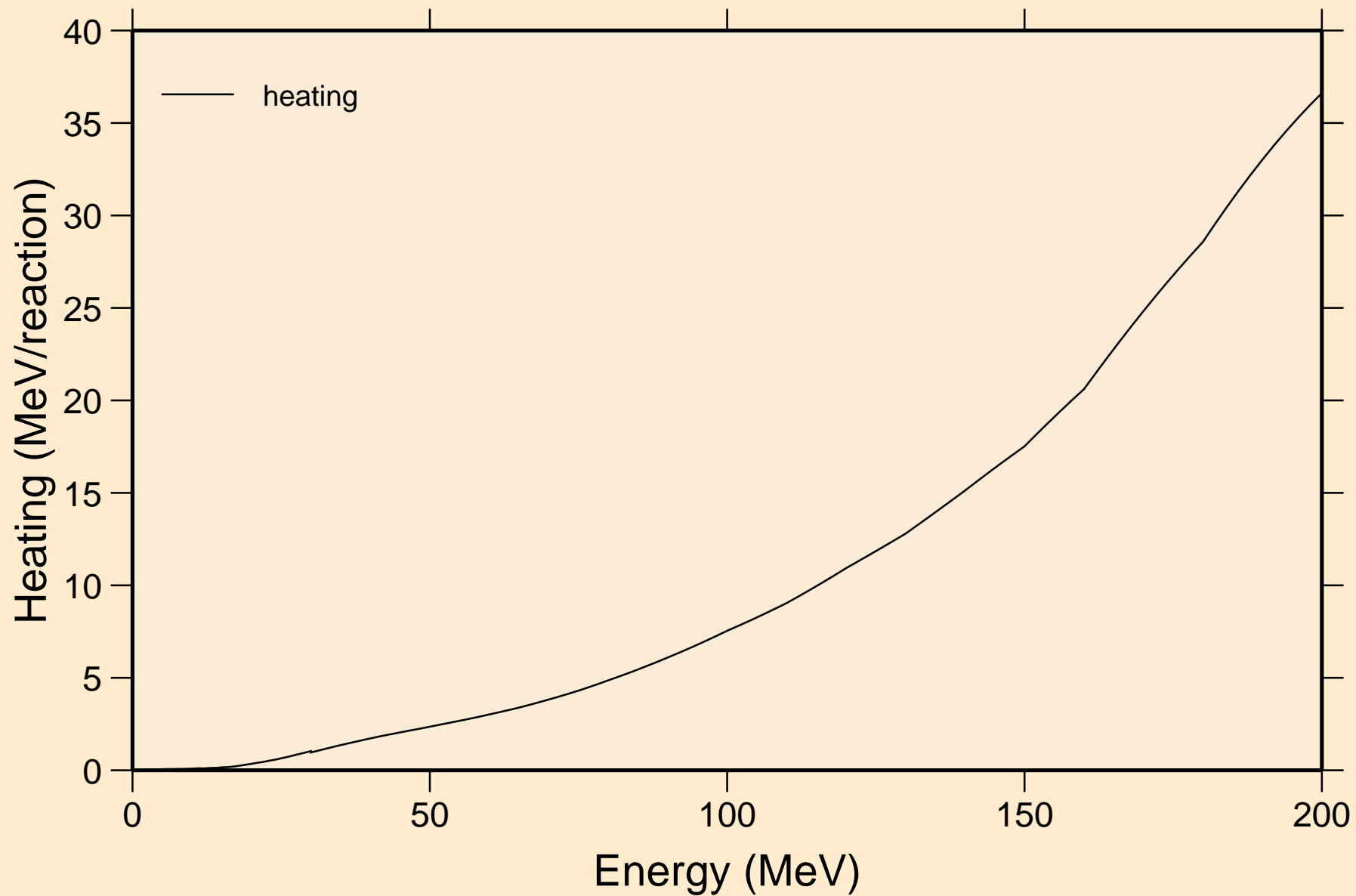

CD115 NEUTRON ACER TENDL-2019 LIBRARY; T=293.16K
Damage

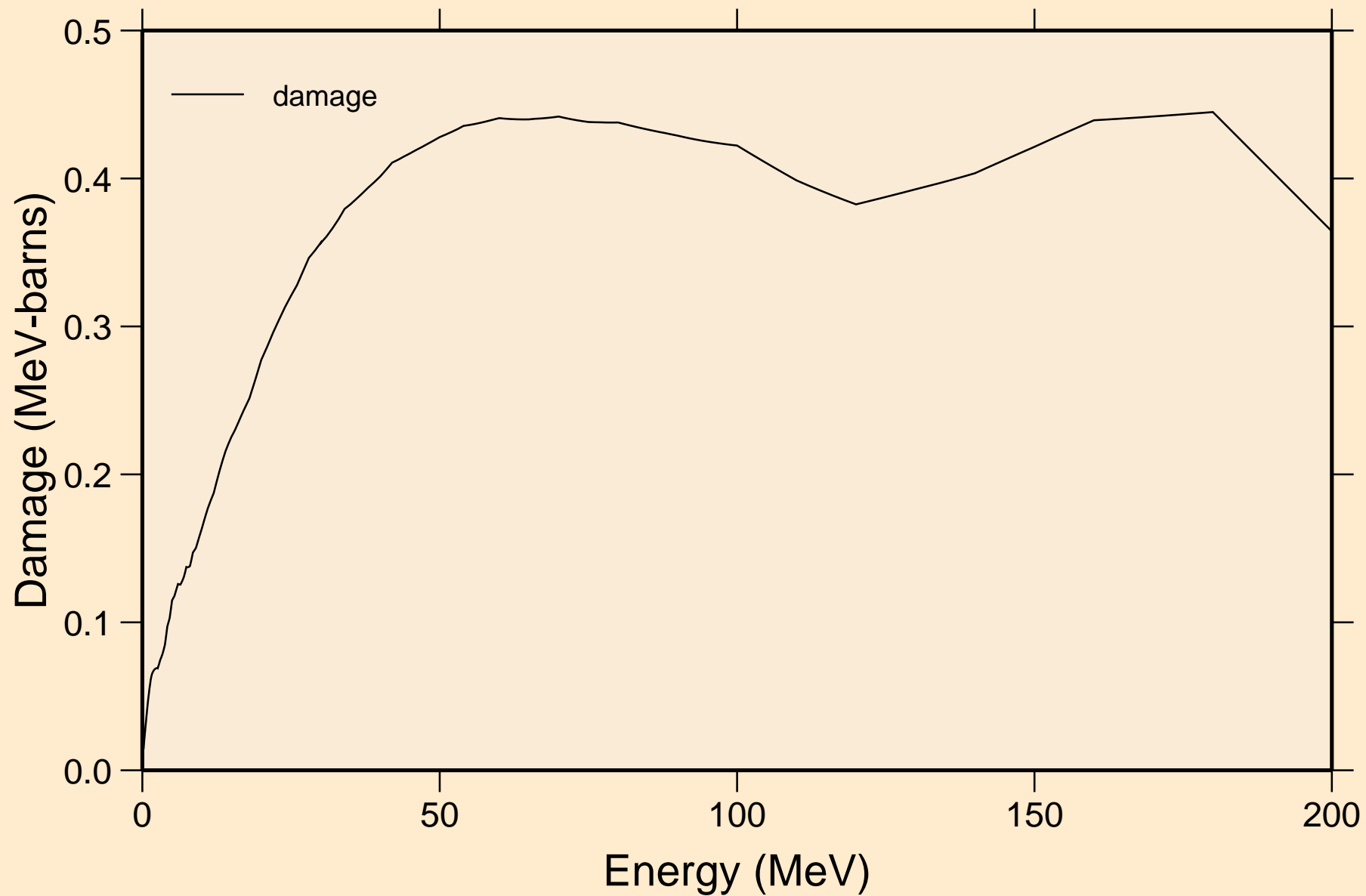

CD115 NEUTRON ACER TENDL-2019 LIBRARY; T=293.16K
Non-threshold reactions

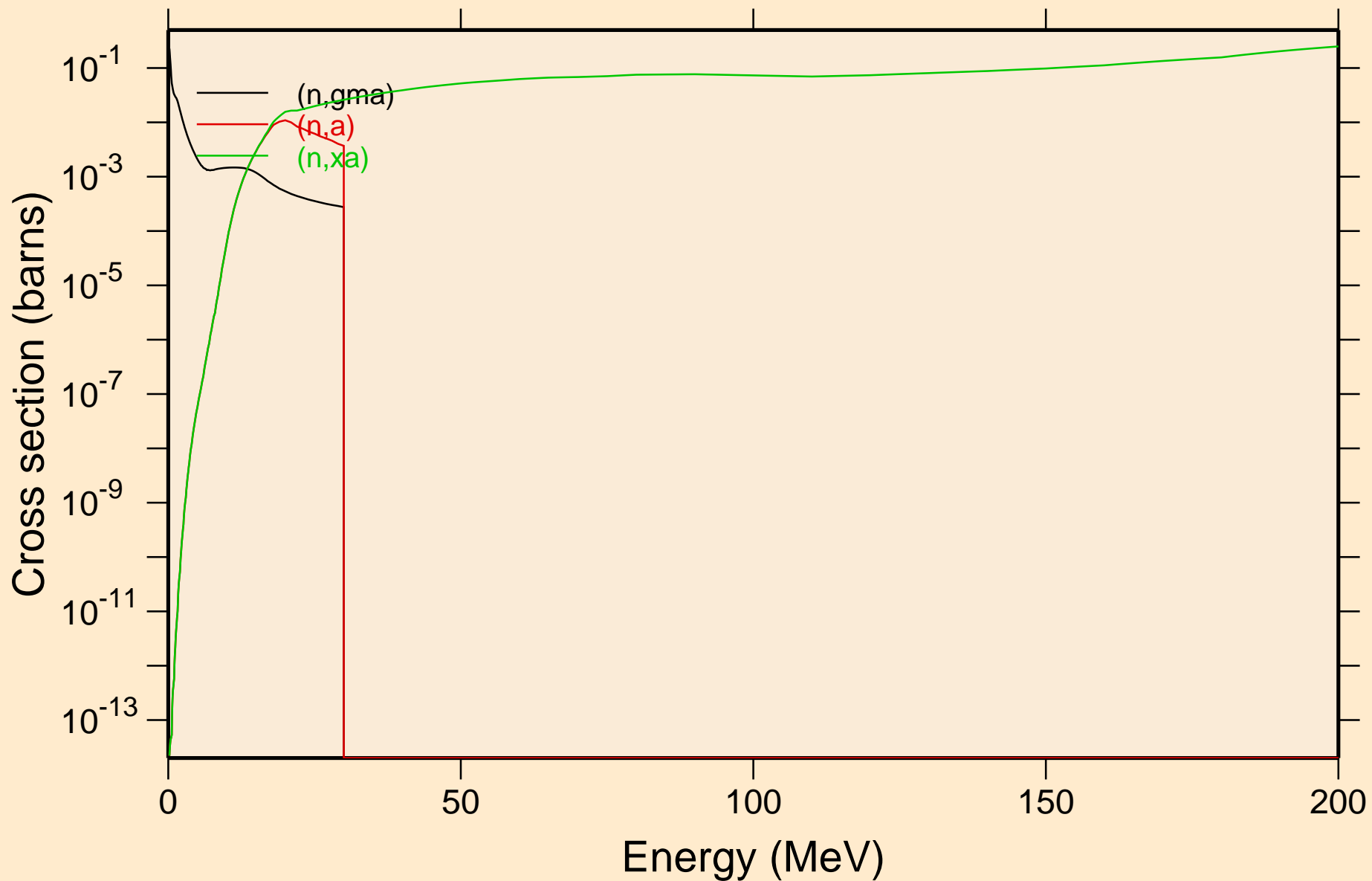

CD115 NEUTRON ACER TENDL-2019 LIBRARY; T=293.16K
Inelastic levels

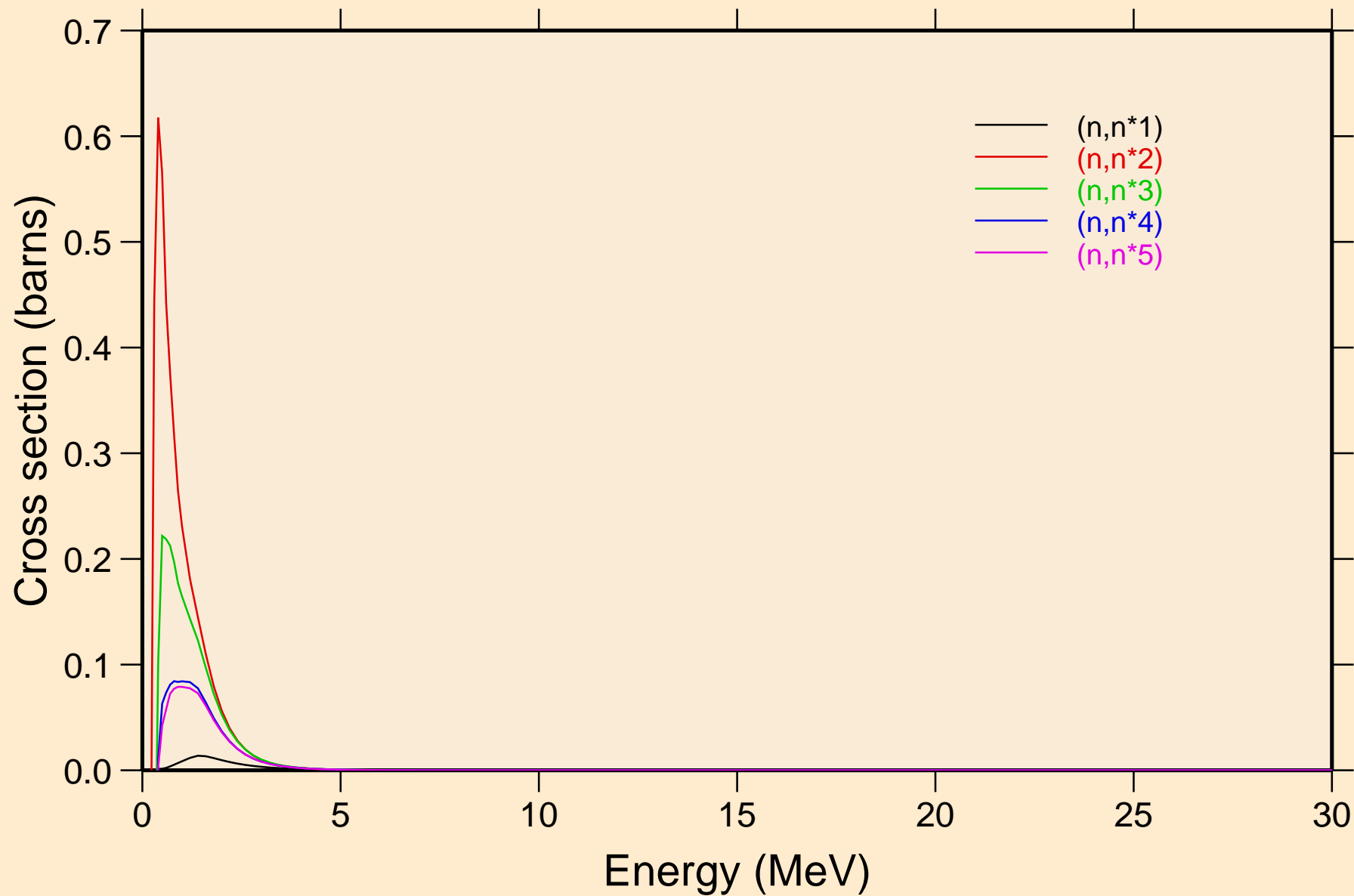

CD115 NEUTRON ACER TENDL-2019 LIBRARY; T=293.16K
Inelastic levels

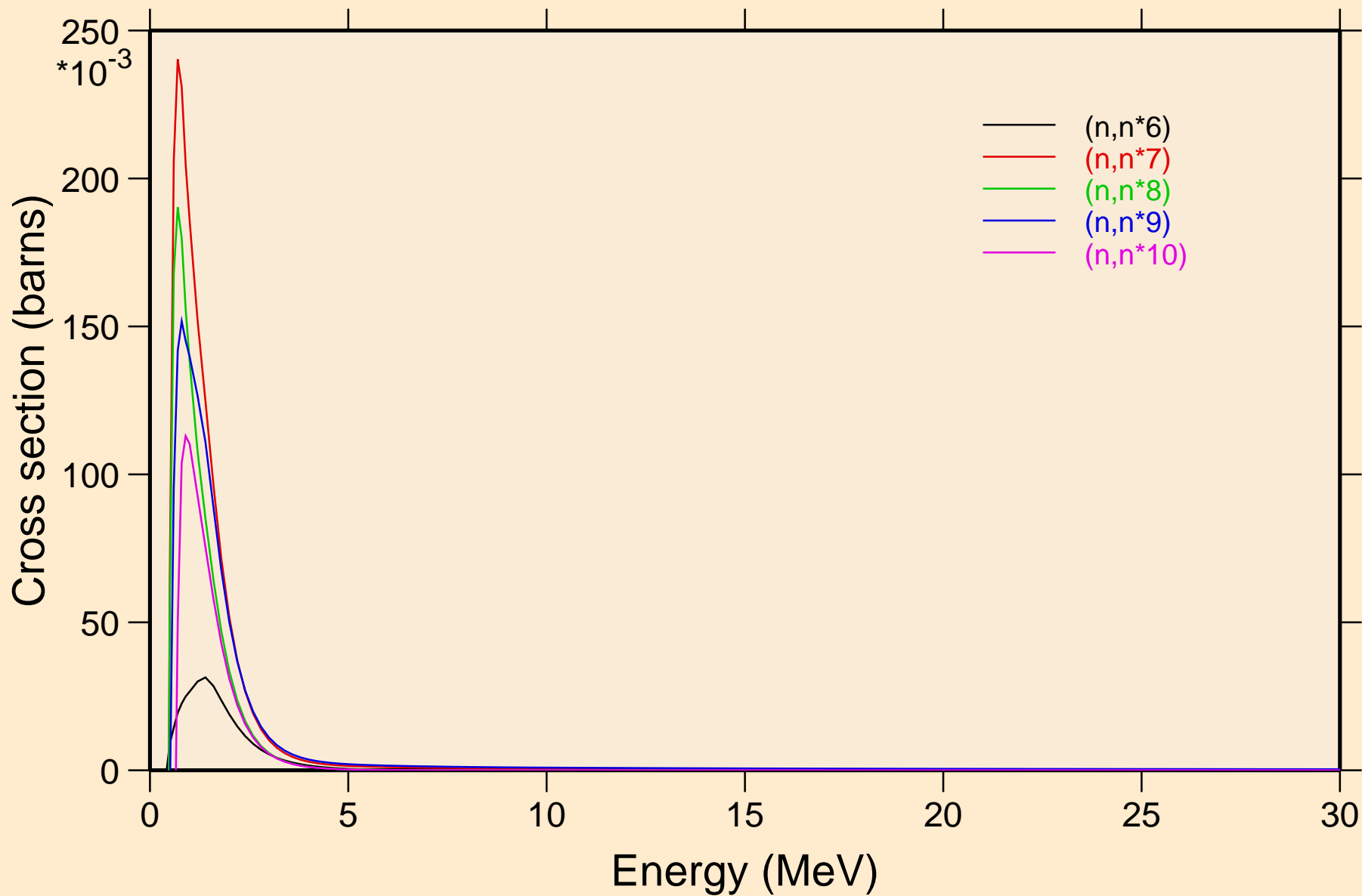

CD115 NEUTRON ACER TENDL-2019 LIBRARY; T=293.16K
Inelastic levels

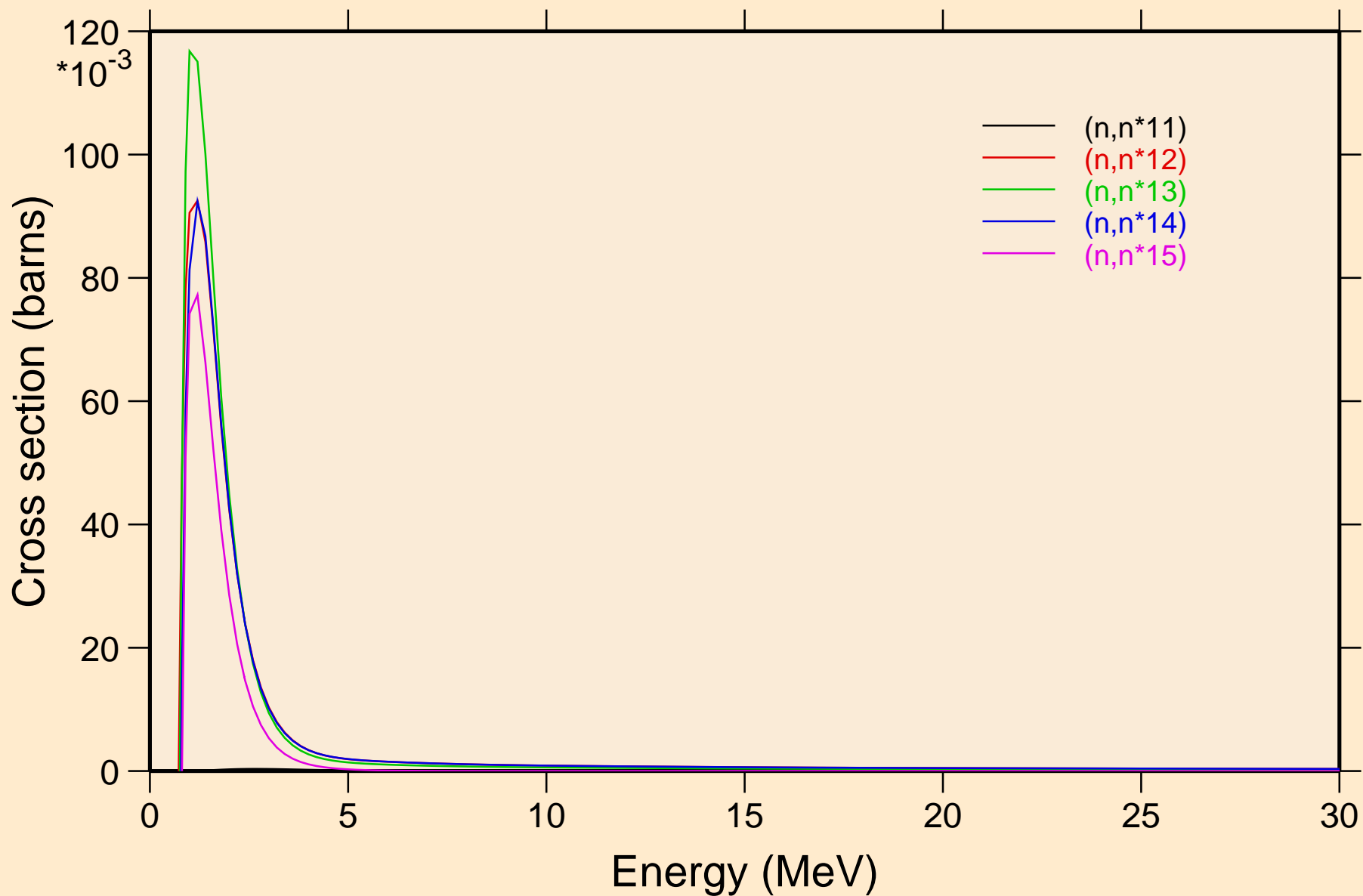

CD115 NEUTRON ACER TENDL-2019 LIBRARY; T=293.16K
Inelastic levels

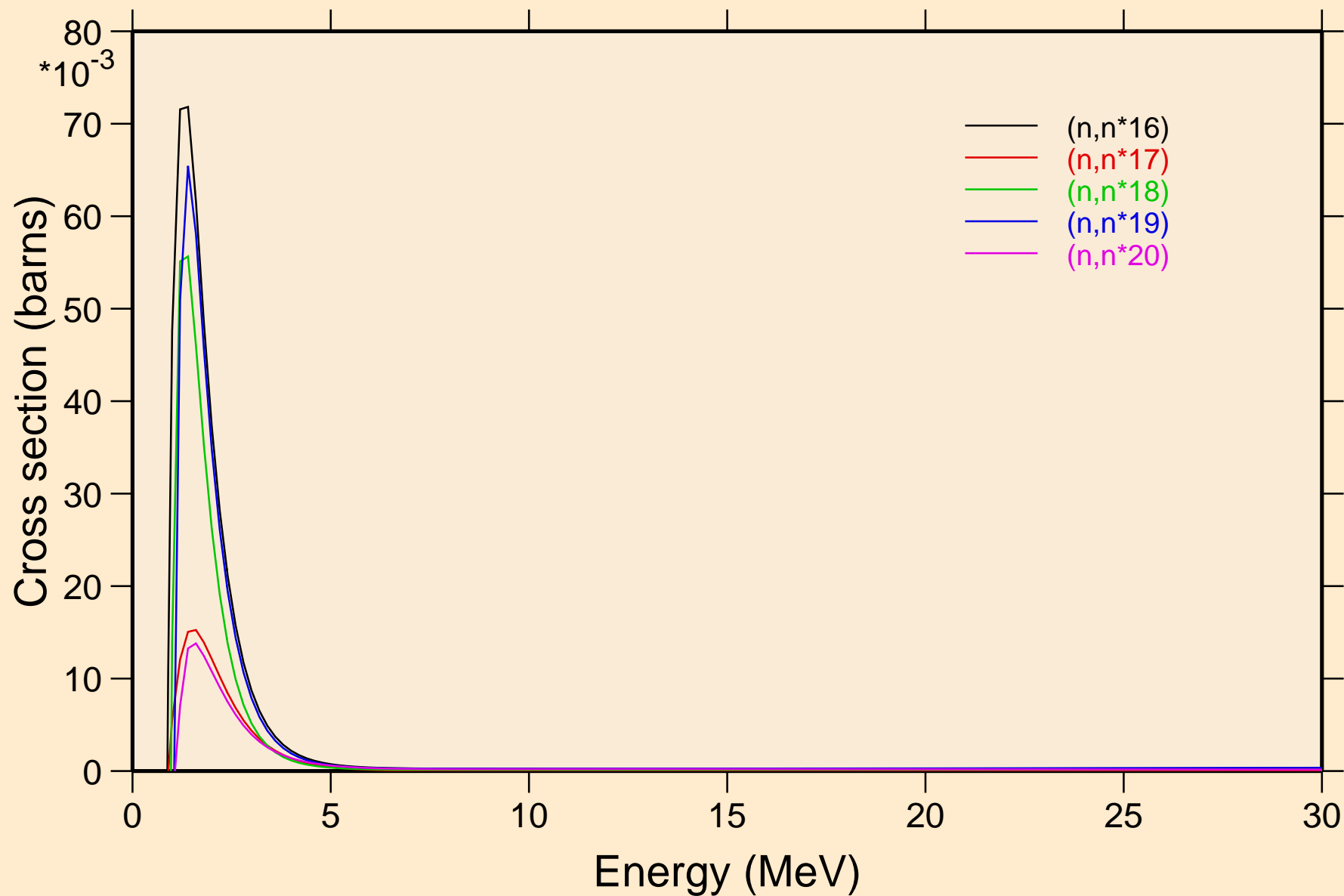

CD115 NEUTRON ACER TENDL-2019 LIBRARY; T=293.16K
Inelastic levels

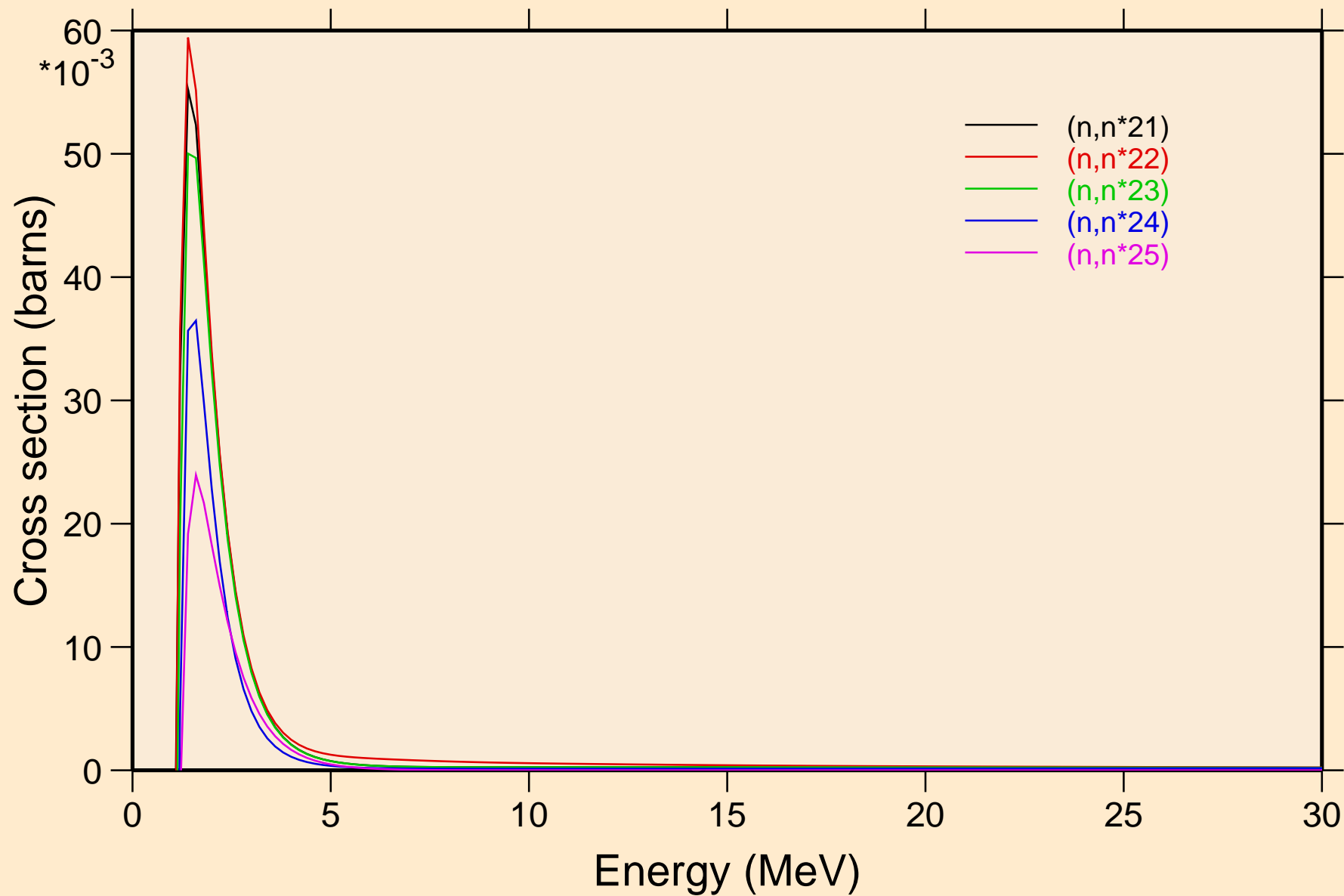

CD115 NEUTRON ACER TENDL-2019 LIBRARY; T=293.16K
Inelastic levels

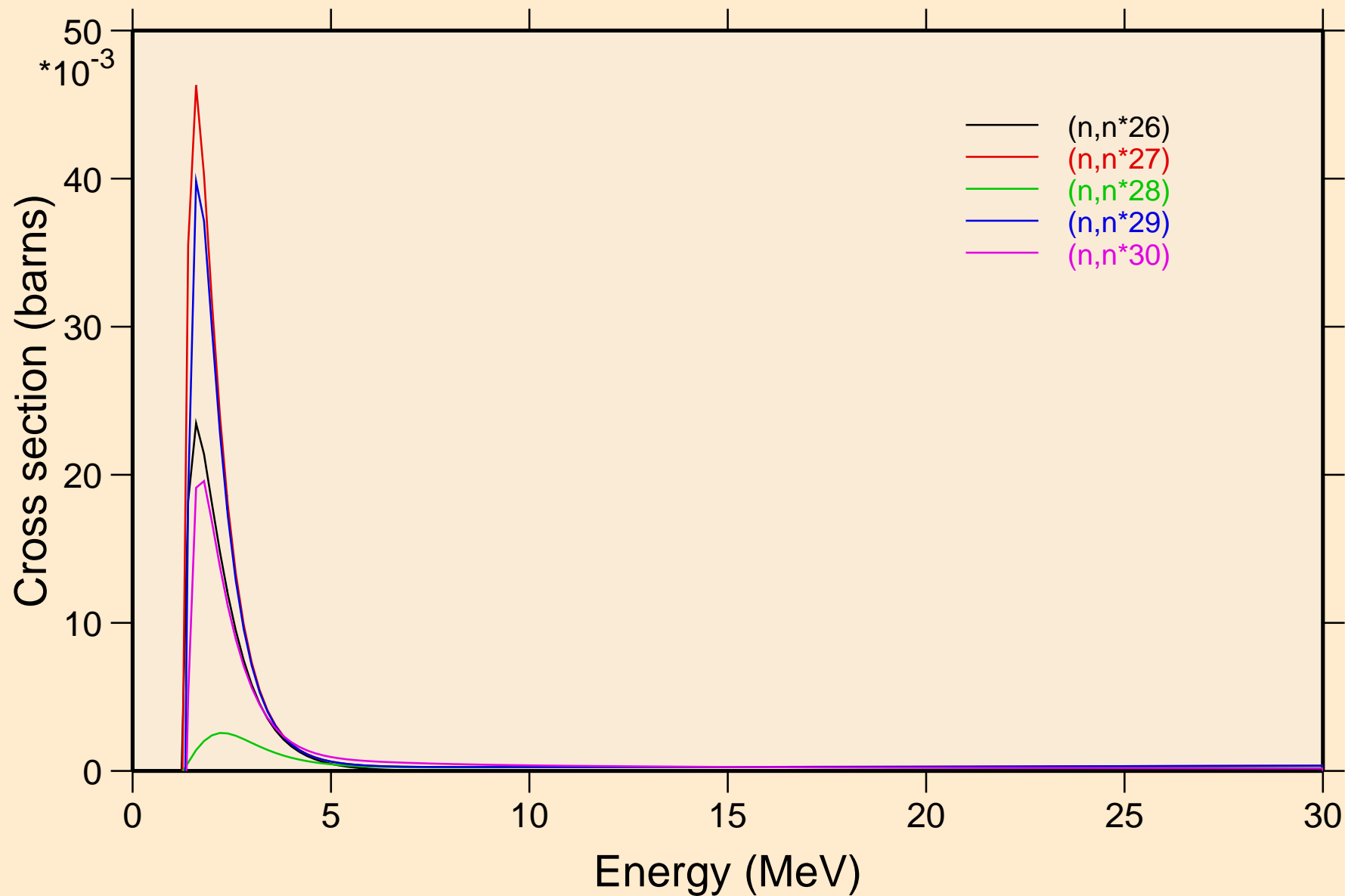

CD115 NEUTRON ACER TENDL-2019 LIBRARY; T=293.16K
Threshold reactions

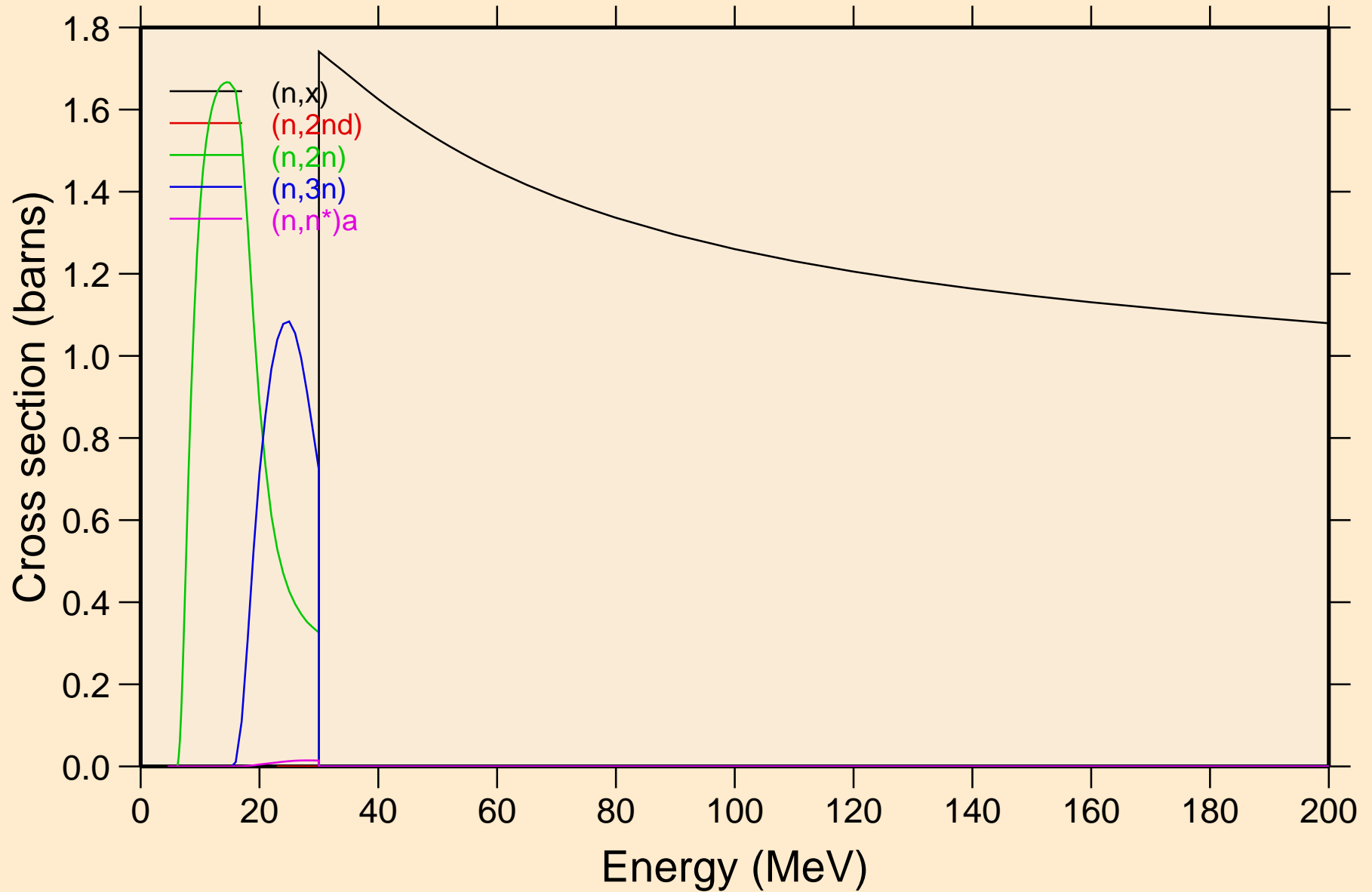

CD115 NEUTRON ACER TENDL-2019 LIBRARY; T=293.16K

Threshold reactions

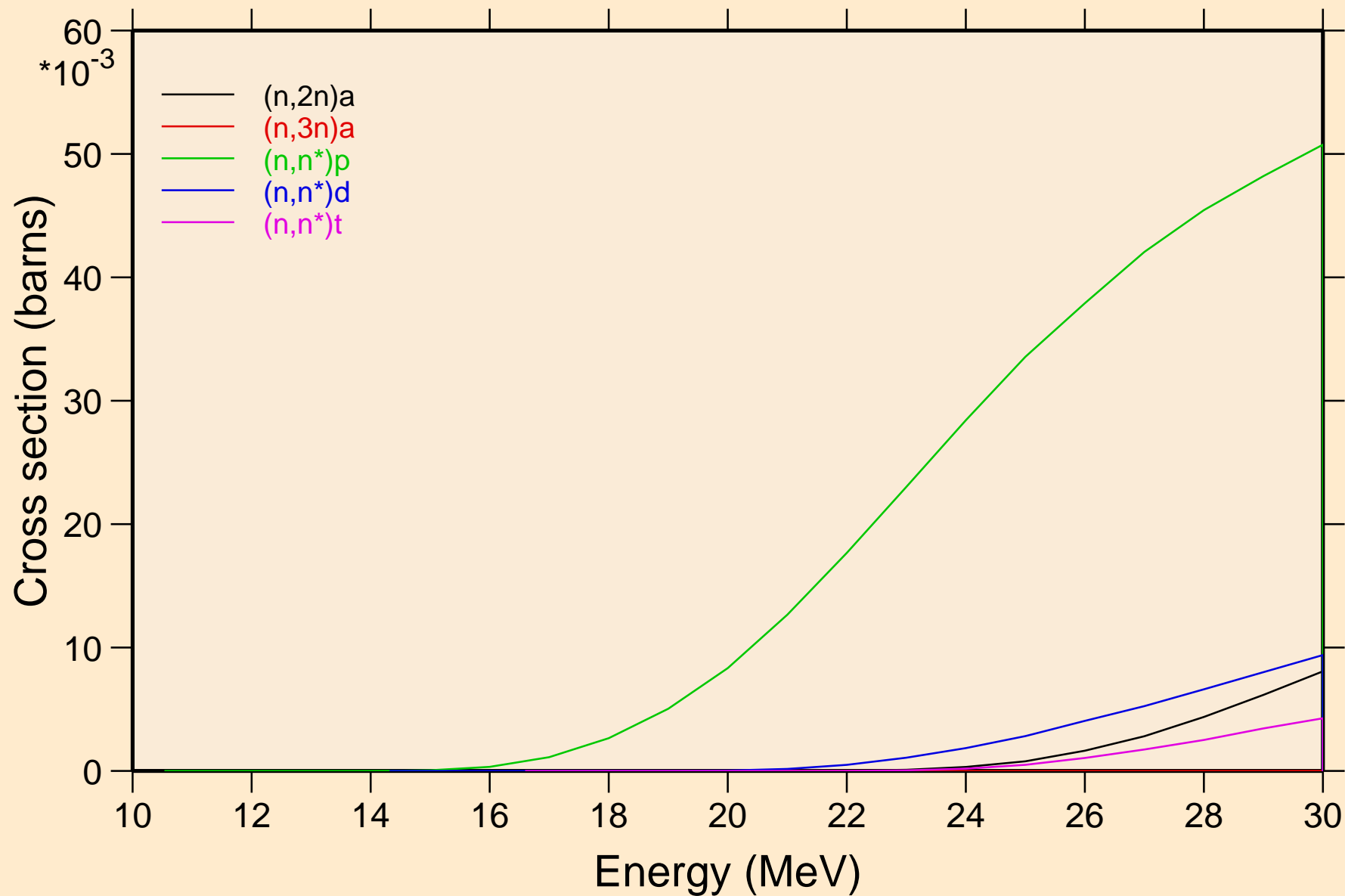

CD115 NEUTRON ACER TENDL-2019 LIBRARY; T=293.16K

Threshold reactions

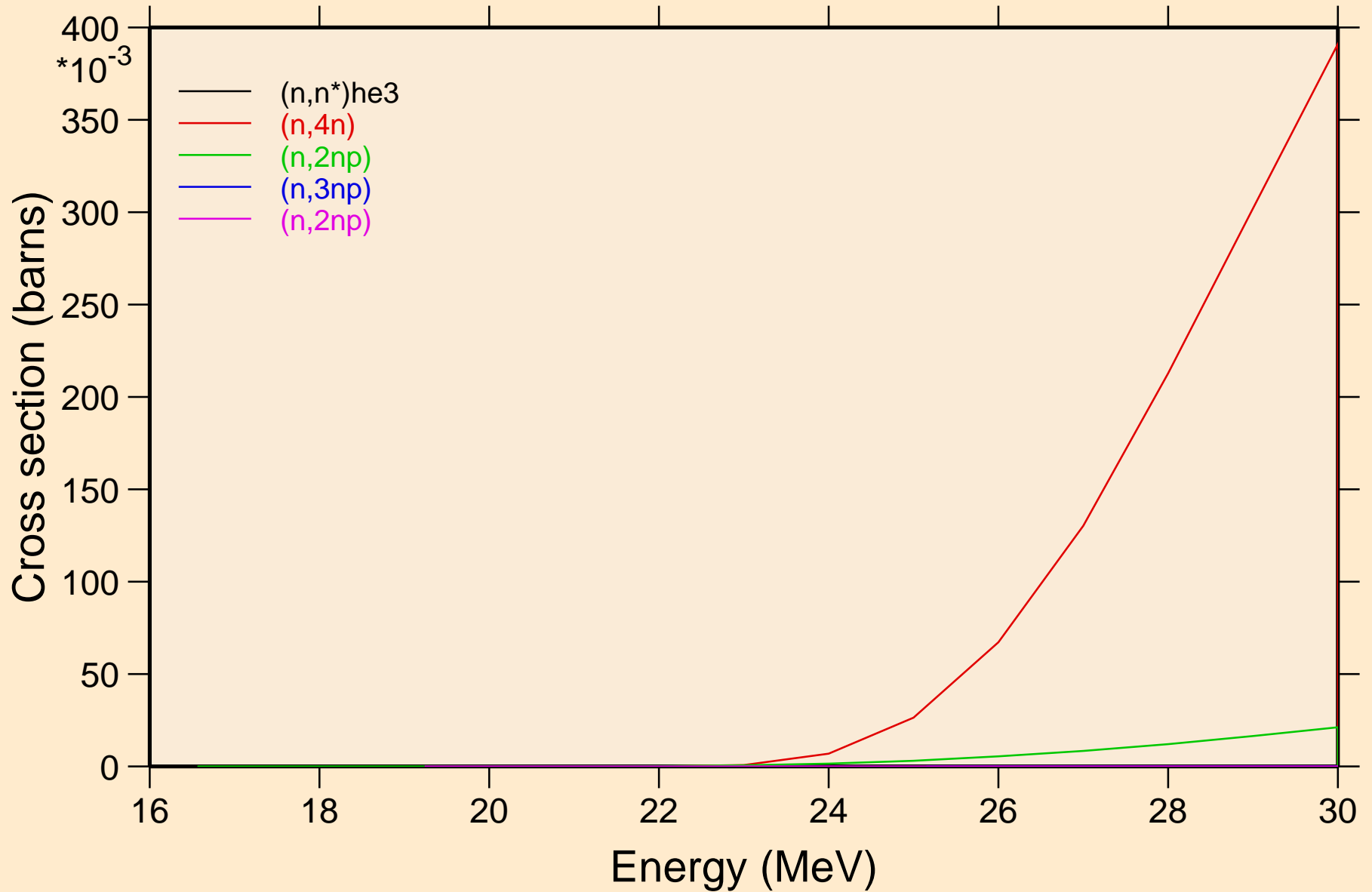

CD115 NEUTRON ACER TENDL-2019 LIBRARY; T=293.16K
Threshold reactions

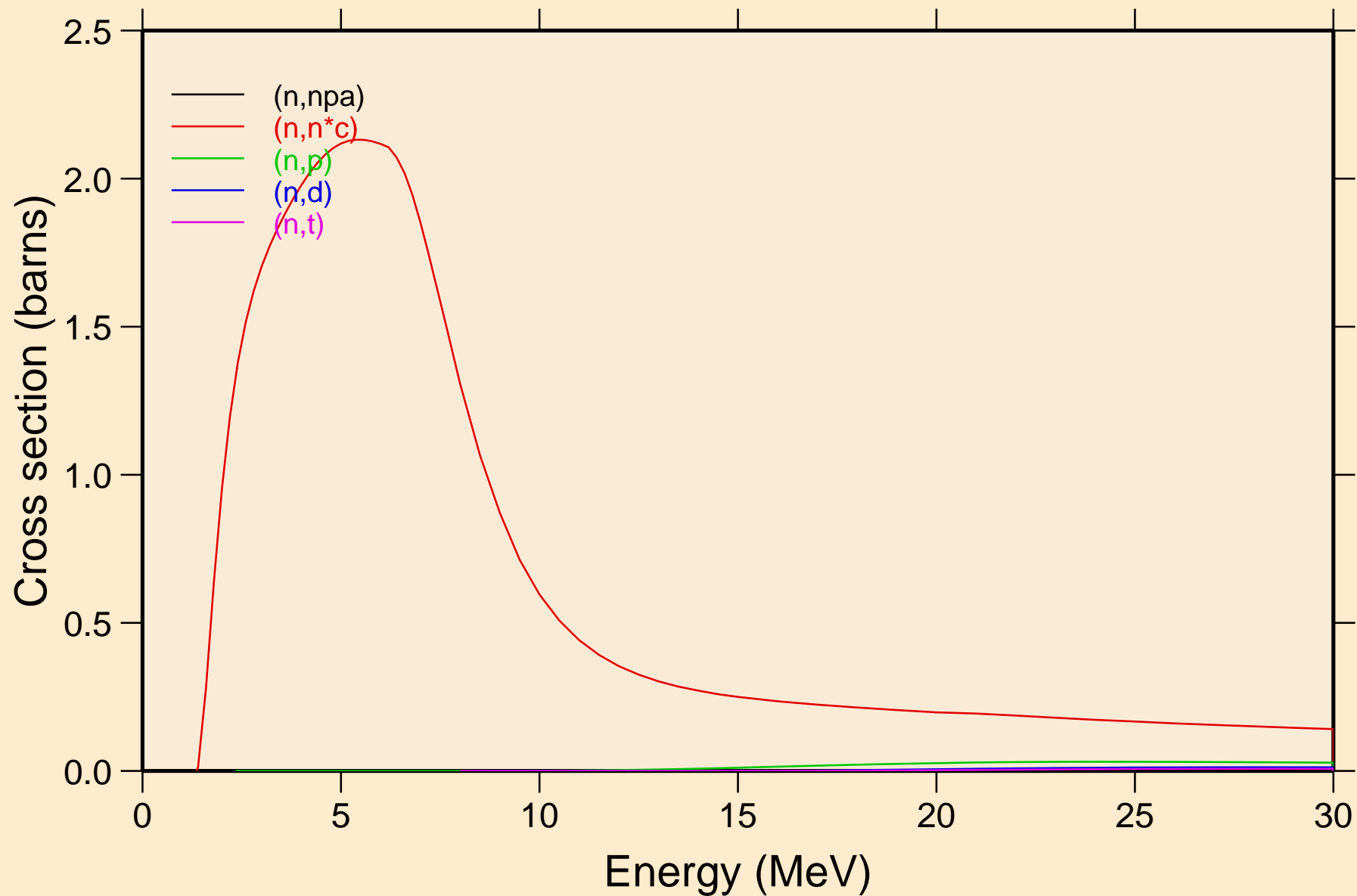

CD115 NEUTRON ACER TENDL-2019 LIBRARY; T=293.16K

Threshold reactions

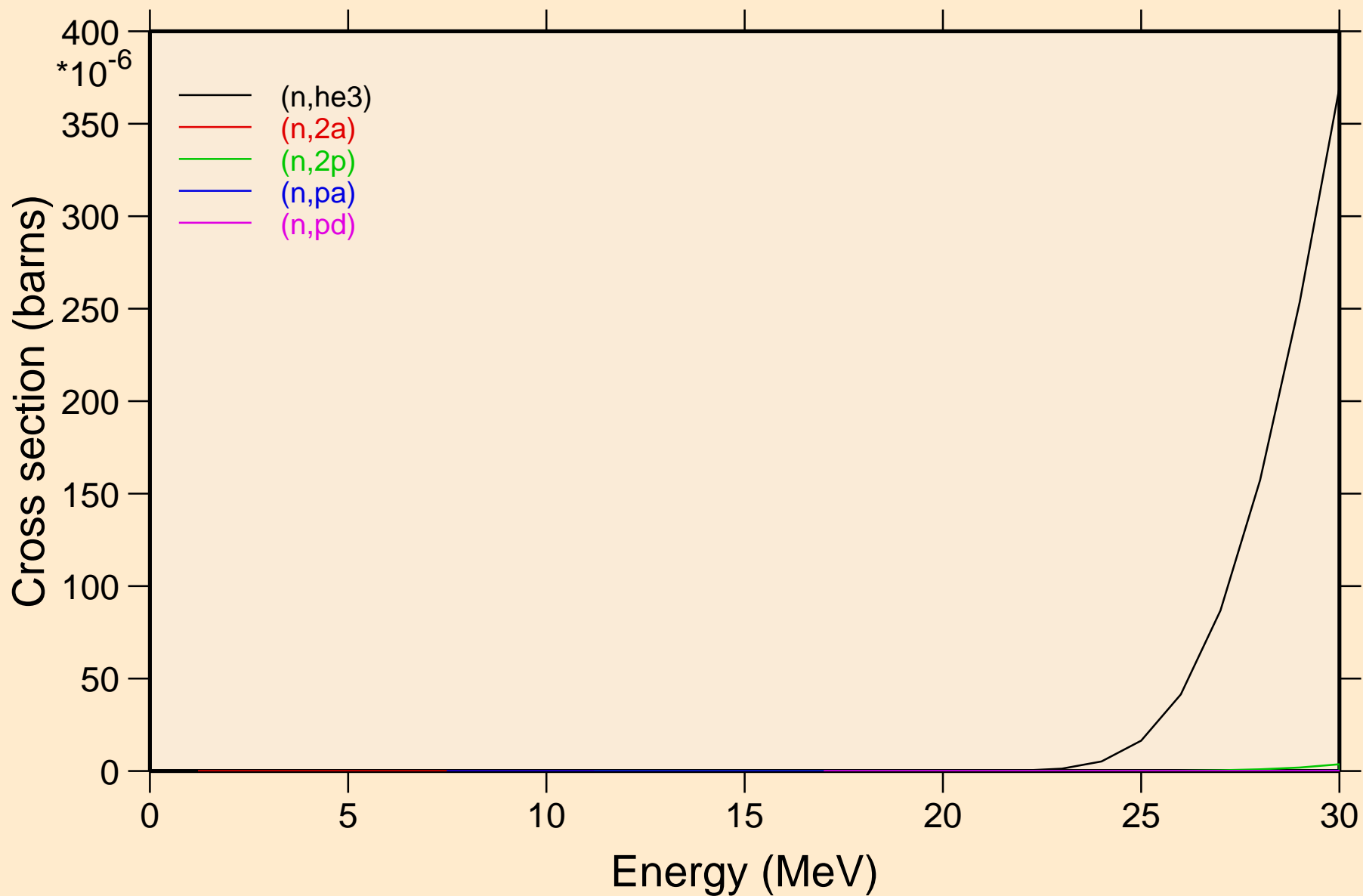

CD115 NEUTRON ACER TENDL-2019 LIBRARY; T=293.16K
Threshold reactions

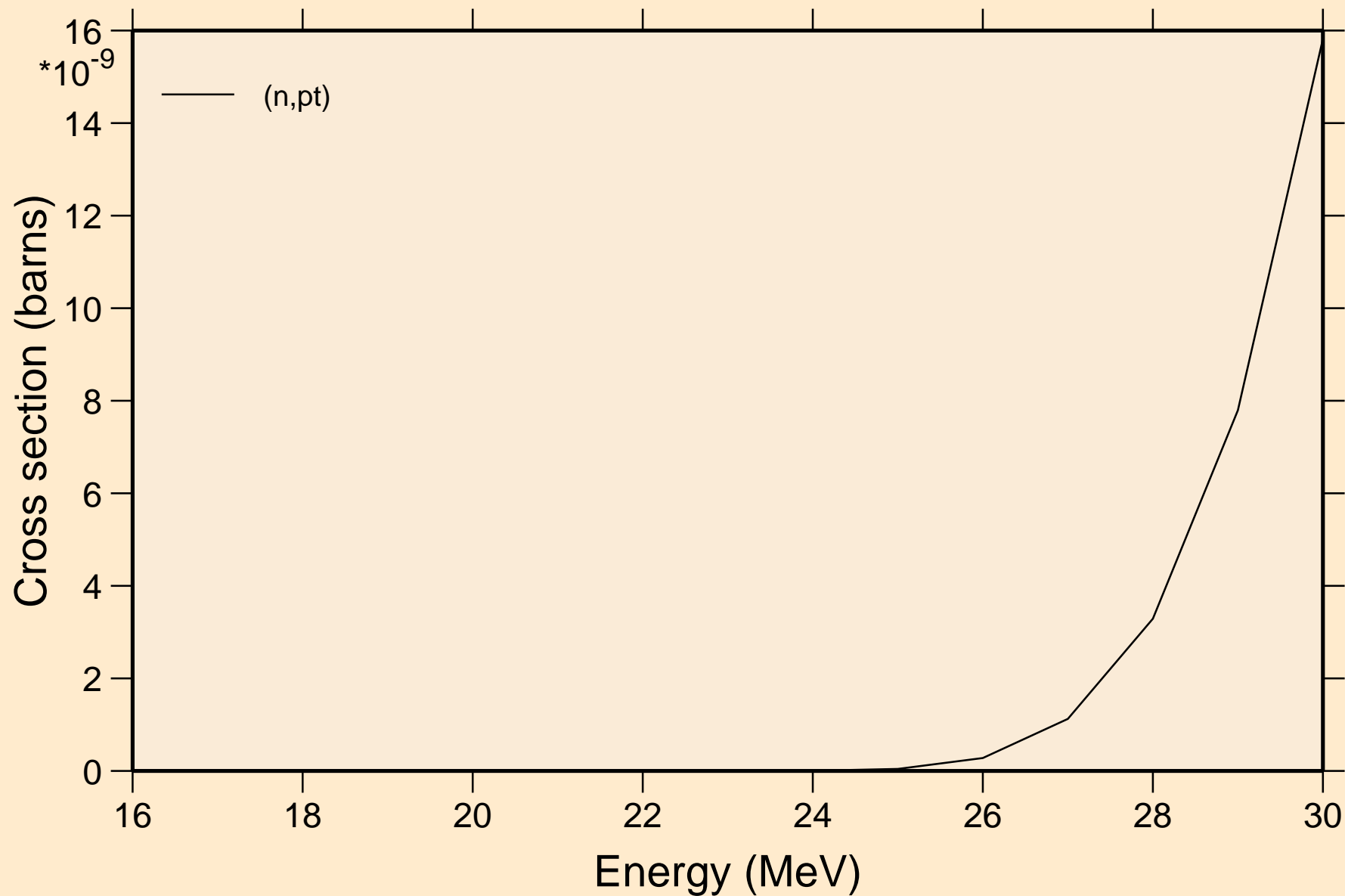

CD115 NEUTRON ACER TENDL-2019 LIBRARY; T=293.16K
Threshold reactions

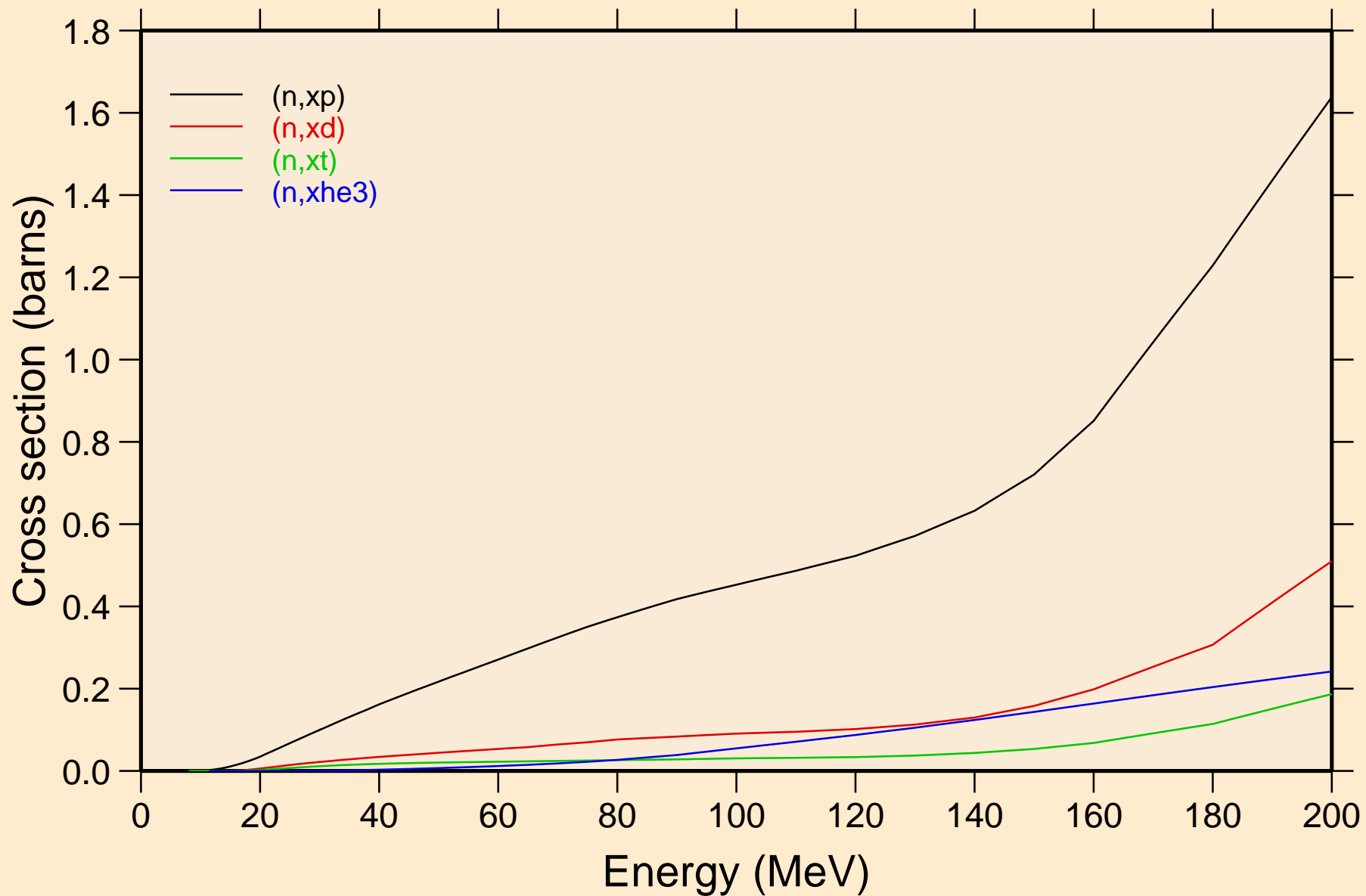

CD115 NEUTRON ACER TENDL-2019 LIBRARY; T=293.16K
angular distribution for elastic

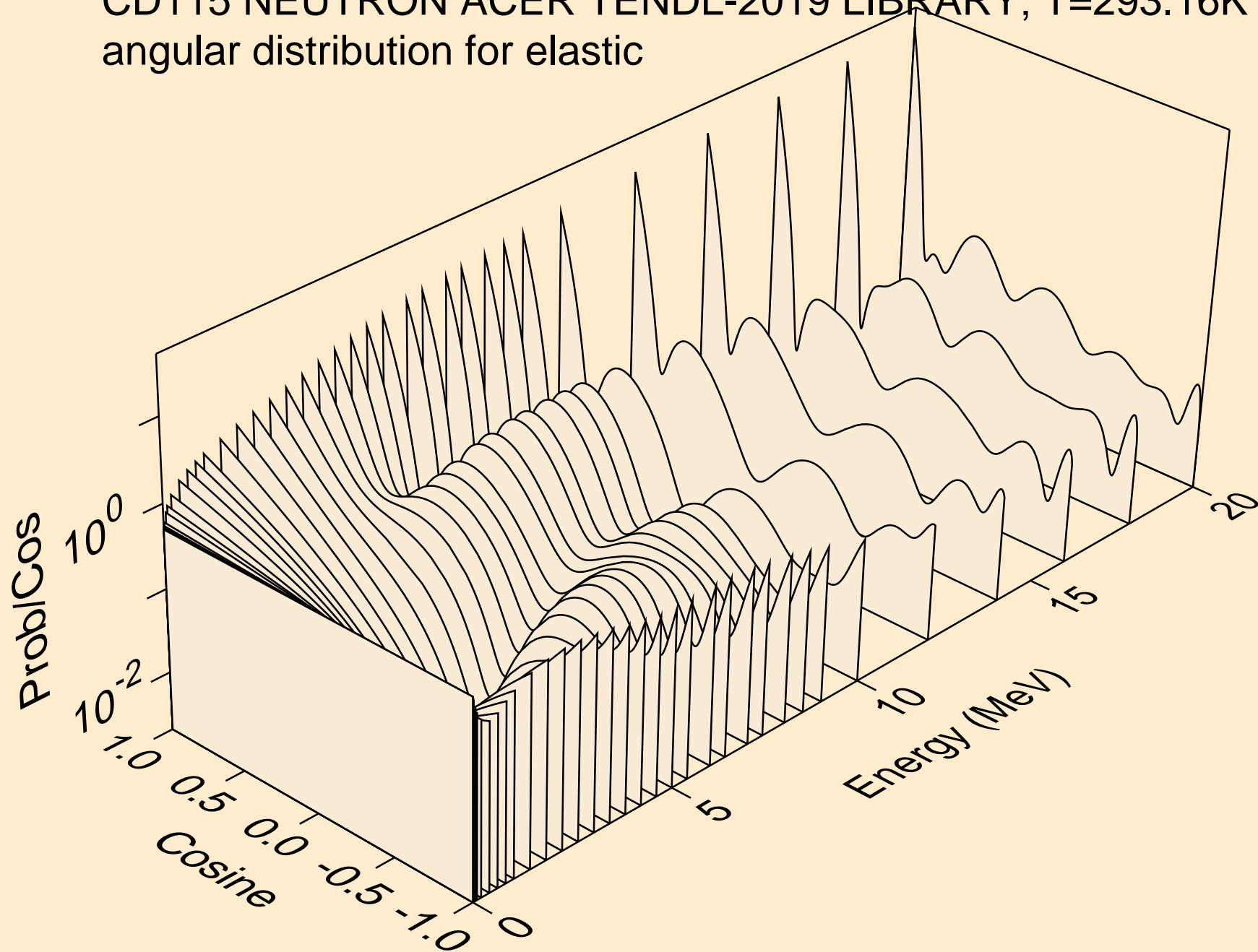

CD115 NEUTRON ACER TENDL-2019 LIBRARY; T=293.16K
angular distribution for elastic

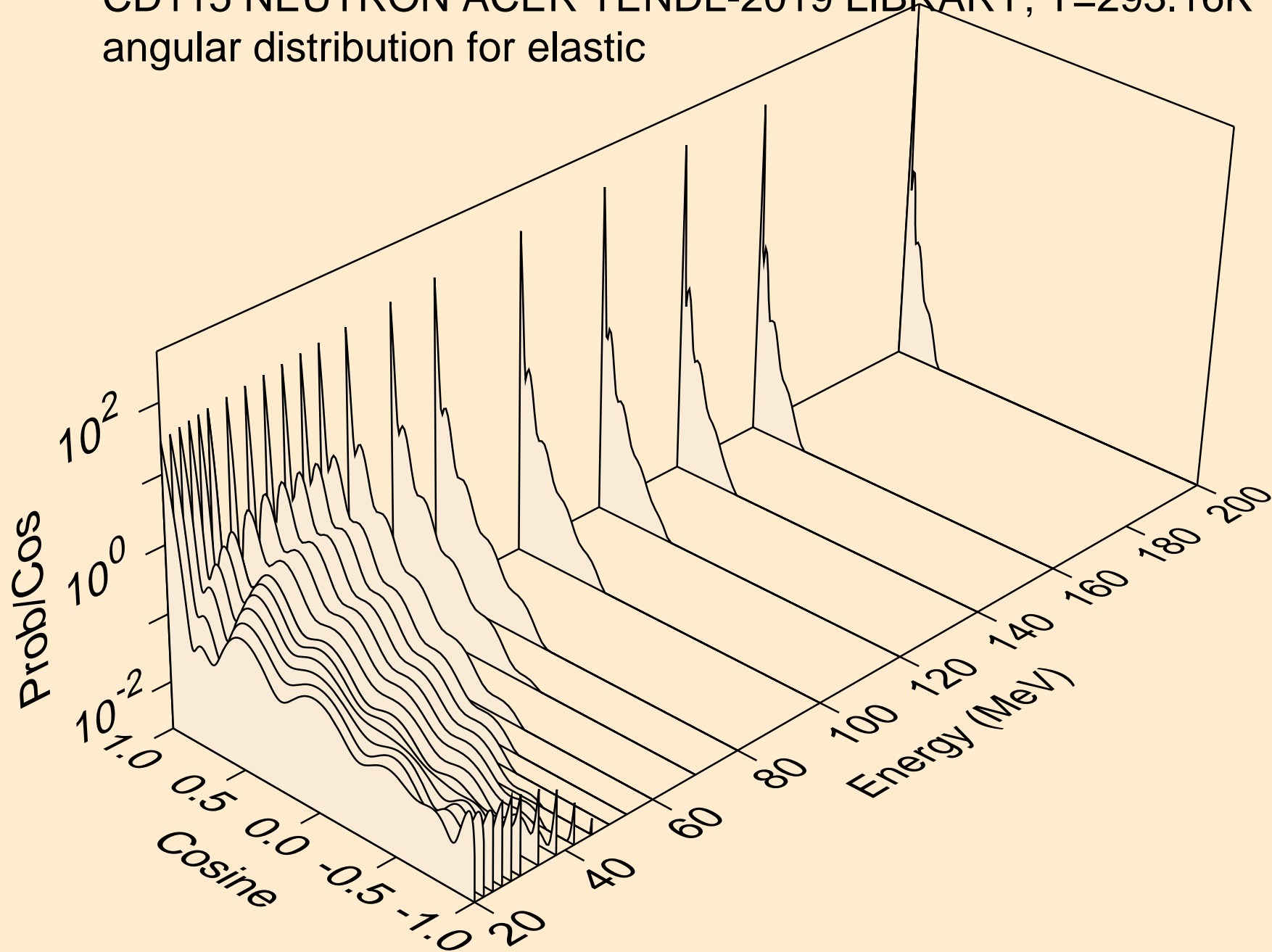

CD115 NEUTRON ACER TENDL-2019 LIBRARY; T=293.16K
angular distribution for (n,n*1)

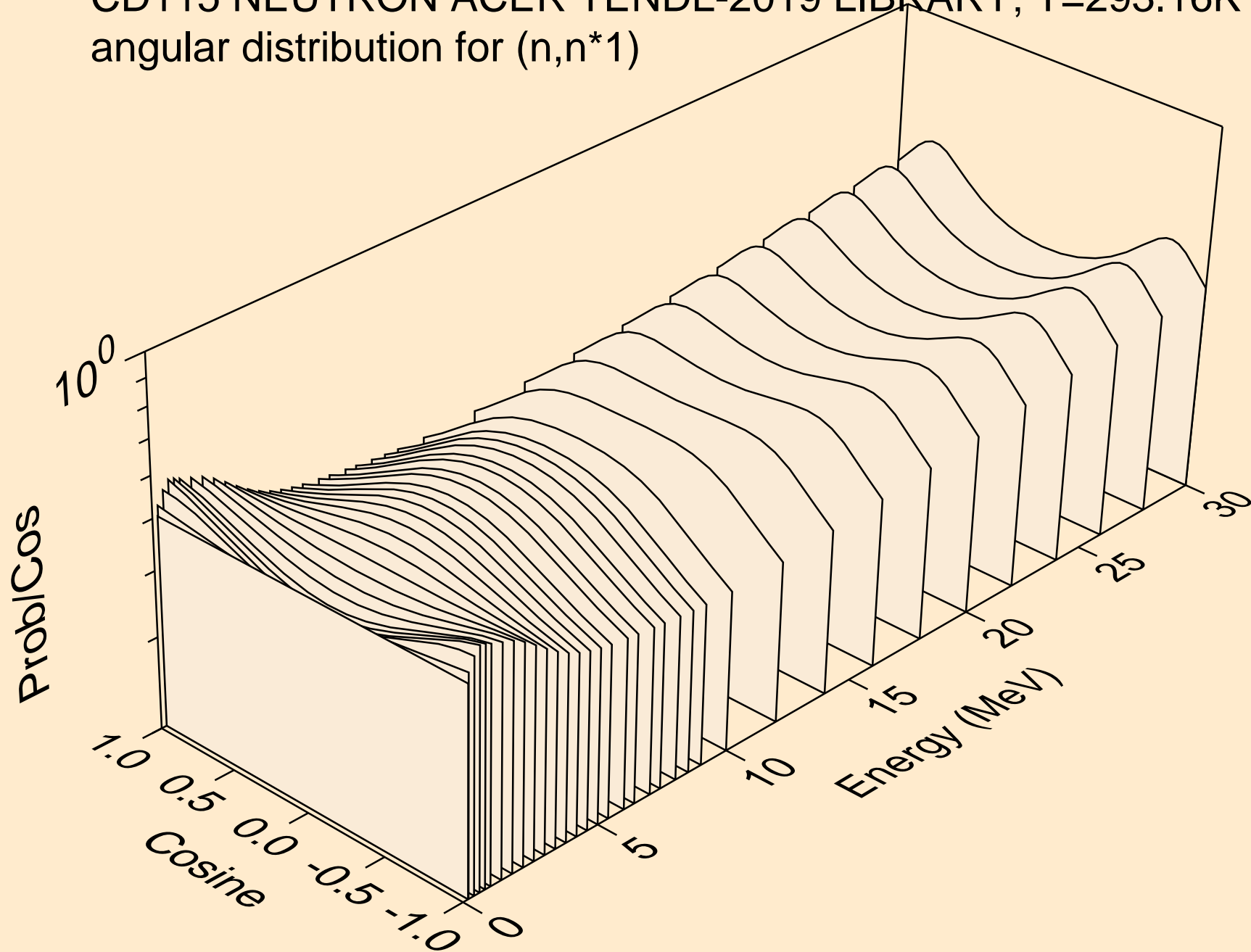

CD115 NEUTRON ACER TENDL-2019 LIBRARY; T=293.16K
angular distribution for (n,n*2)

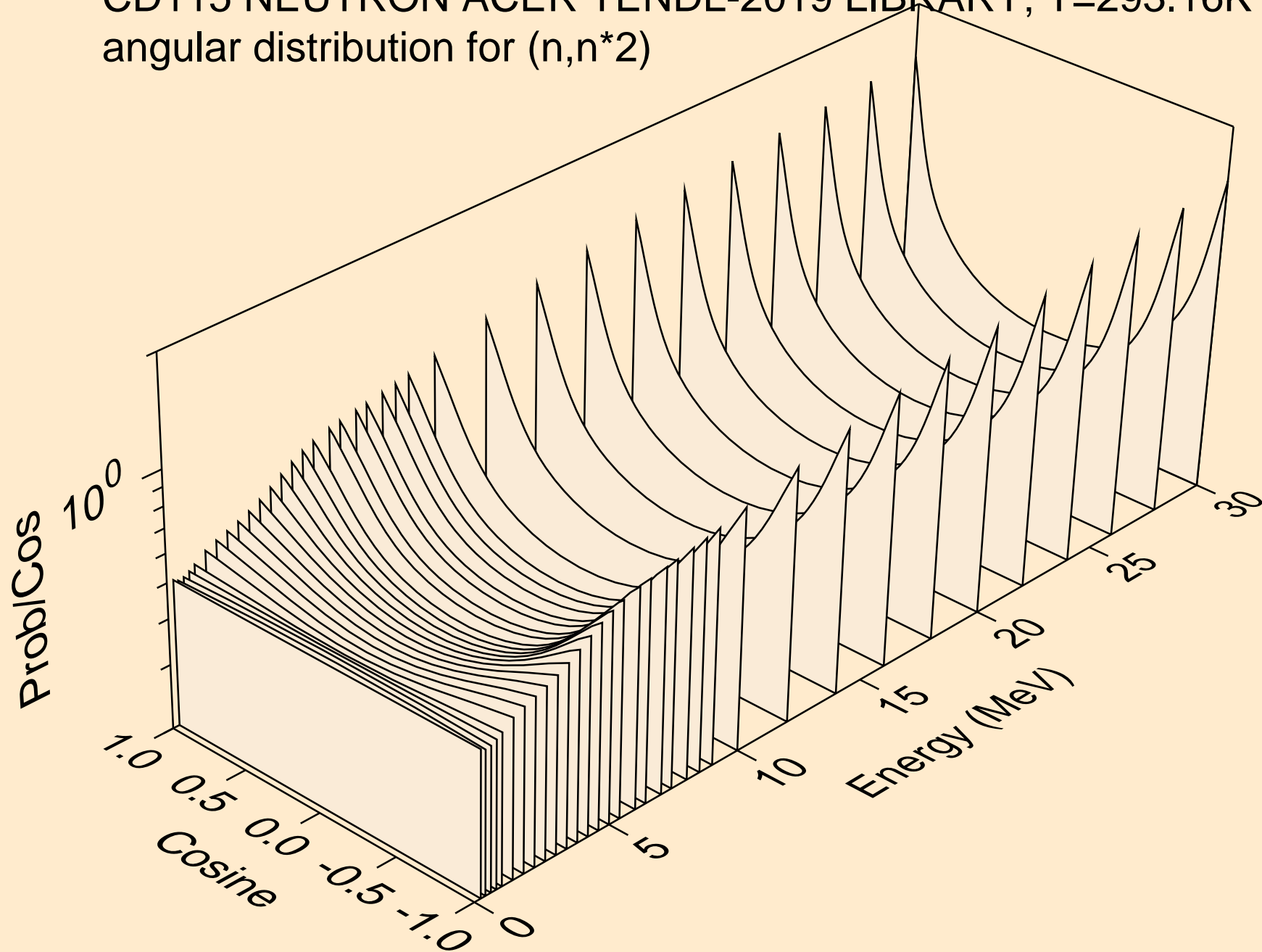

CD115 NEUTRON ACER TENDL-2019 LIBRARY; T=293.16K
angular distribution for (n,n*3)

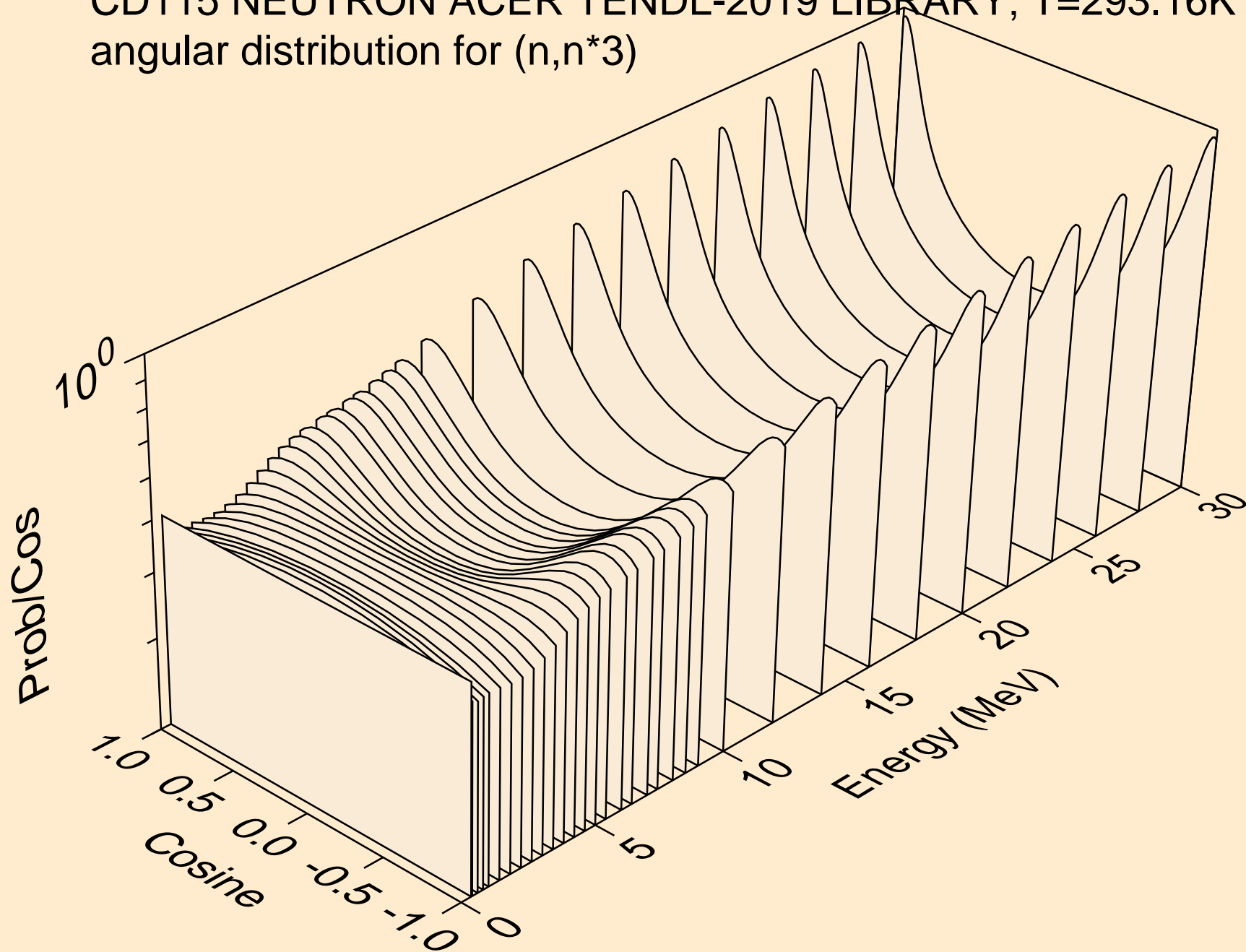

CD115 NEUTRON ACER TENDL-2019 LIBRARY; T=293.16K
angular distribution for (n,n*4)

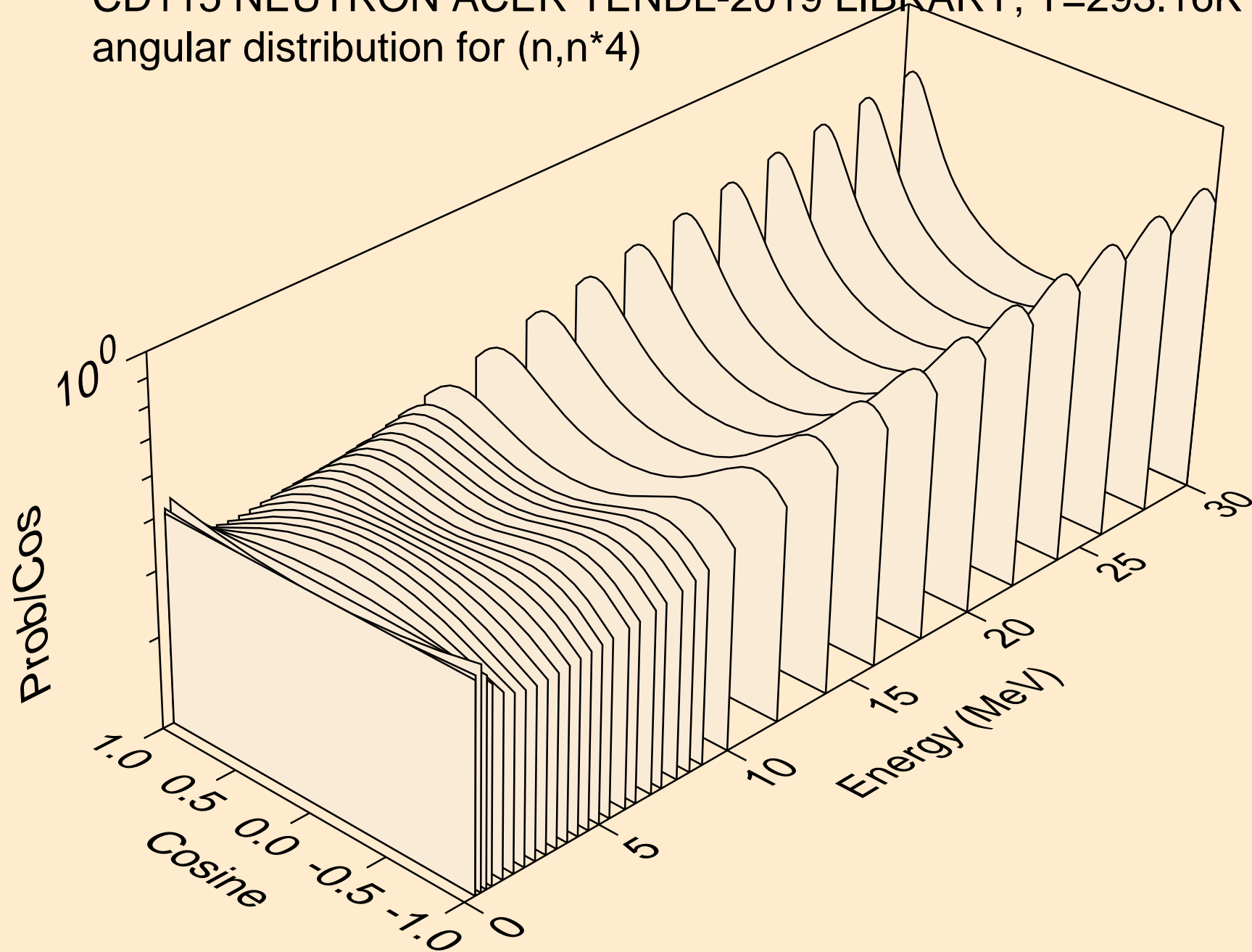

CD115 NEUTRON ACER TENDL-2019 LIBRARY; T=293.16K
angular distribution for (n,n*5)

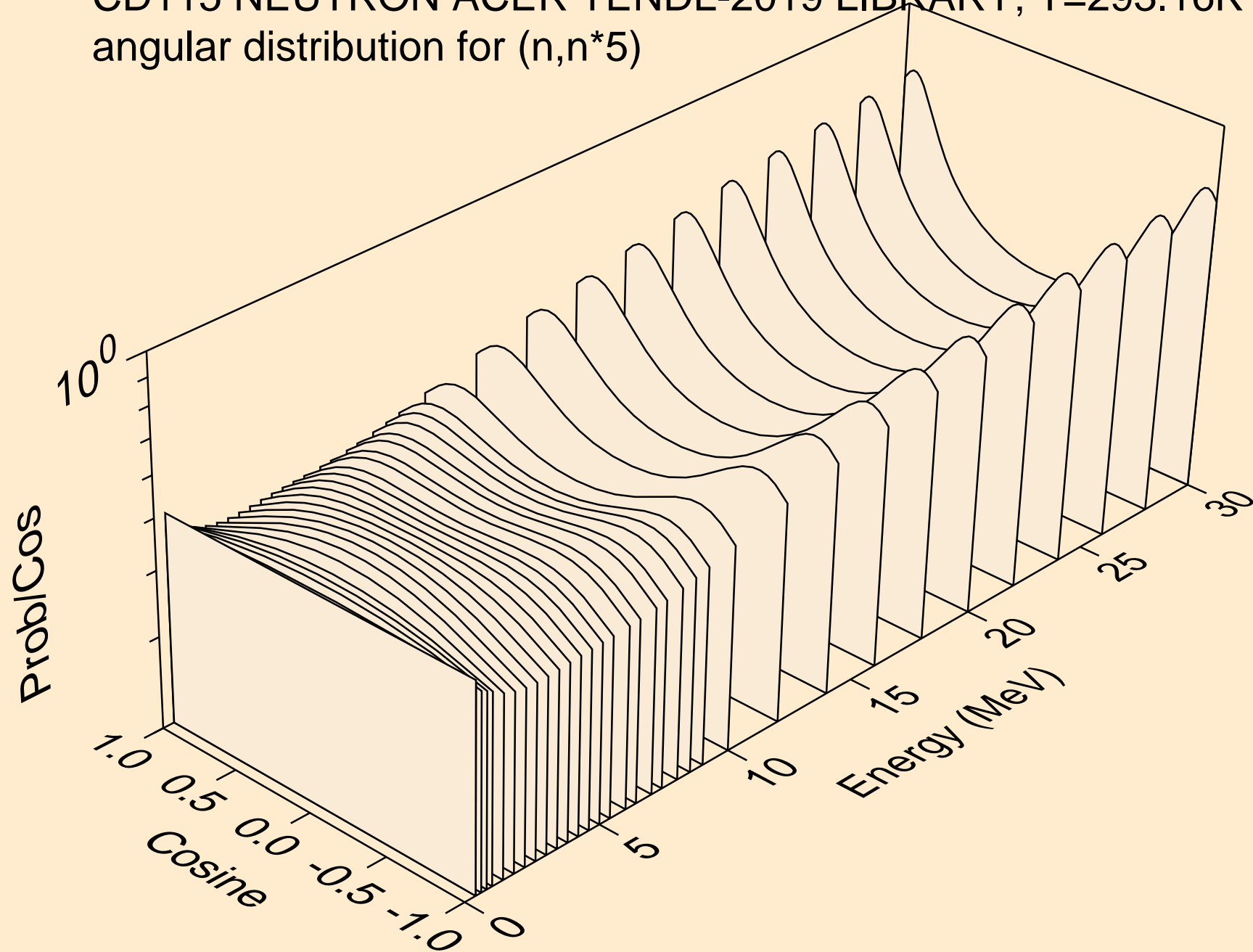

CD115 NEUTRON ACER TENDL-2019 LIBRARY; T=293.16K
angular distribution for (n,n*6)

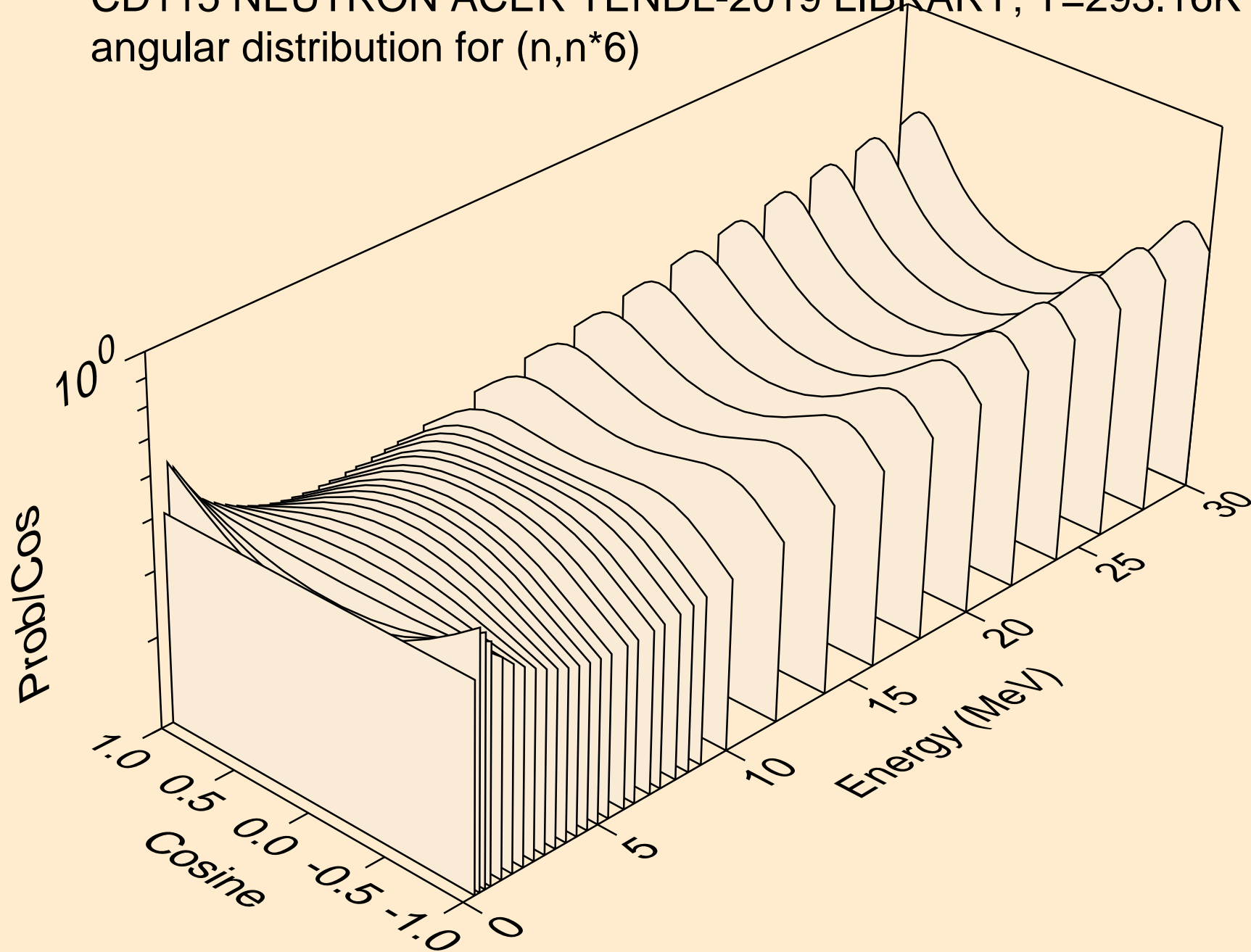

CD115 NEUTRON ACER TENDL-2019 LIBRARY; T=293.16K
angular distribution for (n,n*7)

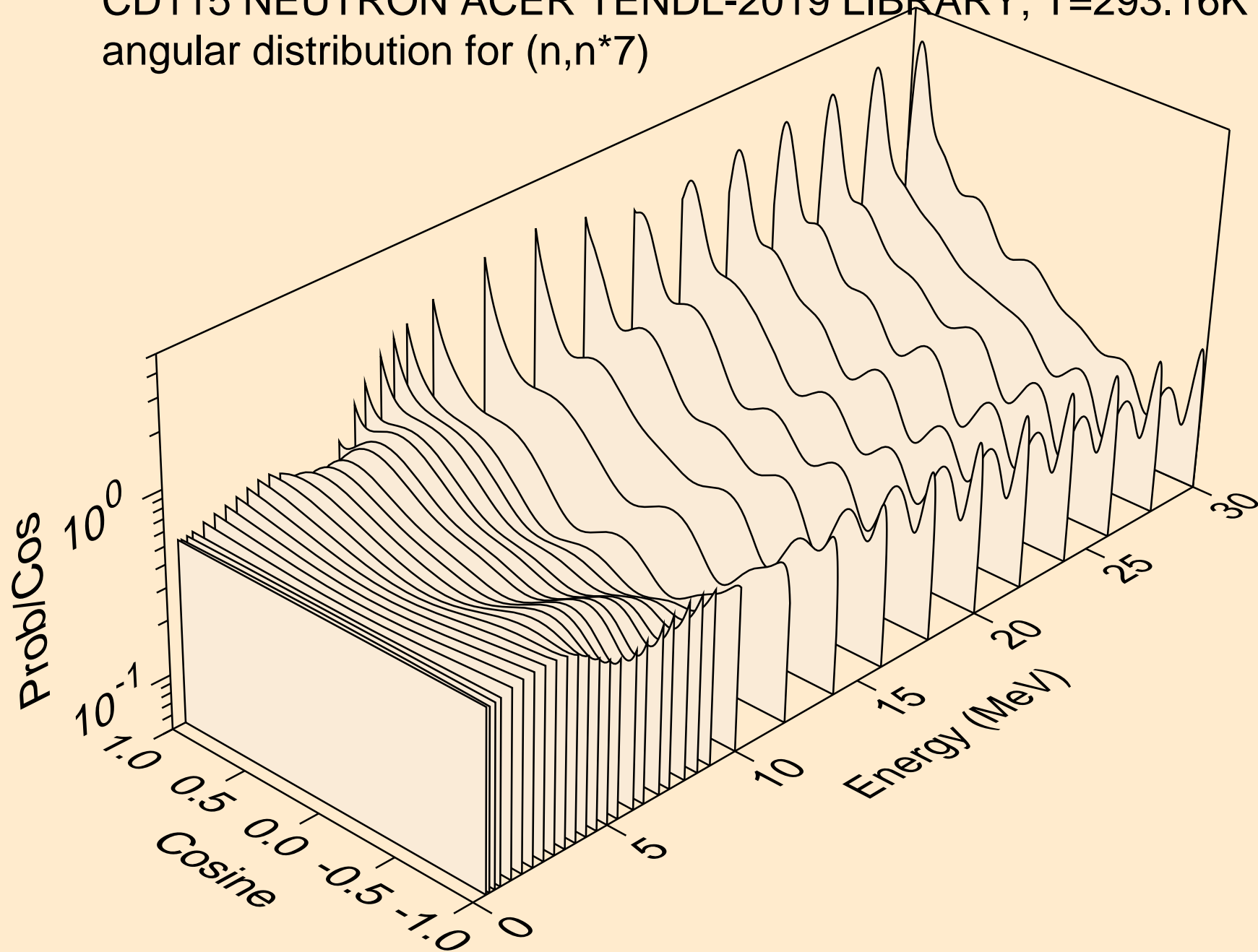

CD115 NEUTRON ACER TENDL-2019 LIBRARY; T=293.16K
angular distribution for (n,n*8)

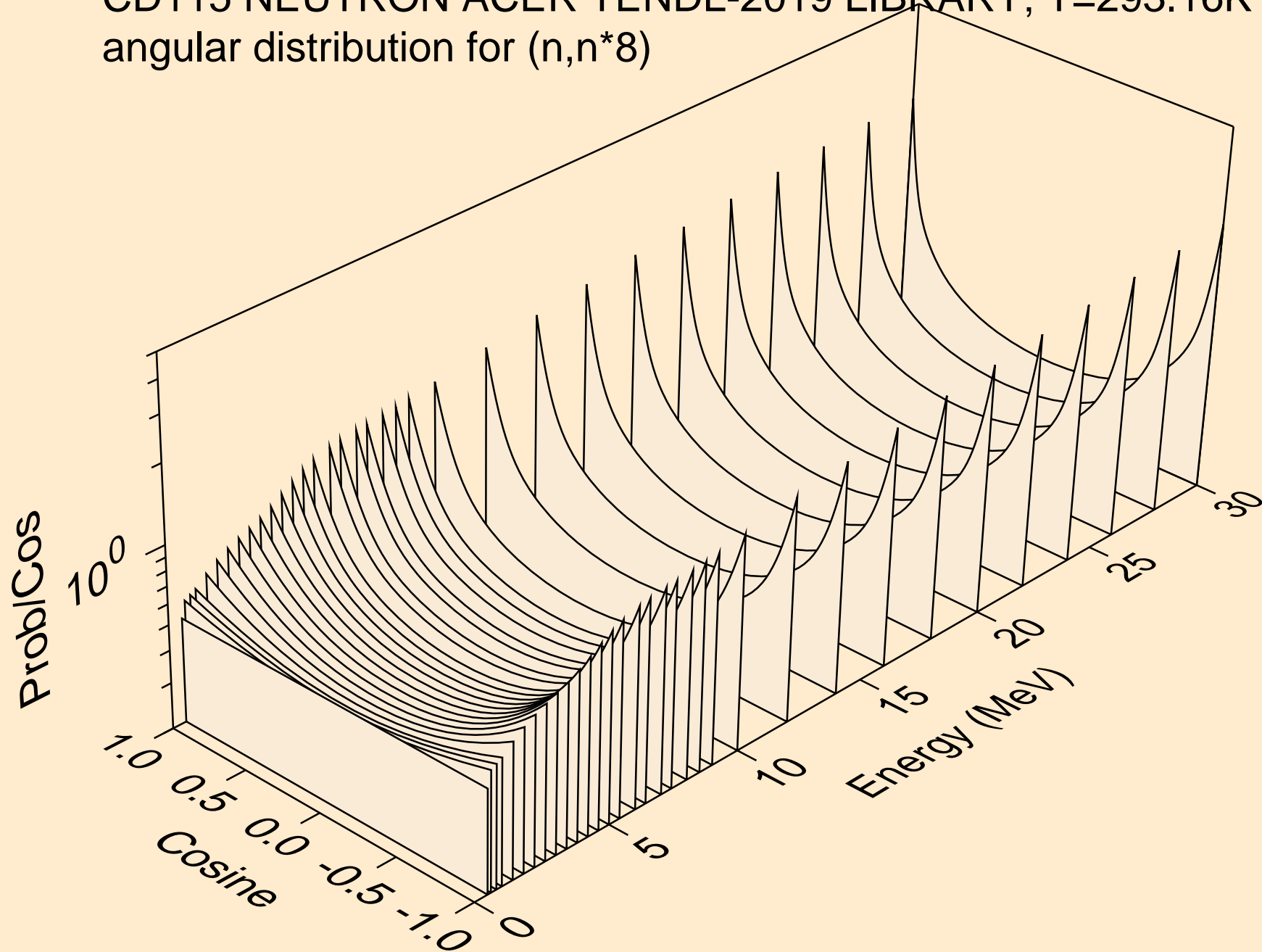

CD115 NEUTRON ACER TENDL-2019 LIBRARY; T=293.16K
angular distribution for (n,n*9)

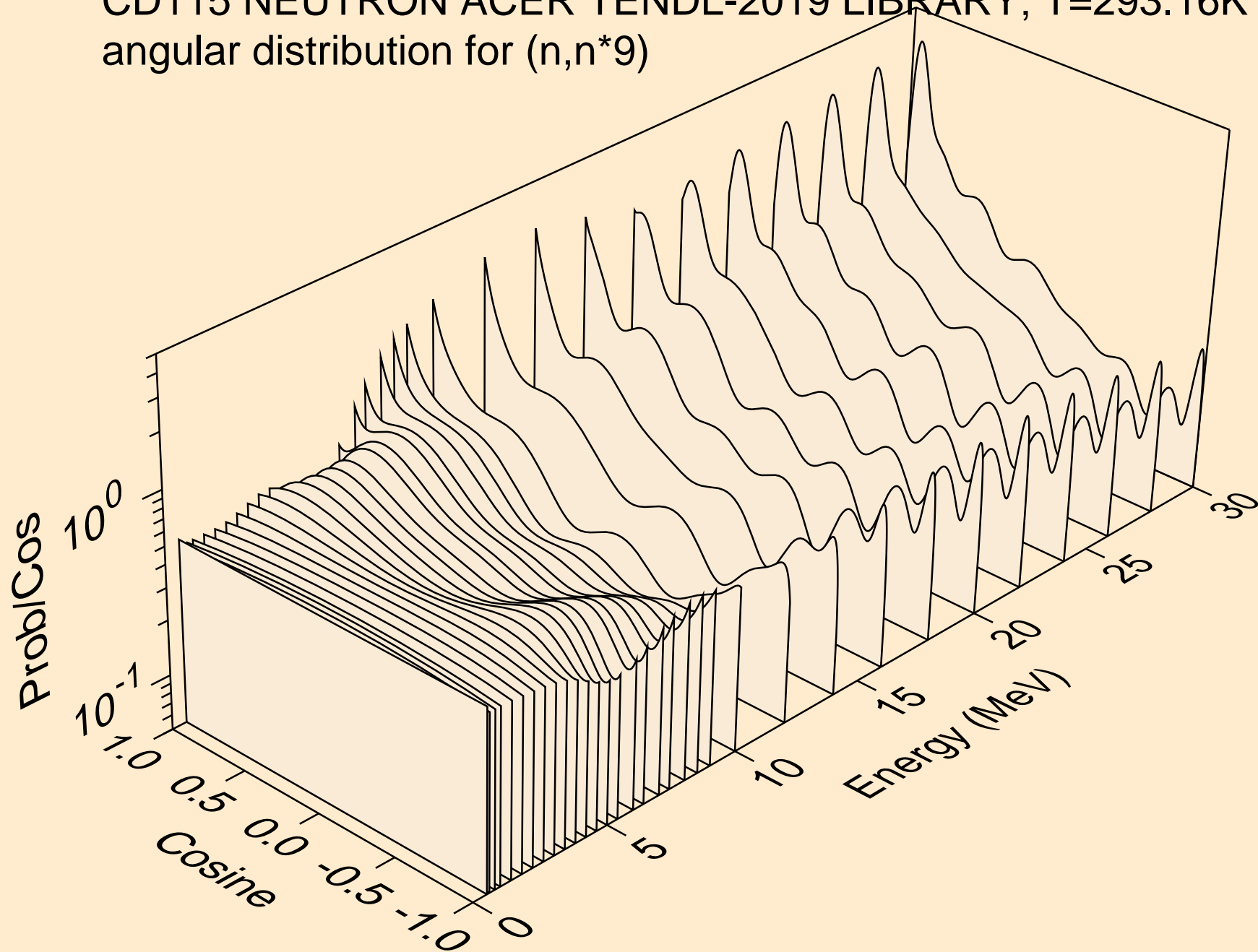

CD115 NEUTRON ACER TENDL-2019 LIBRARY; T=293.16K
angular distribution for (n,n*10)

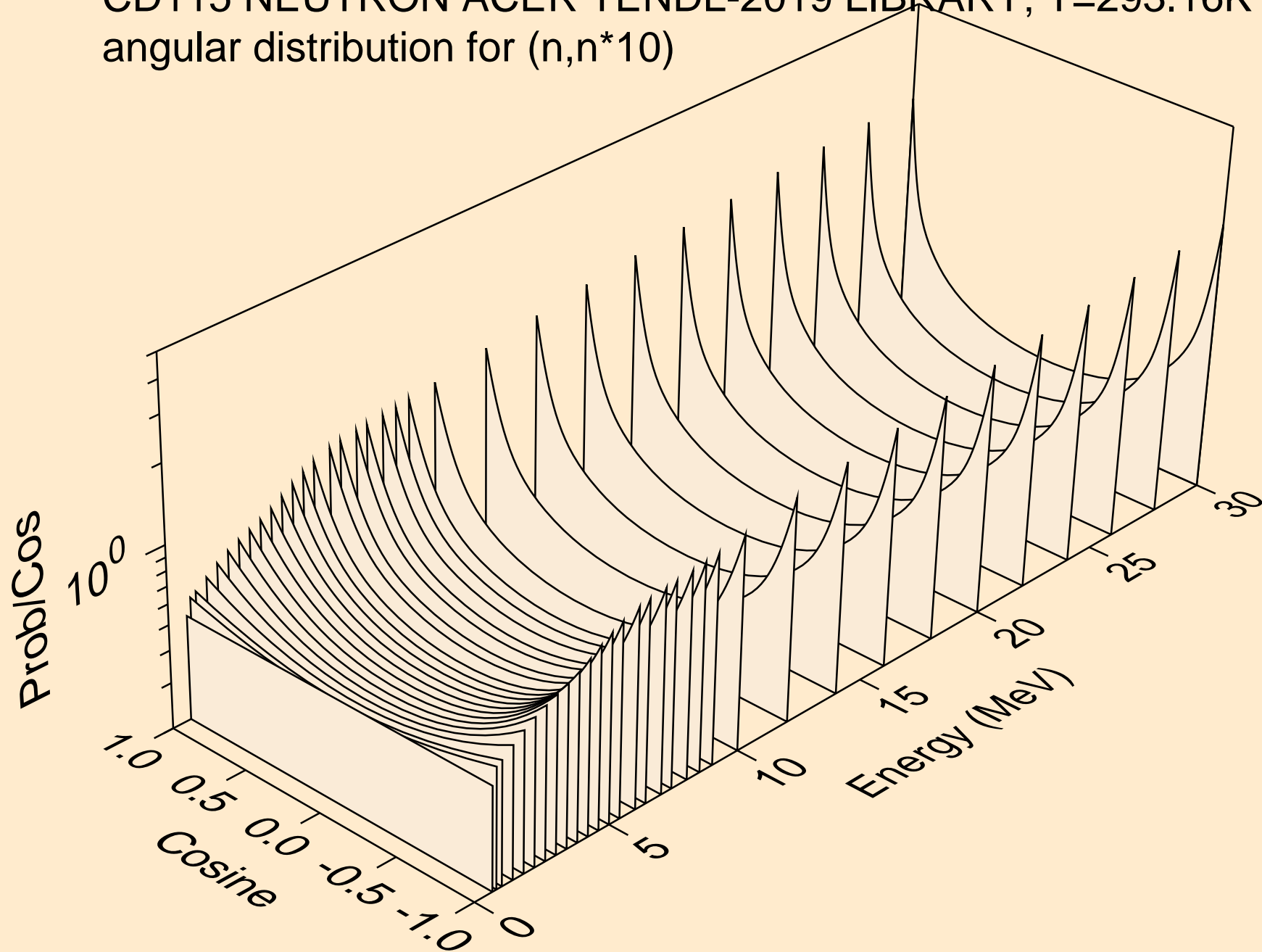

CD115 NEUTRON ACER TENDL-2019 LIBRARY; T=293.16K
angular distribution for (n,n*11)

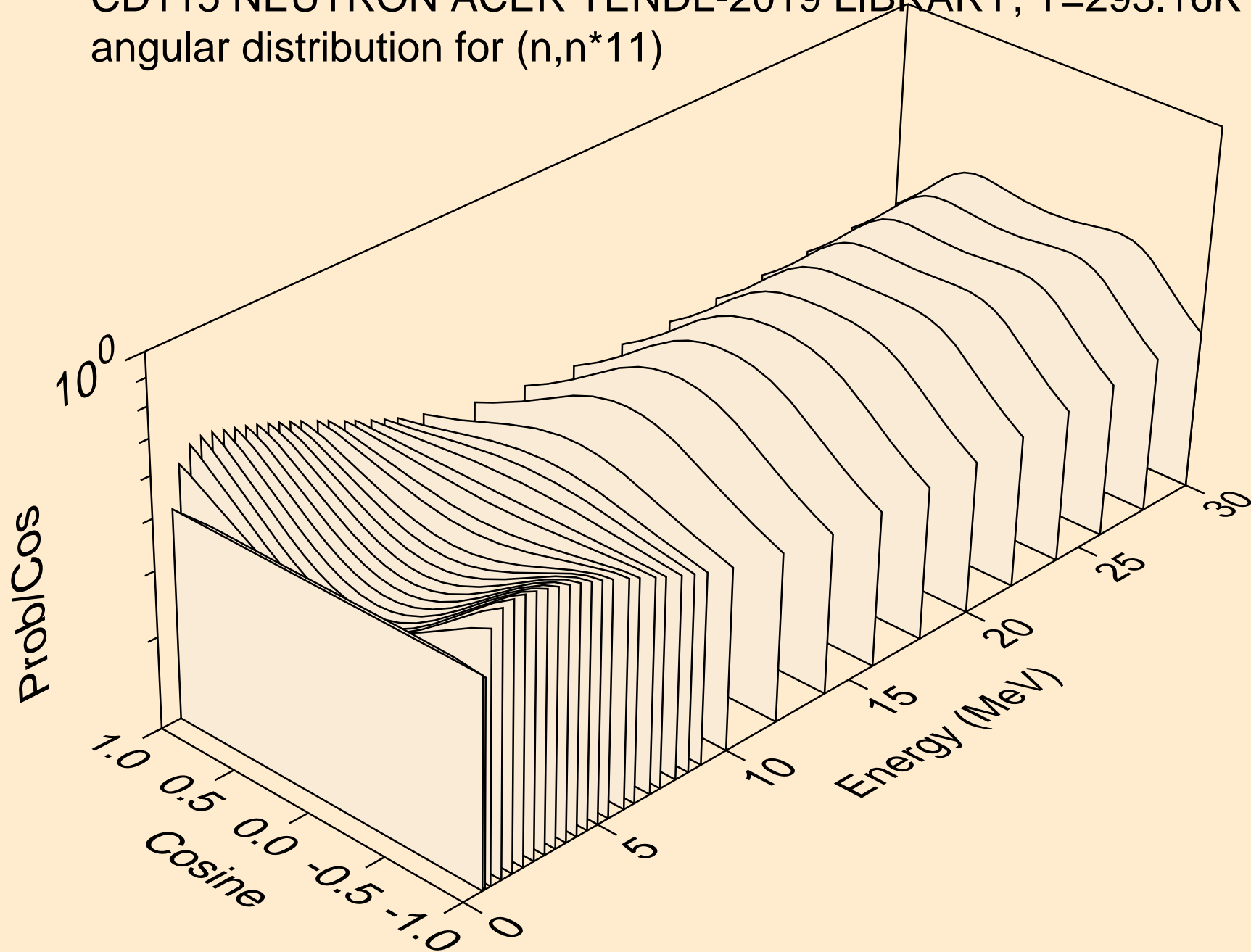

CD115 NEUTRON ACER TENDL-2019 LIBRARY; T=293.16K
angular distribution for (n,n*12)

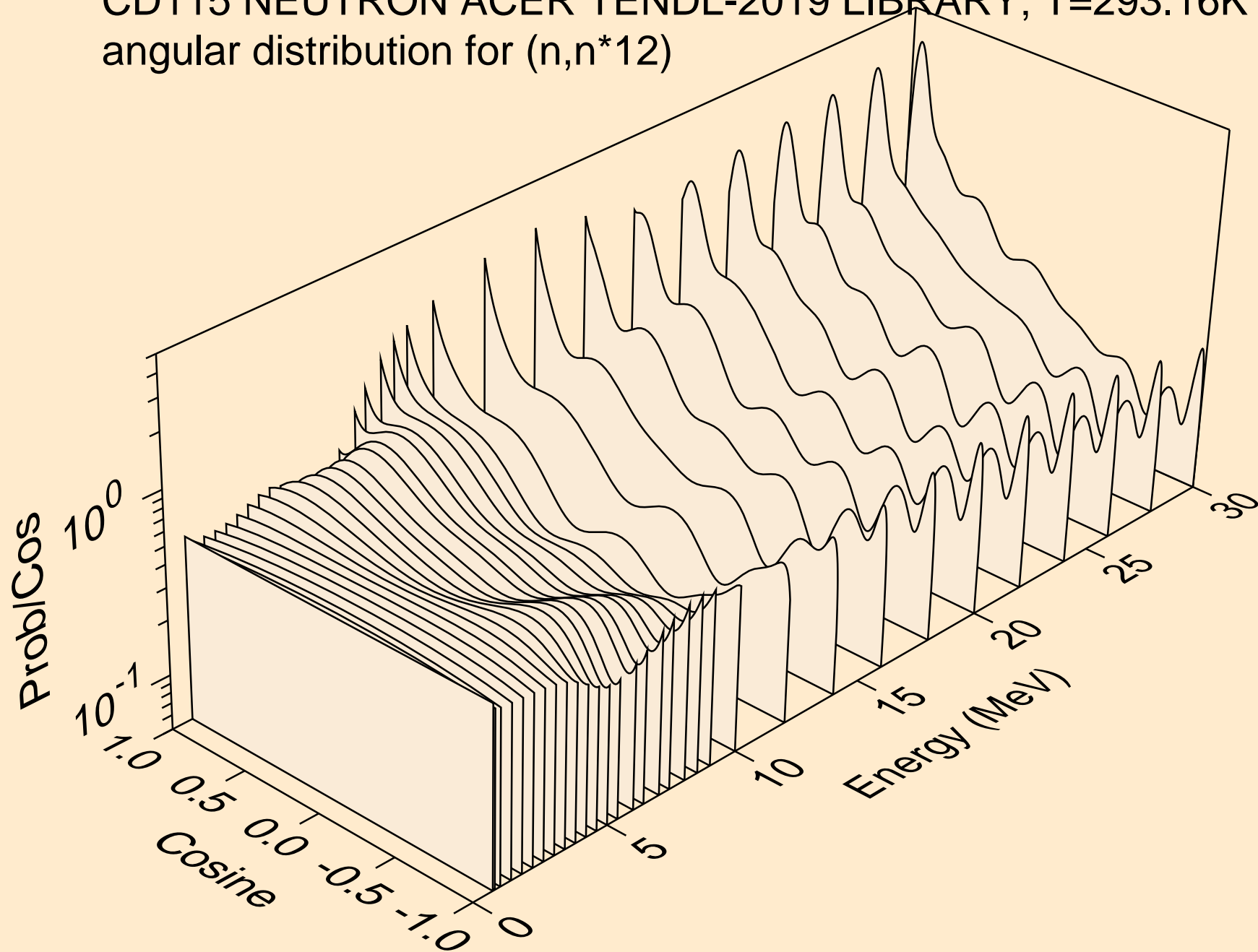

CD115 NEUTRON ACER TENDL-2019 LIBRARY; T=293.16K
angular distribution for (n,n*13)

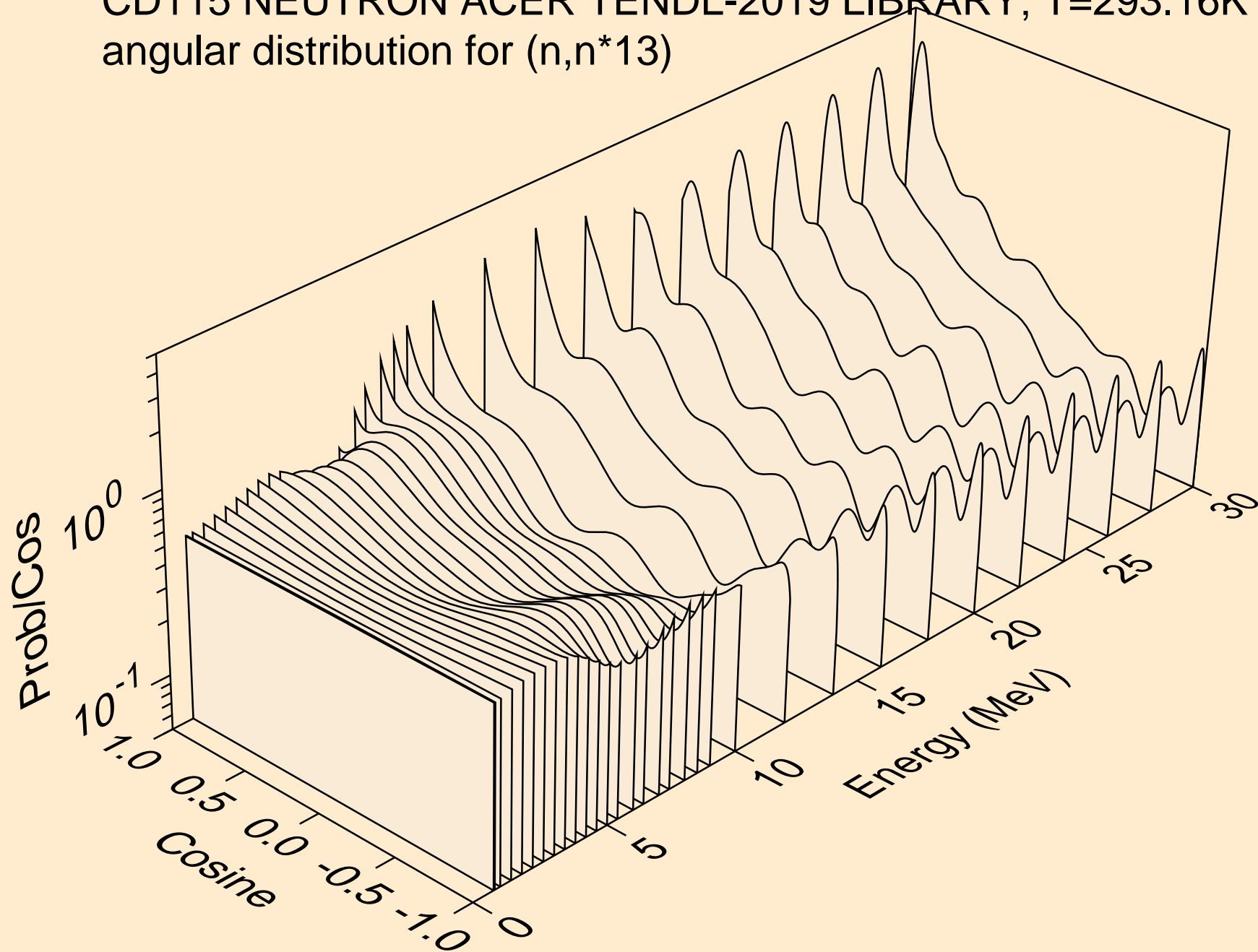

CD115 NEUTRON ACER TENDL-2019 LIBRARY; T=293.16K
angular distribution for (n,n*14)

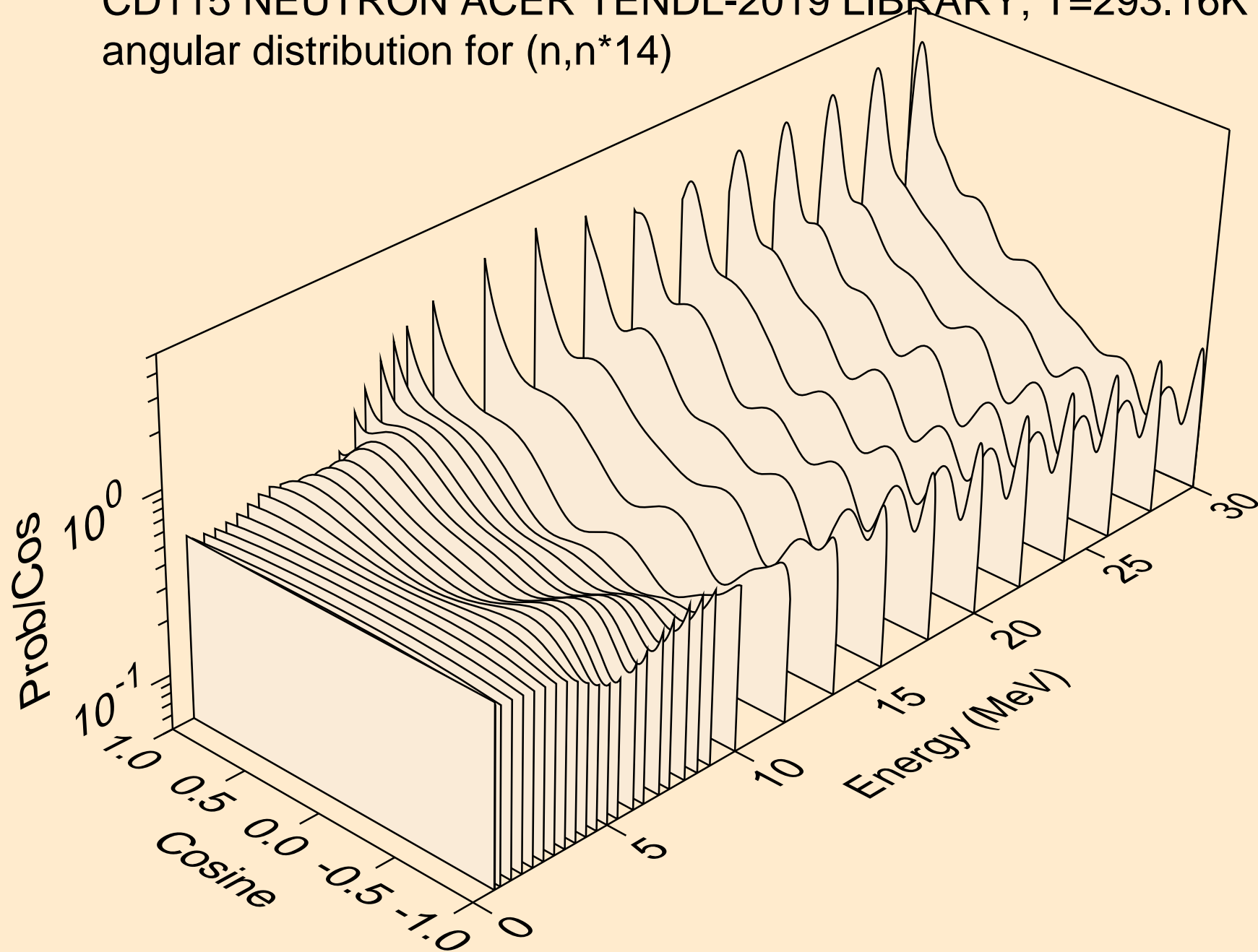

CD115 NEUTRON ACER TENDL-2019 LIBRARY; T=293.16K
angular distribution for (n,n*15)

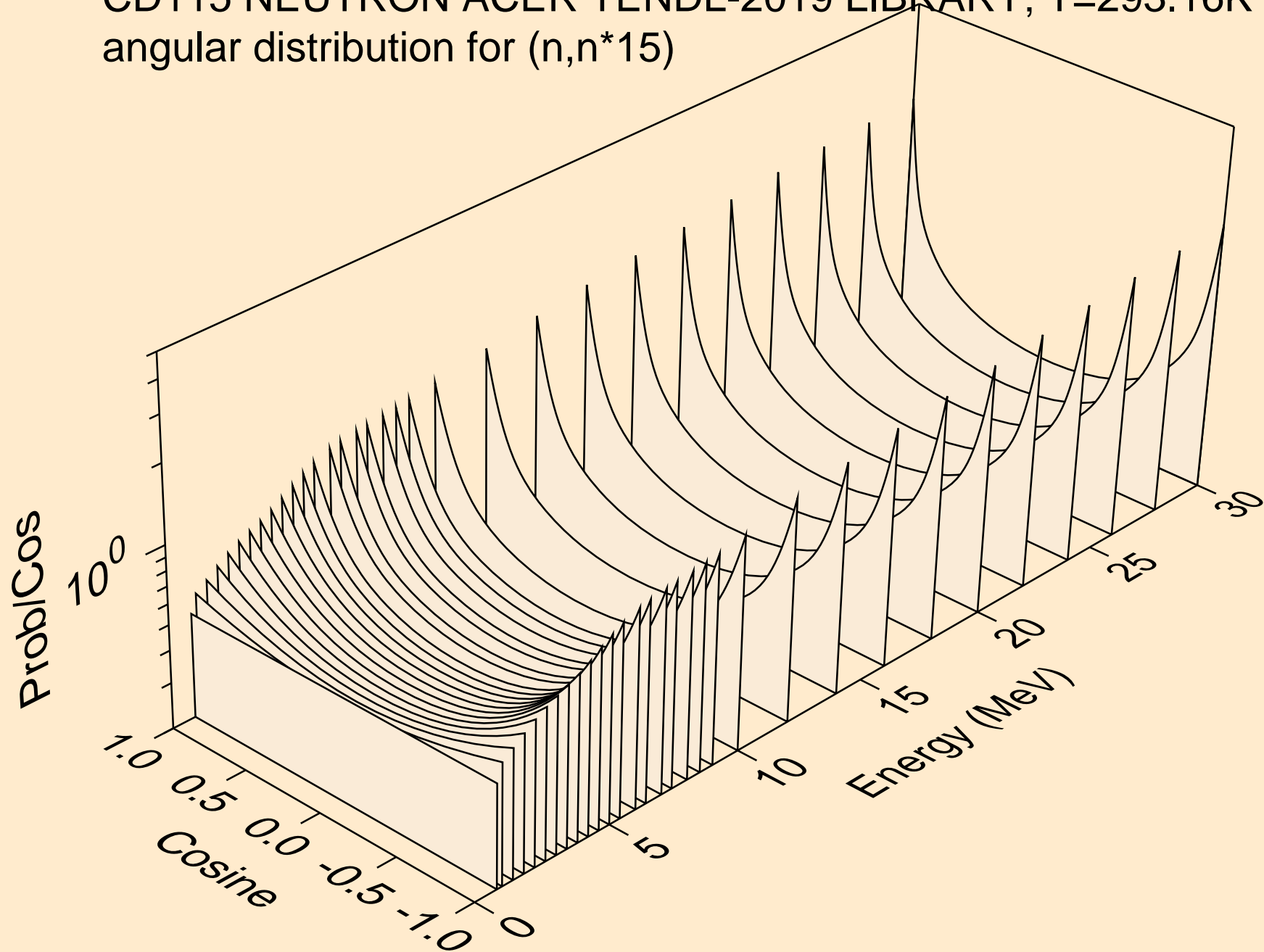

CD115 NEUTRON ACER TENDL-2019 LIBRARY; T=293.16K
angular distribution for (n,n*16)

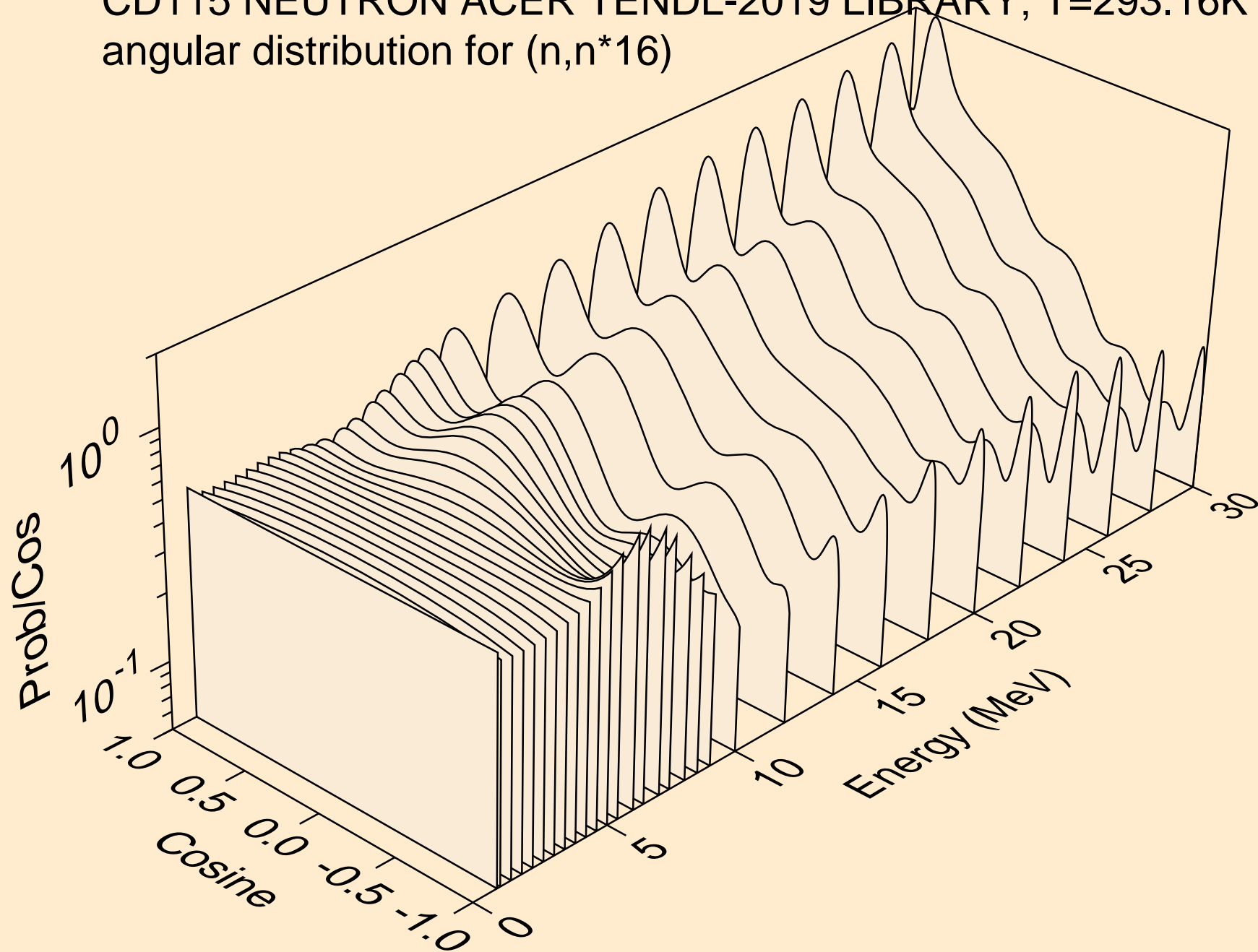

CD115 NEUTRON ACER TENDL-2019 LIBRARY; T=293.16K
angular distribution for (n,n*17)

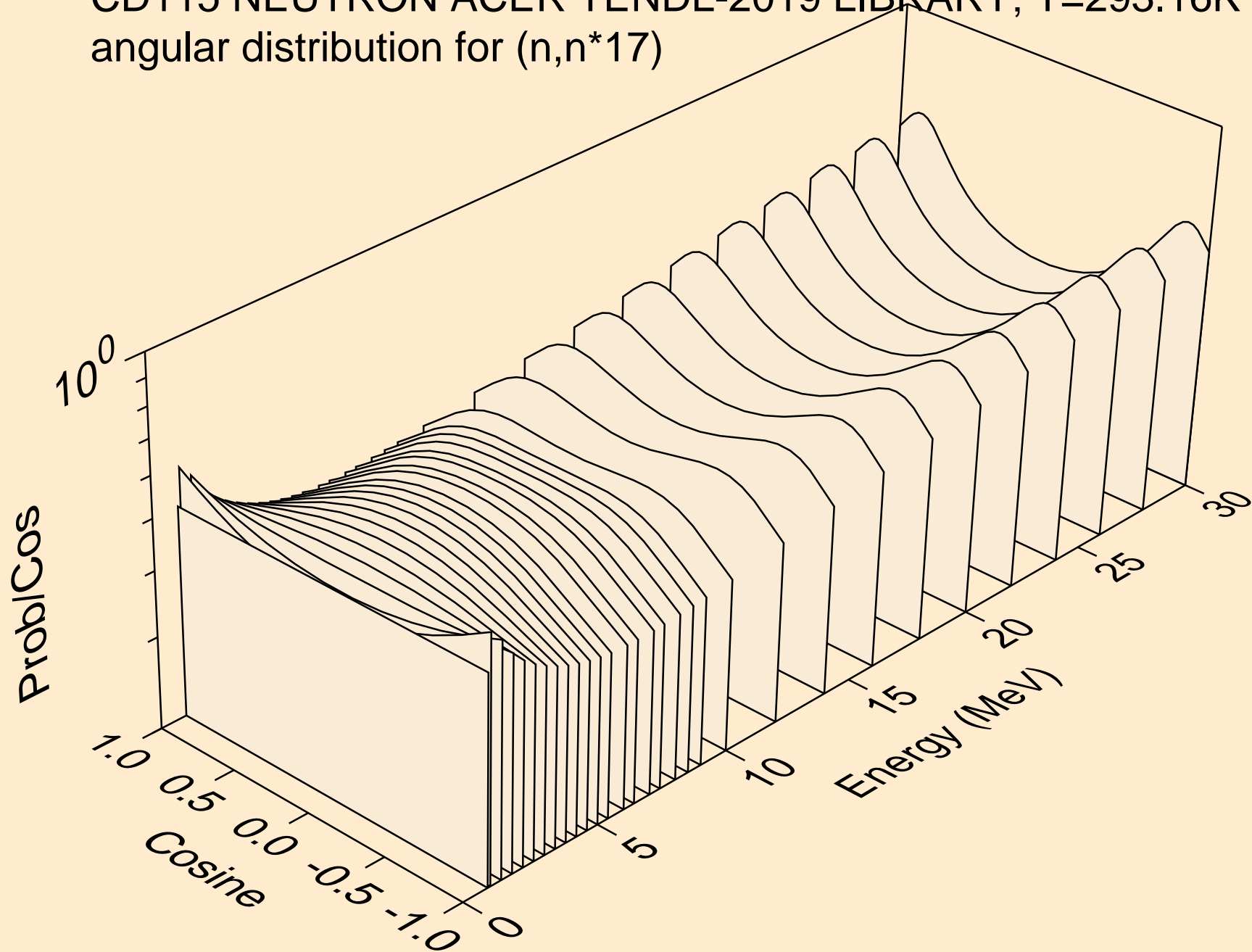

CD115 NEUTRON ACER TENDL-2019 LIBRARY; T=293.16K
angular distribution for (n,n*18)

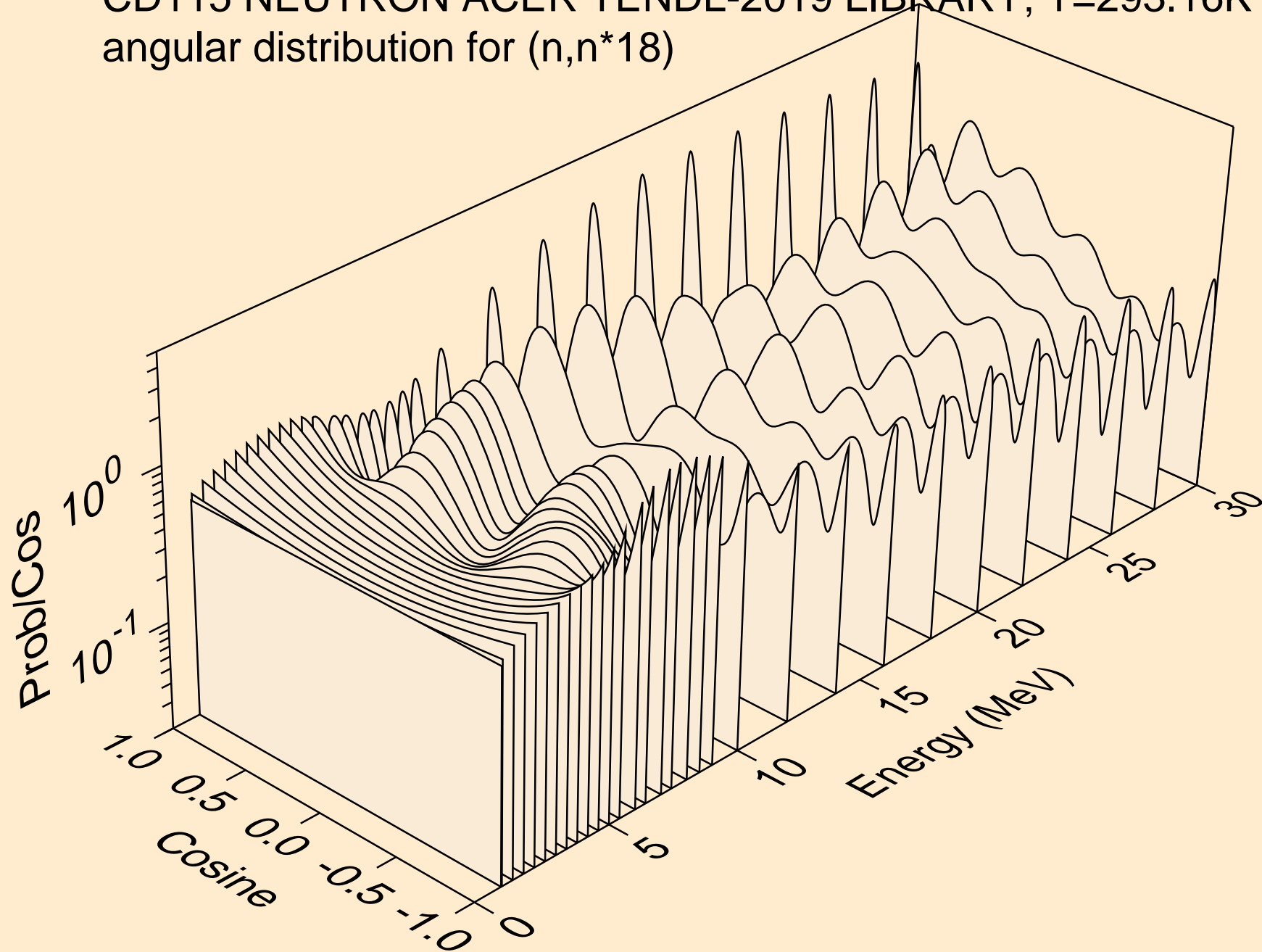

CD115 NEUTRON ACER TENDL-2019 LIBRARY; T=293.16K
angular distribution for (n,n*19)

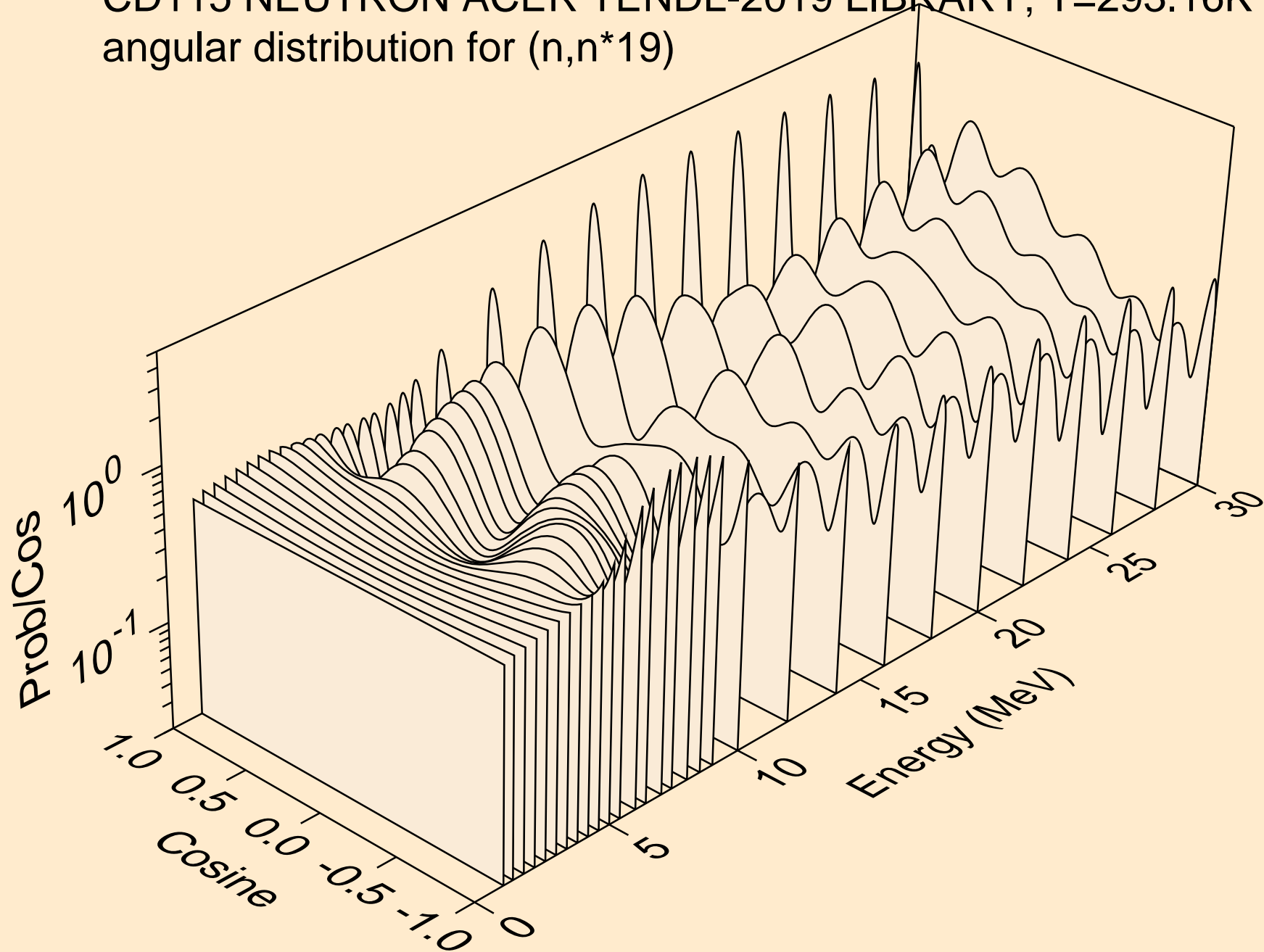

CD115 NEUTRON ACER TENDL-2019 LIBRARY; T=293.16K
angular distribution for (n,n*20)

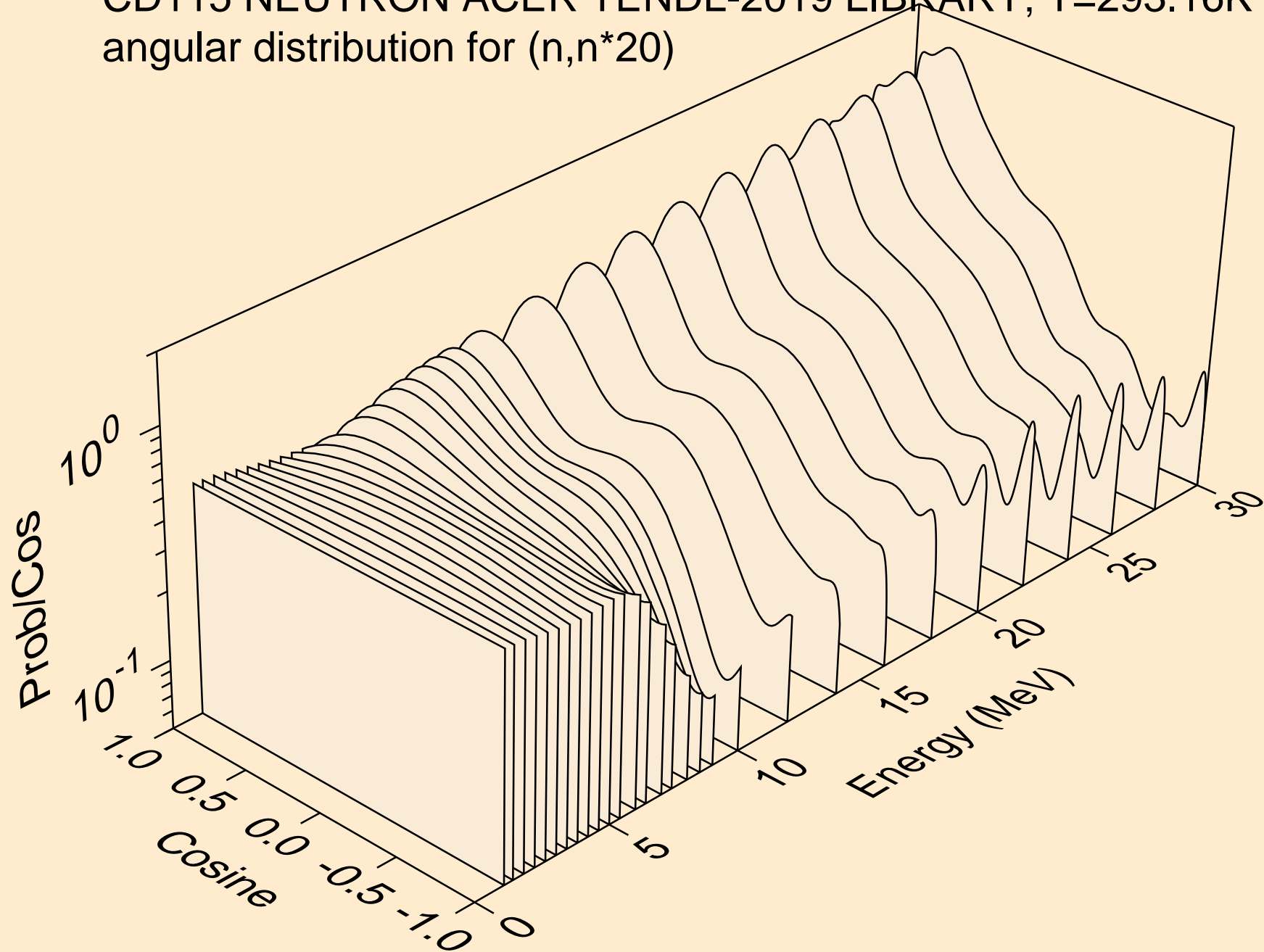

CD115 NEUTRON ACER TENDL-2019 LIBRARY; T=293.16K
angular distribution for (n,n*21)

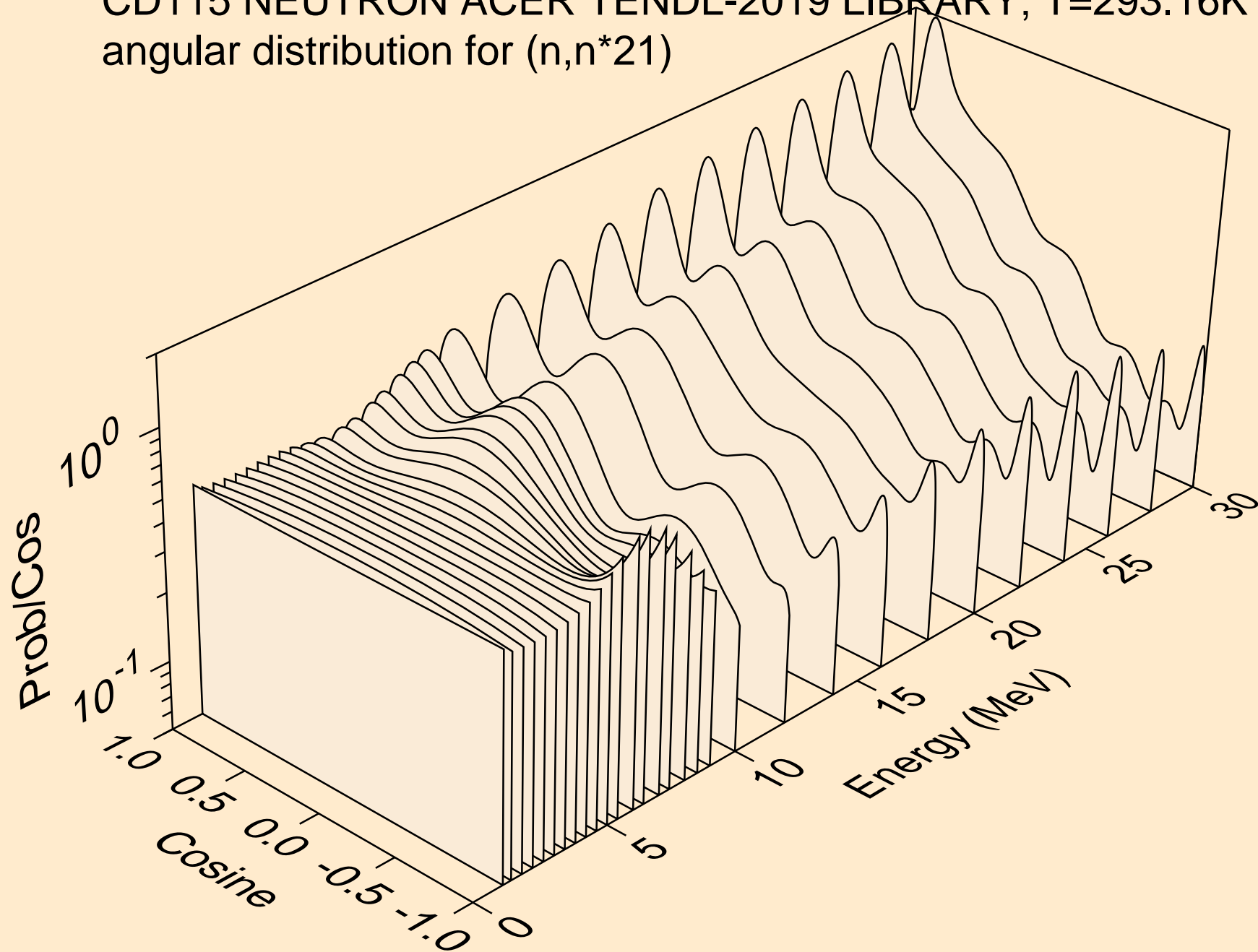

CD115 NEUTRON ACER TENDL-2019 LIBRARY; T=293.16K
angular distribution for (n,n*22)

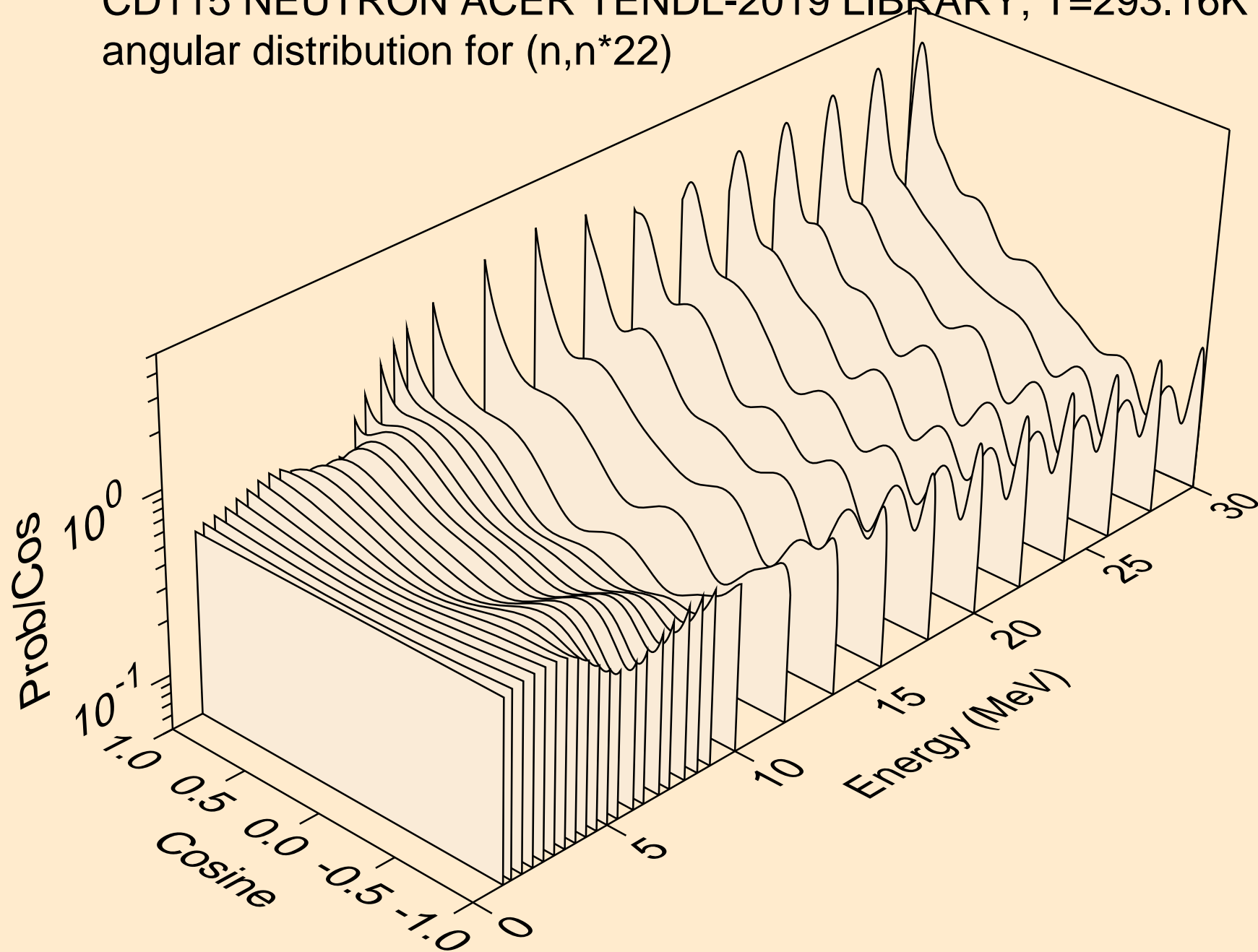

CD115 NEUTRON ACER TENDL-2019 LIBRARY; T=293.16K
angular distribution for (n,n*23)

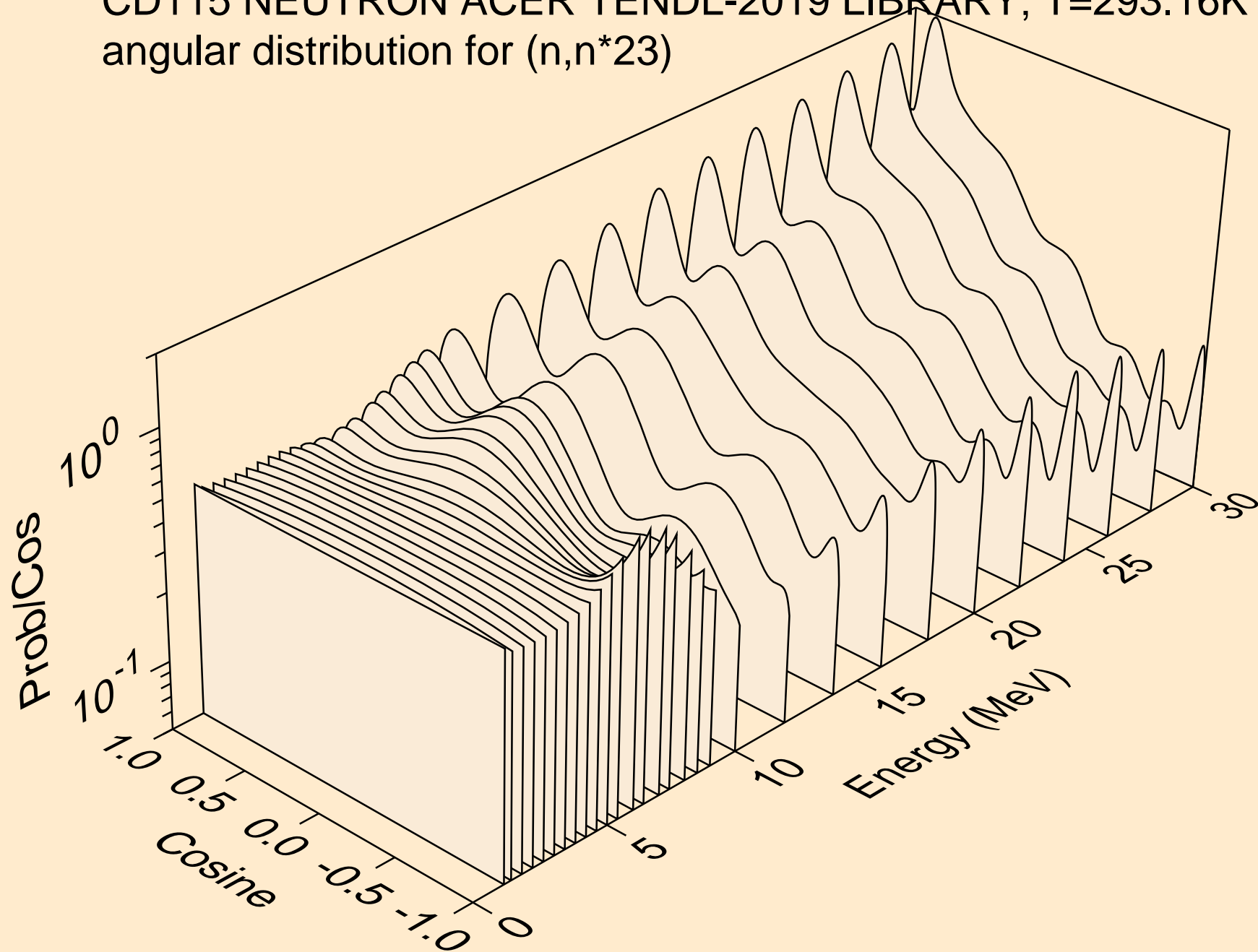

CD115 NEUTRON ACER TENDL-2019 LIBRARY; T=293.16K
angular distribution for (n,n*24)

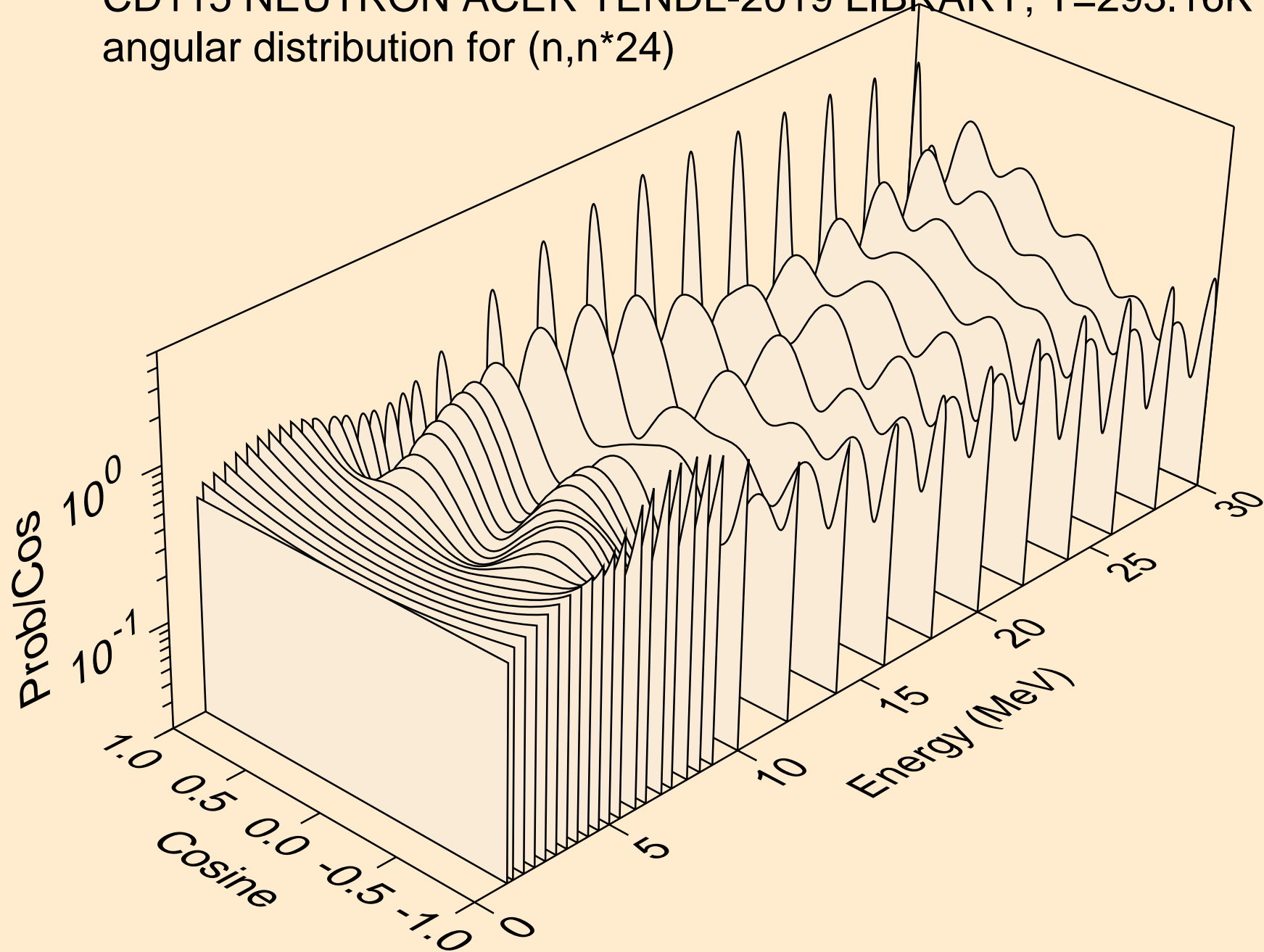

CD115 NEUTRON ACER TENDL-2019 LIBRARY; T=293.16K
angular distribution for (n,n*25)

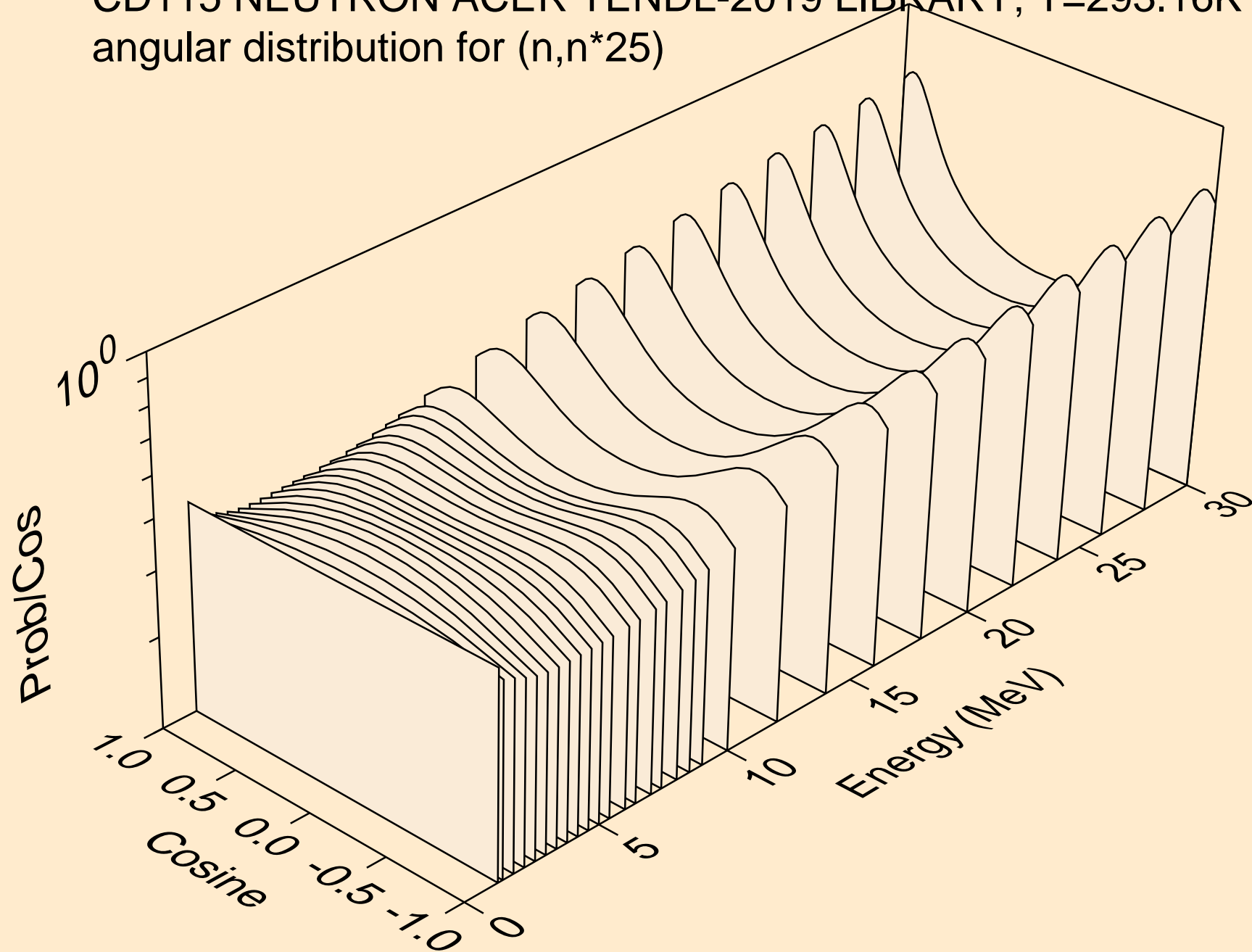

CD115 NEUTRON ACER TENDL-2019 LIBRARY; T=293.16K
angular distribution for (n,n*26)

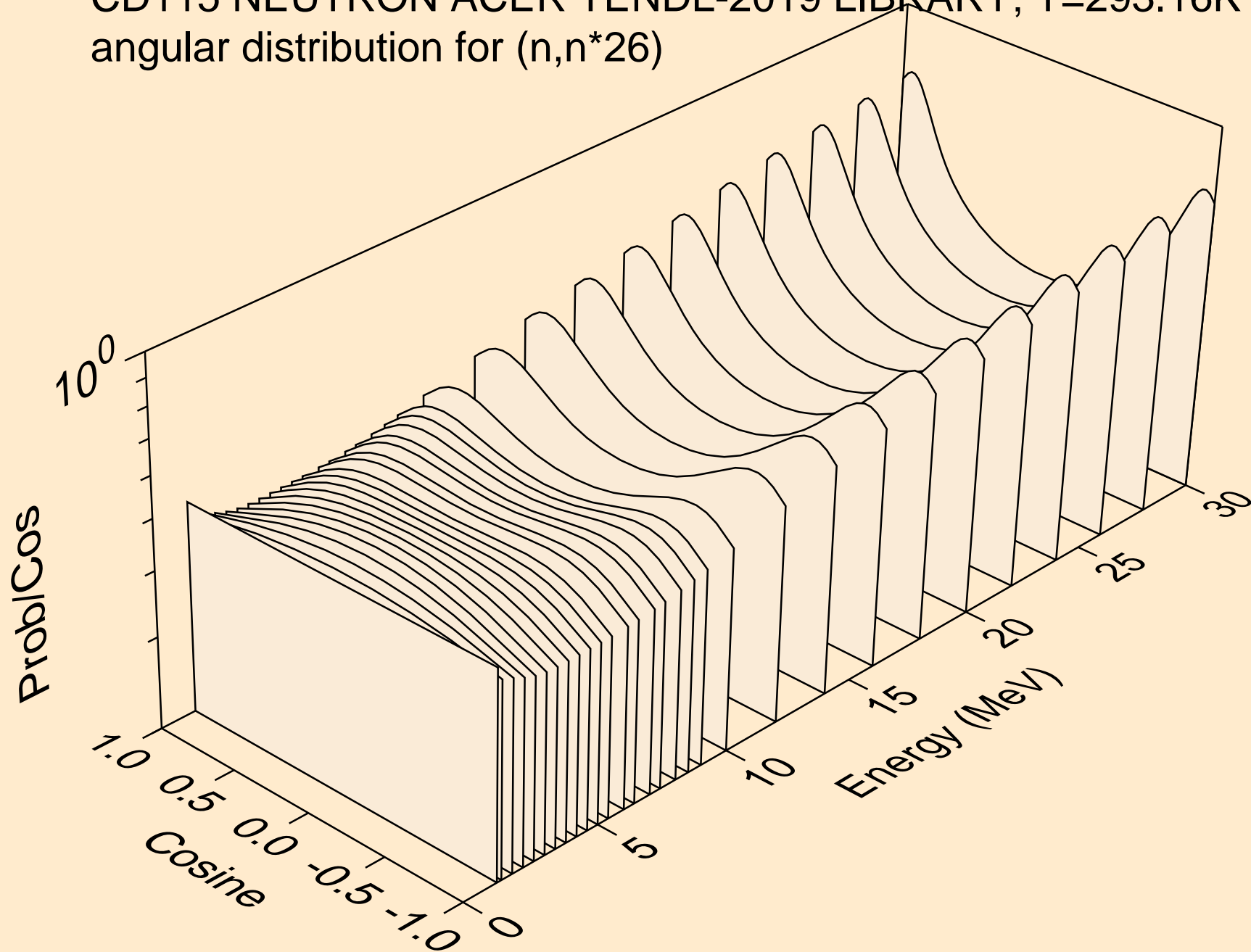

CD115 NEUTRON ACER TENDL-2019 LIBRARY; T=293.16K
angular distribution for (n,n*27)

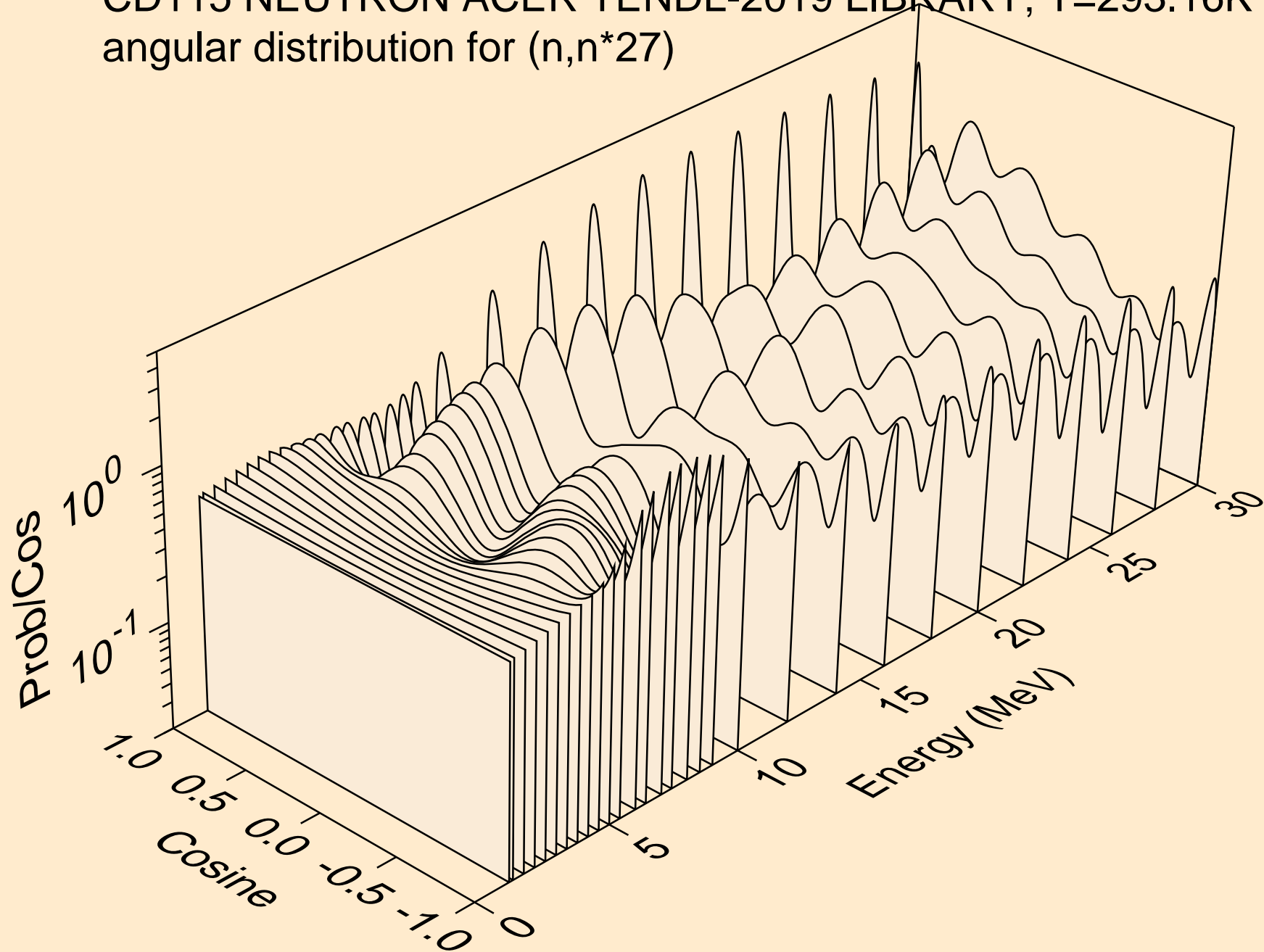

CD115 NEUTRON ACER TENDL-2019 LIBRARY; T=293.16K
angular distribution for (n,n*28)

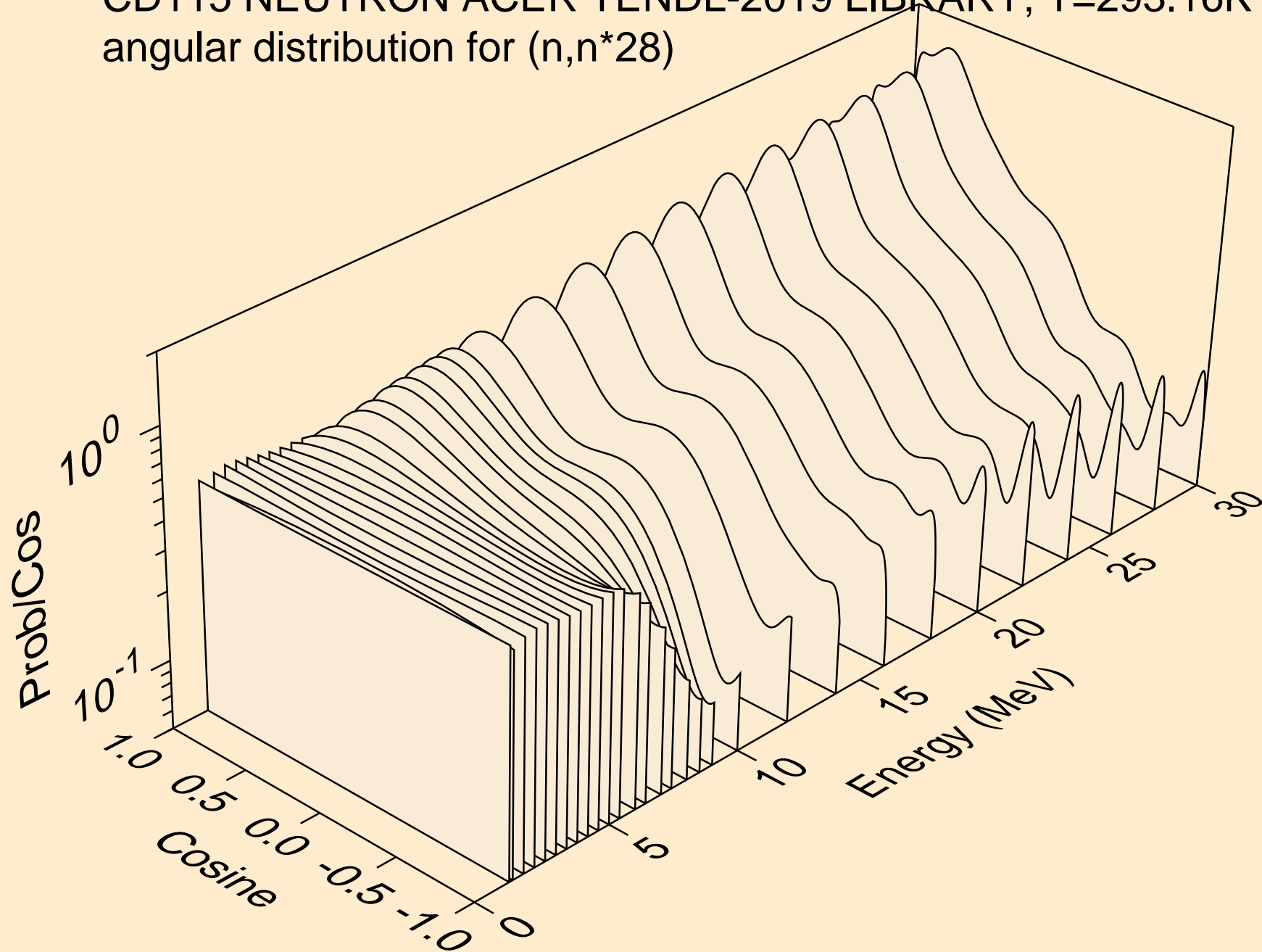

CD115 NEUTRON ACER TENDL-2019 LIBRARY; T=293.16K
angular distribution for (n,n*29)

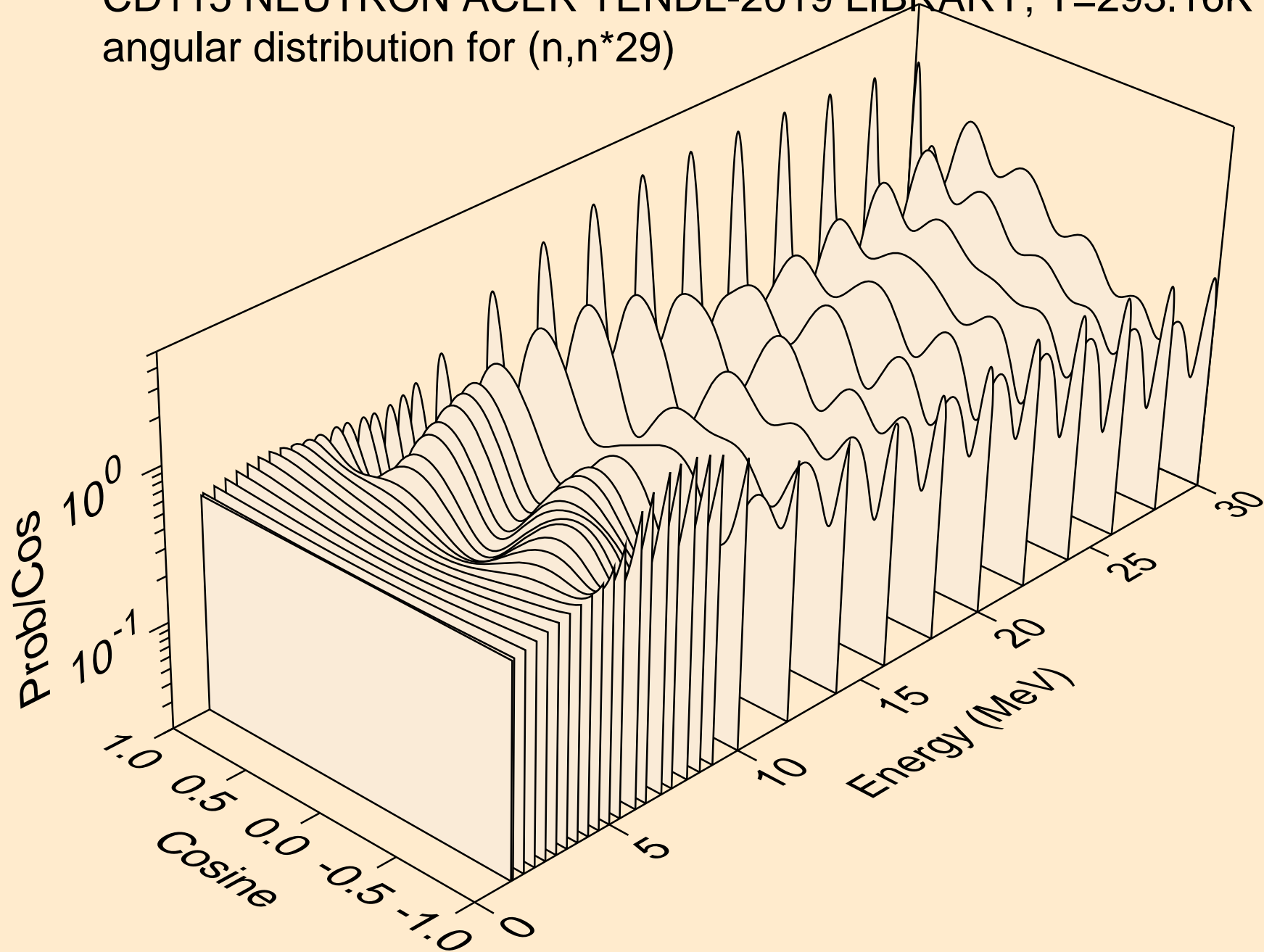

CD115 NEUTRON ACER TENDL-2019 LIBRARY; T=293.16K
angular distribution for (n,n*30)

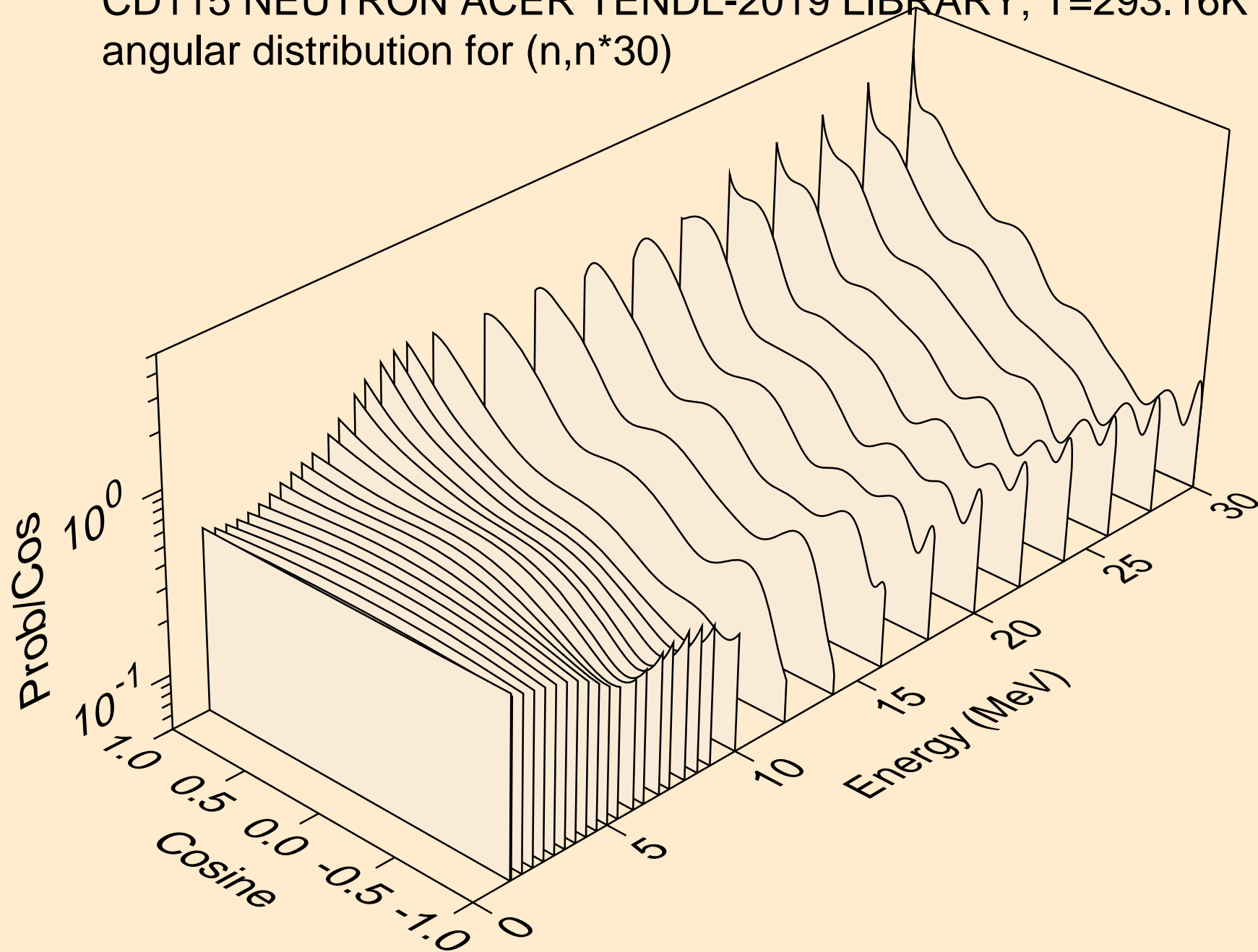

CD115 NEUTRON ACER TENDL-2019 LIBRARY; T=293.16K
Neutron emission for (n,x)

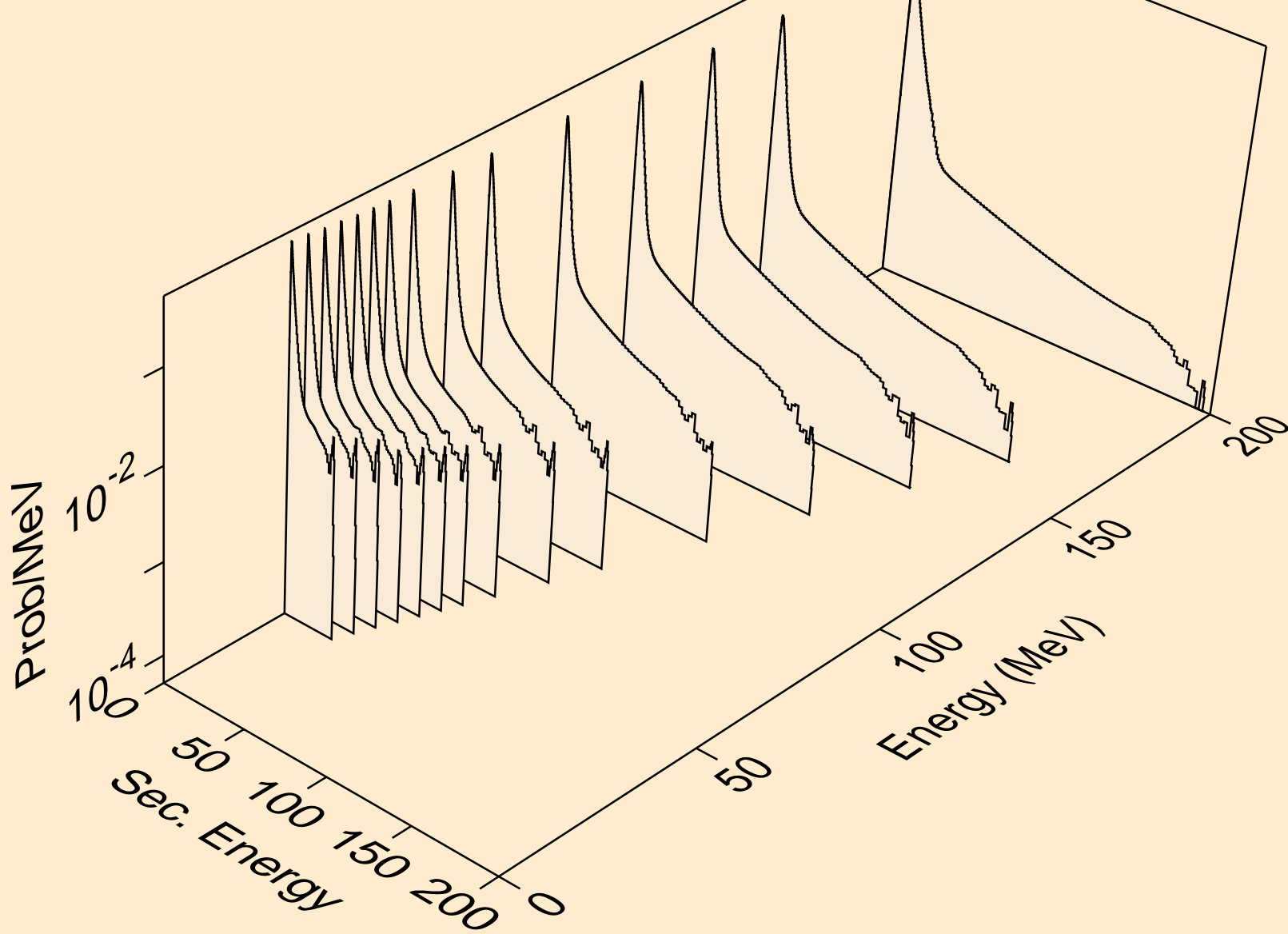

CD115 NEUTRON ACER TENDL-2019 LIBRARY; T=293.16K
Neutron emission for (n,2nd)

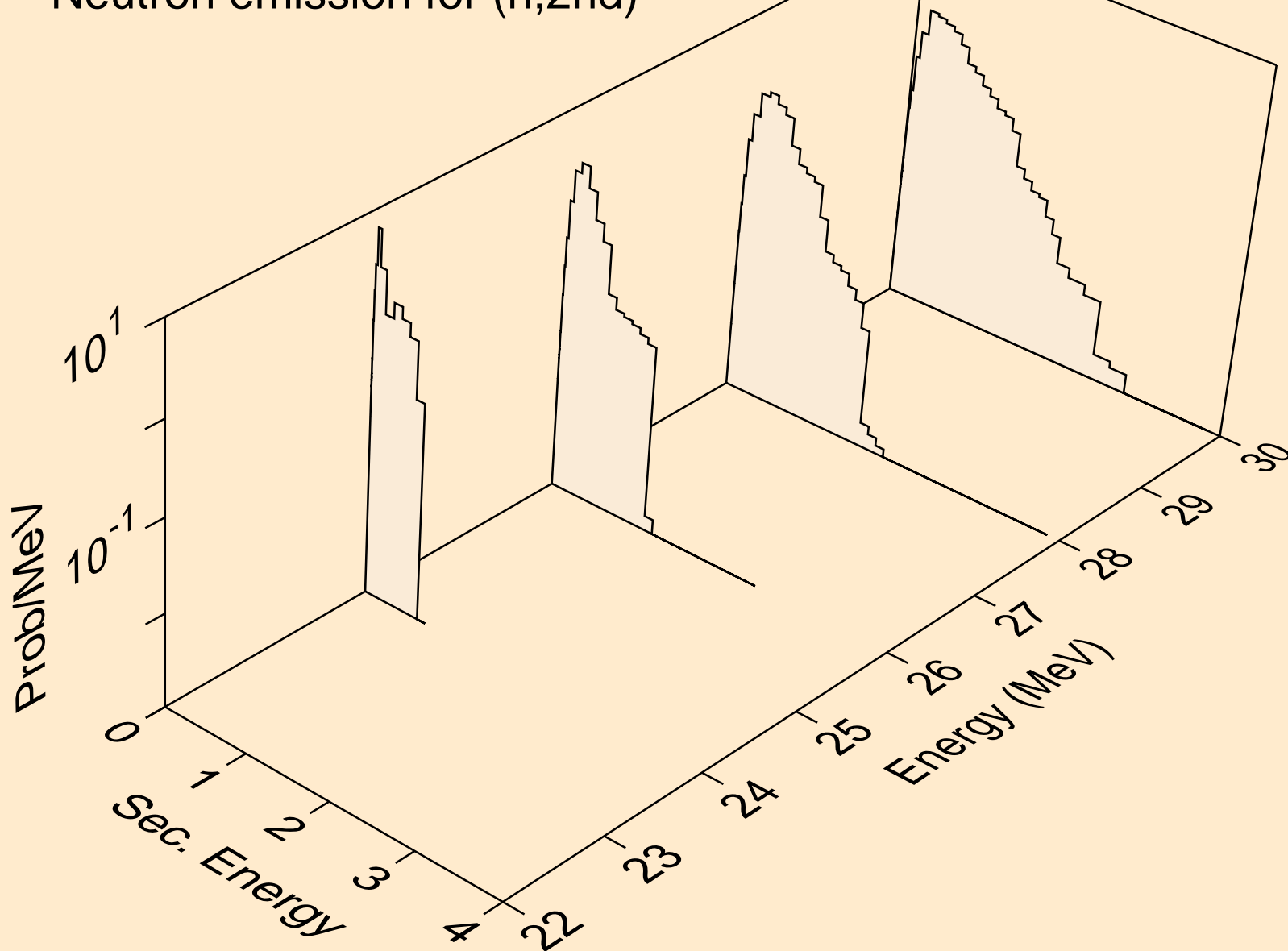

CD115 NEUTRON ACER TENDL-2019 LIBRARY; T=293.16K
Neutron emission for (n,2n)

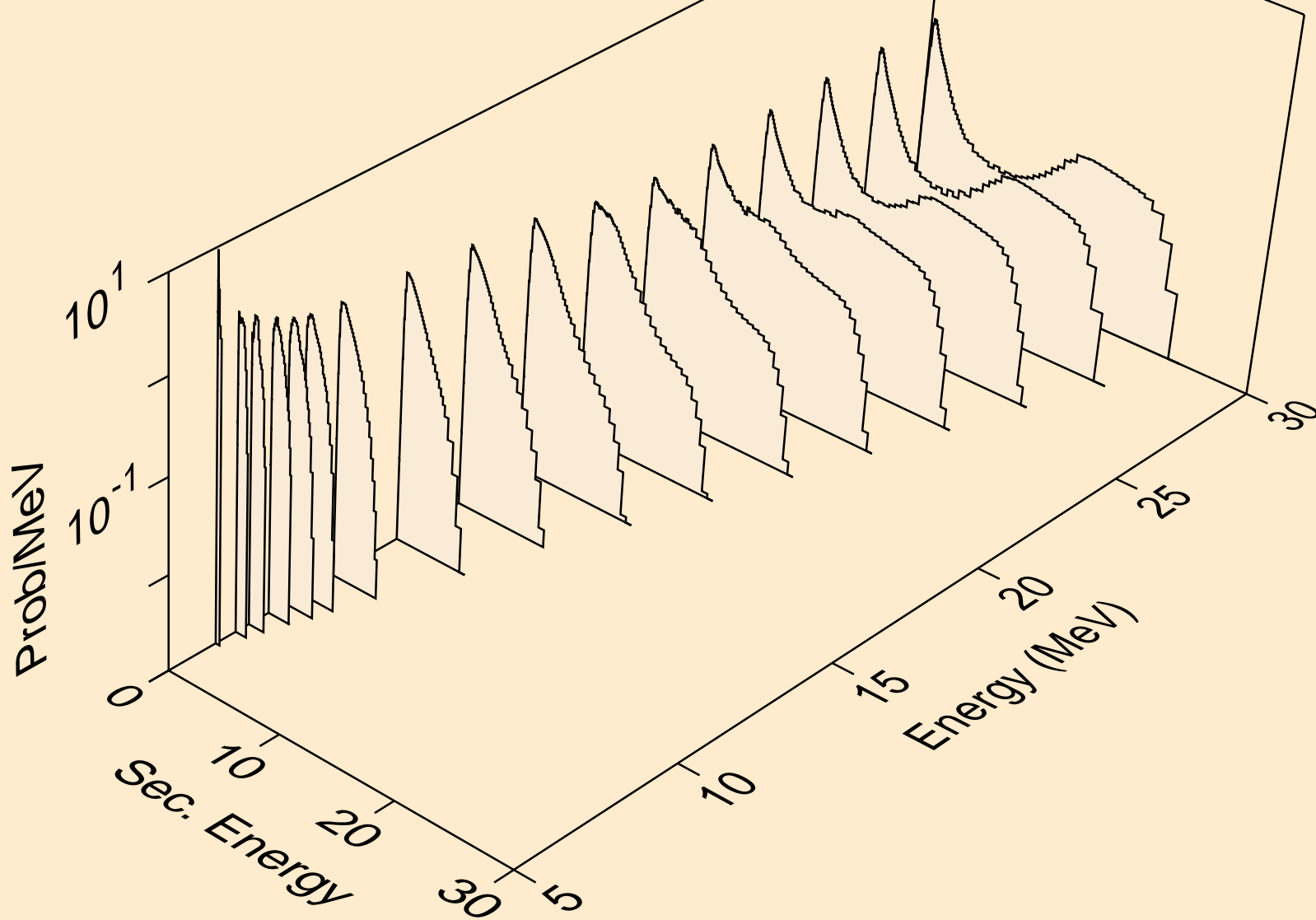

CD115 NEUTRON ACER TENDL-2019 LIBRARY; T=293.16K
Neutron emission for (n,3n)

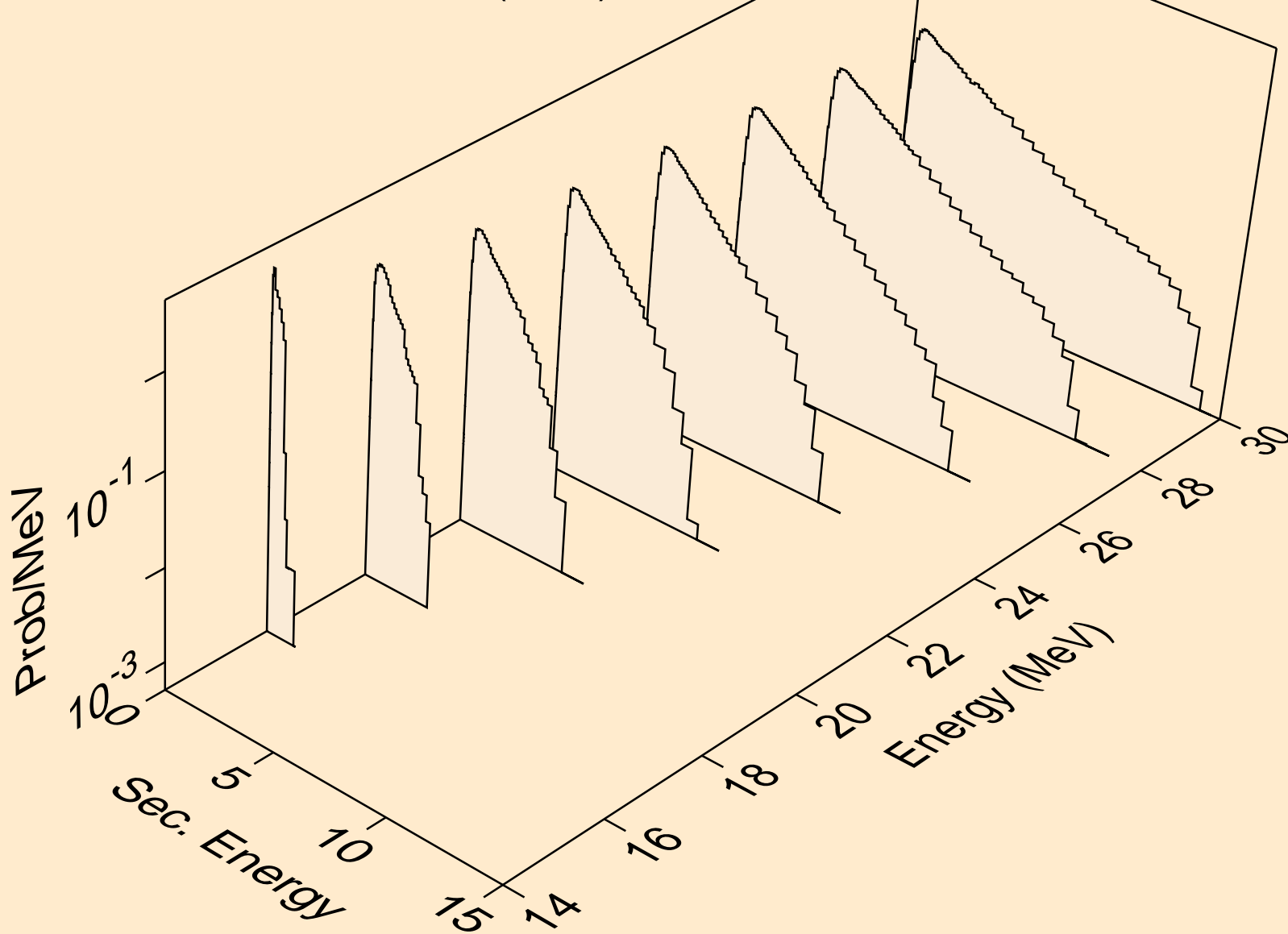

CD115 NEUTRON ACER TENDL-2019 LIBRARY; T=293.16K
Neutron emission for (n,n*)a

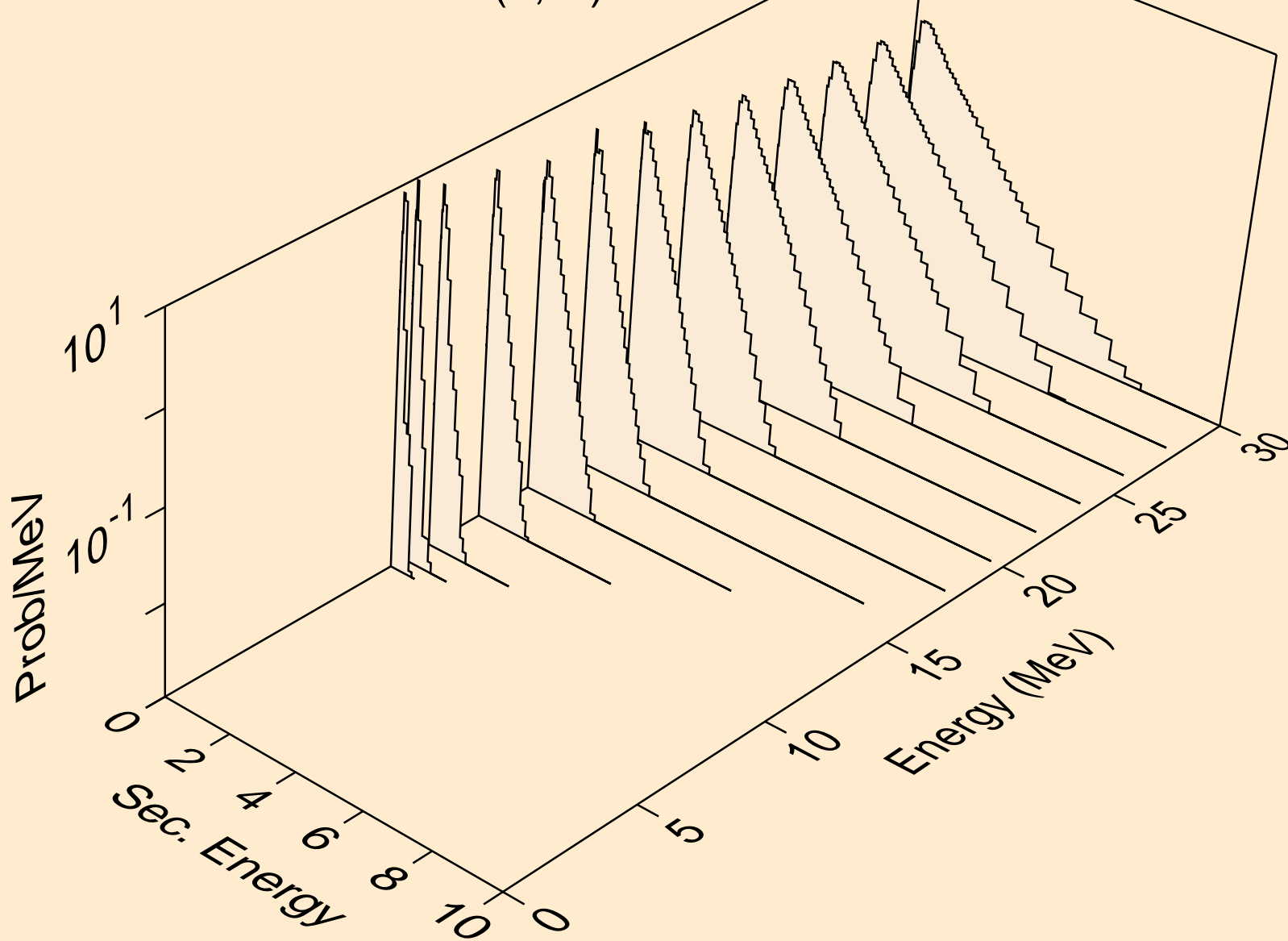

CD115 NEUTRON ACER TENDL-2019 LIBRARY; T=293.16K
Neutron emission for (n,2n)a

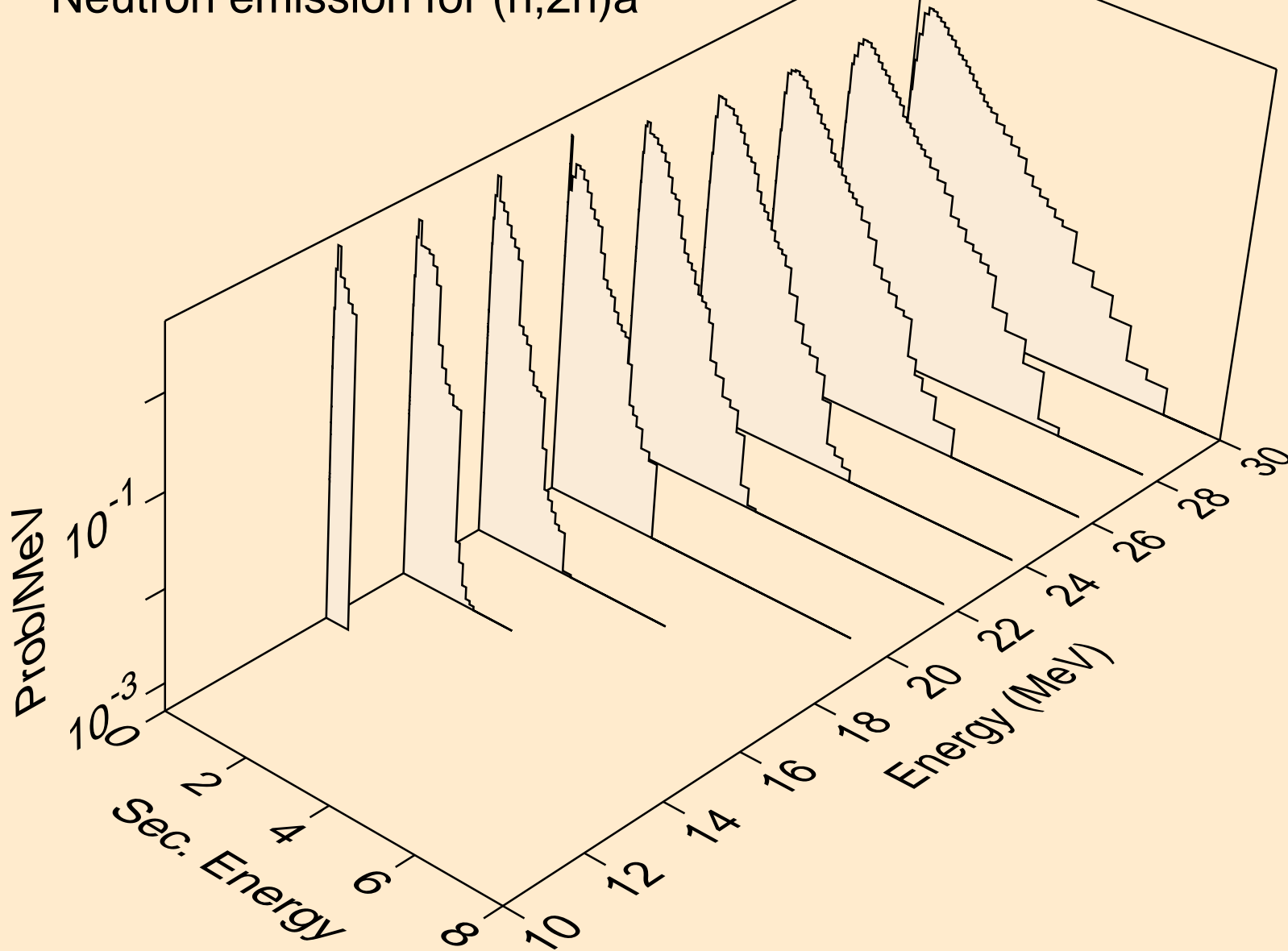

CD115 NEUTRON ACER TENDL-2019 LIBRARY; T=293.16K
Neutron emission for (n,3n)a

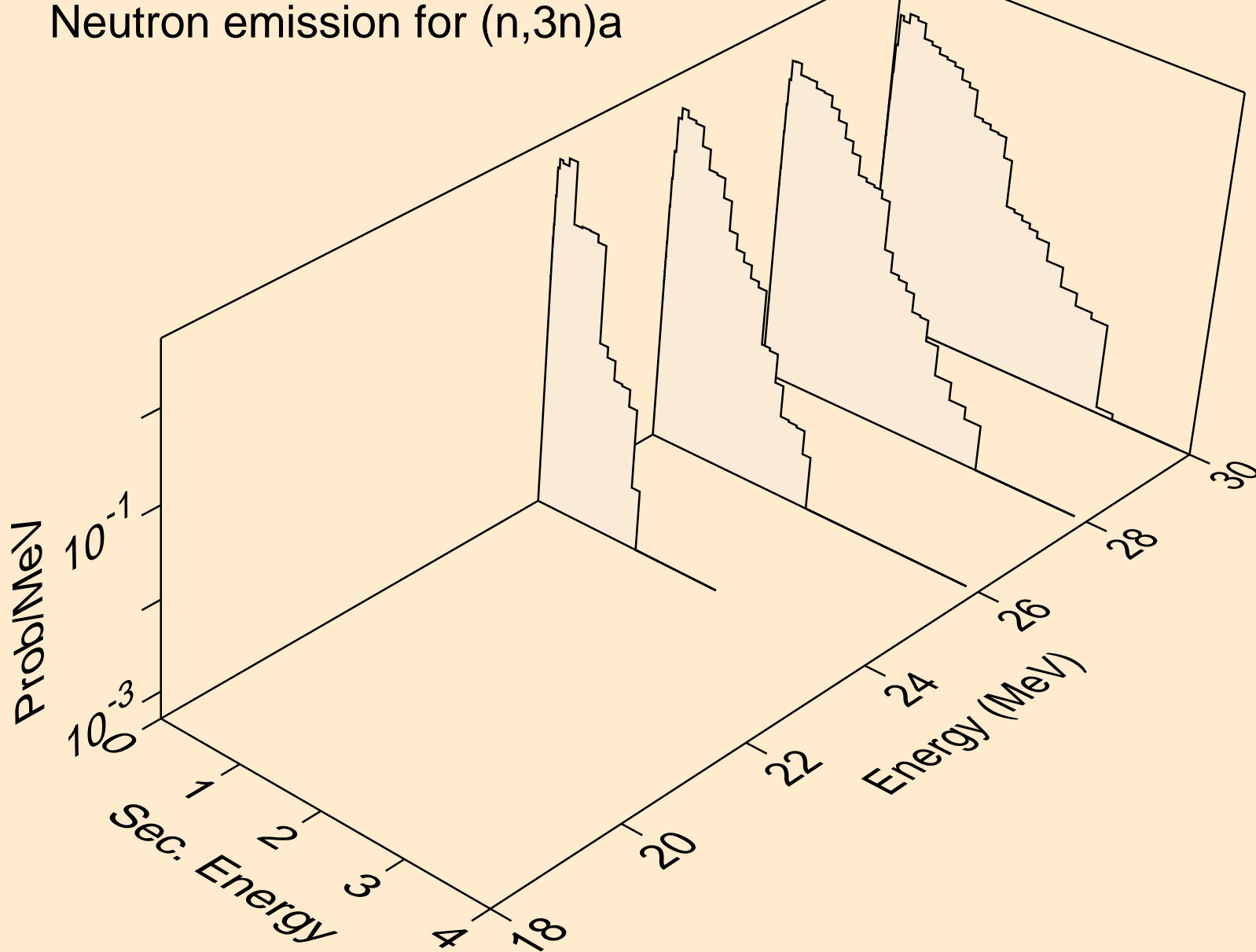

CD115 NEUTRON ACER TENDL-2019 LIBRARY; T=293.16K
Neutron emission for (n,n*)p

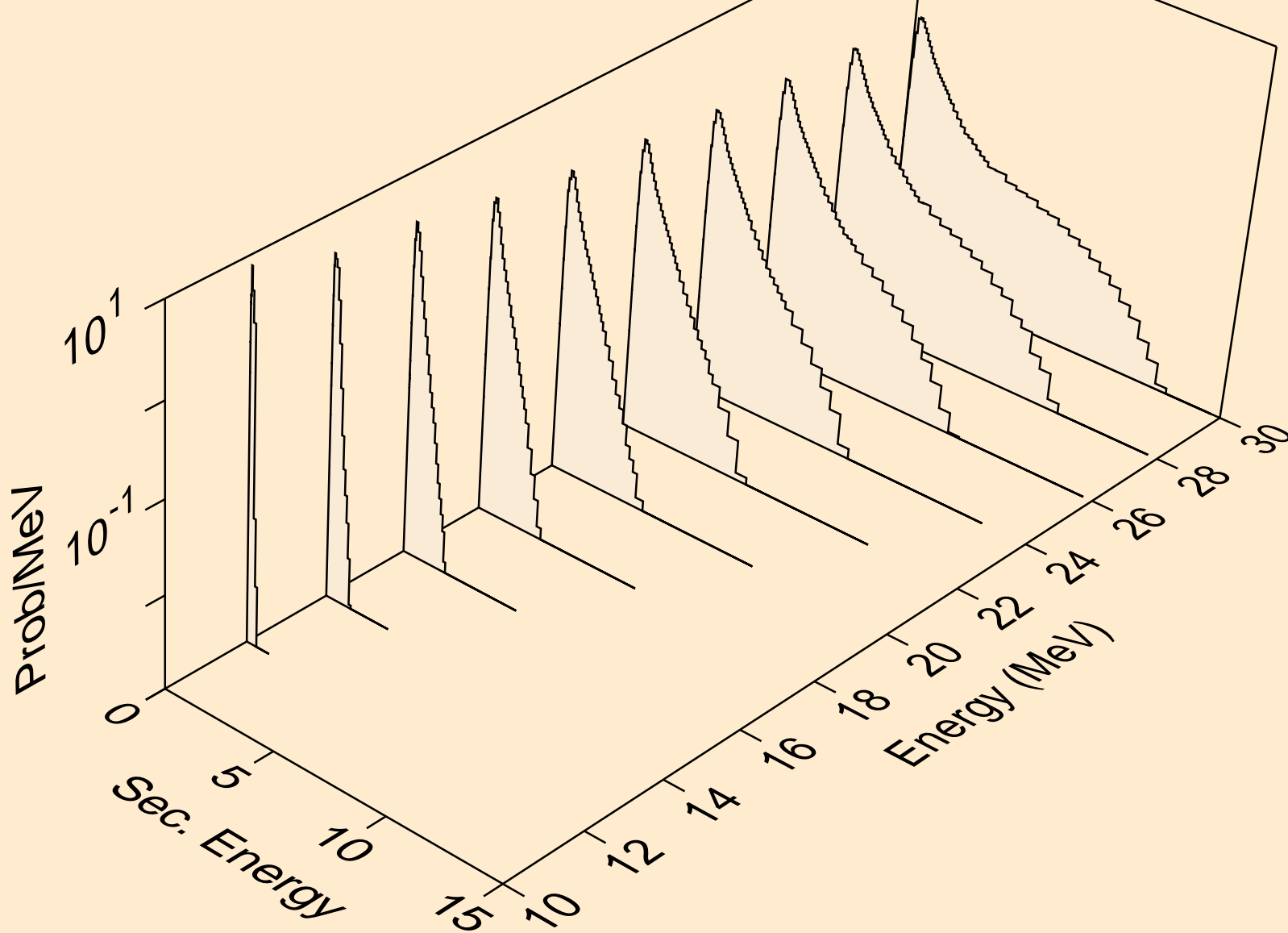

CD115 NEUTRON ACER TENDL-2019 LIBRARY; T=293.16K
Neutron emission for (n,n*)d

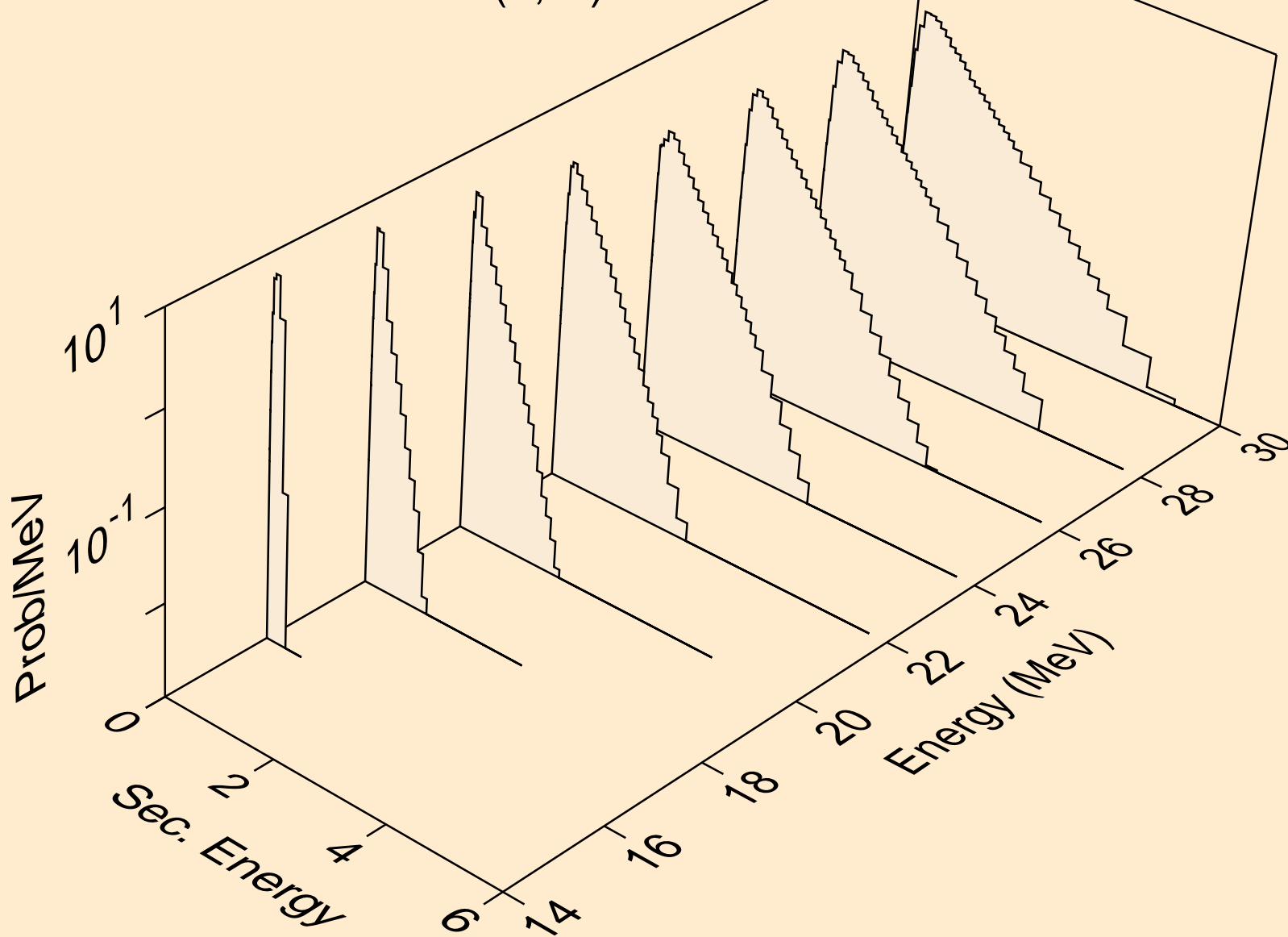

CD115 NEUTRON ACER TENDL-2019 LIBRARY; T=293.16K
Neutron emission for (n,n*)t

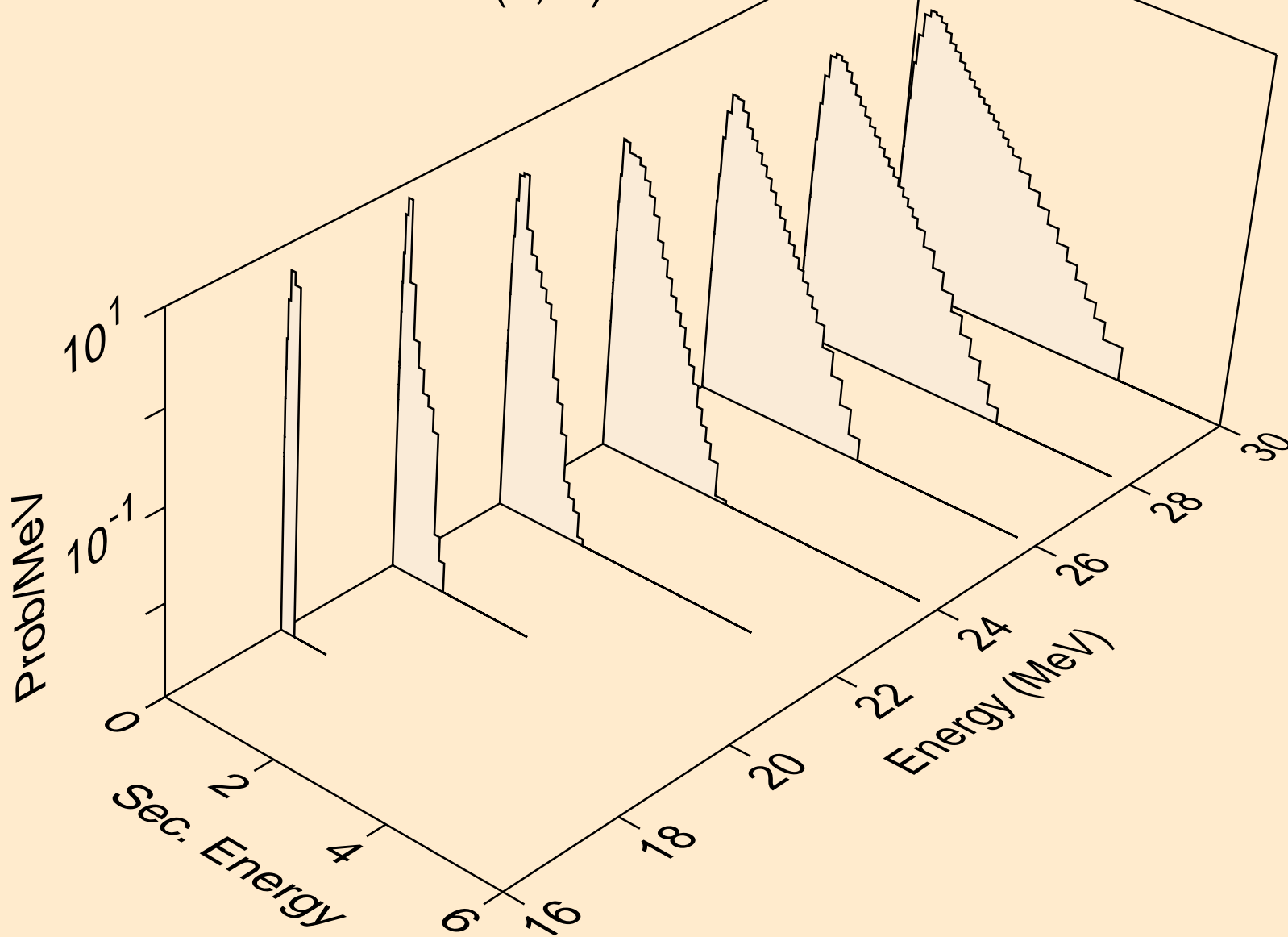

CD115 NEUTRON ACER TENDL-2019 LIBRARY; T=293.16K
Neutron emission for (n,n*)he3

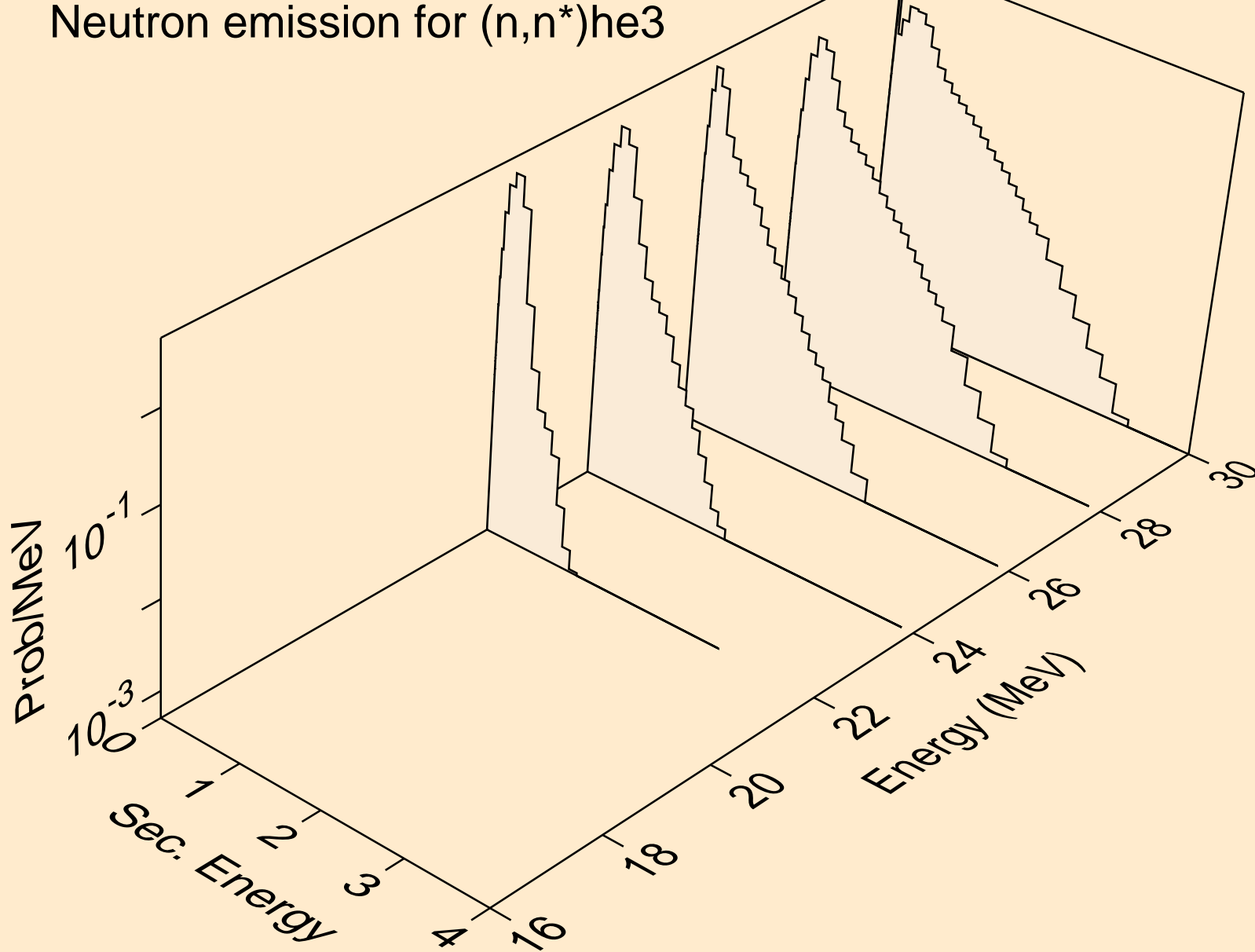

CD115 NEUTRON ACER TENDL-2019 LIBRARY; T=293.16K
Neutron emission for (n,4n)

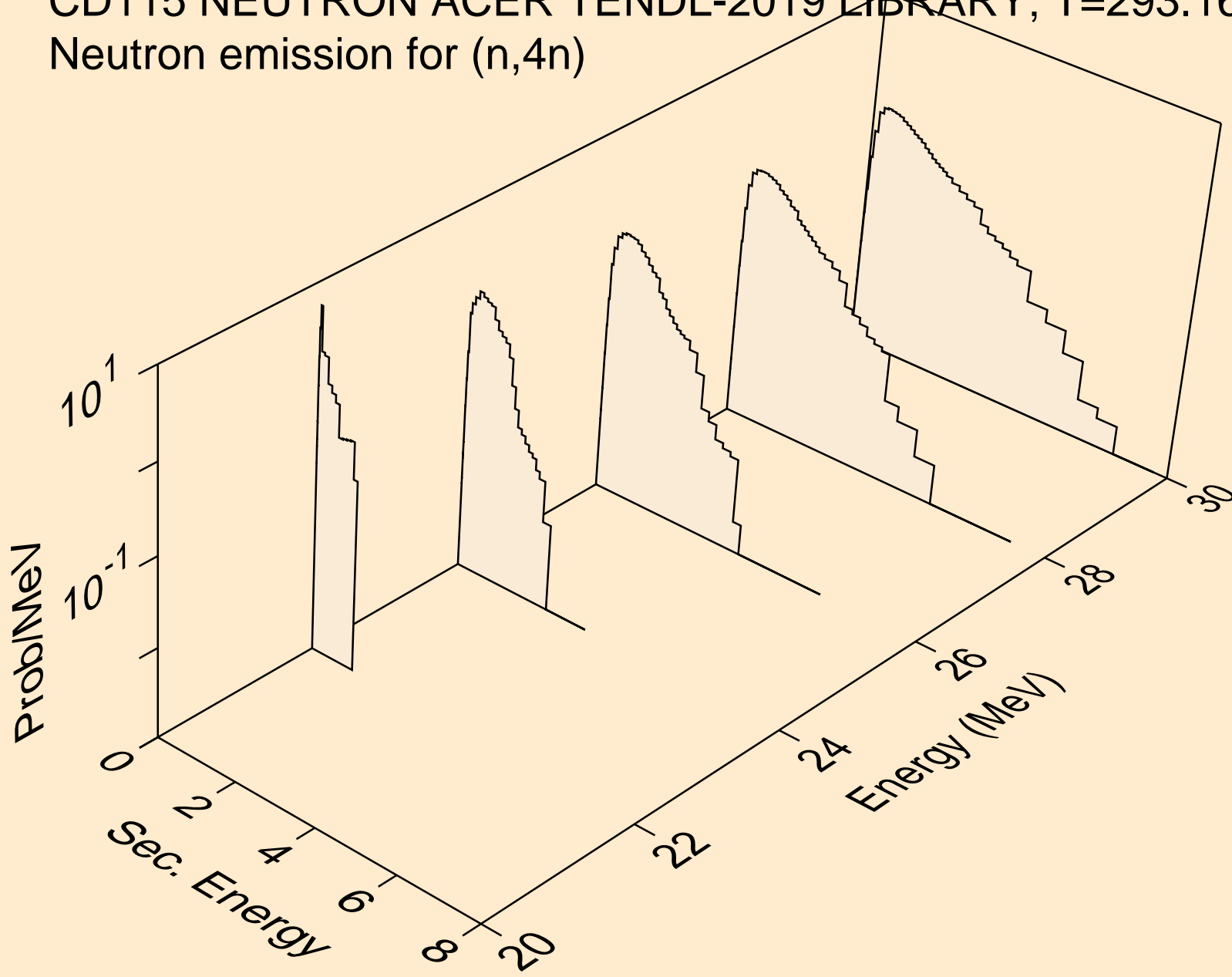

CD115 NEUTRON ACER TENDL-2019 LIBRARY; T=293.16K
Neutron emission for (n,2np)

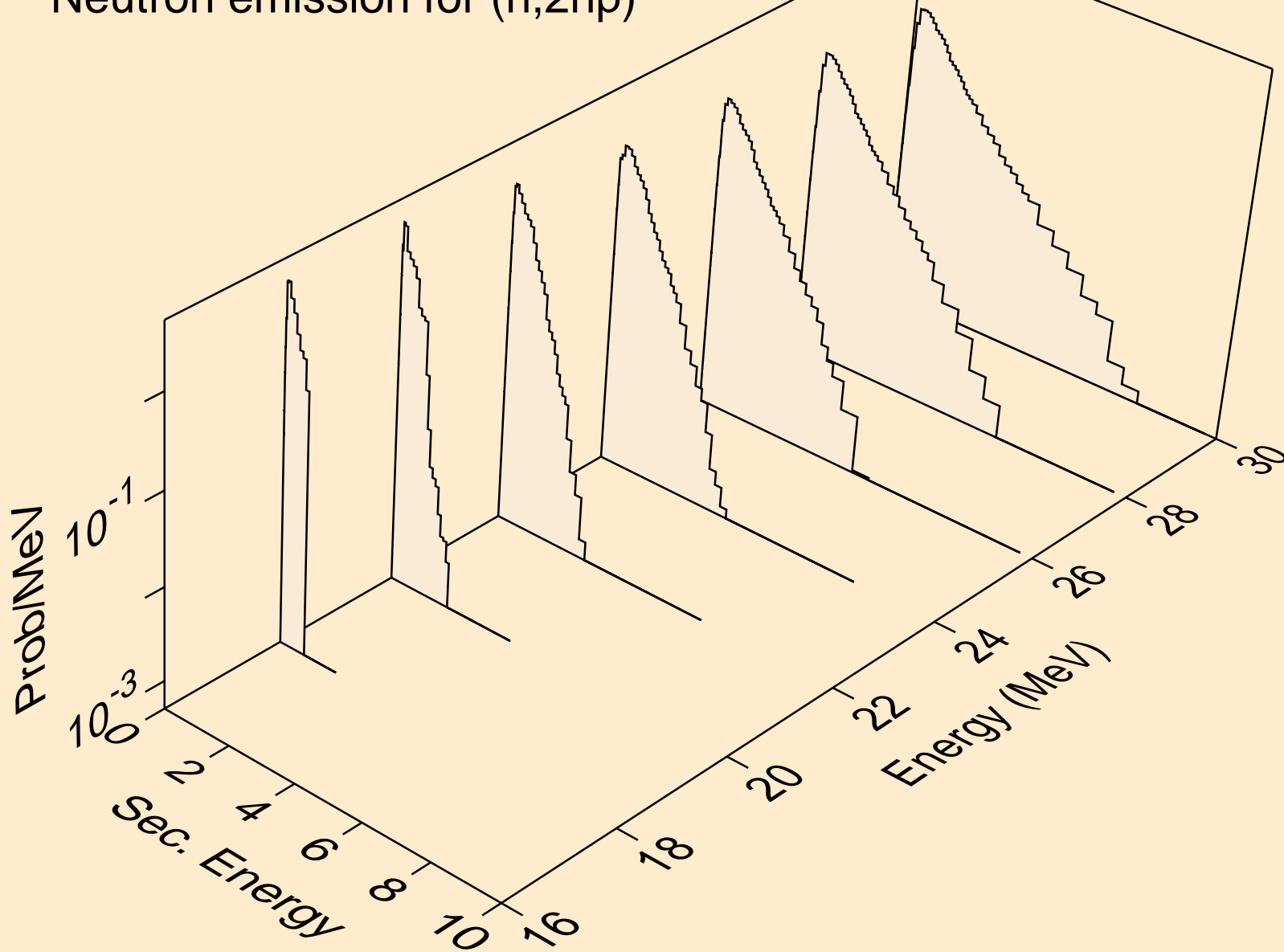

CD115 NEUTRON ACER TENDL-2019 LIBRARY; T=293.16K
Neutron emission for (n,3np)

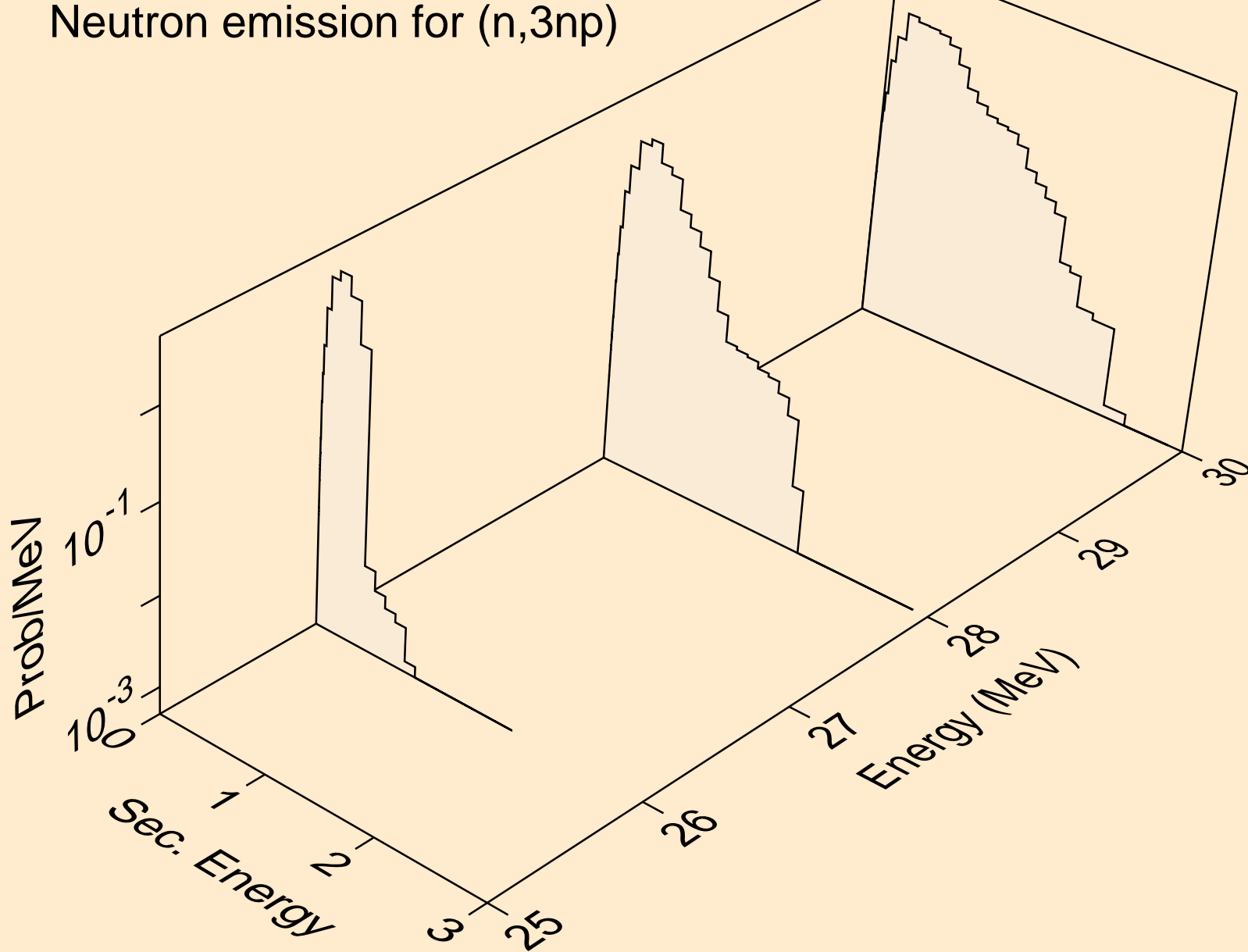

CD115 NEUTRON ACER TENDL-2019 LIBRARY; T=293.16K
Neutron emission for (n,2np)

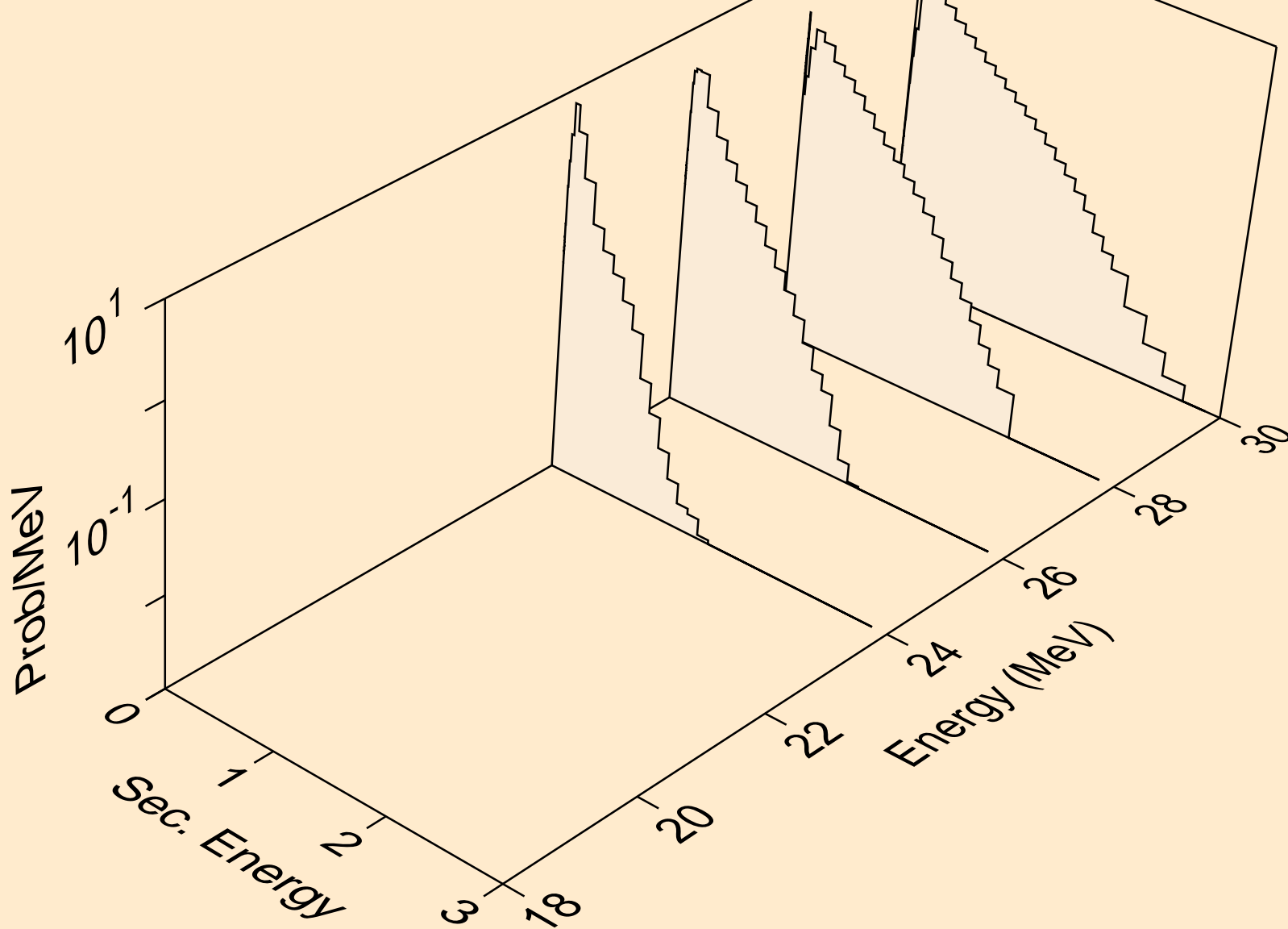

CD115 NEUTRON ACER TENDL-2019 LIBRARY; T=293.16K
Neutron emission for (n,npa)

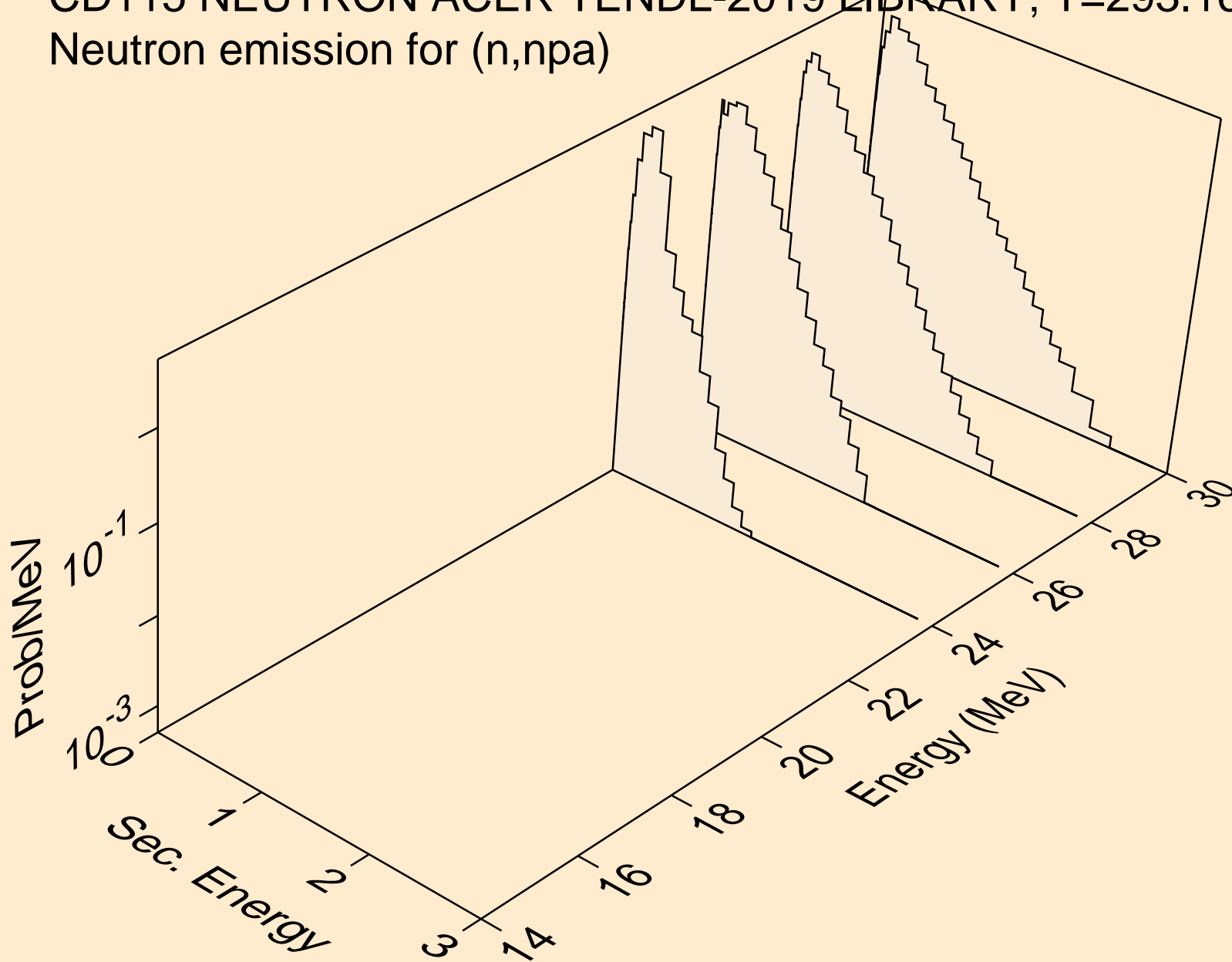

CD115 NEUTRON ACER TENDL-2019 LIBRARY; T=293.16K
Neutron emission for (n,n*c)

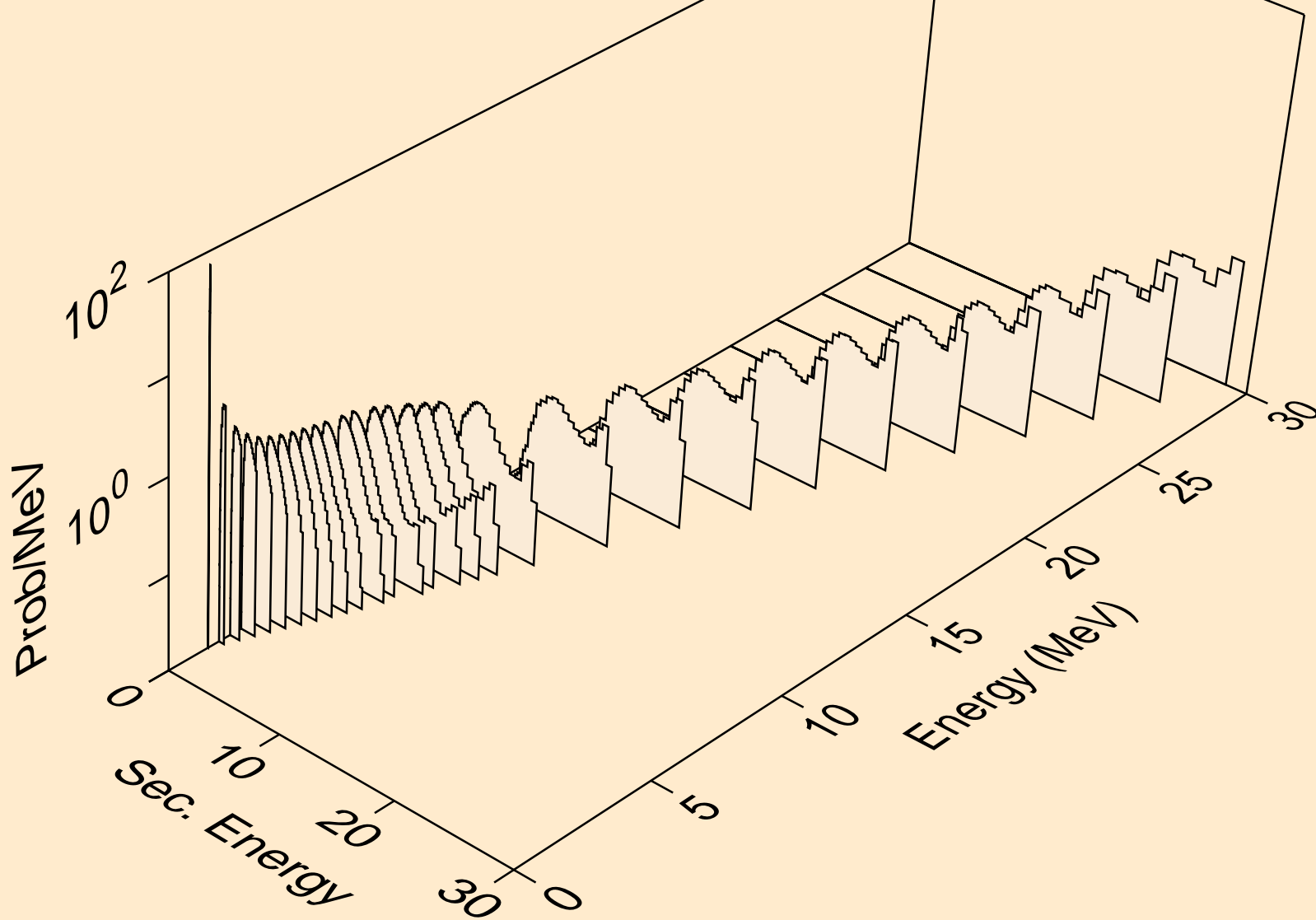

CD115 NEUTRON ACER TENDL-2019 LIBRARY; T=293.16K
Photon emission for (n,x)

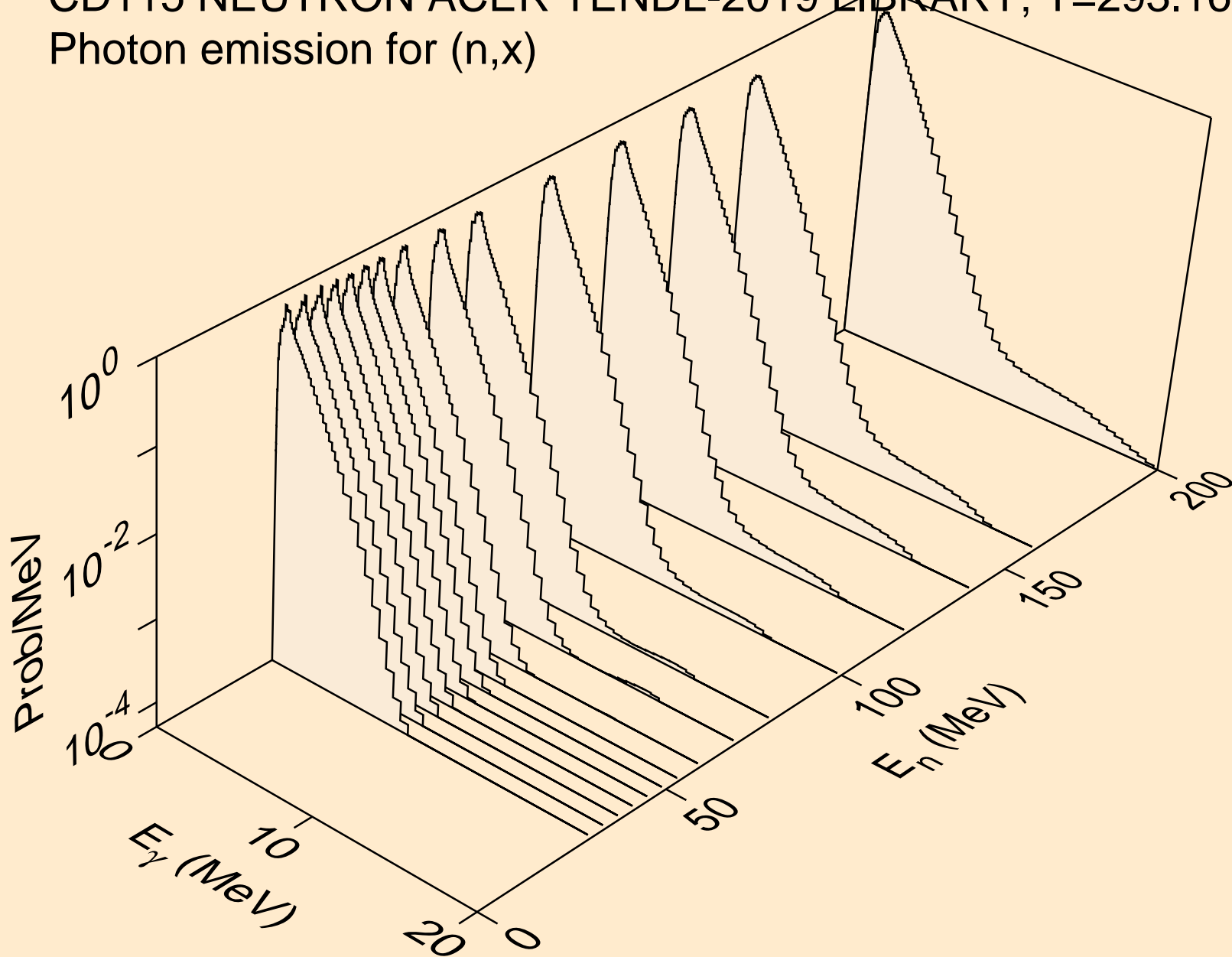

CD115 NEUTRON ACER TENDL-2019 LIBRARY; T=293.16K
Photon emission for (n,2nd)

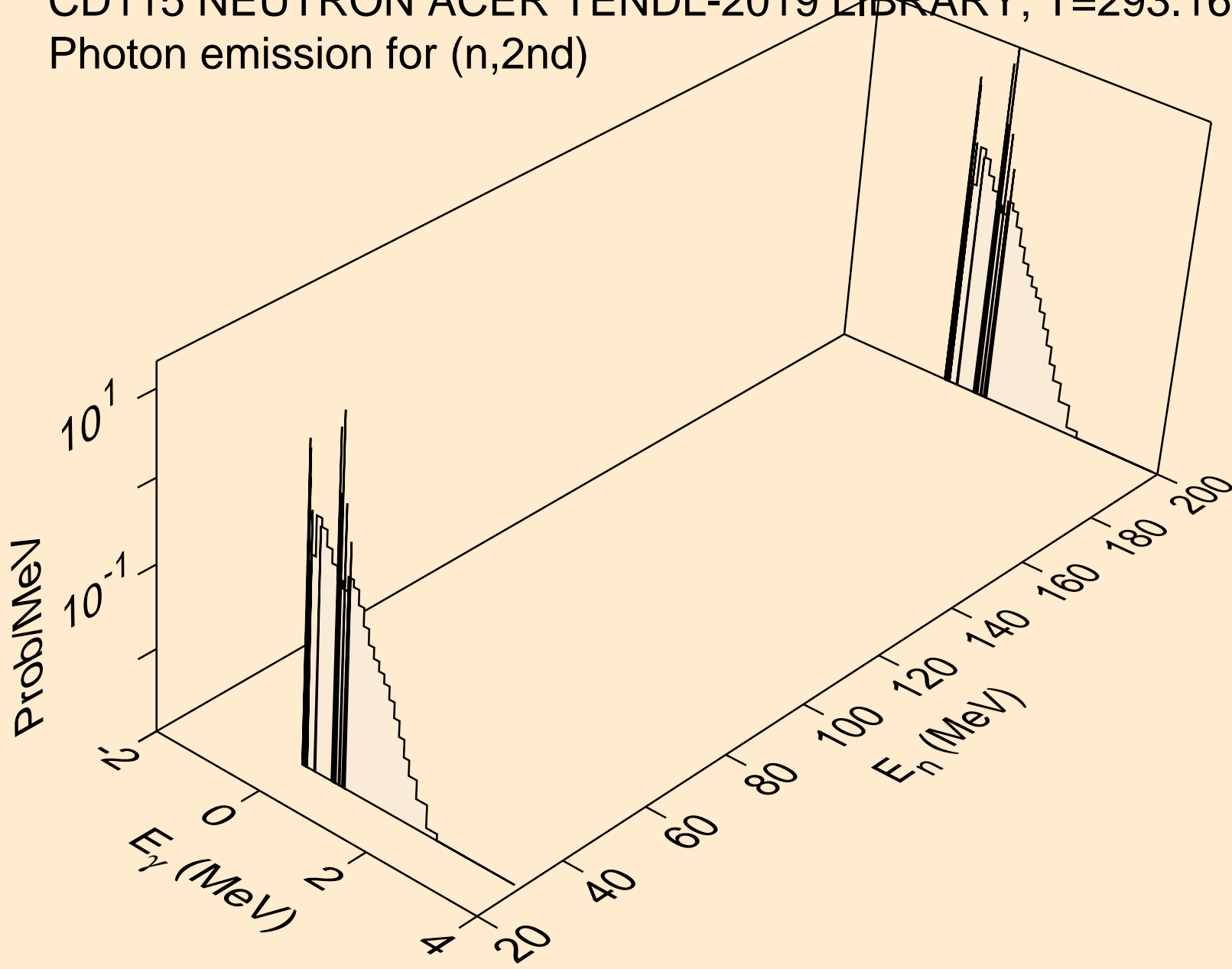

CD115 NEUTRON ACER TENDL-2019 LIBRARY; T=293.16K
Photon emission for (n,2n)

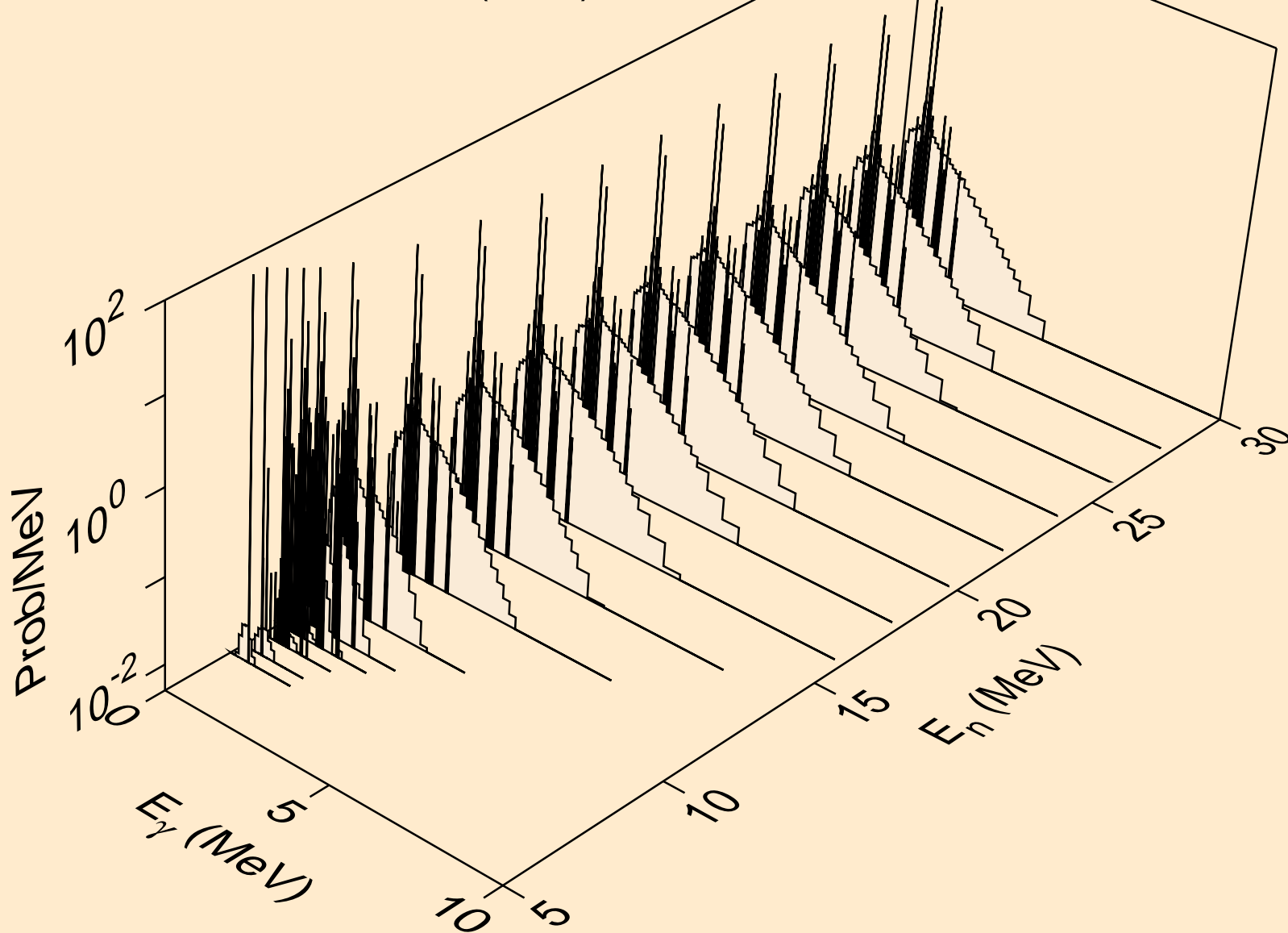

CD115 NEUTRON ACER TENDL-2019 LIBRARY; T=293.16K
Photon emission for (n,3n)

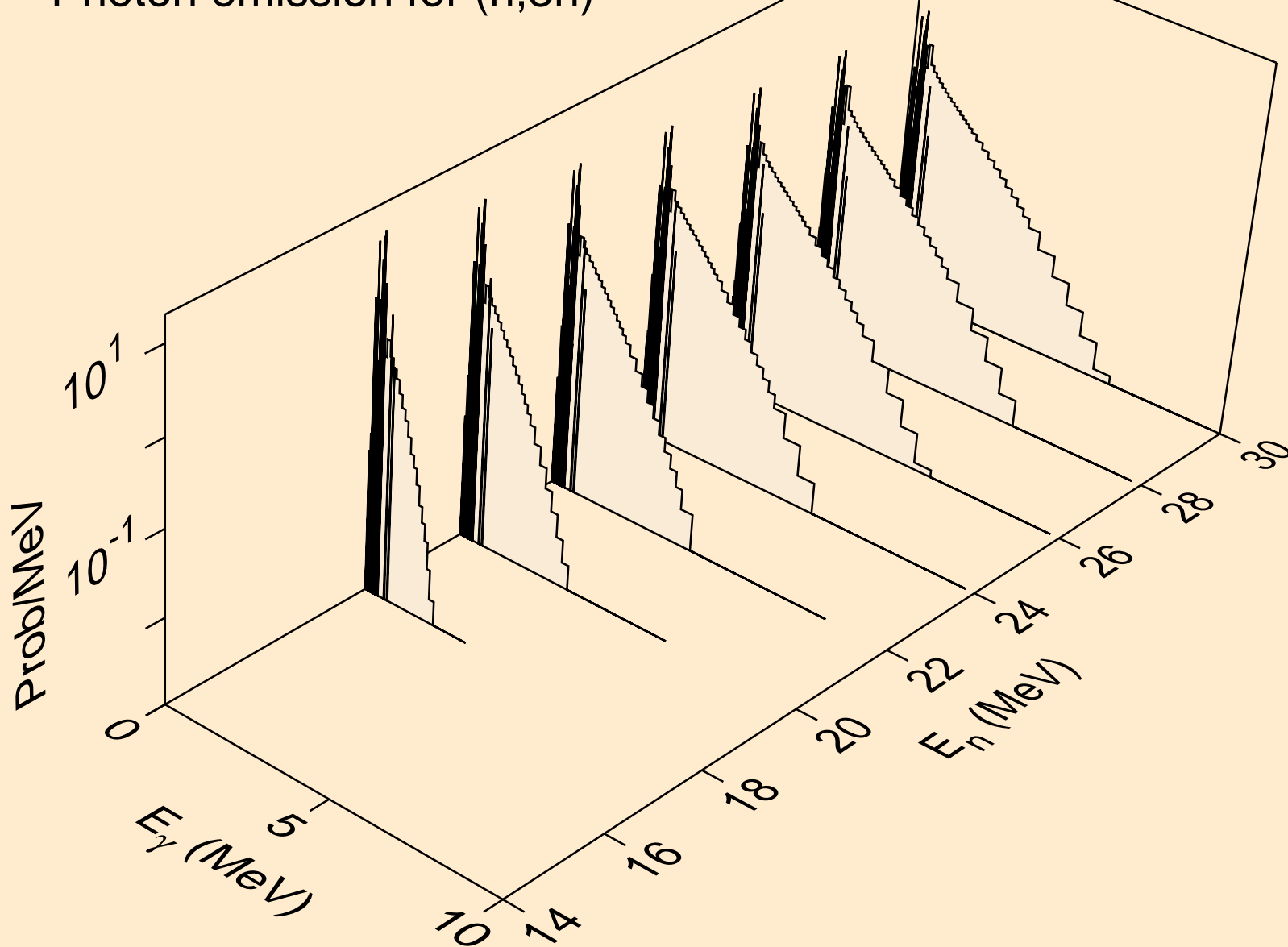

CD115 NEUTRON ACER TENDL-2019 LIBRARY; T=293.16K
Photon emission for (n,n*)a

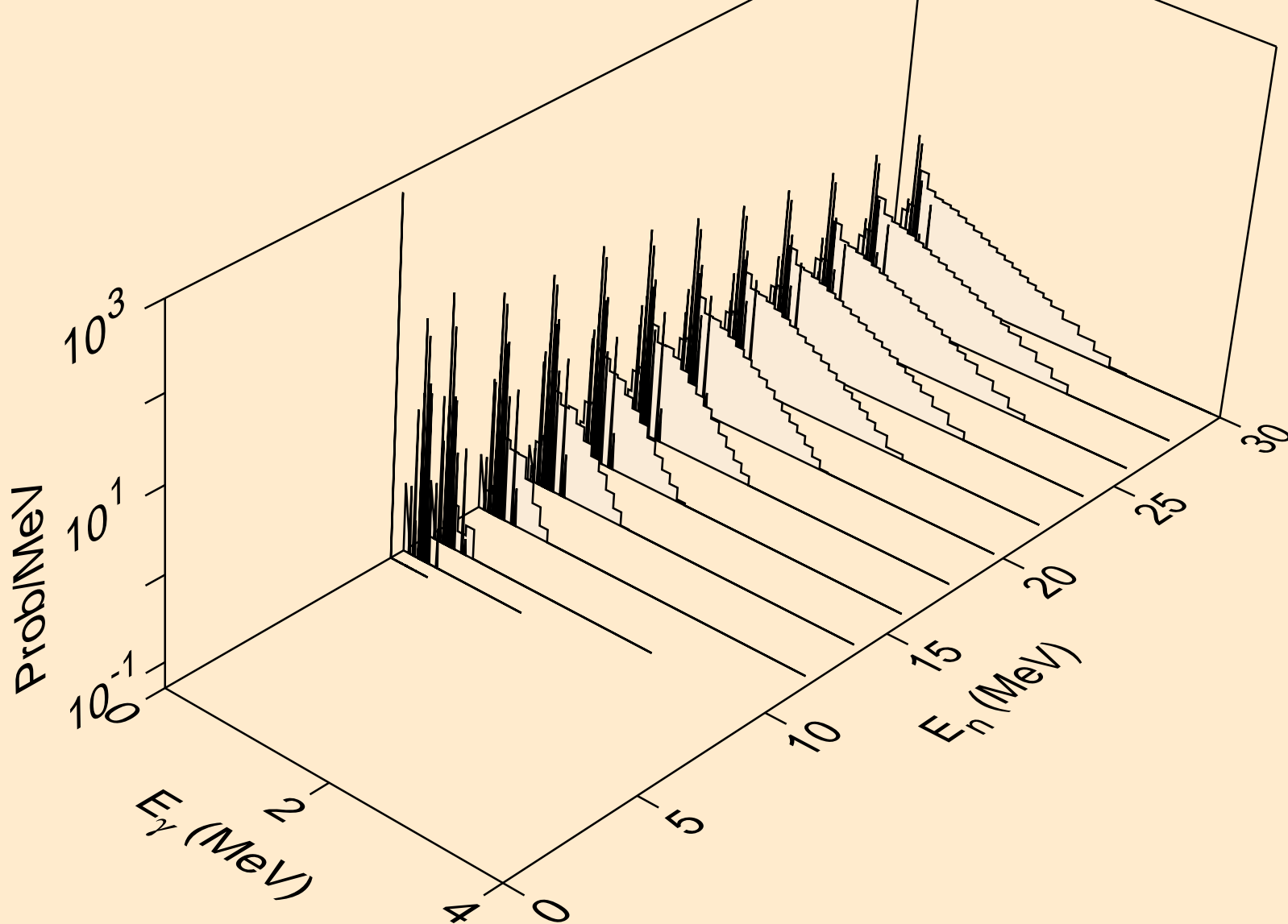

CD115 NEUTRON ACER TENDL-2019 LIBRARY; T=293.16K
Photon emission for (n,2n)a

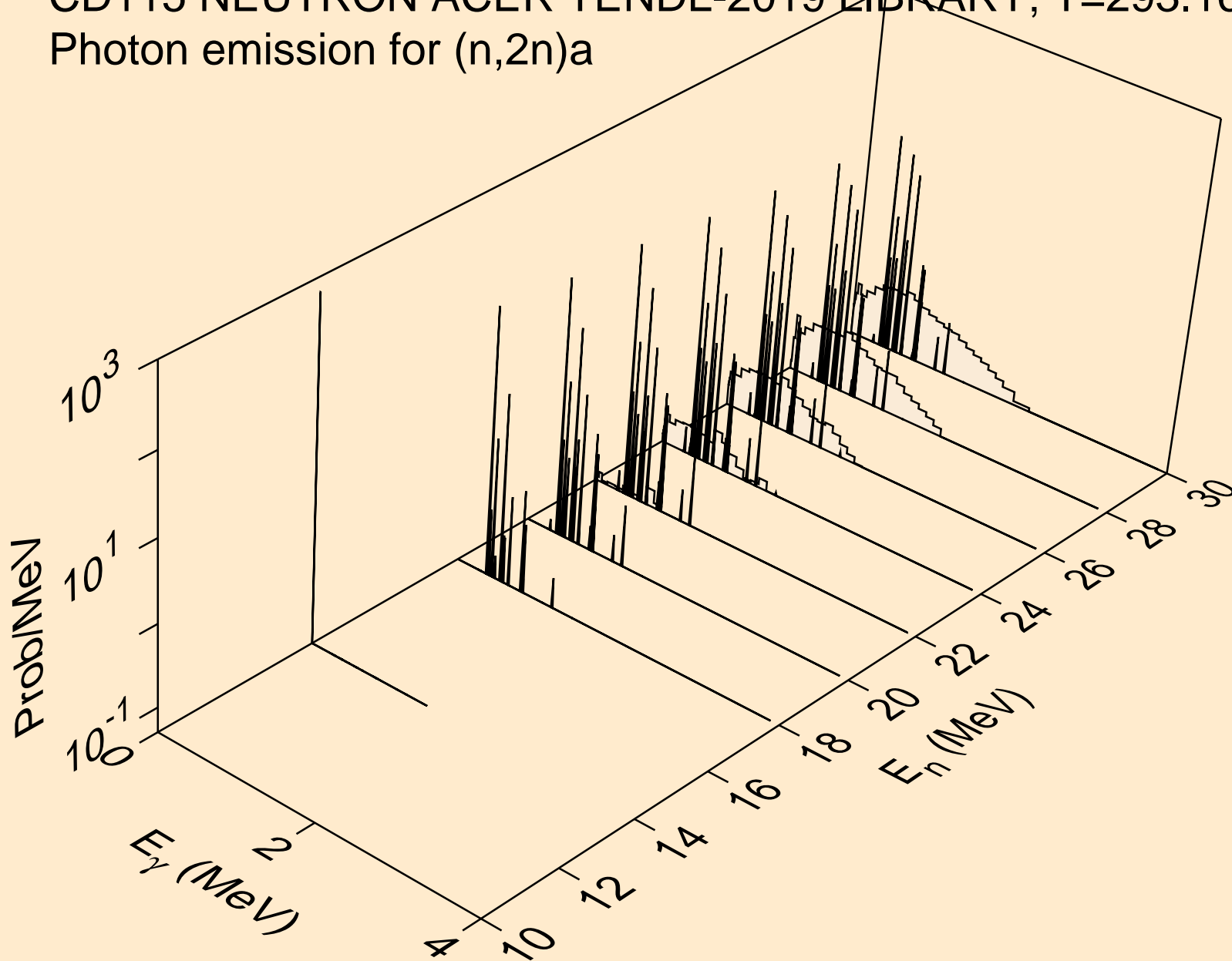

CD115 NEUTRON ACER TENDL-2019 LIBRARY; T=293.16K
Photon emission for (n,3n)a

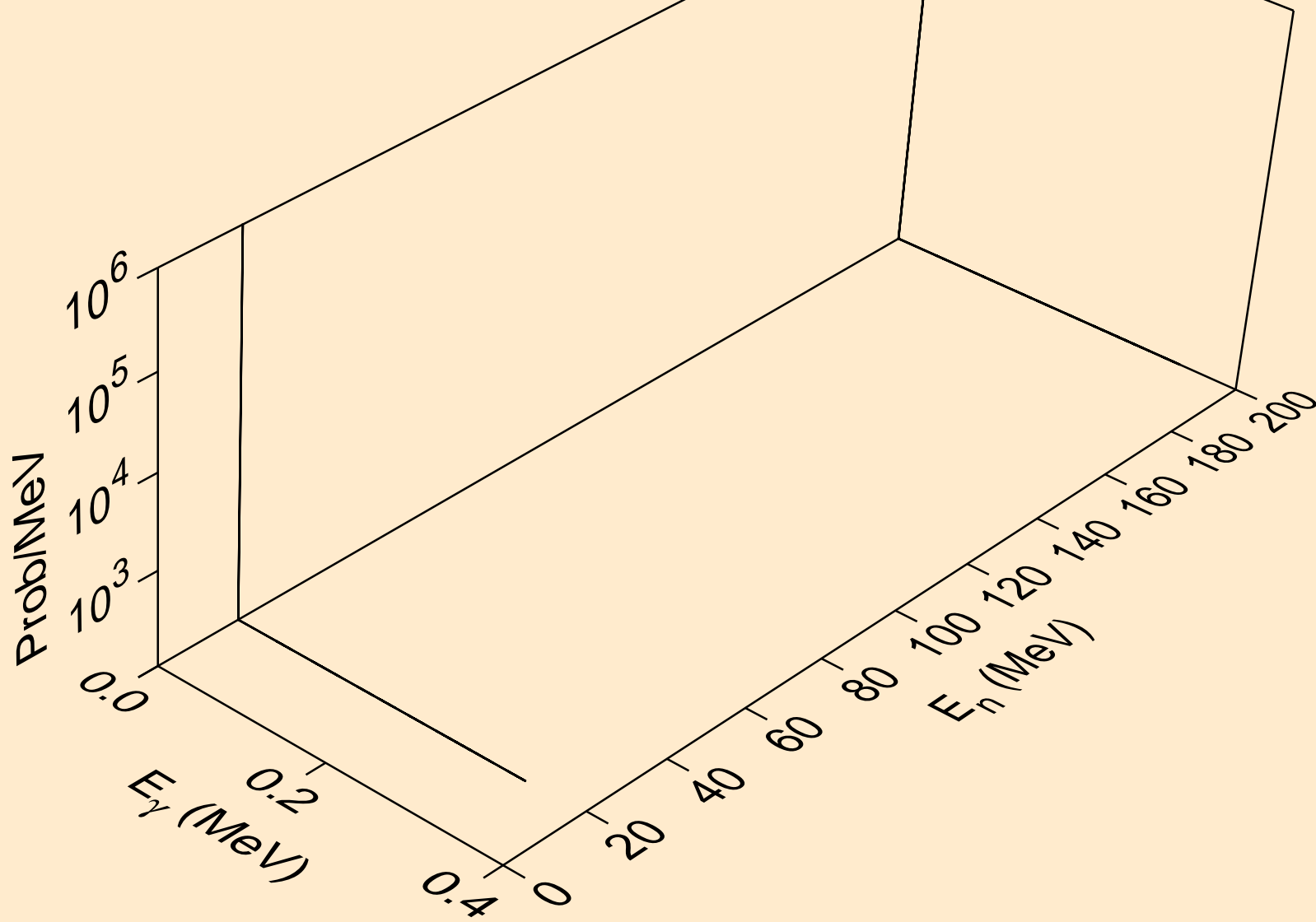

CD115 NEUTRON ACER TENDL-2019 LIBRARY; T=293.16K
Photon emission for (n,n*)p

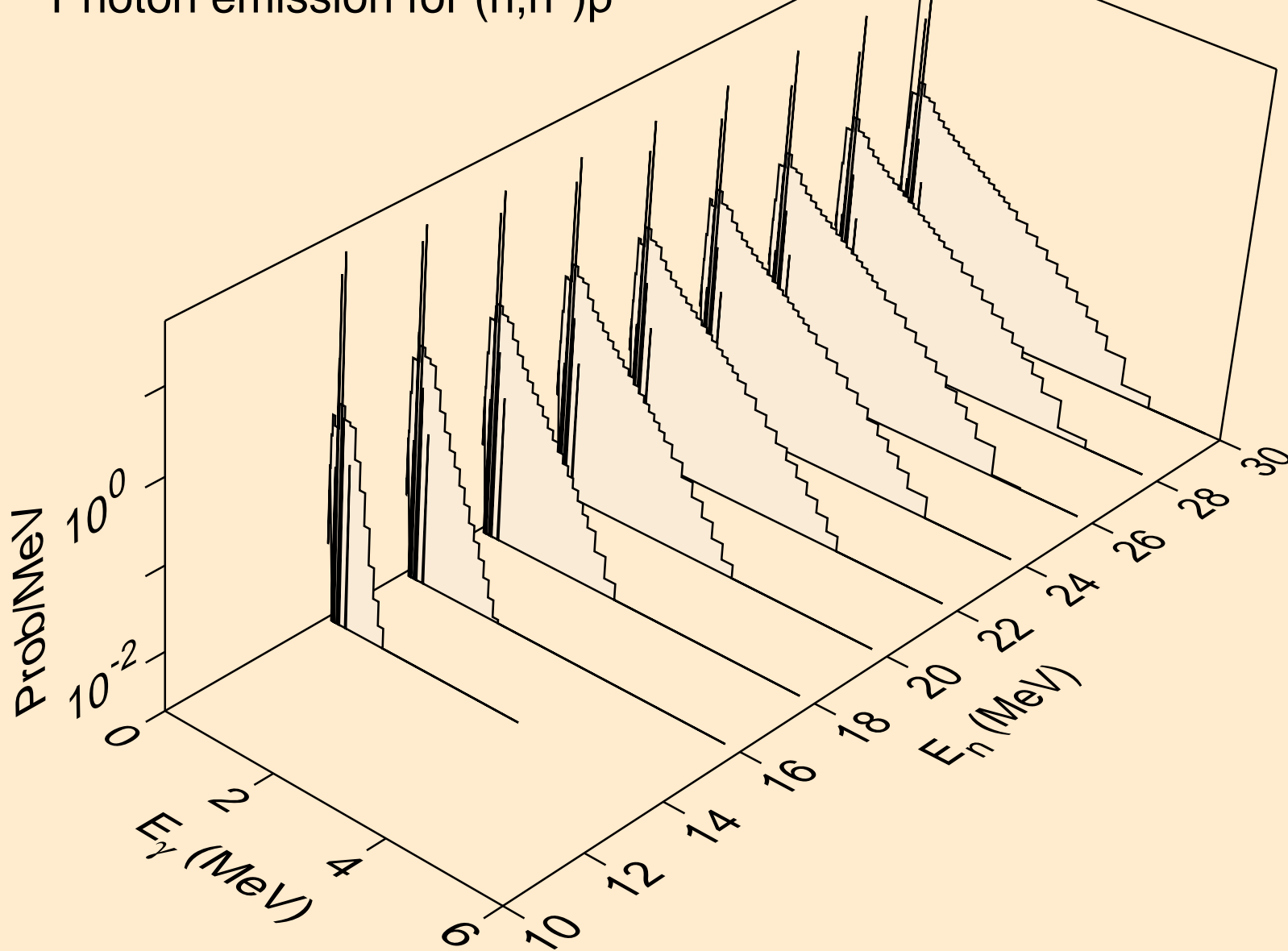

CD115 NEUTRON ACER TENDL-2019 LIBRARY; T=293.16K
Photon emission for (n,n*)d

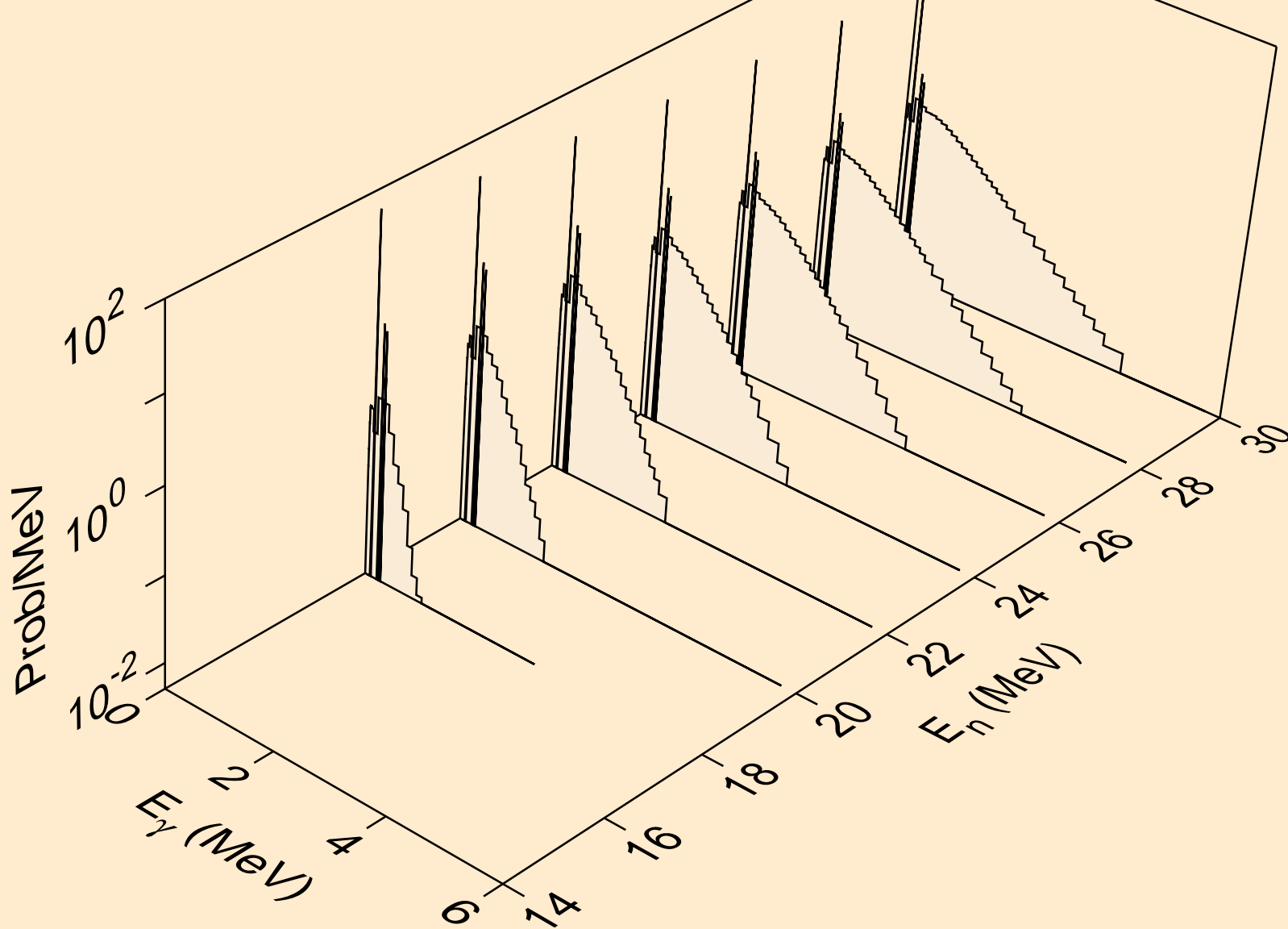

CD115 NEUTRON ACER TENDL-2019 LIBRARY; T=293.16K
Photon emission for (n,n*)t

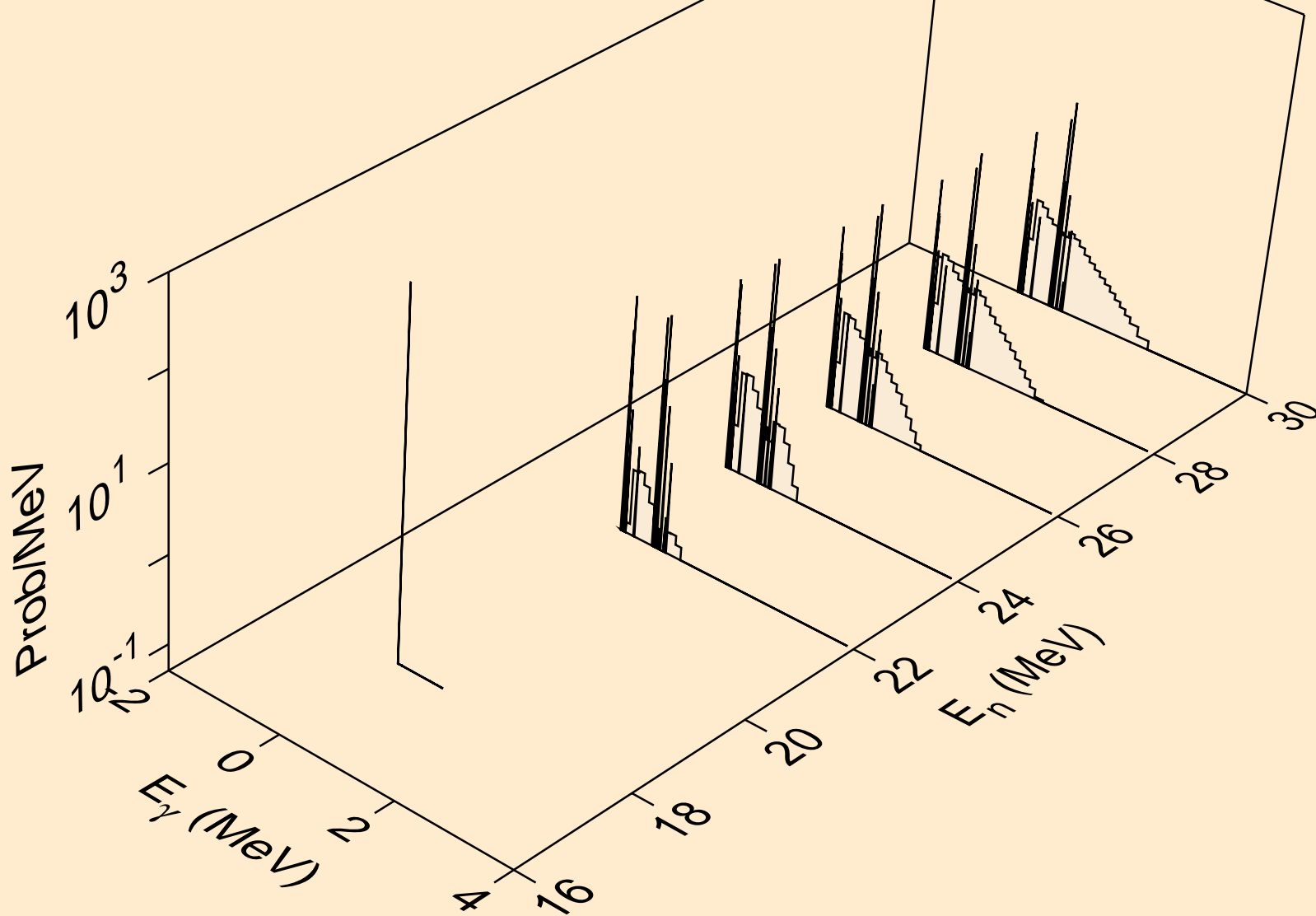

CD115 NEUTRON ACER TENDL-2019 LIBRARY; T=293.16K
Photon emission for (n,n*)he3

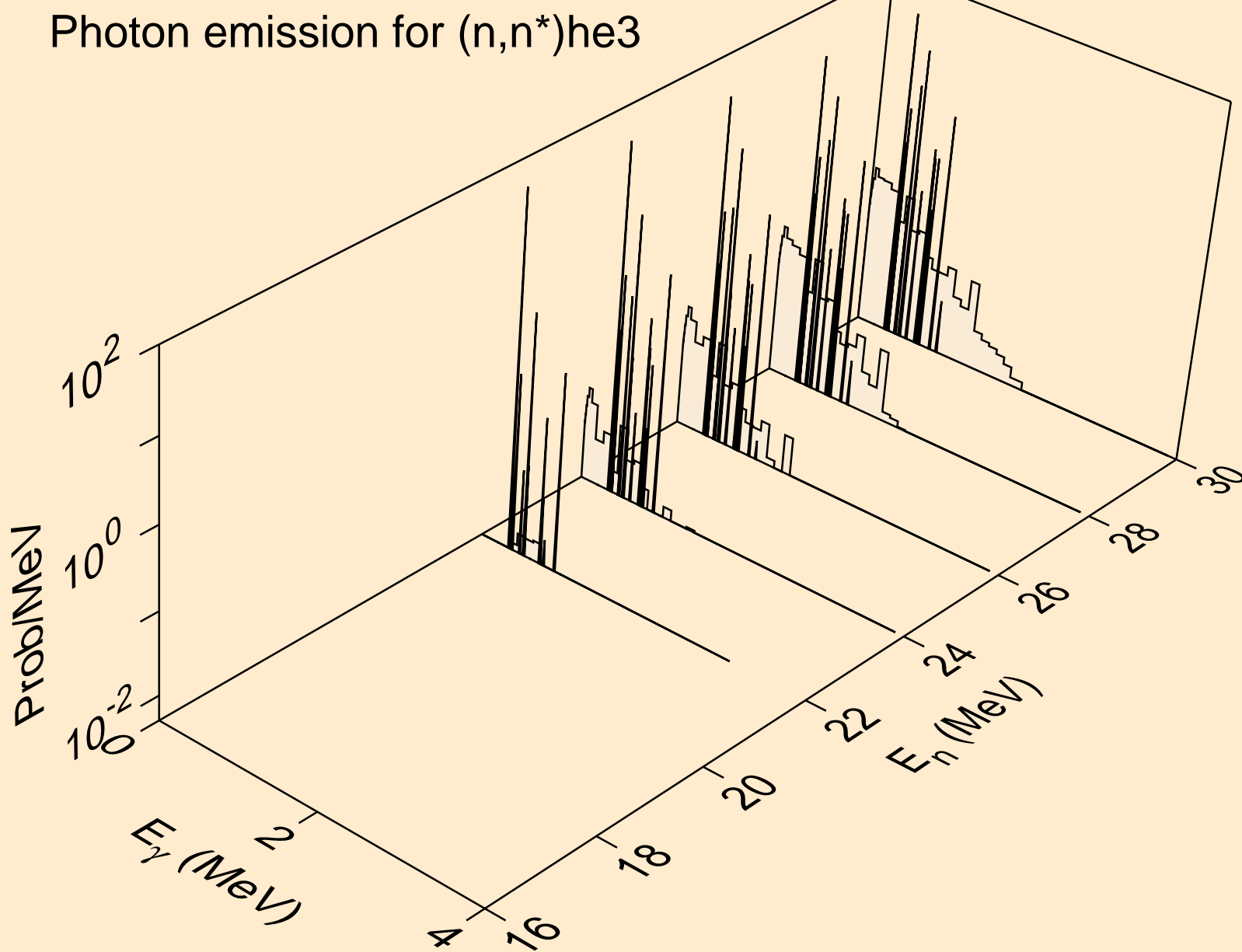

CD115 NEUTRON ACER TENDL-2019 LIBRARY; T=293.16K
Photon emission for (n,4n)

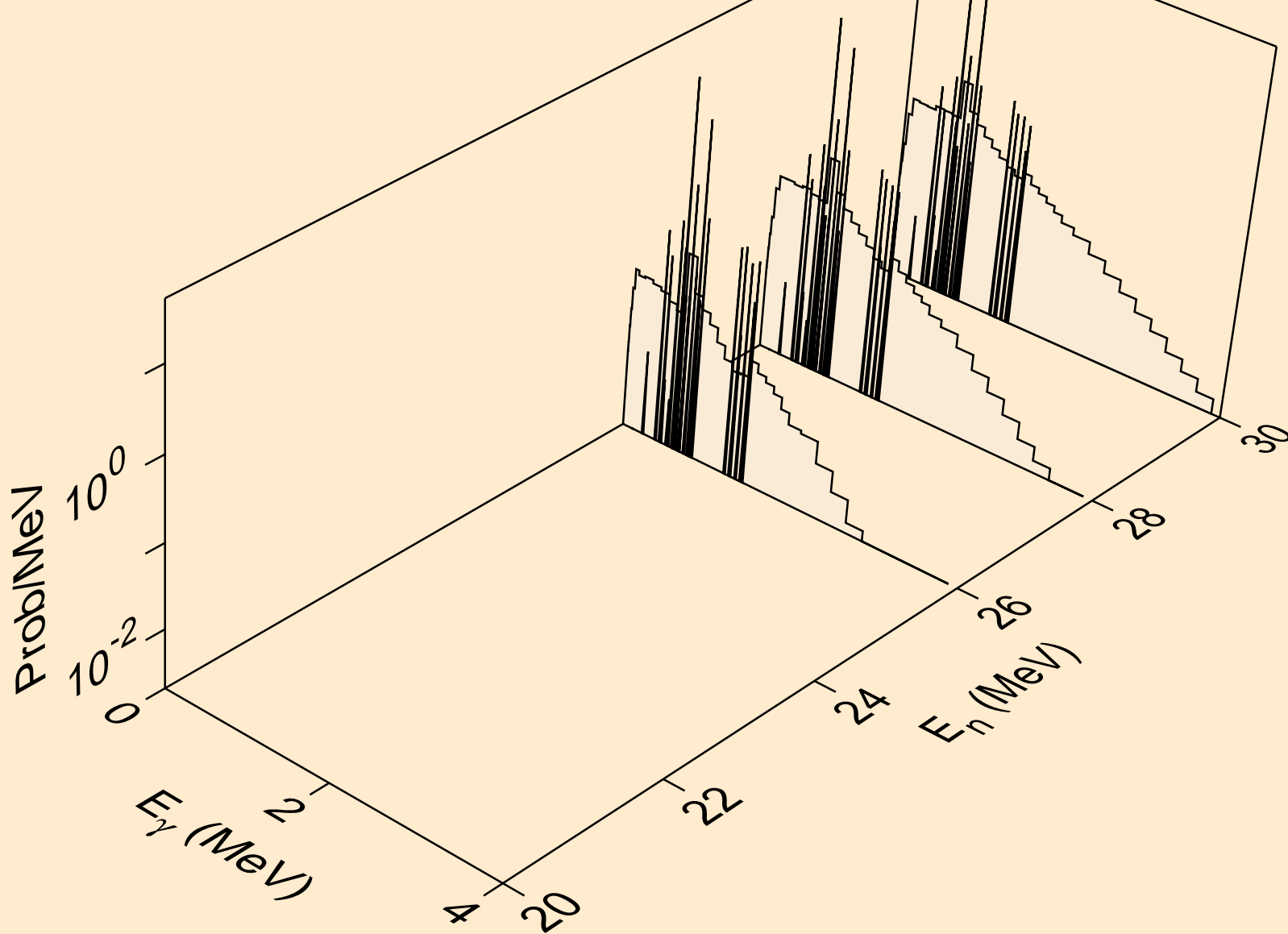

CD115 NEUTRON ACER TENDL-2019 LIBRARY; T=293.16K
Photon emission for (n,2np)

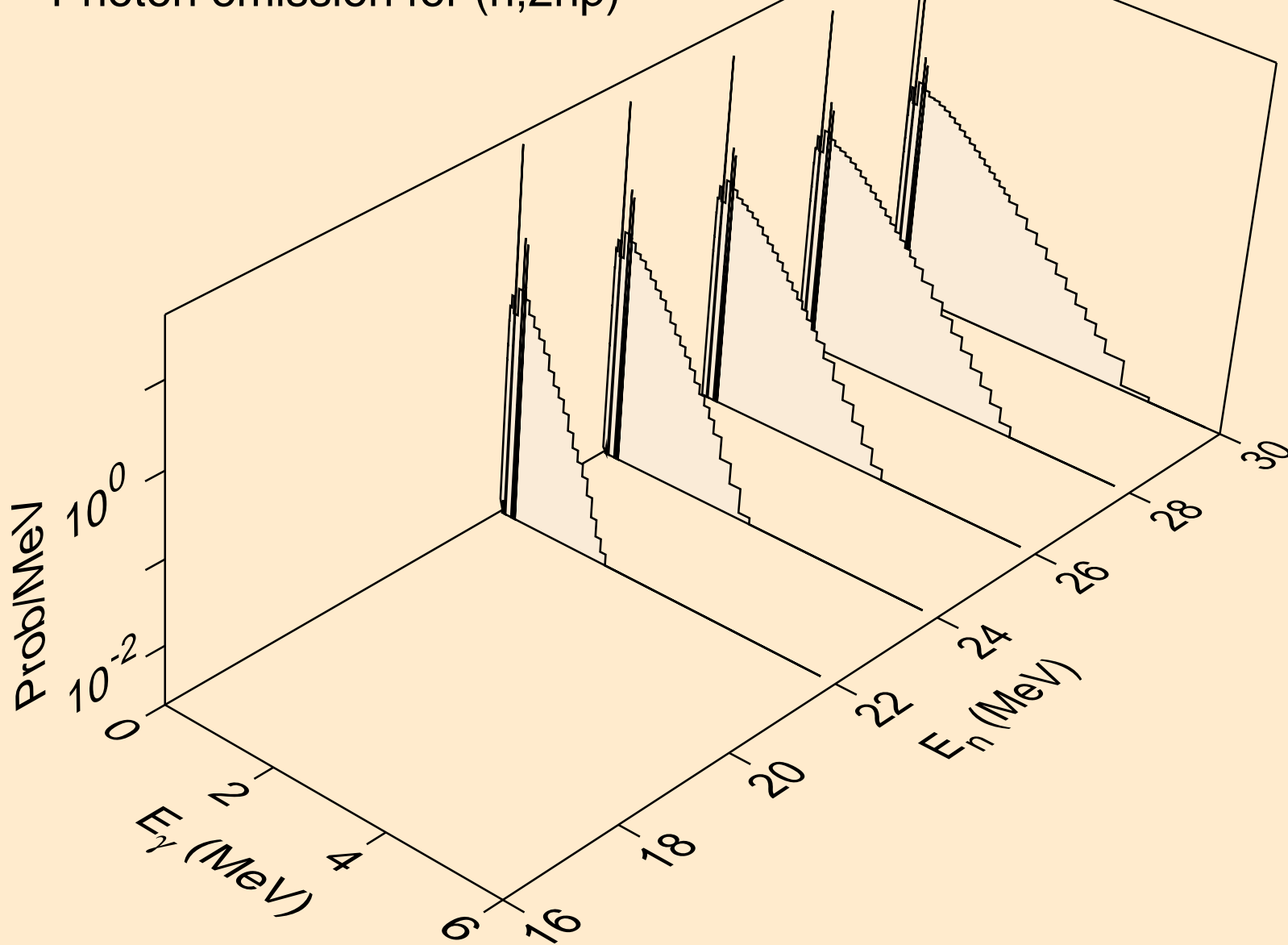

CD115 NEUTRON ACER TENDL-2019 LIBRARY; T=293.16K
Photon emission for (n,3np)

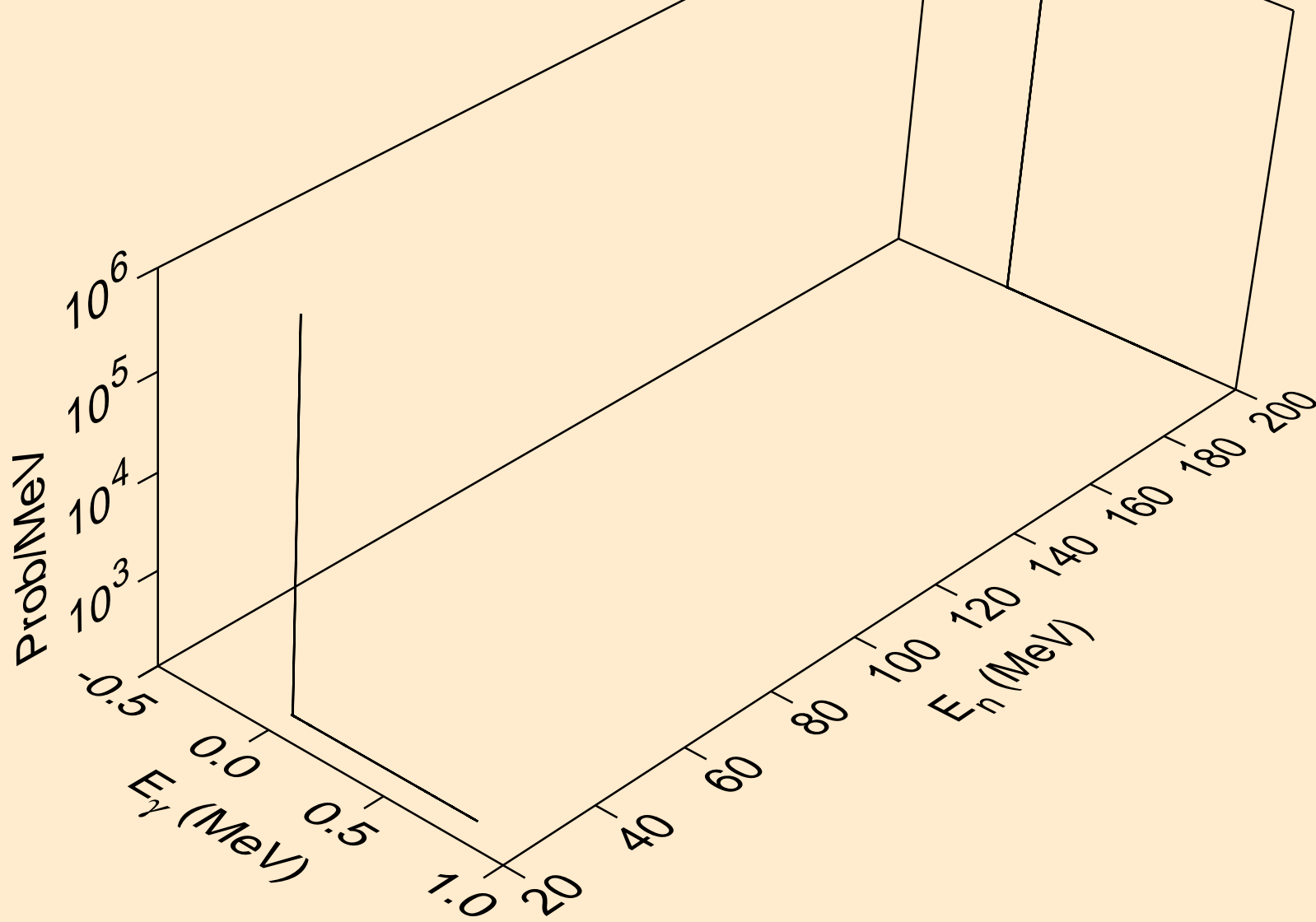

CD115 NEUTRON ACER TENDL-2019 LIBRARY; T=293.16K
Photon emission for (n,2np)

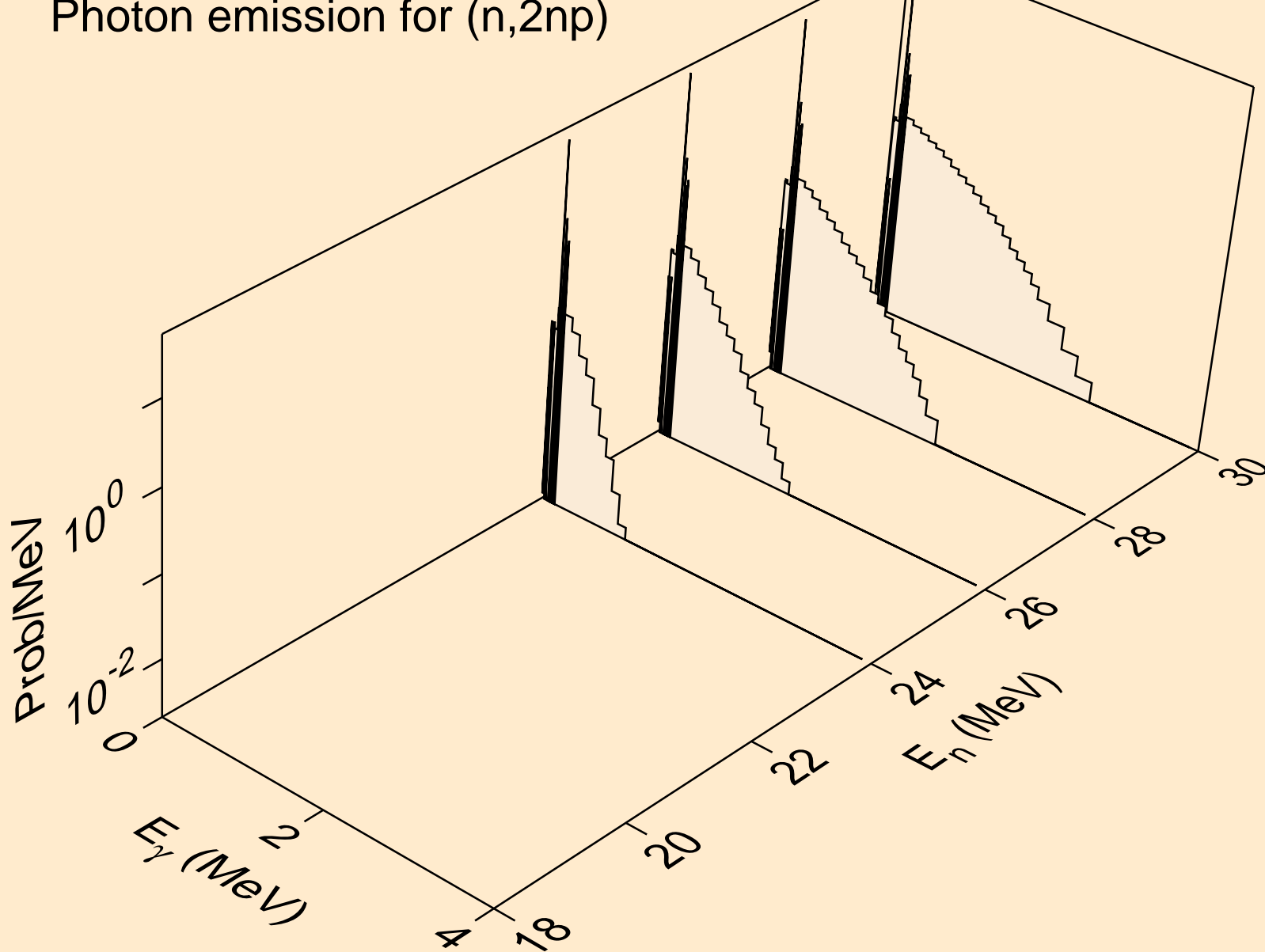

CD115 NEUTRON ACER TENDL-2019 LIBRARY; T=293.16K
Photon emission for (n,npa)

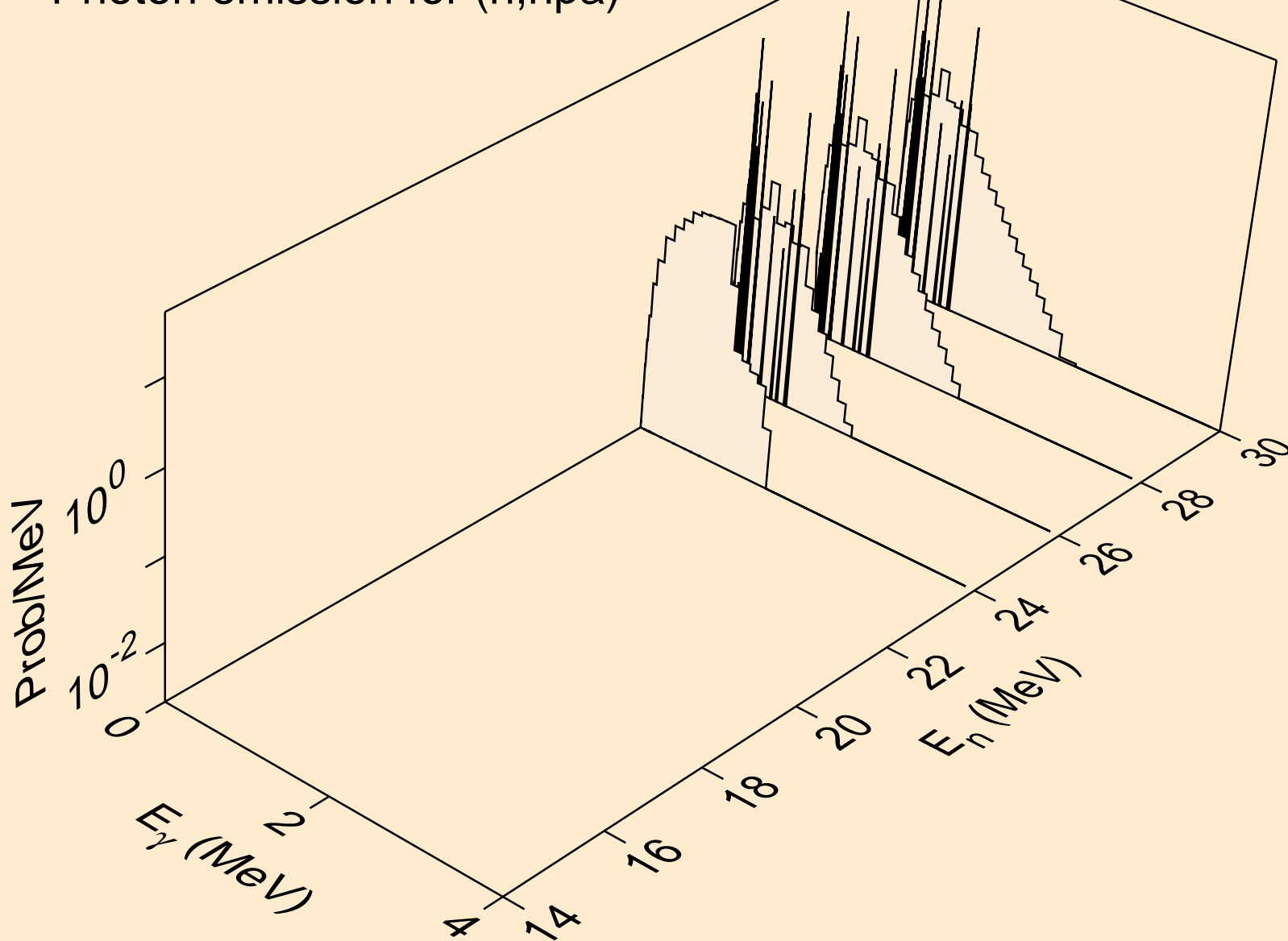

CD115 NEUTRON ACER TENDL-2019 LIBRARY; T=293.16K
Photon emission for (n,n*c)

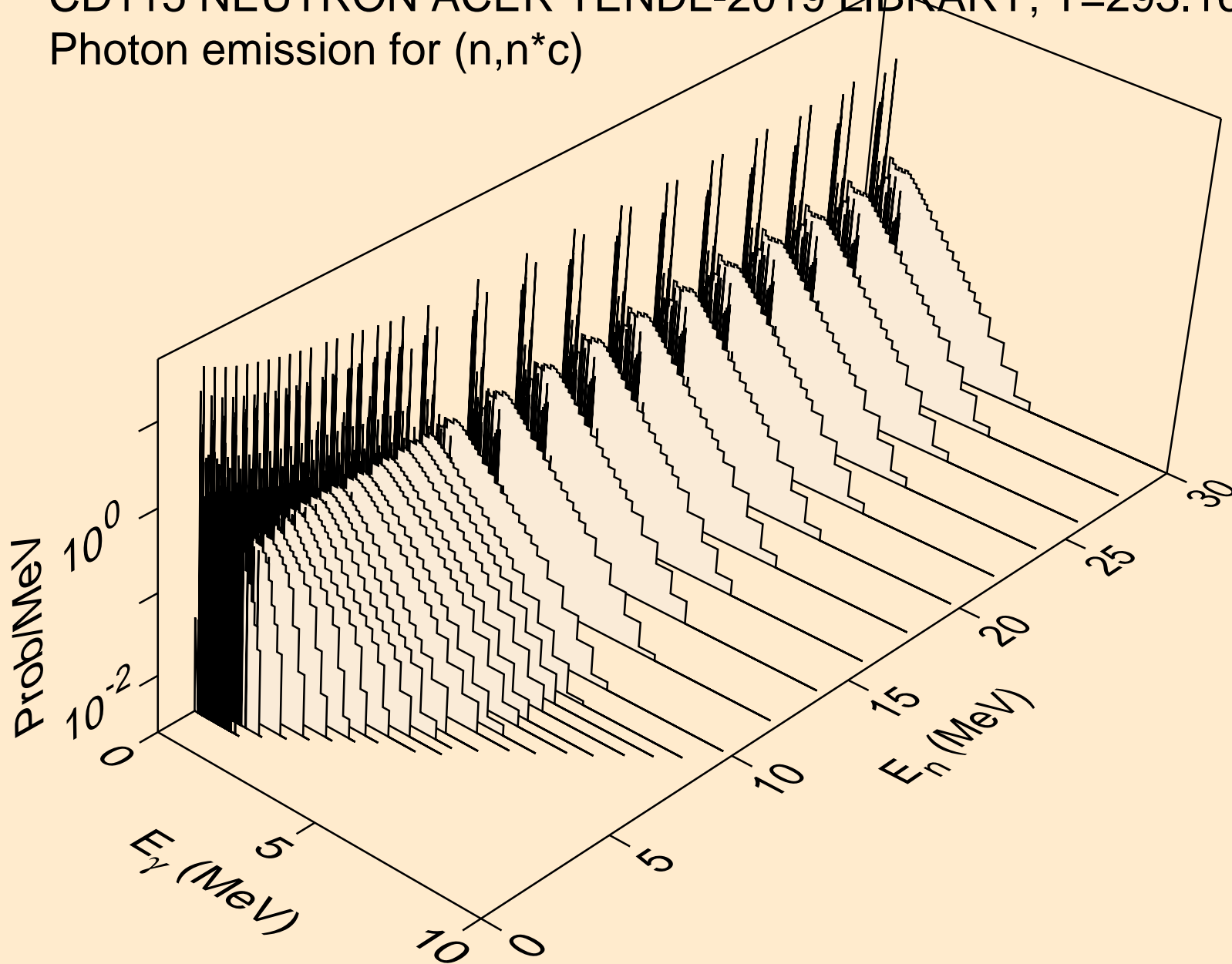

CD115 NEUTRON ACER TENDL-2019 LIBRARY; T=293.16K
Photon emission for (n,gma)

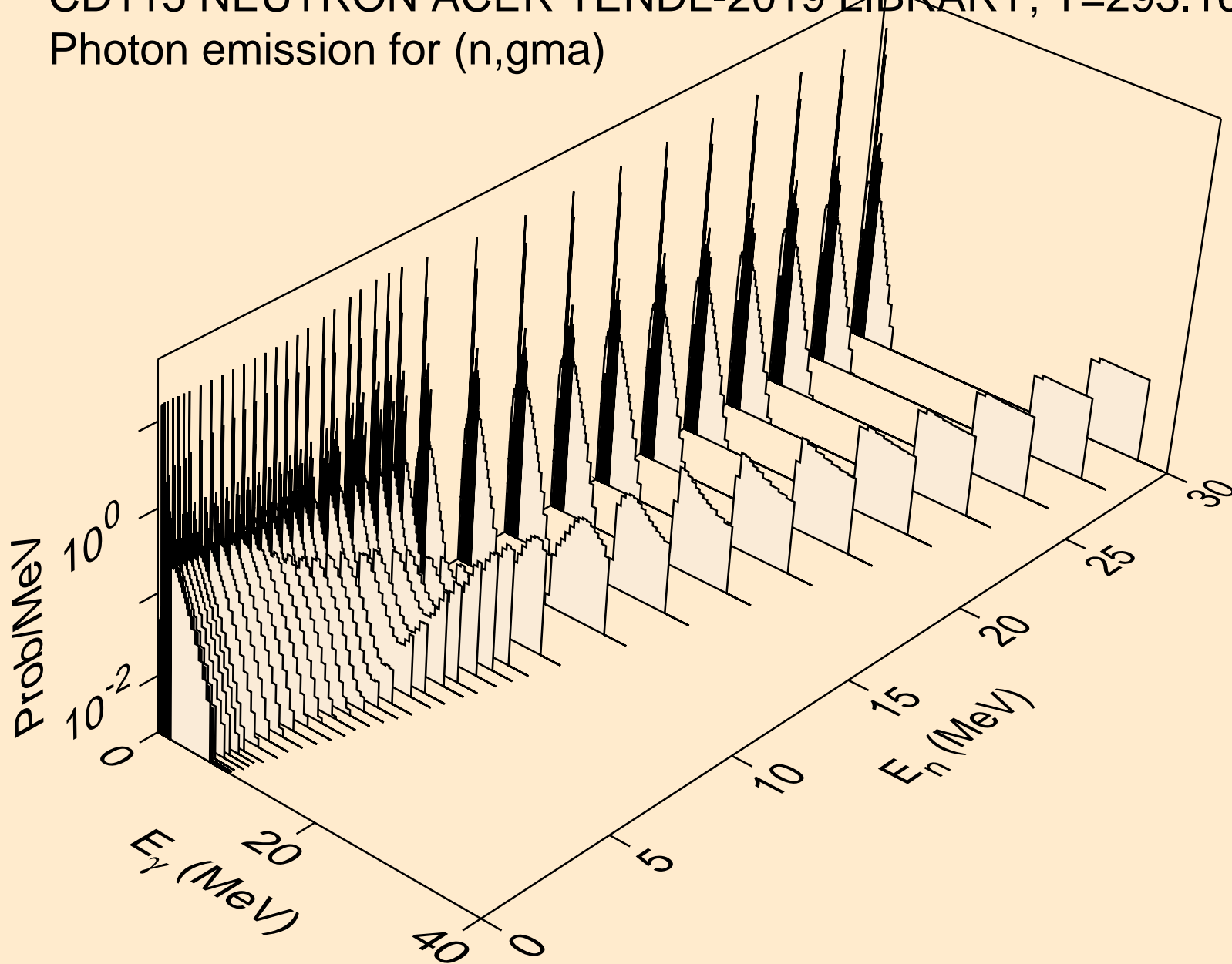

CD115 NEUTRON ACER TENDL-2019 LIBRARY; T=293.16K
Photon emission for (n,p)

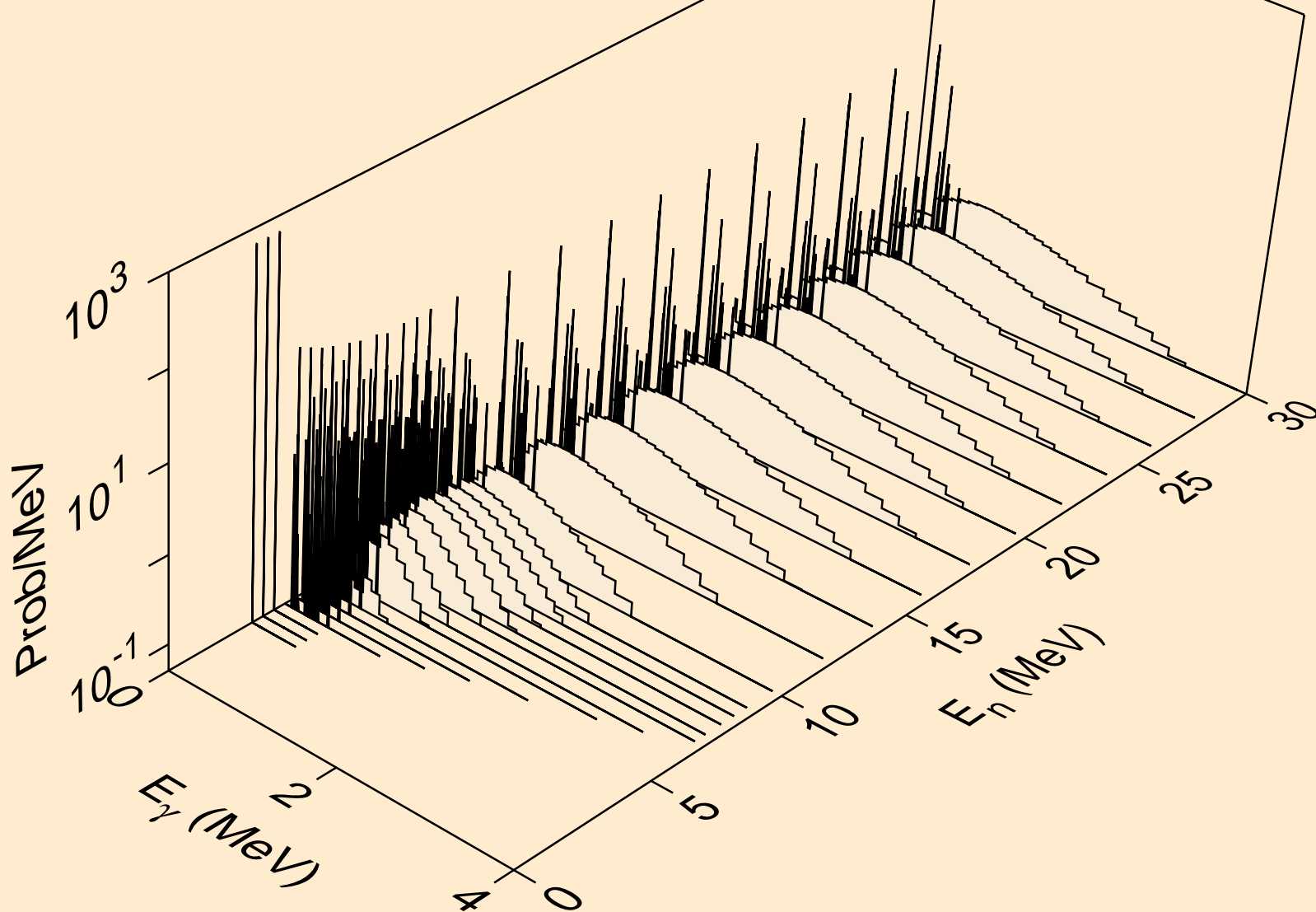

CD115 NEUTRON ACER TENDL-2019 LIBRARY; T=293.16K
Photon emission for (n,d)

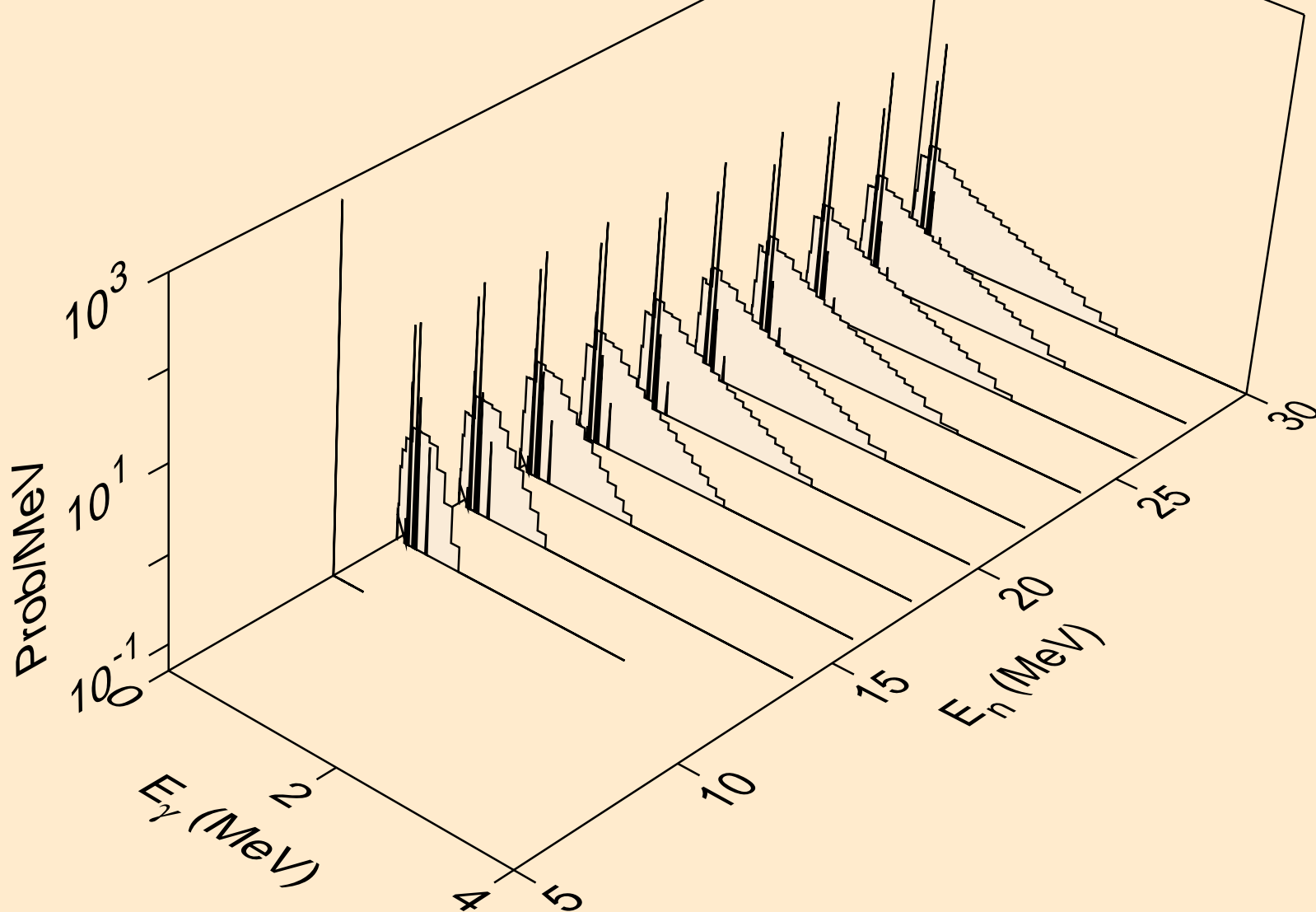

CD115 NEUTRON ACER TENDL-2019 LIBRARY; T=293.16K
Photon emission for (n,t)

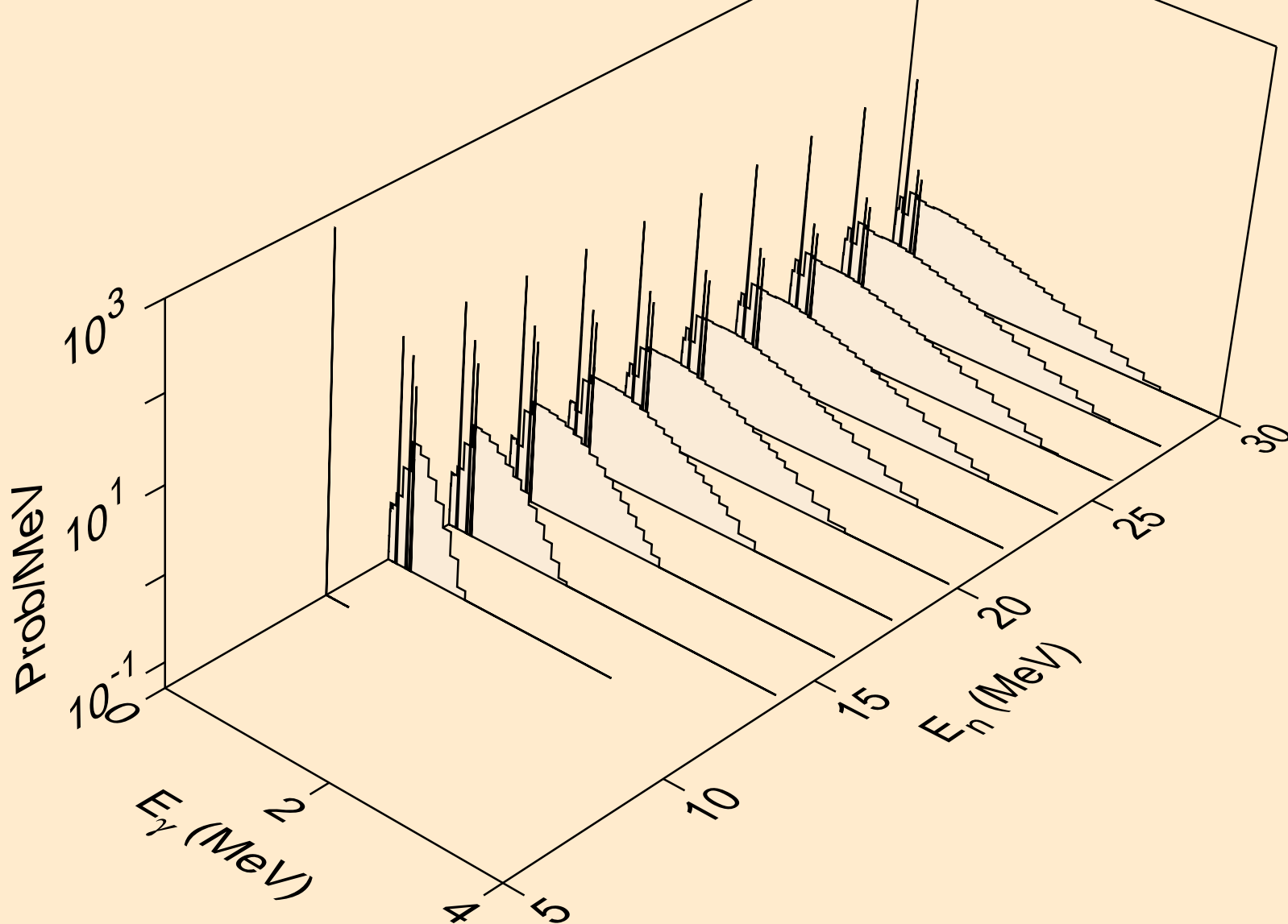

CD115 NEUTRON ACER TENDL-2019 LIBRARY; T=293.16K
Photon emission for (n,he3)

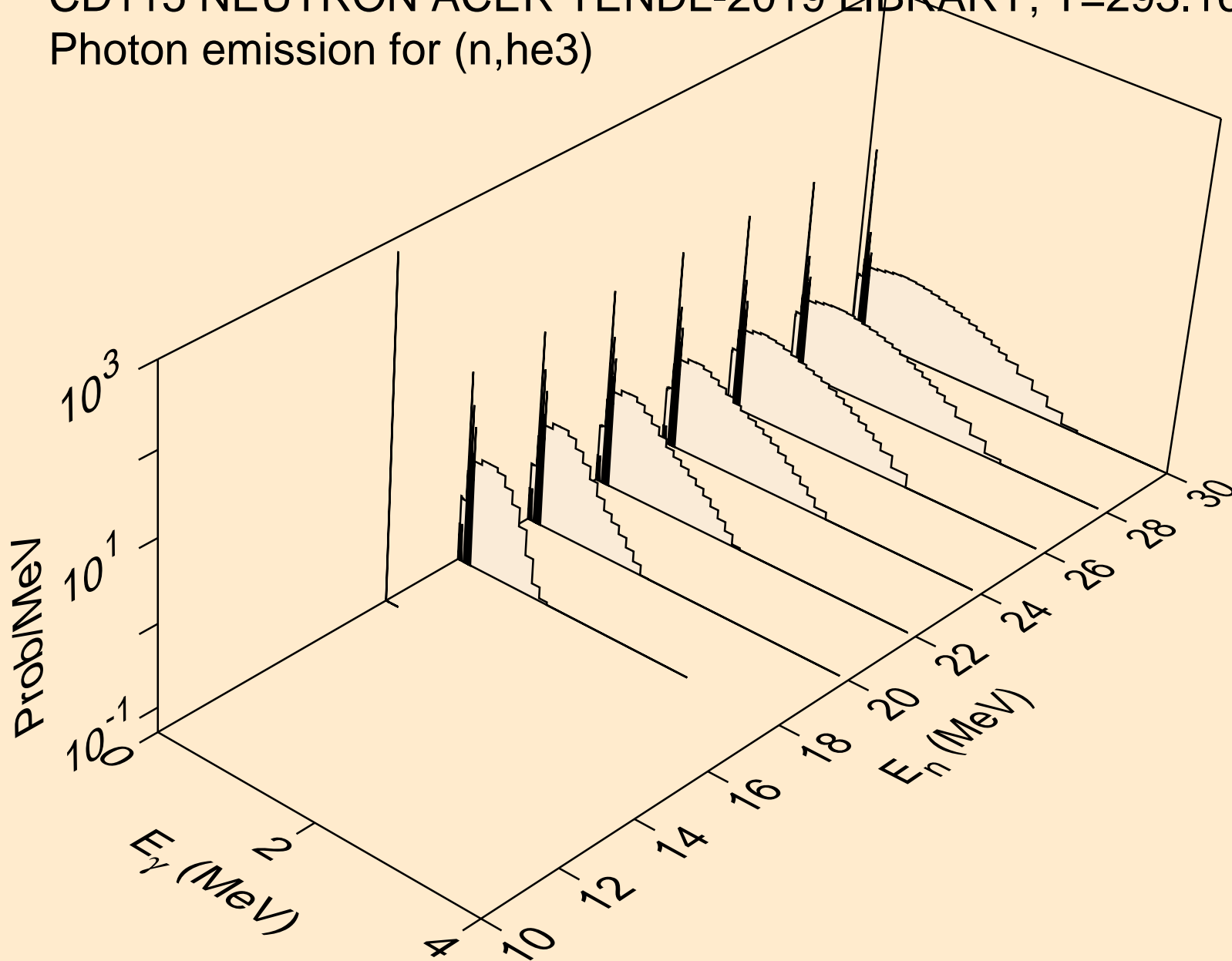

CD115 NEUTRON ACER TENDL-2019 LIBRARY; T=293.16K
Photon emission for (n,a)

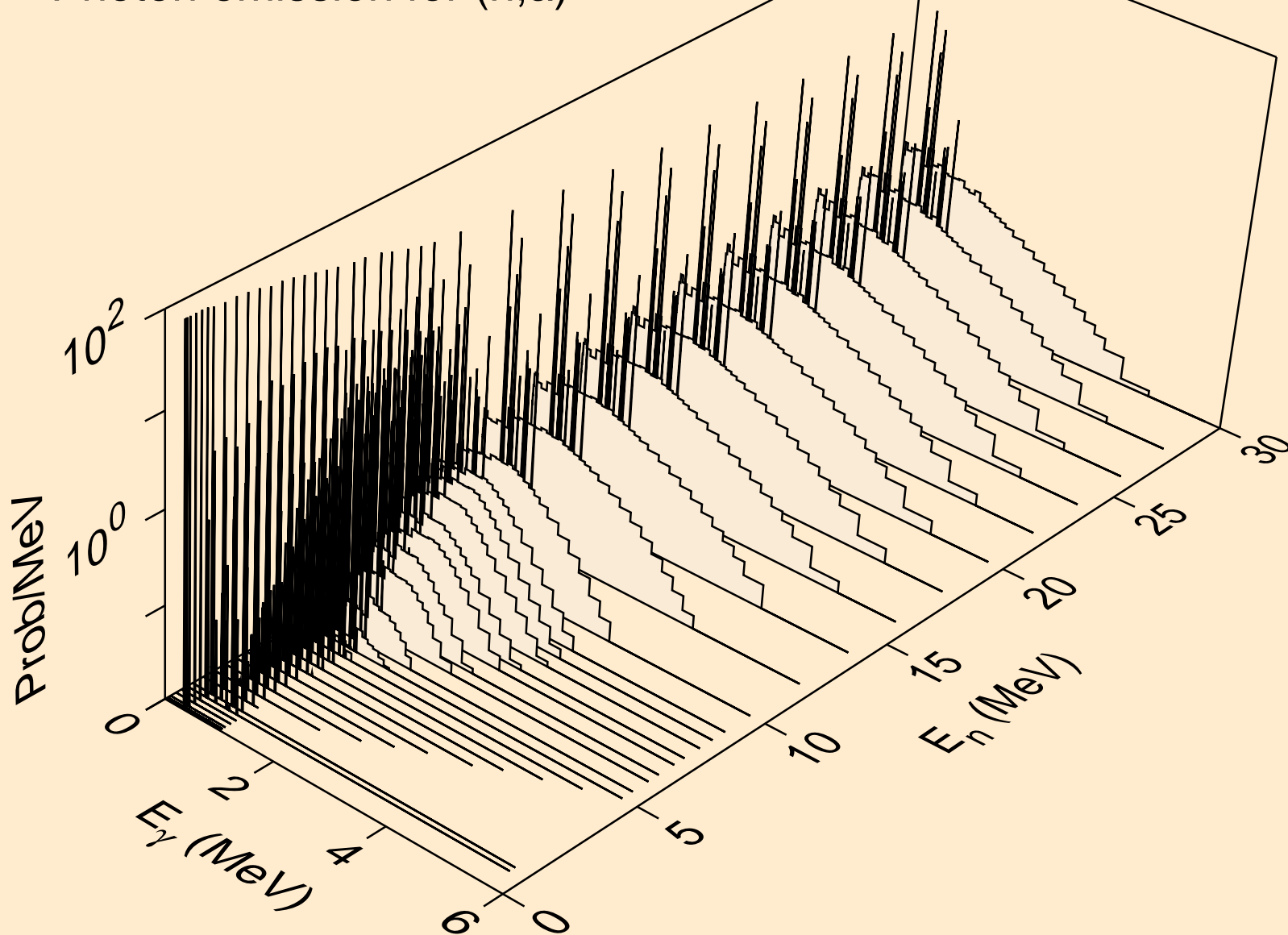

CD115 NEUTRON ACER TENDL-2019 LIBRARY; T=293.16K
Photon emission for (n,2a)

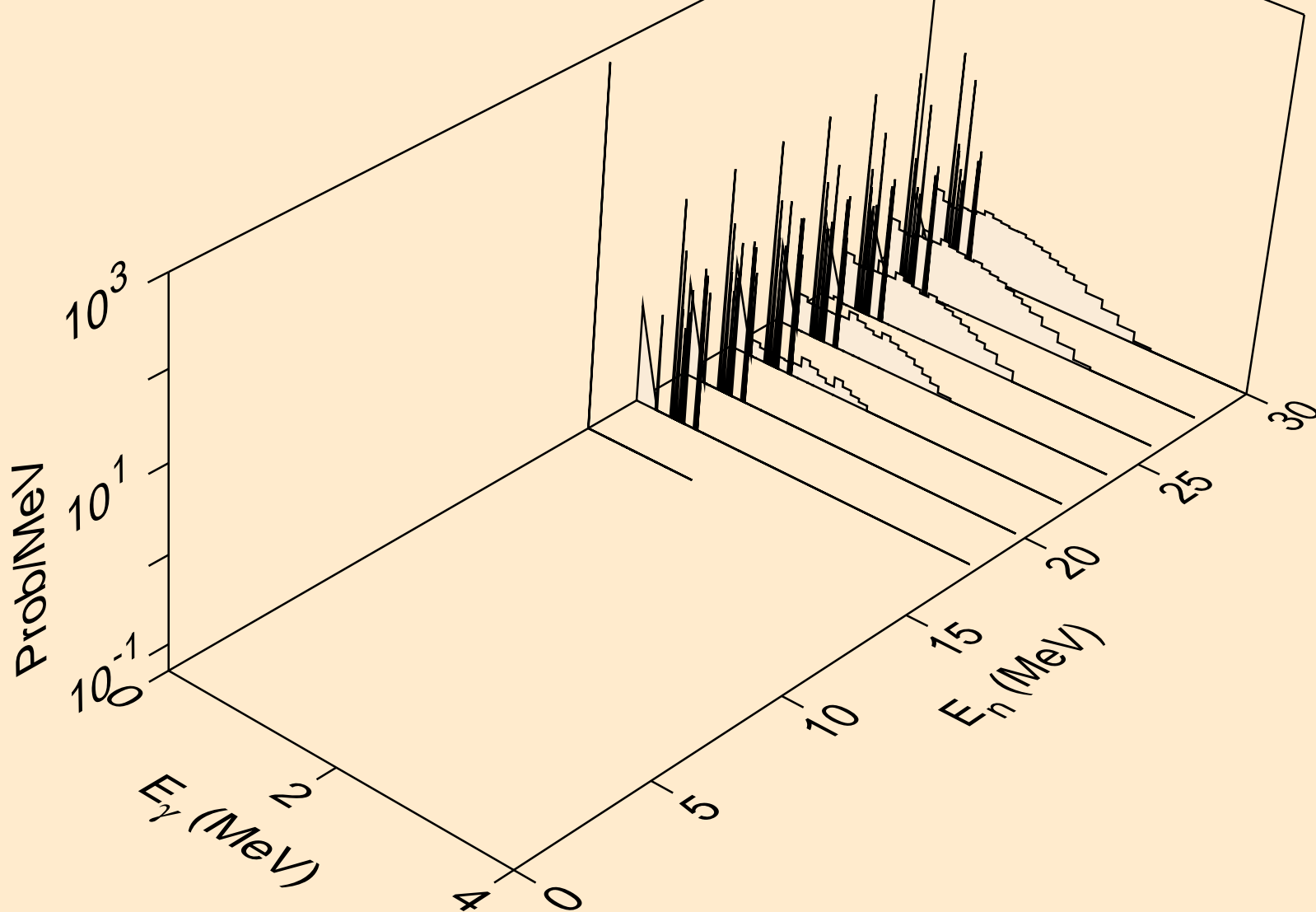

CD115 NEUTRON ACER TENDL-2019 LIBRARY; T=293.16K
Photon emission for (n,2p)

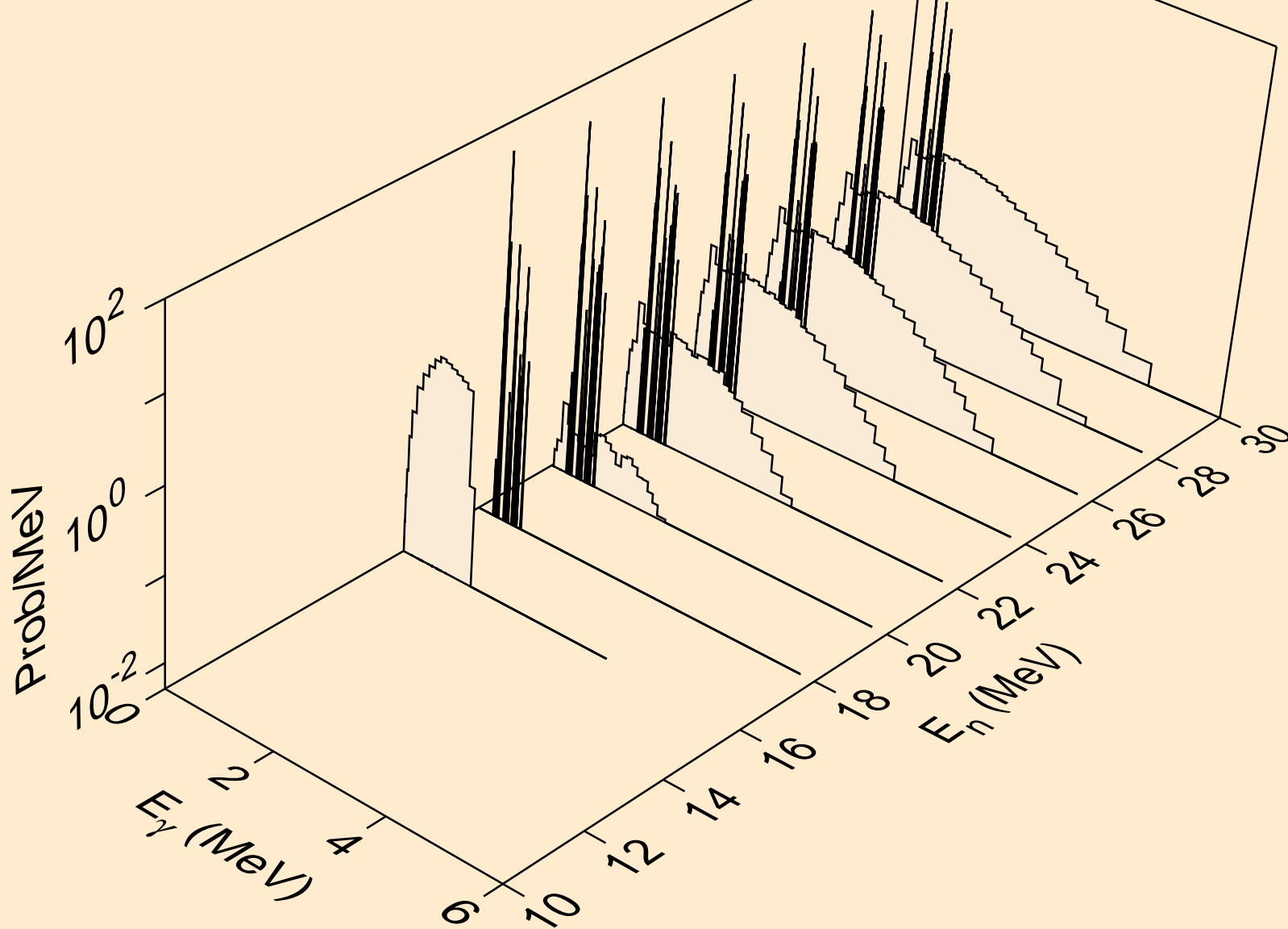

CD115 NEUTRON ACER TENDL-2019 LIBRARY; T=293.16K
Photon emission for (n,p α)

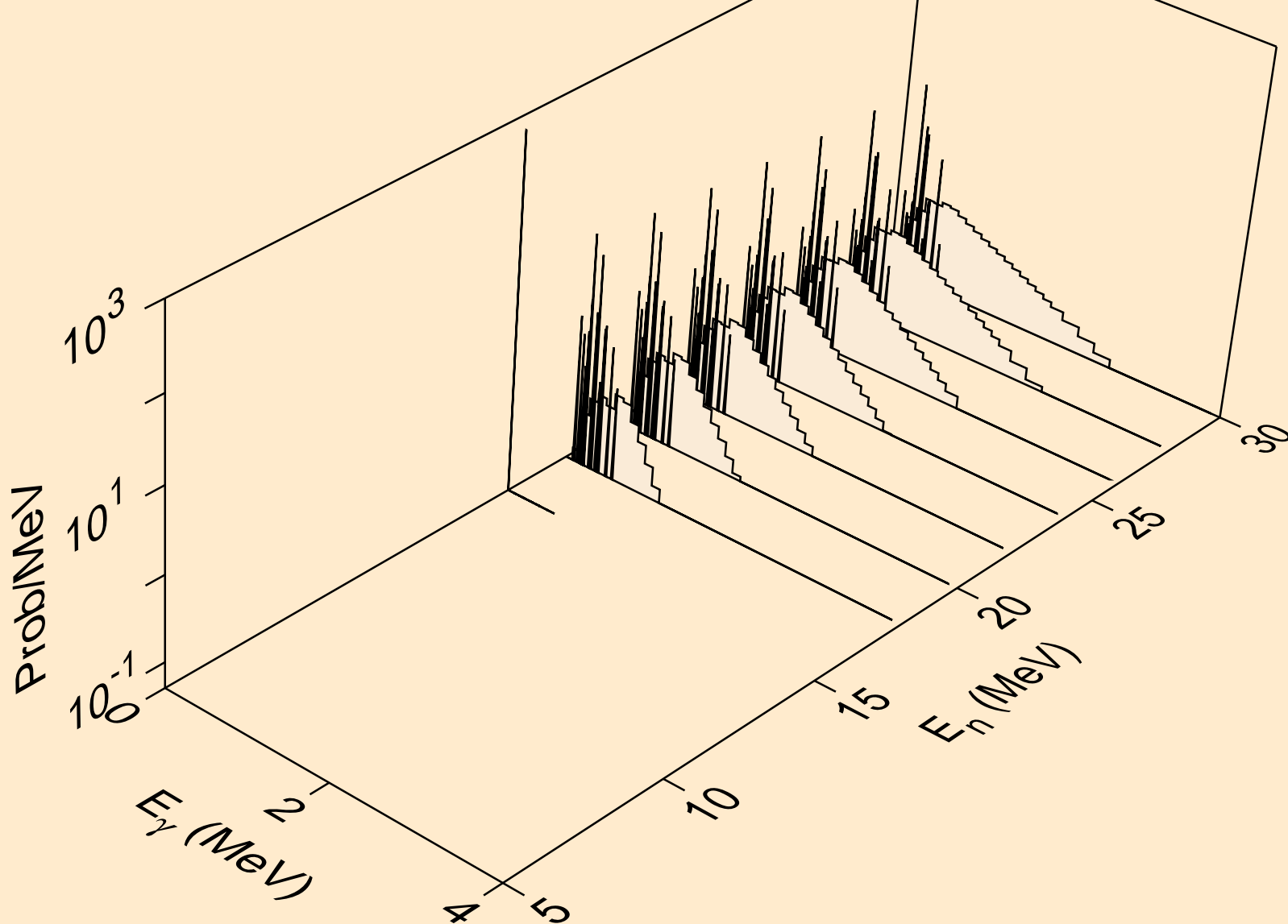

CD115 NEUTRON ACER TENDL-2019 LIBRARY; T=293.16K
Photon emission for (n,pd)

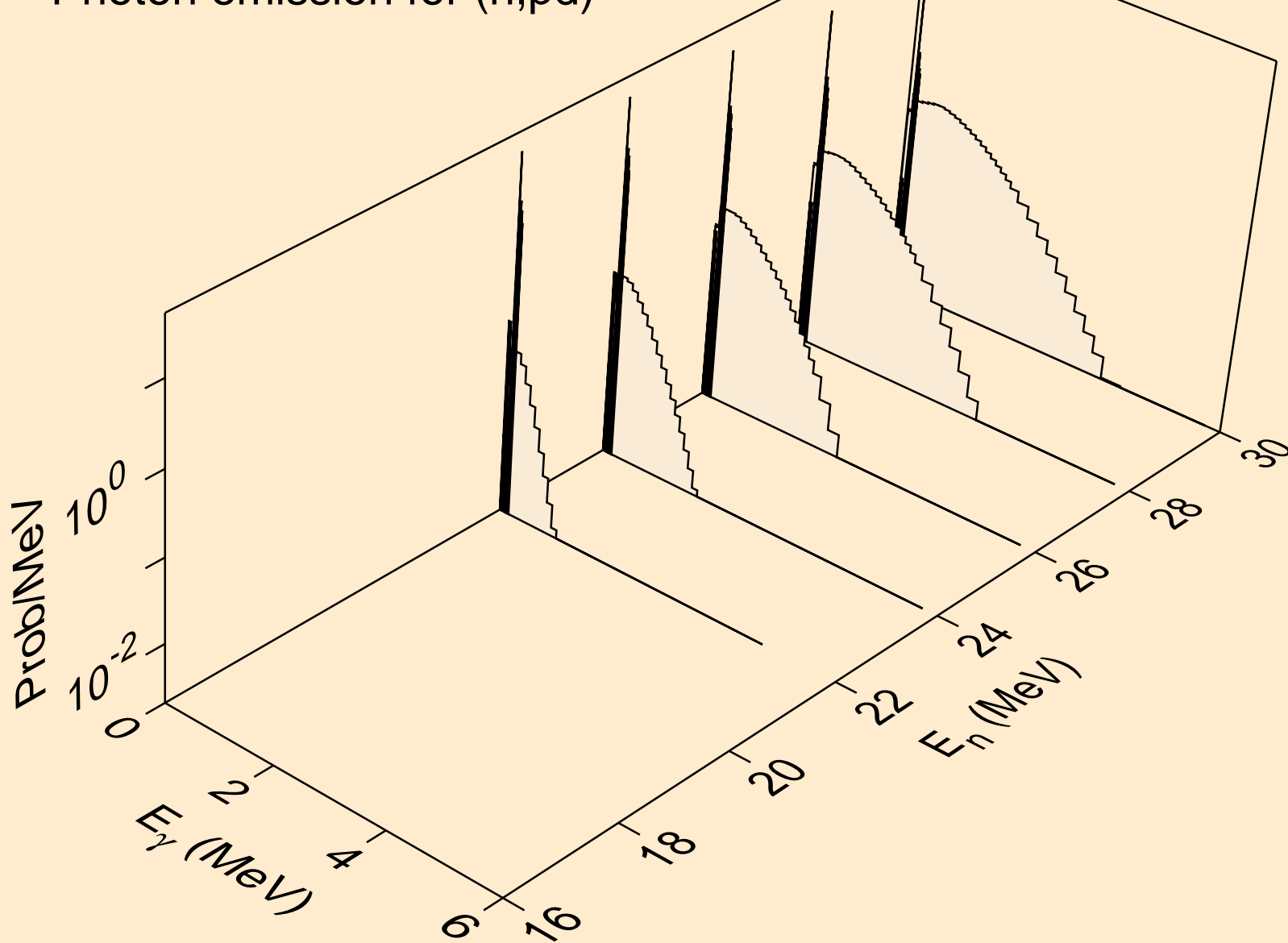

CD115 NEUTRON ACER TENDL-2019 LIBRARY; T=293.16K
Photon emission for (n,pt)

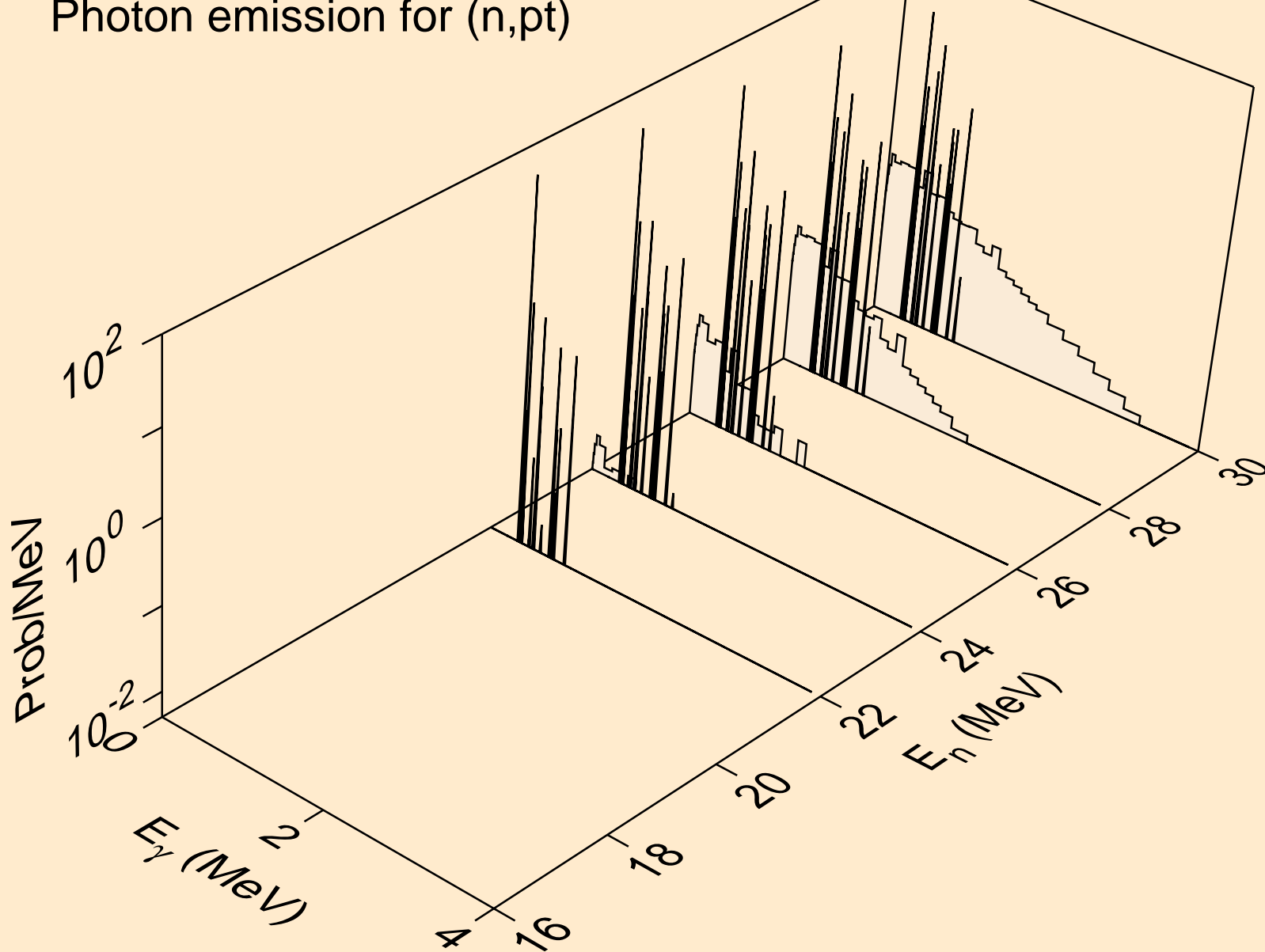

CD115 NEUTRON ACER TENDL-2019 LIBRARY; T=293.16K
thermal capture photon spectrum

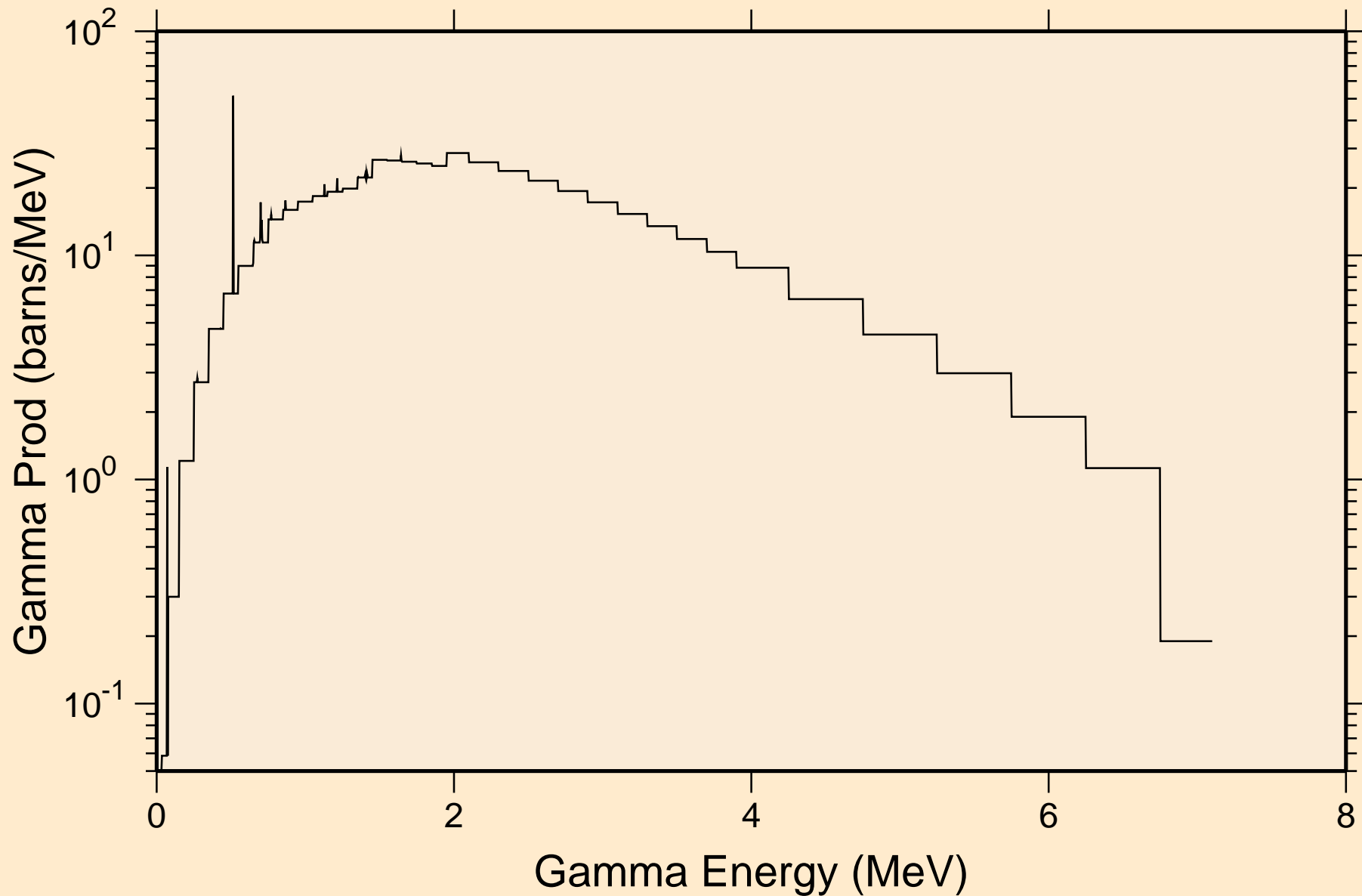

CD115 NEUTRON ACER TENDL-2019 LIBRARY; T=293.16K
14 MeV photon spectrum

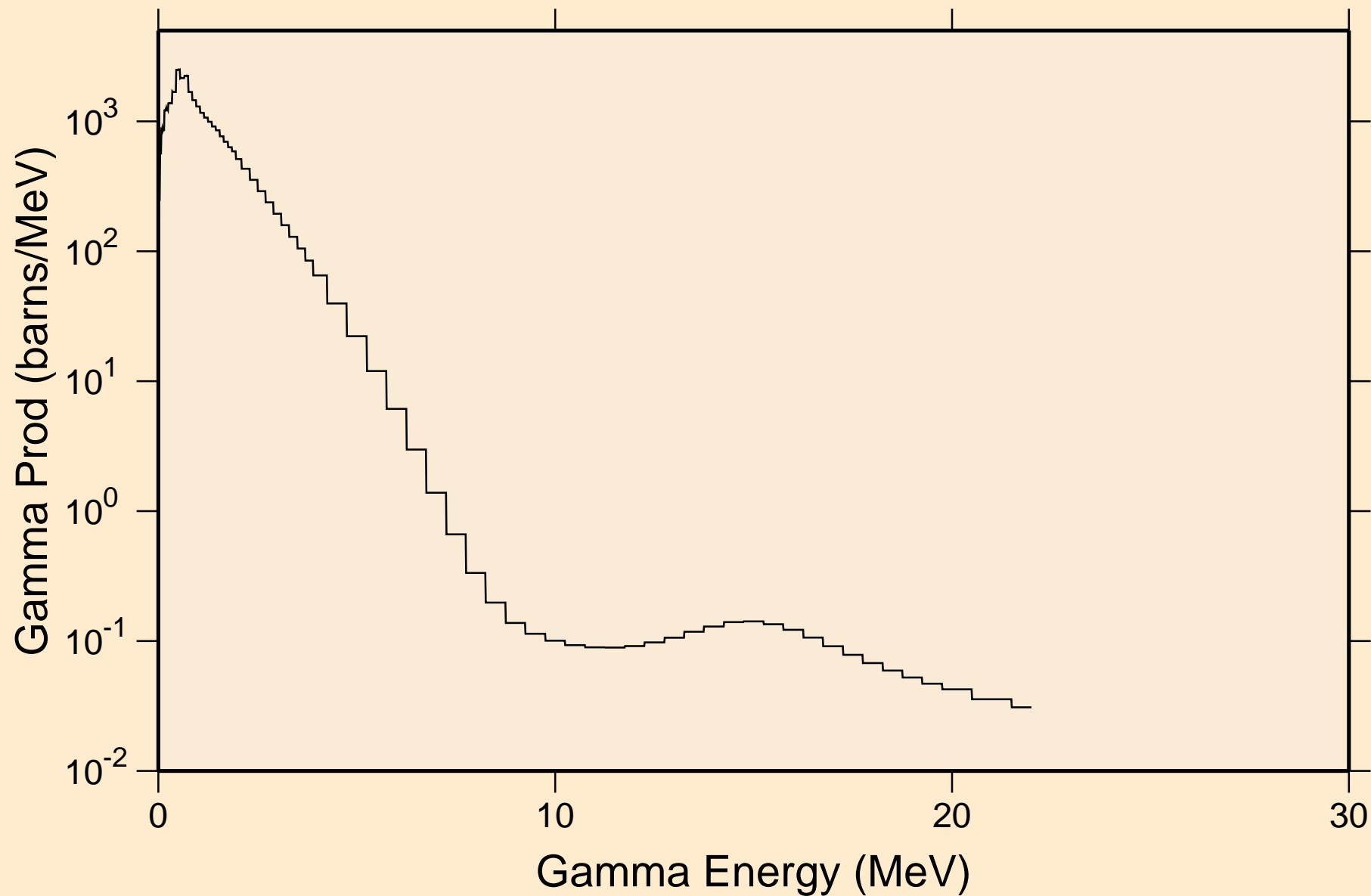

CD115 NEUTRON ACER TENDL-2019 LIBRARY; T=293.16K

Particle heating contributions

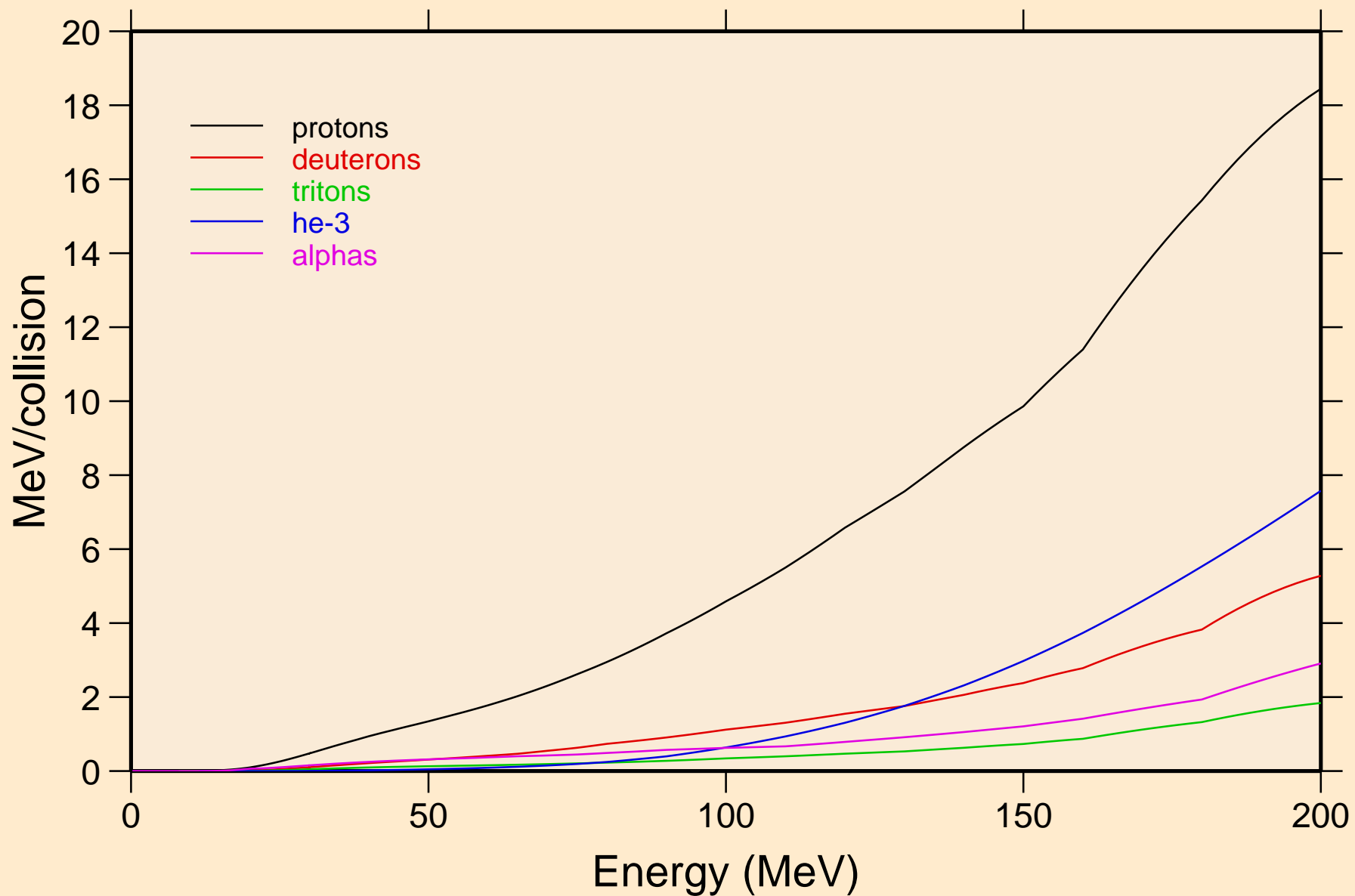

CD115 NEUTRON ACER TENDL-2019 LIBRARY; T=293.16K
Recoil Heating

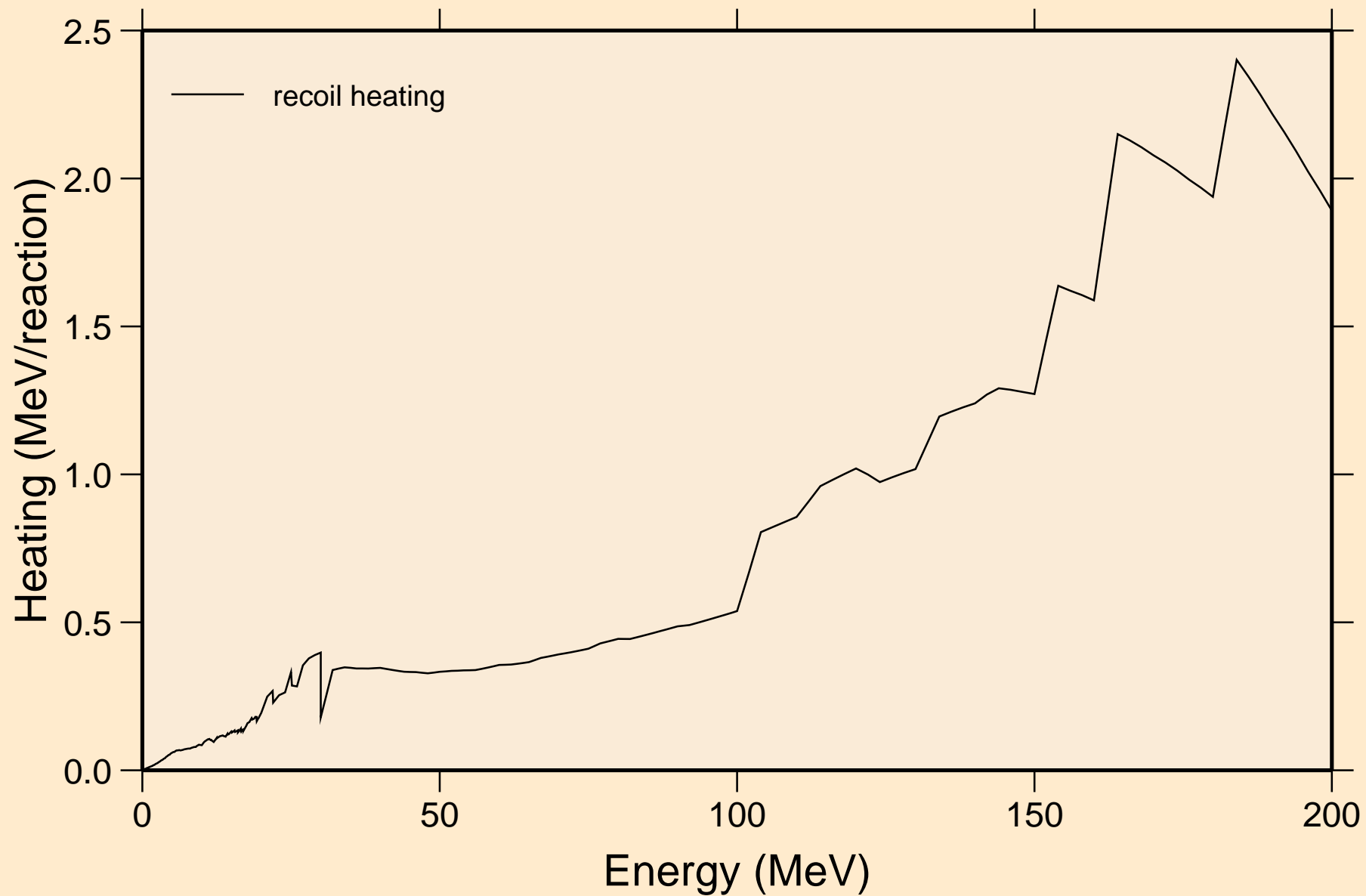

CD115 NEUTRON ACER TENDL-2019 LIBRARY; T=293.16K
Particle production cross sections

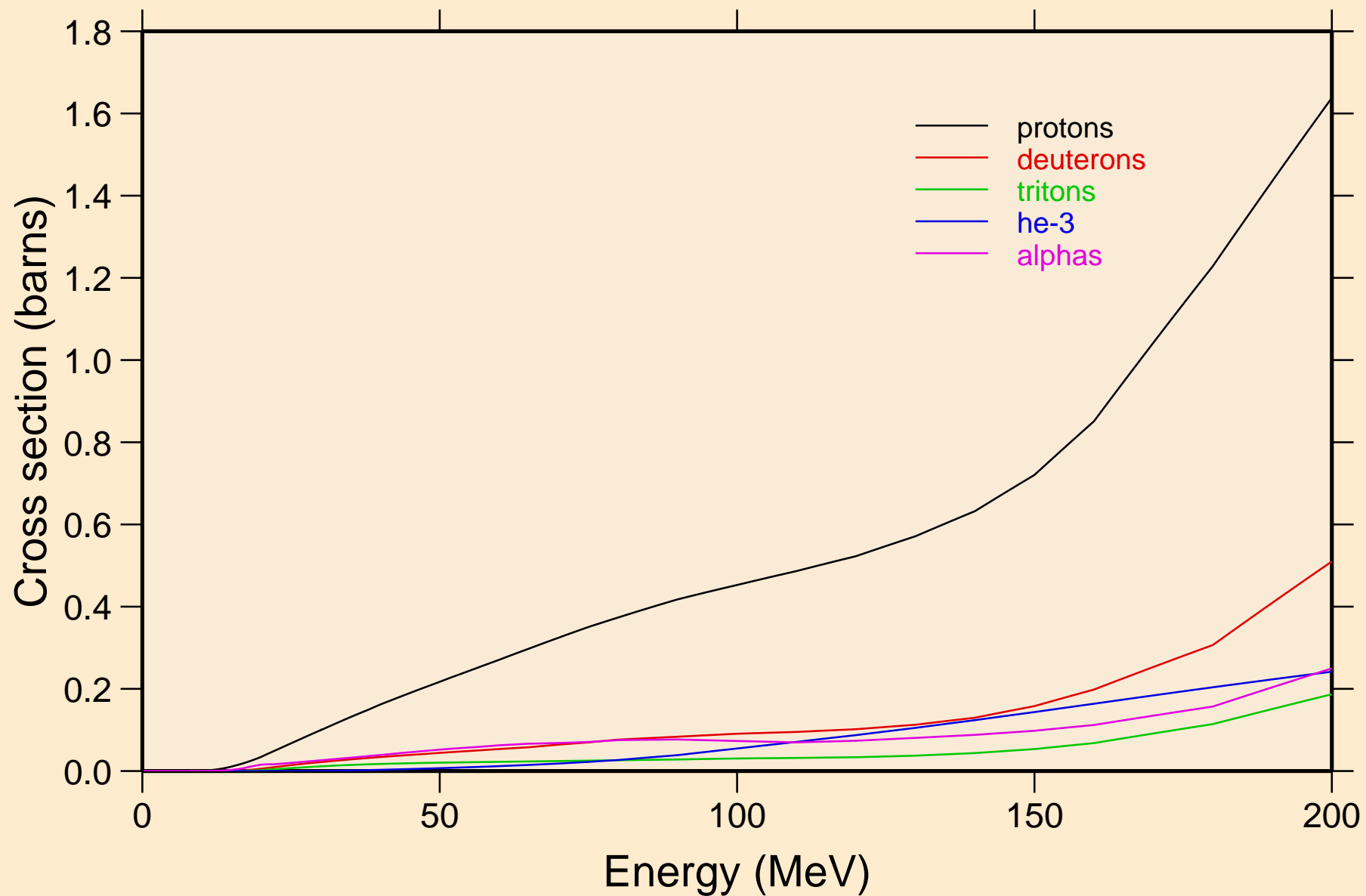

CD115 NEUTRON ACER TENDL-2019 LIBRARY; T=293.16K
protons from (n,x)

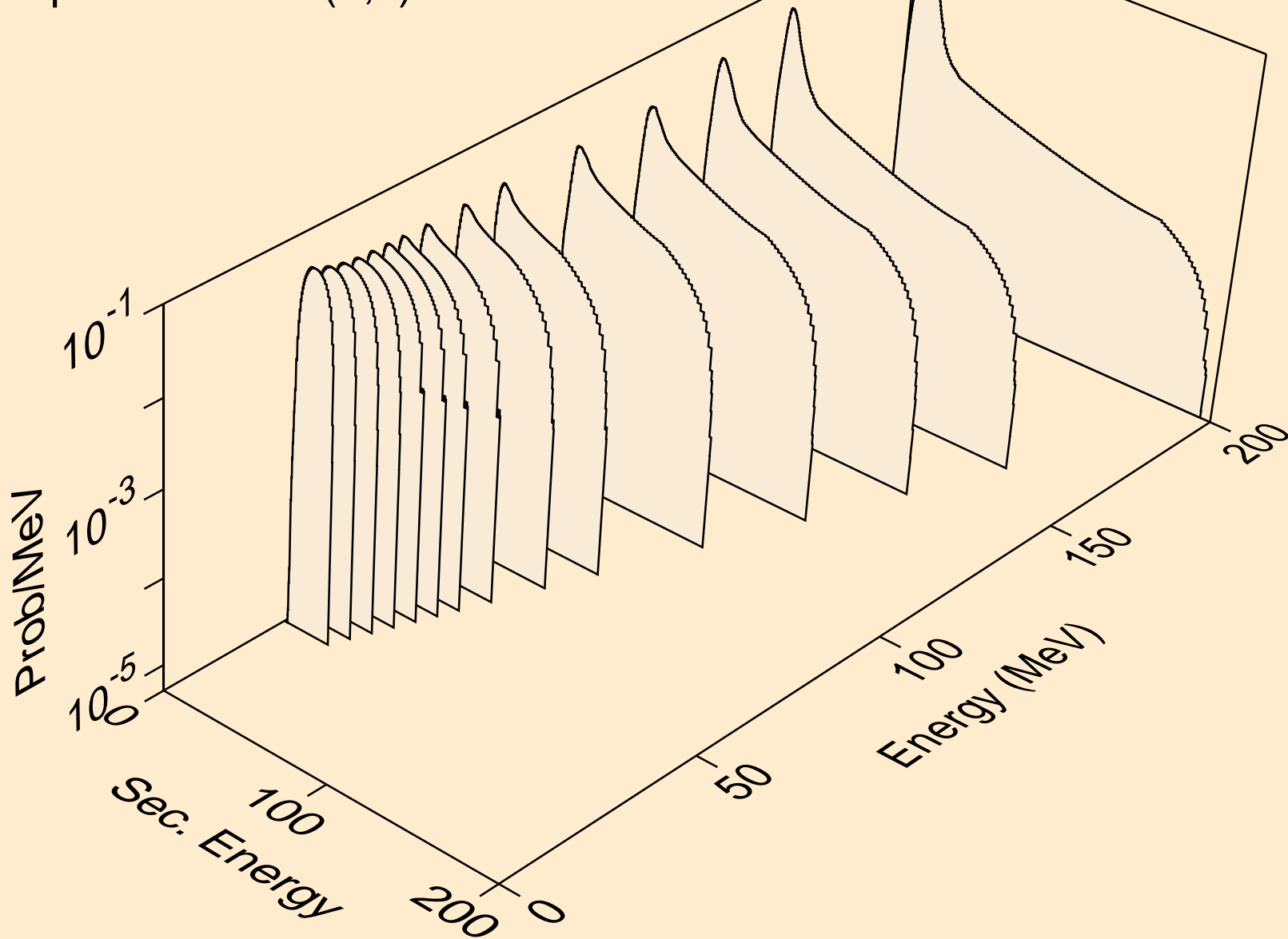

CD115 NEUTRON ACER TENDL-2019 LIBRARY; T=293.16K
protons from (n,n*)p

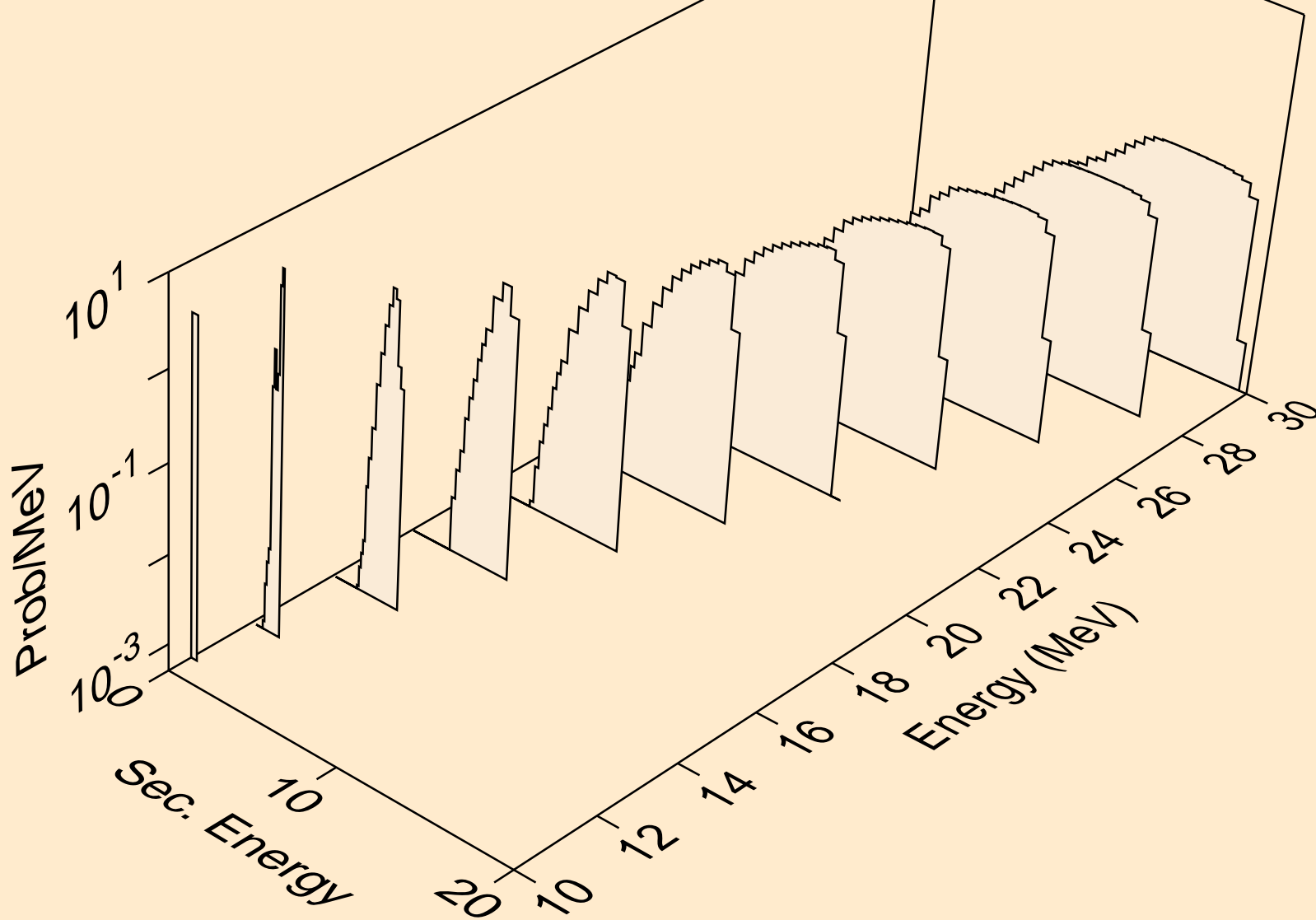

CD115 NEUTRON ACER TENDL-2019 LIBRARY; T=293.16K
protons from (n,2np)

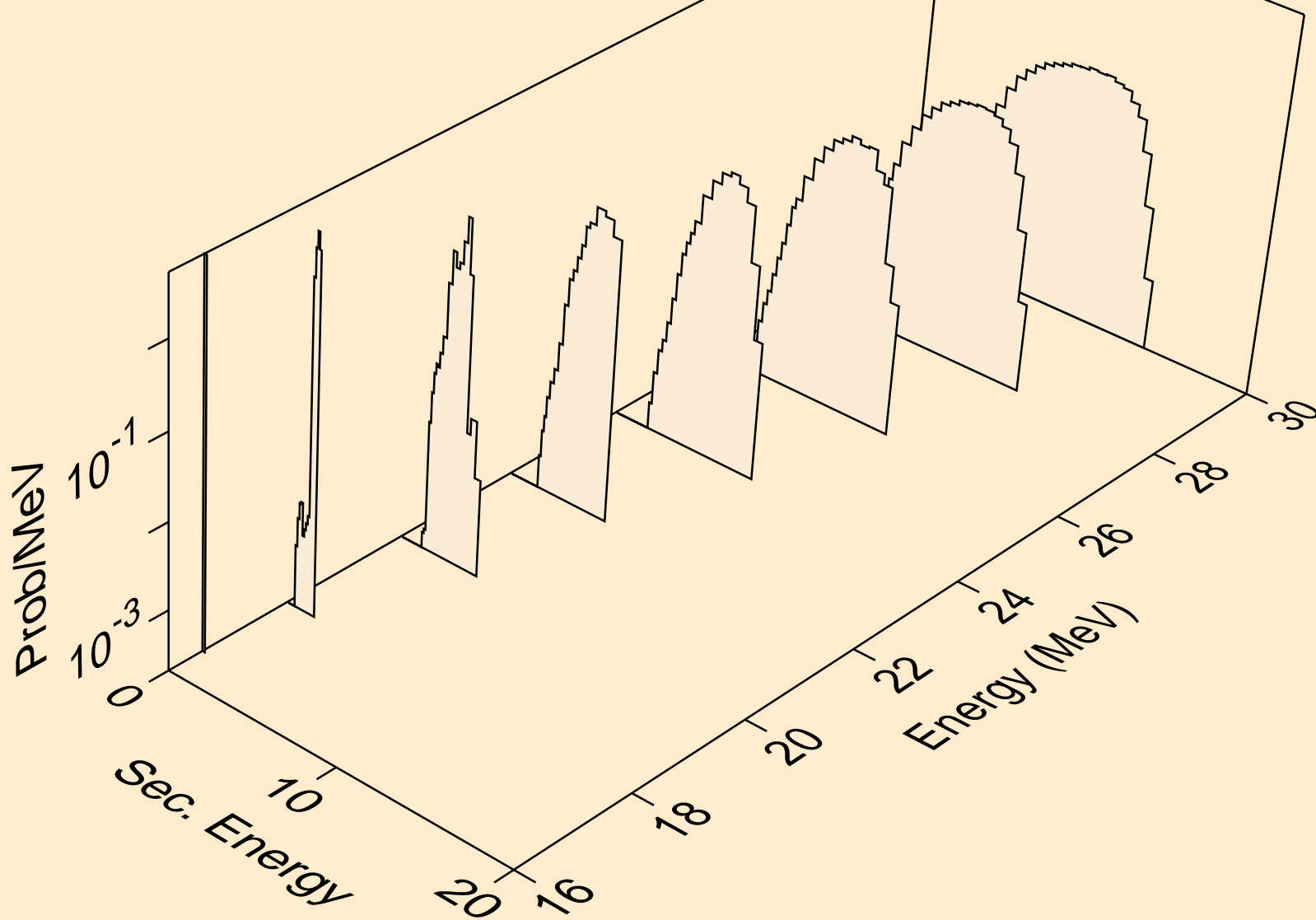

CD115 NEUTRON ACER TENDL-2019 LIBRARY; T=293.16K
protons from (n,3np)

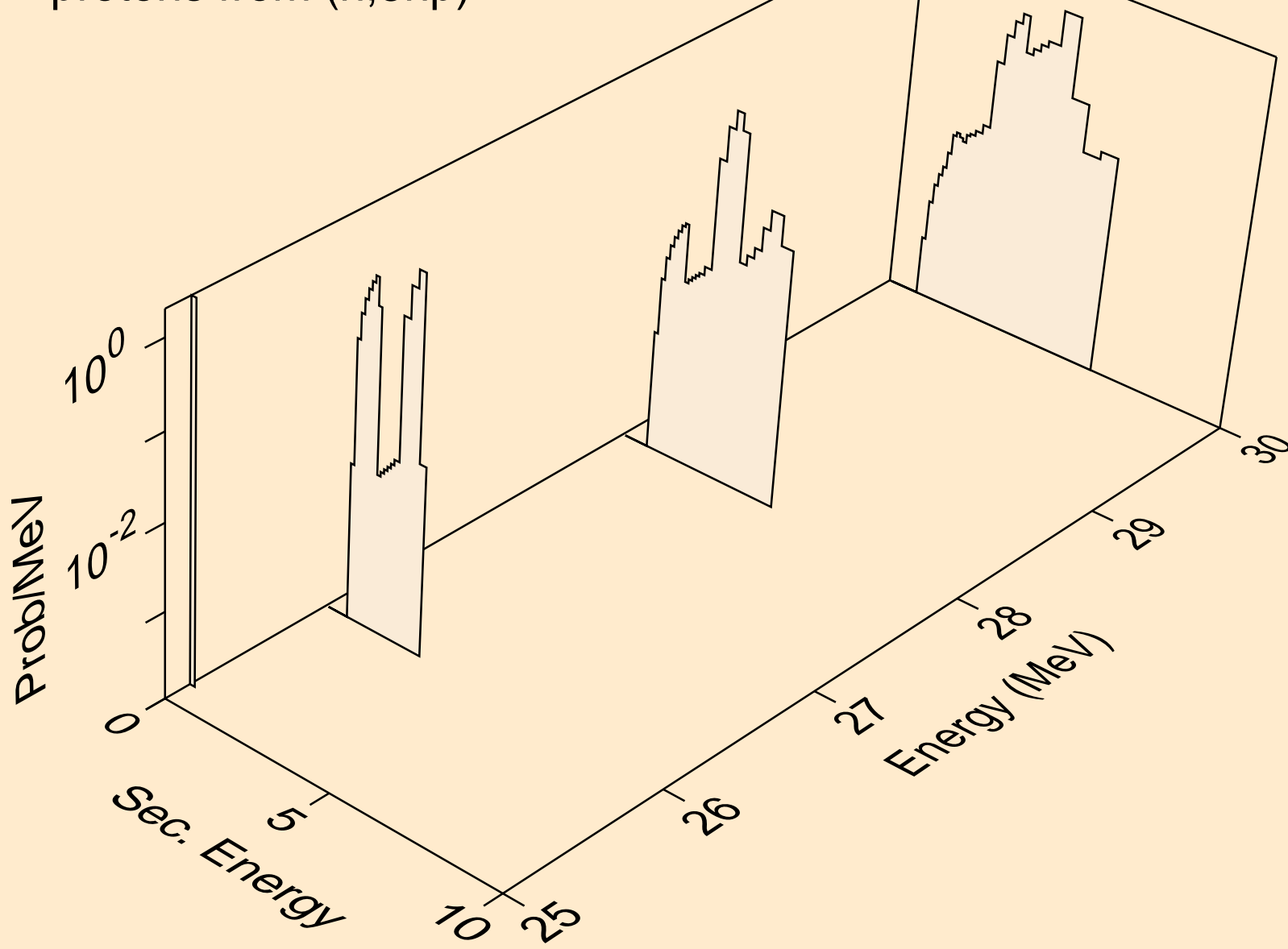

CD115 NEUTRON ACER TENDL-2019 LIBRARY; T=293.16K
protons from (n,2np)

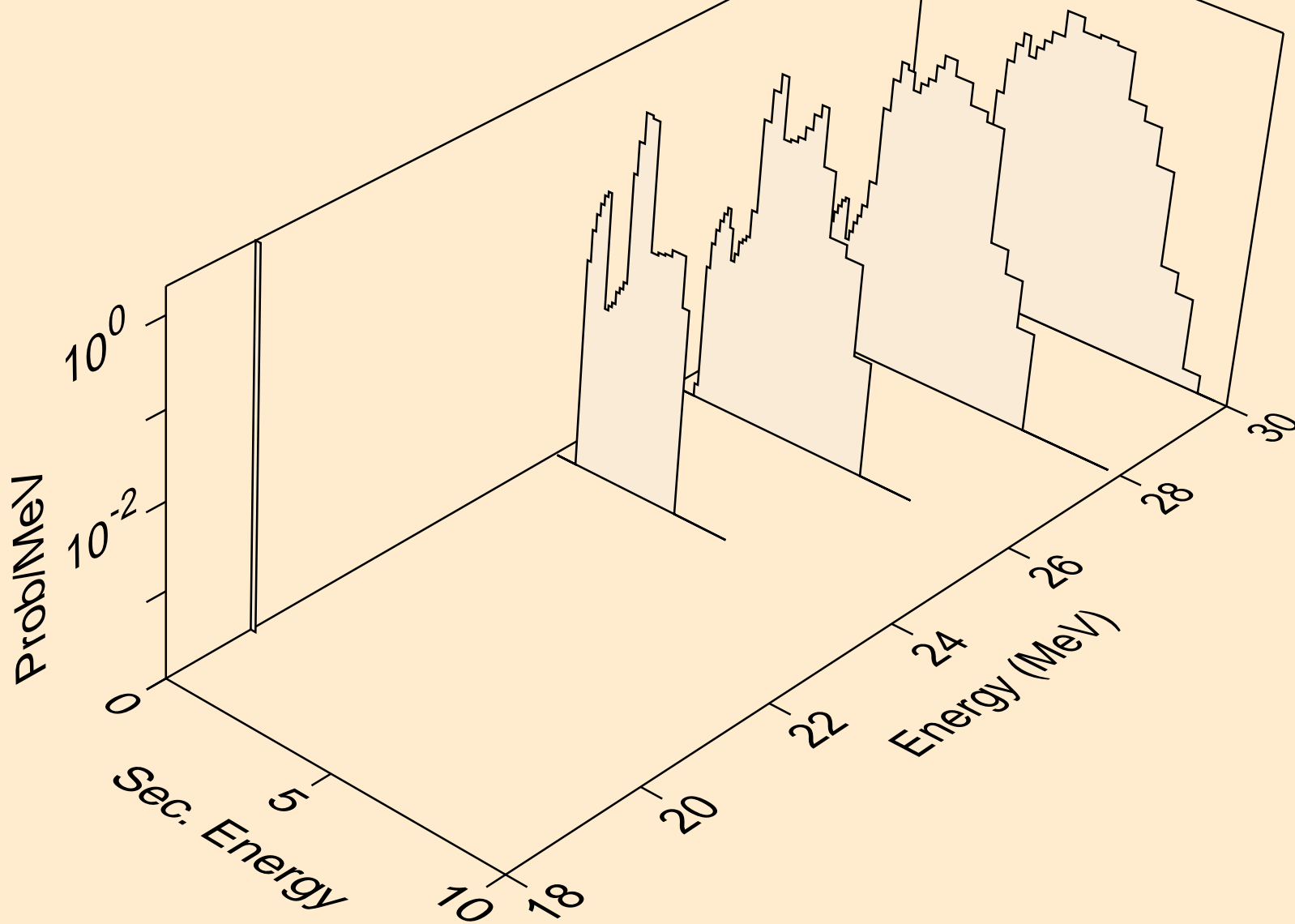

CD115 NEUTRON ACER TENDL-2019 LIBRARY; T=293.16K
protons from (n,npa)

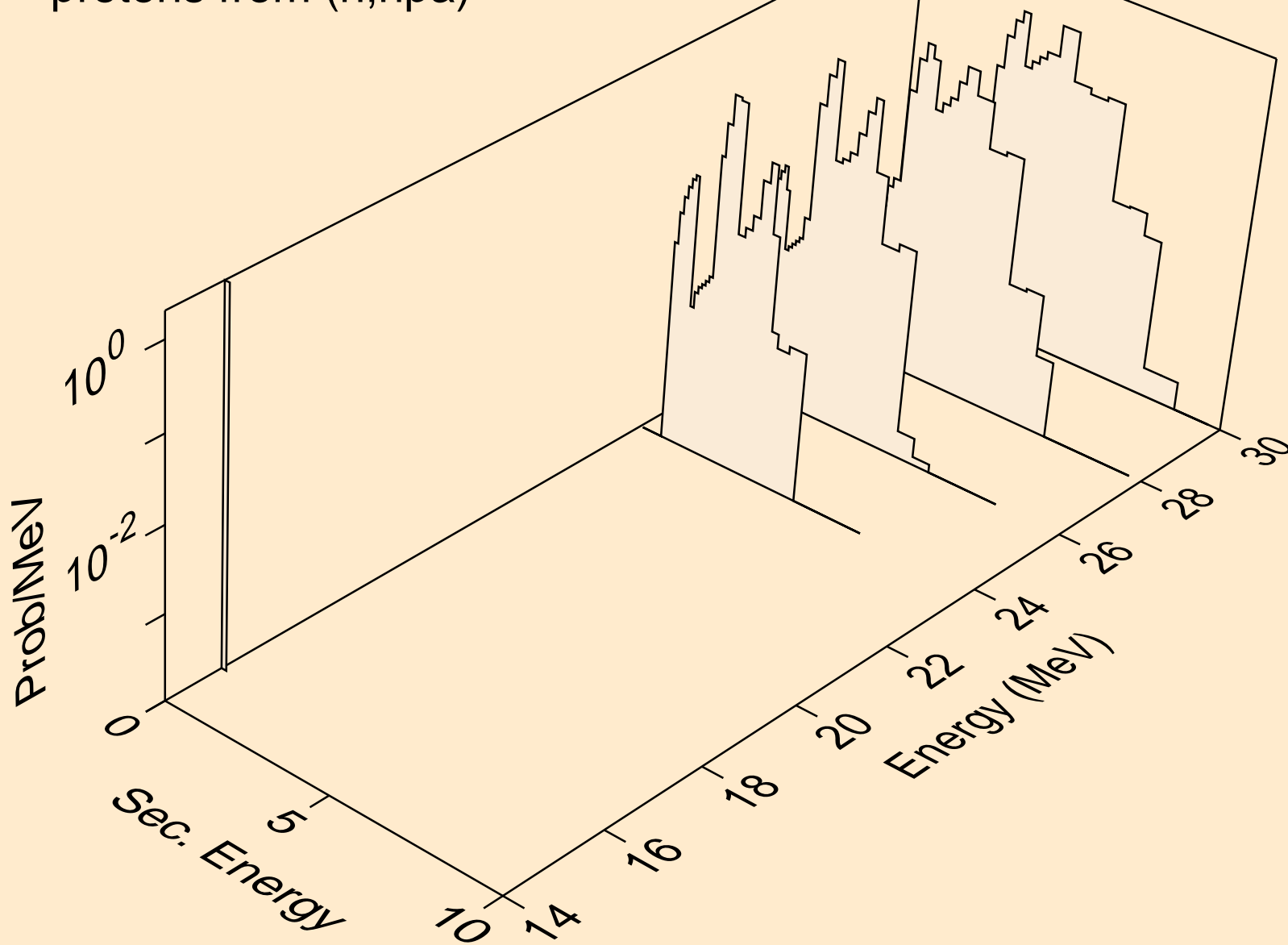

CD115 NEUTRON ACER TENDL-2019 LIBRARY; T=293.16K
protons from (n,p)

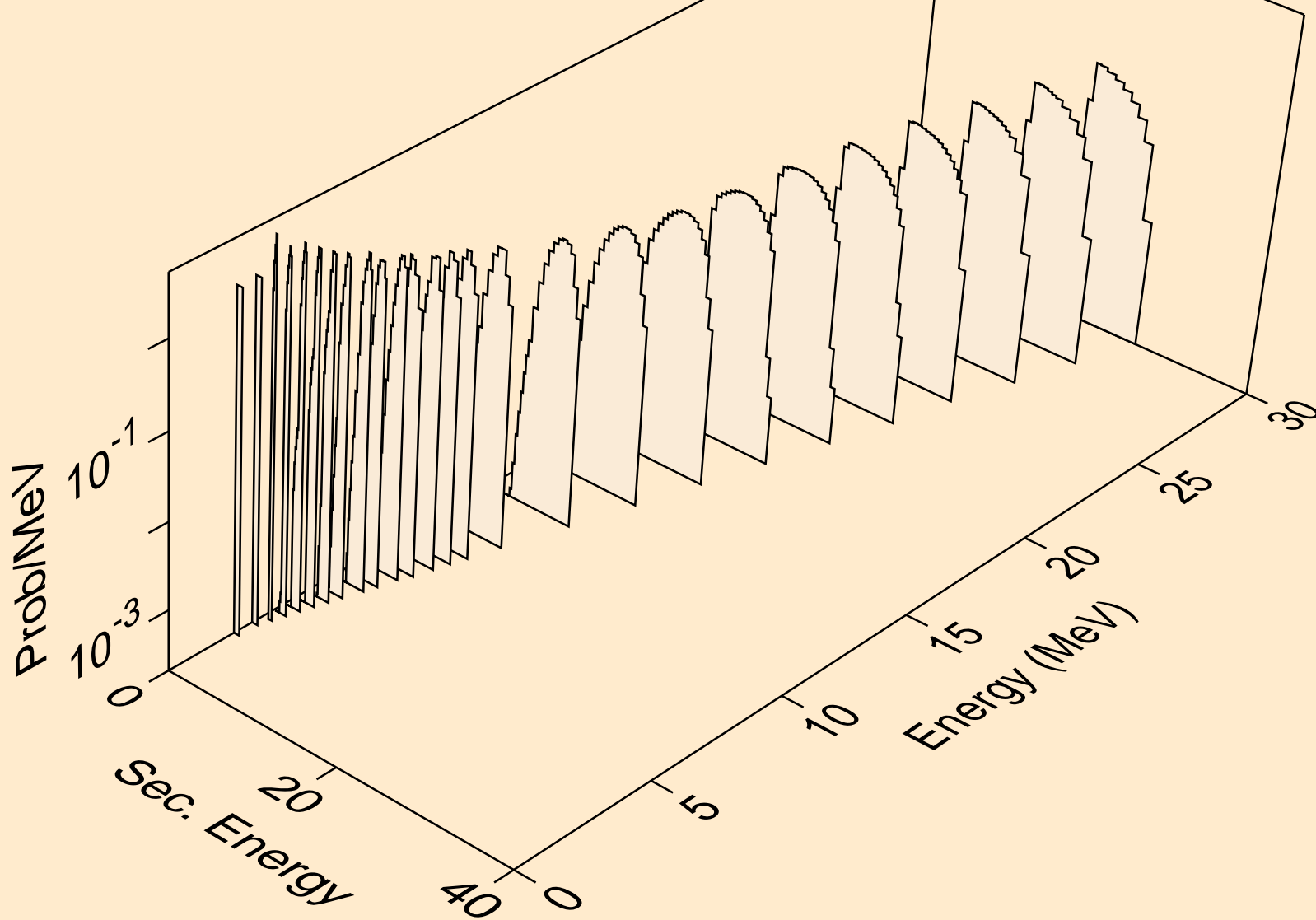

CD115 NEUTRON ACER TENDL-2019 LIBRARY; T=293.16K
protons from (n,2p)

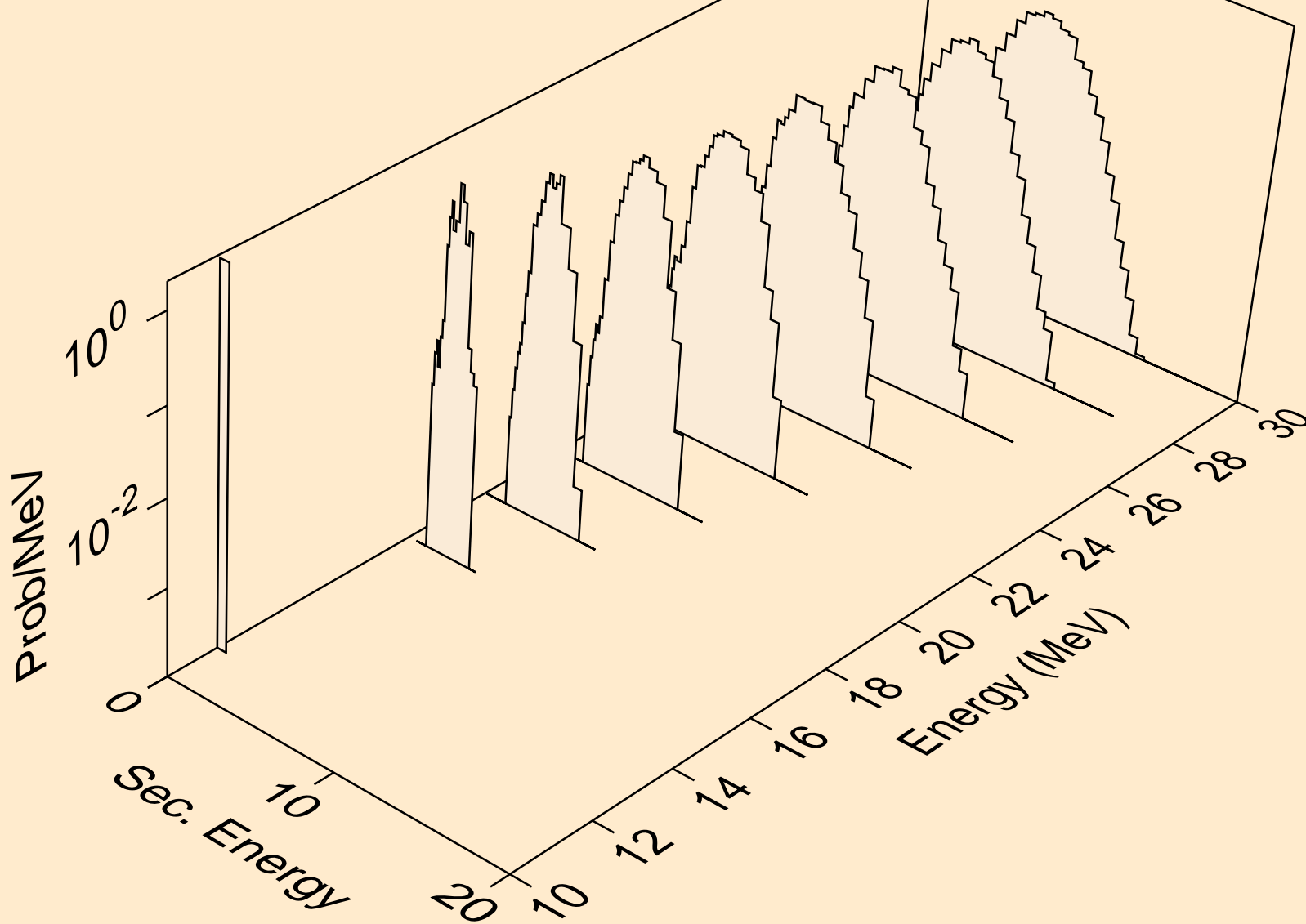

CD115 NEUTRON ACER TENDL-2019 LIBRARY; T=293.16K
protons from (n,p)

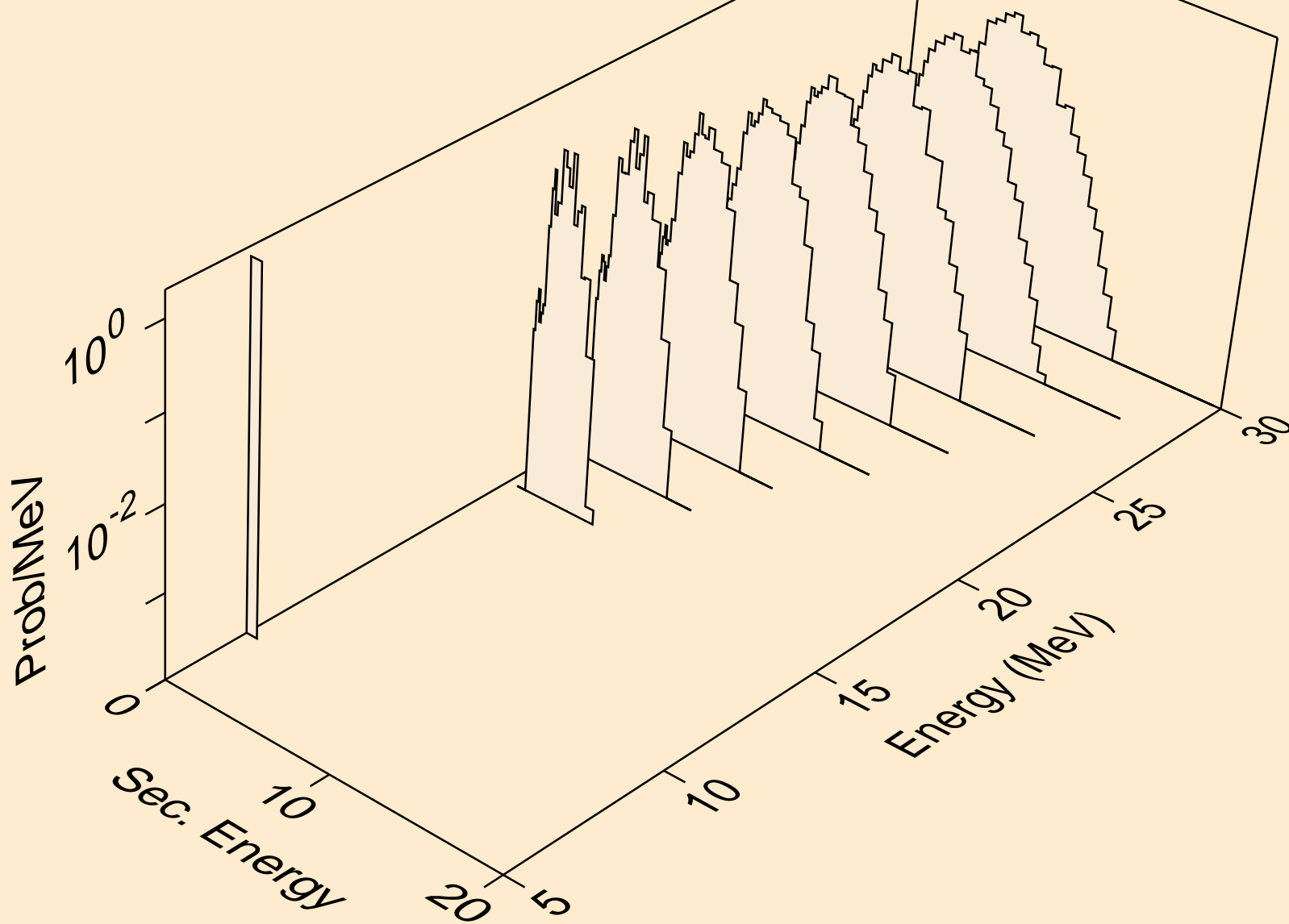

CD115 NEUTRON ACER TENDL-2019 LIBRARY; T=293.16K
protons from (n,pd)

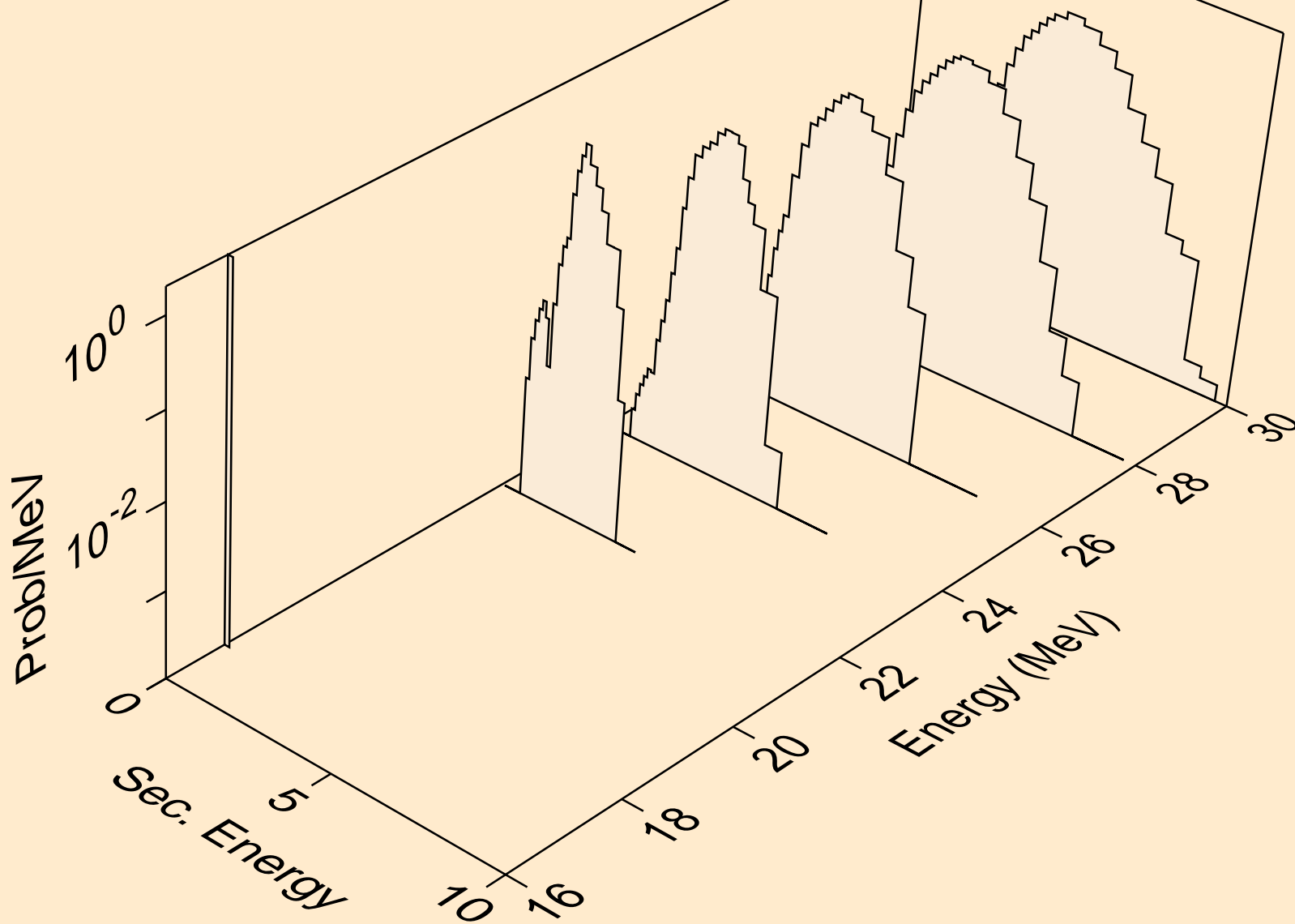

CD115 NEUTRON ACER TENDL-2019 LIBRARY; T=293.16K
protons from (n,pt)

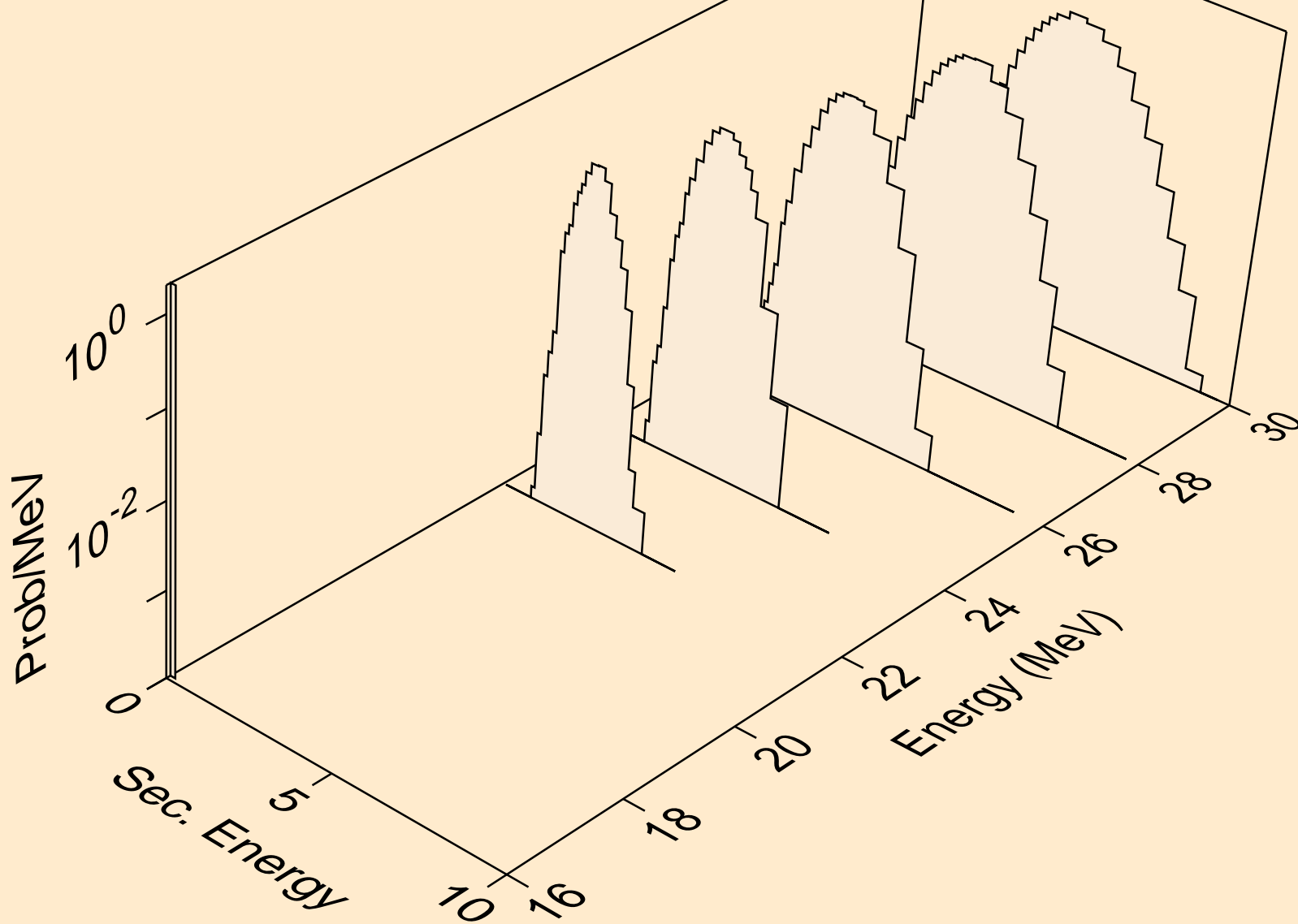

CD115 NEUTRON ACER TENDL-2019 LIBRARY; T=293.16K
deuterons from (n,x)

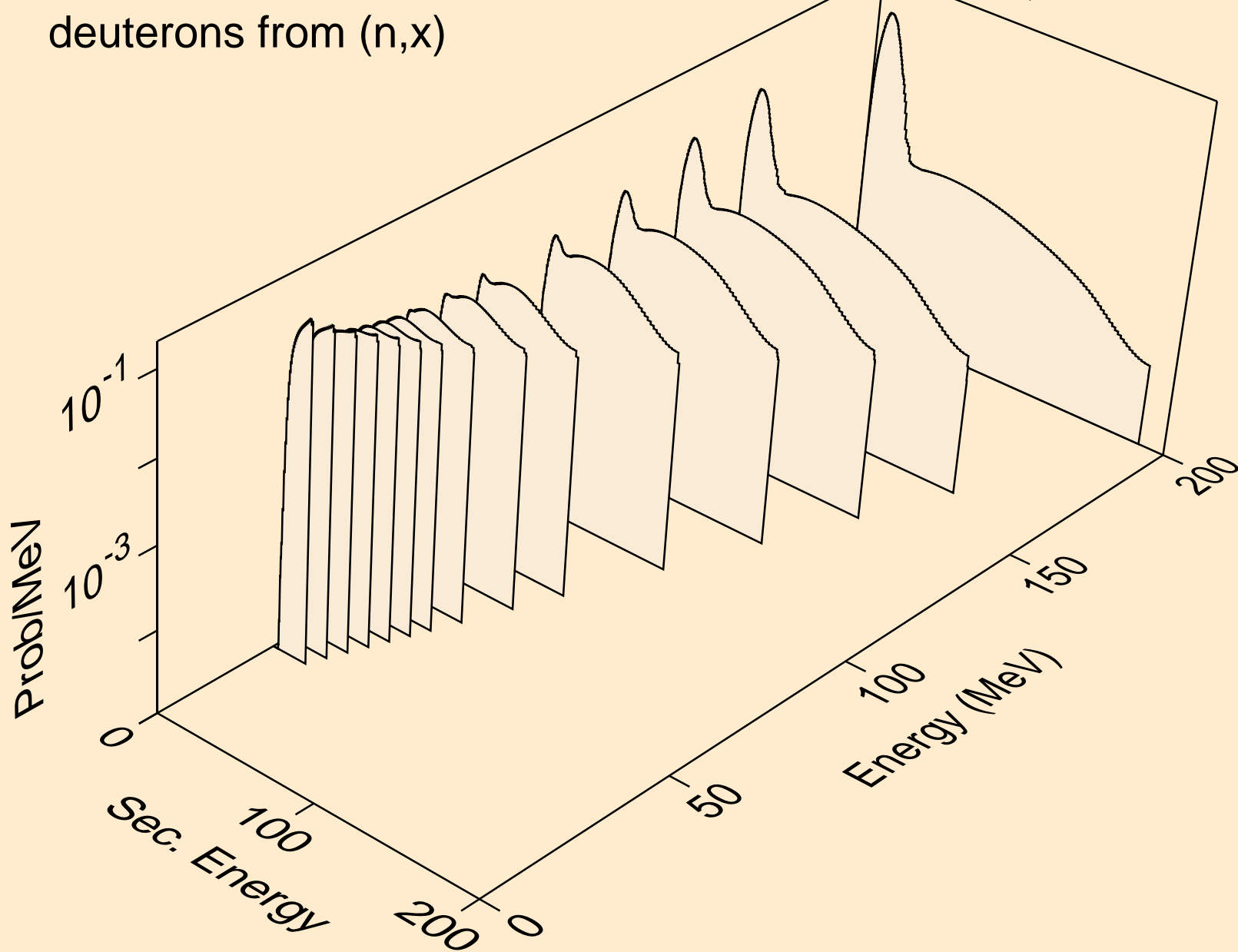

CD115 NEUTRON ACER TENDL-2019 LIBRARY; T=293.16K
deuterons from (n,2nd)

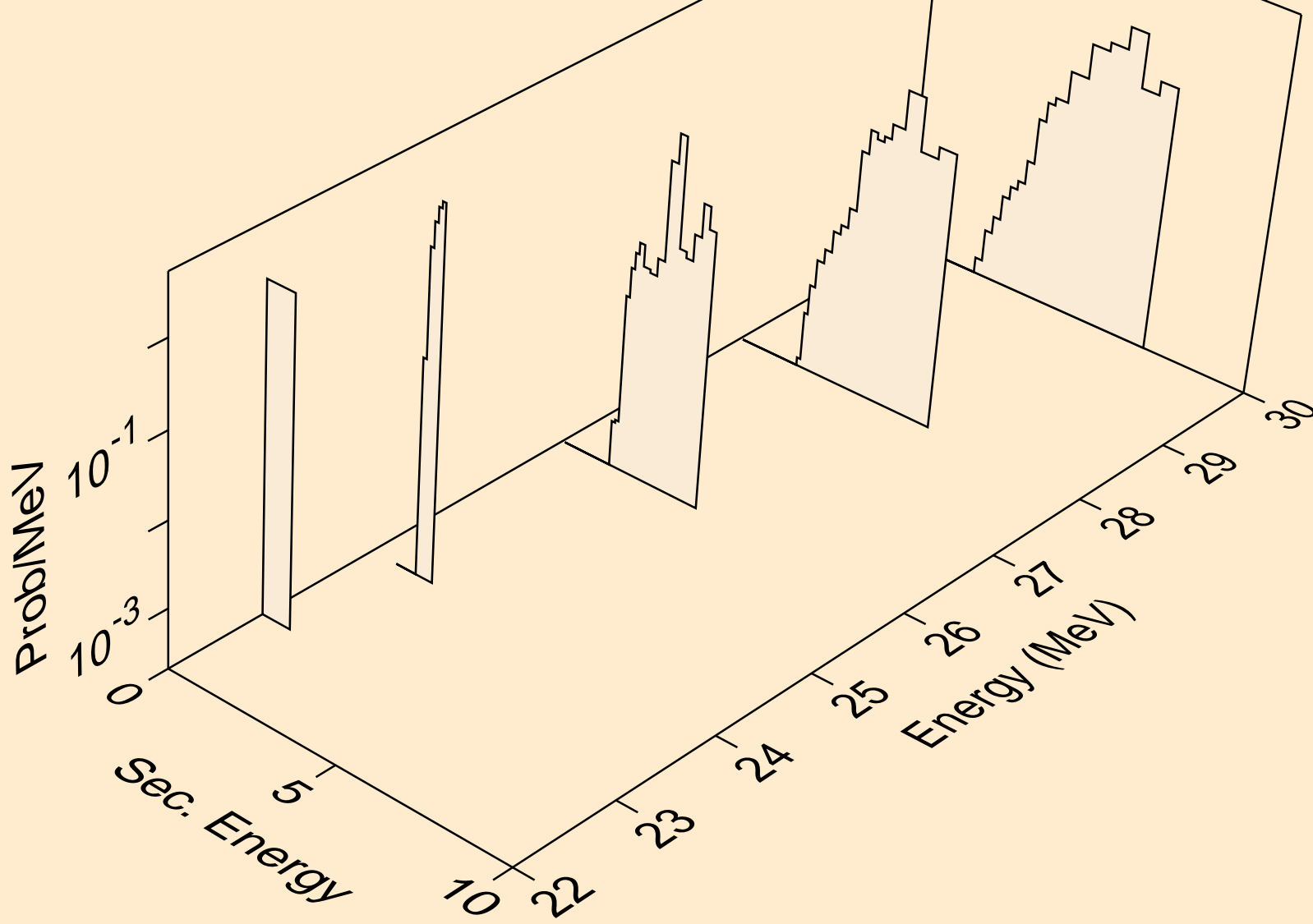

CD115 NEUTRON ACER TENDL-2019 LIBRARY; T=293.16K
deuterons from (n,n*)d

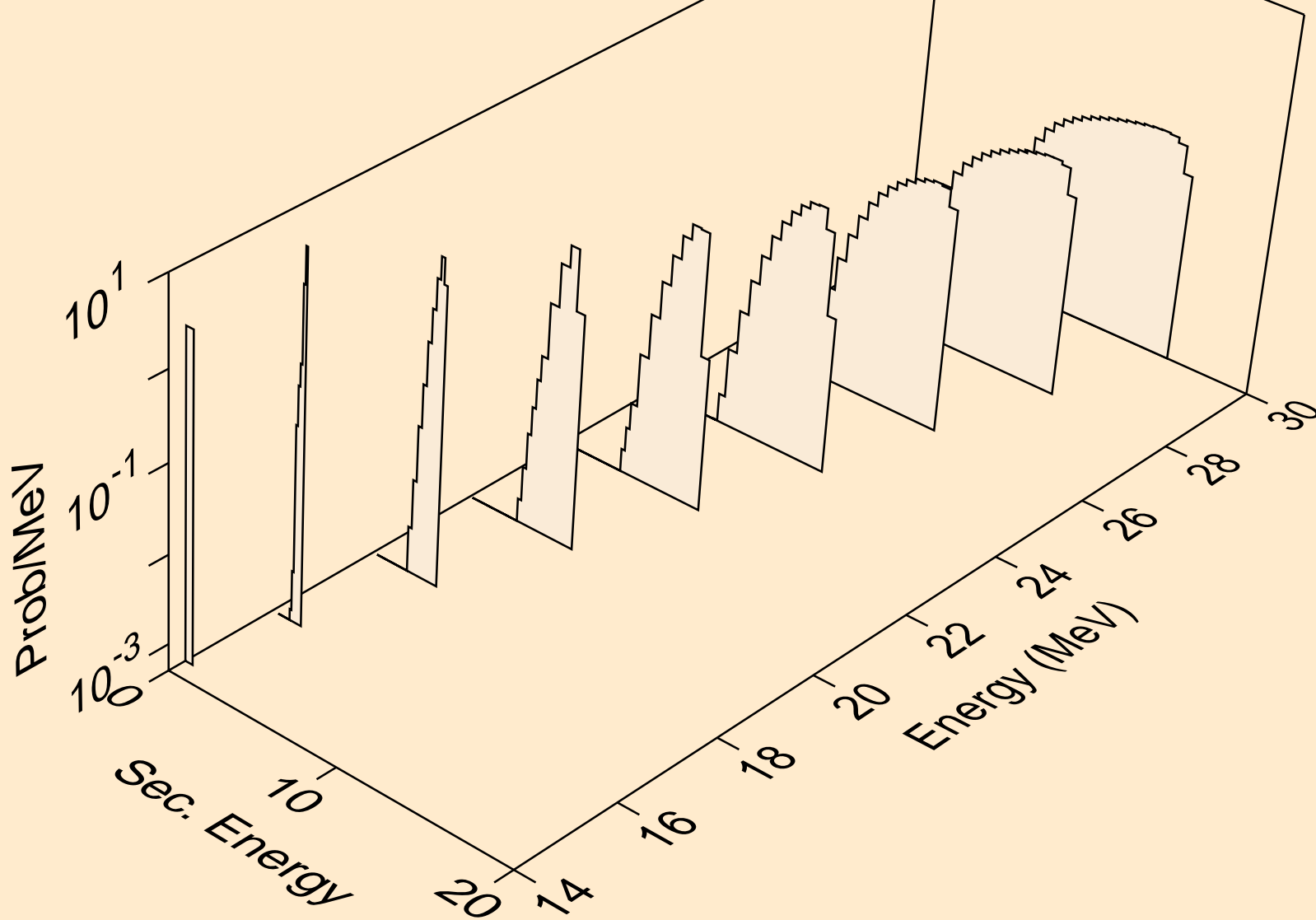

CD115 NEUTRON ACER TENDL-2019 LIBRARY; T=293.16K
deuterons from (n,d)

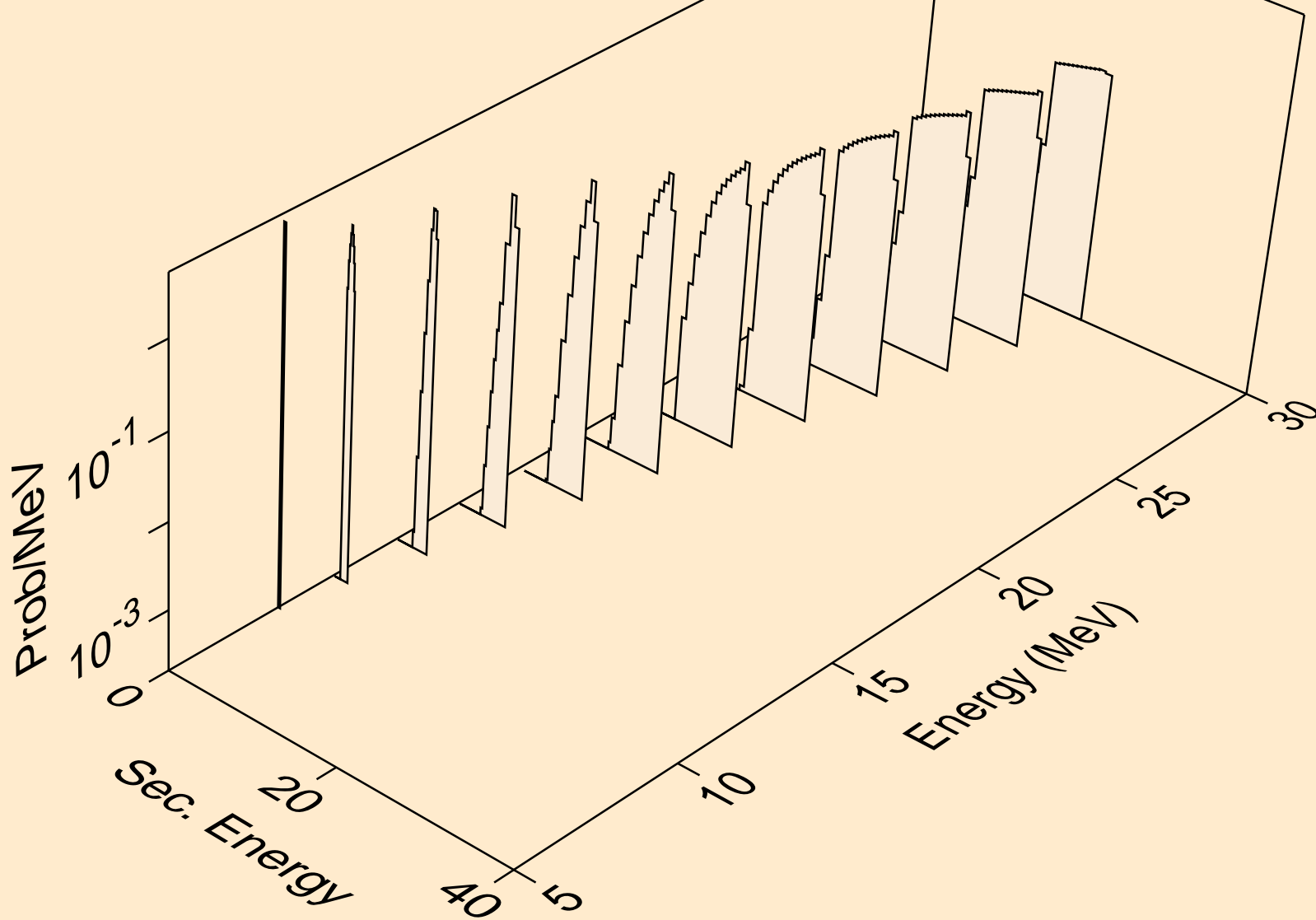

CD115 NEUTRON ACER TENDL-2019 LIBRARY; T=293.16K
deuterons from (n,pd)

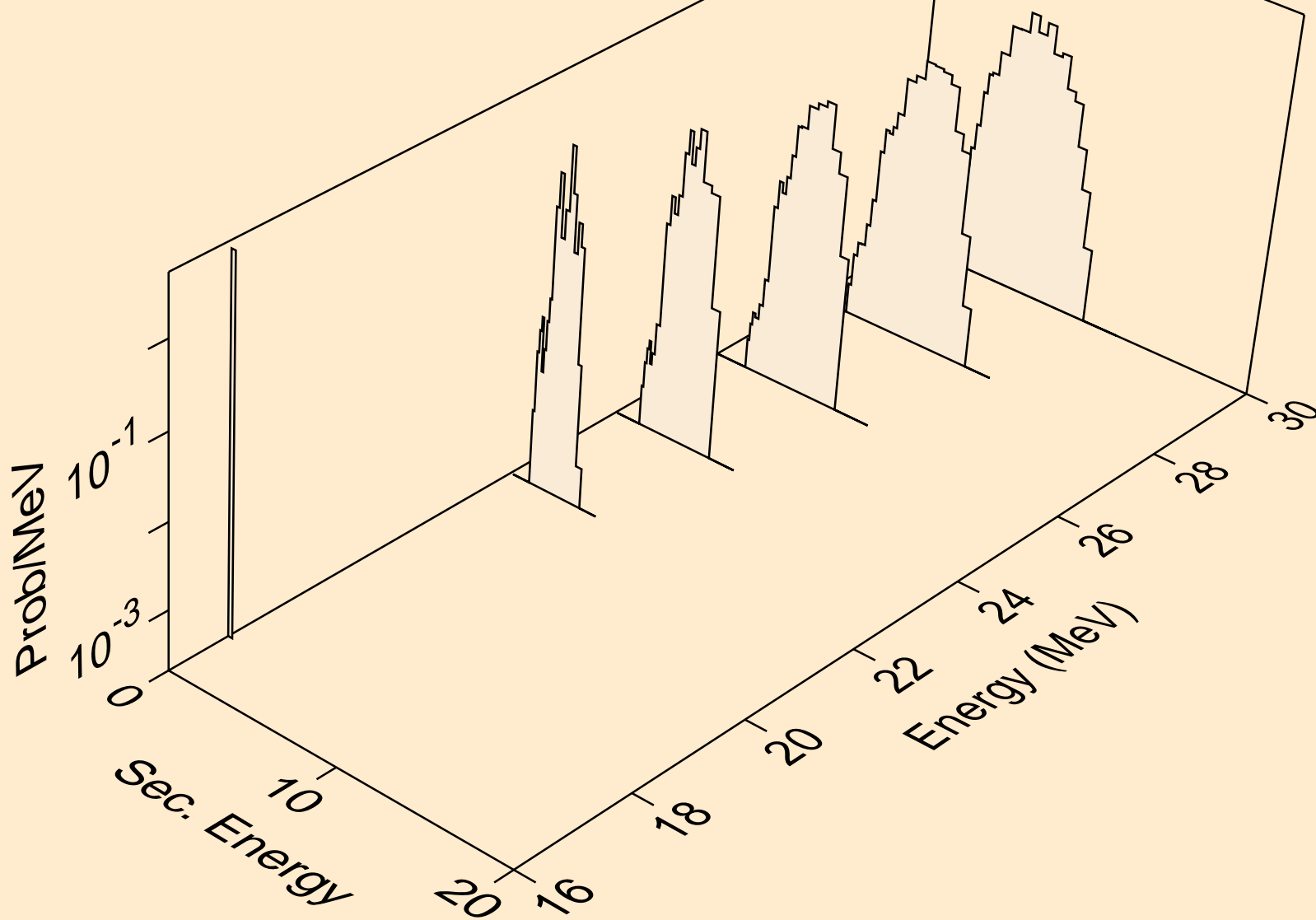

CD115 NEUTRON ACER TENDL-2019 LIBRARY; T=293.16K
tritons from (n,x)

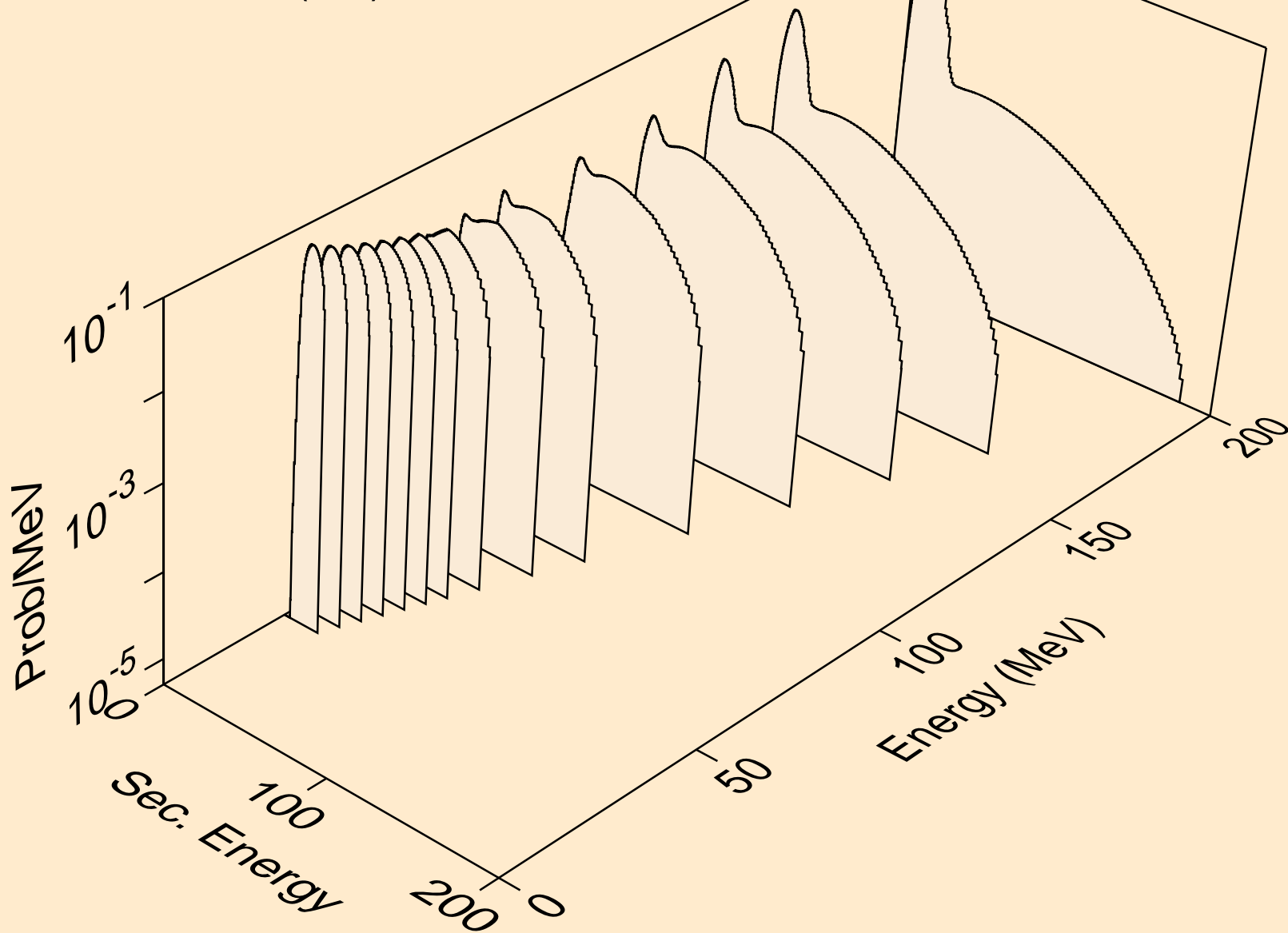

CD115 NEUTRON ACER TENDL-2019 LIBRARY; T=293.16K
tritons from (n,n*)t

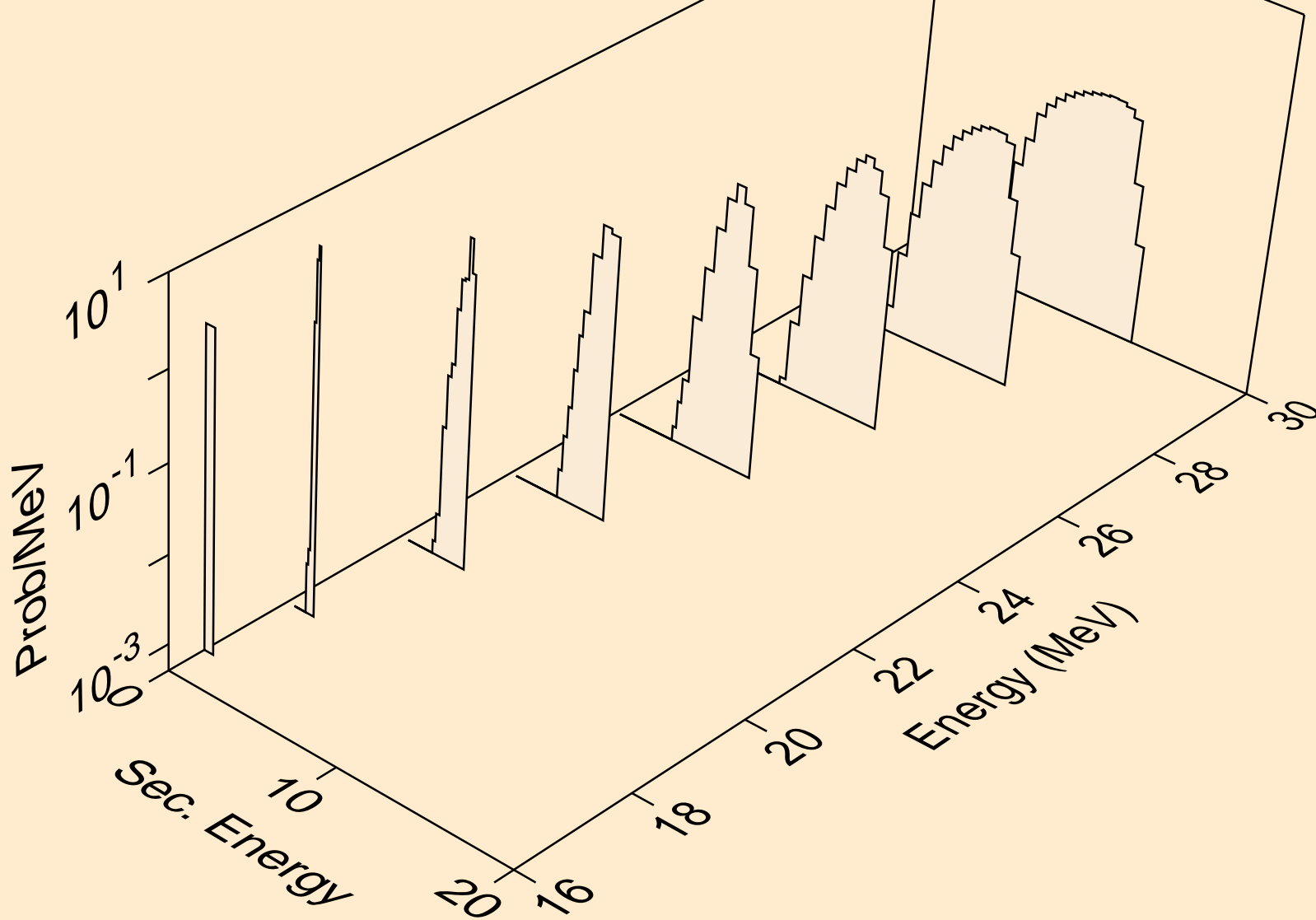

CD115 NEUTRON ACER TENDL-2019 LIBRARY; T=293.16K
tritons from (n,t)

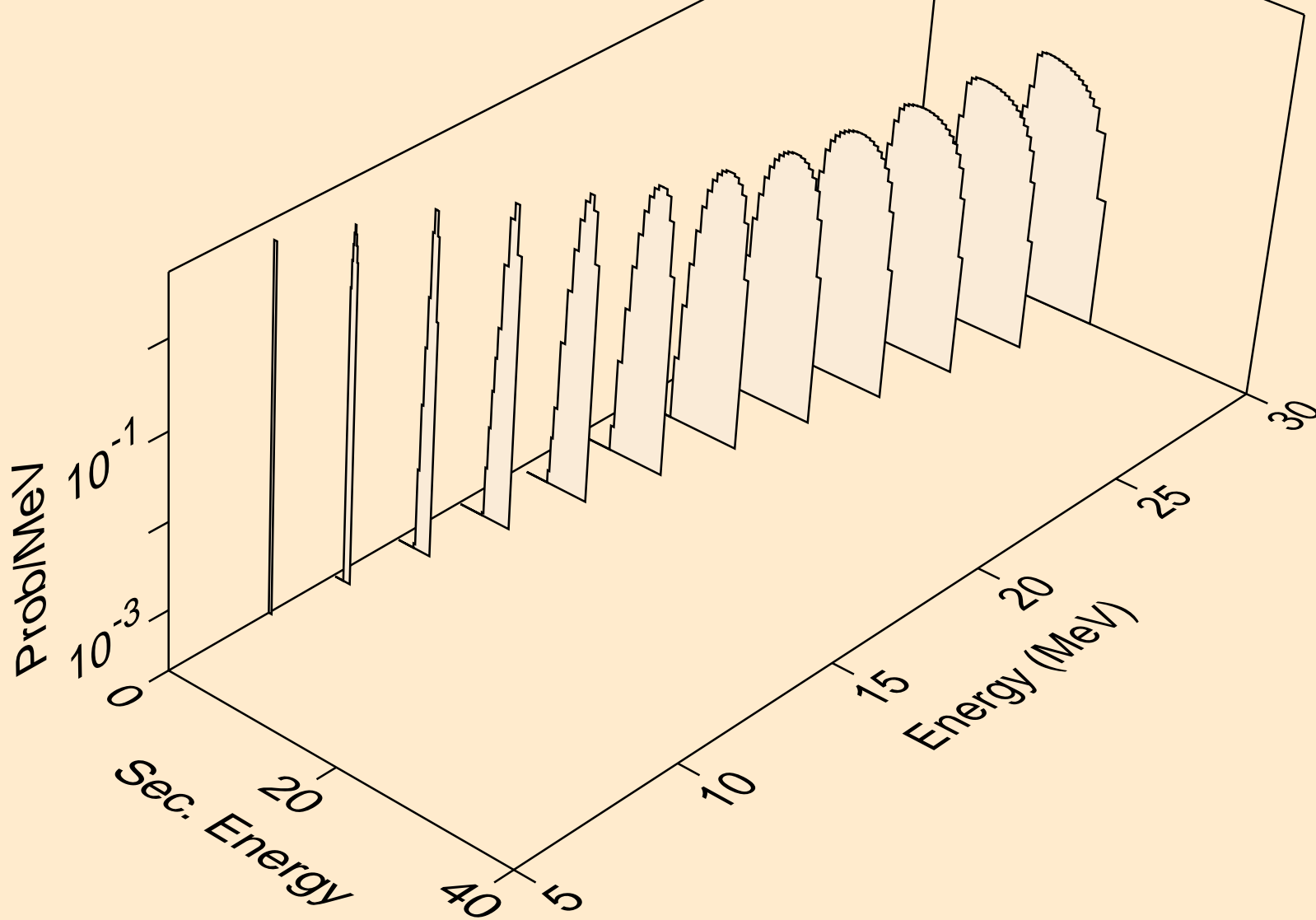

CD115 NEUTRON ACER TENDL-2019 LIBRARY; T=293.16K
tritons from (n,pt)

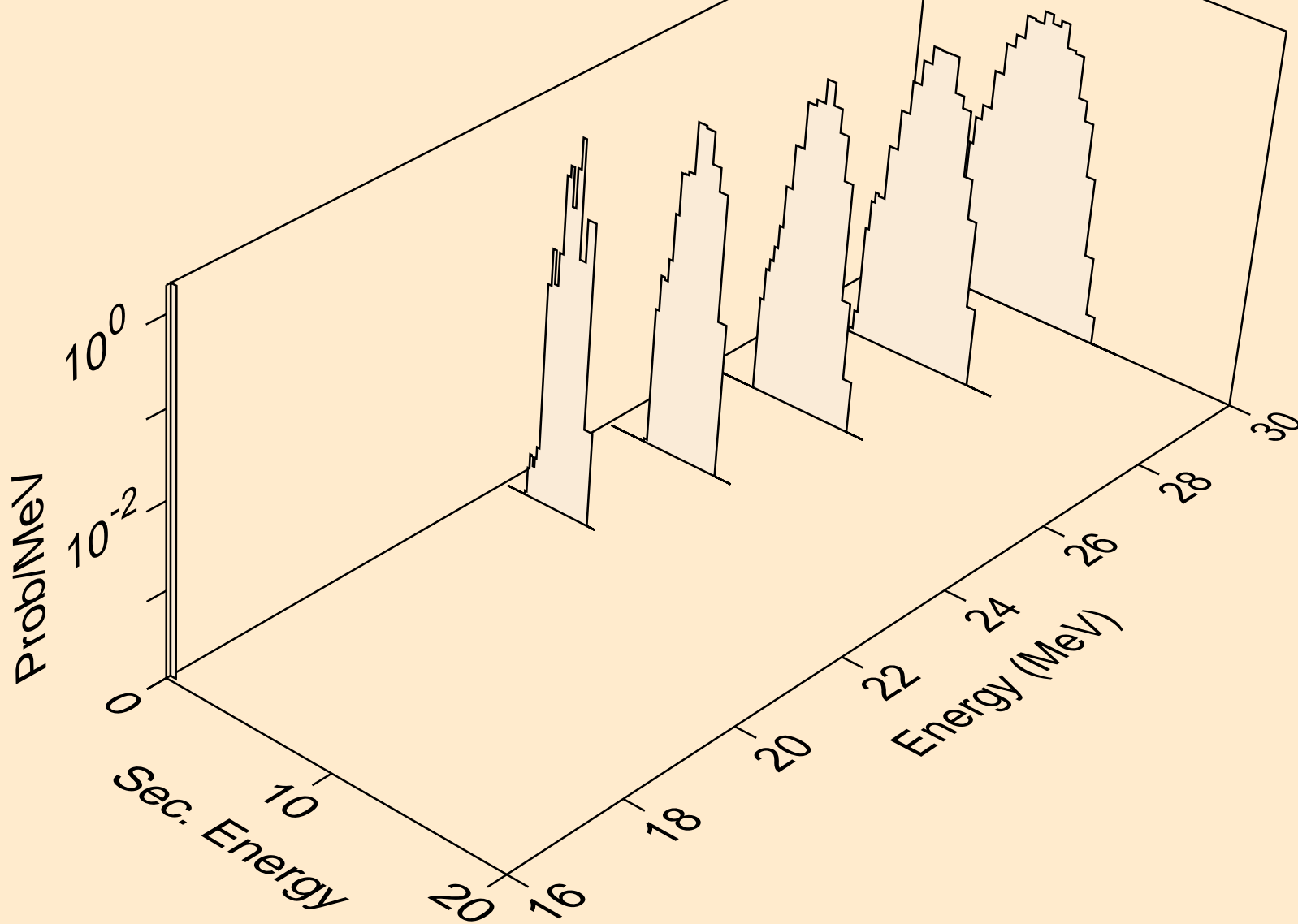

CD115 NEUTRON ACER TENDL-2019 LIBRARY; T=293.16K
he3s from (n,x)

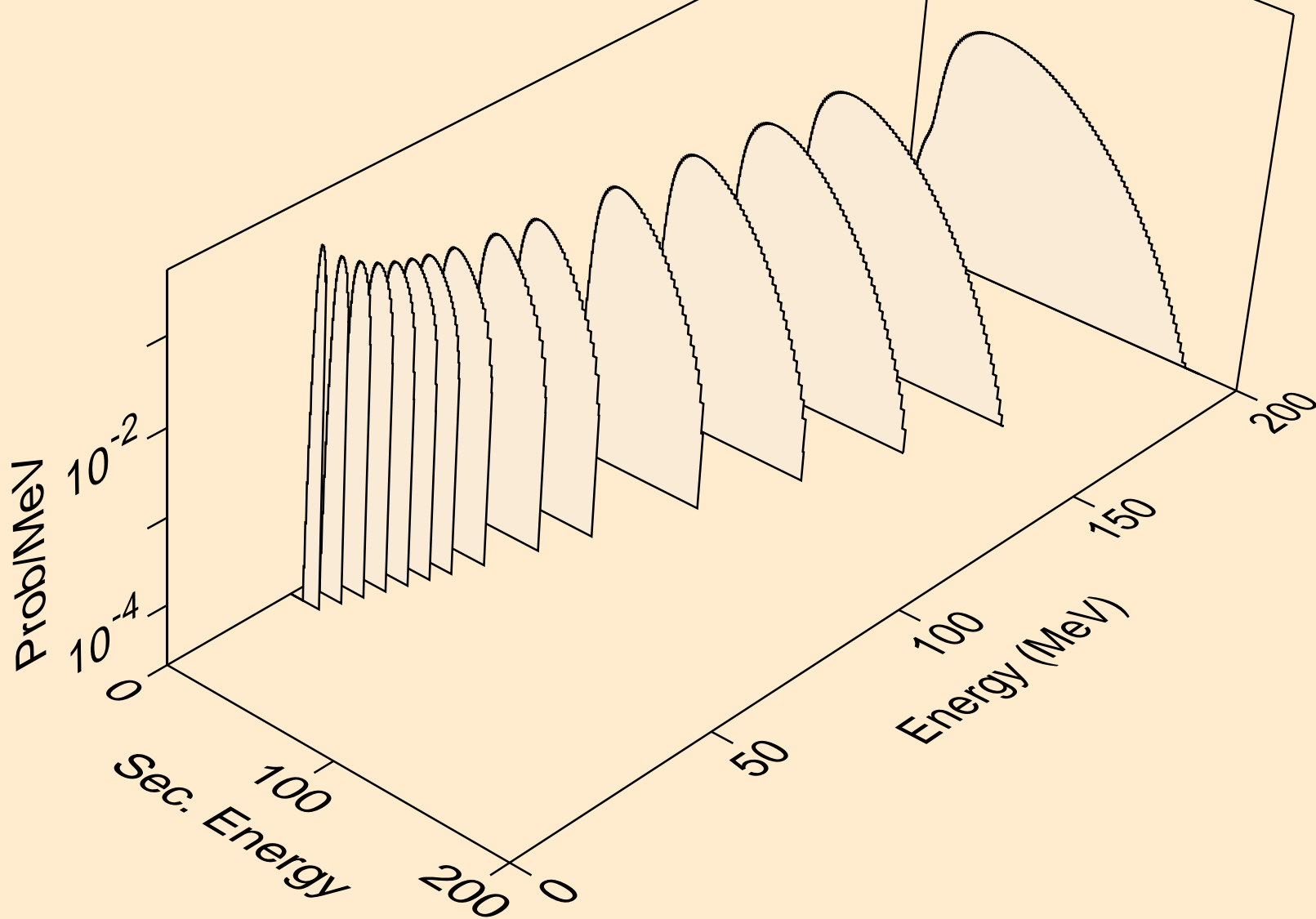

CD115 NEUTRON ACER TENDL-2019 LIBRARY; T=293.16K
he3s from (n,n*)he3

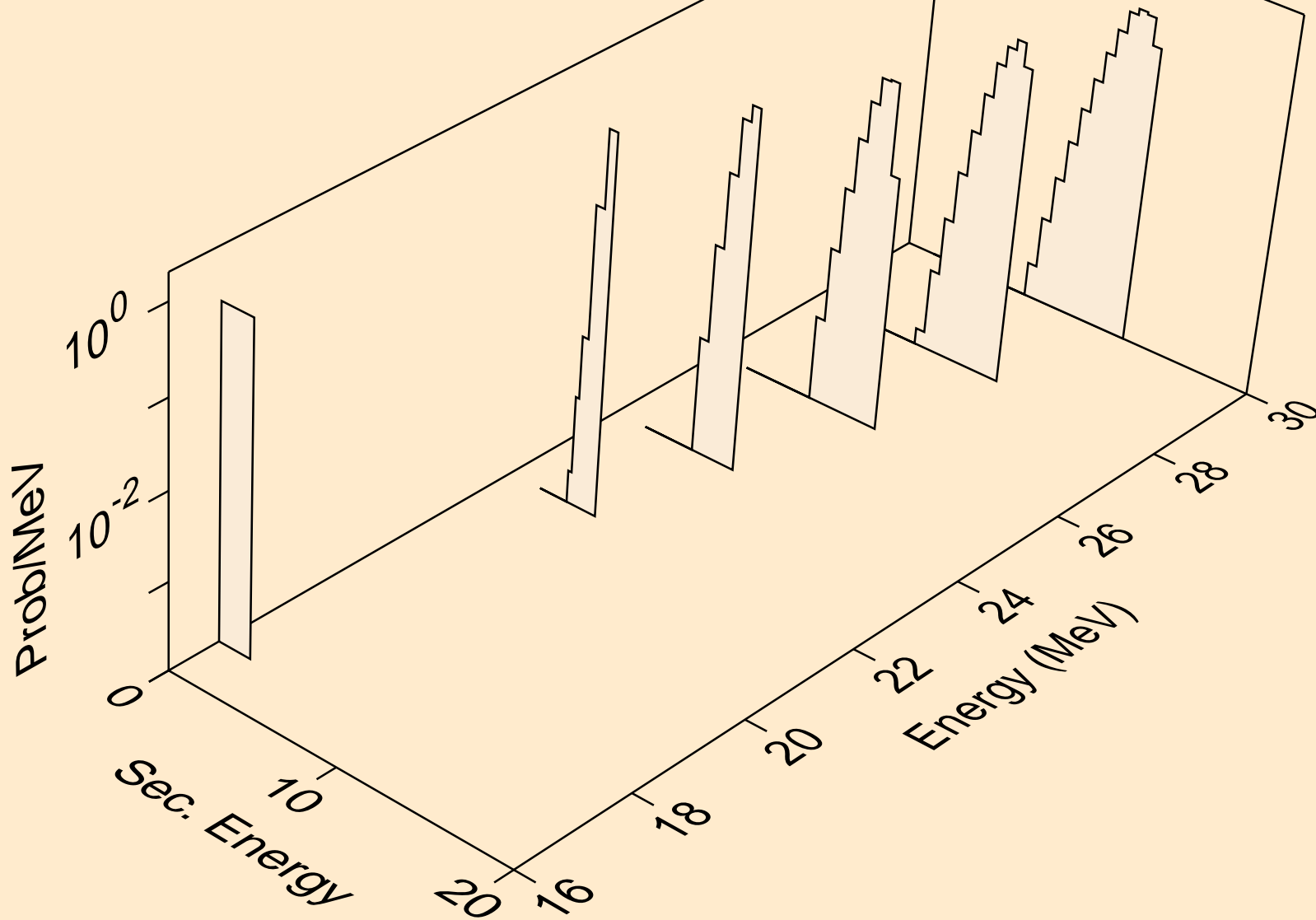

CD115 NEUTRON ACER TENDL-2019 LIBRARY; T=293.16K
he3s from (n,he3)

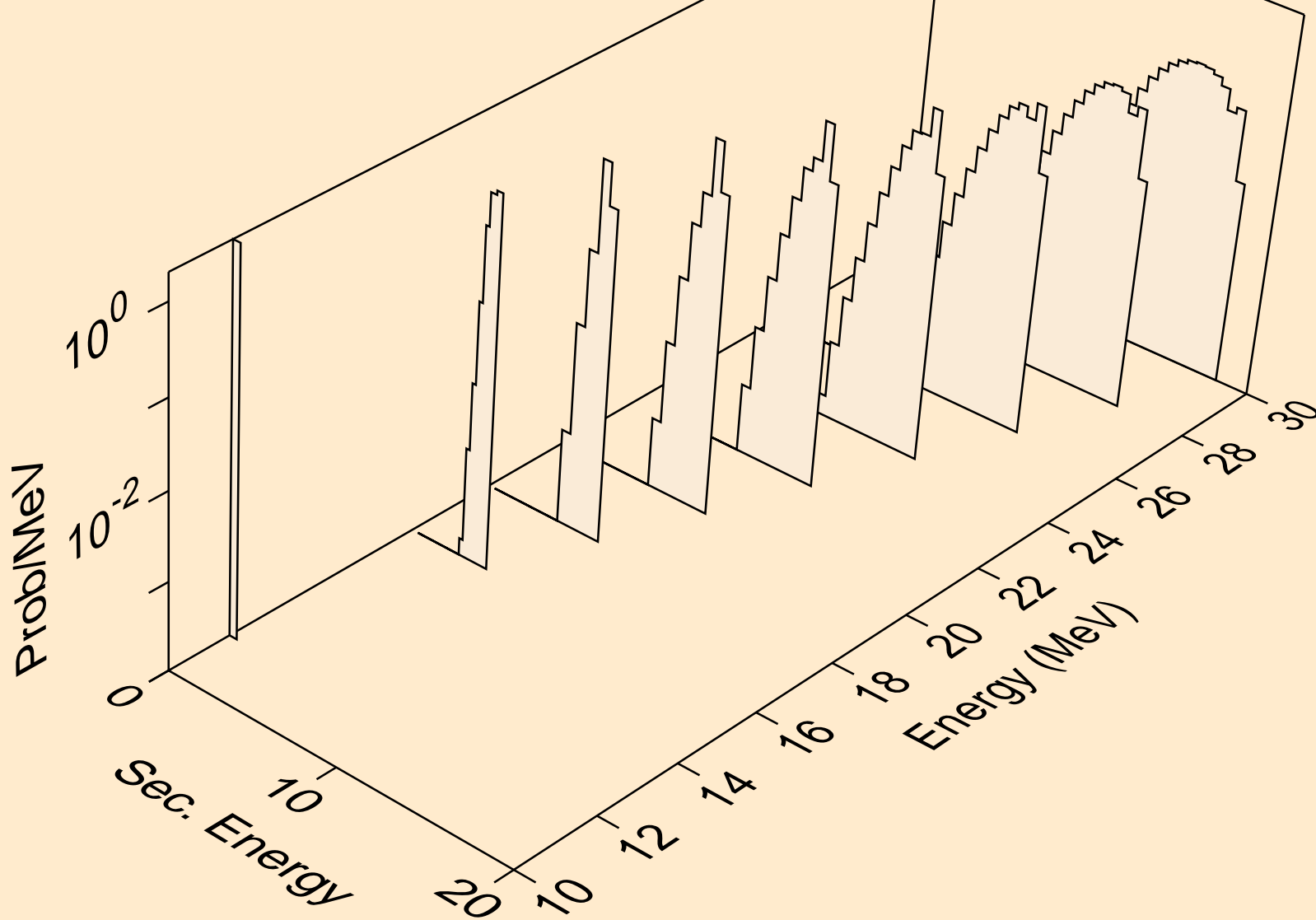

CD115 NEUTRON ACER TENDL-2019 LIBRARY; T=293.16K
alphas from (n,x)

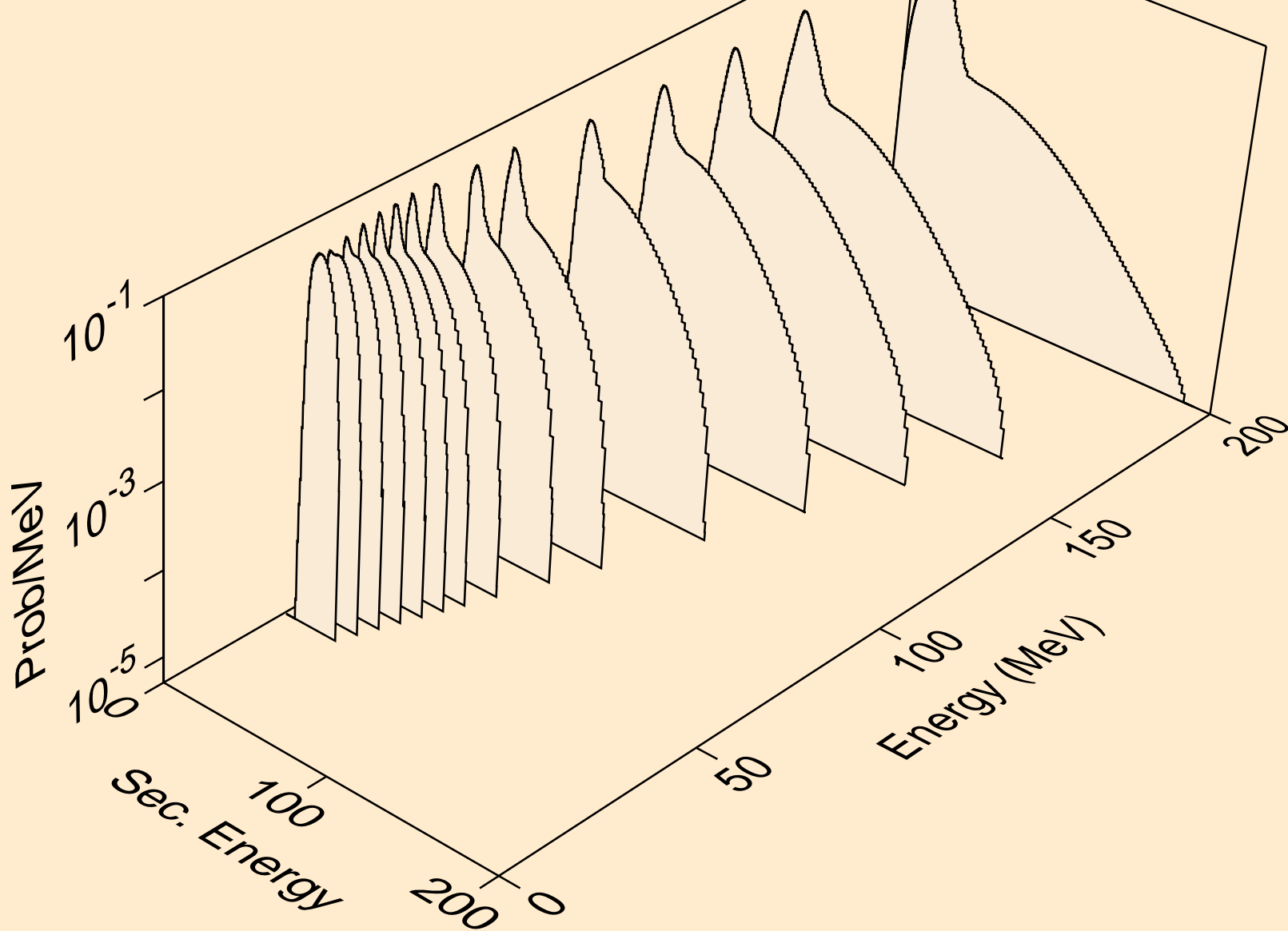

CD115 NEUTRON ACER TENDL-2019 LIBRARY; T=293.16K
alphas from (n,n*)a

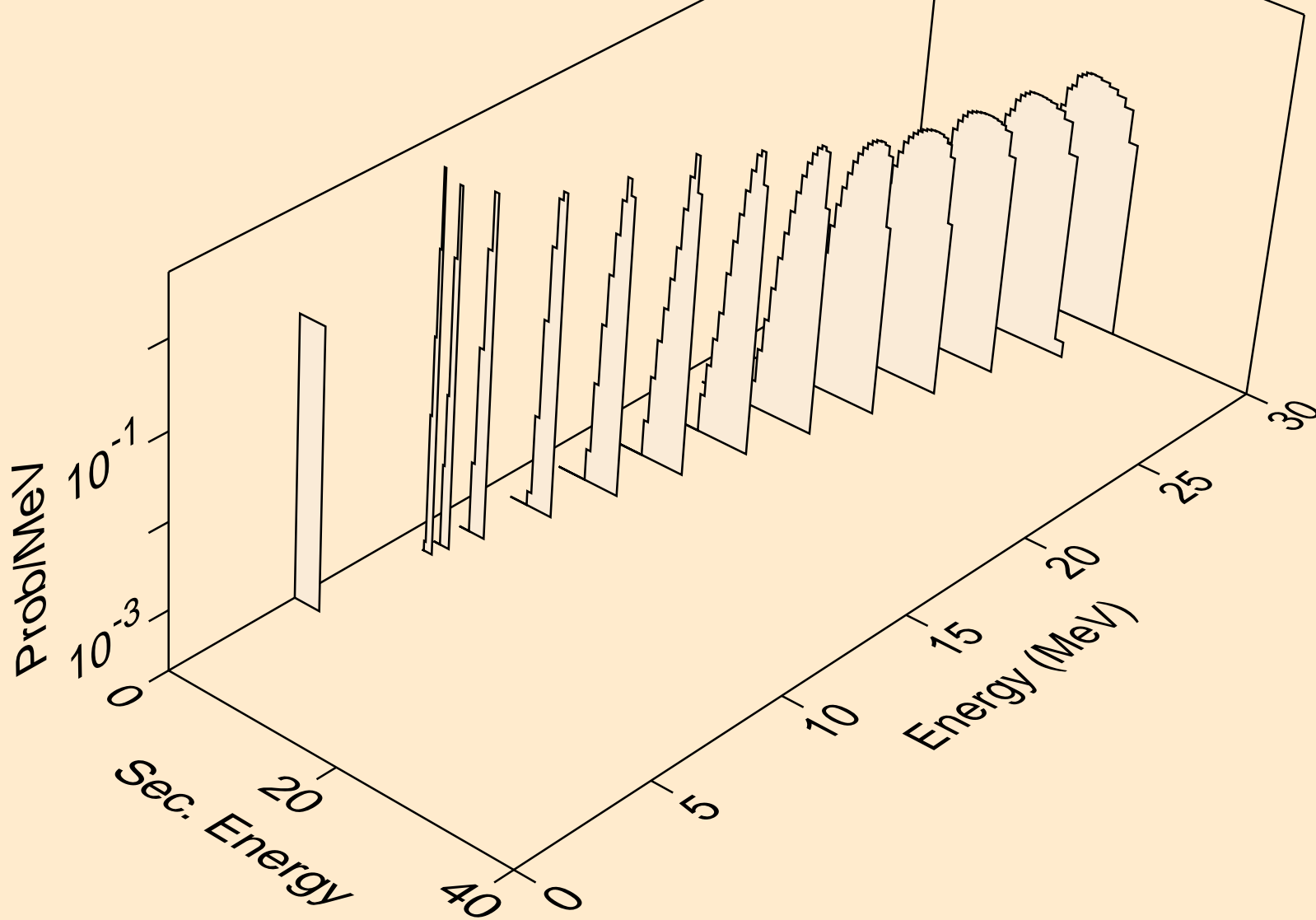

CD115 NEUTRON ACER TENDL-2019 LIBRARY; T=293.16K
alphas from (n,2n)a

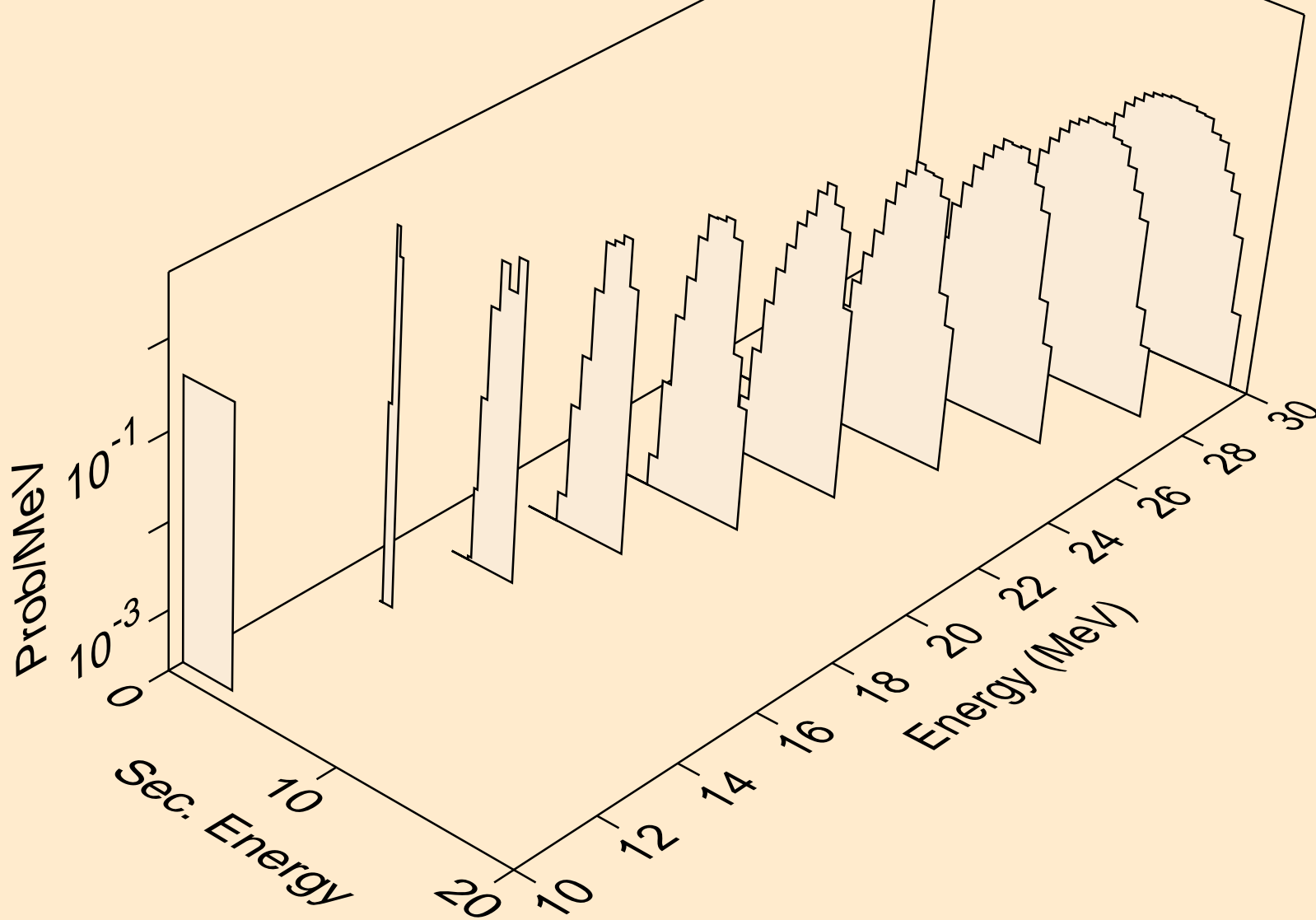

CD115 NEUTRON ACER TENDL-2019 LIBRARY; T=293.16K
alphas from (n,3n)a

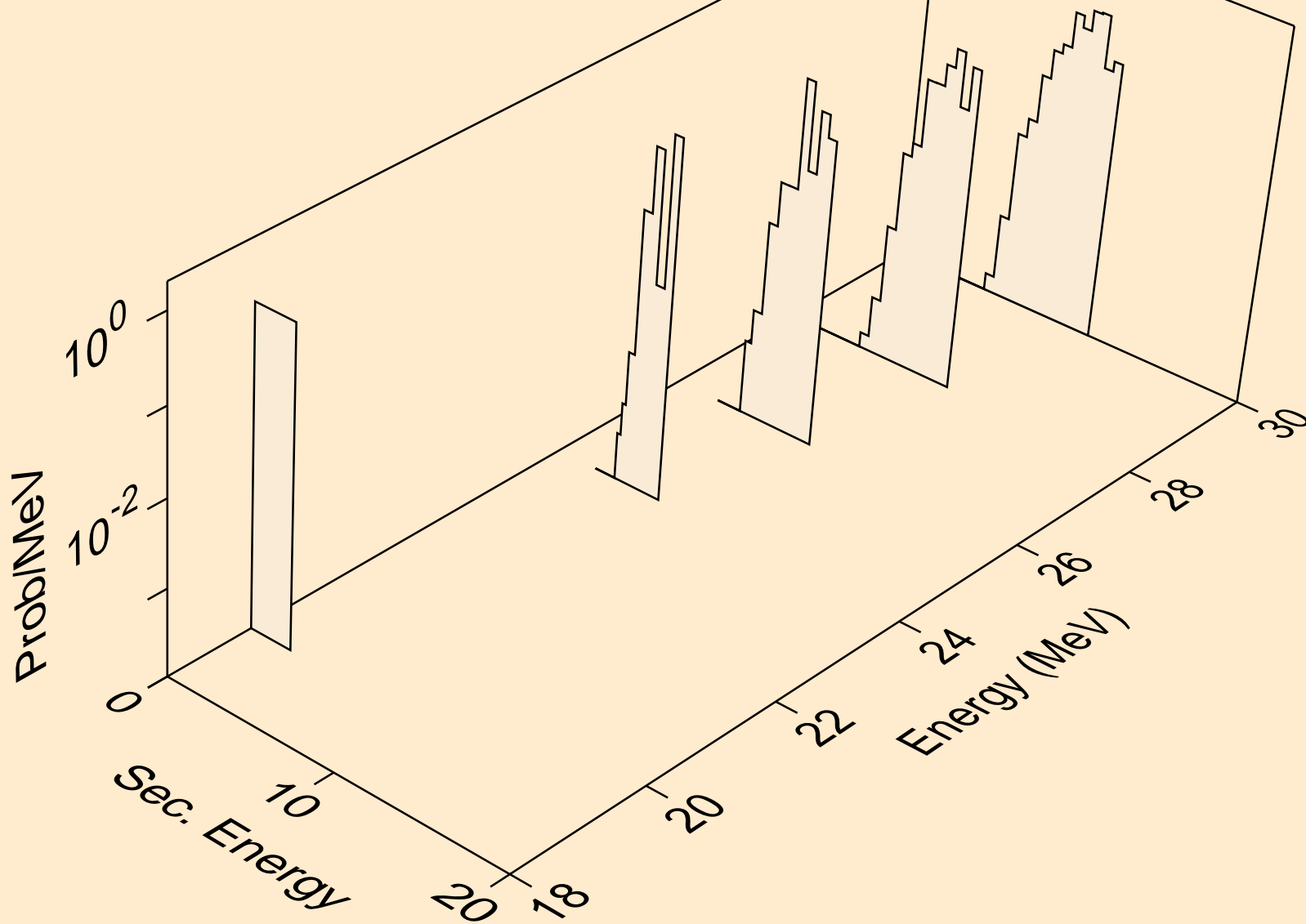

CD115 NEUTRON ACER TENDL-2019 LIBRARY; T=293.16K
alphas from (n,npa)

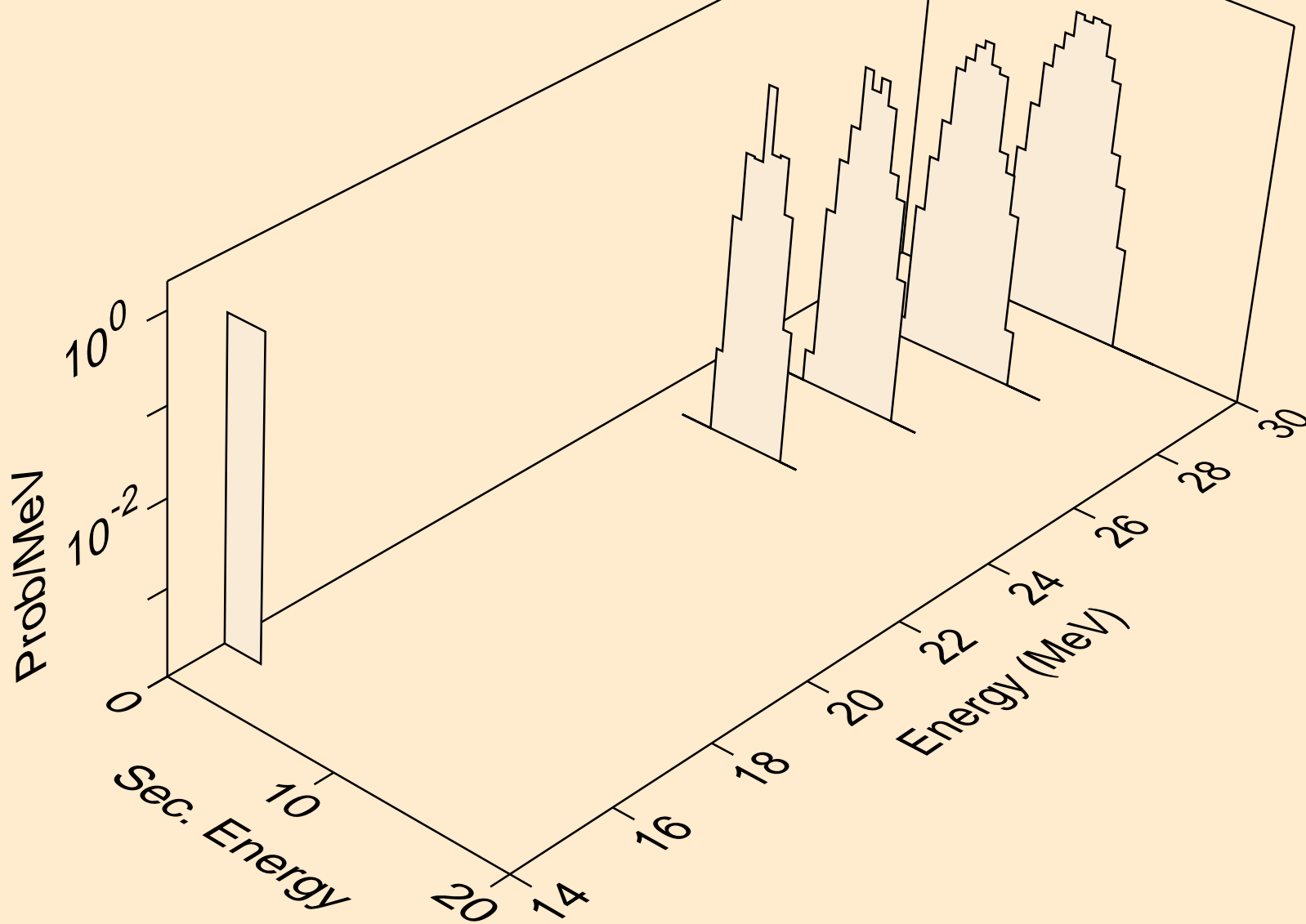

CD115 NEUTRON ACER TENDL-2019 LIBRARY; T=293.16K
alphas from (n,a)

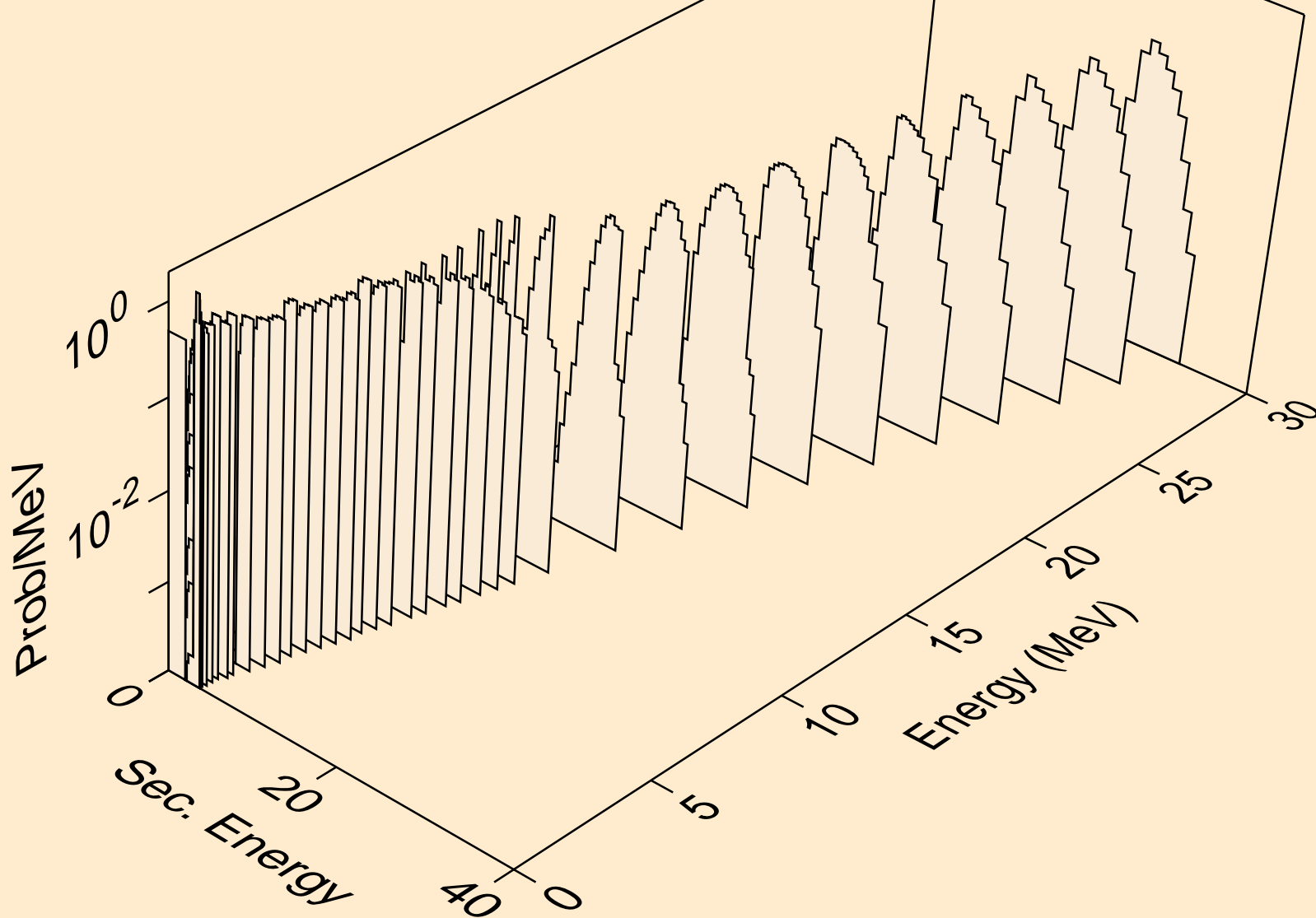

CD115 NEUTRON ACER TENDL-2019 LIBRARY; T=293.16K
alphas from (n,2a)

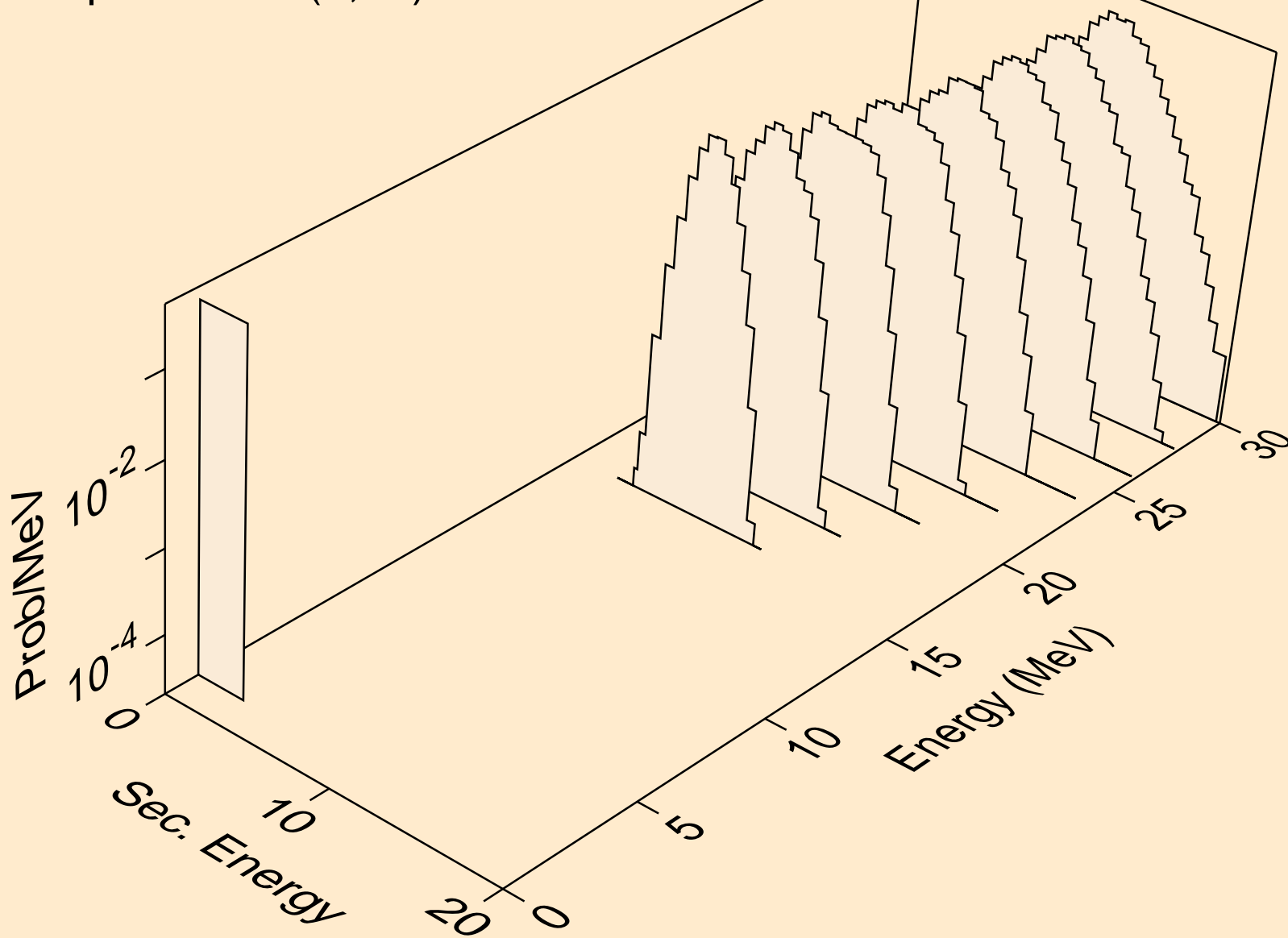

CD115 NEUTRON ACER TENDL-2019 LIBRARY; T=293.16K
alphas from (n,pa)

