

Program EVALPLOT  
(Version 2018-1)

by

Dermott E. Cullen  
(Present Contact Information)

Dermott E. Cullen  
1466 Hudson Way  
Livermore, CA 94550  
U.S.A.

Tele: 925-443-1911

E.Mail:redcullen1@comcast.net  
Web:redcullen1.net/HOMEPAGE.NEW

Press Mouse Button to Start

MAT 2952

Major  
293 Kelvin Cross Sections

29-Cu-72

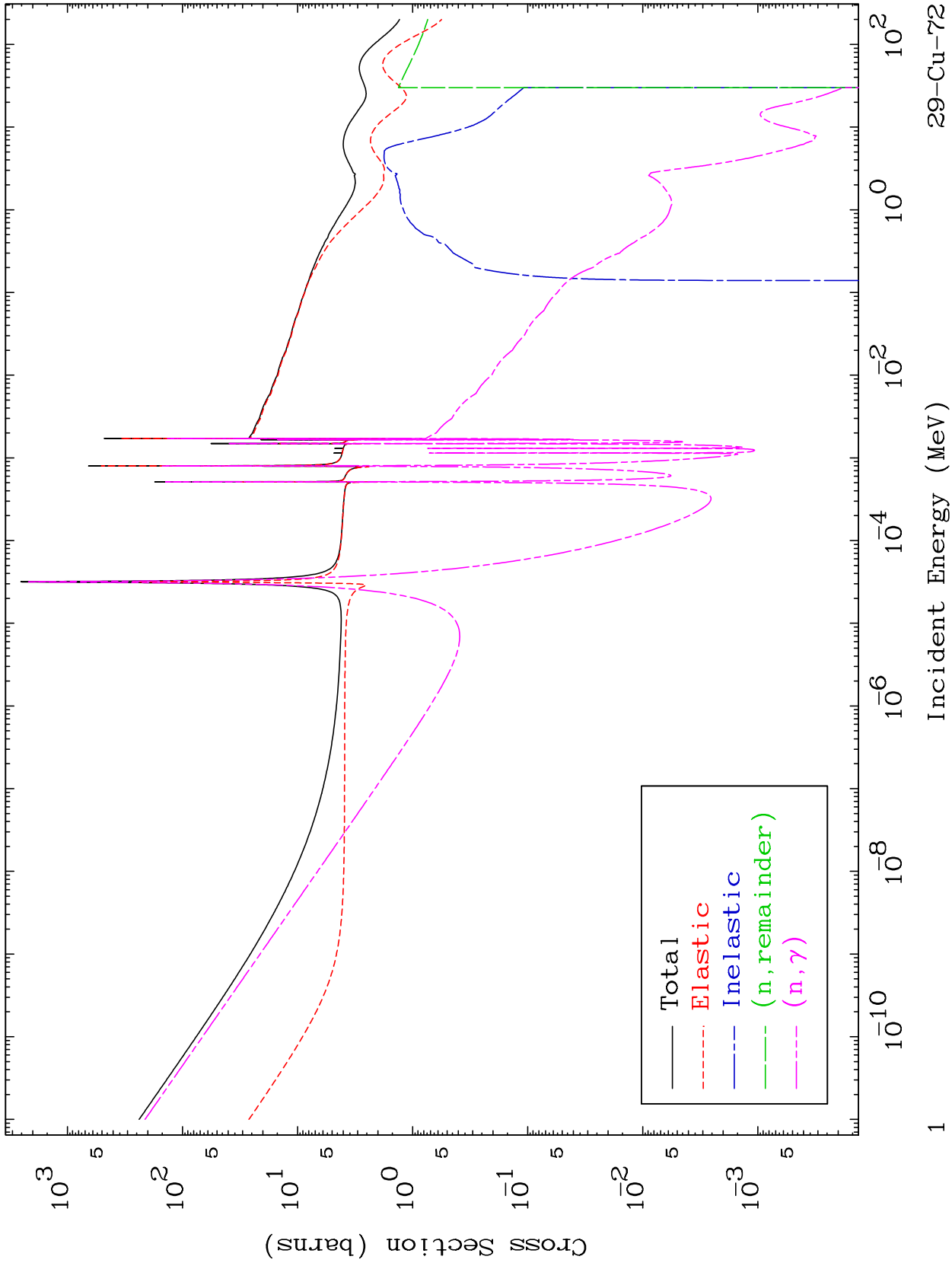

MAT 2952

Neutron Production  
293 Kelvin Cross Sections

29-Cu-72

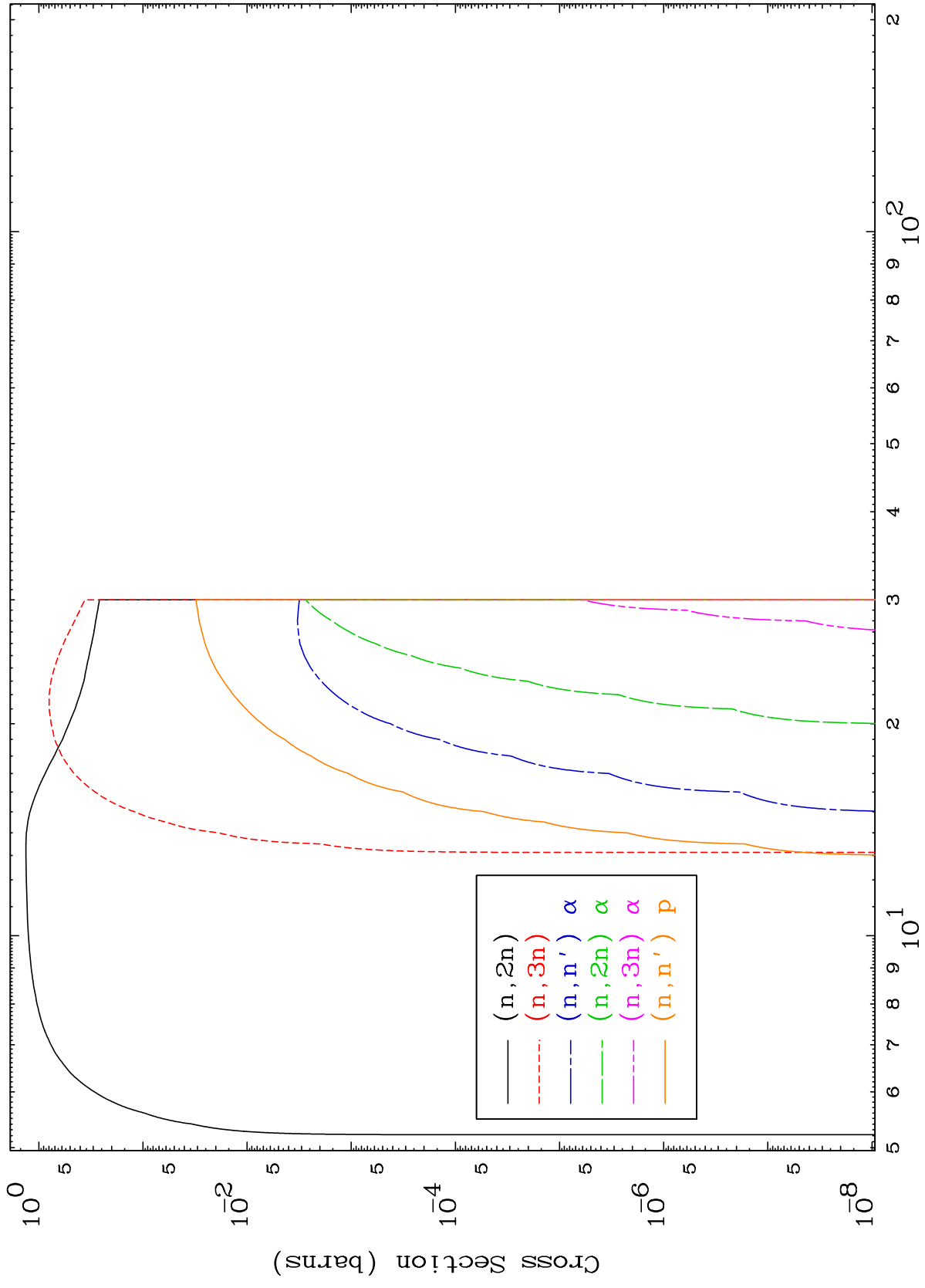

2

Incident Energy (MeV)

29-Cu-72

MAT 2952

Neutron Production  
293 Kelvin Cross Sections

29-Cu-72

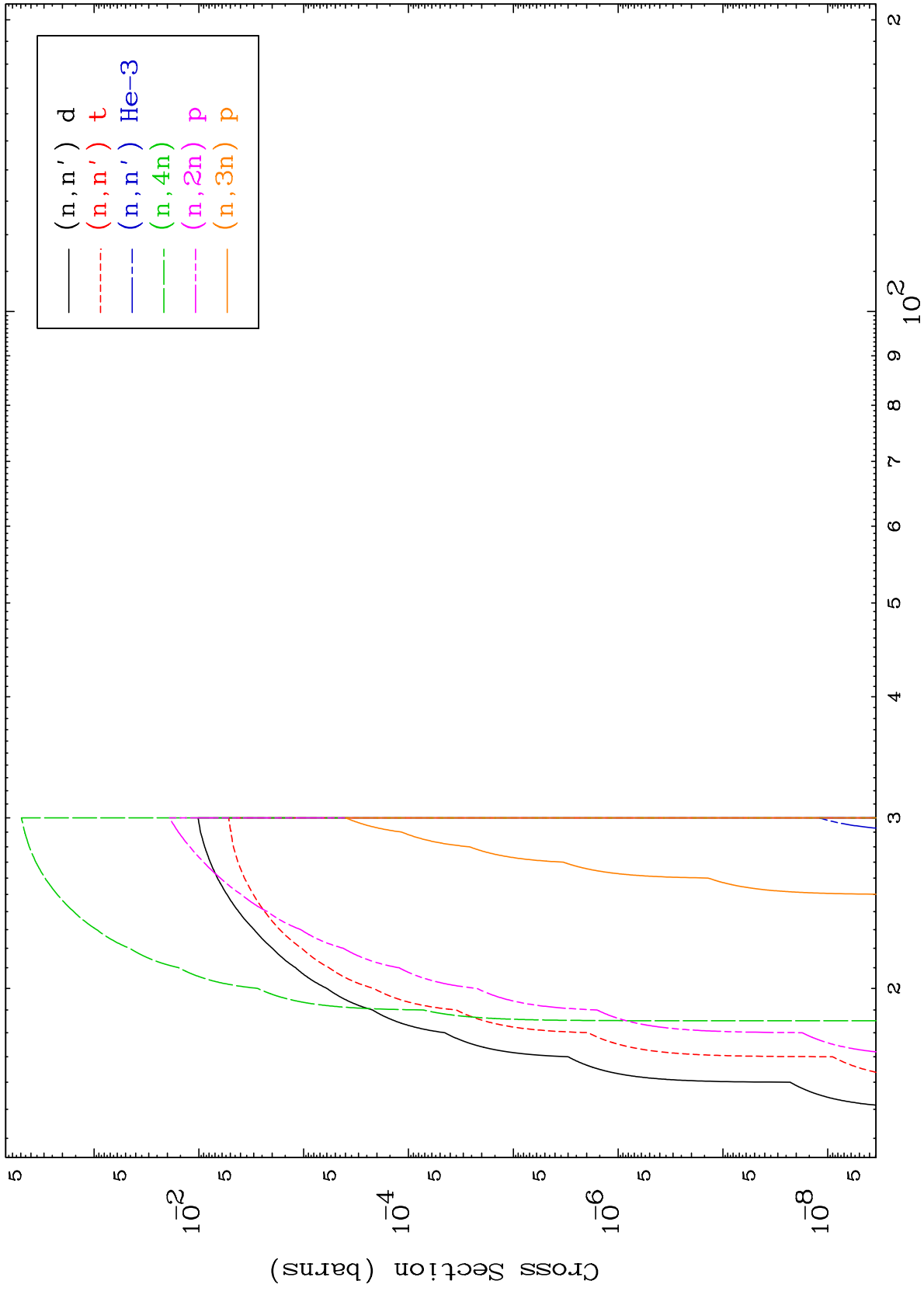

3

Incident Energy (MeV)

29-Cu-72

MAT 2952

Charged Particle  
293 Kelvin Cross Sections

29-Cu-72

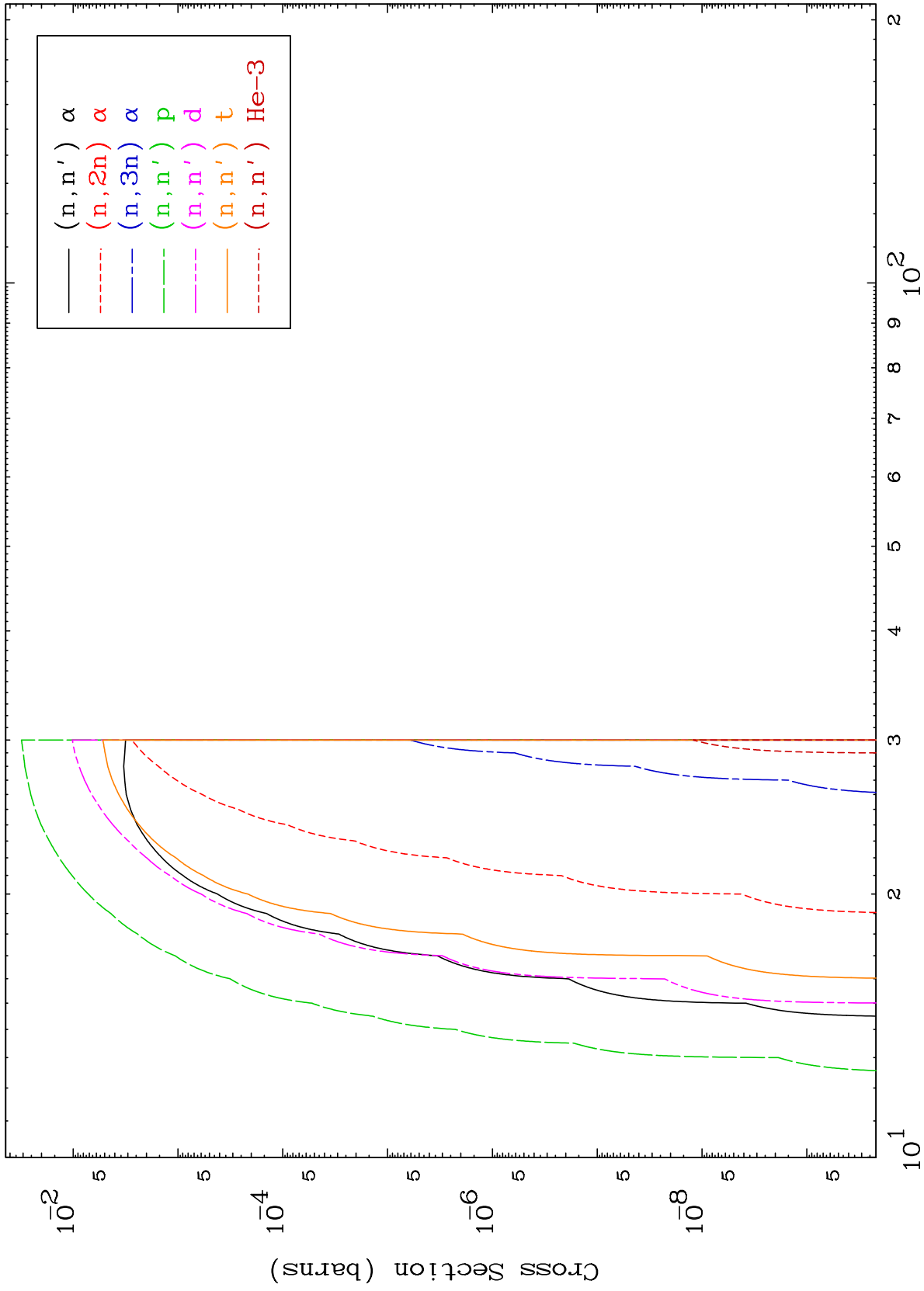

Incident Energy (MeV)

29-Cu-72

MAT 2952

Charged Particle  
293 Kelvin Cross Sections

29-Cu-72

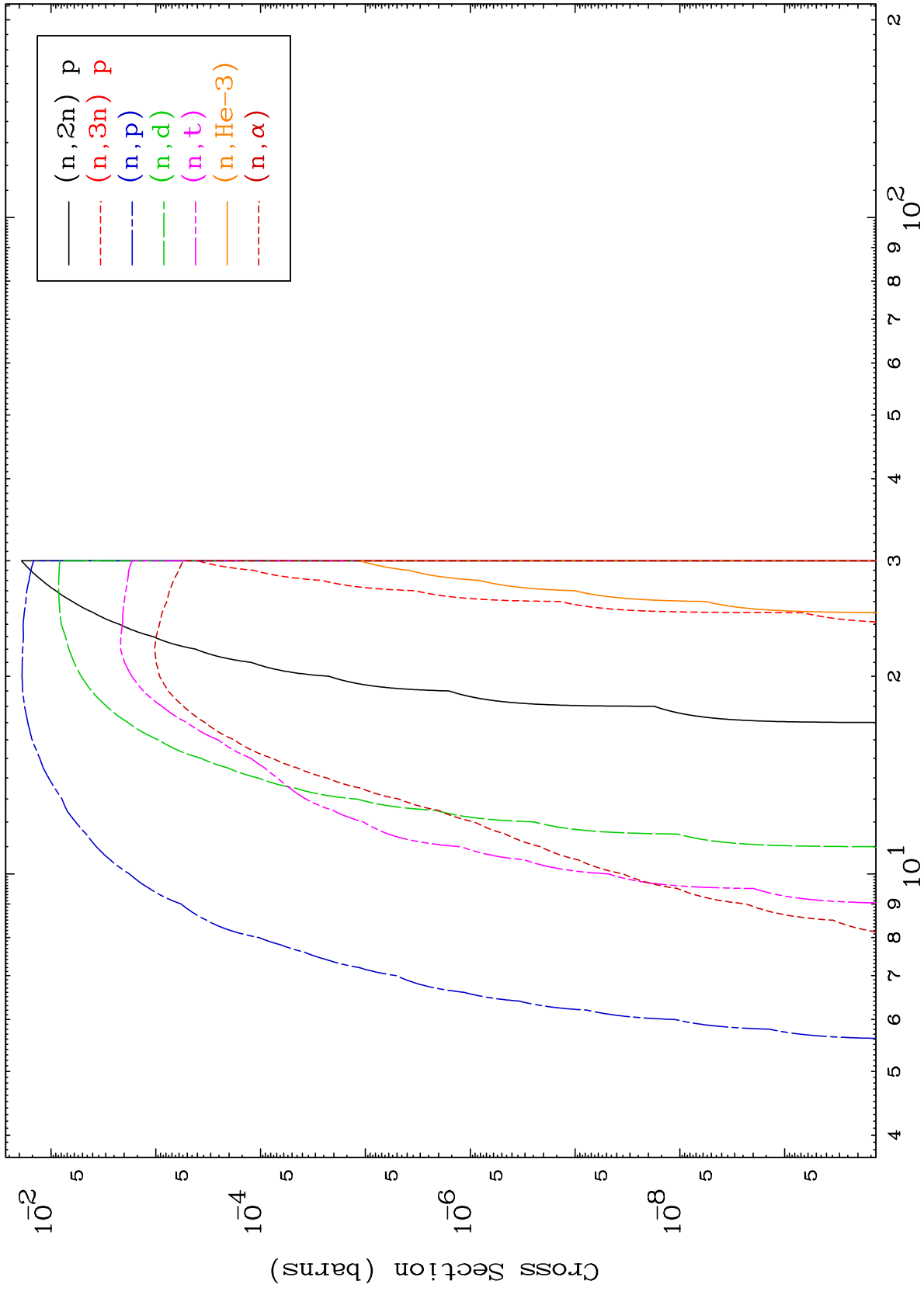

5

Incident Energy (MeV)

29-Cu-72

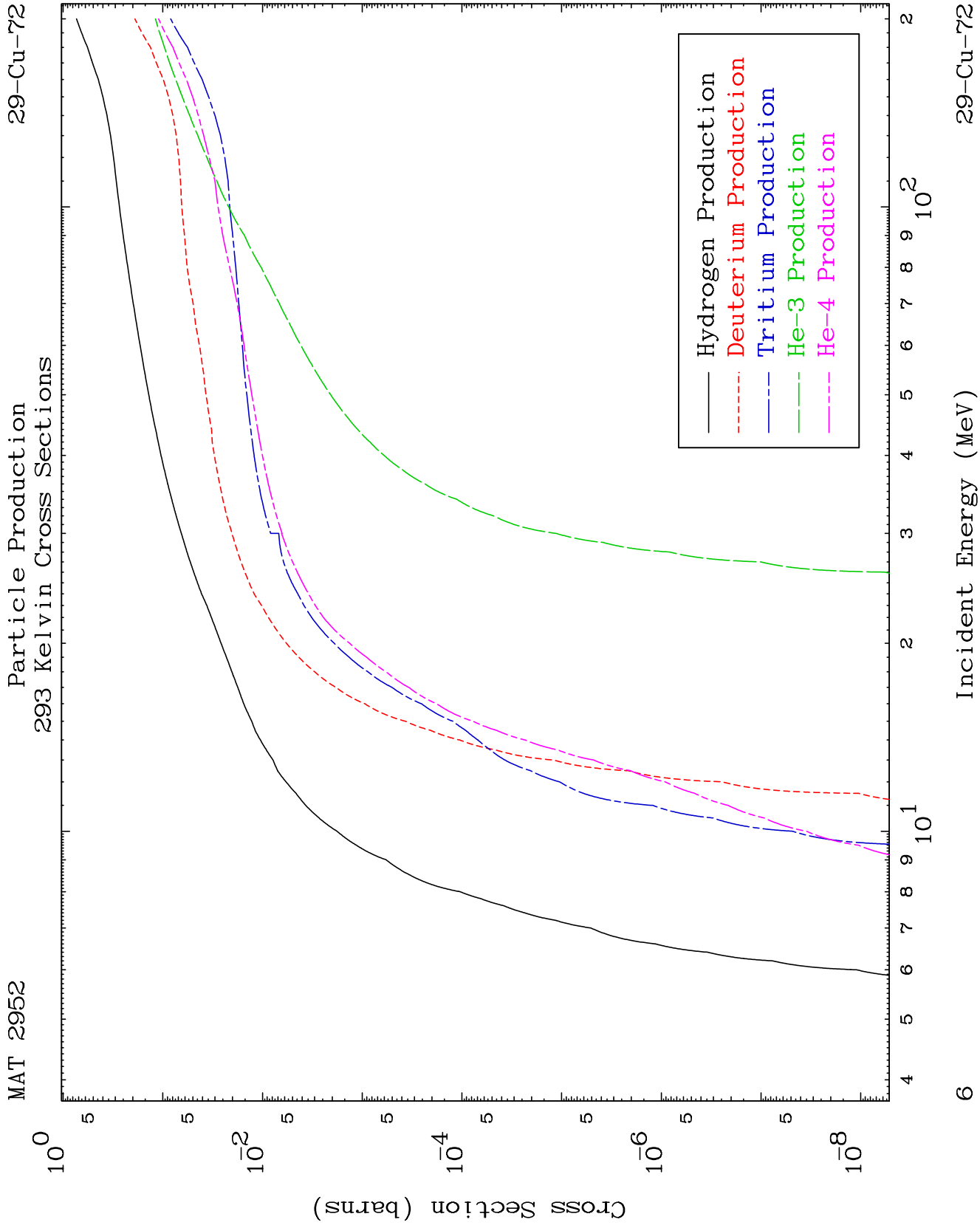

MAT 2952

(n,n') Level  
293 Kelvin Cross Sections

29-Cu-72

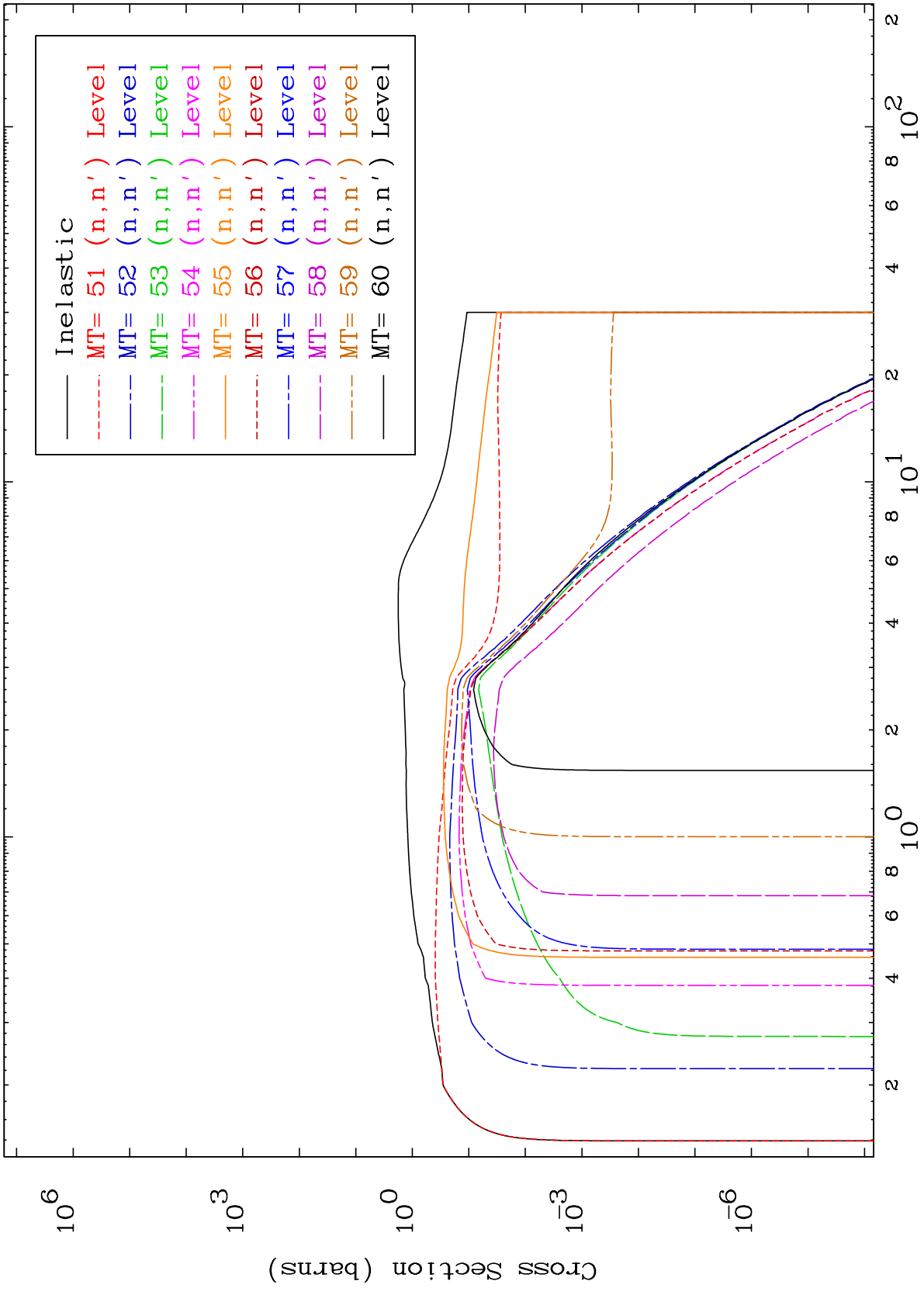

MAT 2952

(n,n') Level

293 Kelvin Cross Sections

29-Cu-72

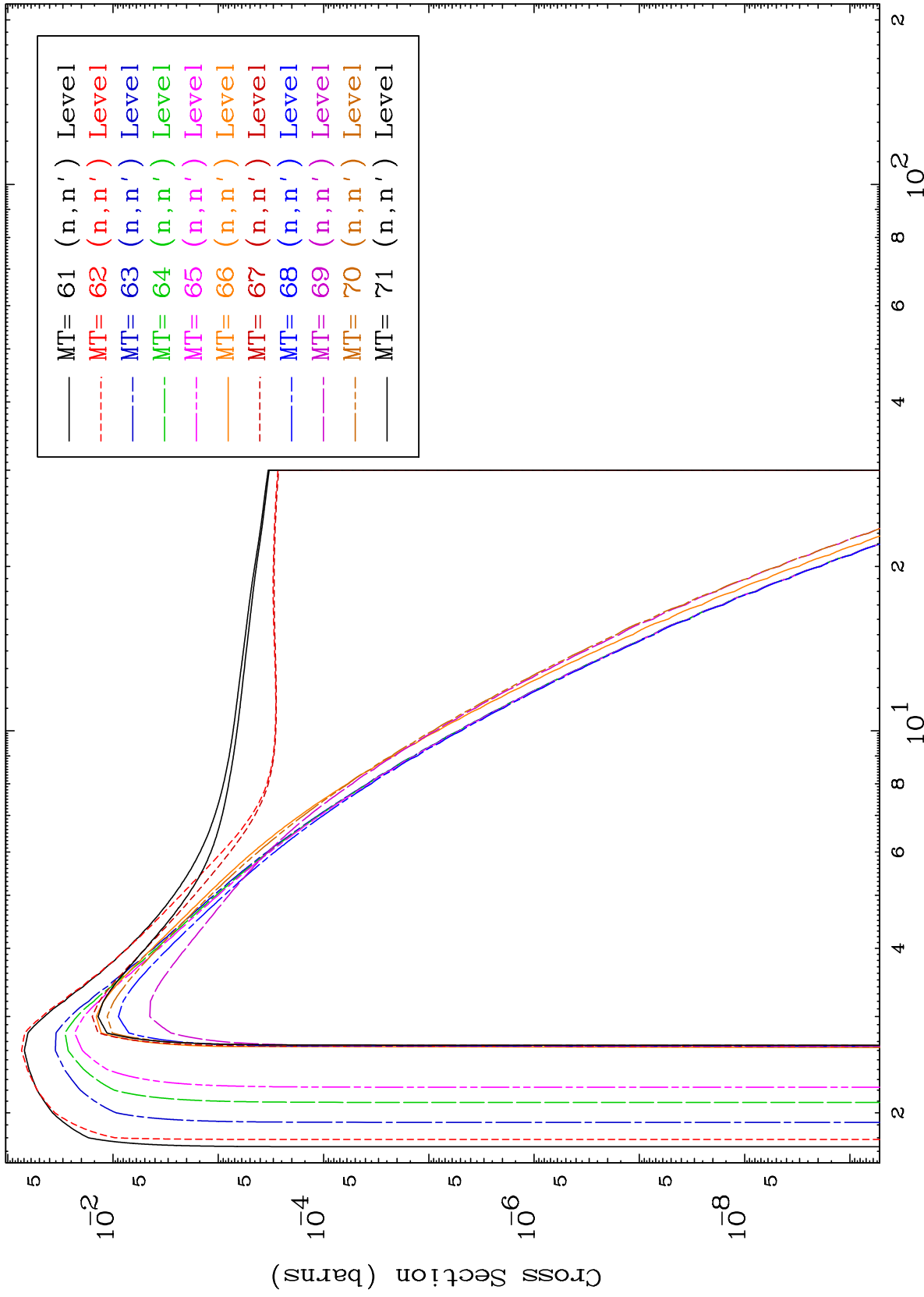

8

Incident Energy (MeV)

29-Cu-72

MAT 2952

(n,n') Level  
293 Kelvin Cross Sections

29-Cu-72

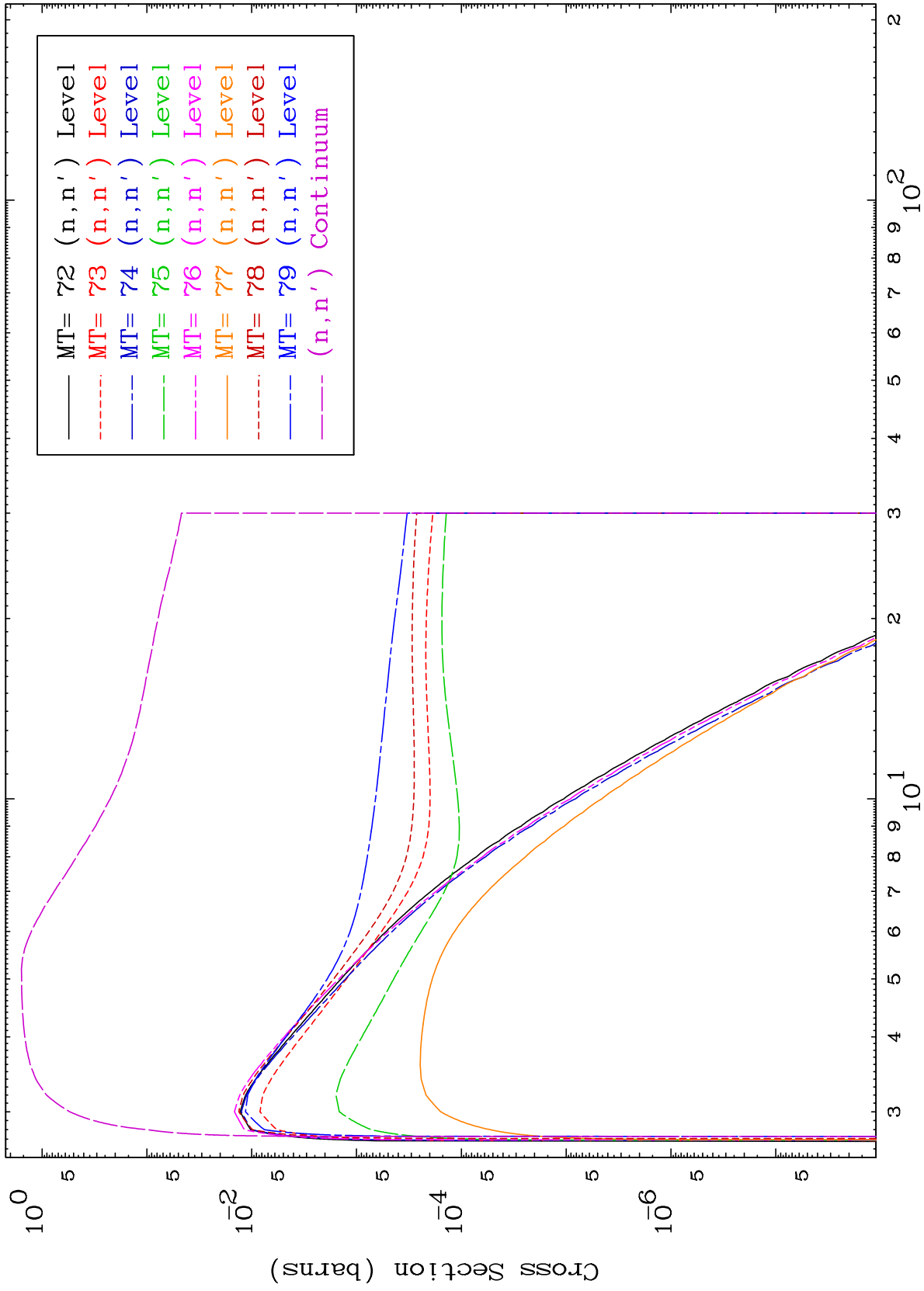

9

MAT 2952

(n,p) Levels  
293 Kelvin Cross Sections

29-Cu-72

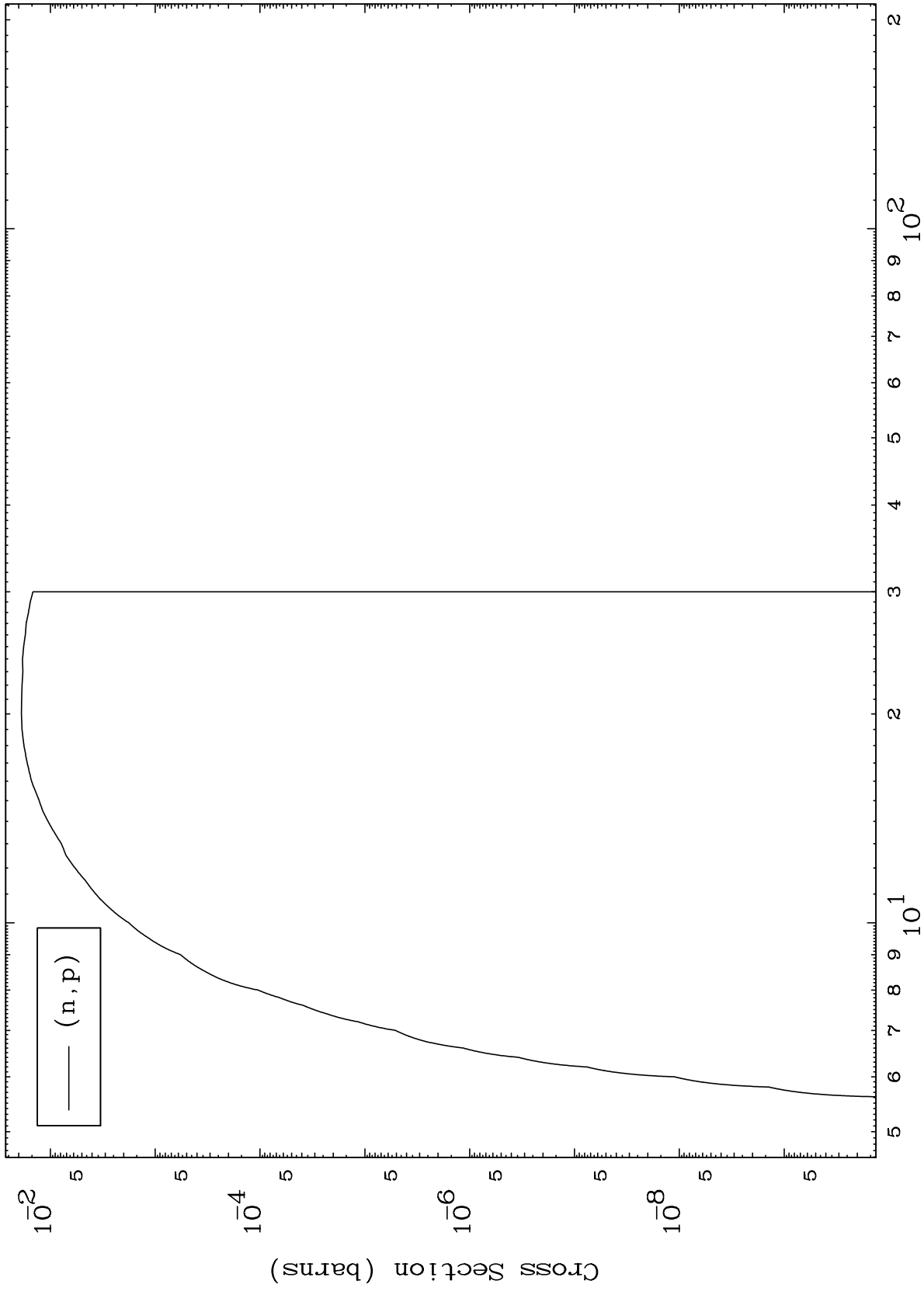

10

Incident Energy (MeV)

29-Cu-72

MAT 2952

(n,d) Levels  
293 Kelvin Cross Sections

29-Cu-72

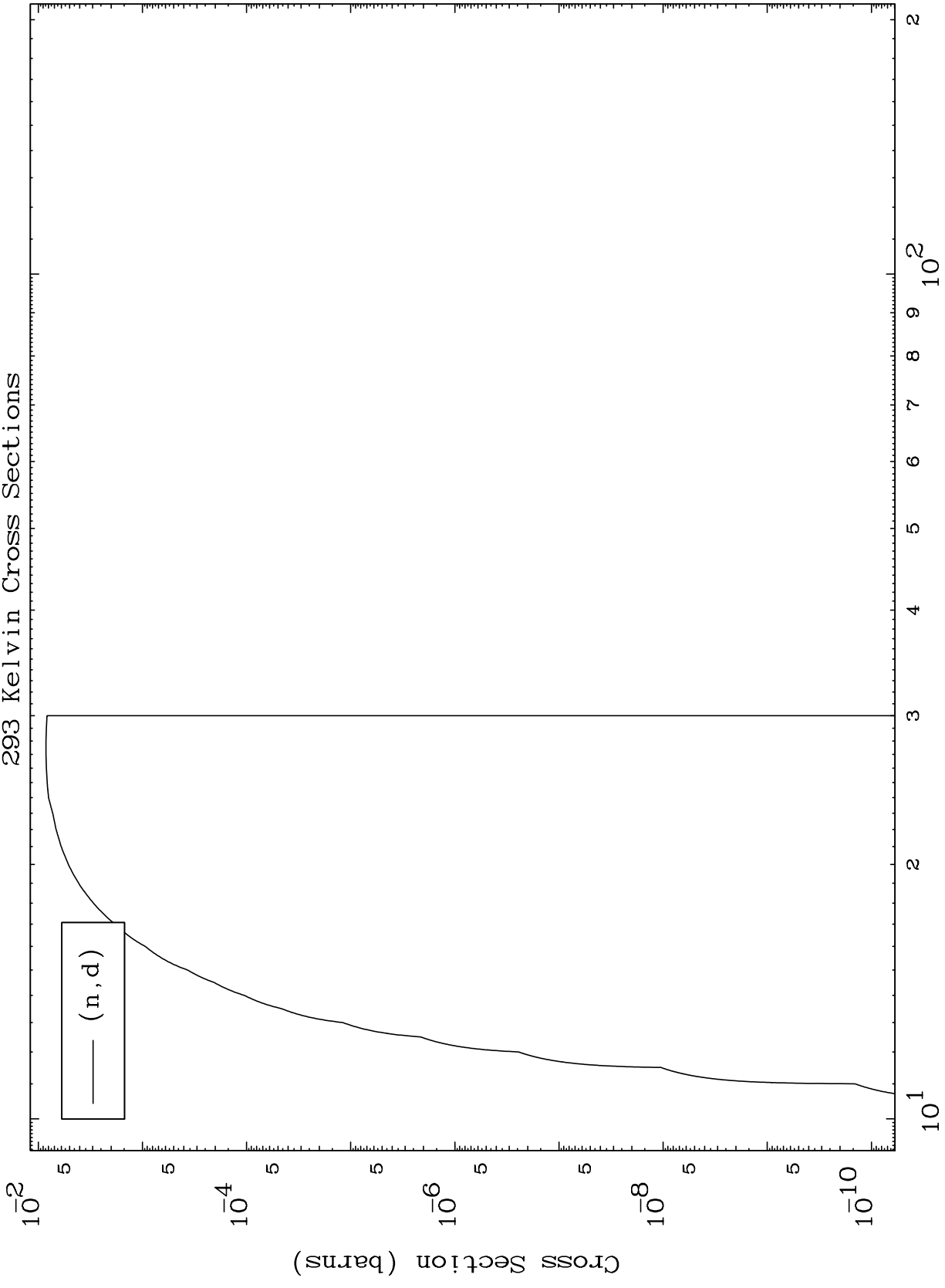

11

Incident Energy (MeV)

29-Cu-72

MAT 2952

29-Cu-72

(n,t) Levels  
293 Kelvin Cross Sections

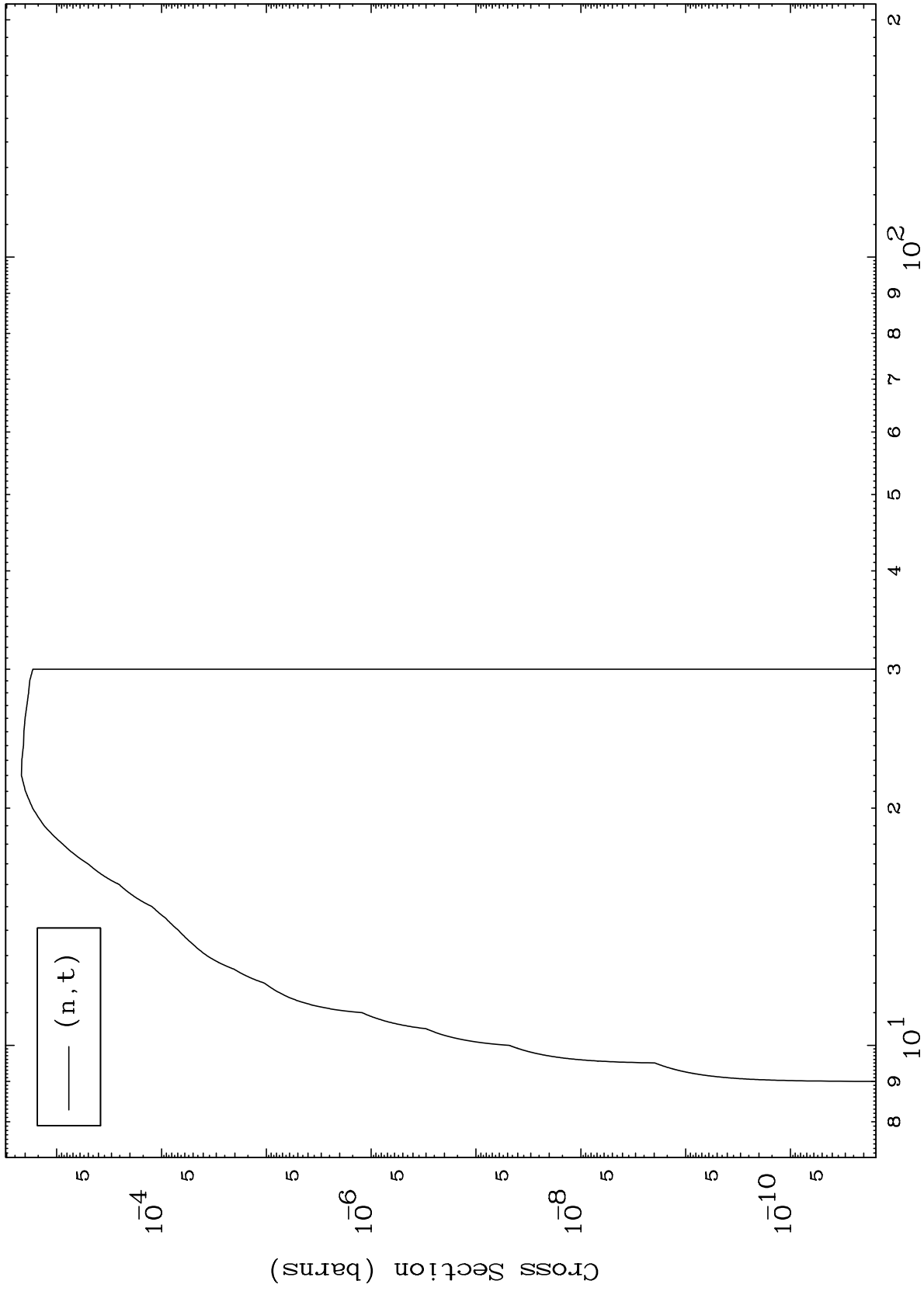

12

Incident Energy (MeV)

29-Cu-72

MAT 2952

(n,He3) Levels  
293 Kelvin Cross Sections

29-Cu-72

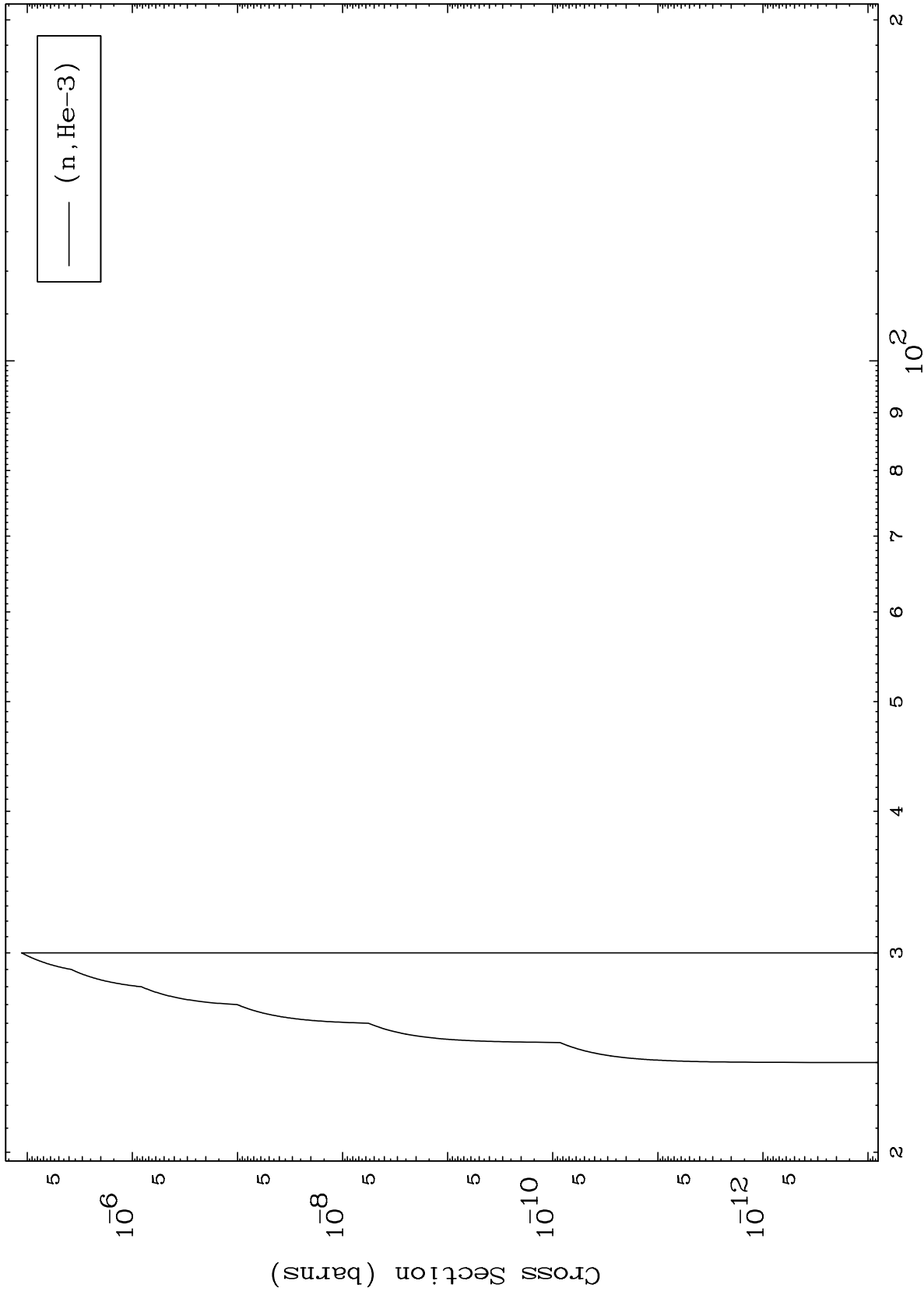

13

Incident Energy (MeV)

29-Cu-72

MAT 2952

(n,α) Levels  
293 Kelvin Cross Sections

29-Cu-72

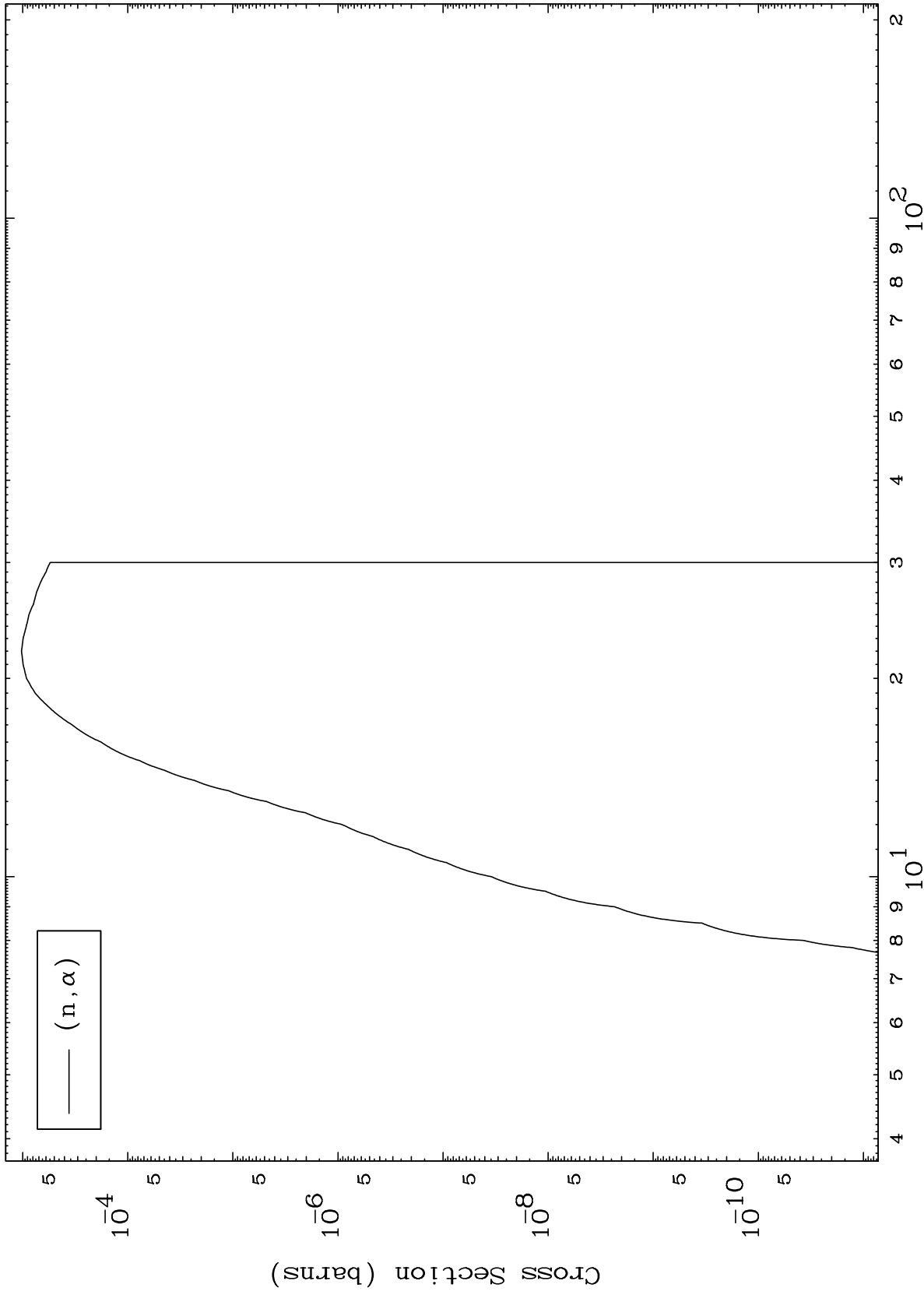

14

Incident Energy (MeV)

29-Cu-72

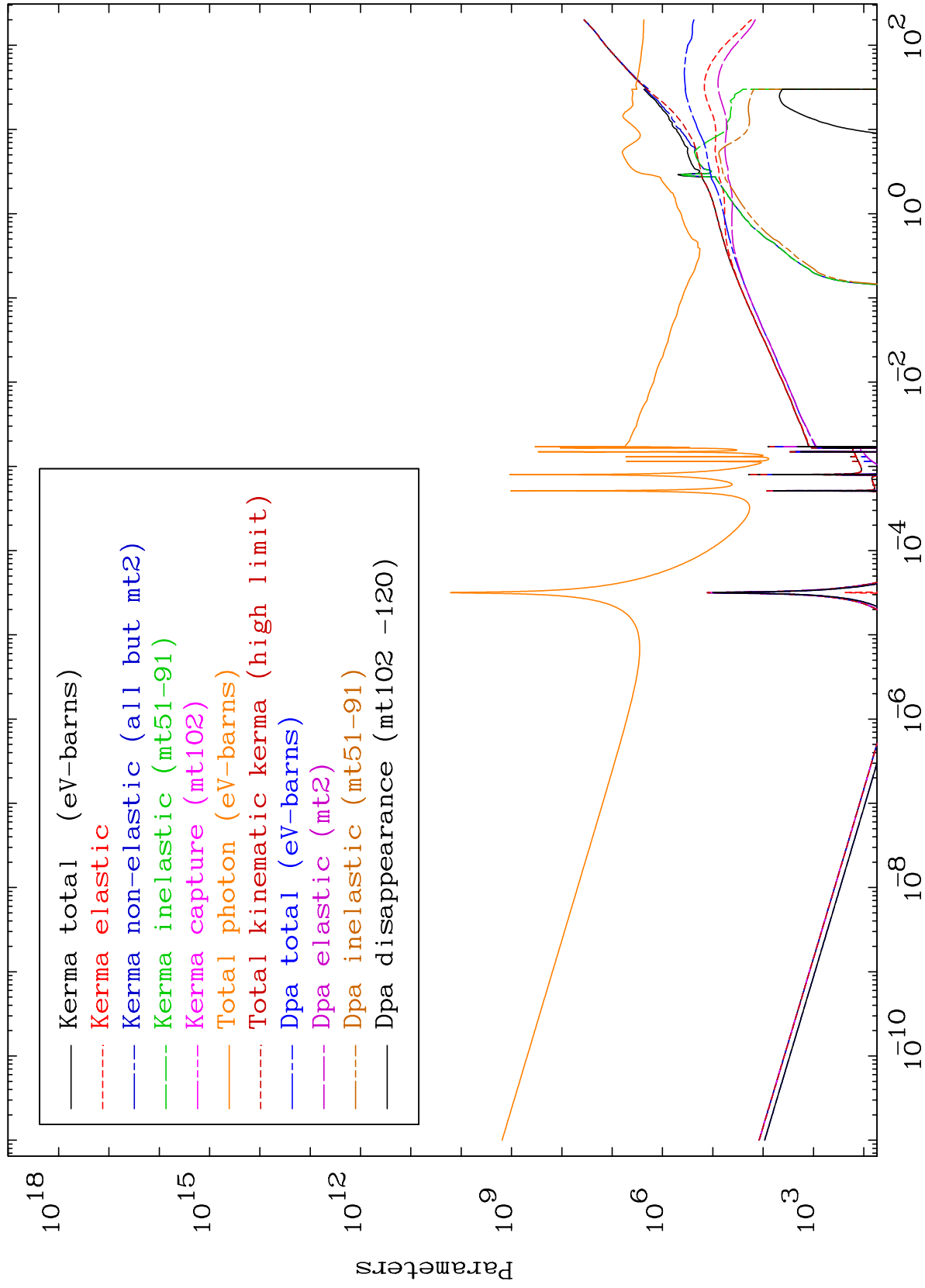

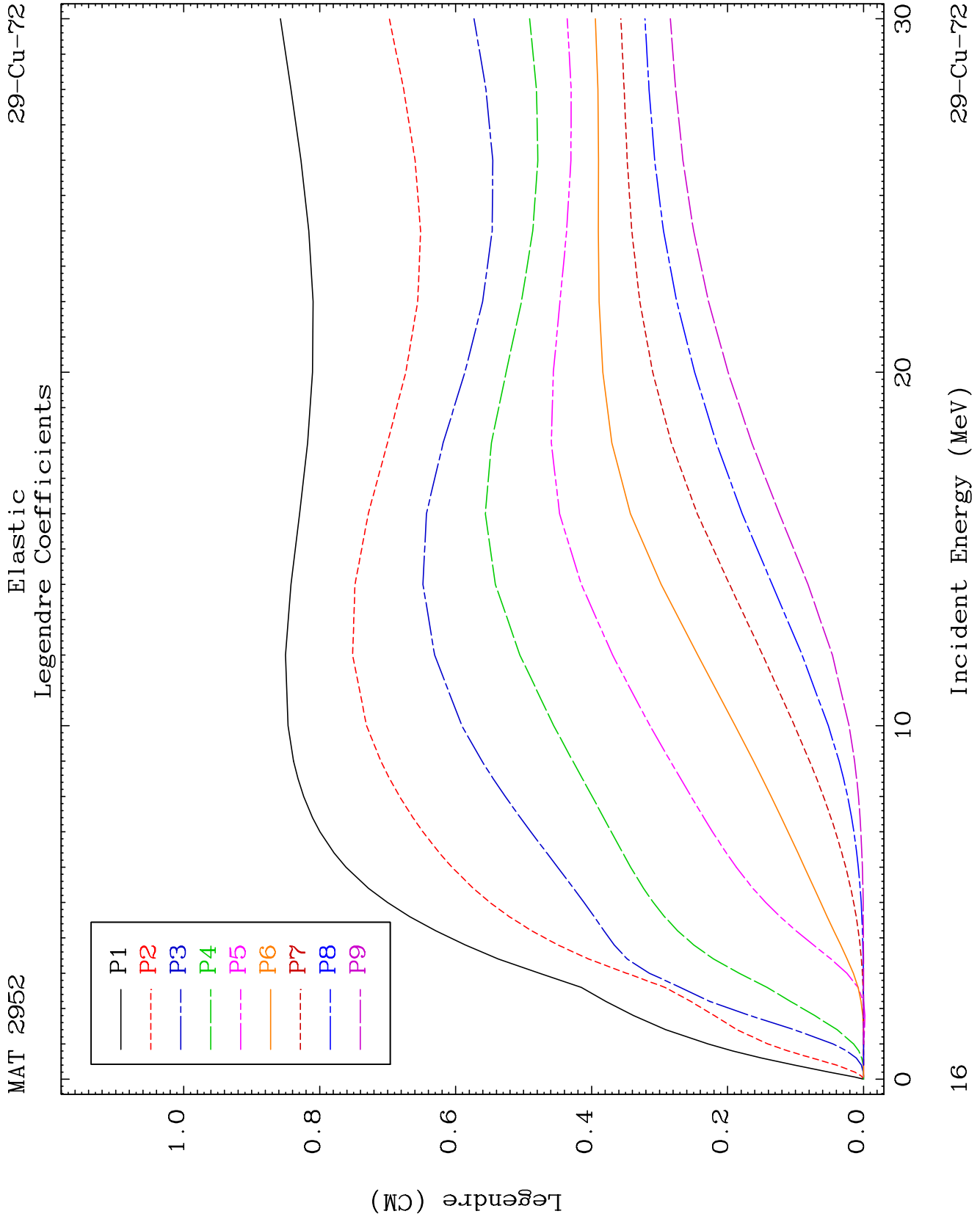

MAT 2952

Elastic Legendre Coefficients

<sup>29</sup>Cu-72

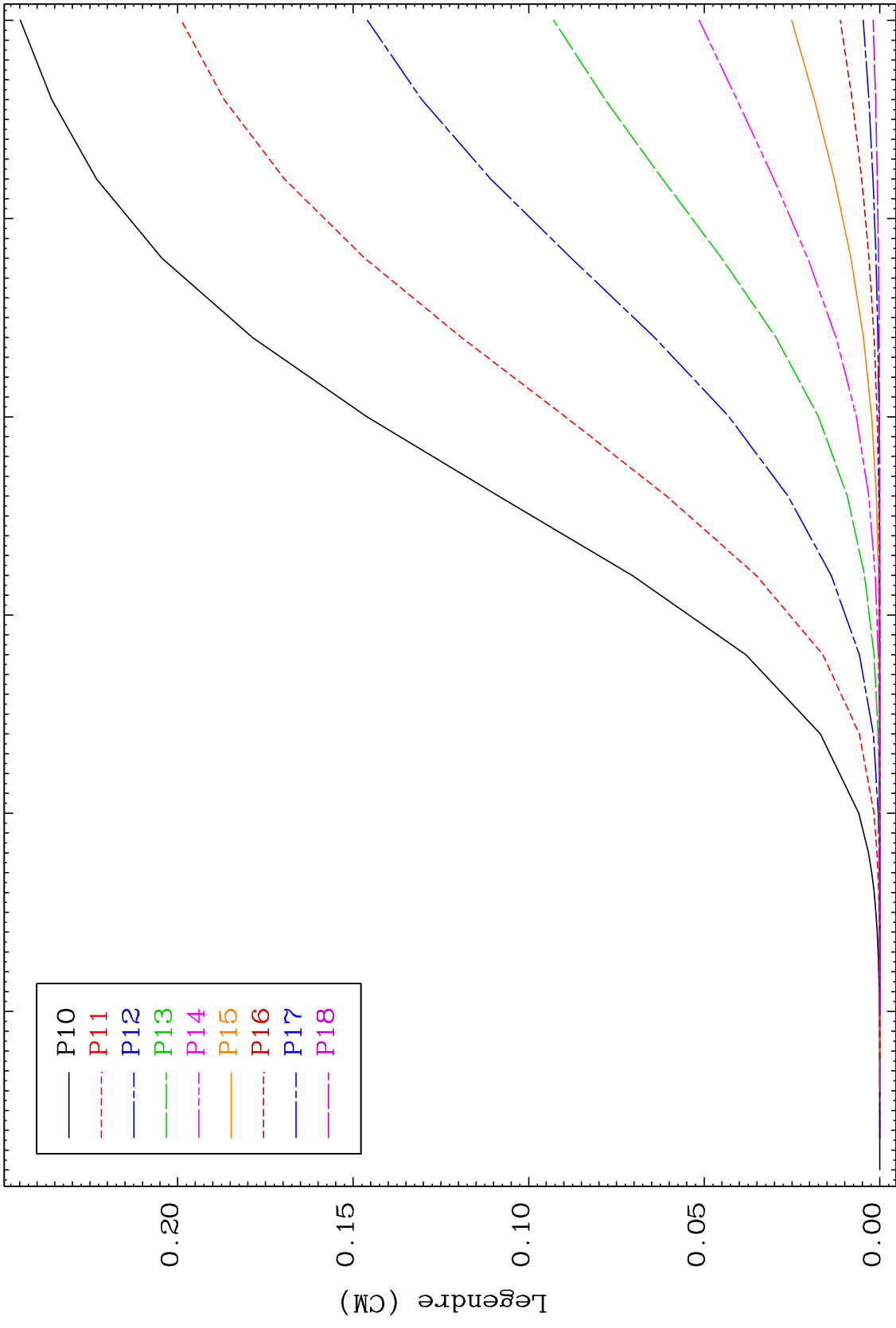

17

<sup>29</sup>Cu-72





MAT 2952 MT= 51 (n,n') Level Legendre Coefficients 29-Cu-72

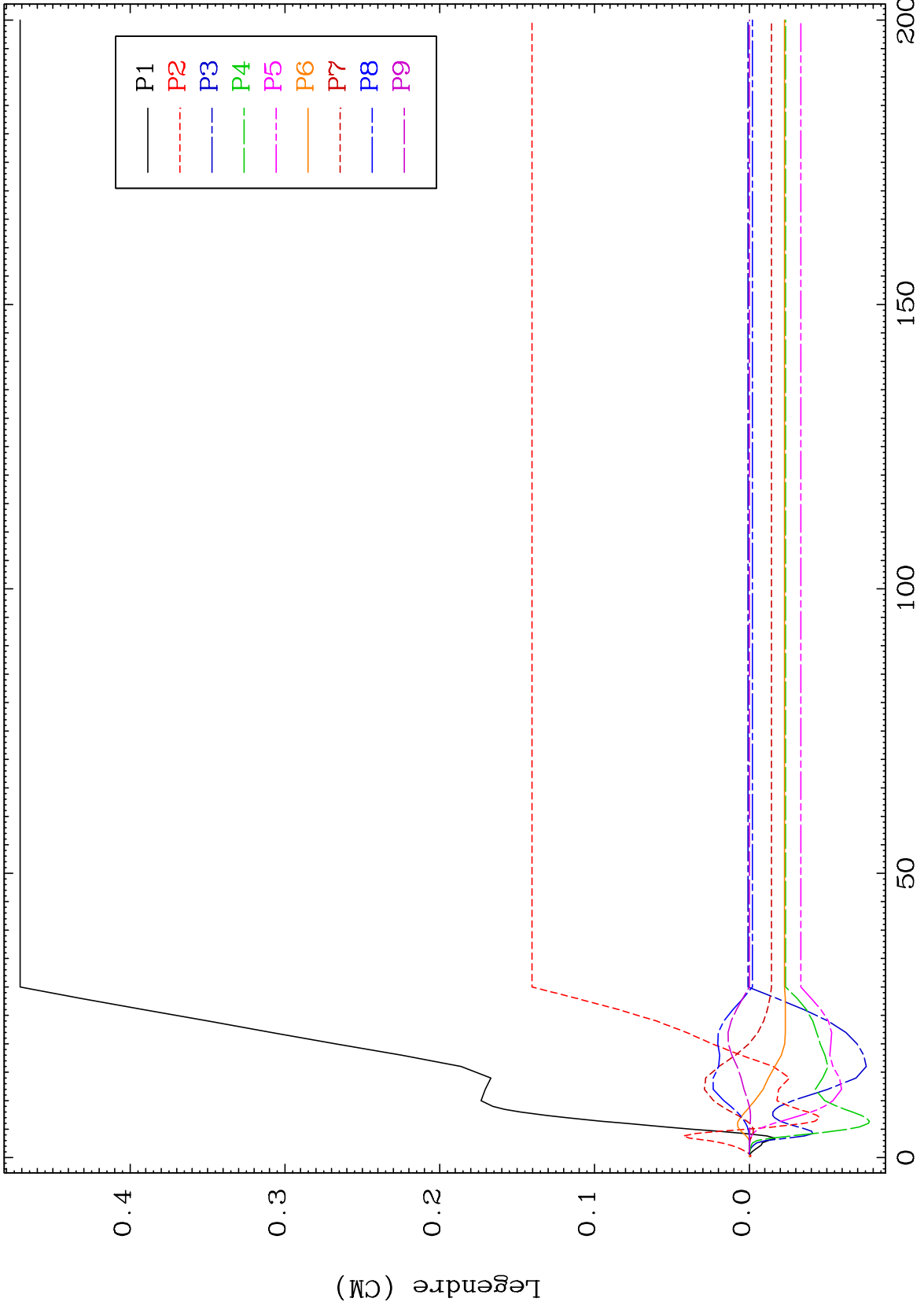

29-Cu-72

MAT 2952

MT= 51 (n,n') Level  
Legendre Coefficients

29-Cu-72

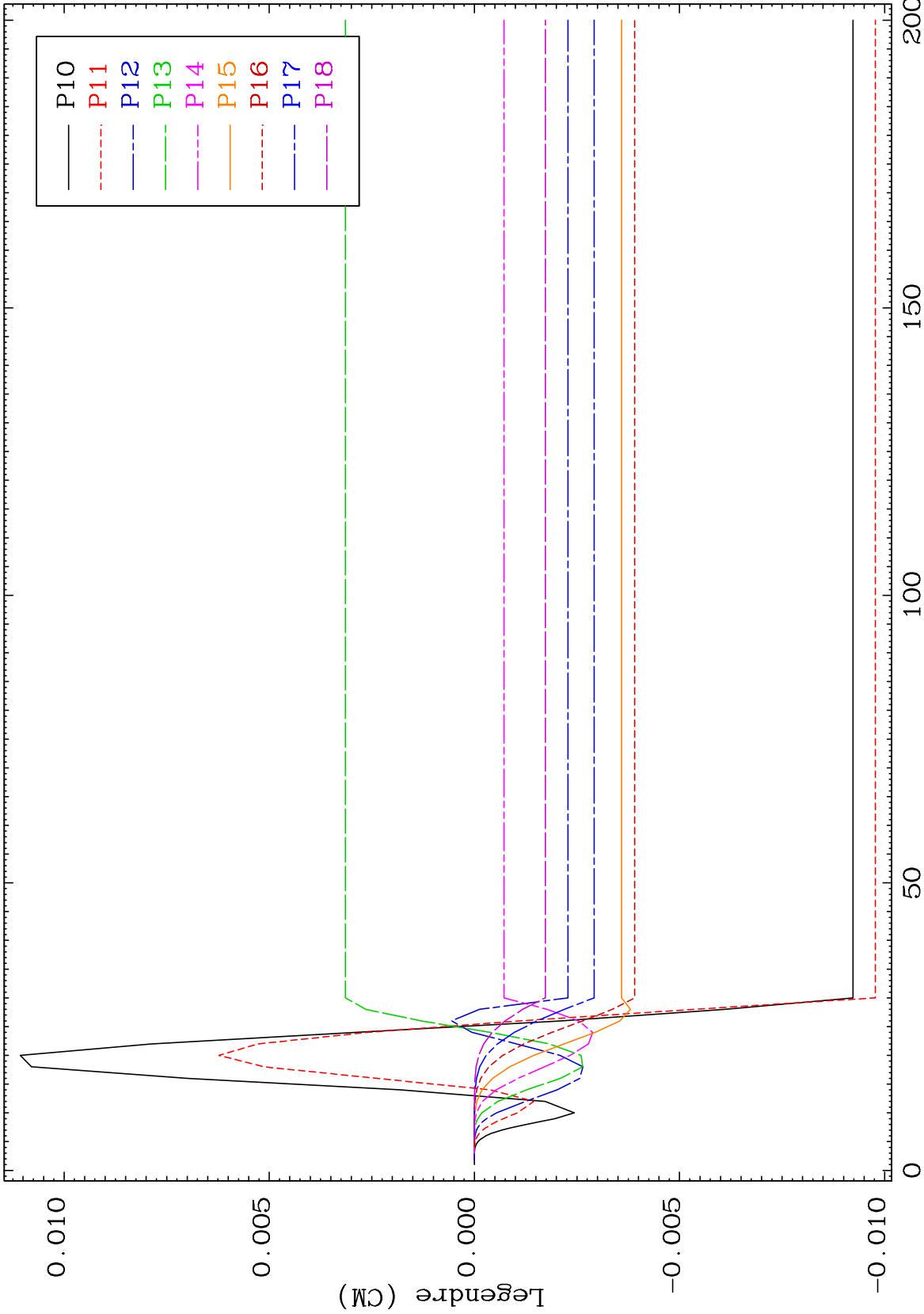

21

Incident Energy (MeV)

29-Cu-72

MAT 2952 MT= 51 (n,n') Level Legendre Coefficients 29-Cu-72

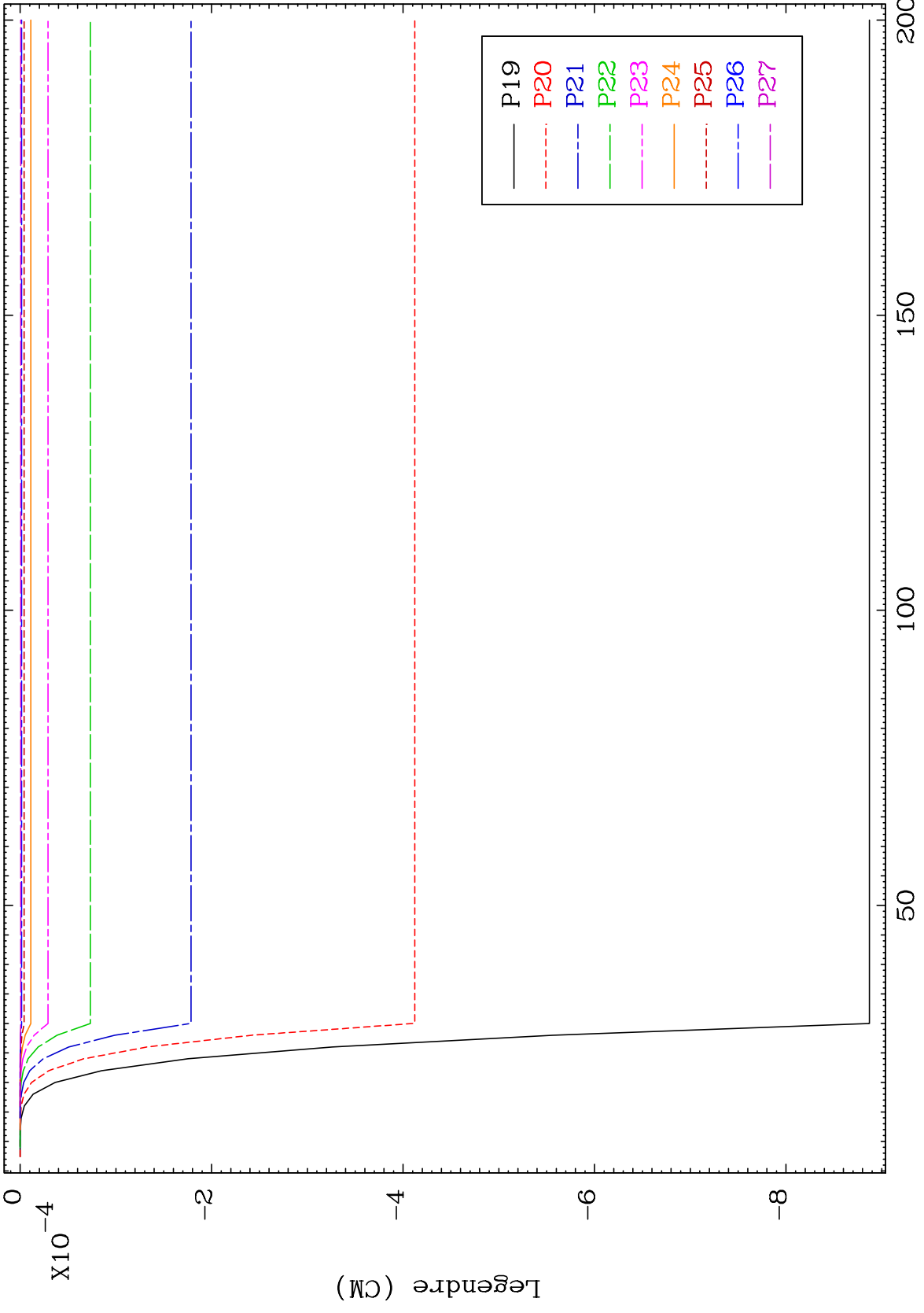

22 Incident Energy (MeV) 29-Cu-72

MAT 2952

MT= 51 (n,n') Level Legendre Coefficients

29-Cu-72

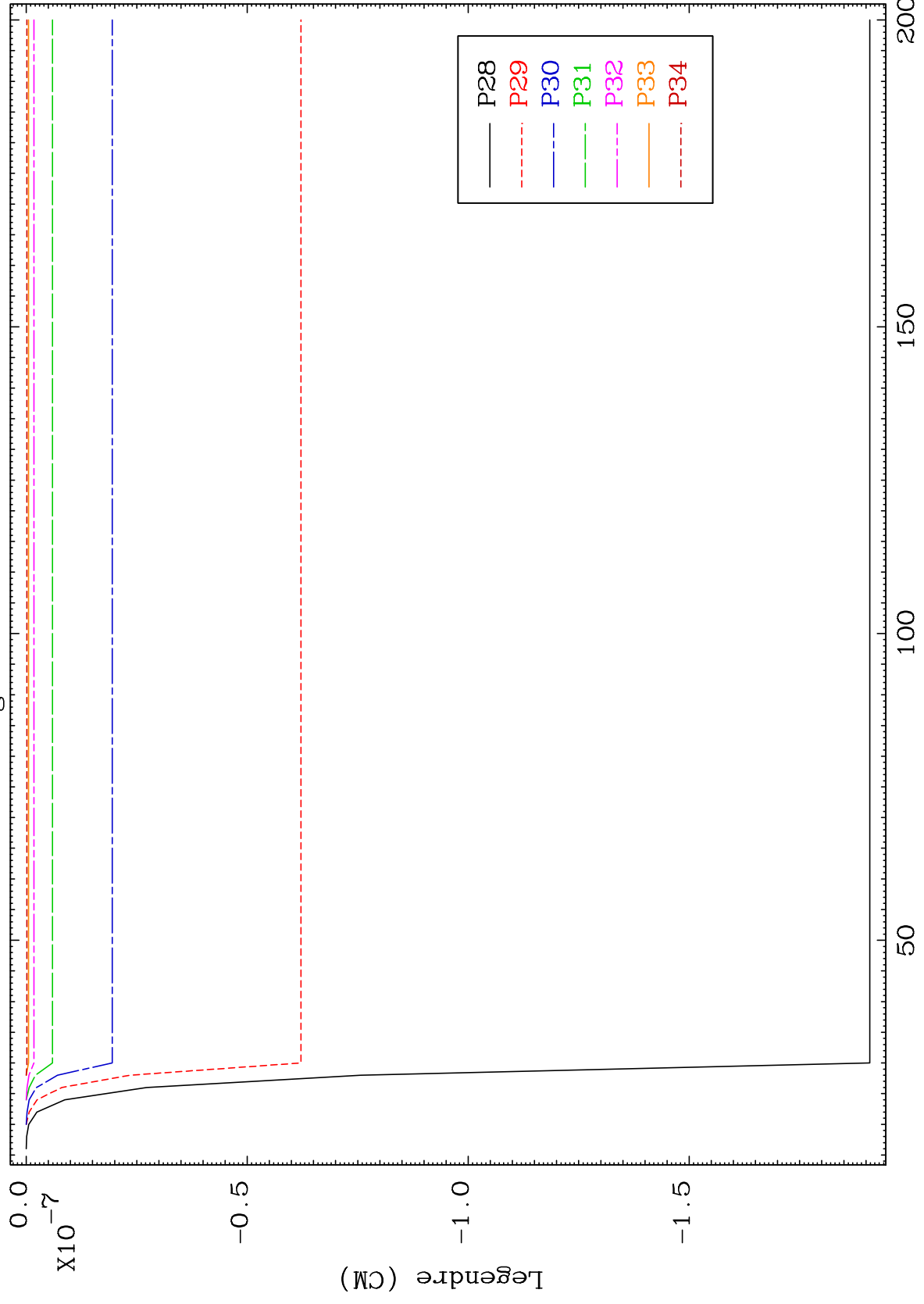

29-Cu-72

Incident Energy (MeV)

23

MAT 2952 MT= 52 (n,n') Level Legendre Coefficients 29-Cu-72

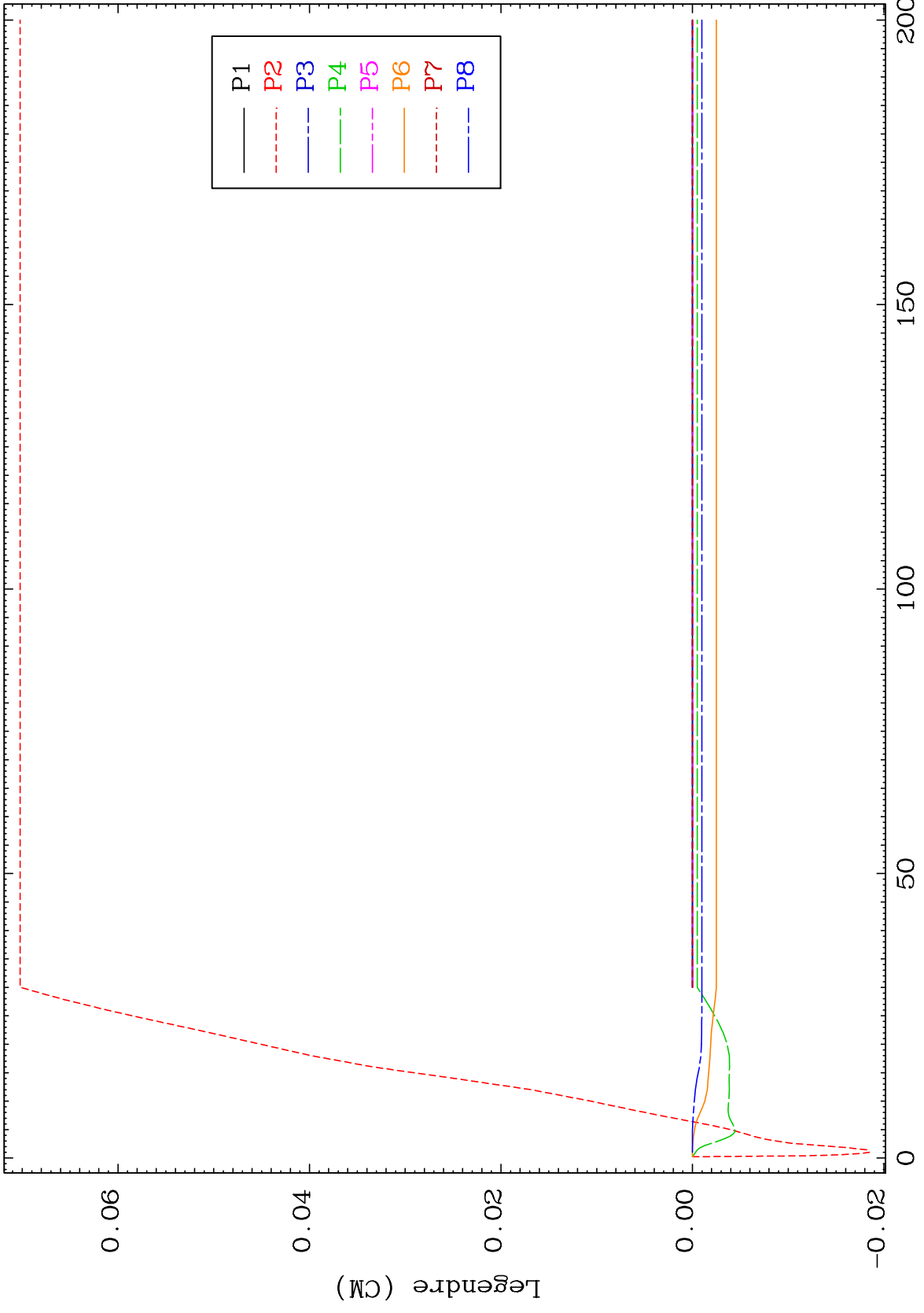

24 29-Cu-72

MAT 2952 MT= 52 (n,n') Level Legendre Coefficients 29-Cu-72

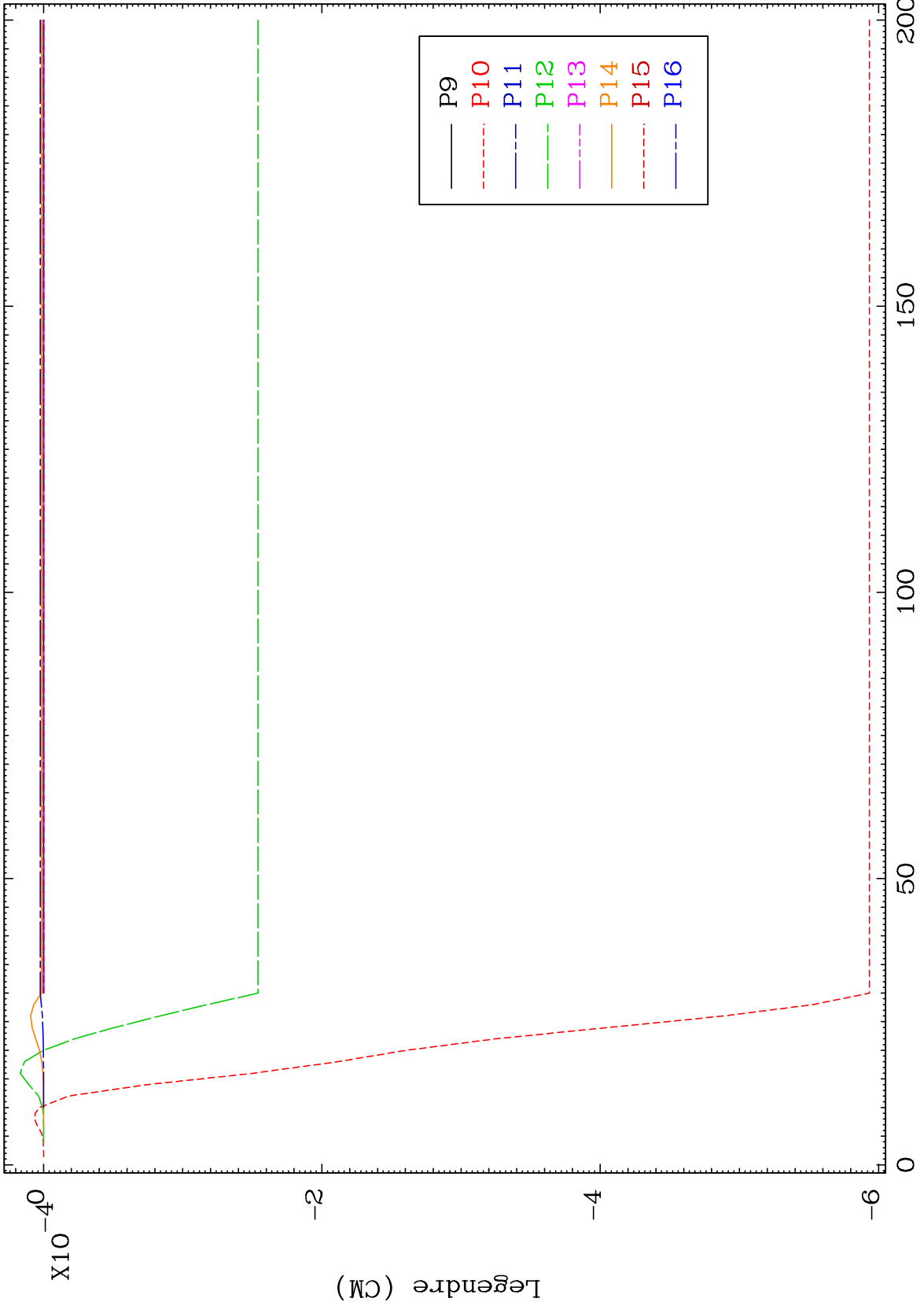

29-Cu-72

MAT 2952 MT= 52 (n,n') Level Legendre Coefficients 29-Cu-72

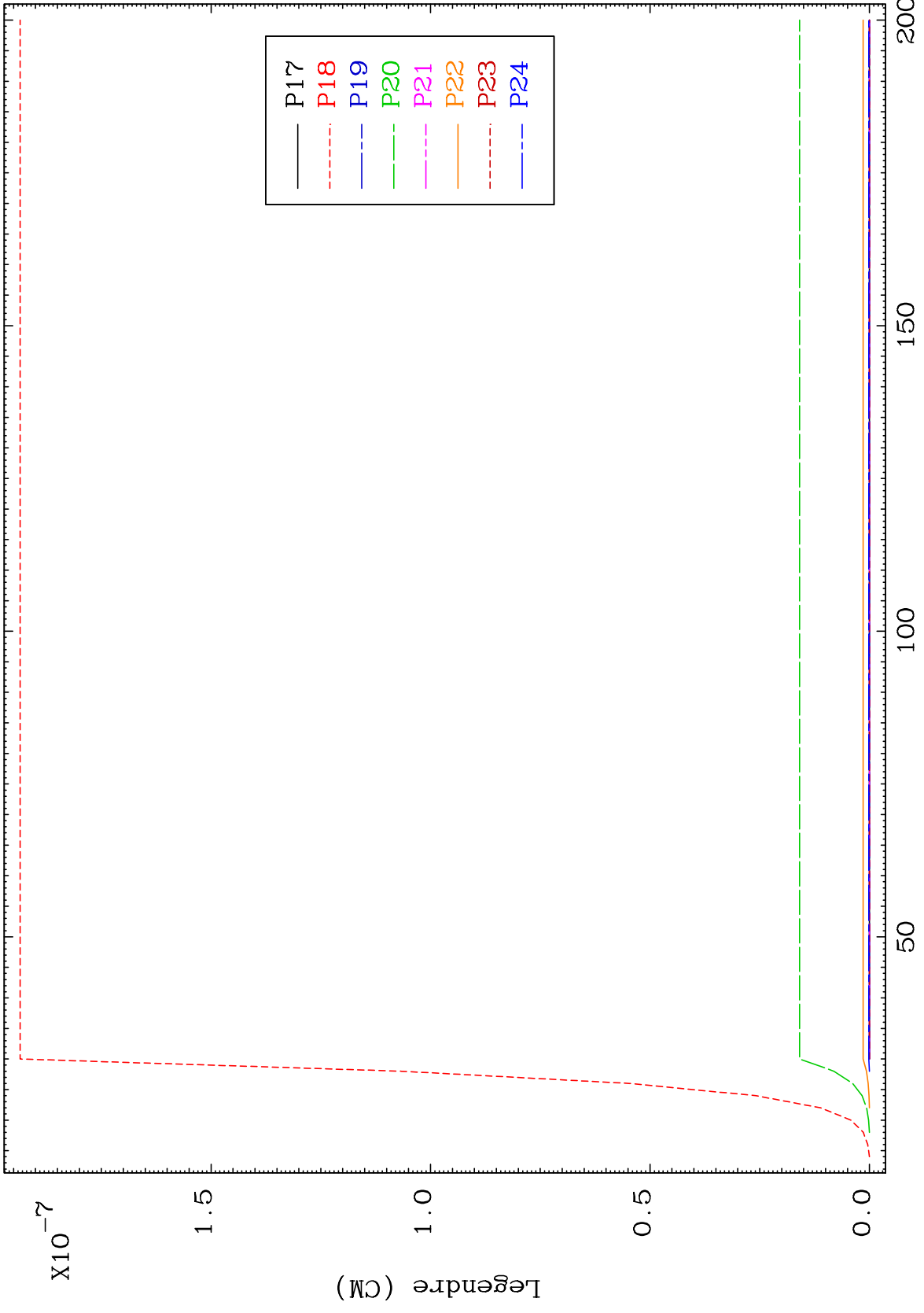

26 Incident Energy (MeV) 200 29-Cu-72

MAT 2952 MT= 53 (n,n') Level Legendre Coefficients 29-Cu-72

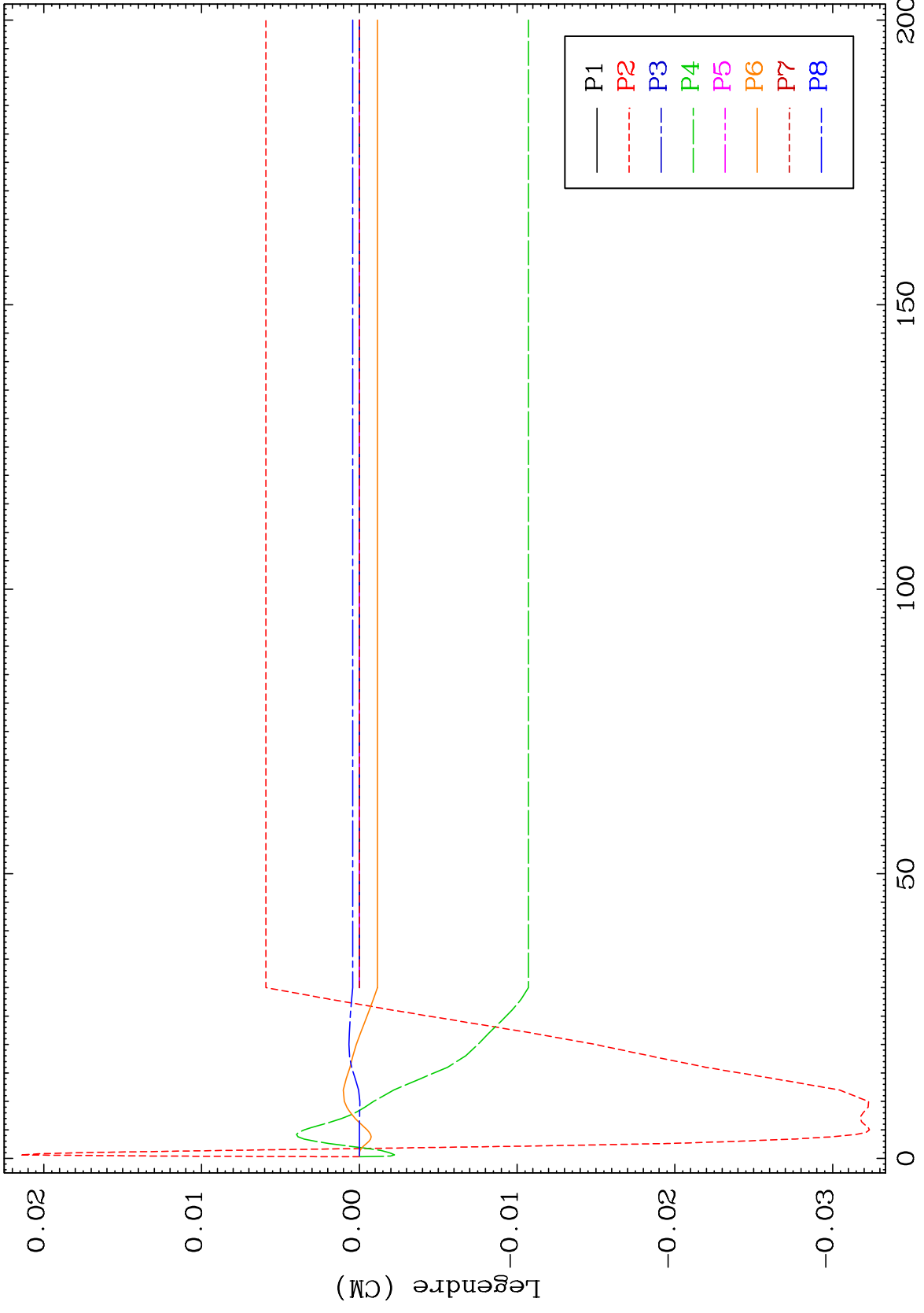

27 29-Cu-72

MAT 2952

MT= 53 (n,n') Level  
Legendre Coefficients

29-Cu-72

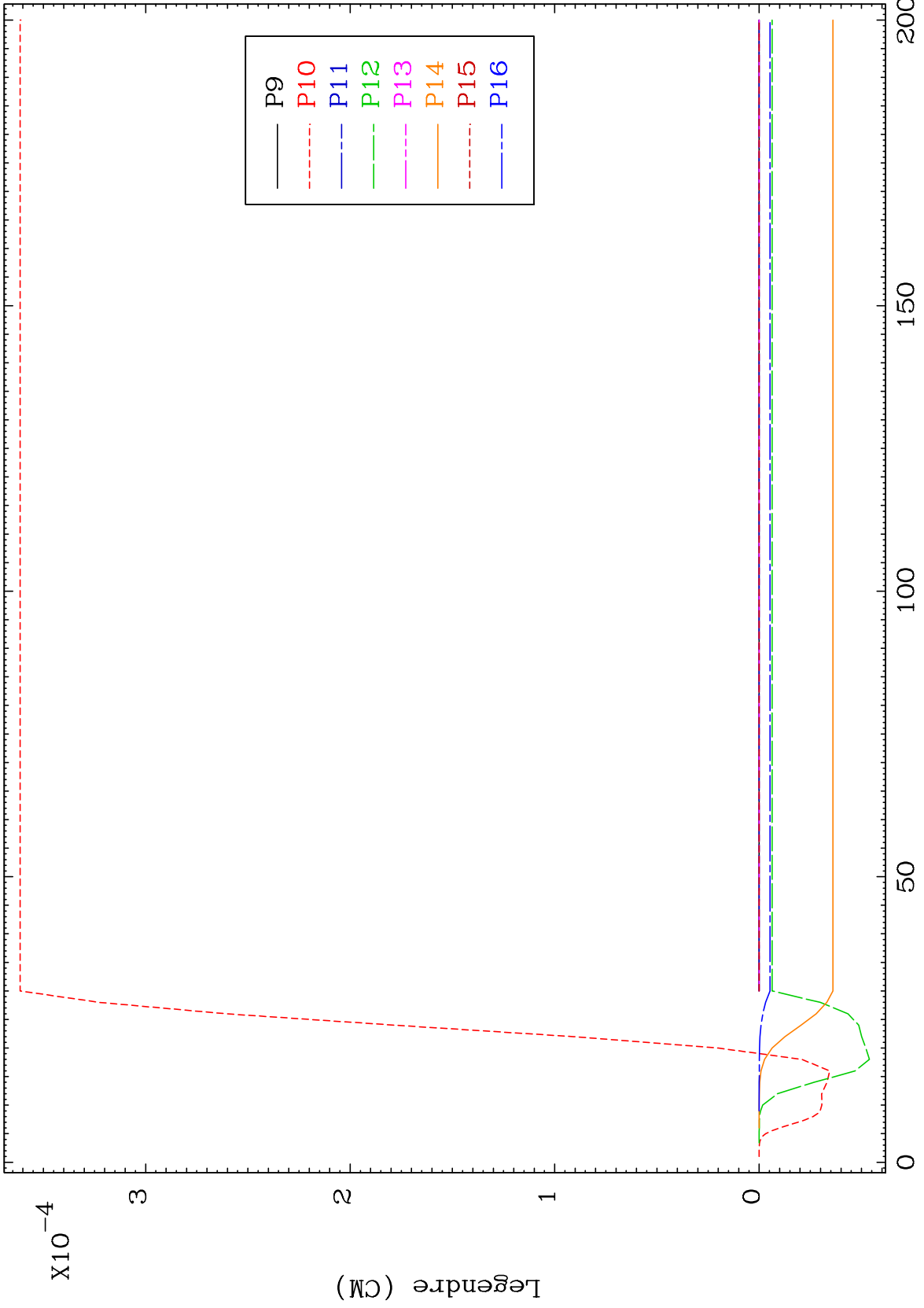

28

Incident Energy (MeV)

29-Cu-72

MAT 2952 MT= 53 (n,n') Level Legendre Coefficients 29-Cu-72

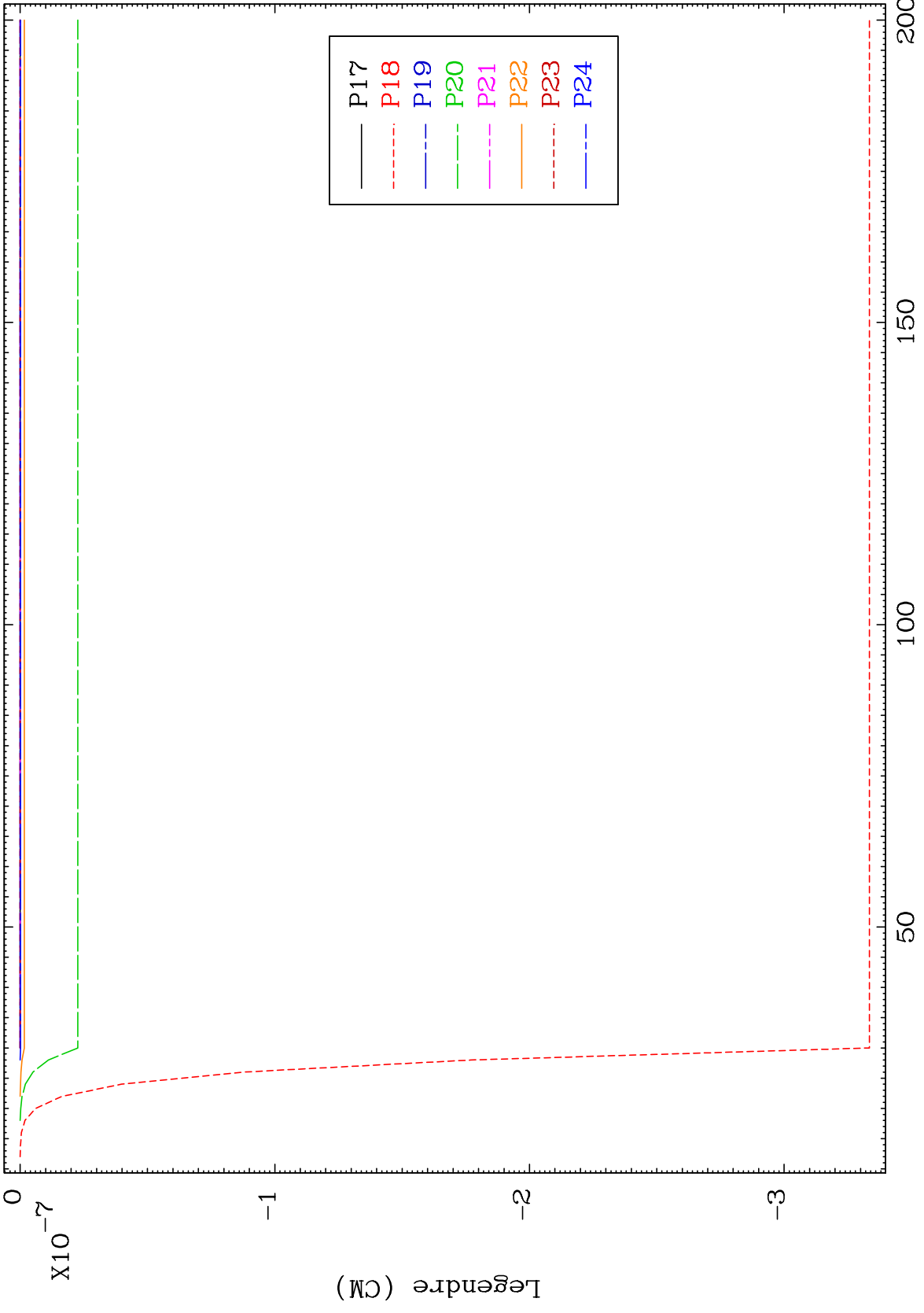

29 50 100 150 200 Incident Energy (MeV) 29-Cu-72



MAT 2952 MT= 54 (n,n') Level Legendre Coefficients 29-Cu-72

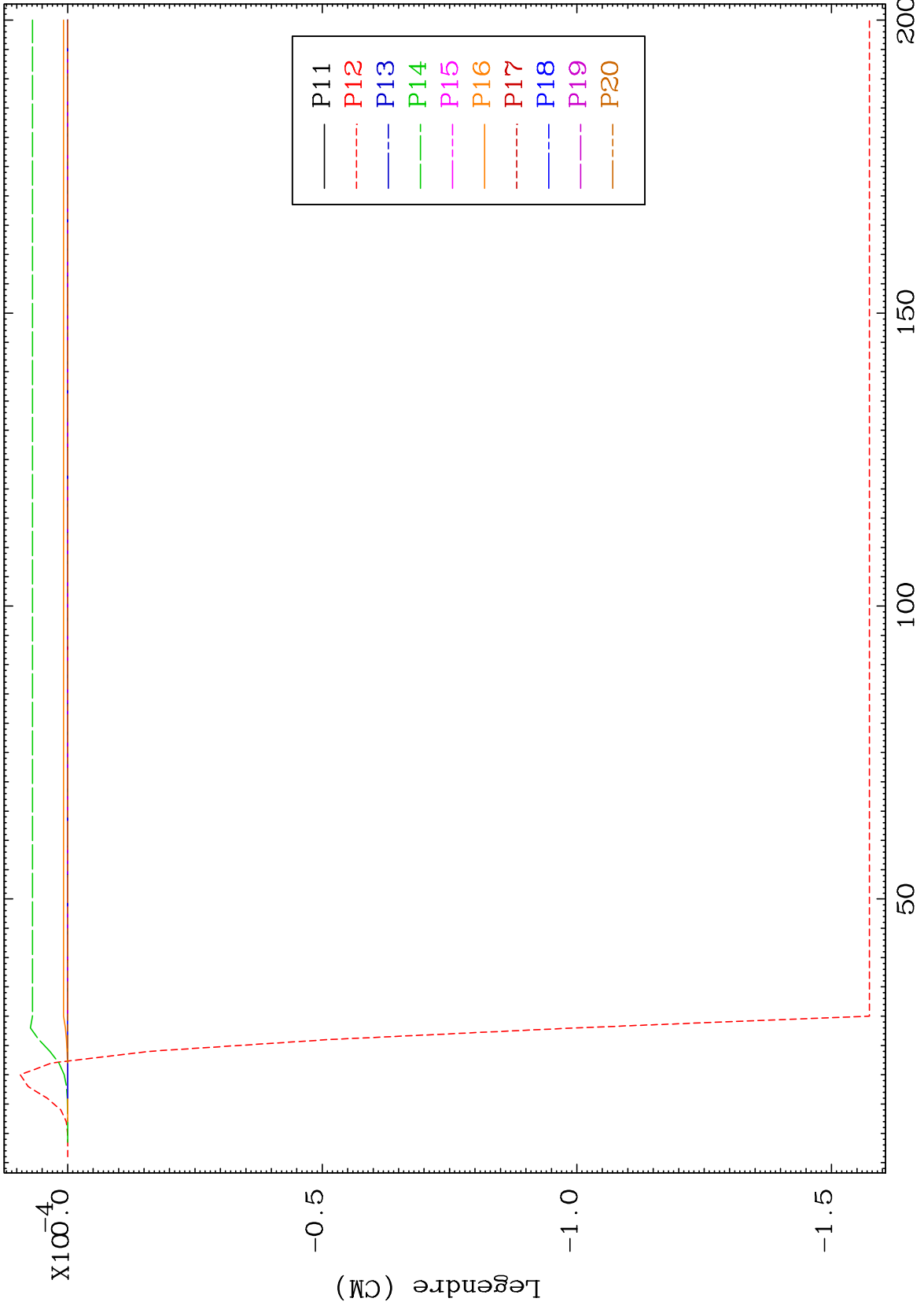

MAT 2952 MT= 55 (n,n') Level Legendre Coefficients 29-Cu-72

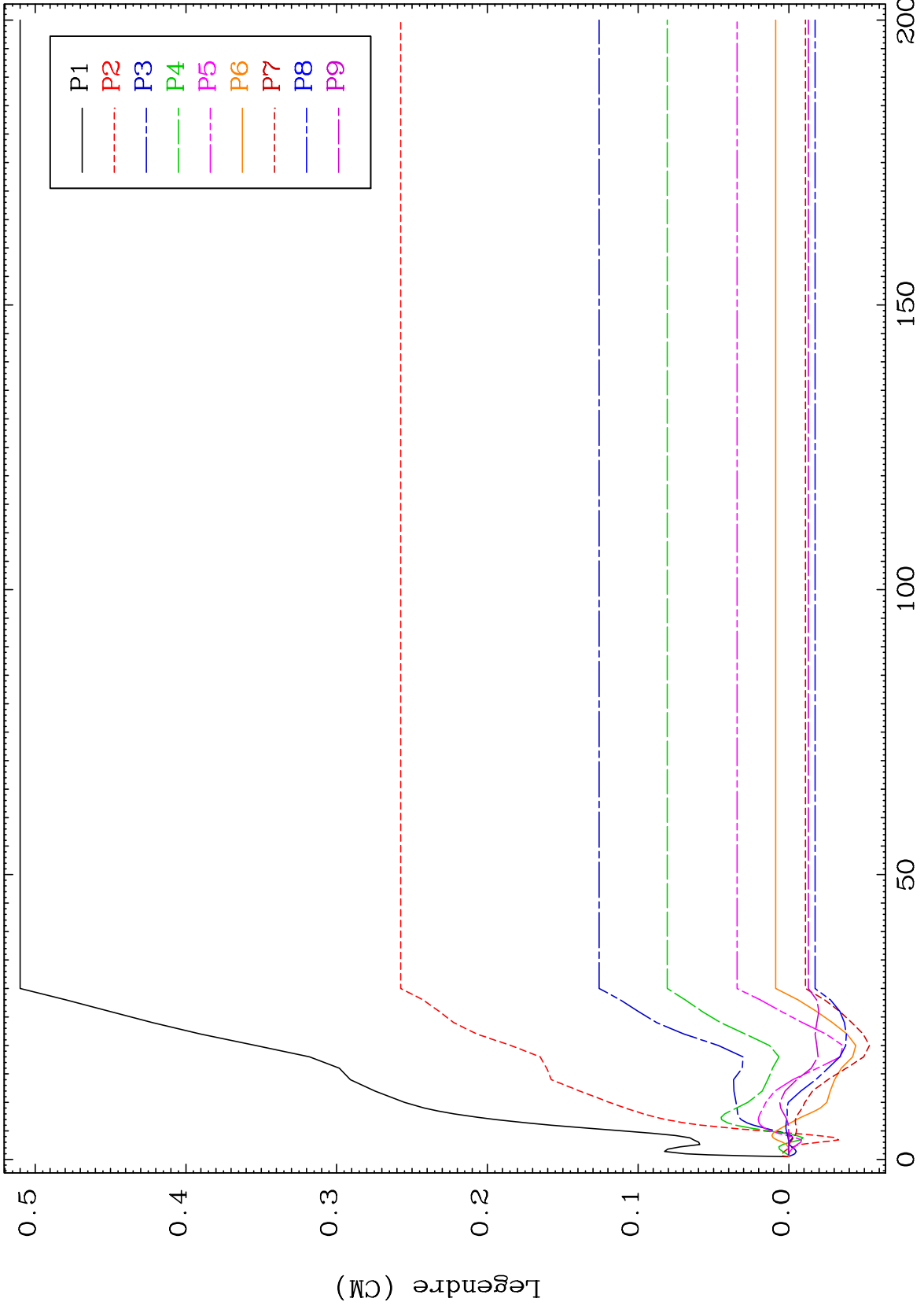

32 29-Cu-72

MAT 2952

MT= 55 (n,n') Level  
Legendre Coefficients

29-Cu-72

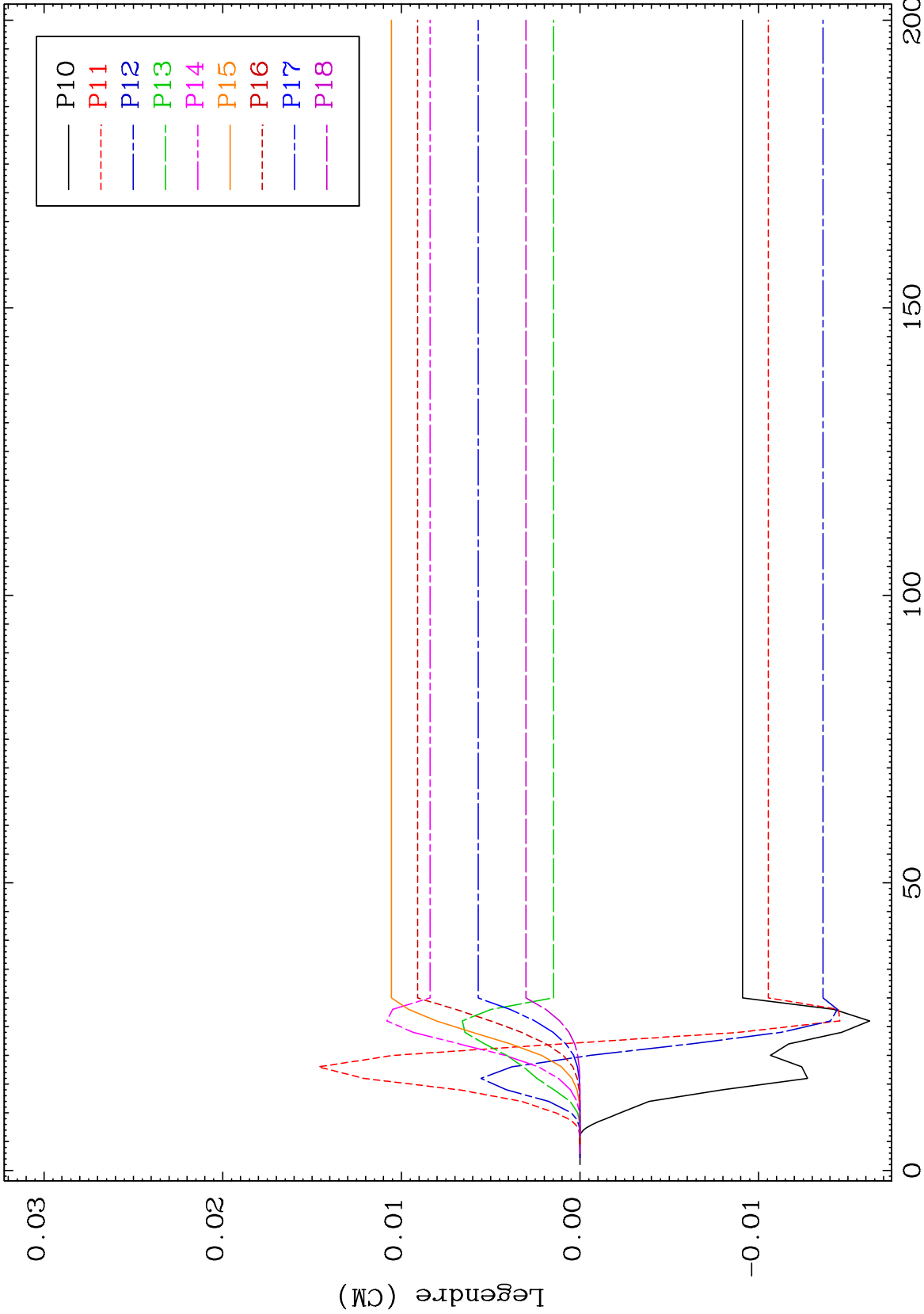

33

Incident Energy (MeV)

29-Cu-72

MAT 2952

MT= 55 (n,n') Level  
Legendre Coefficients

29-Cu-72

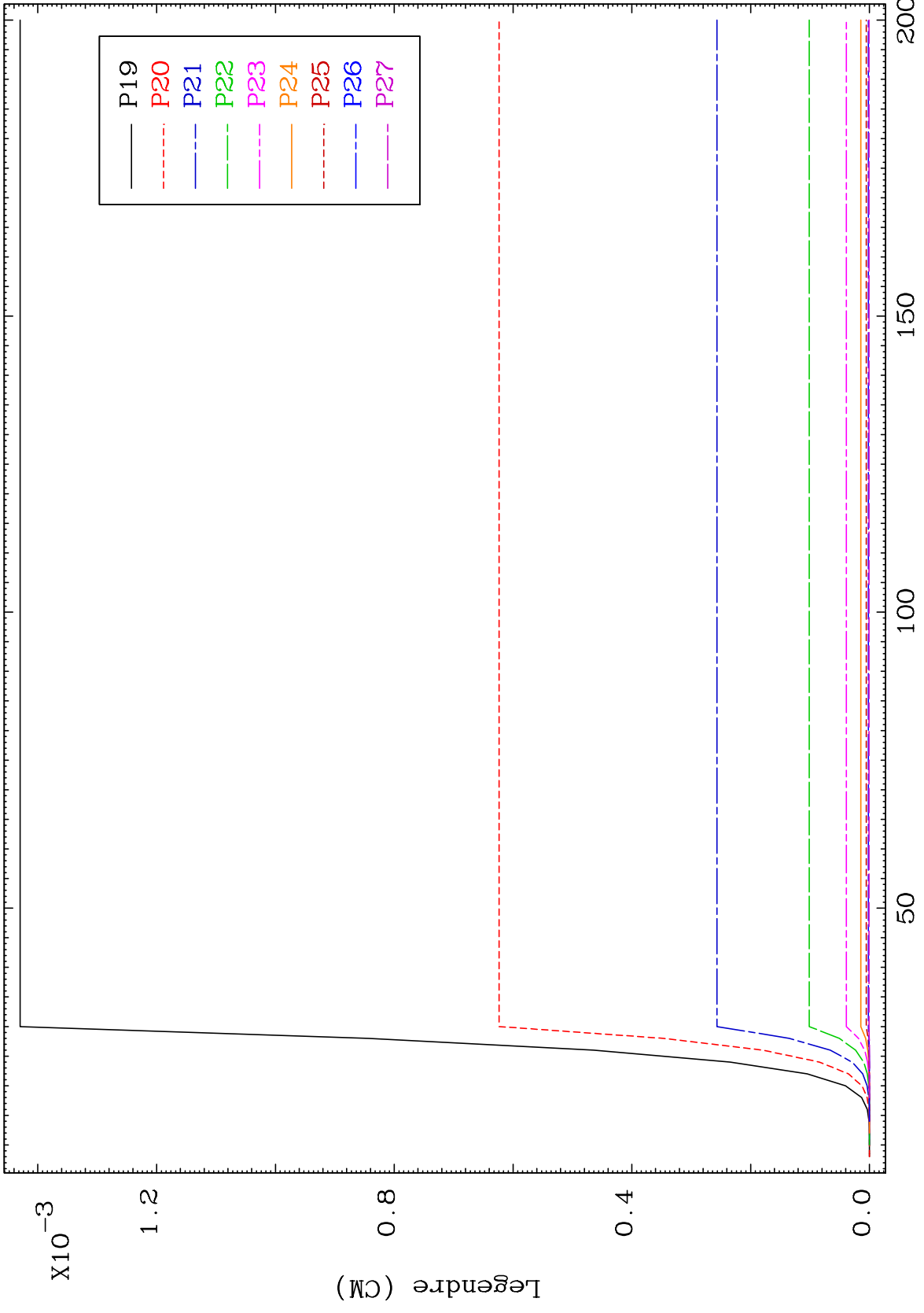

34

Incident Energy (MeV)

29-Cu-72

MAT 2952 MT= 55 (n,n') Level Legendre Coefficients 29-Cu-72

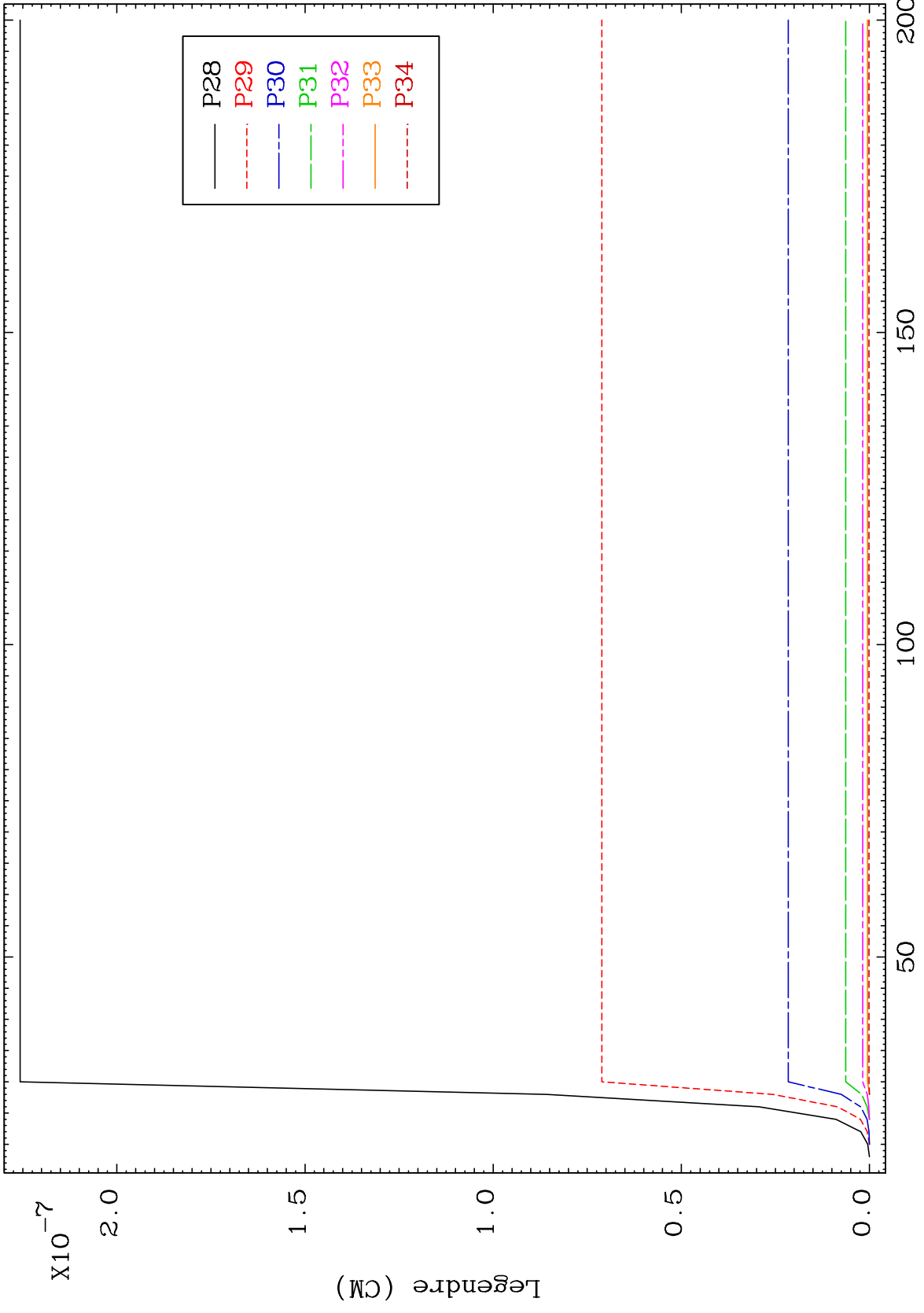

35 Incident Energy (MeV) 200 29-Cu-72

MAT 2952 MT= 56 (n,n') Level Legendre Coefficients 29-Cu-72

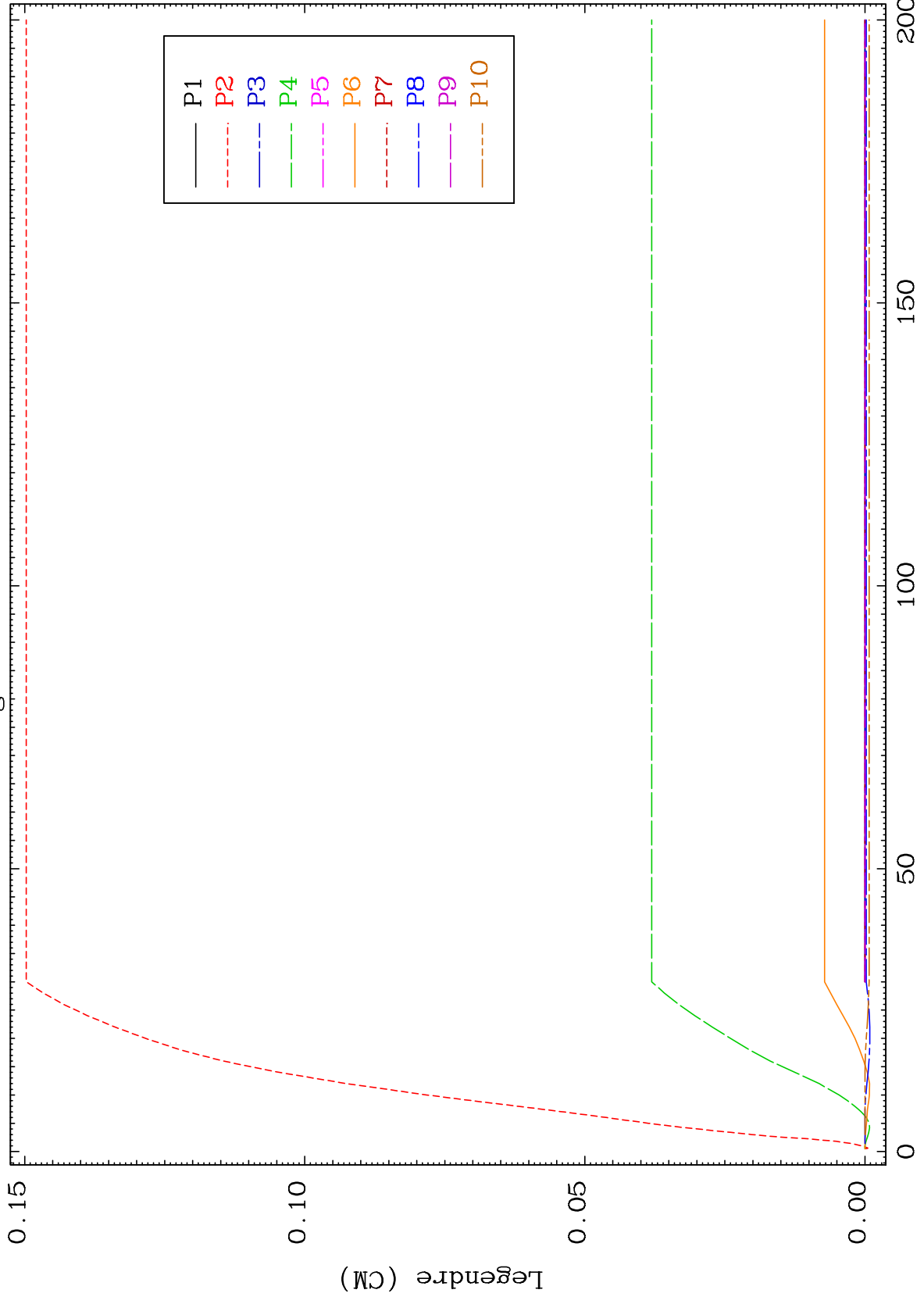

36 Incident Energy (MeV) 29-Cu-72

MAT 2952 MT= 56 (n,n') Level Legendre Coefficients 29-Cu-72

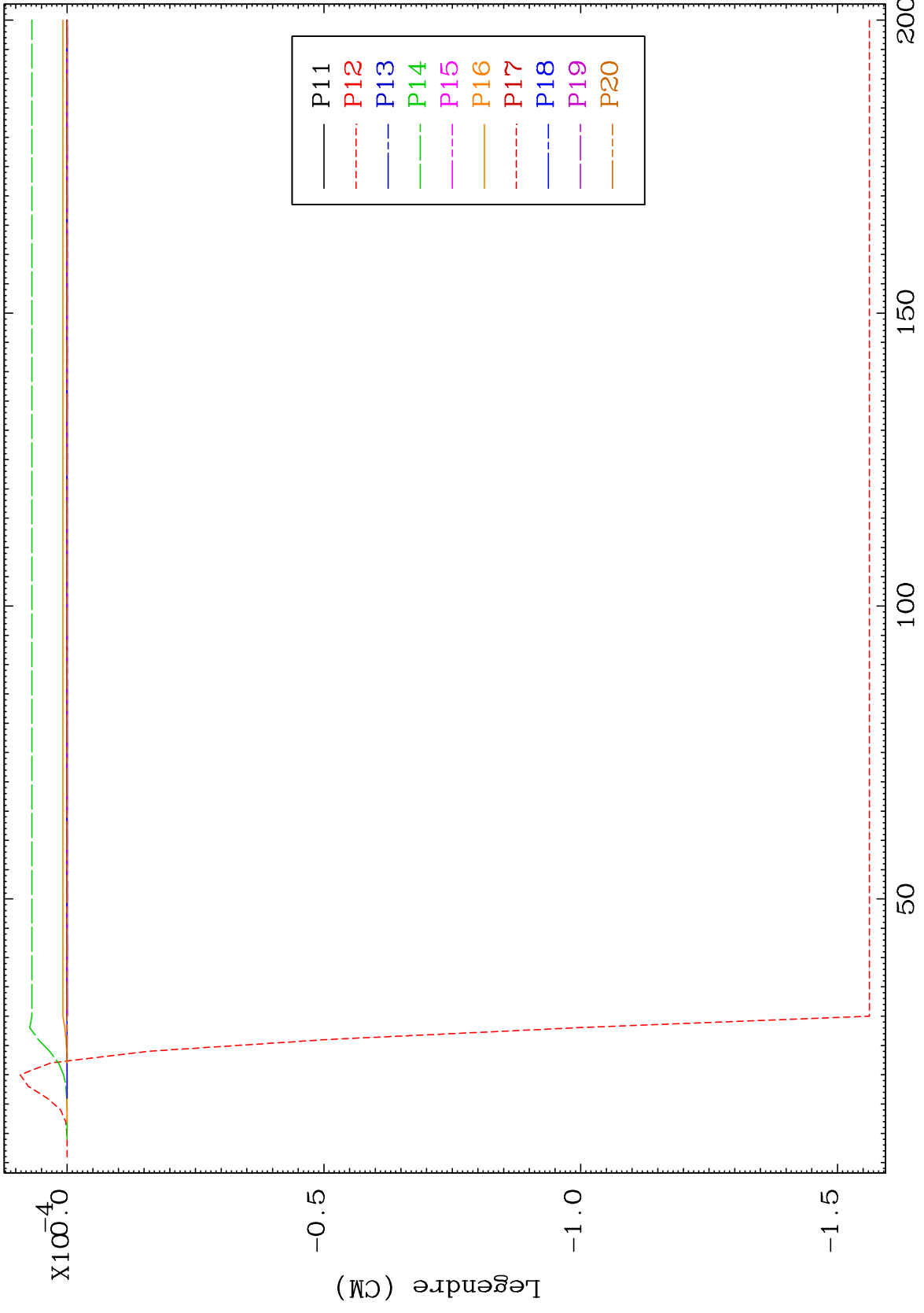

37 29-Cu-72

MAT 2952 MT= 57 (n,n') Level Legendre Coefficients 29-Cu-72

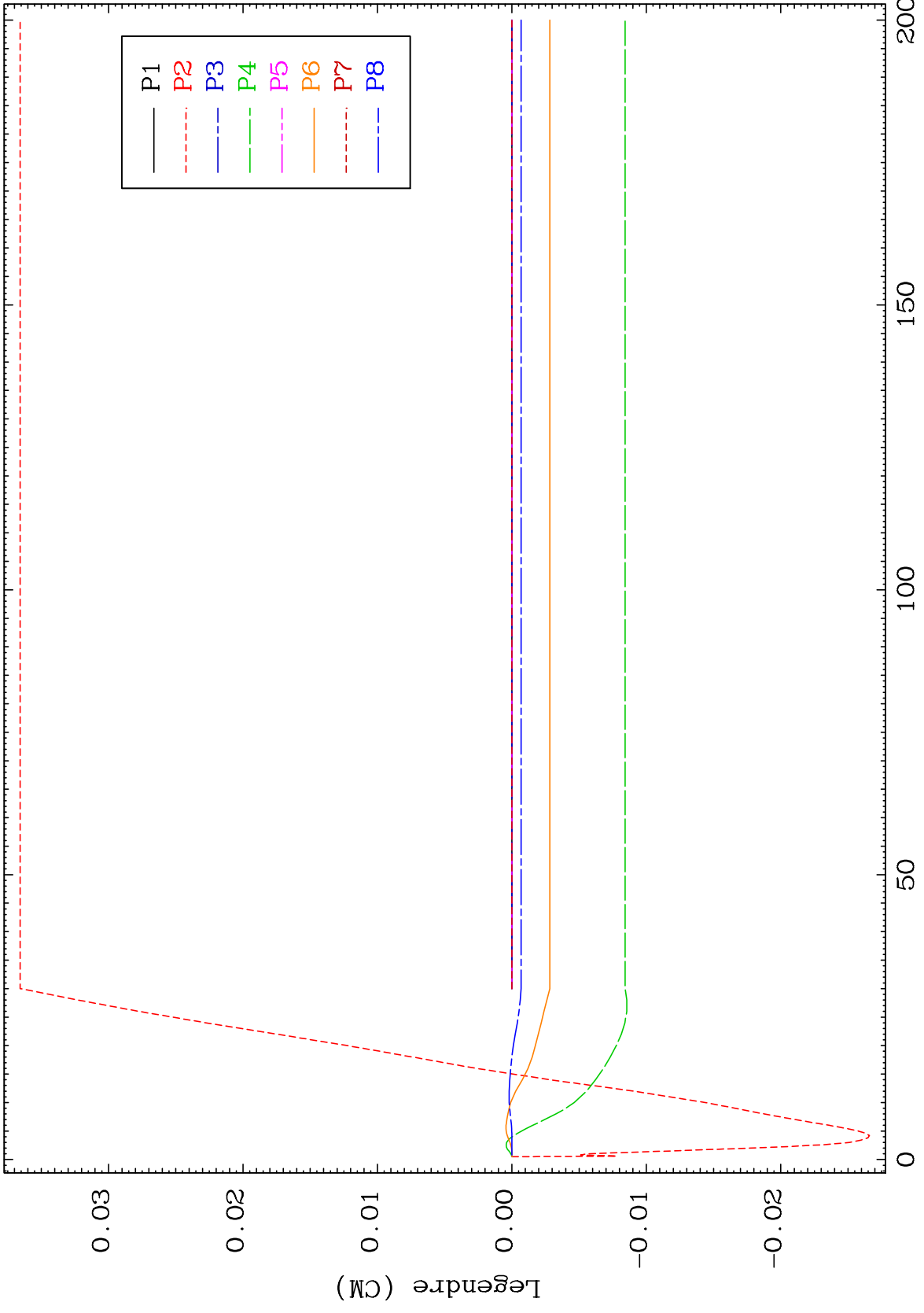

38 29-Cu-72

MAT 2952

MT= 57 (n,n') Level  
Legendre Coefficients

29-Cu-72

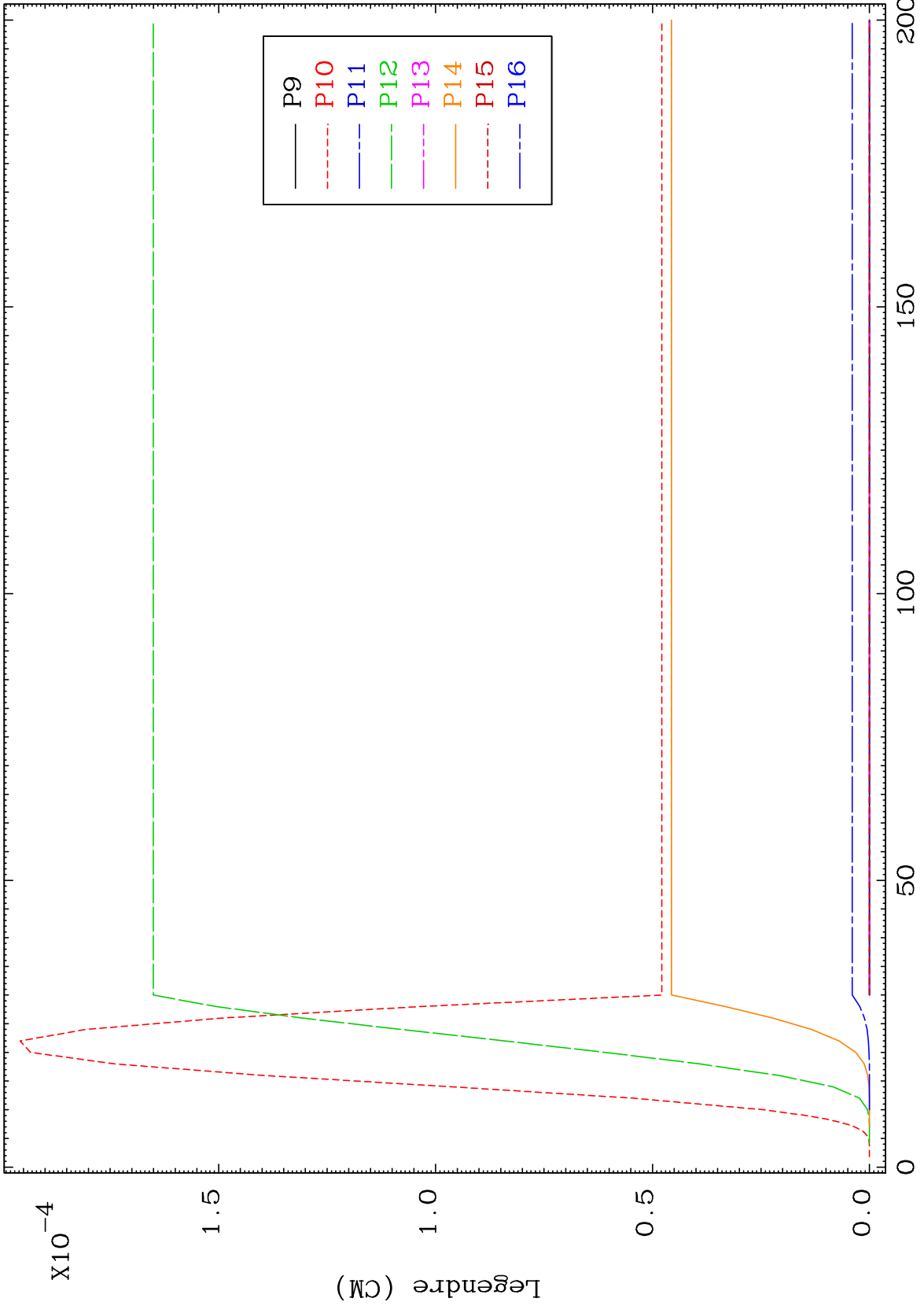

39

Incident Energy (MeV)

29-Cu-72

MAT 2952 MT= 57 (n,n') Level Legendre Coefficients 29-Cu-72

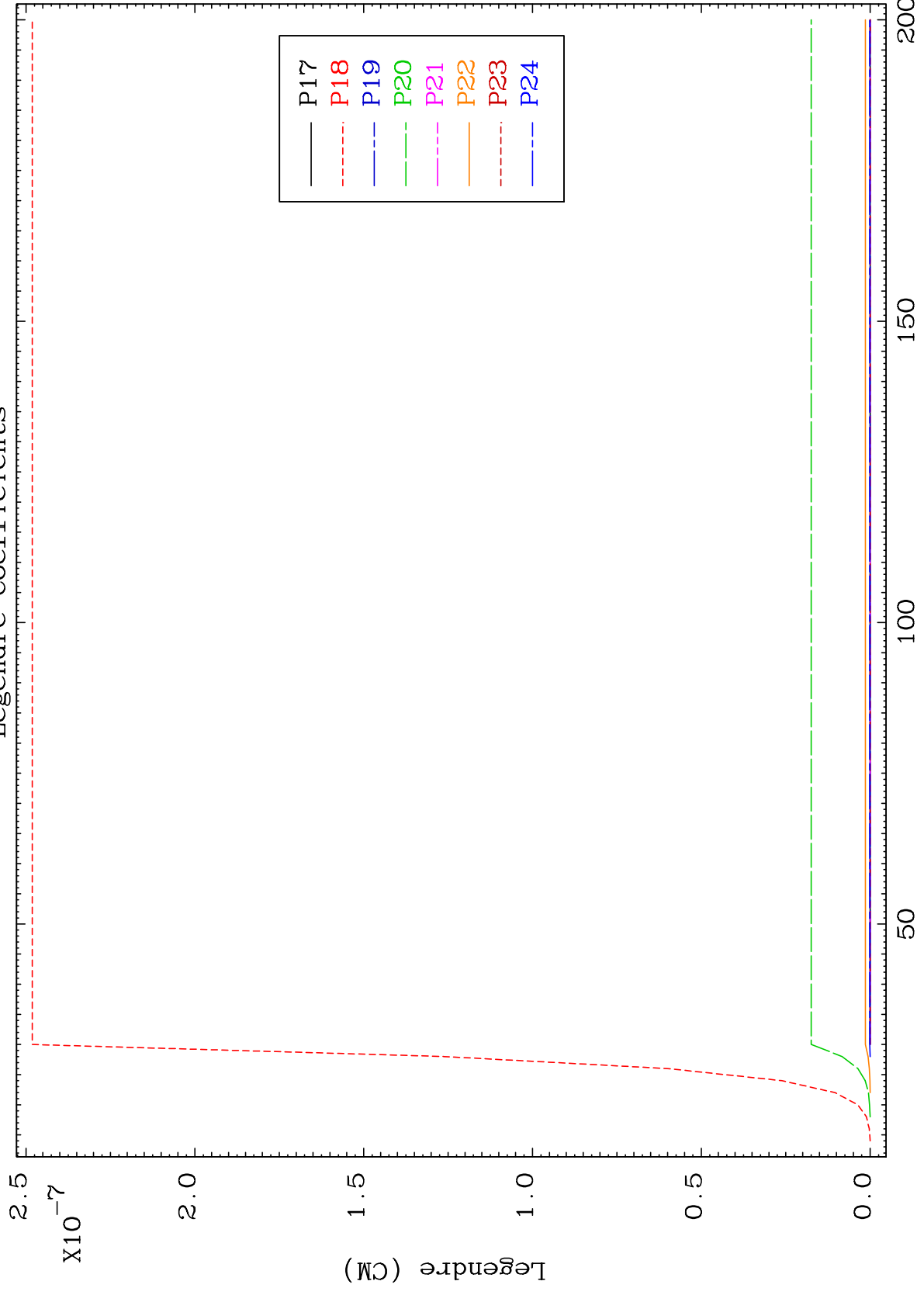

29-Cu-72

MAT 2952 MT= 58 (n,n') Level Legendre Coefficients 29-Cu-72

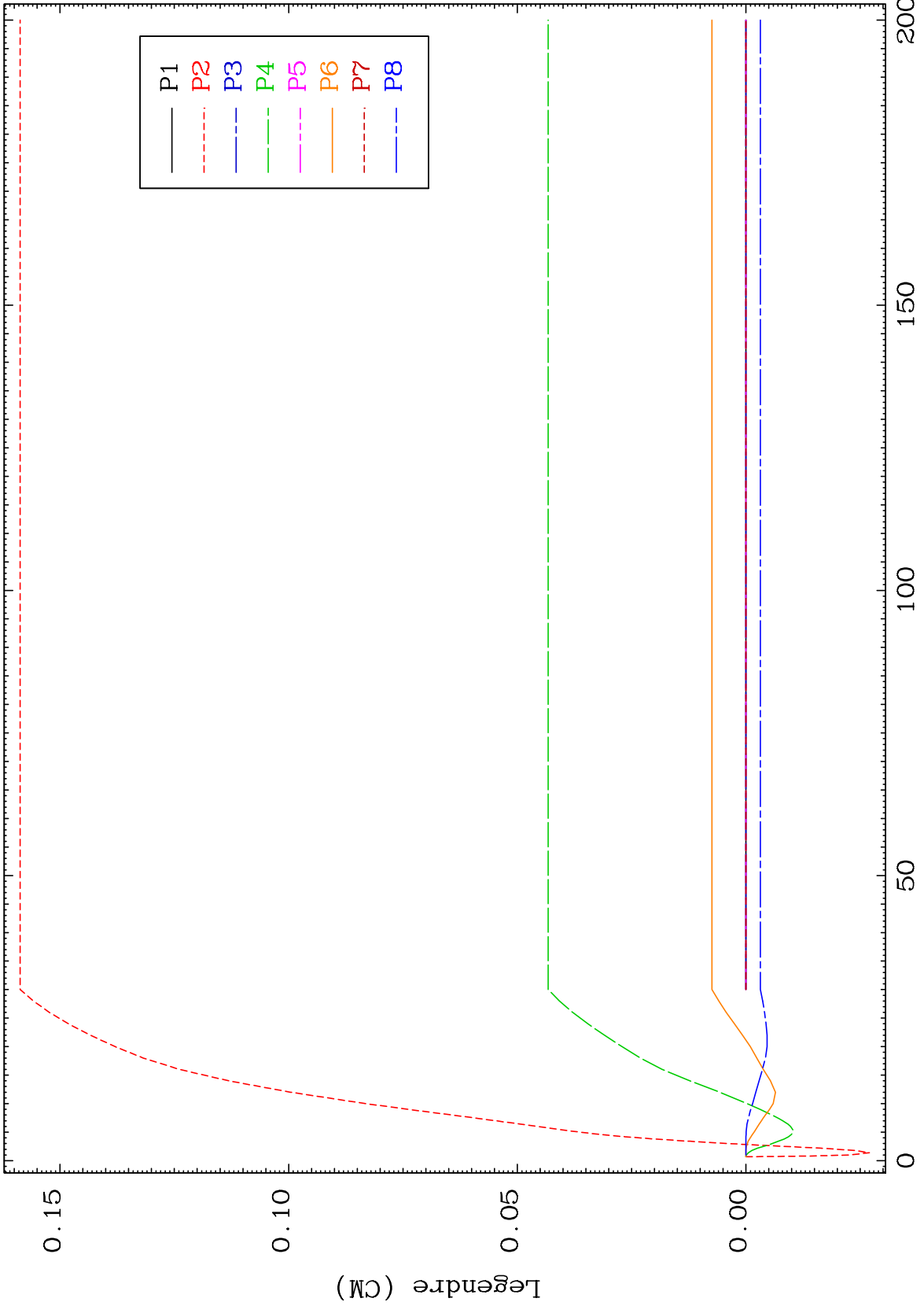

41 29-Cu-72

MAT 2952 MT= 58 (n,n') Level Legendre Coefficients 29-Cu-72

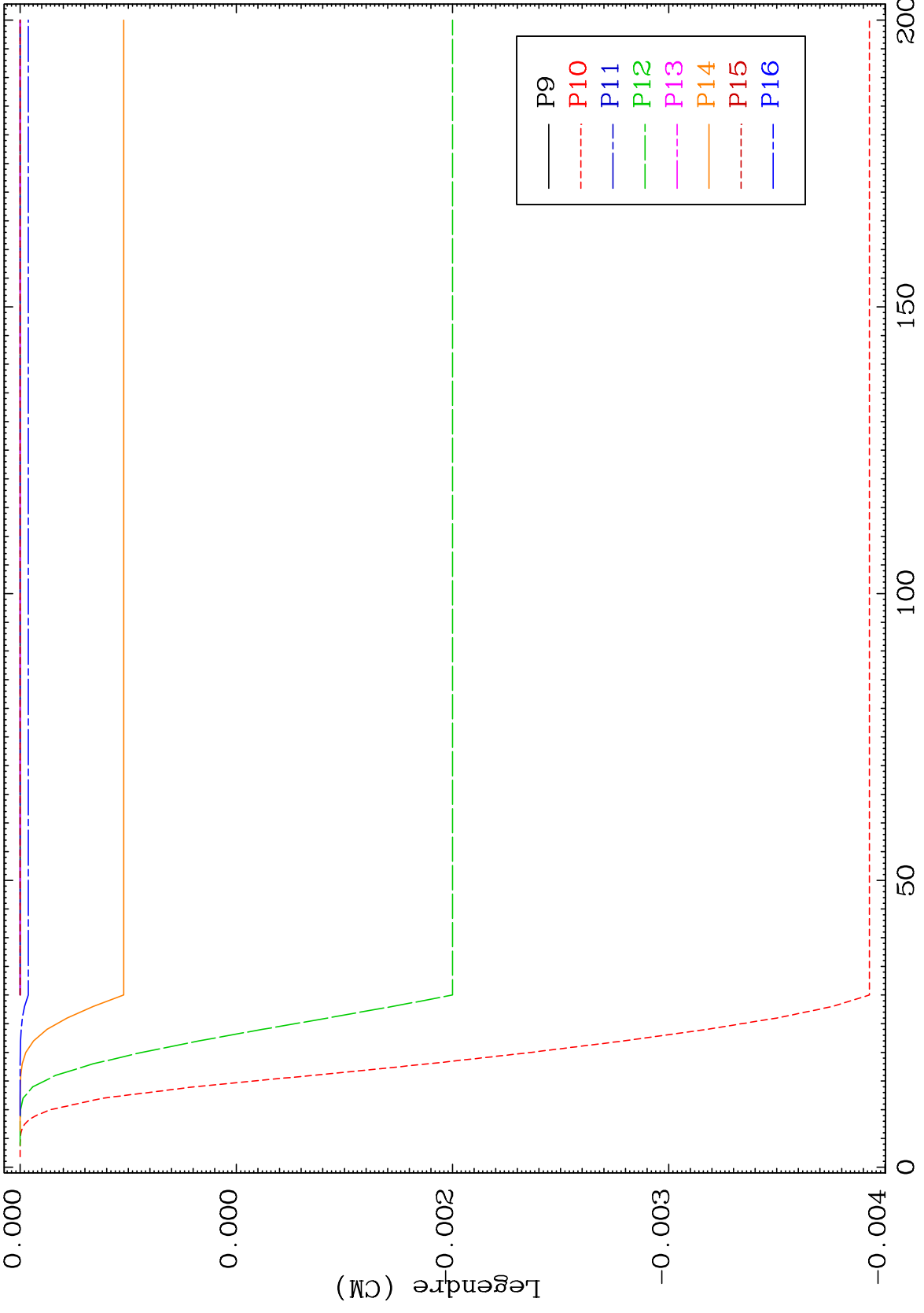

42 29-Cu-72

MAT 2952 MT= 58 (n,n') Level Legendre Coefficients 29-Cu-72

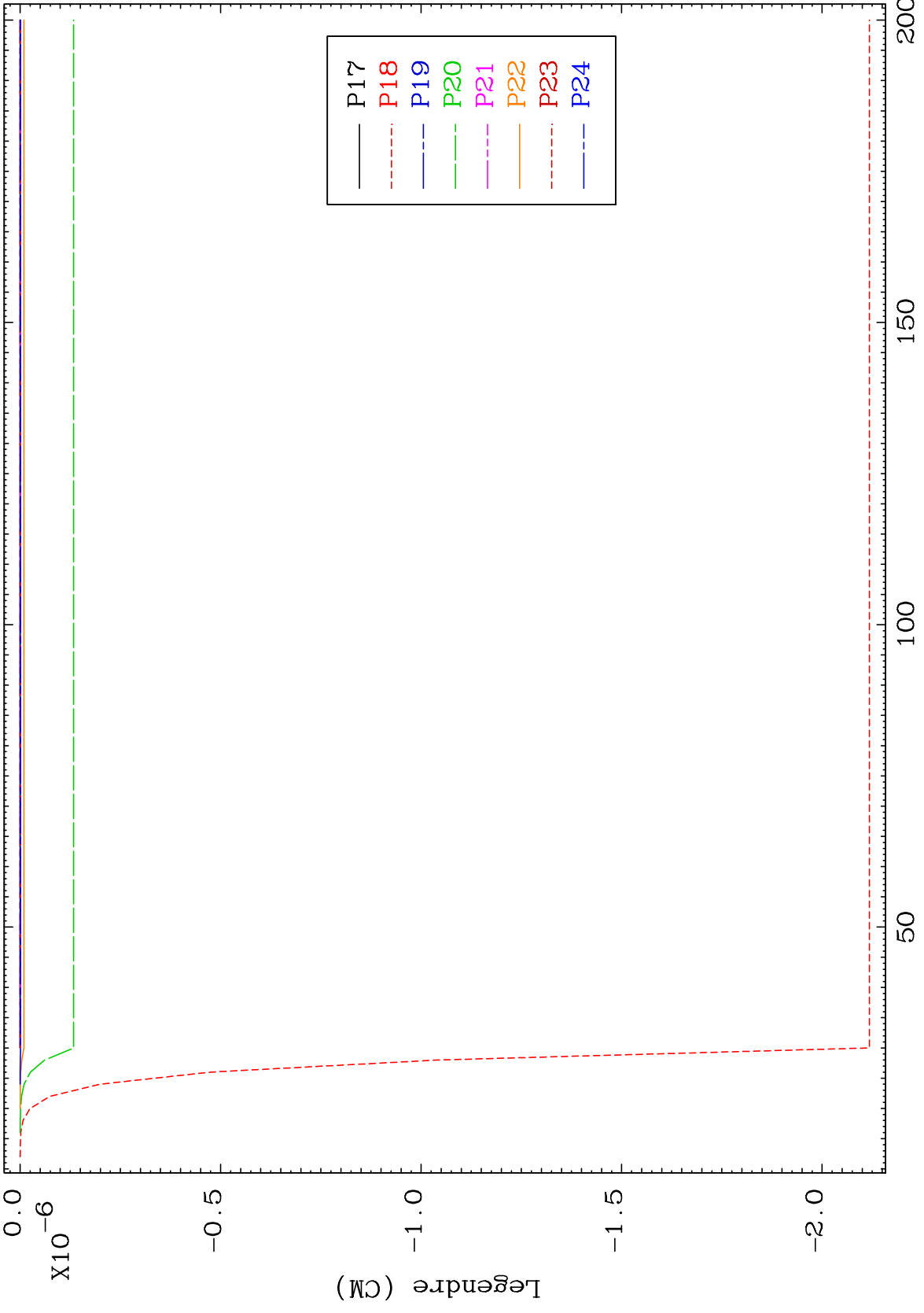

MAT 2952 MT= 59 (n,n') Level Legendre Coefficients 29-Cu-72

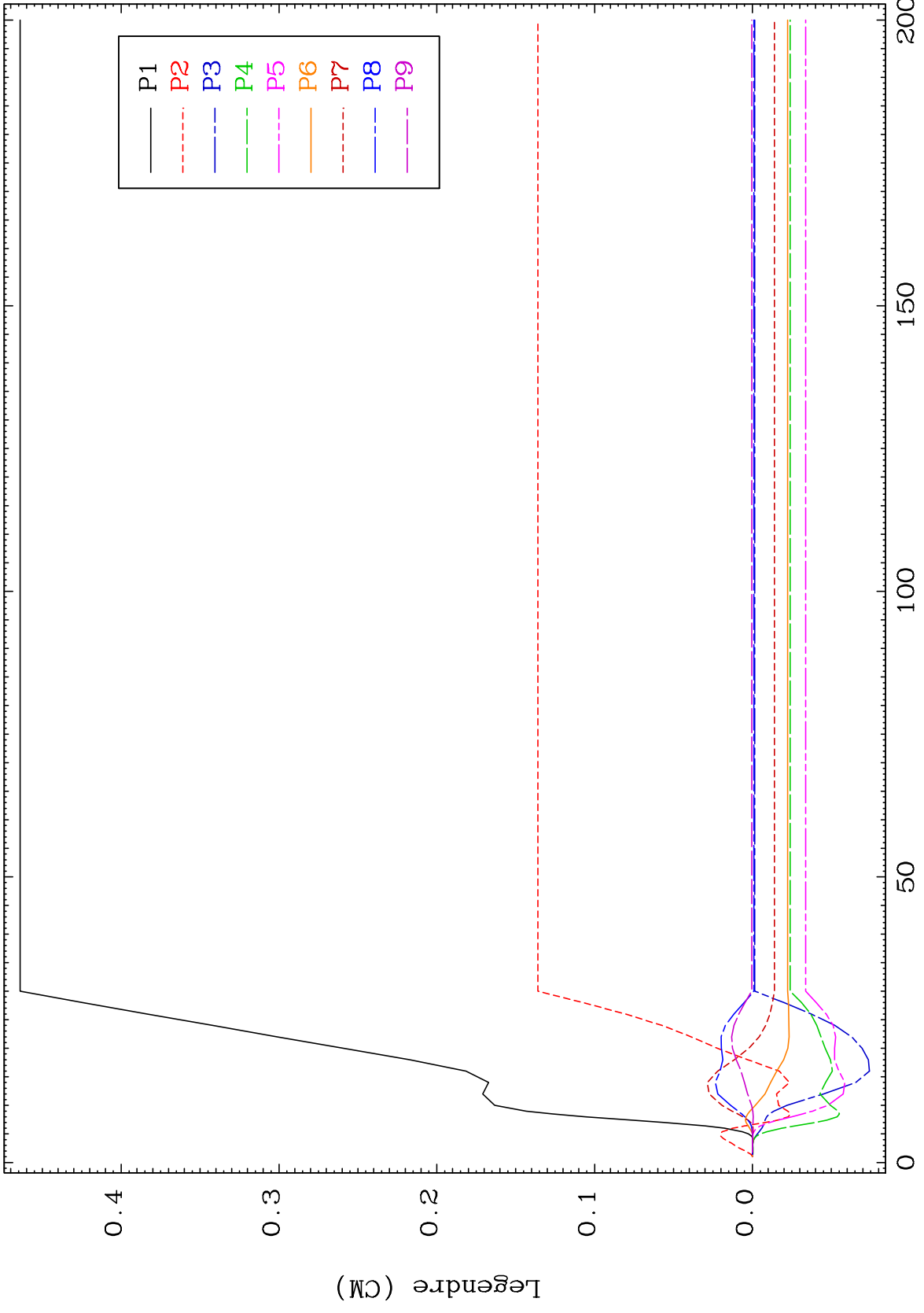

44 29-Cu-72

MAT 2952 MT= 59 (n,n') Level Legendre Coefficients 29-Cu-72

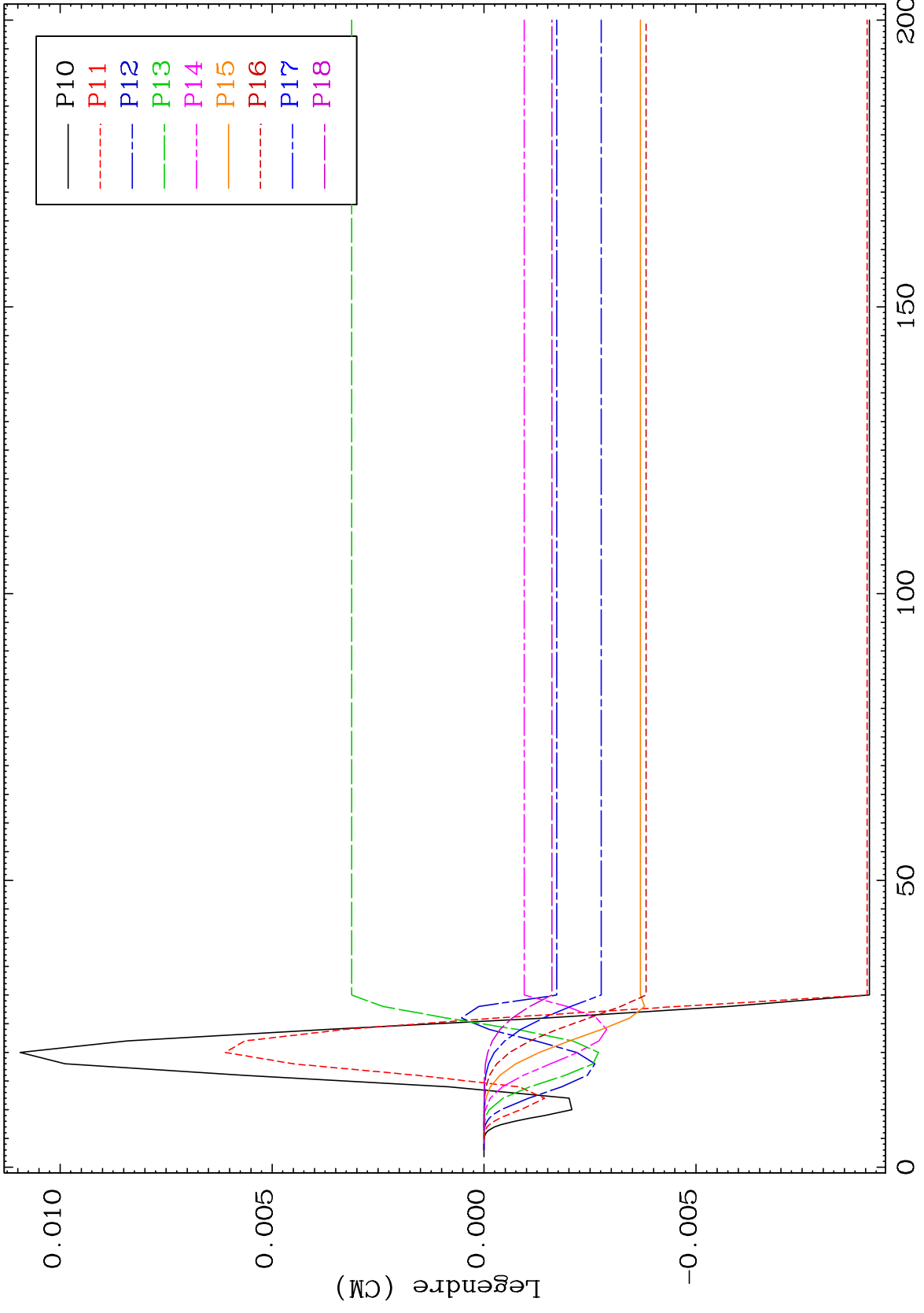

45 29-Cu-72

MAT 2952 MT= 59 (n,n') Level Legendre Coefficients 29-Cu-72

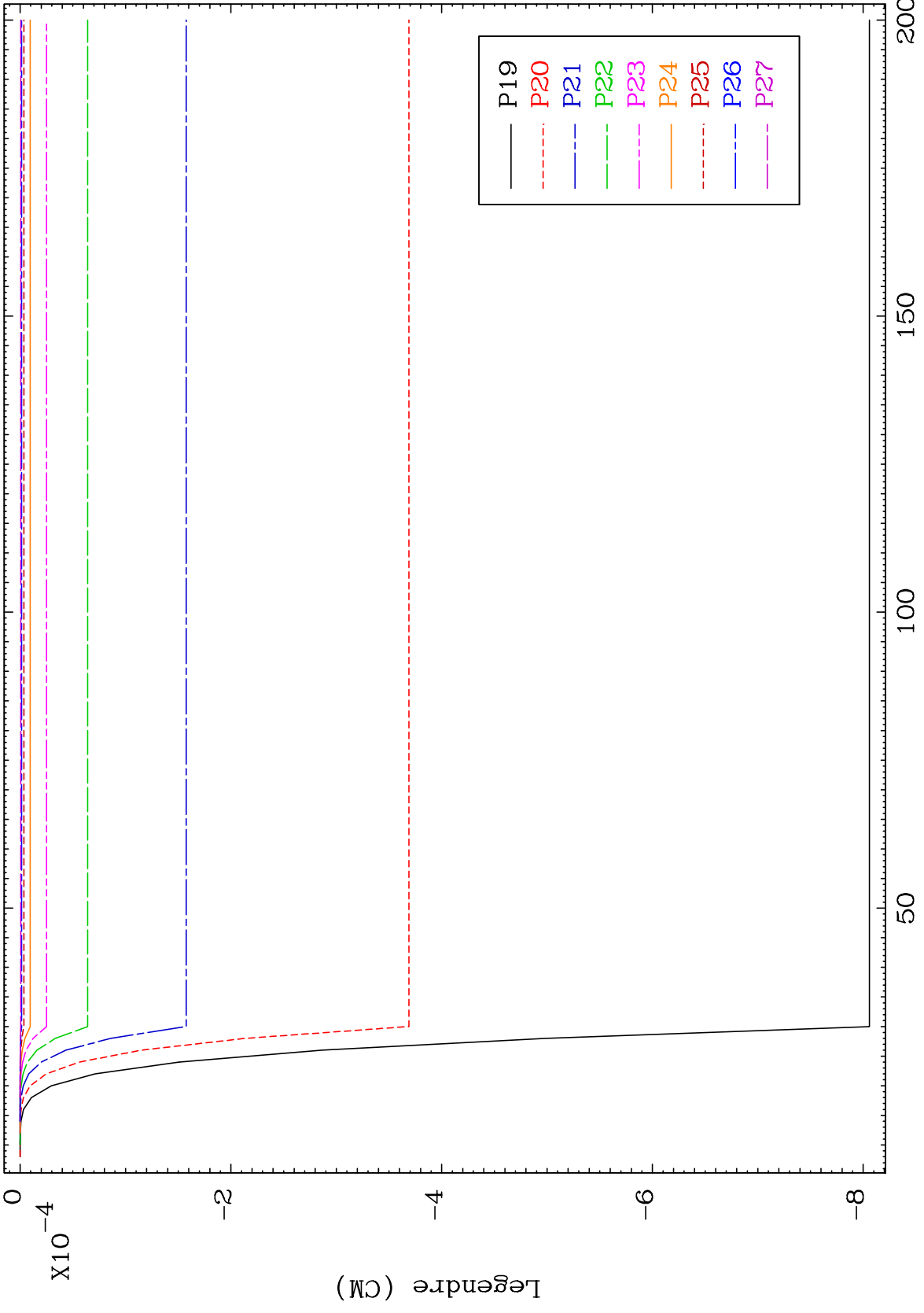

46 Incident Energy (MeV) 29-Cu-72

MAT 2952

MT= 59 (n,n') Level  
Legendre Coefficients

29-Cu-72

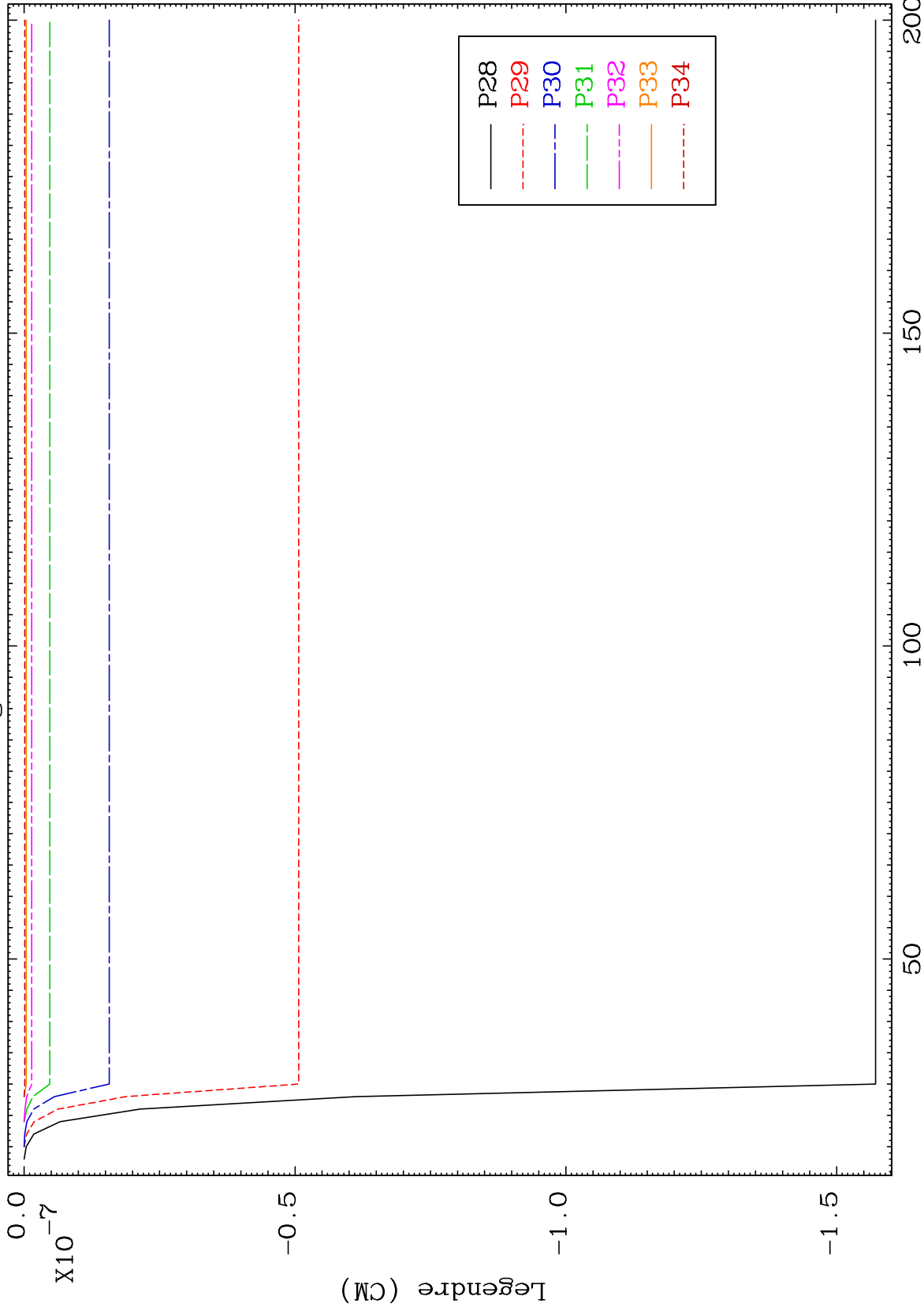

29-Cu-72

Incident Energy (MeV)

47

MAT 2952 MT= 60 (n,n') Level Legendre Coefficients 29-Cu-72

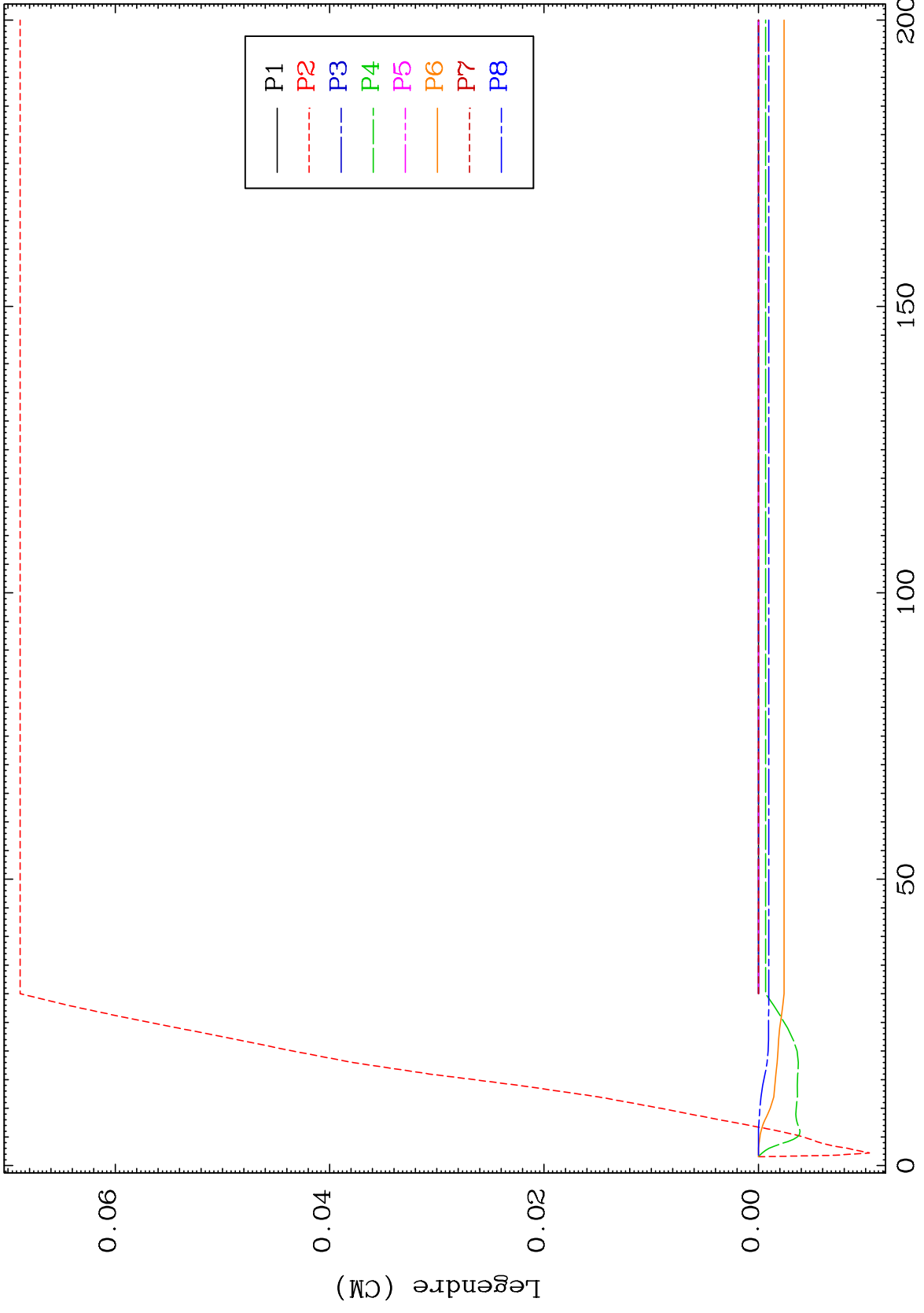

48 29-Cu-72

MAT 2952

MT= 60 (n,n') Level  
Legendre Coefficients

29-Cu-72

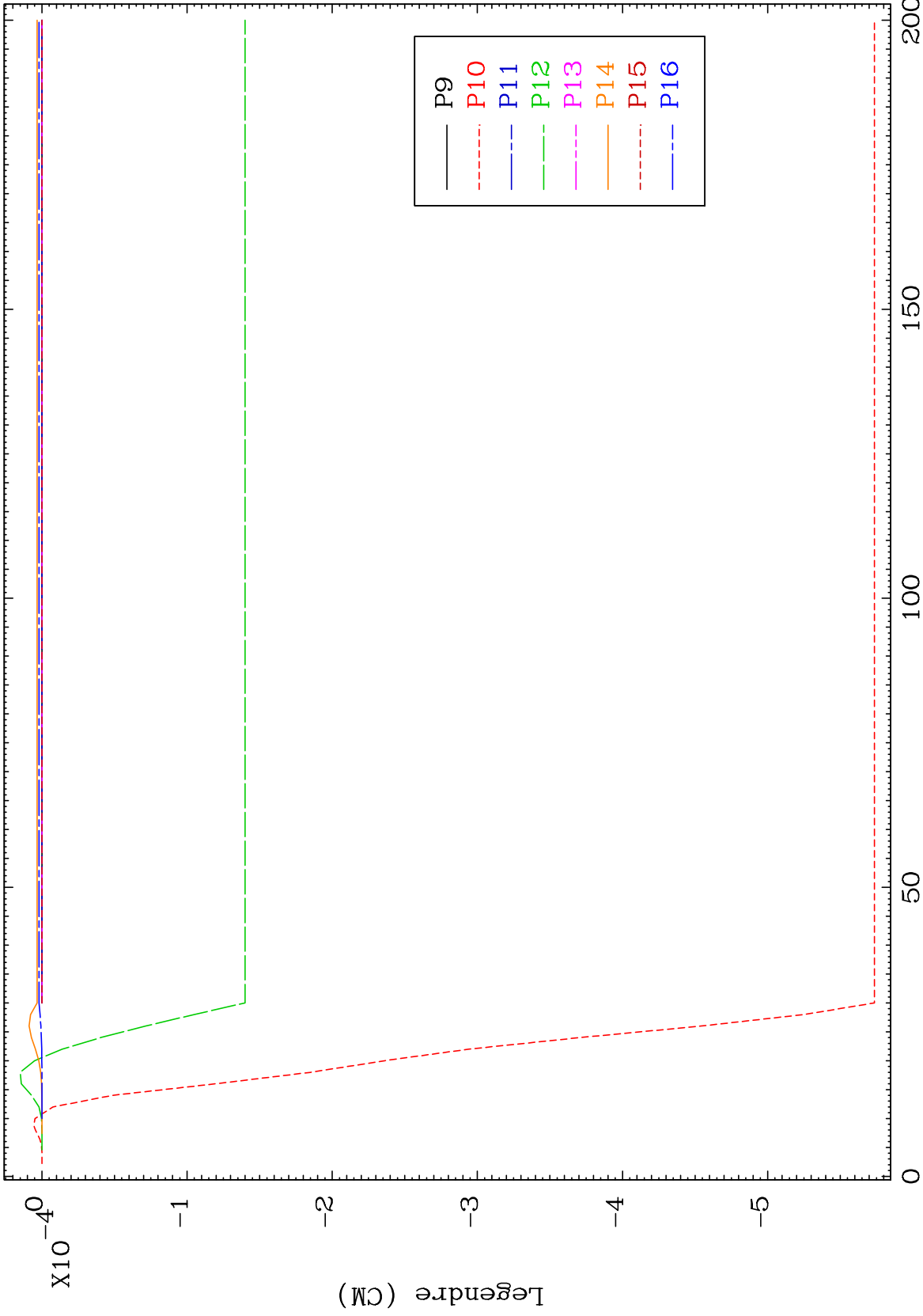

49

Incident Energy (MeV)

29-Cu-72

MAT 2952 MT= 60 (n,n') Level Legendre Coefficients 29-Cu-72

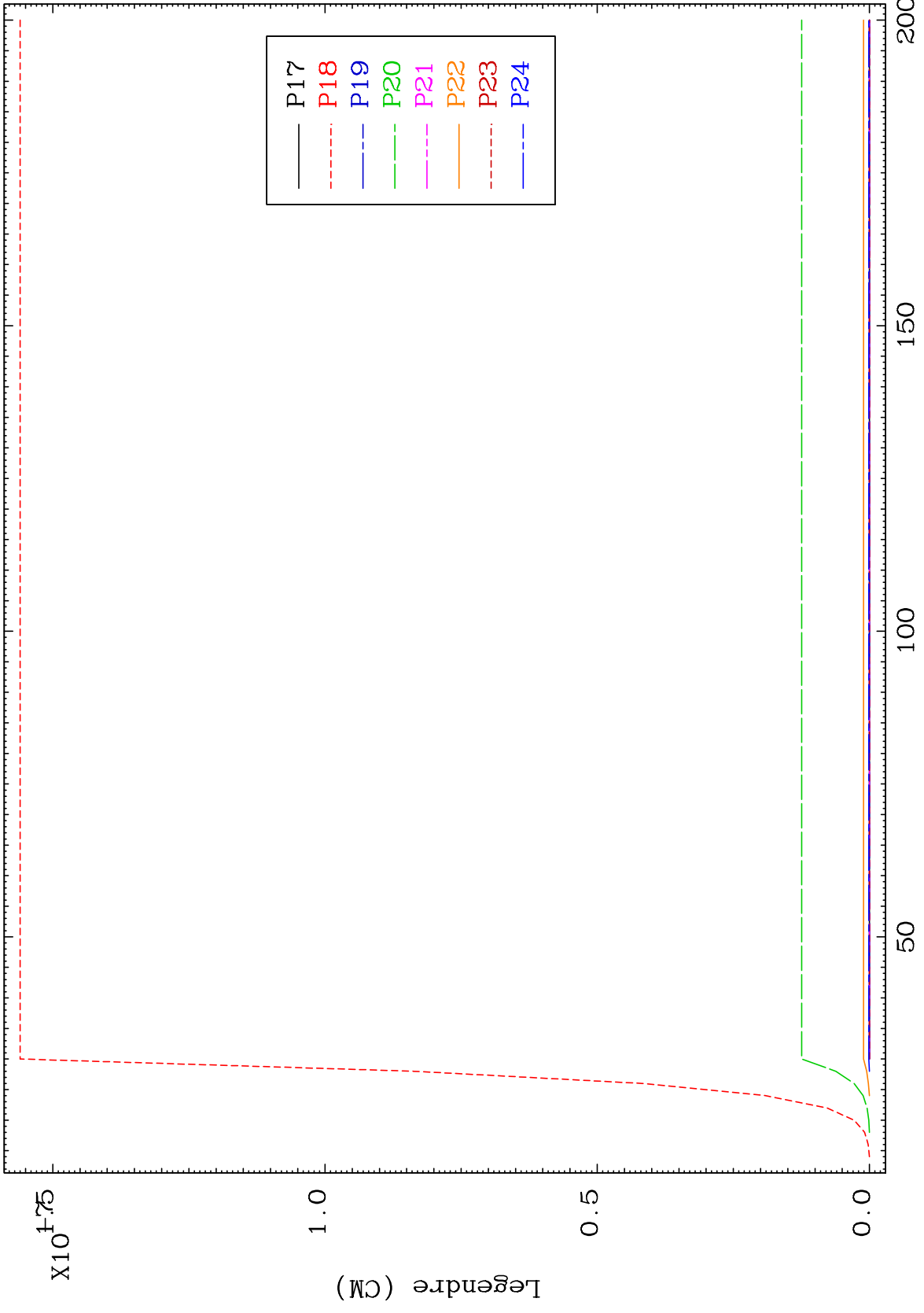

29-Cu-72

MAT 2952

MT= 61 (n,n') Level  
Legendre Coefficients

29-Cu-72

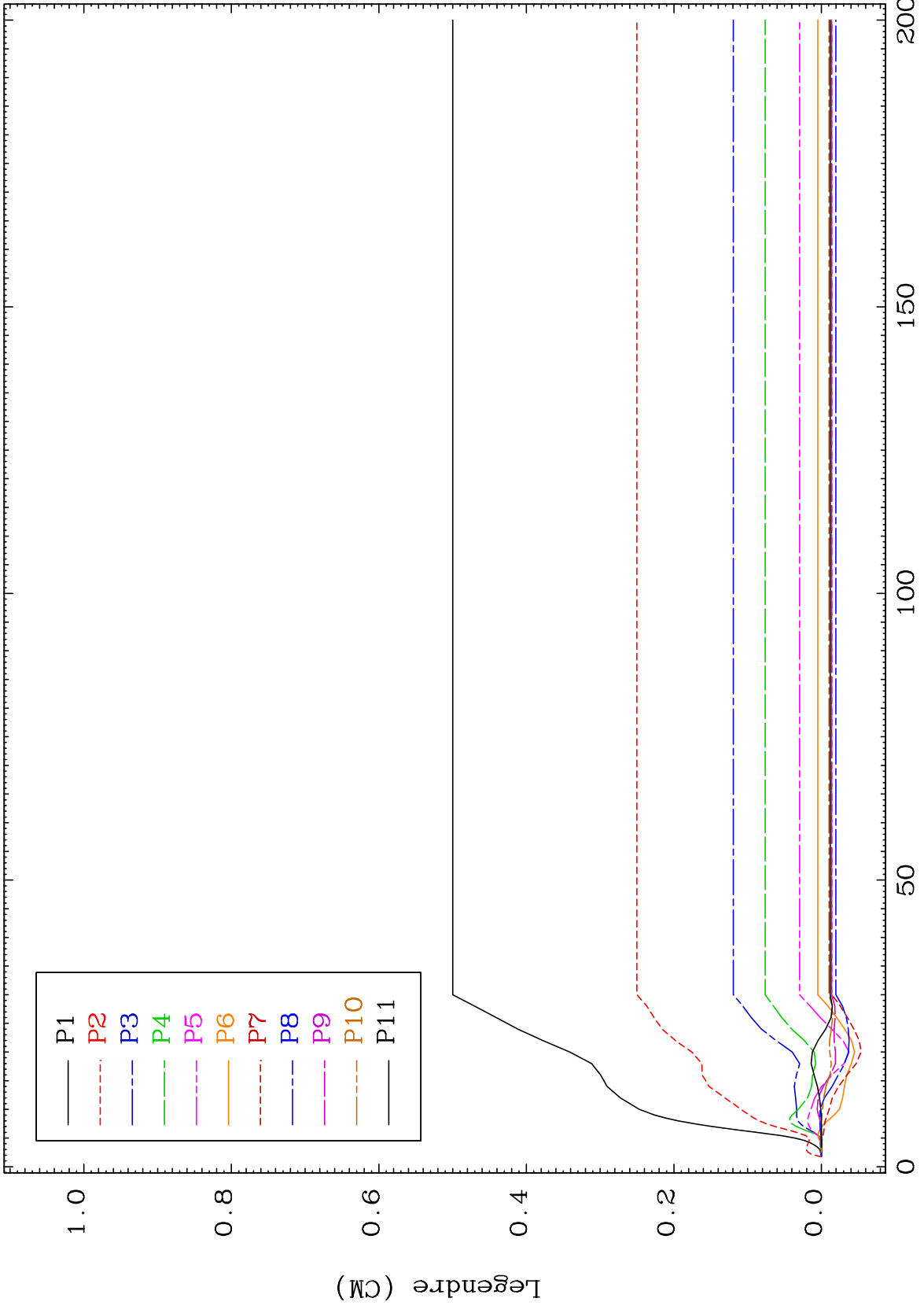

51

Incident Energy (MeV)

29-Cu-72

MAT 2952

MT= 61 (n,n') Level  
Legendre Coefficients

29-Cu-72

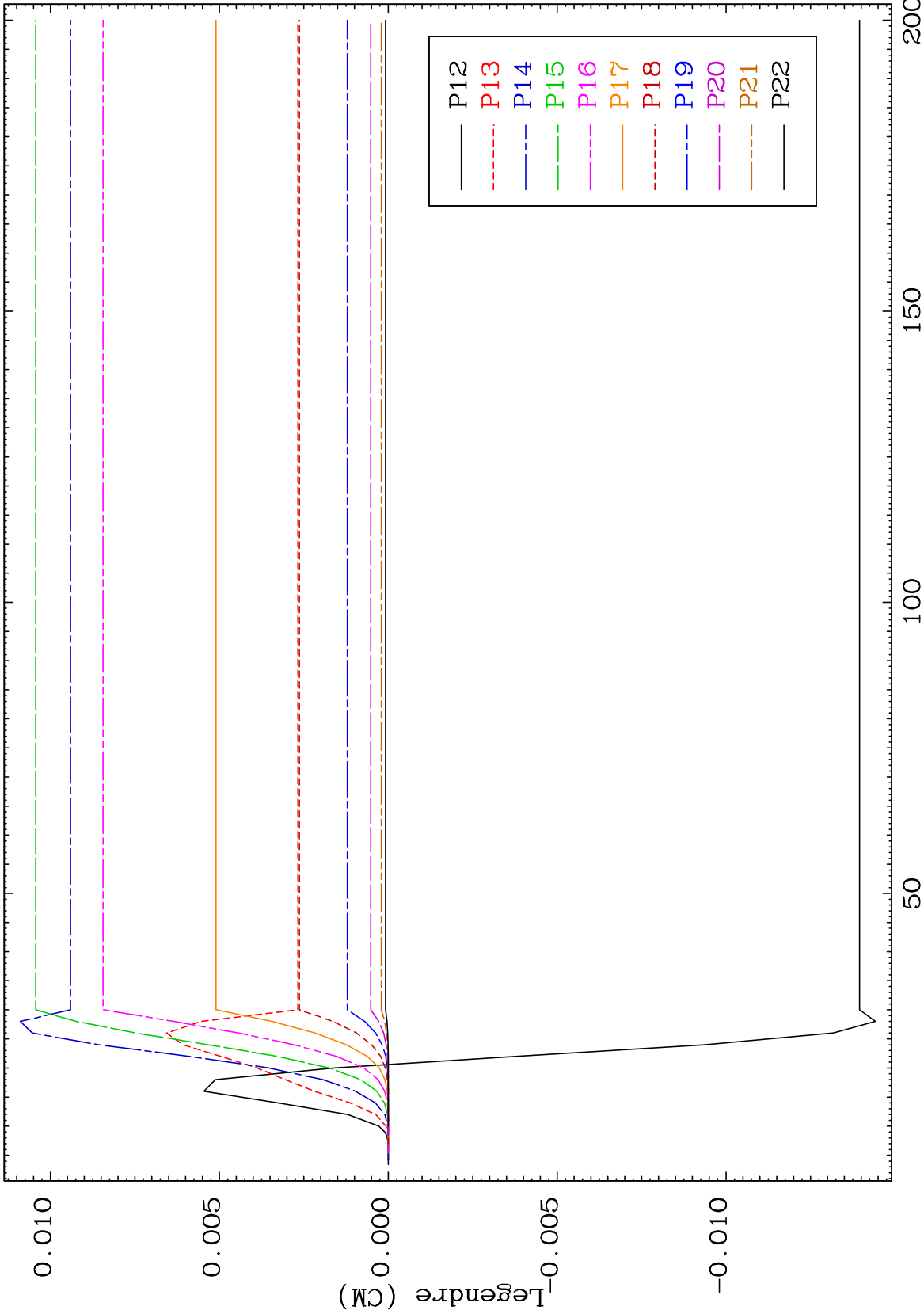

52

Incident Energy (MeV)

29-Cu-72

MAT 2952

MT= 61 (n,n') Level  
Legendre Coefficients

29-Cu-72

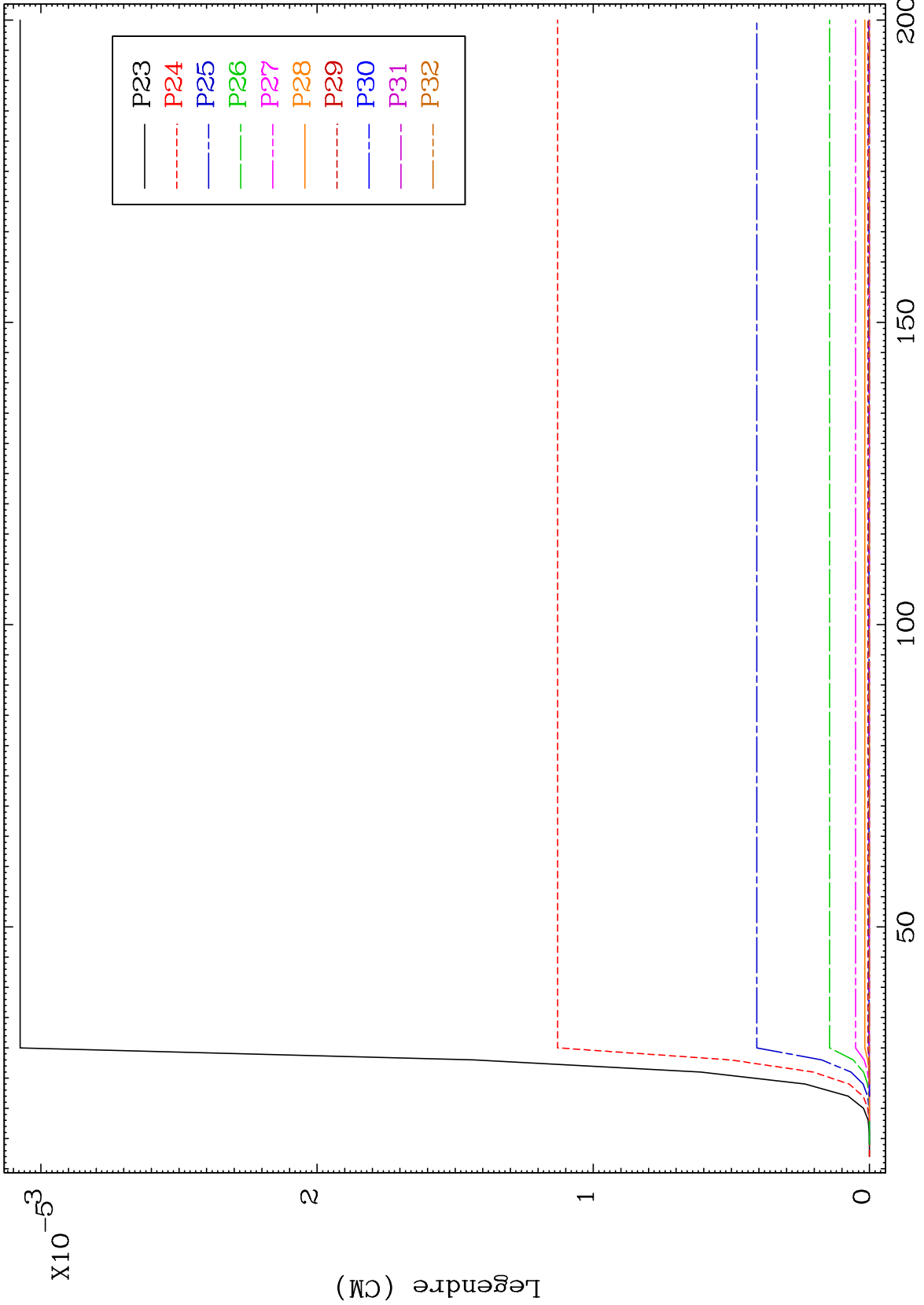

53

Incident Energy (MeV)

29-Cu-72

MAT 2952

MT= 62 (n,n') Level  
Legendre Coefficients

29-Cu-72

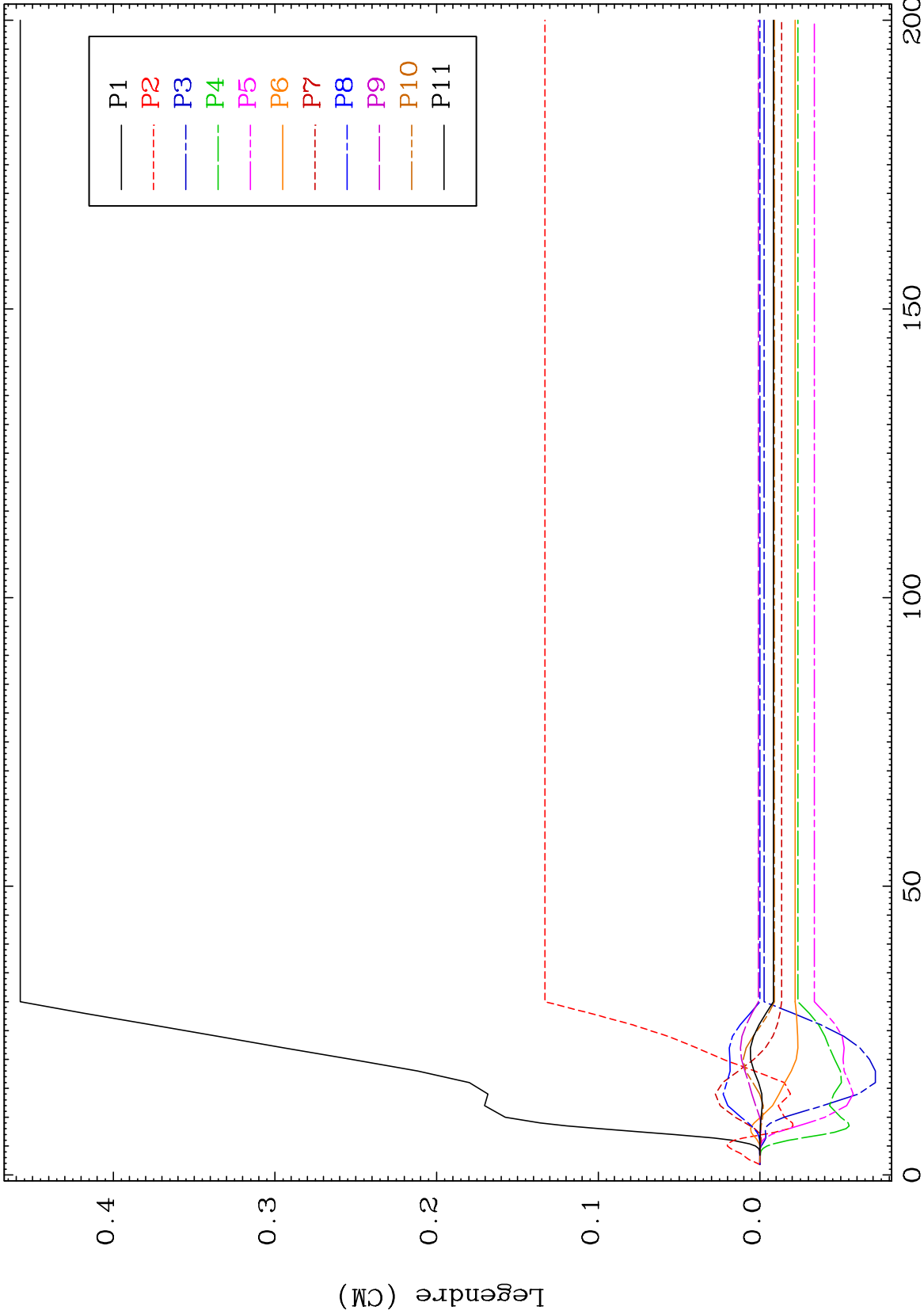

54

Incident Energy (MeV)

29-Cu-72

MAT 2952

MT= 62 (n,n') Level Legendre Coefficients

29-Cu-72

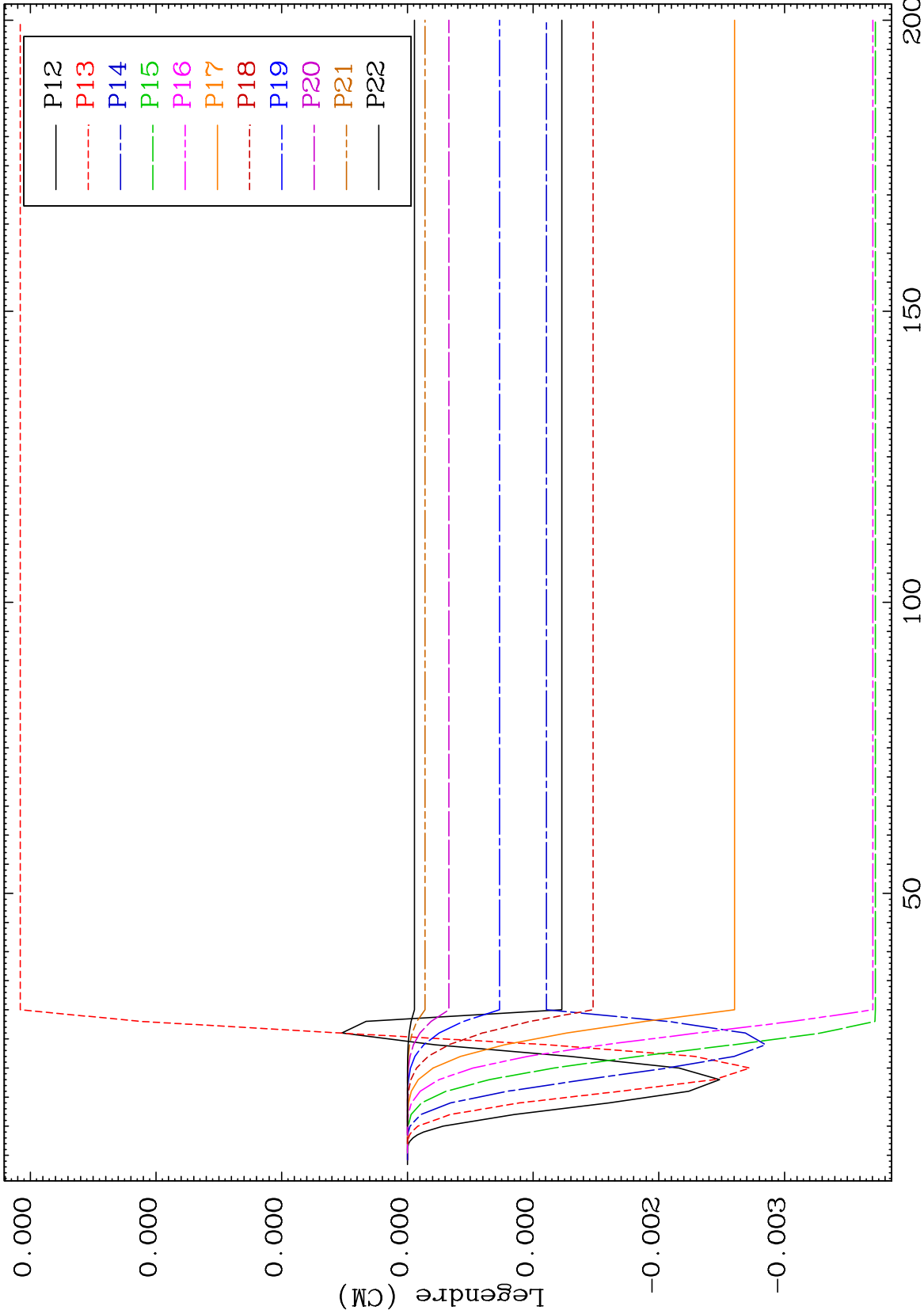

55

Incident Energy (MeV)

29-Cu-72

MAT 2952

MT= 62 (n,n') Level  
Legendre Coefficients

29-Cu-72

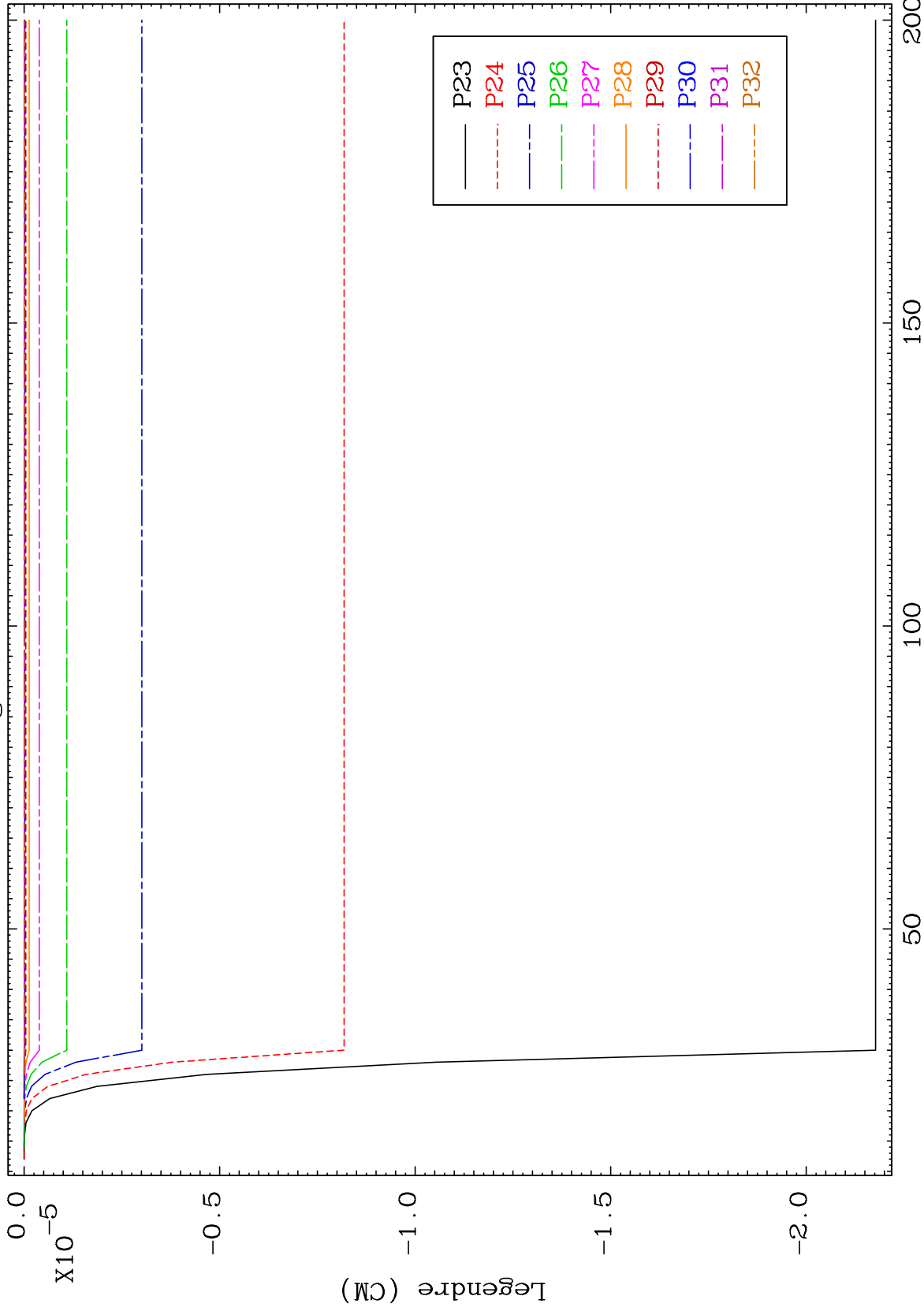

56

Incident Energy (MeV)

29-Cu-72

MAT 2952 MT= 63 (n,n') Level Legendre Coefficients

29-Cu-72

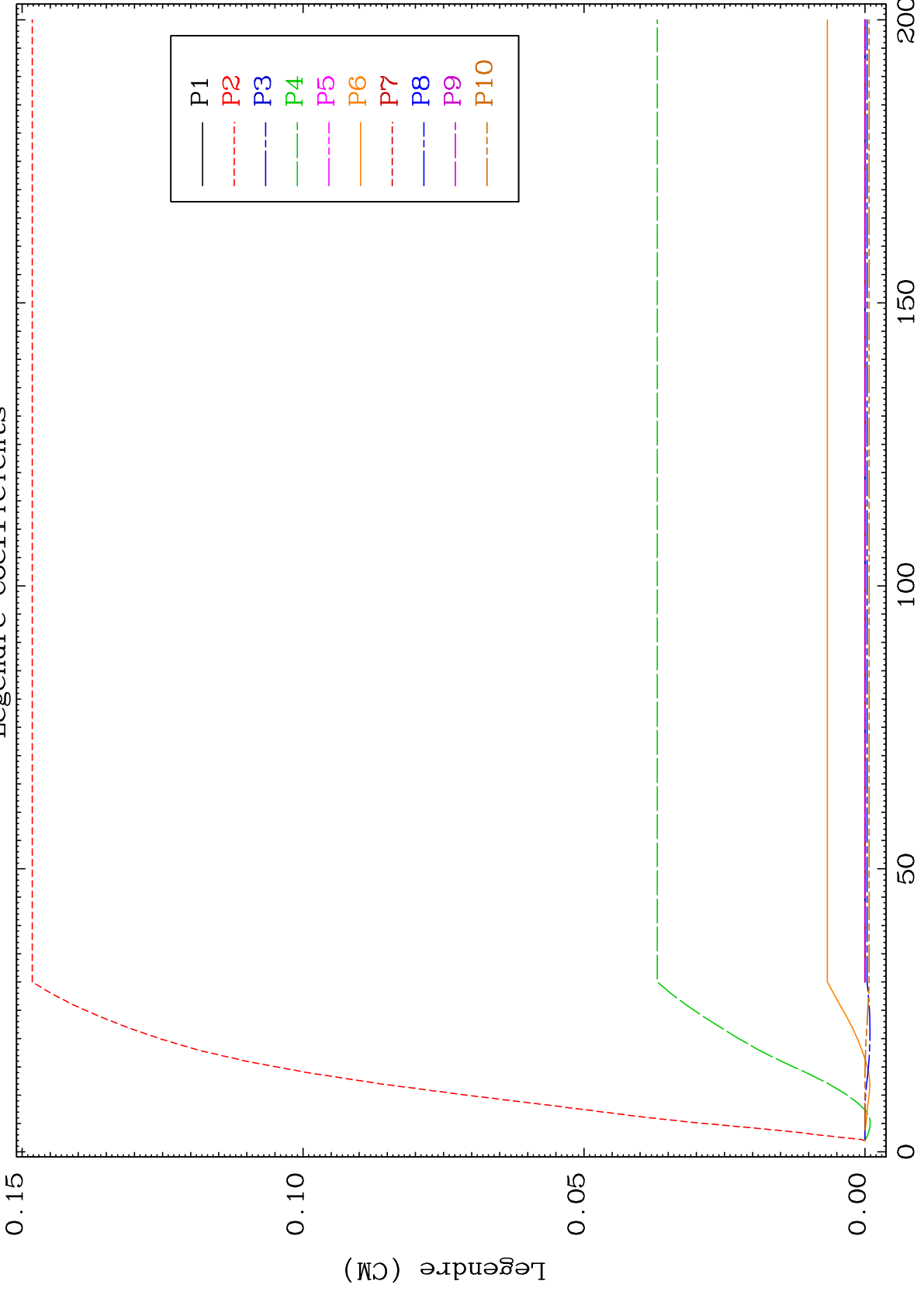

57

29-Cu-72

MAT 2952 MT= 63 (n,n') Level Legendre Coefficients 29-Cu-72

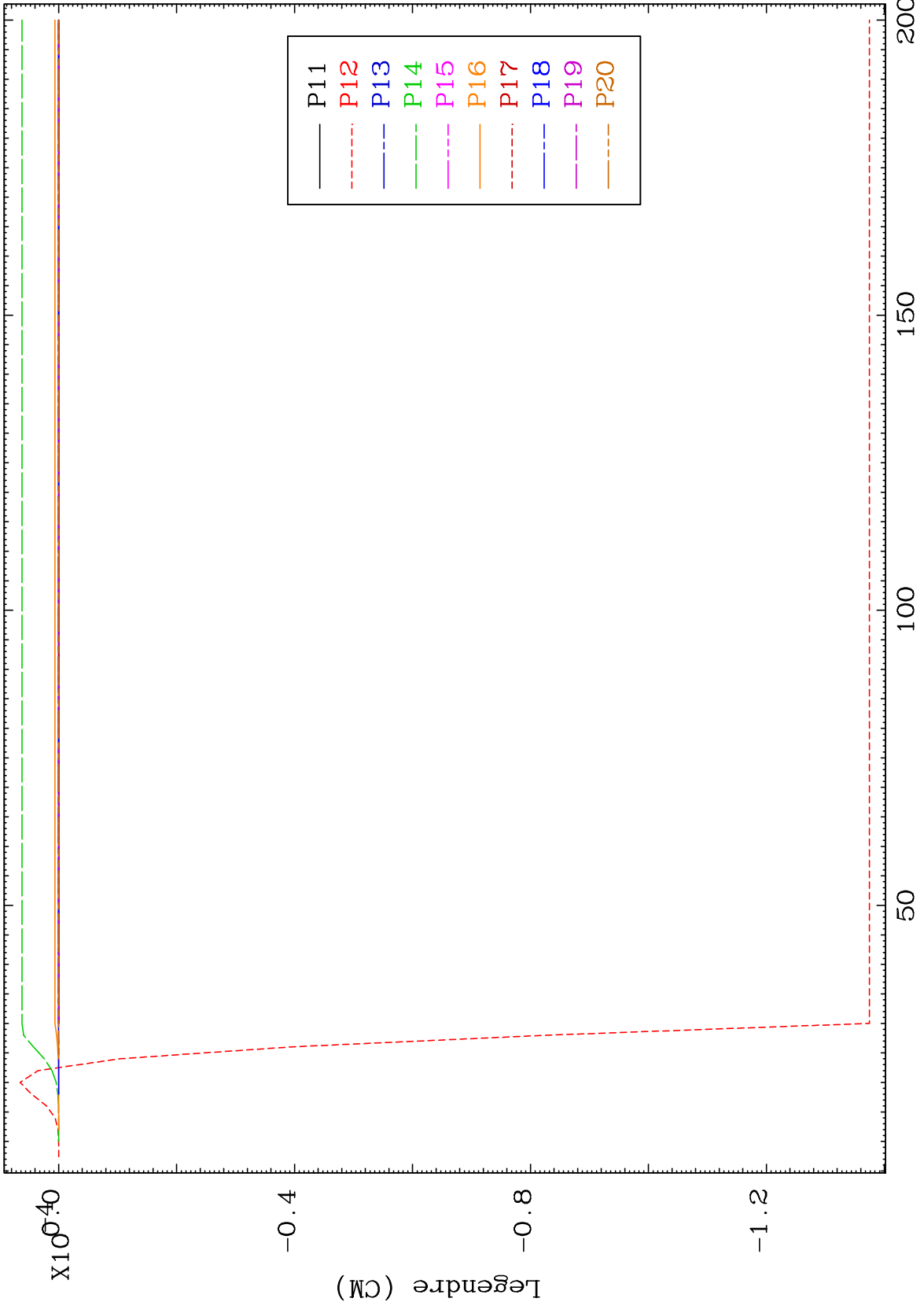

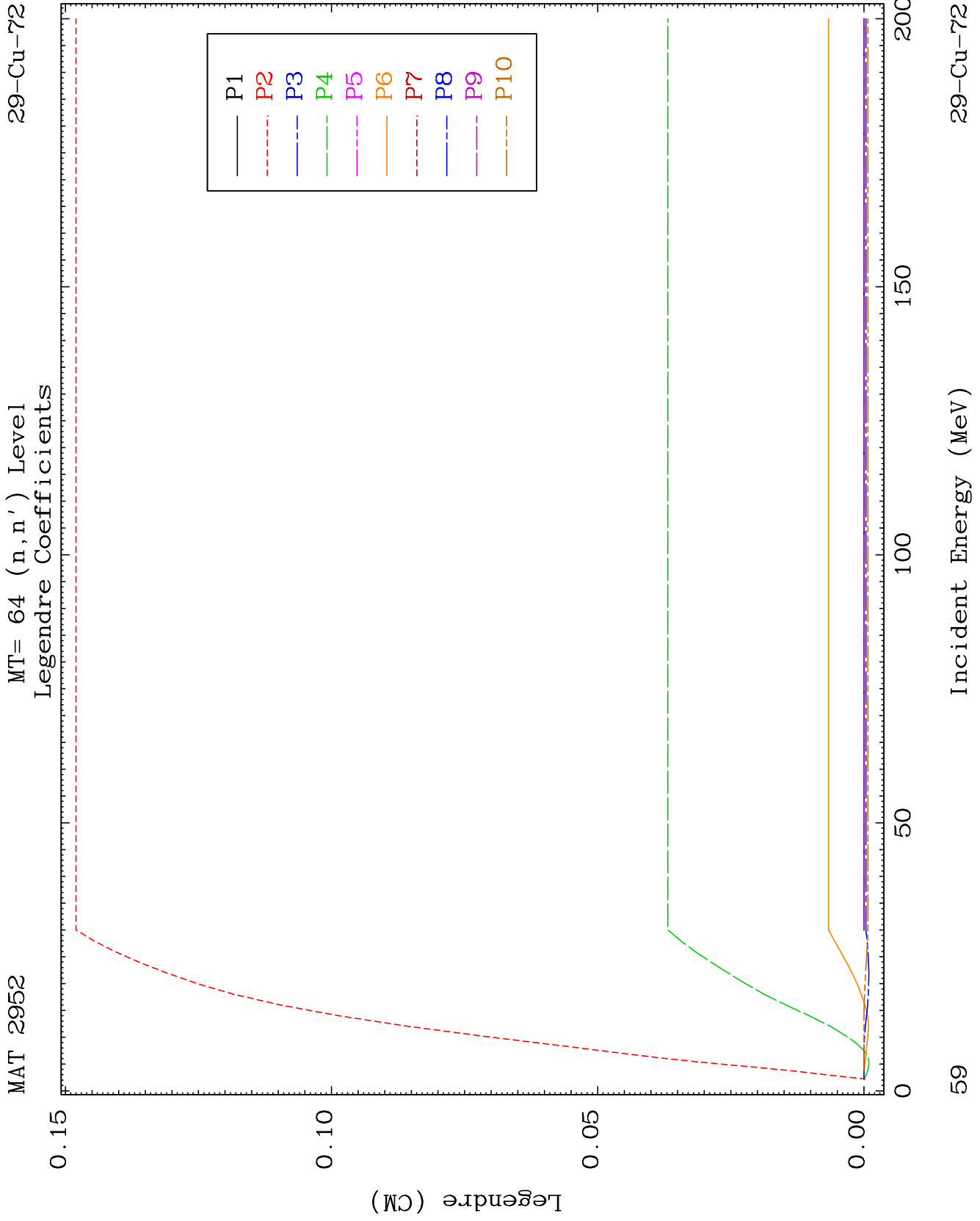

MAT 2952 MT= 64 (n,n') Level Legendre Coefficients 29-Cu-72

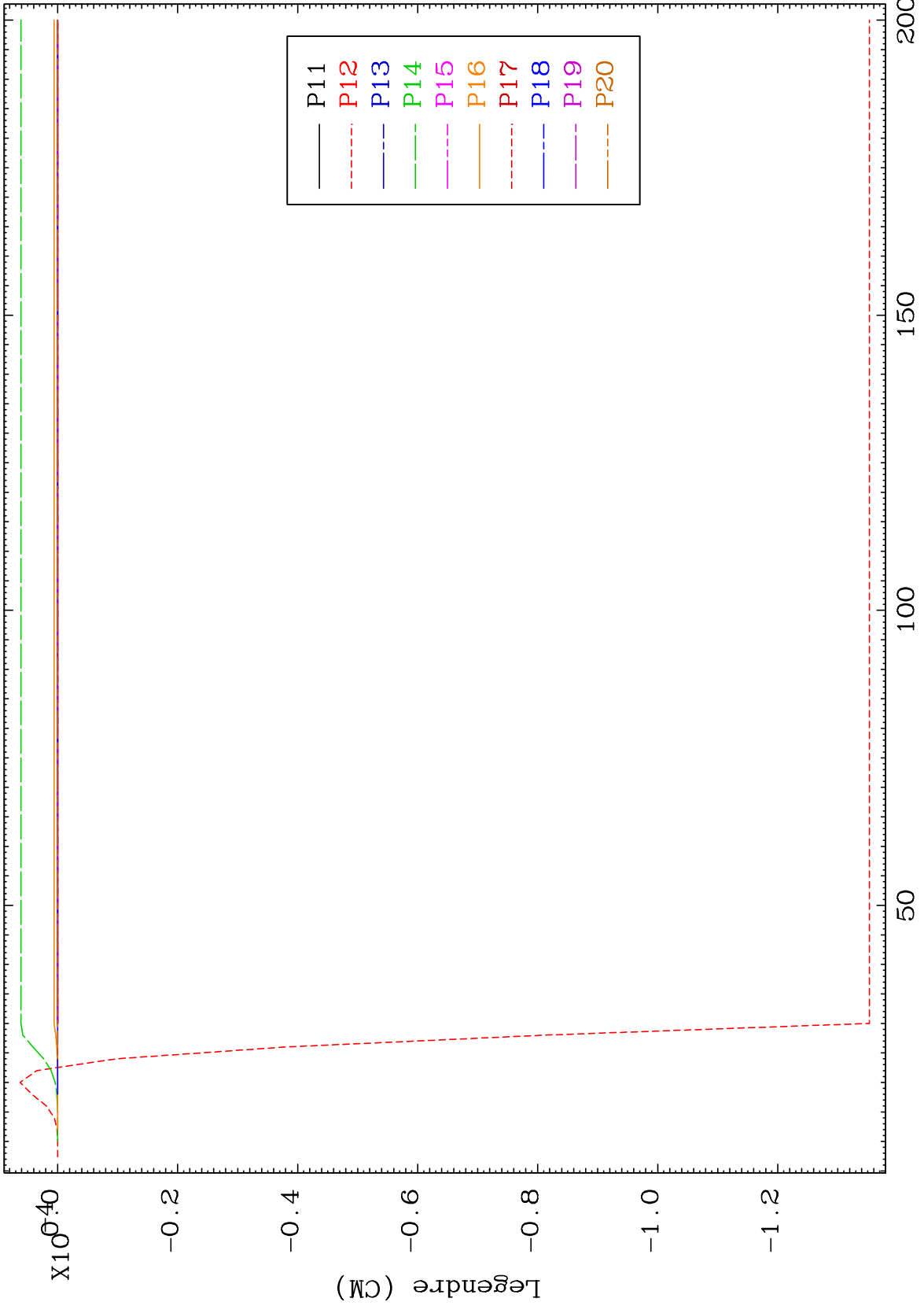

60 50 100 150 200 29-Cu-72

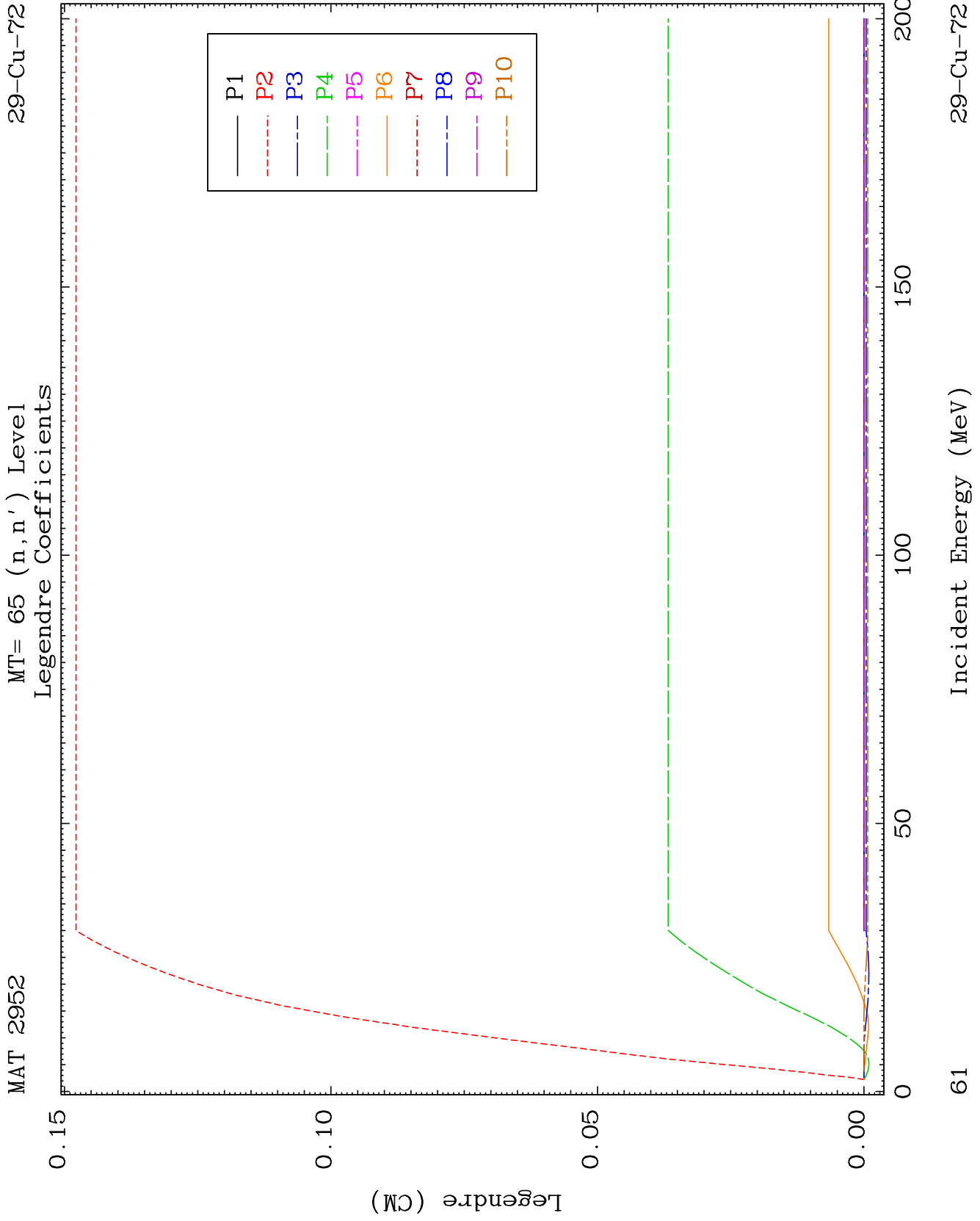

MAT 2952 MT= 65 (n,n') Level Legendre Coefficients 29-Cu-72

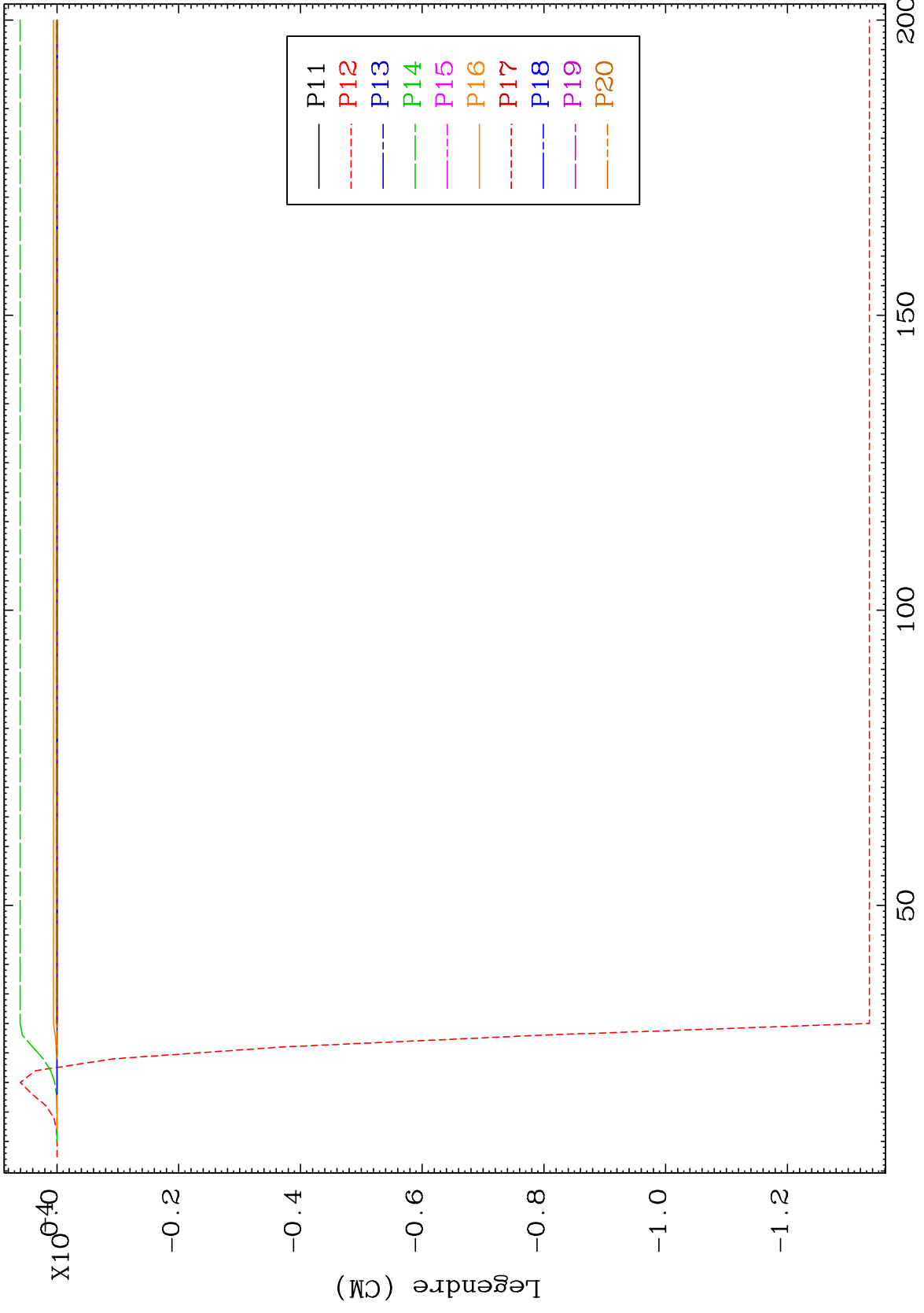

62 29-Cu-72

MAT 2952 MT= 66 (n,n') Level Legendre Coefficients 29-Cu-72

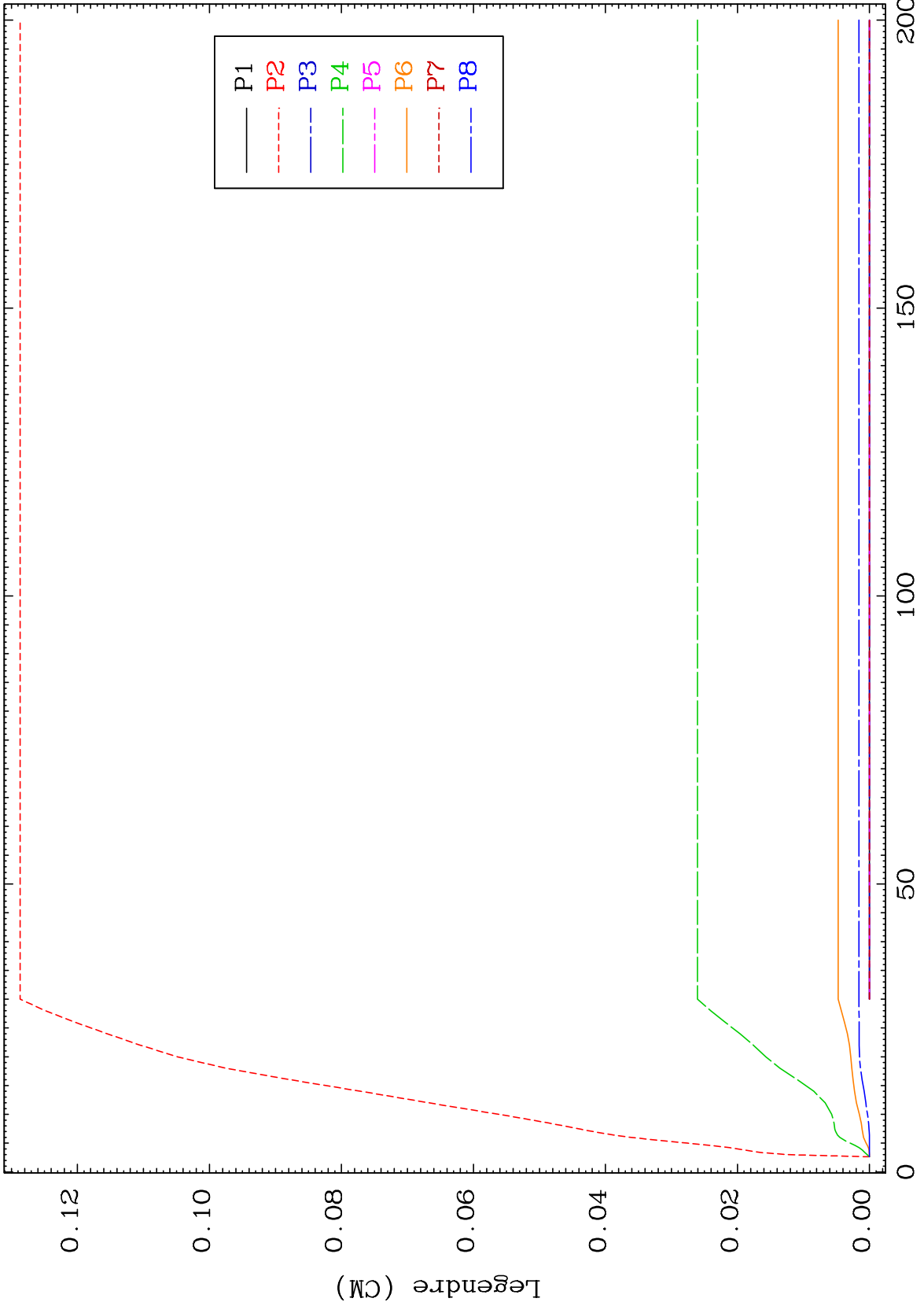

63 29-Cu-72

MAT 2952

MT= 66 (n,n') Level  
Legendre Coefficients

29-Cu-72

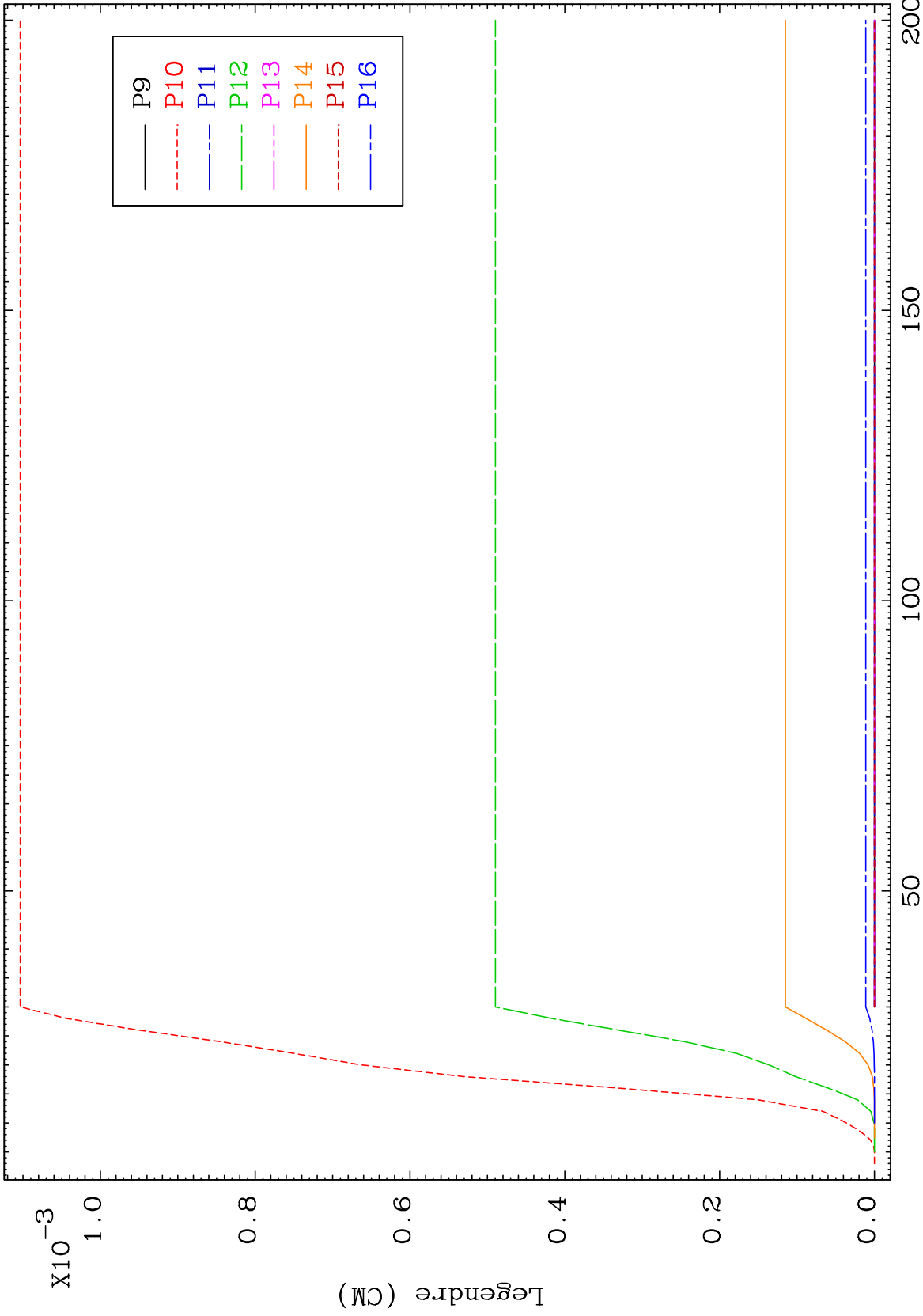

64

Incident Energy (MeV)

29-Cu-72

MAT 2952 MT= 66 (n,n') Level Legendre Coefficients 29-Cu-72

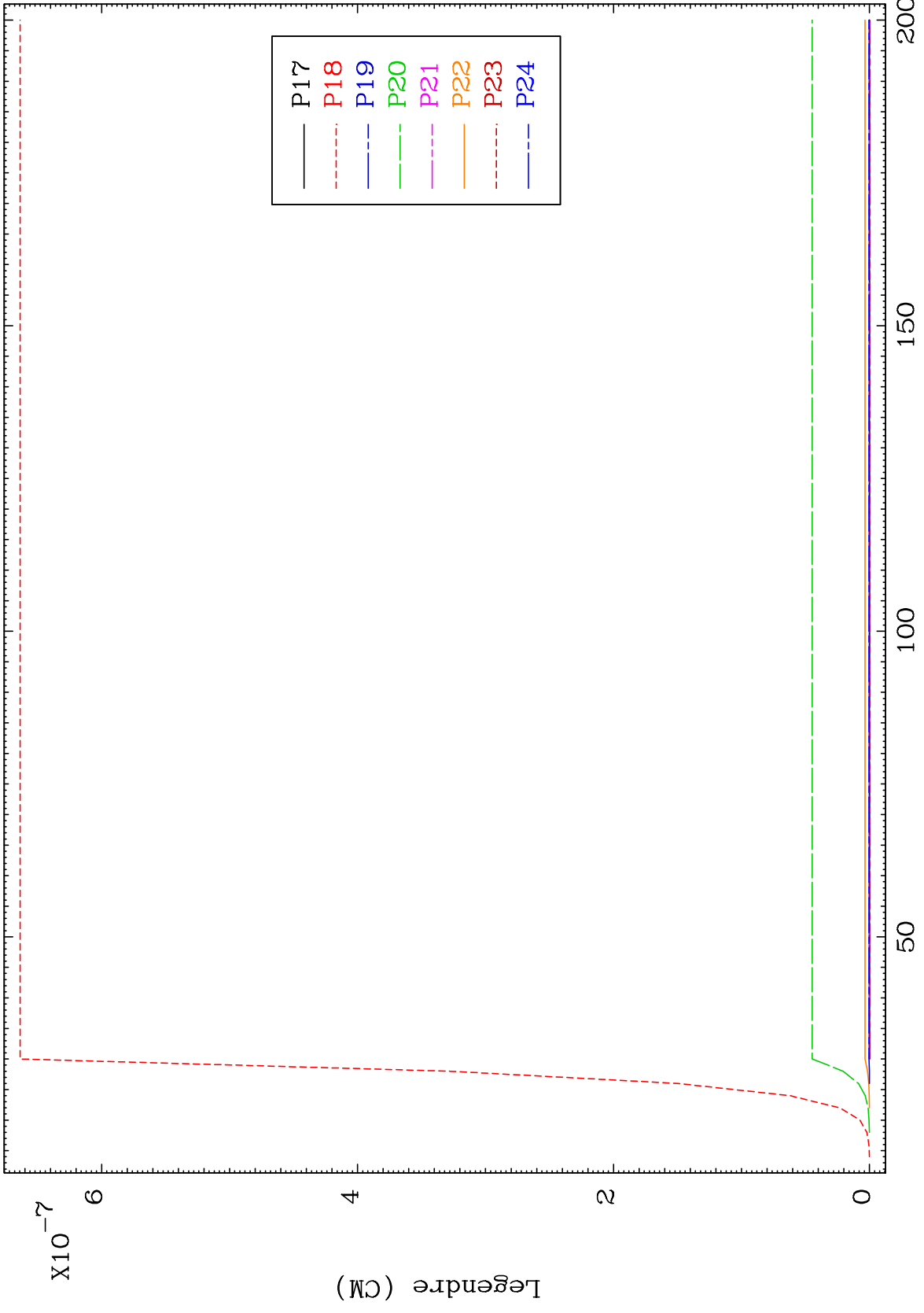

65 Incident Energy (MeV) 29-Cu-72

MAT 2952

MT= 67 (n,n') Level  
Legendre Coefficients

29-Cu-72

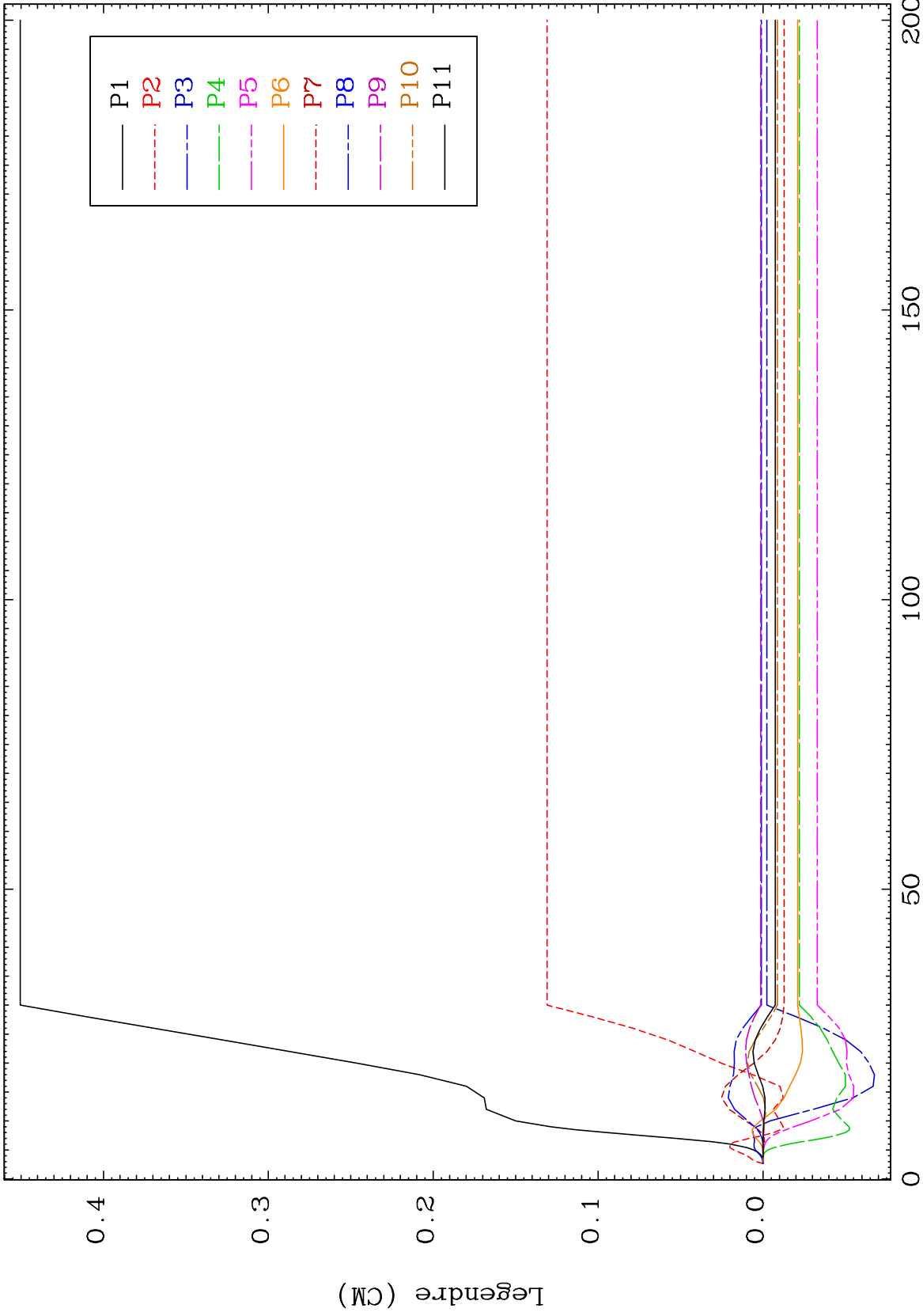

66

Incident Energy (MeV)

29-Cu-72

MAT 2952 MT= 67 (n,n') Level Legendre Coefficients 29-Cu-72

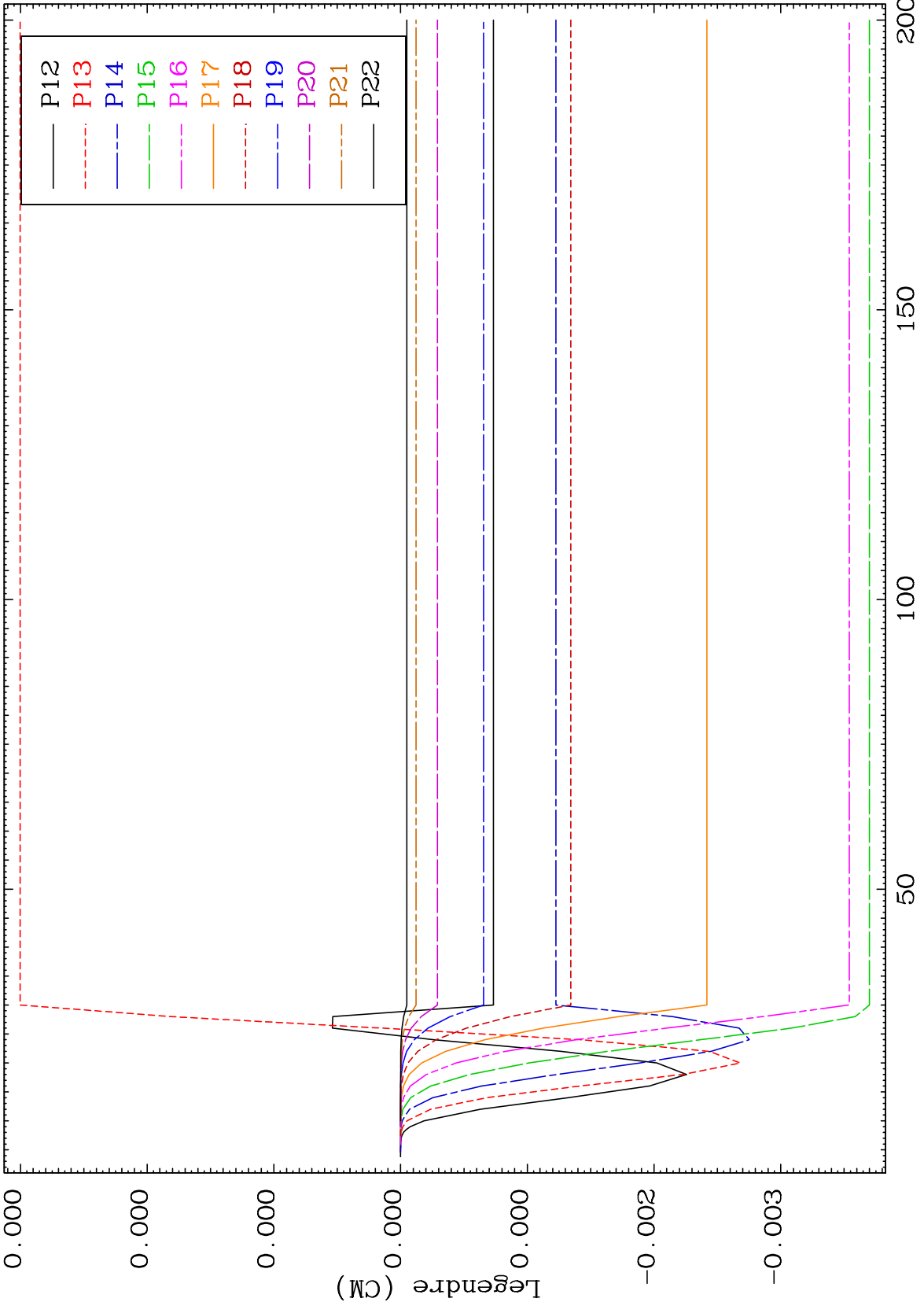

67 29-Cu-72

MAT 2952

MT= 67 (n,n') Level Legendre Coefficients

29-Cu-72

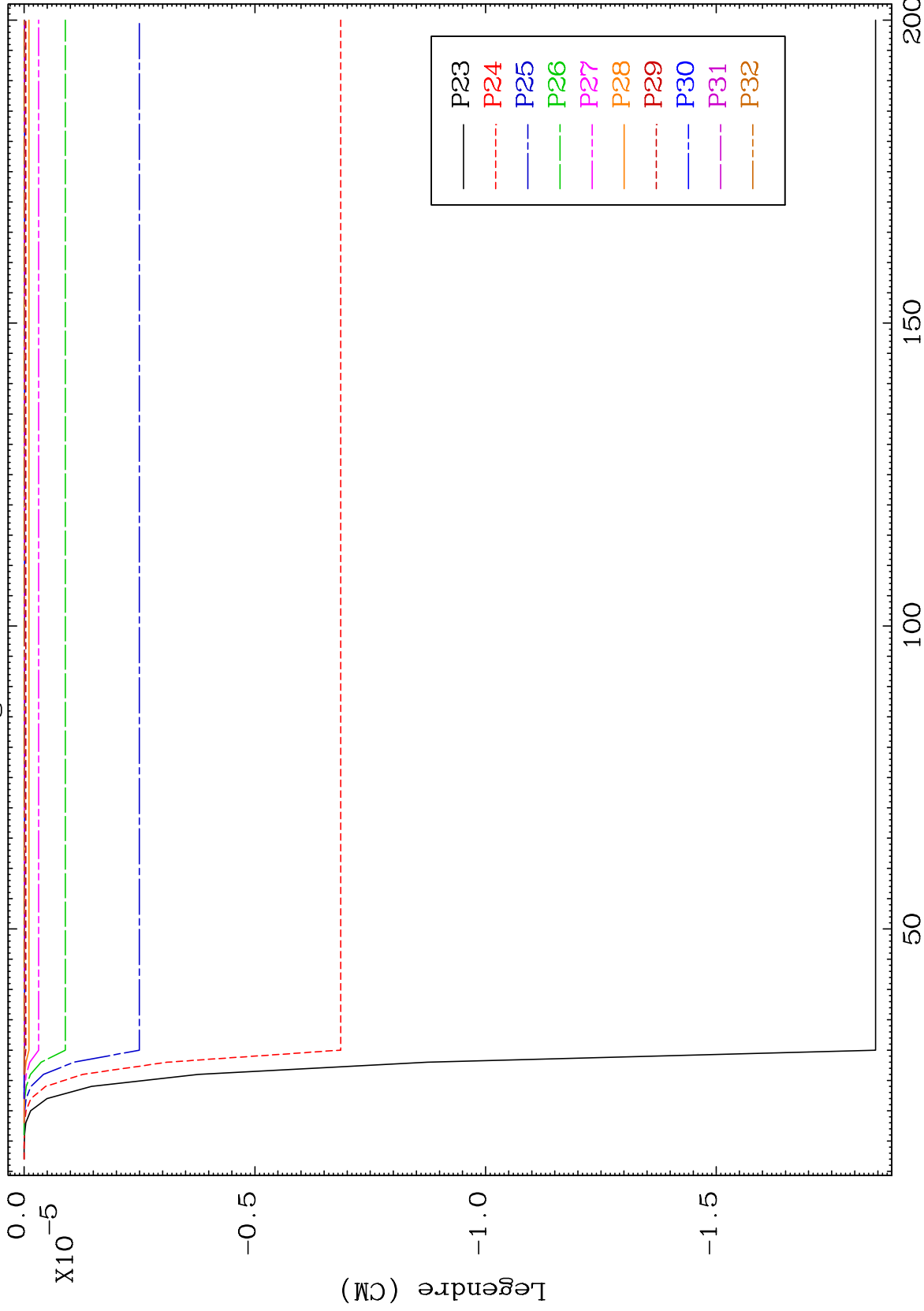

29-Cu-72

Incident Energy (MeV)

68

MAT 2952 MT= 68 (n,n') Level Legendre Coefficients 29-Cu-72

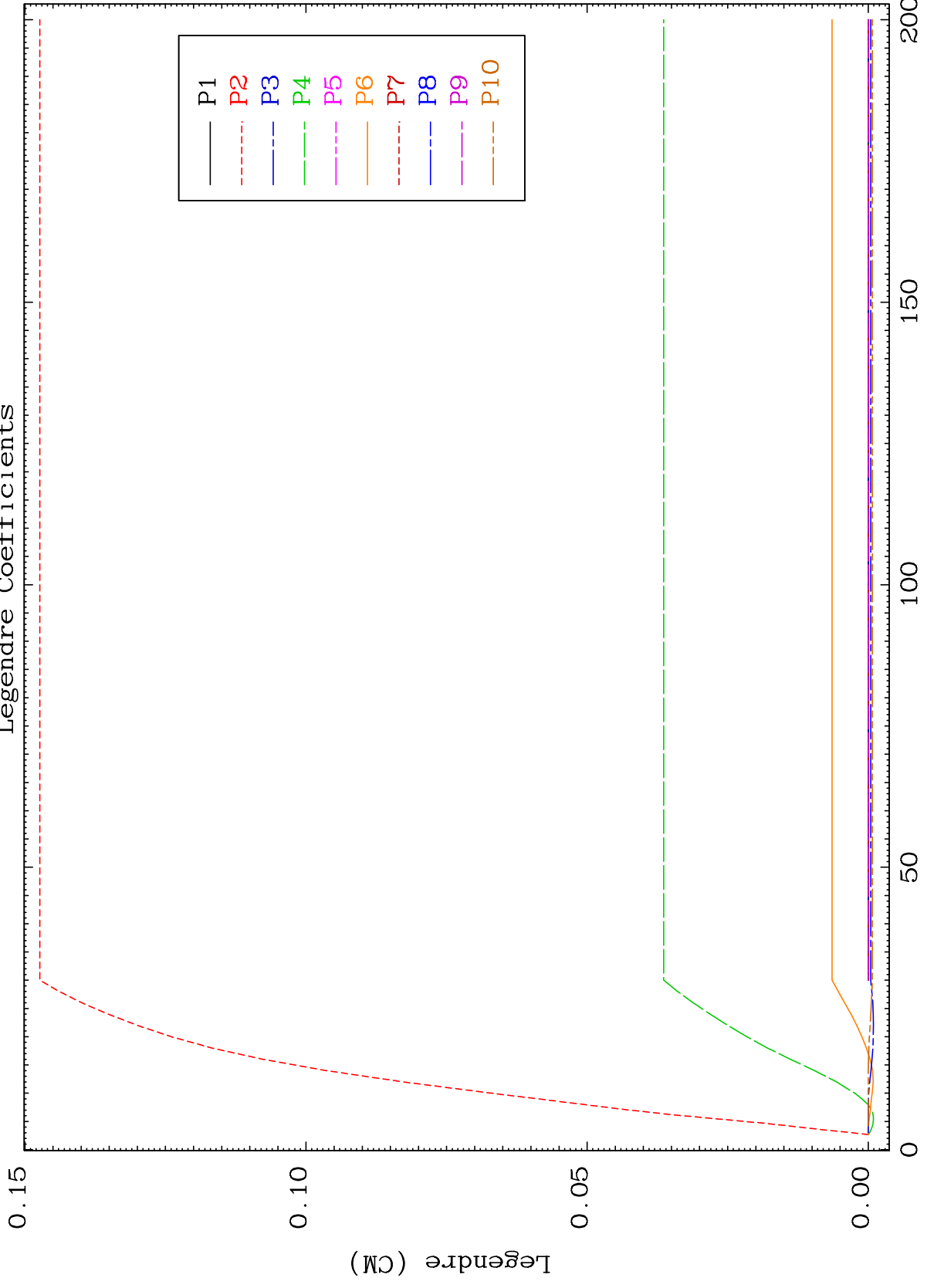

69 29-Cu-72

MAT 2952 MT= 68 (n,n') Level Legendre Coefficients 29-Cu-72

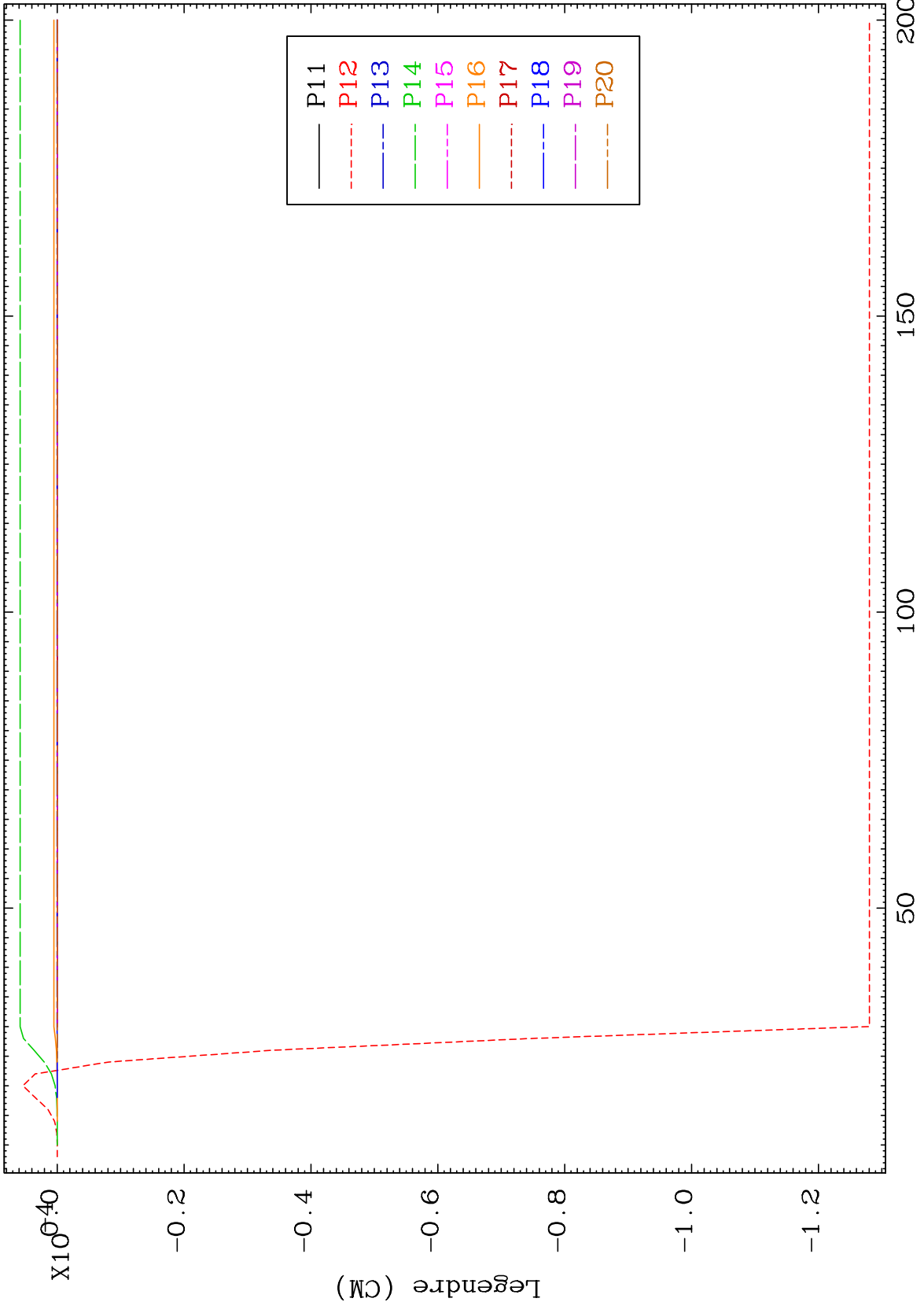

70 50 100 150 200 29-Cu-72

MAT 2952

MT= 69 (n,n') Level  
Legendre Coefficients

29-Cu-72

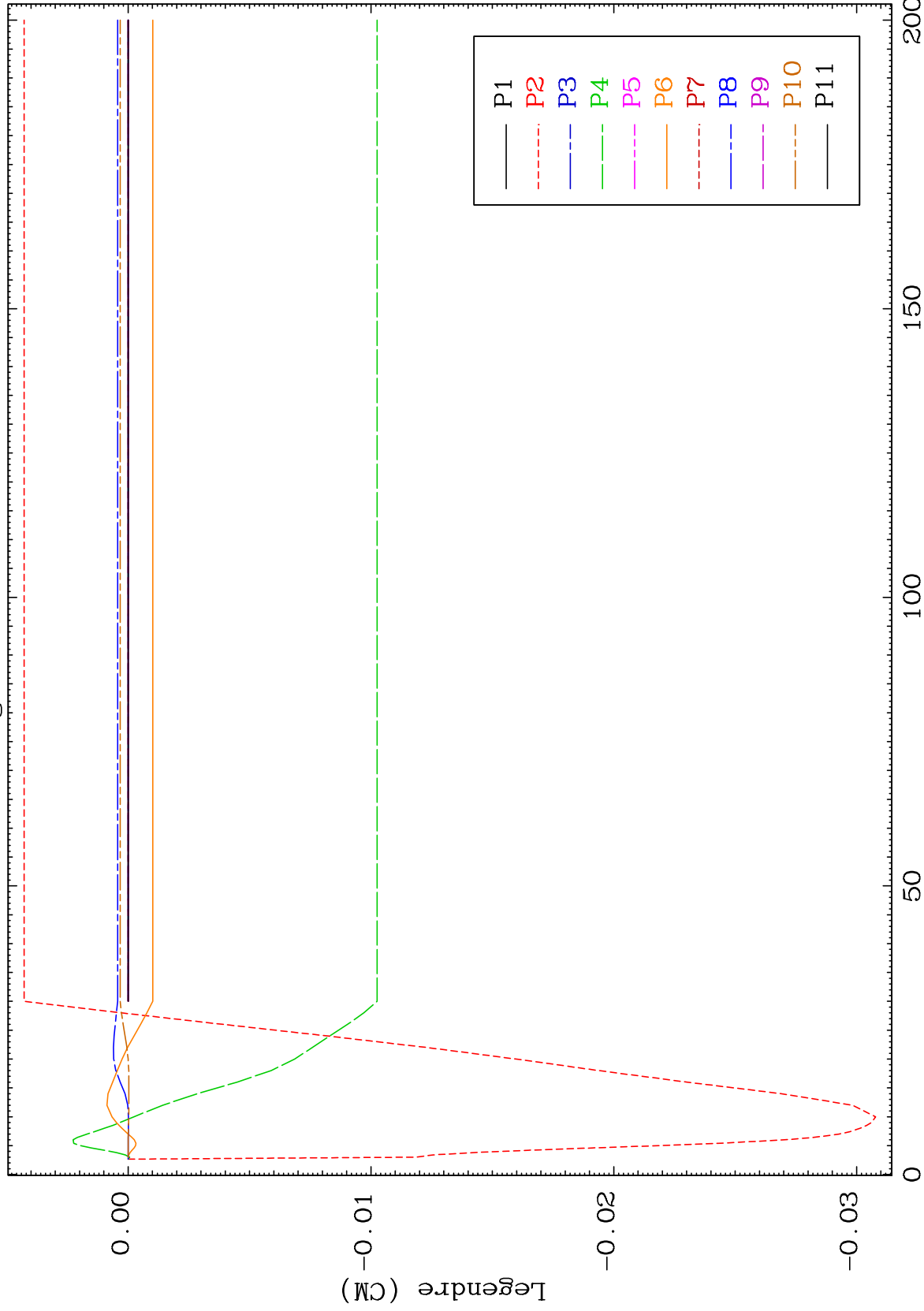

71

Incident Energy (MeV)

29-Cu-72

MAT 2952

MT= 69 (n,n') Level  
Legendre Coefficients

29-Cu-72

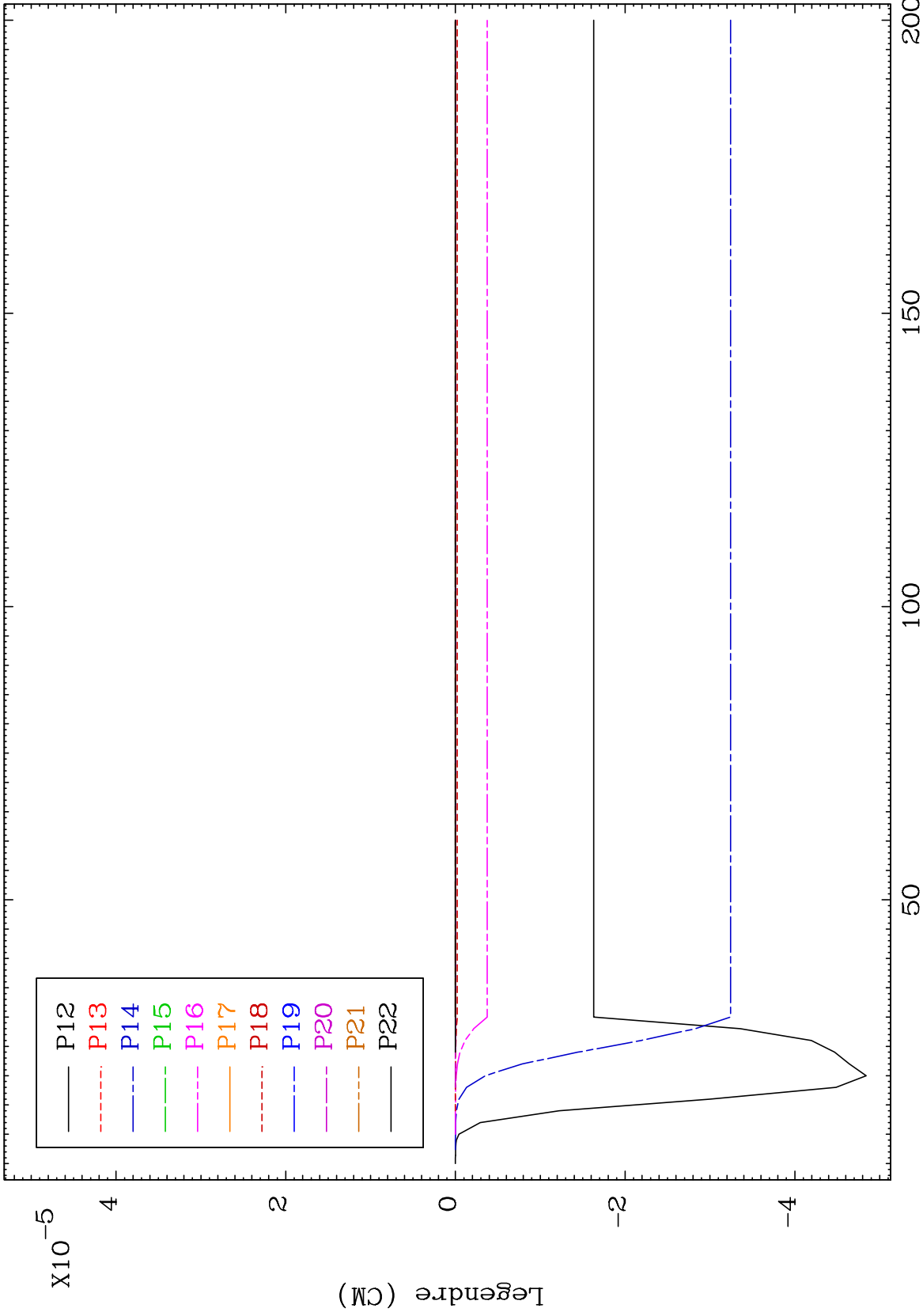

72

Incident Energy (MeV)

29-Cu-72

MAT 2952 MT= 70 (n,n') Level Legendre Coefficients 29-Cu-72

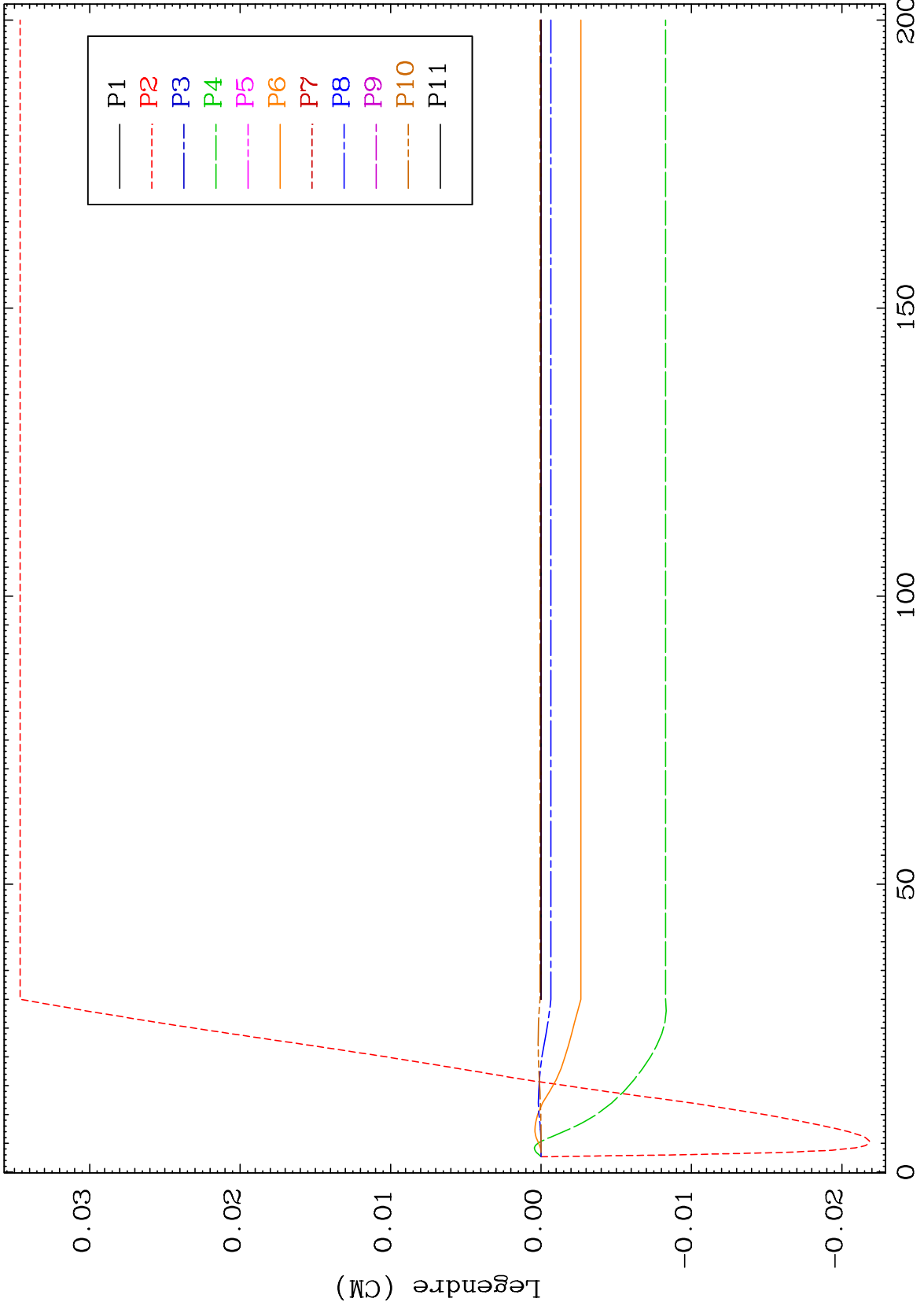

73 29-Cu-72

MAT 2952

MT= 70 (n,n') Level  
Legendre Coefficients

29-Cu-72

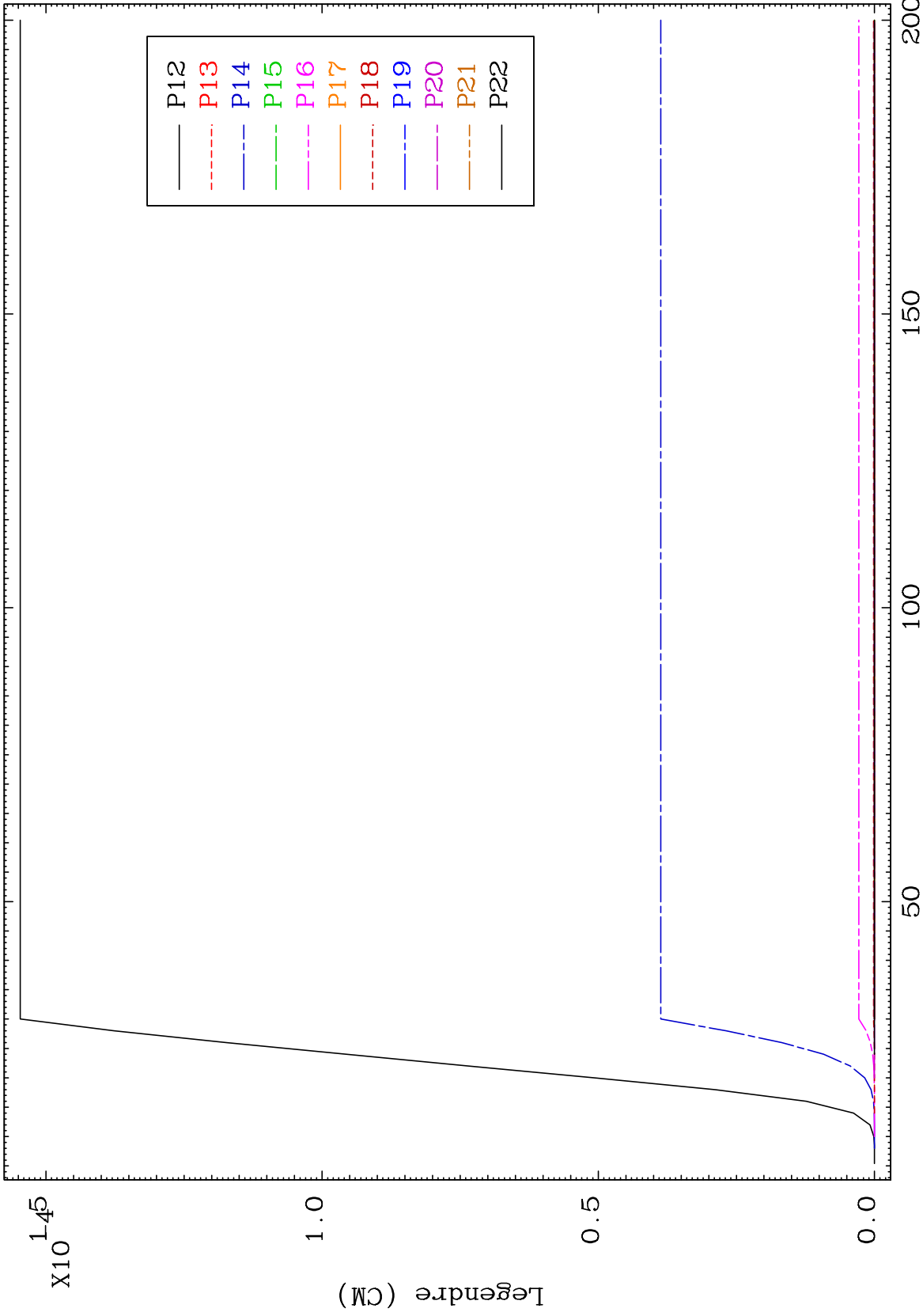

74

Incident Energy (MeV)

29-Cu-72

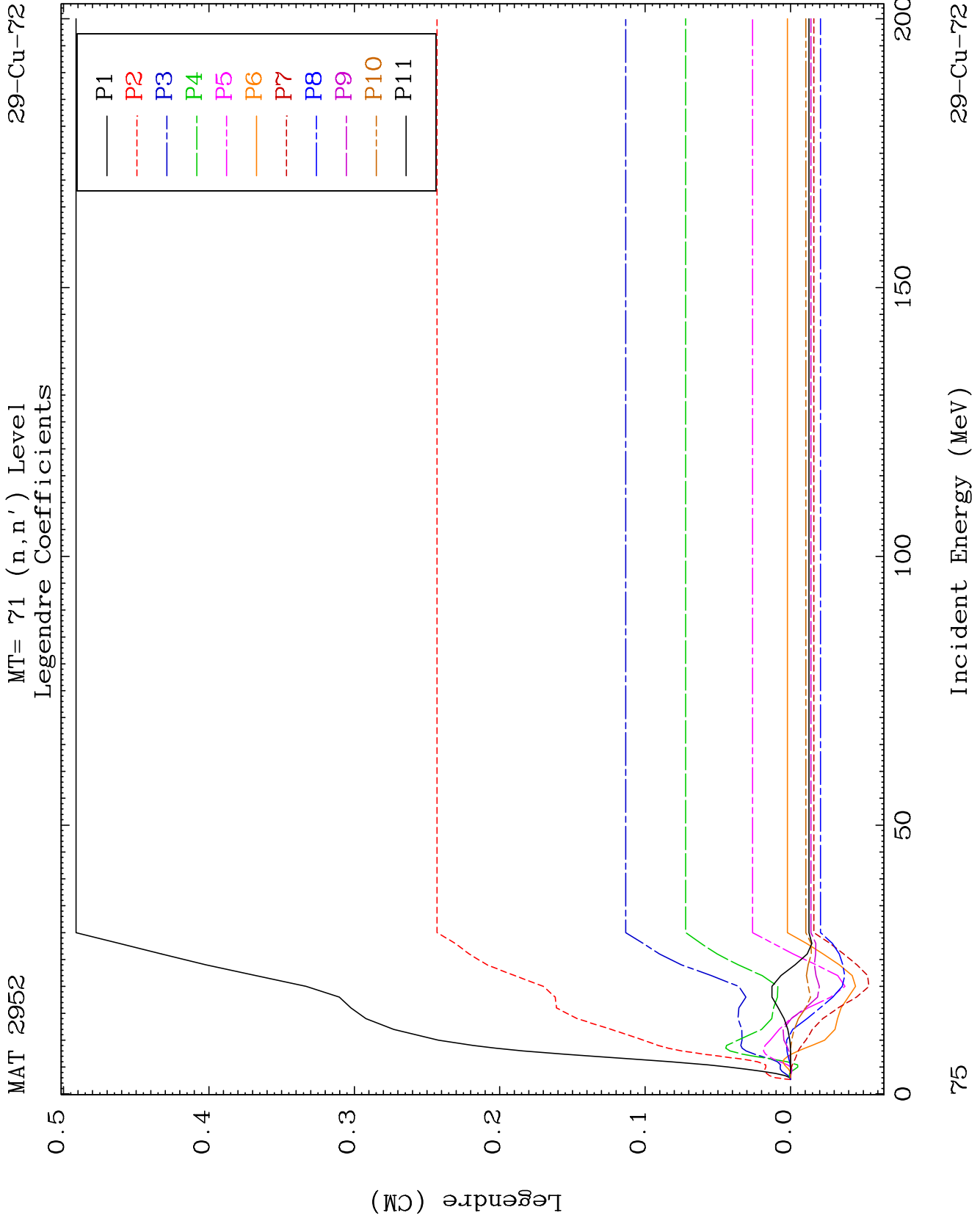

MAT 2952

MT= 71 (n,n') Level  
Legendre Coefficients

29-Cu-72

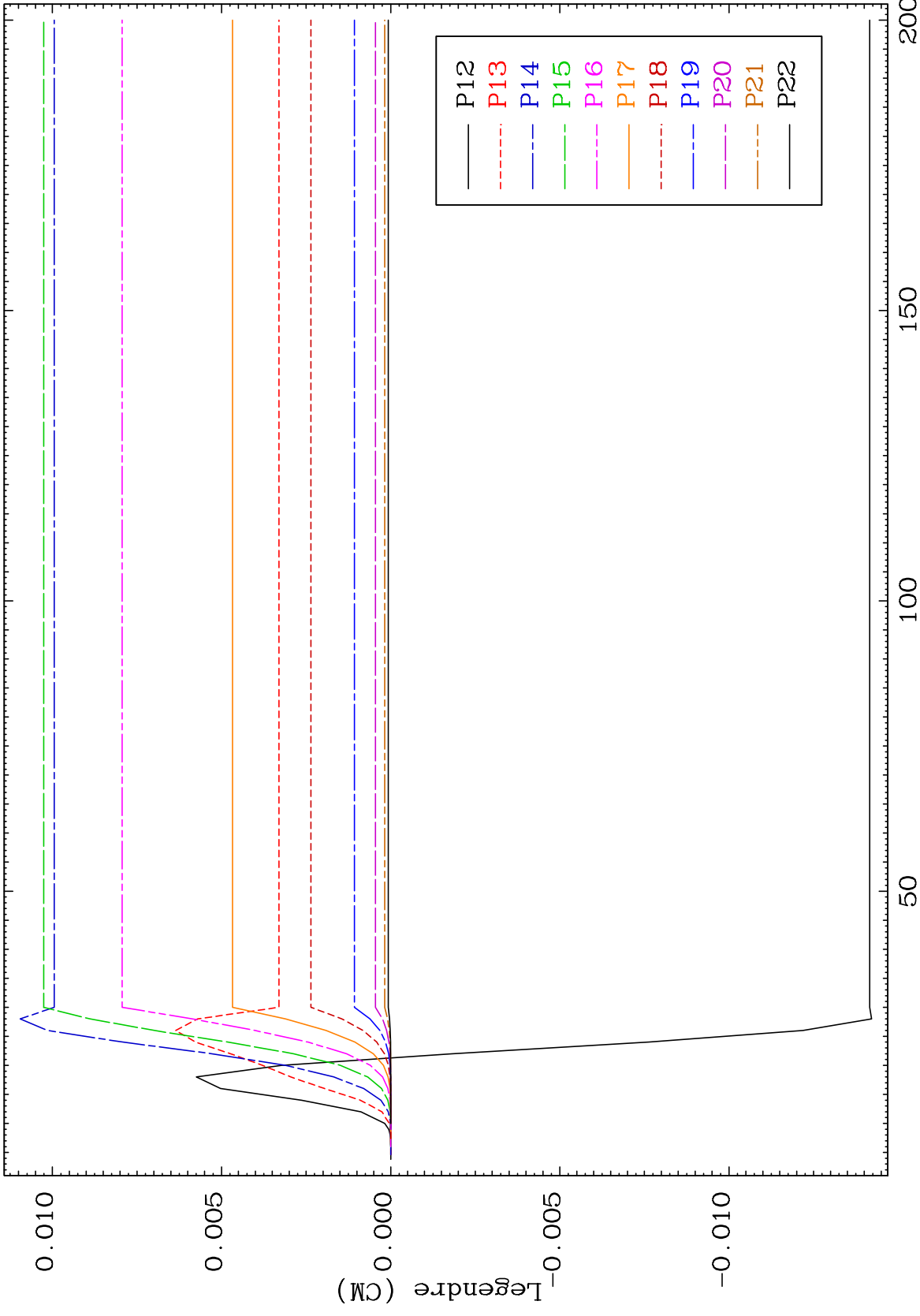

76

Incident Energy (MeV)

29-Cu-72

MAT 2952

MT= 71 (n,n') Level  
Legendre Coefficients

29-Cu-72

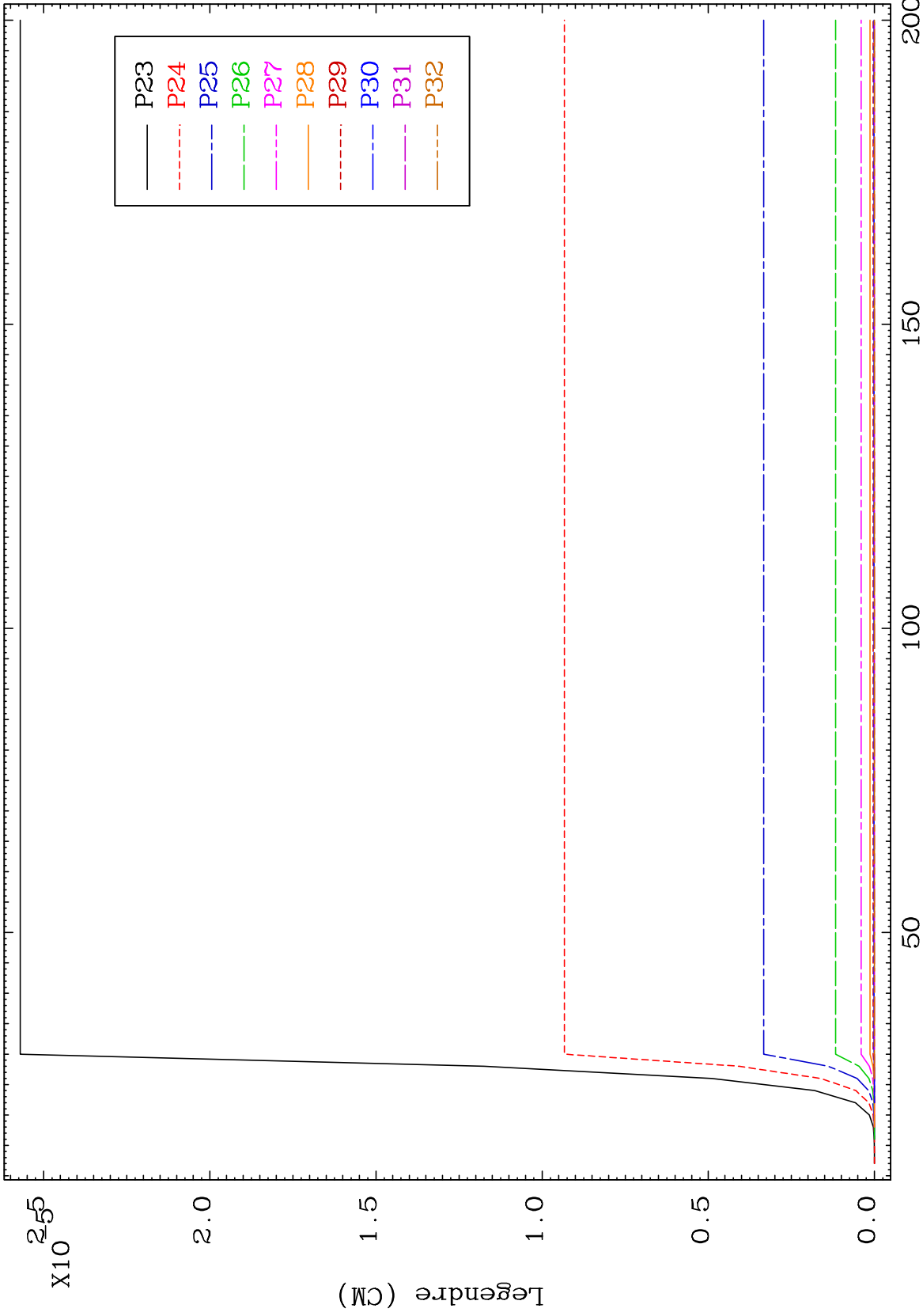

77

Incident Energy (MeV)

29-Cu-72

MAT 2952 MT= 72 (n,n') Level Legendre Coefficients 29-Cu-72

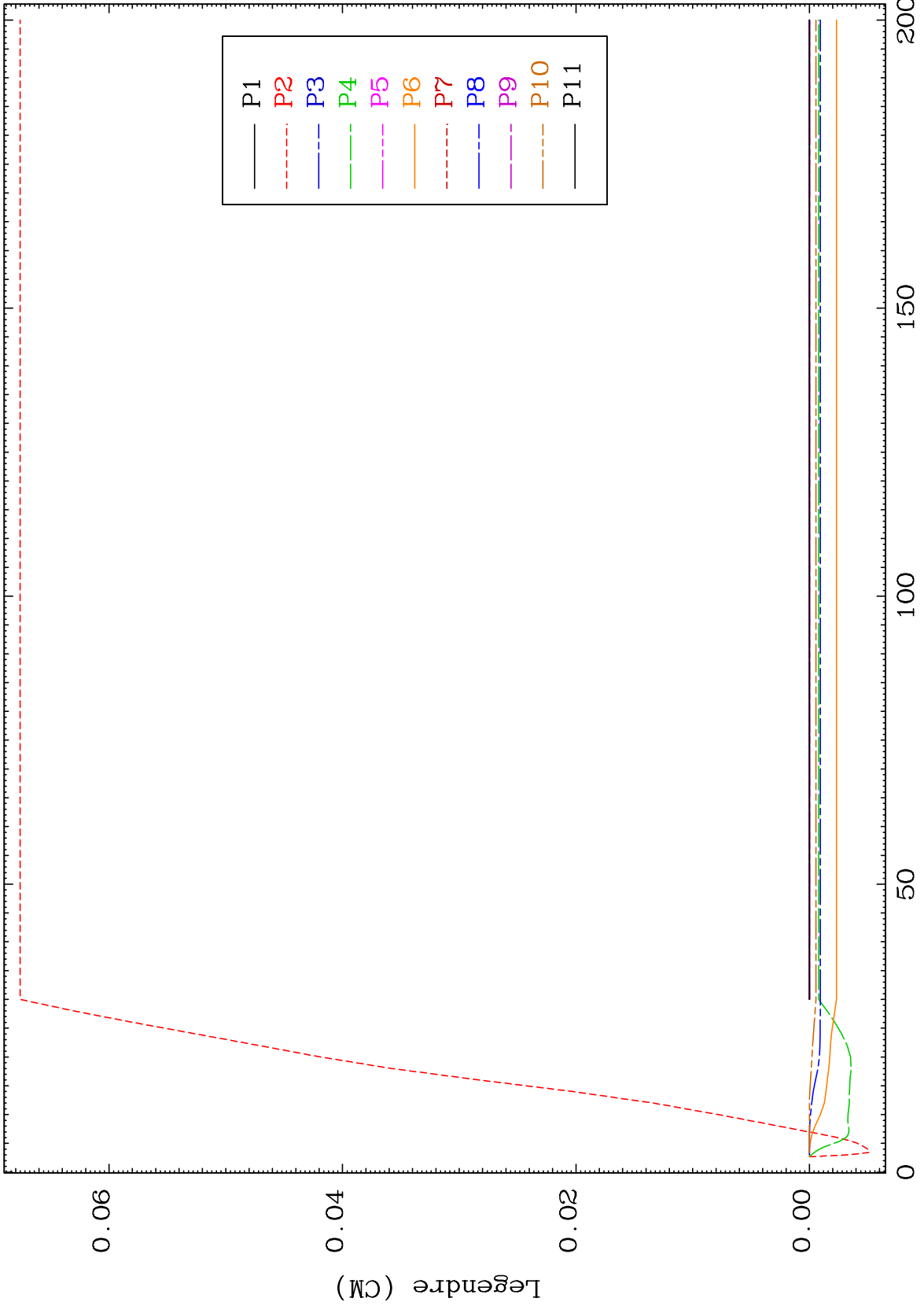

78 Incident Energy (MeV) 29-Cu-72

MAT 2952

MT= 72 (n,n') Level  
Legendre Coefficients

29-Cu-72

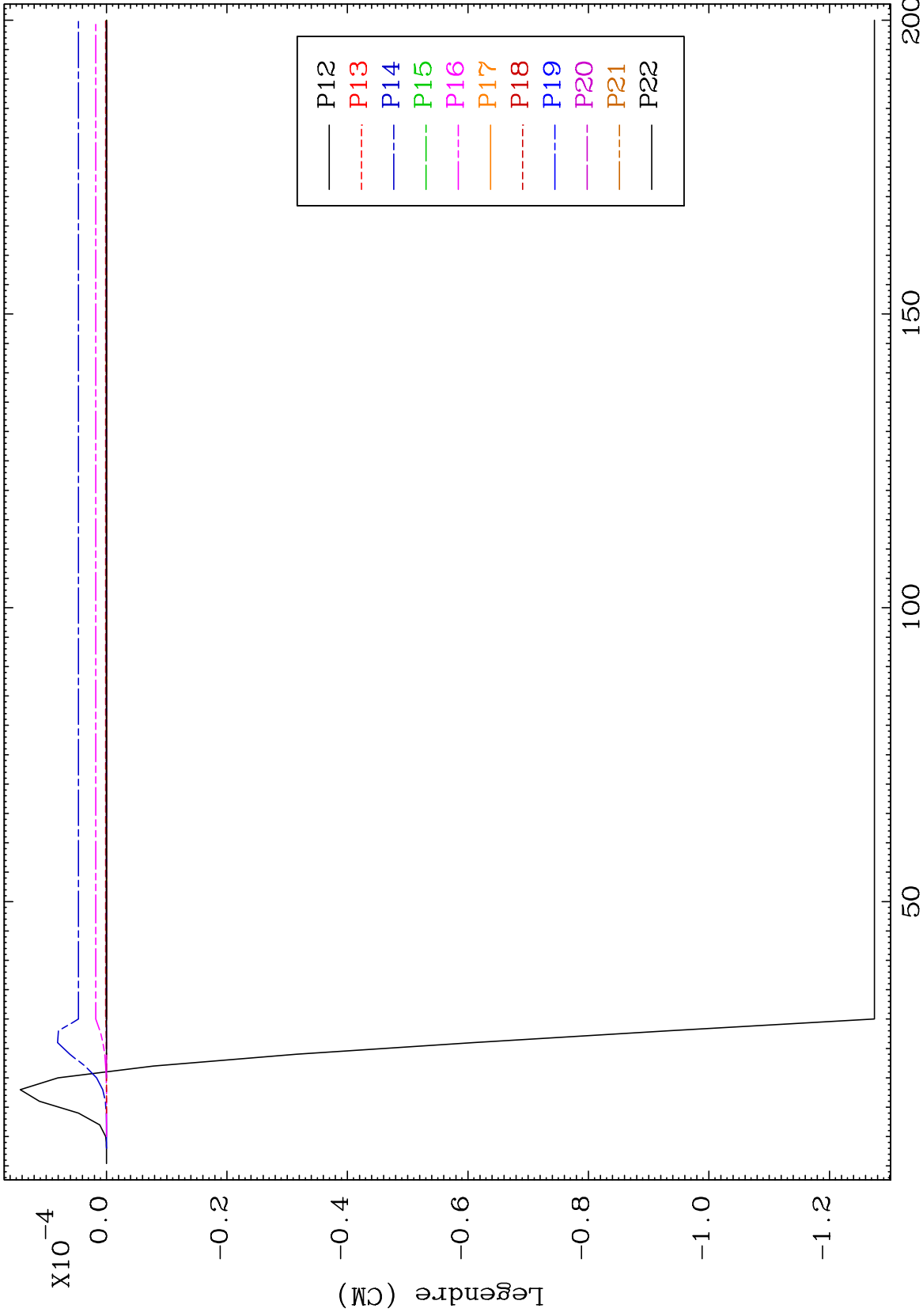

79

Incident Energy (MeV)

29-Cu-72

MAT 2952

MT= 73 (n,n') Level  
Legendre Coefficients

29-Cu-72

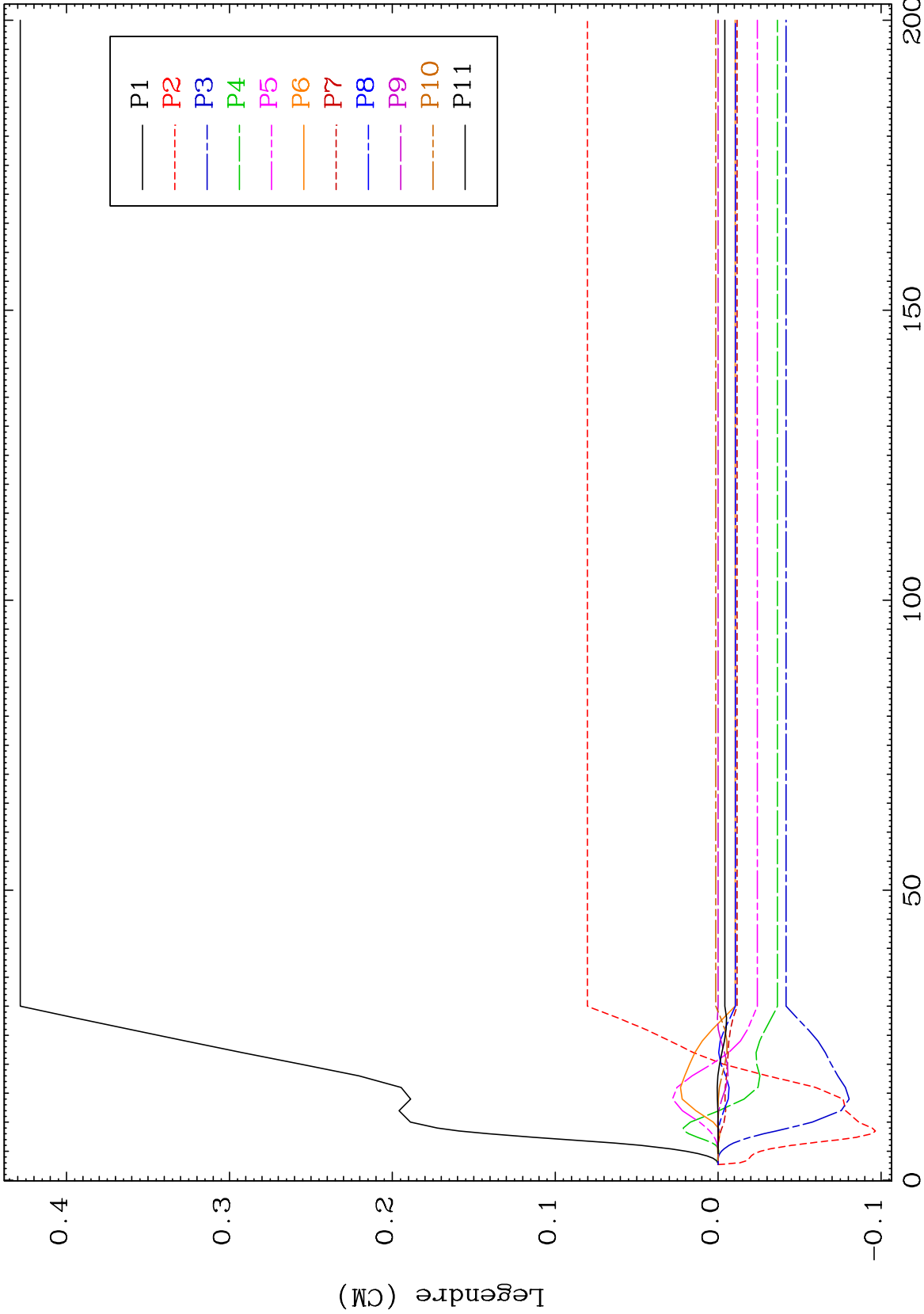

80

Incident Energy (MeV)

29-Cu-72

MAT 2952

MT= 73 (n,n') Level  
Legendre Coefficients

29-Cu-72

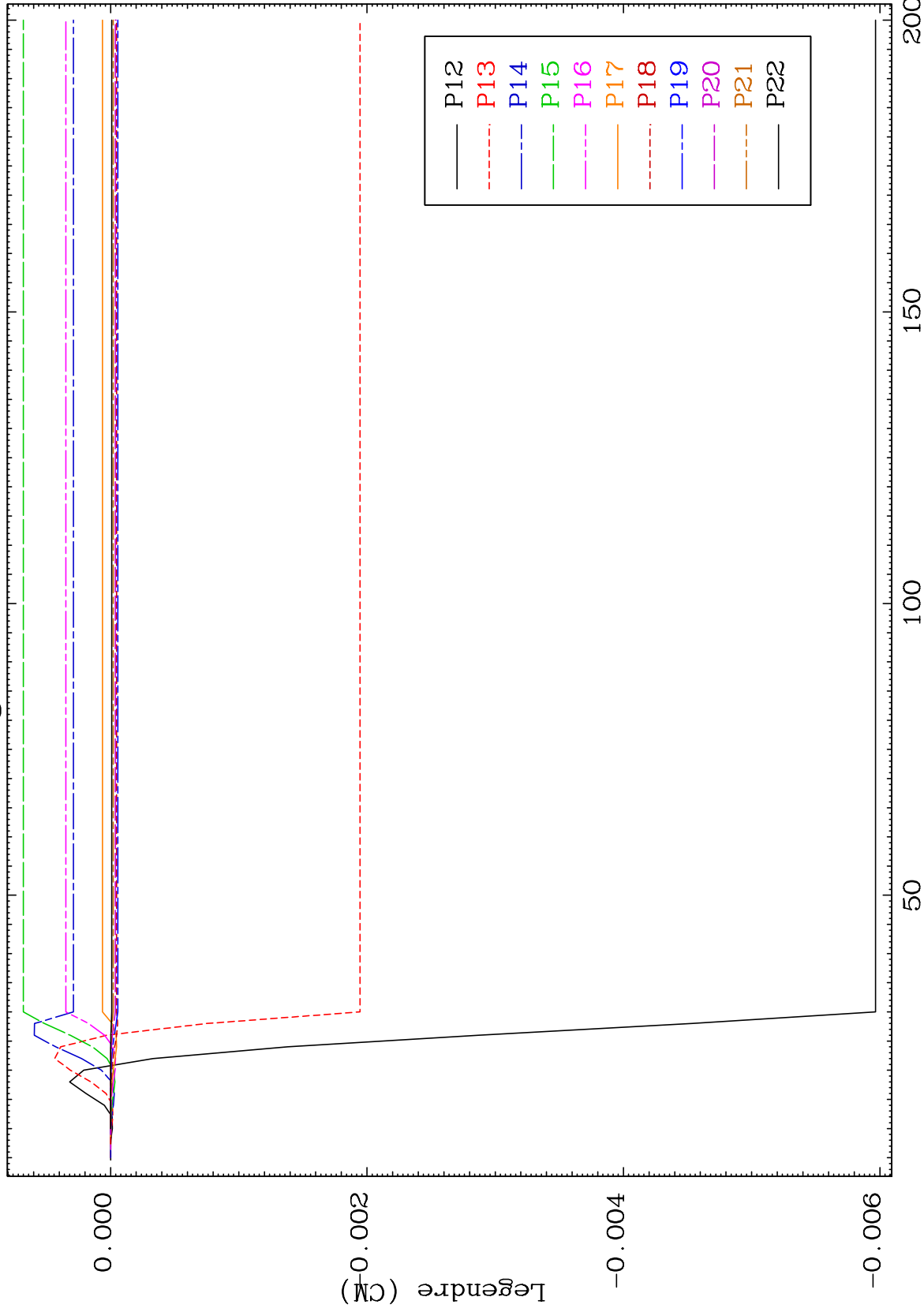

81

Incident Energy (MeV)

29-Cu-72

MAT 2952

MT= 73 (n,n') Level Legendre Coefficients

29-Cu-72

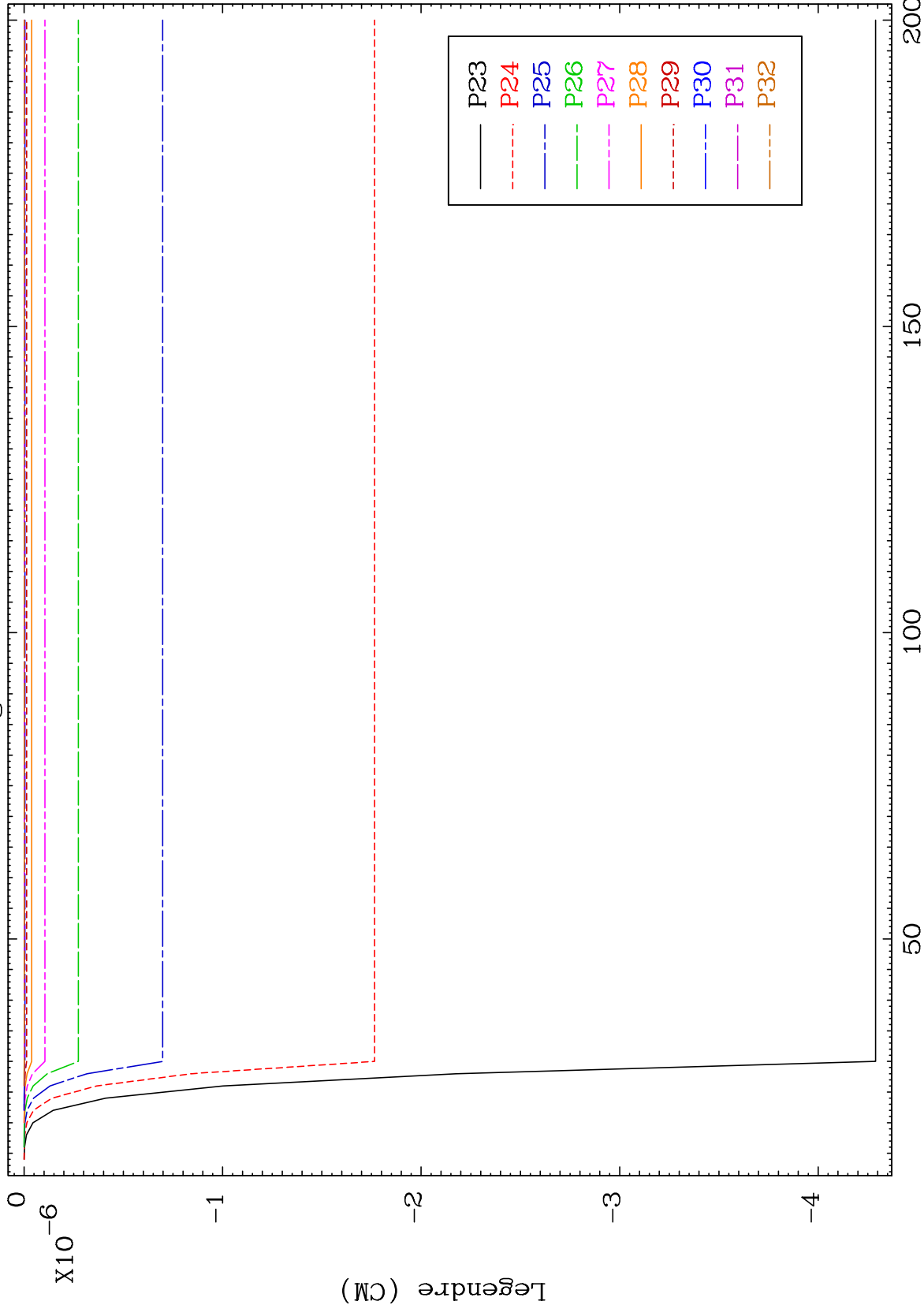

82

Incident Energy (MeV)

29-Cu-72

MAT 2952 MT= 74 (n,n') Level Legendre Coefficients 29-Cu-72

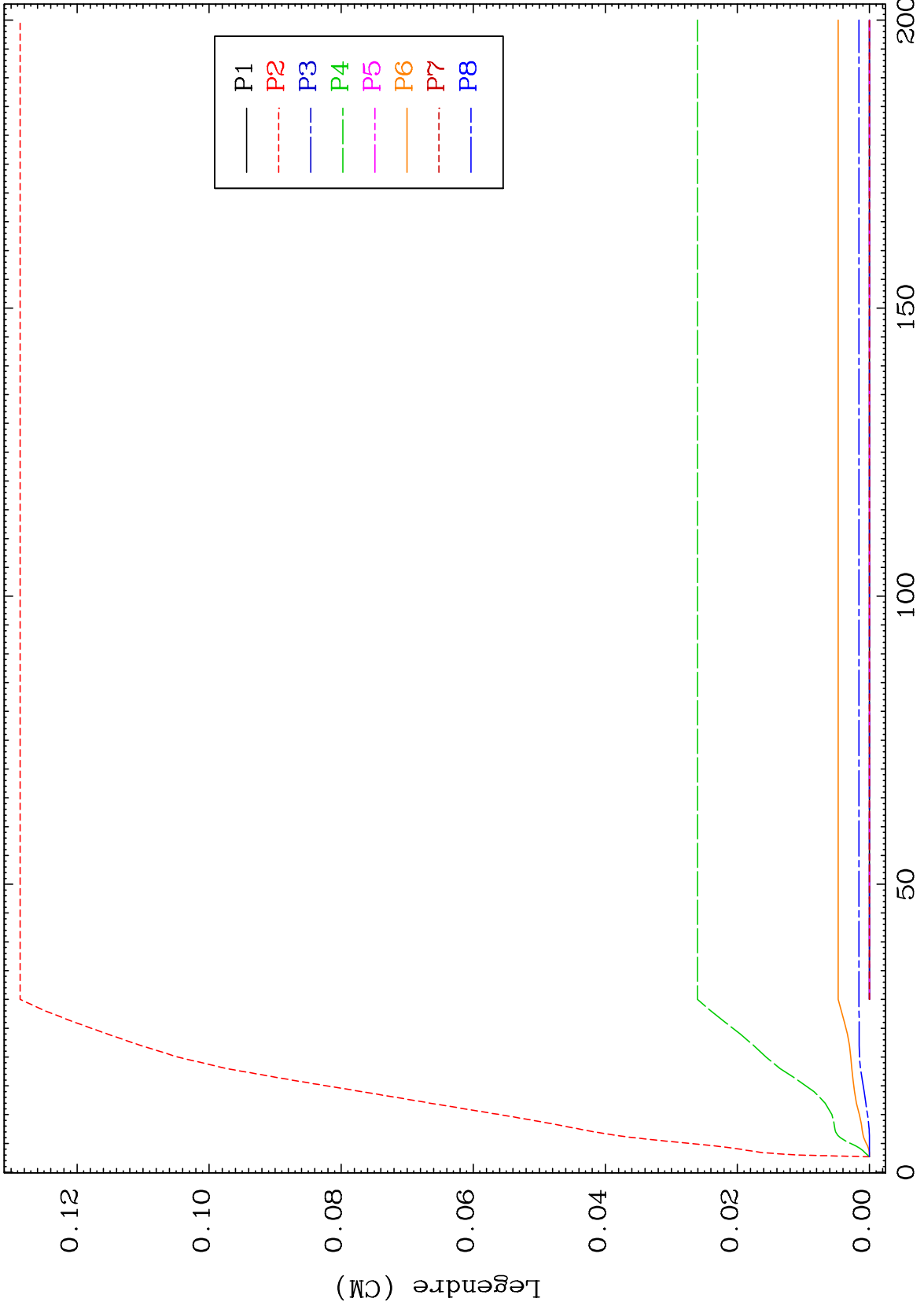

83

29-Cu-72

MAT 2952

MT= 74 (n,n') Level  
Legendre Coefficients

29-Cu-72

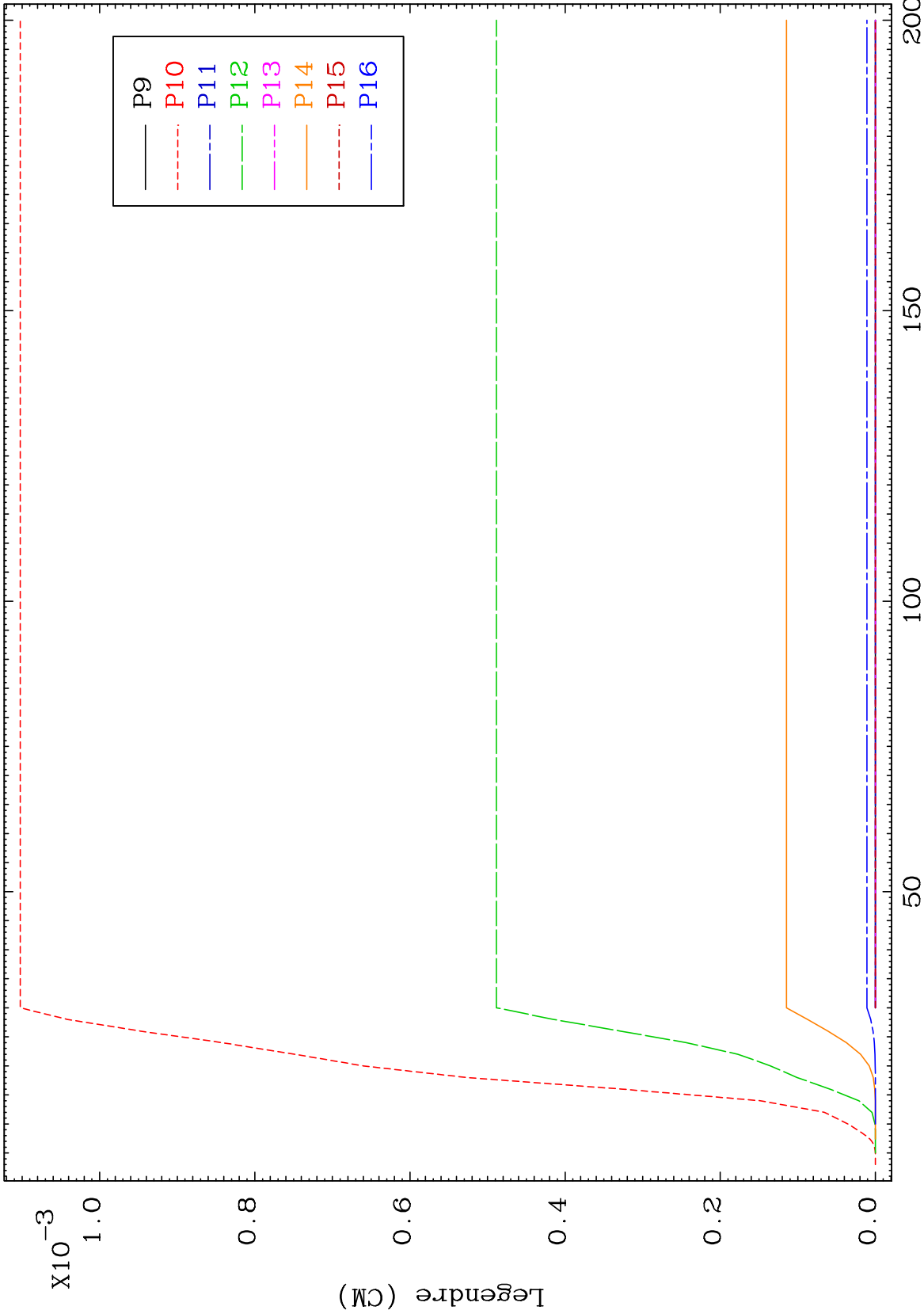

84

Incident Energy (MeV)

29-Cu-72

MAT 2952 MT= 74 (n,n') Level Legendre Coefficients 29-Cu-72

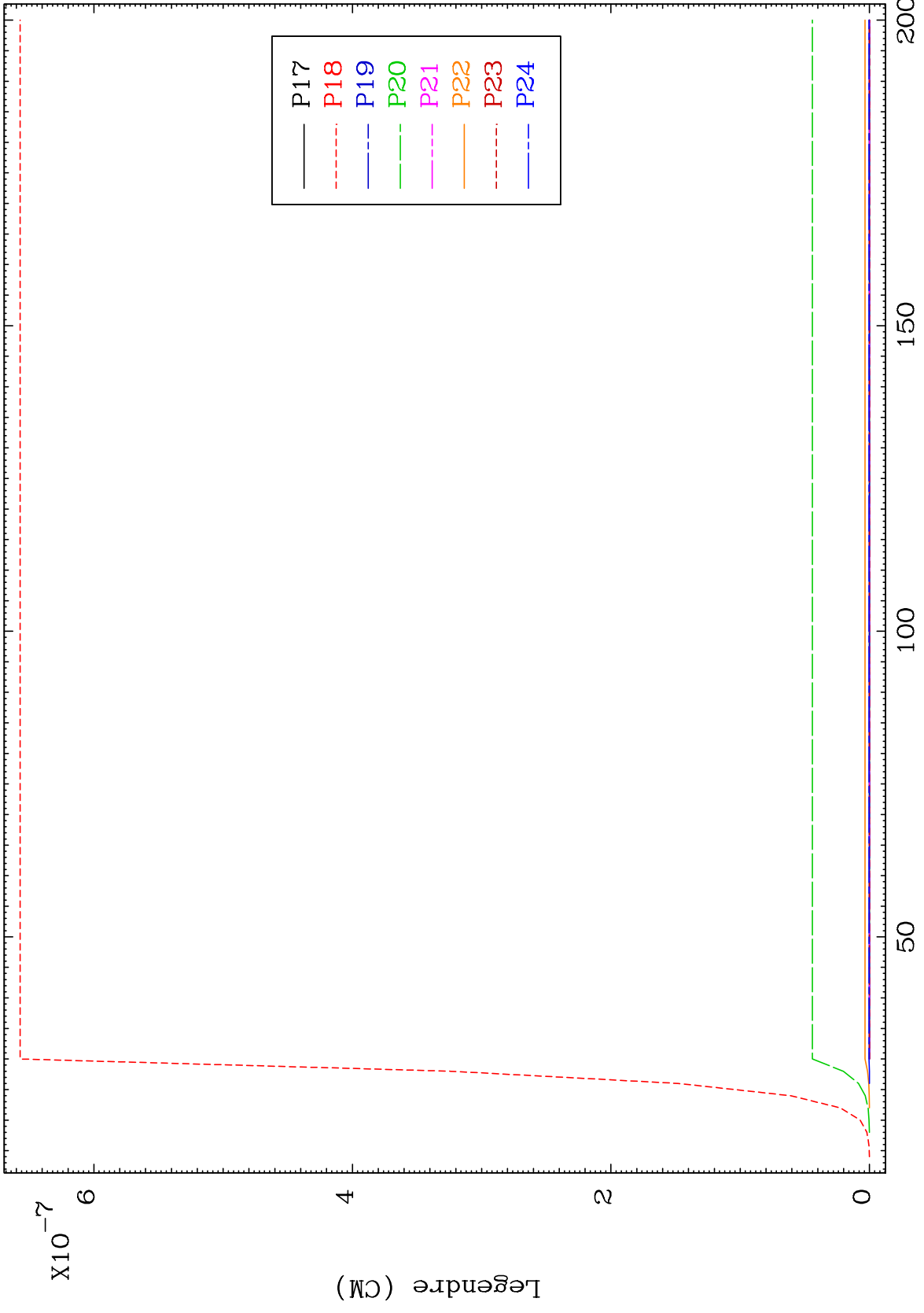

85 50 100 150 200 29-Cu-72

MAT 2952

MT= 75 (n,n') Level  
Legendre Coefficients

29-Cu-72

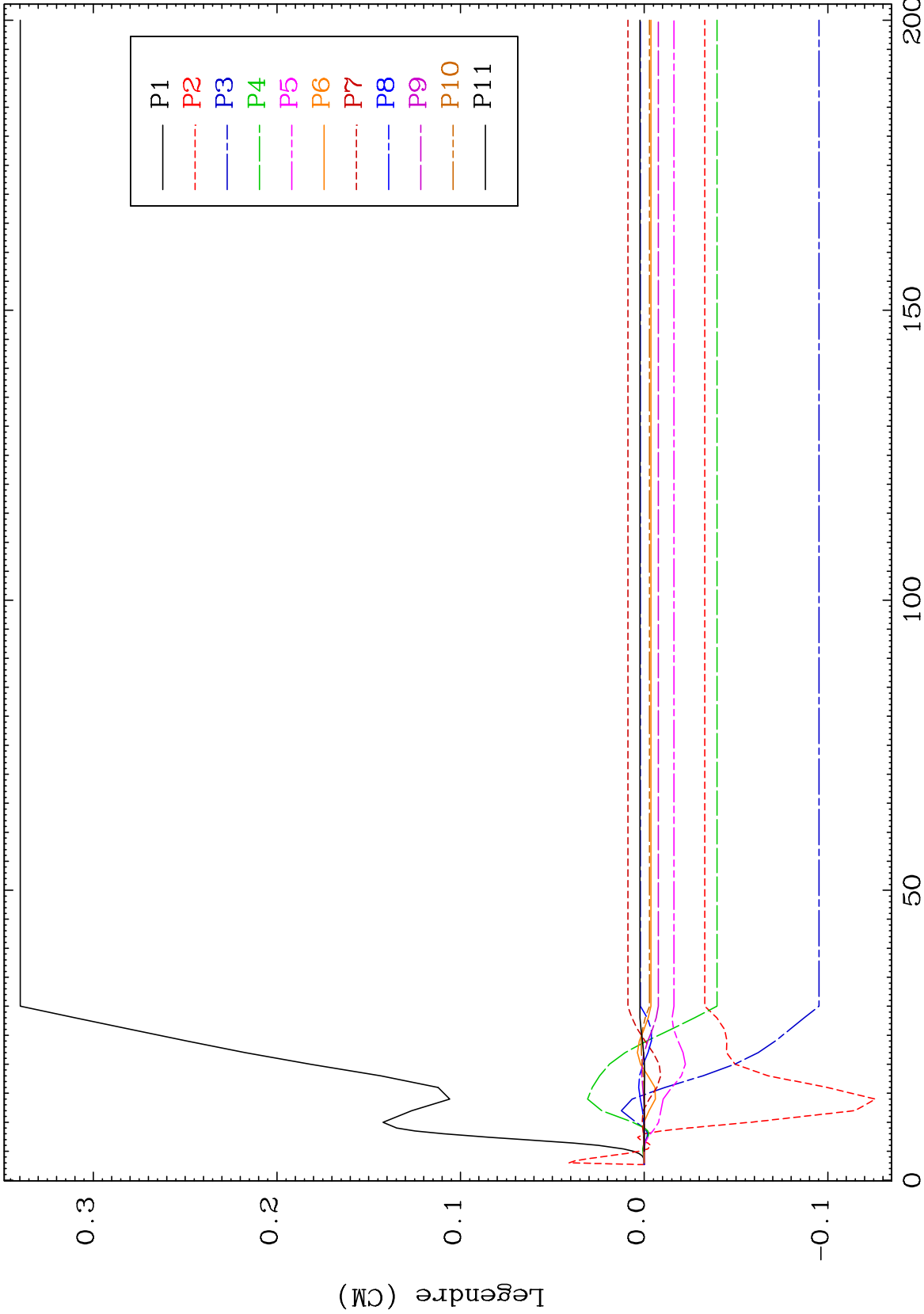

86

Incident Energy (MeV)

29-Cu-72

MAT 2952

MT= 75 (n,n') Level  
Legendre Coefficients

29-Cu-72

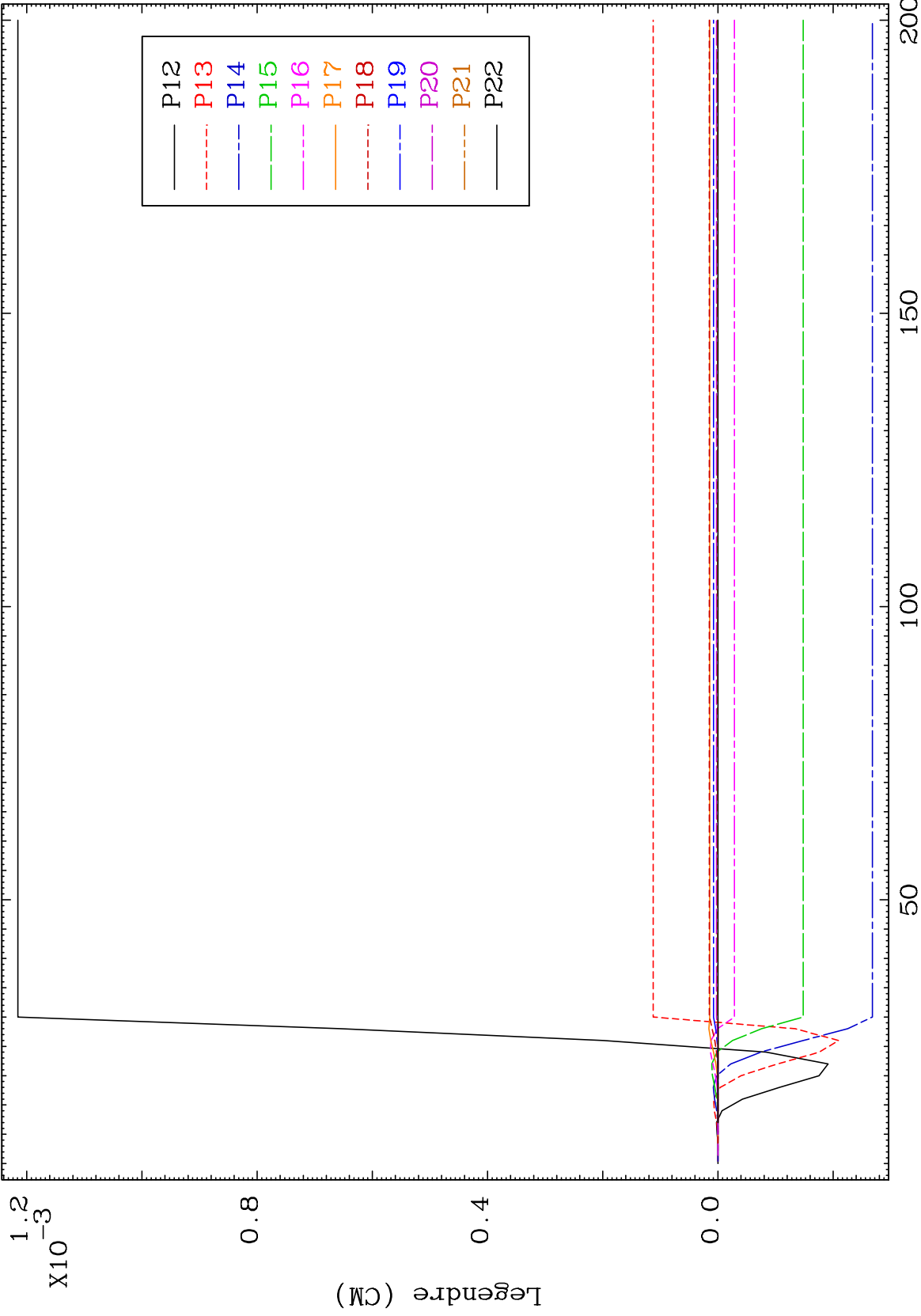

87

29-Cu-72

MAT 2952

MT= 75 (n,n') Level  
Legendre Coefficients

29-Cu-72

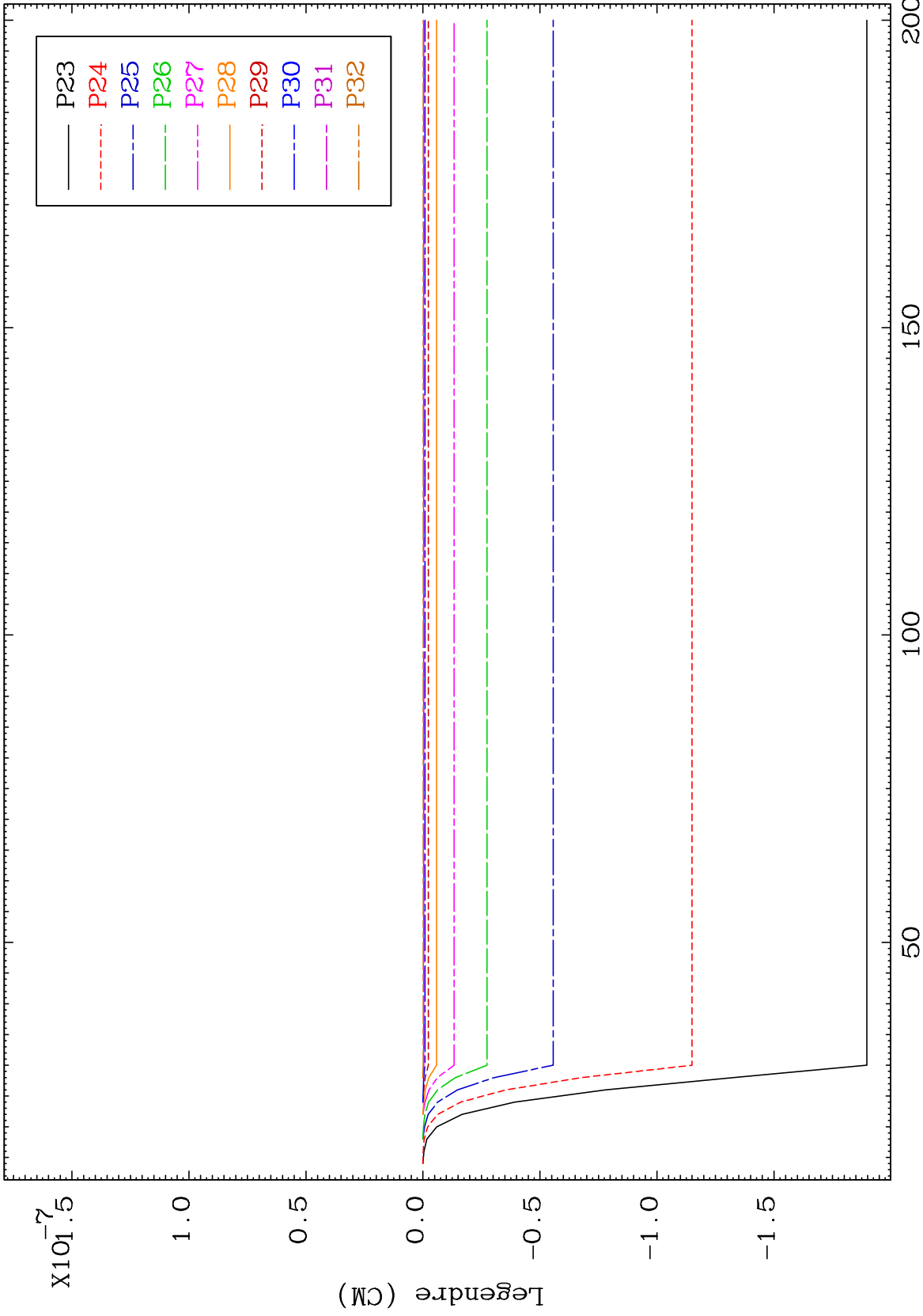

MAT 2952 MT= 76 (n,n') Level Legendre Coefficients 29-Cu-72

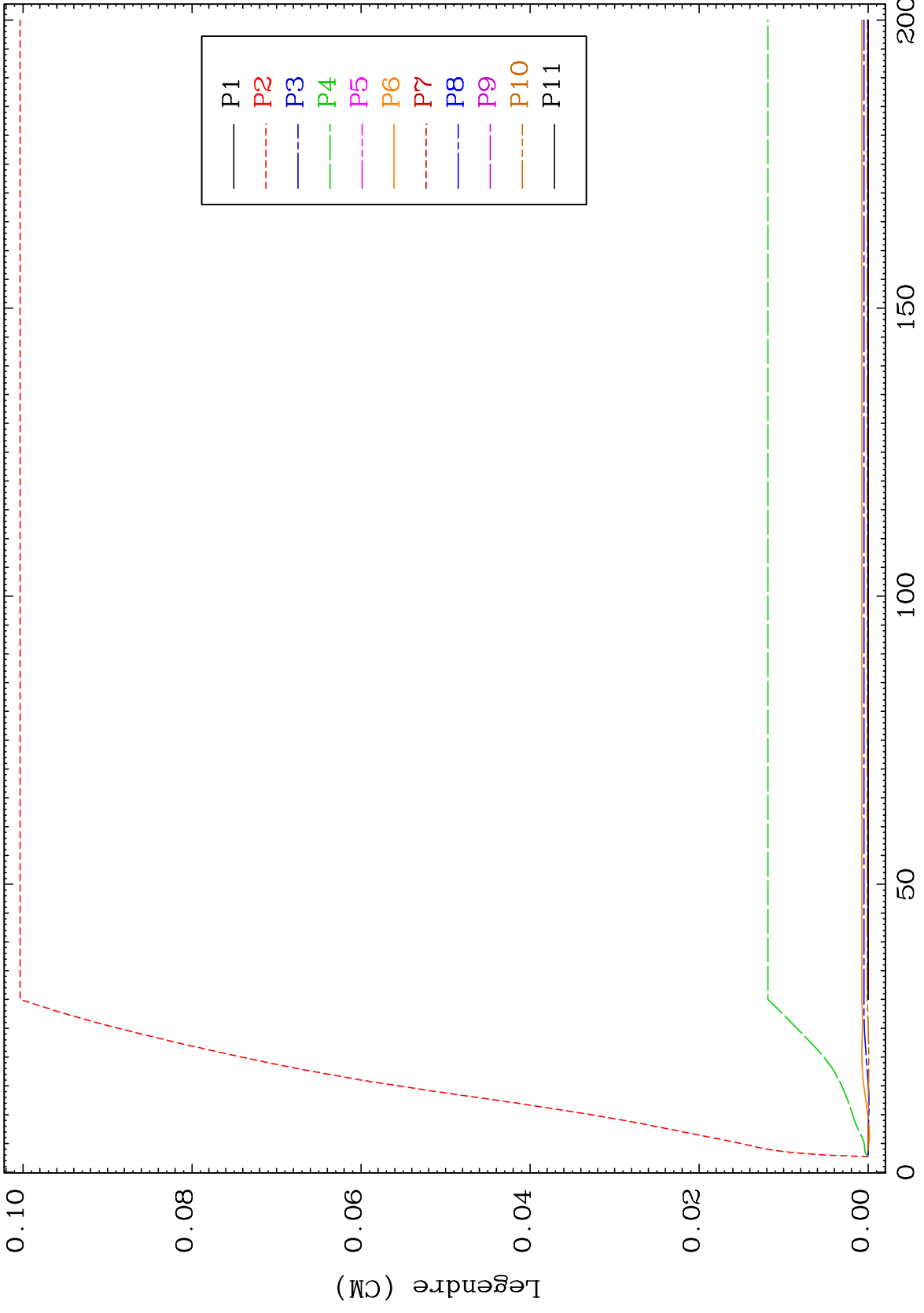

89 Incident Energy (MeV) 29-Cu-72

MAT 2952

MT= 76 (n,n') Level  
Legendre Coefficients

29-Cu-72

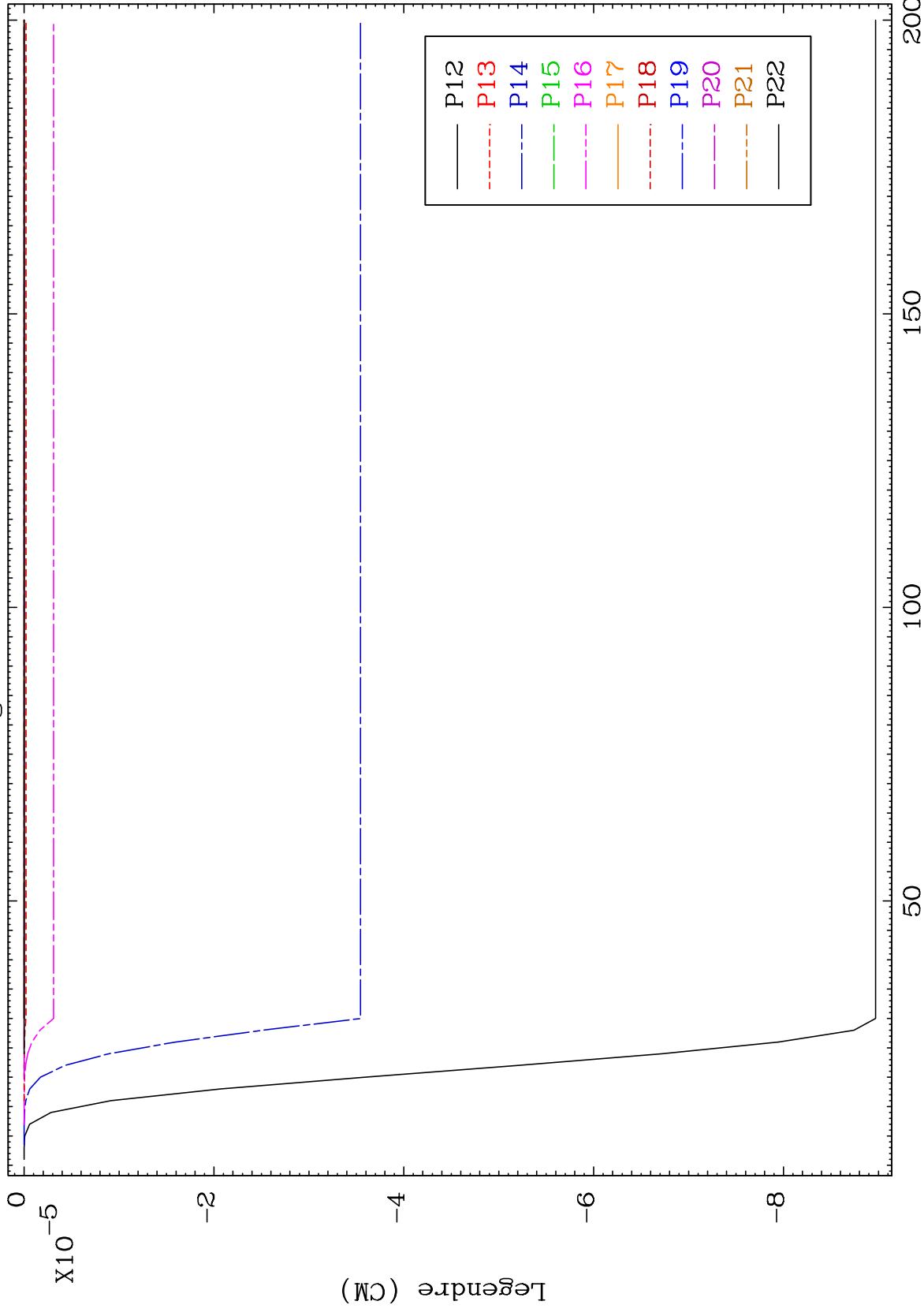

29-Cu-72

Incident Energy (MeV)

90

MAT 2952 MT= 77 (n,n') Level Legendre Coefficients

29-Cu-72

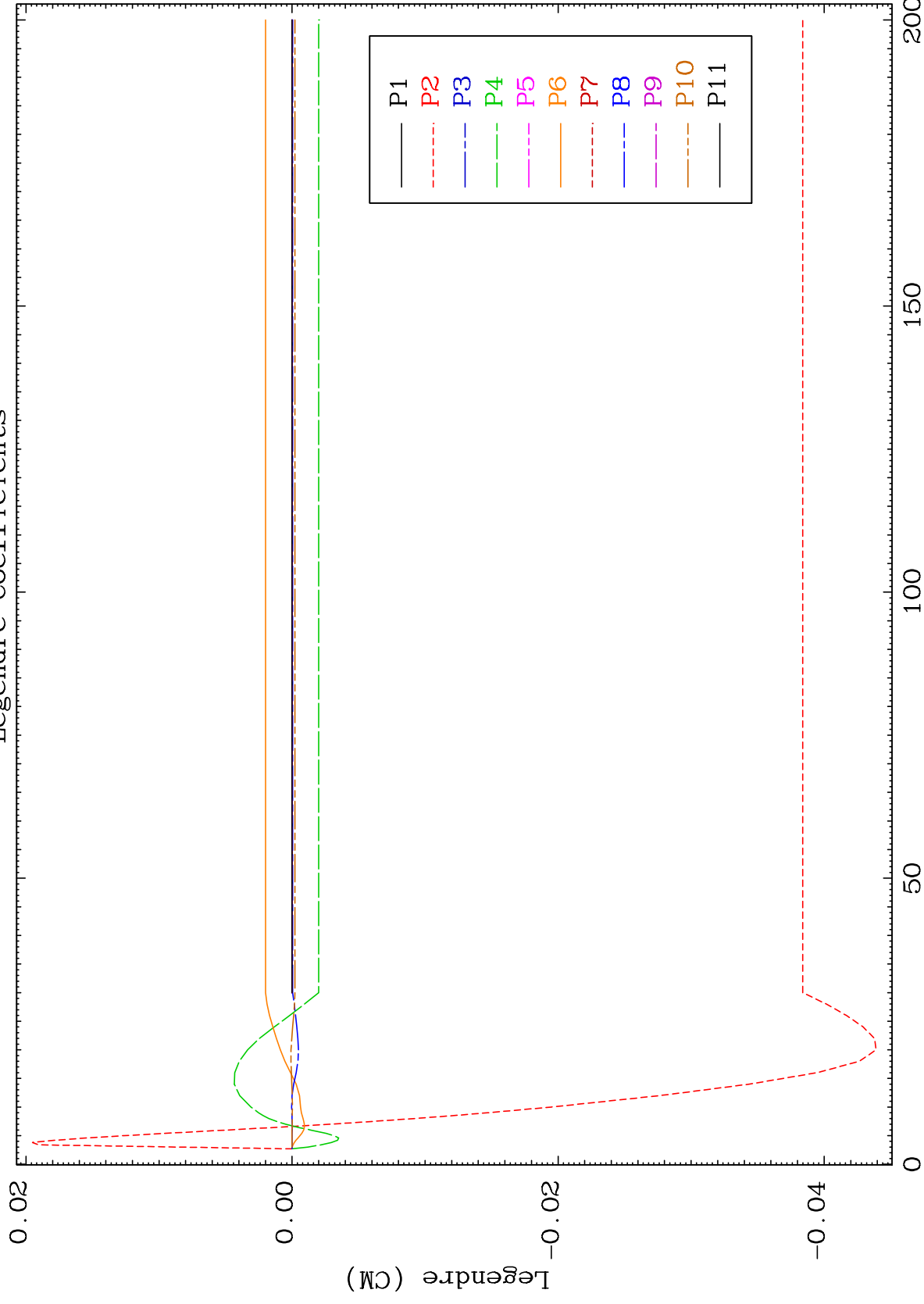

29-Cu-72

Incident Energy (MeV)

91

MAT 2952

MT= 77 (n,n') Level  
Legendre Coefficients

29-Cu-72

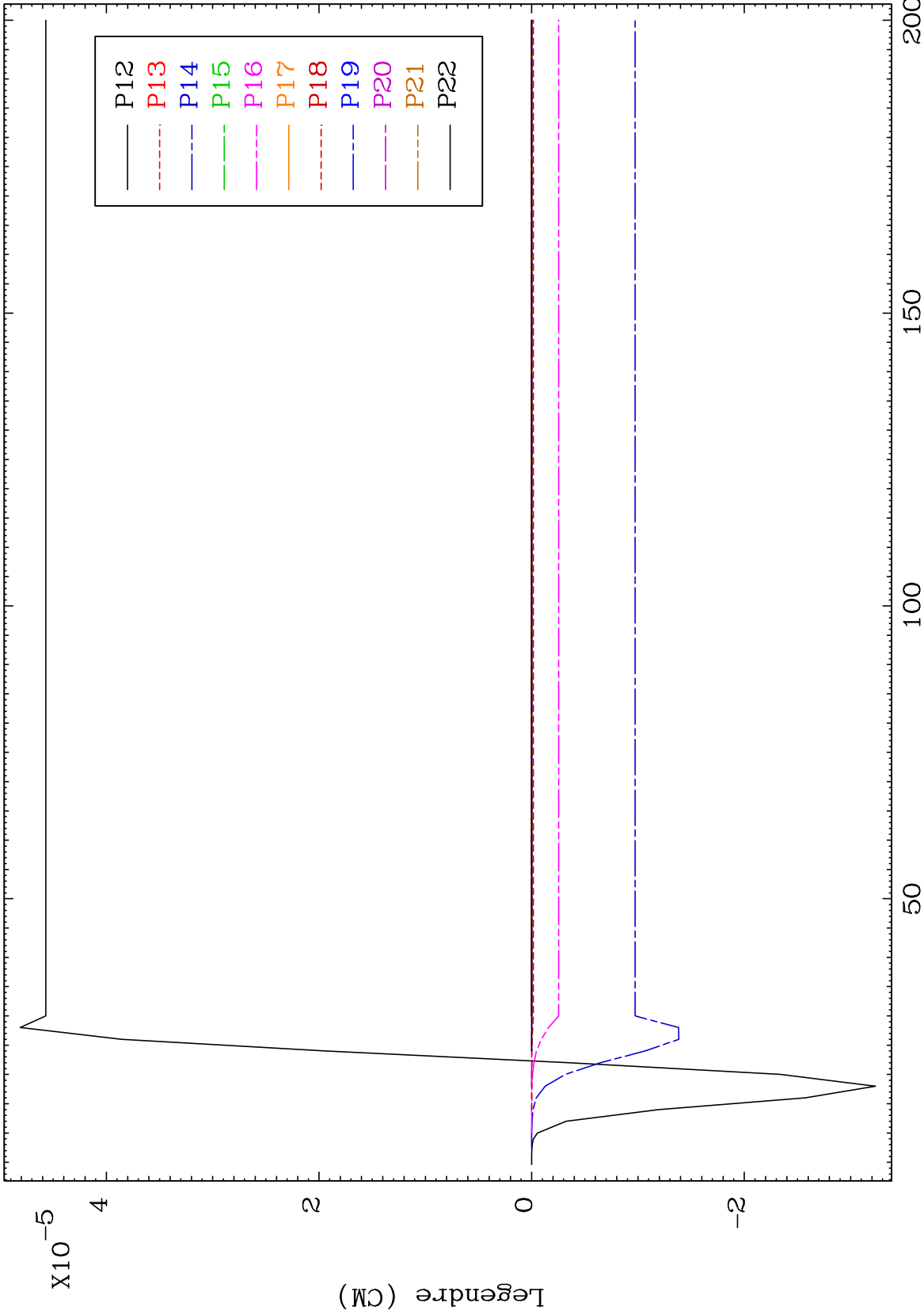

92

Incident Energy (MeV)

29-Cu-72

MAT 2952

MT= 78 (n,n') Level  
Legendre Coefficients

29-Cu-72

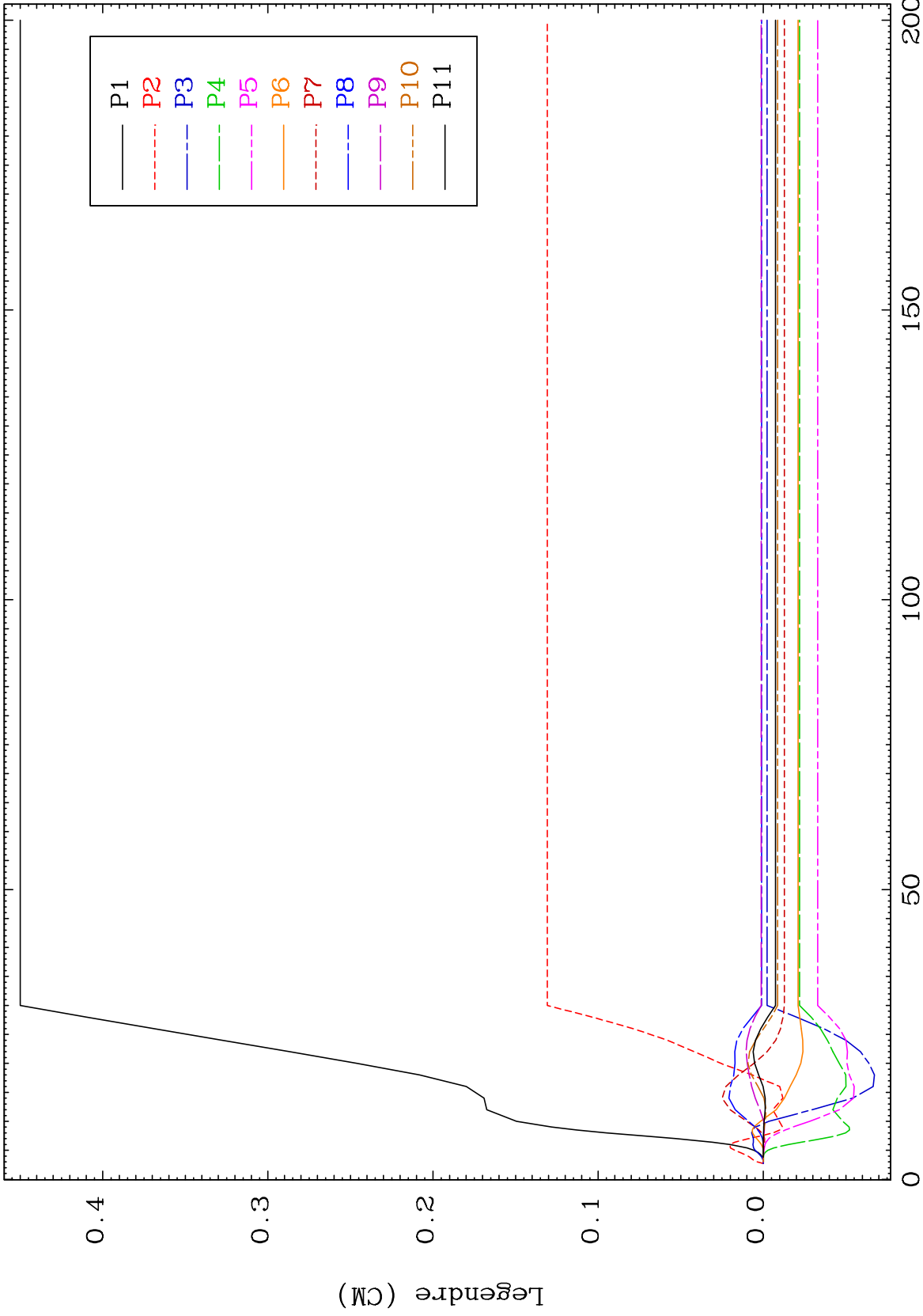

93

Incident Energy (MeV)

29-Cu-72

MAT 2952 MT= 78 (n,n') Level Legendre Coefficients 29-Cu-72

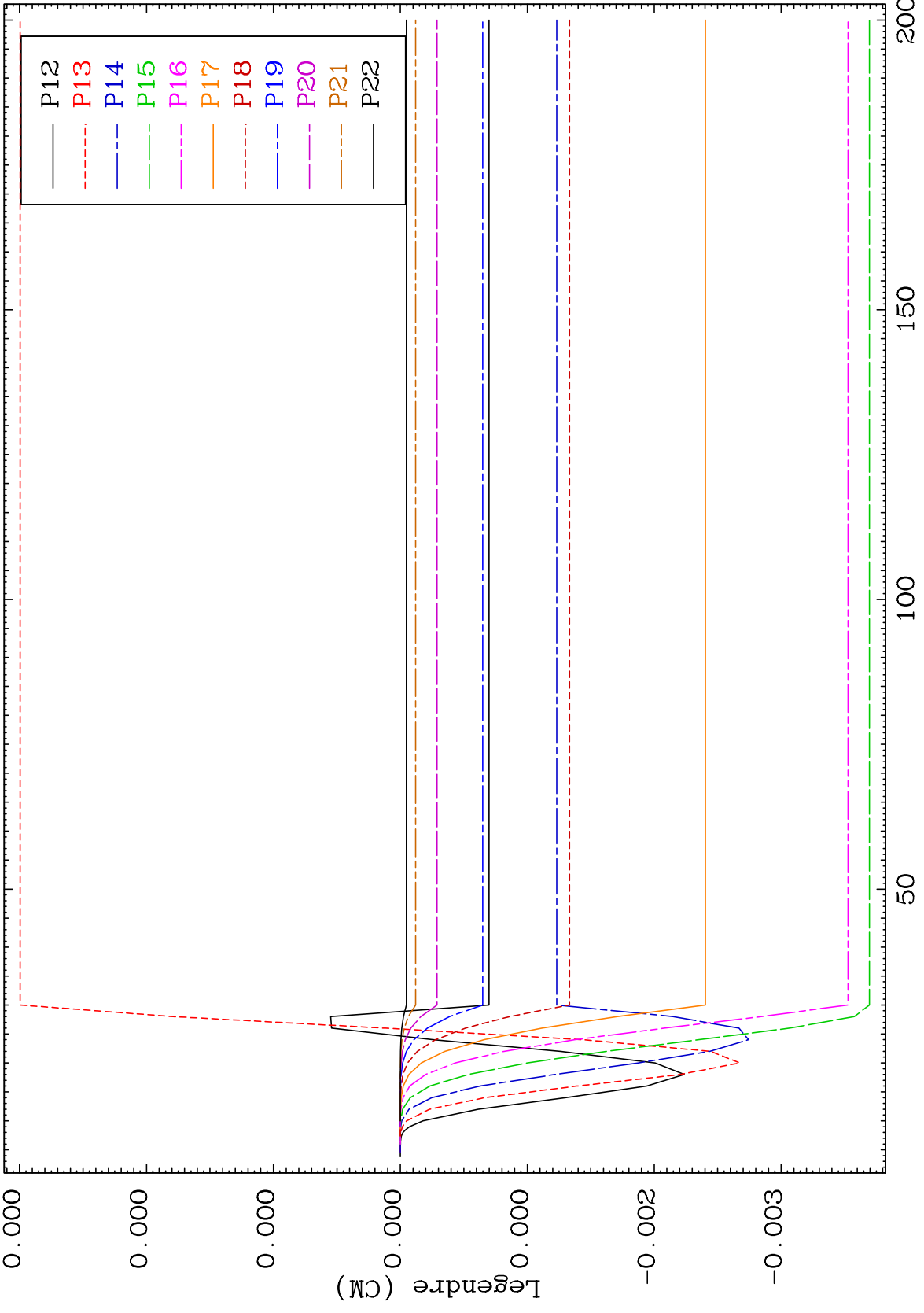

MAT 2952

MT= 78 (n,n') Level Legendre Coefficients

29-Cu-72

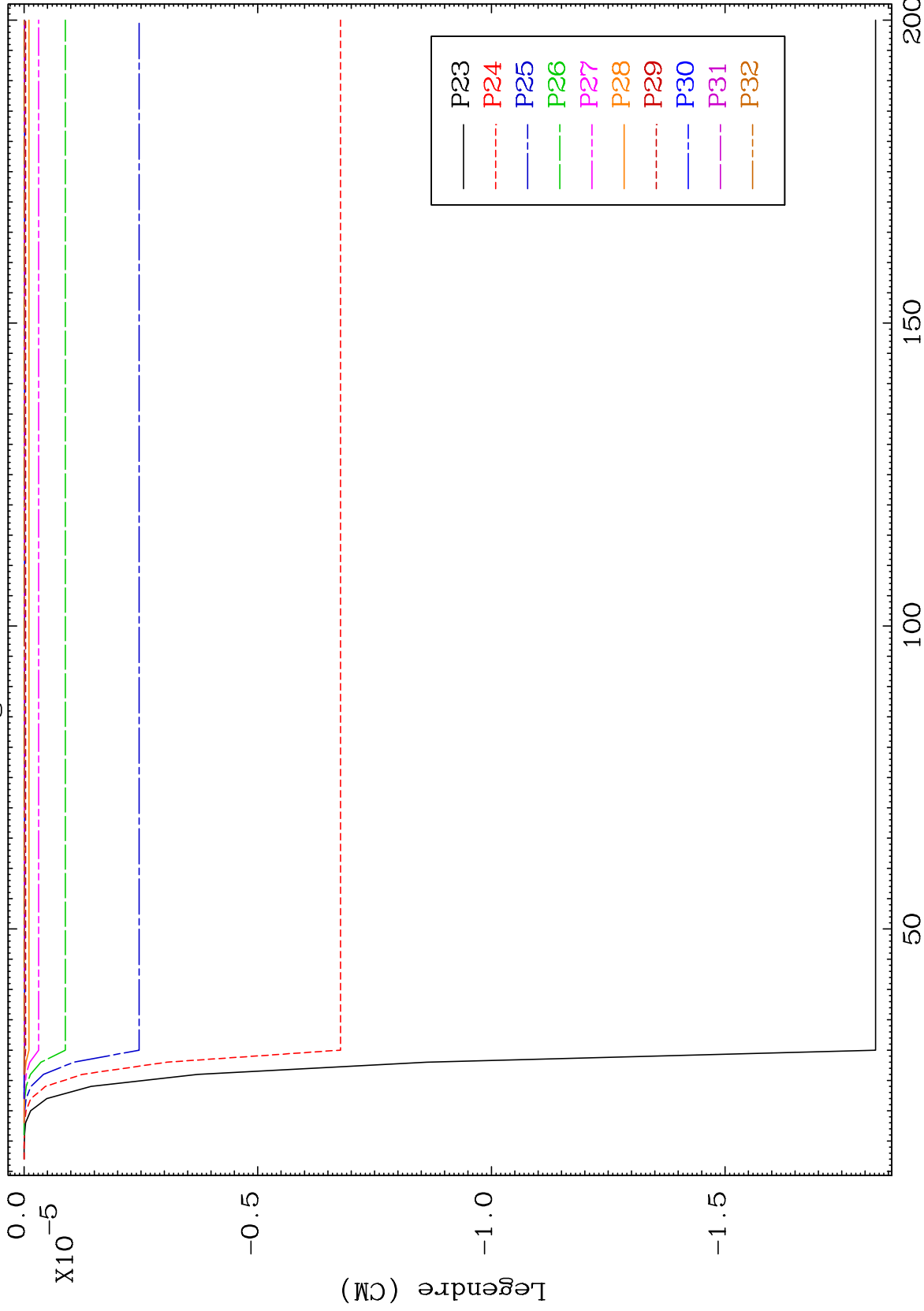

29-Cu-72

Incident Energy (MeV)

95

MAT 2952 MT= 79 (n,n') Level Legendre Coefficients 29-Cu-72

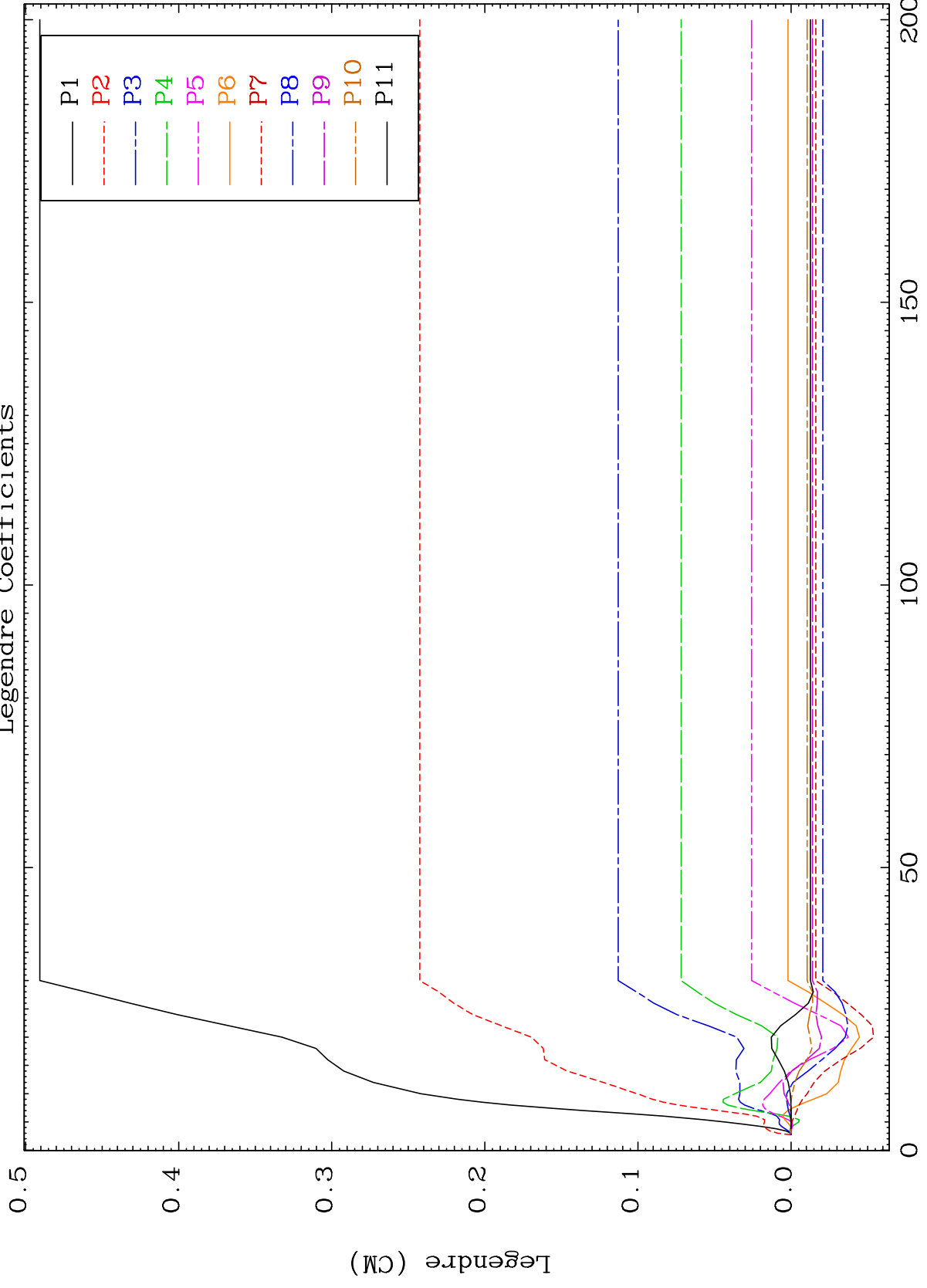

96 Incident Energy (MeV) 29-Cu-72

MAT 2952 MT= 79 (n,n') Level Legendre Coefficients 29-Cu-72

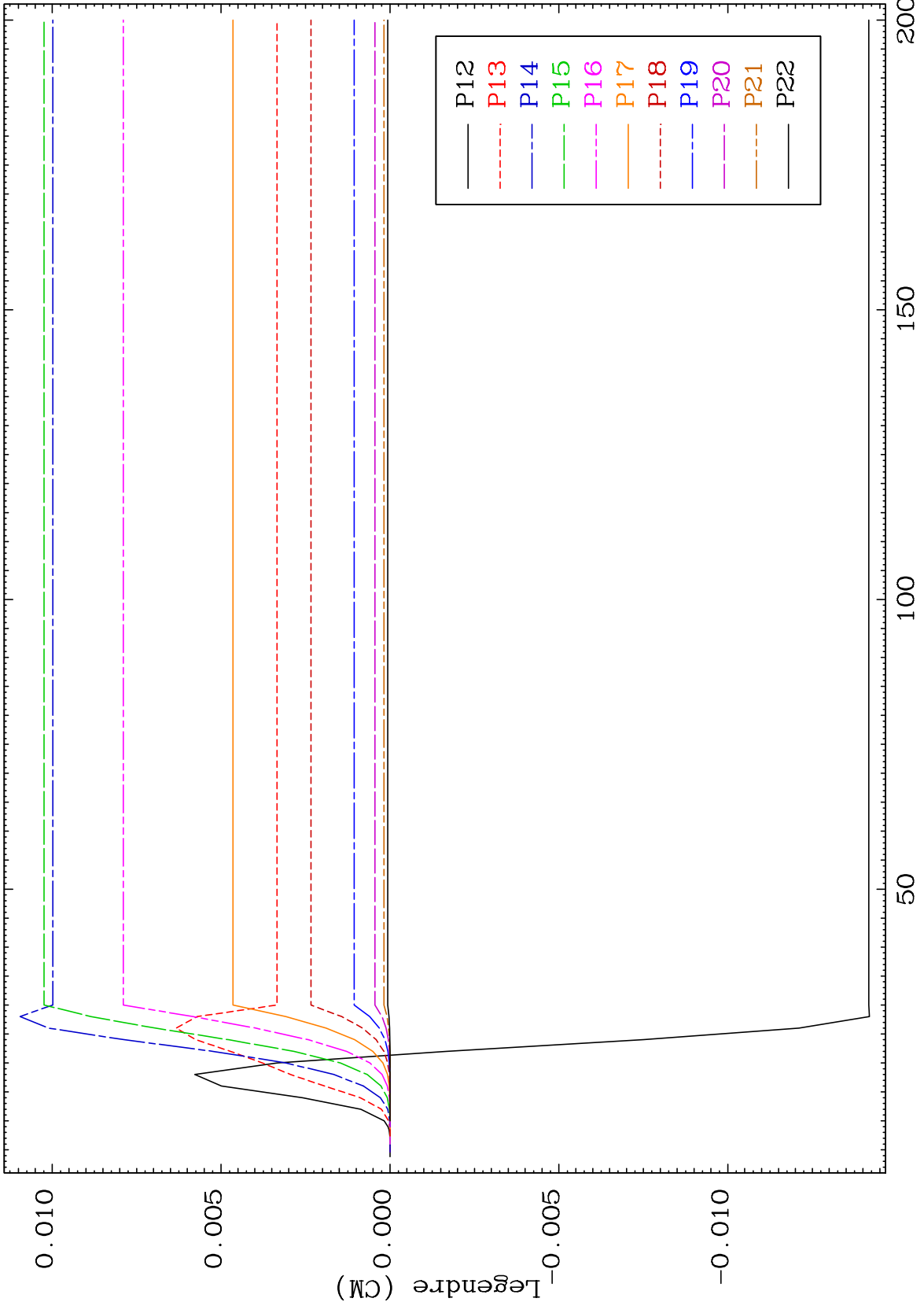

MAT 2952

MT= 79 (n,n') Level  
Legendre Coefficients

29-Cu-72

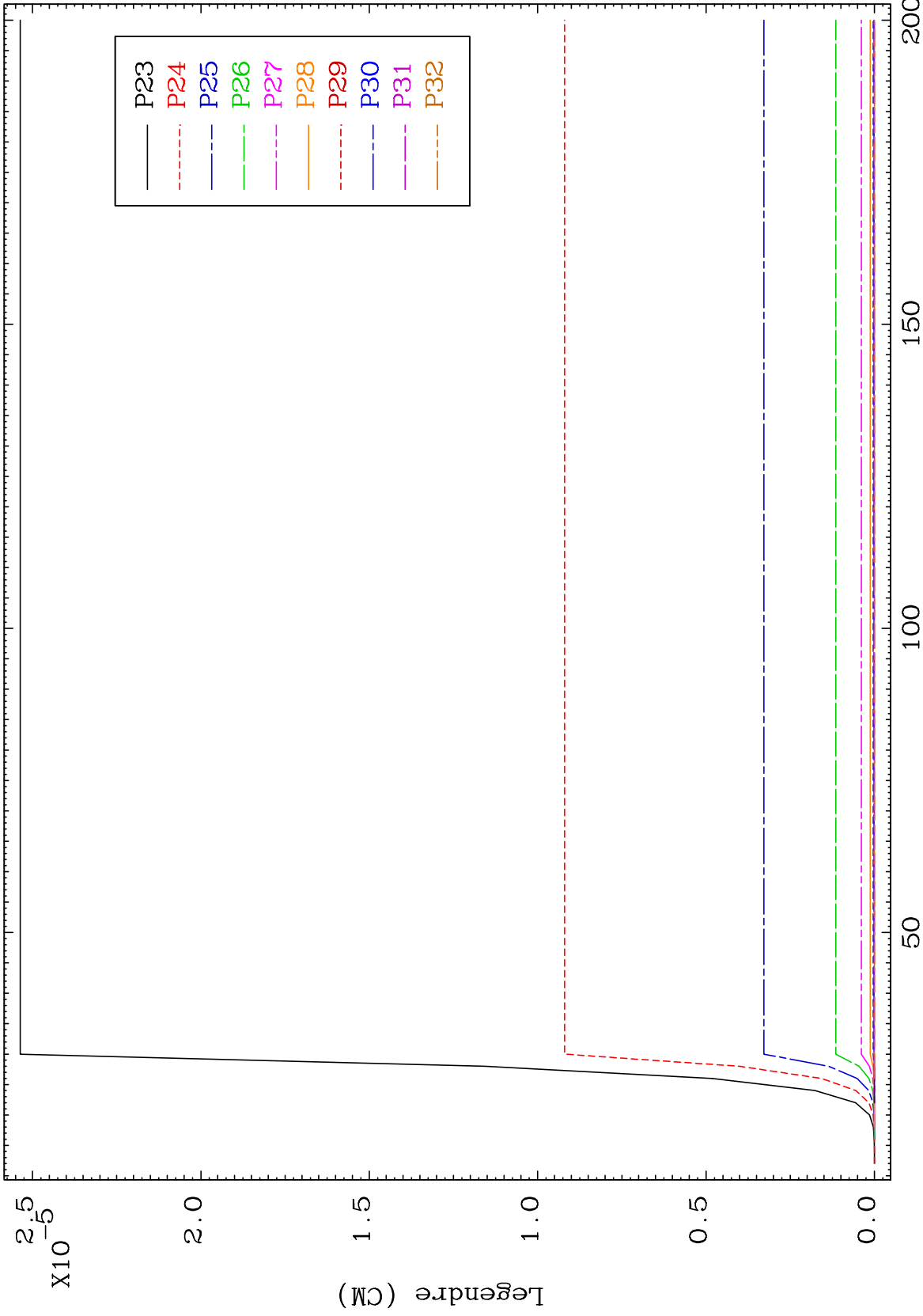

98

Incident Energy (MeV)

29-Cu-72

MAT 2952

29-Cu-72

(n,3n)  
Radionuclide Production Cross Section

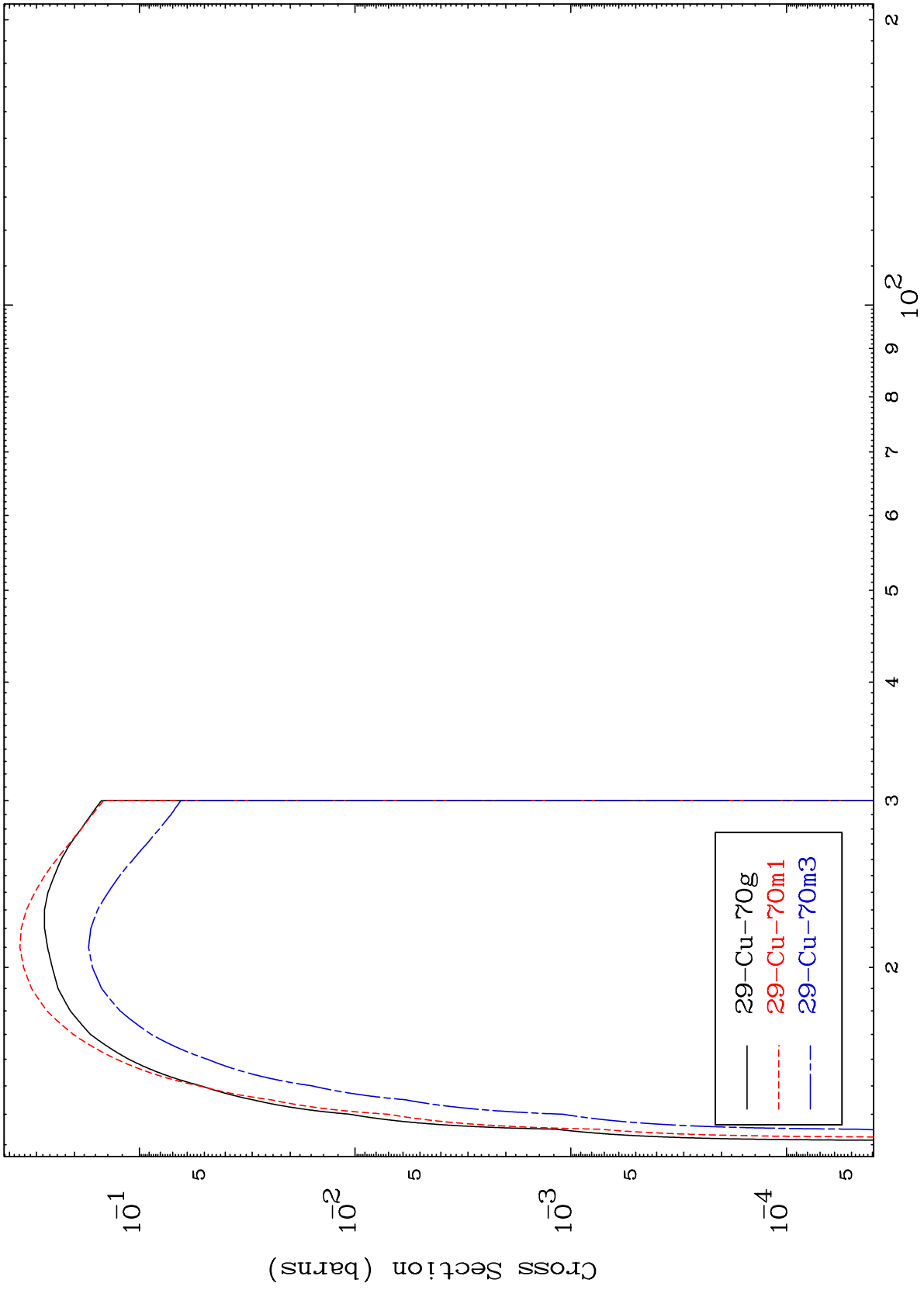

99

Incident Energy (MeV)

29-Cu-72

MAT 2952

(n,n')  $\alpha$

29-Cu-72

Radionuclide Production Cross Section

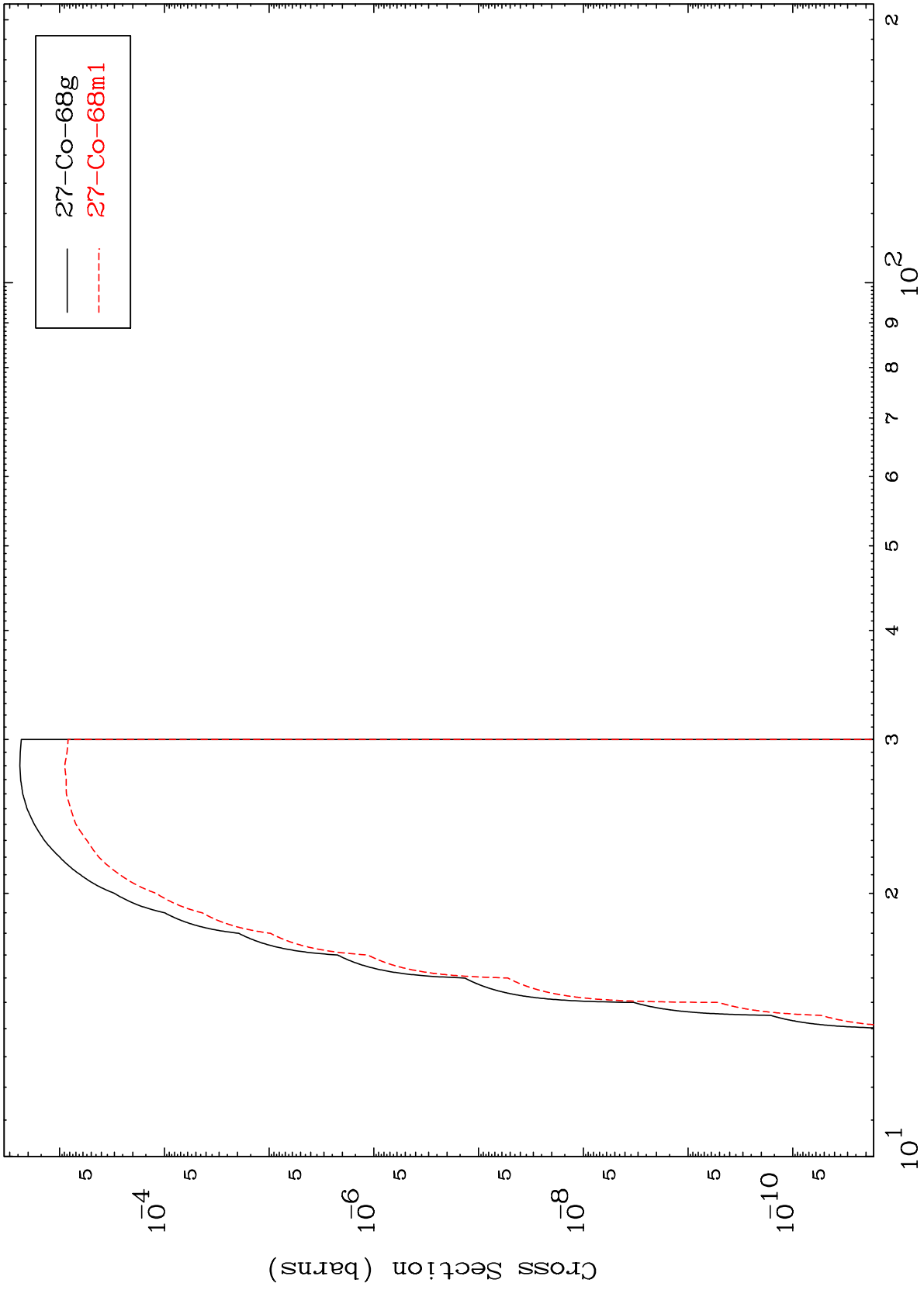

29-Cu-72

Incident Energy (MeV)

MAT 2952

(n,n') p

29-Cu-72

Radionuclide Production Cross Section

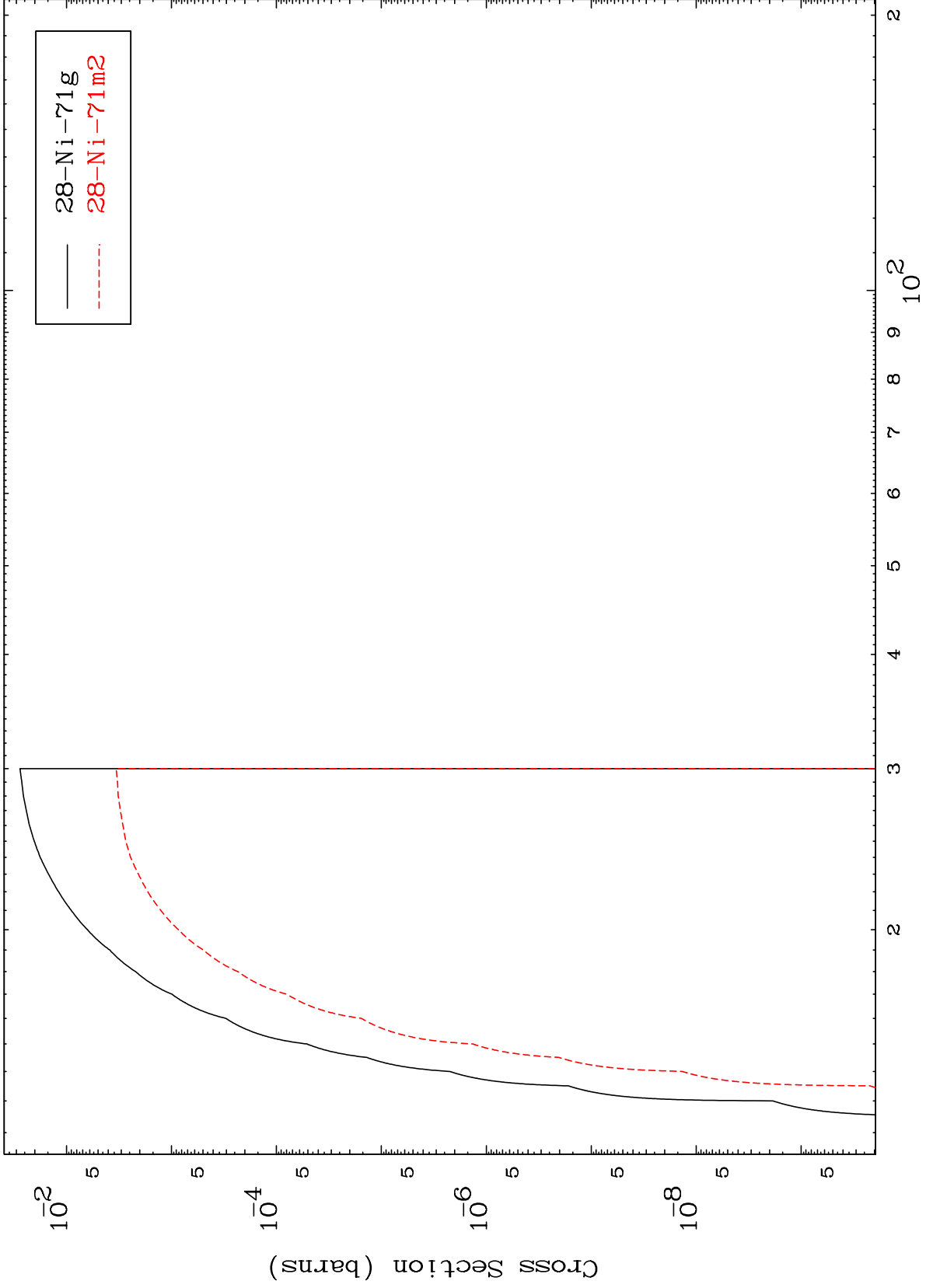

101

Incident Energy (MeV)

29-Cu-72

MAT 2952

(n,d)

29-Cu-72

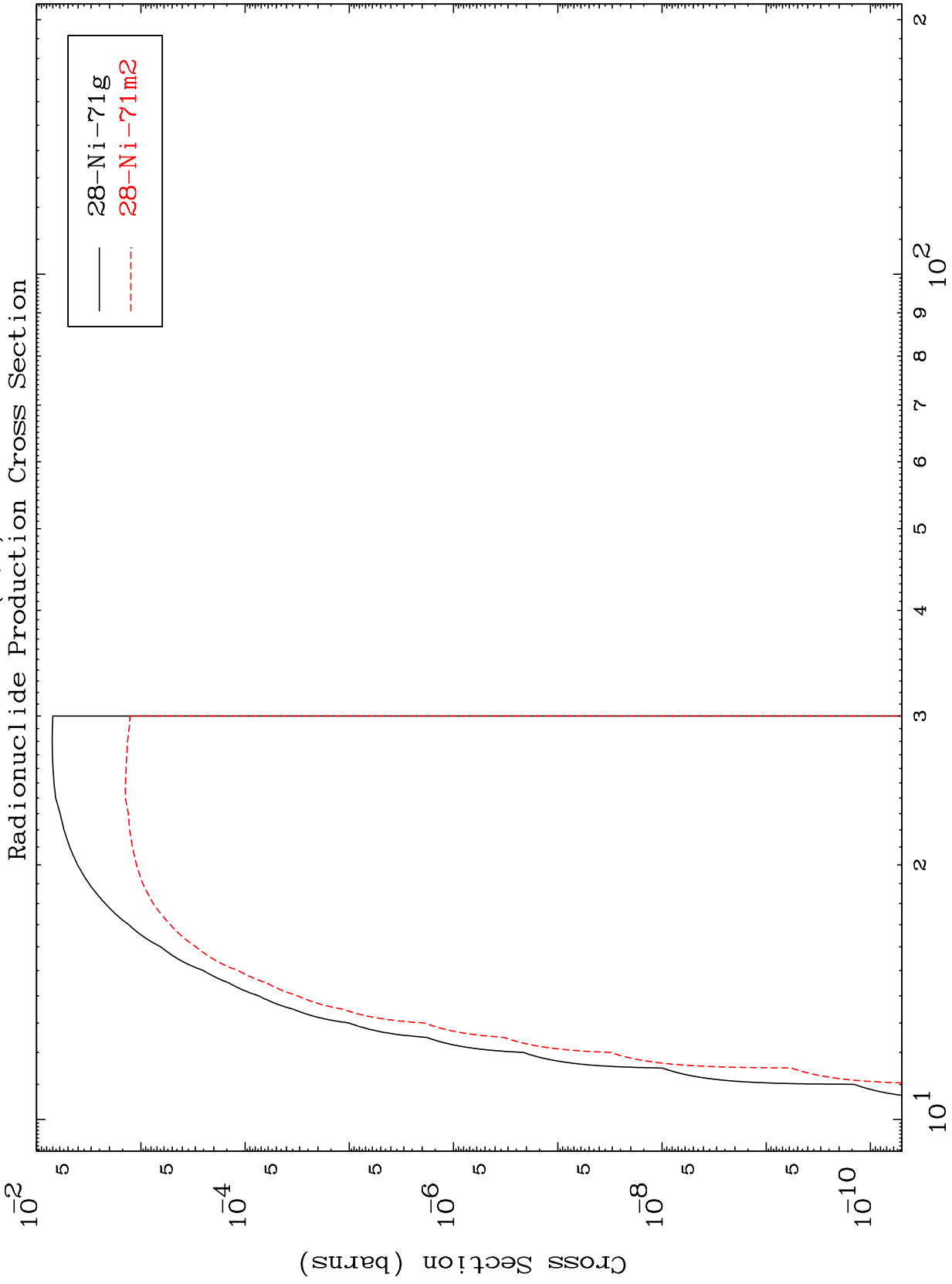

29-Cu-72

102