

DB257 NEUTRON ACER TENDL-2019 LIBRARY; T=293.16K
Principal cross sections

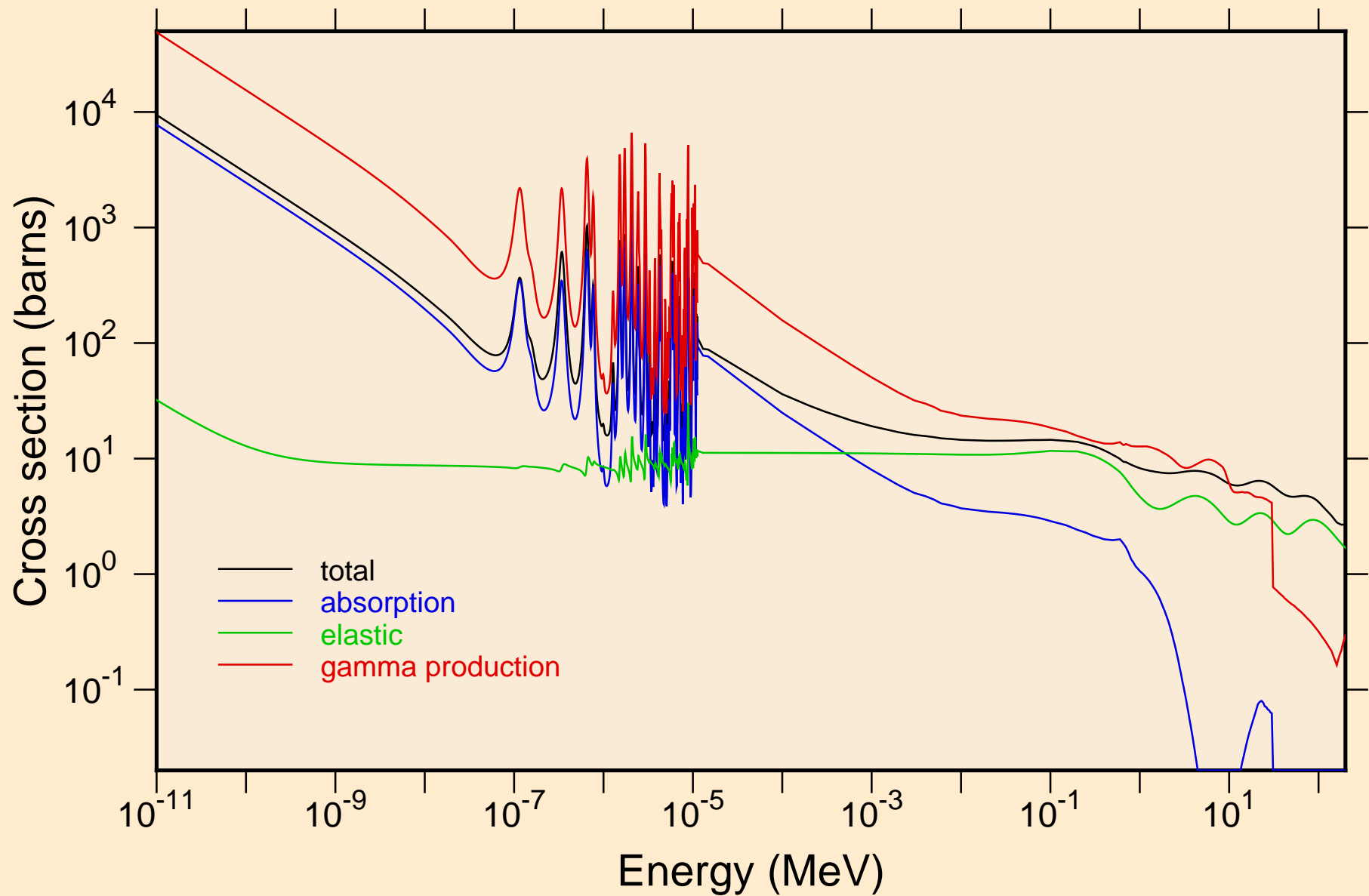

DB257 NEUTRON ACER TENDL-2019 LIBRARY; T=293.16K
resonance total cross section

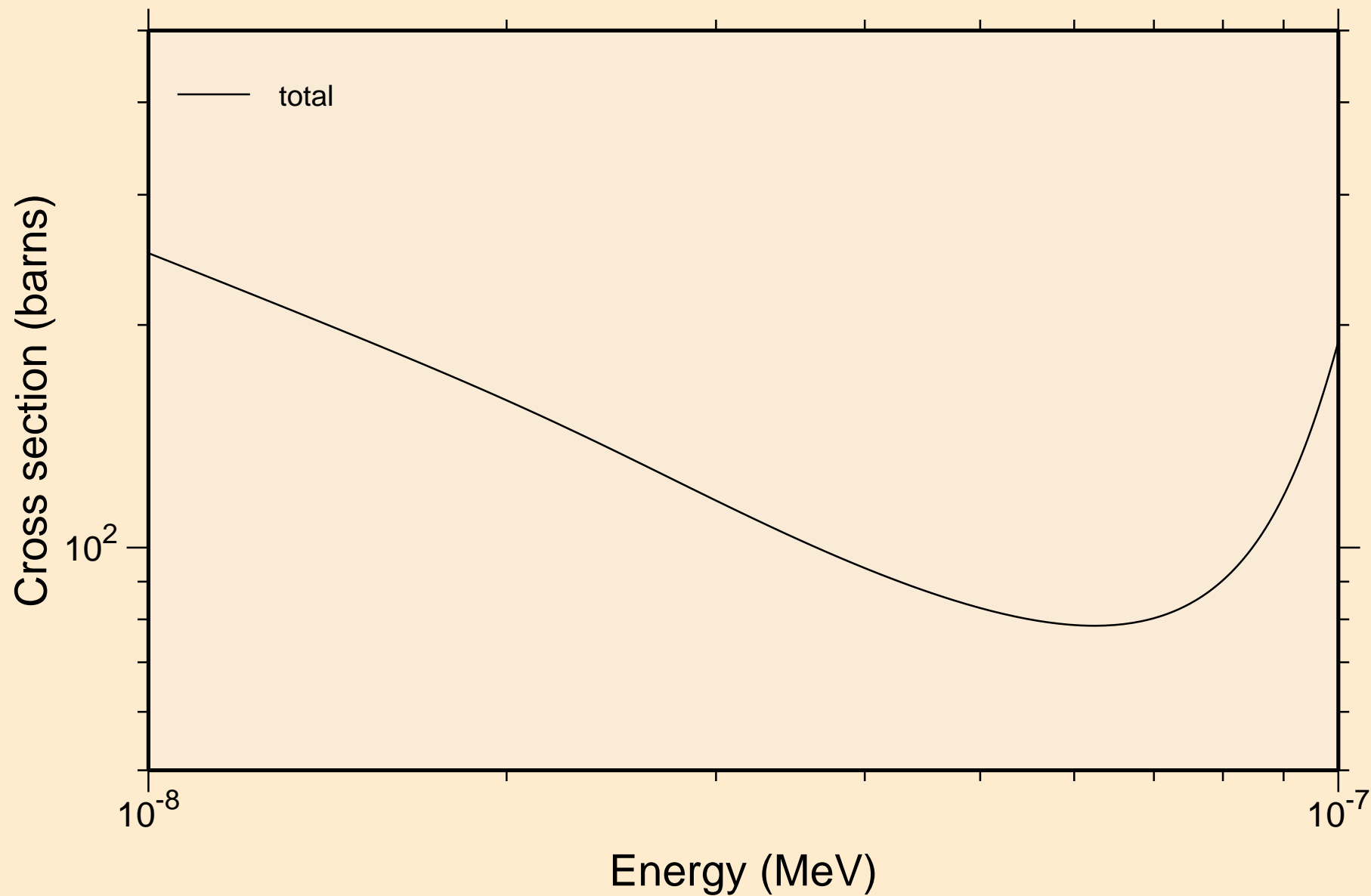

DB257 NEUTRON ACER TENDL-2019 LIBRARY; T=293.16K
resonance total cross section

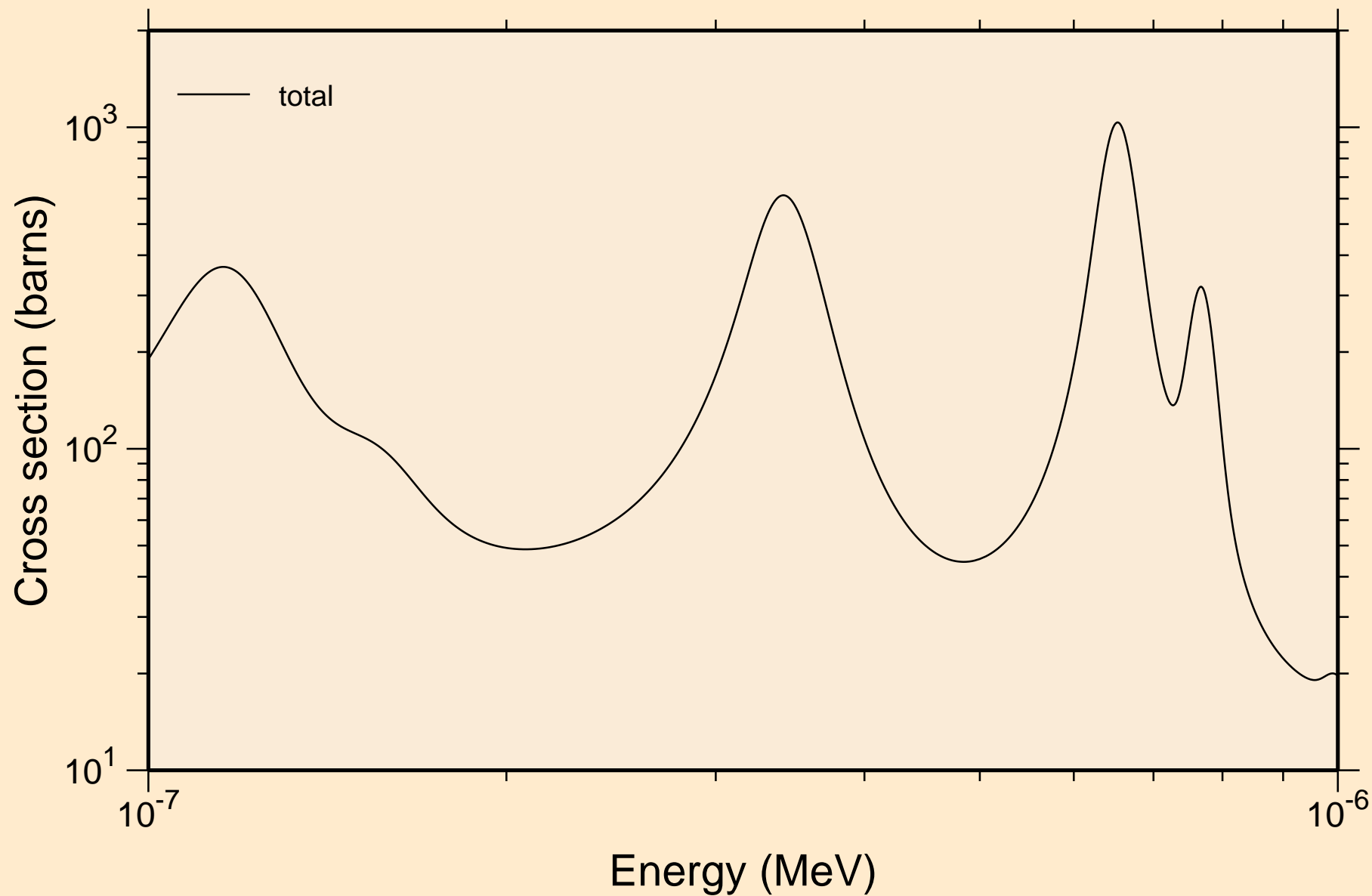

DB257 NEUTRON ACER TENDL-2019 LIBRARY; T=293.16K
resonance total cross section

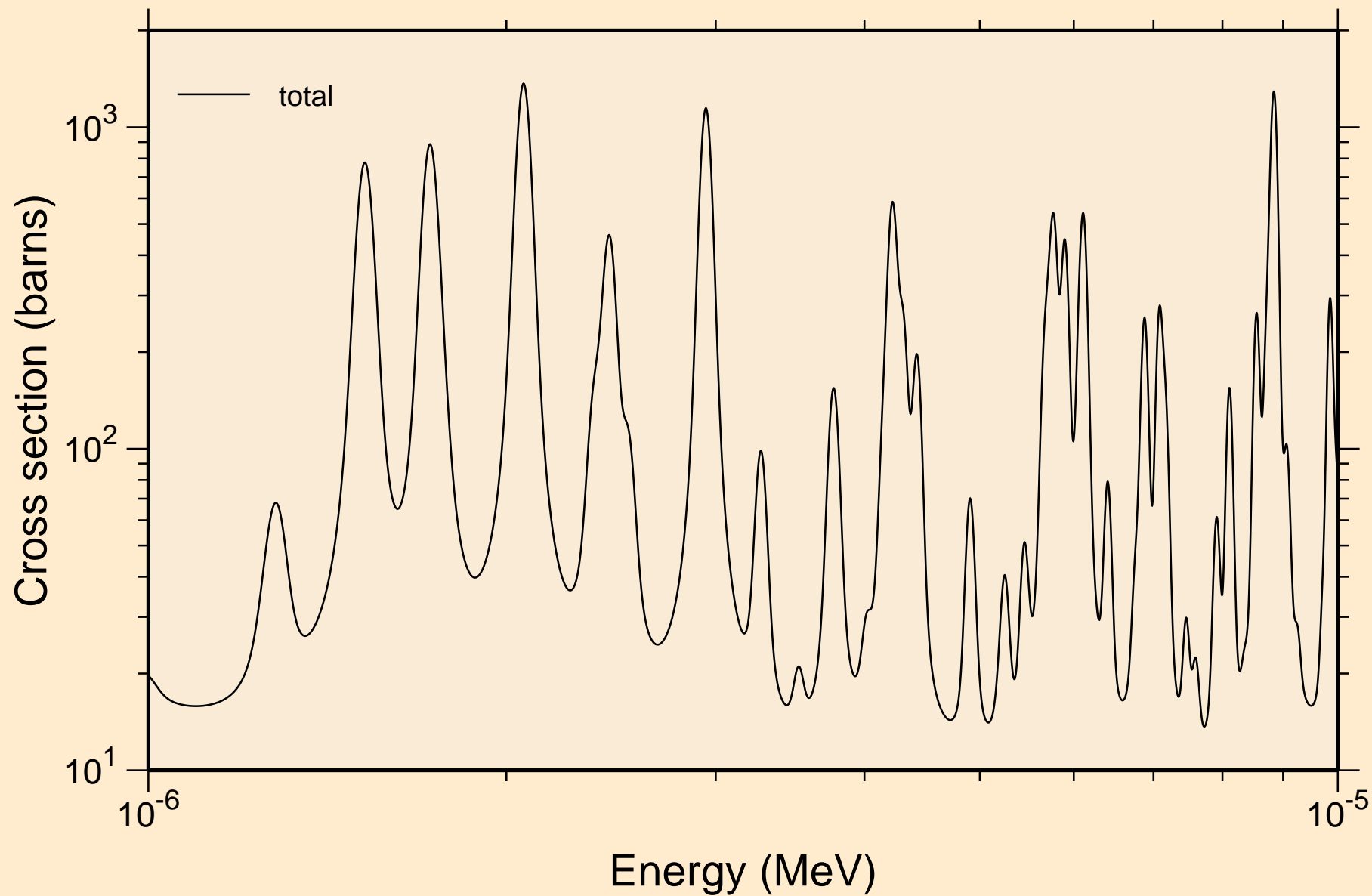

DB257 NEUTRON ACER TENDL-2019 LIBRARY; T=293.16K
resonance total cross section

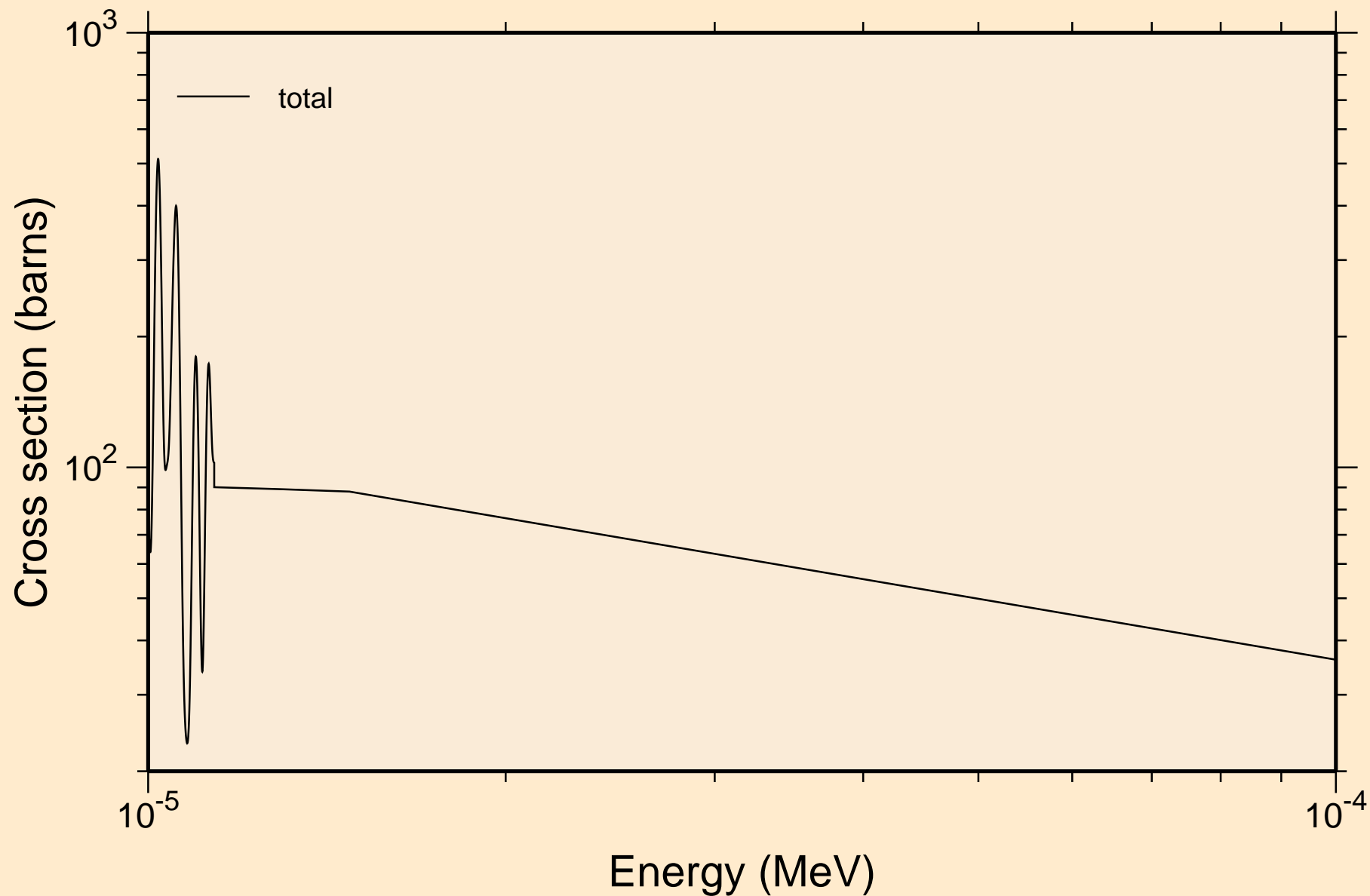

DB257 NEUTRON ACER TENDL-2019 LIBRARY; T=293.16K
resonance total cross section

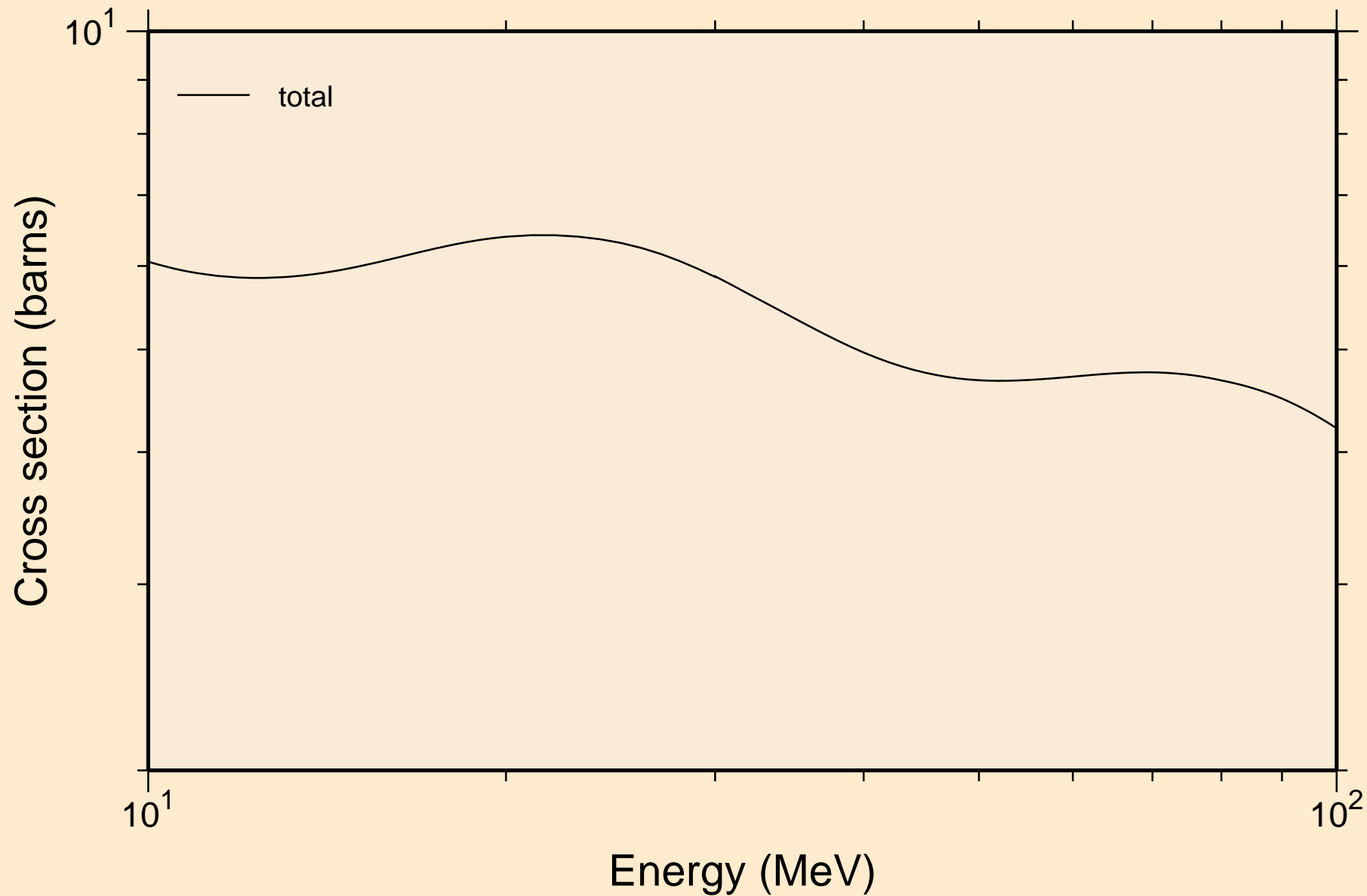

DB257 NEUTRON ACER TENDL-2019 LIBRARY; T=293.16K
resonance absorption cross sections

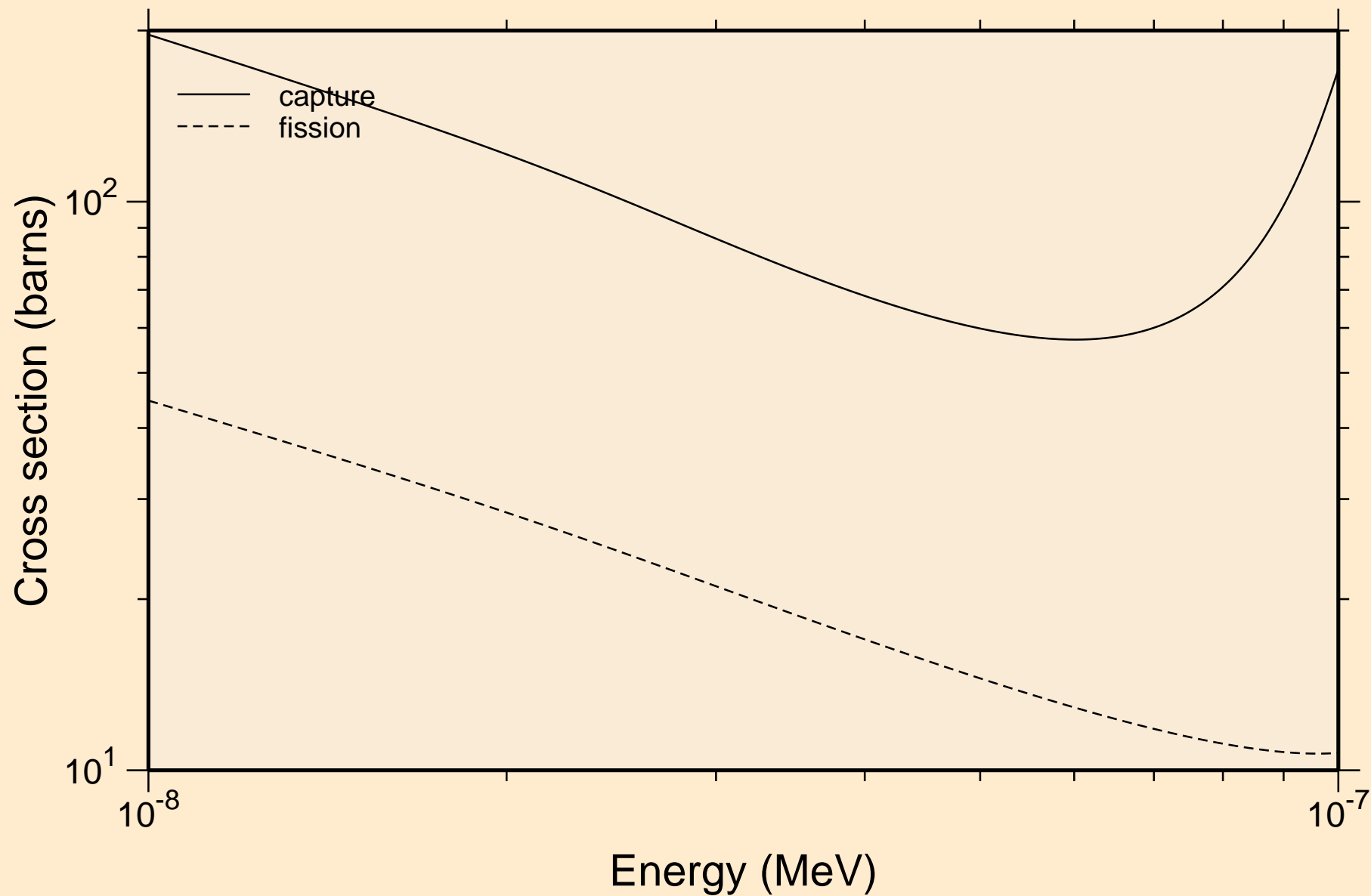

DB257 NEUTRON ACER TENDL-2019 LIBRARY; T=293.16K
resonance absorption cross sections

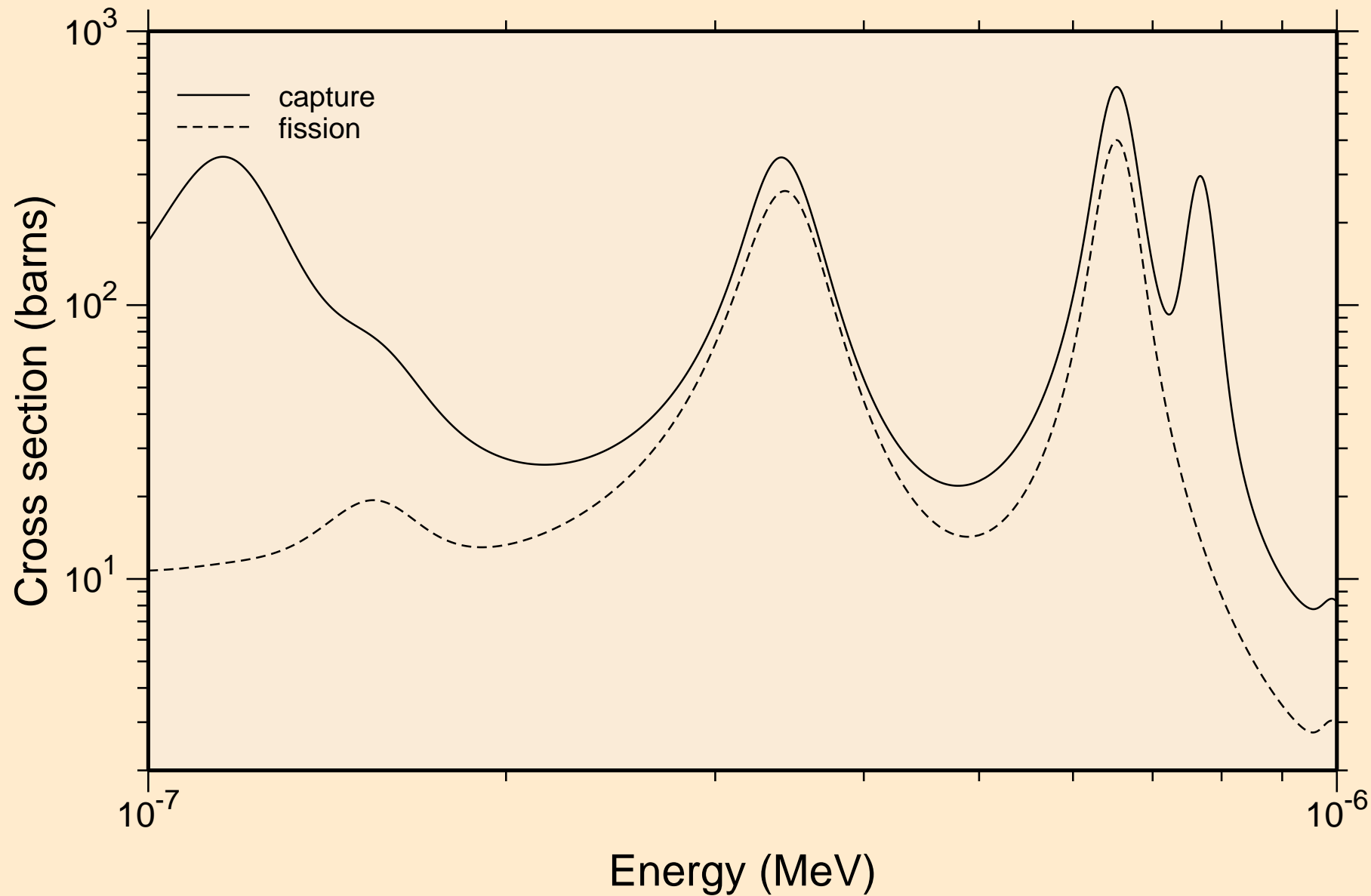

DB257 NEUTRON ACER TENDL-2019 LIBRARY; T=293.16K
resonance absorption cross sections

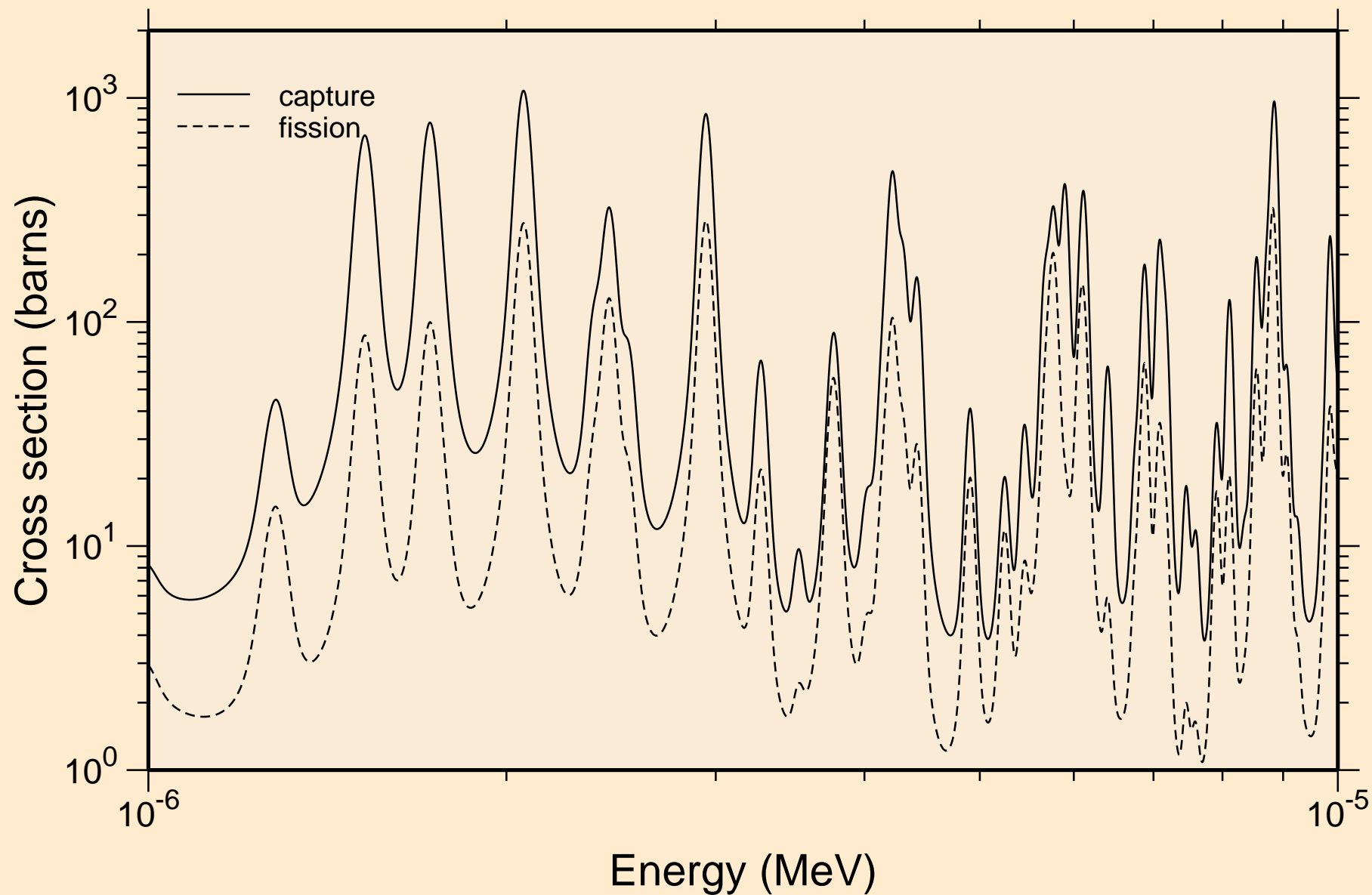

DB257 NEUTRON ACER TENDL-2019 LIBRARY; T=293.16K
resonance absorption cross sections

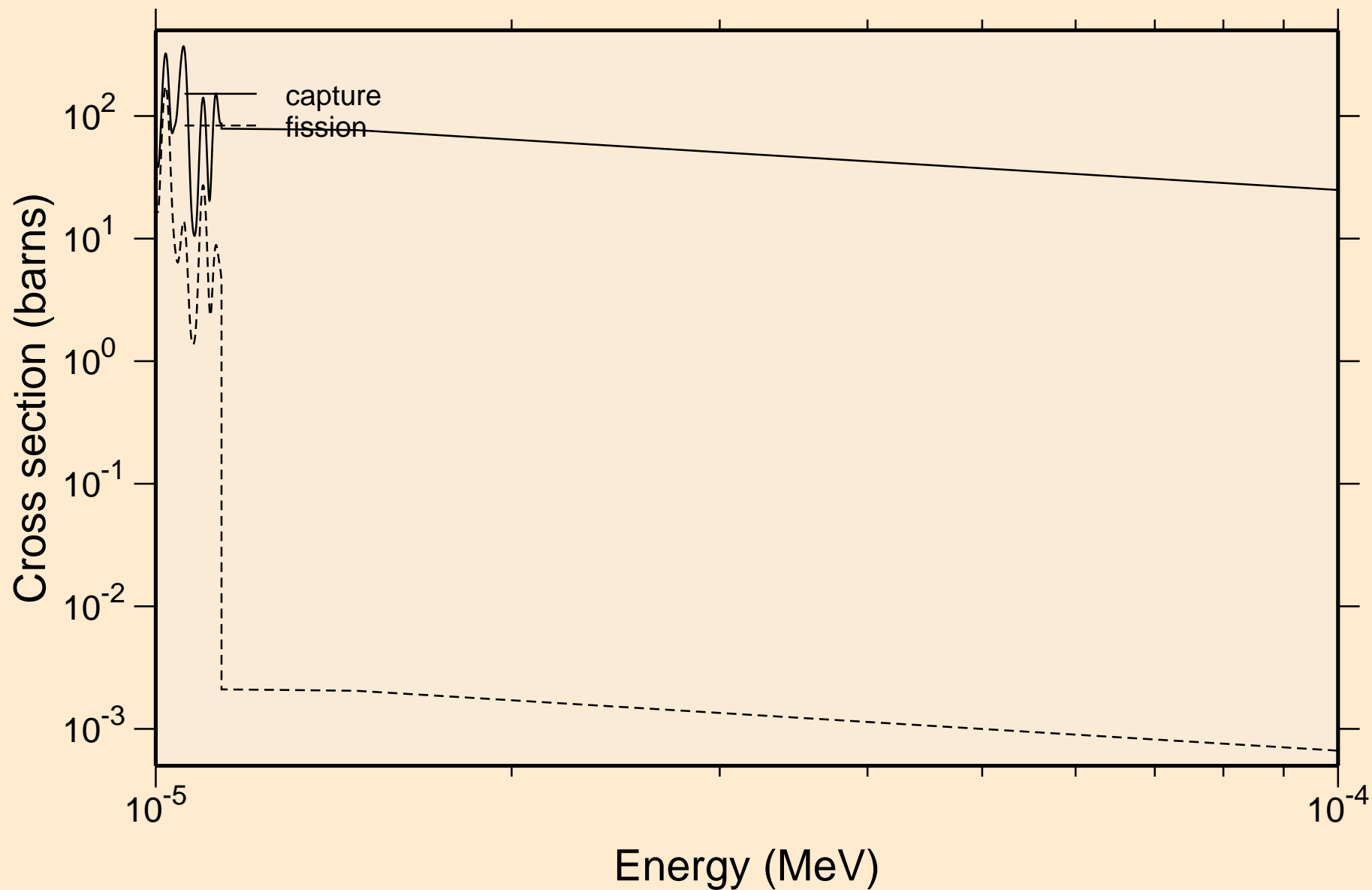

DB257 NEUTRON ACER TENDL-2019 LIBRARY; T=293.16K
resonance absorption cross sections

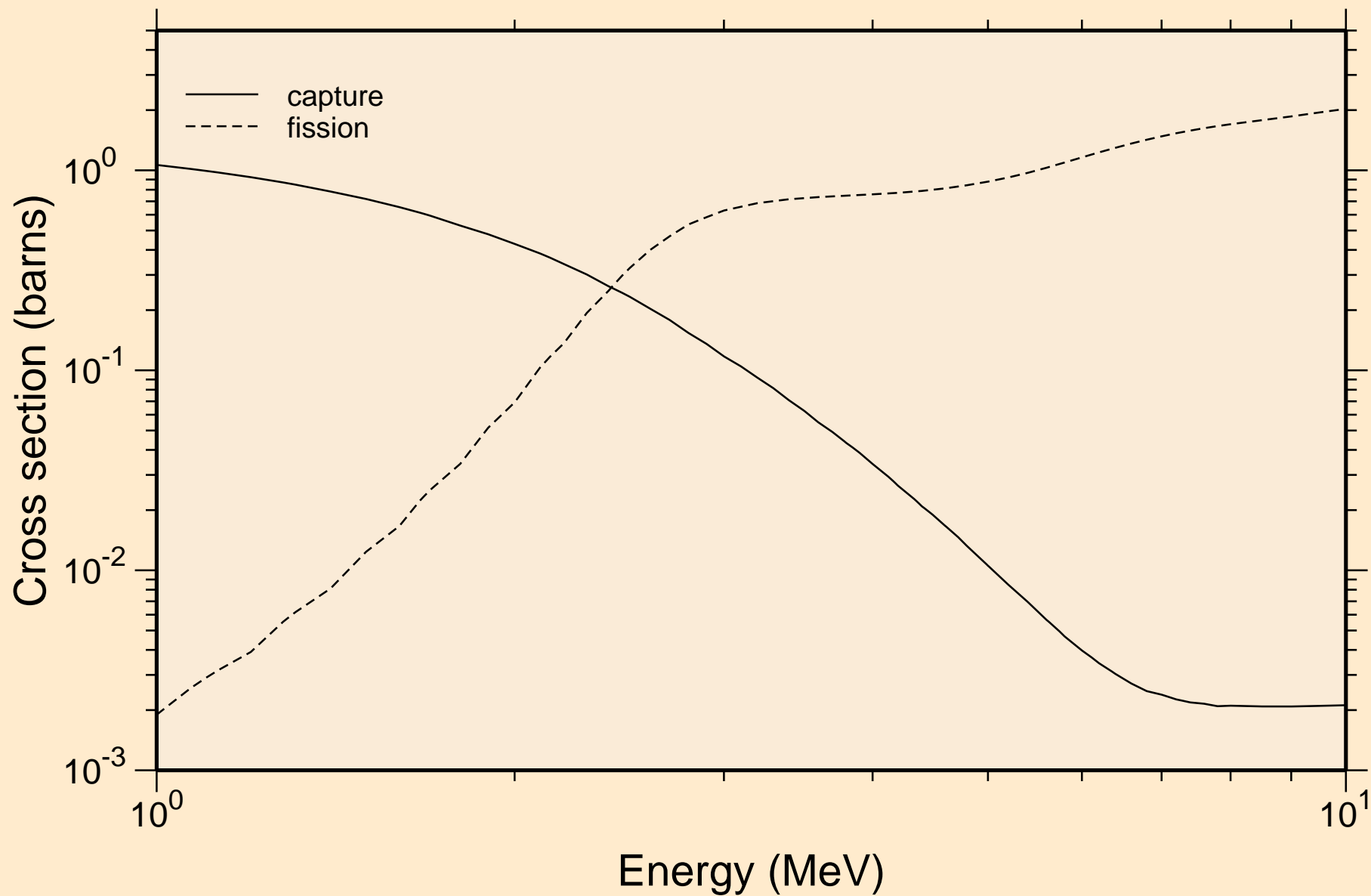

DB257 NEUTRON ACER TENDL-2019 LIBRARY; T=293.16K
Heating

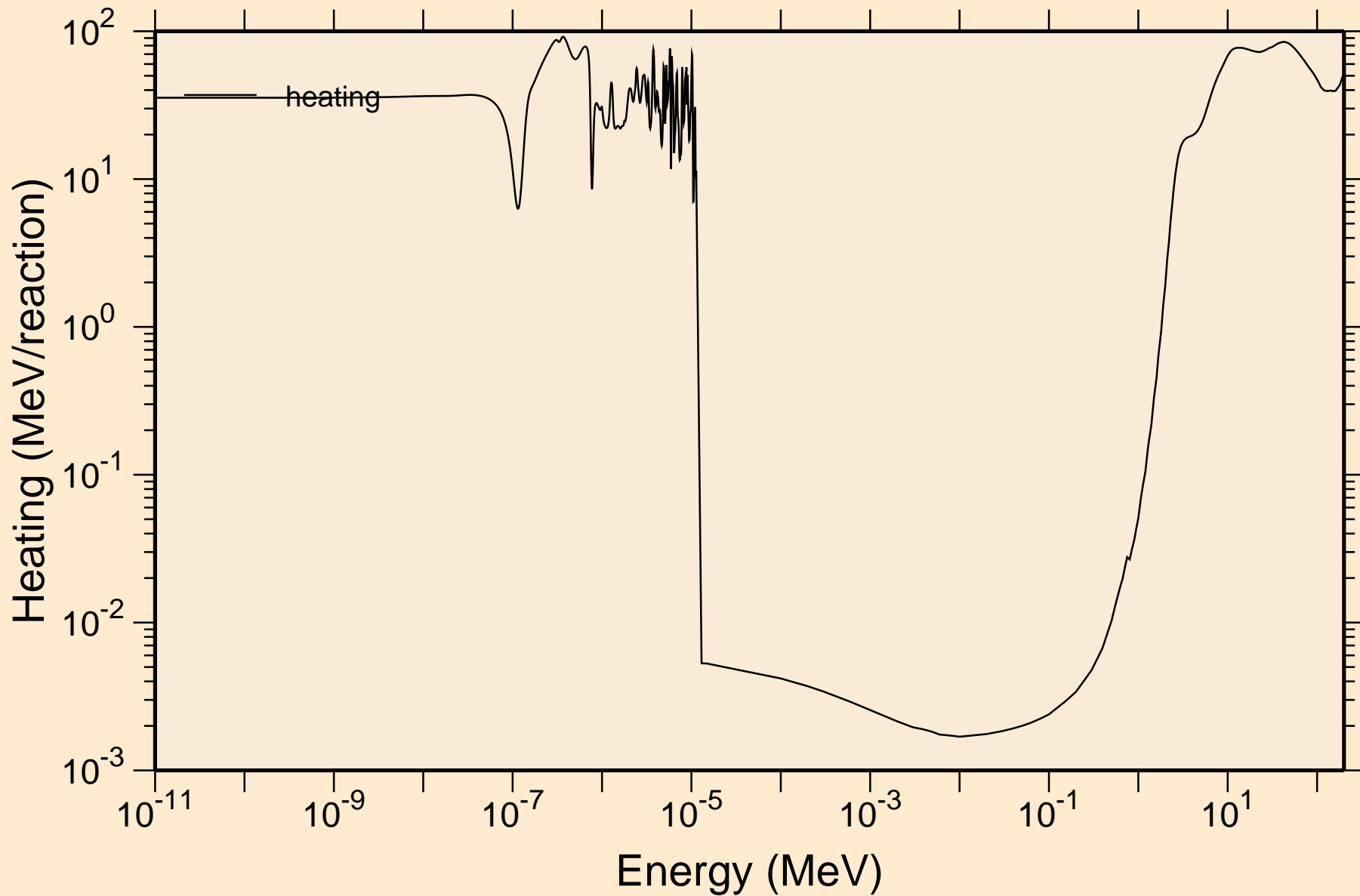

DB257 NEUTRON ACER TENDL-2019 LIBRARY; T=293.16K
Damage

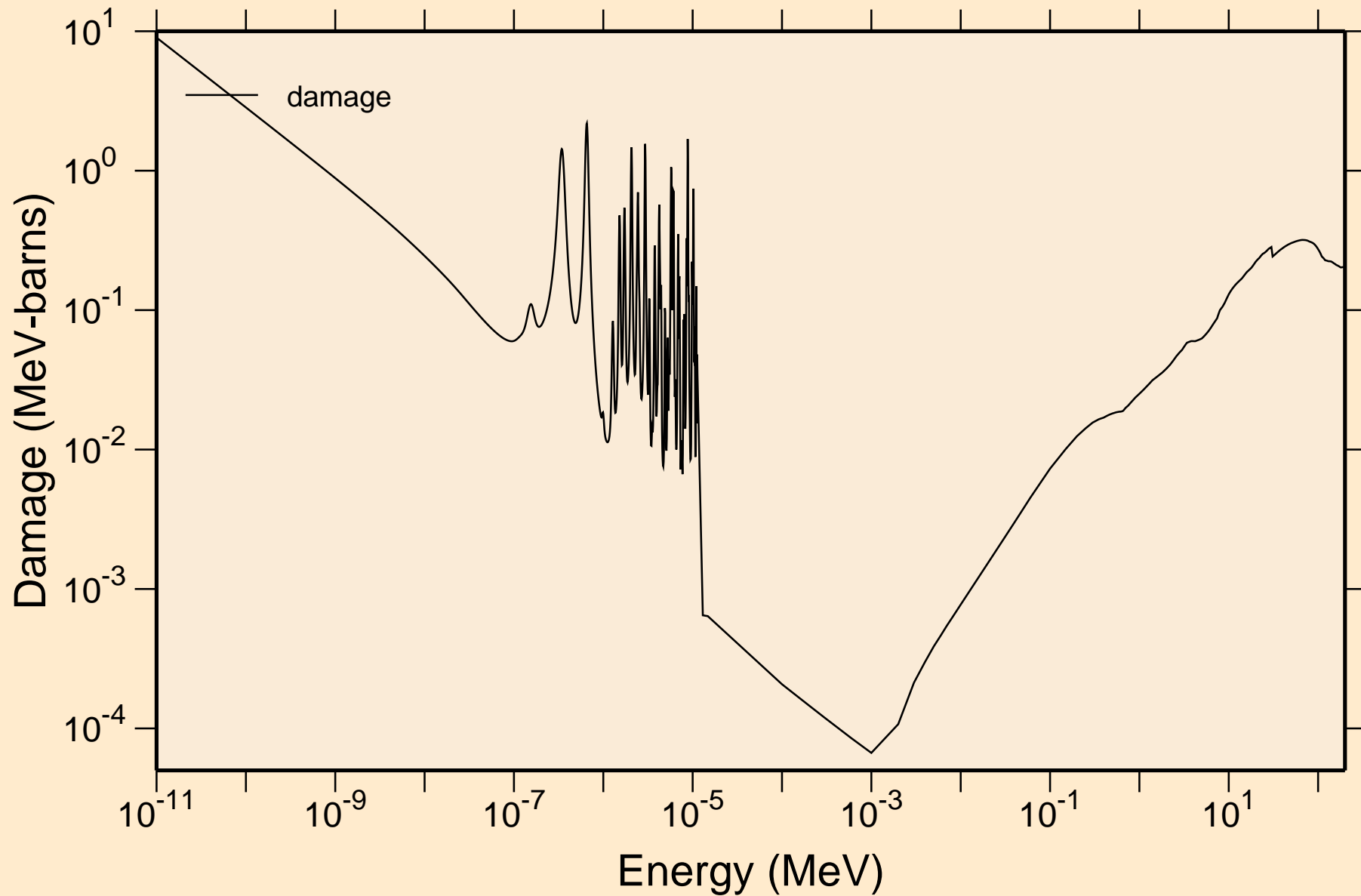

DB257 NEUTRON ACER TENDL-2019 LIBRARY; T=293.16K
Non-threshold reactions

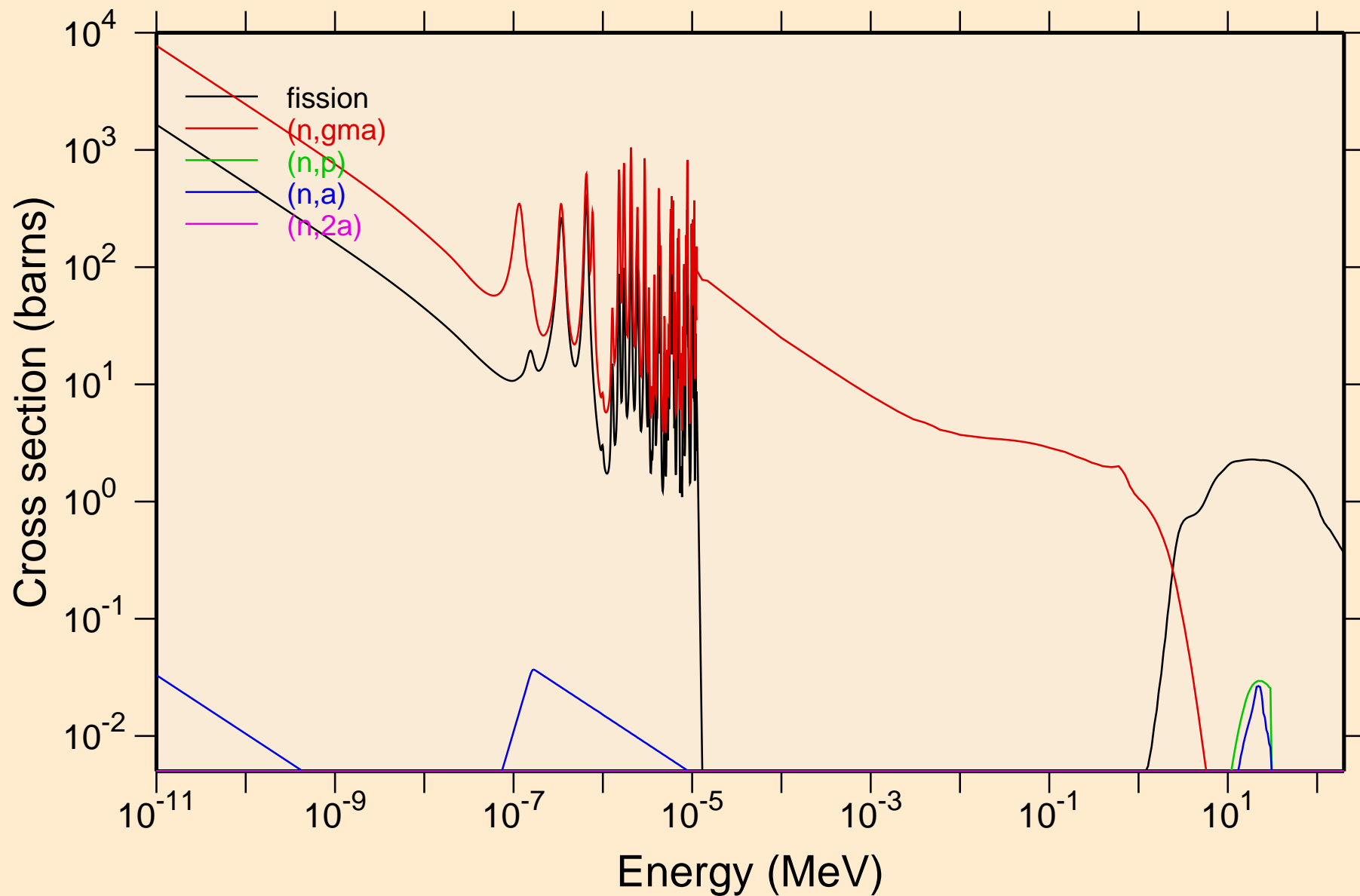

DB257 NEUTRON ACER TENDL-2019 LIBRARY; T=293.16K
Non-threshold reactions

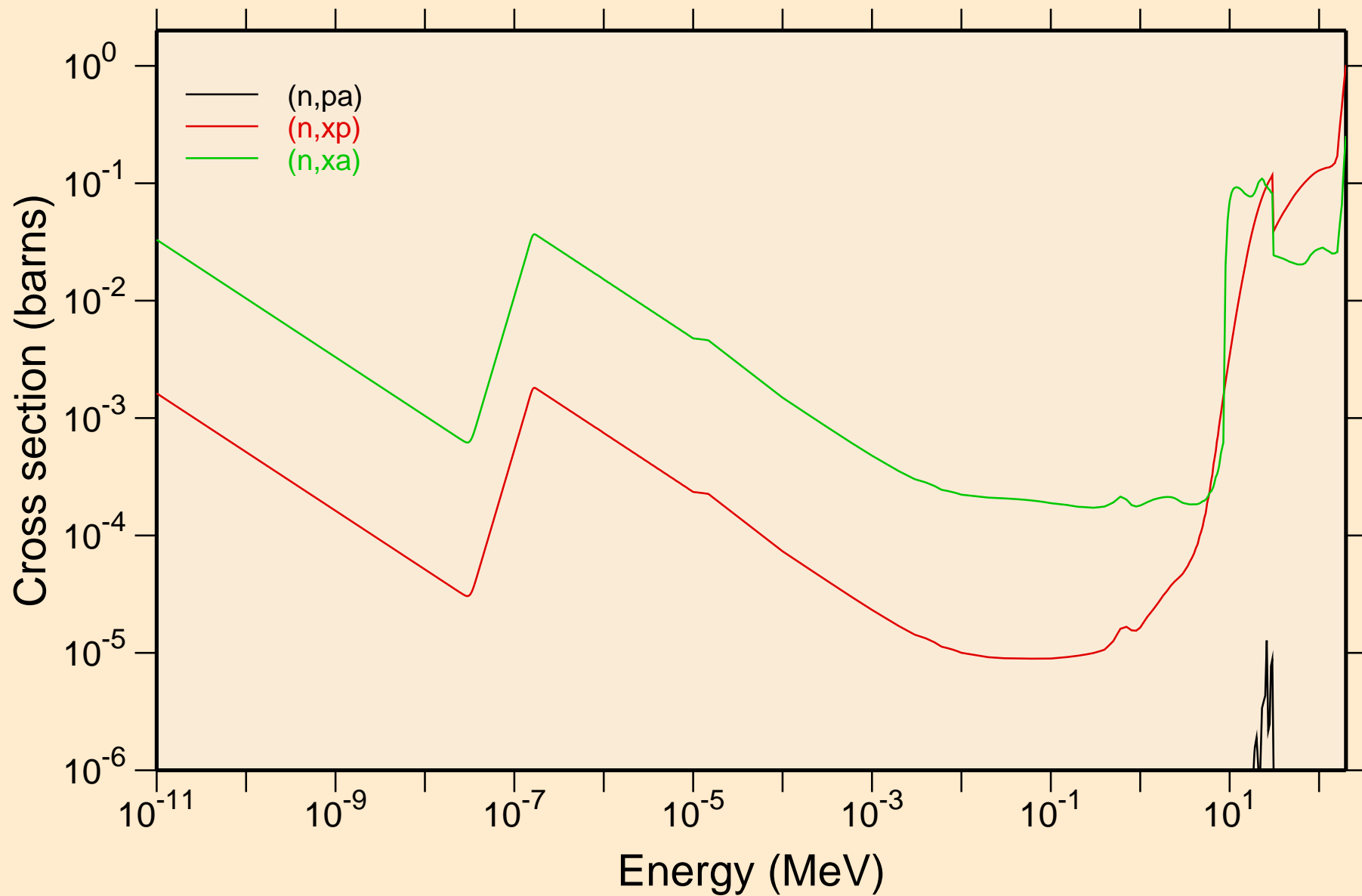

DB257 NEUTRON ACER TENDL-2019 LIBRARY; T=293.16K
Principal cross sections

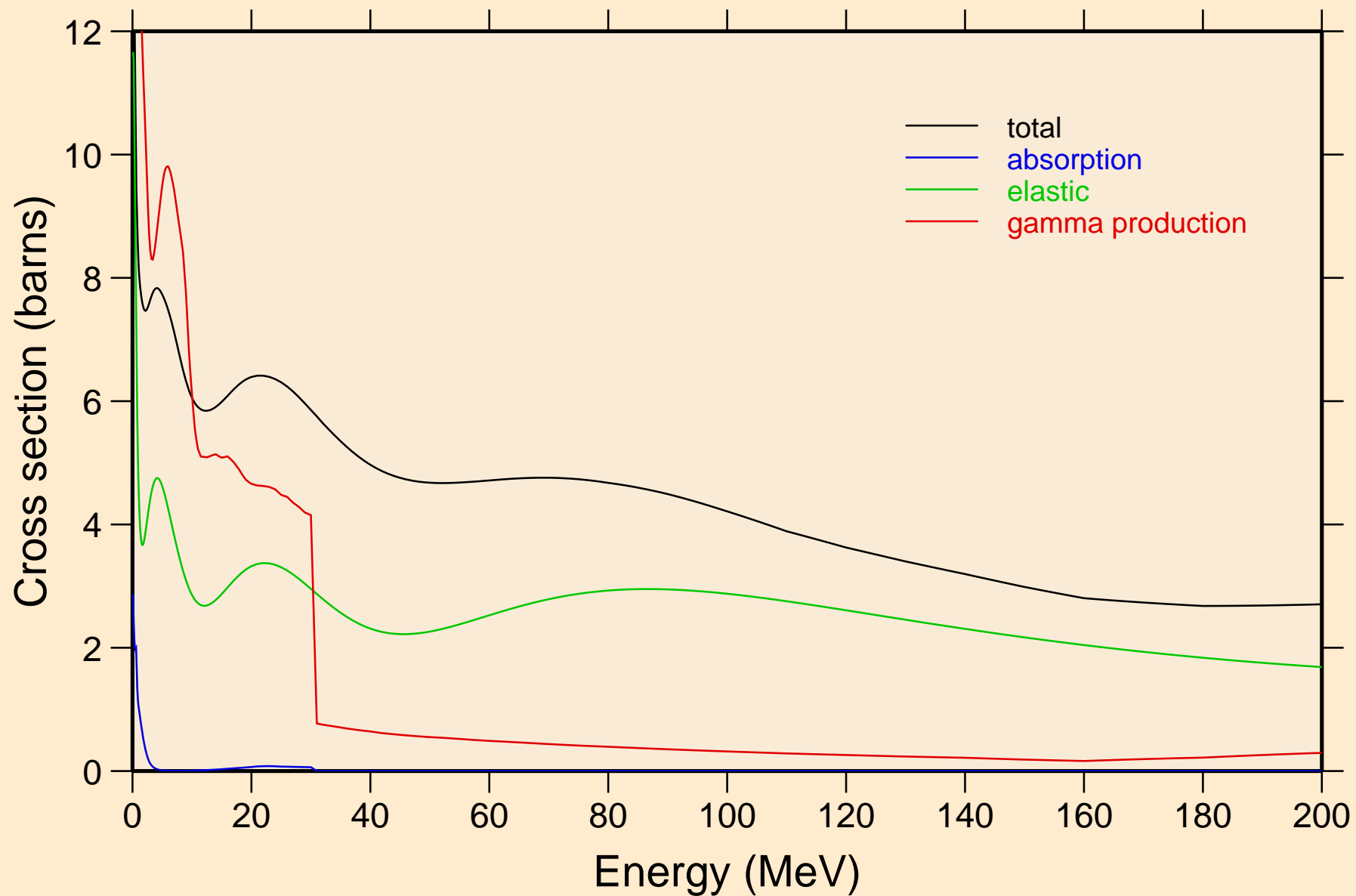

DB257 NEUTRON ACER TENDL-2019 LIBRARY; T=293.16K
Heating

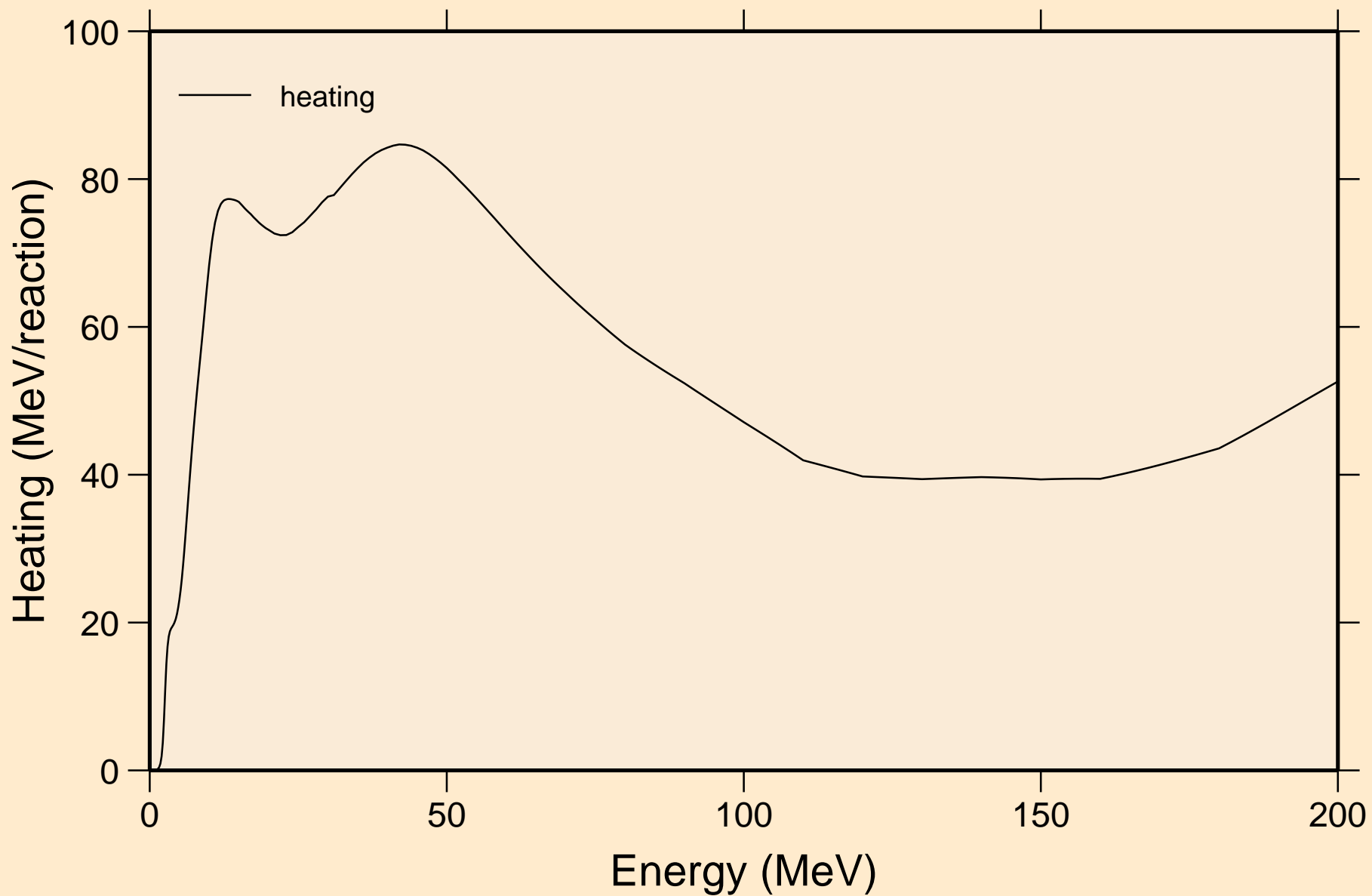

DB257 NEUTRON ACER TENDL-2019 LIBRARY; T=293.16K
Damage

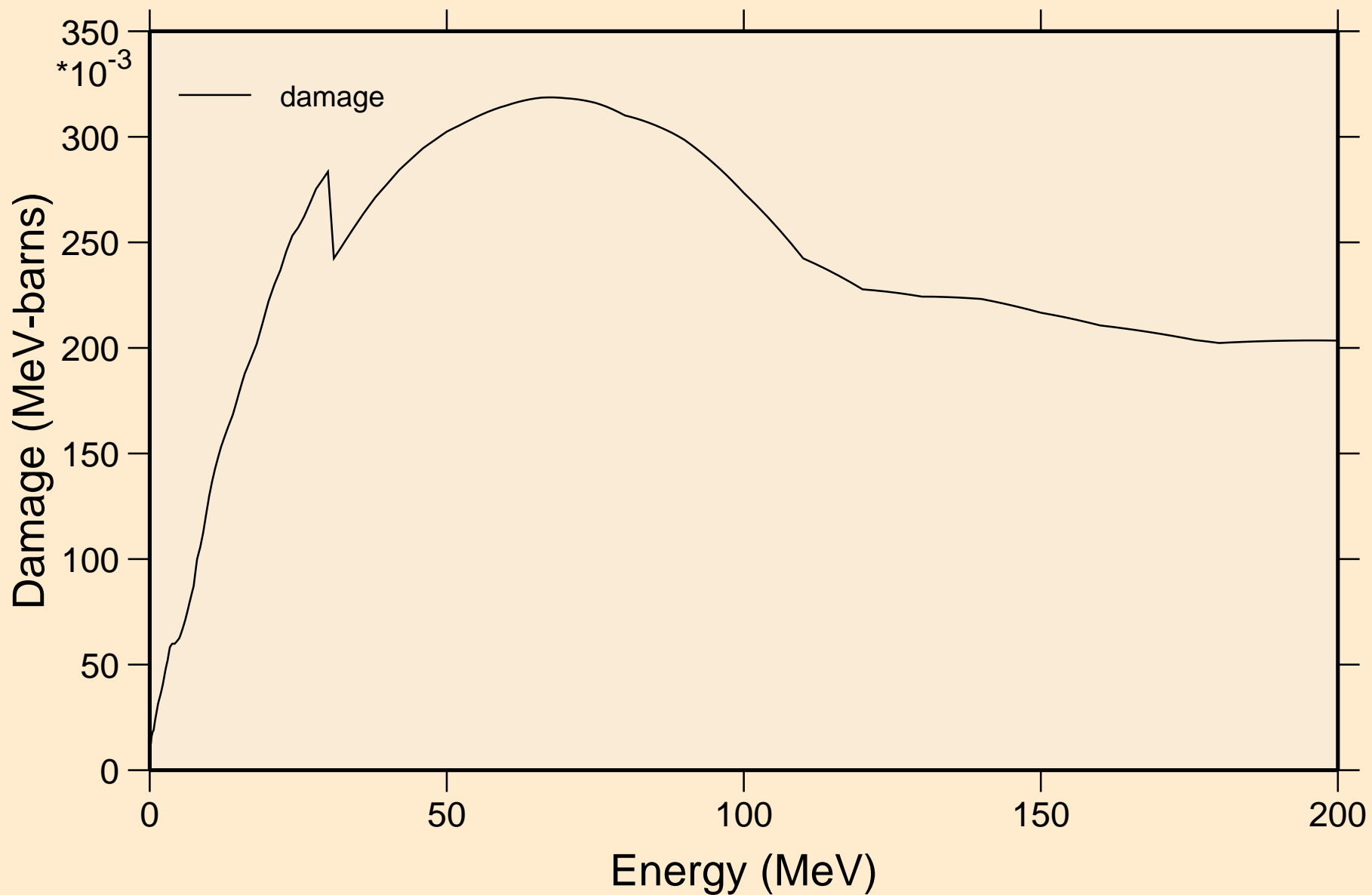

DB257 NEUTRON ACER TENDL-2019 LIBRARY; T=293.16K
Non-threshold reactions

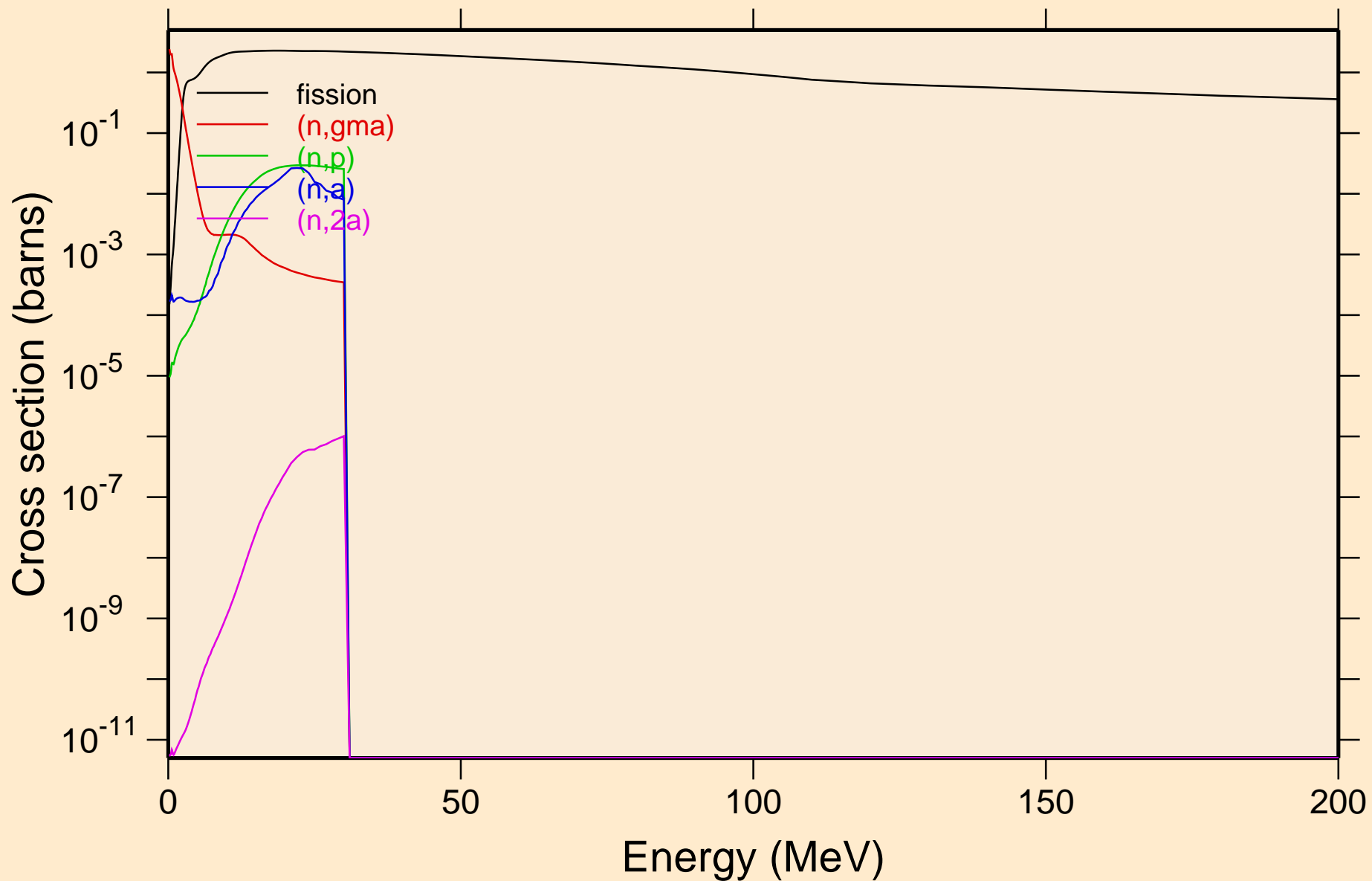

DB257 NEUTRON ACER TENDL-2019 LIBRARY; T=293.16K
Non-threshold reactions

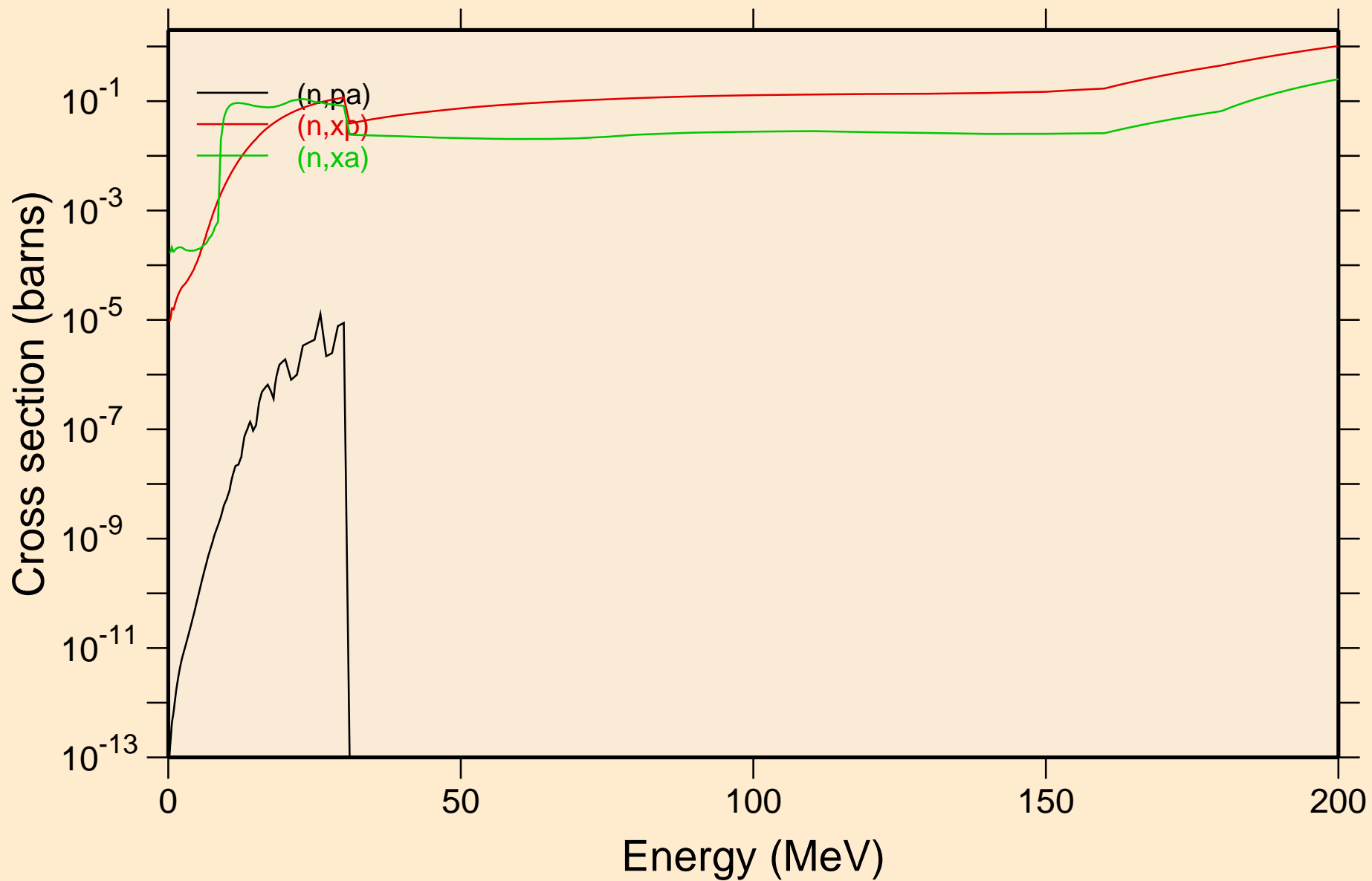

DB257 NEUTRON ACER TENDL-2019 LIBRARY; T=293.16K
Inelastic levels

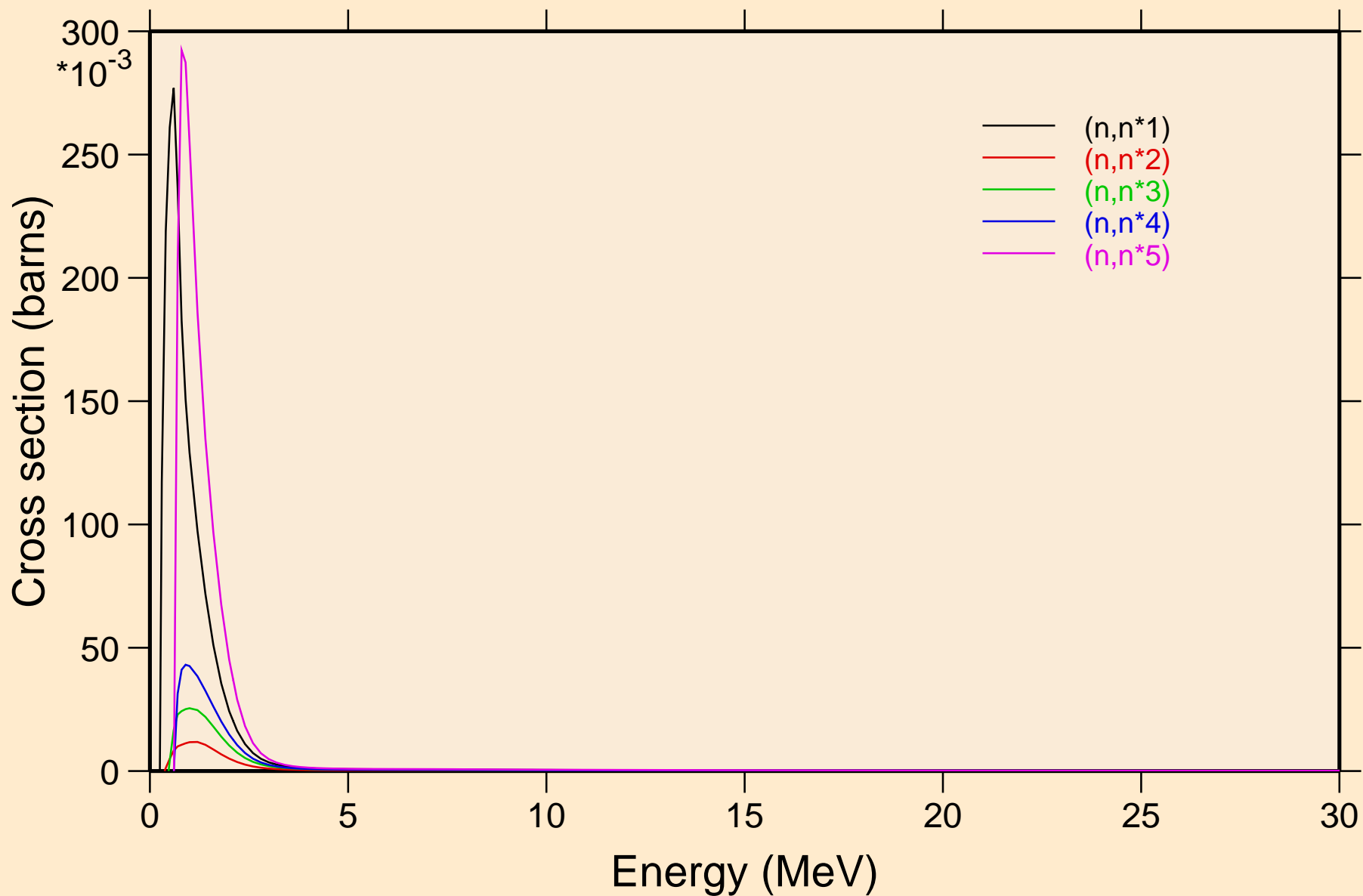

DB257 NEUTRON ACER TENDL-2019 LIBRARY; T=293.16K
Inelastic levels

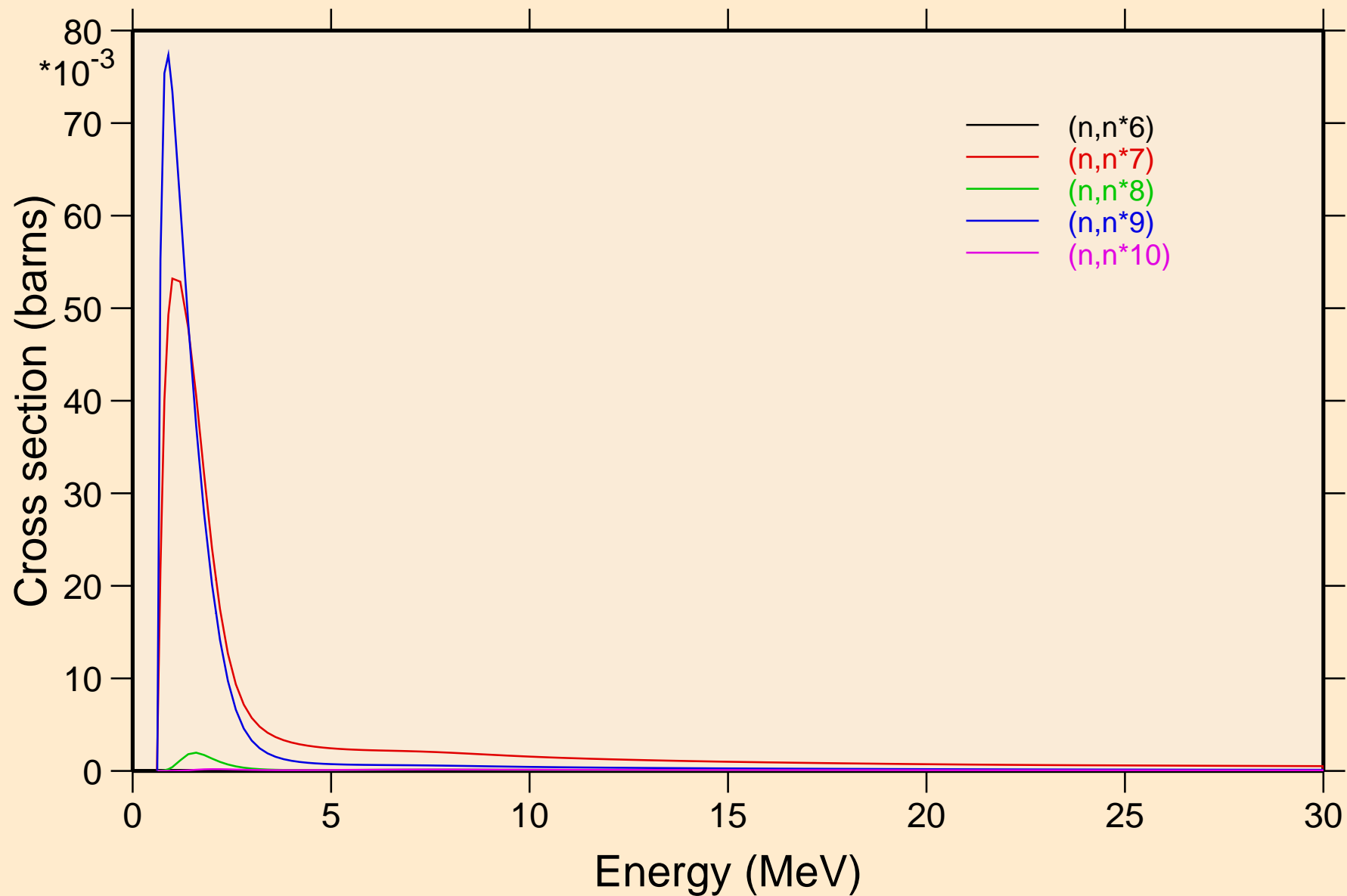

DB257 NEUTRON ACER TENDL-2019 LIBRARY; T=293.16K
Inelastic levels

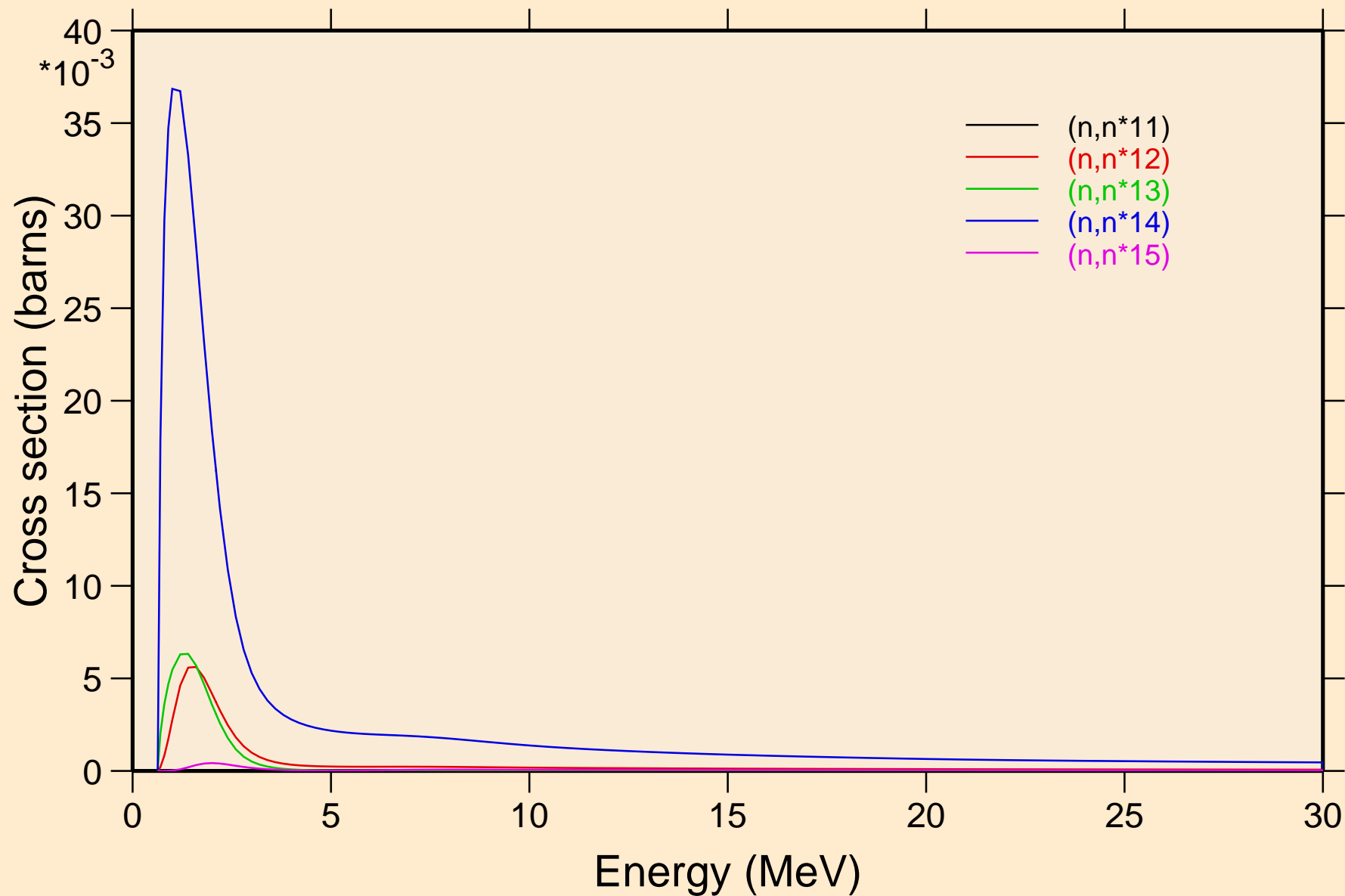

DB257 NEUTRON ACER TENDL-2019 LIBRARY; T=293.16K
Inelastic levels

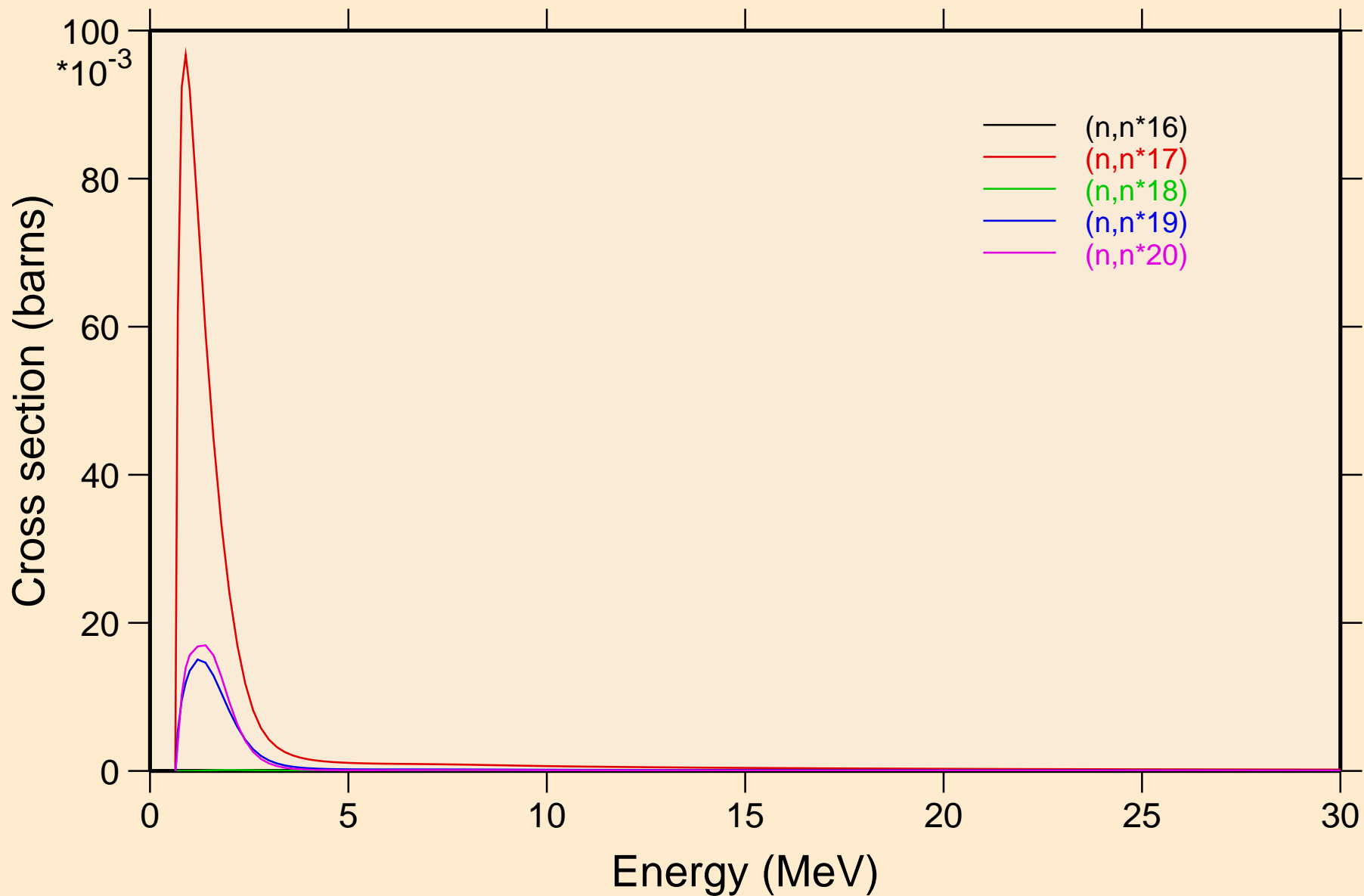

DB257 NEUTRON ACER TENDL-2019 LIBRARY; T=293.16K
Inelastic levels

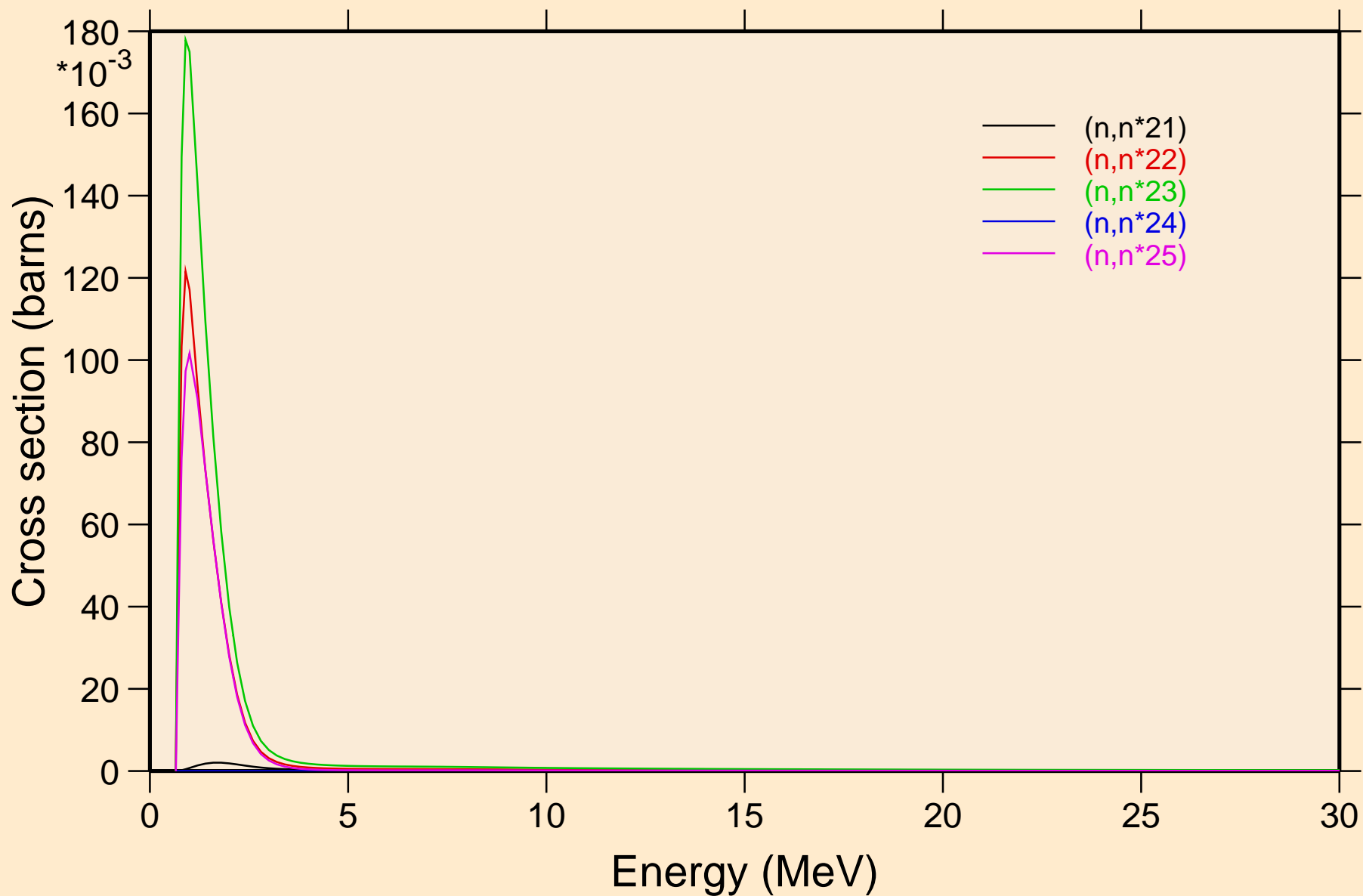

DB257 NEUTRON ACER TENDL-2019 LIBRARY; T=293.16K
Inelastic levels

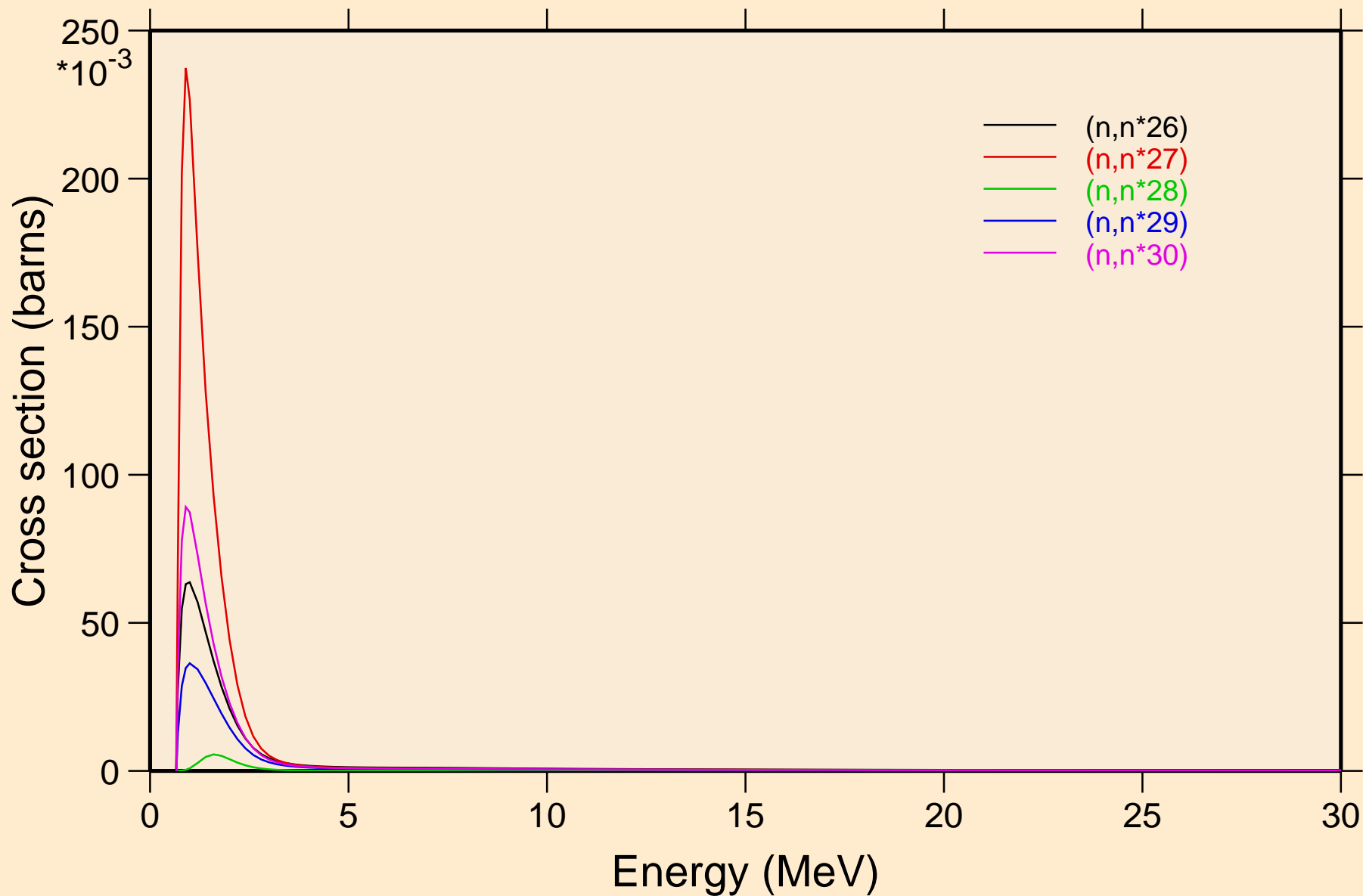

DB257 NEUTRON ACER TENDL-2019 LIBRARY; T=293.16K
Threshold reactions

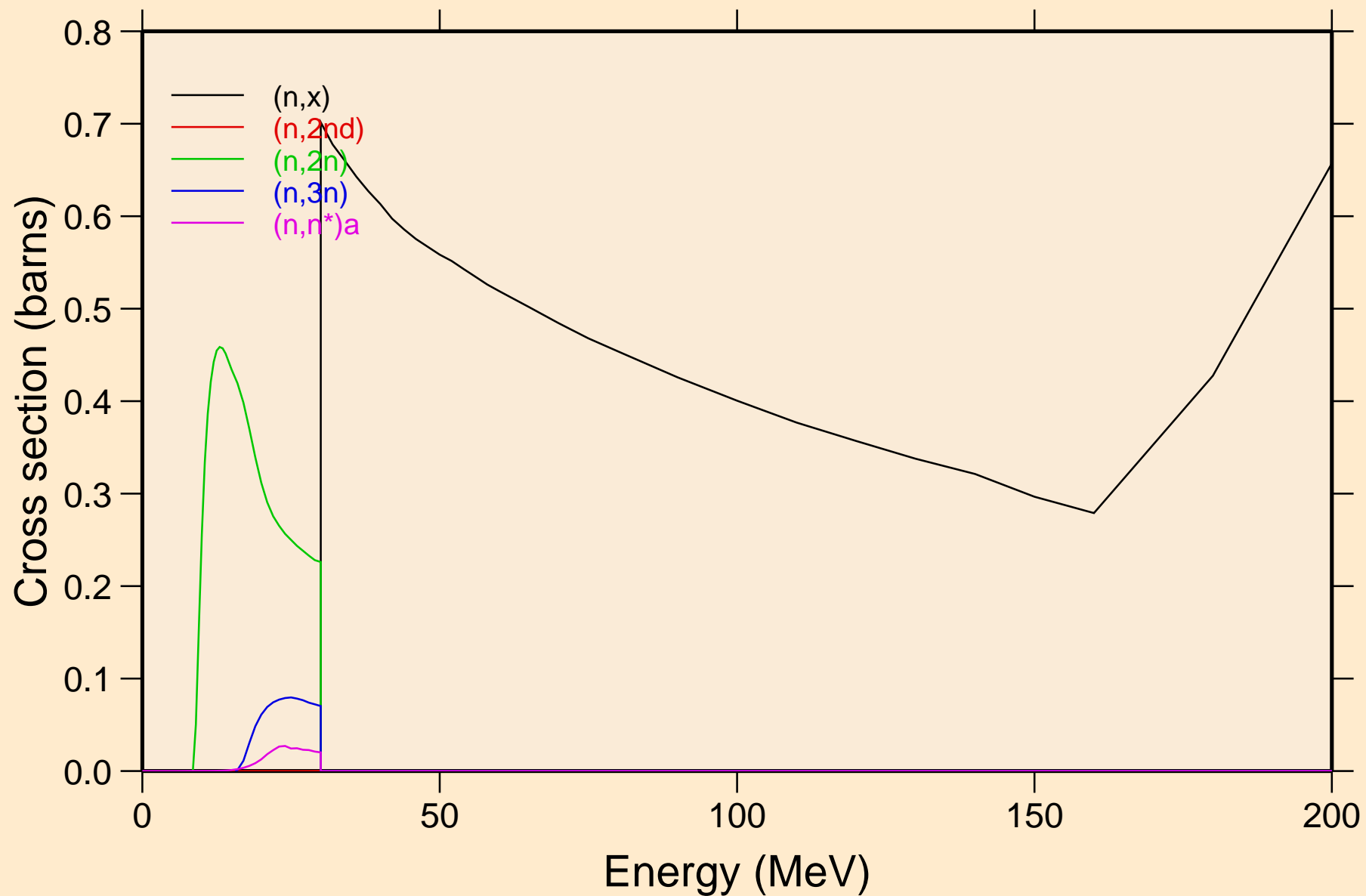

DB257 NEUTRON ACER TENDL-2019 LIBRARY; T=293.16K
Threshold reactions

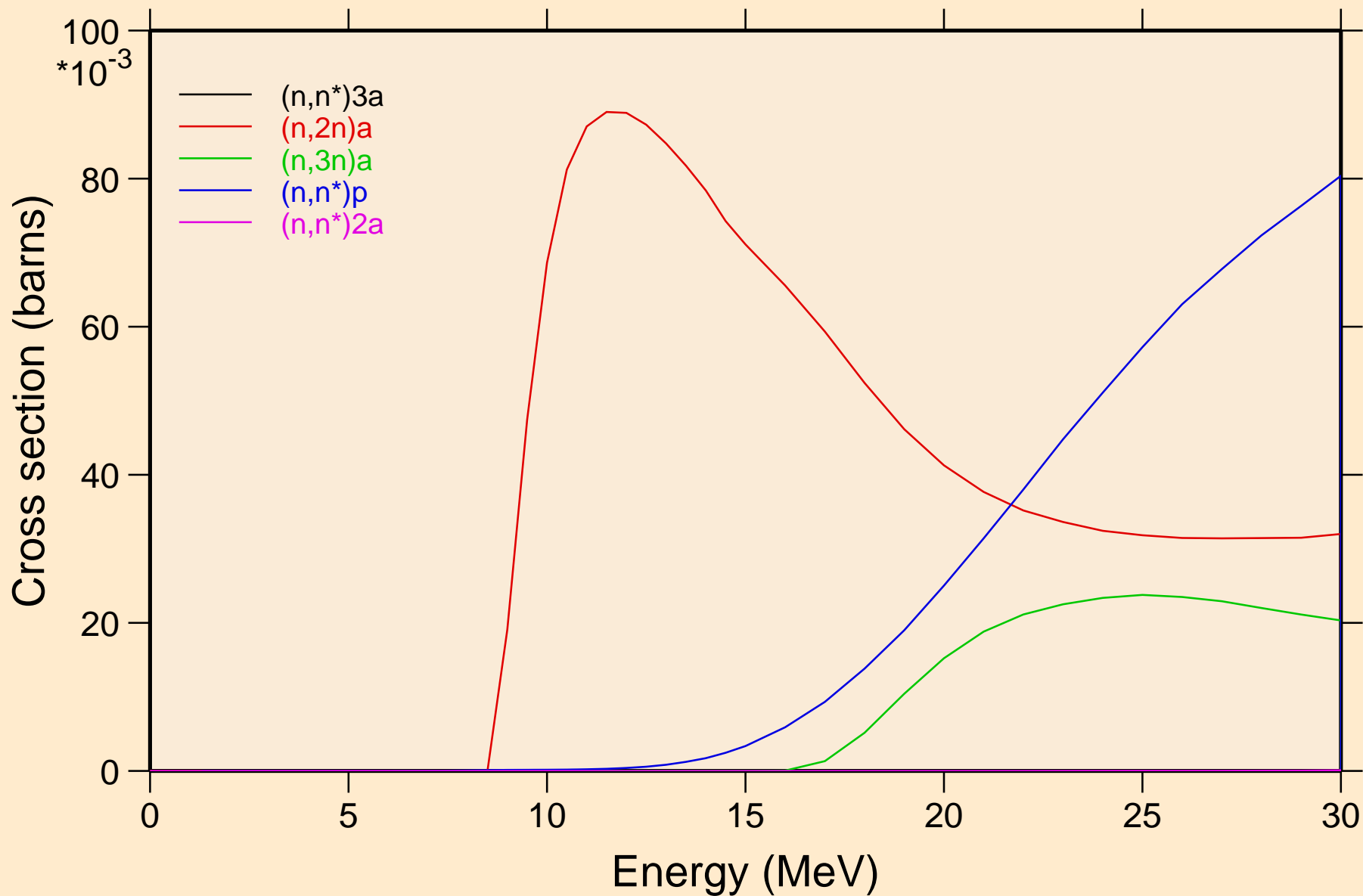

DB257 NEUTRON ACER TENDL-2019 LIBRARY; T=293.16K
Threshold reactions

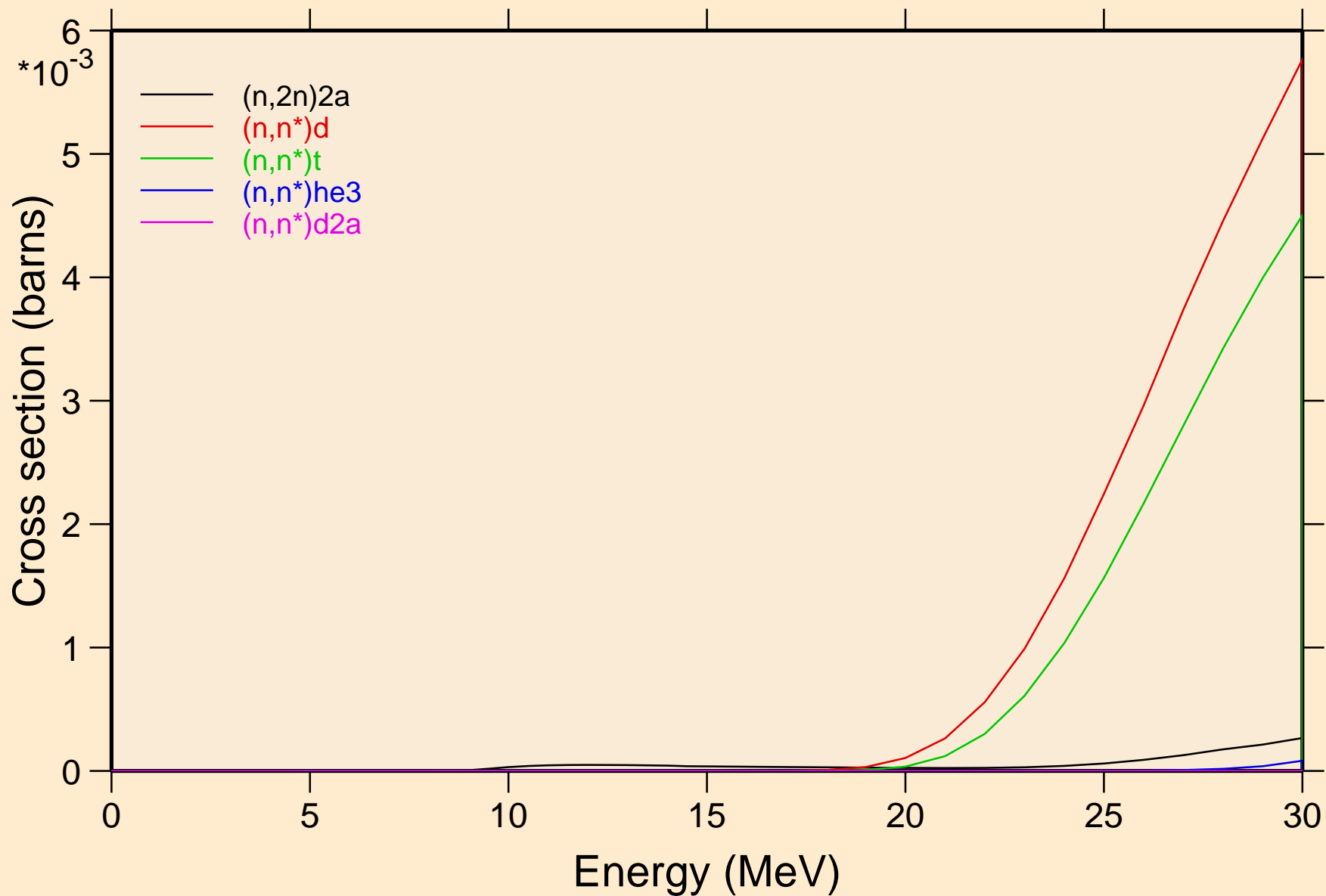

DB257 NEUTRON ACER TENDL-2019 LIBRARY; T=293.16K
Threshold reactions

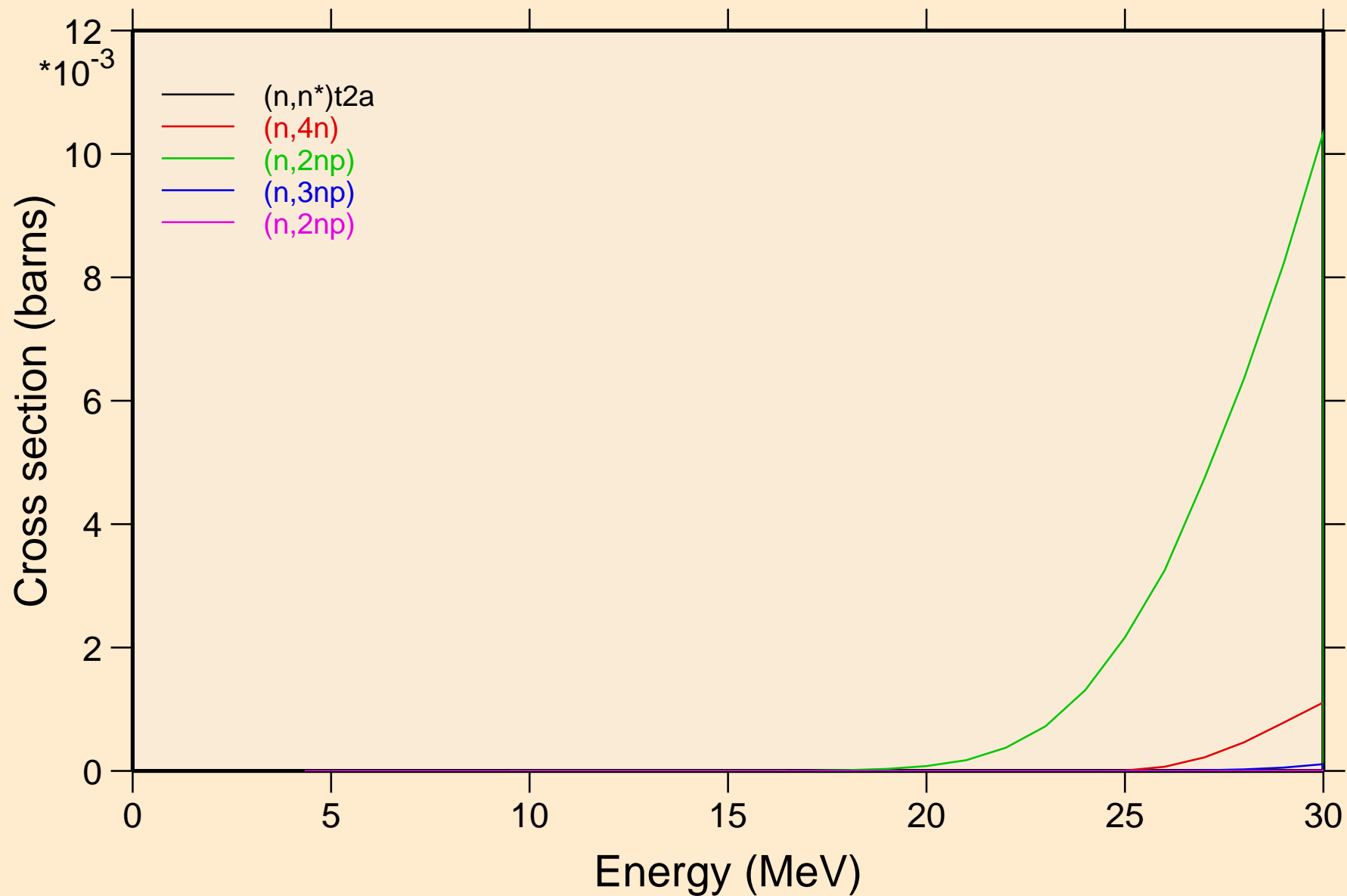

DB257 NEUTRON ACER TENDL-2019 LIBRARY; T=293.16K
Threshold reactions

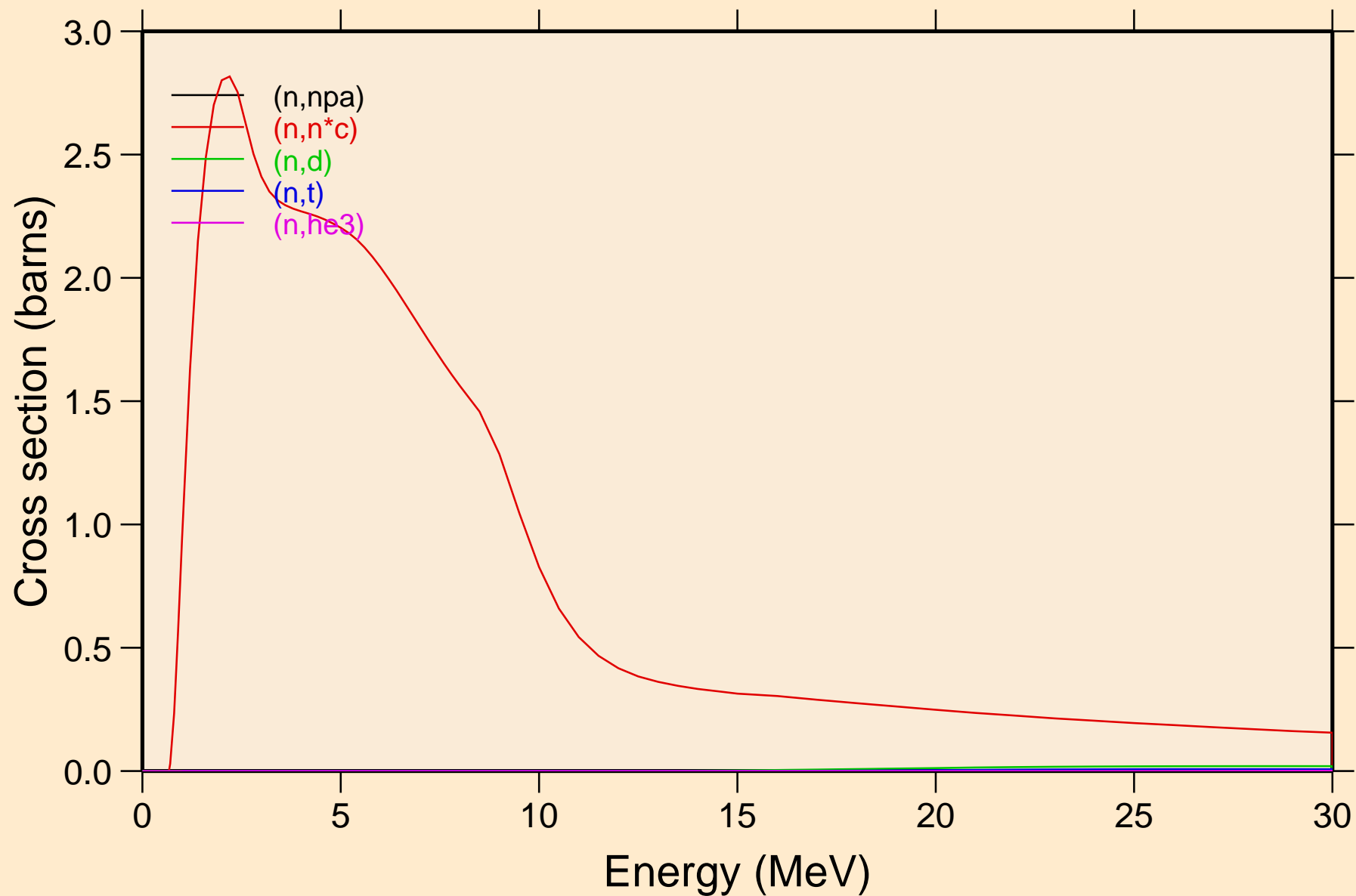

DB257 NEUTRON ACER TENDL-2019 LIBRARY; T=293.16K
Threshold reactions

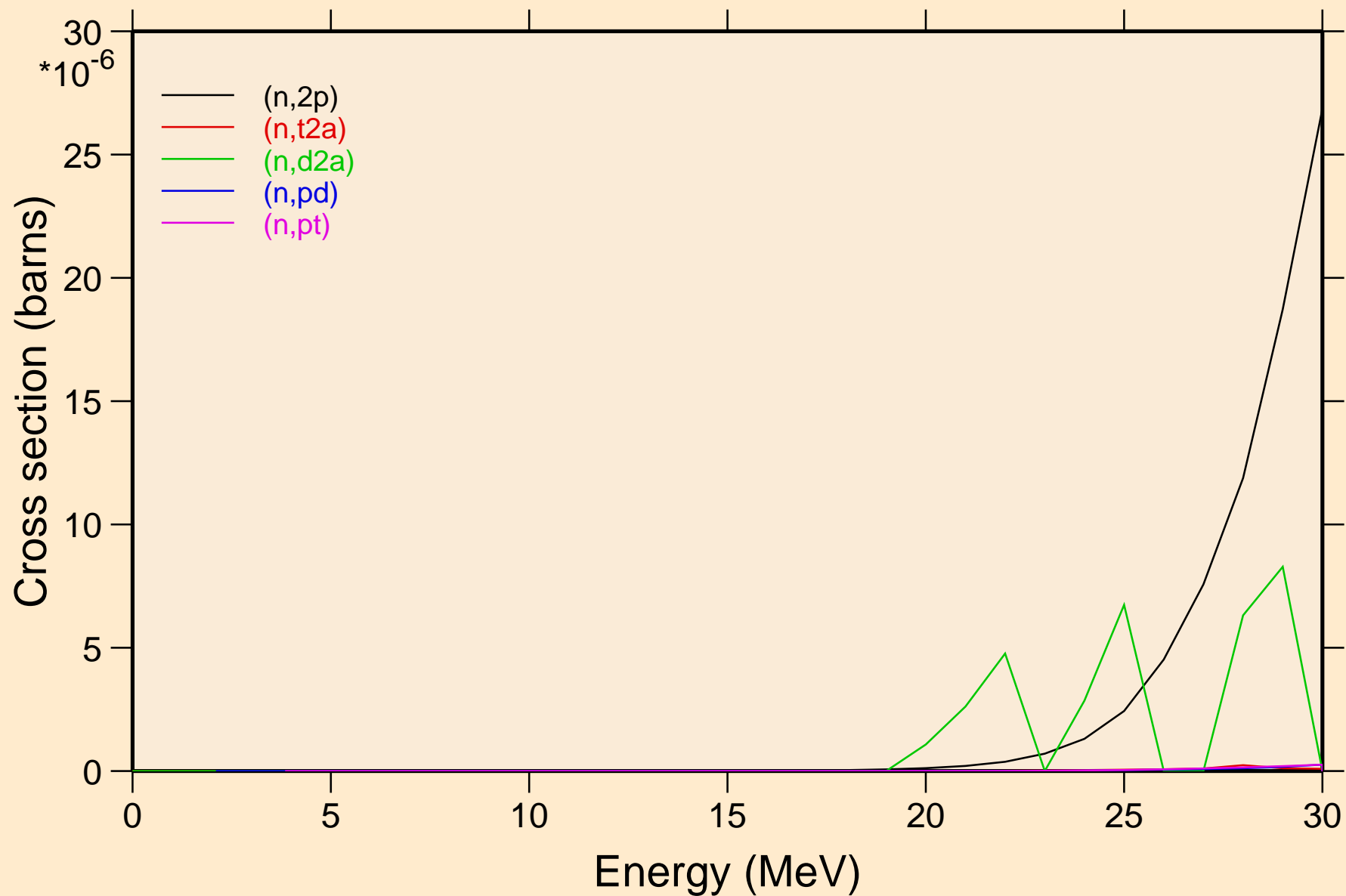

DB257 NEUTRON ACER TENDL-2019 LIBRARY; T=293.16K
Threshold reactions

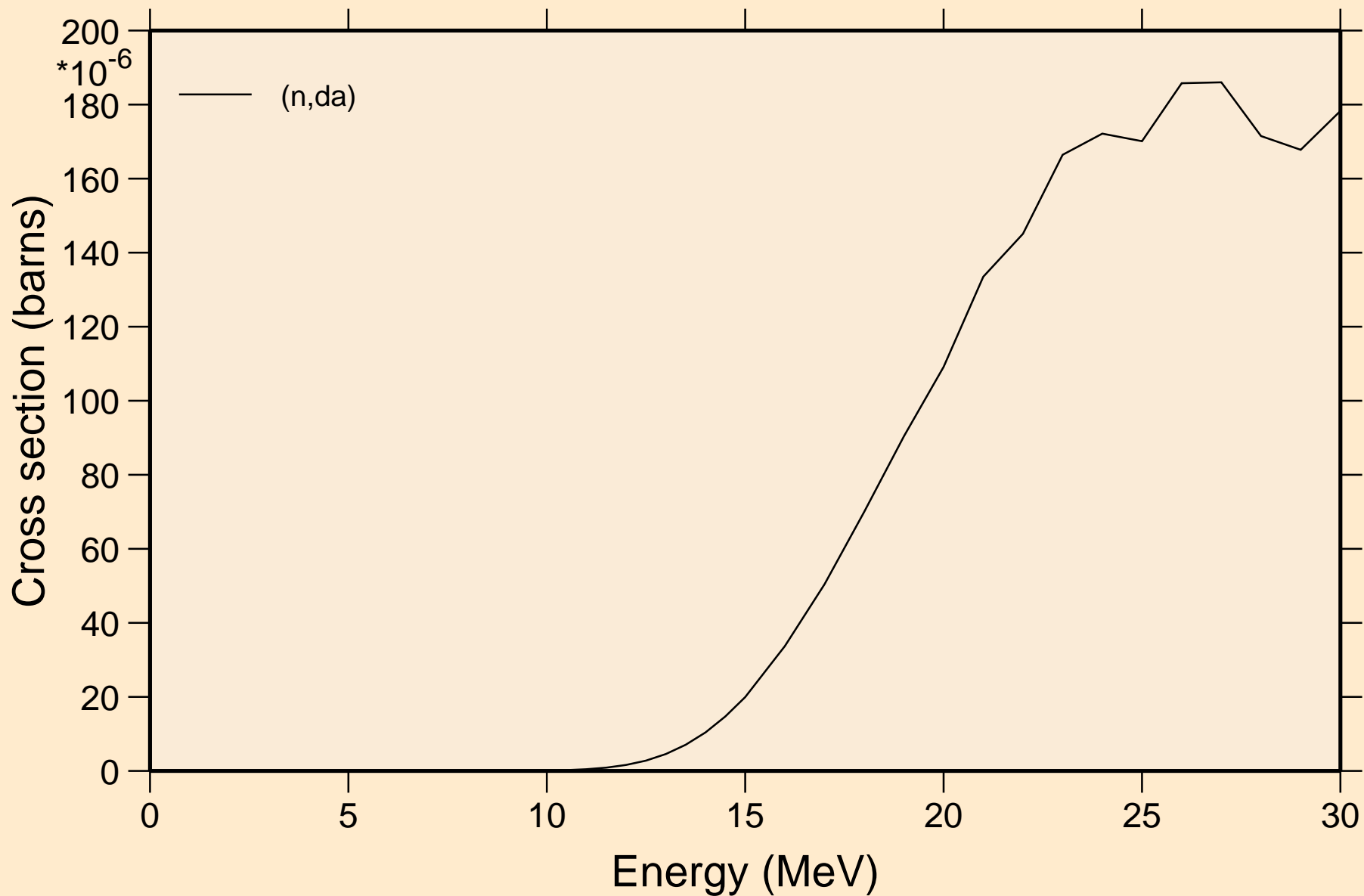

DB257 NEUTRON ACER TENDL-2019 LIBRARY; T=293.16K
Threshold reactions

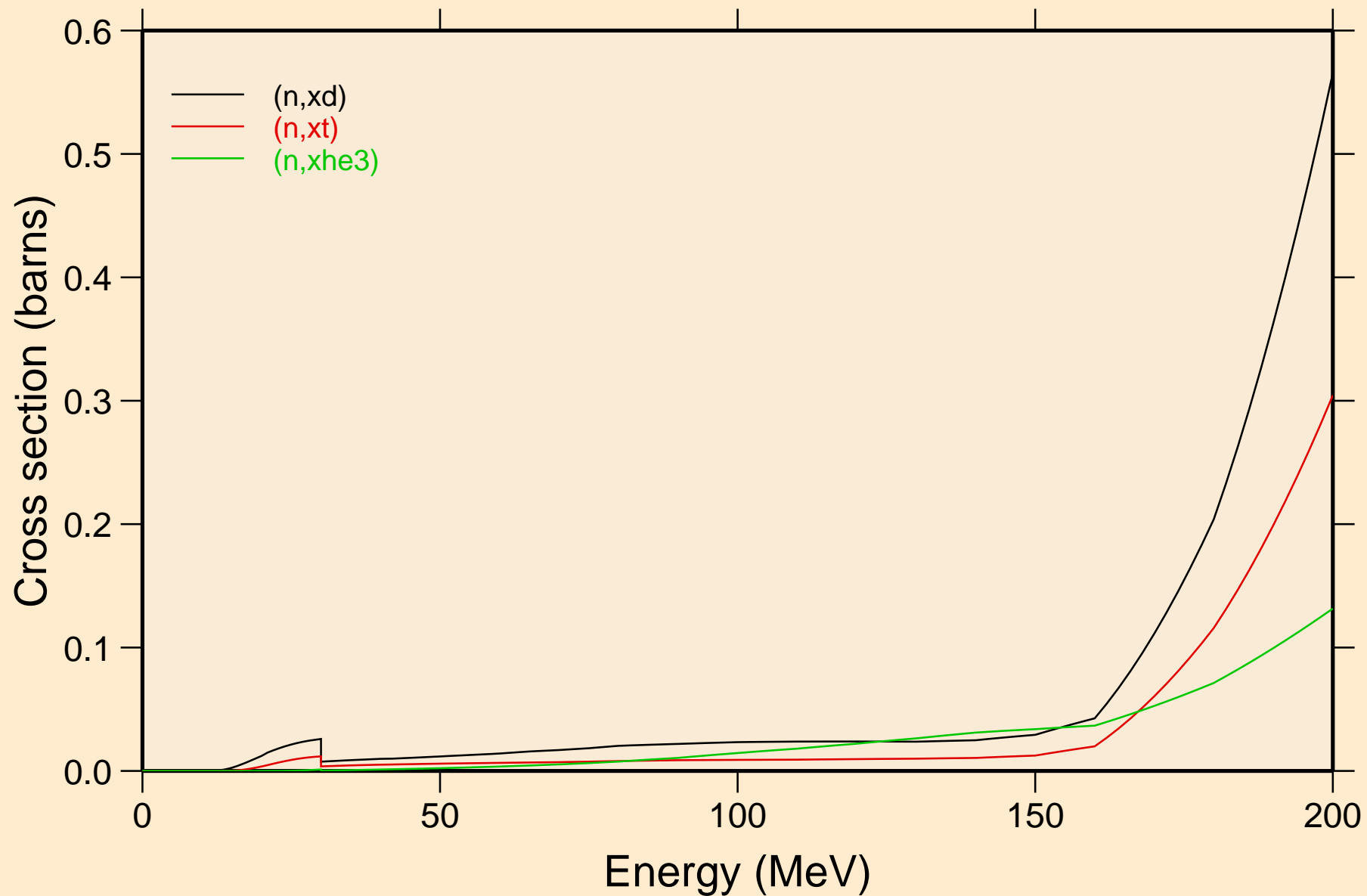

DB257 NEUTRON ACER TENDL-2019 LIBRARY; T=293.16K
angular distribution for elastic

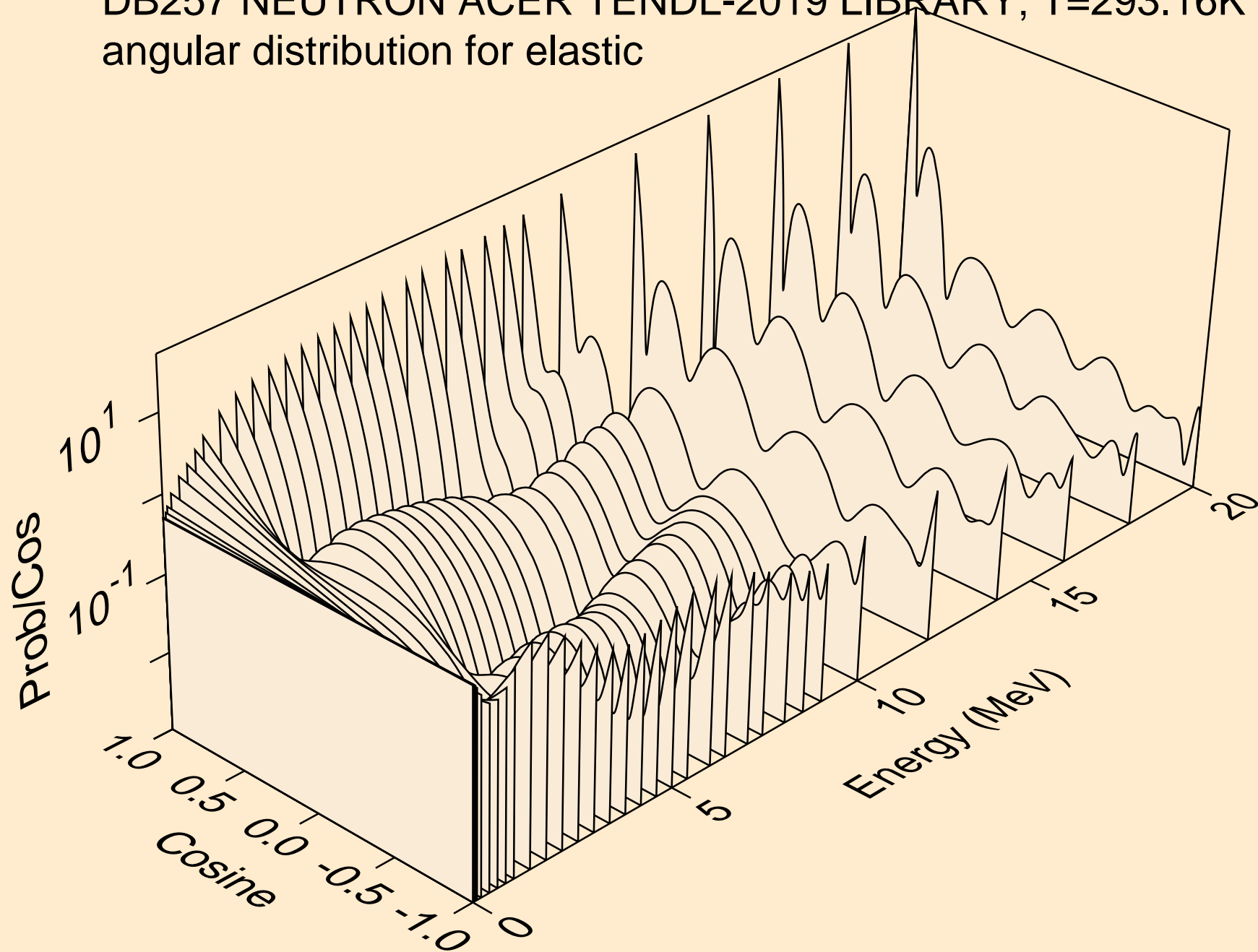

DB257 NEUTRON ACER TENDL-2019 LIBRARY; T=293.16K
angular distribution for elastic

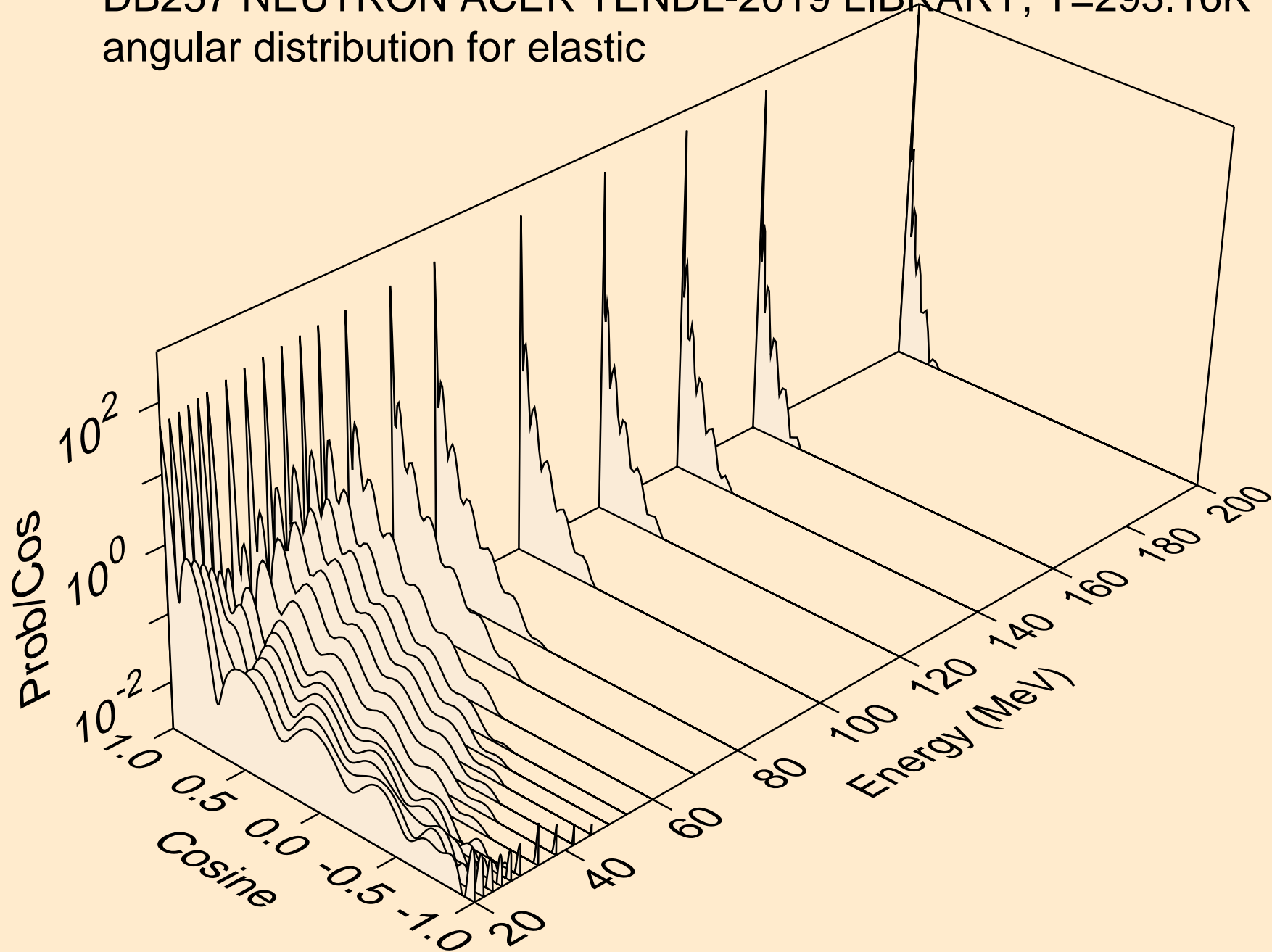

DB257 NEUTRON ACER TENDL-2019 LIBRARY; T=293.16K
angular distribution for (n,n*1)

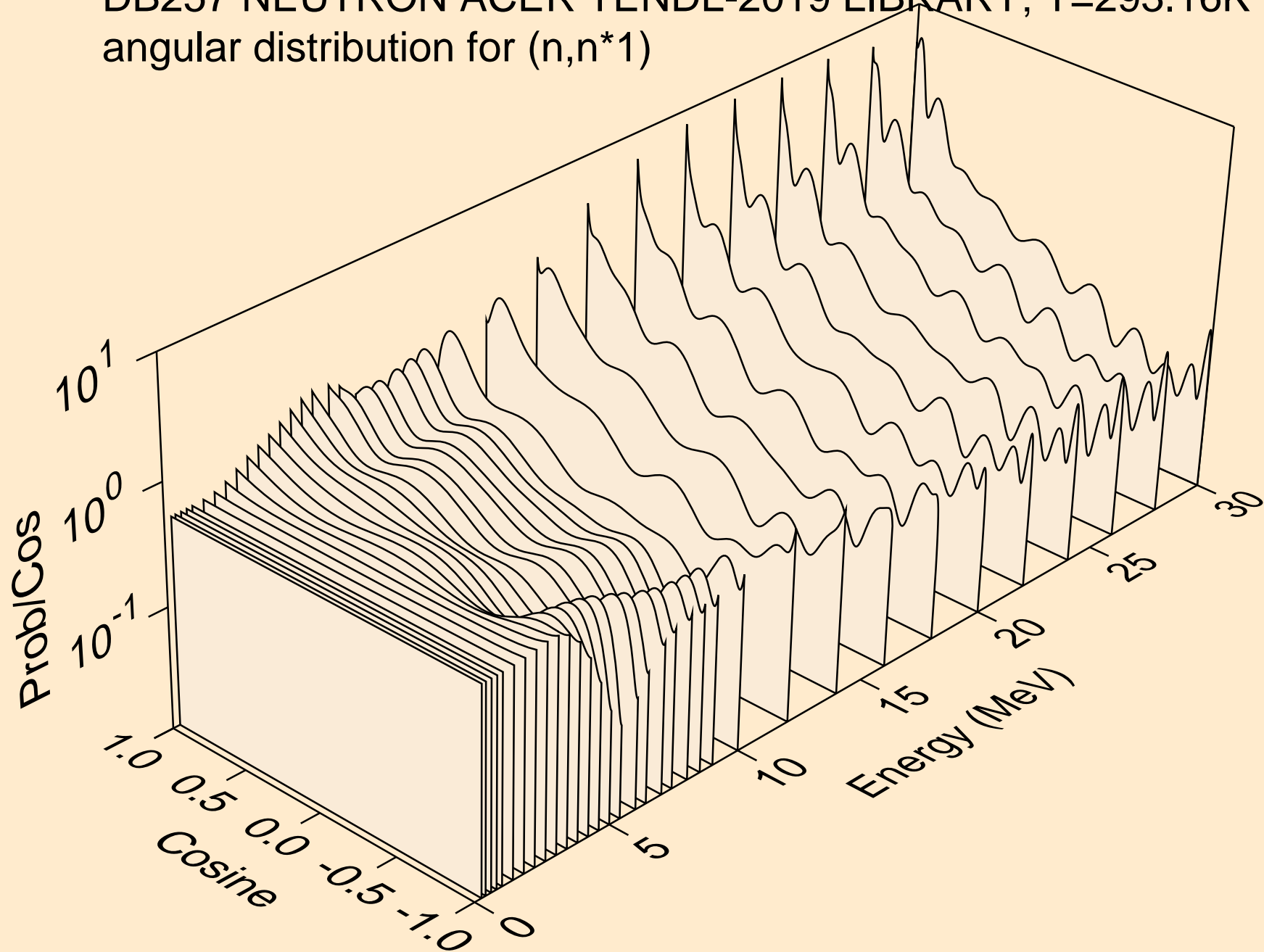

DB257 NEUTRON ACER TENDL-2019 LIBRARY; T=293.16K
angular distribution for (n,n*2)

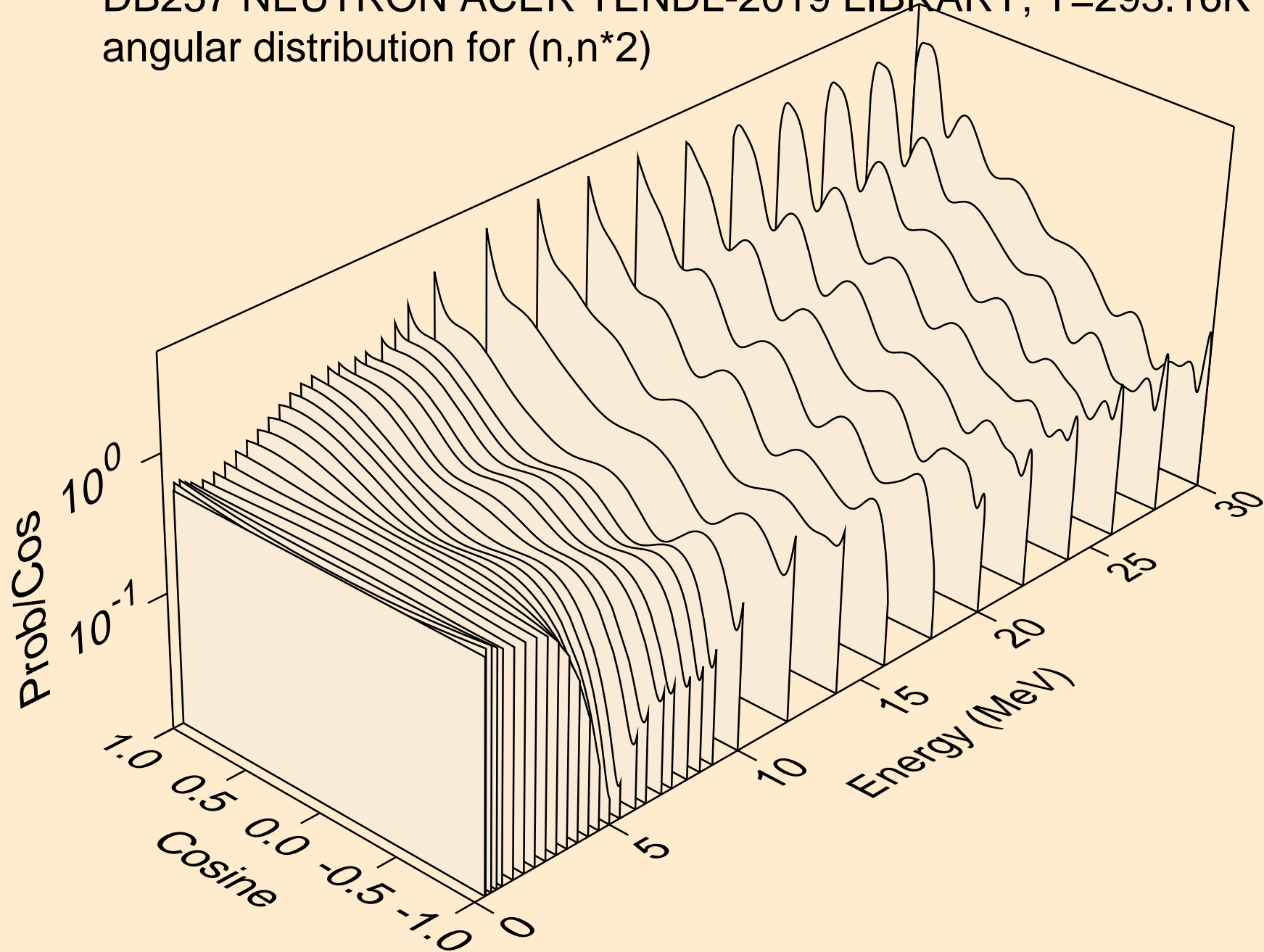

DB257 NEUTRON ACER TENDL-2019 LIBRARY; T=293.16K
angular distribution for (n,n*3)

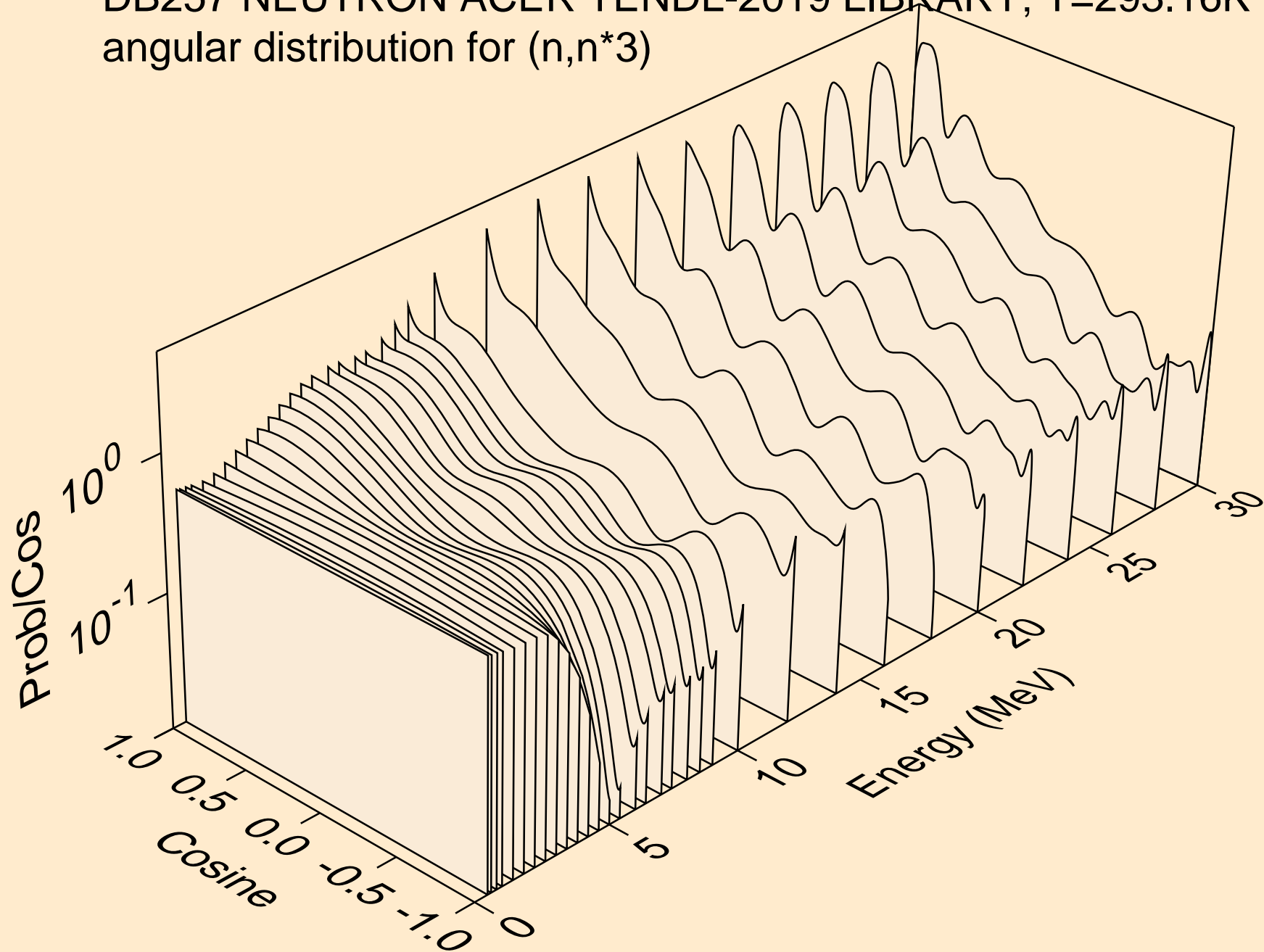

DB257 NEUTRON ACER TENDL-2019 LIBRARY; T=293.16K
angular distribution for (n,n*4)

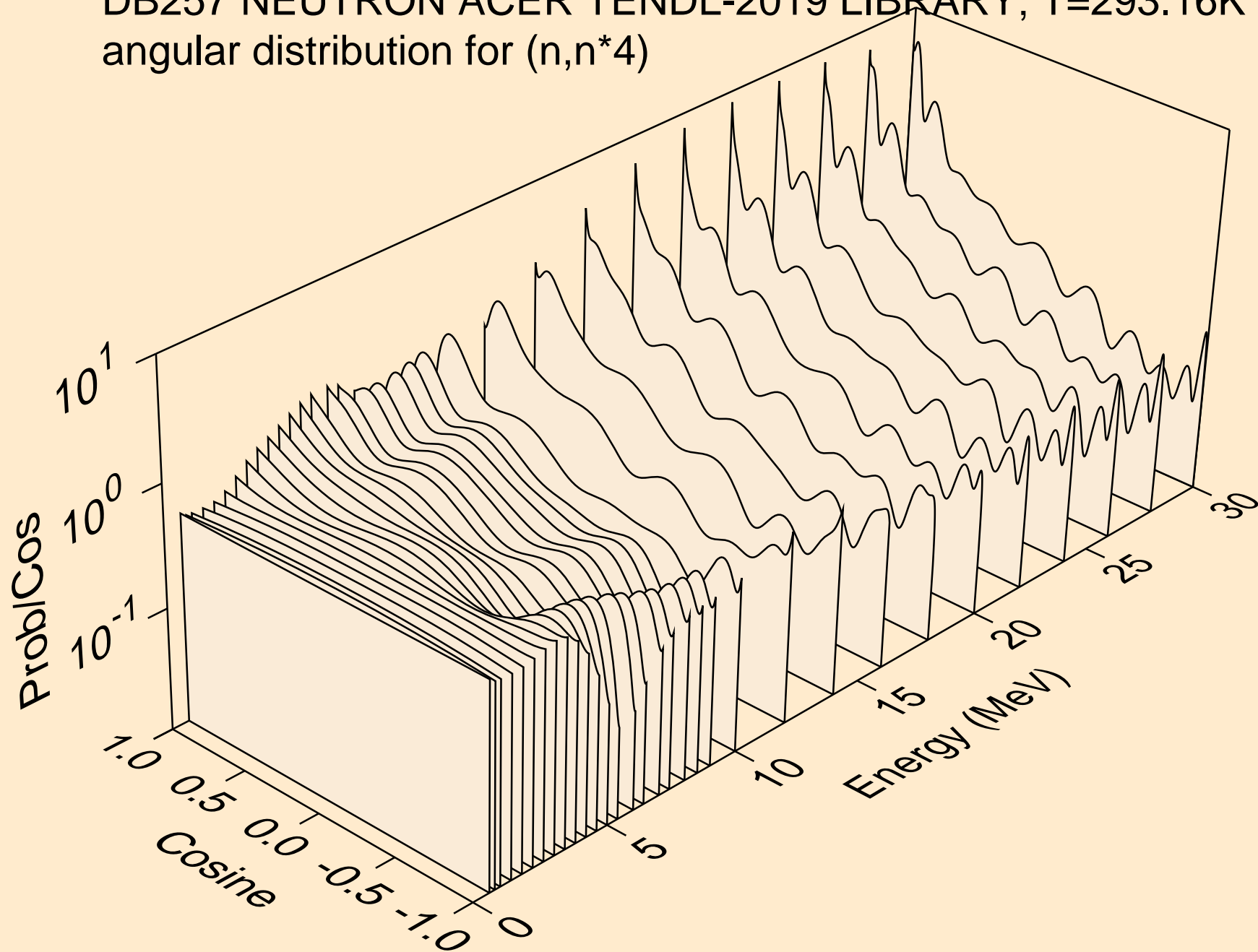

DB257 NEUTRON ACER TENDL-2019 LIBRARY; T=293.16K
angular distribution for (n,n*5)

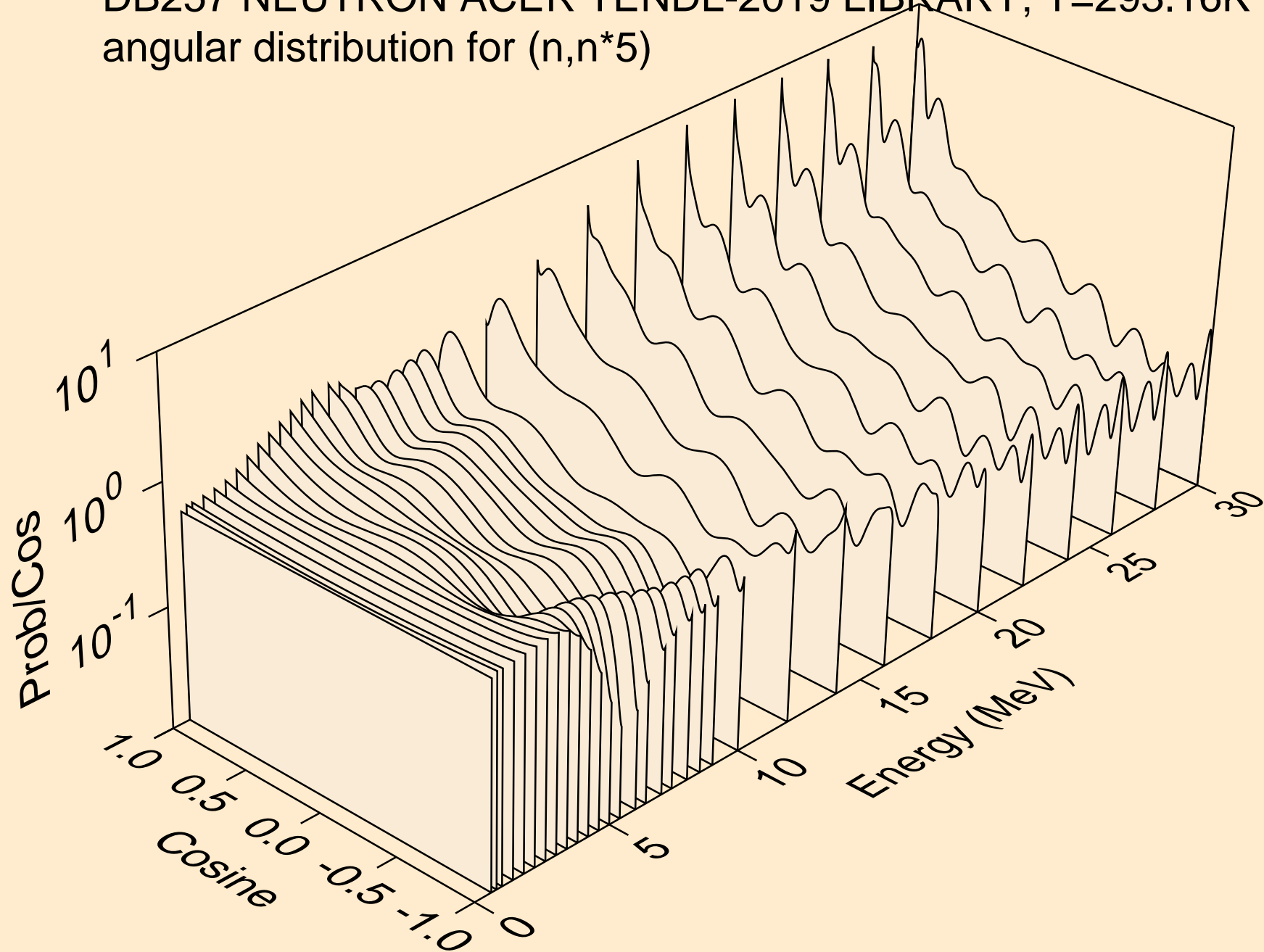

DB257 NEUTRON ACER TENDL-2019 LIBRARY; T=293.16K
angular distribution for (n,n*6)

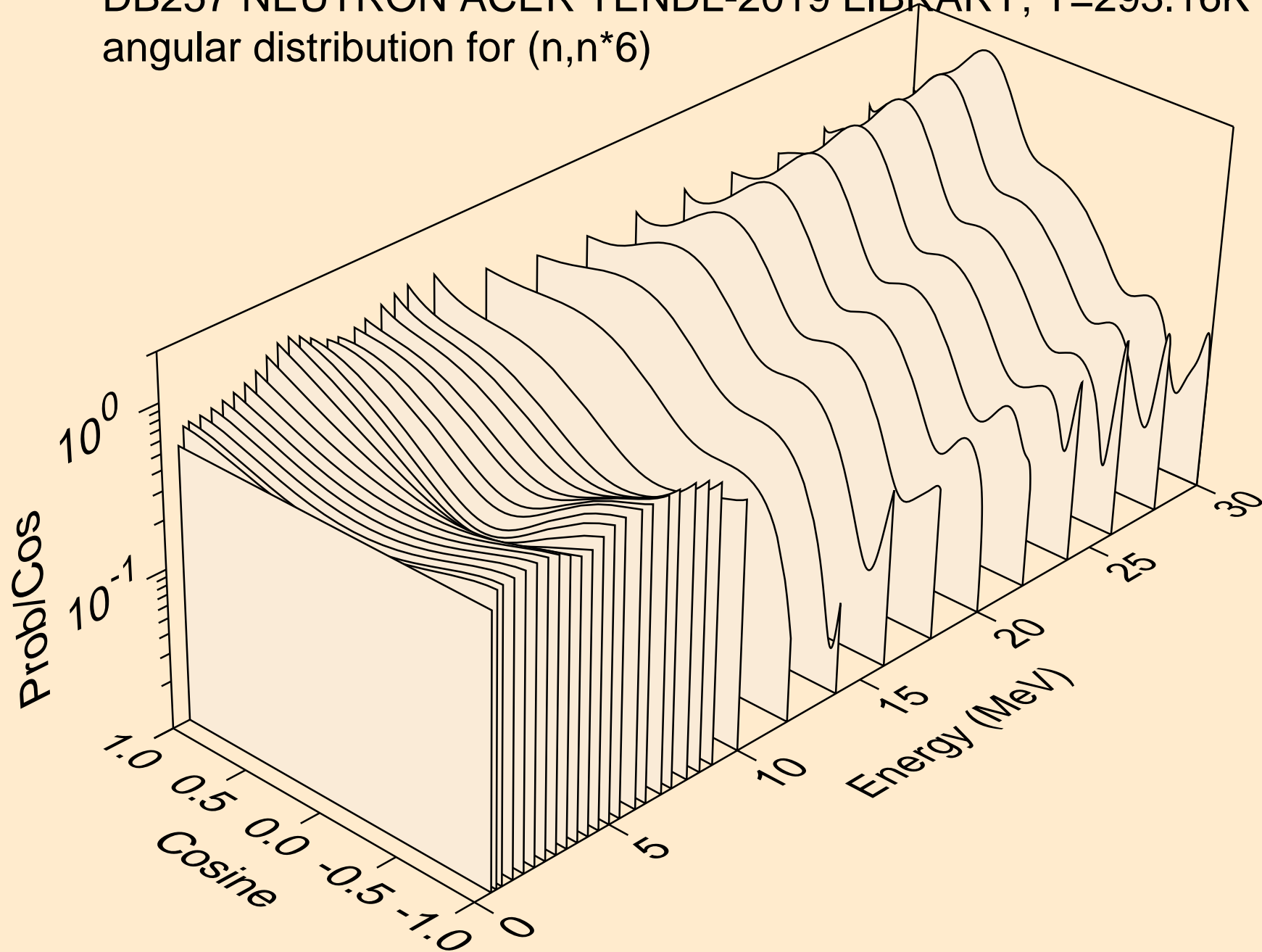

DB257 NEUTRON ACER TENDL-2019 LIBRARY; T=293.16K
angular distribution for (n,n*7)

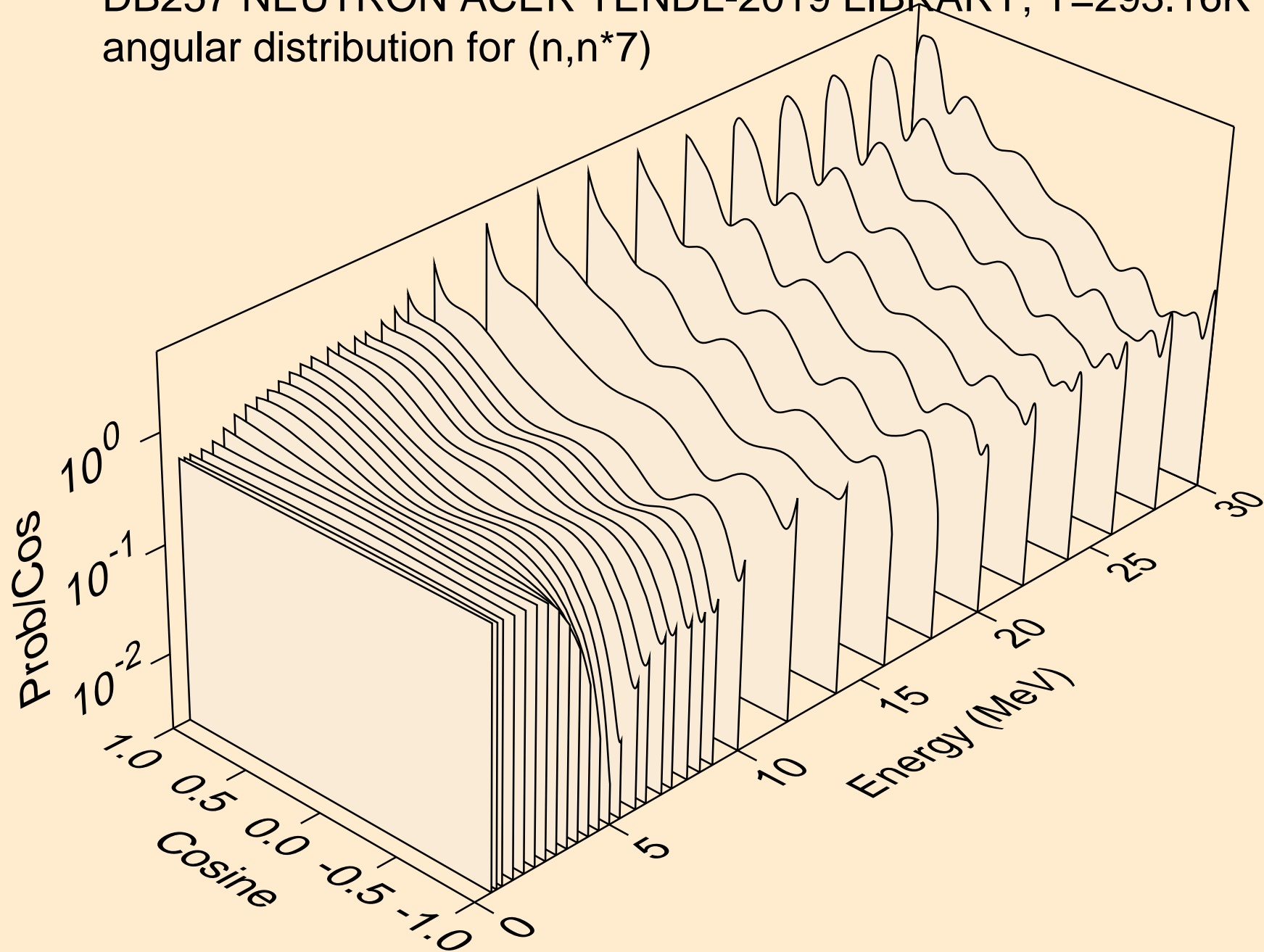

DB257 NEUTRON ACER TENDL-2019 LIBRARY; T=293.16K
angular distribution for (n,n*8)

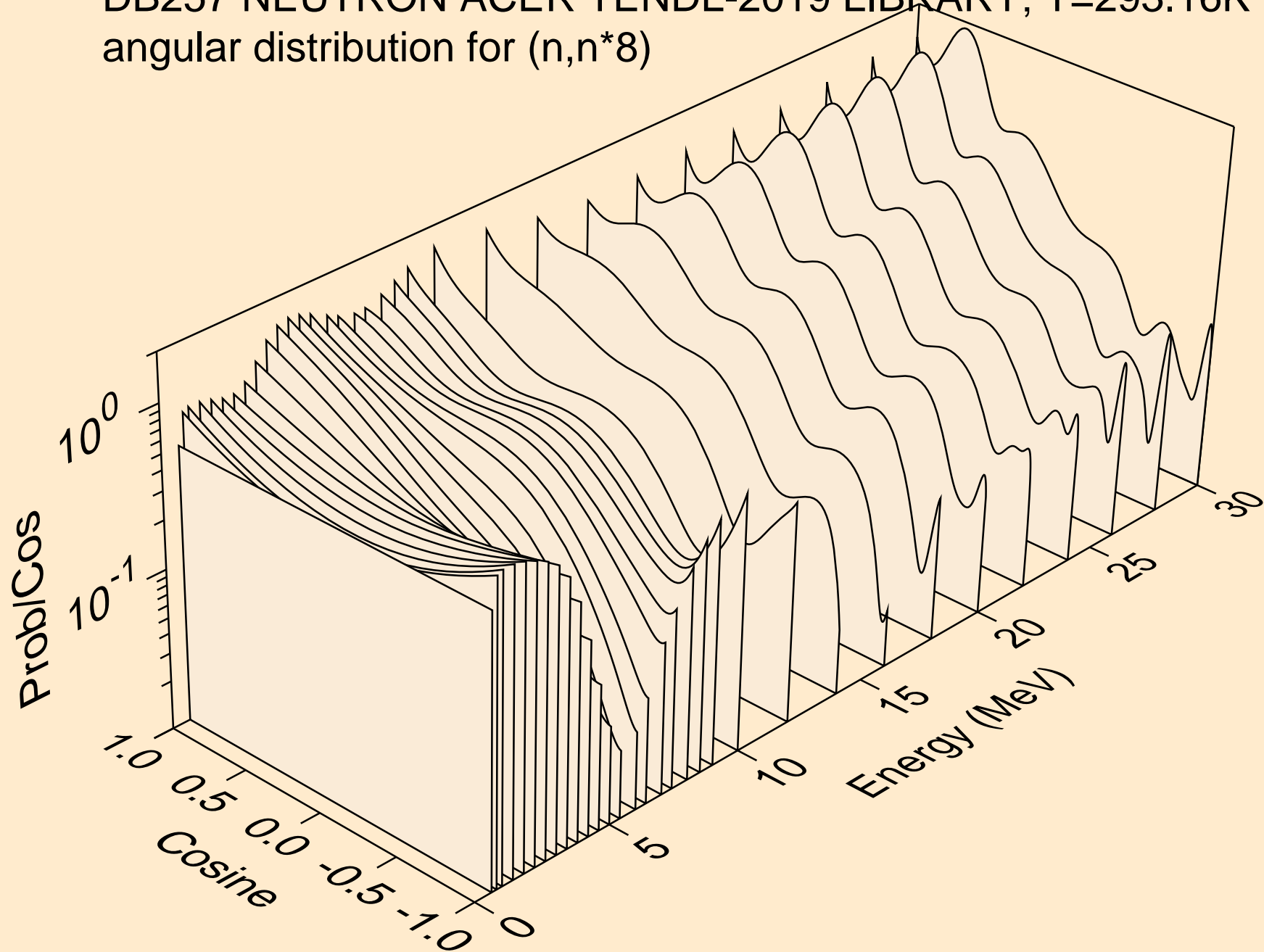

DB257 NEUTRON ACER TENDL-2019 LIBRARY; T=293.16K
angular distribution for (n,n*9)

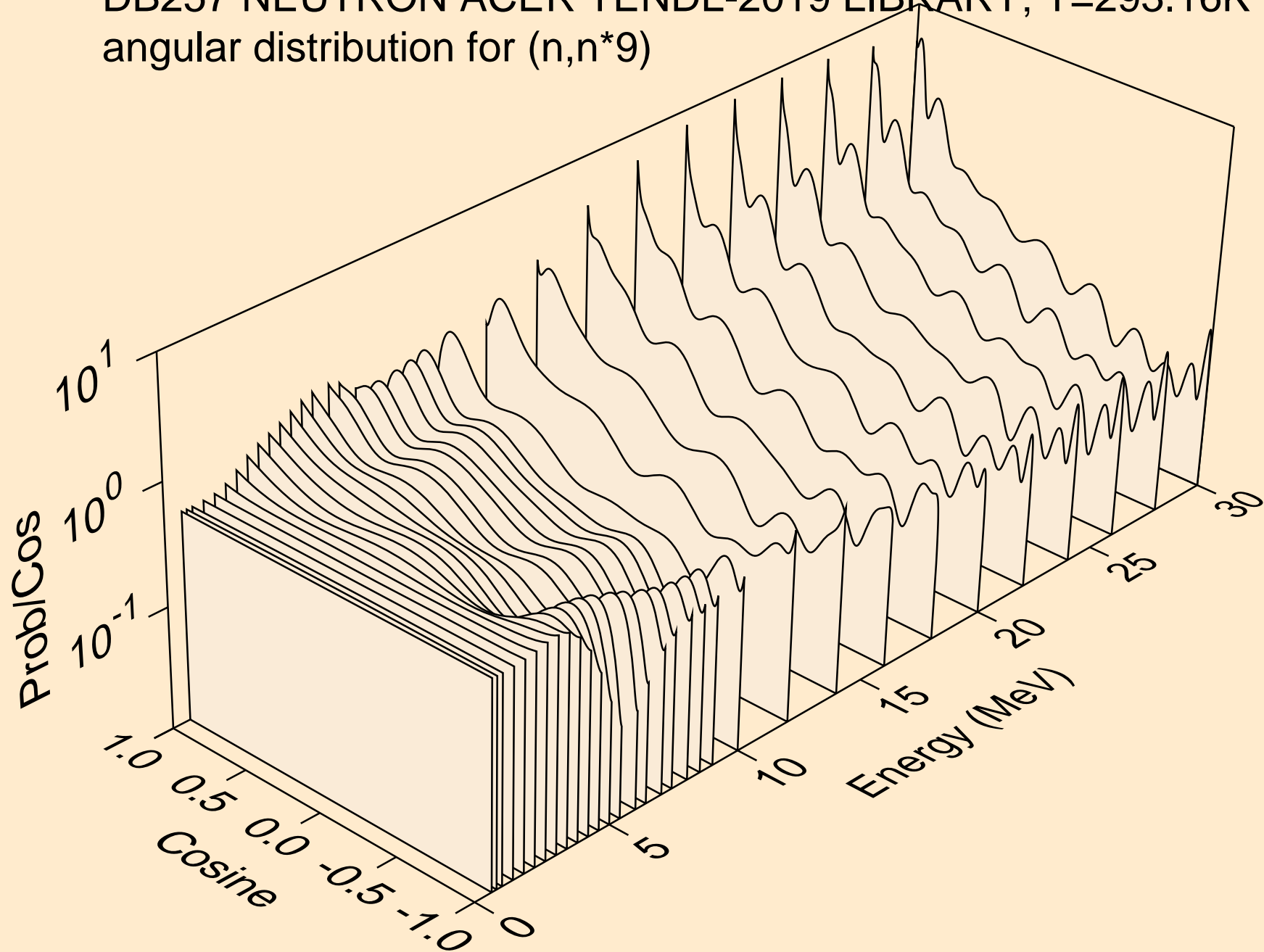

DB257 NEUTRON ACER TENDL-2019 LIBRARY; T=293.16K
angular distribution for (n,n*10)

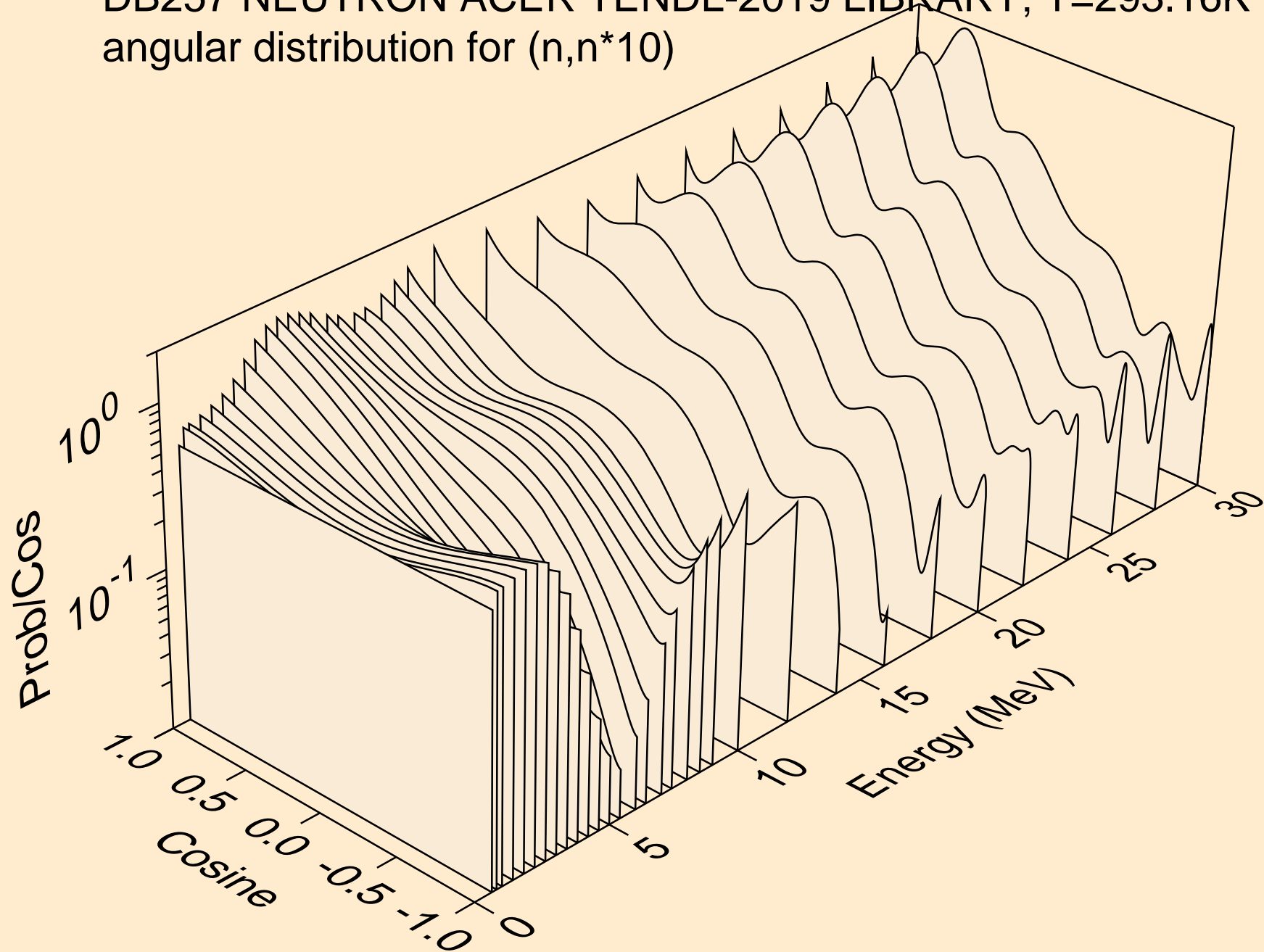

DB257 NEUTRON ACER TENDL-2019 LIBRARY; T=293.16K
angular distribution for (n,n*11)

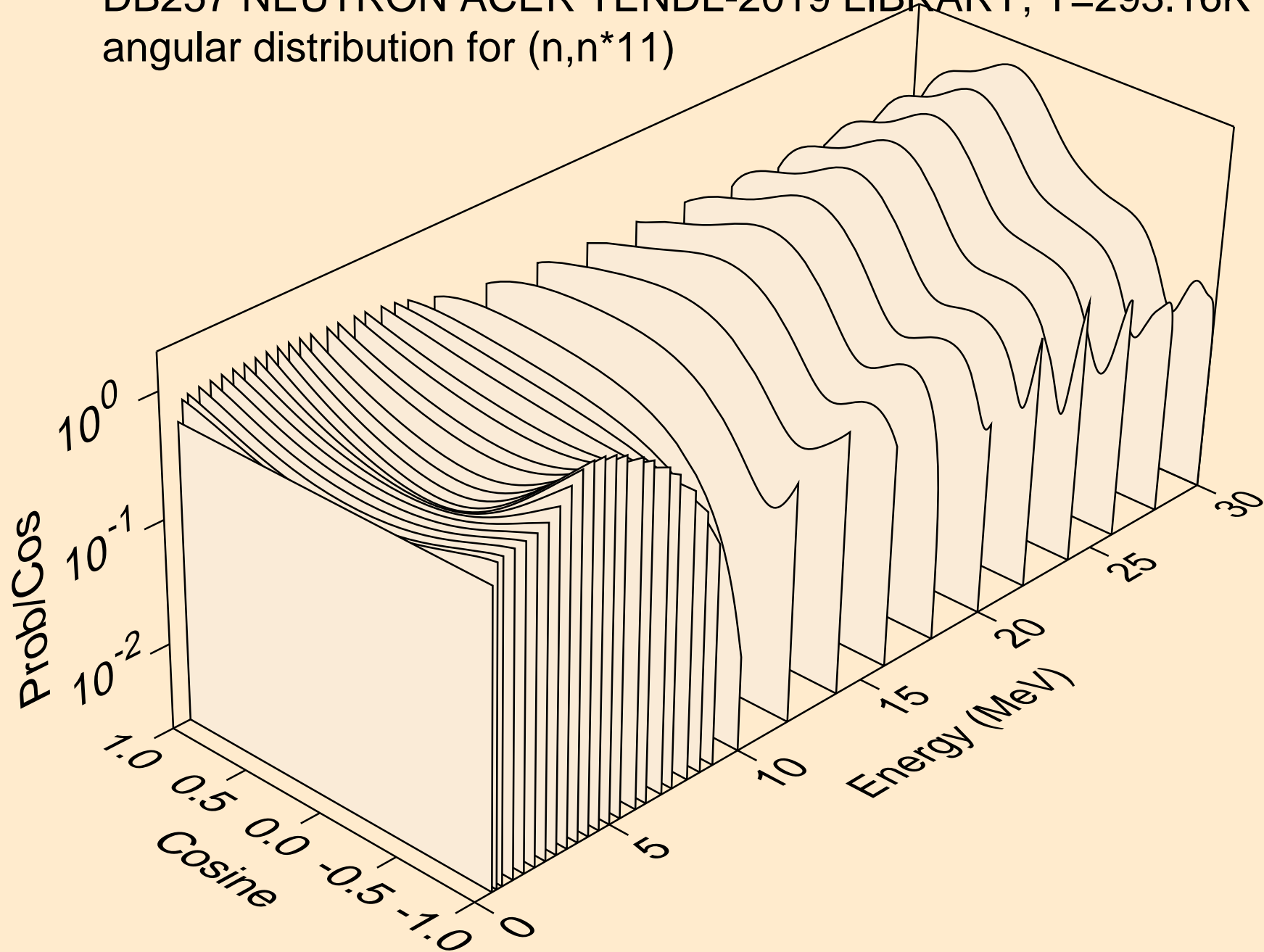

DB257 NEUTRON ACER TENDL-2019 LIBRARY; T=293.16K
angular distribution for (n,n*12)

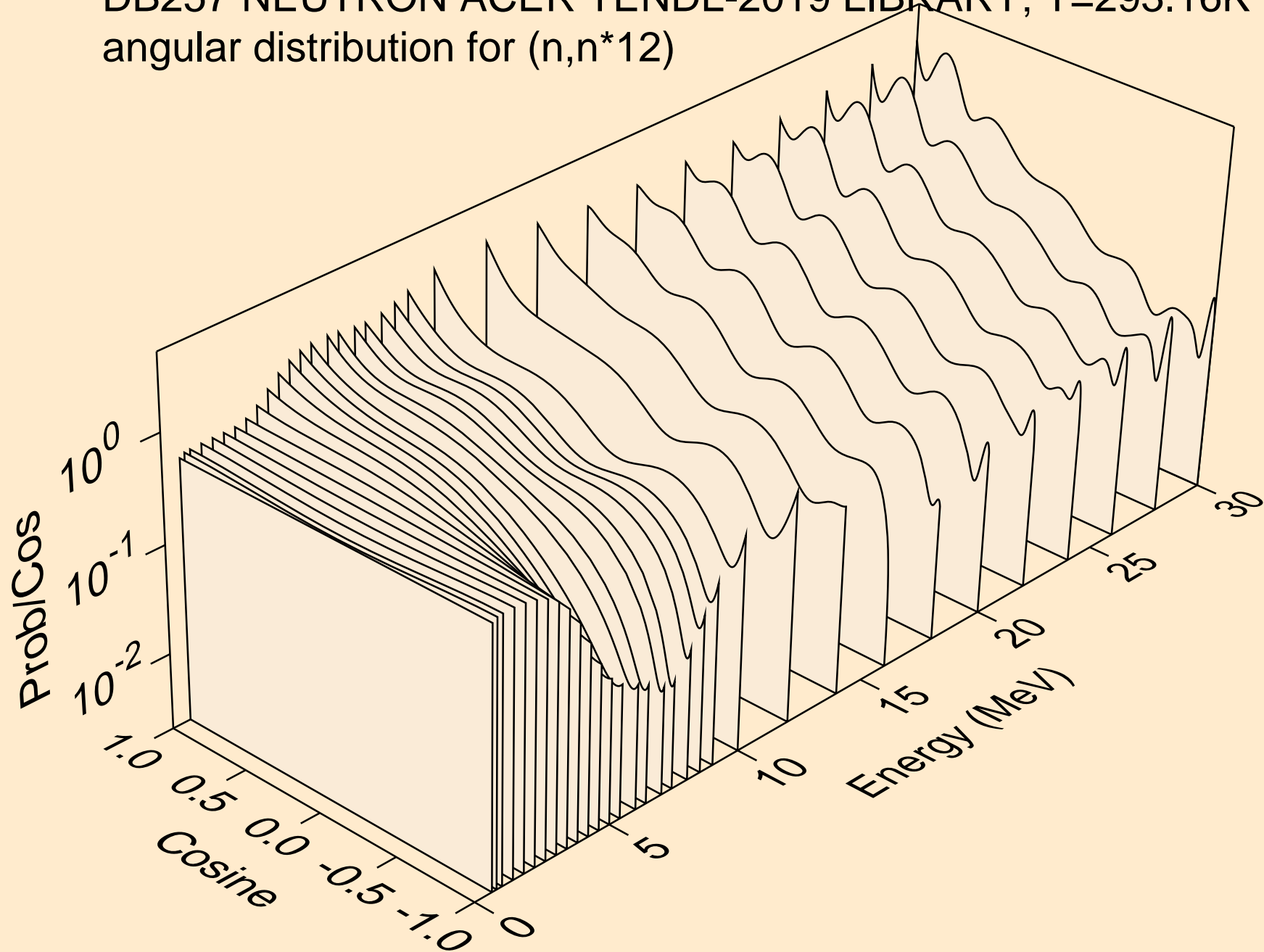

DB257 NEUTRON ACER TENDL-2019 LIBRARY; T=293.16K
angular distribution for (n,n*13)

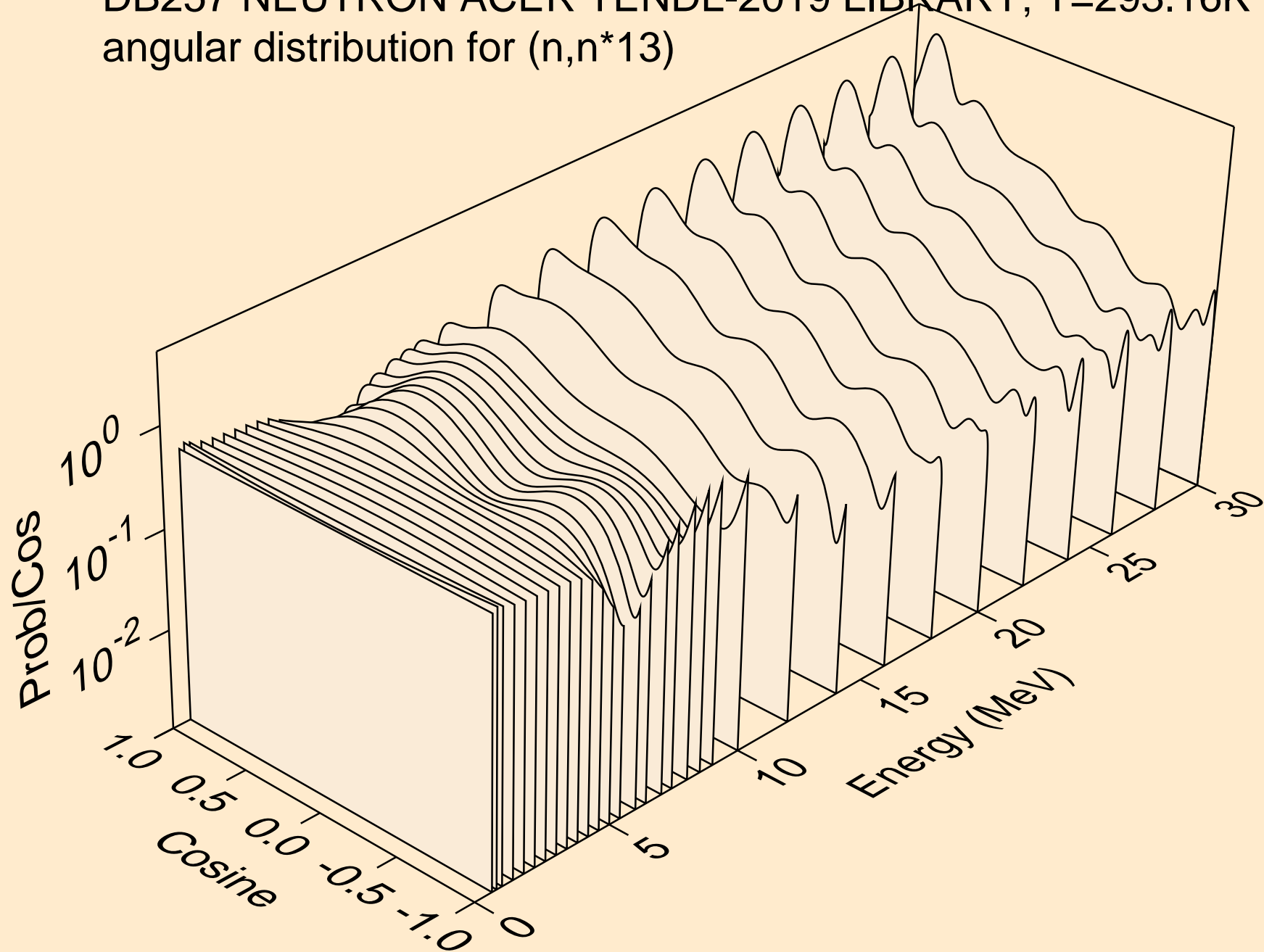

DB257 NEUTRON ACER TENDL-2019 LIBRARY; T=293.16K
angular distribution for (n,n*14)

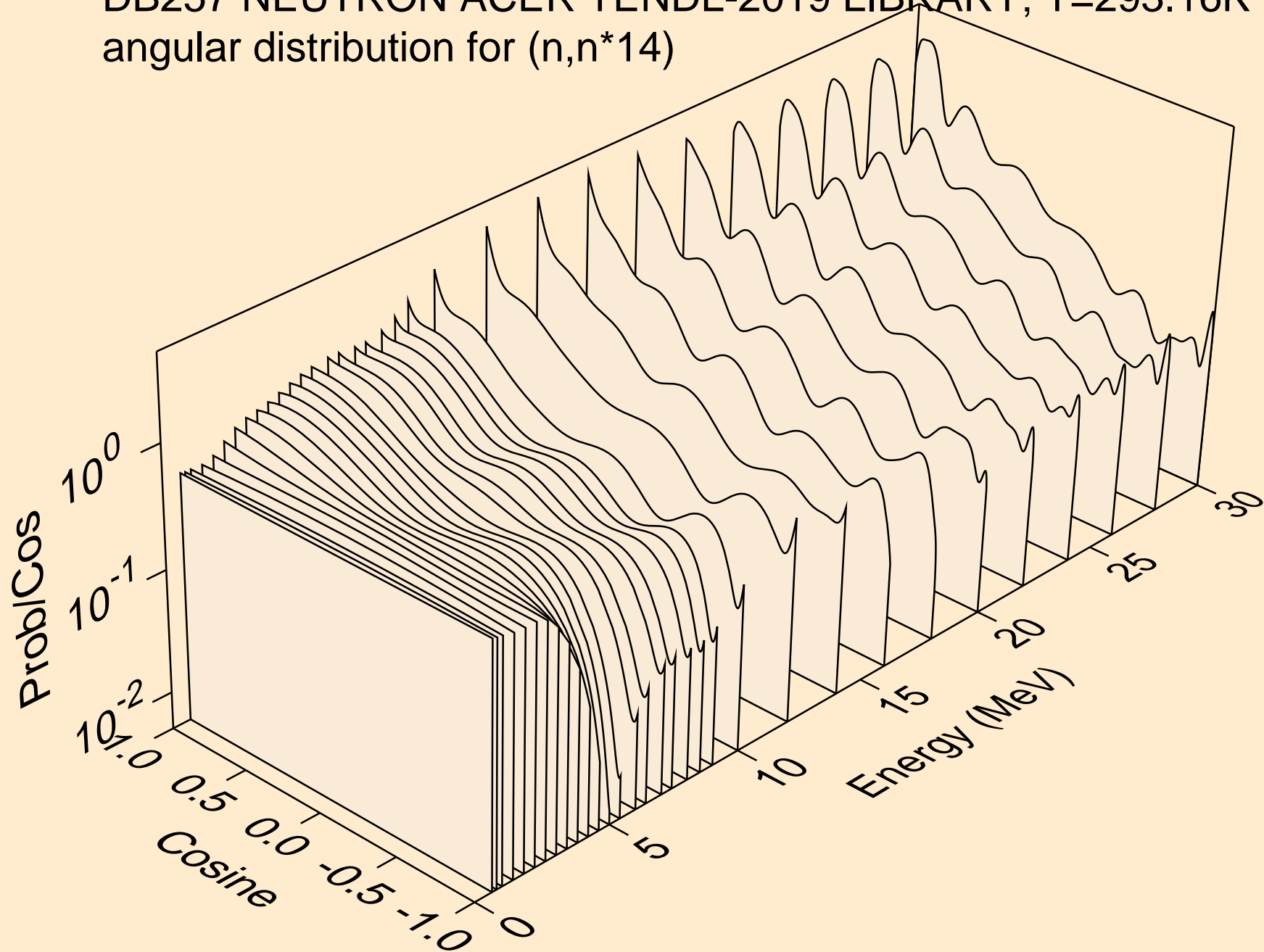

DB257 NEUTRON ACER TENDL-2019 LIBRARY; T=293.16K
angular distribution for (n,n*15)

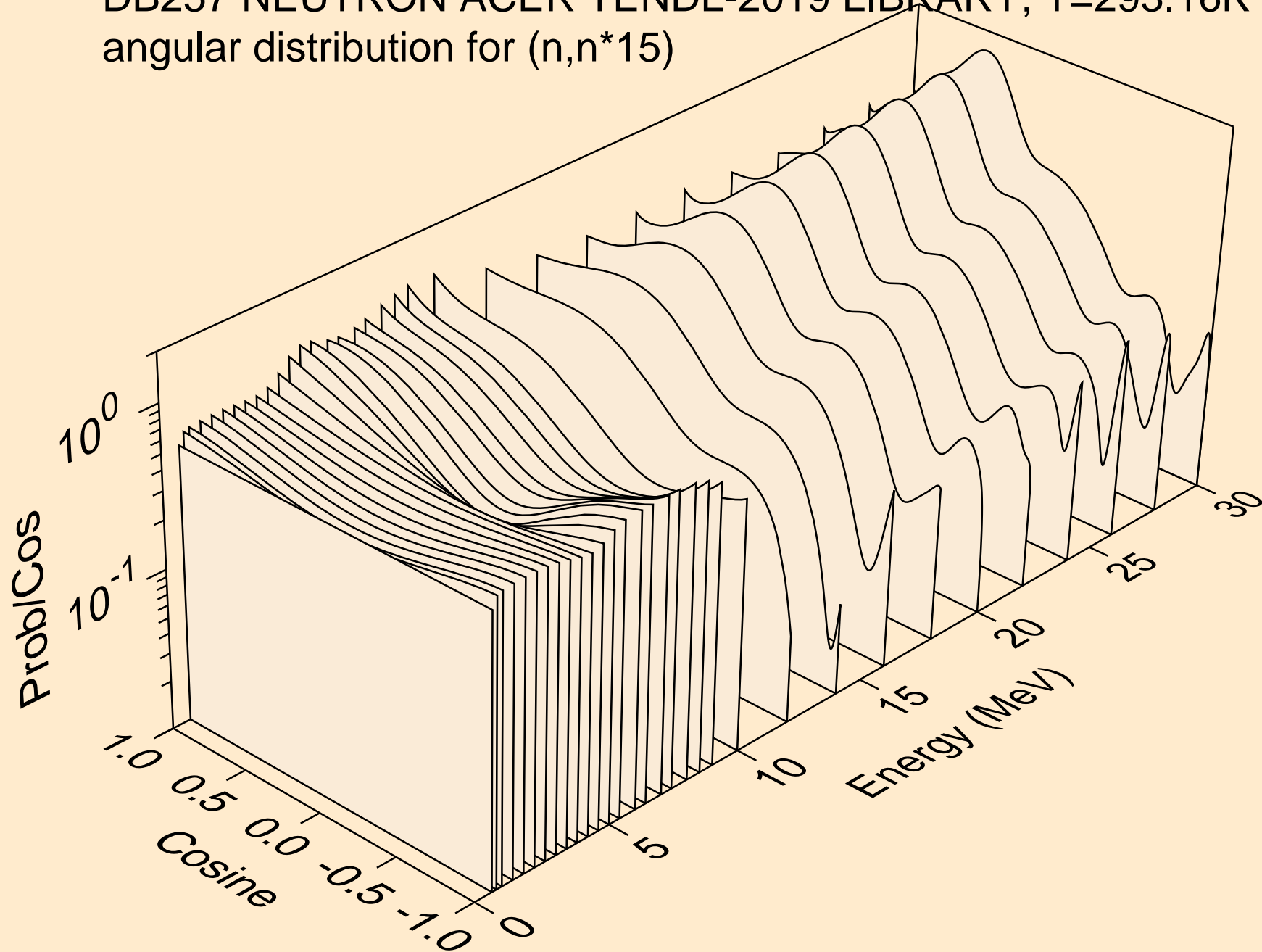

DB257 NEUTRON ACER TENDL-2019 LIBRARY; T=293.16K
angular distribution for (n,n*16)

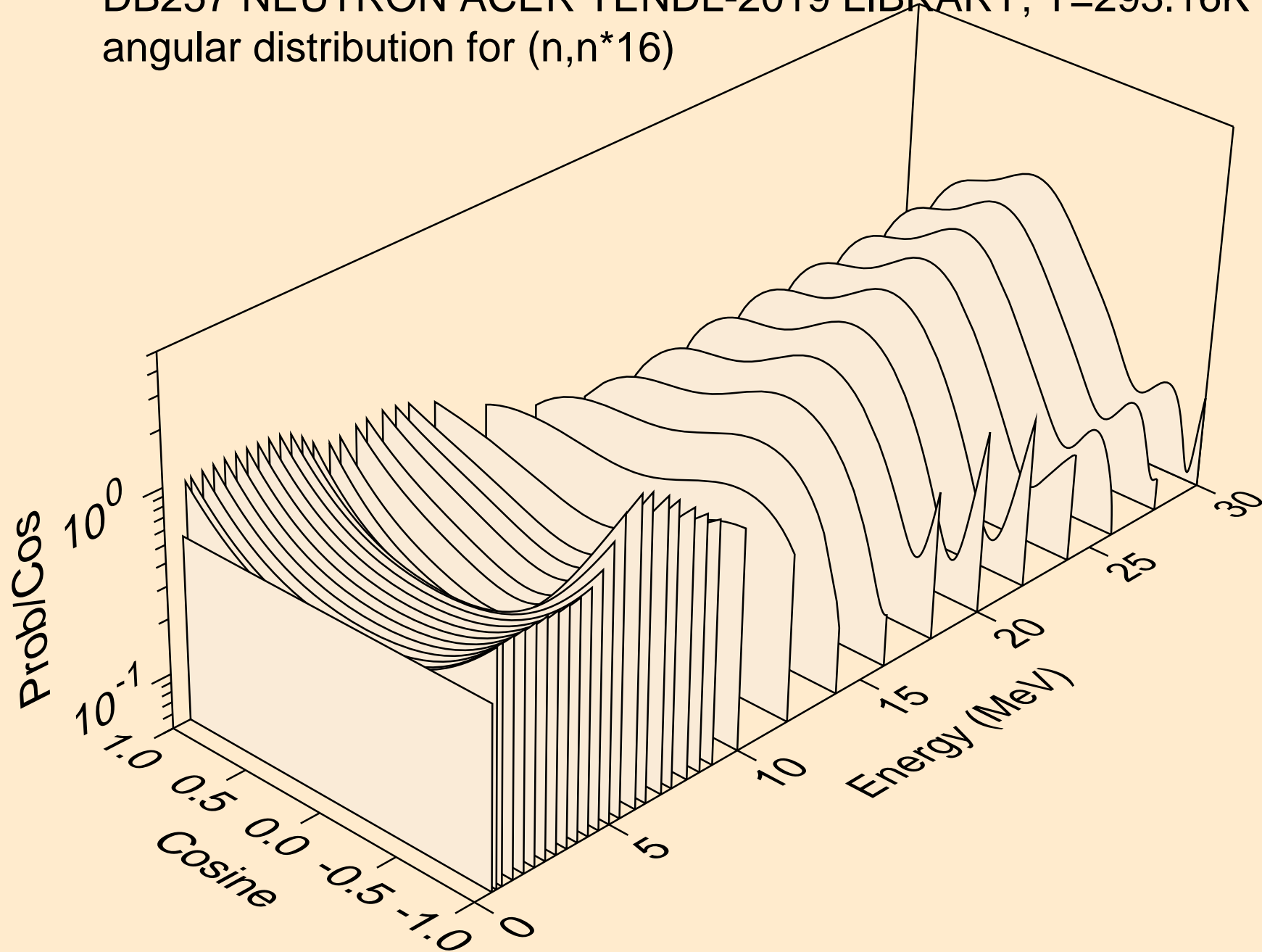

DB257 NEUTRON ACER TENDL-2019 LIBRARY; T=293.16K
angular distribution for (n,n*17)

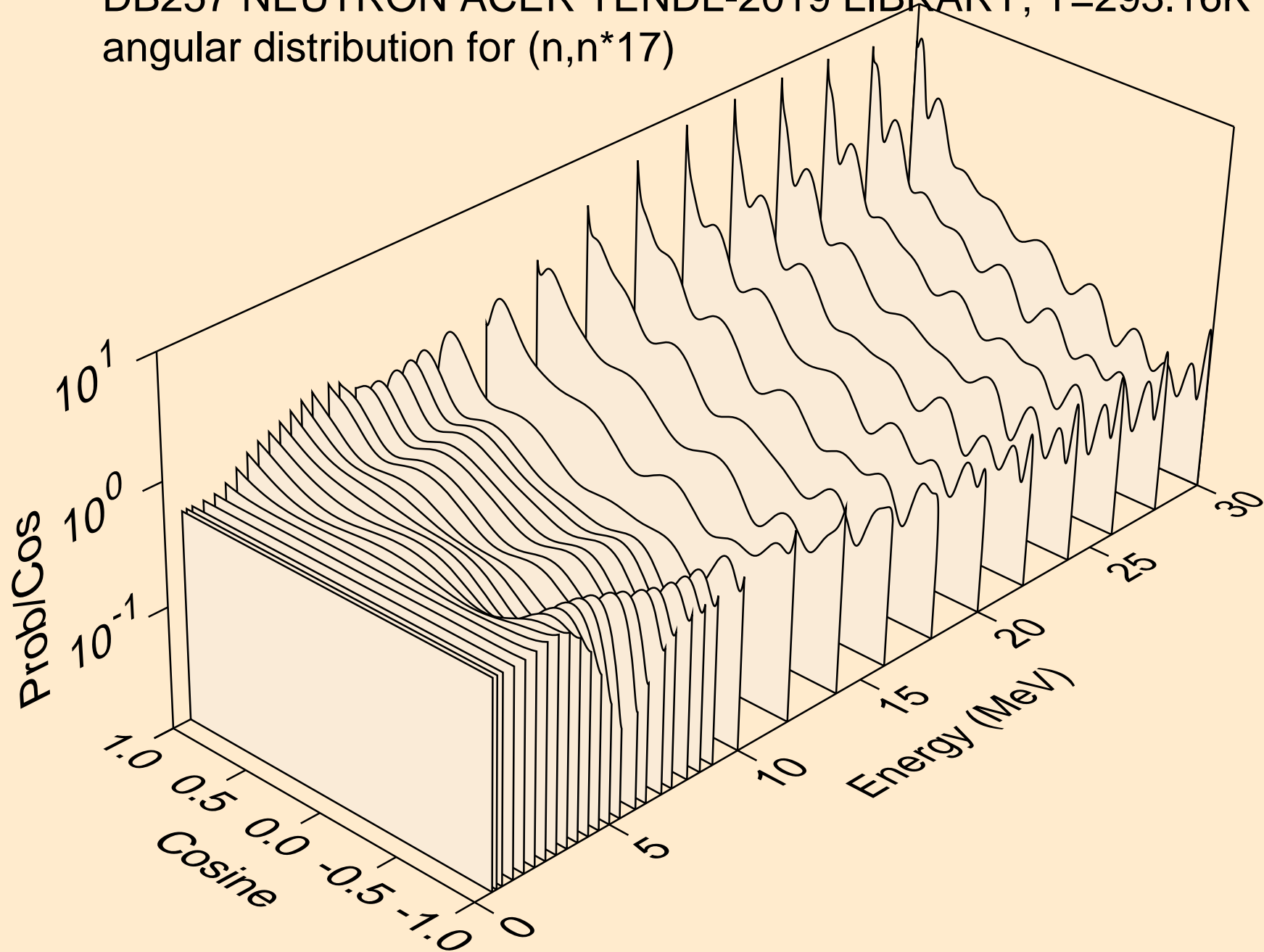

DB257 NEUTRON ACER TENDL-2019 LIBRARY; T=293.16K
angular distribution for (n,n*18)

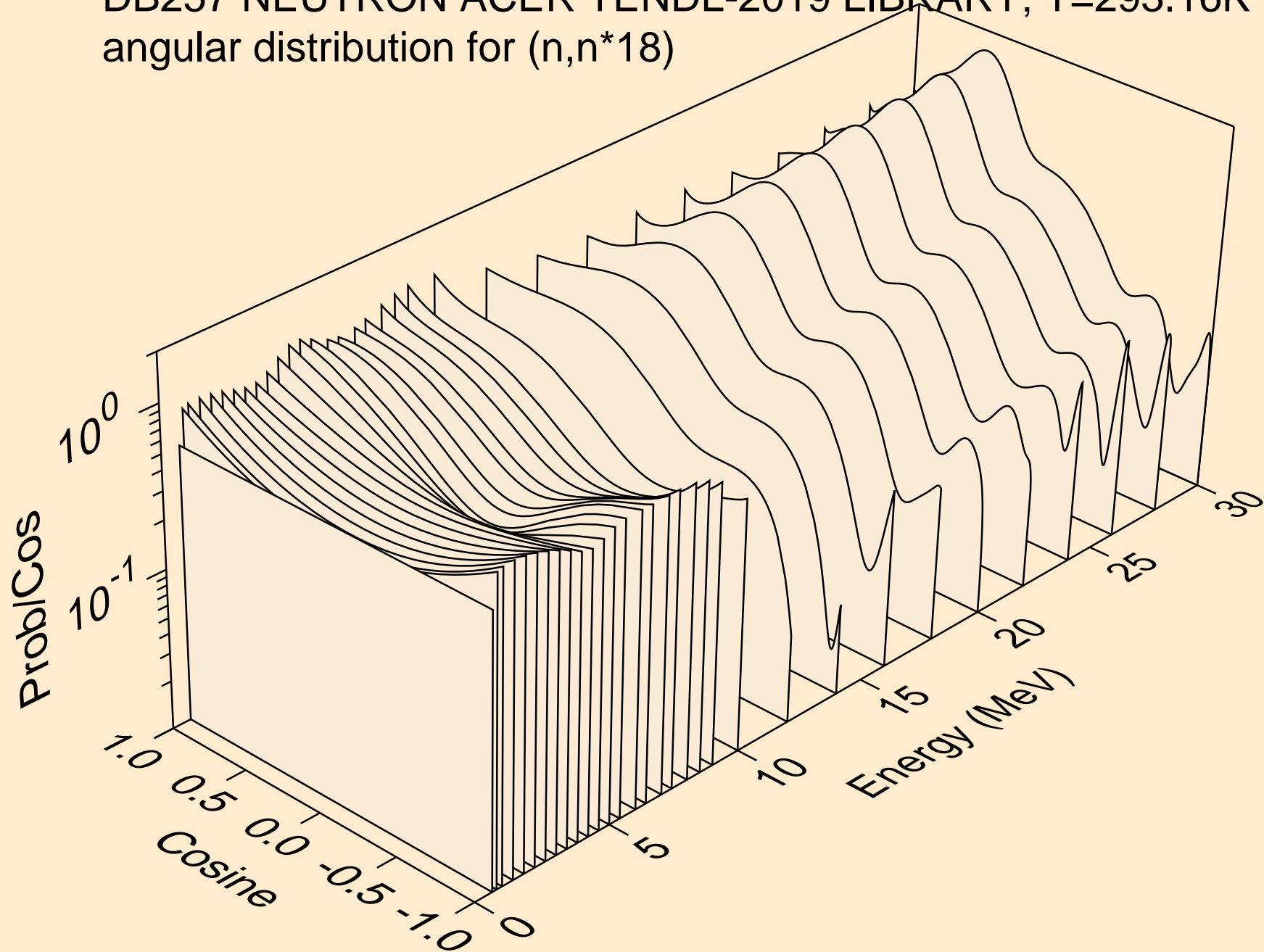

DB257 NEUTRON ACER TENDL-2019 LIBRARY; T=293.16K
angular distribution for (n,n*19)

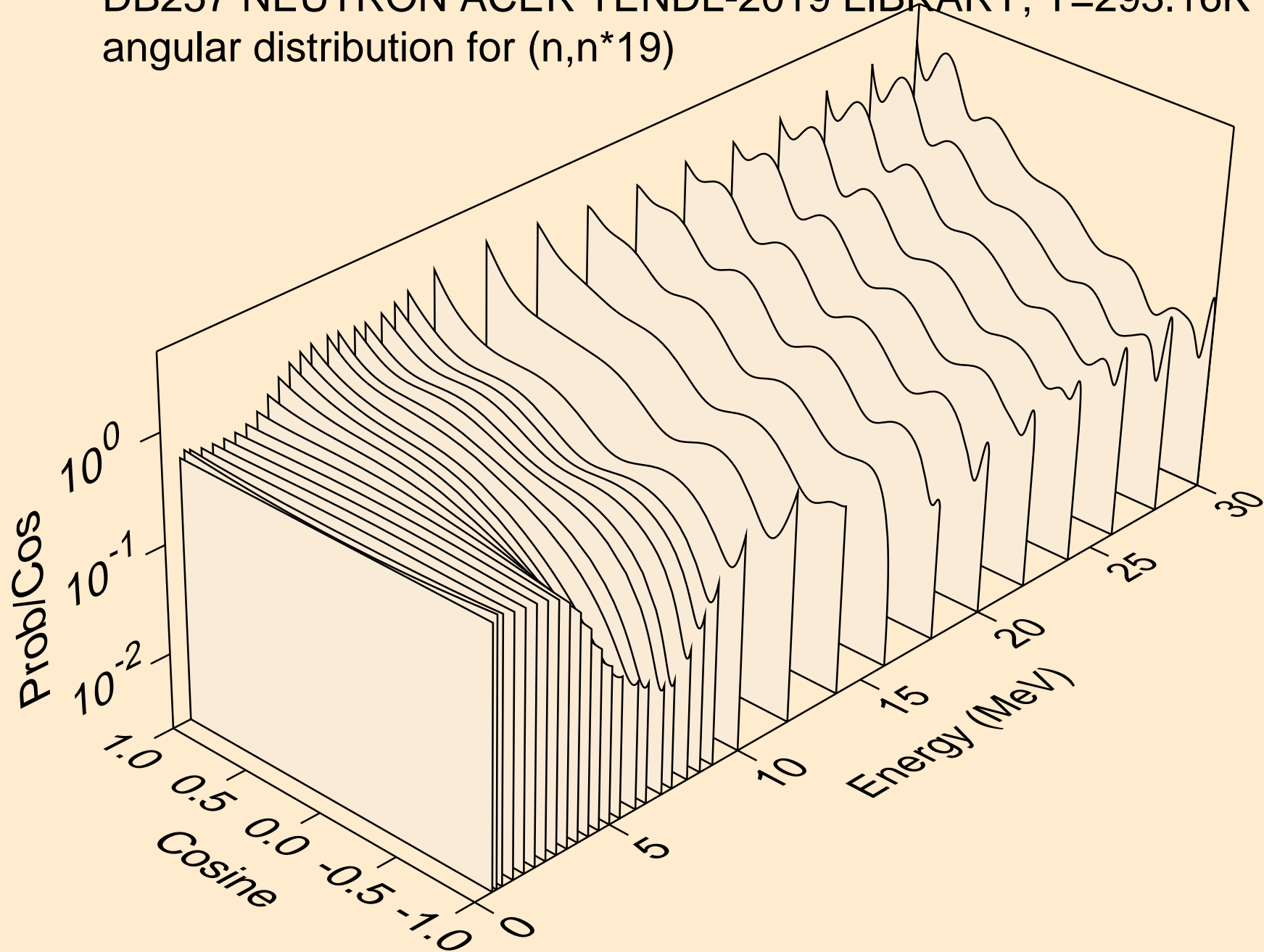

DB257 NEUTRON ACER TENDL-2019 LIBRARY; T=293.16K
angular distribution for (n,n*20)

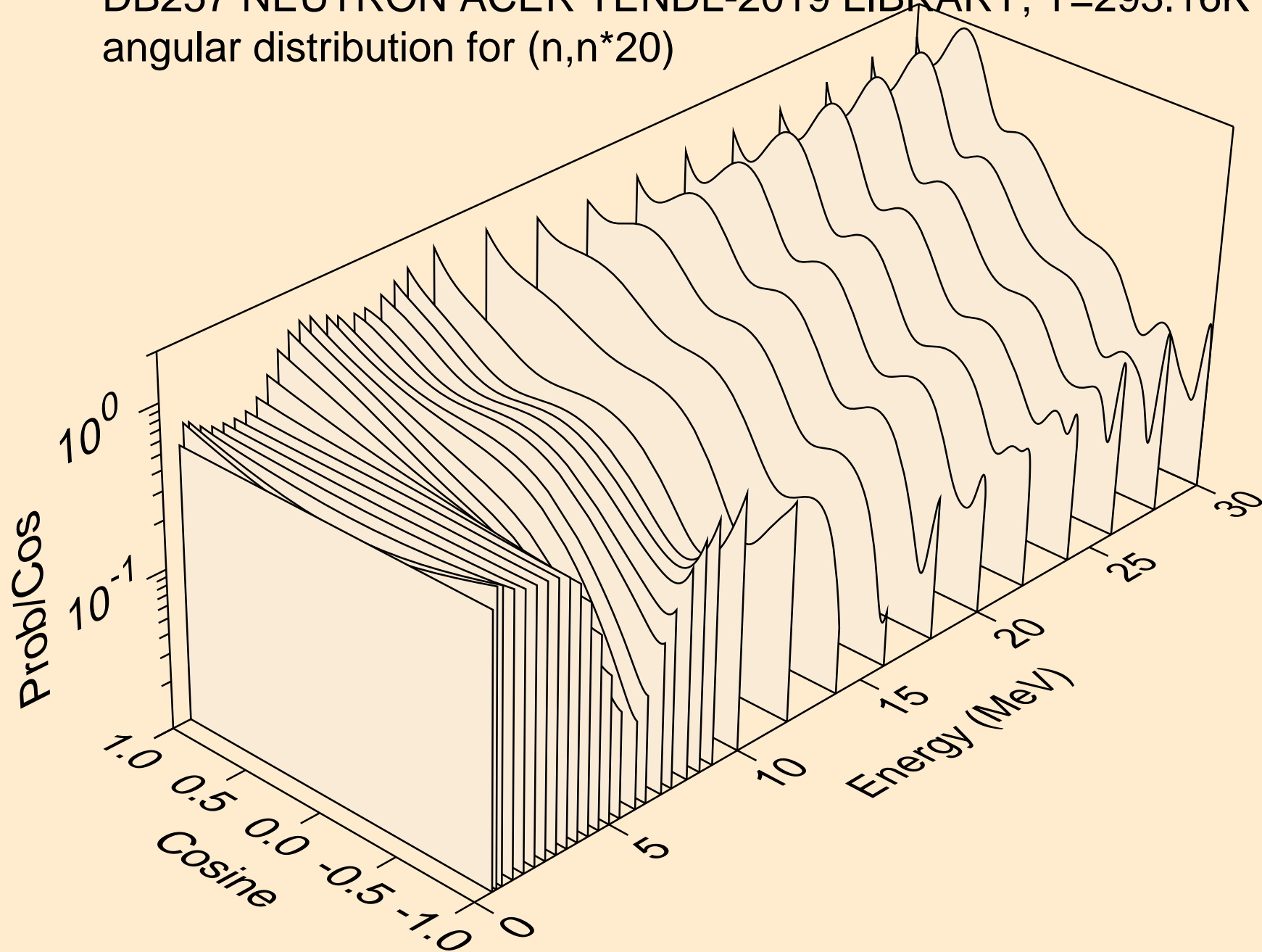

DB257 NEUTRON ACER TENDL-2019 LIBRARY; T=293.16K
angular distribution for (n,n*21)

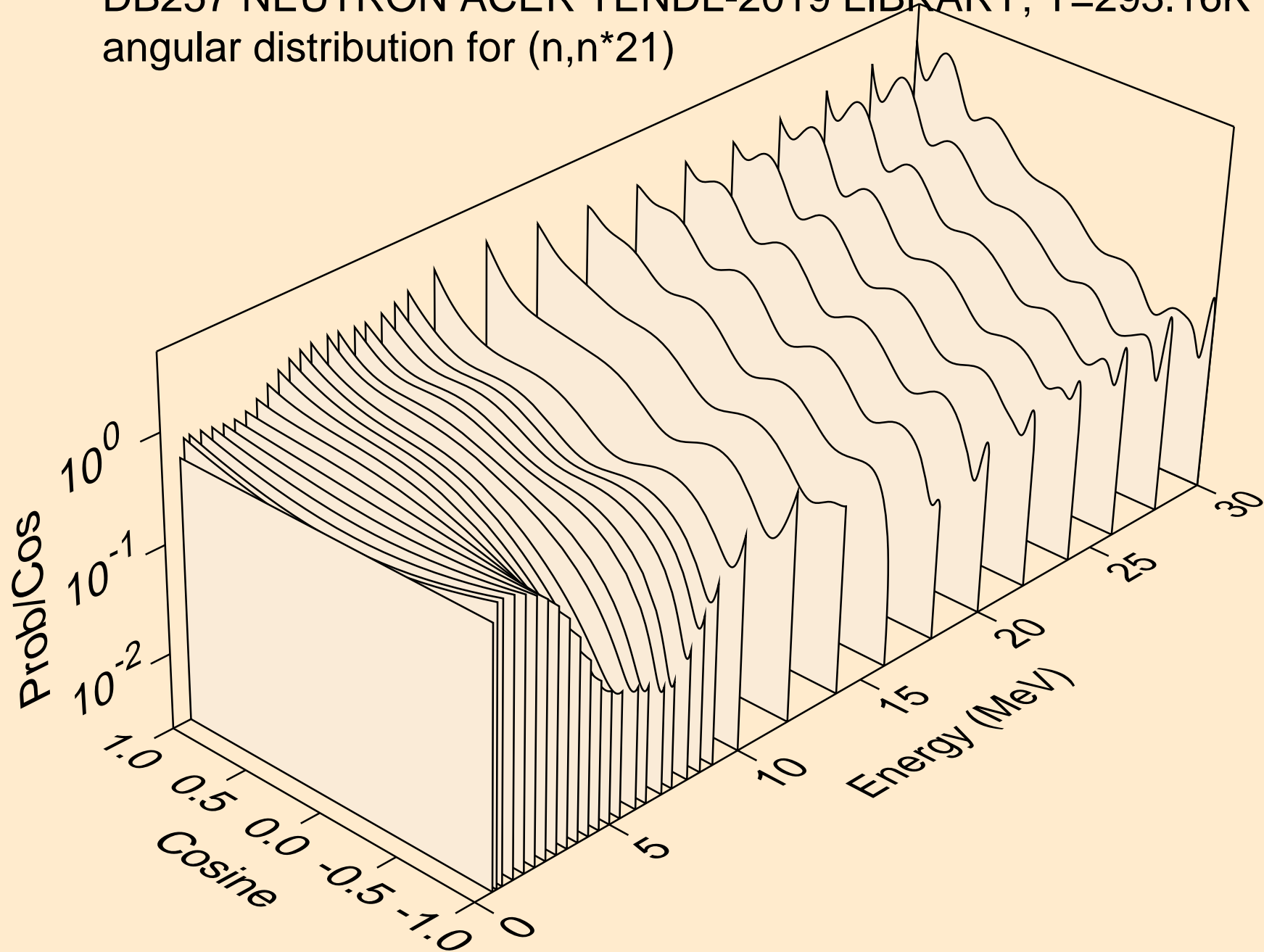

DB257 NEUTRON ACER TENDL-2019 LIBRARY; T=293.16K
angular distribution for (n,n*22)

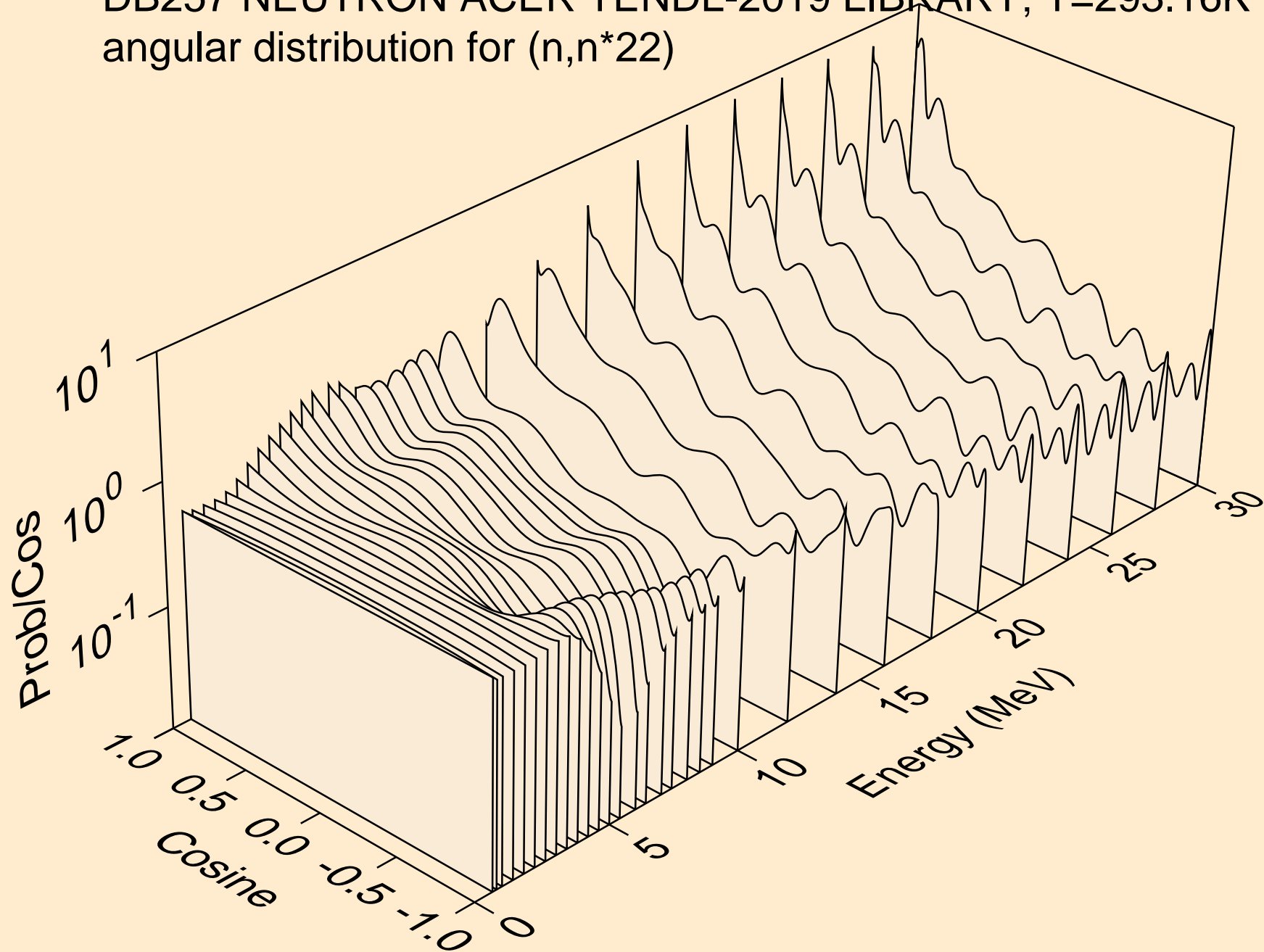

DB257 NEUTRON ACER TENDL-2019 LIBRARY; T=293.16K
angular distribution for (n,n*23)

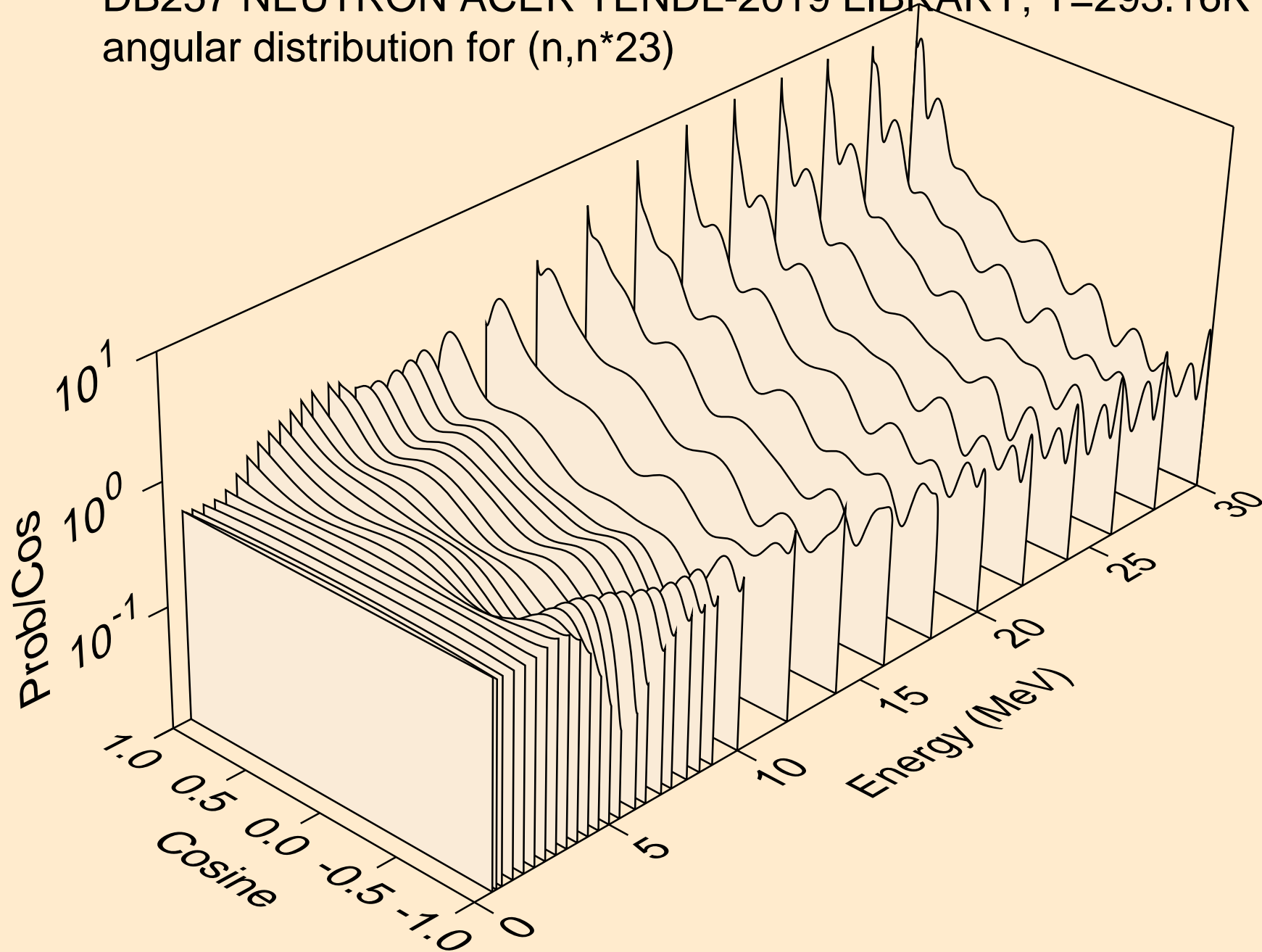

DB257 NEUTRON ACER TENDL-2019 LIBRARY; T=293.16K
angular distribution for (n,n*24)

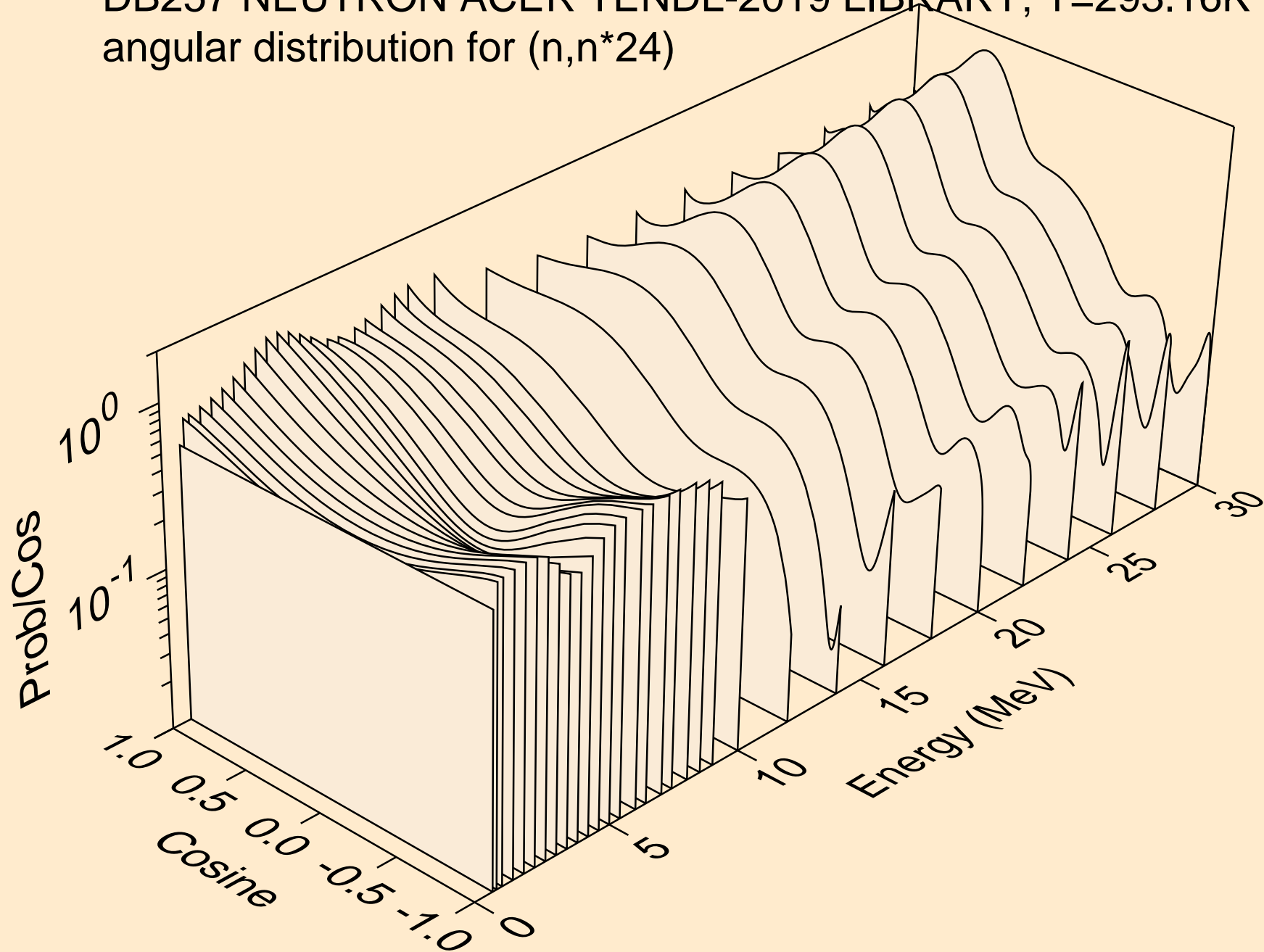

DB257 NEUTRON ACER TENDL-2019 LIBRARY; T=293.16K
angular distribution for (n,n*25)

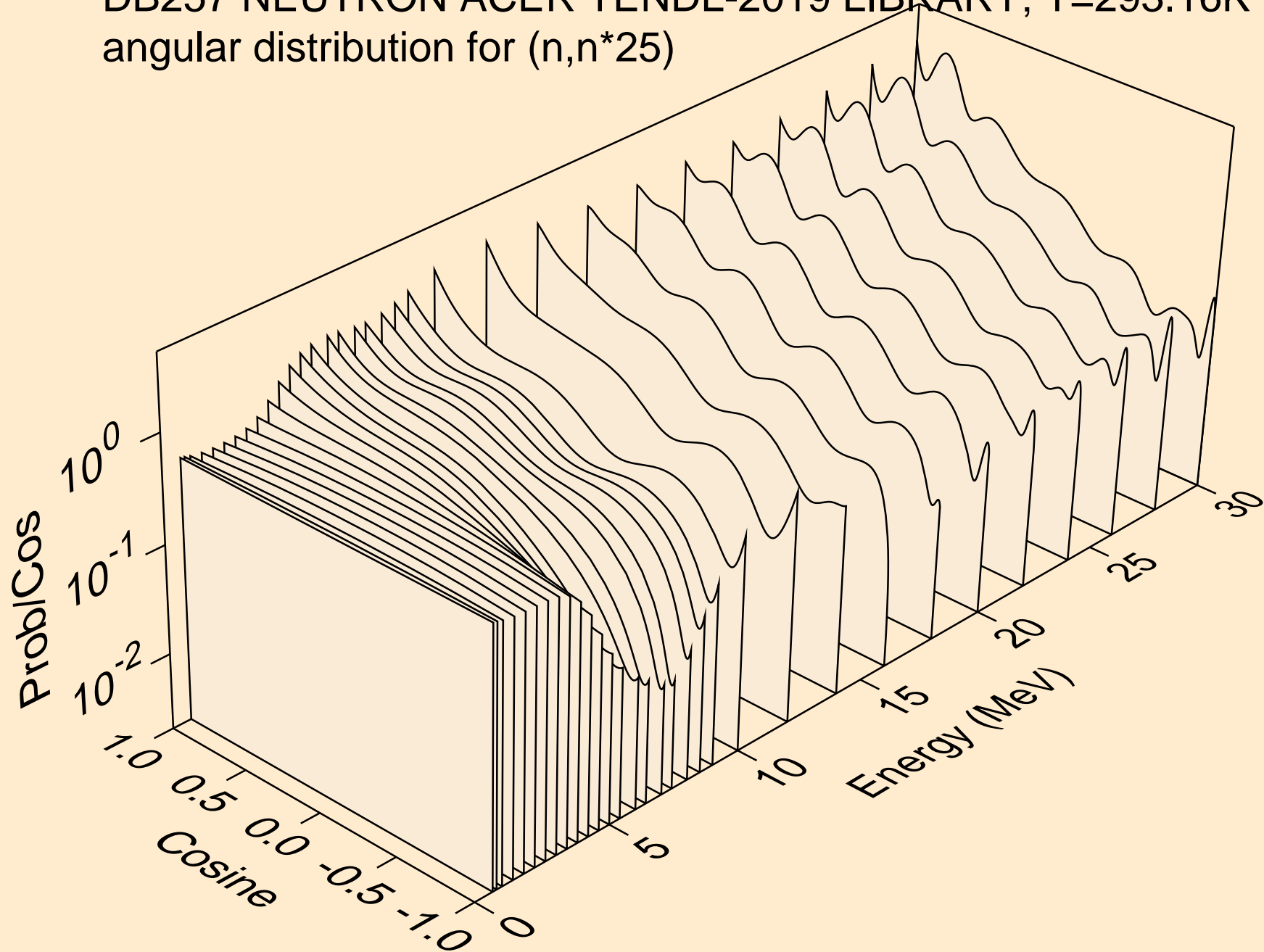

DB257 NEUTRON ACER TENDL-2019 LIBRARY; T=293.16K
angular distribution for (n,n*26)

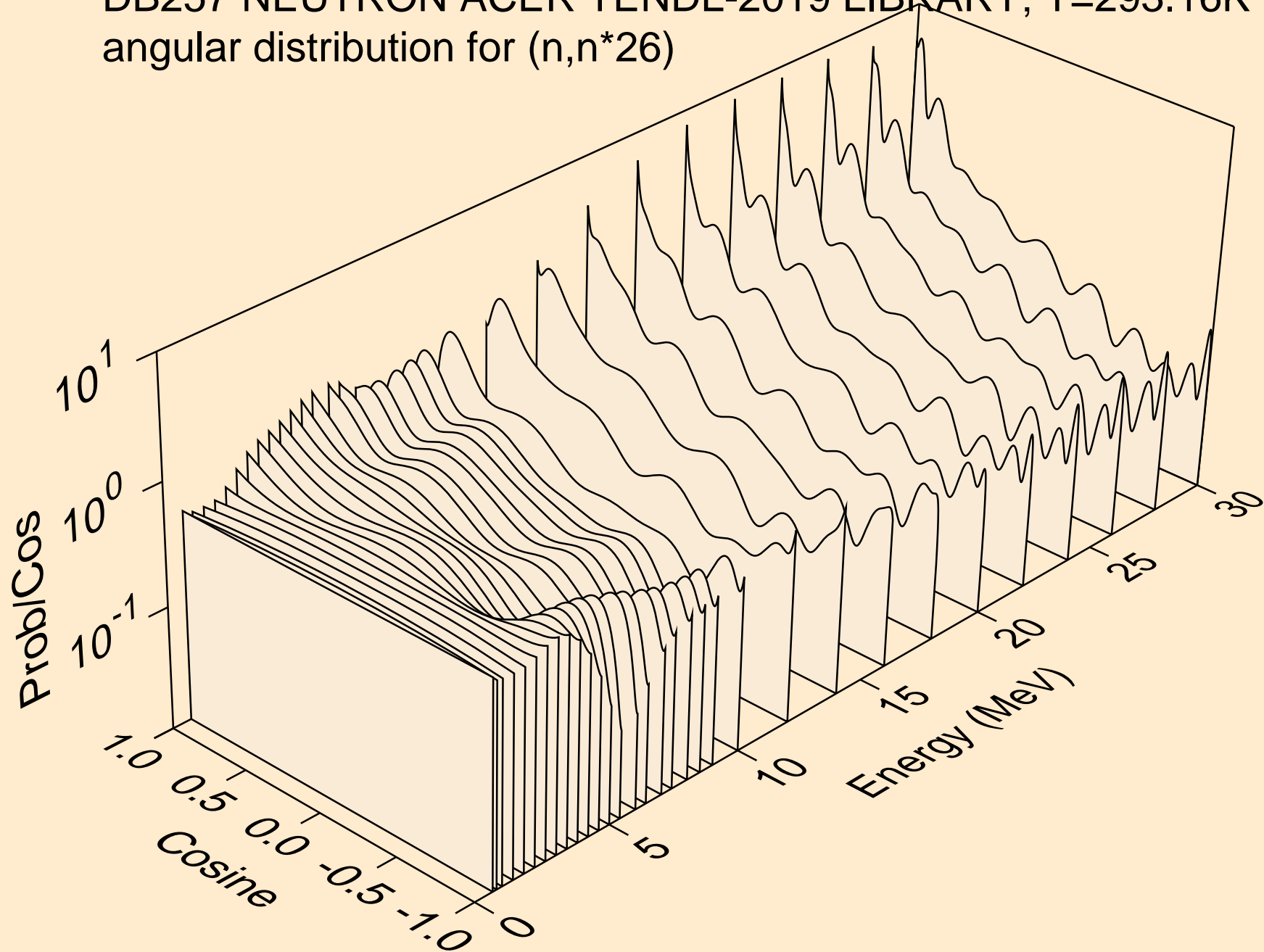

DB257 NEUTRON ACER TENDL-2019 LIBRARY; T=293.16K
angular distribution for (n,n*27)

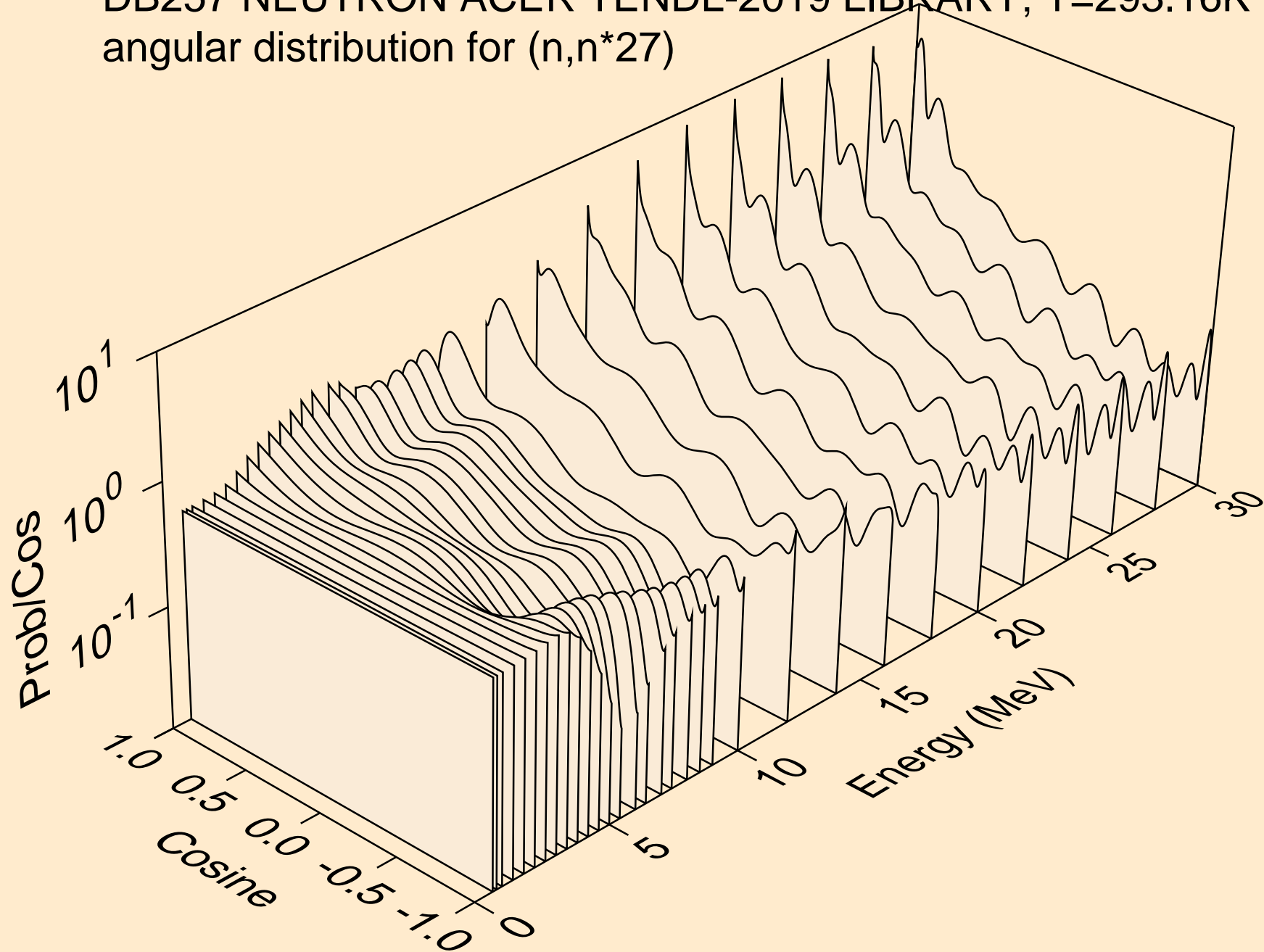

DB257 NEUTRON ACER TENDL-2019 LIBRARY; T=293.16K
angular distribution for (n,n*28)

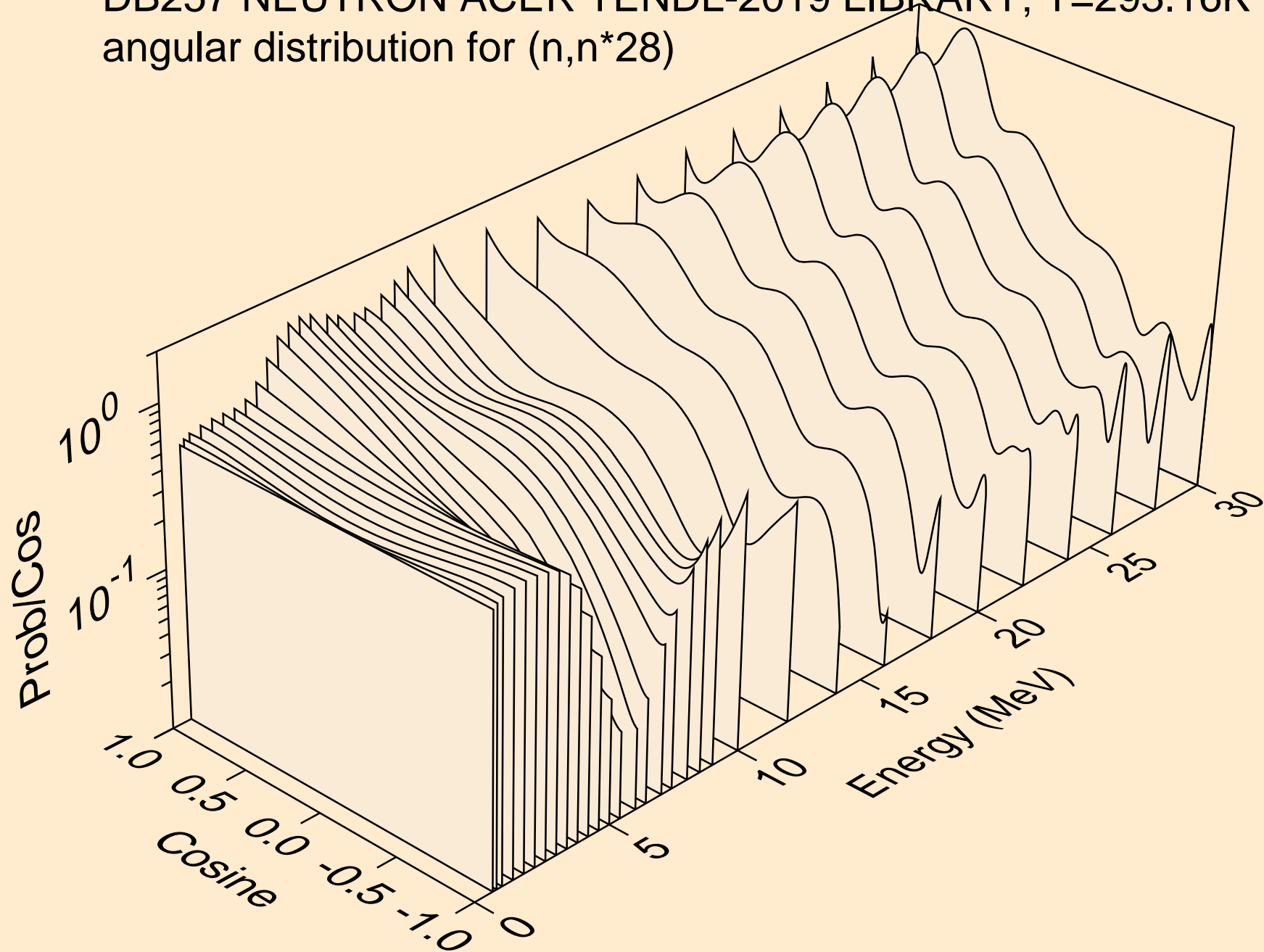

DB257 NEUTRON ACER TENDL-2019 LIBRARY; T=293.16K
angular distribution for (n,n*29)

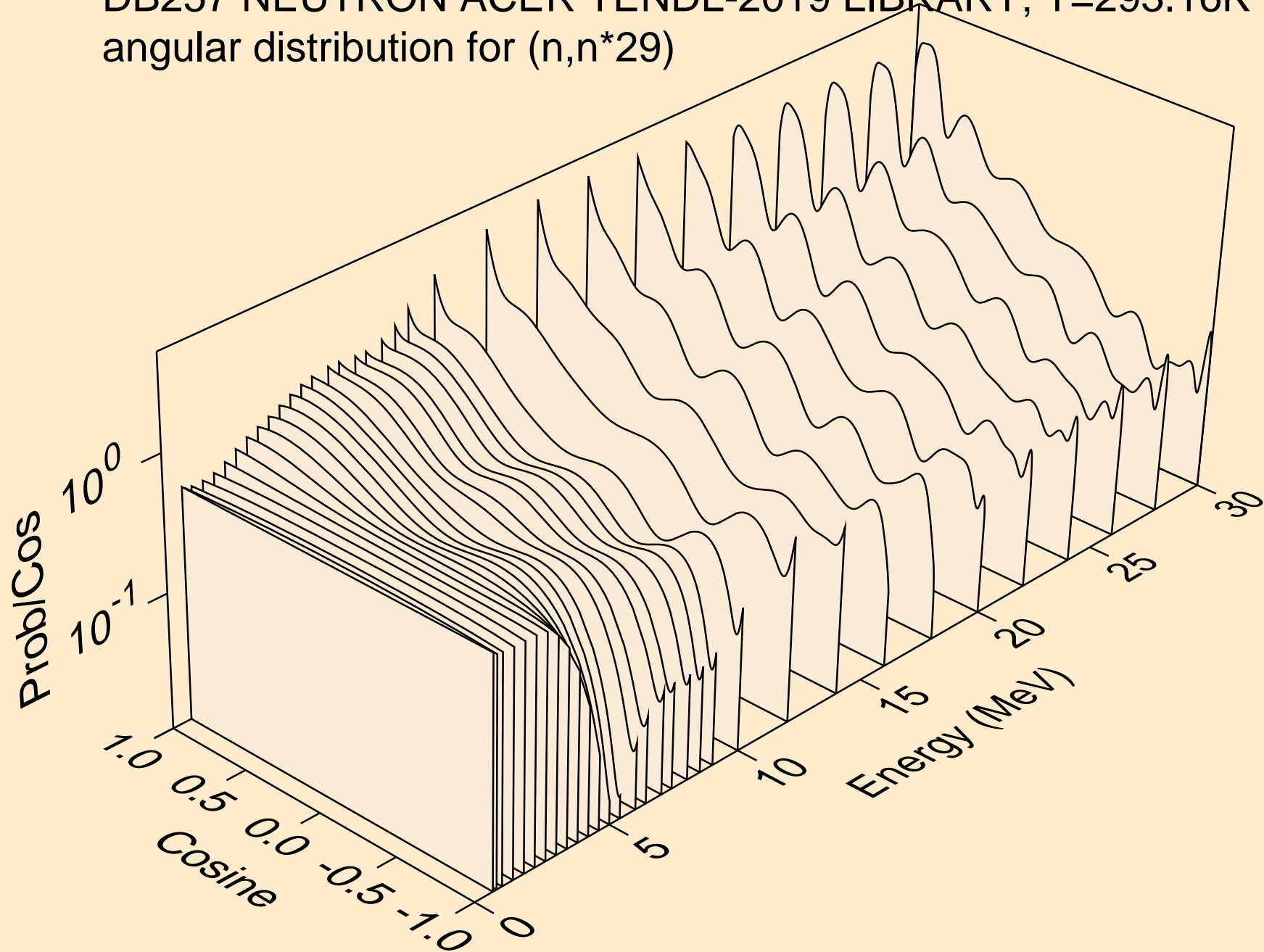

DB257 NEUTRON ACER TENDL-2019 LIBRARY; T=293.16K
angular distribution for (n,n*30)

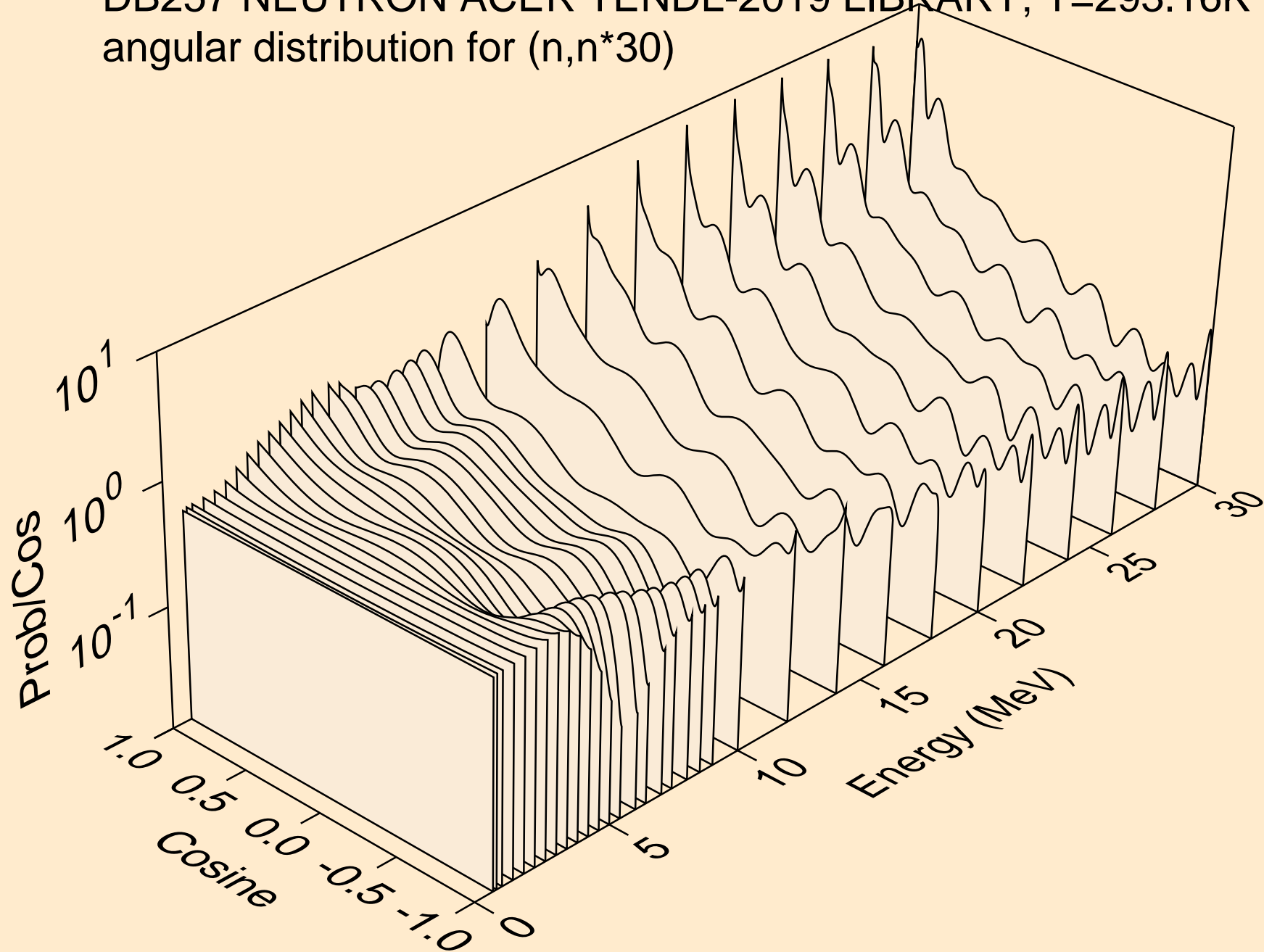

DB257 NEUTRON ACER TENDL-2019 LIBRARY; T=293.16K
Total fission nubar

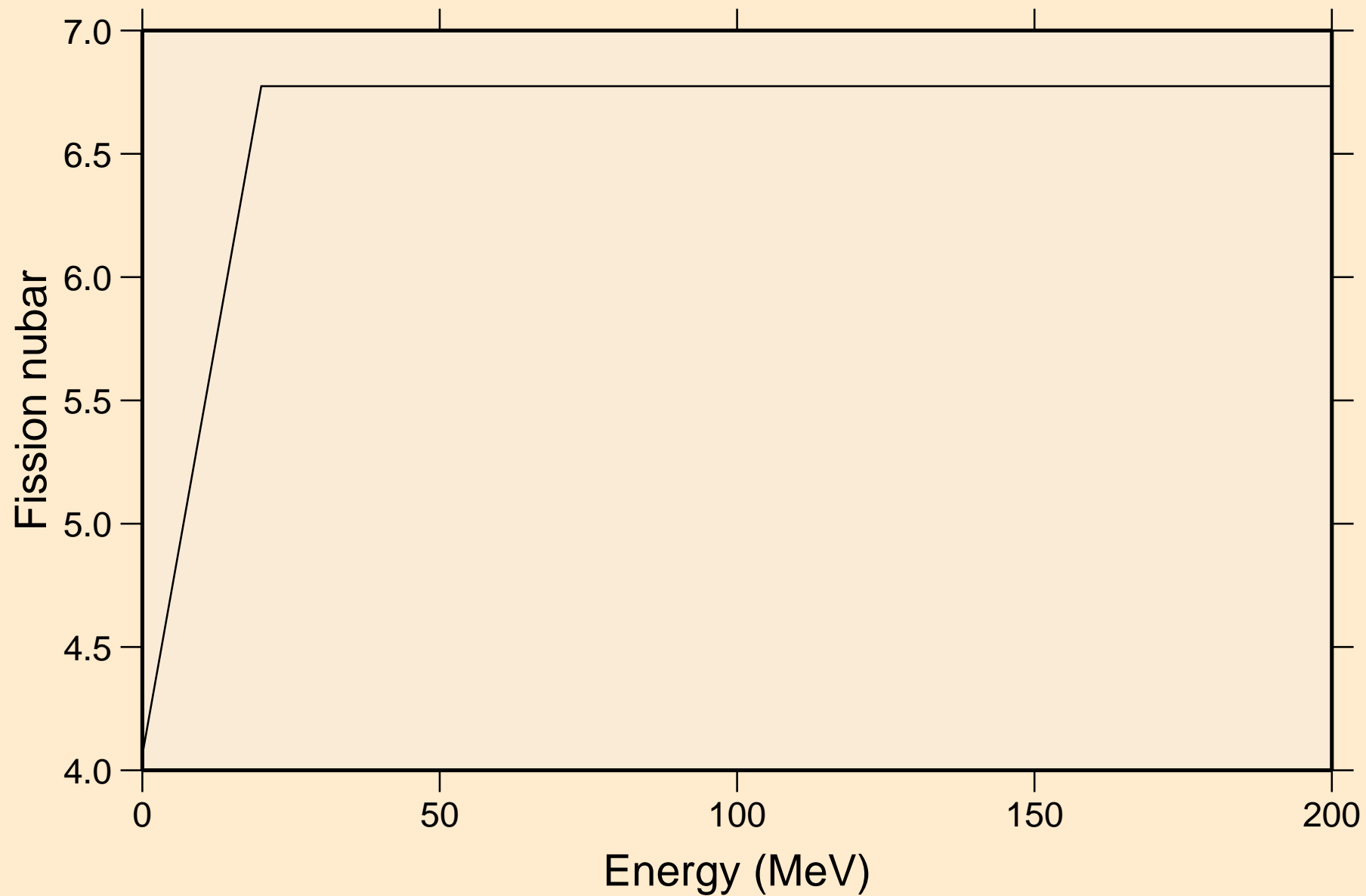

DB257 NEUTRON ACER TENDL-2019 LIBRARY; T=293.16K
Neutron emission for (n,x)

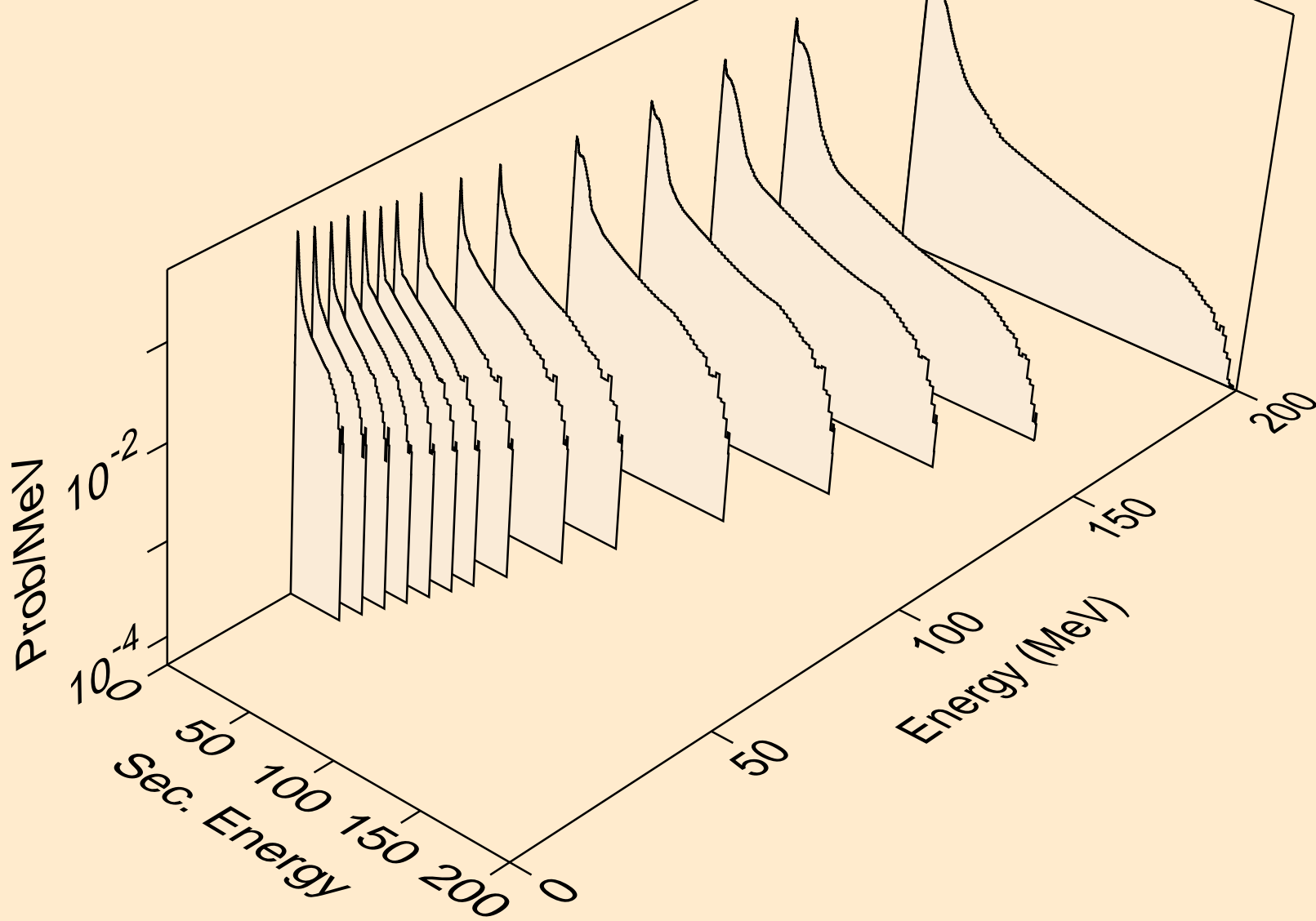

DB257 NEUTRON ACER TENDL-2019 LIBRARY; T=293.16K
Neutron emission for (n,2nd)

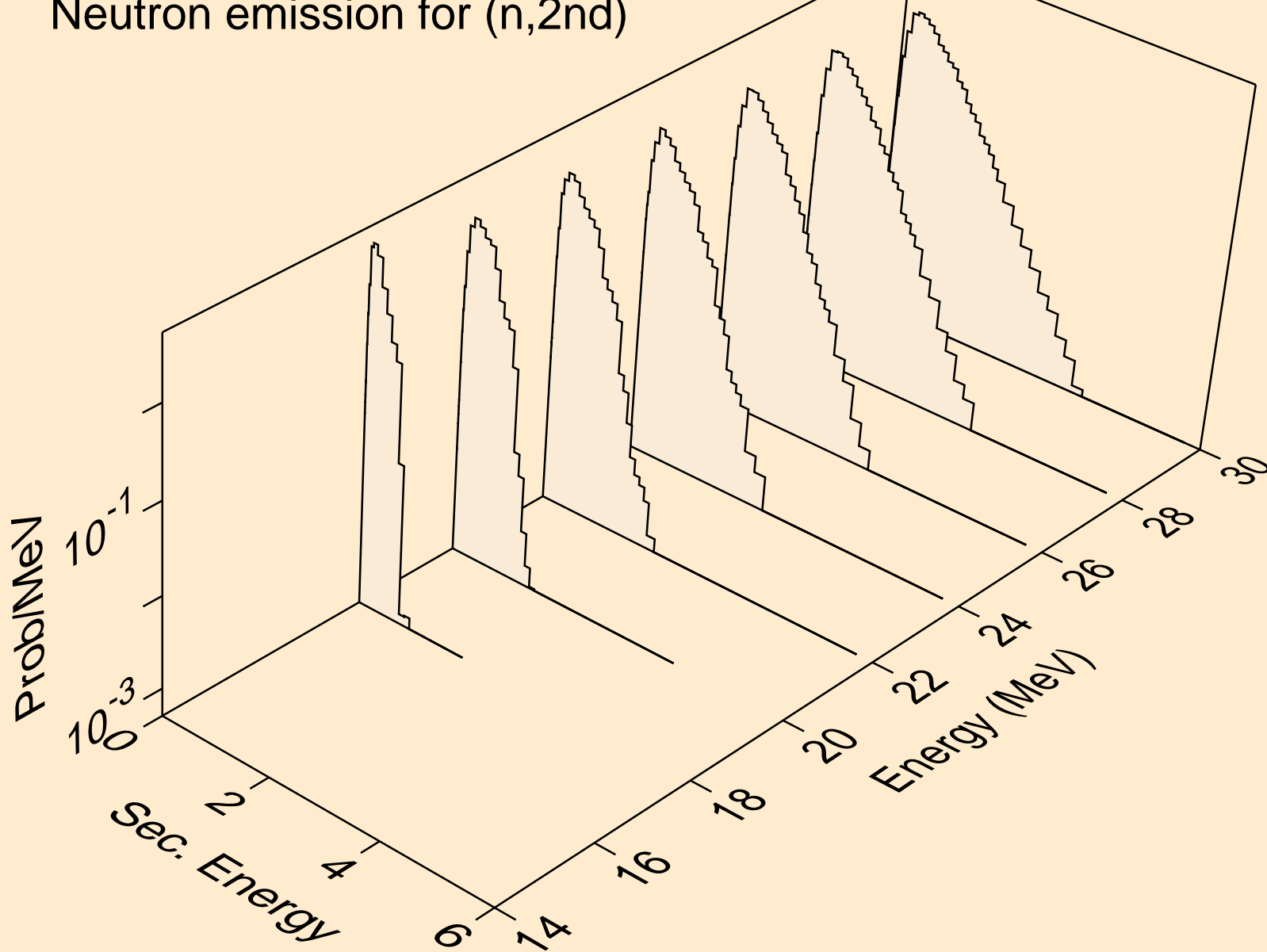

DB257 NEUTRON ACER TENDL-2019 LIBRARY; T=293.16K
Neutron emission for (n,2n)

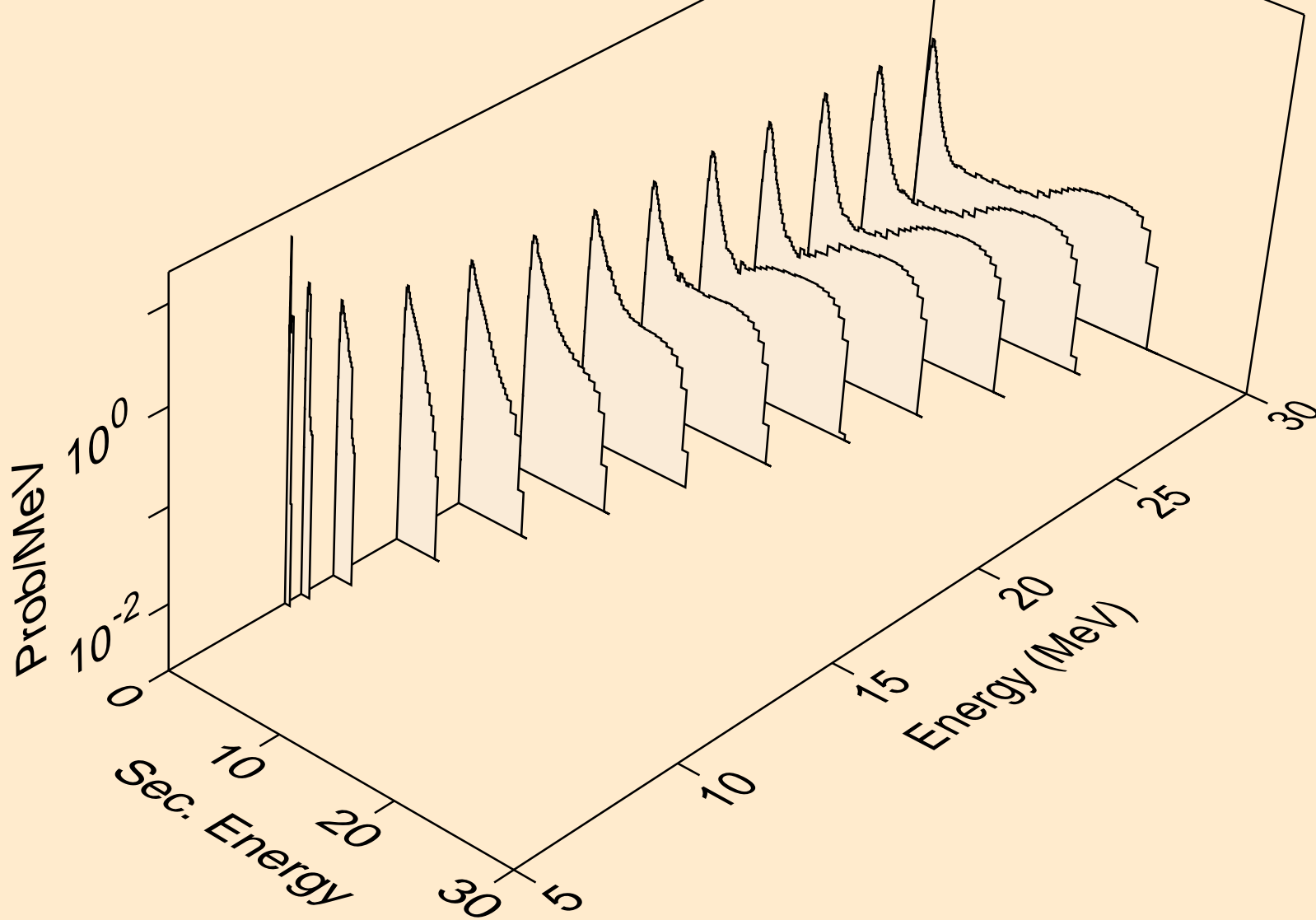

DB257 NEUTRON ACER TENDL-2019 LIBRARY; T=293.16K
Neutron emission for (n,3n)

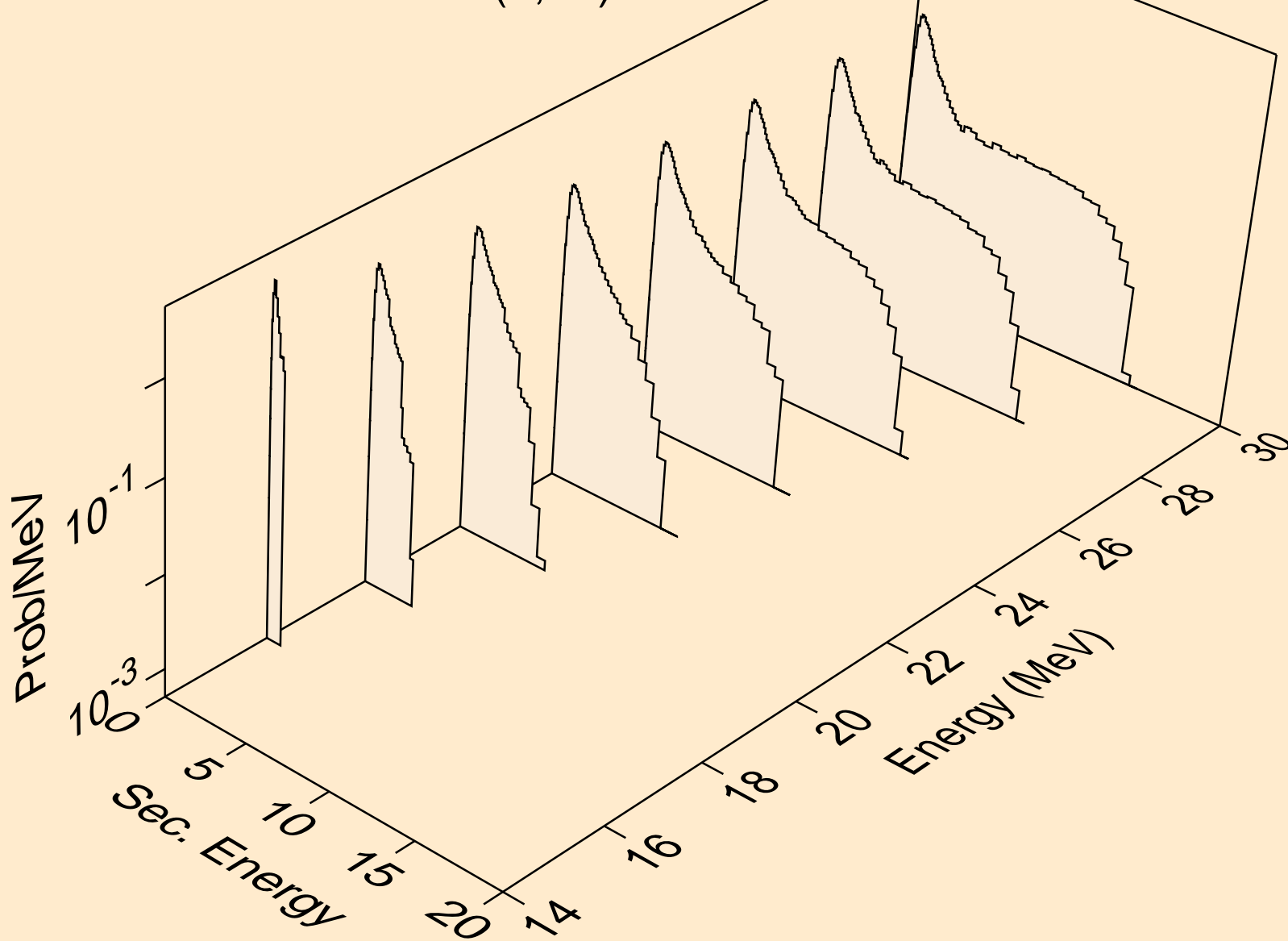

DB257 NEUTRON ACER TENDL-2019 LIBRARY; T=293.16K
Neutron emission for fission

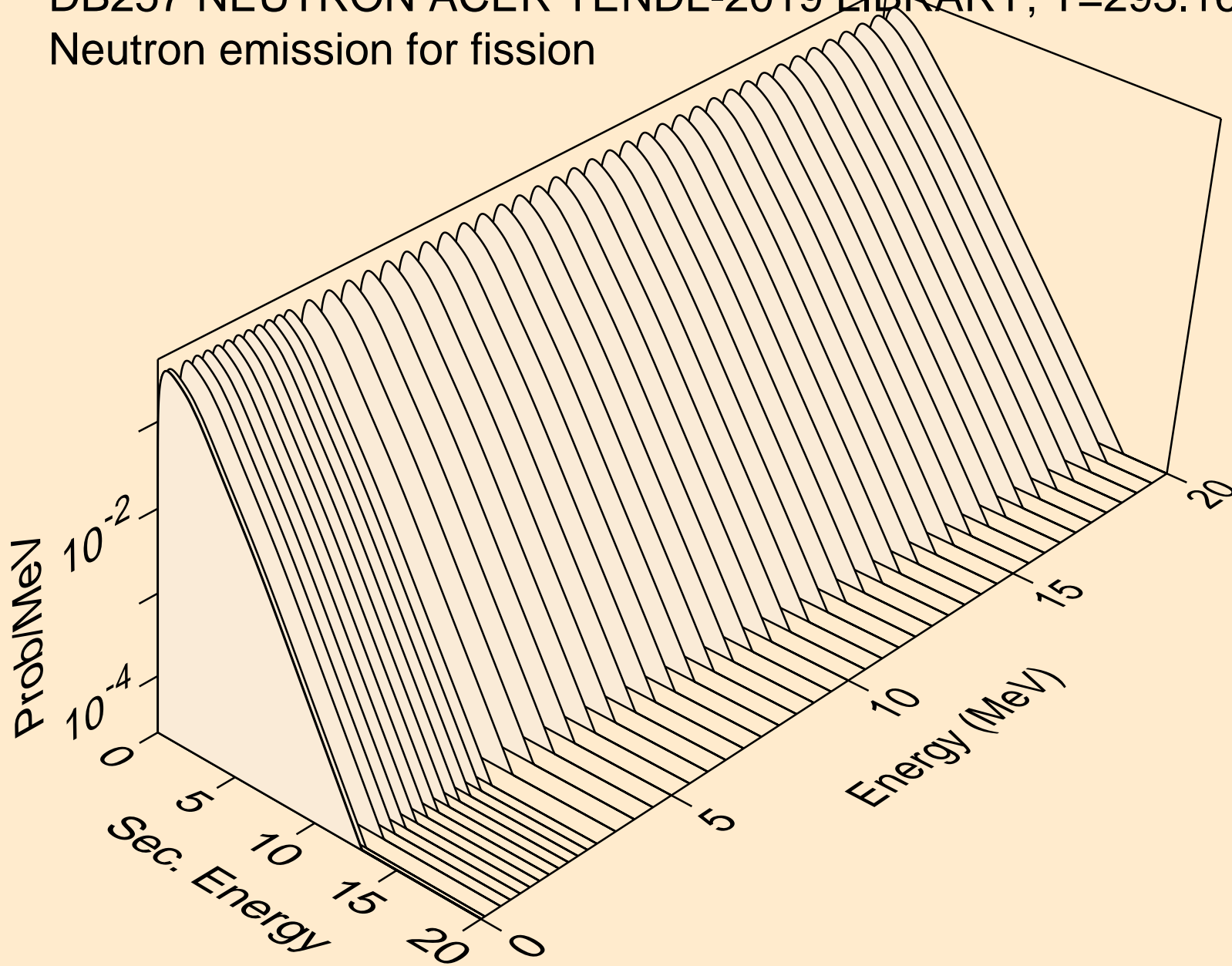

DB257 NEUTRON ACER TENDL-2019 LIBRARY; T=293.16K
Neutron emission for (n,n*)a

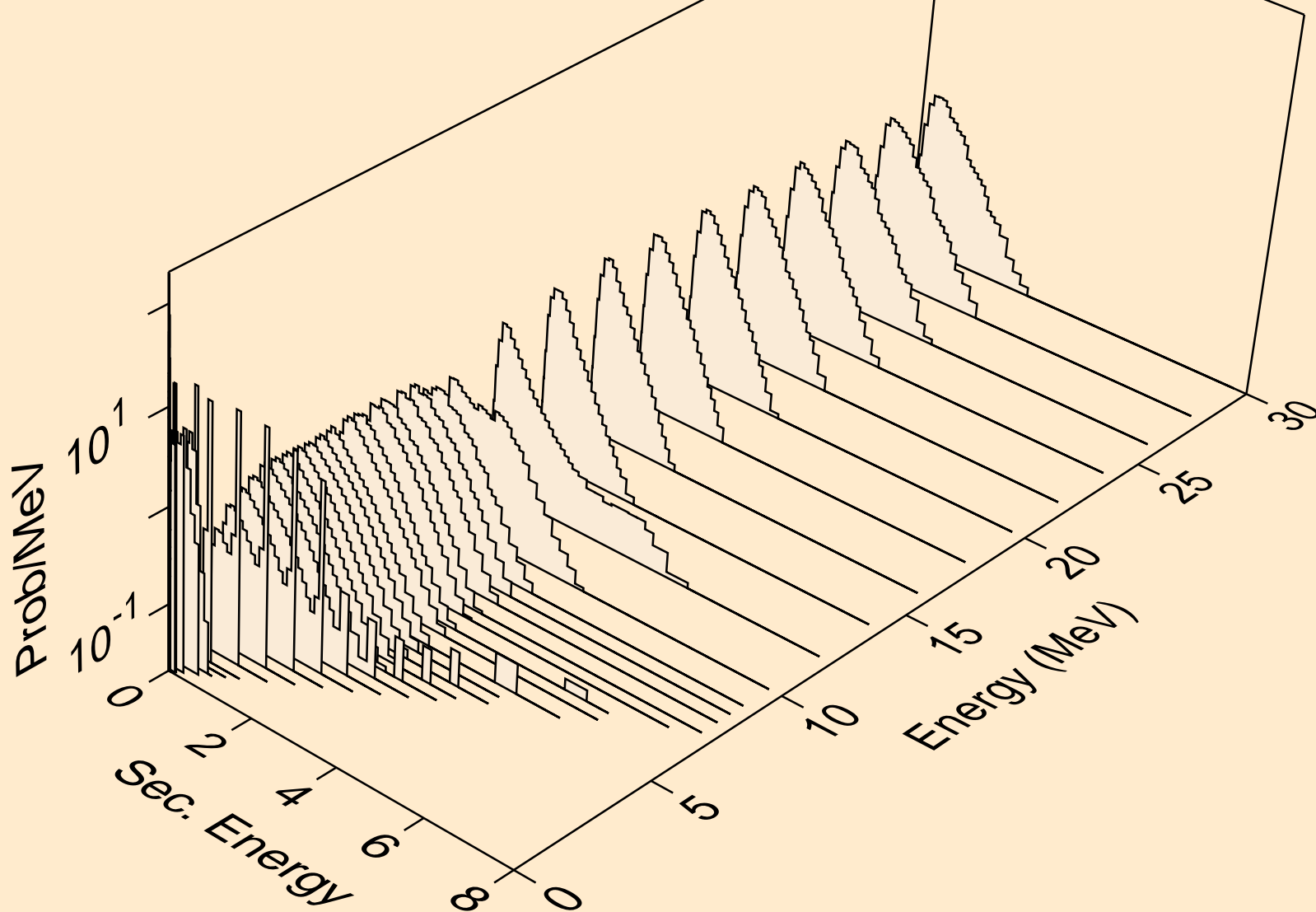

DB257 NEUTRON ACER TENDL-2019 LIBRARY; T=293.16K
Neutron emission for (n,n*)3a

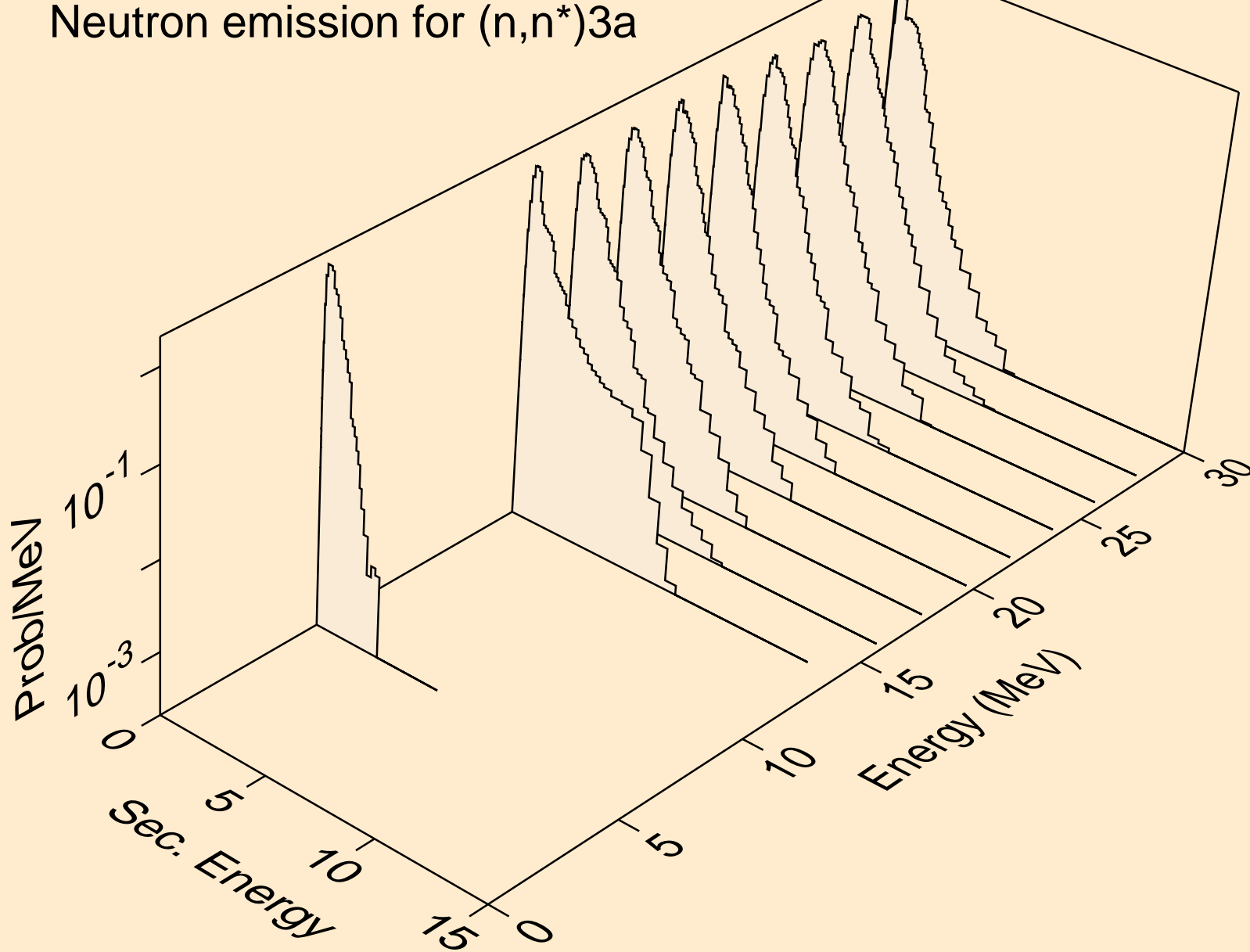

DB257 NEUTRON ACER TENDL-2019 LIBRARY; T=293.16K
Neutron emission for (n,2n)a

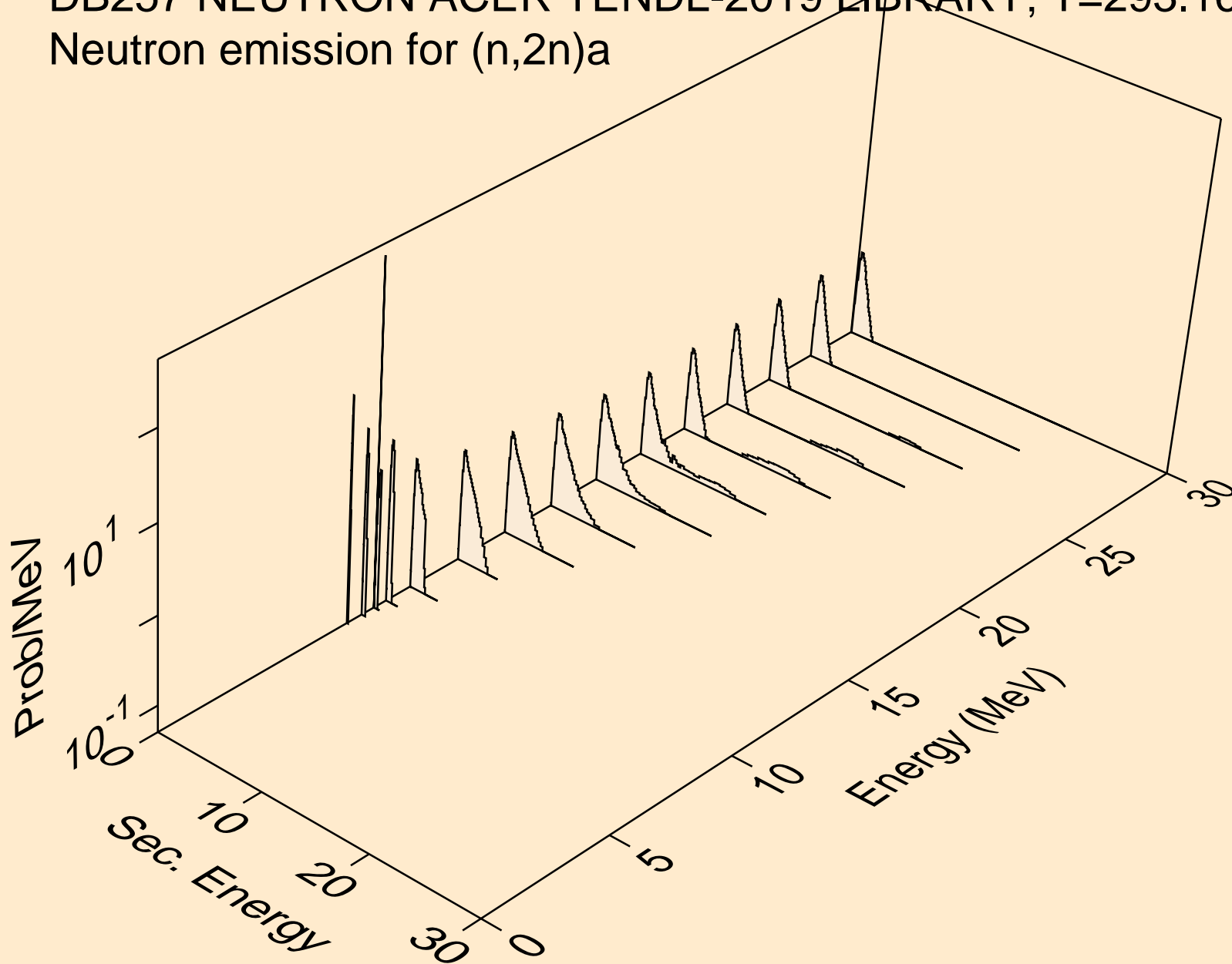

DB257 NEUTRON ACER TENDL-2019 LIBRARY; T=293.16K
Neutron emission for (n,3n)a

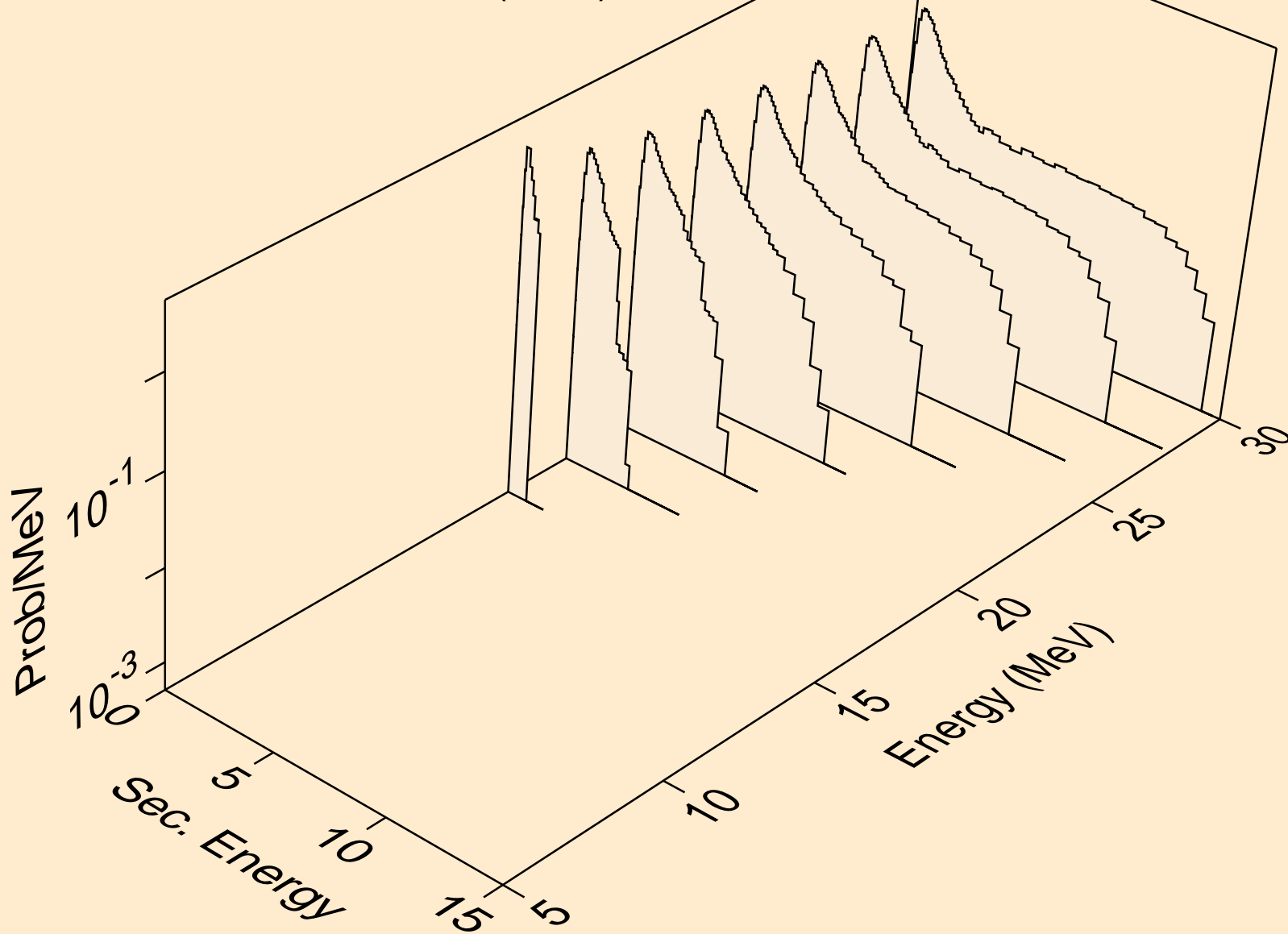

DB257 NEUTRON ACER TENDL-2019 LIBRARY; T=293.16K
Neutron emission for (n,n*)p

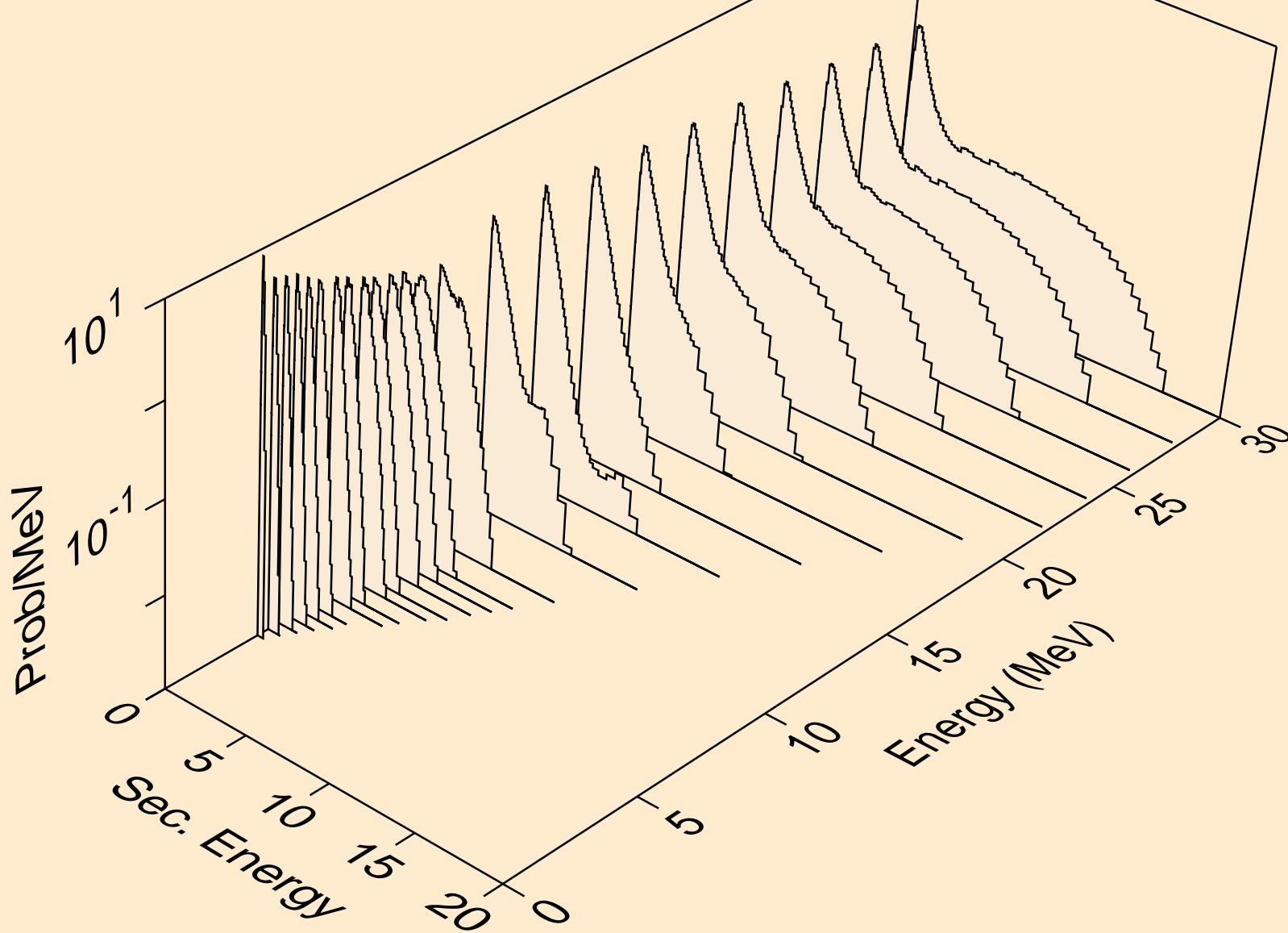

DB257 NEUTRON ACER TENDL-2019 LIBRARY; T=293.16K
Neutron emission for (n,n*)2a

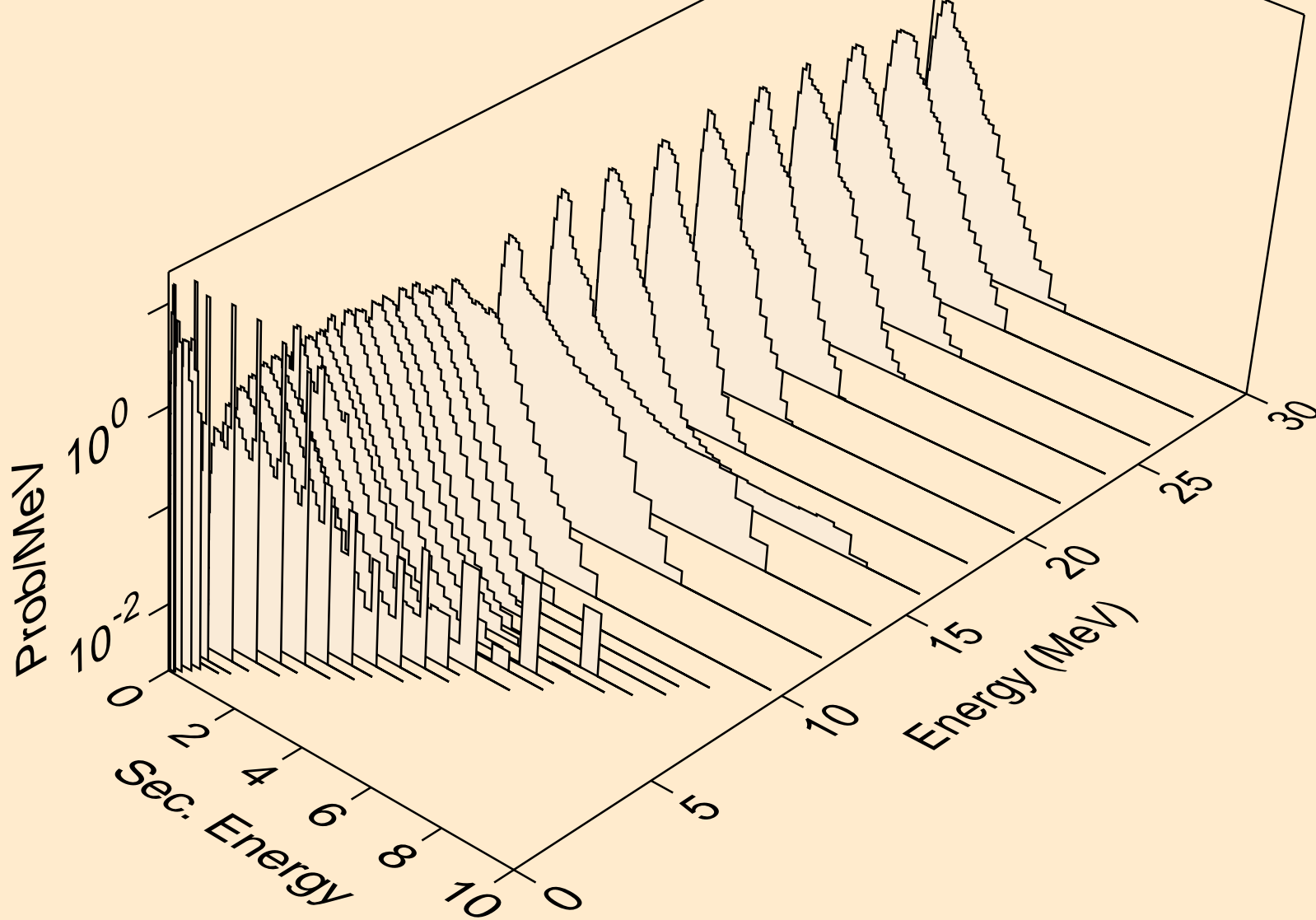

DB257 NEUTRON ACER TENDL-2019 LIBRARY; T=293.16K
Neutron emission for (n,2n)2a

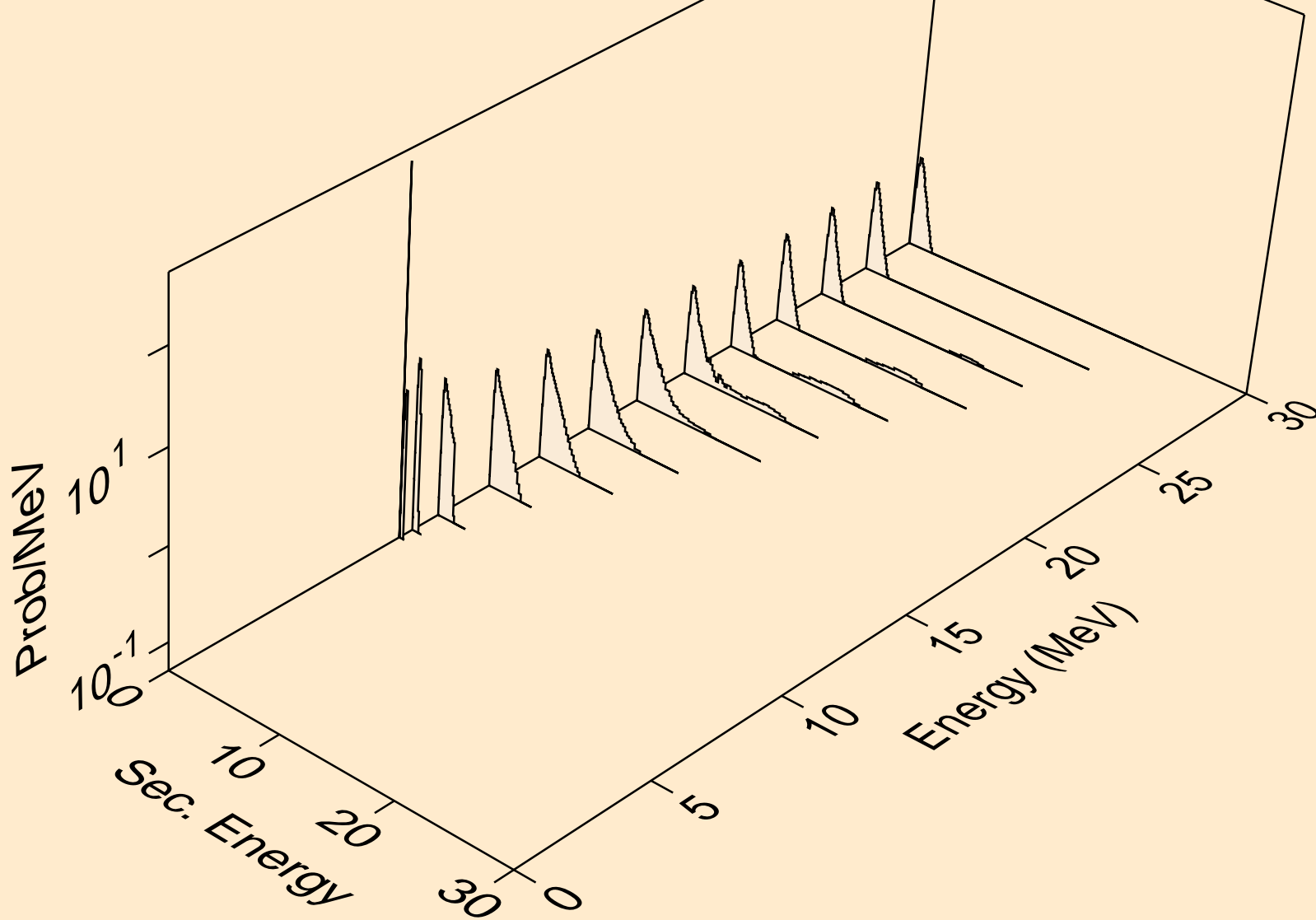

DB257 NEUTRON ACER TENDL-2019 LIBRARY; T=293.16K
Neutron emission for (n,n*)d

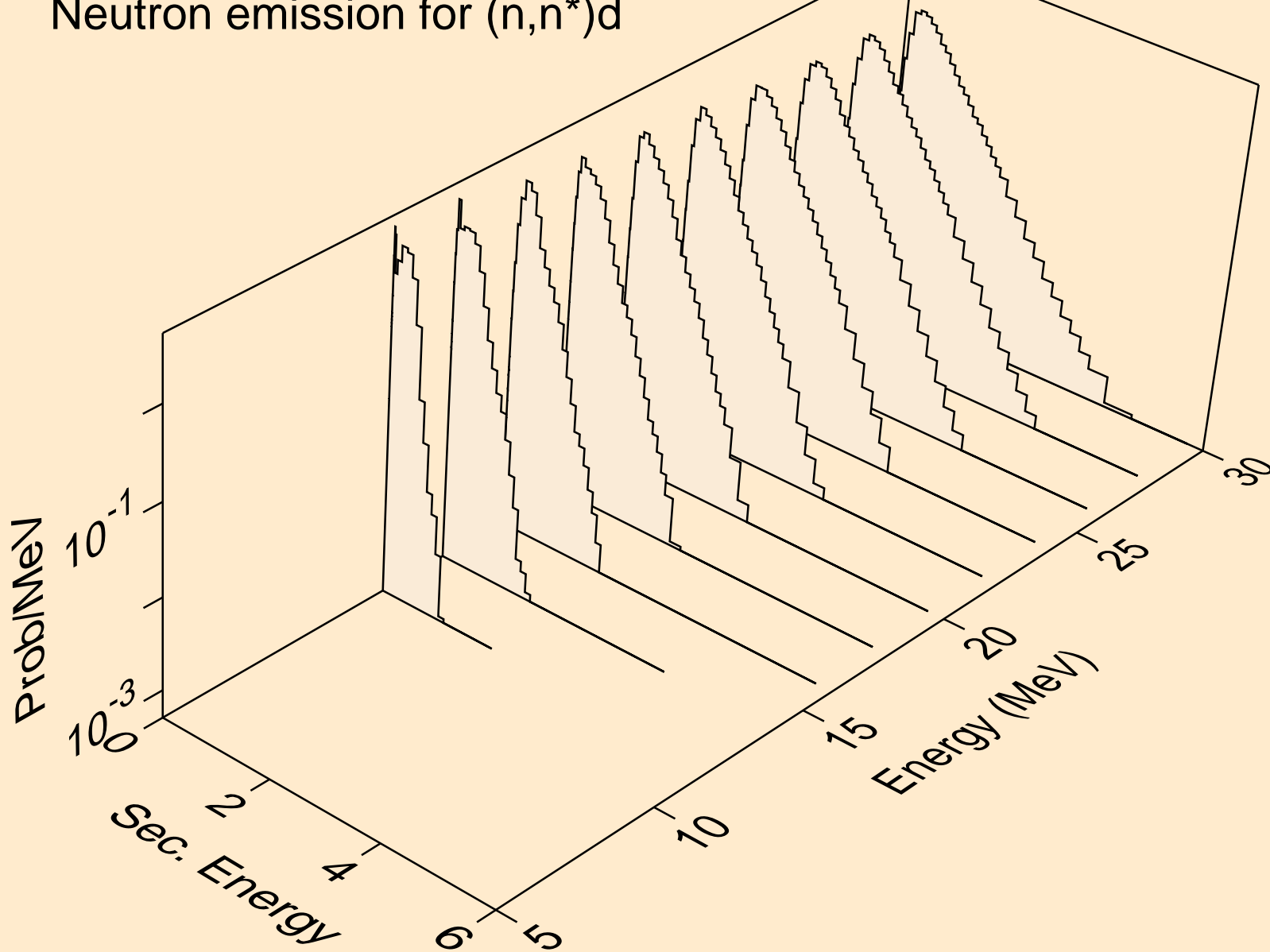

DB257 NEUTRON ACER TENDL-2019 LIBRARY; T=293.16K
Neutron emission for (n,n*)t

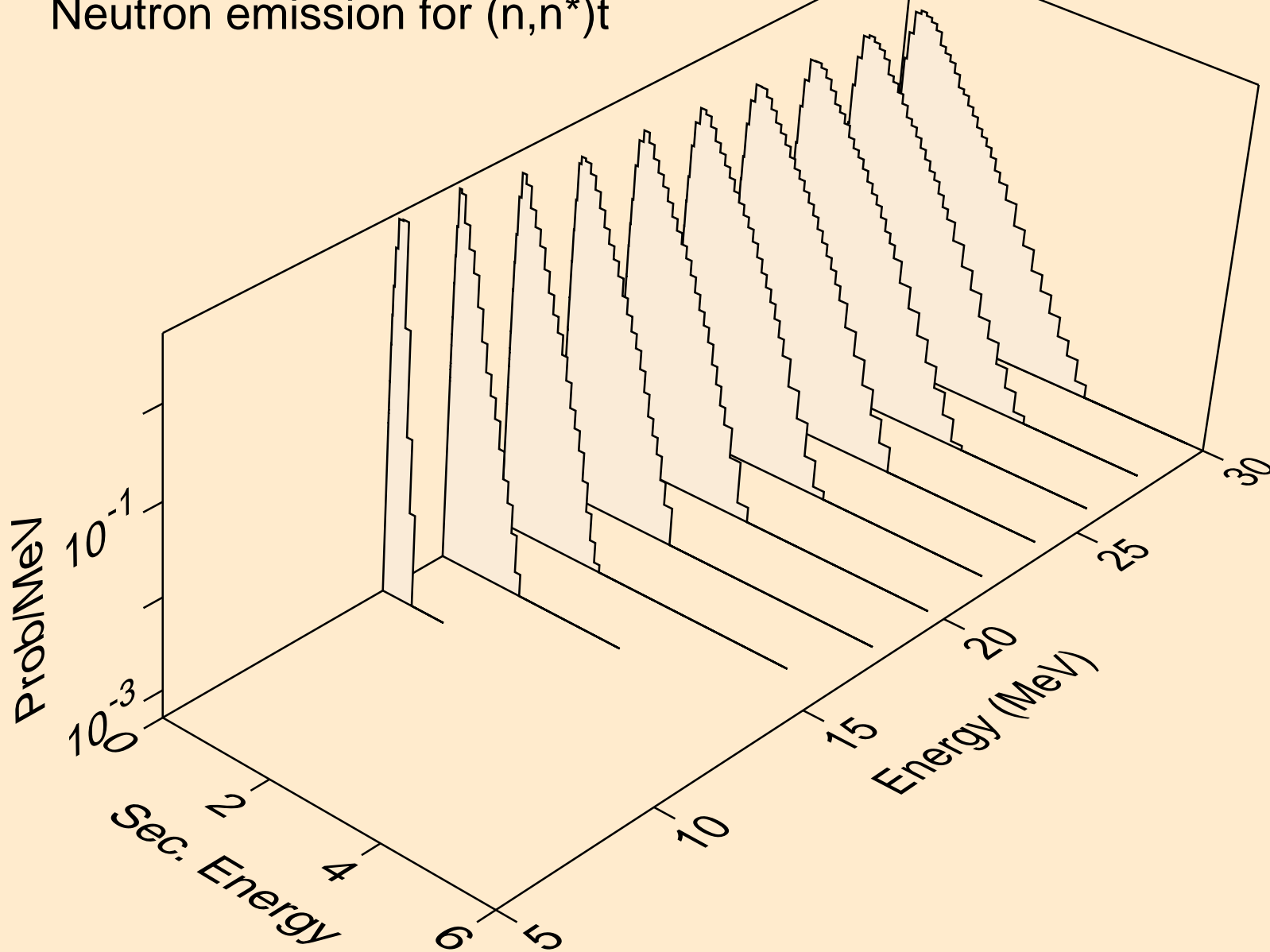

DB257 NEUTRON ACER TENDL-2019 LIBRARY; T=293.16K
Neutron emission for (n,n*)he3

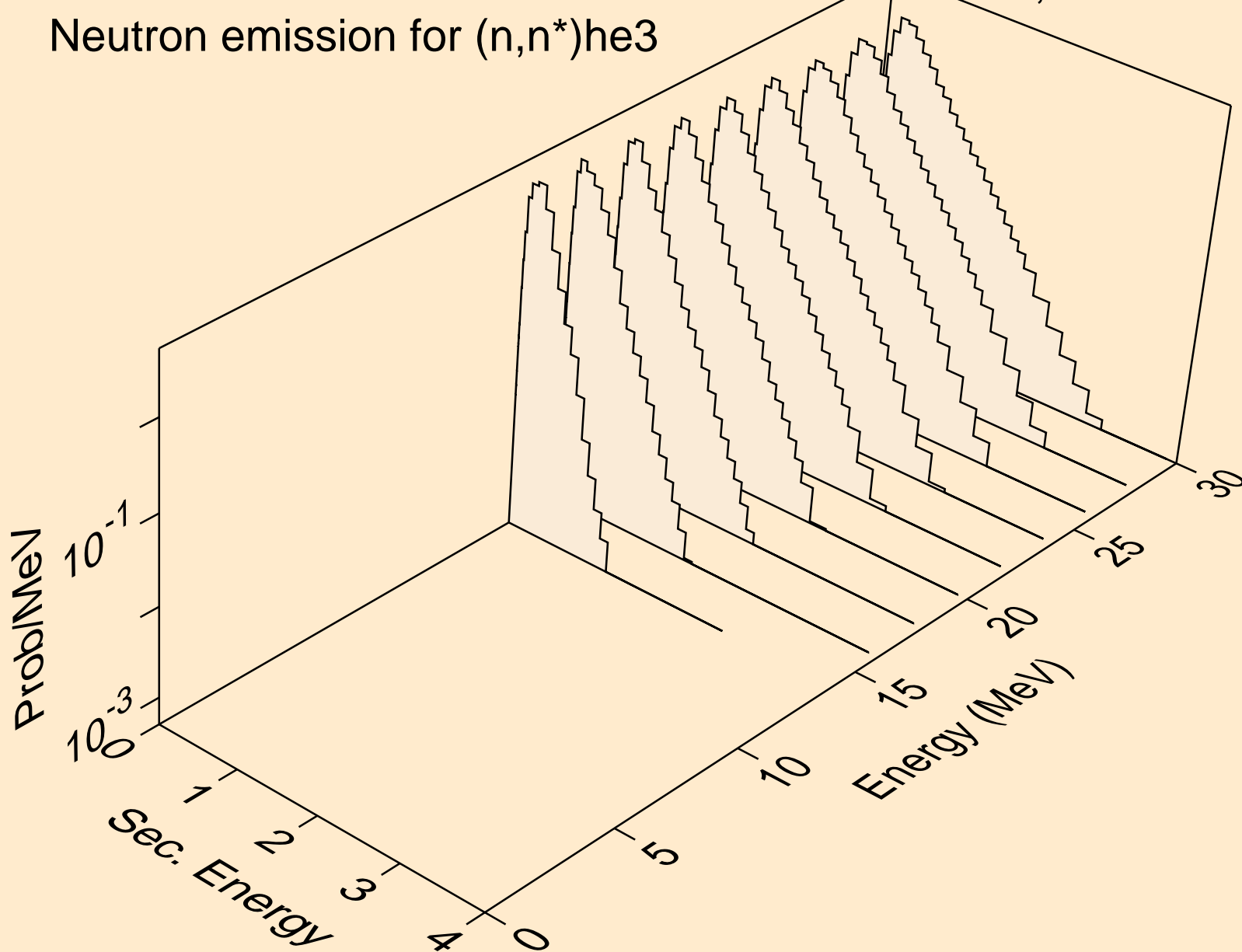

DB257 NEUTRON ACER TENDL-2019 LIBRARY; T=293.16K
Neutron emission for (n,n*)d2a

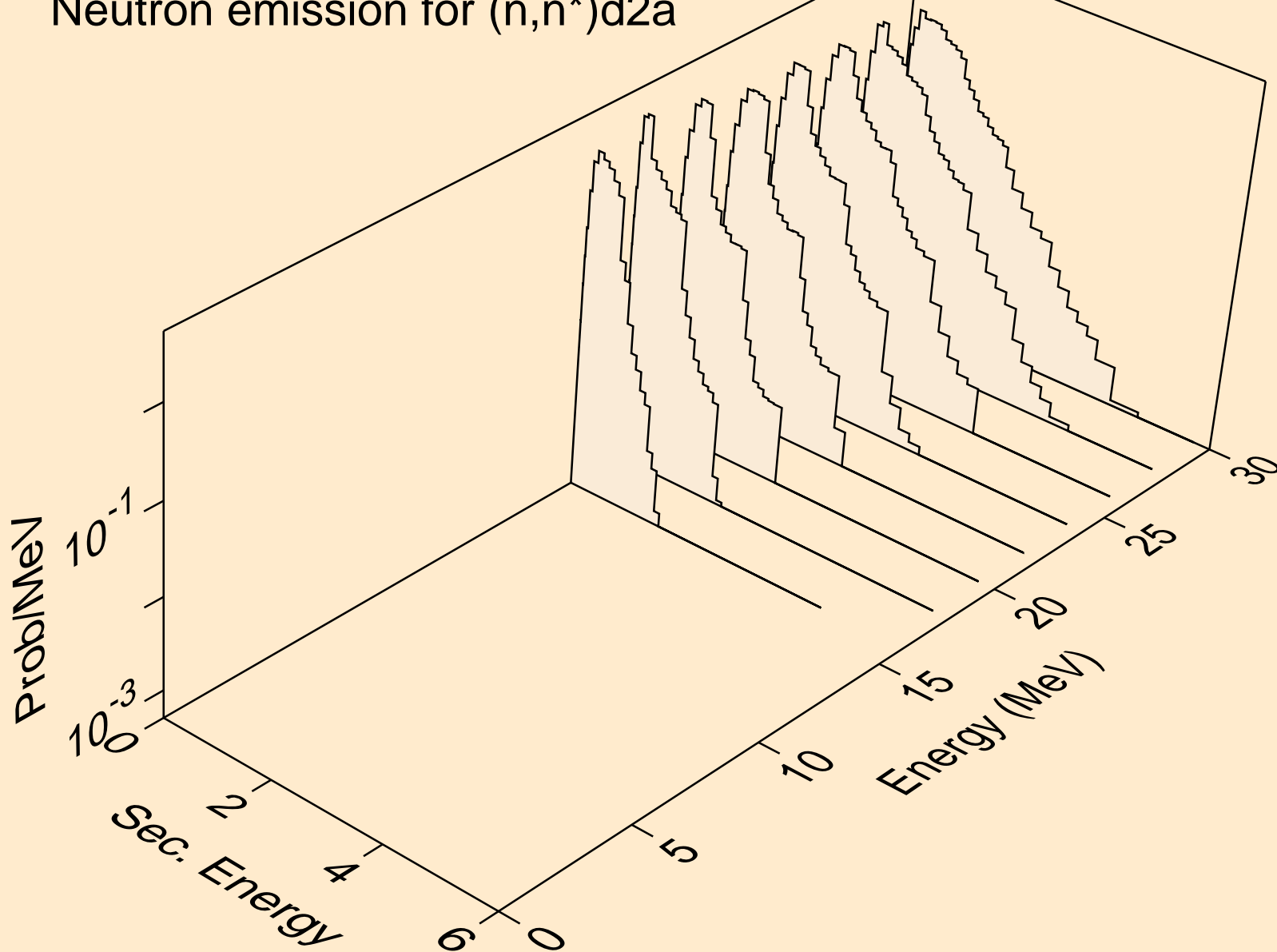

DB257 NEUTRON ACER TENDL-2019 LIBRARY; T=293.16K
Neutron emission for (n,n*)t2a

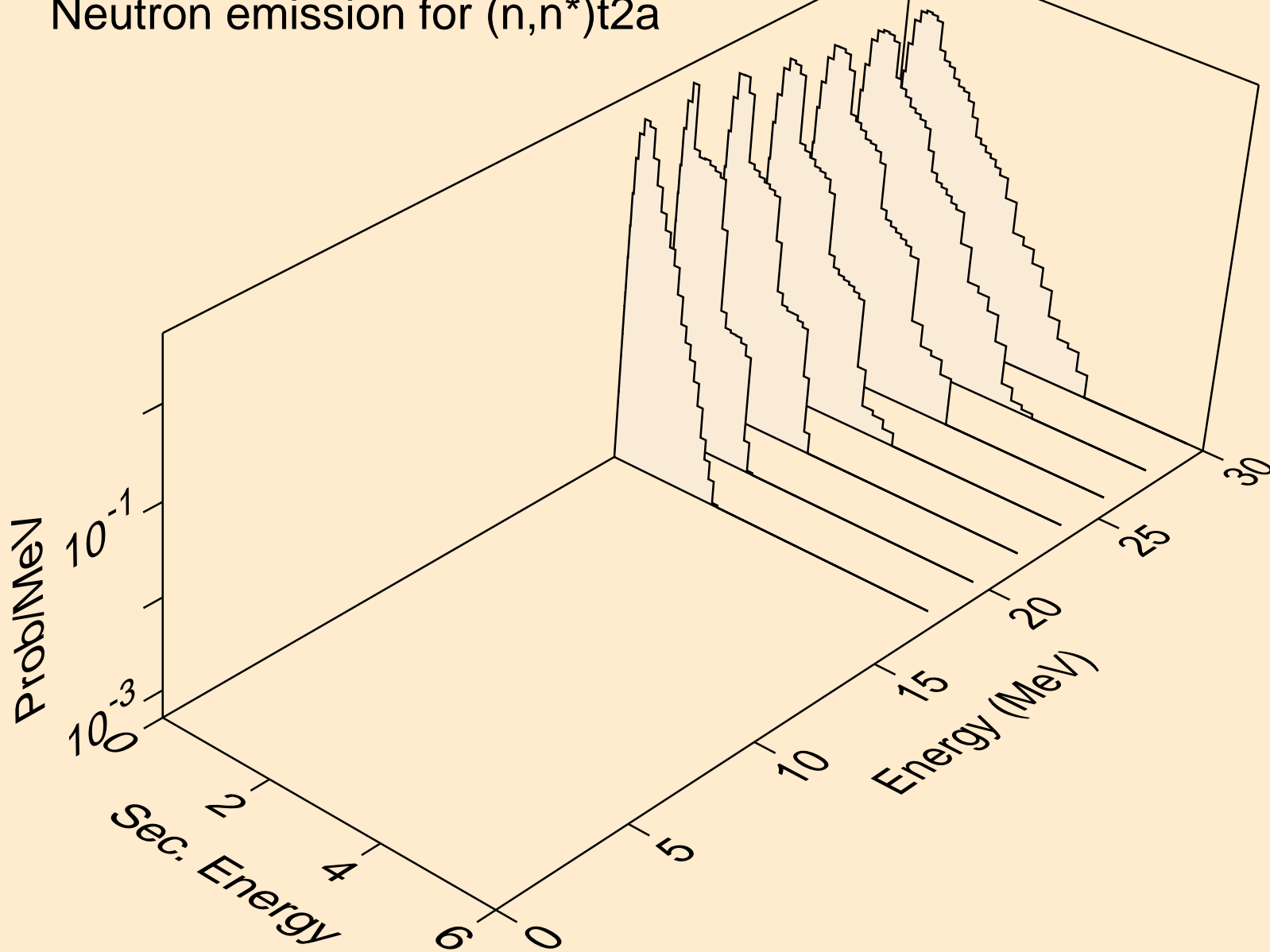

DB257 NEUTRON ACER TENDL-2019 LIBRARY; T=293.16K
Neutron emission for (n,4n)

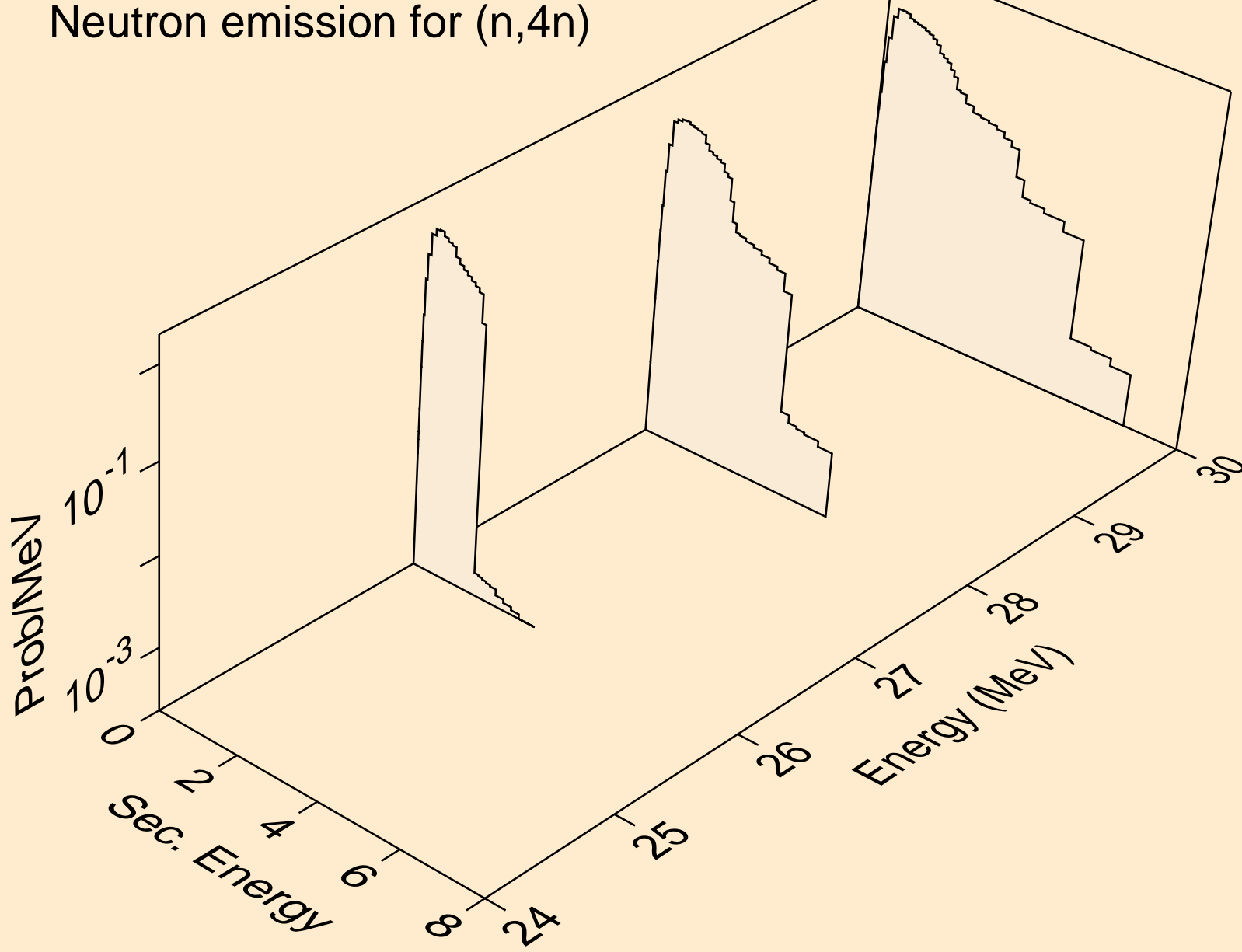

DB257 NEUTRON ACER TENDL-2019 LIBRARY; T=293.16K
Neutron emission for (n,2np)

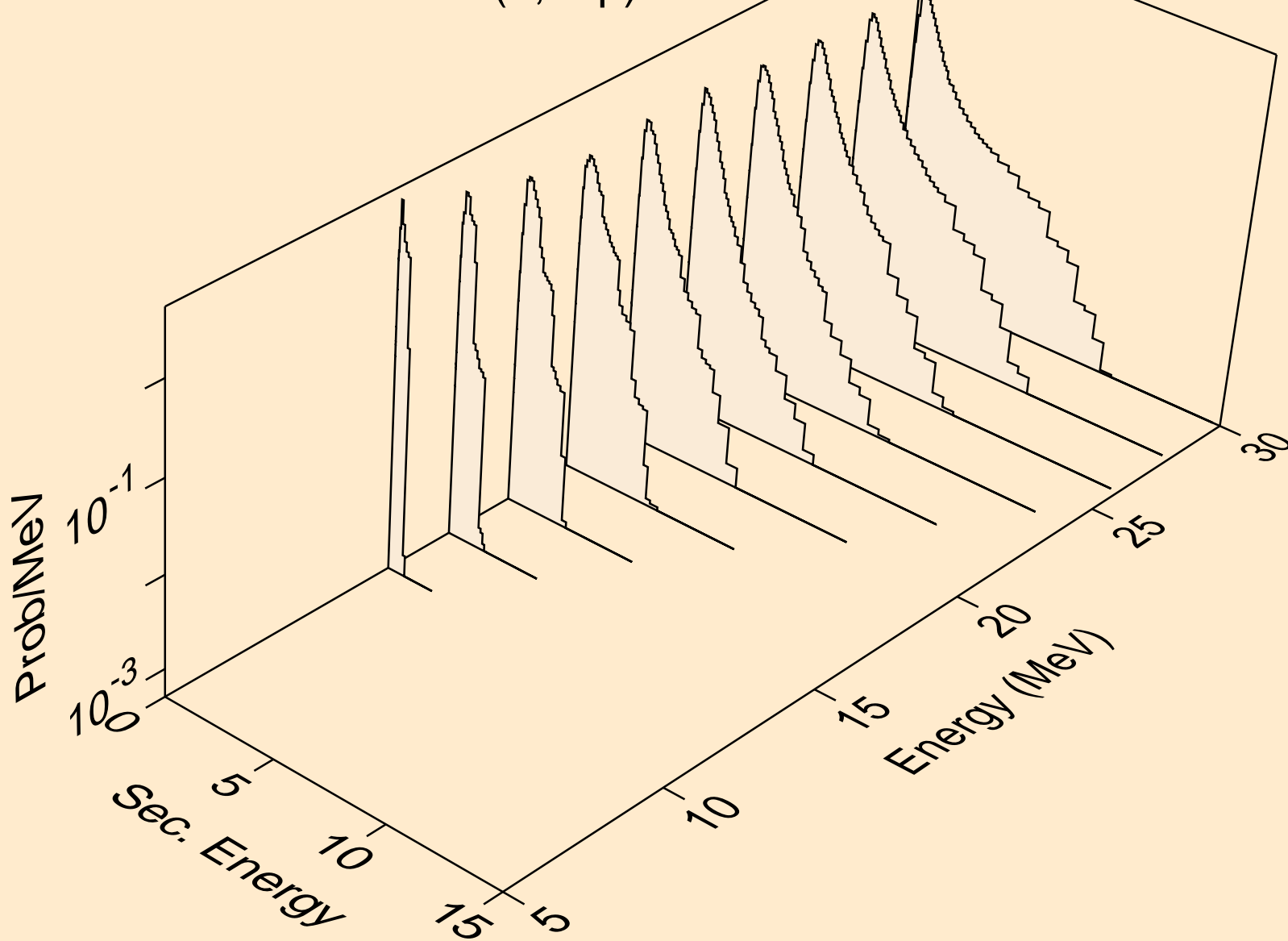

DB257 NEUTRON ACER TENDL-2019 LIBRARY; T=293.16K
Neutron emission for (n,3np)

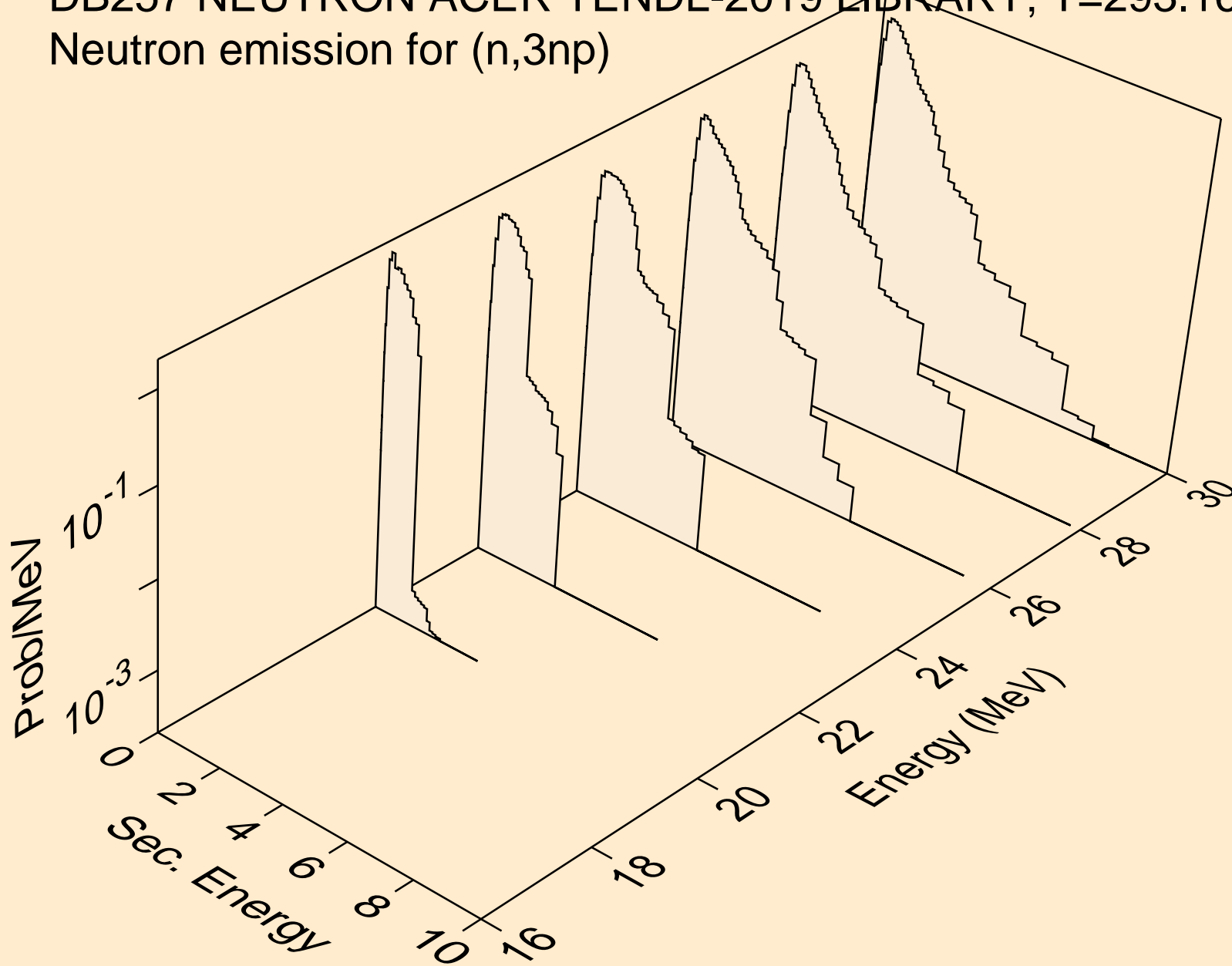

DB257 NEUTRON ACER TENDL-2019 LIBRARY; T=293.16K
Neutron emission for (n,2np)

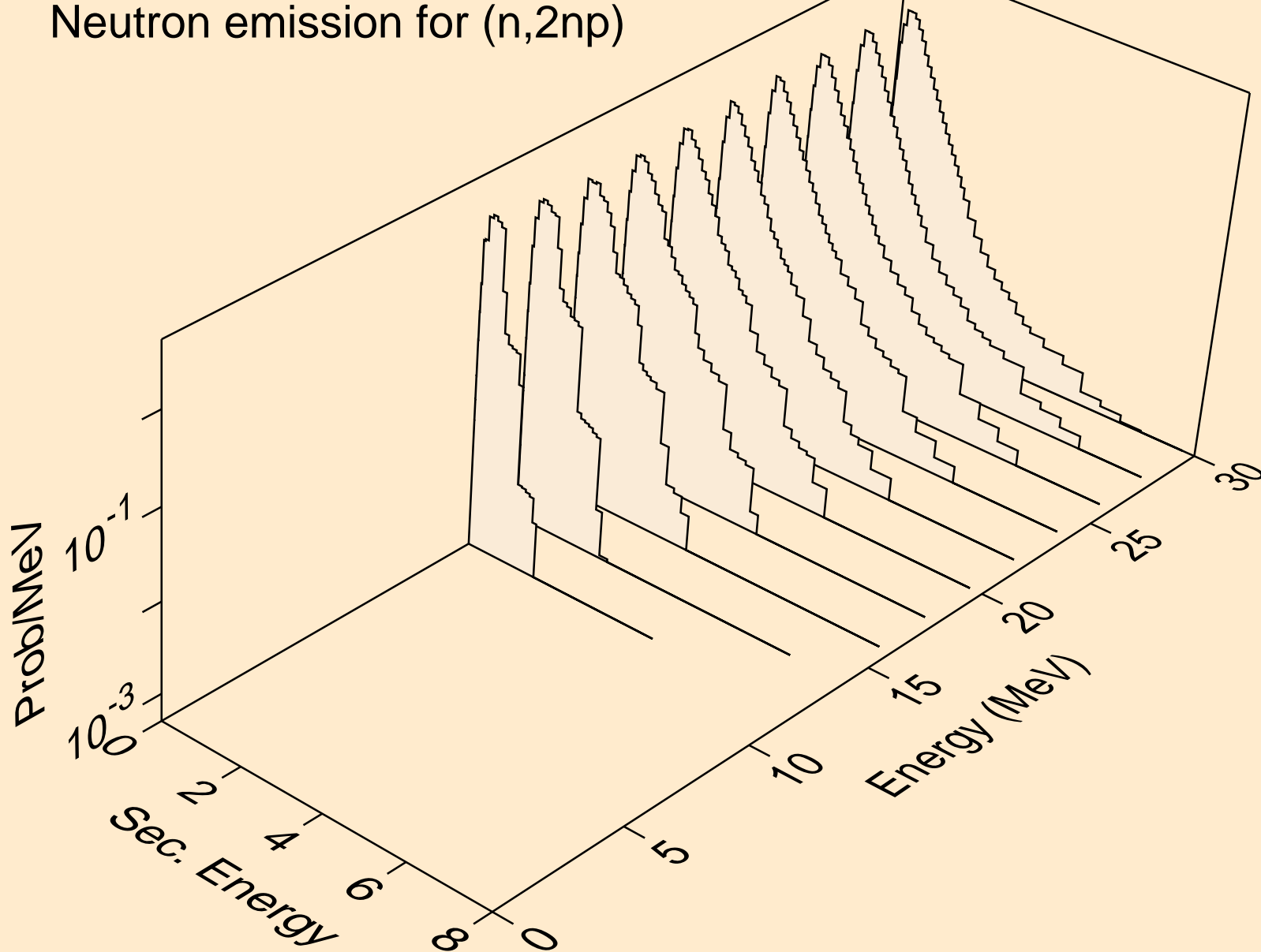

DB257 NEUTRON ACER TENDL-2019 LIBRARY; T=293.16K
Neutron emission for (n,npa)

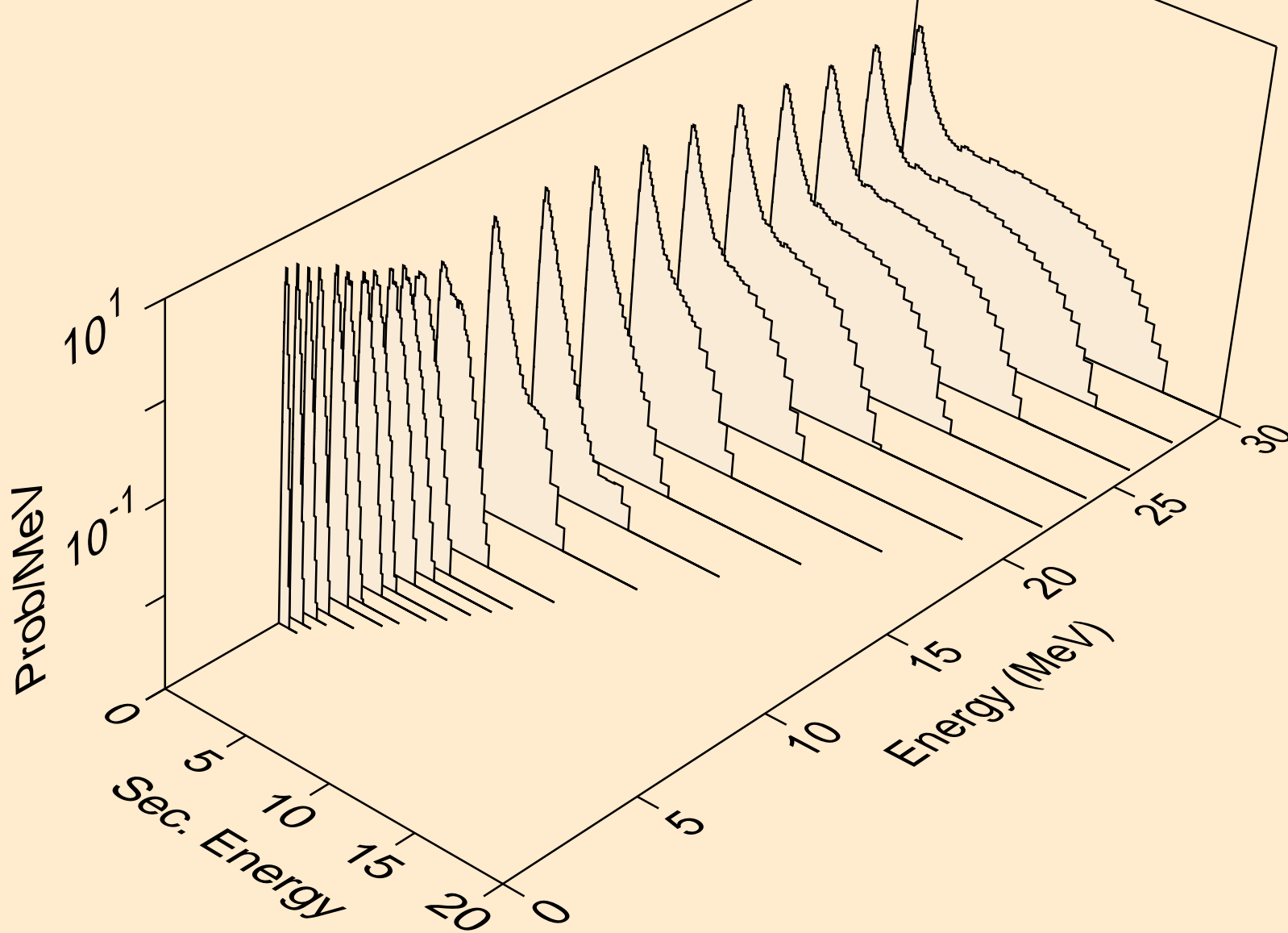

DB257 NEUTRON ACER TENDL-2019 LIBRARY; T=293.16K
Neutron emission for (n,n*c)

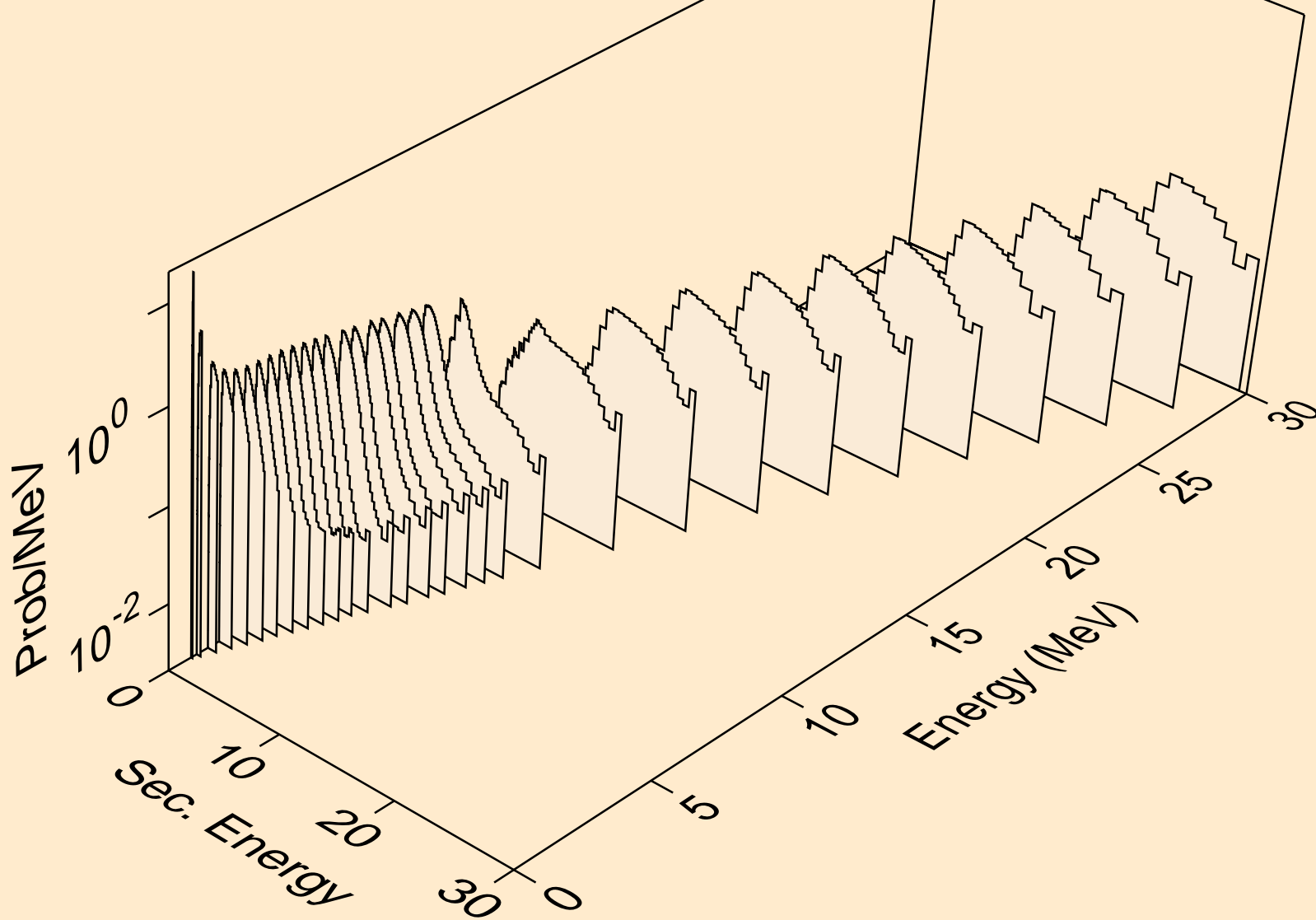

DB257 NEUTRON ACER TENDL-2019 LIBRARY; T=293.16K

Delayed nubar

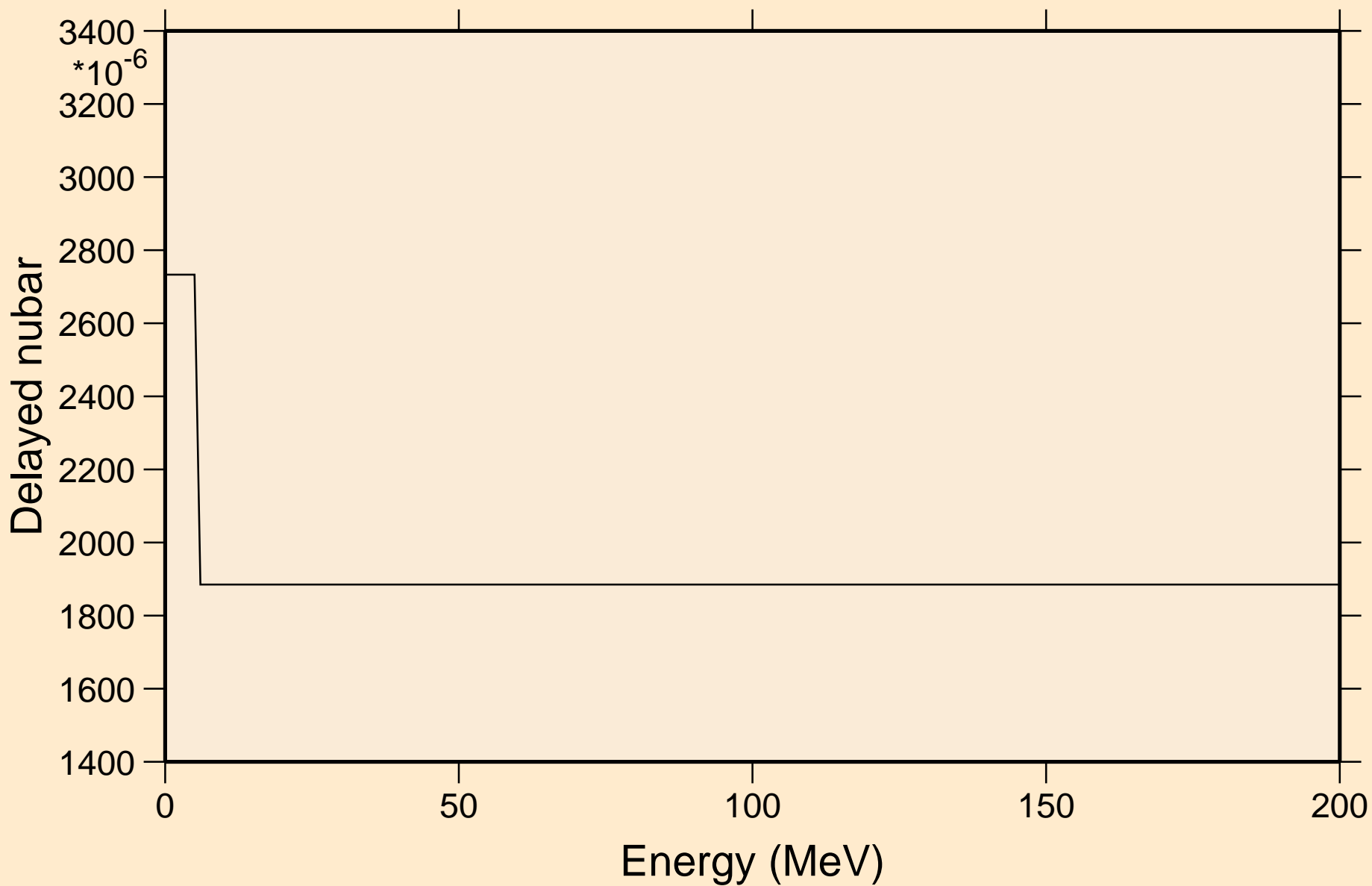

DB257 NEUTRON ACER TENDL-2019 LIBRARY; T=293.16K
Delayed neutron spectra

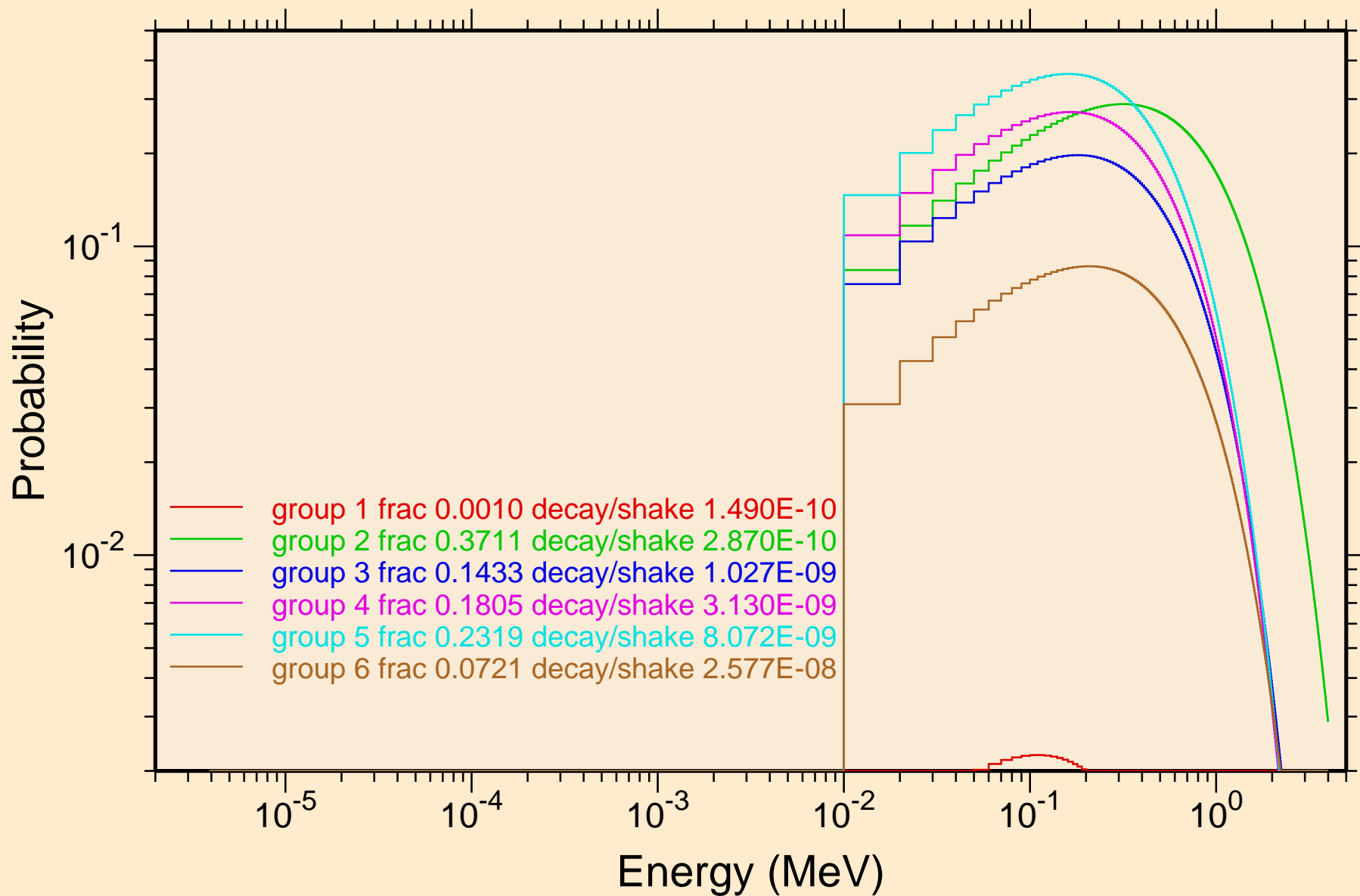

DB257 NEUTRON ACER TENDL-2019 LIBRARY; T=293.16K
Photon emission for (n,x)

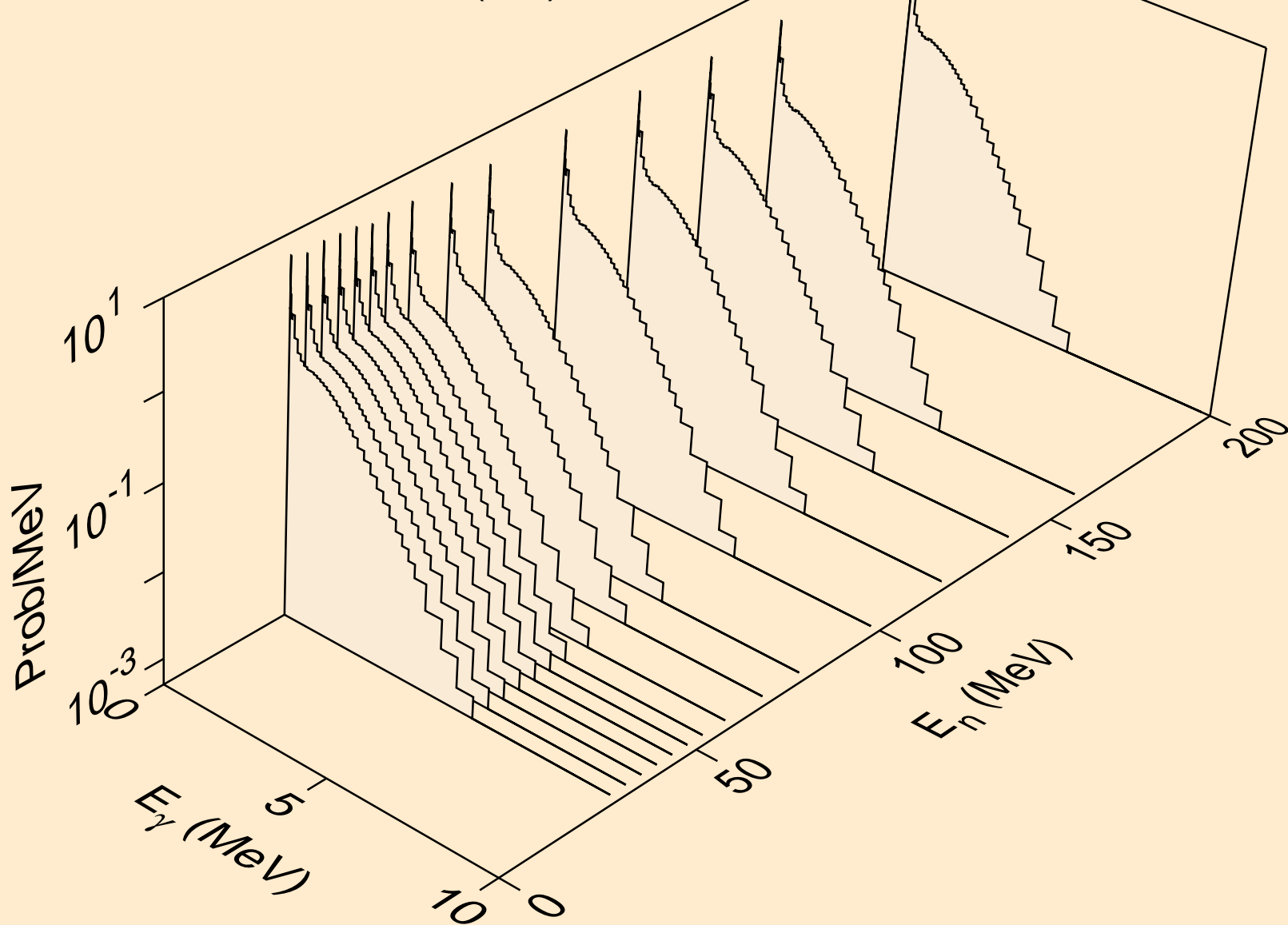

DB257 NEUTRON ACER TENDL-2019 LIBRARY; T=293.16K
Photon emission for (n,2nd)

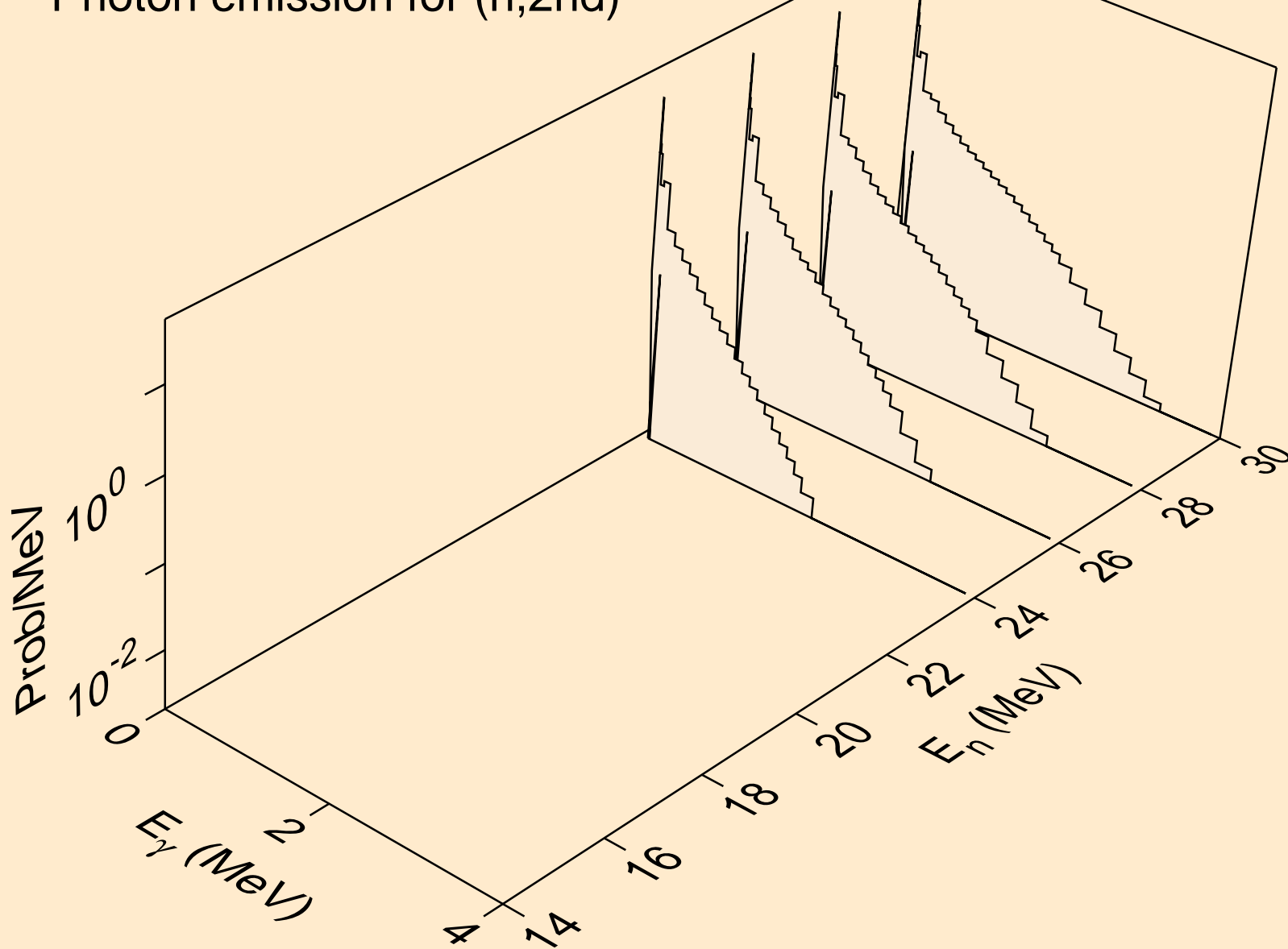

DB257 NEUTRON ACER TENDL-2019 LIBRARY; T=293.16K
Photon emission for (n,2n)

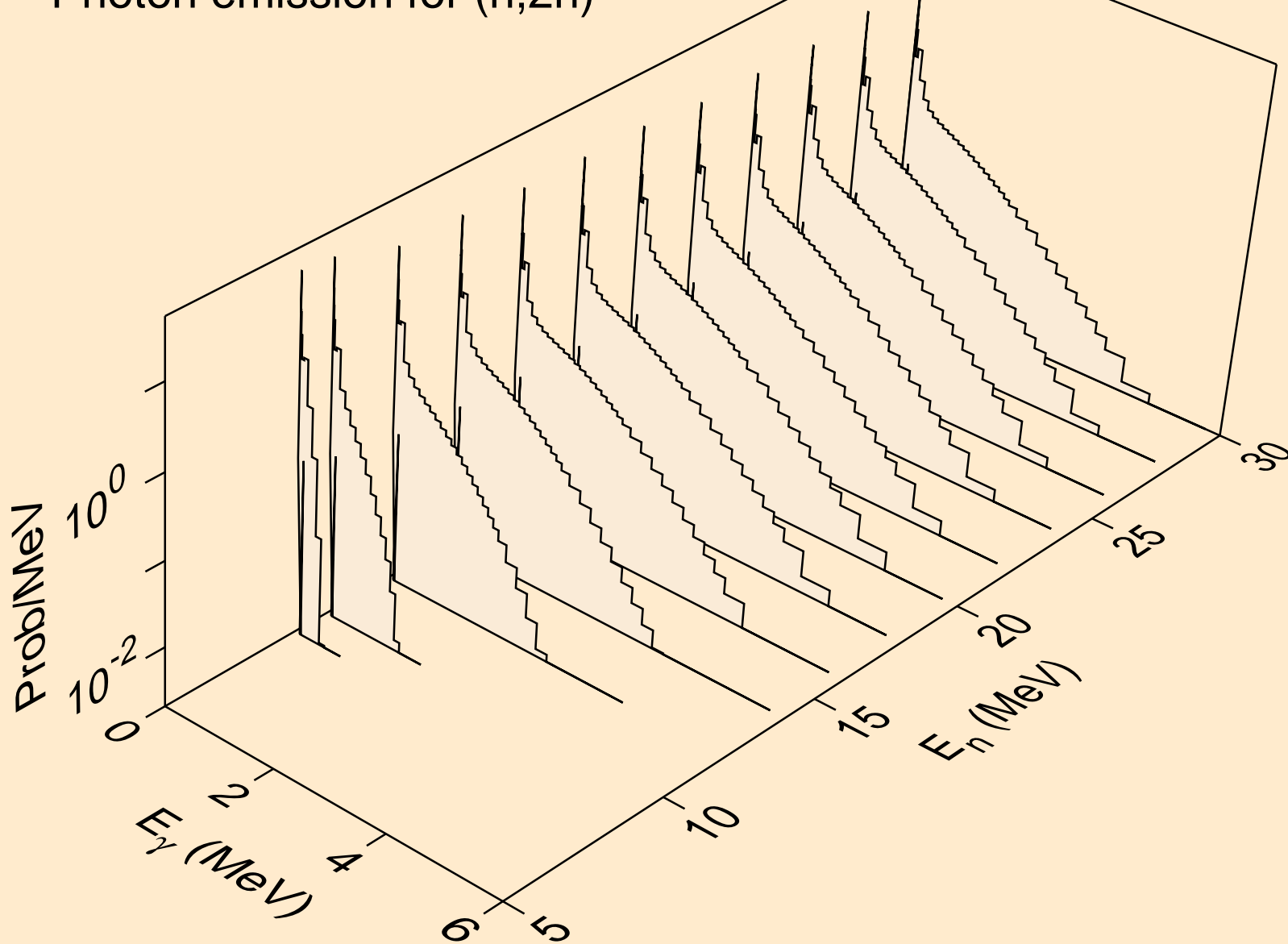

DB257 NEUTRON ACER TENDL-2019 LIBRARY; T=293.16K
Photon emission for (n,3n)

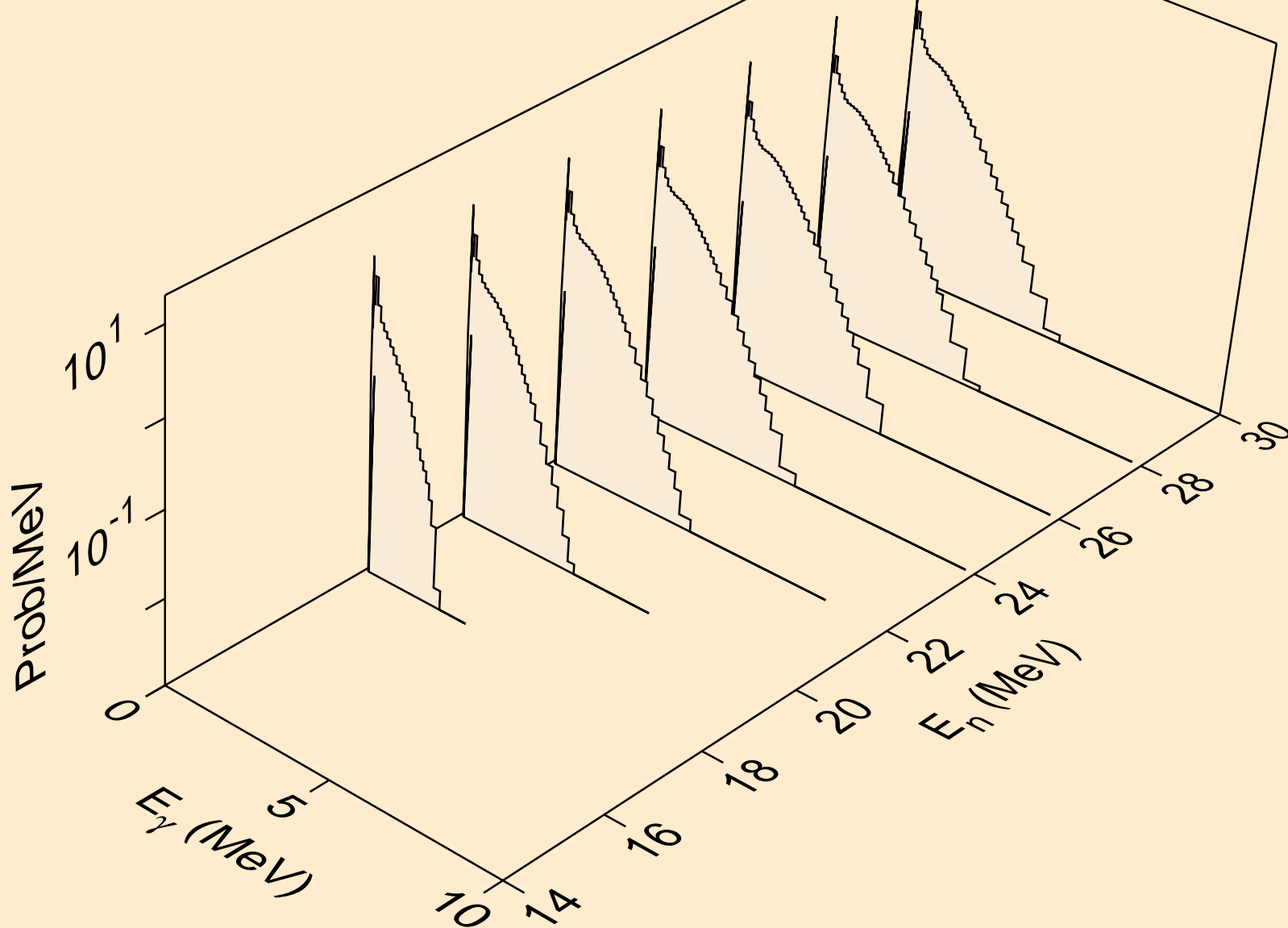

DB257 NEUTRON ACER TENDL-2019 LIBRARY; T=293.16K
Photon emission for (n,n*)a

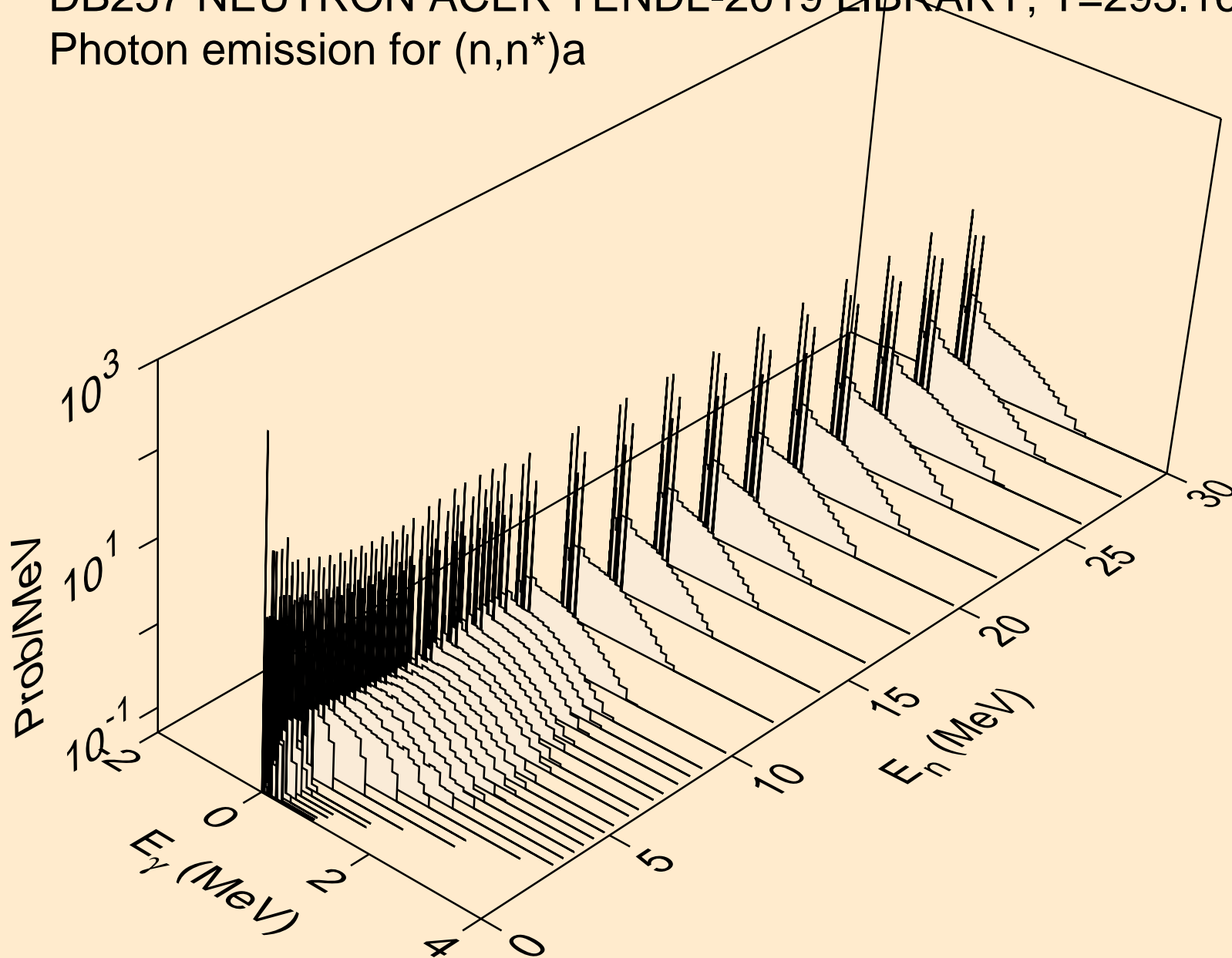

DB257 NEUTRON ACER TENDL-2019 LIBRARY; T=293.16K
Photon emission for (n,n*)3a

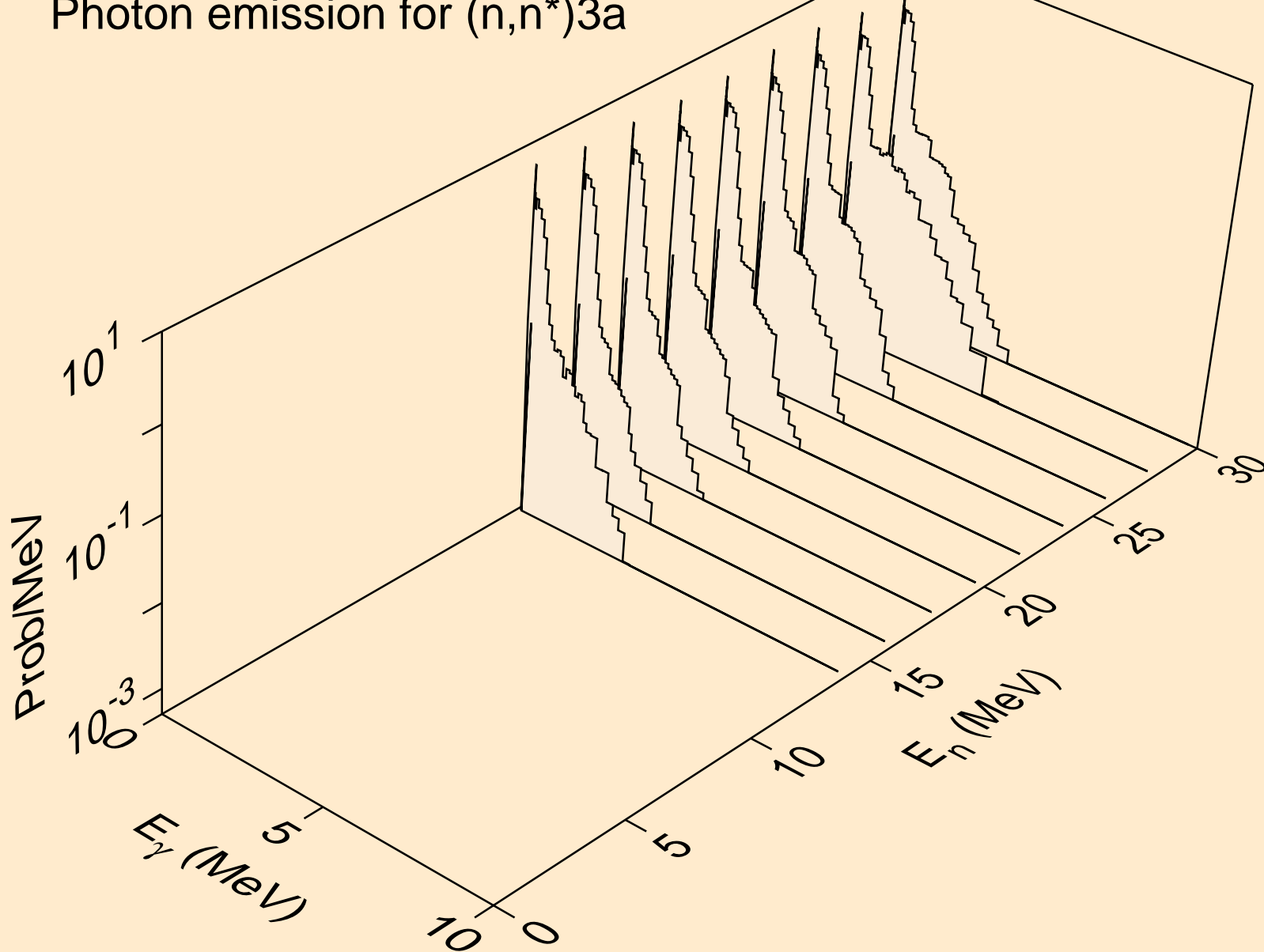

DB257 NEUTRON ACER TENDL-2019 LIBRARY; T=293.16K
Photon emission for (n,2n)a

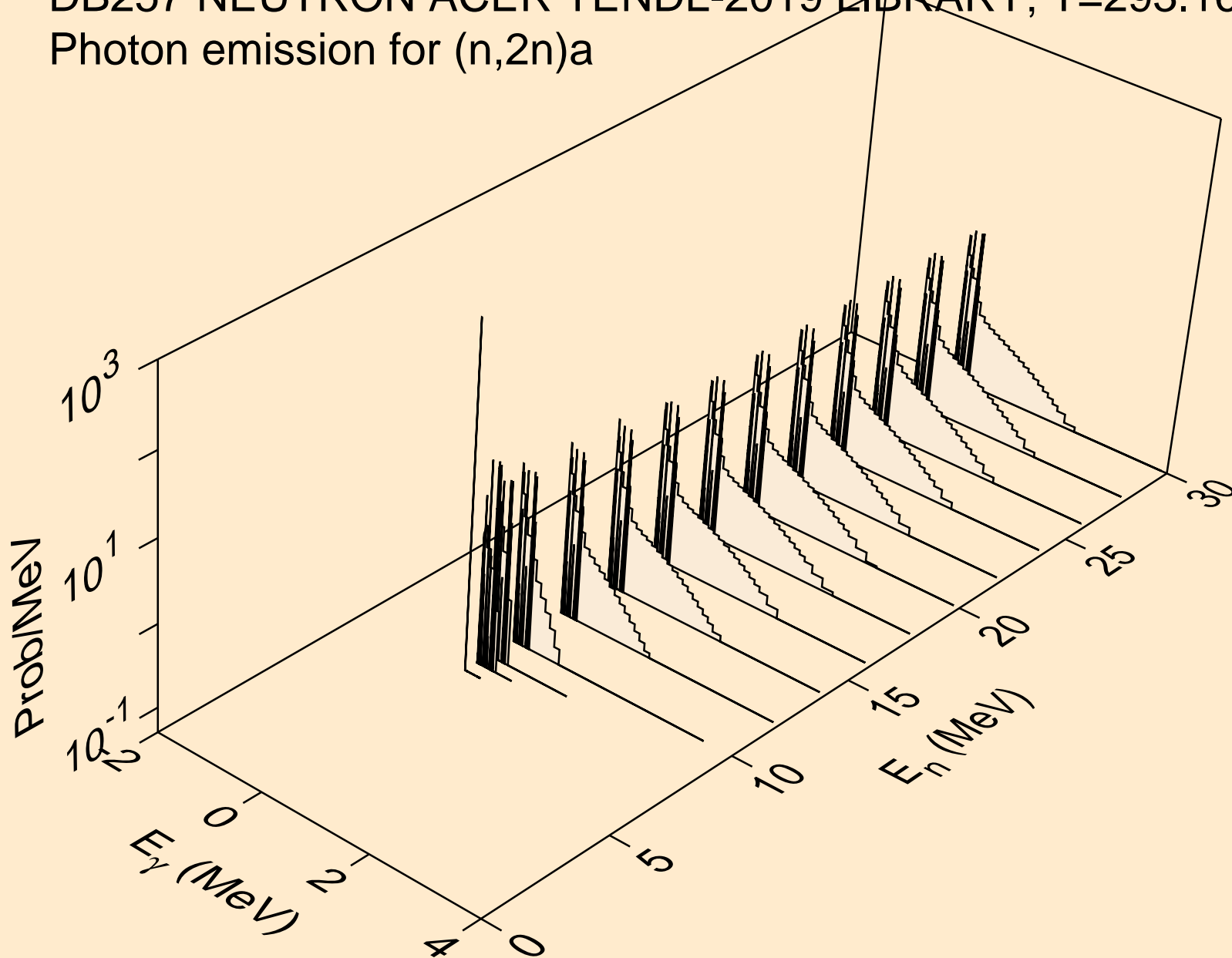

DB257 NEUTRON ACER TENDL-2019 LIBRARY; T=293.16K
Photon emission for (n,3n)a

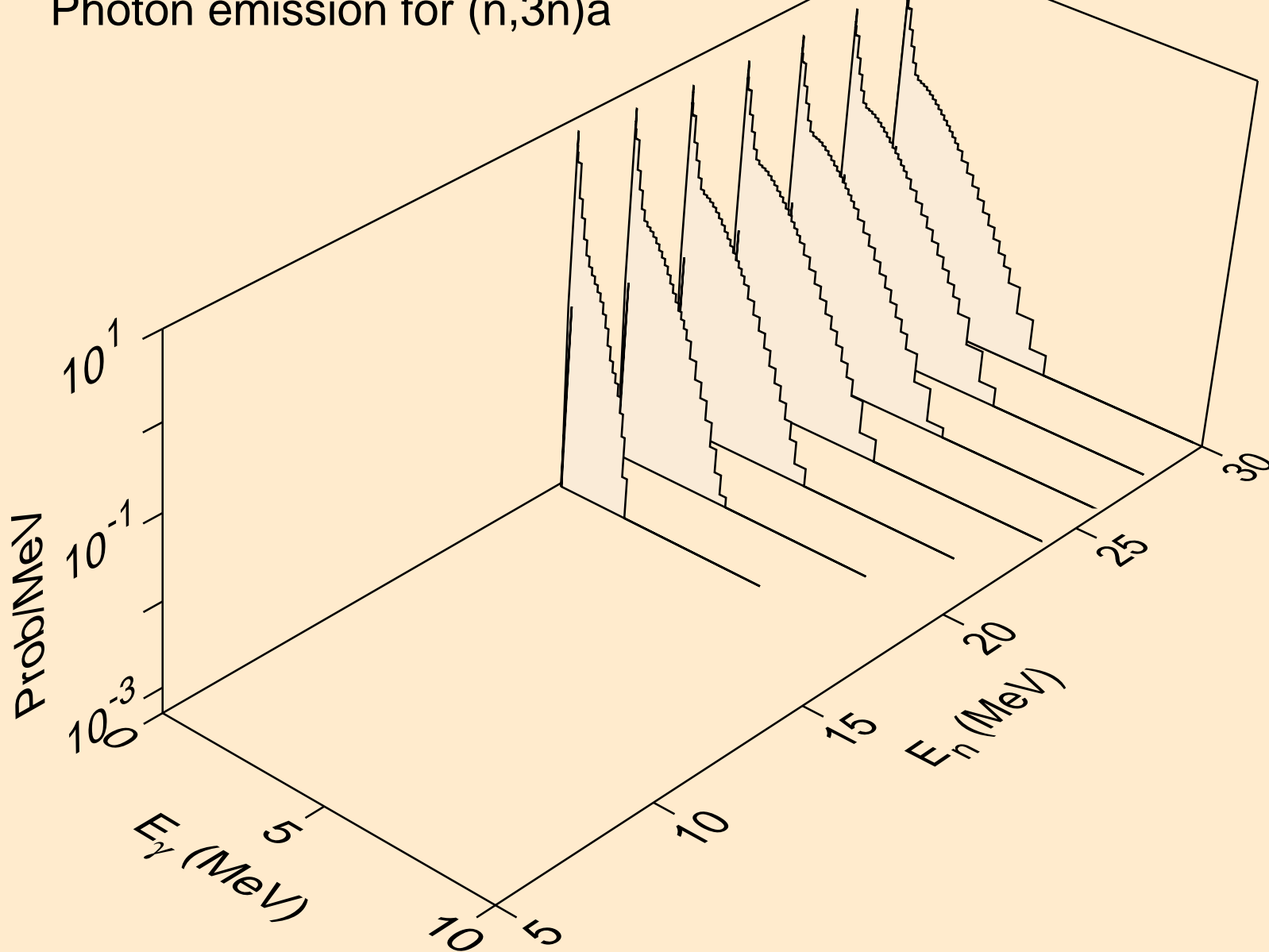

DB257 NEUTRON ACER TENDL-2019 LIBRARY; T=293.16K
Photon emission for (n,n*)p

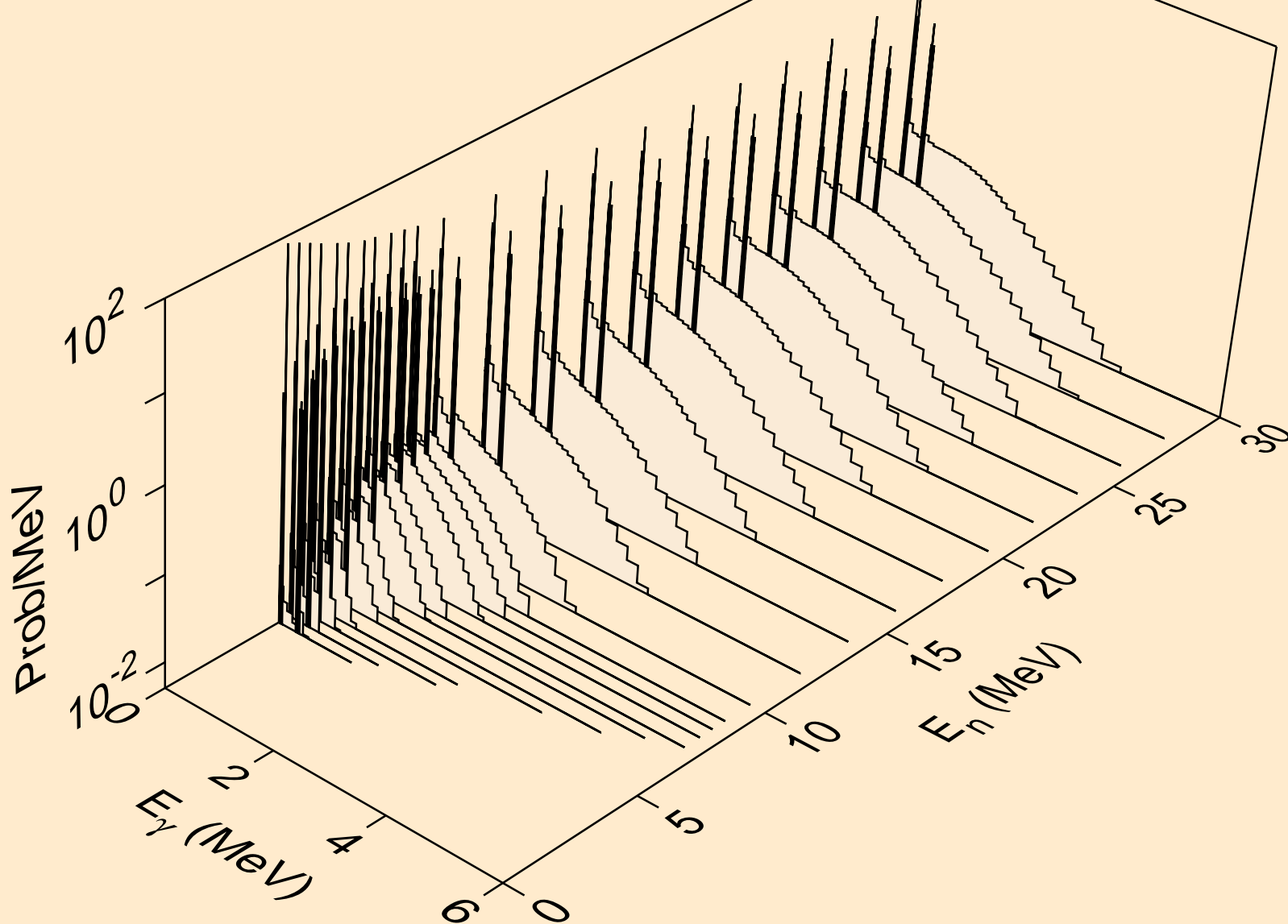

DB257 NEUTRON ACER TENDL-2019 LIBRARY; T=293.16K
Photon emission for (n,n*)2a

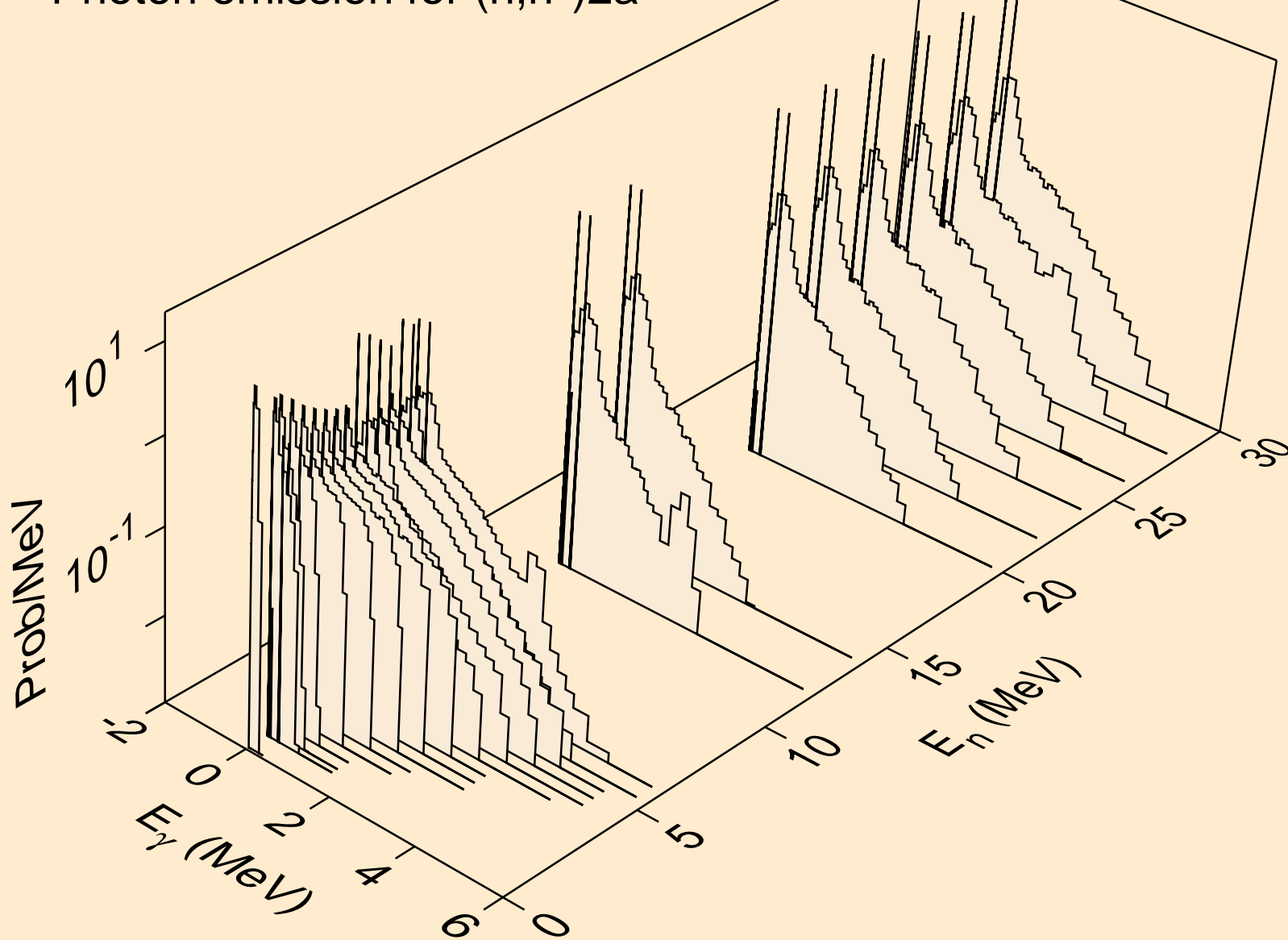

DB257 NEUTRON ACER TENDL-2019 LIBRARY; T=293.16K
Photon emission for (n,2n)2a

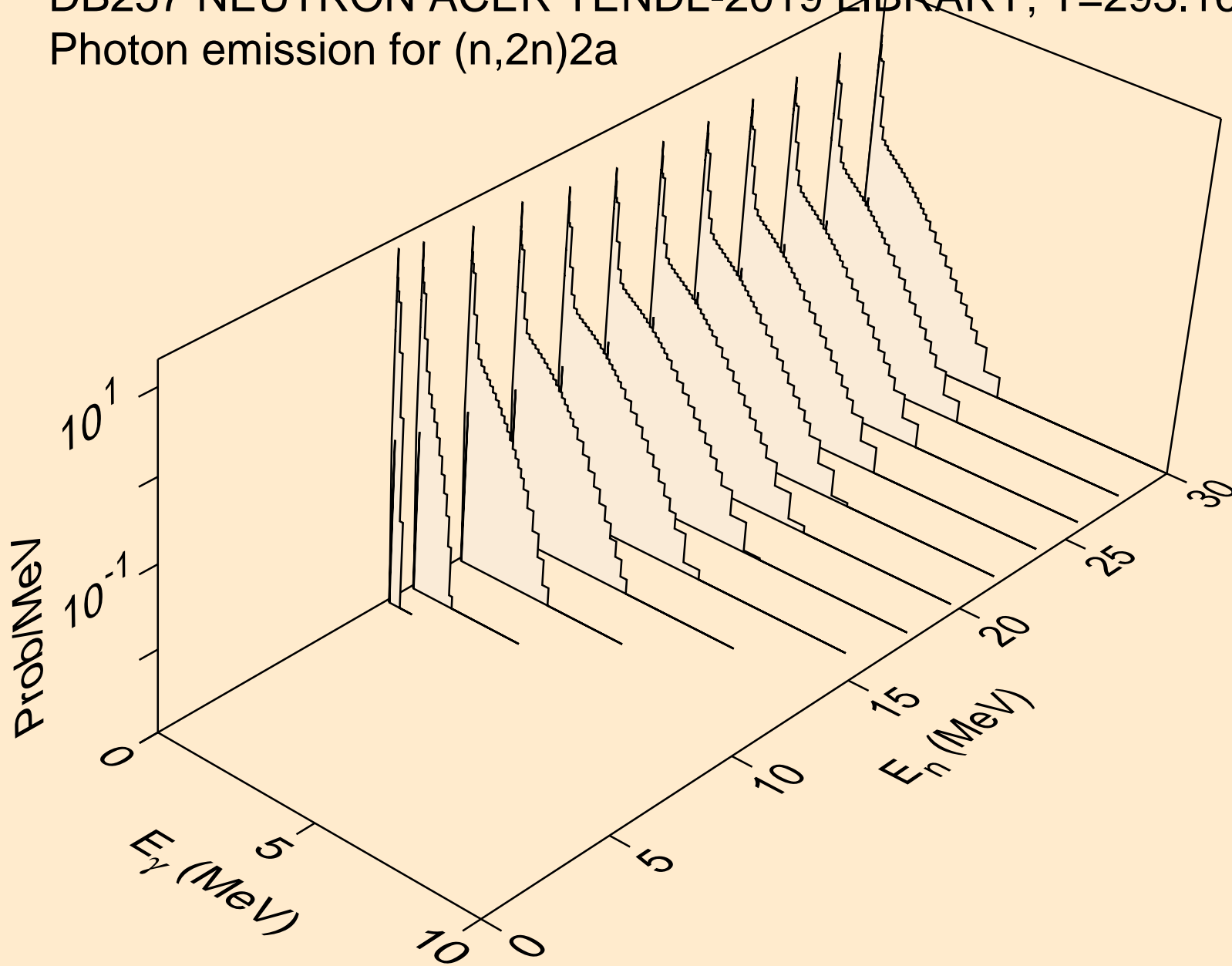

DB257 NEUTRON ACER TENDL-2019 LIBRARY; T=293.16K
Photon emission for (n,n*)d

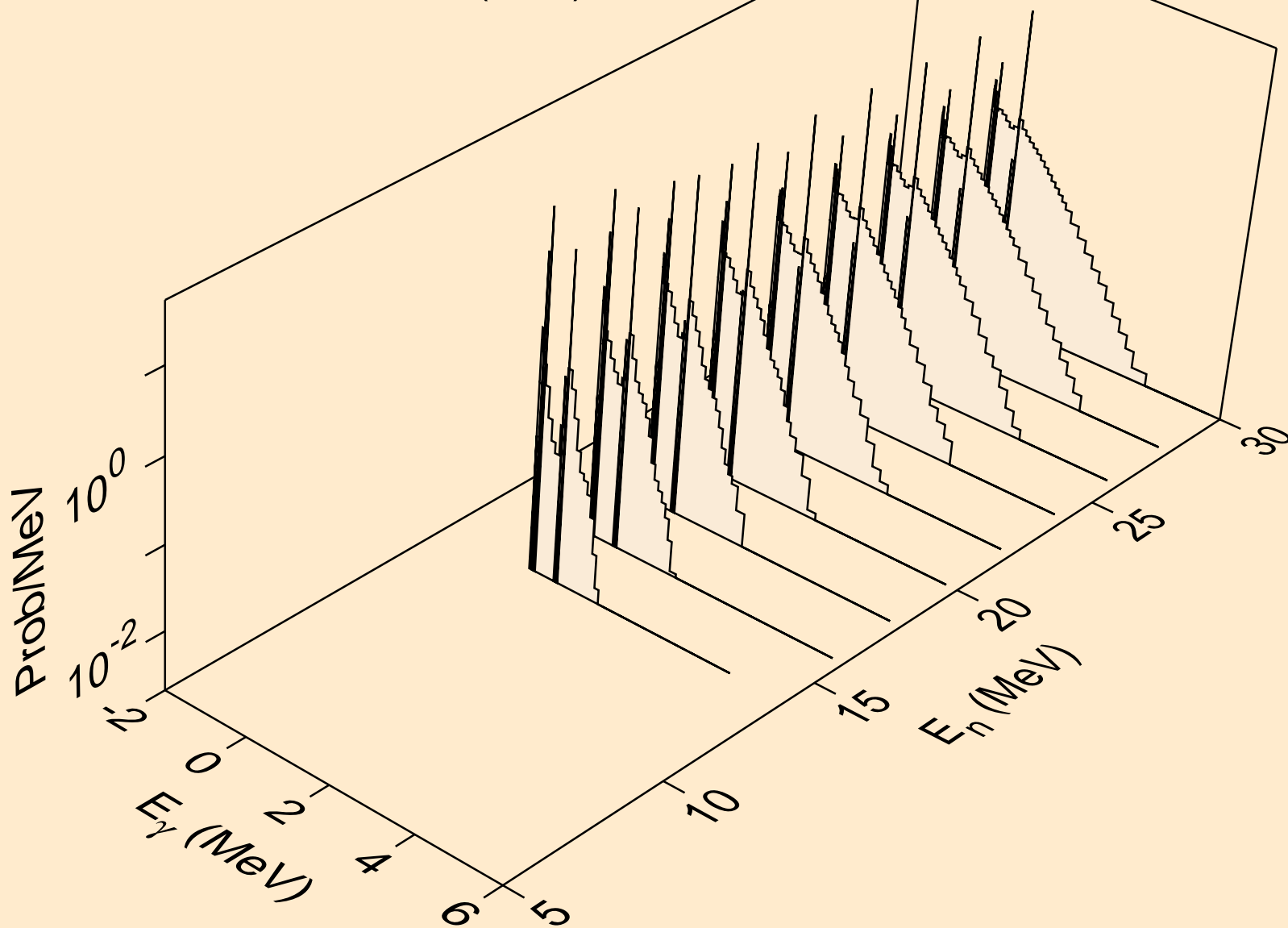

DB257 NEUTRON ACER TENDL-2019 LIBRARY; T=293.16K
Photon emission for (n,n*)t

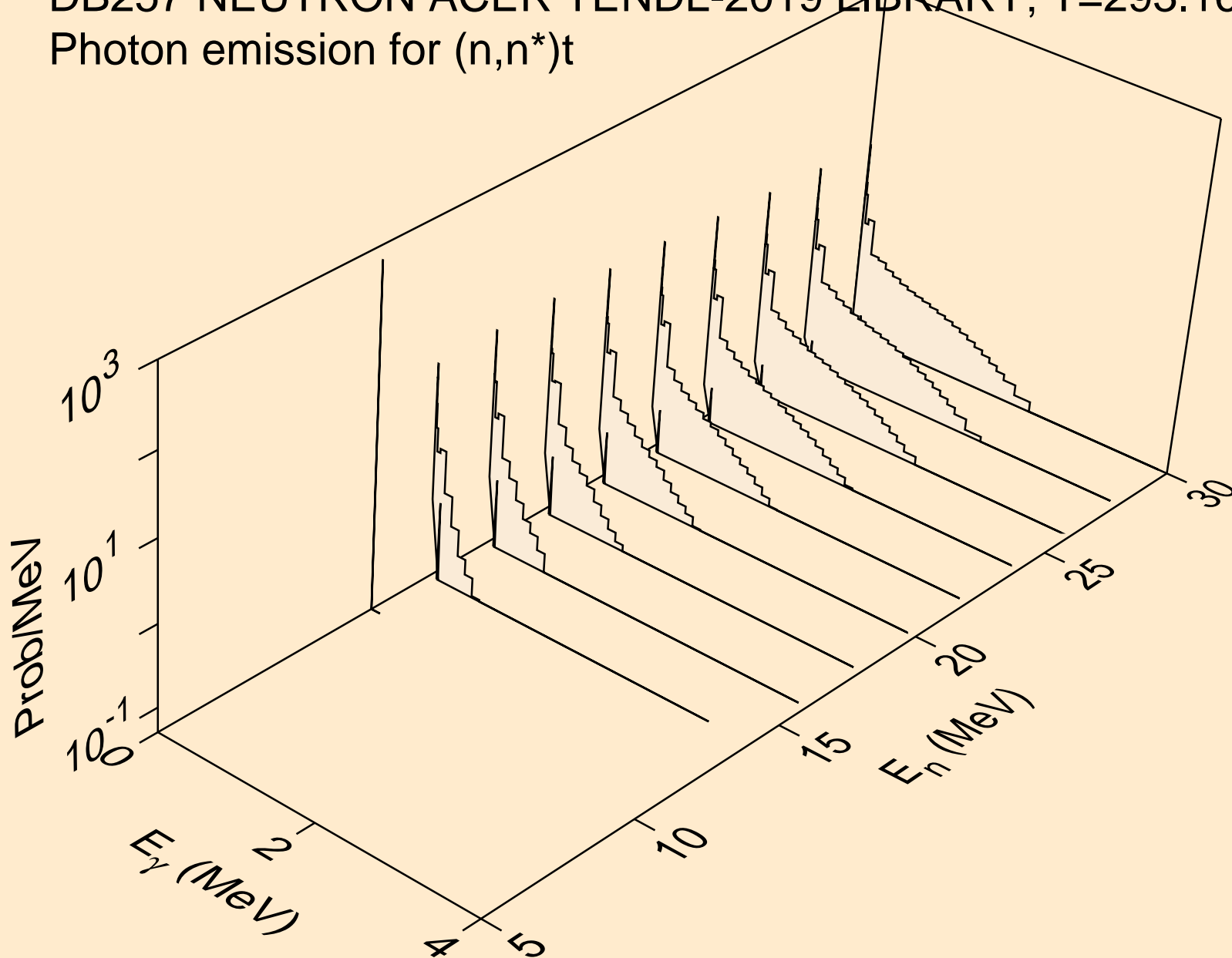

DB257 NEUTRON ACER TENDL-2019 LIBRARY; T=293.16K
Photon emission for (n,n*)he3

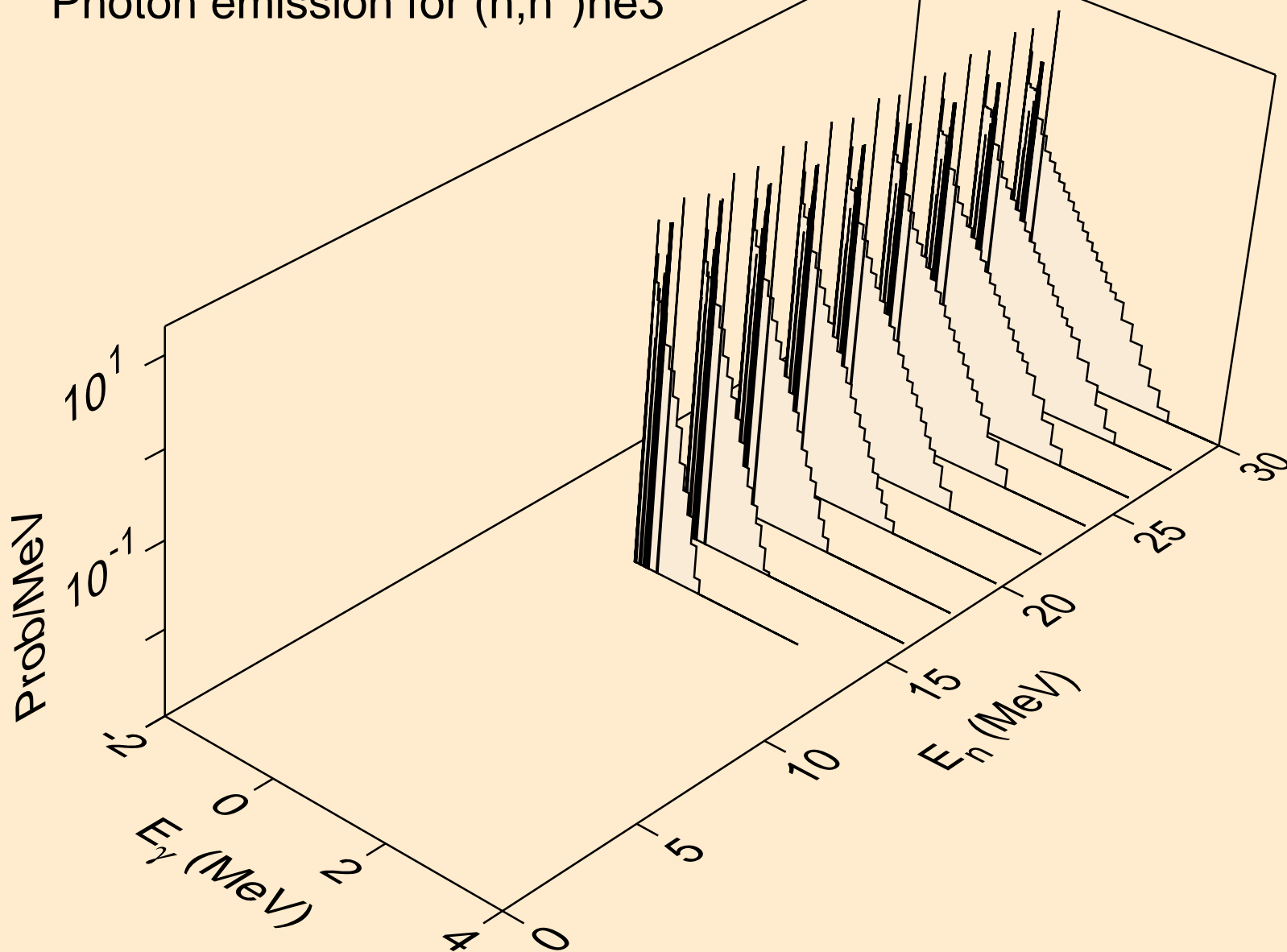

DB257 NEUTRON ACER TENDL-2019 LIBRARY; T=293.16K
Photon emission for (n,n*)d2a

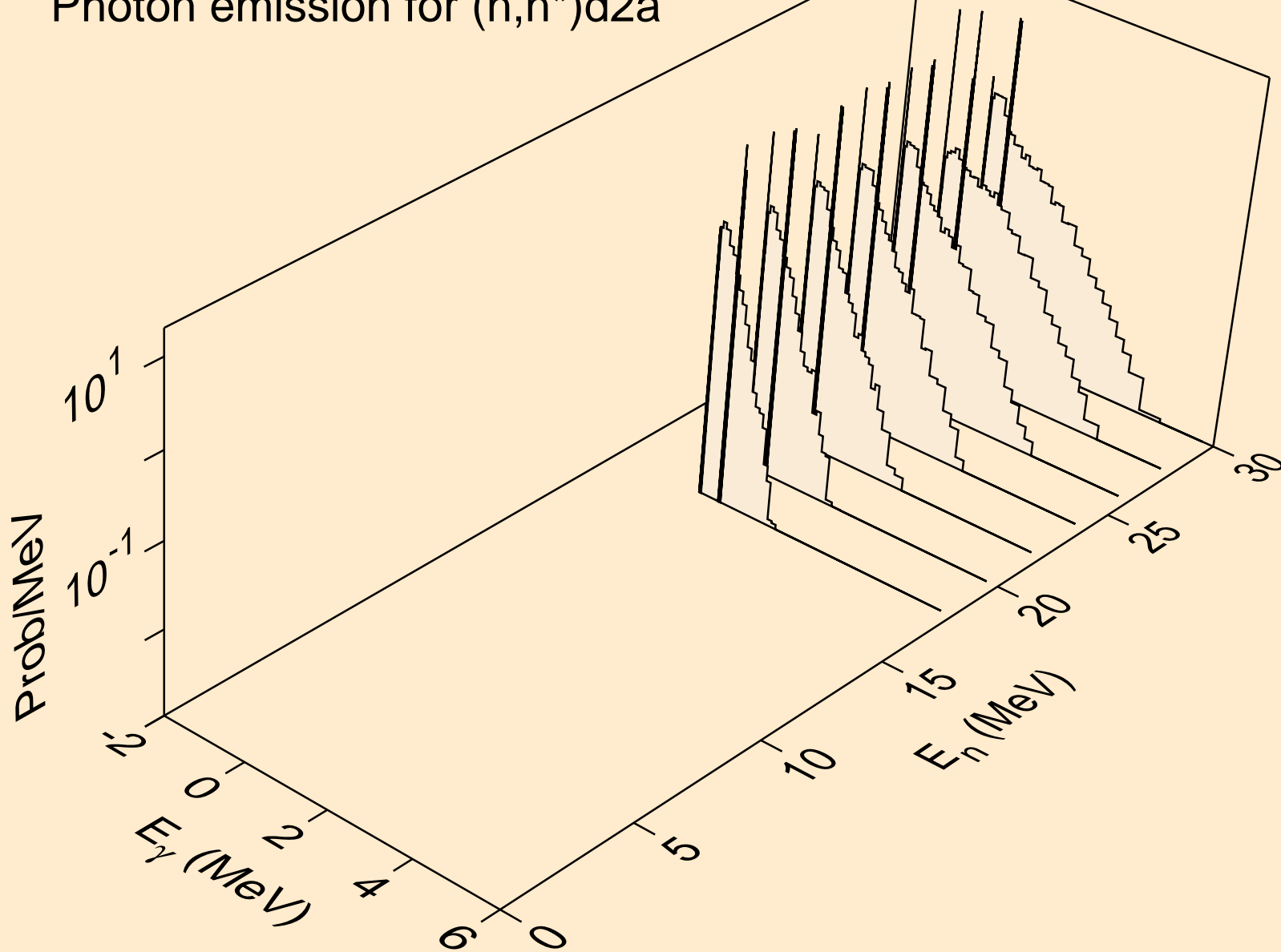

DB257 NEUTRON ACER TENDL-2019 LIBRARY; T=293.16K
Photon emission for (n,n*)t2a

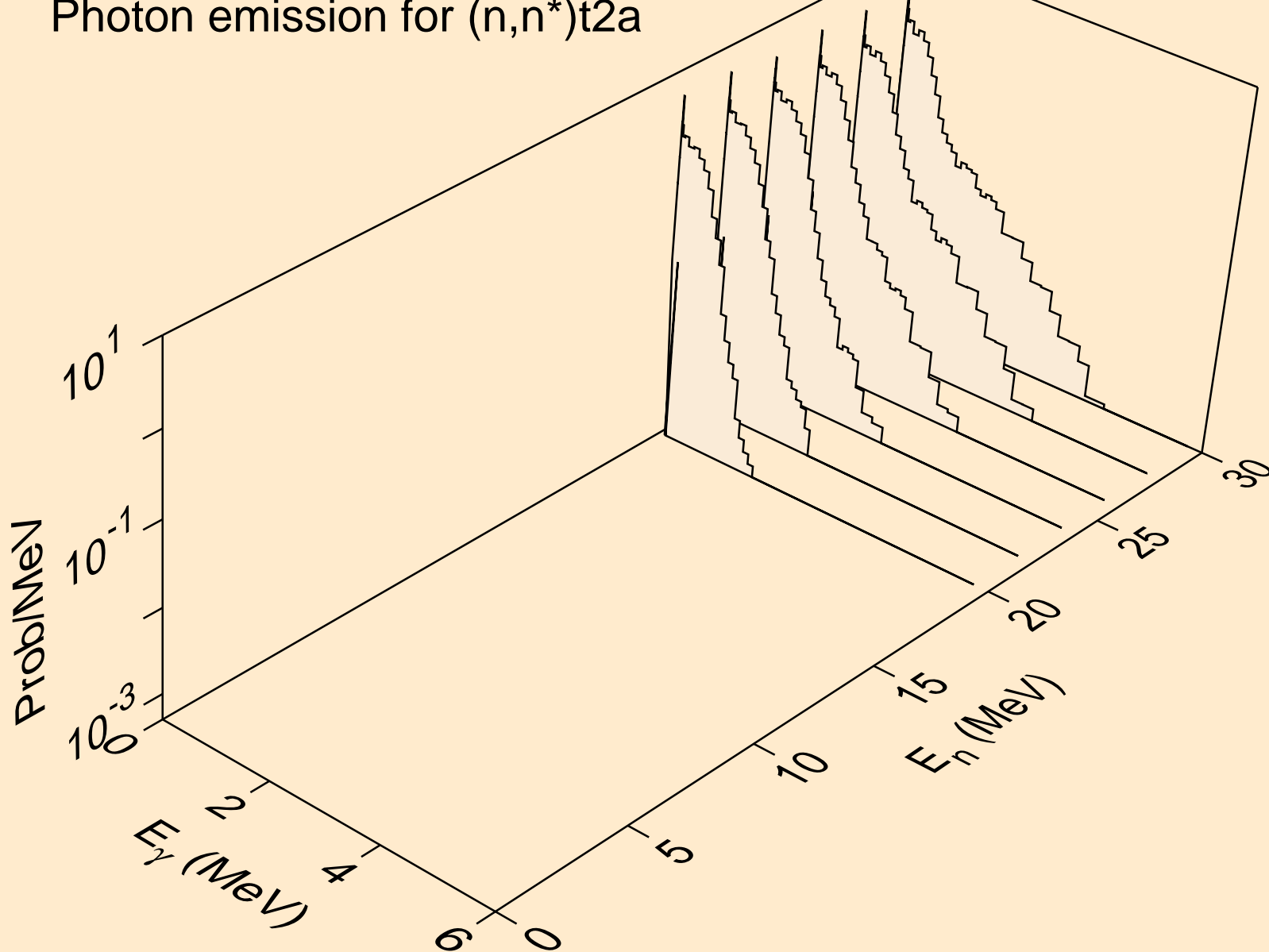

DB257 NEUTRON ACER TENDL-2019 LIBRARY; T=293.16K
Photon emission for (n,4n)

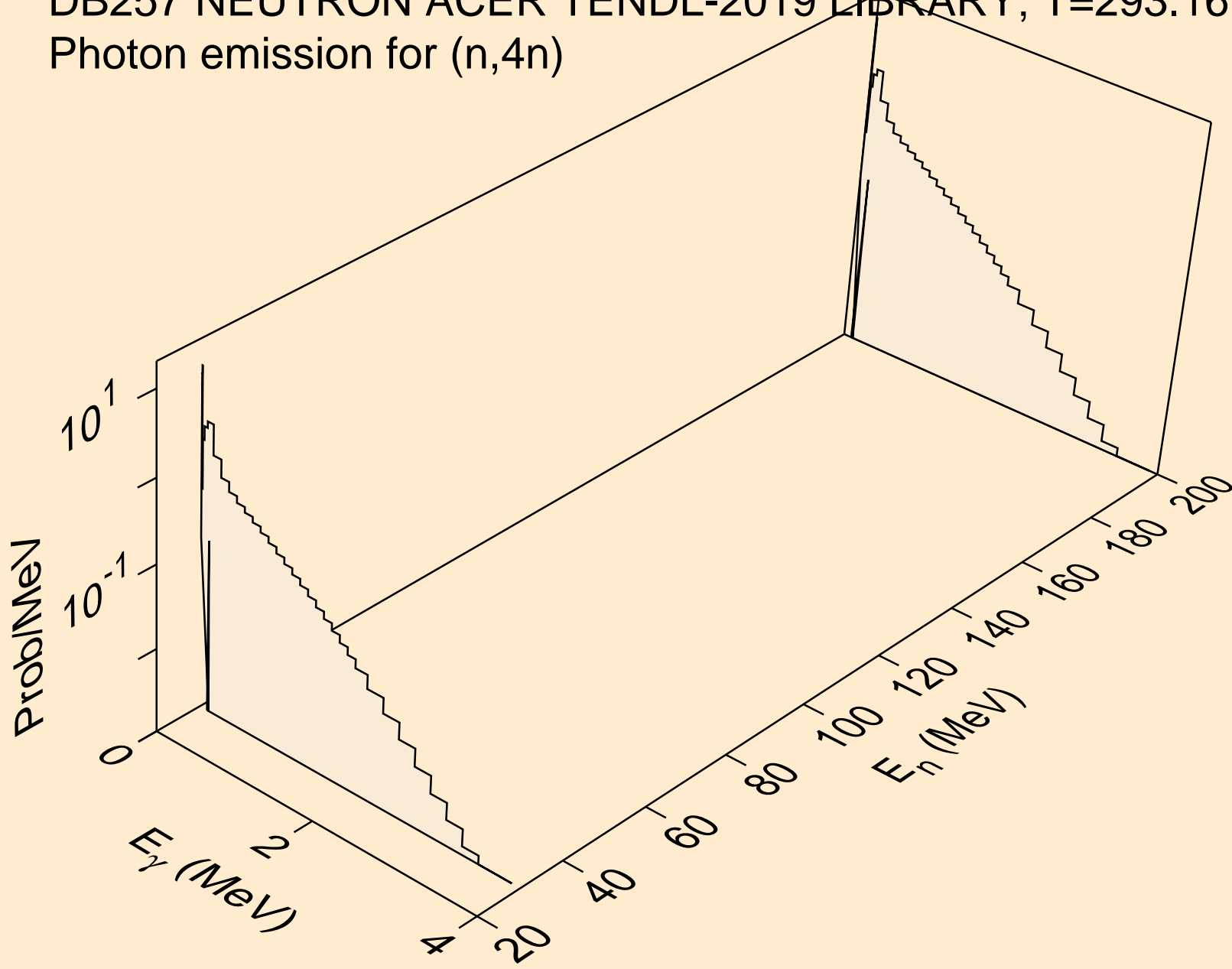

DB257 NEUTRON ACER TENDL-2019 LIBRARY; T=293.16K
Photon emission for (n,2np)

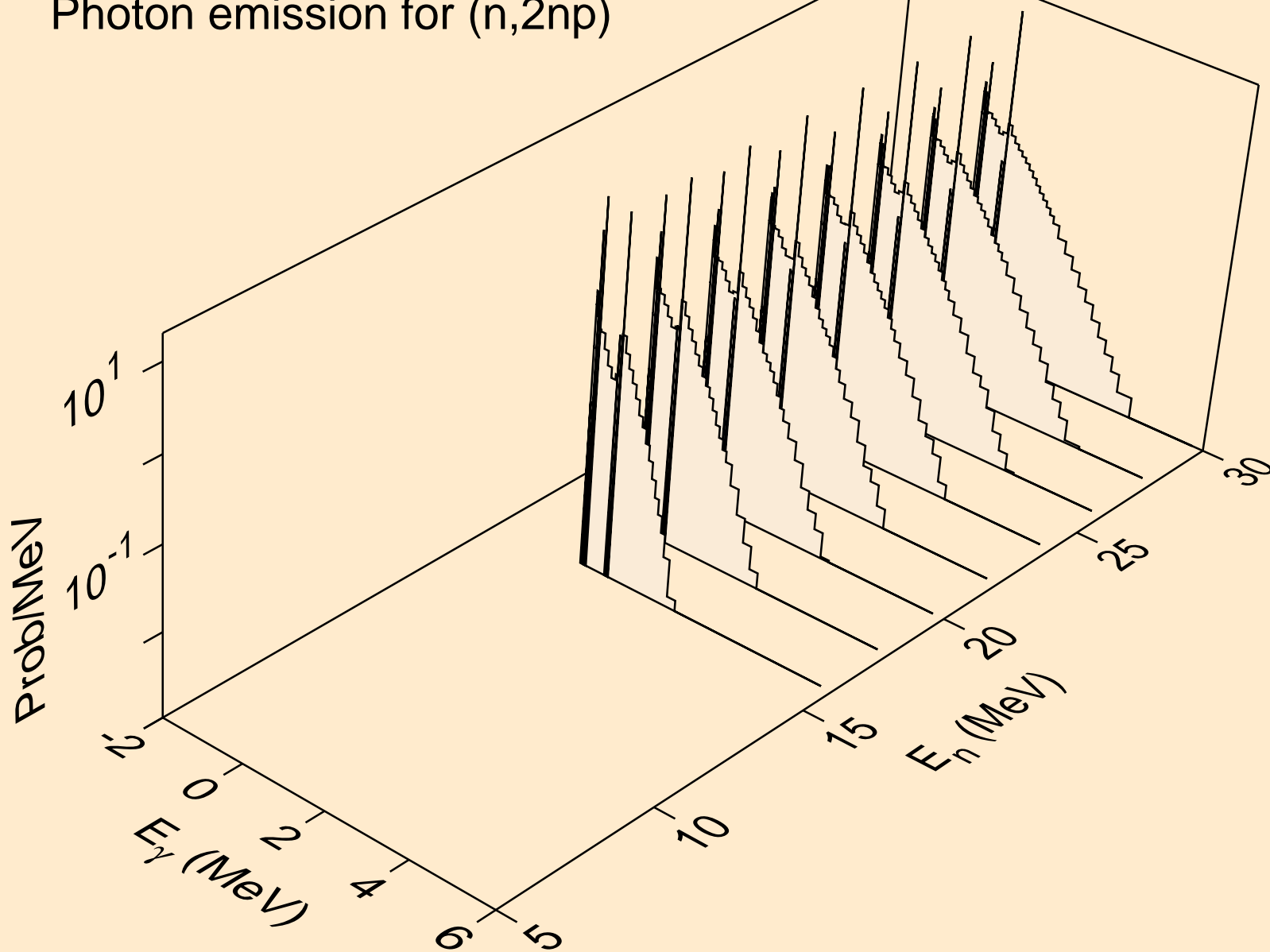

DB257 NEUTRON ACER TENDL-2019 LIBRARY; T=293.16K
Photon emission for (n,3np)

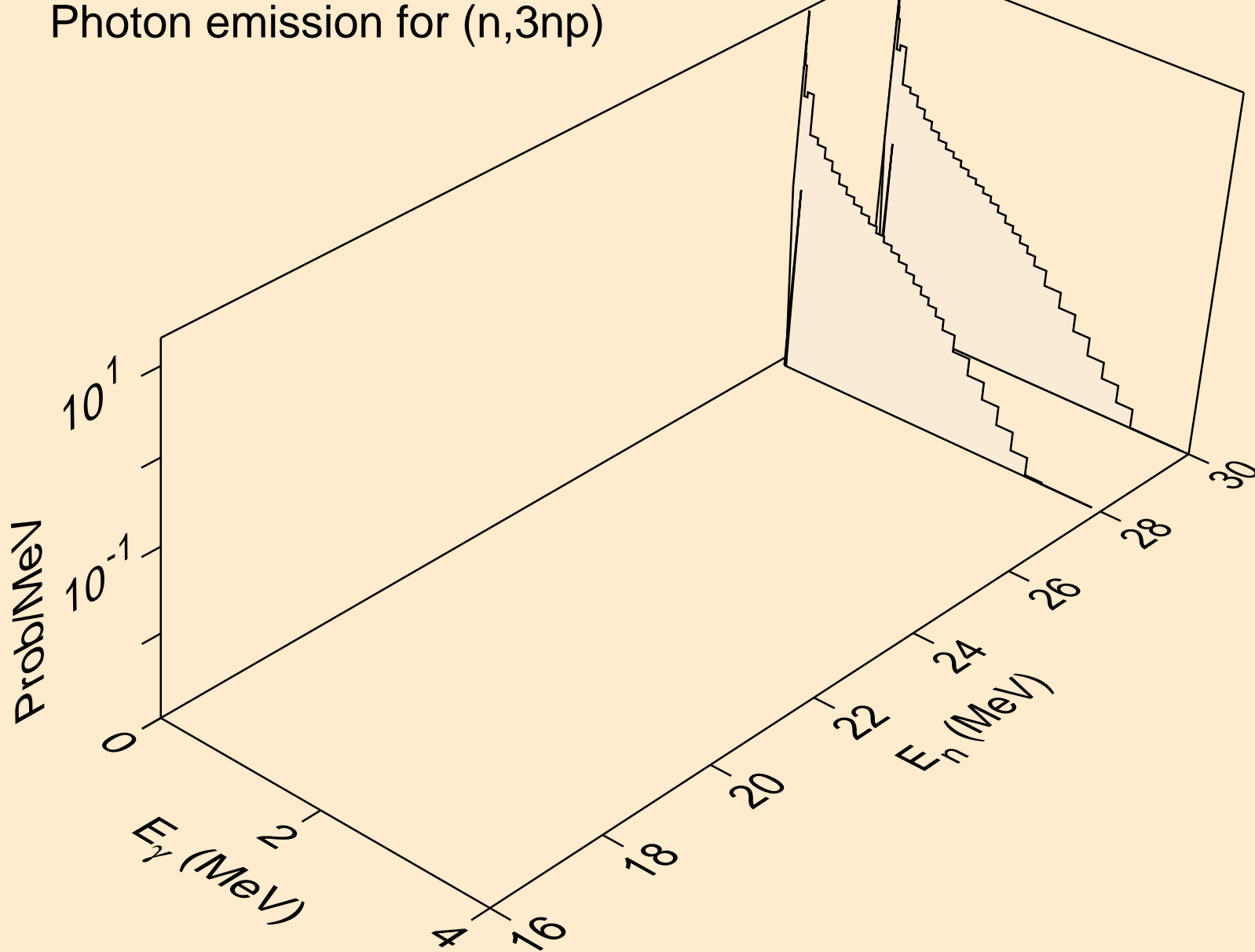

DB257 NEUTRON ACER TENDL-2019 LIBRARY; T=293.16K
Photon emission for (n,2np)

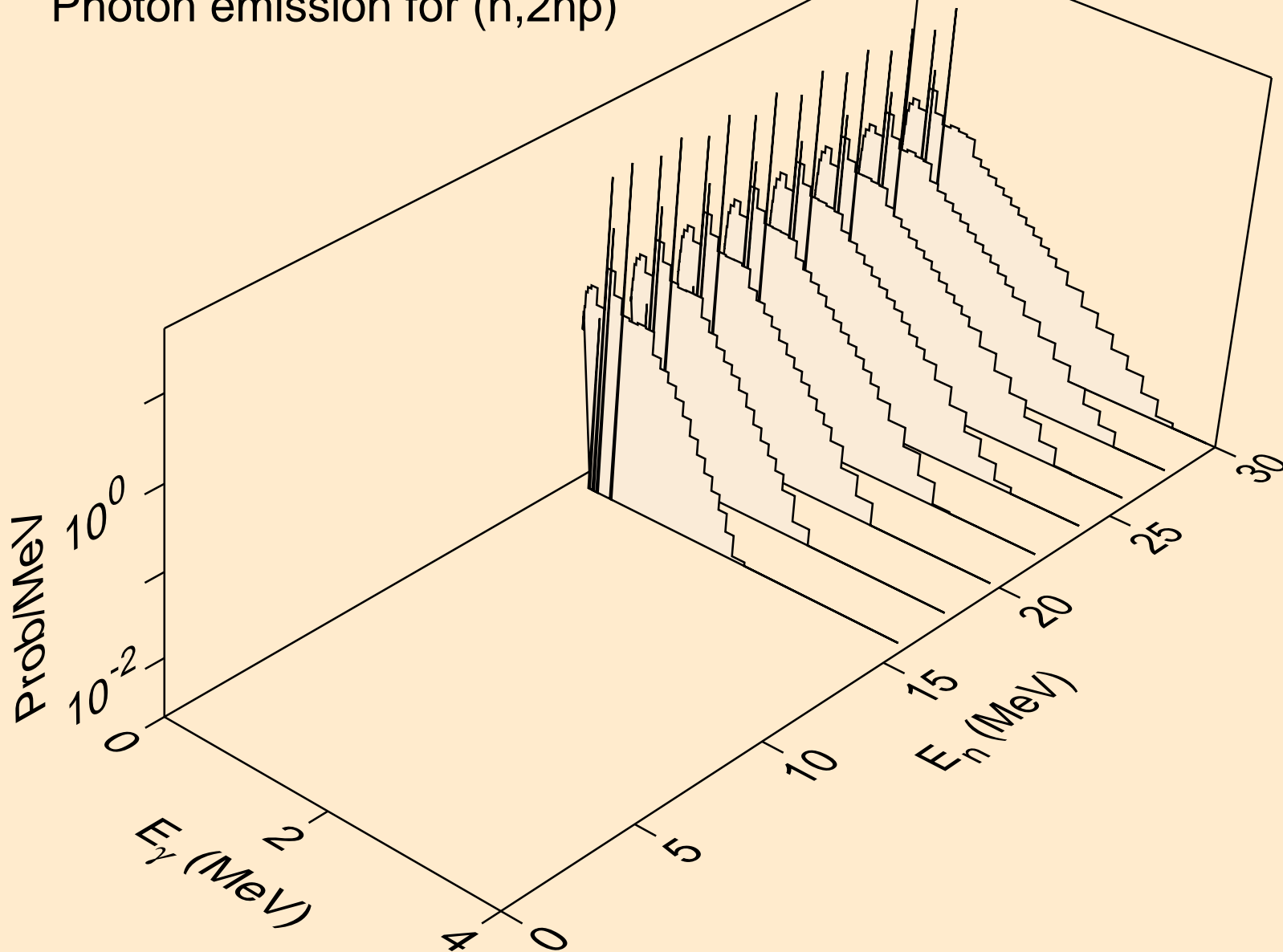

DB257 NEUTRON ACER TENDL-2019 LIBRARY; T=293.16K
Photon emission for (n,npa)

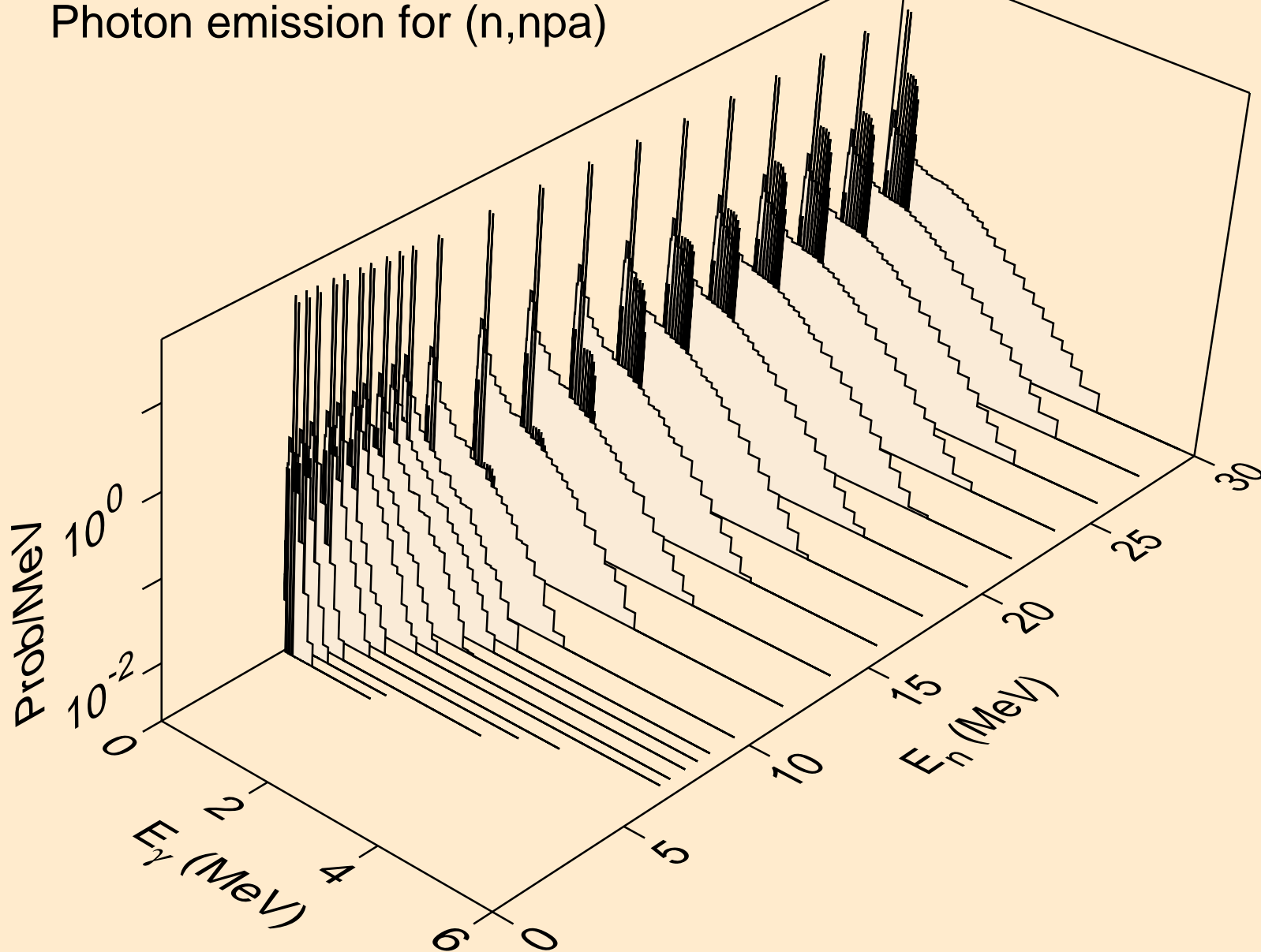

DB257 NEUTRON ACER TENDL-2019 LIBRARY; T=293.16K
Photon emission for (n,n*c)

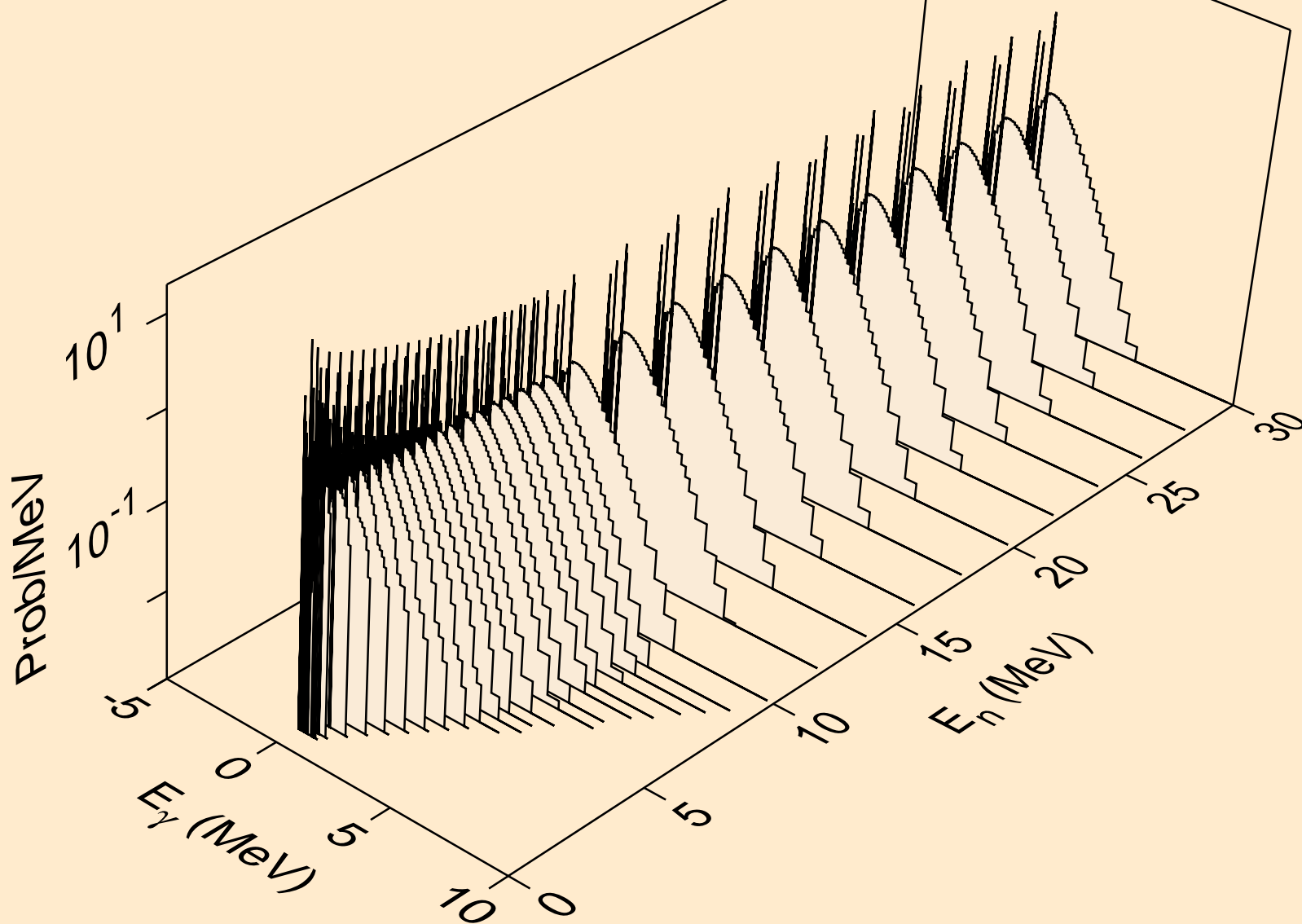

DB257 NEUTRON ACER TENDL-2019 LIBRARY; T=293.16K
Photon emission for (n,gma)

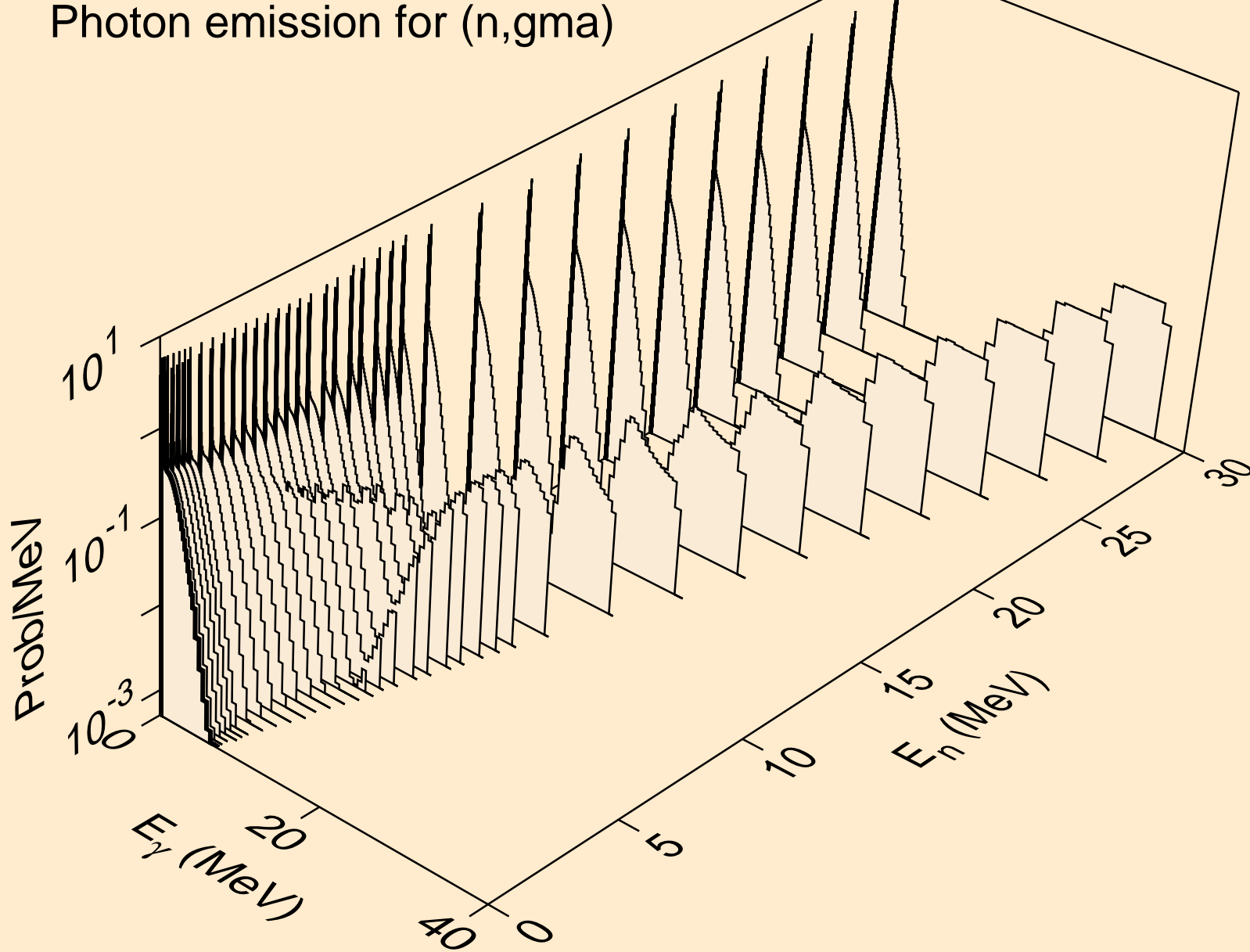

DB257 NEUTRON ACER TENDL-2019 LIBRARY; T=293.16K
Photon emission for (n,p)

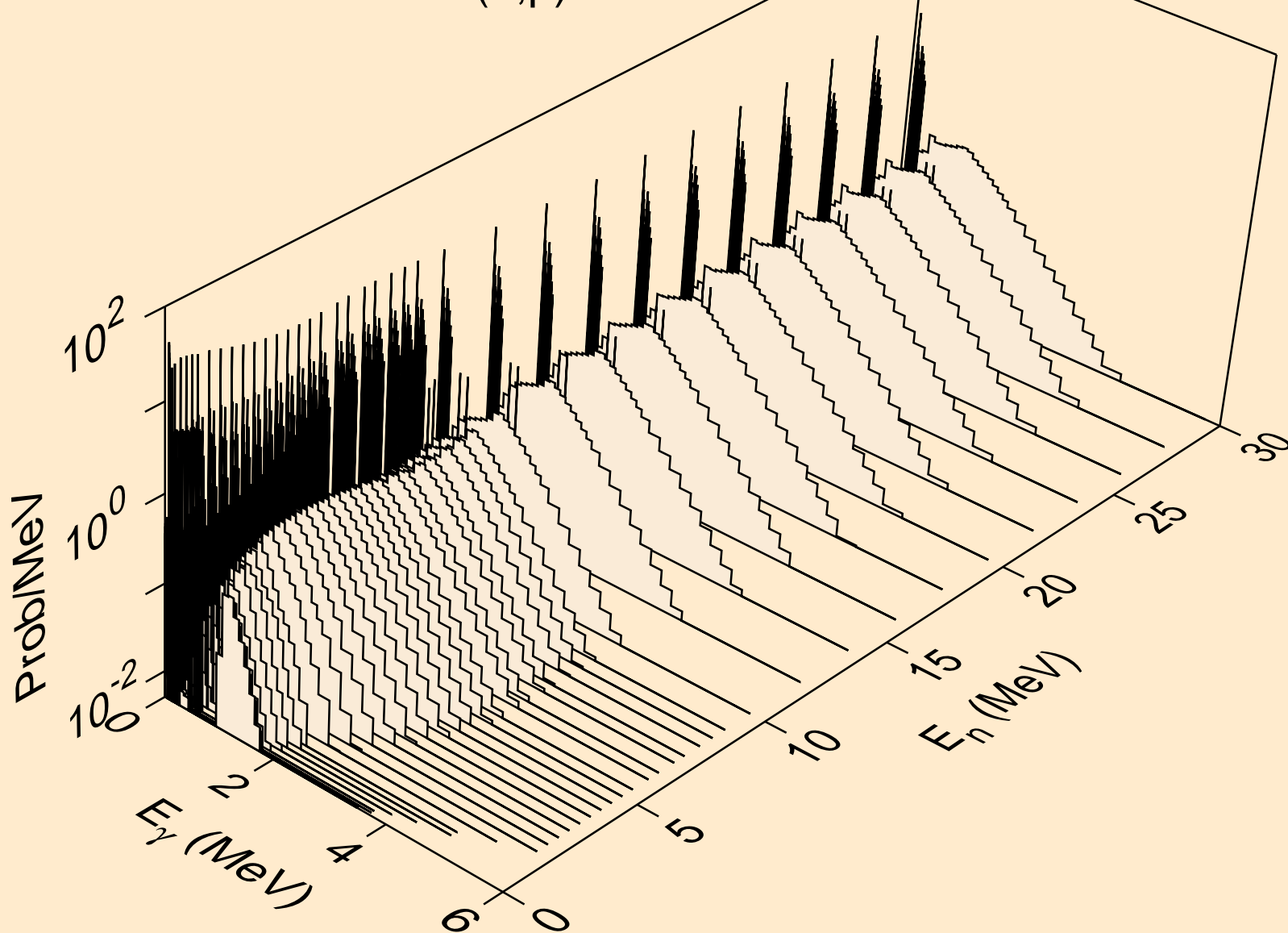

DB257 NEUTRON ACER TENDL-2019 LIBRARY; T=293.16K
Photon emission for (n,d)

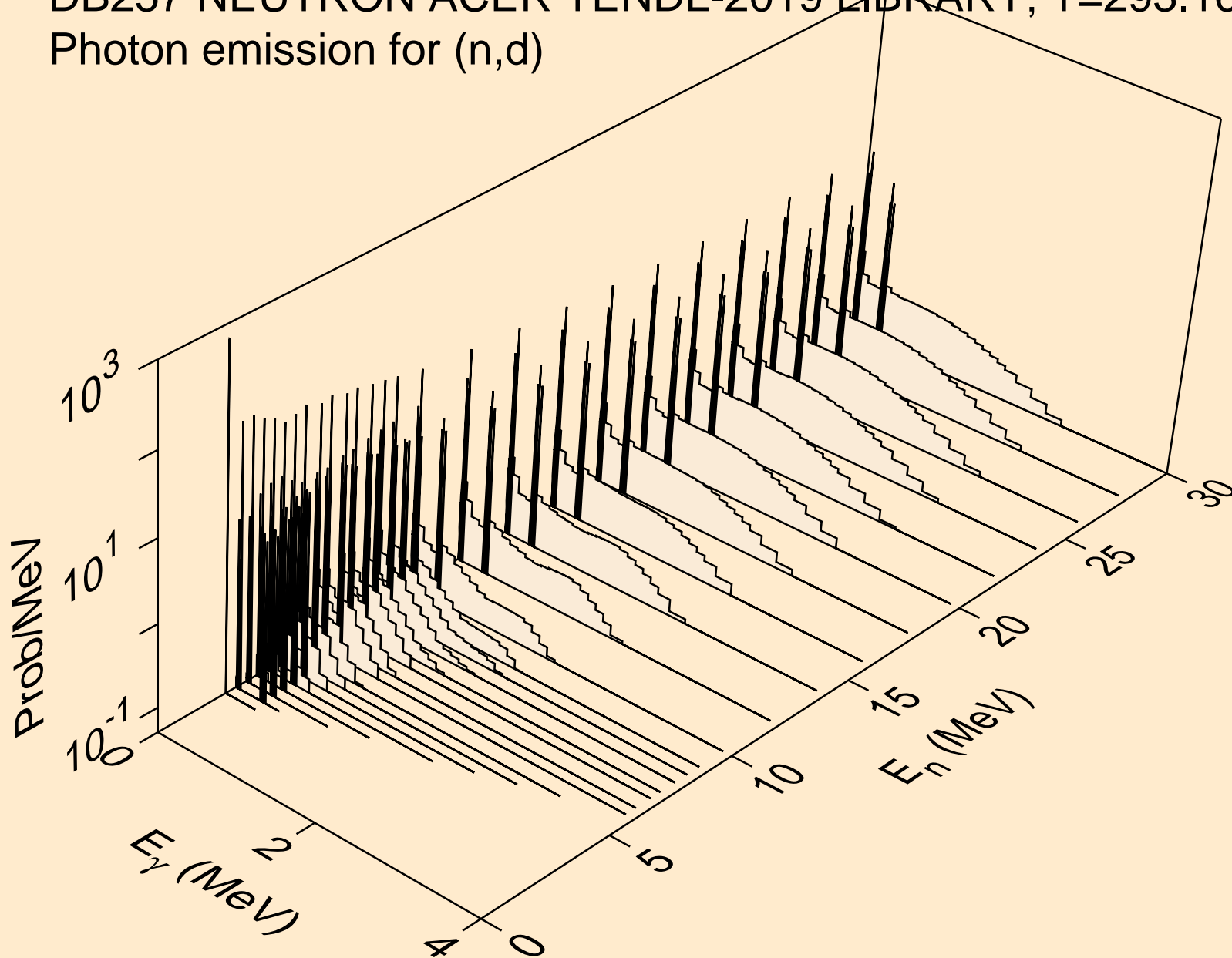

DB257 NEUTRON ACER TENDL-2019 LIBRARY; T=293.16K
Photon emission for (n,t)

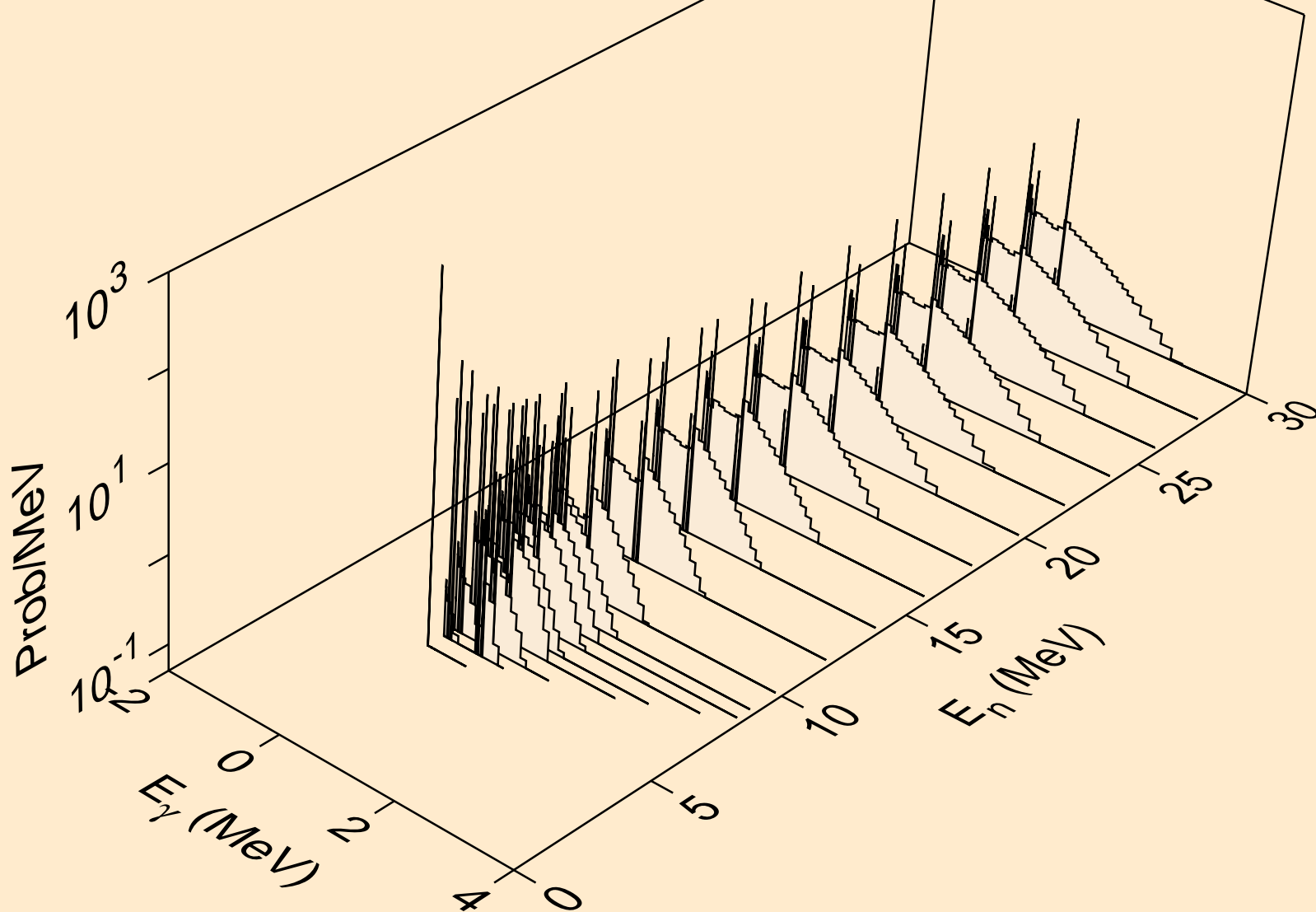

DB257 NEUTRON ACER TENDL-2019 LIBRARY; T=293.16K
Photon emission for (n,he3)

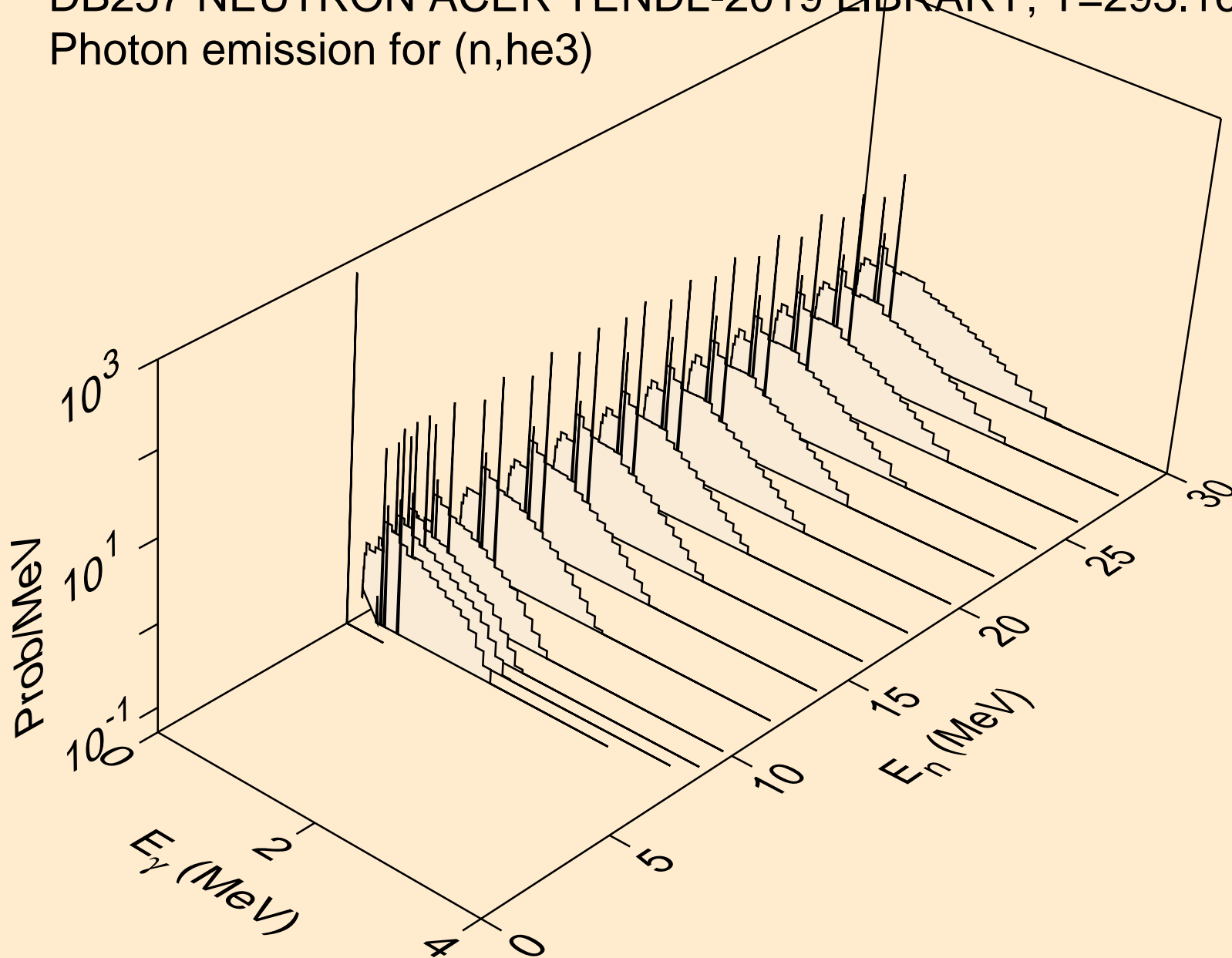

DB257 NEUTRON ACER TENDL-2019 LIBRARY; T=293.16K
Photon emission for (n,a)

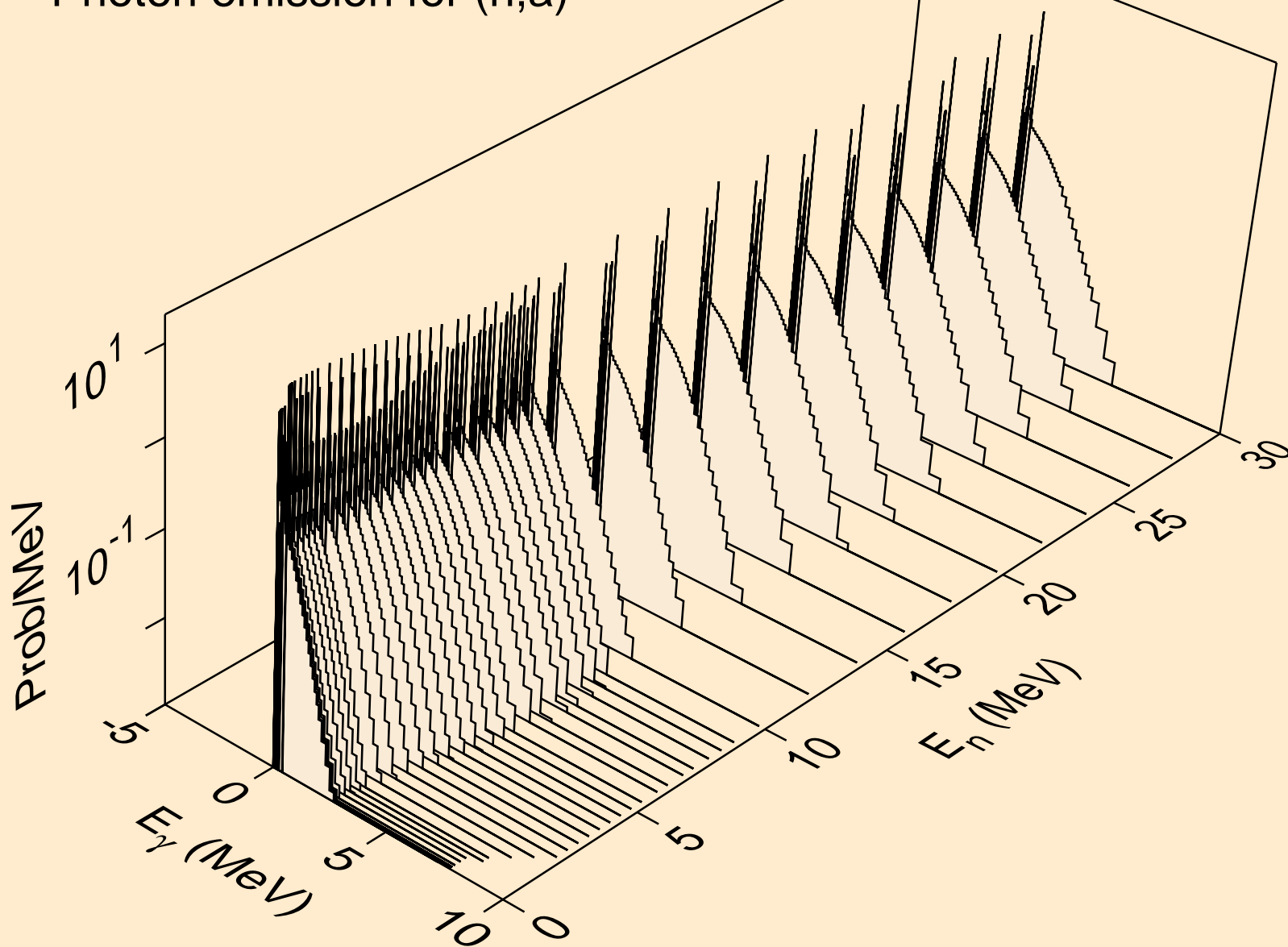

DB257 NEUTRON ACER TENDL-2019 LIBRARY; T=293.16K
Photon emission for (n,2a)

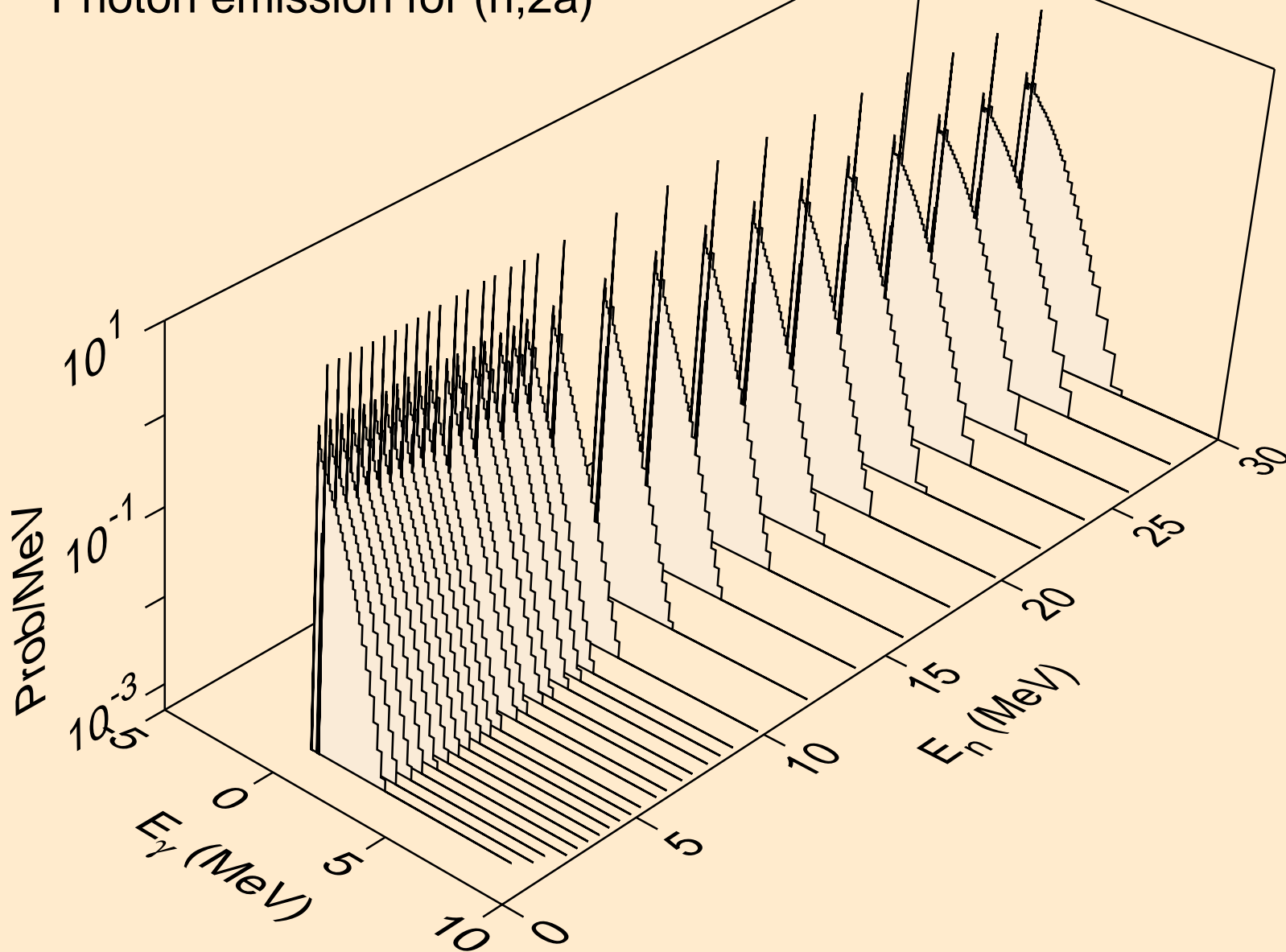

DB257 NEUTRON ACER TENDL-2019 LIBRARY; T=293.16K
Photon emission for (n,2p)

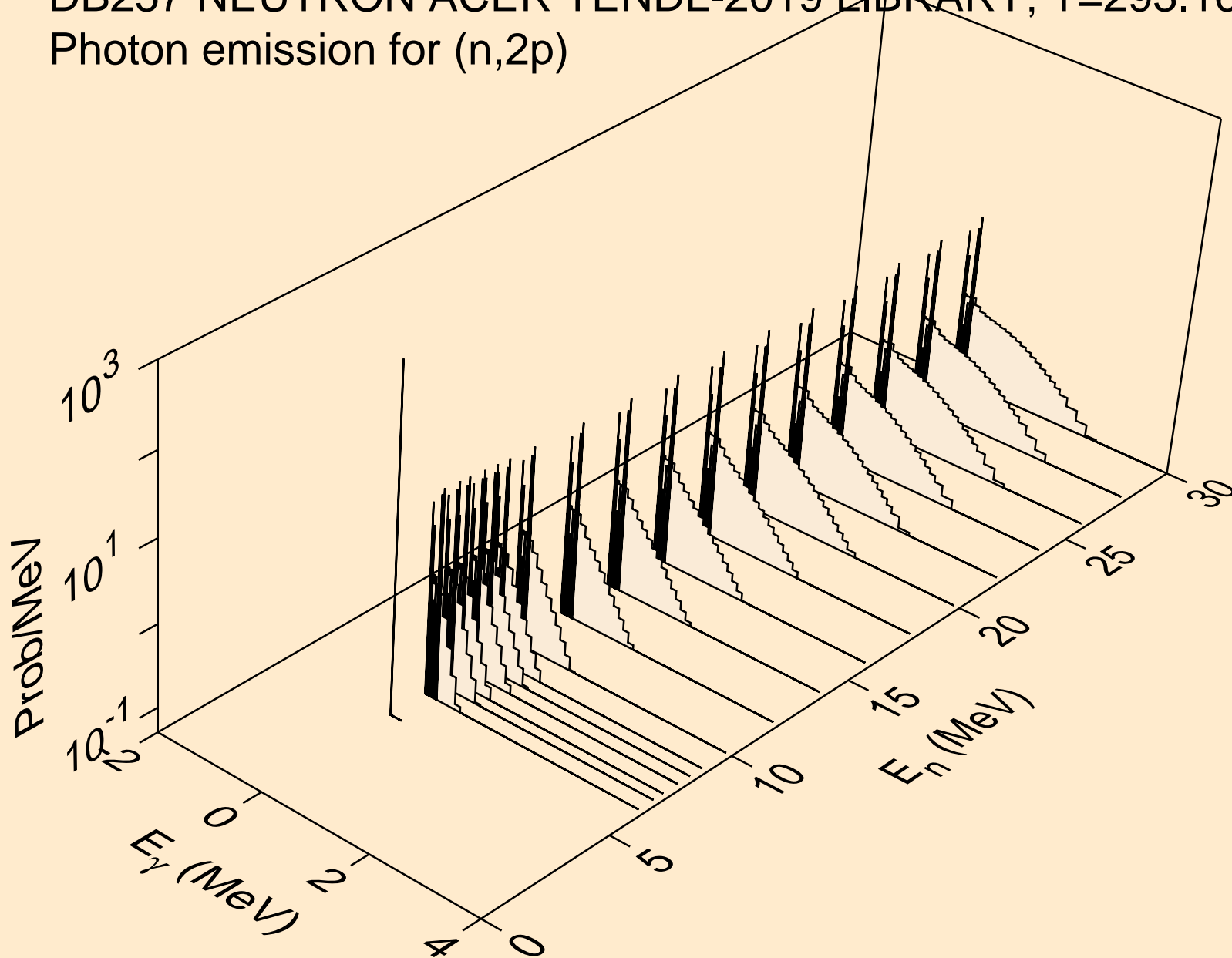

DB257 NEUTRON ACER TENDL-2019 LIBRARY; T=293.16K
Photon emission for (n,p α)

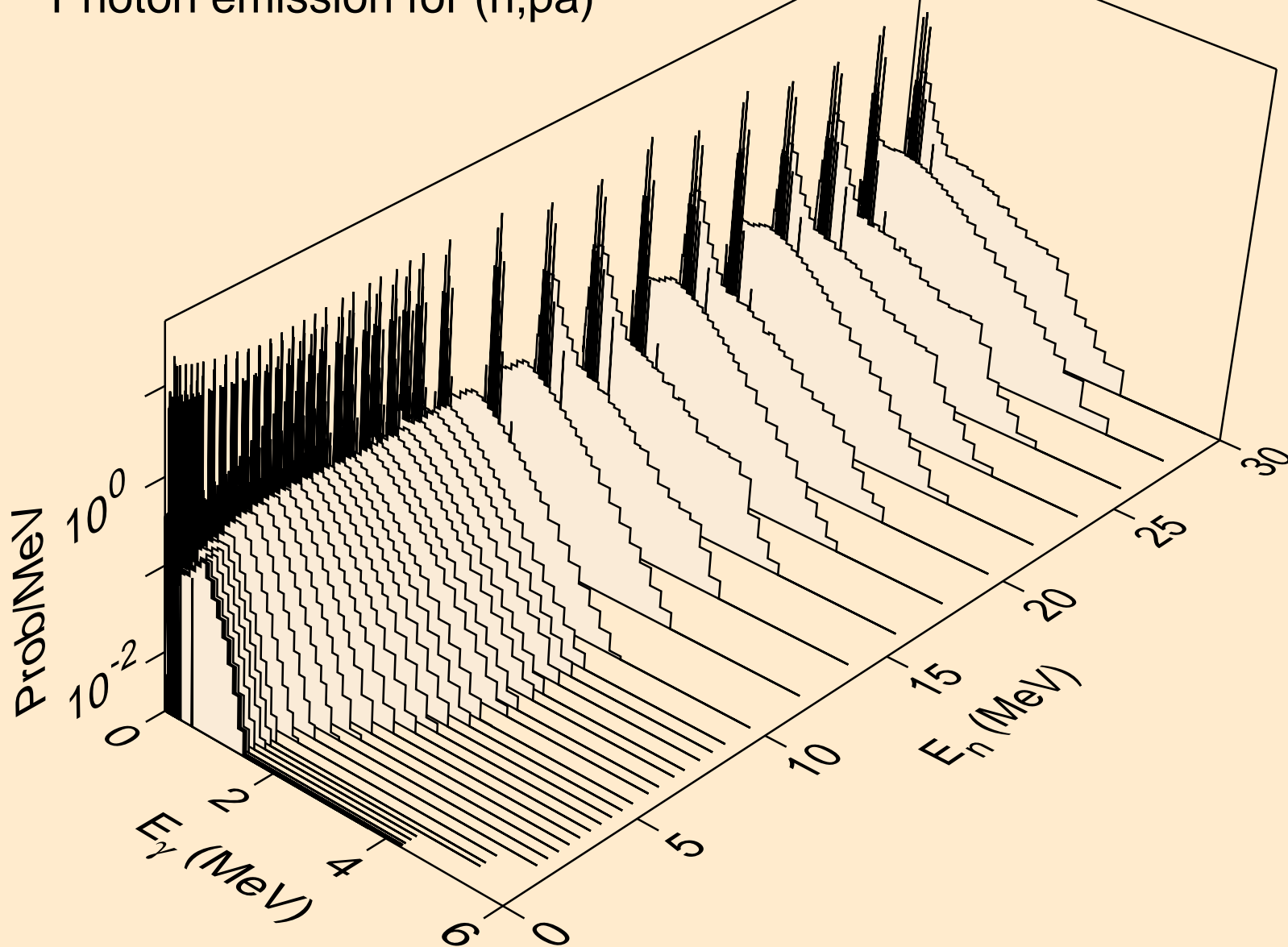

DB257 NEUTRON ACER TENDL-2019 LIBRARY; T=293.16K
Photon emission for (n,t2a)

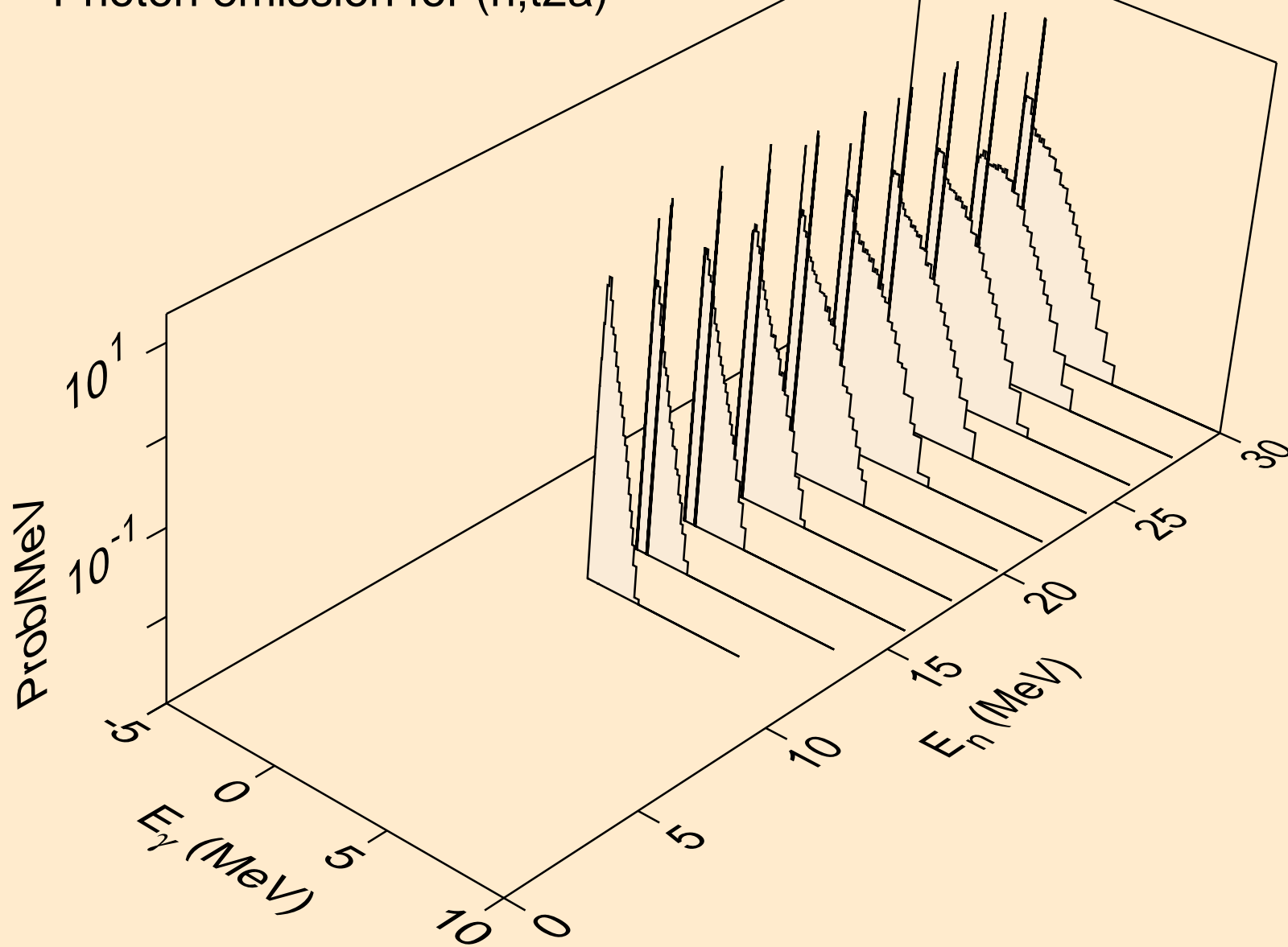

DB257 NEUTRON ACER TENDL-2019 LIBRARY; T=293.16K
Photon emission for (n,d2a)

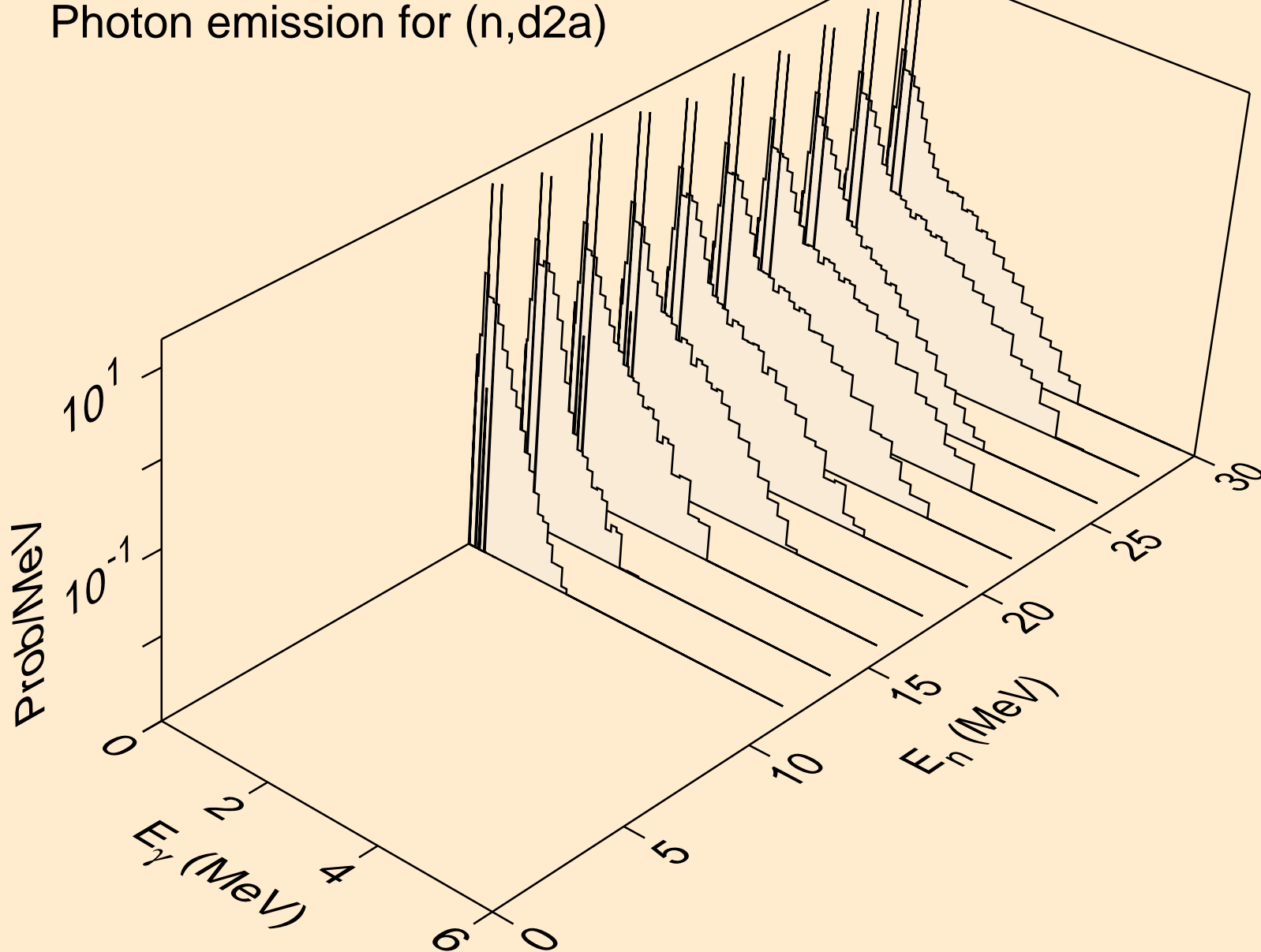

DB257 NEUTRON ACER TENDL-2019 LIBRARY; T=293.16K
Photon emission for (n,pd)

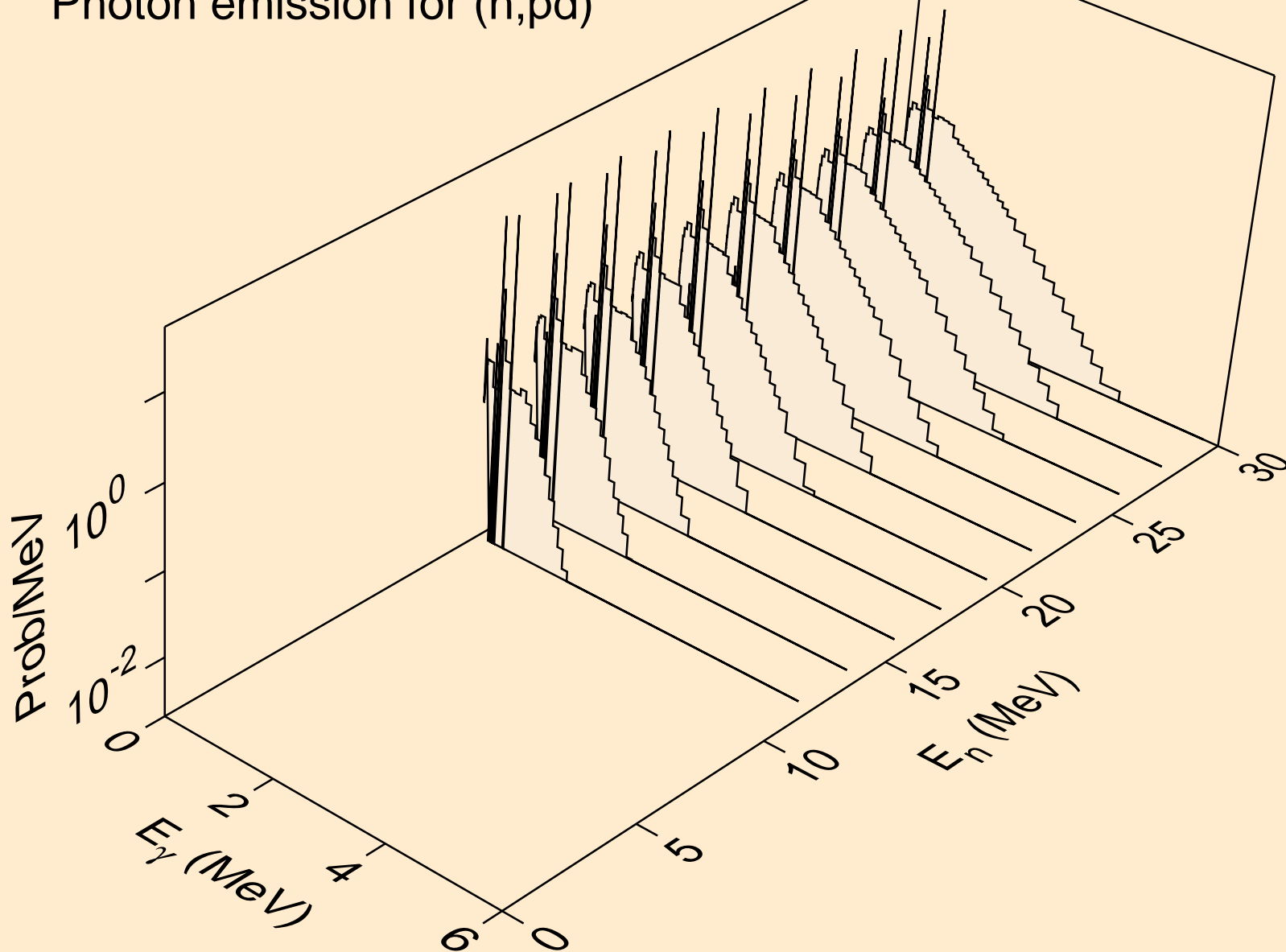

DB257 NEUTRON ACER TENDL-2019 LIBRARY; T=293.16K
Photon emission for (n,pt)

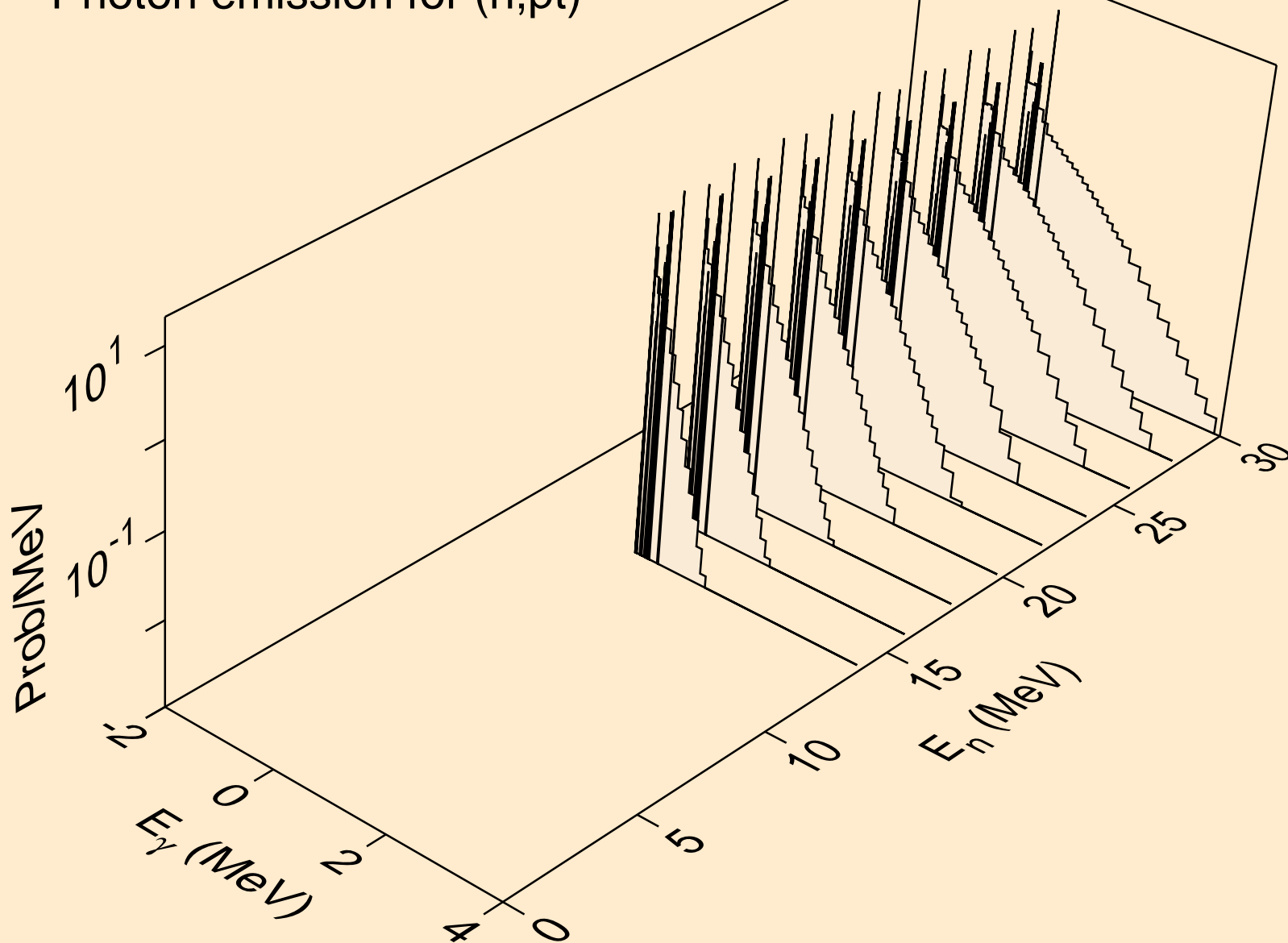

DB257 NEUTRON ACER TENDL-2019 LIBRARY; T=293.16K
Photon emission for (n,da)

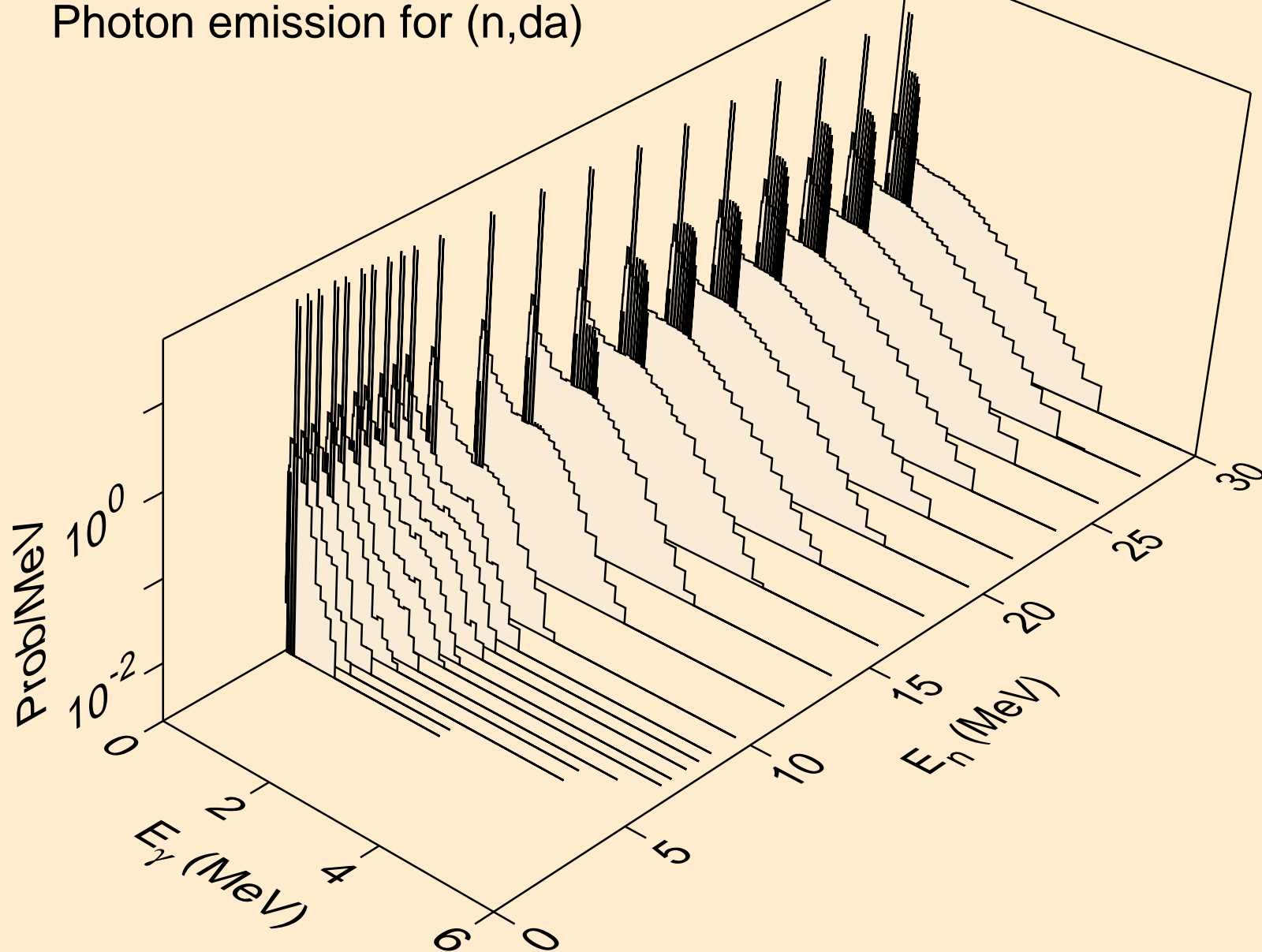

DB257 NEUTRON ACER TENDL-2019 LIBRARY; T=293.16K
thermal capture photon spectrum

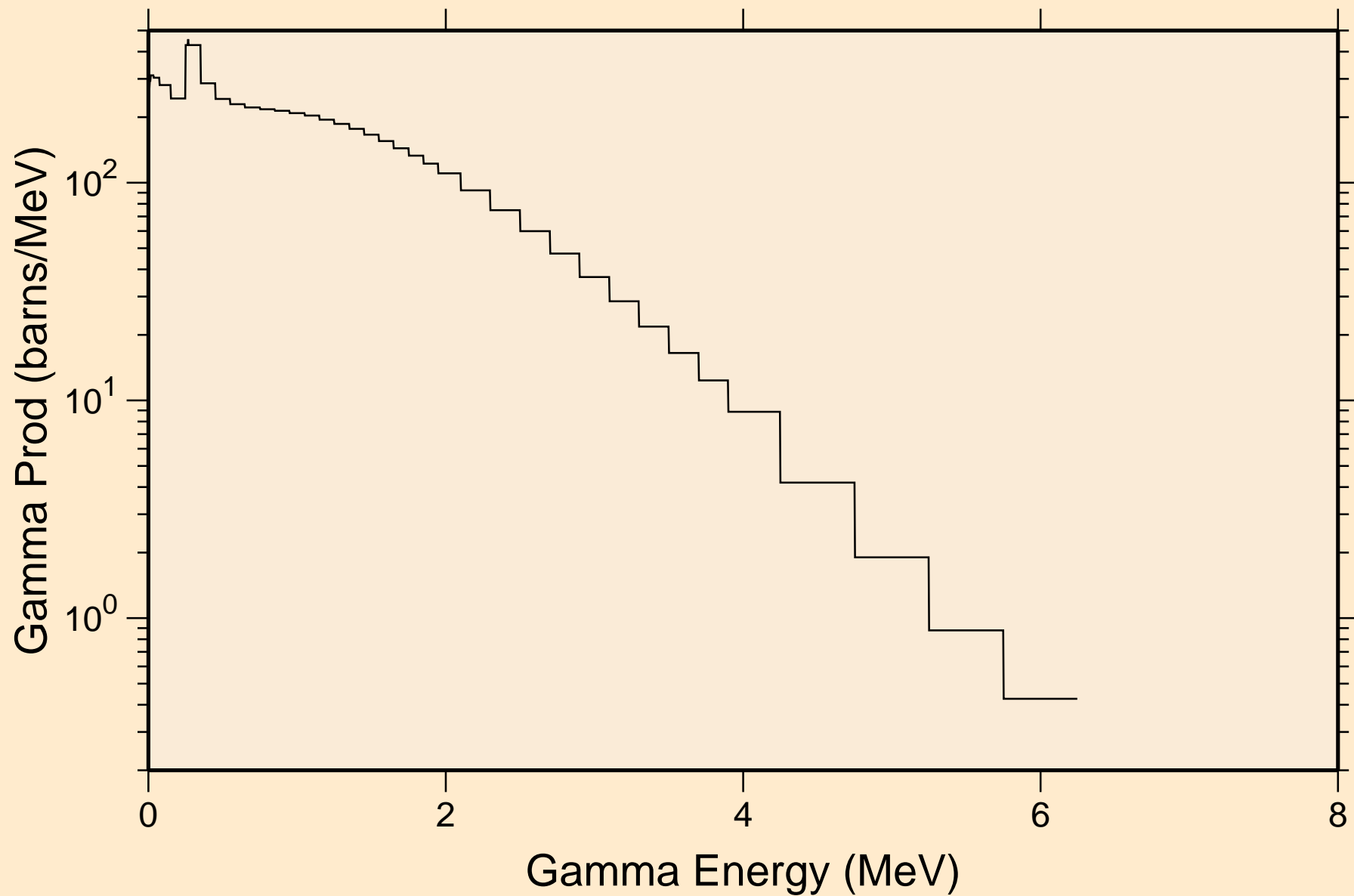

DB257 NEUTRON ACER TENDL-2019 LIBRARY; T=293.16K
14 MeV photon spectrum

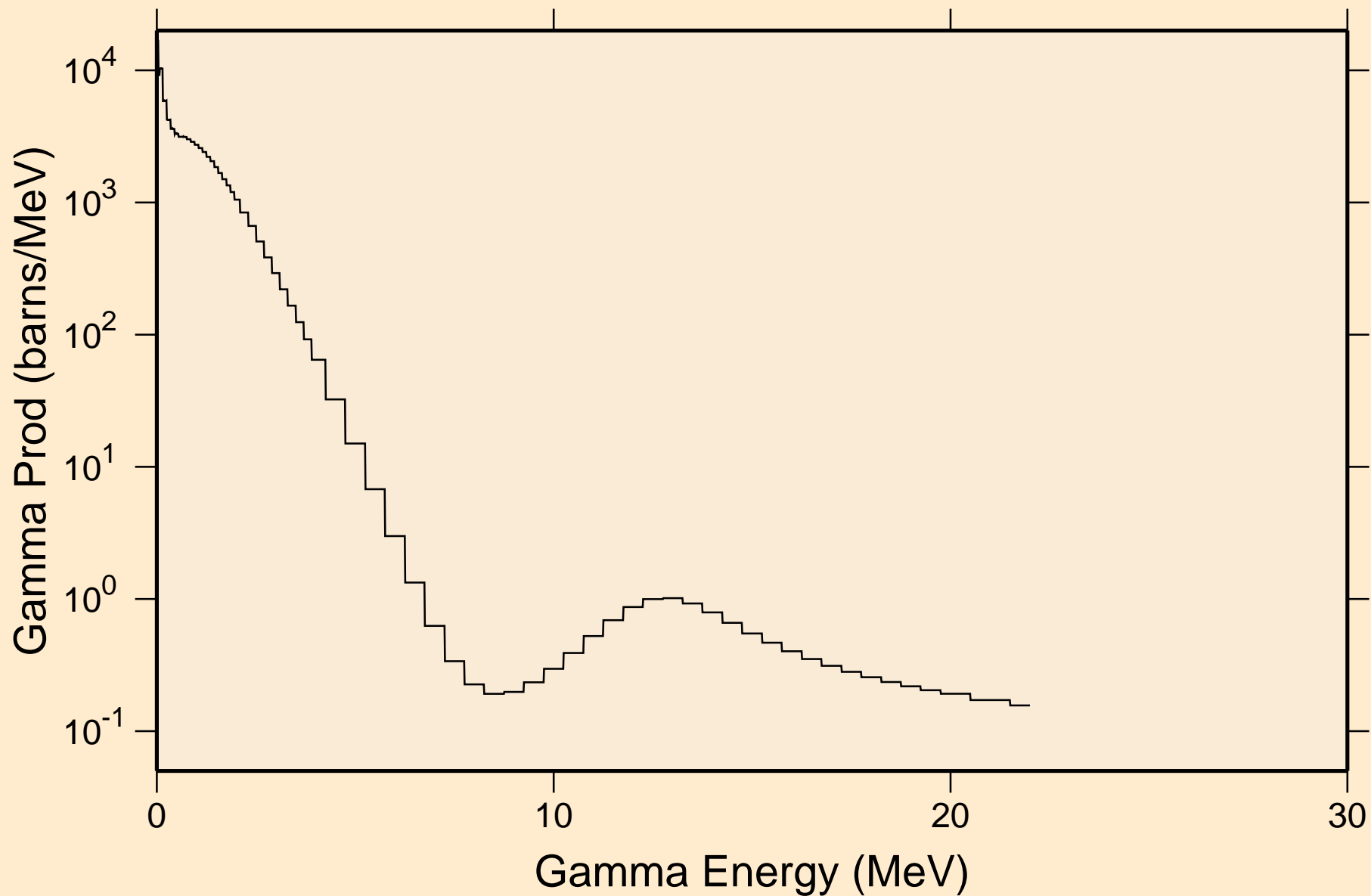

DB257 NEUTRON ACER TENDL-2019 LIBRARY; T=293.16K
Particle heating contributions

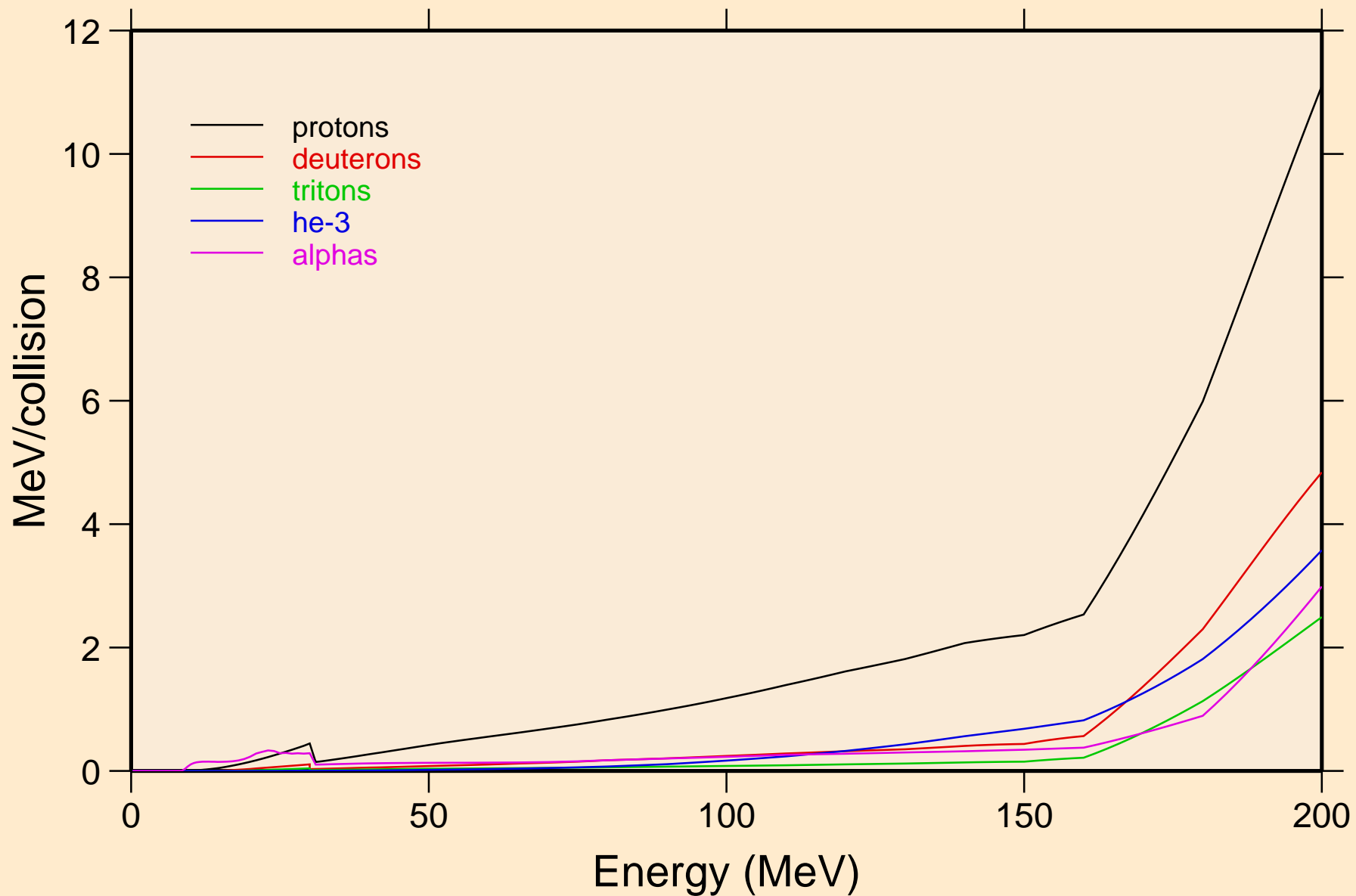

DB257 NEUTRON ACER TENDL-2019 LIBRARY; T=293.16K
Recoil Heating

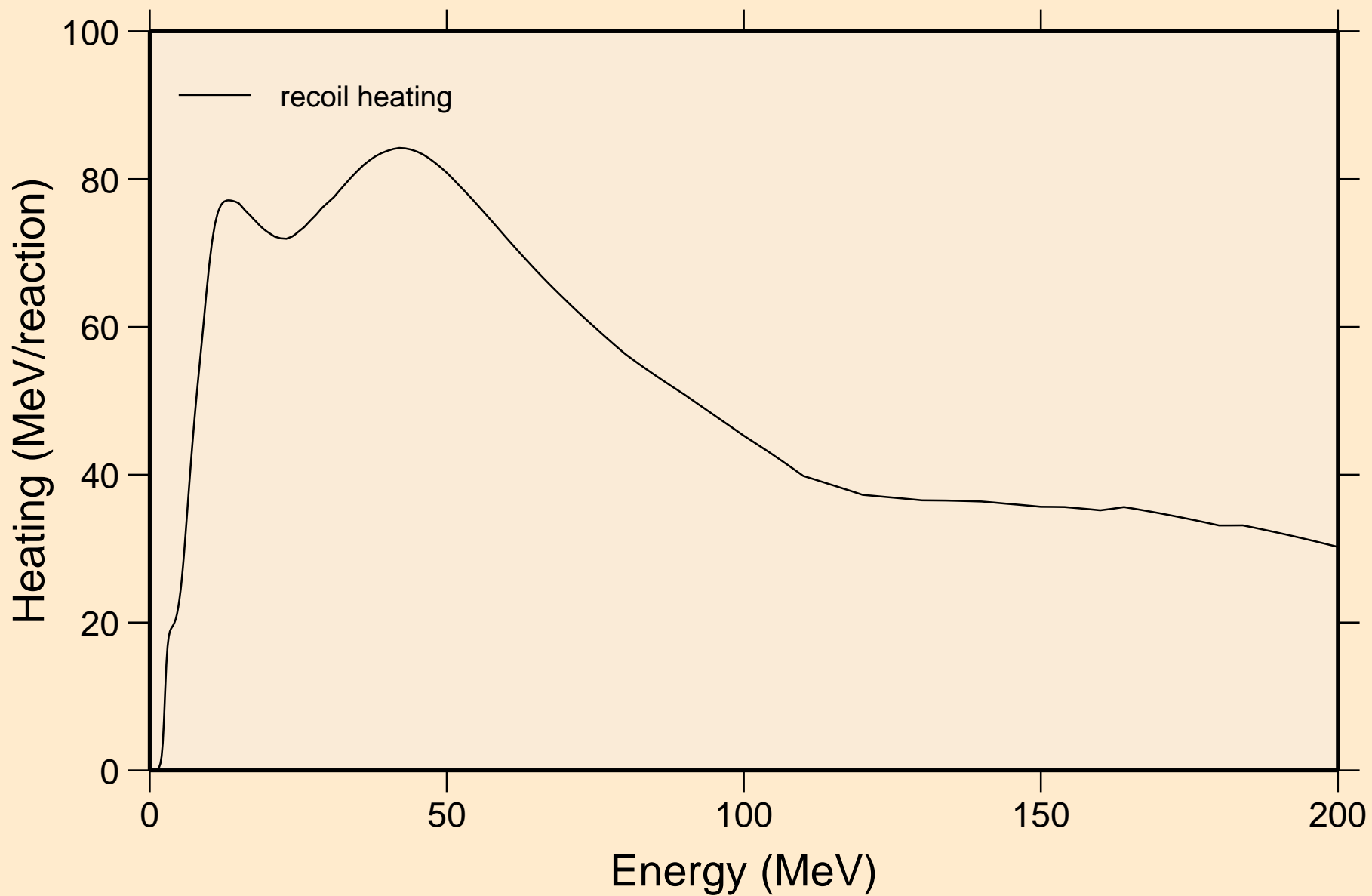

DB257 NEUTRON ACER TENDL-2019 LIBRARY; T=293.16K
Particle production cross sections

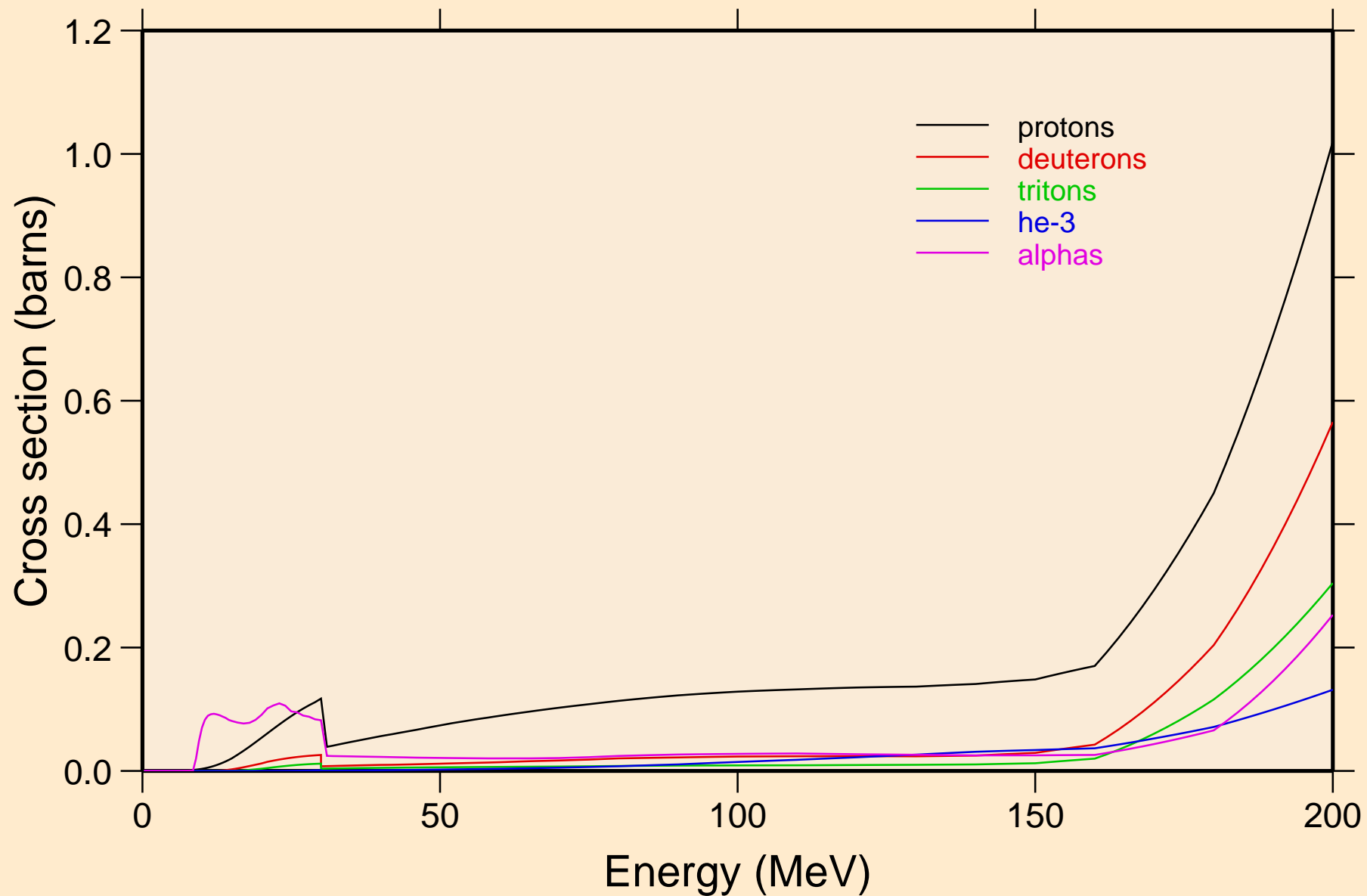

DB257 NEUTRON ACER TENDL-2019 LIBRARY; T=293.16K
protons from (n,x)

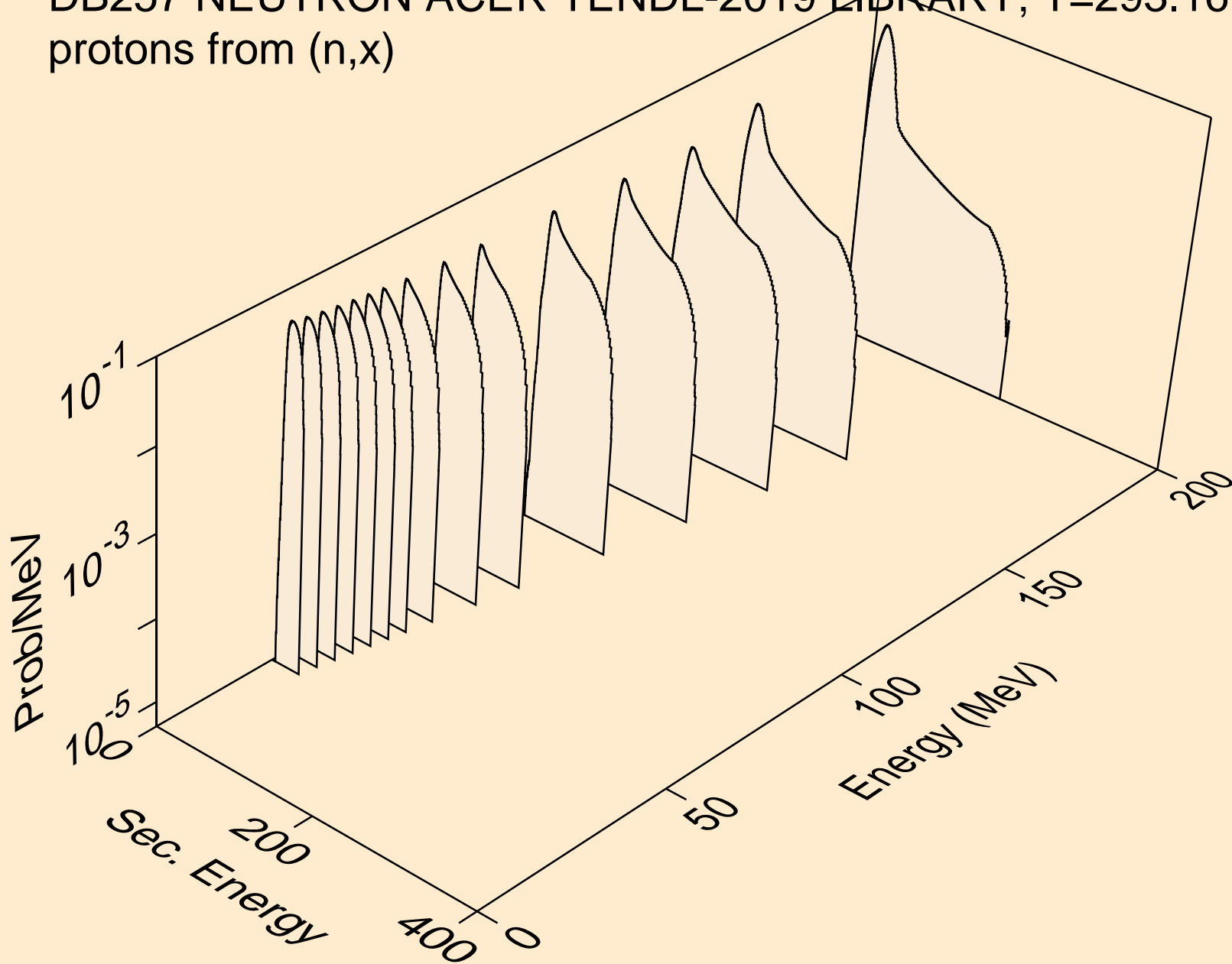

DB257 NEUTRON ACER TENDL-2019 LIBRARY; T=293.16K
protons from (n,n*)p

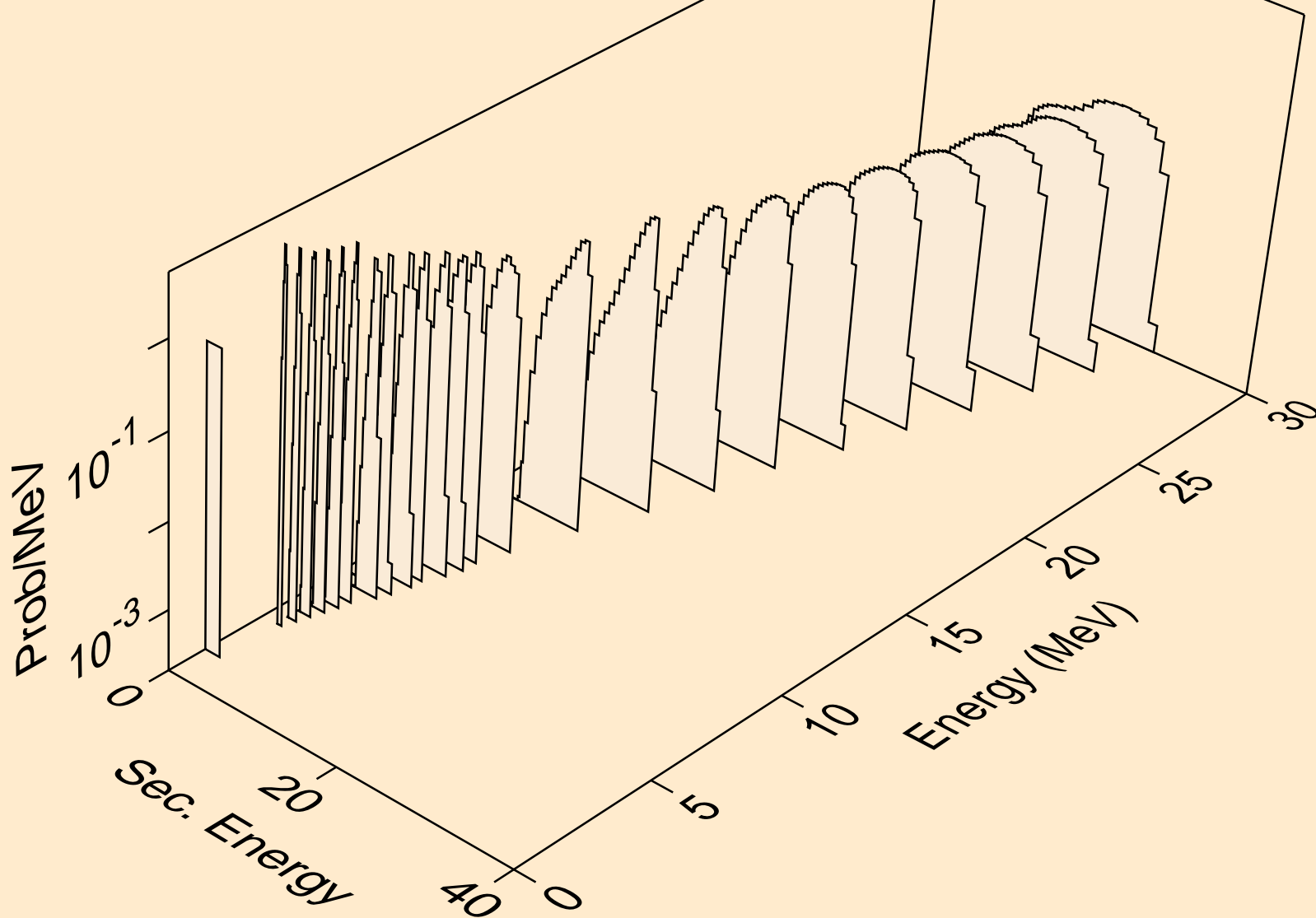

DB257 NEUTRON ACER TENDL-2019 LIBRARY; T=293.16K
protons from (n,2np)

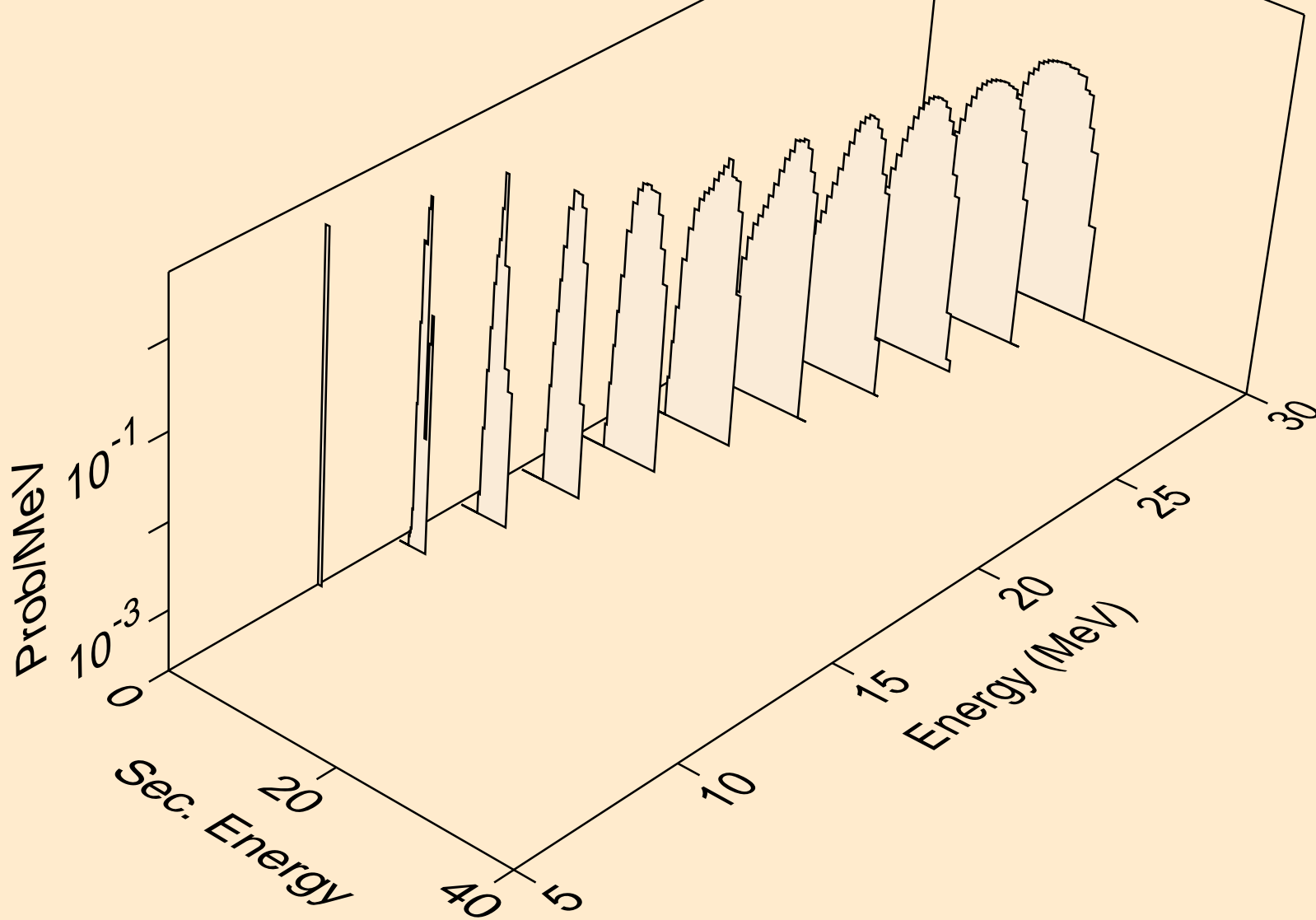

DB257 NEUTRON ACER TENDL-2019 LIBRARY; T=293.16K
protons from (n,3np)

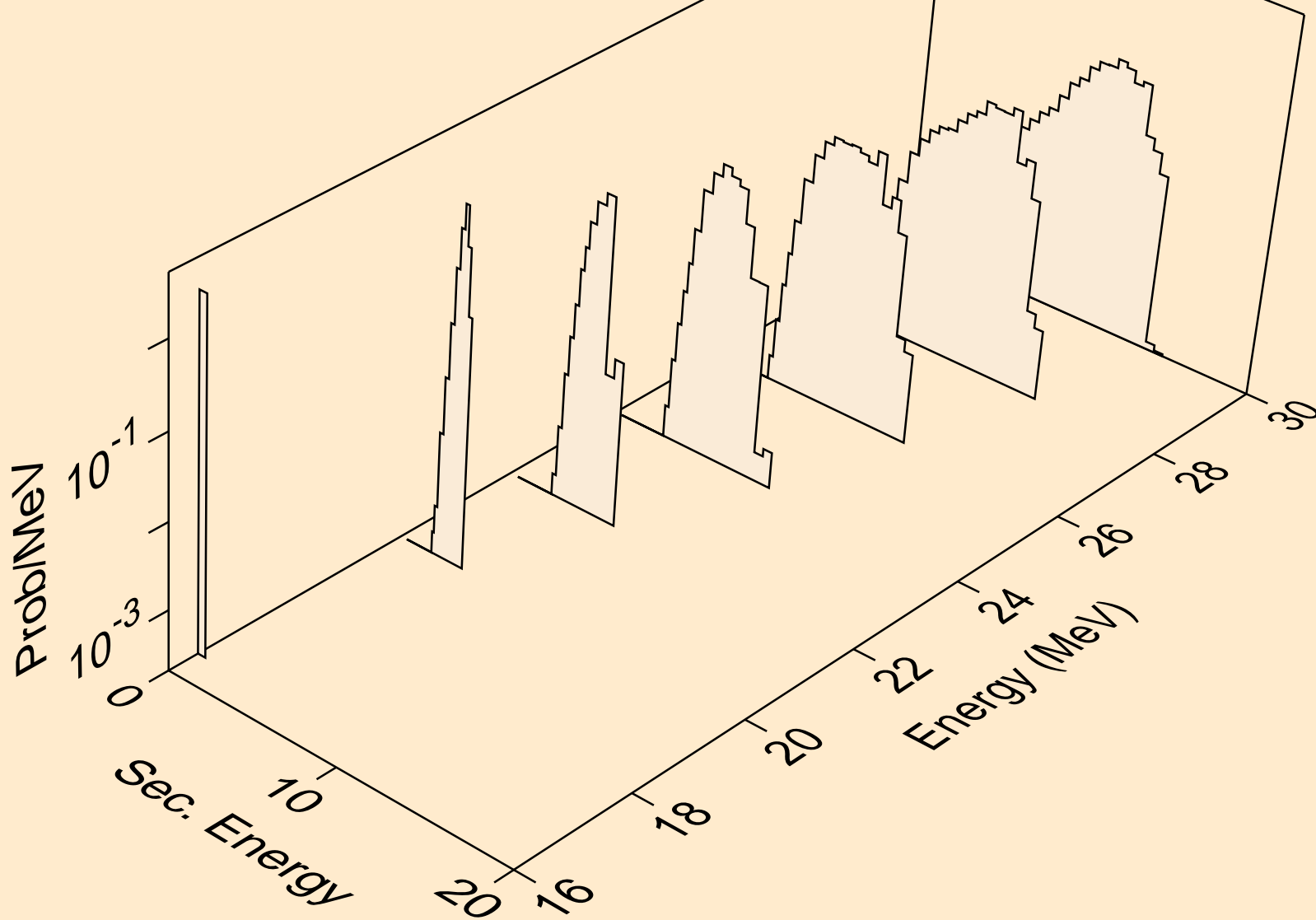

DB257 NEUTRON ACER TENDL-2019 LIBRARY; T=293.16K
protons from (n,2np)

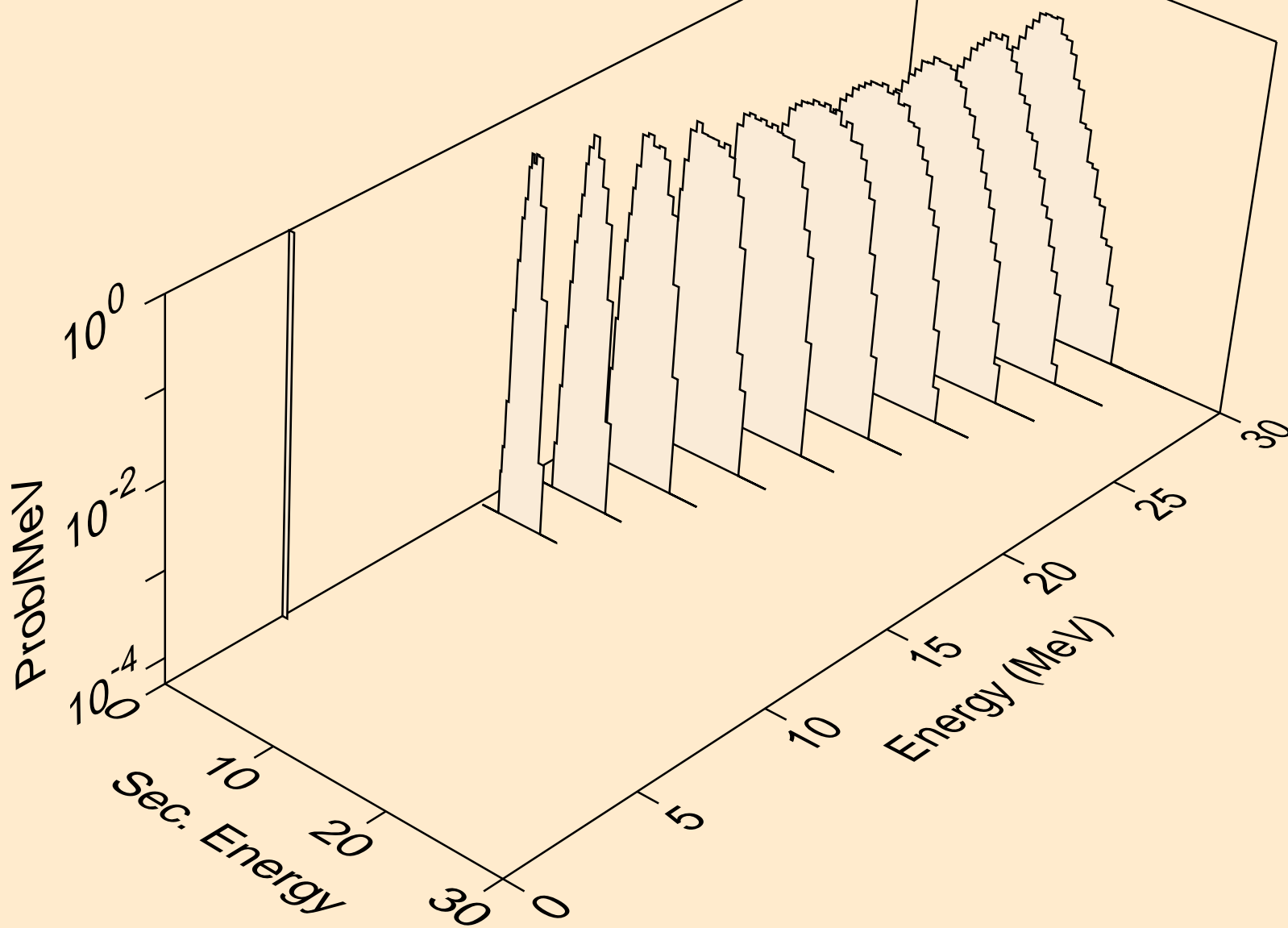

DB257 NEUTRON ACER TENDL-2019 LIBRARY; T=293.16K
protons from (n,npa)

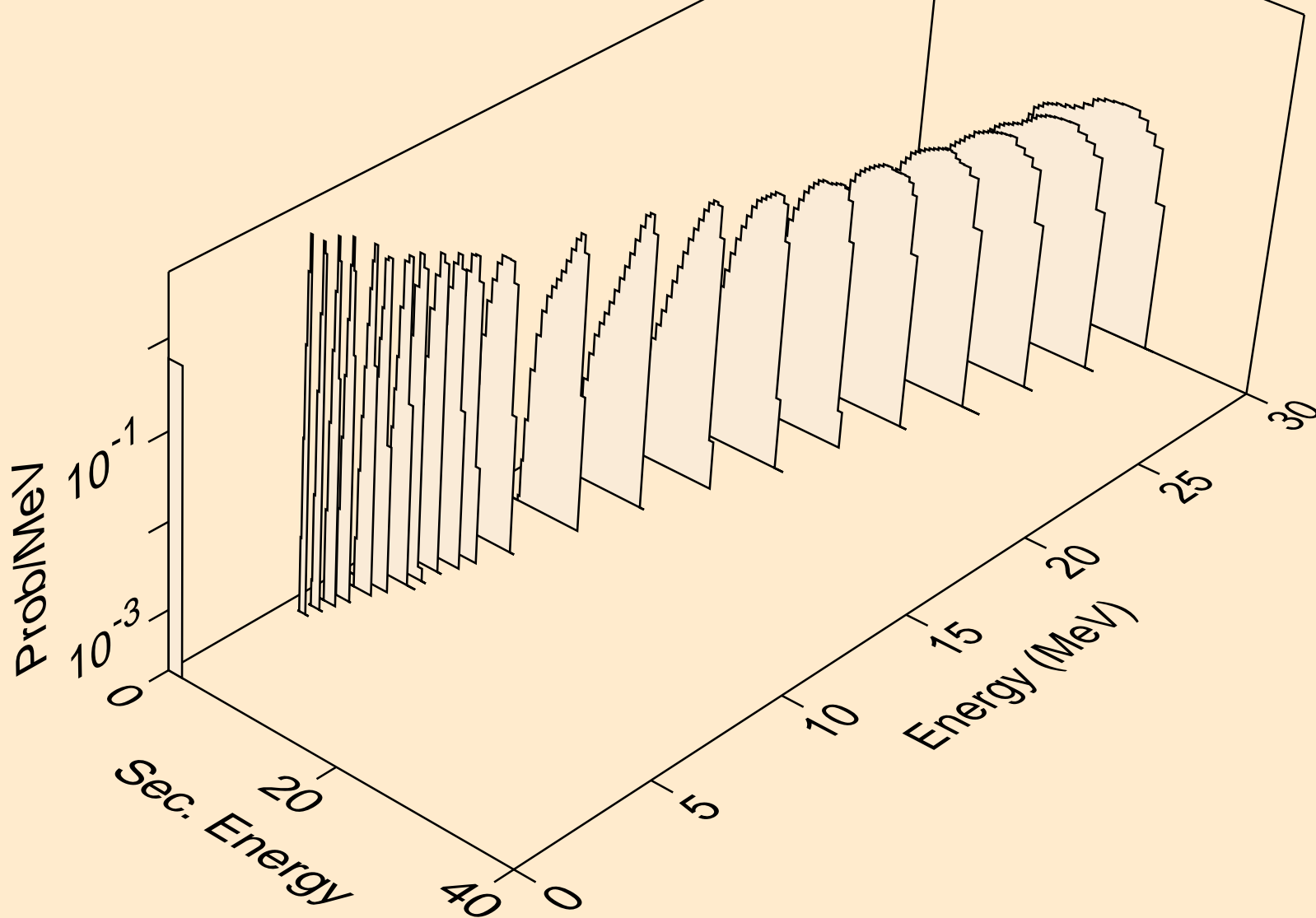

DB257 NEUTRON ACER TENDL-2019 LIBRARY; T=293.16K
protons from (n,p)

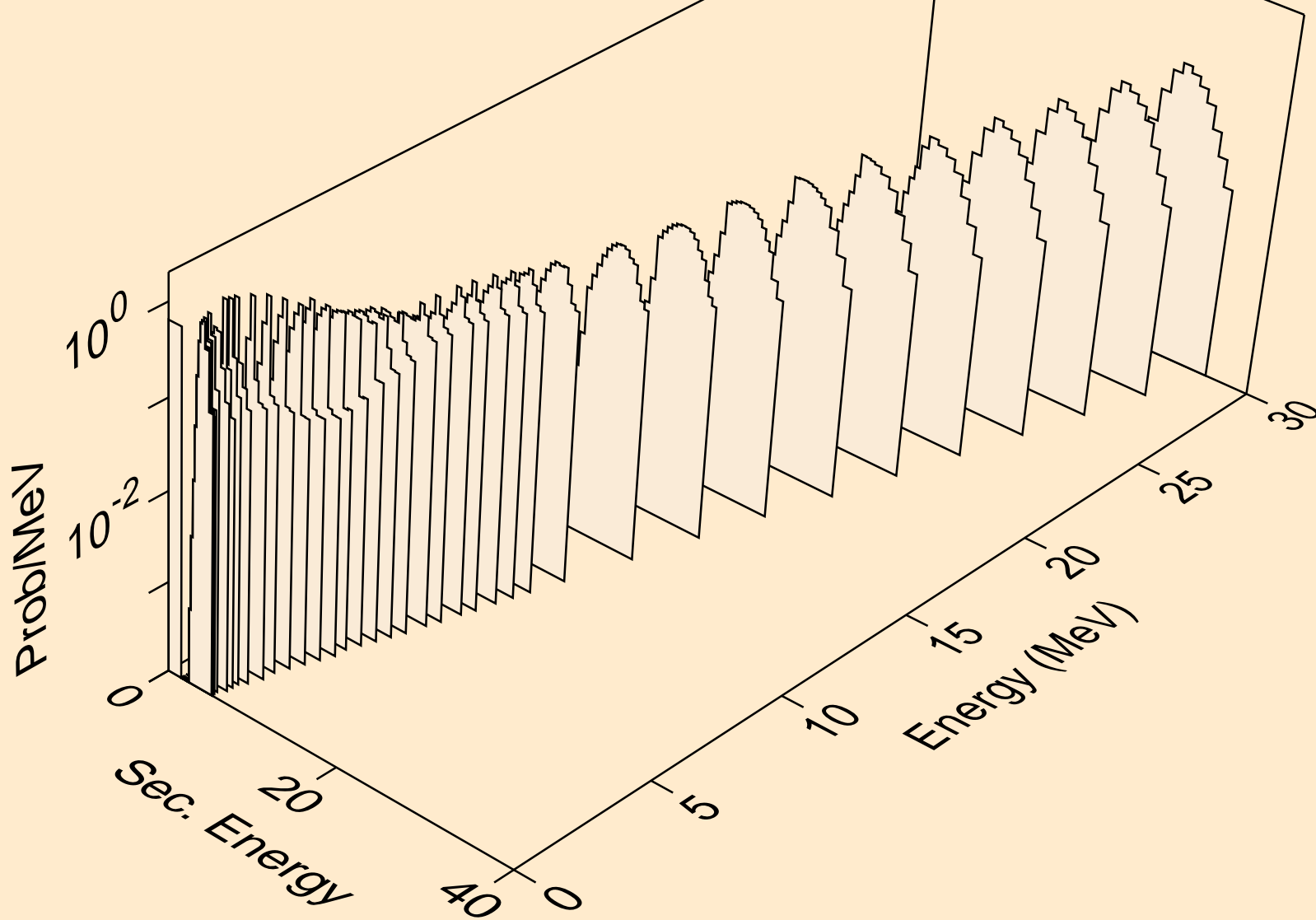

DB257 NEUTRON ACER TENDL-2019 LIBRARY; T=293.16K
protons from (n,2p)

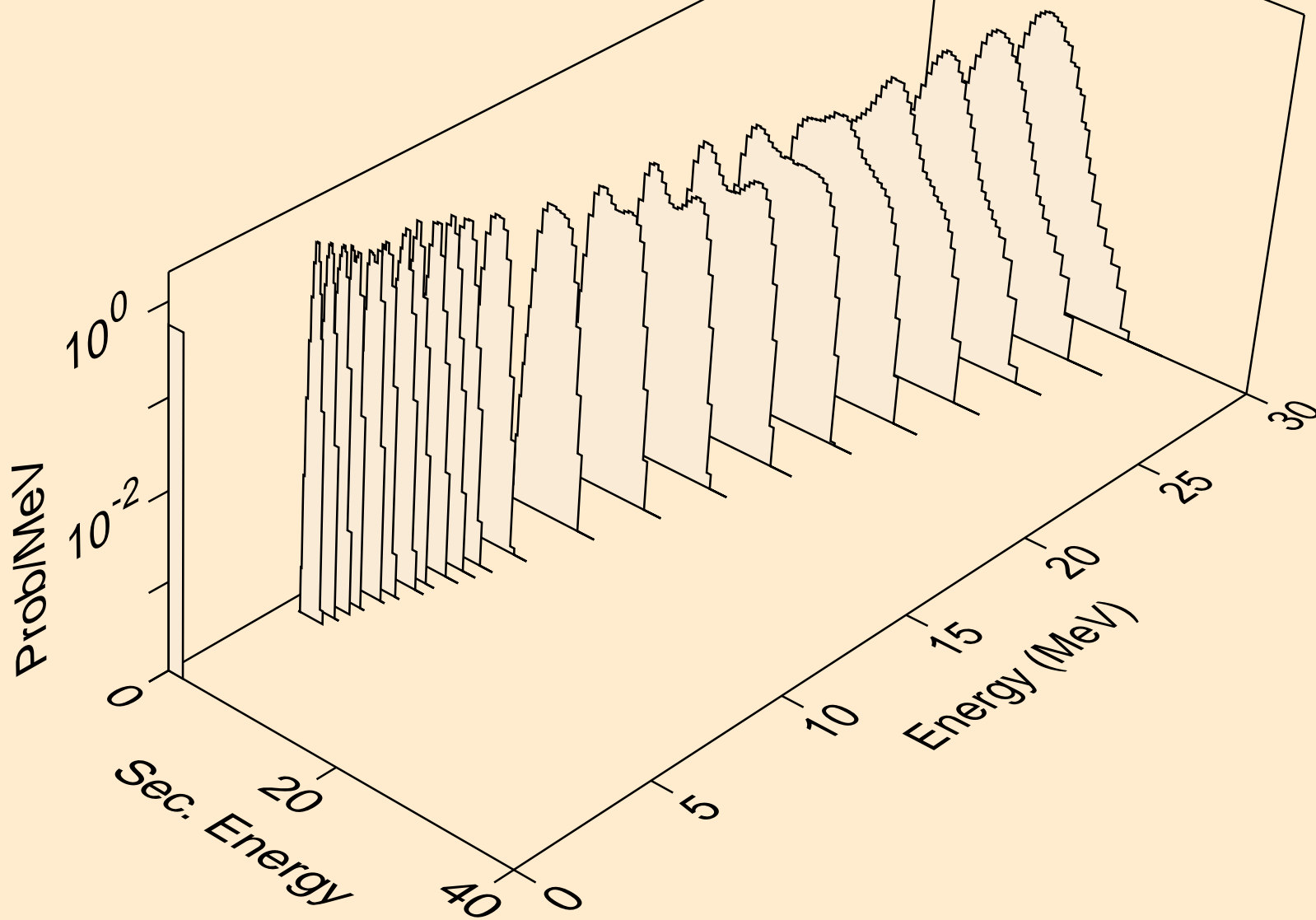

DB257 NEUTRON ACER TENDL-2019 LIBRARY; T=293.16K
protons from (n,p)

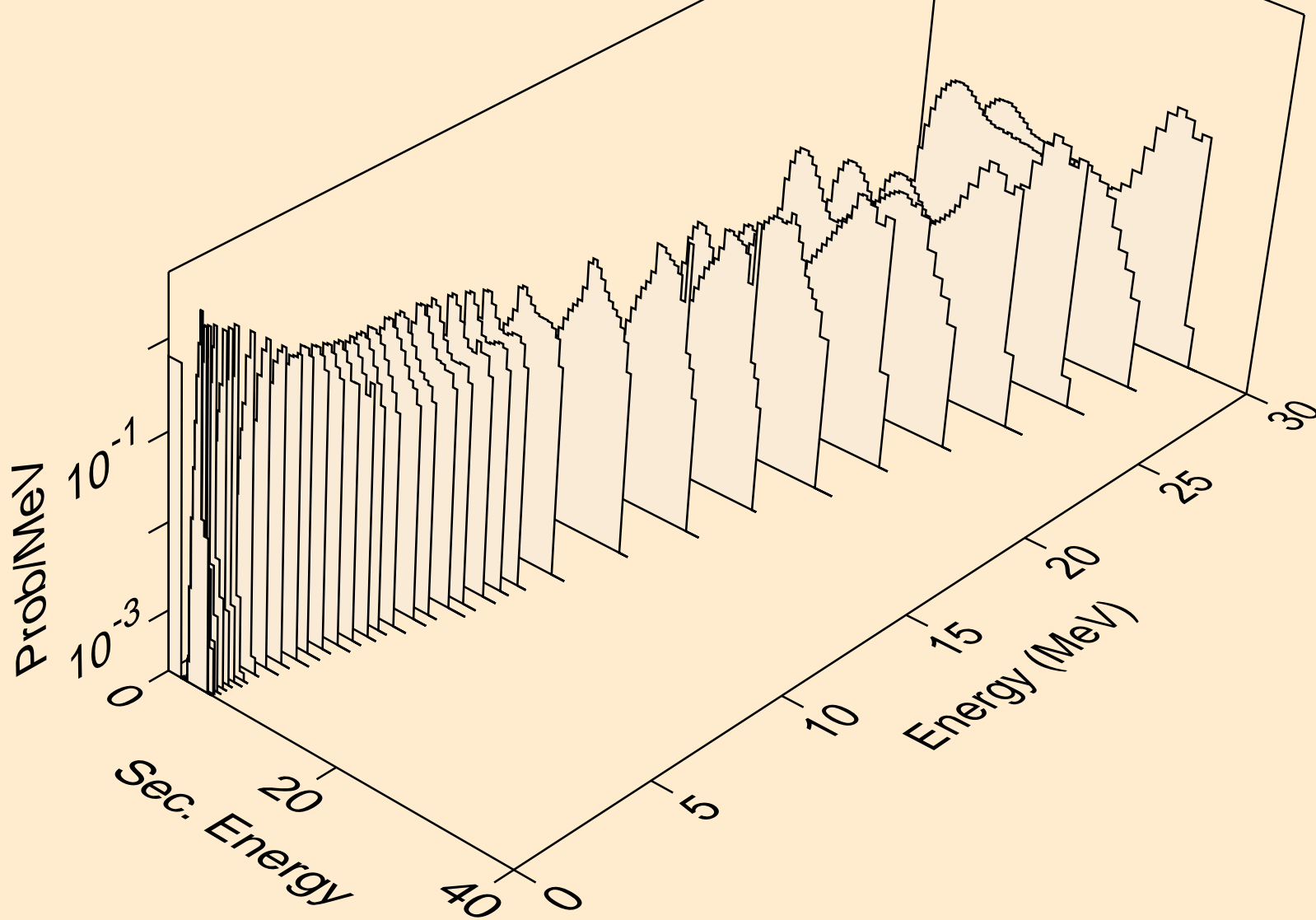

DB257 NEUTRON ACER TENDL-2019 LIBRARY; T=293.16K
protons from (n,pd)

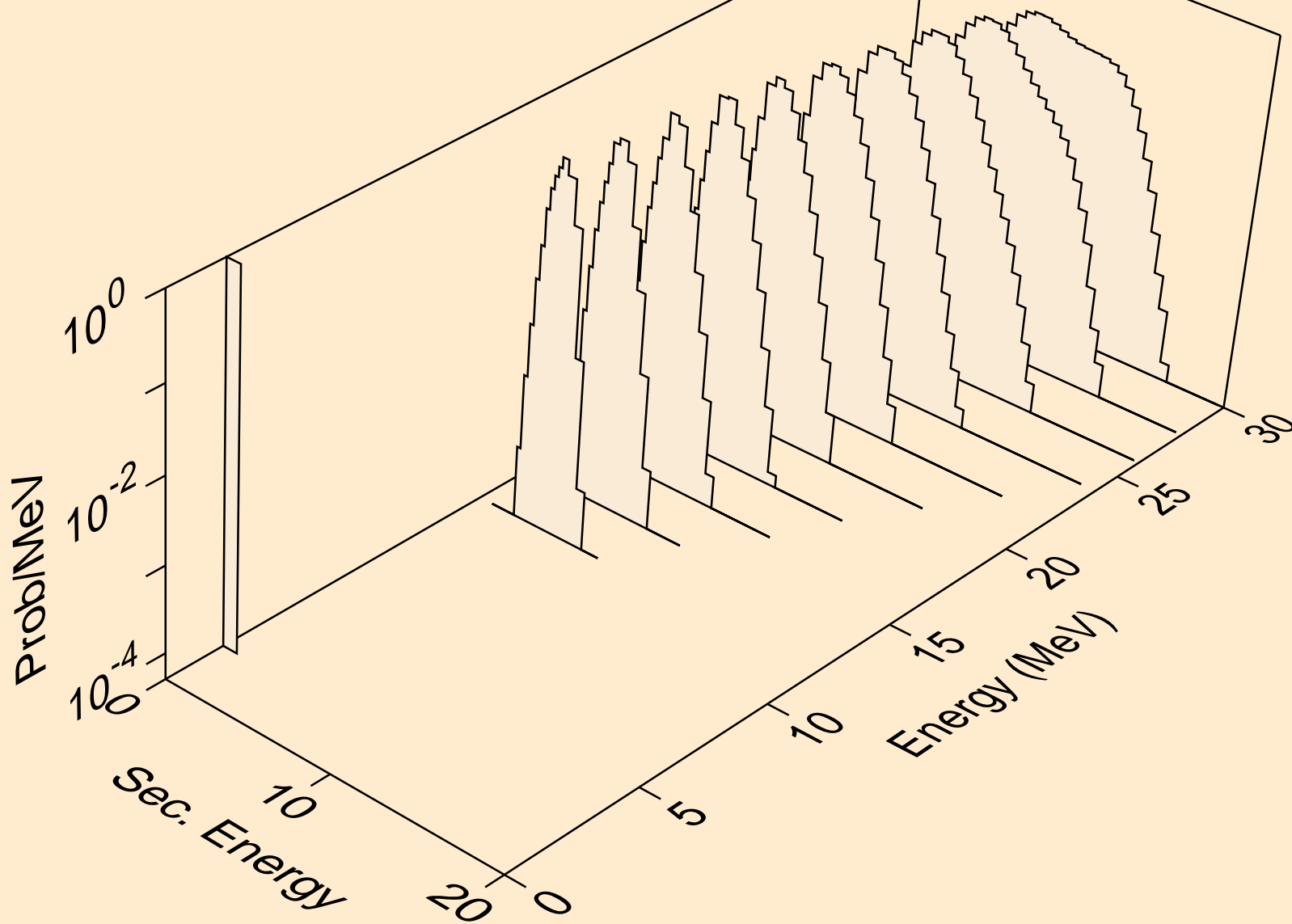

DB257 NEUTRON ACER TENDL-2019 LIBRARY; T=293.16K
protons from (n,pt)

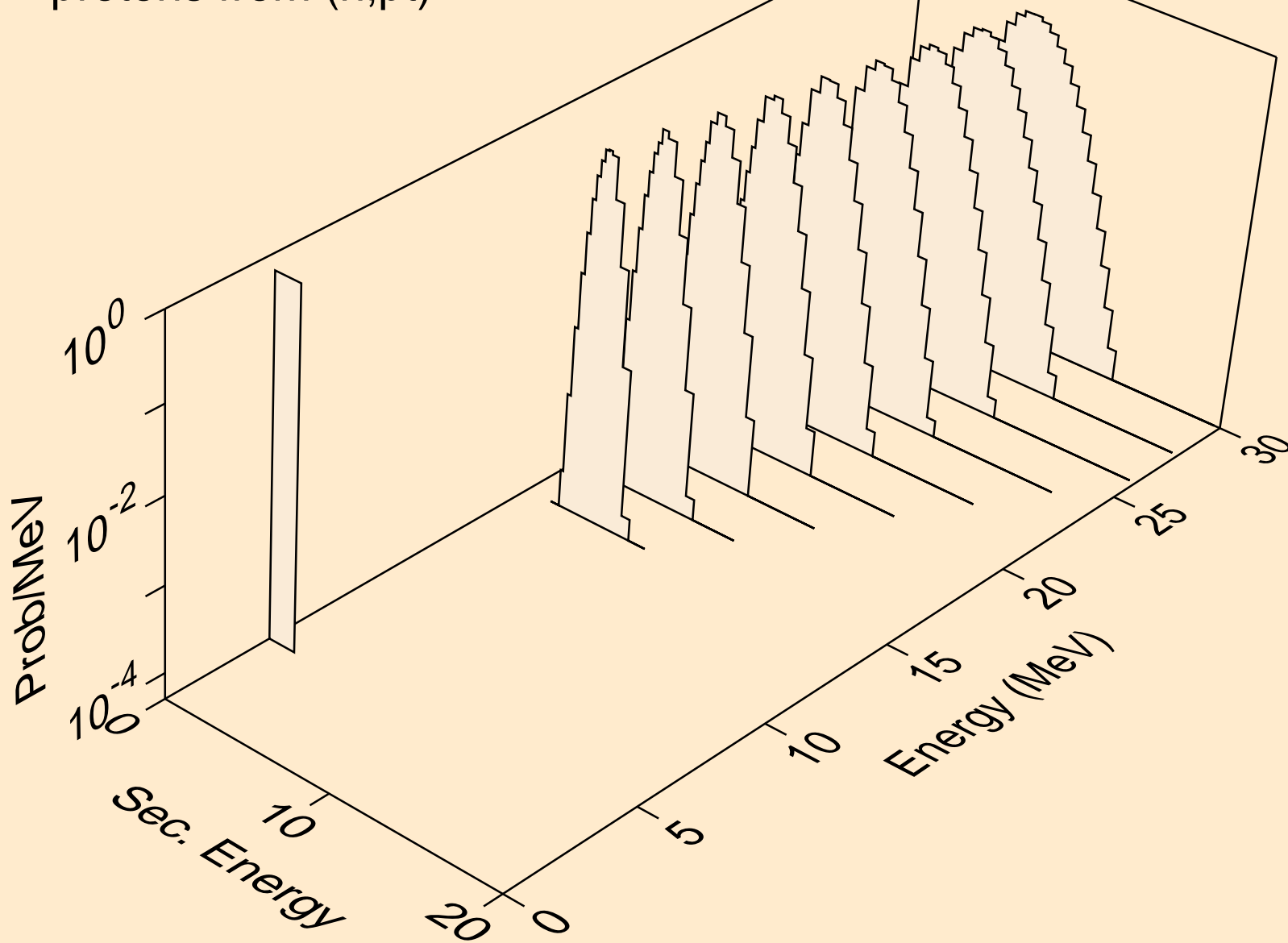

DB257 NEUTRON ACER TENDL-2019 LIBRARY; T=293.16K
deuterons from (n,x)

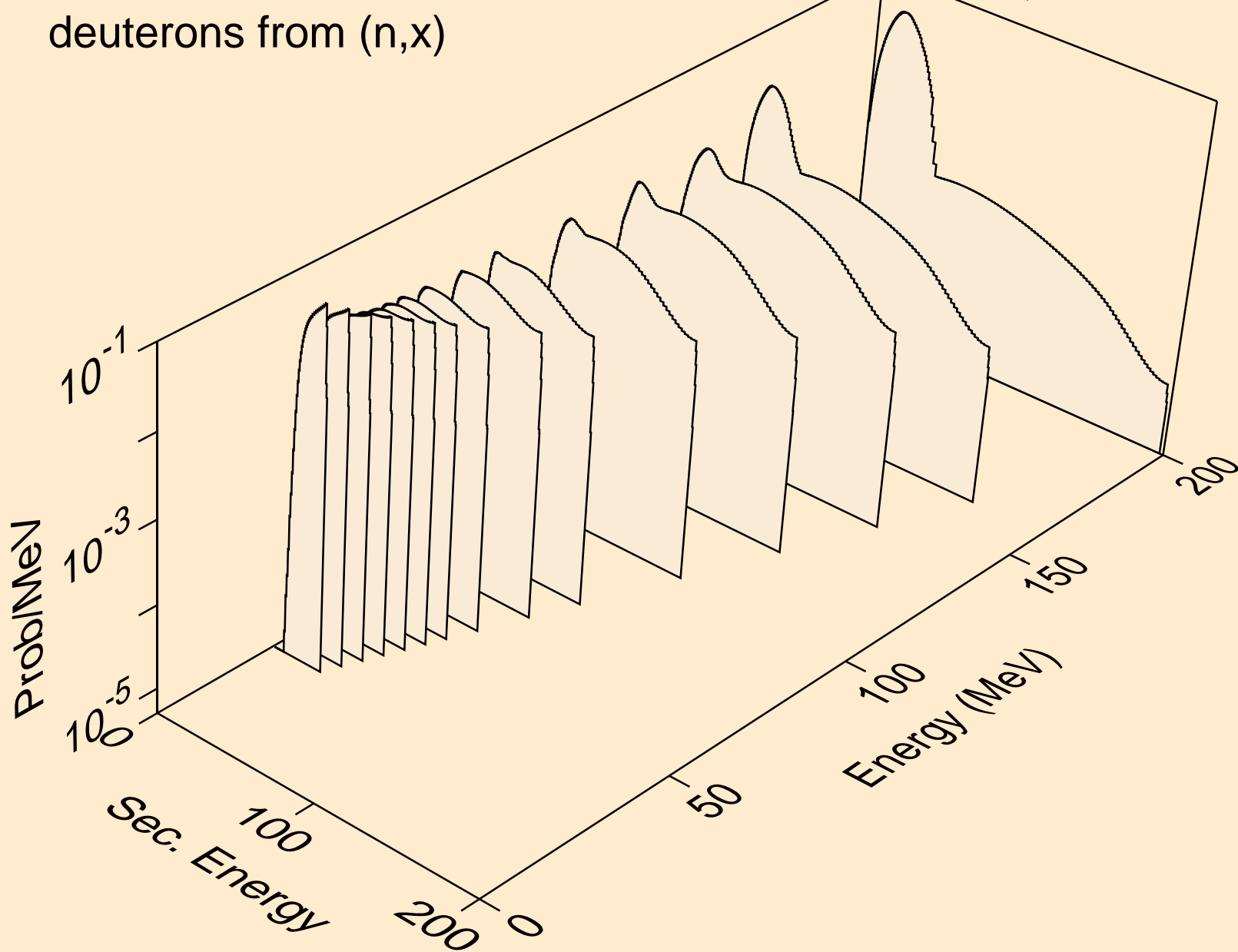

DB257 NEUTRON ACER TENDL-2019 LIBRARY; T=293.16K
deuterons from (n,2nd)

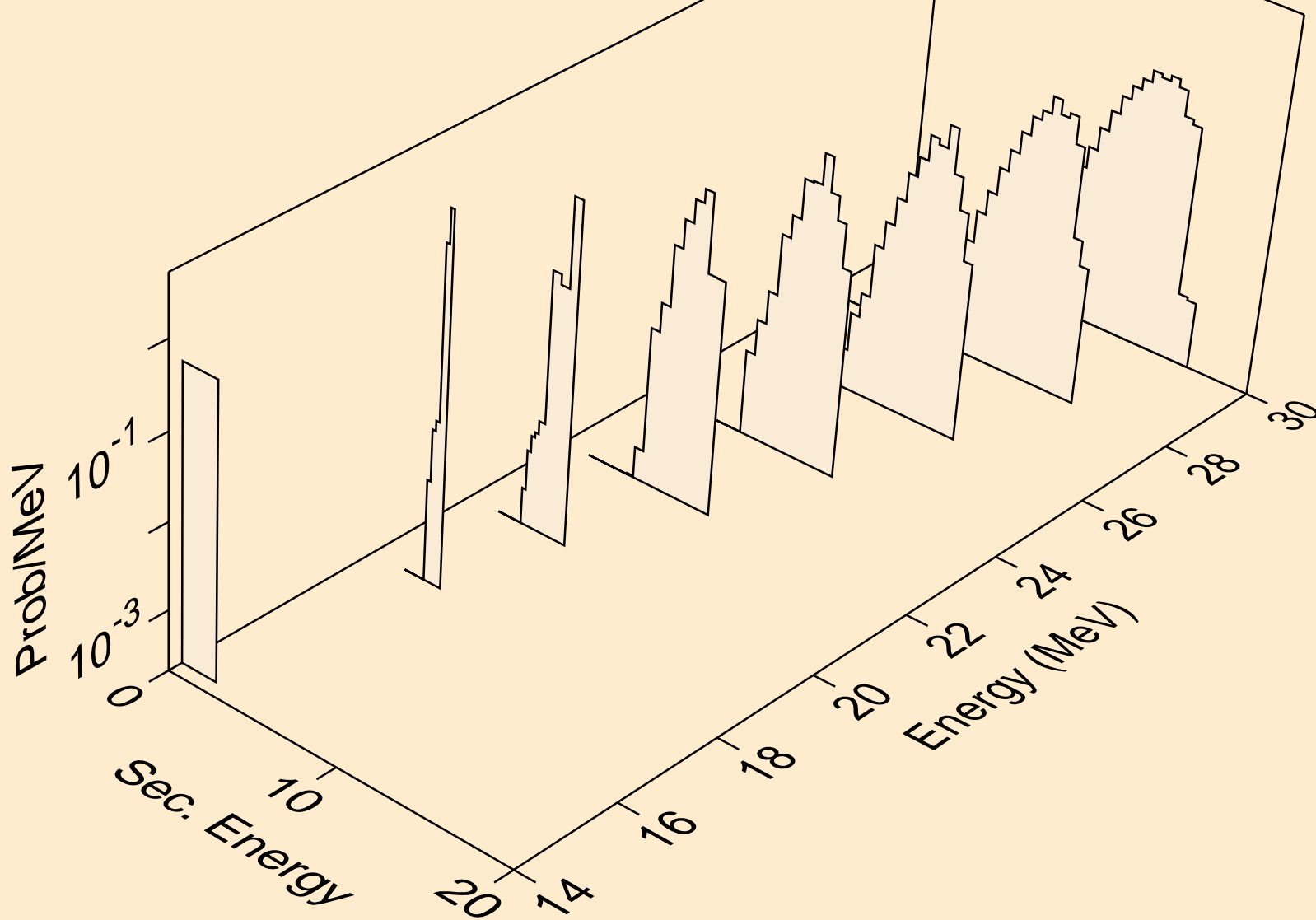

DB257 NEUTRON ACER TENDL-2019 LIBRARY; T=293.16K
deuterons from (n,n*)d

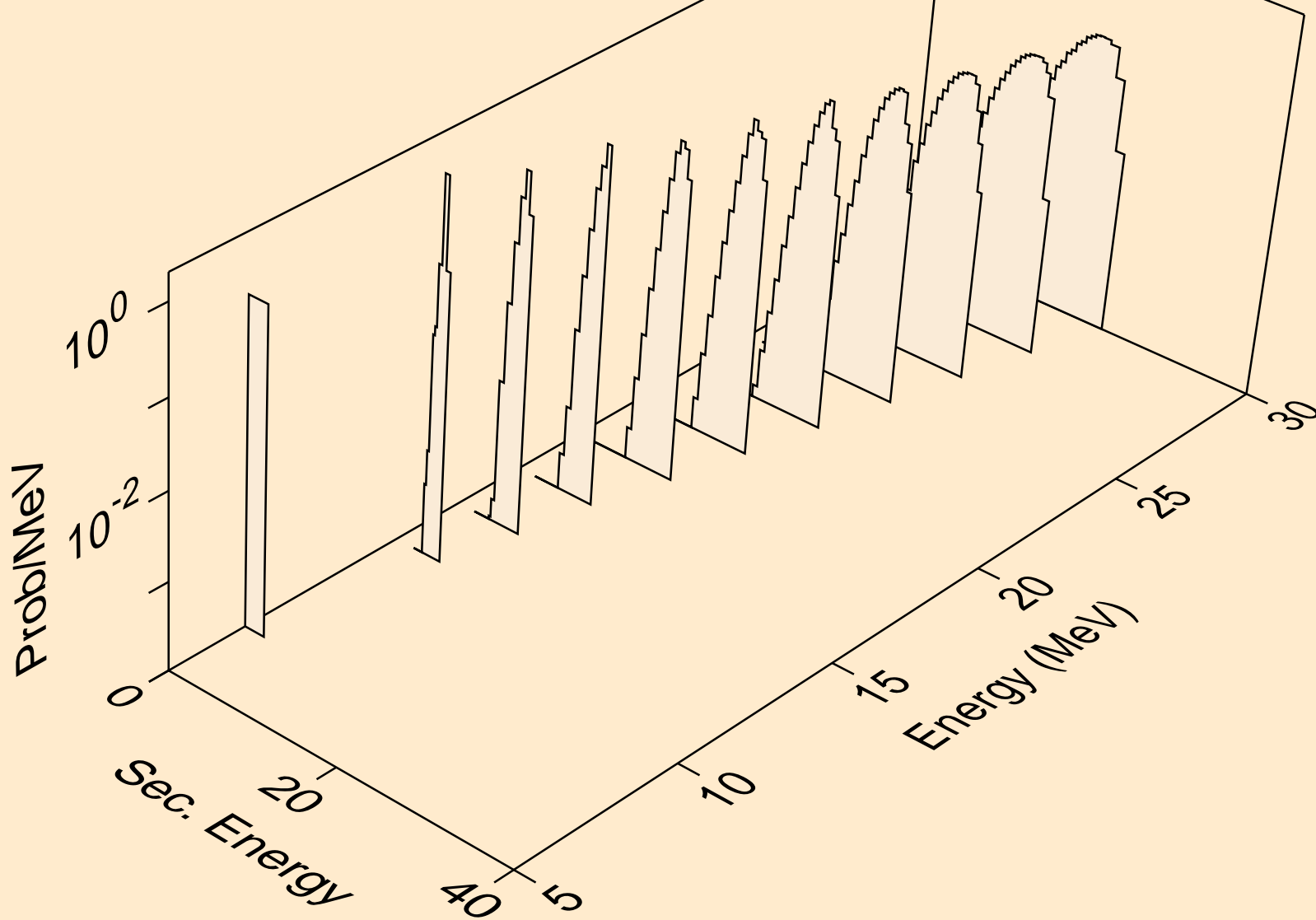

DB257 NEUTRON ACER TENDL-2019 LIBRARY; T=293.16K
deuterons from (n,n*)d2a

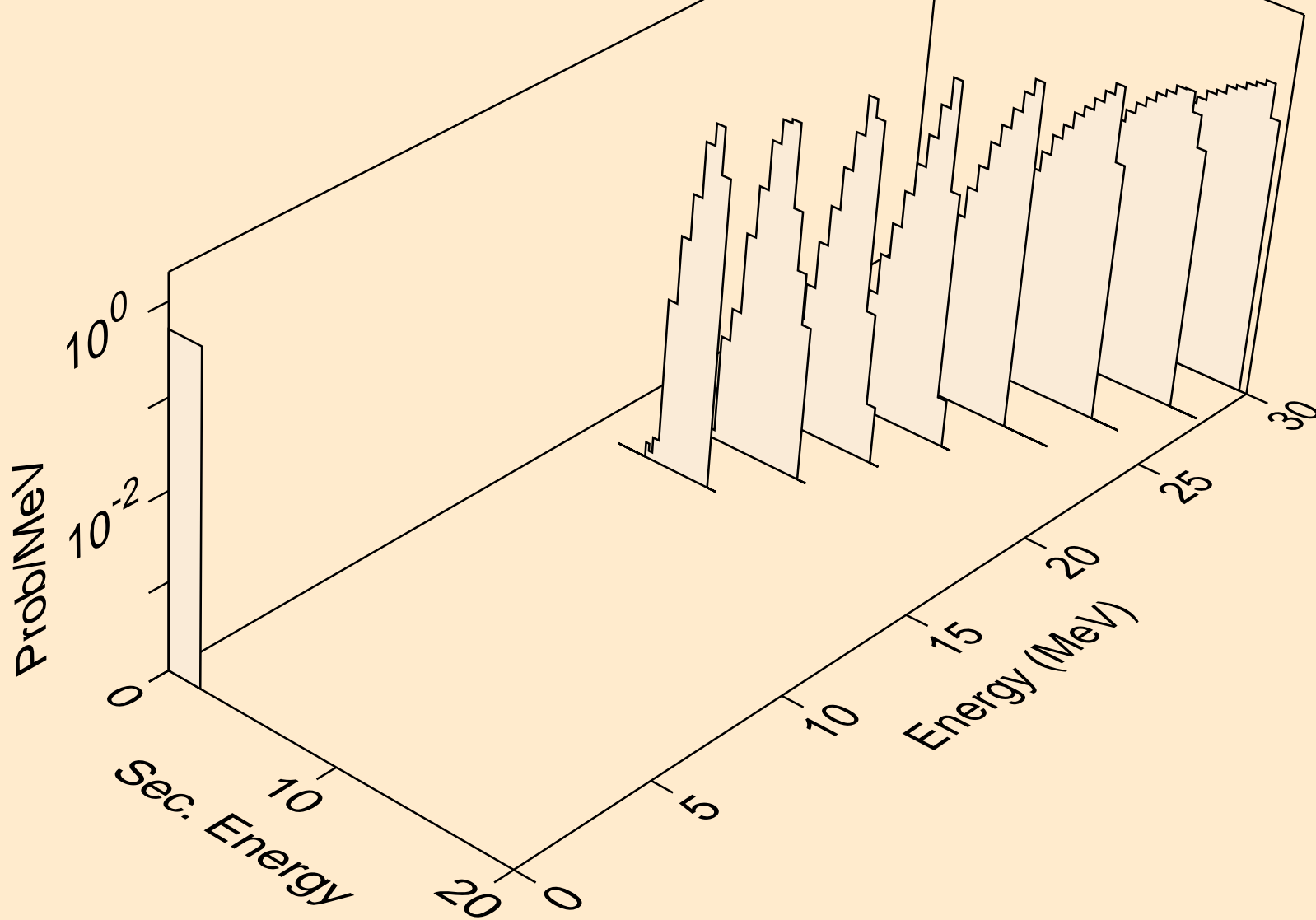

DB257 NEUTRON ACER TENDL-2019 LIBRARY; T=293.16K
deuterons from (n,d)

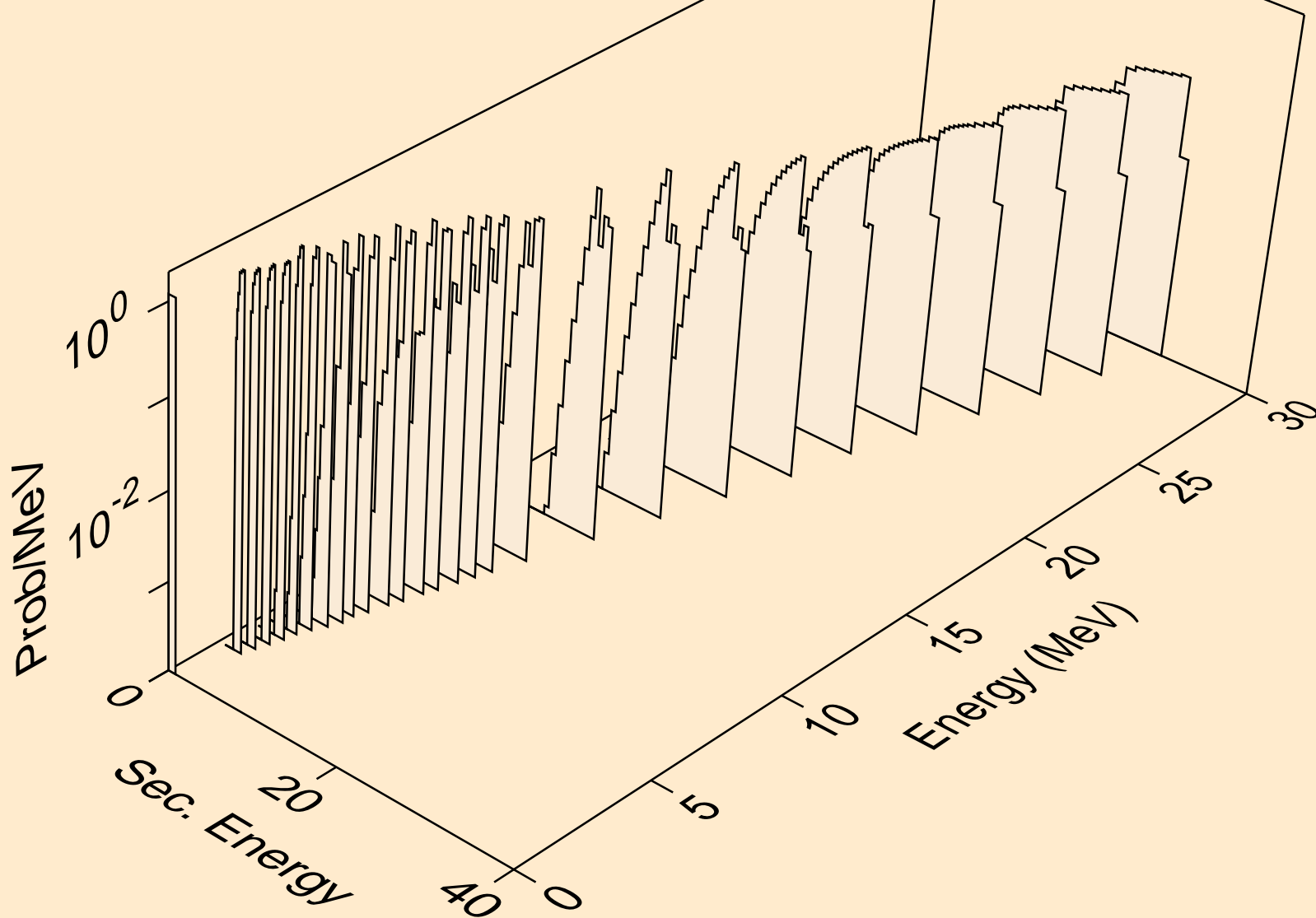

DB257 NEUTRON ACER TENDL-2019 LIBRARY; T=293.16K
deuterons from (n,d2a)

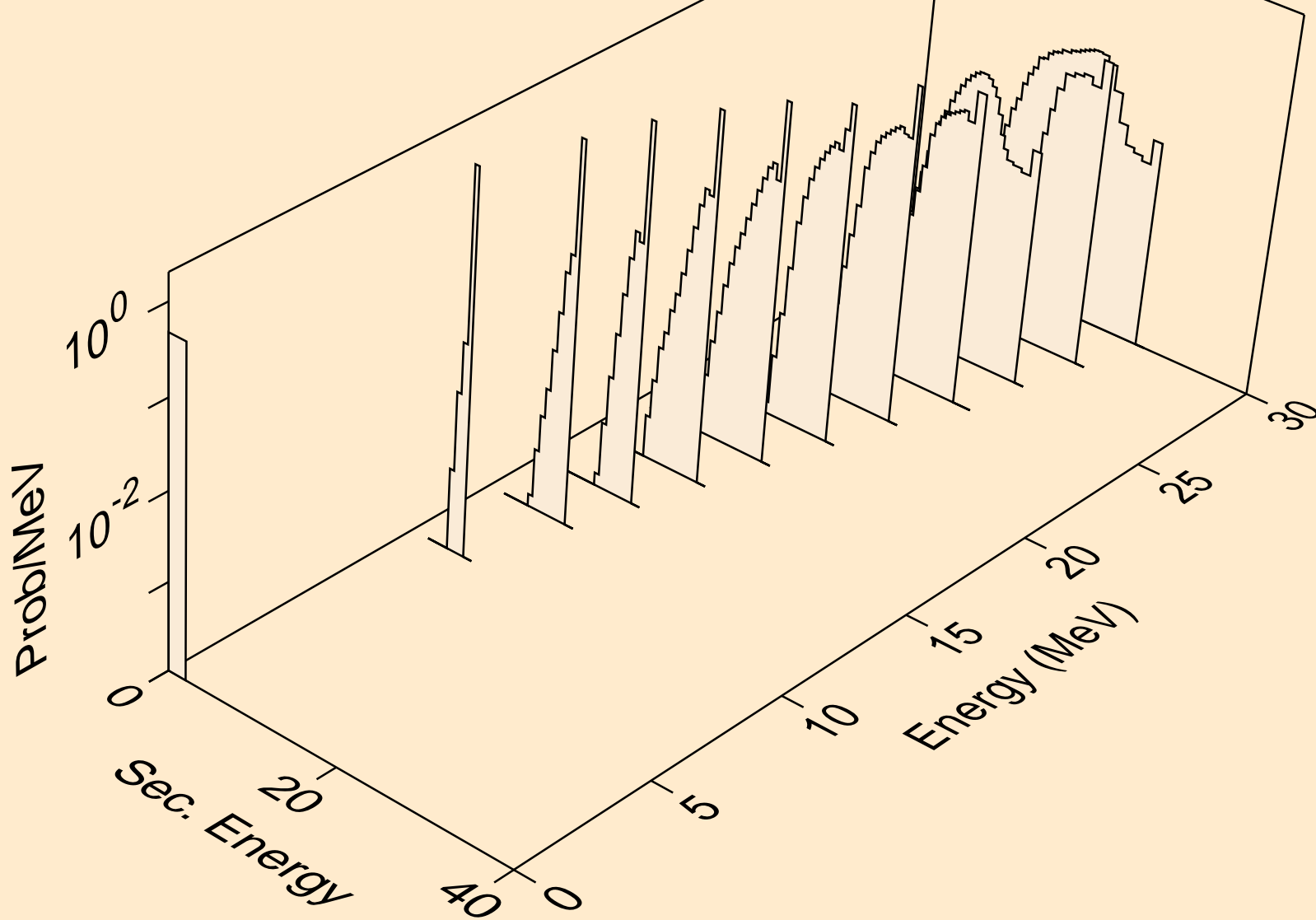

DB257 NEUTRON ACER TENDL-2019 LIBRARY; T=293.16K
deuterons from (n,pd)

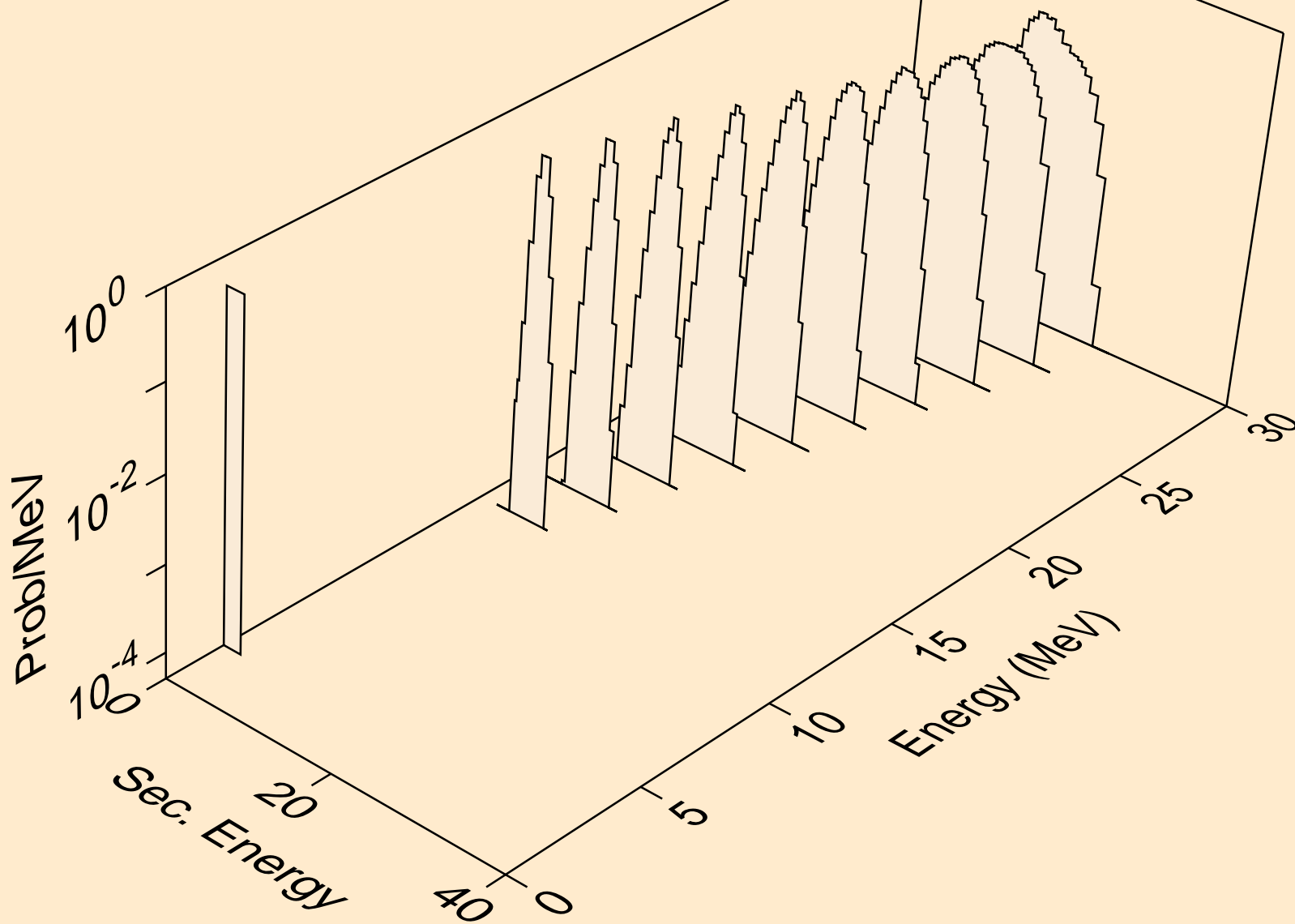

DB257 NEUTRON ACER TENDL-2019 LIBRARY; T=293.16K
deuterons from (n,da)

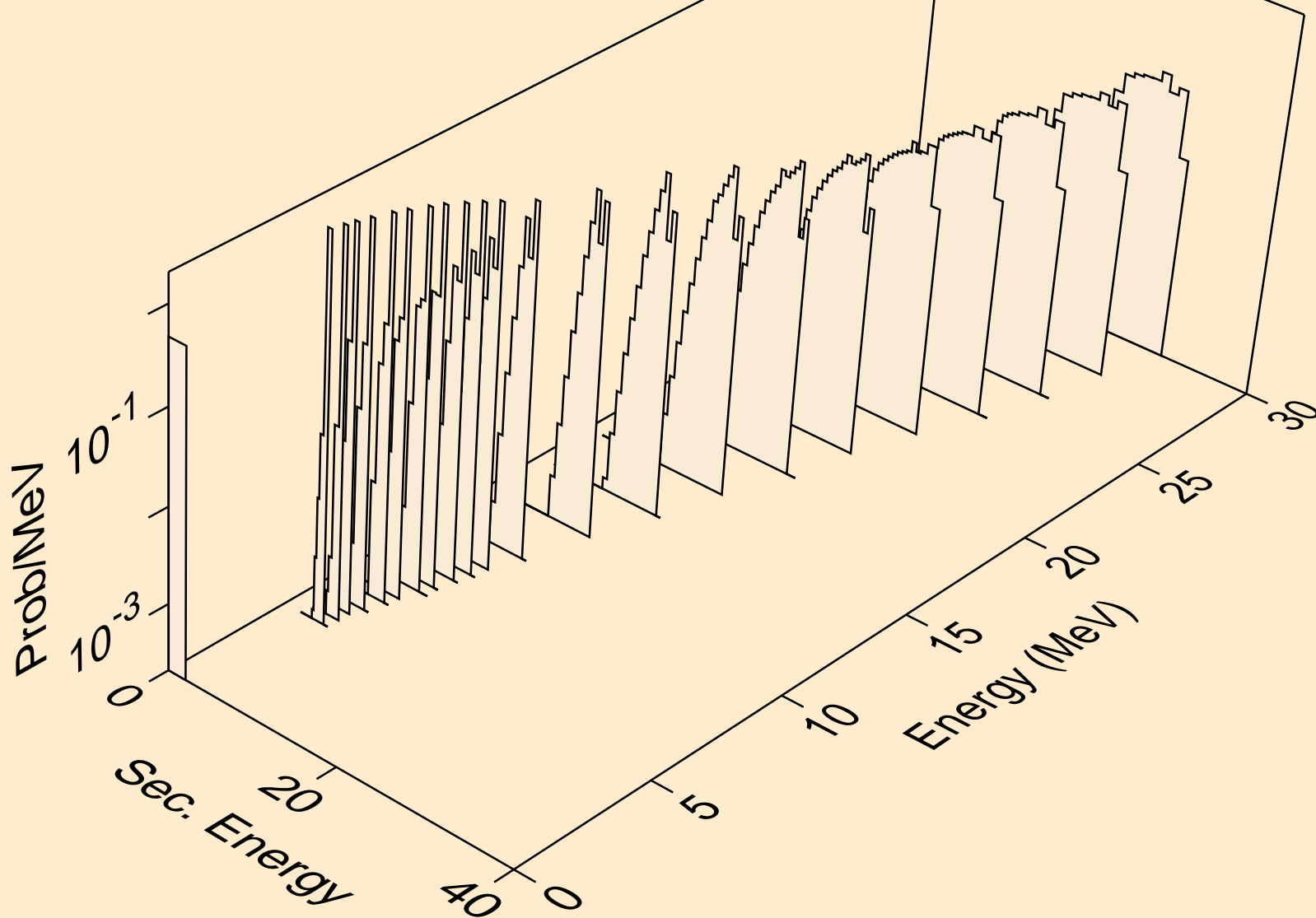

DB257 NEUTRON ACER TENDL-2019 LIBRARY; T=293.16K
tritons from (n,x)

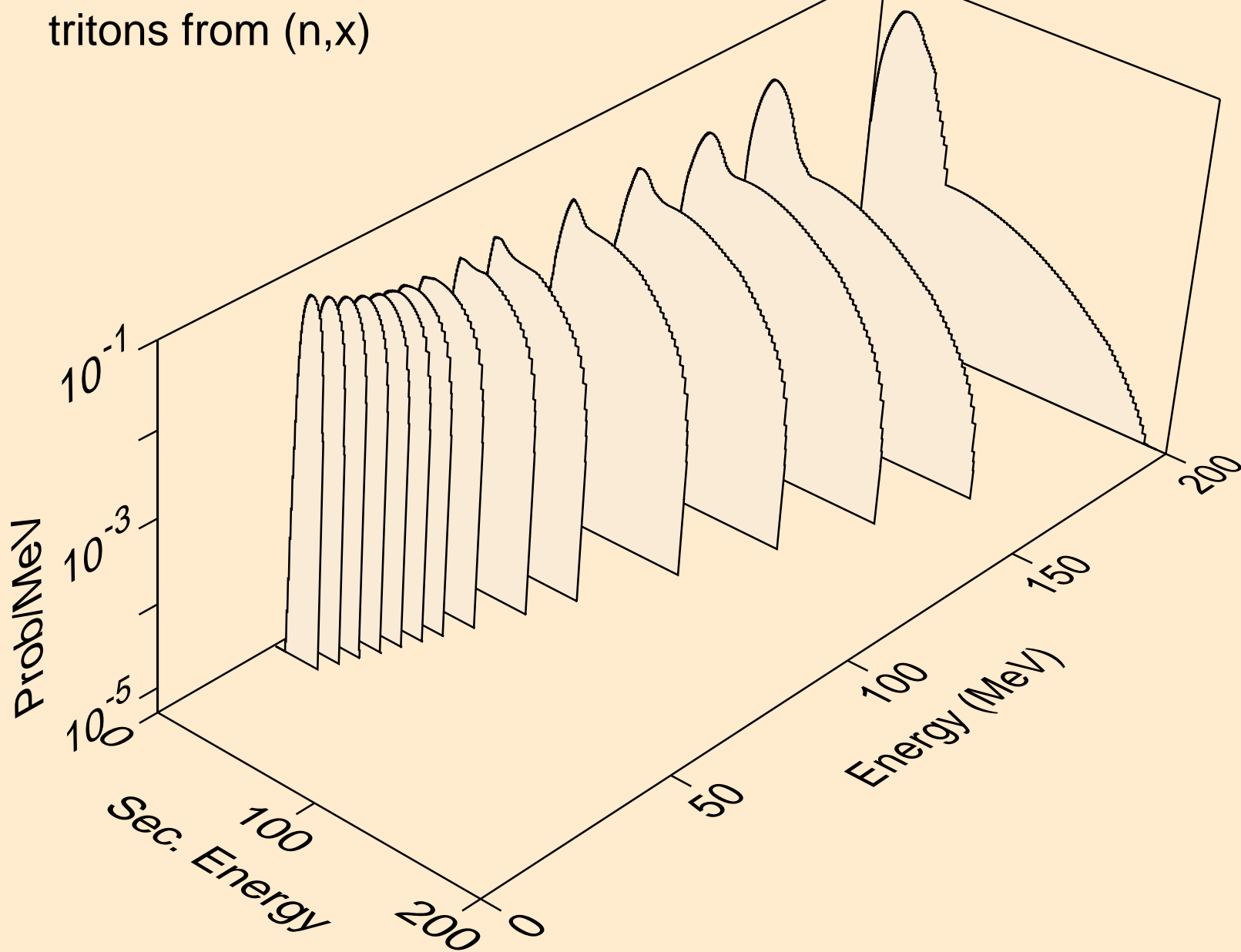

DB257 NEUTRON ACER TENDL-2019 LIBRARY; T=293.16K
tritons from (n,n*)t

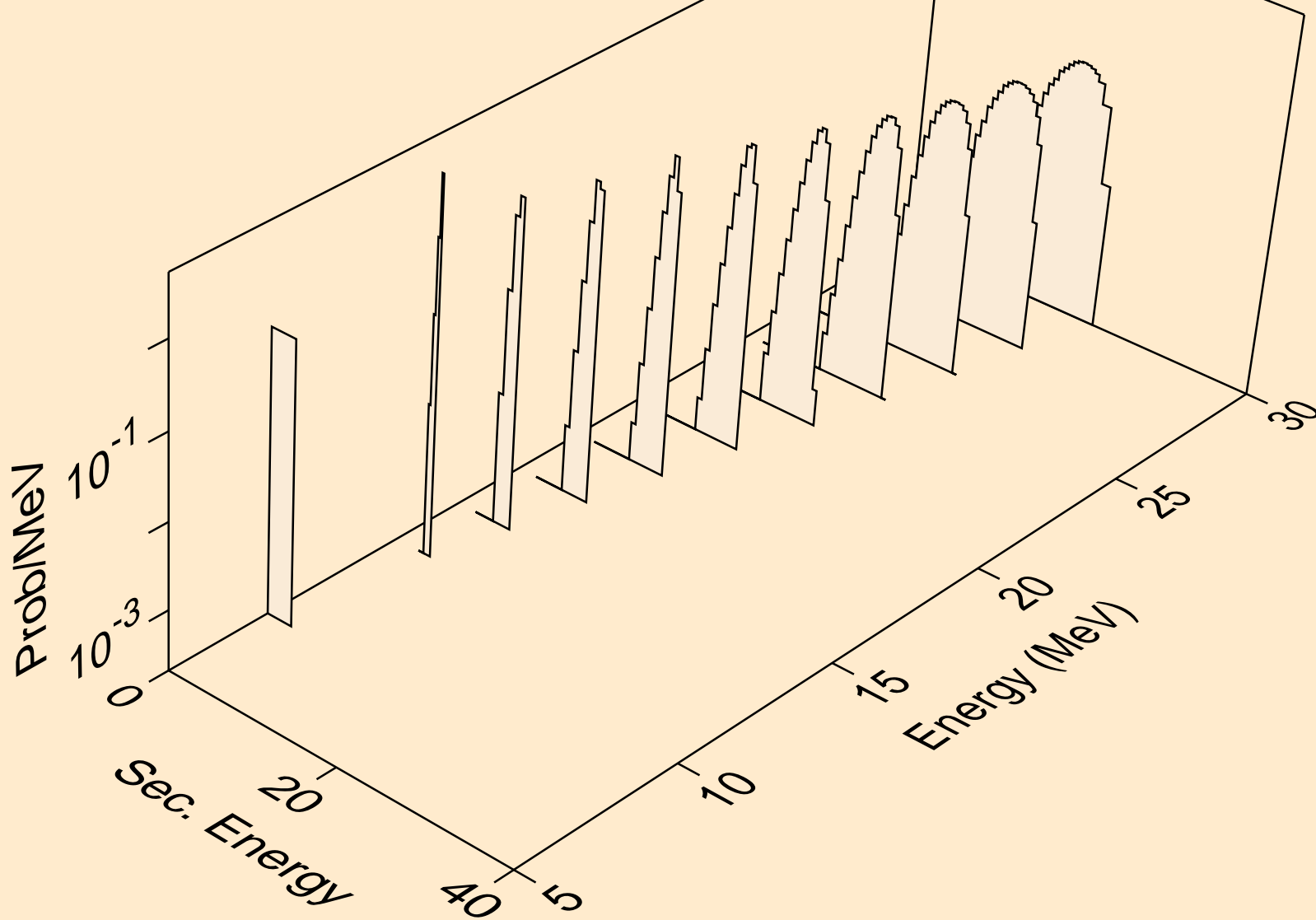

DB257 NEUTRON ACER TENDL-2019 LIBRARY; T=293.16K
tritons from (n,n*)t2a

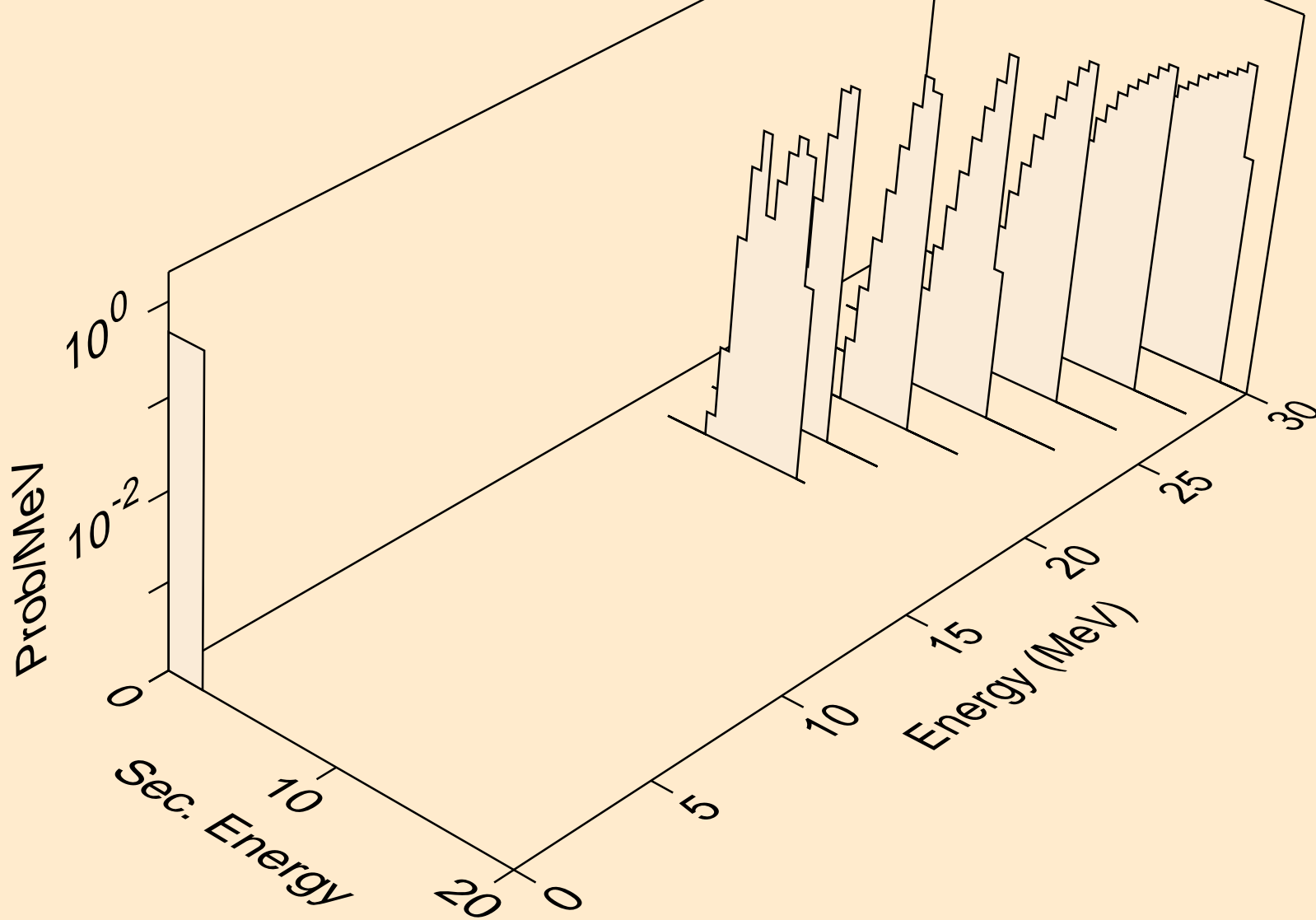

DB257 NEUTRON ACER TENDL-2019 LIBRARY; T=293.16K
tritons from (n,t)

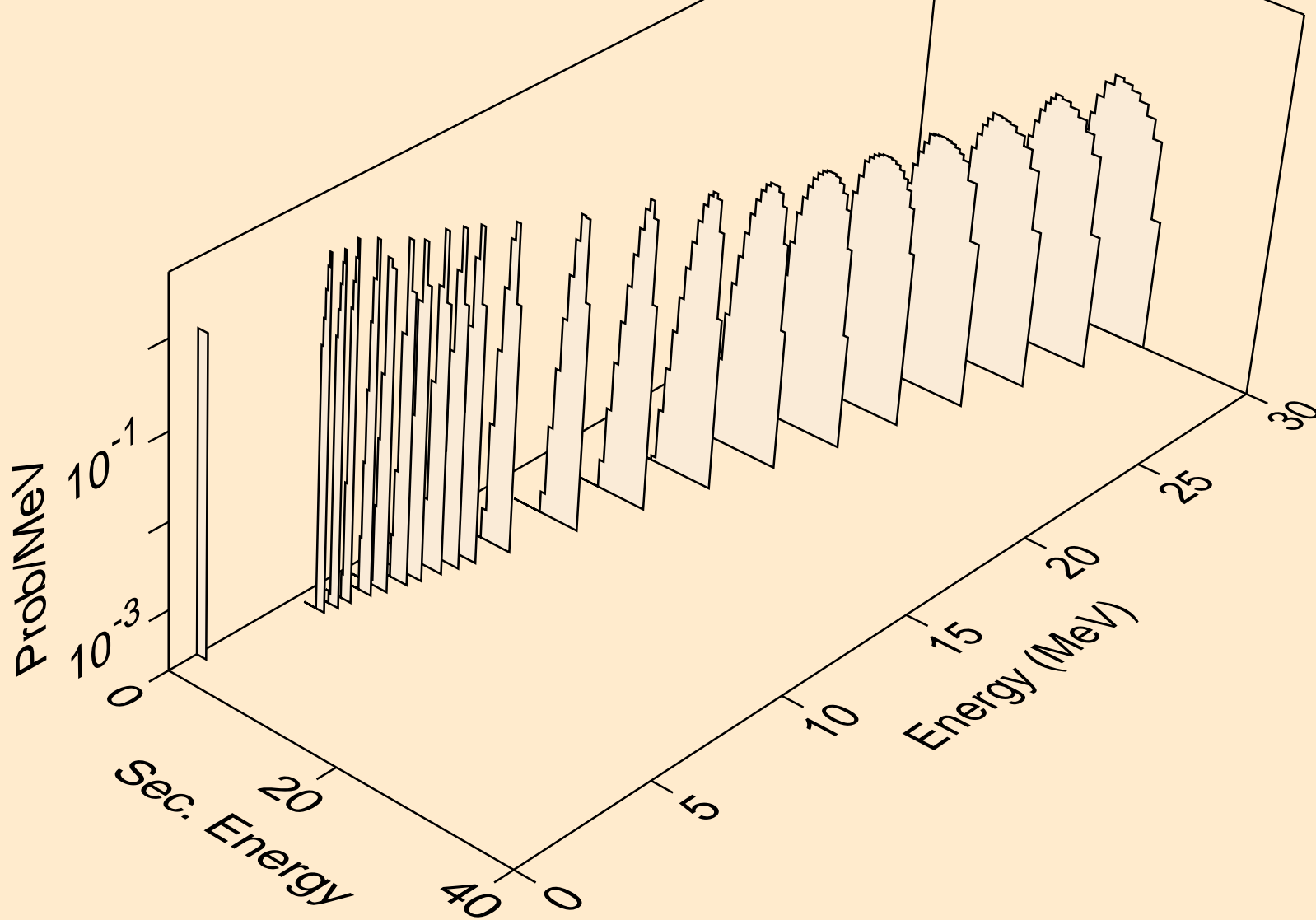

DB257 NEUTRON ACER TENDL-2019 LIBRARY; T=293.16K
tritons from (n,t2a)

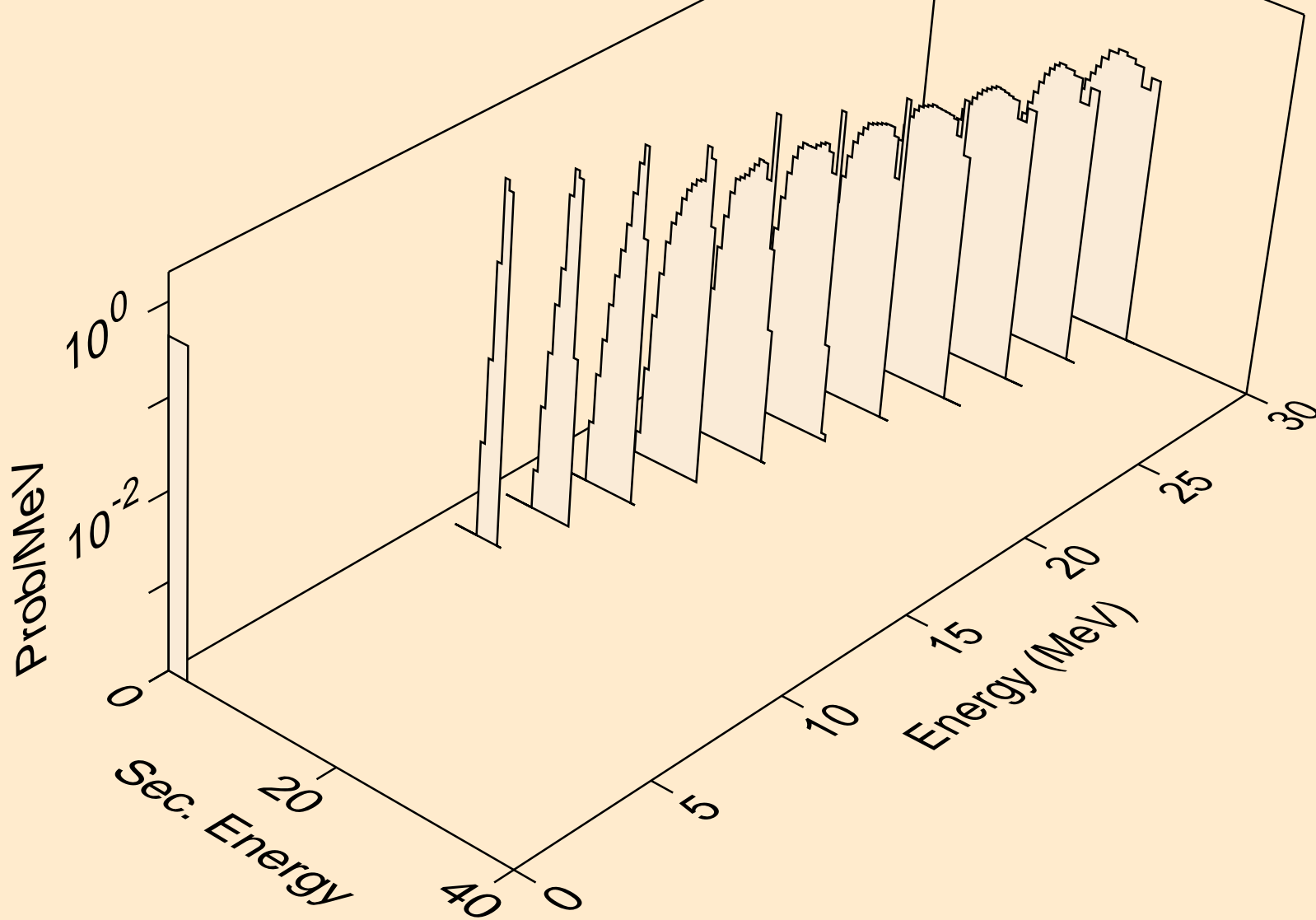

DB257 NEUTRON ACER TENDL-2019 LIBRARY; T=293.16K
tritons from (n,pt)

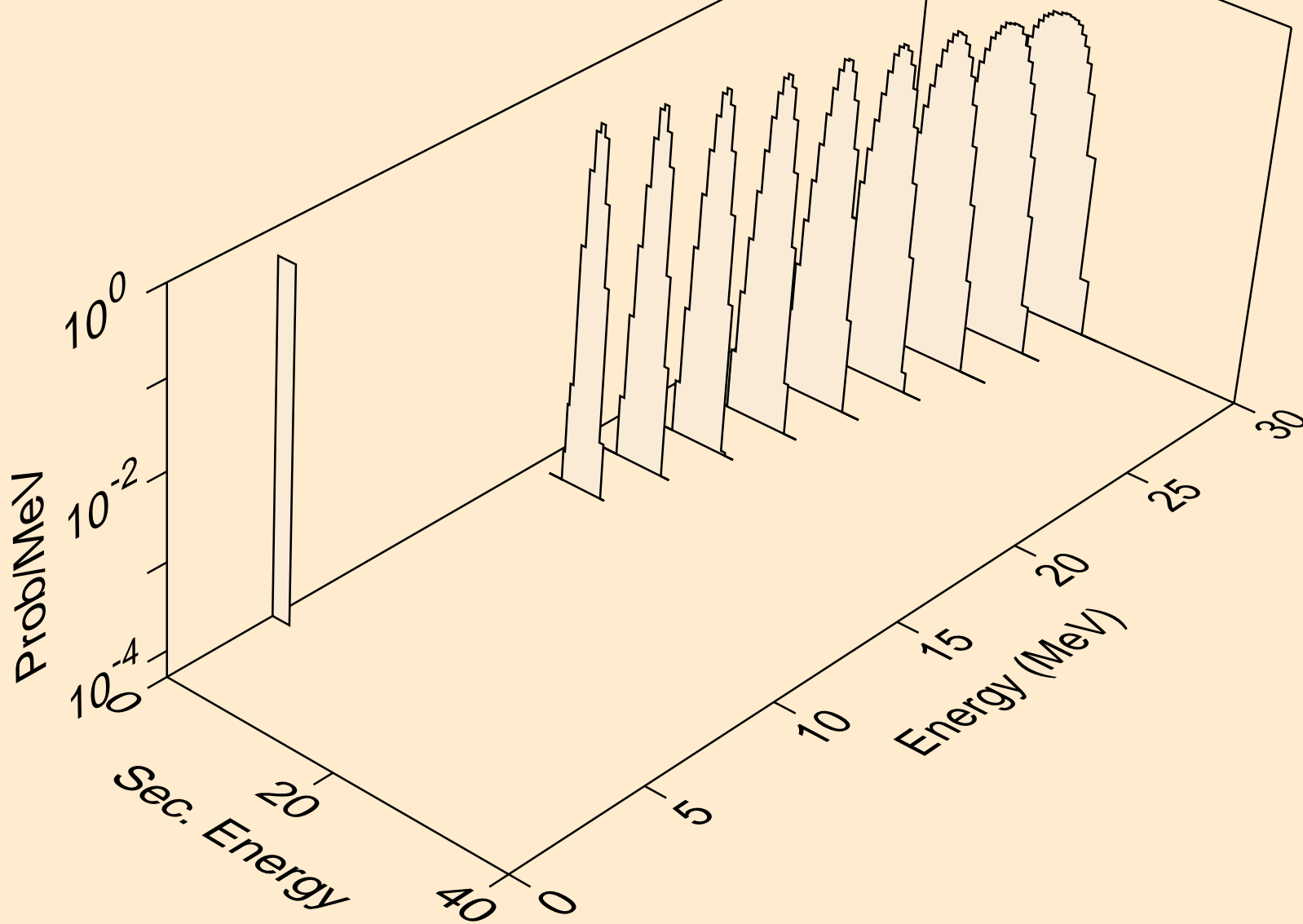

DB257 NEUTRON ACER TENDL-2019 LIBRARY; T=293.16K
he3s from (n,x)

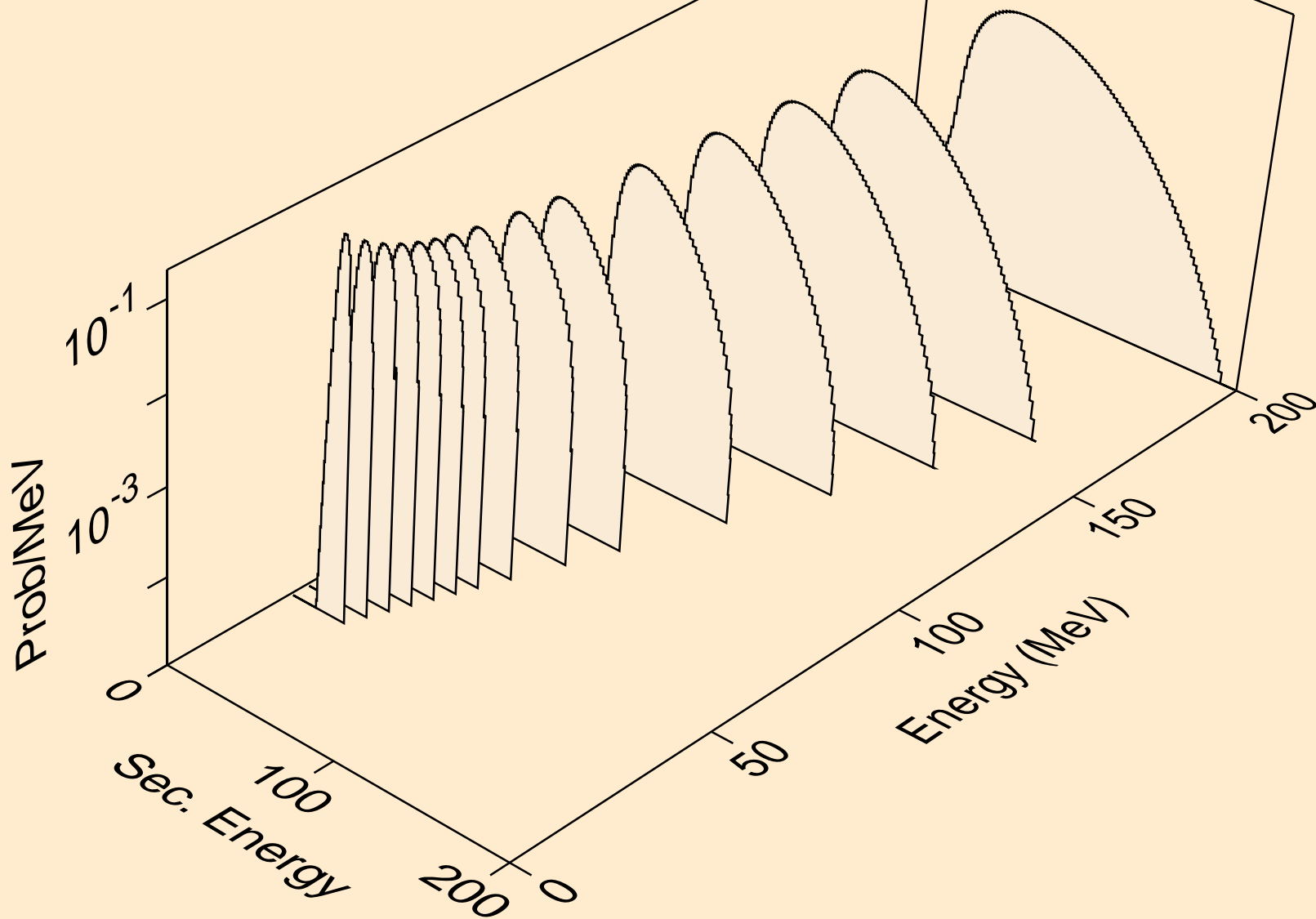

DB257 NEUTRON ACER TENDL-2019 LIBRARY; T=293.16K
he3s from (n,n*)he3

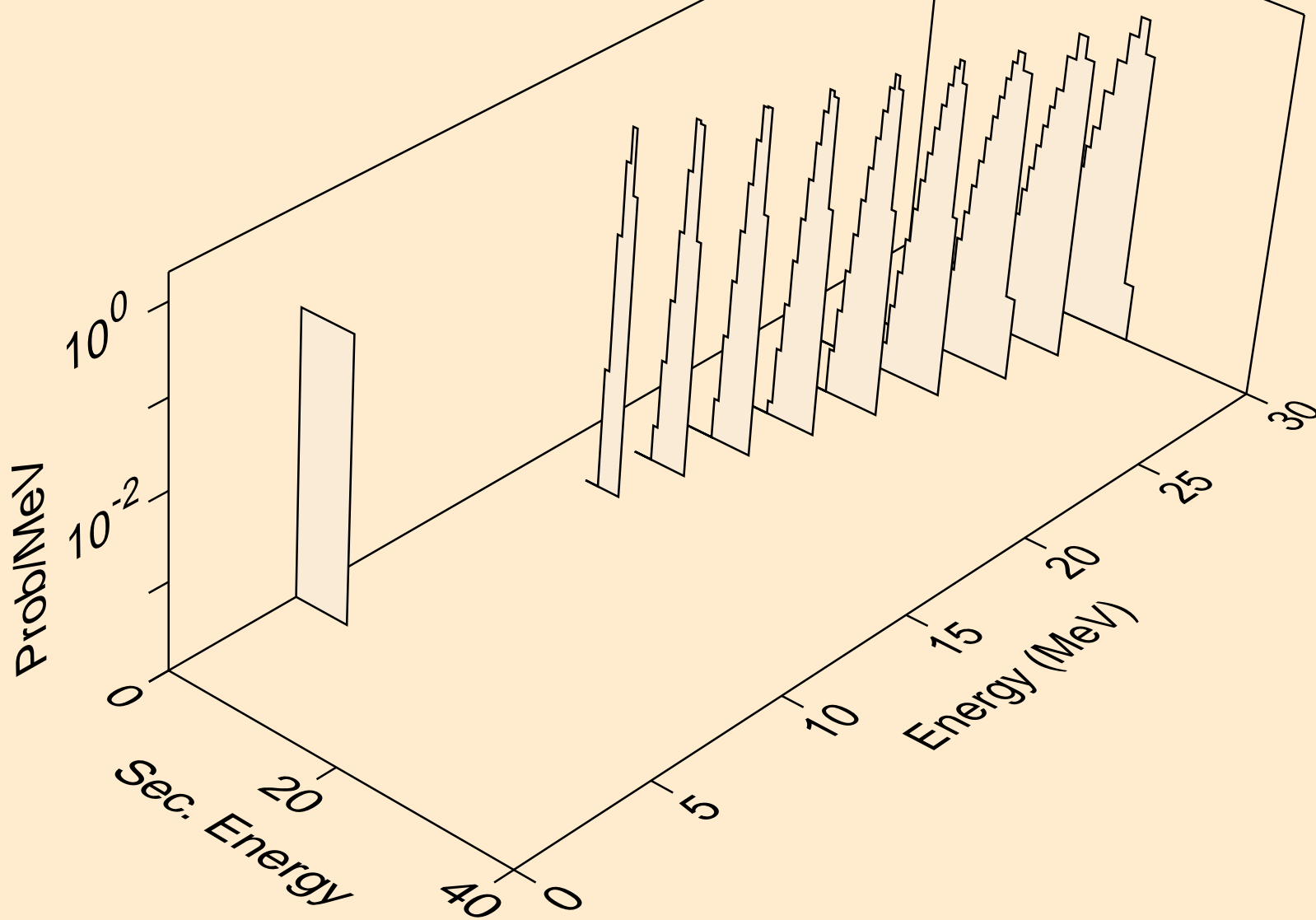

DB257 NEUTRON ACER TENDL-2019 LIBRARY; T=293.16K
he3s from (n,he3)

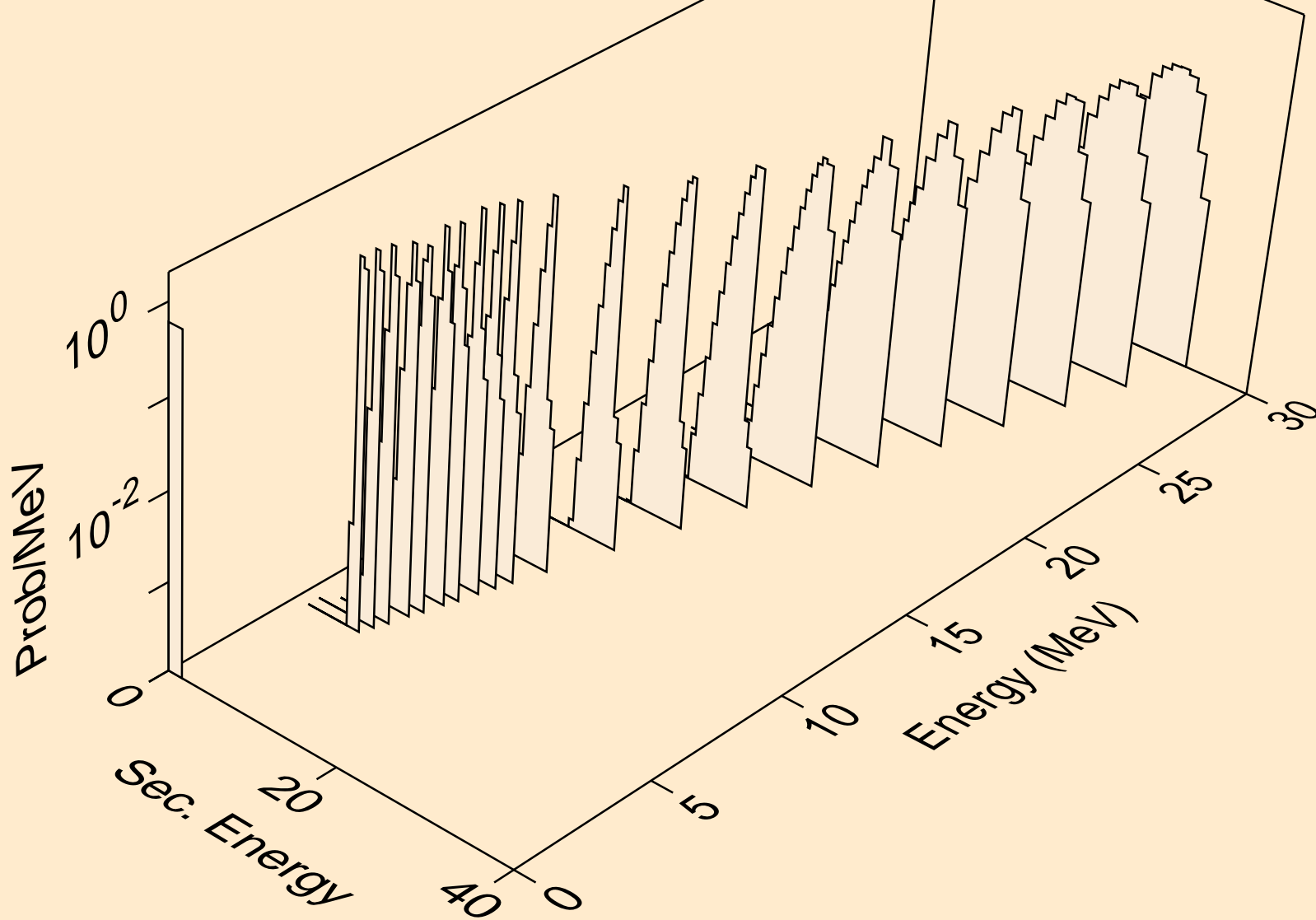

DB257 NEUTRON ACER TENDL-2019 LIBRARY; T=293.16K
alphas from (n,x)

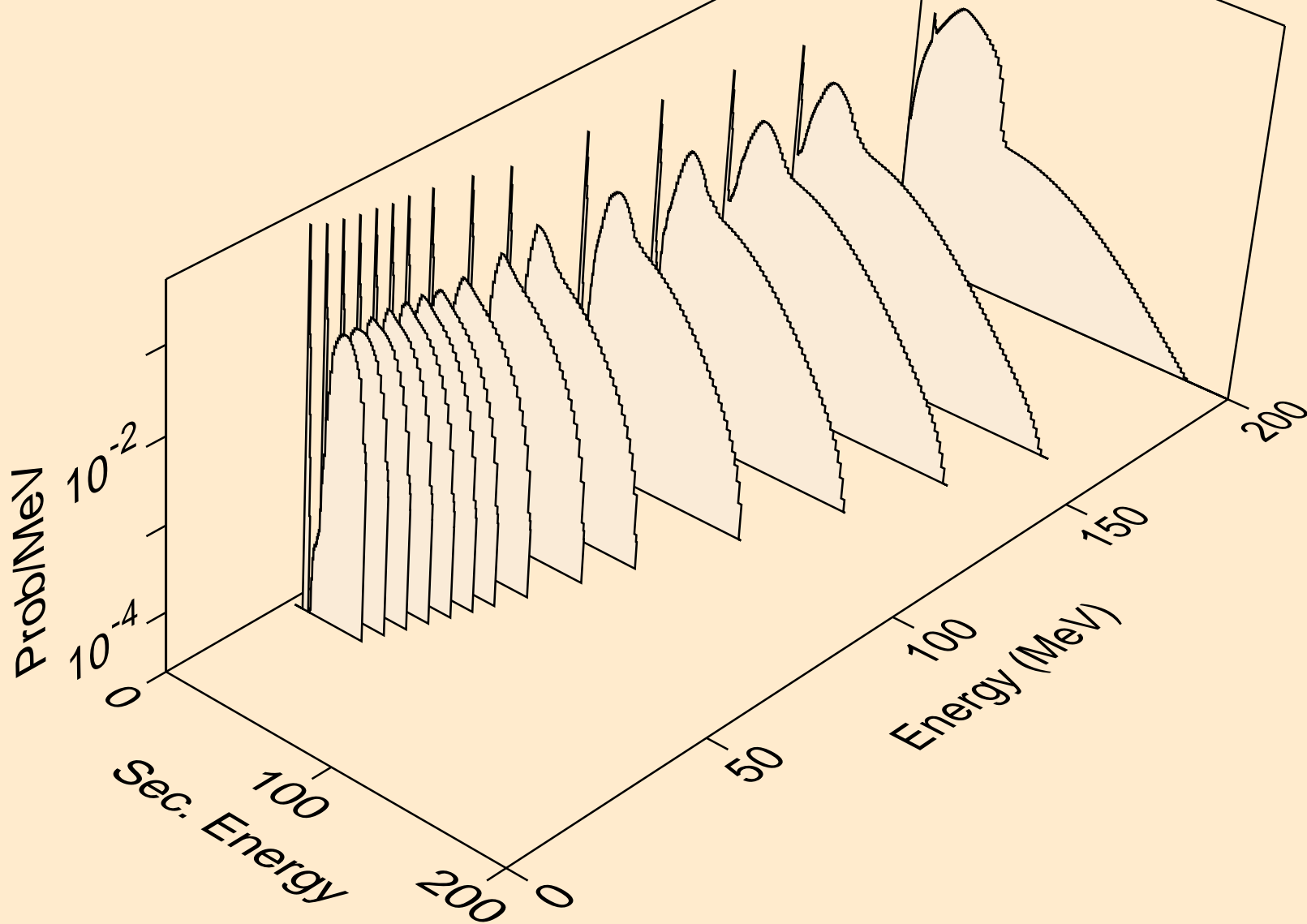

DB257 NEUTRON ACER TENDL-2019 LIBRARY; T=293.16K
alphas from (n,n*)a

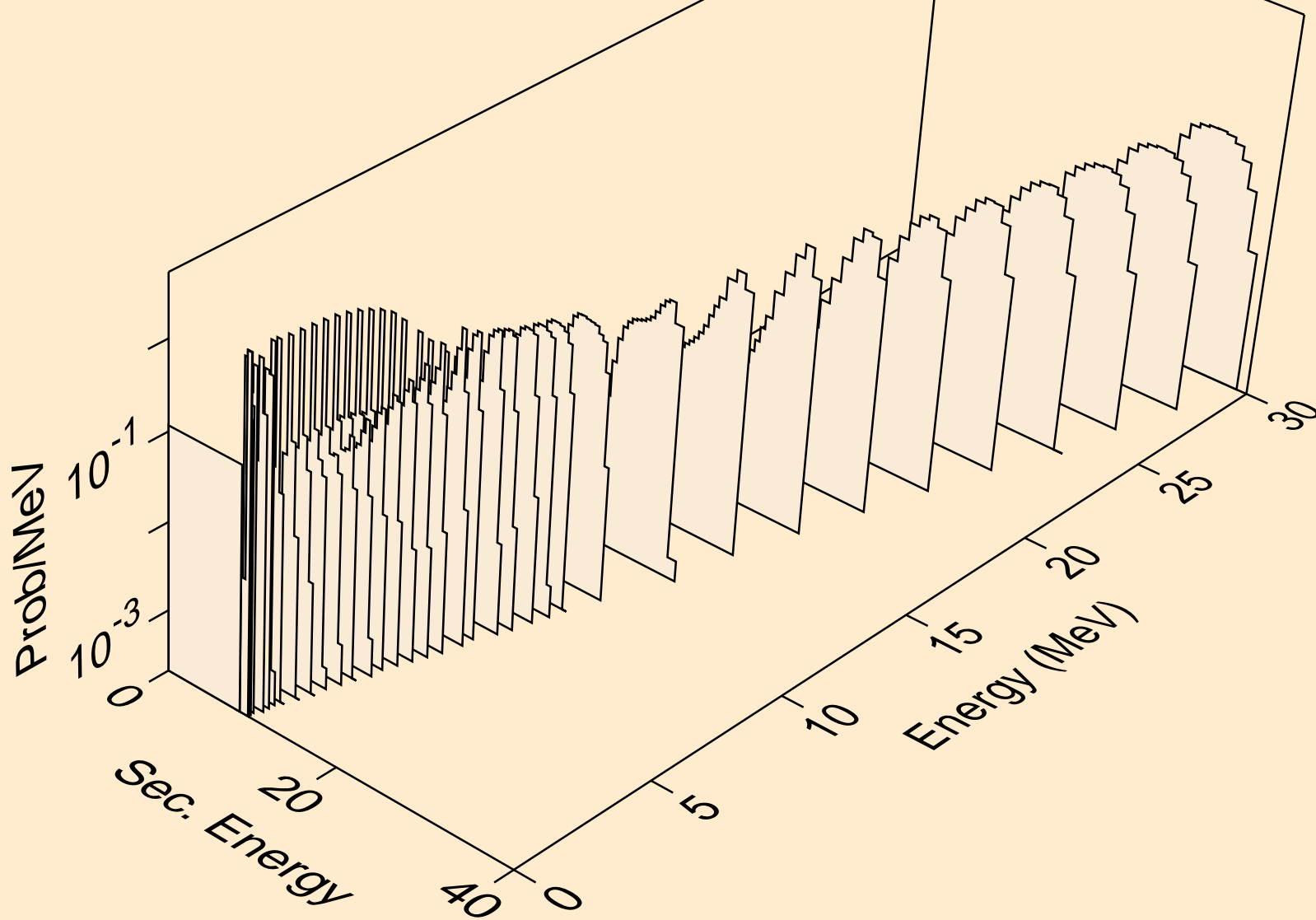

DB257 NEUTRON ACER TENDL-2019 LIBRARY; T=293.16K
alphas from (n,n*)3a

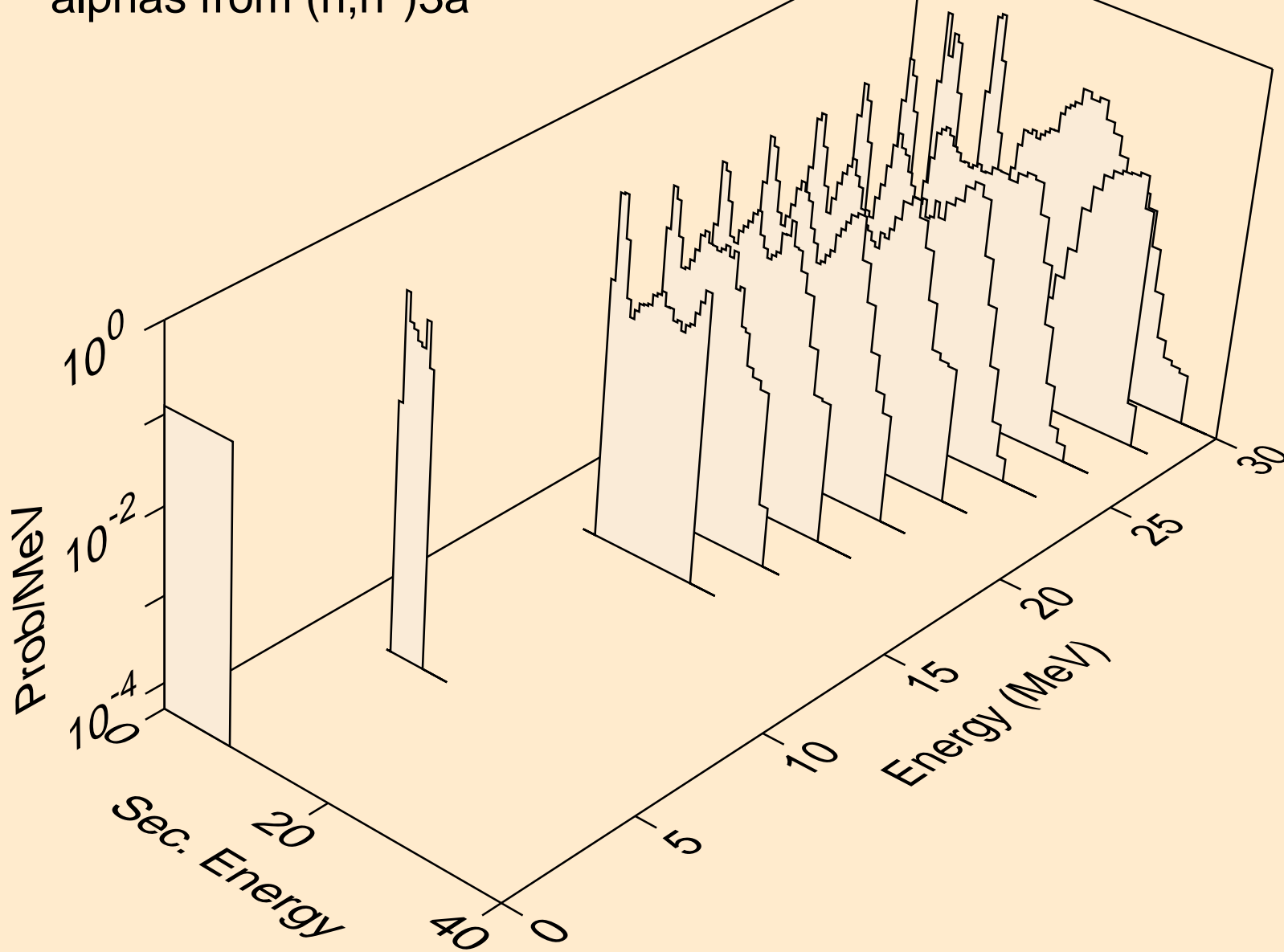

DB257 NEUTRON ACER TENDL-2019 LIBRARY; T=293.16K
alphas from (n,2n)a

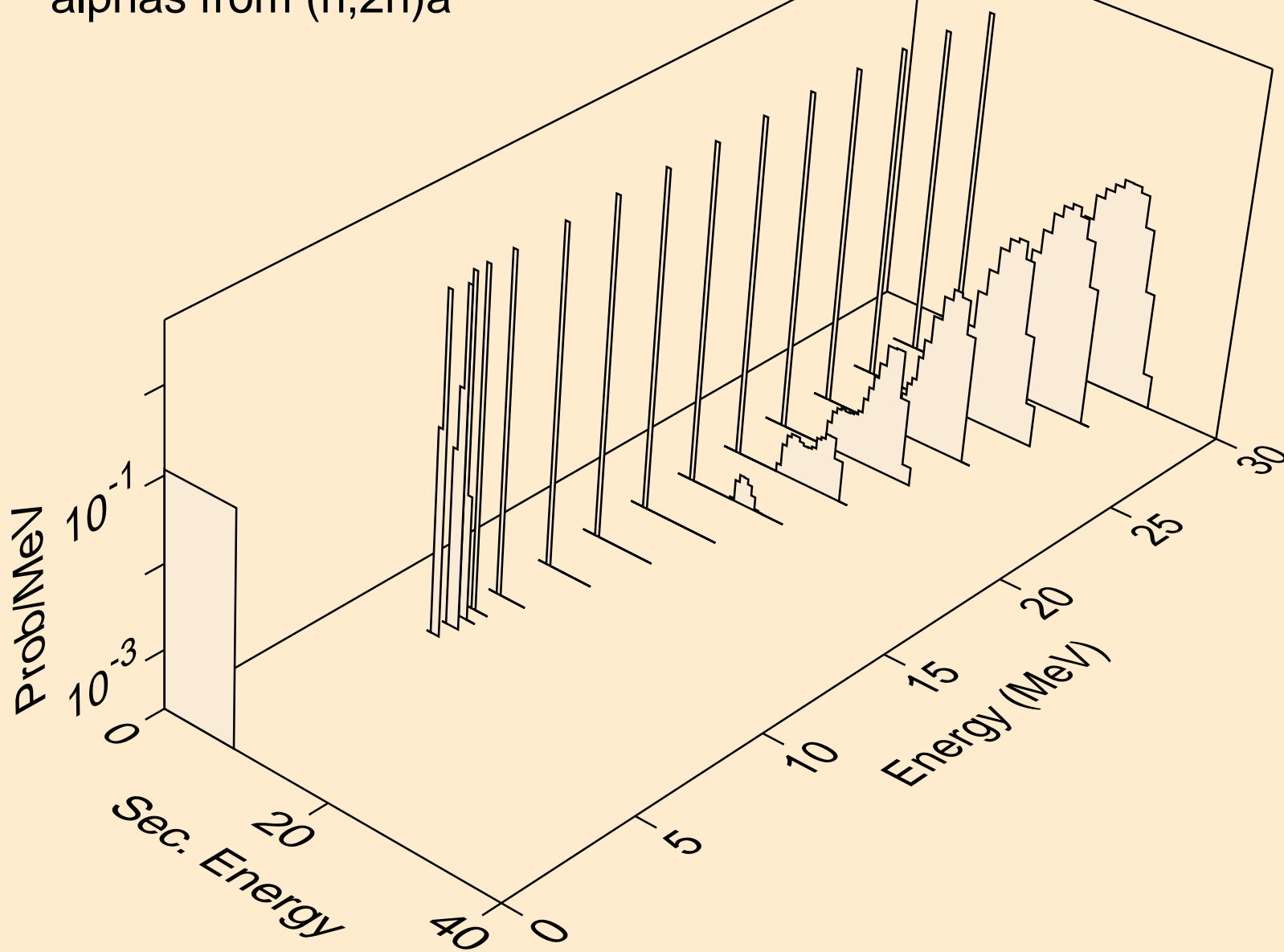

DB257 NEUTRON ACER TENDL-2019 LIBRARY; T=293.16K
alphas from (n,3n)a

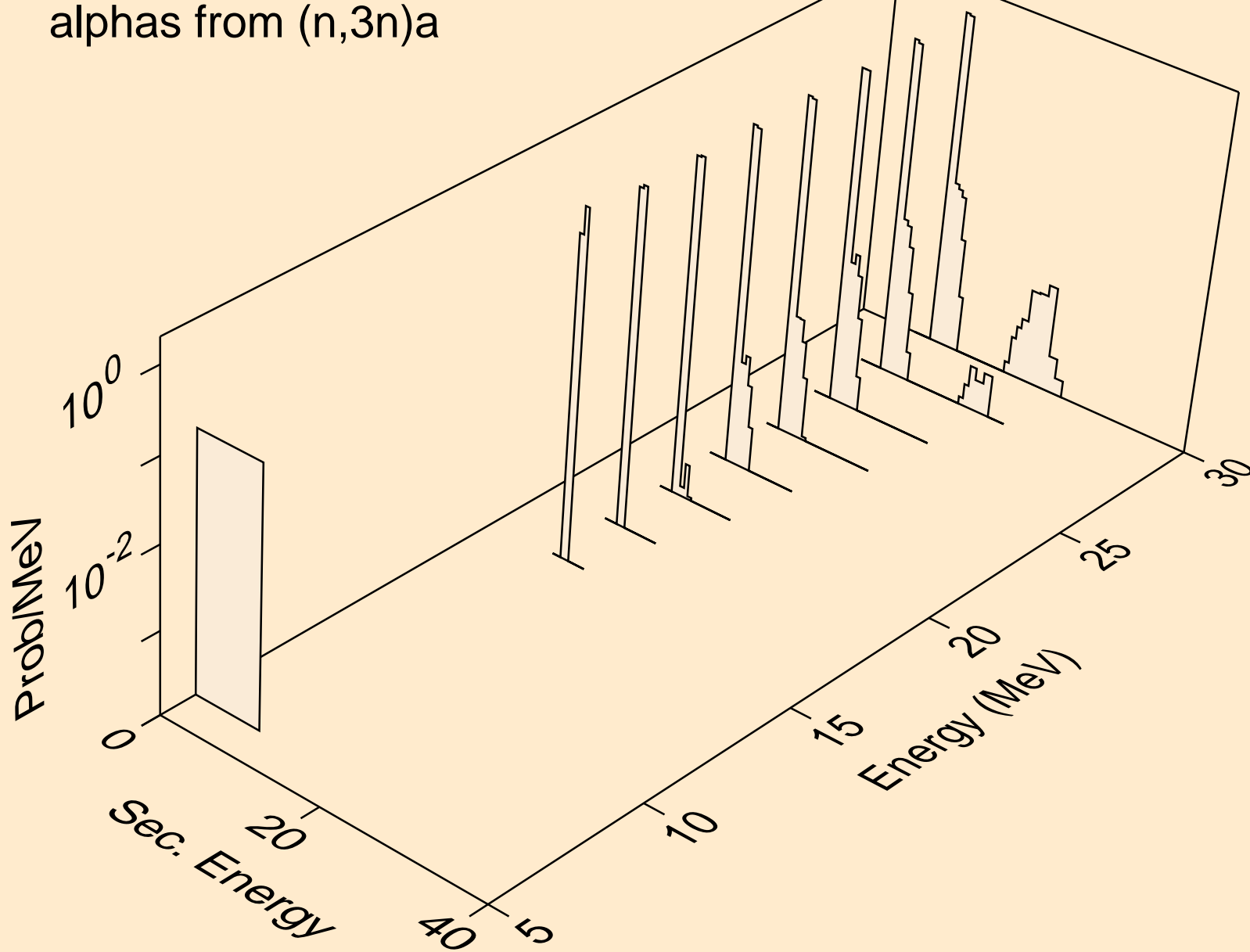

DB257 NEUTRON ACER TENDL-2019 LIBRARY; T=293.16K
alphas from (n,n*)2a

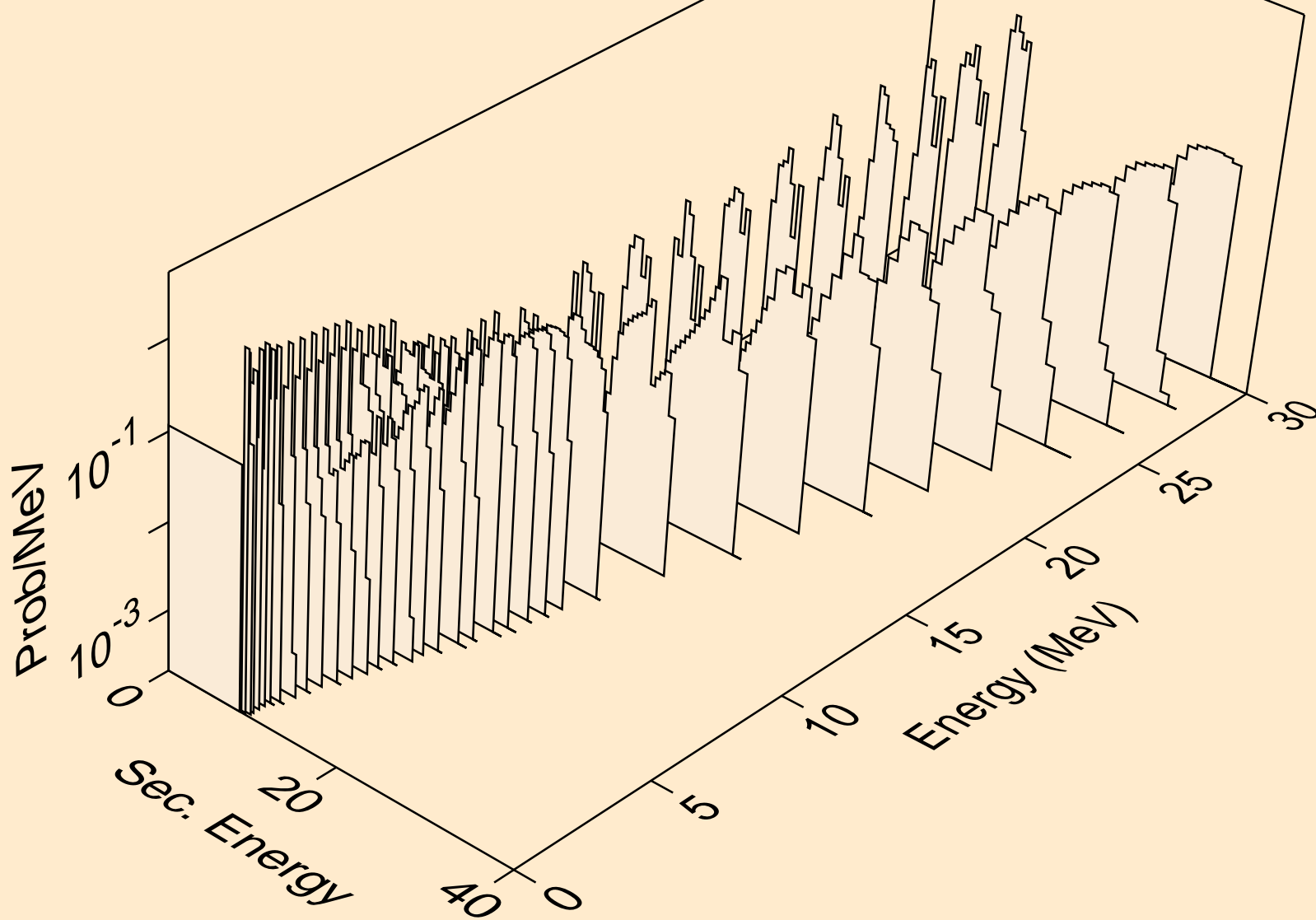

DB257 NEUTRON ACER TENDL-2019 LIBRARY; T=293.16K
alphas from (n,2n)2a

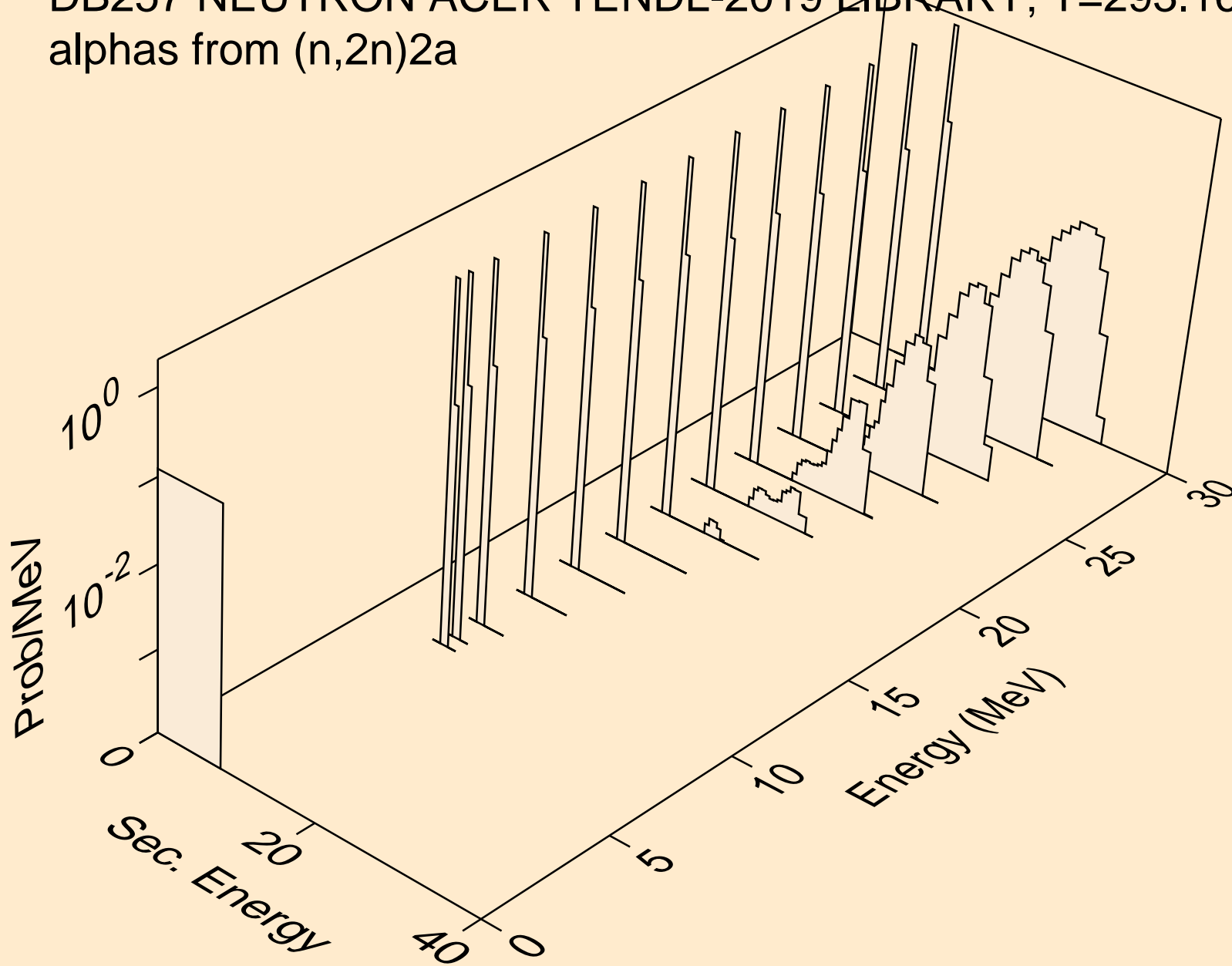

DB257 NEUTRON ACER TENDL-2019 LIBRARY; T=293.16K
alphas from (n,n*)d2a

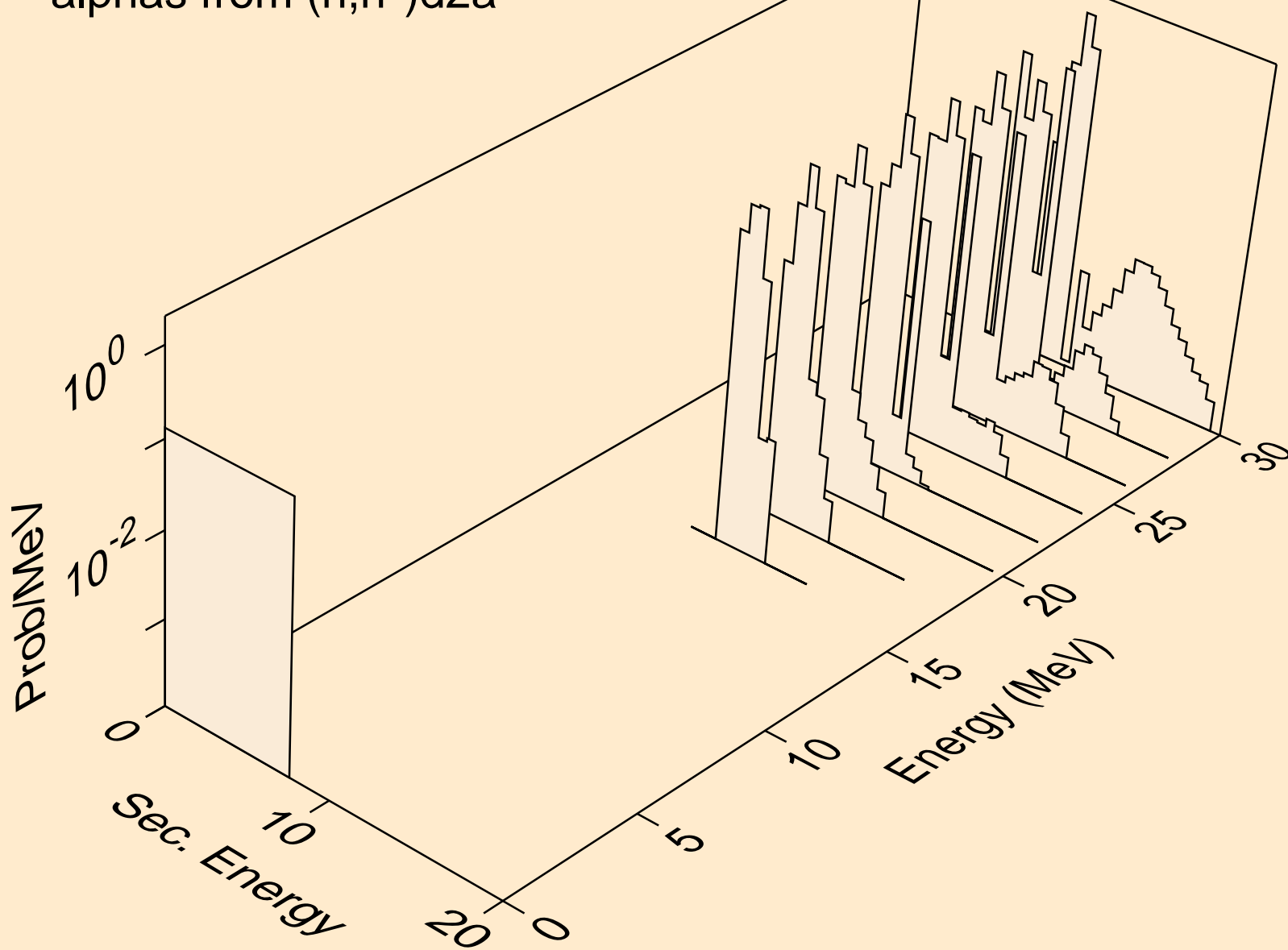

DB257 NEUTRON ACER TENDL-2019 LIBRARY; T=293.16K
alphas from (n,n*)t2a

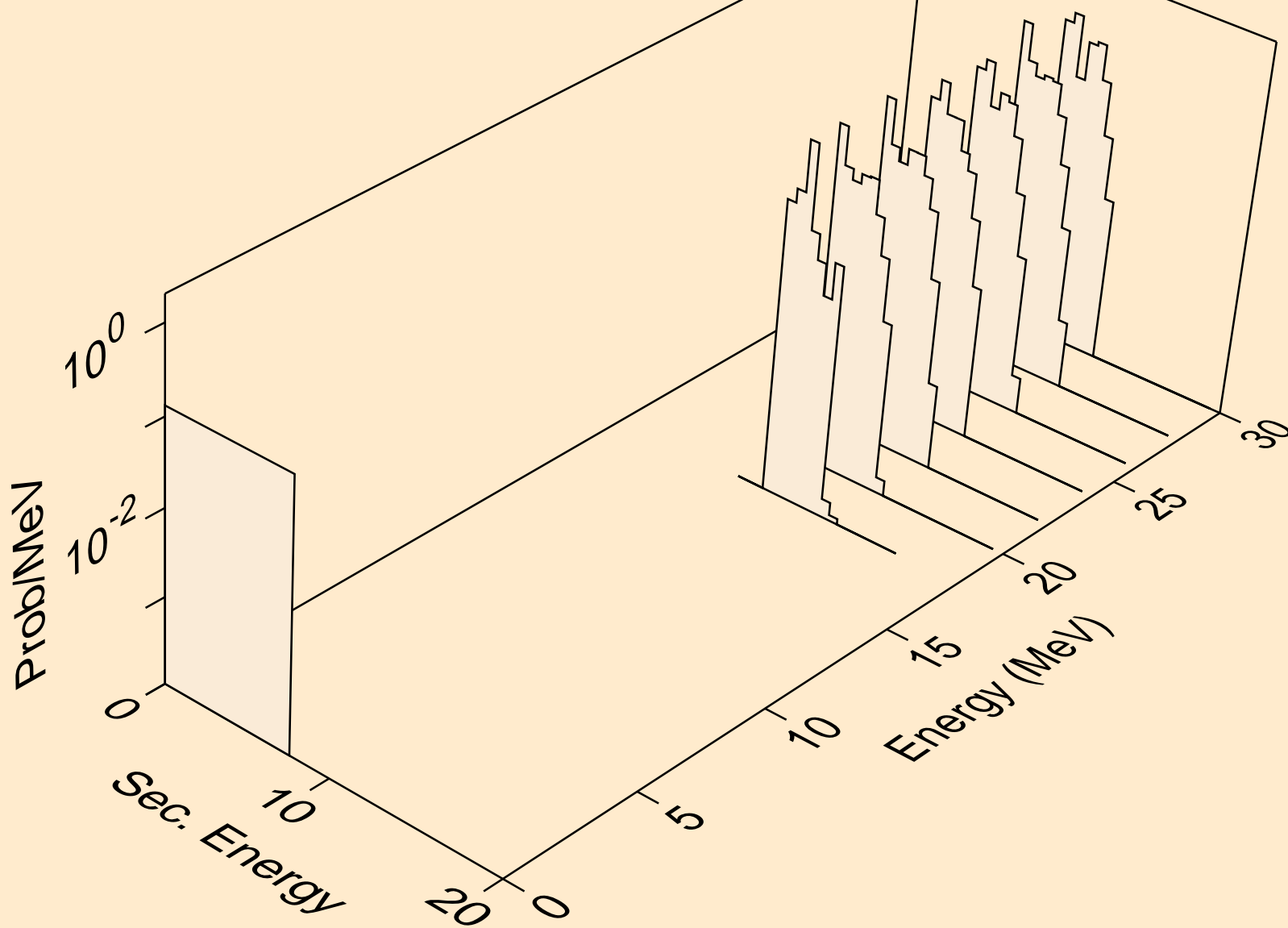

DB257 NEUTRON ACER TENDL-2019 LIBRARY; T=293.16K
alphas from (n,npa)

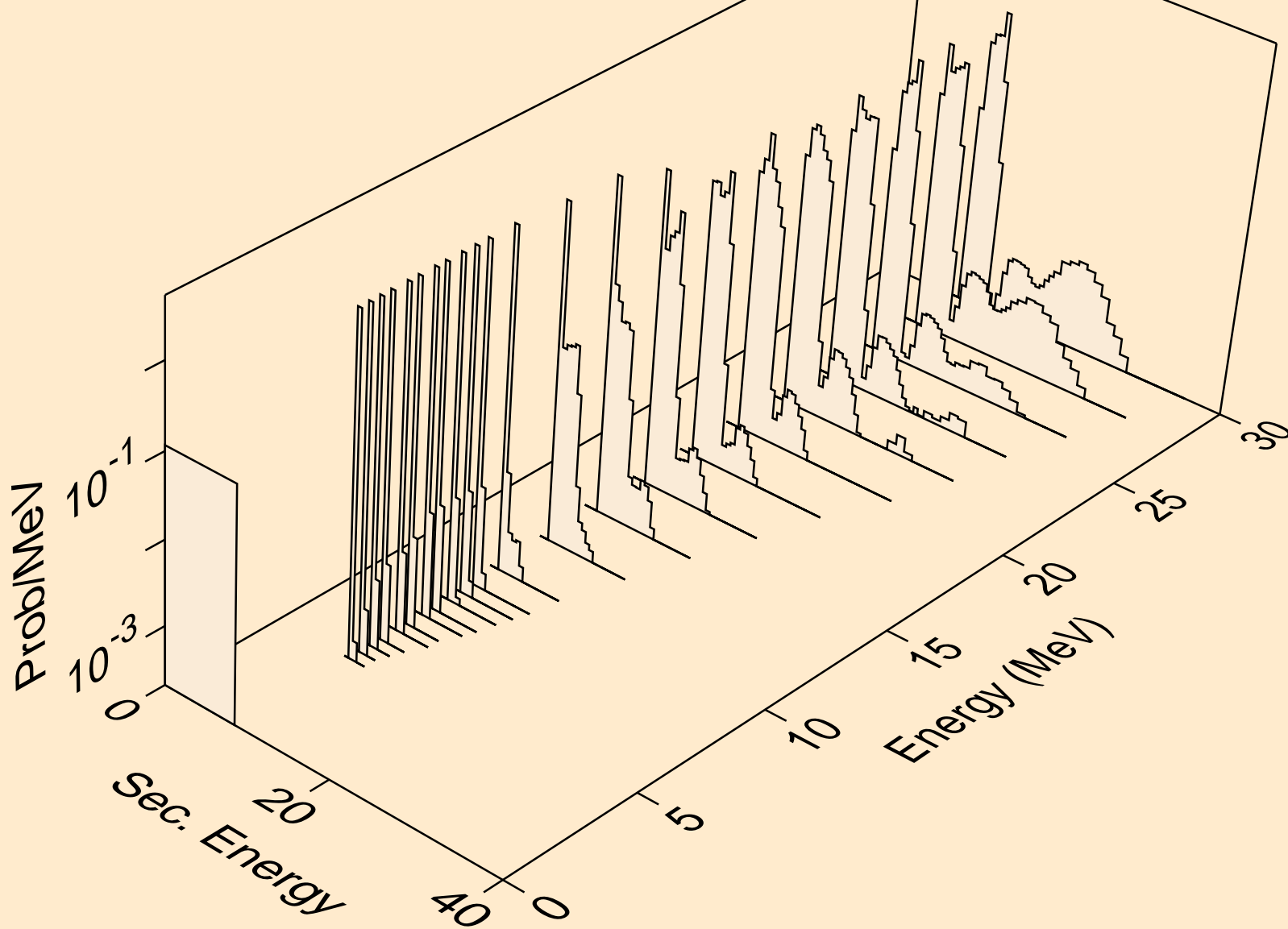

DB257 NEUTRON ACER TENDL-2019 LIBRARY; T=293.16K
alphas from (n,a)

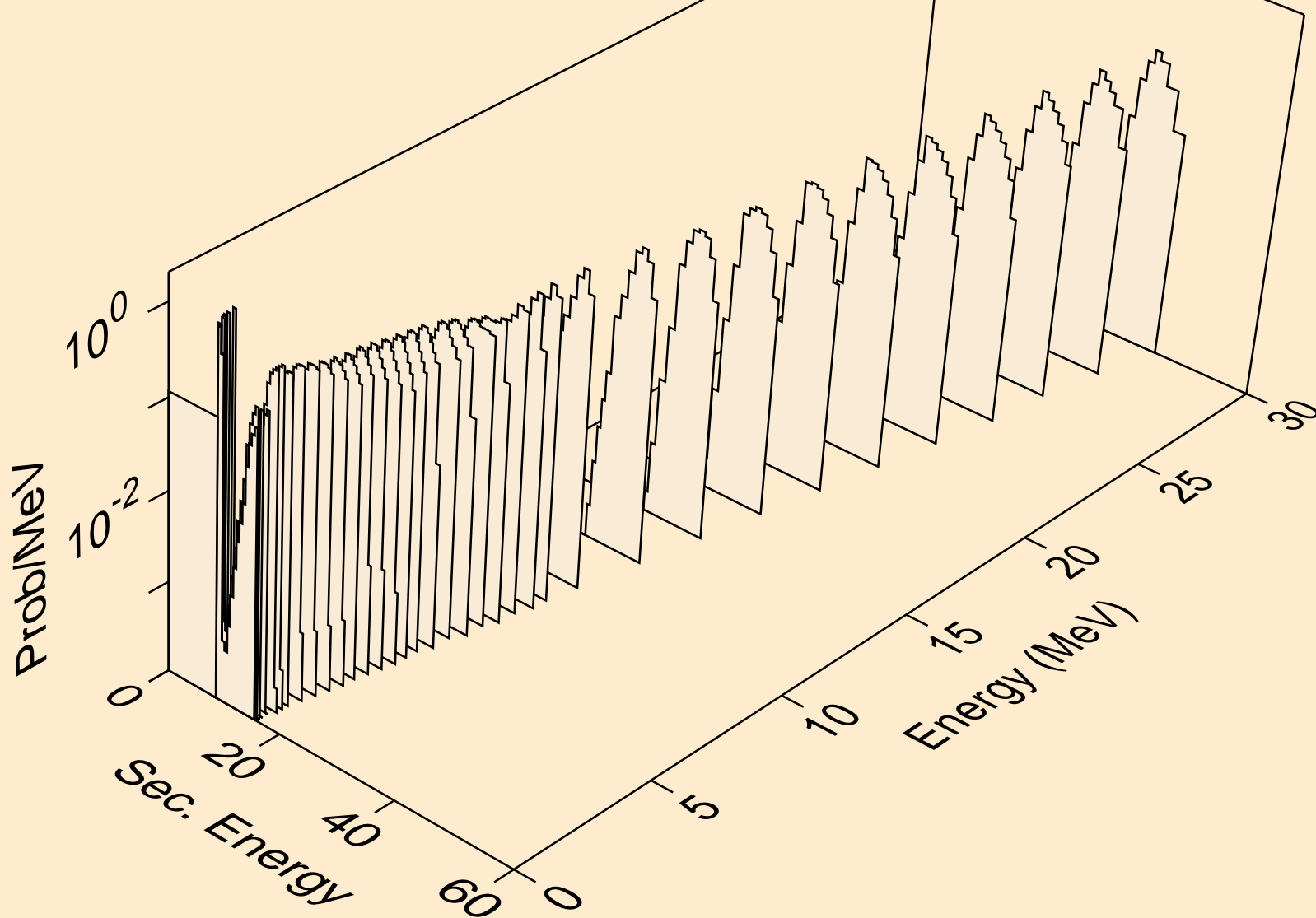

DB257 NEUTRON ACER TENDL-2019 LIBRARY; T=293.16K
alphas from (n,2a)

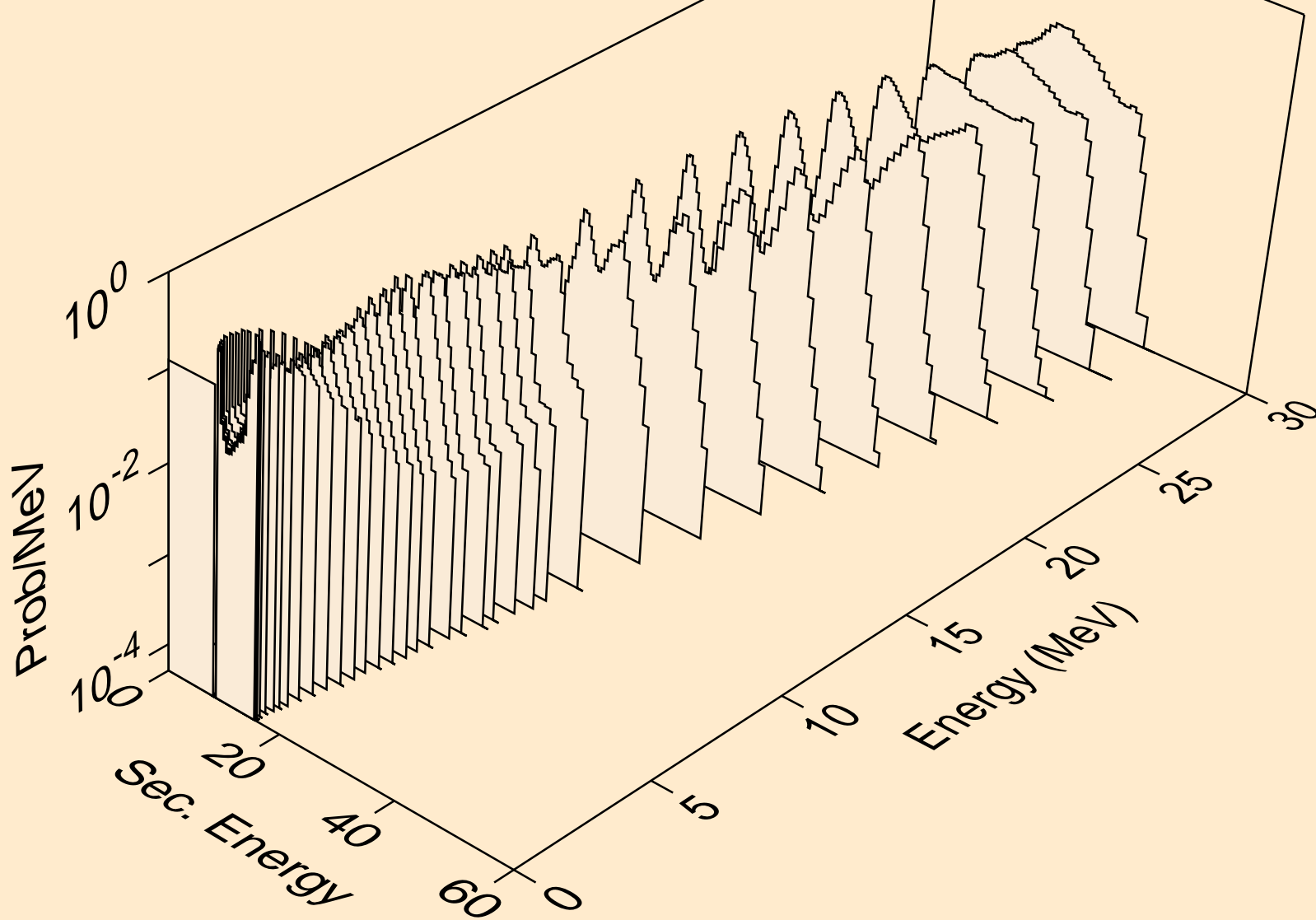

DB257 NEUTRON ACER TENDL-2019 LIBRARY; T=293.16K
alphas from (n,p)

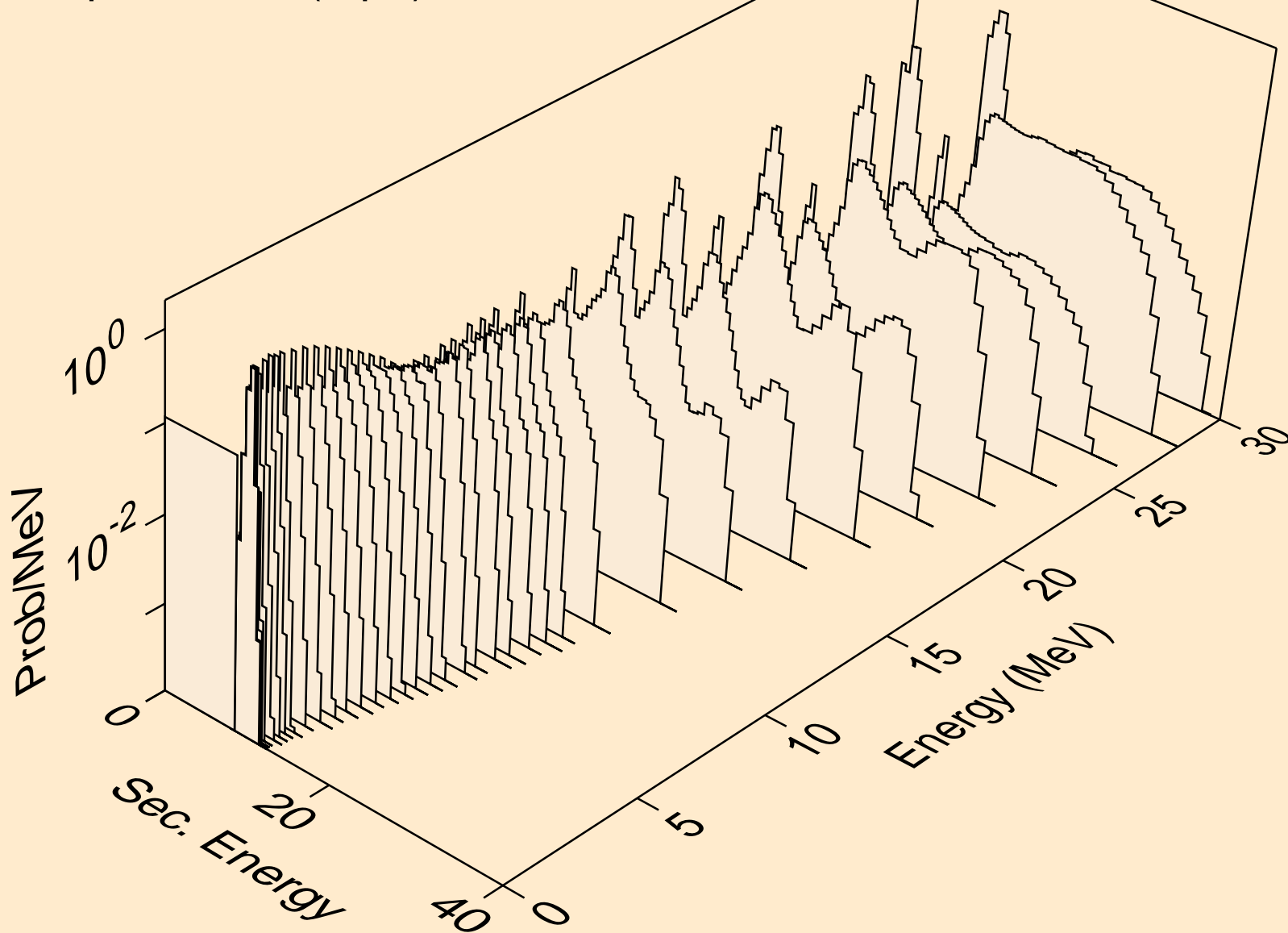

DB257 NEUTRON ACER TENDL-2019 LIBRARY; T=293.16K
alphas from (n,t2a)

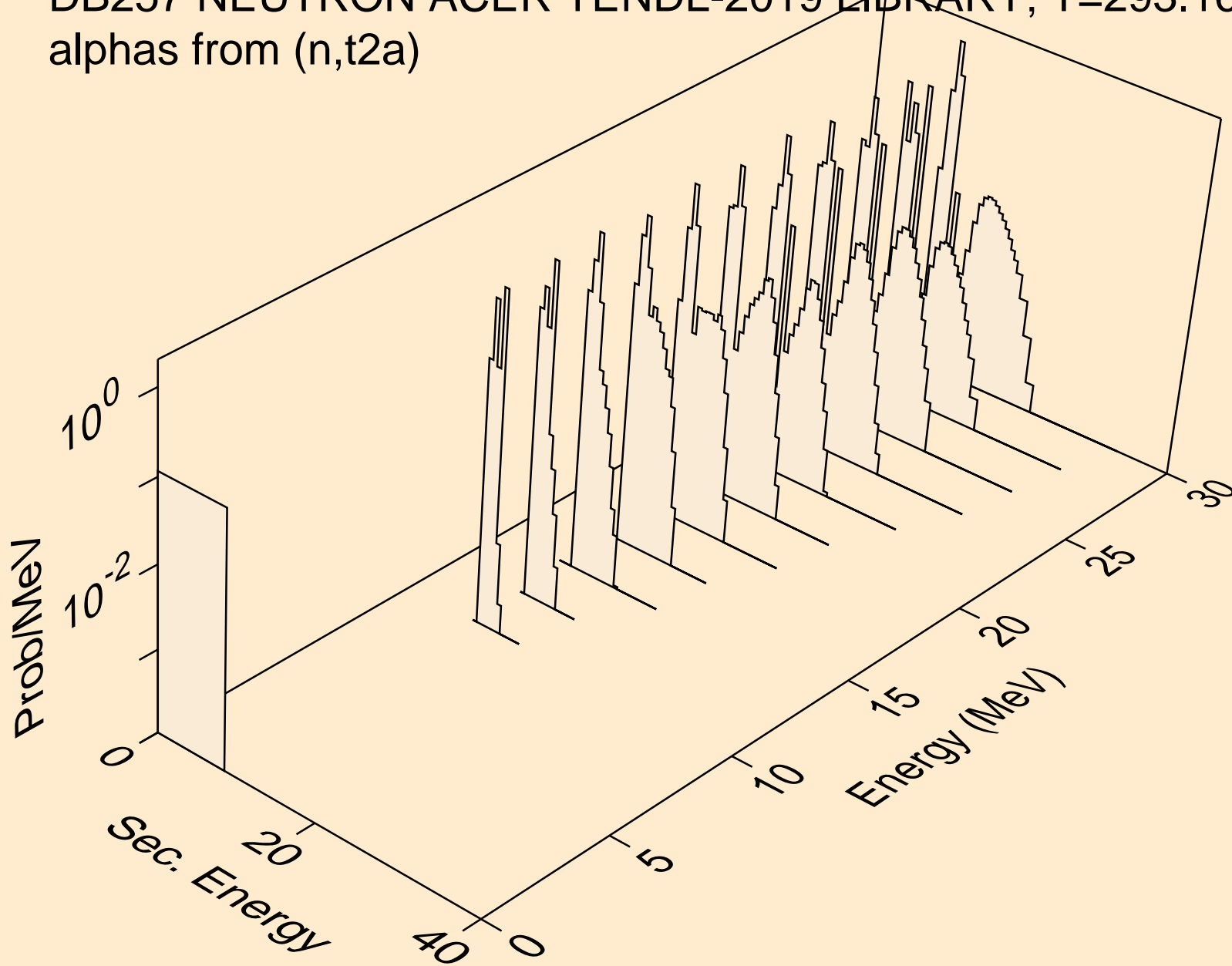

DB257 NEUTRON ACER TENDL-2019 LIBRARY; T=293.16K
alphas from (n,d2a)

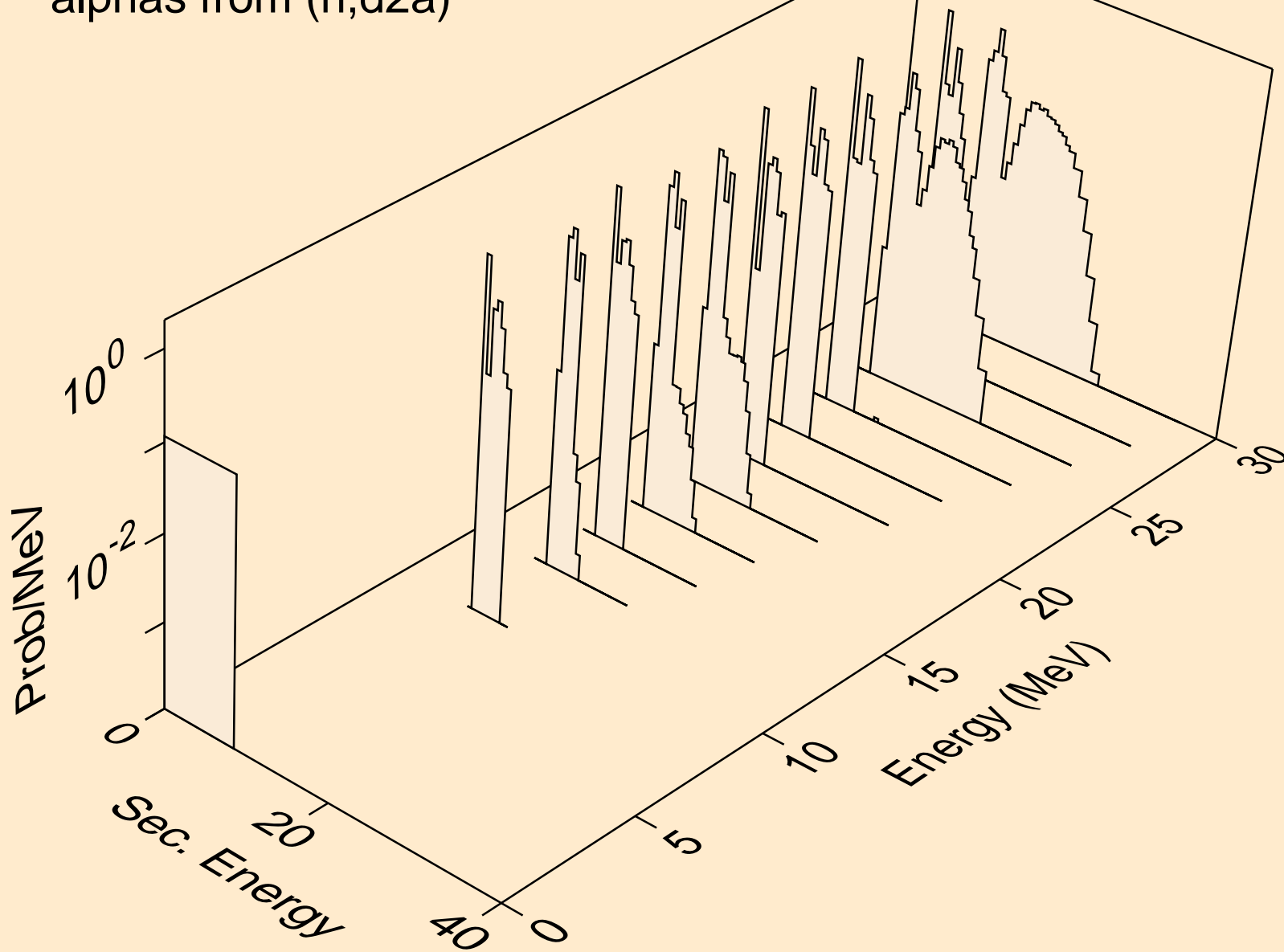

DB257 NEUTRON ACER TENDL-2019 LIBRARY; T=293.16K
alphas from (n,da)

