

DB266 NEUTRON ACER TENDL-2019 LIBRARY; T=293.16K
Principal cross sections

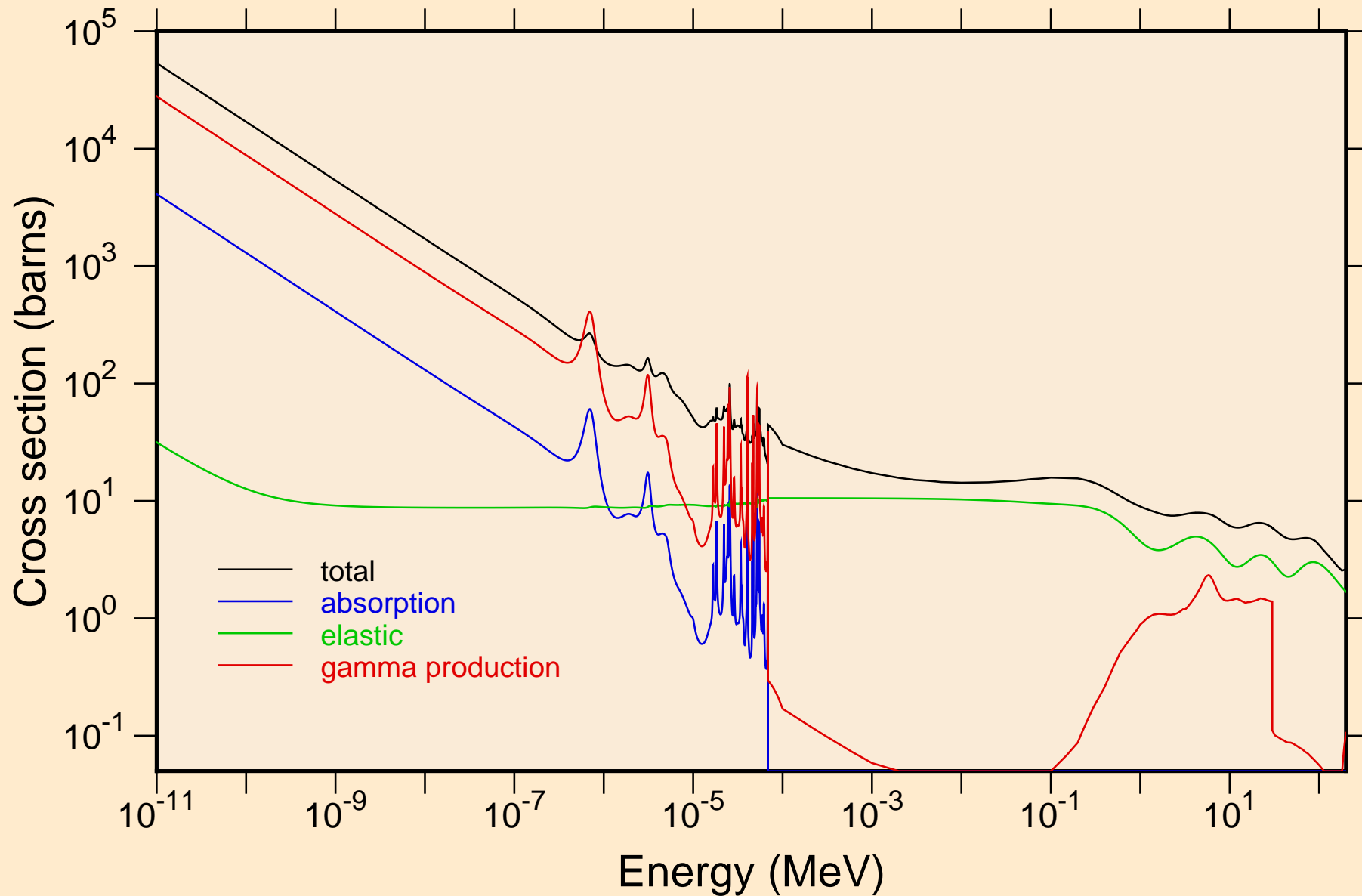

DB266 NEUTRON ACER TENDL-2019 LIBRARY; T=293.16K
resonance total cross section

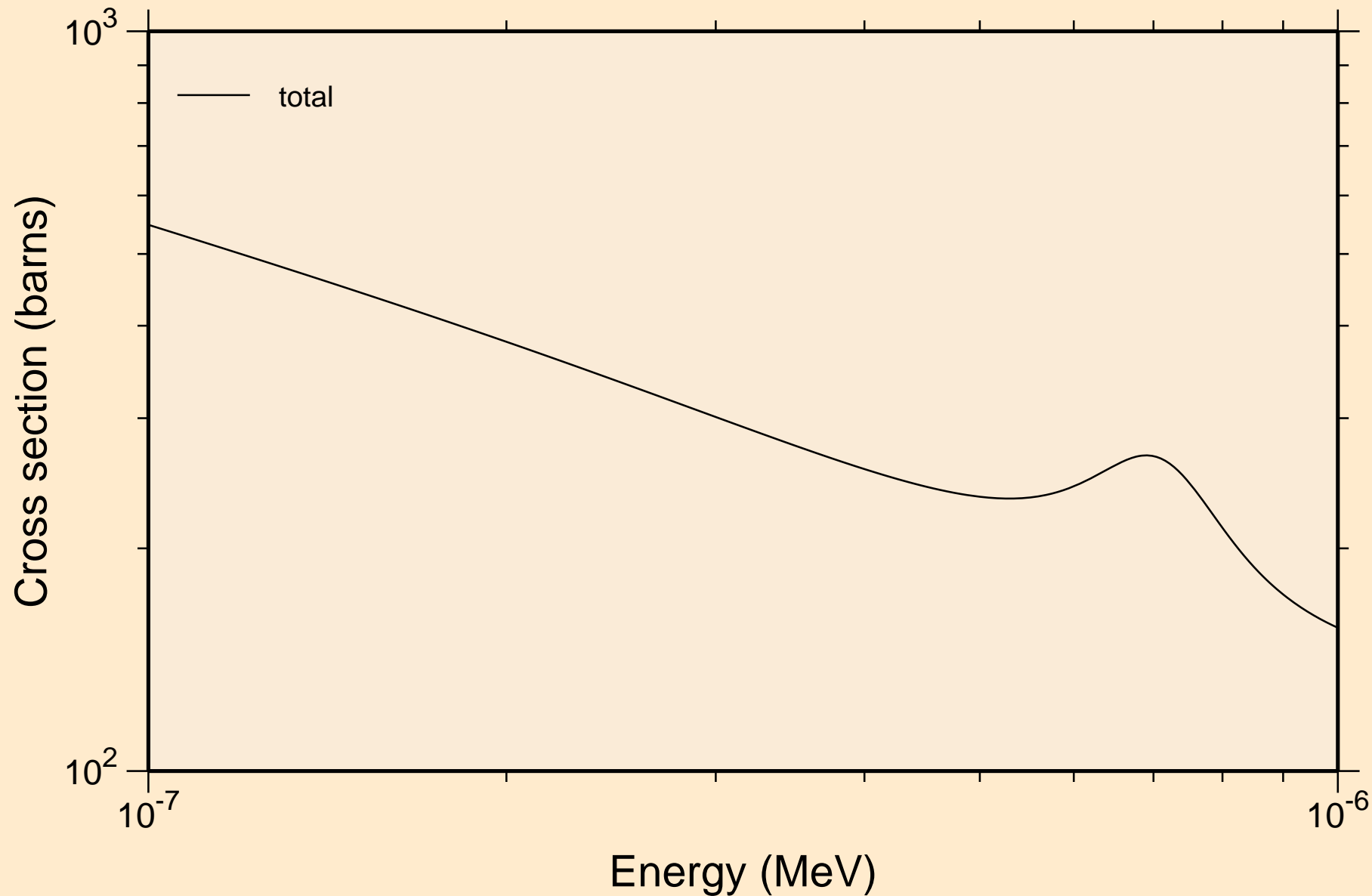

DB266 NEUTRON ACER TENDL-2019 LIBRARY; T=293.16K
resonance total cross section

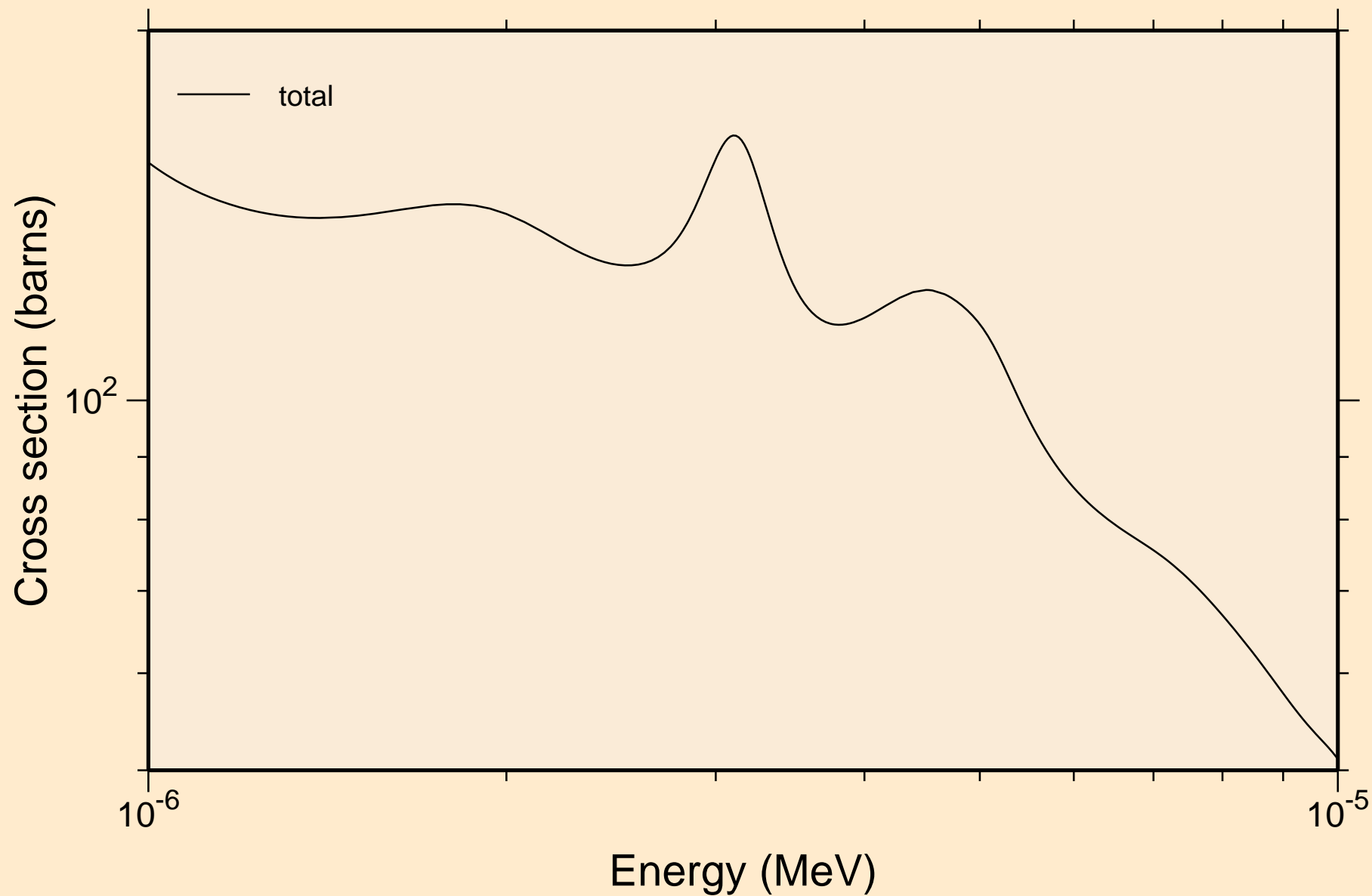

DB266 NEUTRON ACER TENDL-2019 LIBRARY; T=293.16K
resonance total cross section

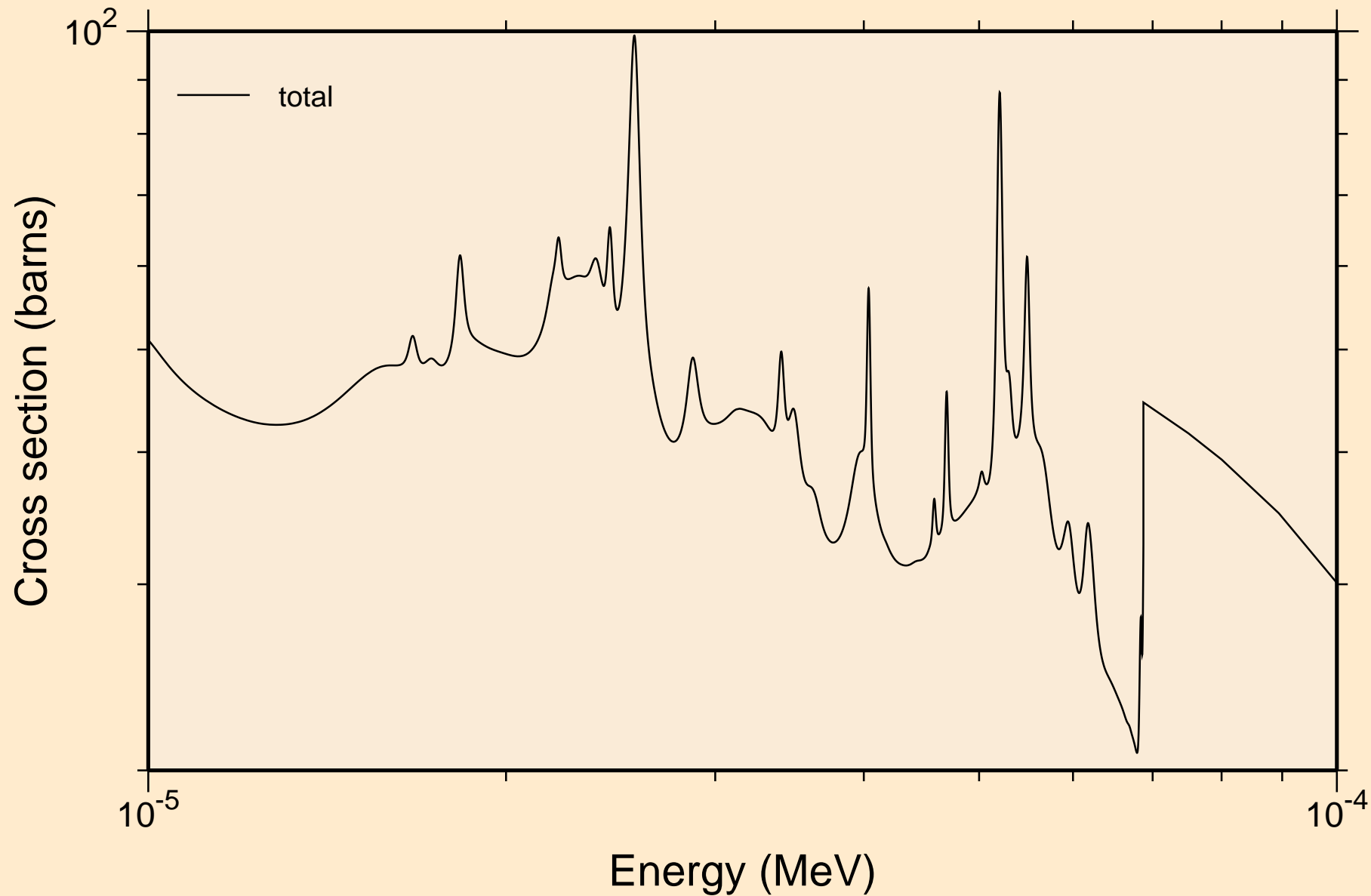

DB266 NEUTRON ACER TENDL-2019 LIBRARY; T=293.16K
resonance total cross section

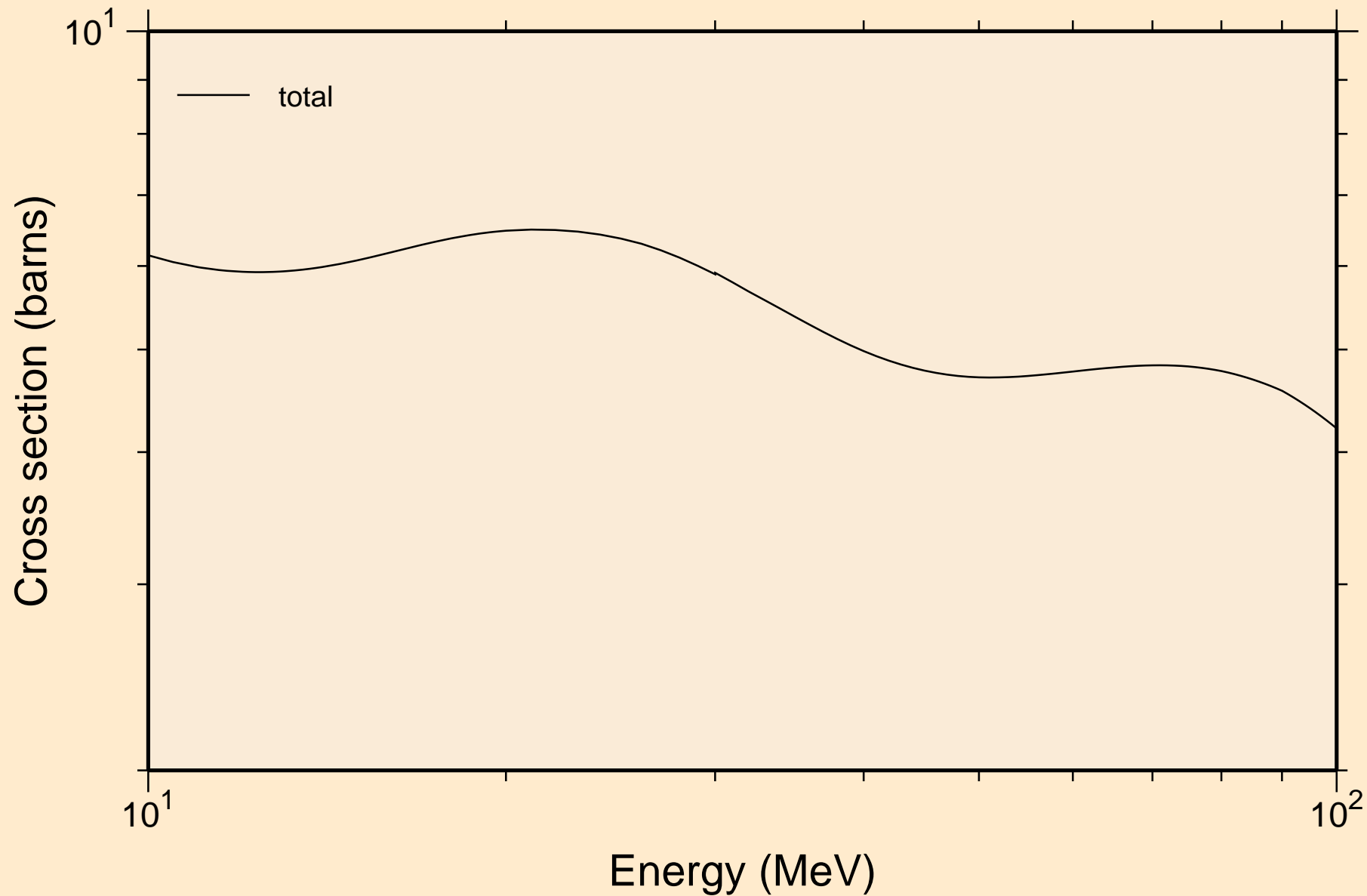

DB266 NEUTRON ACER TENDL-2019 LIBRARY; T=293.16K
resonance absorption cross sections

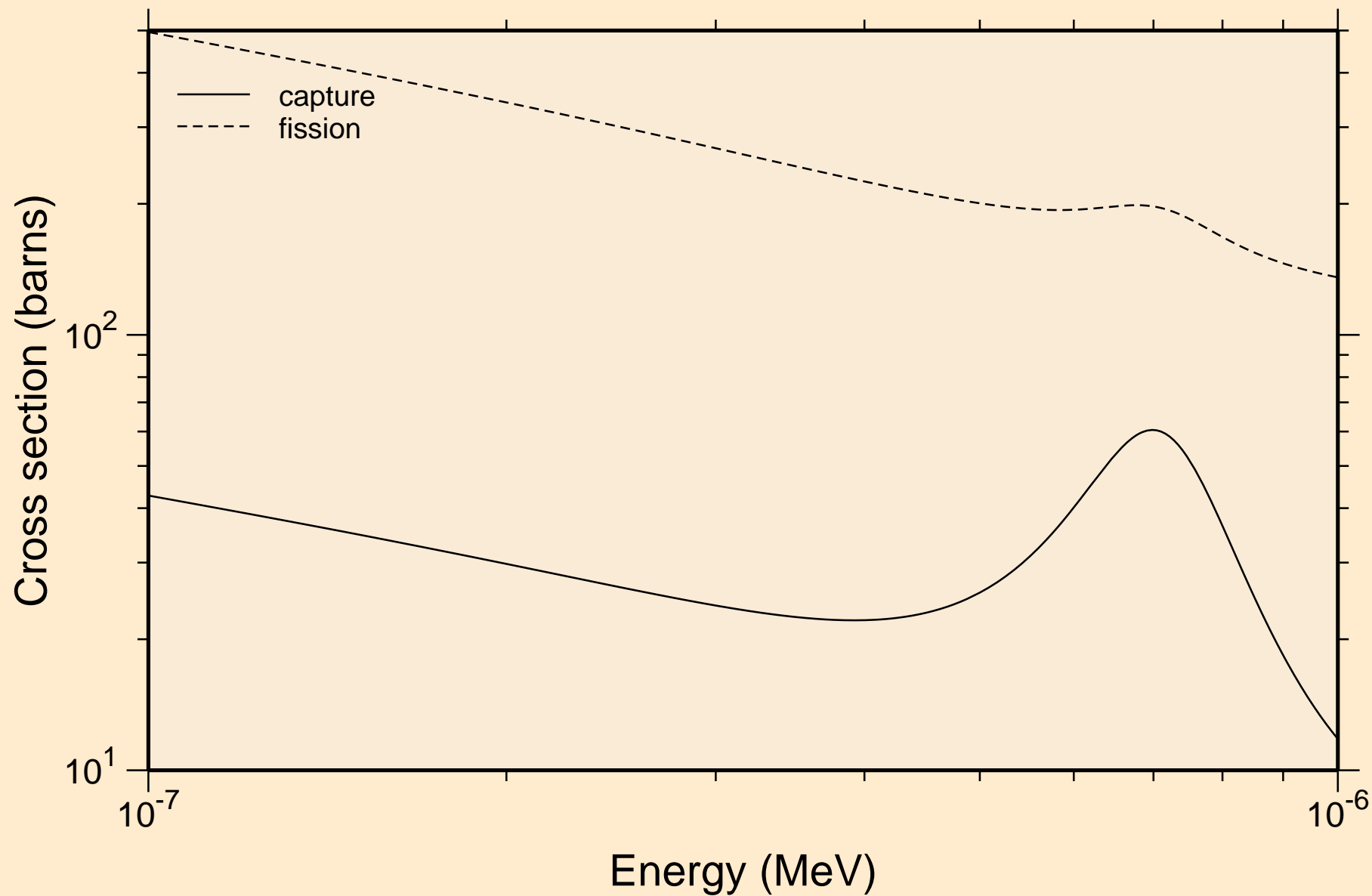

DB266 NEUTRON ACER TENDL-2019 LIBRARY; T=293.16K
resonance absorption cross sections

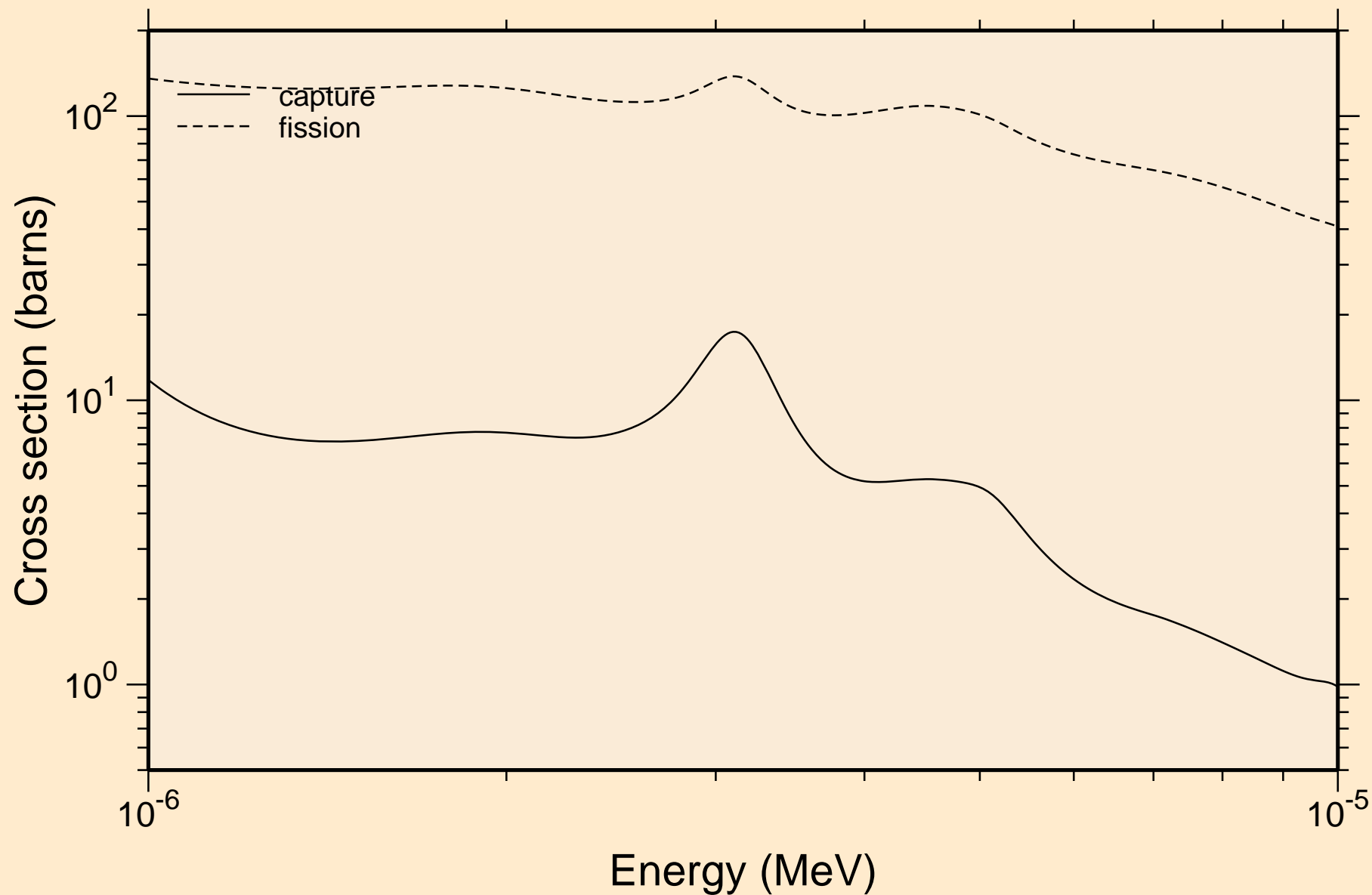

DB266 NEUTRON ACER TENDL-2019 LIBRARY; T=293.16K
resonance absorption cross sections

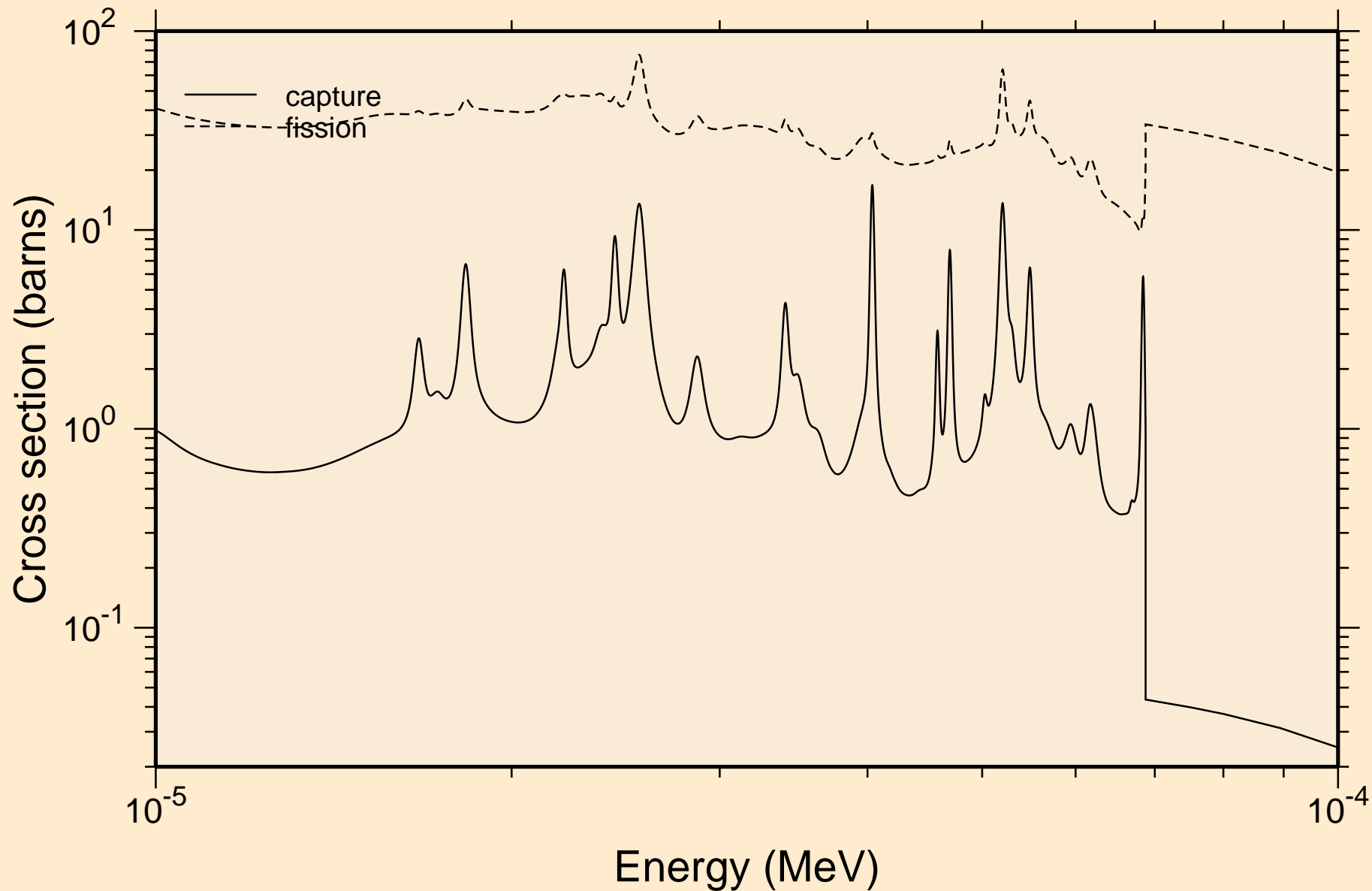

DB266 NEUTRON ACER TENDL-2019 LIBRARY; T=293.16K
resonance absorption cross sections

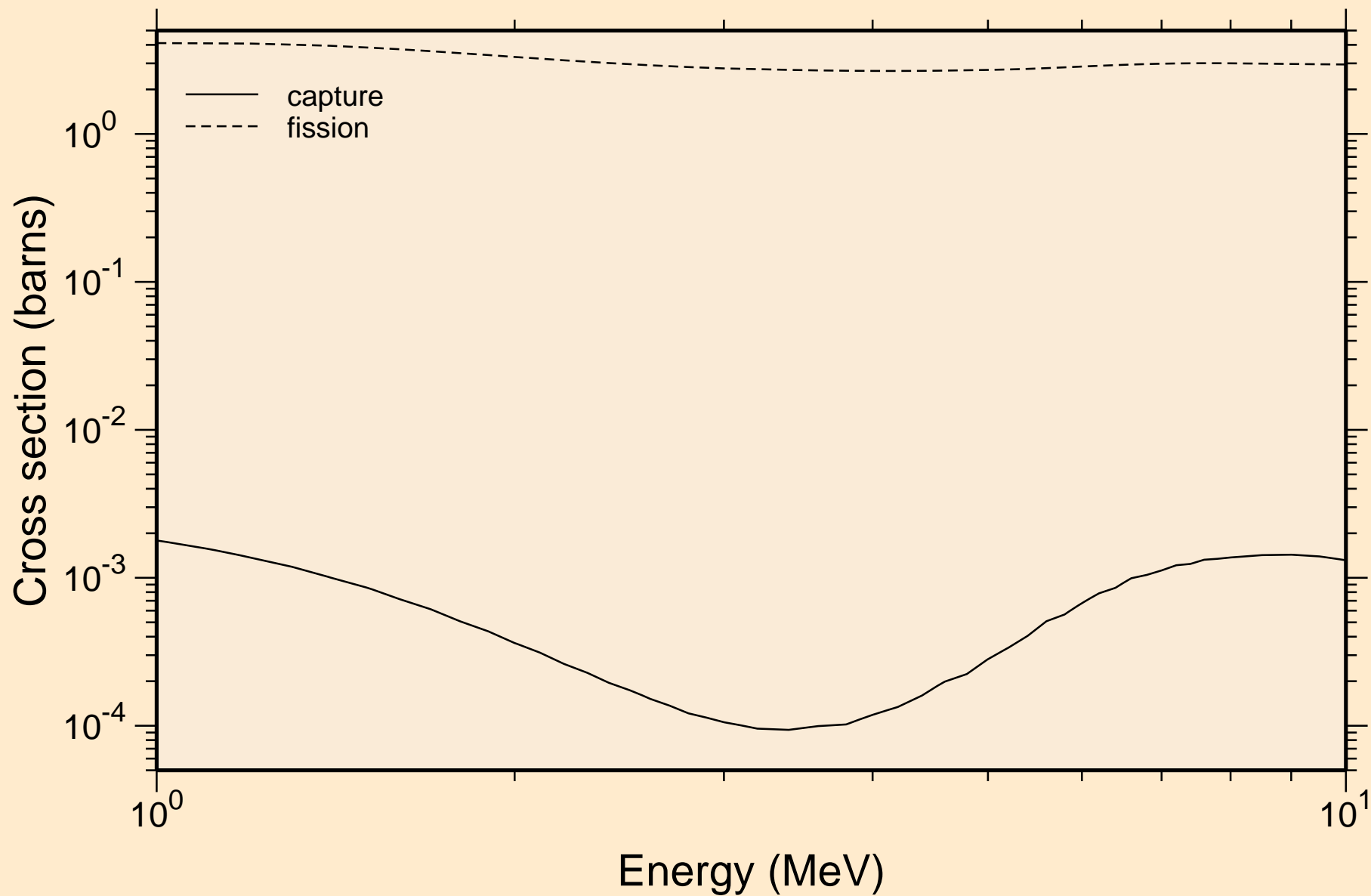

DB266 NEUTRON ACER TENDL-2019 LIBRARY; T=293.16K
Heating

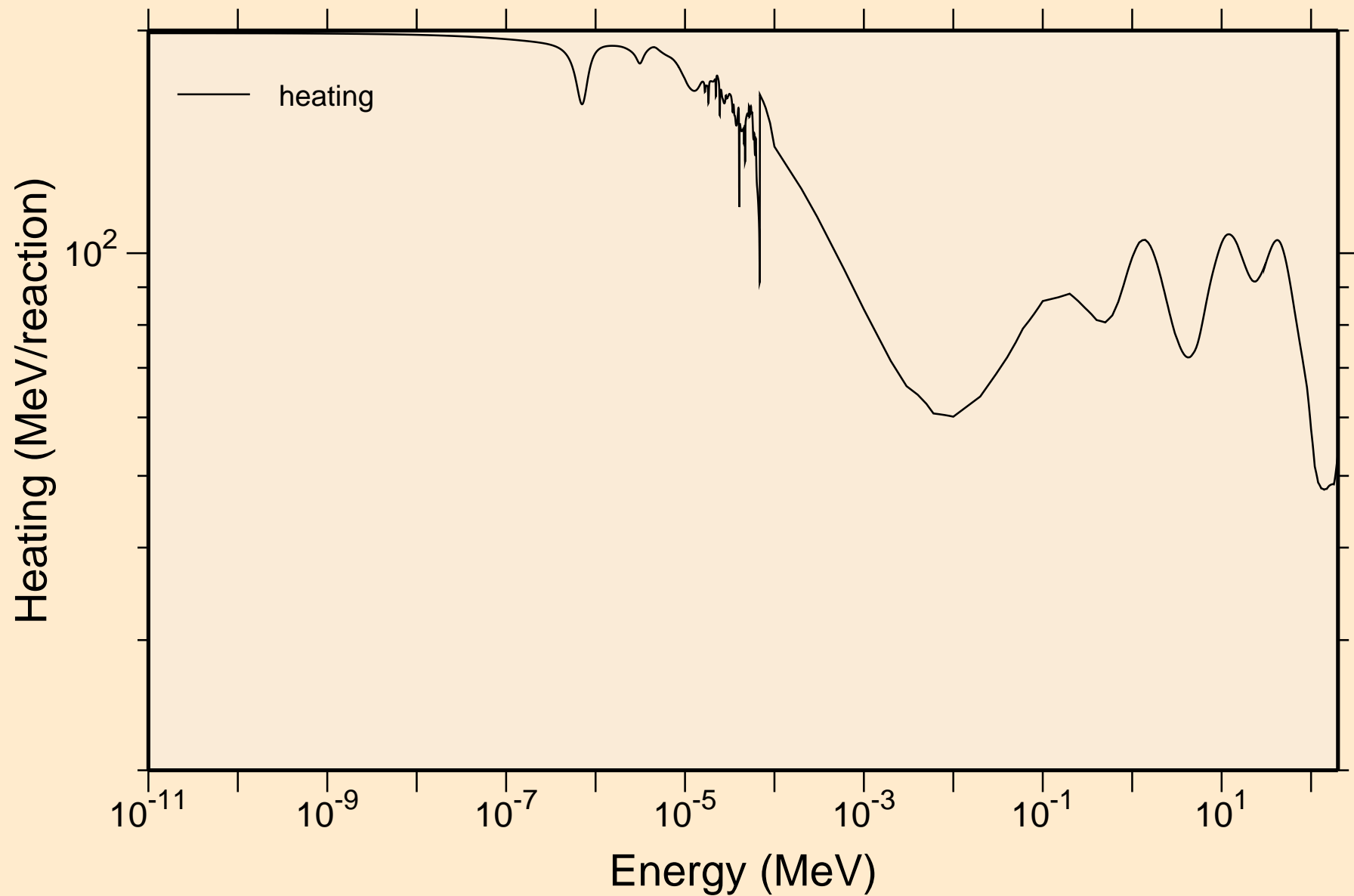

DB266 NEUTRON ACER TENDL-2019 LIBRARY; T=293.16K
Damage

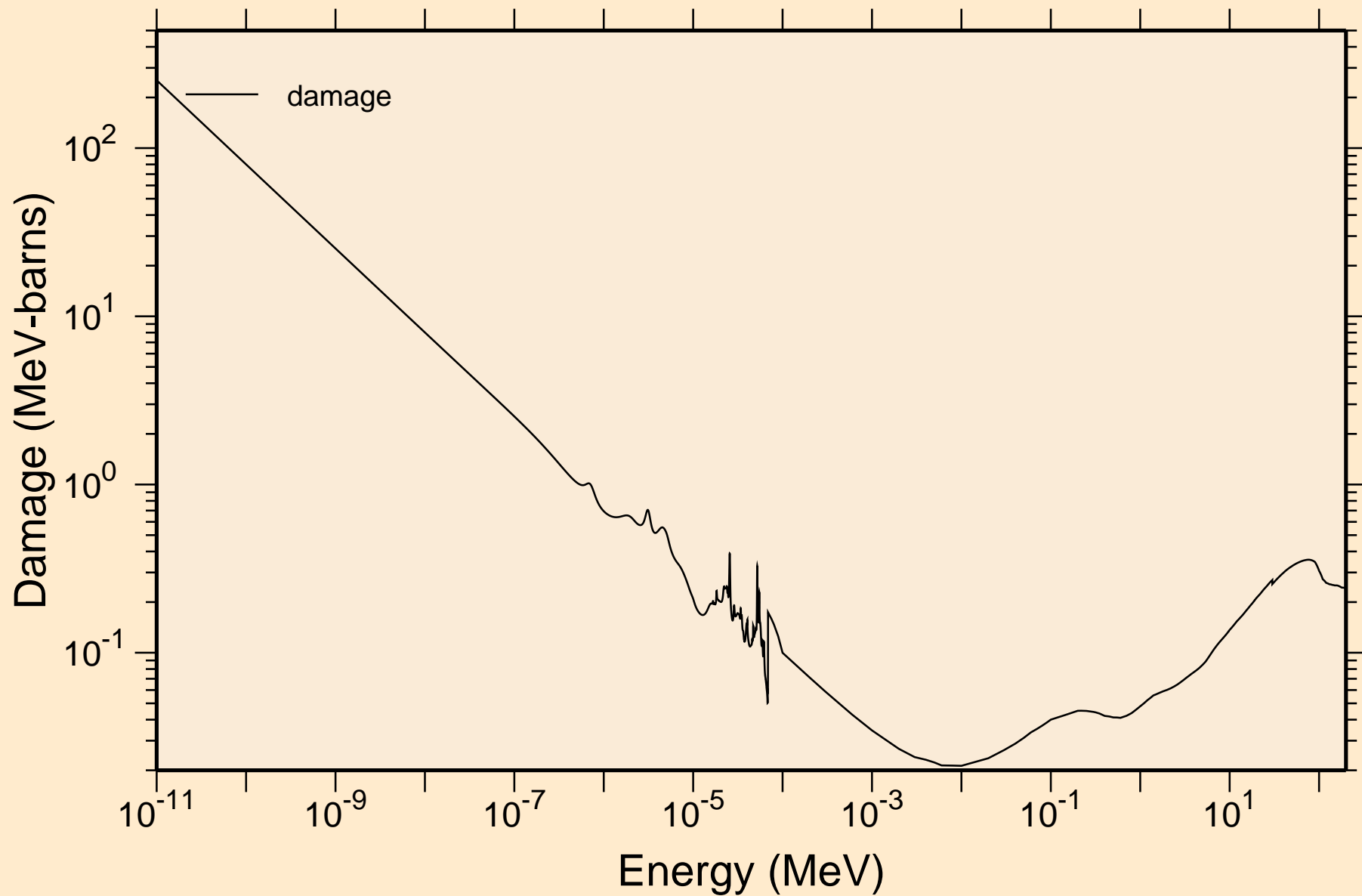

DB266 NEUTRON ACER TENDL-2019 LIBRARY; T=293.16K
Non-threshold reactions

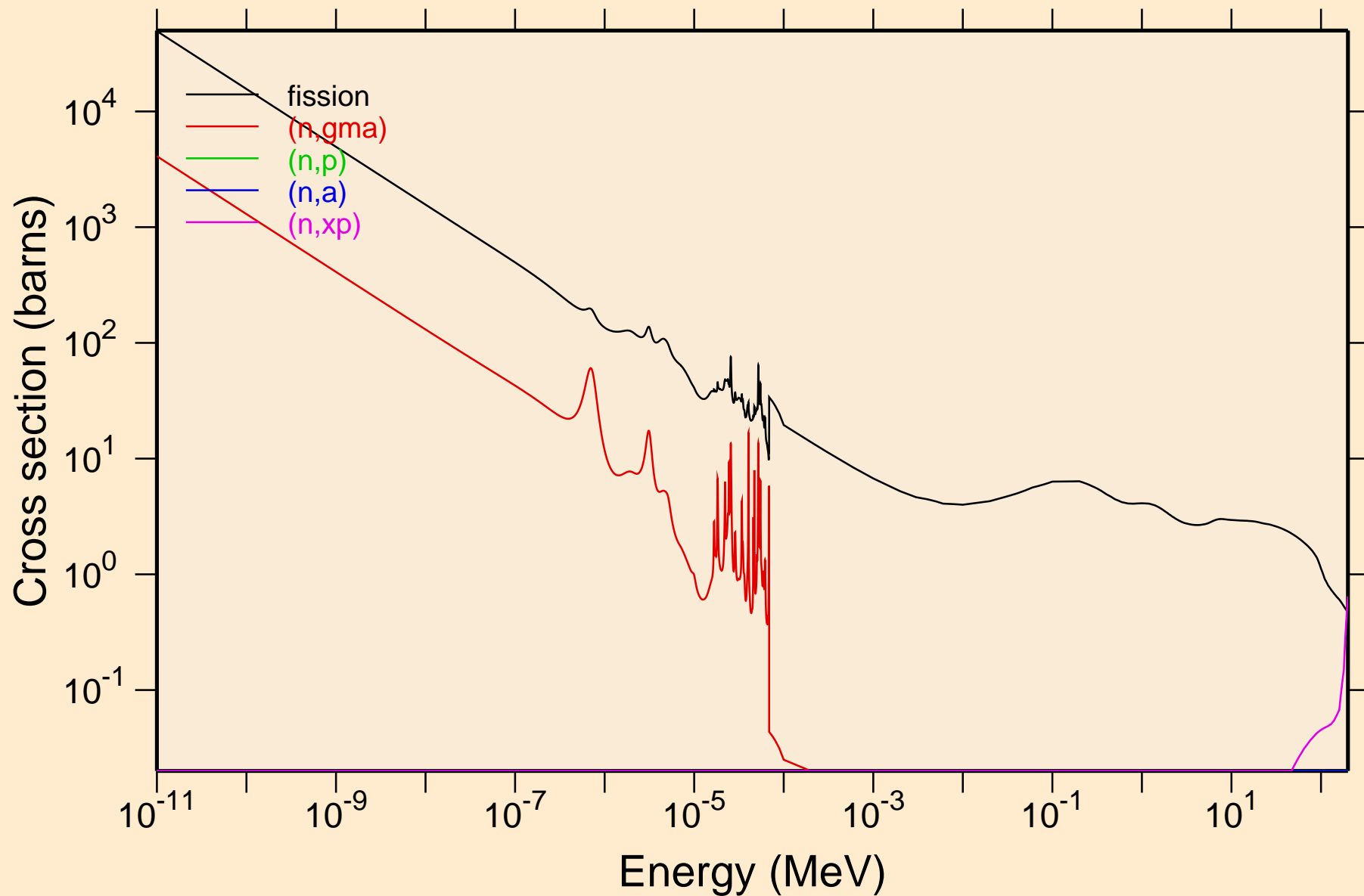

DB266 NEUTRON ACER TENDL-2019 LIBRARY; T=293.16K
Non-threshold reactions

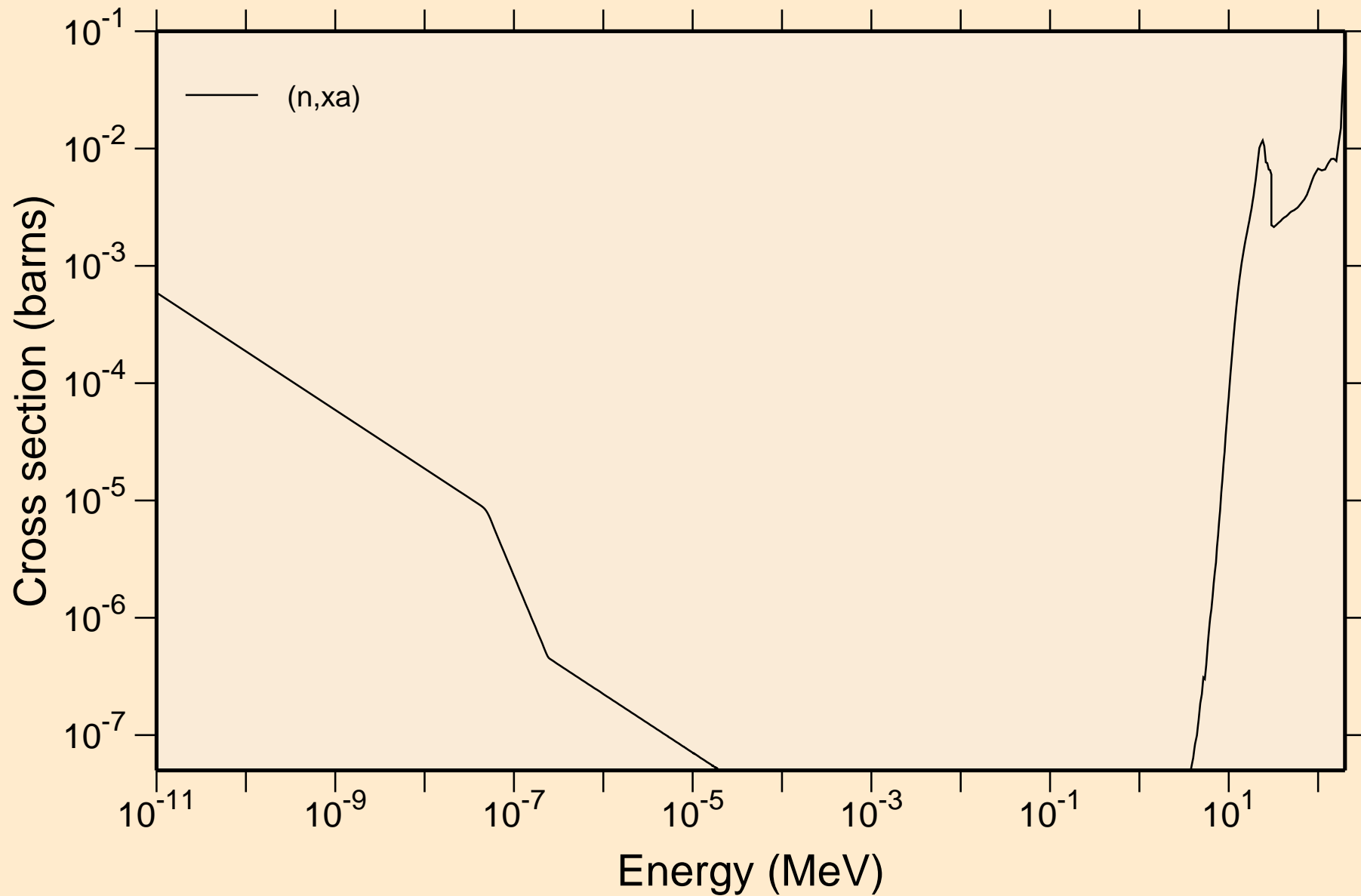

DB266 NEUTRON ACER TENDL-2019 LIBRARY; T=293.16K
Principal cross sections

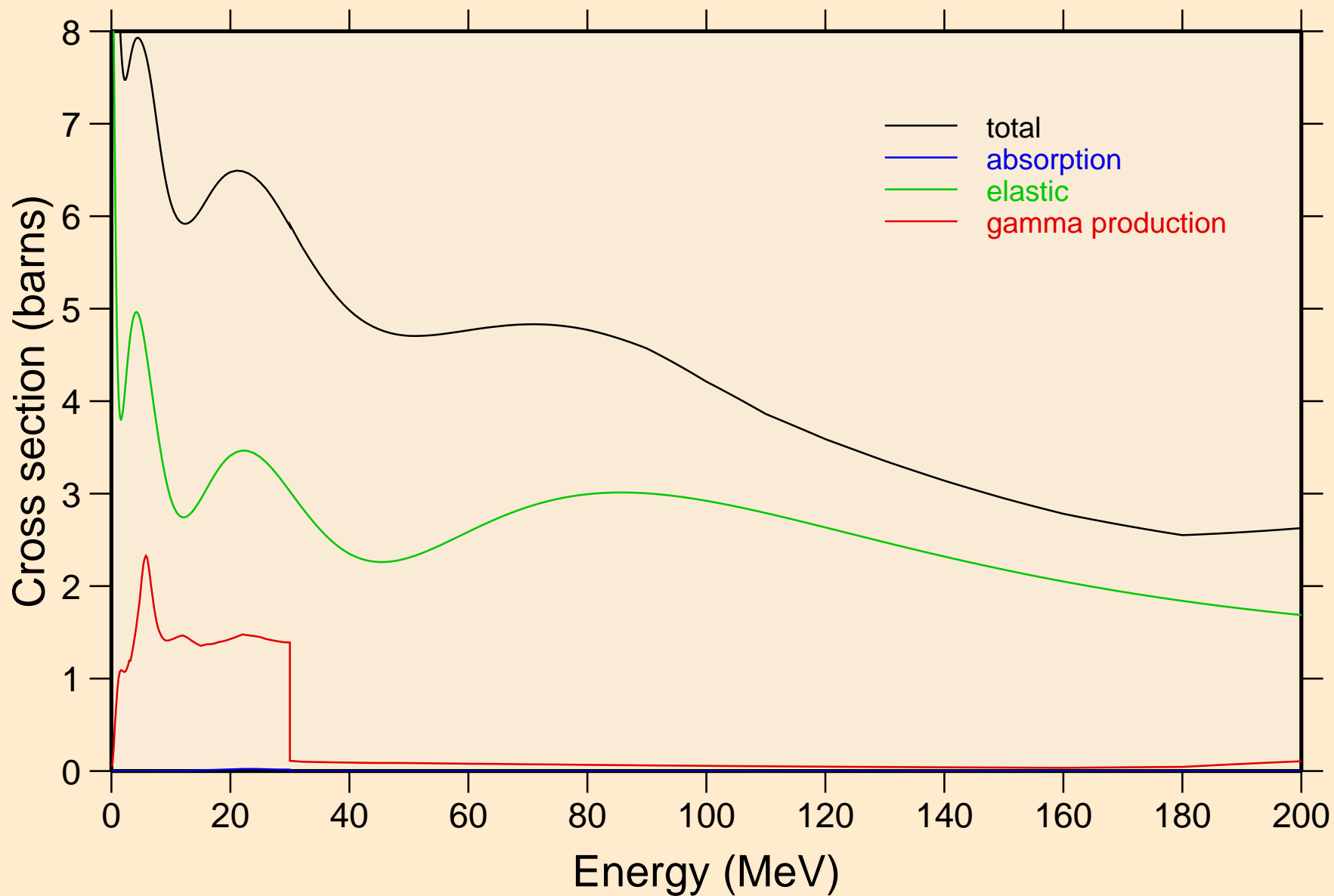

DB266 NEUTRON ACER TENDL-2019 LIBRARY; T=293.16K
Heating

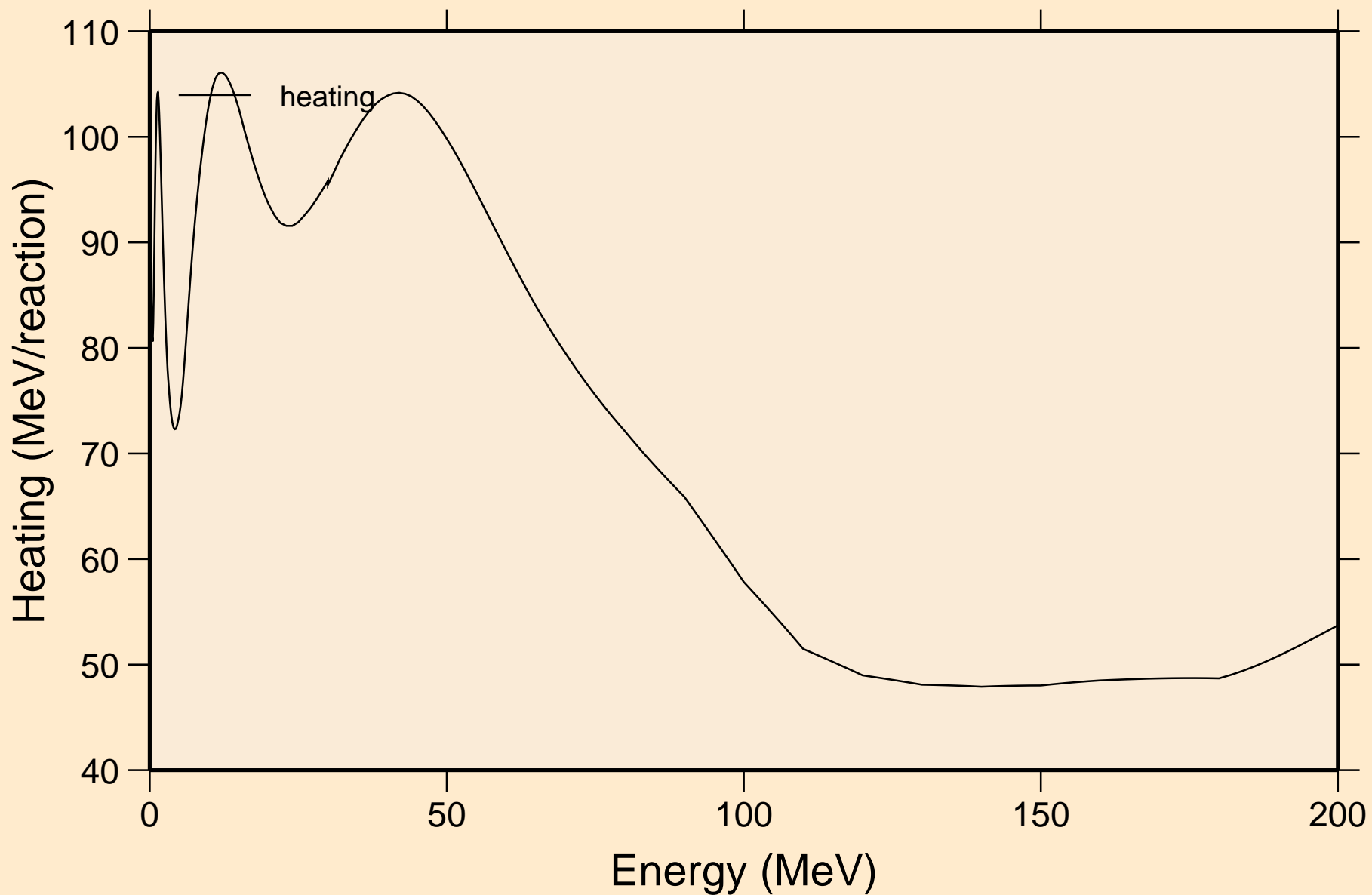

DB266 NEUTRON ACER TENDL-2019 LIBRARY; T=293.16K
Damage

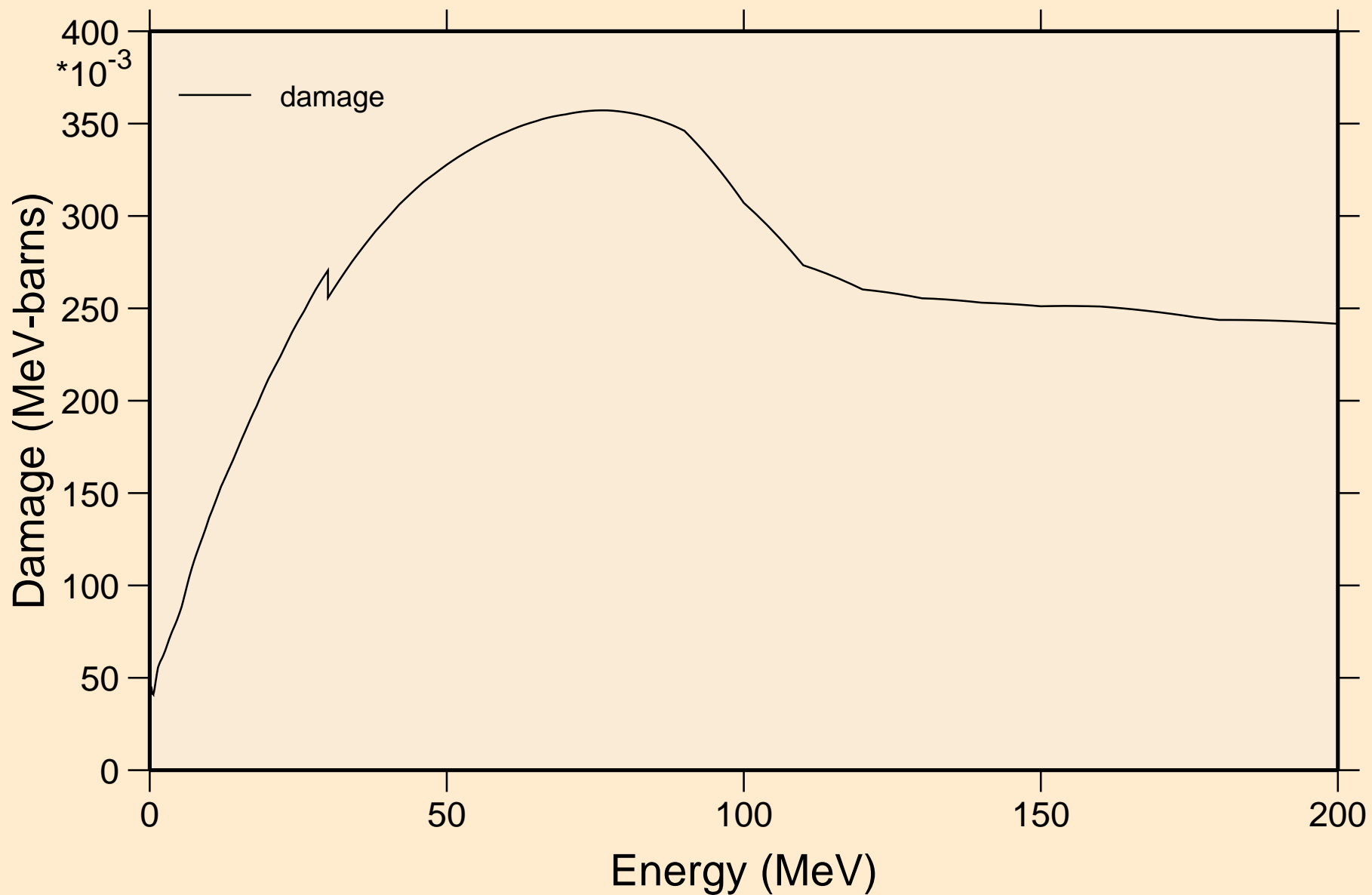

DB266 NEUTRON ACER TENDL-2019 LIBRARY; T=293.16K
Non-threshold reactions

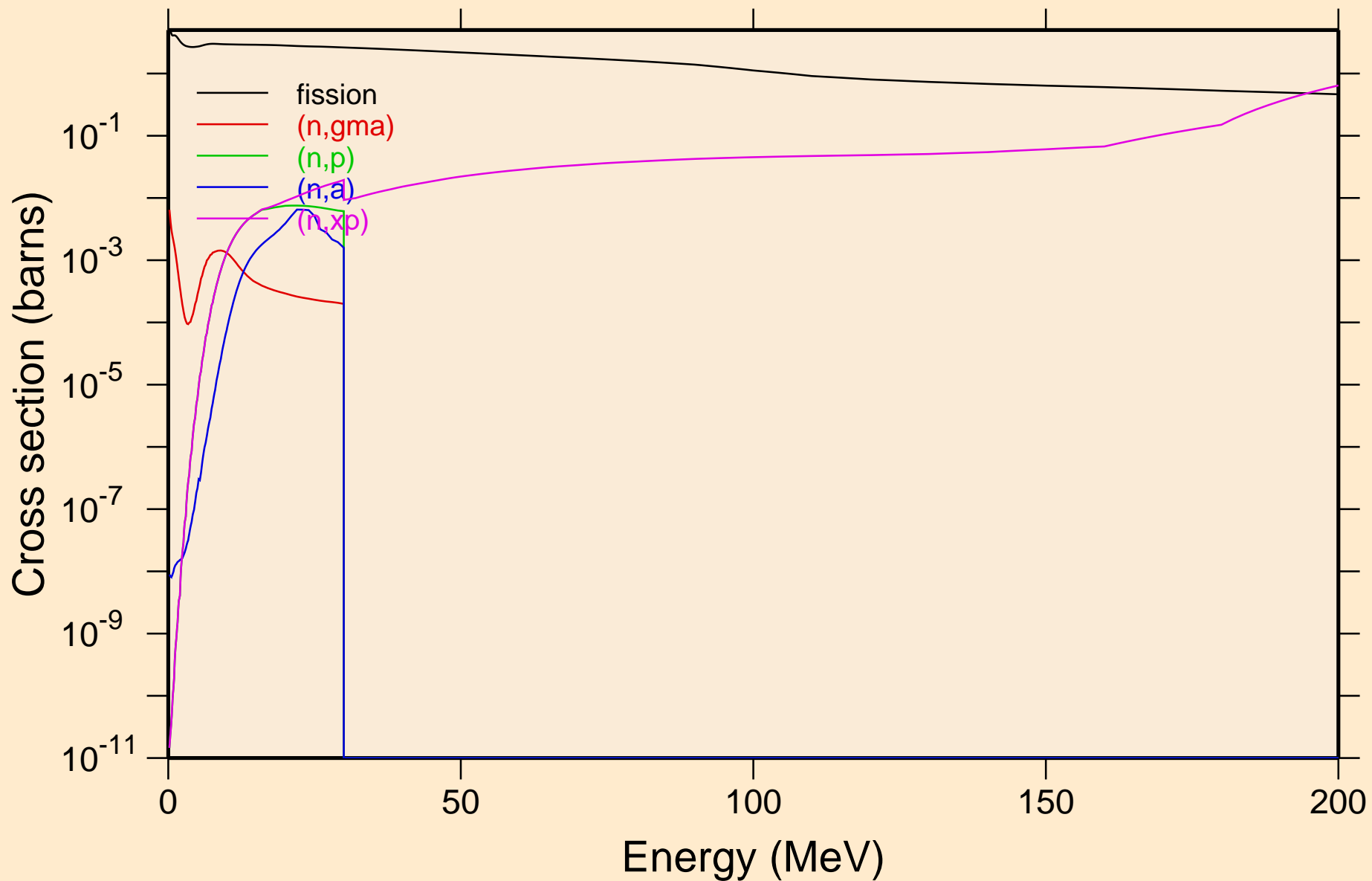

DB266 NEUTRON ACER TENDL-2019 LIBRARY; T=293.16K
Non-threshold reactions

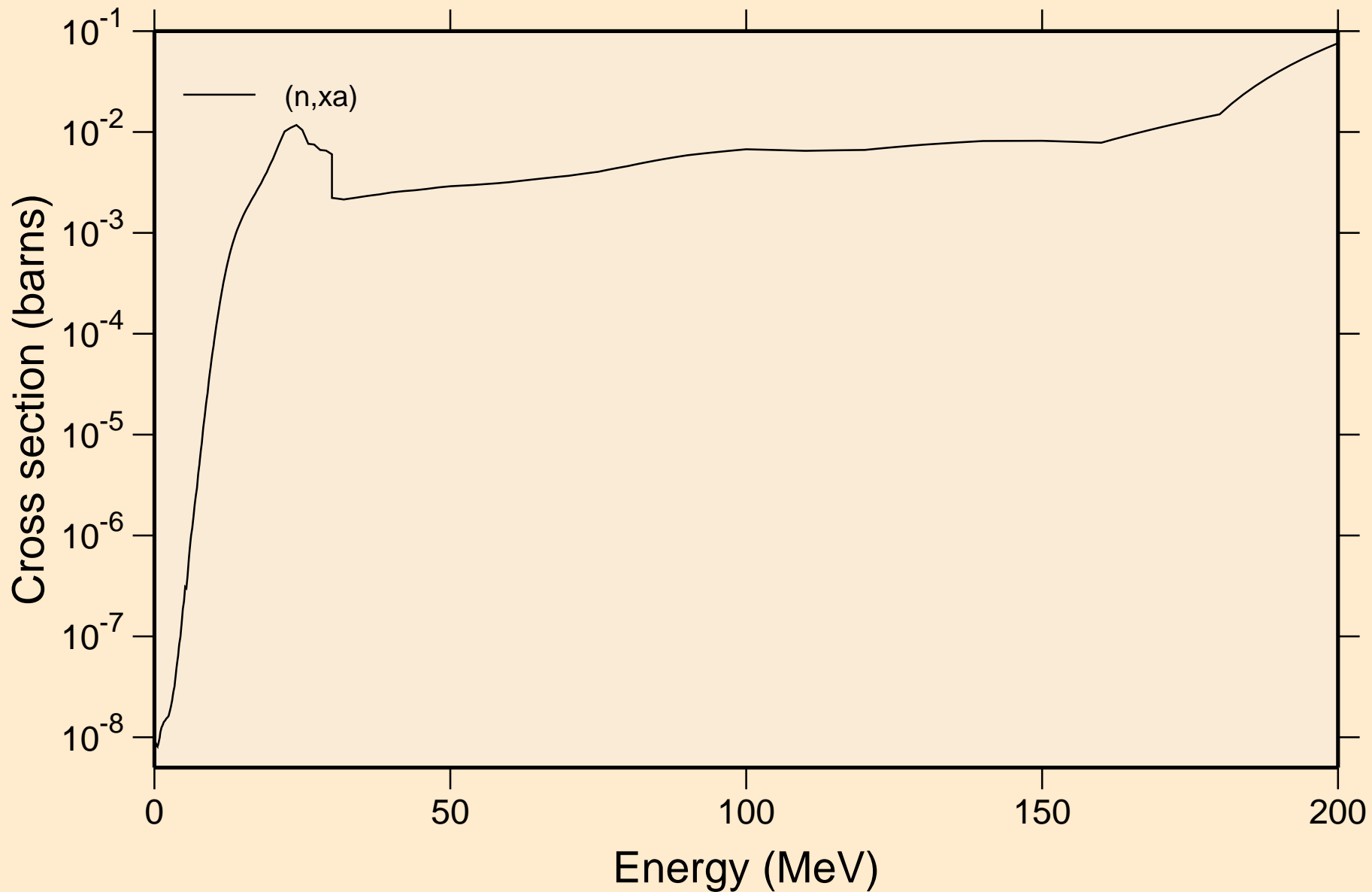

DB266 NEUTRON ACER TENDL-2019 LIBRARY; T=293.16K
Inelastic levels

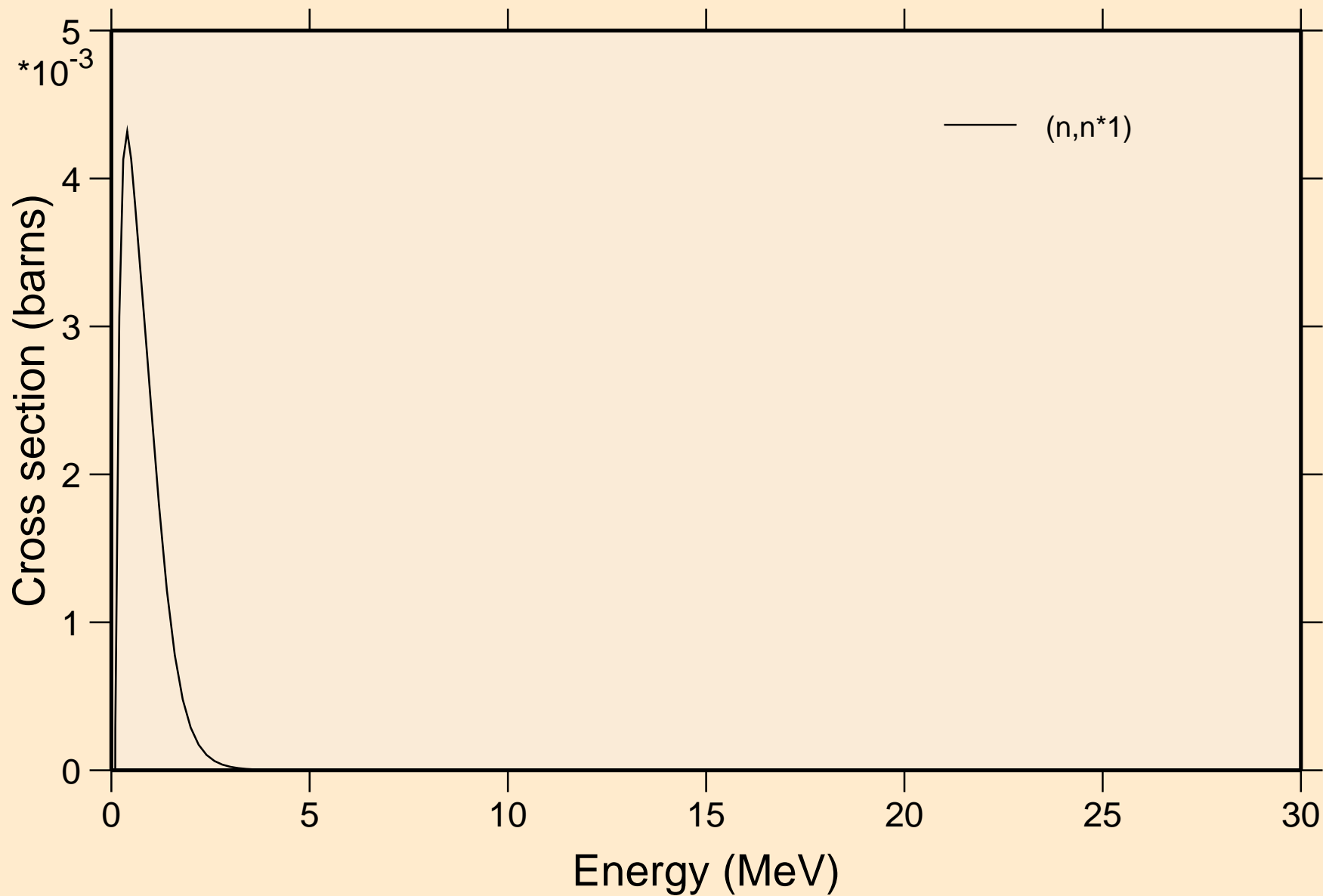

DB266 NEUTRON ACER TENDL-2019 LIBRARY; T=293.16K
Threshold reactions

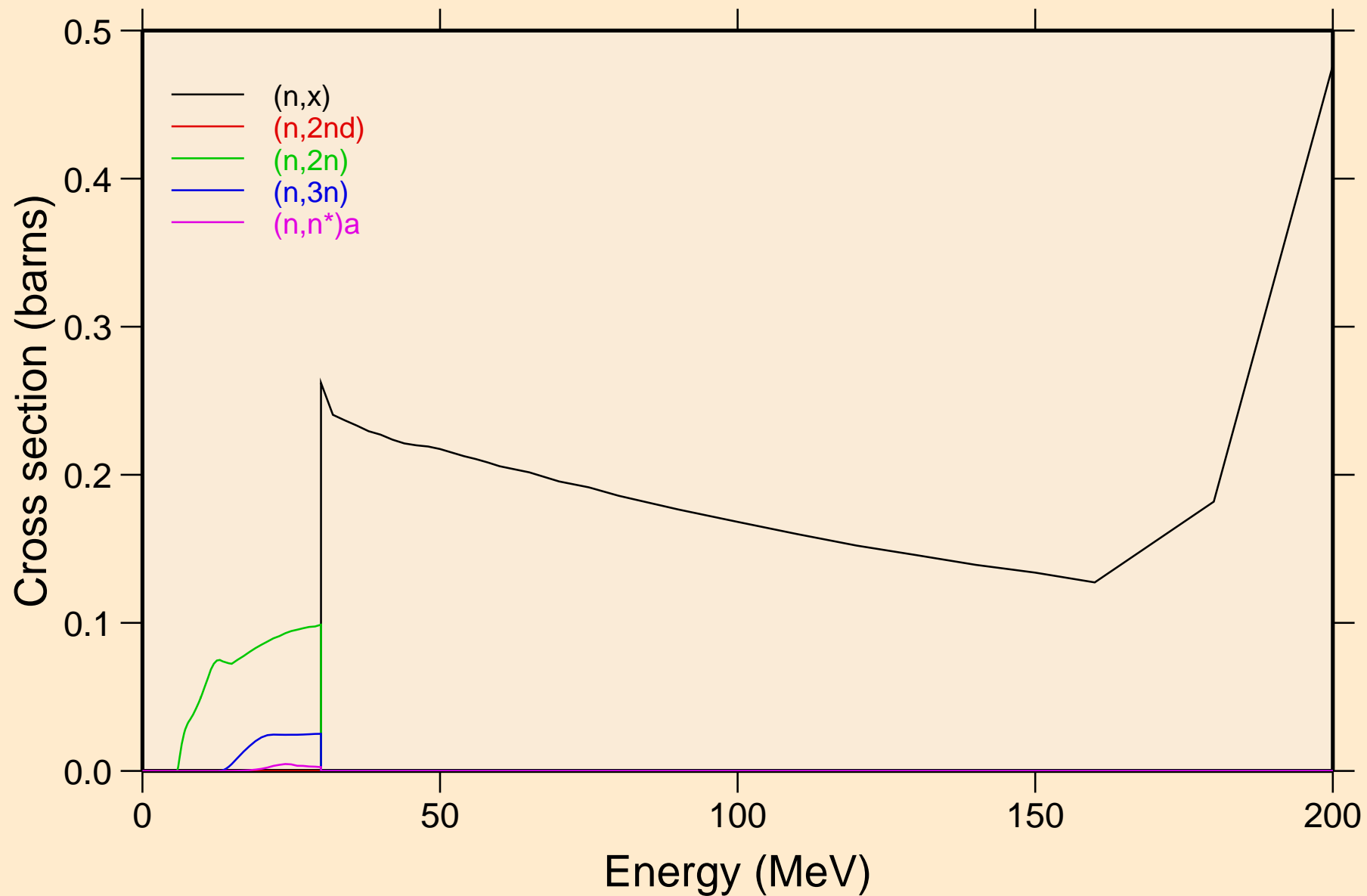

DB266 NEUTRON ACER TENDL-2019 LIBRARY; T=293.16K
Threshold reactions

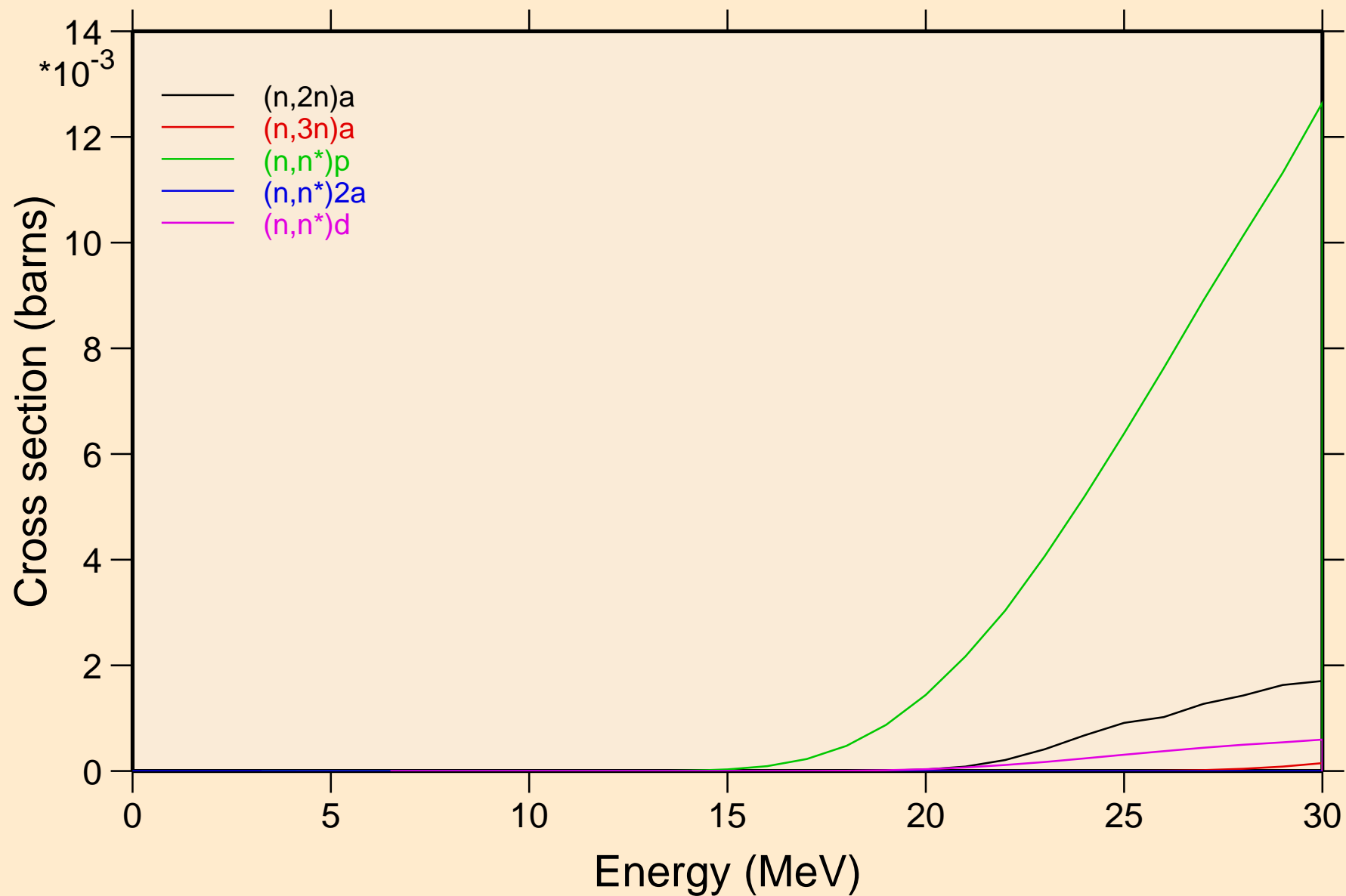

DB266 NEUTRON ACER TENDL-2019 LIBRARY; T=293.16K
Threshold reactions

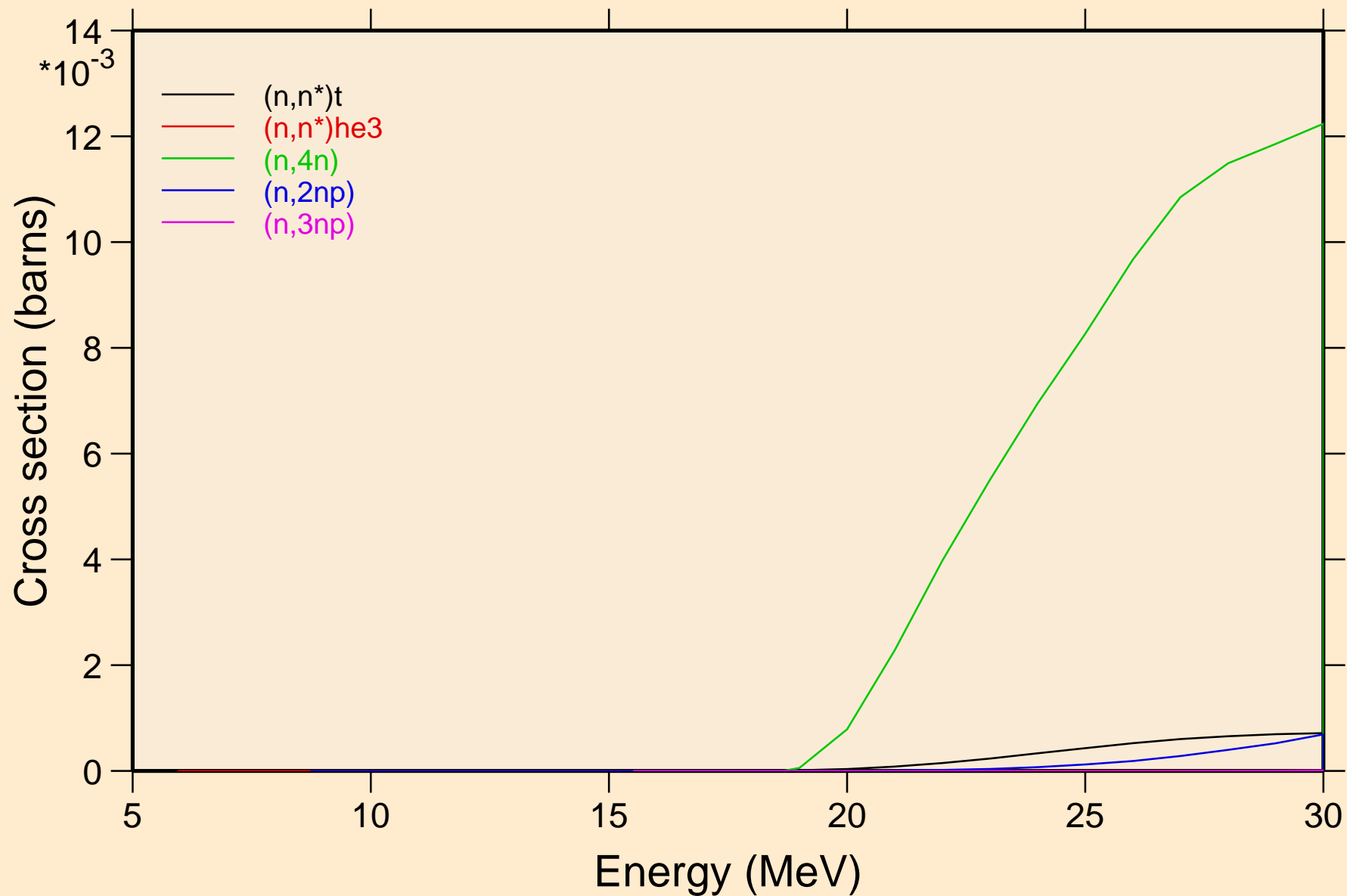

DB266 NEUTRON ACER TENDL-2019 LIBRARY; T=293.16K
Threshold reactions

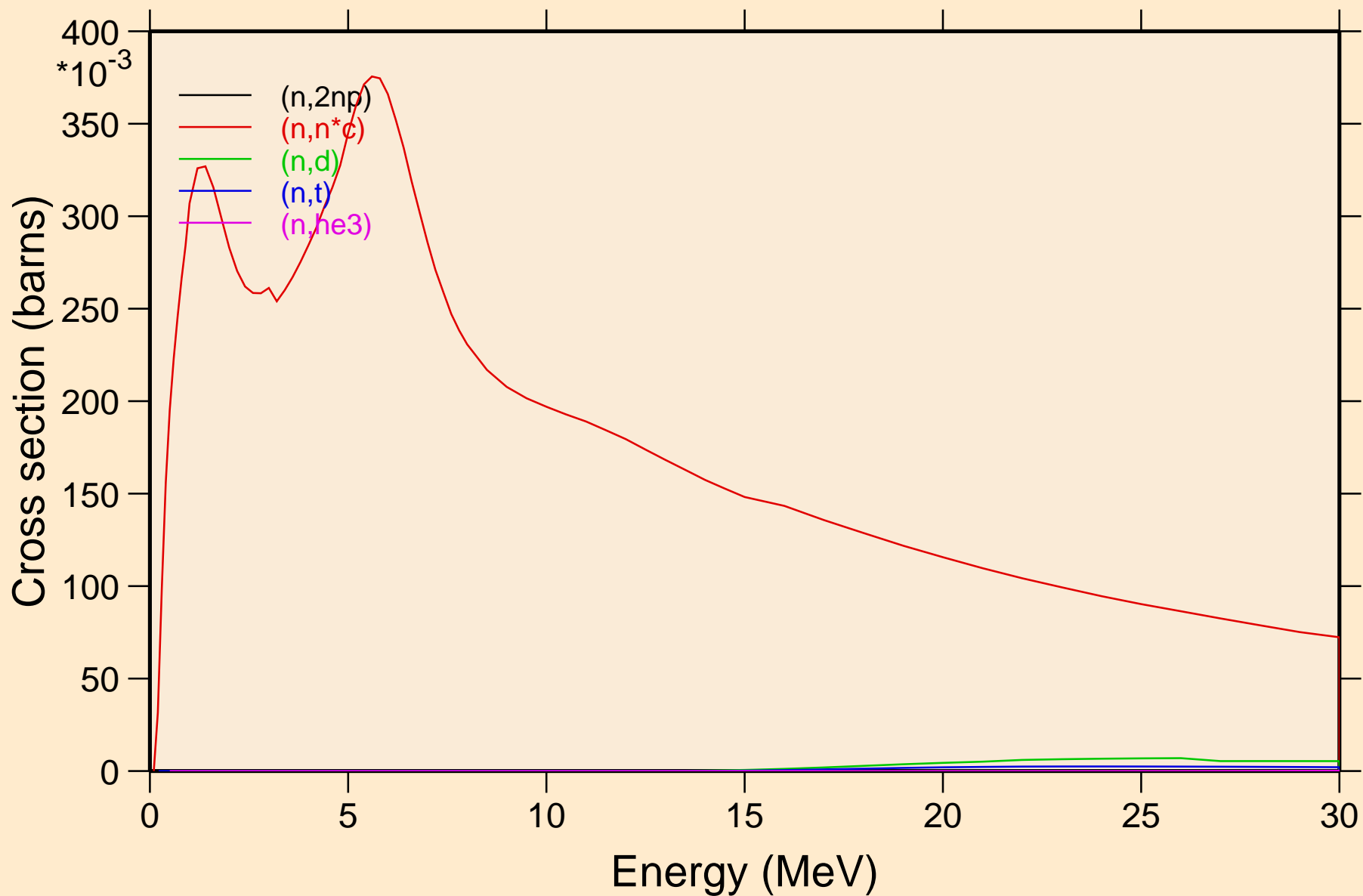

DB266 NEUTRON ACER TENDL-2019 LIBRARY; T=293.16K
Threshold reactions

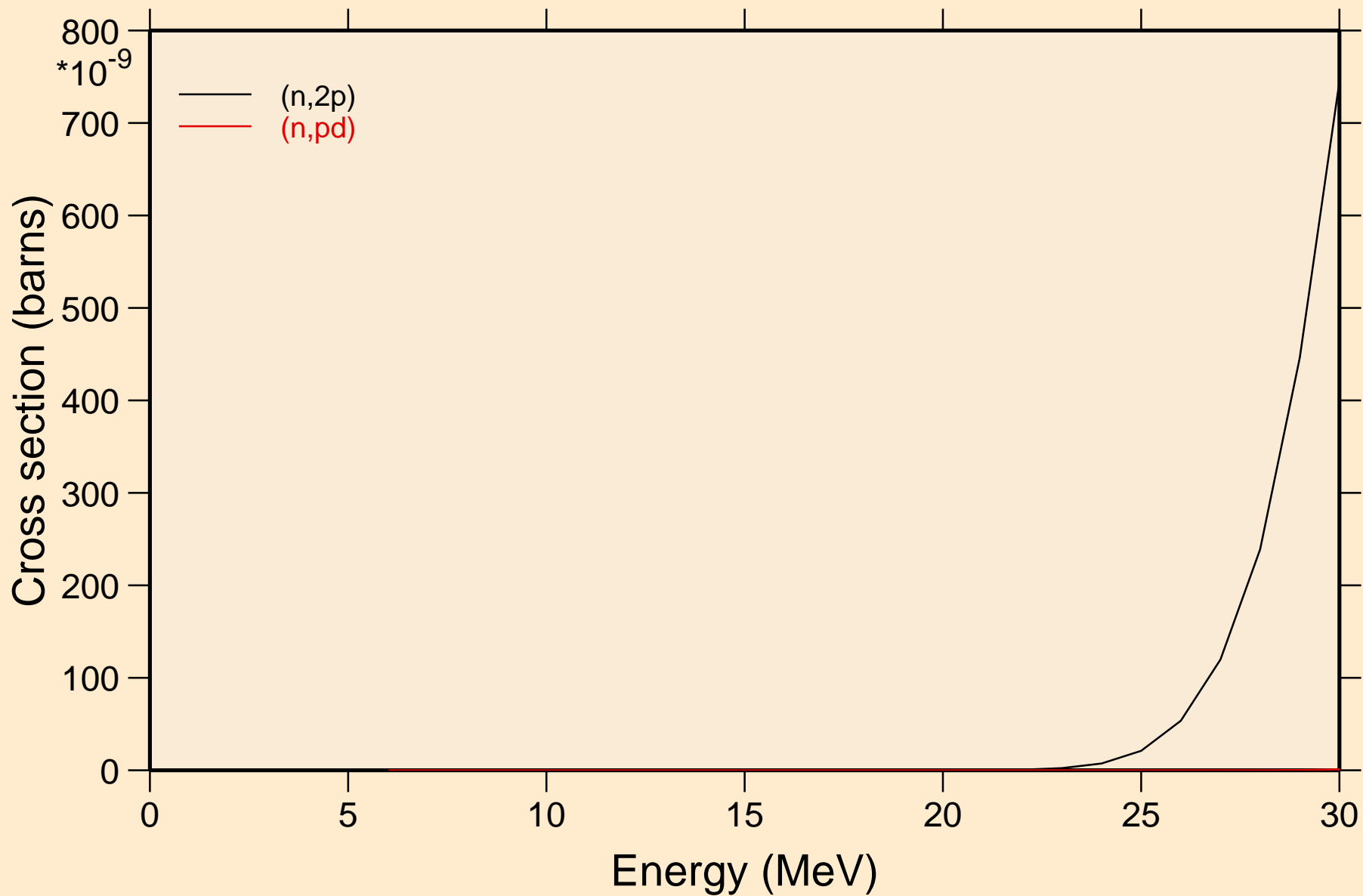

DB266 NEUTRON ACER TENDL-2019 LIBRARY; T=293.16K
Threshold reactions

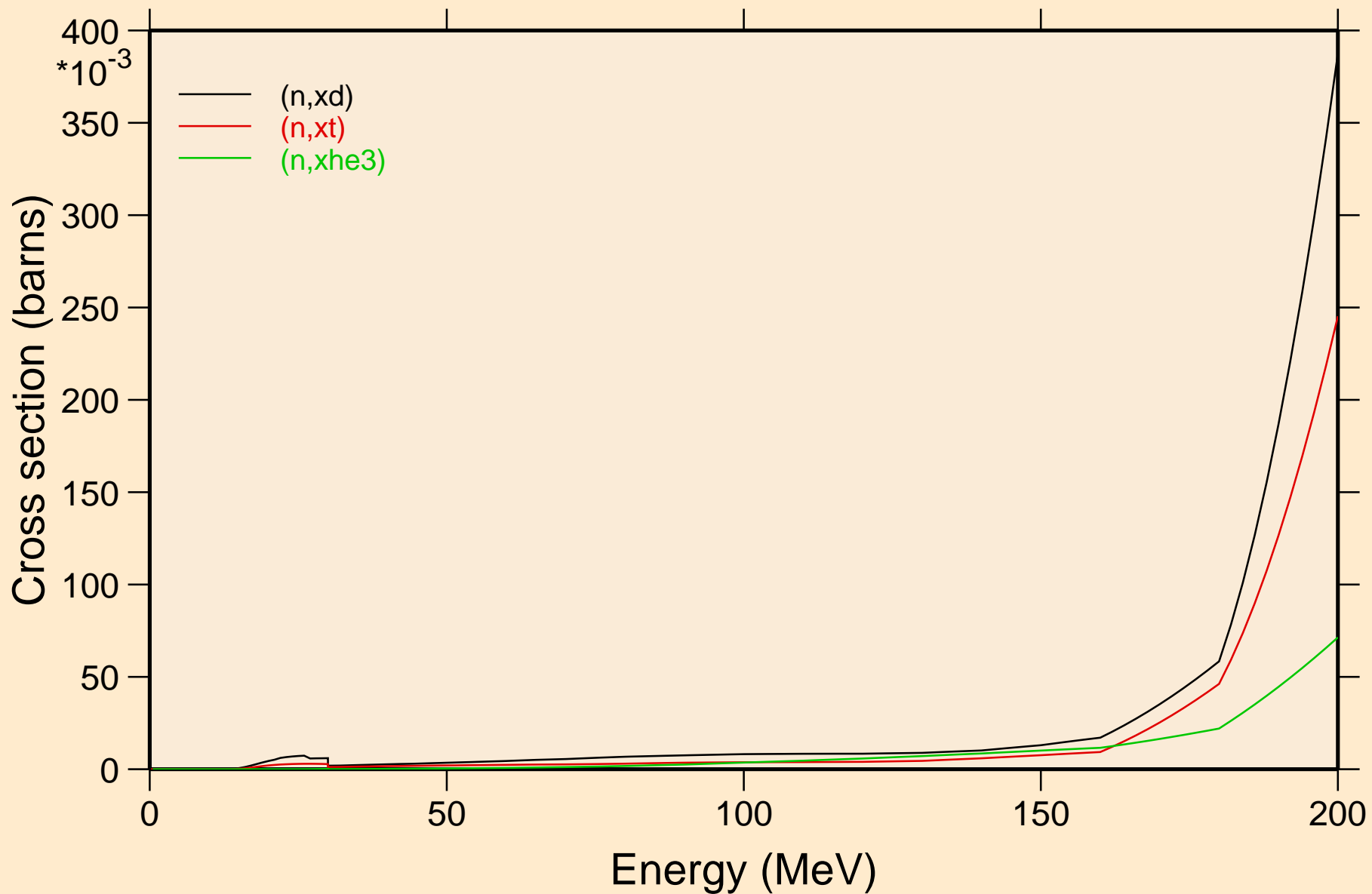

DB266 NEUTRON ACER TENDL-2019 LIBRARY; T=293.16K
angular distribution for elastic

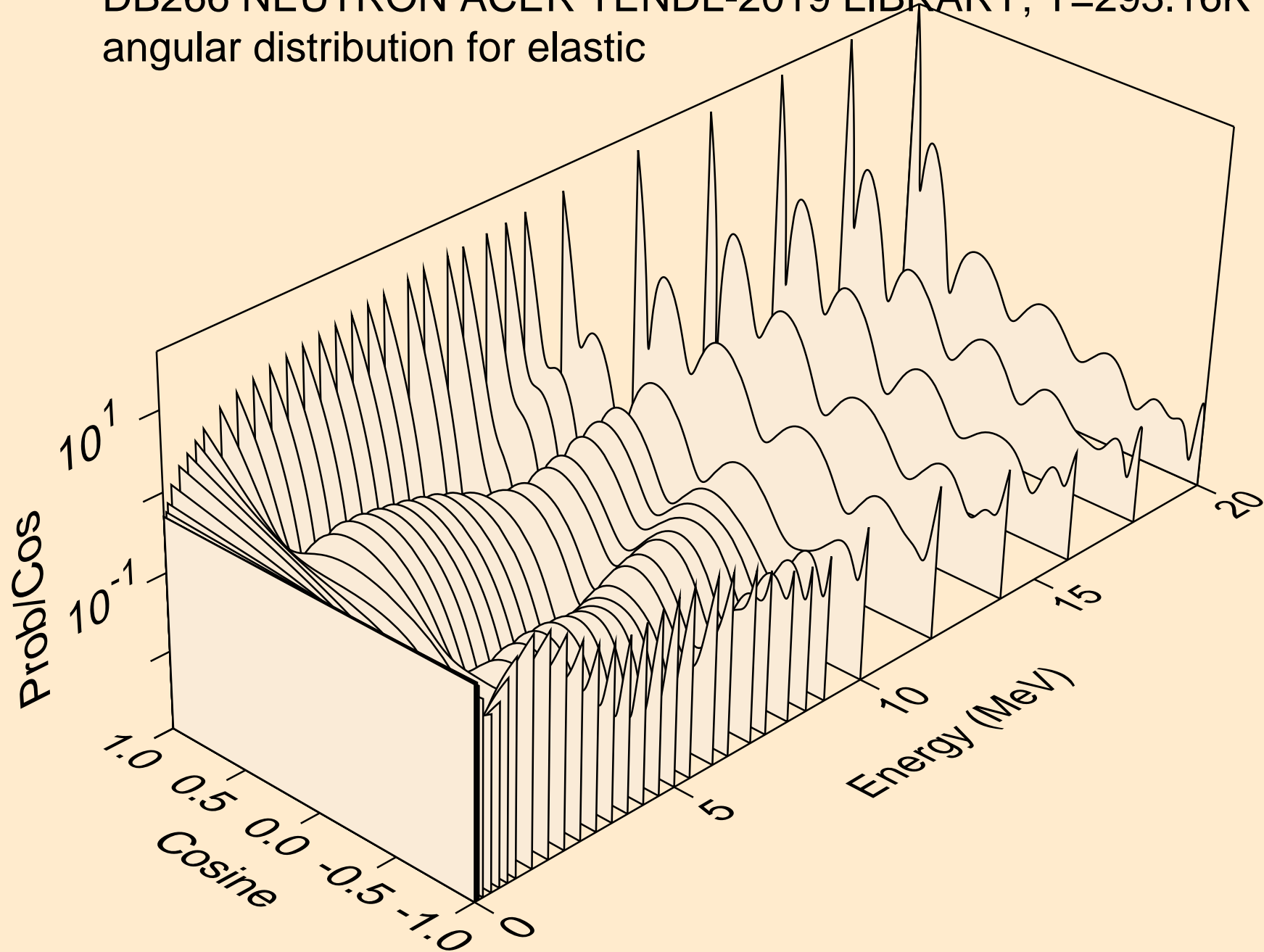

DB266 NEUTRON ACER TENDL-2019 LIBRARY; T=293.16K
angular distribution for elastic

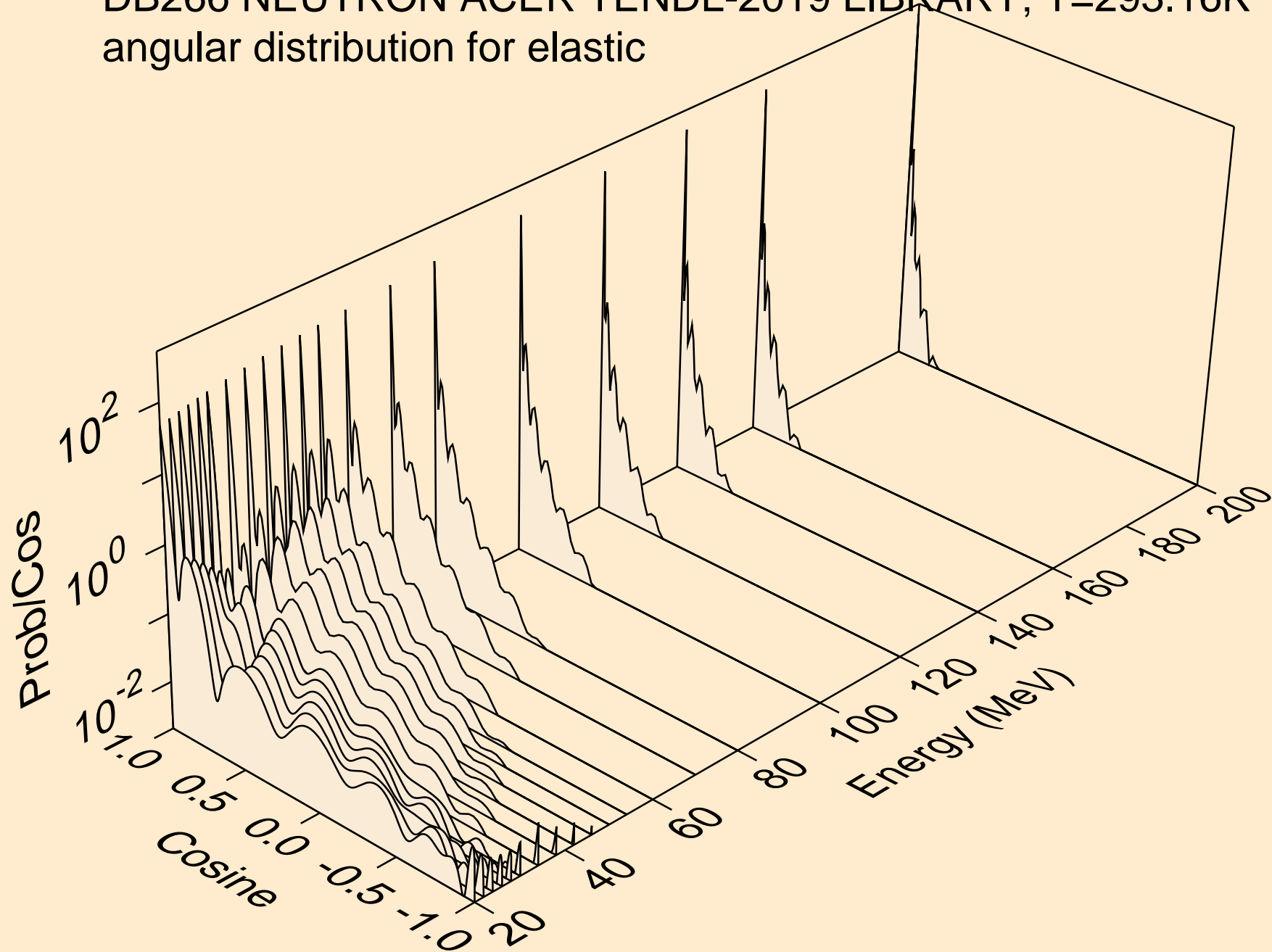

DB266 NEUTRON ACER TENDL-2019 LIBRARY; T=293.16K
angular distribution for (n,n*1)

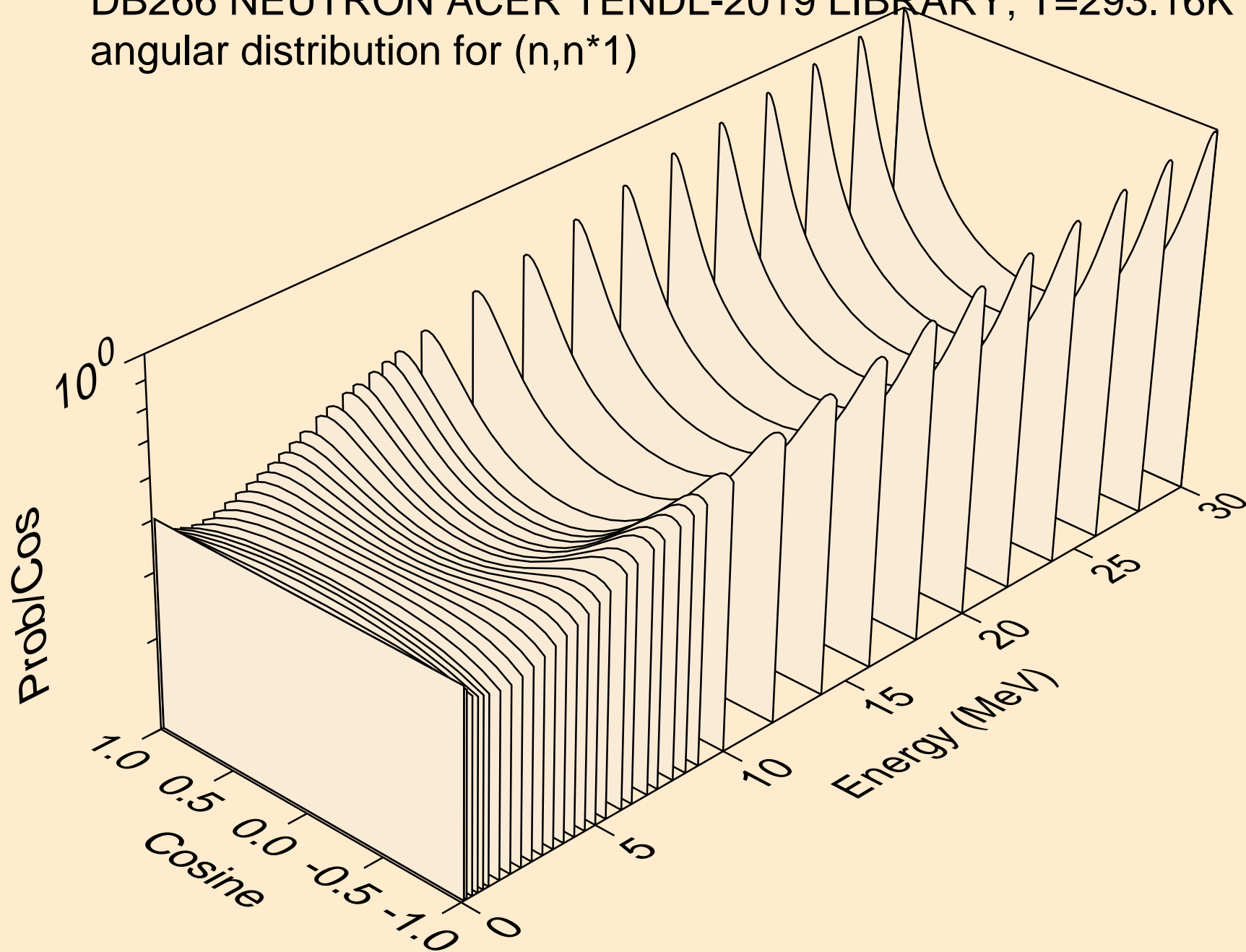

DB266 NEUTRON ACER TENDL-2019 LIBRARY; T=293.16K
Total fission nubar

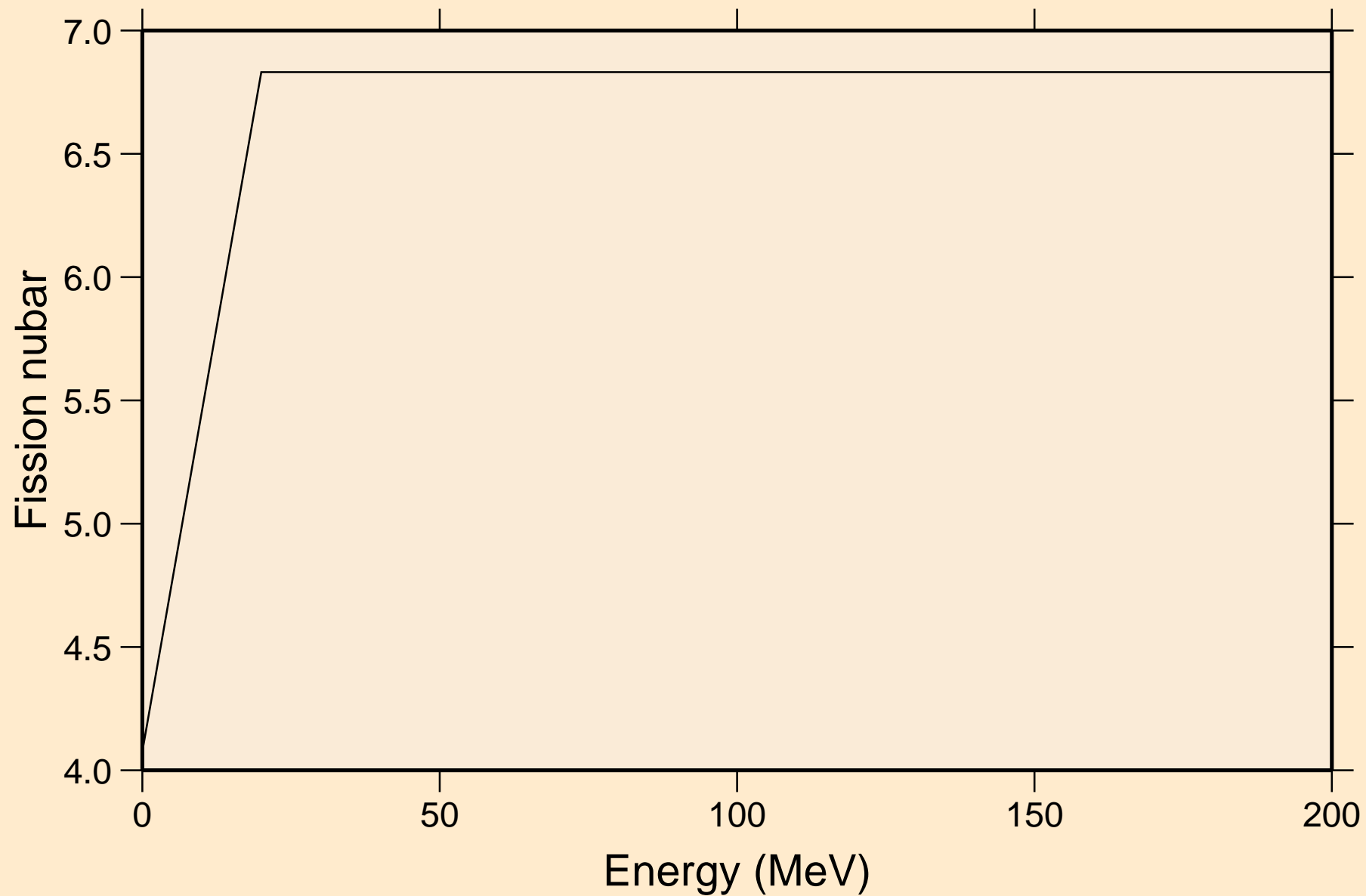

DB266 NEUTRON ACER TENDL-2019 LIBRARY; T=293.16K
Neutron emission for (n,x)

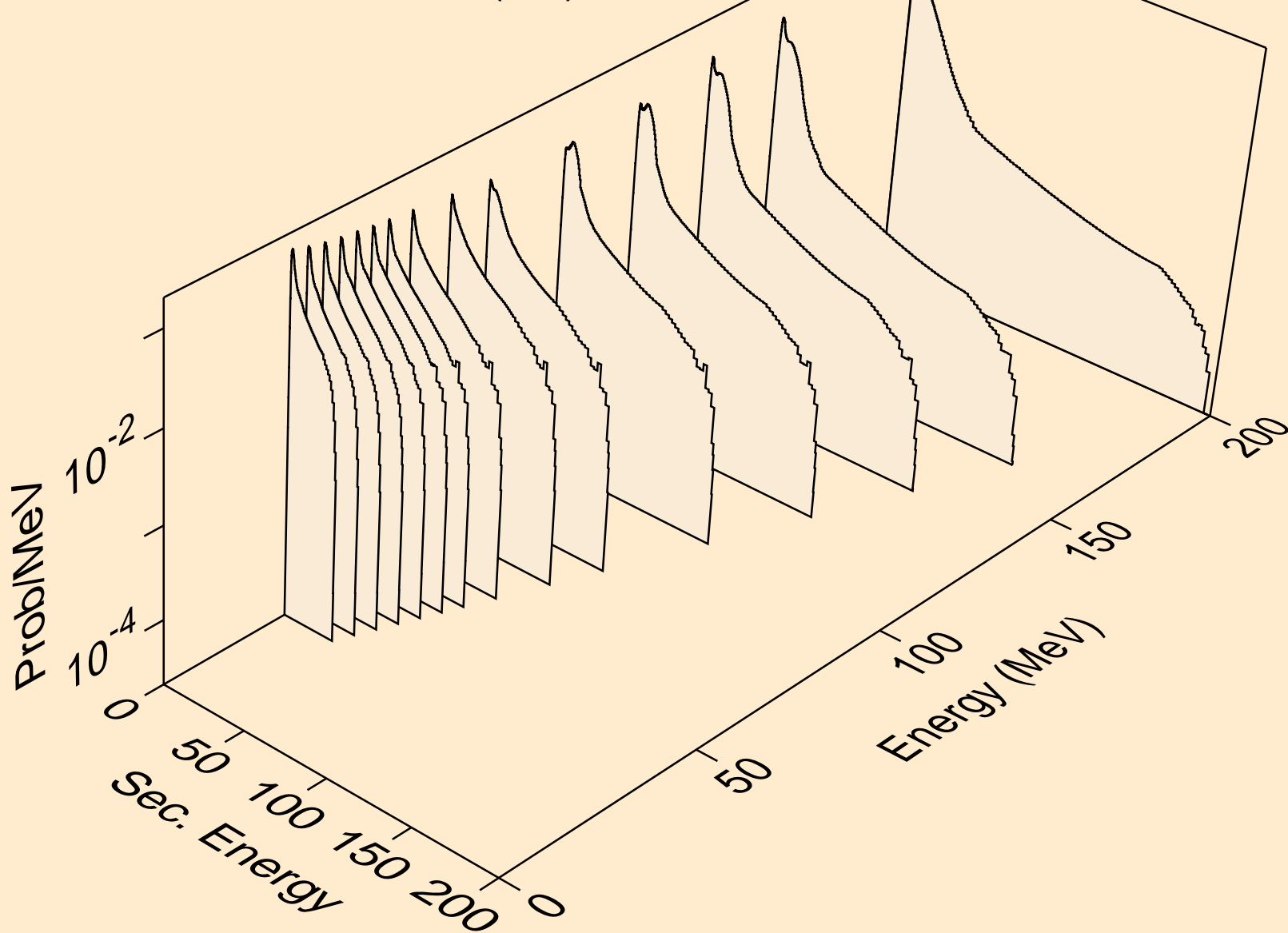

DB266 NEUTRON ACER TENDL-2019 LIBRARY; T=293.16K
Neutron emission for (n,2nd)

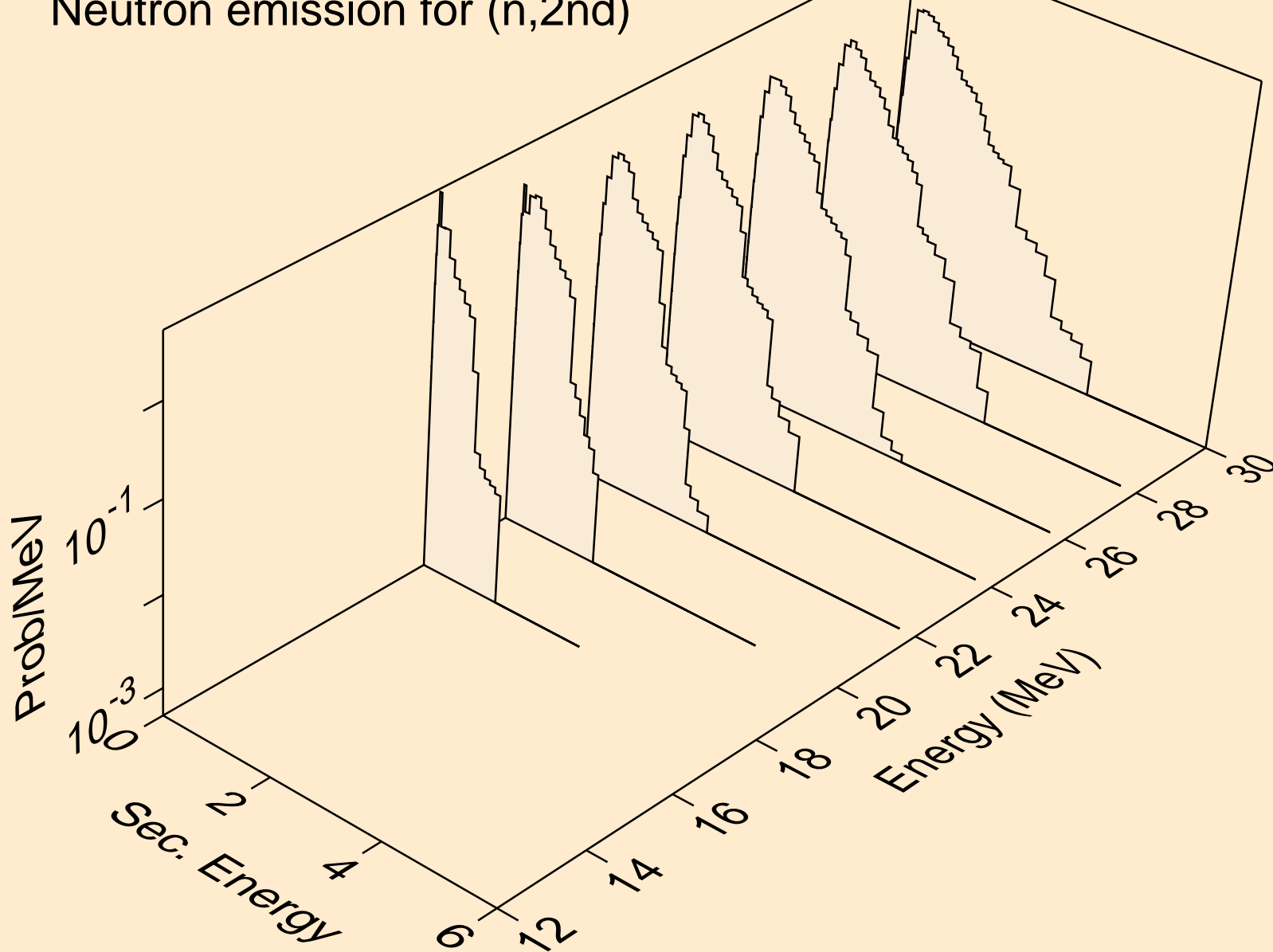

DB266 NEUTRON ACER TENDL-2019 LIBRARY; T=293.16K
Neutron emission for (n,2n)

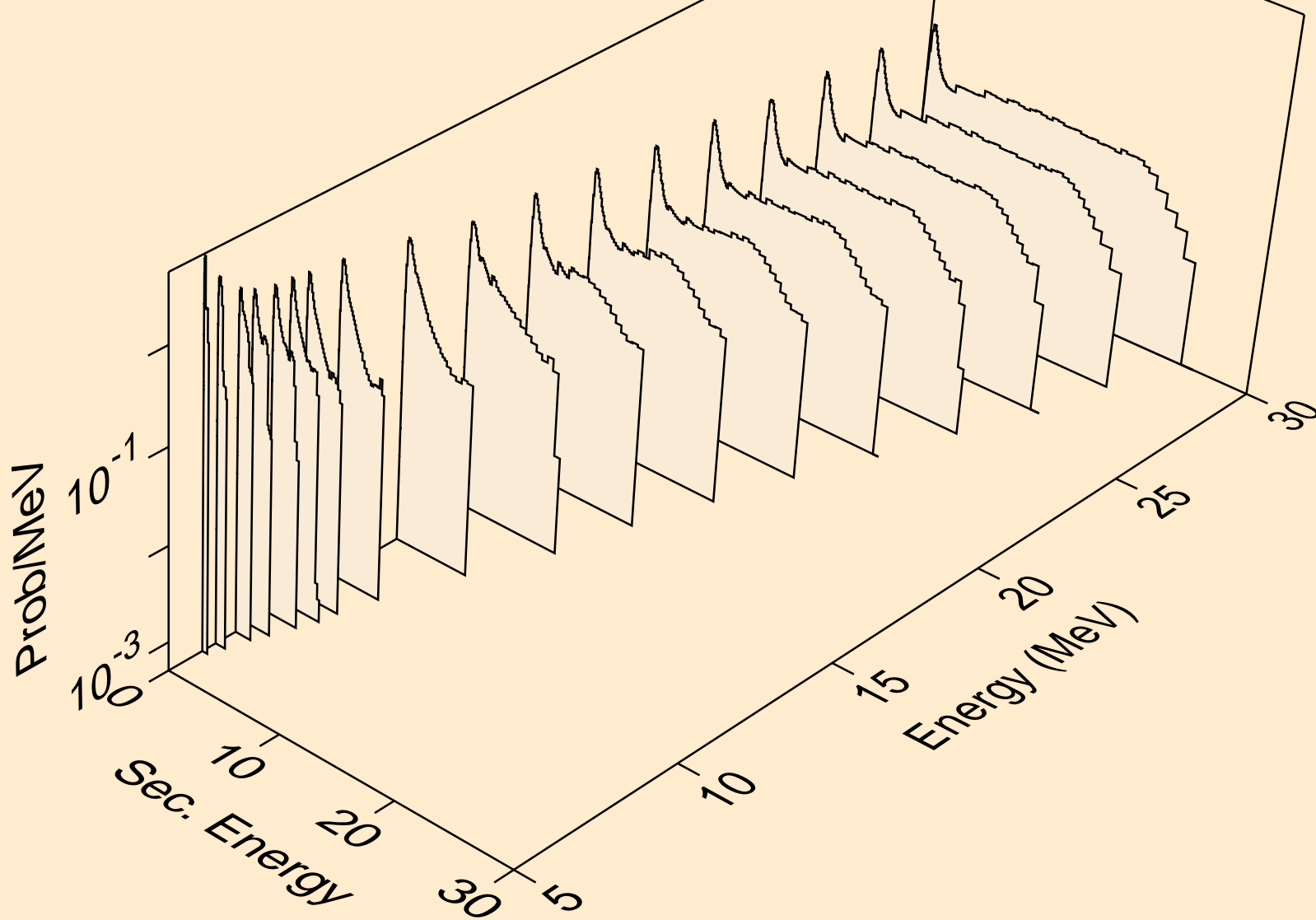

DB266 NEUTRON ACER TENDL-2019 LIBRARY; T=293.16K
Neutron emission for (n,3n)

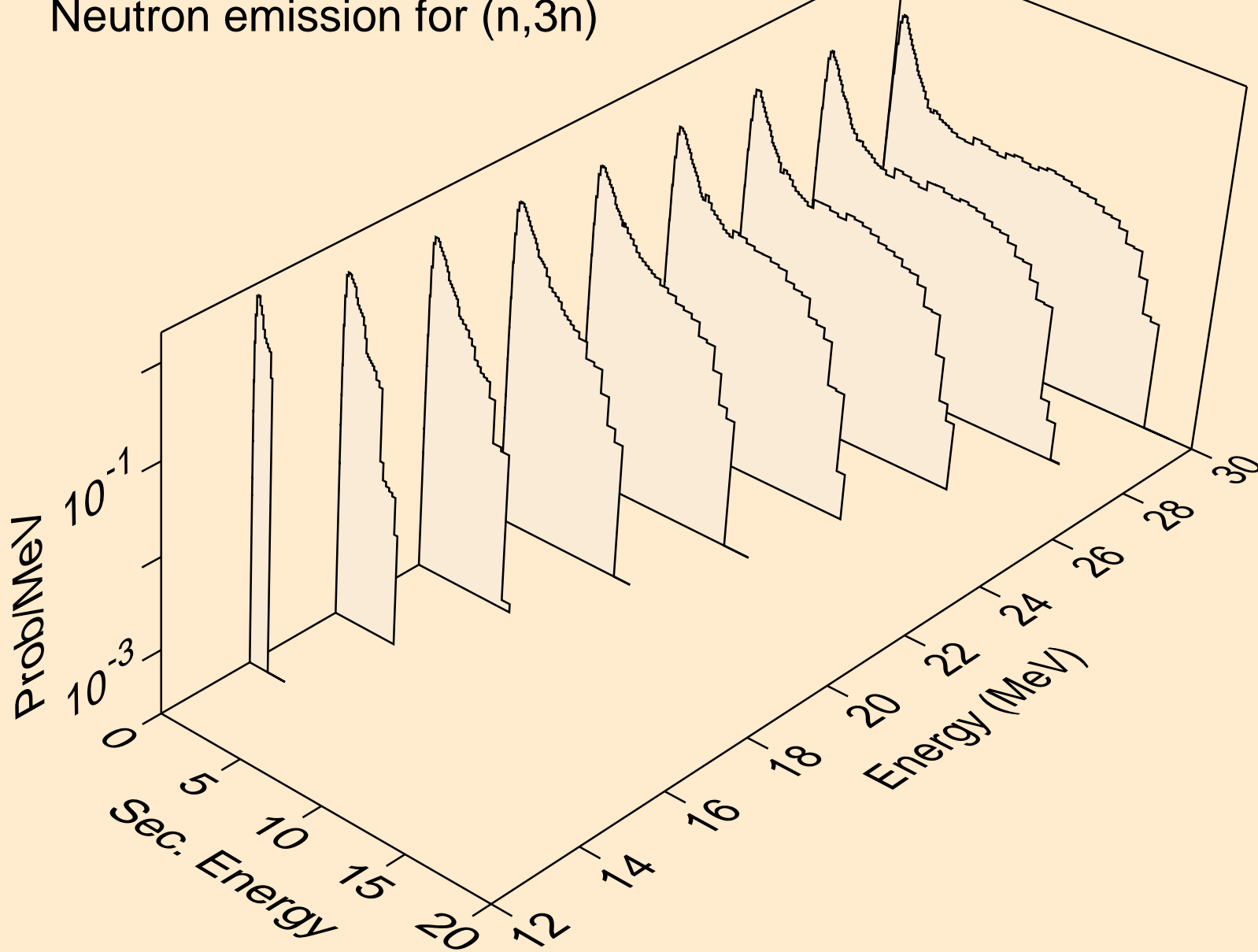

DB266 NEUTRON ACER TENDL-2019 LIBRARY; T=293.16K
Neutron emission for fission

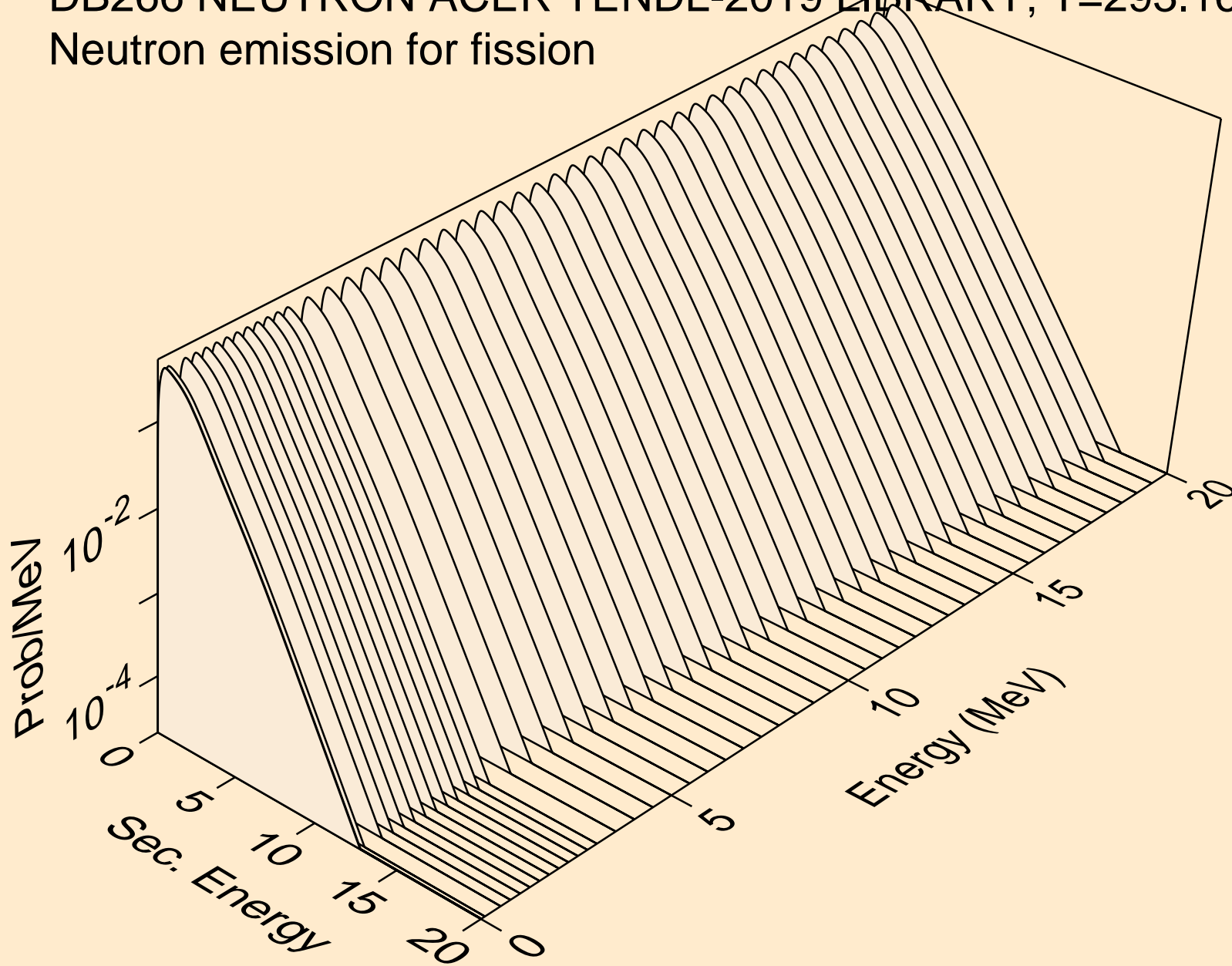

DB266 NEUTRON ACER TENDL-2019 LIBRARY; T=293.16K
Neutron emission for (n,n*)a

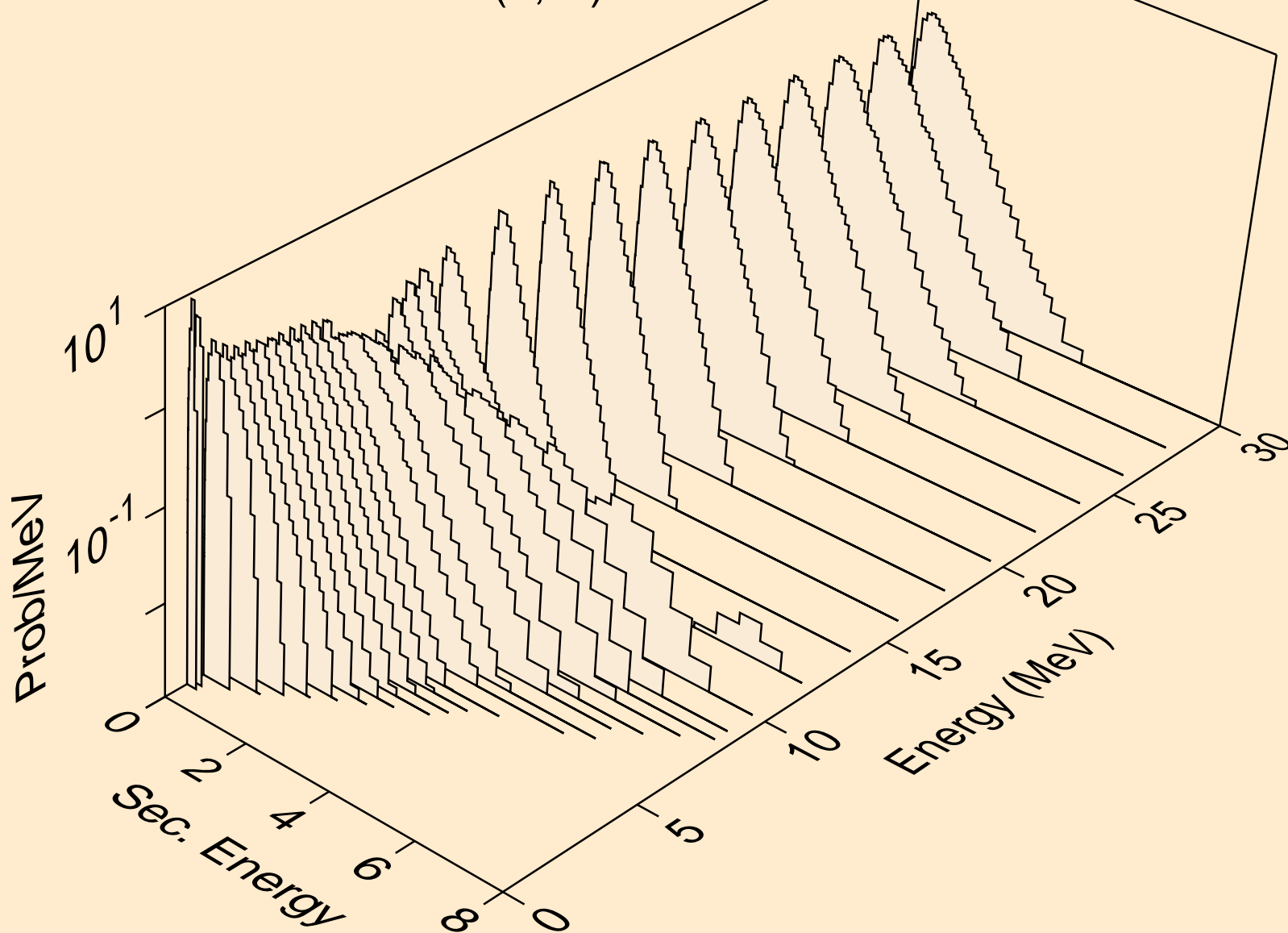

DB266 NEUTRON ACER TENDL-2019 LIBRARY; T=293.16K
Neutron emission for (n,2n)a

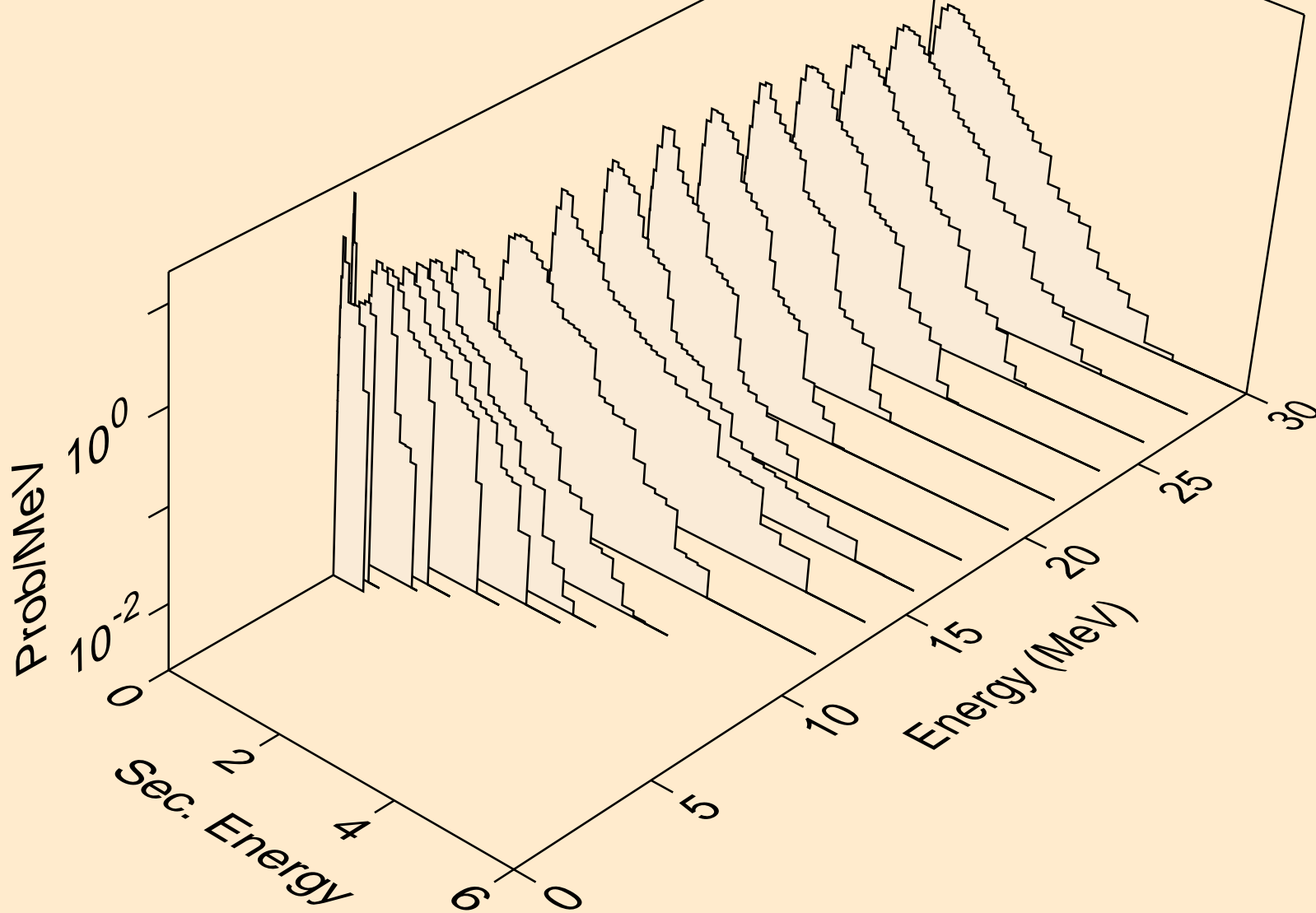

DB266 NEUTRON ACER TENDL-2019 LIBRARY; T=293.16K
Neutron emission for (n,3n)a

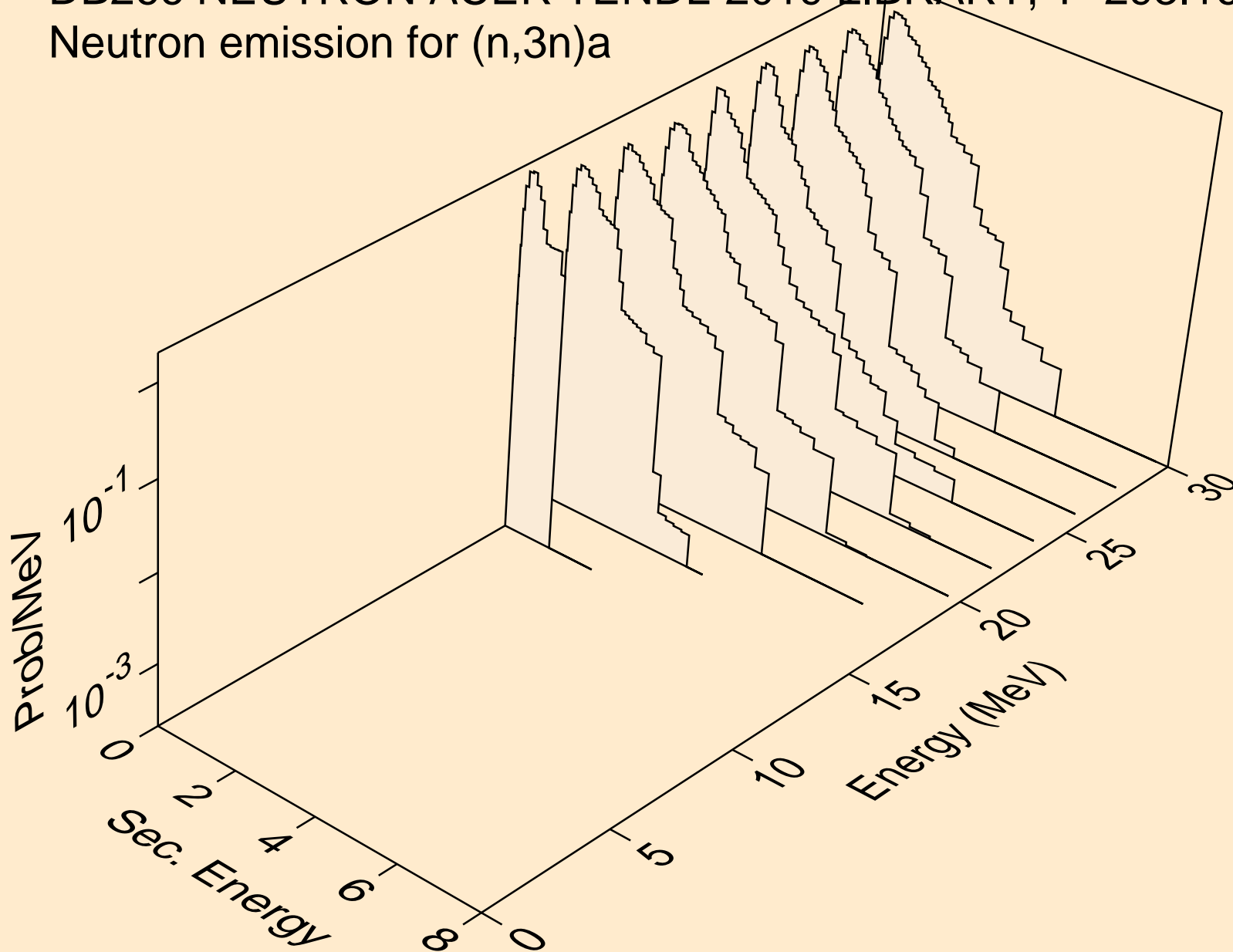

DB266 NEUTRON ACER TENDL-2019 LIBRARY; T=293.16K
Neutron emission for (n,n*)p

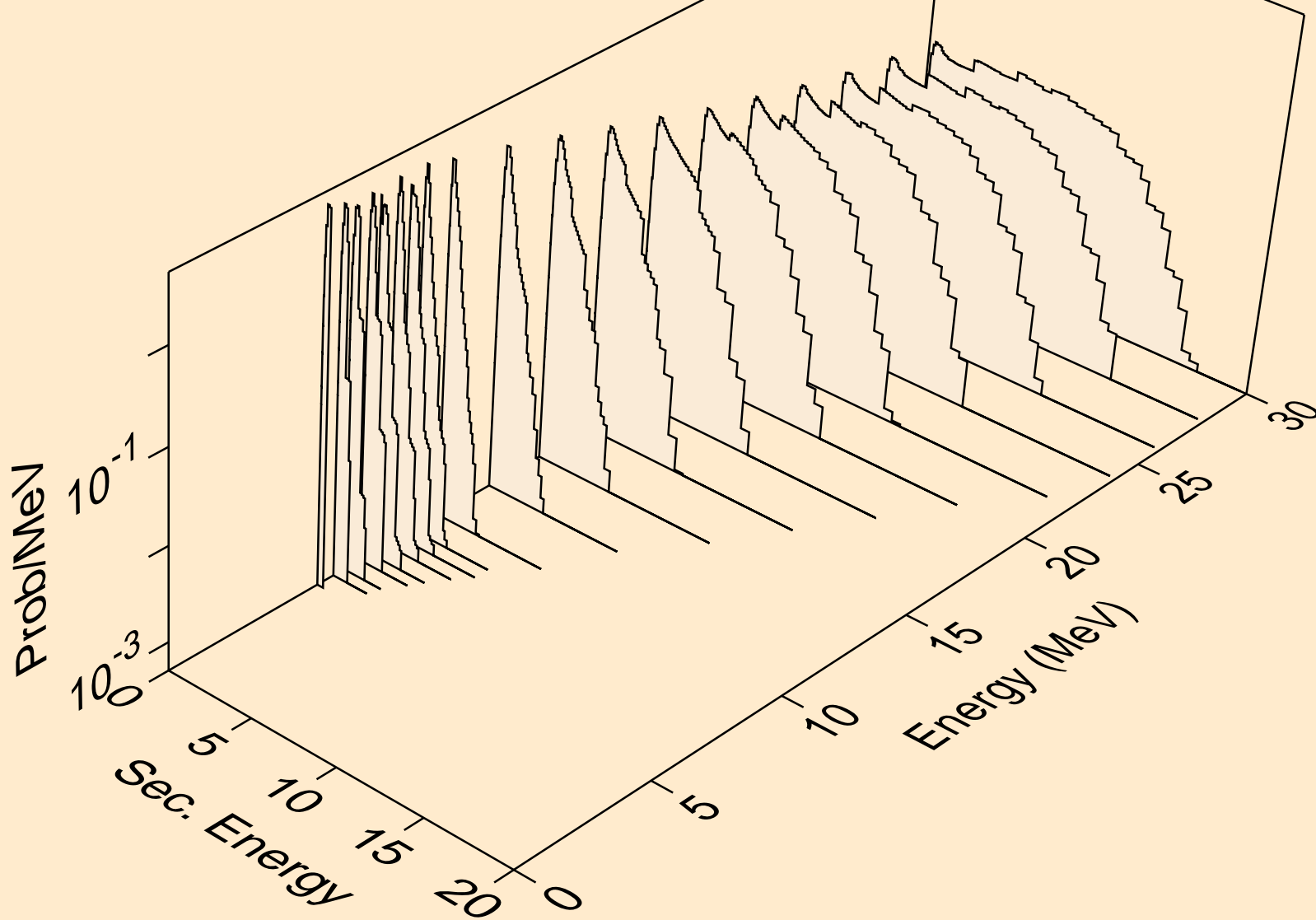

DB266 NEUTRON ACER TENDL-2019 LIBRARY; T=293.16K
Neutron emission for (n,n*)2a

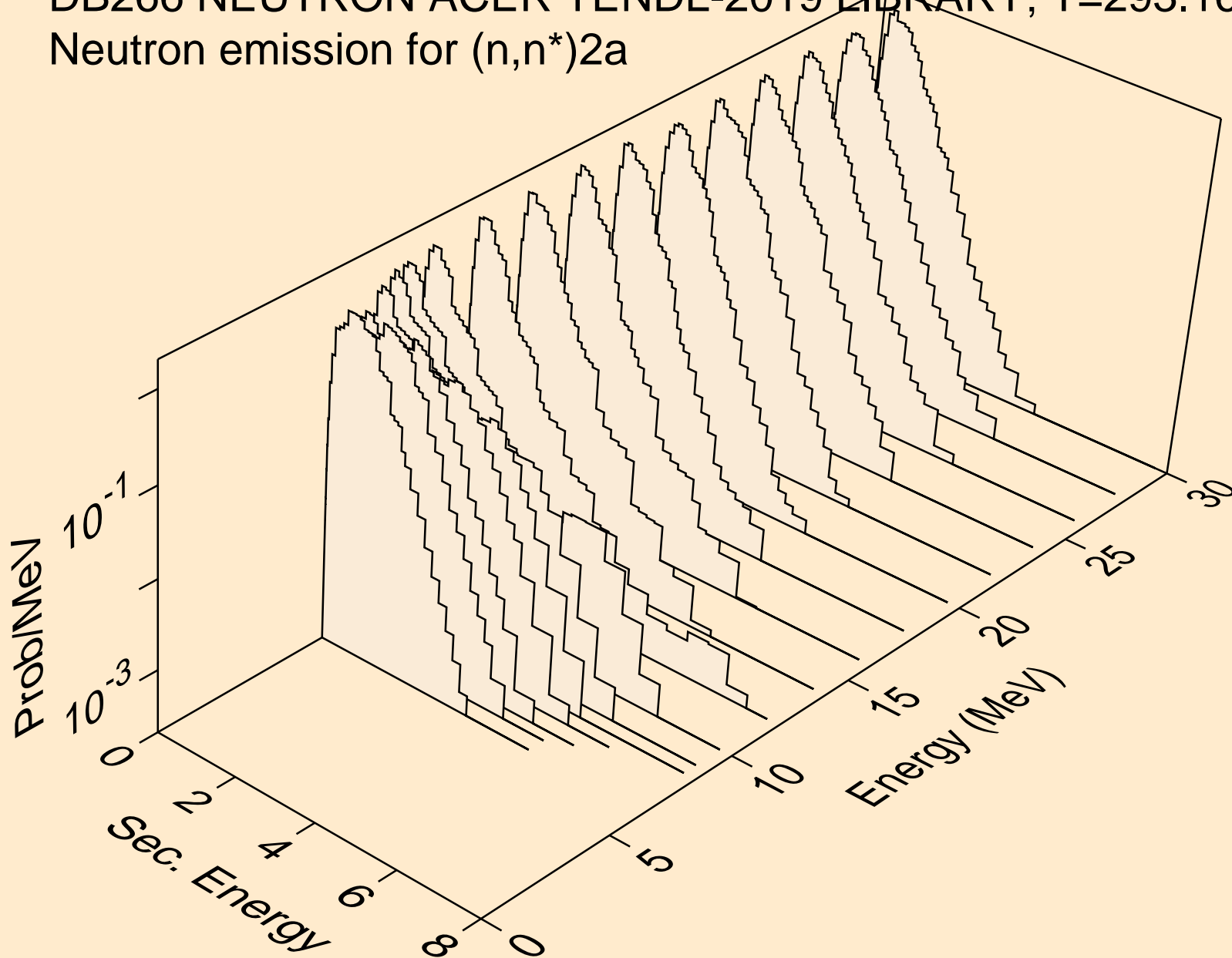

DB266 NEUTRON ACER TENDL-2019 LIBRARY; T=293.16K
Neutron emission for (n,n*)d

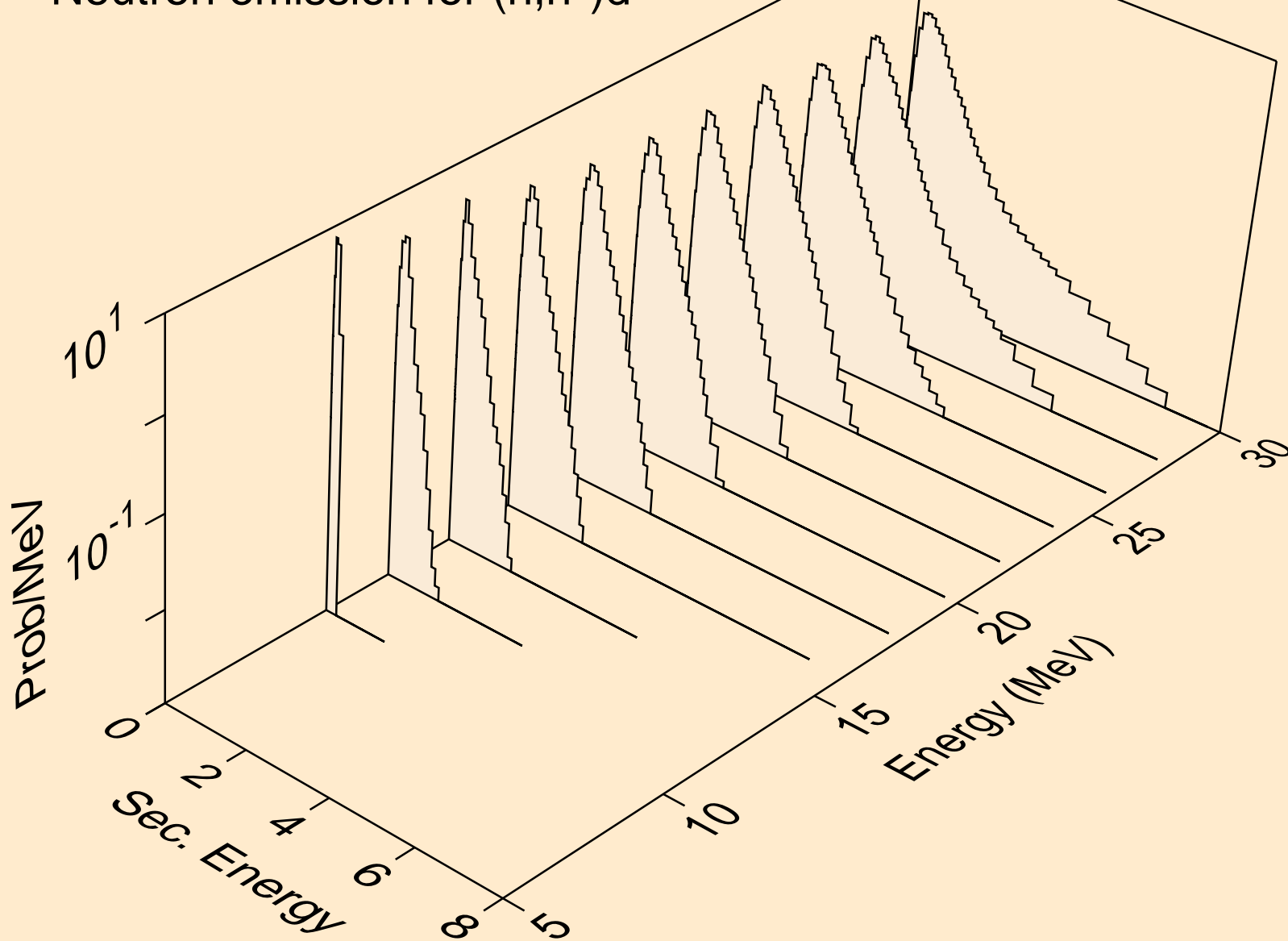

DB266 NEUTRON ACER TENDL-2019 LIBRARY; T=293.16K
Neutron emission for (n,n*)t

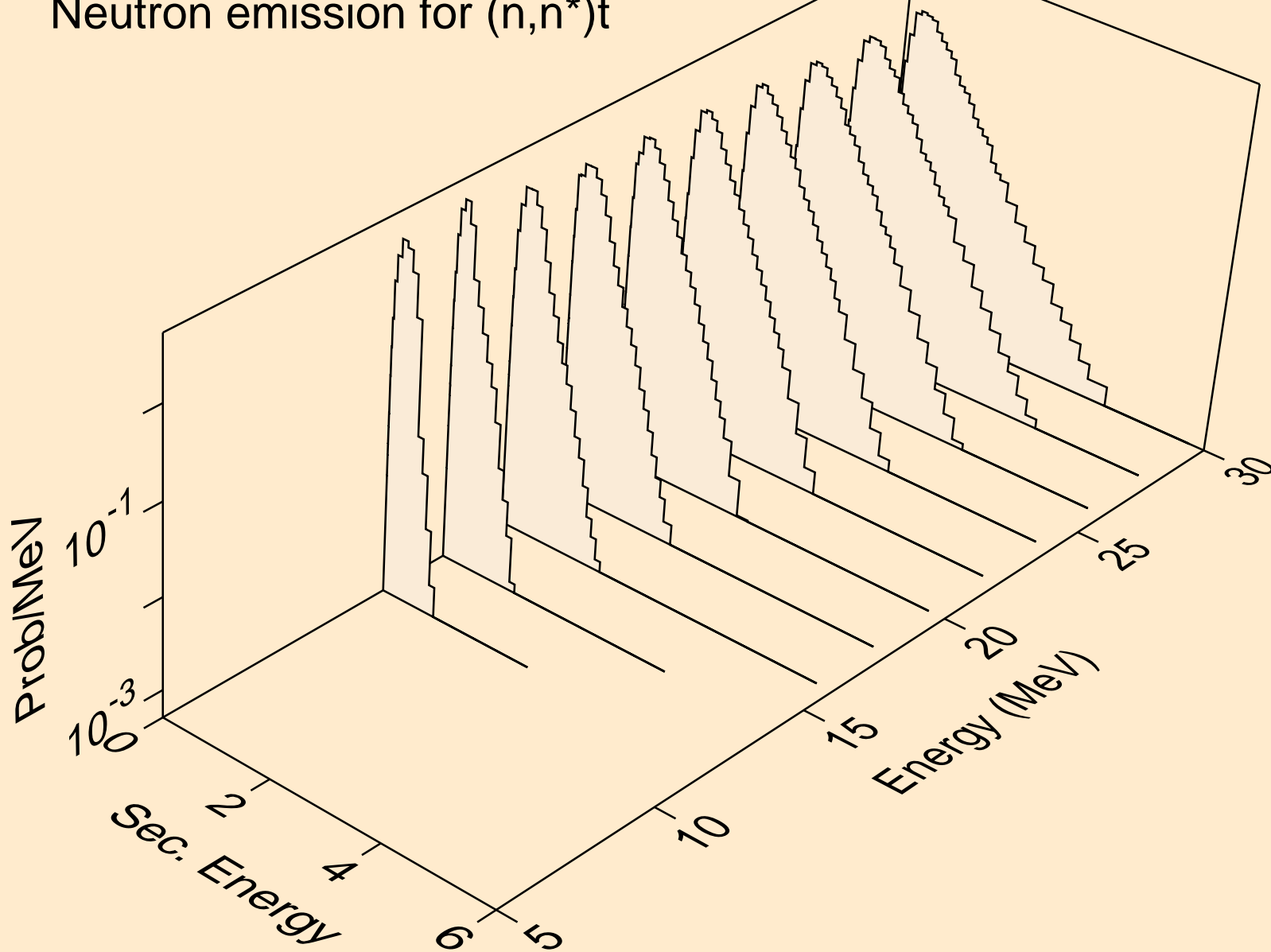

DB266 NEUTRON ACER TENDL-2019 LIBRARY; T=293.16K
Neutron emission for (n,n*)he3

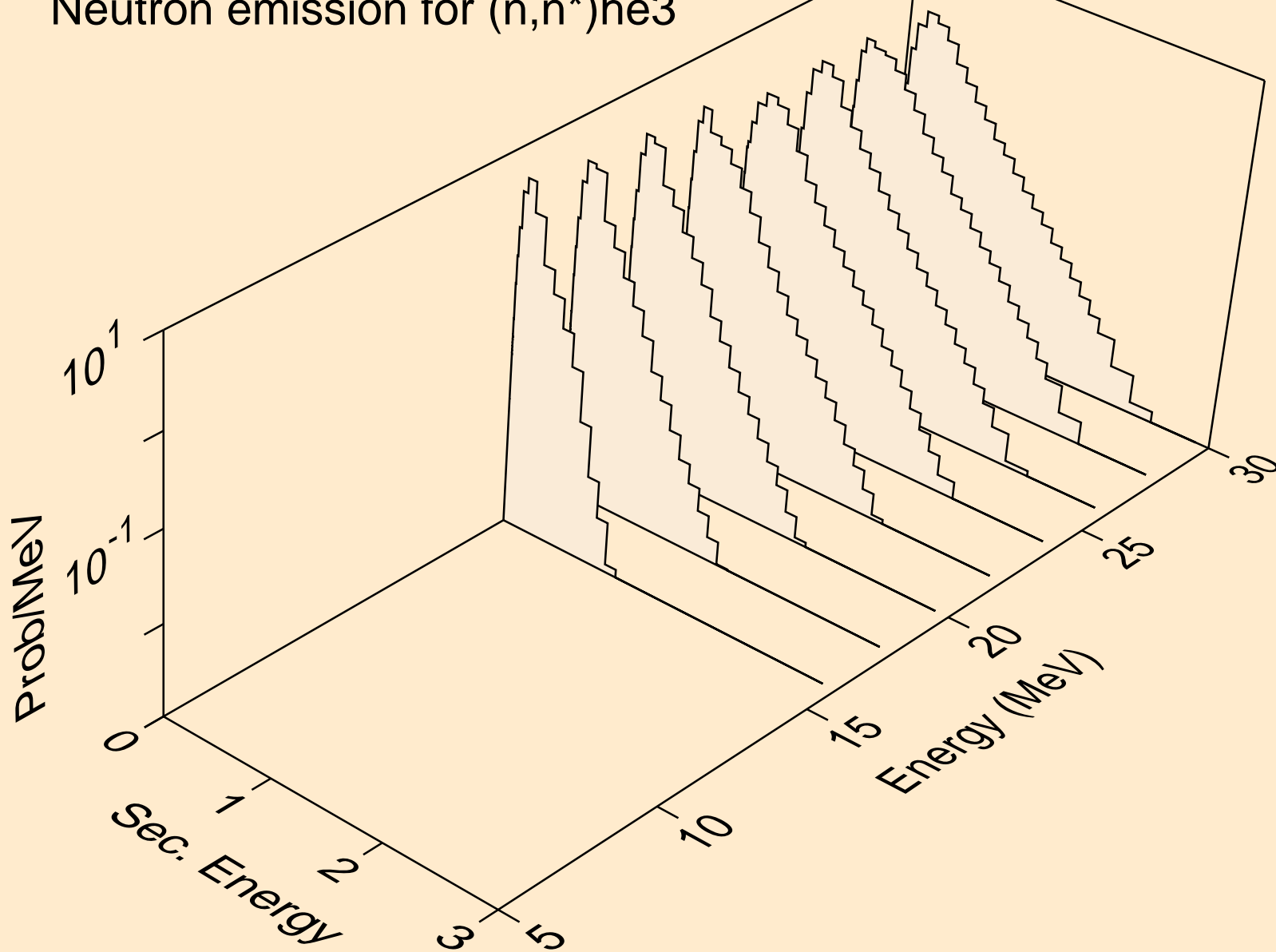

DB266 NEUTRON ACER TENDL-2019 LIBRARY; T=293.16K
Neutron emission for (n,4n)

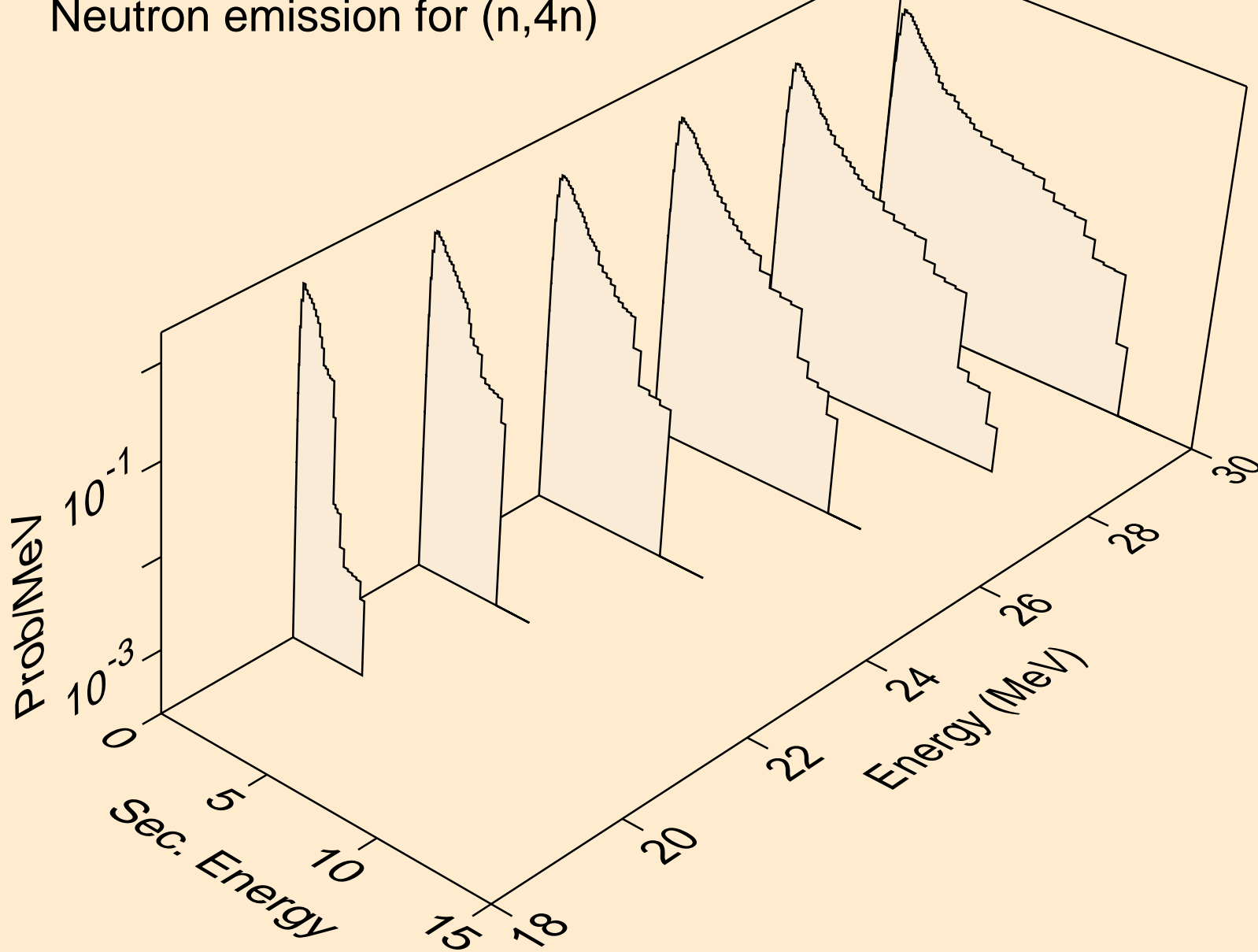

DB266 NEUTRON ACER TENDL-2019 LIBRARY; T=293.16K
Neutron emission for (n,2np)

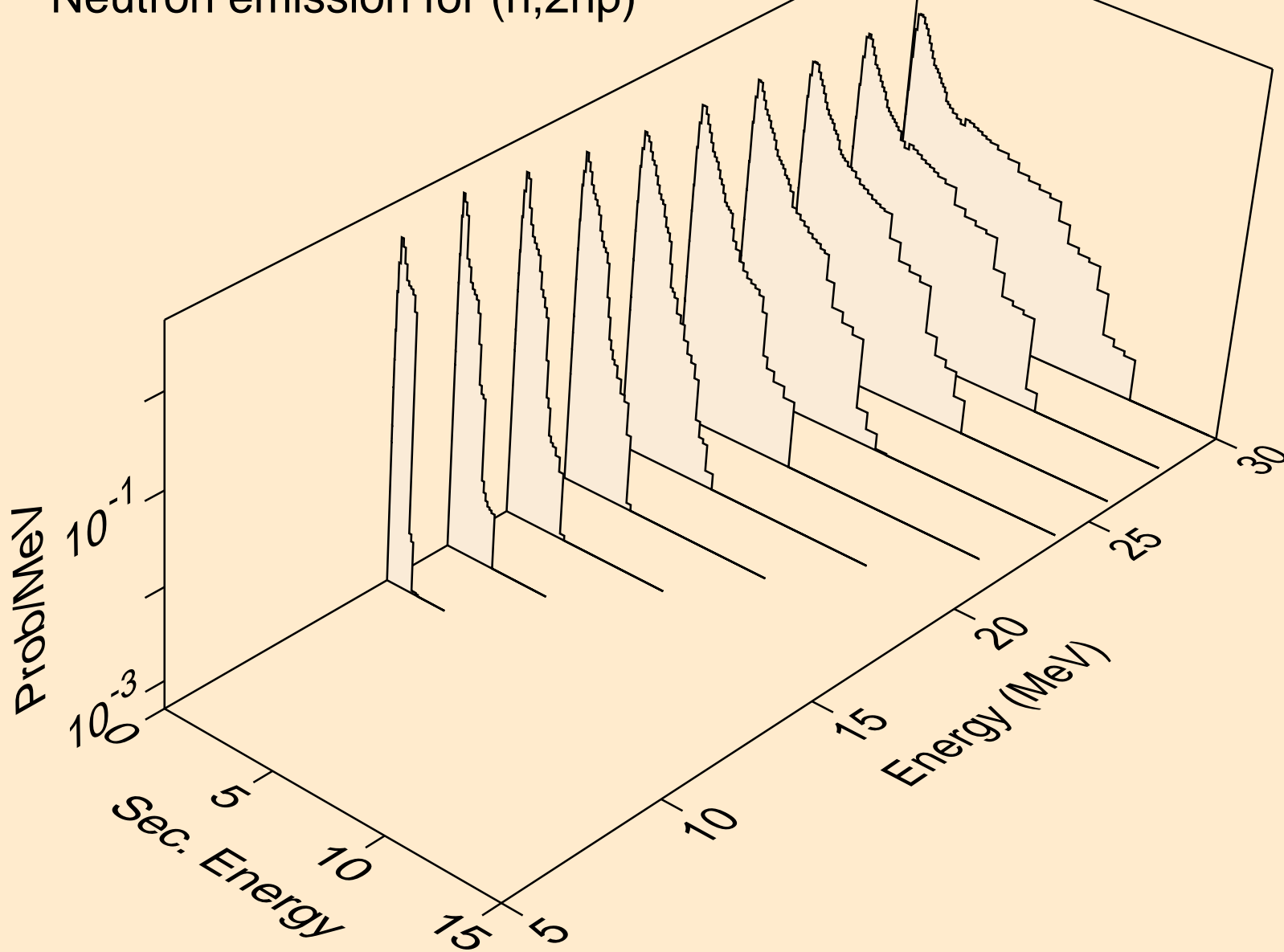

DB266 NEUTRON ACER TENDL-2019 LIBRARY; T=293.16K
Neutron emission for (n,3np)

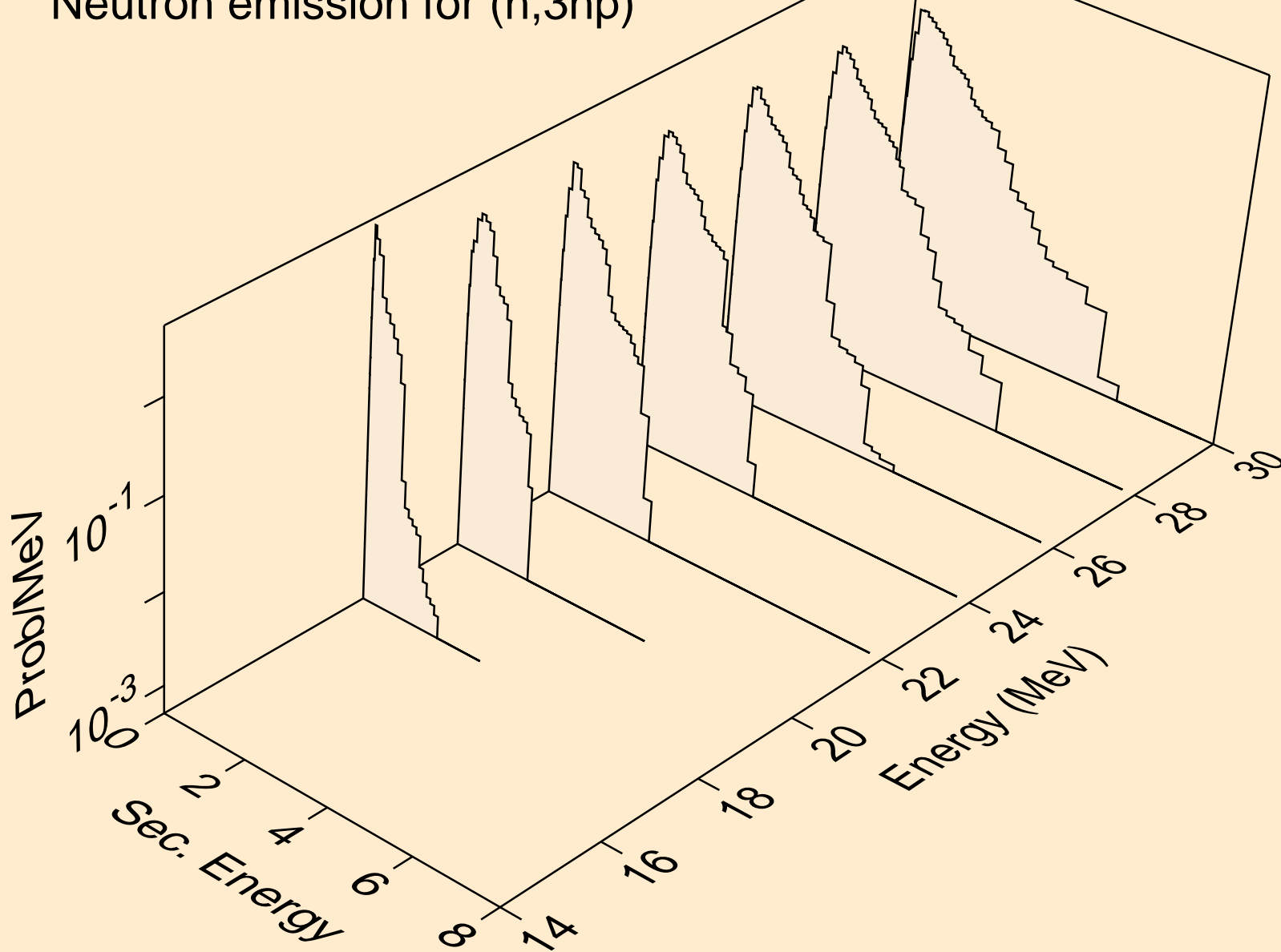

DB266 NEUTRON ACER TENDL-2019 LIBRARY; T=293.16K
Neutron emission for (n,2np)

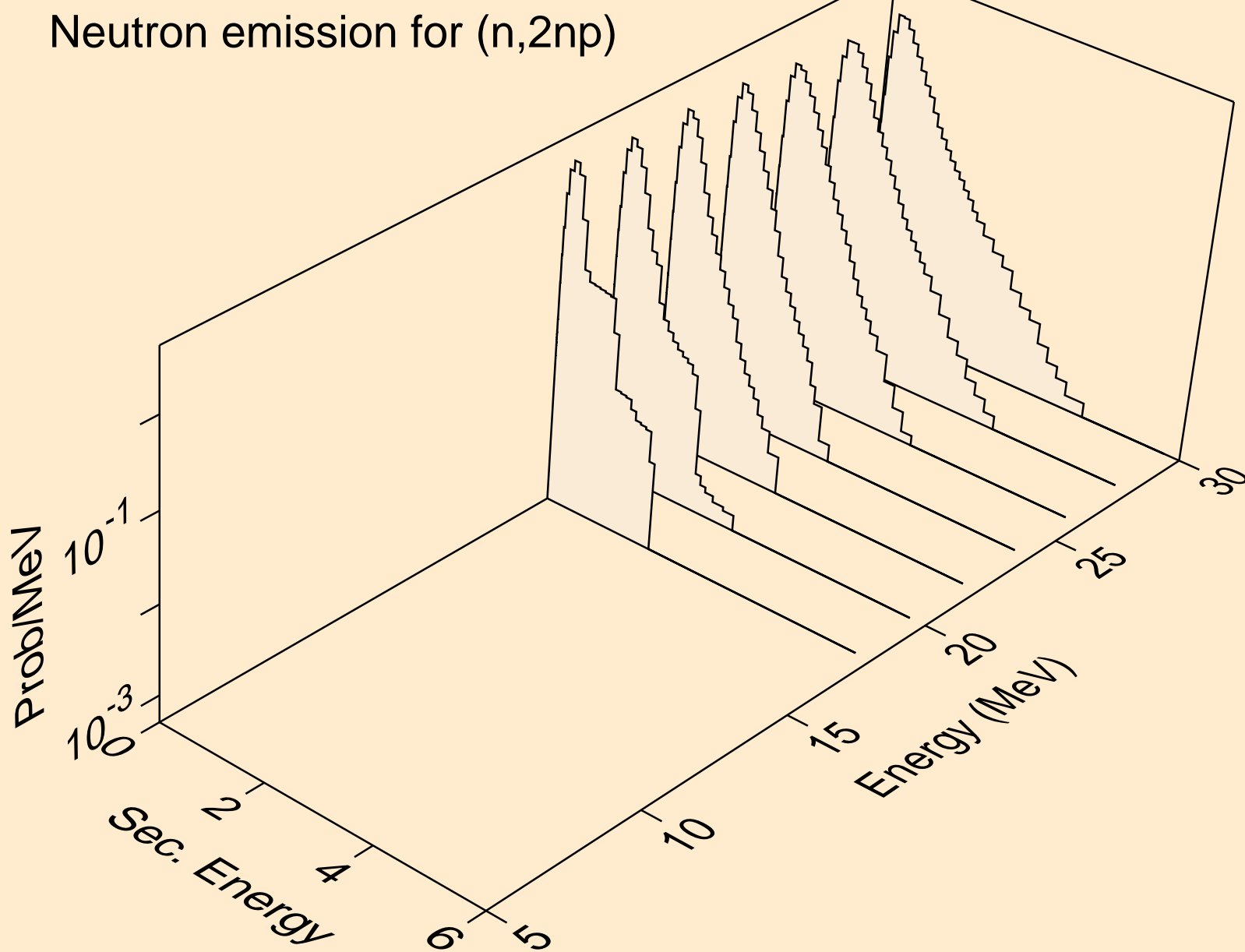

DB266 NEUTRON ACER TENDL-2019 LIBRARY; T=293.16K
Neutron emission for (n,n*c)

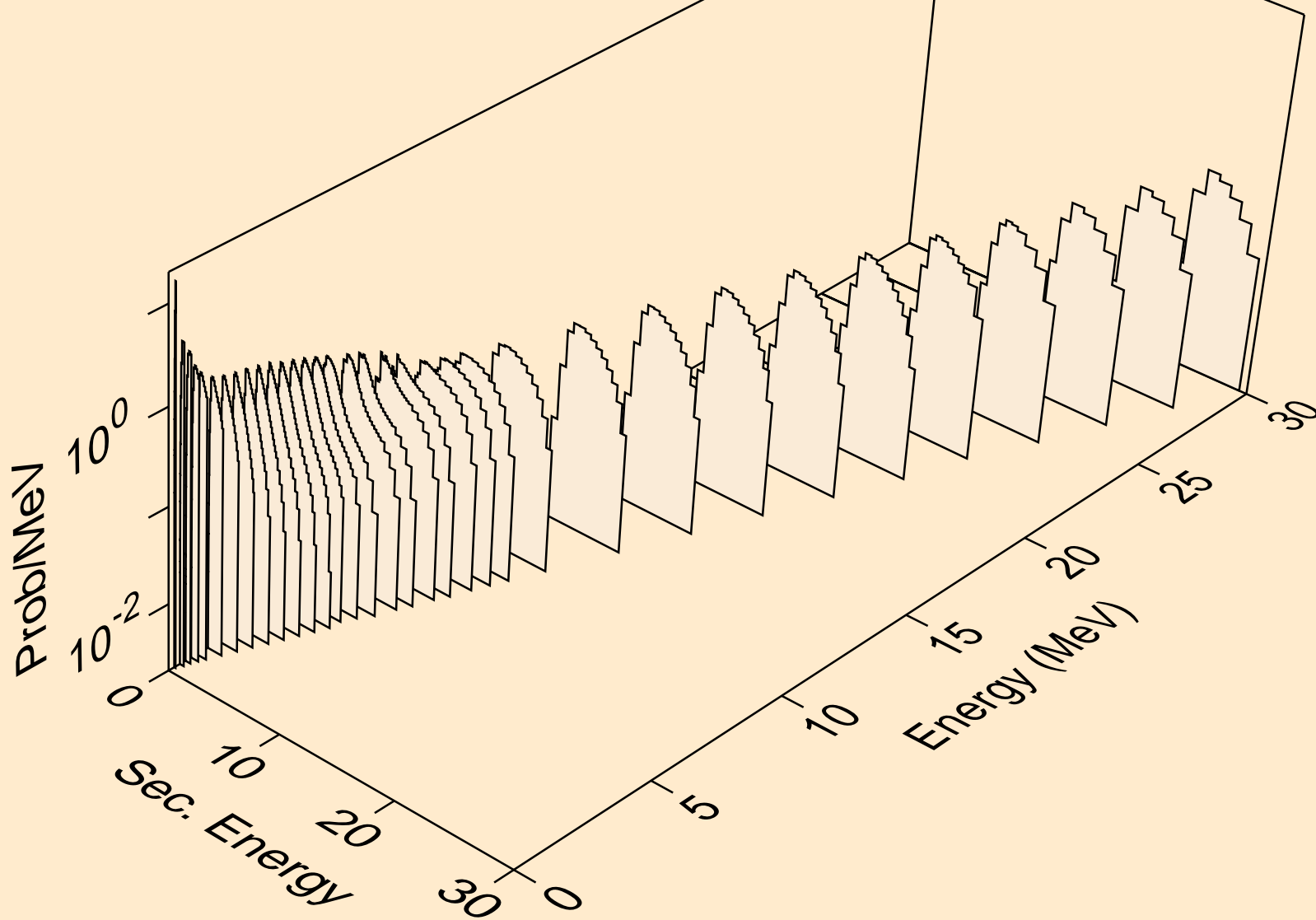

DB266 NEUTRON ACER TENDL-2019 LIBRARY; T=293.16K

Delayed nubar

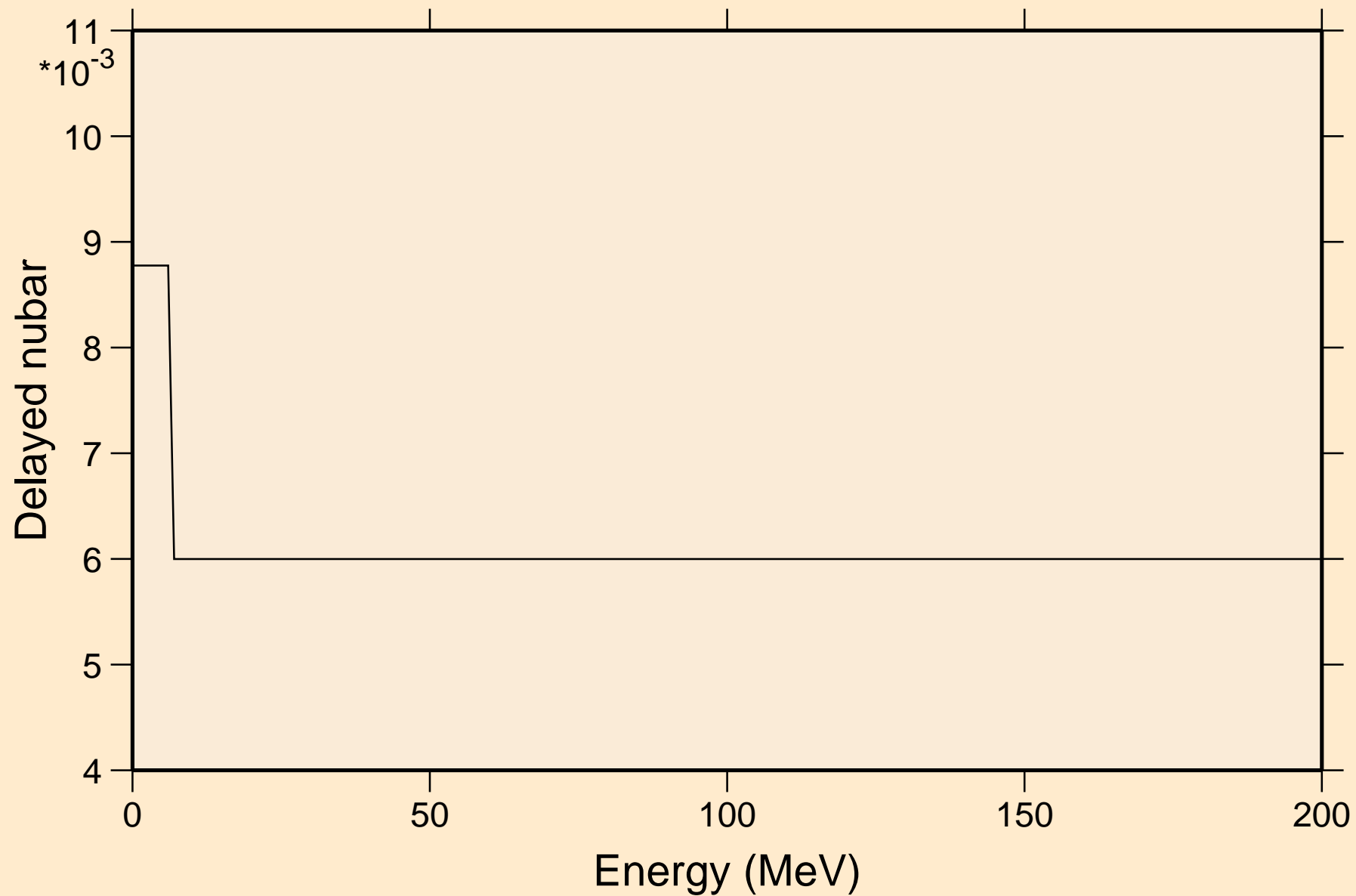

DB266 NEUTRON ACER TENDL-2019 LIBRARY; T=293.16K

Delayed neutron spectra

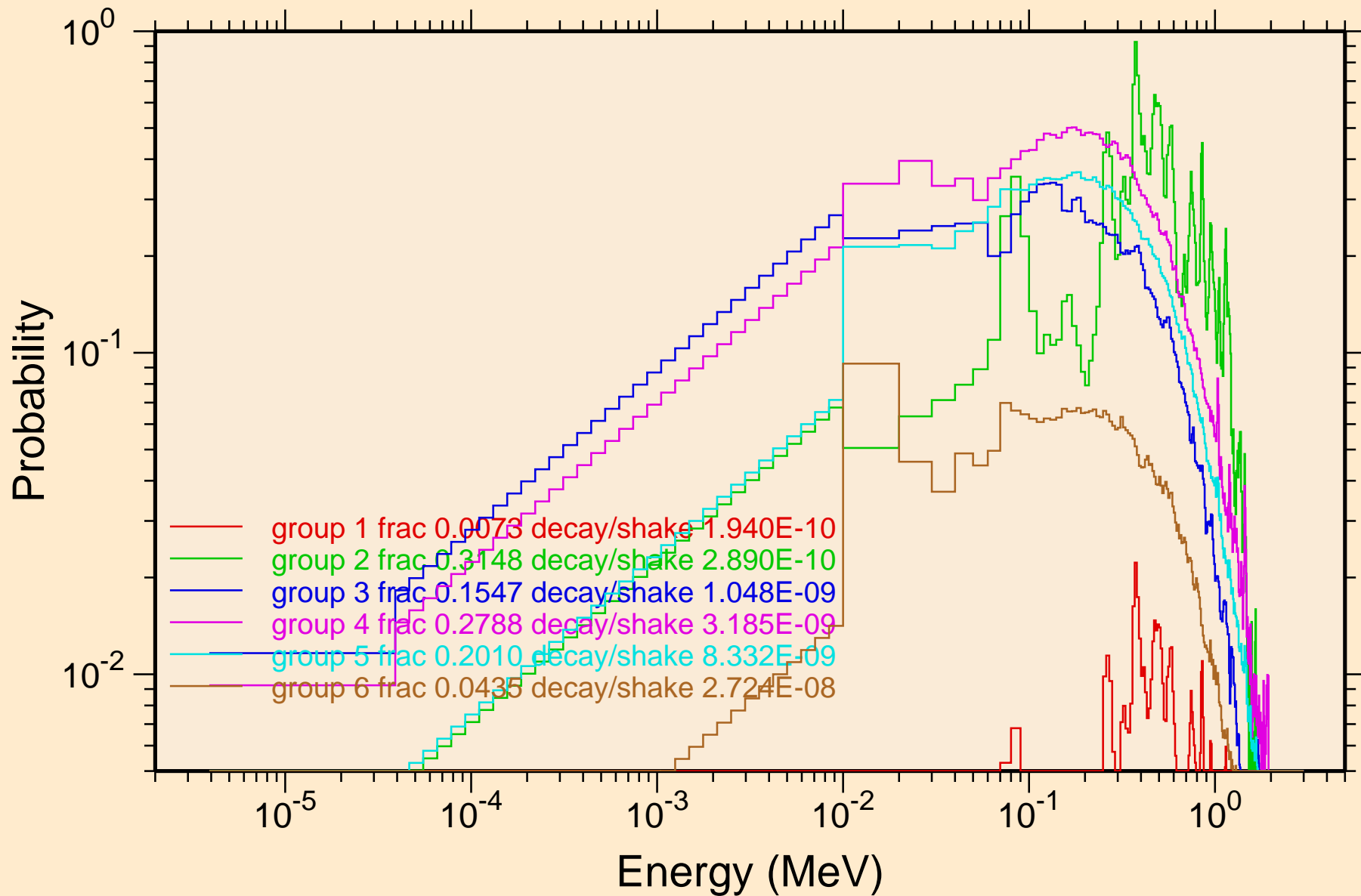

DB266 NEUTRON ACER TENDL-2019 LIBRARY; T=293.16K
Photon emission for (n,x)

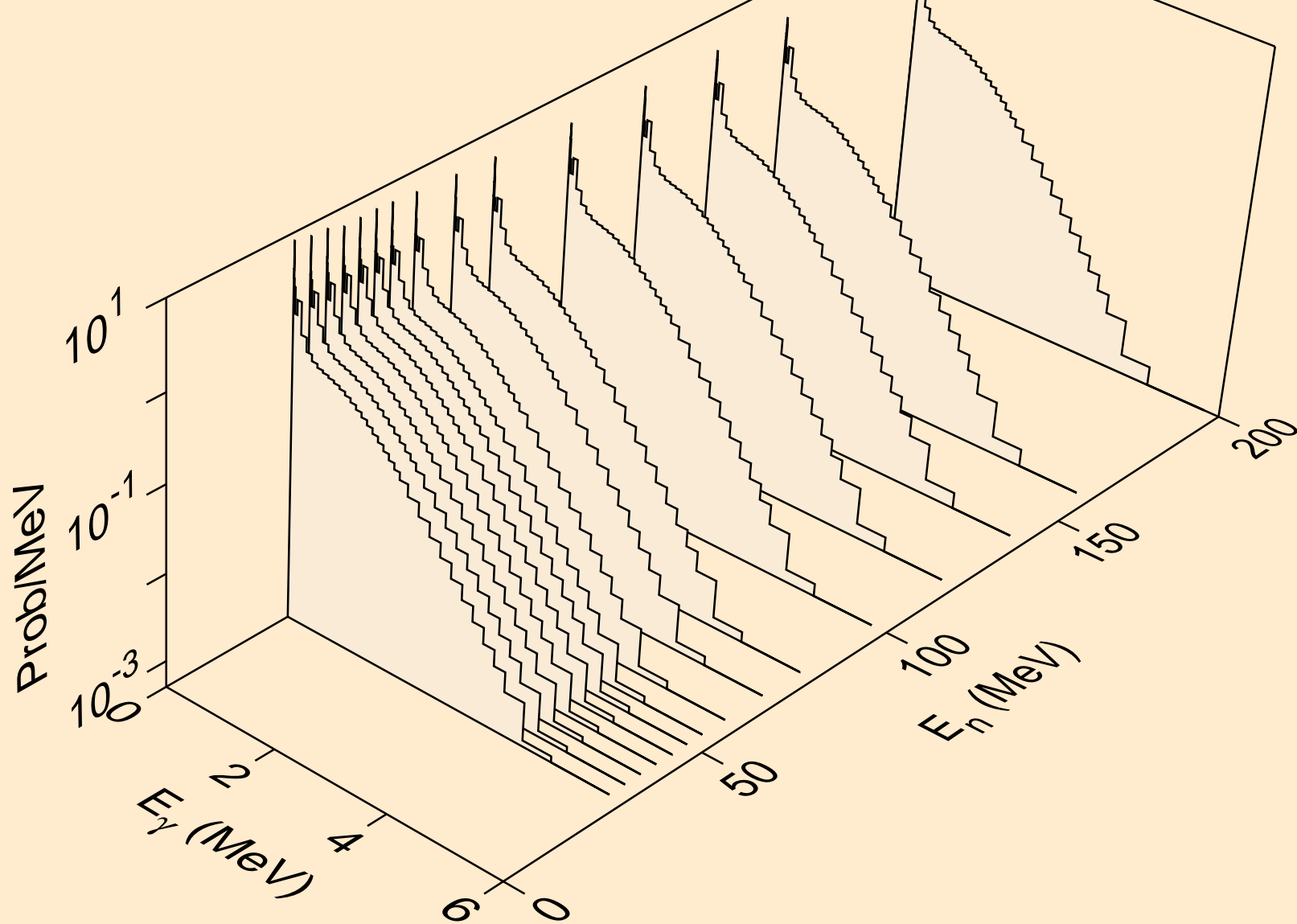

DB266 NEUTRON ACER TENDL-2019 LIBRARY; T=293.16K
Photon emission for (n,2nd)

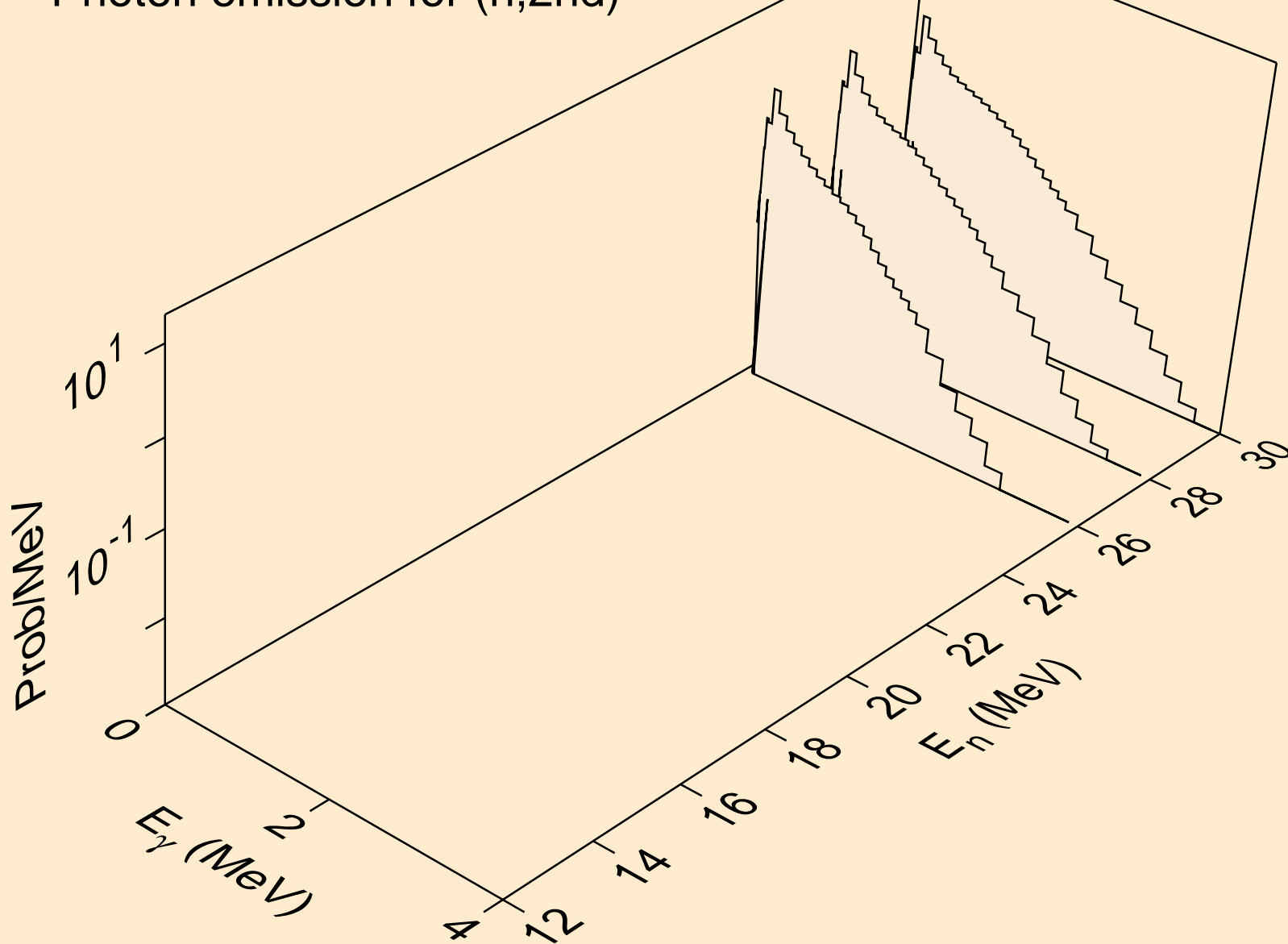

DB266 NEUTRON ACER TENDL-2019 LIBRARY; T=293.16K
Photon emission for (n,2n)

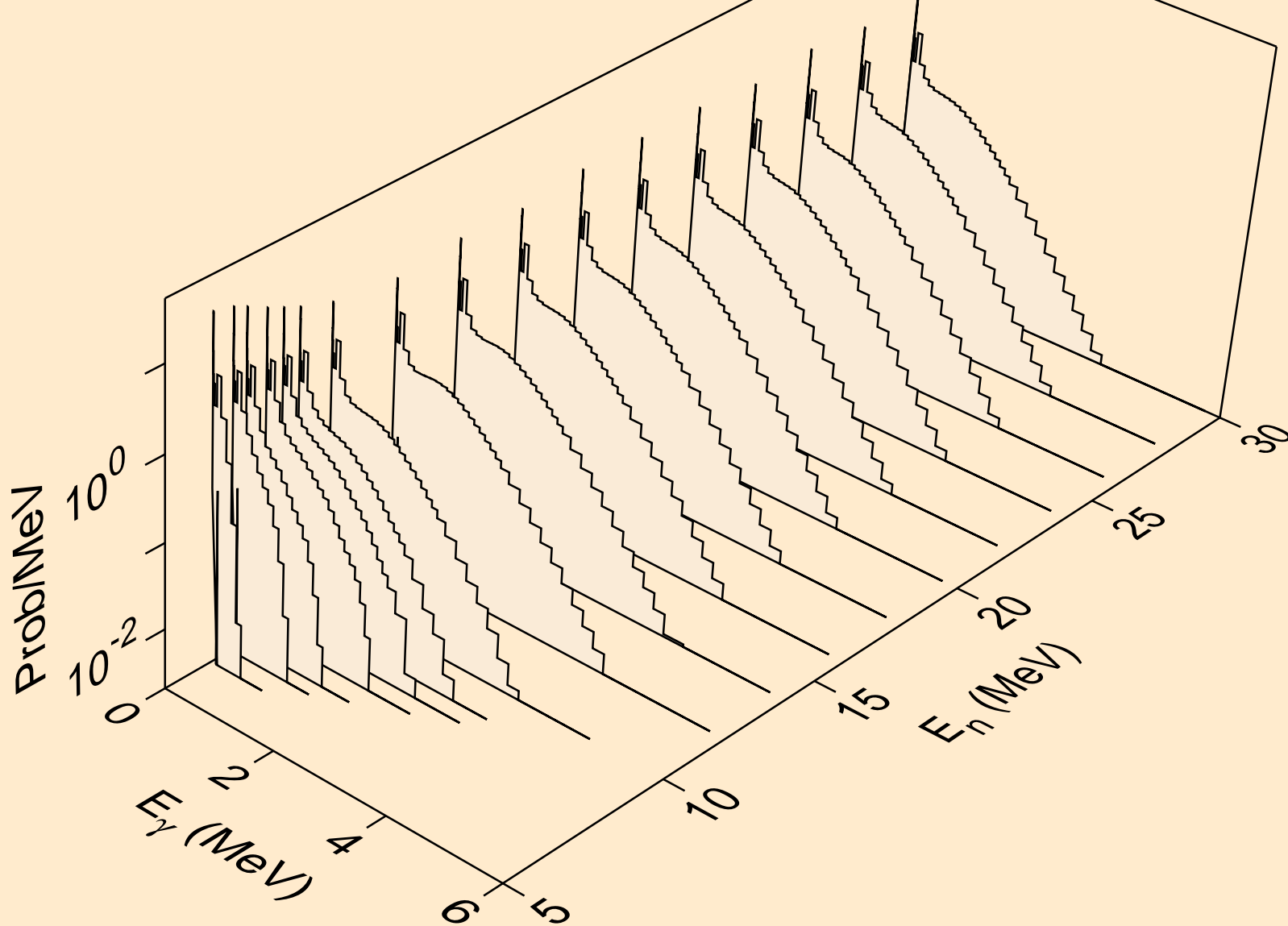

DB266 NEUTRON ACER TENDL-2019 LIBRARY; T=293.16K
Photon emission for (n,3n)

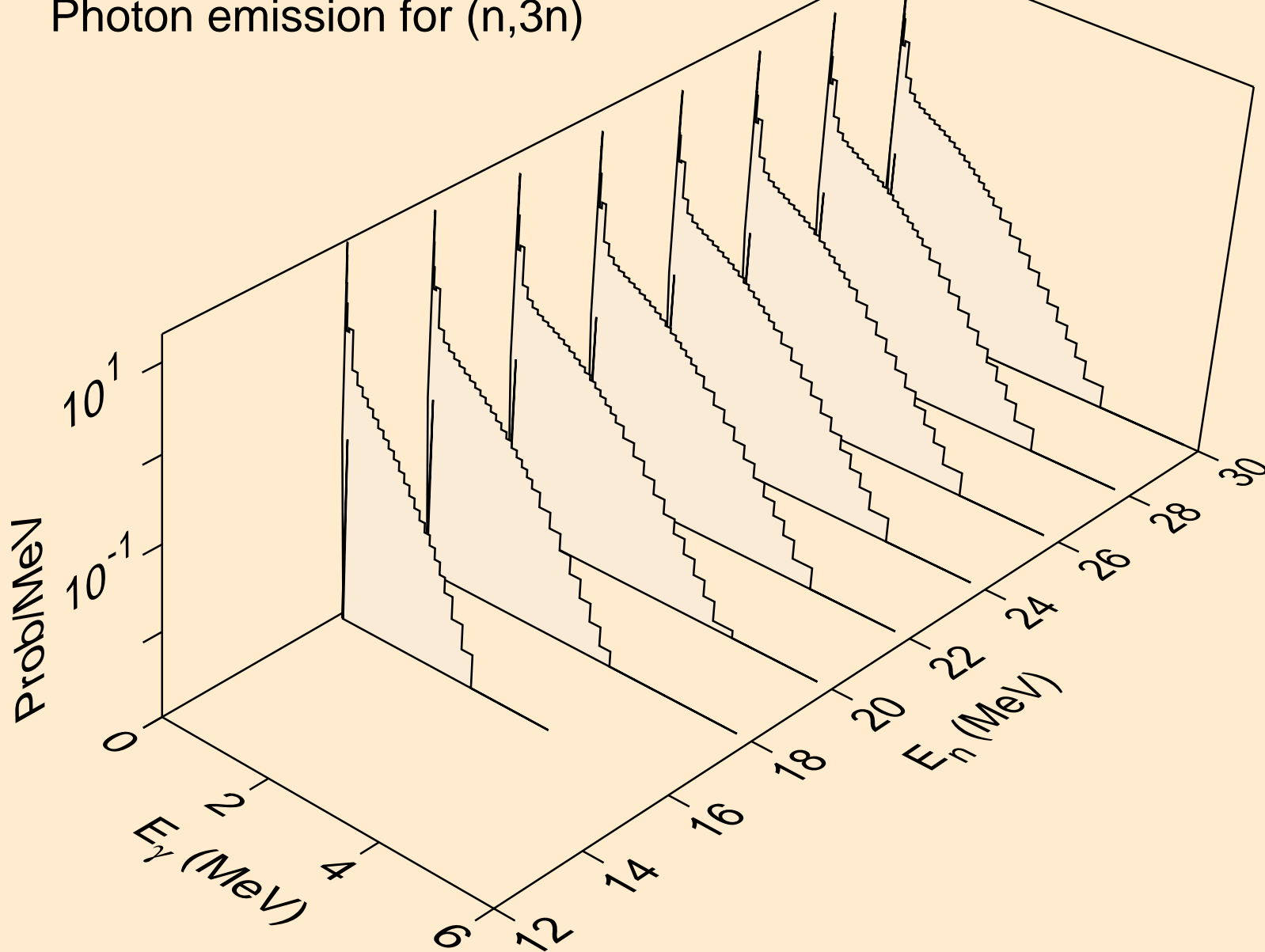

DB266 NEUTRON ACER TENDL-2019 LIBRARY; T=293.16K
Photon emission for (n,n*)a

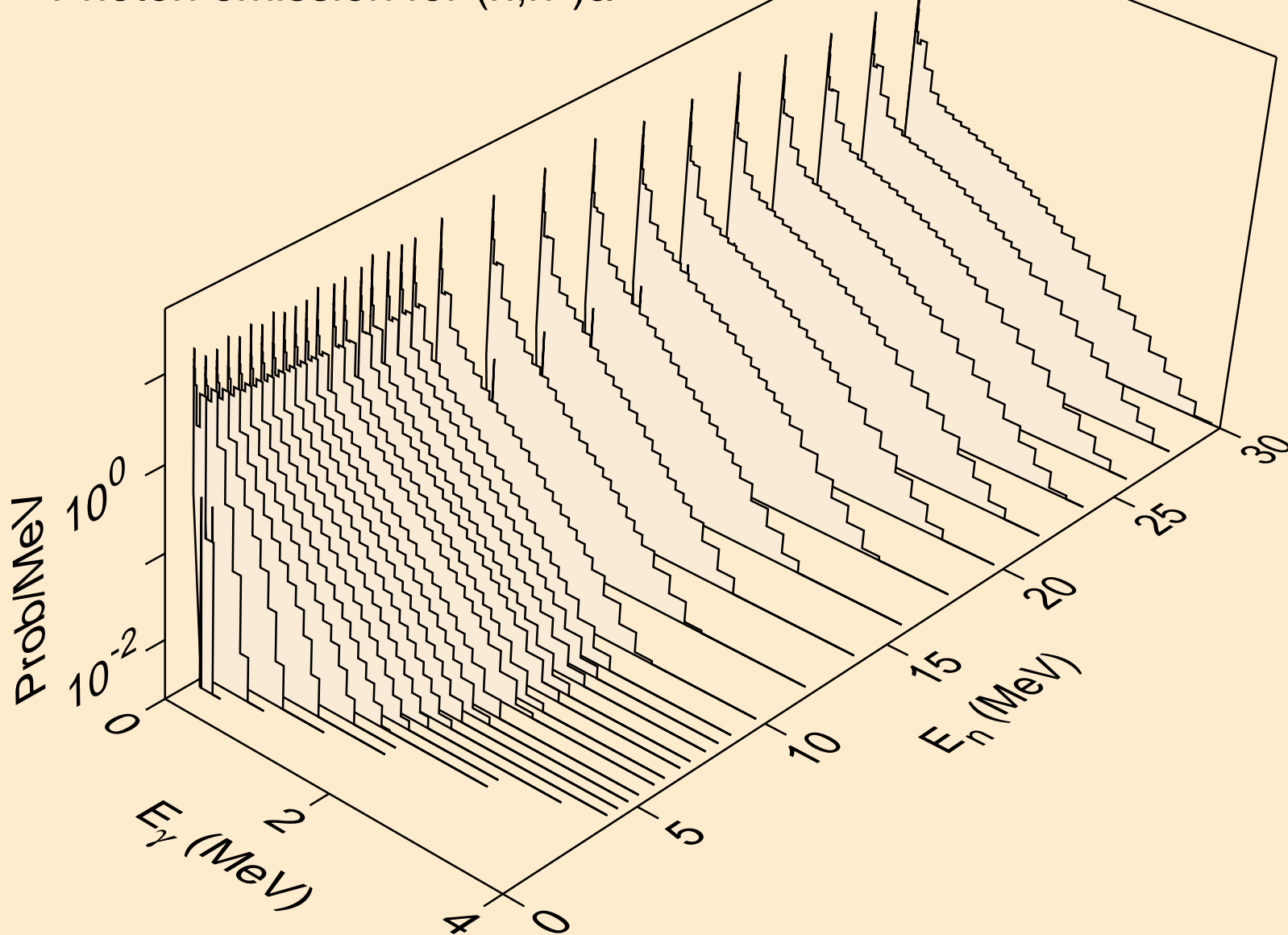

DB266 NEUTRON ACER TENDL-2019 LIBRARY; T=293.16K
Photon emission for (n,2n)a

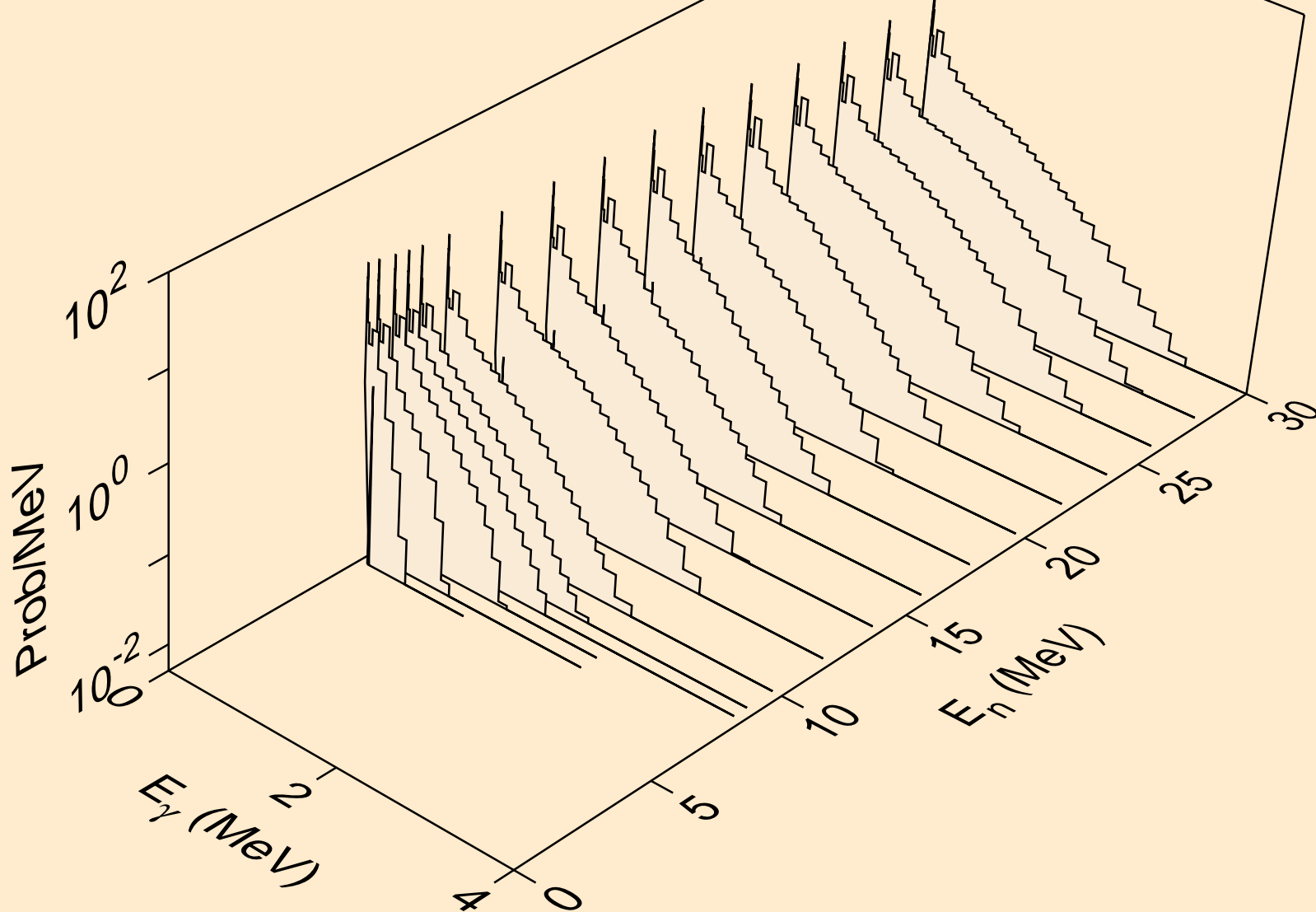

DB266 NEUTRON ACER TENDL-2019 LIBRARY; T=293.16K
Photon emission for (n,3n)a

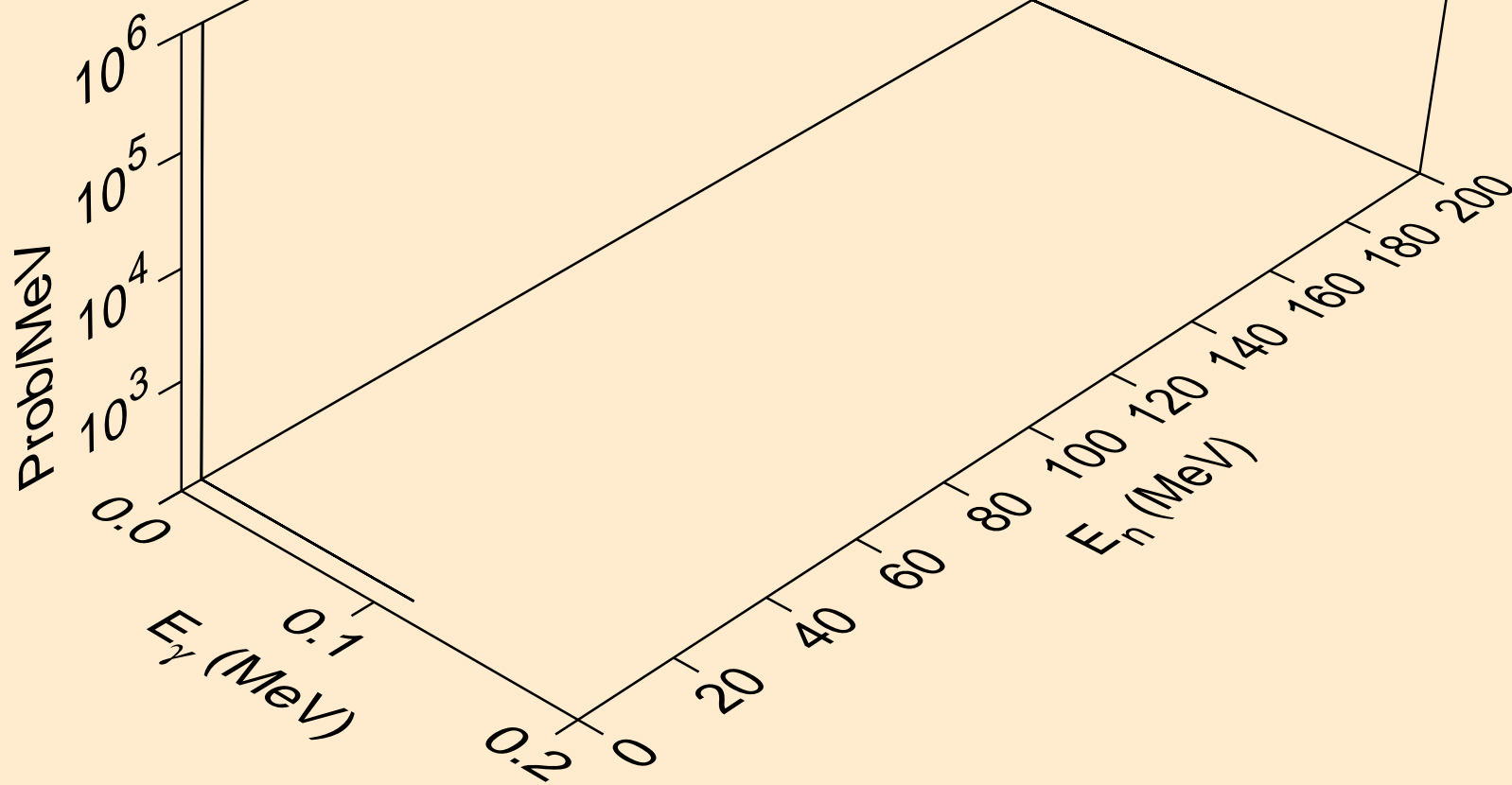

DB266 NEUTRON ACER TENDL-2019 LIBRARY; T=293.16K
Photon emission for (n,n*)p

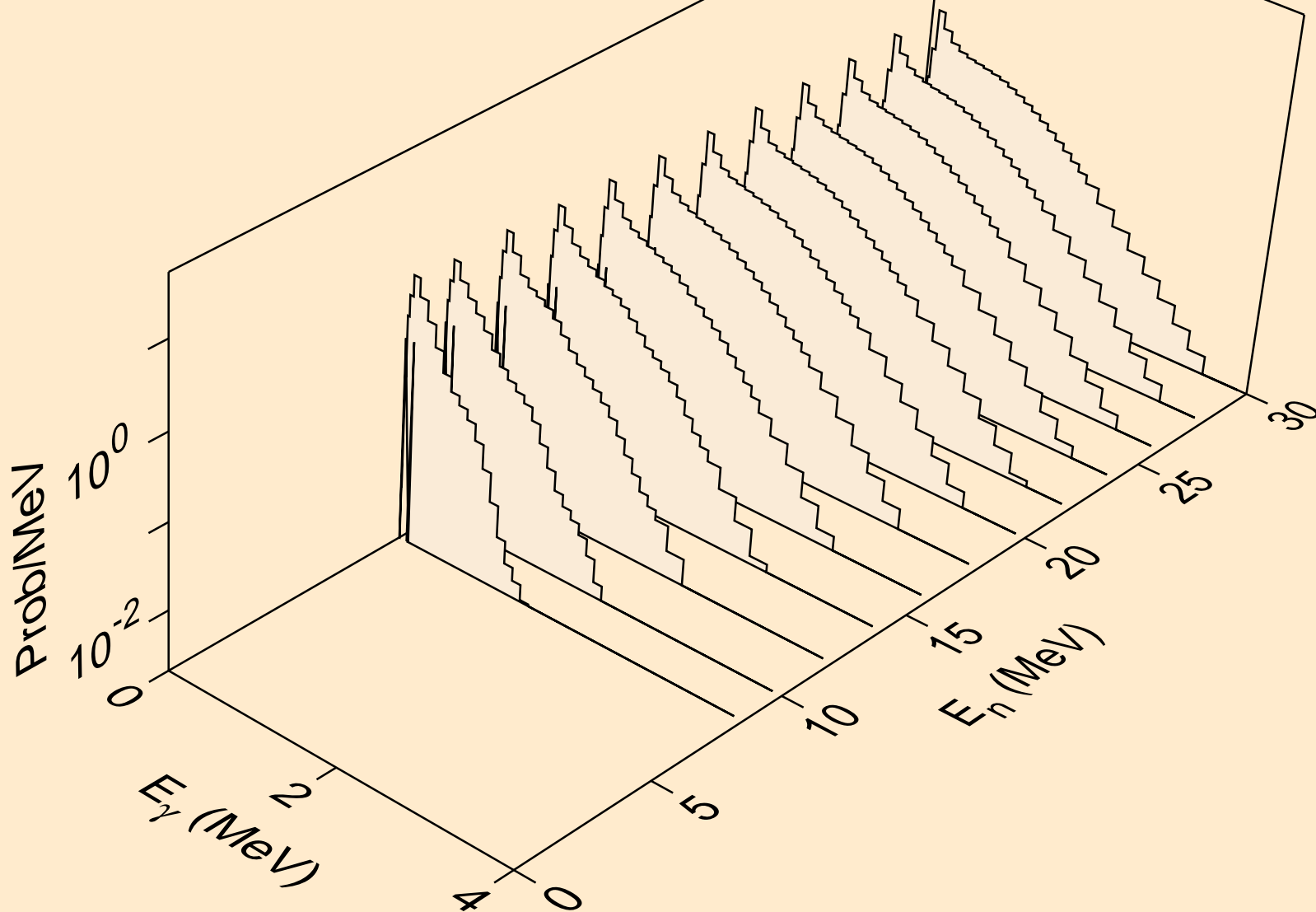

DB266 NEUTRON ACER TENDL-2019 LIBRARY; T=293.16K
Photon emission for (n,n*)2a

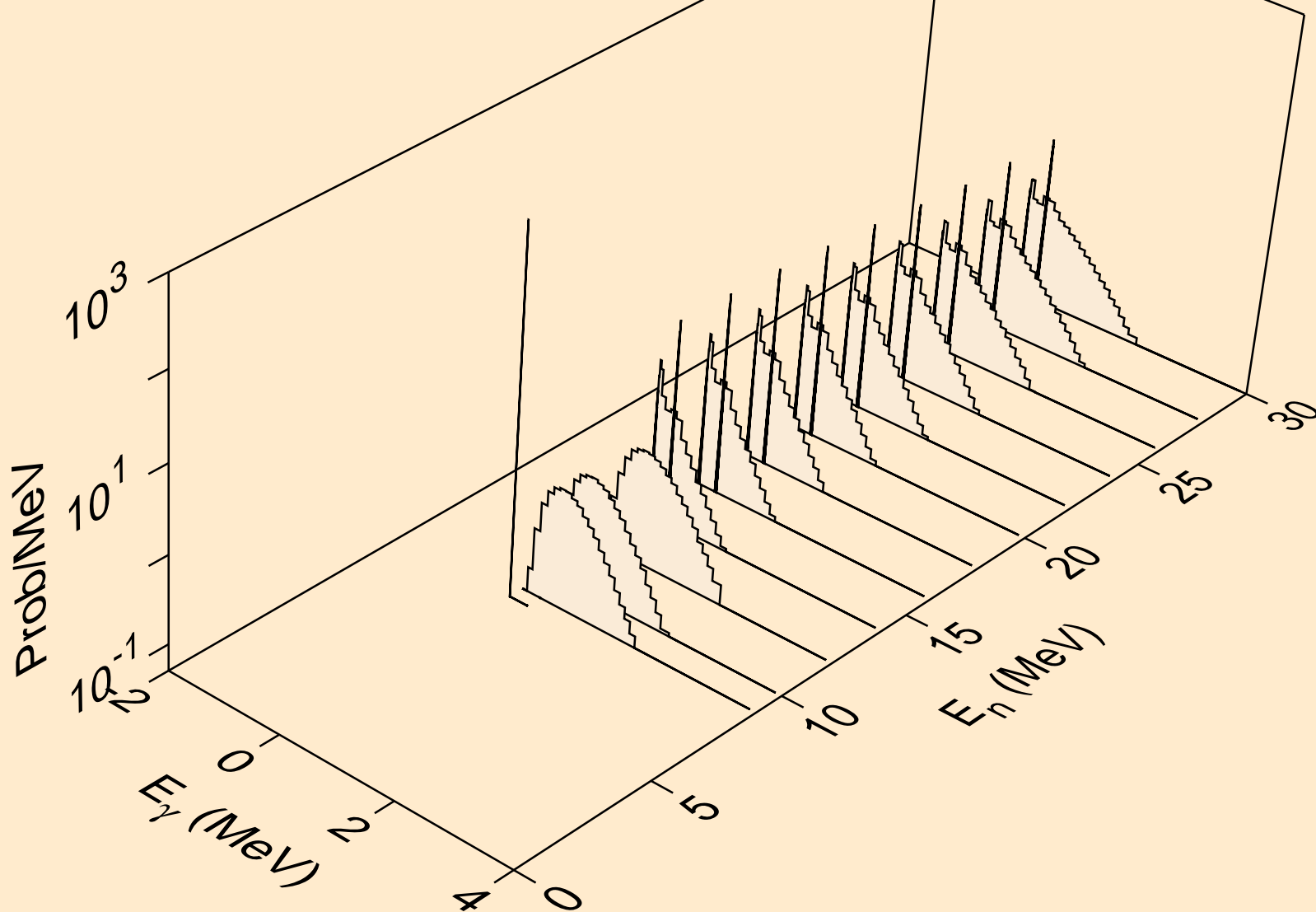

DB266 NEUTRON ACER TENDL-2019 LIBRARY; T=293.16K
Photon emission for (n,n*)d

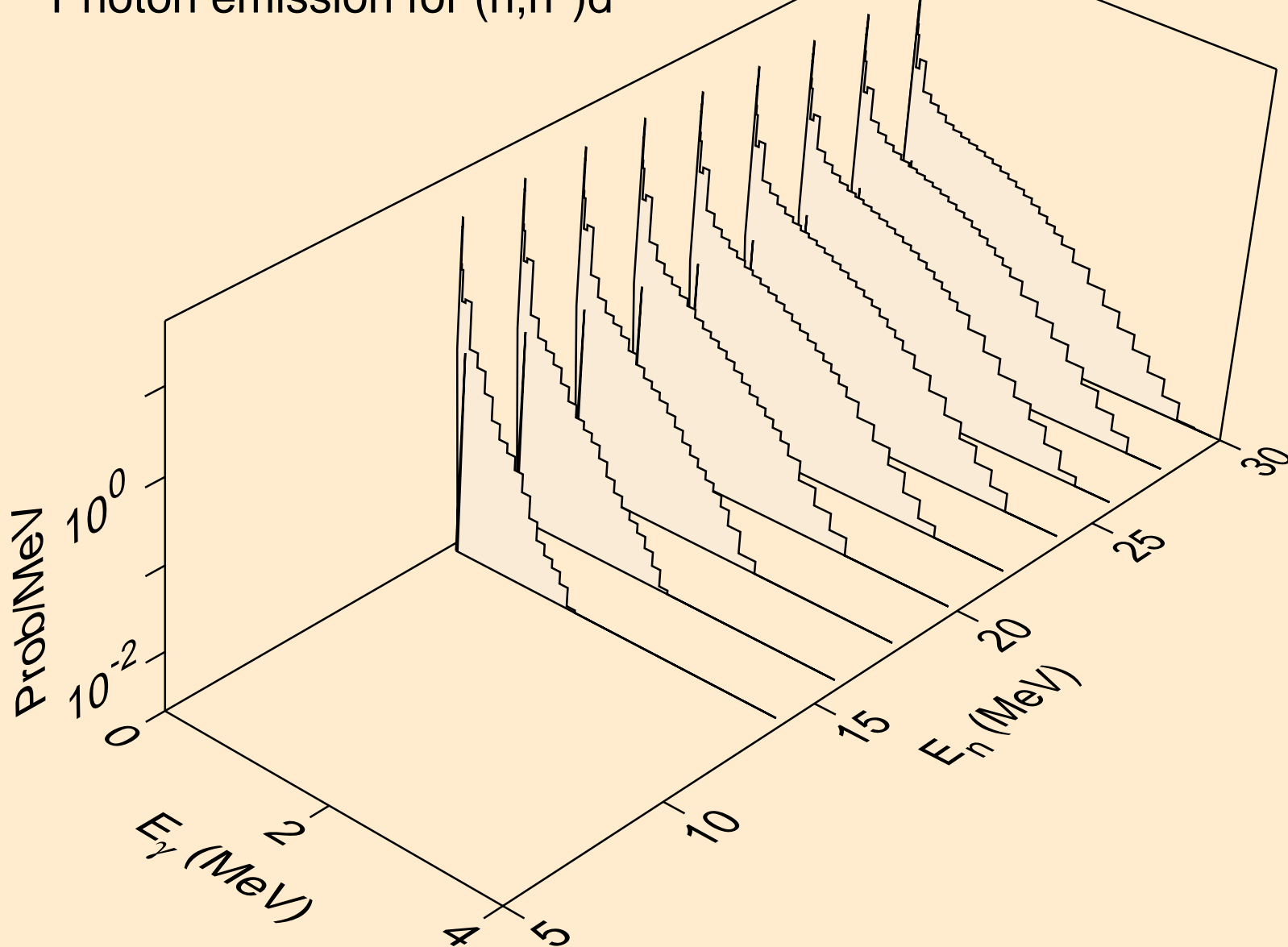

DB266 NEUTRON ACER TENDL-2019 LIBRARY; T=293.16K
Photon emission for (n,n*)t

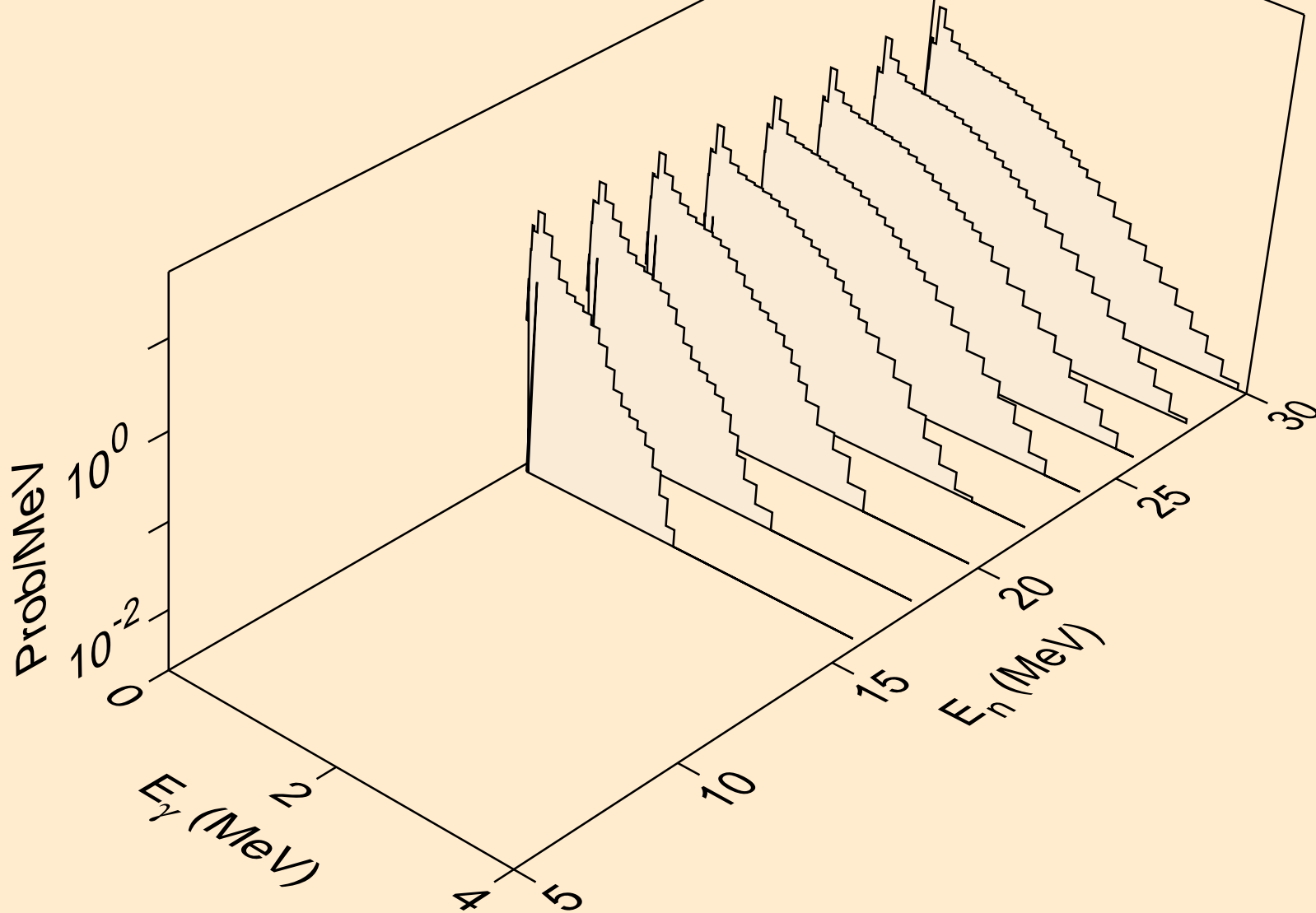

DB266 NEUTRON ACER TENDL-2019 LIBRARY; T=293.16K
Photon emission for (n,n*)he3

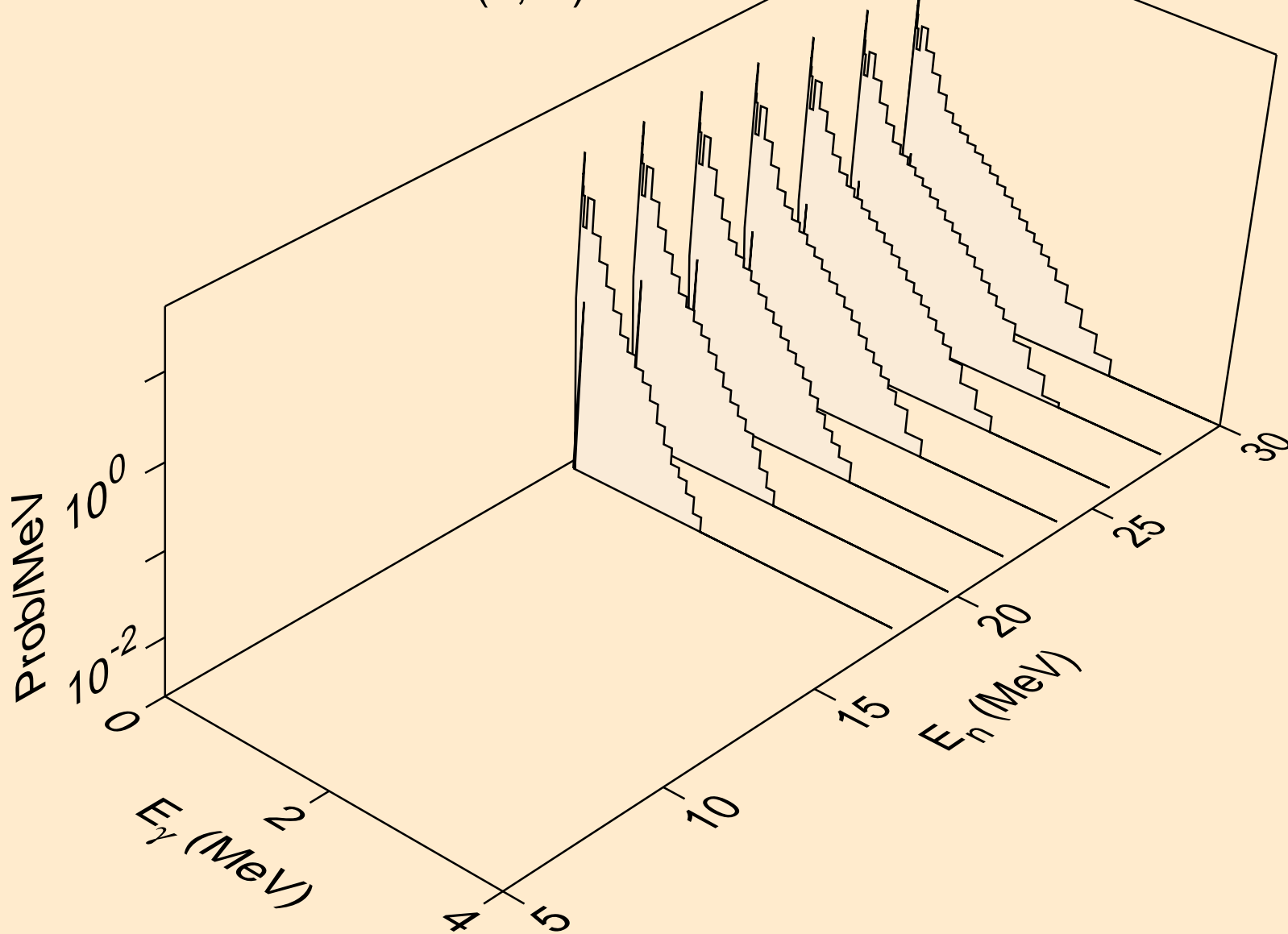

DB266 NEUTRON ACER TENDL-2019 LIBRARY; T=293.16K
Photon emission for (n,4n)

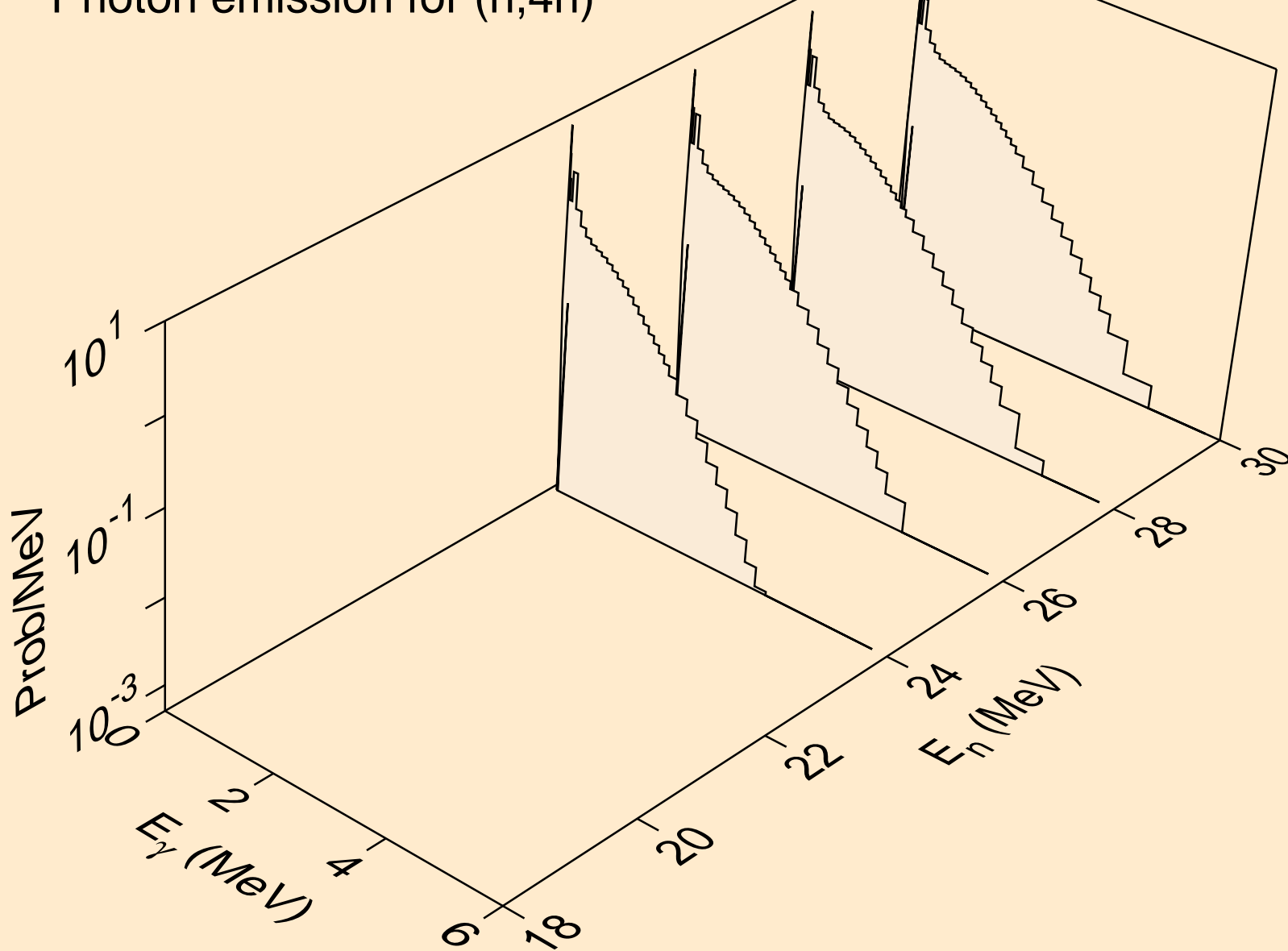

DB266 NEUTRON ACER TENDL-2019 LIBRARY; T=293.16K
Photon emission for (n,2np)

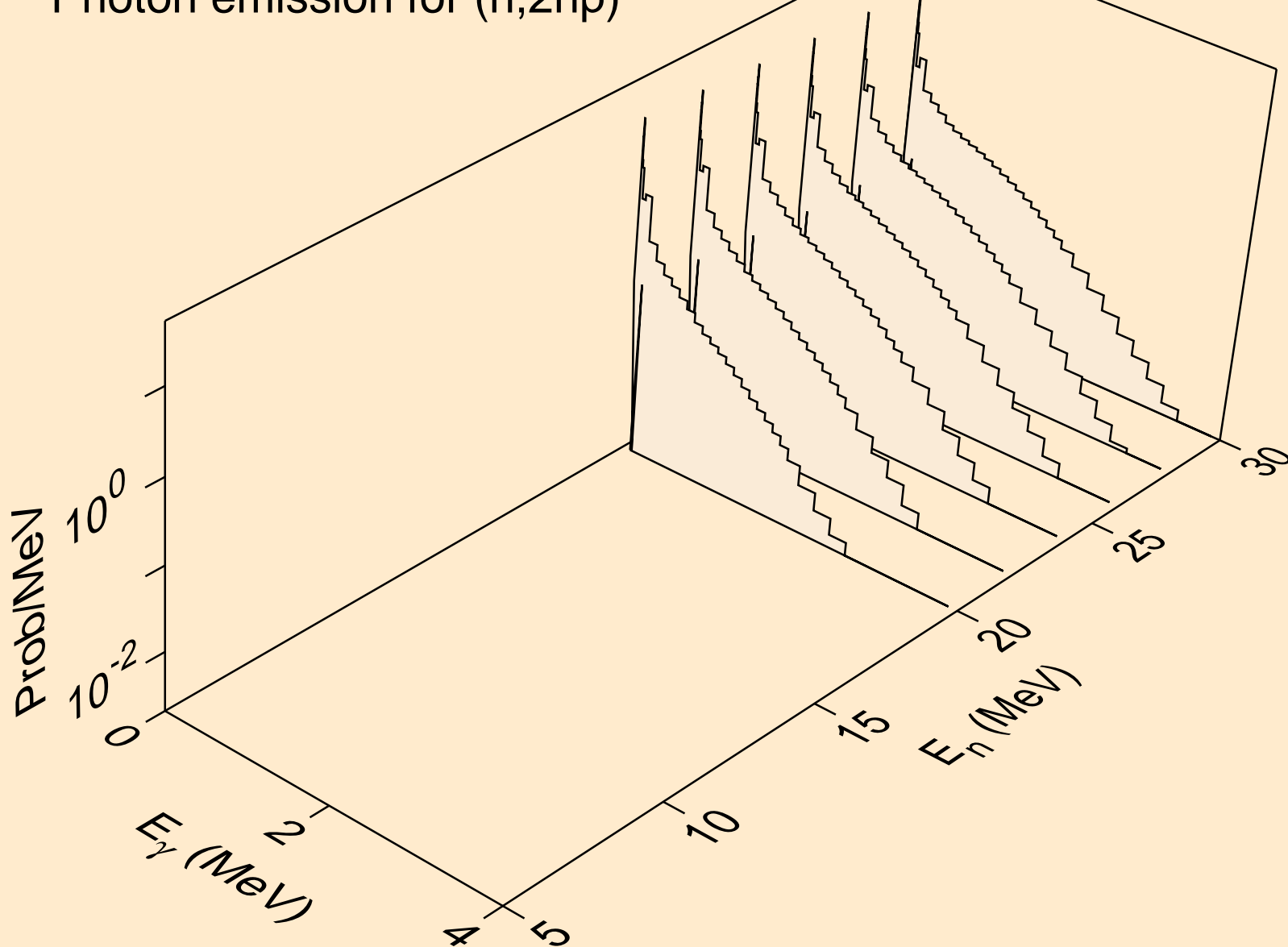

DB266 NEUTRON ACER TENDL-2019 LIBRARY; T=293.16K
Photon emission for (n,3np)

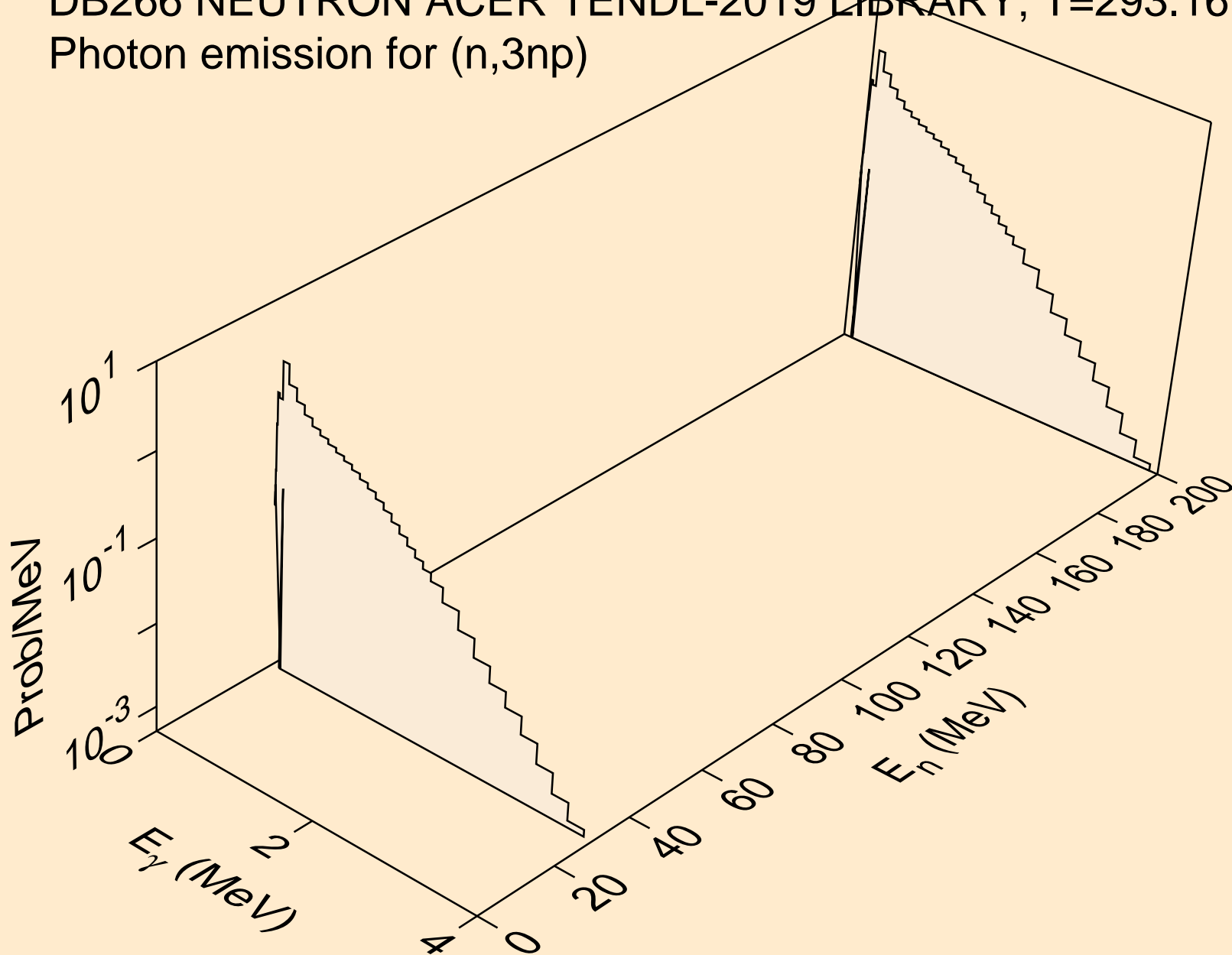

DB266 NEUTRON ACER TENDL-2019 LIBRARY; T=293.16K
Photon emission for (n,2np)

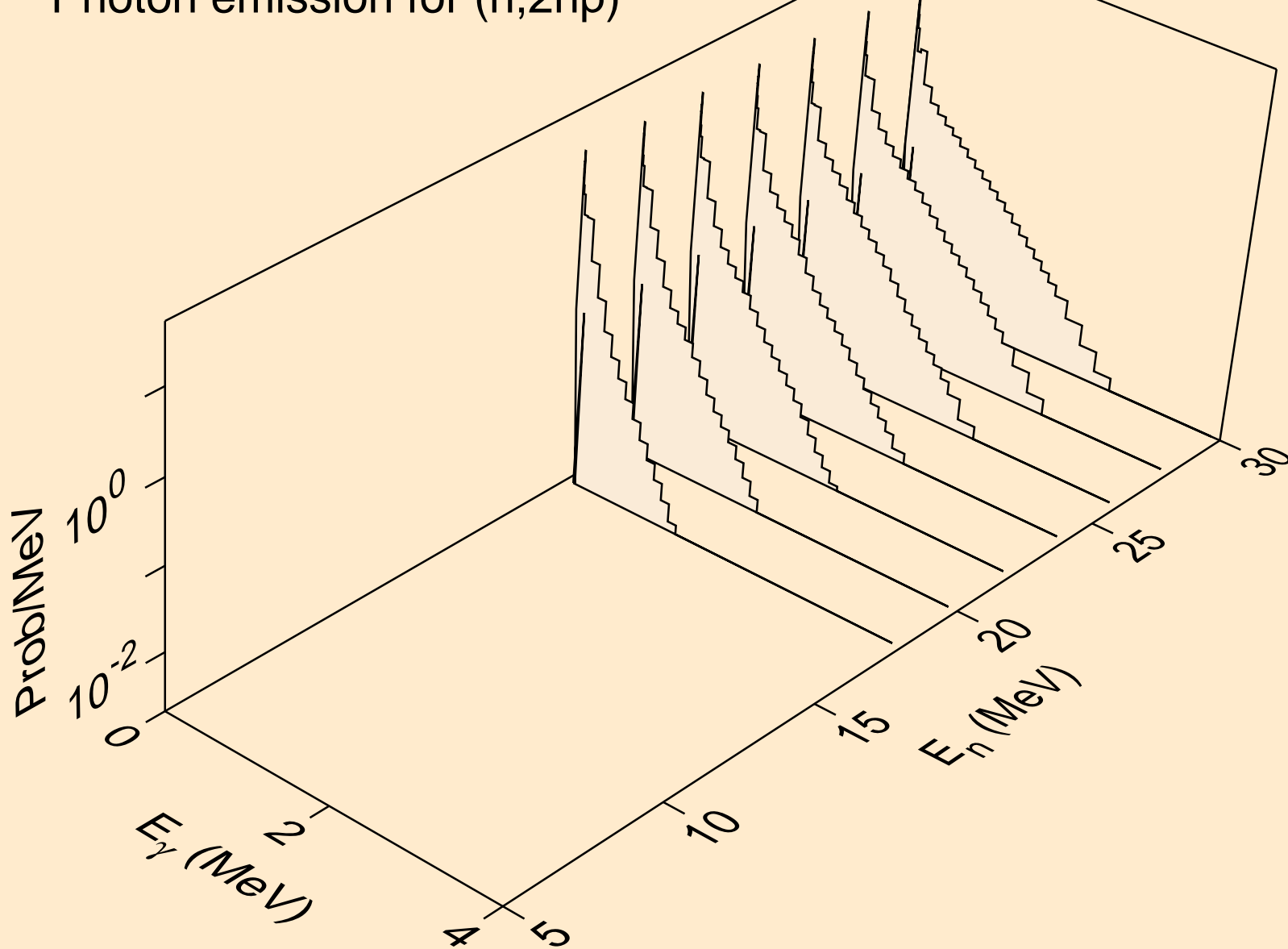

DB266 NEUTRON ACER TENDL-2019 LIBRARY; T=293.16K
Photon emission for (n,n*c)

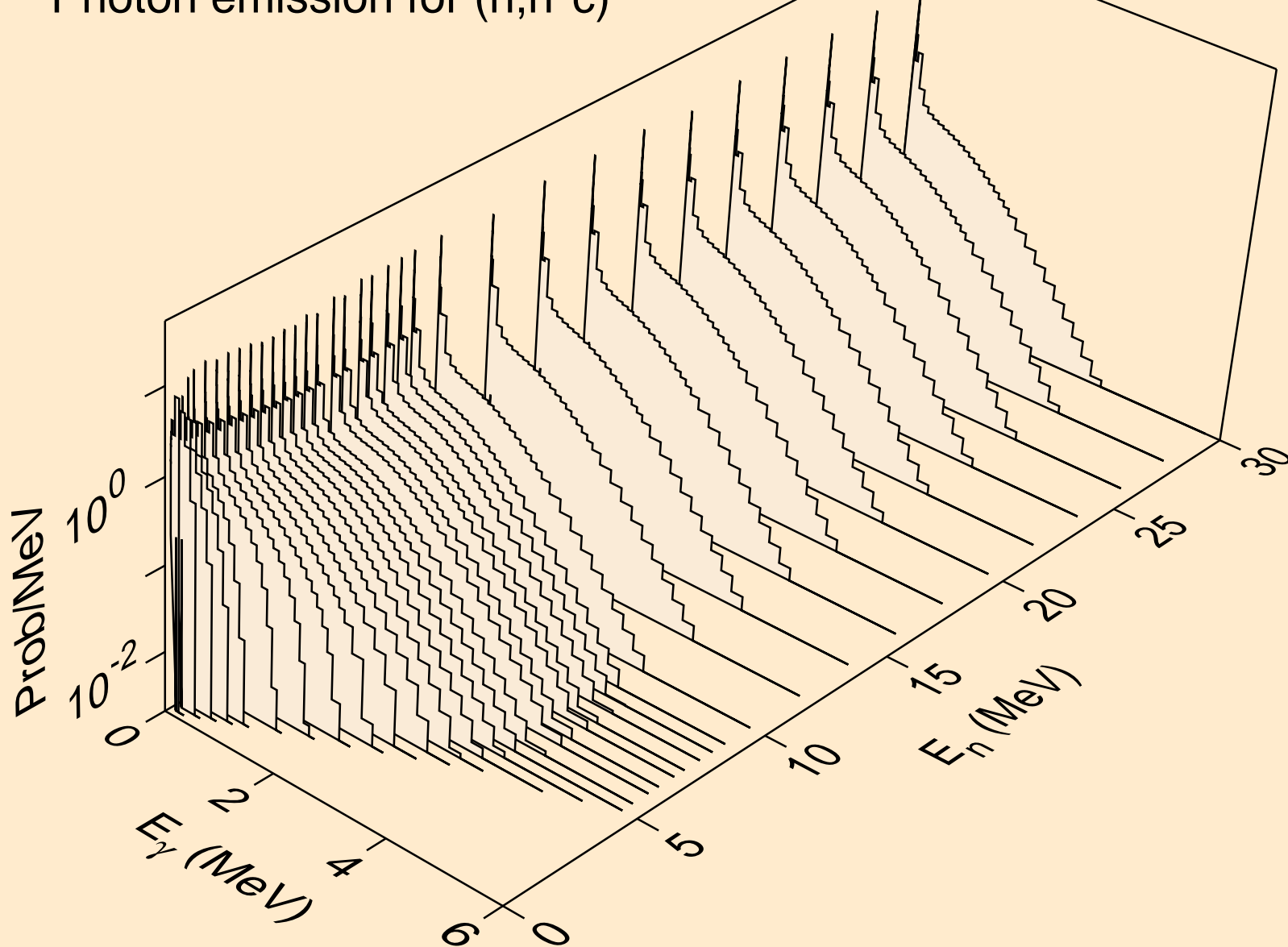

DB266 NEUTRON ACER TENDL-2019 LIBRARY; T=293.16K
Photon emission for (n,gma)

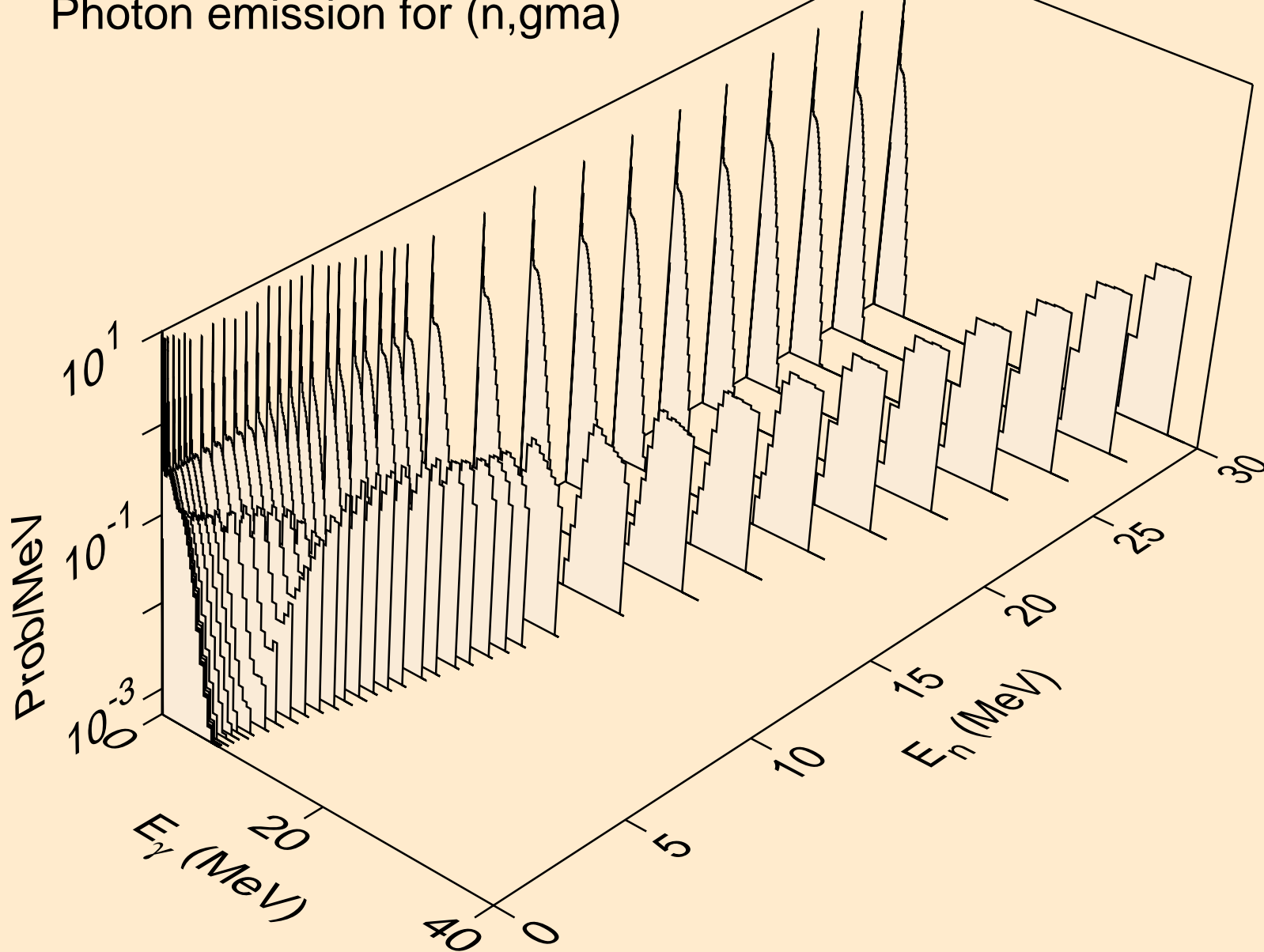

DB266 NEUTRON ACER TENDL-2019 LIBRARY; T=293.16K
Photon emission for (n,p)

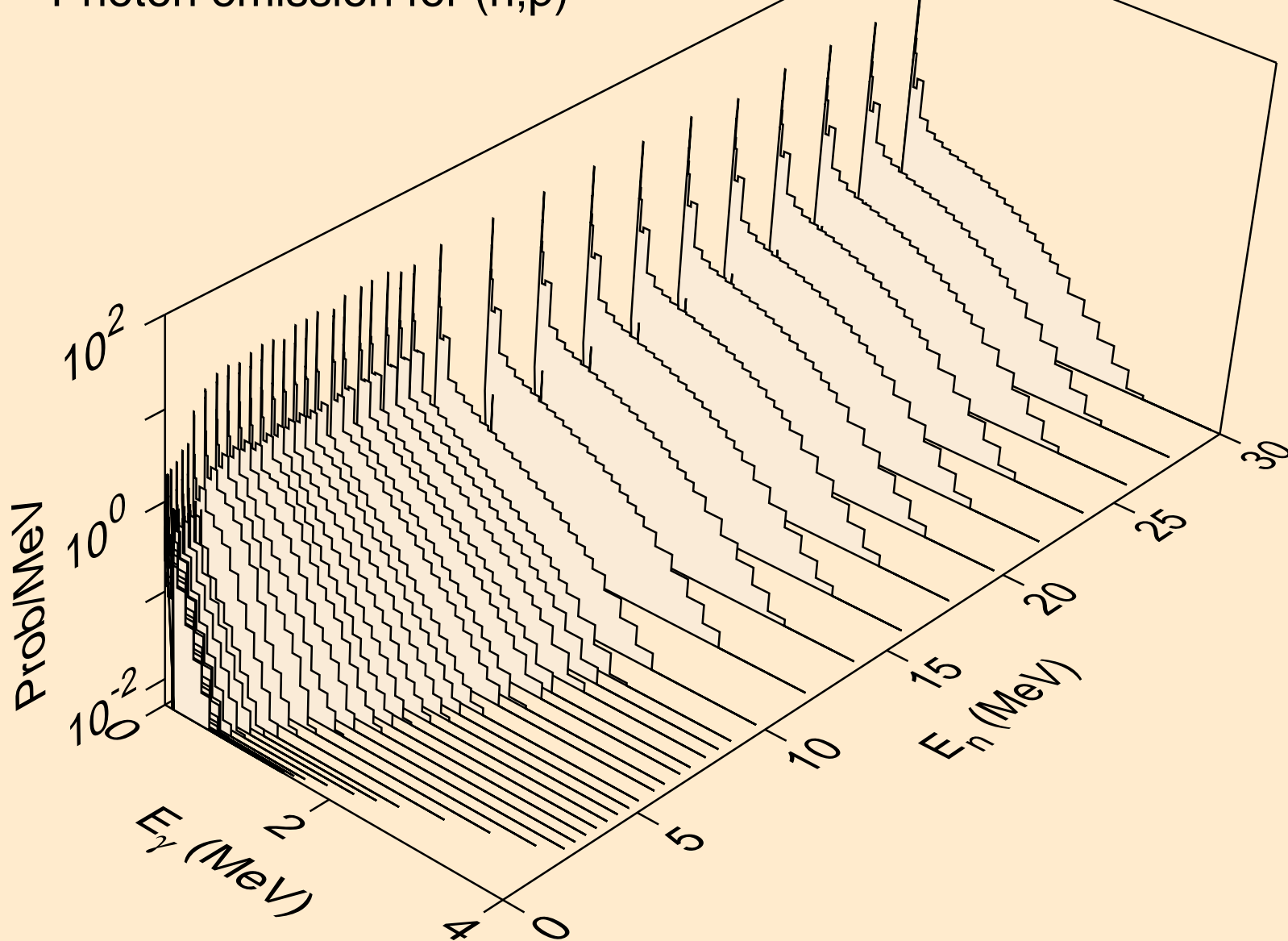

DB266 NEUTRON ACER TENDL-2019 LIBRARY; T=293.16K
Photon emission for (n,d)

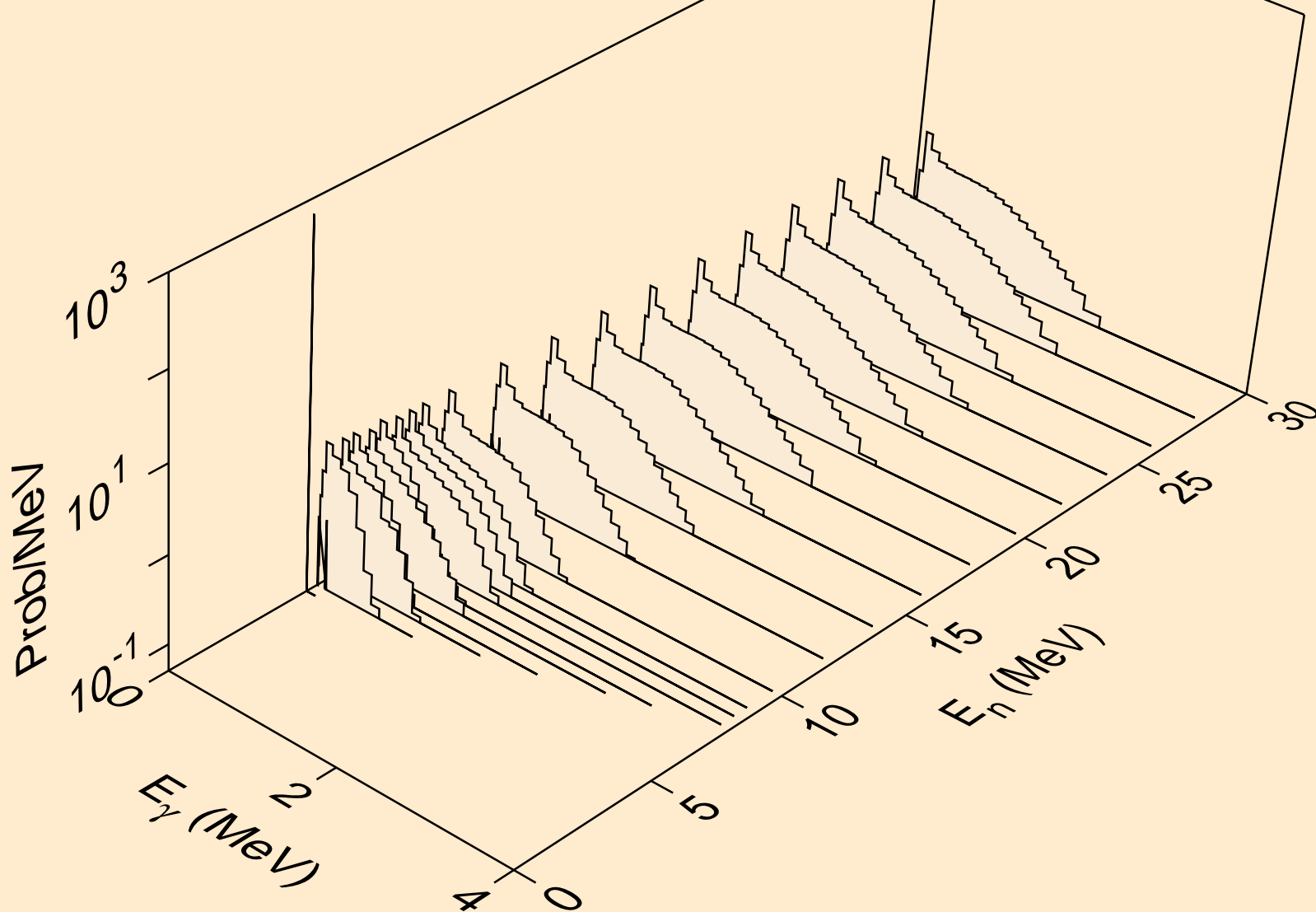

DB266 NEUTRON ACER TENDL-2019 LIBRARY; T=293.16K
Photon emission for (n,t)

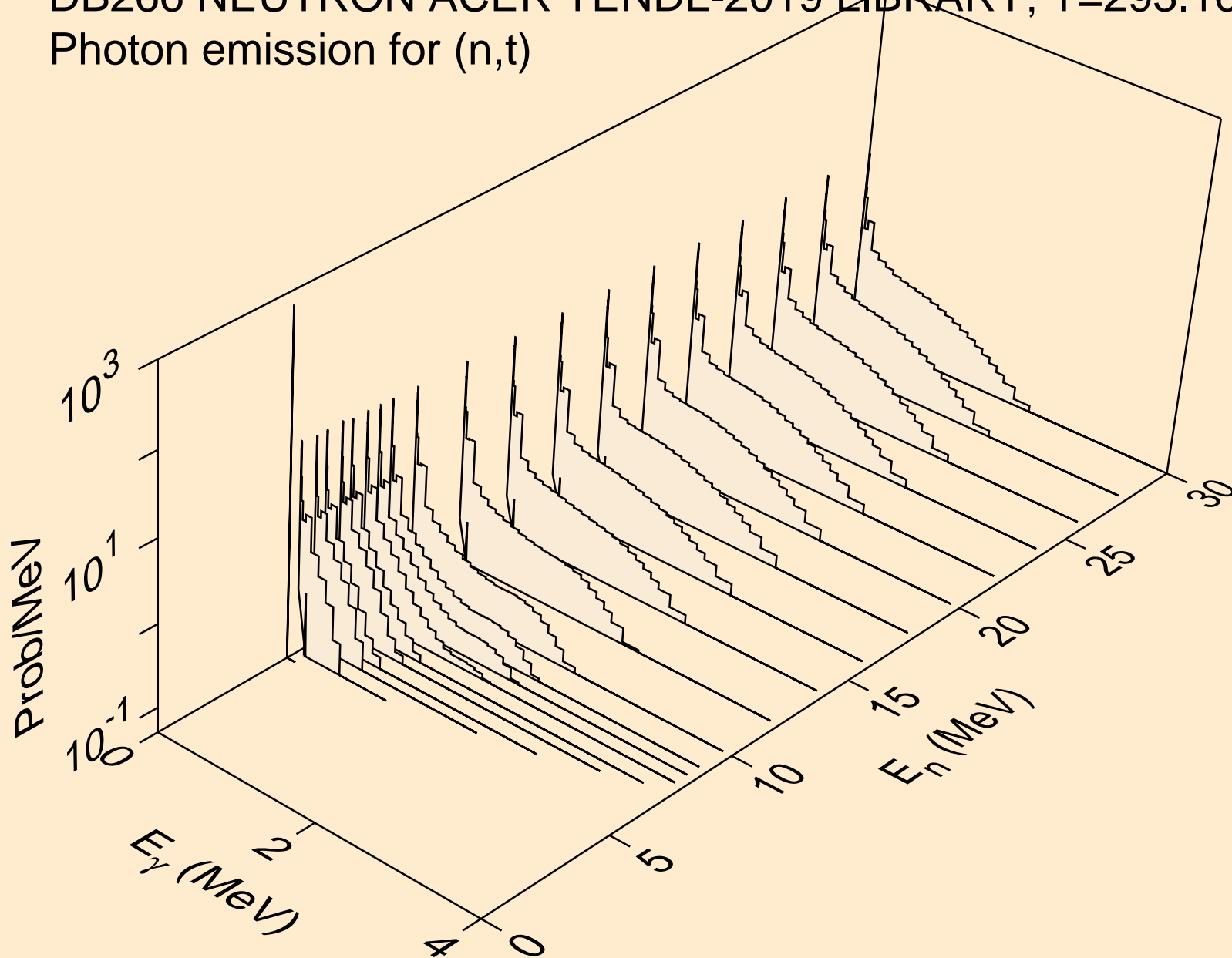

DB266 NEUTRON ACER TENDL-2019 LIBRARY; T=293.16K
Photon emission for (n,he3)

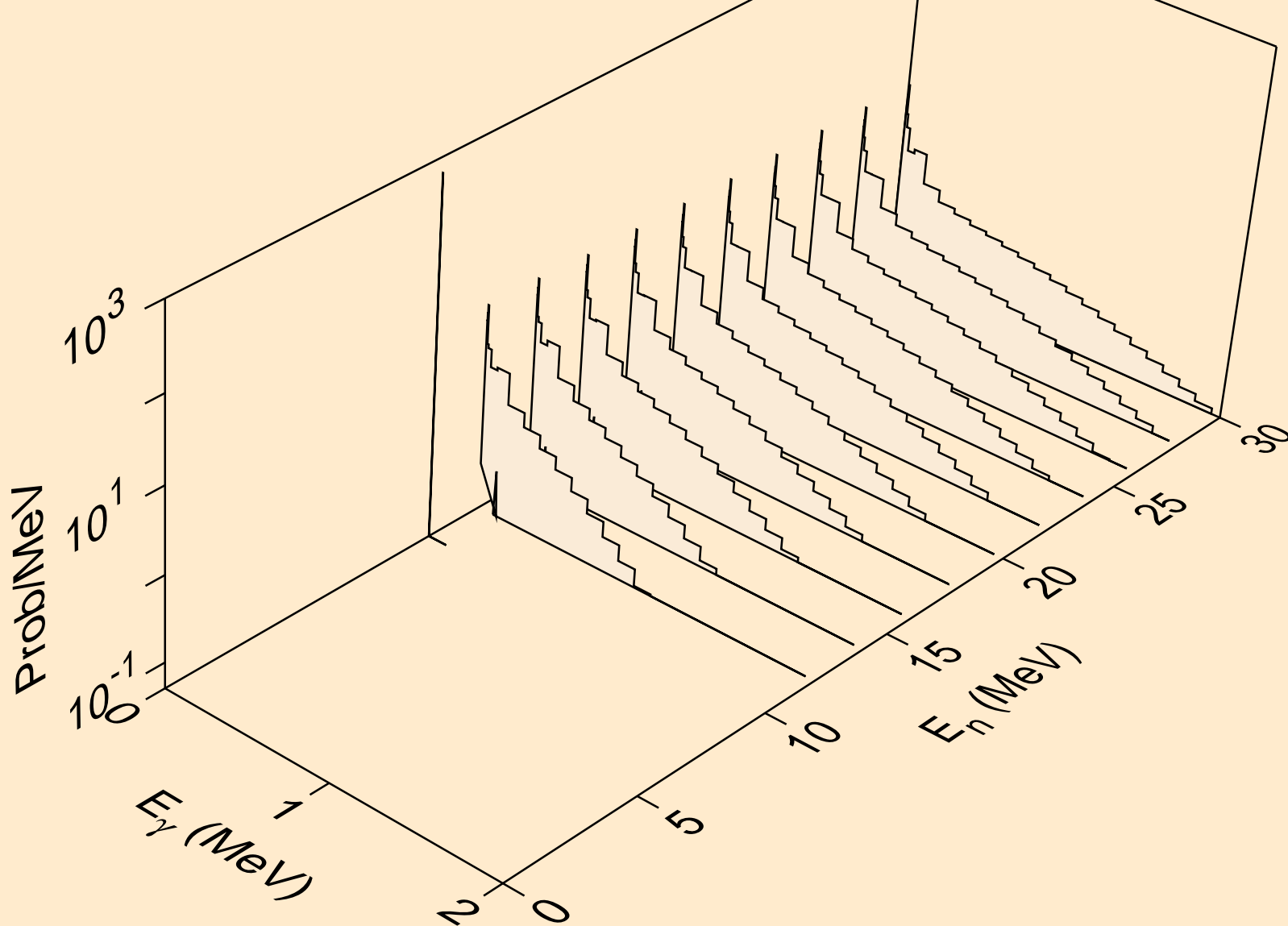

DB266 NEUTRON ACER TENDL-2019 LIBRARY; T=293.16K
Photon emission for (n,a)

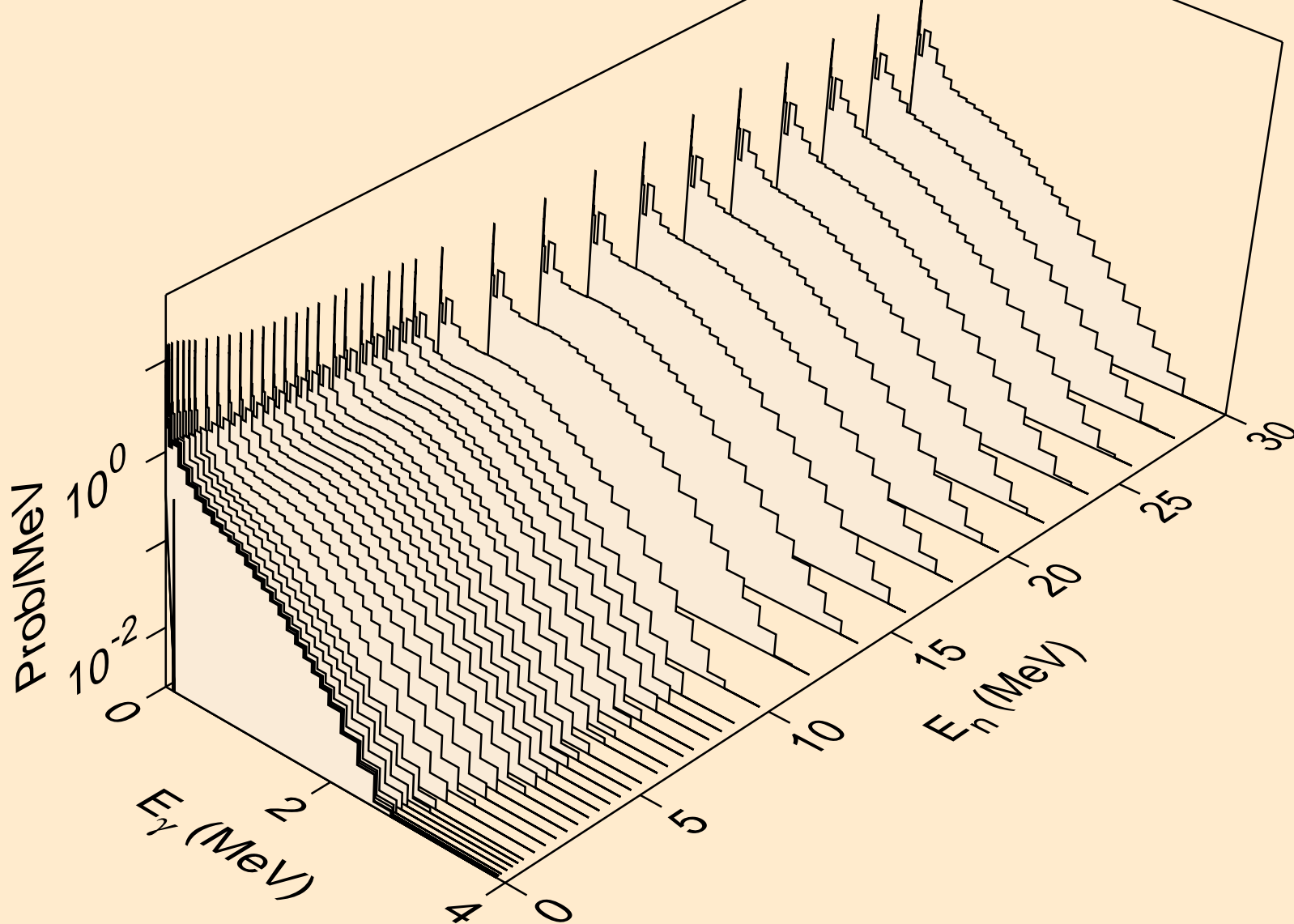

DB266 NEUTRON ACER TENDL-2019 LIBRARY; T=293.16K
Photon emission for (n,2p)

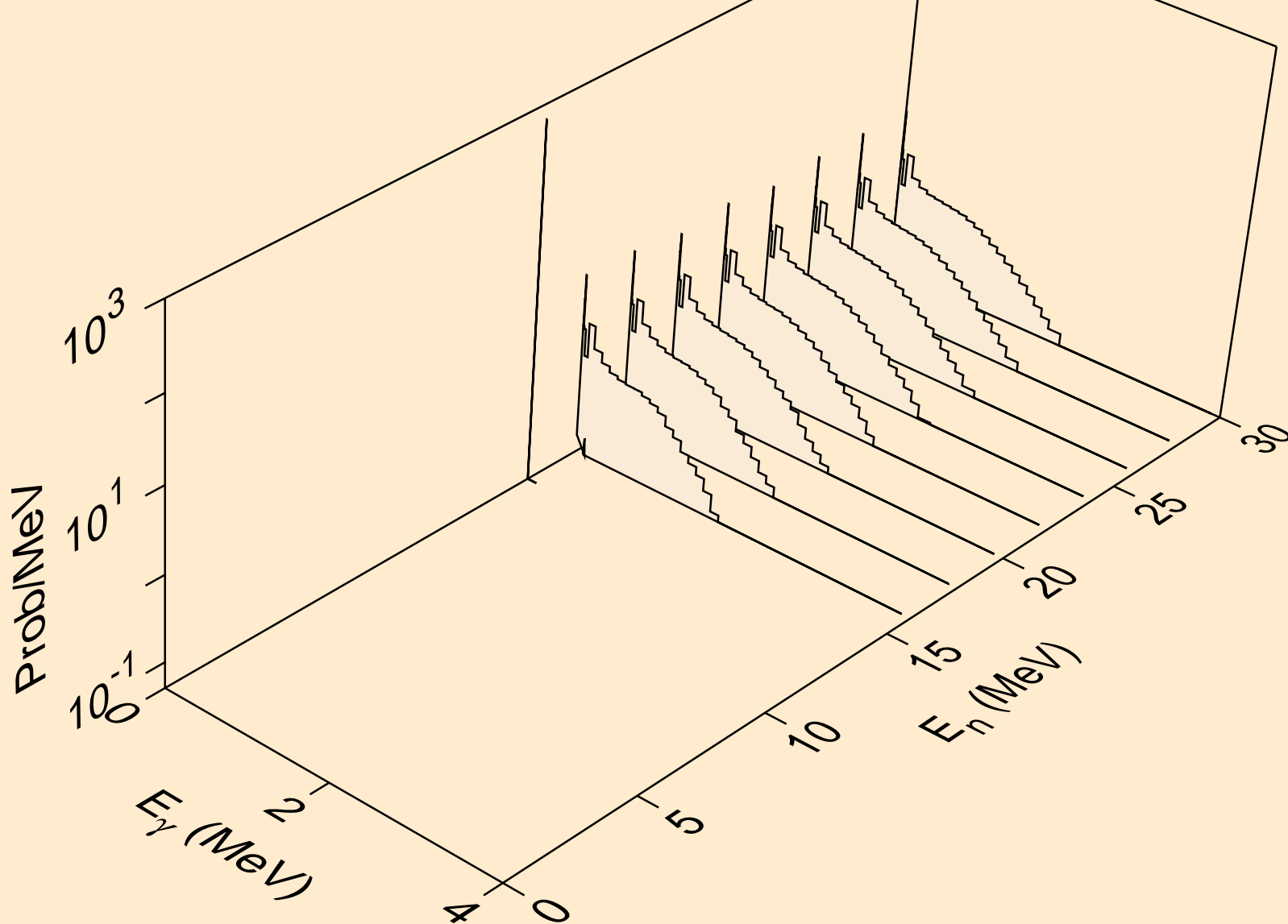

DB266 NEUTRON ACER TENDL-2019 LIBRARY; T=293.16K
Photon emission for (n,pd)

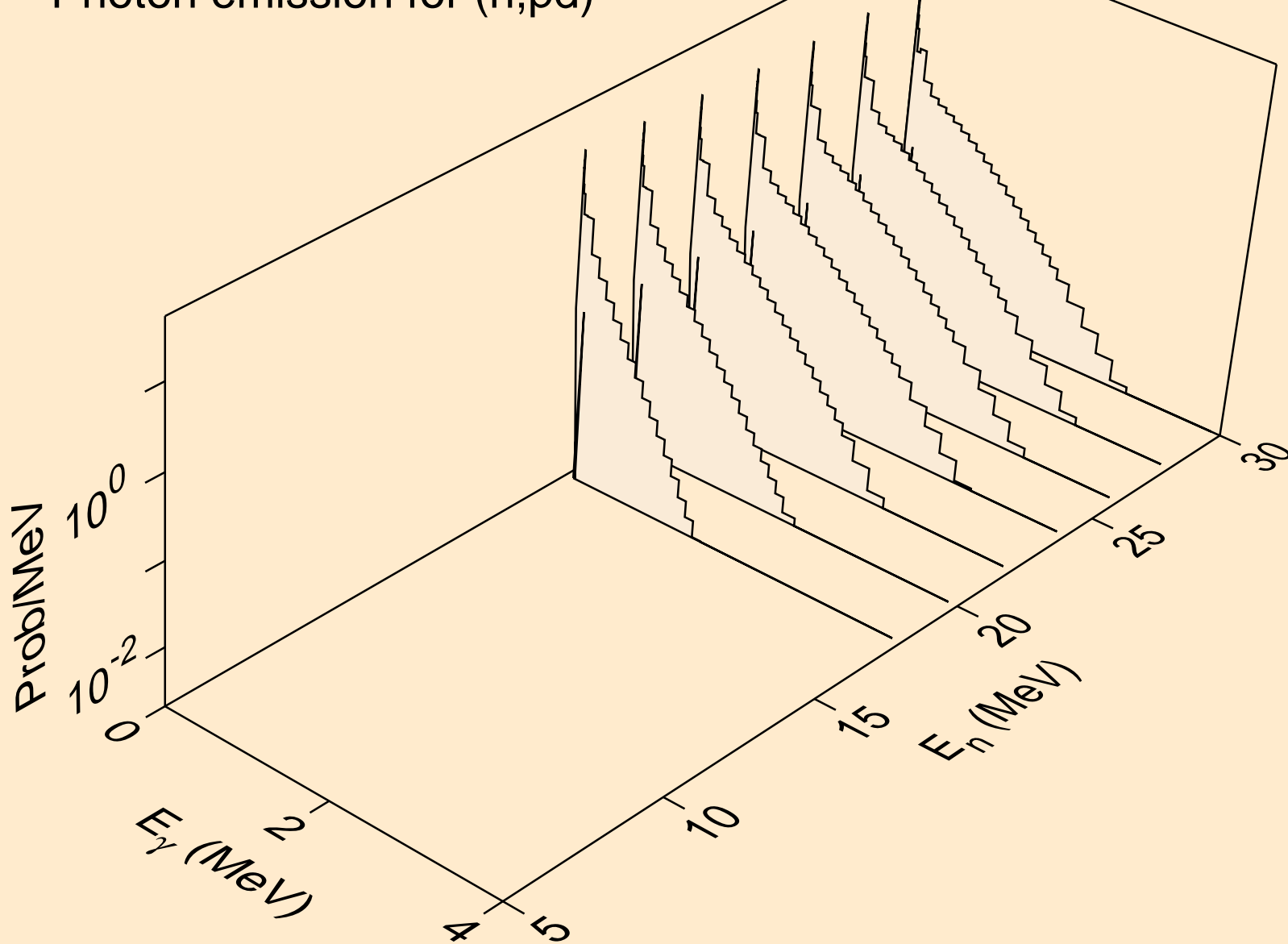

DB266 NEUTRON ACER TENDL-2019 LIBRARY; T=293.16K
thermal capture photon spectrum

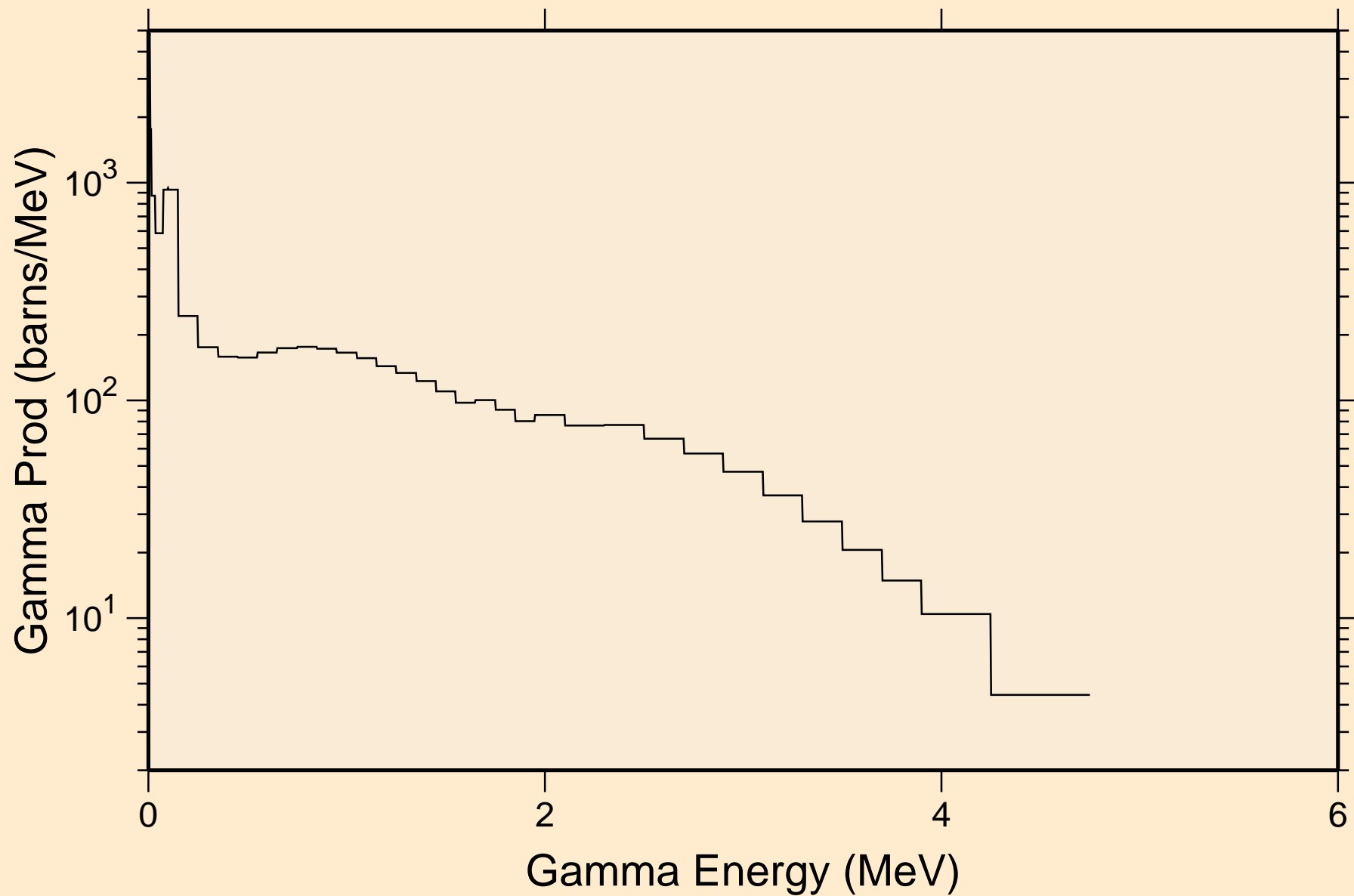

DB266 NEUTRON ACER TENDL-2019 LIBRARY; T=293.16K
14 MeV photon spectrum

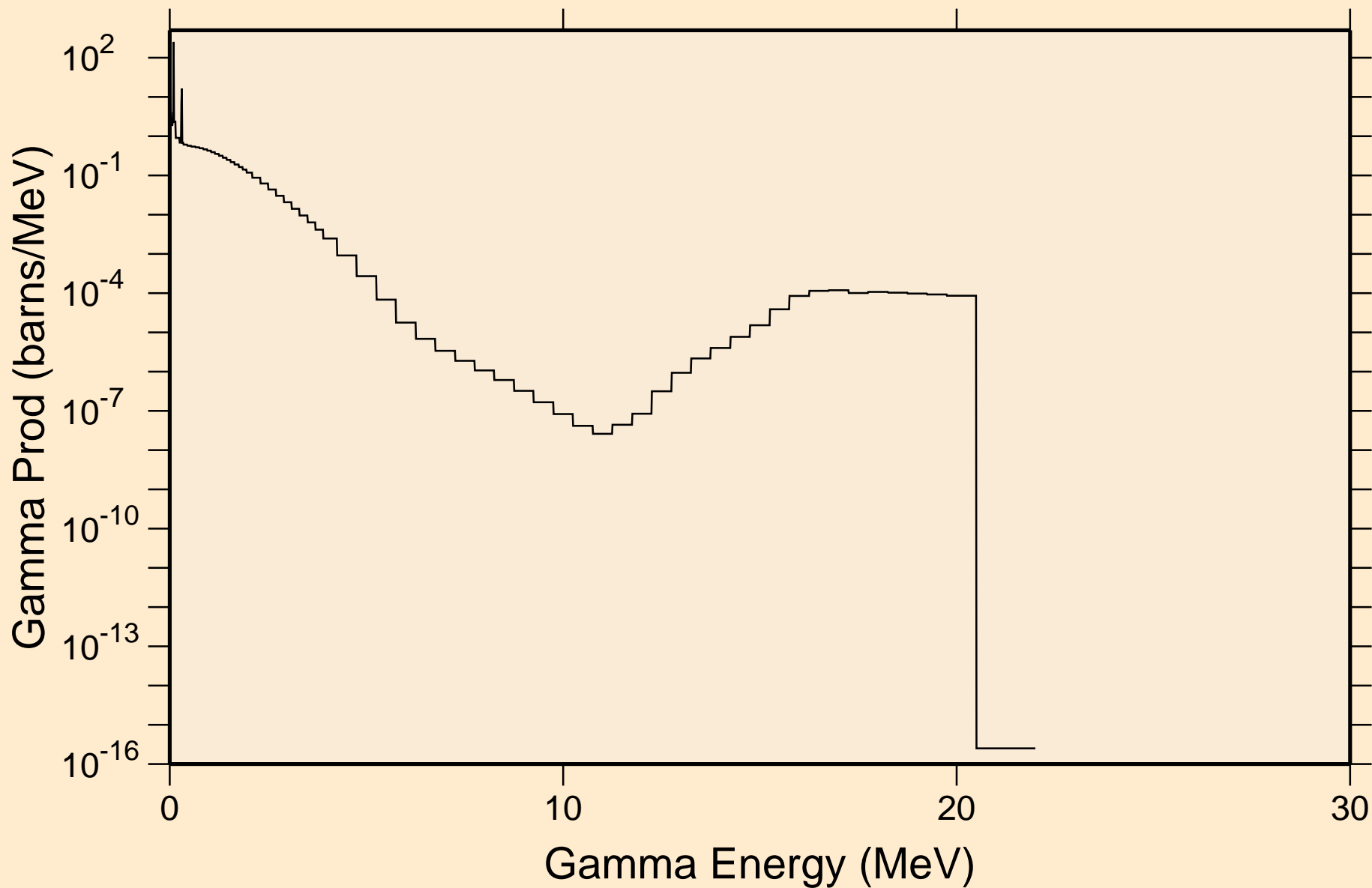

DB266 NEUTRON ACER TENDL-2019 LIBRARY; T=293.16K
Particle heating contributions

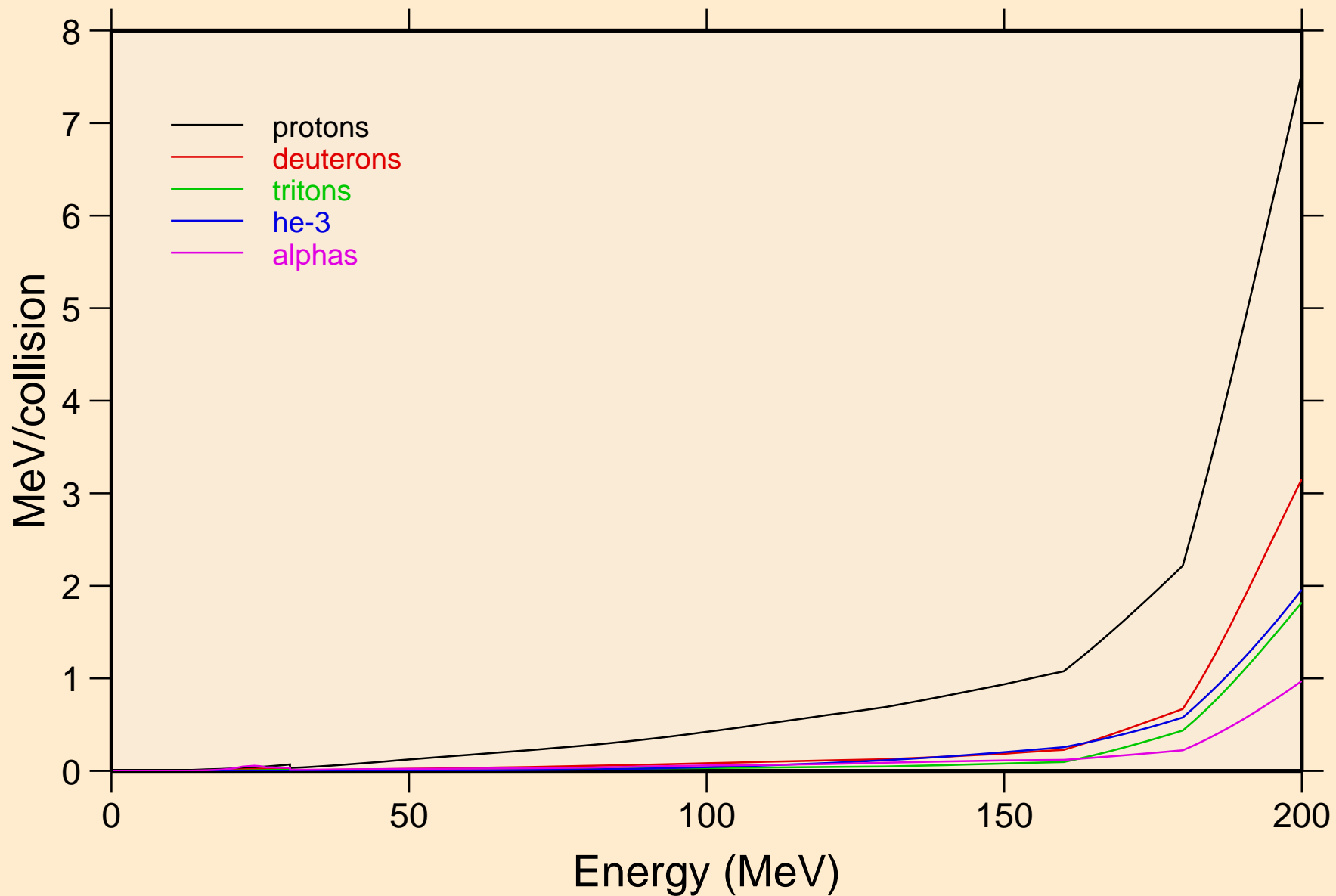

DB266 NEUTRON ACER TENDL-2019 LIBRARY; T=293.16K
Recoil Heating

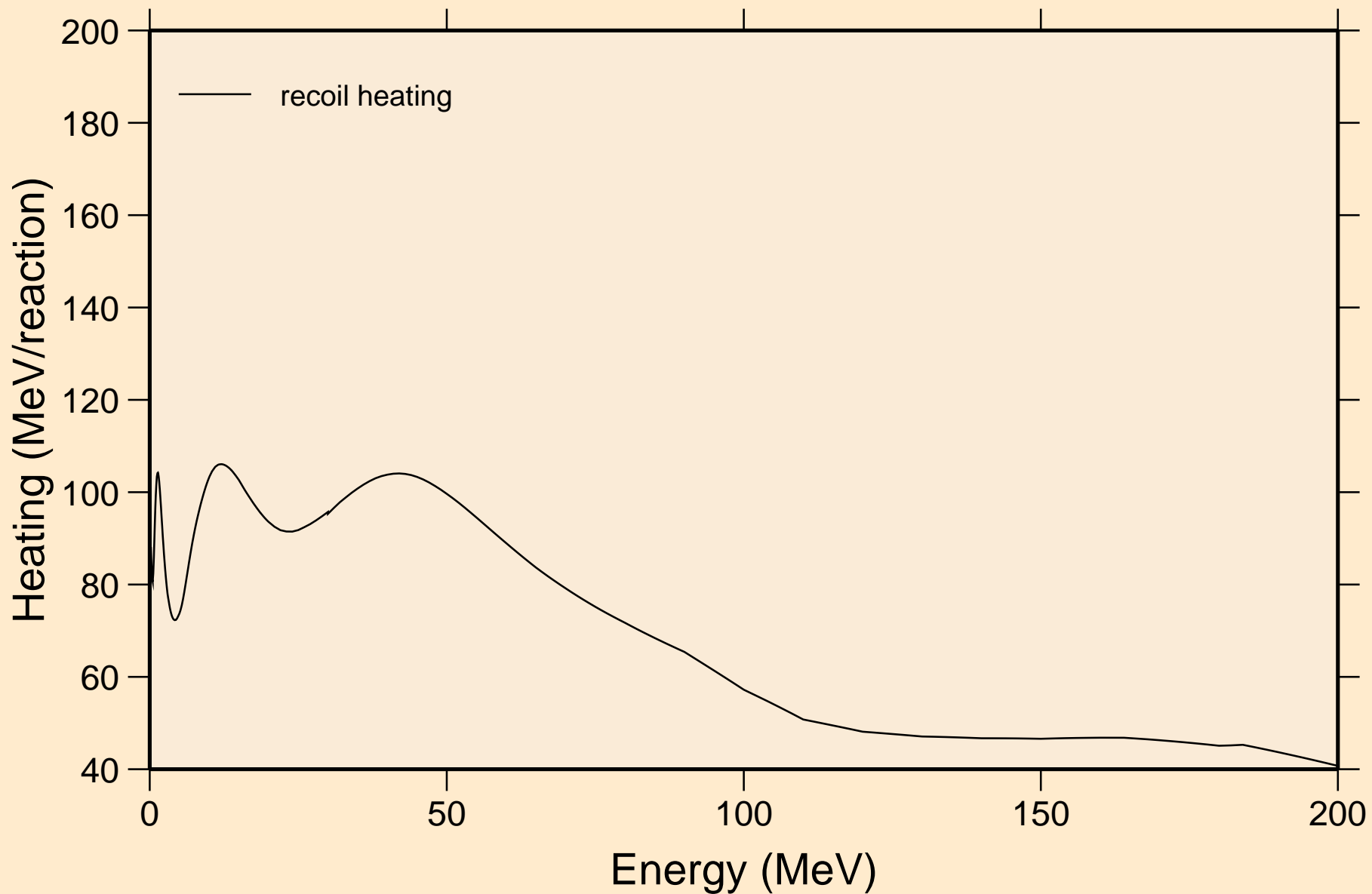

DB266 NEUTRON ACER TENDL-2019 LIBRARY; T=293.16K
Particle production cross sections

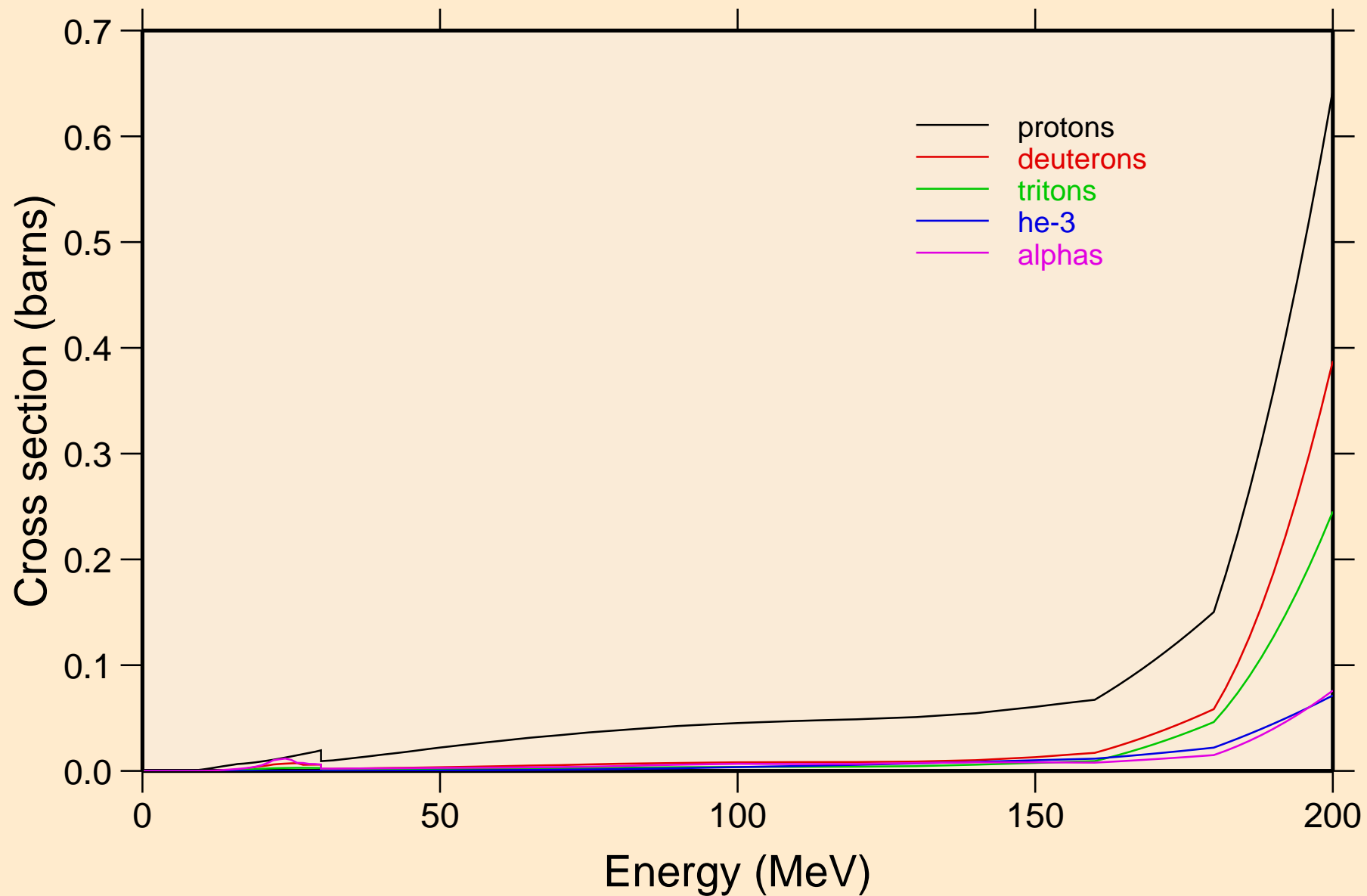

DB266 NEUTRON ACER TENDL-2019 LIBRARY; T=293.16K
protons from (n,x)

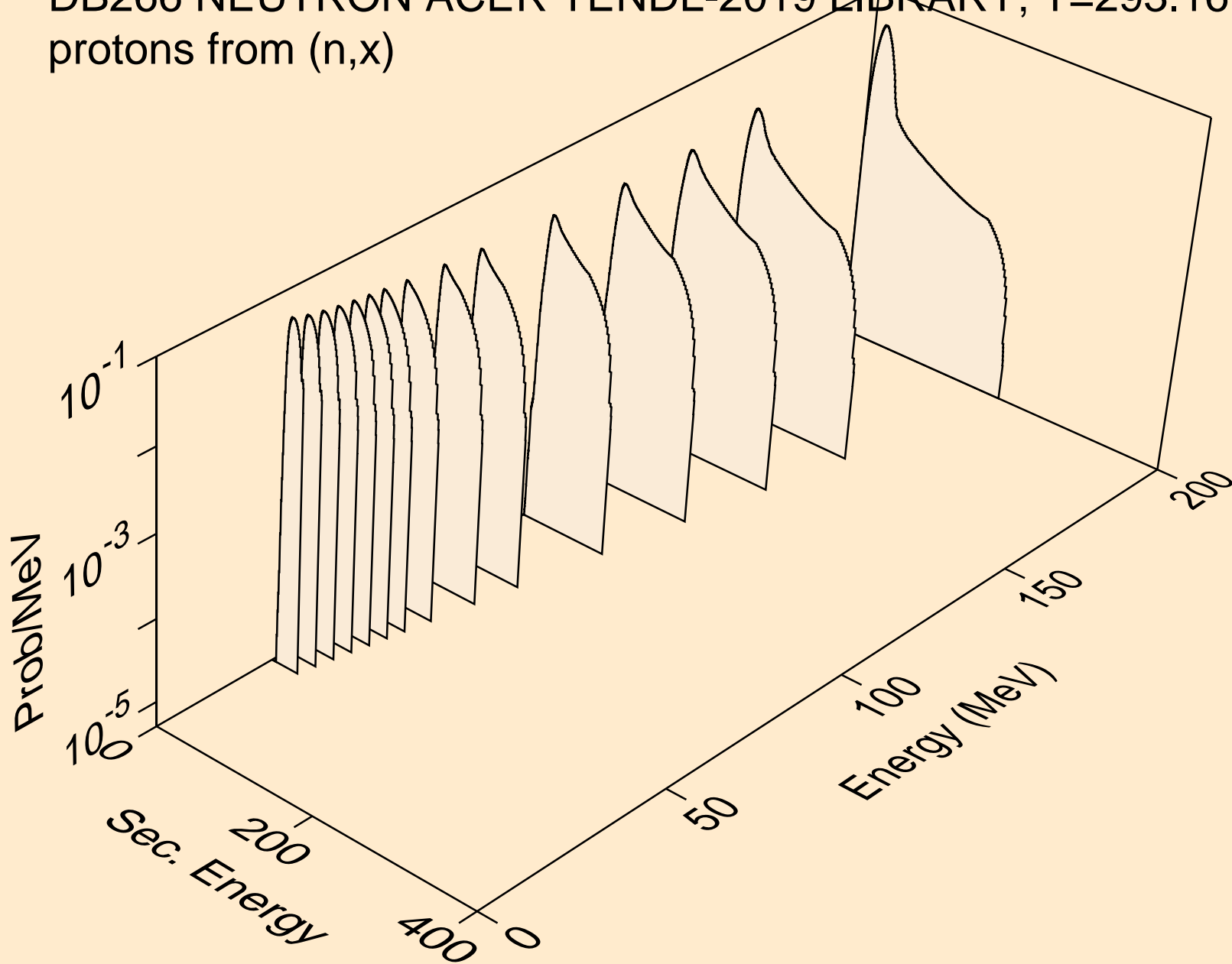

DB266 NEUTRON ACER TENDL-2019 LIBRARY; T=293.16K
protons from (n,n*)p

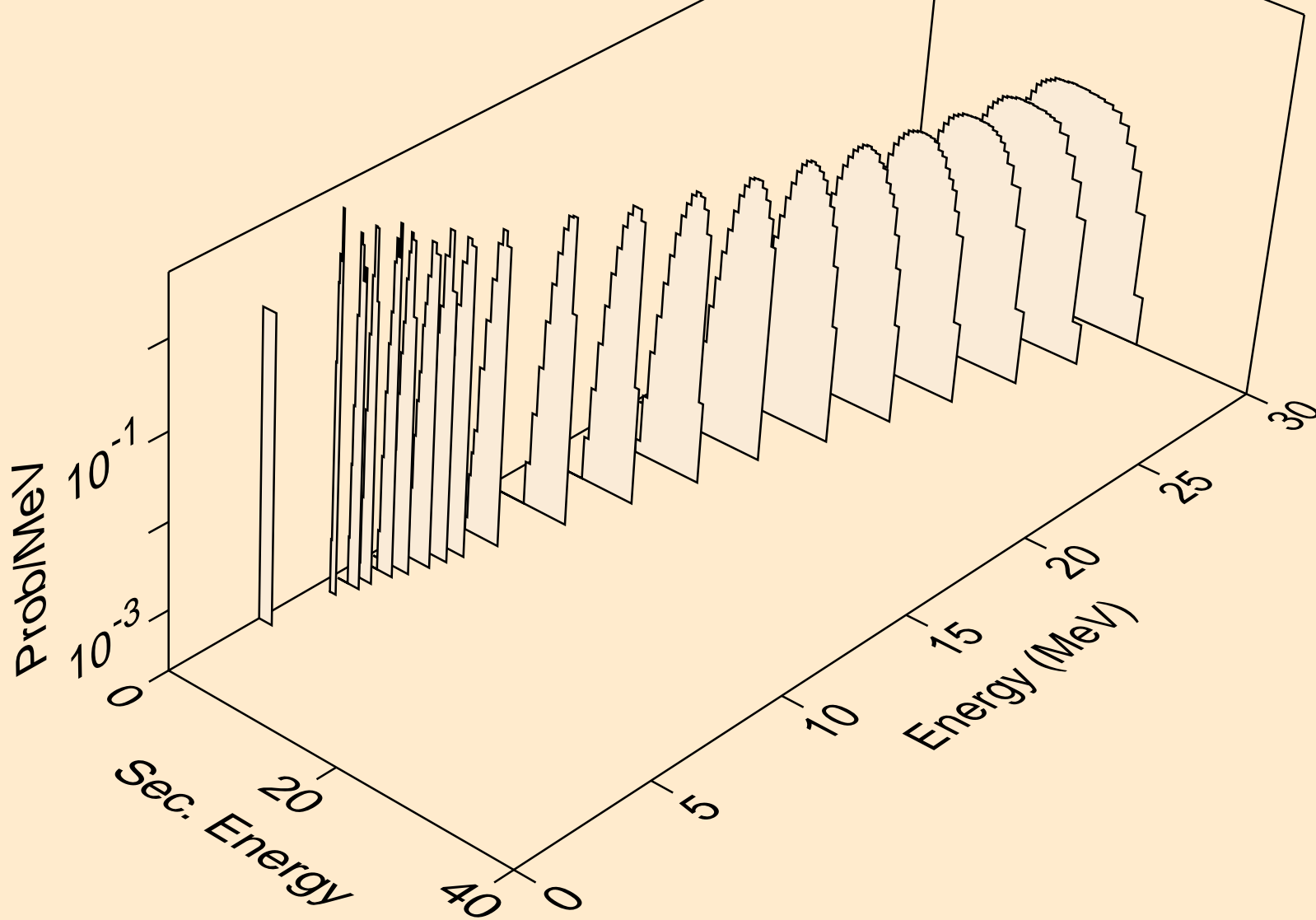

DB266 NEUTRON ACER TENDL-2019 LIBRARY; T=293.16K
protons from (n,2np)

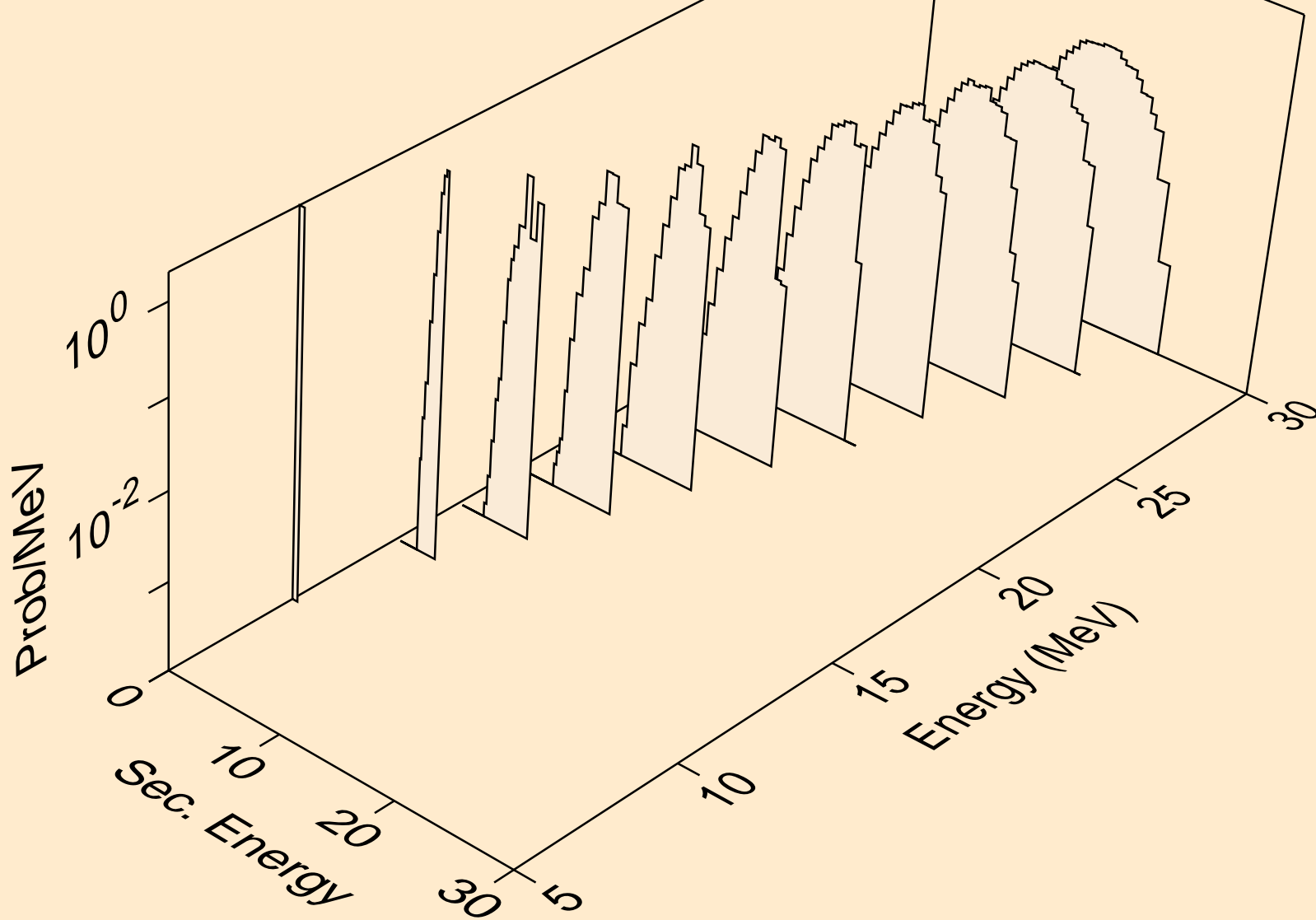

DB266 NEUTRON ACER TENDL-2019 LIBRARY; T=293.16K
protons from (n,3np)

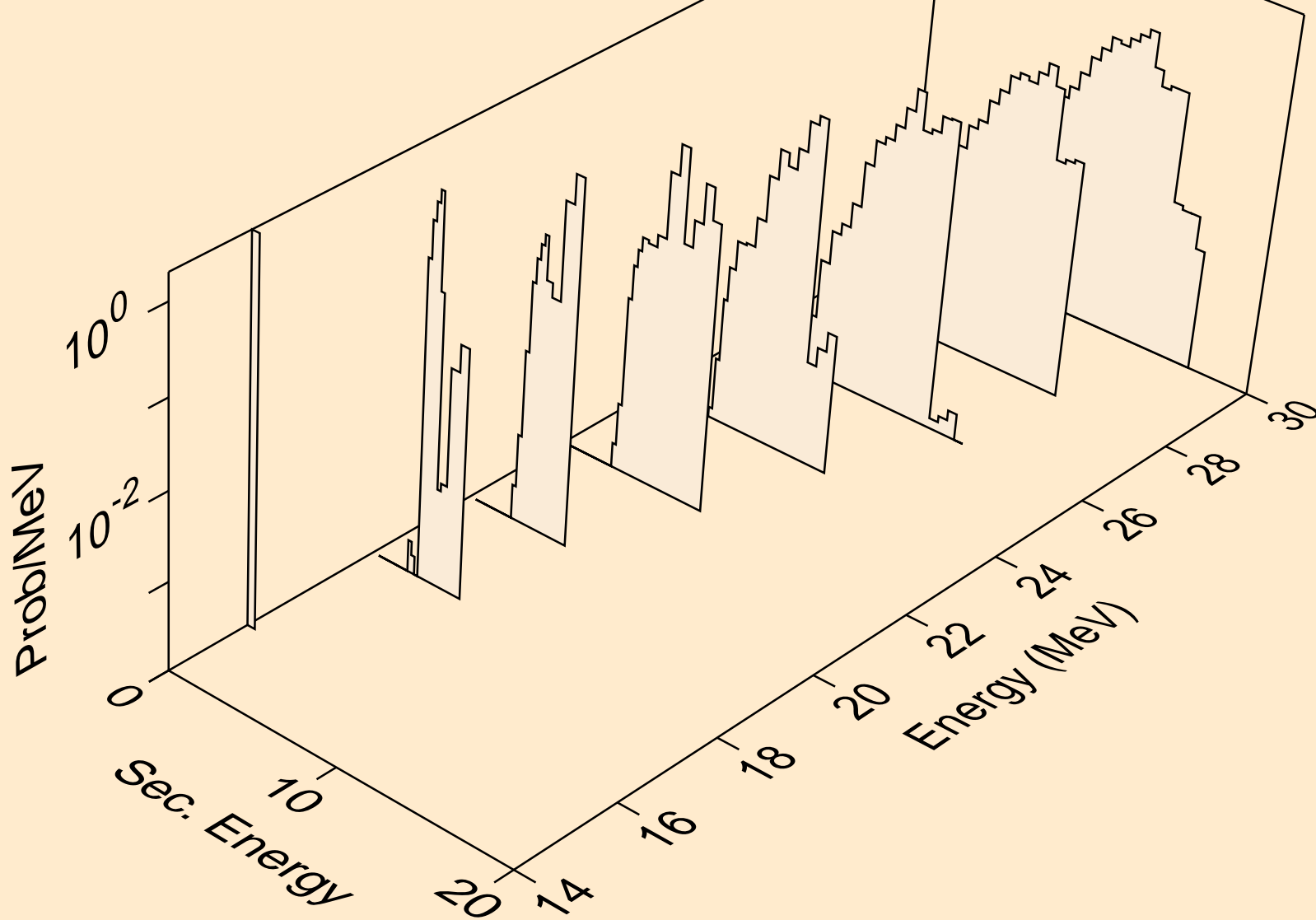

DB266 NEUTRON ACER TENDL-2019 LIBRARY; T=293.16K
protons from (n,2np)

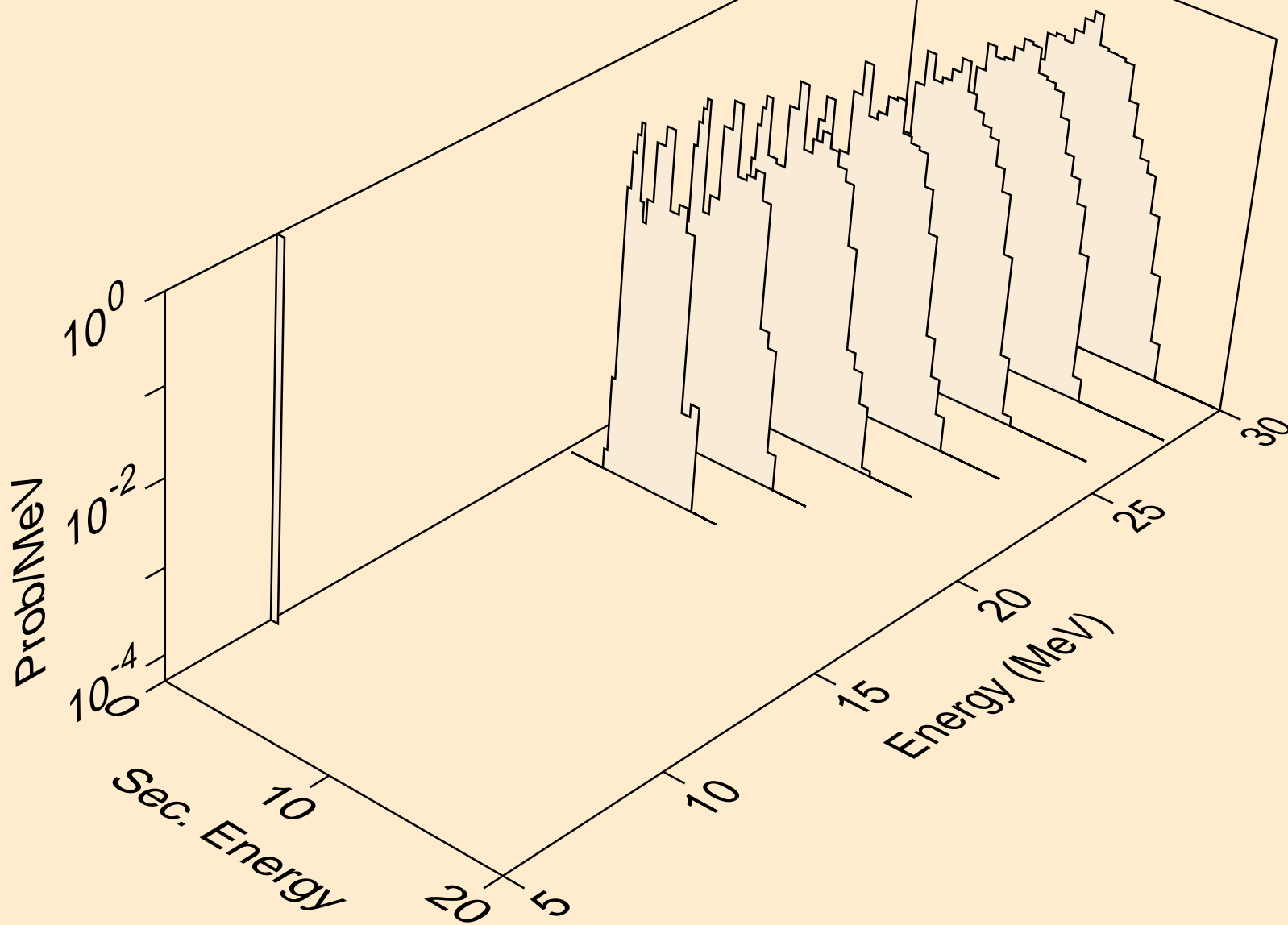

DB266 NEUTRON ACER TENDL-2019 LIBRARY; T=293.16K
protons from (n,p)

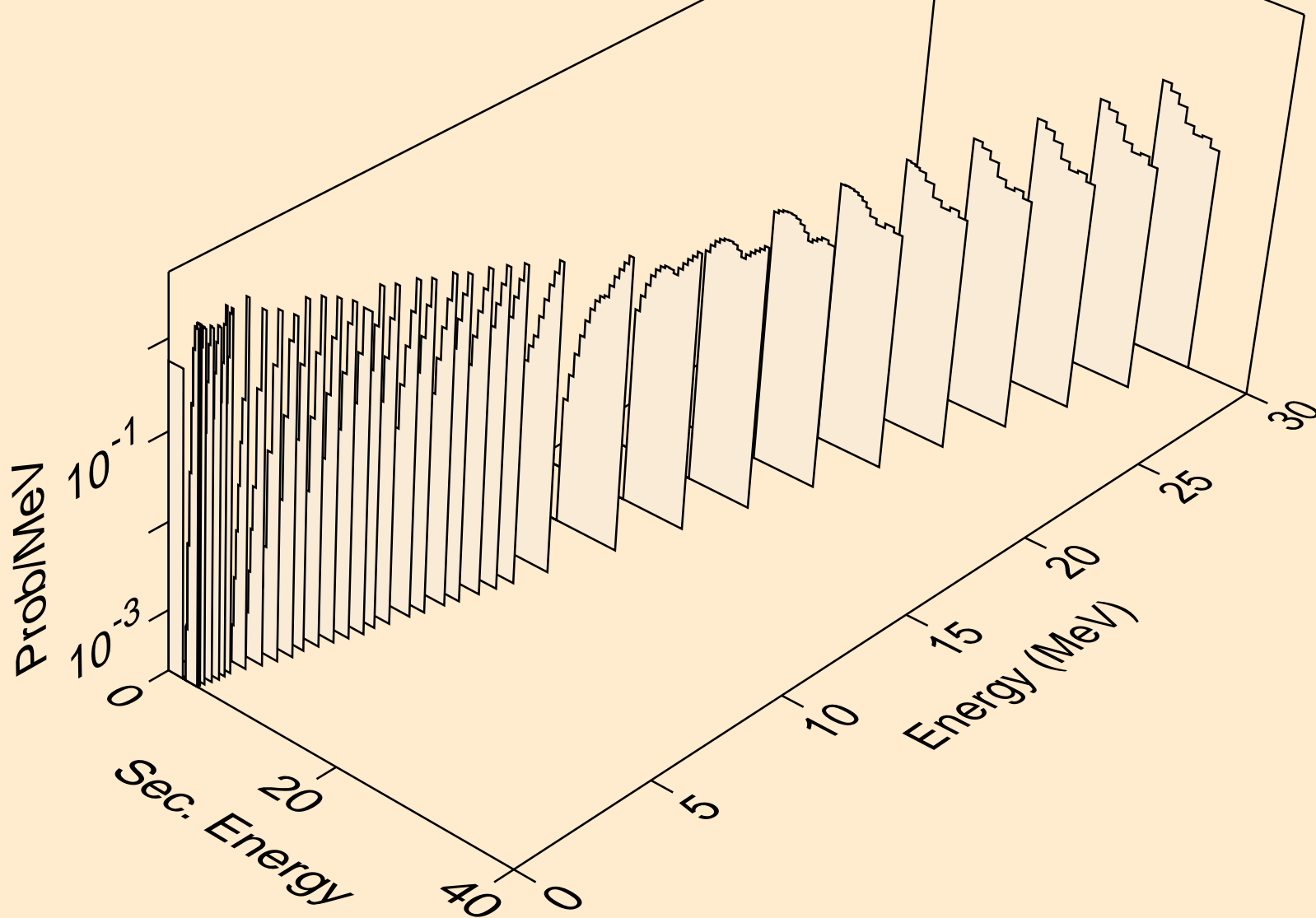

DB266 NEUTRON ACER TENDL-2019 LIBRARY; T=293.16K
protons from (n,2p)

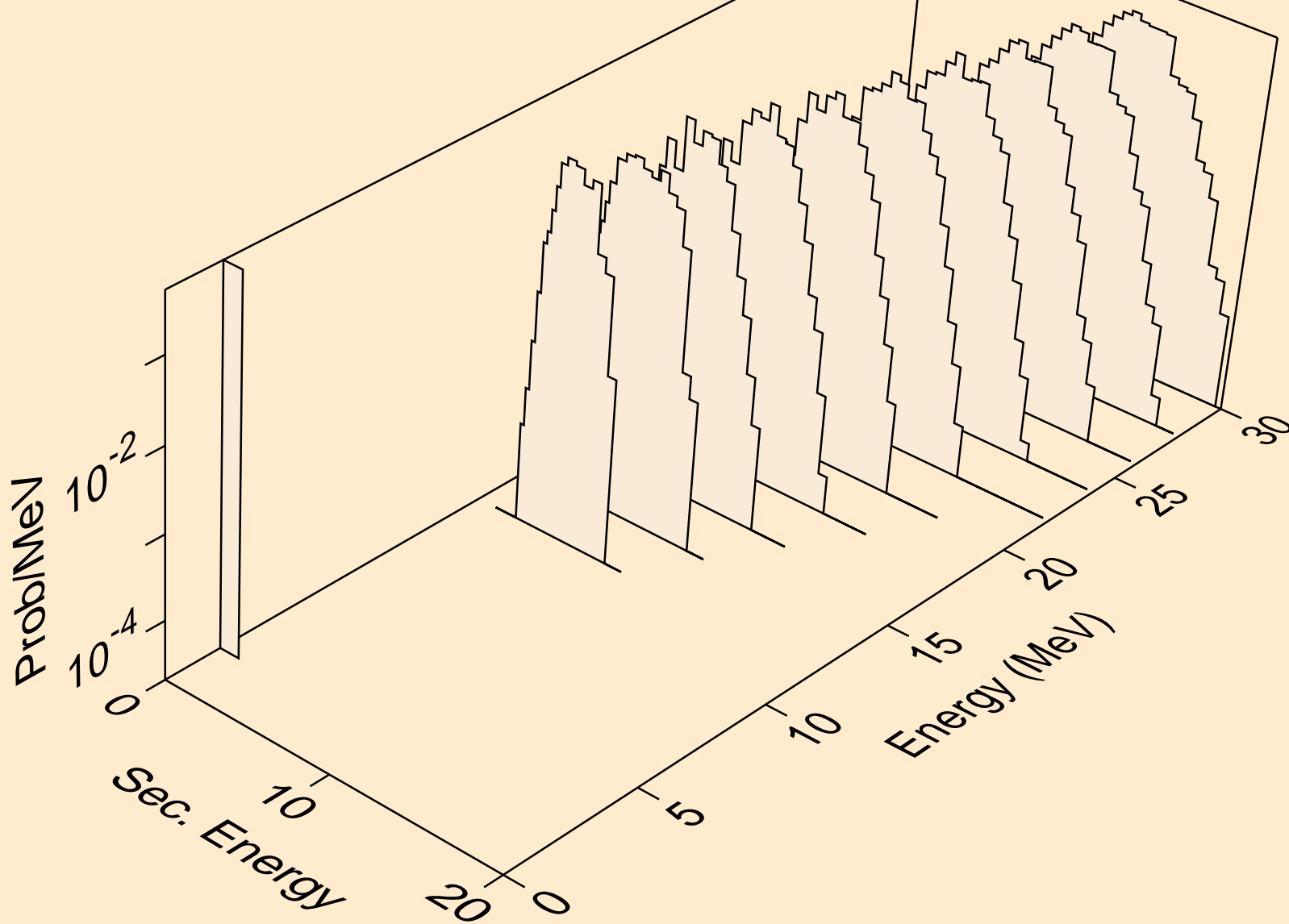

DB266 NEUTRON ACER TENDL-2019 LIBRARY; T=293.16K
protons from (n,pd)

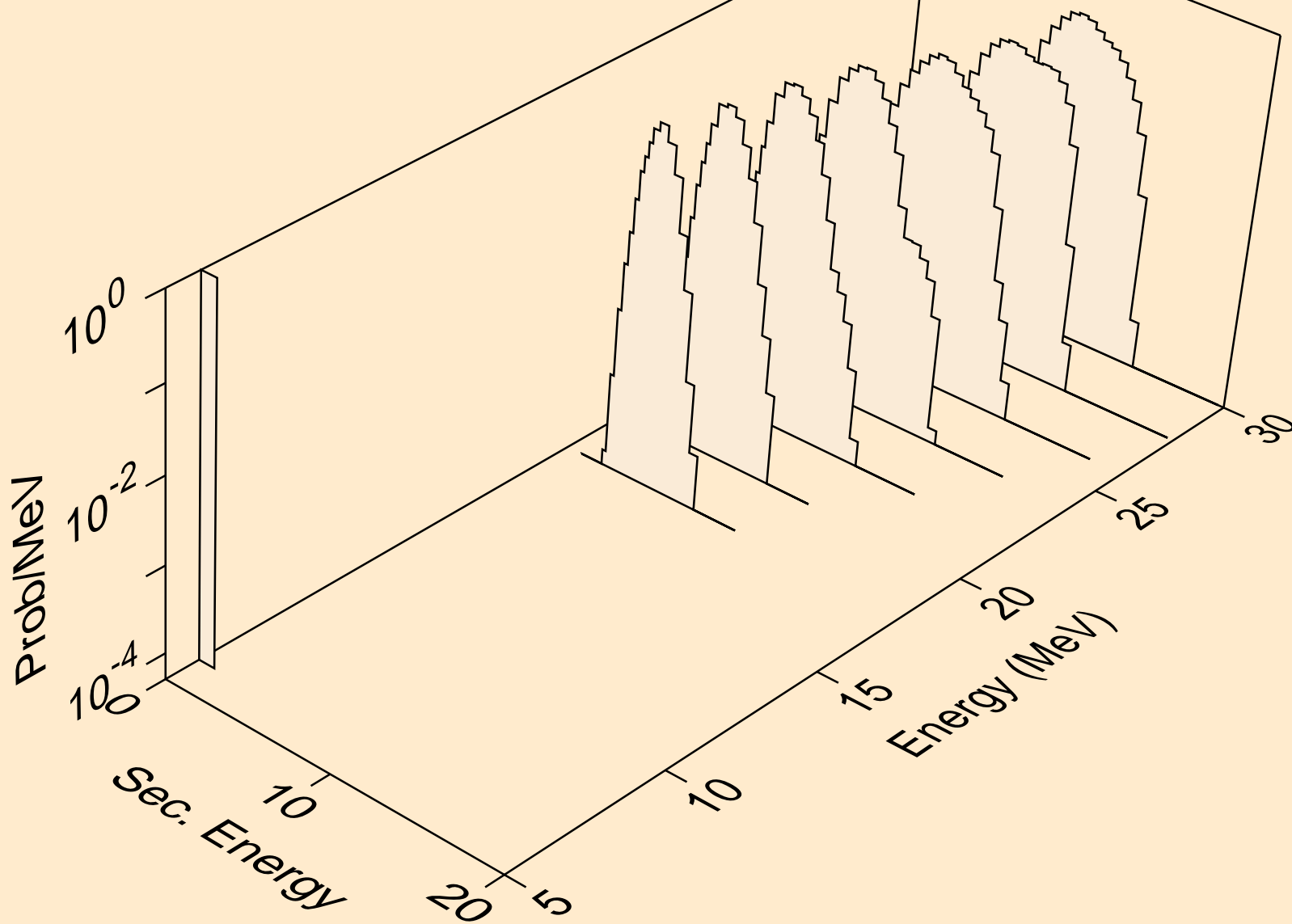

DB266 NEUTRON ACER TENDL-2019 LIBRARY; T=293.16K
deuterons from (n,x)

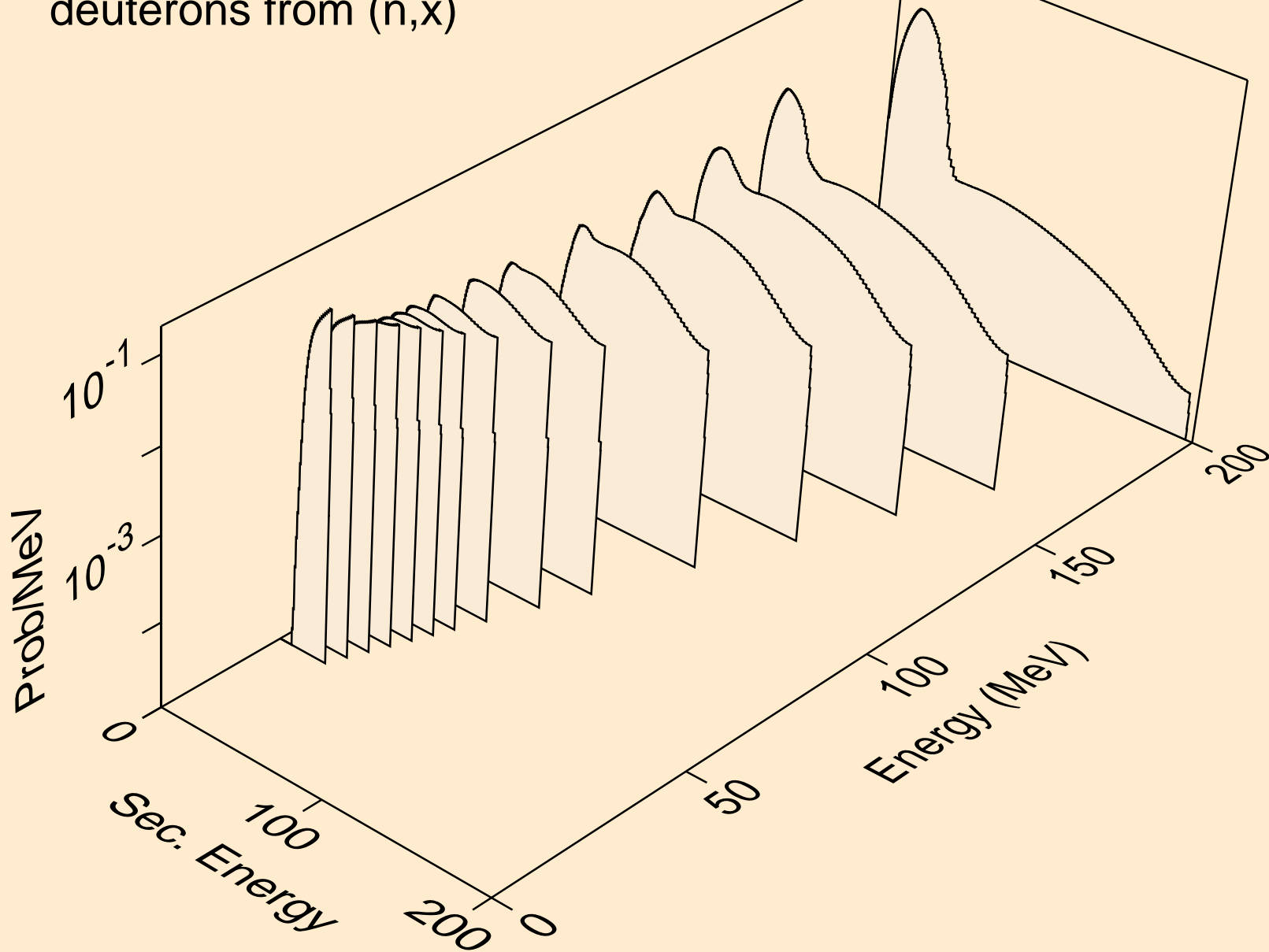

DB266 NEUTRON ACER TENDL-2019 LIBRARY; T=293.16K
deuterons from (n,2nd)

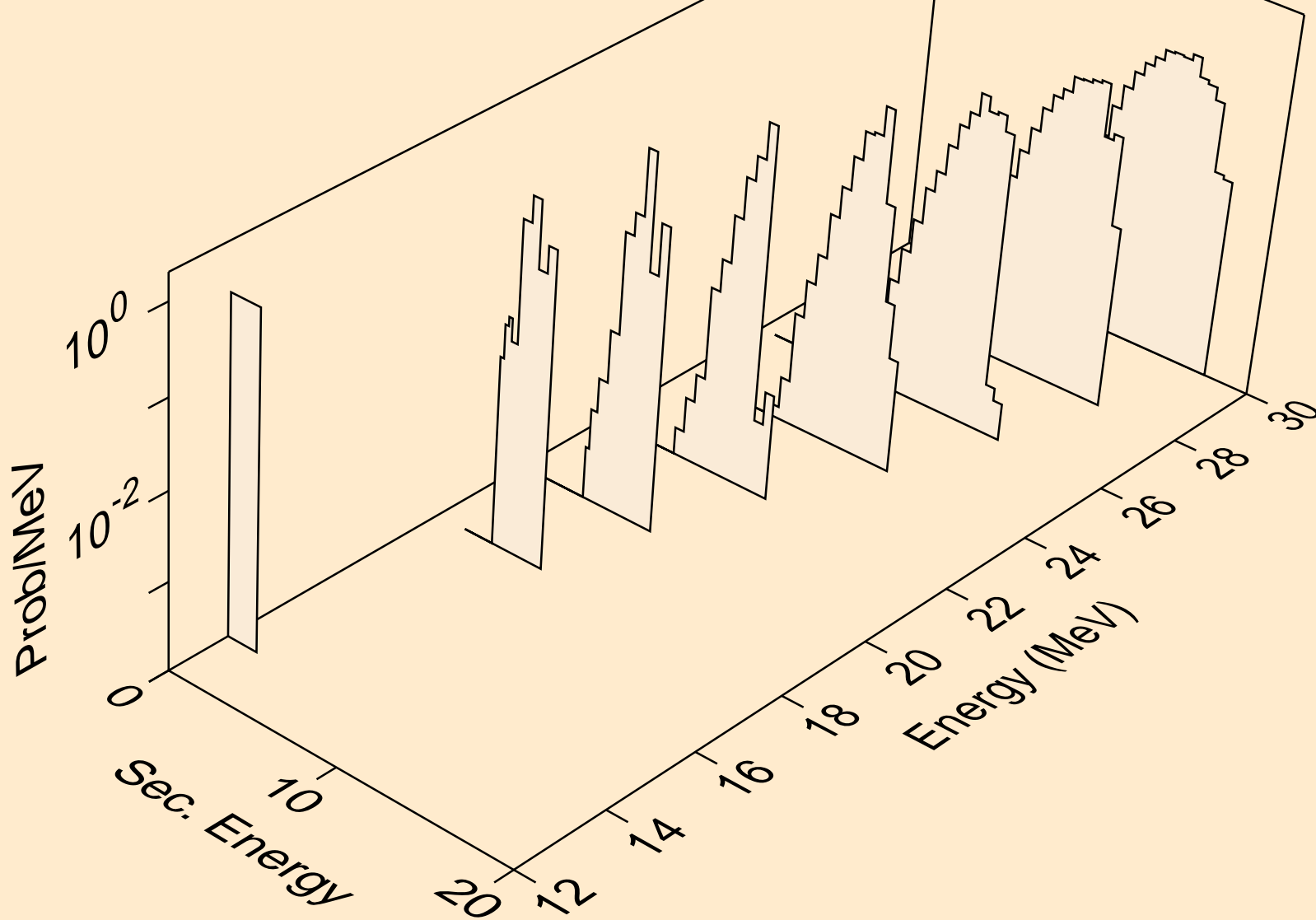

DB266 NEUTRON ACER TENDL-2019 LIBRARY; T=293.16K
deuterons from (n,n*)d

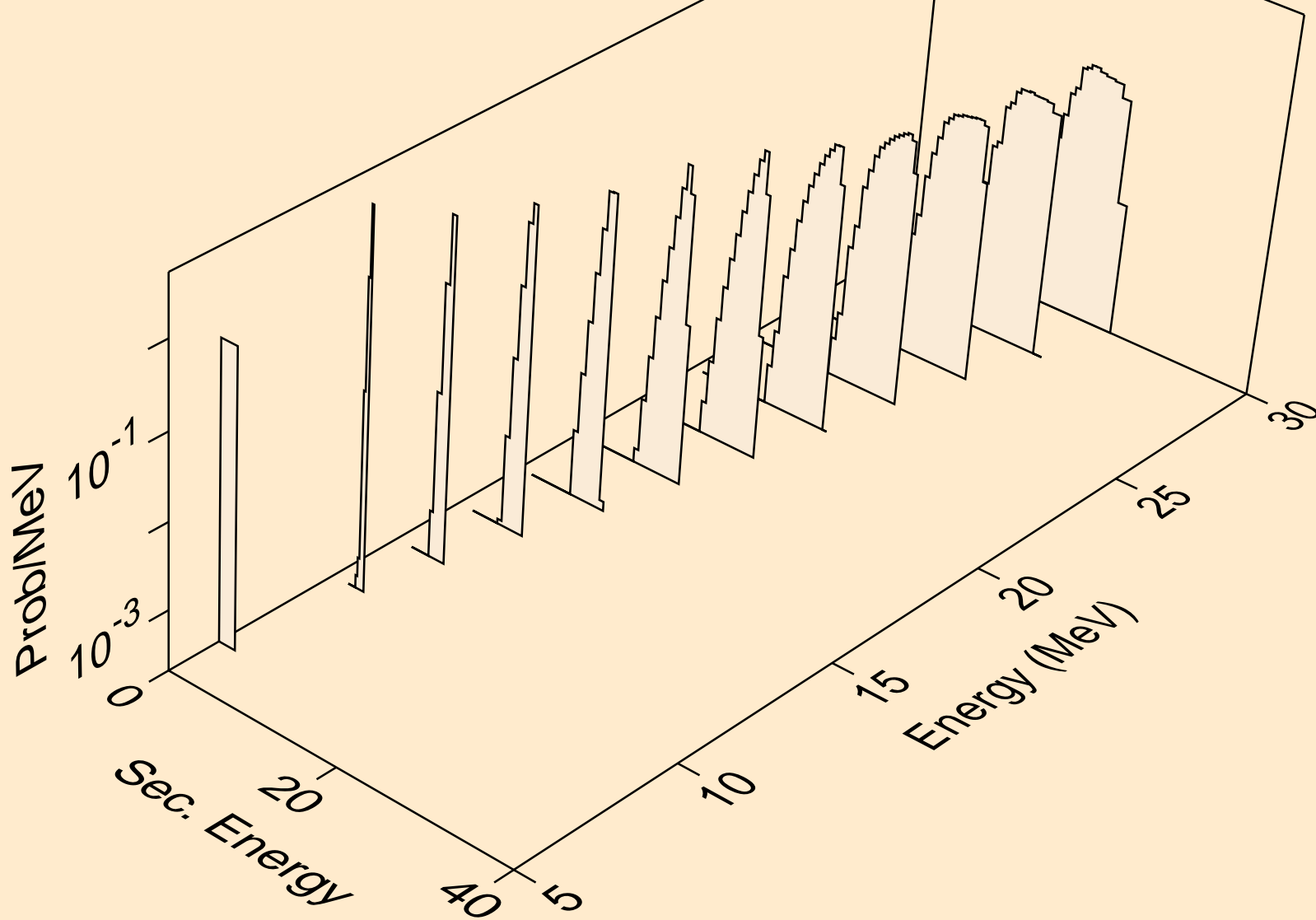

DB266 NEUTRON ACER TENDL-2019 LIBRARY; T=293.16K
deuterons from (n,d)

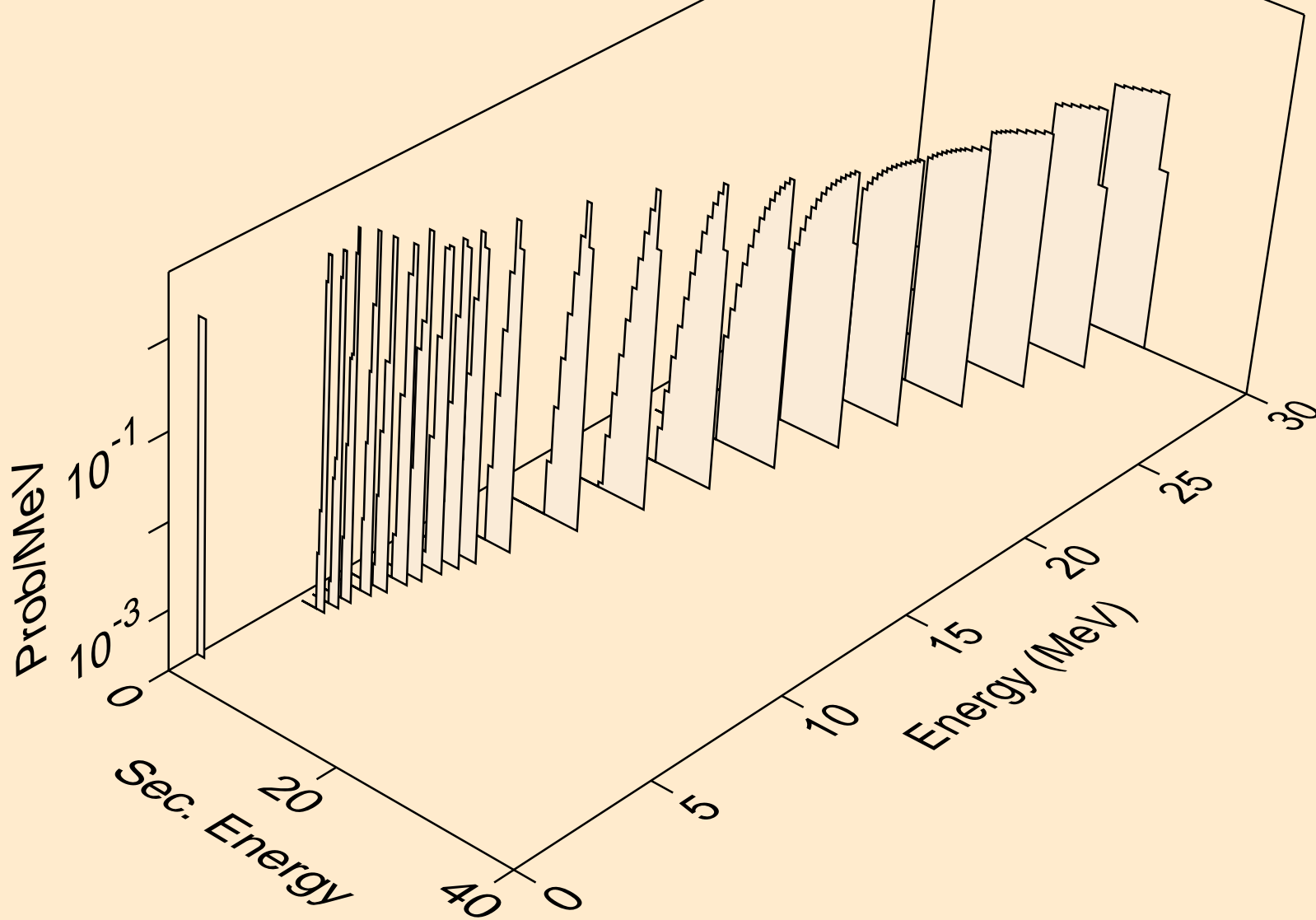

DB266 NEUTRON ACER TENDL-2019 LIBRARY; T=293.16K
deuterons from (n,pd)

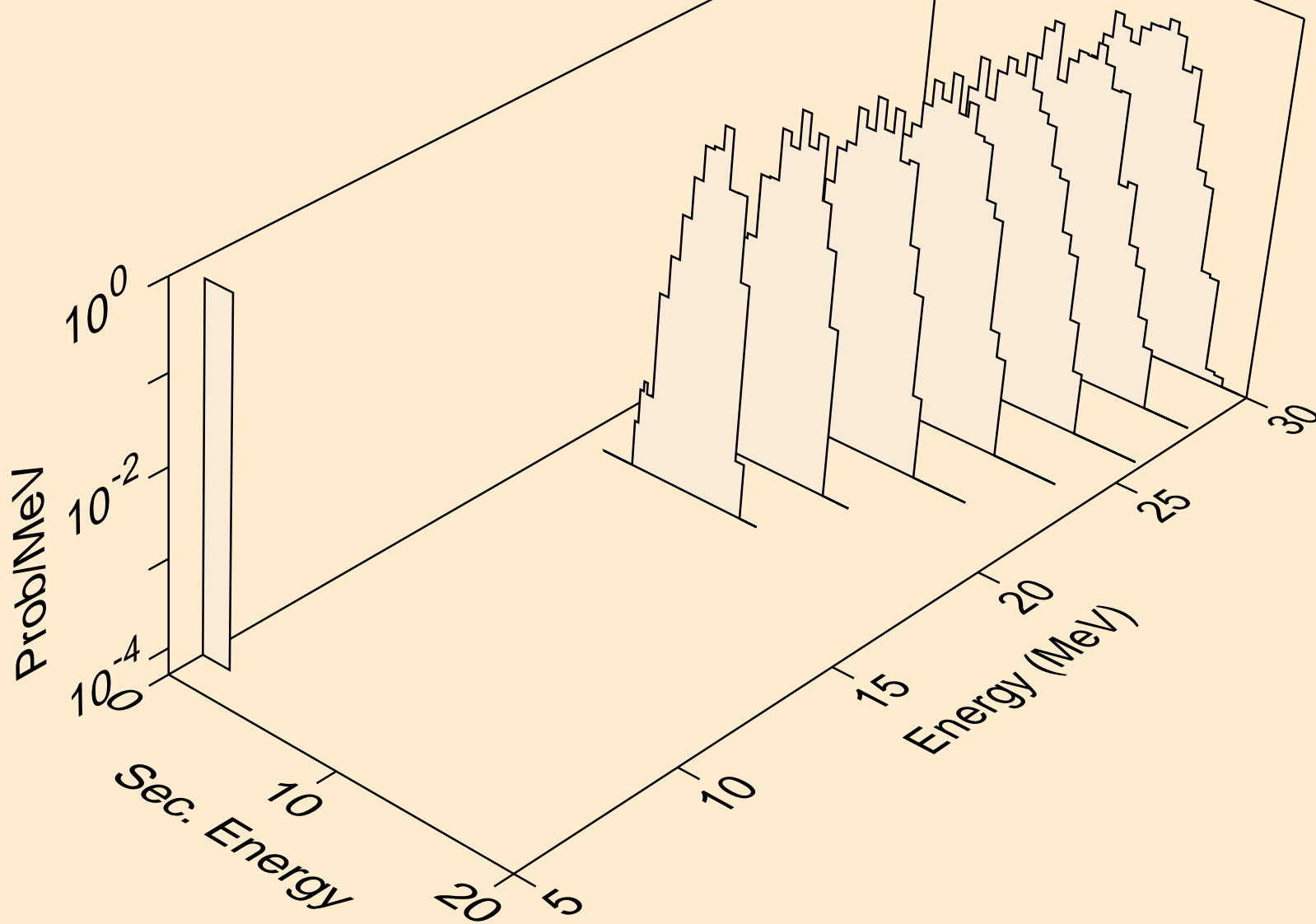

DB266 NEUTRON ACER TENDL-2019 LIBRARY; T=293.16K
tritons from (n,x)

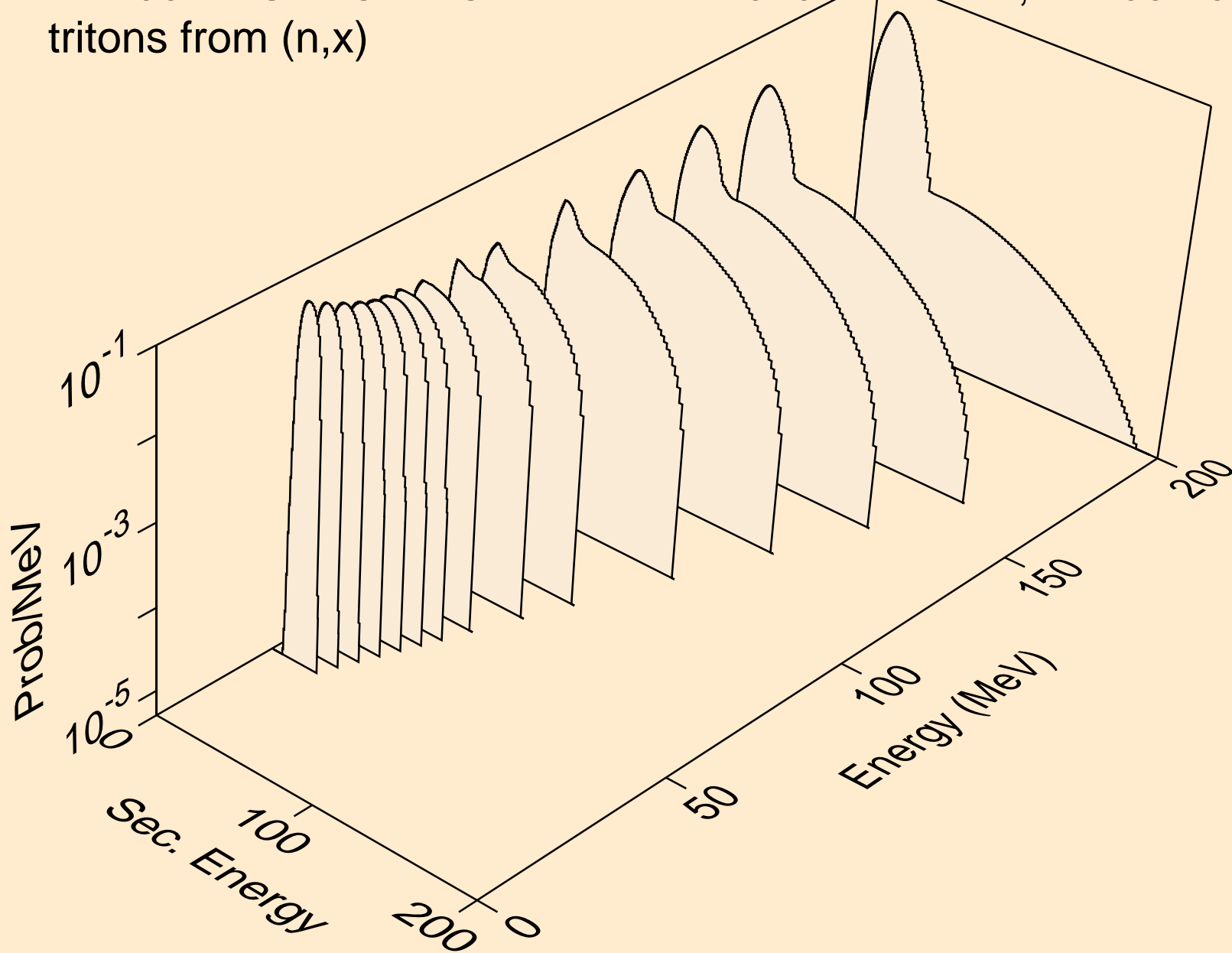

DB266 NEUTRON ACER TENDL-2019 LIBRARY; T=293.16K
tritons from (n,n*)t

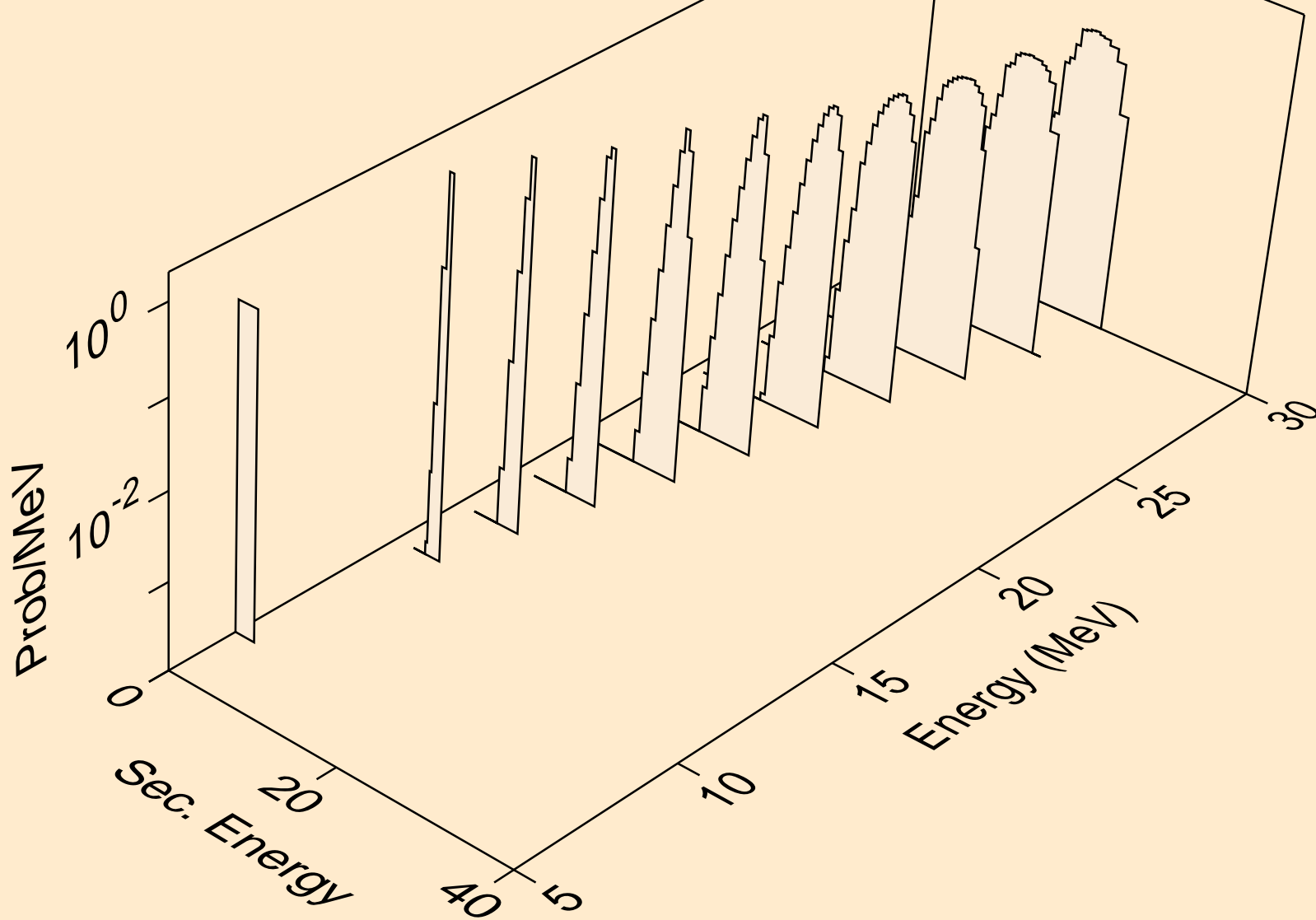

DB266 NEUTRON ACER TENDL-2019 LIBRARY; T=293.16K
tritons from (n,t)

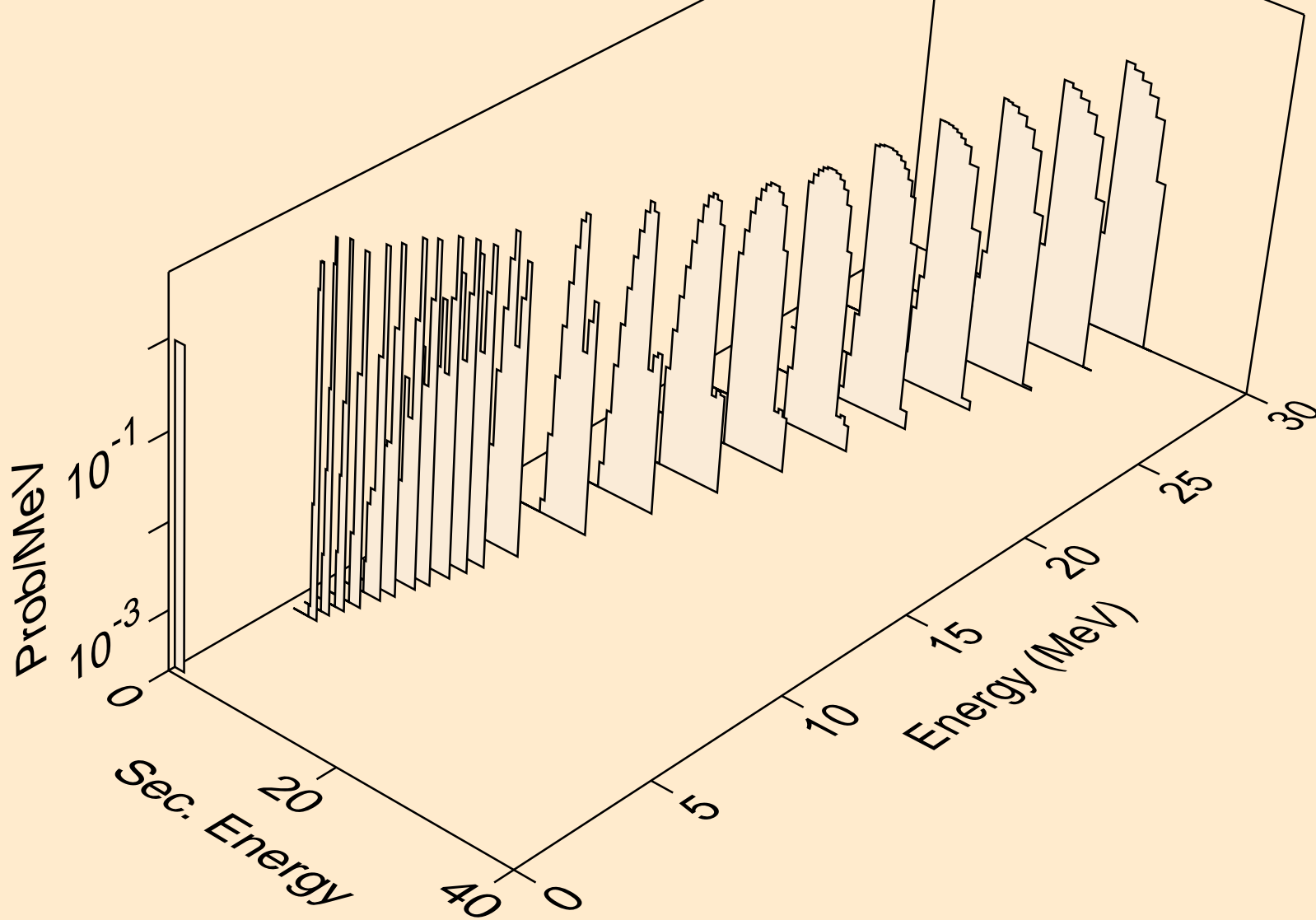

DB266 NEUTRON ACER TENDL-2019 LIBRARY; T=293.16K
he3s from (n,x)

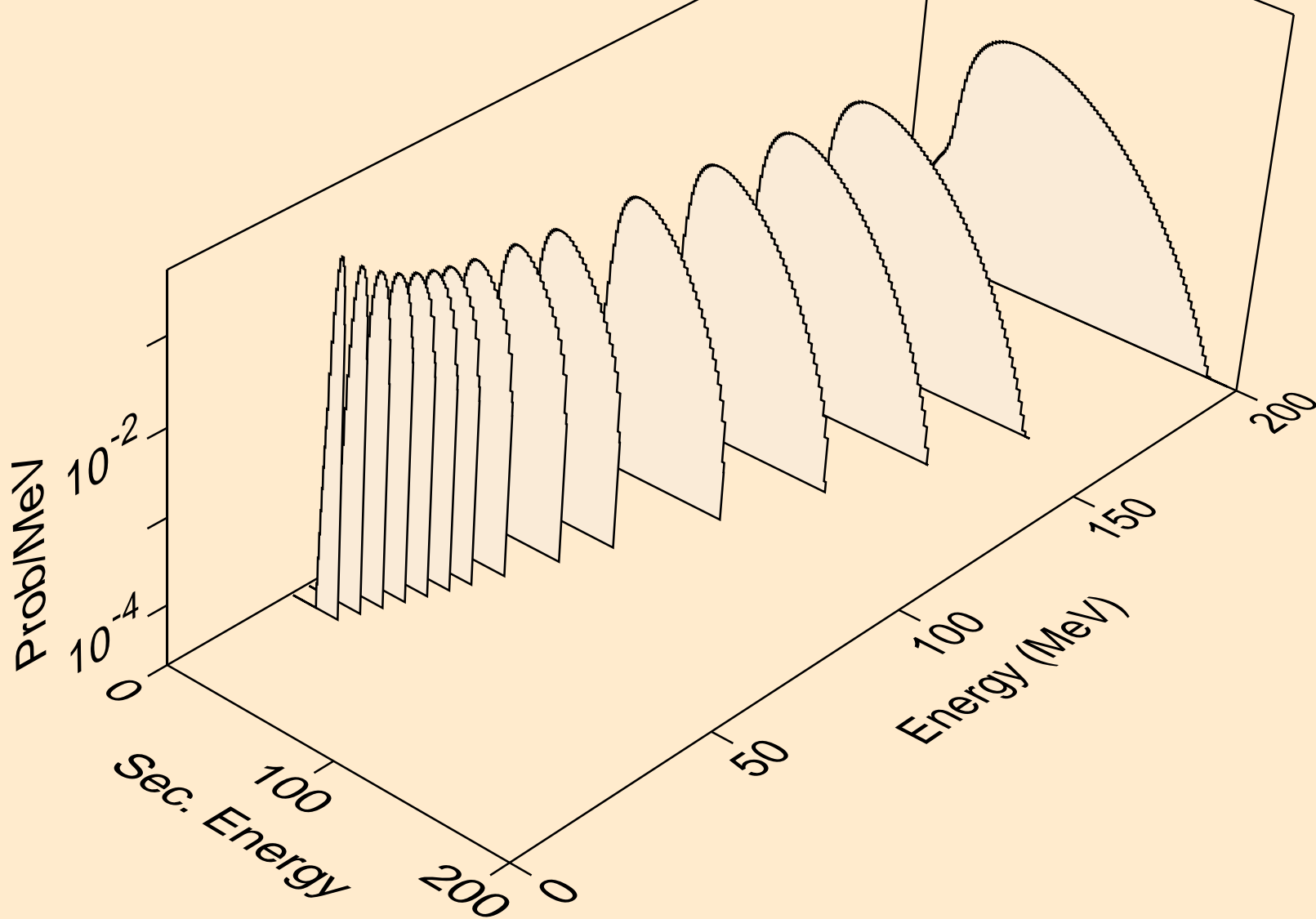

DB266 NEUTRON ACER TENDL-2019 LIBRARY; T=293.16K
he3s from (n,n*)he3

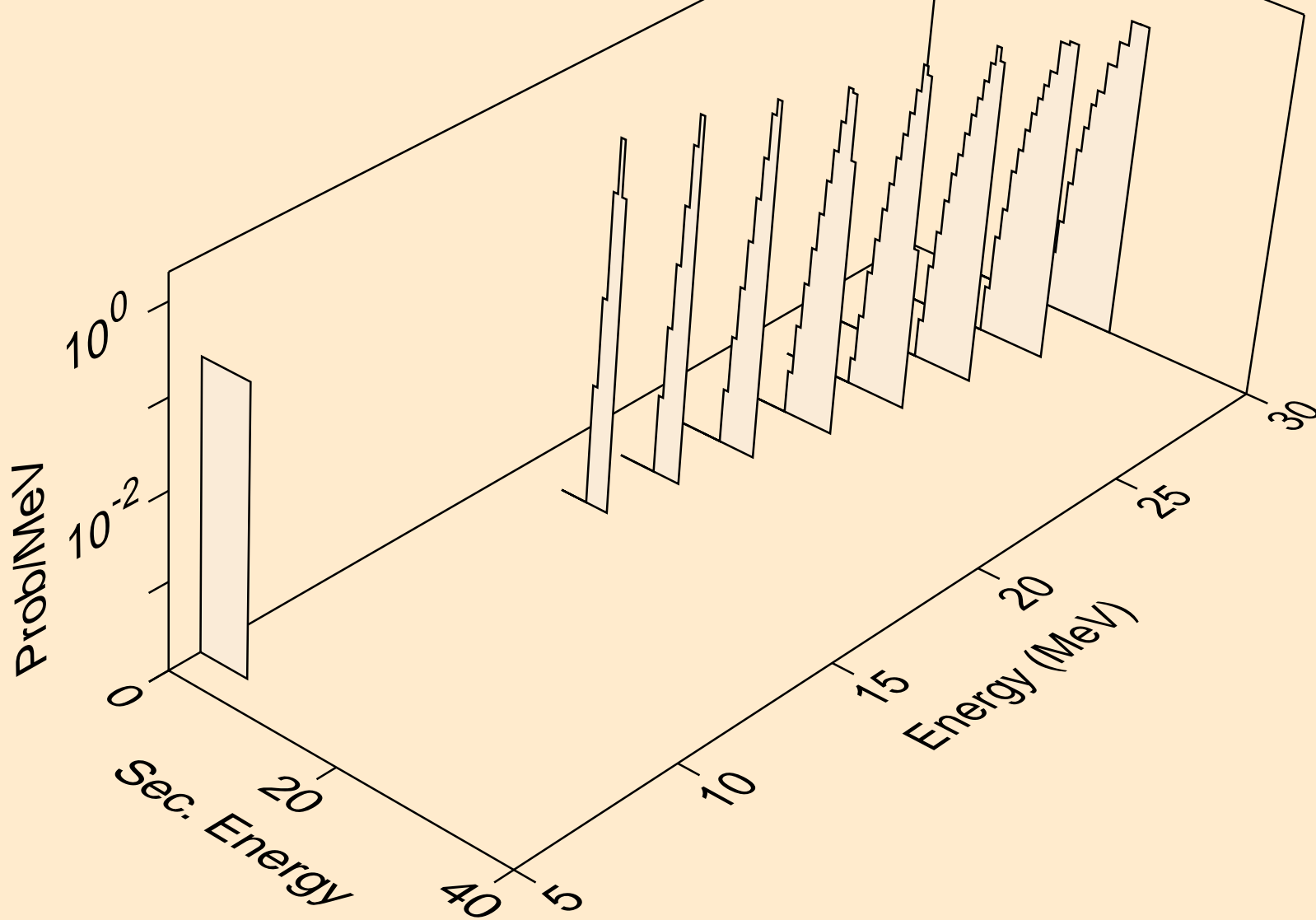

DB266 NEUTRON ACER TENDL-2019 LIBRARY; T=293.16K
he3s from (n,he3)

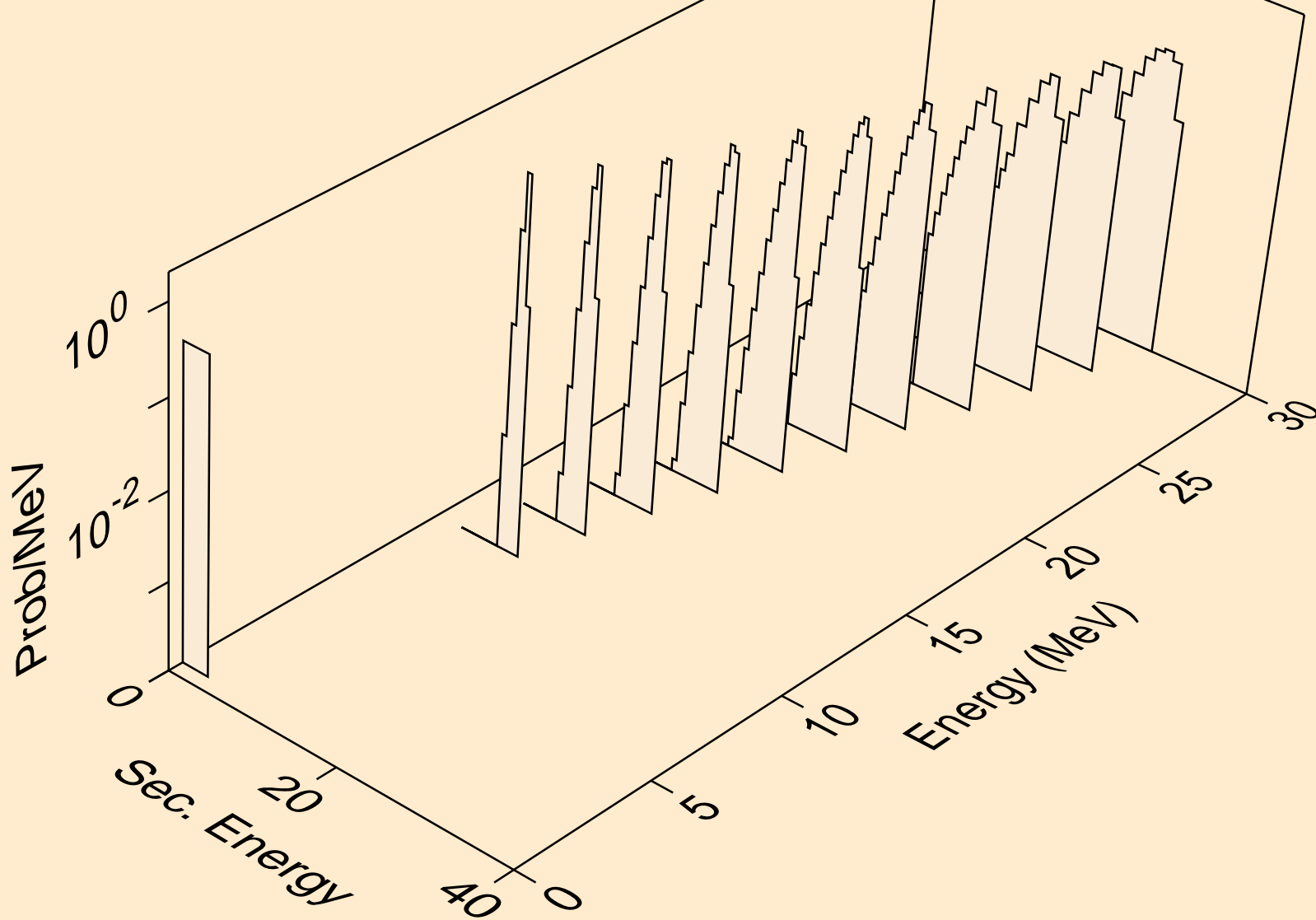

DB266 NEUTRON ACER TENDL-2019 LIBRARY; T=293.16K
alphas from (n,x)

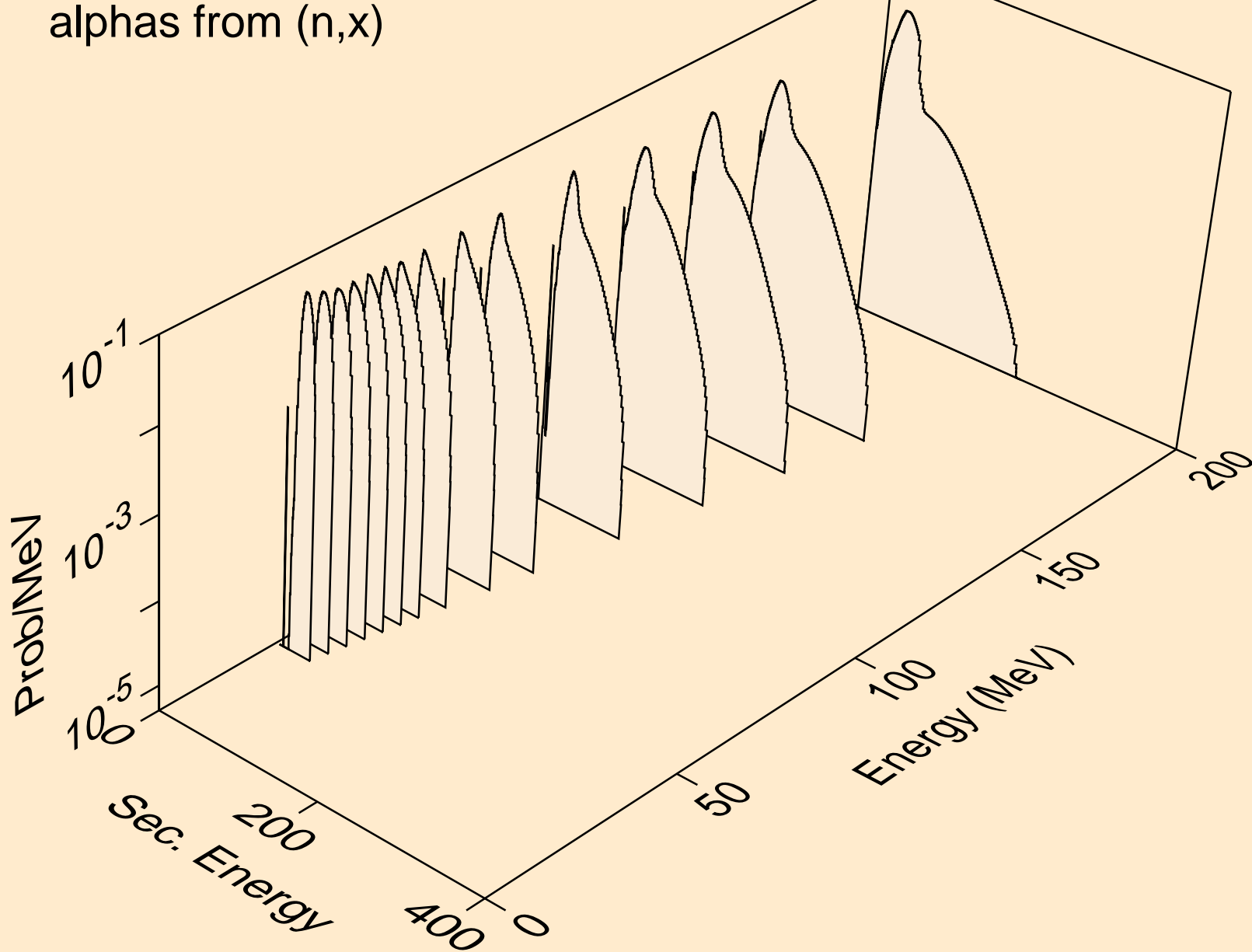

DB266 NEUTRON ACER TENDL-2019 LIBRARY; T=293.16K
alphas from (n,n*)a

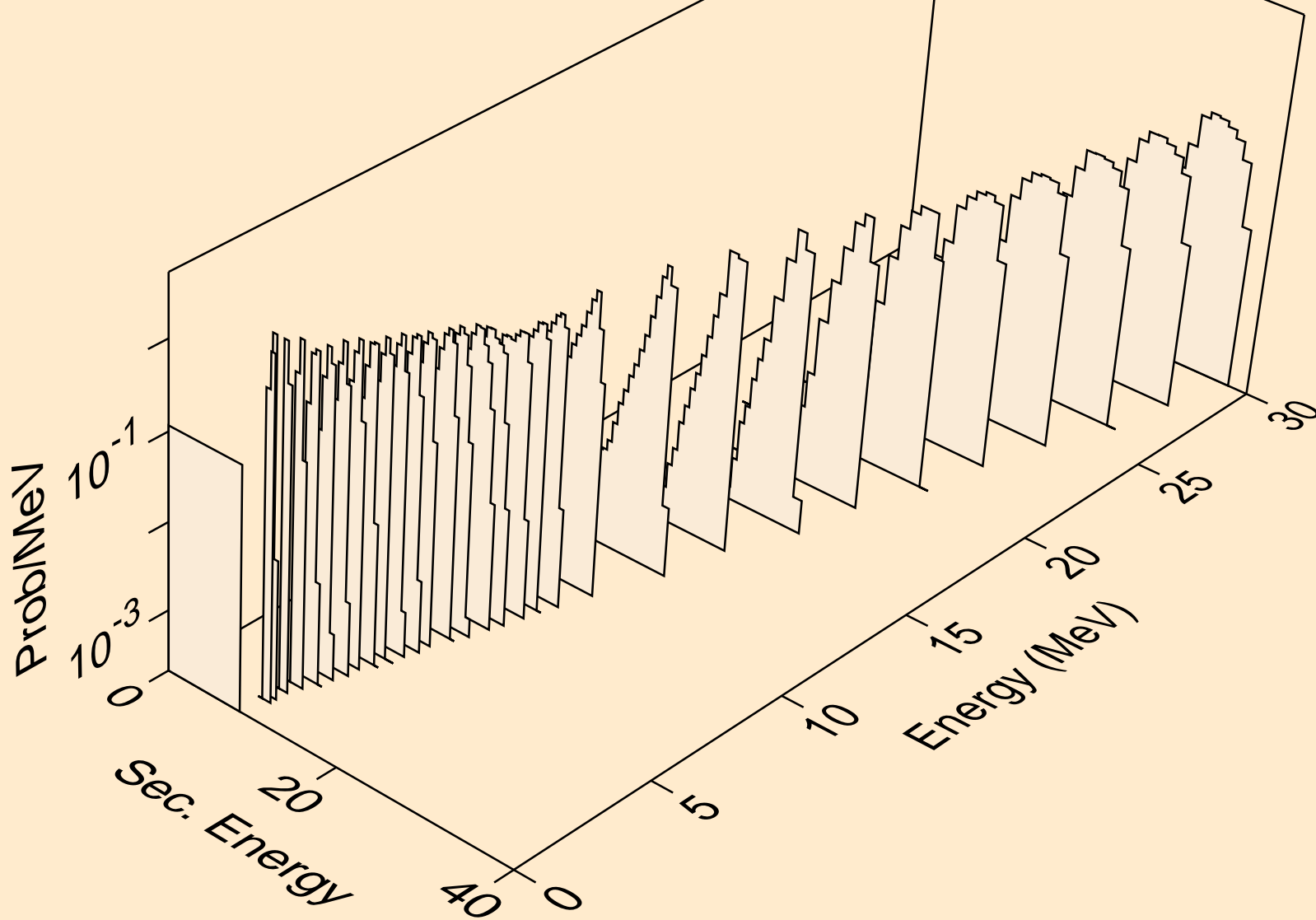

DB266 NEUTRON ACER TENDL-2019 LIBRARY; T=293.16K
alphas from (n,2n)a

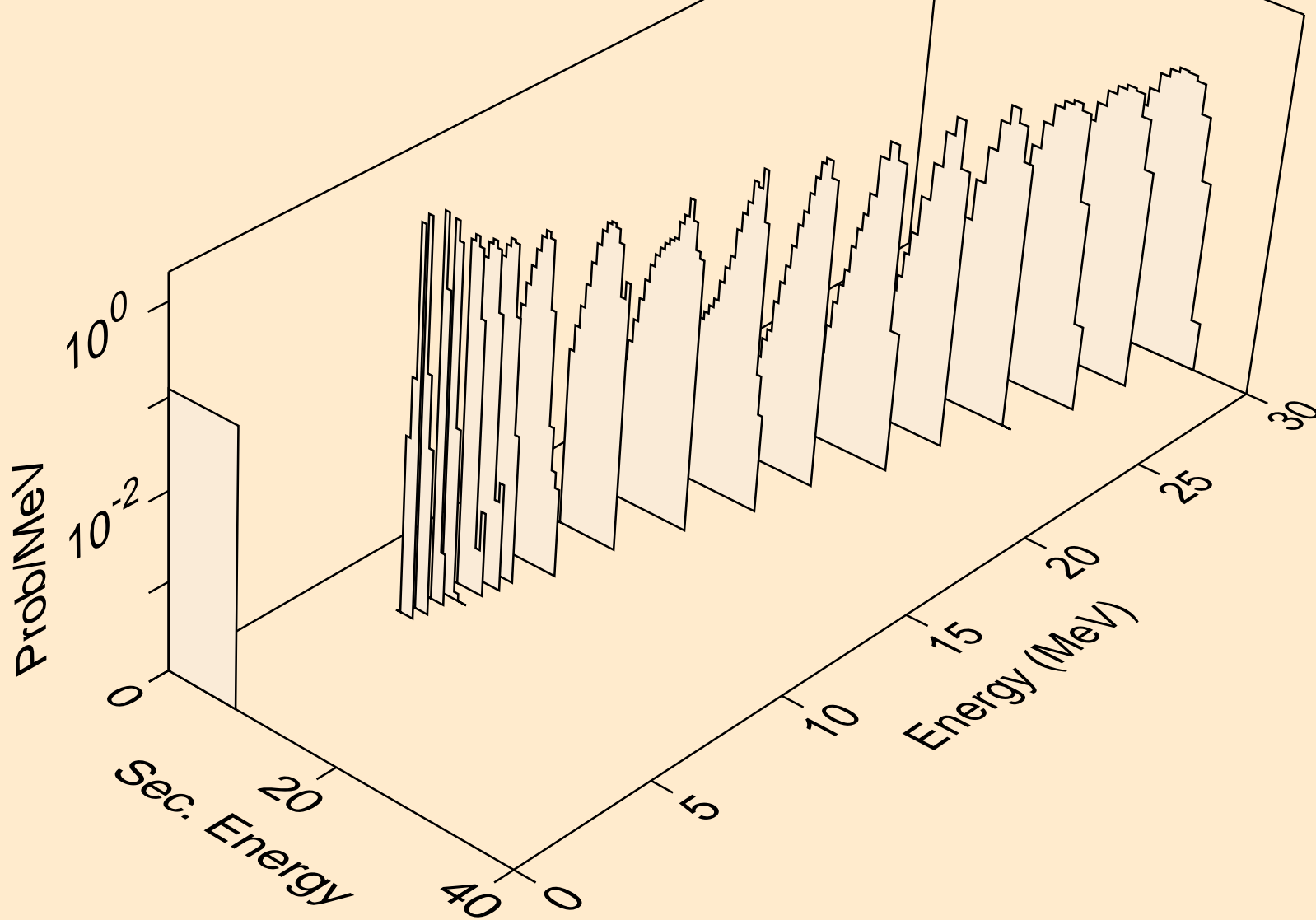

DB266 NEUTRON ACER TENDL-2019 LIBRARY; T=293.16K
alphas from (n,3n)a

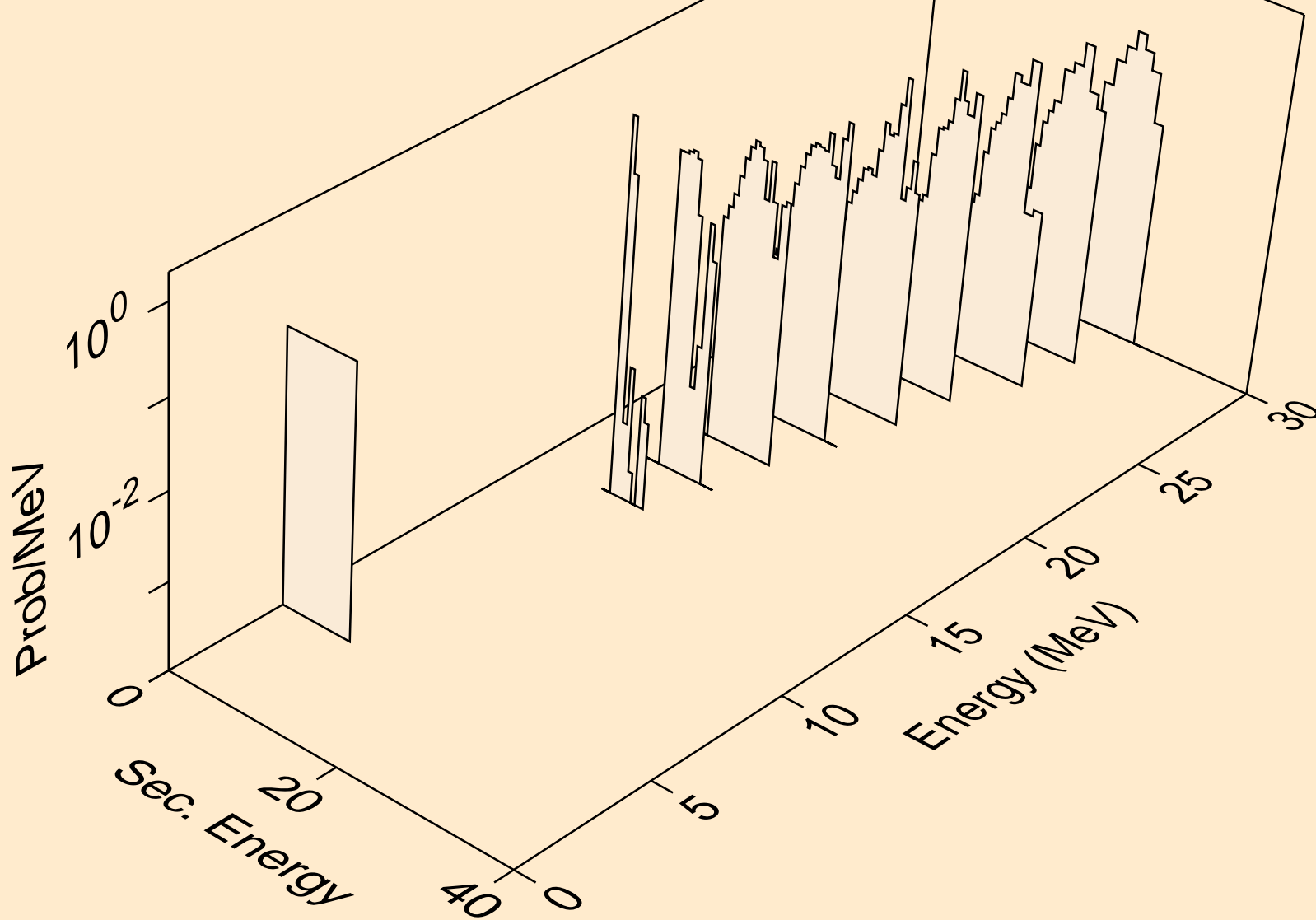

DB266 NEUTRON ACER TENDL-2019 LIBRARY; T=293.16K
alphas from (n,n*)2a

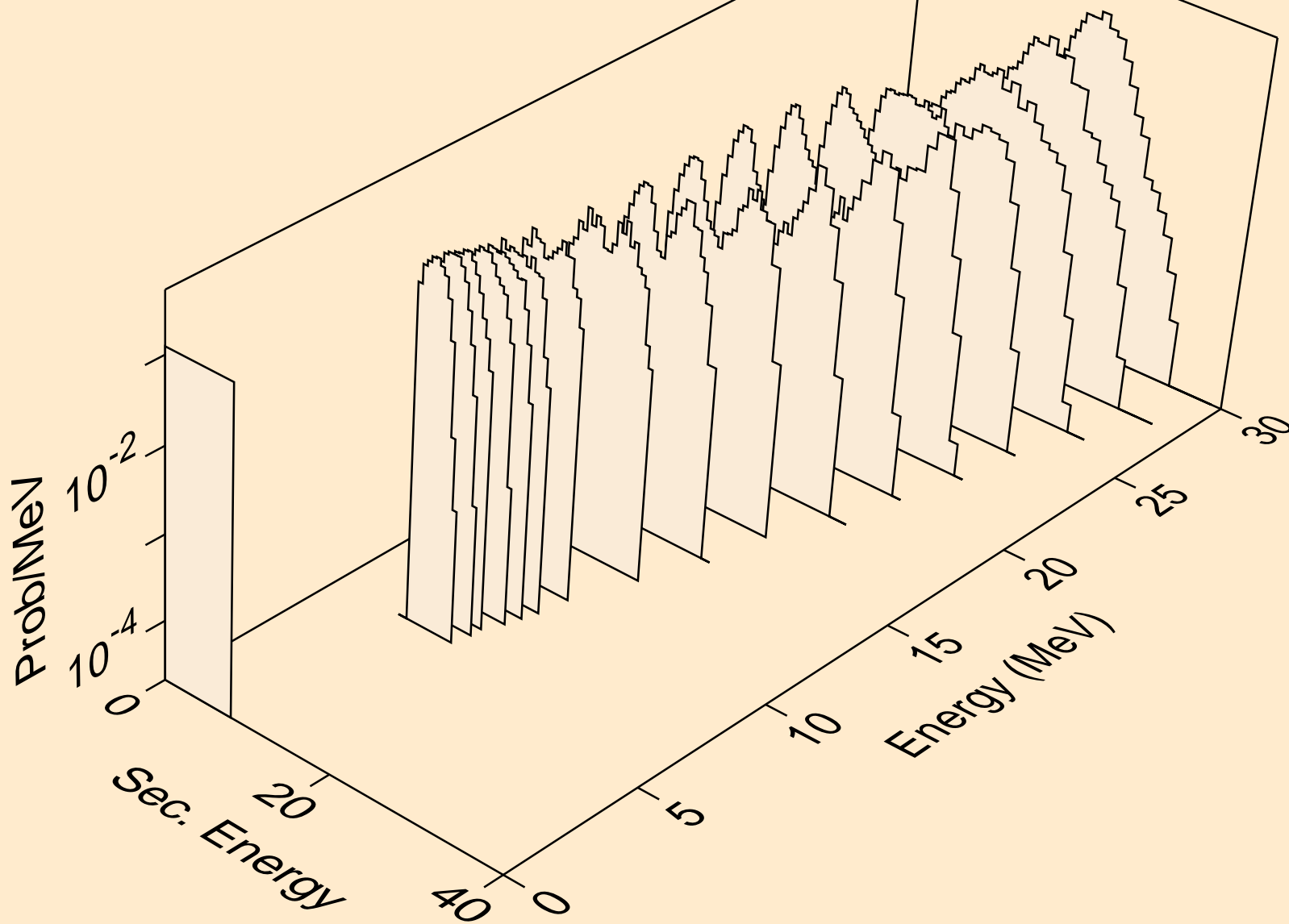

DB266 NEUTRON ACER TENDL-2019 LIBRARY; T=293.16K
alphas from (n,a)

