

# GA066 NEUTRON ACER TENDL-2019 LIBRARY; T=293.16K

## Principal cross sections

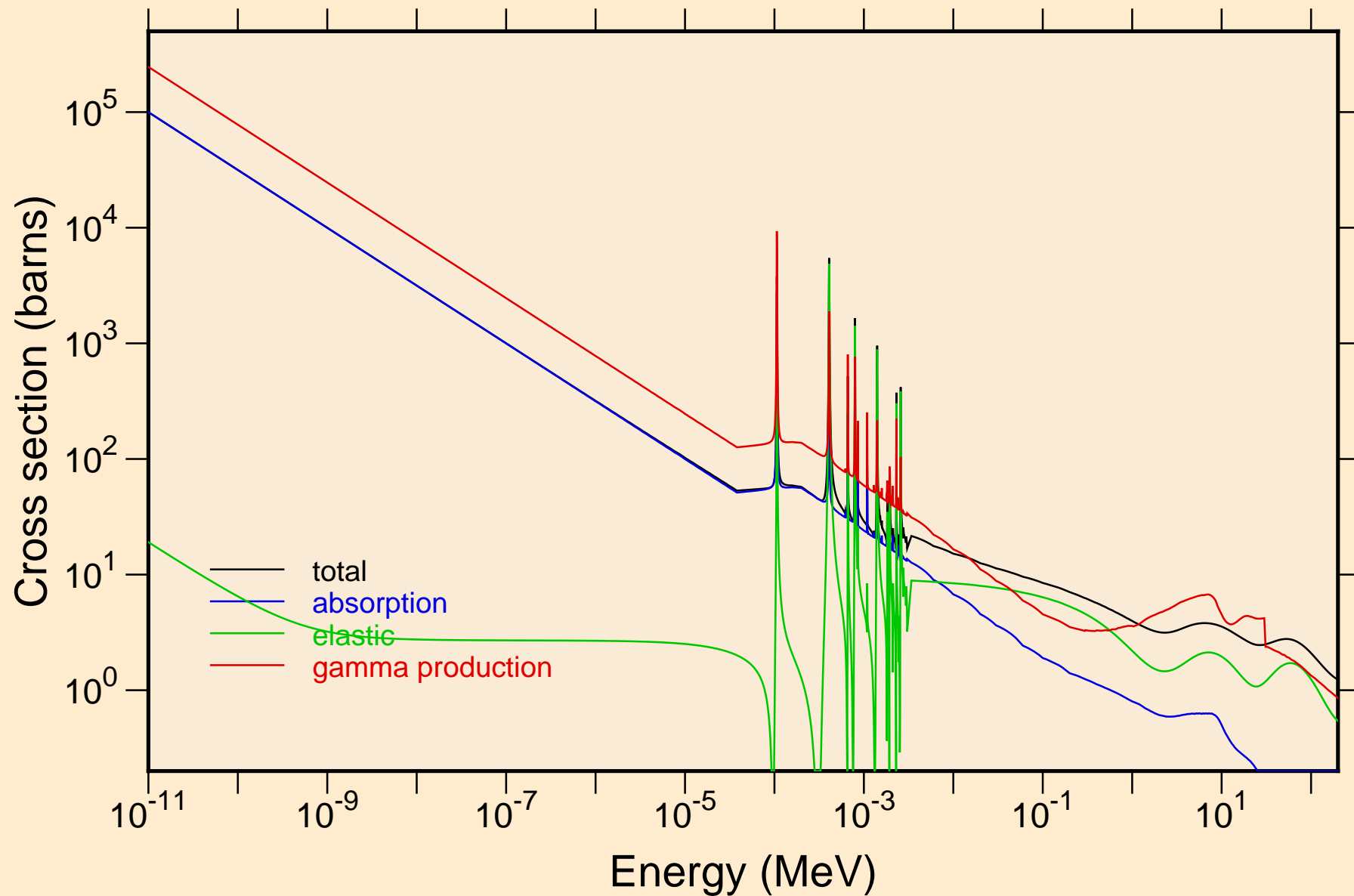

GA066 NEUTRON ACER TENDL-2019 LIBRARY; T=293.16K  
resonance total cross section

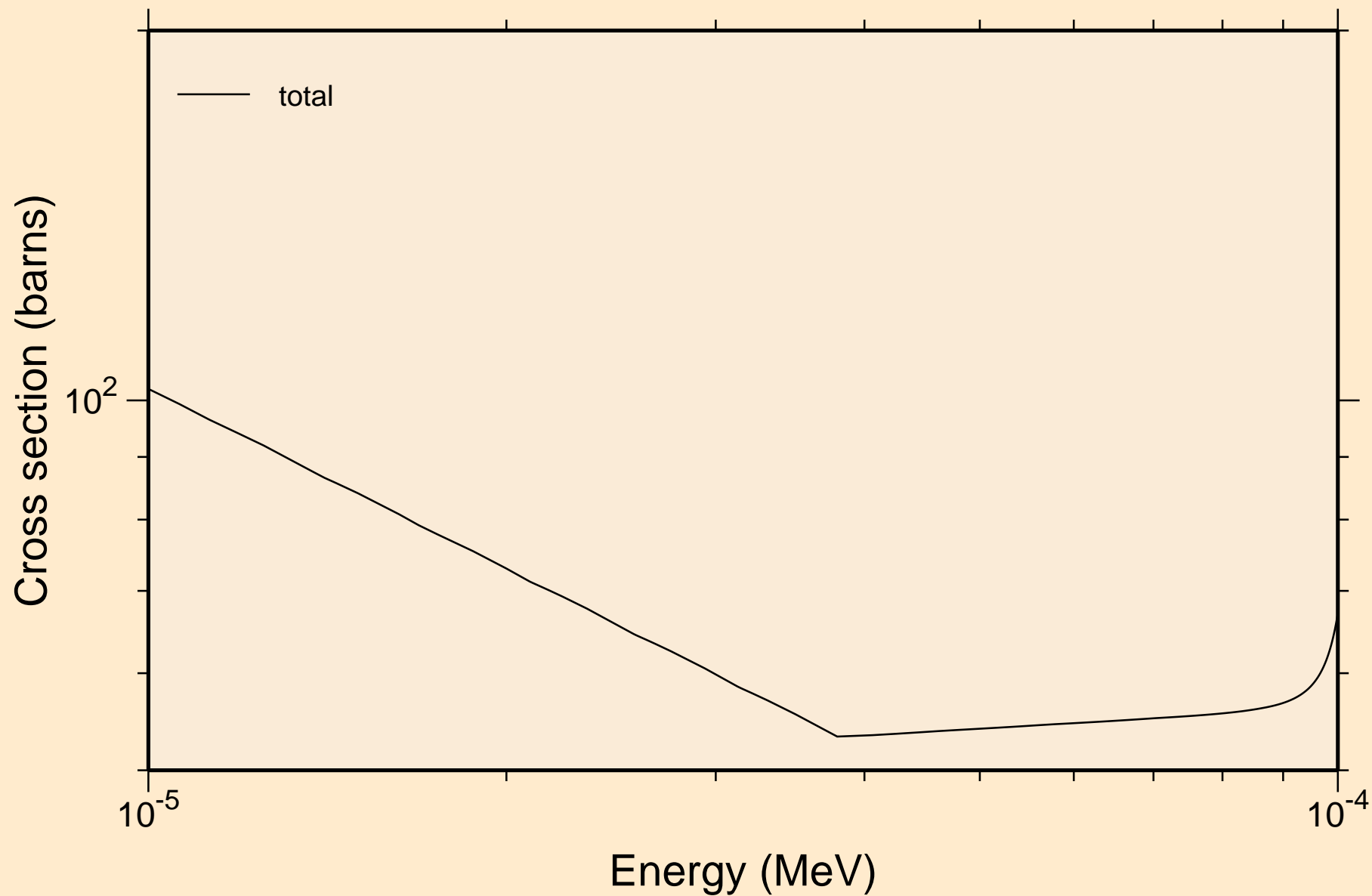

GA066 NEUTRON ACER TENDL-2019 LIBRARY; T=293.16K  
resonance total cross section

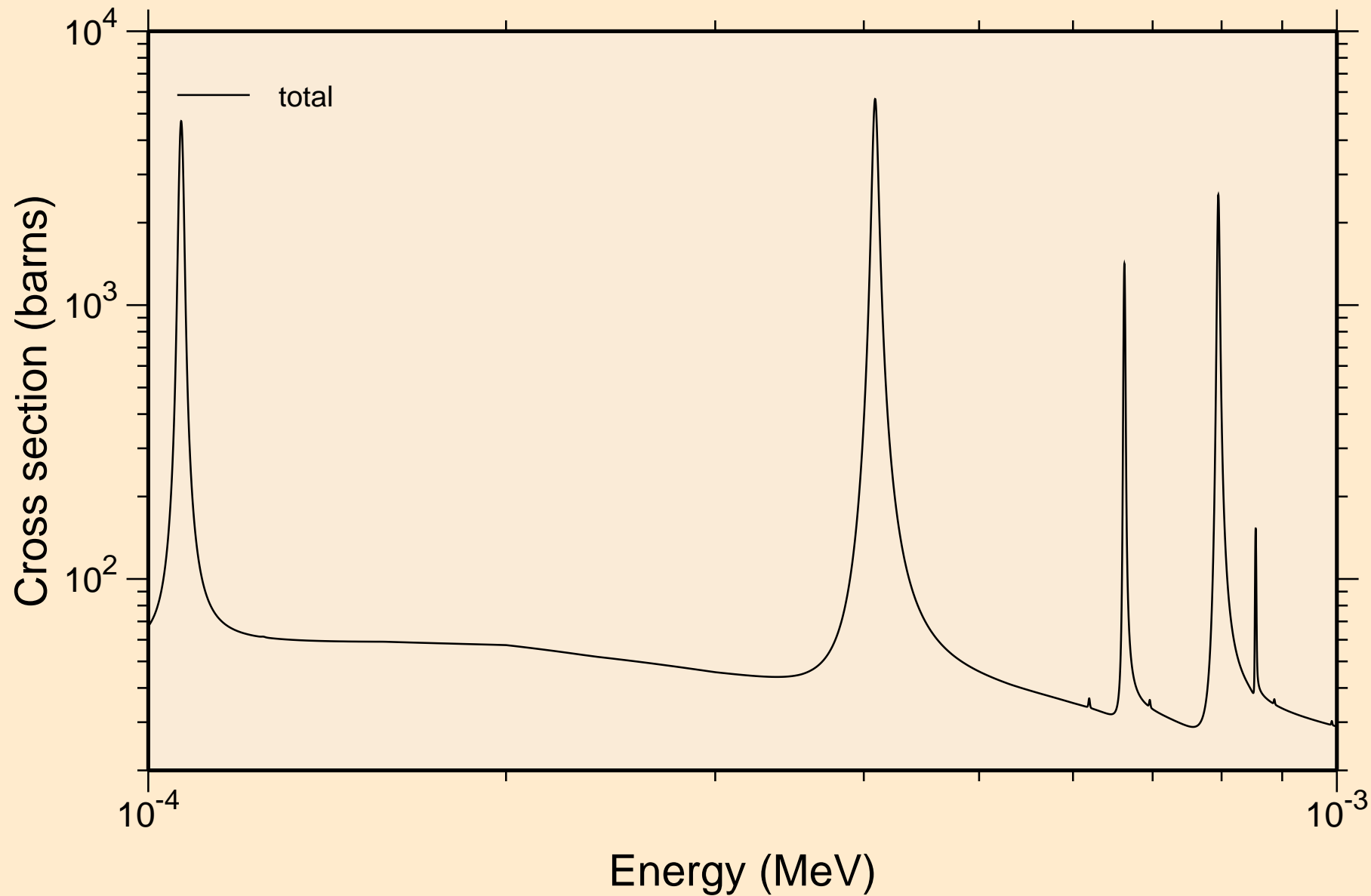

GA066 NEUTRON ACER TENDL-2019 LIBRARY; T=293.16K  
resonance total cross section

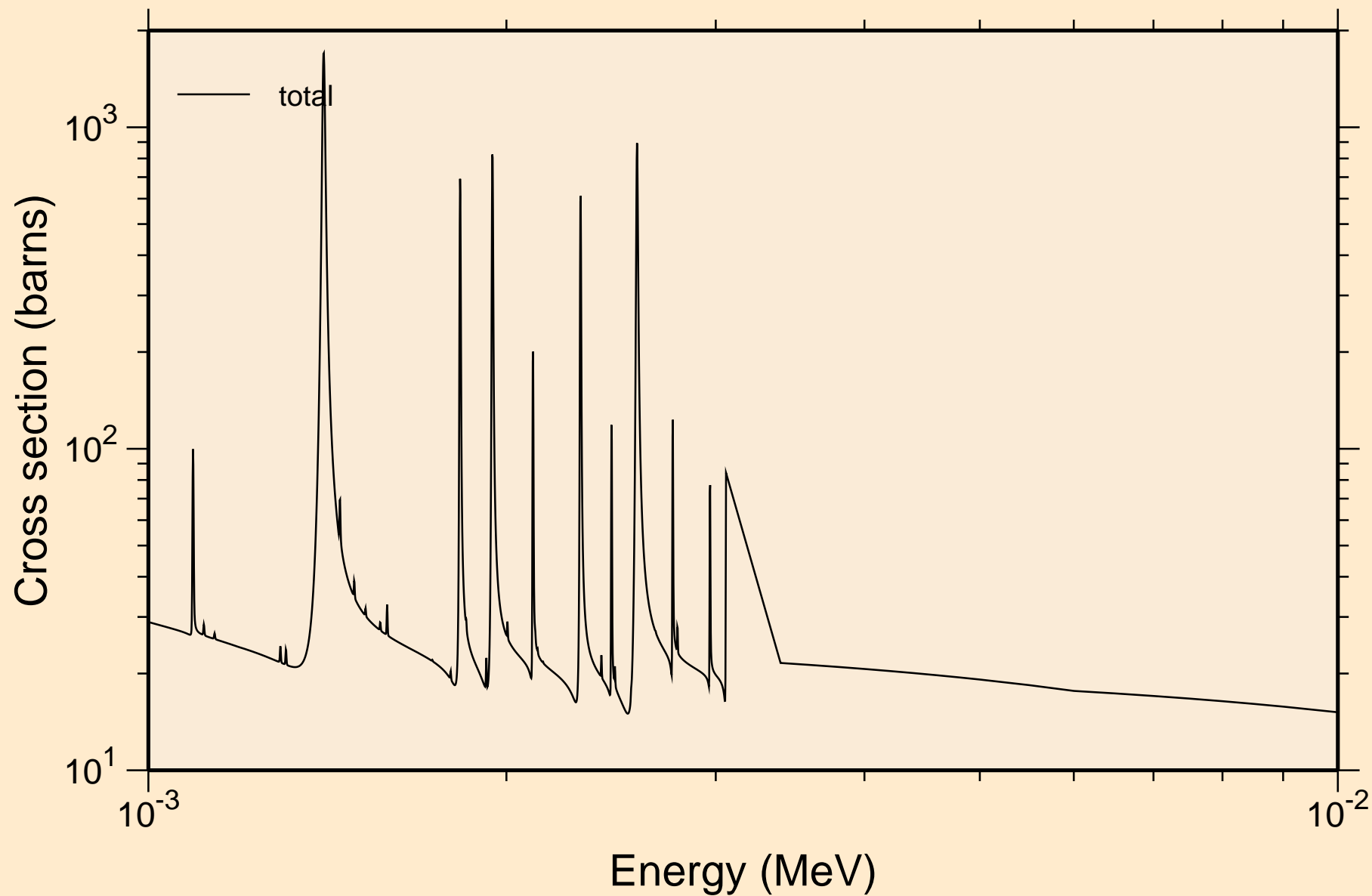

GA066 NEUTRON ACER TENDL-2019 LIBRARY; T=293.16K  
resonance total cross section

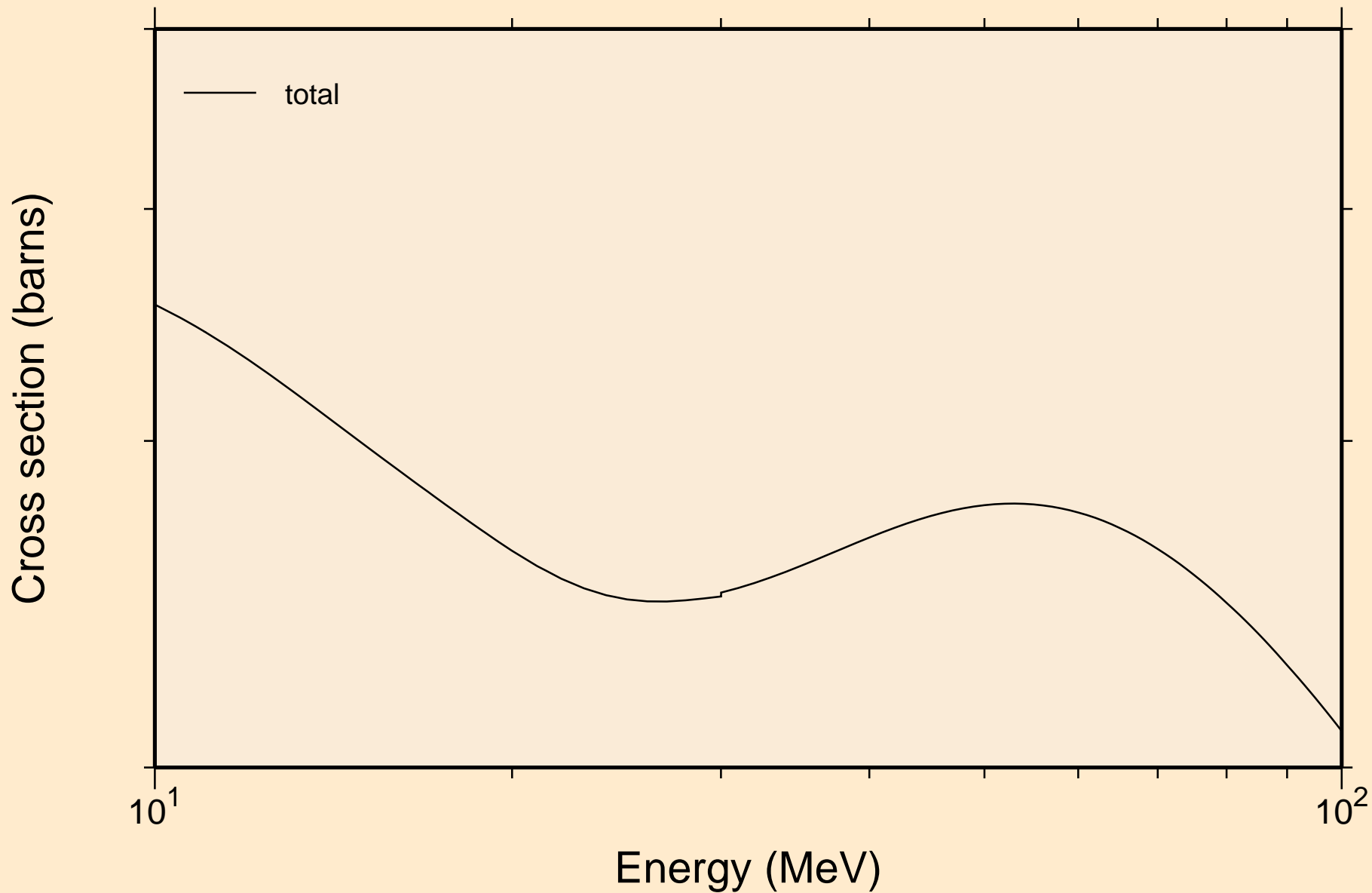

GA066 NEUTRON ACER TENDL-2019 LIBRARY; T=293.16K  
resonance absorption cross sections

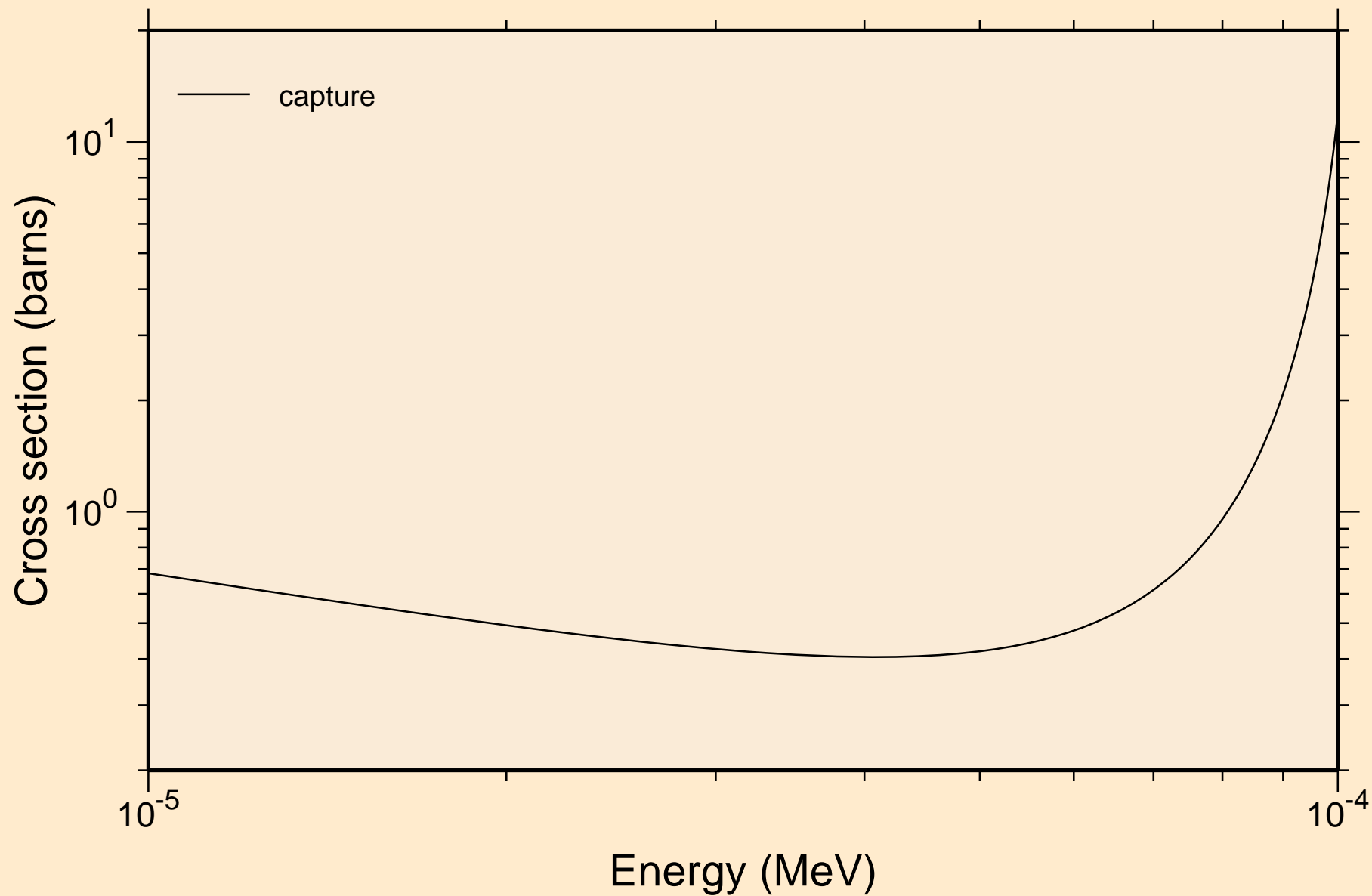

GA066 NEUTRON ACER TENDL-2019 LIBRARY; T=293.16K  
resonance absorption cross sections

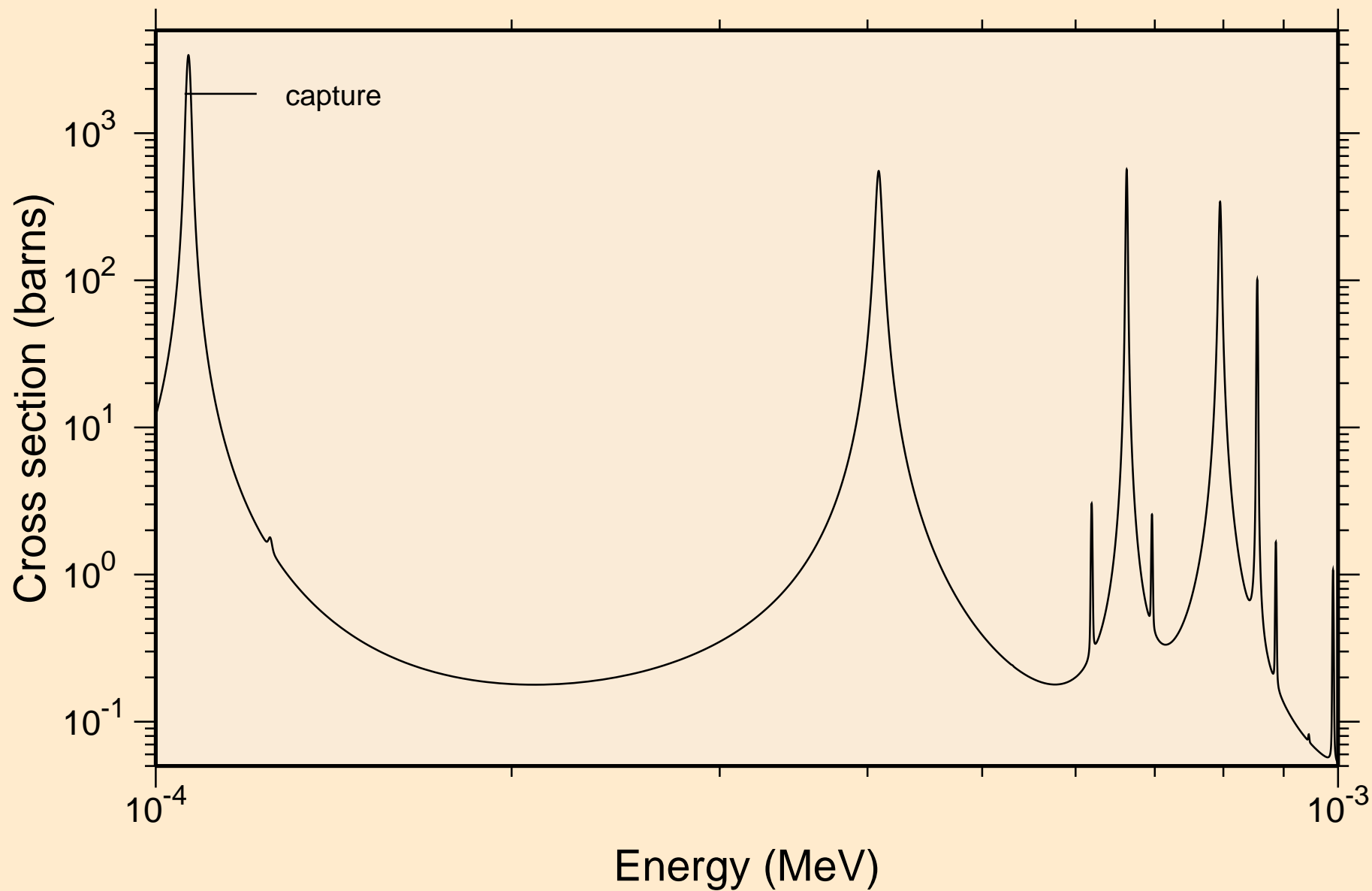

GA066 NEUTRON ACER TENDL-2019 LIBRARY; T=293.16K  
resonance absorption cross sections

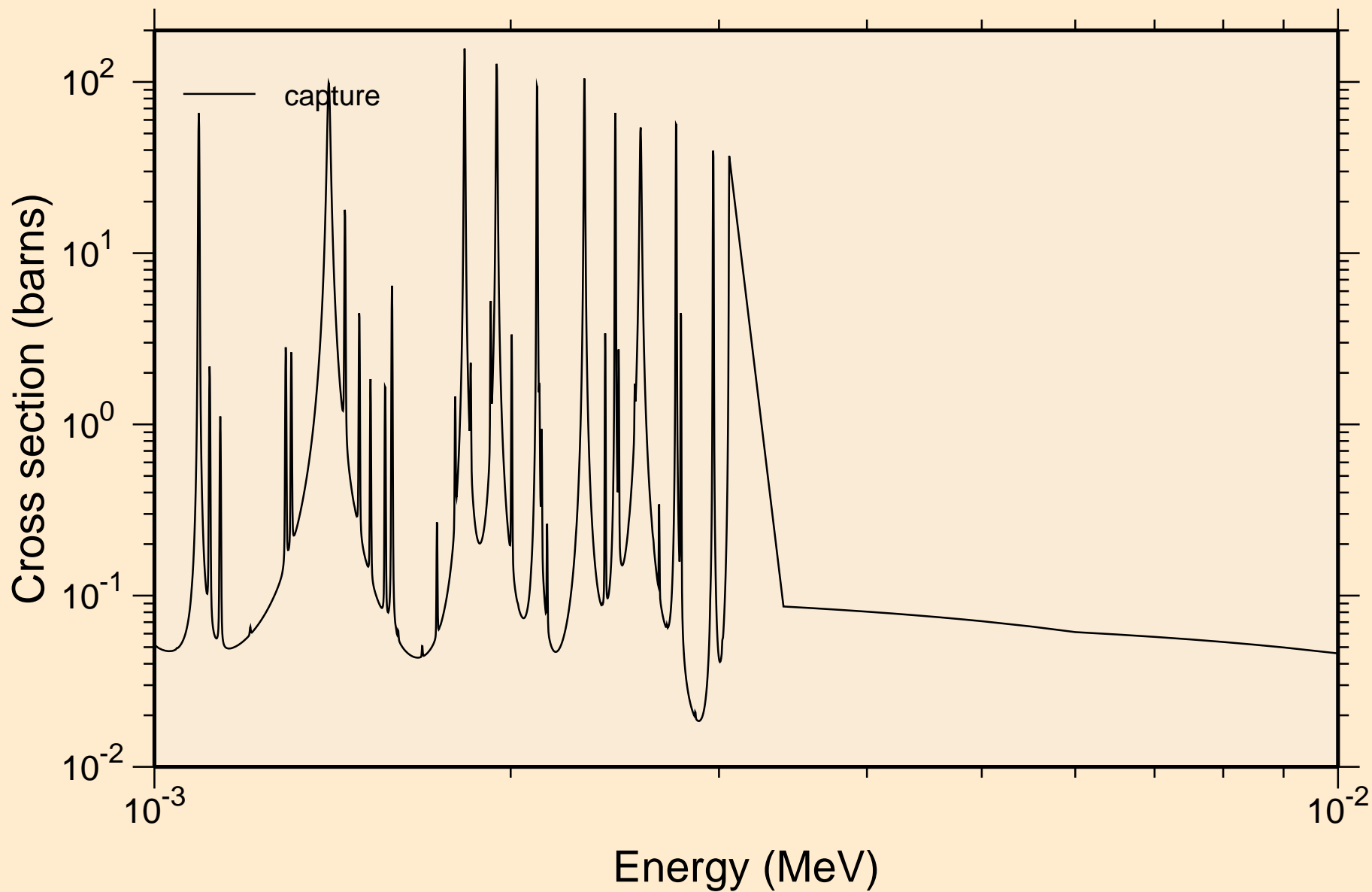

GA066 NEUTRON ACER TENDL-2019 LIBRARY; T=293.16K  
resonance absorption cross sections

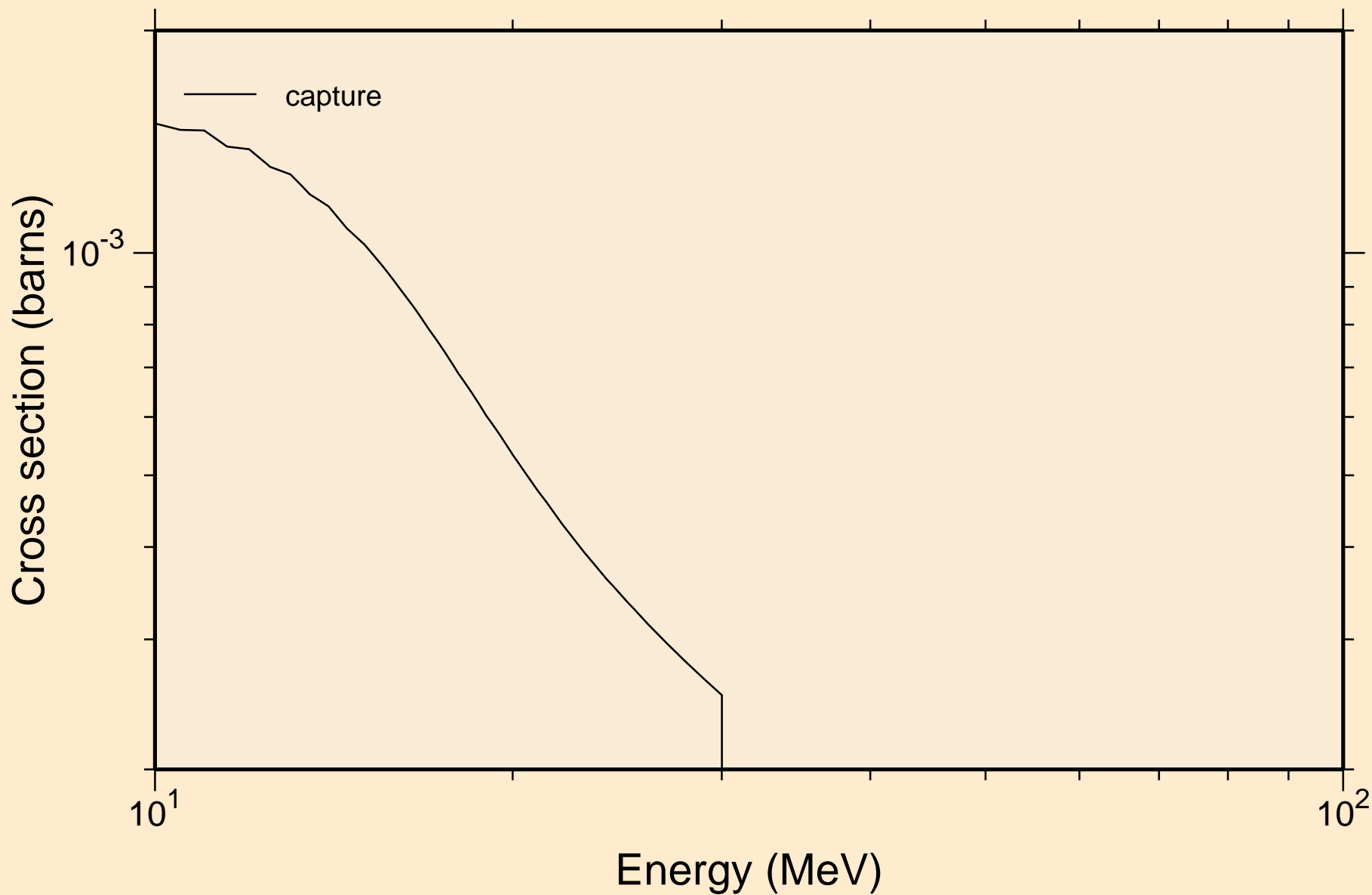

GA066 NEUTRON ACER TENDL-2019 LIBRARY; T=293.16K  
Heating

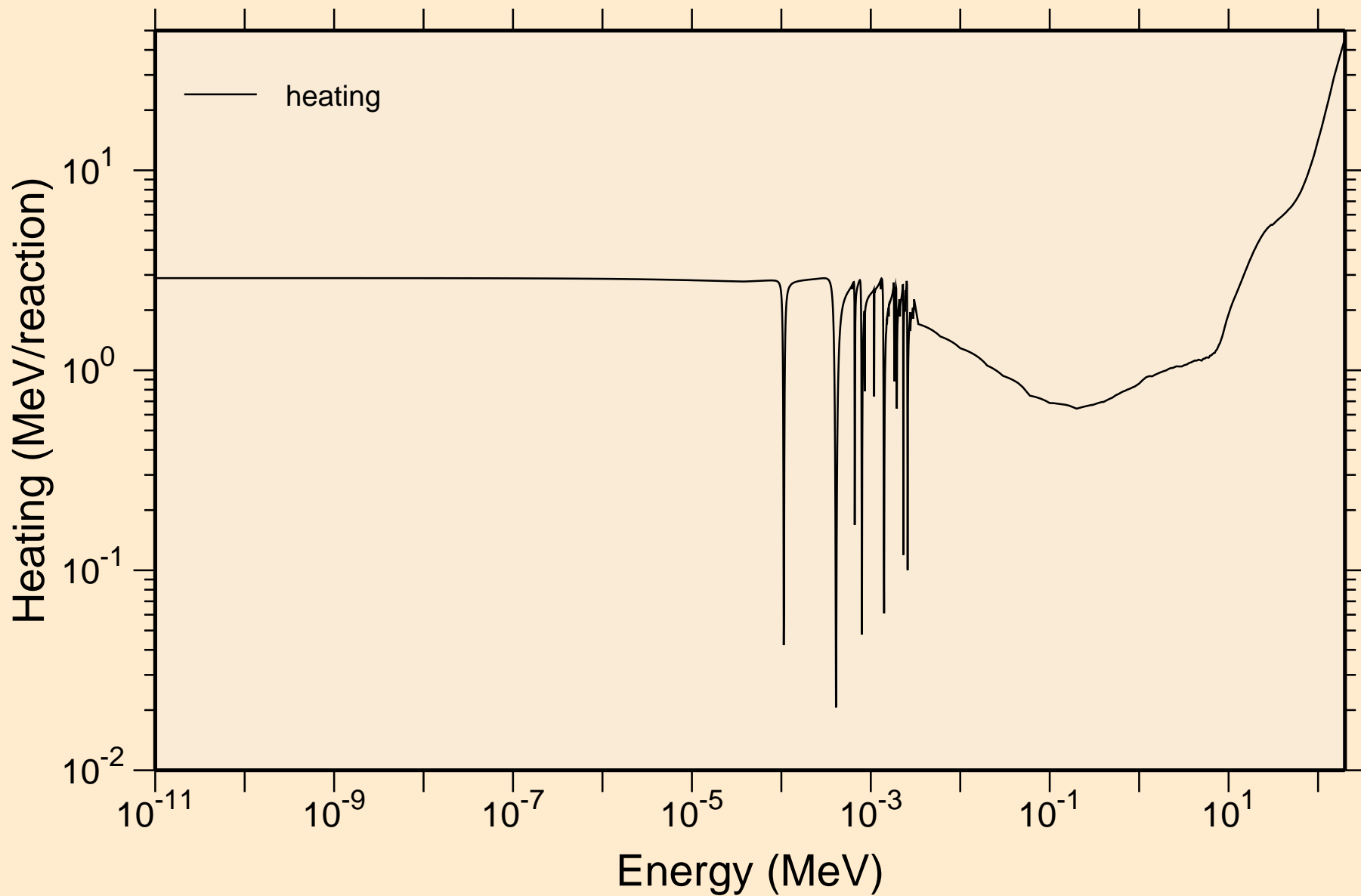

GA066 NEUTRON ACER TENDL-2019 LIBRARY; T=293.16K  
Damage

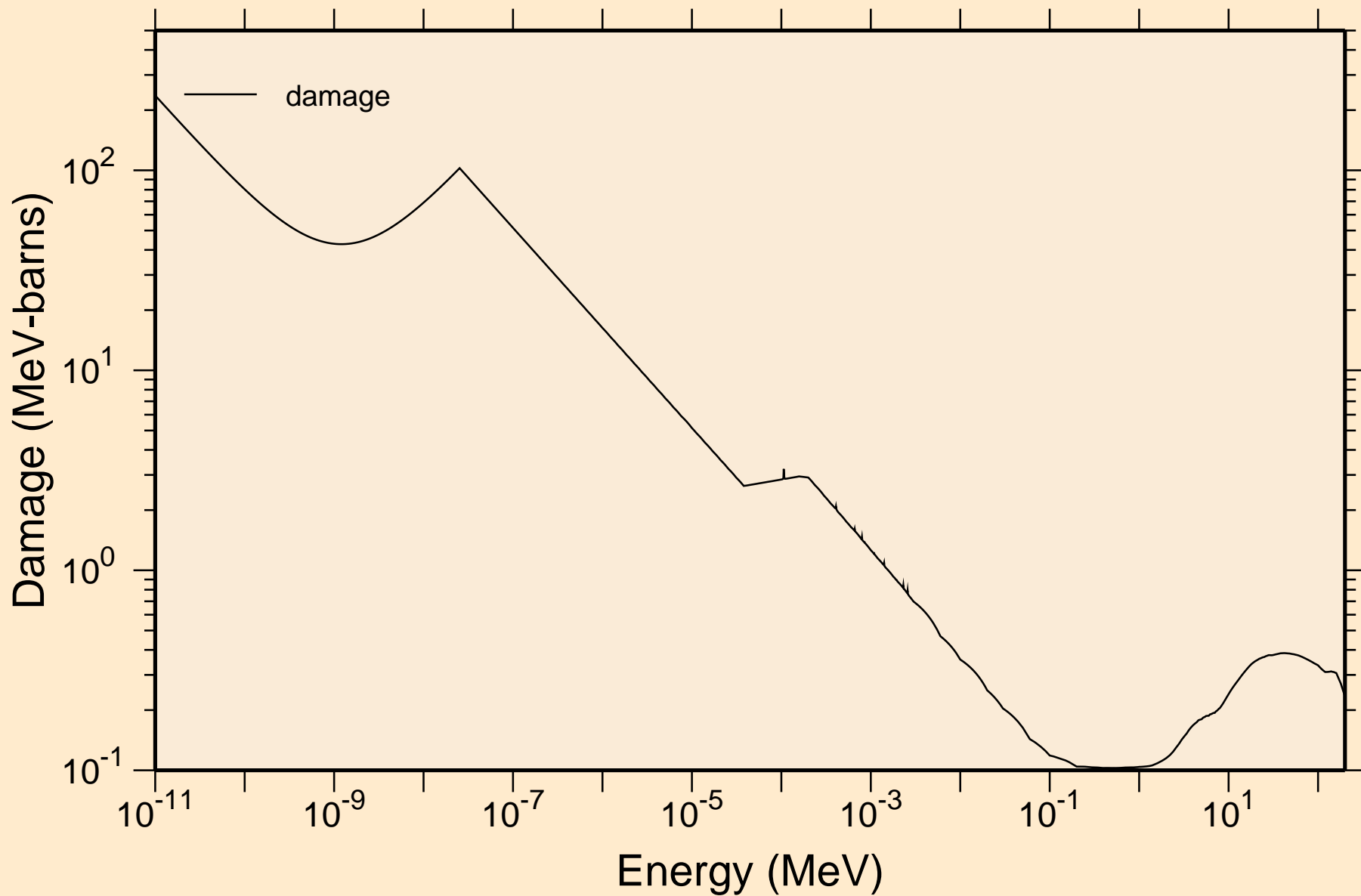

GA066 NEUTRON ACER TENDL-2019 LIBRARY; T=293.16K  
Non-threshold reactions

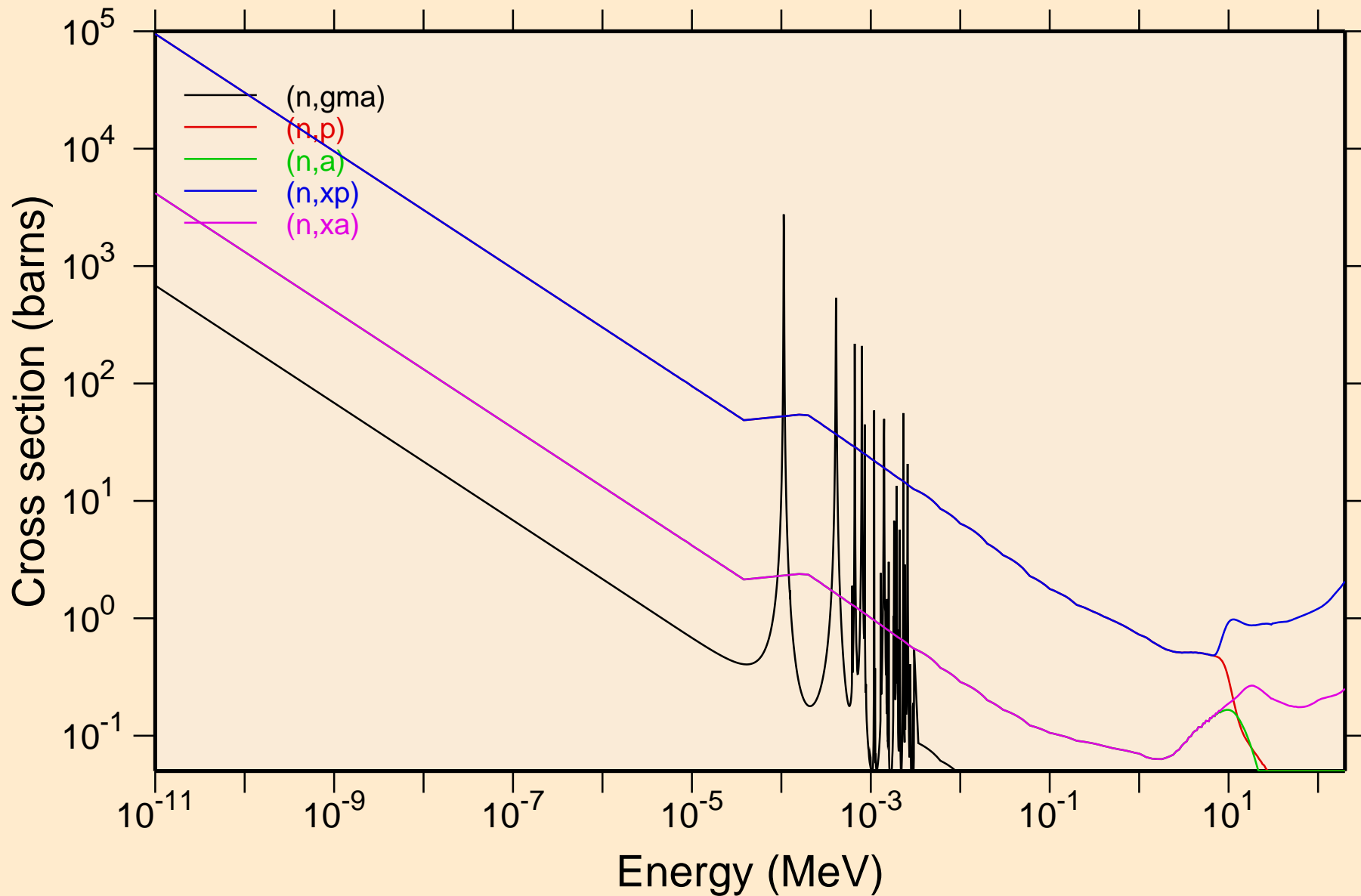

# GA066 NEUTRON ACER TENDL-2019 LIBRARY; T=293.16K

## Principal cross sections

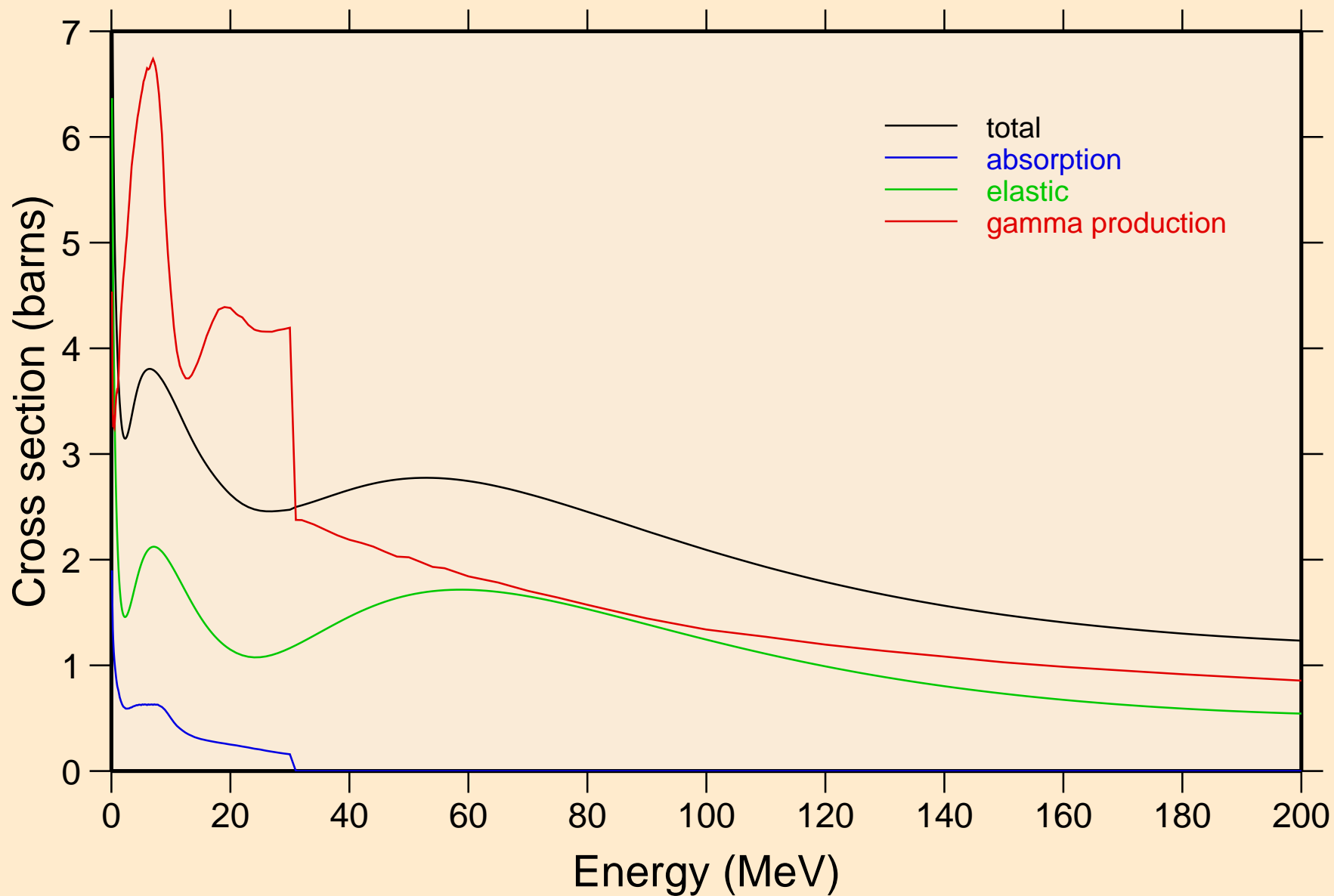

GA066 NEUTRON ACER TENDL-2019 LIBRARY; T=293.16K  
Heating

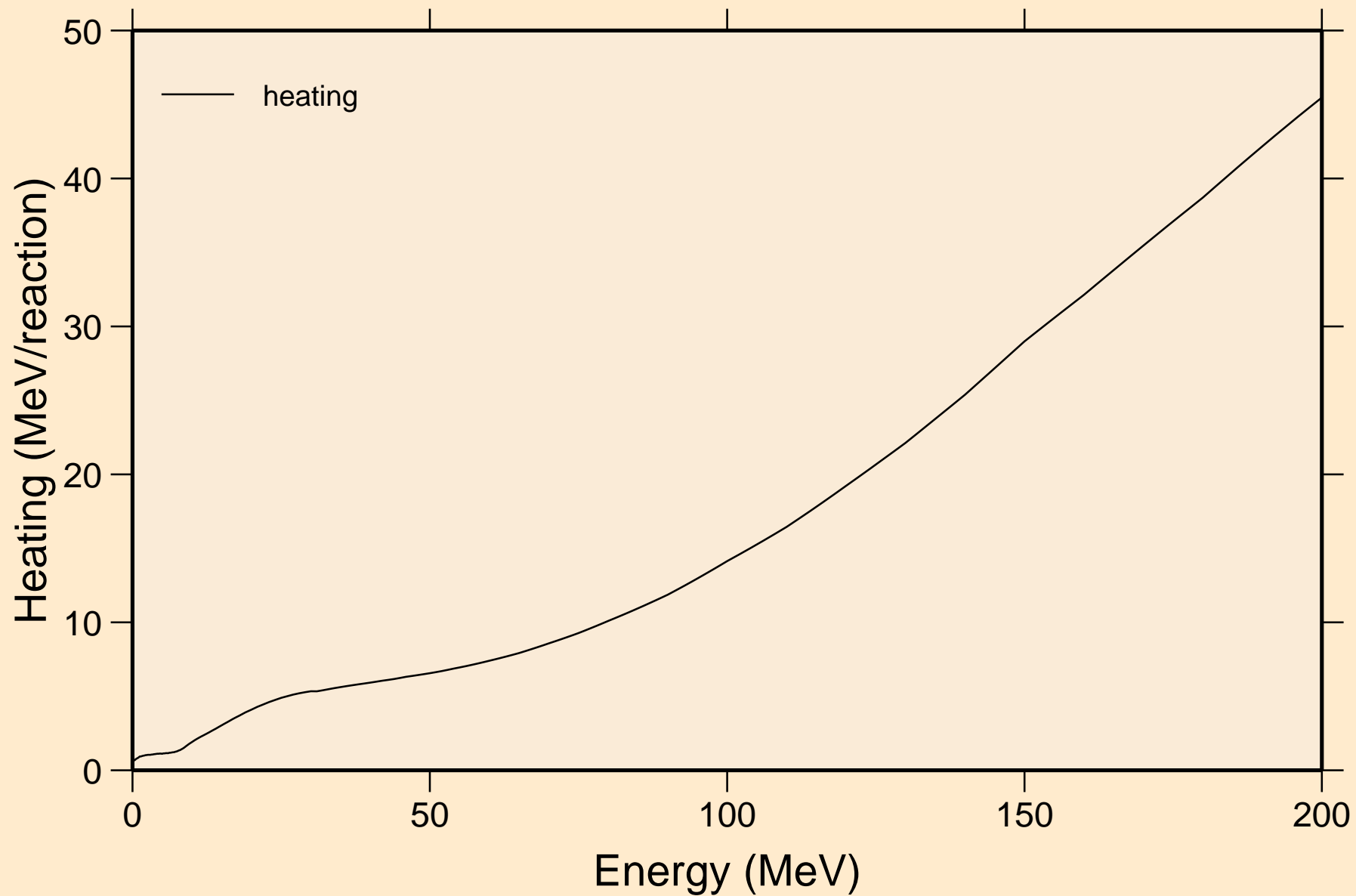

GA066 NEUTRON ACER TENDL-2019 LIBRARY; T=293.16K  
Damage

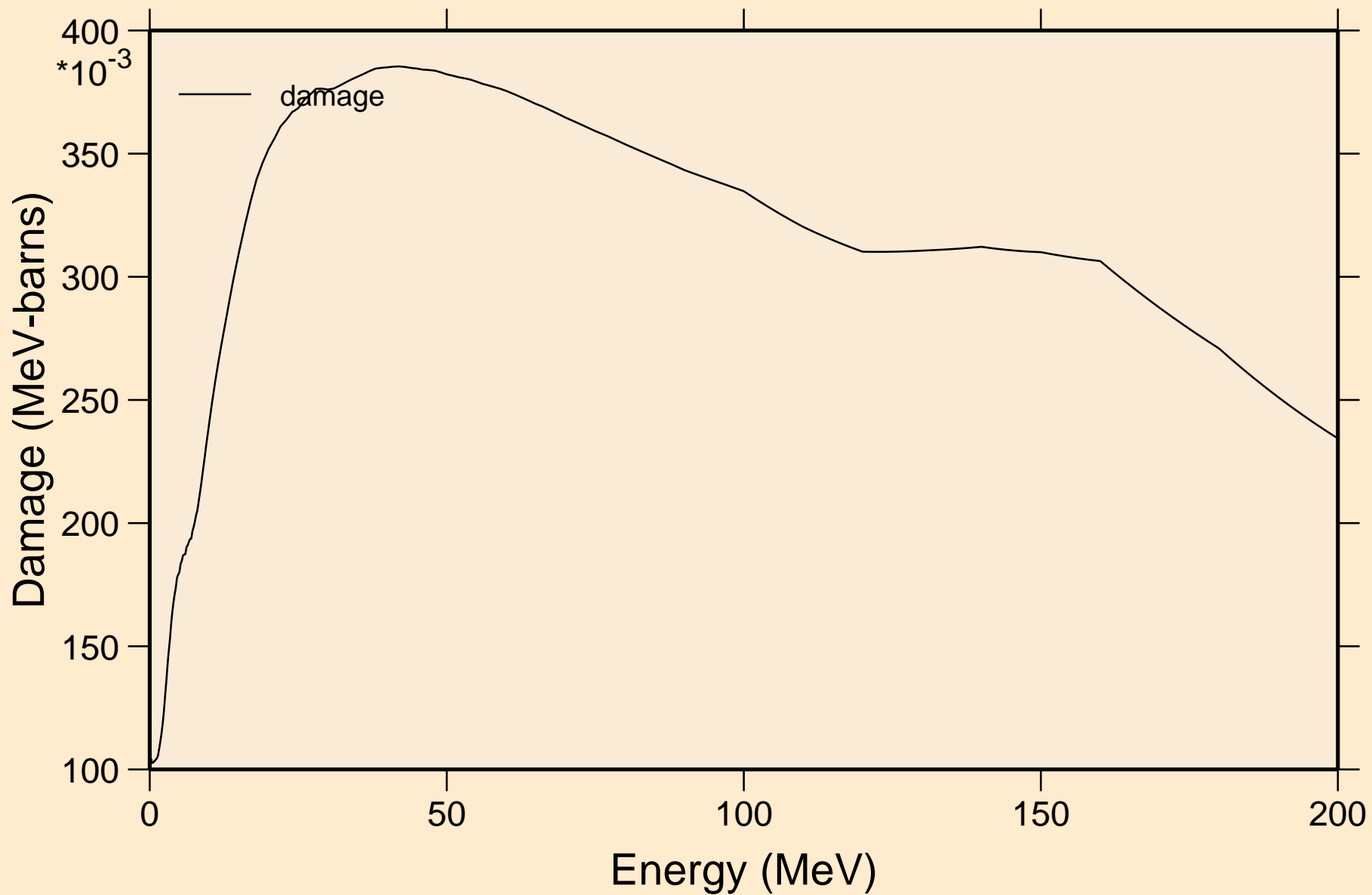

GA066 NEUTRON ACER TENDL-2019 LIBRARY; T=293.16K  
Non-threshold reactions

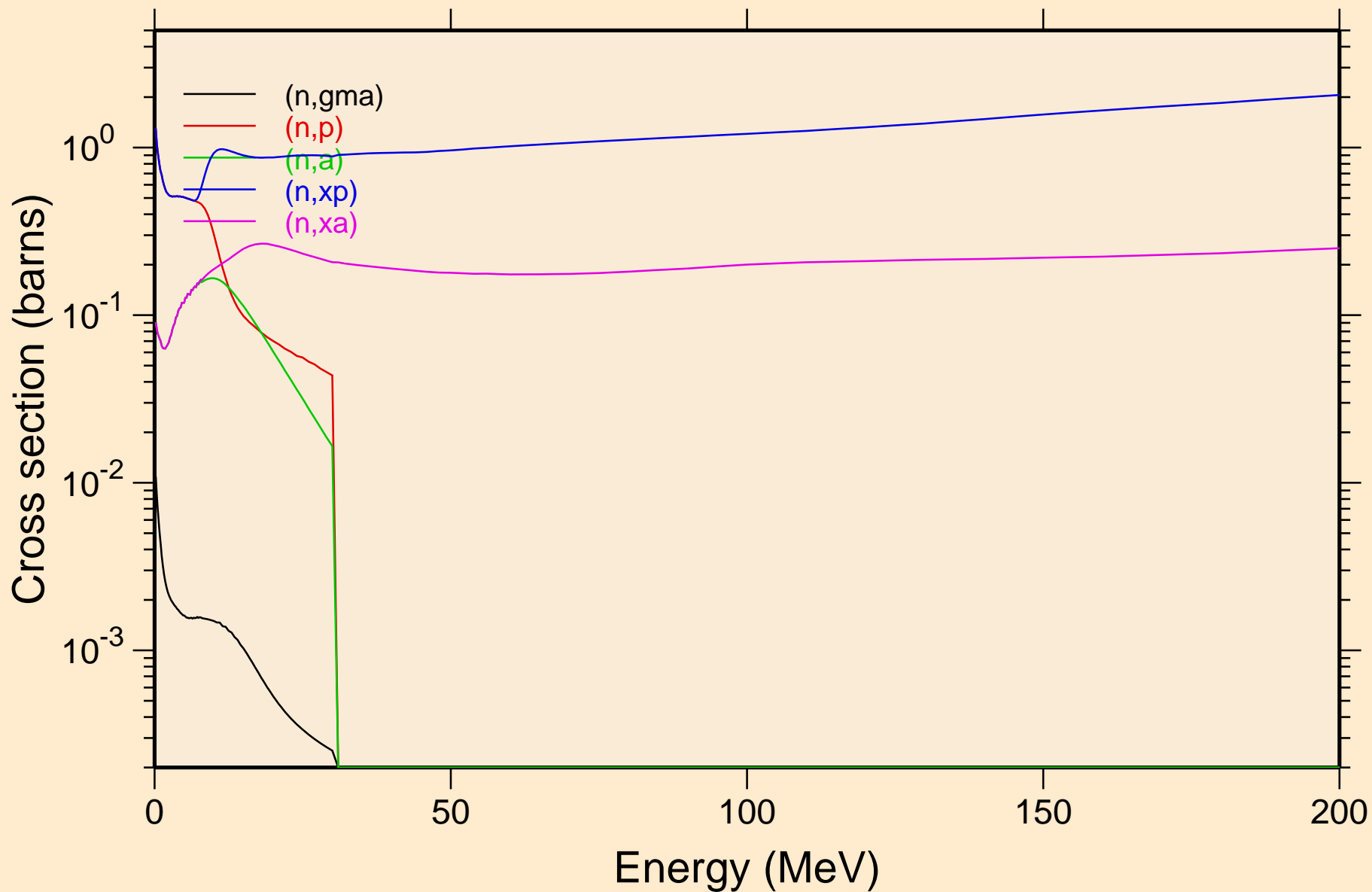

GA066 NEUTRON ACER TENDL-2019 LIBRARY; T=293.16K  
Inelastic levels

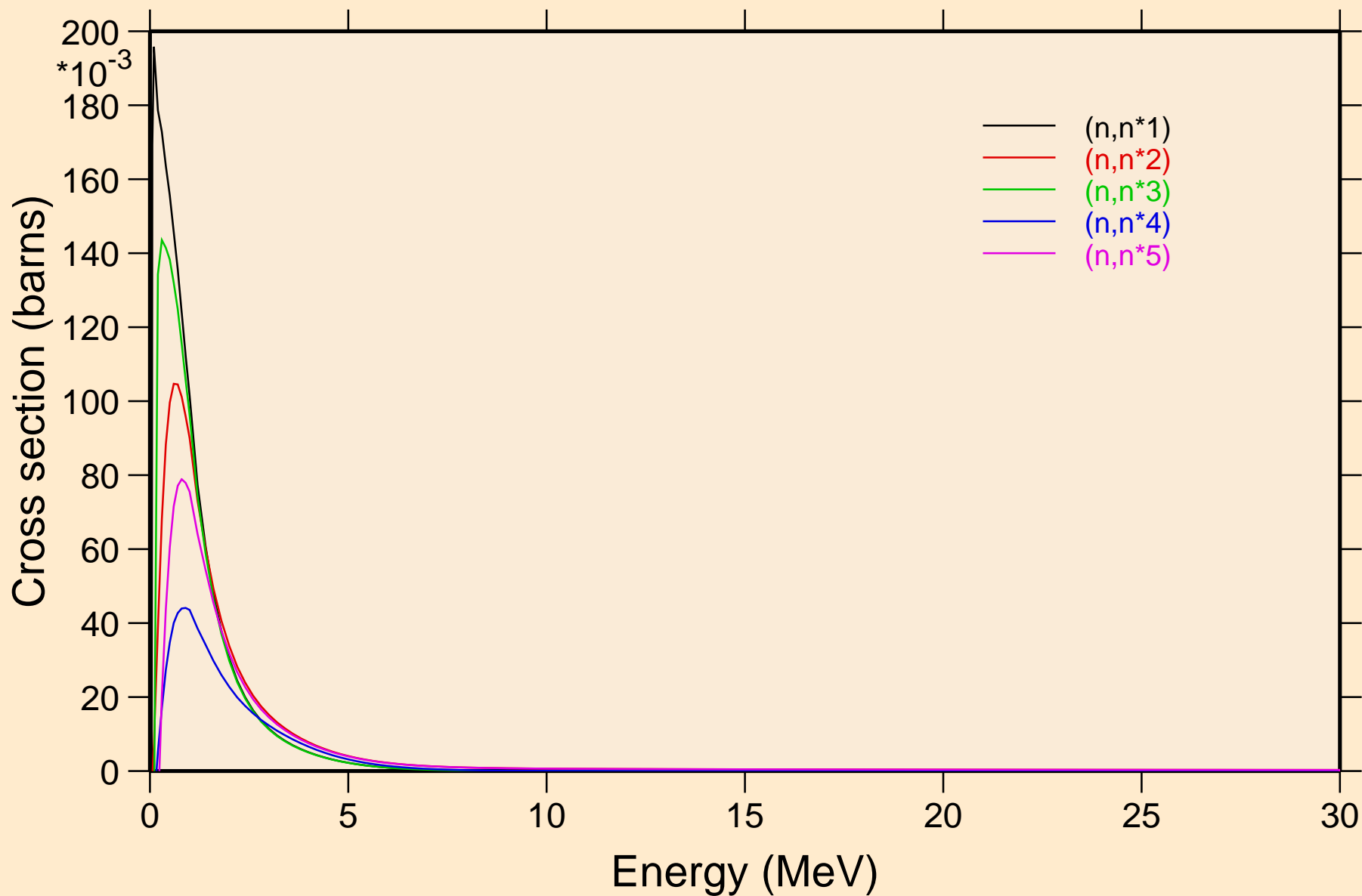

GA066 NEUTRON ACER TENDL-2019 LIBRARY; T=293.16K  
Inelastic levels

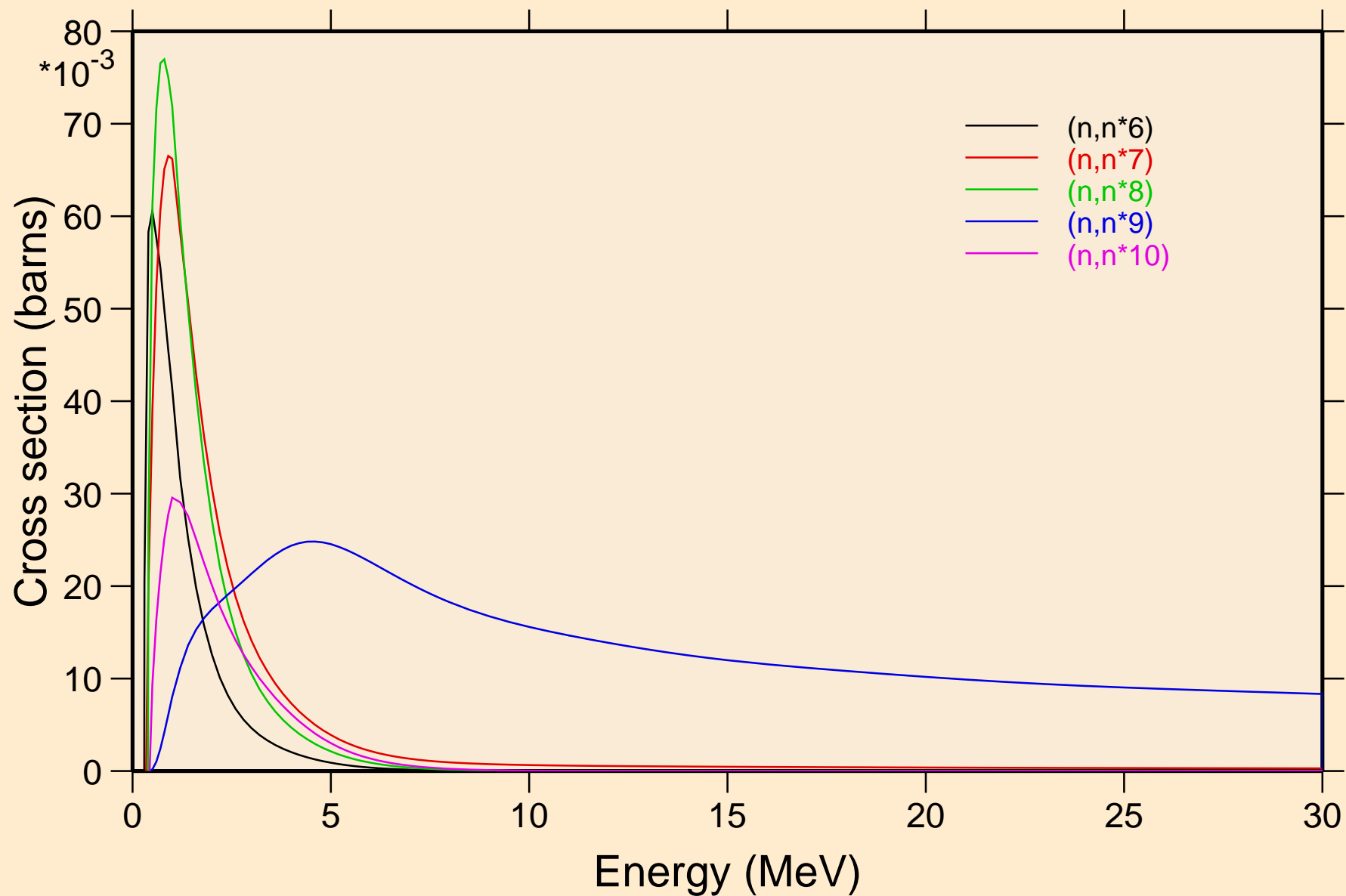

GA066 NEUTRON ACER TENDL-2019 LIBRARY; T=293.16K  
Inelastic levels

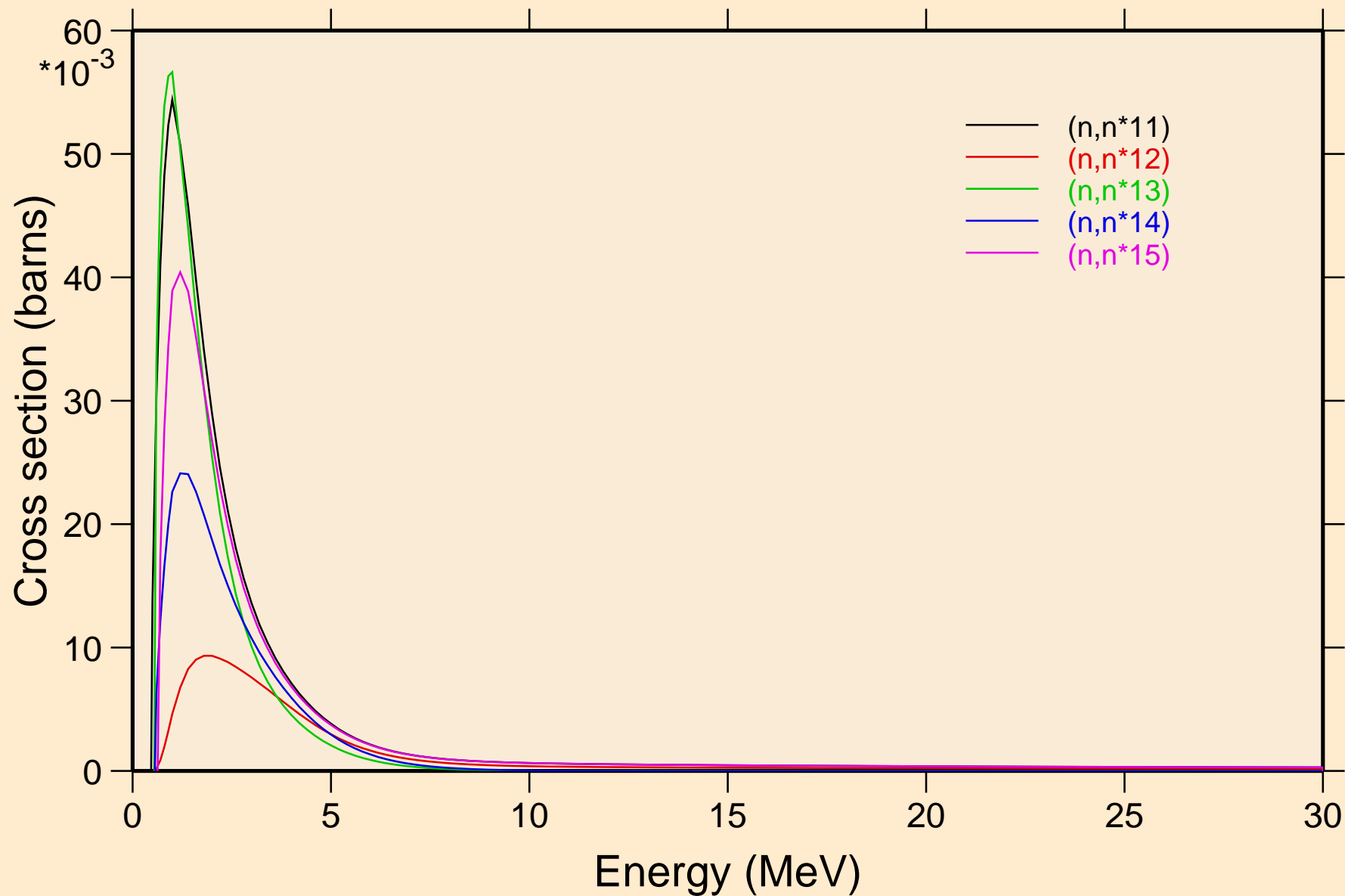

GA066 NEUTRON ACER TENDL-2019 LIBRARY; T=293.16K  
Inelastic levels

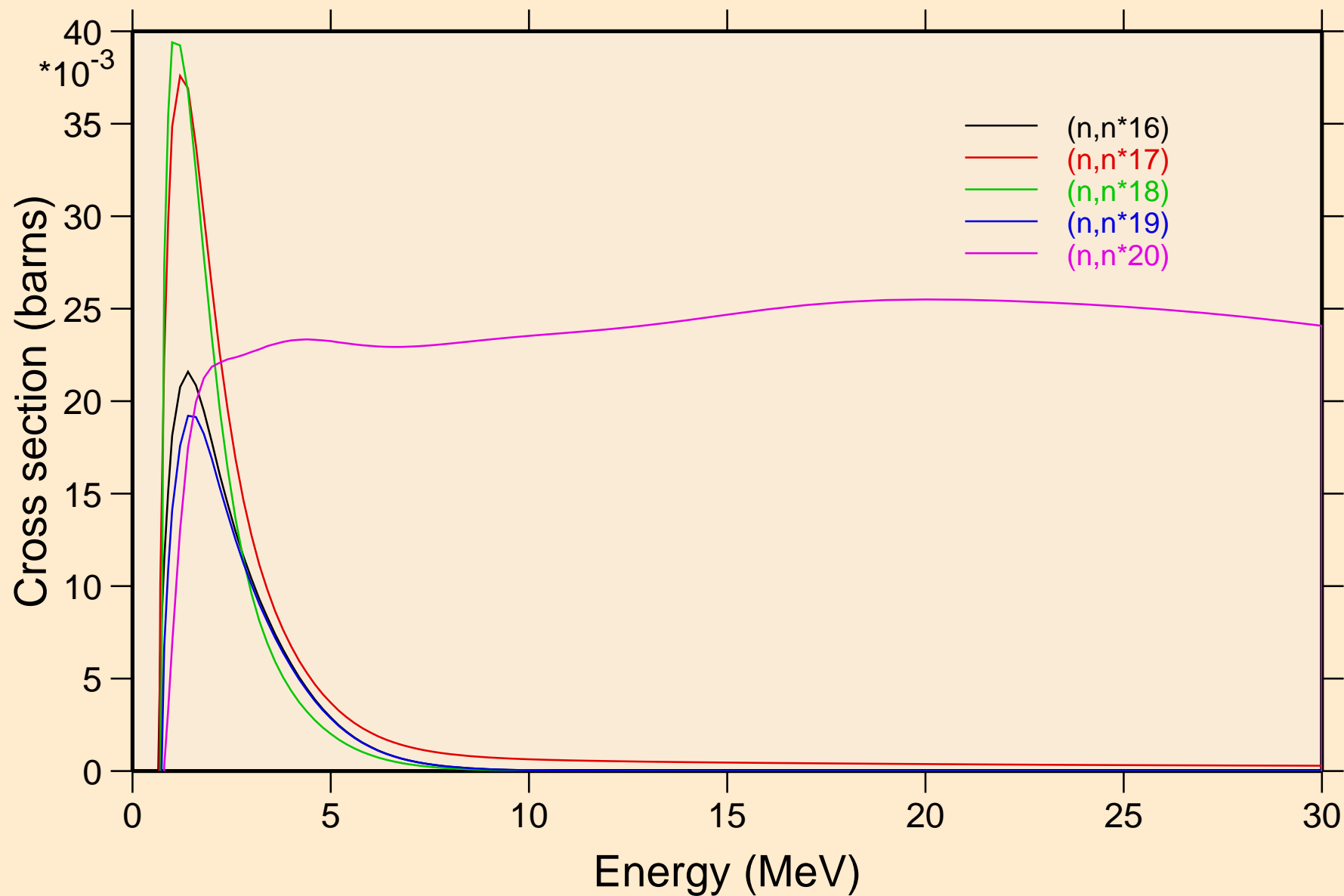

GA066 NEUTRON ACER TENDL-2019 LIBRARY; T=293.16K  
Inelastic levels

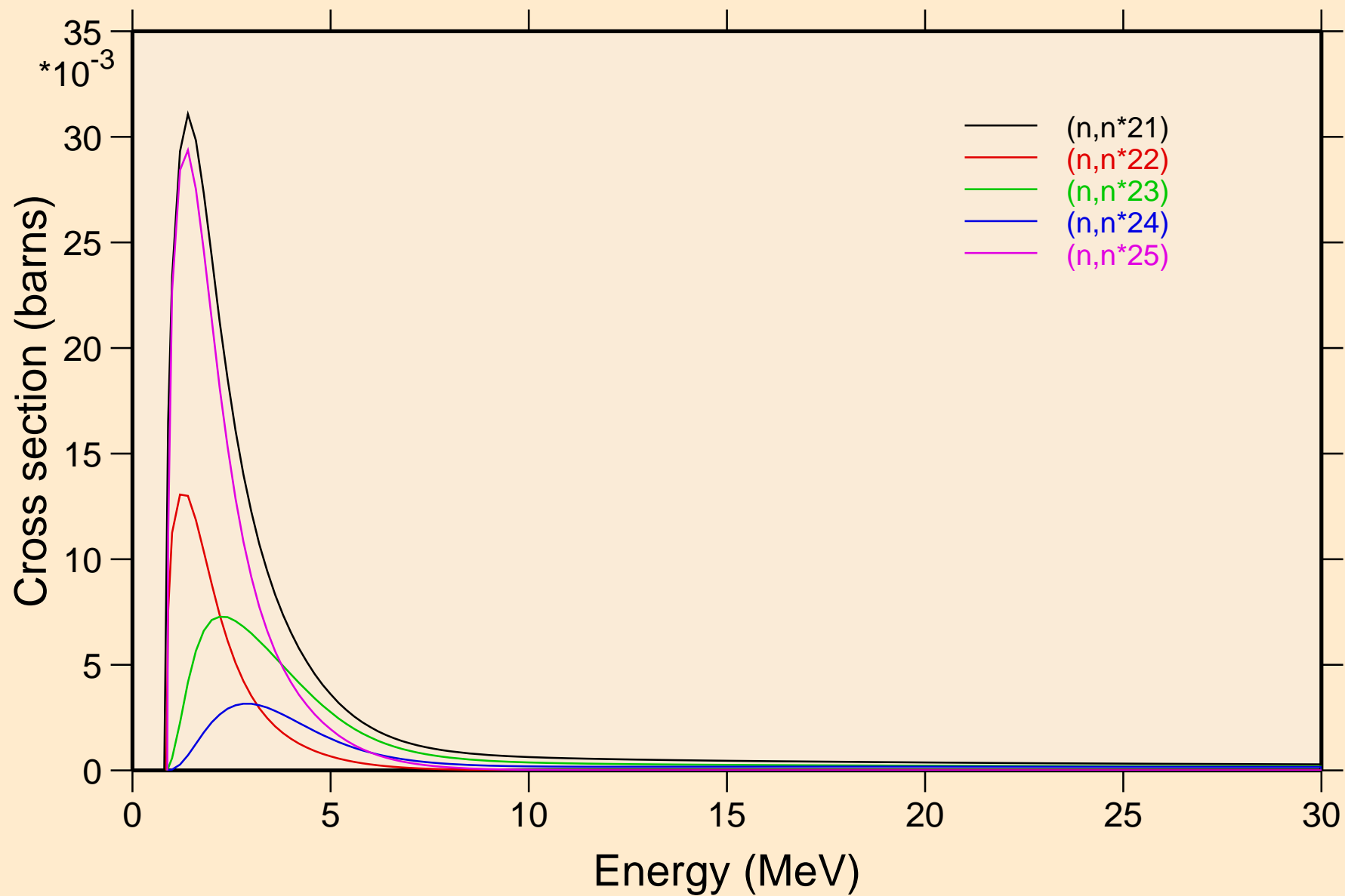

GA066 NEUTRON ACER TENDL-2019 LIBRARY; T=293.16K  
Inelastic levels

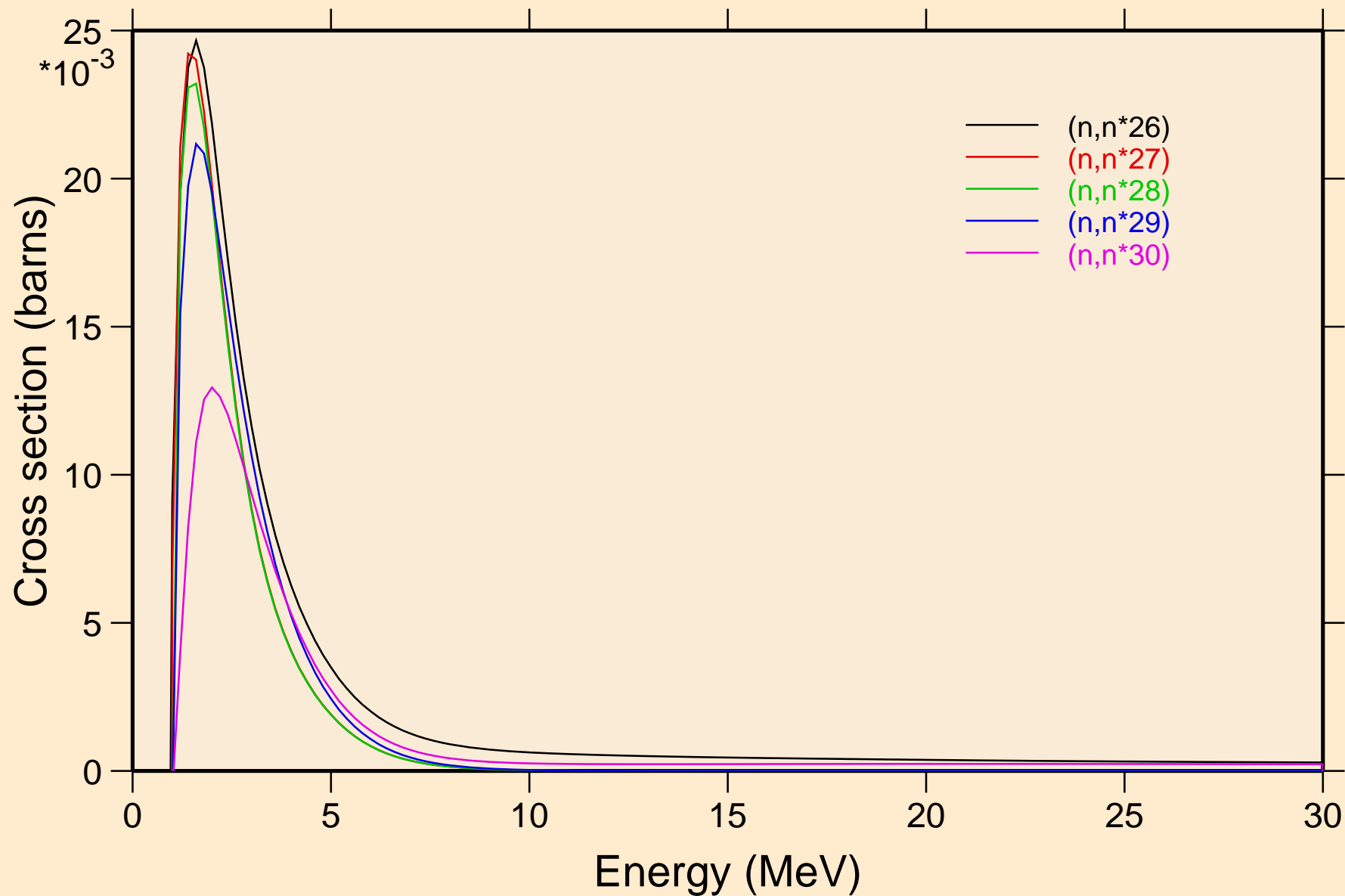

GA066 NEUTRON ACER TENDL-2019 LIBRARY; T=293.16K  
Threshold reactions

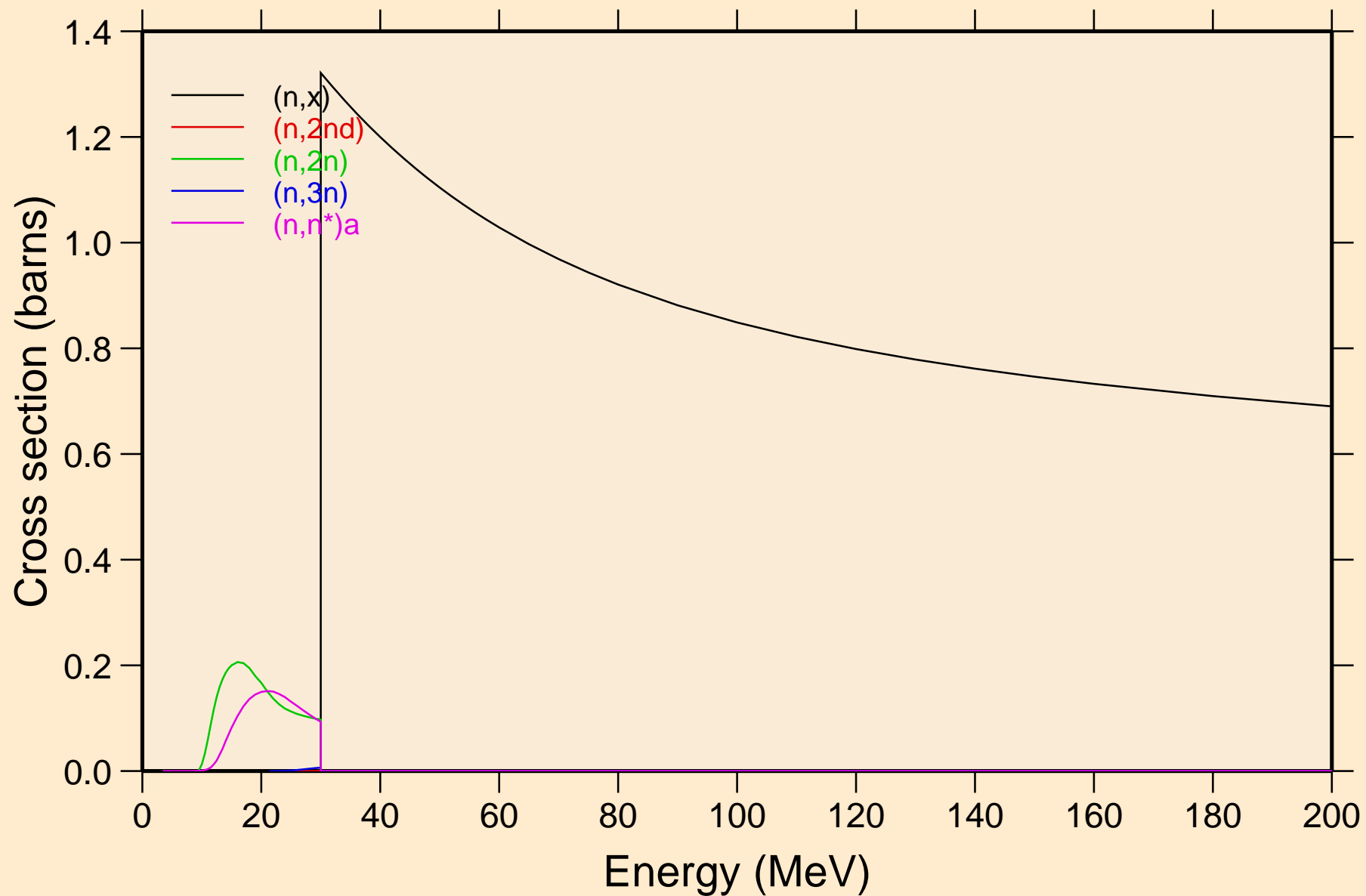

GA066 NEUTRON ACER TENDL-2019 LIBRARY; T=293.16K  
Threshold reactions

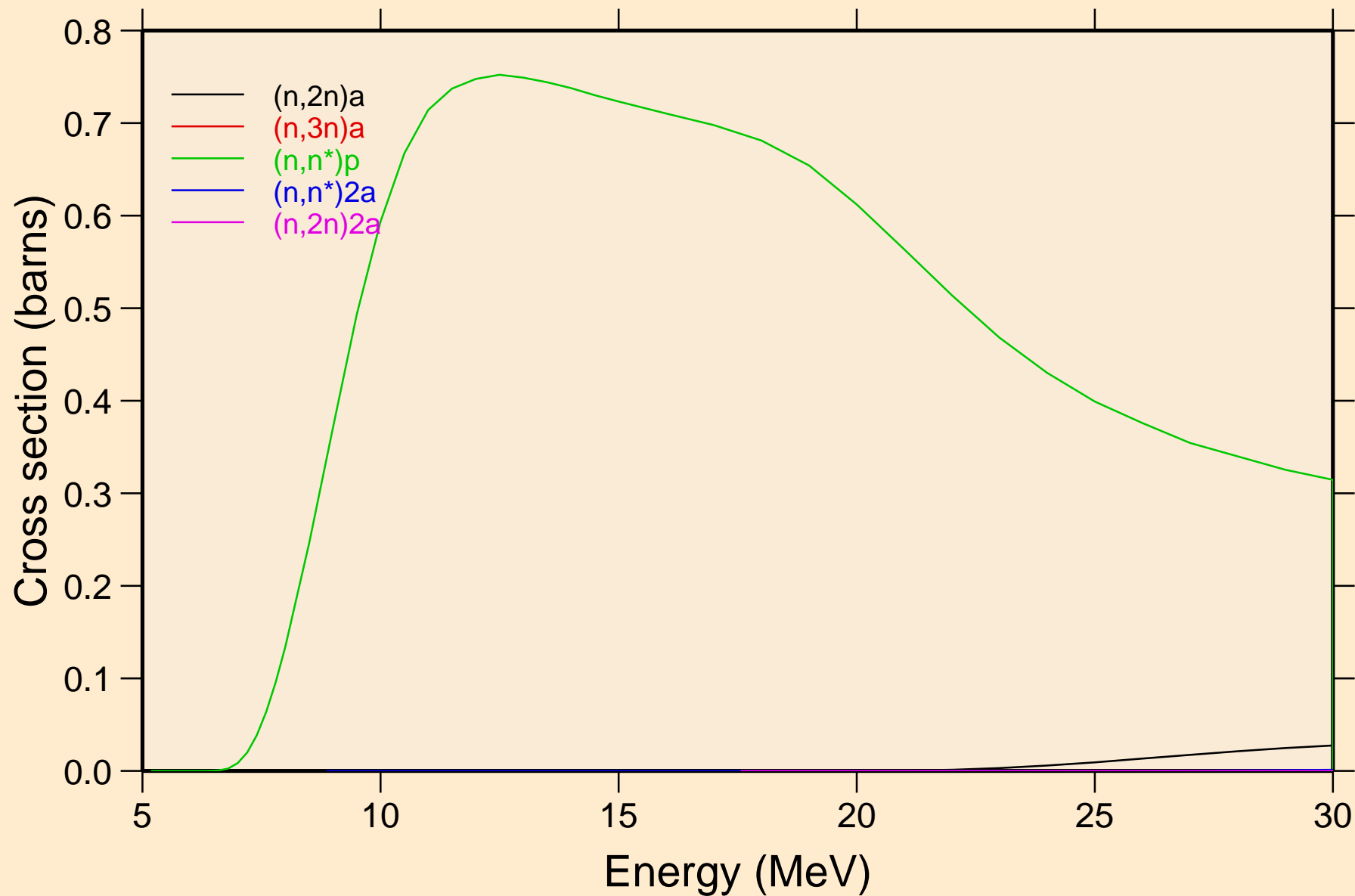

GA066 NEUTRON ACER TENDL-2019 LIBRARY; T=293.16K  
Threshold reactions

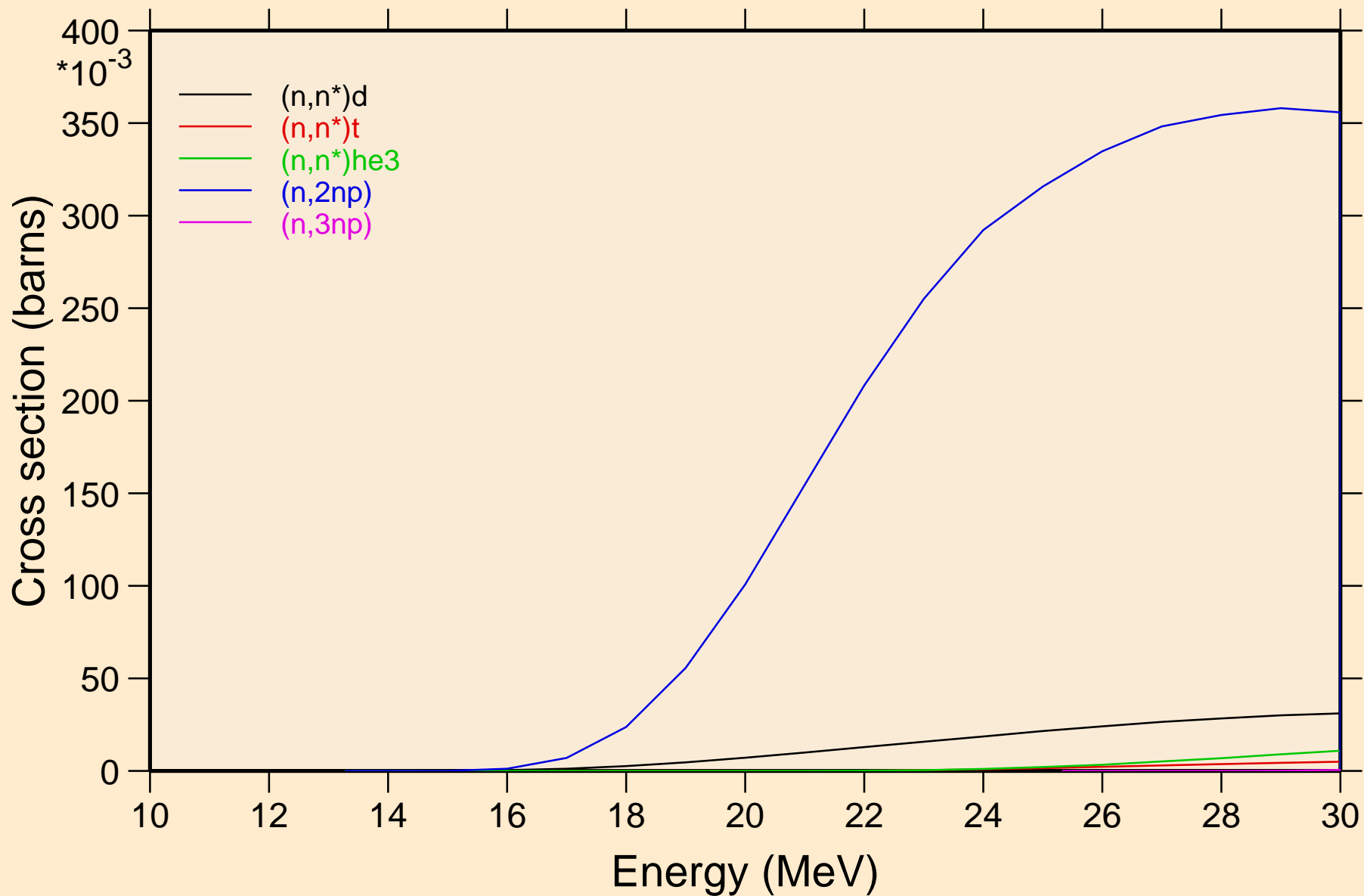

GA066 NEUTRON ACER TENDL-2019 LIBRARY; T=293.16K  
Threshold reactions

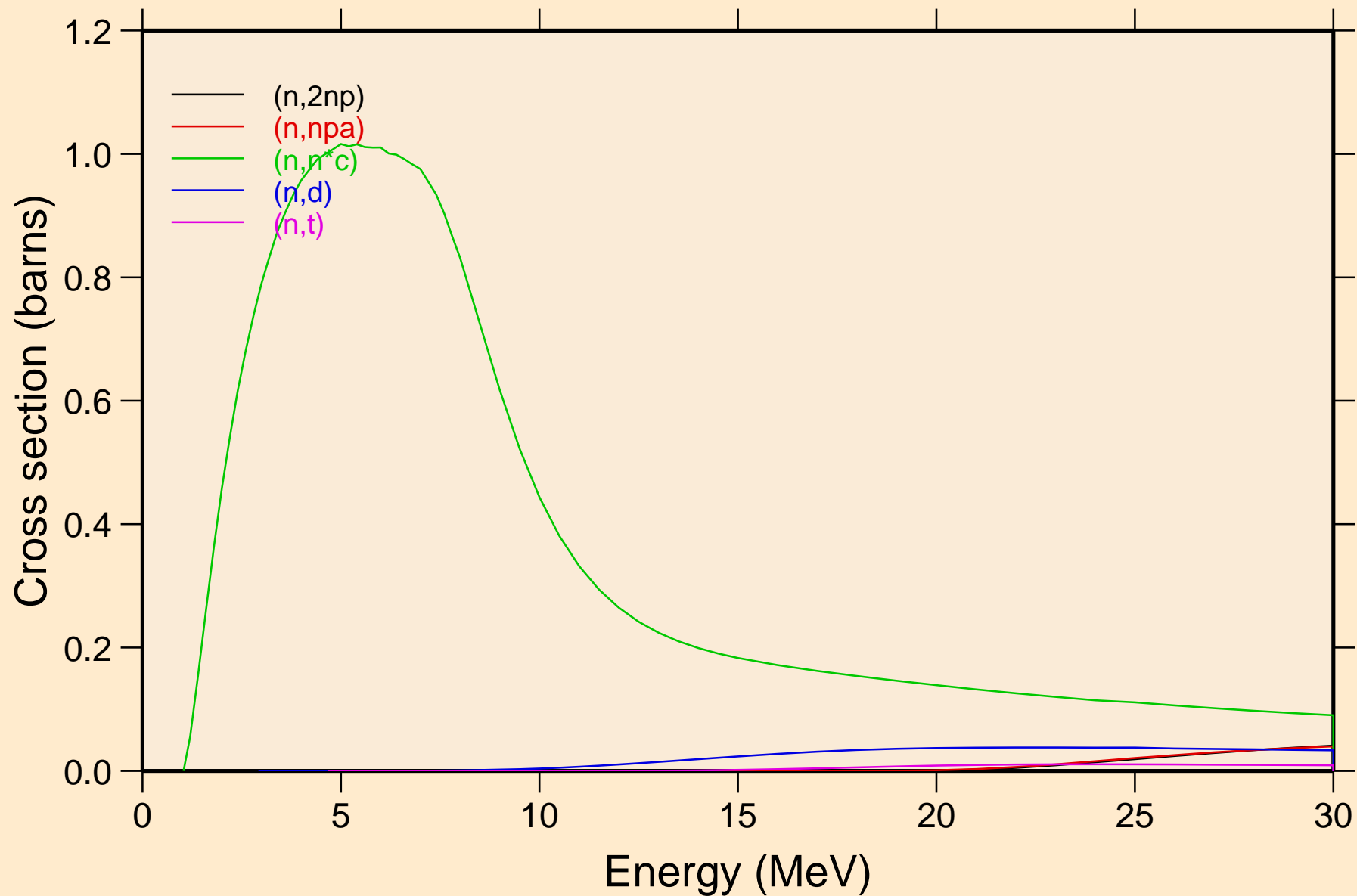

GA066 NEUTRON ACER TENDL-2019 LIBRARY; T=293.16K  
Threshold reactions

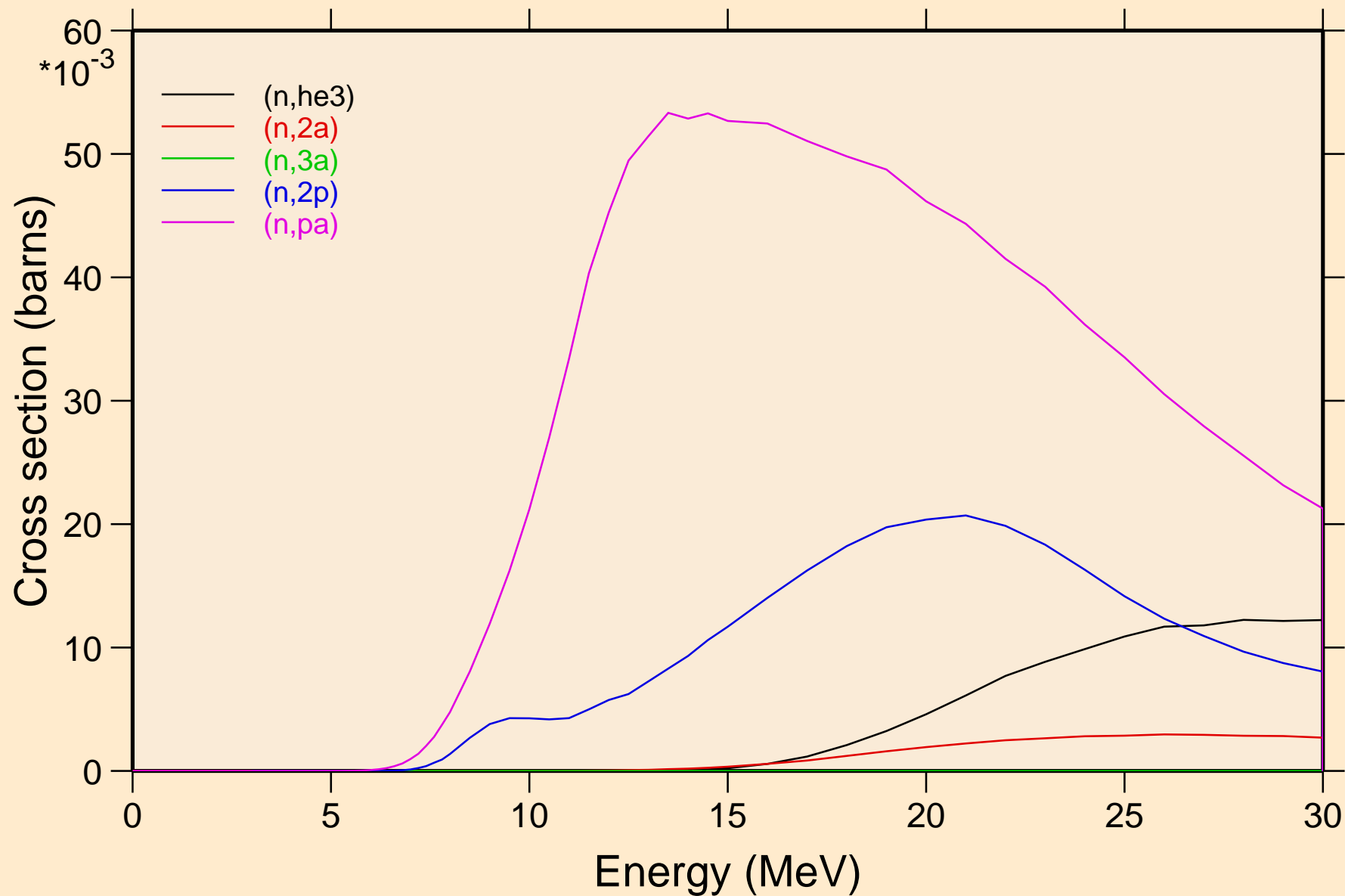

GA066 NEUTRON ACER TENDL-2019 LIBRARY; T=293.16K  
Threshold reactions

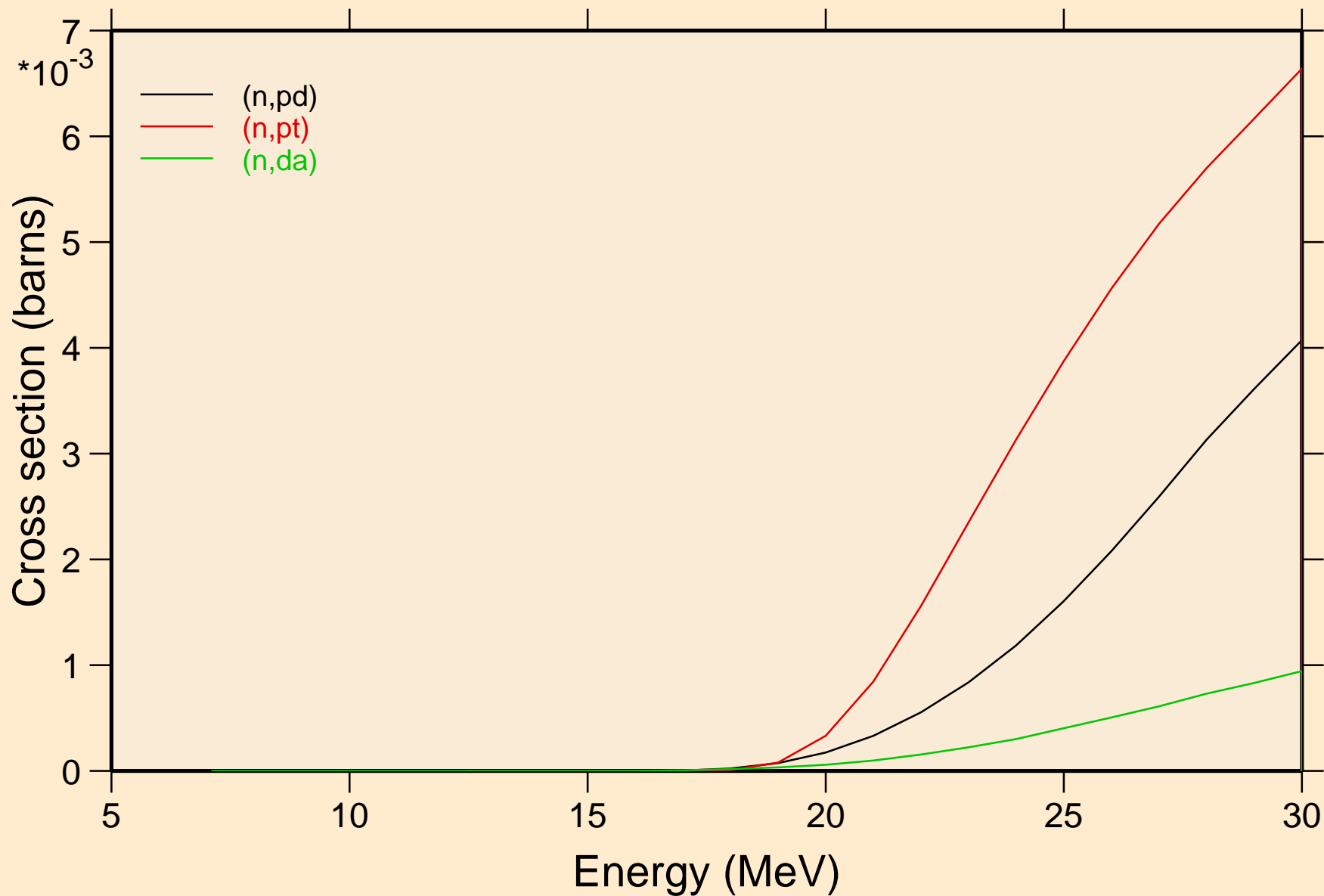

GA066 NEUTRON ACER TENDL-2019 LIBRARY; T=293.16K  
Threshold reactions

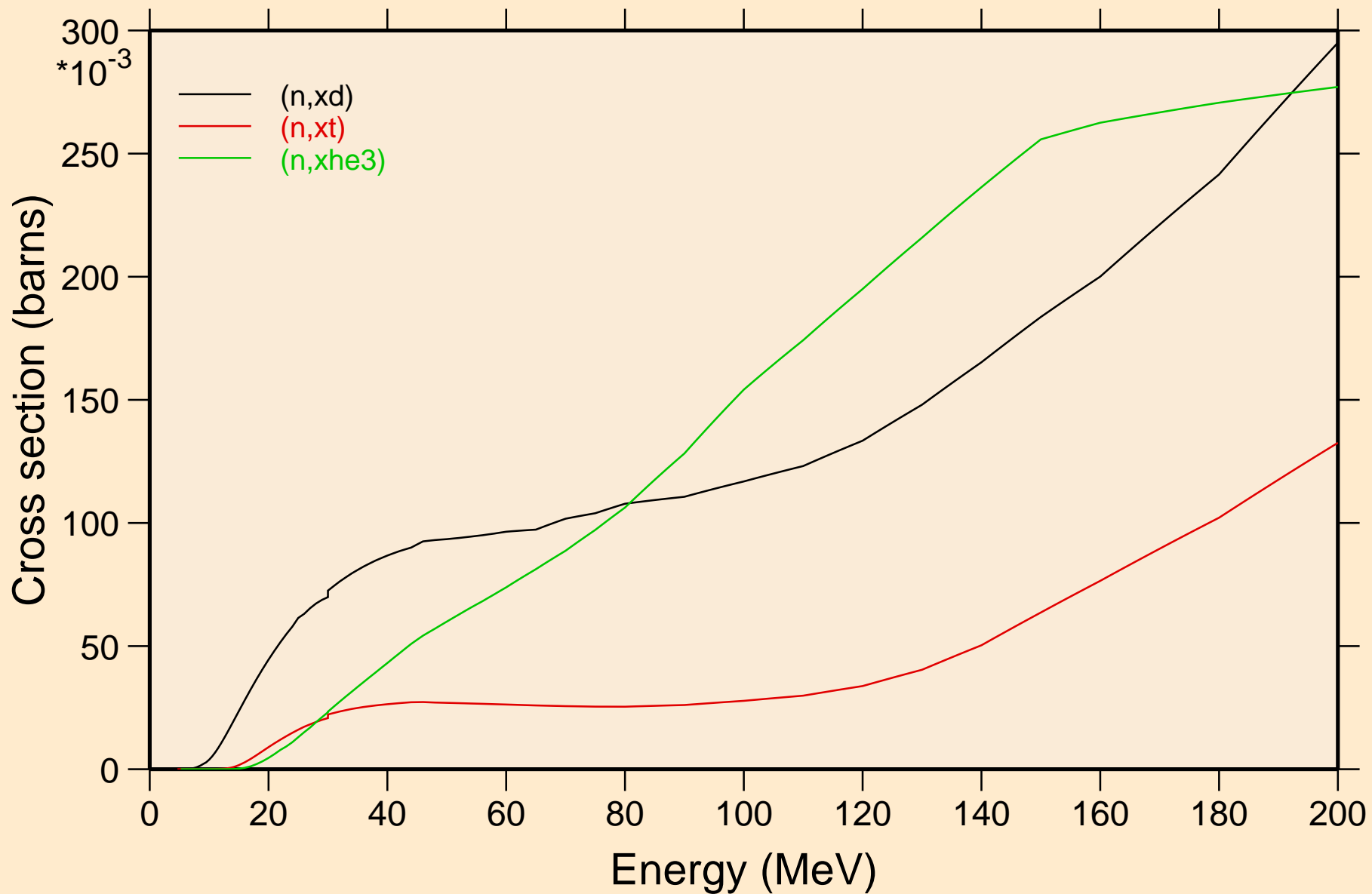

GA066 NEUTRON ACER TENDL-2019 LIBRARY; T=293.16K  
angular distribution for elastic

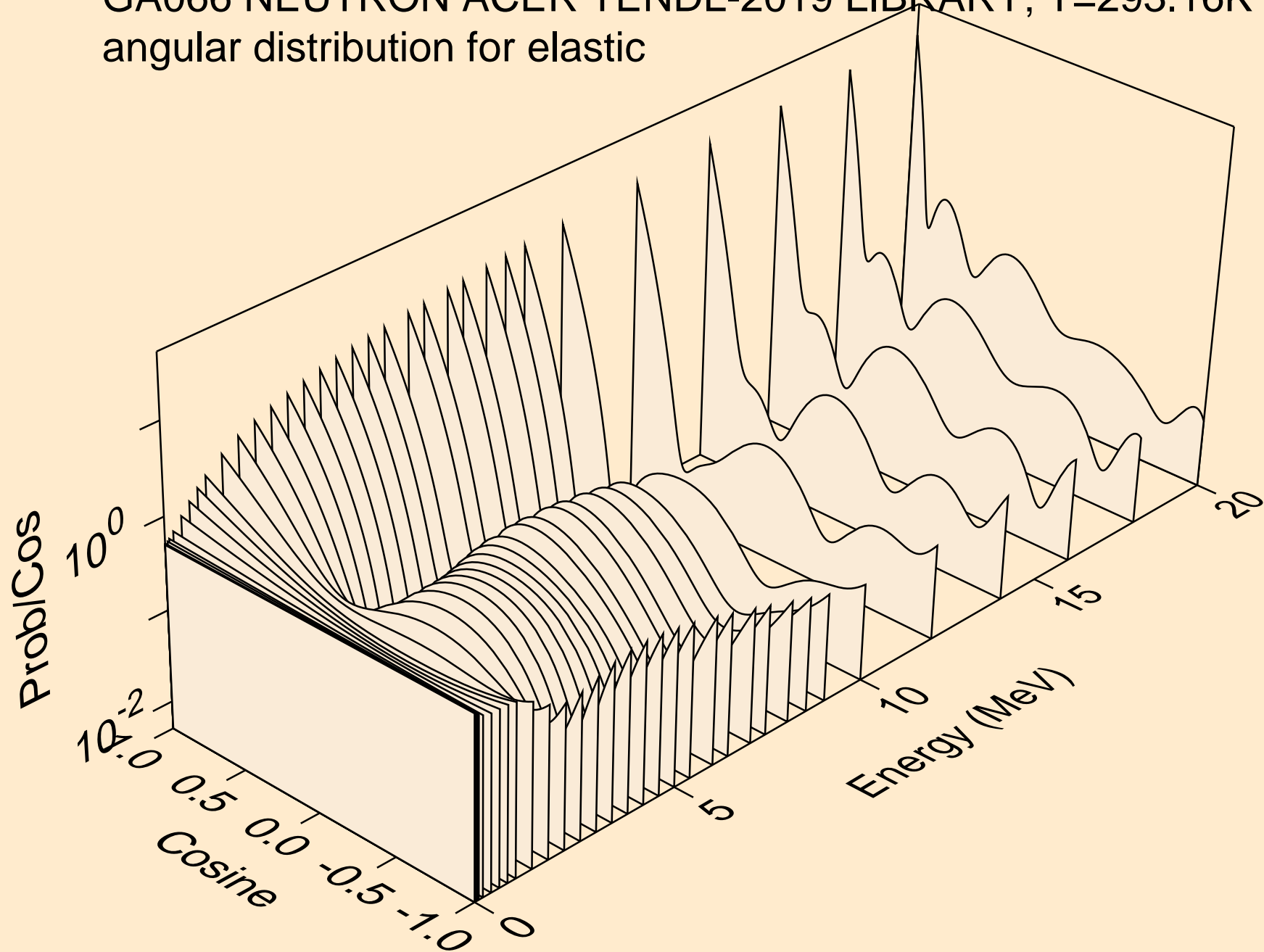

GA066 NEUTRON ACER TENDL-2019 LIBRARY; T=293.16K  
angular distribution for elastic

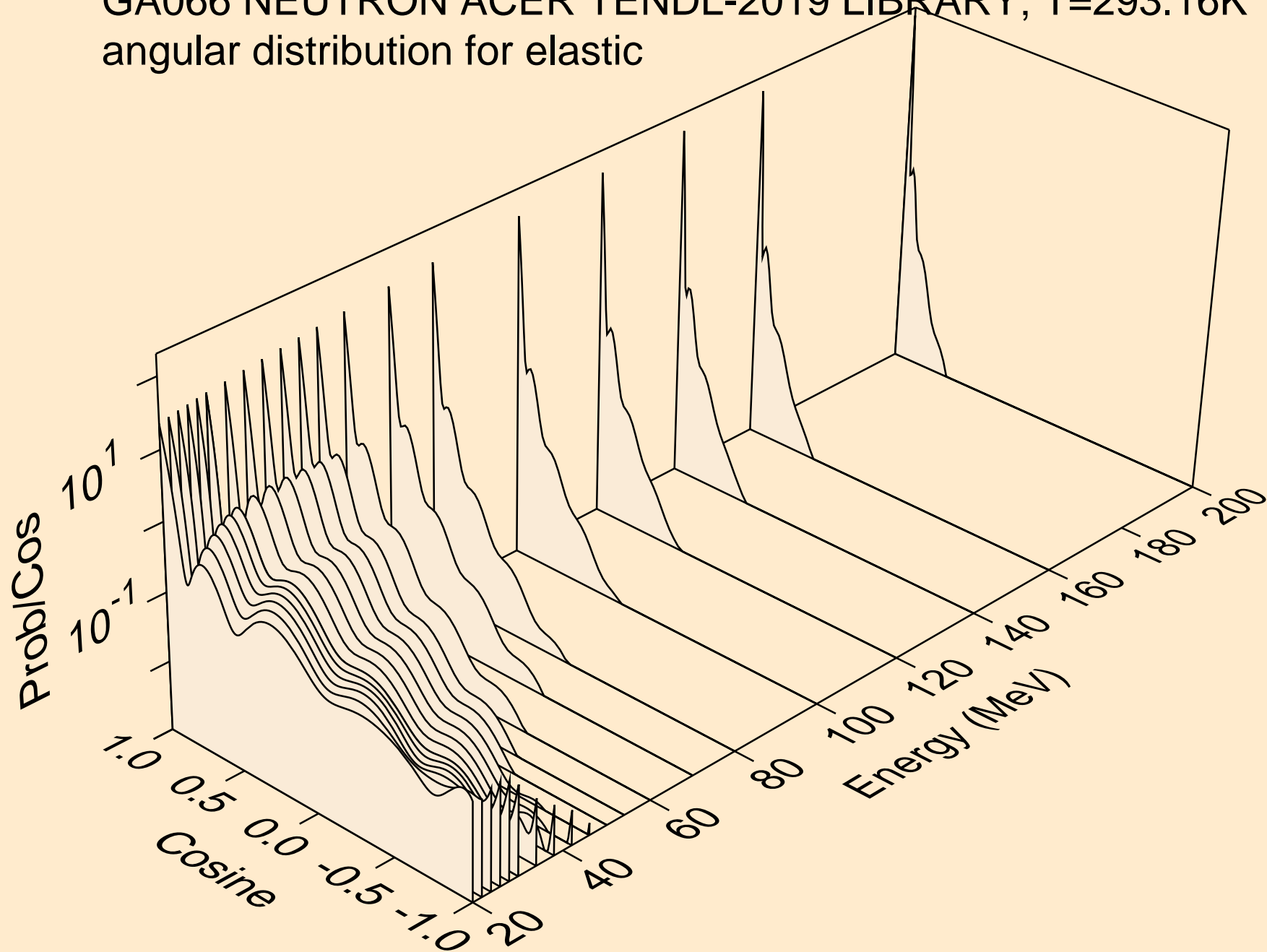

GA066 NEUTRON ACER TENDL-2019 LIBRARY; T=293.16K  
angular distribution for (n,n\*1)

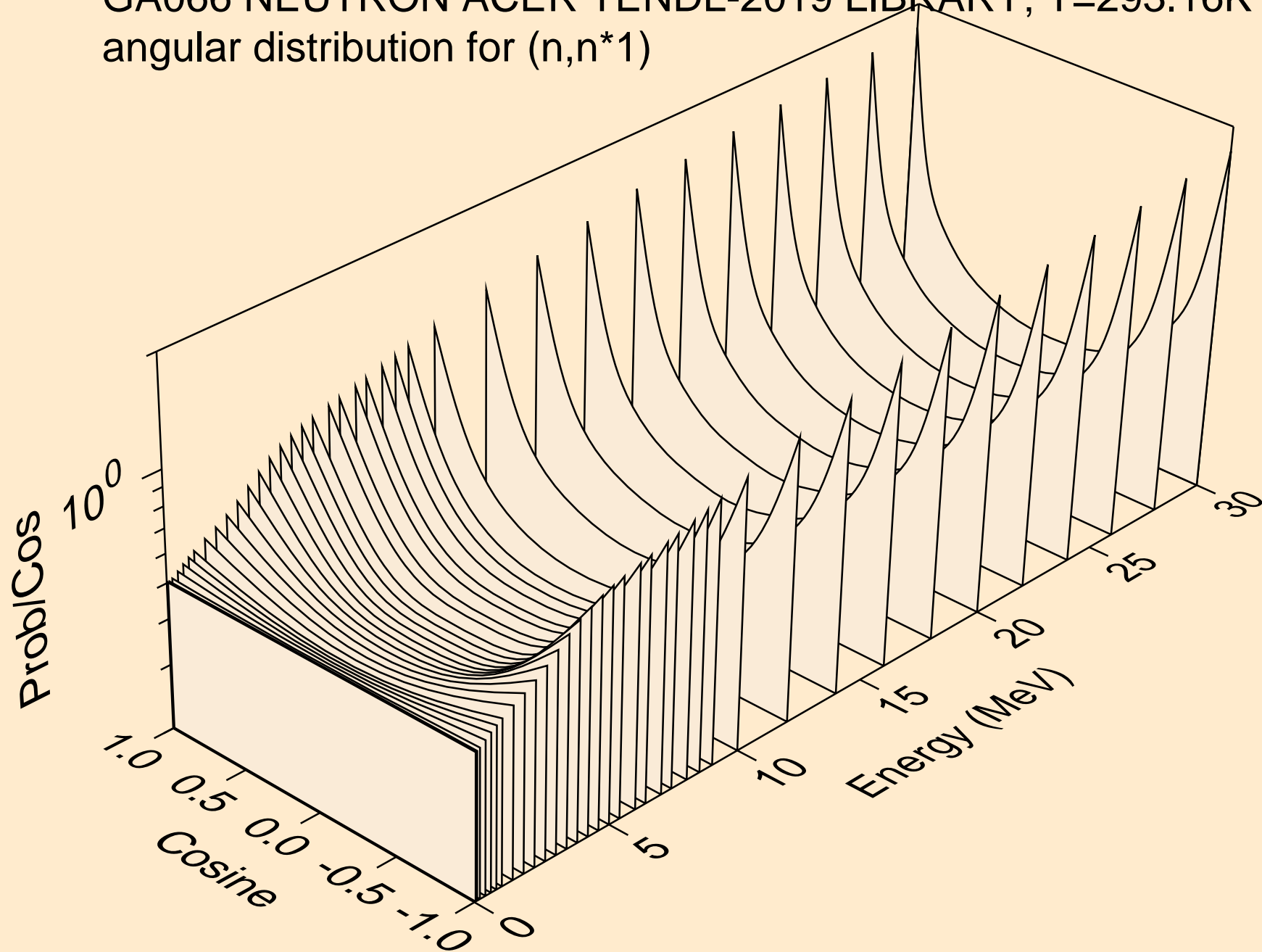

GA066 NEUTRON ACER TENDL-2019 LIBRARY; T=293.16K  
angular distribution for (n,n\*2)

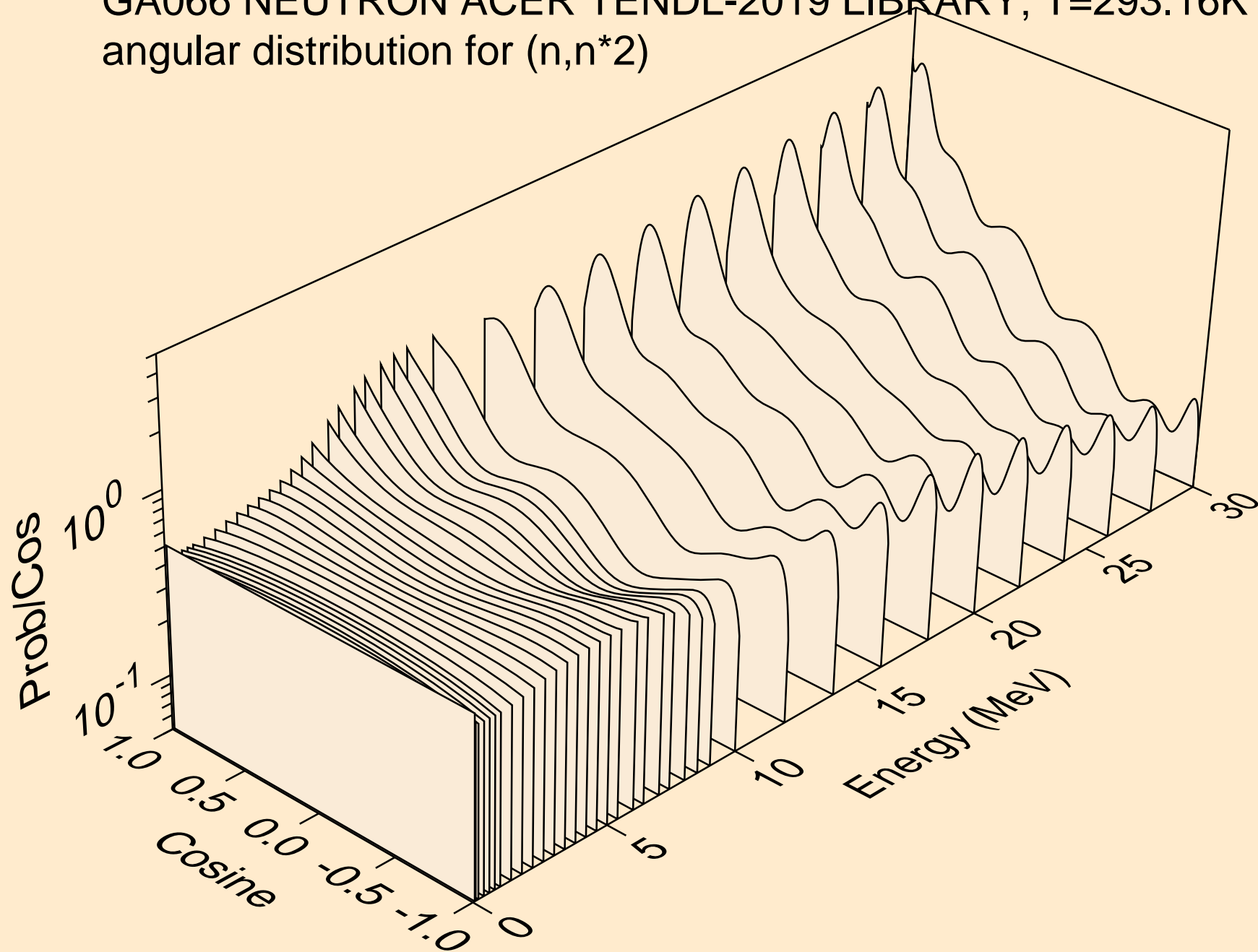

GA066 NEUTRON ACER TENDL-2019 LIBRARY; T=293.16K  
angular distribution for (n,n\*3)

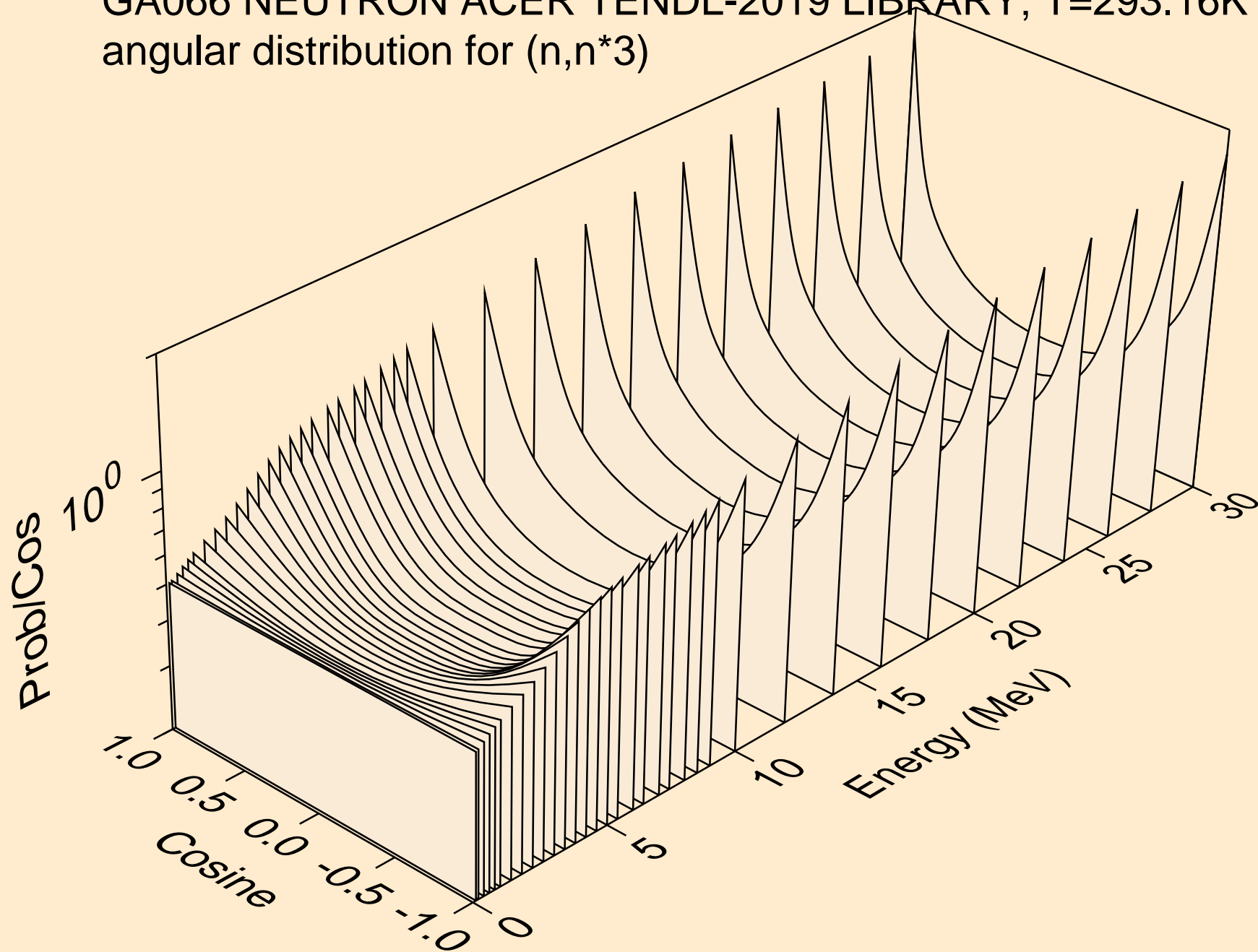

GA066 NEUTRON ACER TENDL-2019 LIBRARY; T=293.16K  
angular distribution for (n,n\*4)

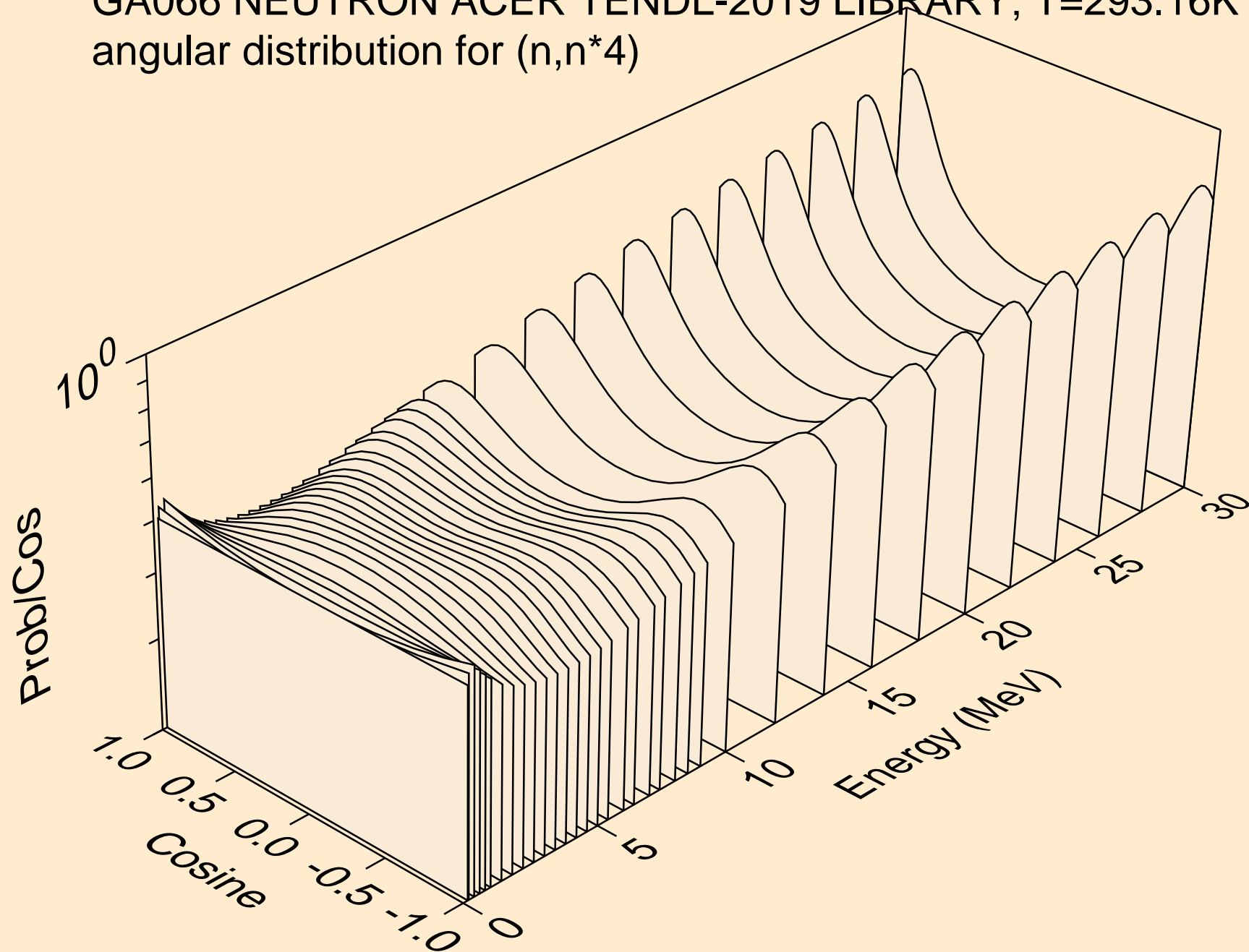

GA066 NEUTRON ACER TENDL-2019 LIBRARY; T=293.16K  
angular distribution for (n,n\*5)

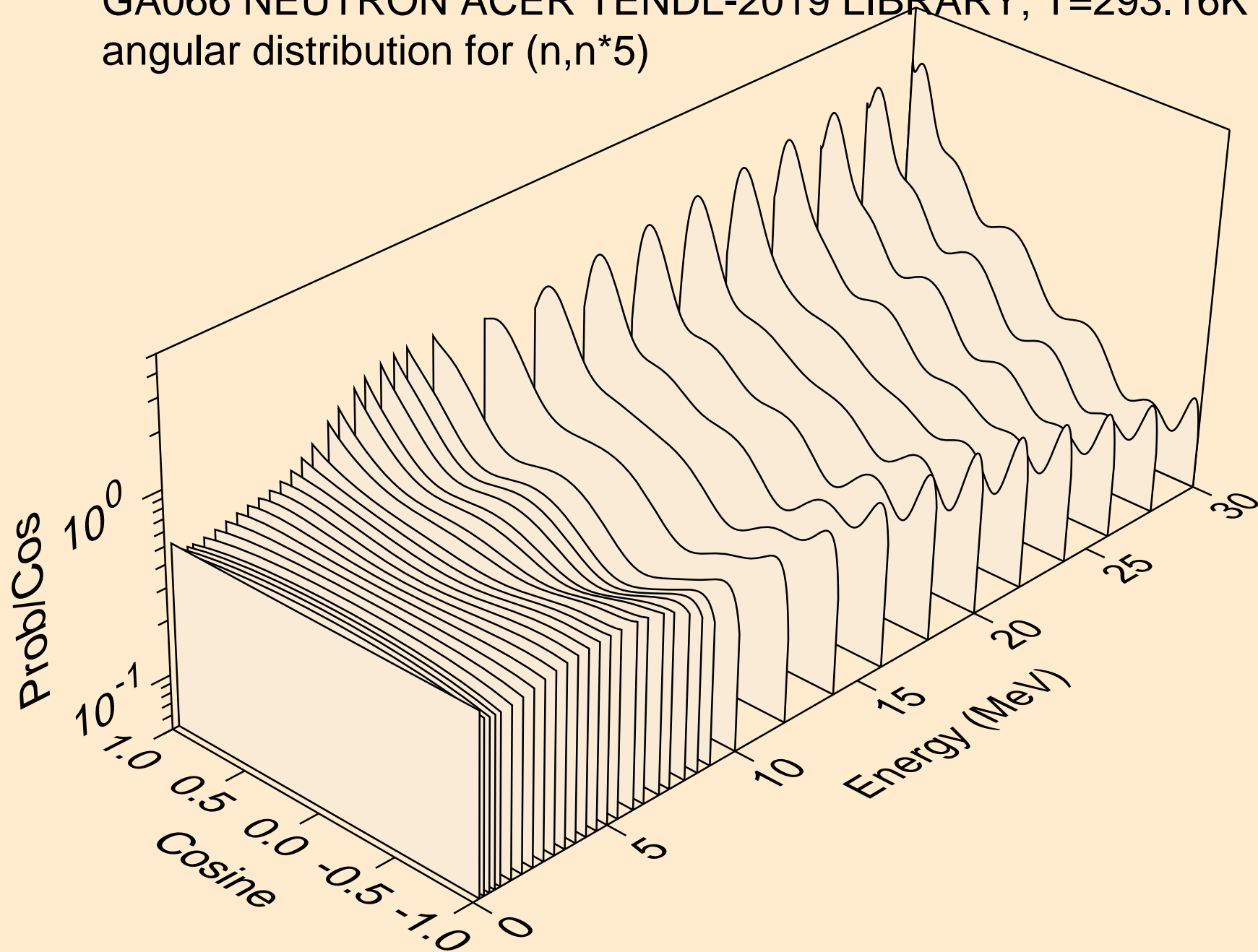

GA066 NEUTRON ACER TENDL-2019 LIBRARY; T=293.16K  
angular distribution for (n,n\*6)

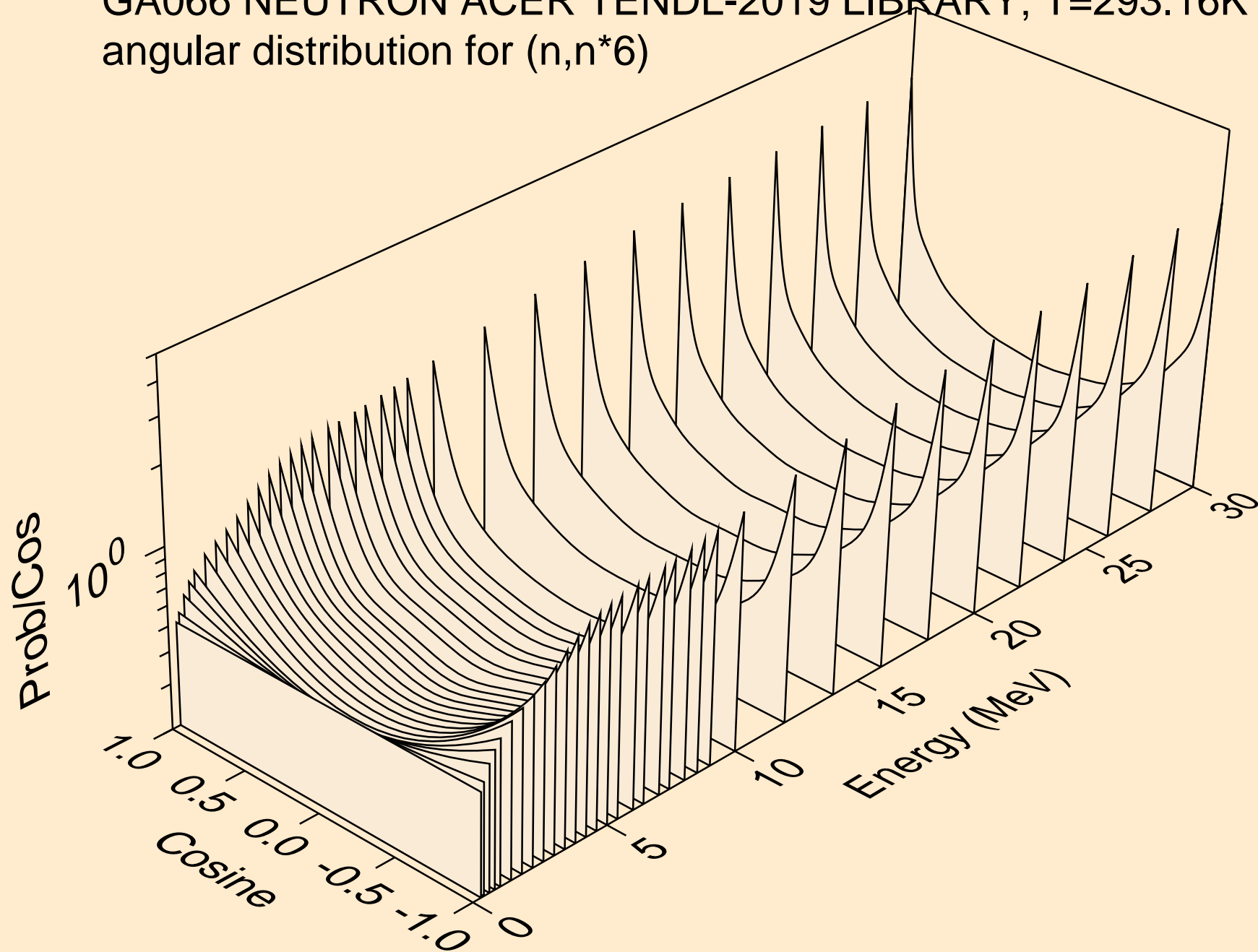

GA066 NEUTRON ACER TENDL-2019 LIBRARY; T=293.16K  
angular distribution for (n,n\*7)

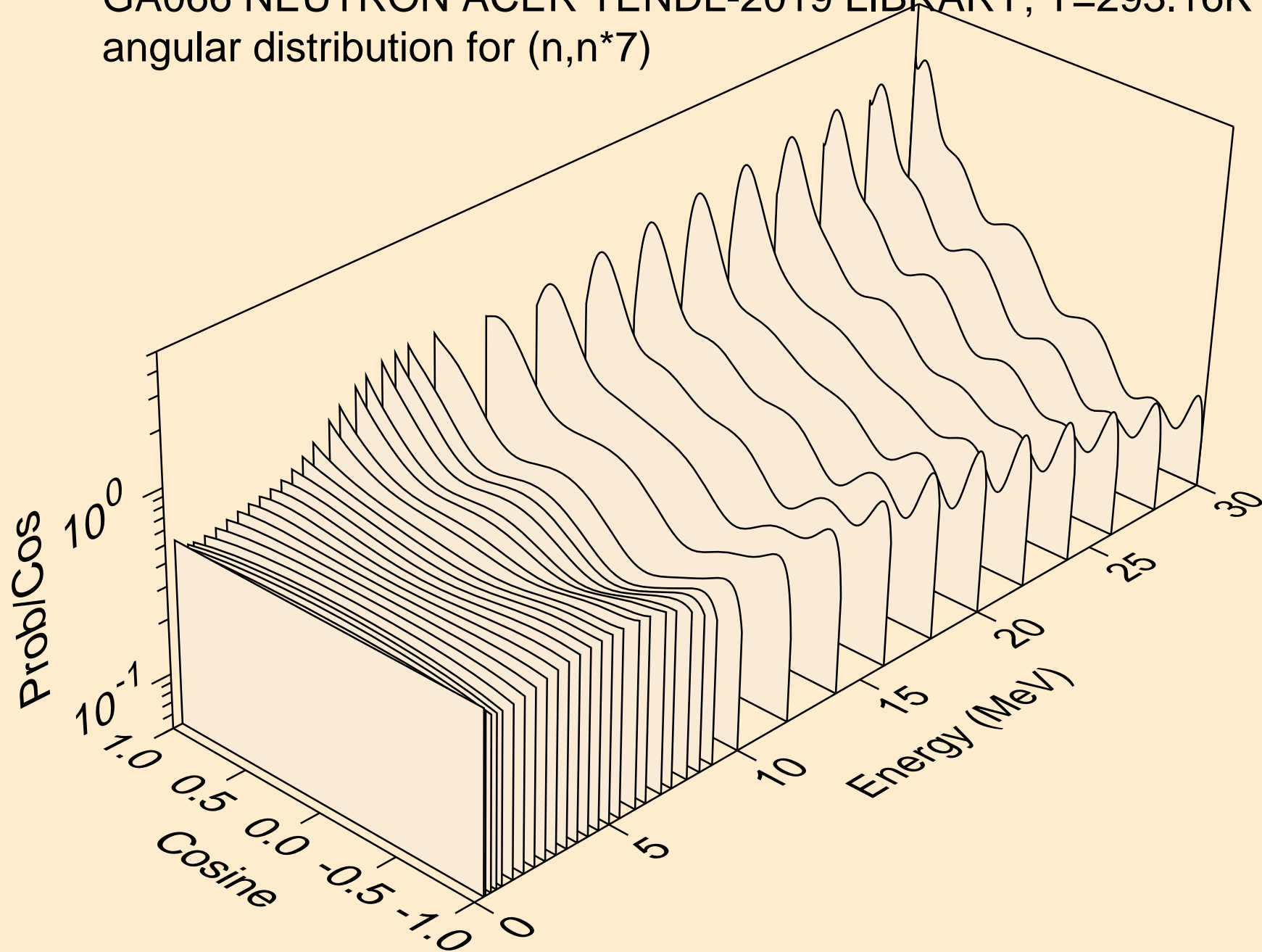

GA066 NEUTRON ACER TENDL-2019 LIBRARY; T=293.16K  
angular distribution for (n,n\*8)

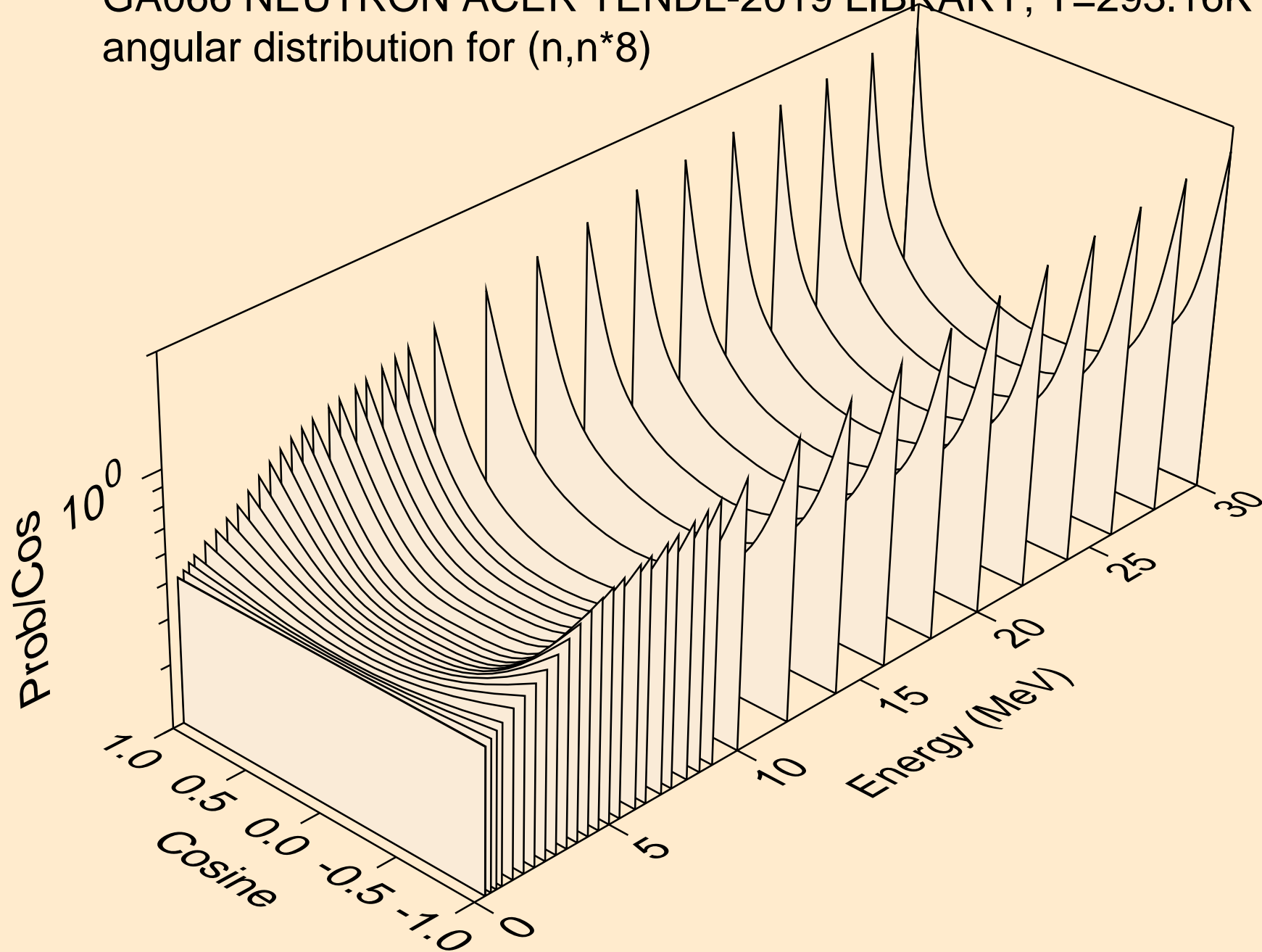

GA066 NEUTRON ACER TENDL-2019 LIBRARY; T=293.16K  
angular distribution for (n,n\*9)

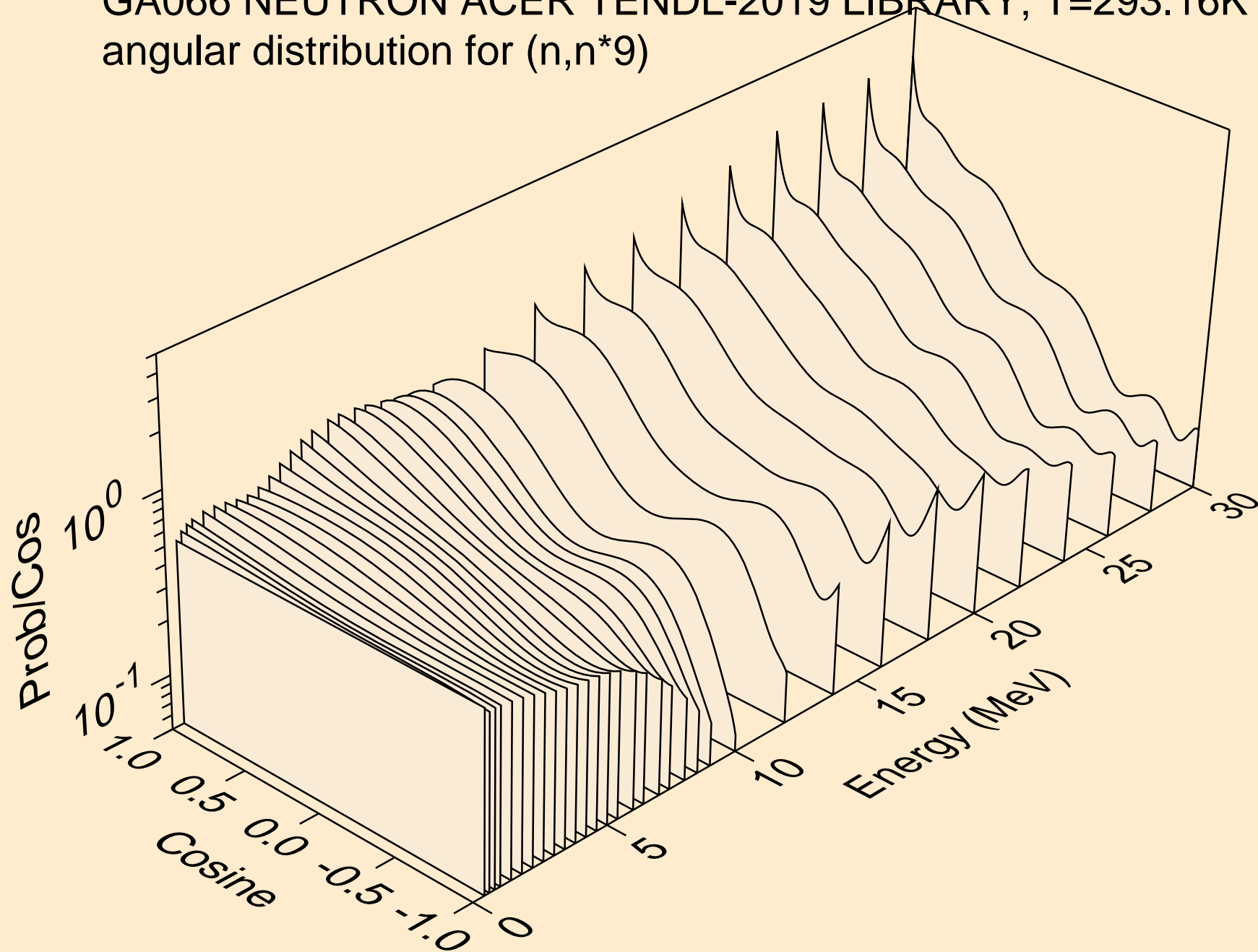

GA066 NEUTRON ACER TENDL-2019 LIBRARY; T=293.16K  
angular distribution for (n,n\*10)

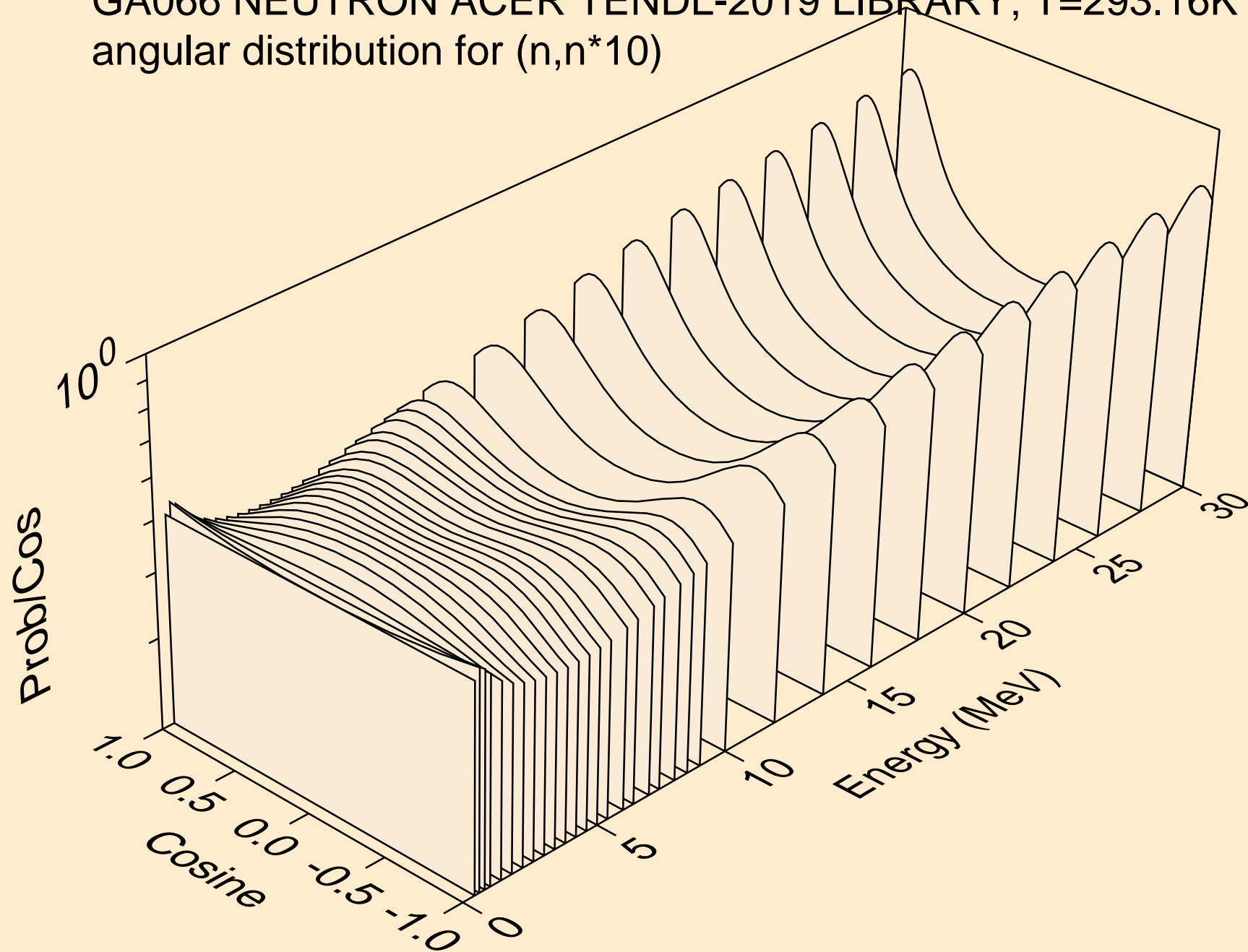

GA066 NEUTRON ACER TENDL-2019 LIBRARY; T=293.16K  
angular distribution for (n,n\*11)

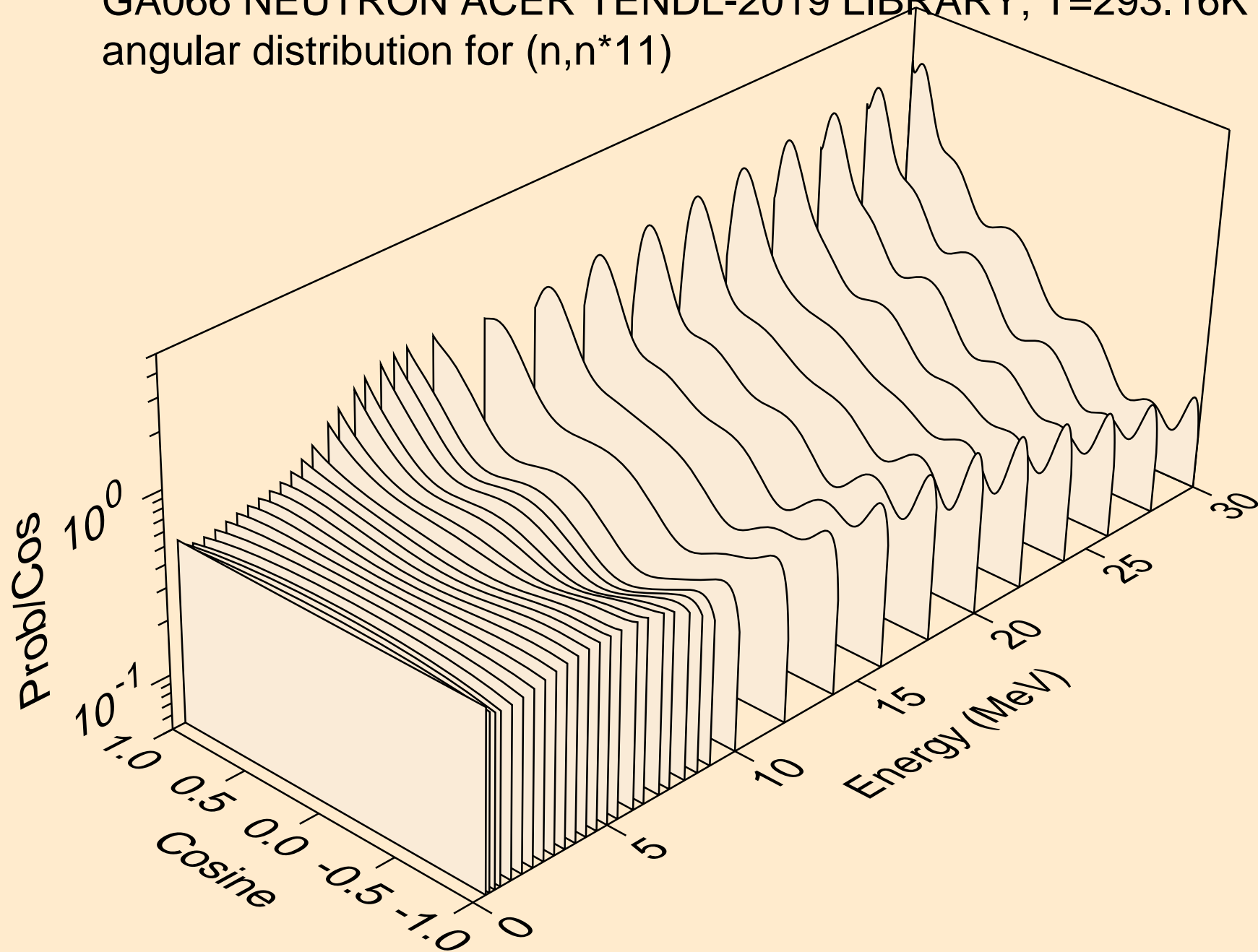

GA066 NEUTRON ACER TENDL-2019 LIBRARY; T=293.16K  
angular distribution for (n,n\*12)

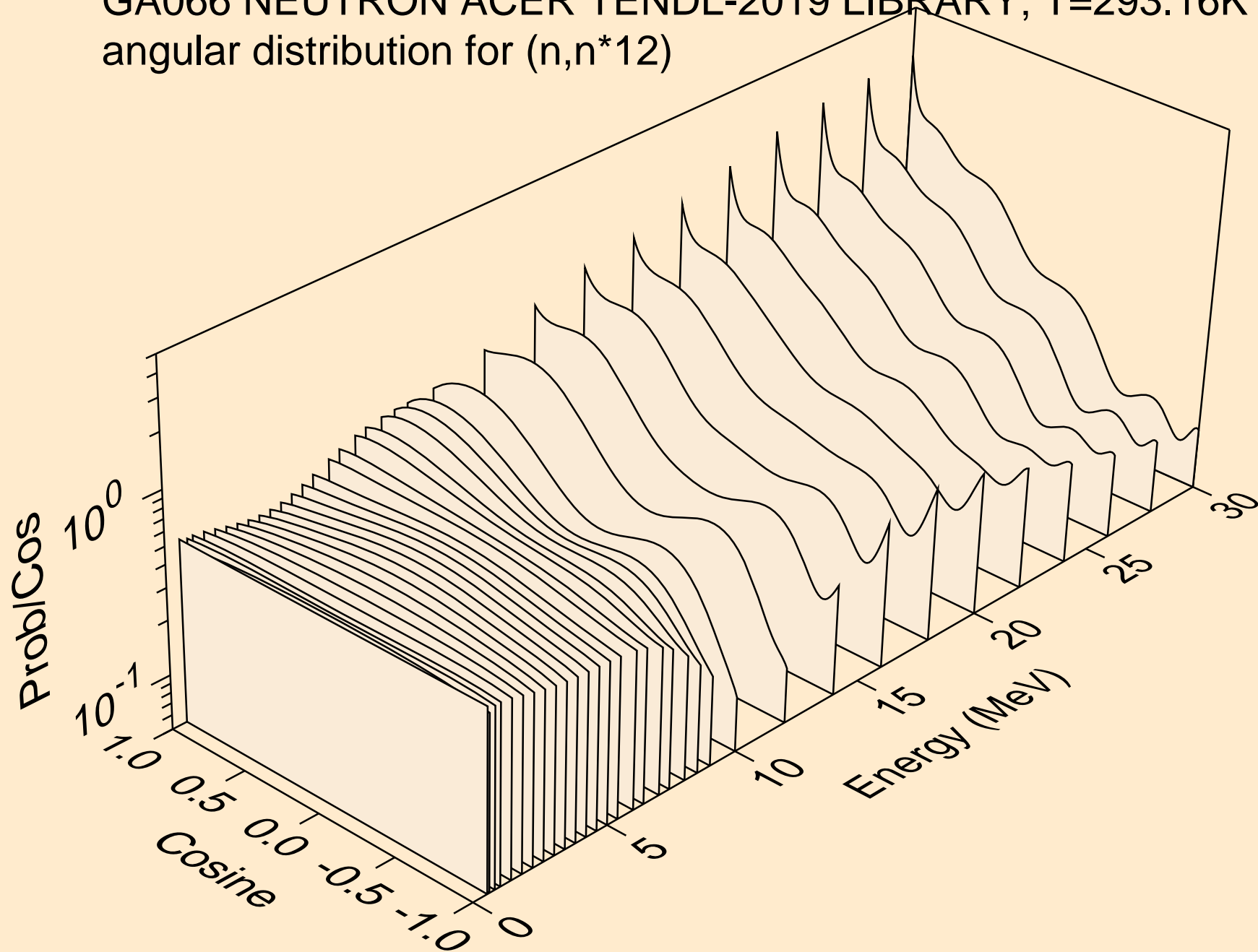

GA066 NEUTRON ACER TENDL-2019 LIBRARY; T=293.16K  
angular distribution for (n,n\*13)

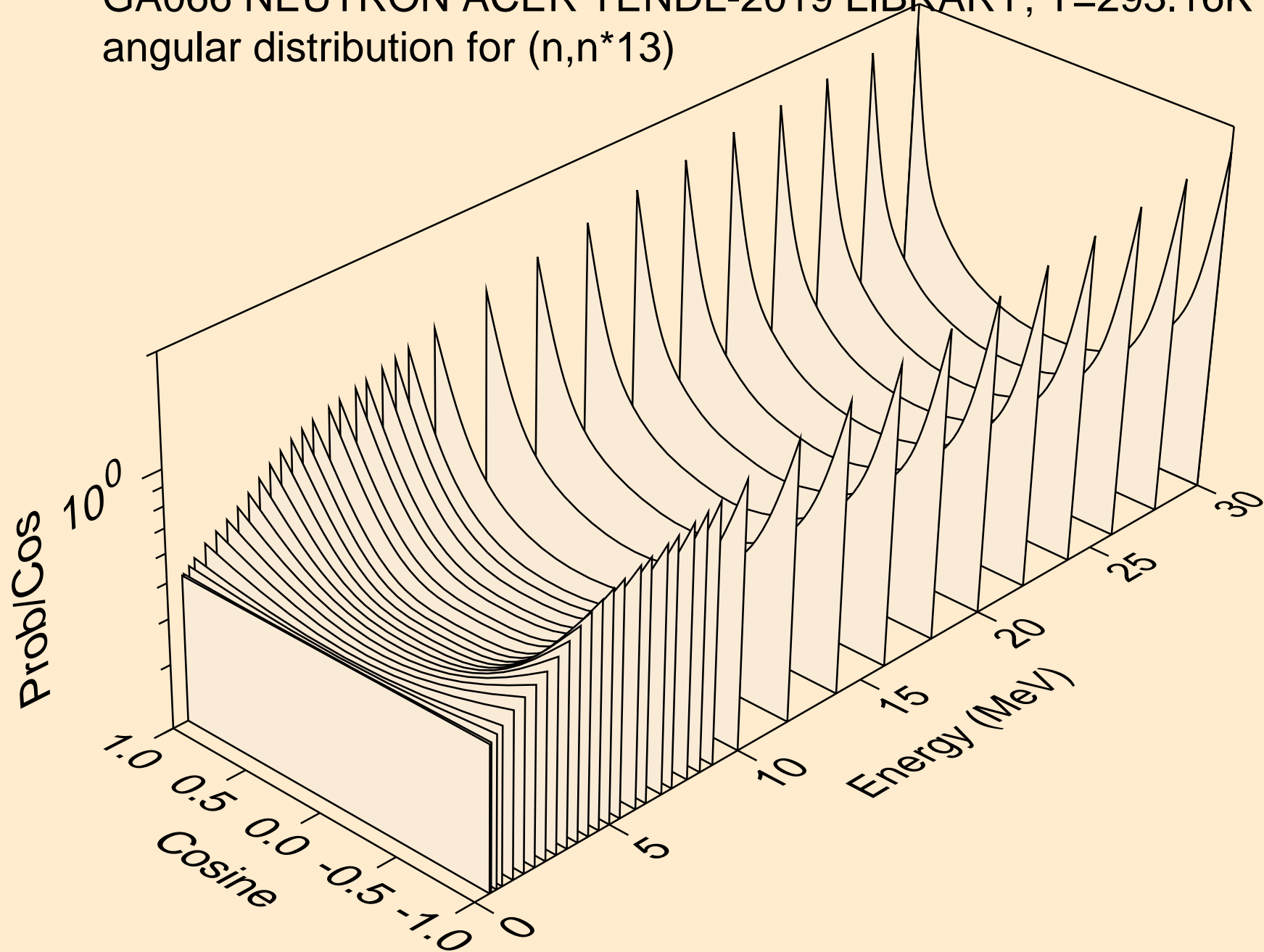

GA066 NEUTRON ACER TENDL-2019 LIBRARY; T=293.16K  
angular distribution for (n,n\*14)

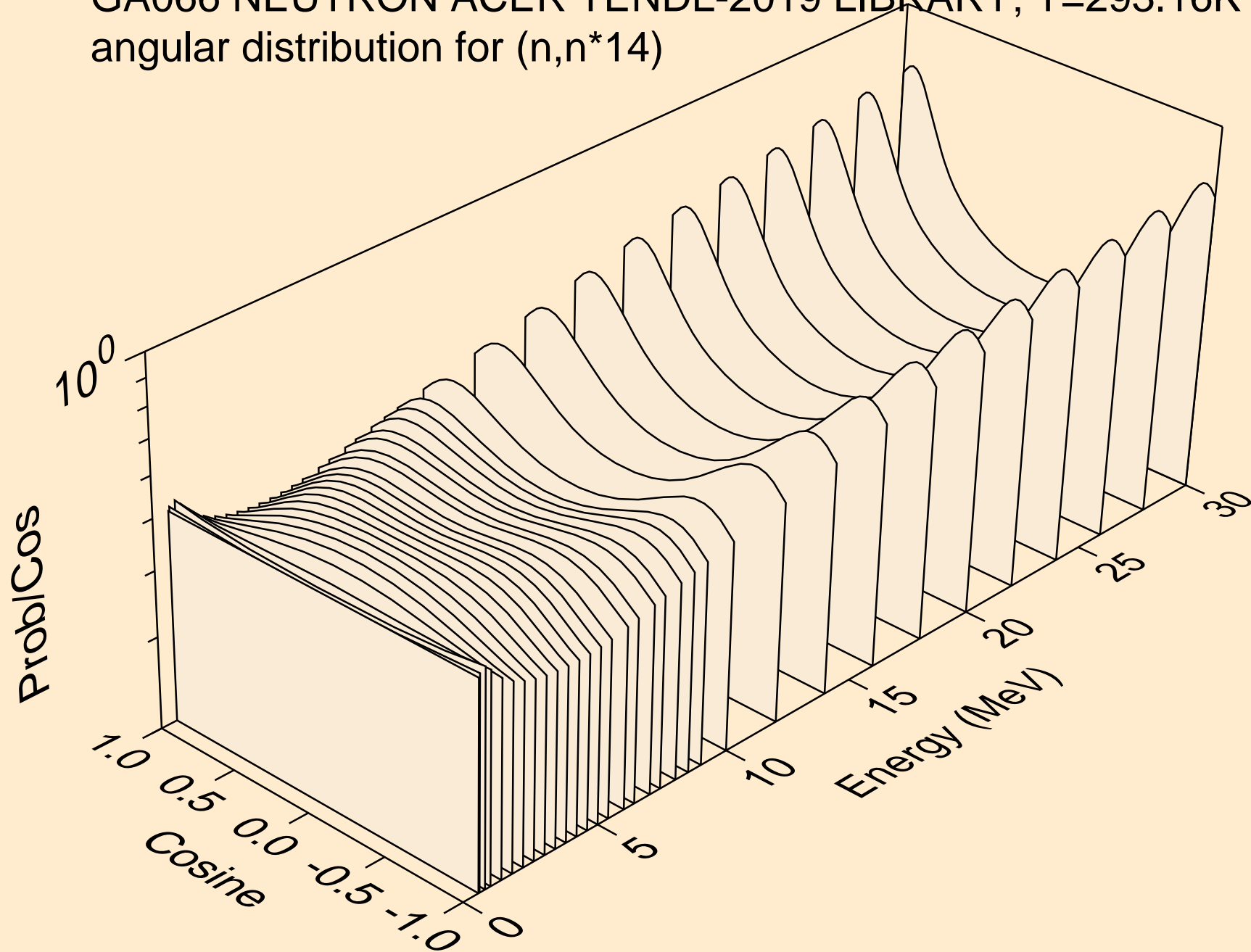

GA066 NEUTRON ACER TENDL-2019 LIBRARY; T=293.16K  
angular distribution for (n,n\*15)

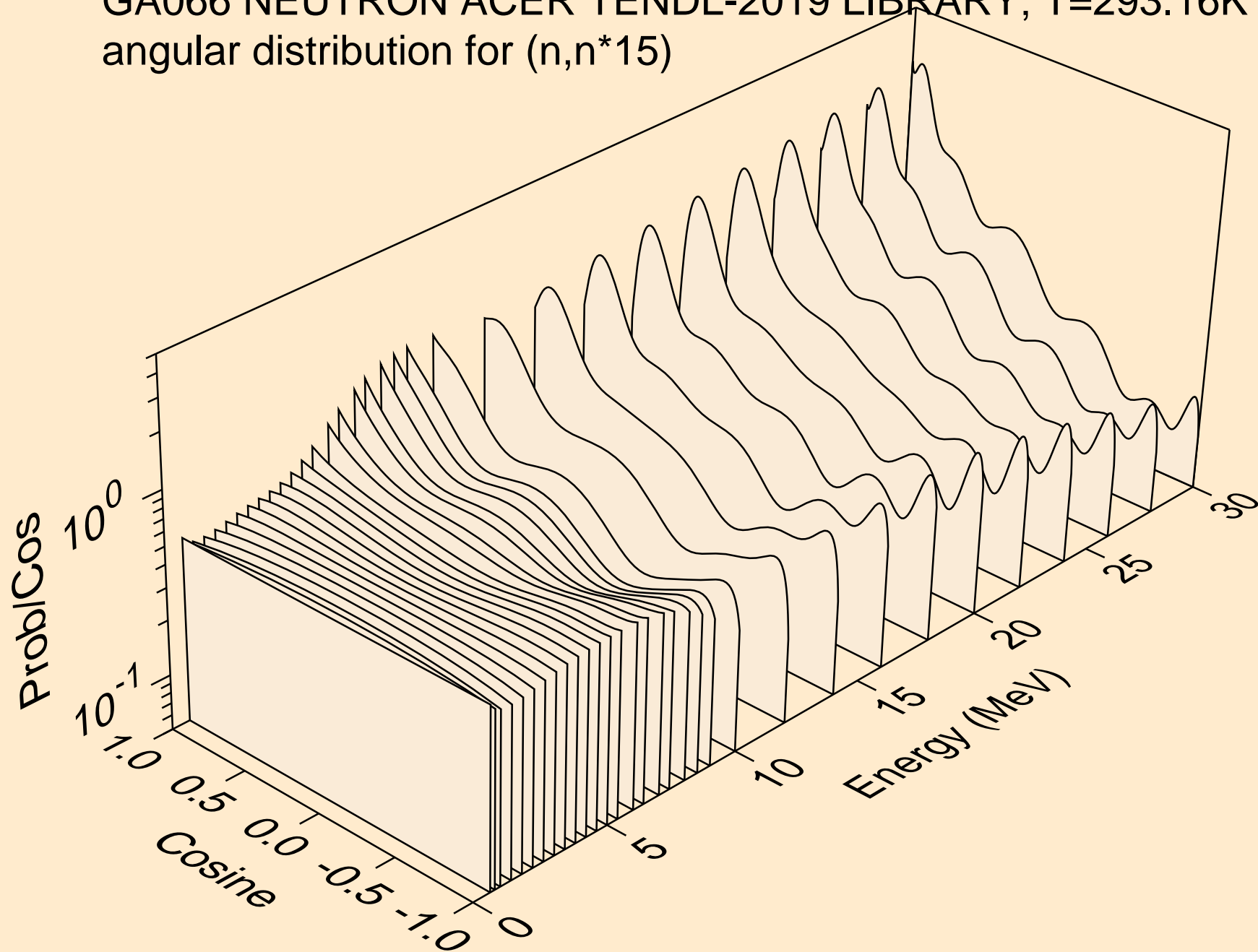

GA066 NEUTRON ACER TENDL-2019 LIBRARY; T=293.16K  
angular distribution for (n,n\*16)

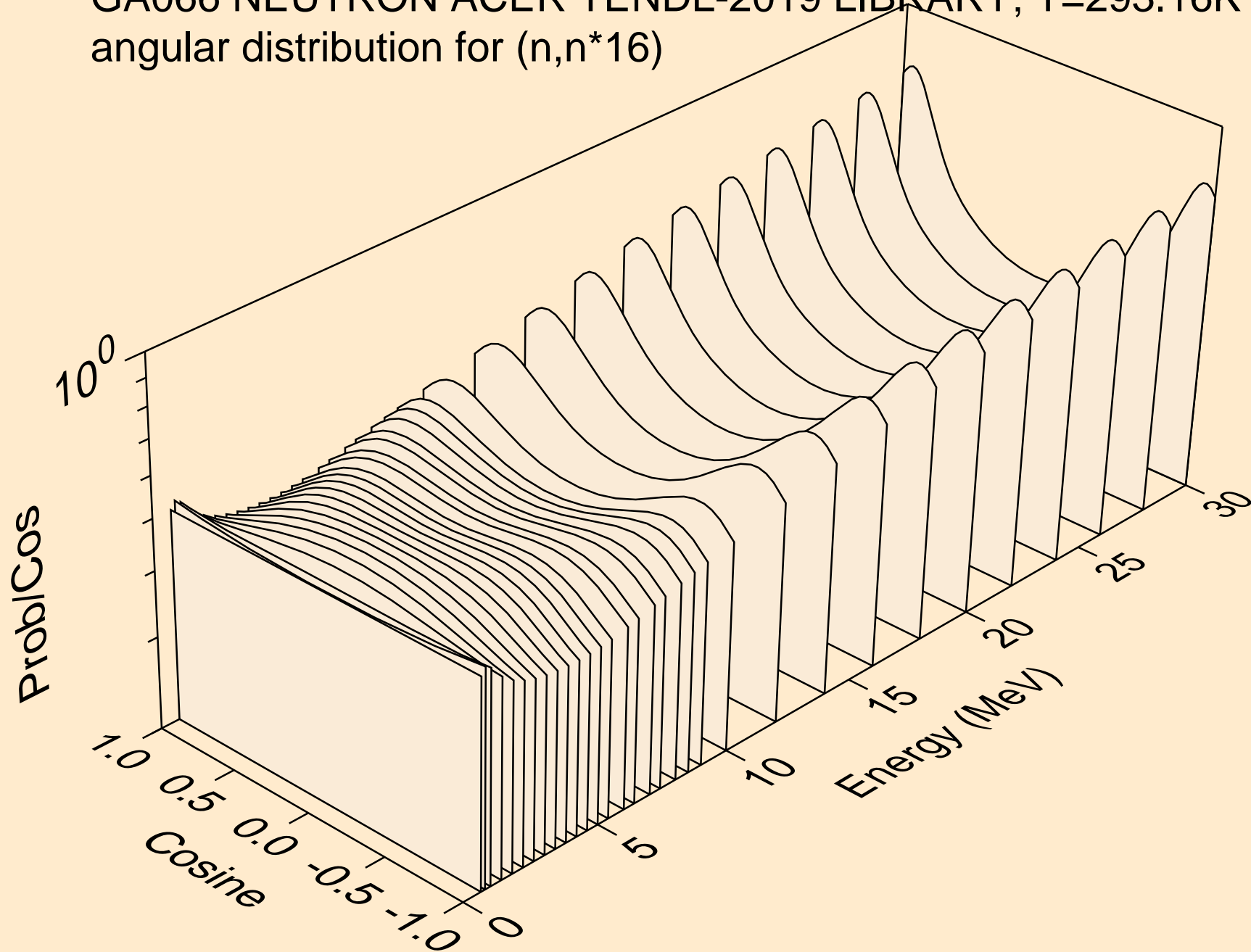

GA066 NEUTRON ACER TENDL-2019 LIBRARY; T=293.16K  
angular distribution for (n,n\*17)

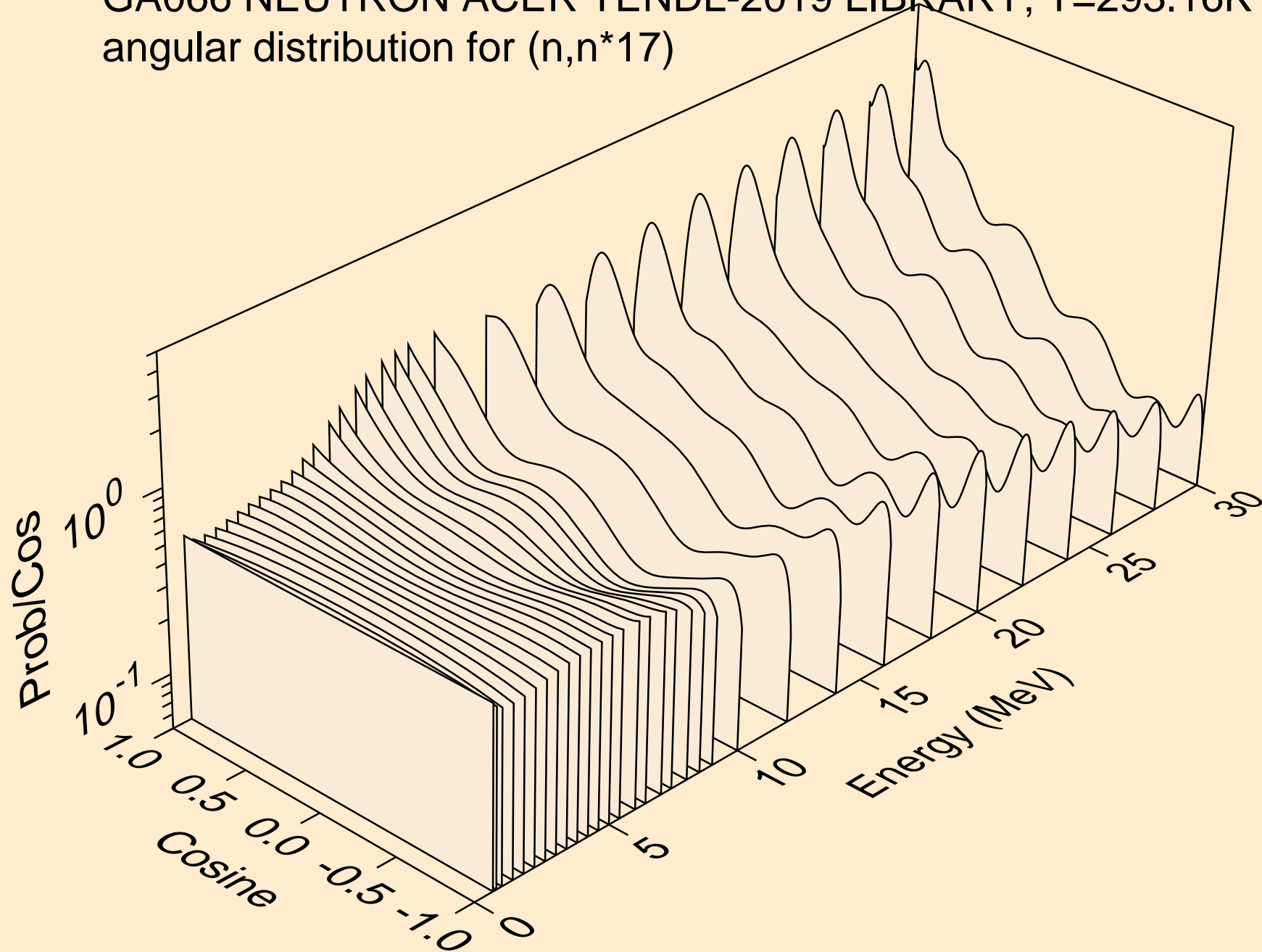

GA066 NEUTRON ACER TENDL-2019 LIBRARY; T=293.16K  
angular distribution for (n,n\*18)

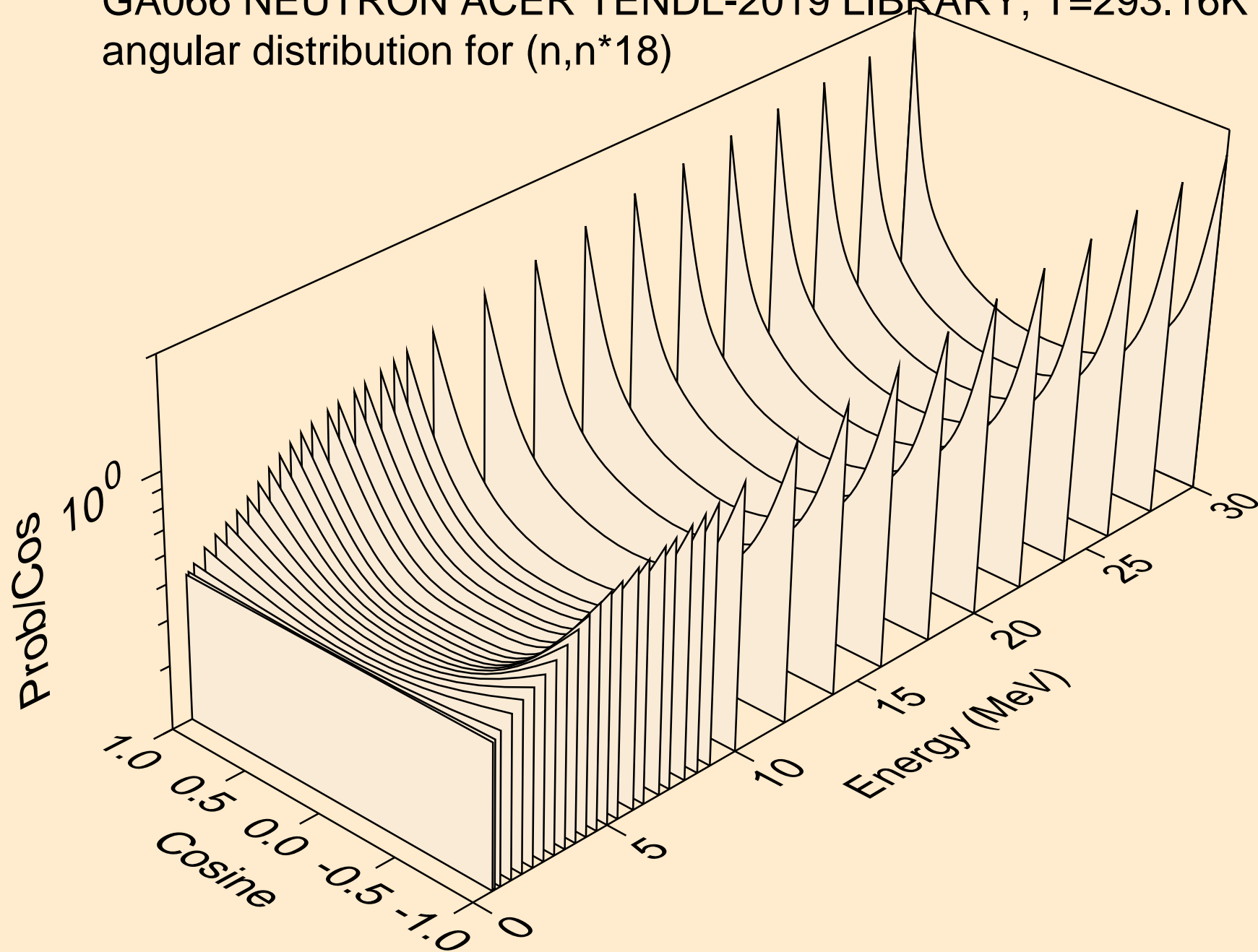

GA066 NEUTRON ACER TENDL-2019 LIBRARY; T=293.16K  
angular distribution for (n,n\*19)

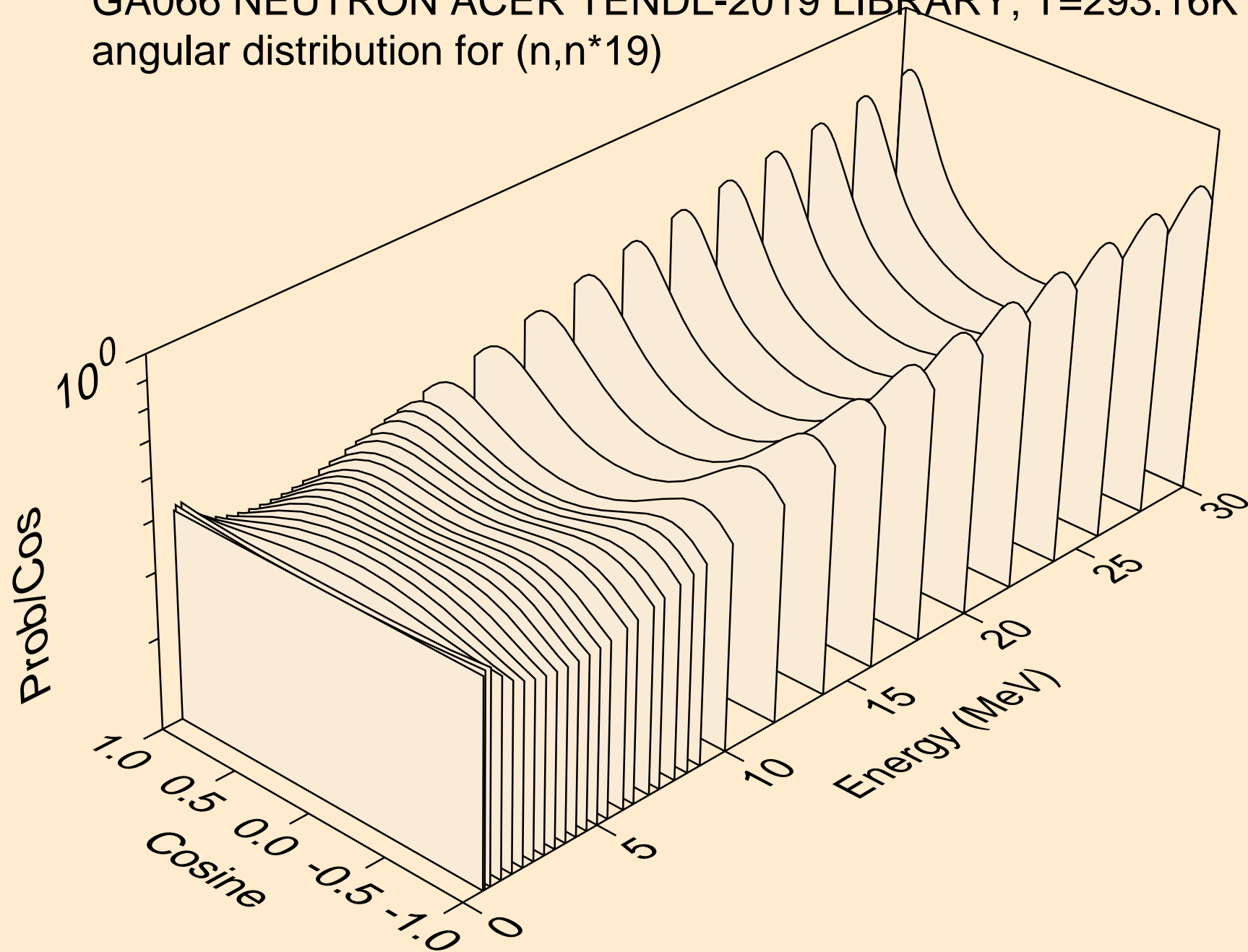

GA066 NEUTRON ACER TENDL-2019 LIBRARY; T=293.16K  
angular distribution for (n,n\*20)

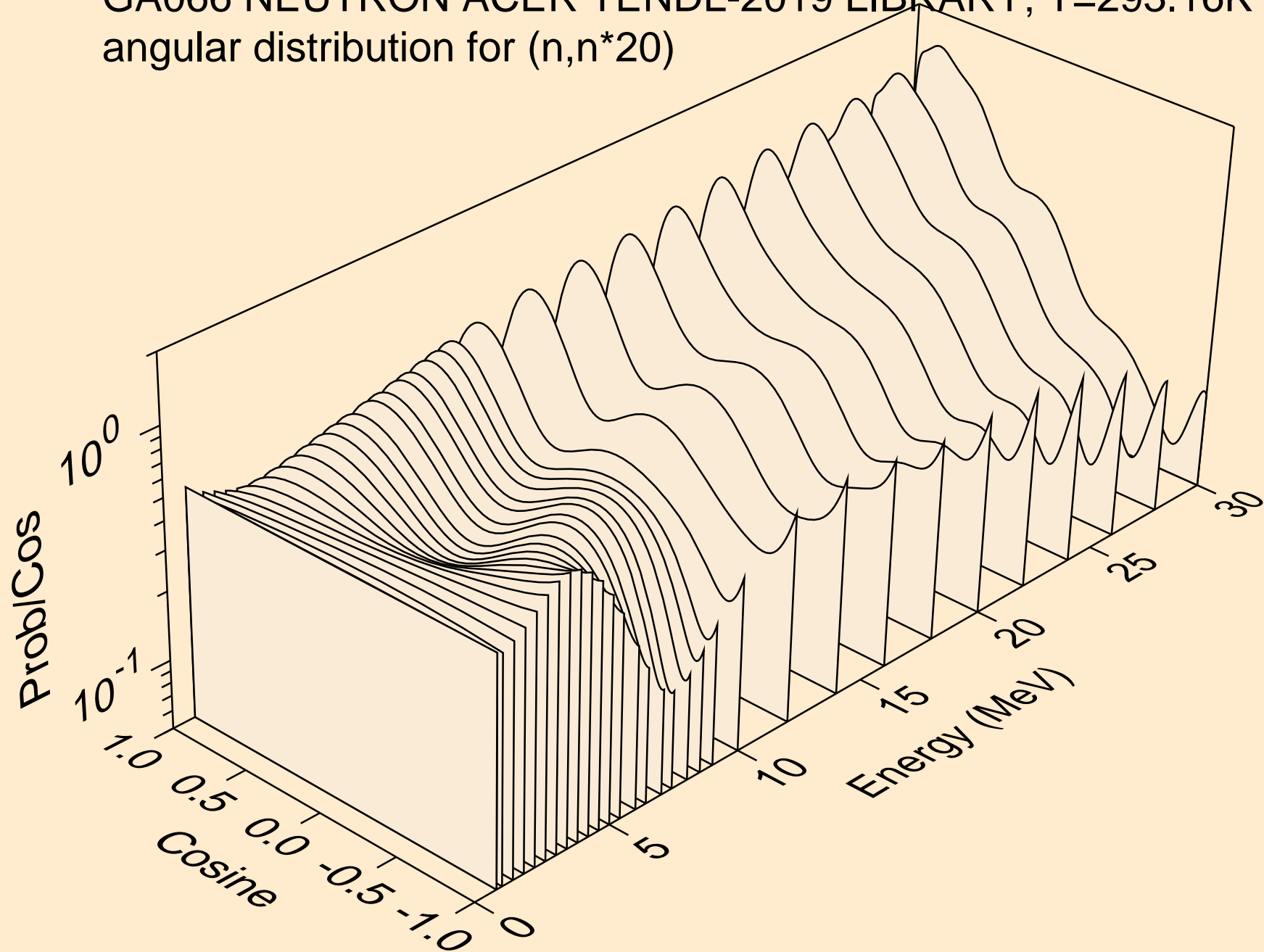

GA066 NEUTRON ACER TENDL-2019 LIBRARY; T=293.16K  
angular distribution for (n,n\*21)

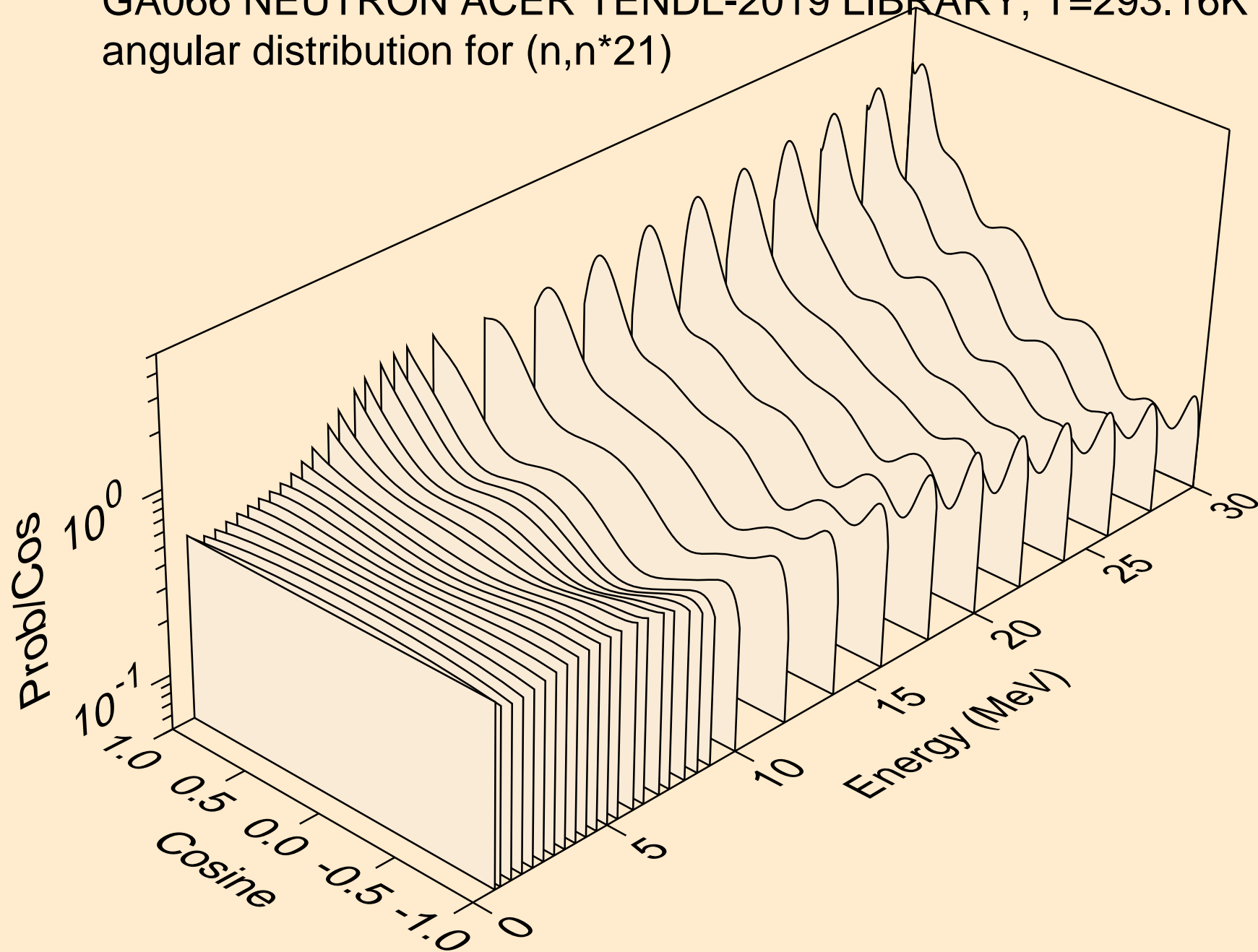

GA066 NEUTRON ACER TENDL-2019 LIBRARY; T=293.16K  
angular distribution for (n,n\*22)

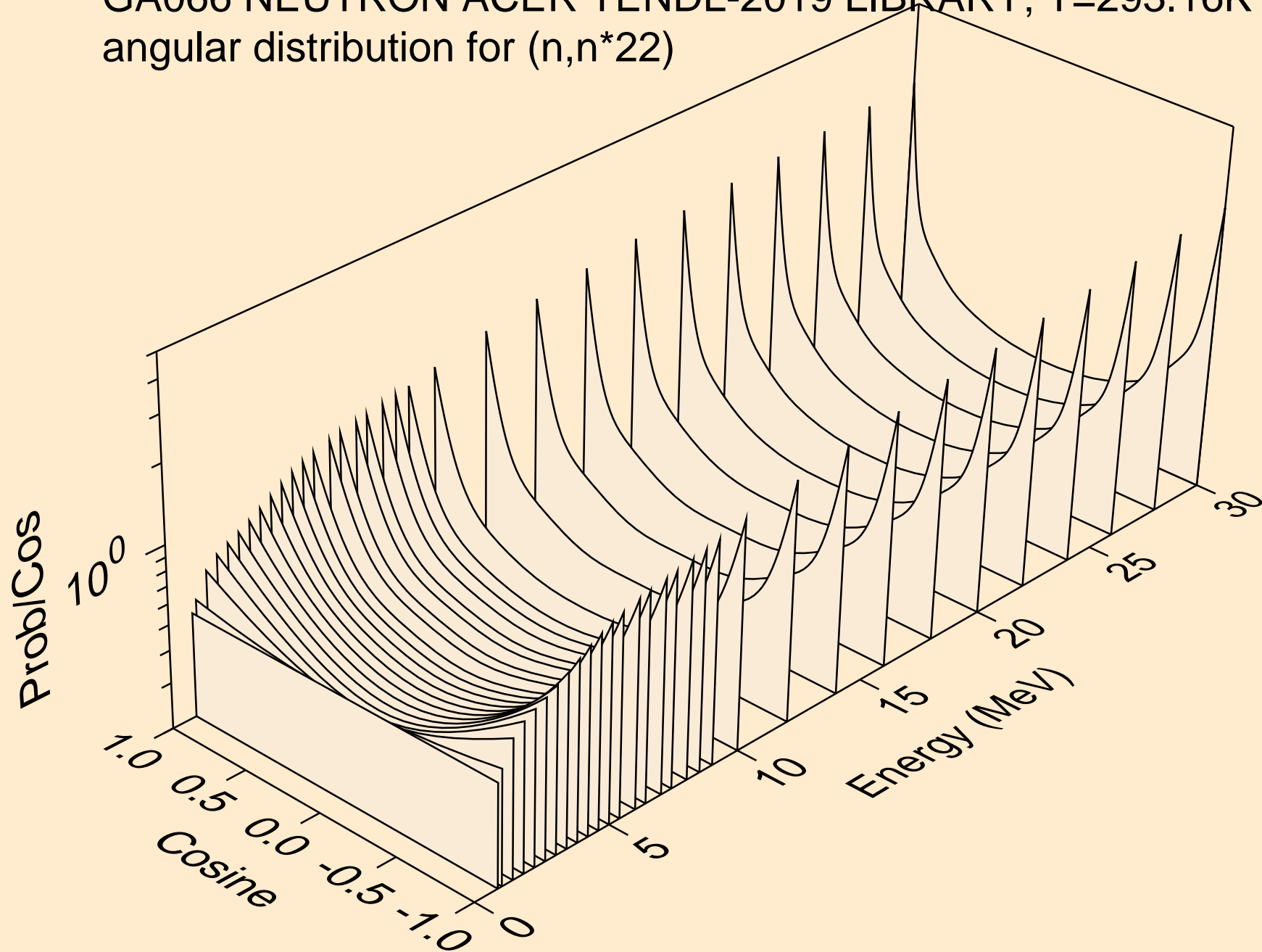

GA066 NEUTRON ACER TENDL-2019 LIBRARY; T=293.16K  
angular distribution for (n,n\*23)

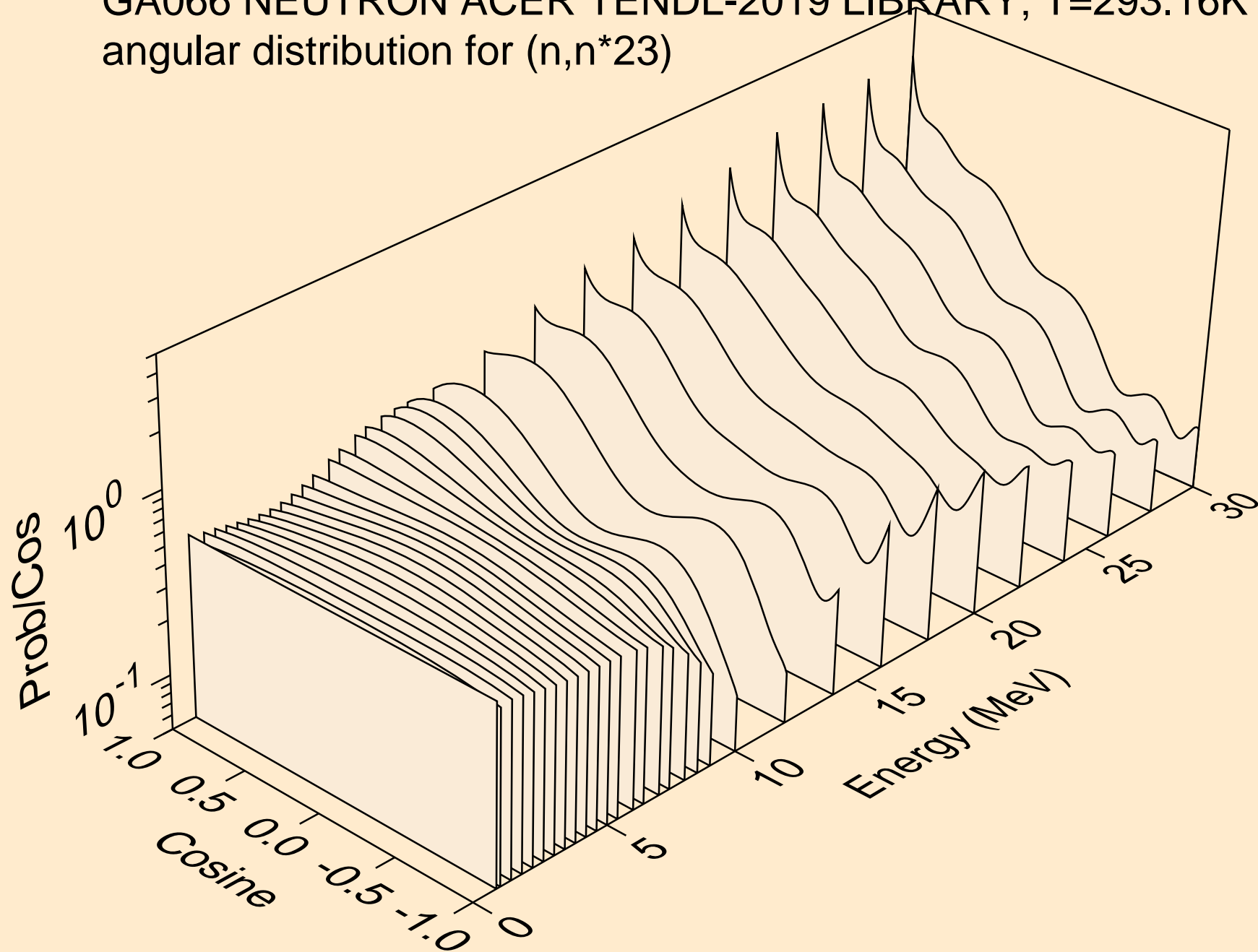

GA066 NEUTRON ACER TENDL-2019 LIBRARY; T=293.16K  
angular distribution for (n,n\*24)

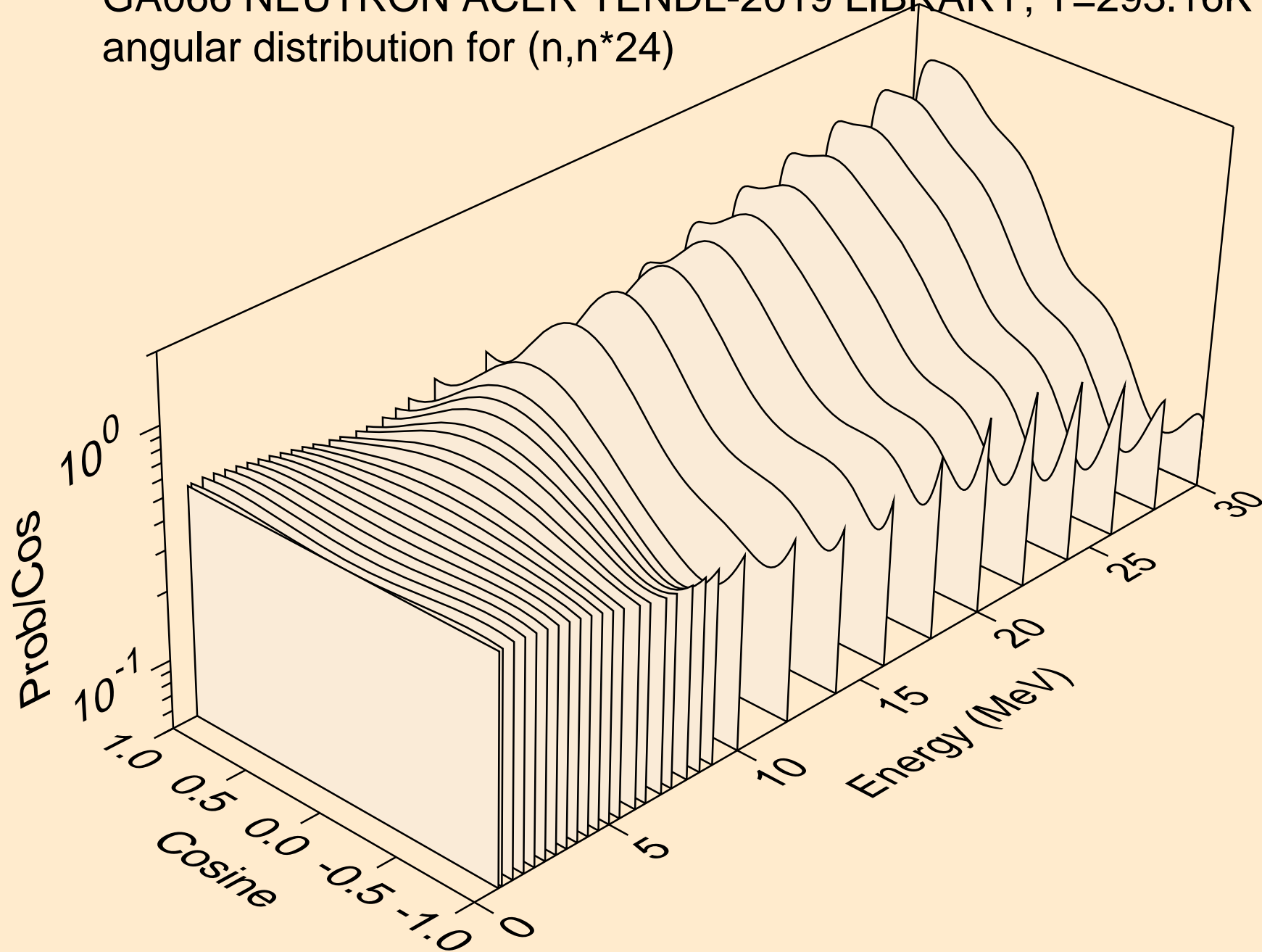

GA066 NEUTRON ACER TENDL-2019 LIBRARY; T=293.16K  
angular distribution for (n,n\*25)

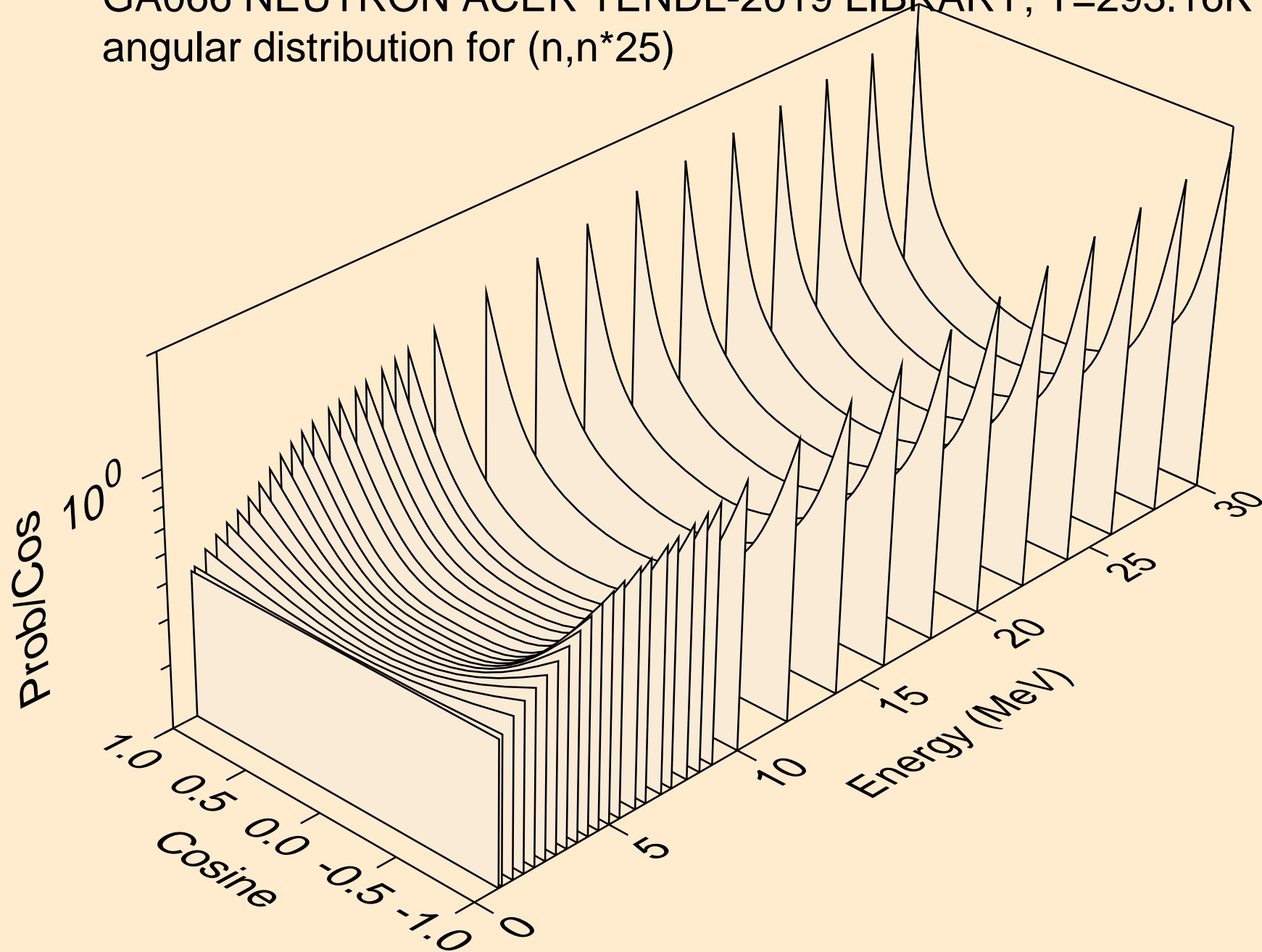

GA066 NEUTRON ACER TENDL-2019 LIBRARY; T=293.16K  
angular distribution for (n,n\*26)

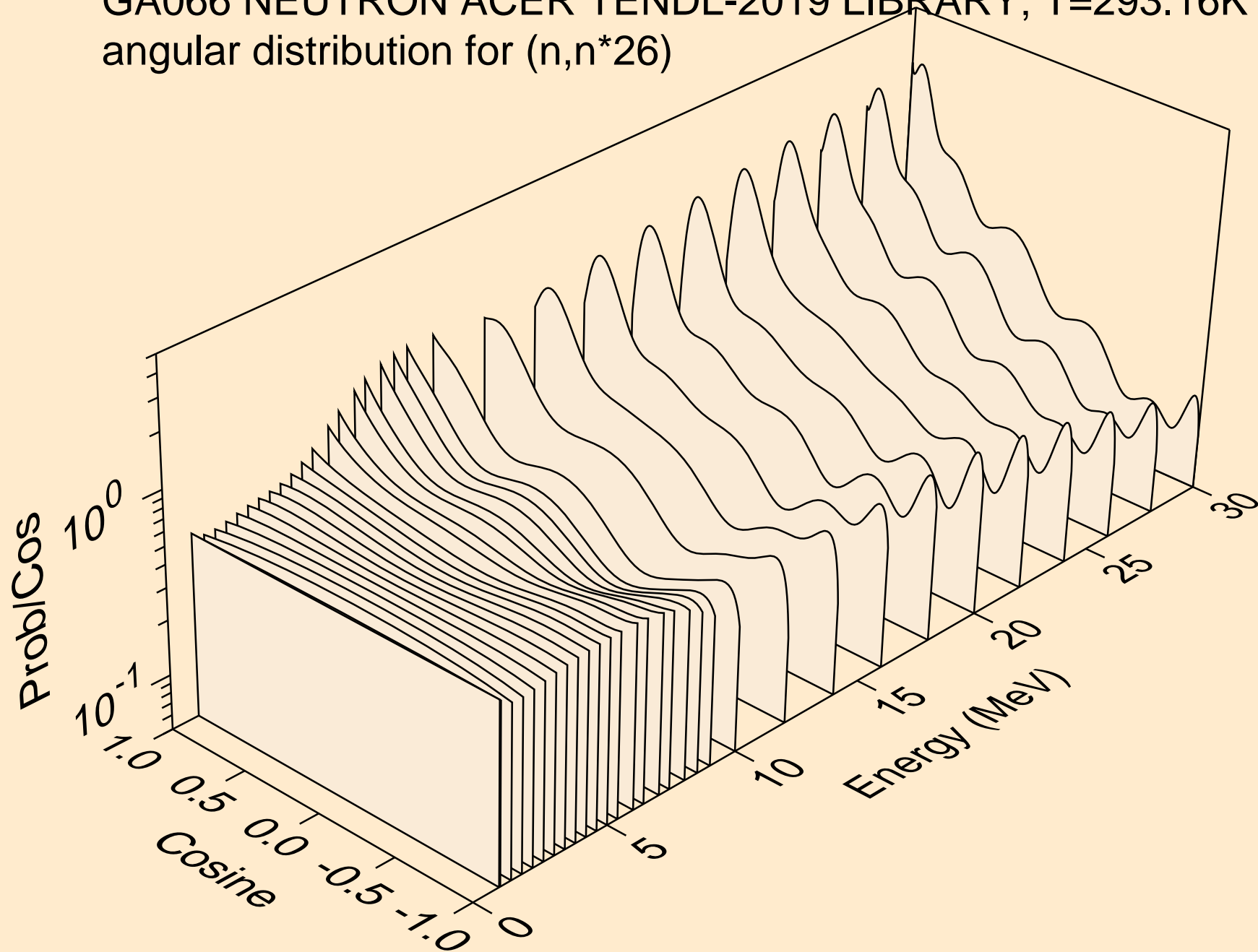

GA066 NEUTRON ACER TENDL-2019 LIBRARY; T=293.16K  
angular distribution for (n,n\*27)

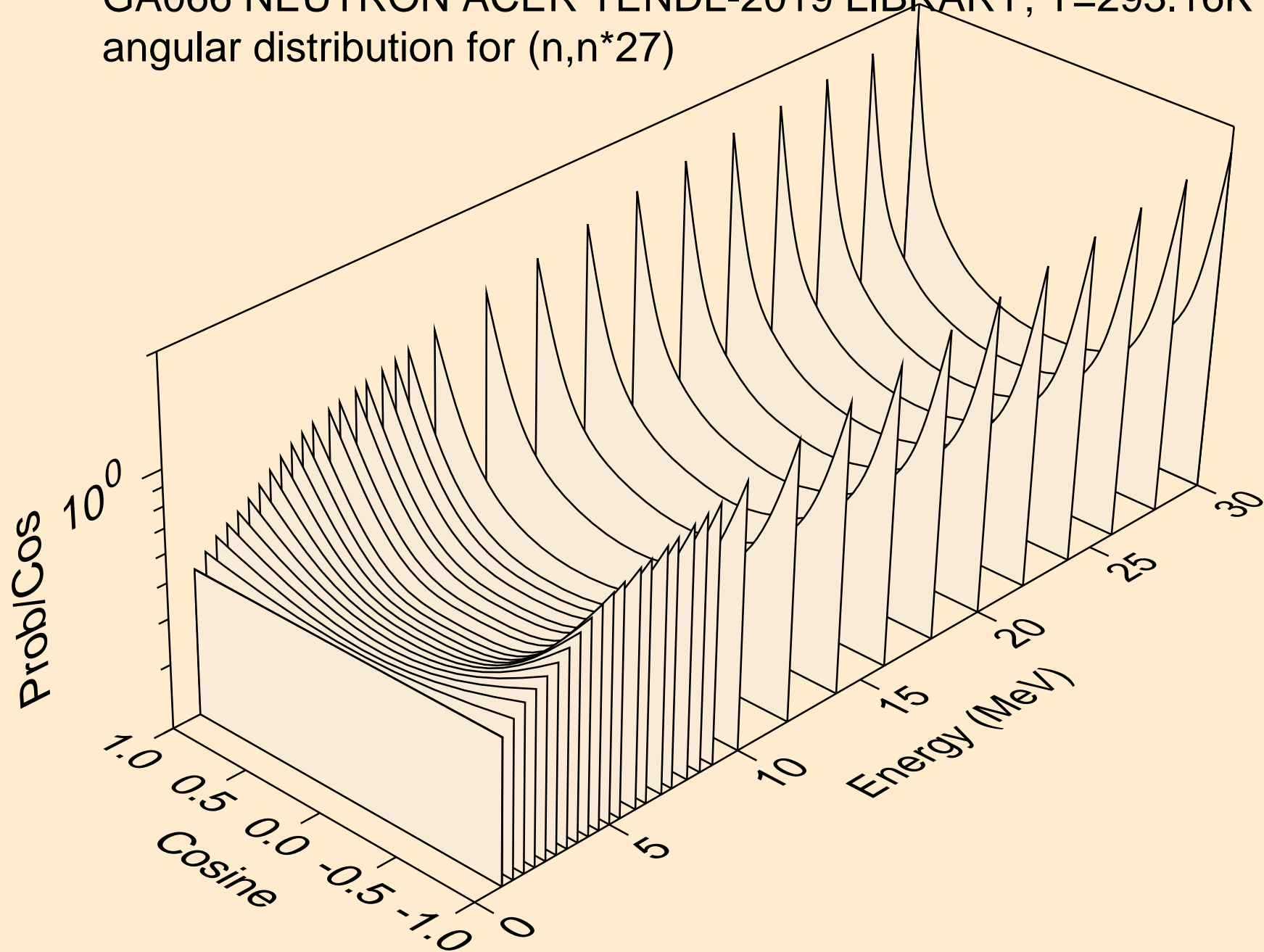

GA066 NEUTRON ACER TENDL-2019 LIBRARY; T=293.16K  
angular distribution for (n,n\*28)

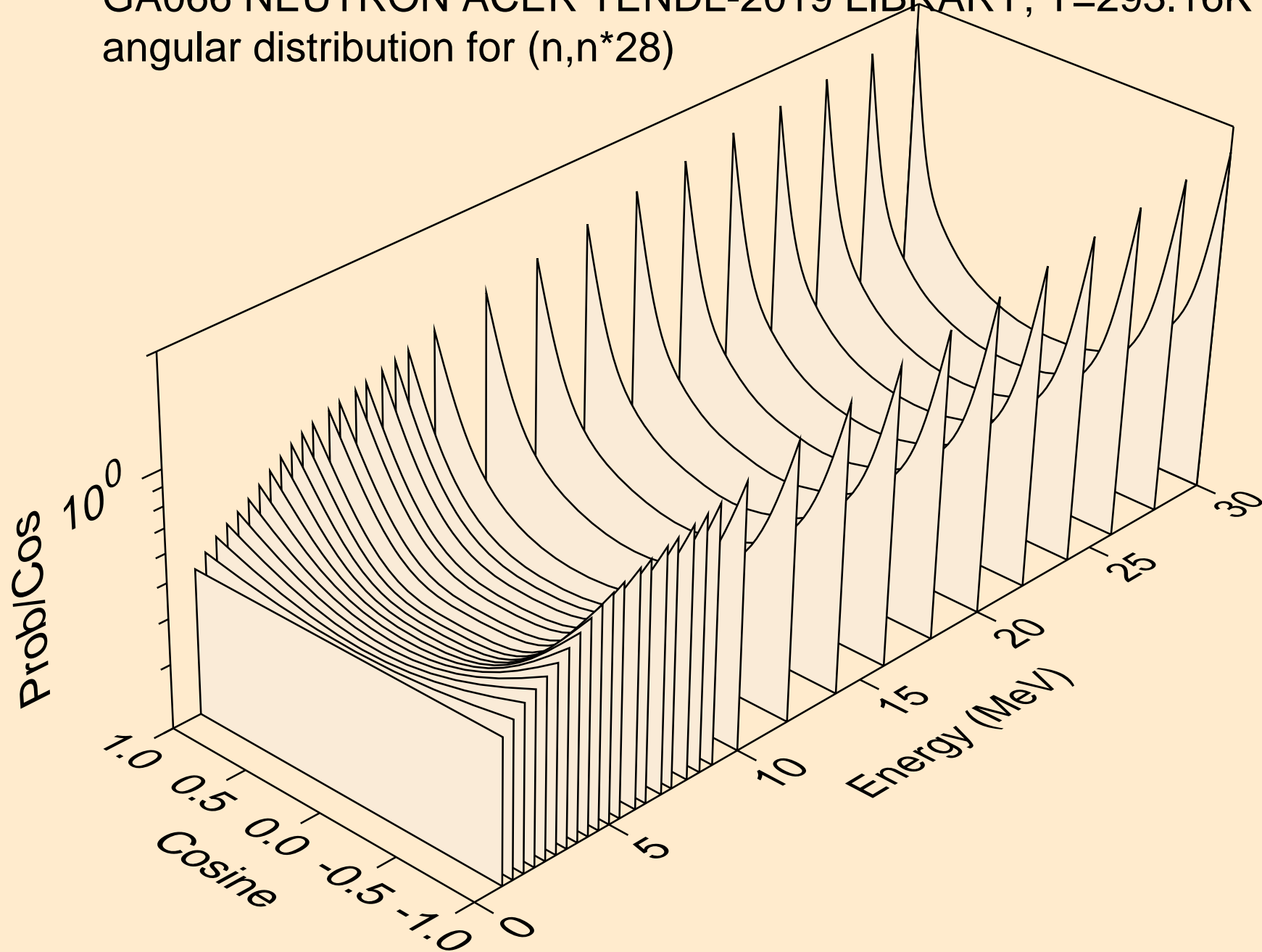

GA066 NEUTRON ACER TENDL-2019 LIBRARY; T=293.16K  
angular distribution for (n,n\*29)

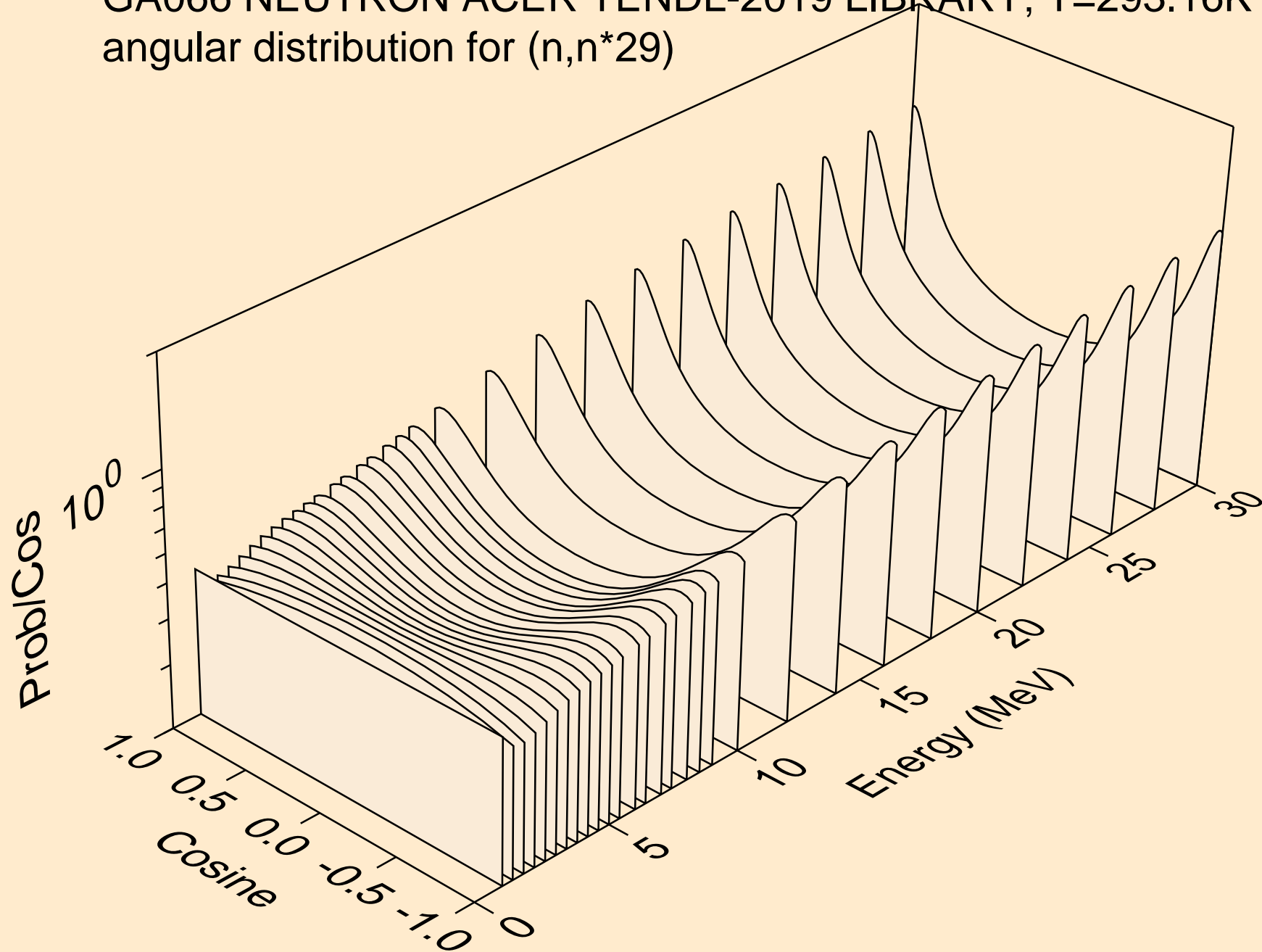

GA066 NEUTRON ACER TENDL-2019 LIBRARY; T=293.16K  
angular distribution for (n,n\*30)

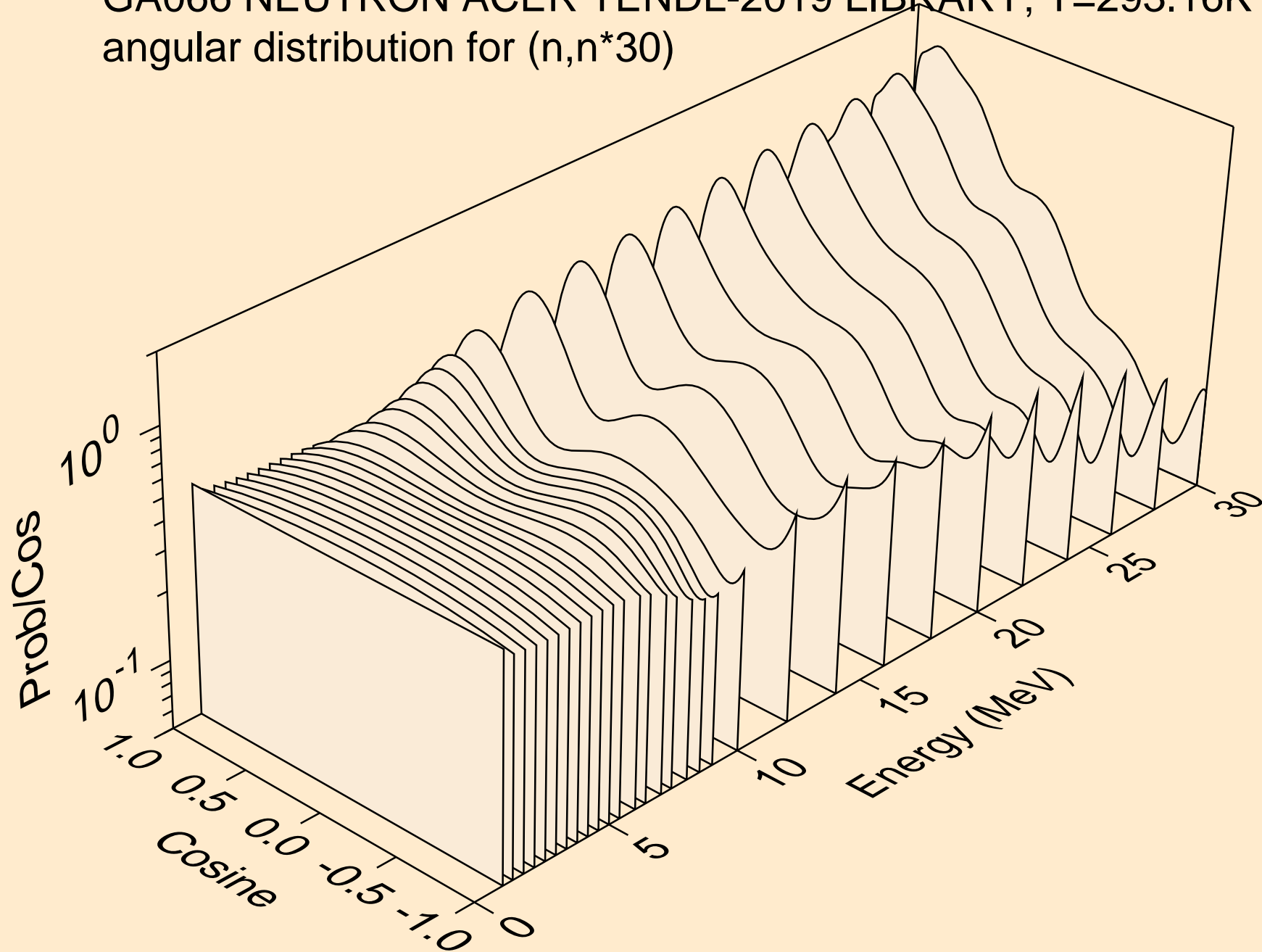

GA066 NEUTRON ACER TENDL-2019 LIBRARY; T=293.16K  
Neutron emission for (n,x)

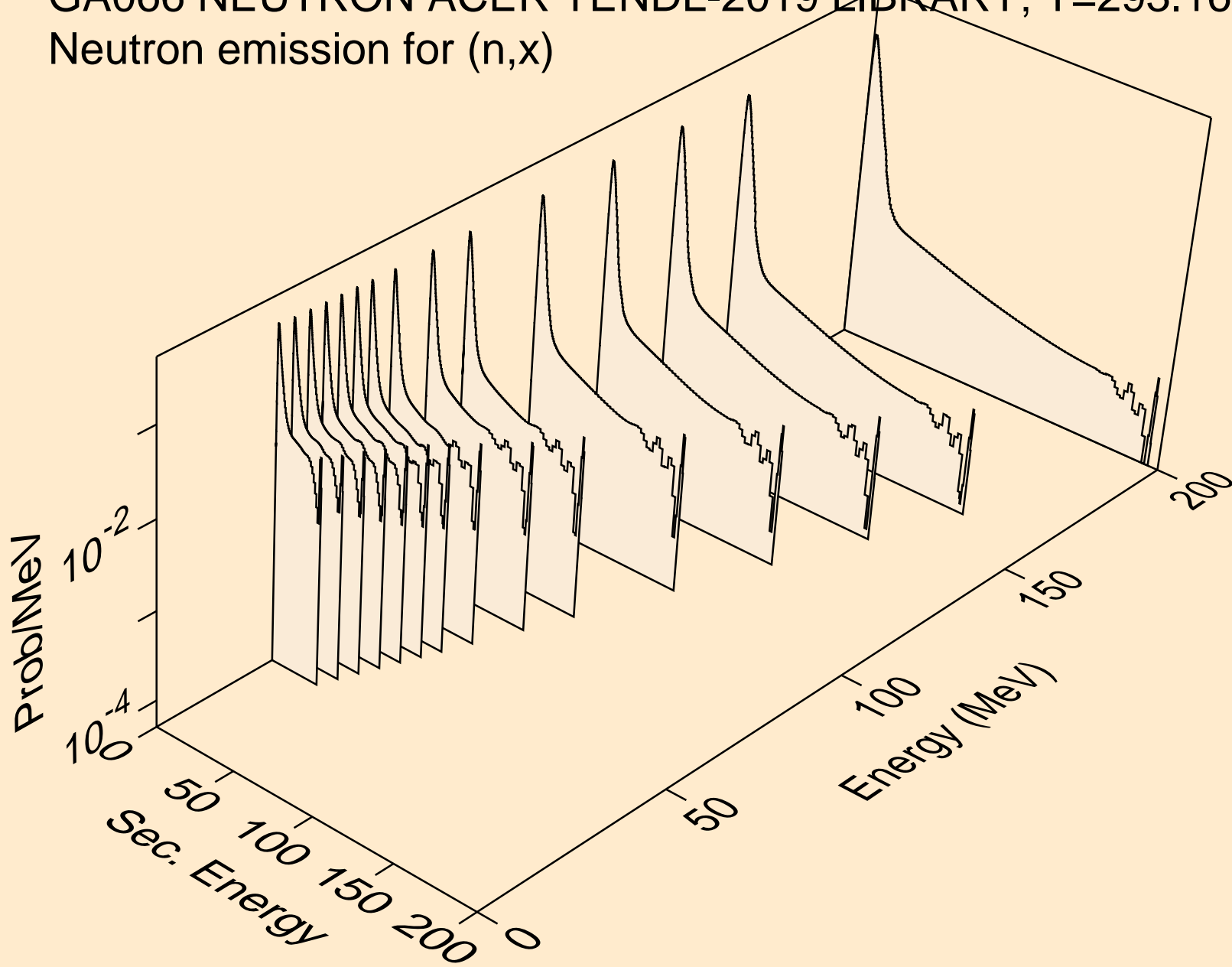

GA066 NEUTRON ACER TENDL-2019 LIBRARY; T=293.16K  
Neutron emission for (n,2nd)

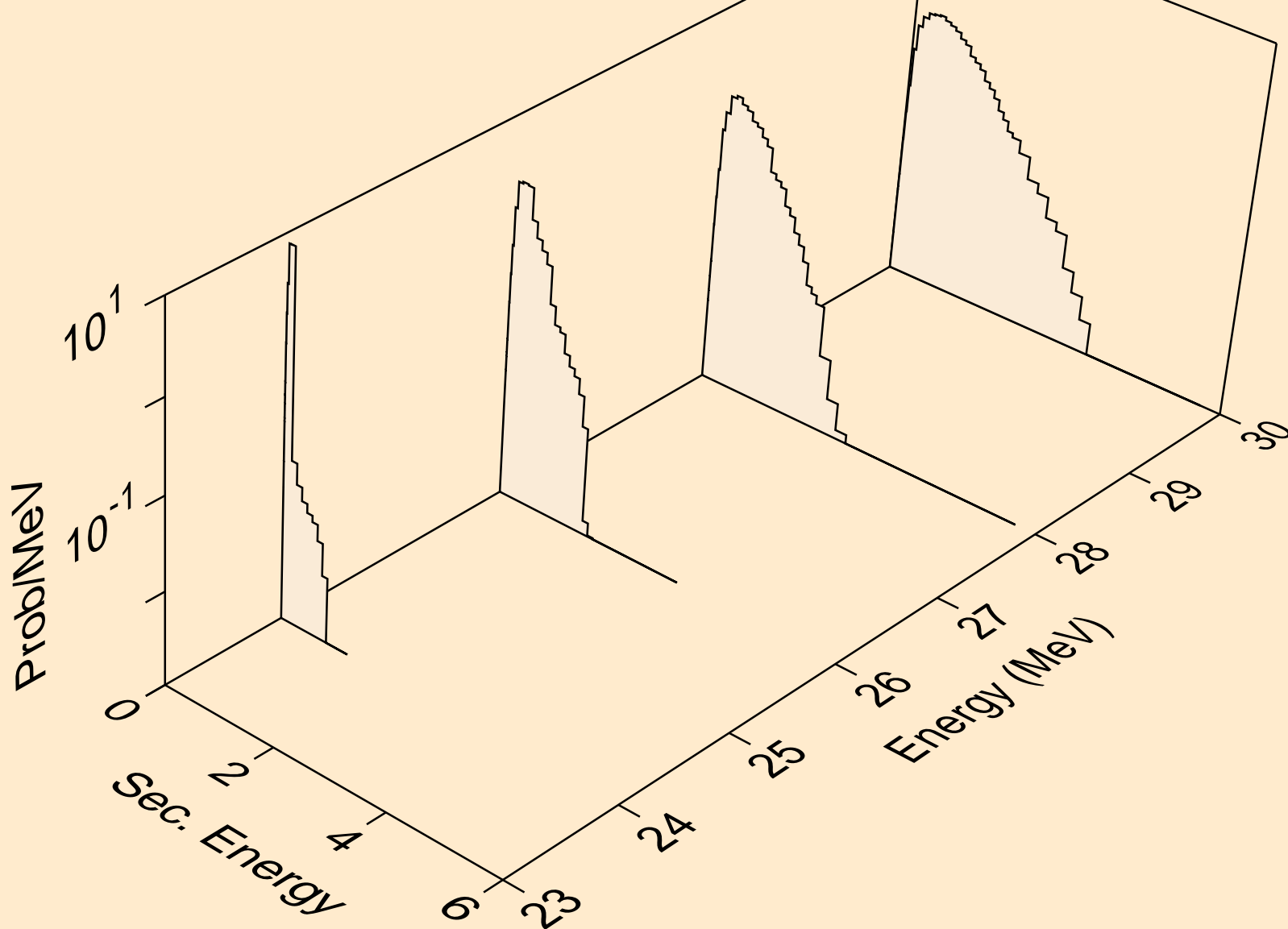

GA066 NEUTRON ACER TENDL-2019 LIBRARY; T=293.16K  
Neutron emission for (n,2n)

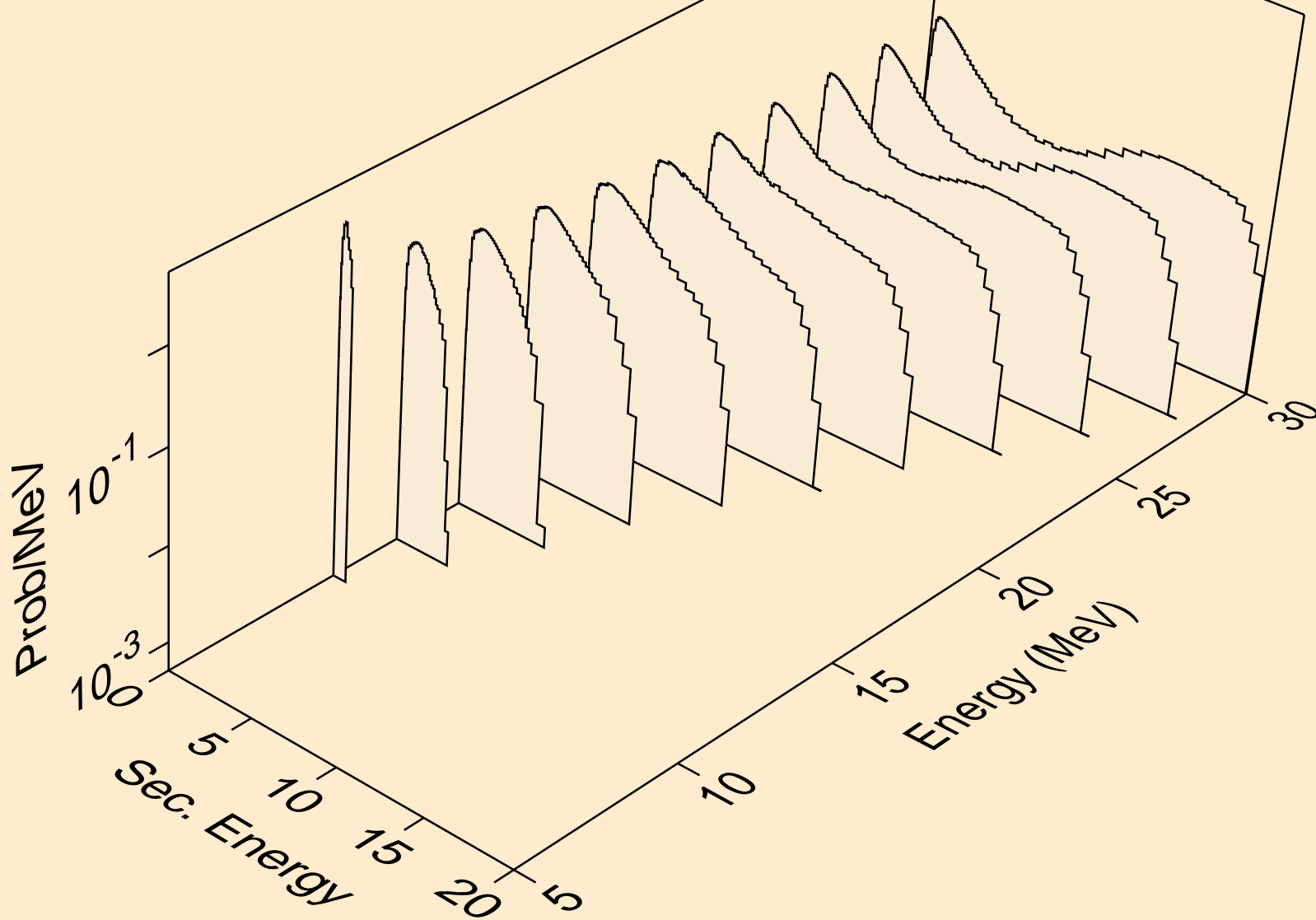

GA066 NEUTRON ACER TENDL-2019 LIBRARY; T=293.16K  
Neutron emission for (n,3n)

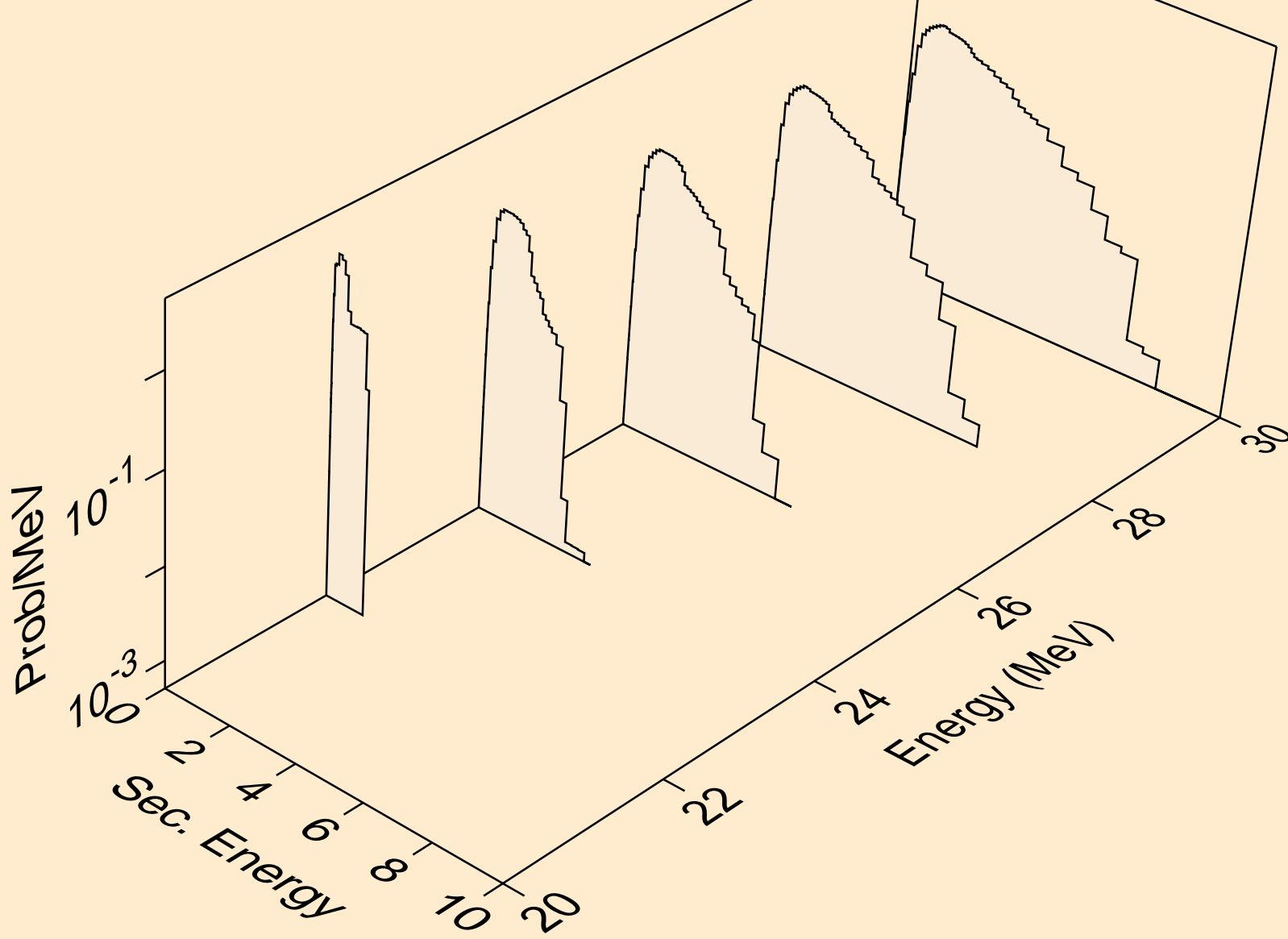

GA066 NEUTRON ACER TENDL-2019 LIBRARY; T=293.16K  
Neutron emission for (n,n\*)a

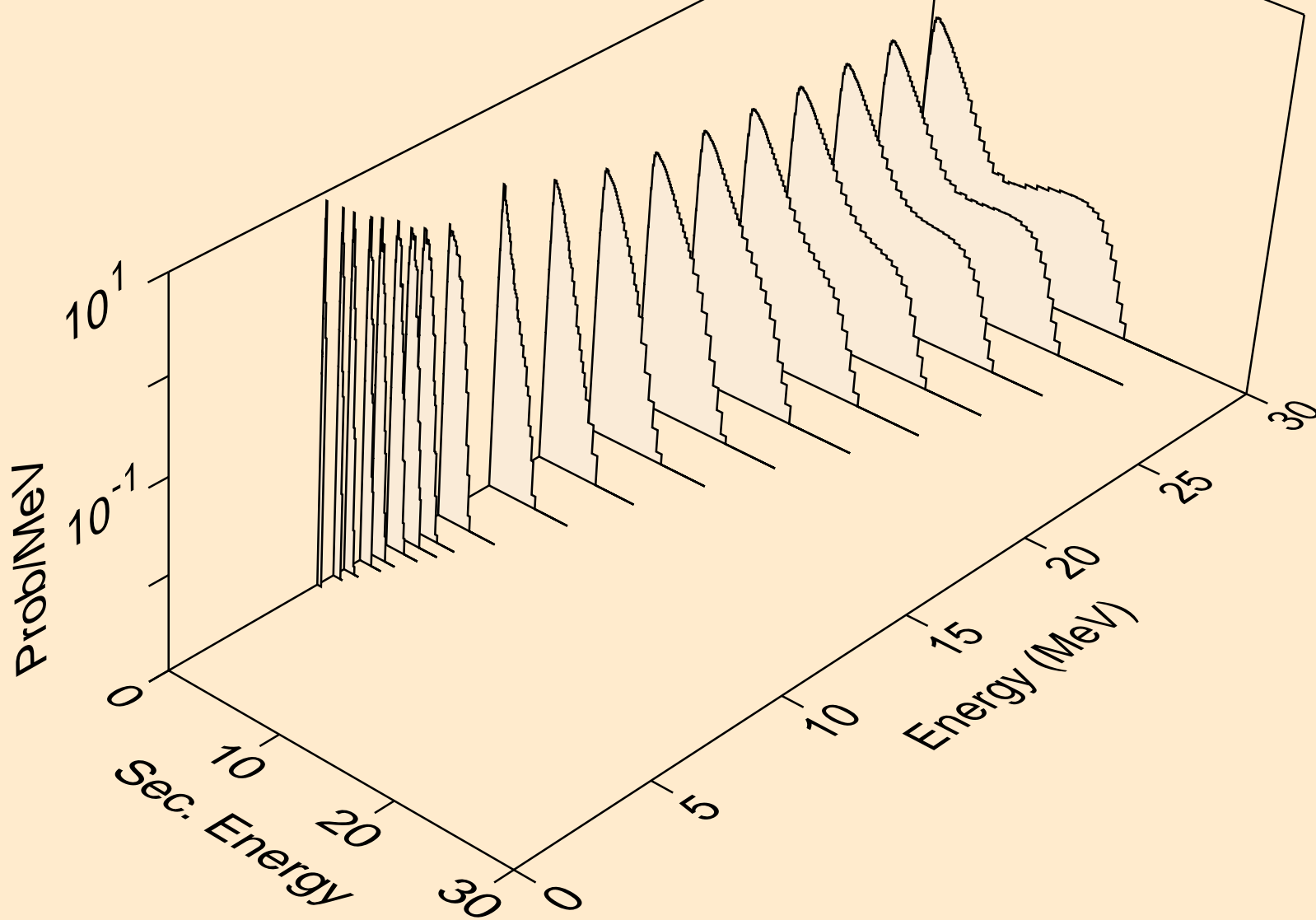

GA066 NEUTRON ACER TENDL-2019 LIBRARY; T=293.16K  
Neutron emission for (n,2n)a

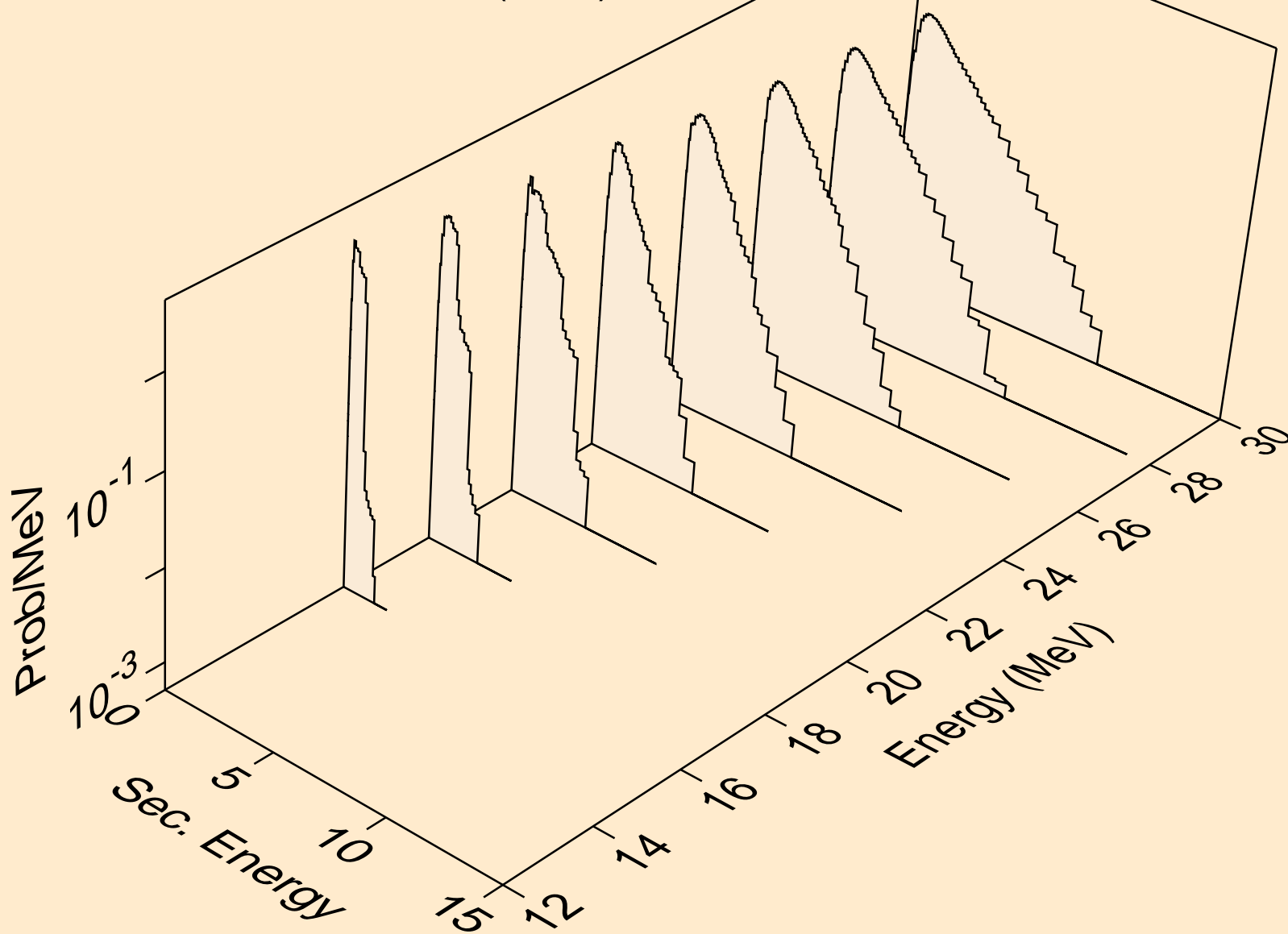

GA066 NEUTRON ACER TENDL-2019 LIBRARY; T=293.16K  
Neutron emission for (n,3n)a

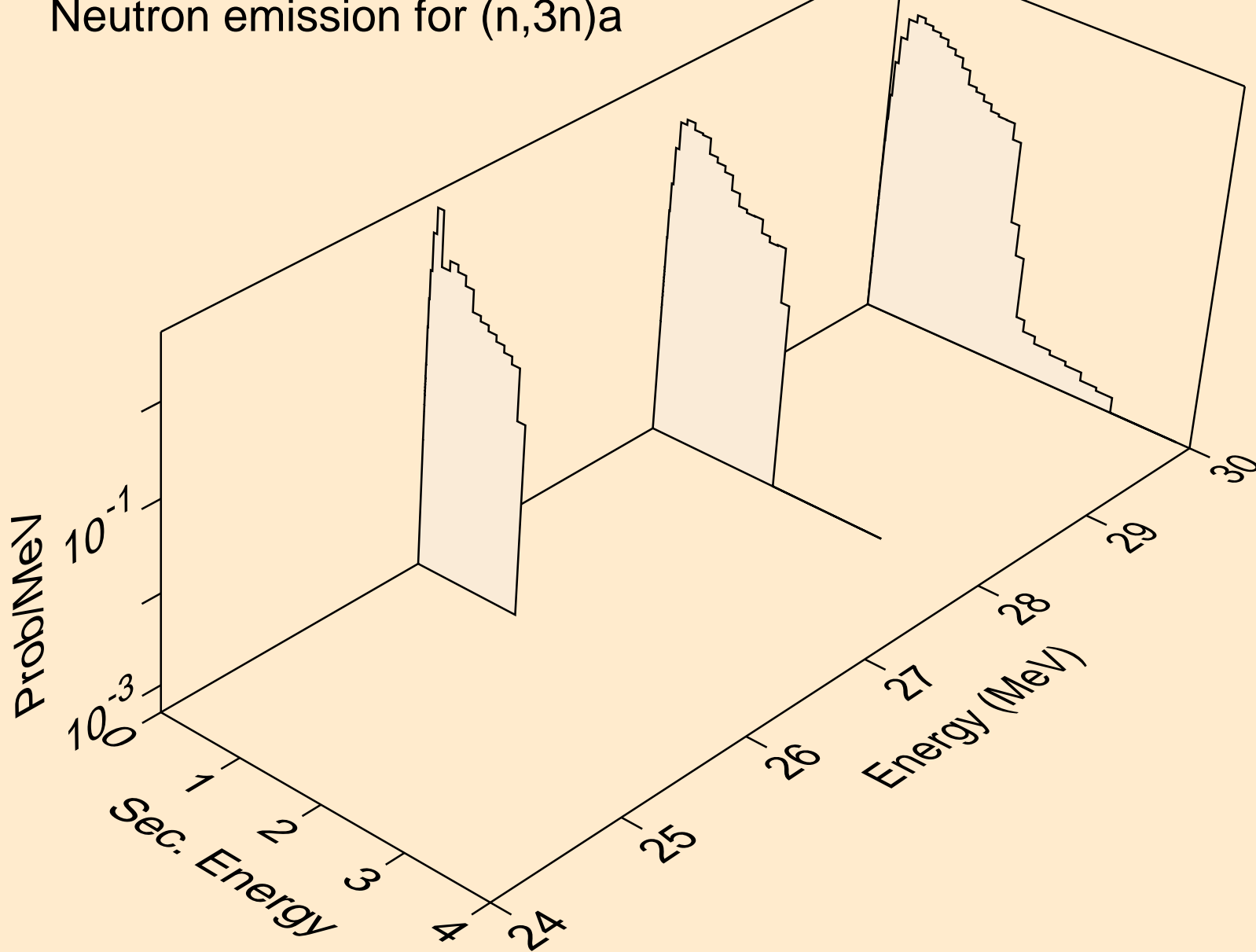

GA066 NEUTRON ACER TENDL-2019 LIBRARY; T=293.16K  
Neutron emission for (n,n\*)p

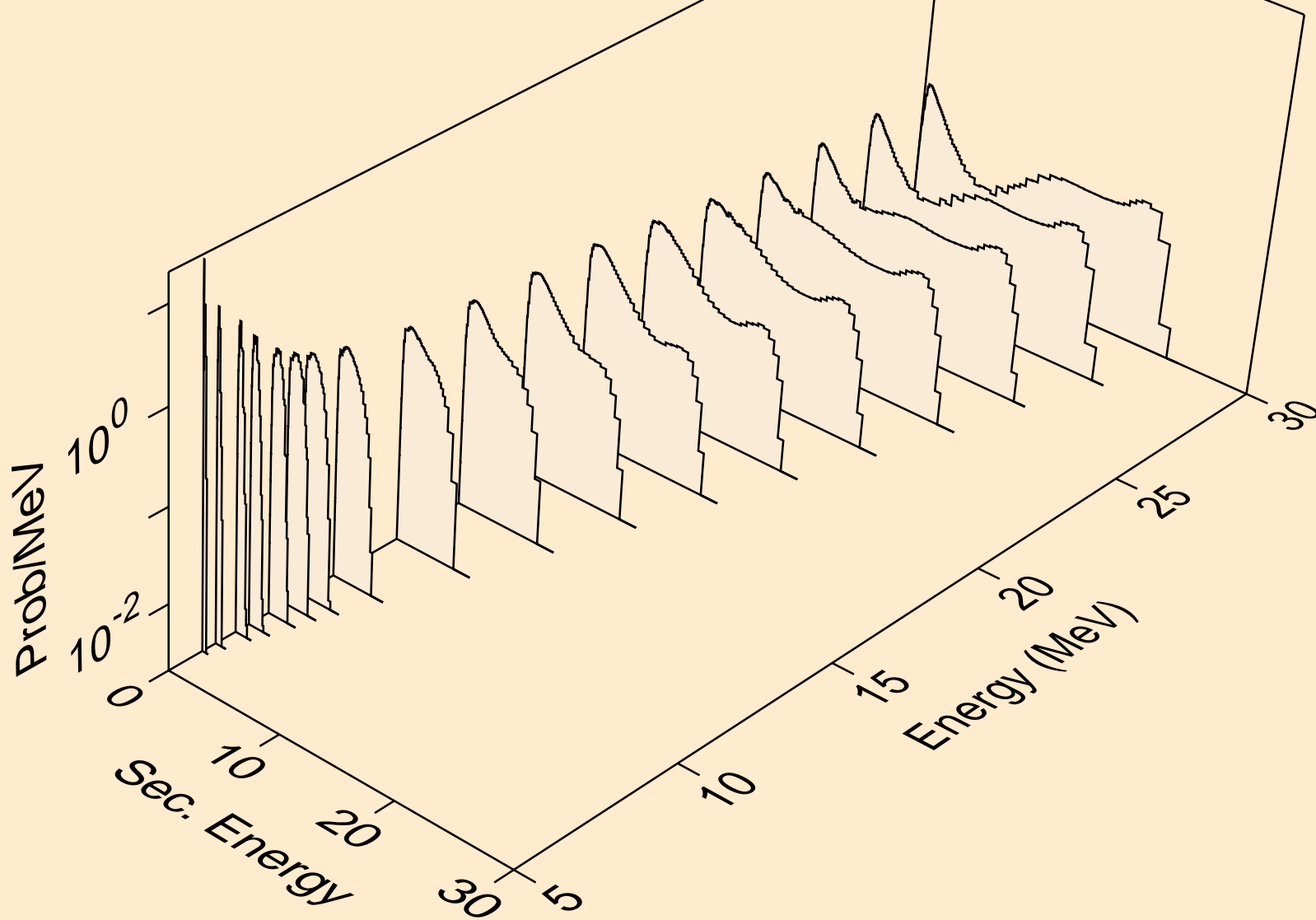

GA066 NEUTRON ACER TENDL-2019 LIBRARY; T=293.16K  
Neutron emission for (n,n\*)2a

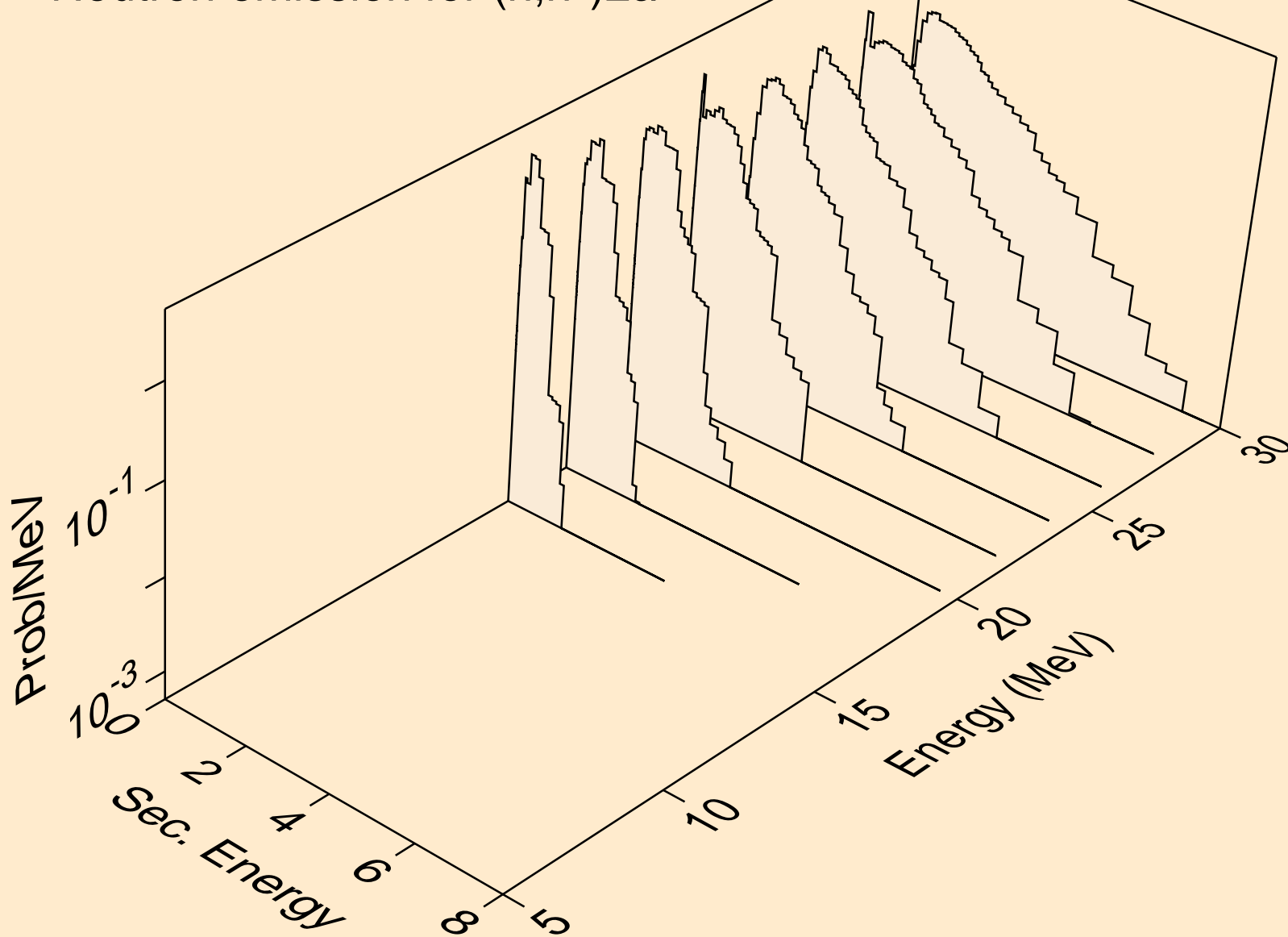

GA066 NEUTRON ACER TENDL-2019 LIBRARY; T=293.16K  
Neutron emission for (n,2n)2a

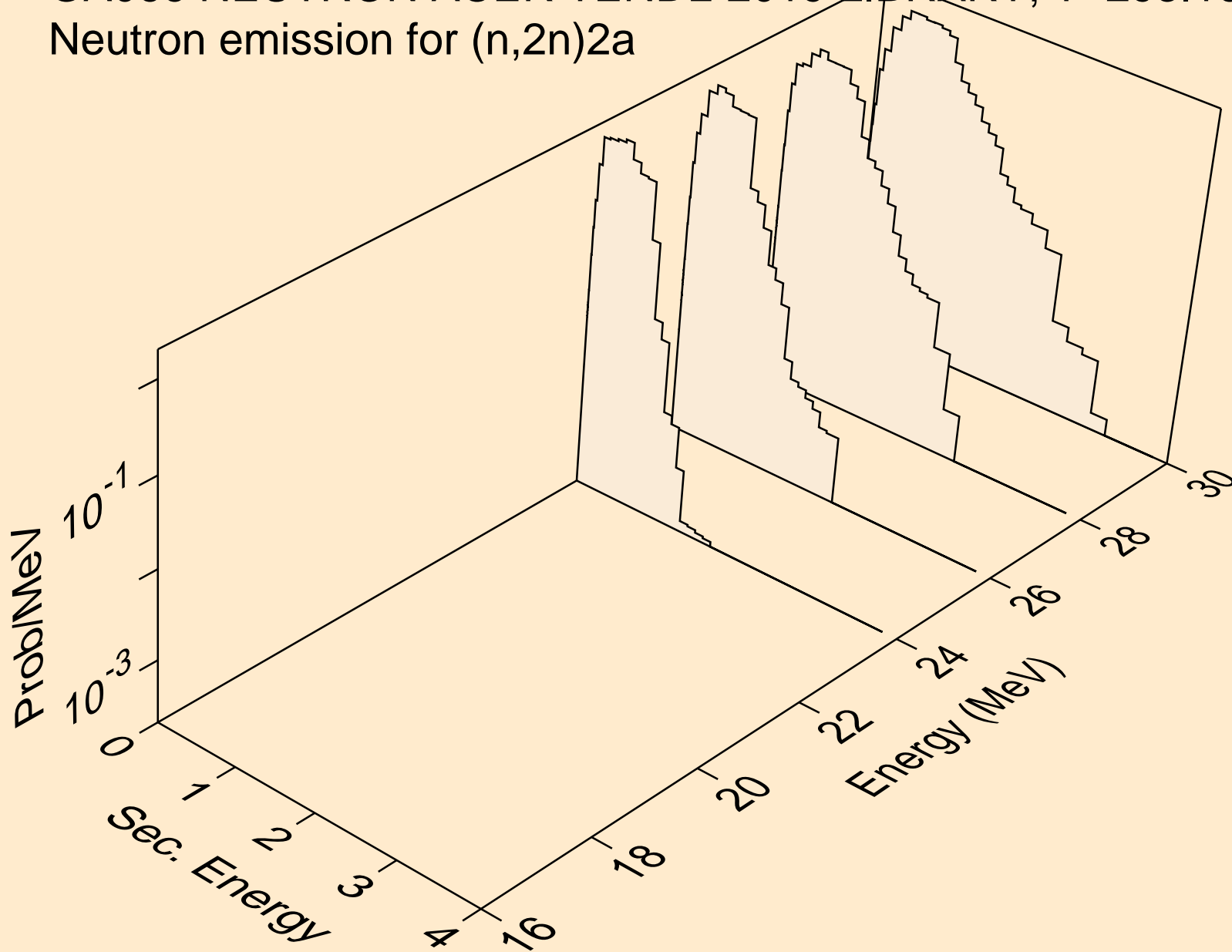

GA066 NEUTRON ACER TENDL-2019 LIBRARY; T=293.16K  
Neutron emission for (n,n\*)d

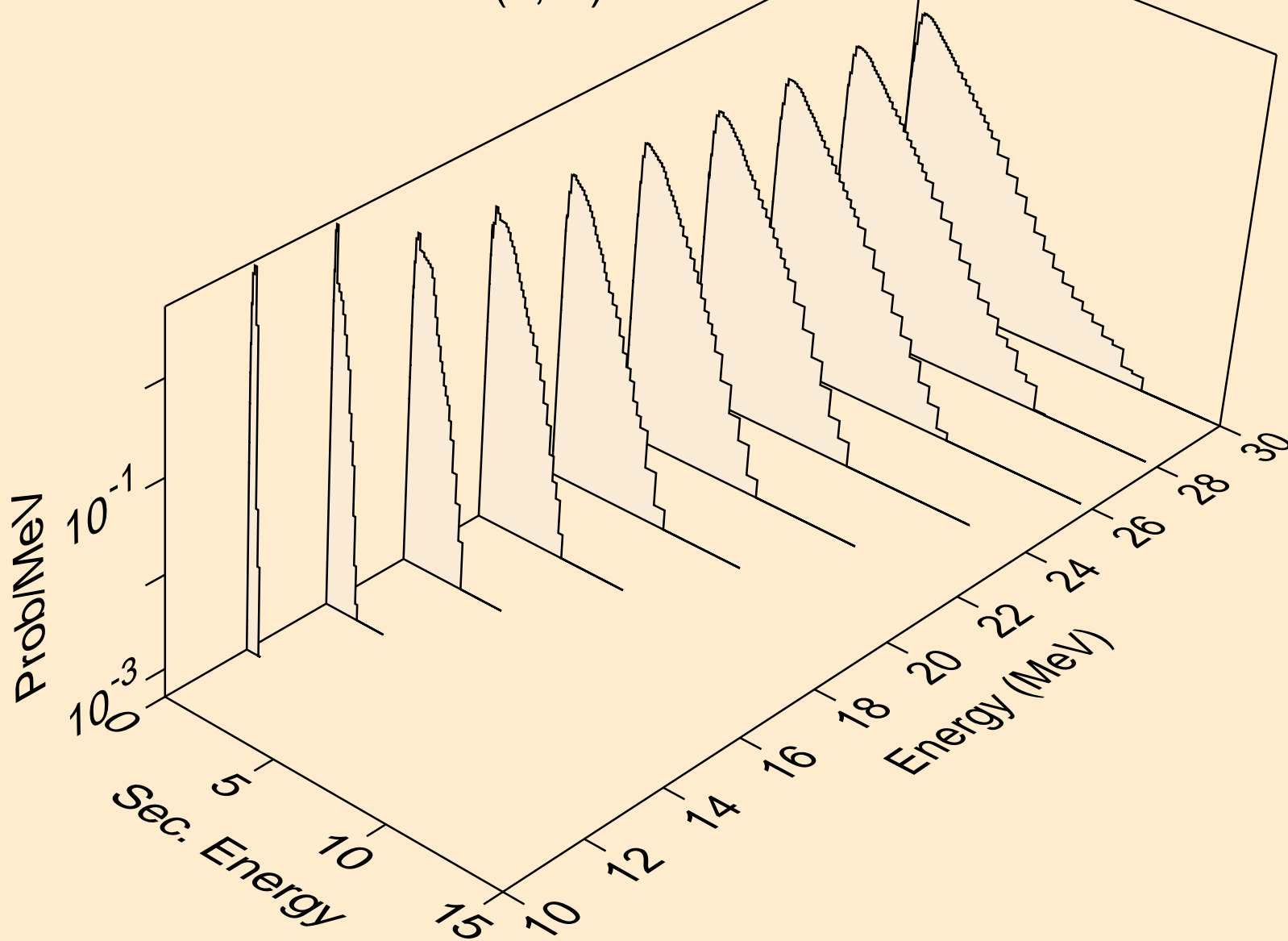

GA066 NEUTRON ACER TENDL-2019 LIBRARY; T=293.16K  
Neutron emission for (n,n\*)t

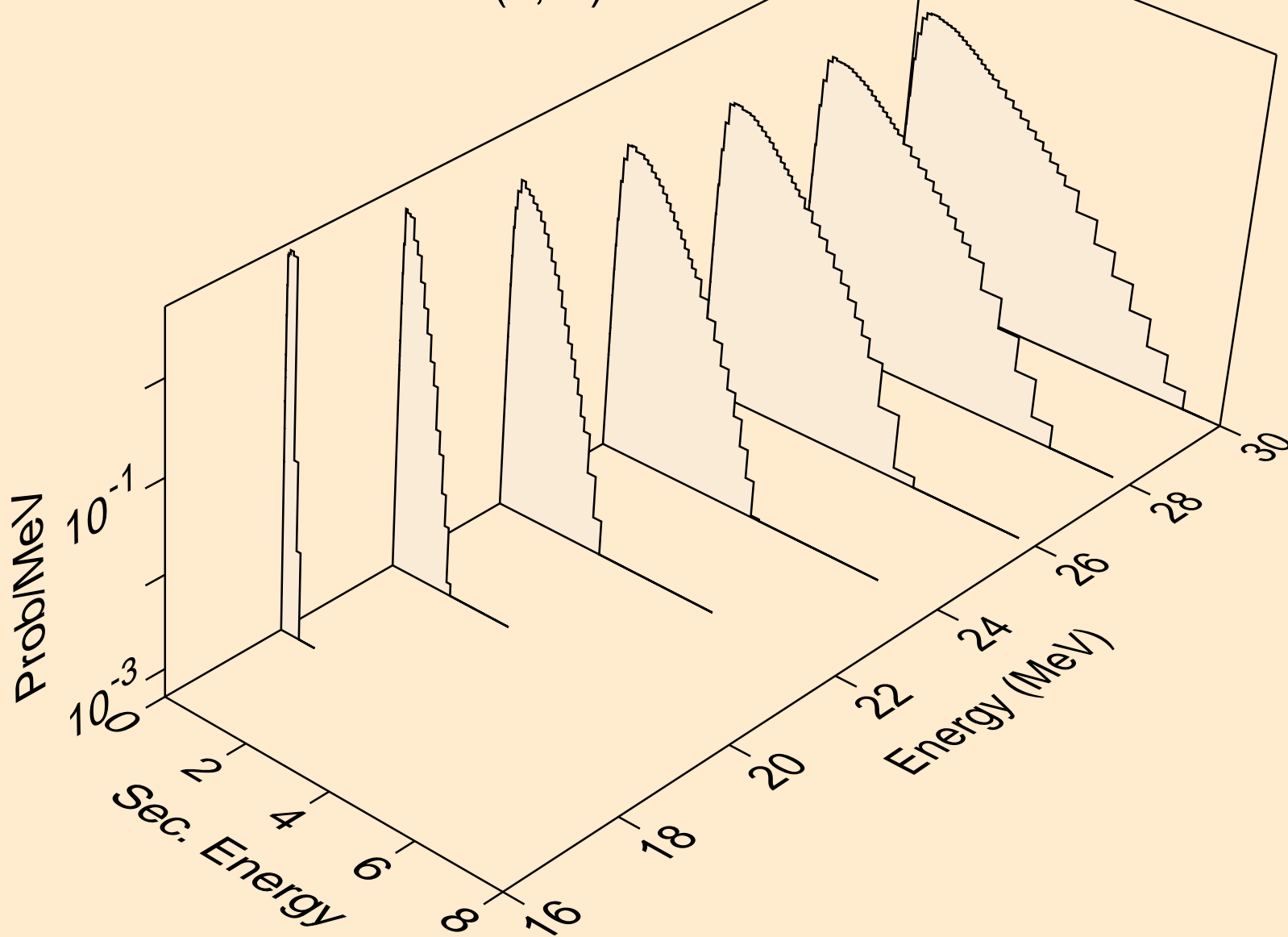

GA066 NEUTRON ACER TENDL-2019 LIBRARY; T=293.16K  
Neutron emission for (n,n\*)he3

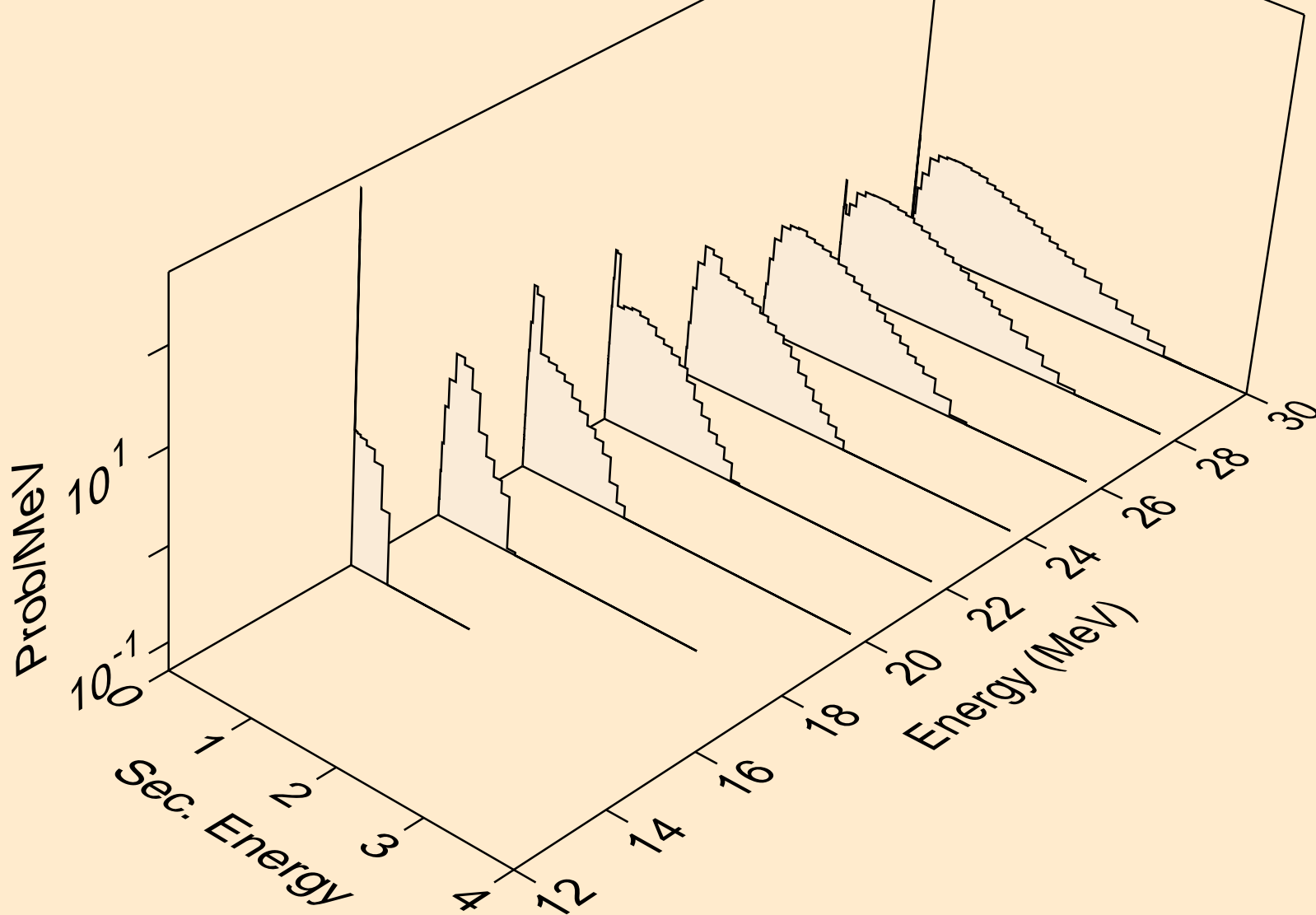

GA066 NEUTRON ACER TENDL-2019 LIBRARY; T=293.16K  
Neutron emission for (n,2np)

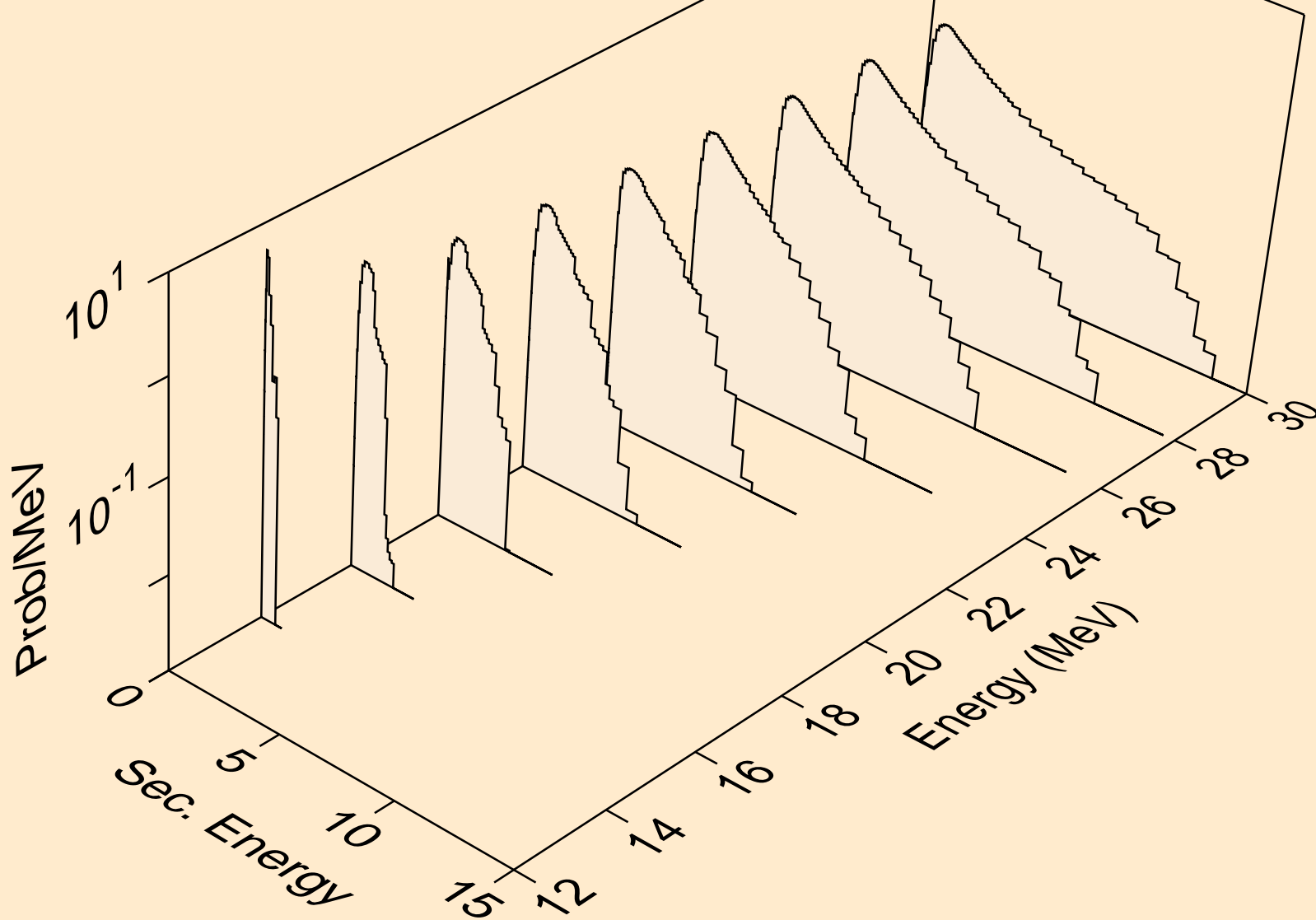

GA066 NEUTRON ACER TENDL-2019 LIBRARY; T=293.16K  
Neutron emission for (n,3np)

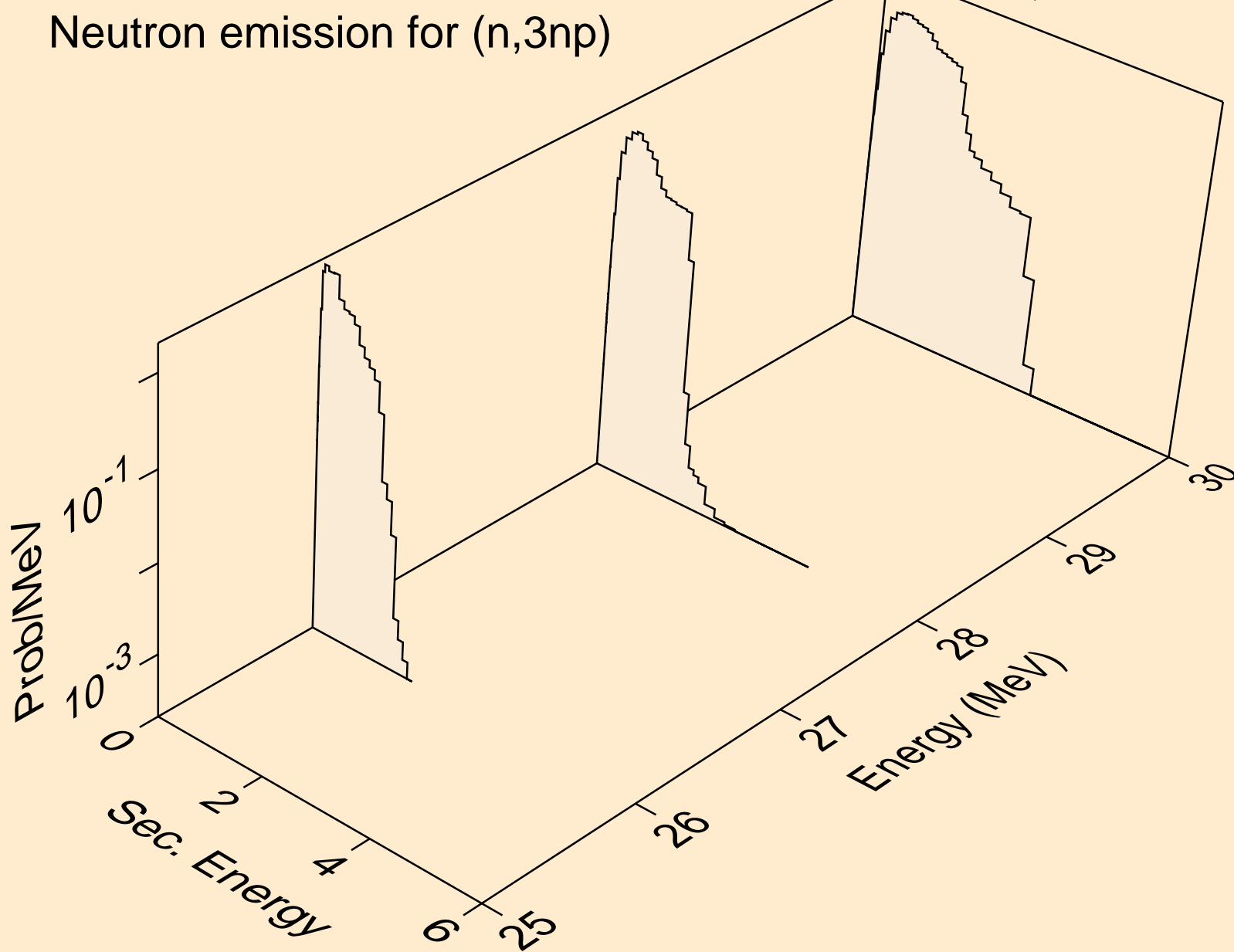

GA066 NEUTRON ACER TENDL-2019 LIBRARY; T=293.16K  
Neutron emission for (n,2np)

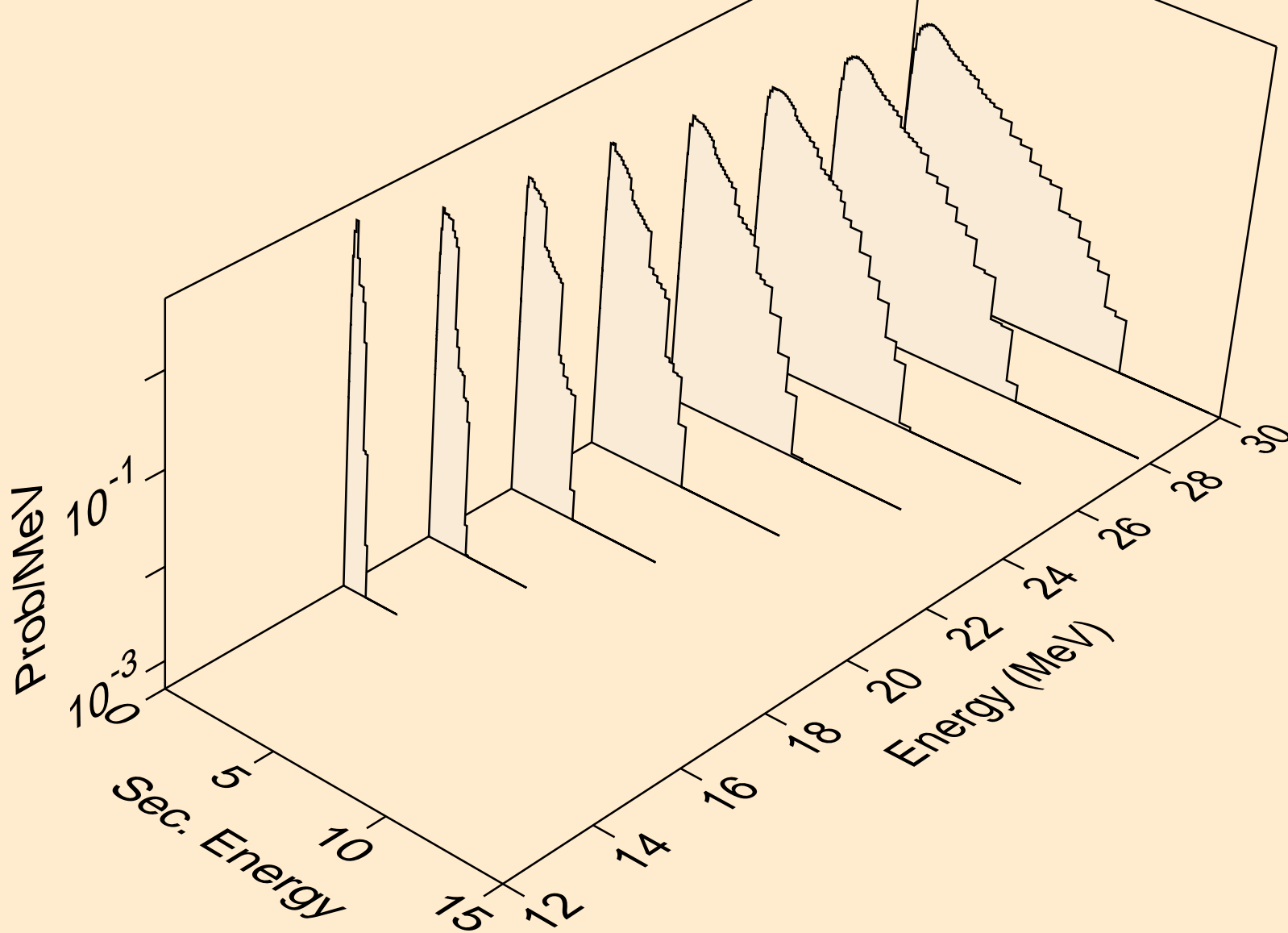

GA066 NEUTRON ACER TENDL-2019 LIBRARY; T=293.16K  
Neutron emission for (n,npa)

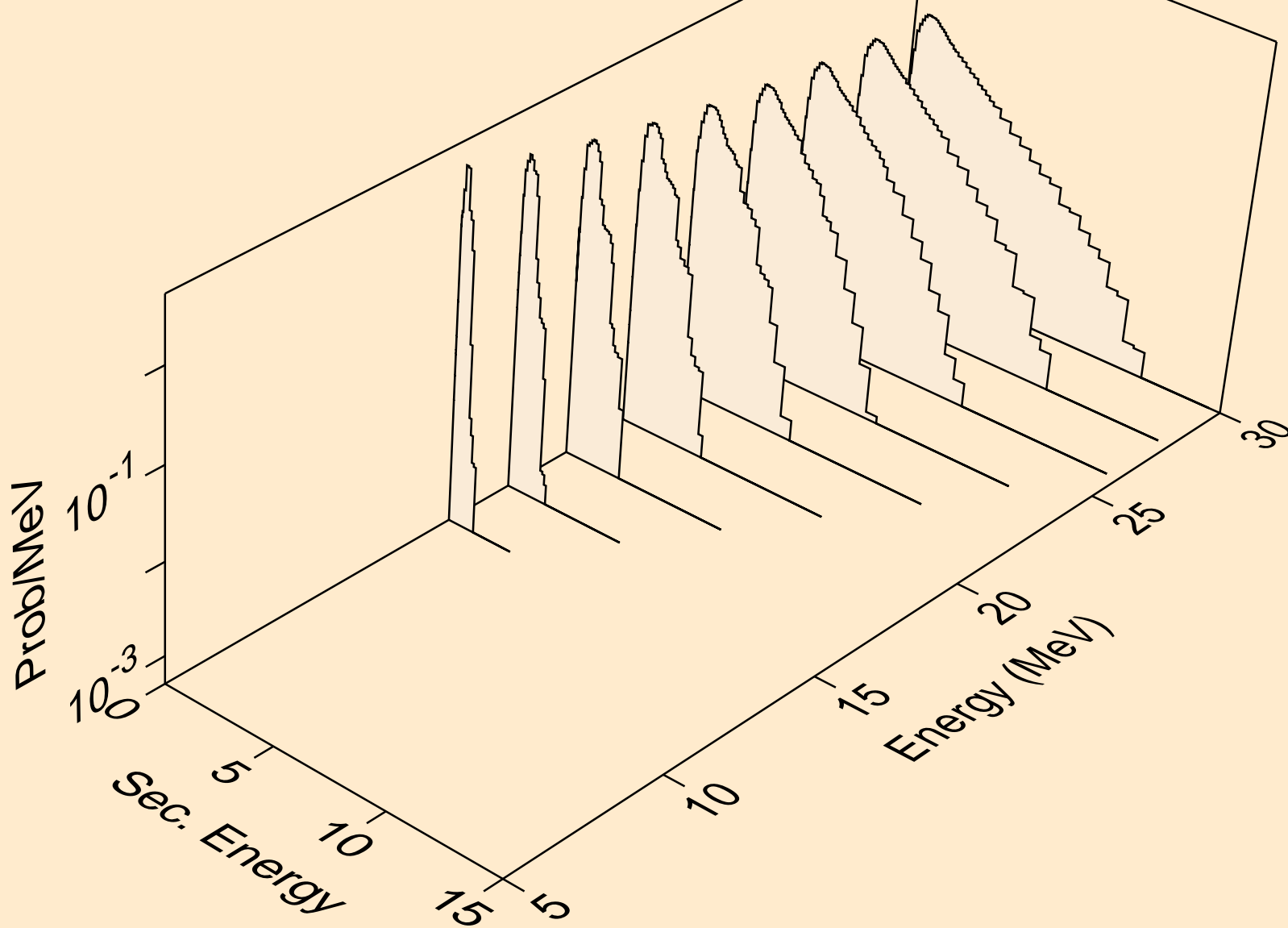

GA066 NEUTRON ACER TENDL-2019 LIBRARY; T=293.16K  
Neutron emission for (n,n\*c)

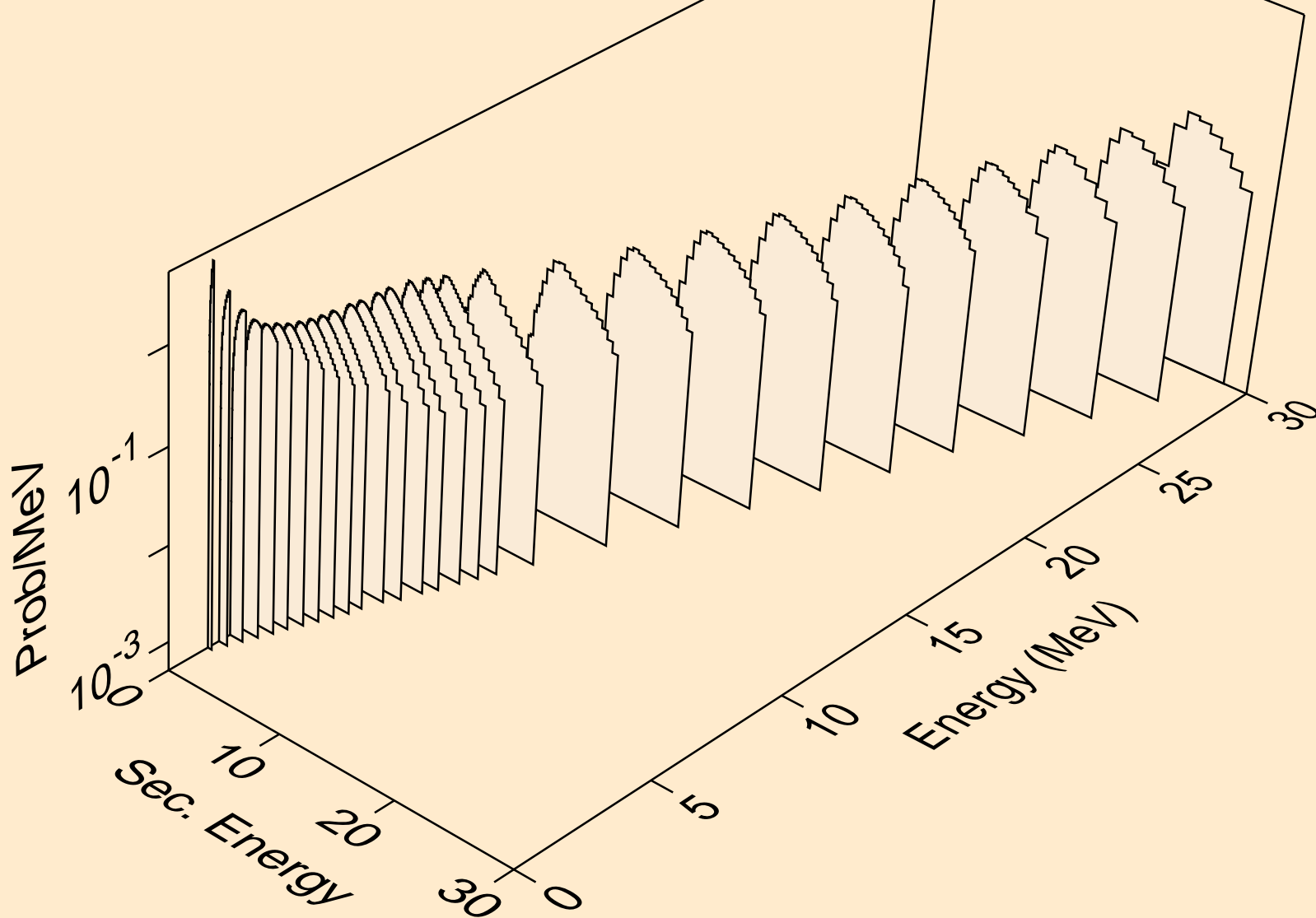

GA066 NEUTRON ACER TENDL-2019 LIBRARY; T=293.16K  
Photon emission for (n,x)

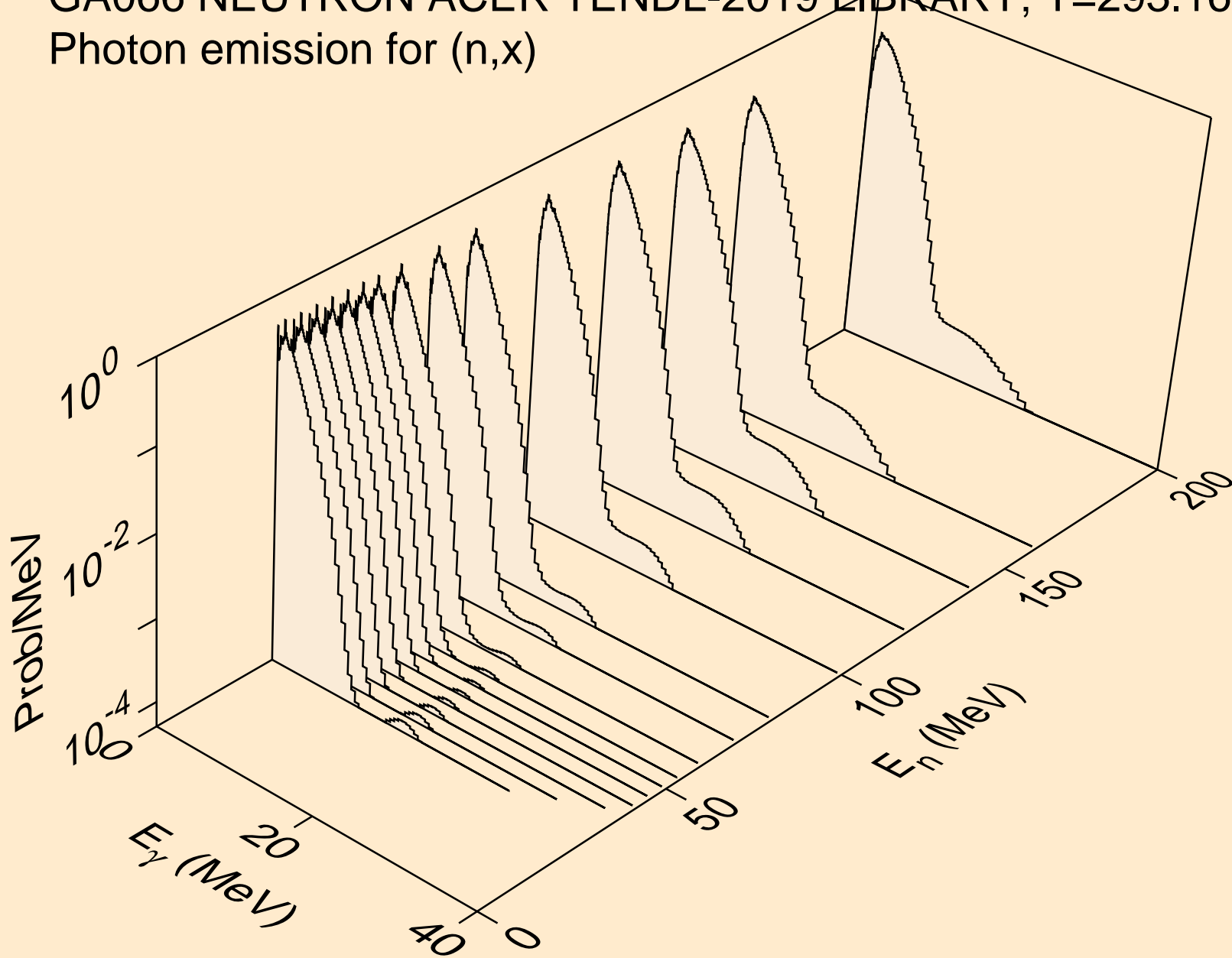

GA066 NEUTRON ACER TENDL-2019 LIBRARY; T=293.16K  
Photon emission for (n,2nd)

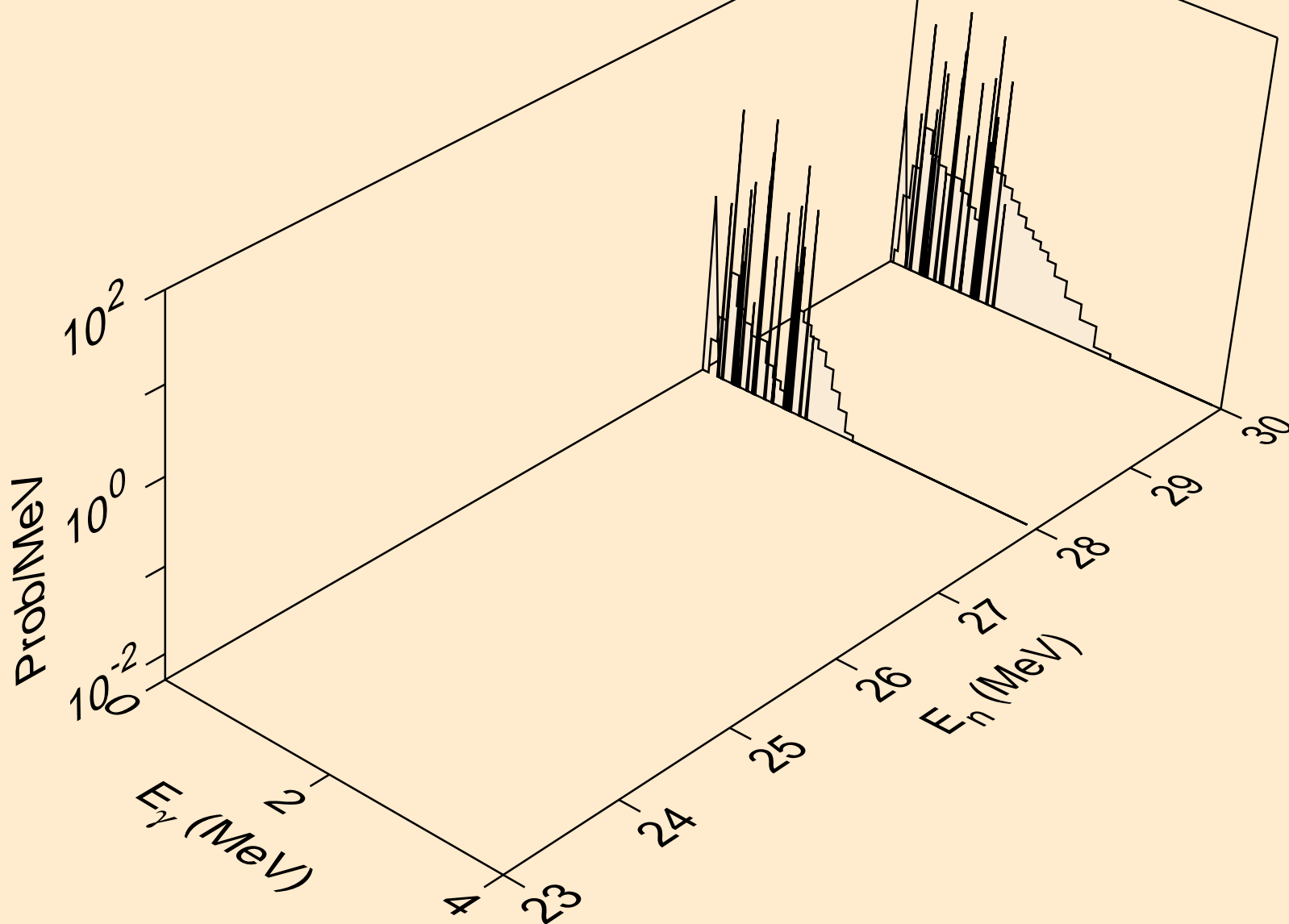

GA066 NEUTRON ACER TENDL-2019 LIBRARY; T=293.16K  
Photon emission for (n,2n)

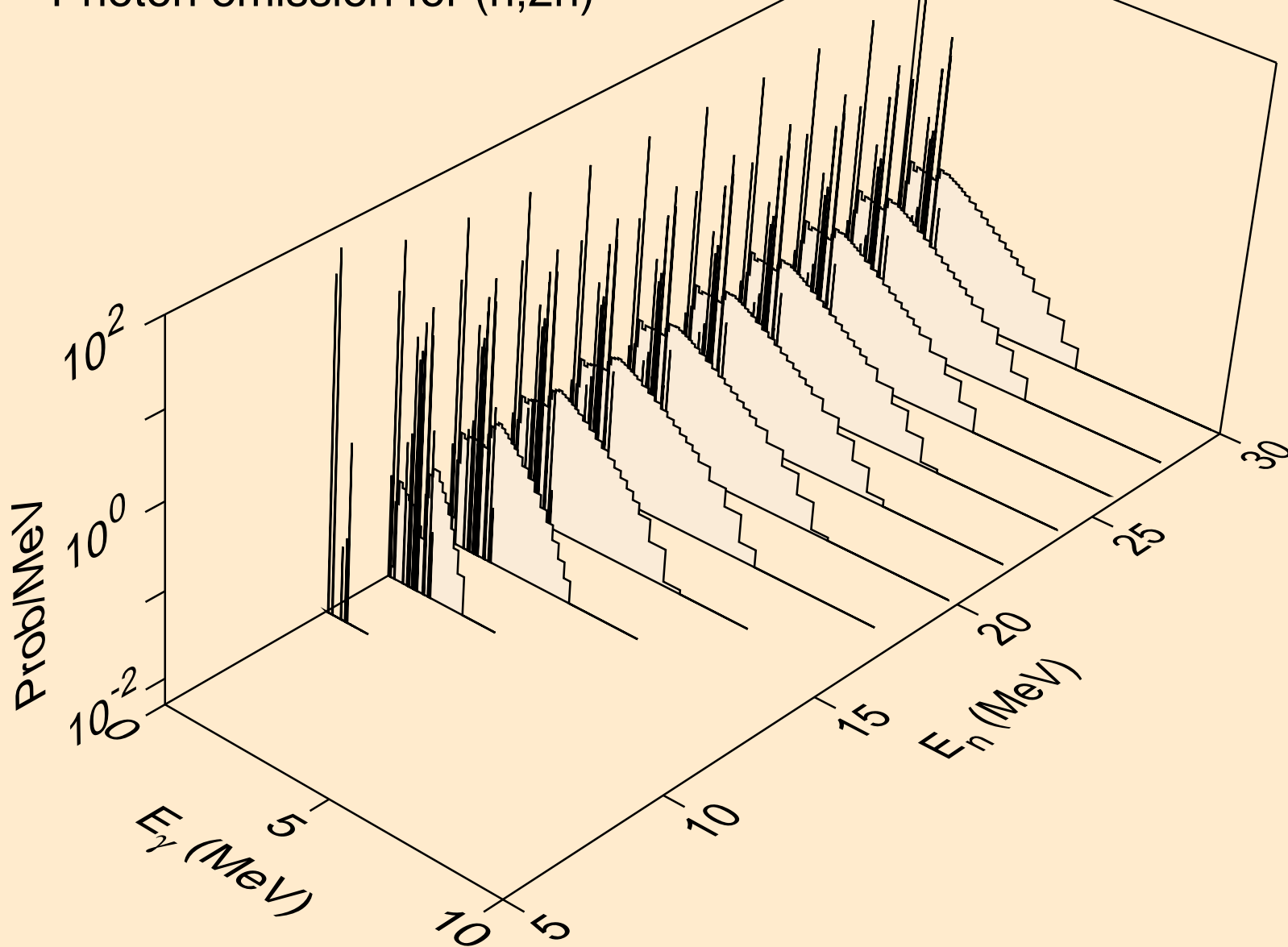

GA066 NEUTRON ACER TENDL-2019 LIBRARY; T=293.16K  
Photon emission for (n,3n)

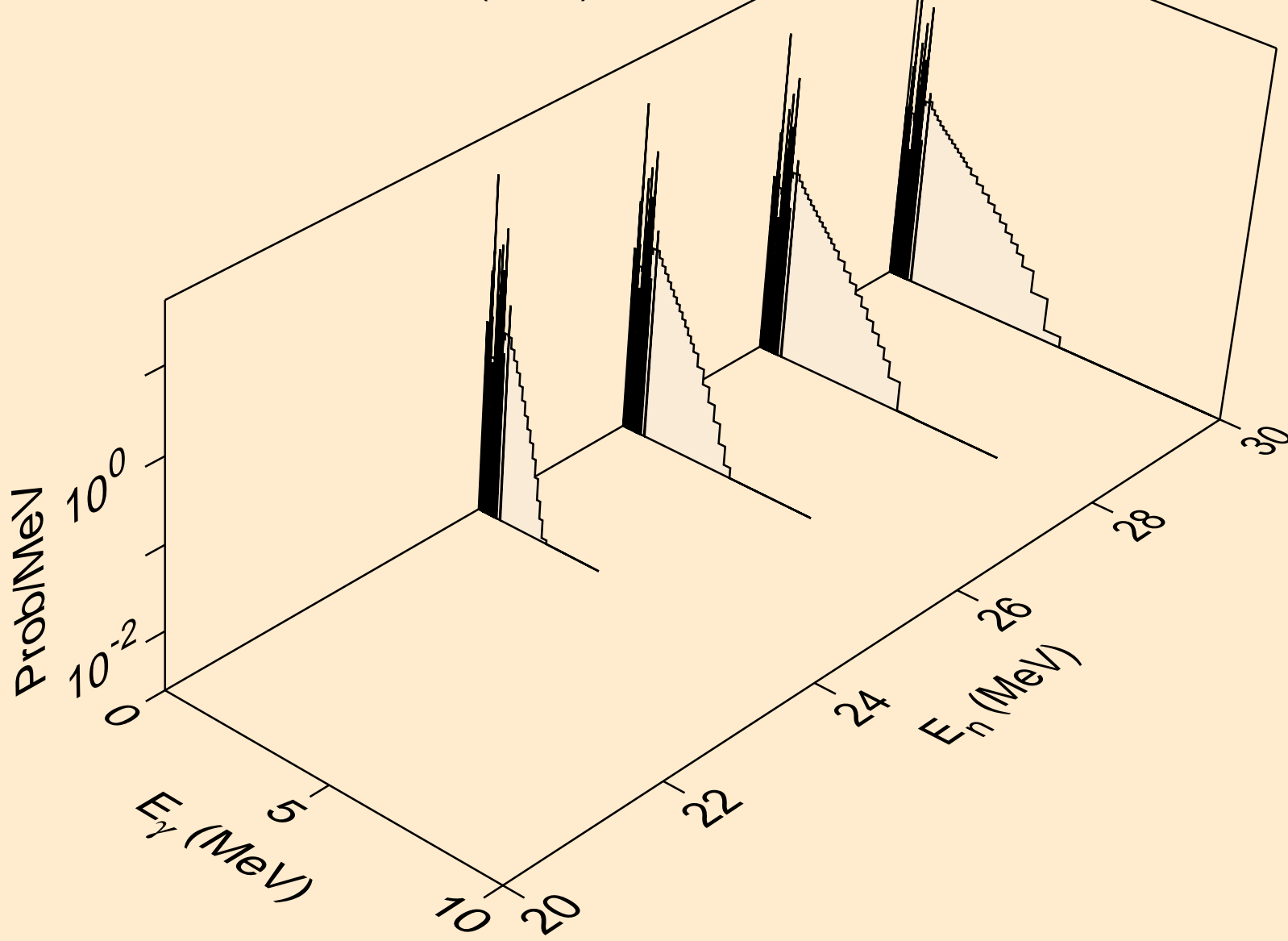

GA066 NEUTRON ACER TENDL-2019 LIBRARY; T=293.16K  
Photon emission for (n,n\*)a

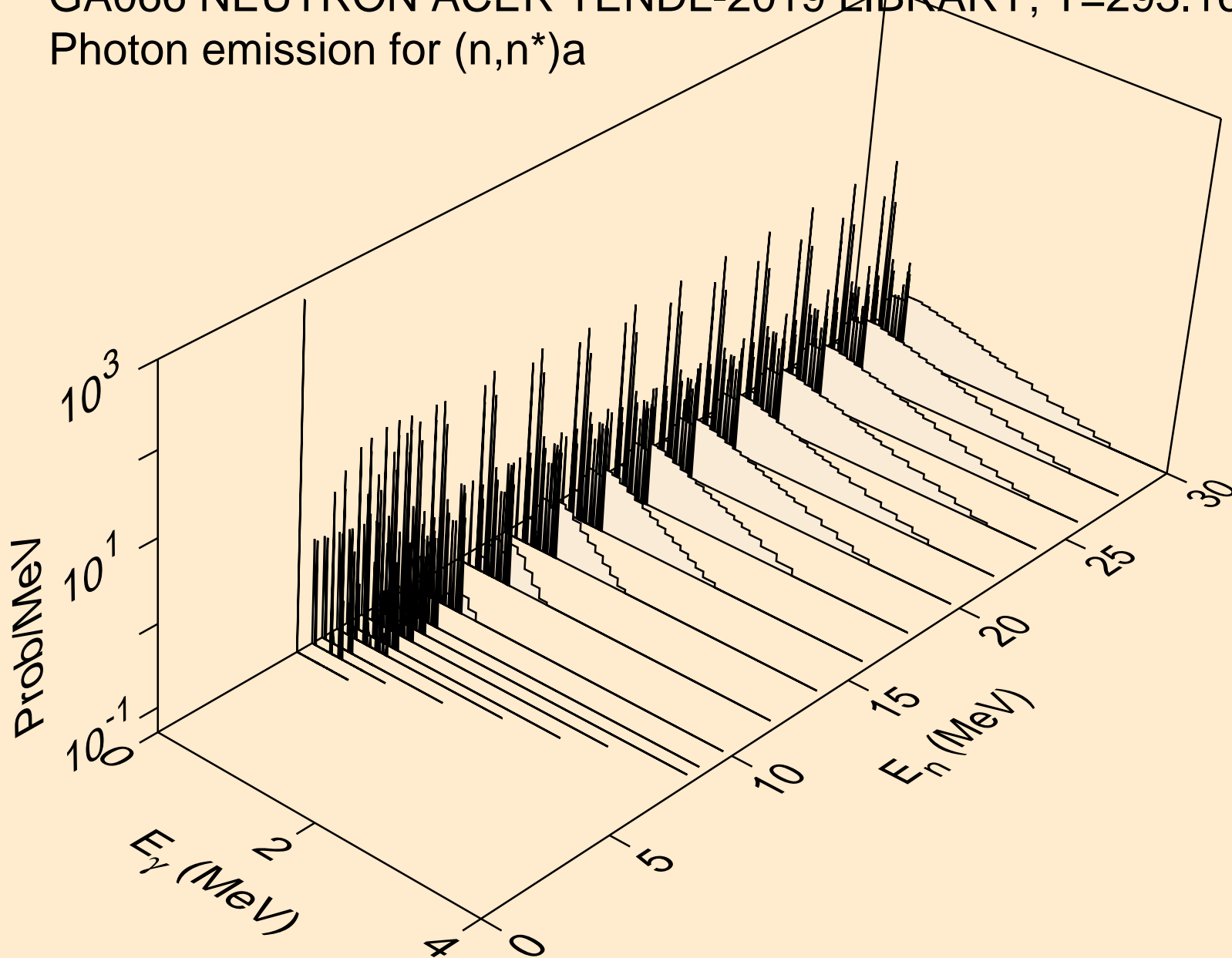

GA066 NEUTRON ACER TENDL-2019 LIBRARY; T=293.16K  
Photon emission for (n,2n)a

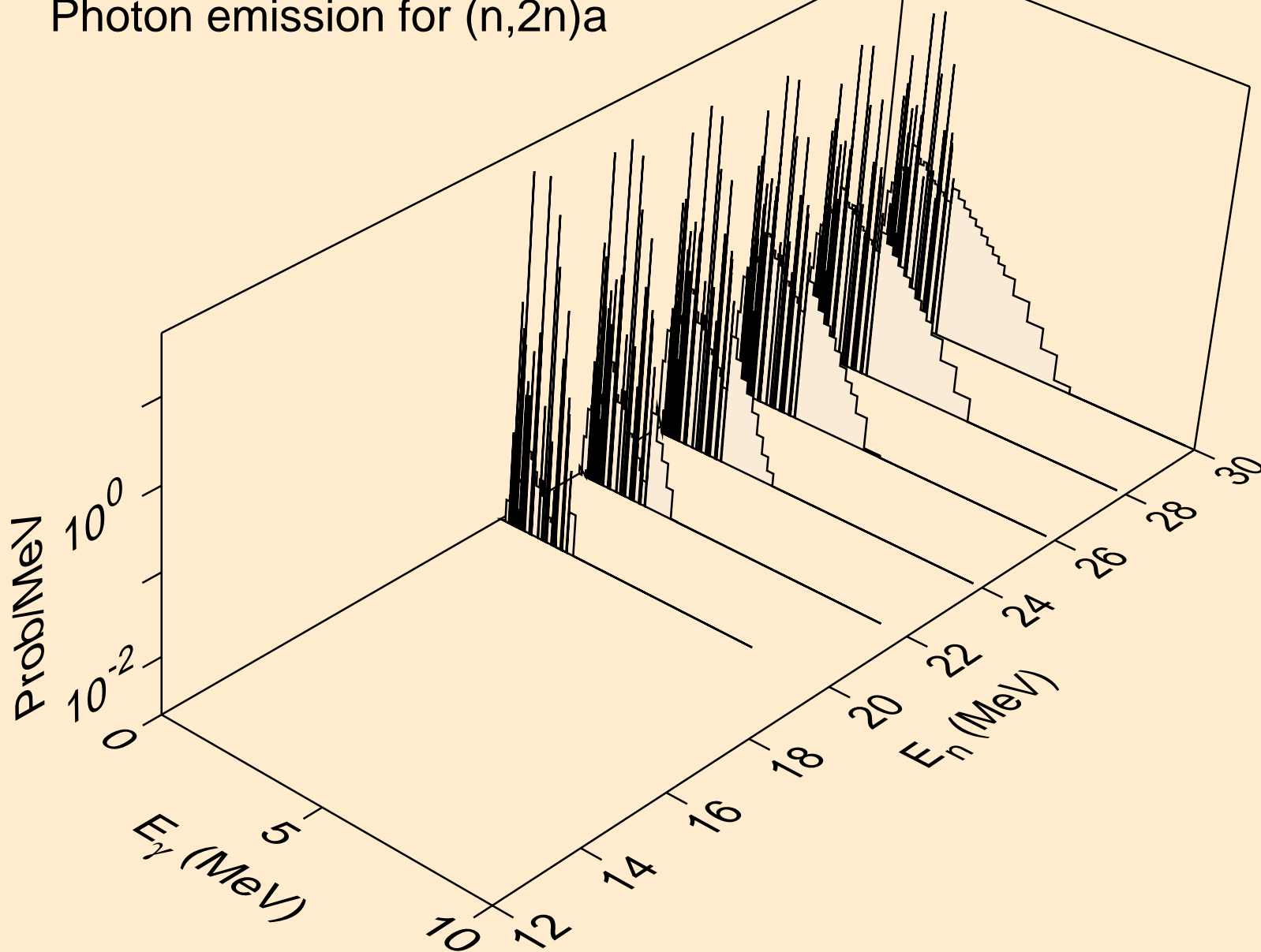

GA066 NEUTRON ACER TENDL-2019 LIBRARY; T=293.16K  
Photon emission for (n,3n)a

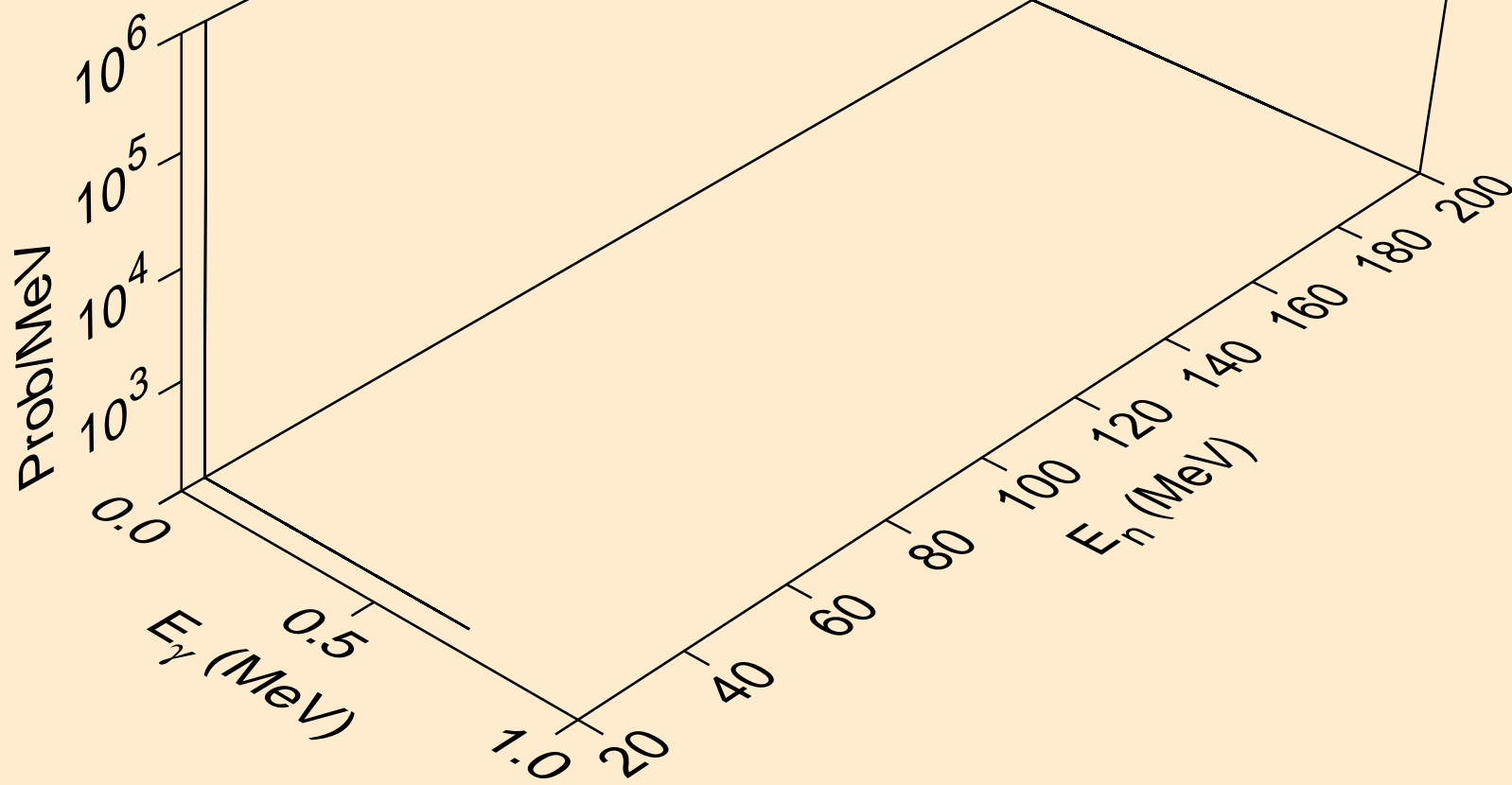

GA066 NEUTRON ACER TENDL-2019 LIBRARY; T=293.16K  
Photon emission for (n,n\*)p

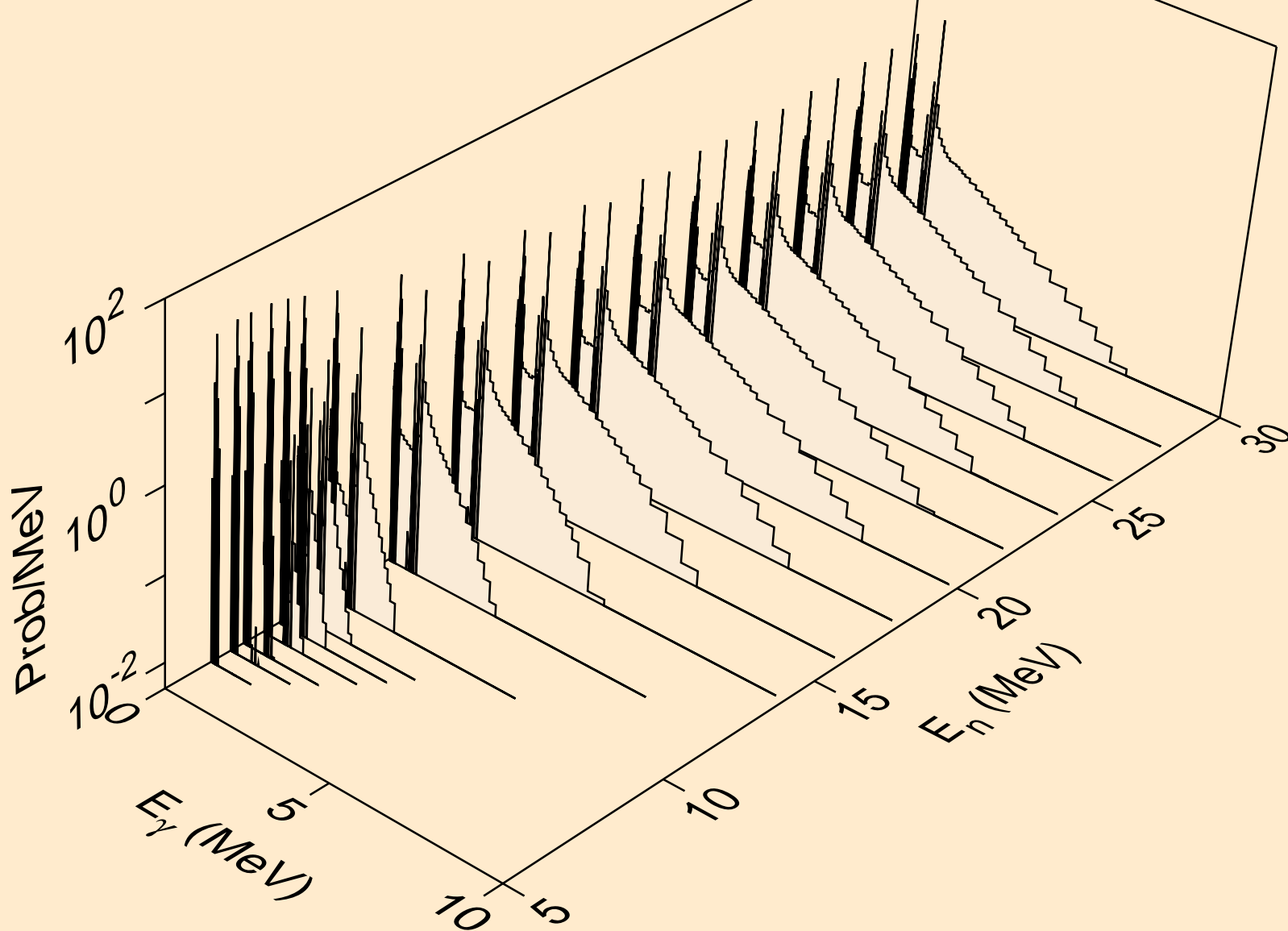

GA066 NEUTRON ACER TENDL-2019 LIBRARY; T=293.16K  
Photon emission for (n,n\*)2a

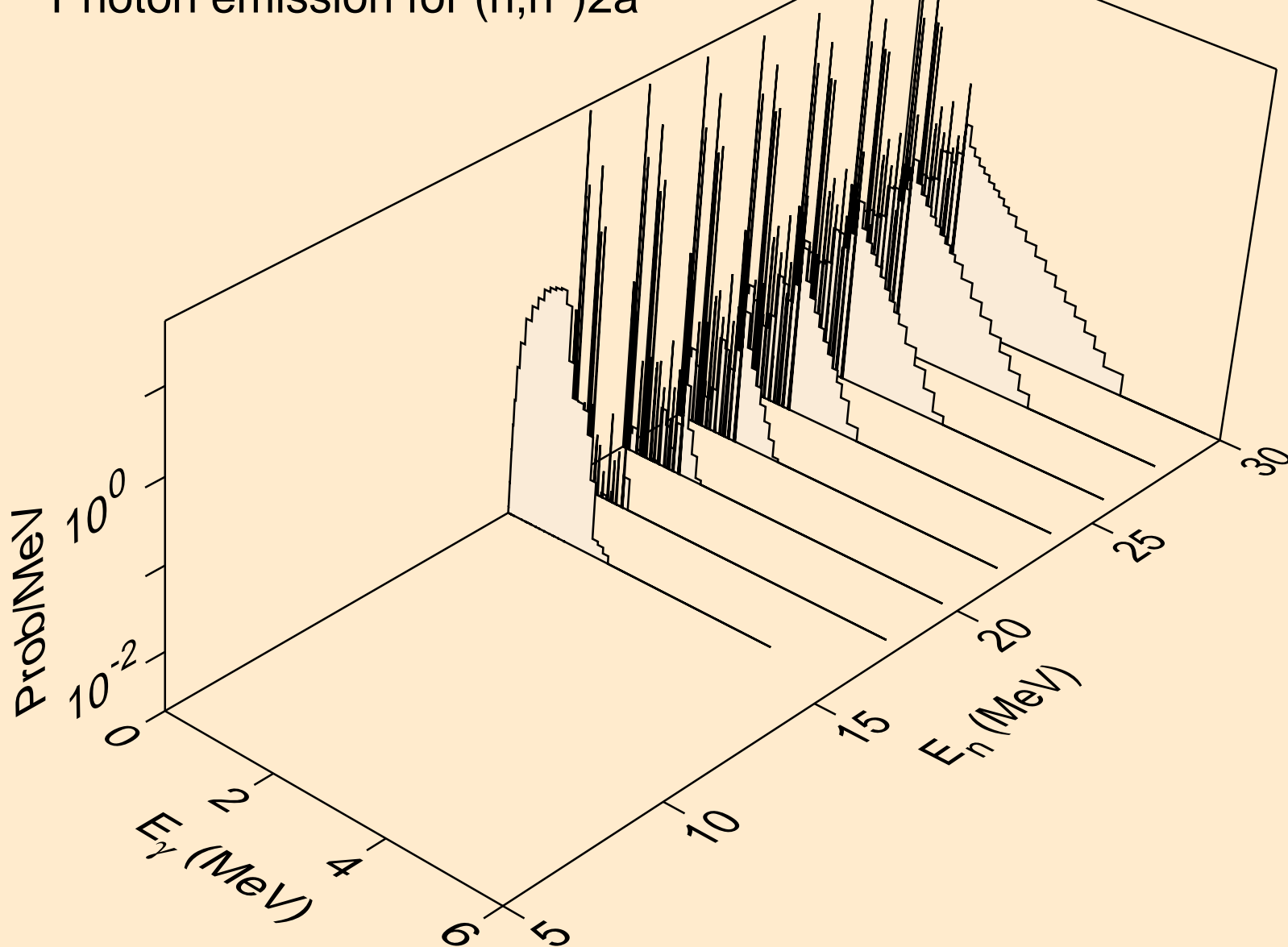

GA066 NEUTRON ACER TENDL-2019 LIBRARY; T=293.16K  
Photon emission for (n,2n)2a

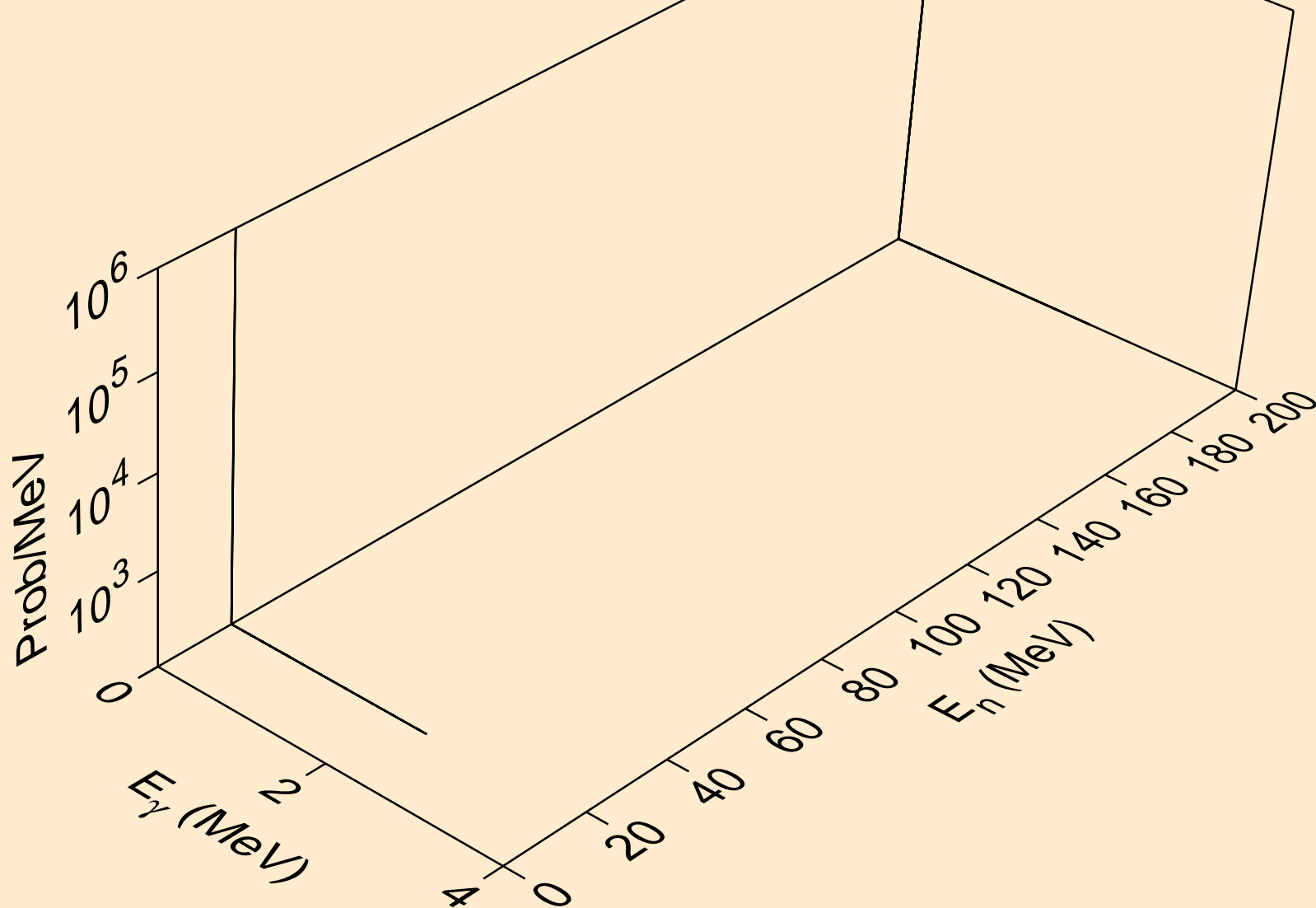

GA066 NEUTRON ACER TENDL-2019 LIBRARY; T=293.16K  
Photon emission for (n,n\*)d

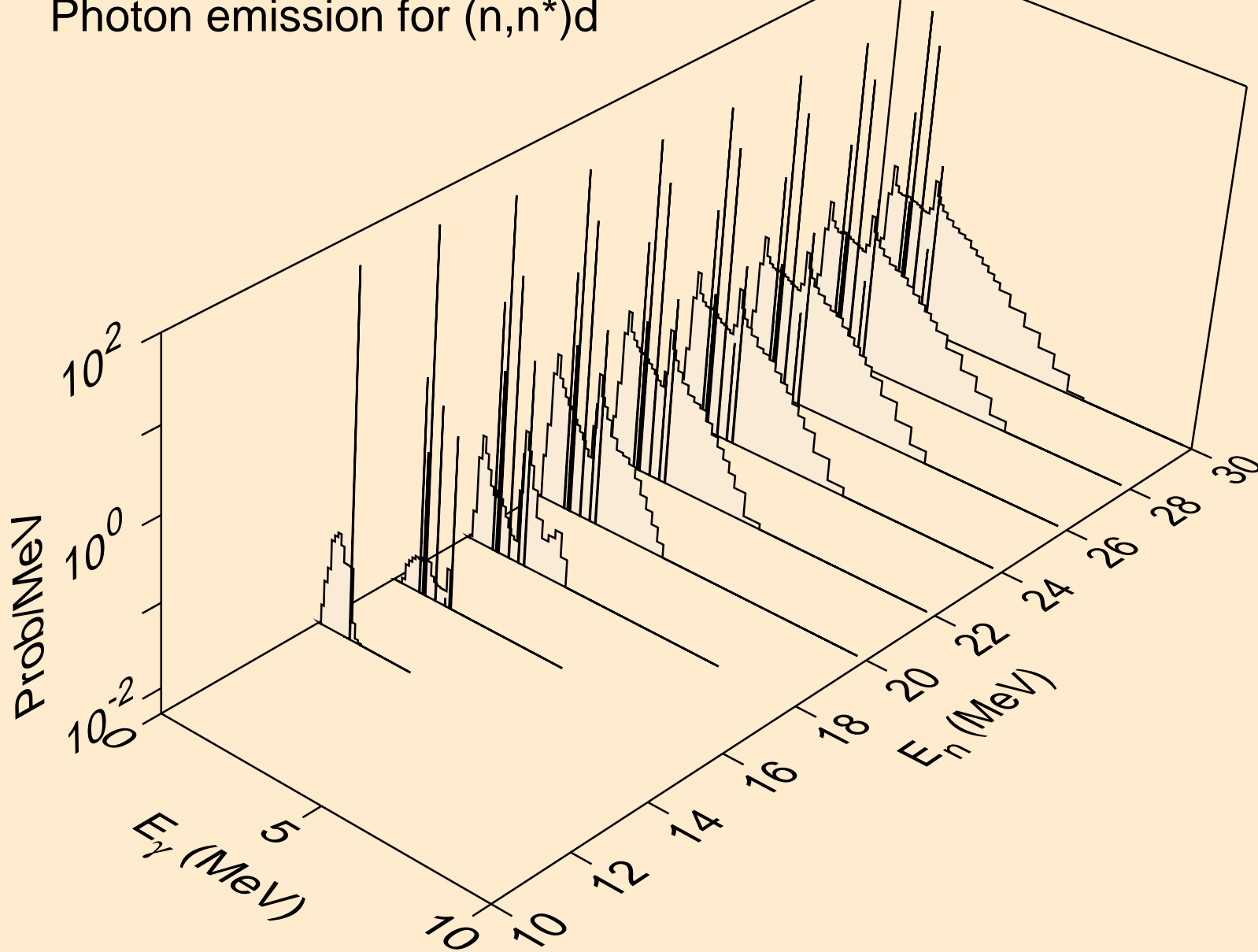

GA066 NEUTRON ACER TENDL-2019 LIBRARY; T=293.16K  
Photon emission for (n,n\*)t

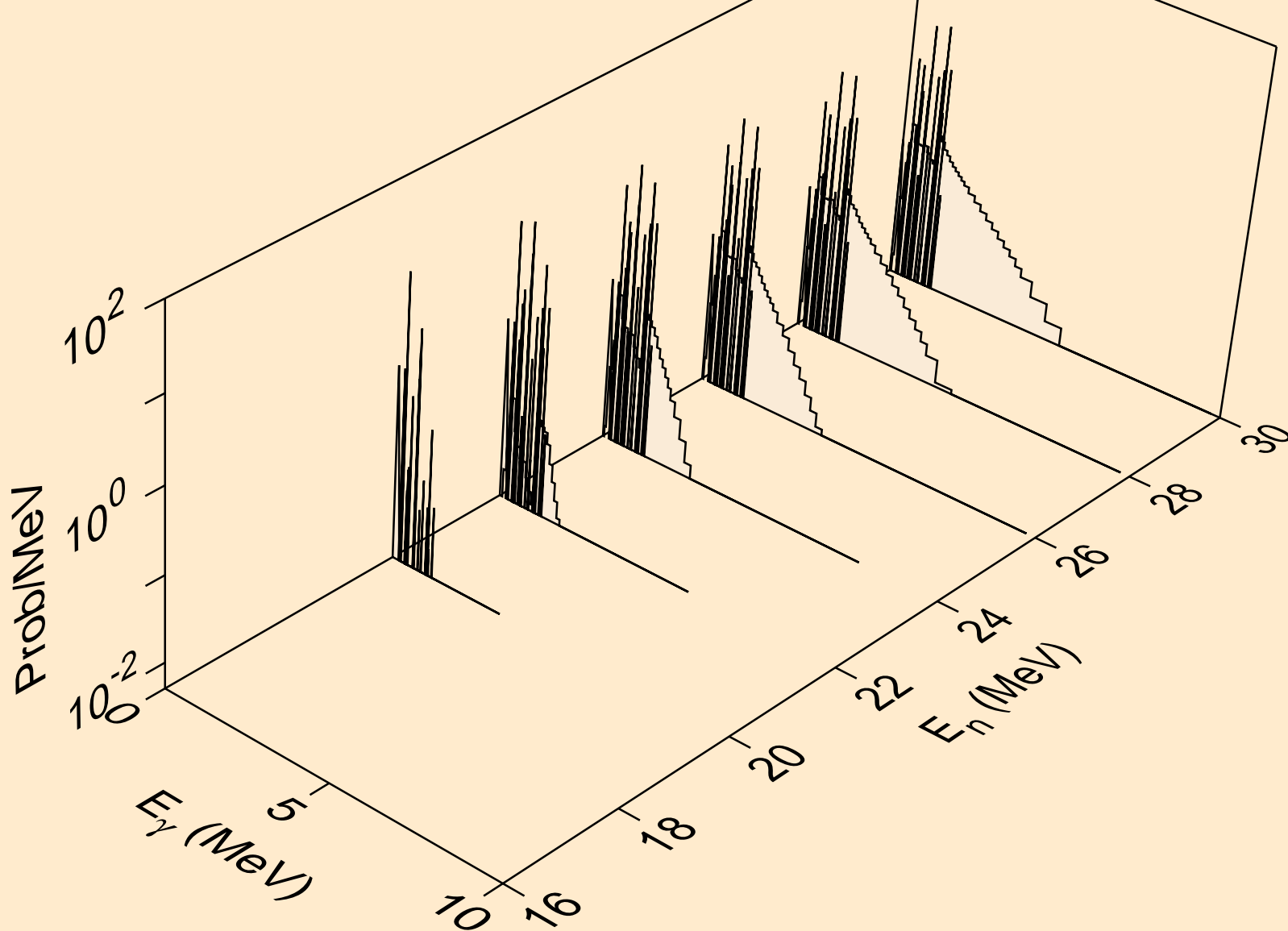

GA066 NEUTRON ACER TENDL-2019 LIBRARY; T=293.16K  
Photon emission for (n,n\*)he3

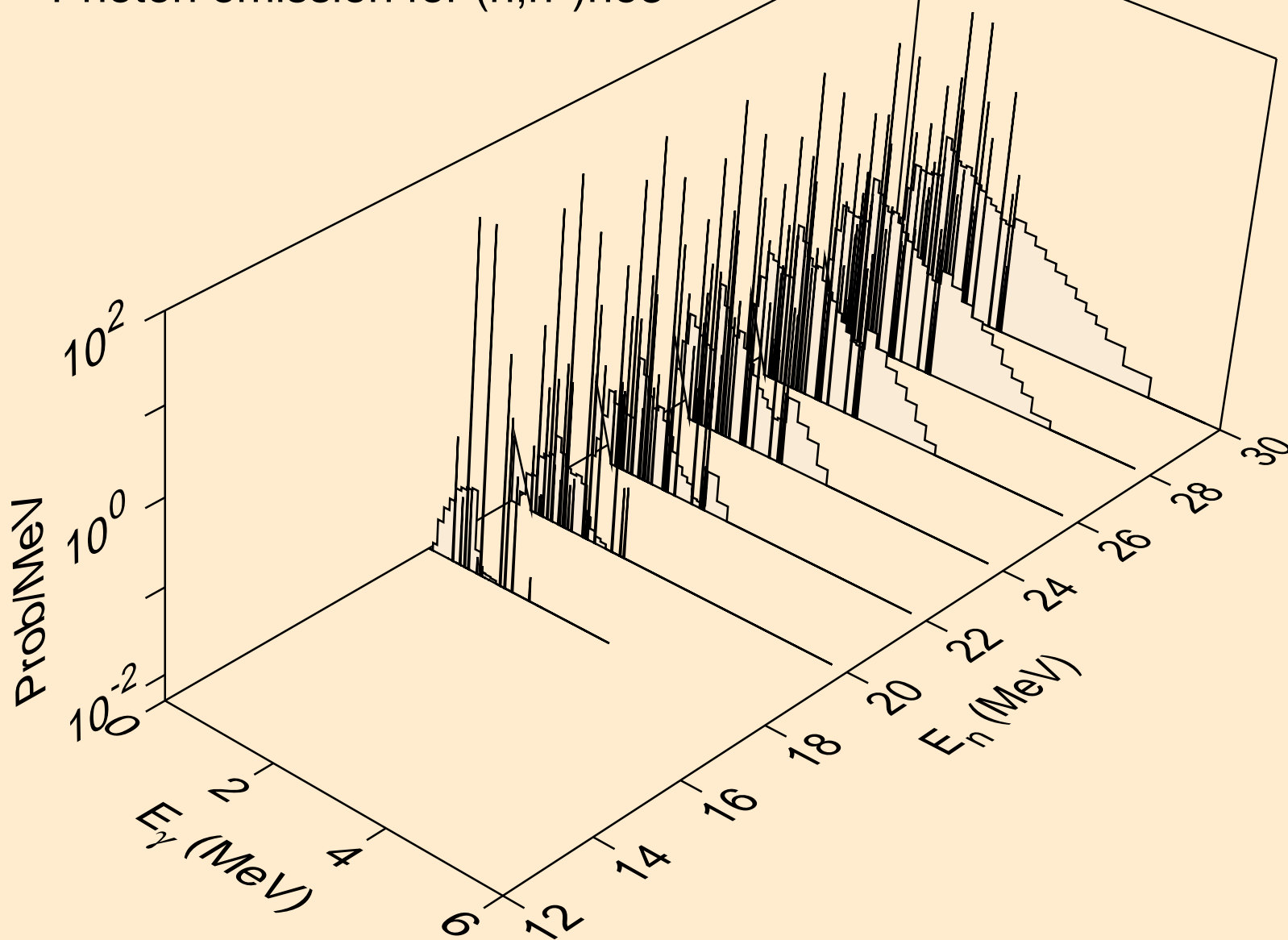

GA066 NEUTRON ACER TENDL-2019 LIBRARY; T=293.16K  
Photon emission for (n,2np)

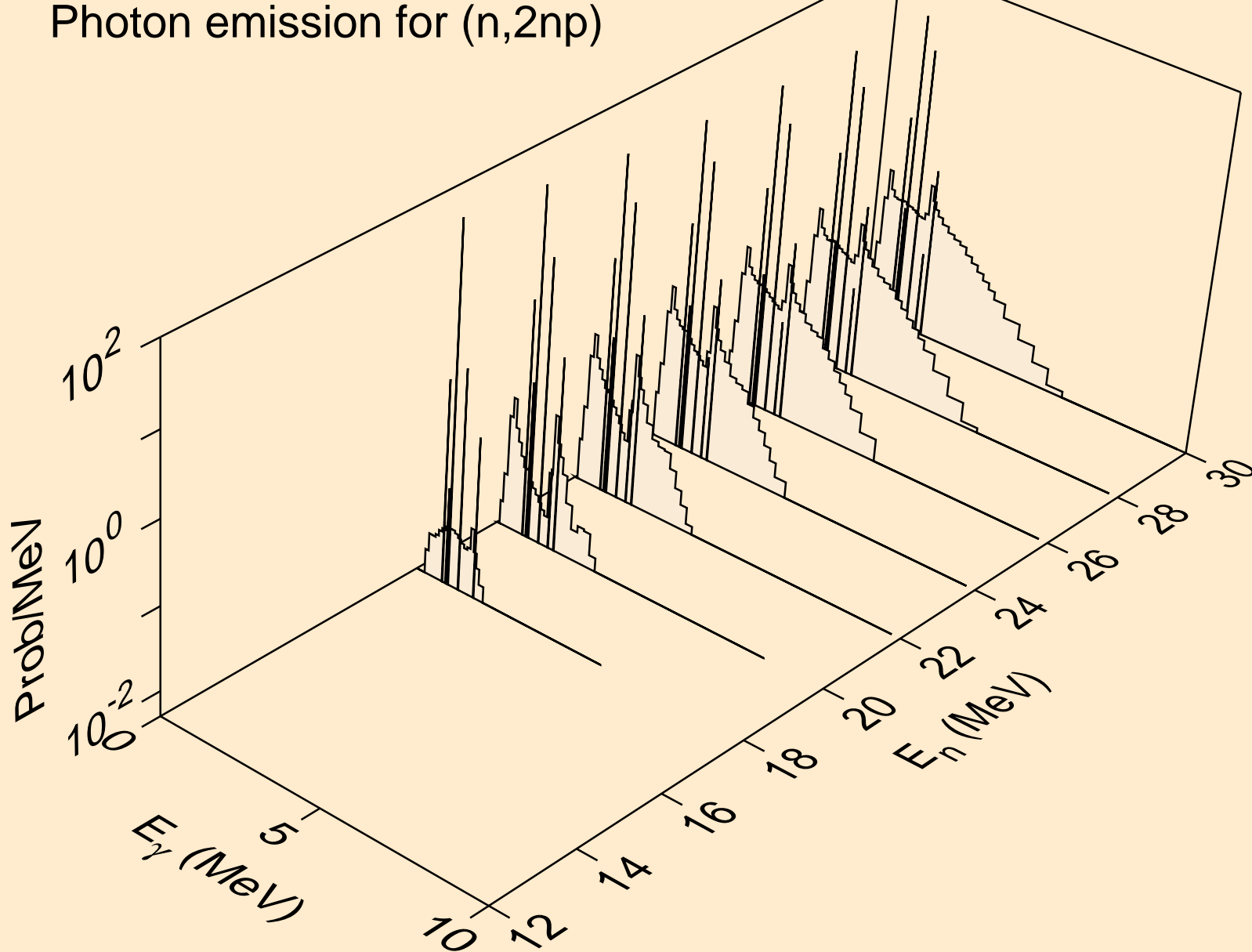

GA066 NEUTRON ACER TENDL-2019 LIBRARY; T=293.16K  
Photon emission for (n,3np)

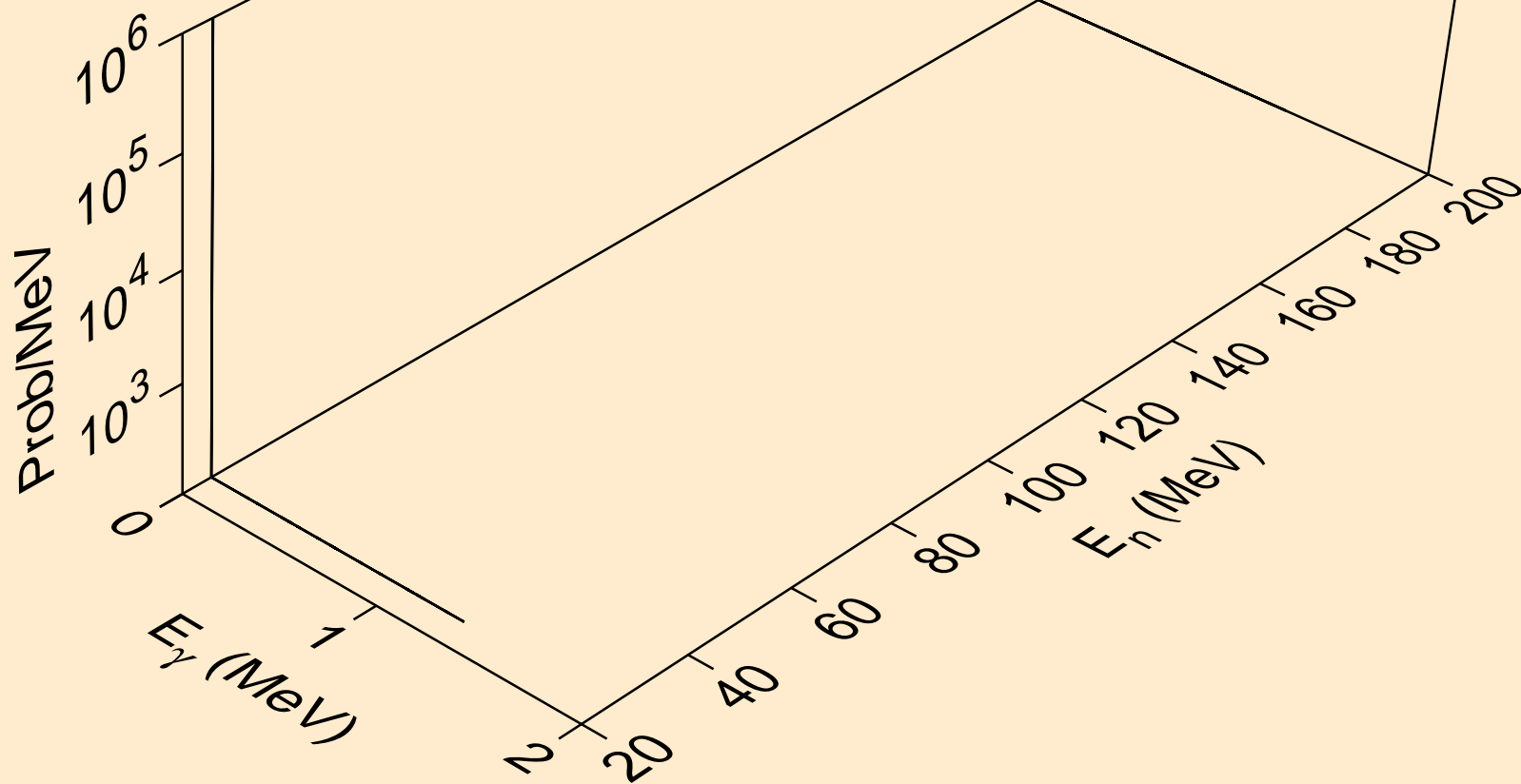

GA066 NEUTRON ACER TENDL-2019 LIBRARY; T=293.16K  
Photon emission for (n,2np)

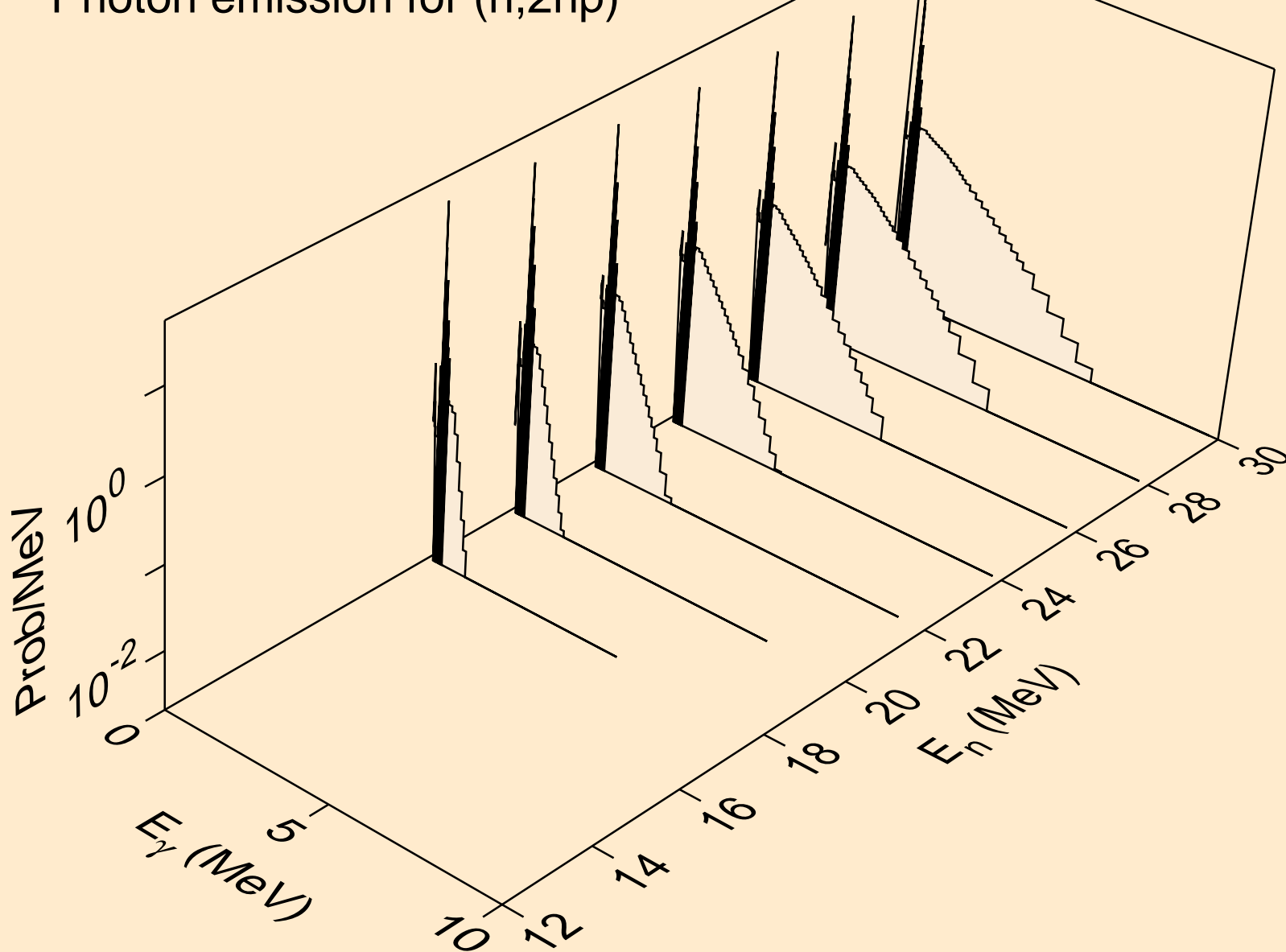

GA066 NEUTRON ACER TENDL-2019 LIBRARY; T=293.16K  
Photon emission for (n,npa)

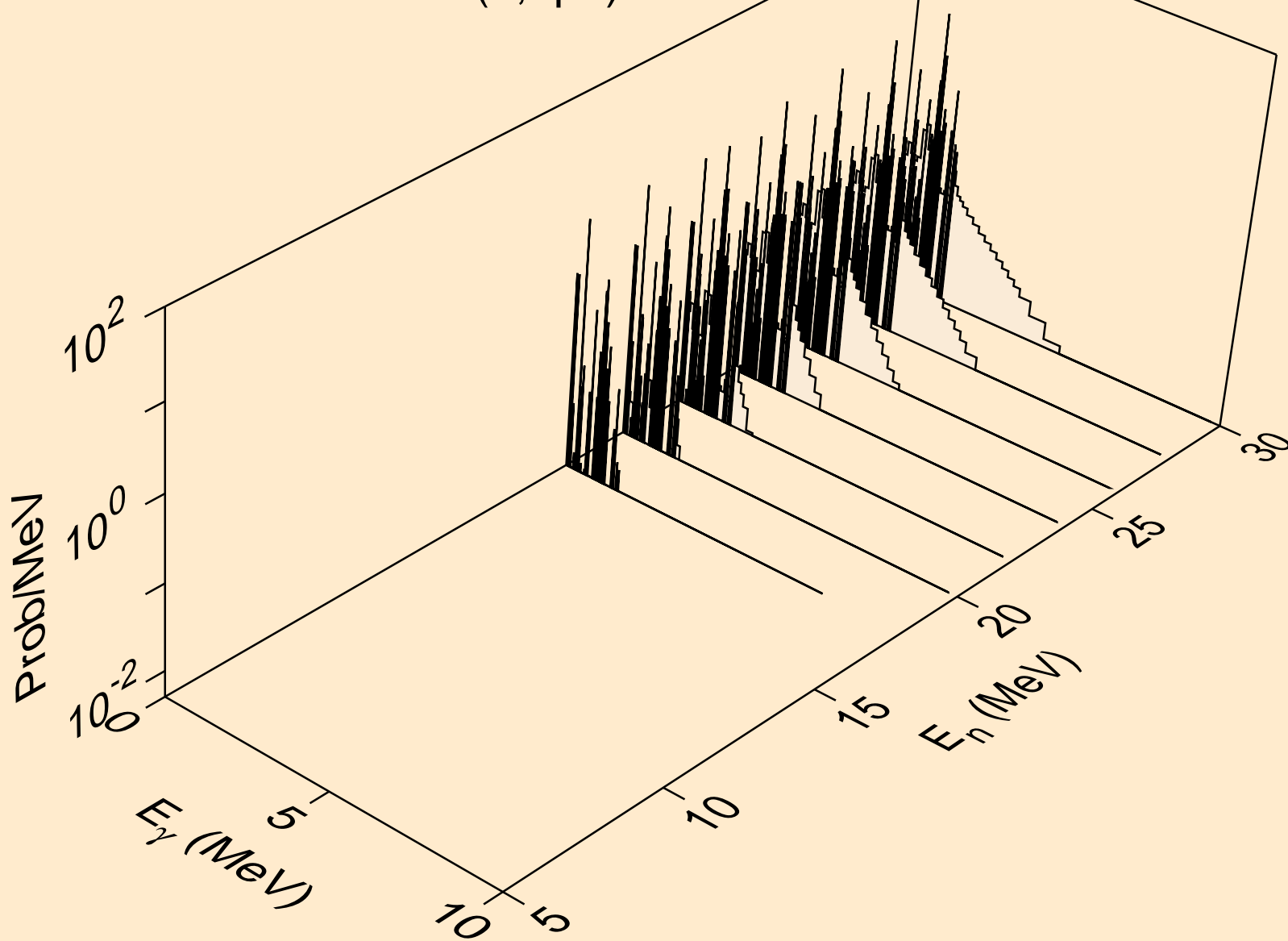

GA066 NEUTRON ACER TENDL-2019 LIBRARY; T=293.16K  
Photon emission for (n,n\*c)

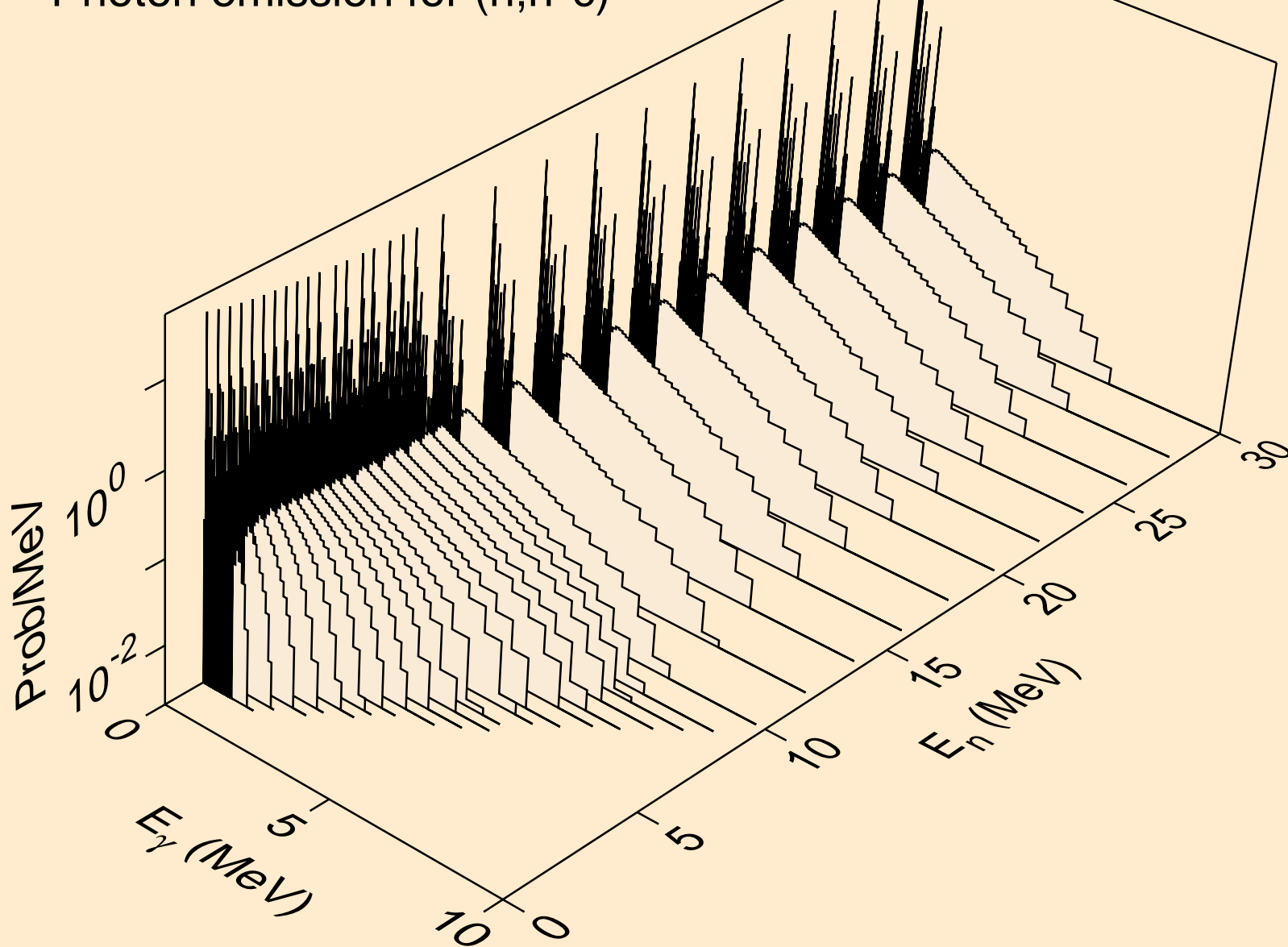

GA066 NEUTRON ACER TENDL-2019 LIBRARY; T=293.16K  
Photon emission for (n,gma)

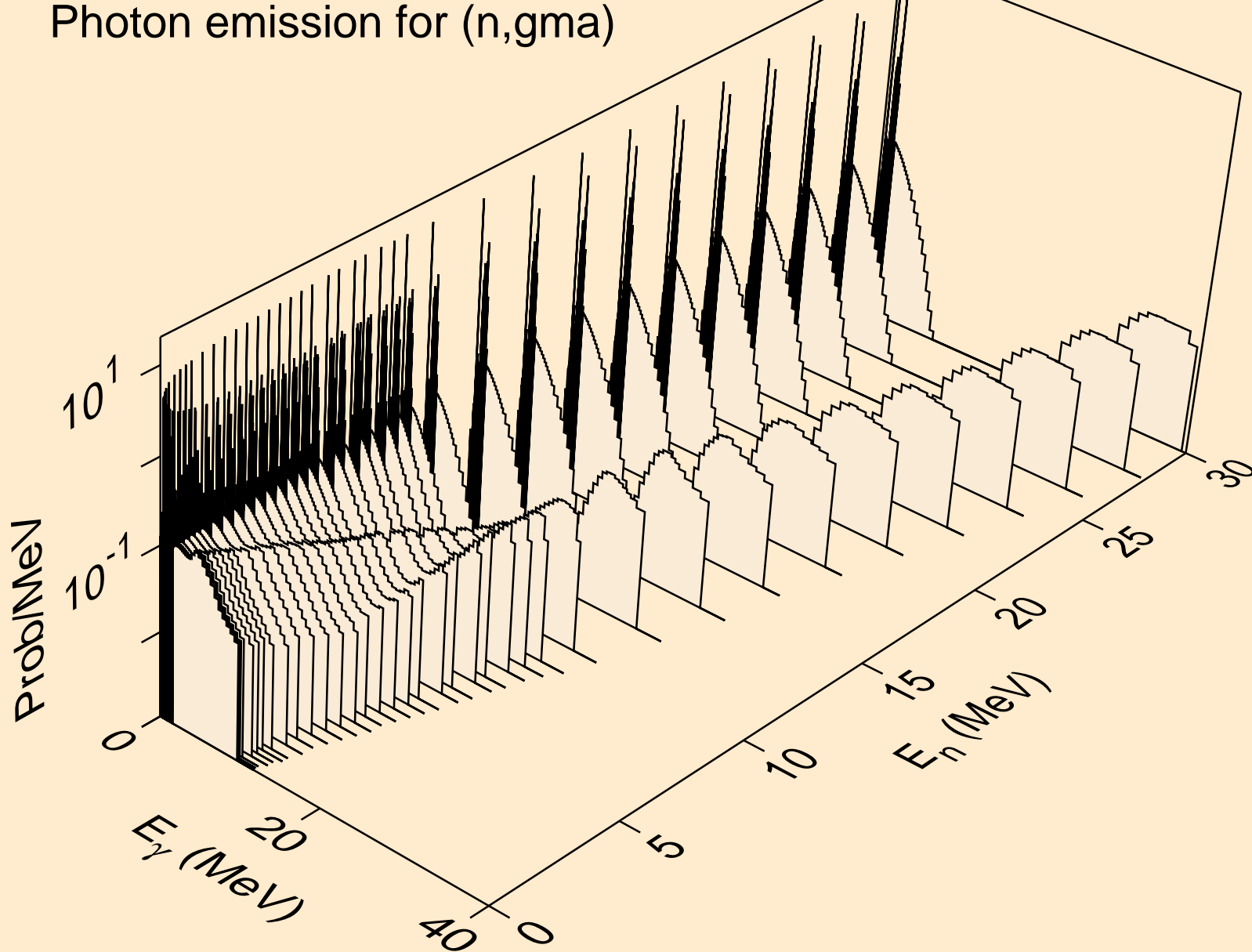

GA066 NEUTRON ACER TENDL-2019 LIBRARY; T=293.16K  
Photon emission for (n,p)

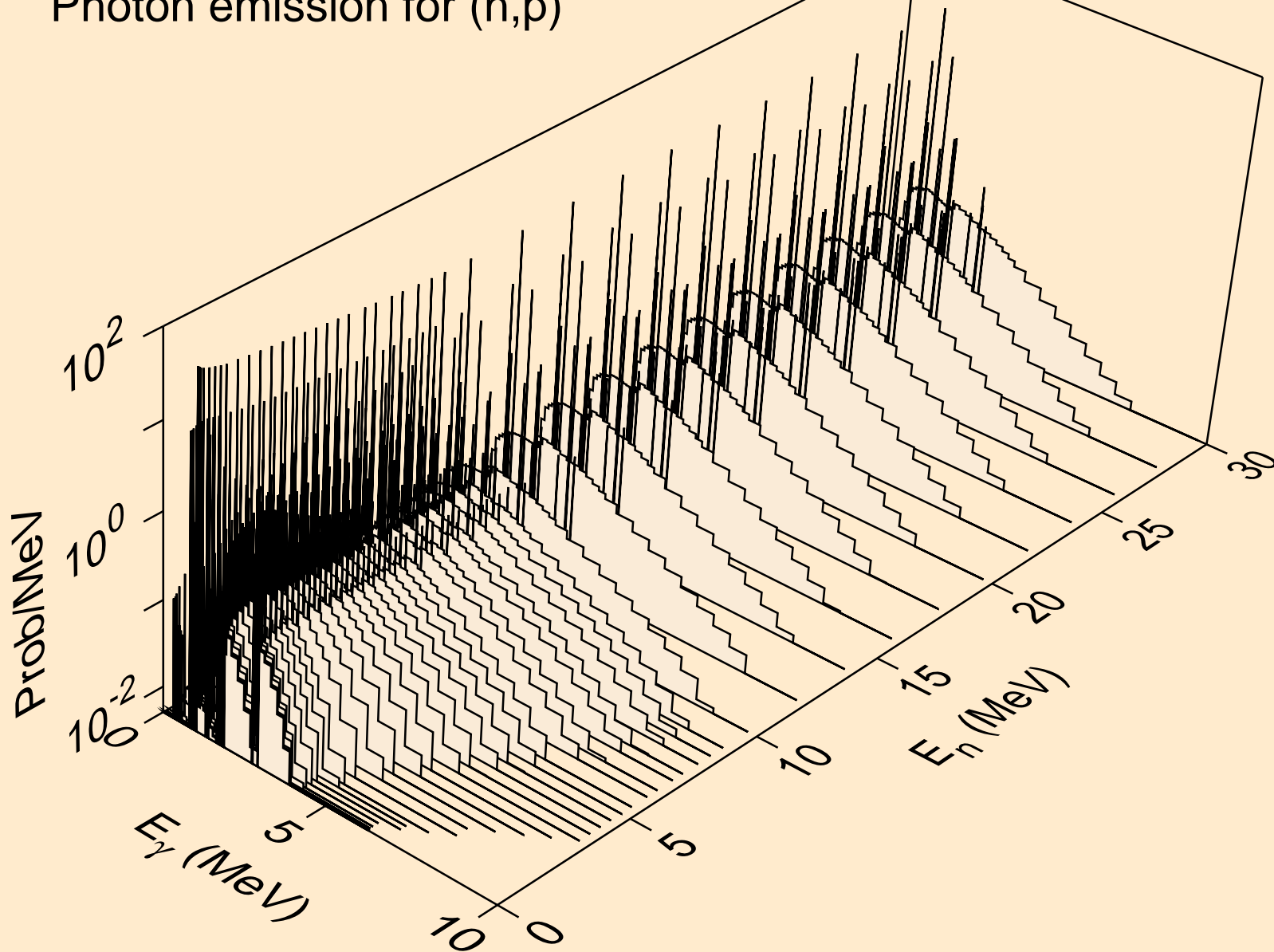

GA066 NEUTRON ACER TENDL-2019 LIBRARY; T=293.16K  
Photon emission for (n,d)

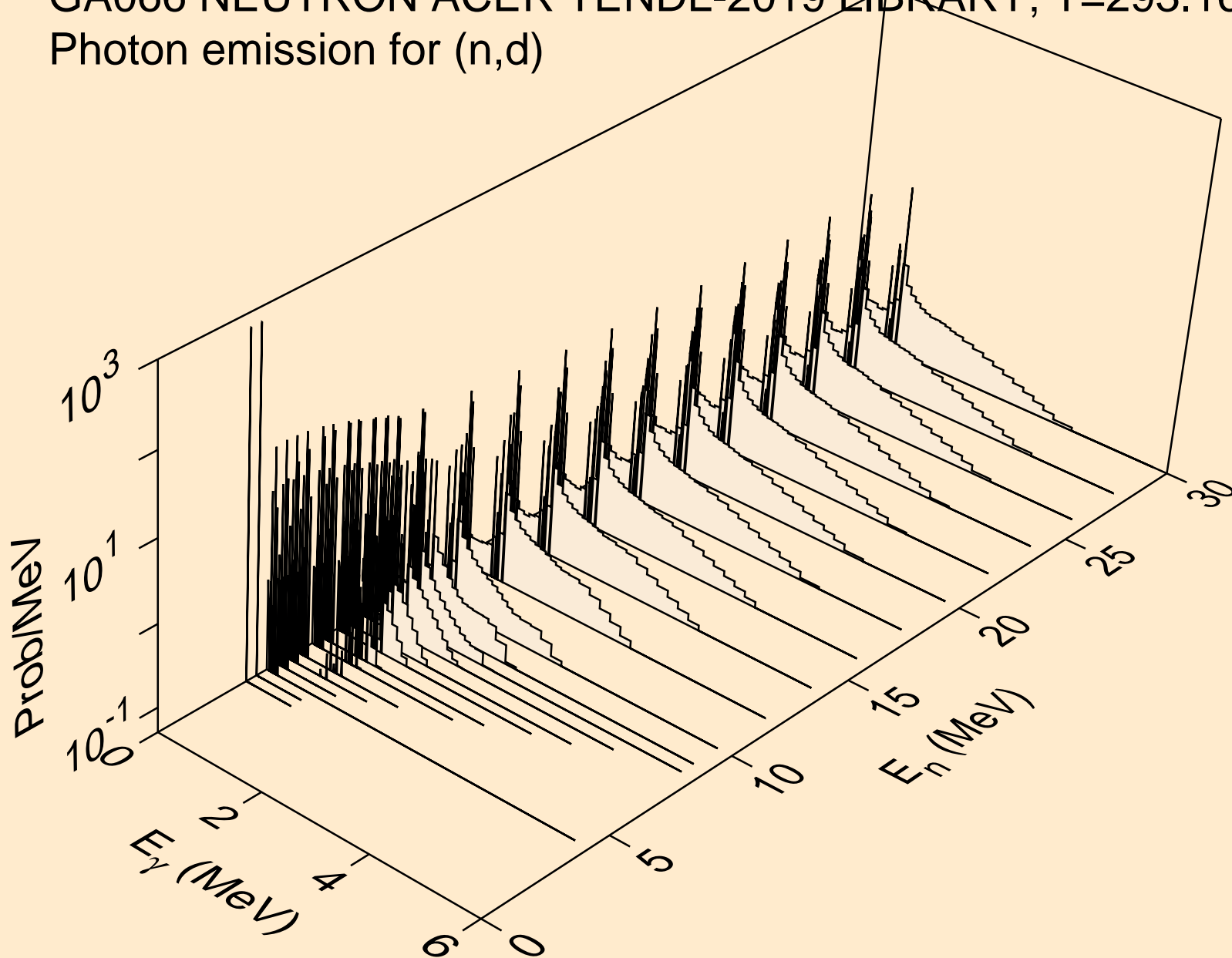

GA066 NEUTRON ACER TENDL-2019 LIBRARY; T=293.16K  
Photon emission for (n,t)

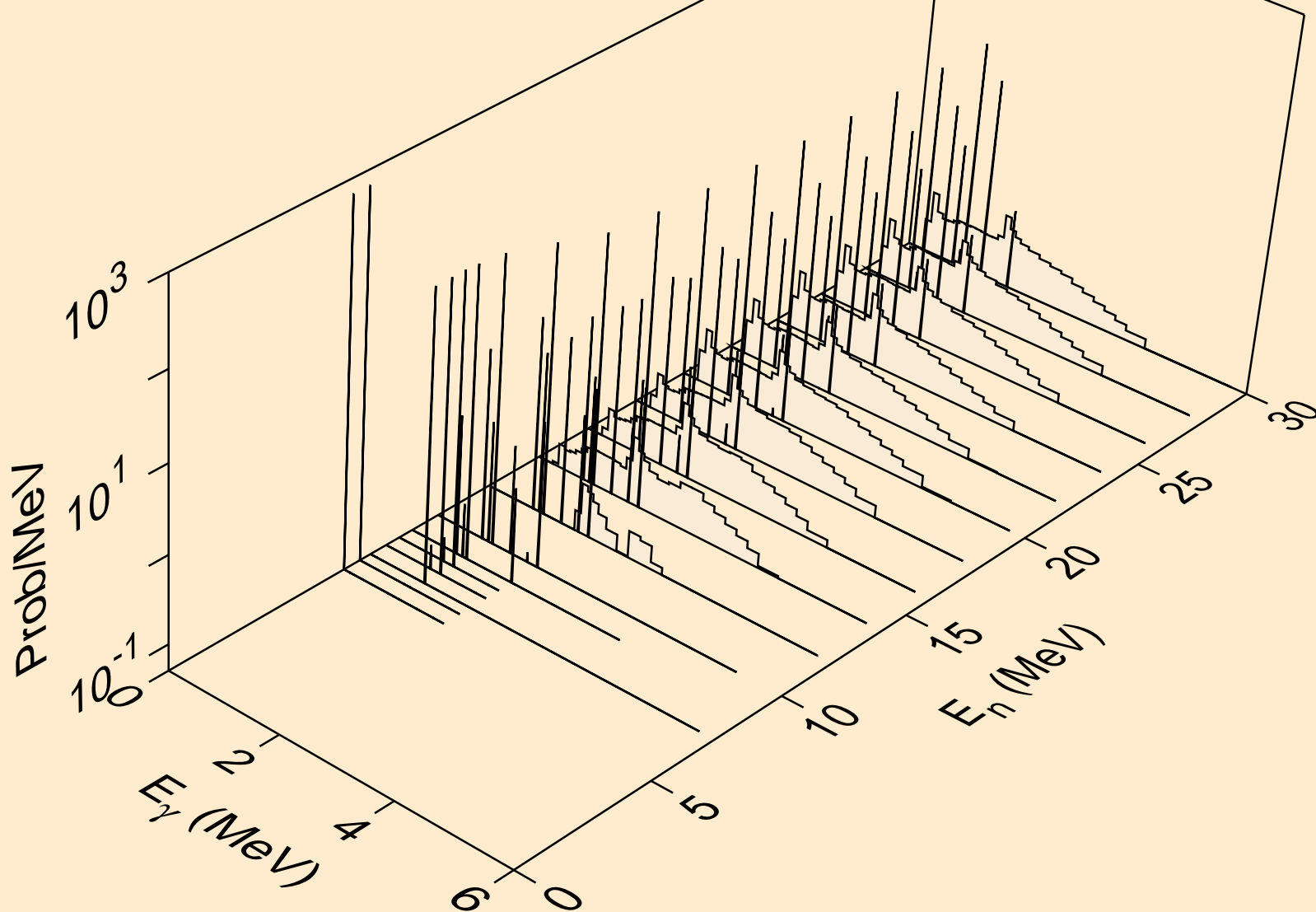

GA066 NEUTRON ACER TENDL-2019 LIBRARY; T=293.16K  
Photon emission for (n,he3)

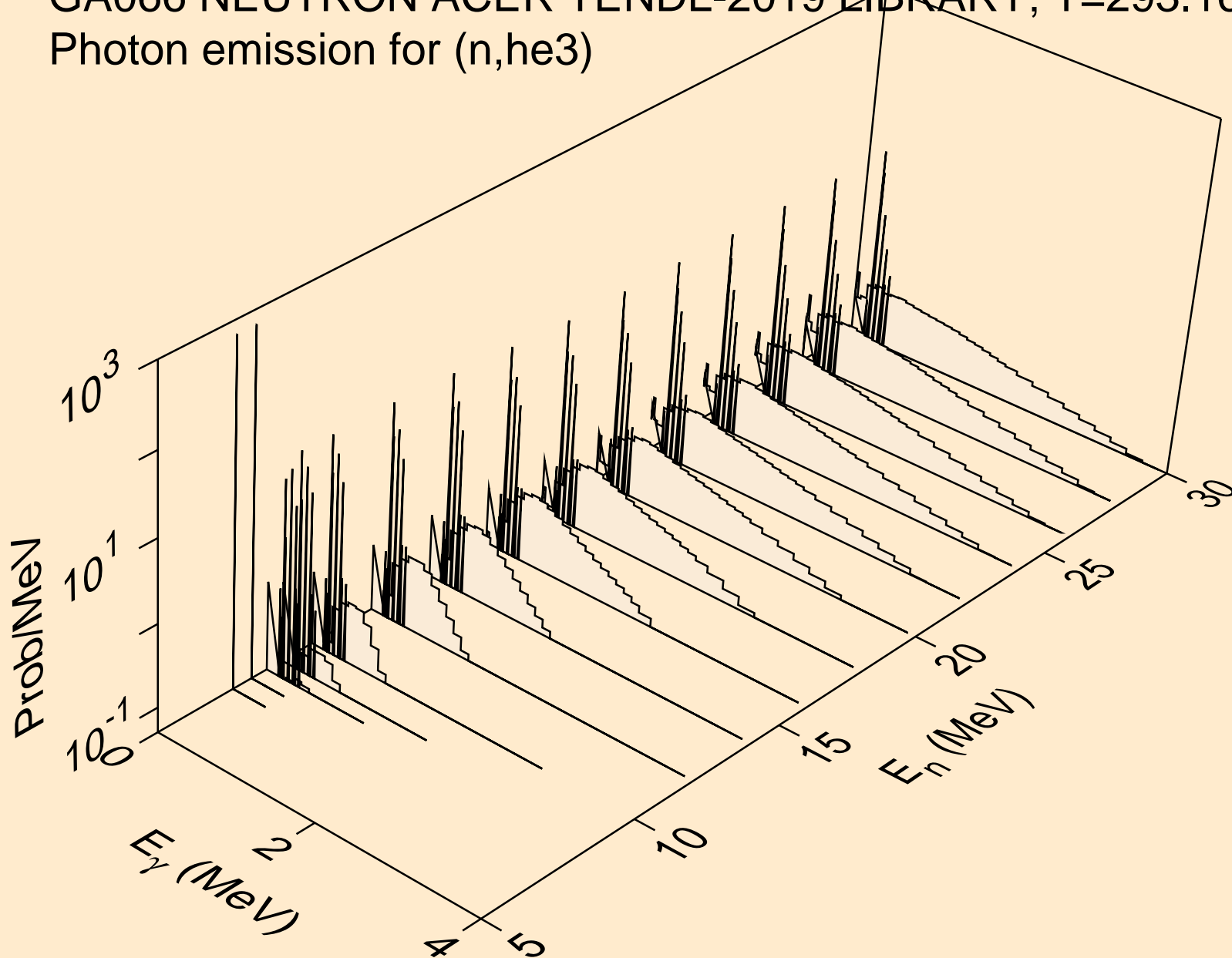

GA066 NEUTRON ACER TENDL-2019 LIBRARY; T=293.16K  
Photon emission for (n,a)

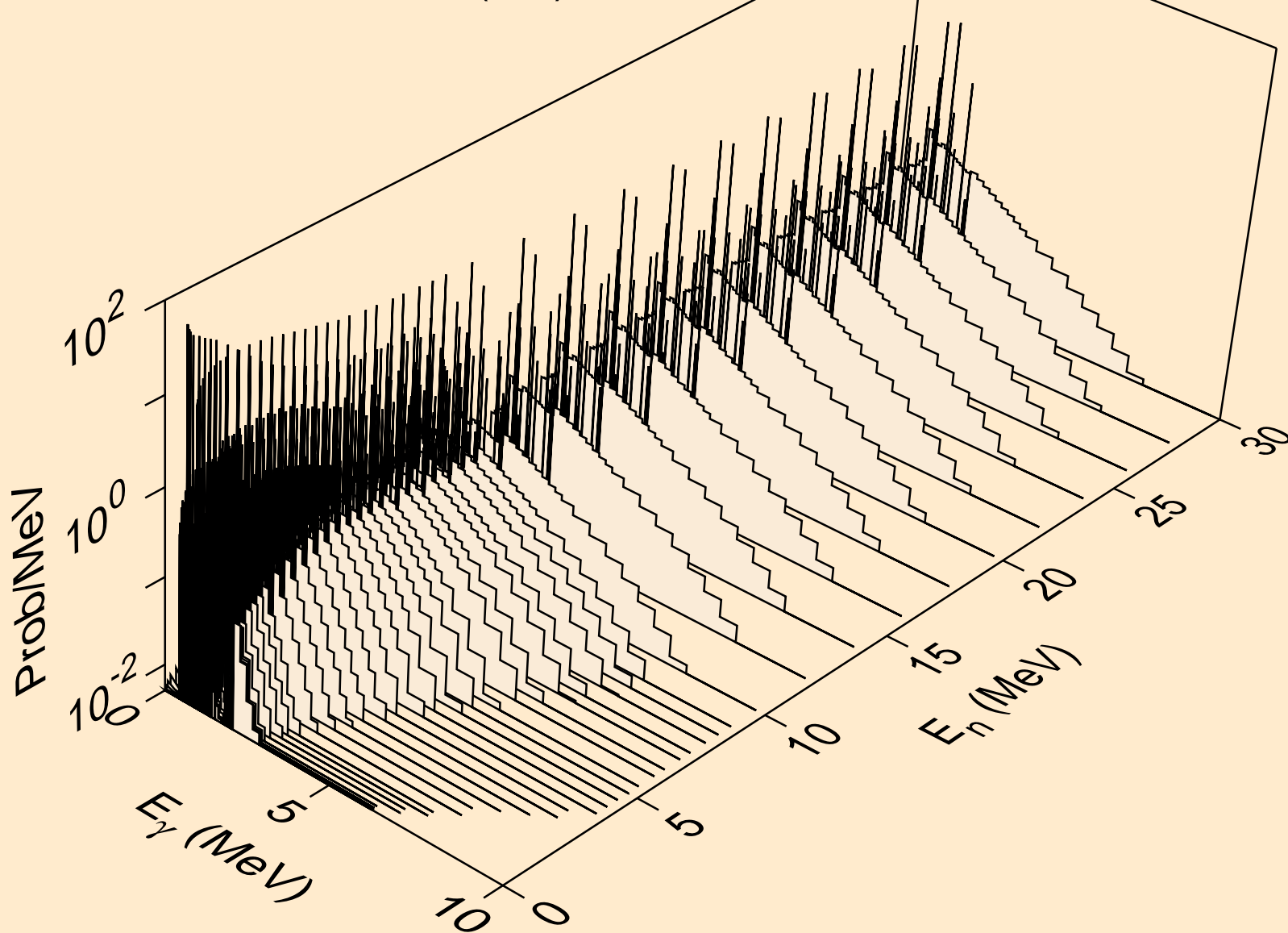

GA066 NEUTRON ACER TENDL-2019 LIBRARY; T=293.16K  
Photon emission for (n,2a)

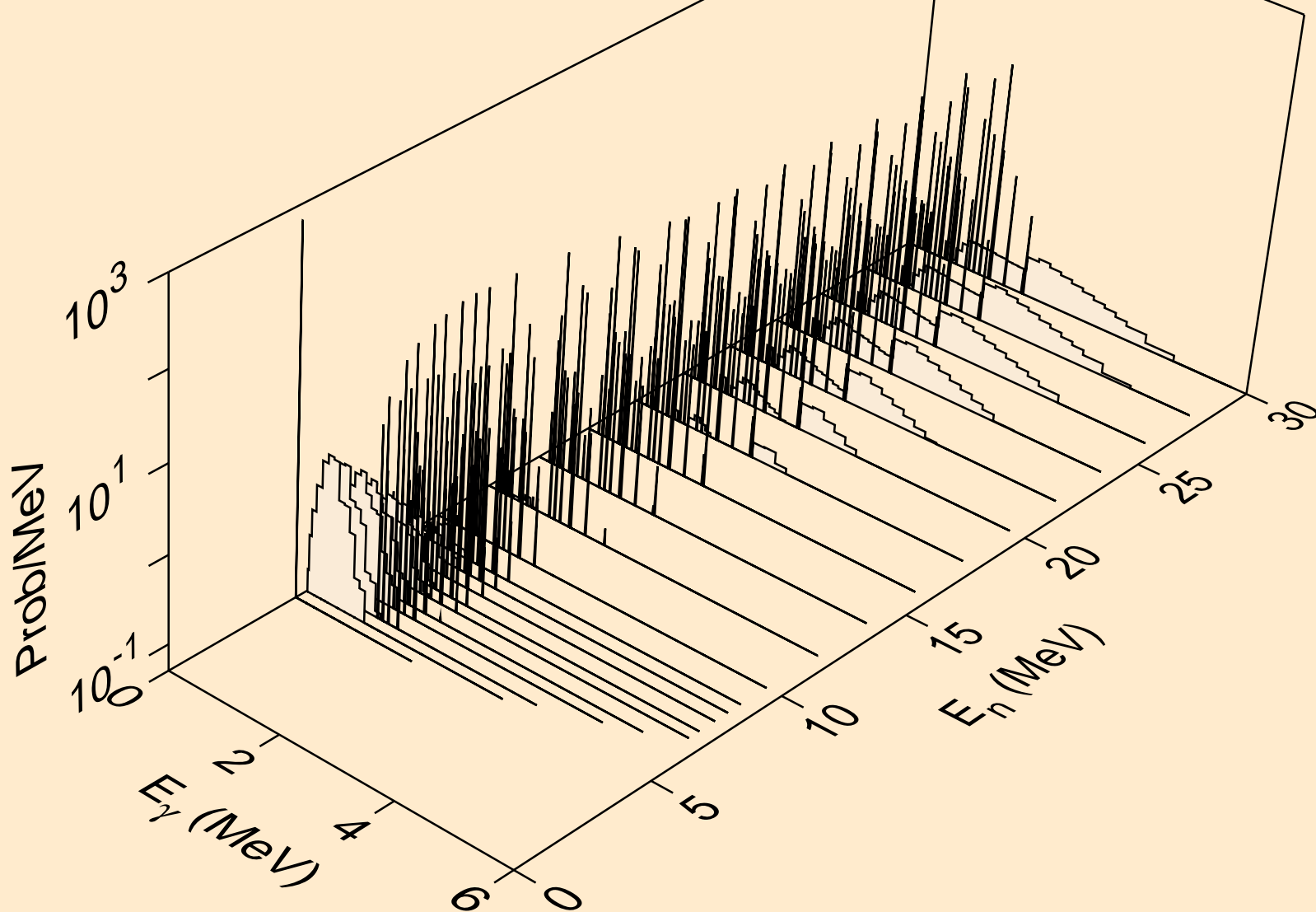

GA066 NEUTRON ACER TENDL-2019 LIBRARY; T=293.16K  
Photon emission for (n,3a)

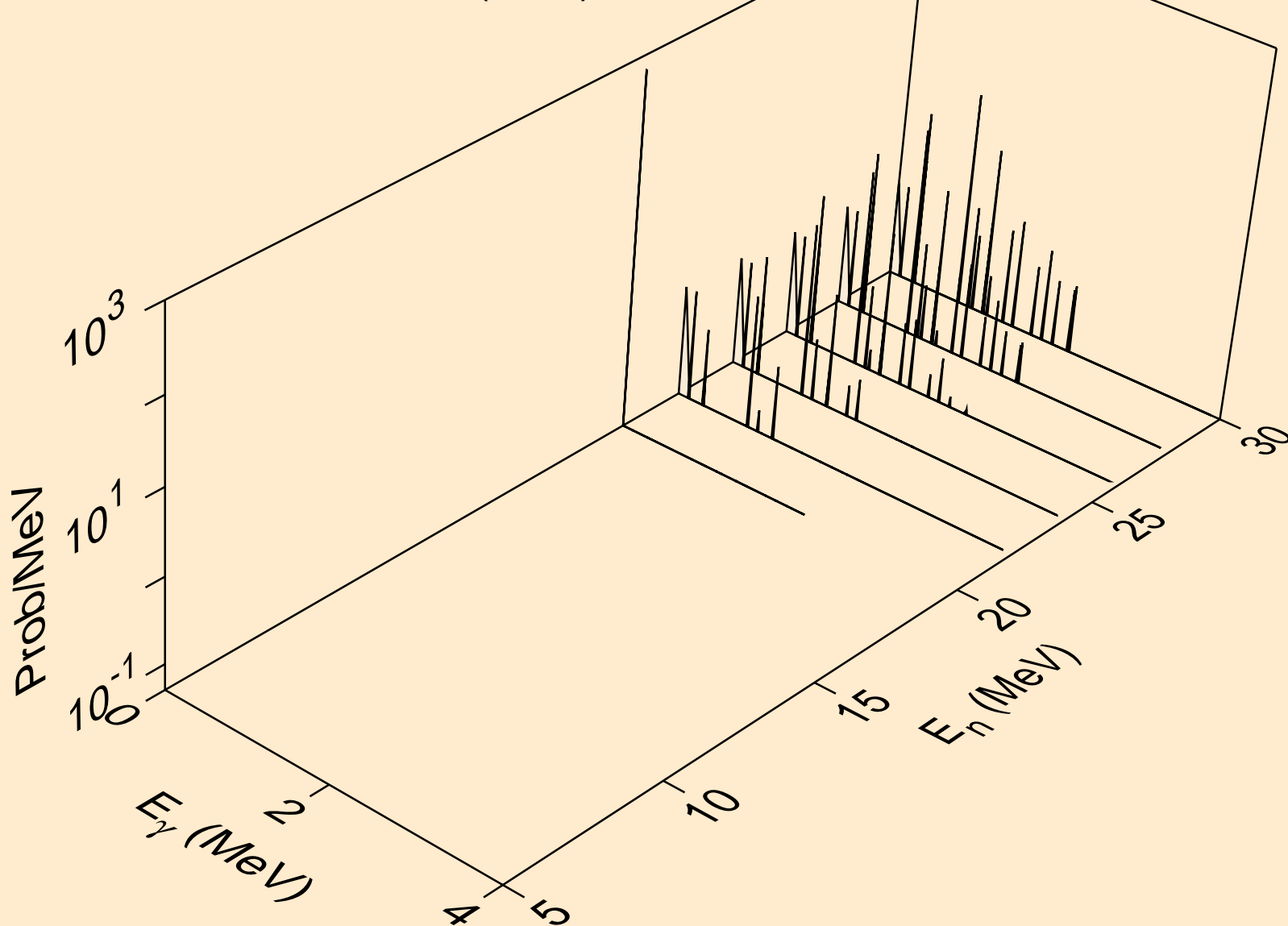

GA066 NEUTRON ACER TENDL-2019 LIBRARY; T=293.16K  
Photon emission for (n,2p)

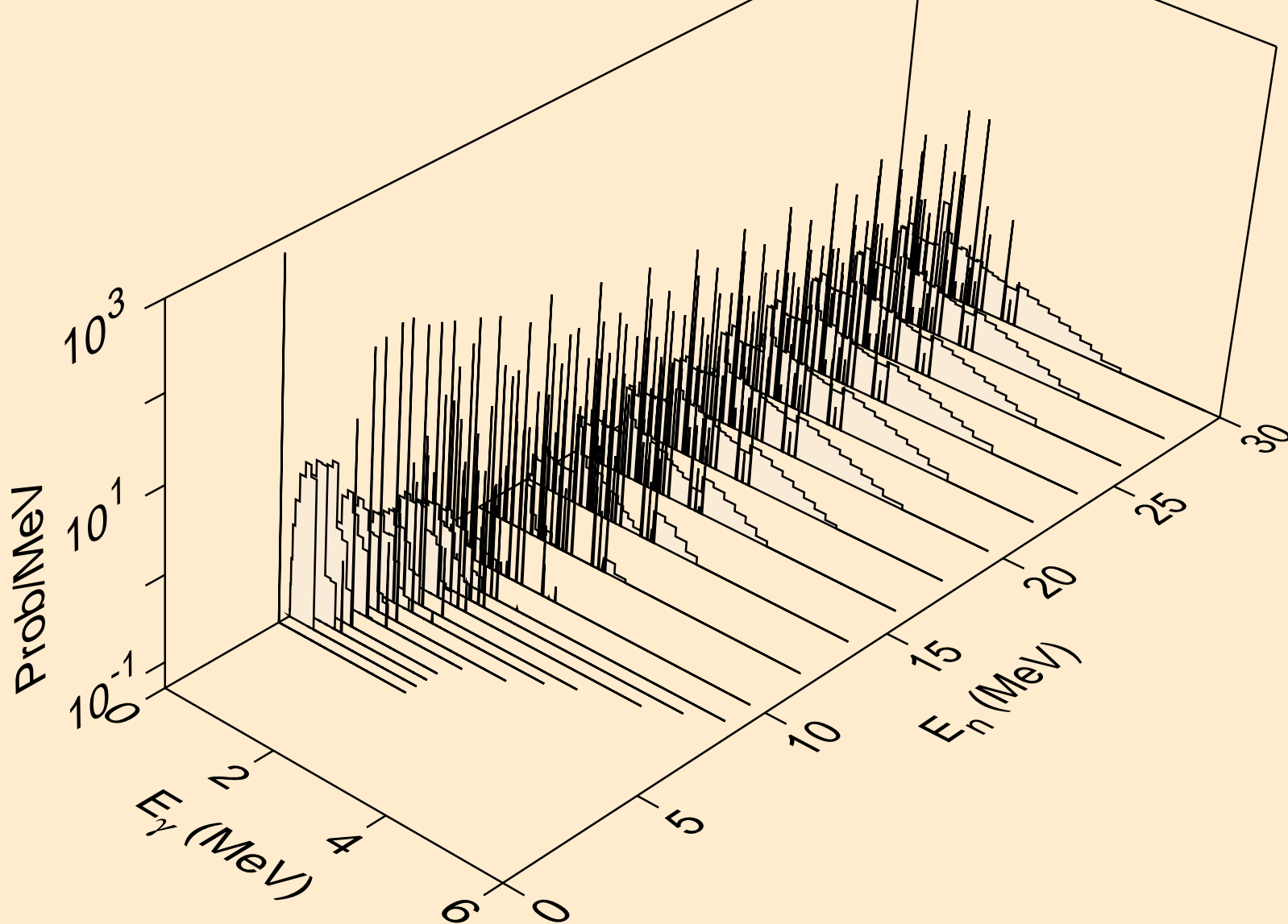

GA066 NEUTRON ACER TENDL-2019 LIBRARY; T=293.16K  
Photon emission for (n,p $\alpha$ )

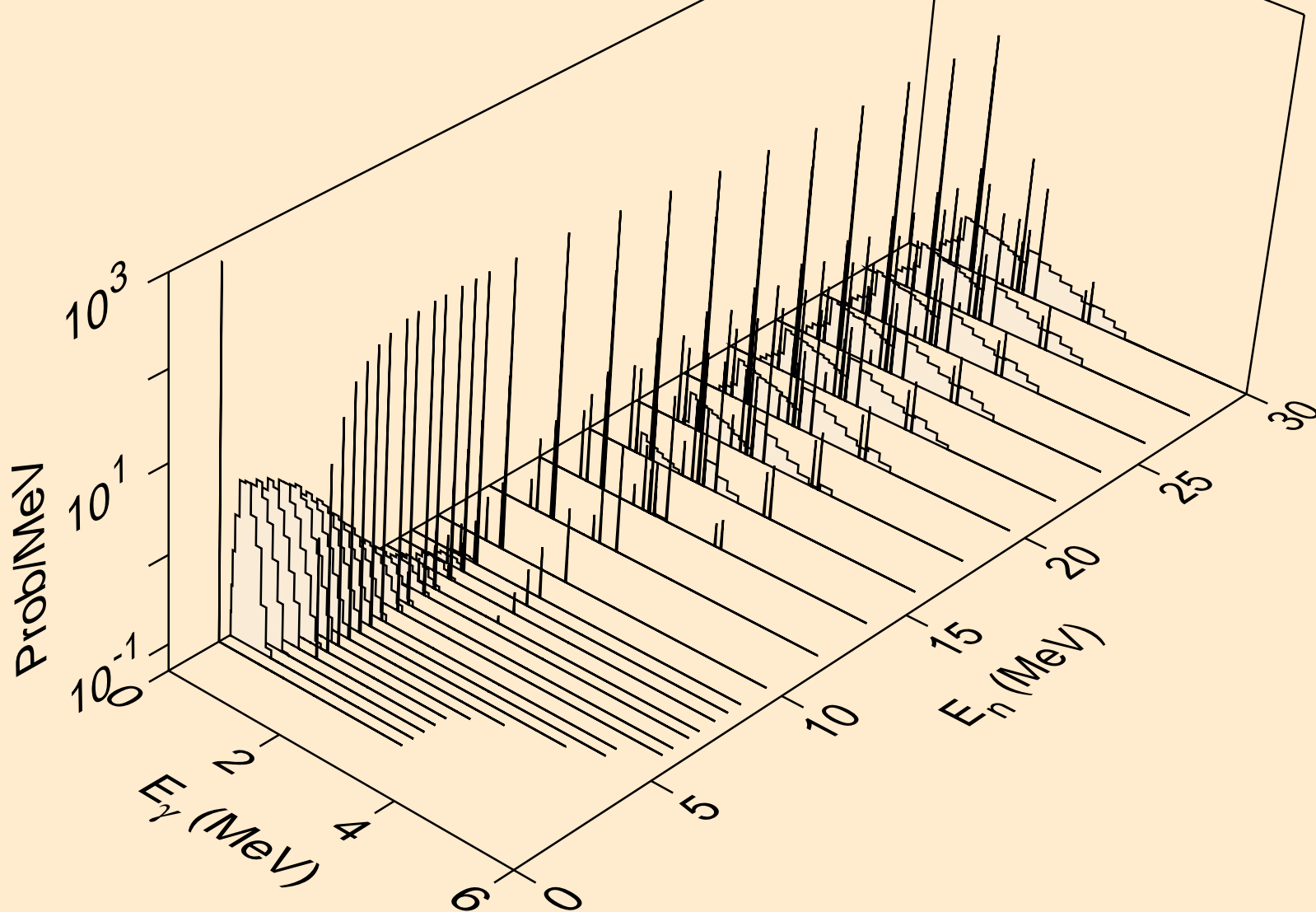

GA066 NEUTRON ACER TENDL-2019 LIBRARY; T=293.16K  
Photon emission for (n,pd)

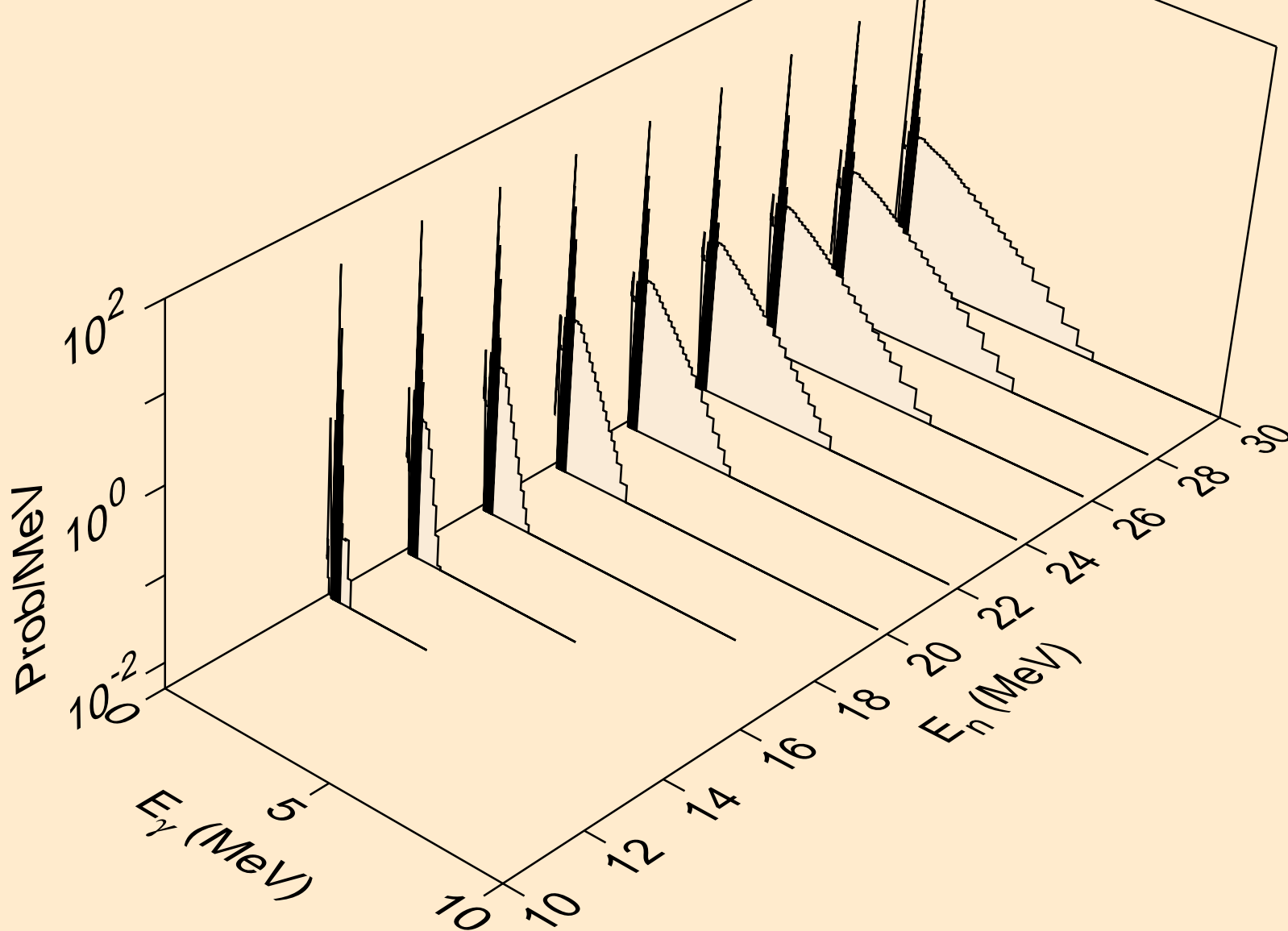

GA066 NEUTRON ACER TENDL-2019 LIBRARY; T=293.16K  
Photon emission for (n,pt)

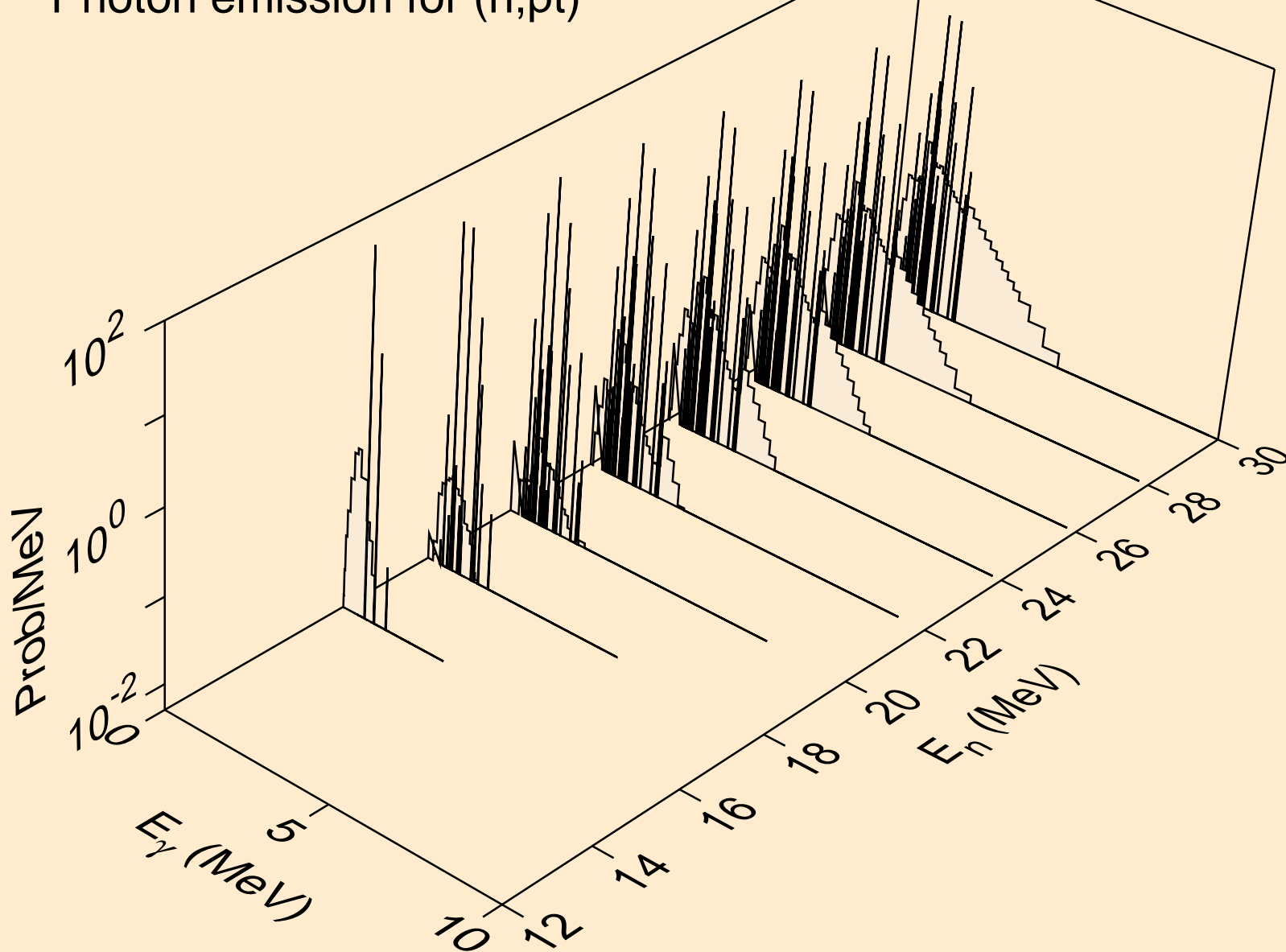

GA066 NEUTRON ACER TENDL-2019 LIBRARY; T=293.16K  
Photon emission for (n,da)

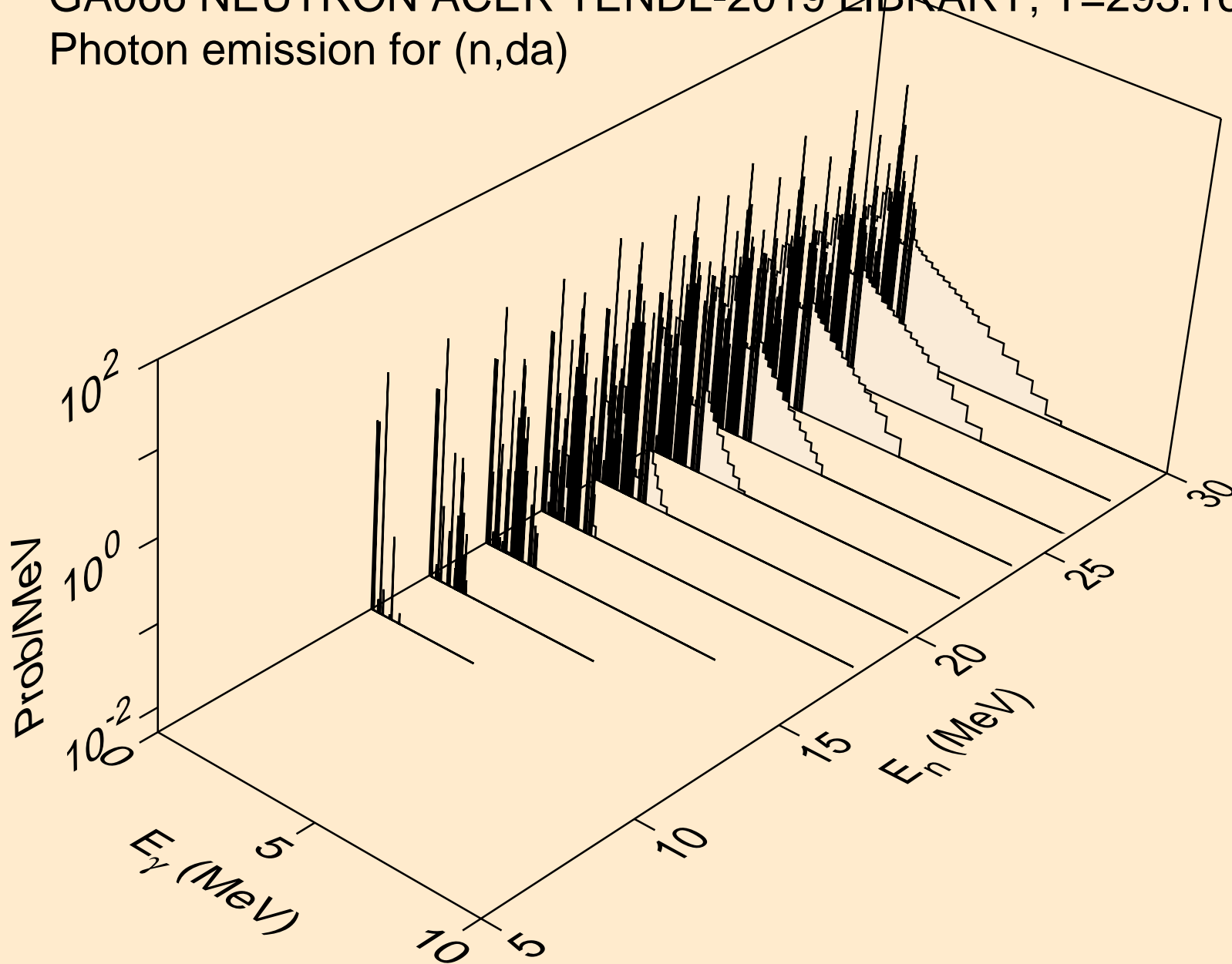

GA066 NEUTRON ACER TENDL-2019 LIBRARY; T=293.16K  
thermal capture photon spectrum

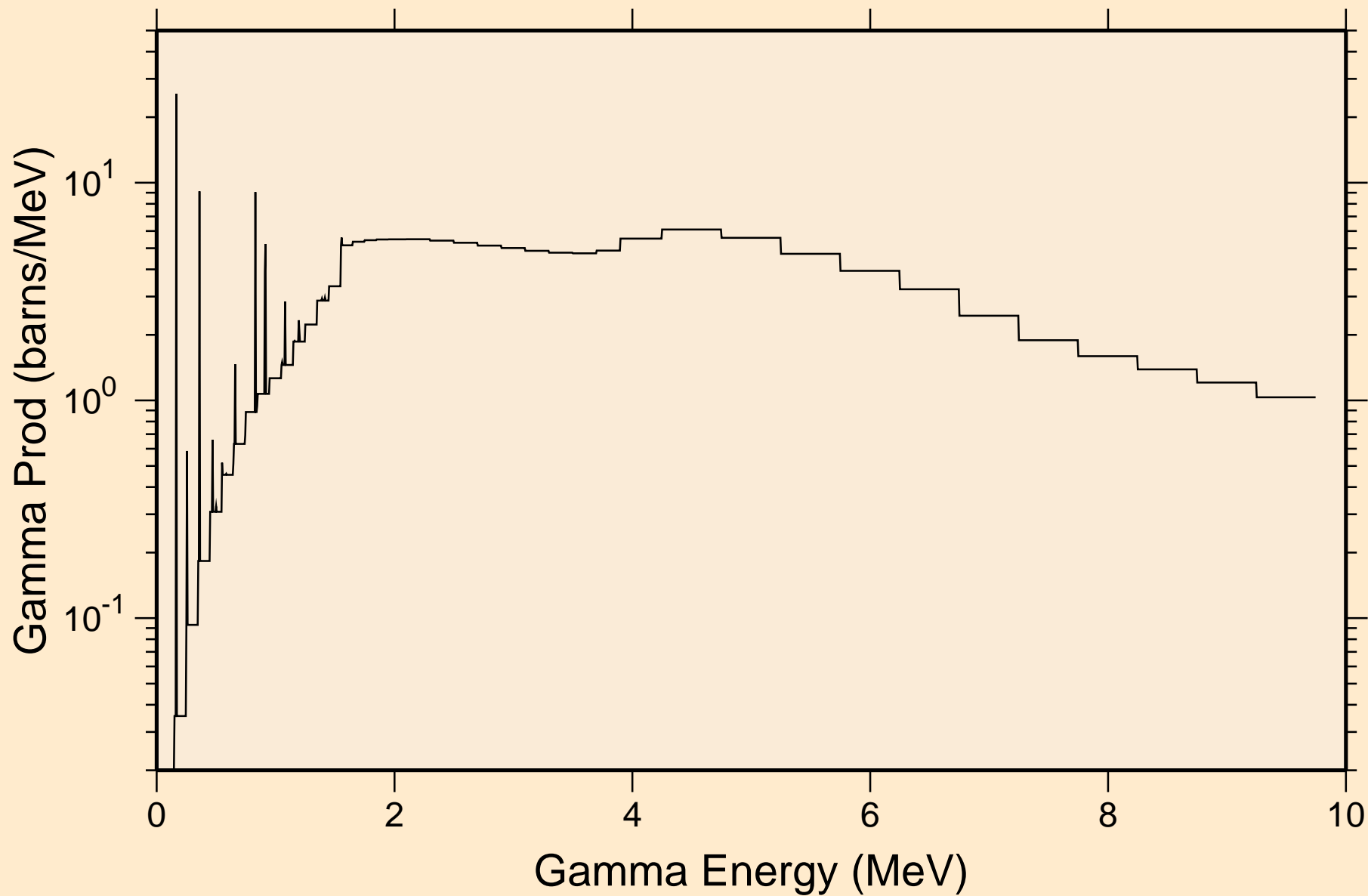

GA066 NEUTRON ACER TENDL-2019 LIBRARY; T=293.16K  
14 MeV photon spectrum

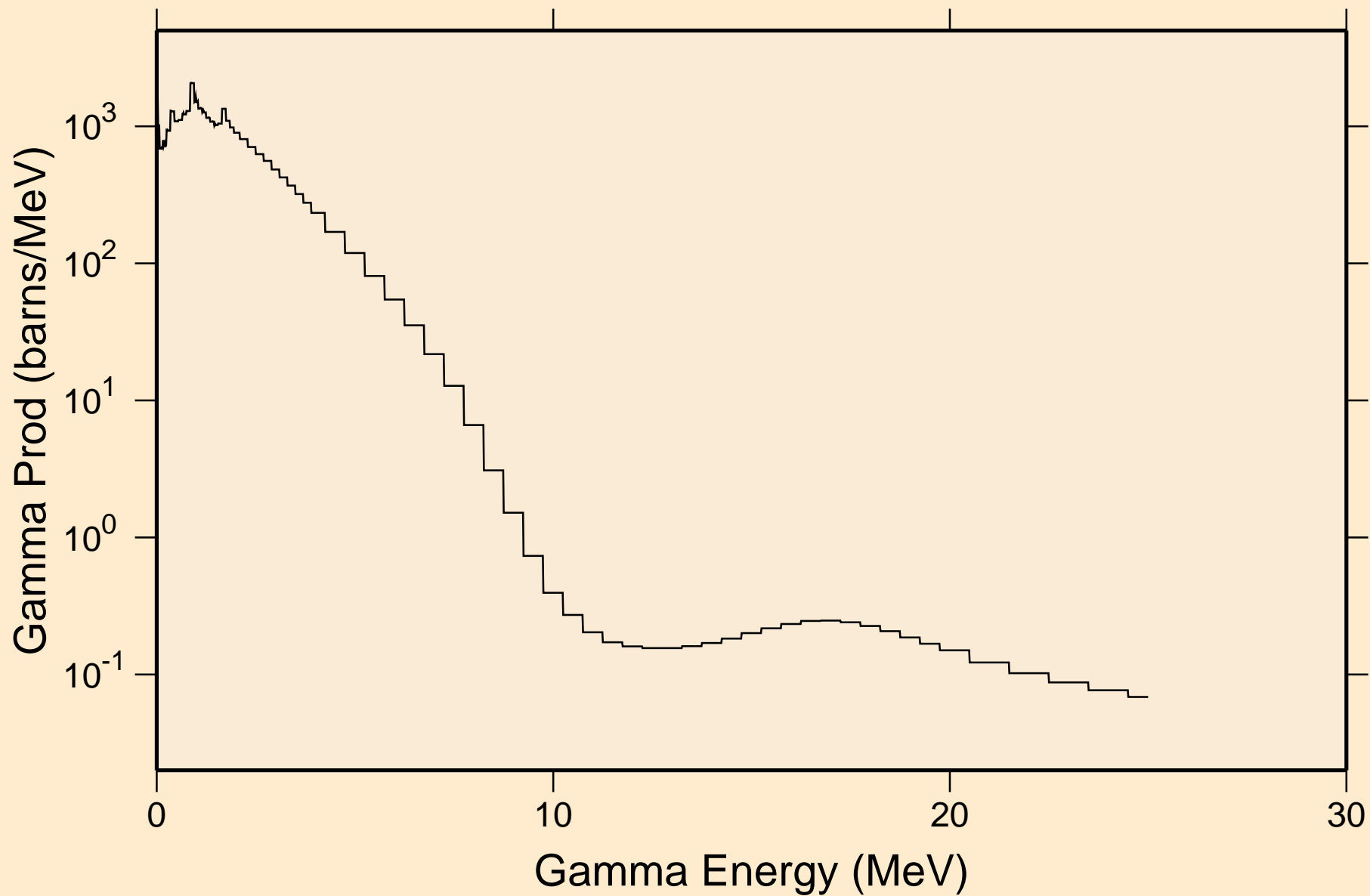

GA066 NEUTRON ACER TENDL-2019 LIBRARY; T=293.16K  
Particle heating contributions

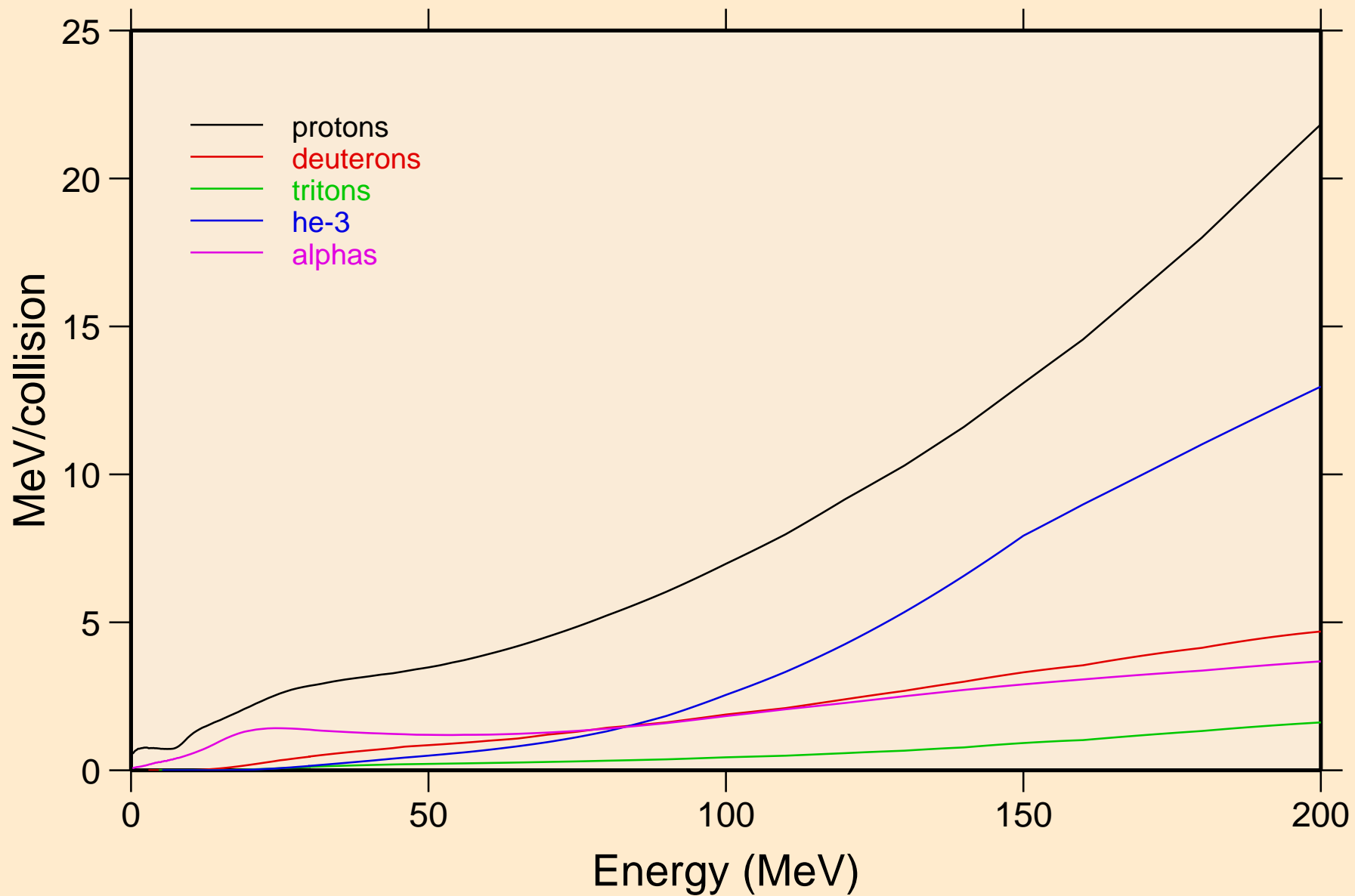

GA066 NEUTRON ACER TENDL-2019 LIBRARY; T=293.16K  
Recoil Heating

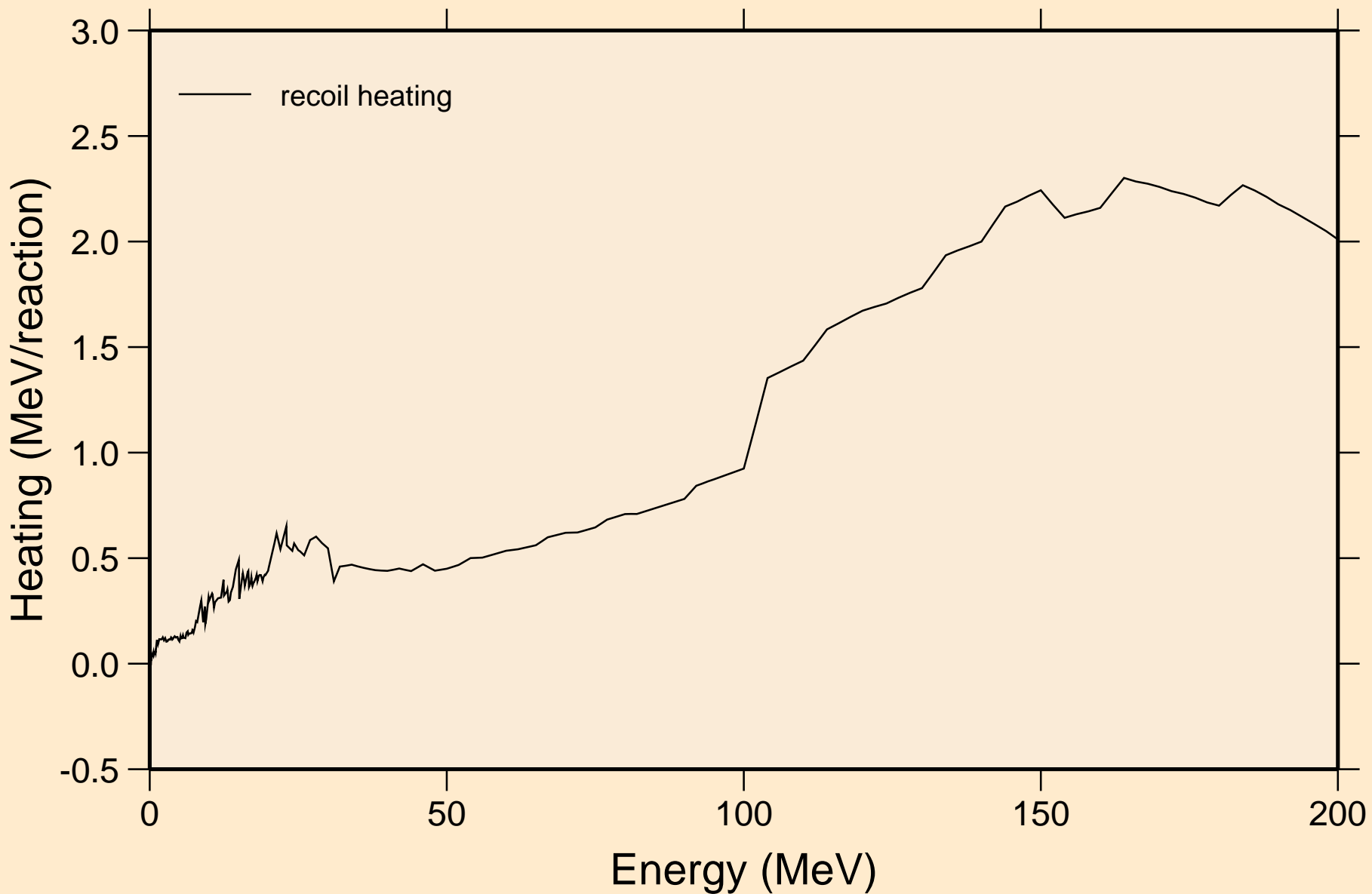

GA066 NEUTRON ACER TENDL-2019 LIBRARY; T=293.16K  
Particle production cross sections

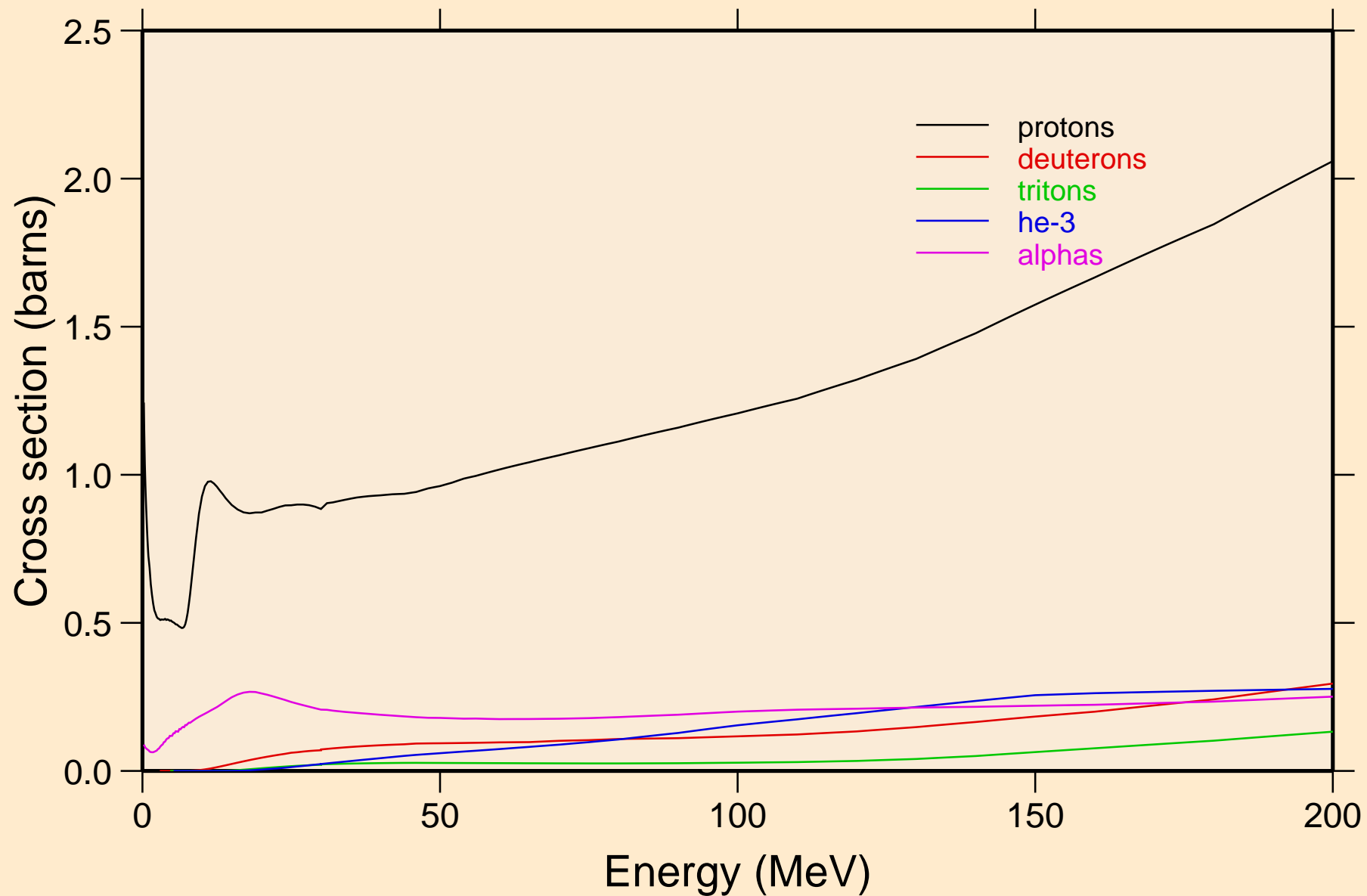

GA066 NEUTRON ACER TENDL-2019 LIBRARY; T=293.16K  
protons from (n,x)

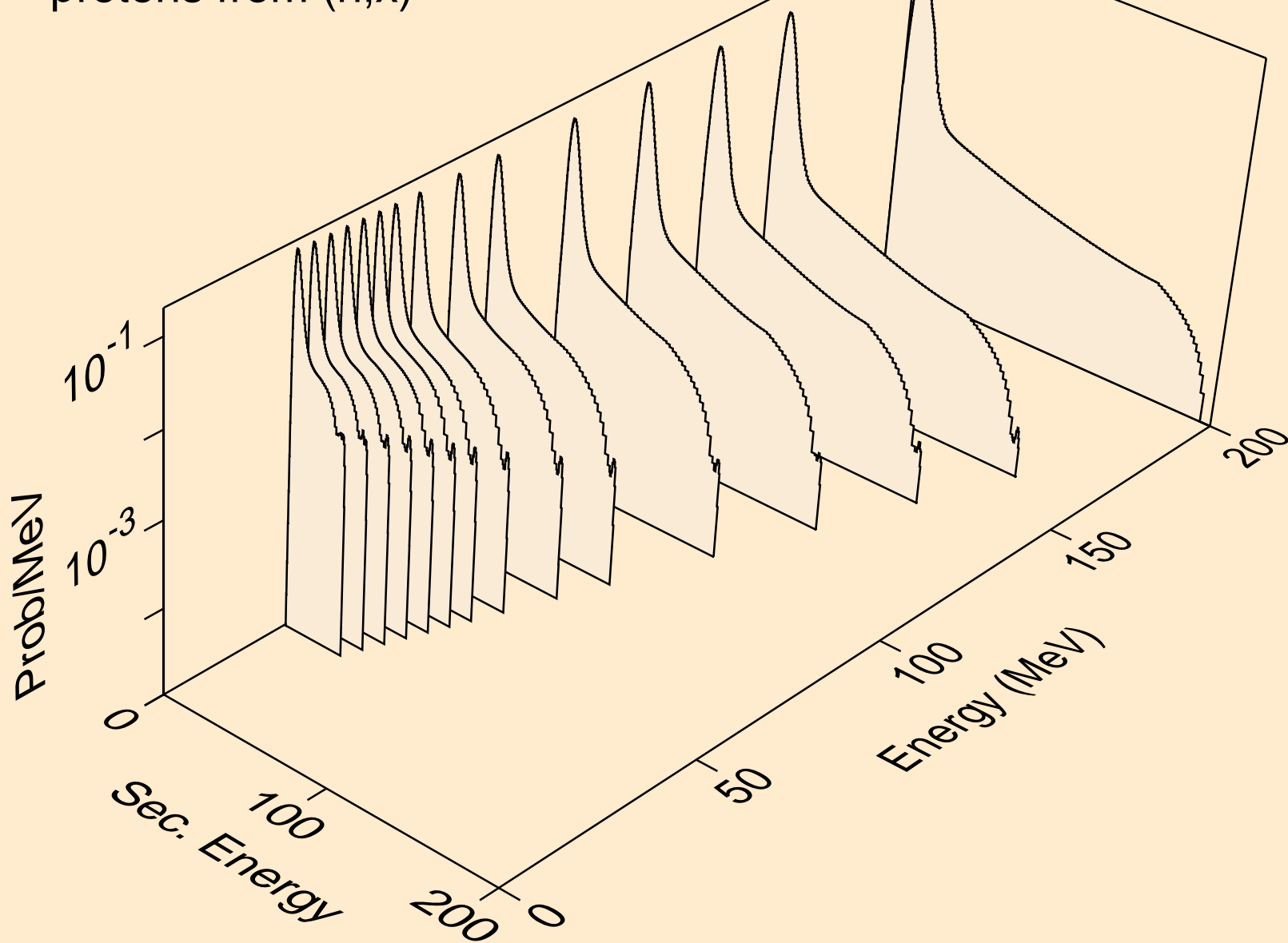

GA066 NEUTRON ACER TENDL-2019 LIBRARY; T=293.16K  
protons from (n,n\*)p

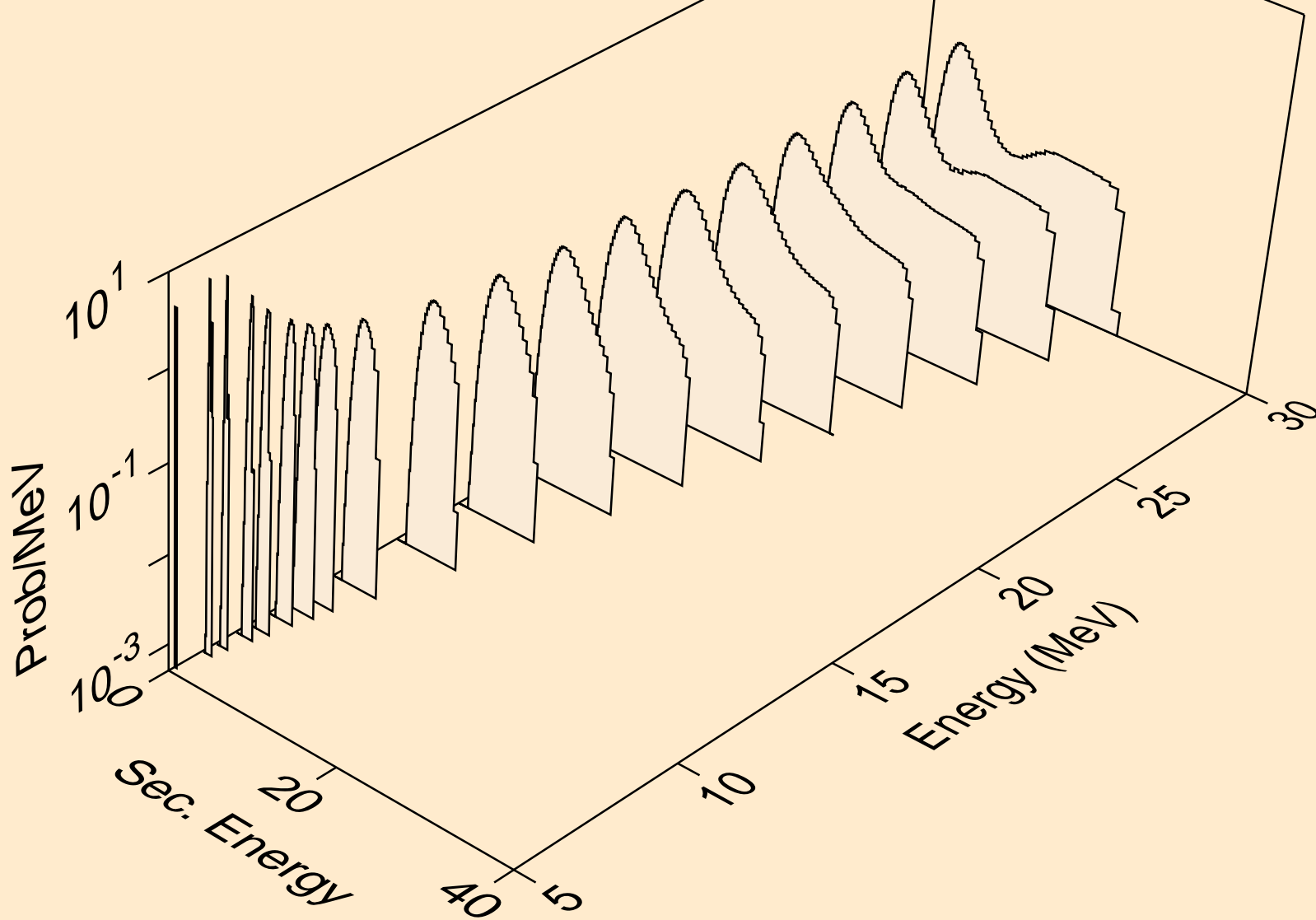

GA066 NEUTRON ACER TENDL-2019 LIBRARY; T=293.16K  
protons from (n,2np)

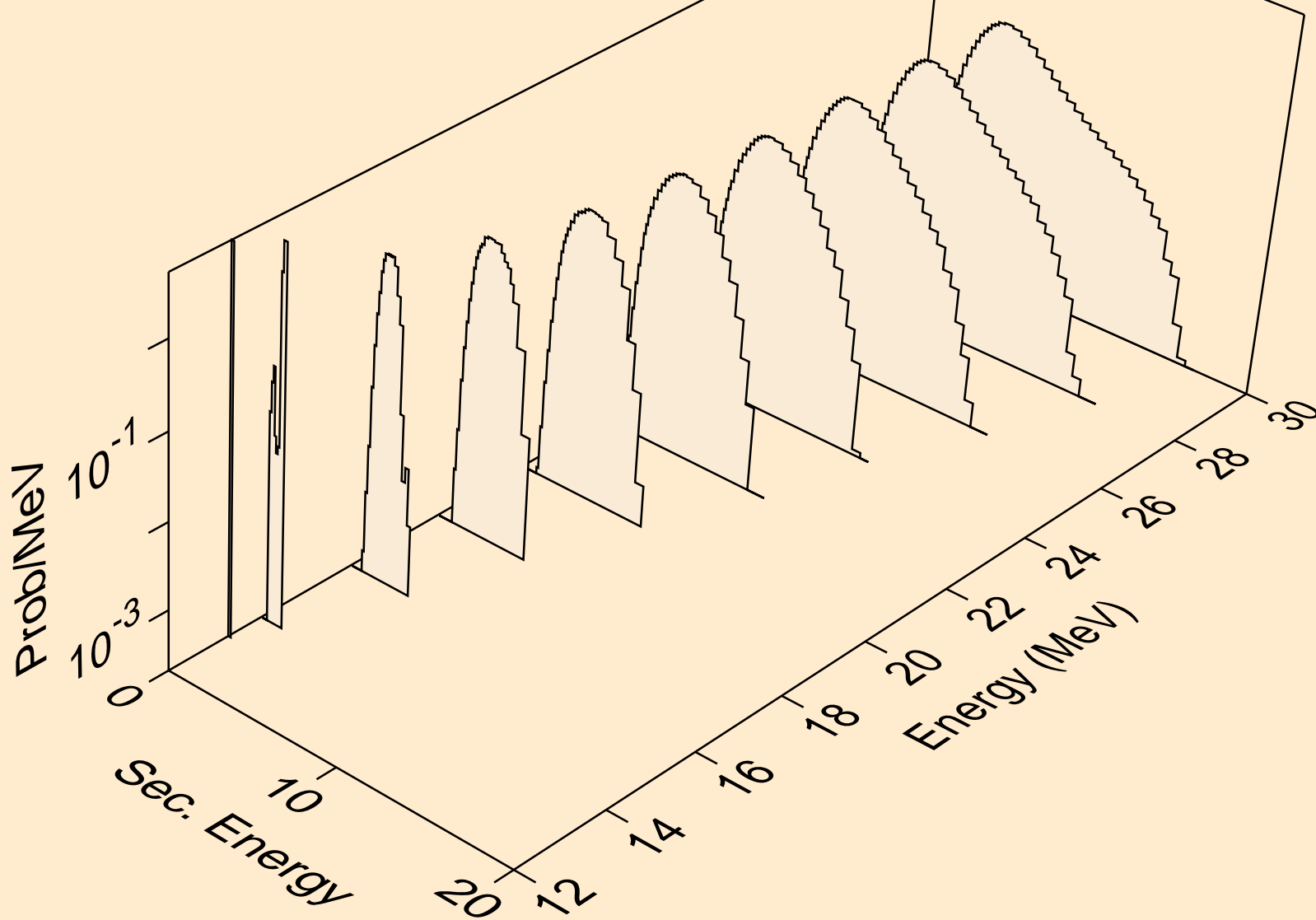

GA066 NEUTRON ACER TENDL-2019 LIBRARY; T=293.16K  
protons from (n,3np)

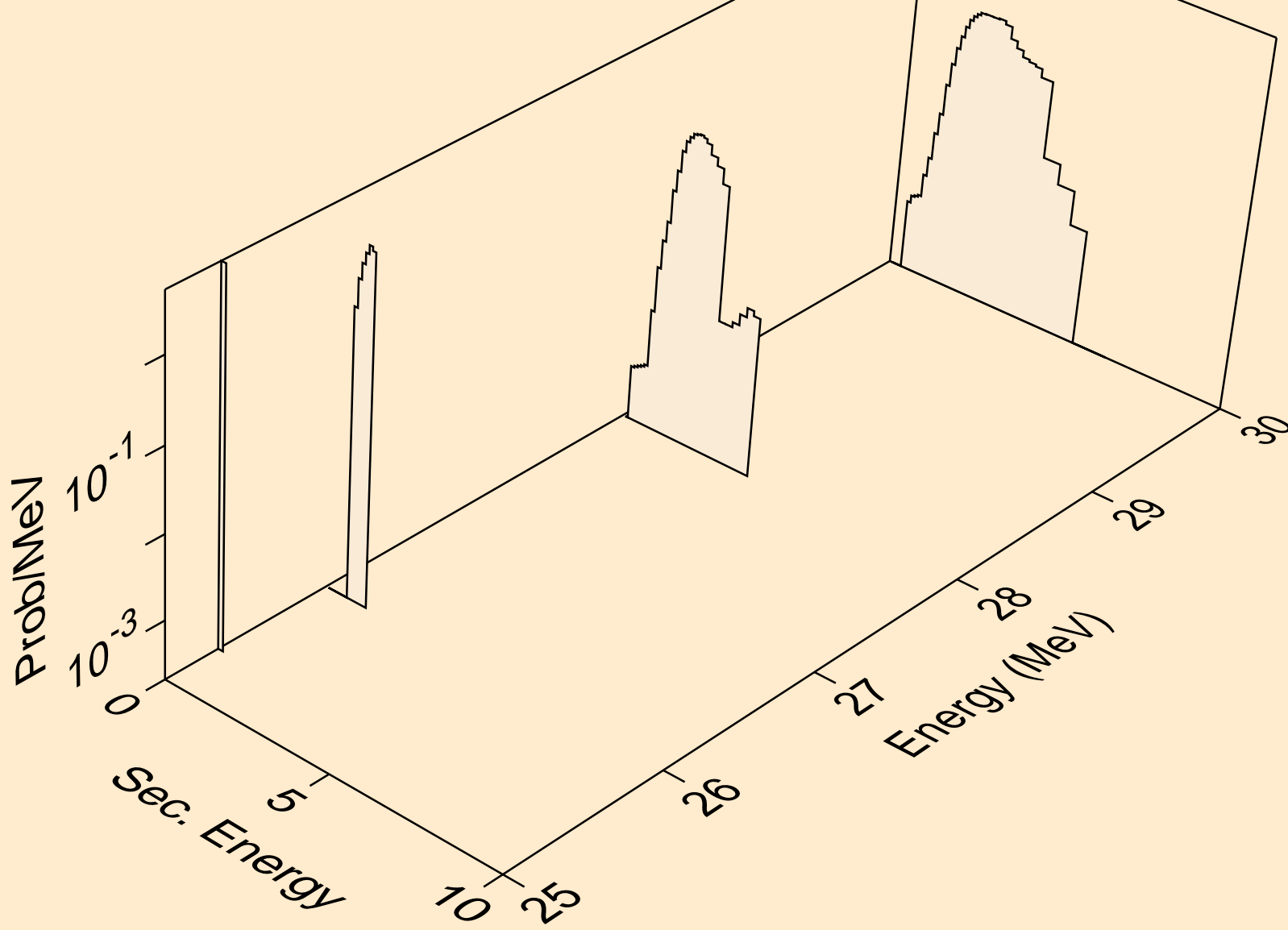

GA066 NEUTRON ACER TENDL-2019 LIBRARY; T=293.16K  
protons from (n,2np)

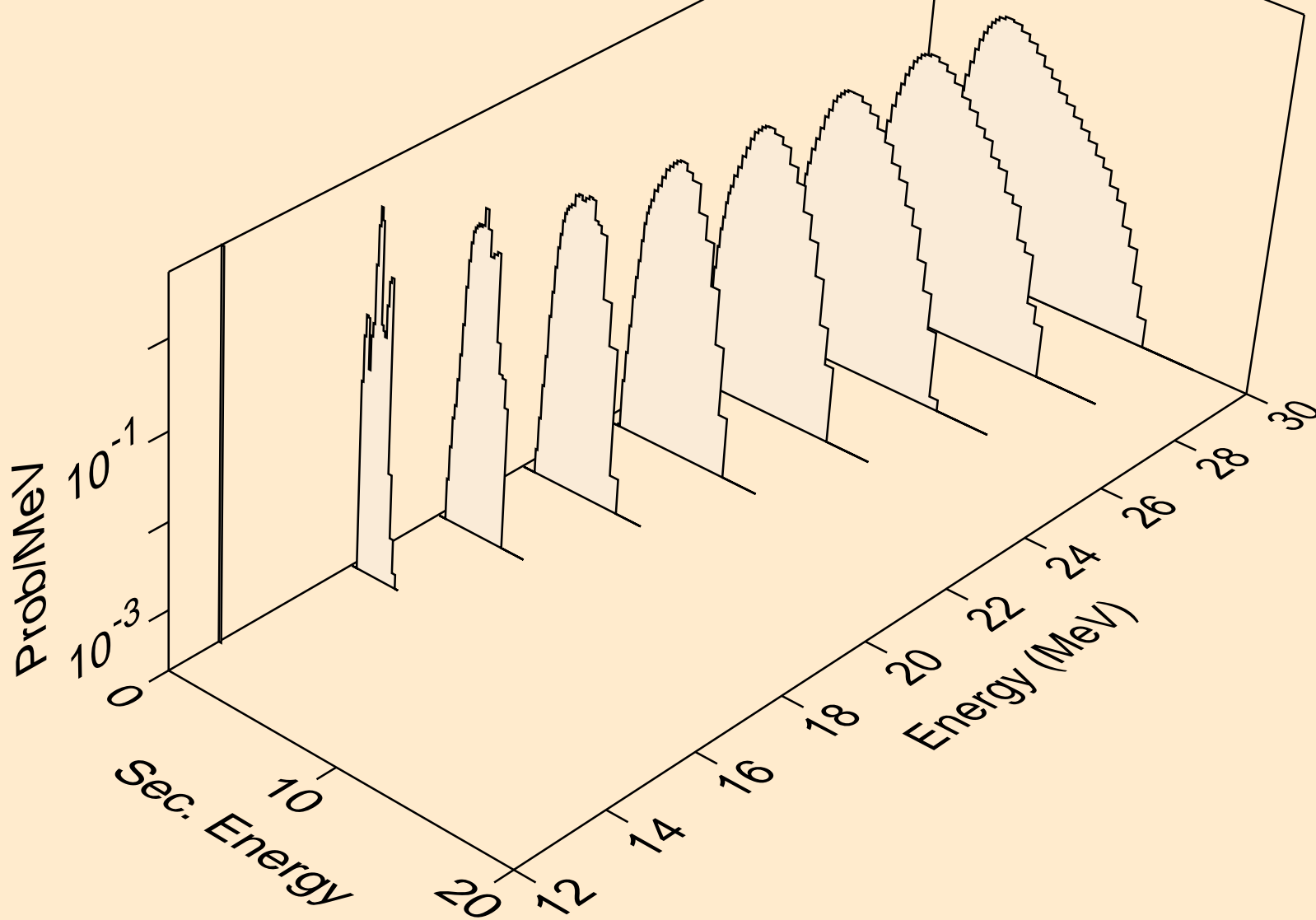

GA066 NEUTRON ACER TENDL-2019 LIBRARY; T=293.16K  
protons from (n,npa)

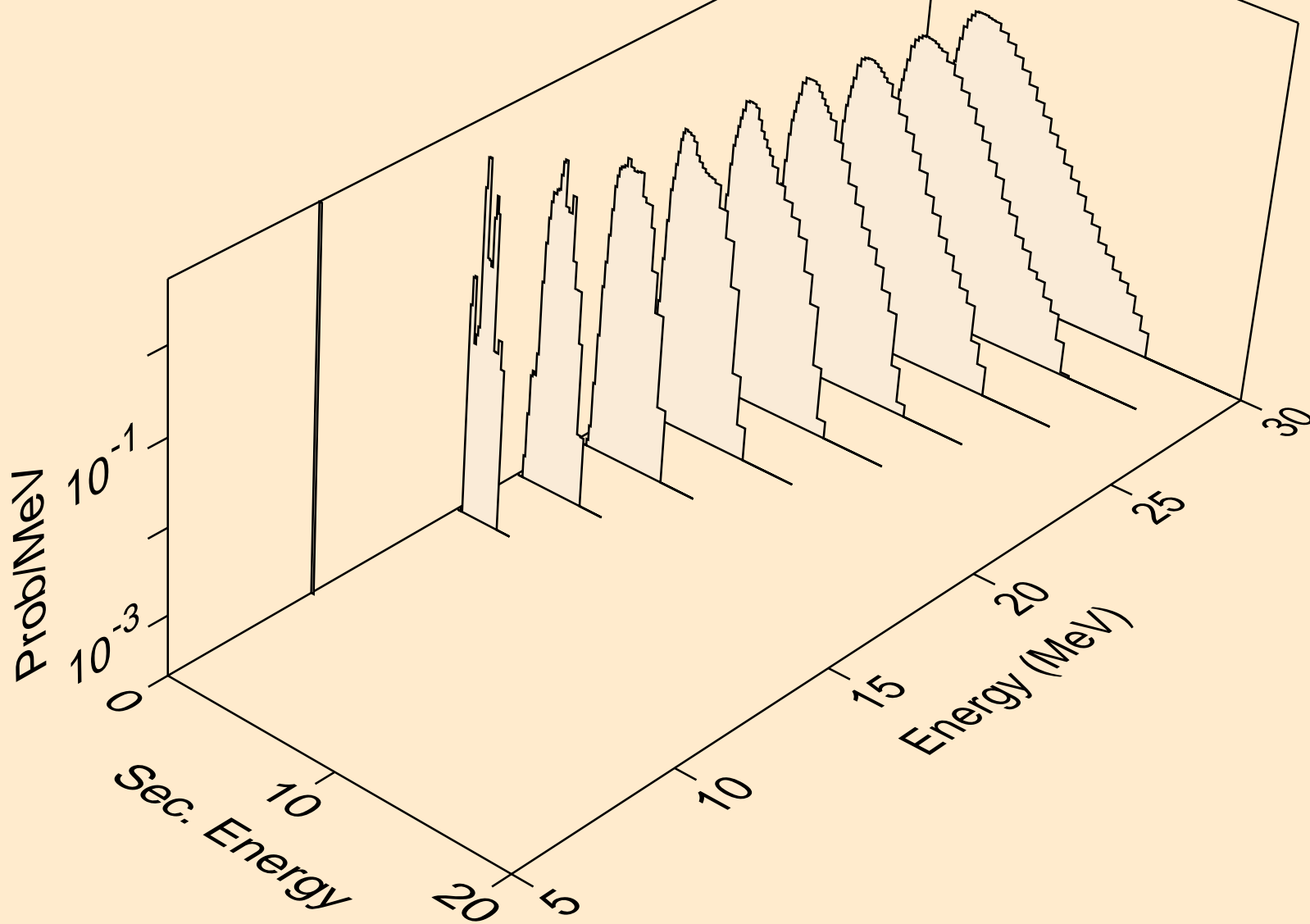

GA066 NEUTRON ACER TENDL-2019 LIBRARY; T=293.16K  
protons from (n,p)

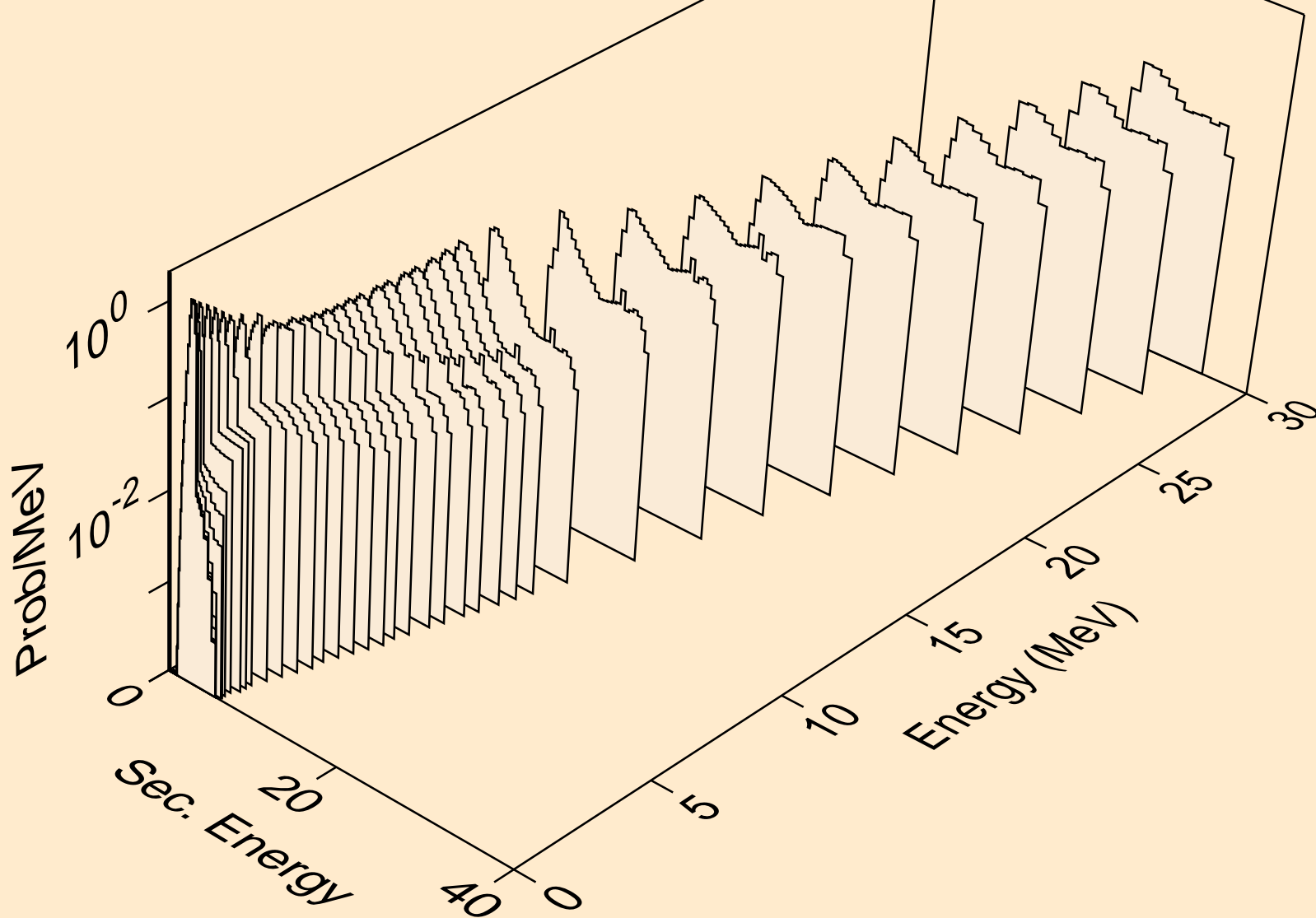

GA066 NEUTRON ACER TENDL-2019 LIBRARY; T=293.16K  
protons from (n,2p)

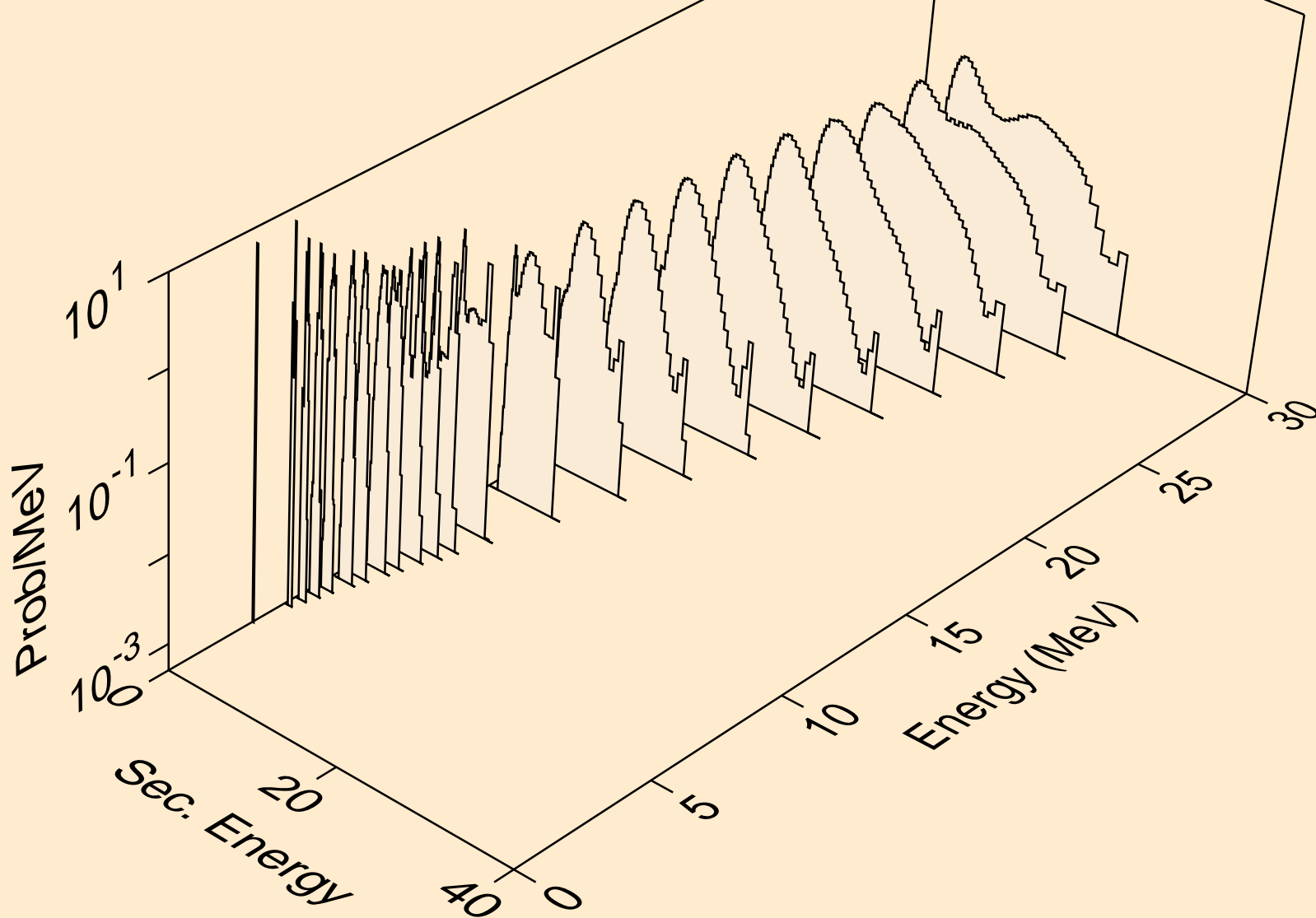

GA066 NEUTRON ACER TENDL-2019 LIBRARY; T=293.16K  
protons from (n,p)

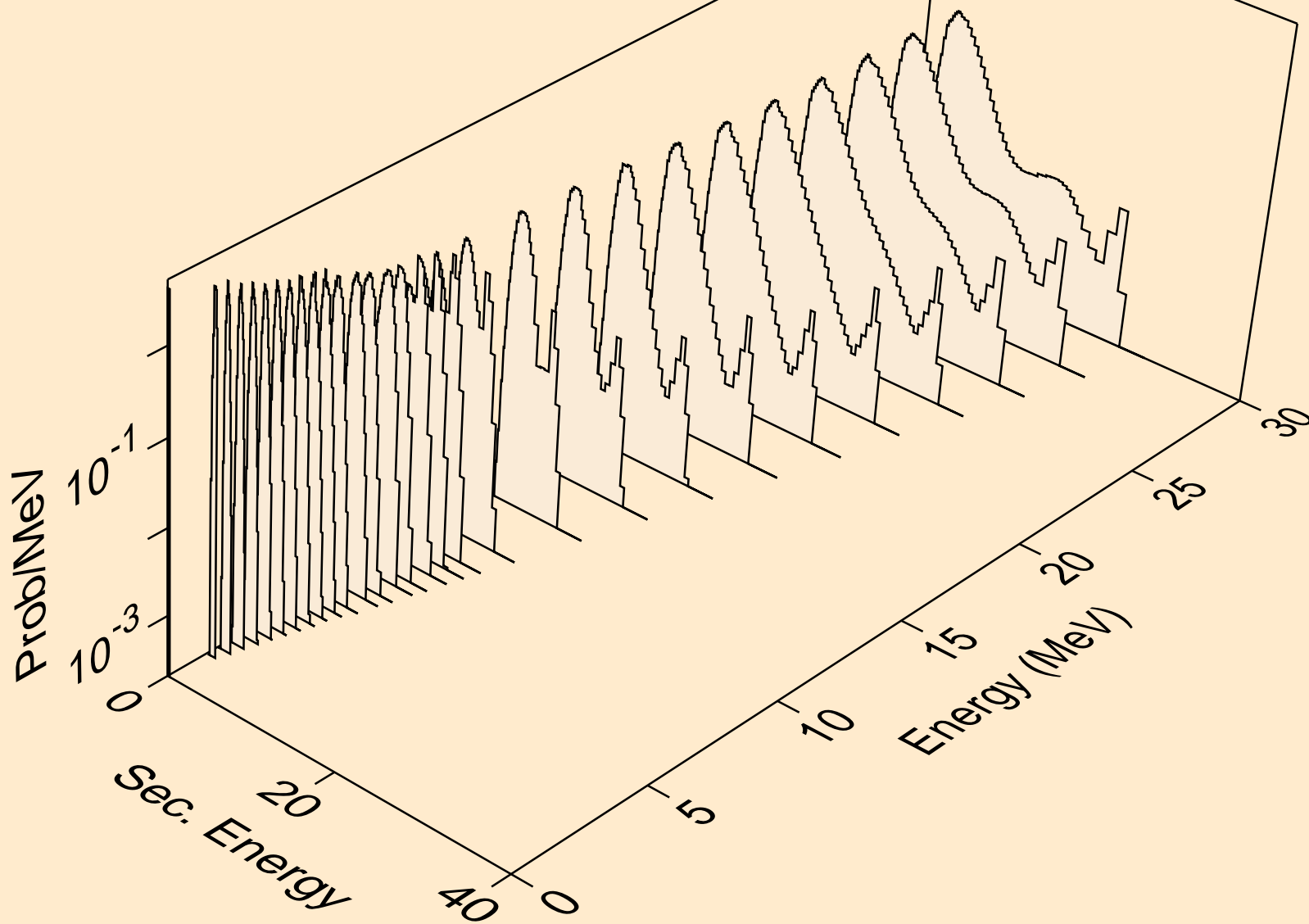

GA066 NEUTRON ACER TENDL-2019 LIBRARY; T=293.16K  
protons from (n,pd)

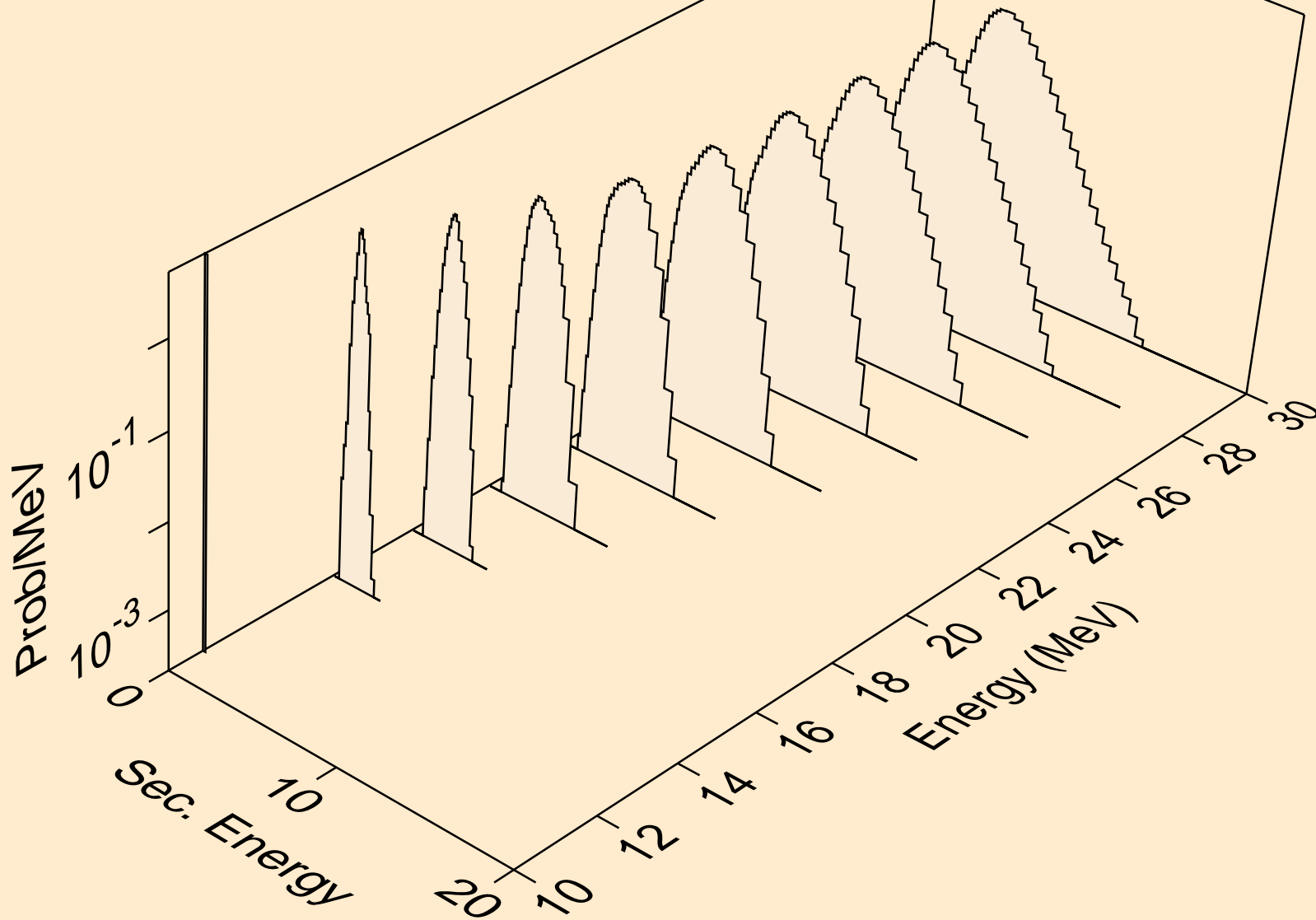

GA066 NEUTRON ACER TENDL-2019 LIBRARY; T=293.16K  
protons from (n,pt)

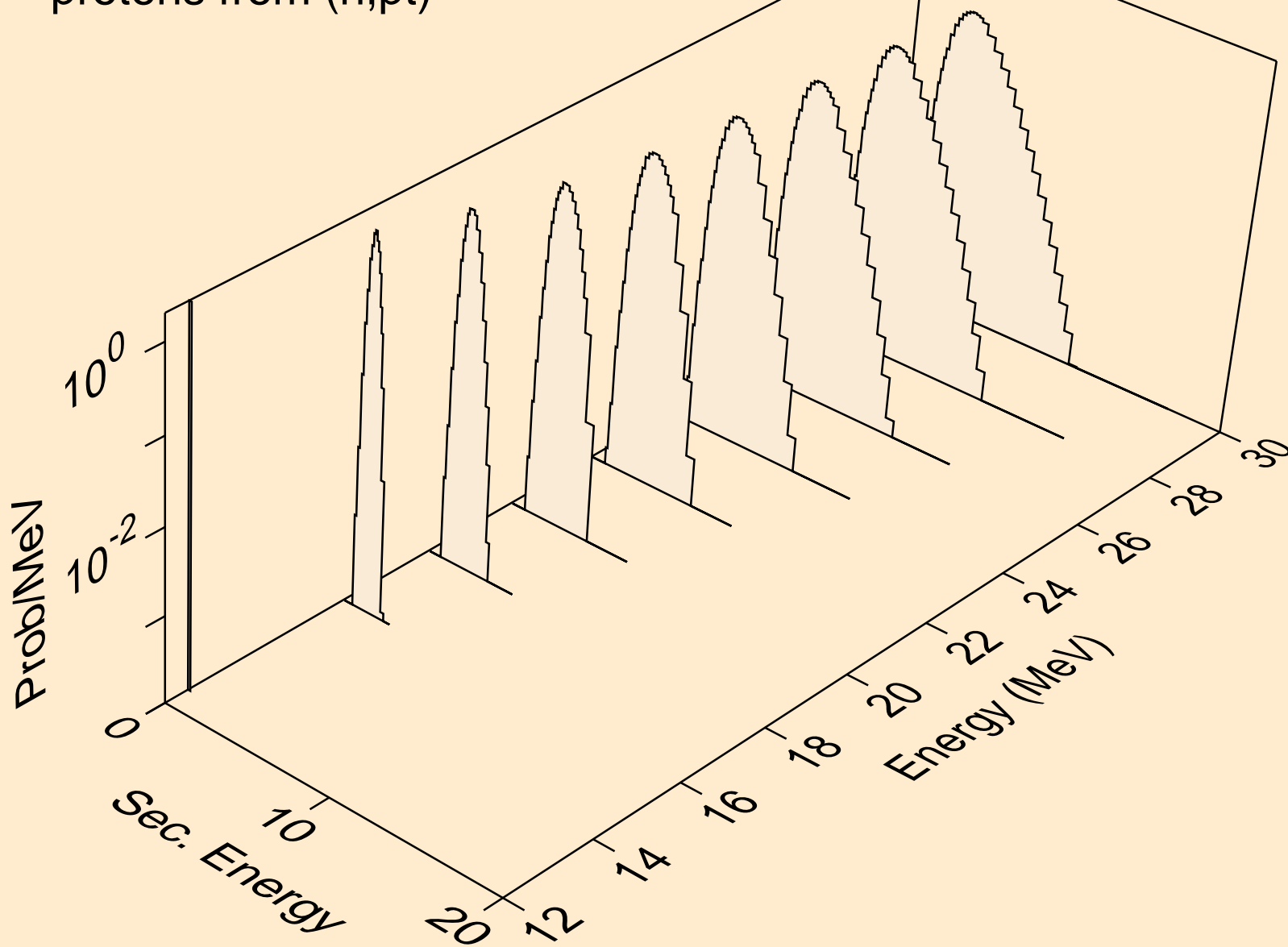

GA066 NEUTRON ACER TENDL-2019 LIBRARY; T=293.16K  
deuterons from (n,x)

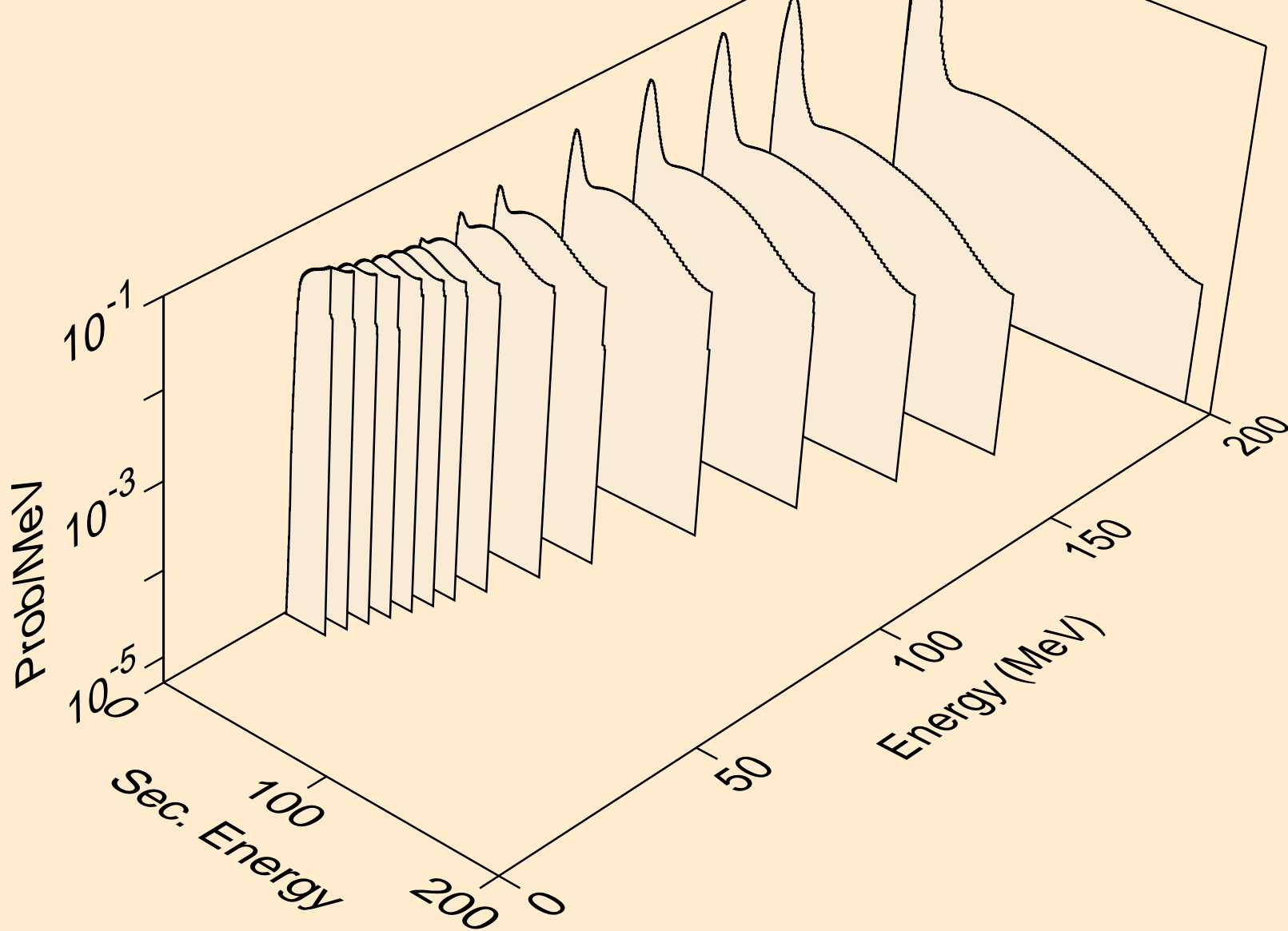

GA066 NEUTRON ACER TENDL-2019 LIBRARY; T=293.16K  
deuterons from (n,2nd)

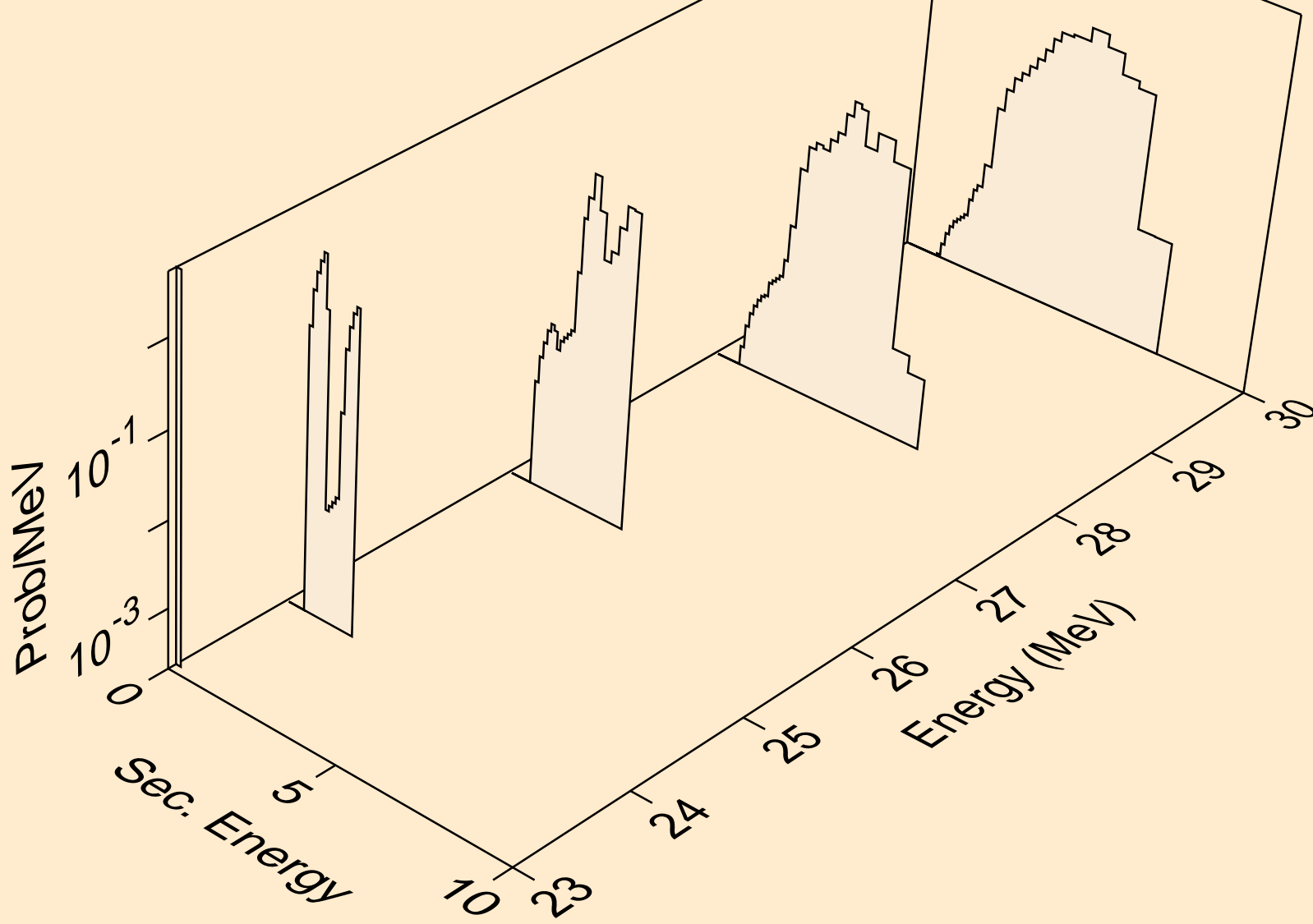

GA066 NEUTRON ACER TENDL-2019 LIBRARY; T=293.16K  
deuterons from (n,n\*)d

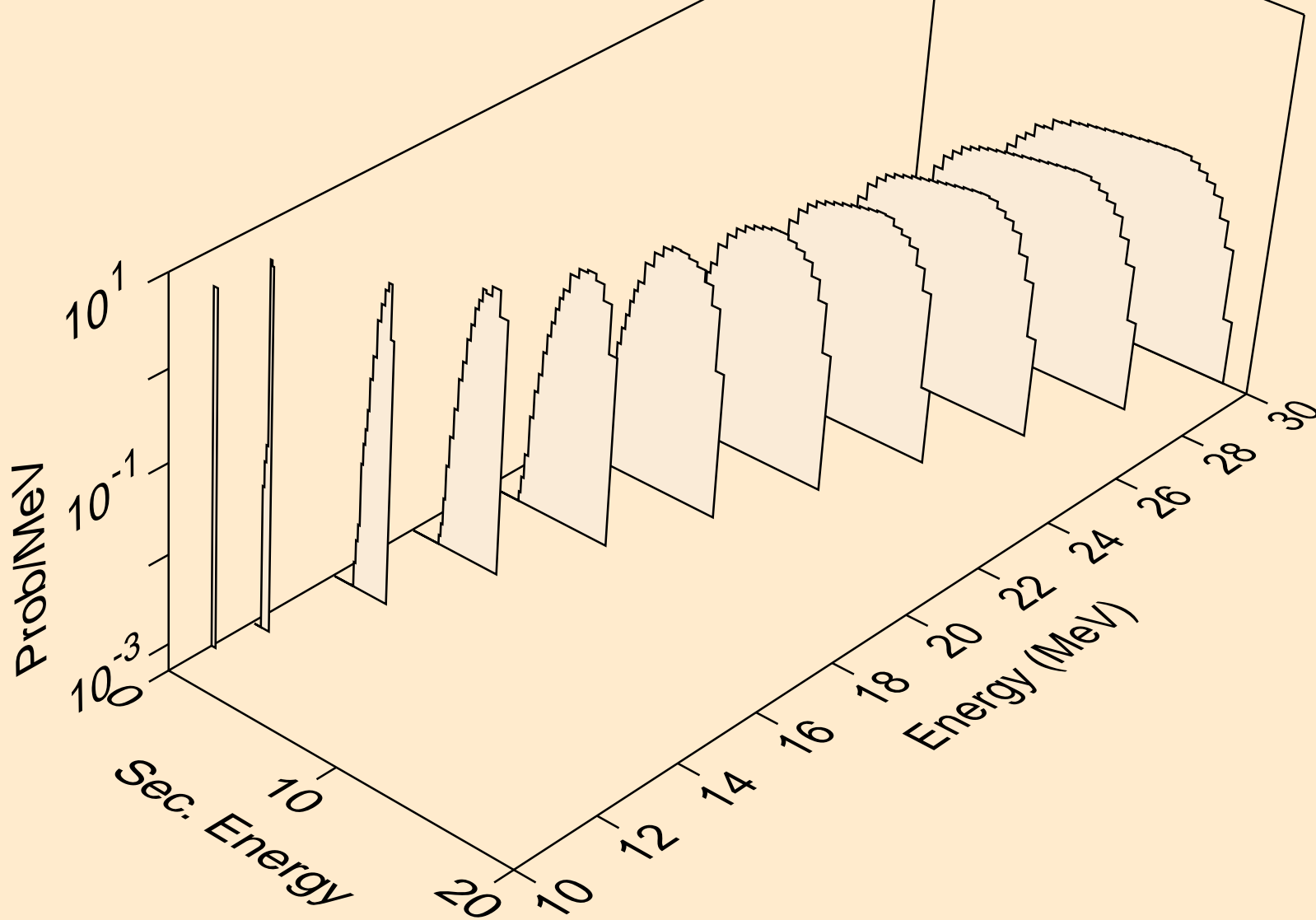

GA066 NEUTRON ACER TENDL-2019 LIBRARY; T=293.16K  
deuterons from (n,d)

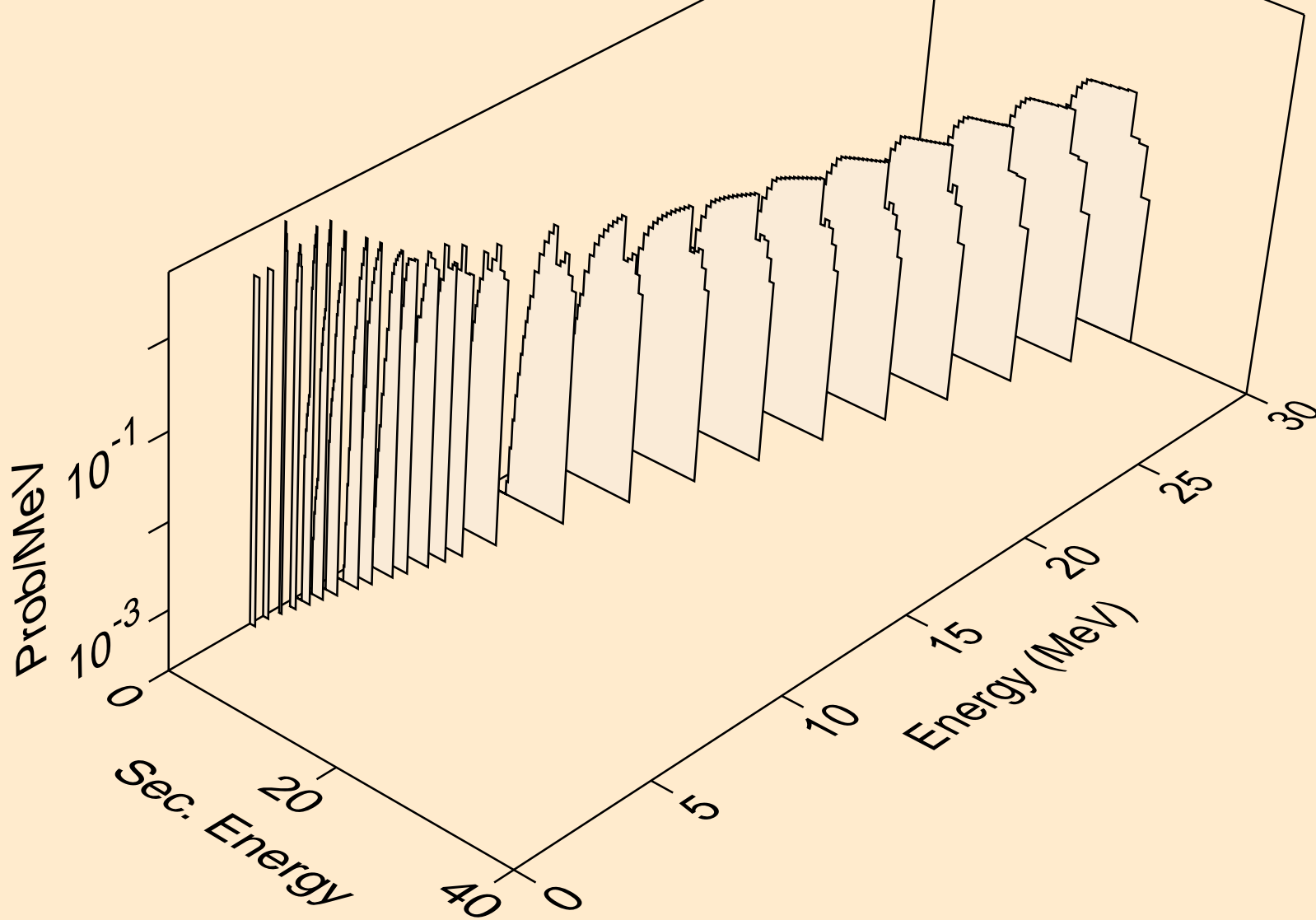

GA066 NEUTRON ACER TENDL-2019 LIBRARY; T=293.16K  
deuterons from (n,pd)

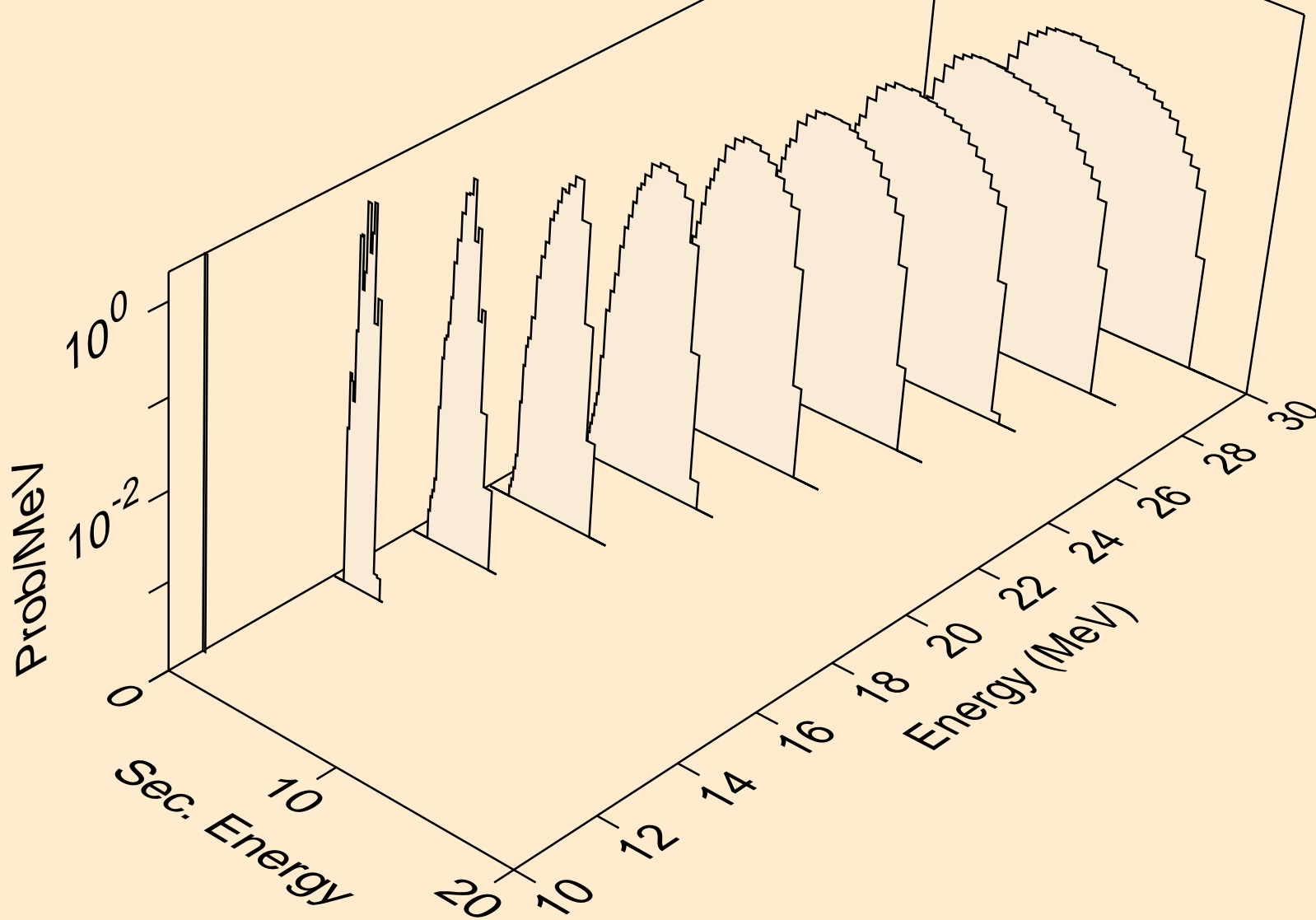

GA066 NEUTRON ACER TENDL-2019 LIBRARY; T=293.16K  
deuterons from (n,da)

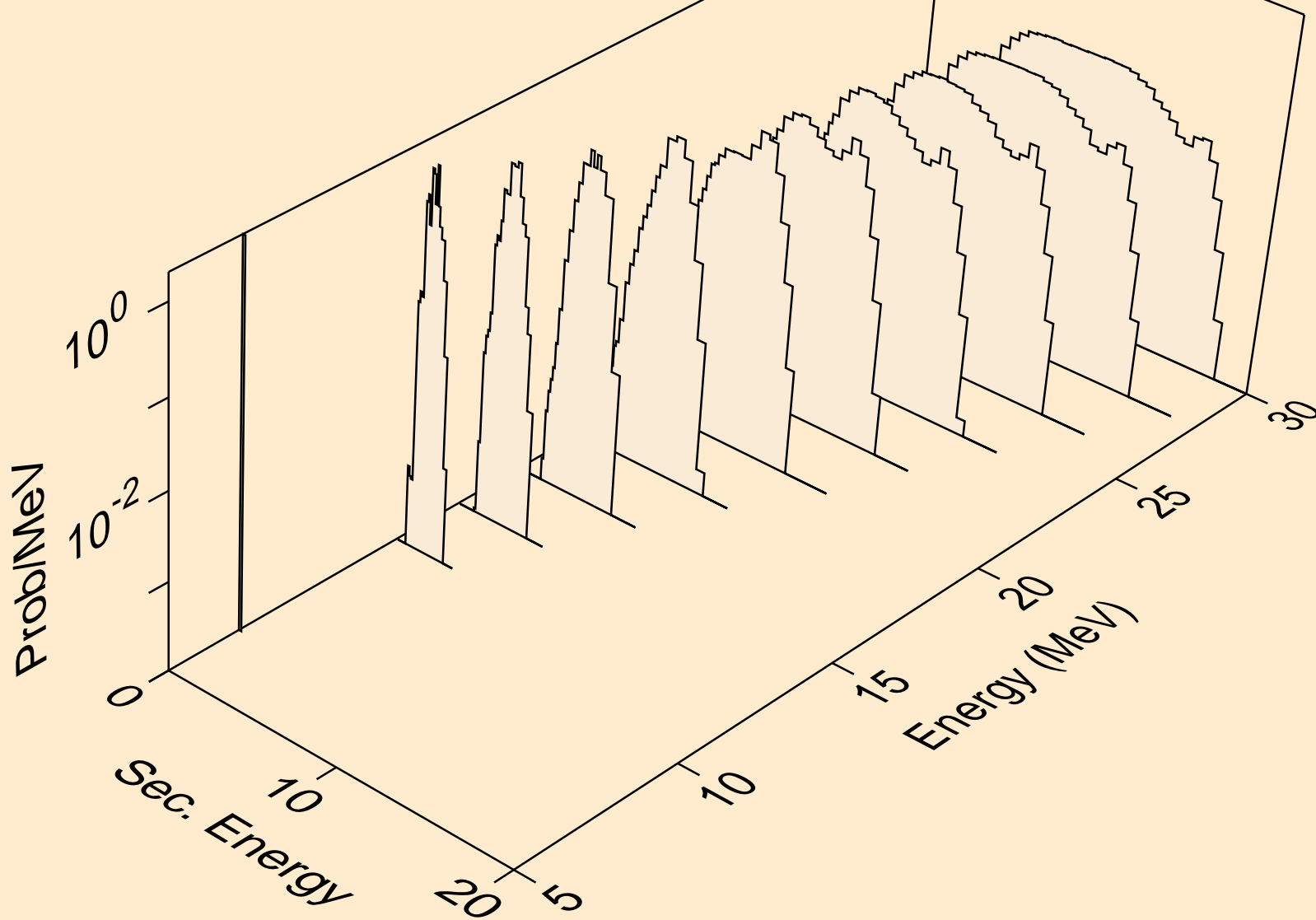

GA066 NEUTRON ACER TENDL-2019 LIBRARY; T=293.16K  
tritons from (n,x)

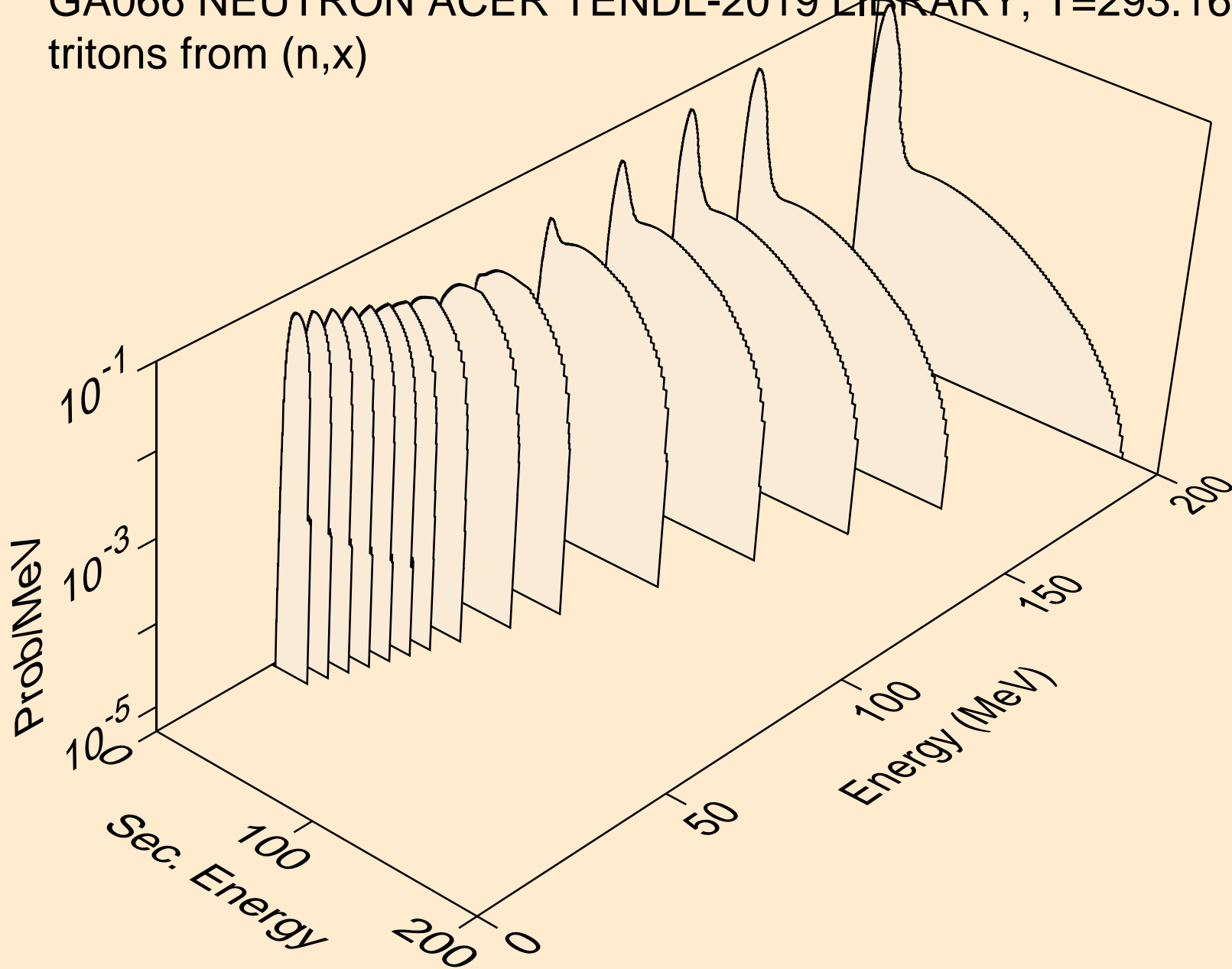

GA066 NEUTRON ACER TENDL-2019 LIBRARY; T=293.16K  
tritons from (n,n\*)t

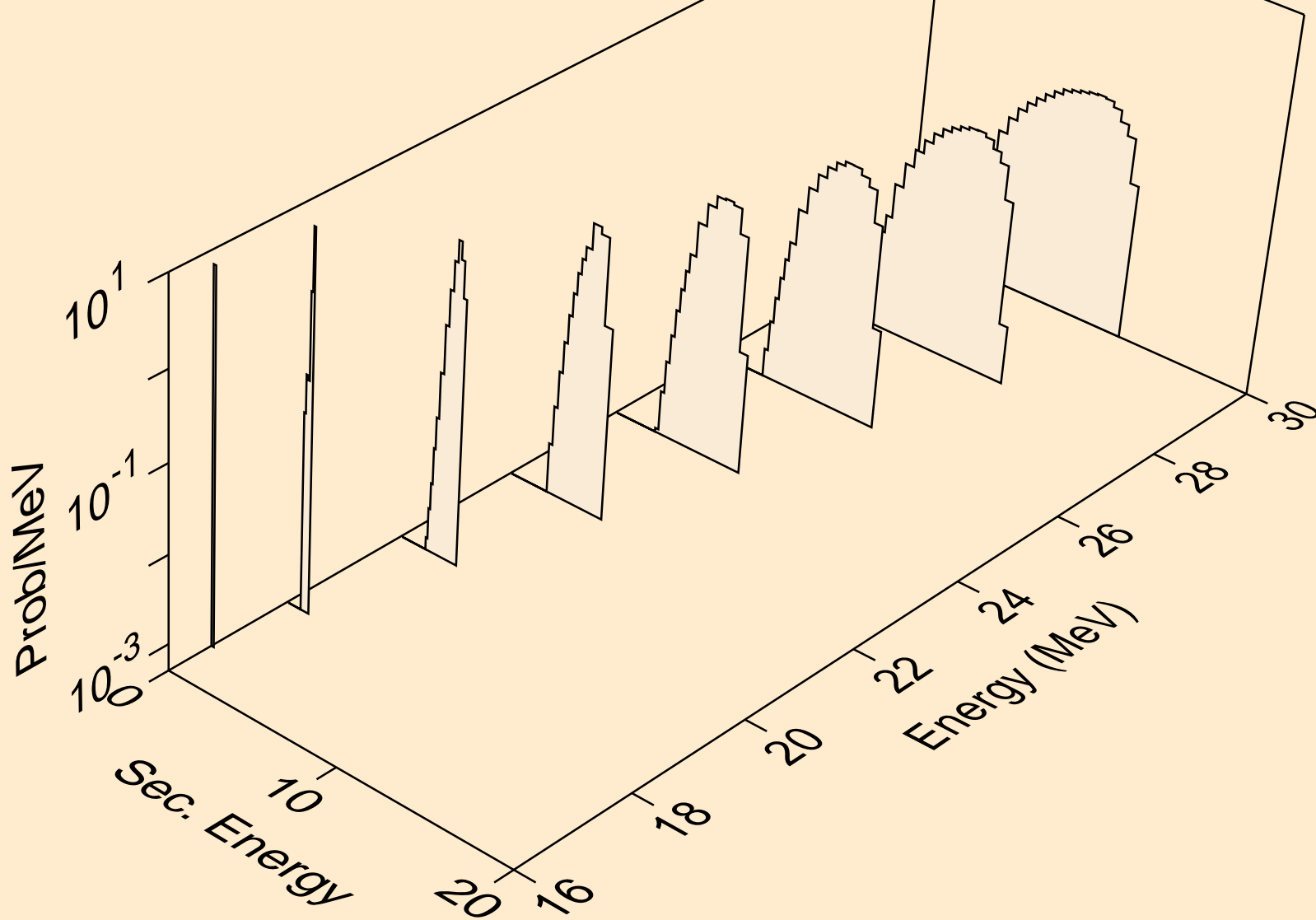

GA066 NEUTRON ACER TENDL-2019 LIBRARY; T=293.16K  
tritons from (n,t)

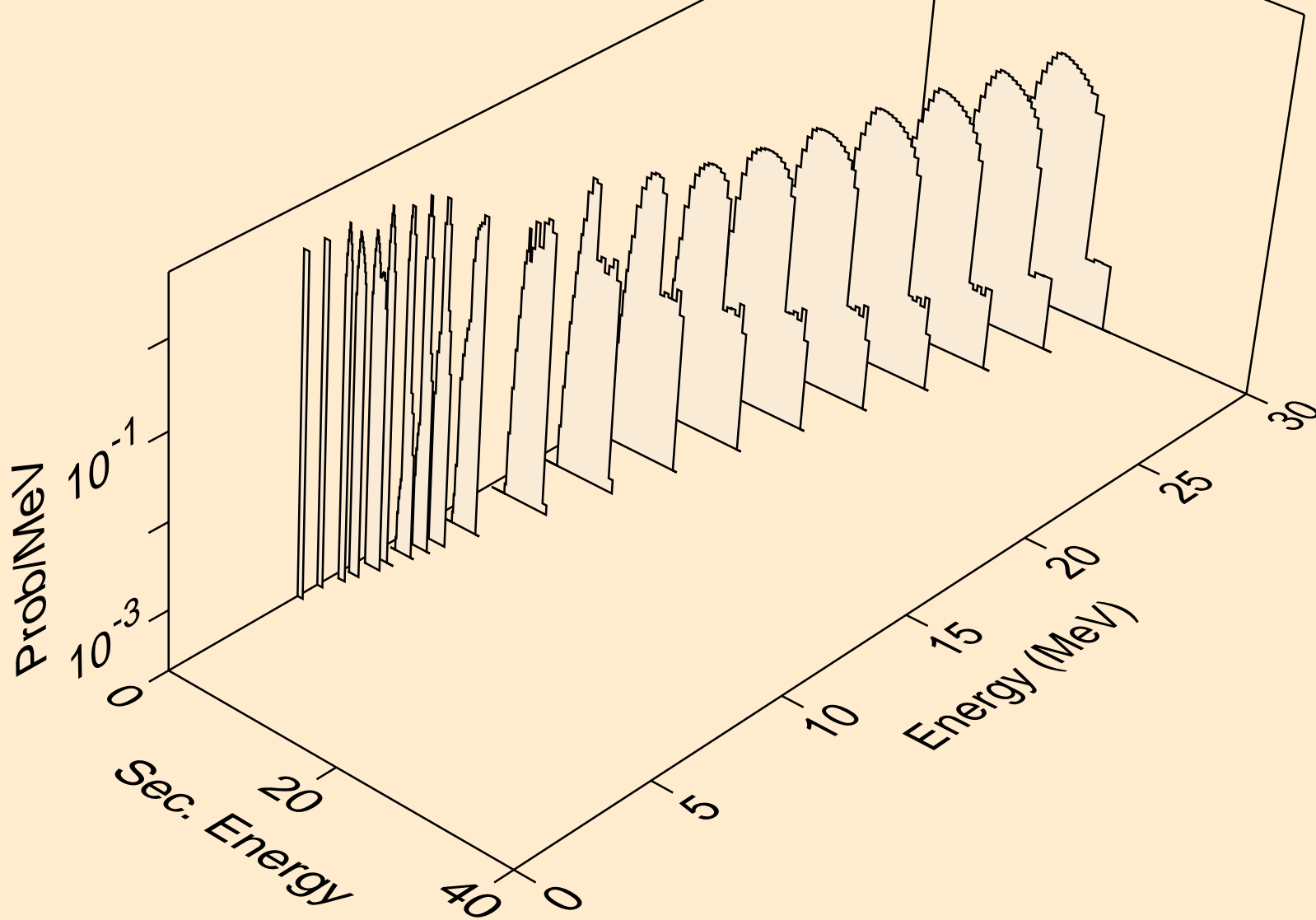

GA066 NEUTRON ACER TENDL-2019 LIBRARY; T=293.16K  
tritons from (n,pt)

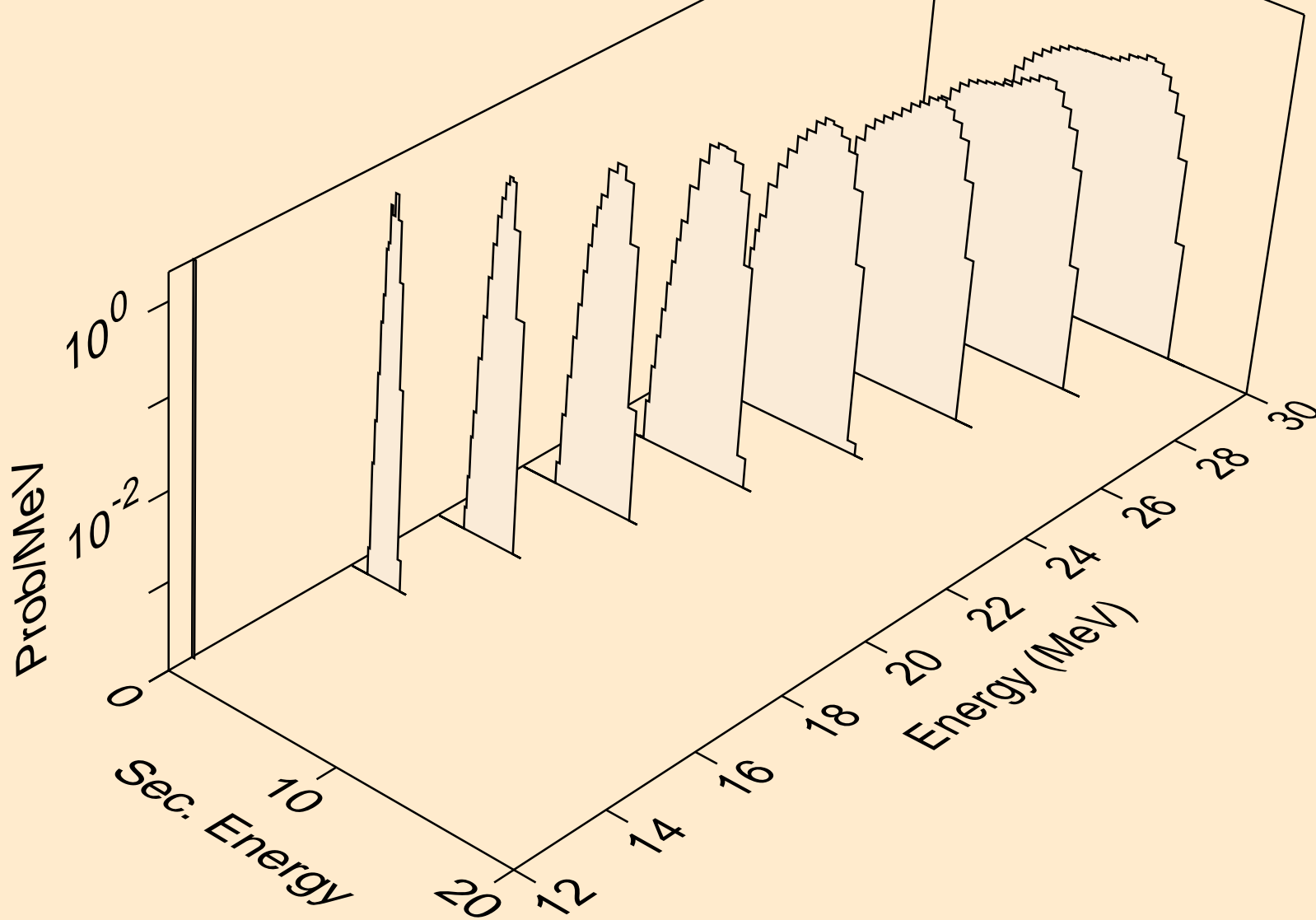

GA066 NEUTRON ACER TENDL-2019 LIBRARY; T=293.16K  
he3s from (n,x)

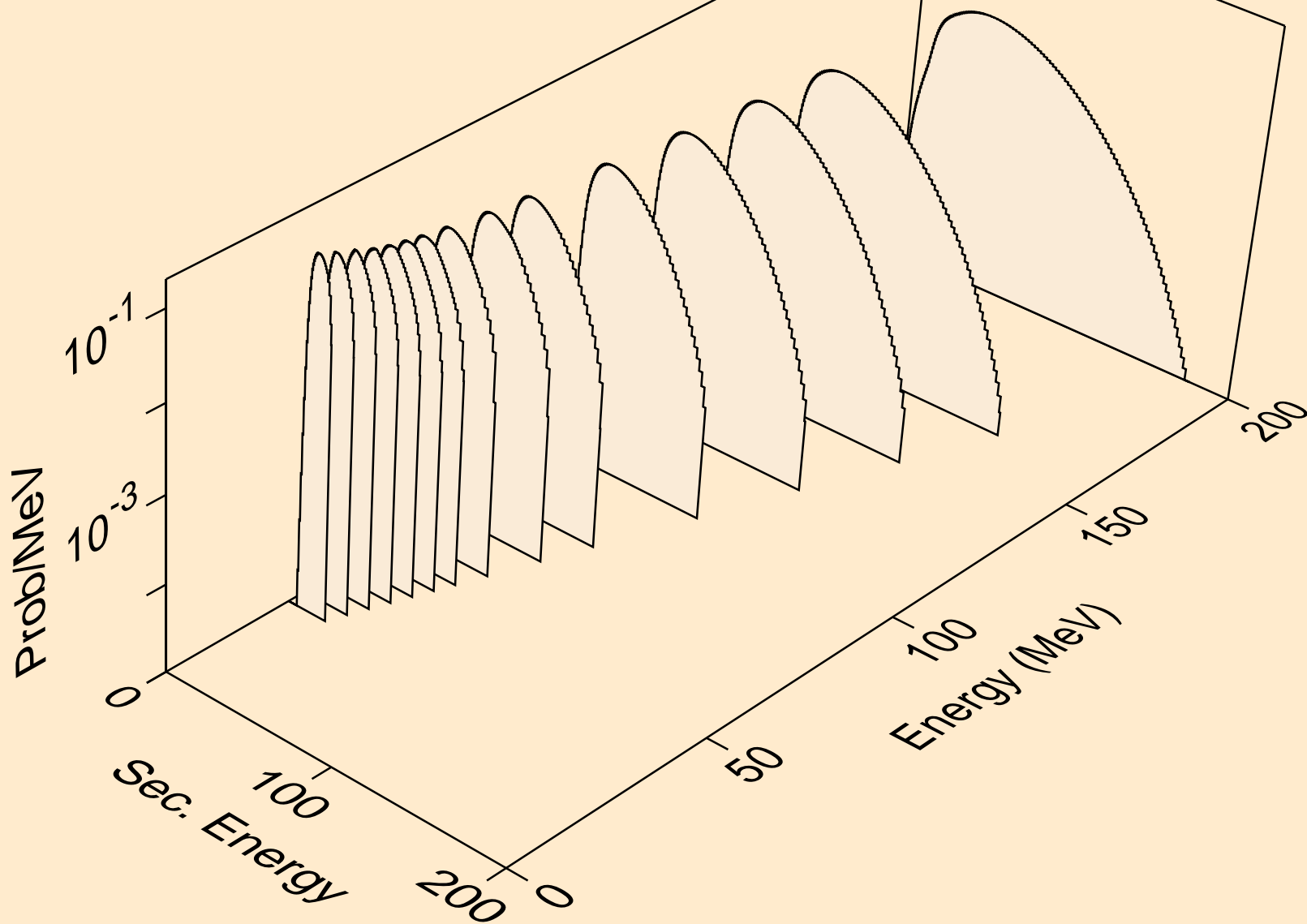

GA066 NEUTRON ACER TENDL-2019 LIBRARY; T=293.16K  
he3s from (n,n\*)he3

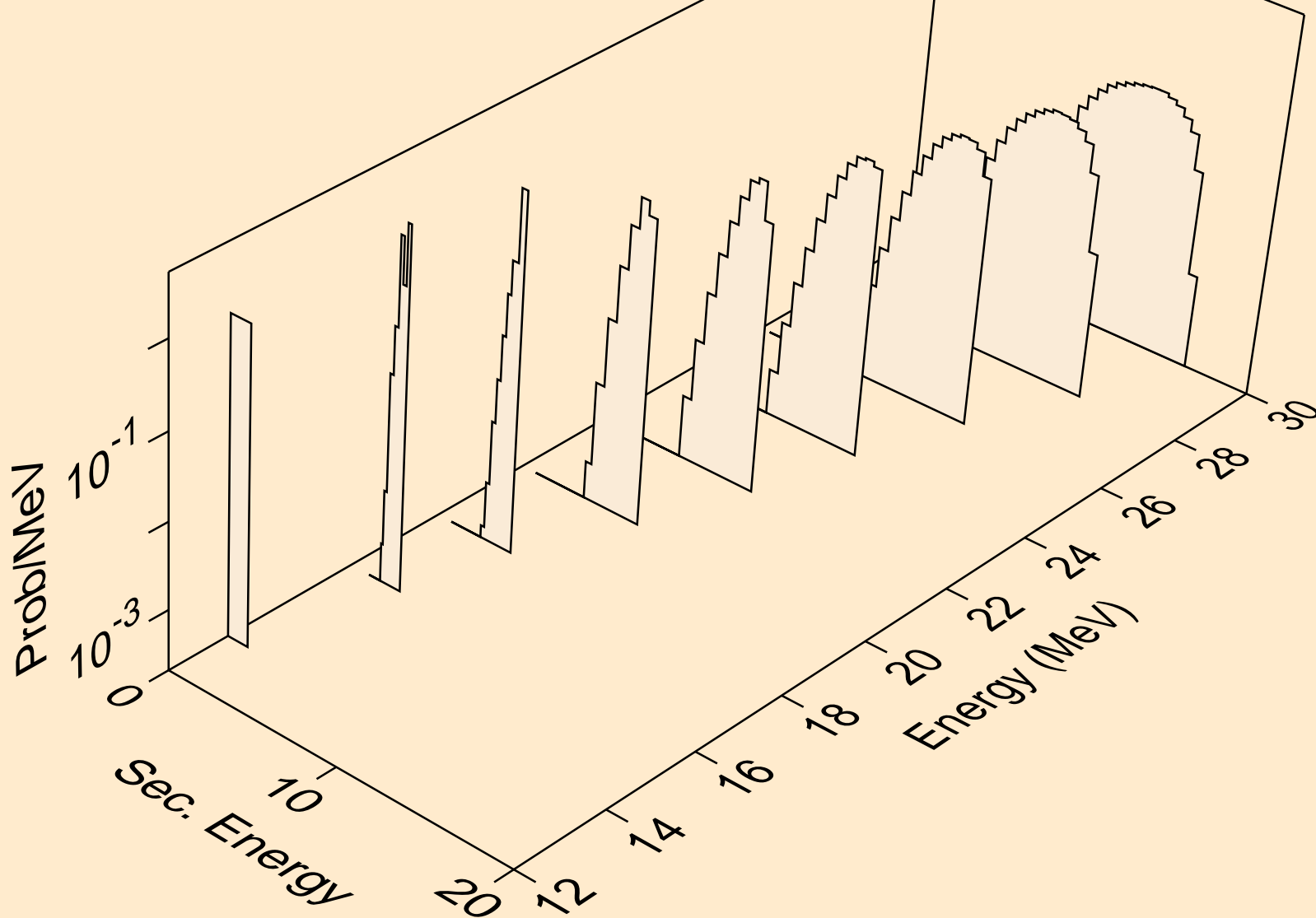

GA066 NEUTRON ACER TENDL-2019 LIBRARY; T=293.16K  
he3s from (n,he3)

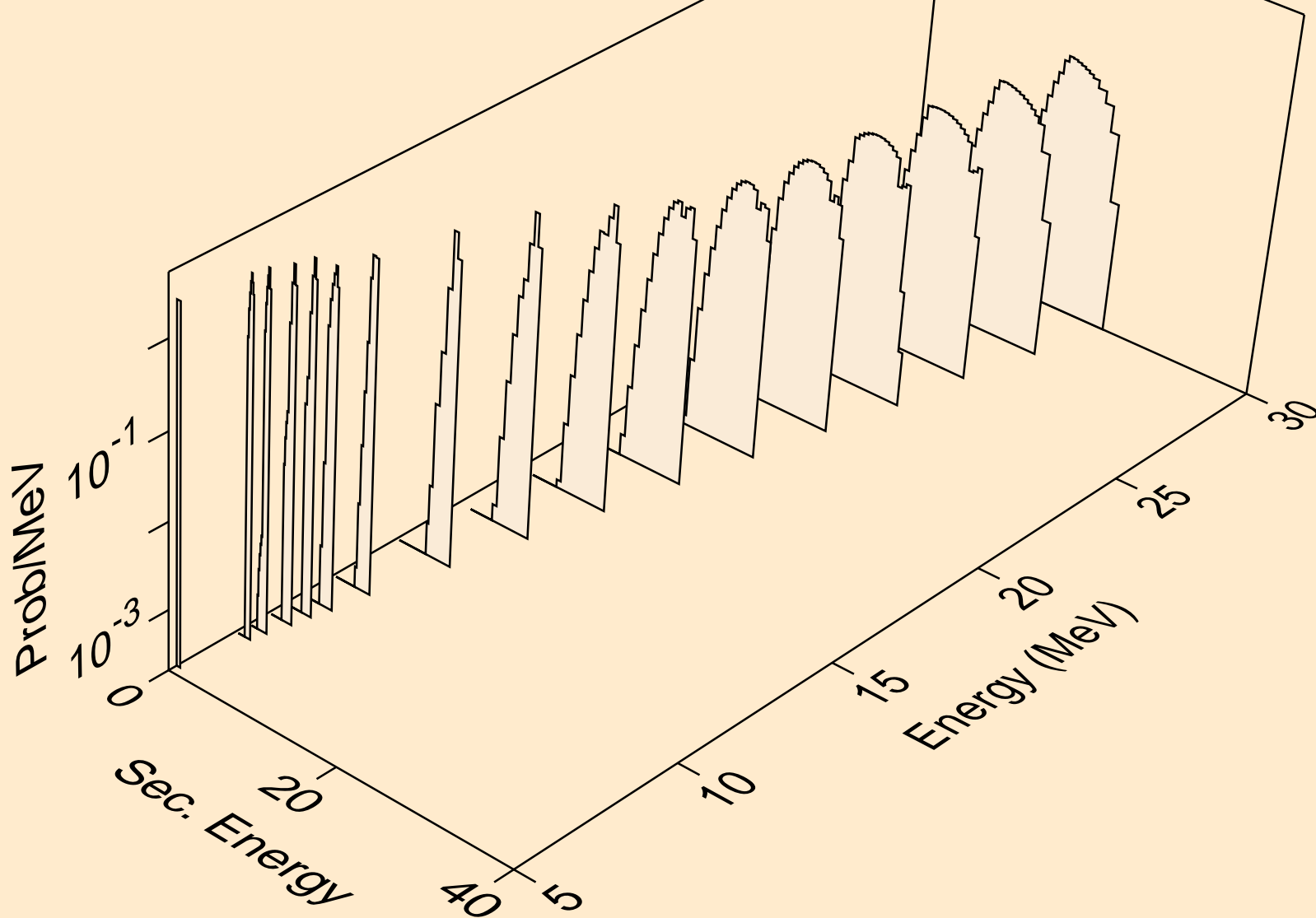

GA066 NEUTRON ACER TENDL-2019 LIBRARY; T=293.16K  
alphas from (n,x)

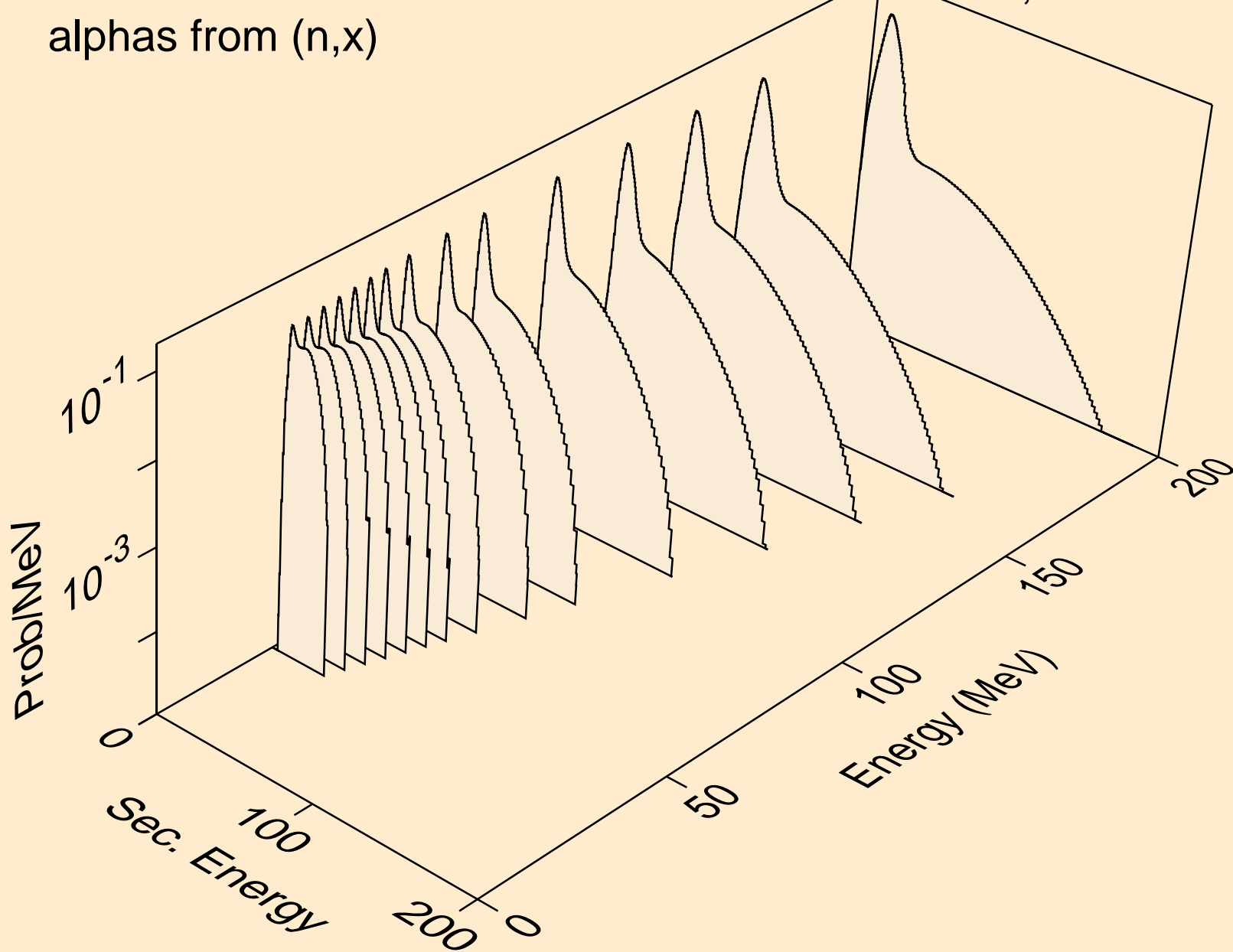

GA066 NEUTRON ACER TENDL-2019 LIBRARY; T=293.16K  
alphas from (n,n\*)a

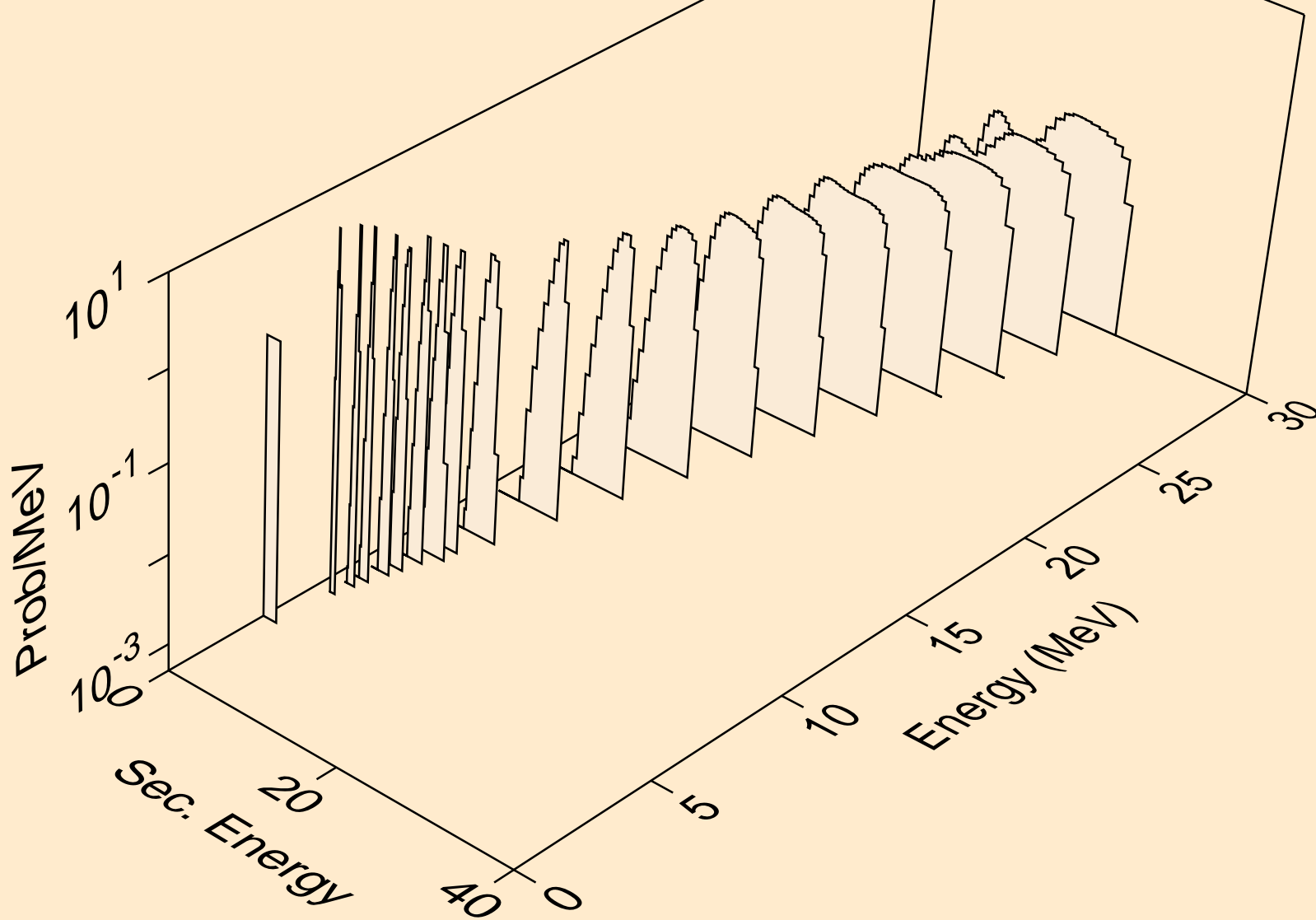

GA066 NEUTRON ACER TENDL-2019 LIBRARY; T=293.16K  
alphas from (n,2n)a

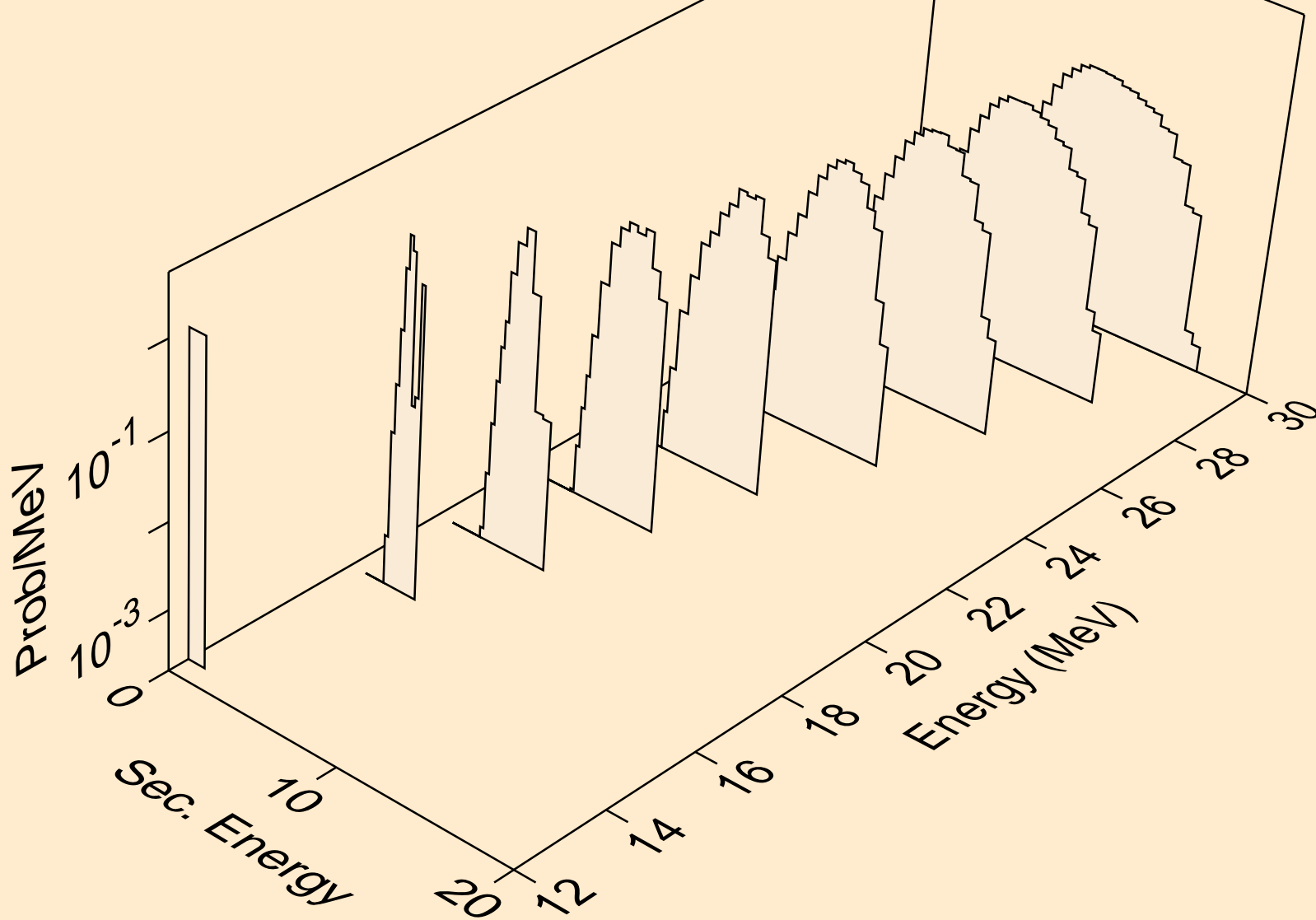

GA066 NEUTRON ACER TENDL-2019 LIBRARY; T=293.16K  
alphas from (n,3n)a

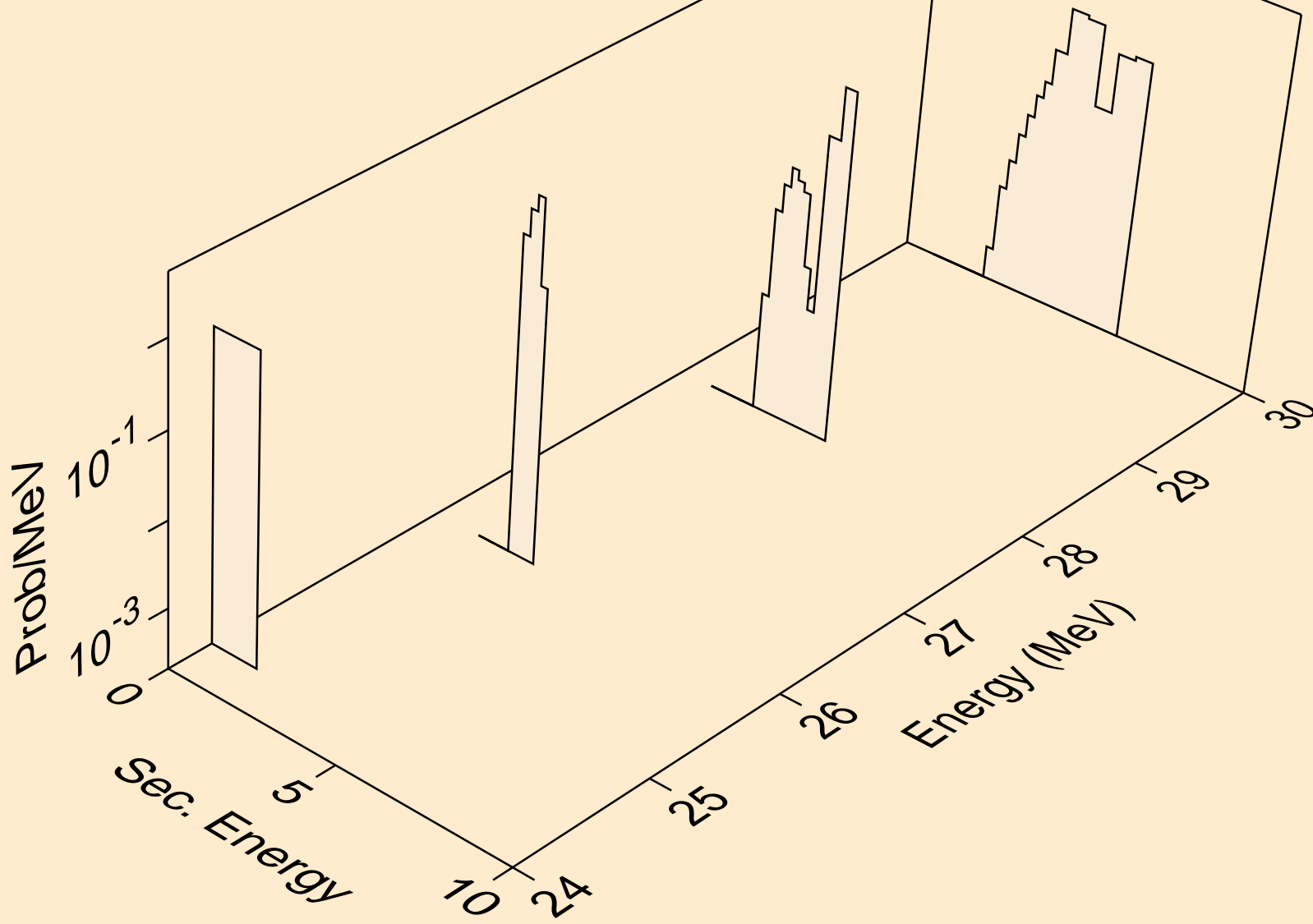

GA066 NEUTRON ACER TENDL-2019 LIBRARY; T=293.16K  
alphas from (n,n\*)2a

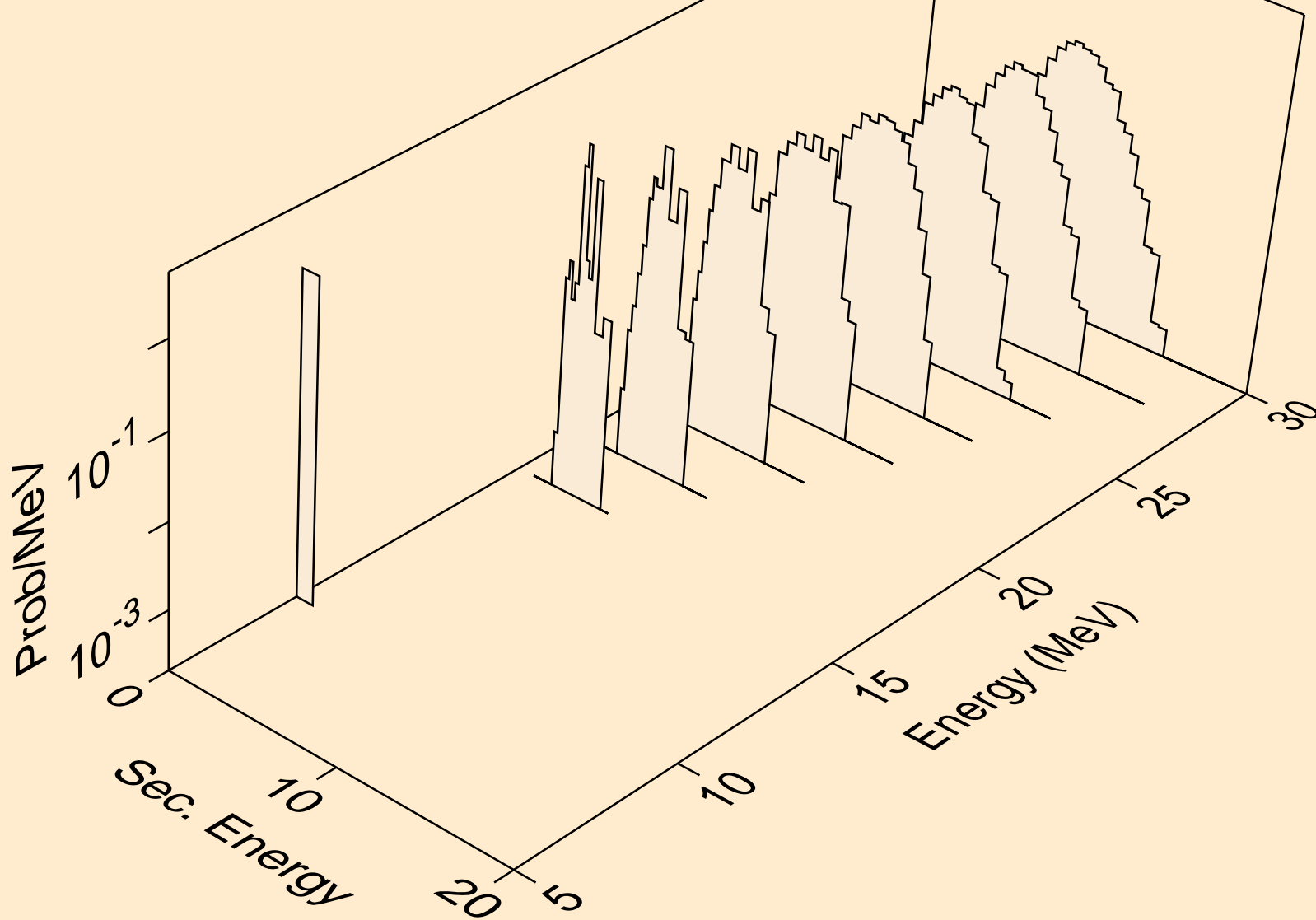

GA066 NEUTRON ACER TENDL-2019 LIBRARY; T=293.16K  
alphas from (n,2n)2a

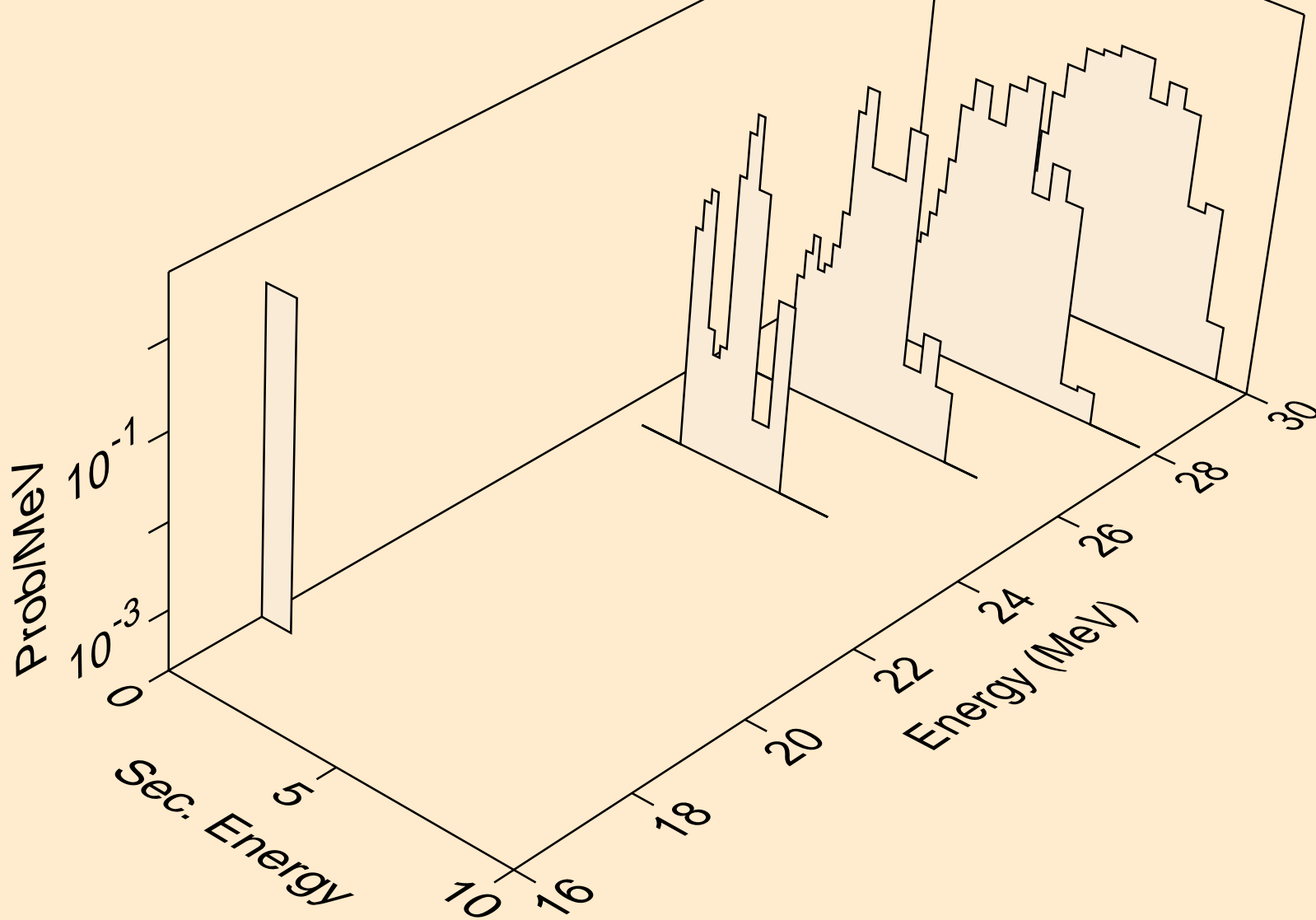

GA066 NEUTRON ACER TENDL-2019 LIBRARY; T=293.16K  
alphas from (n,npa)

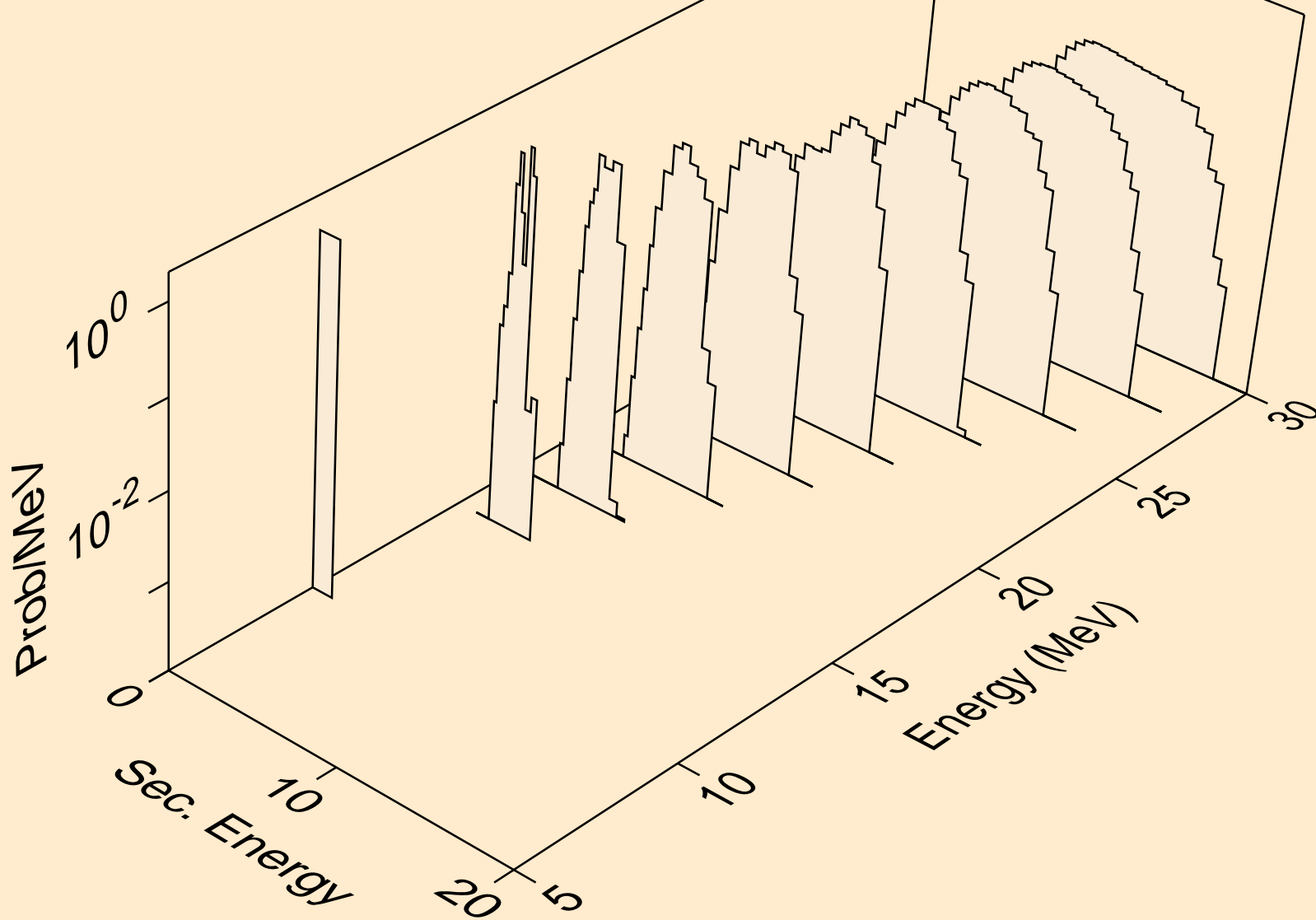

GA066 NEUTRON ACER TENDL-2019 LIBRARY; T=293.16K  
alphas from (n,a)

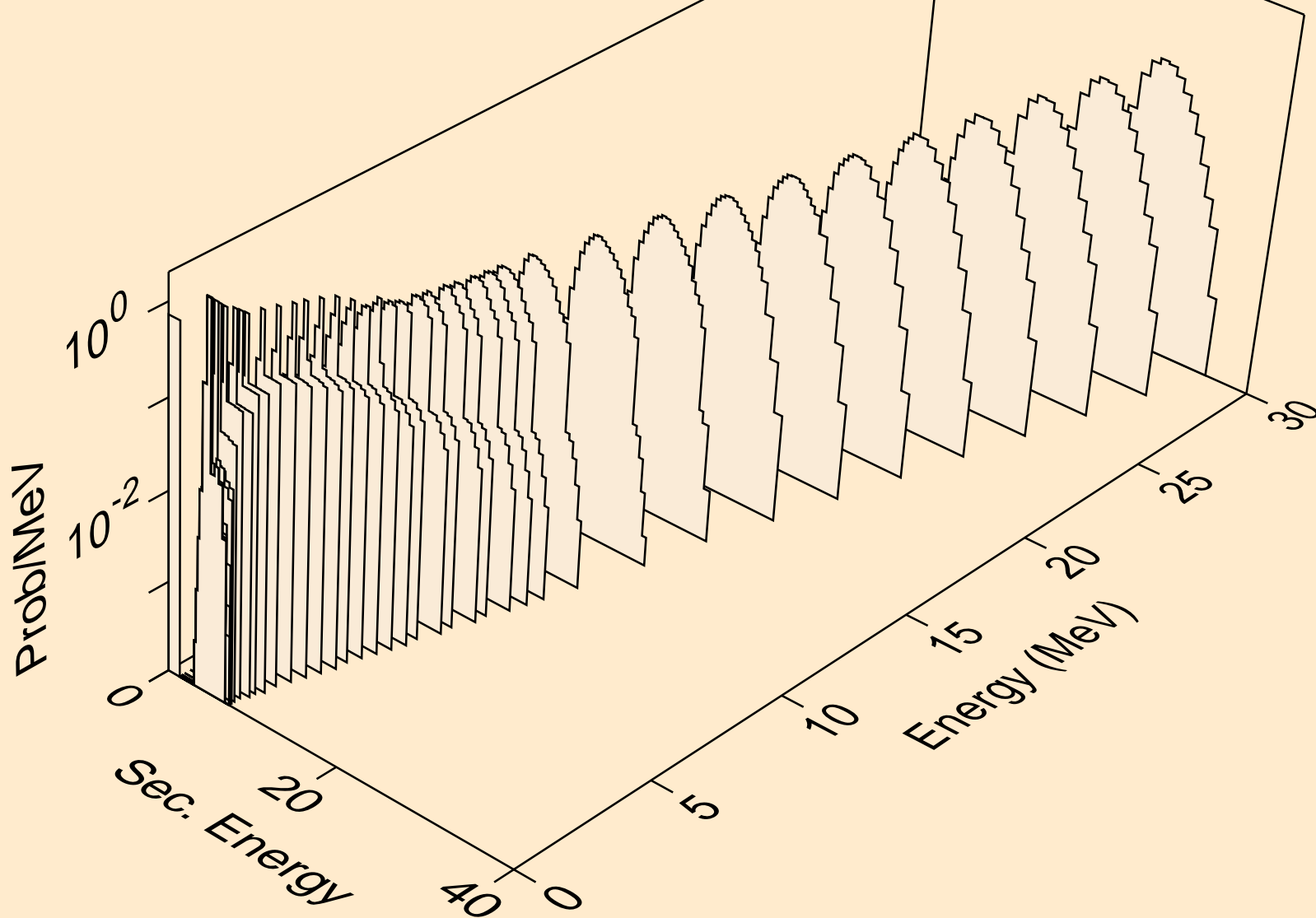

GA066 NEUTRON ACER TENDL-2019 LIBRARY; T=293.16K  
alphas from (n,2a)

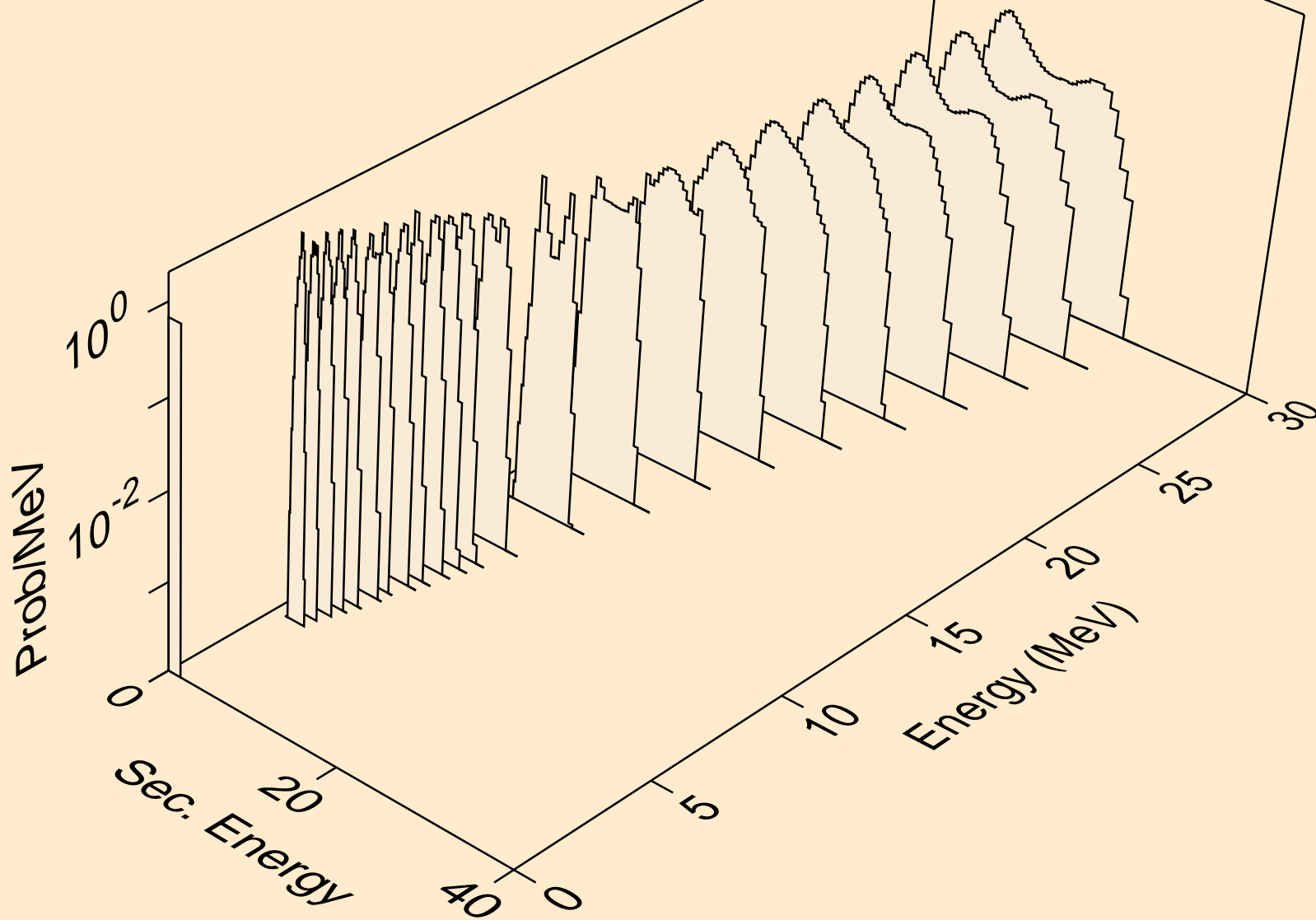

GA066 NEUTRON ACER TENDL-2019 LIBRARY; T=293.16K  
alphas from (n,3a)

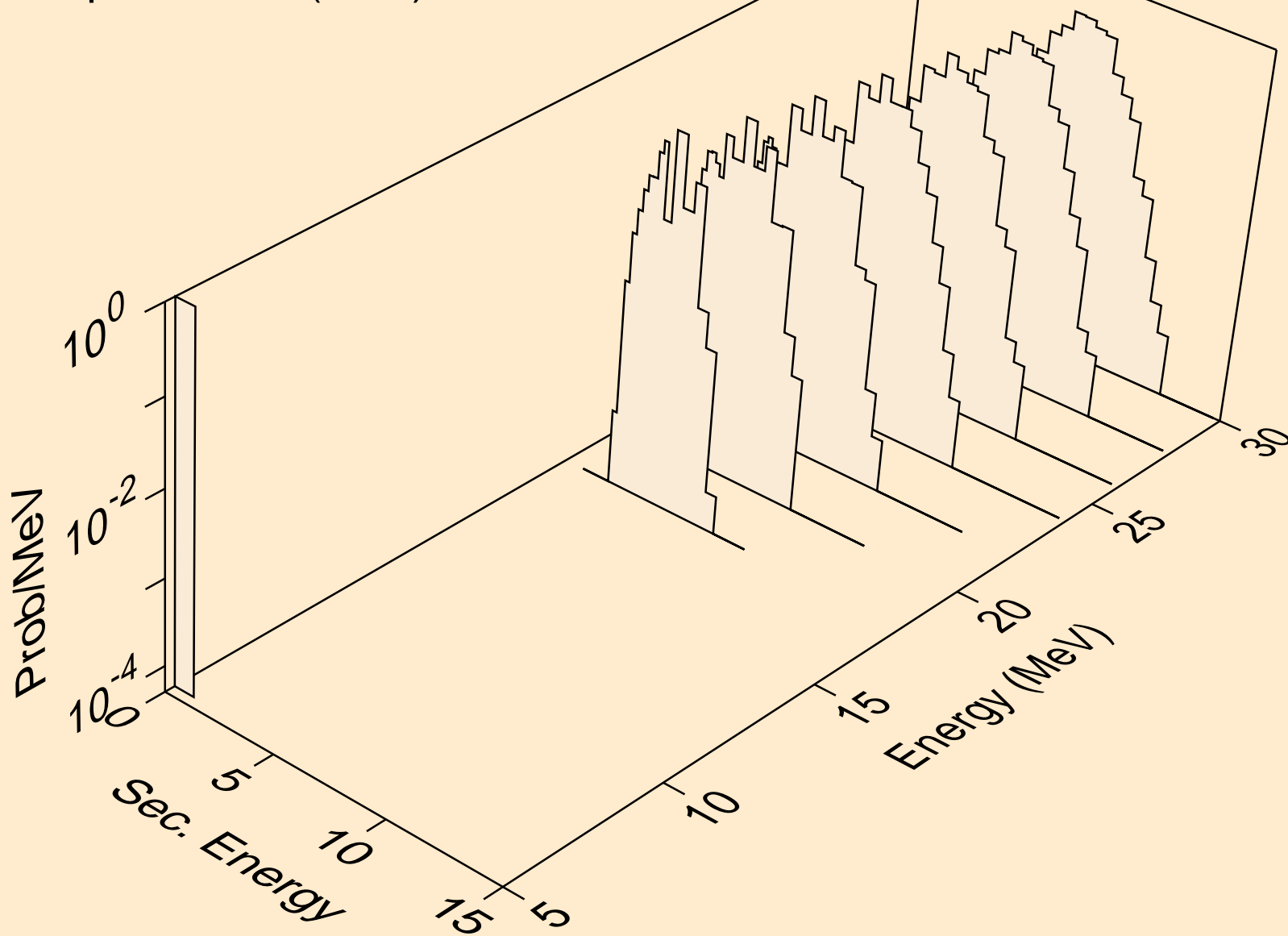

GA066 NEUTRON ACER TENDL-2019 LIBRARY; T=293.16K  
alphas from (n,pa)

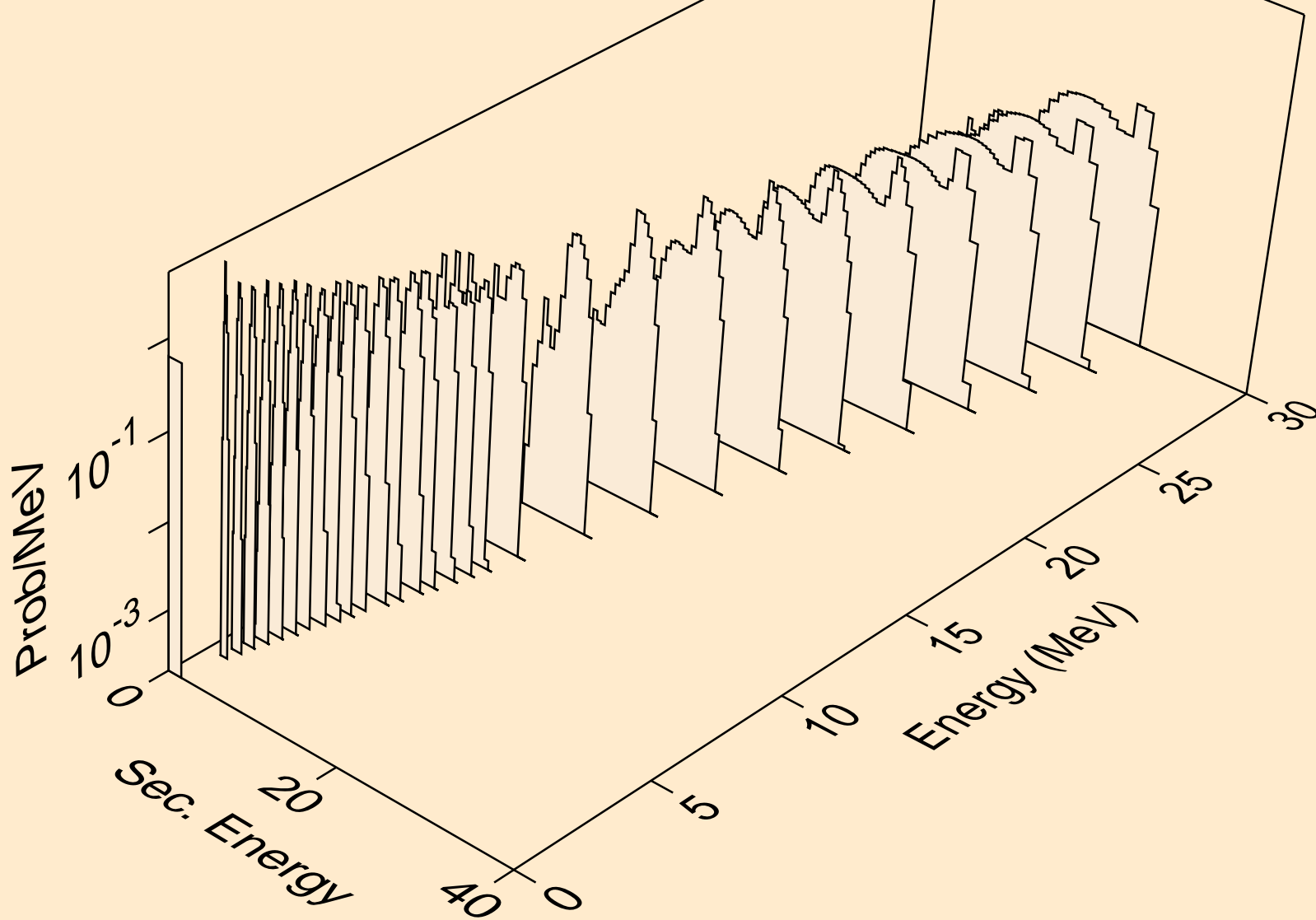

GA066 NEUTRON ACER TENDL-2019 LIBRARY; T=293.16K  
alphas from (n,da)

