

# HG182 NEUTRON ACER TENDL-2019 LIBRARY; T=293.16K

## Principal cross sections

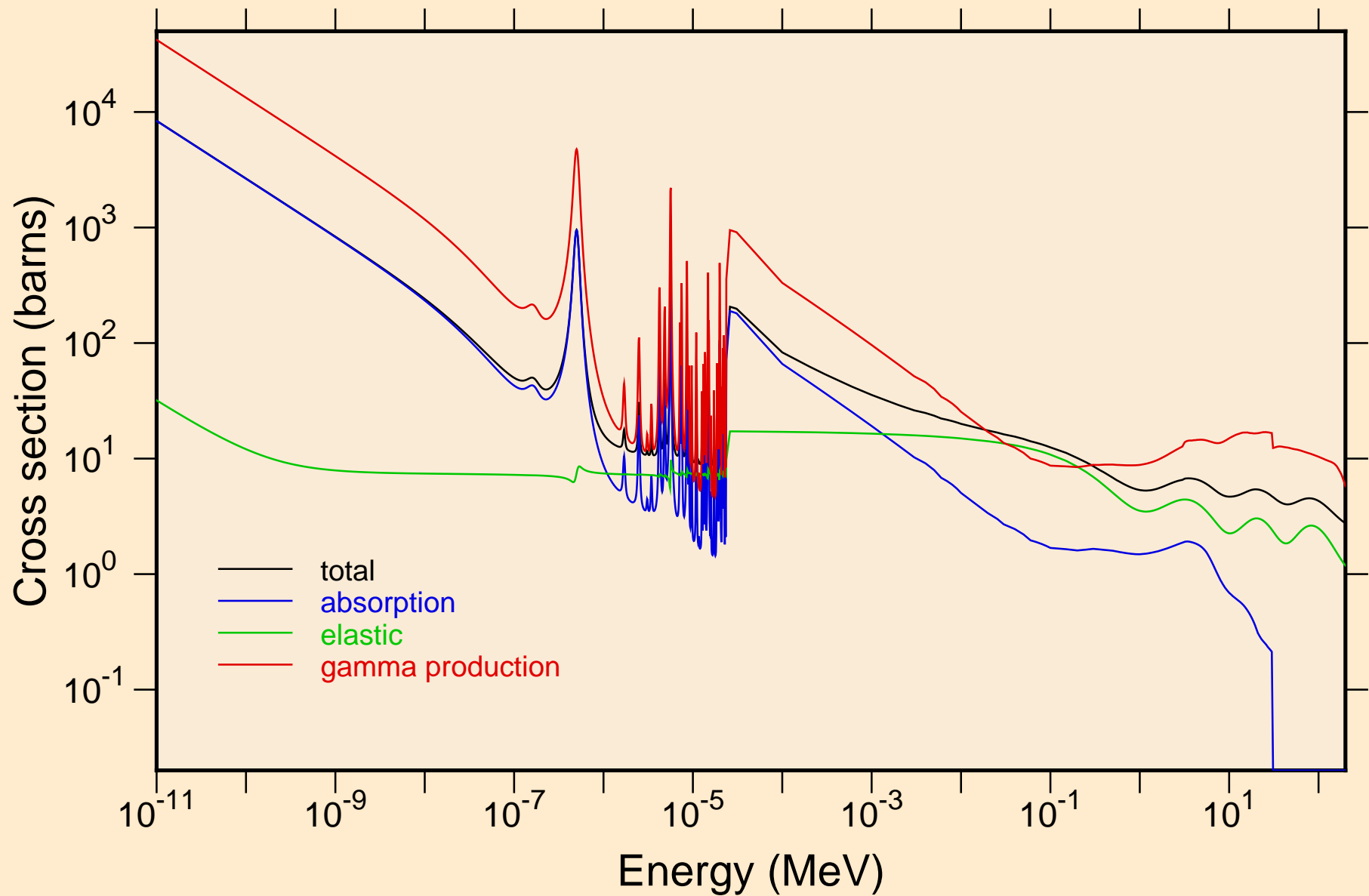

HG182 NEUTRON ACER TENDL-2019 LIBRARY; T=293.16K  
resonance total cross section

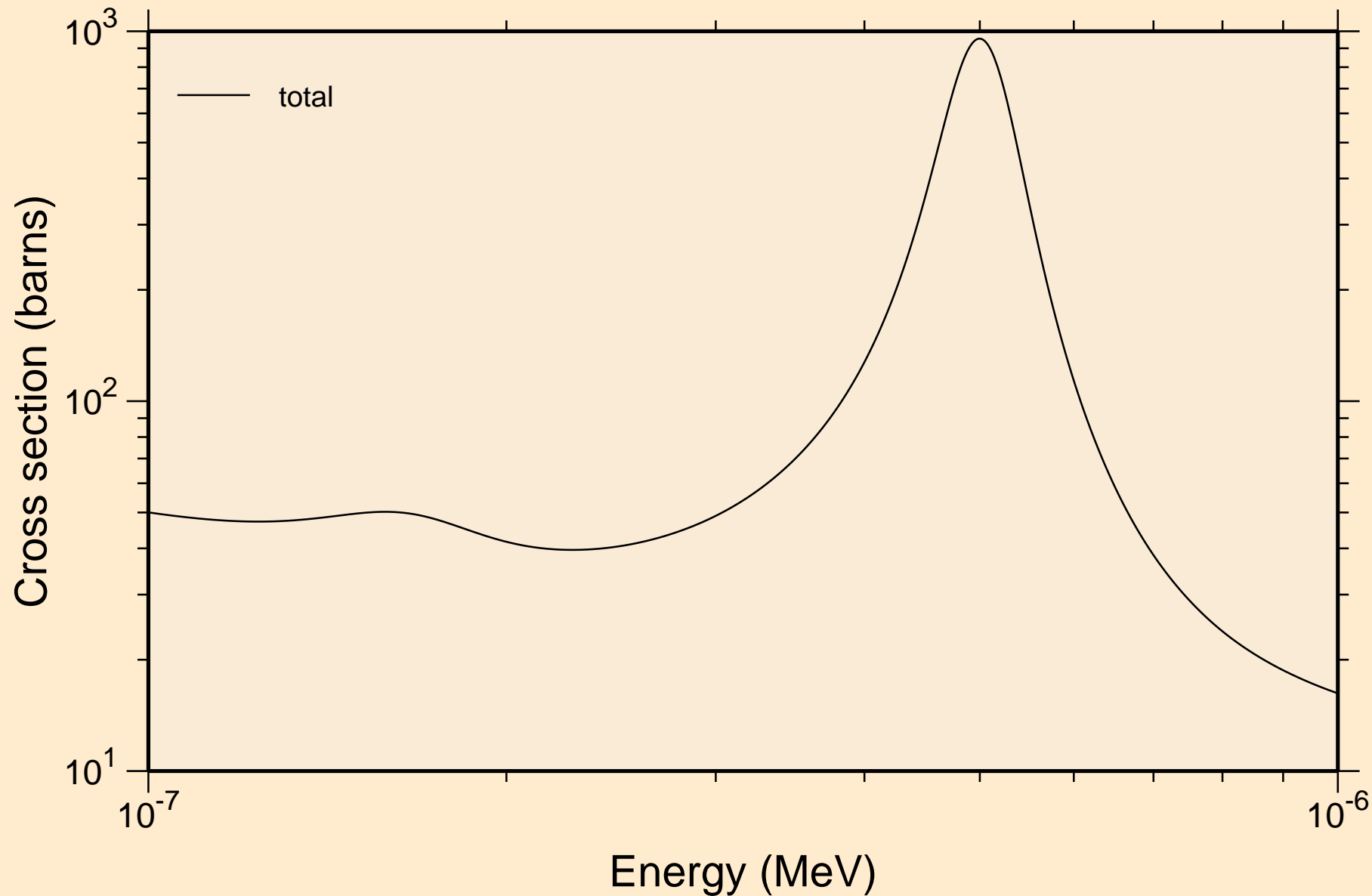

HG182 NEUTRON ACER TENDL-2019 LIBRARY; T=293.16K  
resonance total cross section

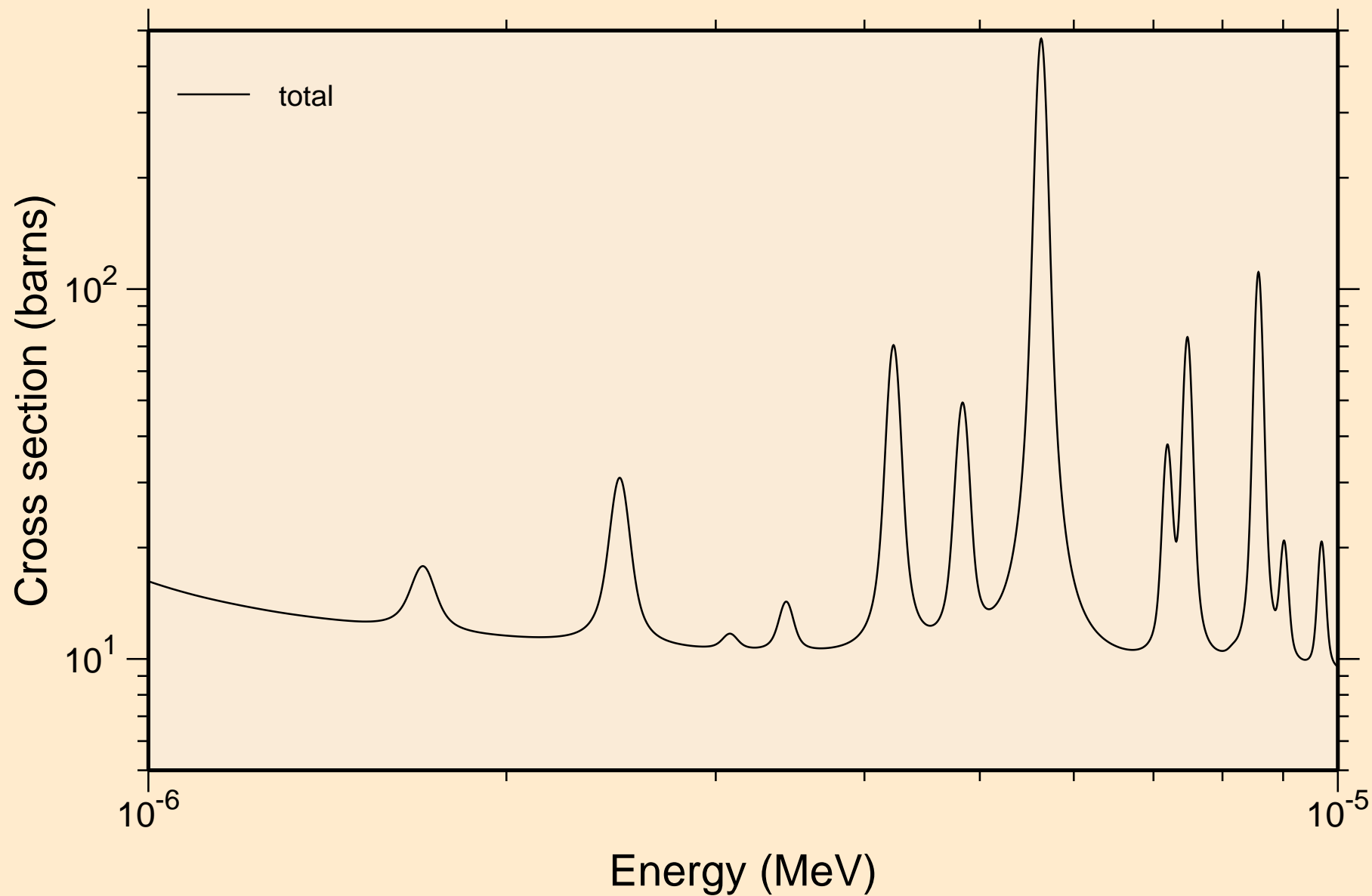

HG182 NEUTRON ACER TENDL-2019 LIBRARY; T=293.16K  
resonance total cross section

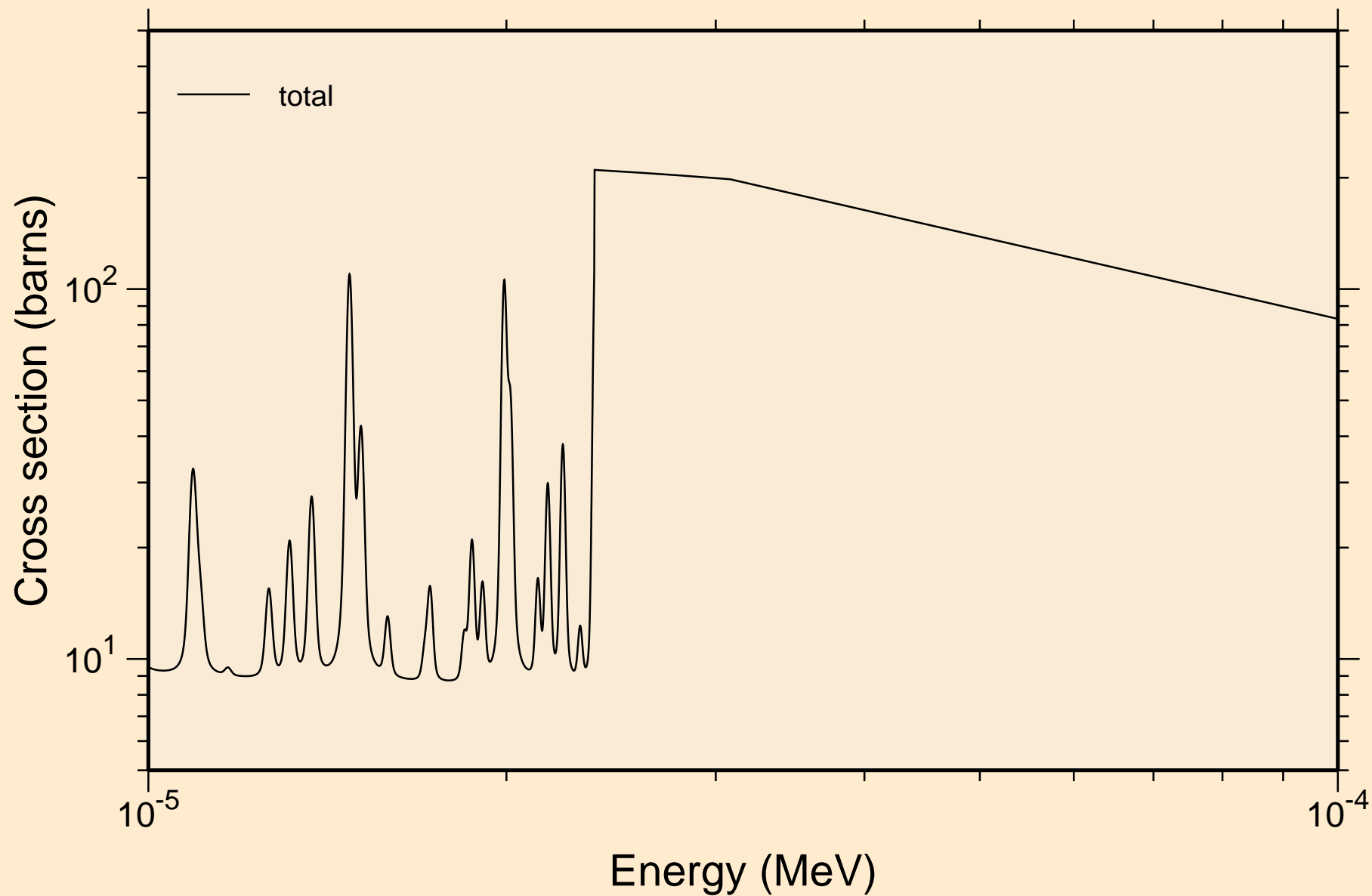

HG182 NEUTRON ACER TENDL-2019 LIBRARY; T=293.16K  
resonance total cross section

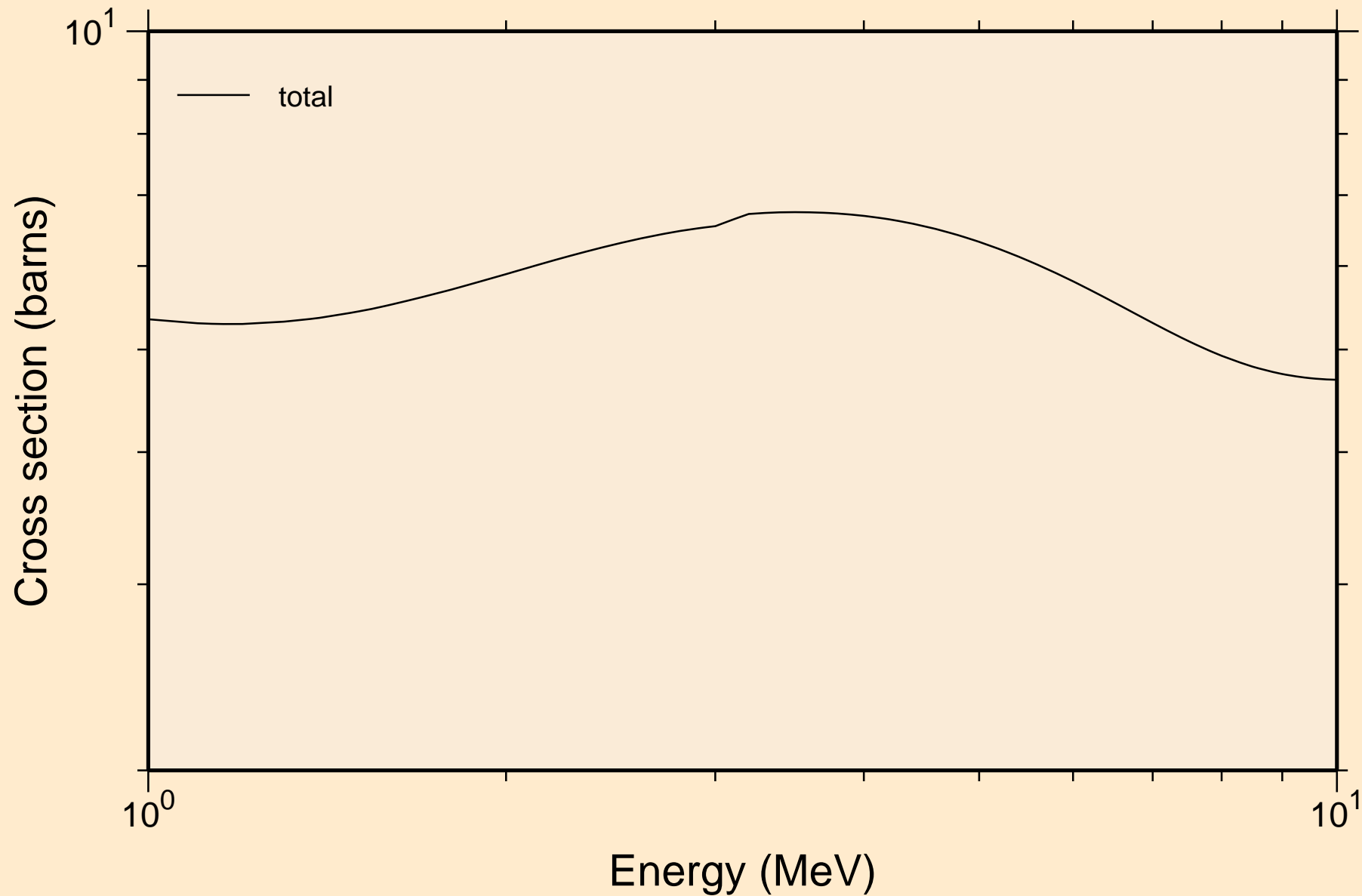

HG182 NEUTRON ACER TENDL-2019 LIBRARY; T=293.16K  
resonance absorption cross sections

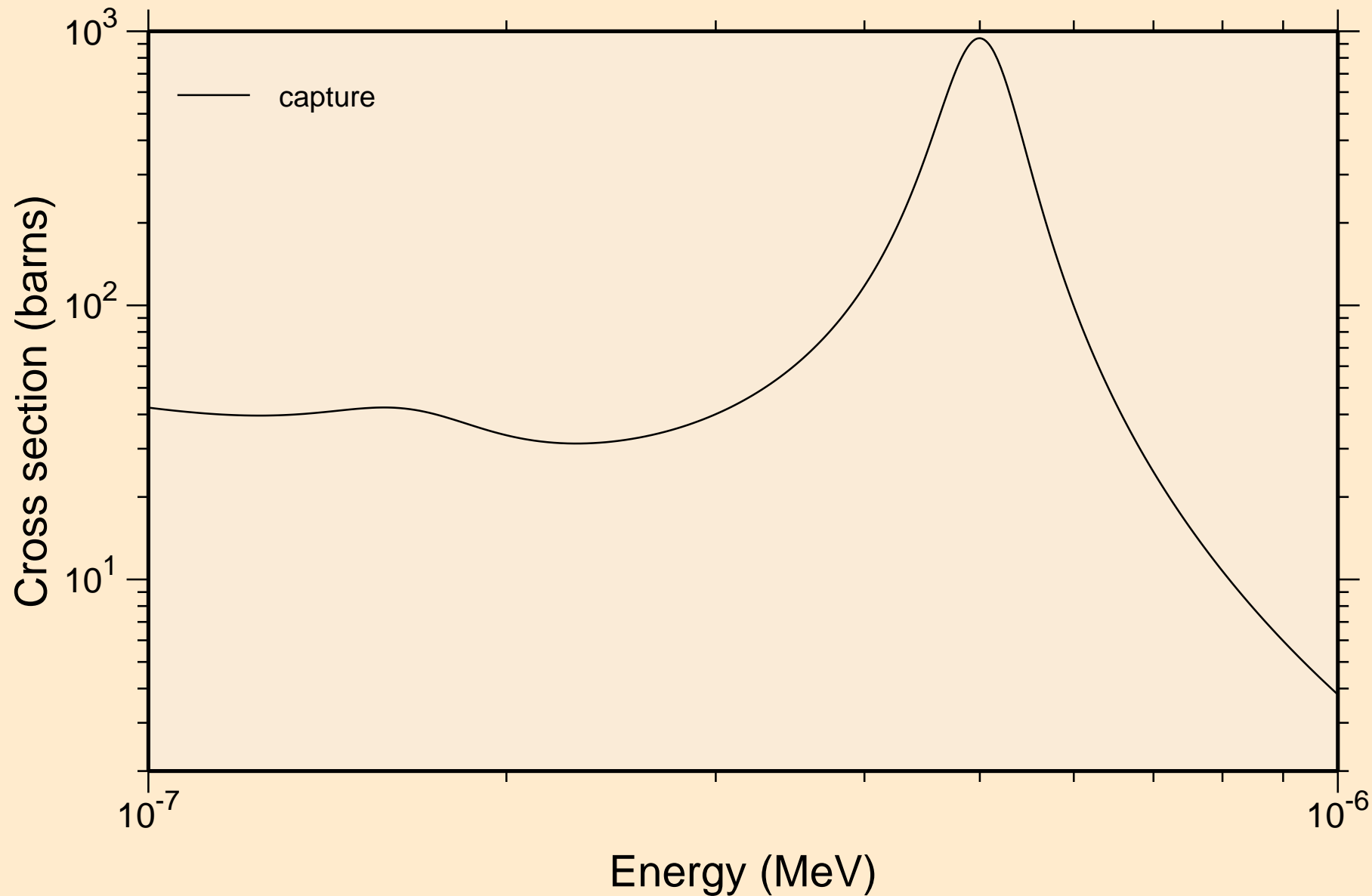

HG182 NEUTRON ACER TENDL-2019 LIBRARY; T=293.16K  
resonance absorption cross sections

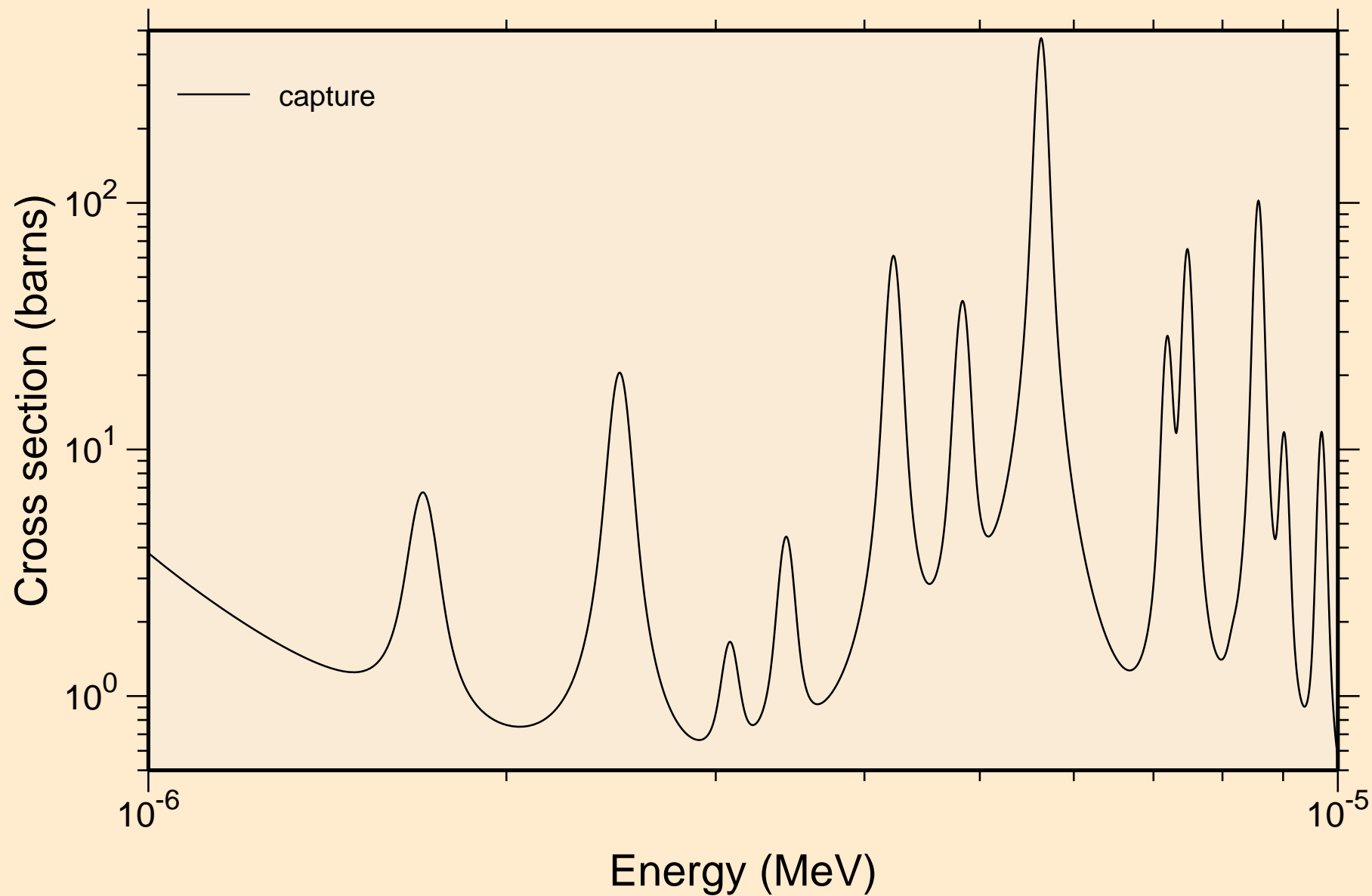

HG182 NEUTRON ACER TENDL-2019 LIBRARY; T=293.16K  
resonance absorption cross sections

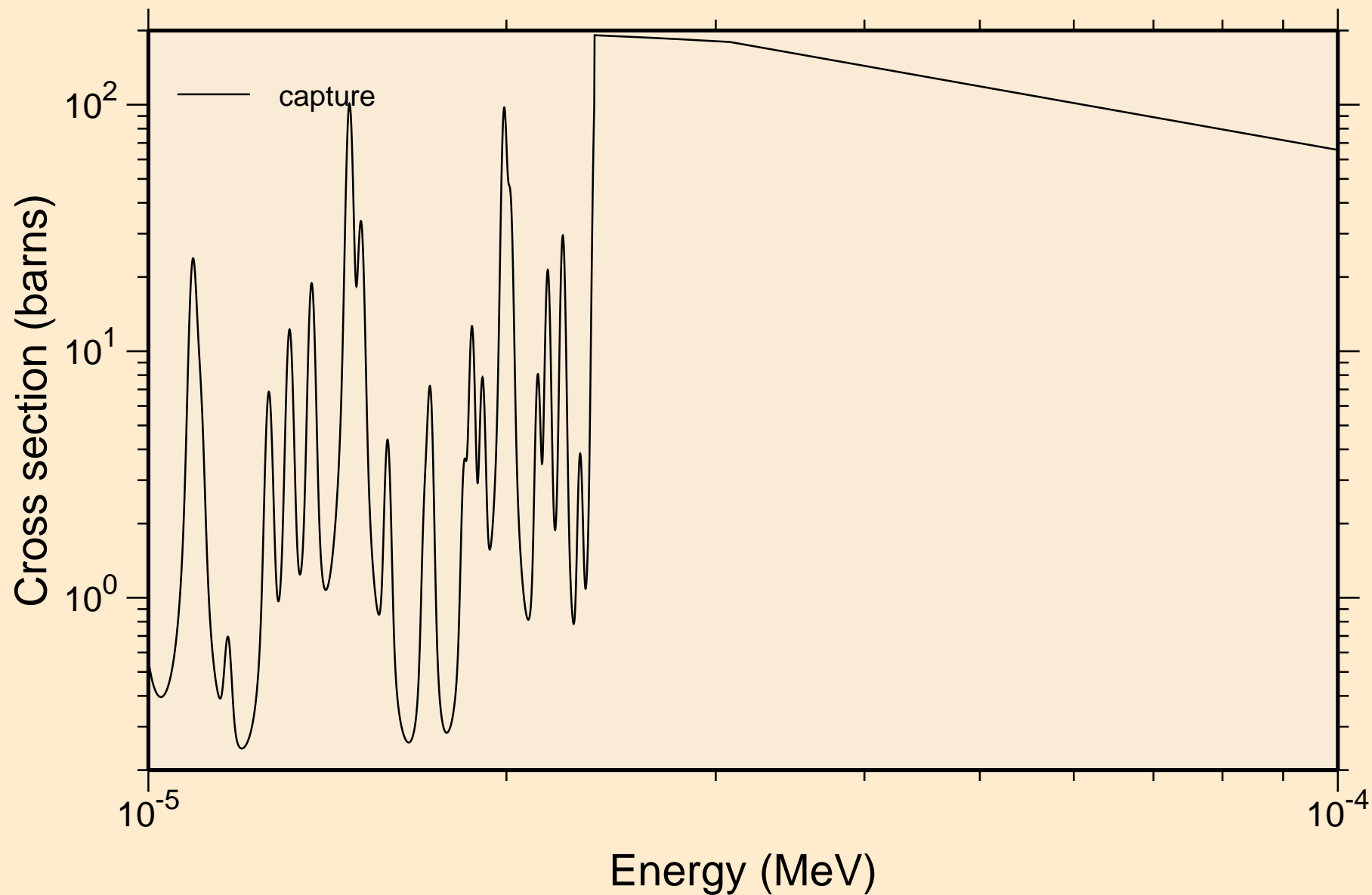

HG182 NEUTRON ACER TENDL-2019 LIBRARY; T=293.16K  
resonance absorption cross sections

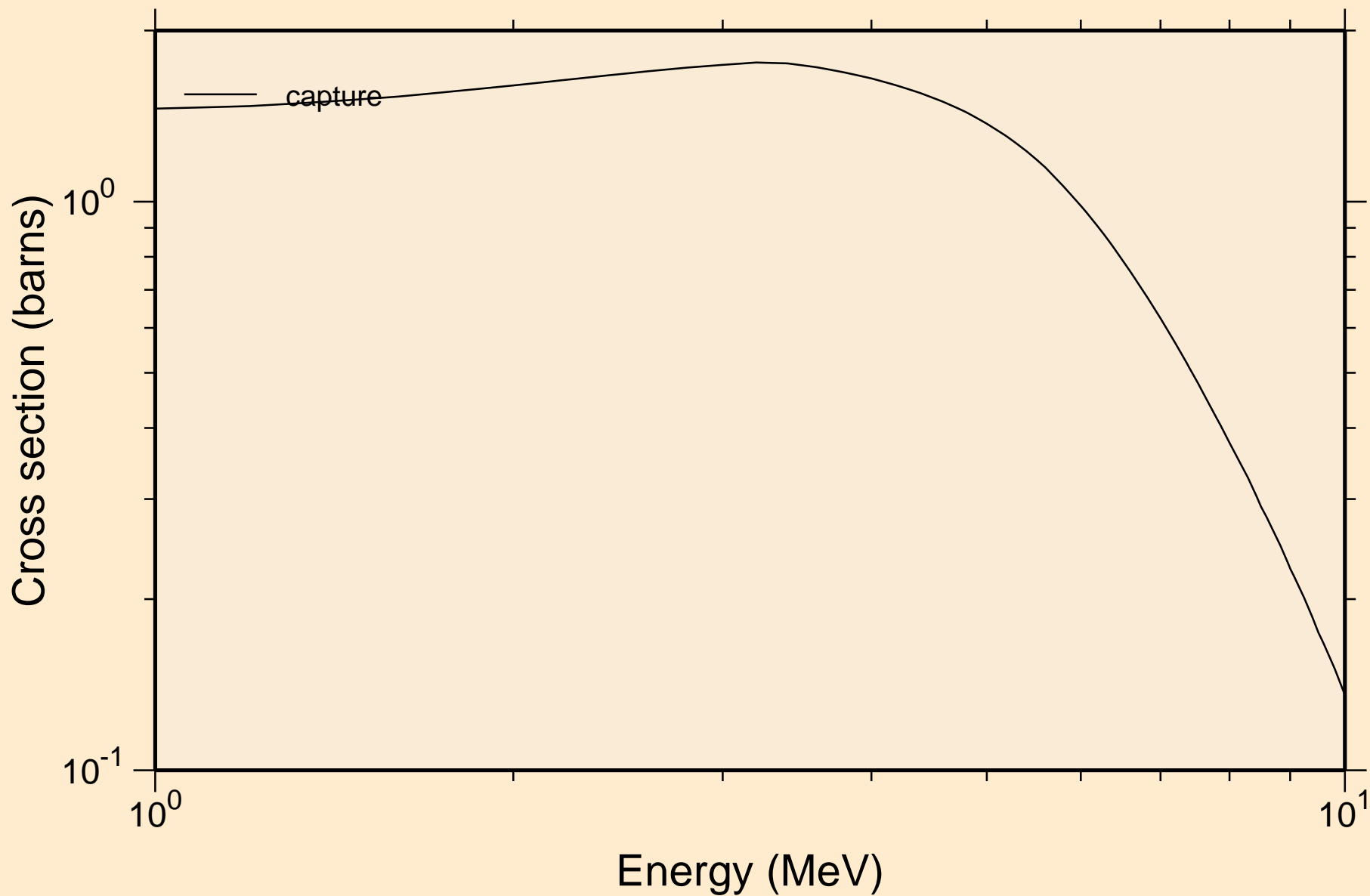

HG182 NEUTRON ACER TENDL-2019 LIBRARY; T=293.16K  
Heating

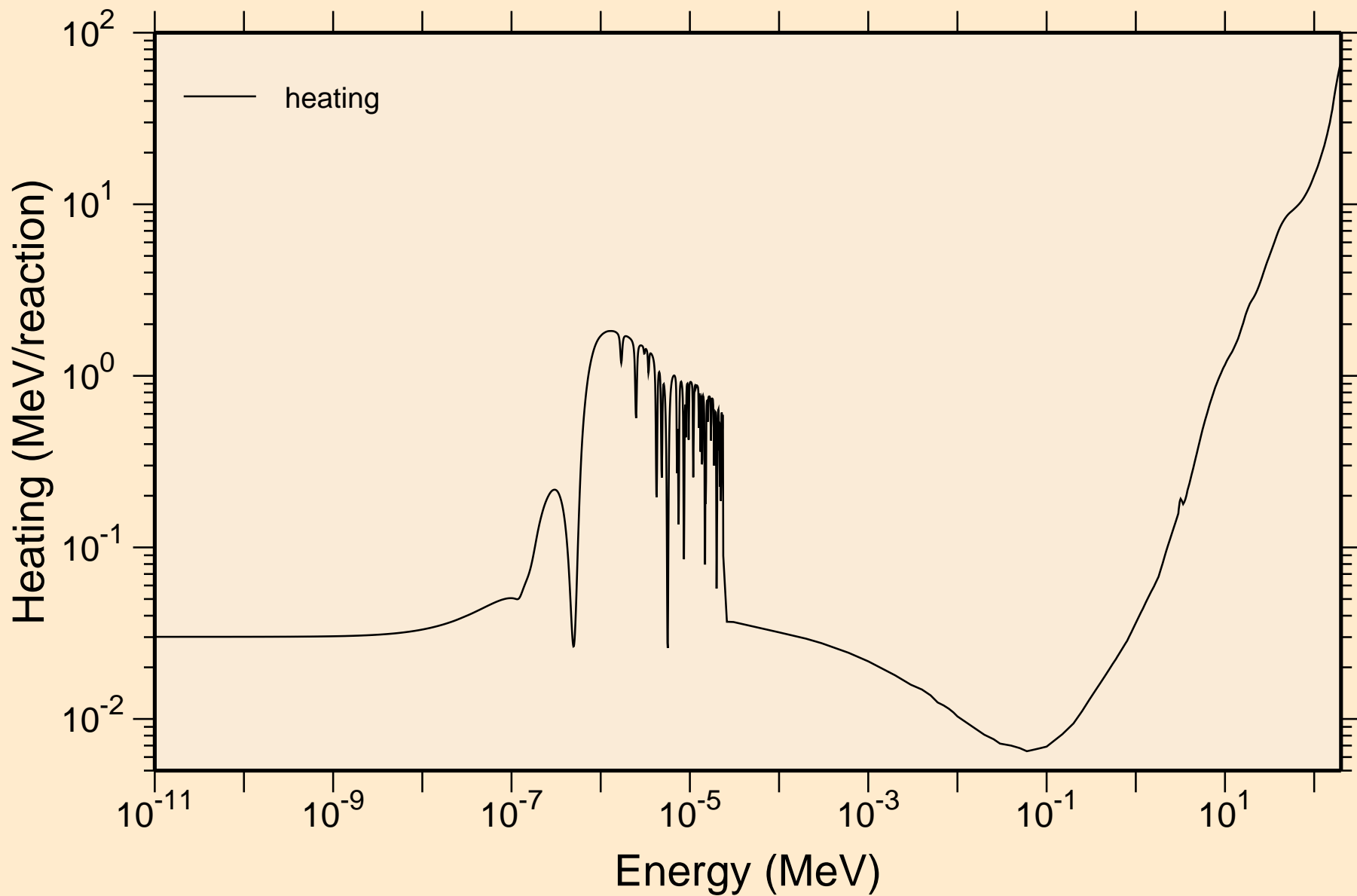

# HG182 NEUTRON ACER TENDL-2019 LIBRARY; T=293.16K Damage

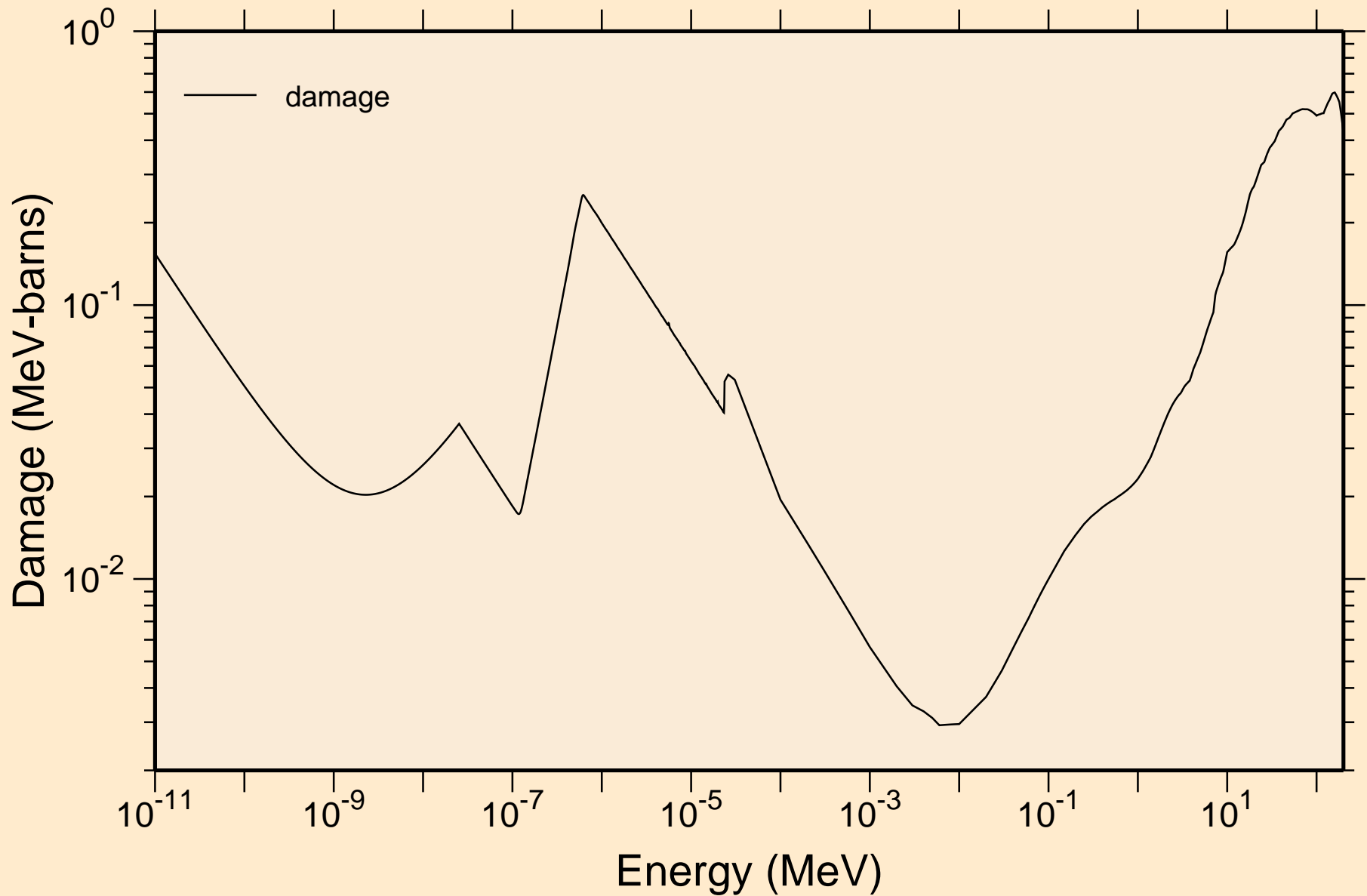

HG182 NEUTRON ACER TENDL-2019 LIBRARY; T=293.16K  
Non-threshold reactions

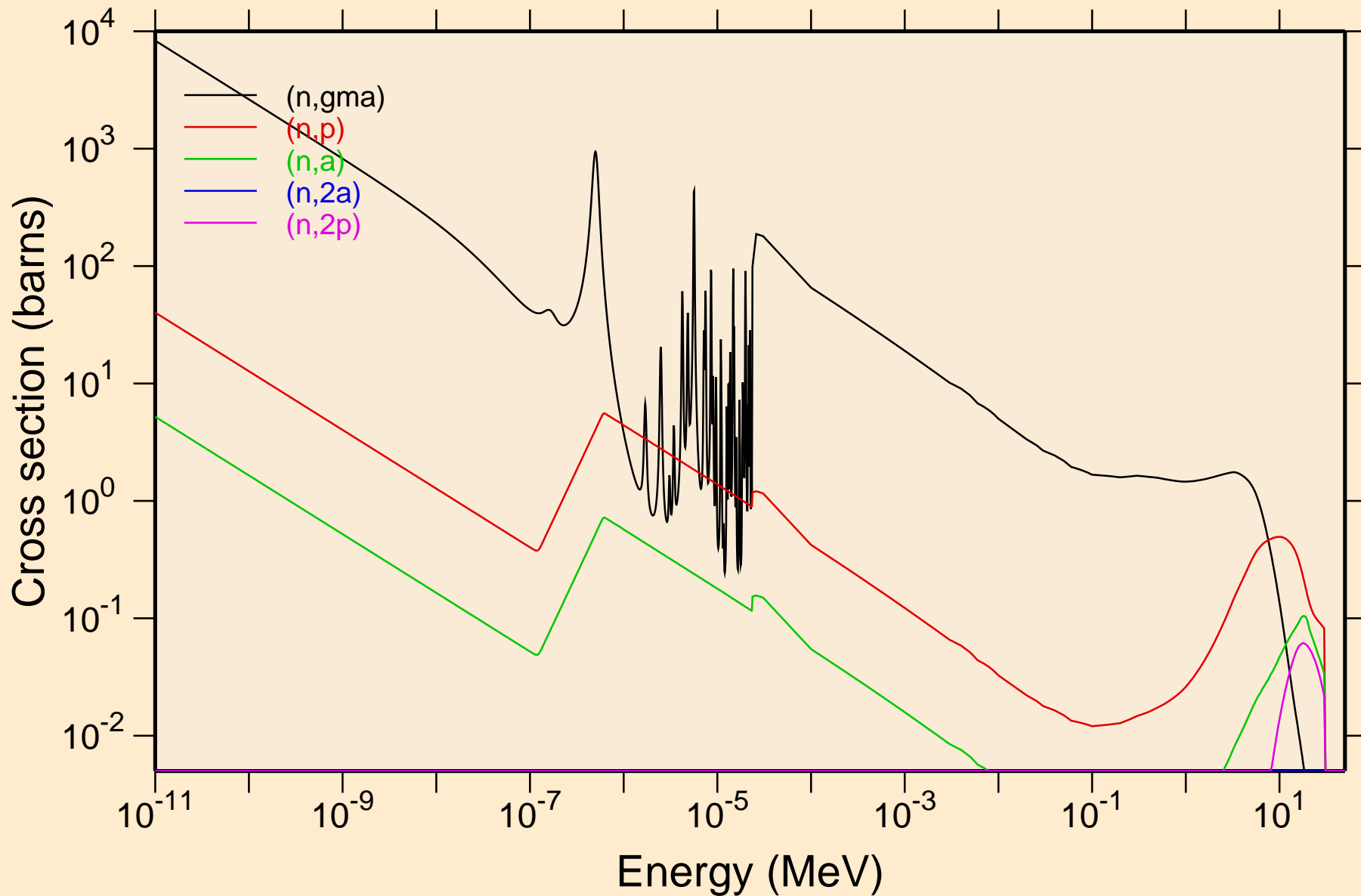

HG182 NEUTRON ACER TENDL-2019 LIBRARY; T=293.16K  
Non-threshold reactions

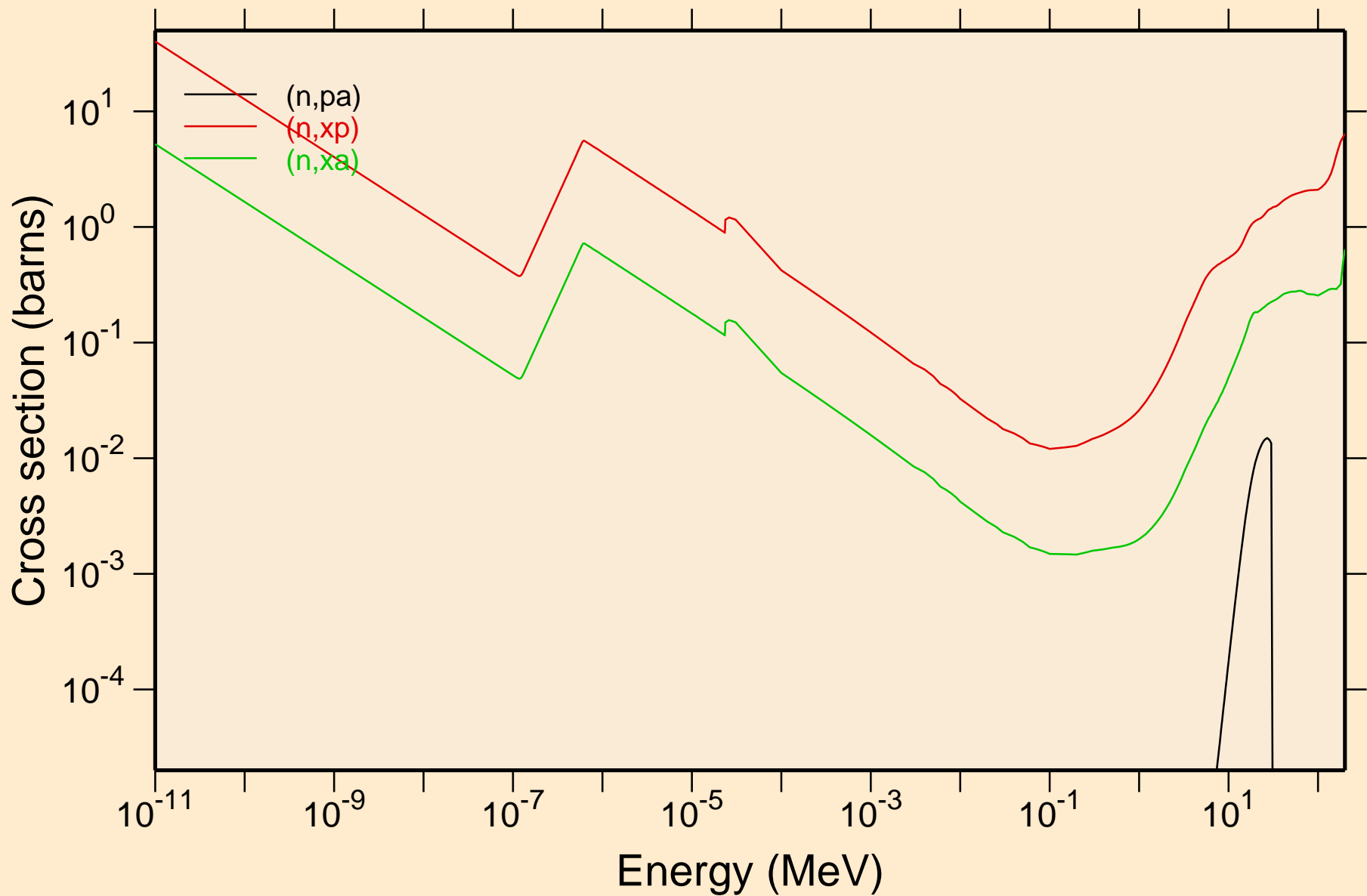

# HG182 NEUTRON ACER TENDL-2019 LIBRARY; T=293.16K

## Principal cross sections

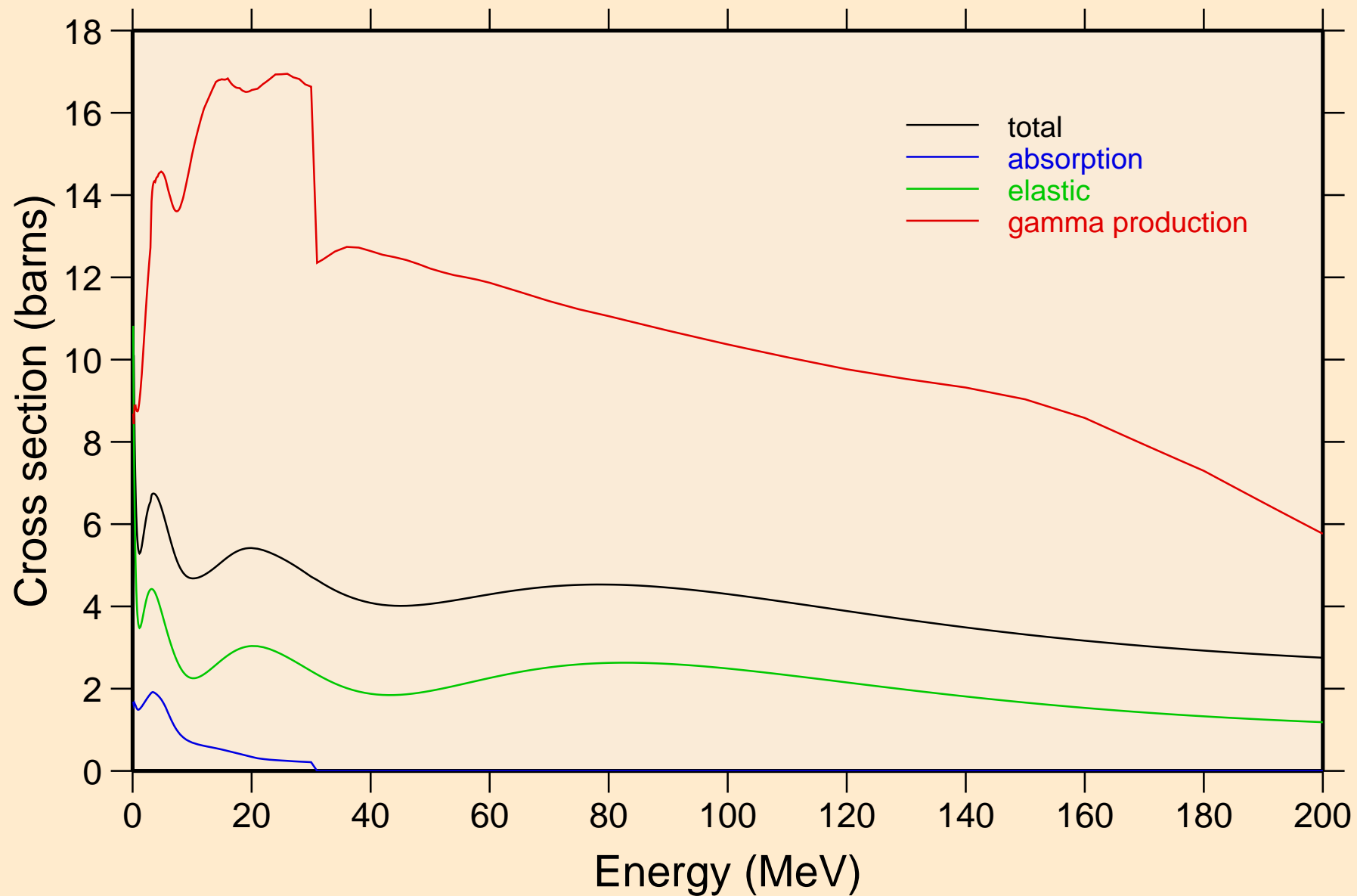

HG182 NEUTRON ACER TENDL-2019 LIBRARY; T=293.16K  
Heating

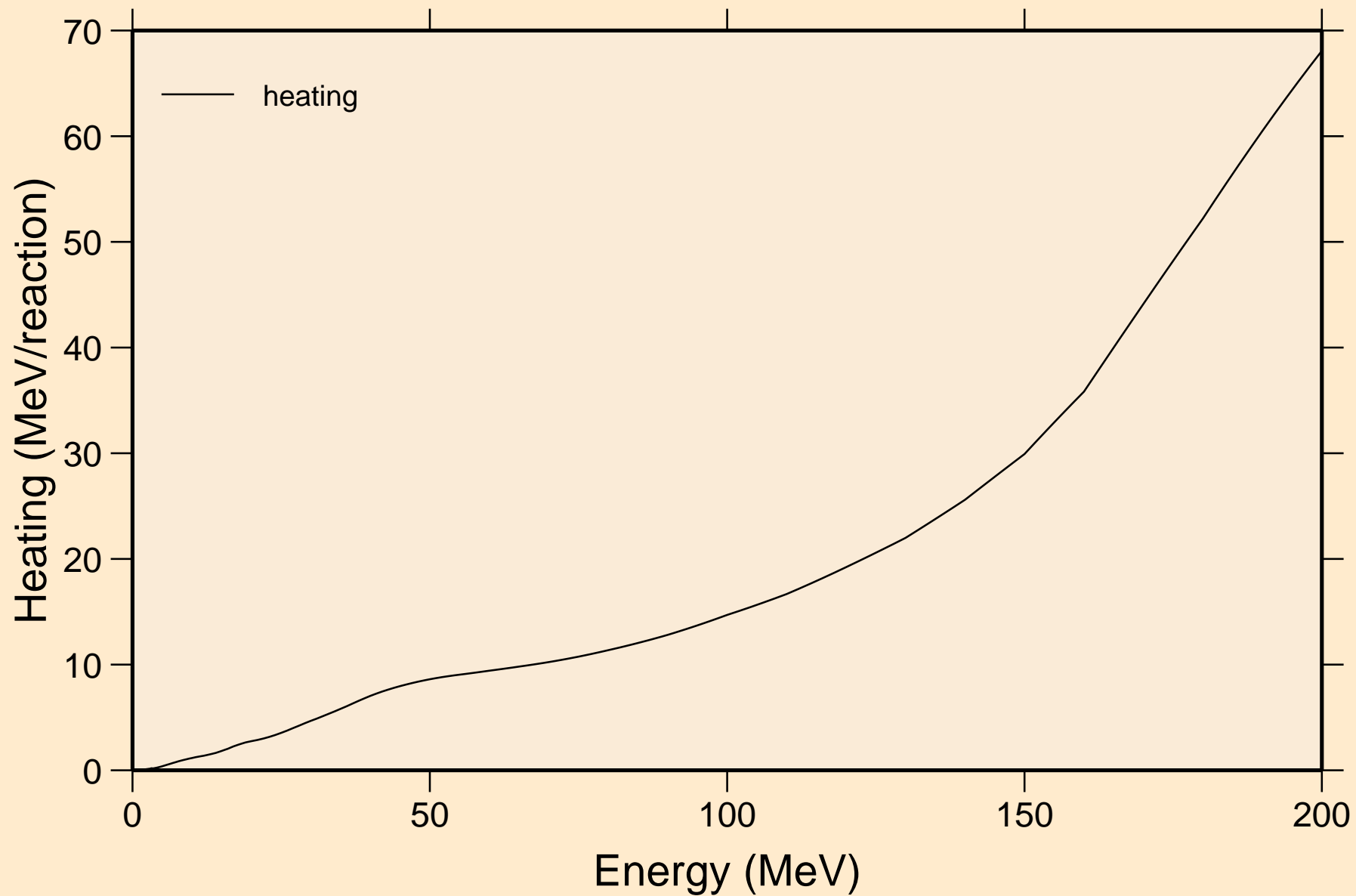

# HG182 NEUTRON ACER TENDL-2019 LIBRARY; T=293.16K Damage

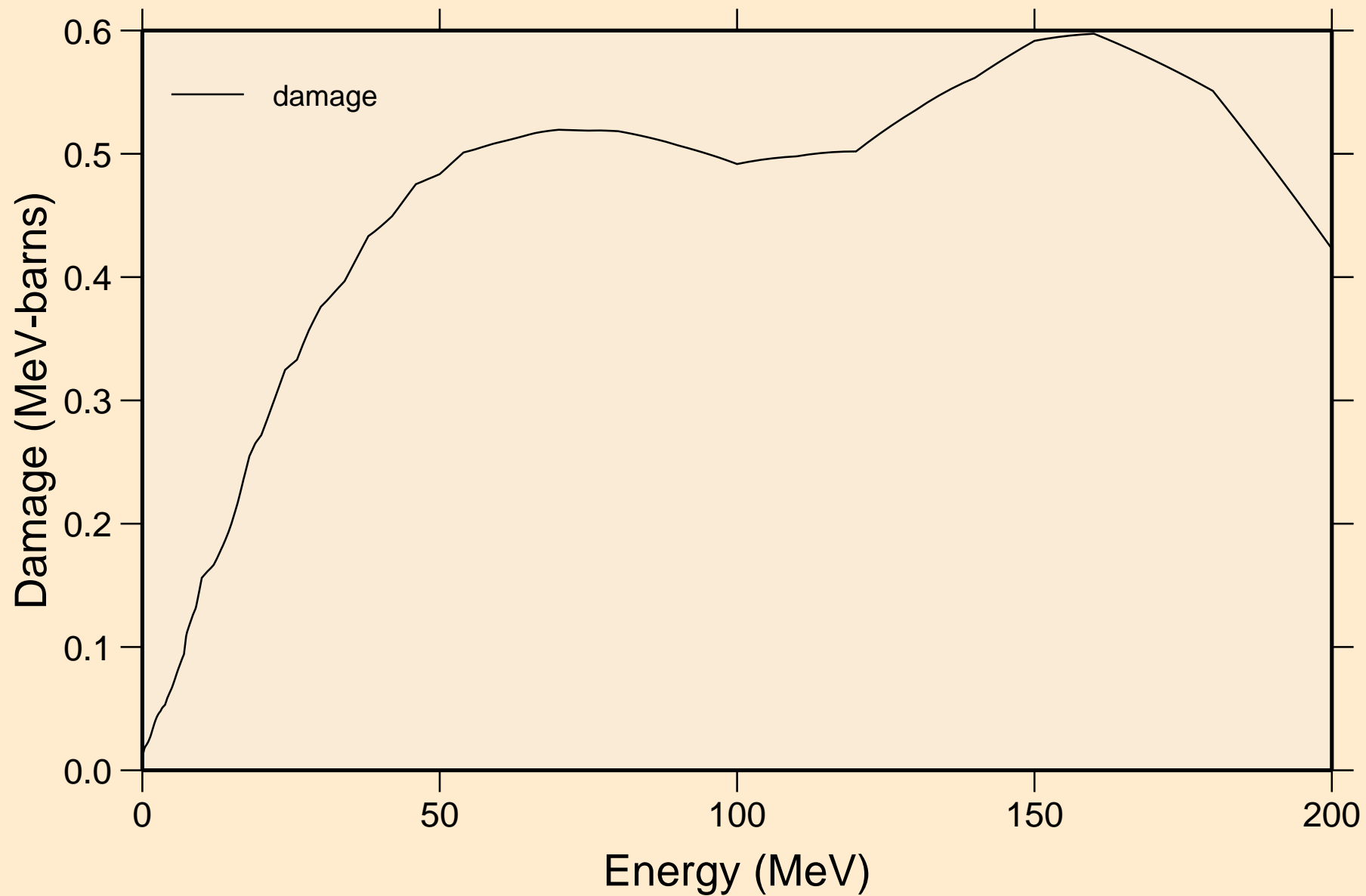

HG182 NEUTRON ACER TENDL-2019 LIBRARY; T=293.16K  
Non-threshold reactions

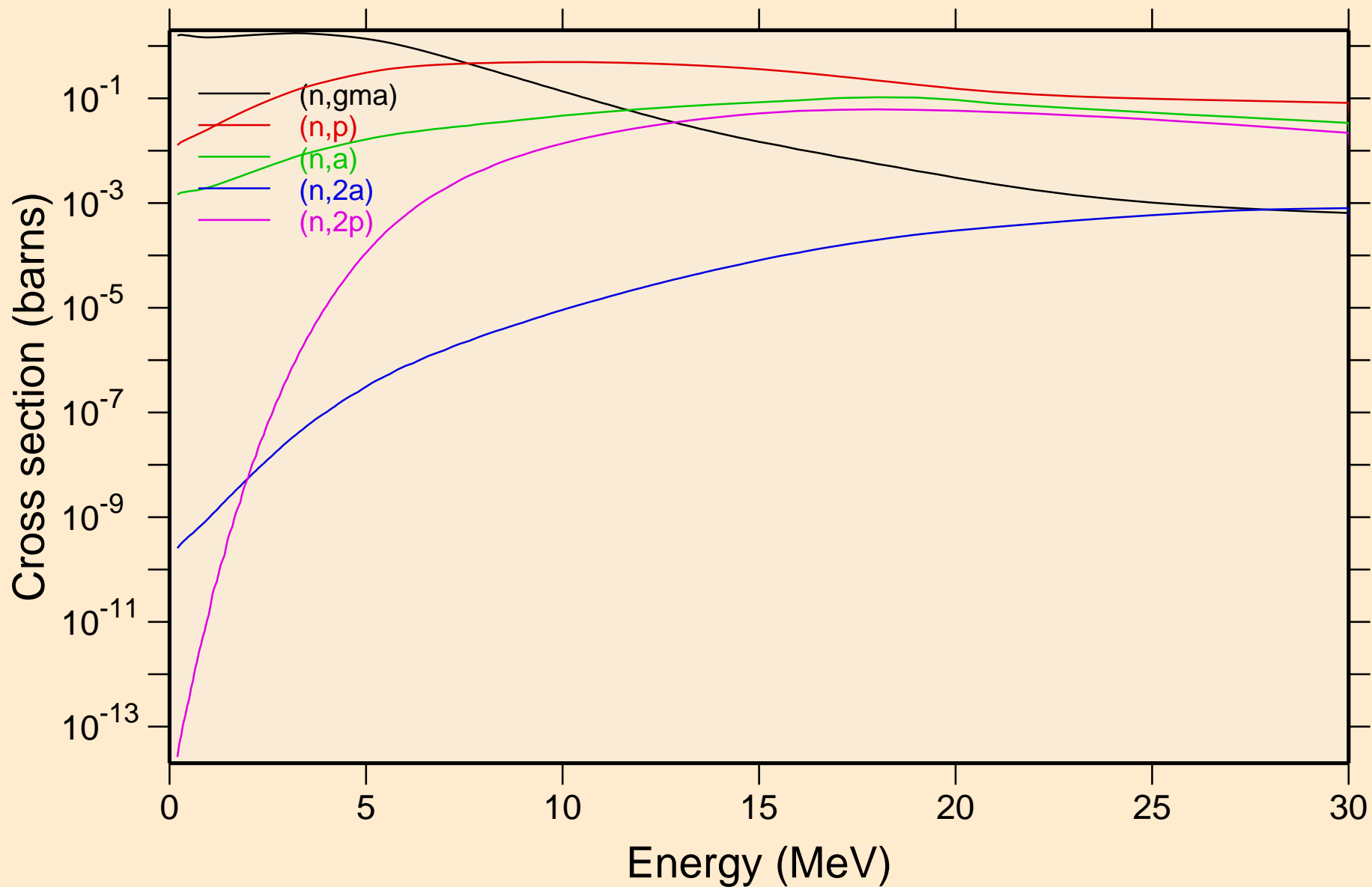

HG182 NEUTRON ACER TENDL-2019 LIBRARY; T=293.16K  
Non-threshold reactions

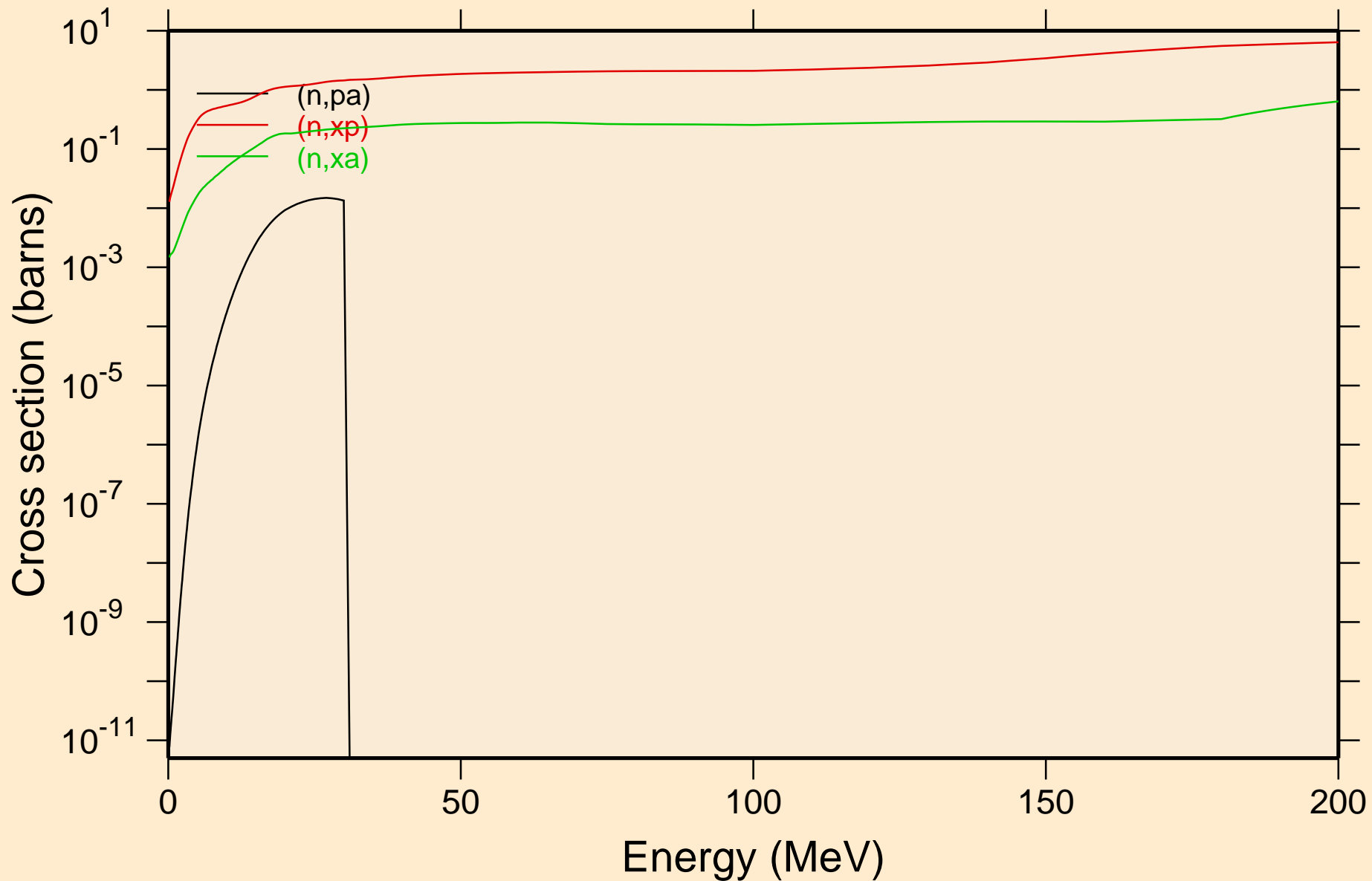

# HG182 NEUTRON ACER TENDL-2019 LIBRARY; T=293.16K

## Inelastic levels

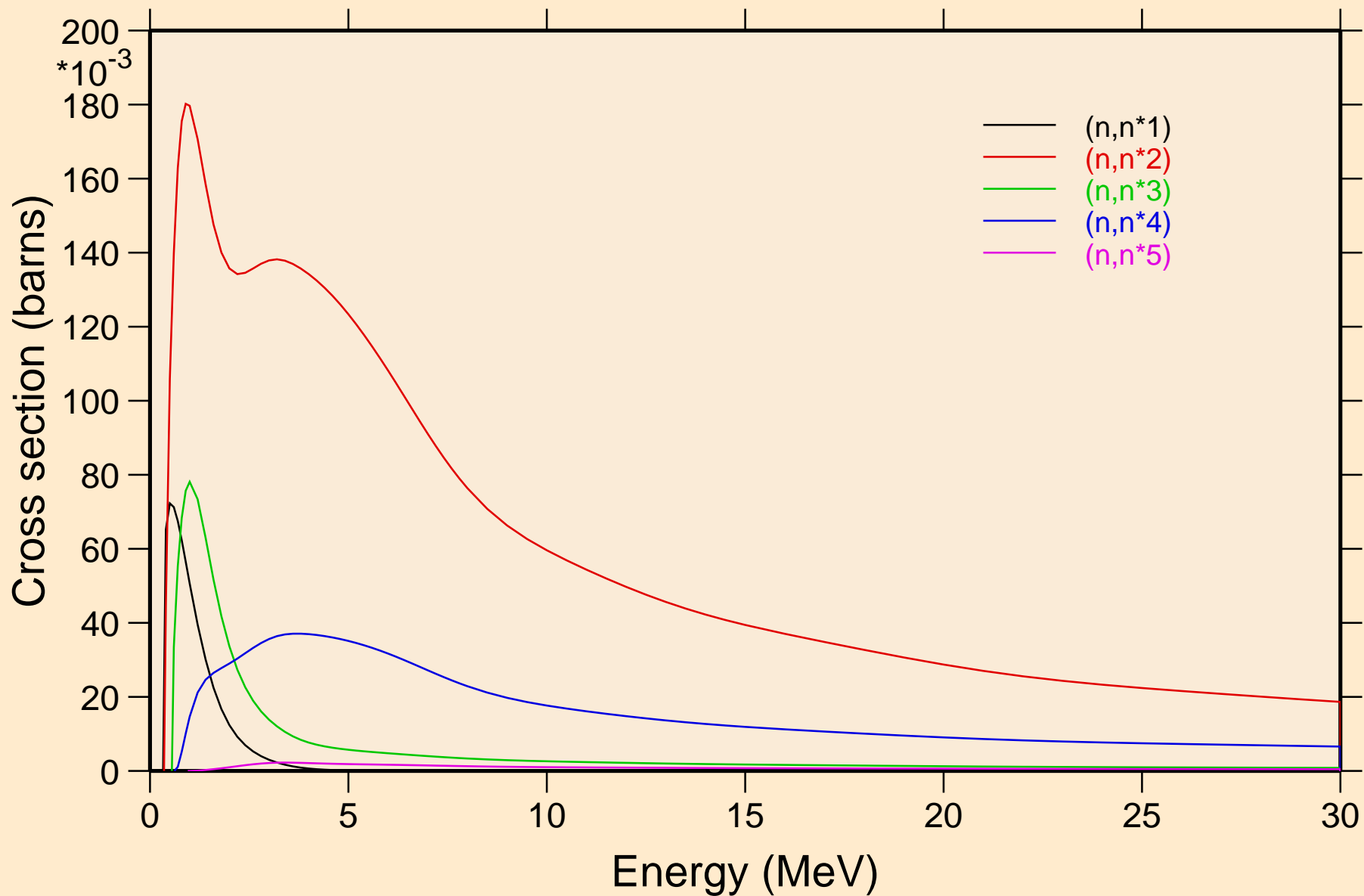

# HG182 NEUTRON ACER TENDL-2019 LIBRARY; T=293.16K

## Inelastic levels

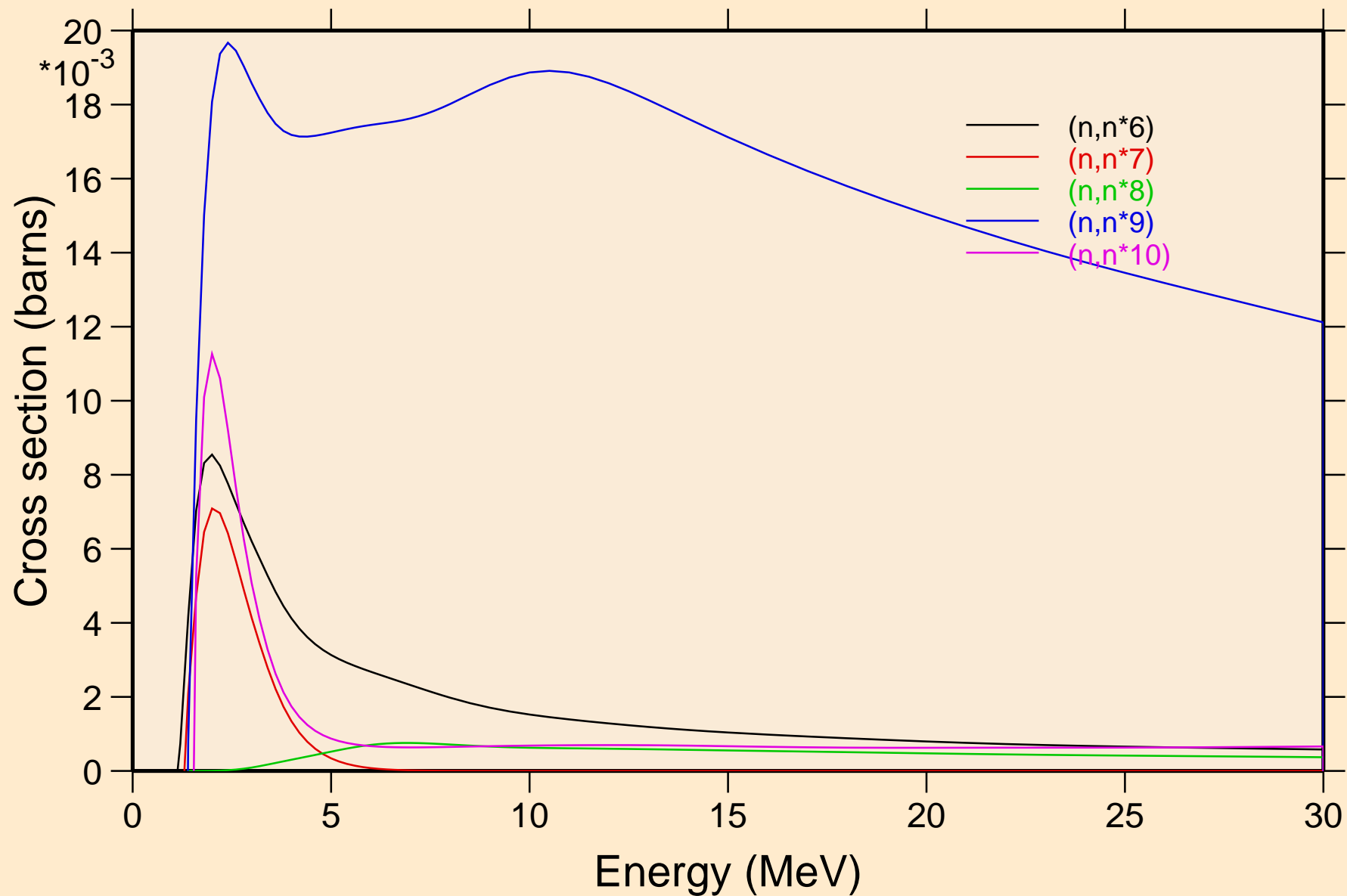

# HG182 NEUTRON ACER TENDL-2019 LIBRARY; T=293.16K

## Threshold reactions

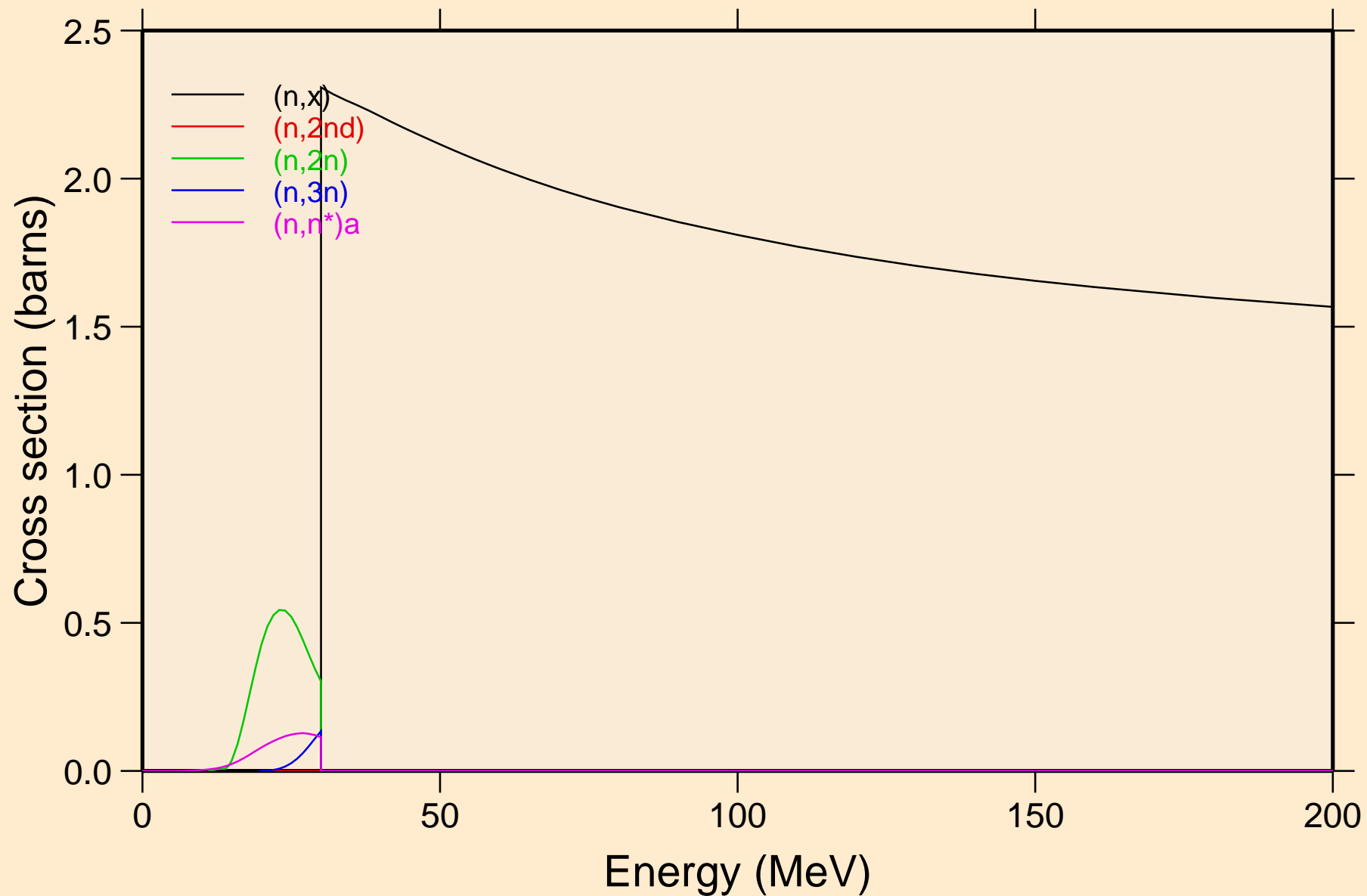

HG182 NEUTRON ACER TENDL-2019 LIBRARY; T=293.16K  
Threshold reactions

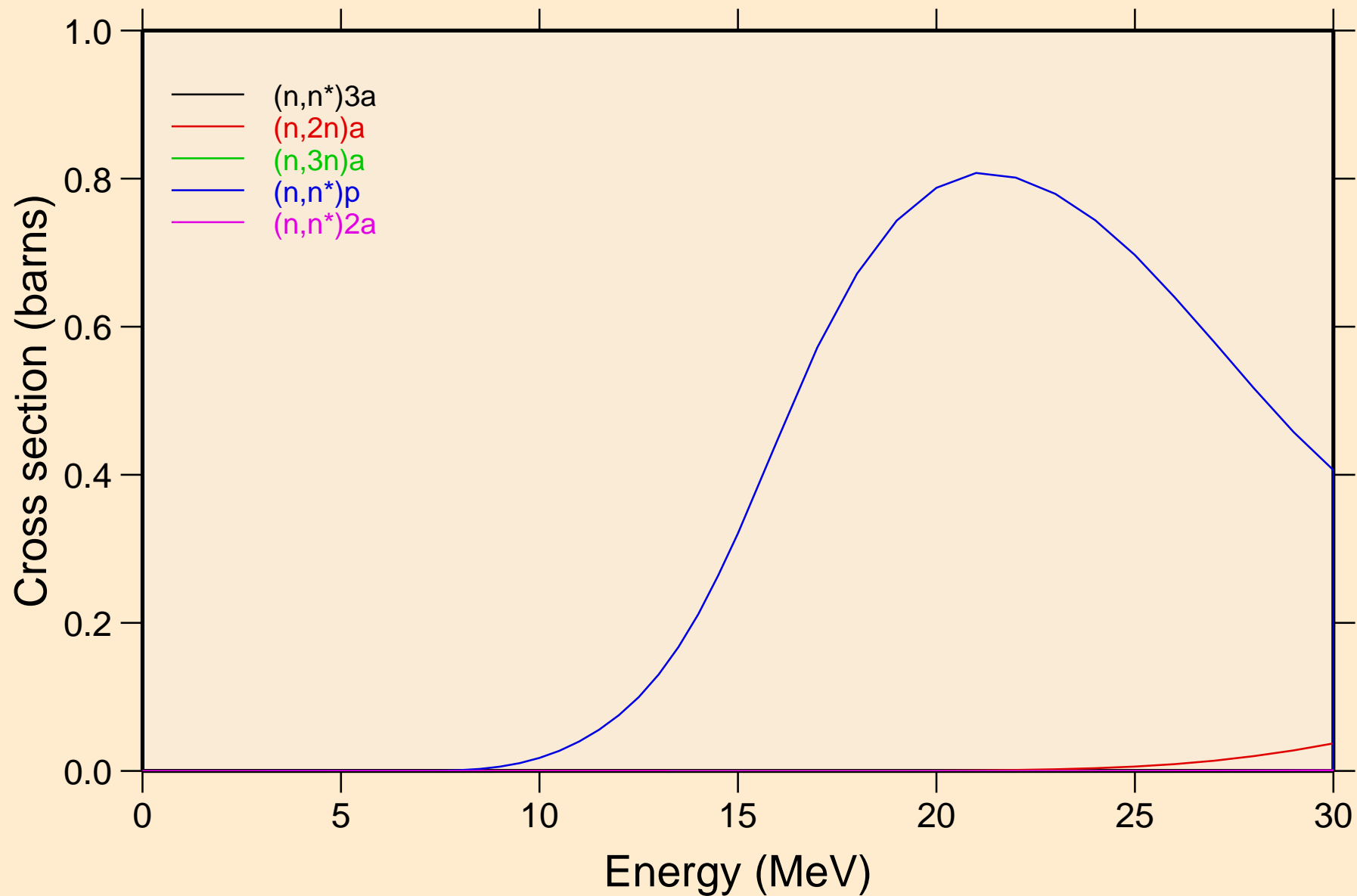

HG182 NEUTRON ACER TENDL-2019 LIBRARY; T=293.16K  
Threshold reactions

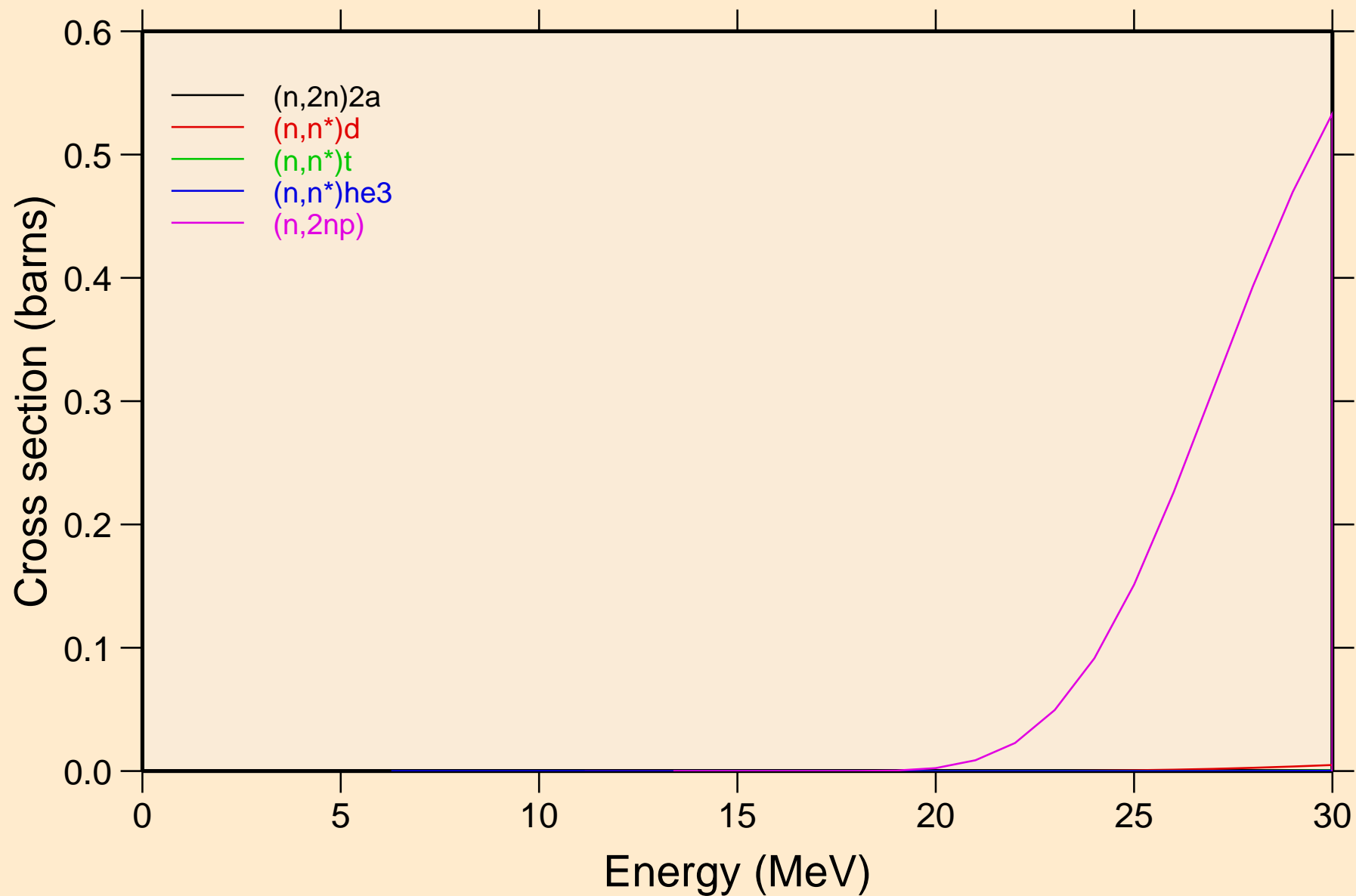

# HG182 NEUTRON ACER TENDL-2019 LIBRARY; T=293.16K

## Threshold reactions

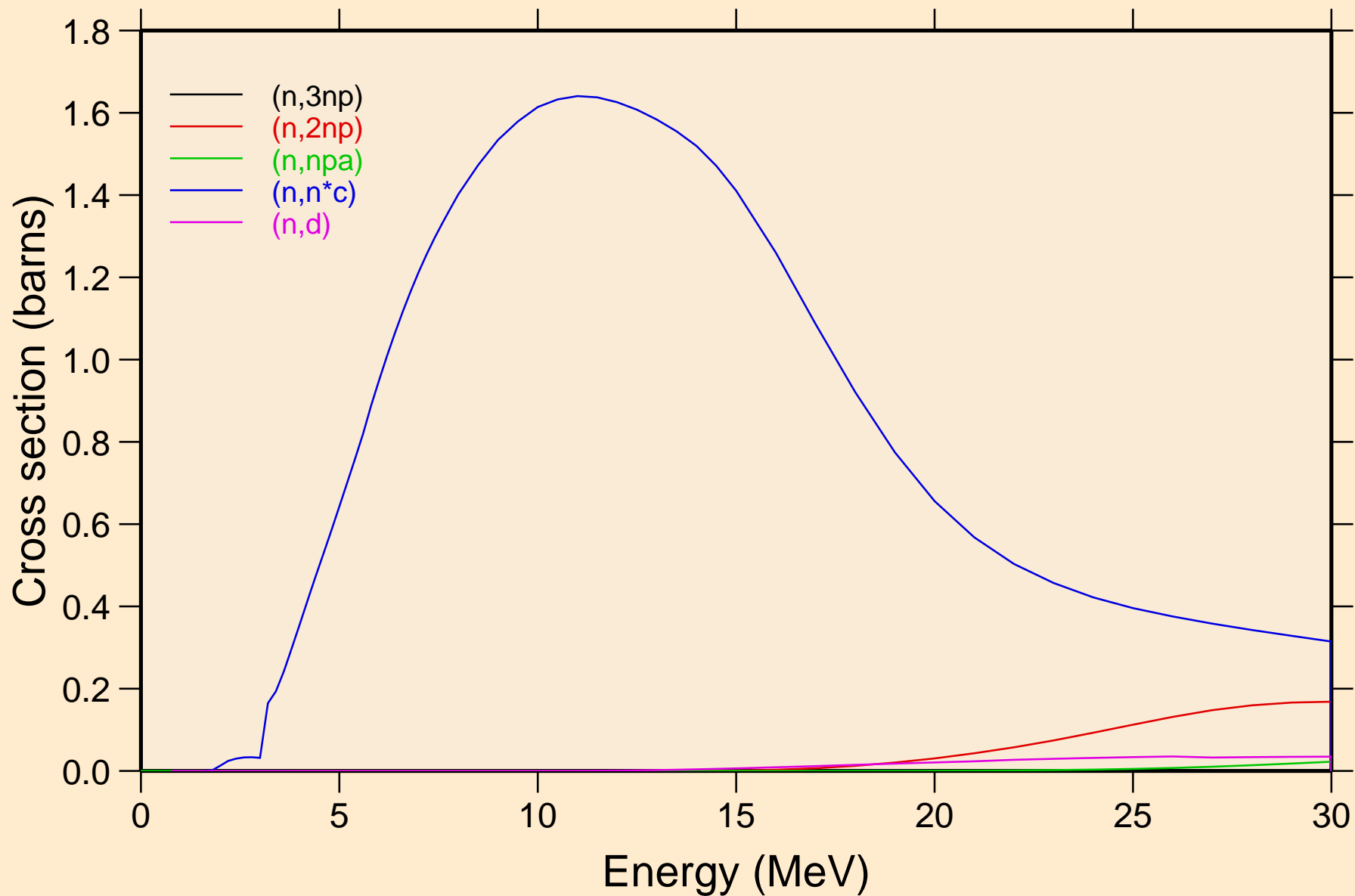

HG182 NEUTRON ACER TENDL-2019 LIBRARY; T=293.16K  
Threshold reactions

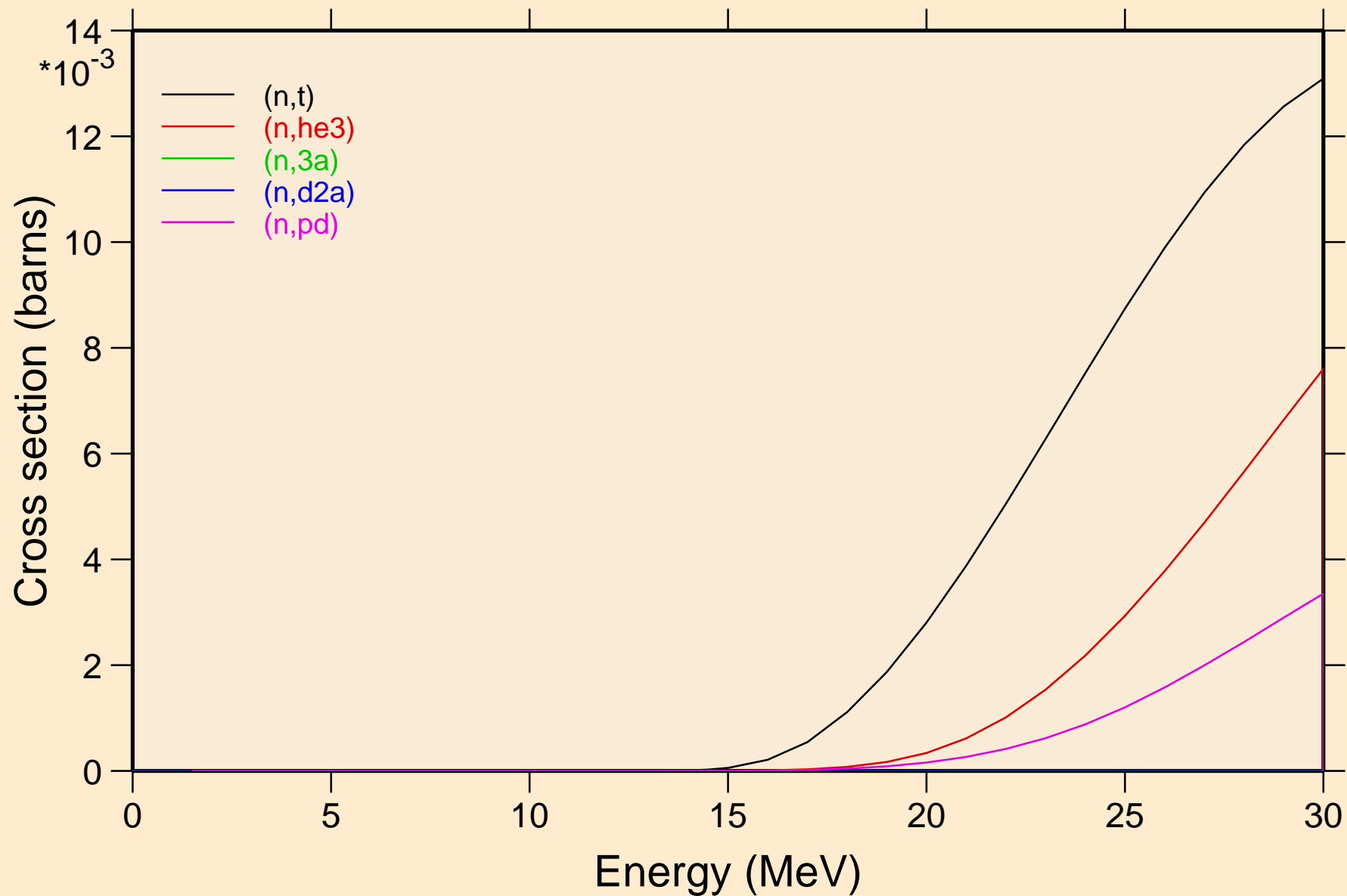

# HG182 NEUTRON ACER TENDL-2019 LIBRARY; T=293.16K

## Threshold reactions

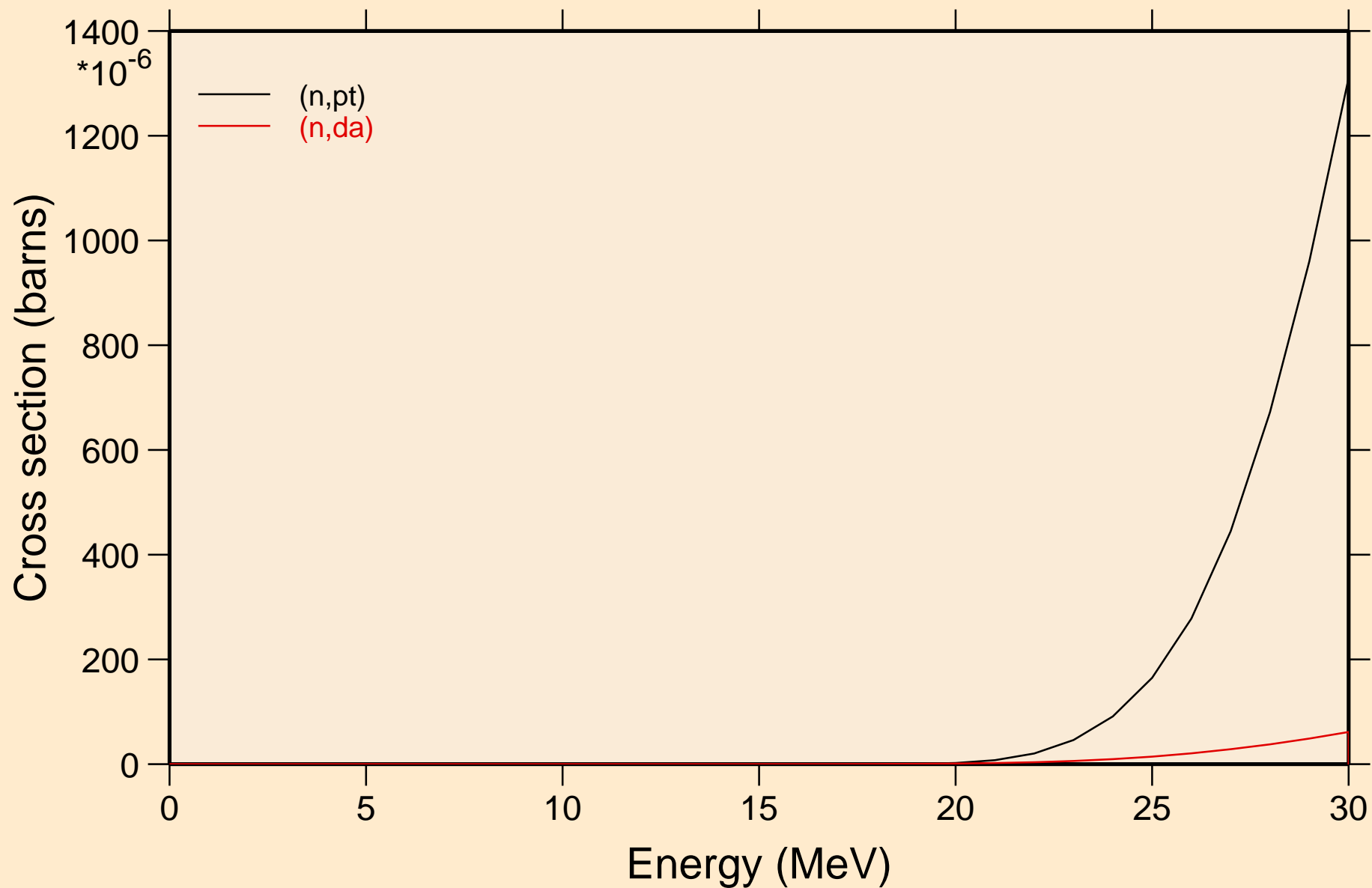

# HG182 NEUTRON ACER TENDL-2019 LIBRARY; T=293.16K

## Threshold reactions

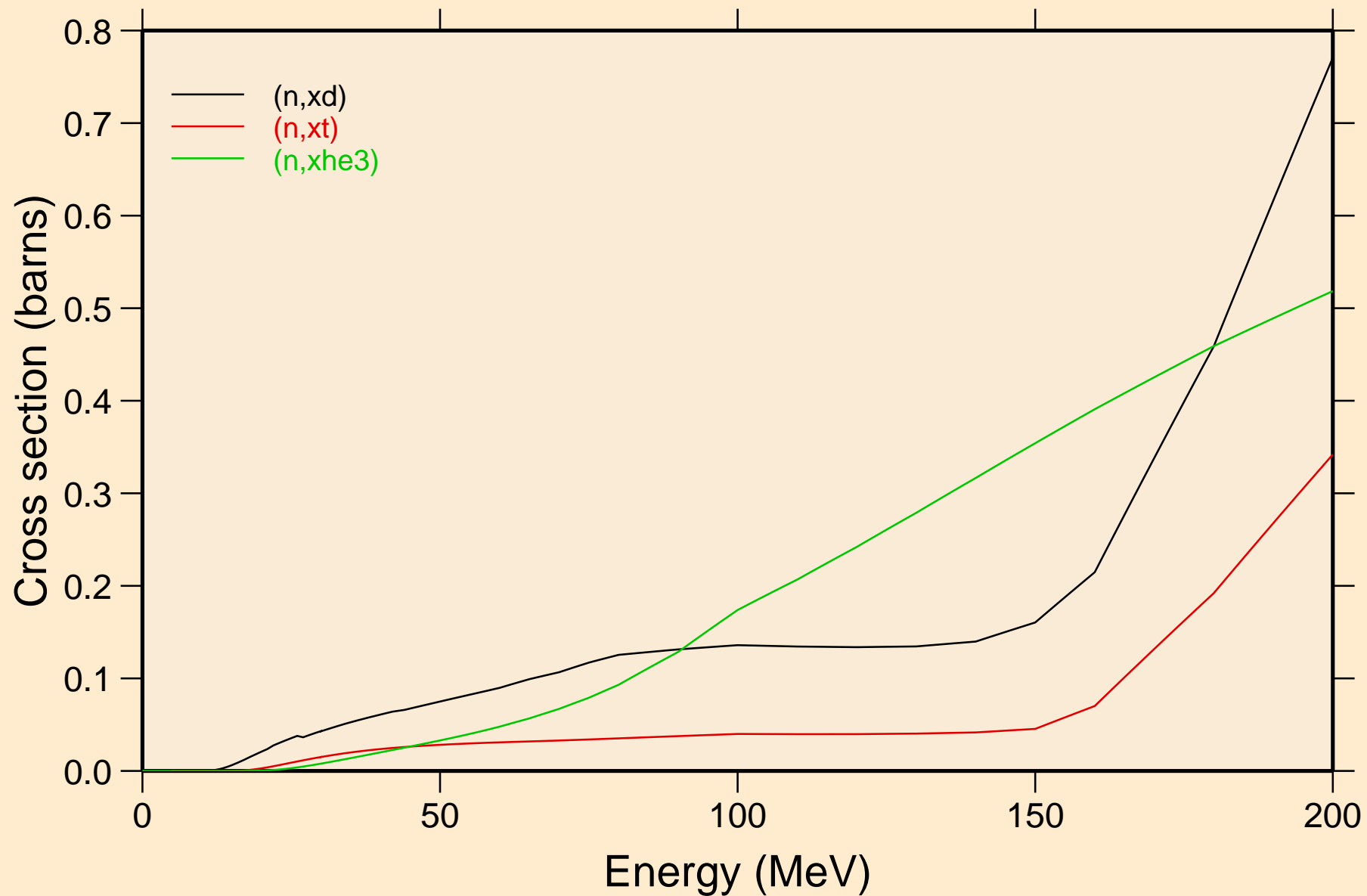

HG182 NEUTRON ACER TENDL-2019 LIBRARY; T=293.16K  
angular distribution for elastic

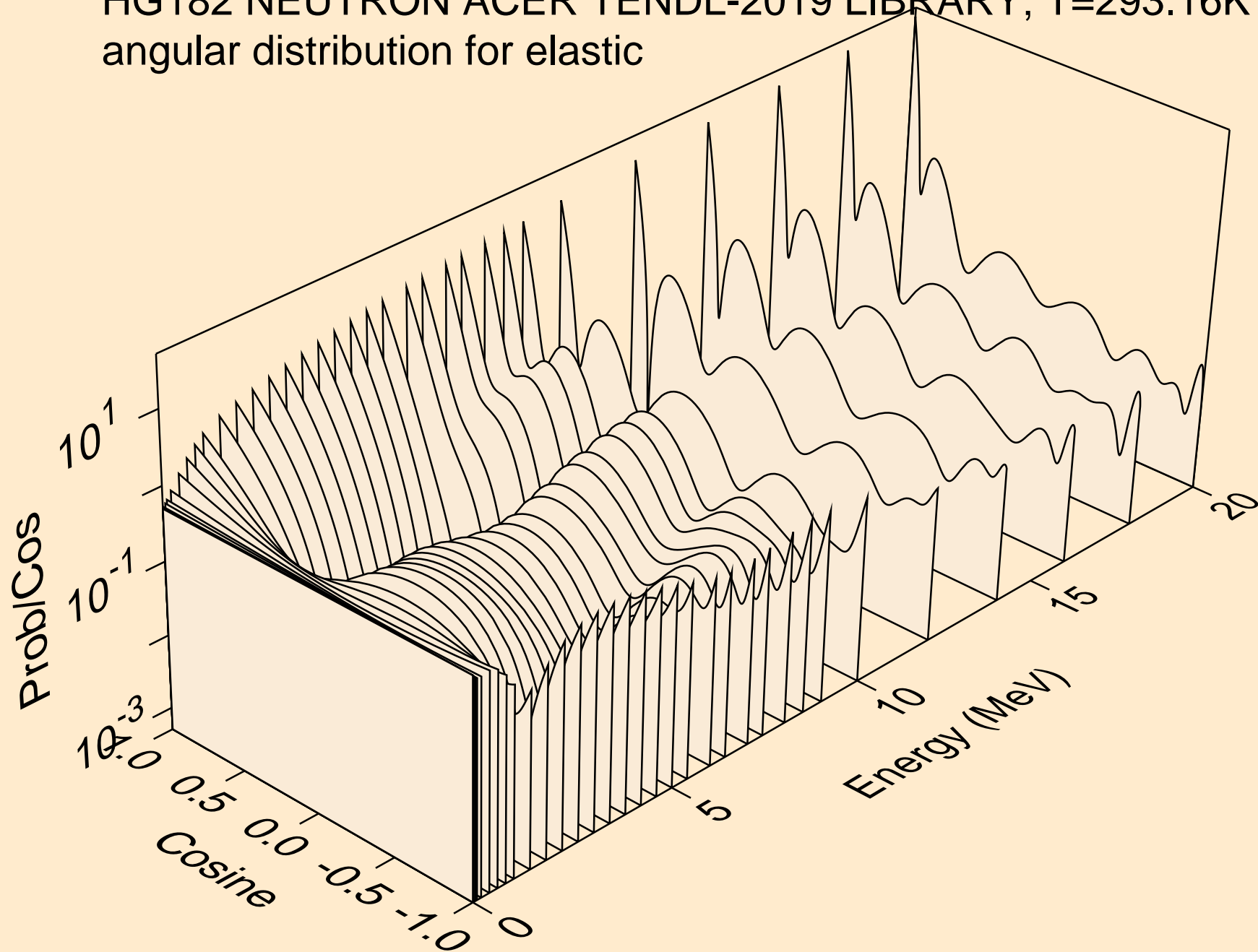

HG182 NEUTRON ACER TENDL-2019 LIBRARY; T=293.16K  
angular distribution for elastic

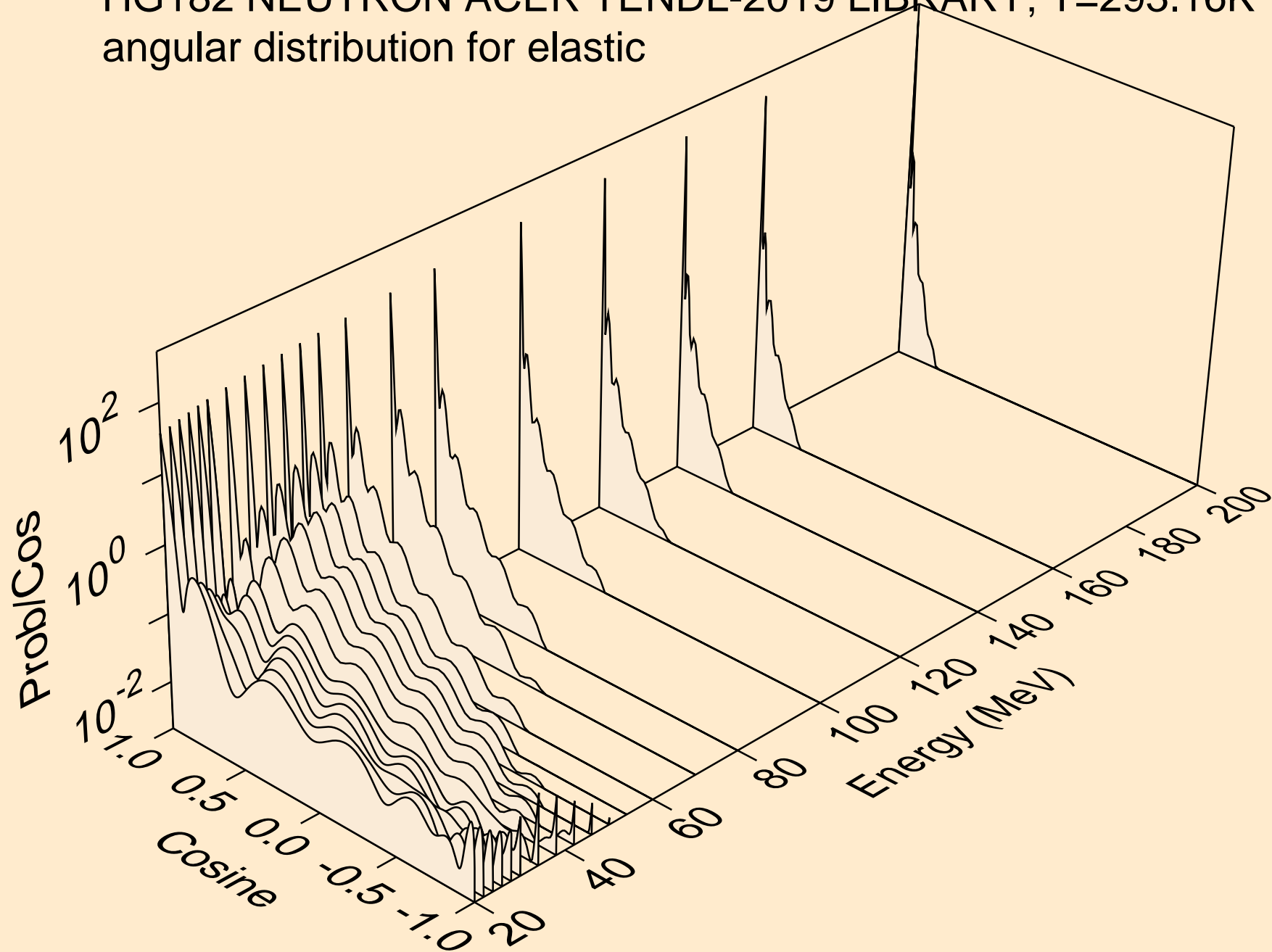

HG182 NEUTRON ACER TENDL-2019 LIBRARY; T=293.16K  
angular distribution for (n,n\*1)

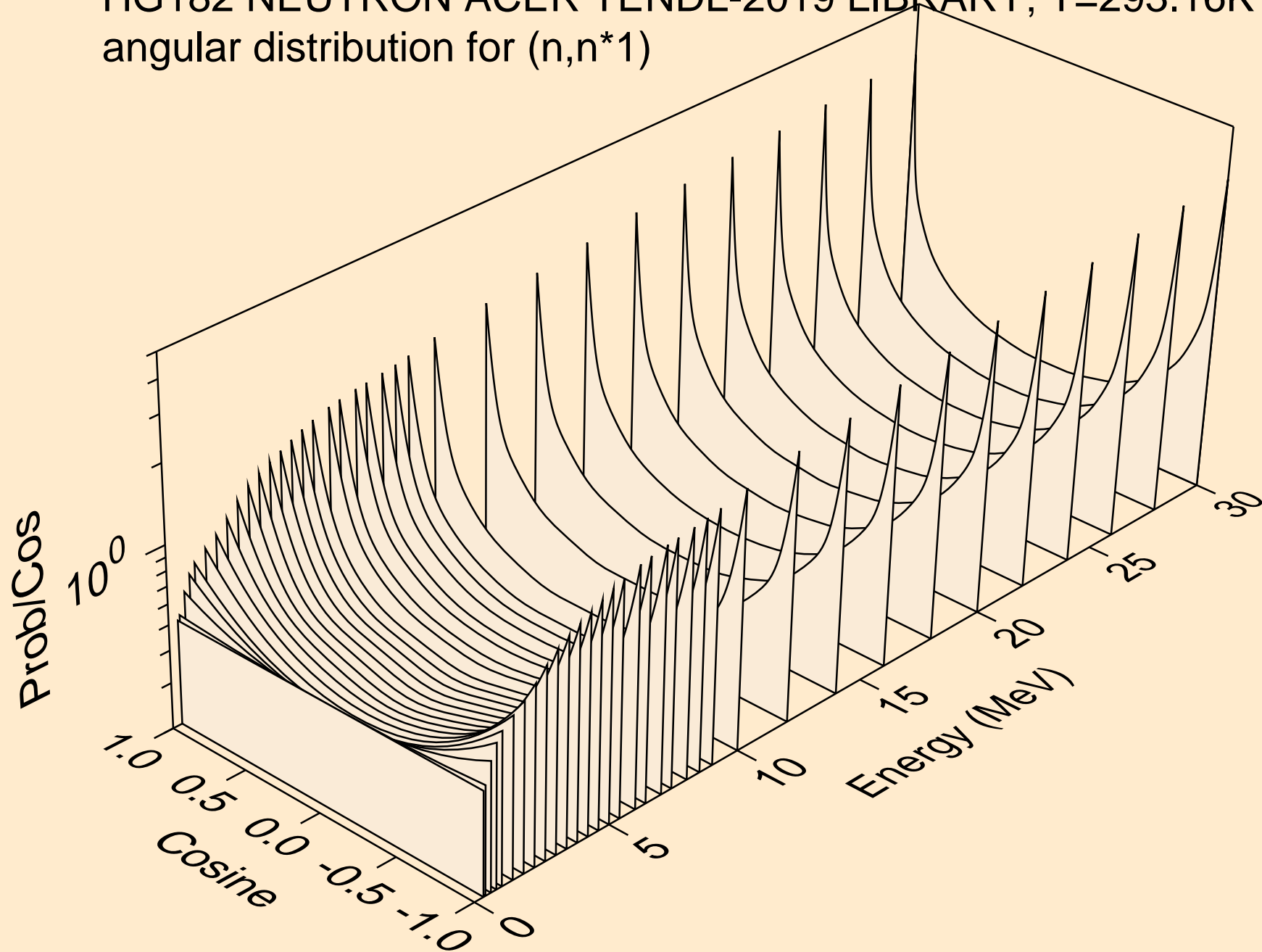

HG182 NEUTRON ACER TENDL-2019 LIBRARY; T=293.16K  
angular distribution for (n,n\*2)

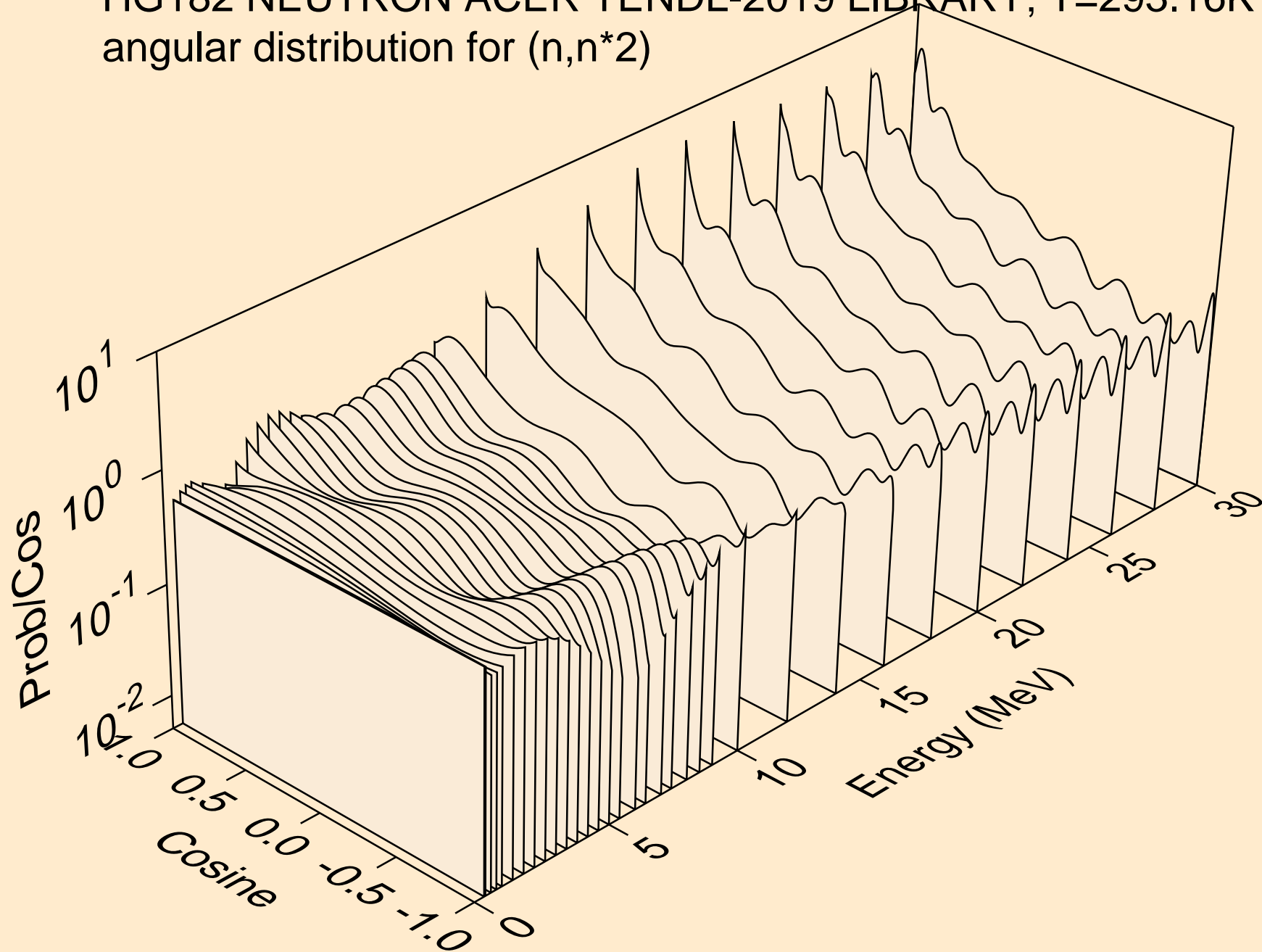

HG182 NEUTRON ACER TENDL-2019 LIBRARY; T=293.16K  
angular distribution for (n,n\*3)

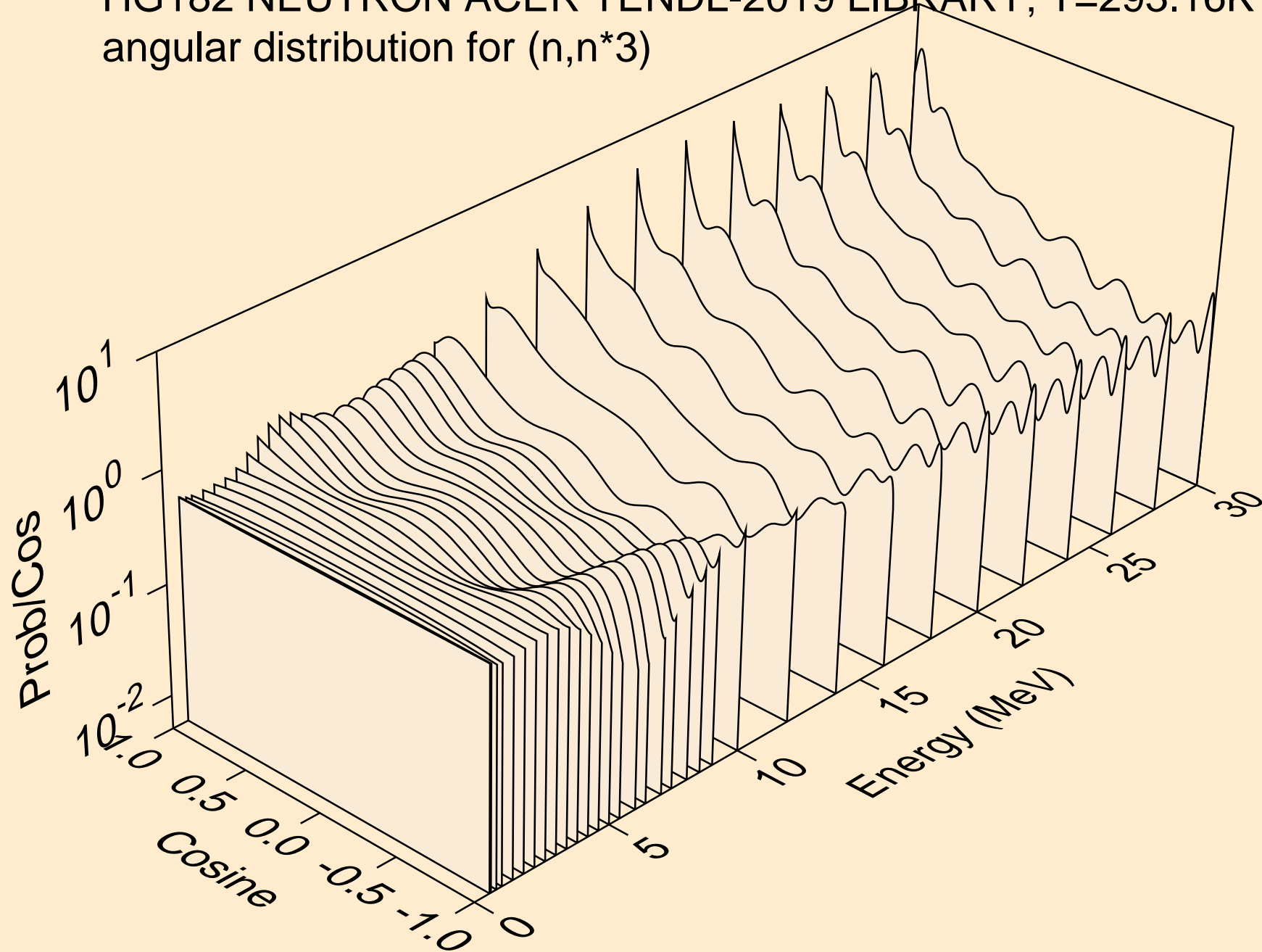

HG182 NEUTRON ACER TENDL-2019 LIBRARY; T=293.16K  
angular distribution for (n,n\*4)

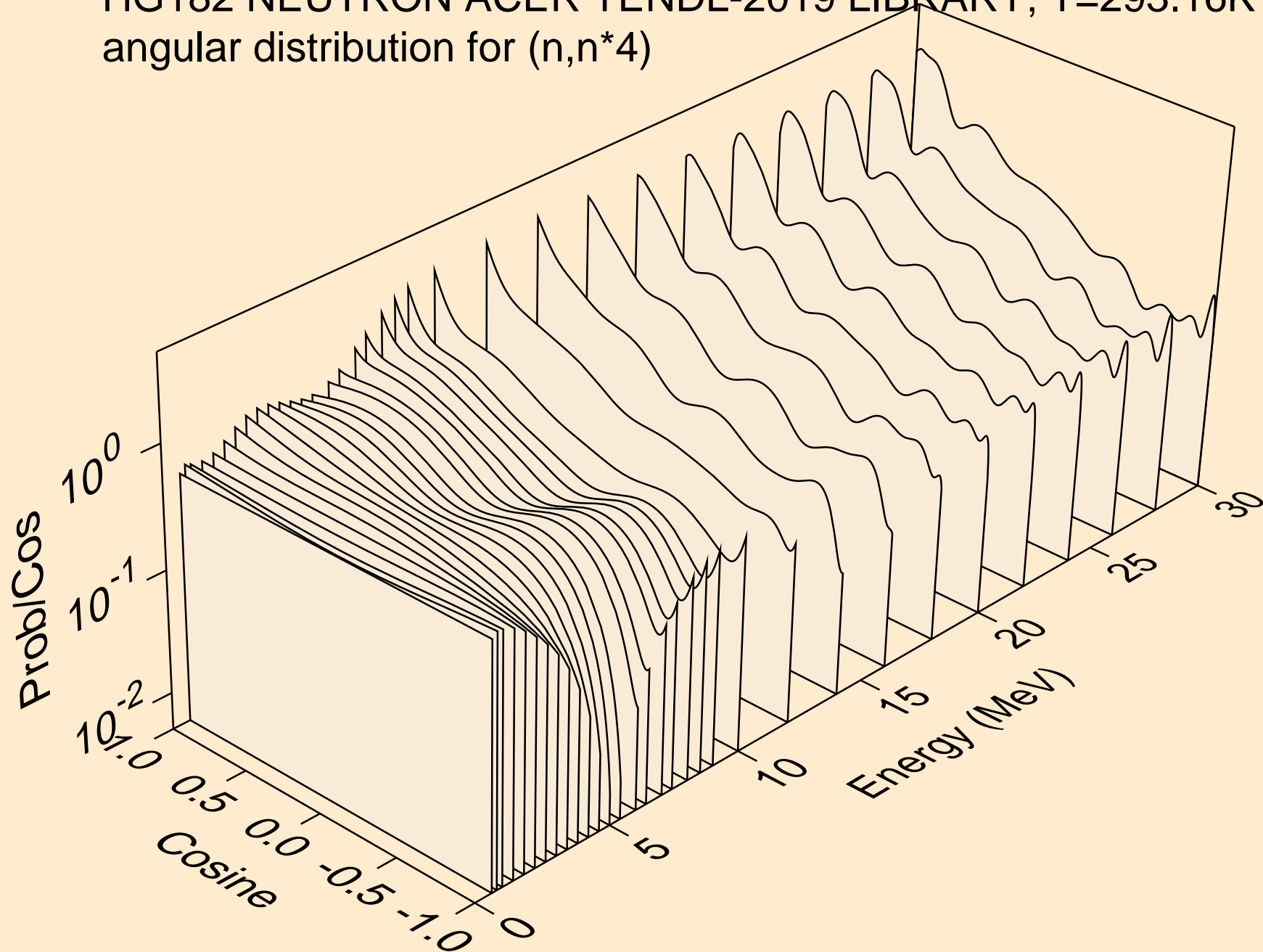

HG182 NEUTRON ACER TENDL-2019 LIBRARY; T=293.16K  
angular distribution for (n,n\*5)

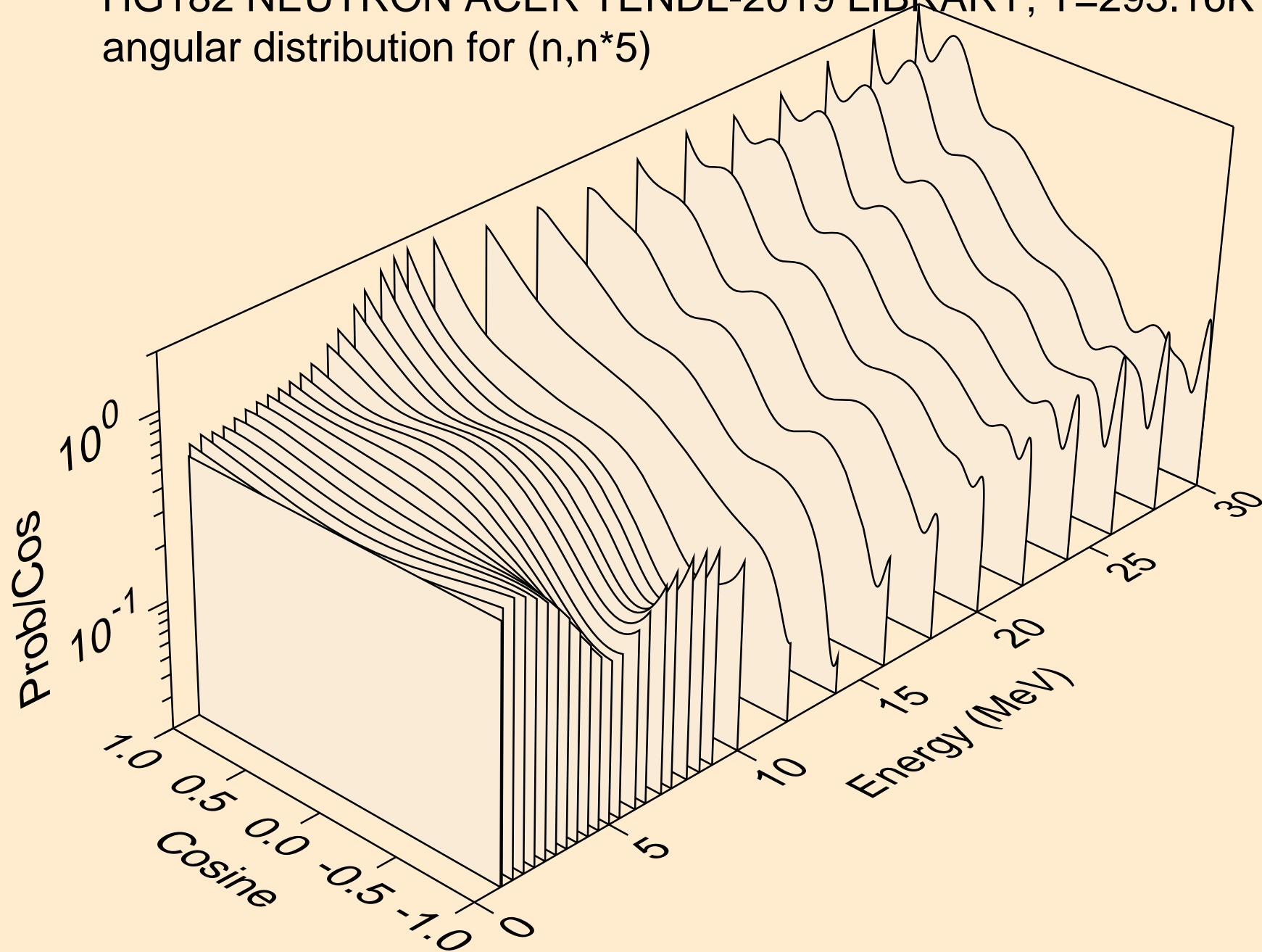

HG182 NEUTRON ACER TENDL-2019 LIBRARY; T=293.16K  
angular distribution for (n,n\*6)

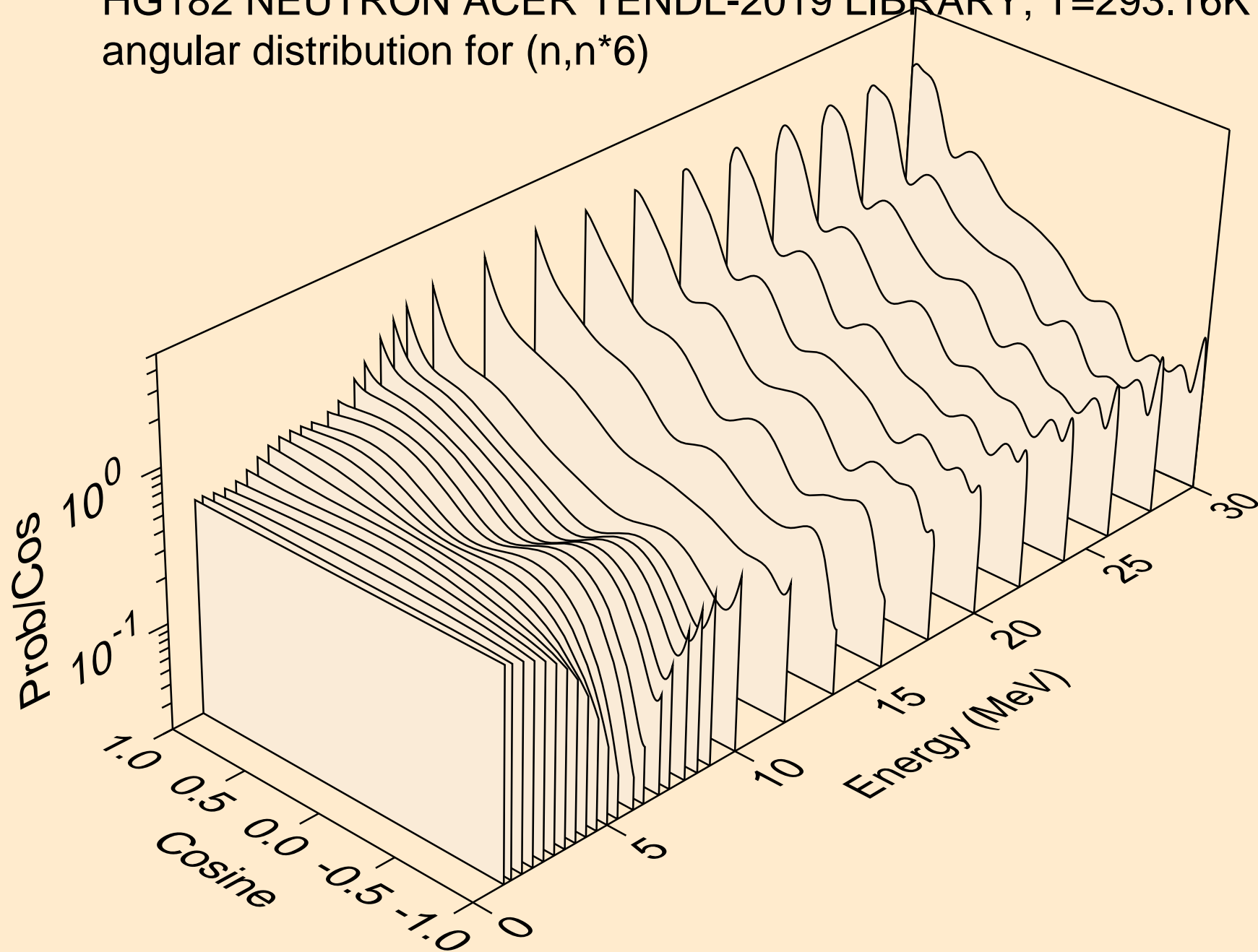

HG182 NEUTRON ACER TENDL-2019 LIBRARY; T=293.16K  
angular distribution for (n,n\*7)

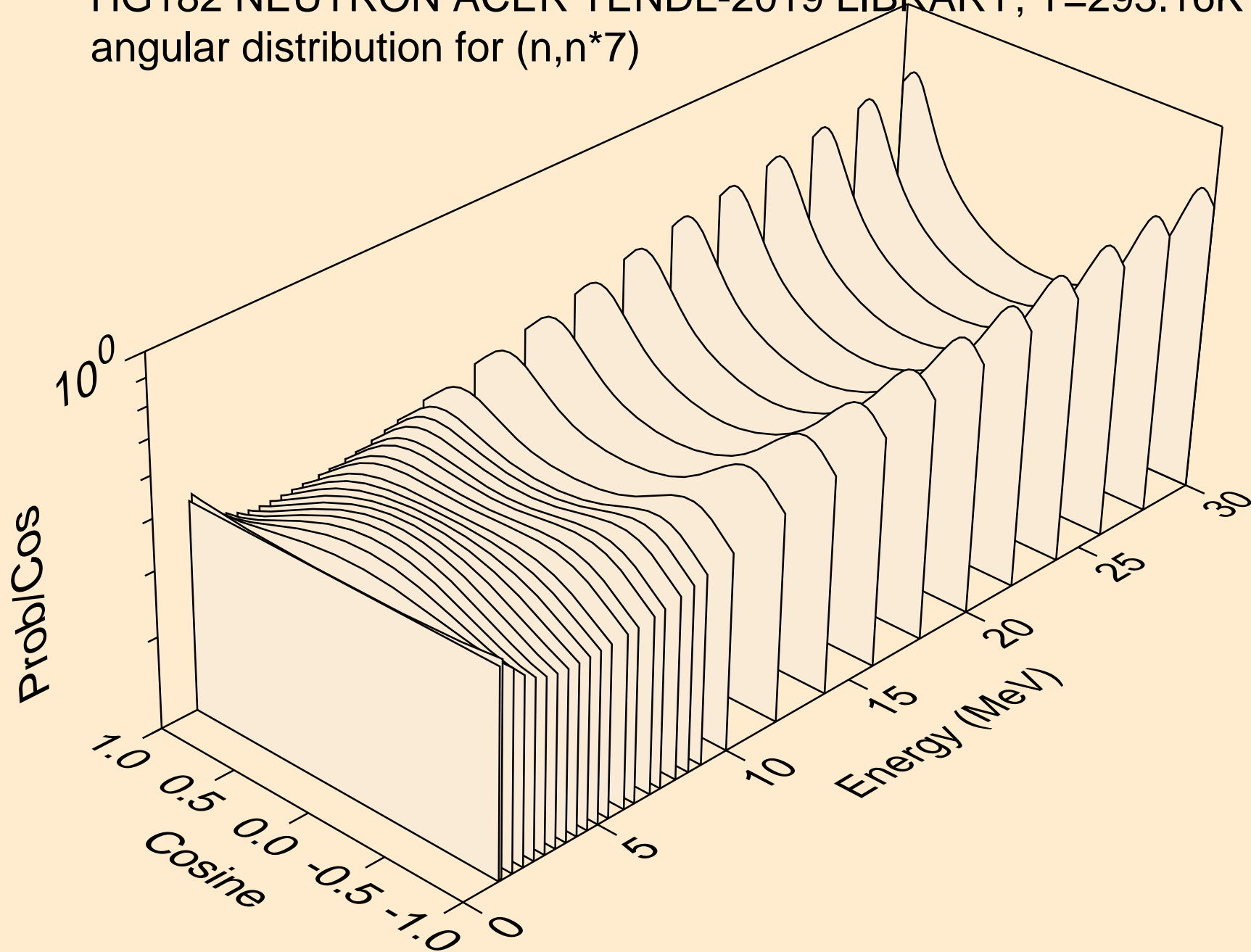

HG182 NEUTRON ACER TENDL-2019 LIBRARY; T=293.16K  
angular distribution for (n,n\*8)

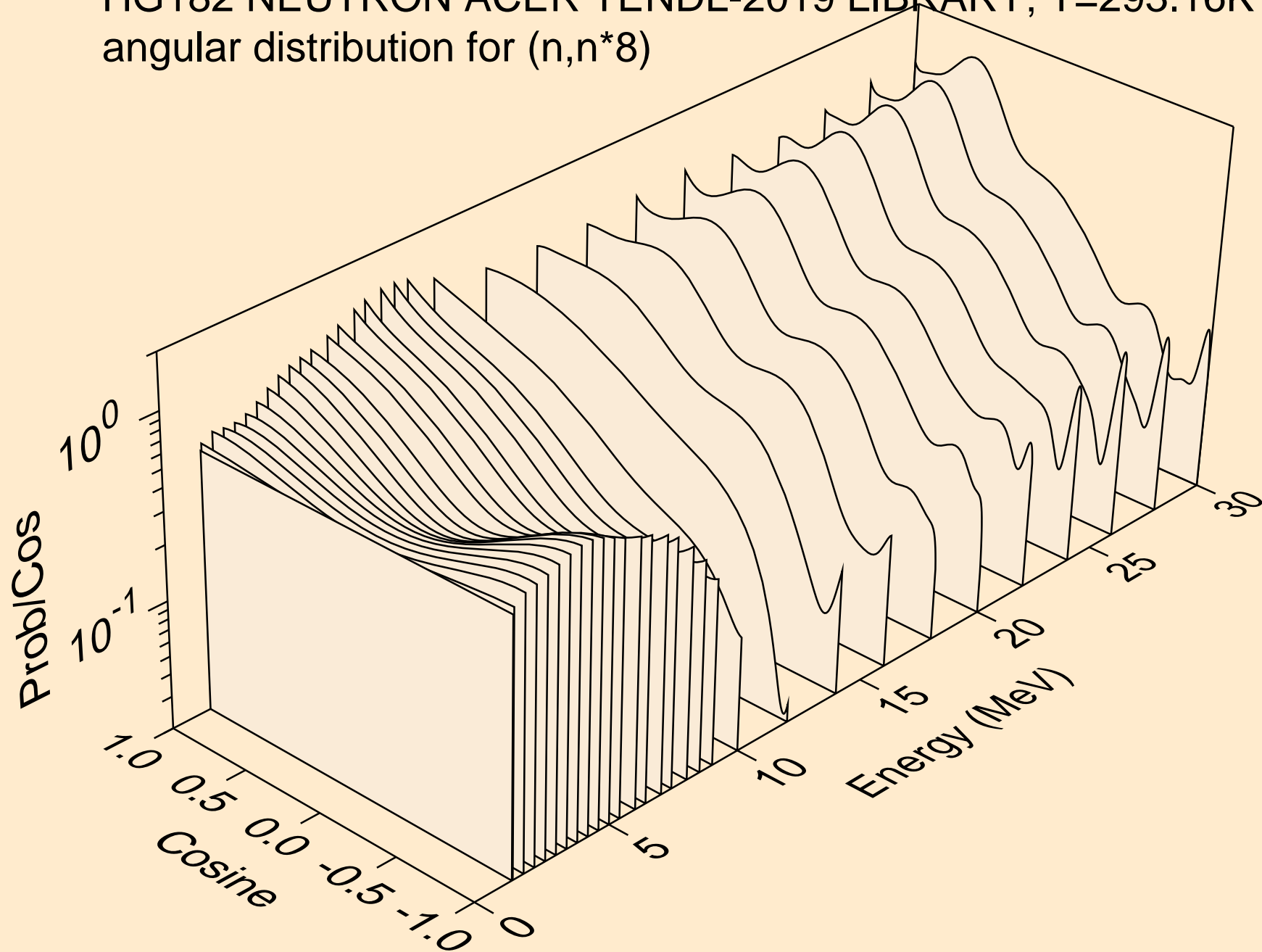

HG182 NEUTRON ACER TENDL-2019 LIBRARY; T=293.16K  
angular distribution for (n,n\*9)

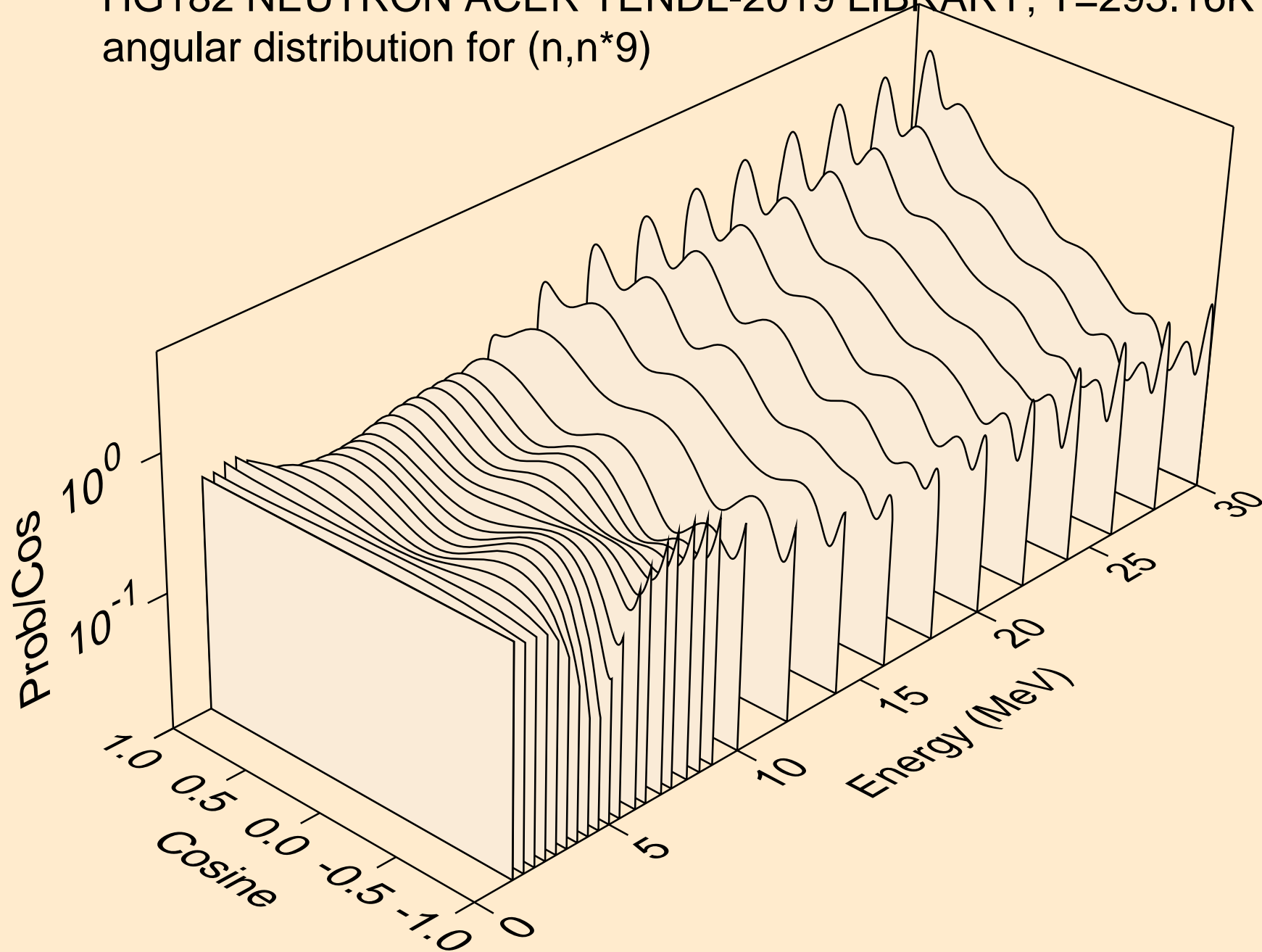

HG182 NEUTRON ACER TENDL-2019 LIBRARY; T=293.16K  
angular distribution for (n,n\*10)

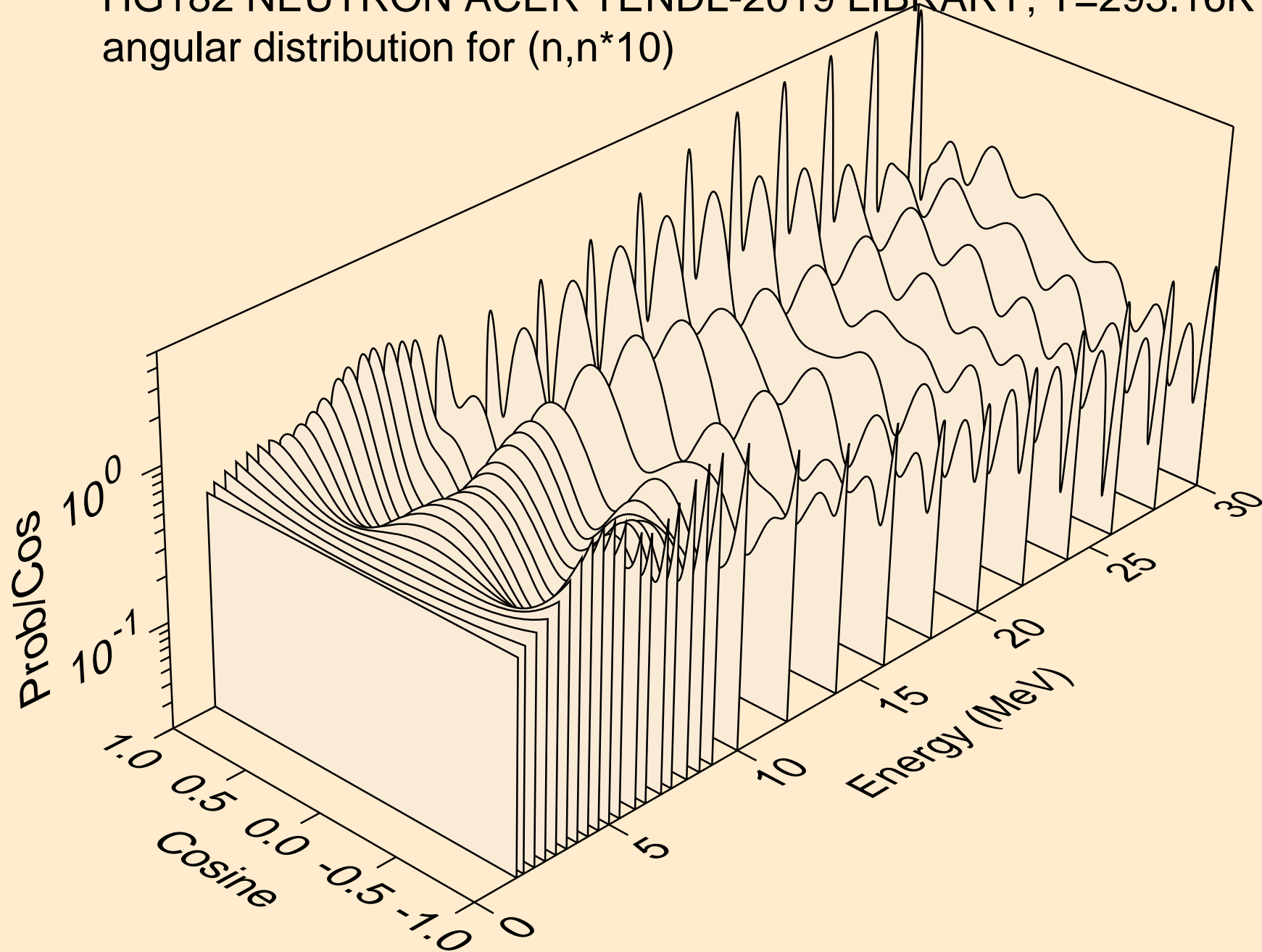

HG182 NEUTRON ACER TENDL-2019 LIBRARY; T=293.16K  
Neutron emission for (n,x)

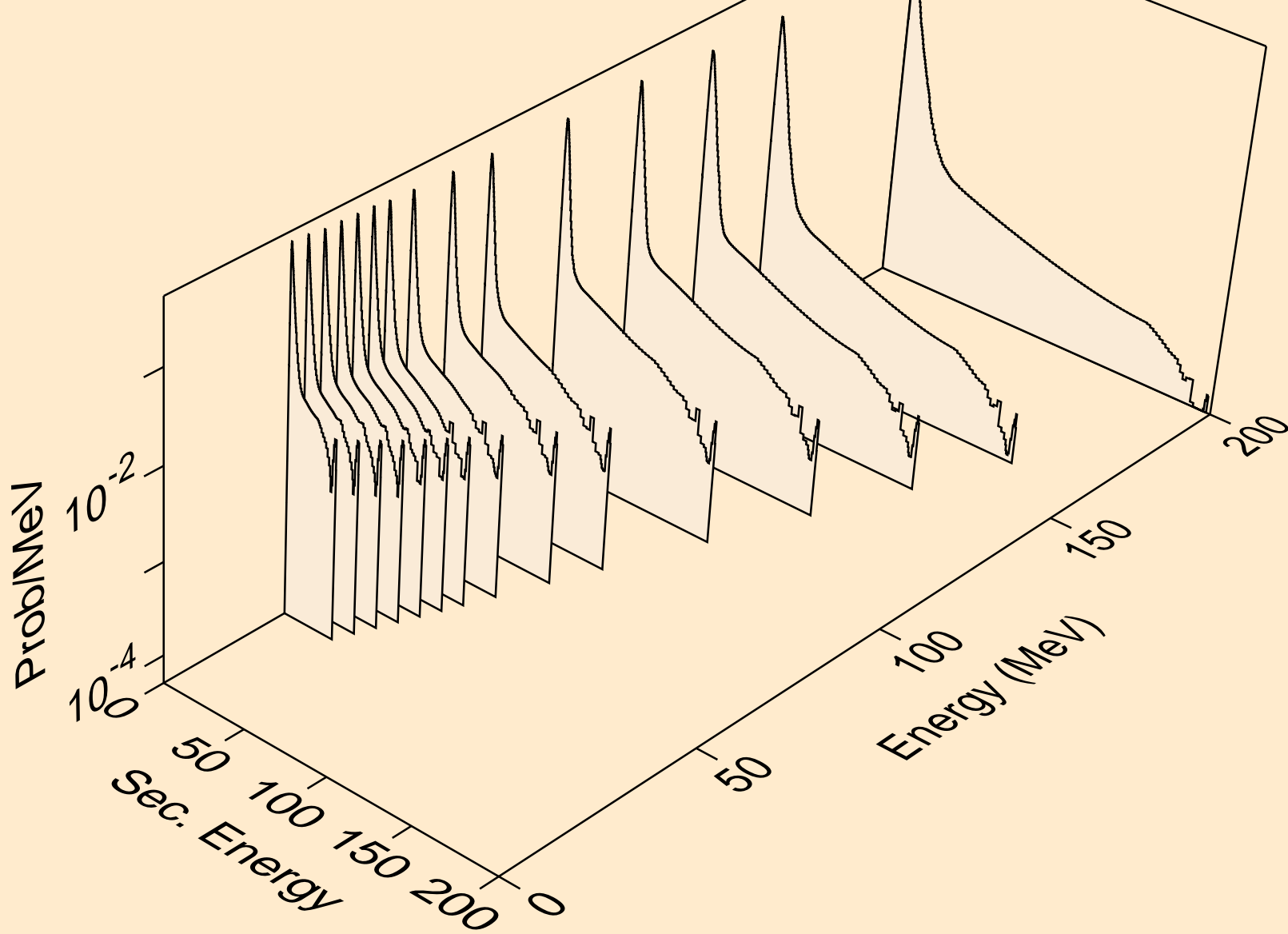

HG182 NEUTRON ACER TENDL-2019 LIBRARY; T=293.16K  
Neutron emission for (n,2nd)

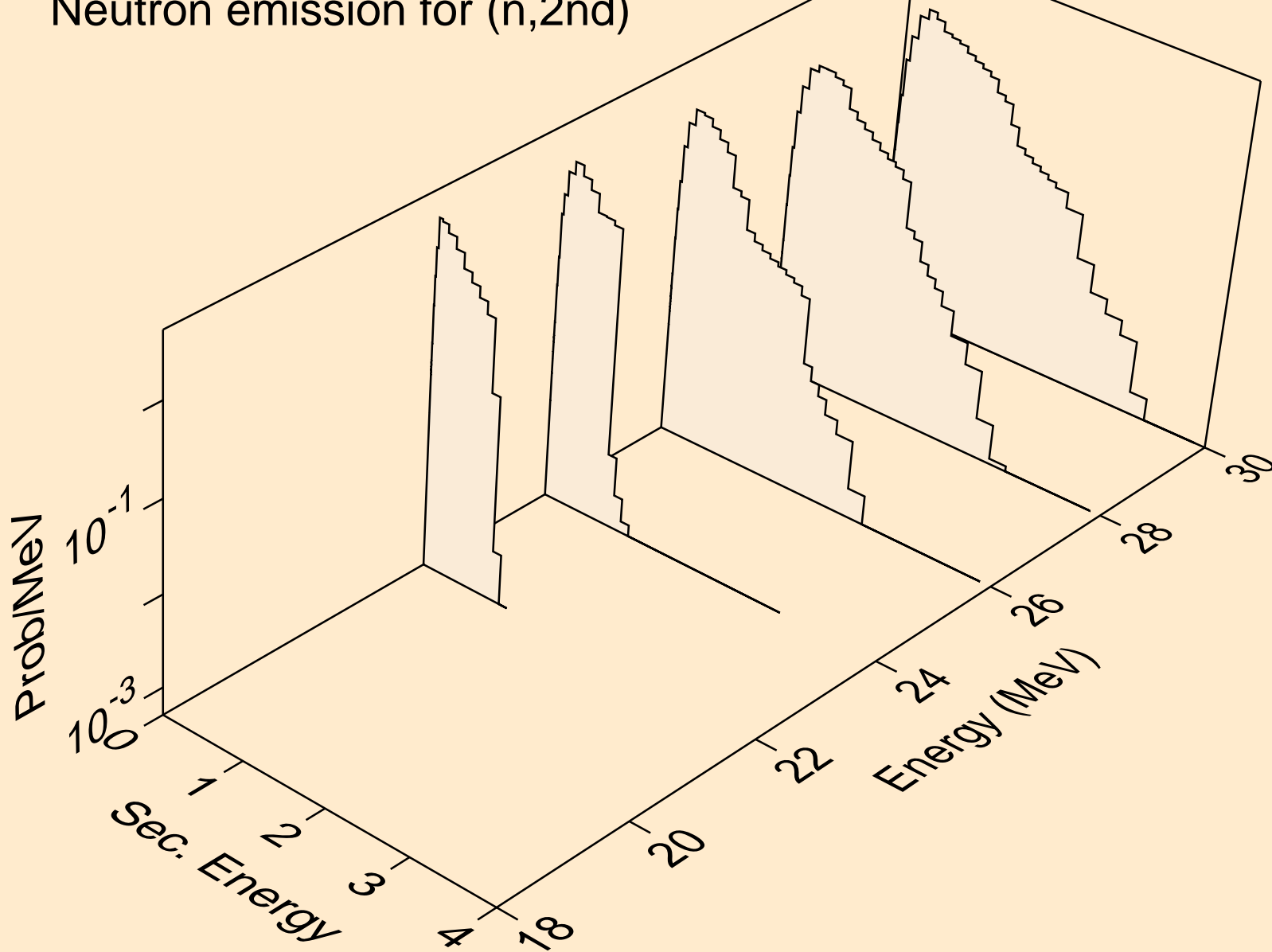

HG182 NEUTRON ACER TENDL-2019 LIBRARY; T=293.16K  
Neutron emission for (n,2n)

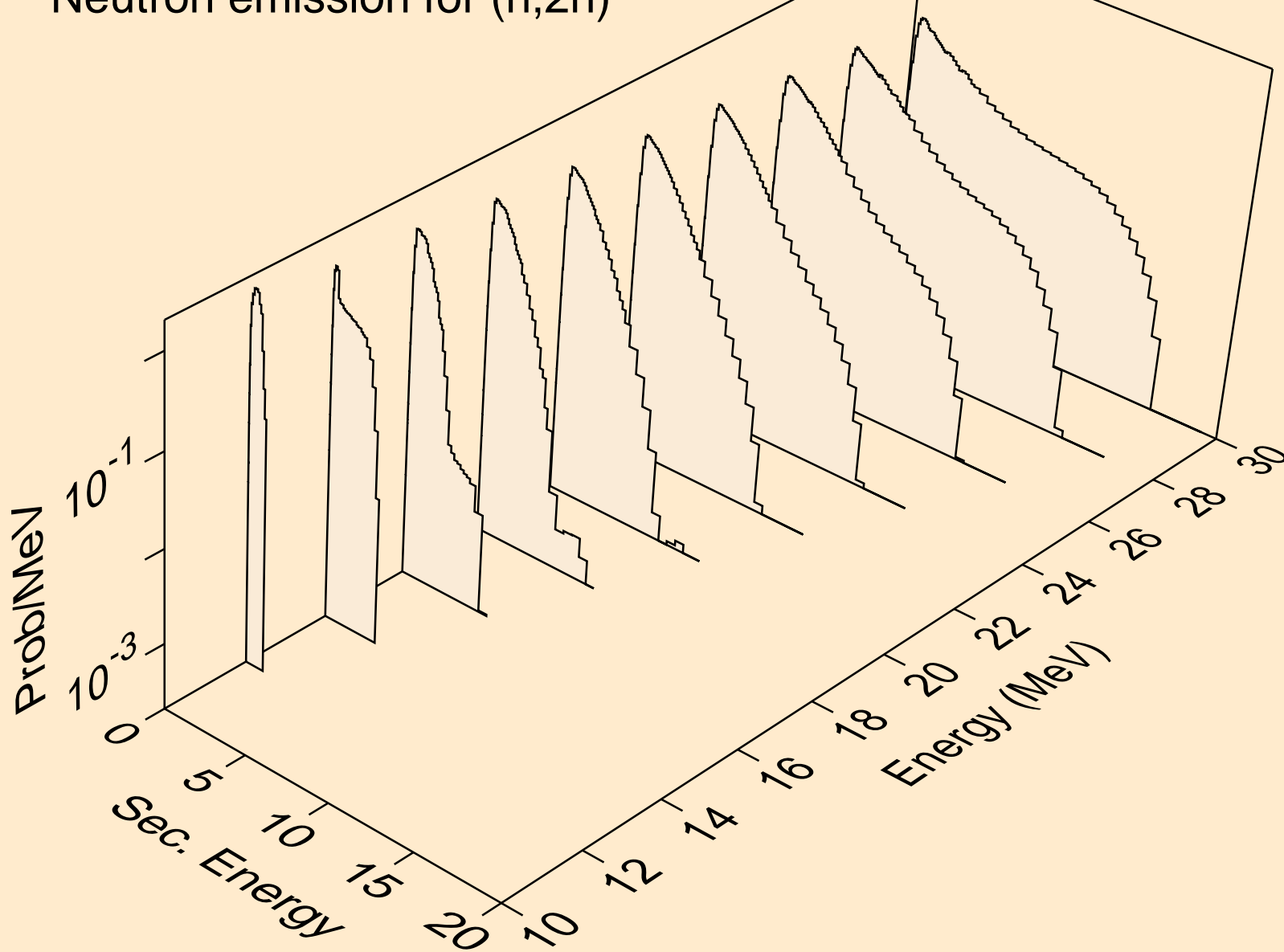

HG182 NEUTRON ACER TENDL-2019 LIBRARY; T=293.16K  
Neutron emission for (n,3n)

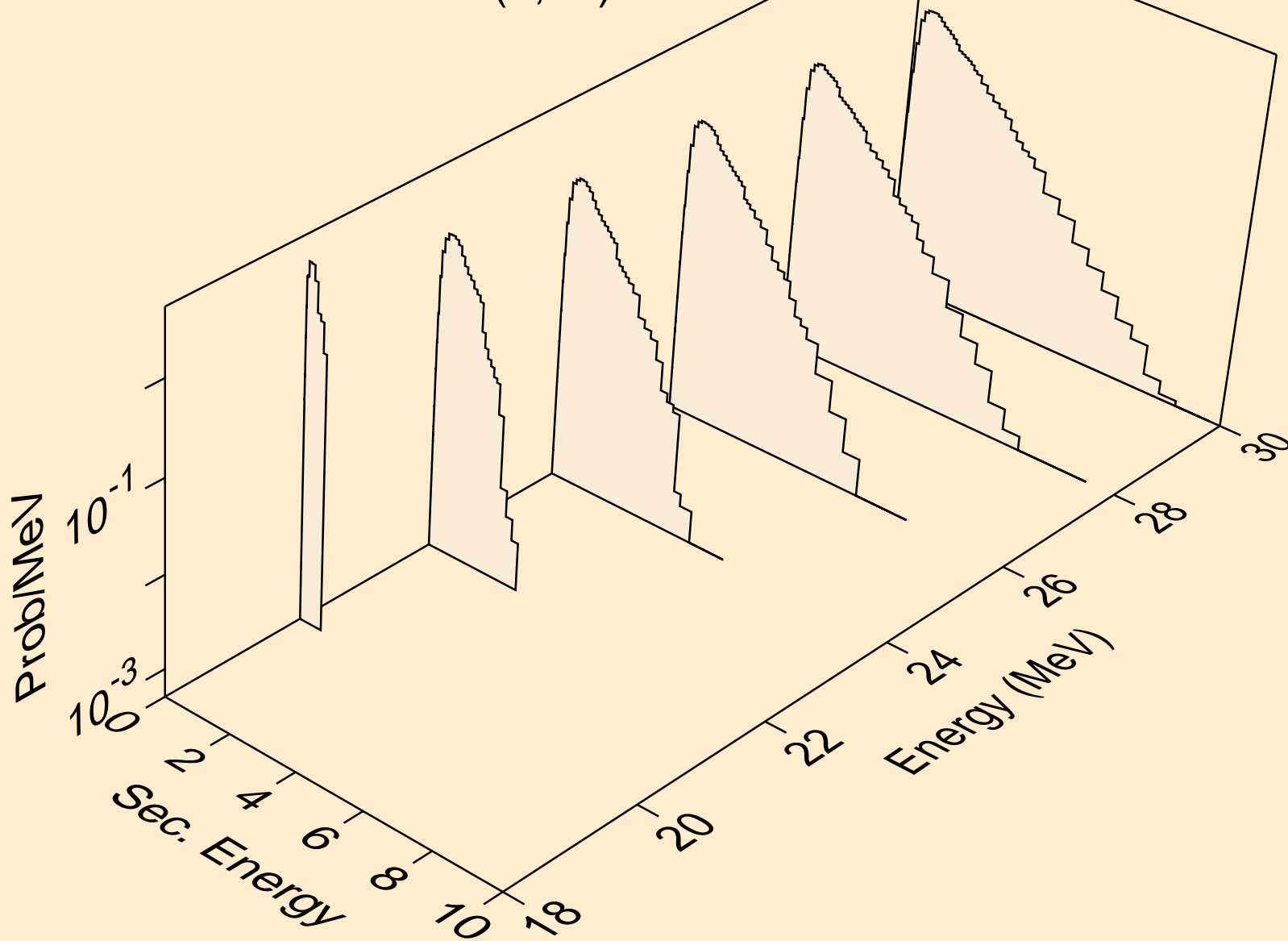

HG182 NEUTRON ACER TENDL-2019 LIBRARY; T=293.16K  
Neutron emission for (n,n\*)a

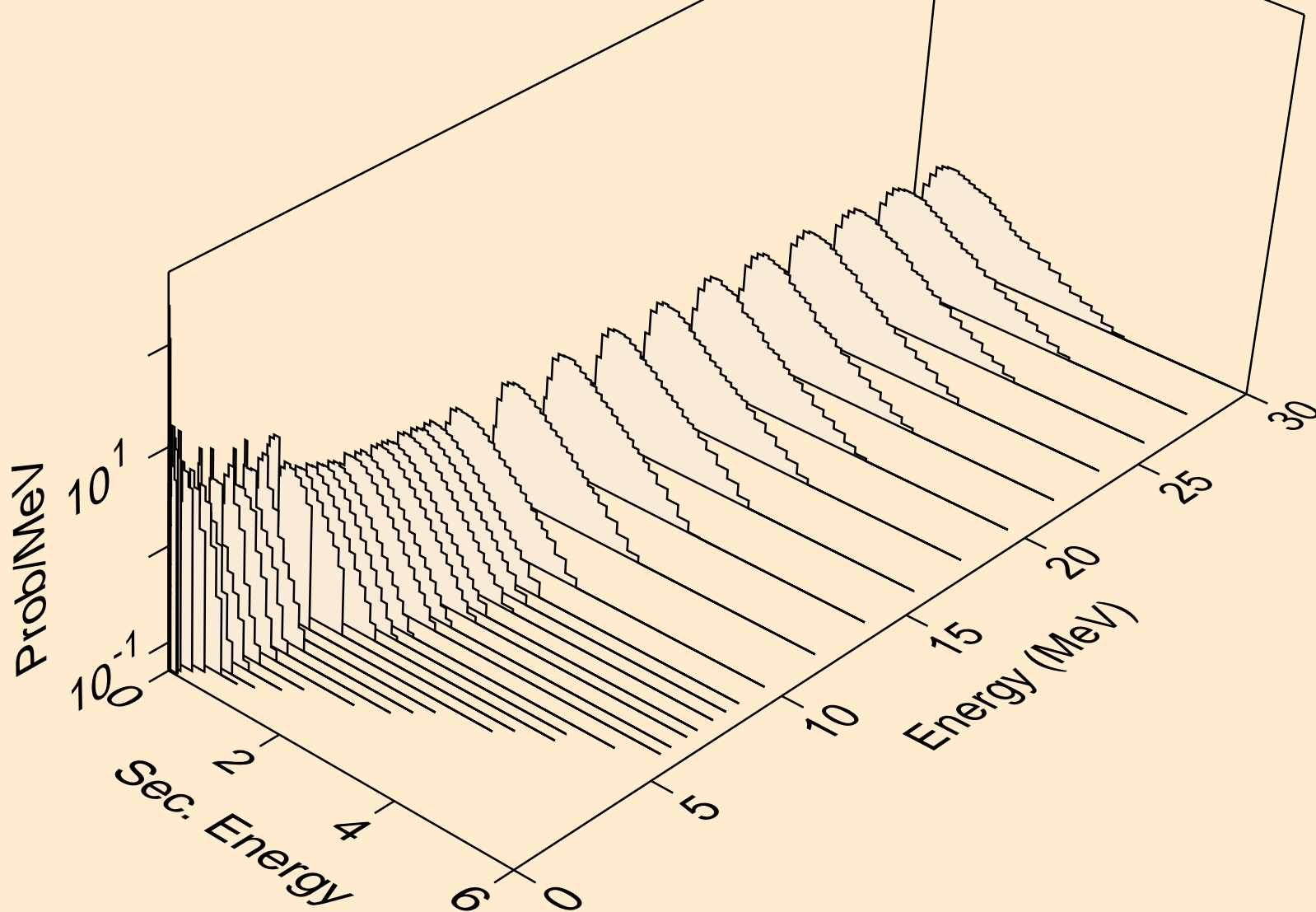

HG182 NEUTRON ACER TENDL-2019 LIBRARY; T=293.16K  
Neutron emission for (n,n\*)3a

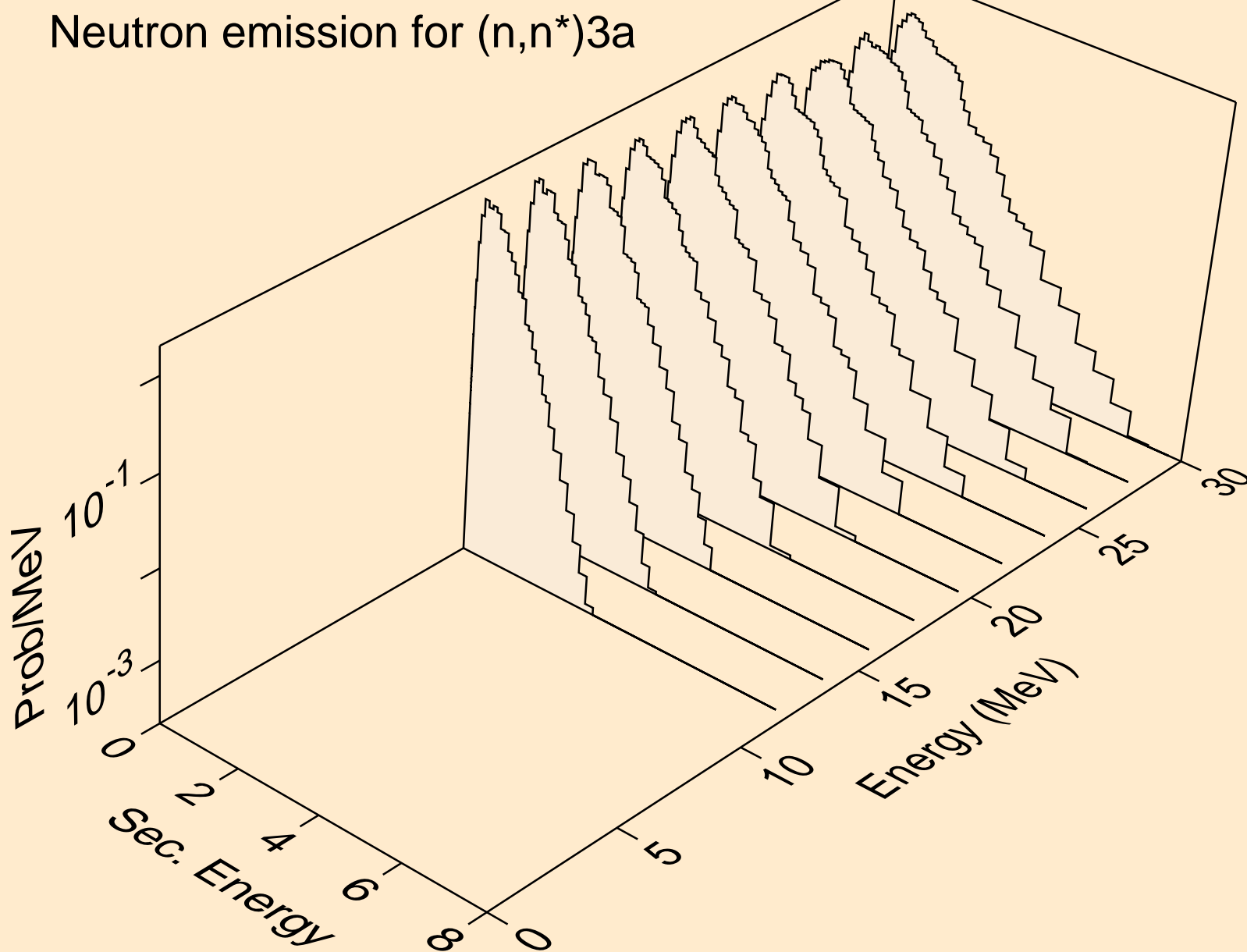

HG182 NEUTRON ACER TENDL-2019 LIBRARY; T=293.16K  
Neutron emission for (n,2n)a

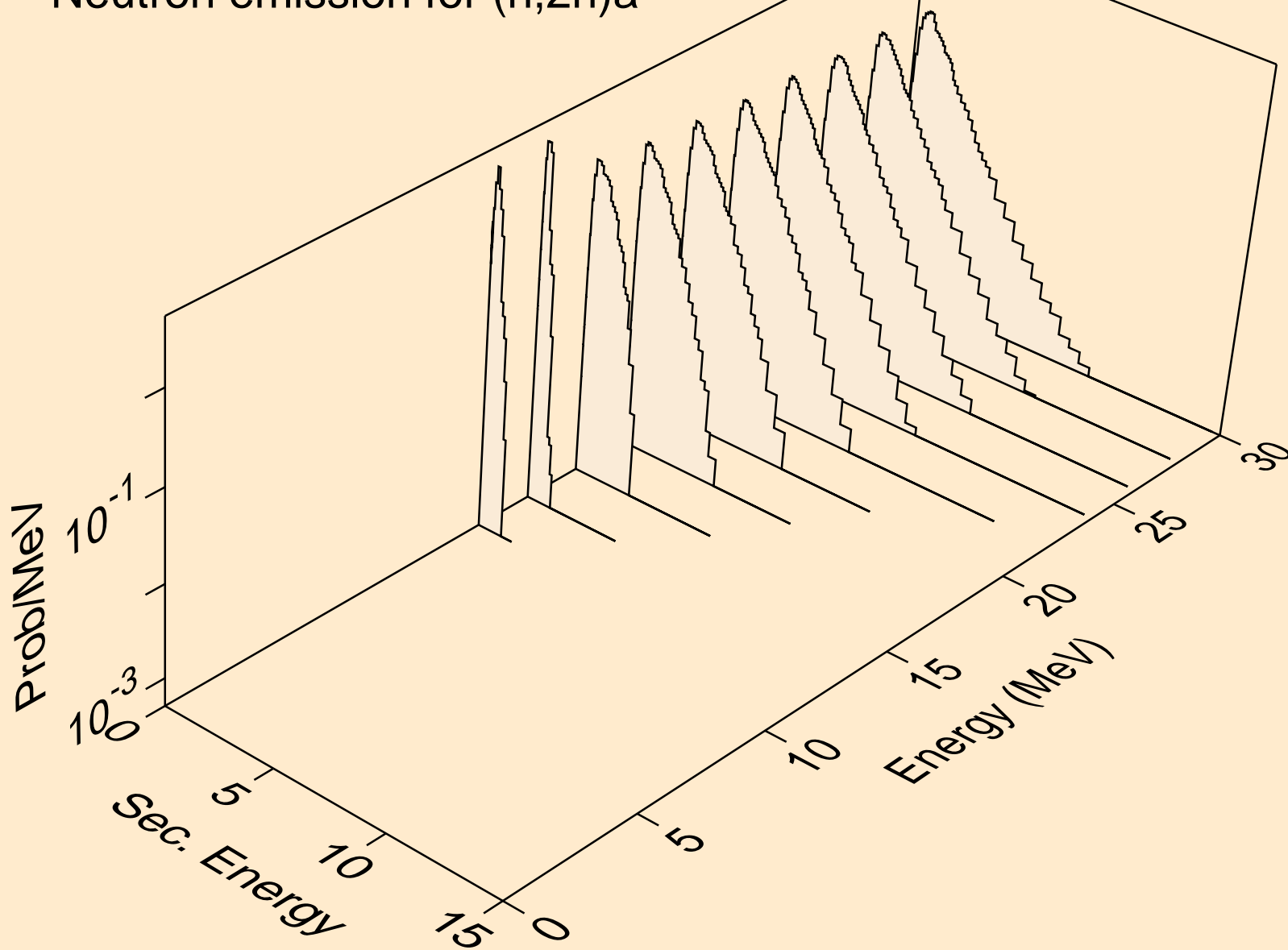

HG182 NEUTRON ACER TENDL-2019 LIBRARY; T=293.16K  
Neutron emission for (n,3n)a

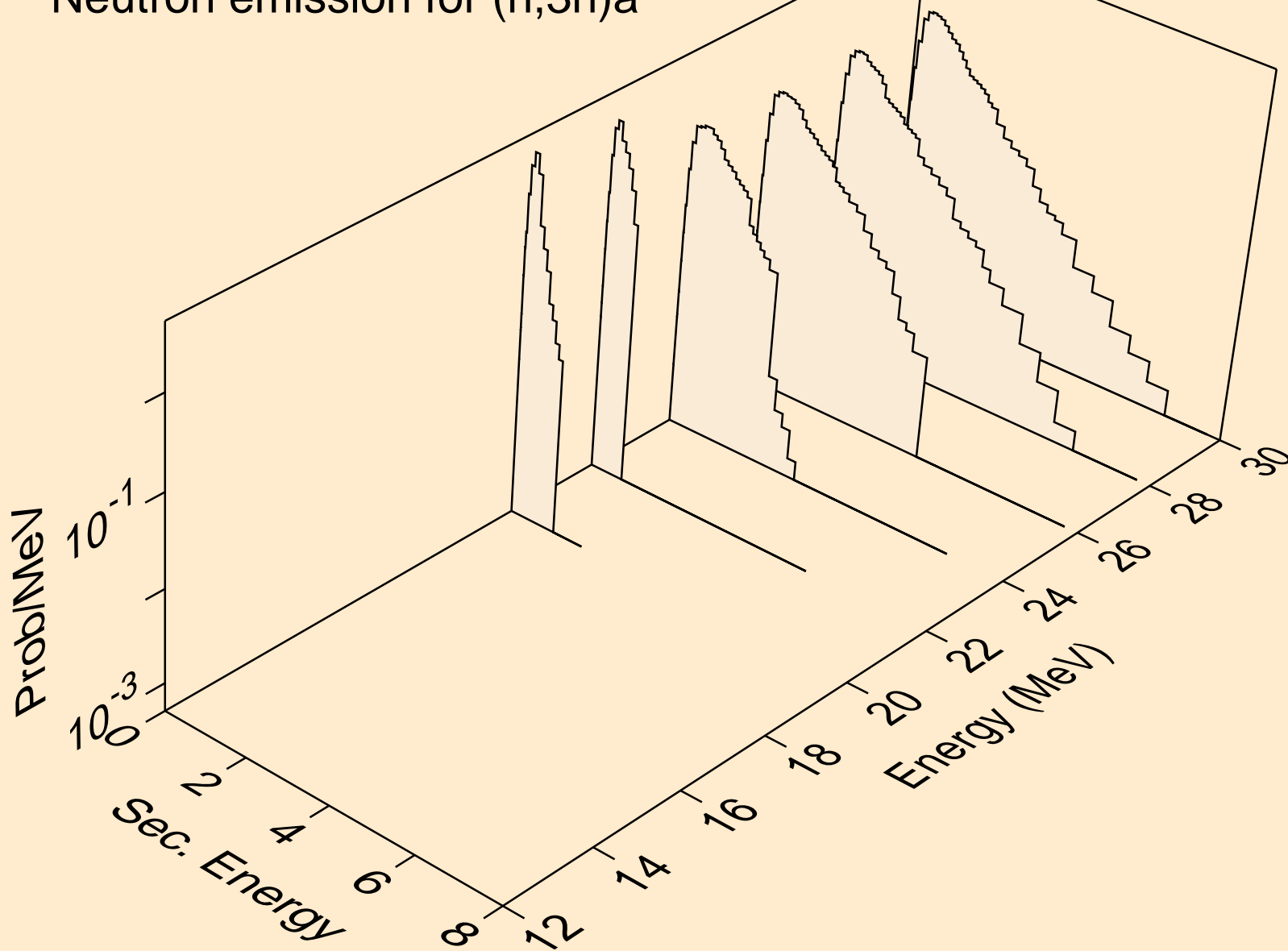

HG182 NEUTRON ACER TENDL-2019 LIBRARY; T=293.16K  
Neutron emission for (n,n\*)p

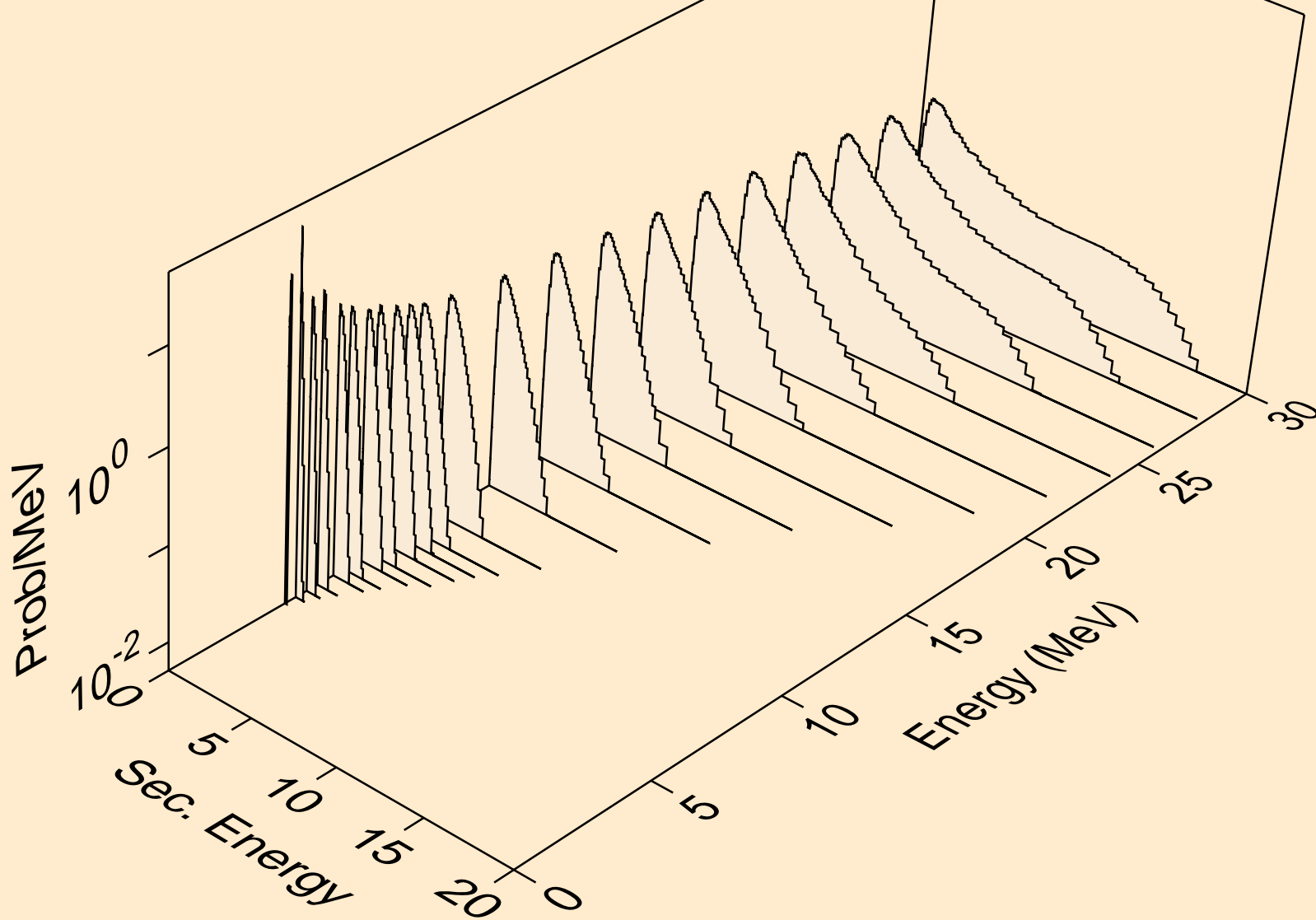

HG182 NEUTRON ACER TENDL-2019 LIBRARY; T=293.16K  
Neutron emission for (n,n\*)2a

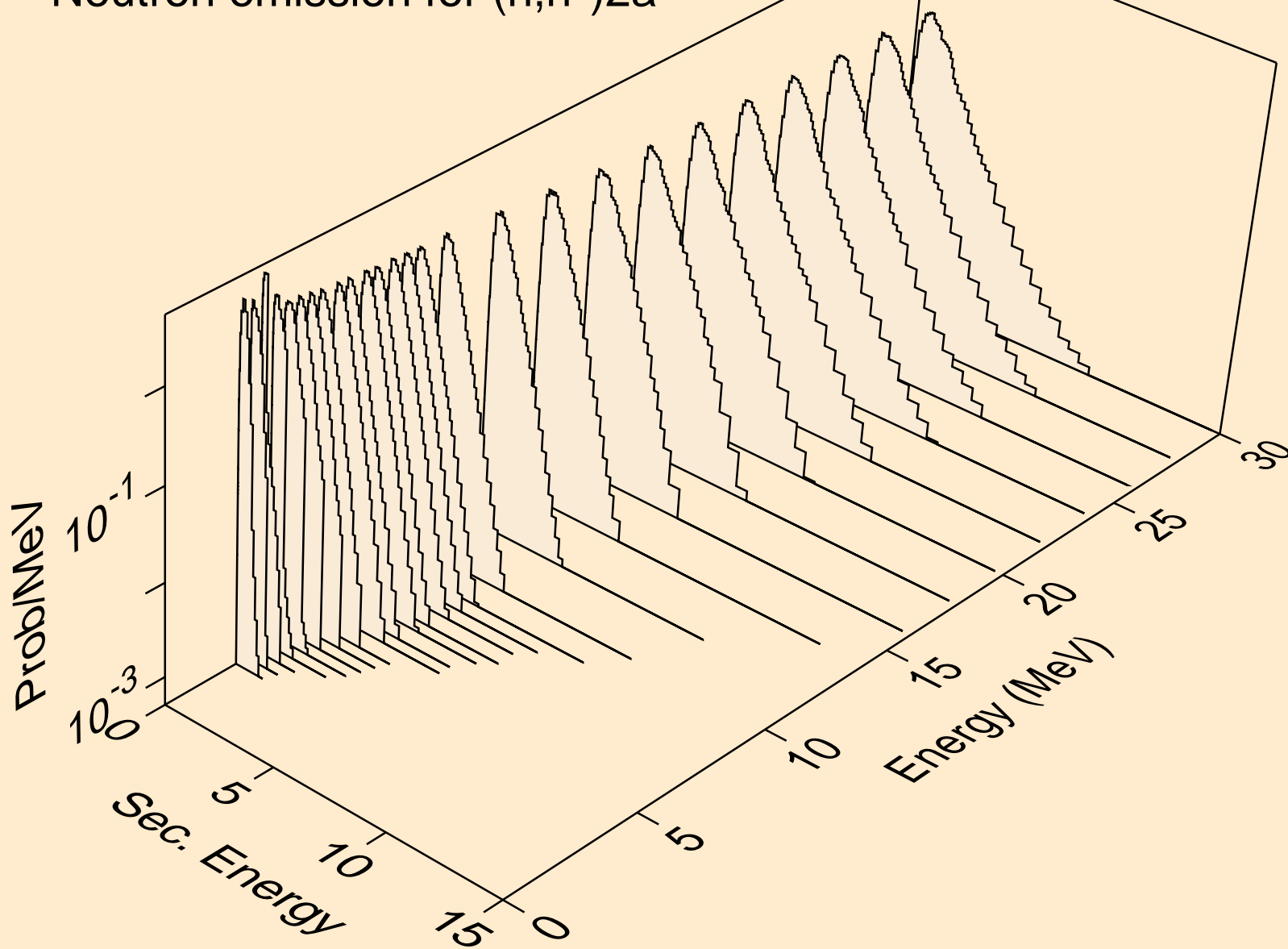

HG182 NEUTRON ACER TENDL-2019 LIBRARY; T=293.16K  
Neutron emission for (n,2n)2a

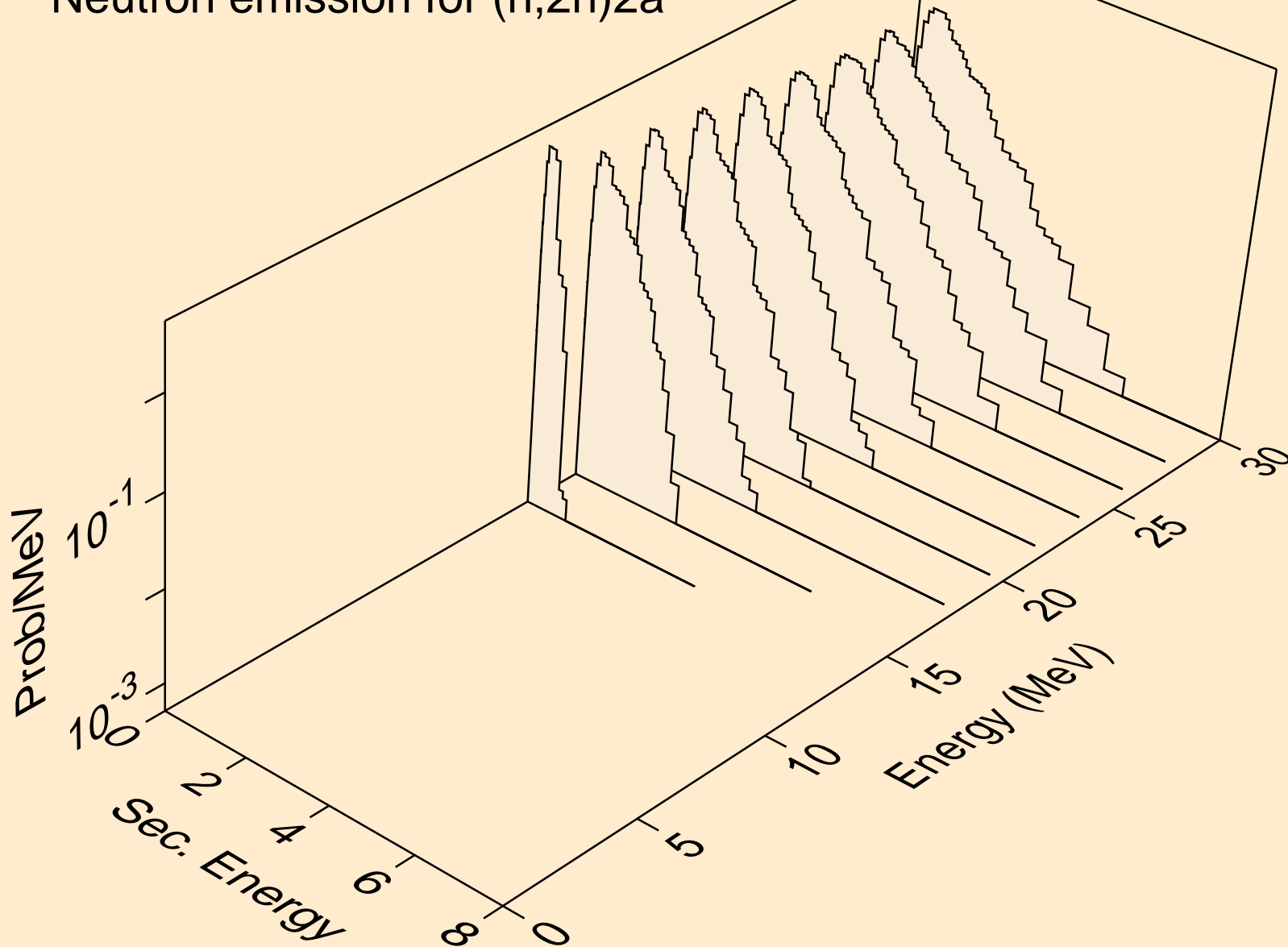

HG182 NEUTRON ACER TENDL-2019 LIBRARY; T=293.16K  
Neutron emission for (n,n\*)d

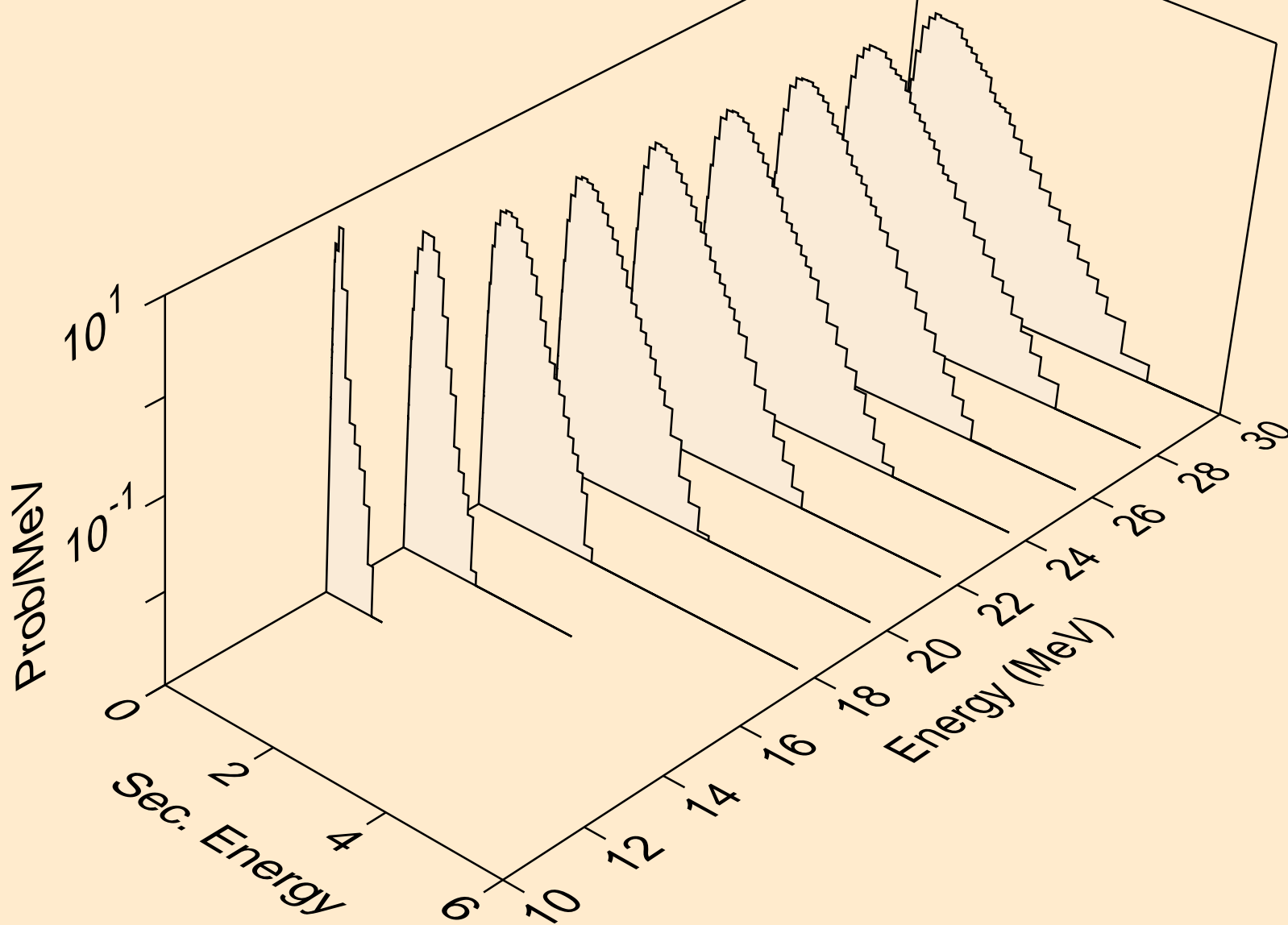

HG182 NEUTRON ACER TENDL-2019 LIBRARY; T=293.16K  
Neutron emission for (n,n\*)t

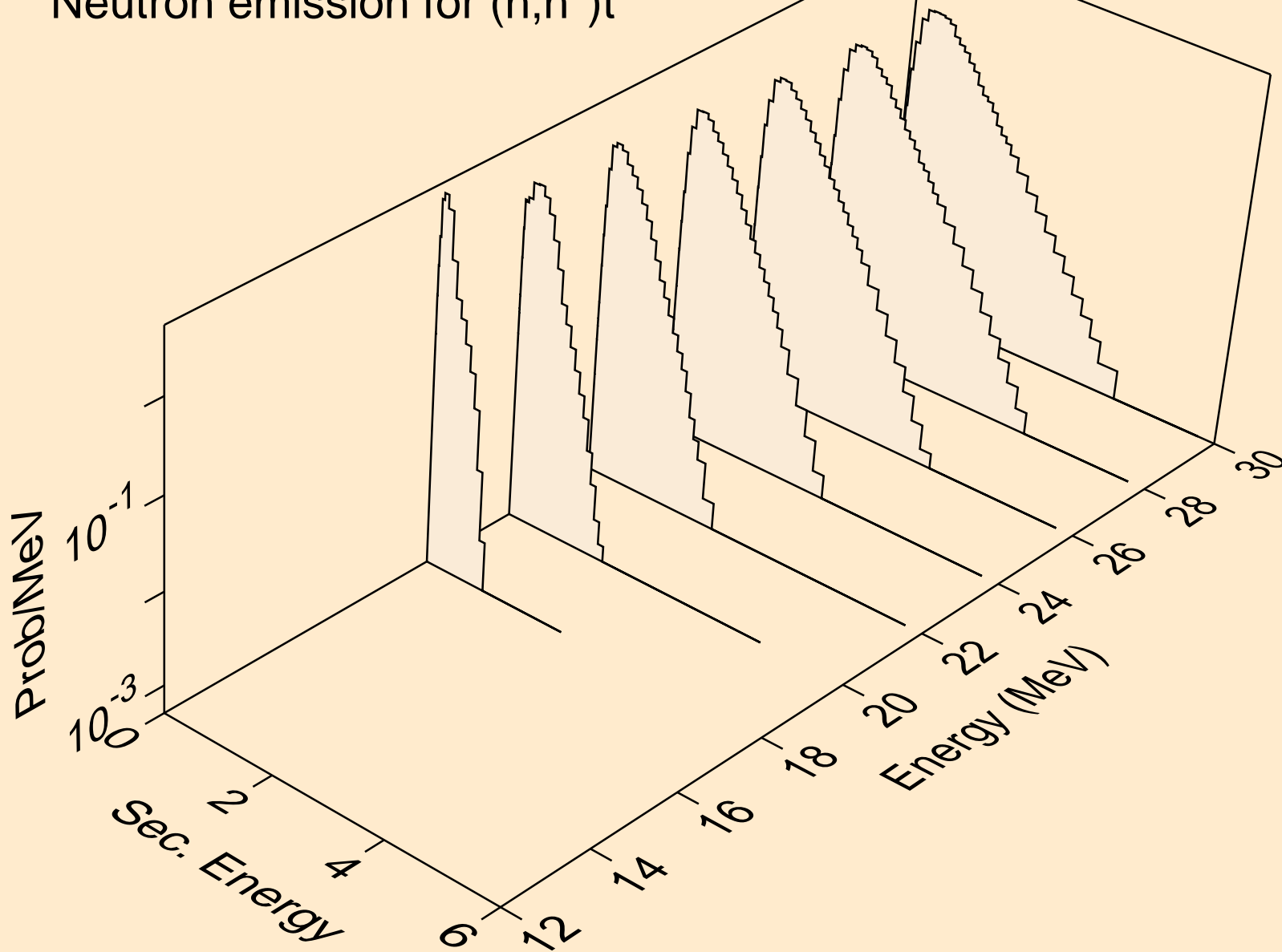

HG182 NEUTRON ACER TENDL-2019 LIBRARY; T=293.16K  
Neutron emission for (n,n\*)he3

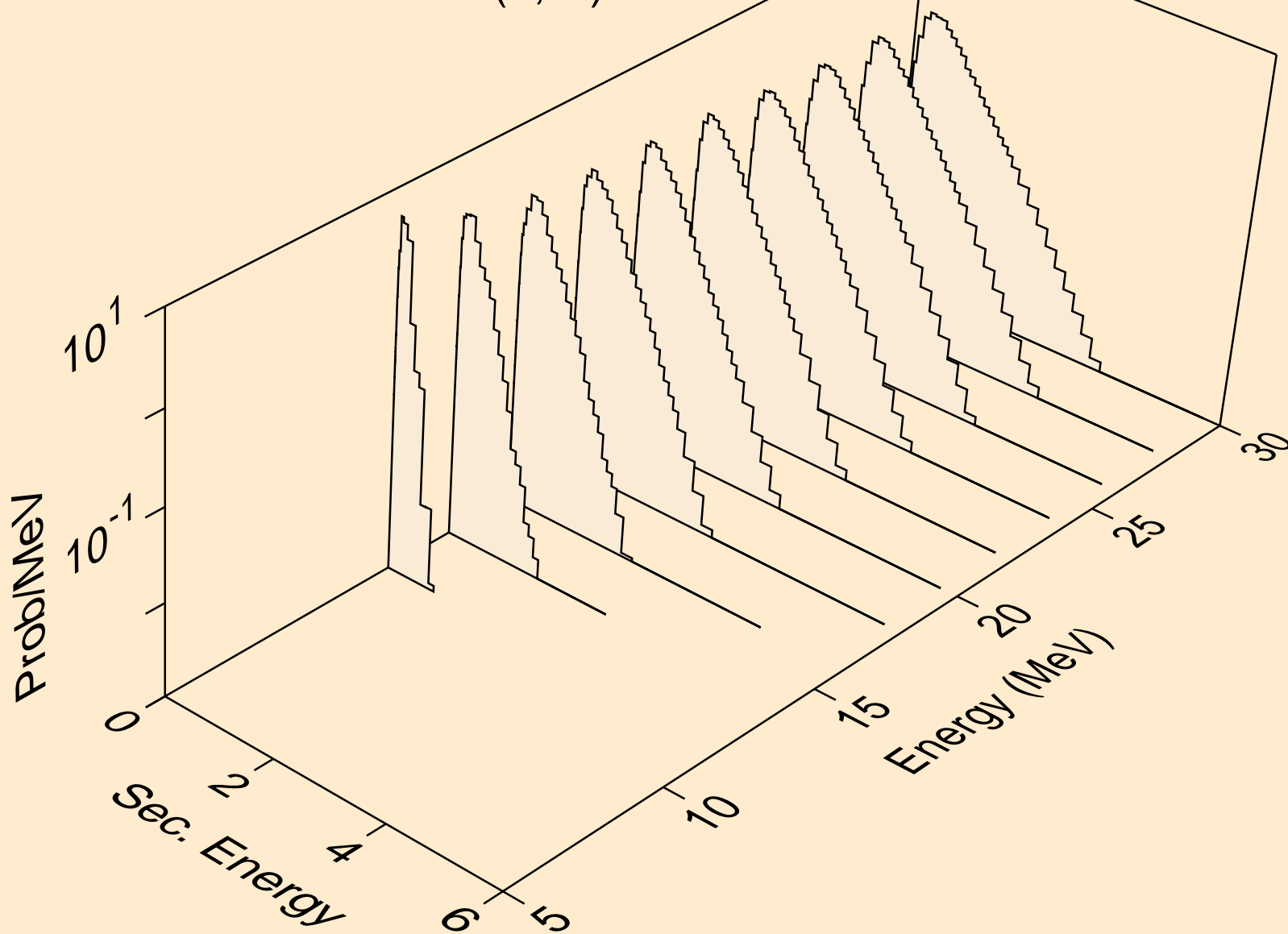

HG182 NEUTRON ACER TENDL-2019 LIBRARY; T=293.16K  
Neutron emission for (n,2np)

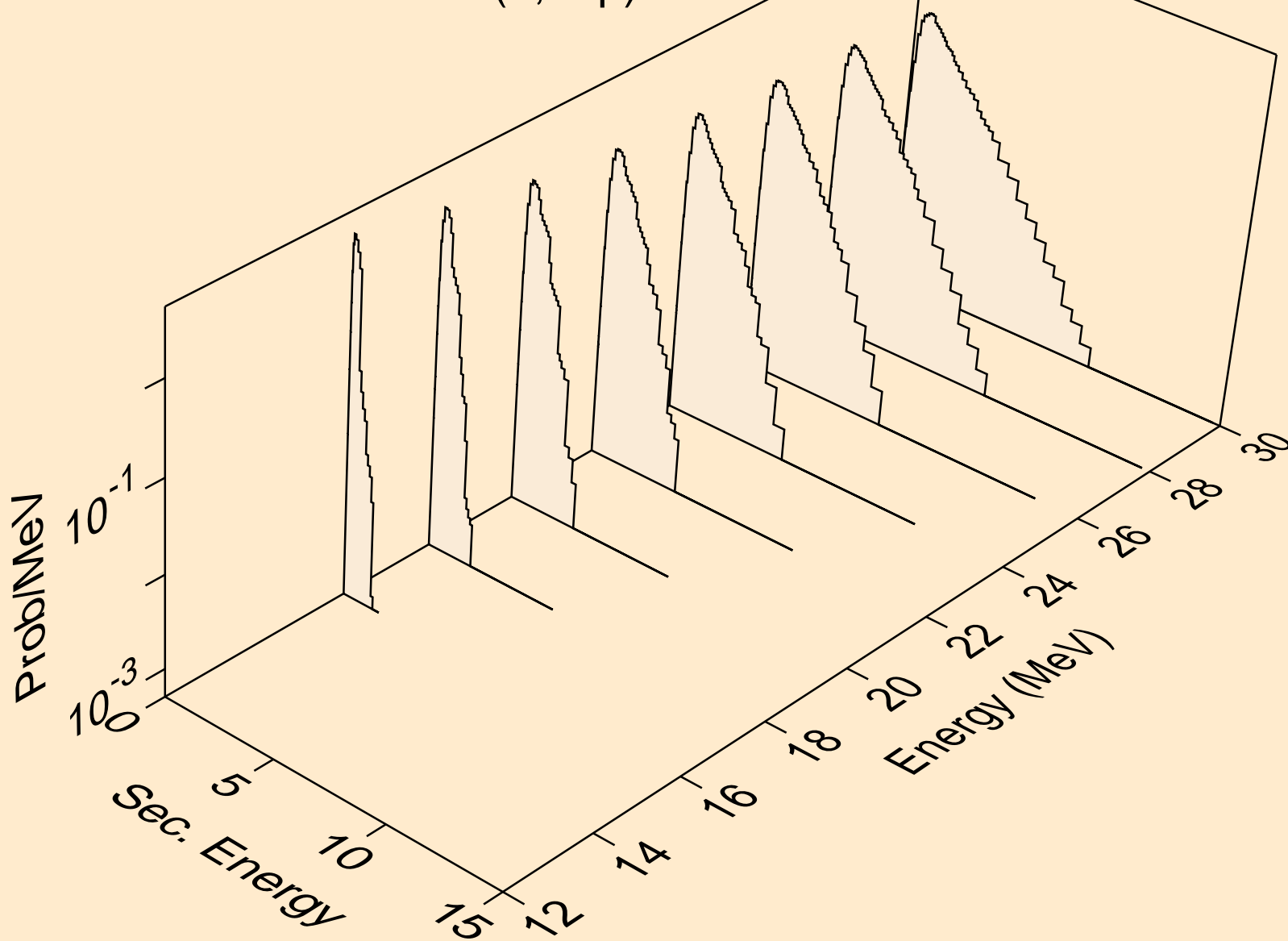

HG182 NEUTRON ACER TENDL-2019 LIBRARY; T=293.16K  
Neutron emission for (n,3np)

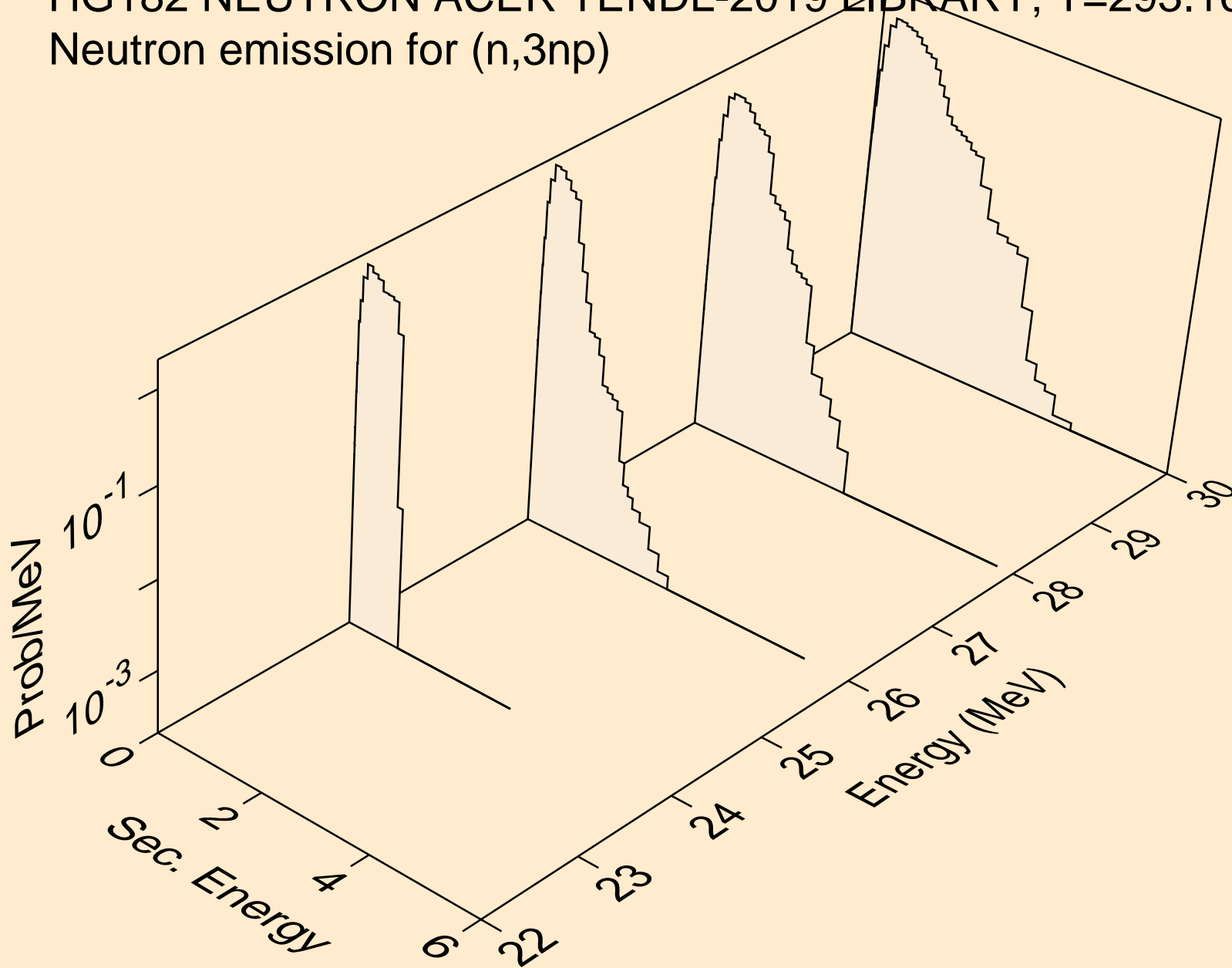

HG182 NEUTRON ACER TENDL-2019 LIBRARY; T=293.16K  
Neutron emission for (n,2np)

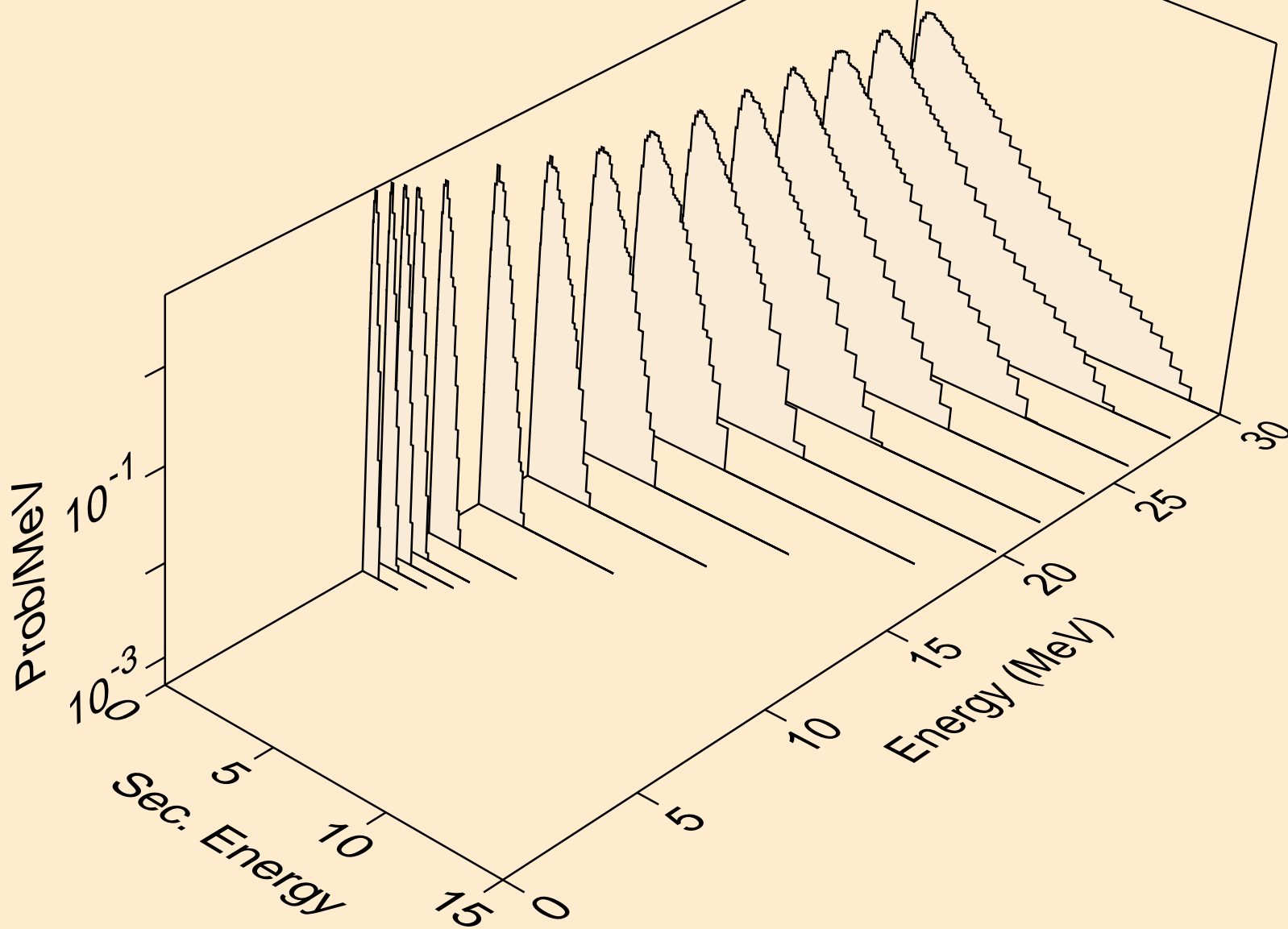

HG182 NEUTRON ACER TENDL-2019 LIBRARY; T=293.16K  
Neutron emission for (n,npa)

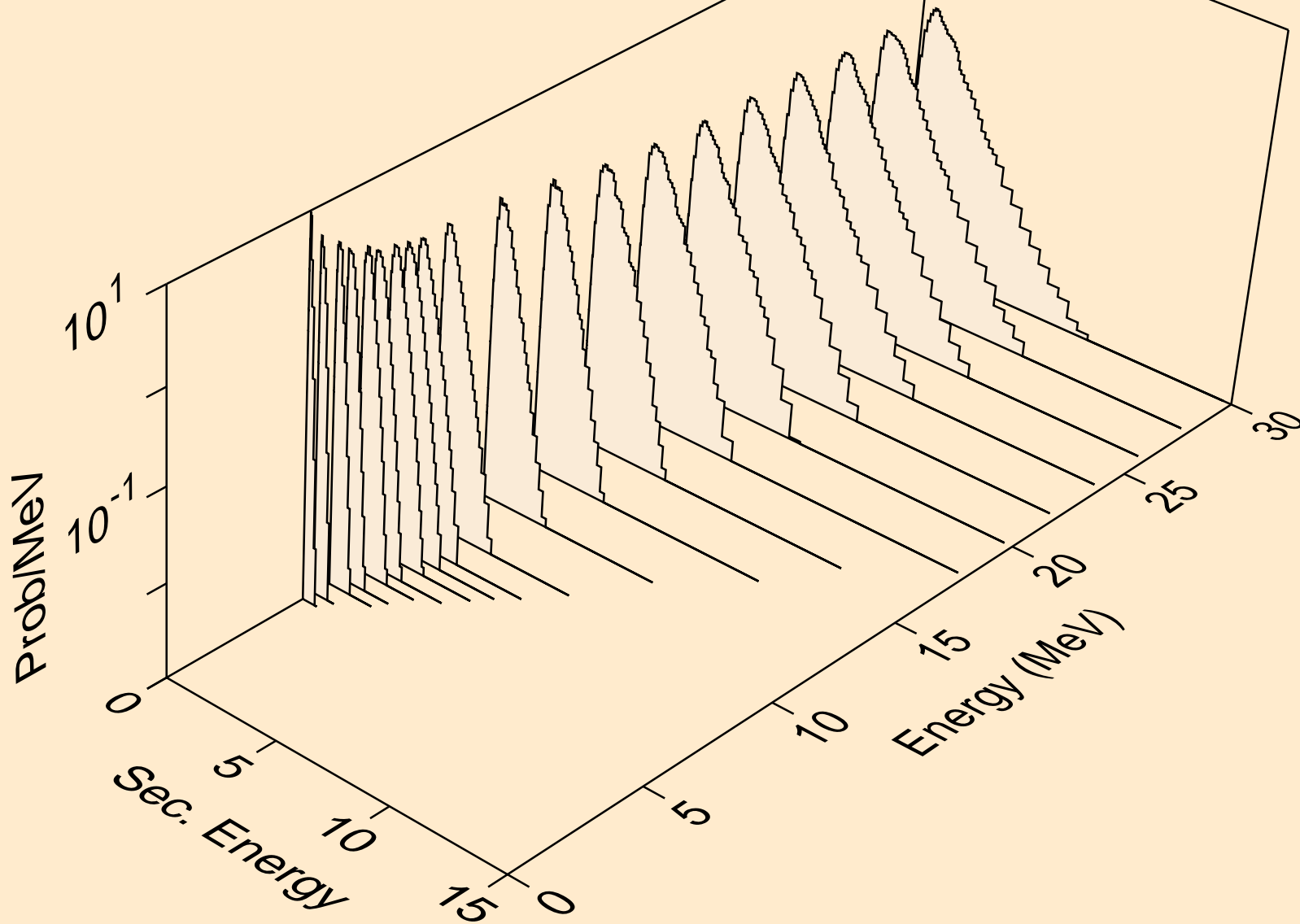

HG182 NEUTRON ACER TENDL-2019 LIBRARY; T=293.16K  
Neutron emission for (n,n\*c)

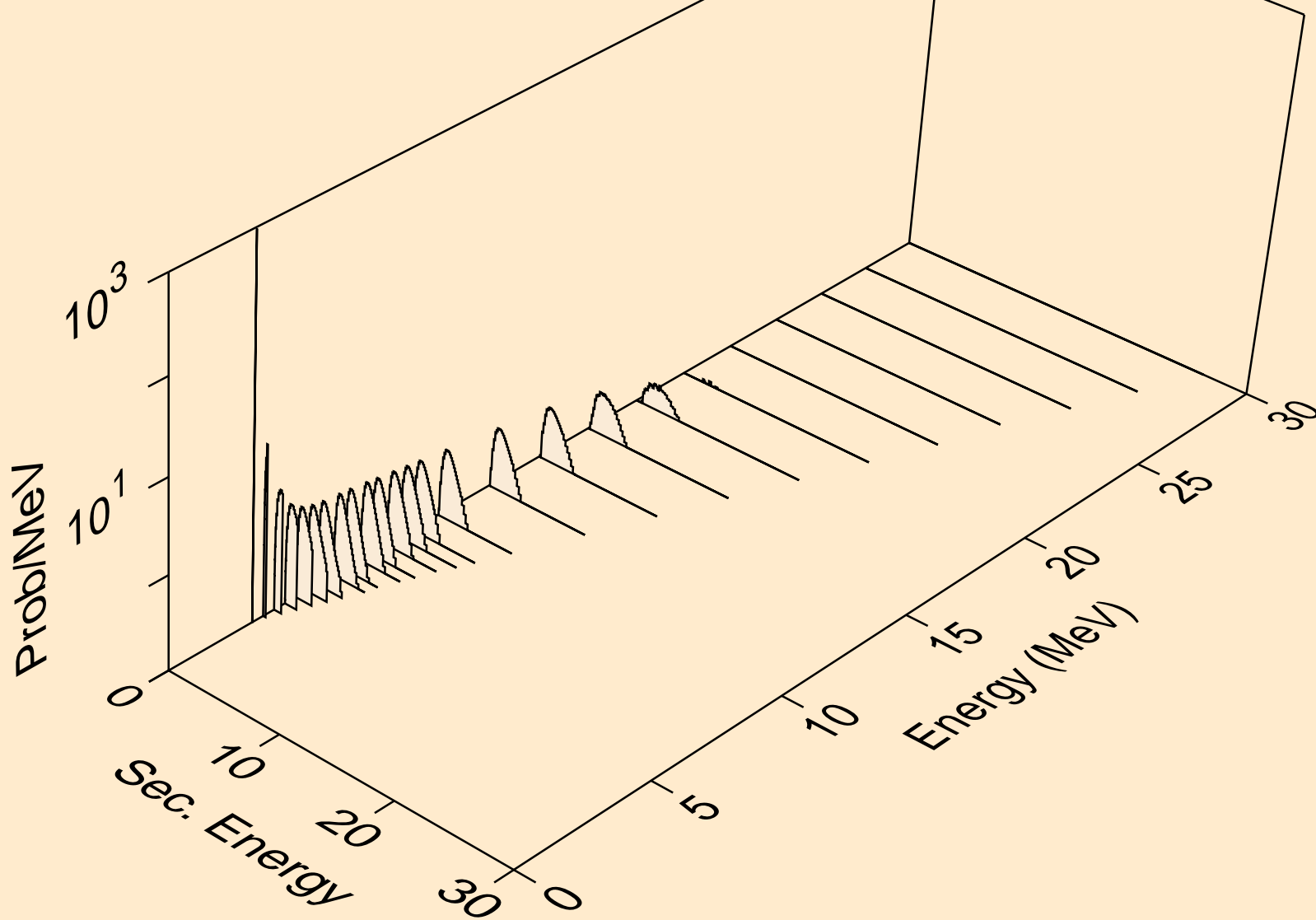

HG182 NEUTRON ACER TENDL-2019 LIBRARY; T=293.16K  
Photon emission for (n,x)

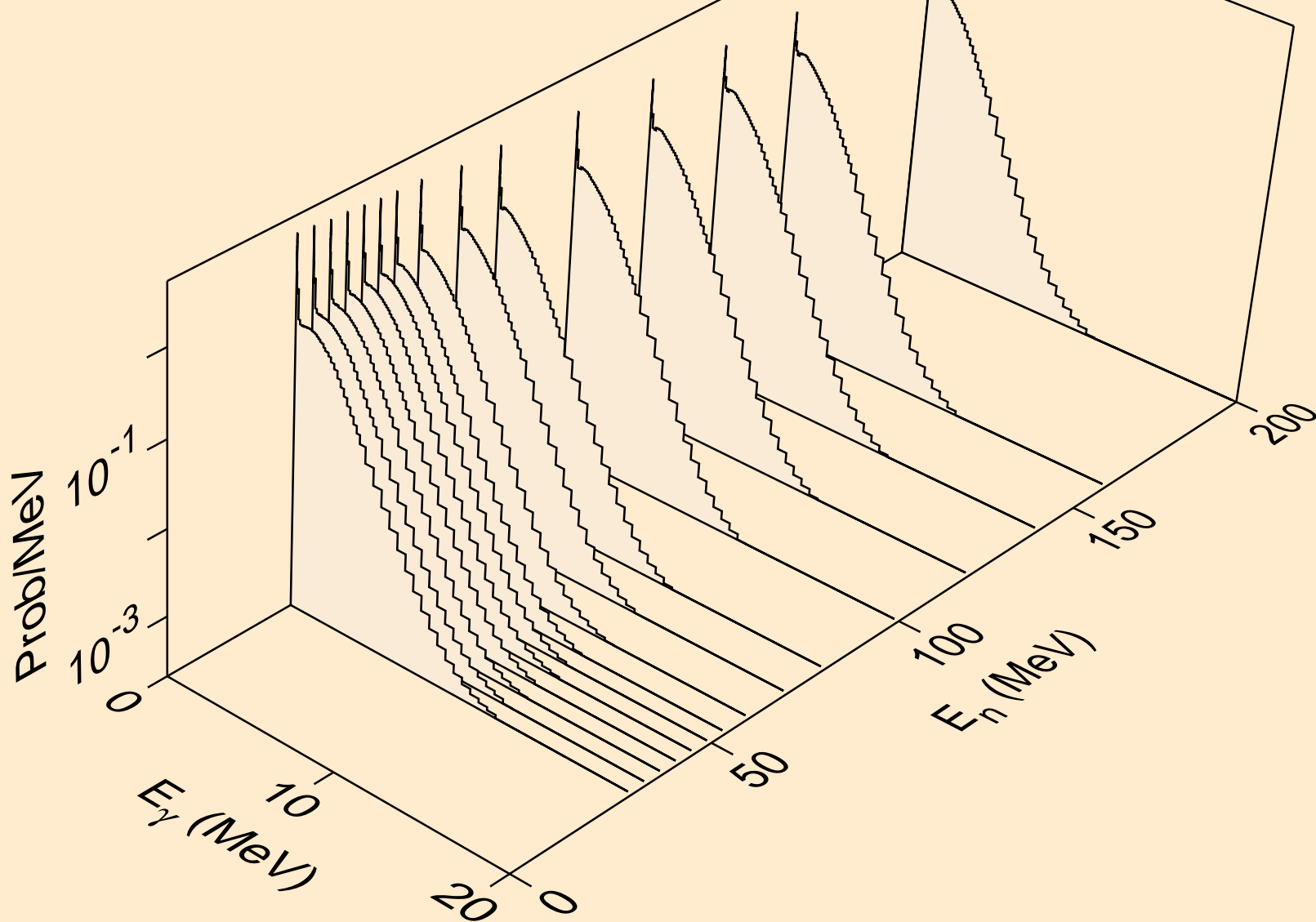

HG182 NEUTRON ACER TENDL-2019 LIBRARY; T=293.16K  
Photon emission for (n,2nd)

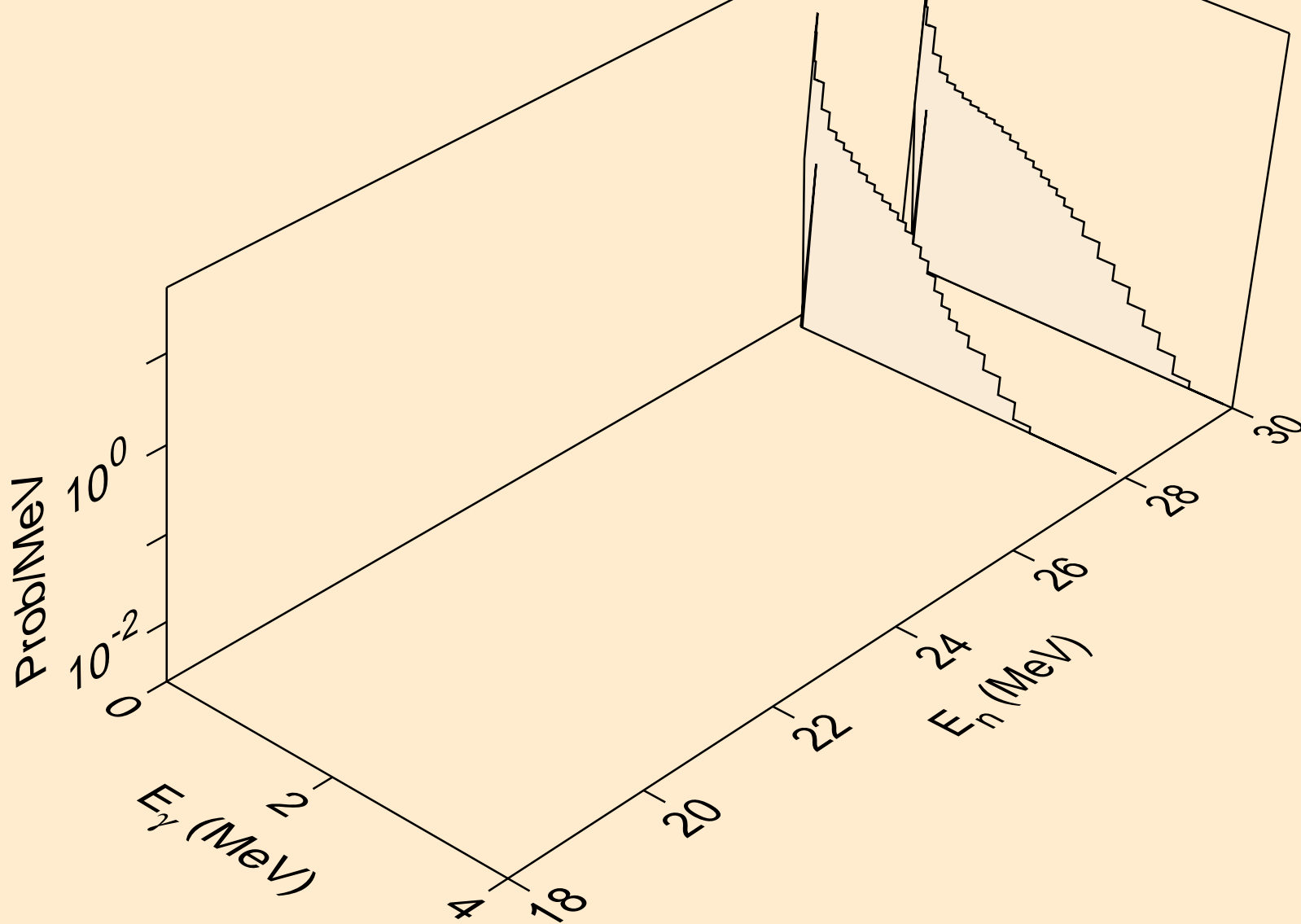

HG182 NEUTRON ACER TENDL-2019 LIBRARY; T=293.16K  
Photon emission for (n,2n)

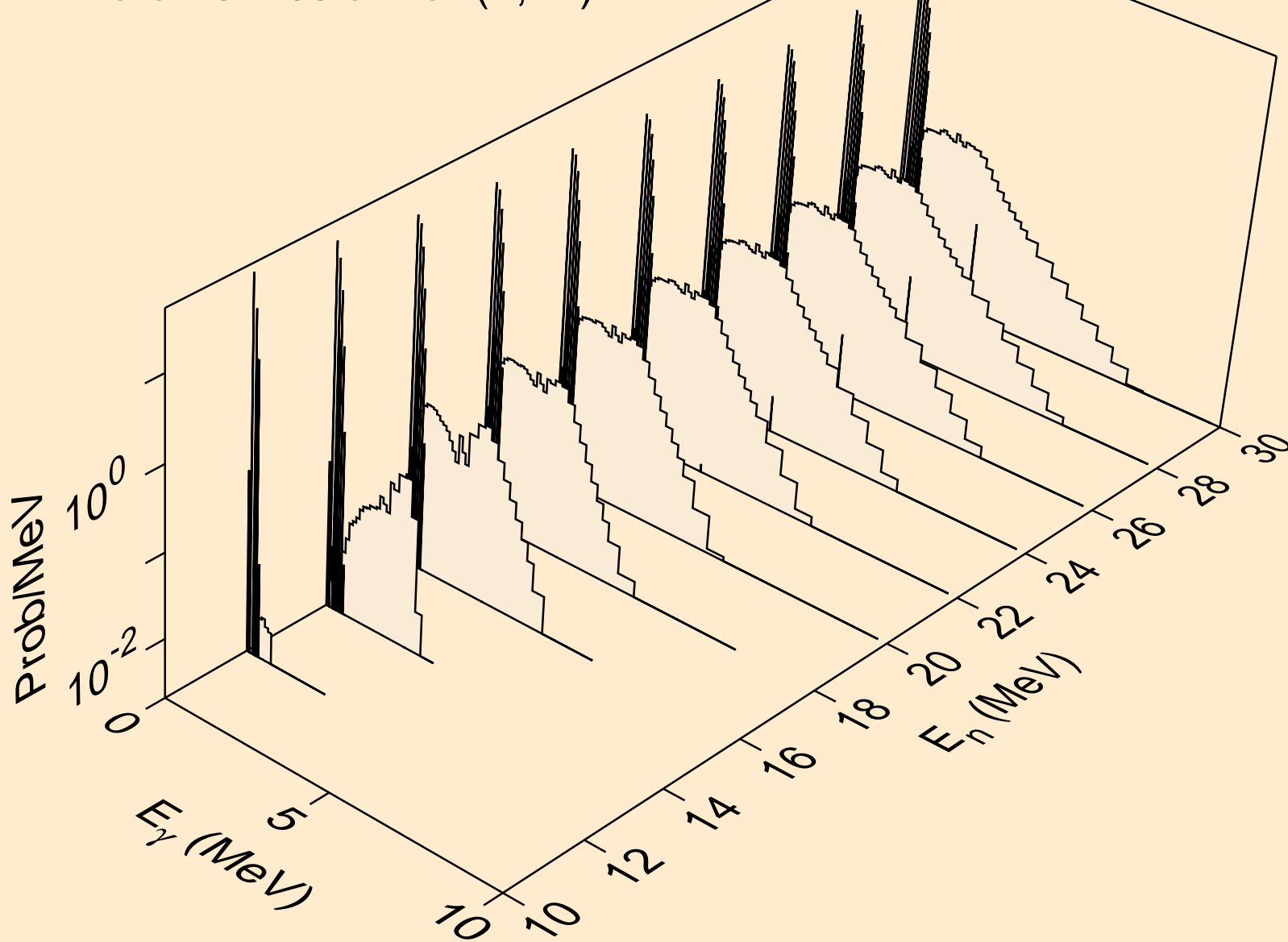

HG182 NEUTRON ACER TENDL-2019 LIBRARY; T=293.16K  
Photon emission for (n,3n)

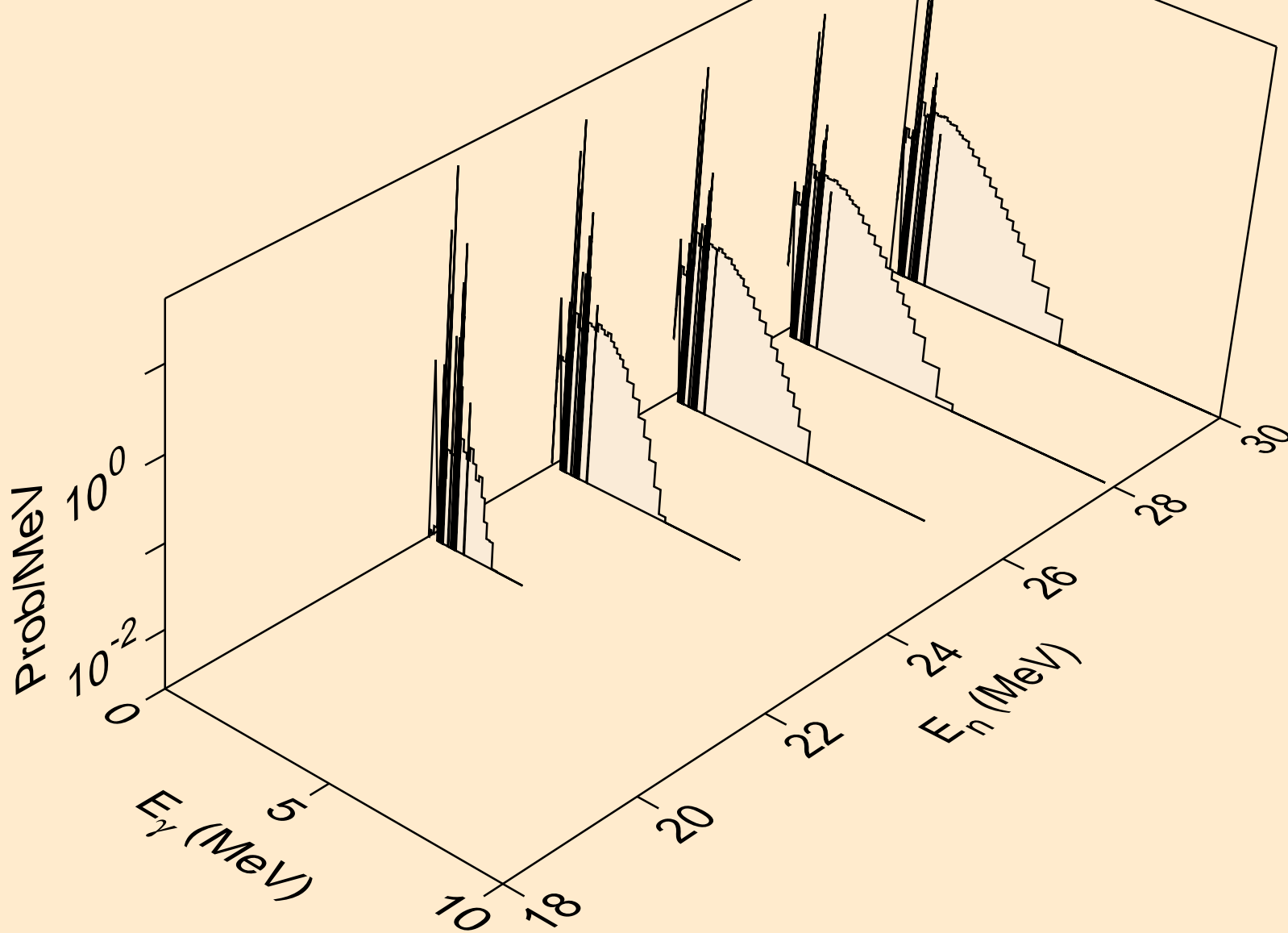

HG182 NEUTRON ACER TENDL-2019 LIBRARY; T=293.16K  
Photon emission for (n,n\*)a

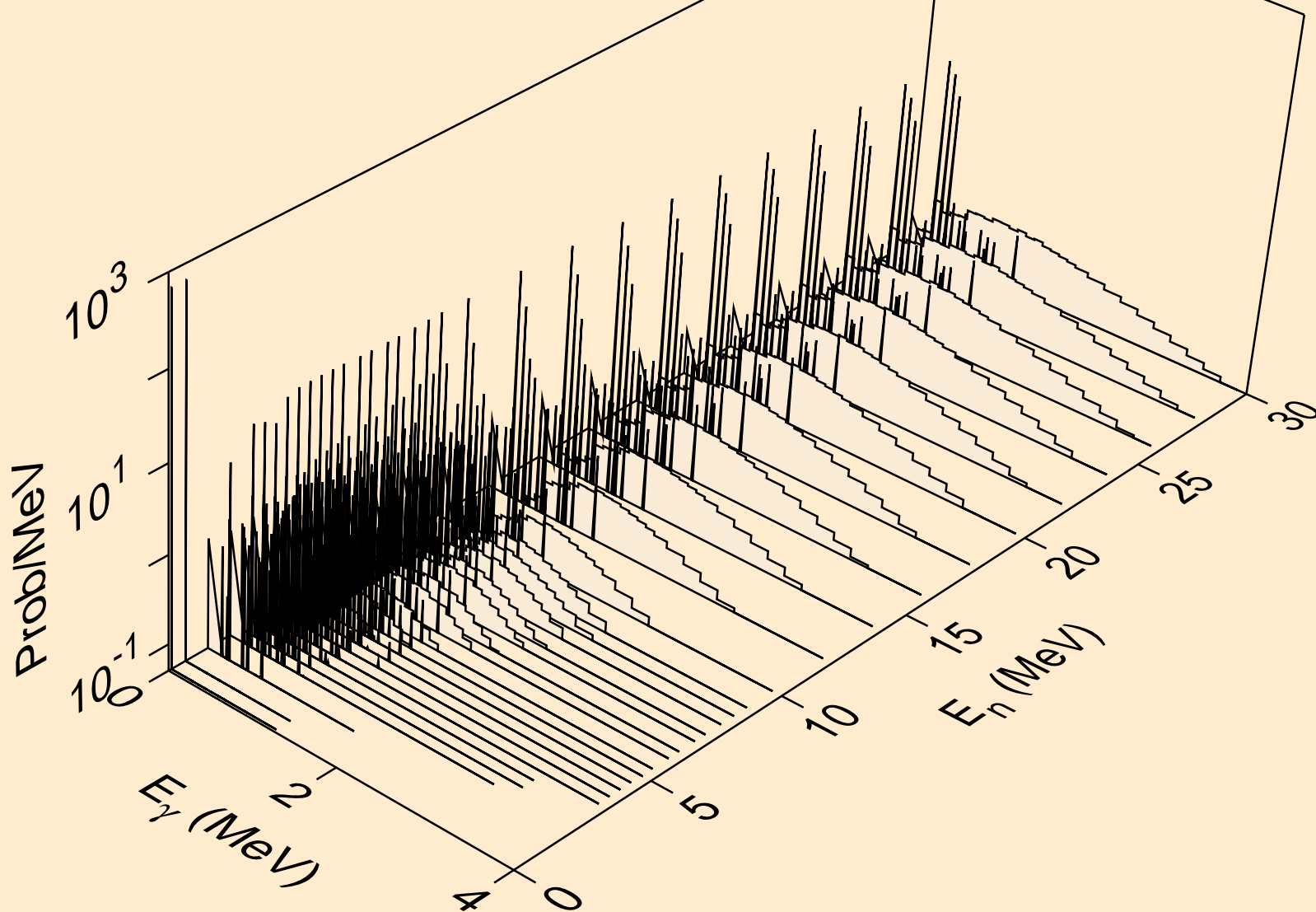

HG182 NEUTRON ACER TENDL-2019 LIBRARY; T=293.16K  
Photon emission for (n,n\*)3a

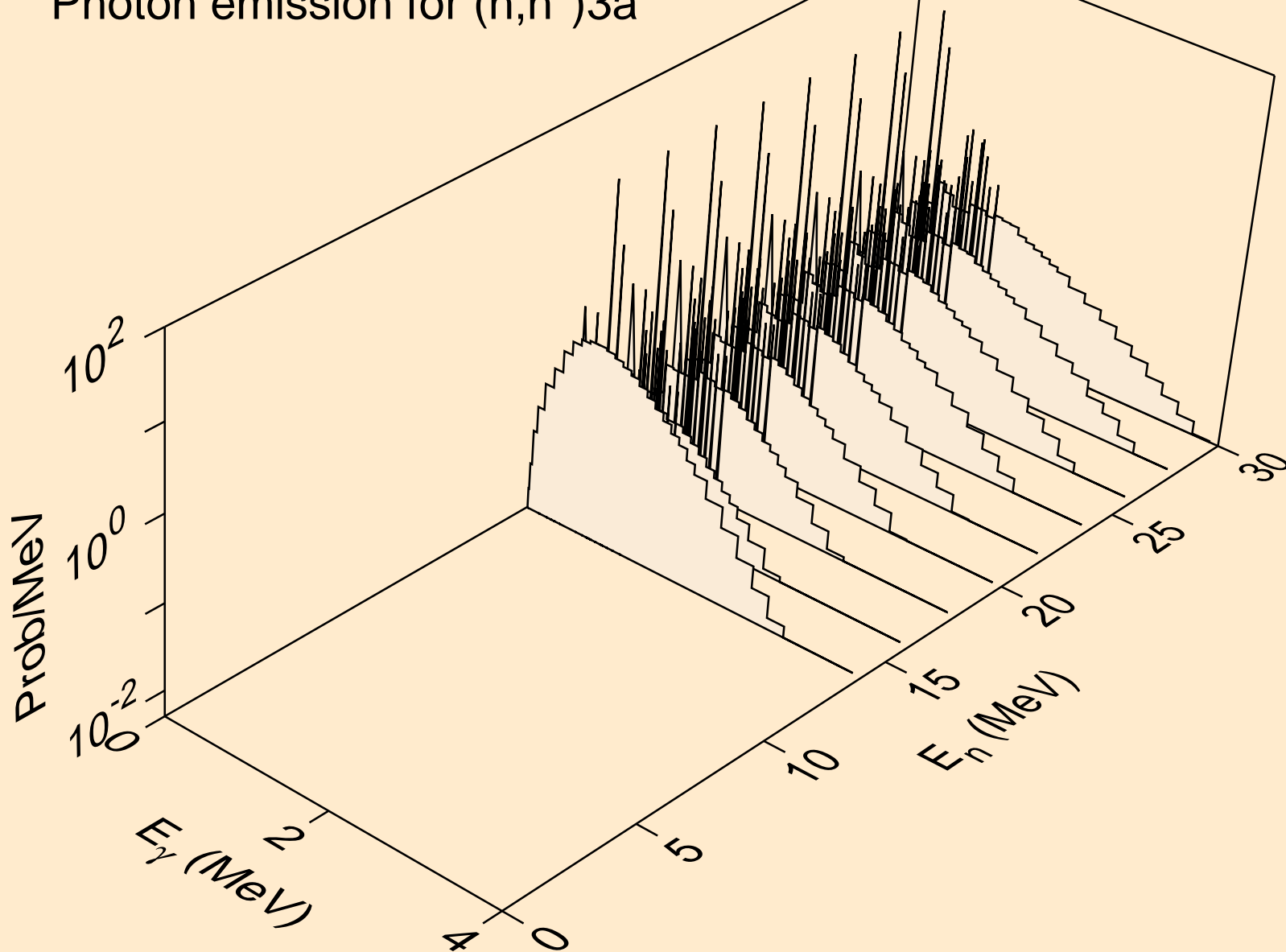

HG182 NEUTRON ACER TENDL-2019 LIBRARY; T=293.16K  
Photon emission for (n,2n)a

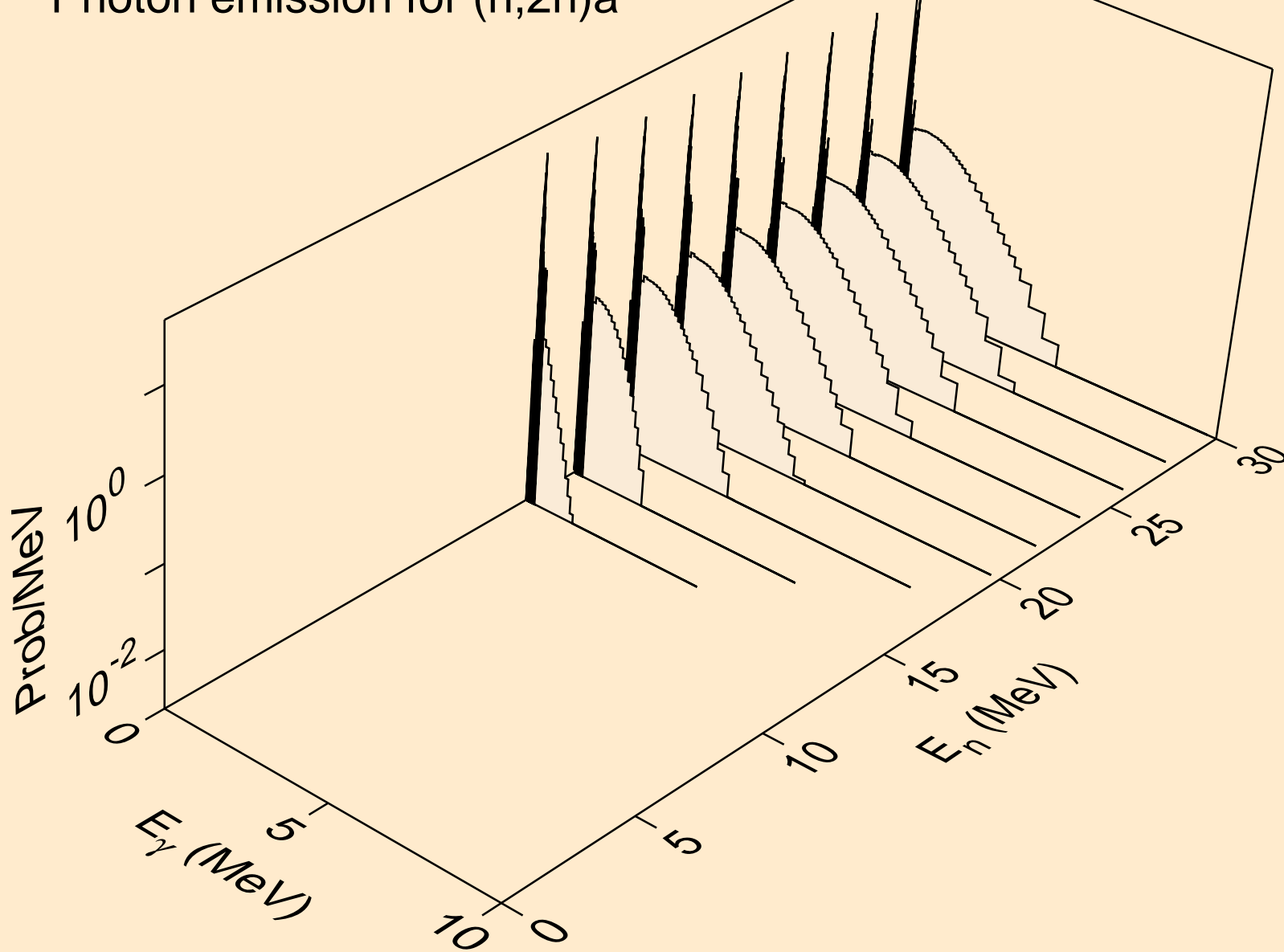

HG182 NEUTRON ACER TENDL-2019 LIBRARY; T=293.16K  
Photon emission for (n,3n)a

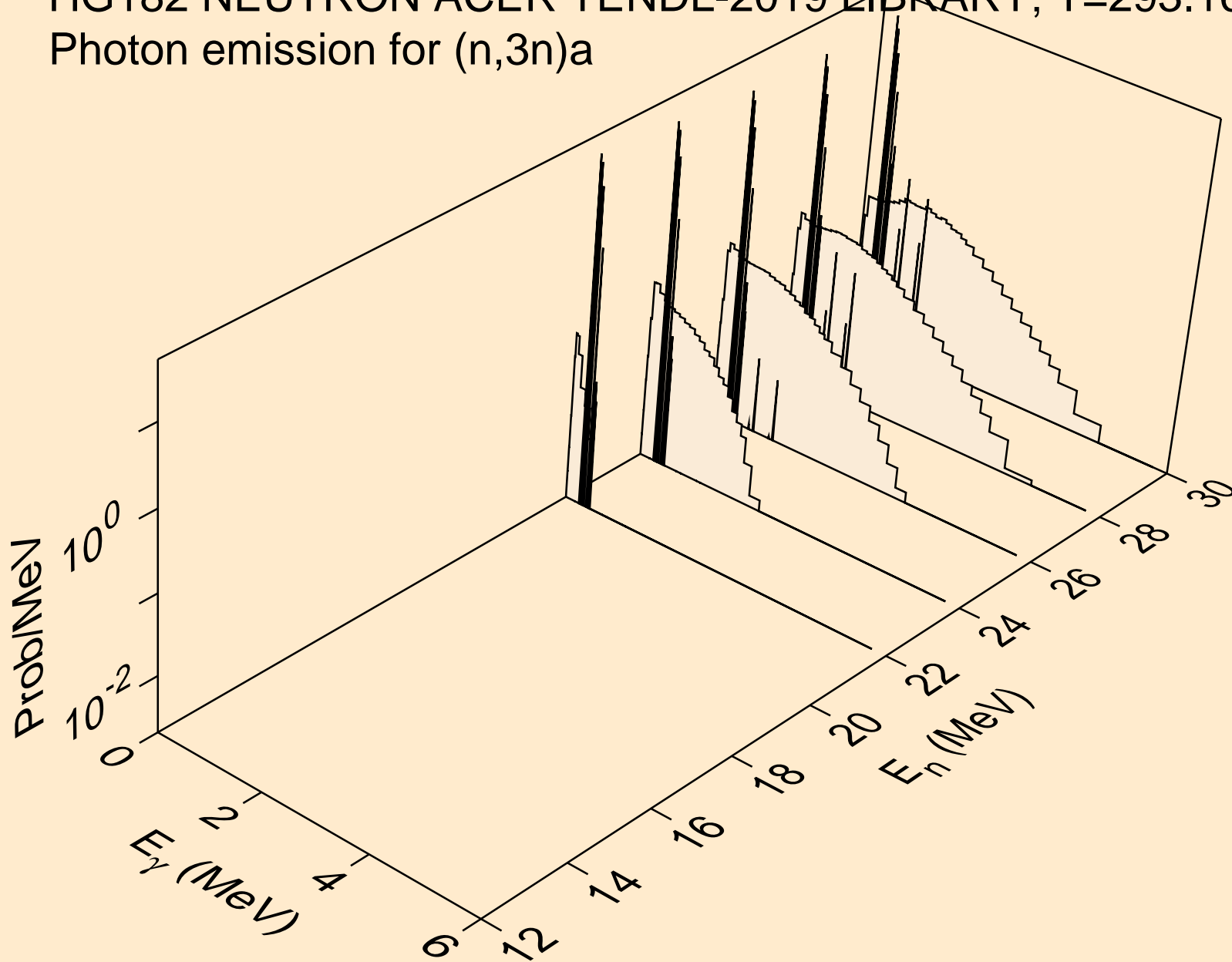

HG182 NEUTRON ACER TENDL-2019 LIBRARY; T=293.16K  
Photon emission for (n,n\*)p

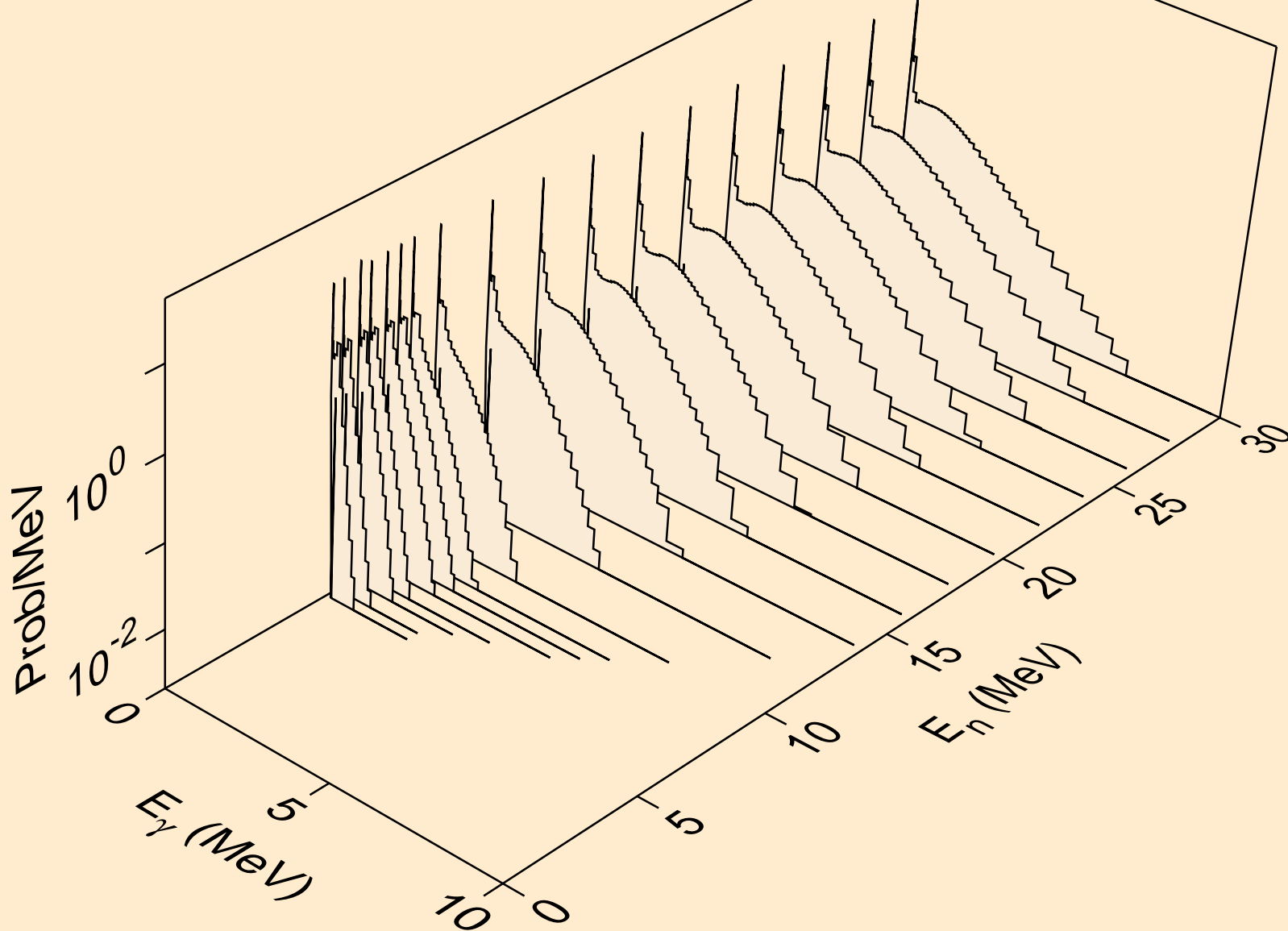

HG182 NEUTRON ACER TENDL-2019 LIBRARY; T=293.16K  
Photon emission for (n,n\*)2a

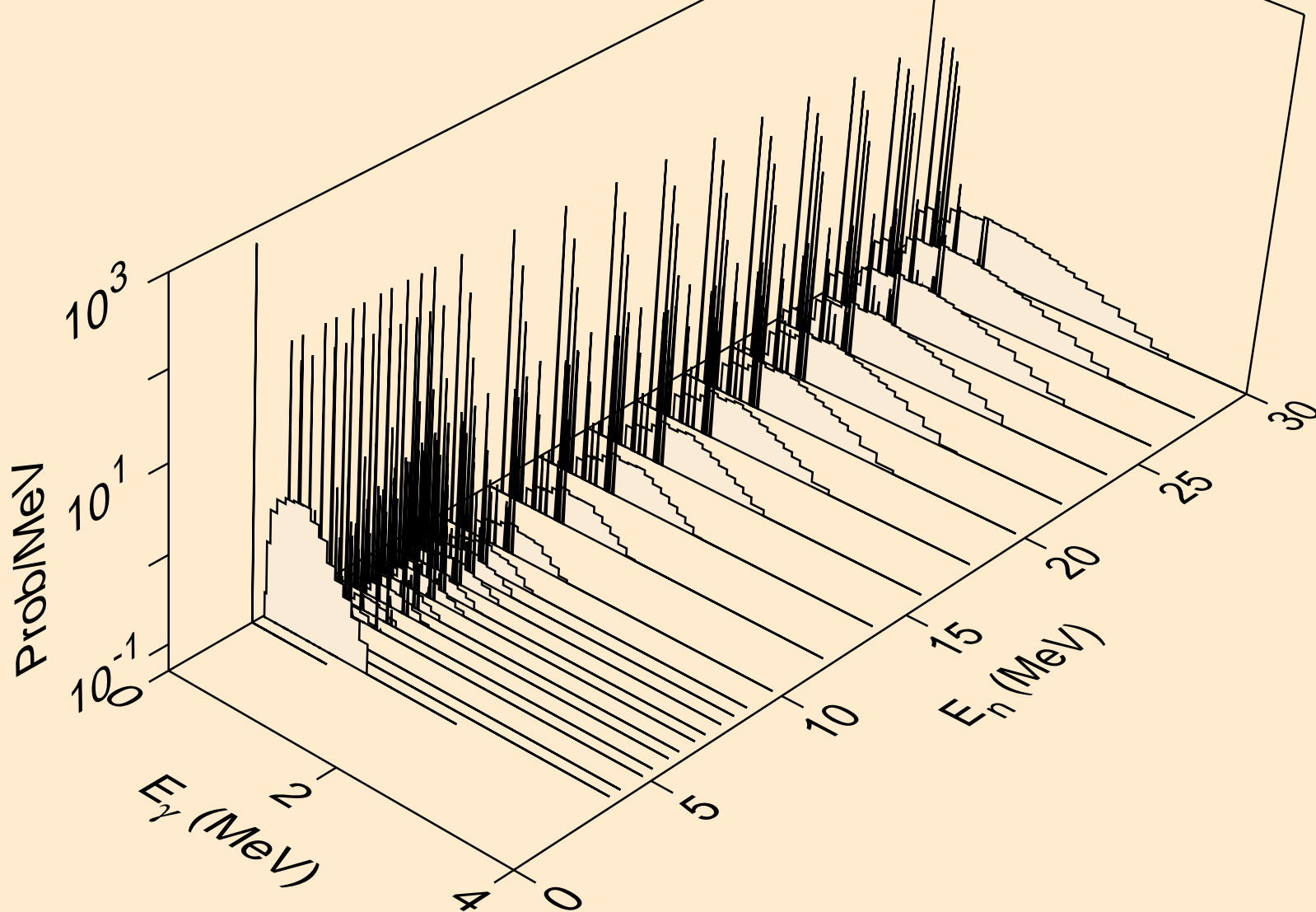

HG182 NEUTRON ACER TENDL-2019 LIBRARY; T=293.16K  
Photon emission for (n,2n)2a

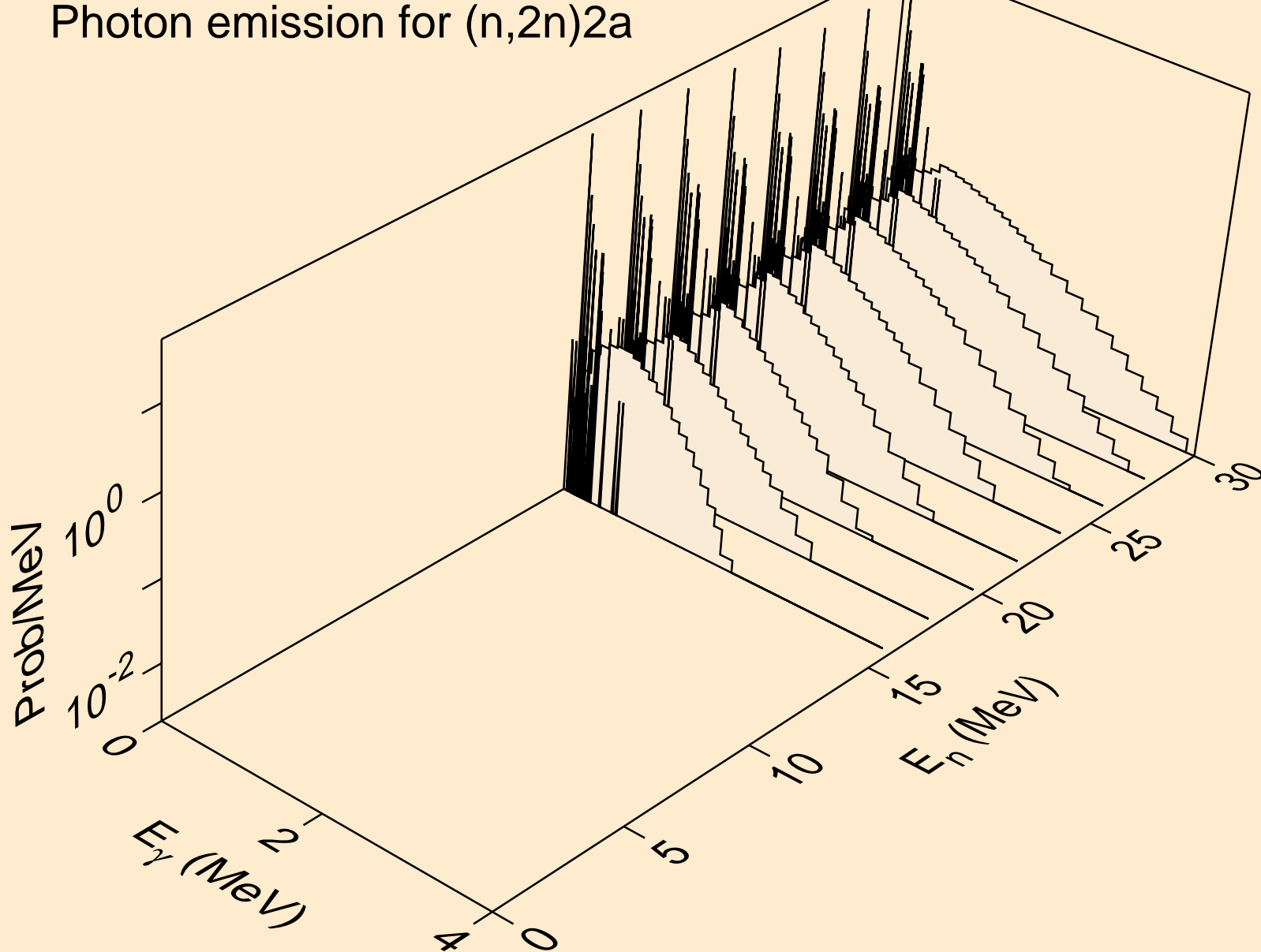

HG182 NEUTRON ACER TENDL-2019 LIBRARY; T=293.16K  
Photon emission for (n,n\*)d

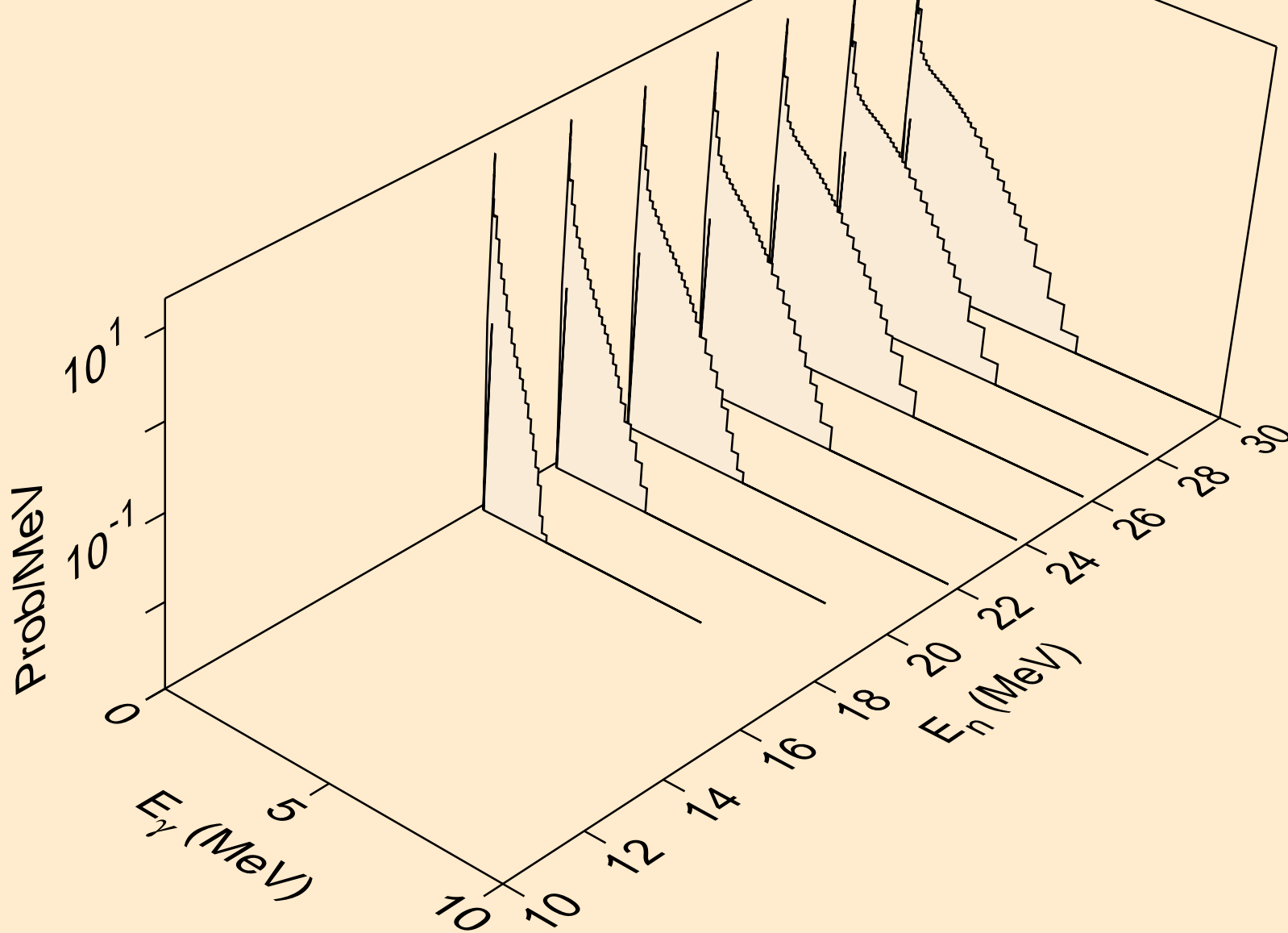

HG182 NEUTRON ACER TENDL-2019 LIBRARY; T=293.16K  
Photon emission for (n,n\*)t

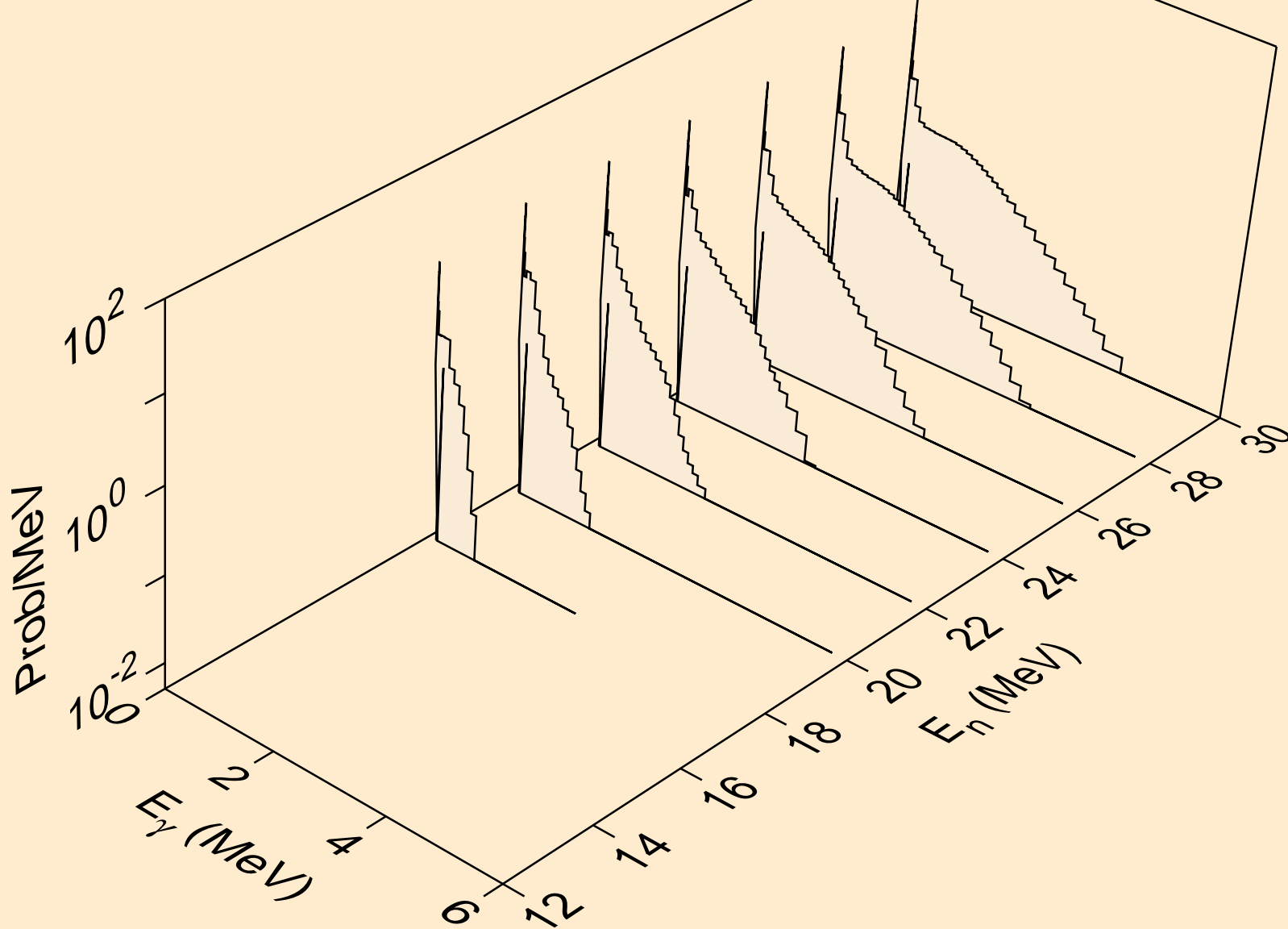

HG182 NEUTRON ACER TENDL-2019 LIBRARY; T=293.16K  
Photon emission for (n,n\*)he3

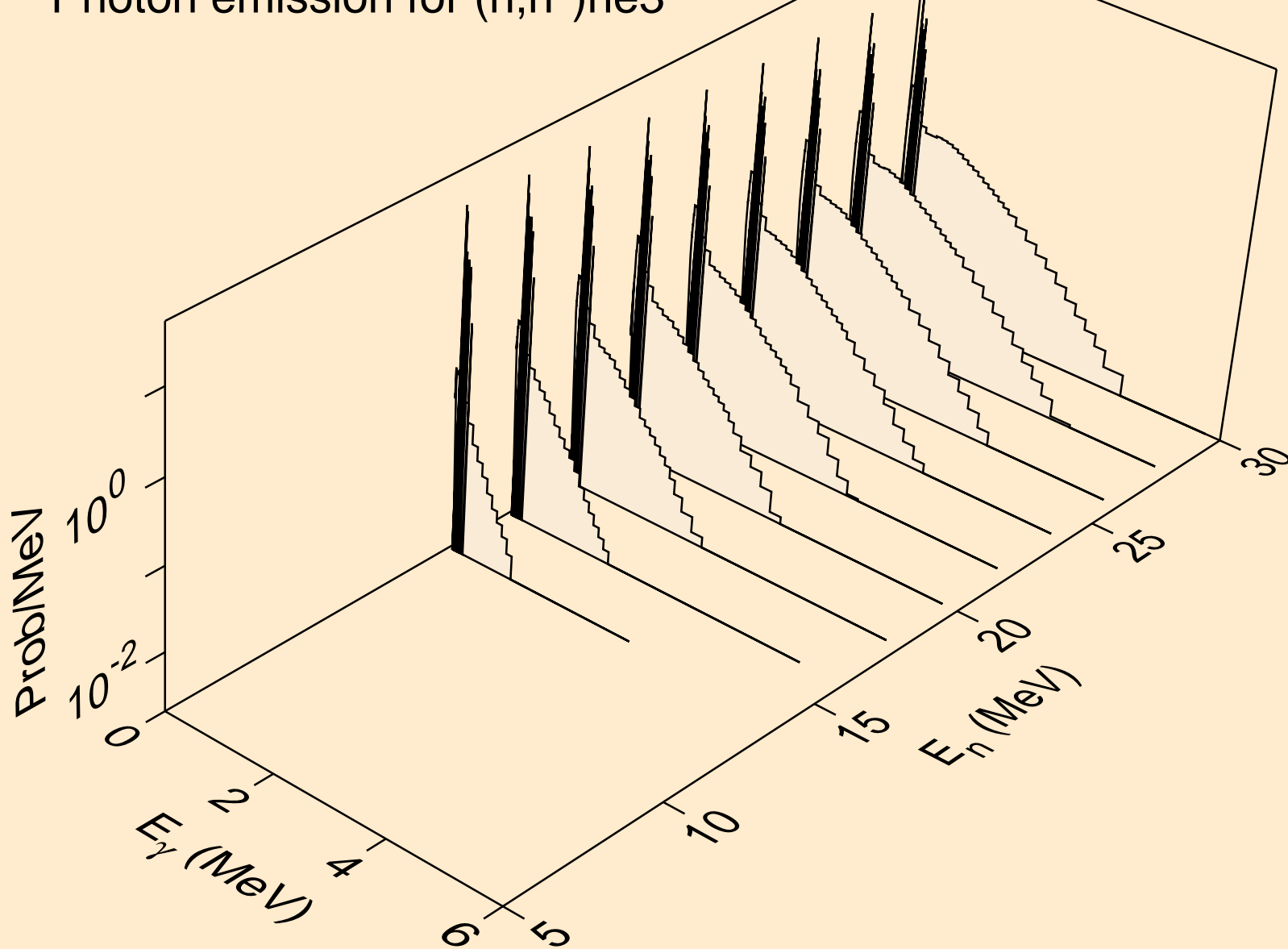

HG182 NEUTRON ACER TENDL-2019 LIBRARY; T=293.16K  
Photon emission for (n,2np)

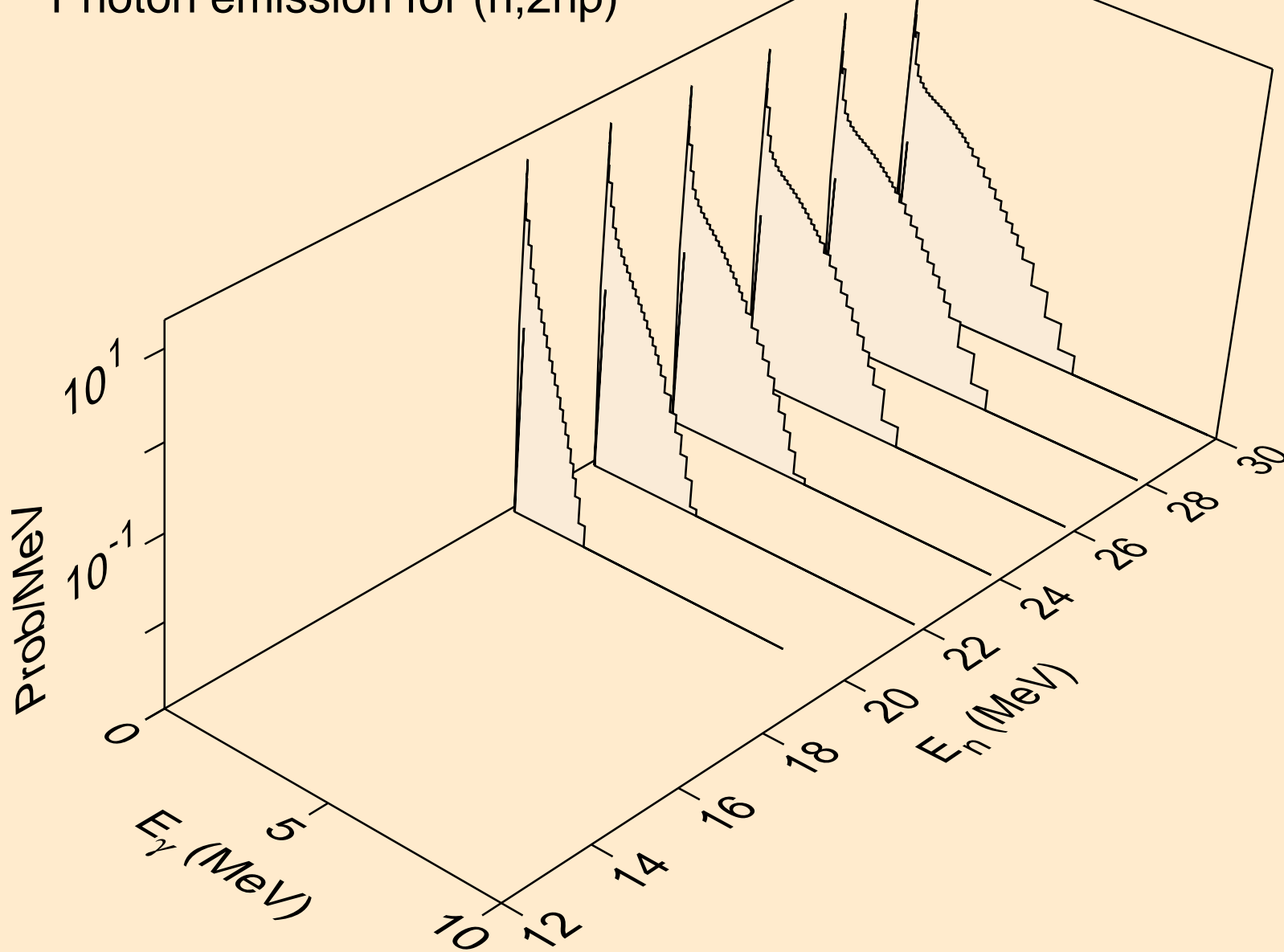

HG182 NEUTRON ACER TENDL-2019 LIBRARY; T=293.16K  
Photon emission for (n,3np)

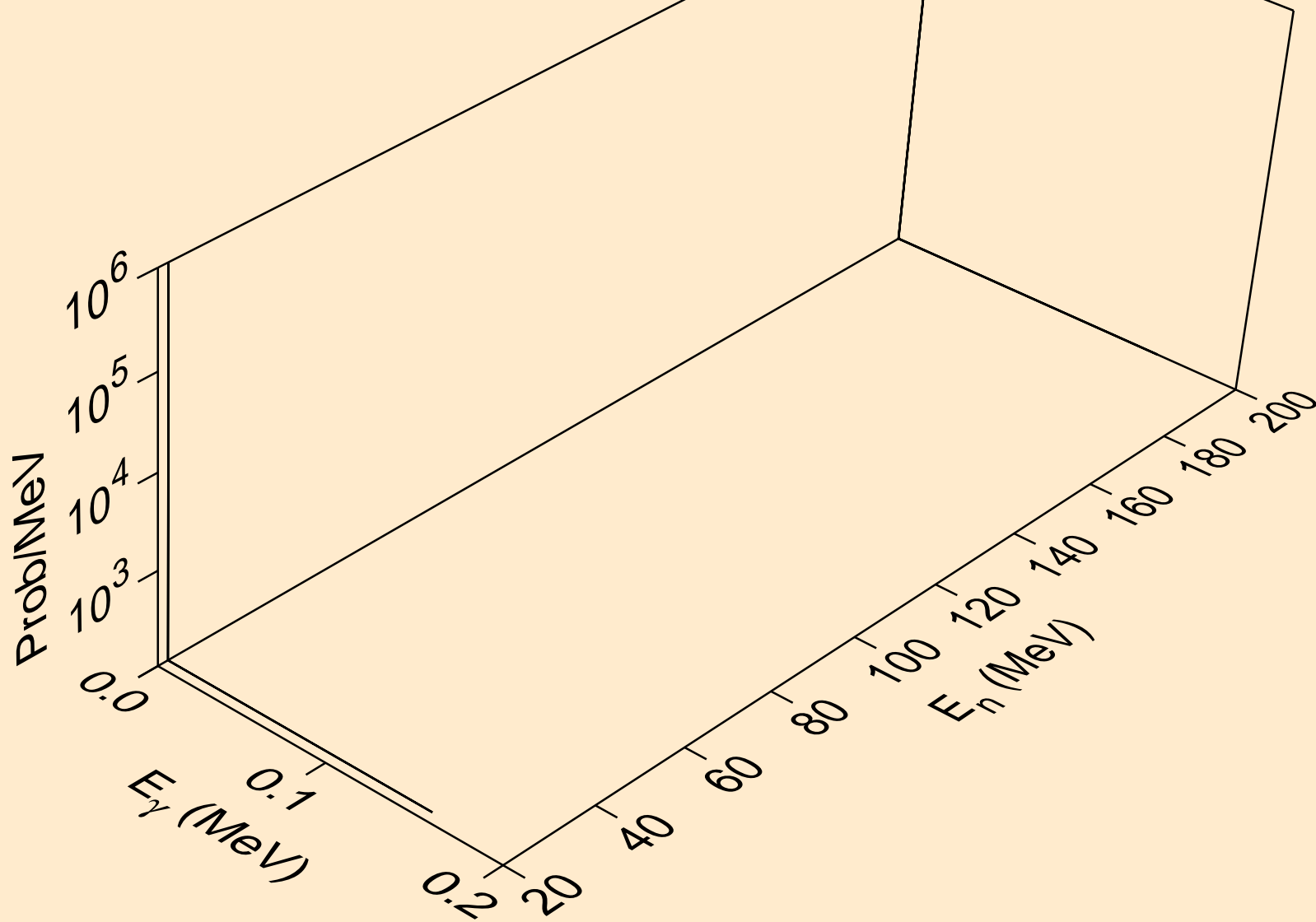

HG182 NEUTRON ACER TENDL-2019 LIBRARY; T=293.16K  
Photon emission for (n,2np)

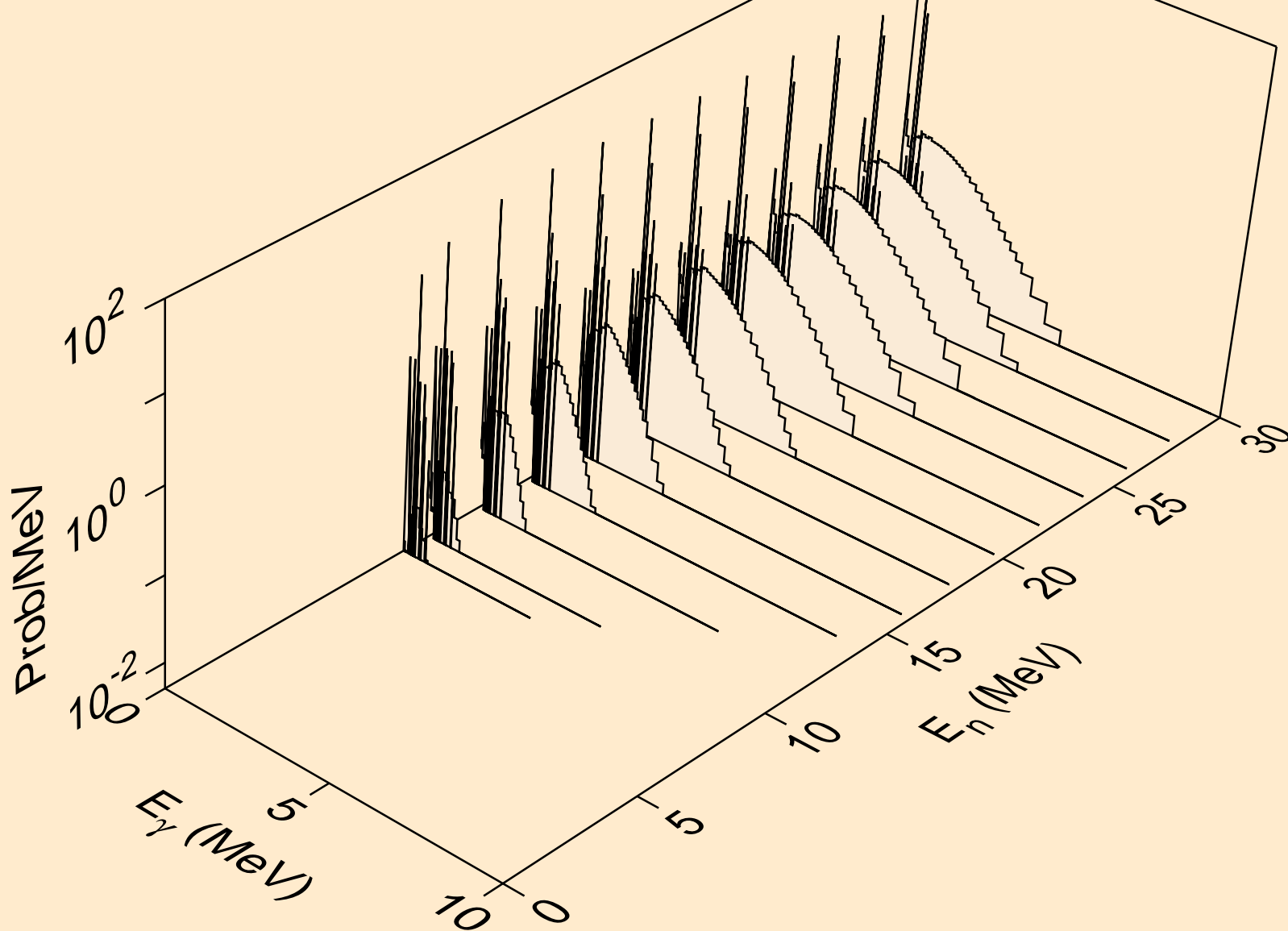

HG182 NEUTRON ACER TENDL-2019 LIBRARY; T=293.16K  
Photon emission for (n,npa)

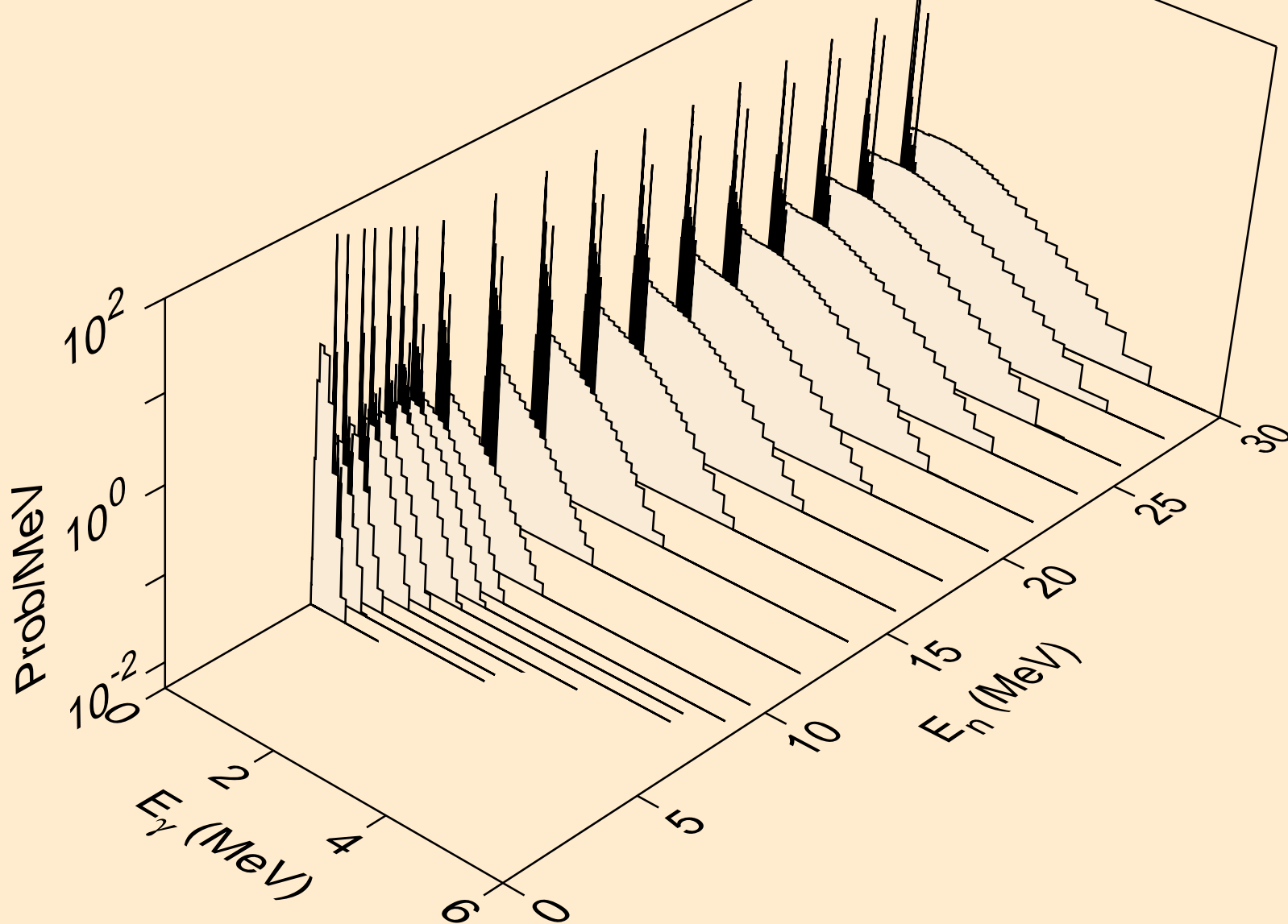

HG182 NEUTRON ACER TENDL-2019 LIBRARY; T=293.16K  
Photon emission for (n,n\*c)

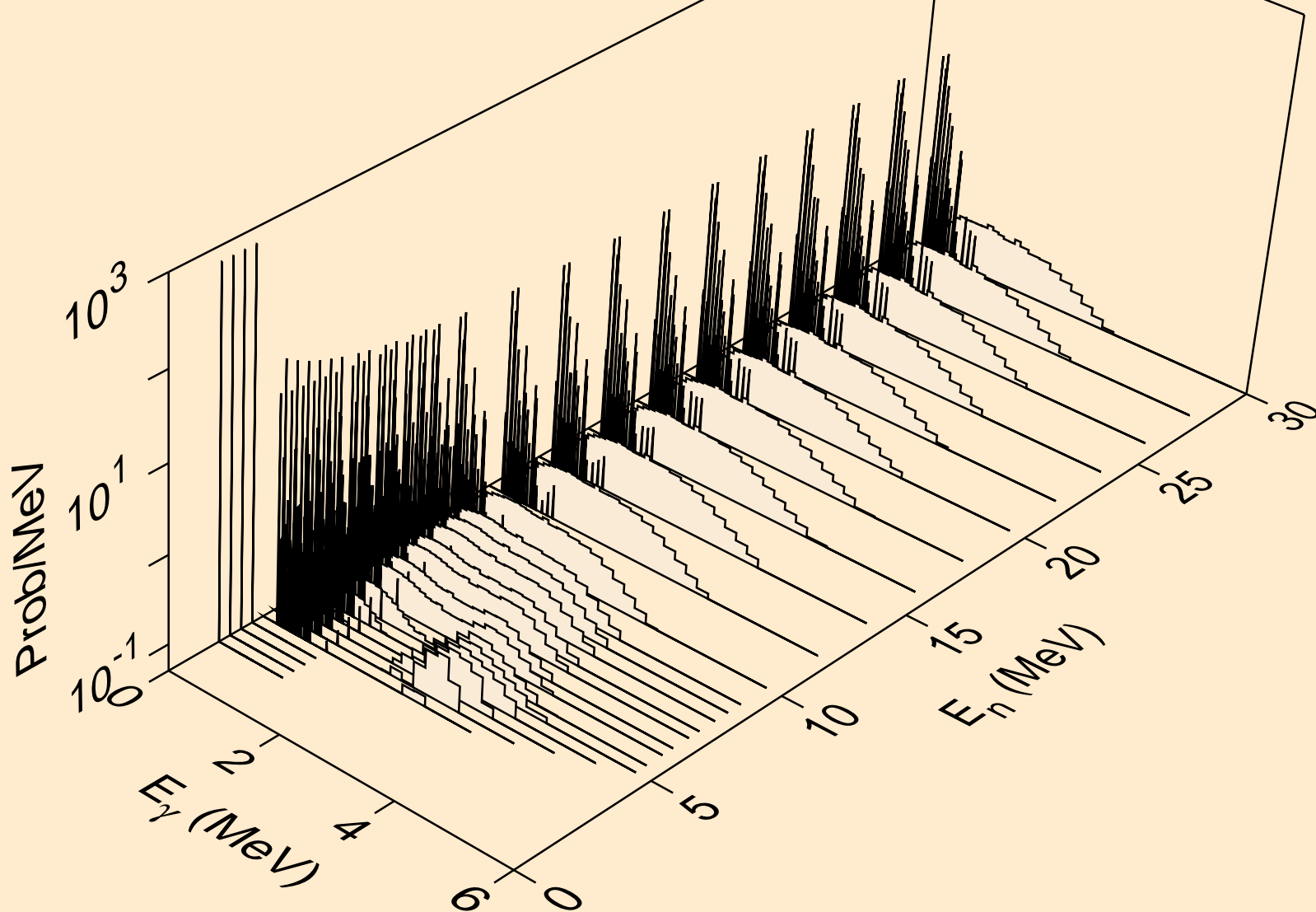

HG182 NEUTRON ACER TENDL-2019 LIBRARY; T=293.16K  
Photon emission for (n,gma)

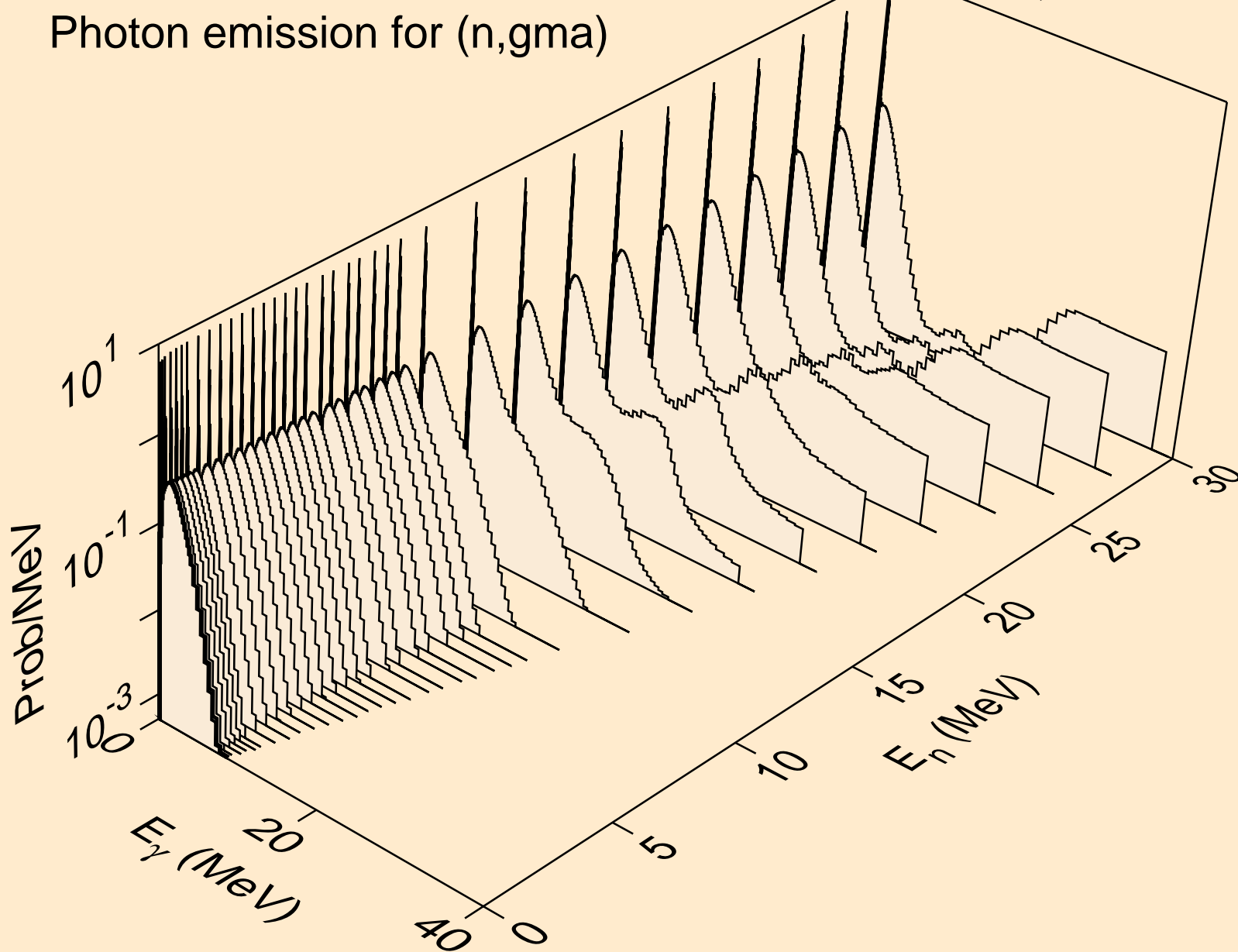

HG182 NEUTRON ACER TENDL-2019 LIBRARY; T=293.16K  
Photon emission for (n,p)

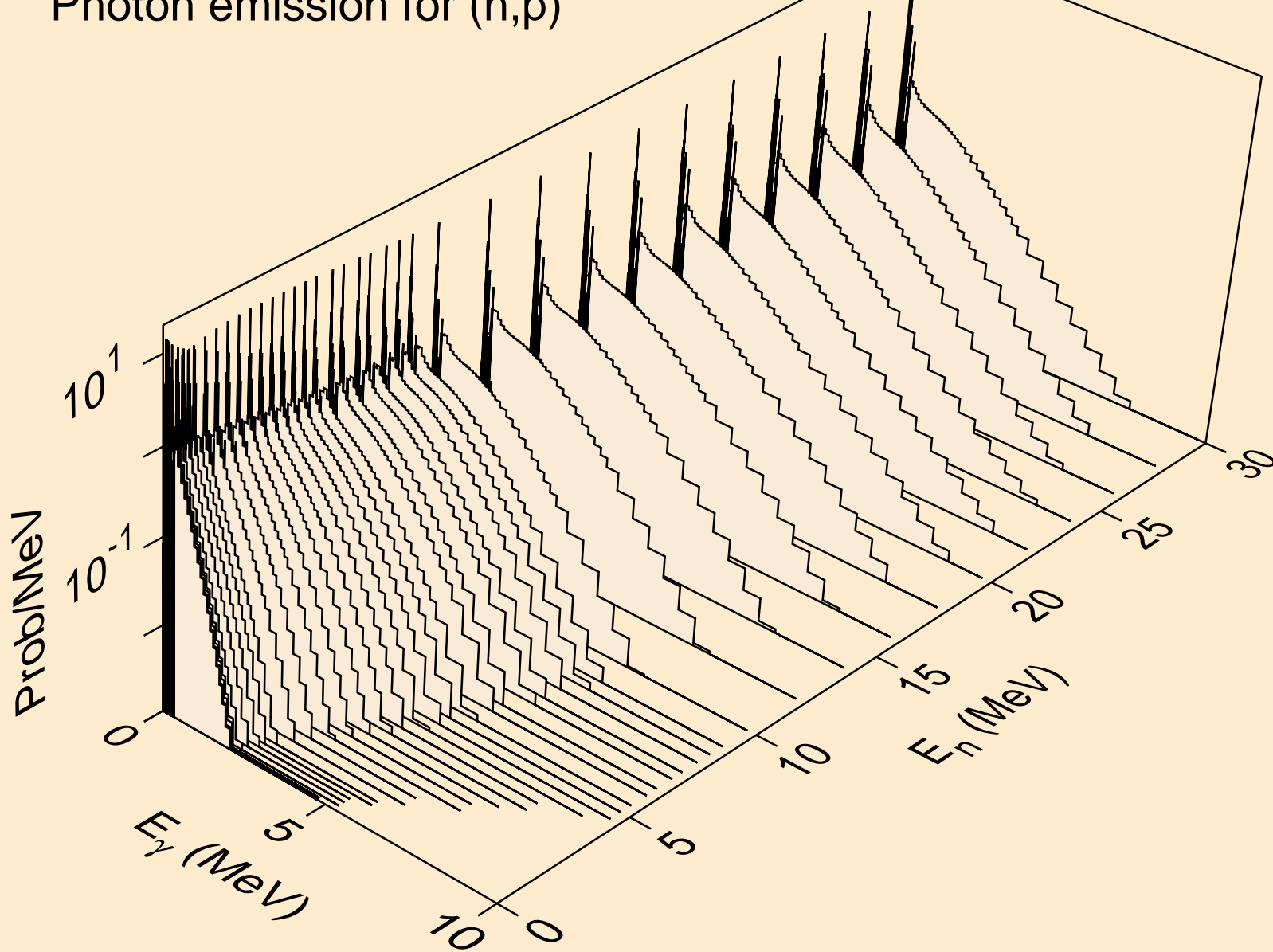

HG182 NEUTRON ACER TENDL-2019 LIBRARY; T=293.16K  
Photon emission for (n,d)

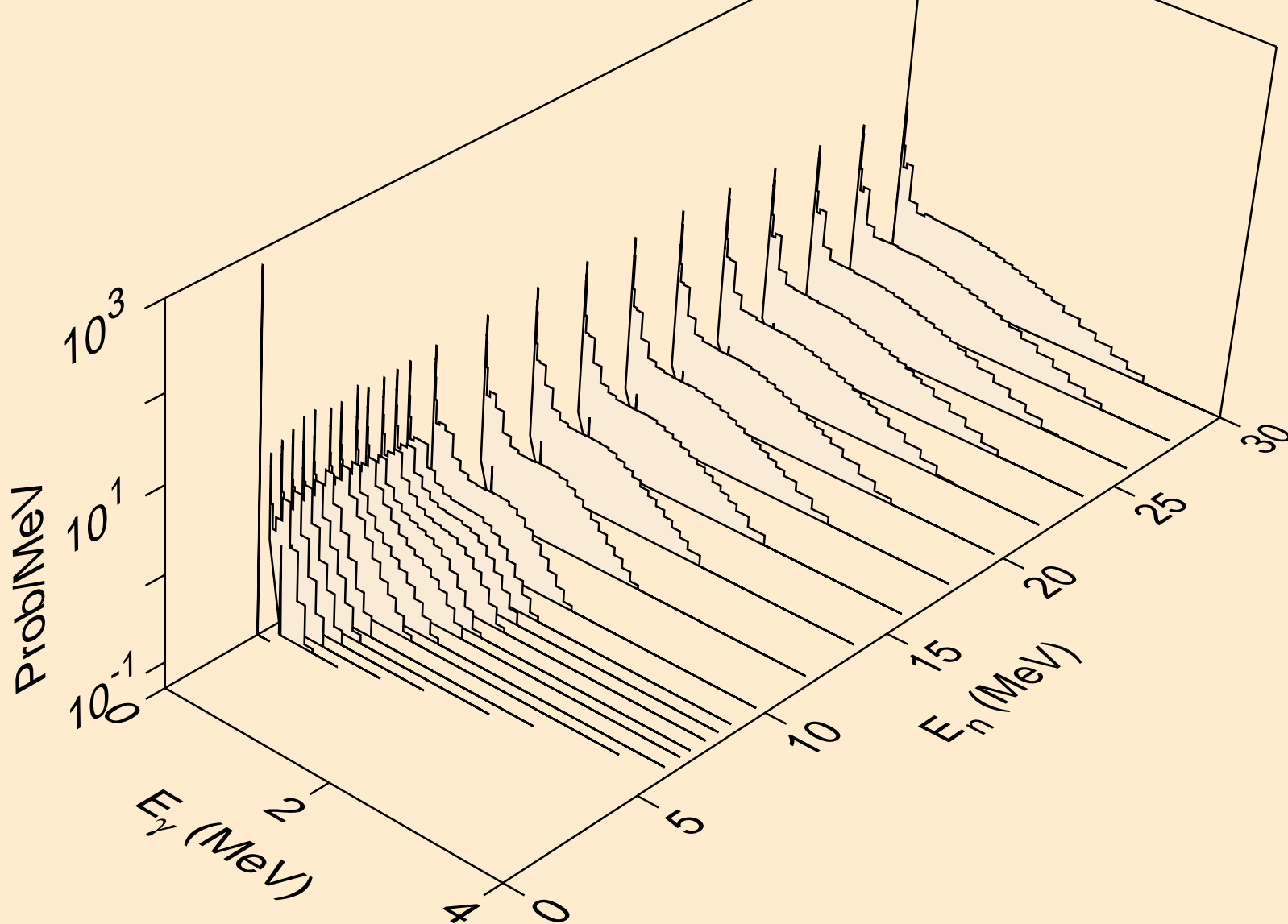

HG182 NEUTRON ACER TENDL-2019 LIBRARY; T=293.16K  
Photon emission for (n,t)

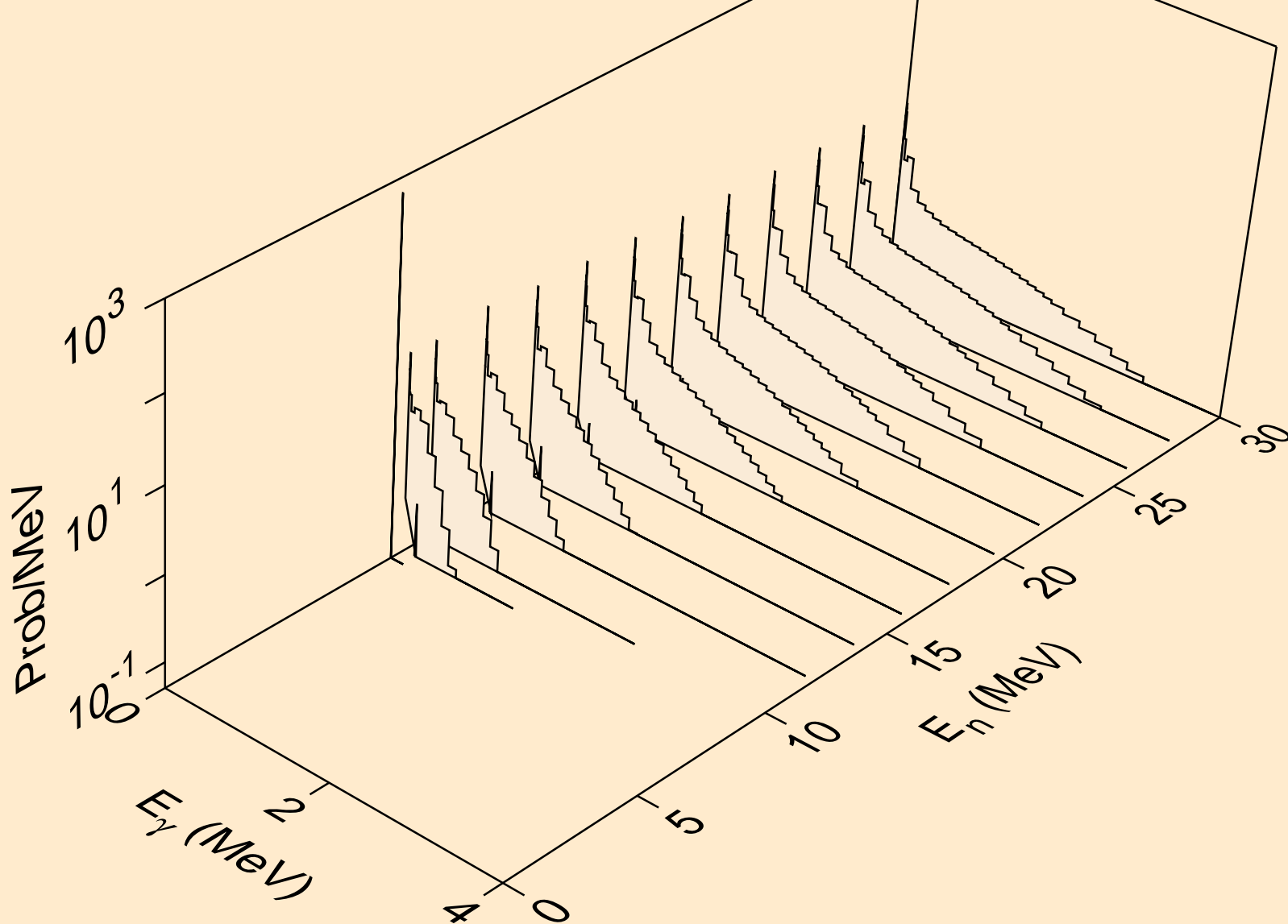

HG182 NEUTRON ACER TENDL-2019 LIBRARY; T=293.16K  
Photon emission for (n,he3)

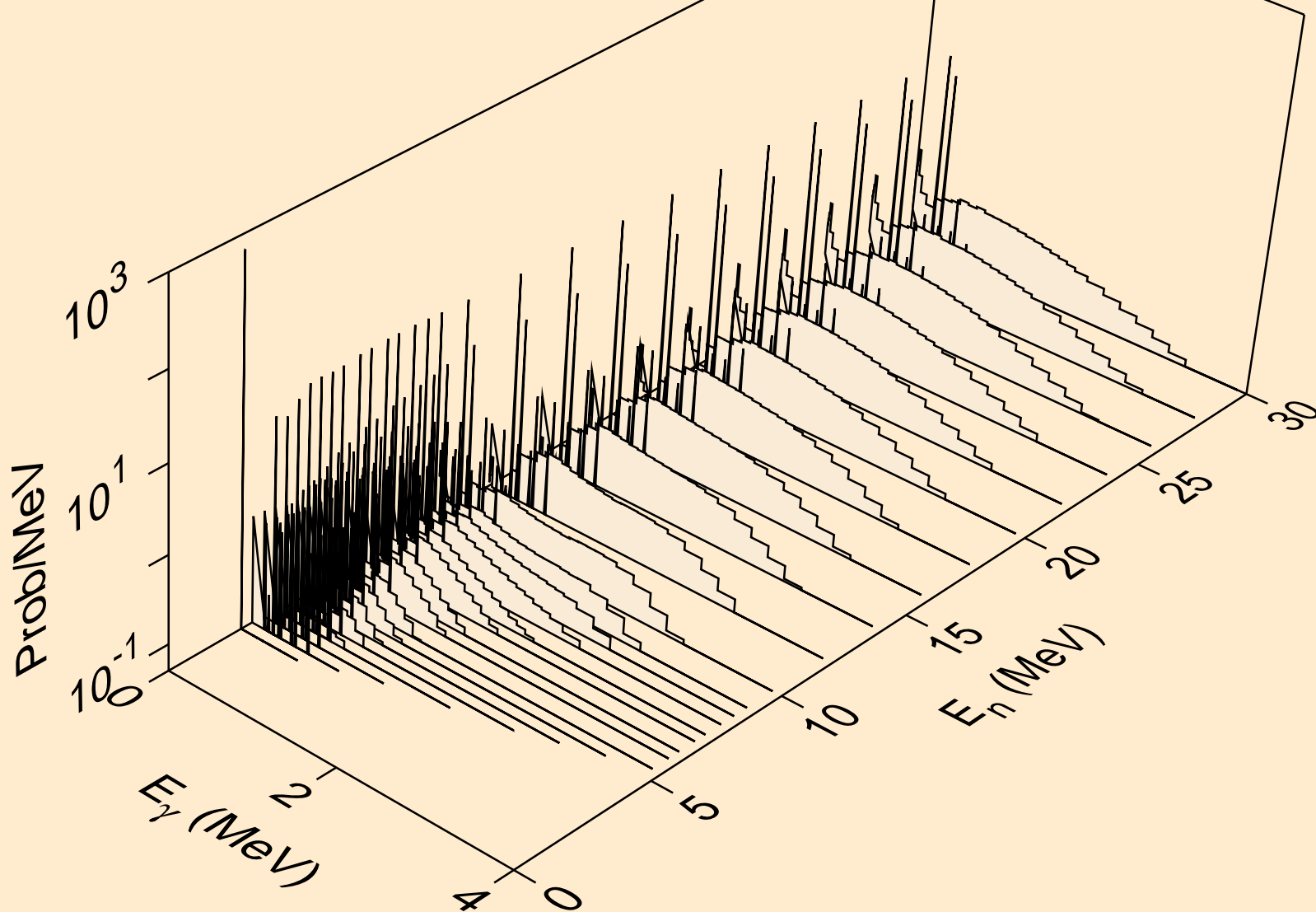

HG182 NEUTRON ACER TENDL-2019 LIBRARY; T=293.16K  
Photon emission for (n,a)

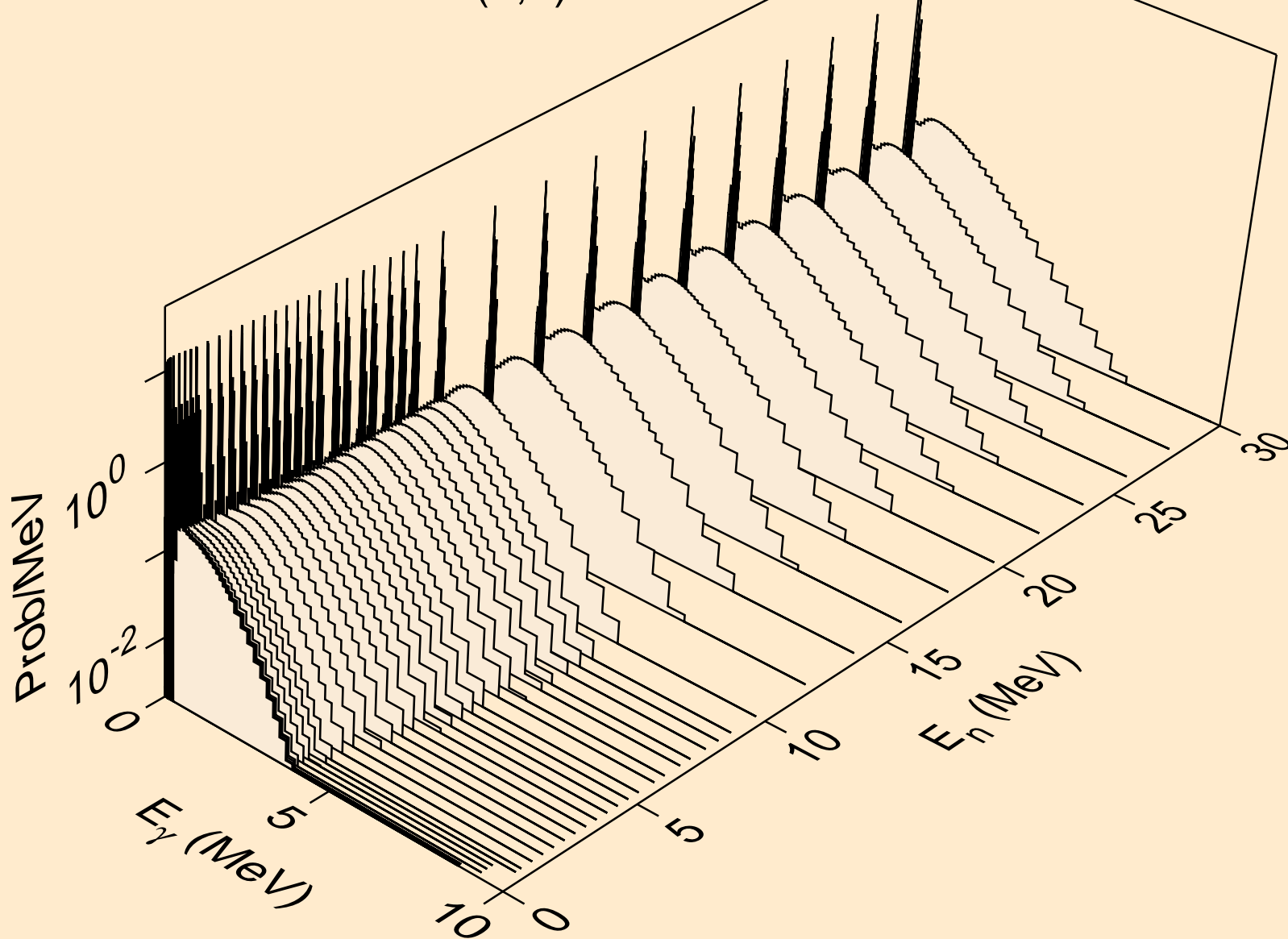

HG182 NEUTRON ACER TENDL-2019 LIBRARY; T=293.16K  
Photon emission for (n,2a)

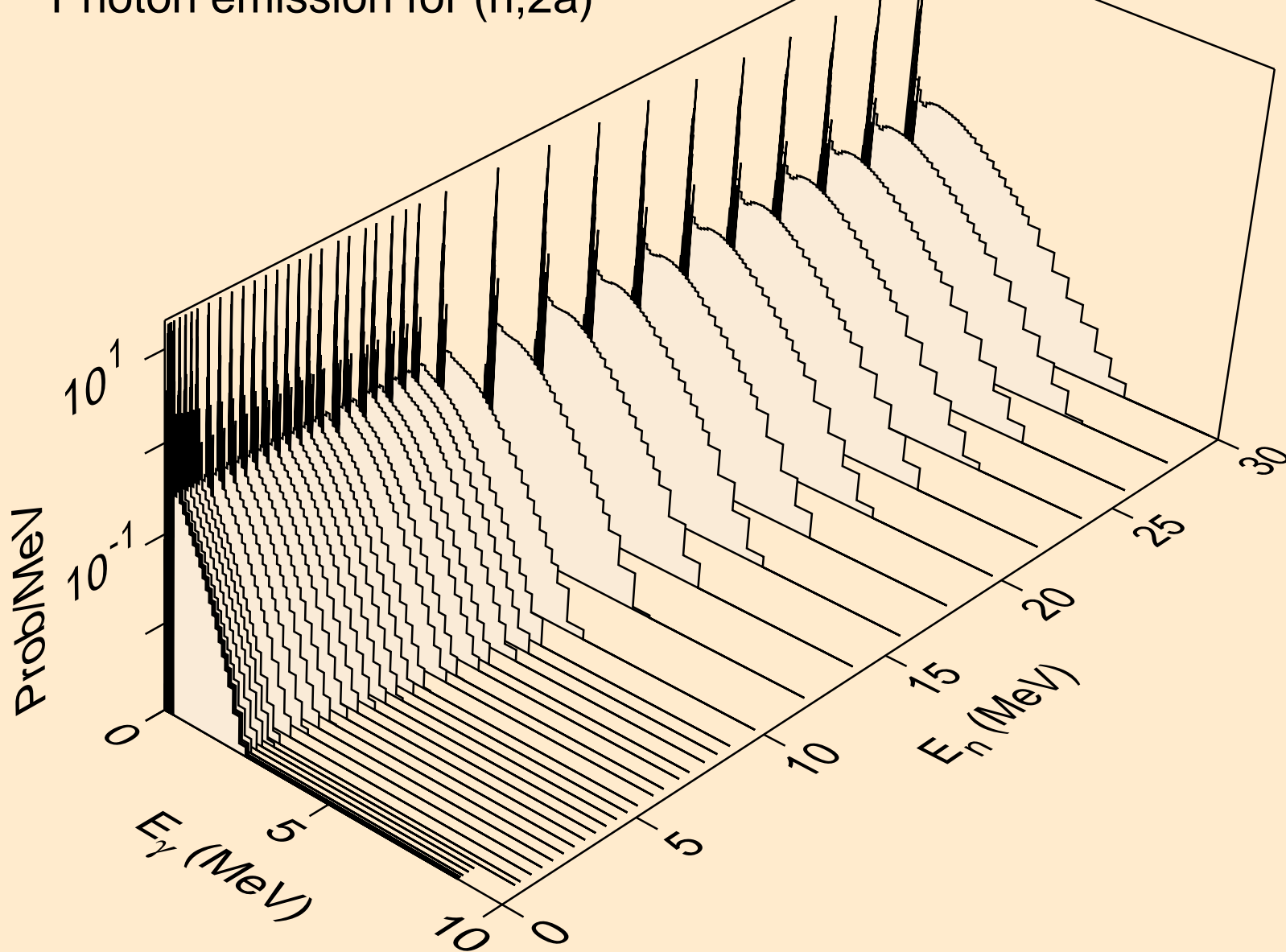

HG182 NEUTRON ACER TENDL-2019 LIBRARY; T=293.16K  
Photon emission for (n,3a)

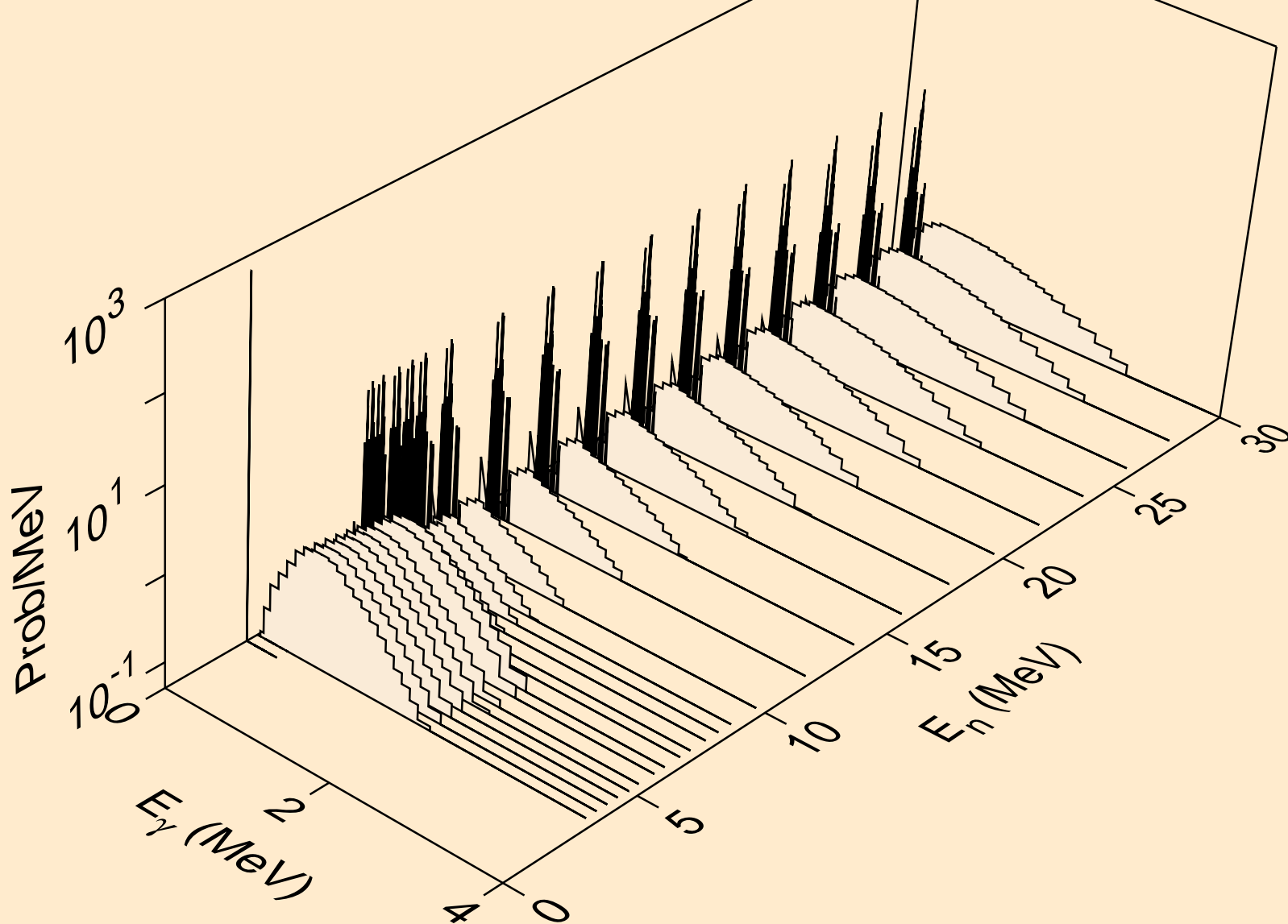

HG182 NEUTRON ACER TENDL-2019 LIBRARY; T=293.16K  
Photon emission for (n,2p)

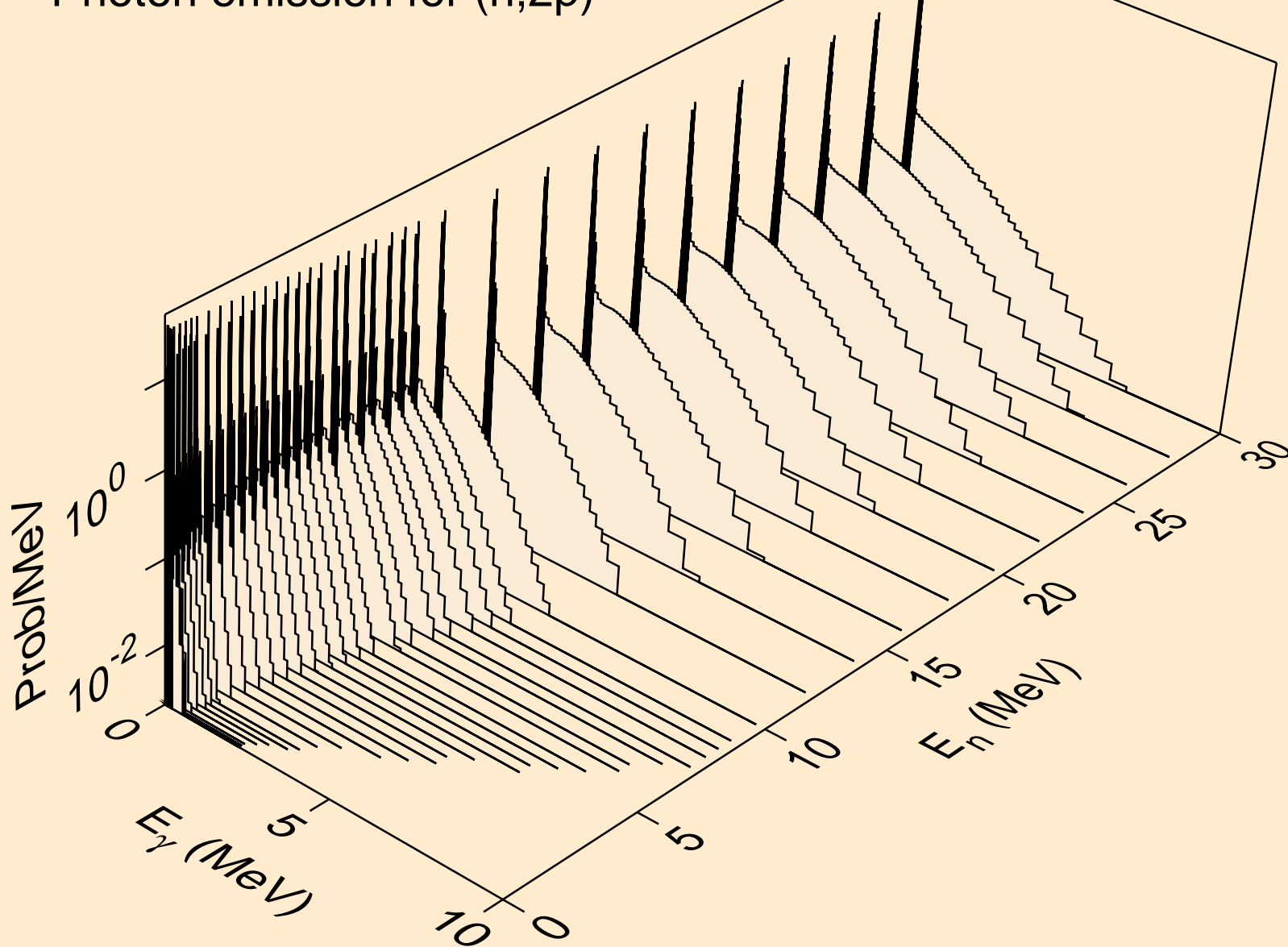

HG182 NEUTRON ACER TENDL-2019 LIBRARY; T=293.16K  
Photon emission for (n,p $\alpha$ )

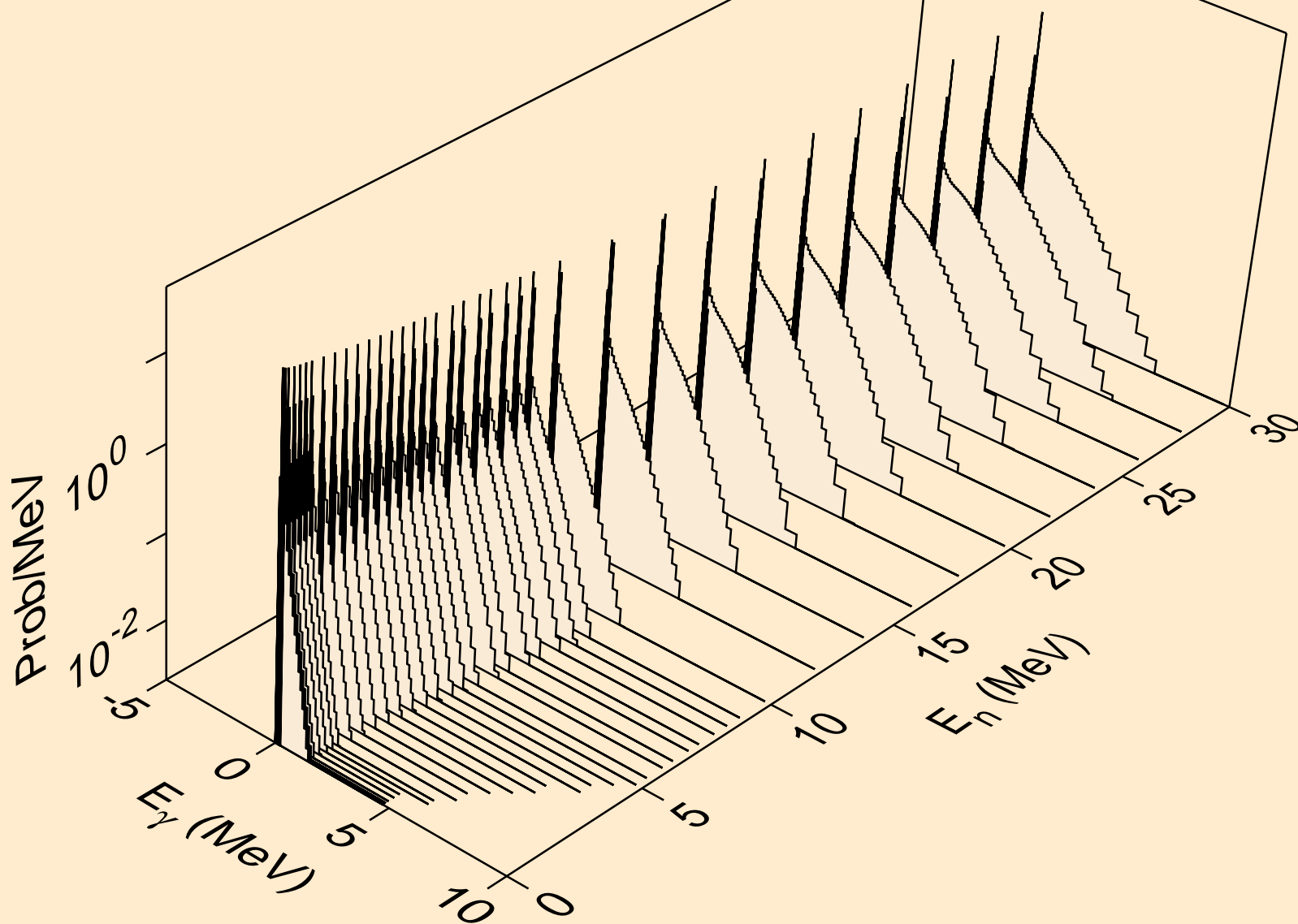

HG182 NEUTRON ACER TENDL-2019 LIBRARY; T=293.16K  
Photon emission for (n,d2a)

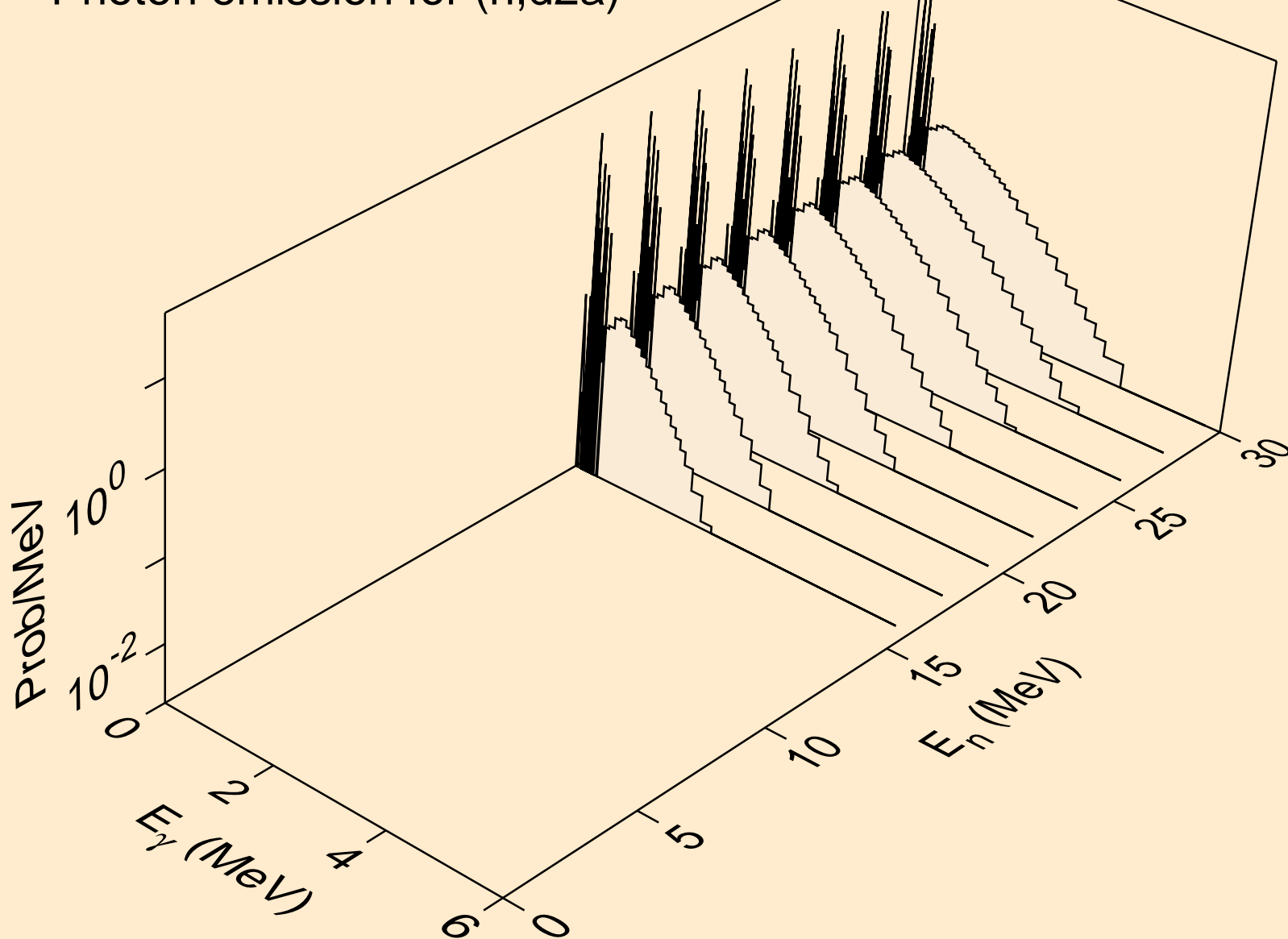

HG182 NEUTRON ACER TENDL-2019 LIBRARY; T=293.16K  
Photon emission for (n,pd)

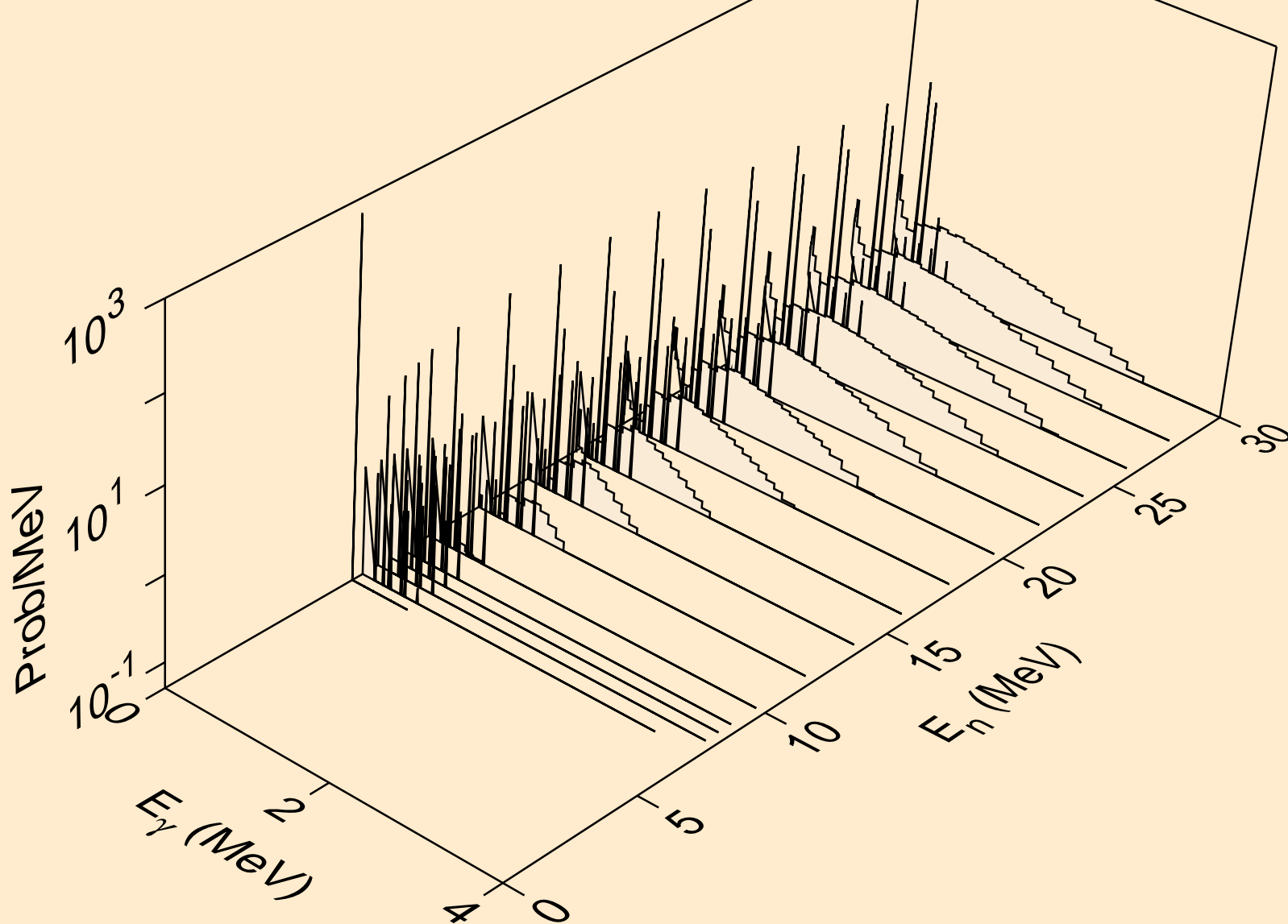

HG182 NEUTRON ACER TENDL-2019 LIBRARY; T=293.16K  
Photon emission for (n,pt)

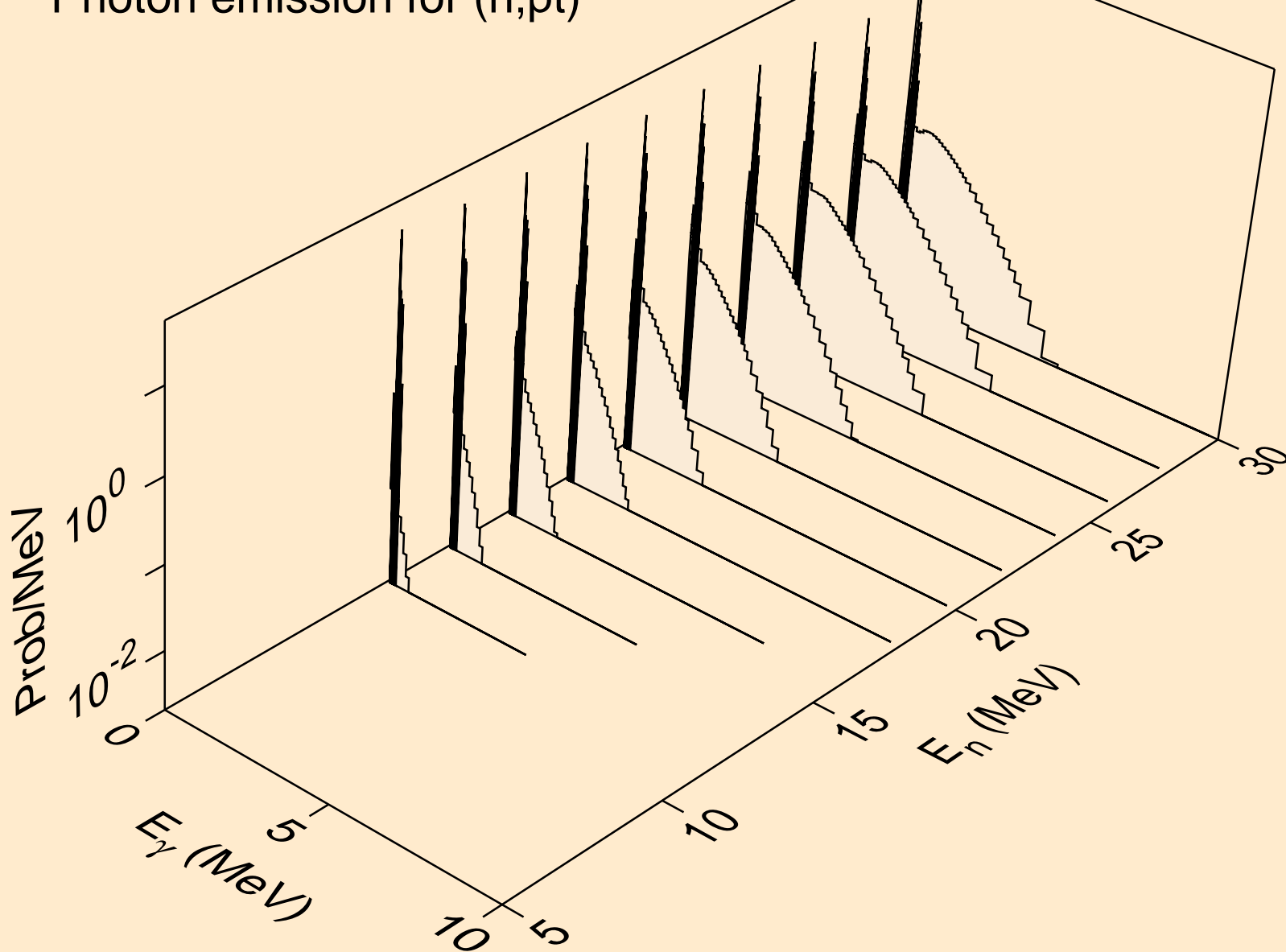

HG182 NEUTRON ACER TENDL-2019 LIBRARY; T=293.16K  
Photon emission for (n,da)

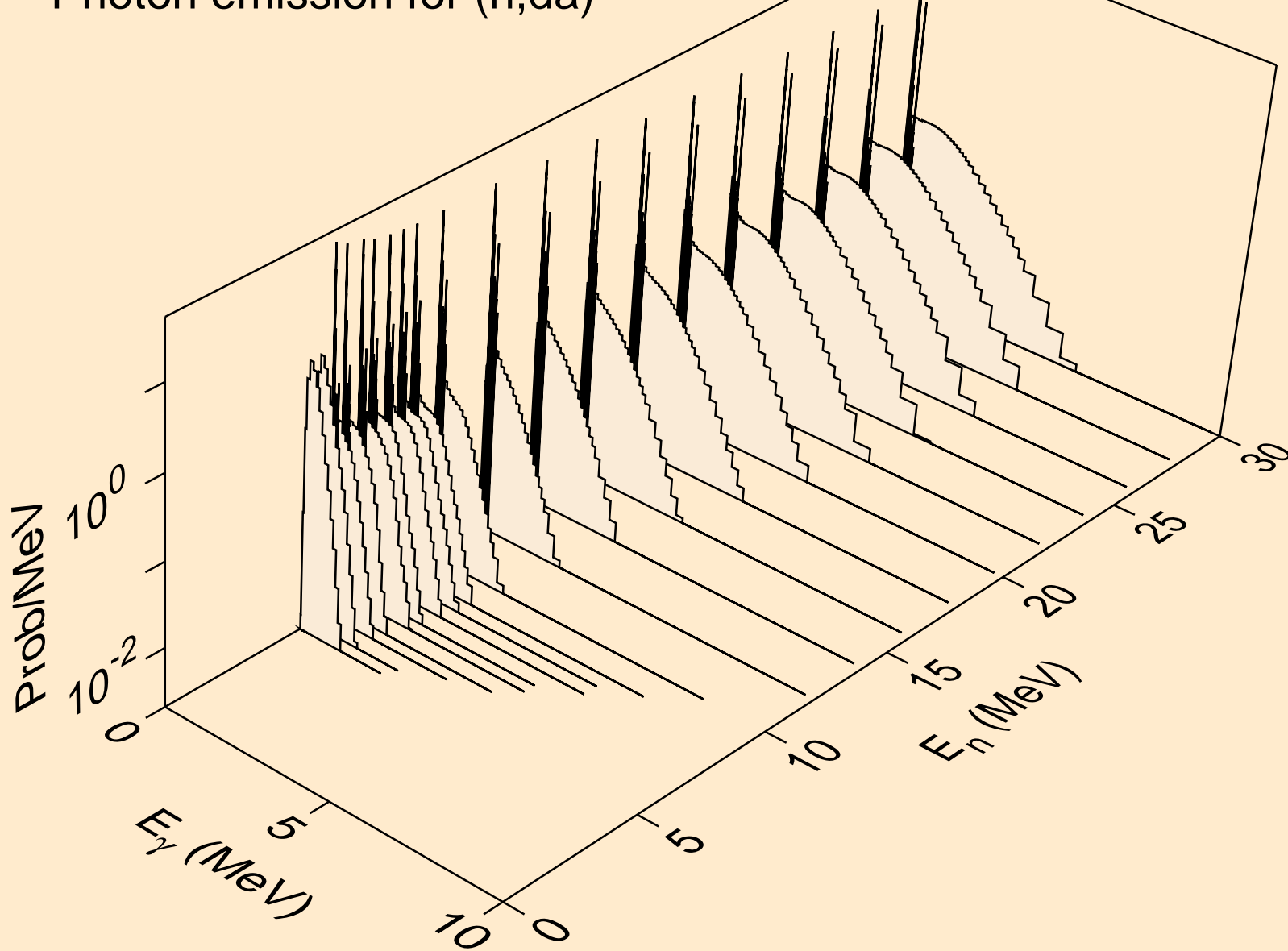

HG182 NEUTRON ACER TENDL-2019 LIBRARY; T=293.16K  
thermal capture photon spectrum

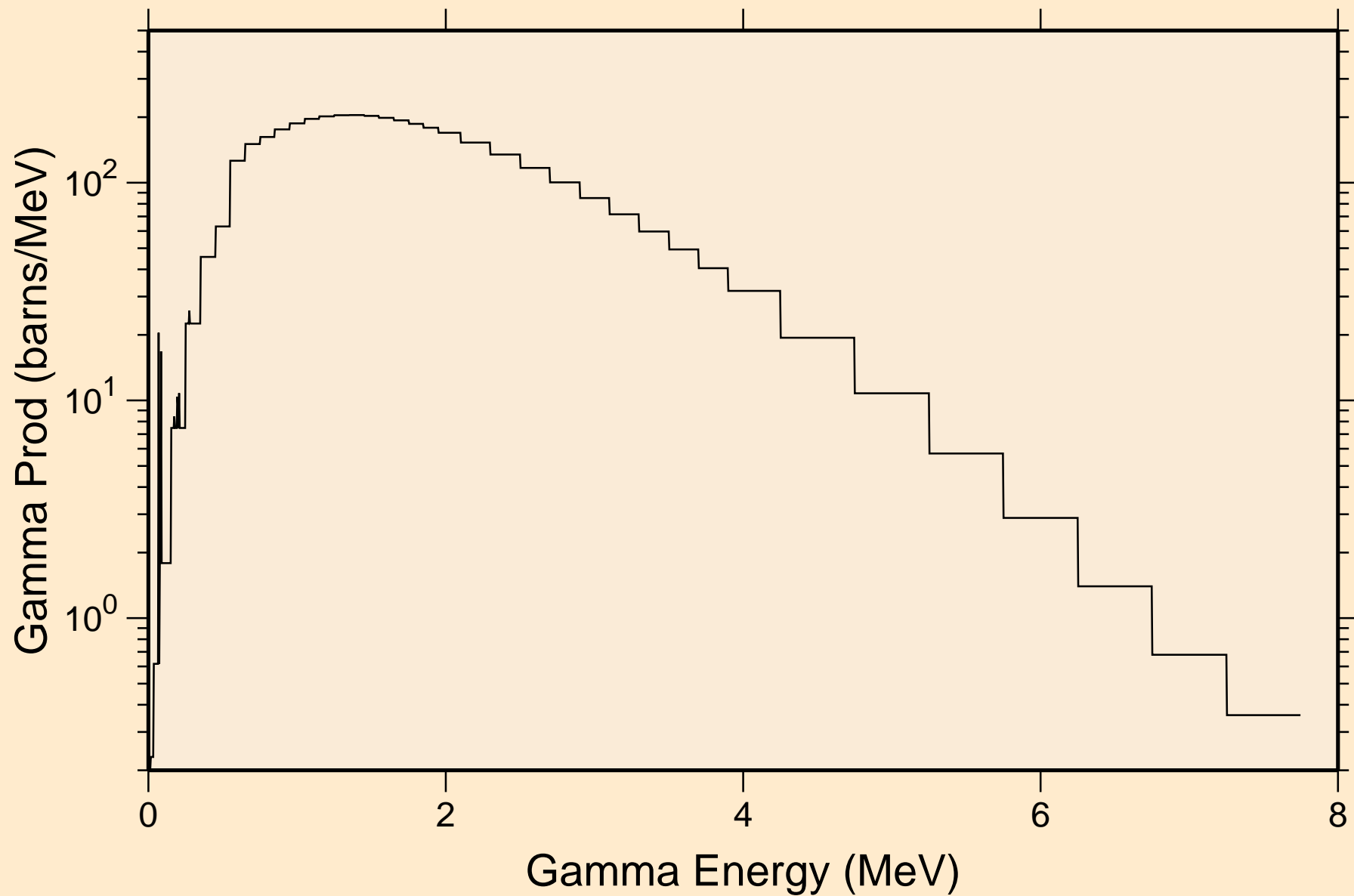

HG182 NEUTRON ACER TENDL-2019 LIBRARY; T=293.16K  
14 MeV photon spectrum

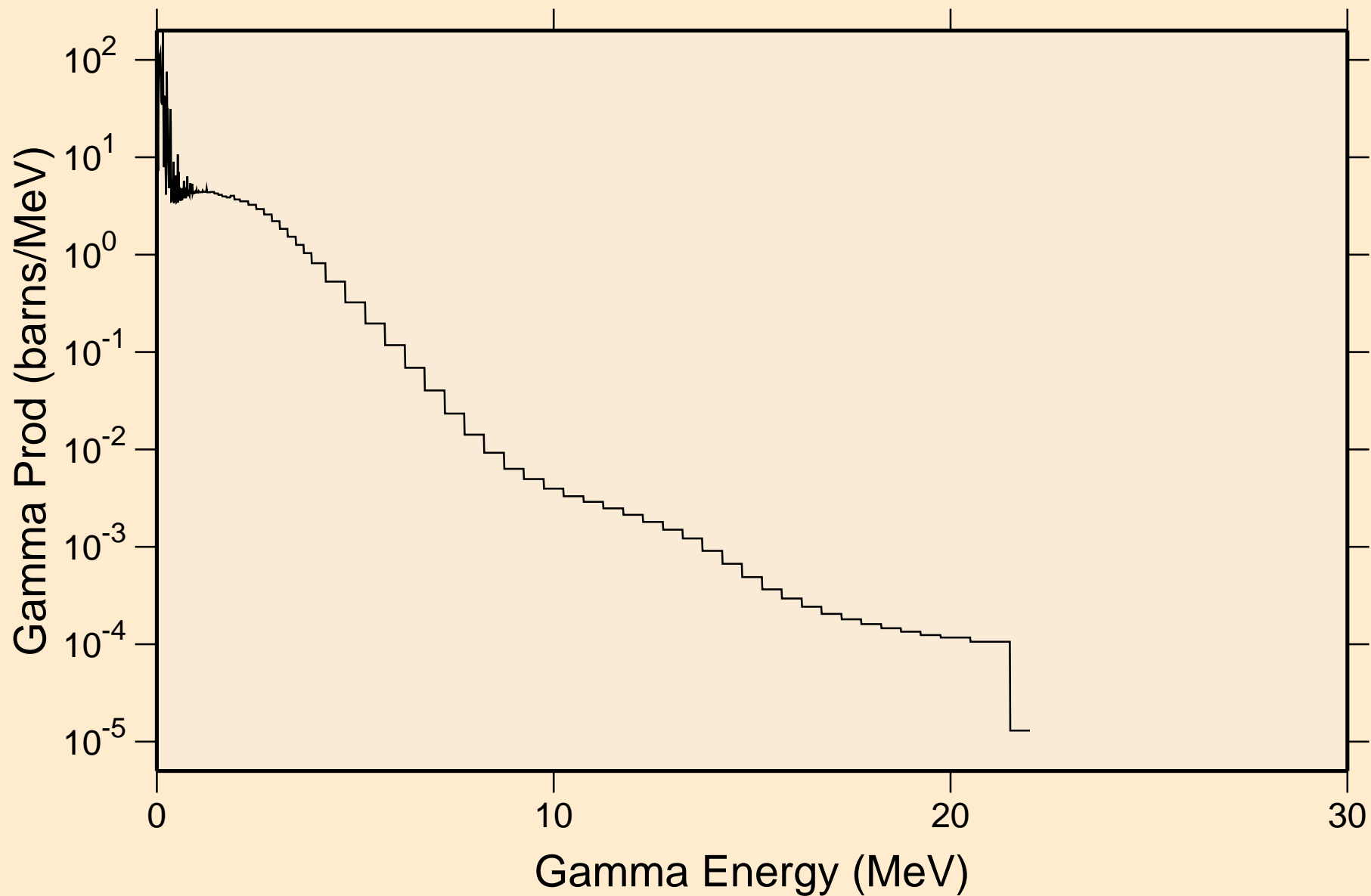

# HG182 NEUTRON ACER TENDL-2019 LIBRARY; T=293.16K

## Particle heating contributions

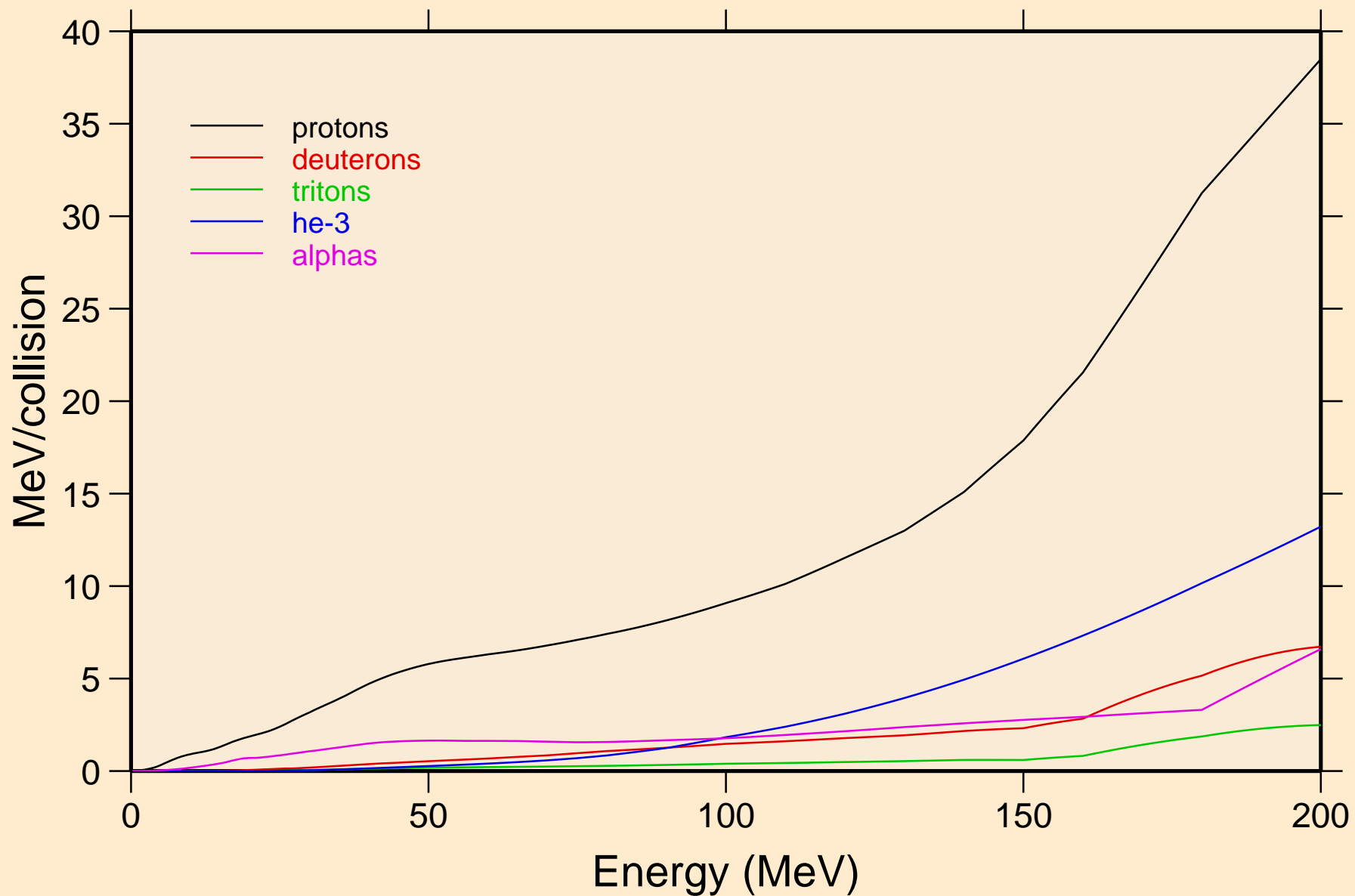

HG182 NEUTRON ACER TENDL-2019 LIBRARY; T=293.16K  
Recoil Heating

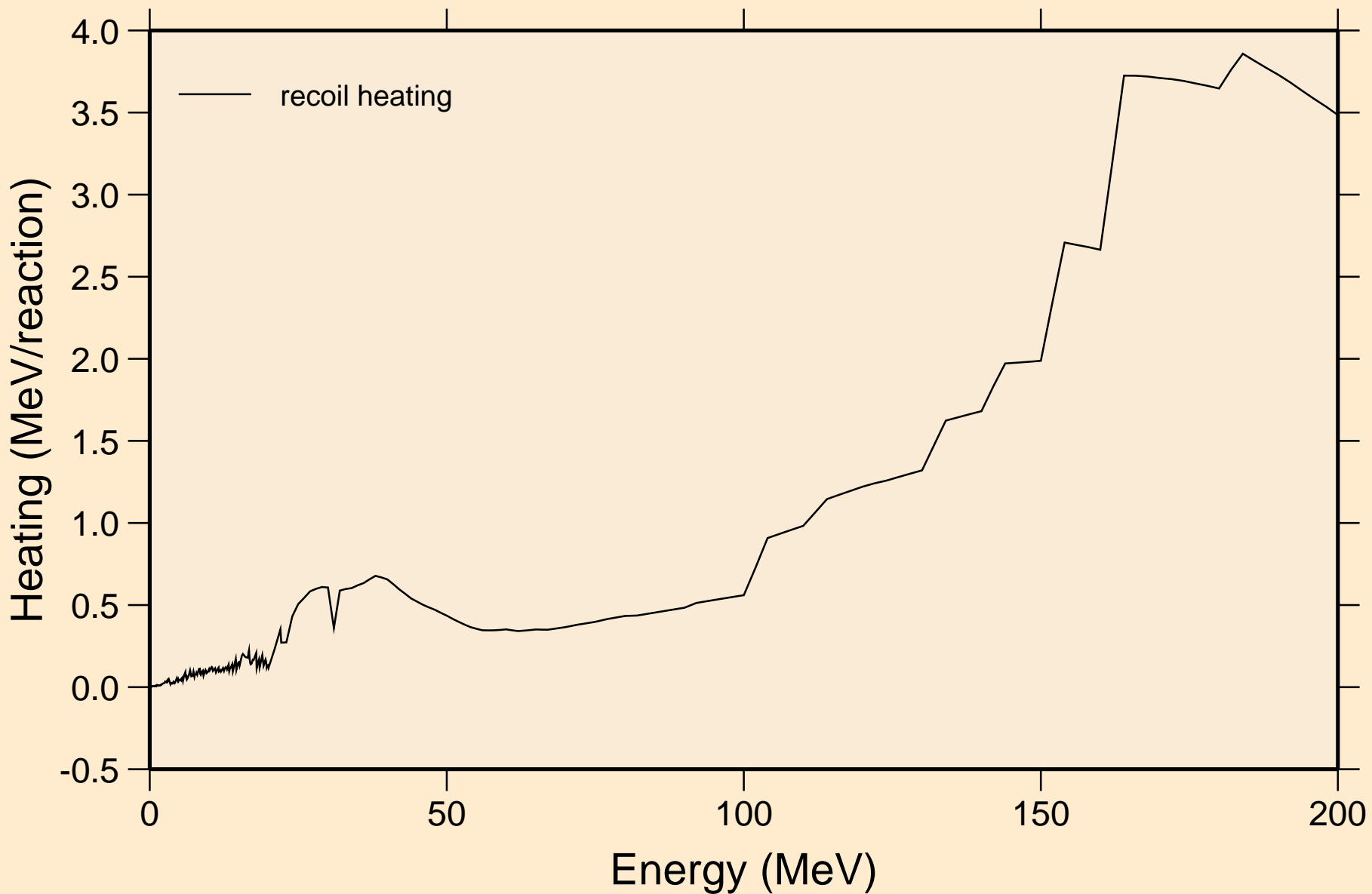

HG182 NEUTRON ACER TENDL-2019 LIBRARY; T=293.16K  
Particle production cross sections

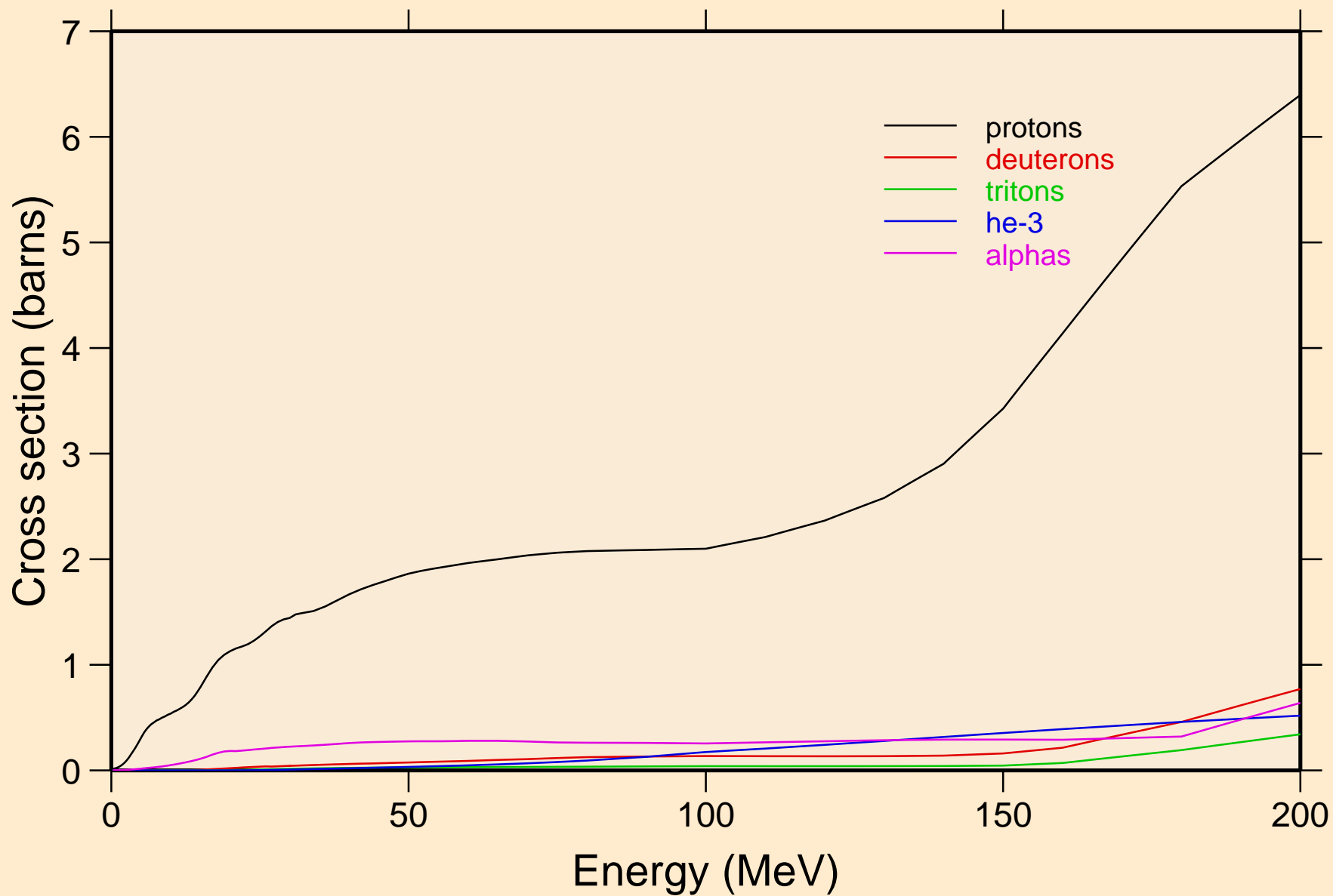

HG182 NEUTRON ACER TENDL-2019 LIBRARY; T=293.16K  
protons from (n,x)

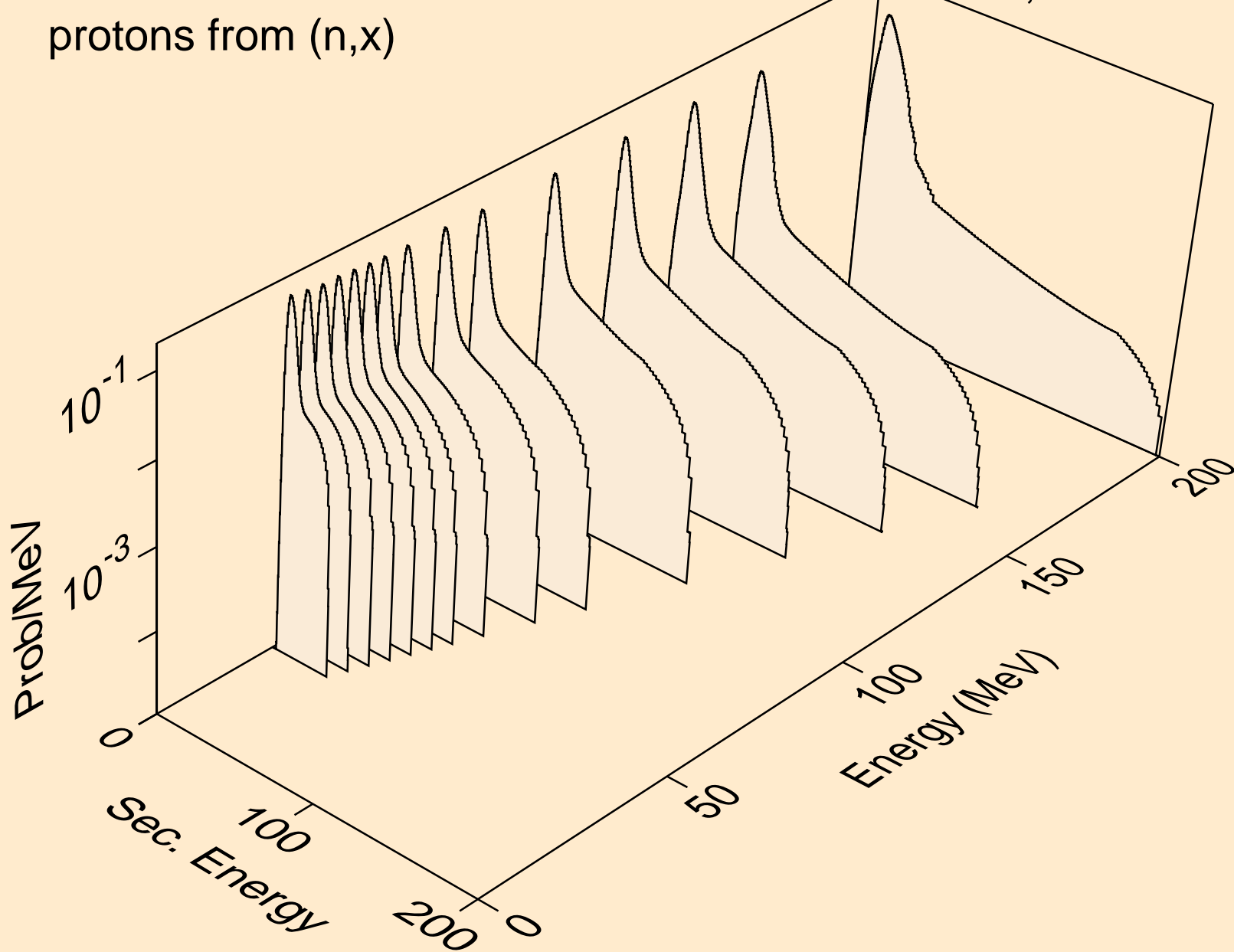

HG182 NEUTRON ACER TENDL-2019 LIBRARY; T=293.16K  
protons from (n,n\*)p

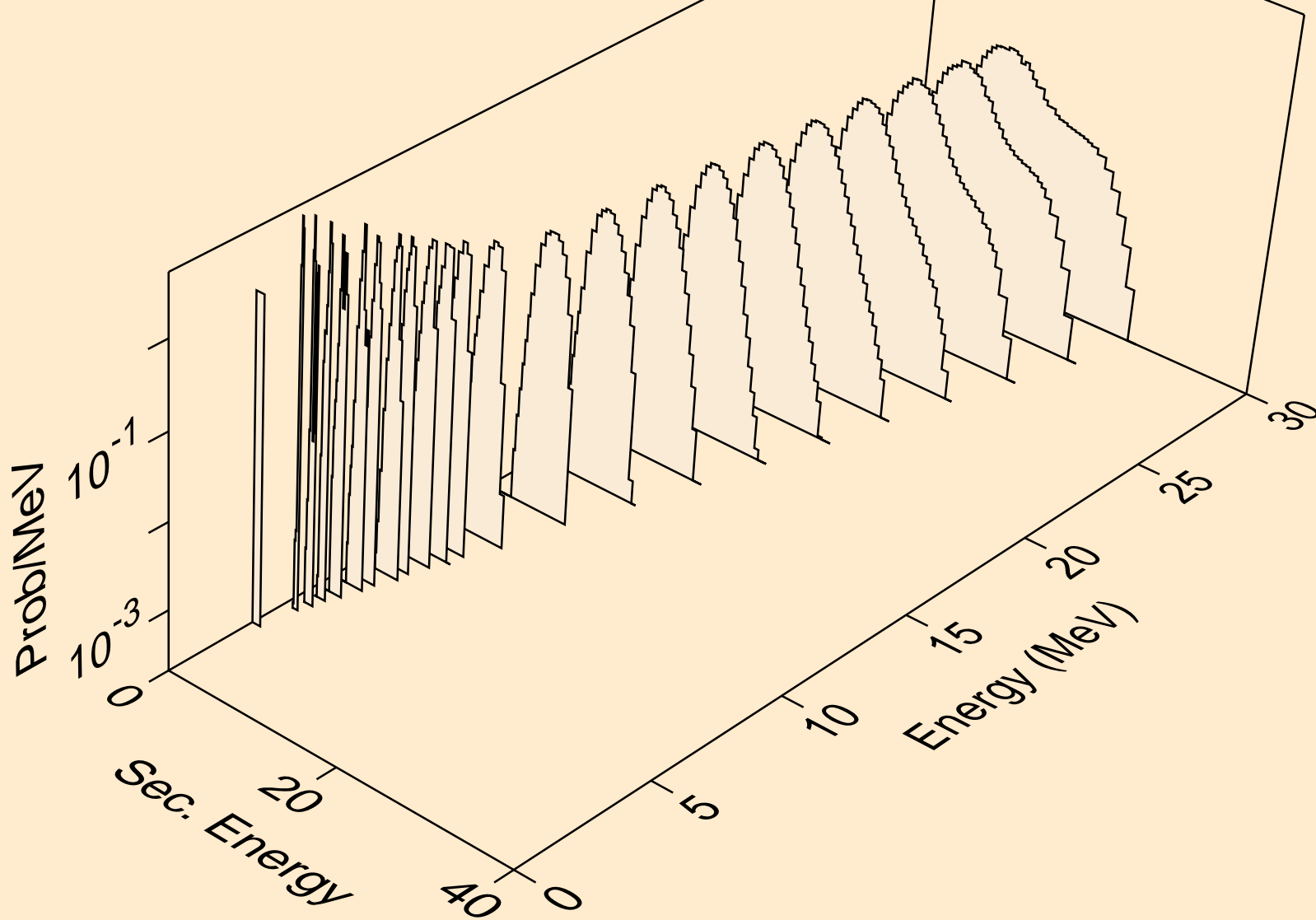

HG182 NEUTRON ACER TENDL-2019 LIBRARY; T=293.16K  
protons from (n,2np)

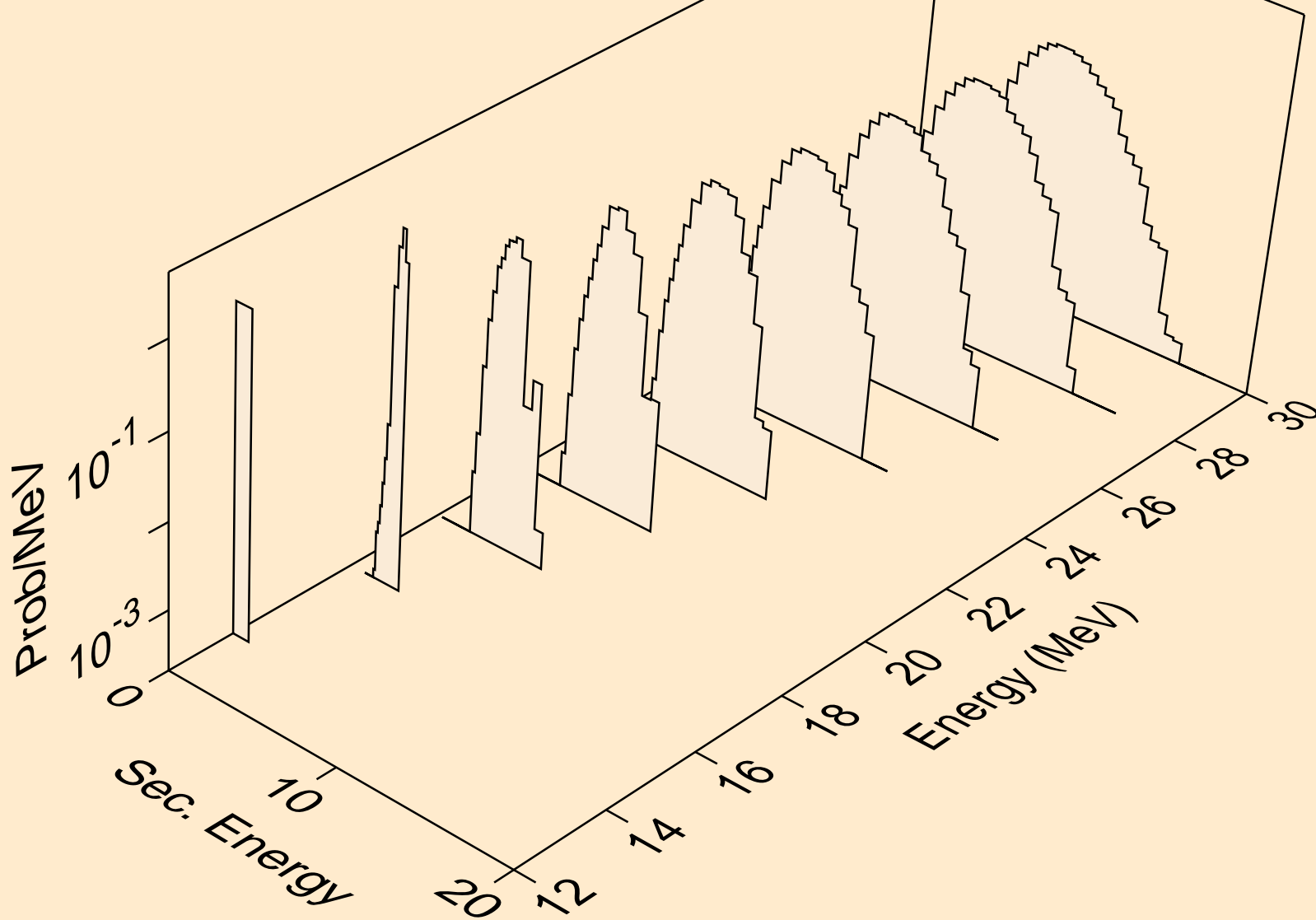

HG182 NEUTRON ACER TENDL-2019 LIBRARY; T=293.16K  
protons from (n,3np)

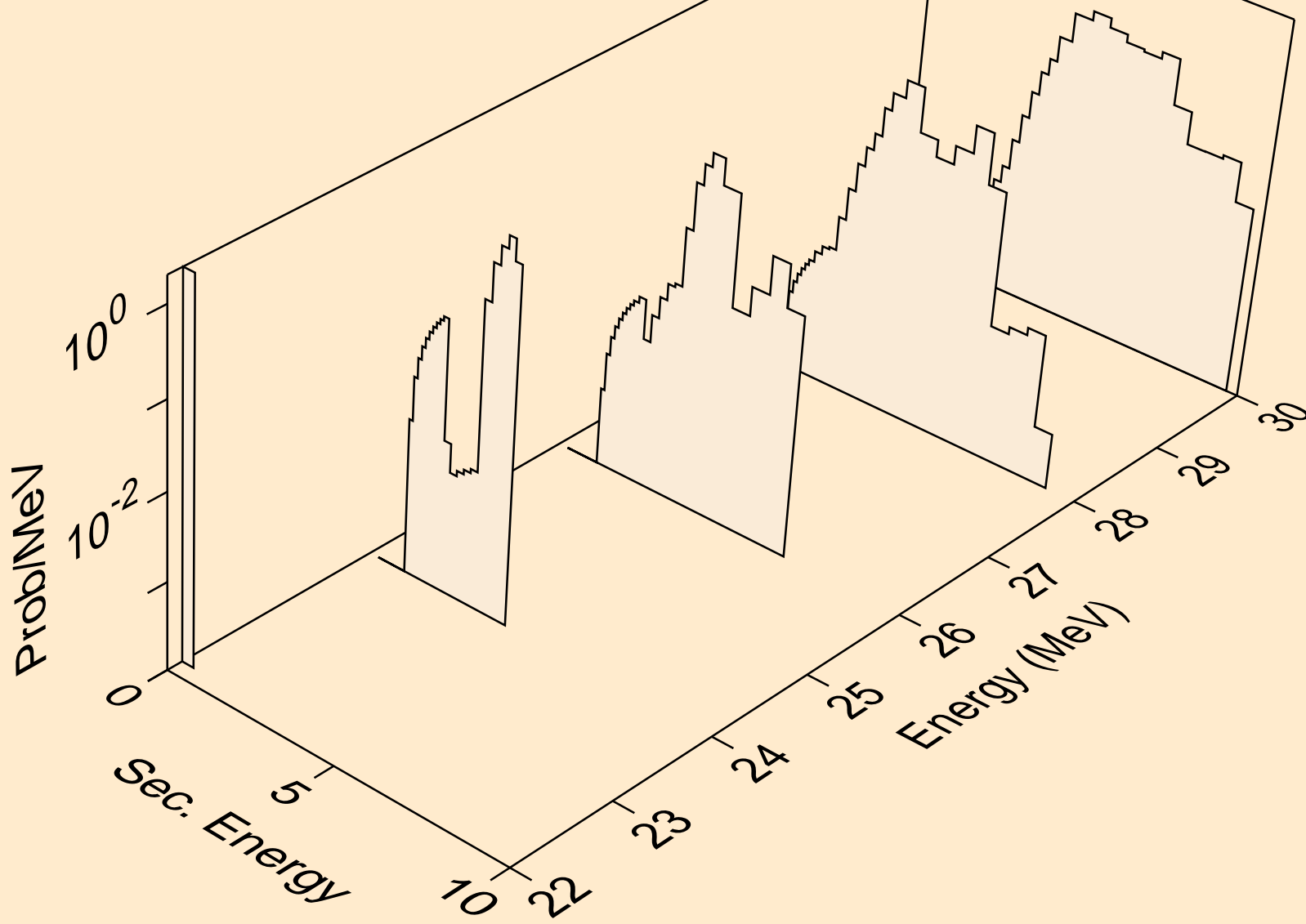

HG182 NEUTRON ACER TENDL-2019 LIBRARY; T=293.16K  
protons from (n,2np)

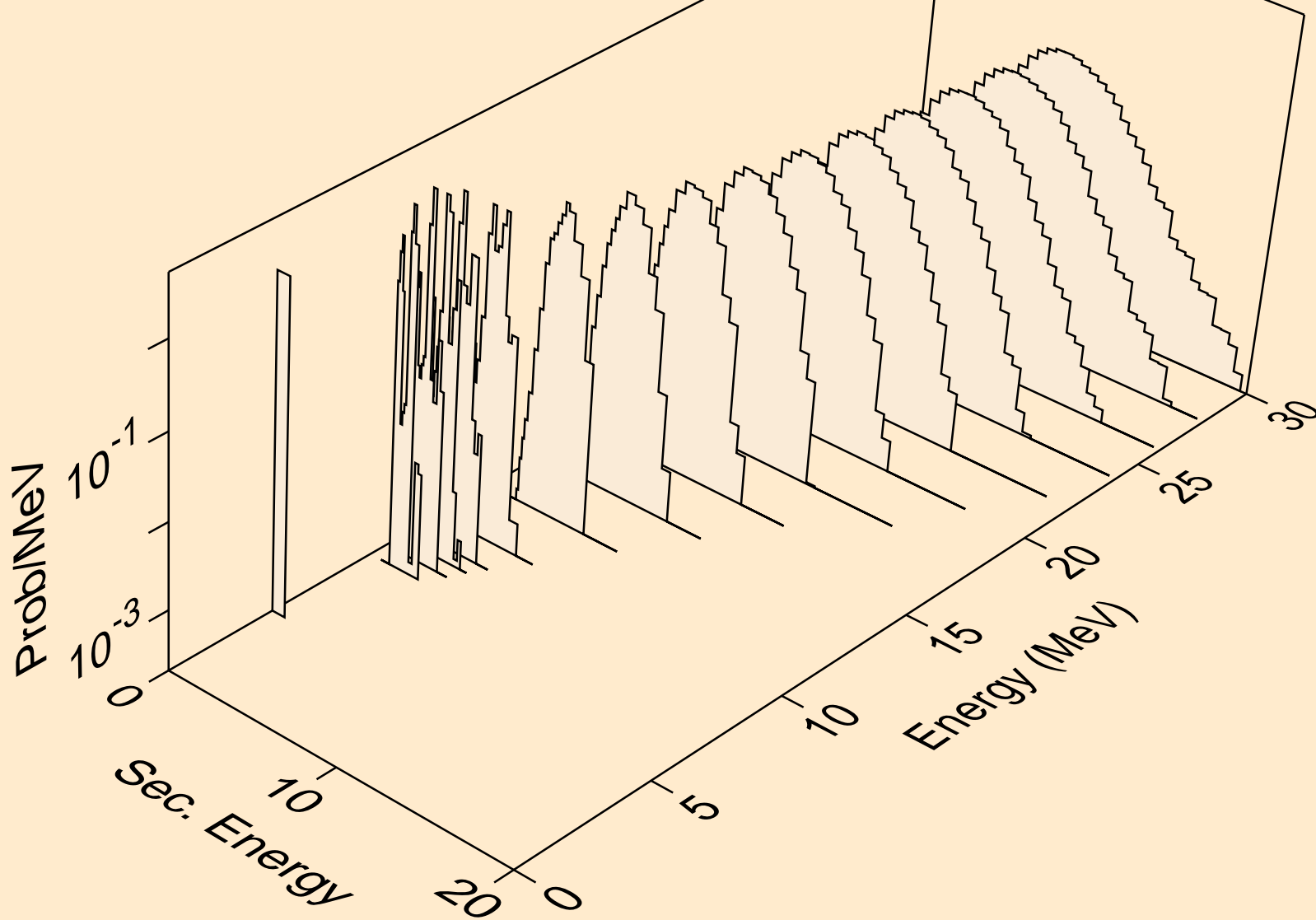

HG182 NEUTRON ACER TENDL-2019 LIBRARY; T=293.16K  
protons from (n,npa)

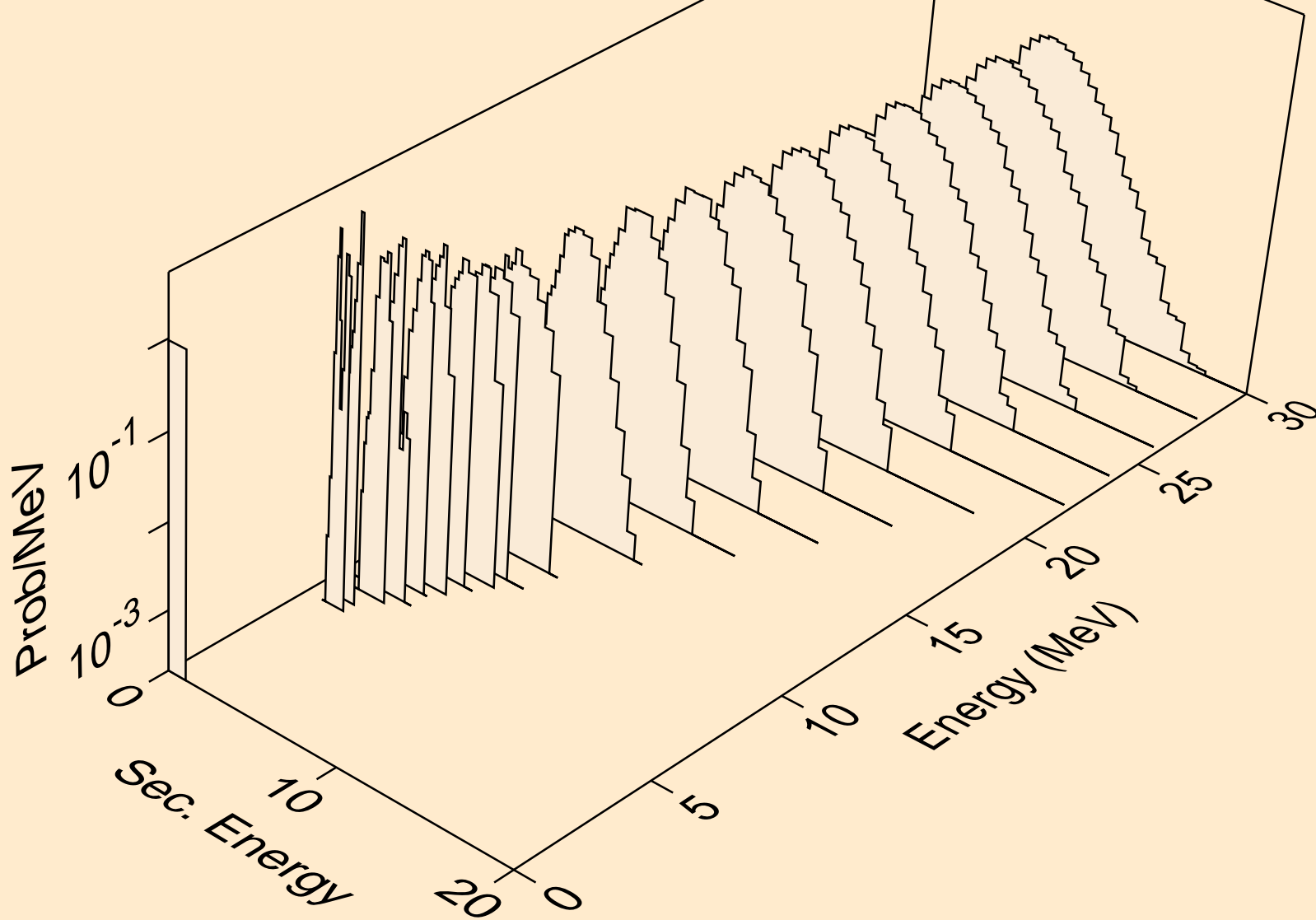

HG182 NEUTRON ACER TENDL-2019 LIBRARY; T=293.16K  
protons from (n,p)

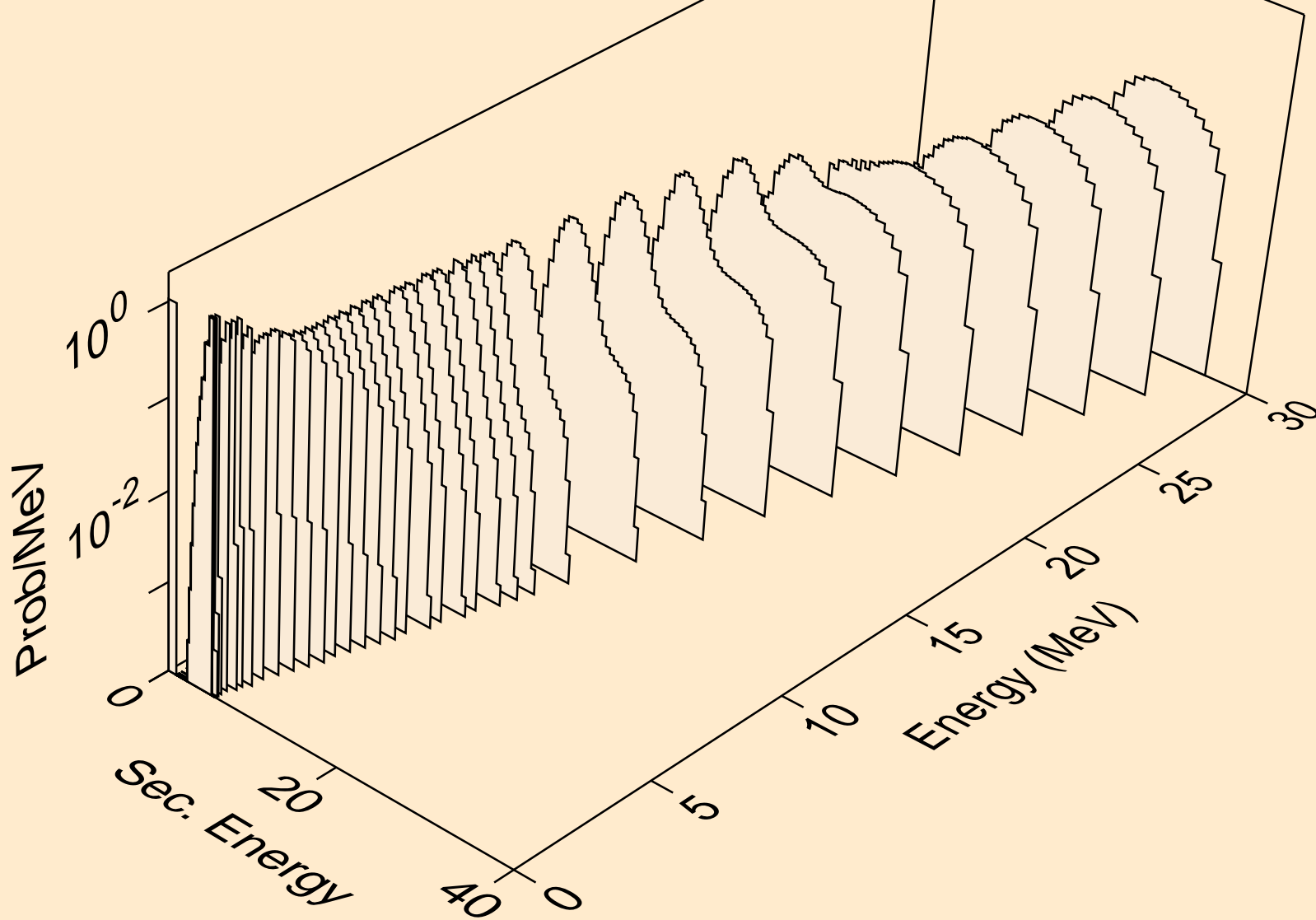

HG182 NEUTRON ACER TENDL-2019 LIBRARY; T=293.16K  
protons from (n,2p)

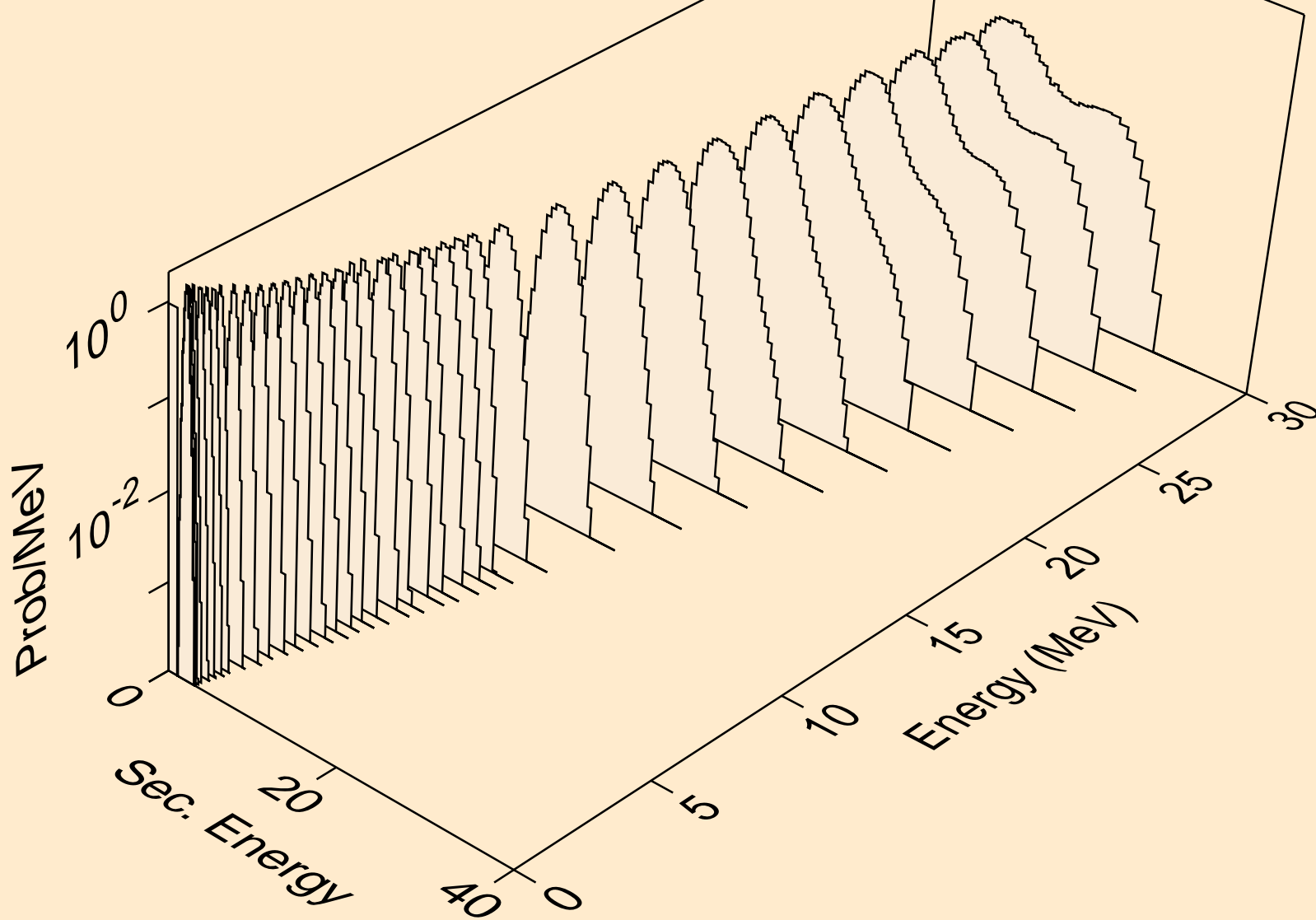

HG182 NEUTRON ACER TENDL-2019 LIBRARY; T=293.16K  
protons from (n,p)

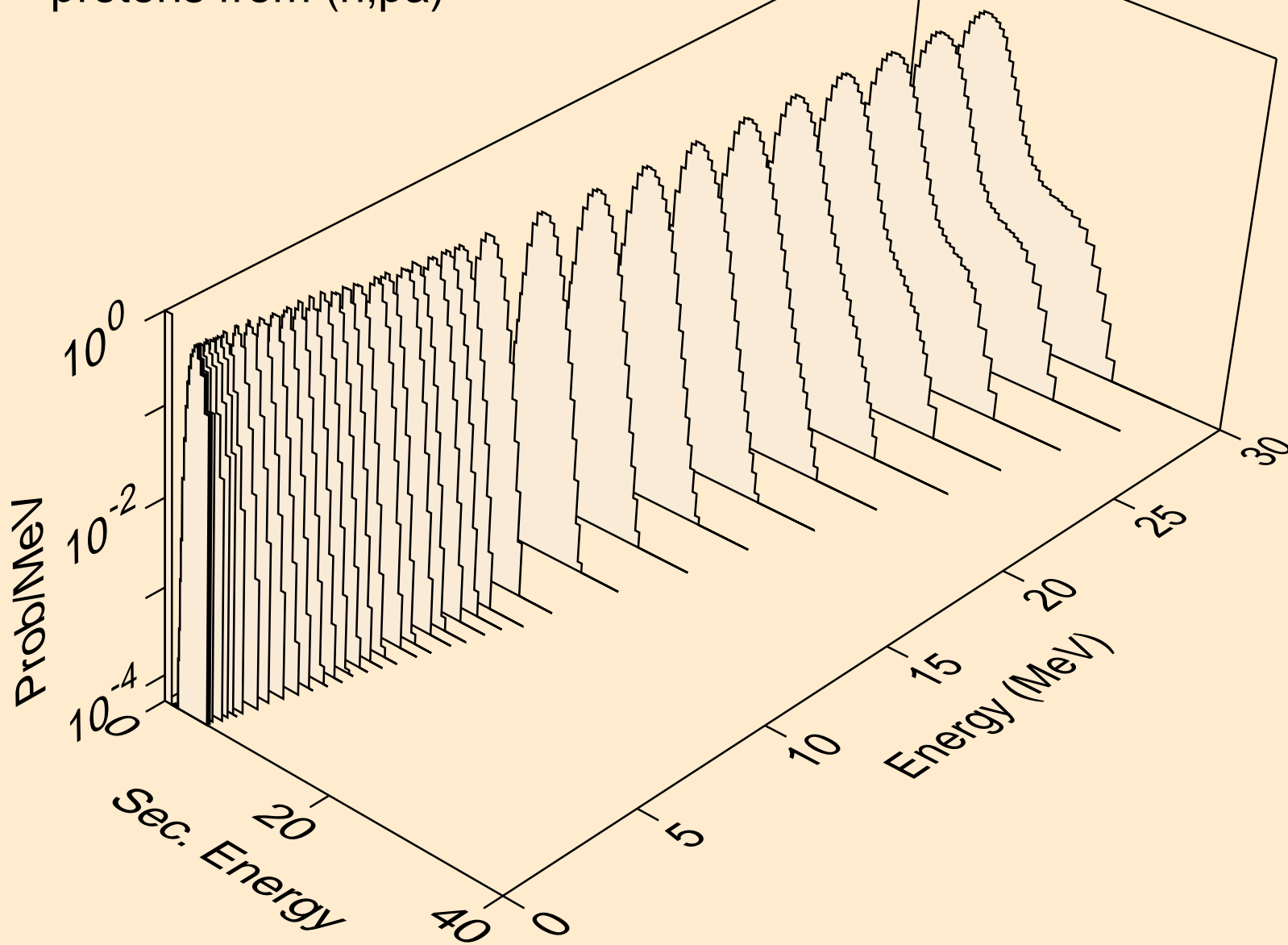

HG182 NEUTRON ACER TENDL-2019 LIBRARY; T=293.16K  
protons from (n,pd)

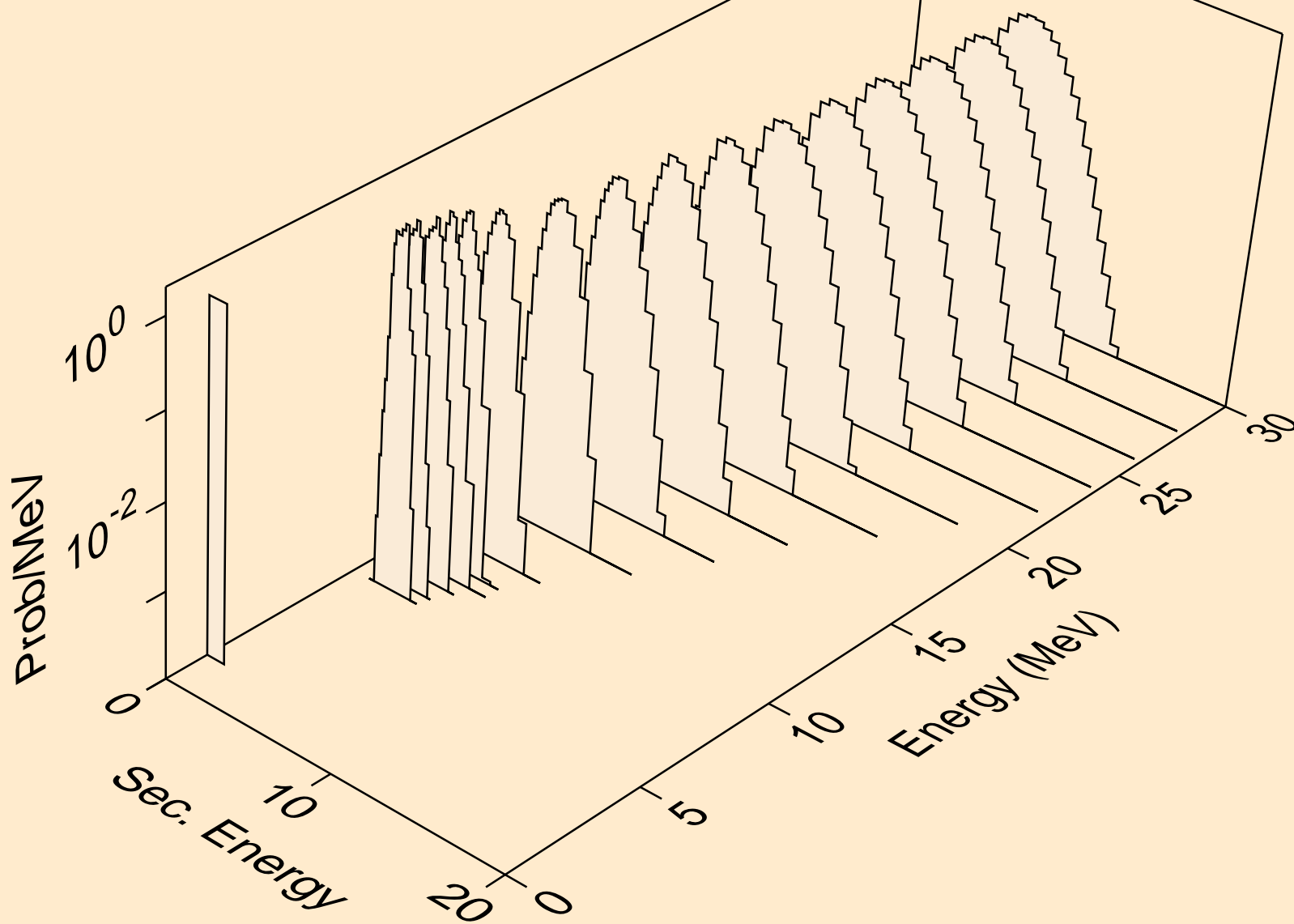

HG182 NEUTRON ACER TENDL-2019 LIBRARY; T=293.16K  
protons from (n,pt)

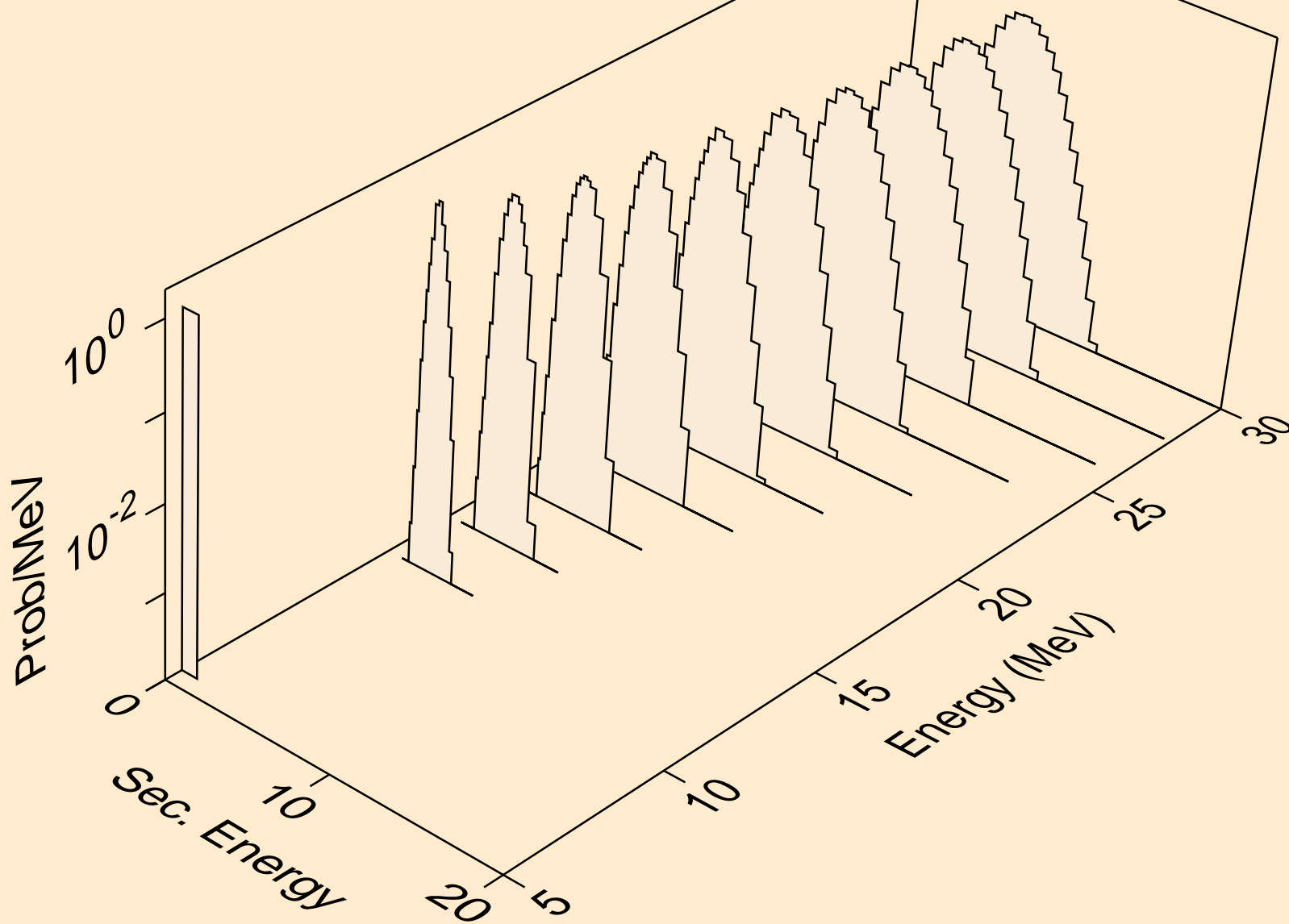

HG182 NEUTRON ACER TENDL-2019 LIBRARY; T=293.16K  
deuterons from (n,x)

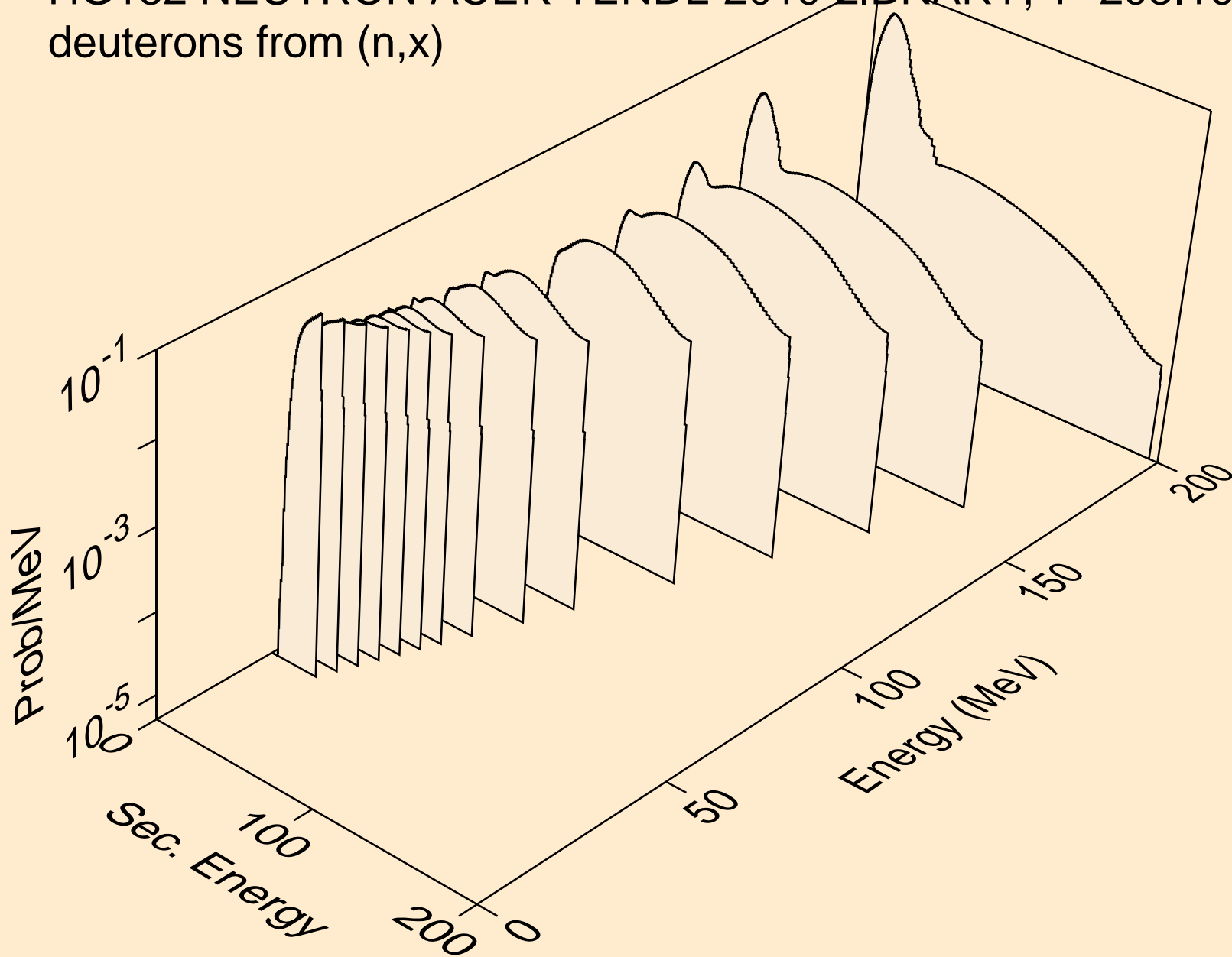

HG182 NEUTRON ACER TENDL-2019 LIBRARY; T=293.16K  
deuterons from (n,2nd)

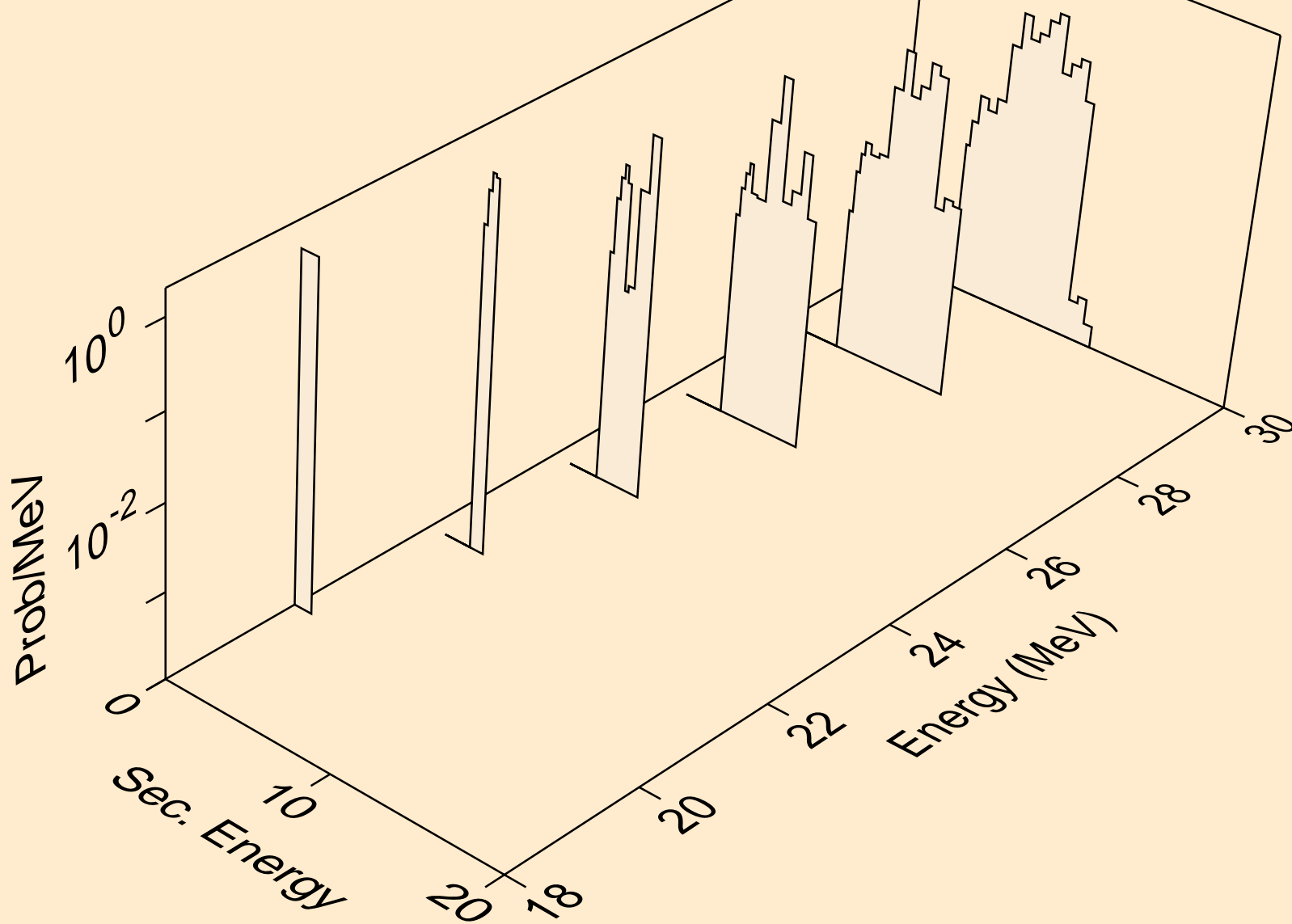

HG182 NEUTRON ACER TENDL-2019 LIBRARY; T=293.16K  
deuterons from (n,n\*)d

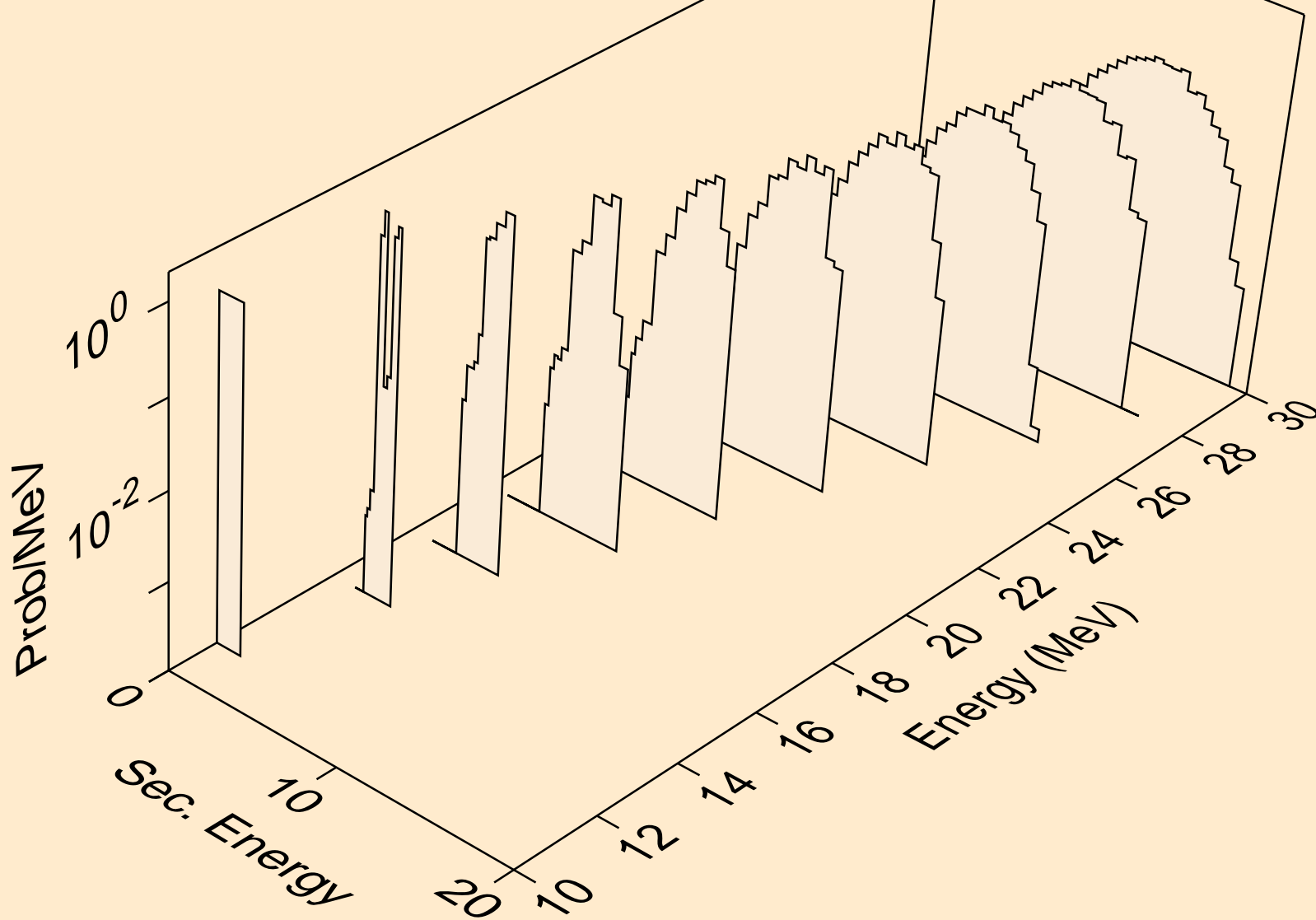

HG182 NEUTRON ACER TENDL-2019 LIBRARY; T=293.16K  
deuterons from (n,d)

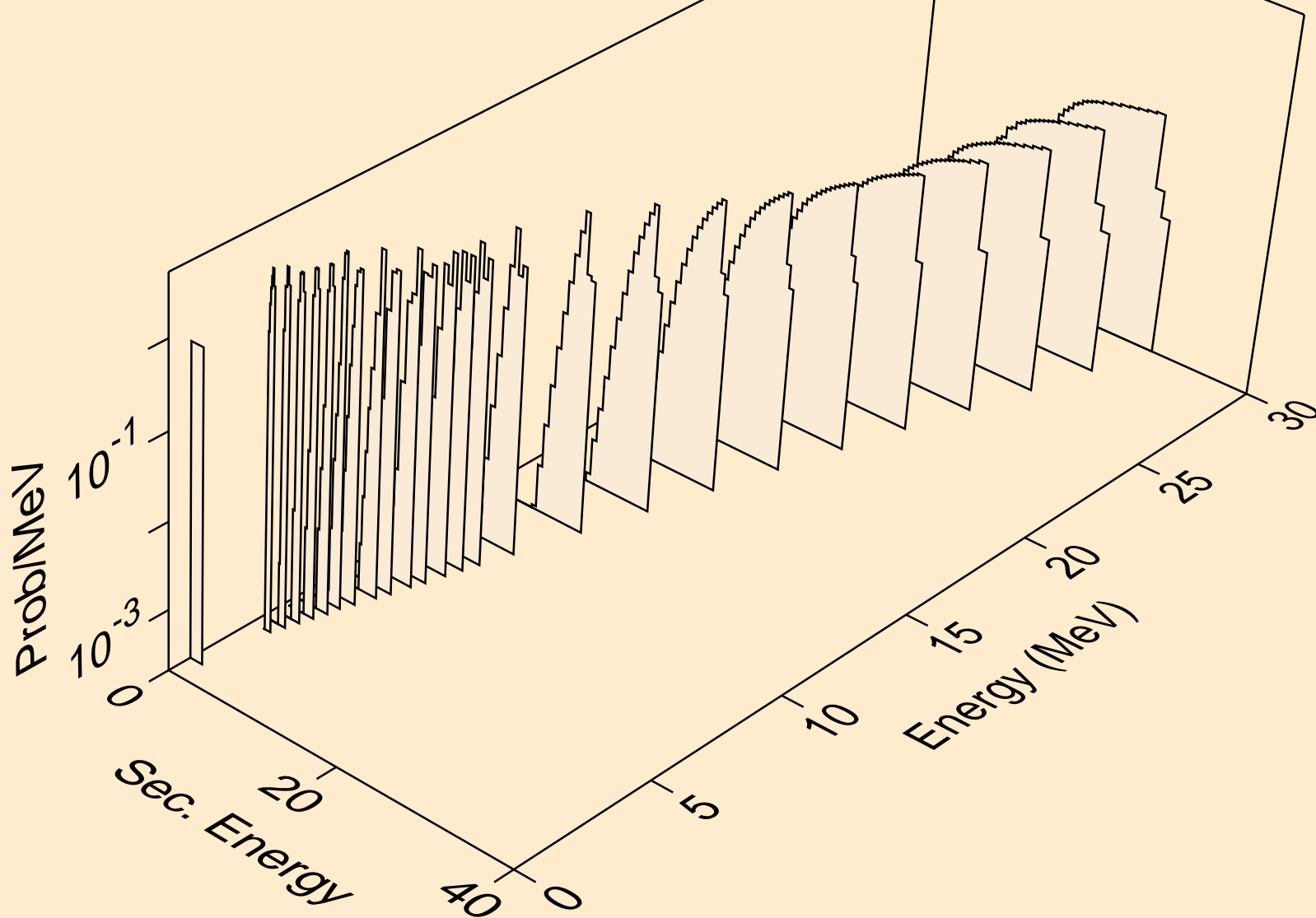

HG182 NEUTRON ACER TENDL-2019 LIBRARY; T=293.16K  
deuterons from (n,d2a)

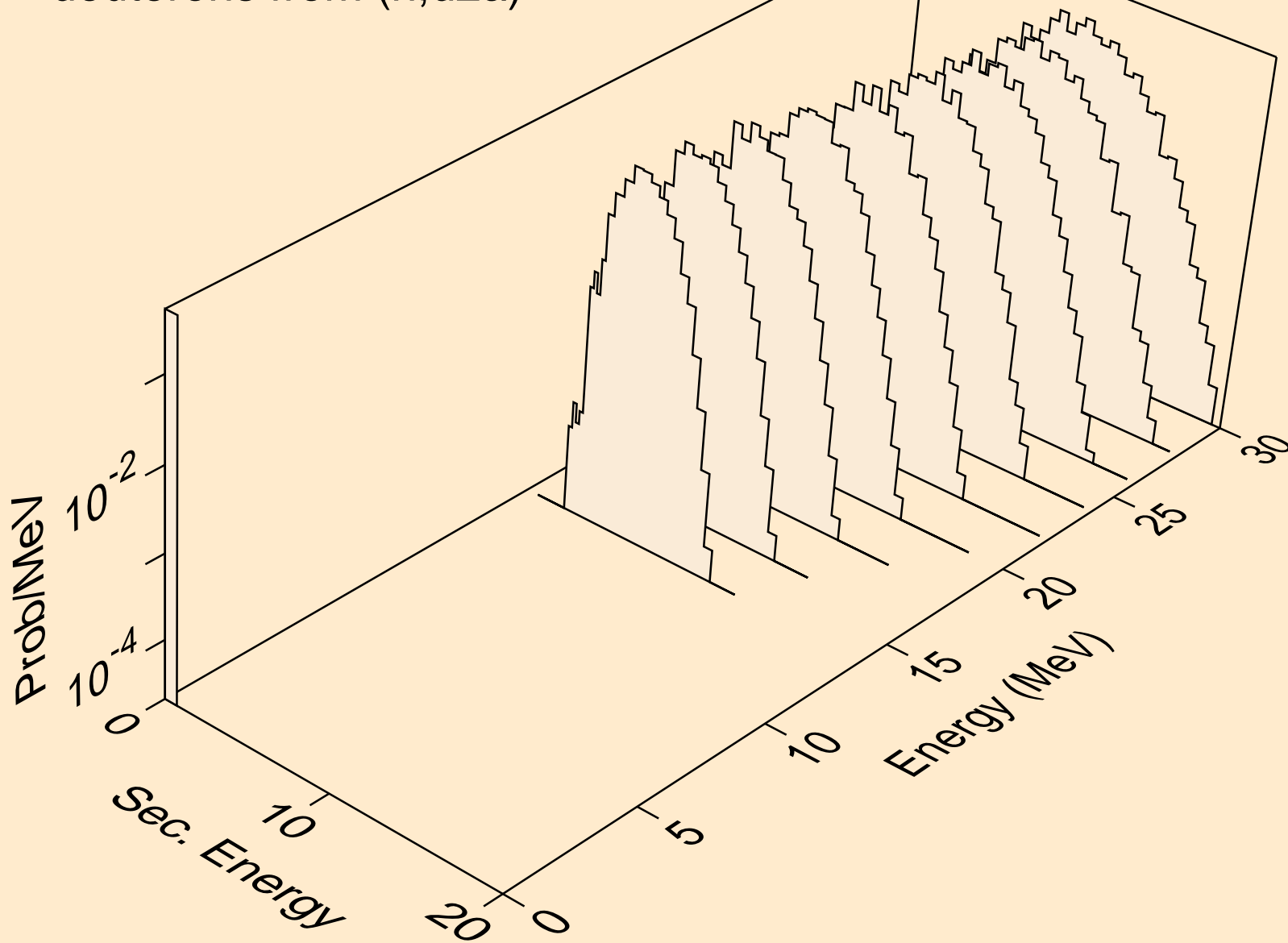

HG182 NEUTRON ACER TENDL-2019 LIBRARY; T=293.16K  
deuterons from (n,pd)

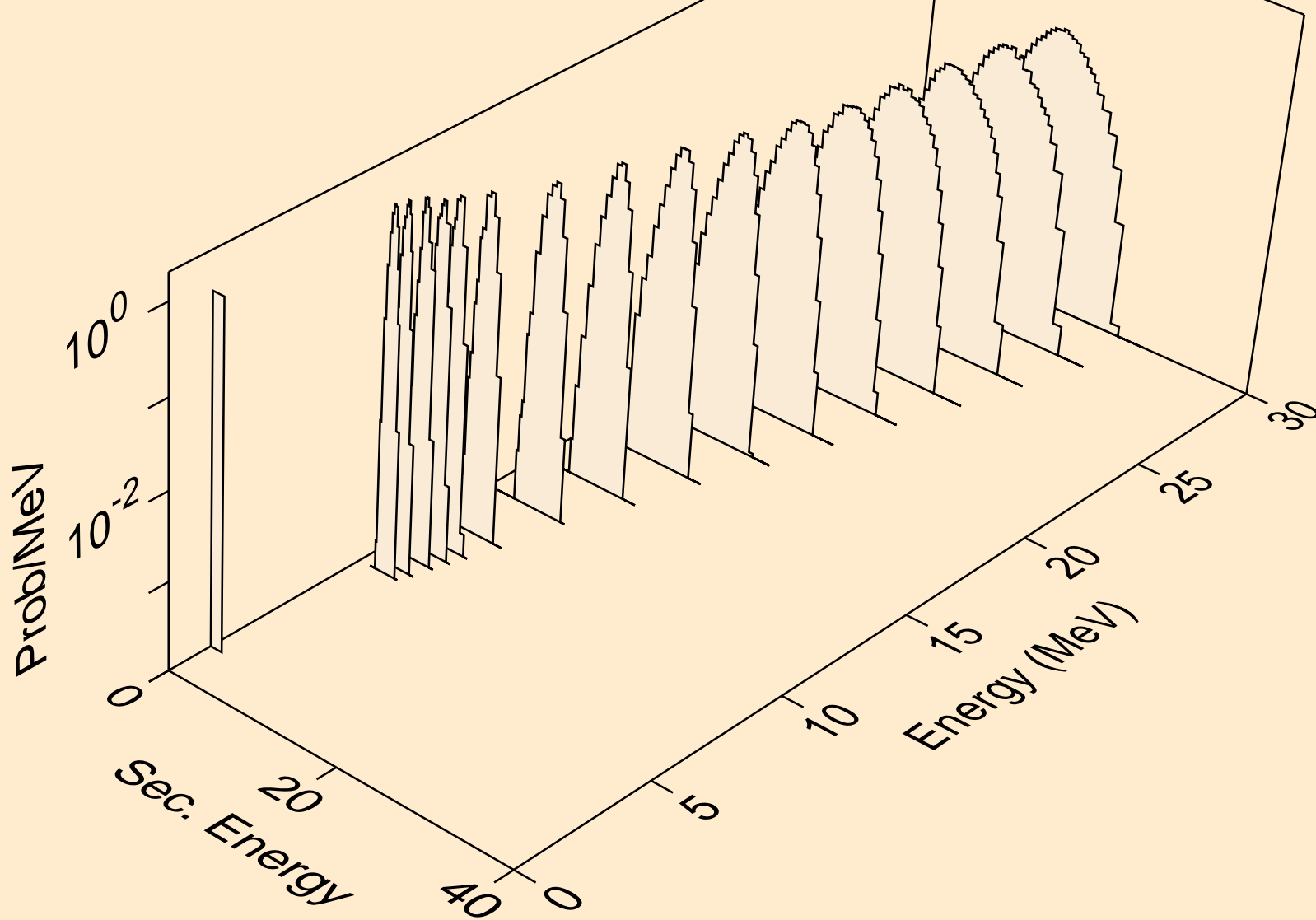

HG182 NEUTRON ACER TENDL-2019 LIBRARY; T=293.16K  
deuterons from (n,da)

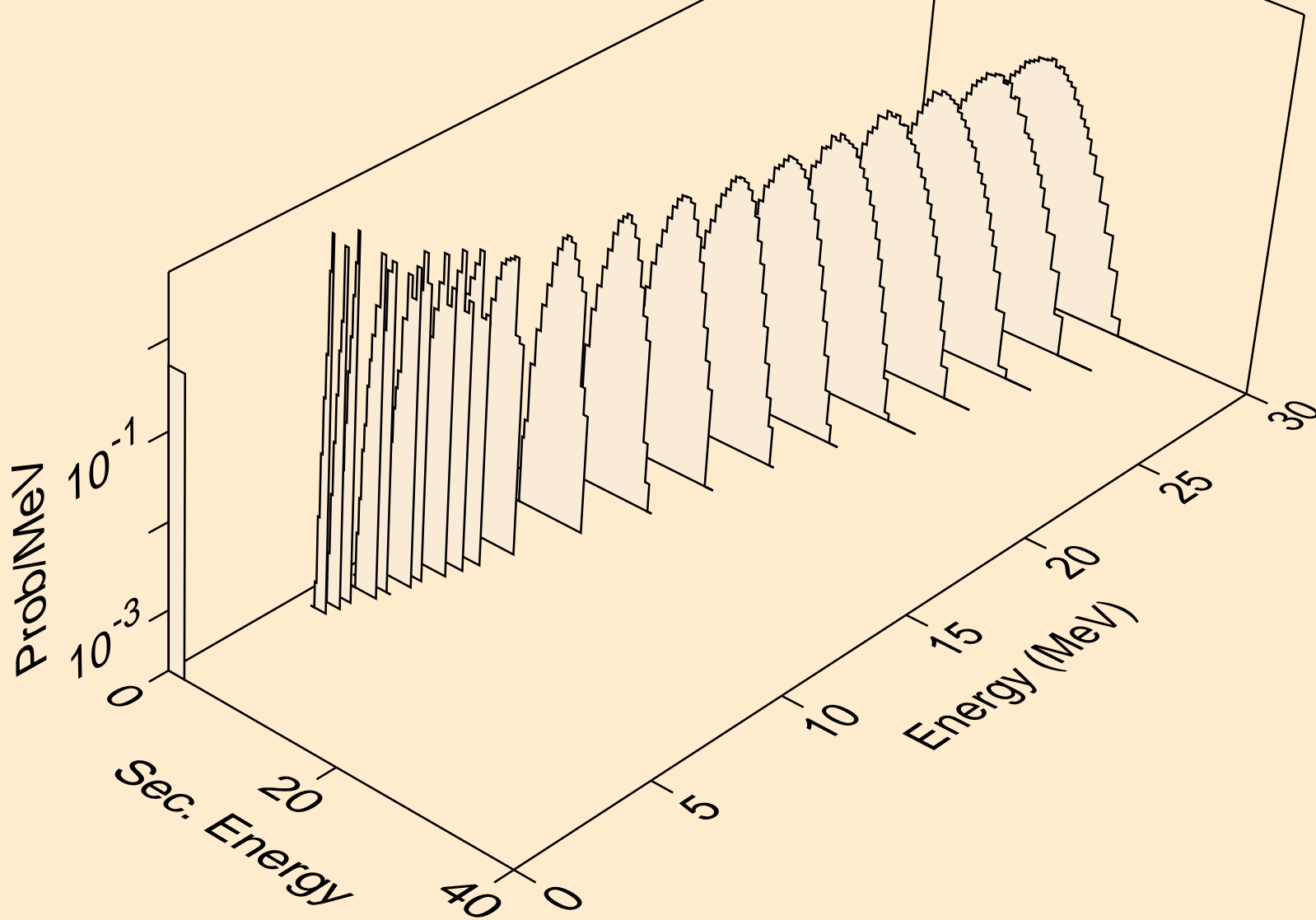

HG182 NEUTRON ACER TENDL-2019 LIBRARY; T=293.16K  
tritons from (n,x)

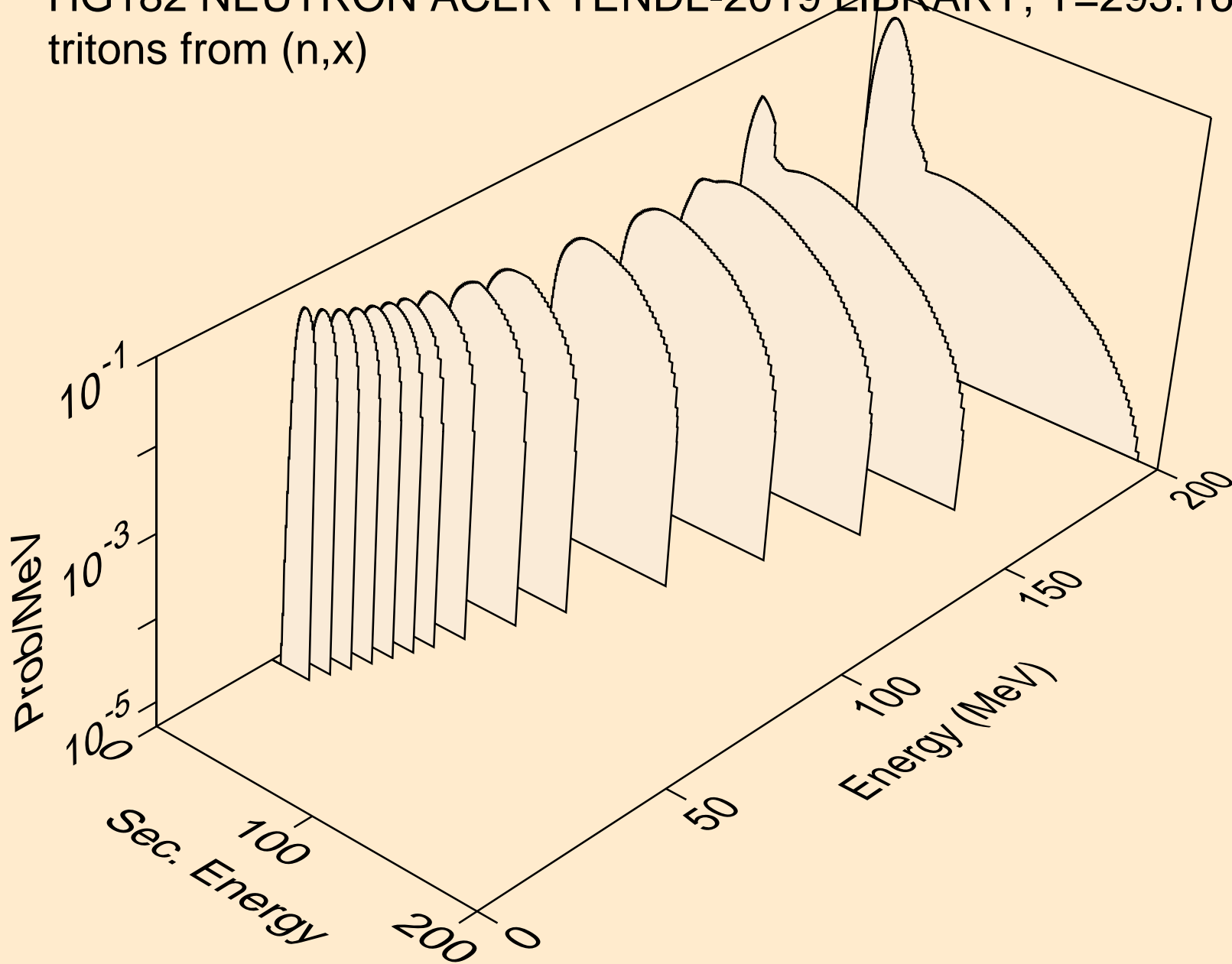

HG182 NEUTRON ACER TENDL-2019 LIBRARY; T=293.16K  
tritons from (n,n\*)t

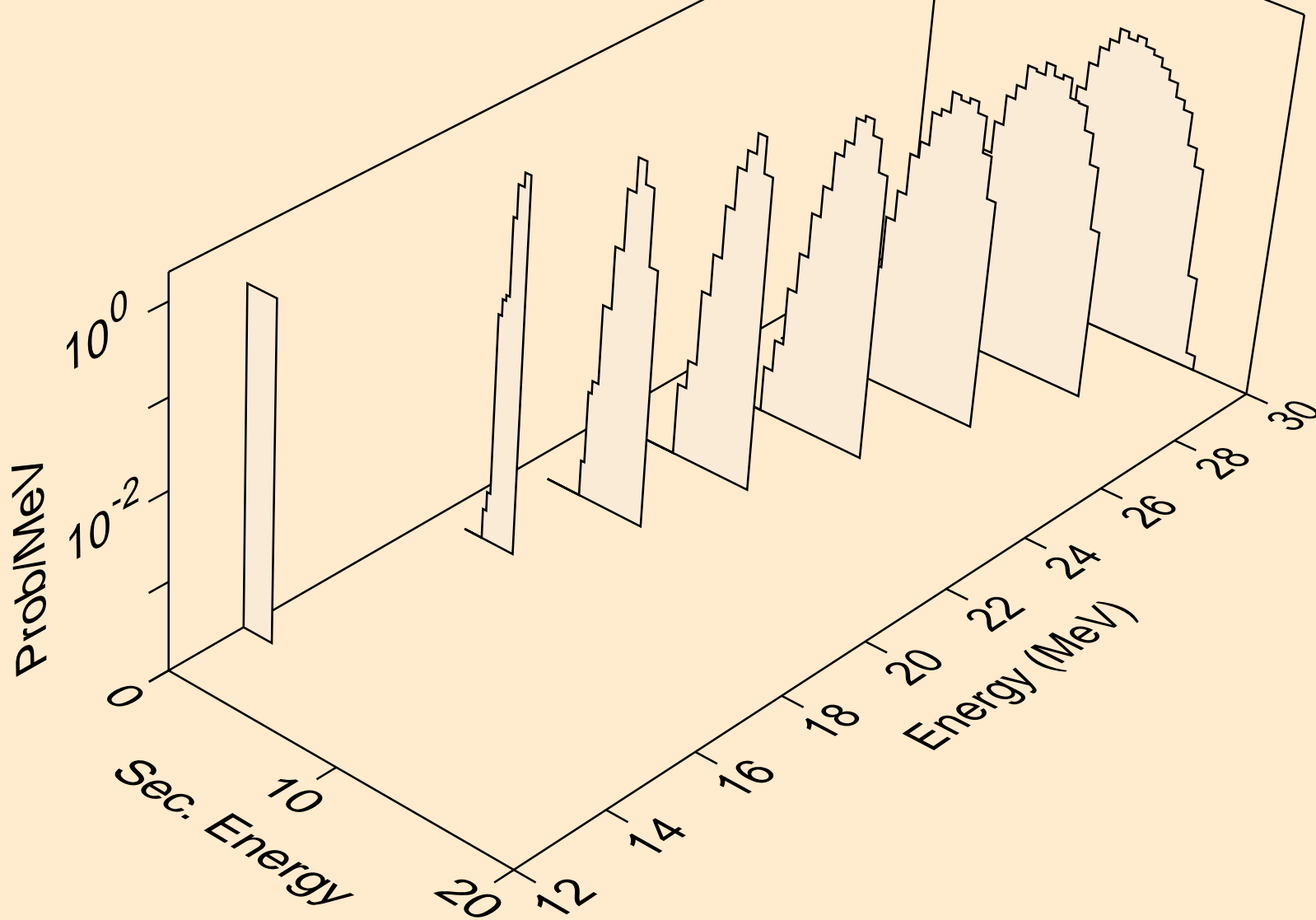

HG182 NEUTRON ACER TENDL-2019 LIBRARY; T=293.16K  
tritons from (n,t)

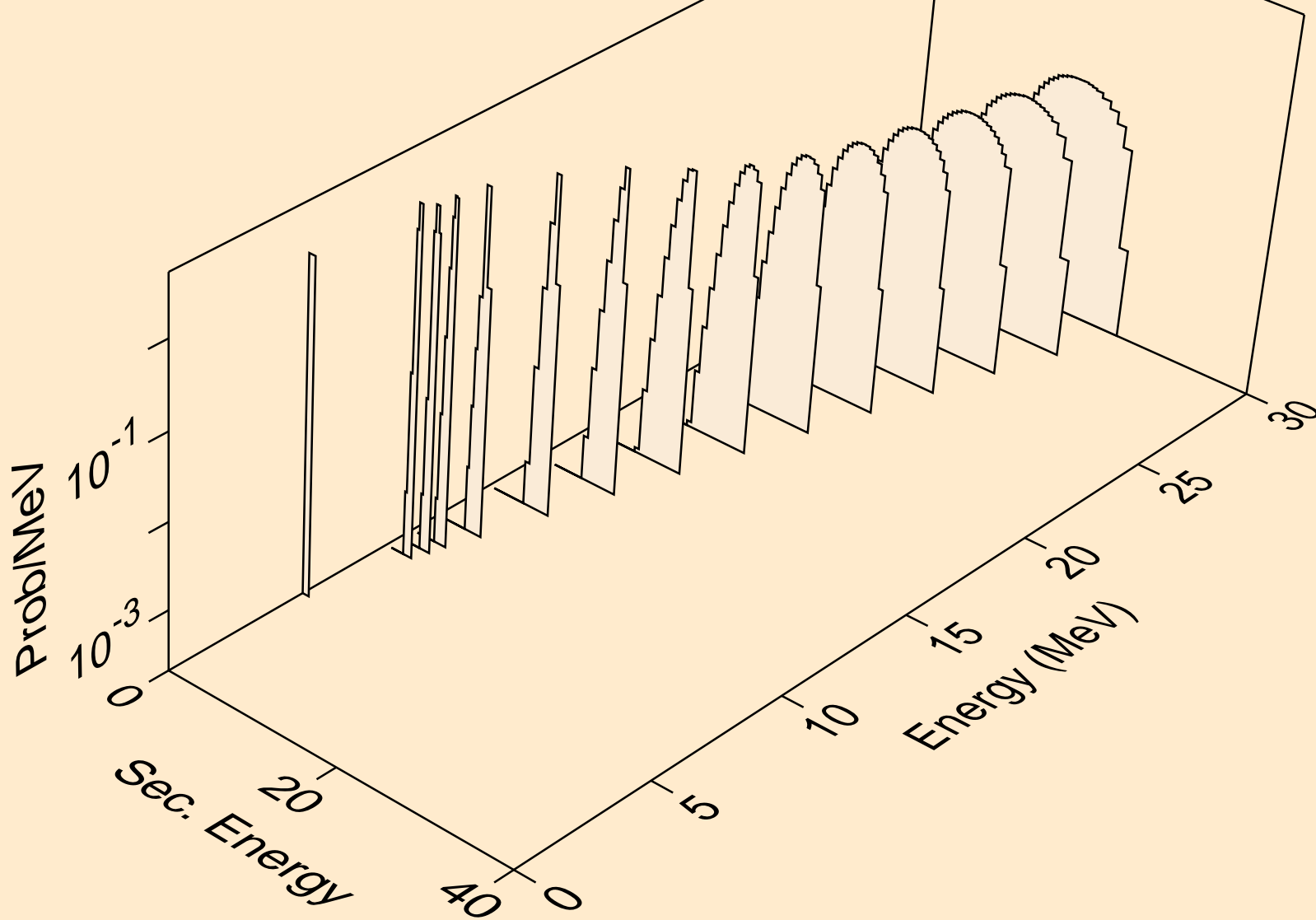

HG182 NEUTRON ACER TENDL-2019 LIBRARY; T=293.16K  
tritons from (n,pt)

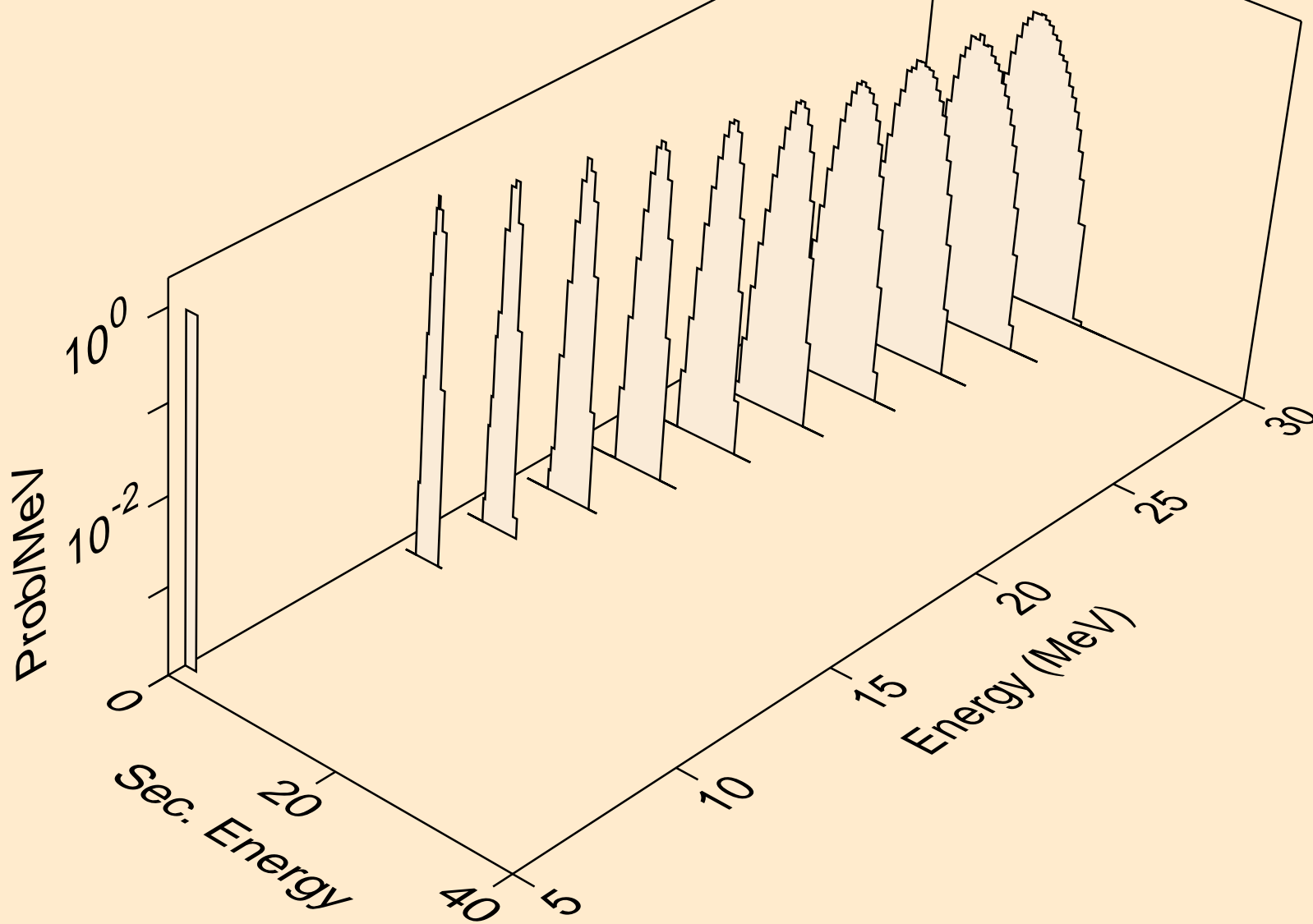

HG182 NEUTRON ACER TENDL-2019 LIBRARY; T=293.16K  
he3s from (n,x)

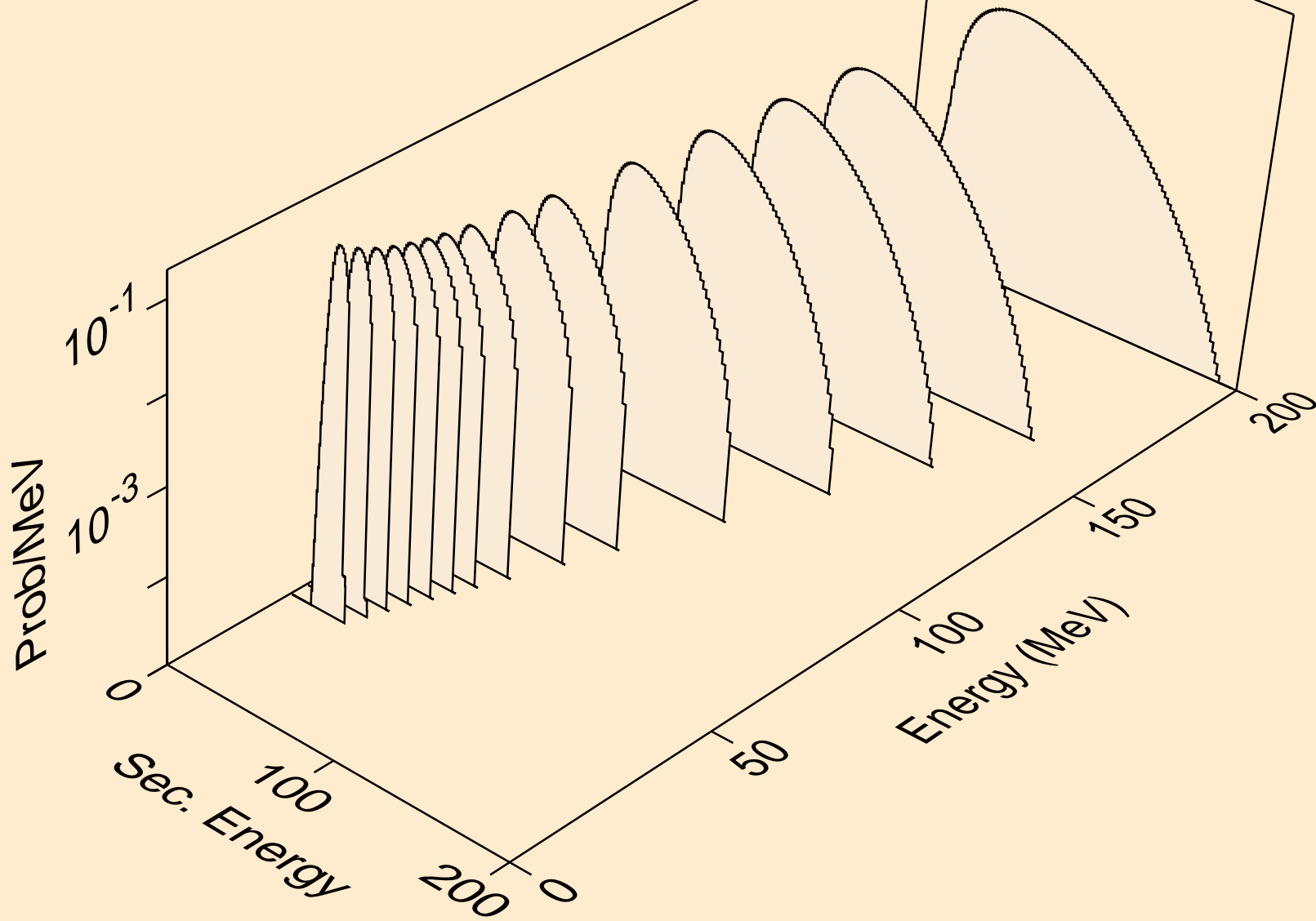

HG182 NEUTRON ACER TENDL-2019 LIBRARY; T=293.16K  
he3s from (n,n\*)he3

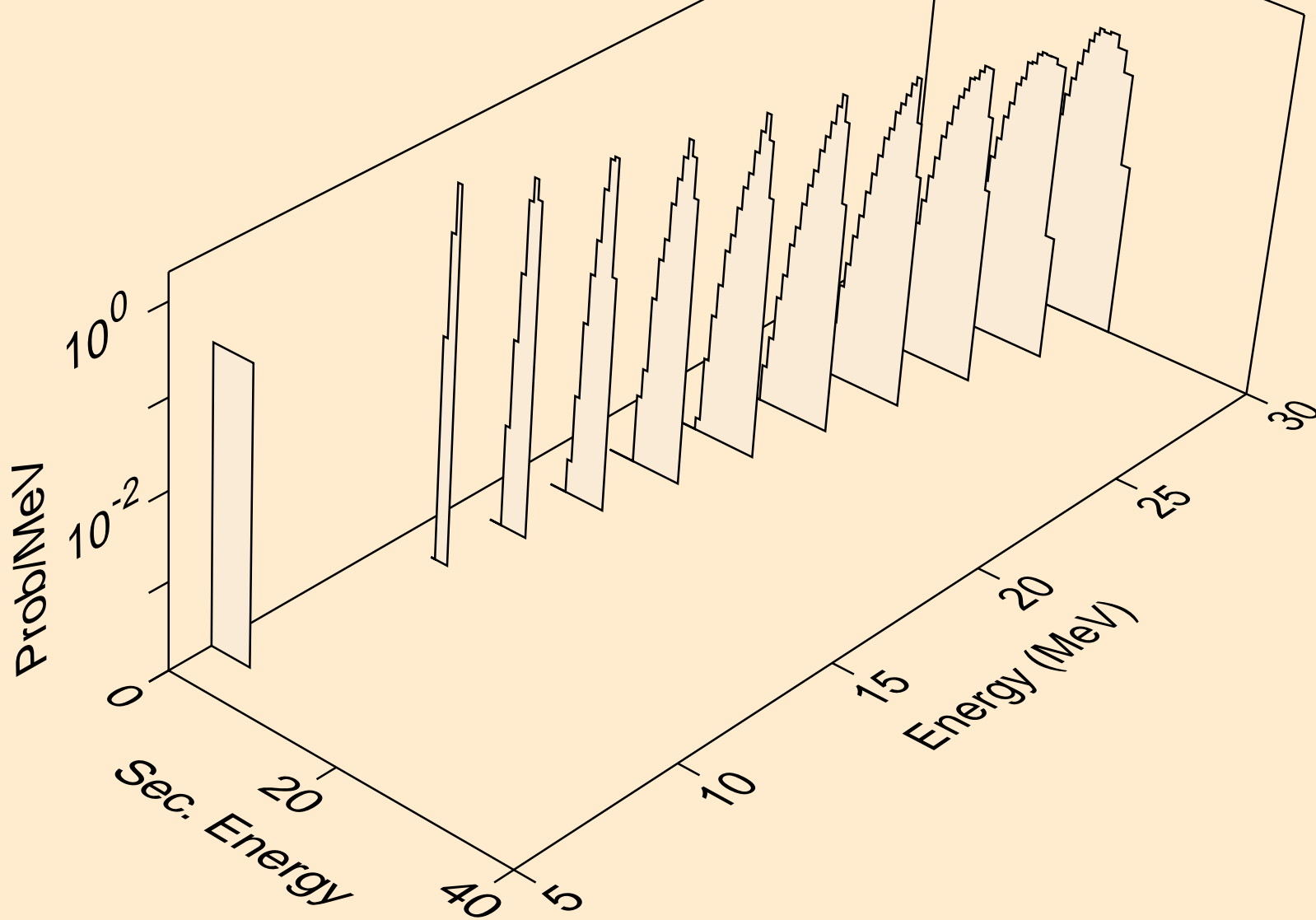

HG182 NEUTRON ACER TENDL-2019 LIBRARY; T=293.16K  
he3s from (n,he3)

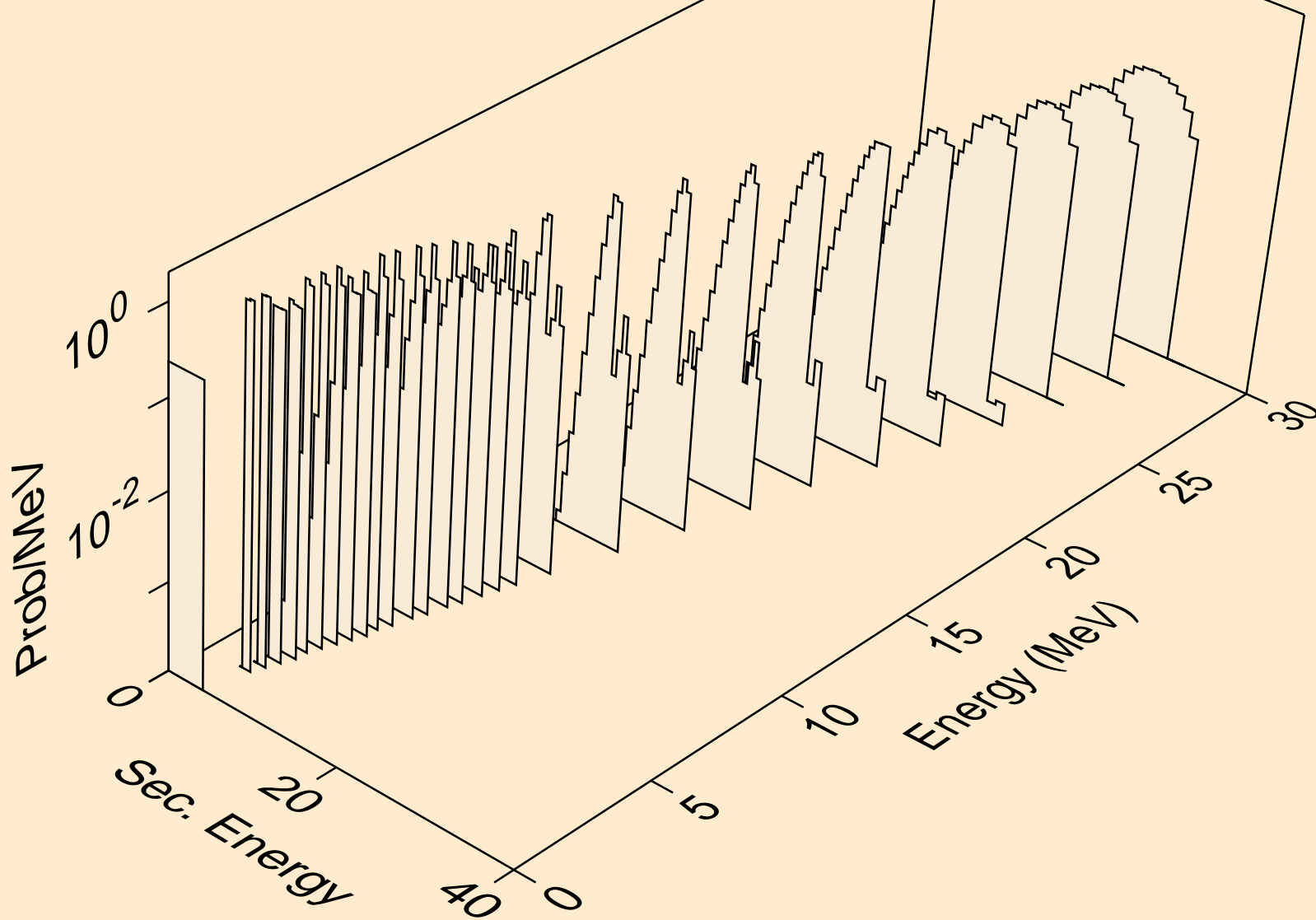

HG182 NEUTRON ACER TENDL-2019 LIBRARY; T=293.16K  
alphas from (n,x)

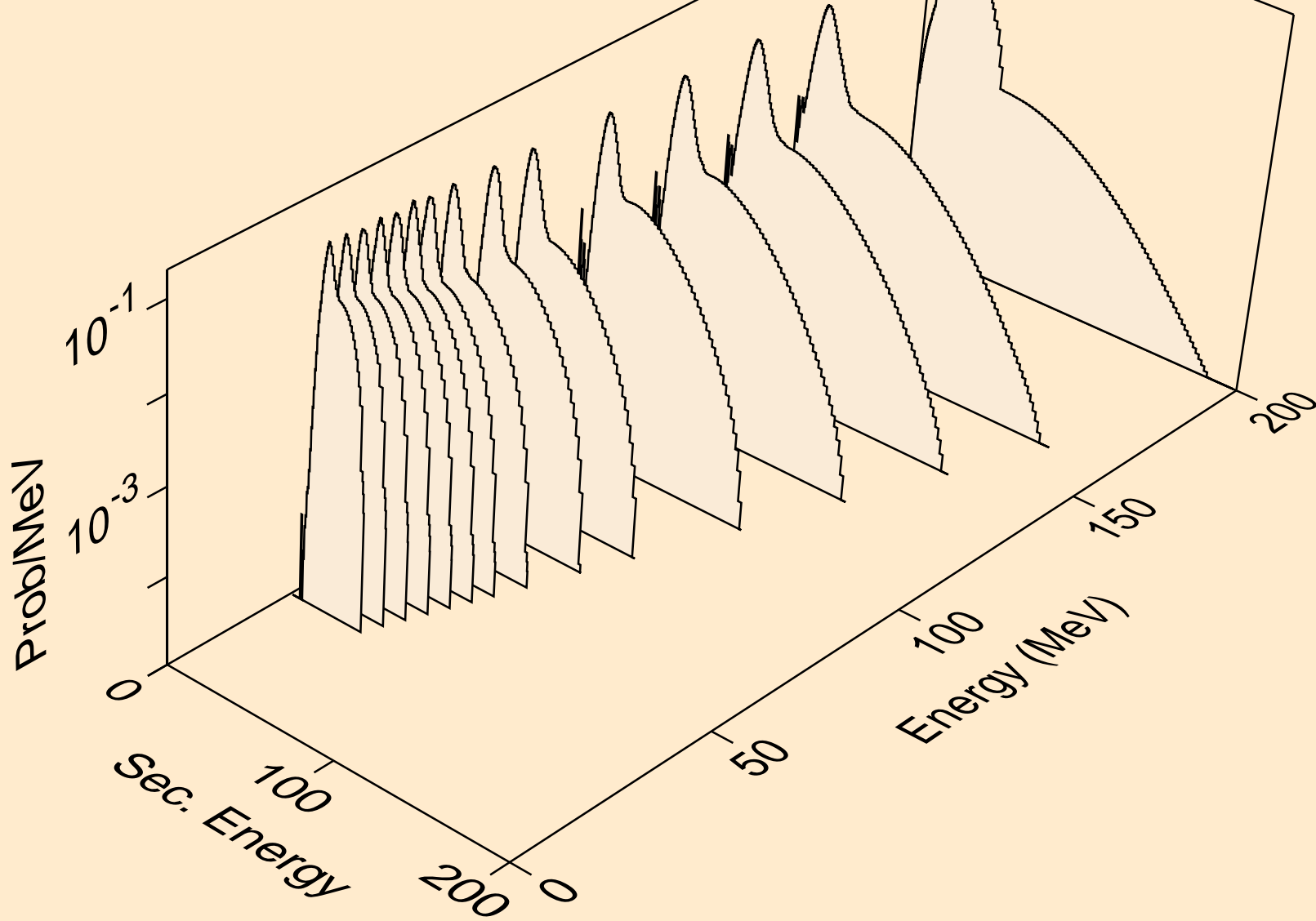

HG182 NEUTRON ACER TENDL-2019 LIBRARY; T=293.16K  
alphas from (n,n\*)a

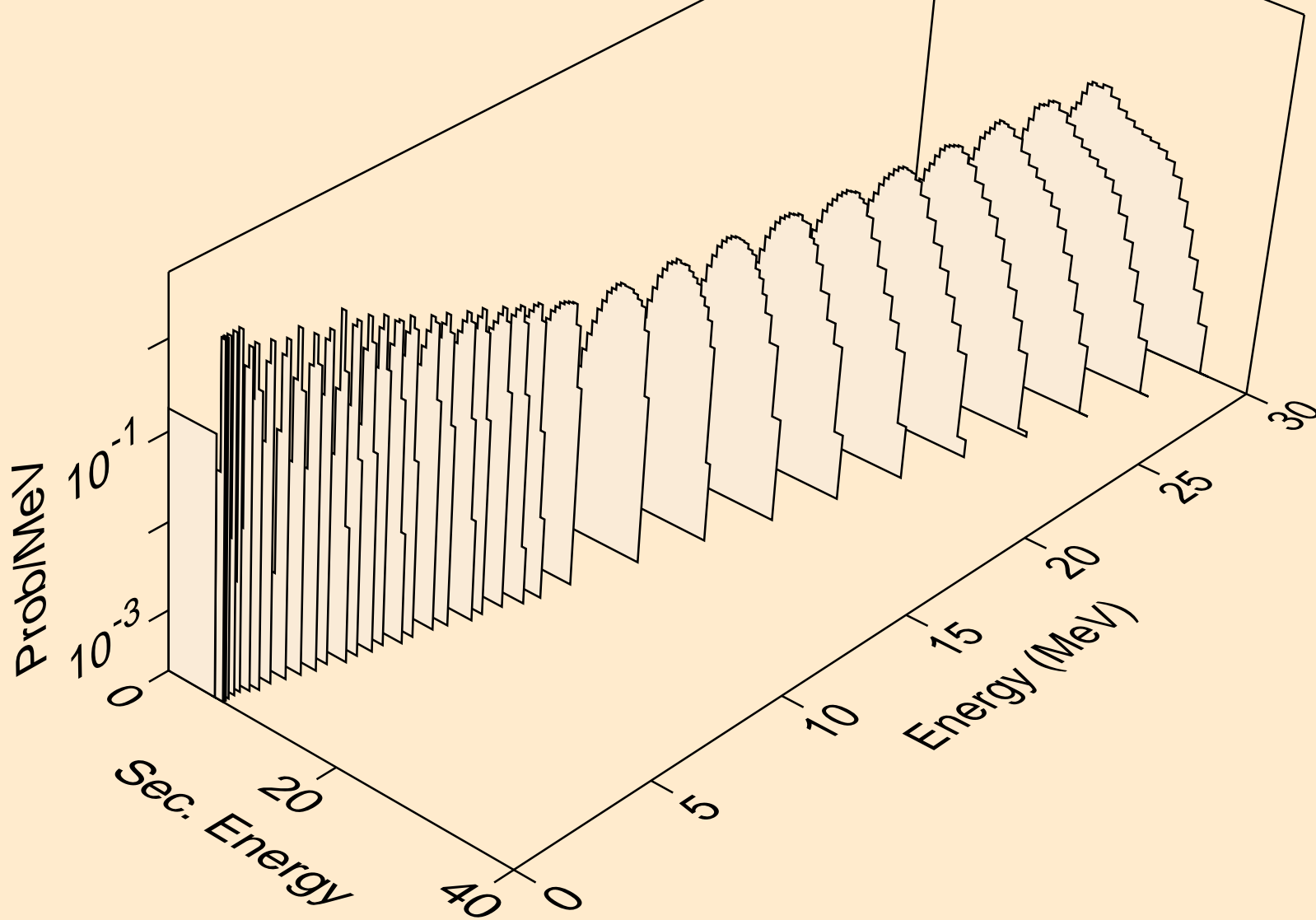

HG182 NEUTRON ACER TENDL-2019 LIBRARY; T=293.16K  
alphas from (n,n\*)3a

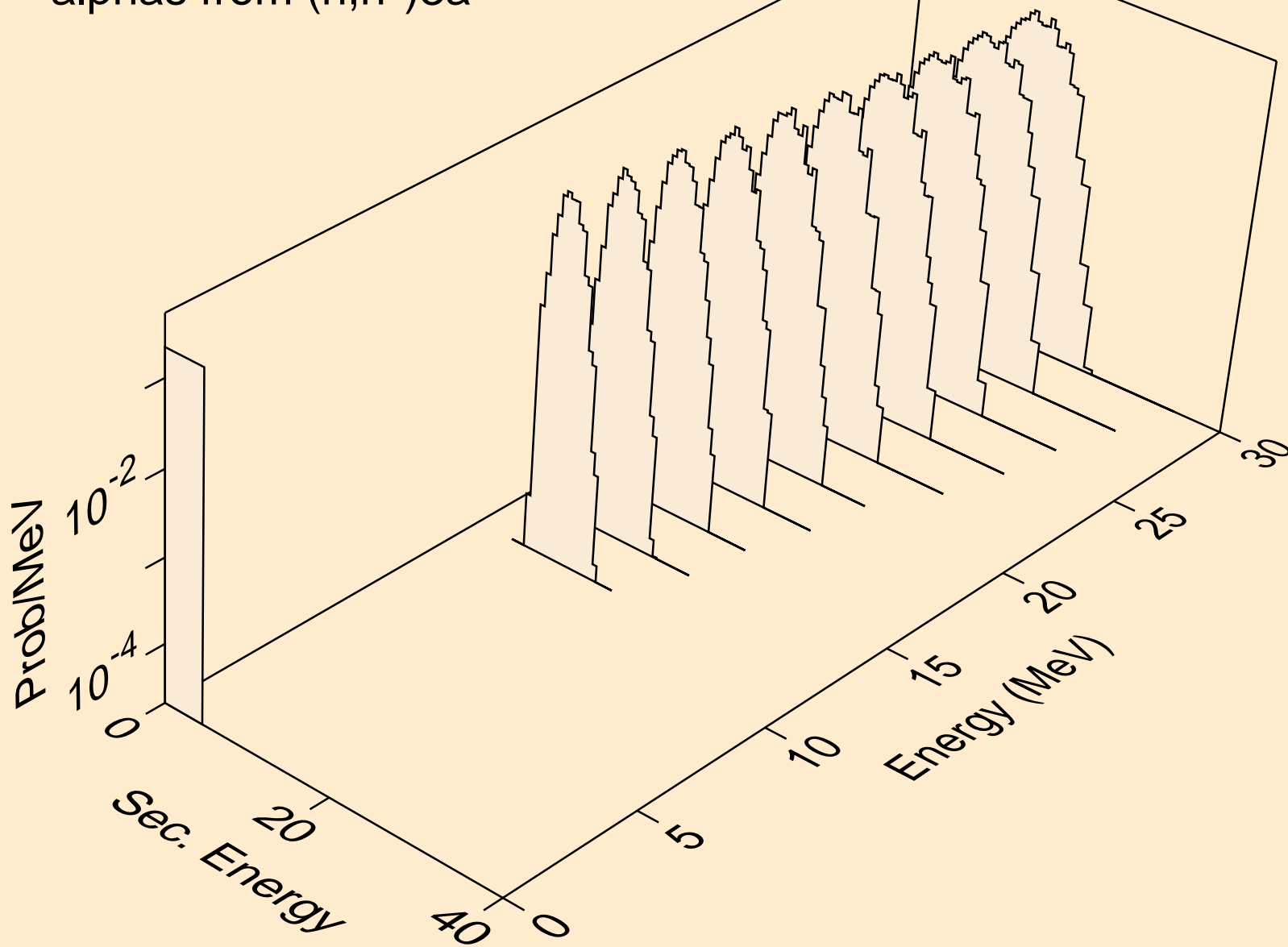

HG182 NEUTRON ACER TENDL-2019 LIBRARY; T=293.16K  
alphas from (n,2n)a

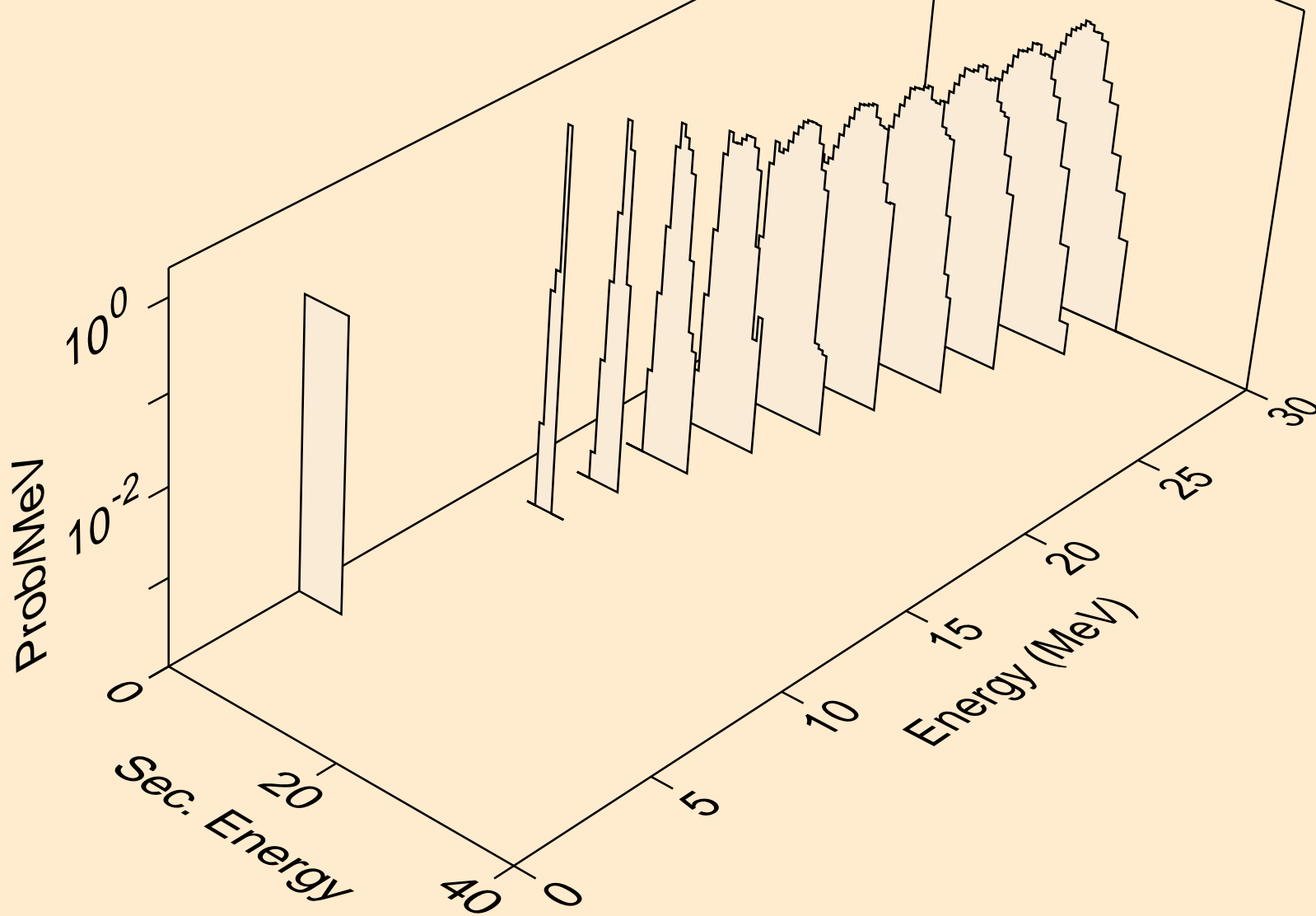

HG182 NEUTRON ACER TENDL-2019 LIBRARY; T=293.16K  
alphas from (n,3n)a

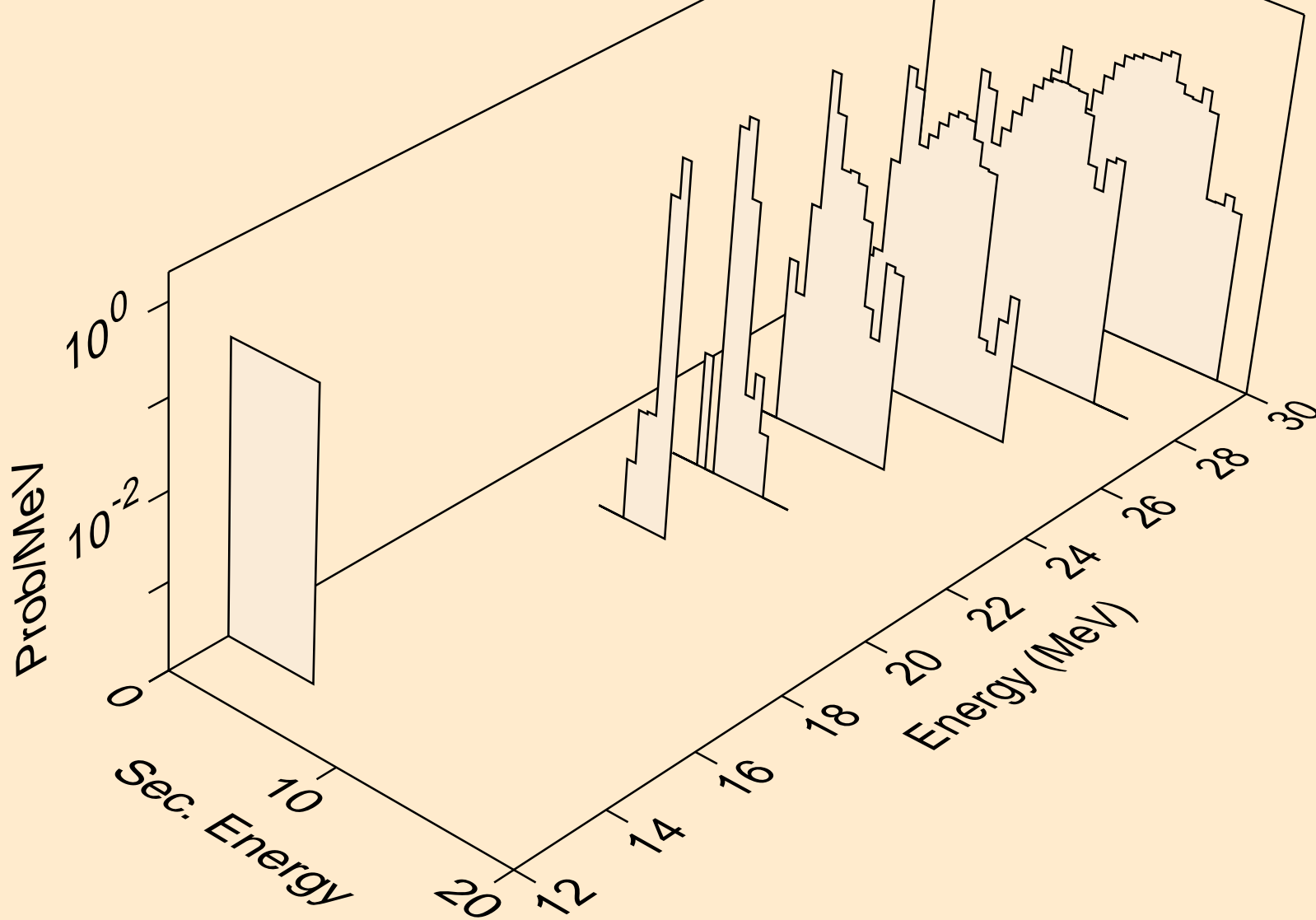

HG182 NEUTRON ACER TENDL-2019 LIBRARY; T=293.16K  
alphas from (n,n\*)2a

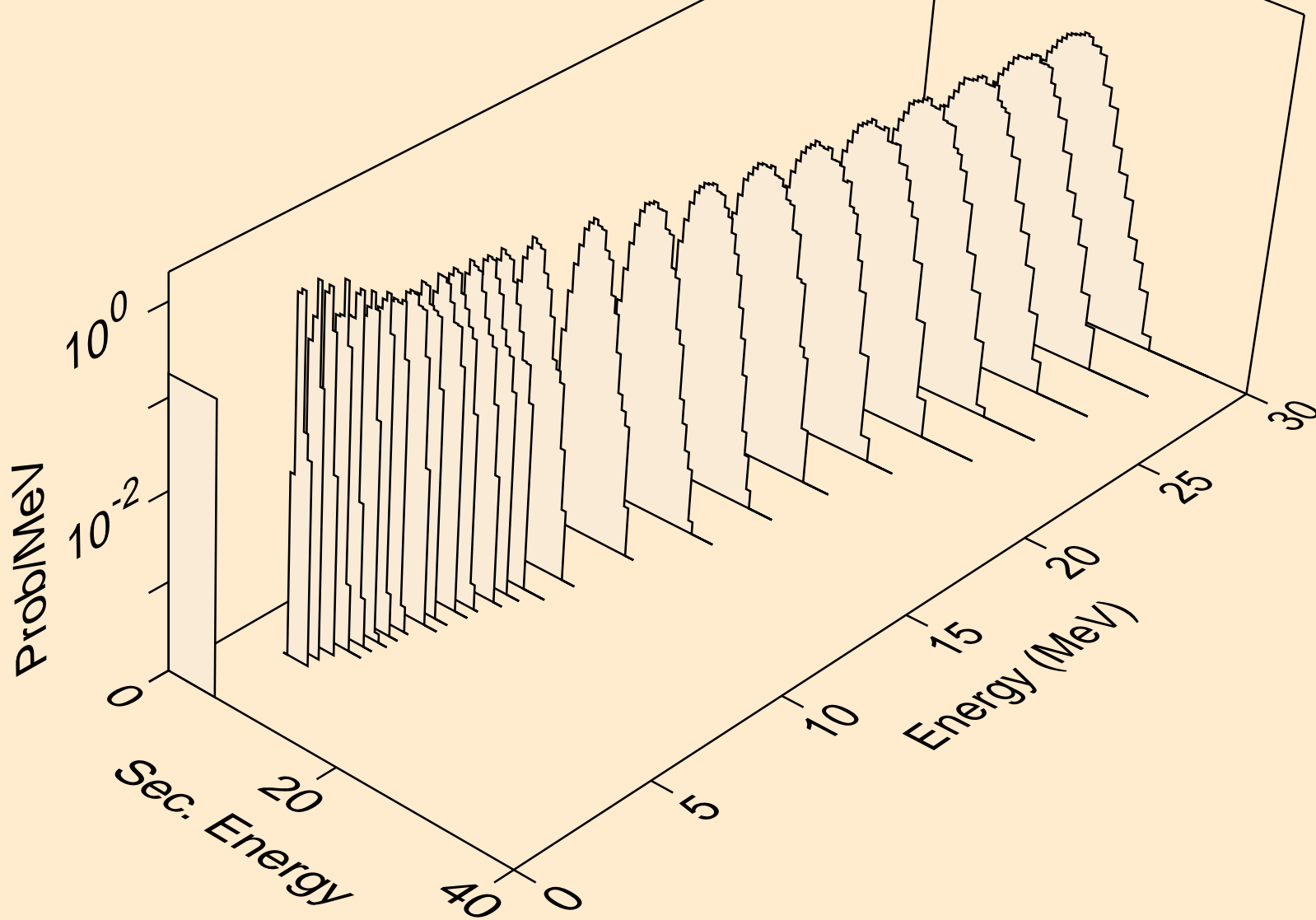

HG182 NEUTRON ACER TENDL-2019 LIBRARY; T=293.16K  
alphas from (n,2n)2a

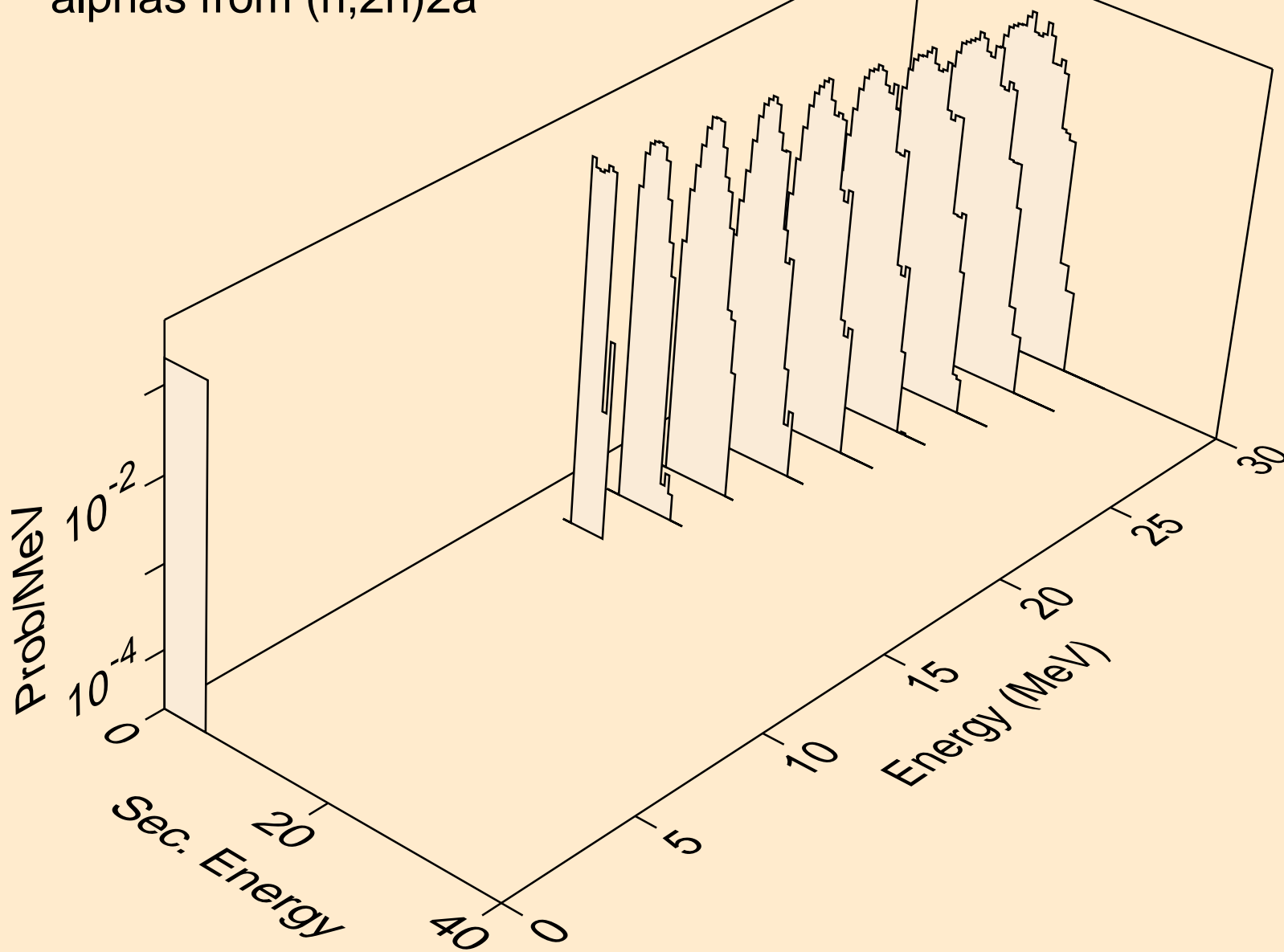

HG182 NEUTRON ACER TENDL-2019 LIBRARY; T=293.16K  
alphas from (n,npa)

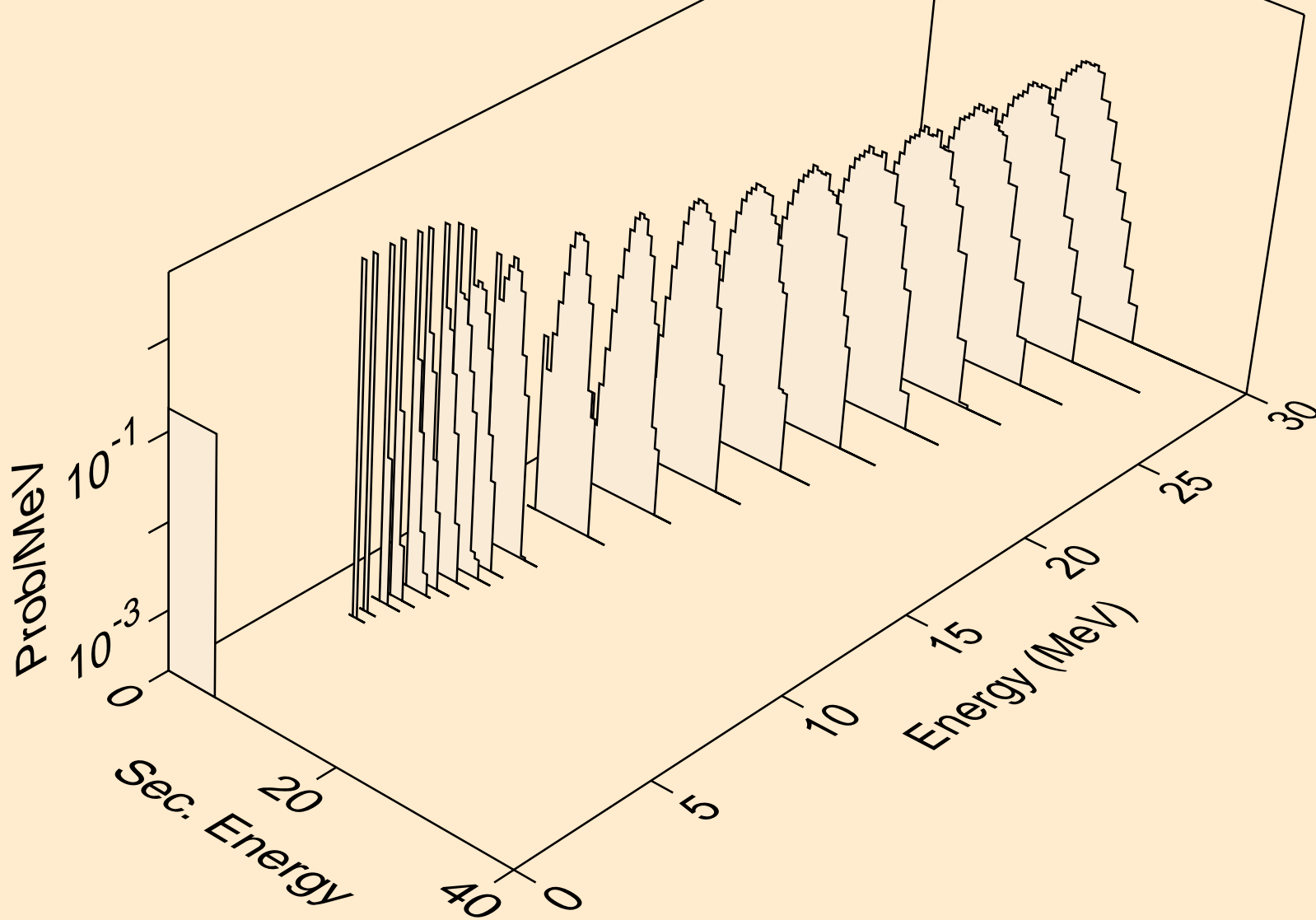

HG182 NEUTRON ACER TENDL-2019 LIBRARY; T=293.16K  
alphas from (n,a)

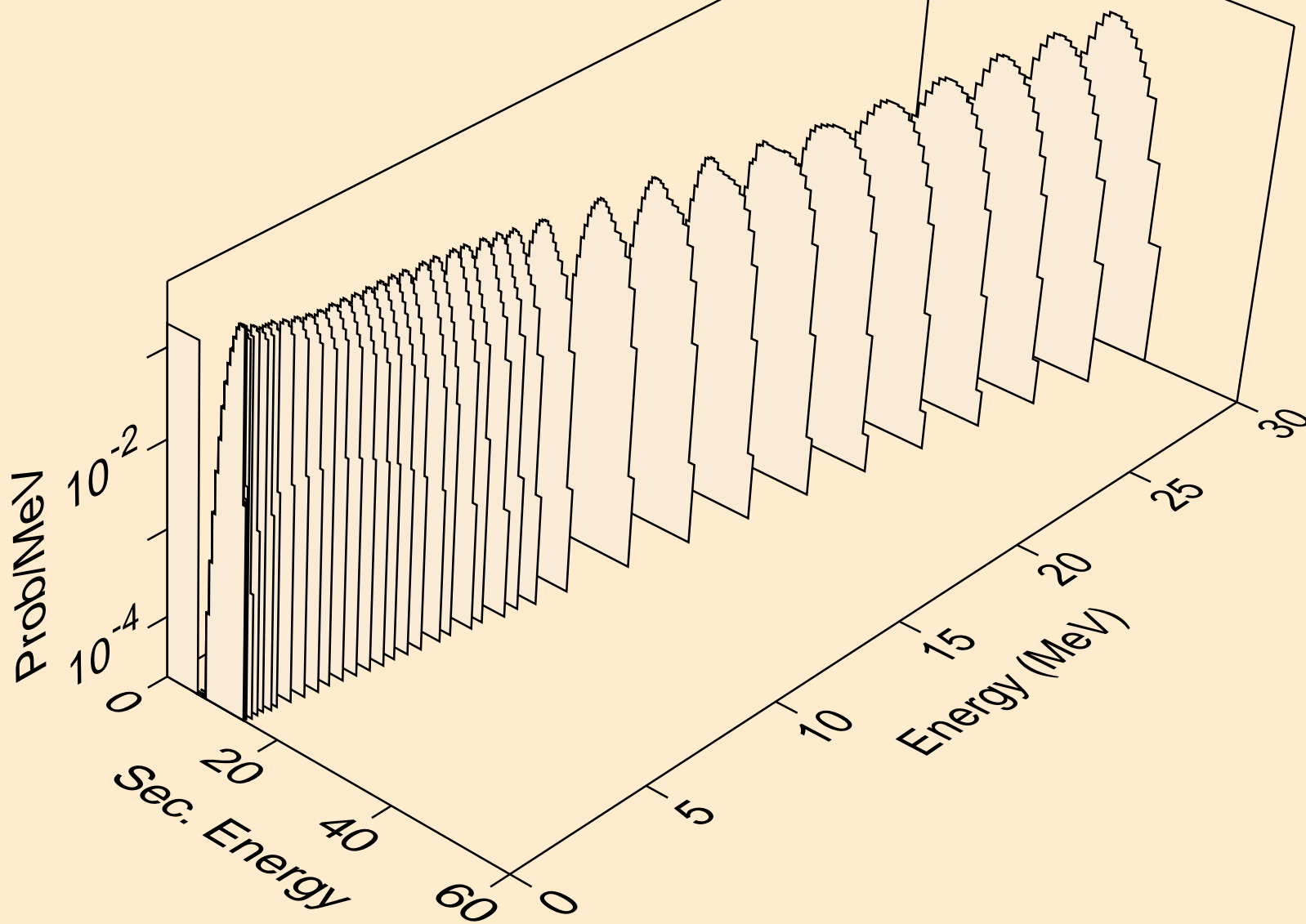

HG182 NEUTRON ACER TENDL-2019 LIBRARY; T=293.16K  
alphas from (n,2a)

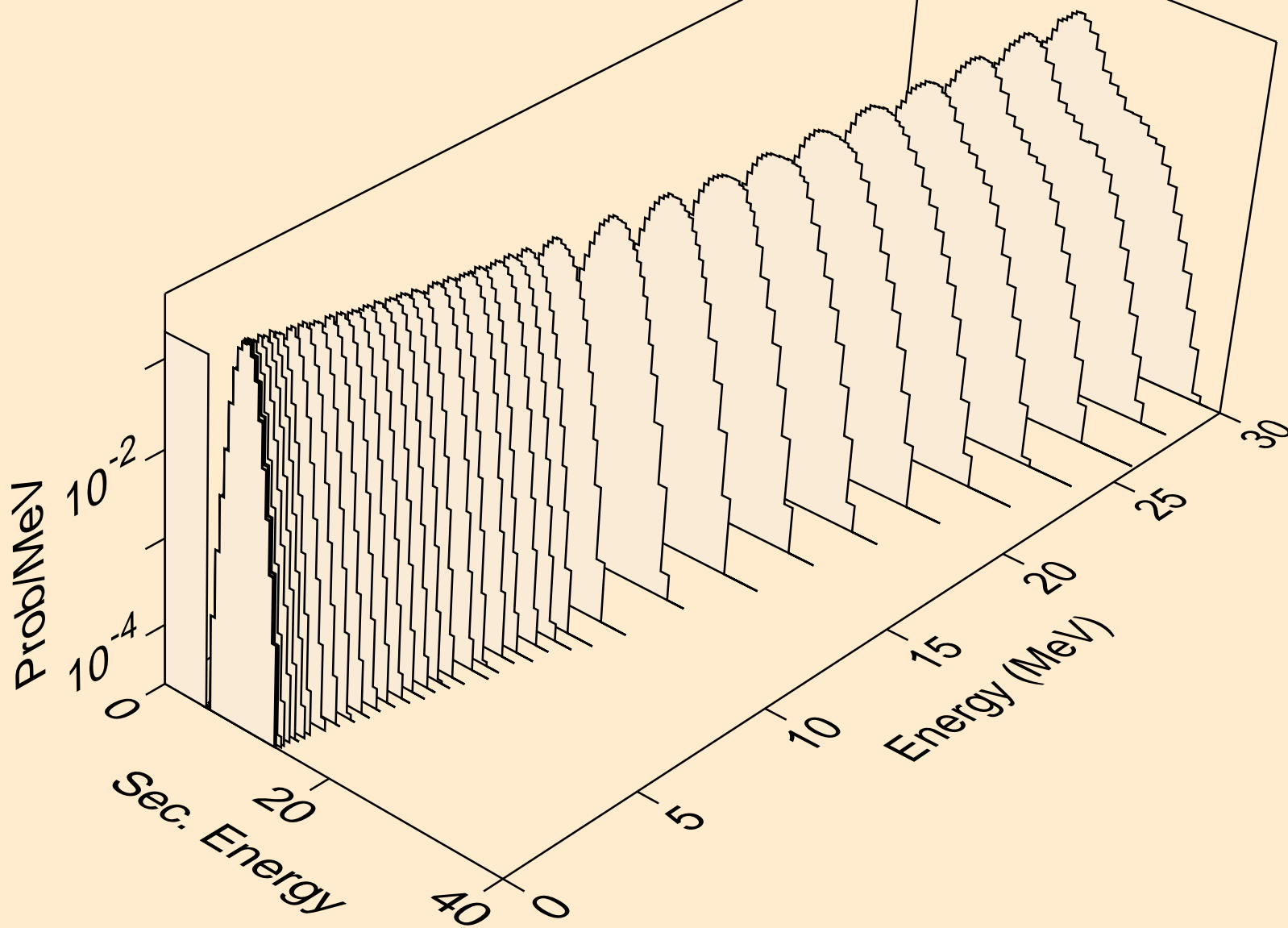

HG182 NEUTRON ACER TENDL-2019 LIBRARY; T=293.16K  
alphas from (n,3a)

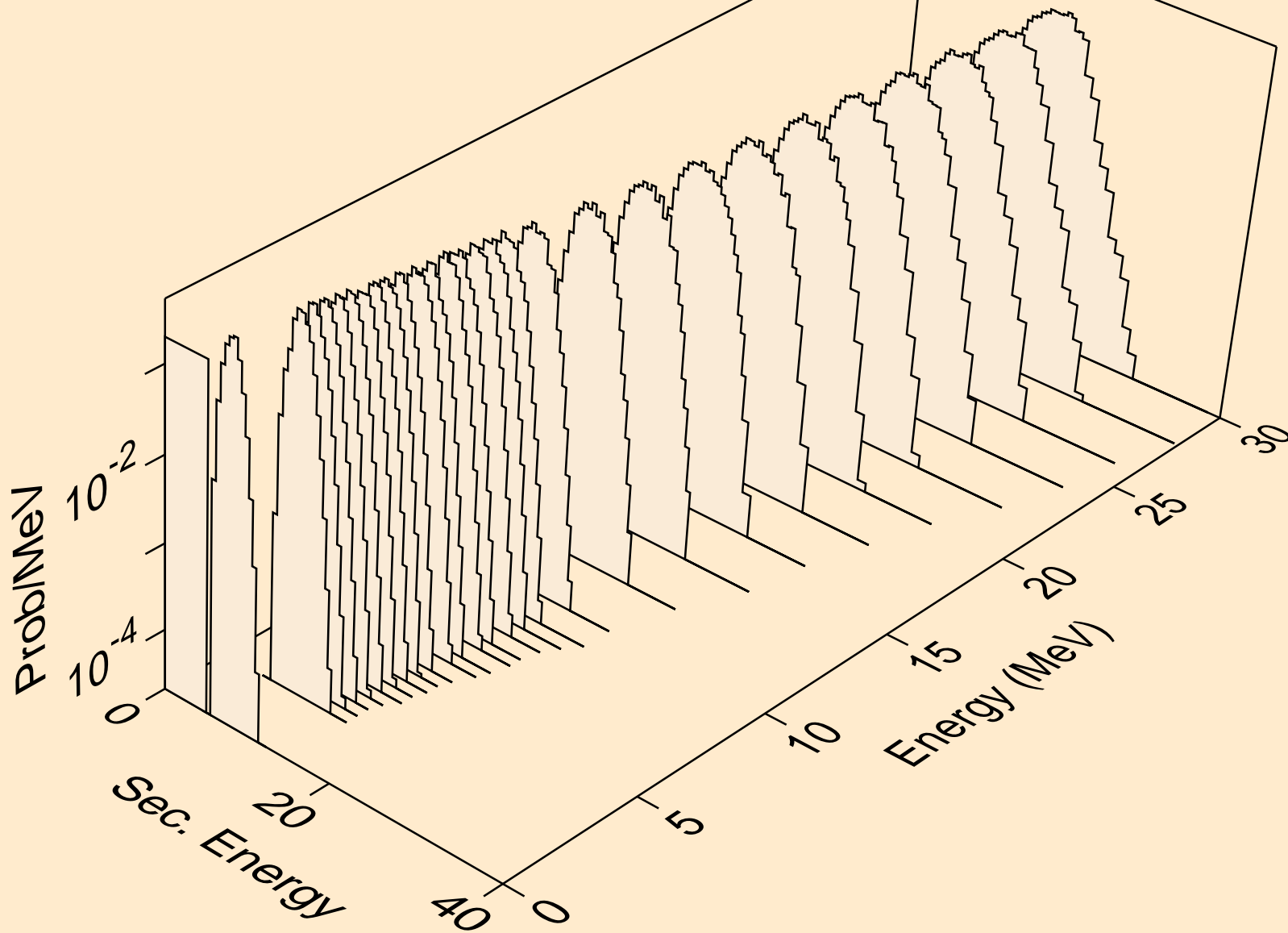

HG182 NEUTRON ACER TENDL-2019 LIBRARY; T=293.16K  
alphas from (n,p)

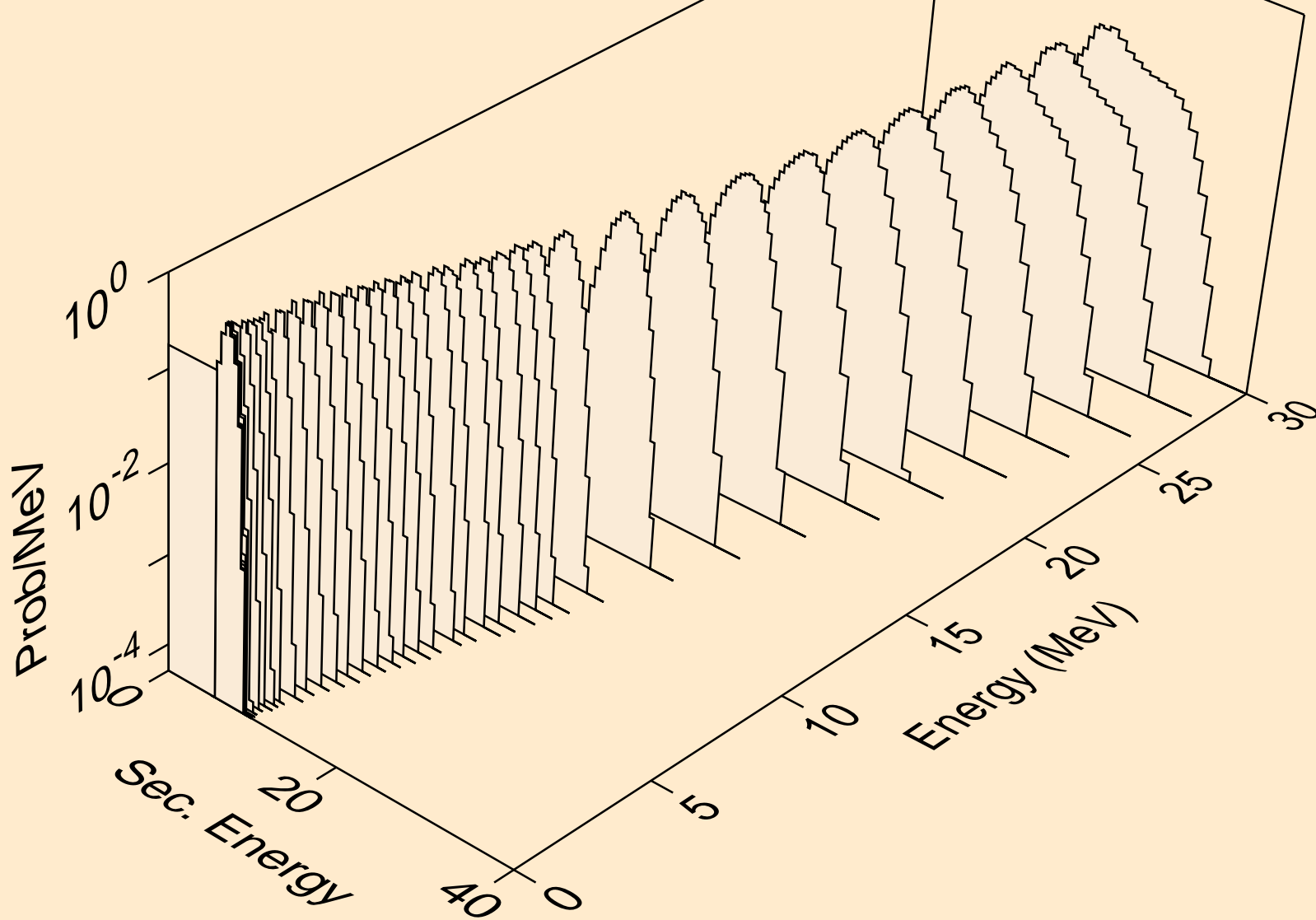

HG182 NEUTRON ACER TENDL-2019 LIBRARY; T=293.16K  
alphas from (n,d2a)

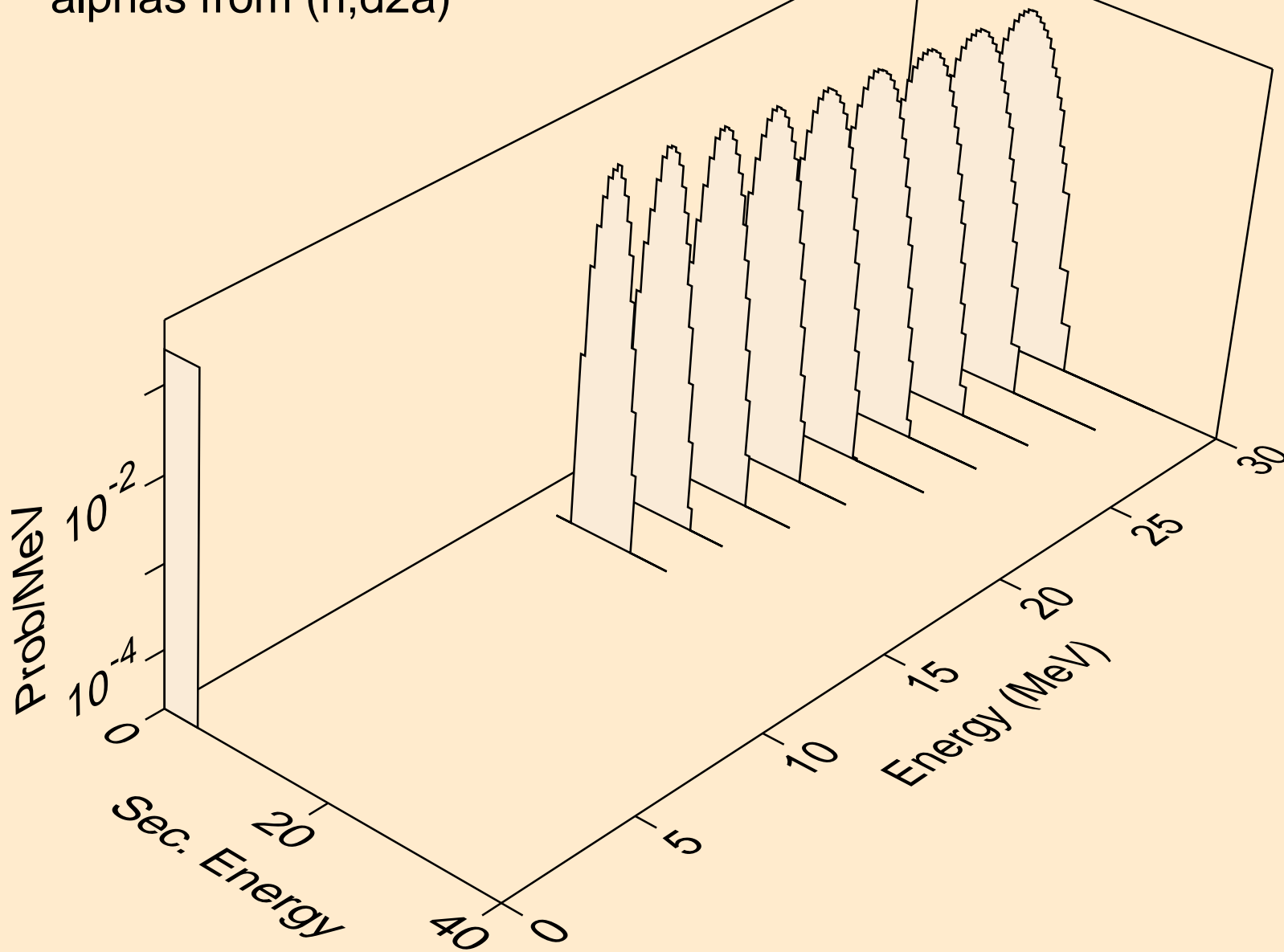

HG182 NEUTRON ACER TENDL-2019 LIBRARY; T=293.16K  
alphas from (n,da)

