

KR077 NEUTRON ACER TENDL-2019 LIBRARY; T=293.16K  
Principal cross sections

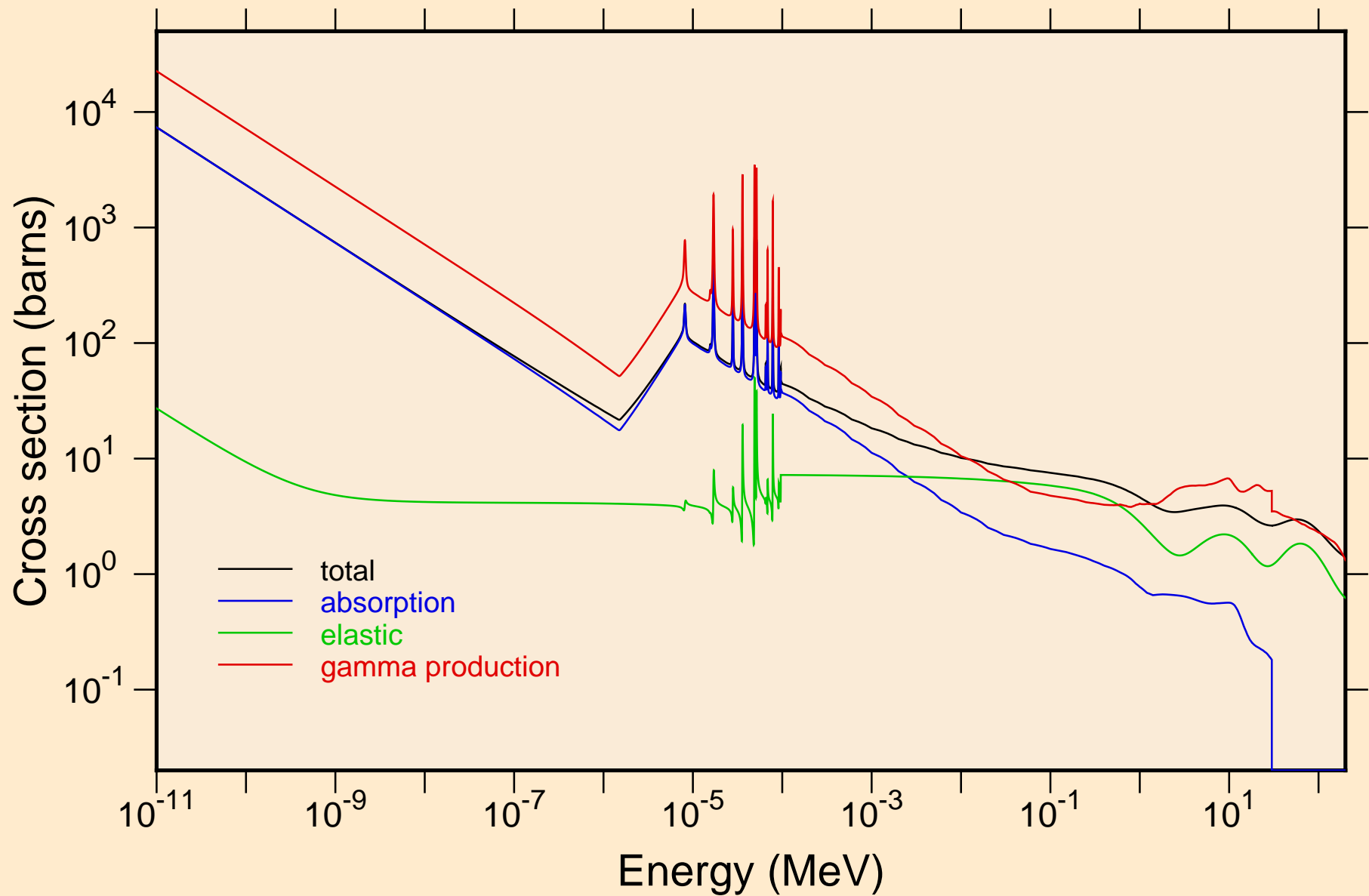

KR077 NEUTRON ACER TENDL-2019 LIBRARY; T=293.16K  
resonance total cross section

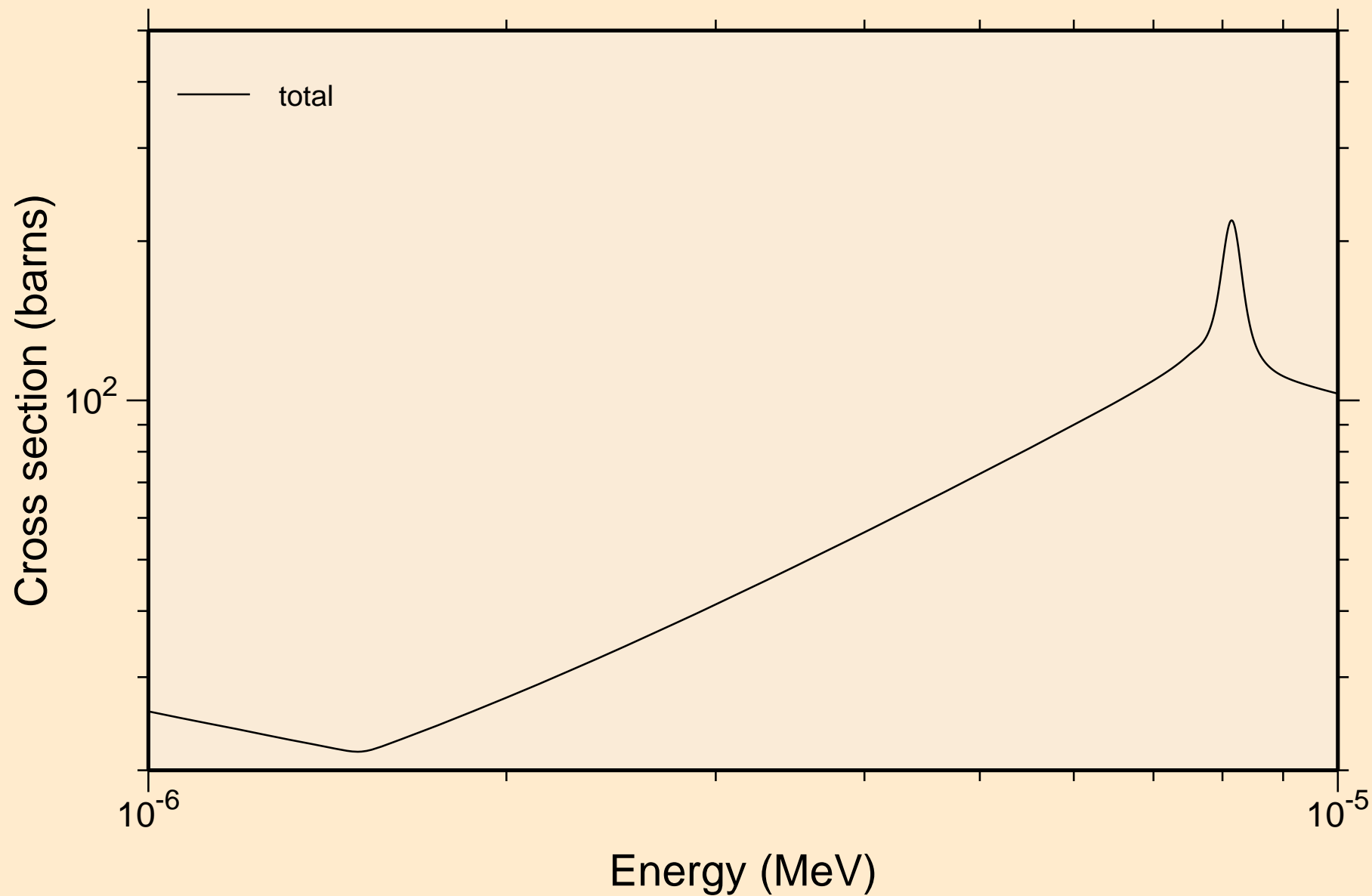

KR077 NEUTRON ACER TENDL-2019 LIBRARY; T=293.16K  
resonance total cross section

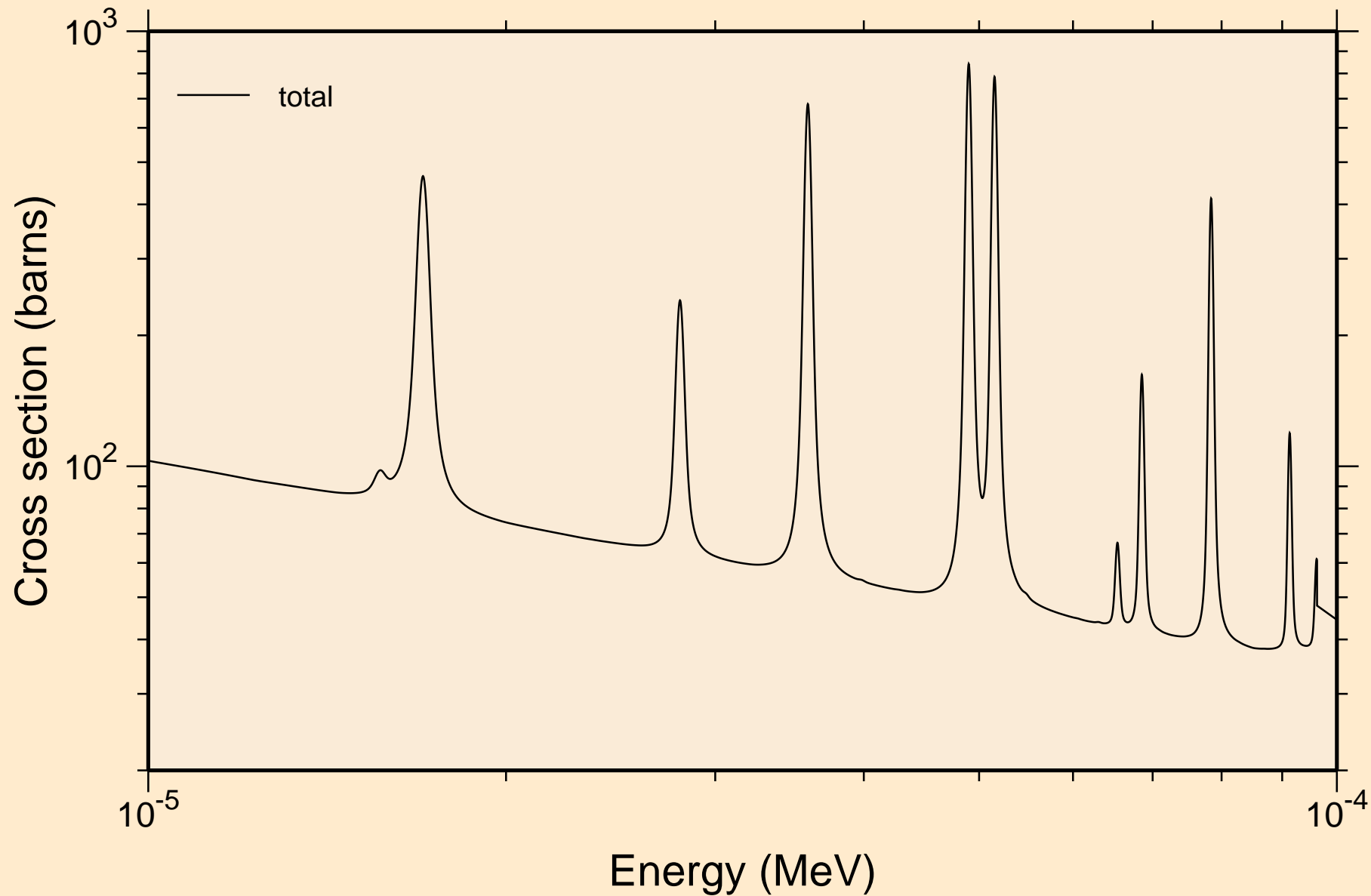

KR077 NEUTRON ACER TENDL-2019 LIBRARY; T=293.16K  
resonance total cross section

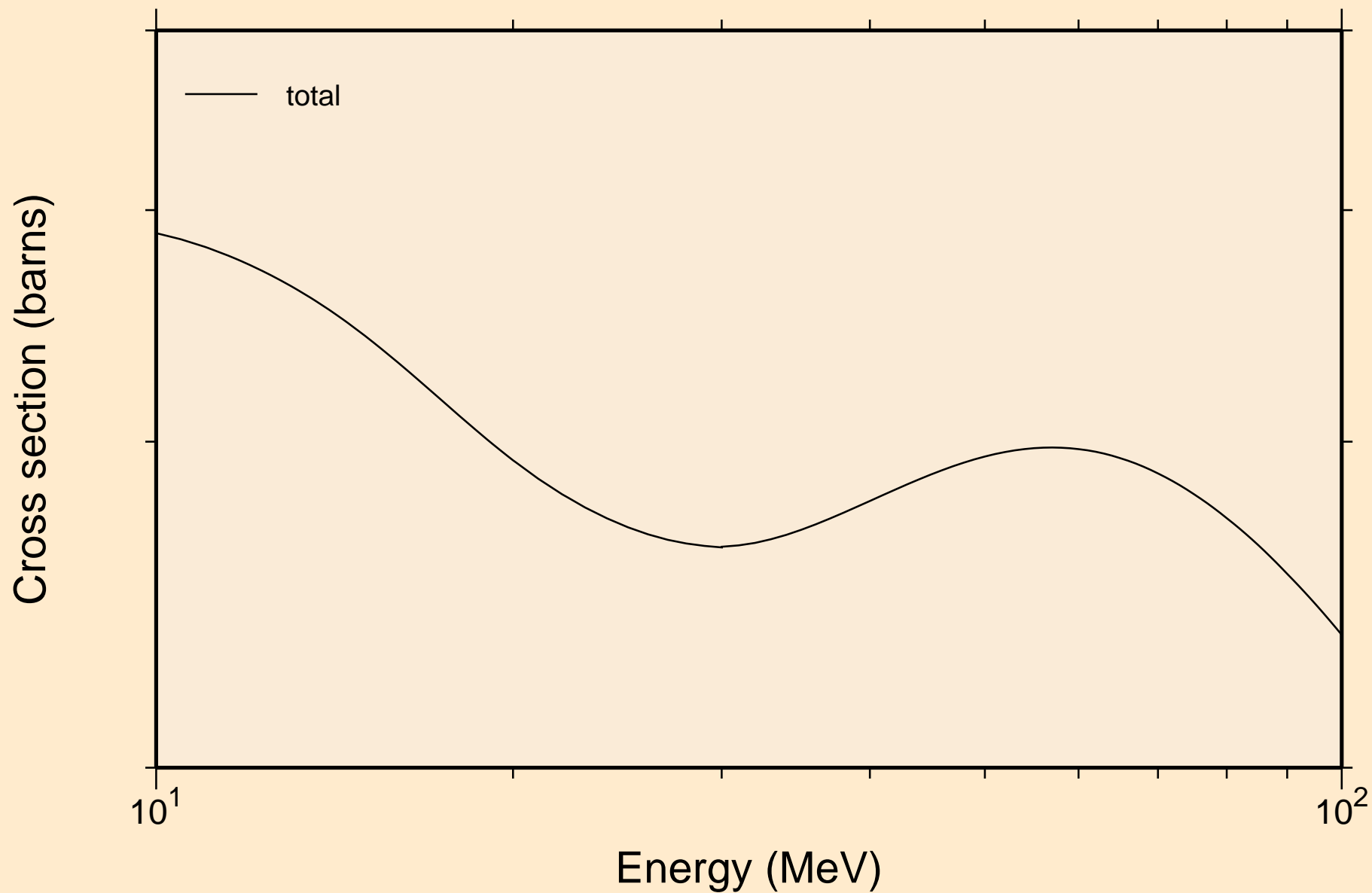

KR077 NEUTRON ACER TENDL-2019 LIBRARY; T=293.16K  
resonance absorption cross sections

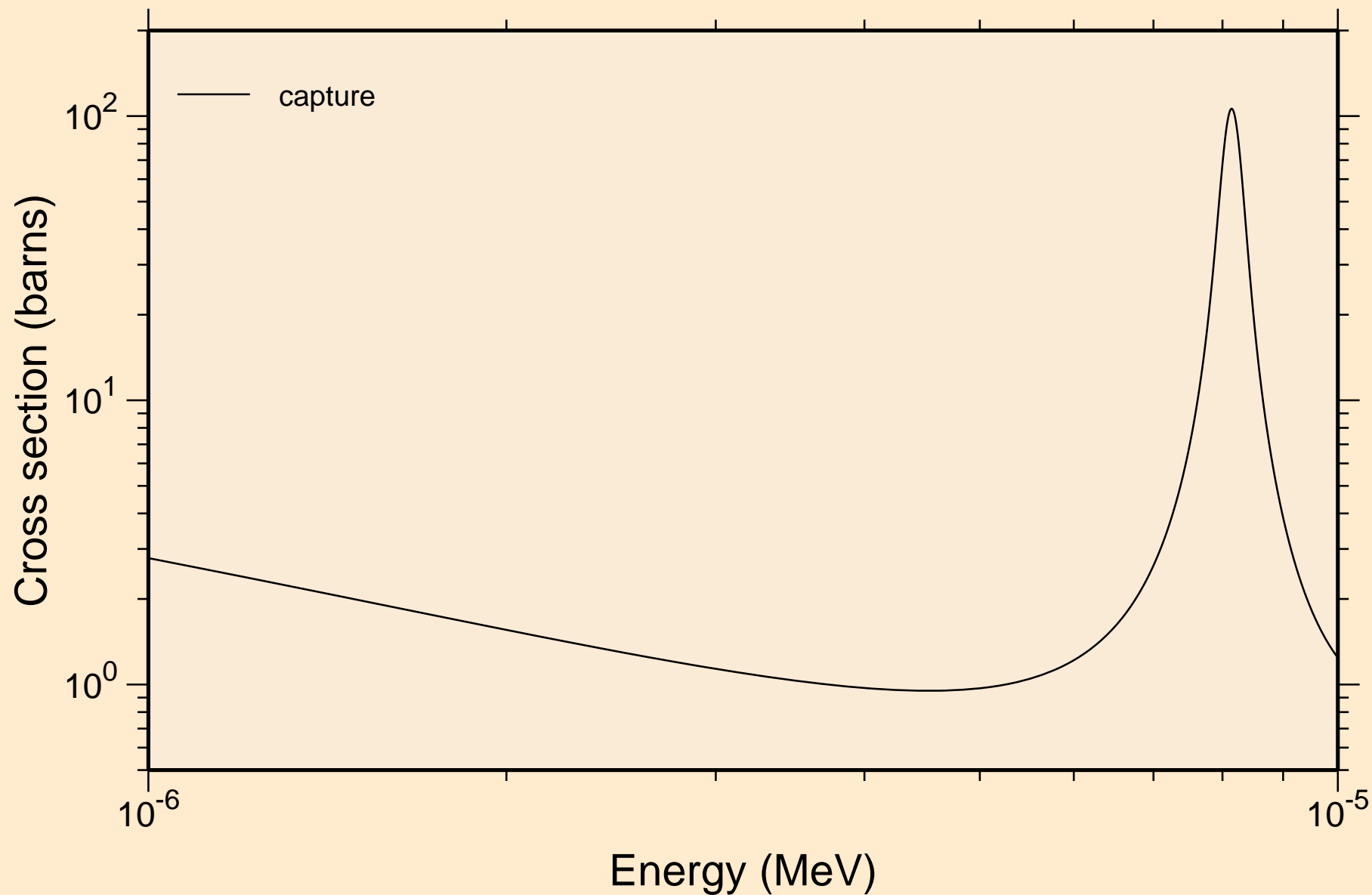

KR077 NEUTRON ACER TENDL-2019 LIBRARY; T=293.16K  
resonance absorption cross sections

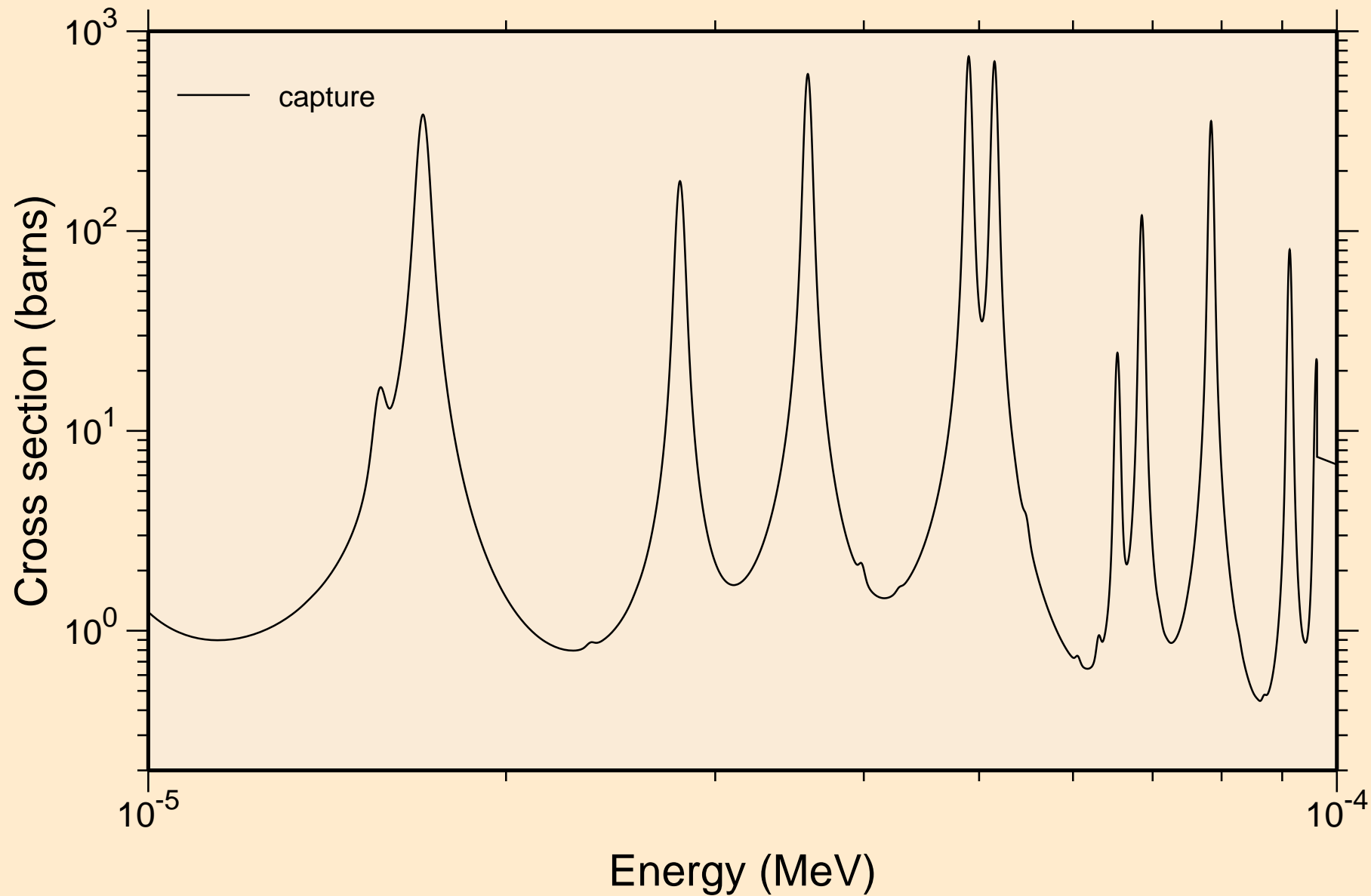

KR077 NEUTRON ACER TENDL-2019 LIBRARY; T=293.16K  
resonance absorption cross sections

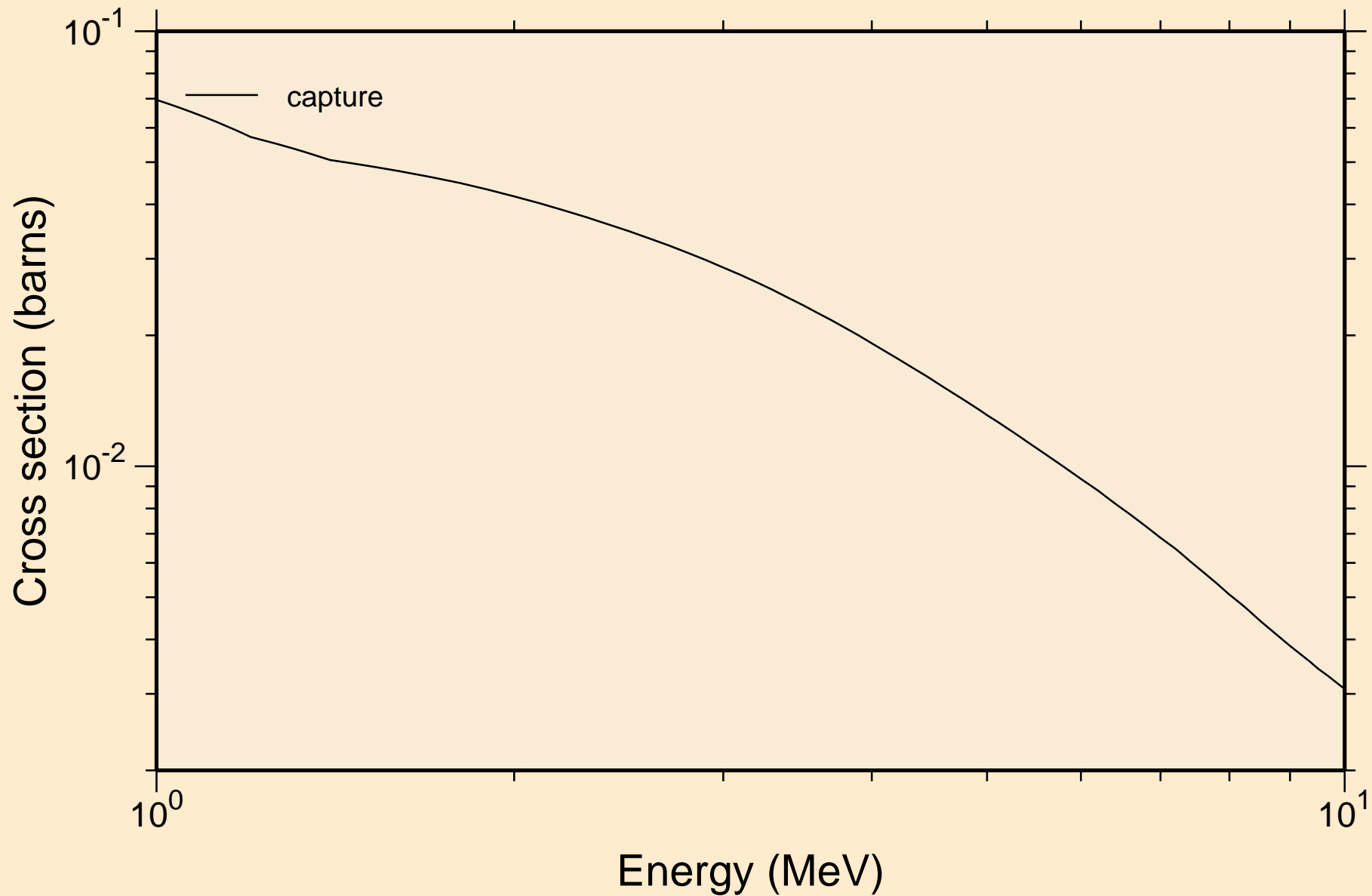

KR077 NEUTRON ACER TENDL-2019 LIBRARY; T=293.16K  
Heating

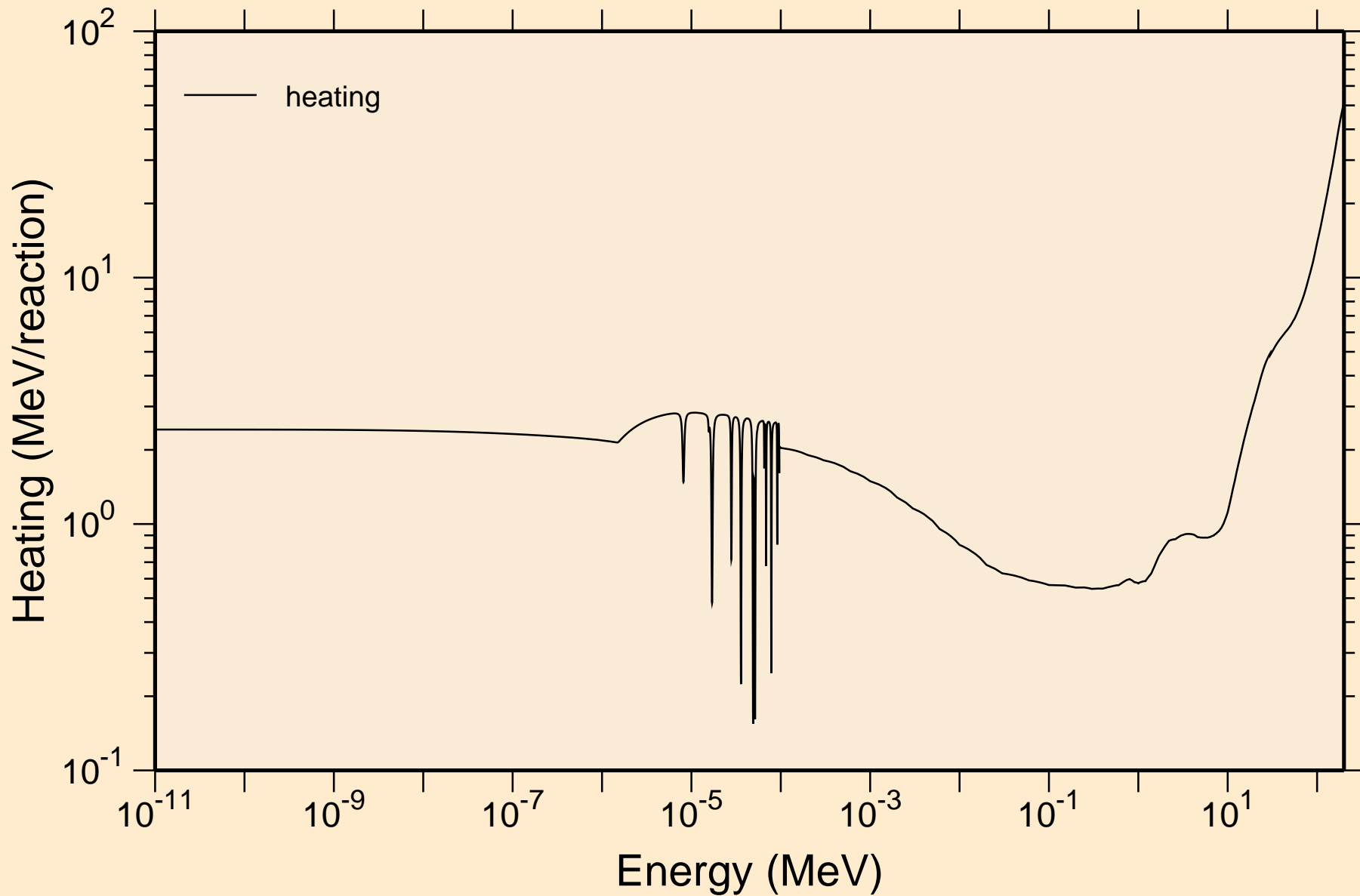

KR077 NEUTRON ACER TENDL-2019 LIBRARY; T=293.16K  
Damage

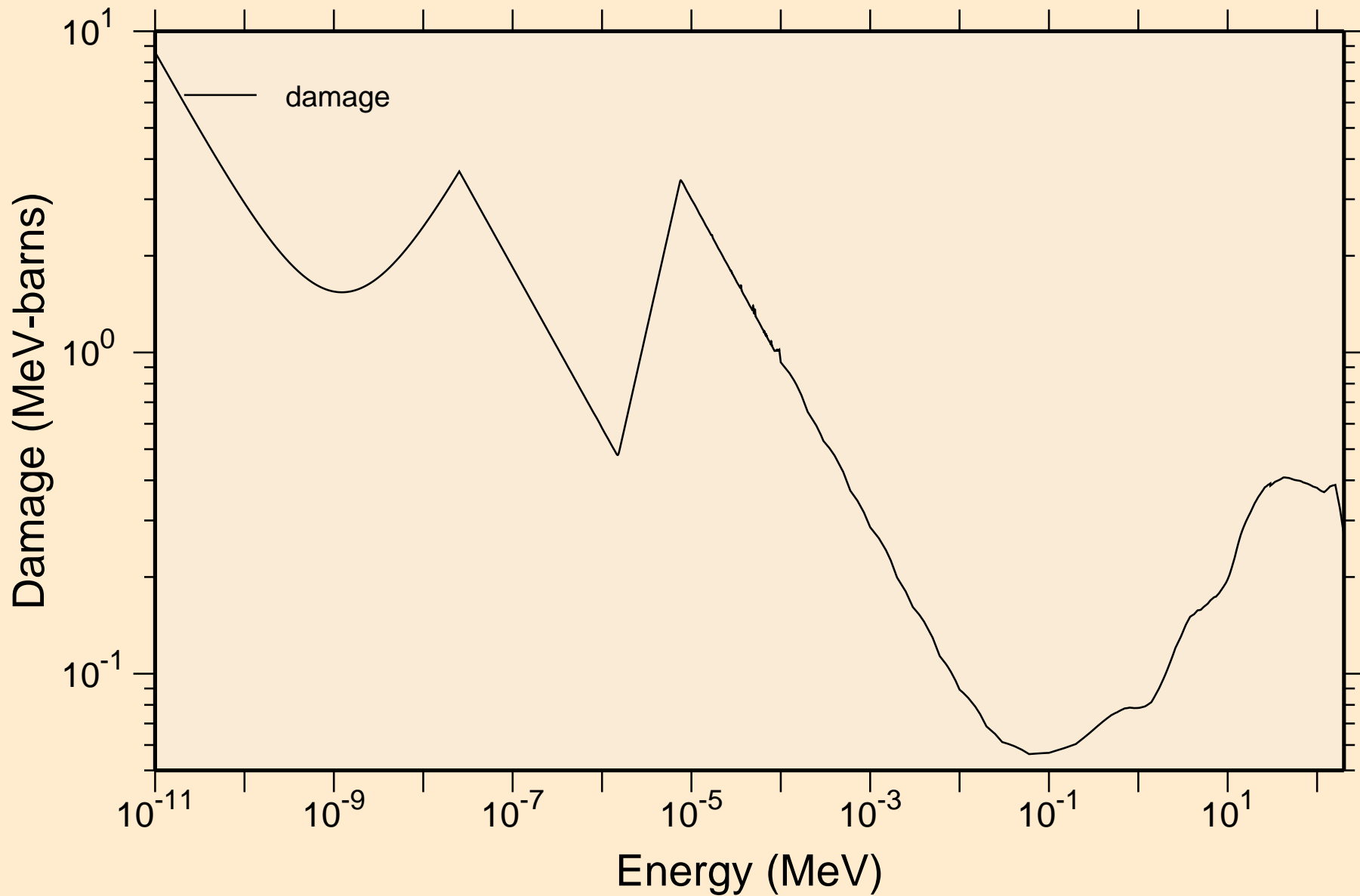

KR077 NEUTRON ACER TENDL-2019 LIBRARY; T=293.16K  
Non-threshold reactions

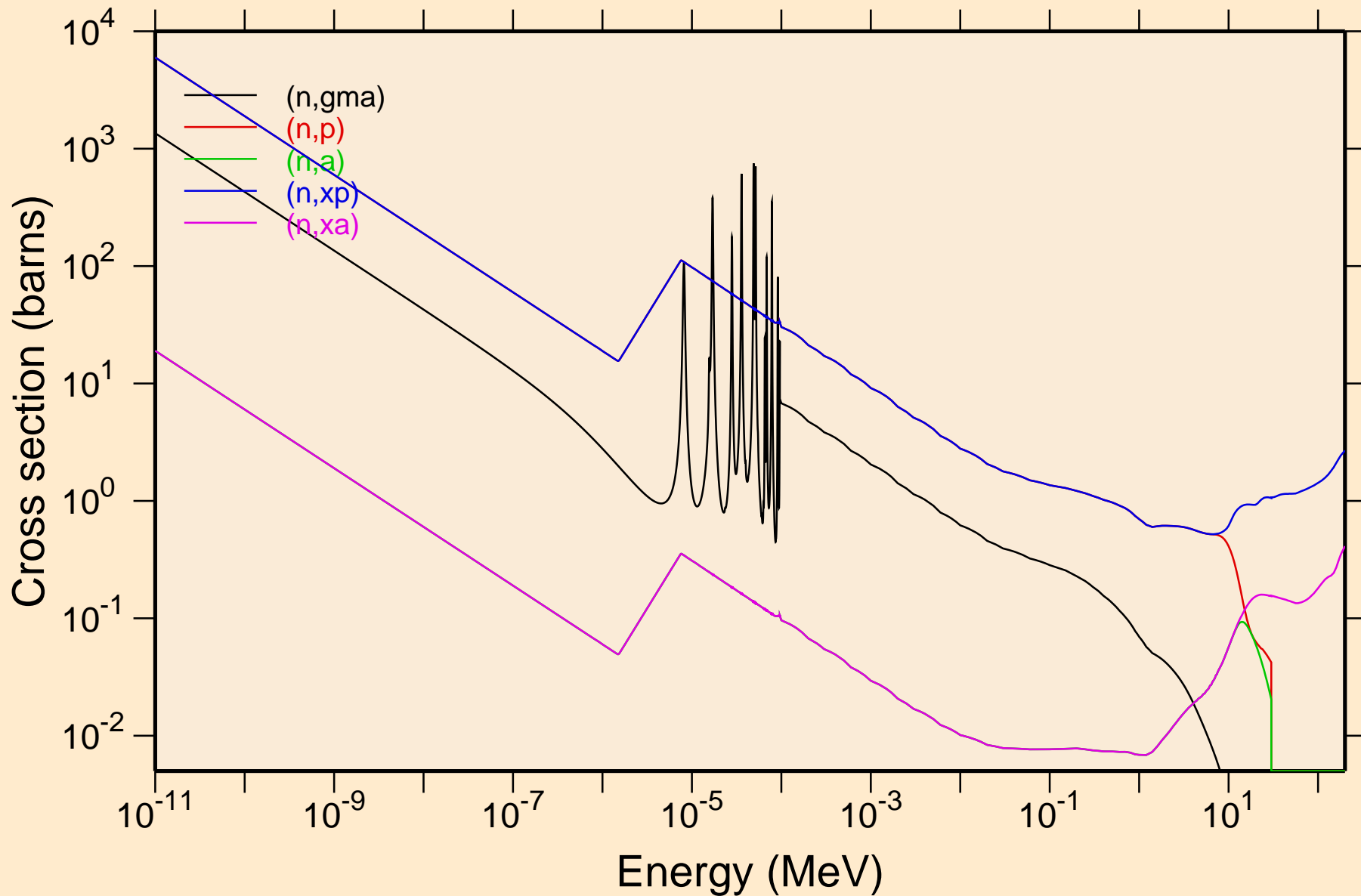

KR077 NEUTRON ACER TENDL-2019 LIBRARY; T=293.16K  
Principal cross sections

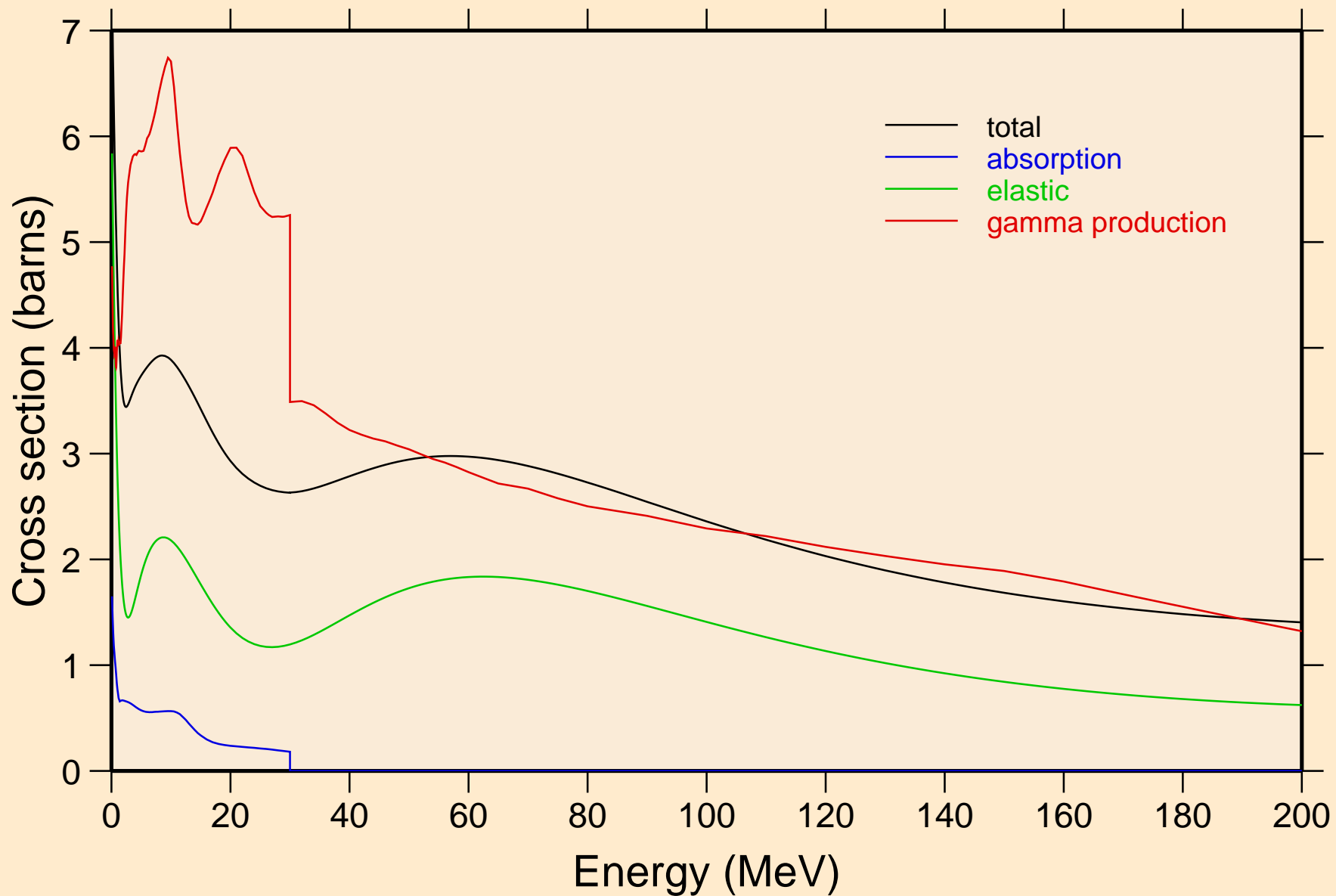

KR077 NEUTRON ACER TENDL-2019 LIBRARY; T=293.16K  
Heating

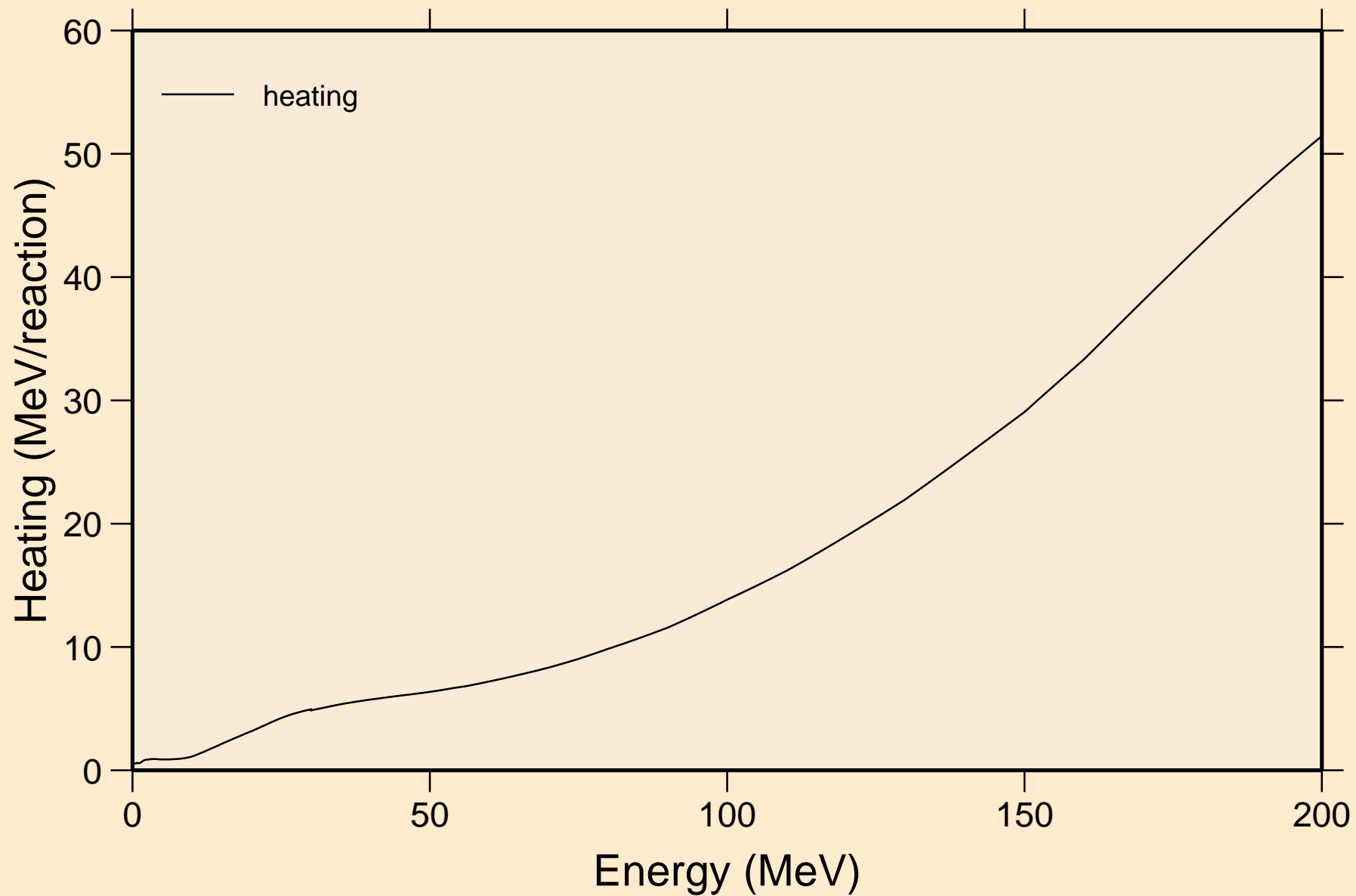

KR077 NEUTRON ACER TENDL-2019 LIBRARY; T=293.16K  
Damage

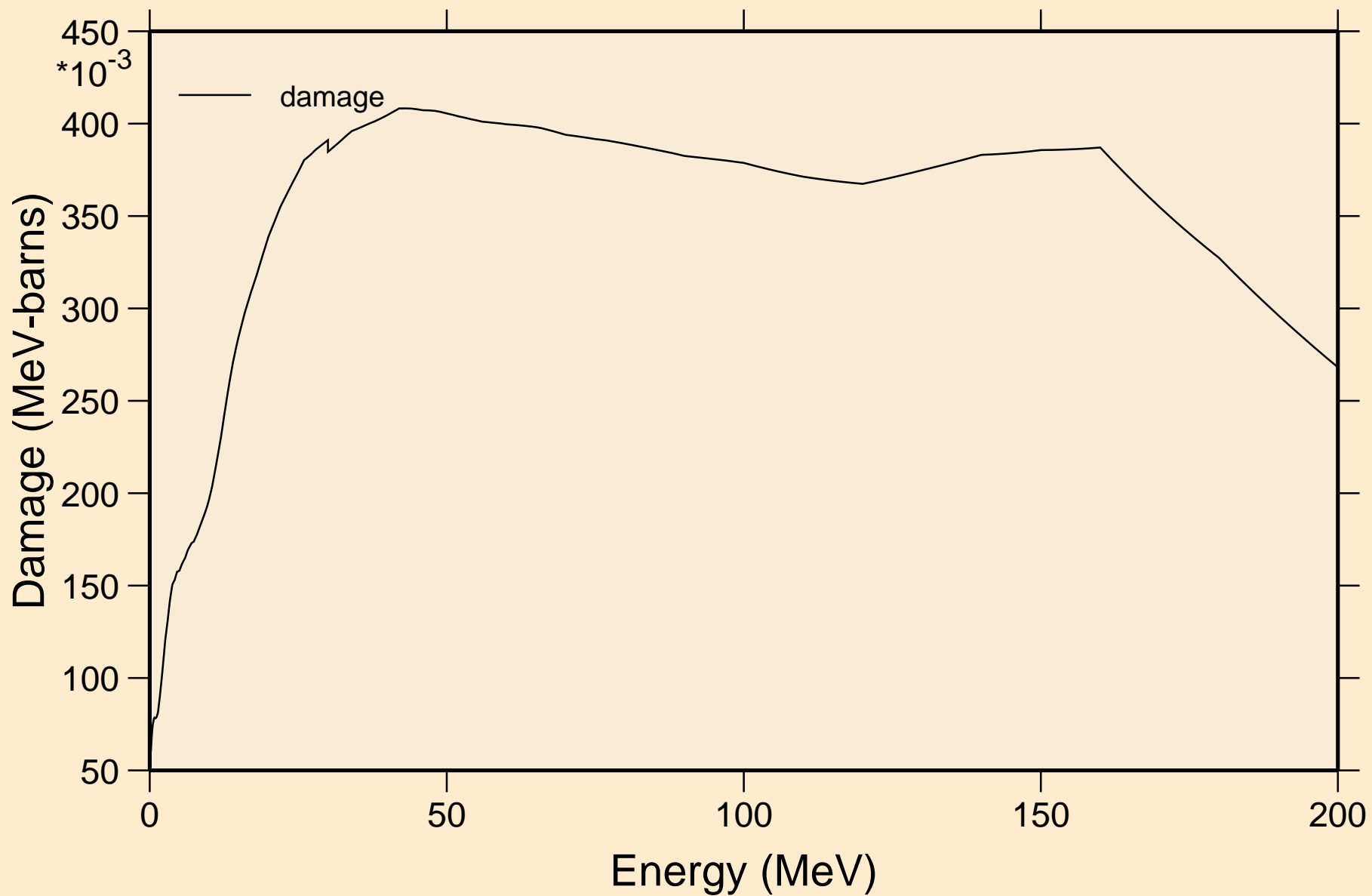

KR077 NEUTRON ACER TENDL-2019 LIBRARY; T=293.16K  
Non-threshold reactions

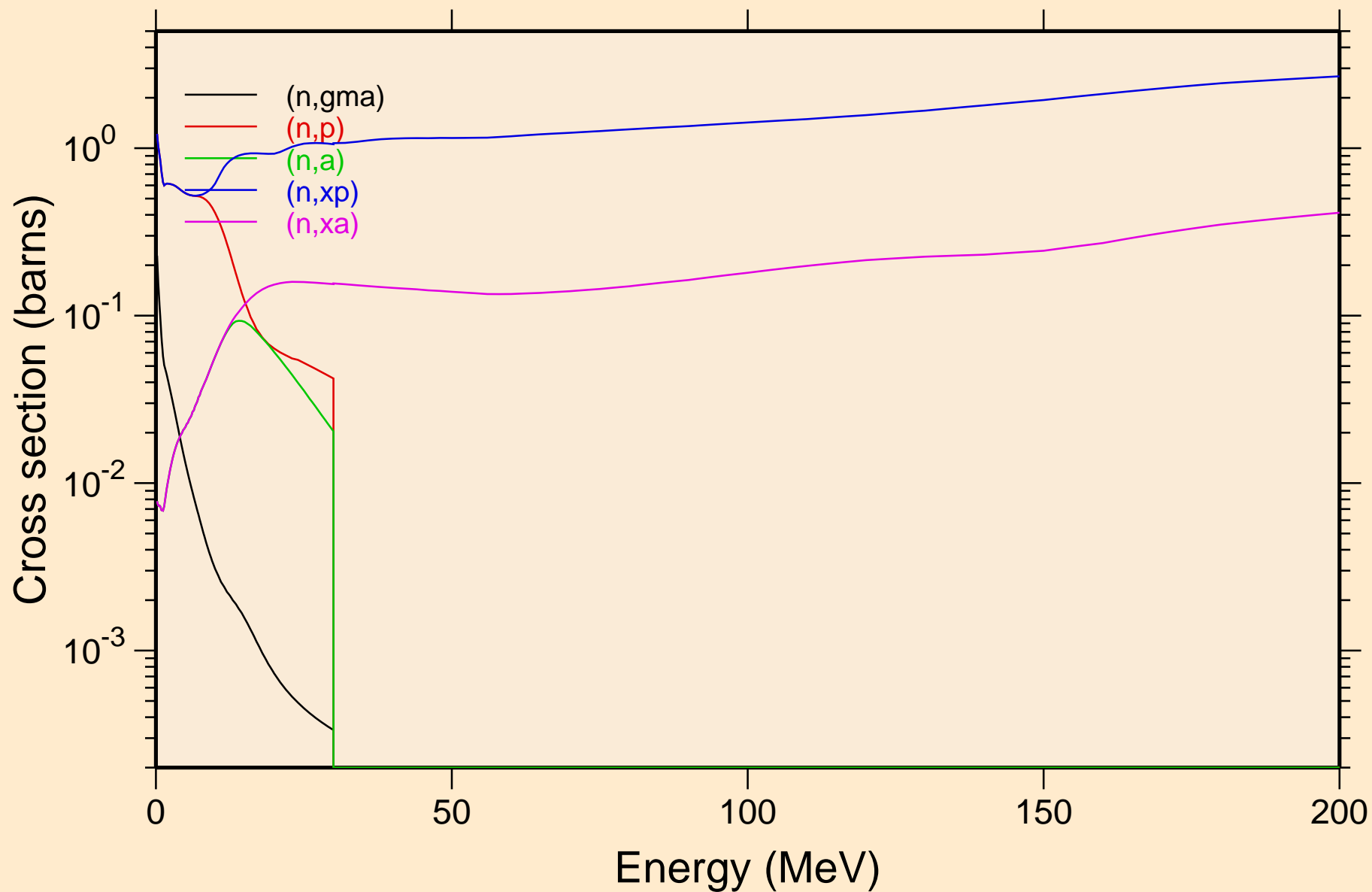

KR077 NEUTRON ACER TENDL-2019 LIBRARY; T=293.16K  
Inelastic levels

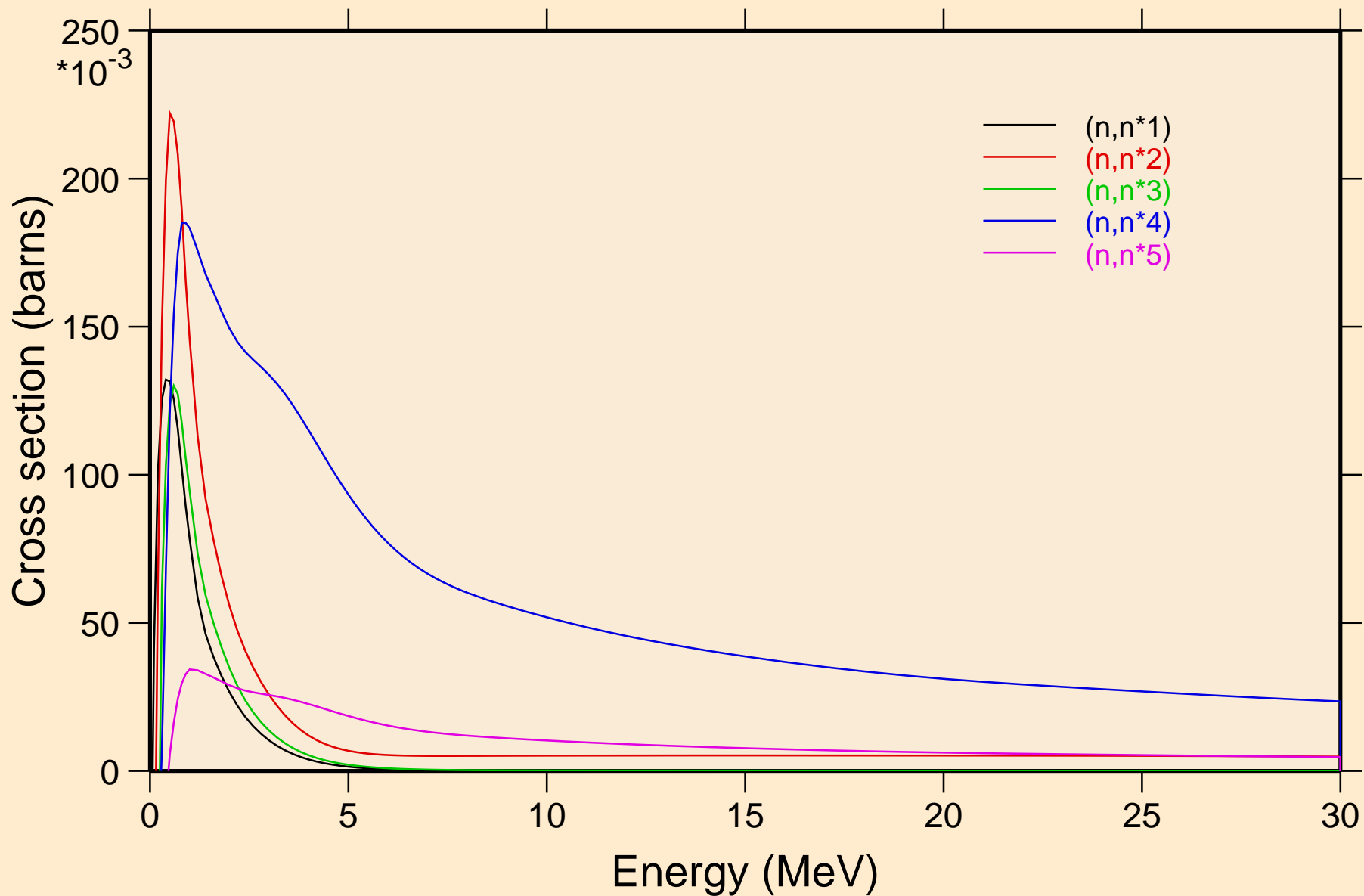

KR077 NEUTRON ACER TENDL-2019 LIBRARY; T=293.16K  
Inelastic levels

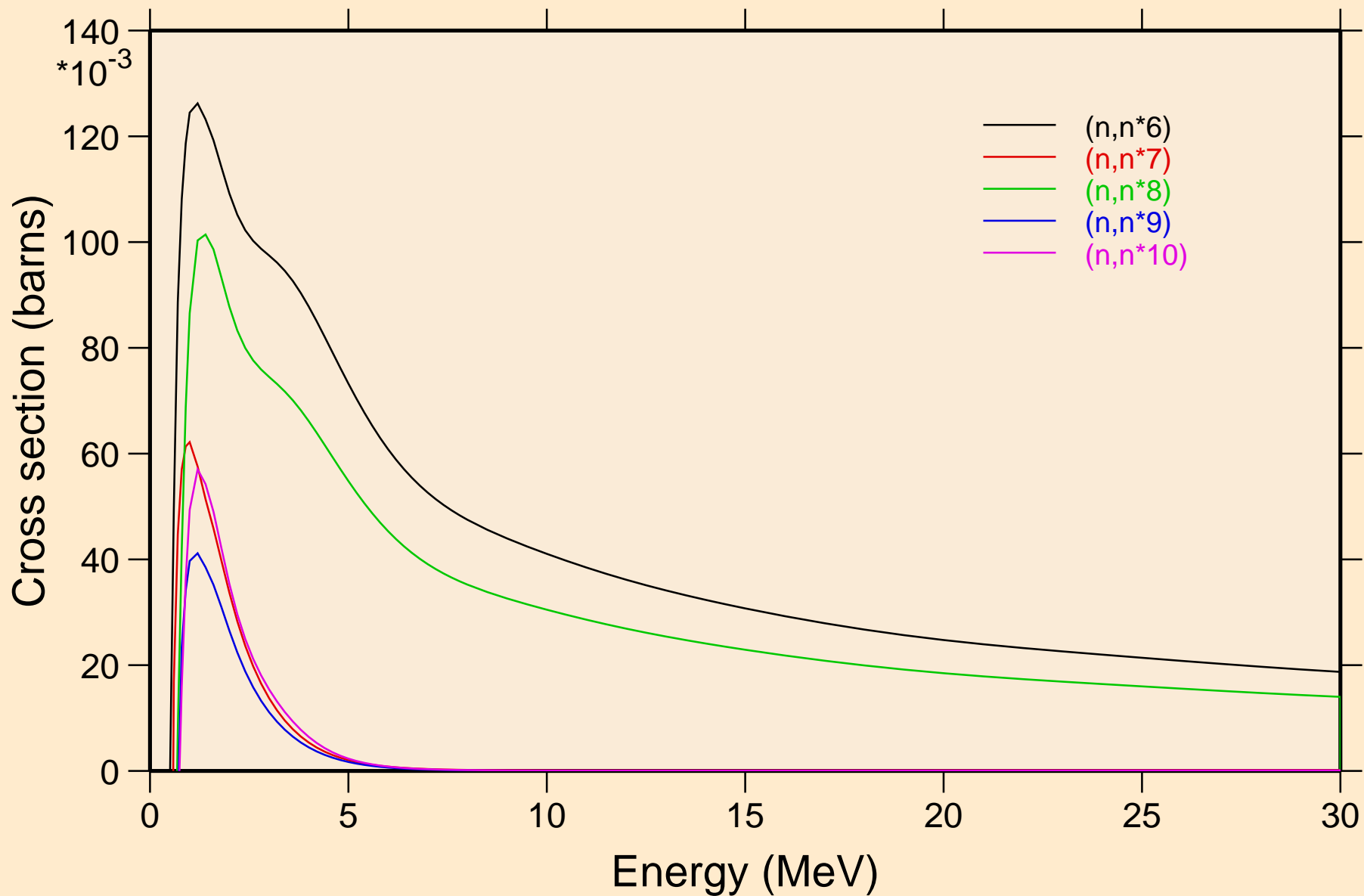

KR077 NEUTRON ACER TENDL-2019 LIBRARY; T=293.16K  
Inelastic levels

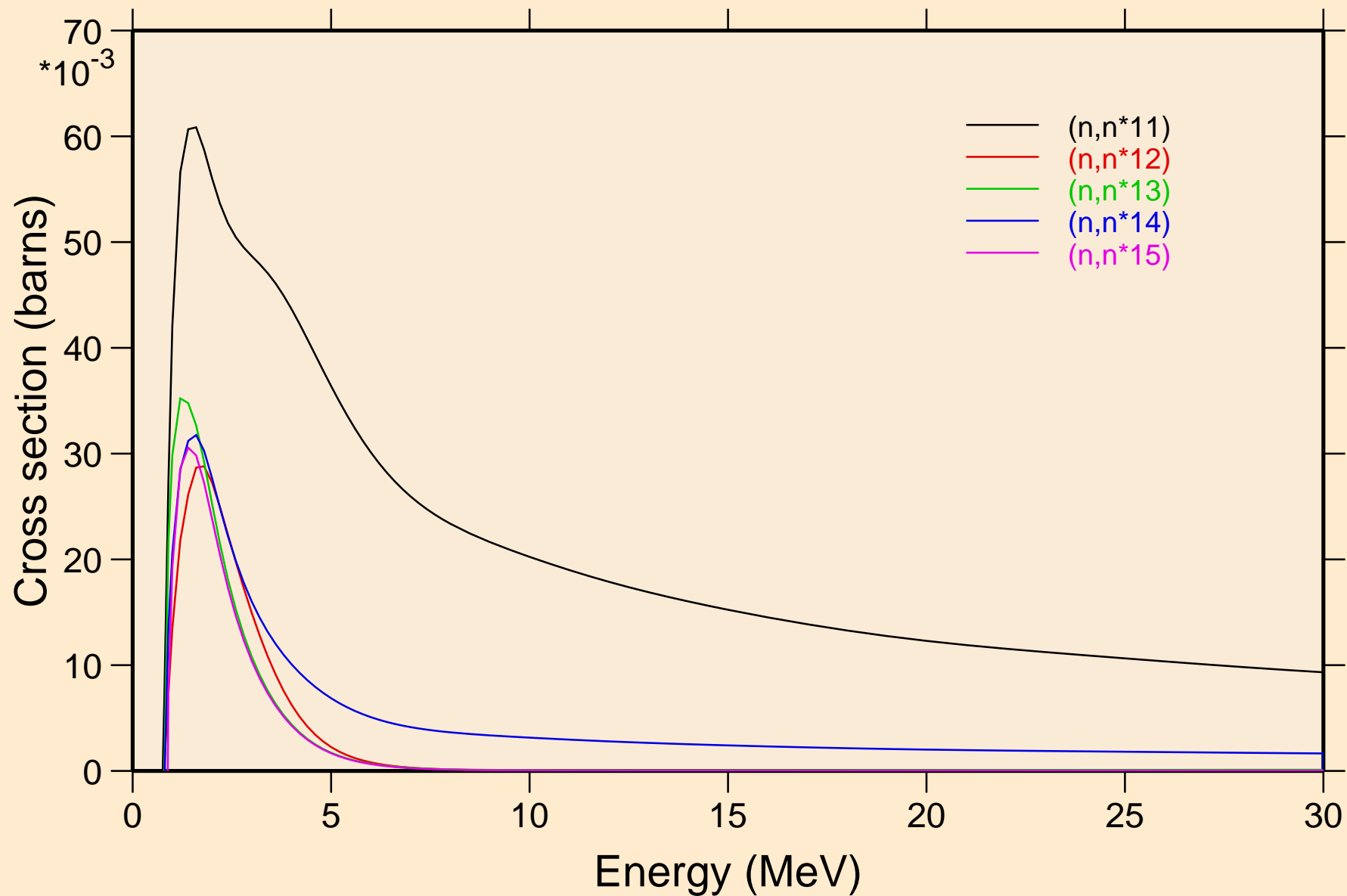

KR077 NEUTRON ACER TENDL-2019 LIBRARY; T=293.16K  
Inelastic levels

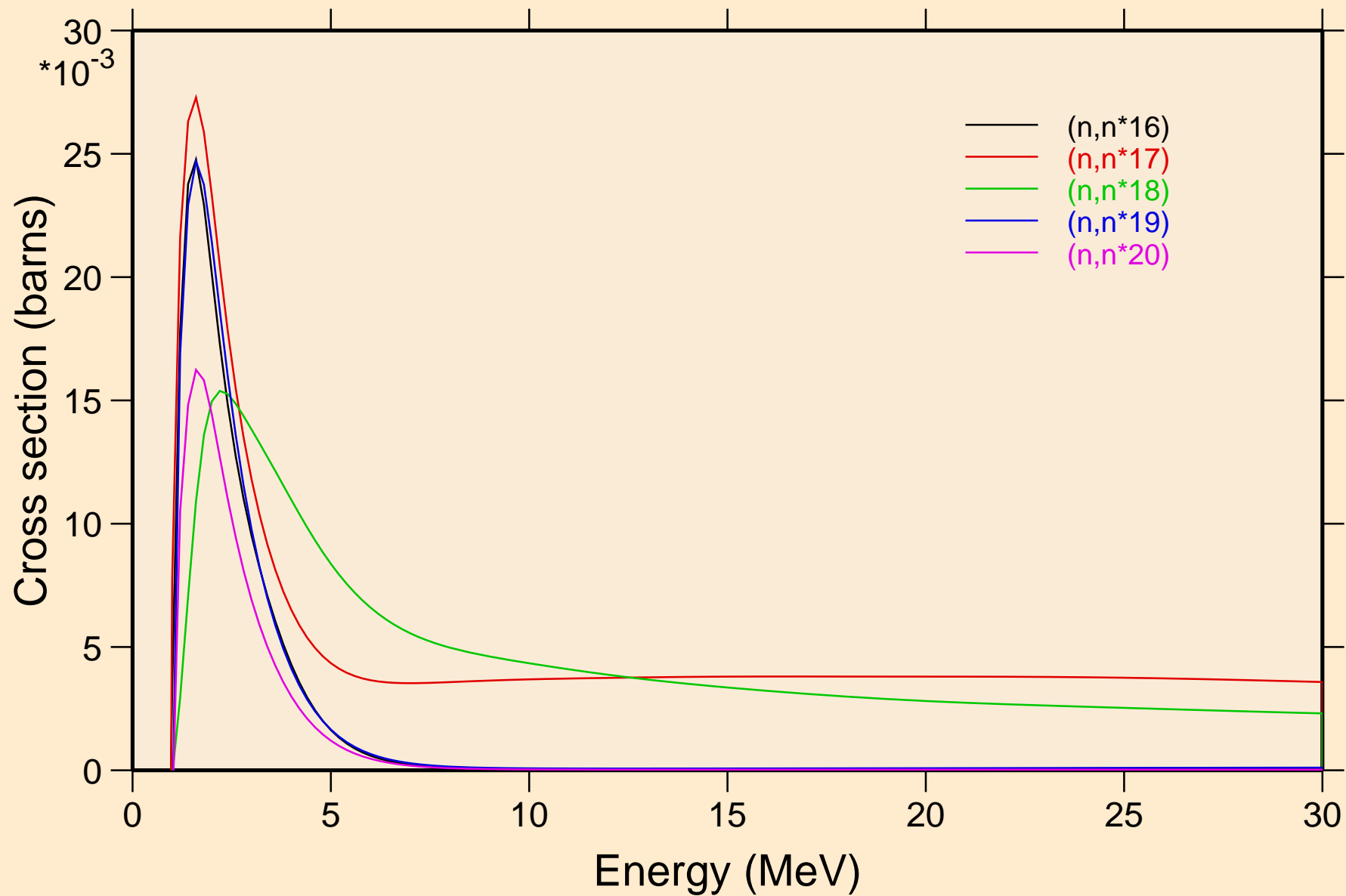

KR077 NEUTRON ACER TENDL-2019 LIBRARY; T=293.16K  
Inelastic levels

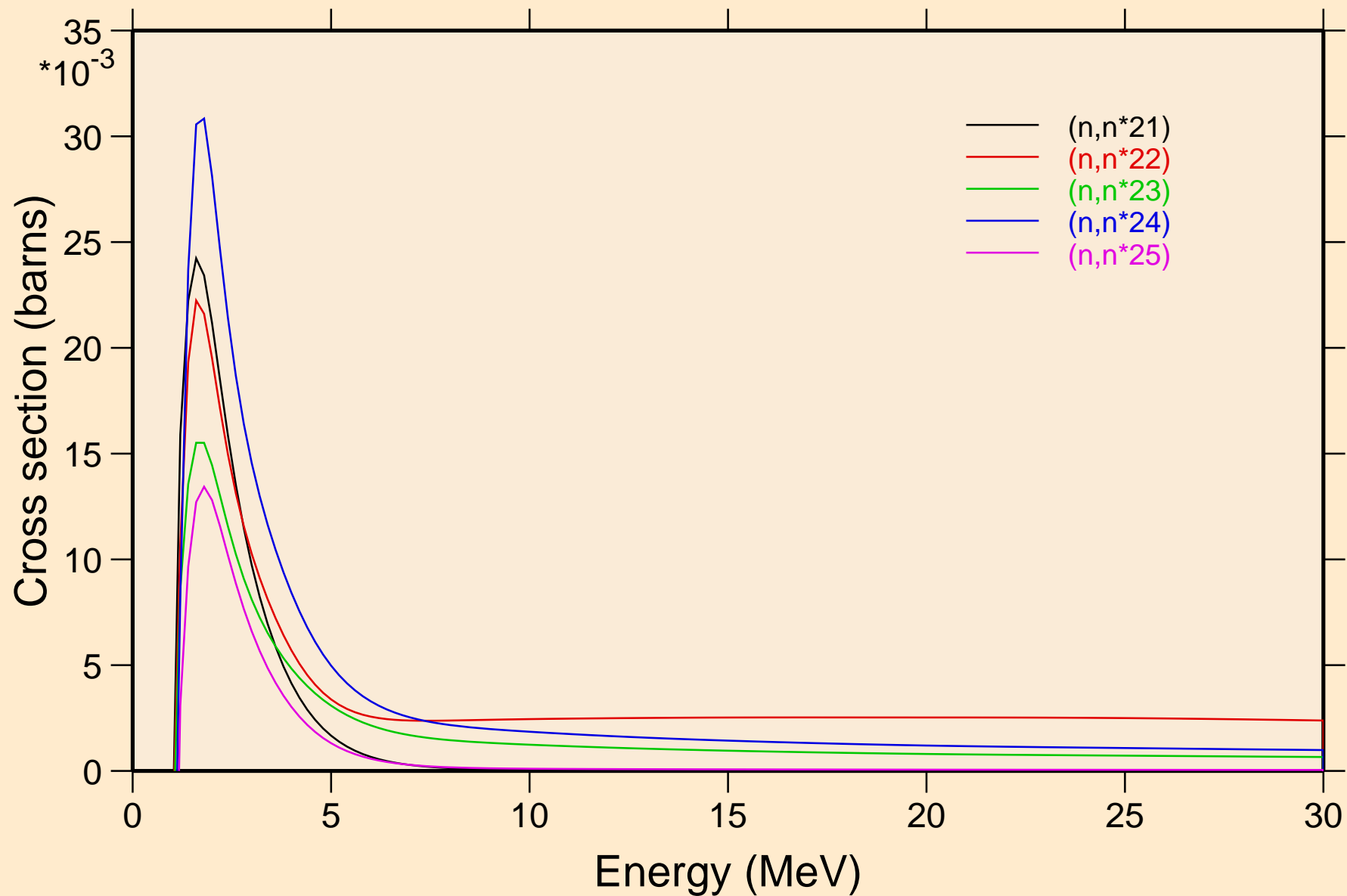

KR077 NEUTRON ACER TENDL-2019 LIBRARY; T=293.16K  
Inelastic levels

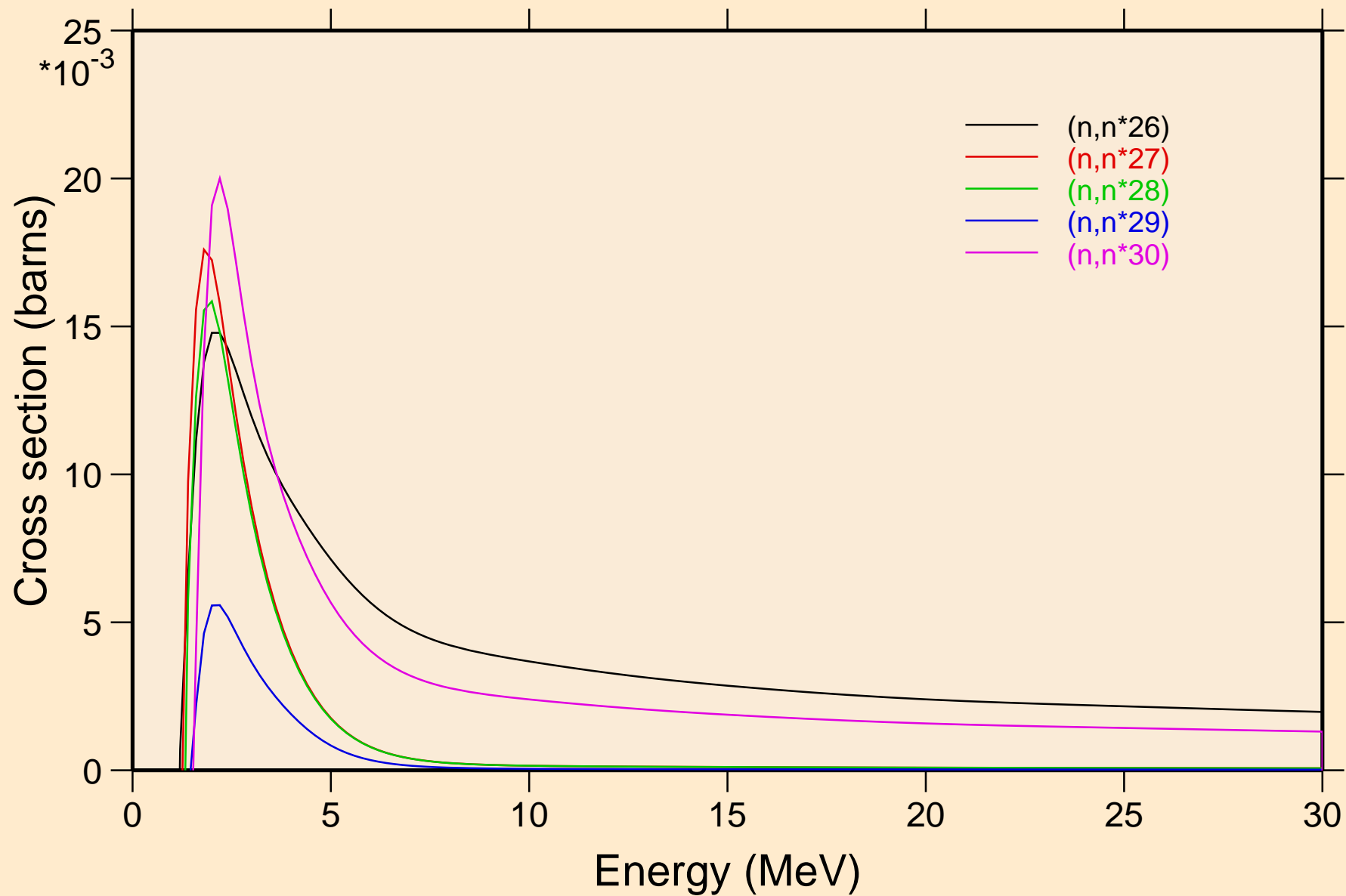

KR077 NEUTRON ACER TENDL-2019 LIBRARY; T=293.16K  
Threshold reactions

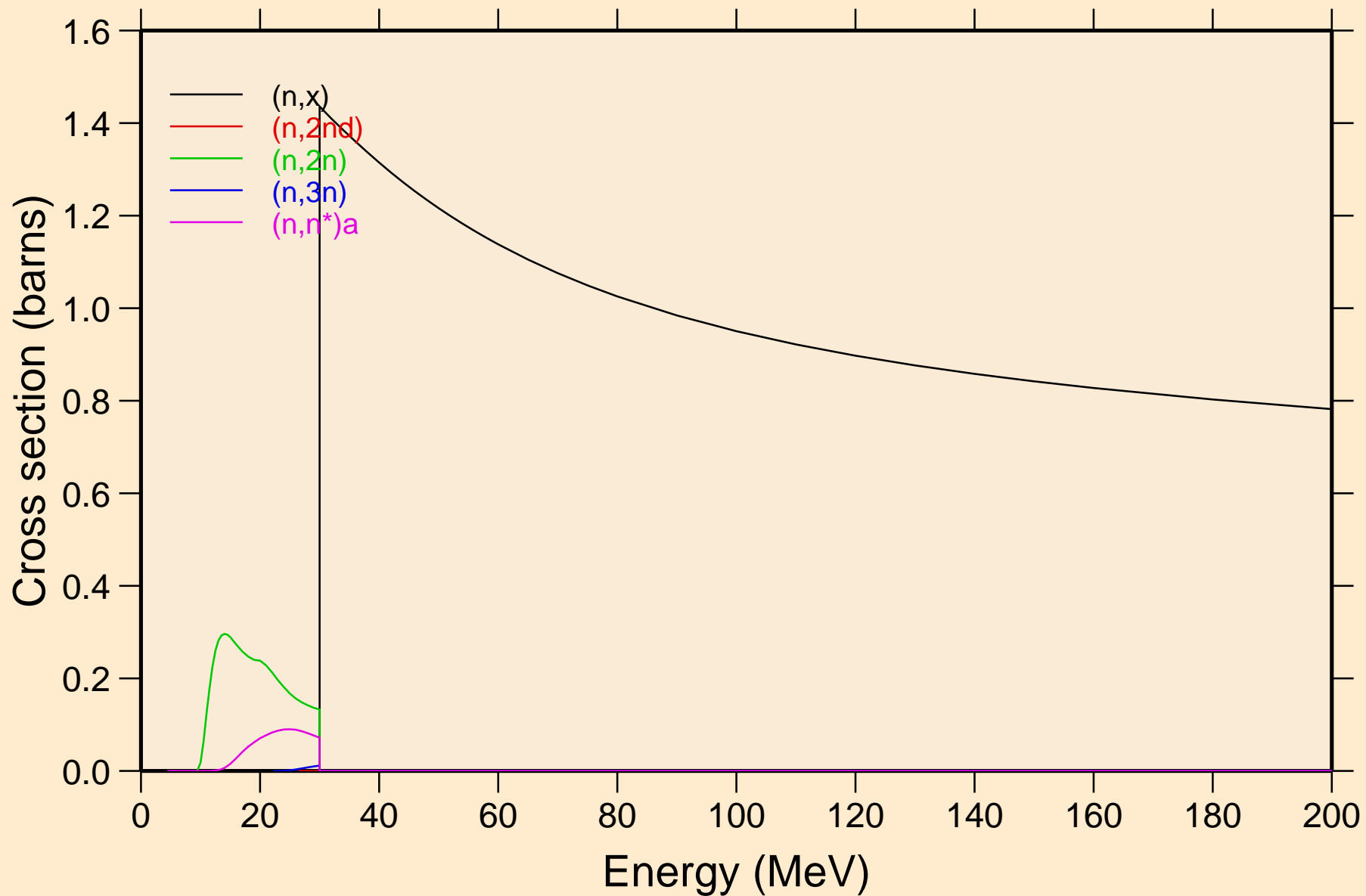

KR077 NEUTRON ACER TENDL-2019 LIBRARY; T=293.16K  
Threshold reactions

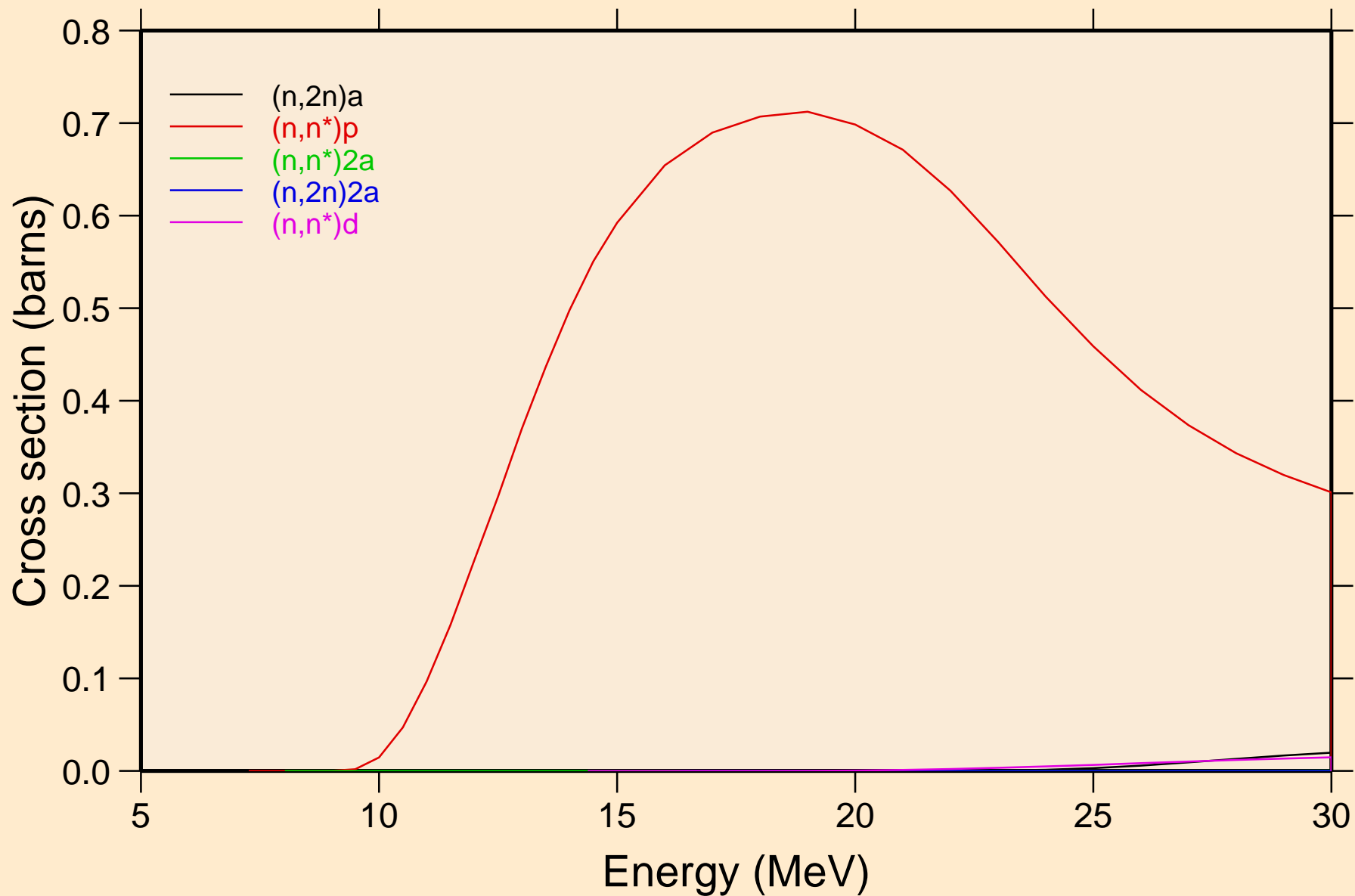

KR077 NEUTRON ACER TENDL-2019 LIBRARY; T=293.16K  
Threshold reactions

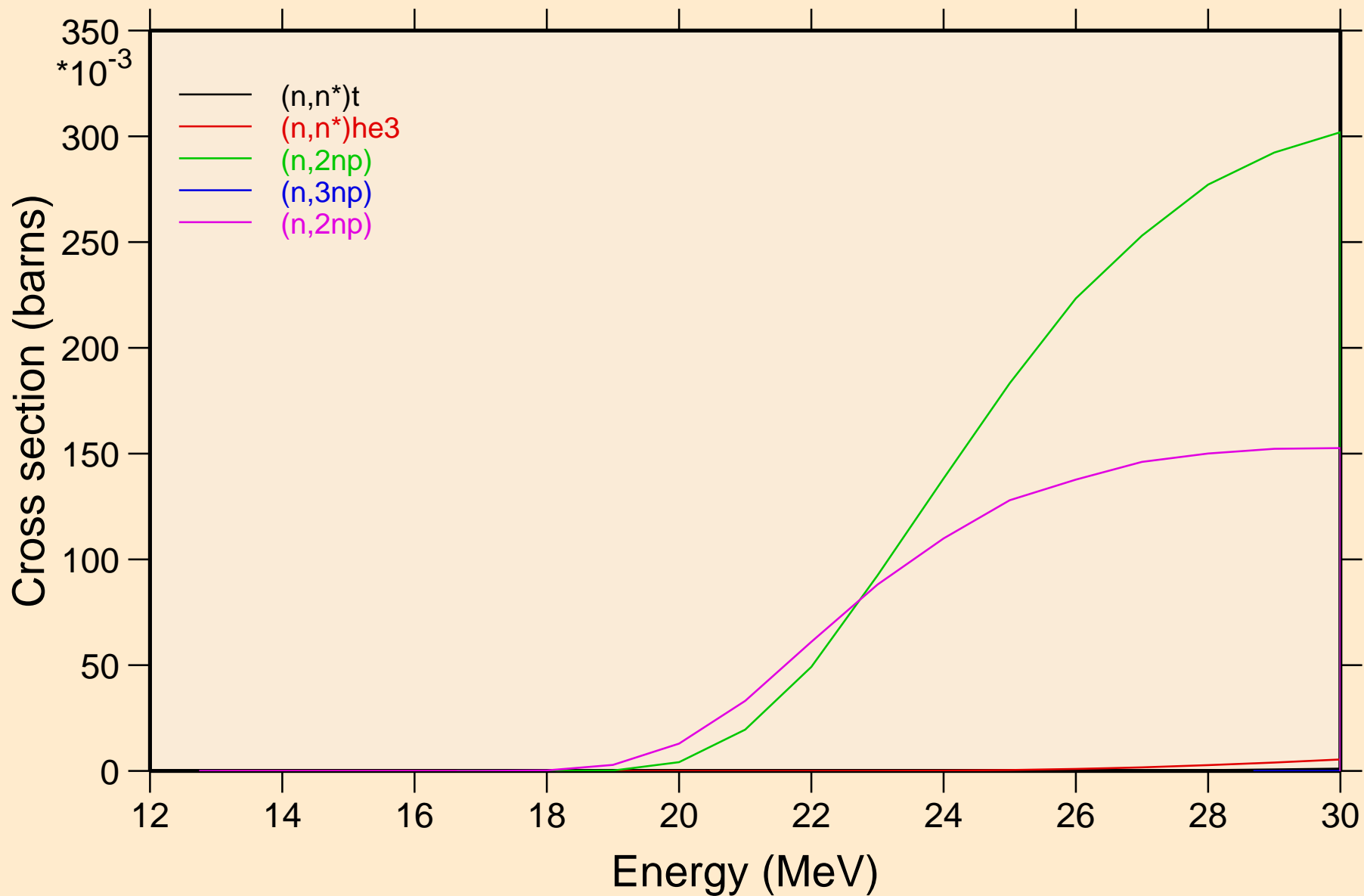

KR077 NEUTRON ACER TENDL-2019 LIBRARY; T=293.16K  
Threshold reactions

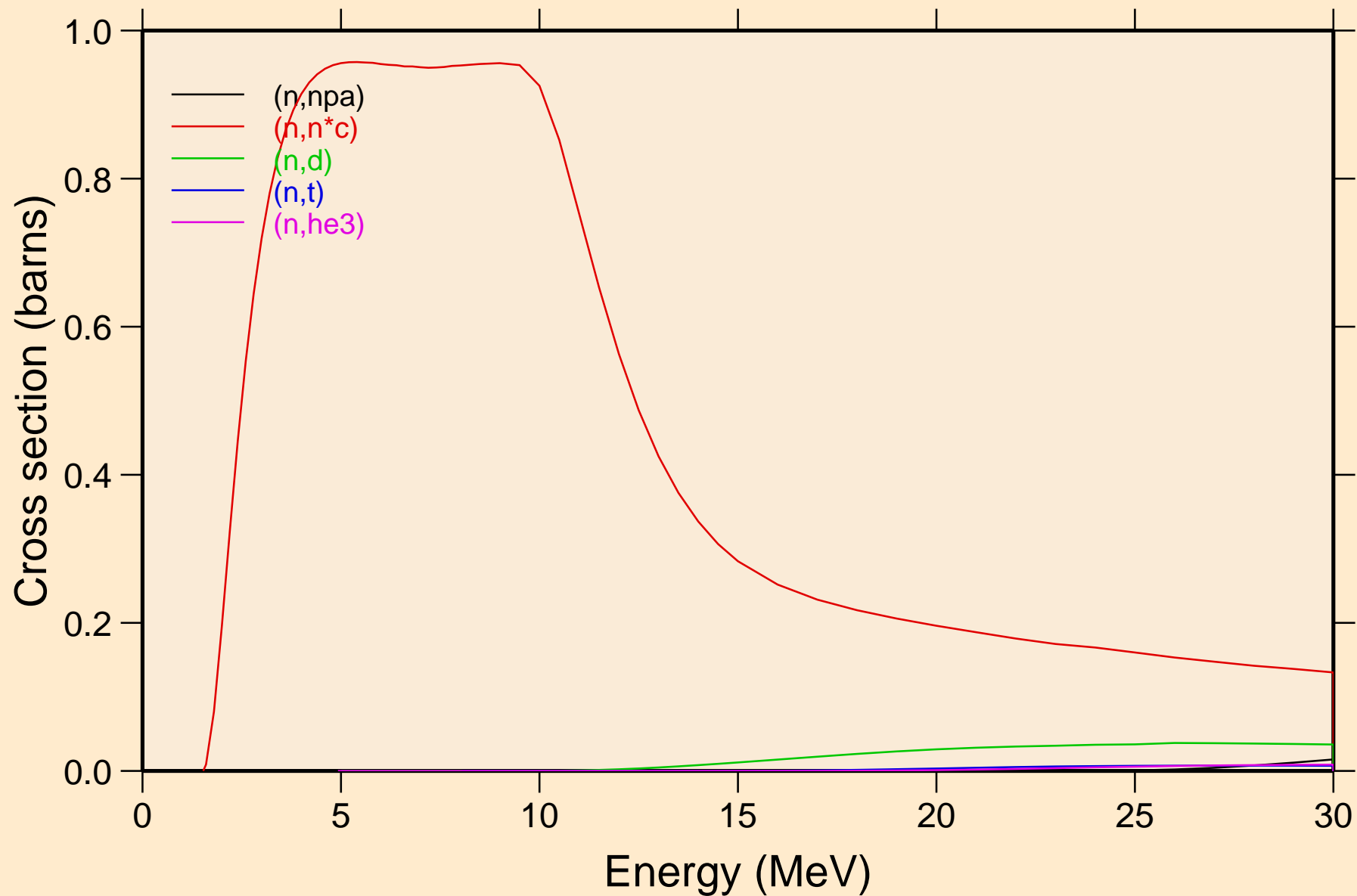

KR077 NEUTRON ACER TENDL-2019 LIBRARY; T=293.16K  
Threshold reactions

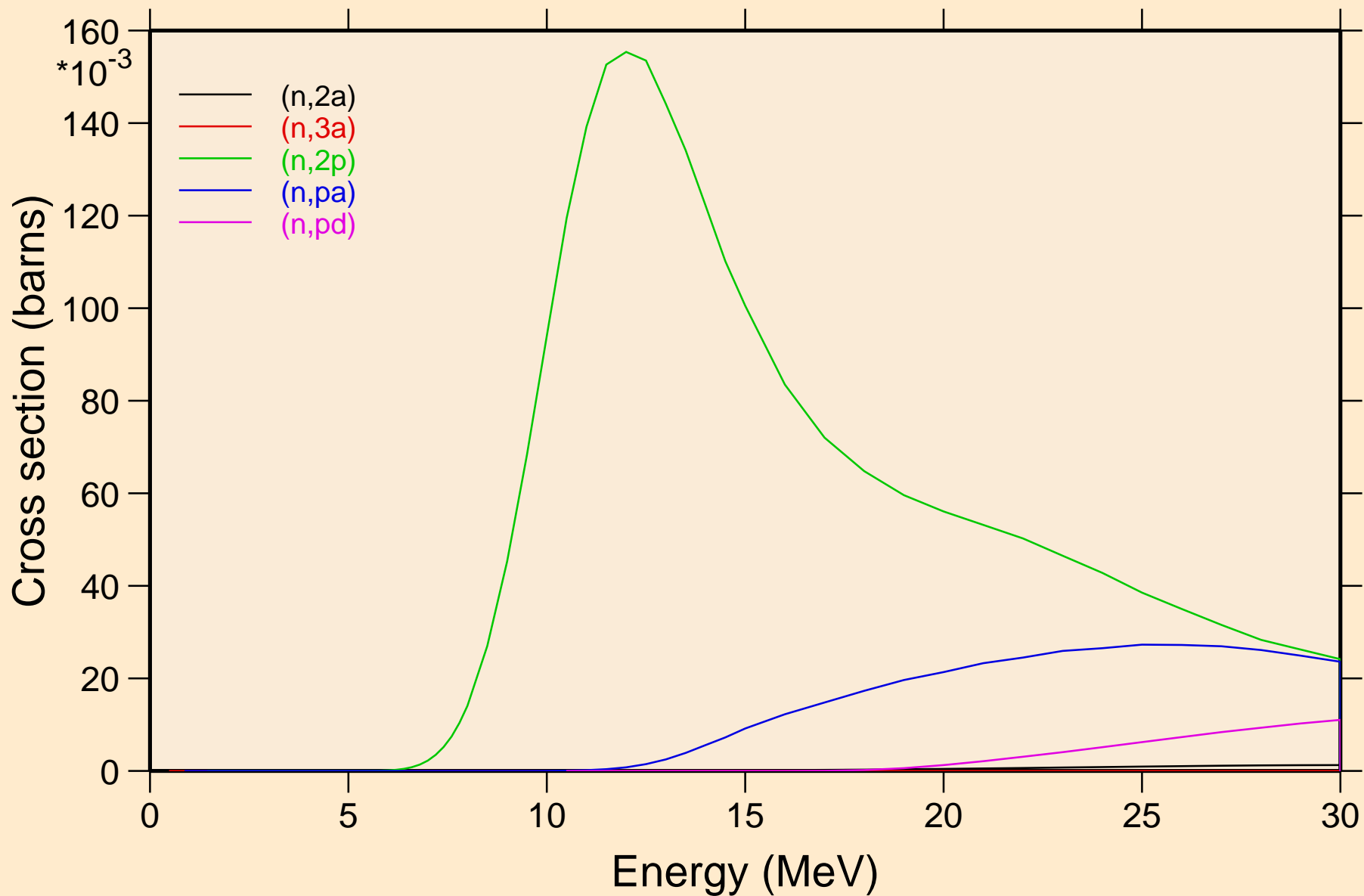

KR077 NEUTRON ACER TENDL-2019 LIBRARY; T=293.16K  
Threshold reactions

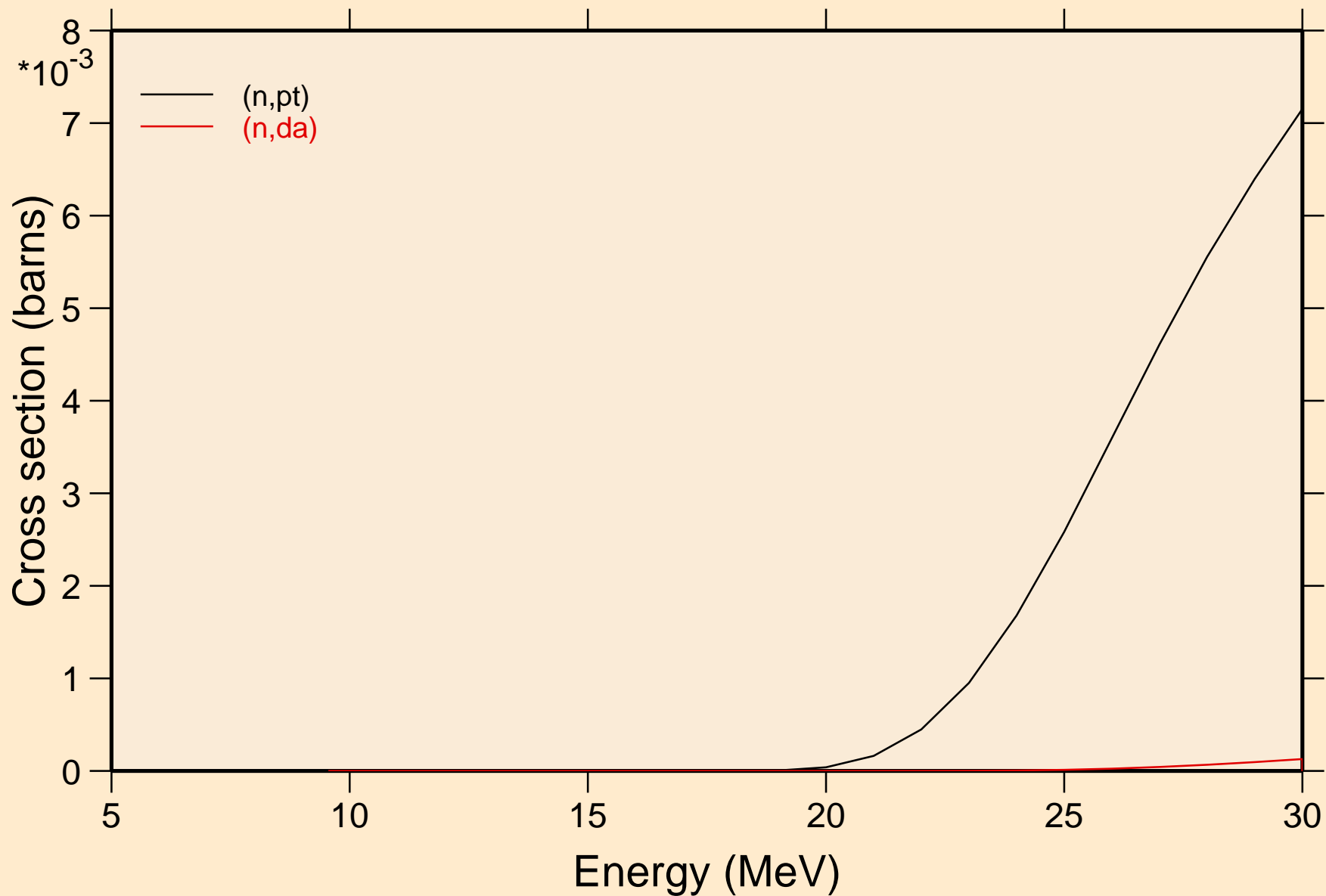

KR077 NEUTRON ACER TENDL-2019 LIBRARY; T=293.16K  
Threshold reactions

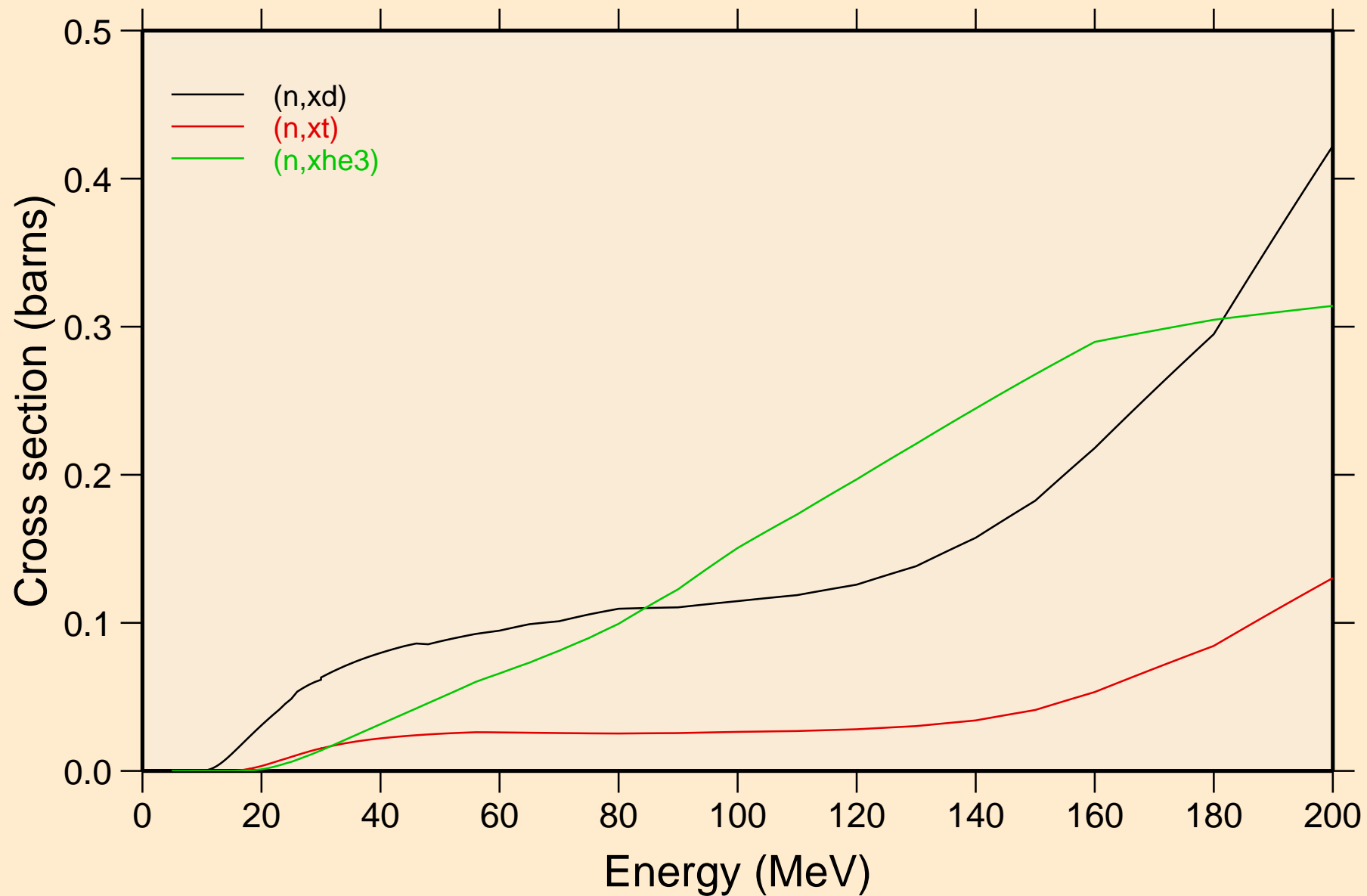

KR077 NEUTRON ACER TENDL-2019 LIBRARY; T=293.16K  
angular distribution for elastic

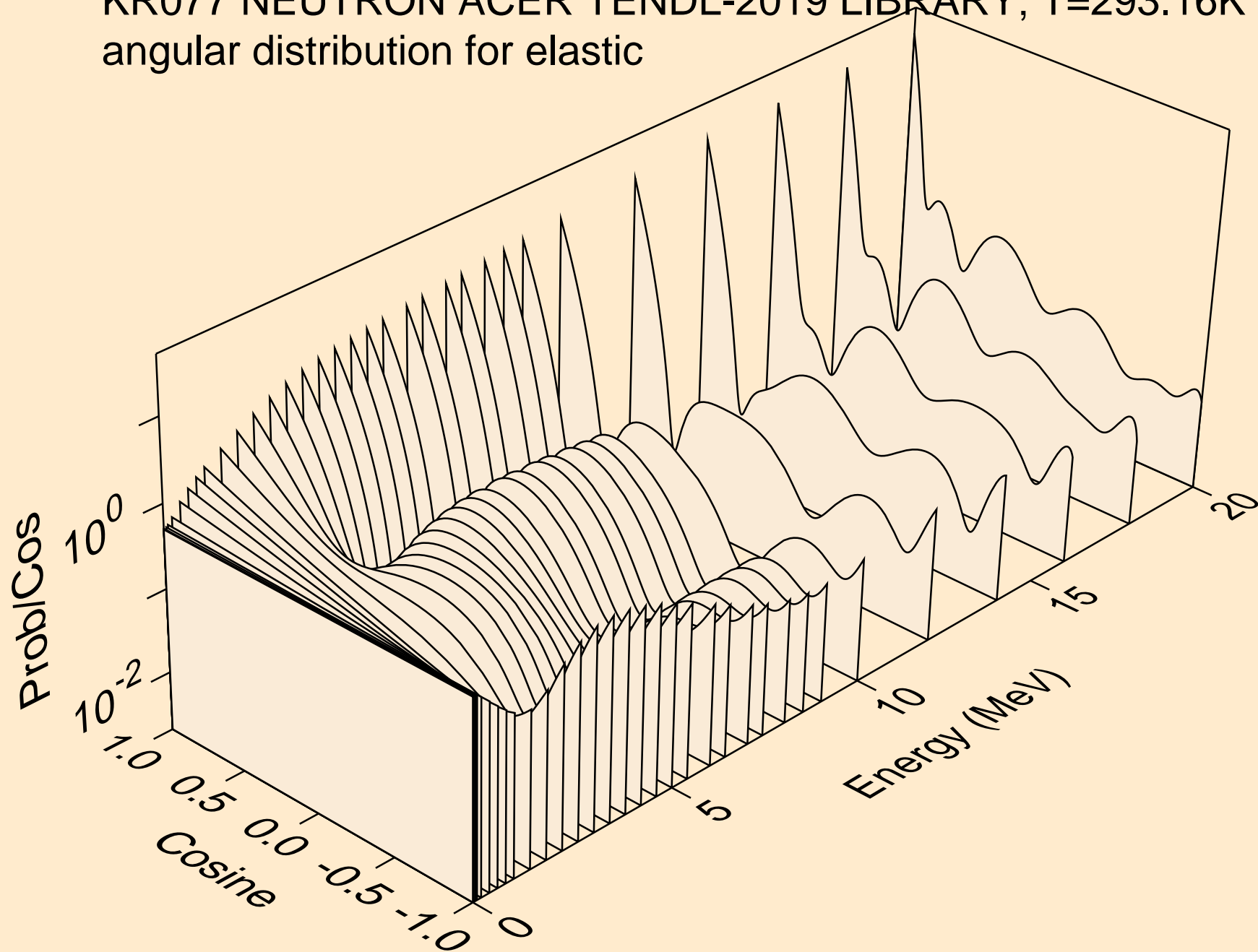

KR077 NEUTRON ACER TENDL-2019 LIBRARY; T=293.16K  
angular distribution for elastic

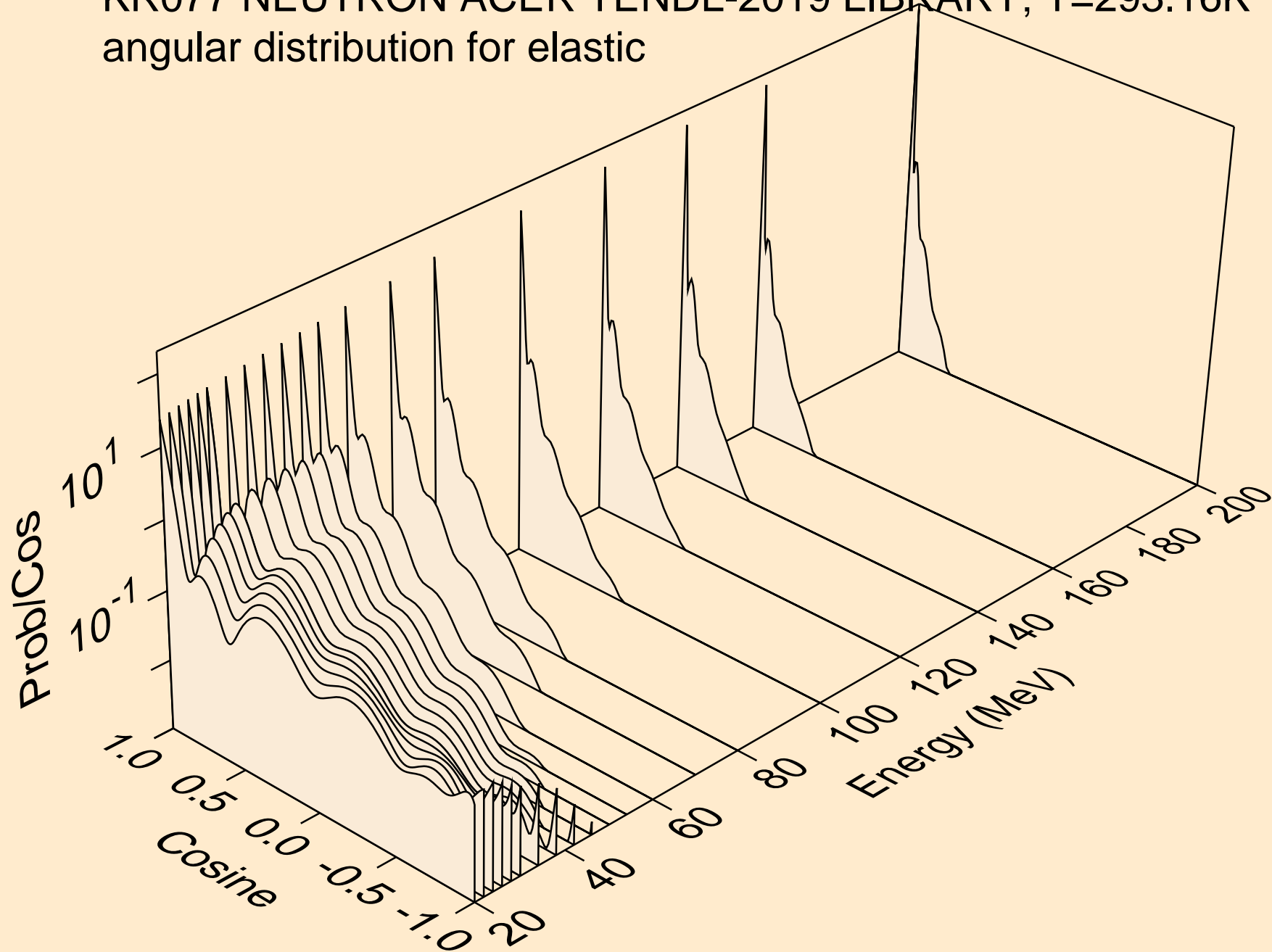

KR077 NEUTRON ACER TENDL-2019 LIBRARY; T=293.16K  
angular distribution for (n,n\*1)

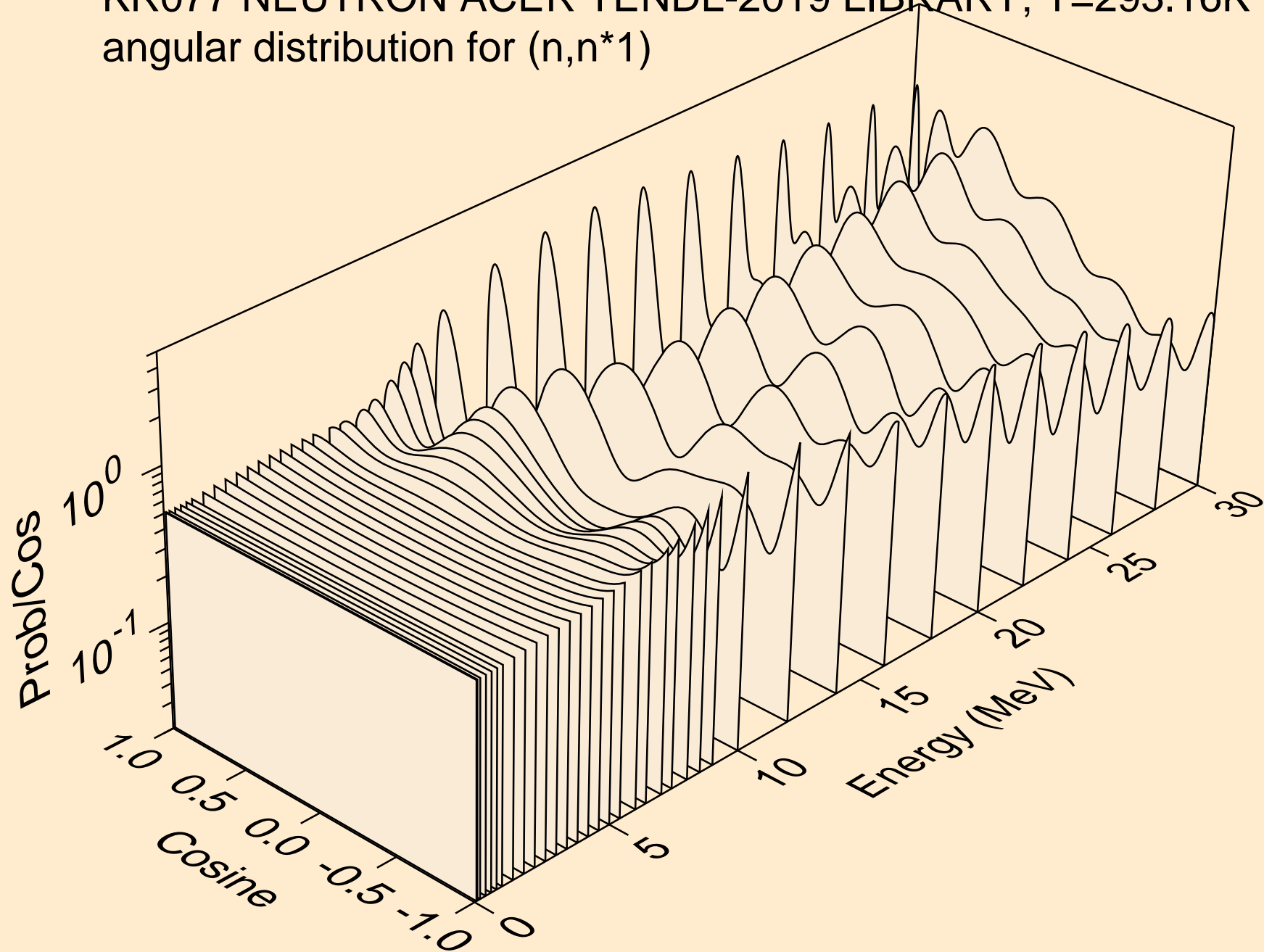

KR077 NEUTRON ACER TENDL-2019 LIBRARY; T=293.16K  
angular distribution for (n,n\*2)

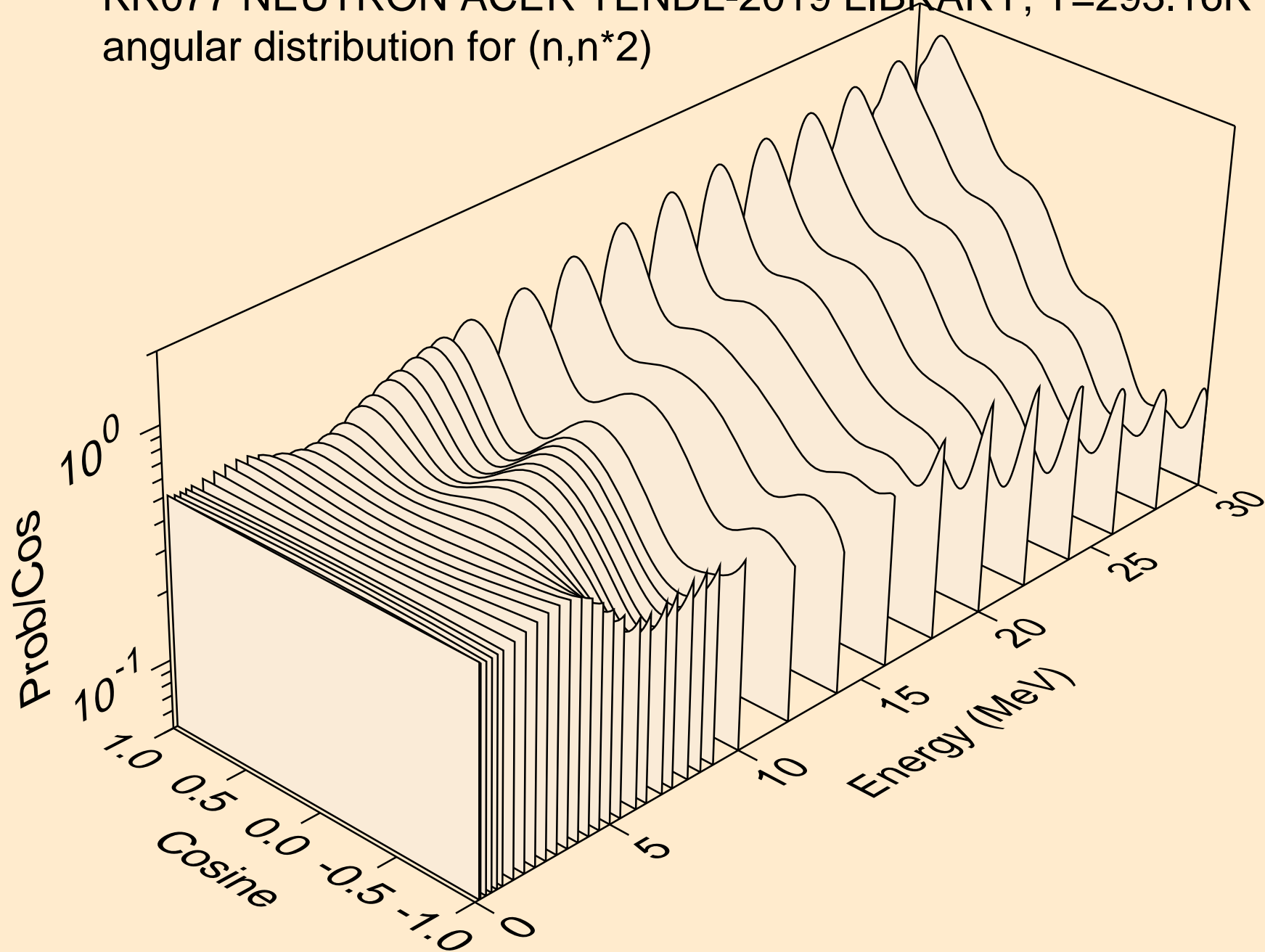

KR077 NEUTRON ACER TENDL-2019 LIBRARY; T=293.16K  
angular distribution for (n,n\*3)

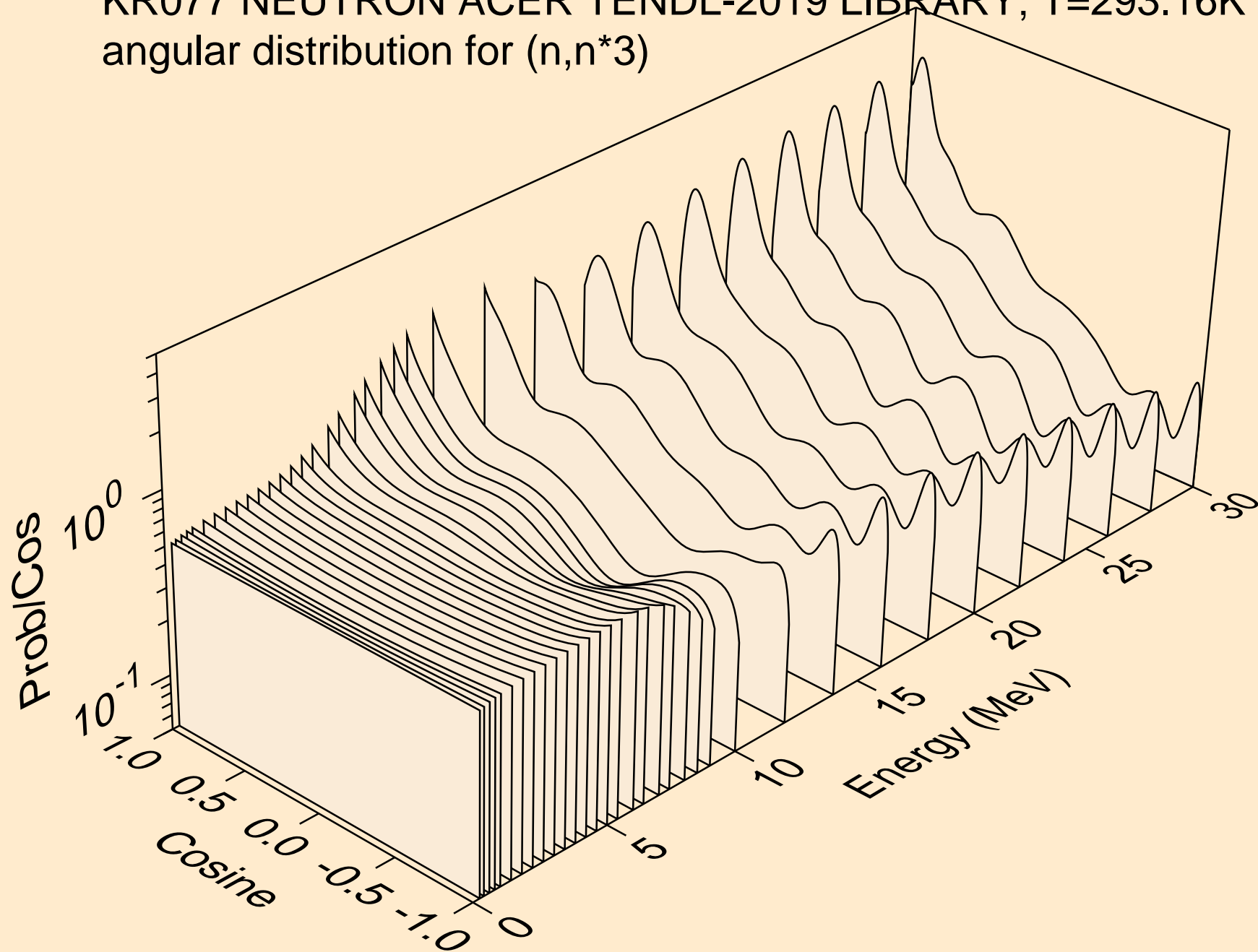

KR077 NEUTRON ACER TENDL-2019 LIBRARY; T=293.16K  
angular distribution for (n,n\*4)

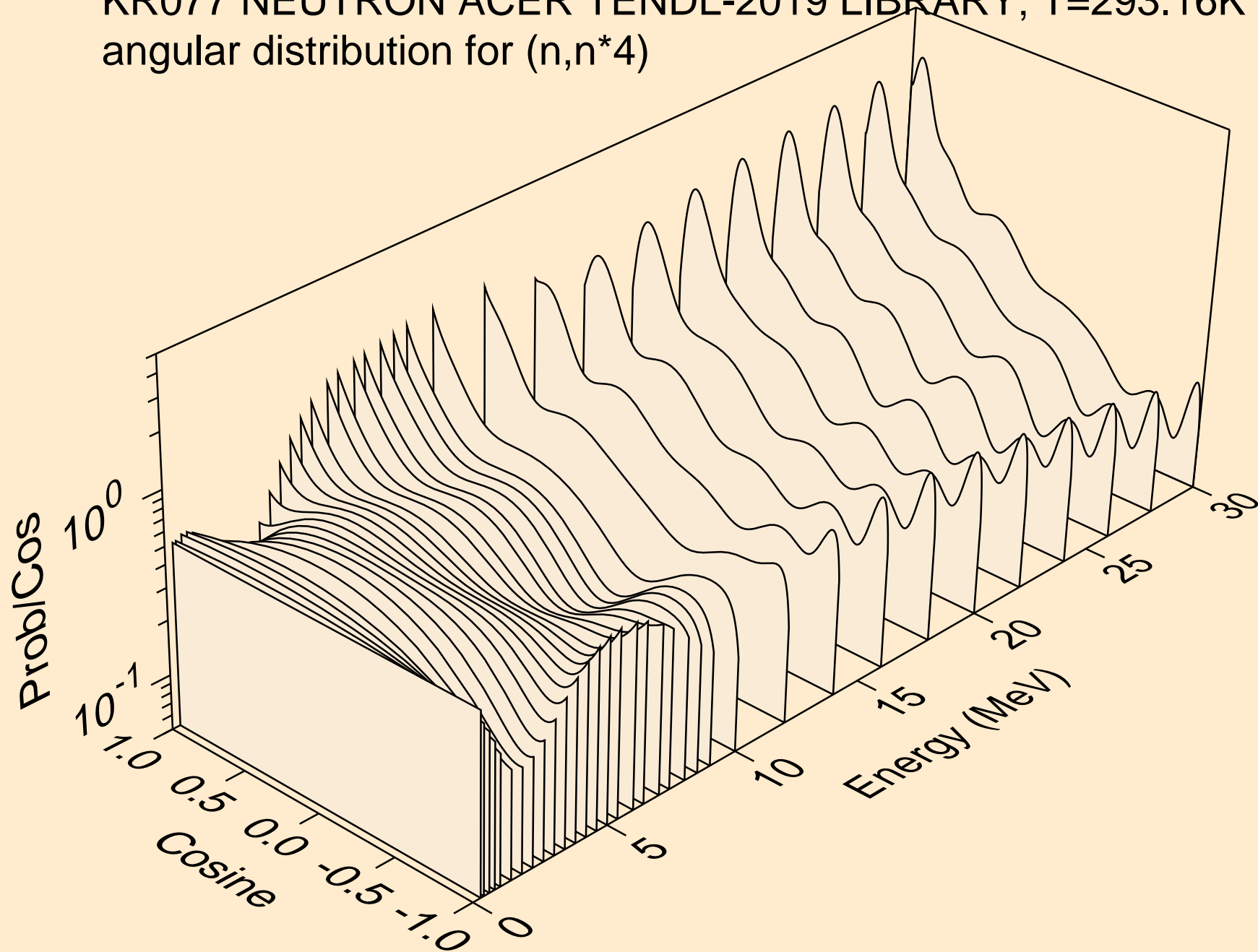

KR077 NEUTRON ACER TENDL-2019 LIBRARY; T=293.16K  
angular distribution for (n,n\*5)

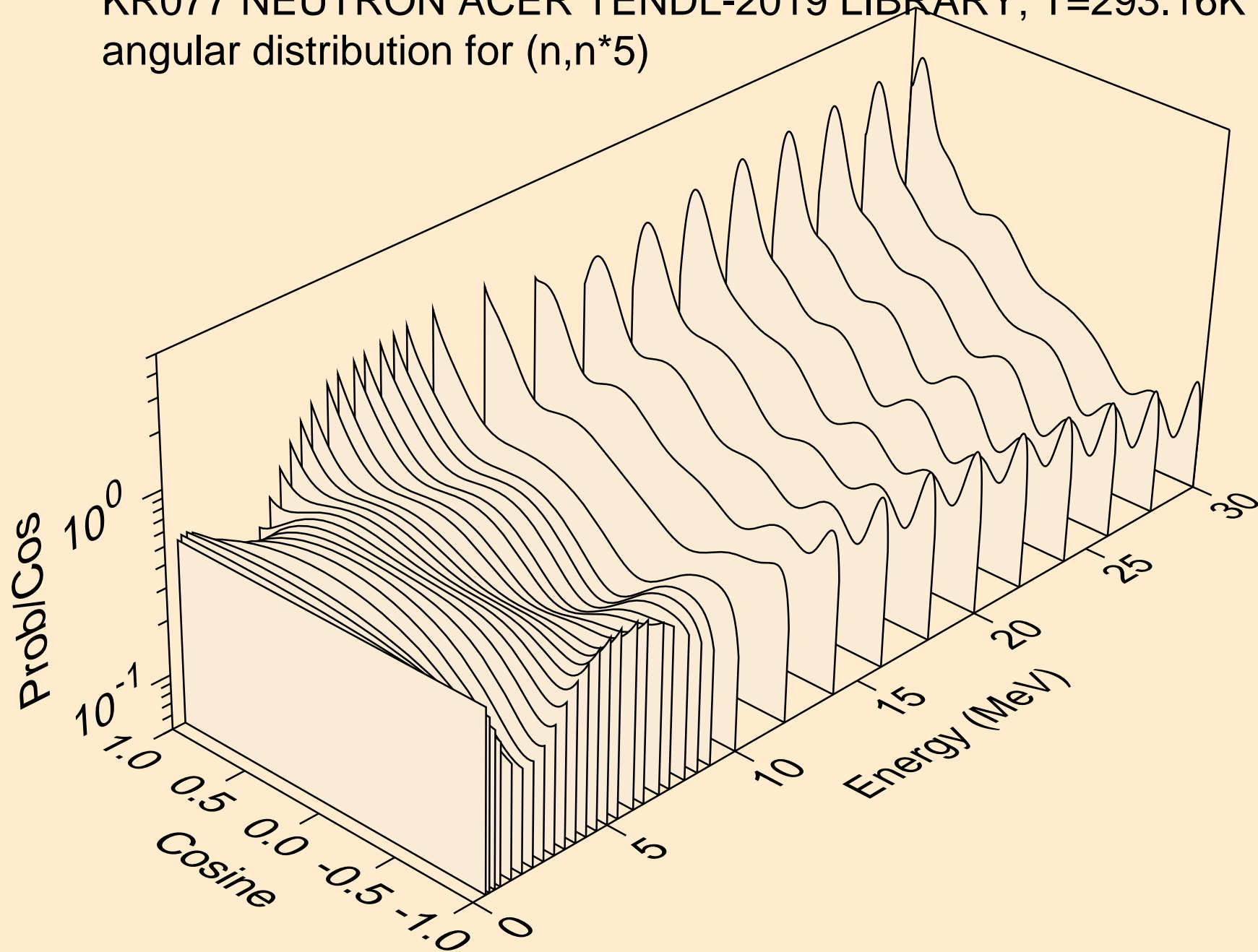

KR077 NEUTRON ACER TENDL-2019 LIBRARY; T=293.16K  
angular distribution for (n,n\*6)

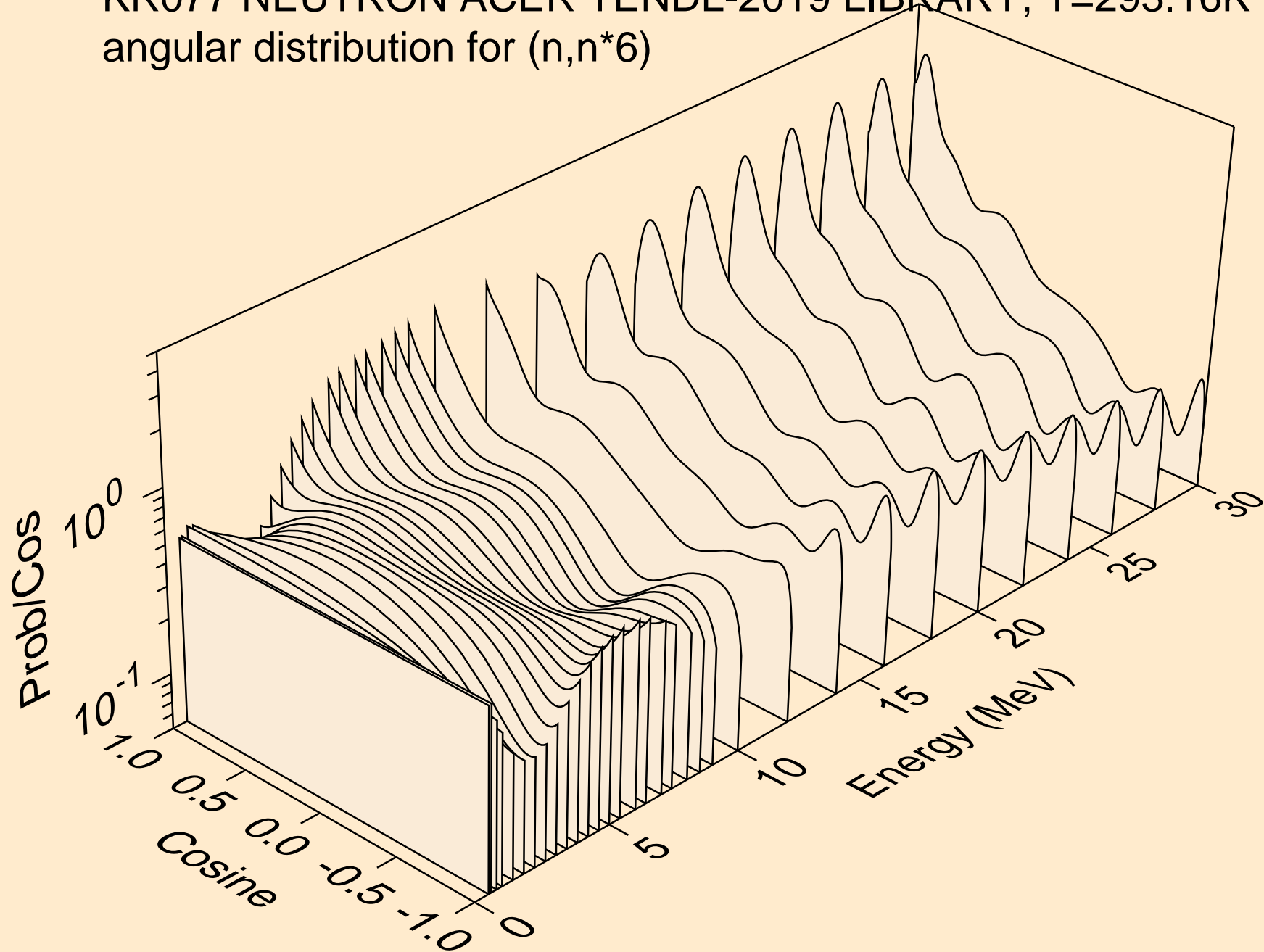

KR077 NEUTRON ACER TENDL-2019 LIBRARY; T=293.16K  
angular distribution for (n,n\*7)

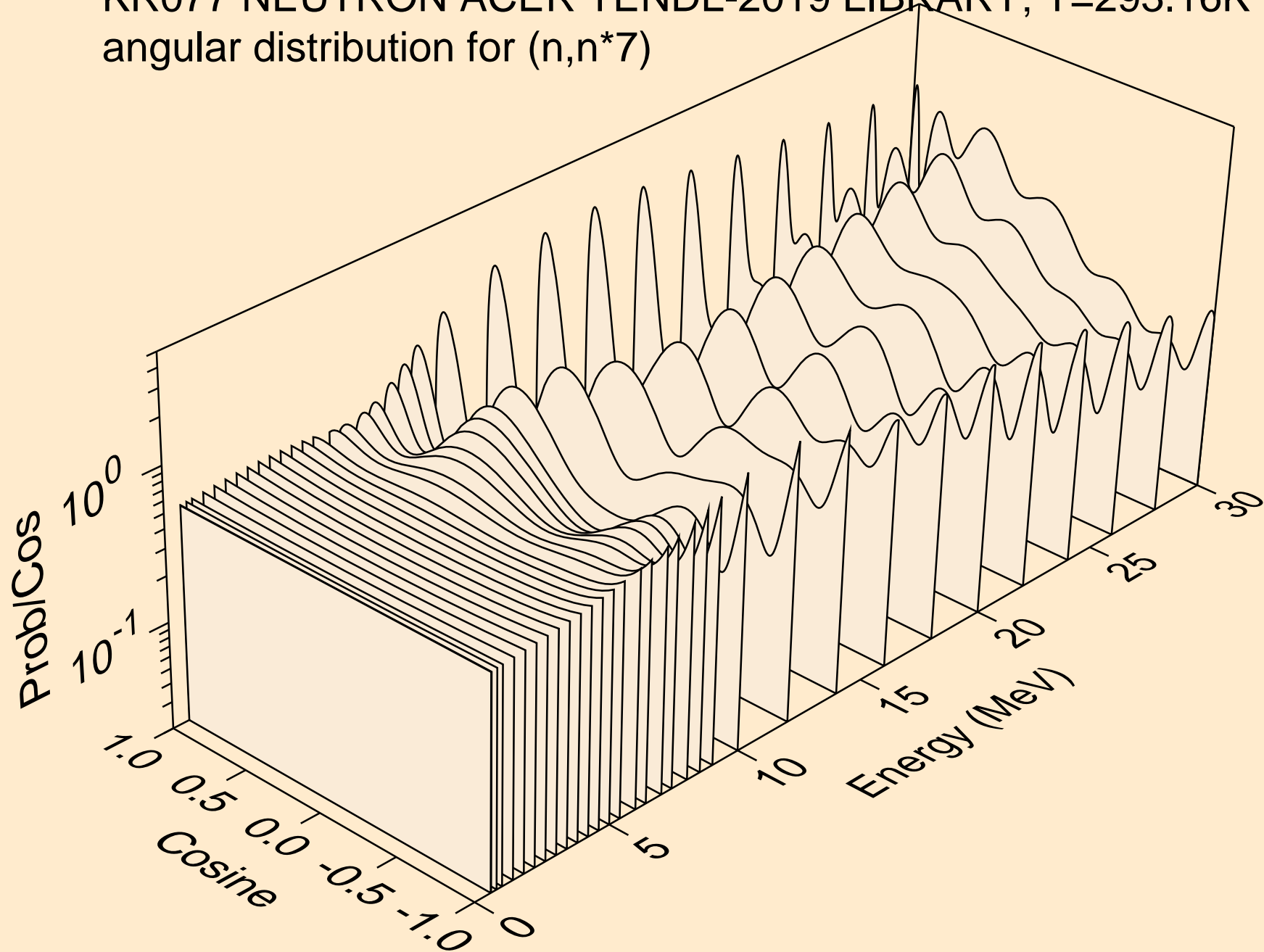

KR077 NEUTRON ACER TENDL-2019 LIBRARY; T=293.16K  
angular distribution for (n,n\*8)

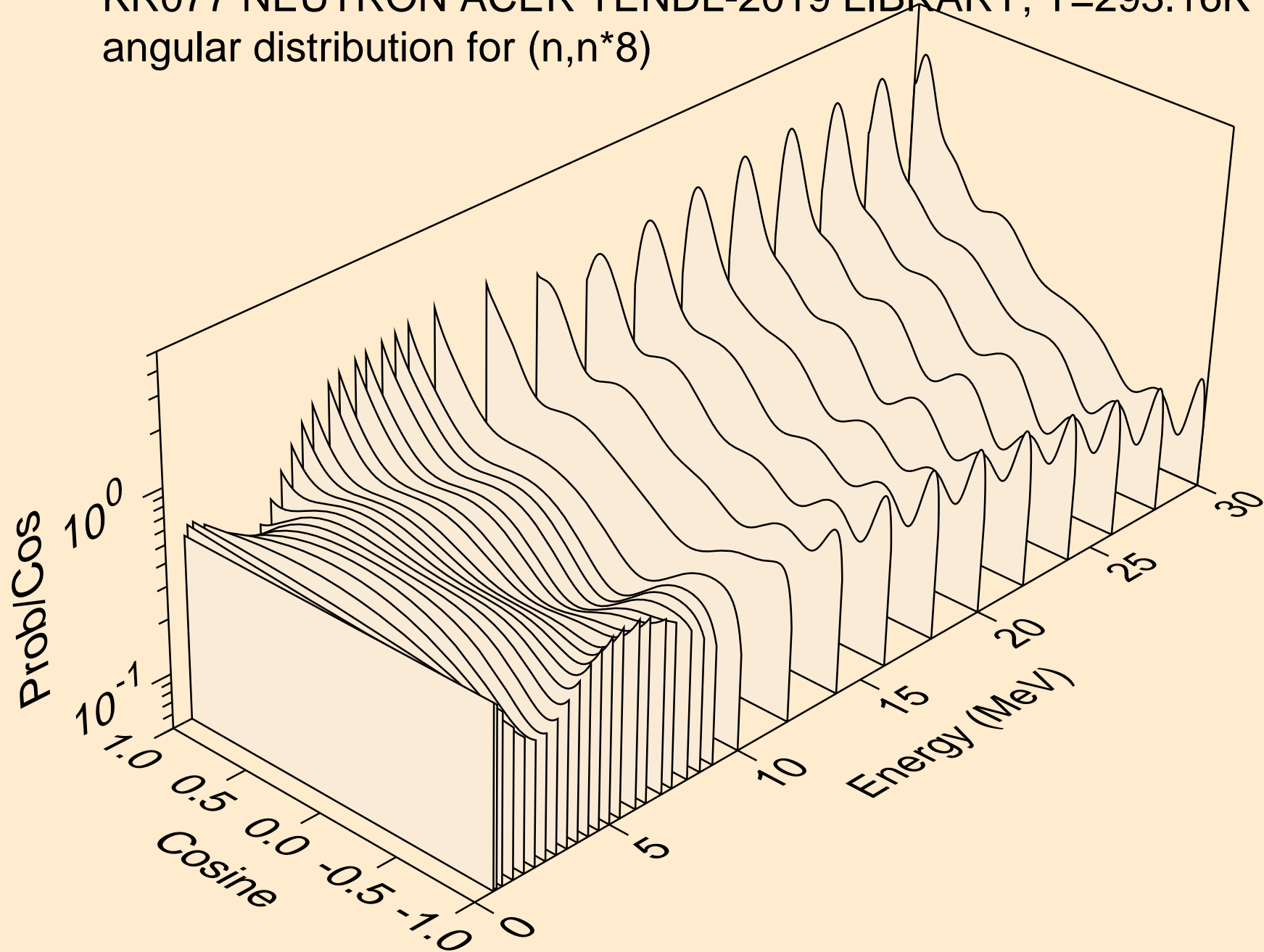

KR077 NEUTRON ACER TENDL-2019 LIBRARY; T=293.16K  
angular distribution for (n,n\*9)

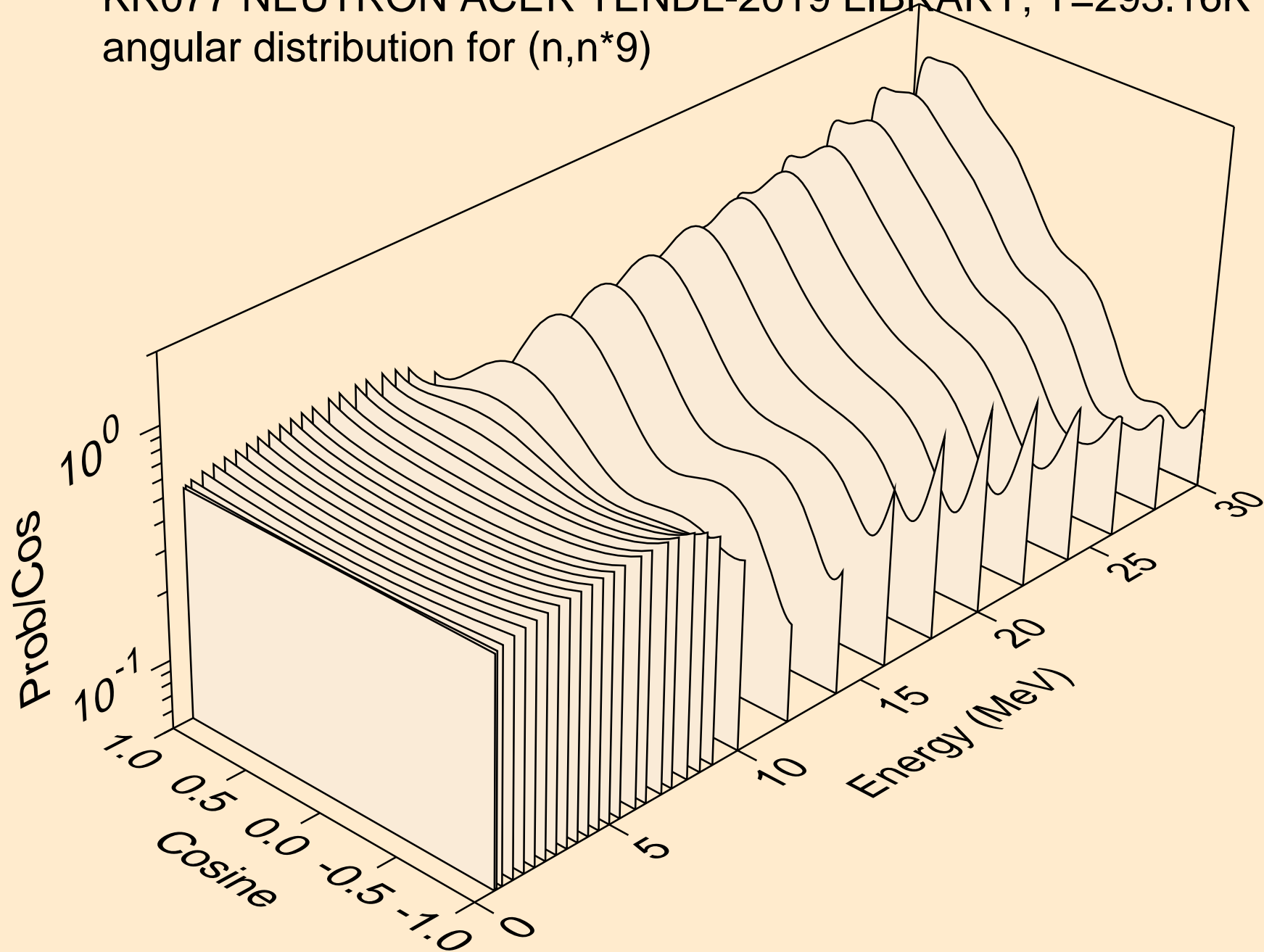

KR077 NEUTRON ACER TENDL-2019 LIBRARY; T=293.16K  
angular distribution for (n,n\*10)

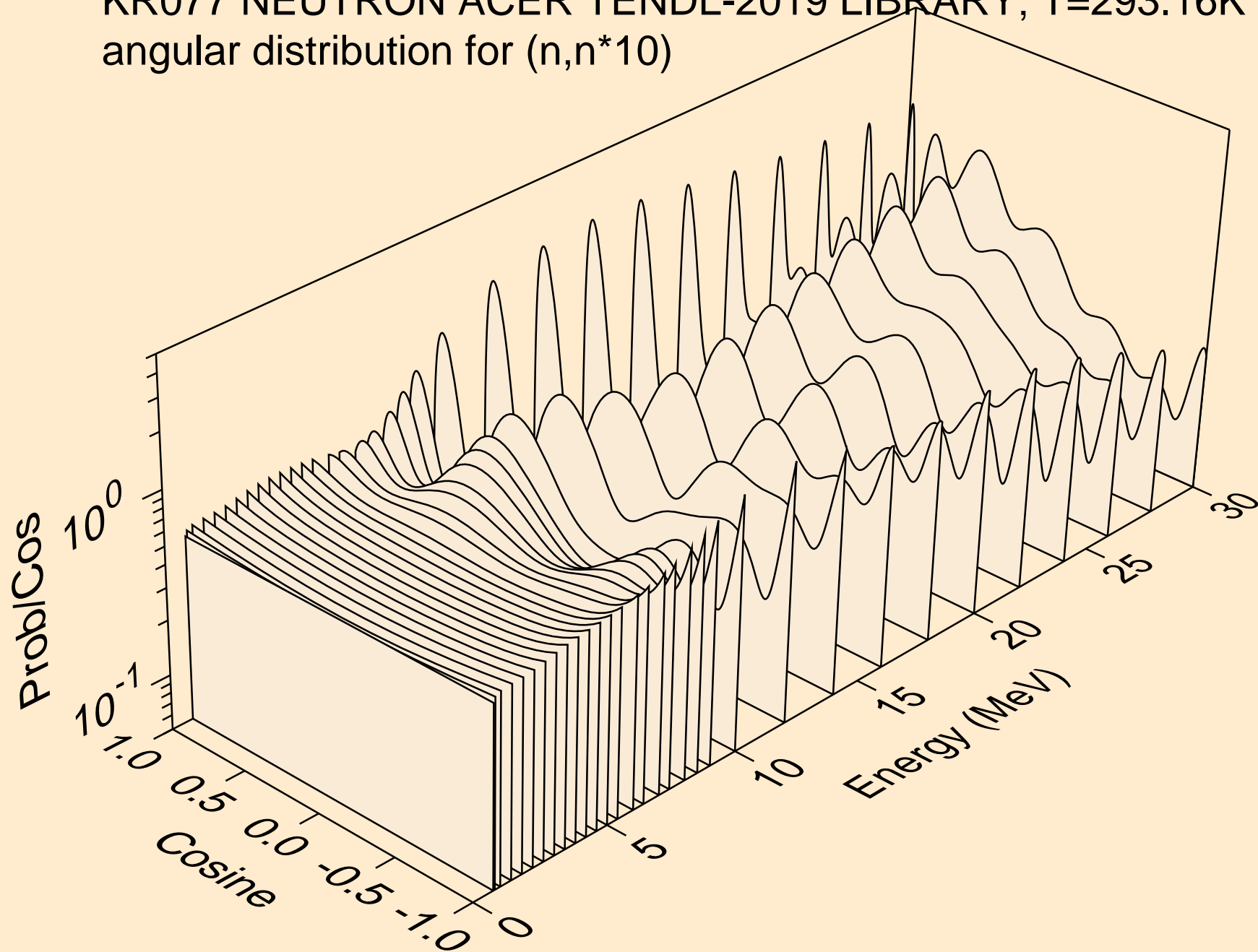

KR077 NEUTRON ACER TENDL-2019 LIBRARY; T=293.16K  
angular distribution for (n,n\*11)

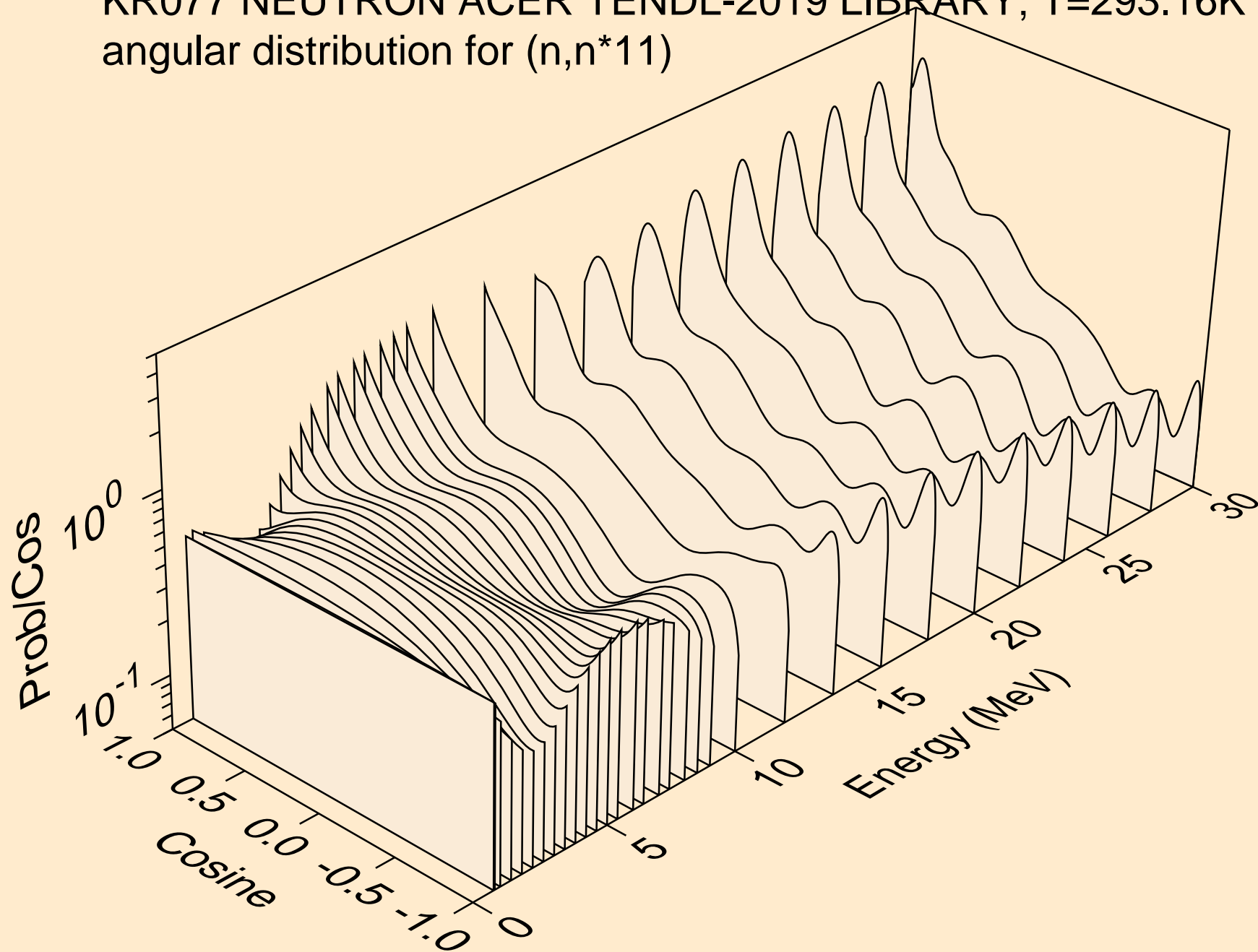

KR077 NEUTRON ACER TENDL-2019 LIBRARY; T=293.16K  
angular distribution for (n,n\*12)

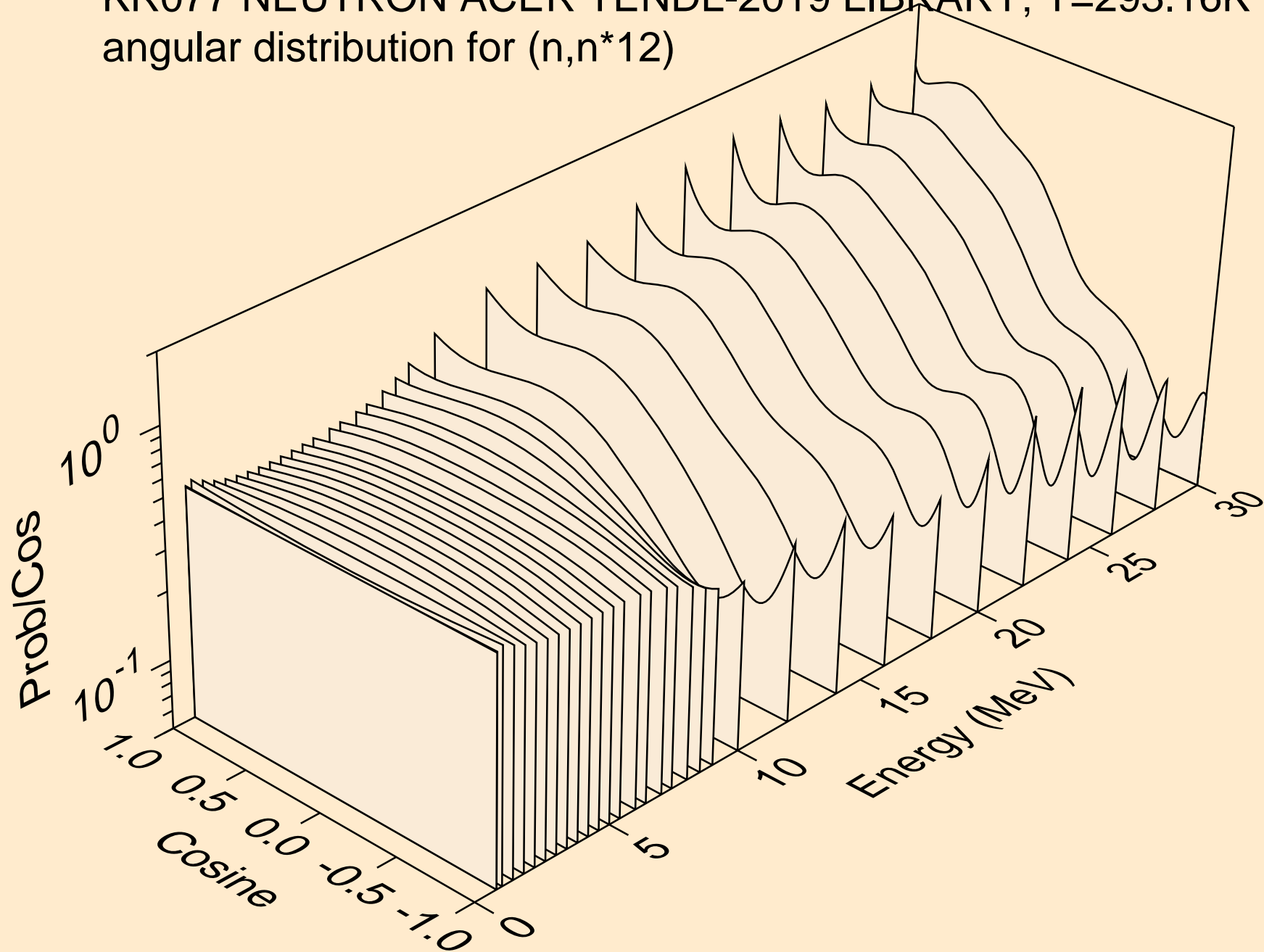

KR077 NEUTRON ACER TENDL-2019 LIBRARY; T=293.16K  
angular distribution for (n,n\*13)

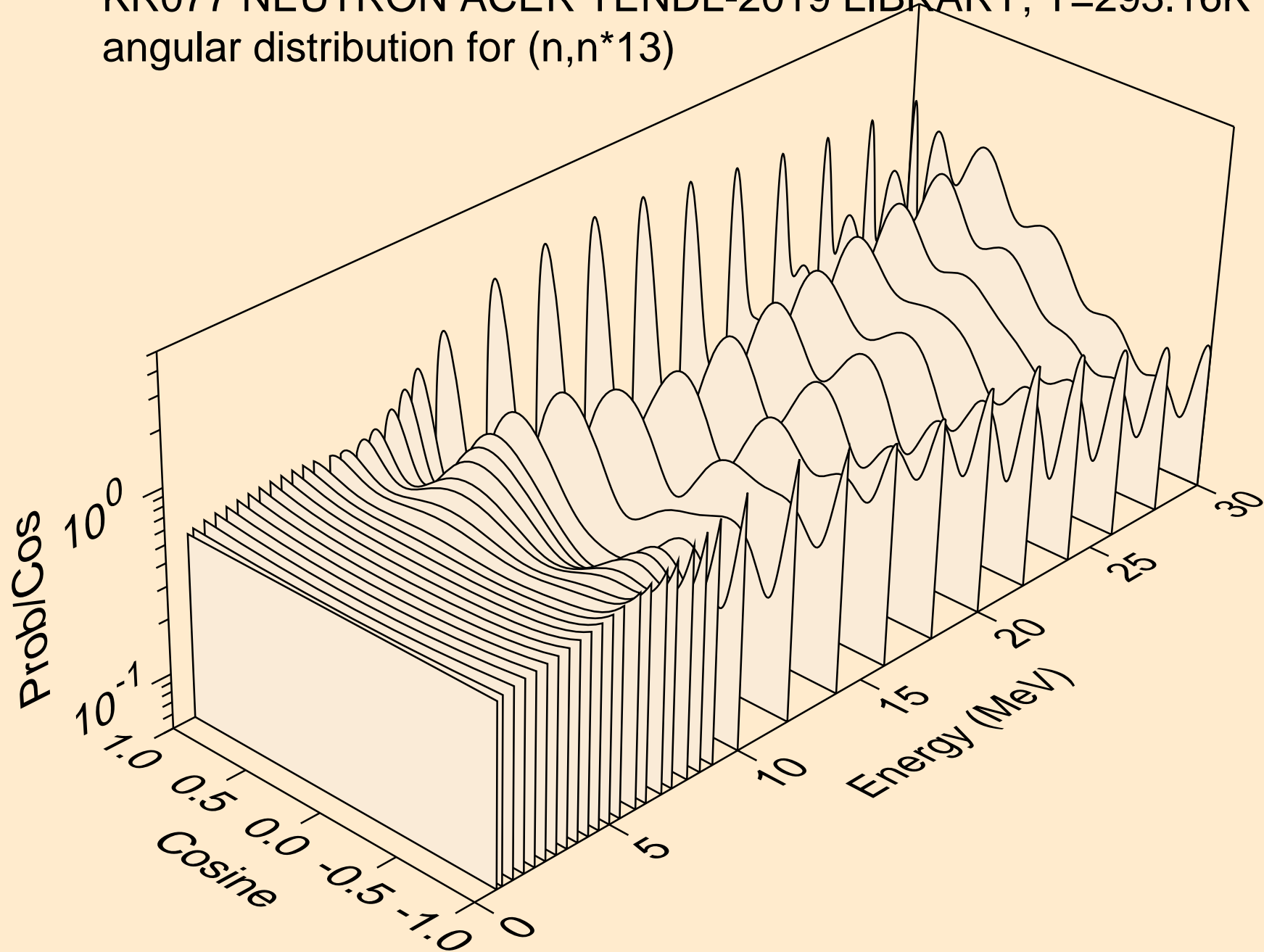

KR077 NEUTRON ACER TENDL-2019 LIBRARY; T=293.16K  
angular distribution for (n,n\*14)

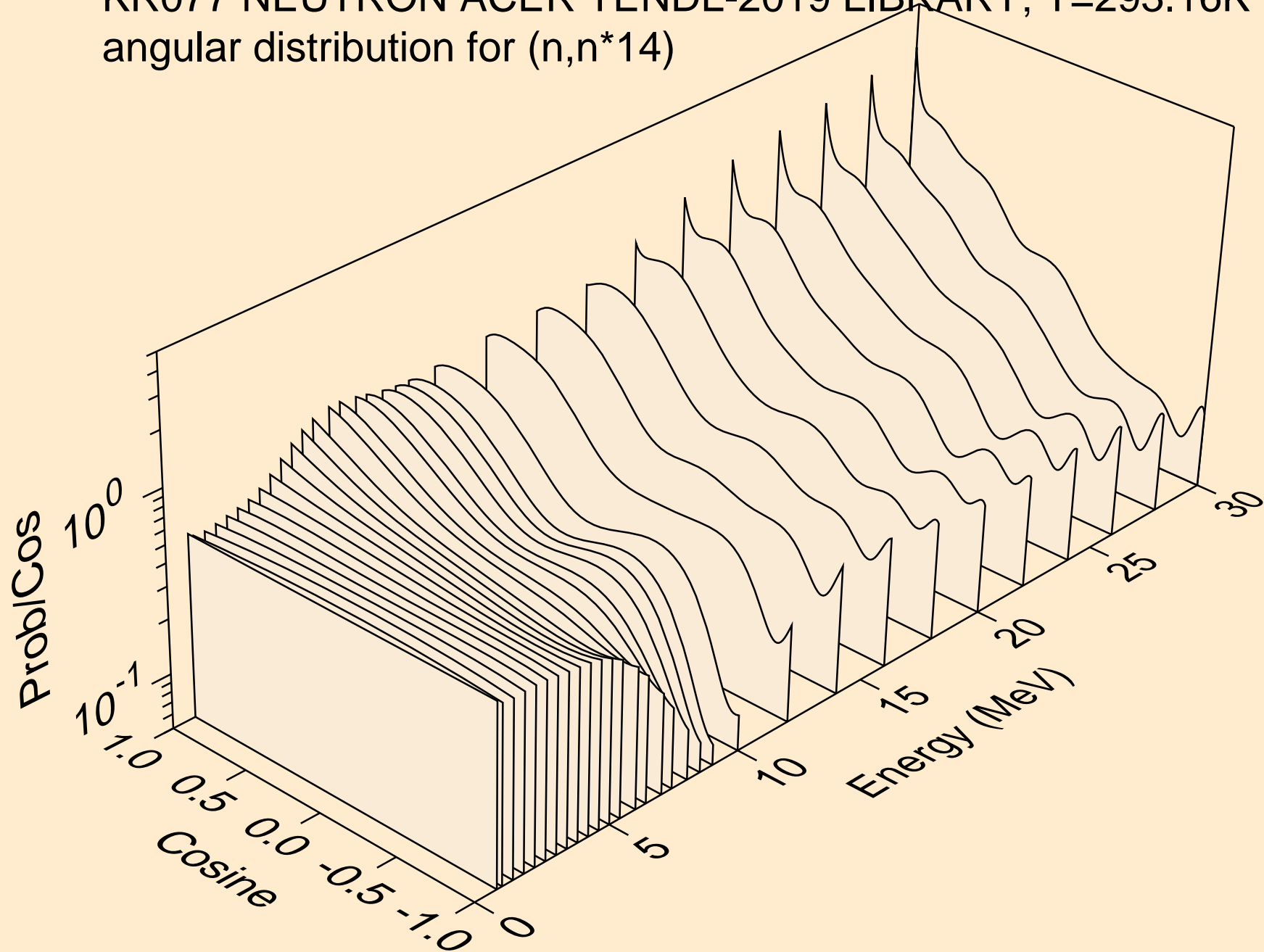

KR077 NEUTRON ACER TENDL-2019 LIBRARY; T=293.16K  
angular distribution for (n,n\*15)

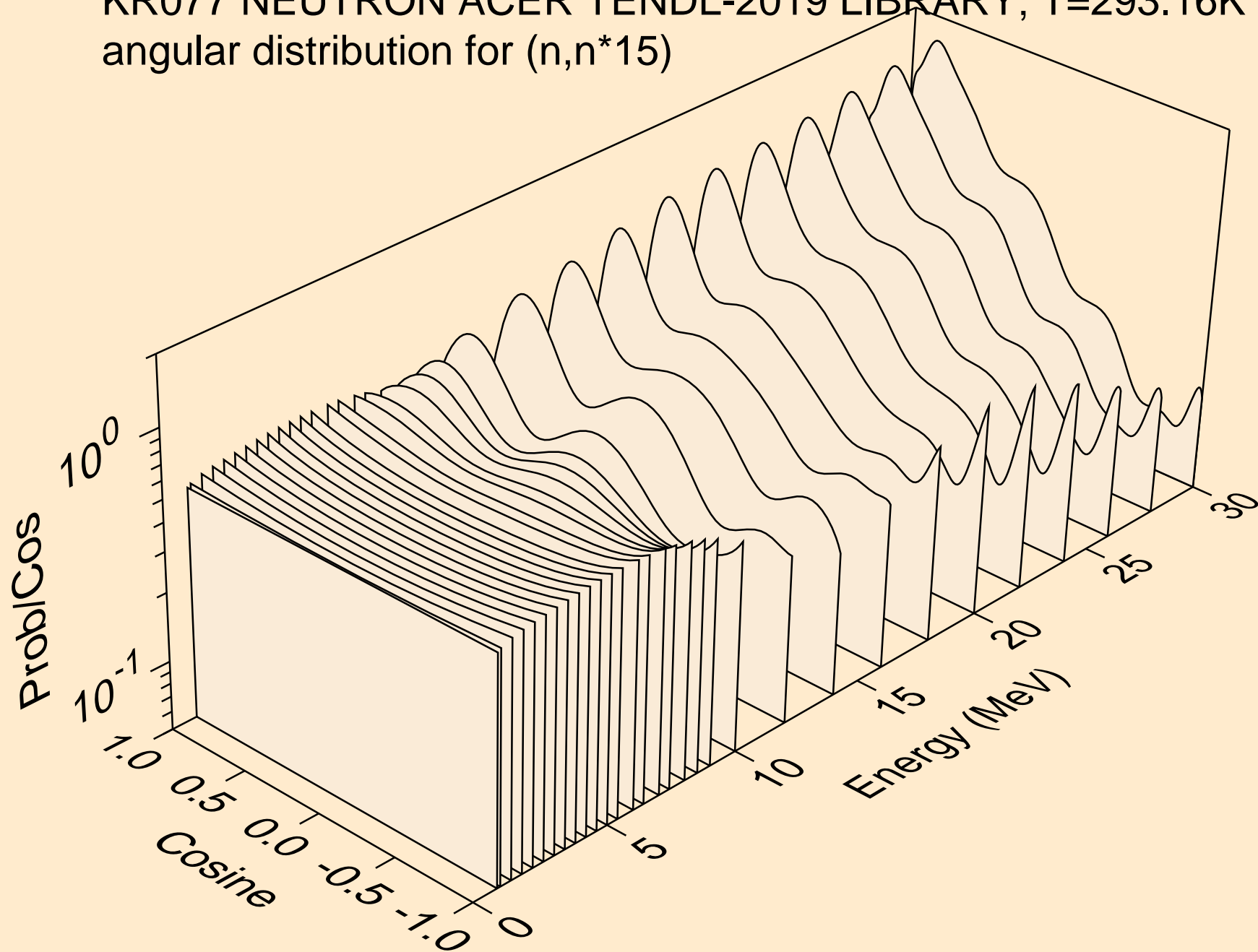

KR077 NEUTRON ACER TENDL-2019 LIBRARY; T=293.16K  
angular distribution for (n,n\*16)

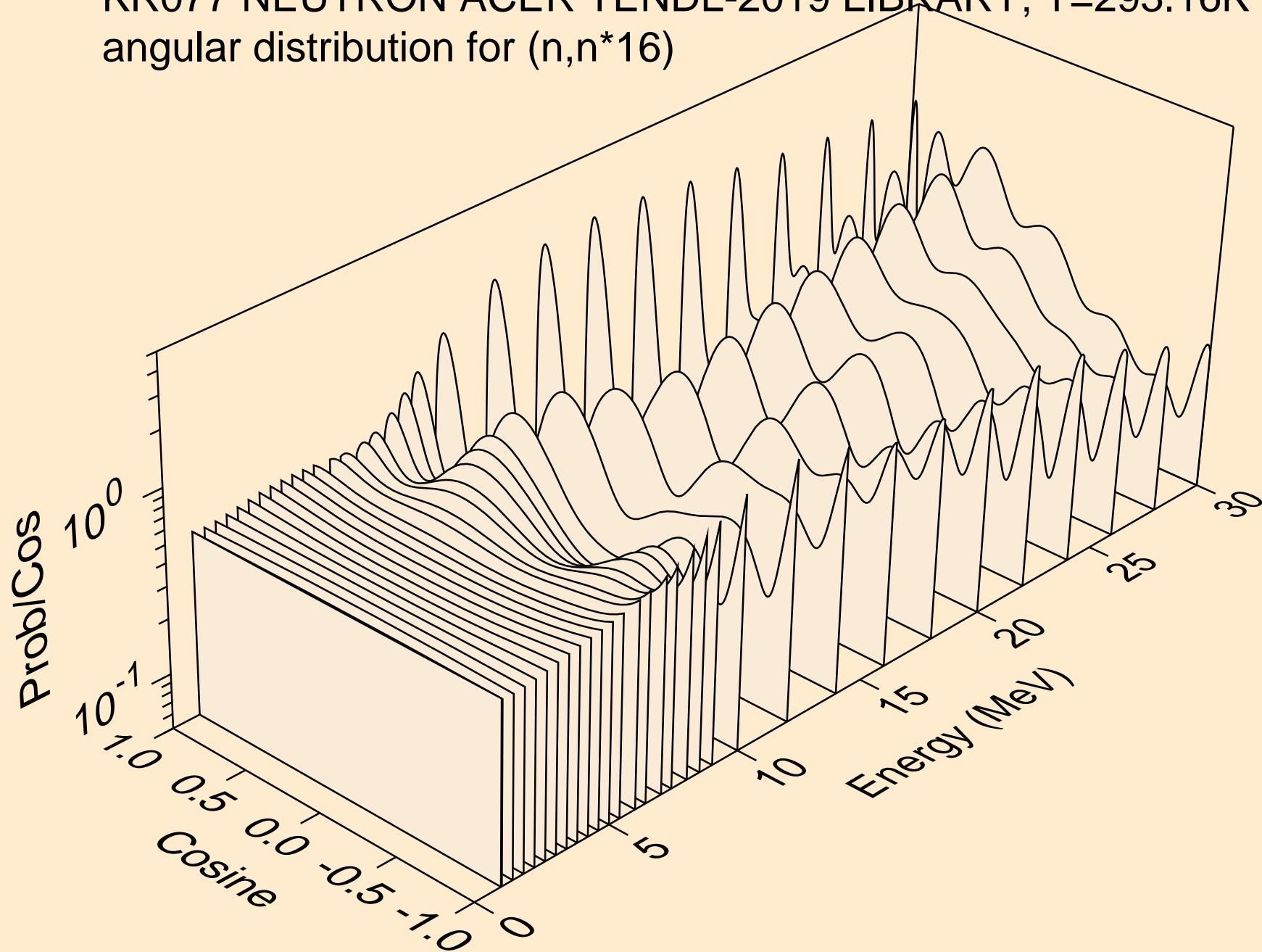

KR077 NEUTRON ACER TENDL-2019 LIBRARY; T=293.16K  
angular distribution for (n,n\*17)

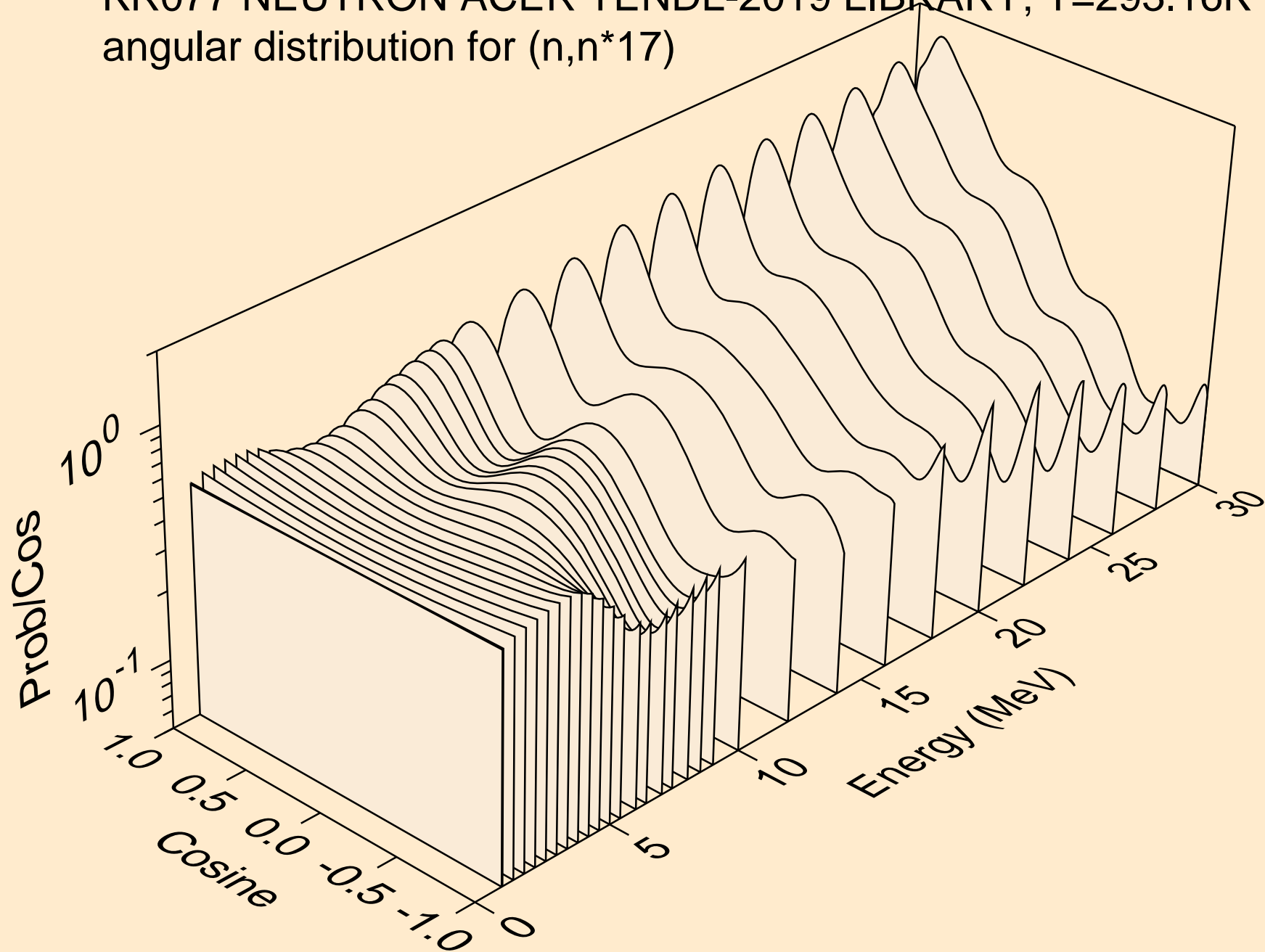

KR077 NEUTRON ACER TENDL-2019 LIBRARY; T=293.16K  
angular distribution for (n,n\*18)

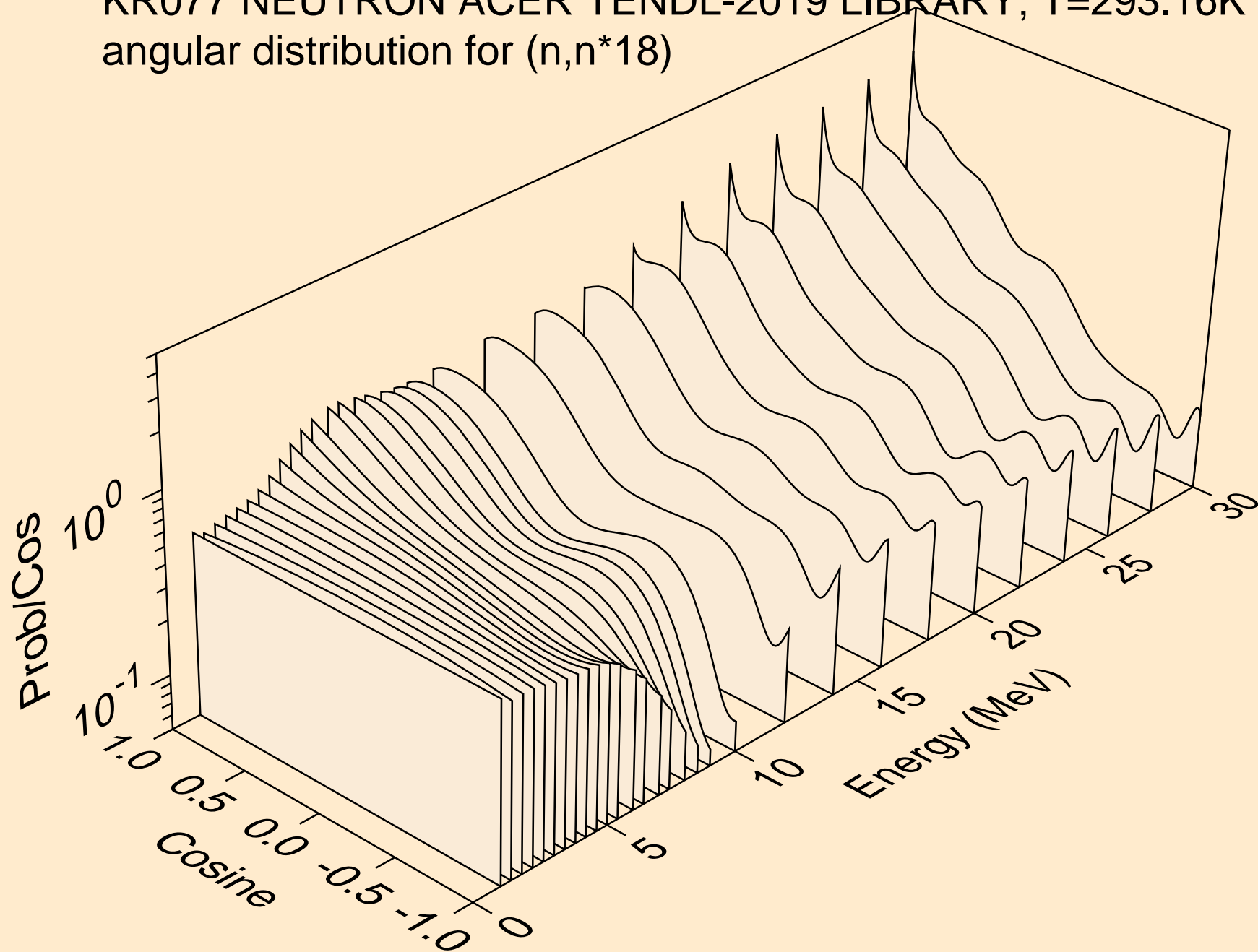

KR077 NEUTRON ACER TENDL-2019 LIBRARY; T=293.16K  
angular distribution for (n,n\*19)

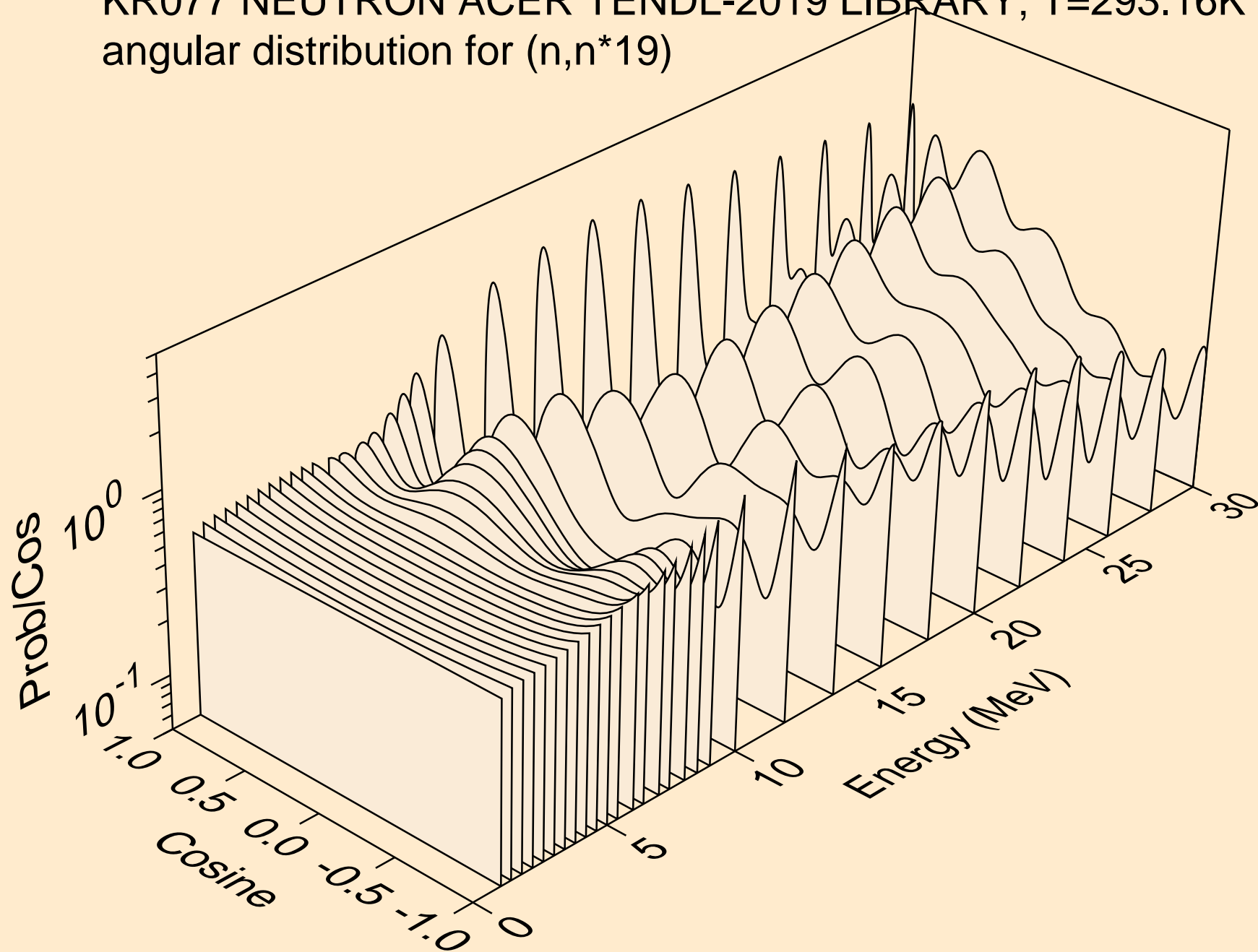

KR077 NEUTRON ACER TENDL-2019 LIBRARY; T=293.16K  
angular distribution for (n,n\*20)

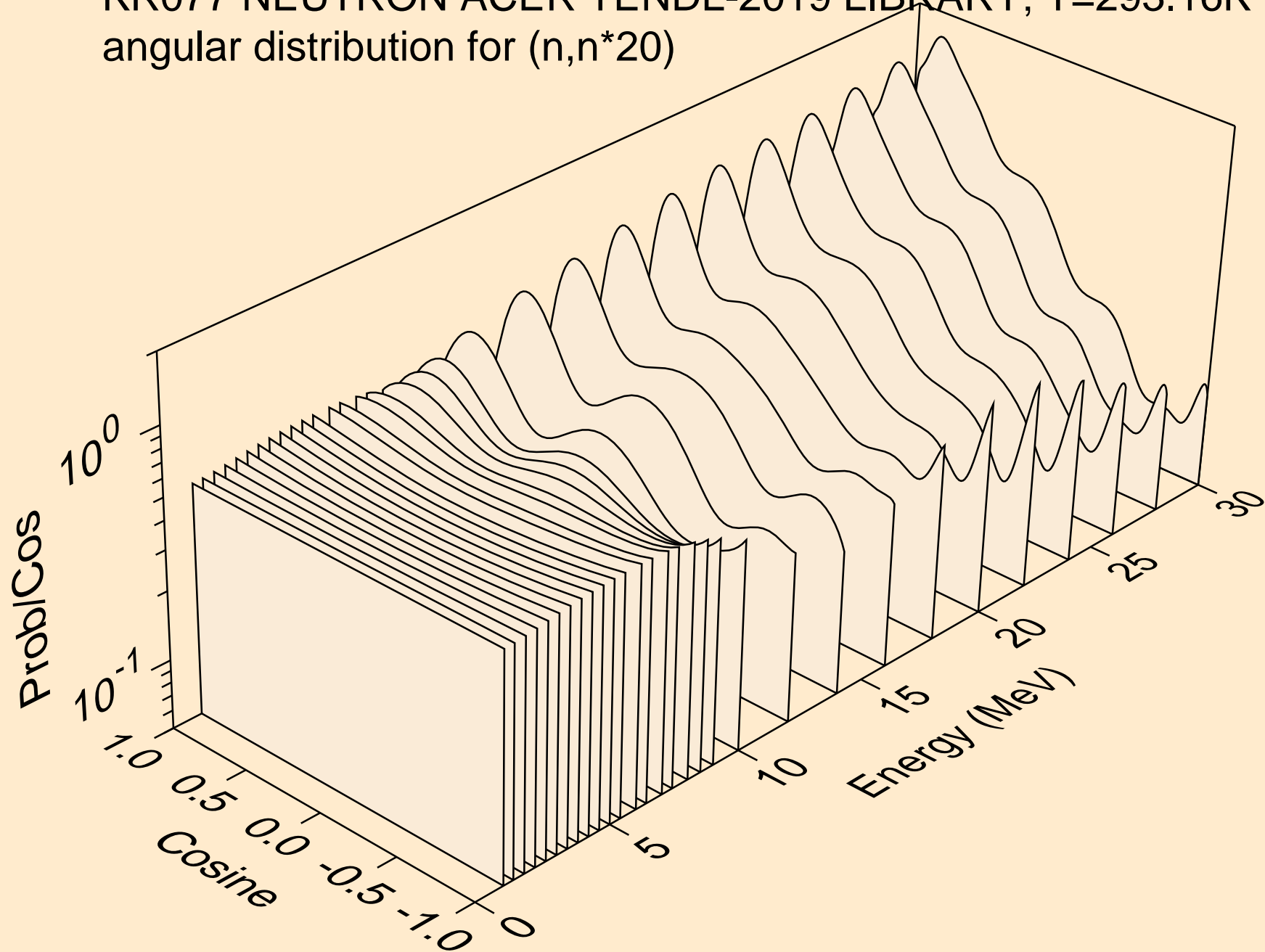

KR077 NEUTRON ACER TENDL-2019 LIBRARY; T=293.16K  
angular distribution for (n,n\*21)

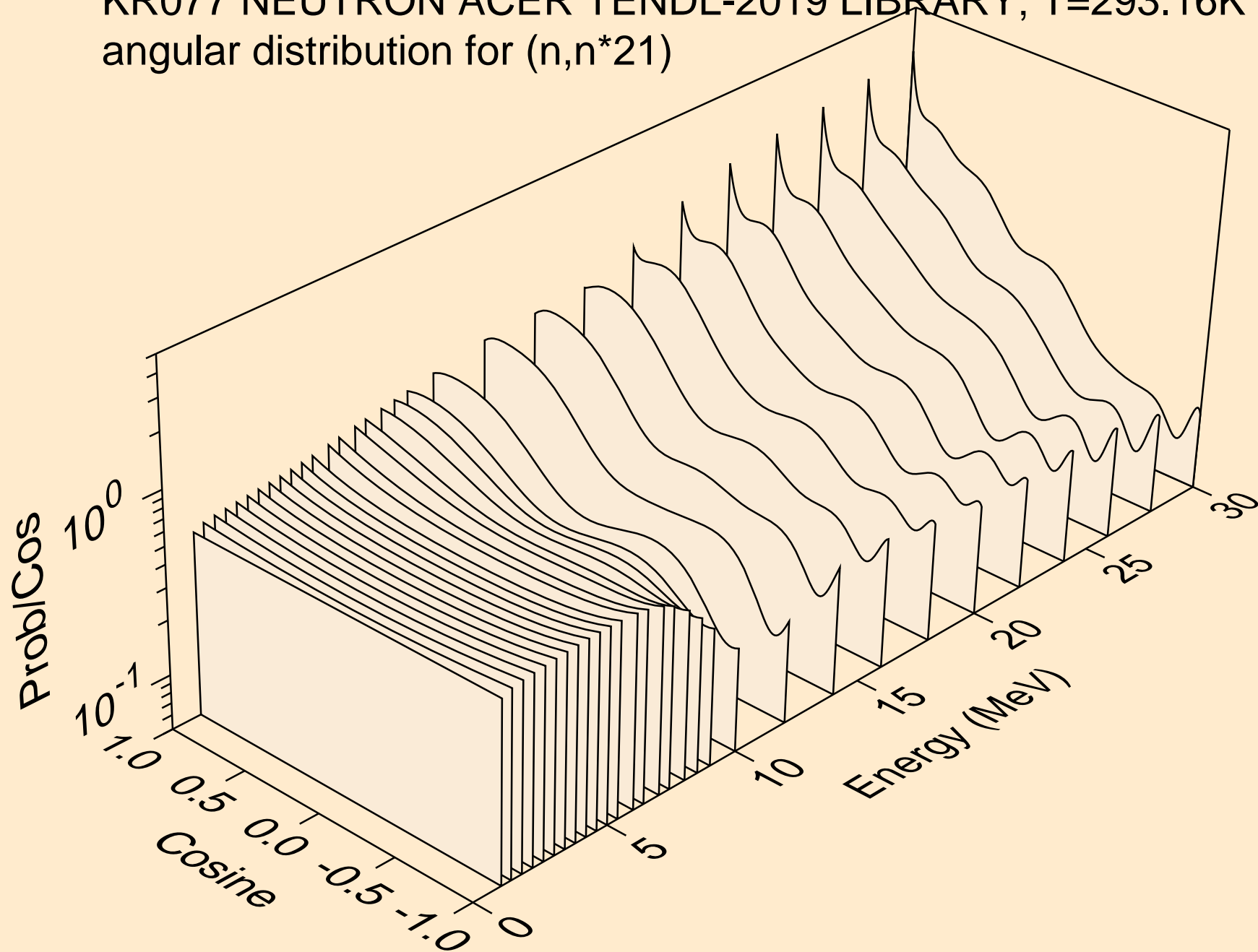

KR077 NEUTRON ACER TENDL-2019 LIBRARY; T=293.16K  
angular distribution for (n,n\*22)

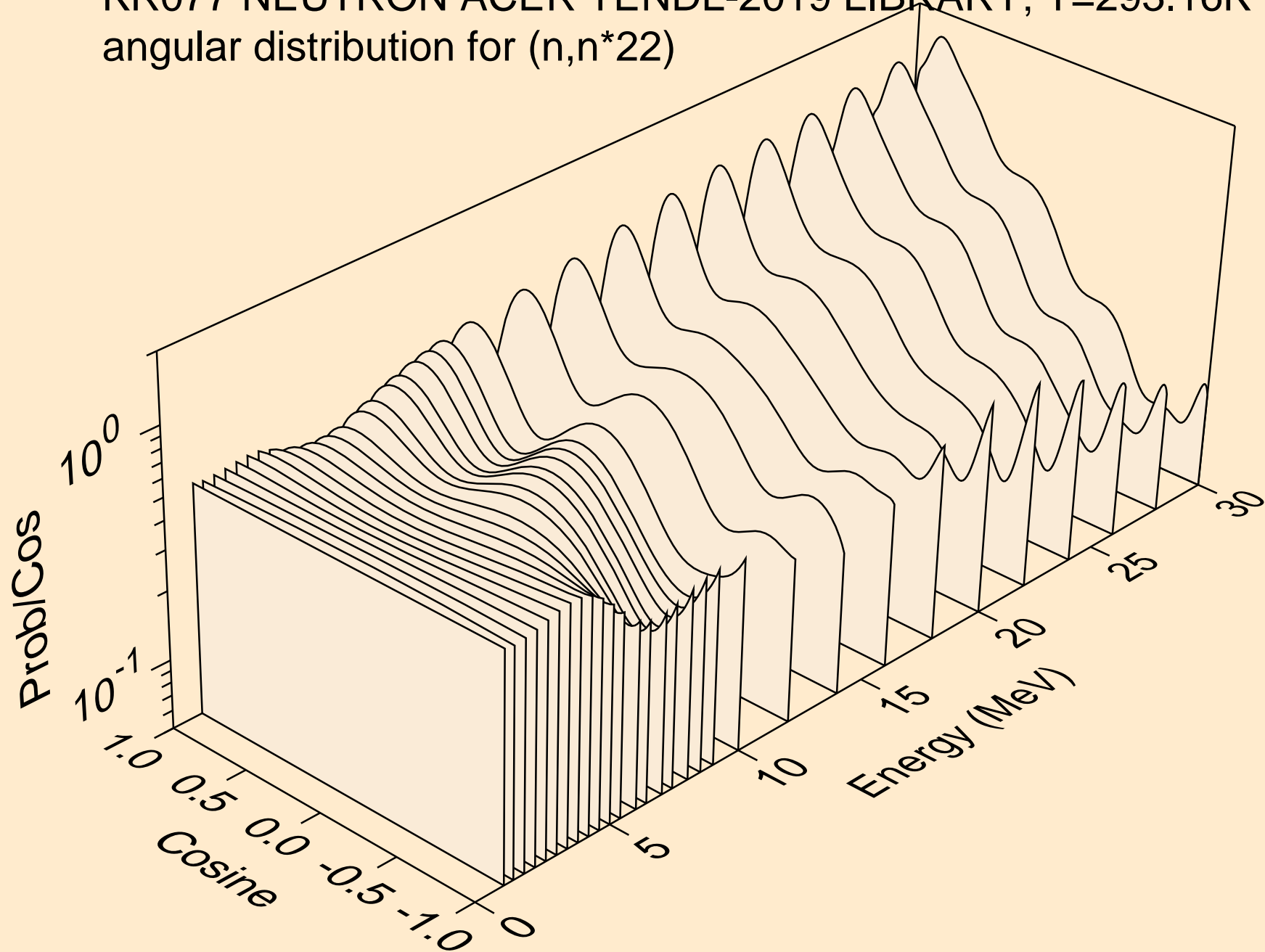

KR077 NEUTRON ACER TENDL-2019 LIBRARY; T=293.16K  
angular distribution for (n,n\*23)

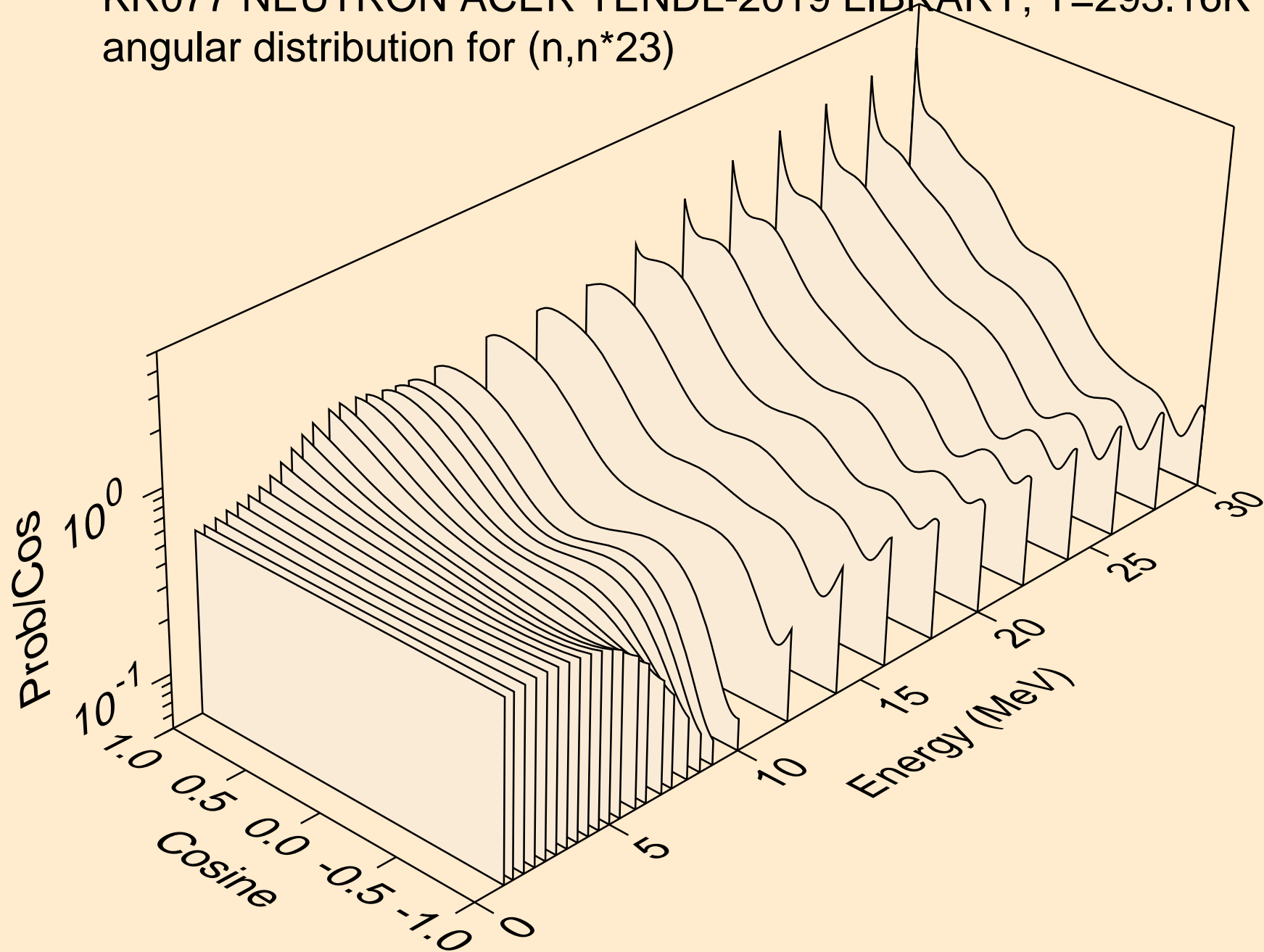

KR077 NEUTRON ACER TENDL-2019 LIBRARY; T=293.16K  
angular distribution for (n,n\*24)

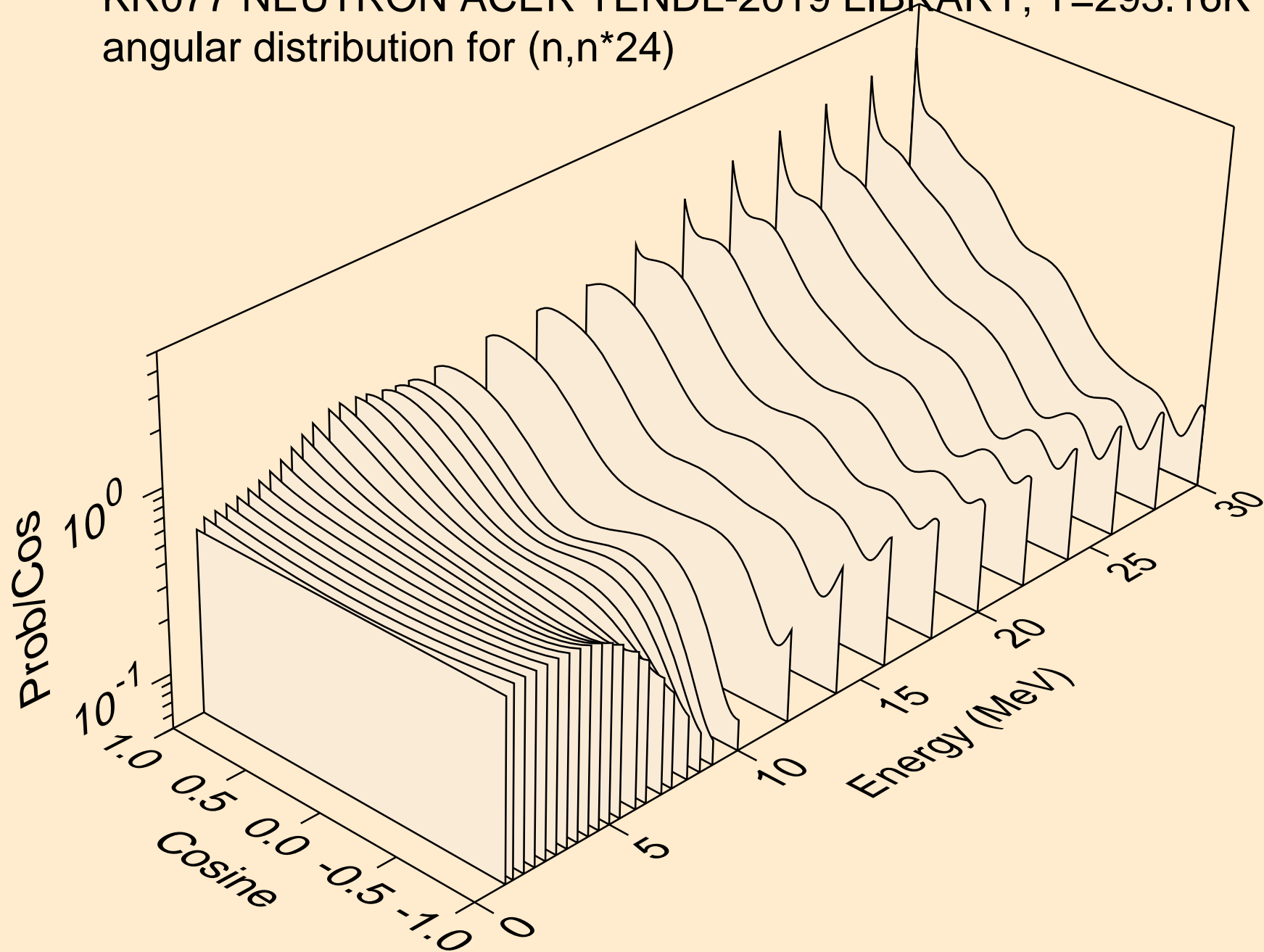

KR077 NEUTRON ACER TENDL-2019 LIBRARY; T=293.16K  
angular distribution for (n,n\*25)

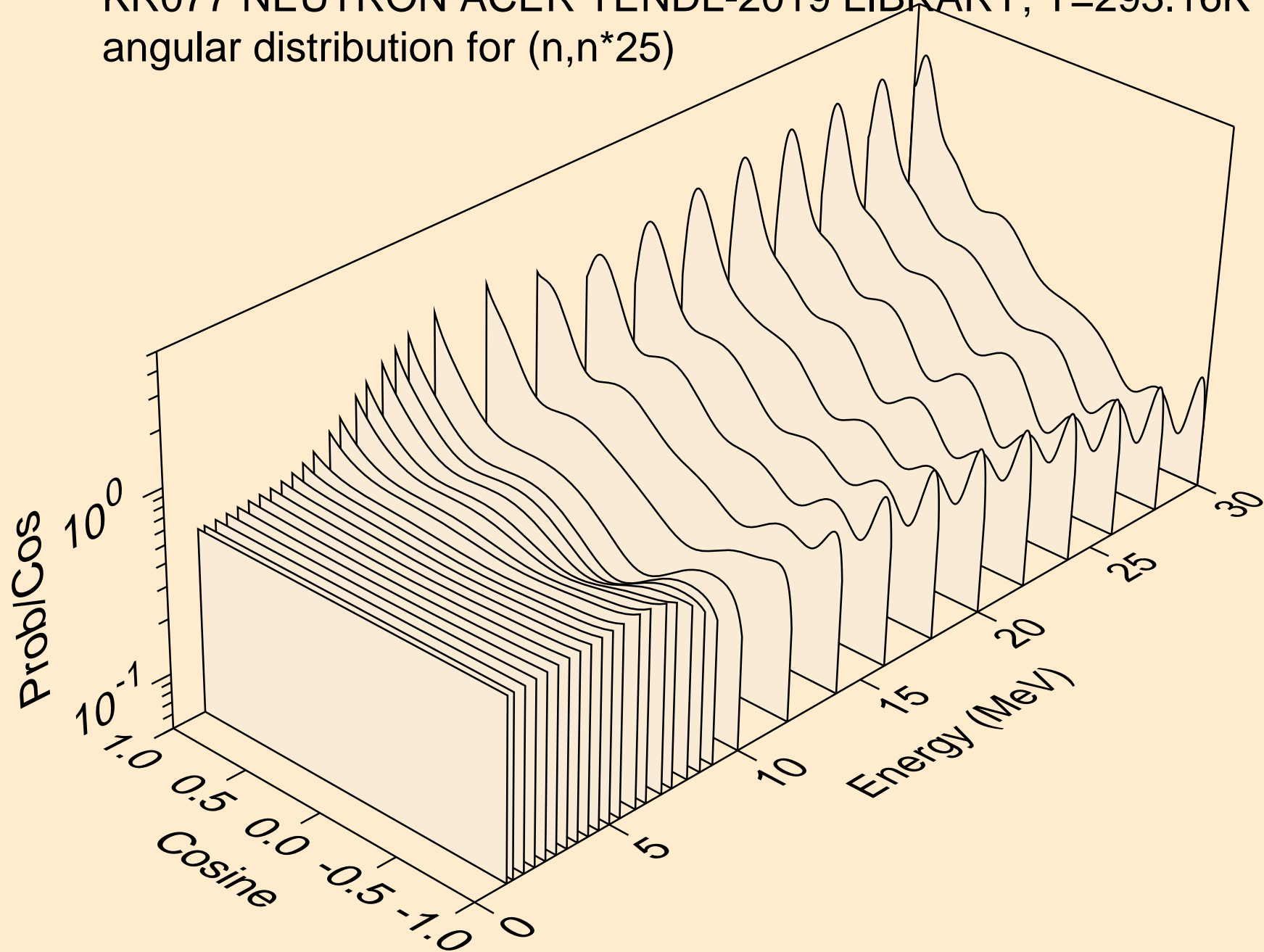

KR077 NEUTRON ACER TENDL-2019 LIBRARY; T=293.16K  
angular distribution for (n,n\*26)

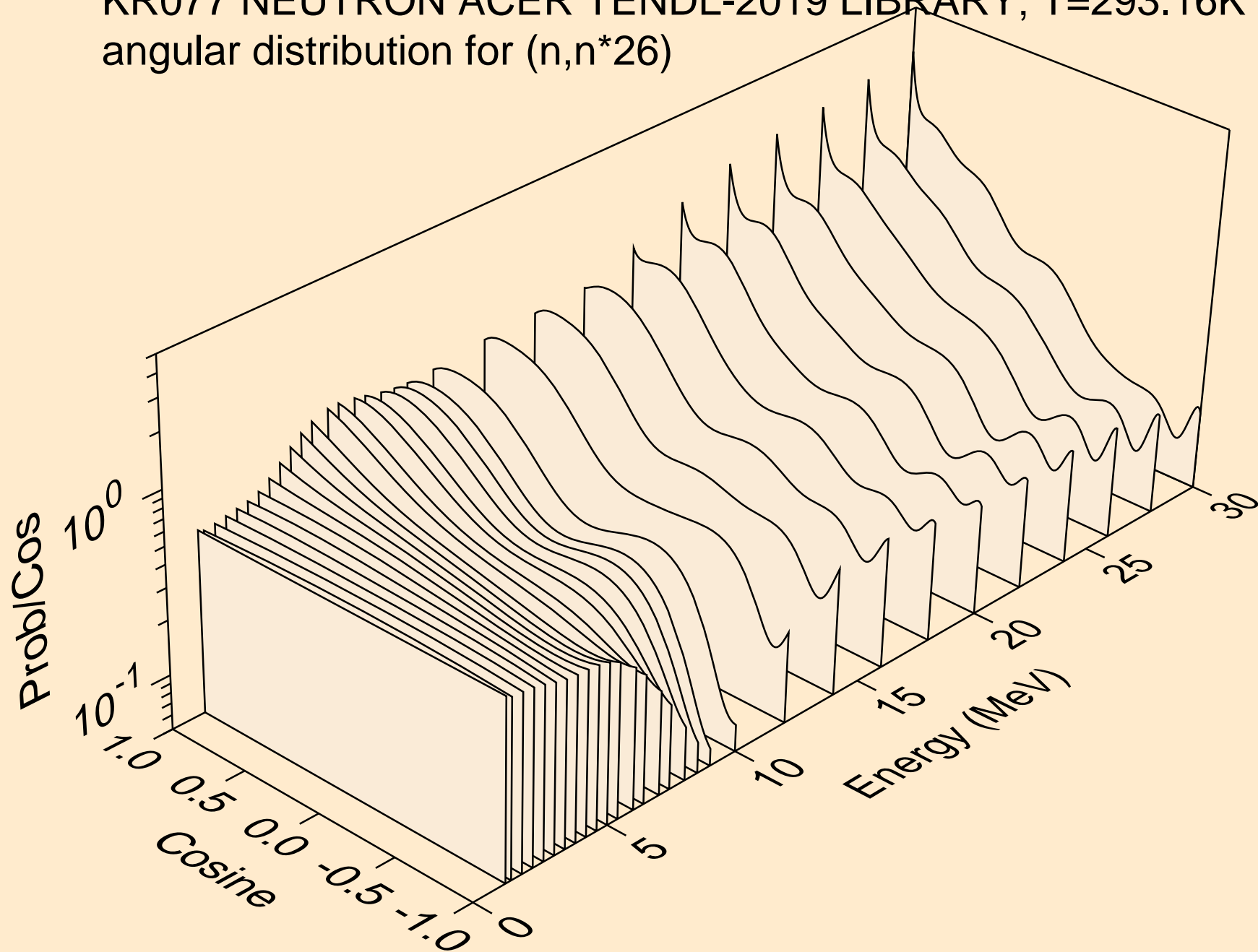

KR077 NEUTRON ACER TENDL-2019 LIBRARY; T=293.16K  
angular distribution for (n,n\*27)

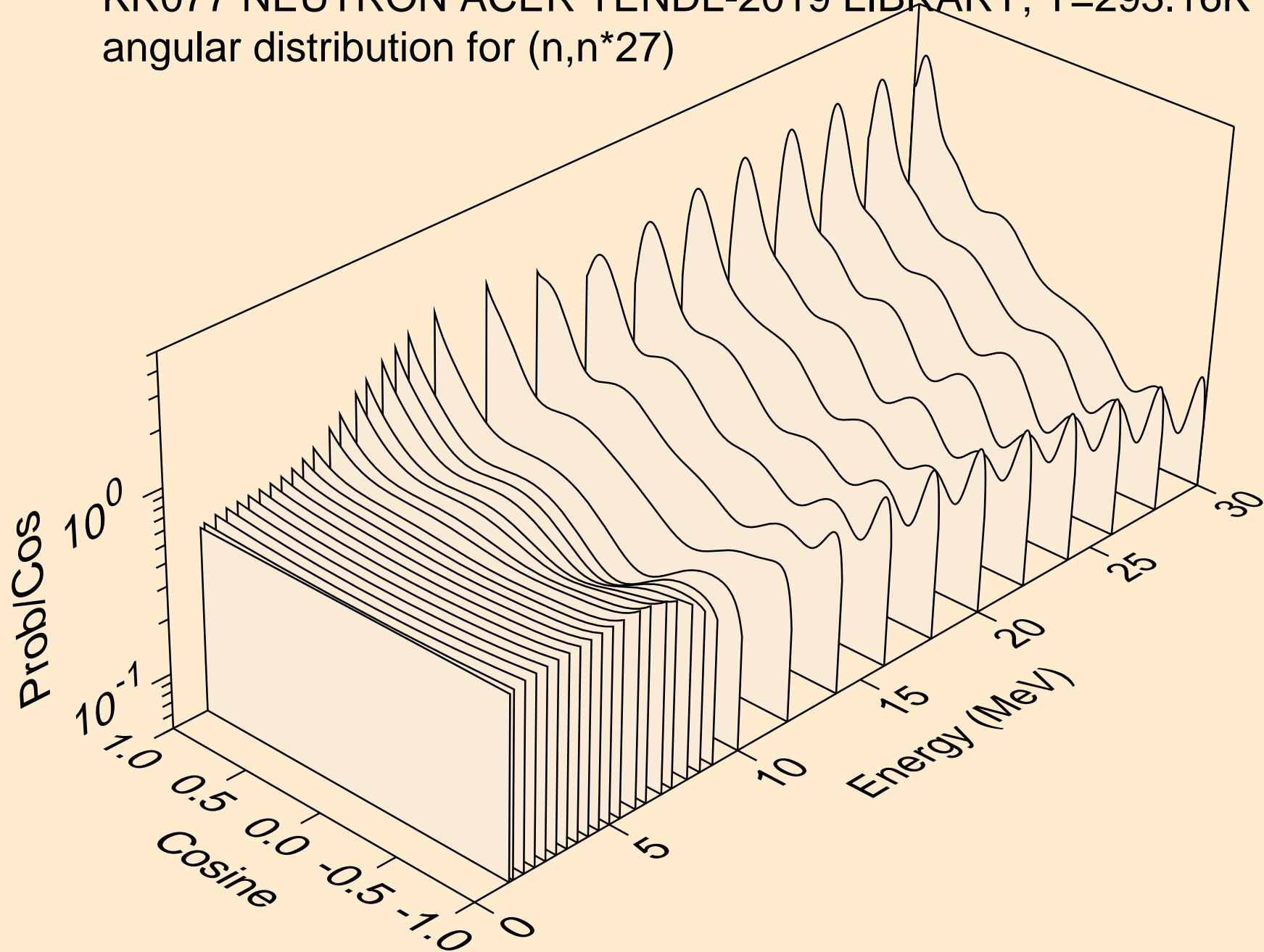

KR077 NEUTRON ACER TENDL-2019 LIBRARY; T=293.16K  
angular distribution for (n,n\*28)

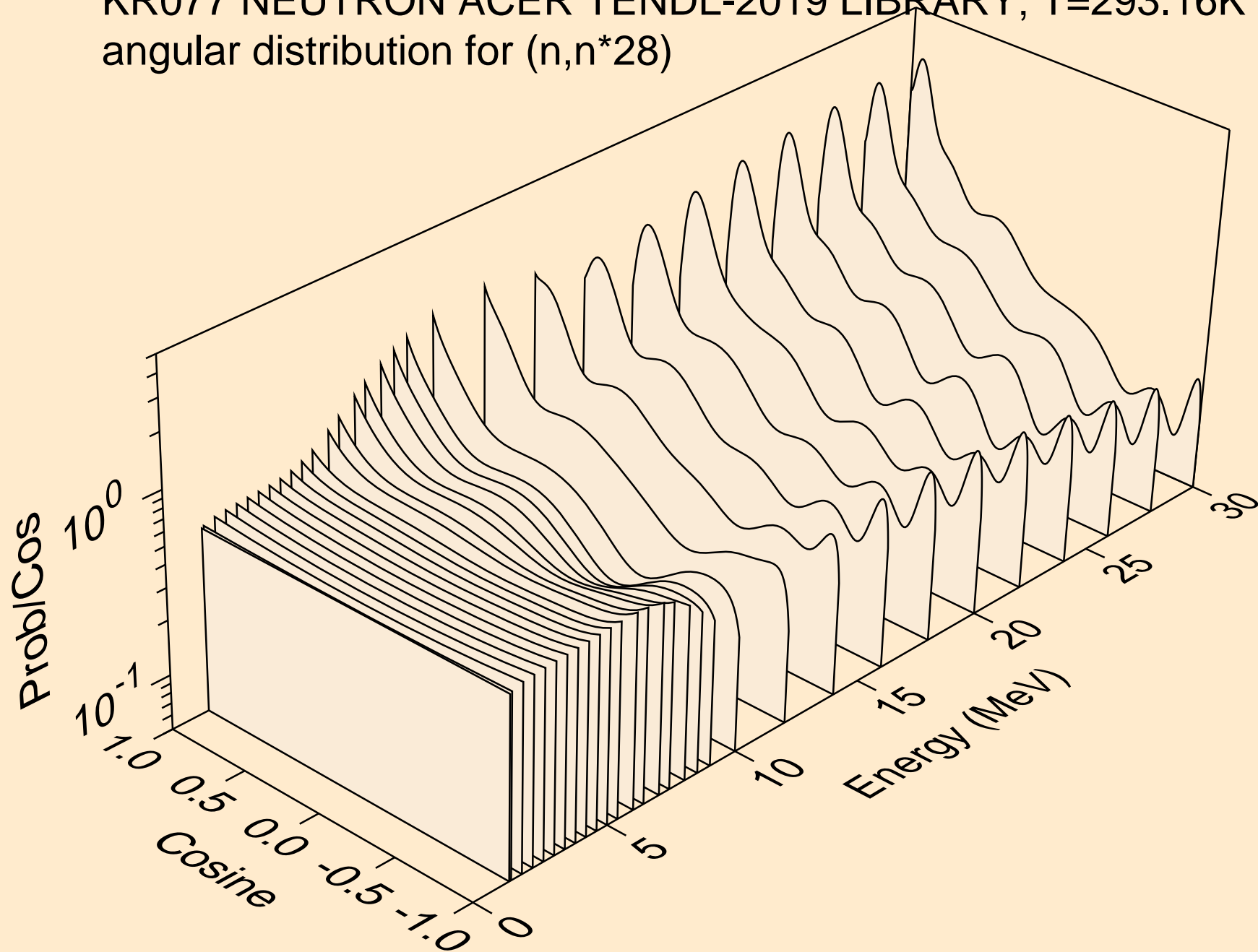

KR077 NEUTRON ACER TENDL-2019 LIBRARY; T=293.16K  
angular distribution for (n,n\*29)

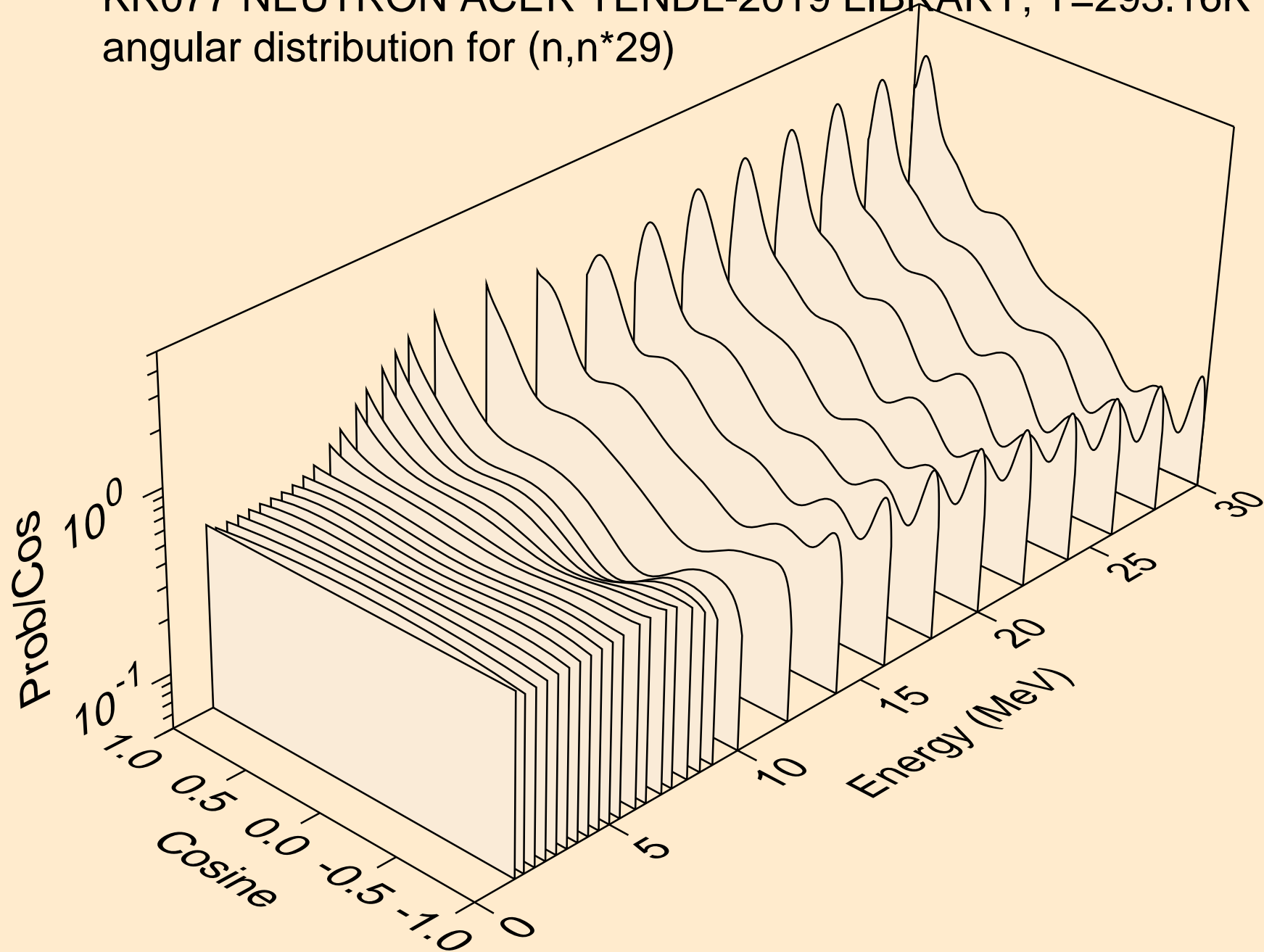

KR077 NEUTRON ACER TENDL-2019 LIBRARY; T=293.16K  
angular distribution for (n,n\*30)

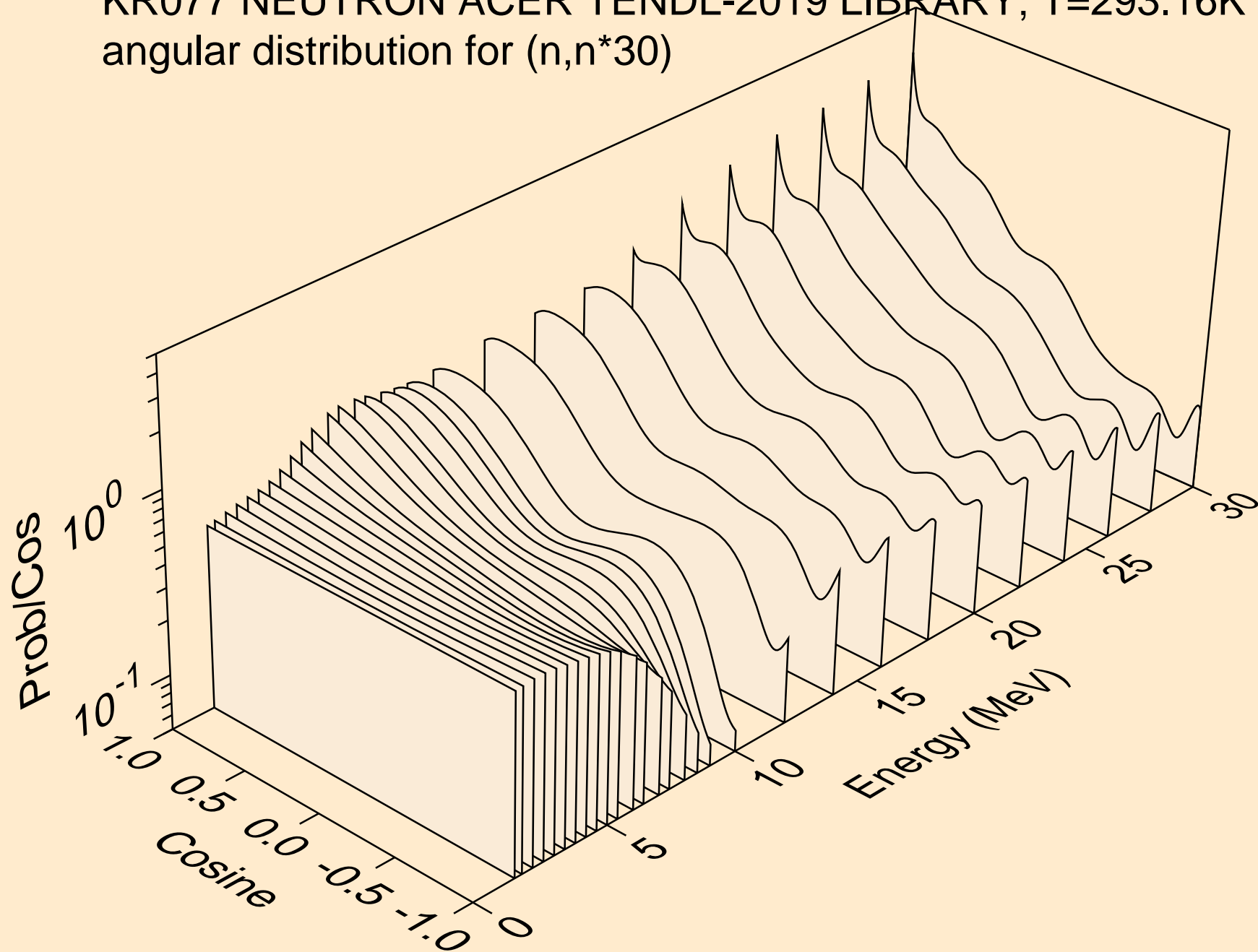

KR077 NEUTRON ACER TENDL-2019 LIBRARY; T=293.16K  
Neutron emission for (n,x)

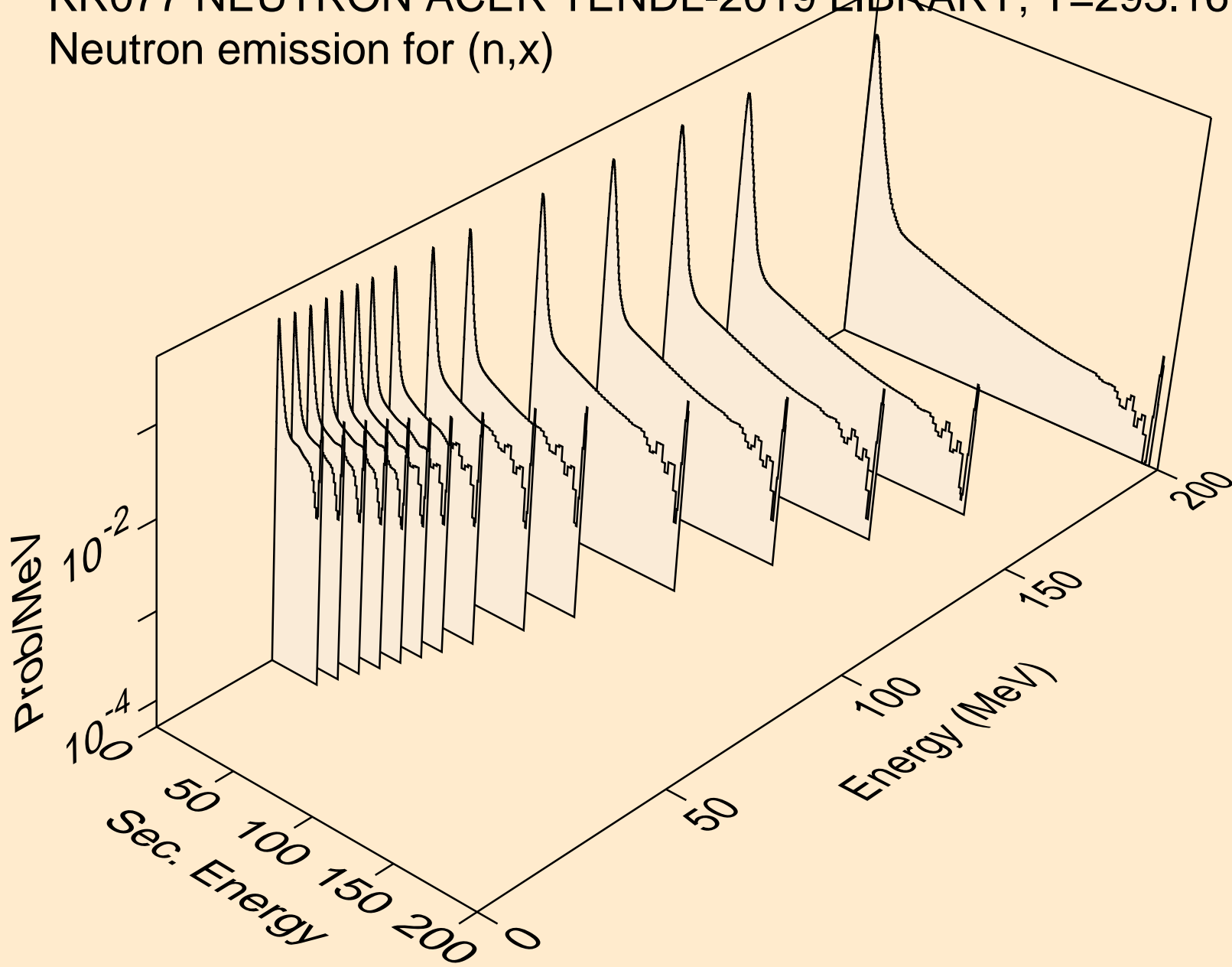

KR077 NEUTRON ACER TENDL-2019 LIBRARY; T=293.16K  
Neutron emission for (n,2nd)

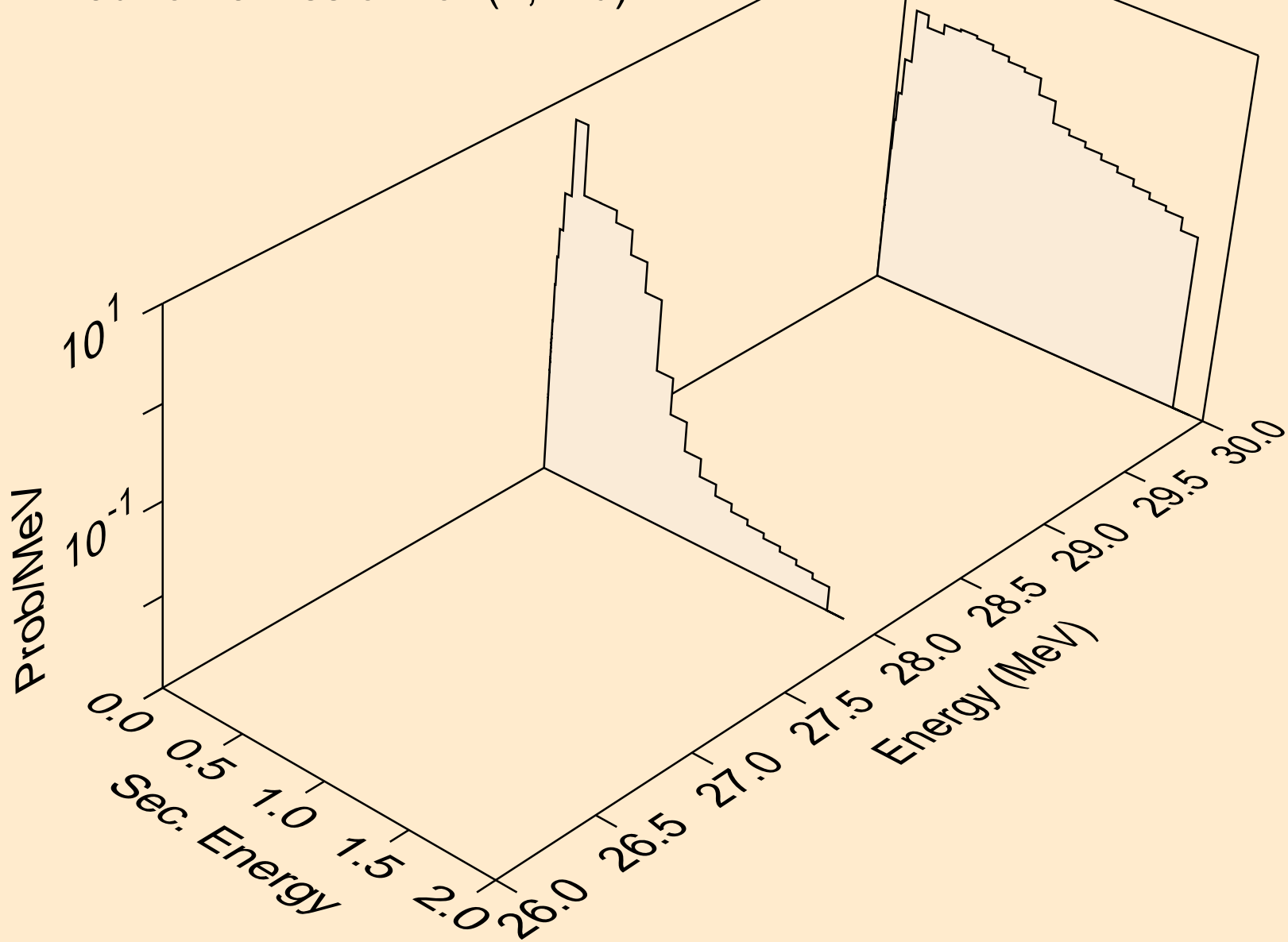

KR077 NEUTRON ACER TENDL-2019 LIBRARY; T=293.16K  
Neutron emission for (n,2n)

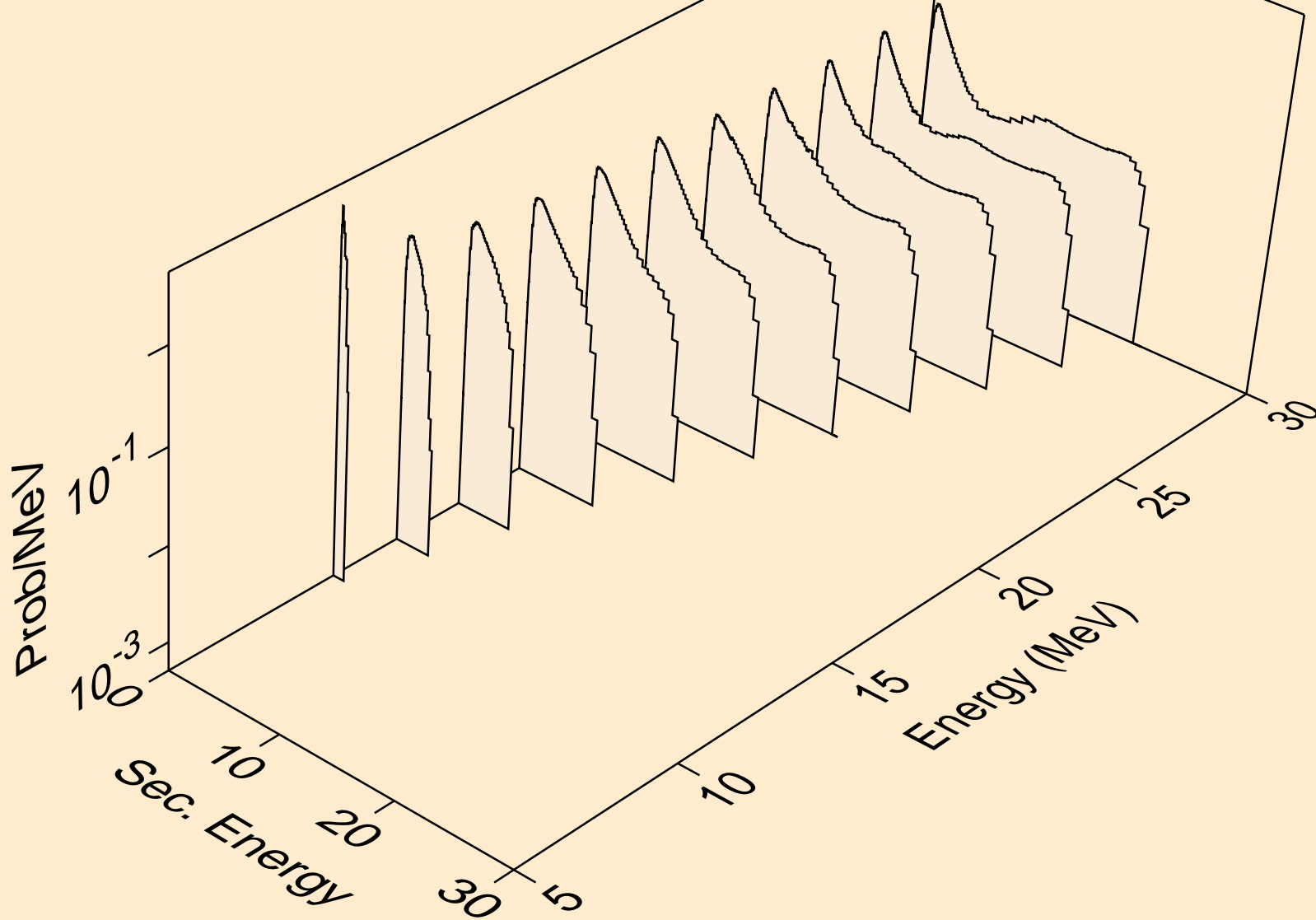

KR077 NEUTRON ACER TENDL-2019 LIBRARY; T=293.16K  
Neutron emission for (n,3n)

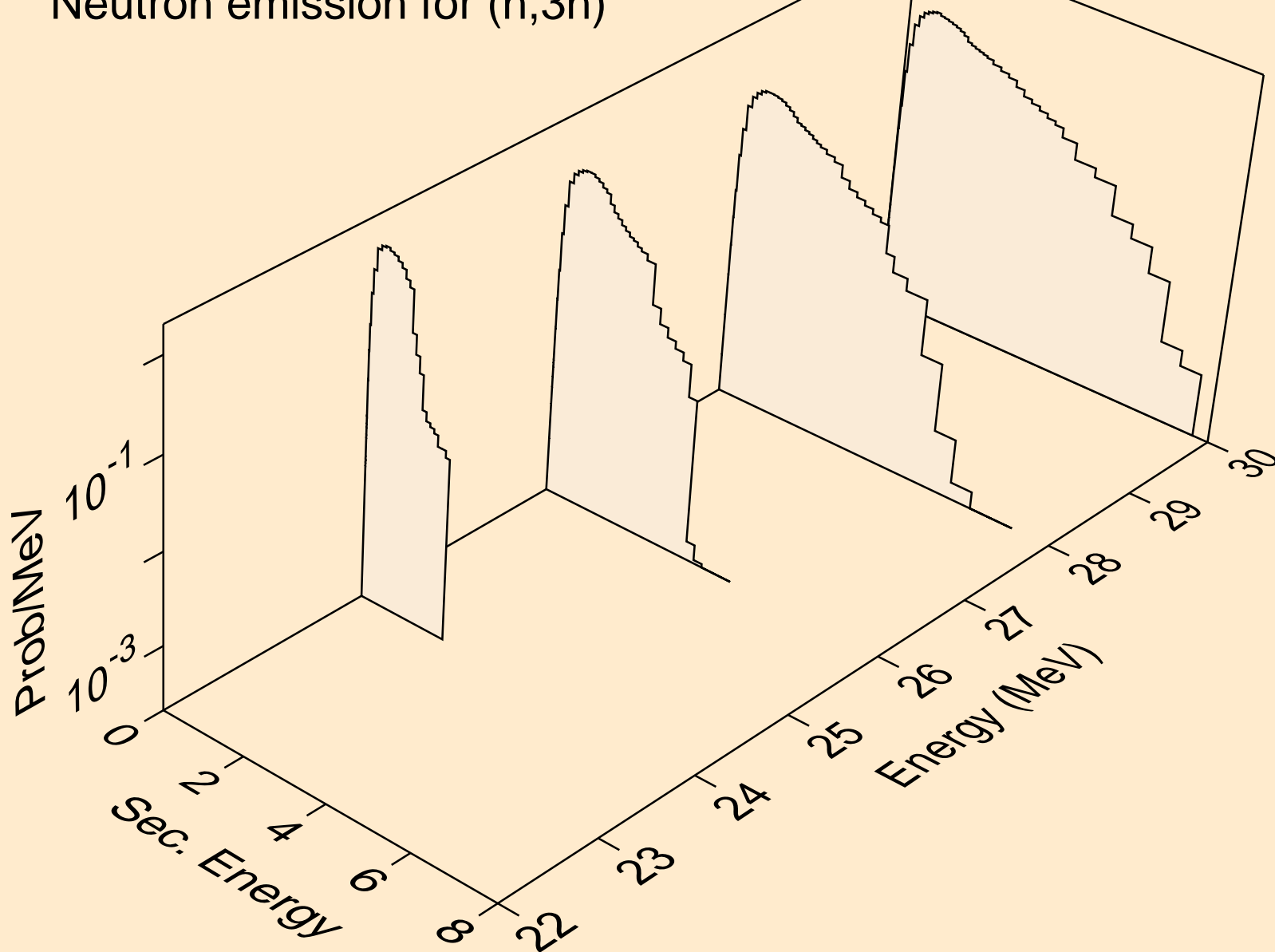

KR077 NEUTRON ACER TENDL-2019 LIBRARY; T=293.16K  
Neutron emission for (n,n\*)a

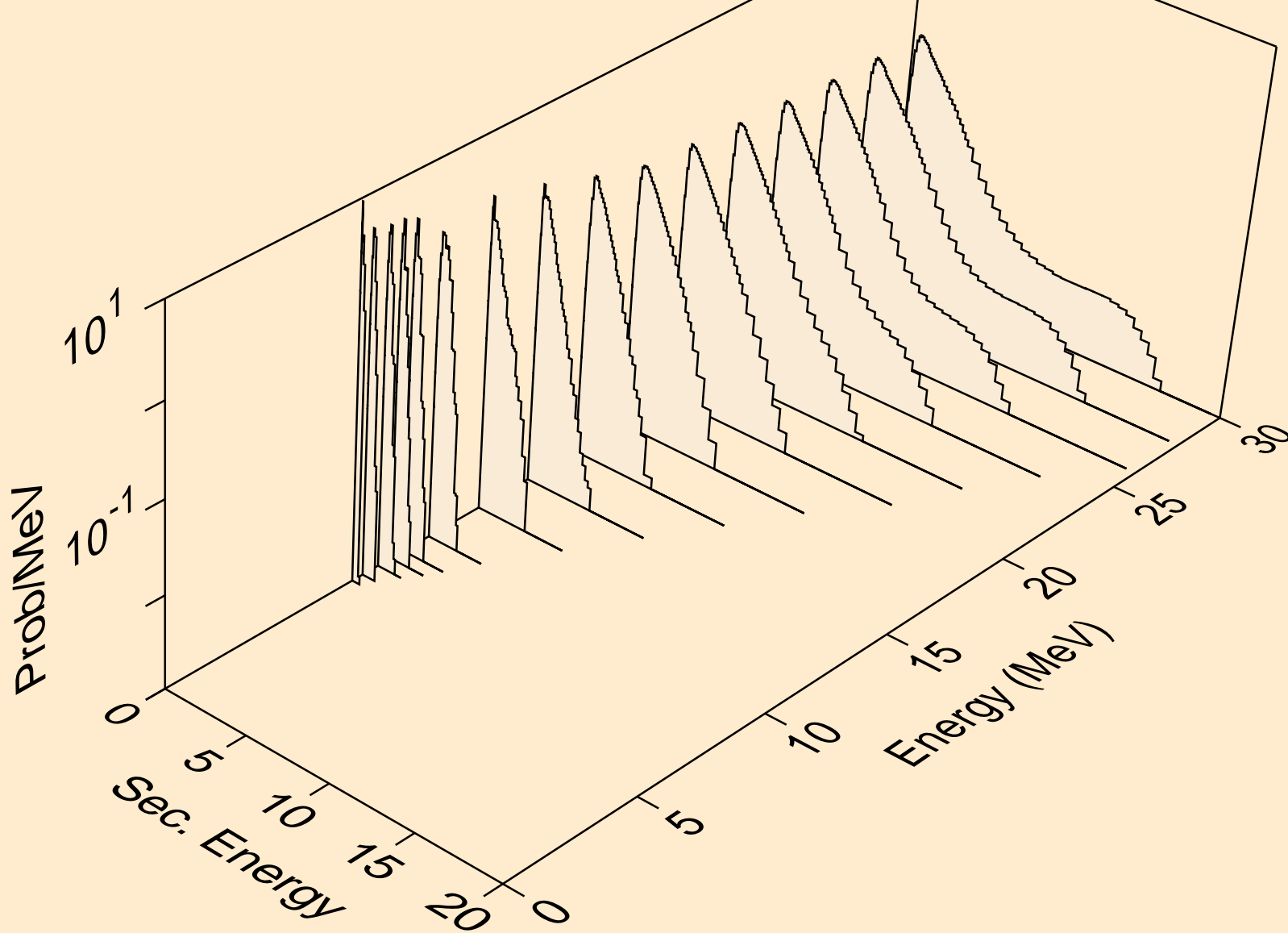

KR077 NEUTRON ACER TENDL-2019 LIBRARY; T=293.16K  
Neutron emission for (n,2n)a

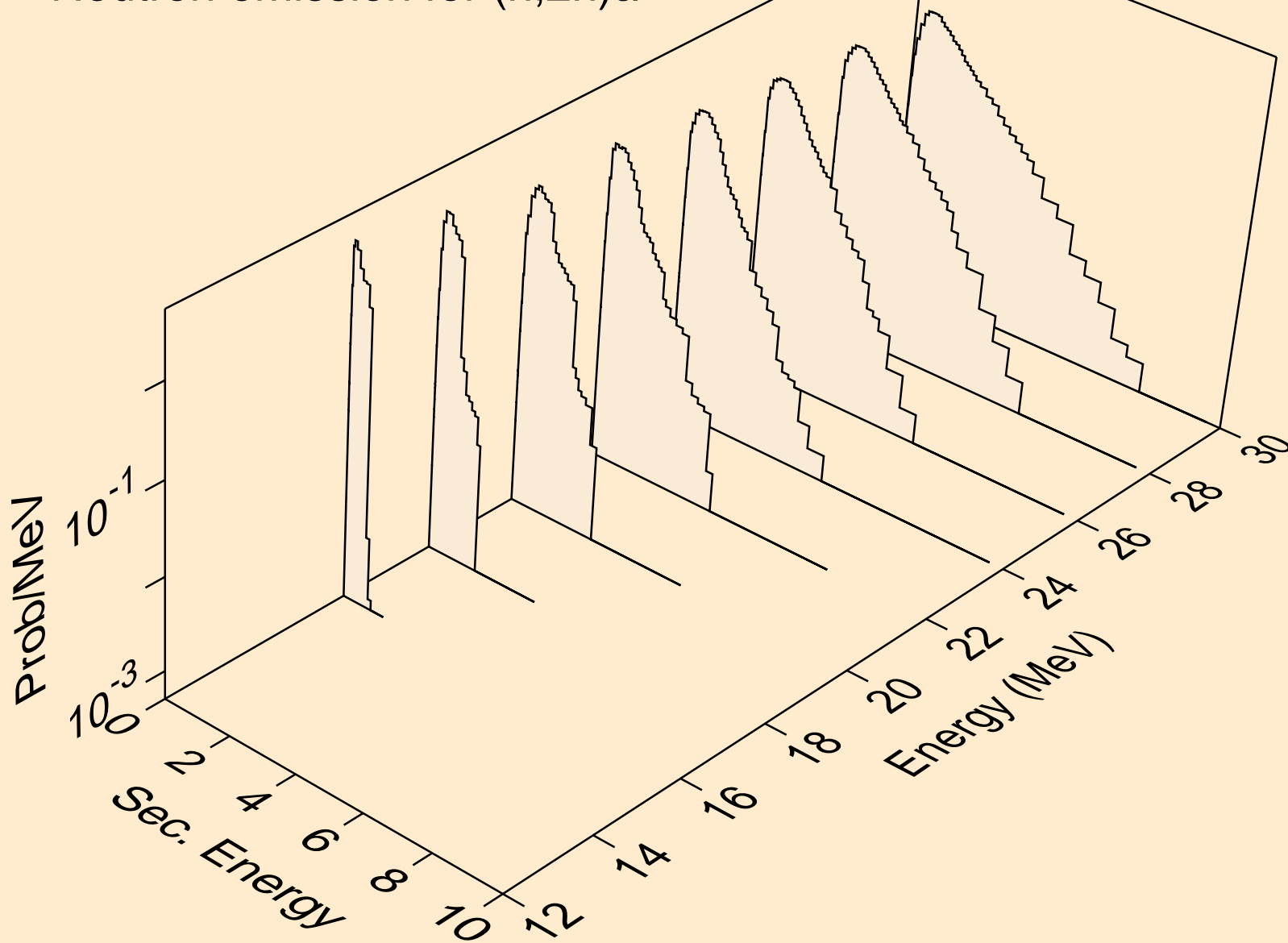

KR077 NEUTRON ACER TENDL-2019 LIBRARY; T=293.16K  
Neutron emission for (n,n\*)p

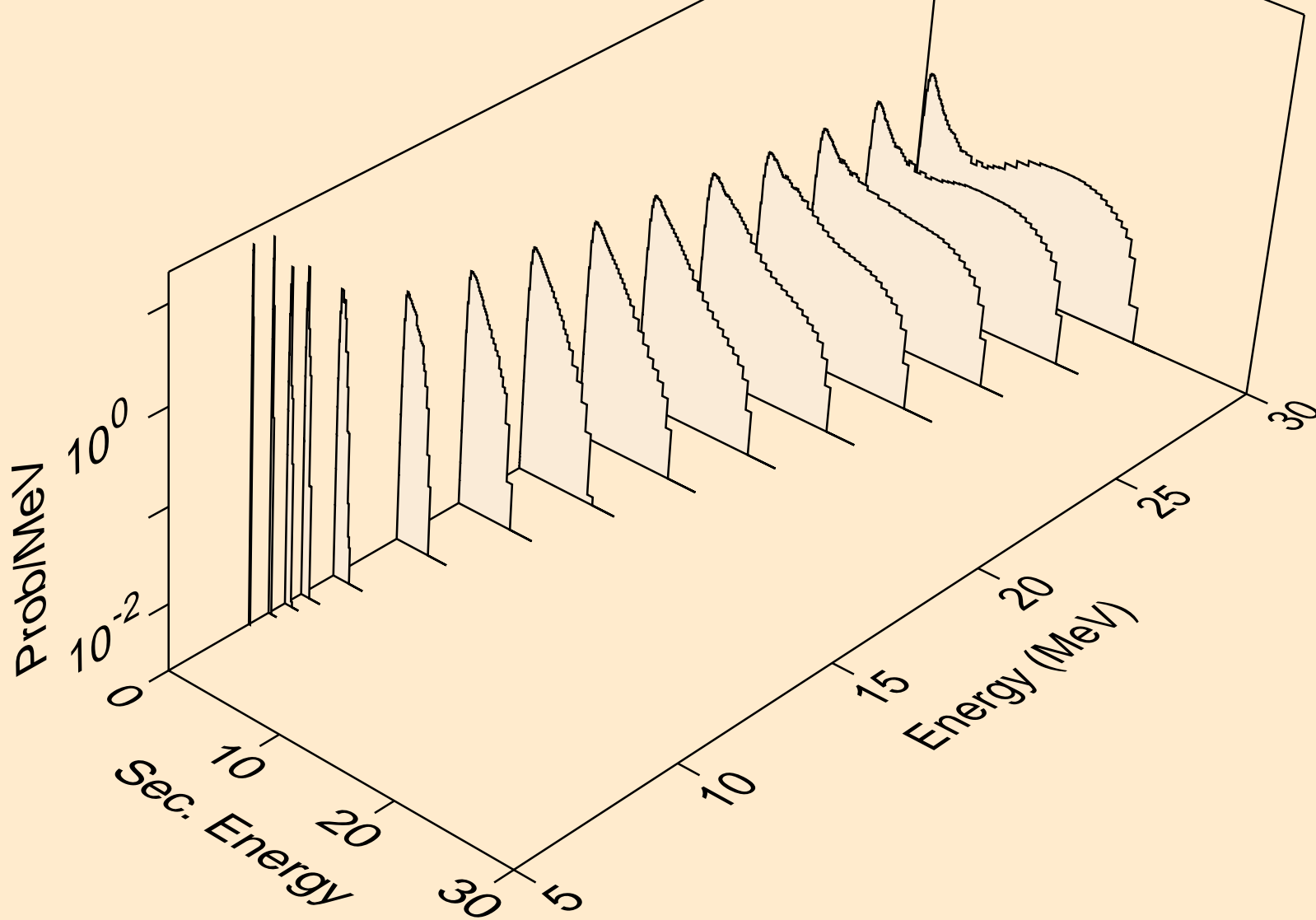

KR077 NEUTRON ACER TENDL-2019 LIBRARY; T=293.16K  
Neutron emission for (n,n\*)2a

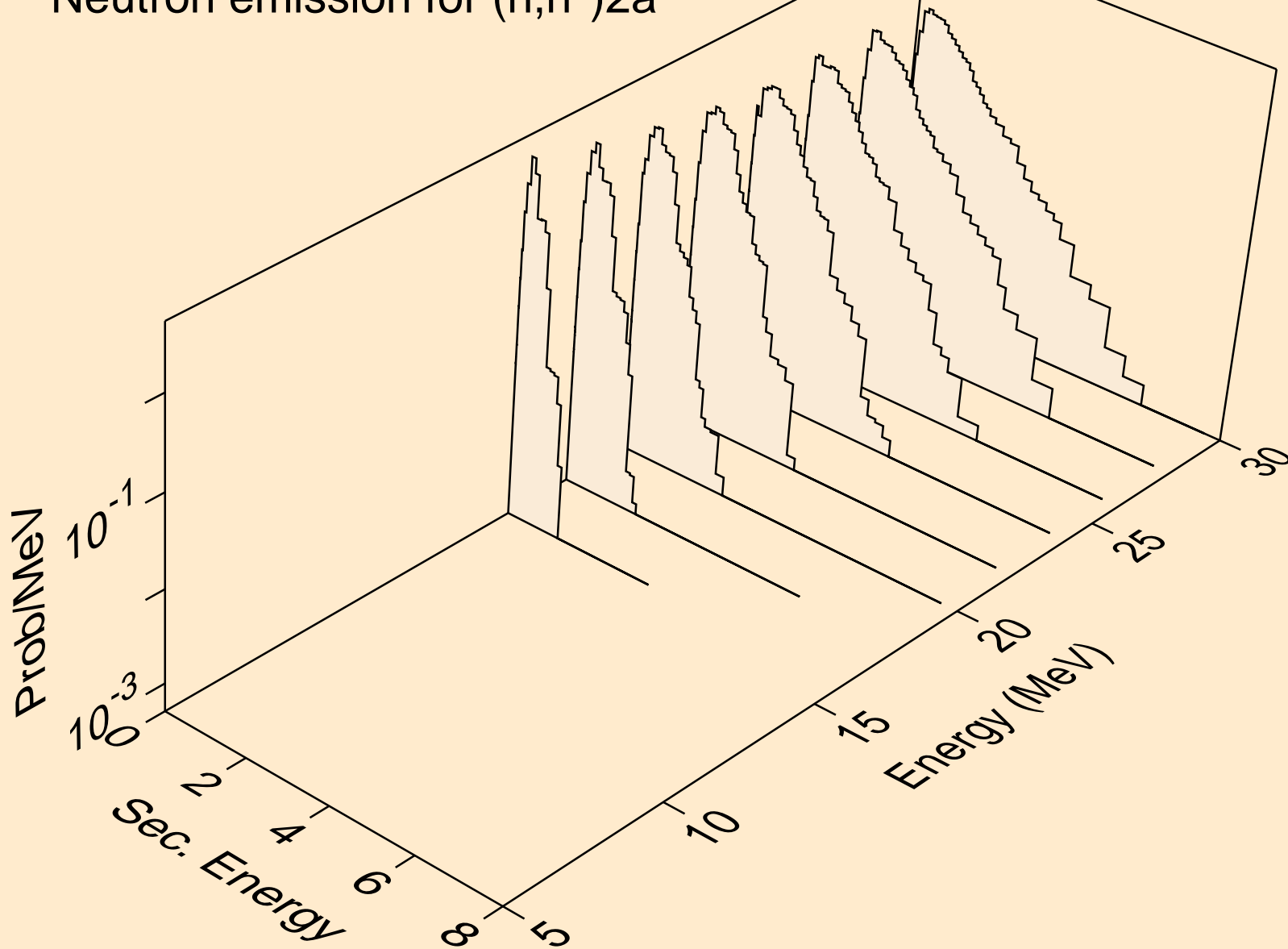

KR077 NEUTRON ACER TENDL-2019 LIBRARY; T=293.16K  
Neutron emission for (n,2n)2a

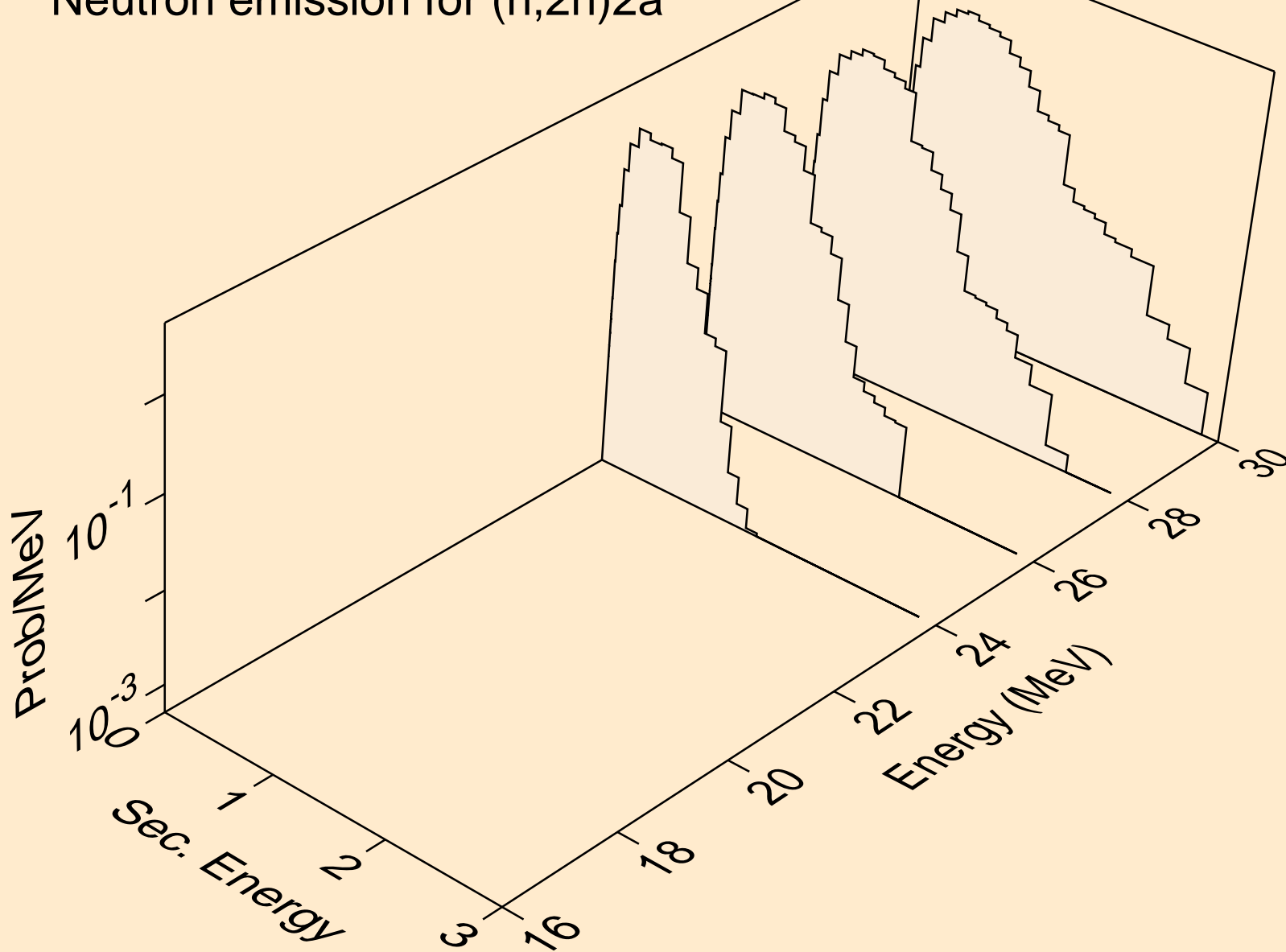

KR077 NEUTRON ACER TENDL-2019 LIBRARY; T=293.16K  
Neutron emission for (n,n\*)d

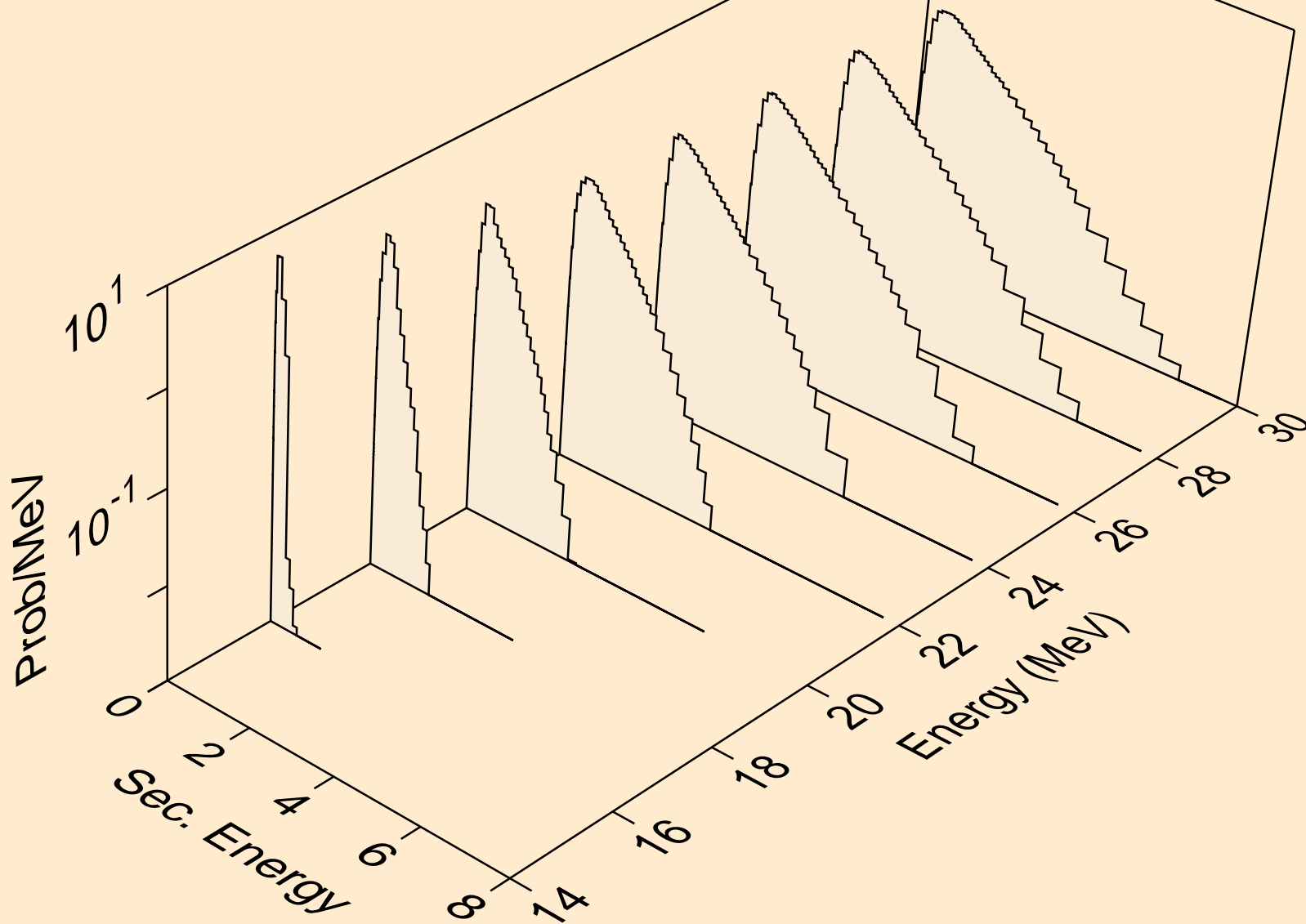

KR077 NEUTRON ACER TENDL-2019 LIBRARY; T=293.16K  
Neutron emission for (n,n\*)t

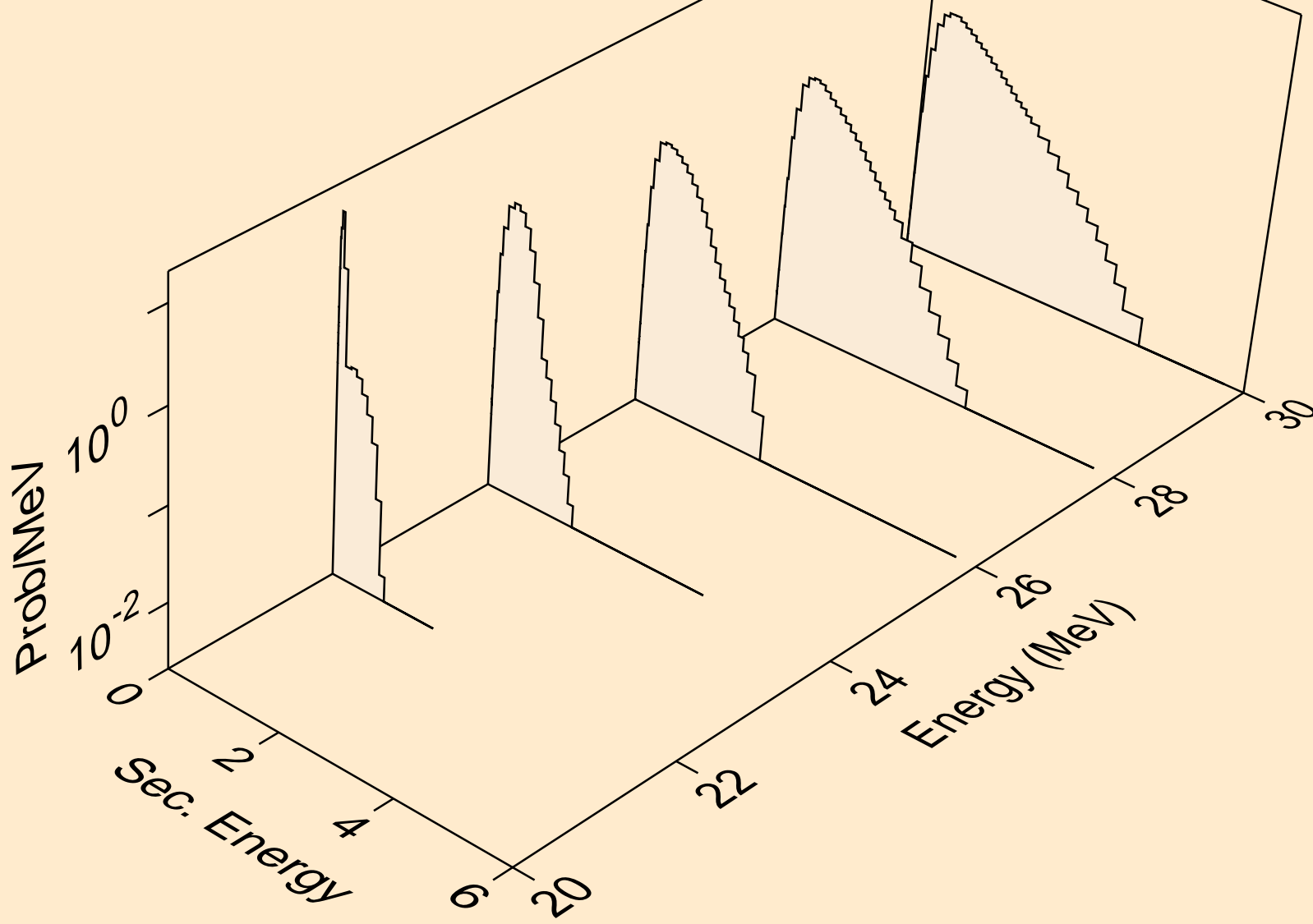

KR077 NEUTRON ACER TENDL-2019 LIBRARY; T=293.16K  
Neutron emission for (n,n\*)he3

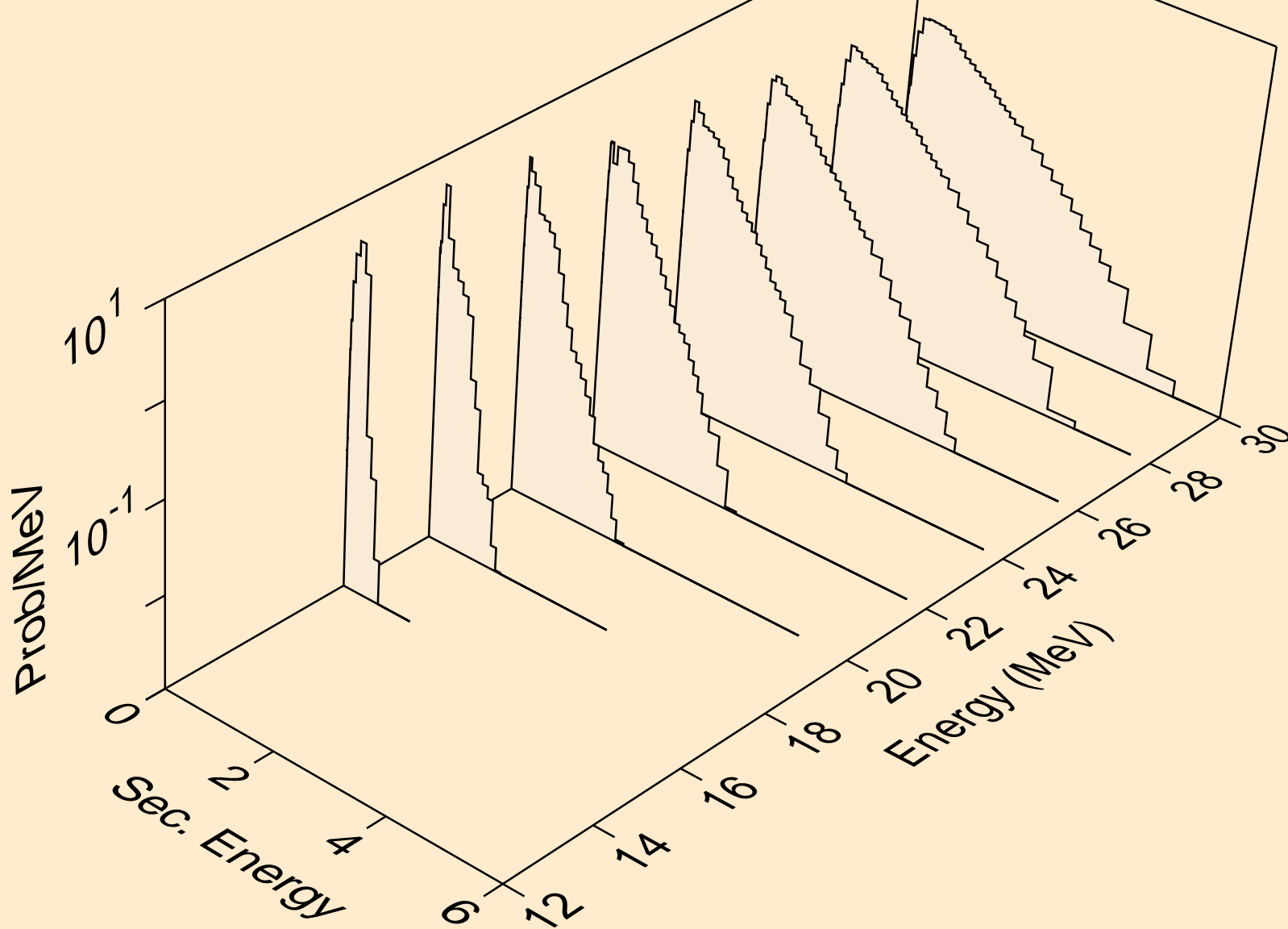

KR077 NEUTRON ACER TENDL-2019 LIBRARY; T=293.16K  
Neutron emission for (n,2np)

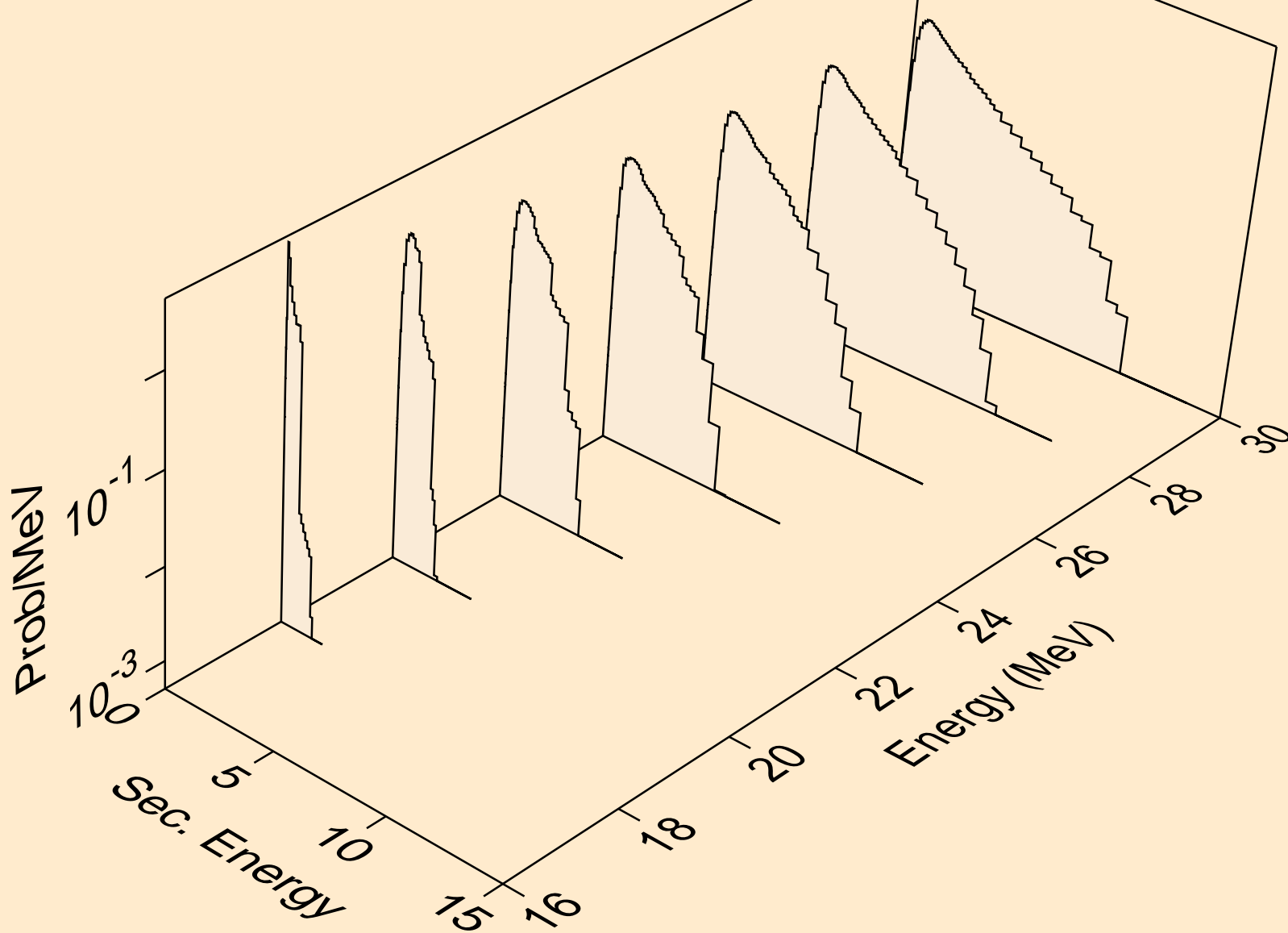

KR077 NEUTRON ACER TENDL-2019 LIBRARY; T=293.16K  
Neutron emission for (n,3np)

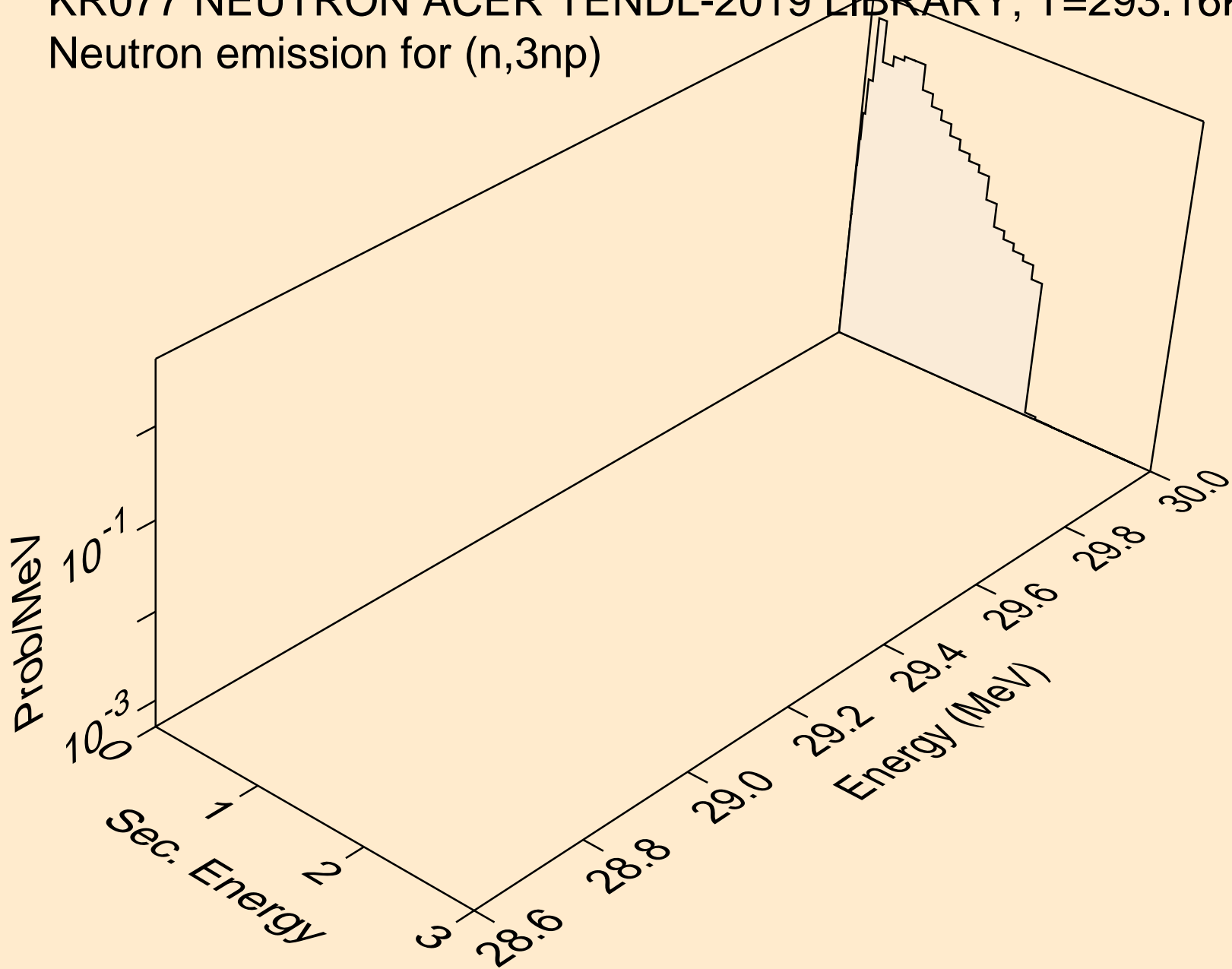

KR077 NEUTRON ACER TENDL-2019 LIBRARY; T=293.16K  
Neutron emission for (n,2np)

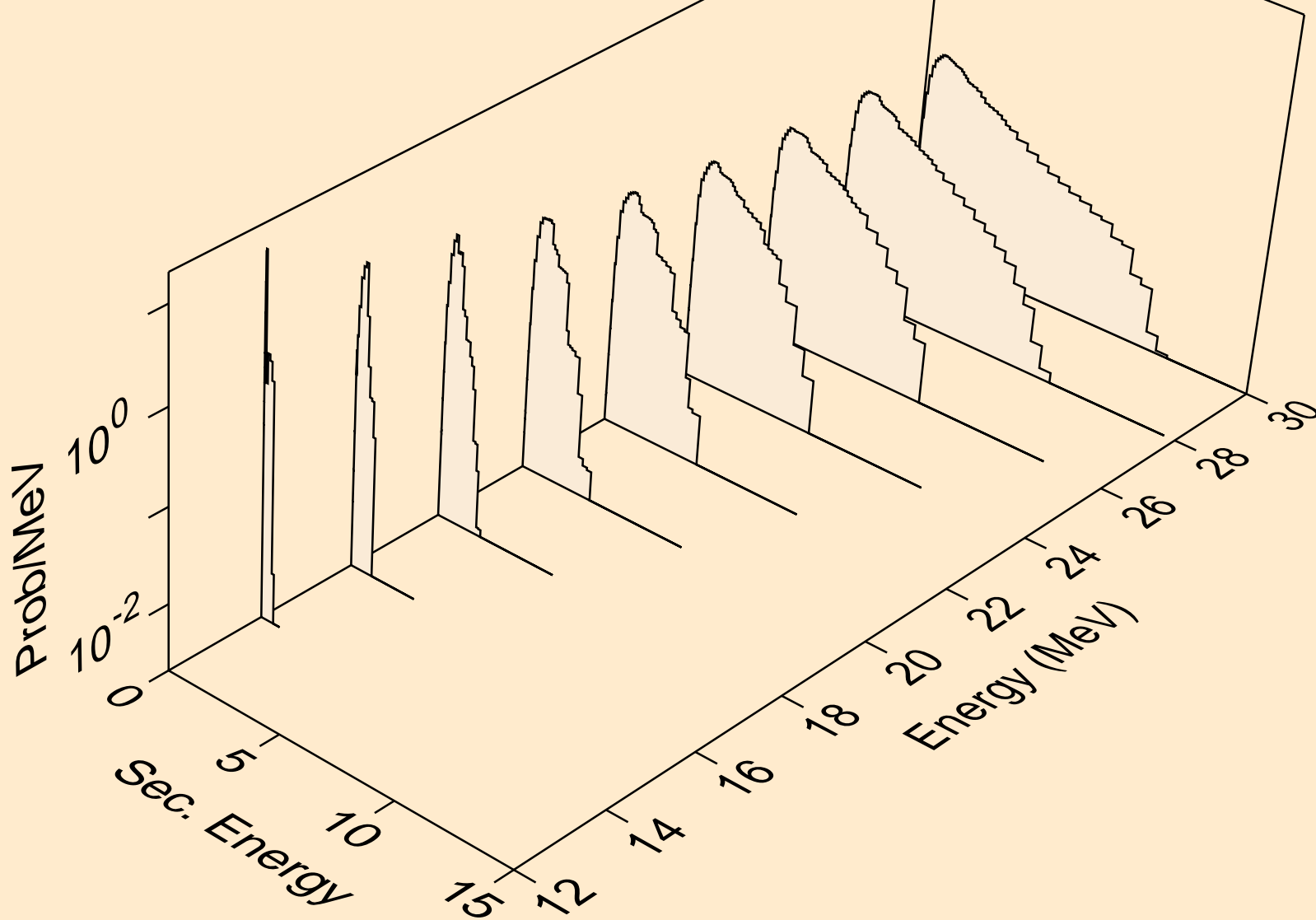

KR077 NEUTRON ACER TENDL-2019 LIBRARY; T=293.16K  
Neutron emission for (n,npa)

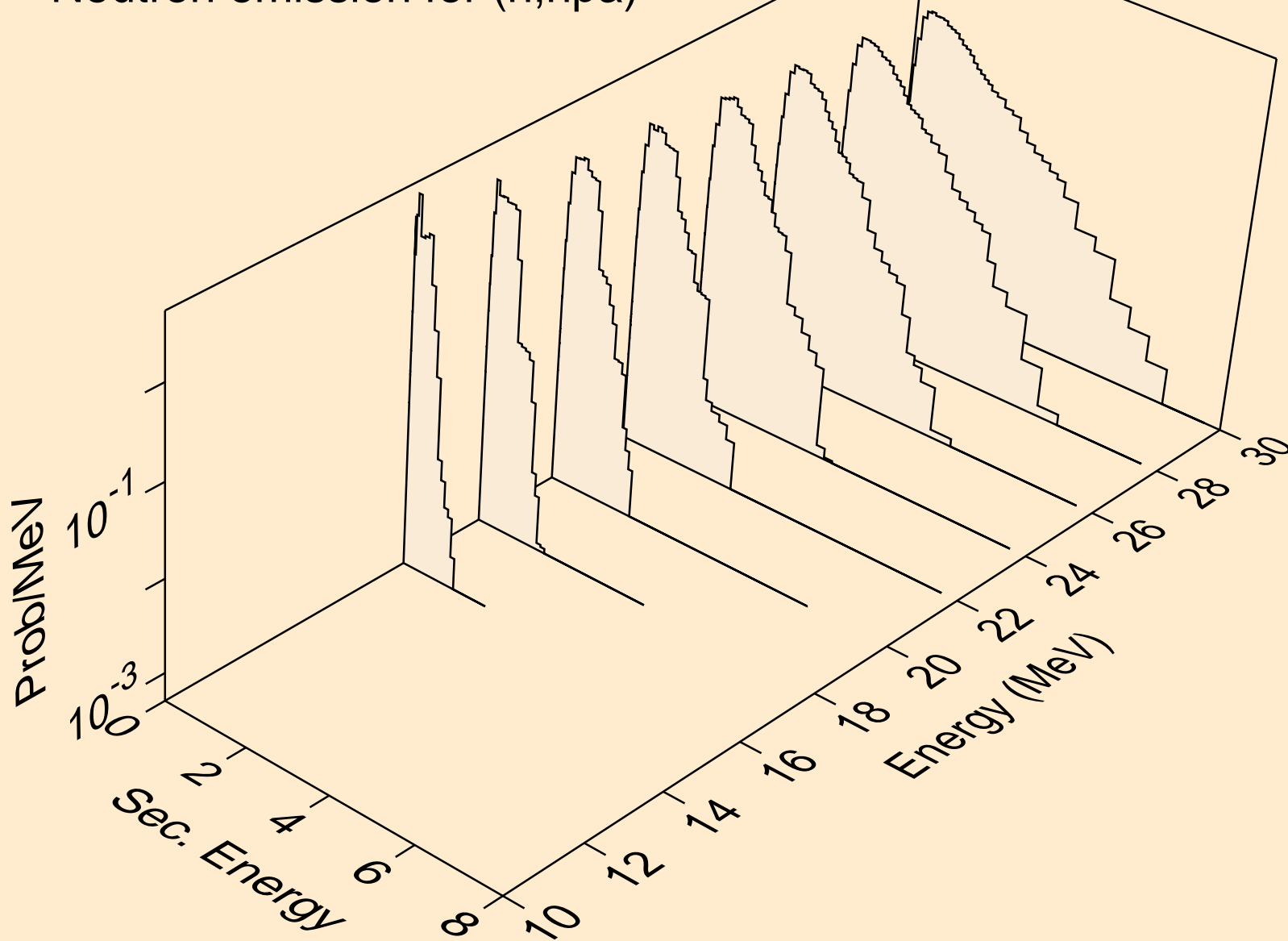

KR077 NEUTRON ACER TENDL-2019 LIBRARY; T=293.16K  
Neutron emission for (n,n\*c)

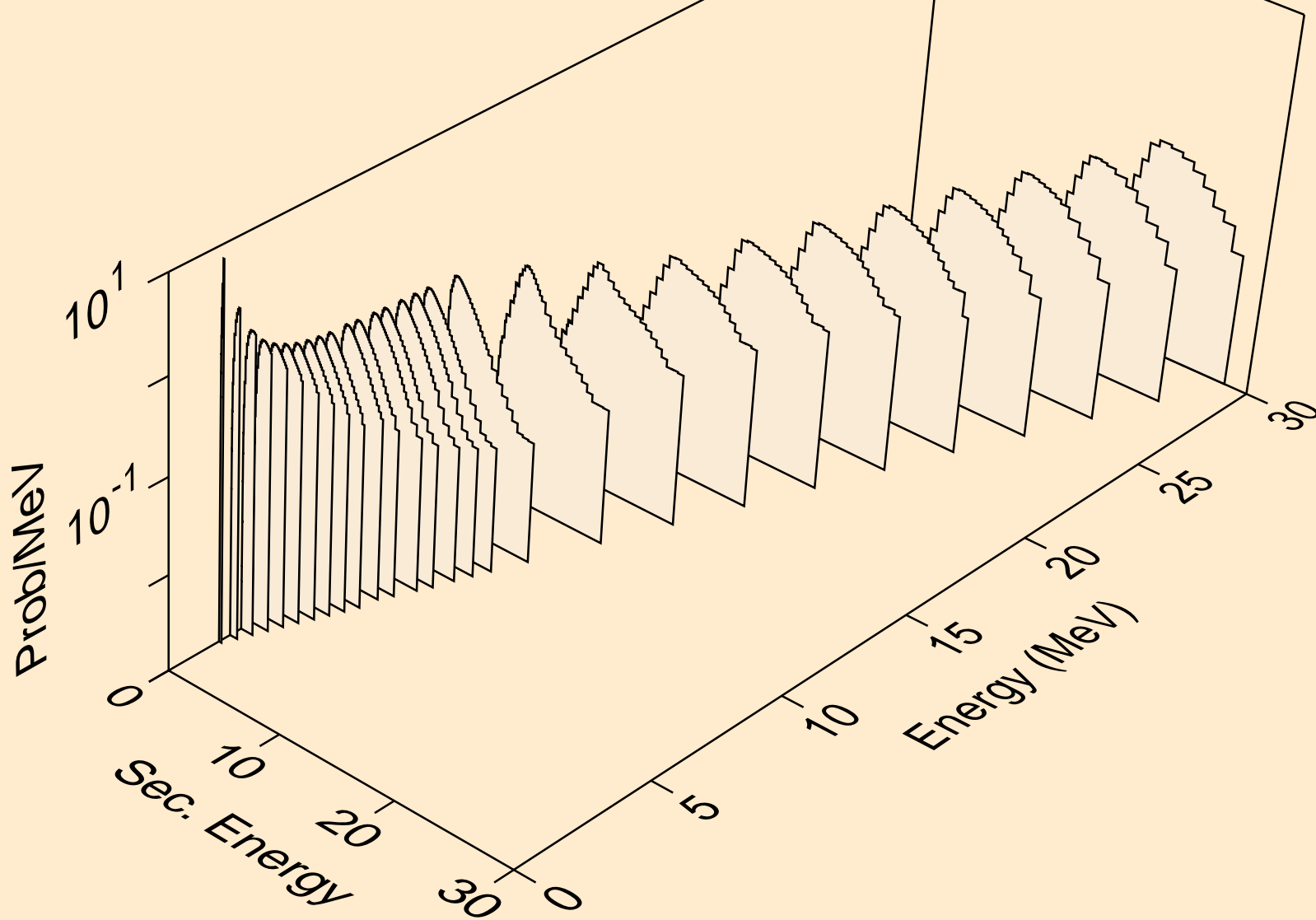

KR077 NEUTRON ACER TENDL-2019 LIBRARY; T=293.16K  
Photon emission for (n,x)

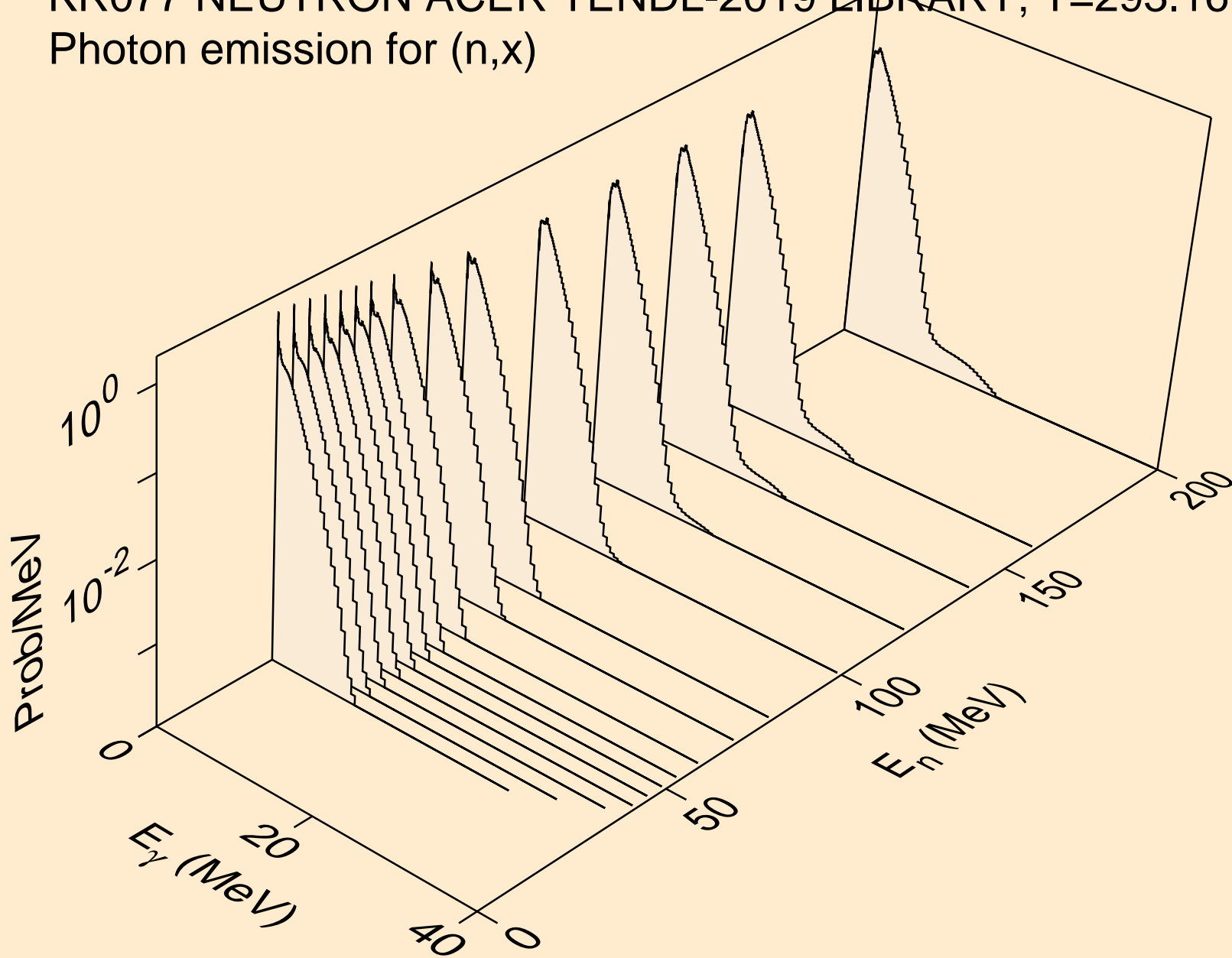

KR077 NEUTRON ACER TENDL-2019 LIBRARY; T=293.16K  
Photon emission for (n,2nd)

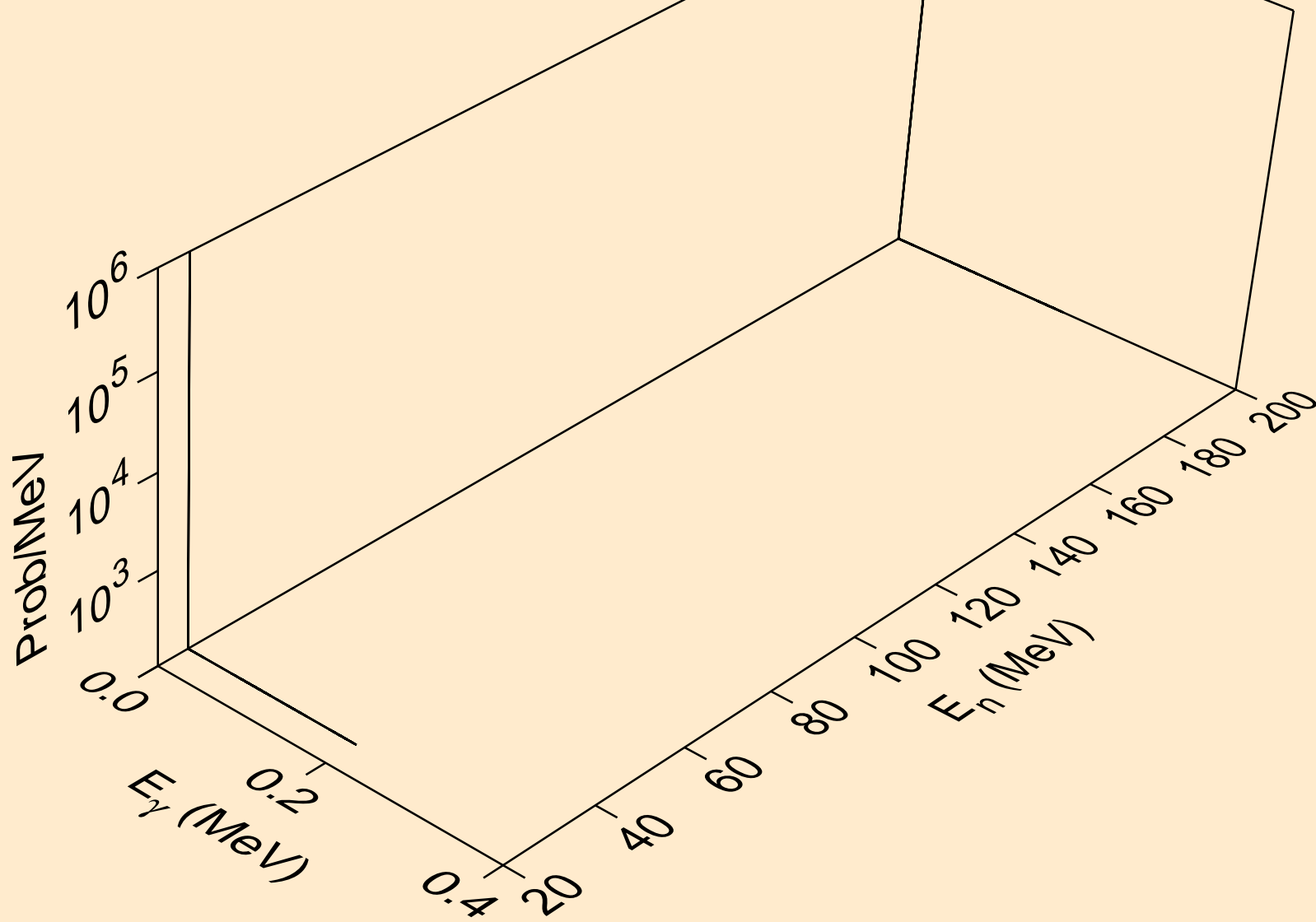

KR077 NEUTRON ACER TENDL-2019 LIBRARY; T=293.16K  
Photon emission for (n,2n)

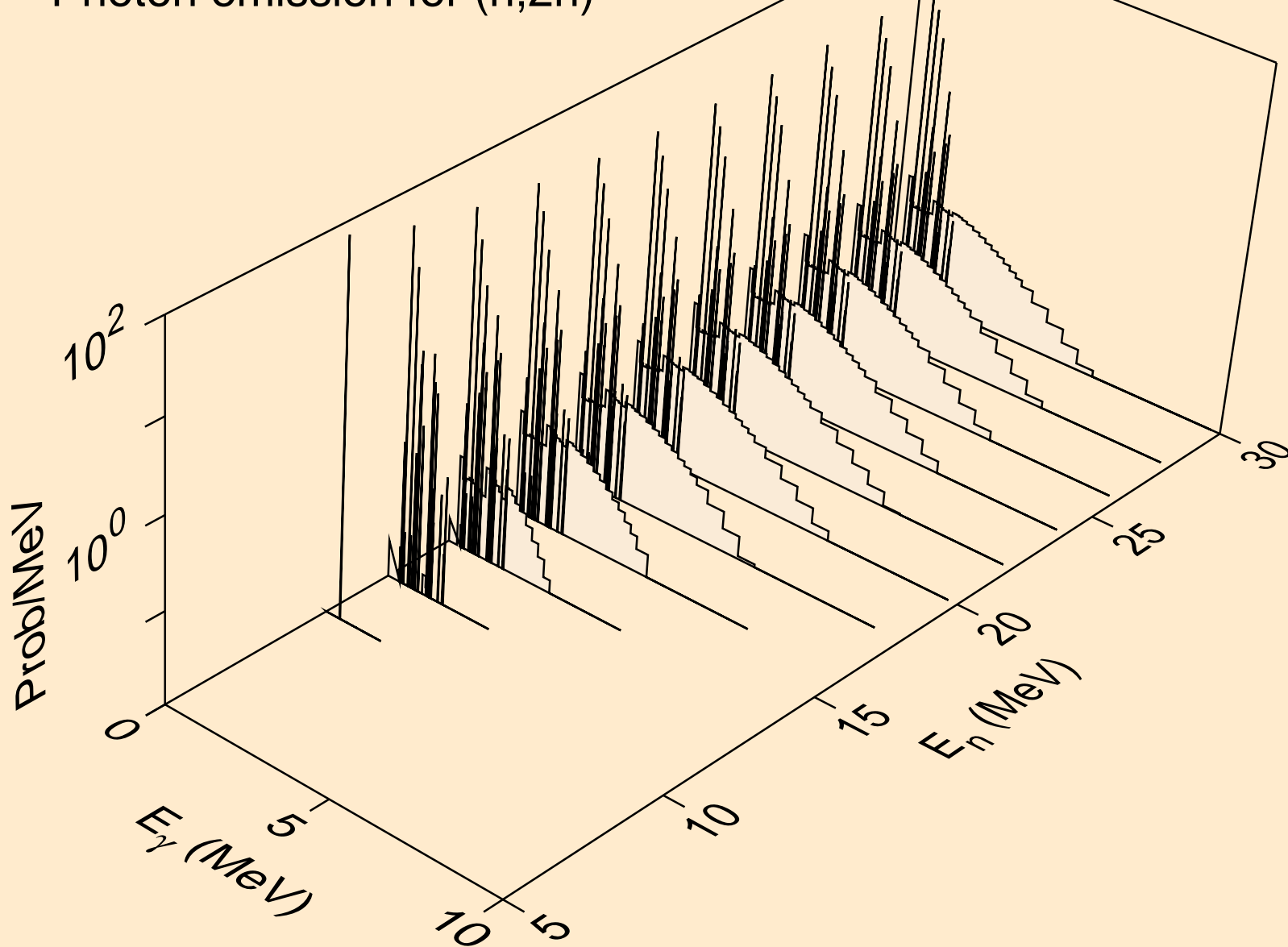

KR077 NEUTRON ACER TENDL-2019 LIBRARY; T=293.16K  
Photon emission for (n,3n)

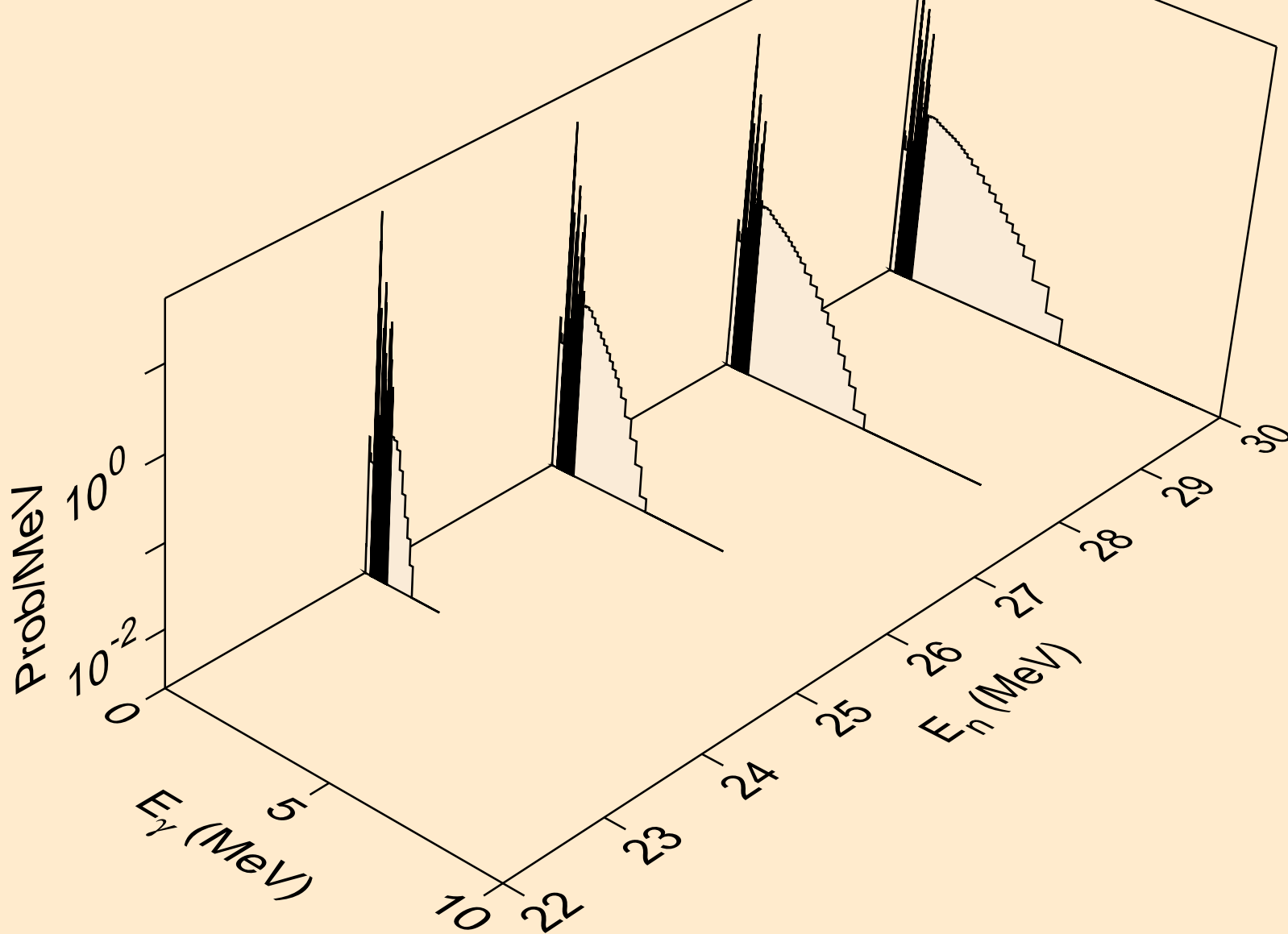

KR077 NEUTRON ACER TENDL-2019 LIBRARY; T=293.16K  
Photon emission for (n,n\*)a

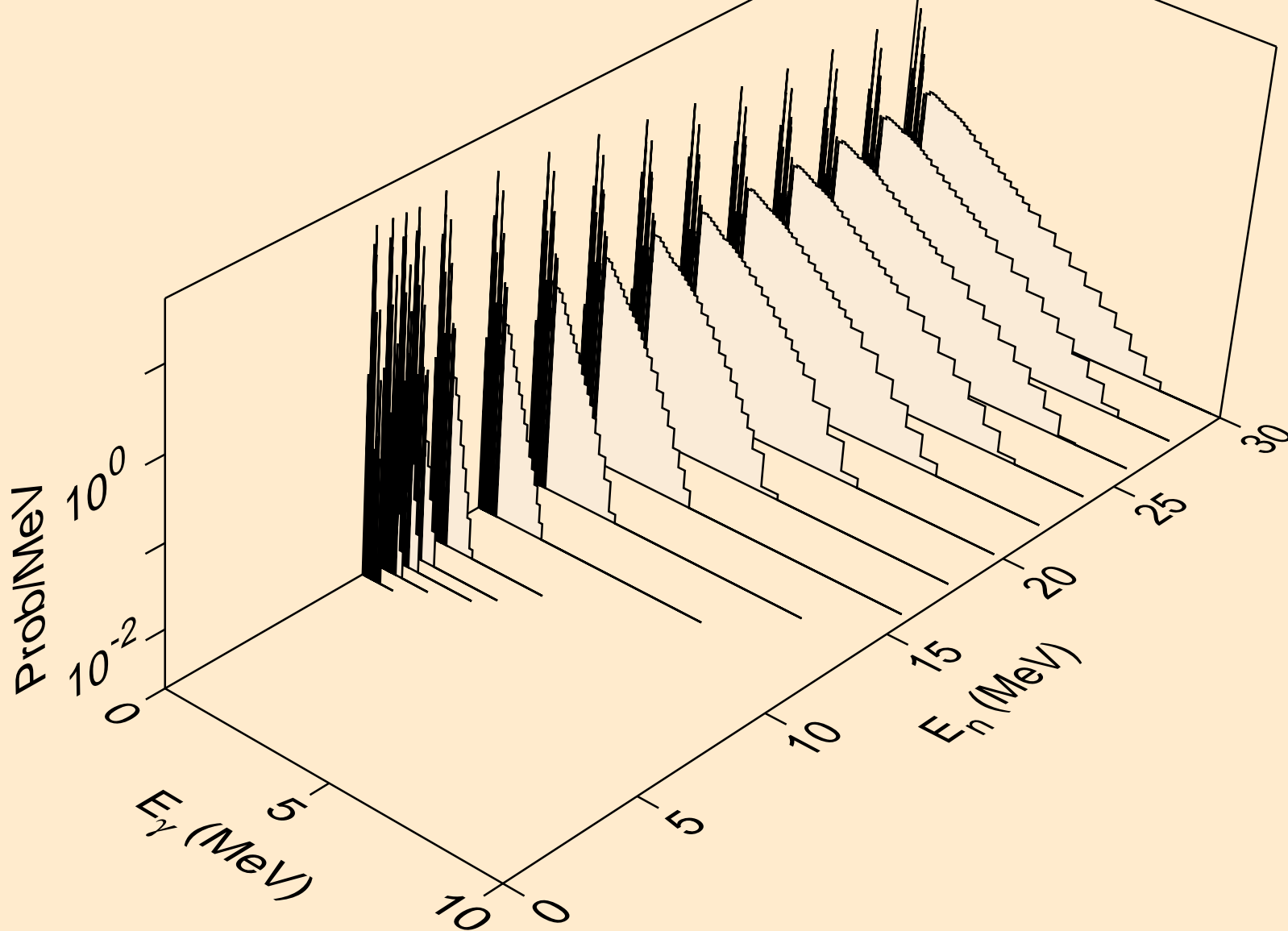

KR077 NEUTRON ACER TENDL-2019 LIBRARY; T=293.16K  
Photon emission for (n,2n)a

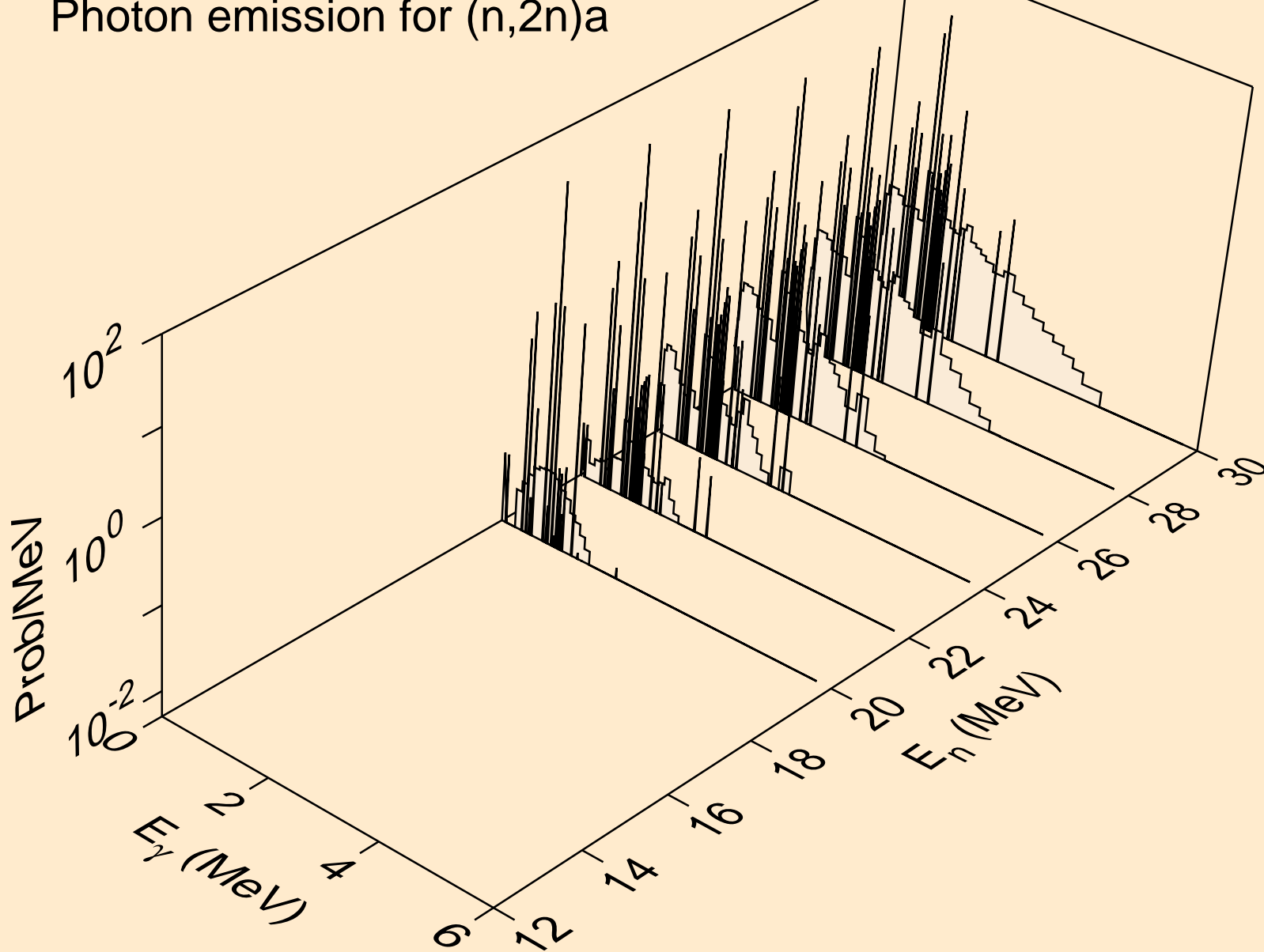

KR077 NEUTRON ACER TENDL-2019 LIBRARY; T=293.16K  
Photon emission for (n,n\*)p

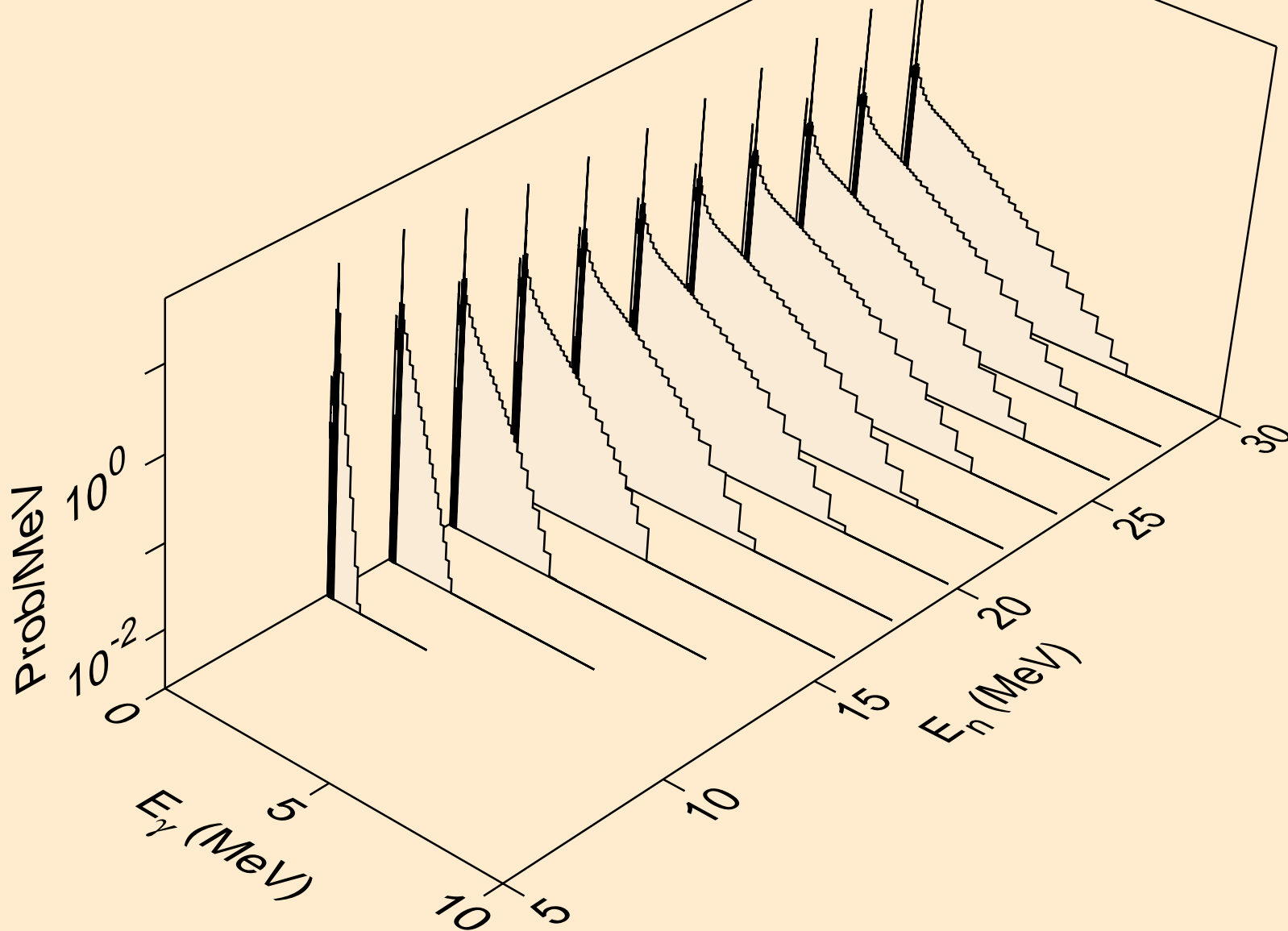

KR077 NEUTRON ACER TENDL-2019 LIBRARY; T=293.16K  
Photon emission for (n,n\*)2a

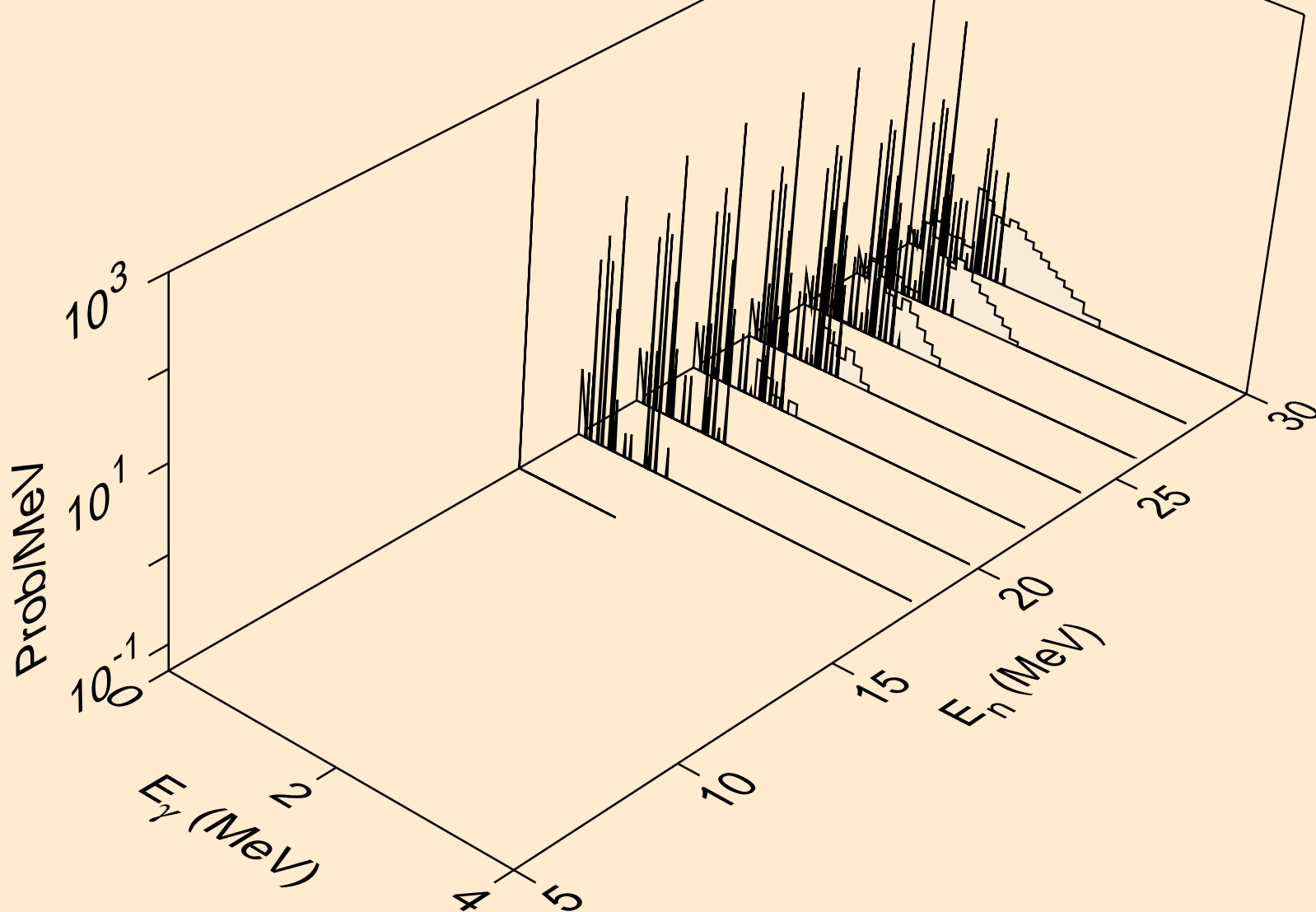

KR077 NEUTRON ACER TENDL-2019 LIBRARY; T=293.16K  
Photon emission for (n,2n)2a

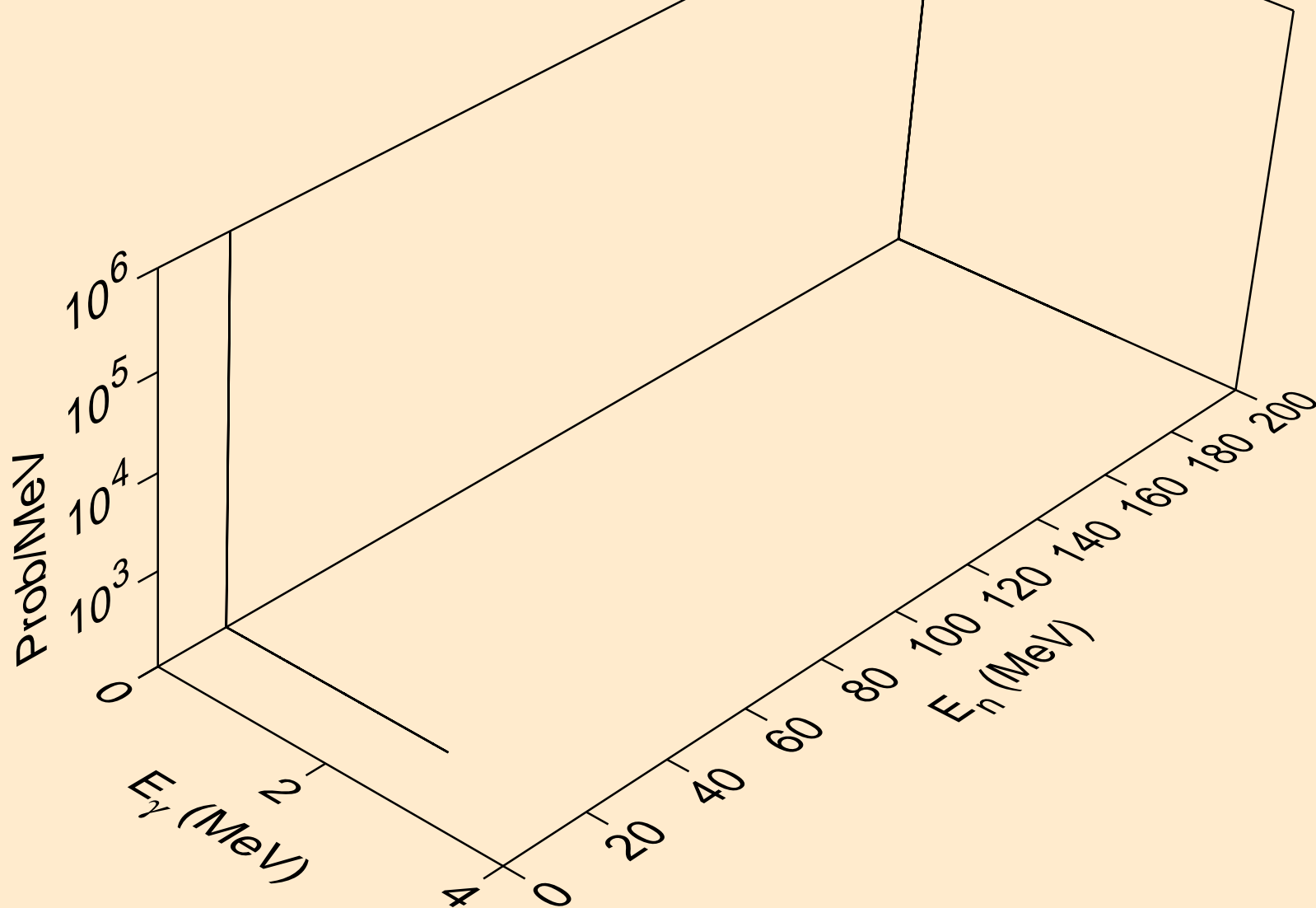

KR077 NEUTRON ACER TENDL-2019 LIBRARY; T=293.16K  
Photon emission for (n,n\*)d

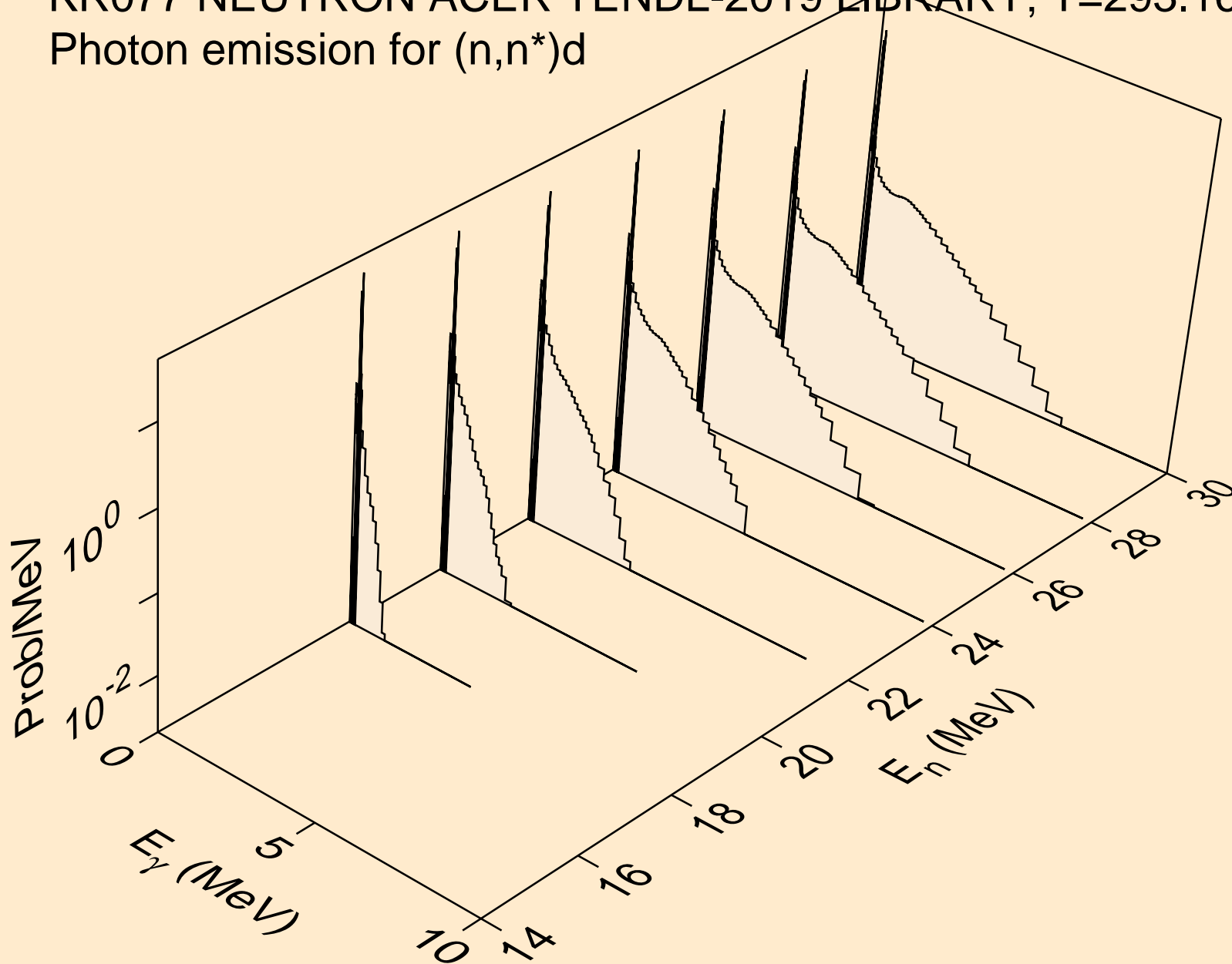

KR077 NEUTRON ACER TENDL-2019 LIBRARY; T=293.16K  
Photon emission for (n,n\*)t

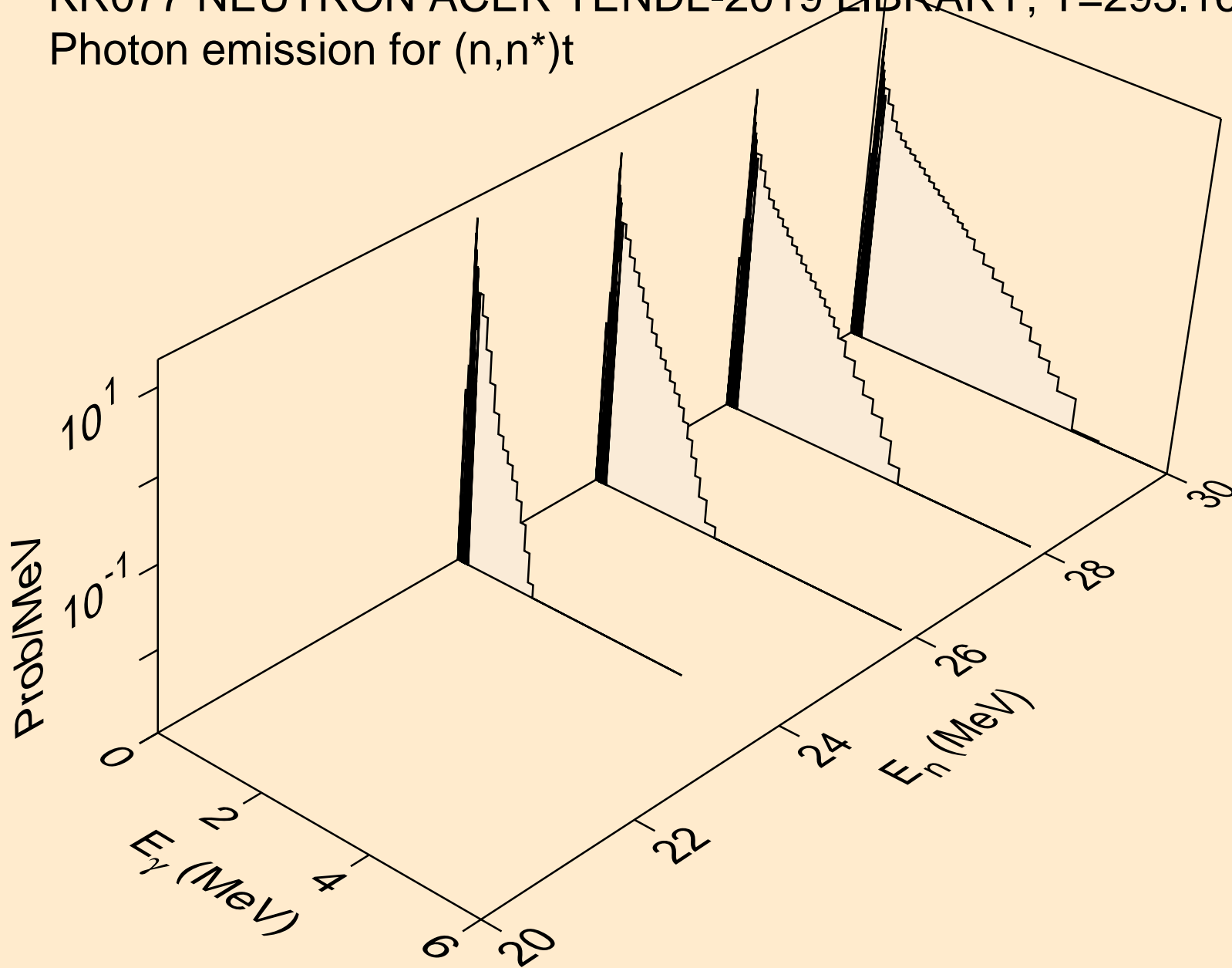

KR077 NEUTRON ACER TENDL-2019 LIBRARY; T=293.16K  
Photon emission for (n,n\*)he3

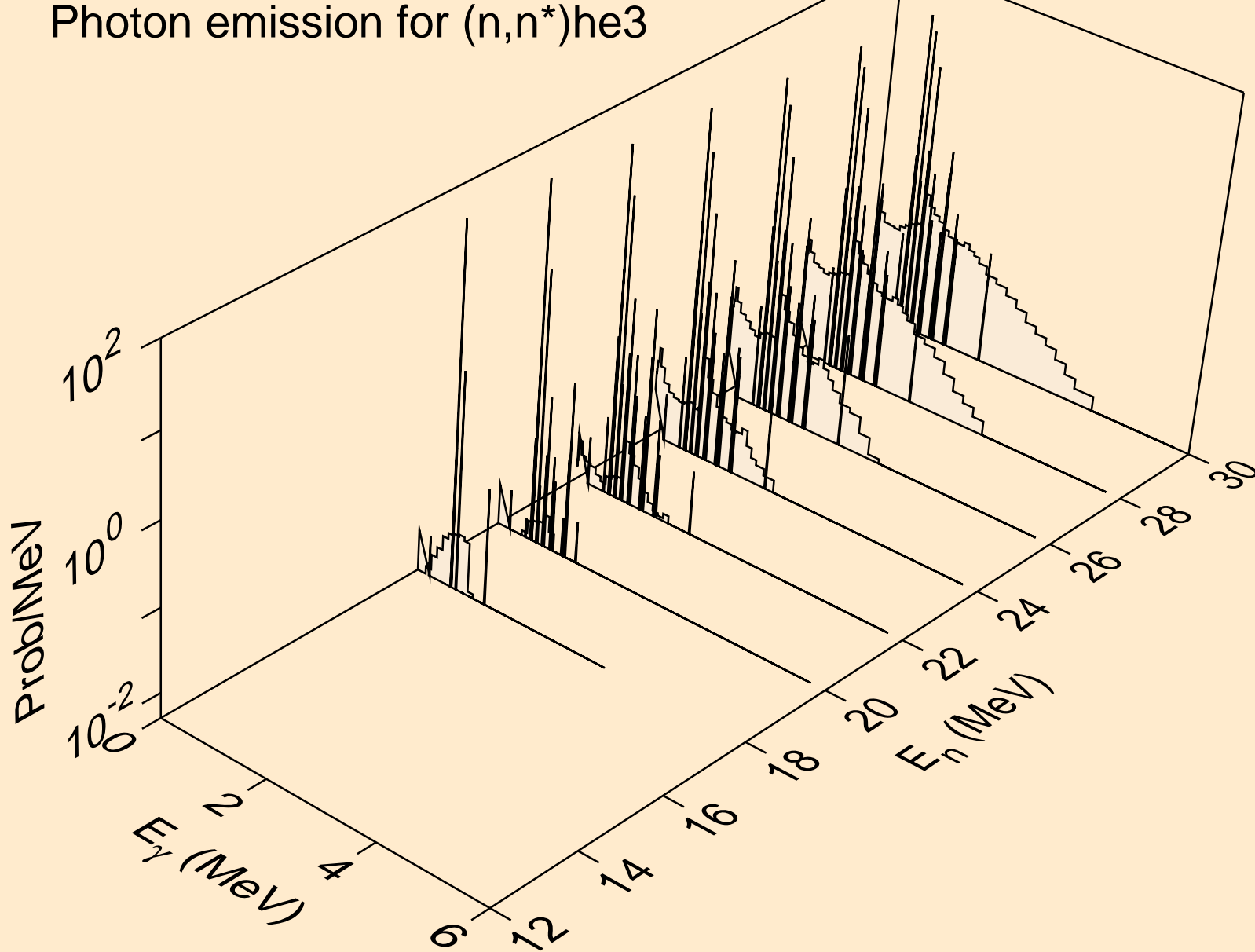

KR077 NEUTRON ACER TENDL-2019 LIBRARY; T=293.16K  
Photon emission for (n,2np)

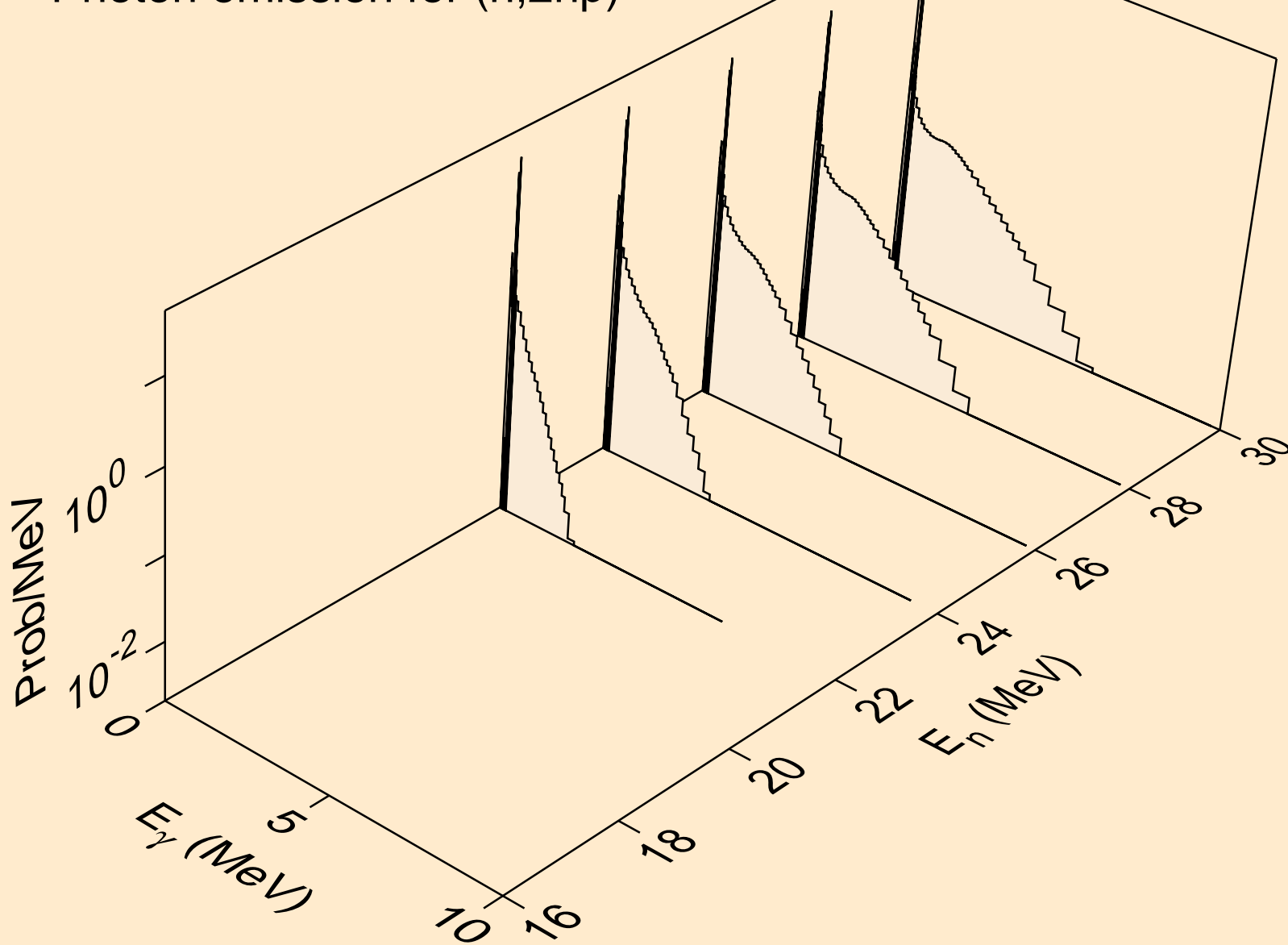

KR077 NEUTRON ACER TENDL-2019 LIBRARY; T=293.16K  
Photon emission for (n,3np)

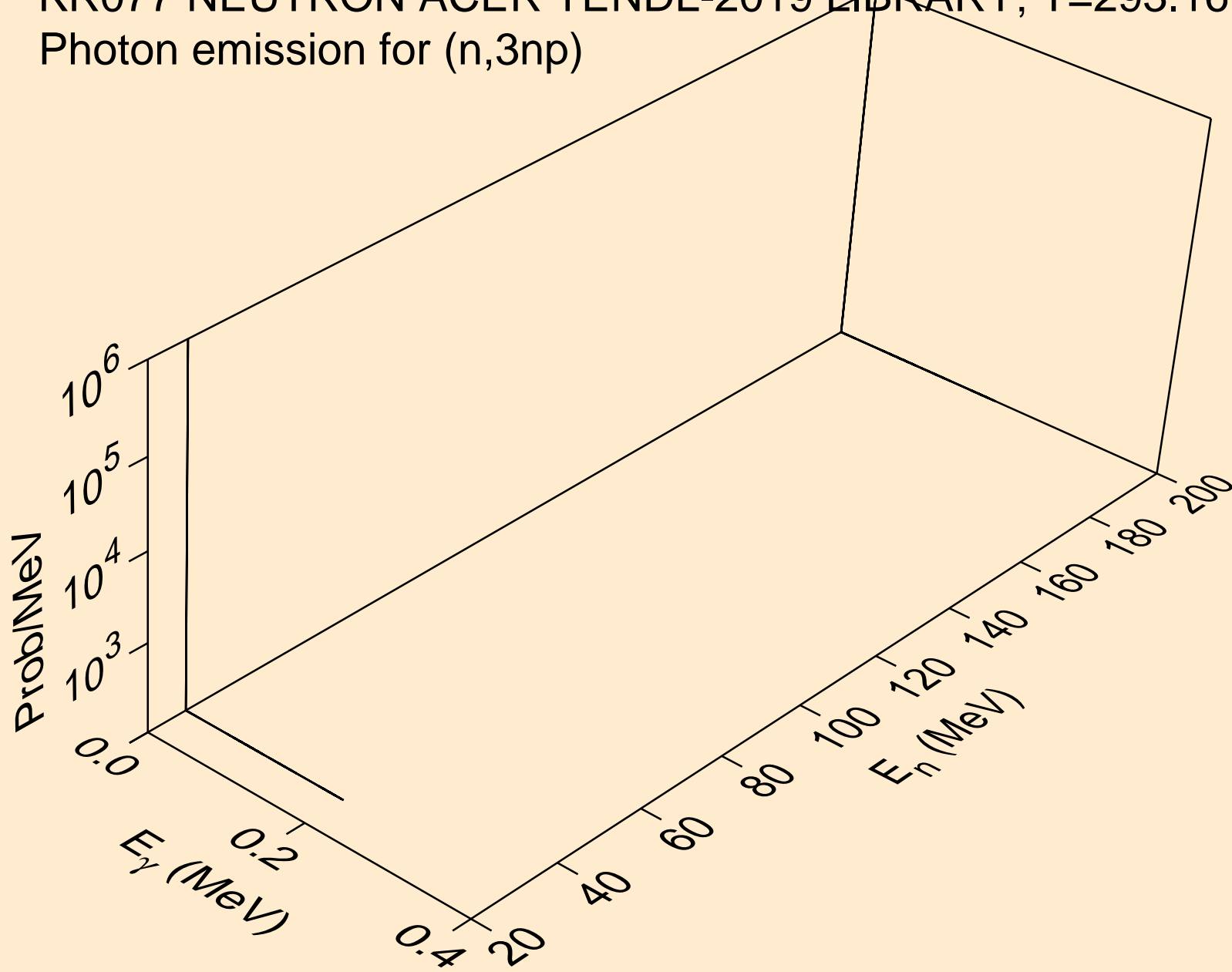

KR077 NEUTRON ACER TENDL-2019 LIBRARY; T=293.16K  
Photon emission for (n,2np)

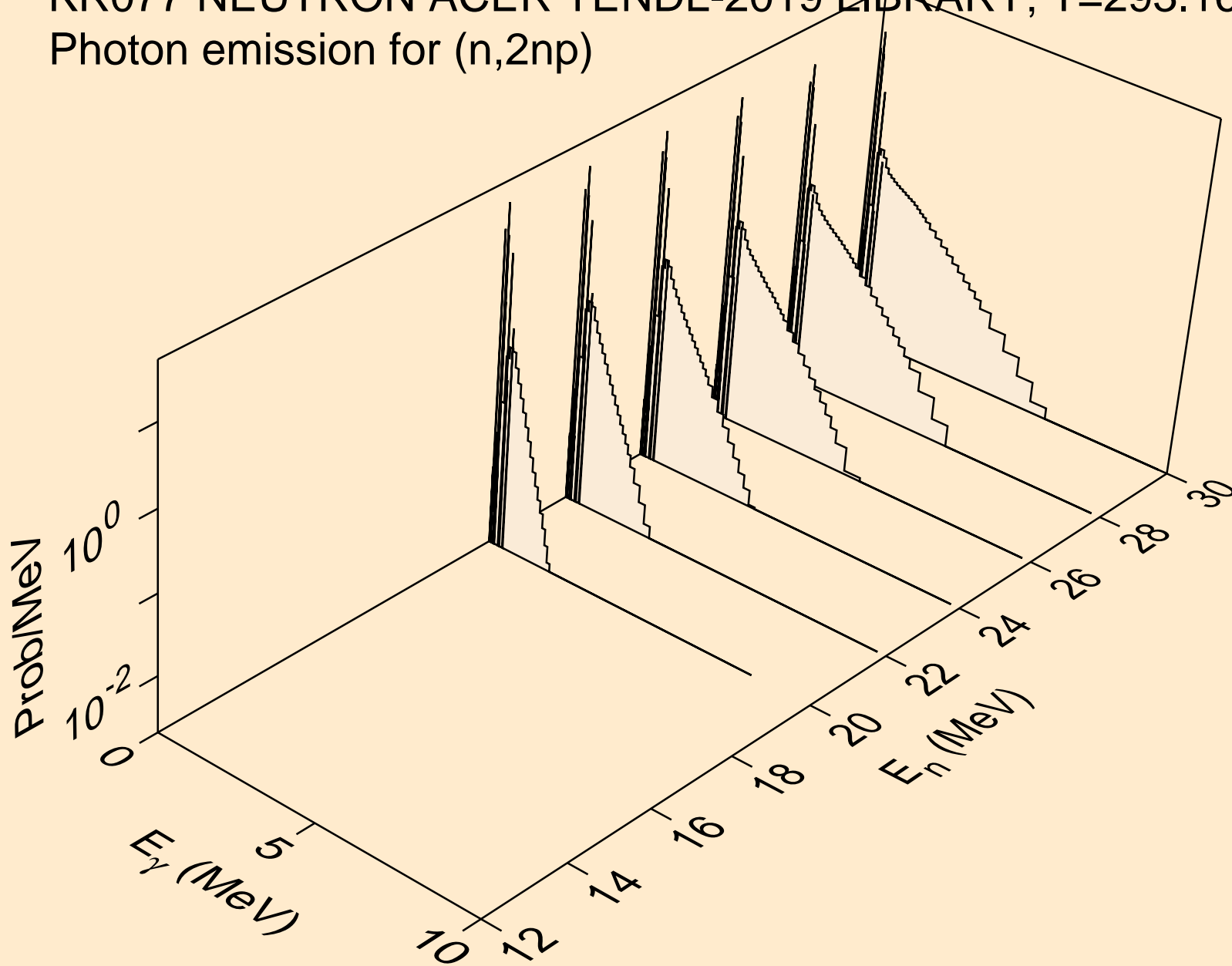

KR077 NEUTRON ACER TENDL-2019 LIBRARY; T=293.16K  
Photon emission for (n,npa)

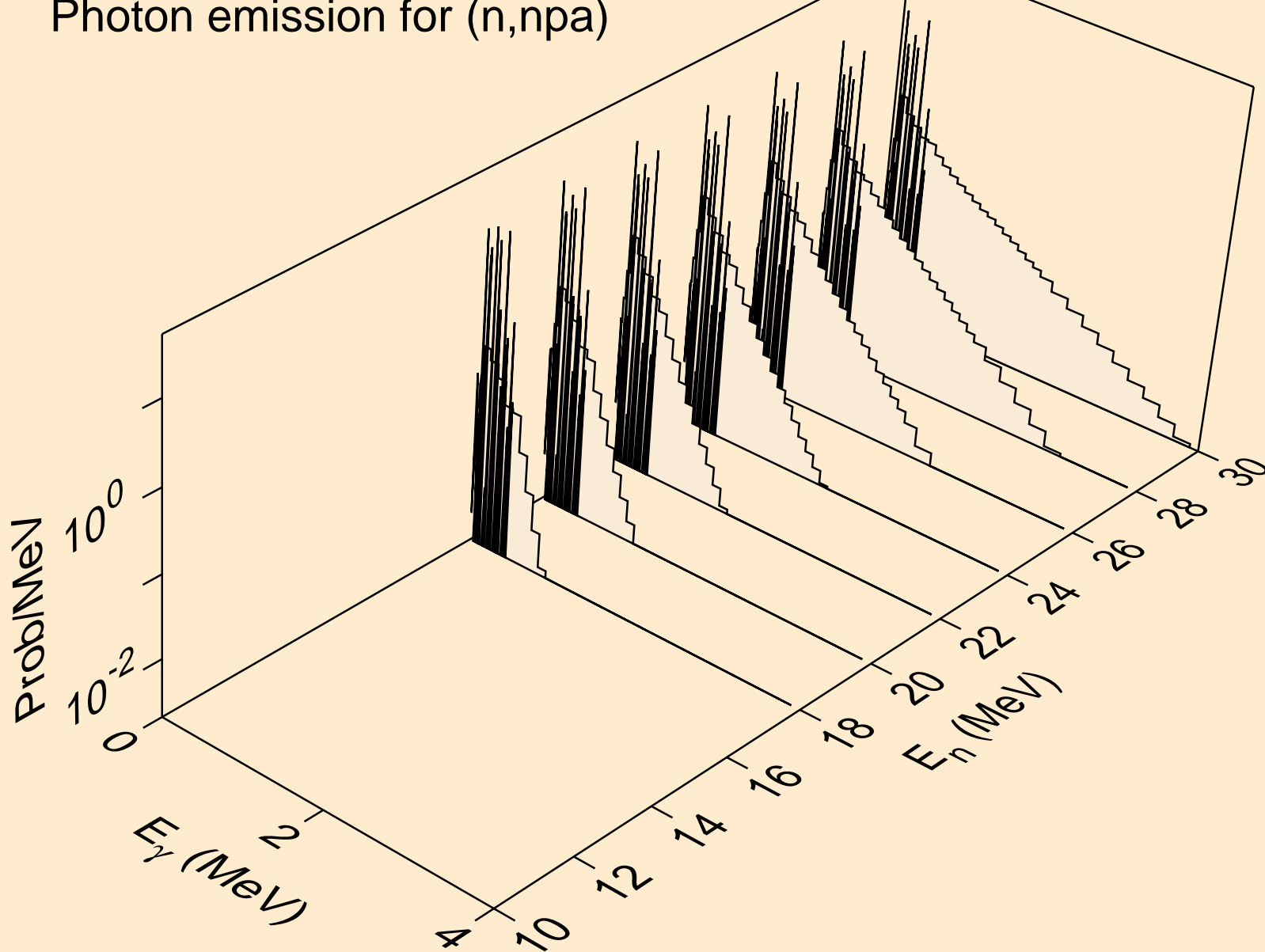

KR077 NEUTRON ACER TENDL-2019 LIBRARY; T=293.16K  
Photon emission for (n,n\*c)

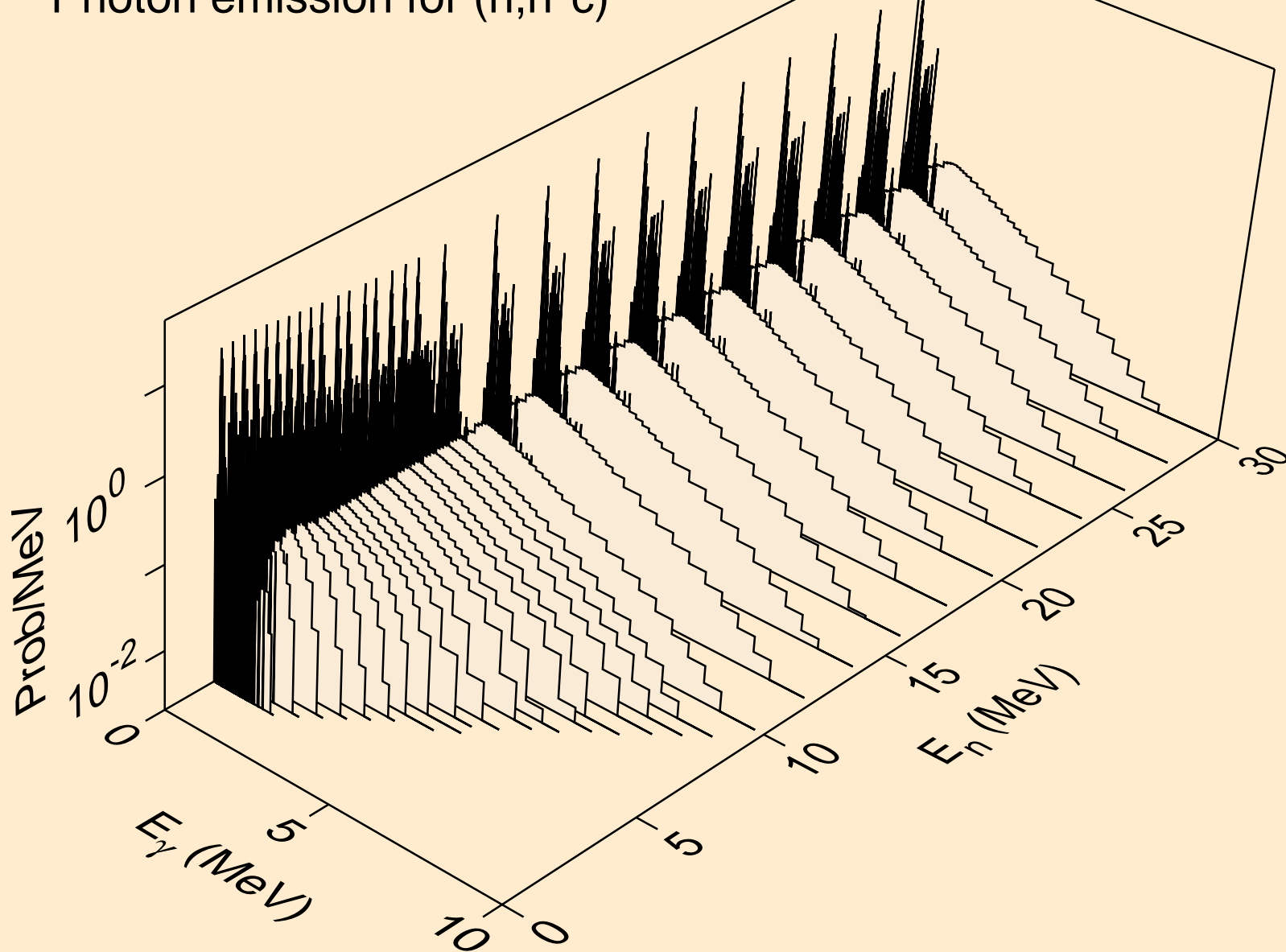

KR077 NEUTRON ACER TENDL-2019 LIBRARY; T=293.16K  
Photon emission for (n,gma)

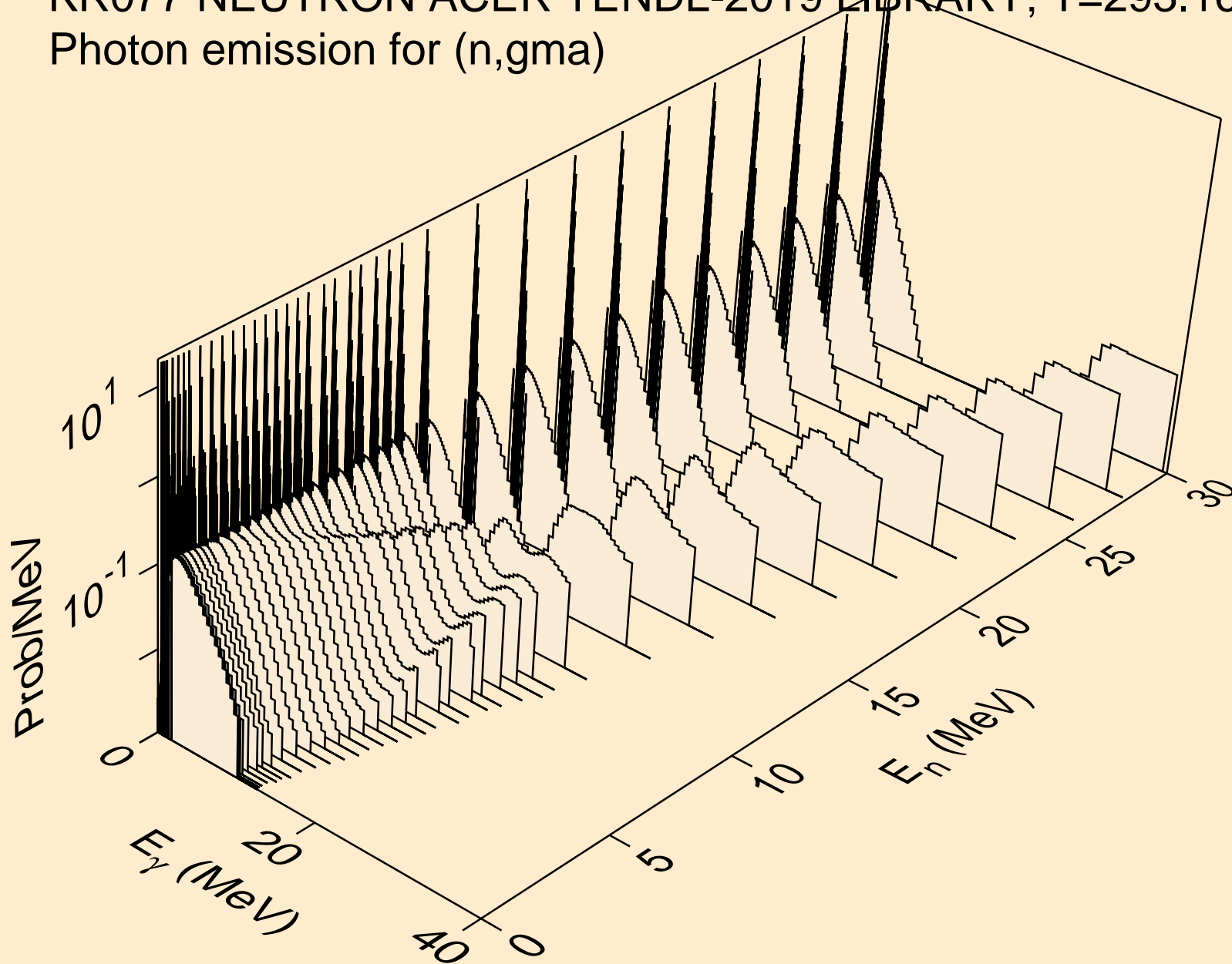

KR077 NEUTRON ACER TENDL-2019 LIBRARY; T=293.16K  
Photon emission for (n,p)

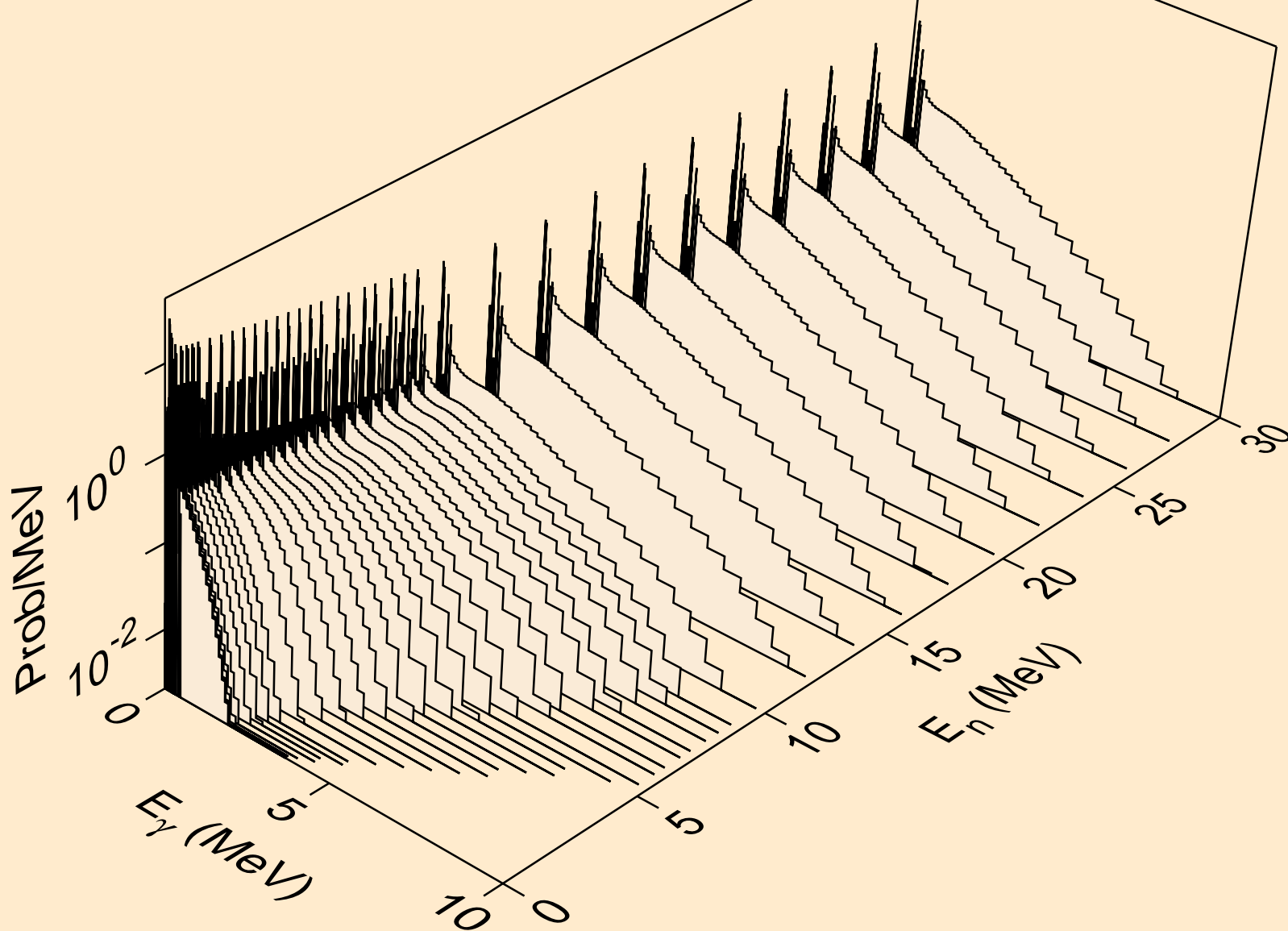

KR077 NEUTRON ACER TENDL-2019 LIBRARY; T=293.16K  
Photon emission for (n,d)

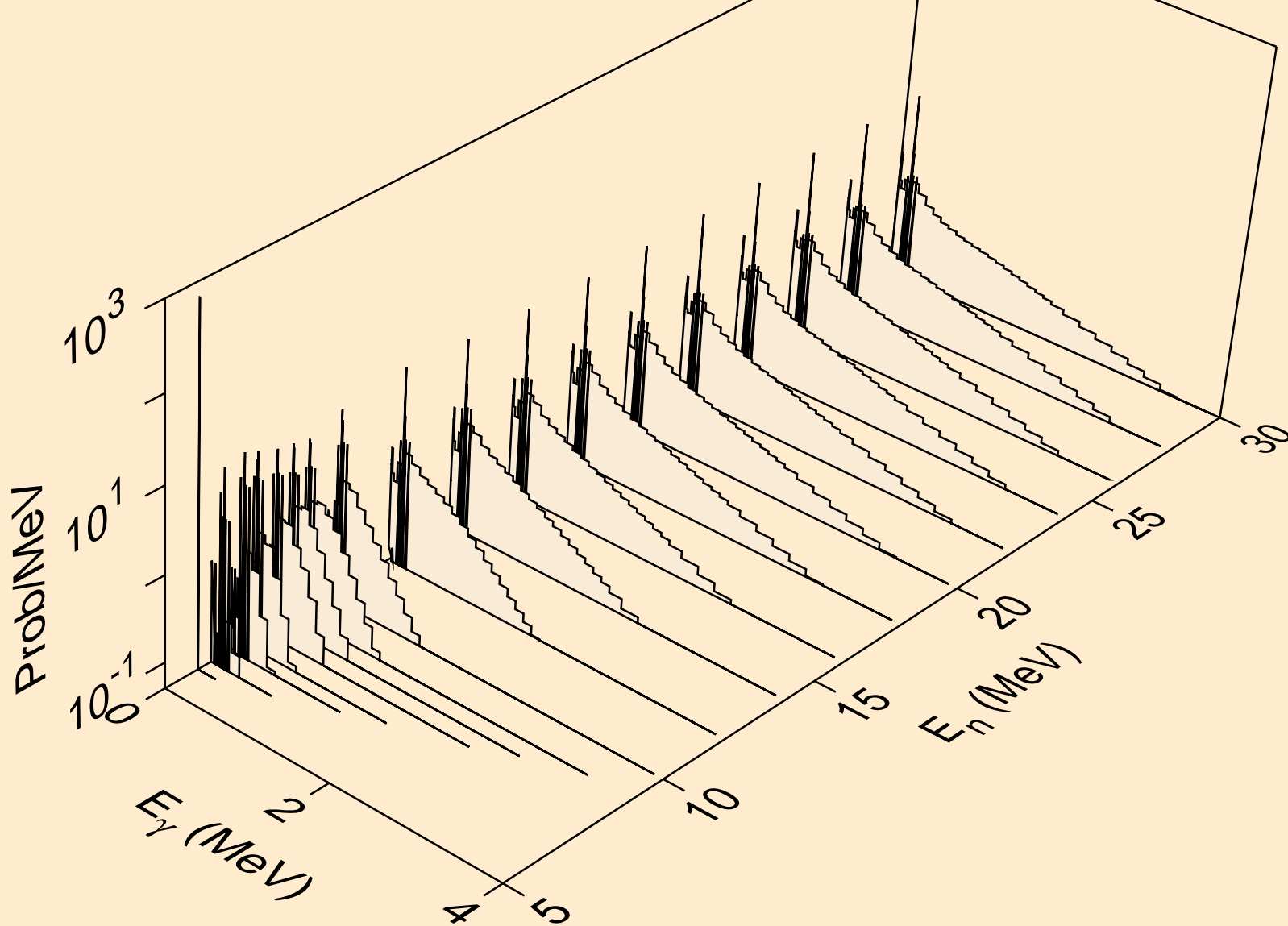

KR077 NEUTRON ACER TENDL-2019 LIBRARY; T=293.16K  
Photon emission for (n,t)

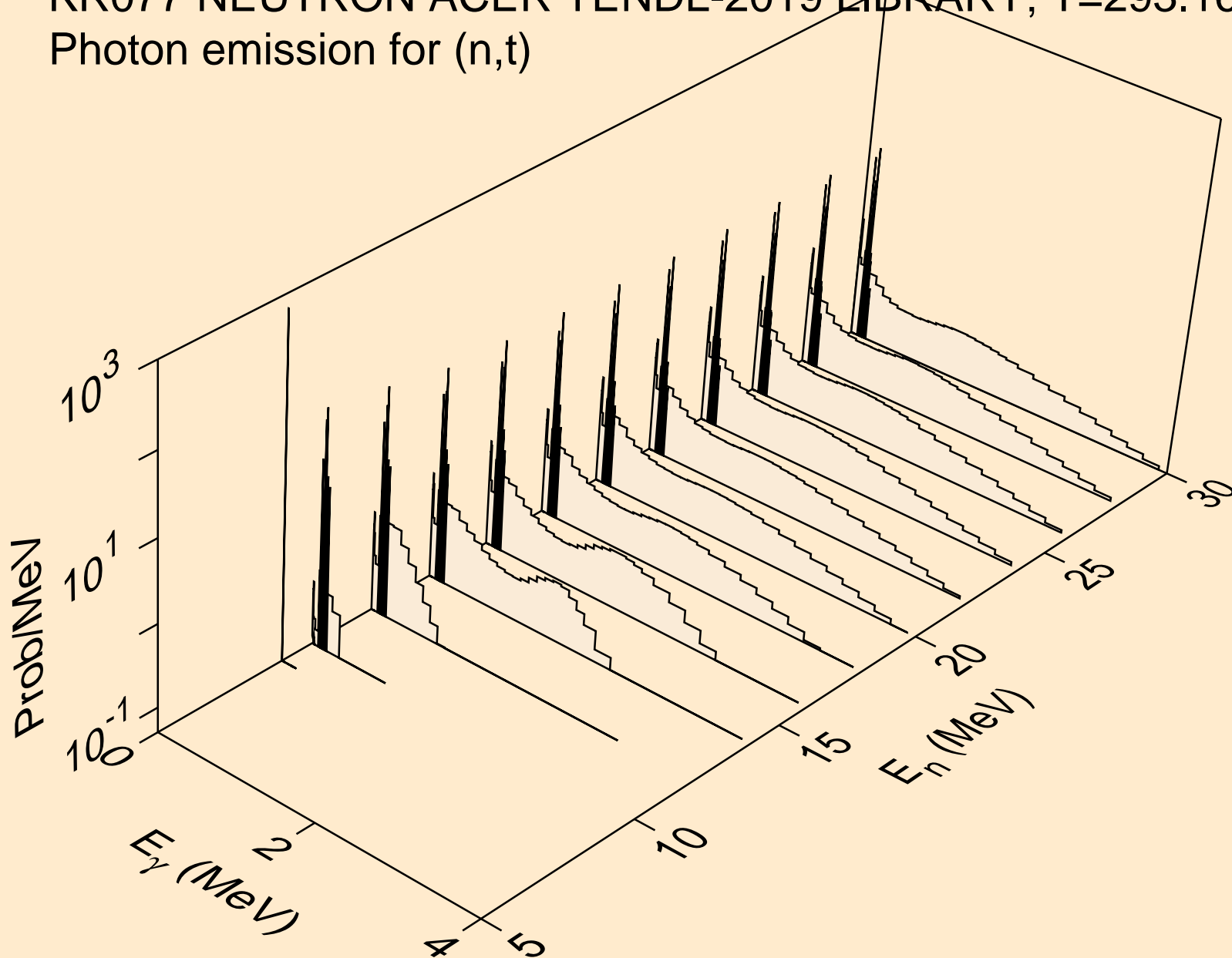

KR077 NEUTRON ACER TENDL-2019 LIBRARY; T=293.16K  
Photon emission for (n,he3)

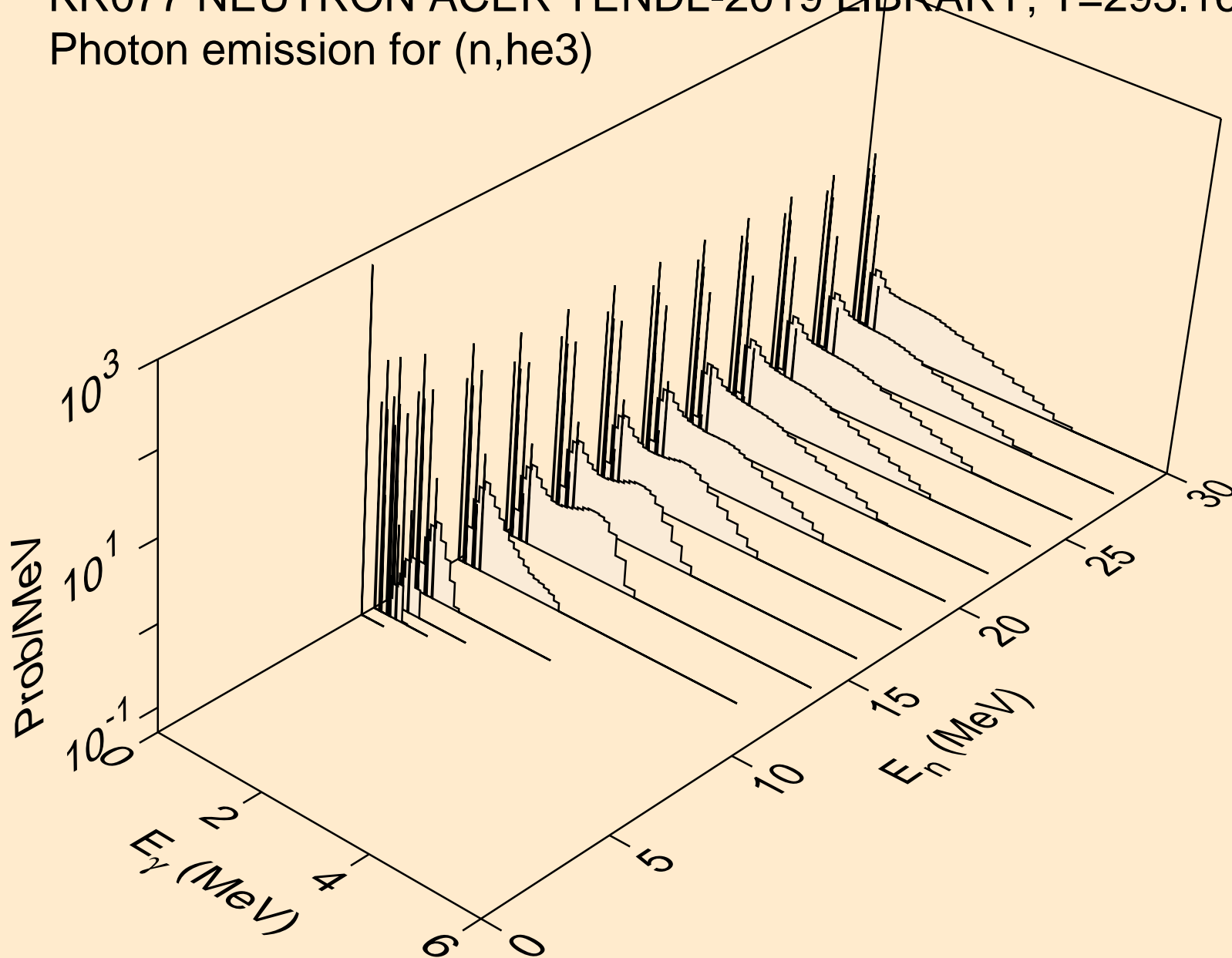

KR077 NEUTRON ACER TENDL-2019 LIBRARY; T=293.16K  
Photon emission for (n,a)

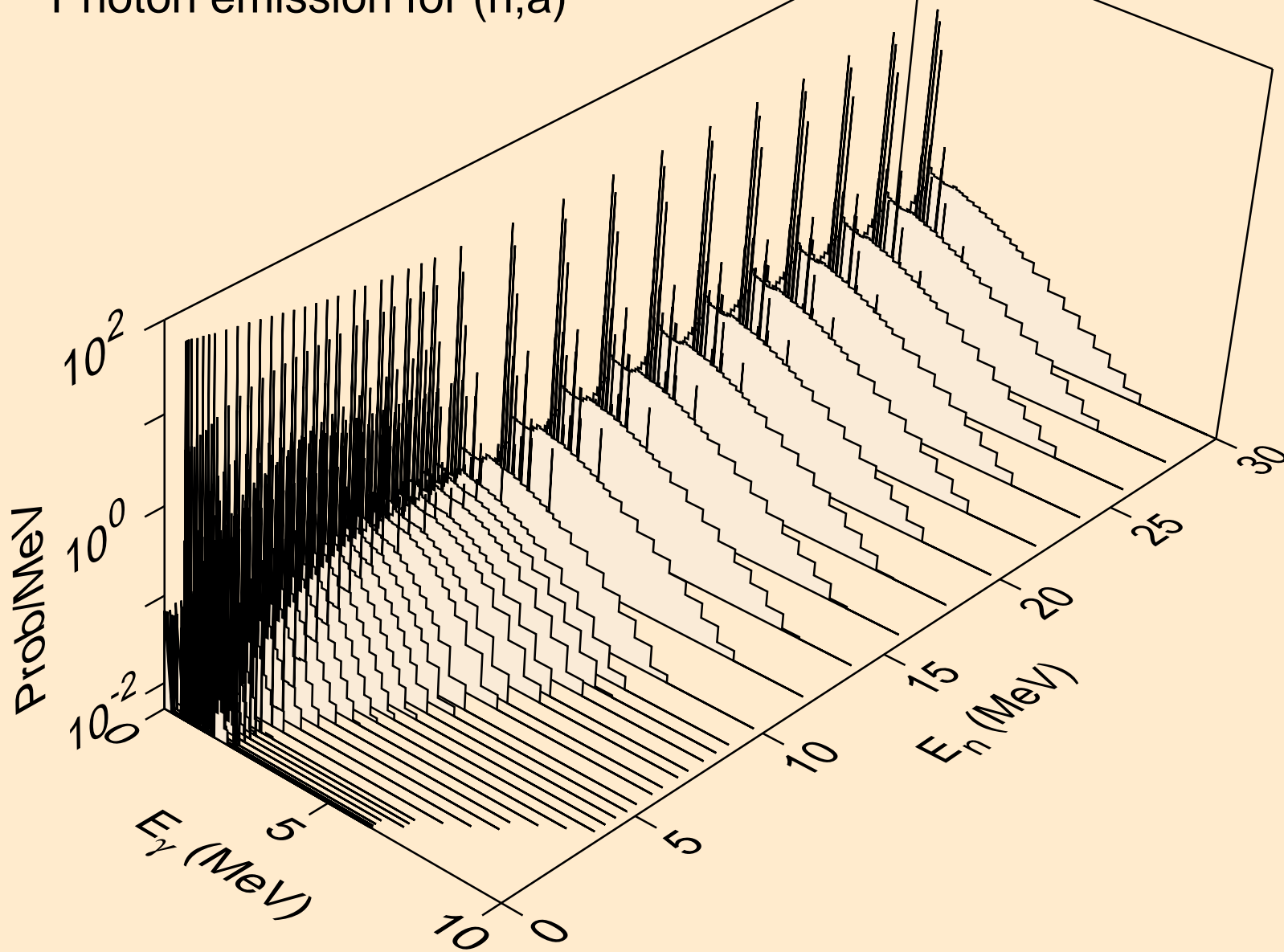

KR077 NEUTRON ACER TENDL-2019 LIBRARY; T=293.16K  
Photon emission for (n,2a)

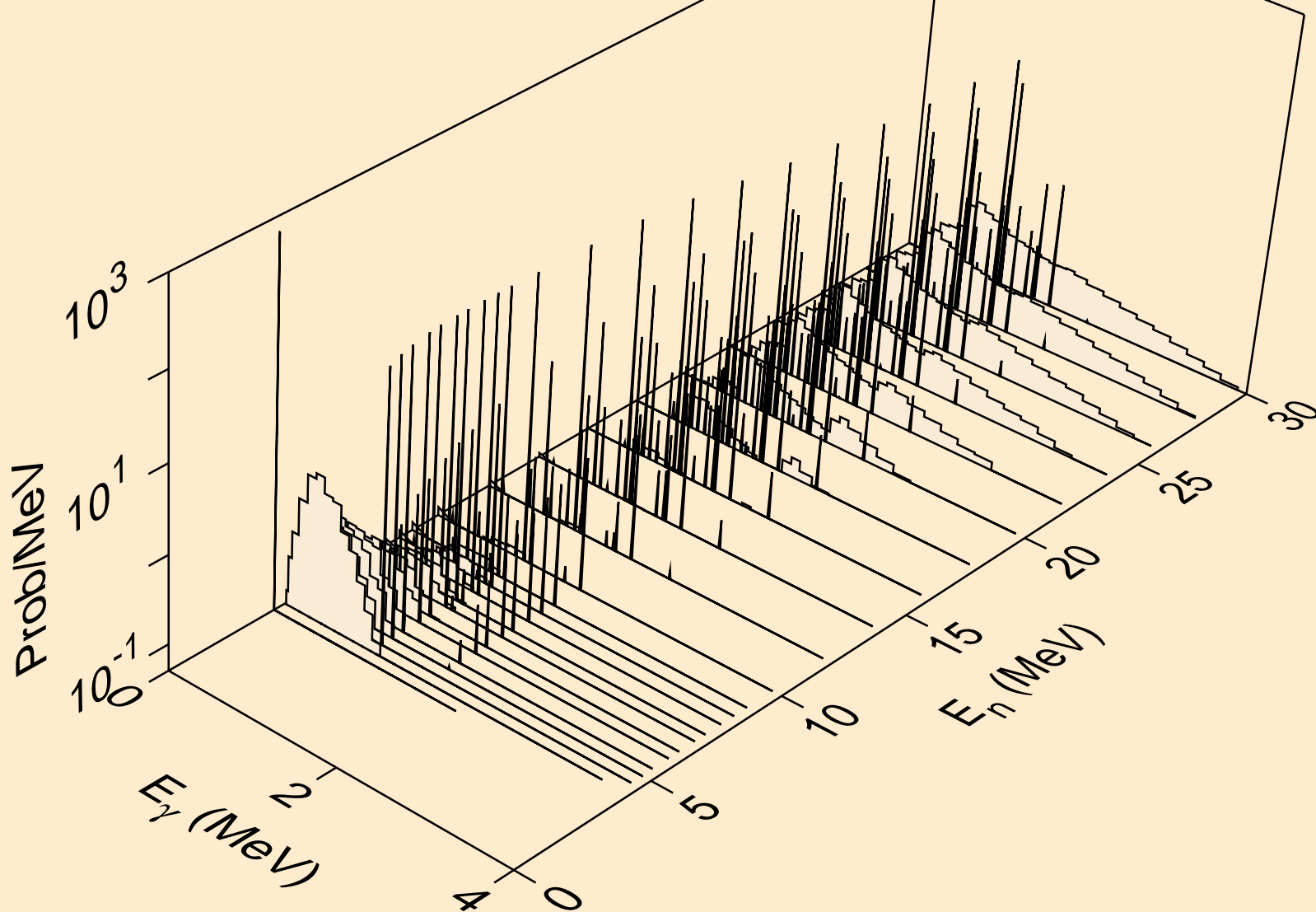

KR077 NEUTRON ACER TENDL-2019 LIBRARY; T=293.16K  
Photon emission for (n,3a)

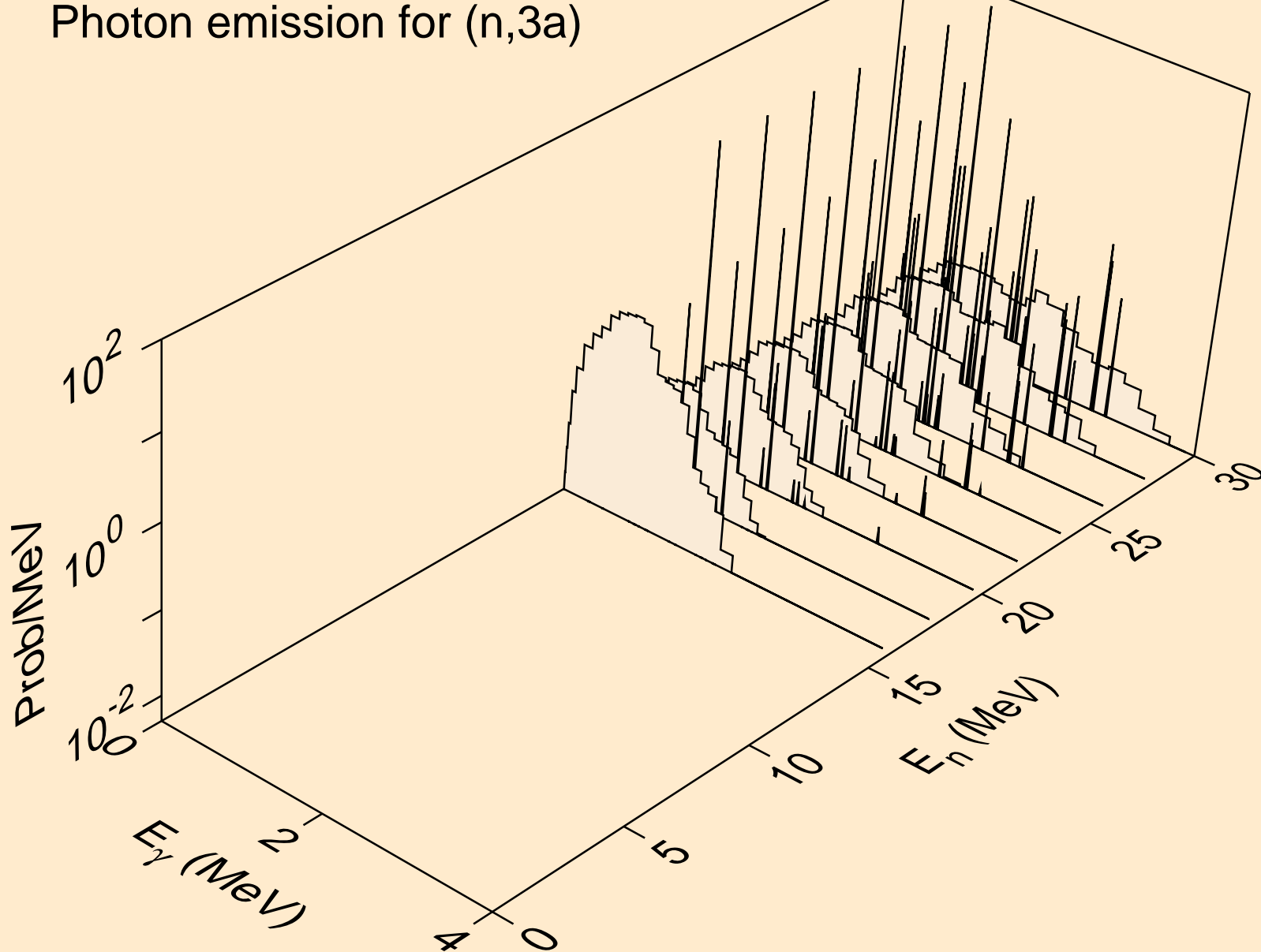

KR077 NEUTRON ACER TENDL-2019 LIBRARY; T=293.16K  
Photon emission for (n,2p)

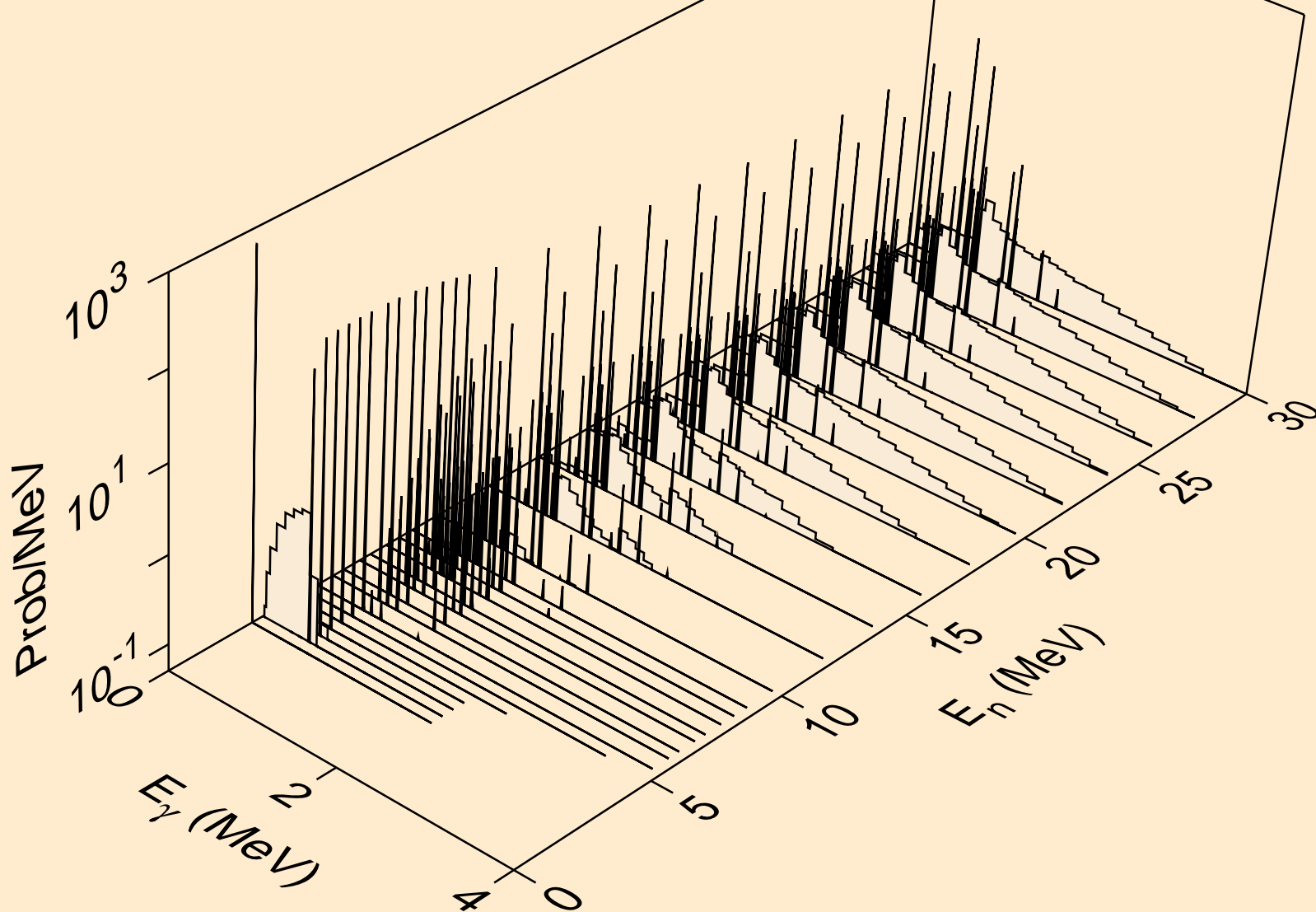

KR077 NEUTRON ACER TENDL-2019 LIBRARY; T=293.16K  
Photon emission for (n,p $\alpha$ )

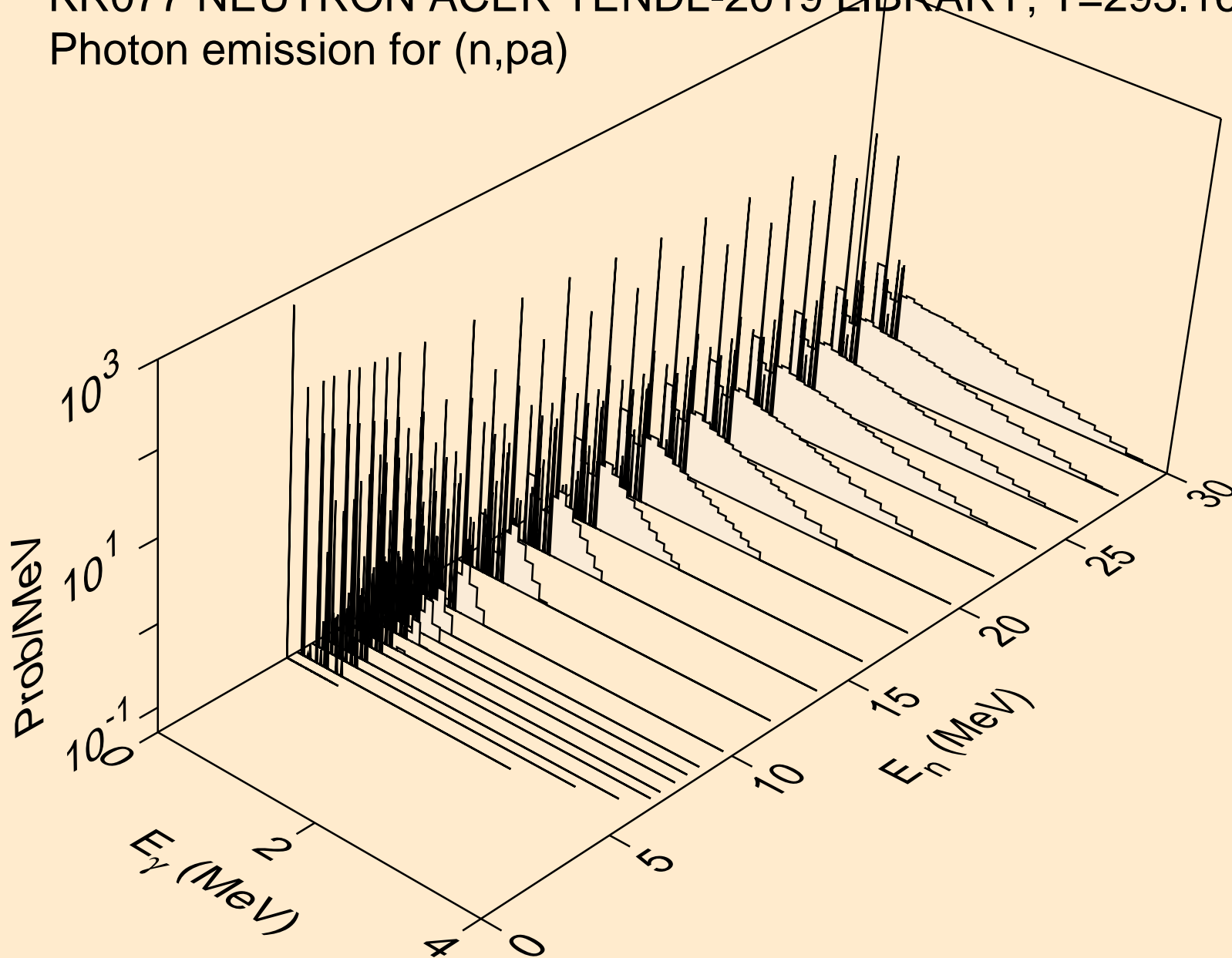

KR077 NEUTRON ACER TENDL-2019 LIBRARY; T=293.16K  
Photon emission for (n,pd)

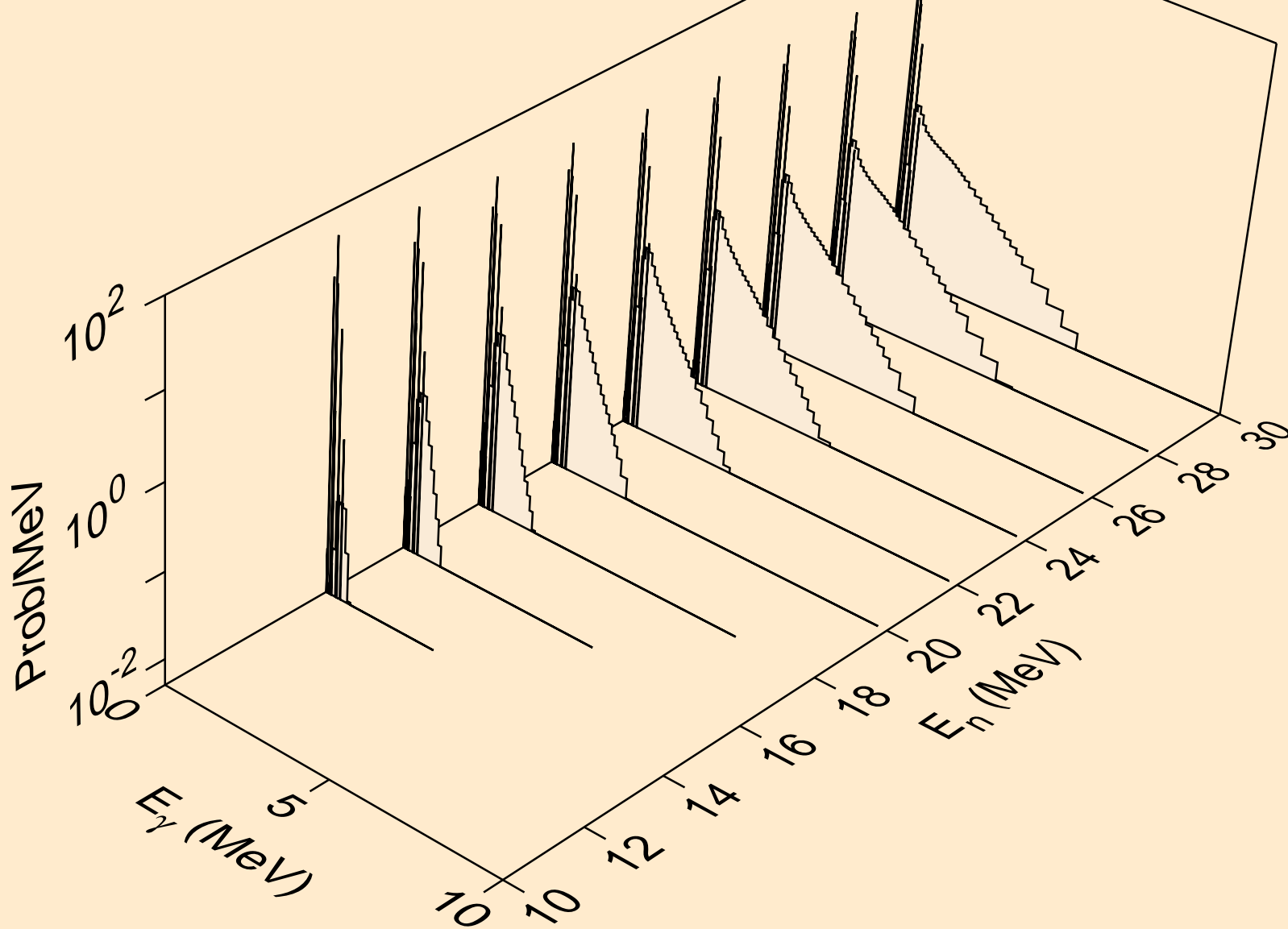

KR077 NEUTRON ACER TENDL-2019 LIBRARY; T=293.16K  
Photon emission for (n,pt)

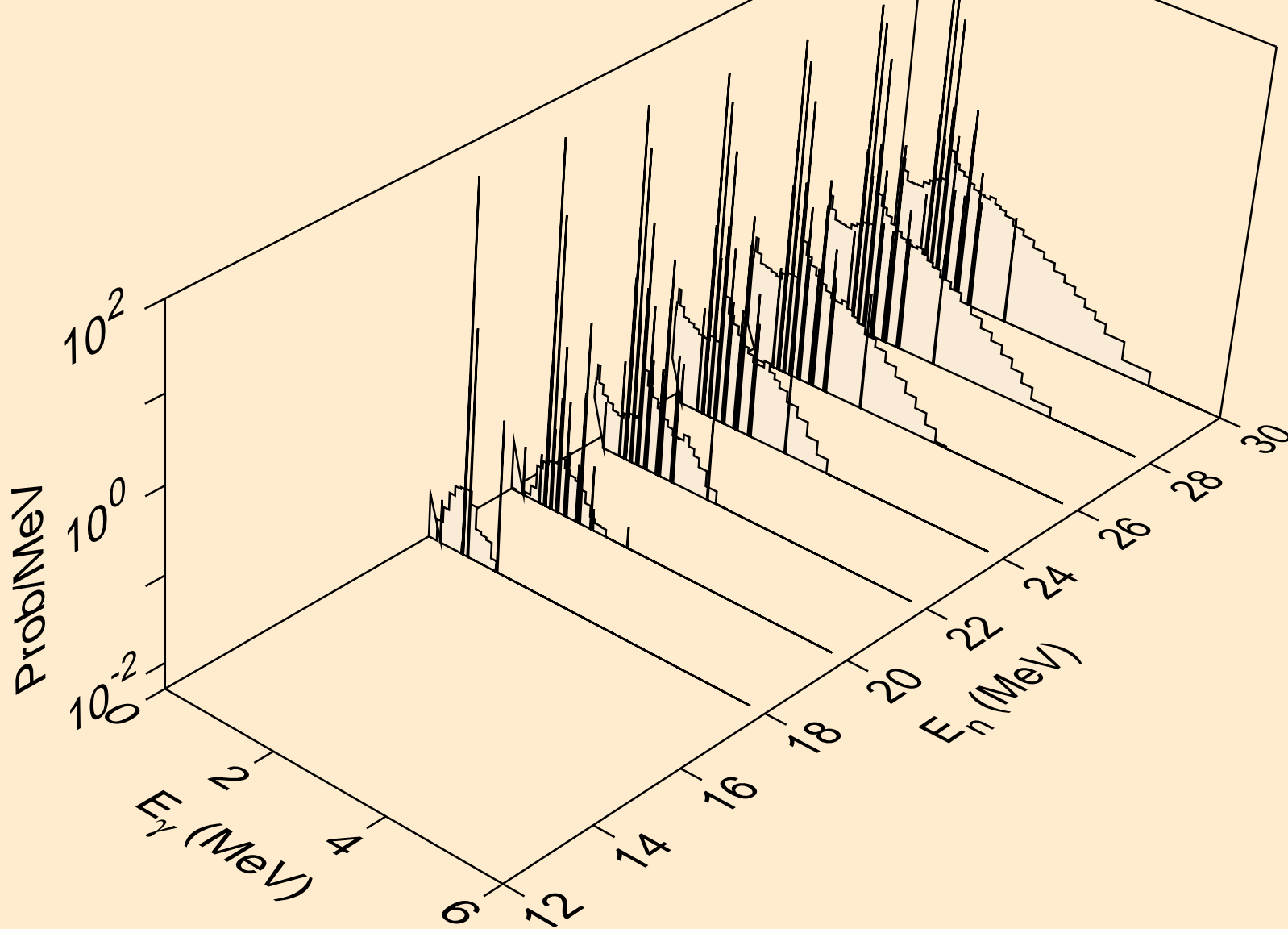

KR077 NEUTRON ACER TENDL-2019 LIBRARY; T=293.16K  
Photon emission for (n,da)

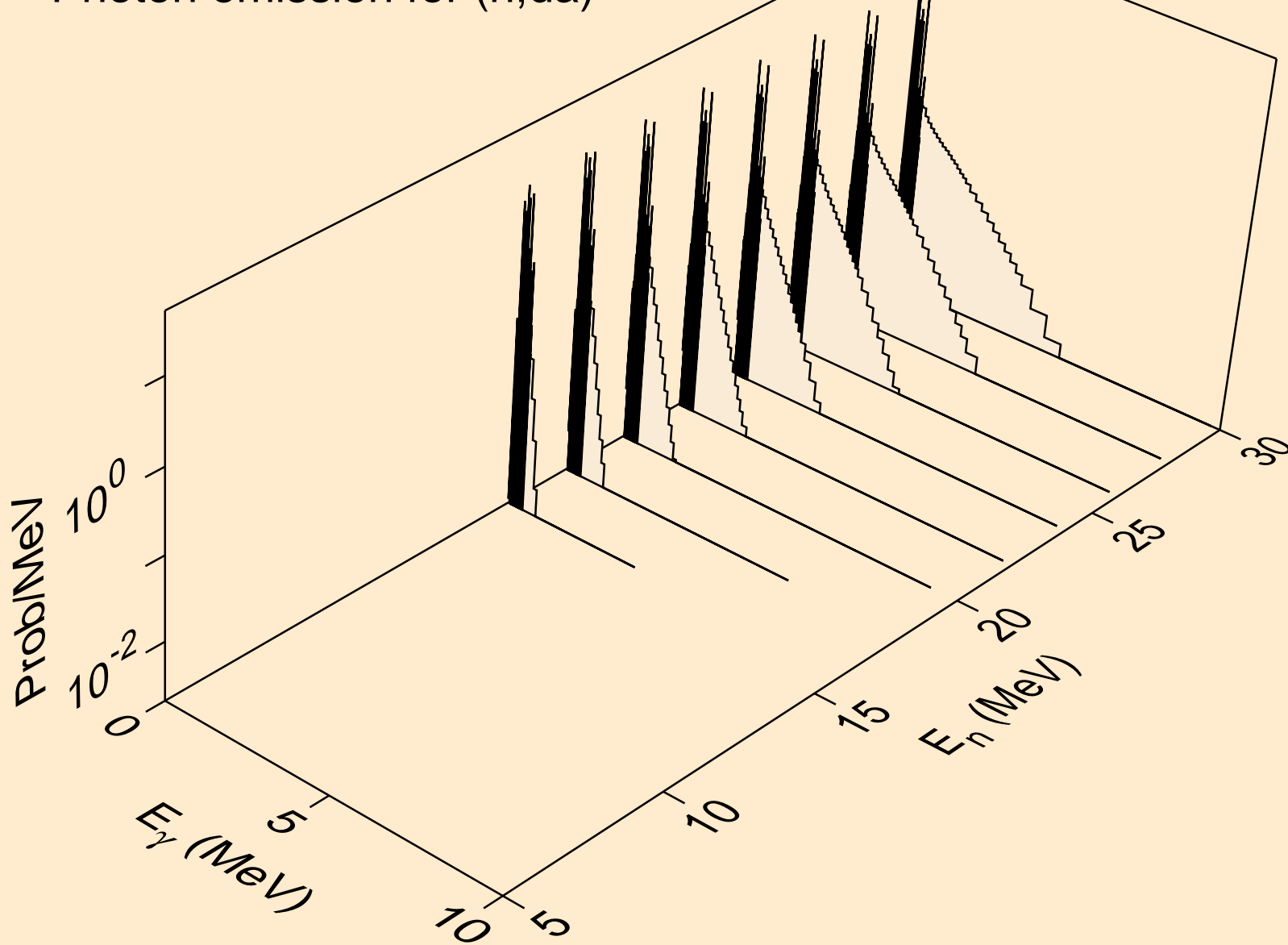

KR077 NEUTRON ACER TENDL-2019 LIBRARY; T=293.16K  
thermal capture photon spectrum

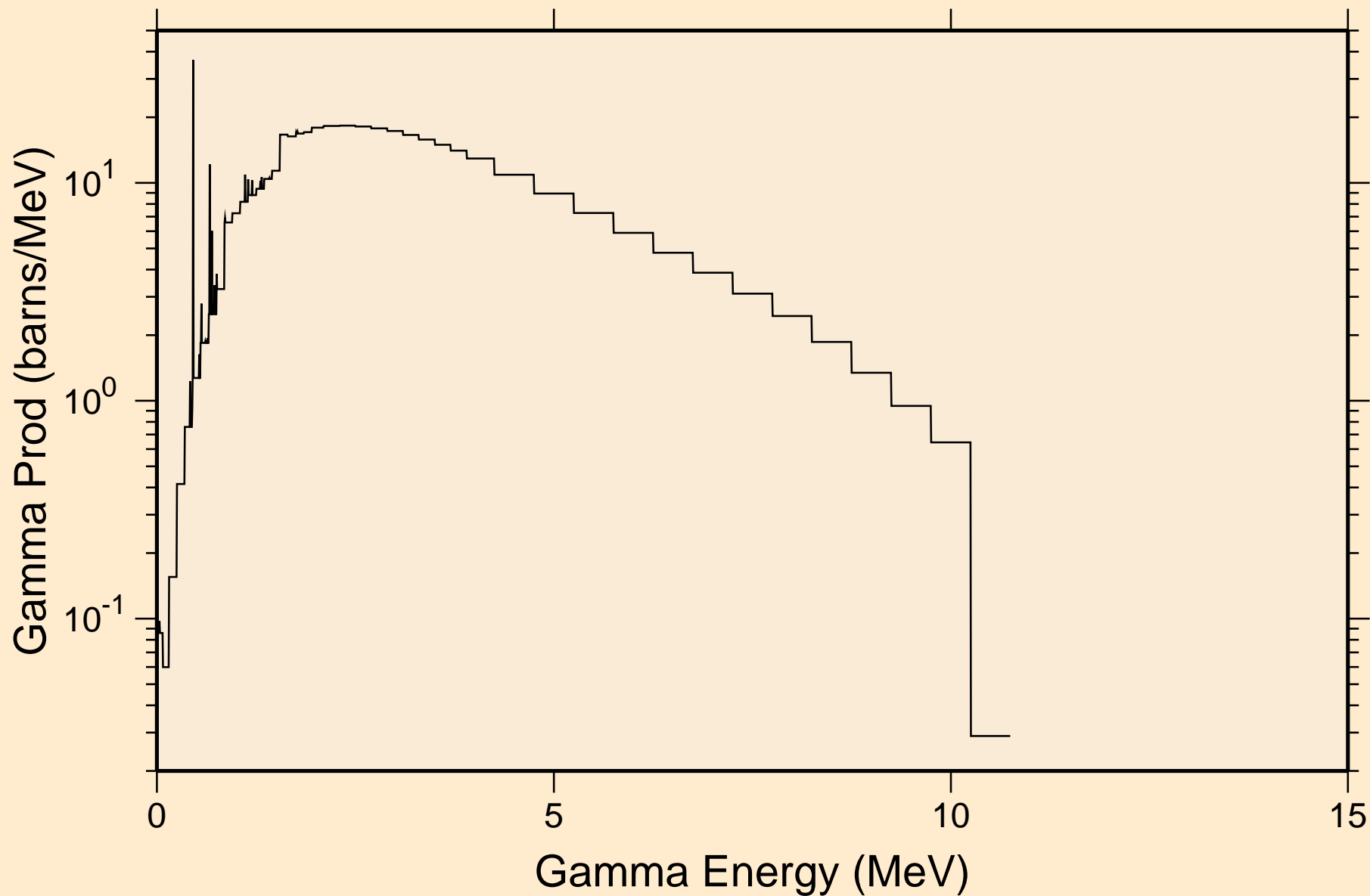

KR077 NEUTRON ACER TENDL-2019 LIBRARY; T=293.16K  
14 MeV photon spectrum

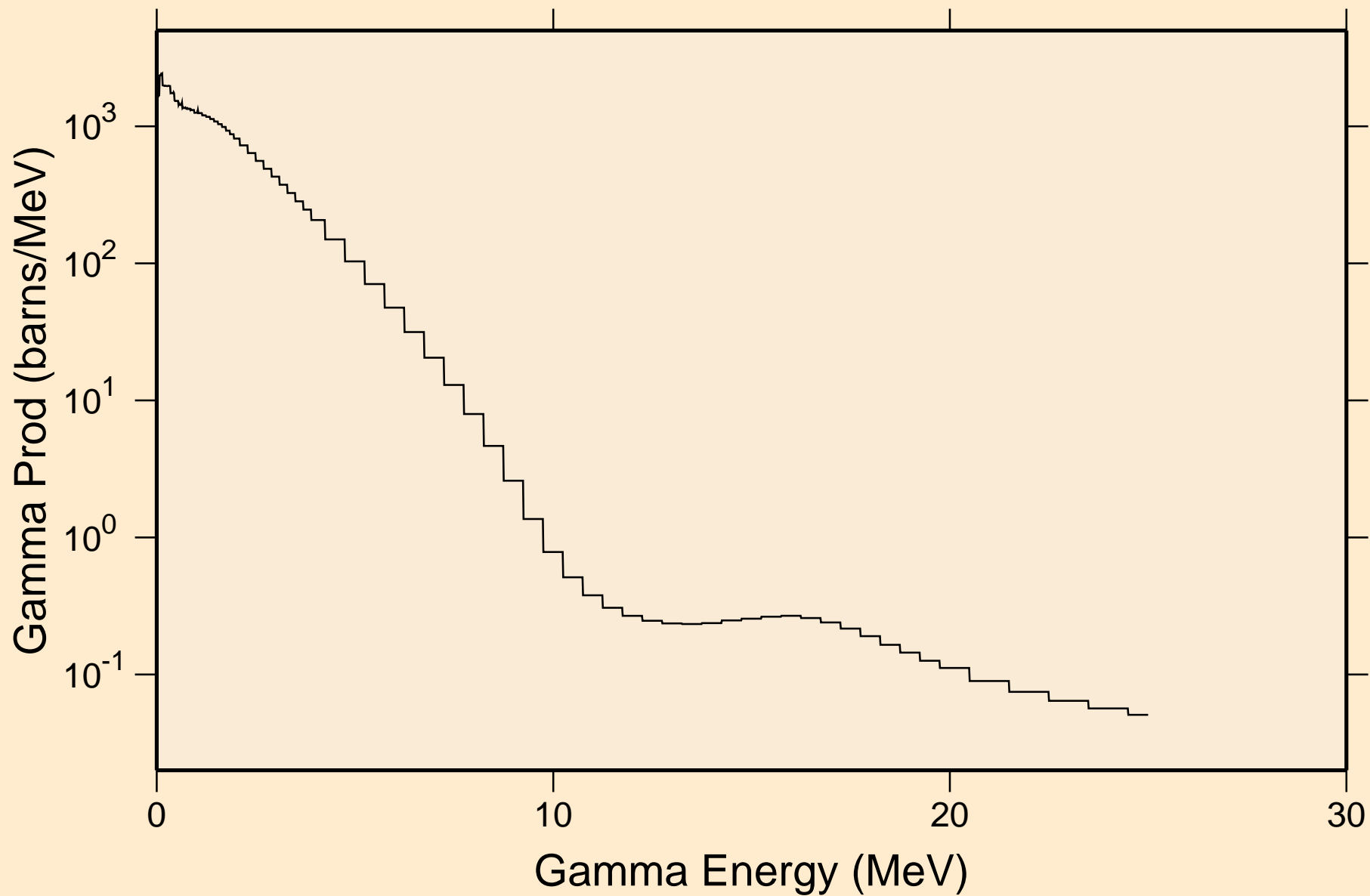

KR077 NEUTRON ACER TENDL-2019 LIBRARY; T=293.16K  
Particle heating contributions

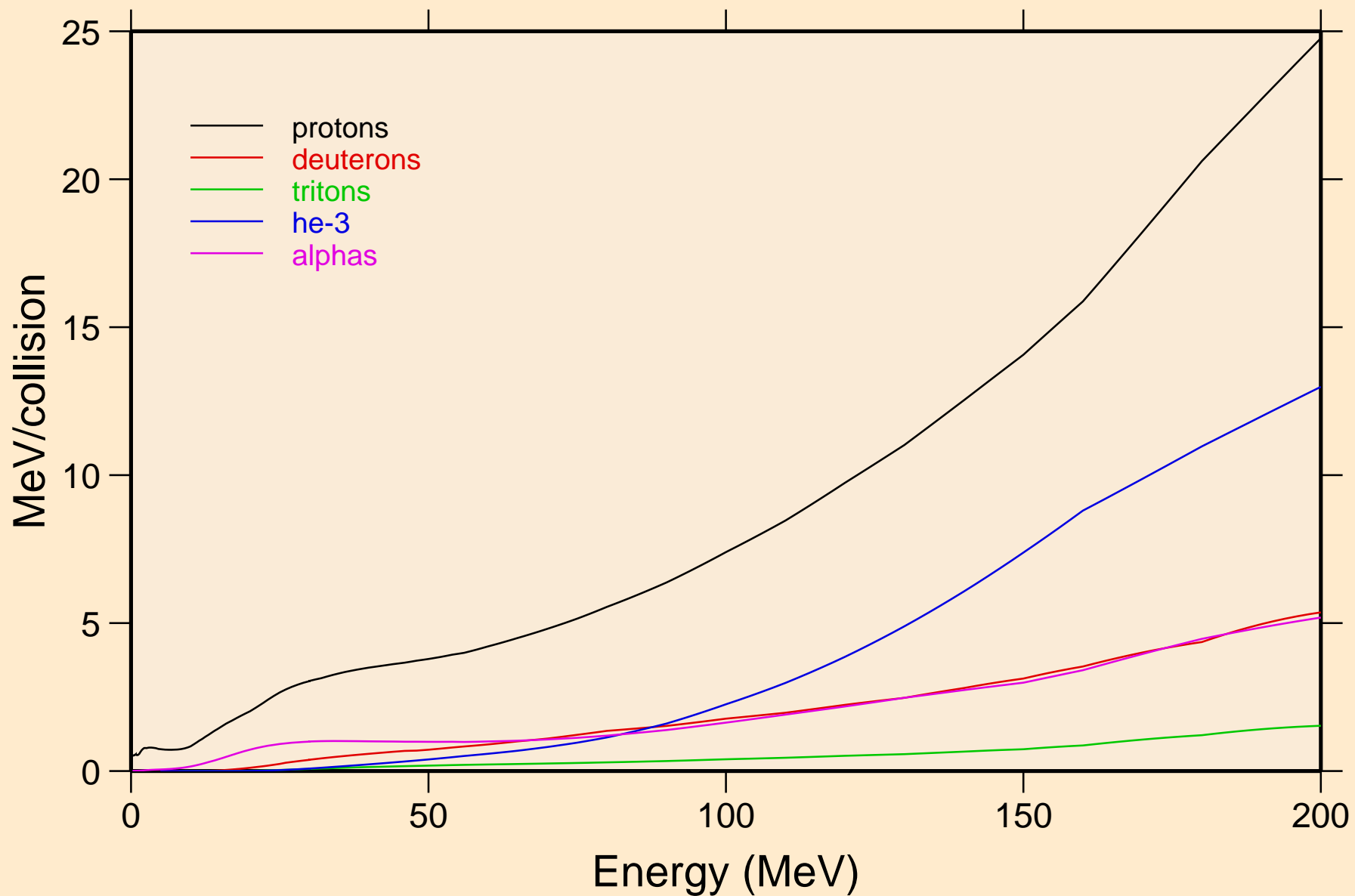

KR077 NEUTRON ACER TENDL-2019 LIBRARY; T=293.16K  
Recoil Heating

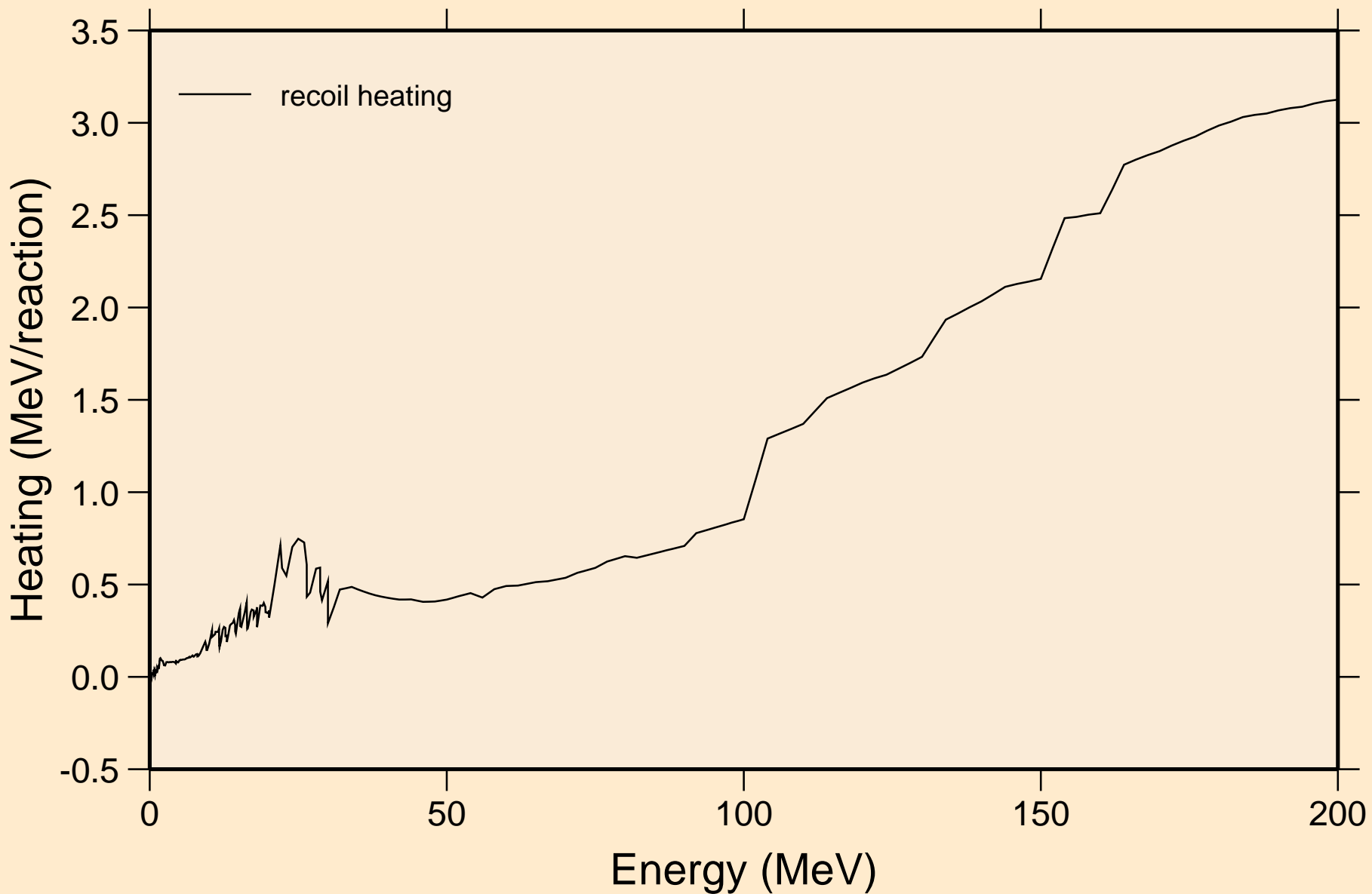

KR077 NEUTRON ACER TENDL-2019 LIBRARY; T=293.16K  
Particle production cross sections

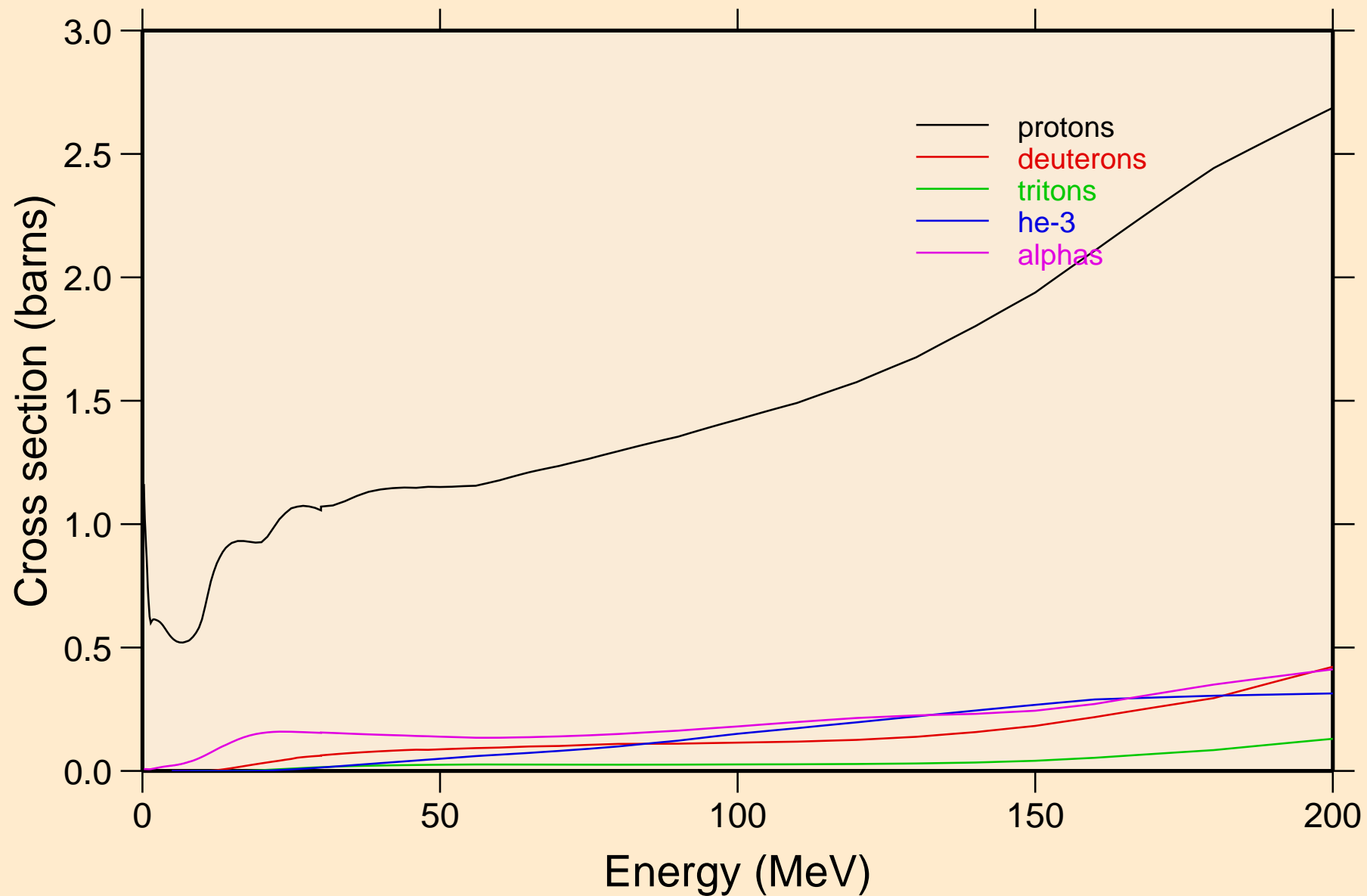

KR077 NEUTRON ACER TENDL-2019 LIBRARY; T=293.16K  
protons from (n,x)

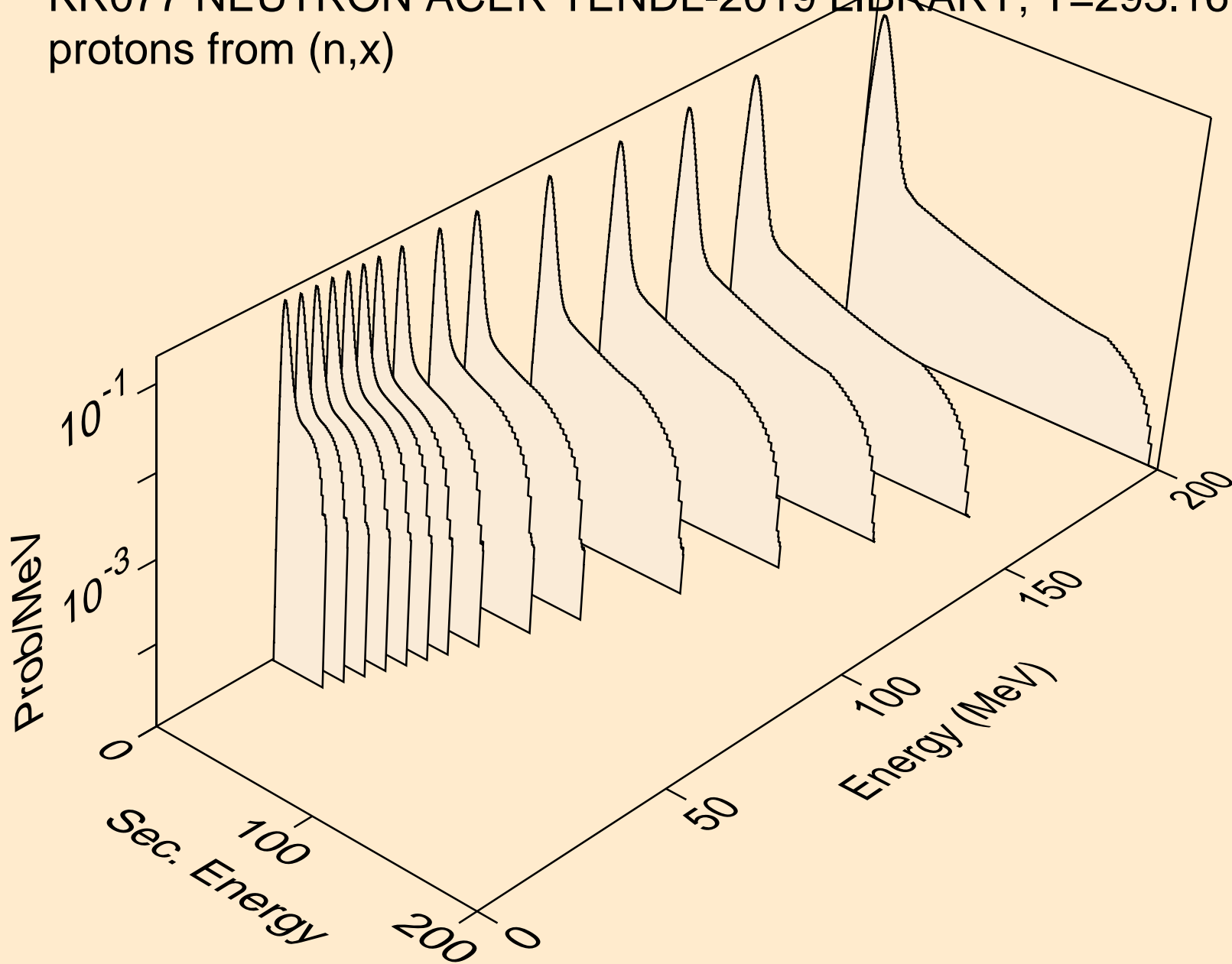

KR077 NEUTRON ACER TENDL-2019 LIBRARY; T=293.16K  
protons from (n,n\*)p

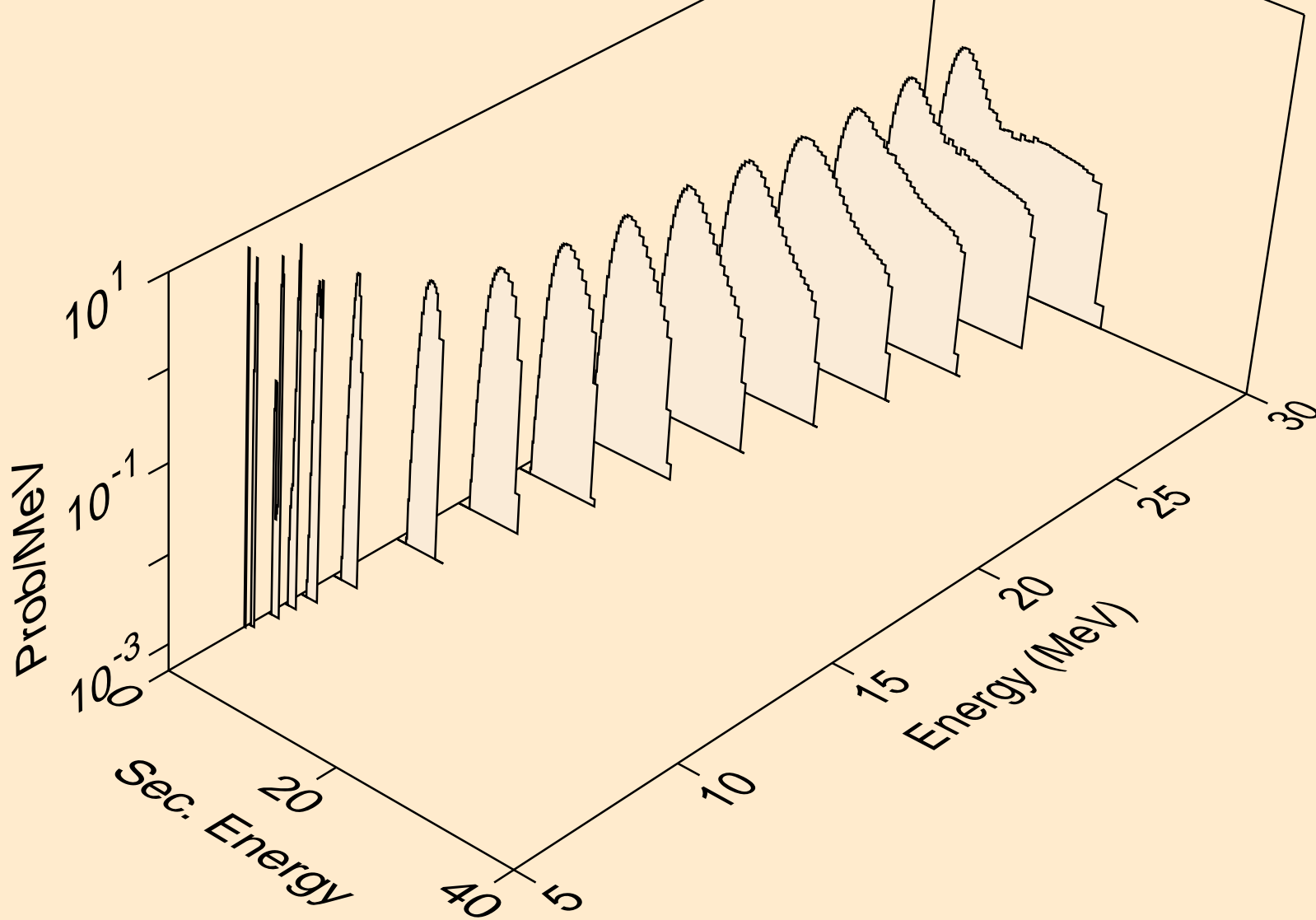

KR077 NEUTRON ACER TENDL-2019 LIBRARY; T=293.16K  
protons from (n,2np)

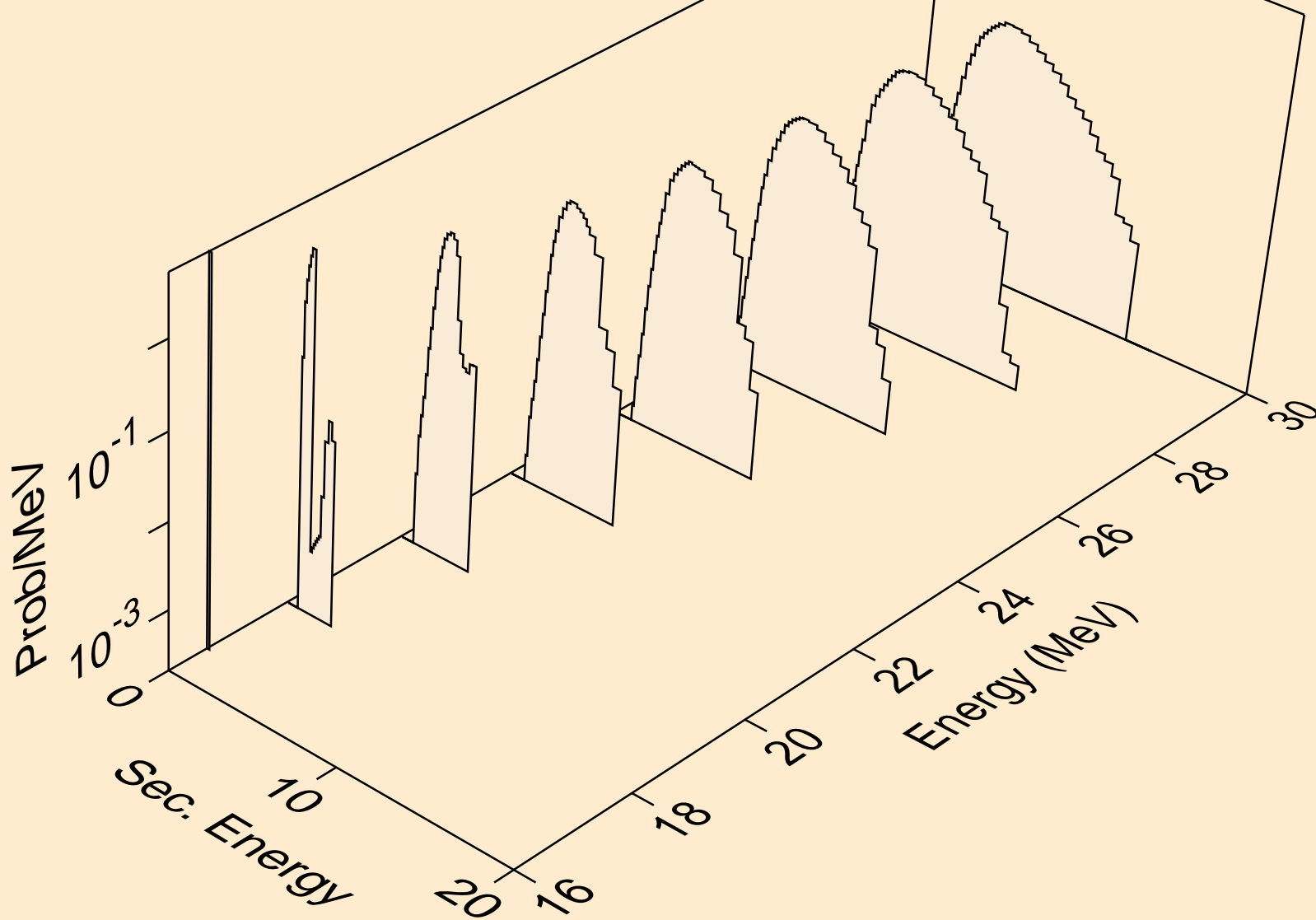

KR077 NEUTRON ACER TENDL-2019 LIBRARY; T=293.16K  
protons from (n,3np)

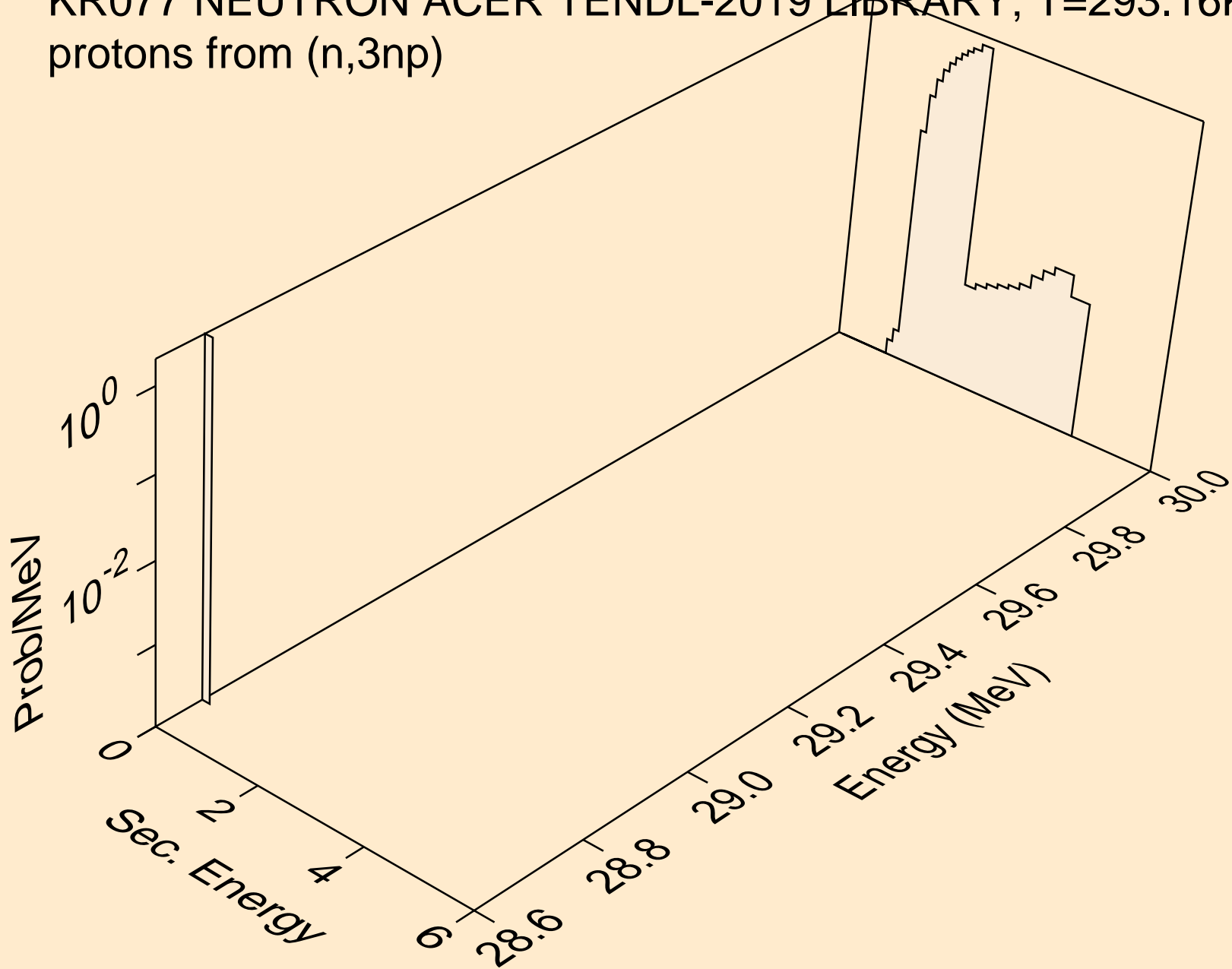

KR077 NEUTRON ACER TENDL-2019 LIBRARY; T=293.16K  
protons from (n,2np)

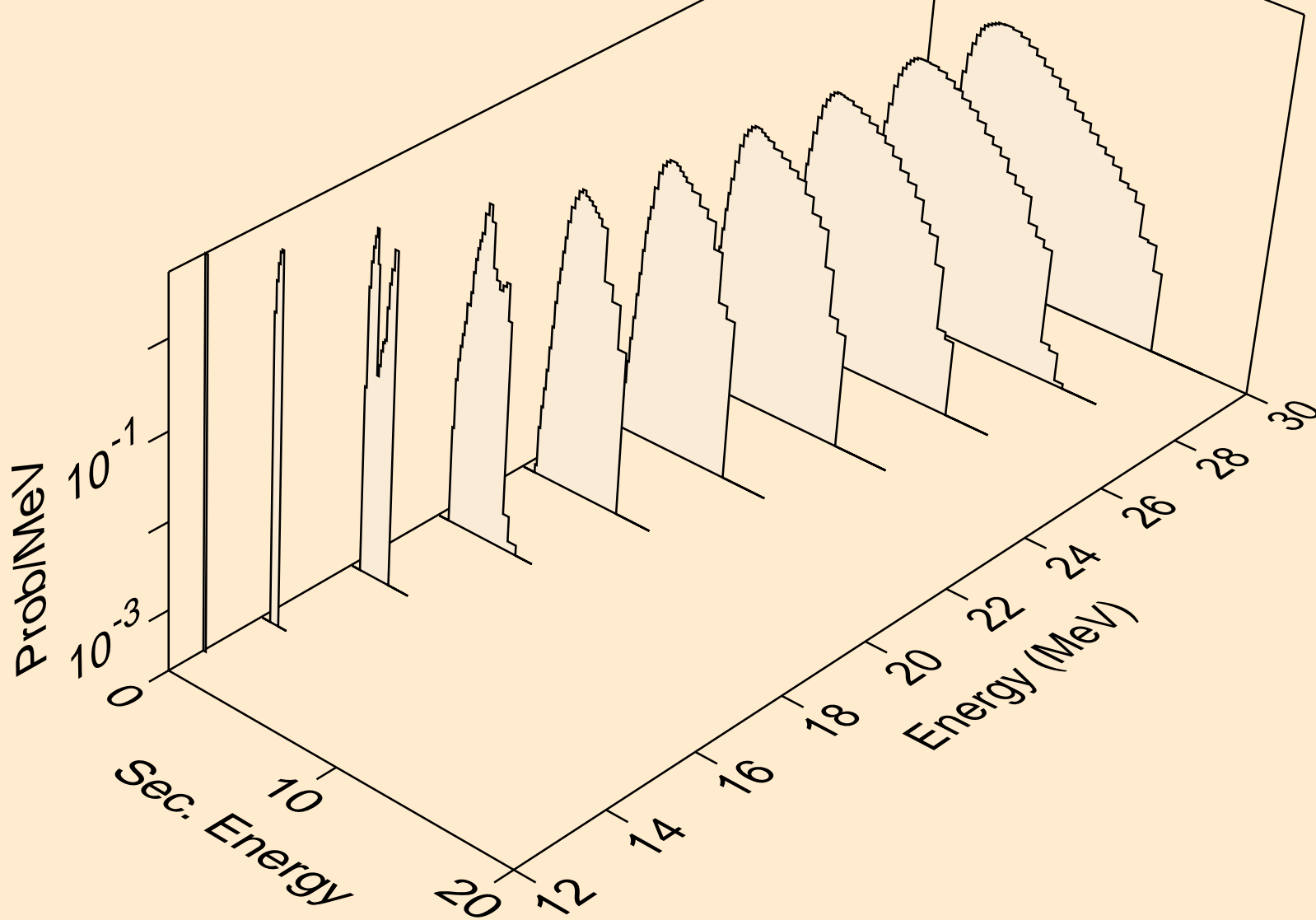

KR077 NEUTRON ACER TENDL-2019 LIBRARY; T=293.16K  
protons from (n,npa)

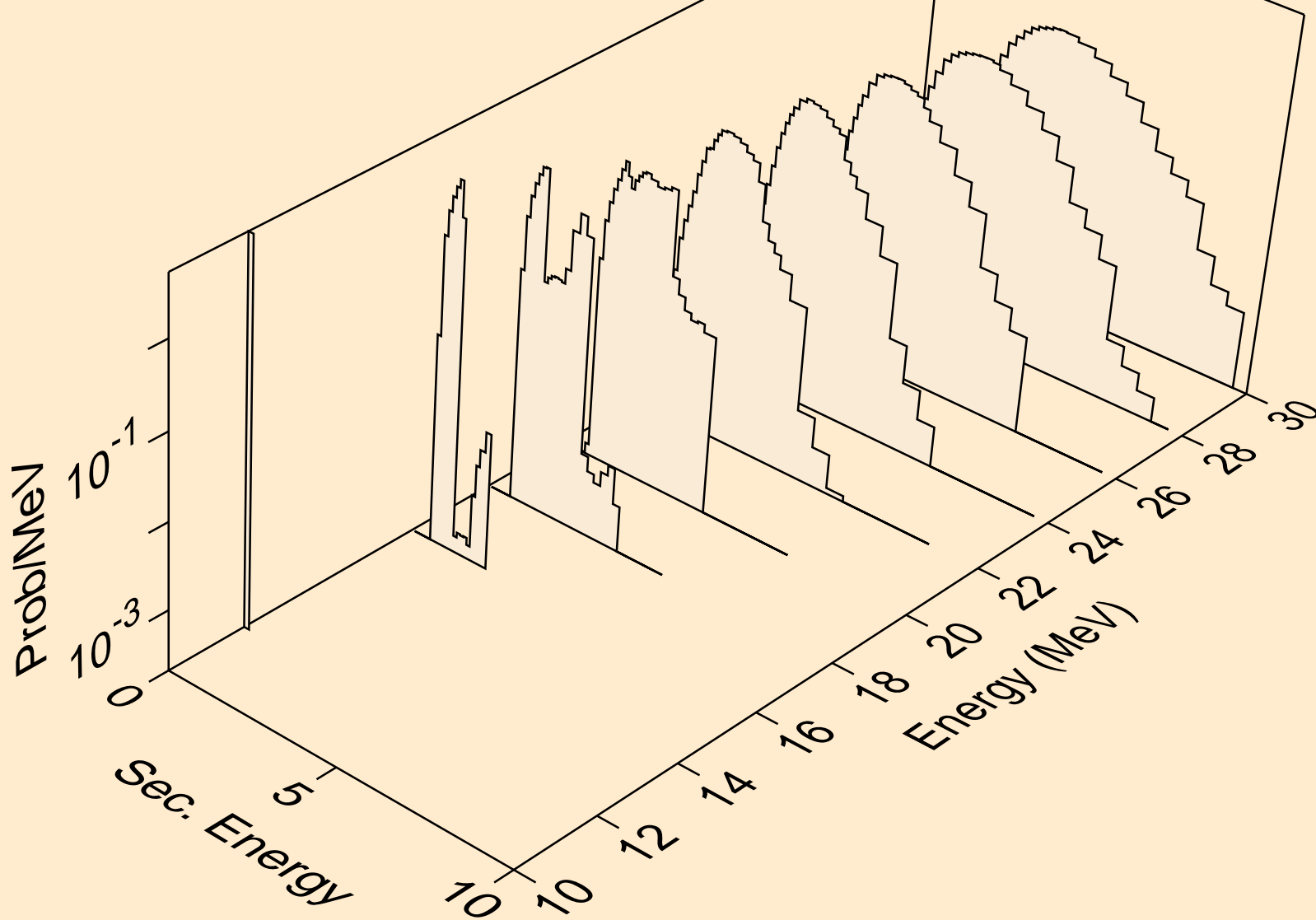

KR077 NEUTRON ACER TENDL-2019 LIBRARY; T=293.16K  
protons from (n,p)

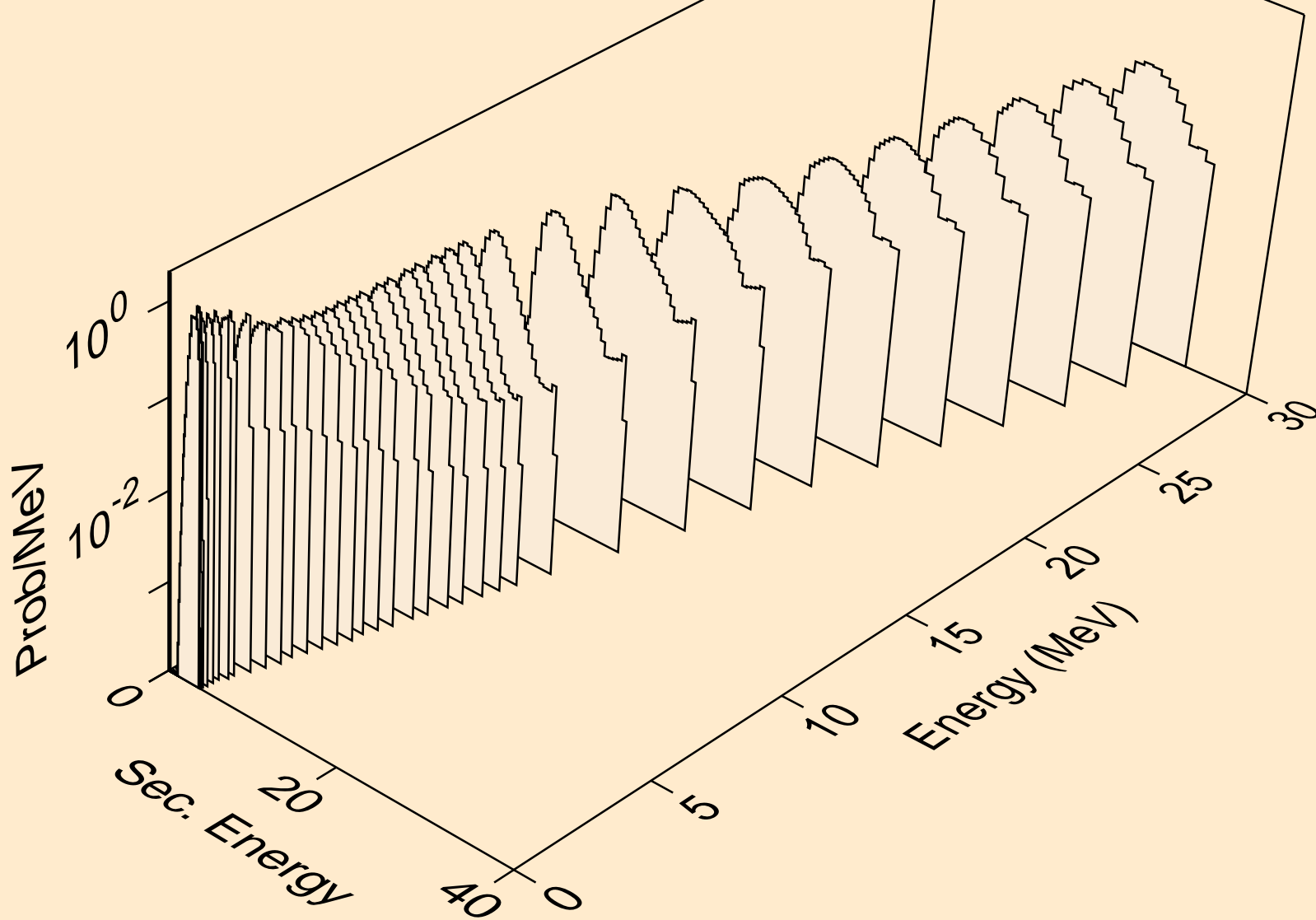

KR077 NEUTRON ACER TENDL-2019 LIBRARY; T=293.16K  
protons from (n,2p)

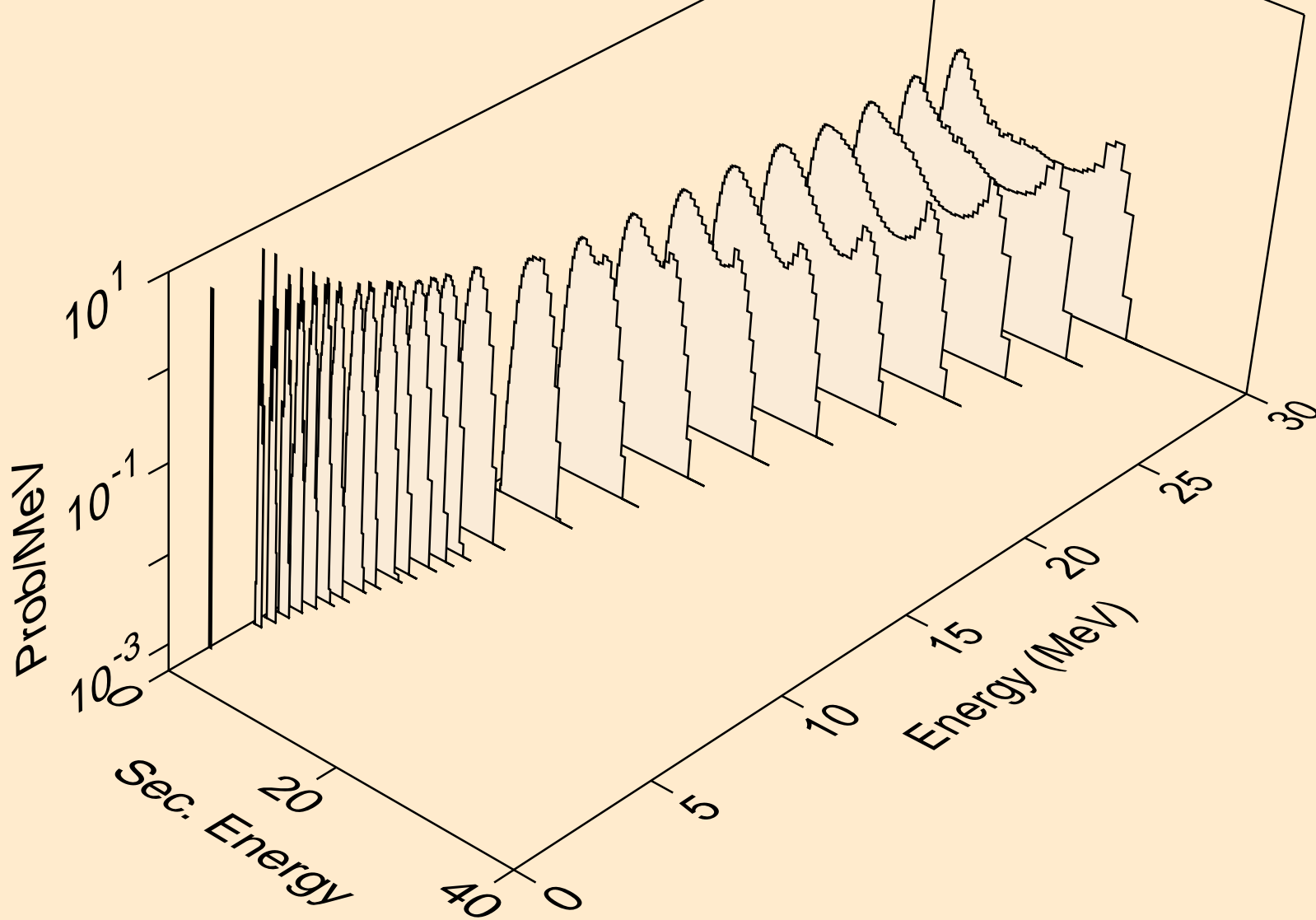

KR077 NEUTRON ACER TENDL-2019 LIBRARY; T=293.16K  
protons from (n,p)

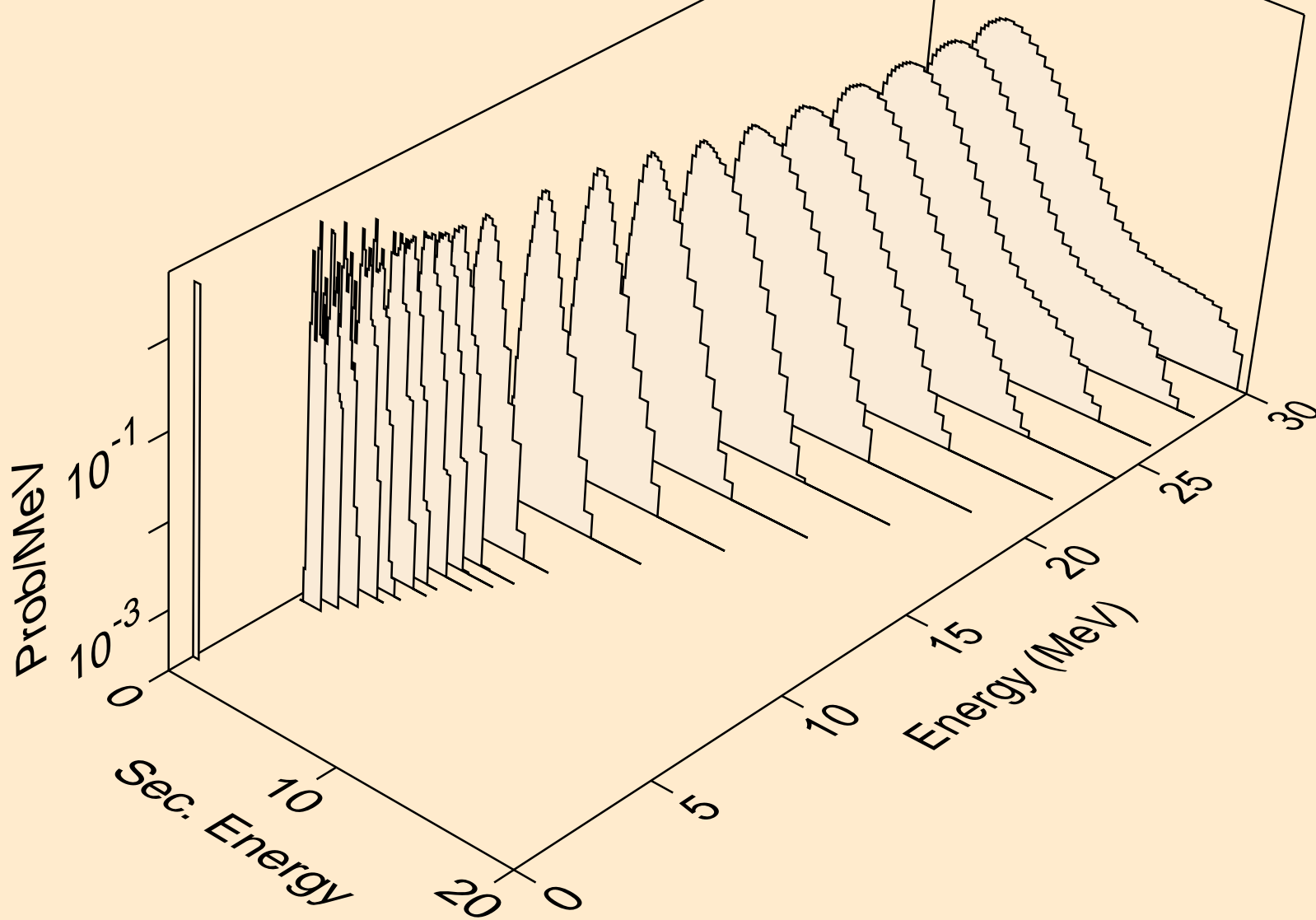

KR077 NEUTRON ACER TENDL-2019 LIBRARY; T=293.16K  
protons from (n,pd)

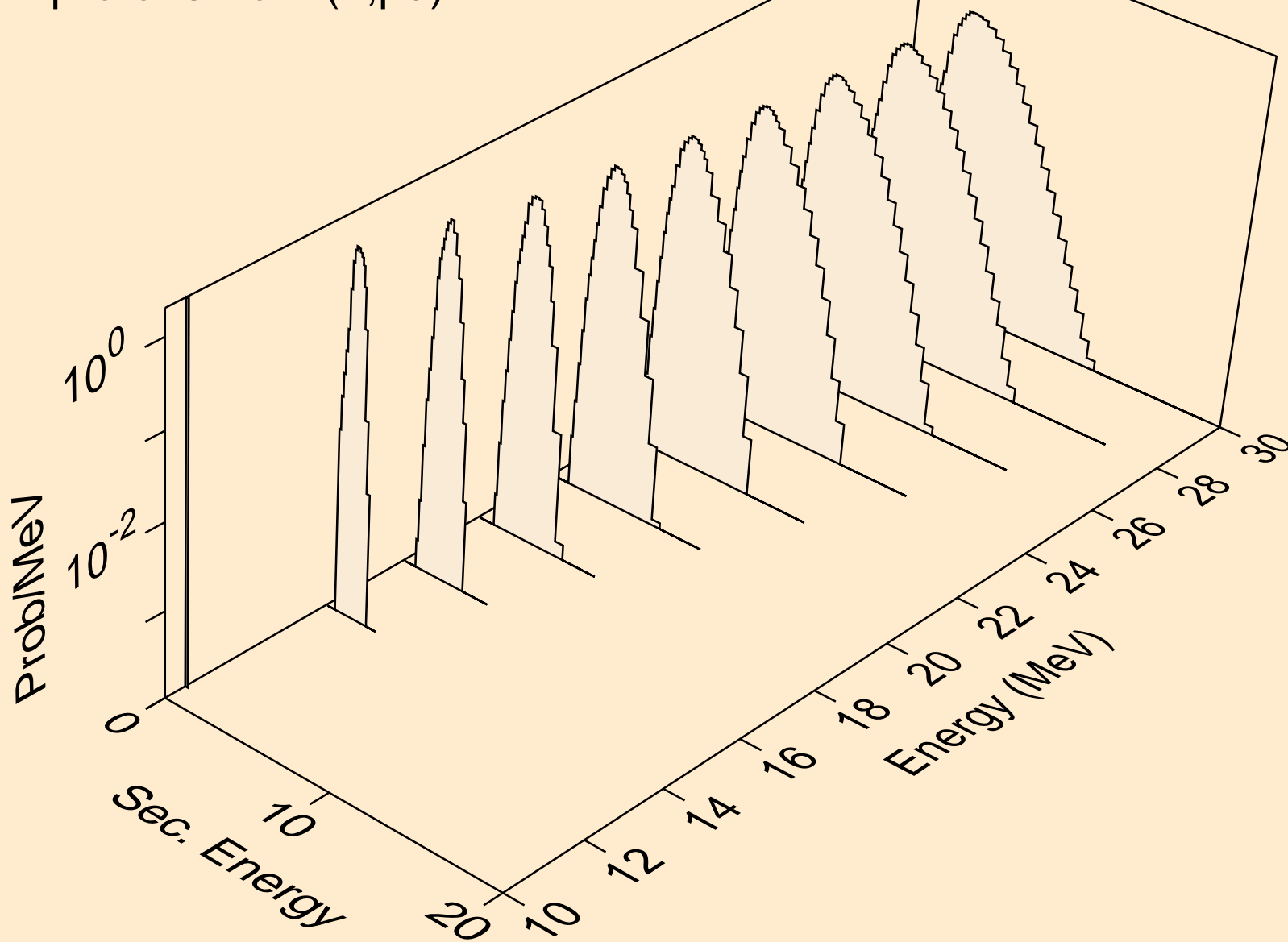

KR077 NEUTRON ACER TENDL-2019 LIBRARY; T=293.16K  
protons from (n,pt)

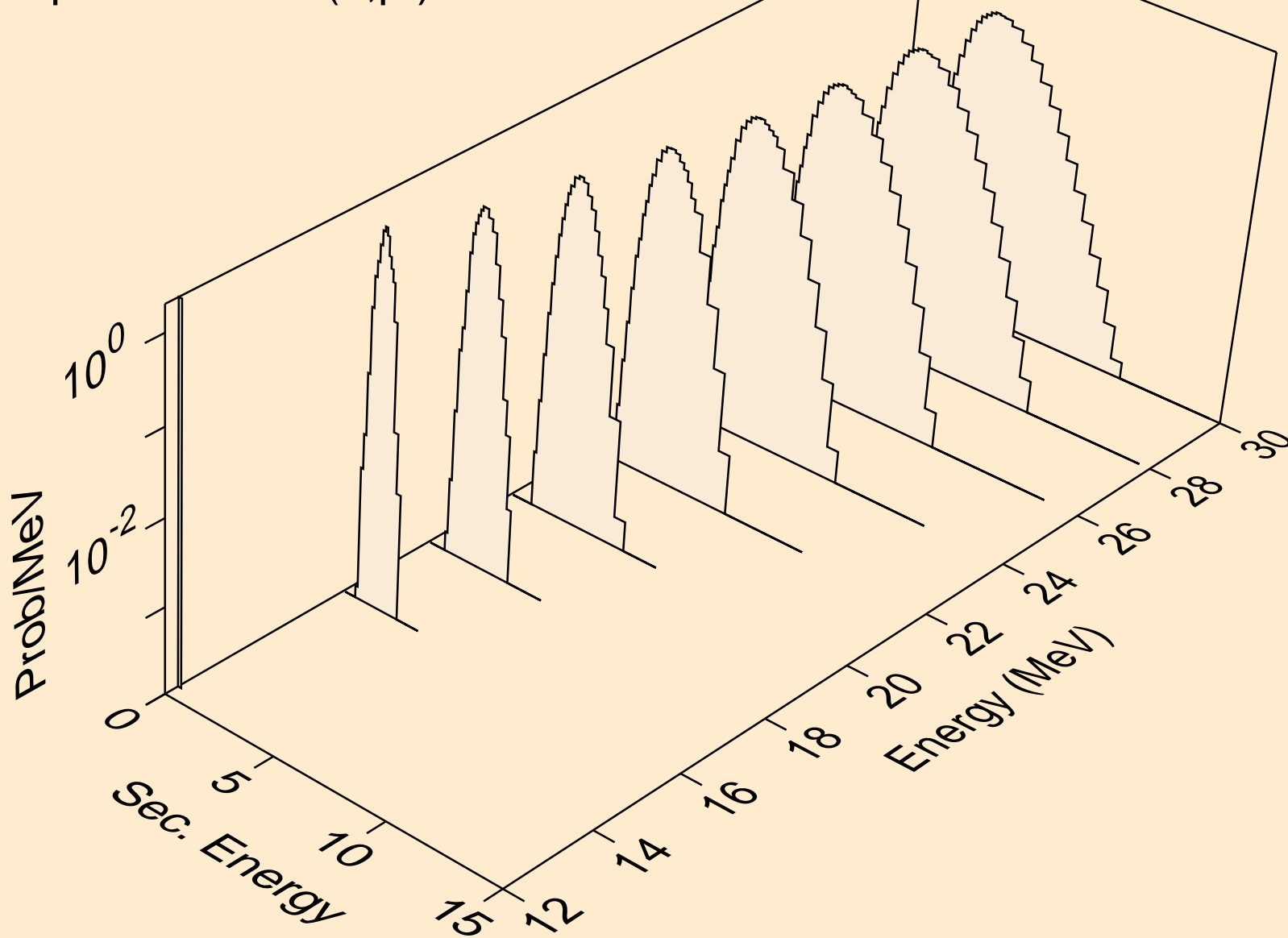

KR077 NEUTRON ACER TENDL-2019 LIBRARY; T=293.16K  
deuterons from (n,x)

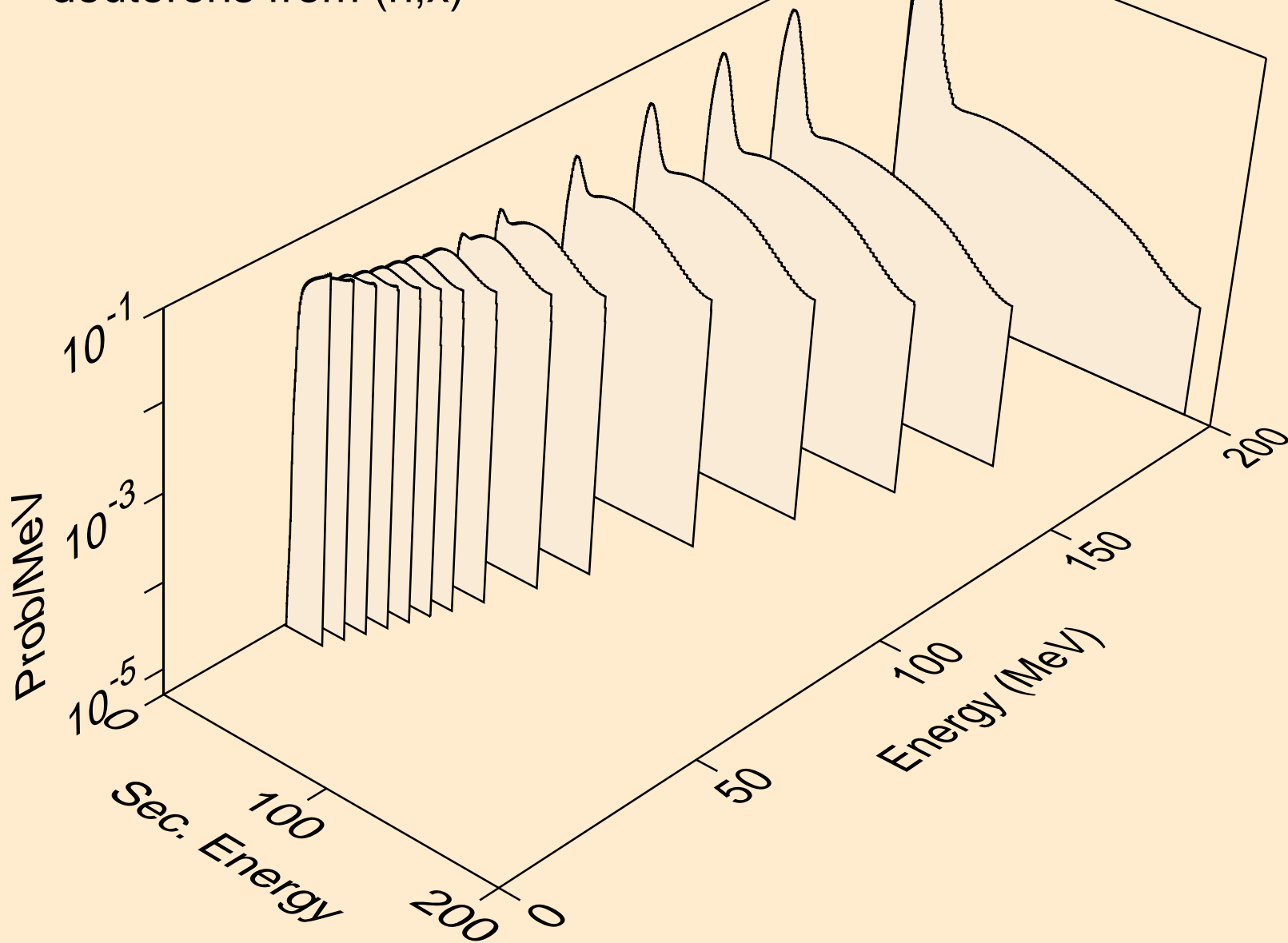

KR077 NEUTRON ACER TENDL-2019 LIBRARY; T=293.16K  
deuterons from (n,2nd)

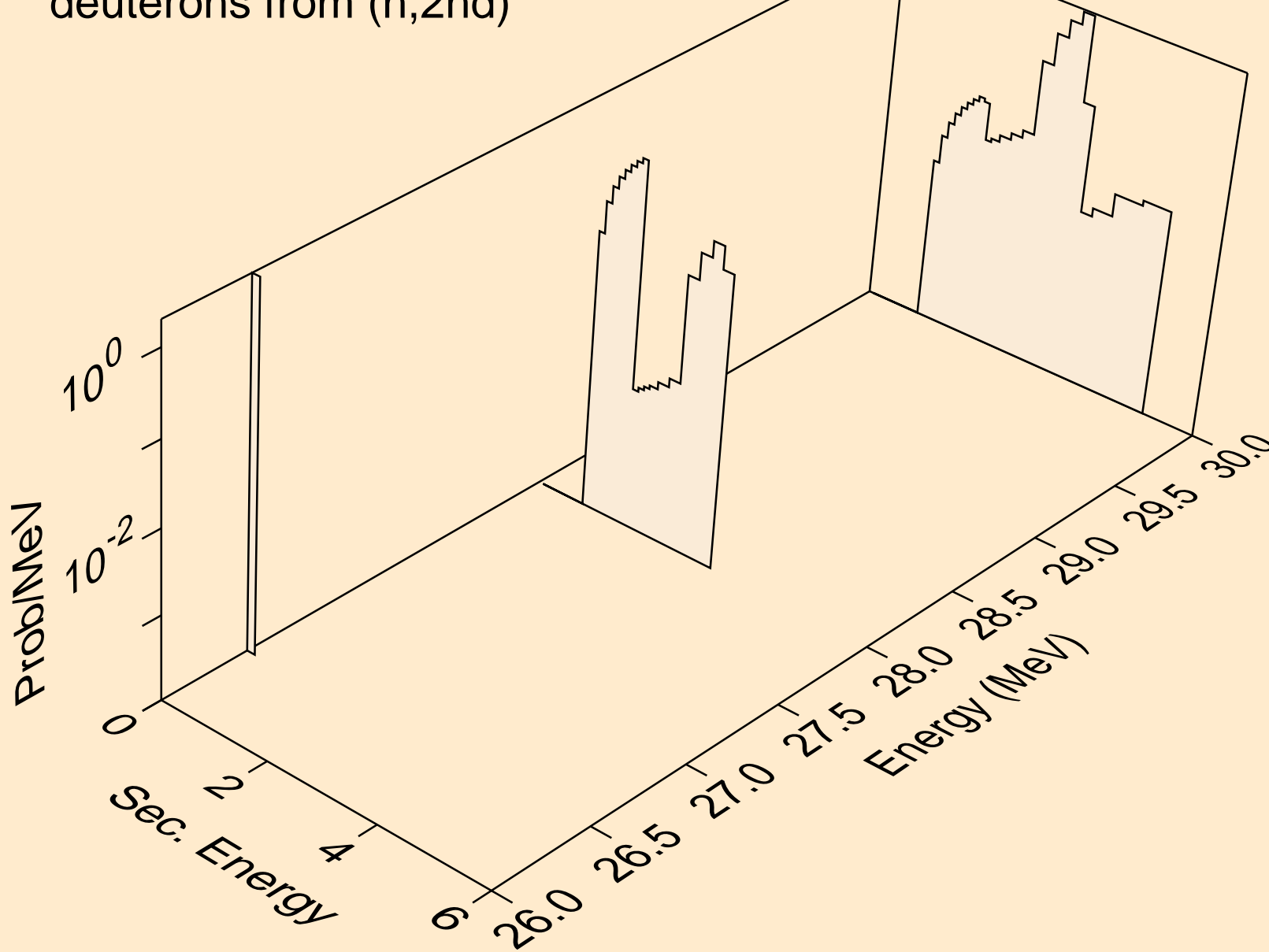

KR077 NEUTRON ACER TENDL-2019 LIBRARY; T=293.16K  
deuterons from (n,n\*)d

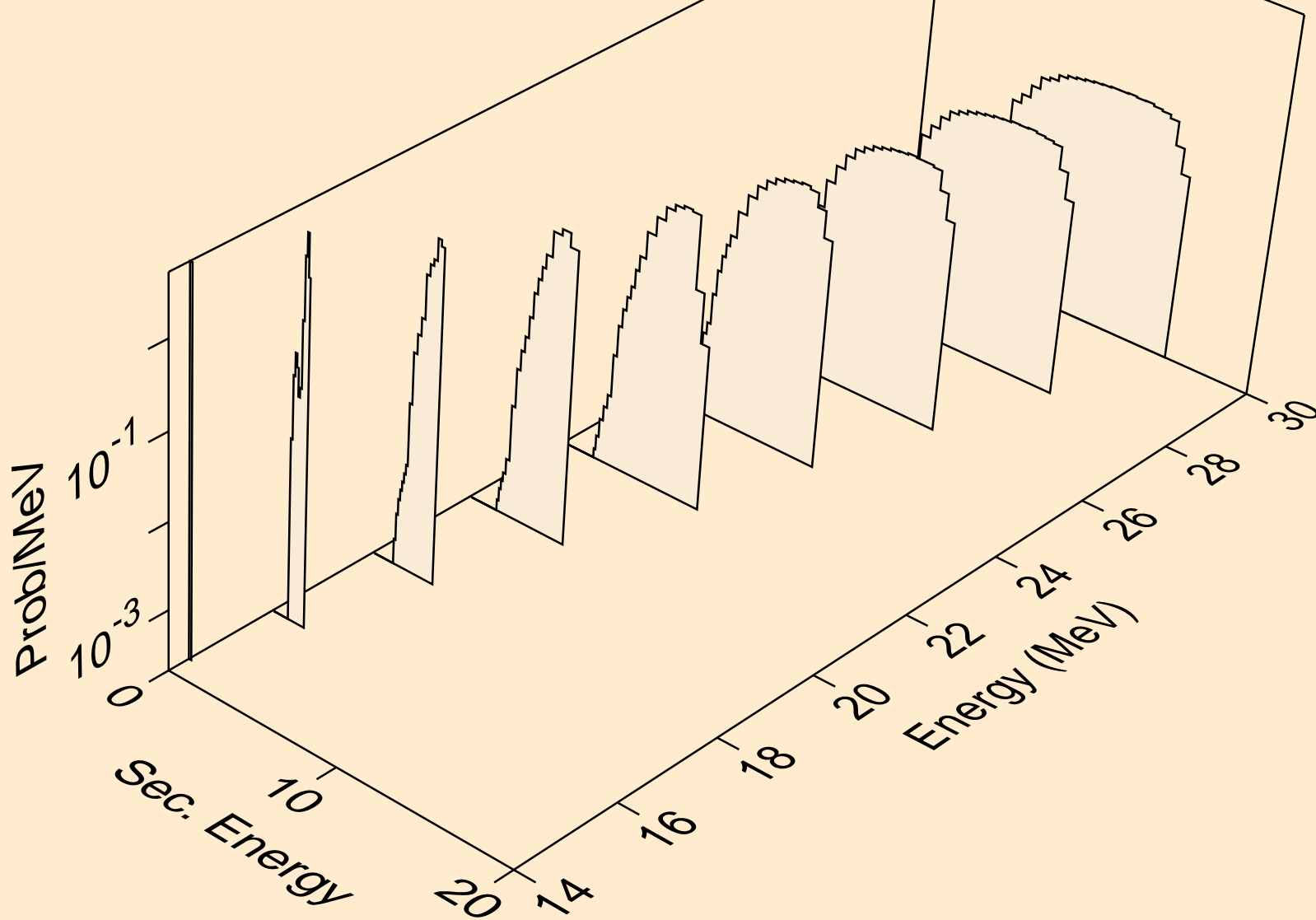

KR077 NEUTRON ACER TENDL-2019 LIBRARY; T=293.16K  
deuterons from (n,d)

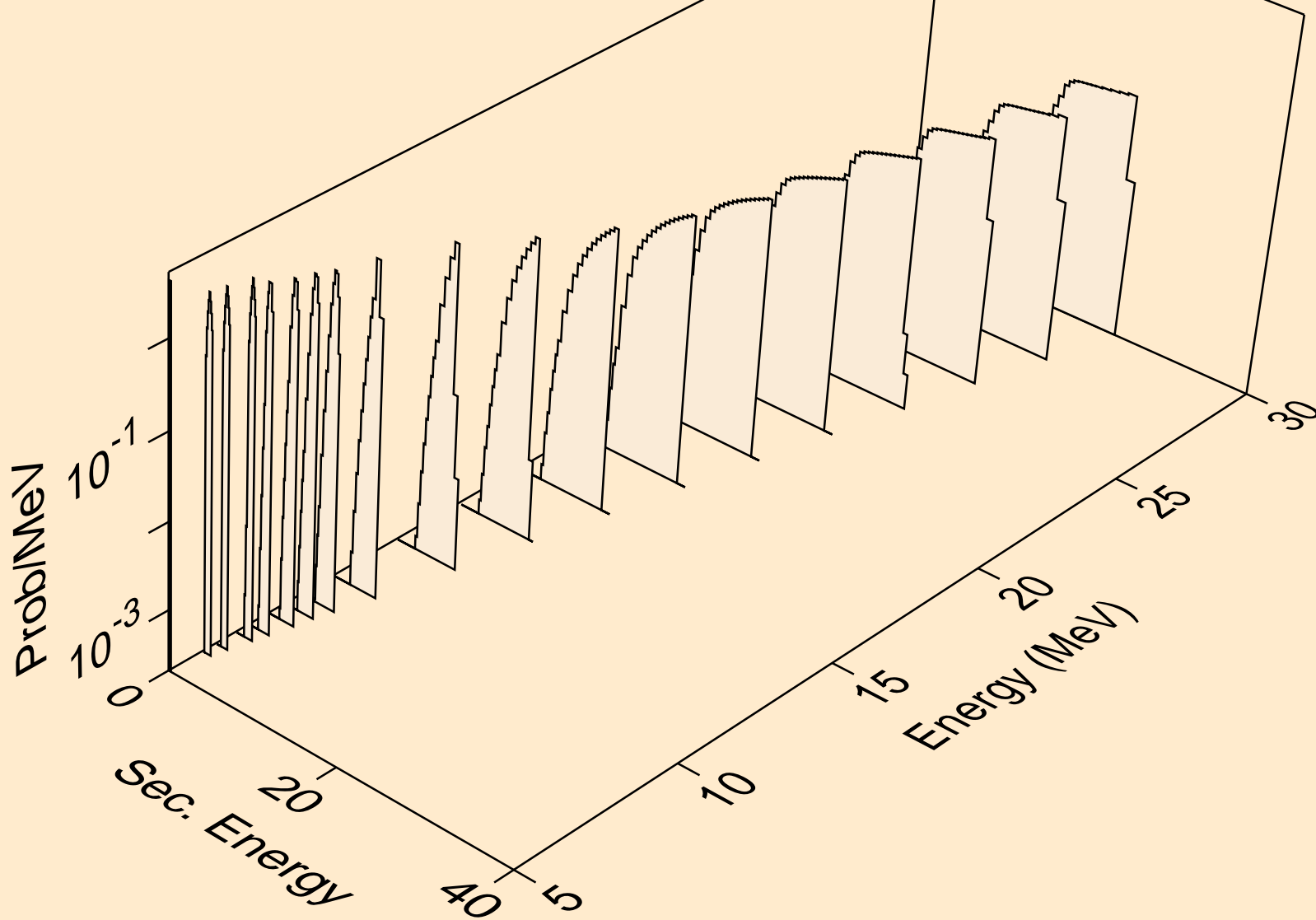

KR077 NEUTRON ACER TENDL-2019 LIBRARY; T=293.16K  
deuterons from (n,pd)

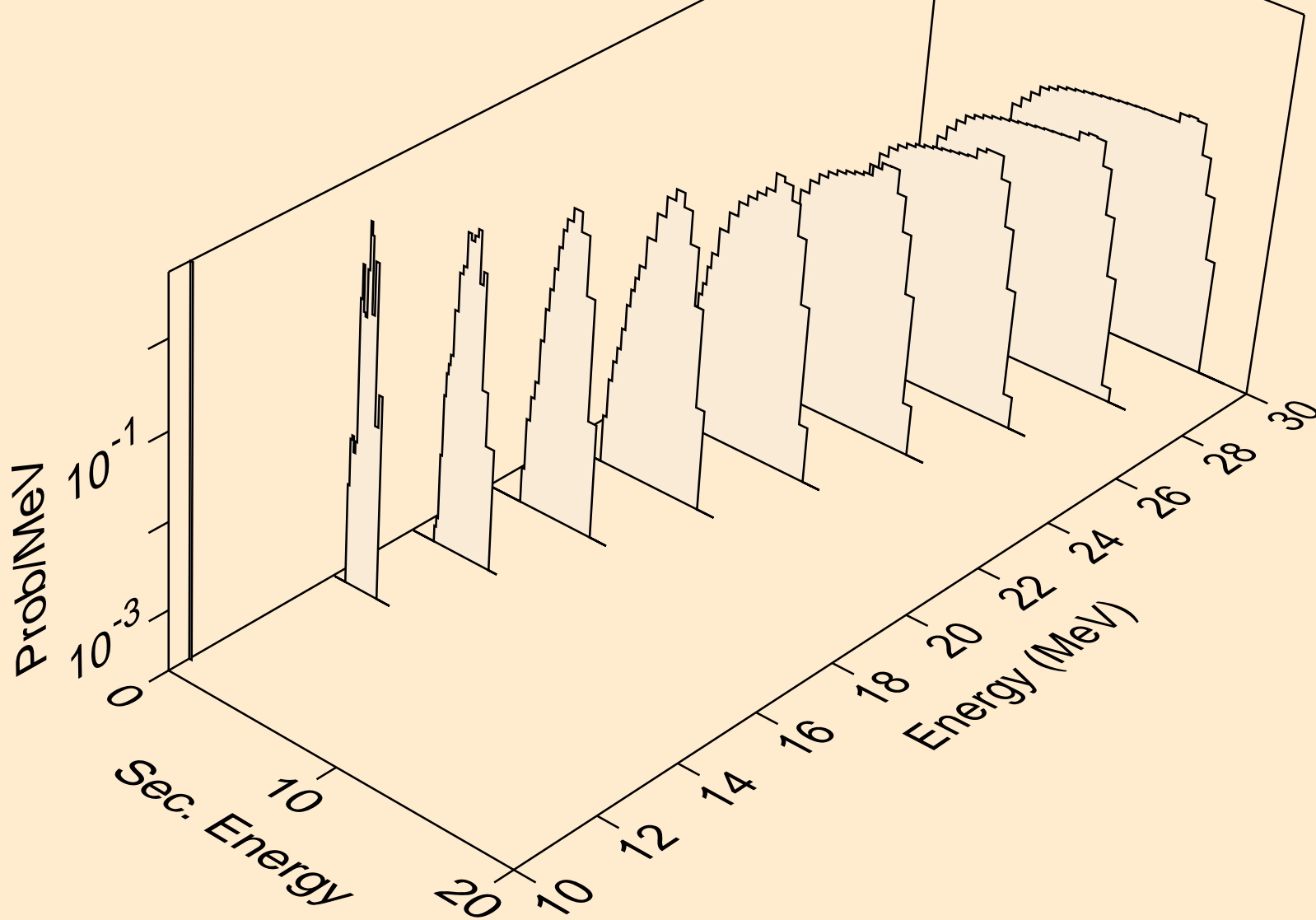

KR077 NEUTRON ACER TENDL-2019 LIBRARY; T=293.16K  
deuterons from (n,da)

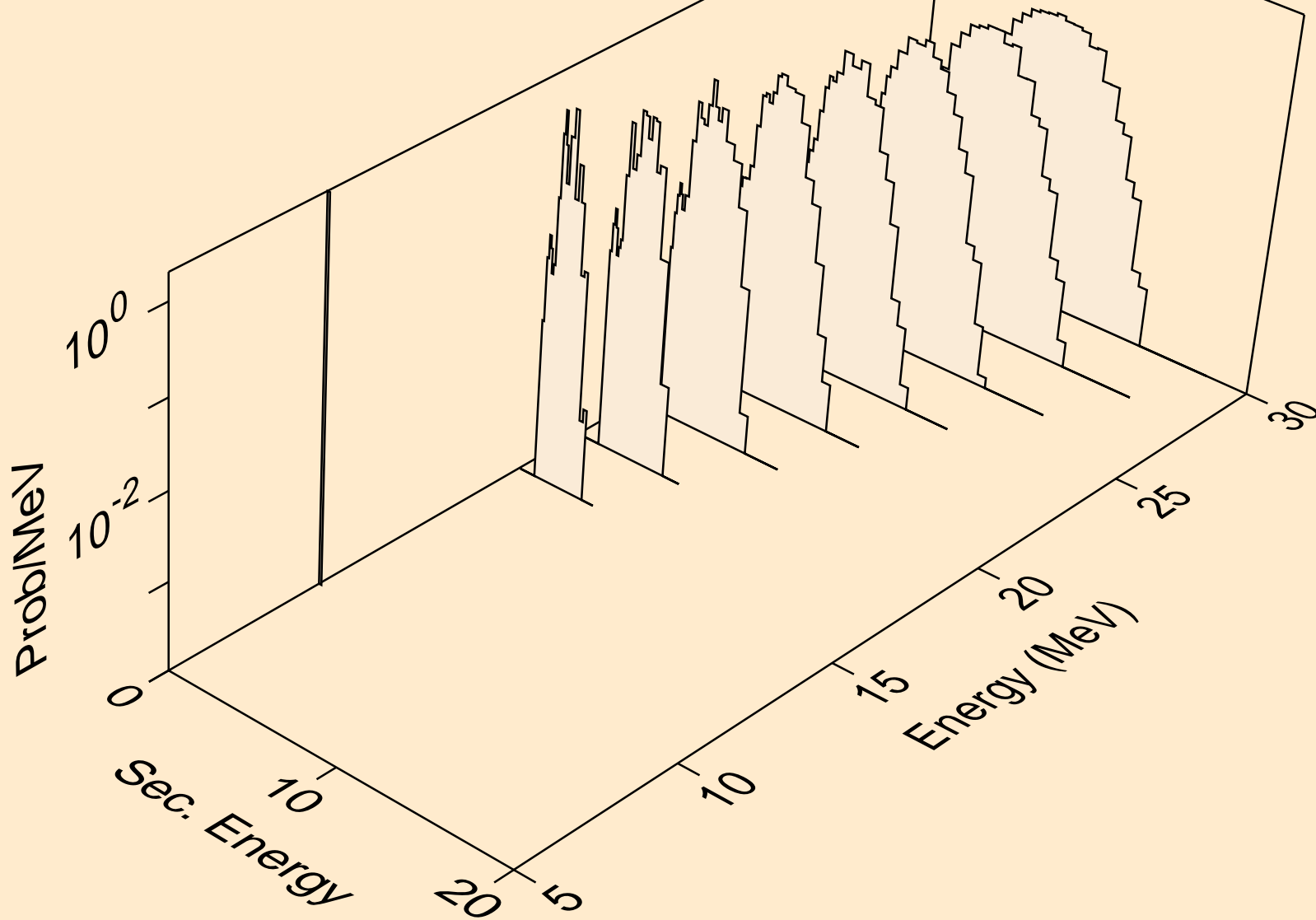

KR077 NEUTRON ACER TENDL-2019 LIBRARY; T=293.16K  
tritons from (n,x)

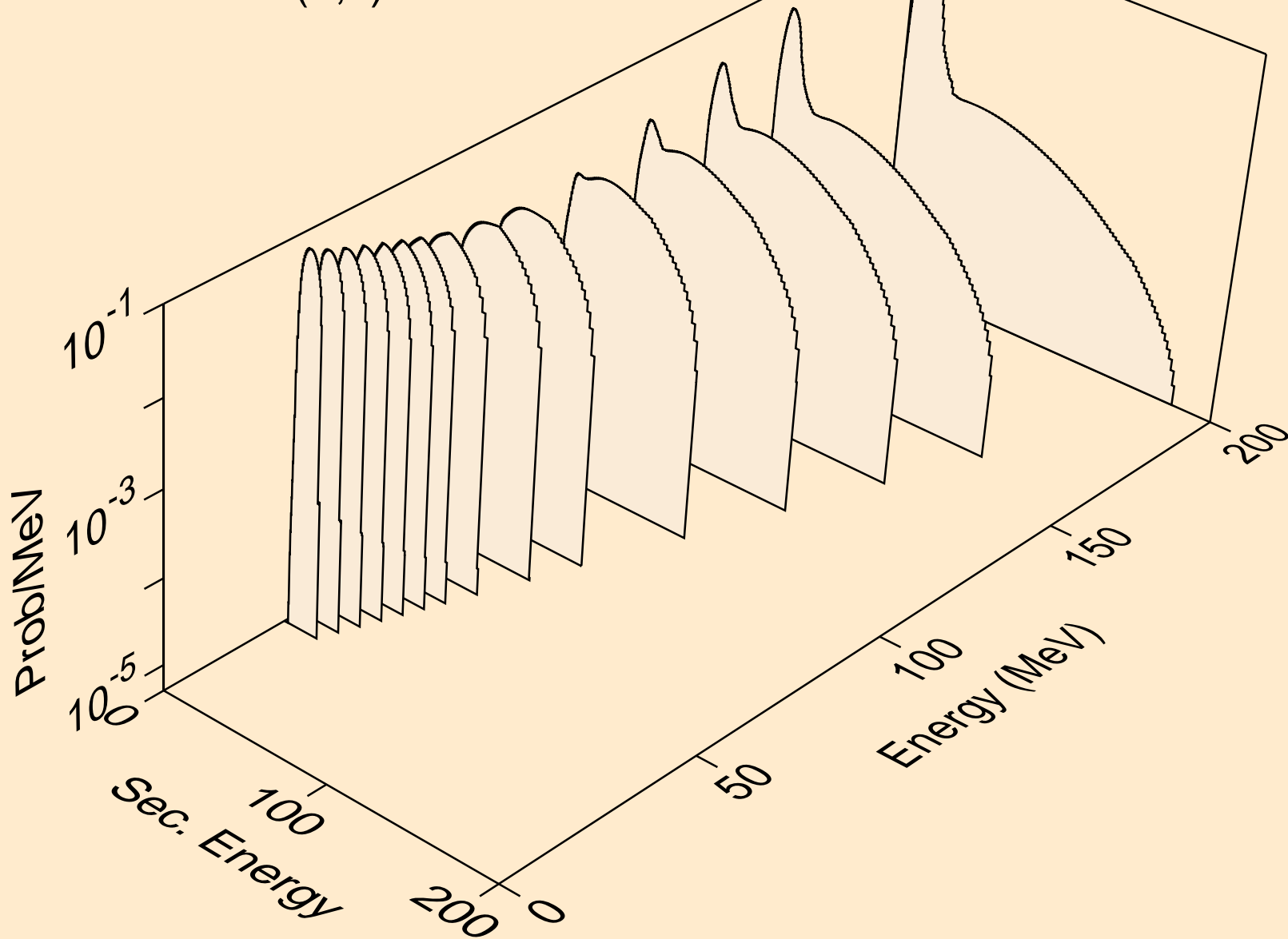

KR077 NEUTRON ACER TENDL-2019 LIBRARY; T=293.16K  
tritons from (n,n\*)t

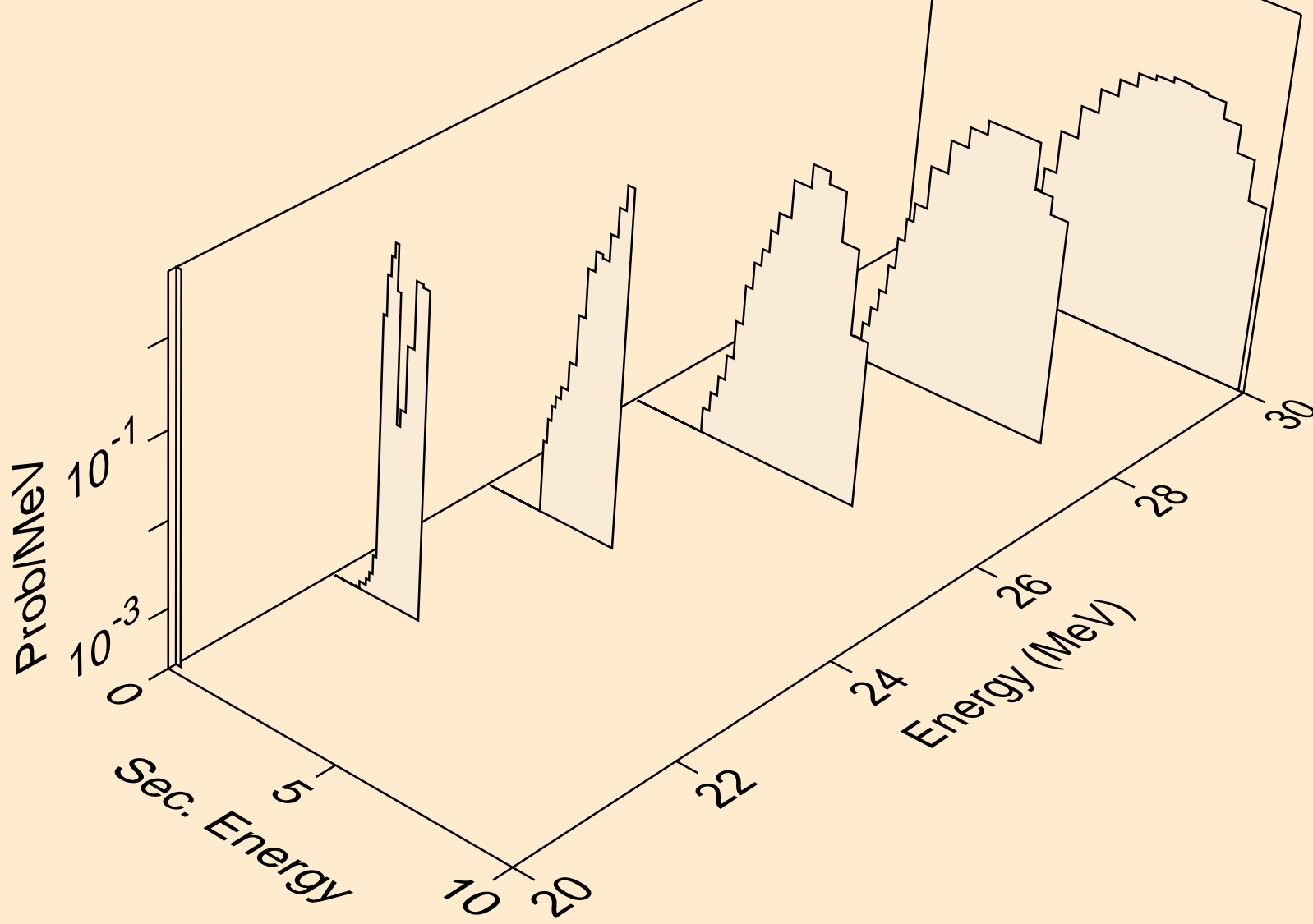

KR077 NEUTRON ACER TENDL-2019 LIBRARY; T=293.16K  
tritons from (n,t)

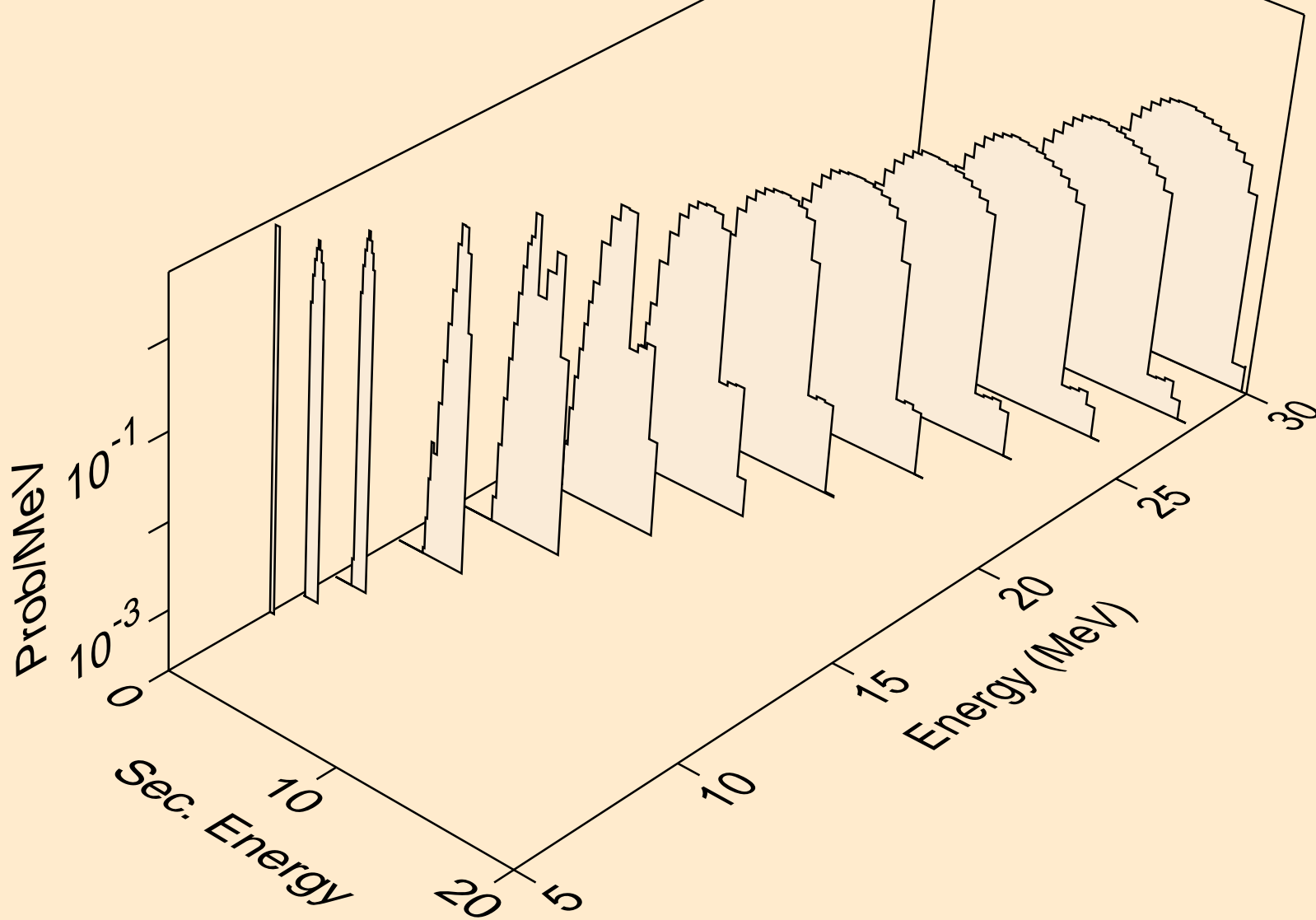

KR077 NEUTRON ACER TENDL-2019 LIBRARY; T=293.16K  
tritons from (n,pt)

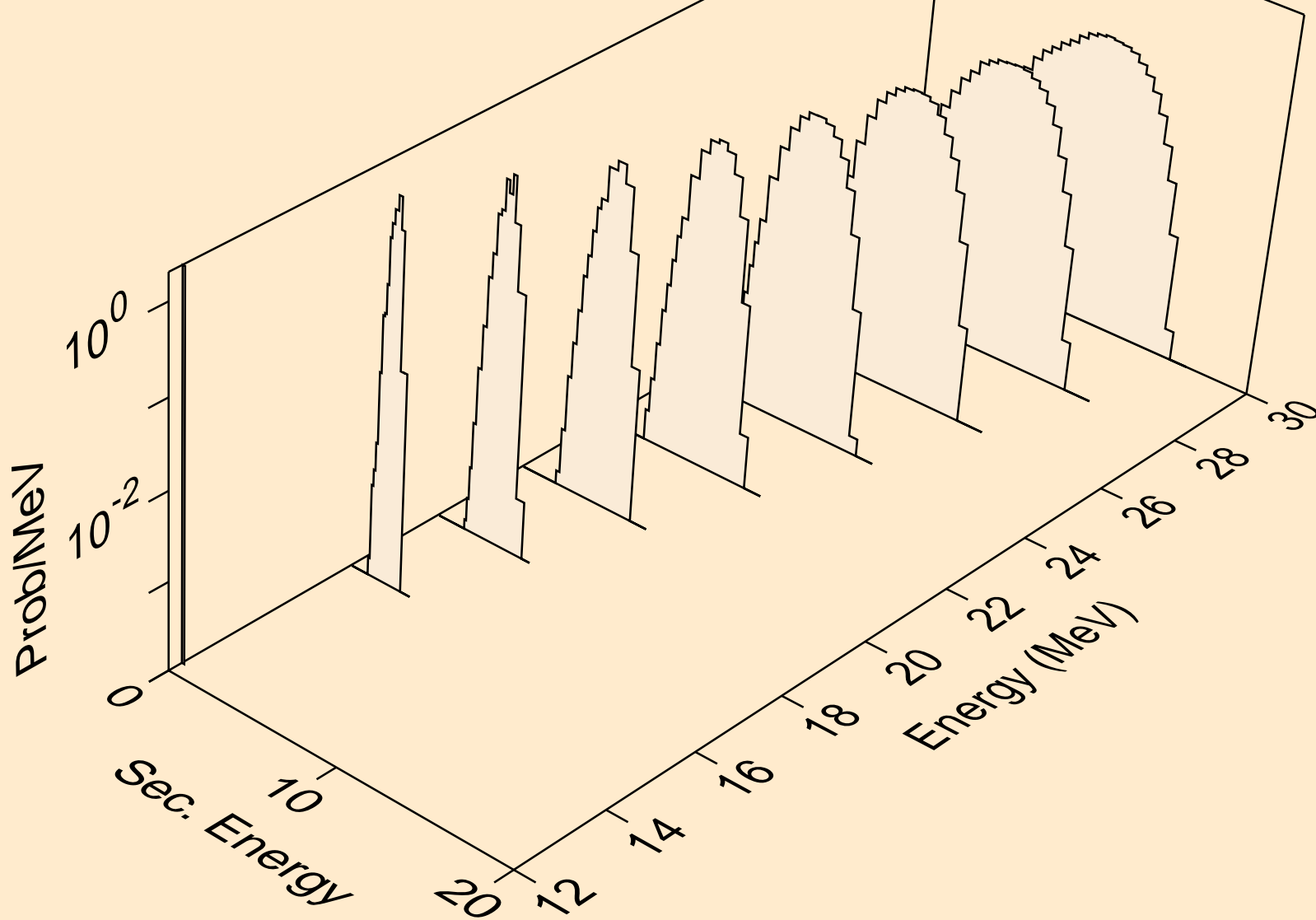

KR077 NEUTRON ACER TENDL-2019 LIBRARY; T=293.16K  
he3s from (n,x)

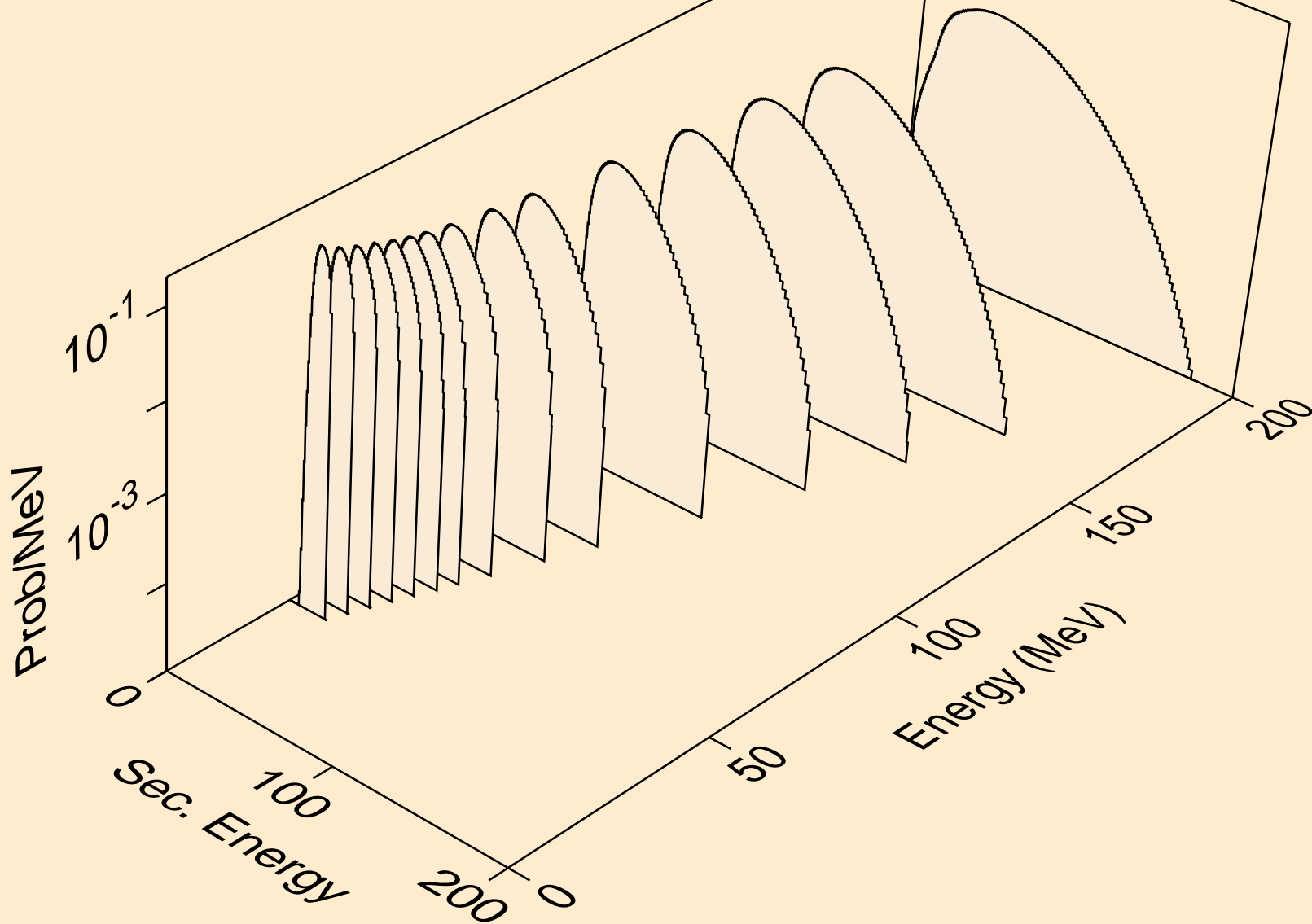

KR077 NEUTRON ACER TENDL-2019 LIBRARY; T=293.16K  
he3s from (n,n\*)he3

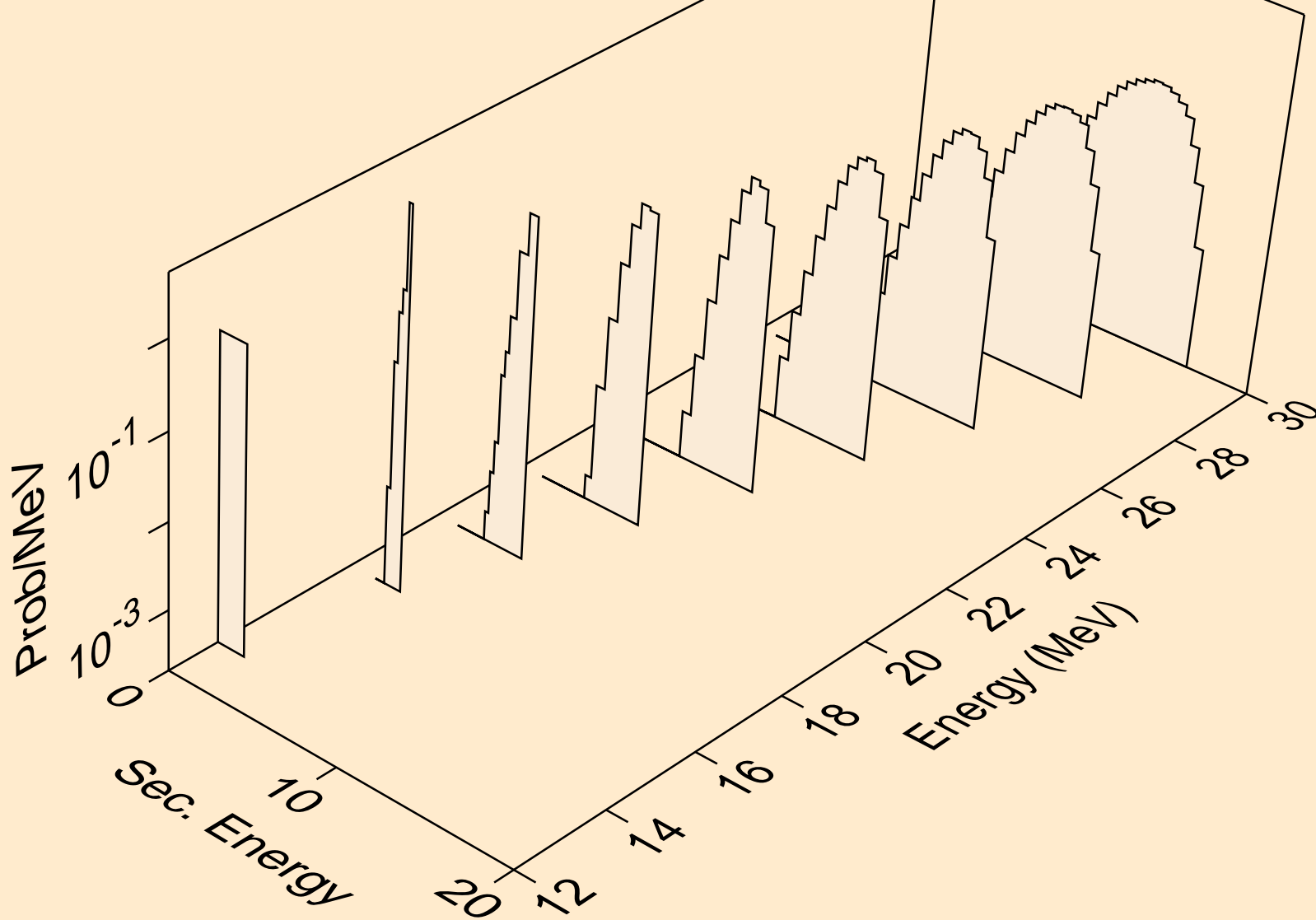

KR077 NEUTRON ACER TENDL-2019 LIBRARY; T=293.16K  
he3s from (n,he3)

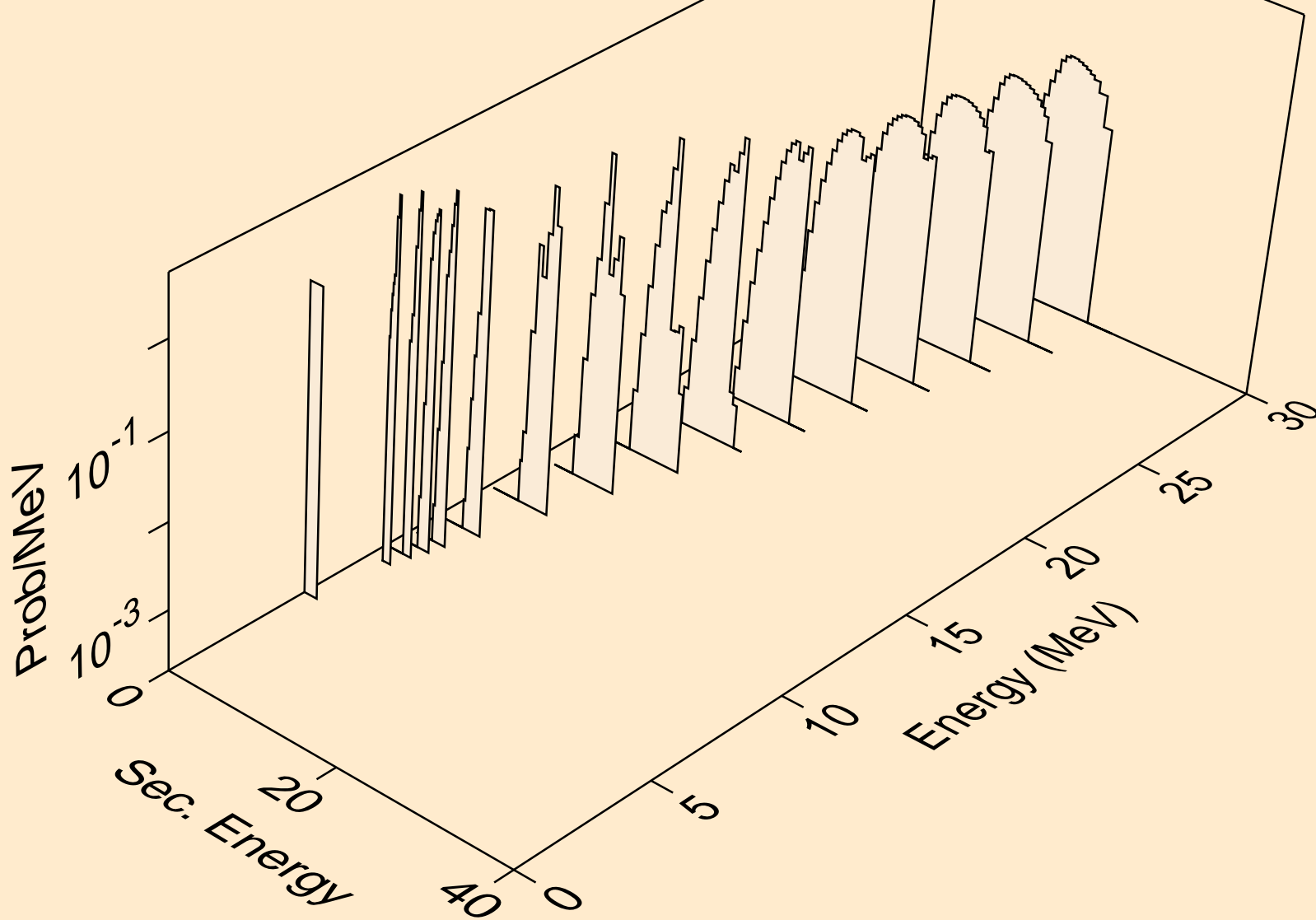

KR077 NEUTRON ACER TENDL-2019 LIBRARY; T=293.16K  
alphas from (n,x)

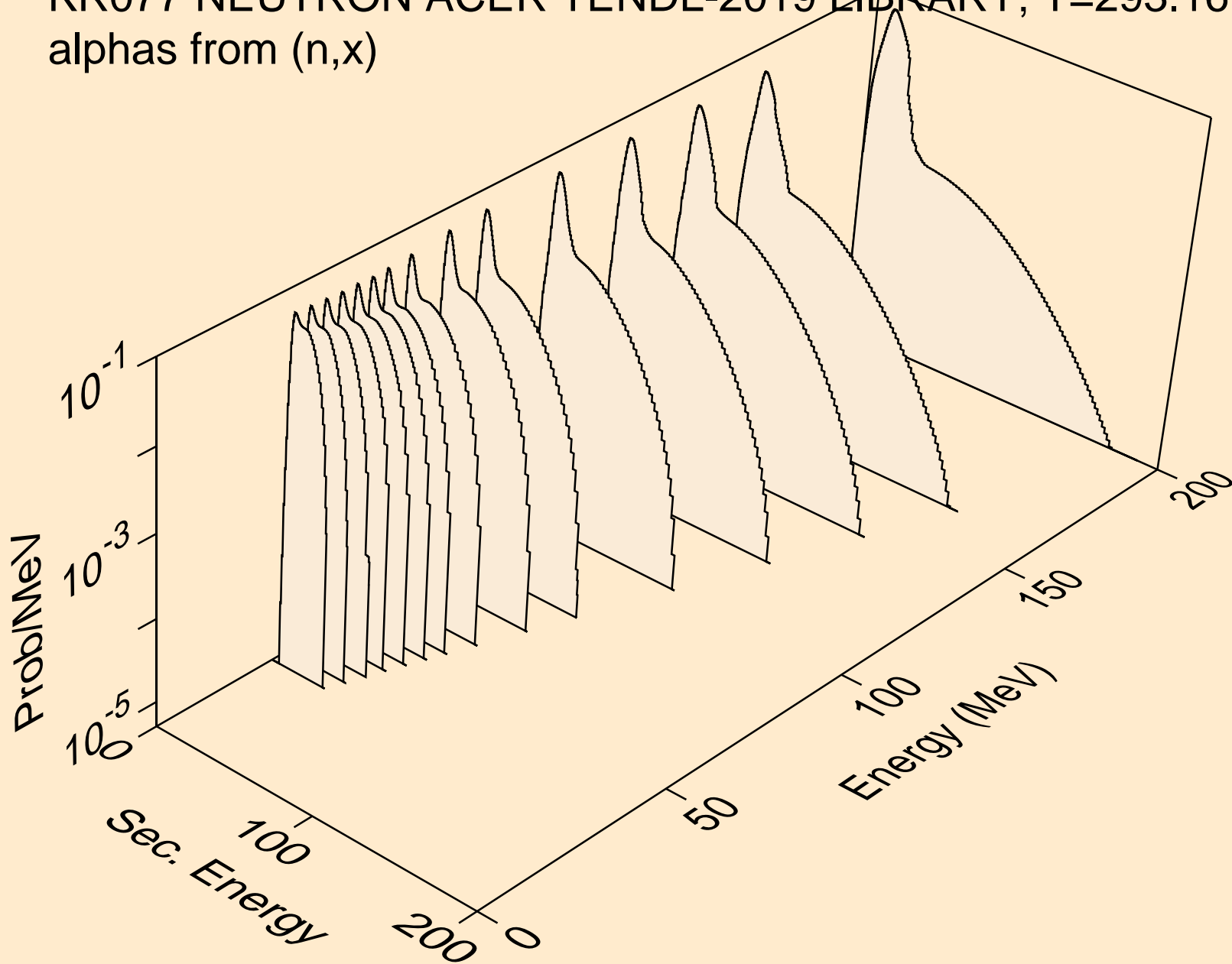

KR077 NEUTRON ACER TENDL-2019 LIBRARY; T=293.16K  
alphas from (n,n\*)a

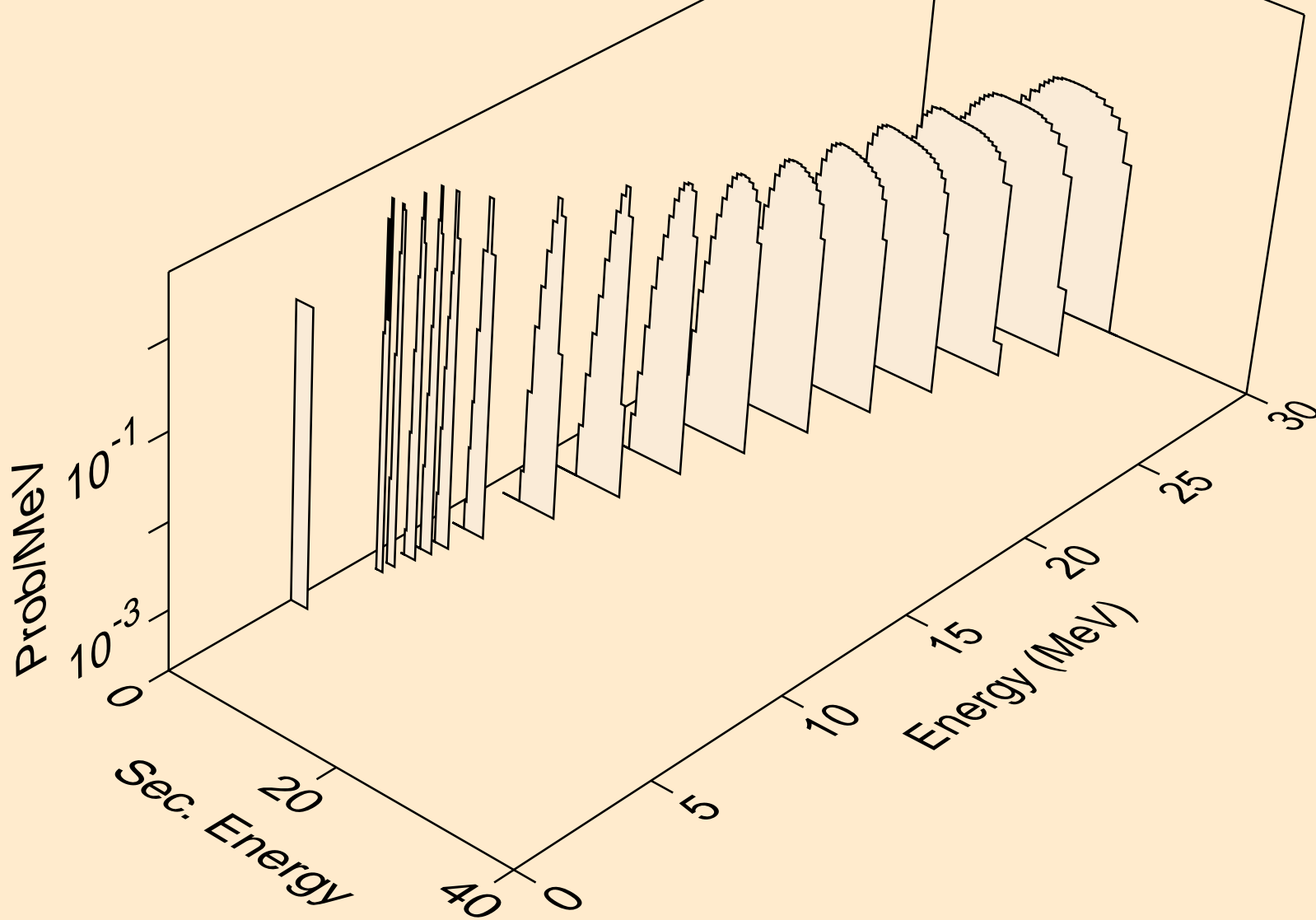

KR077 NEUTRON ACER TENDL-2019 LIBRARY; T=293.16K  
alphas from (n,2n)a

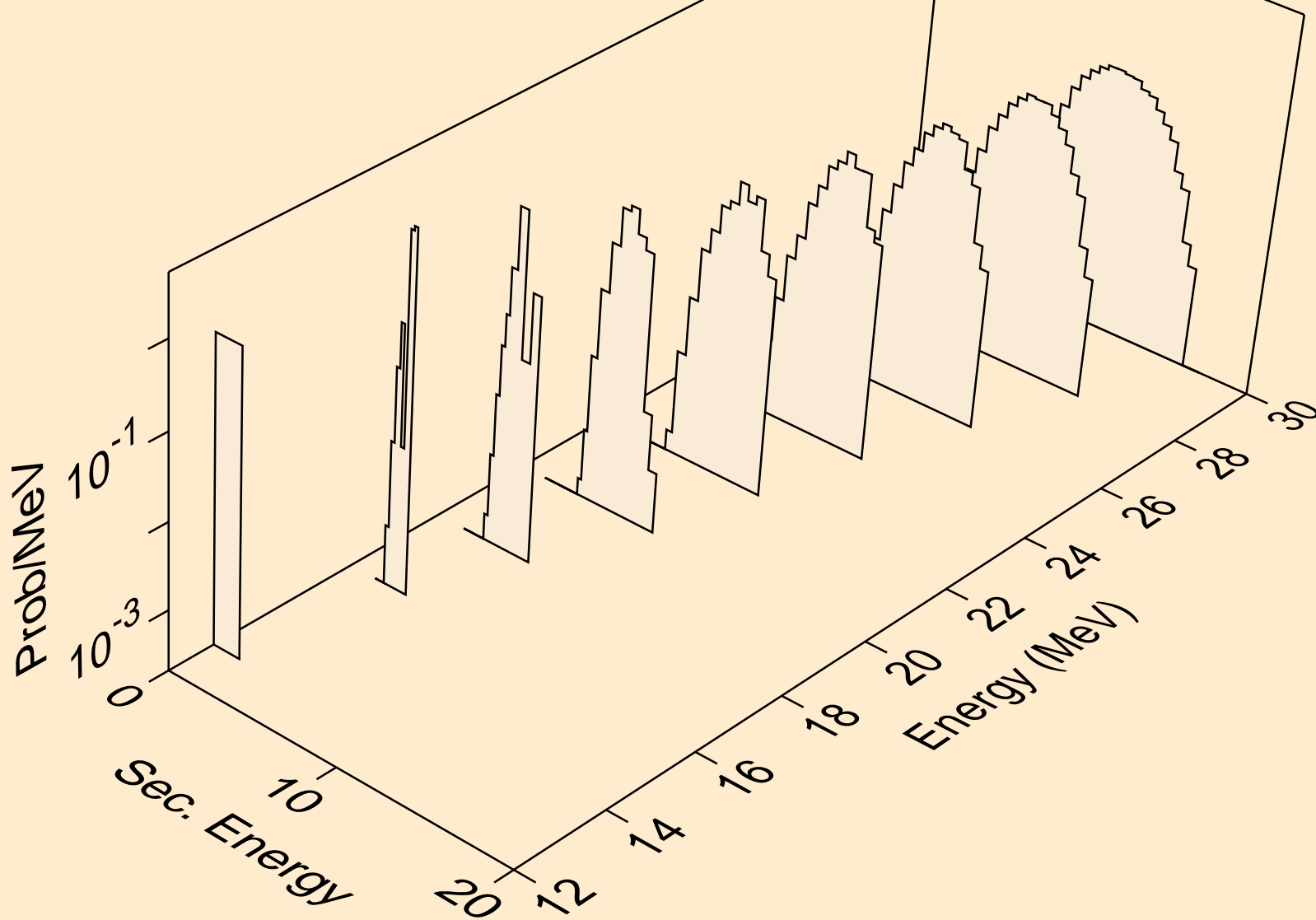

KR077 NEUTRON ACER TENDL-2019 LIBRARY; T=293.16K  
alphas from (n,n\*)2a

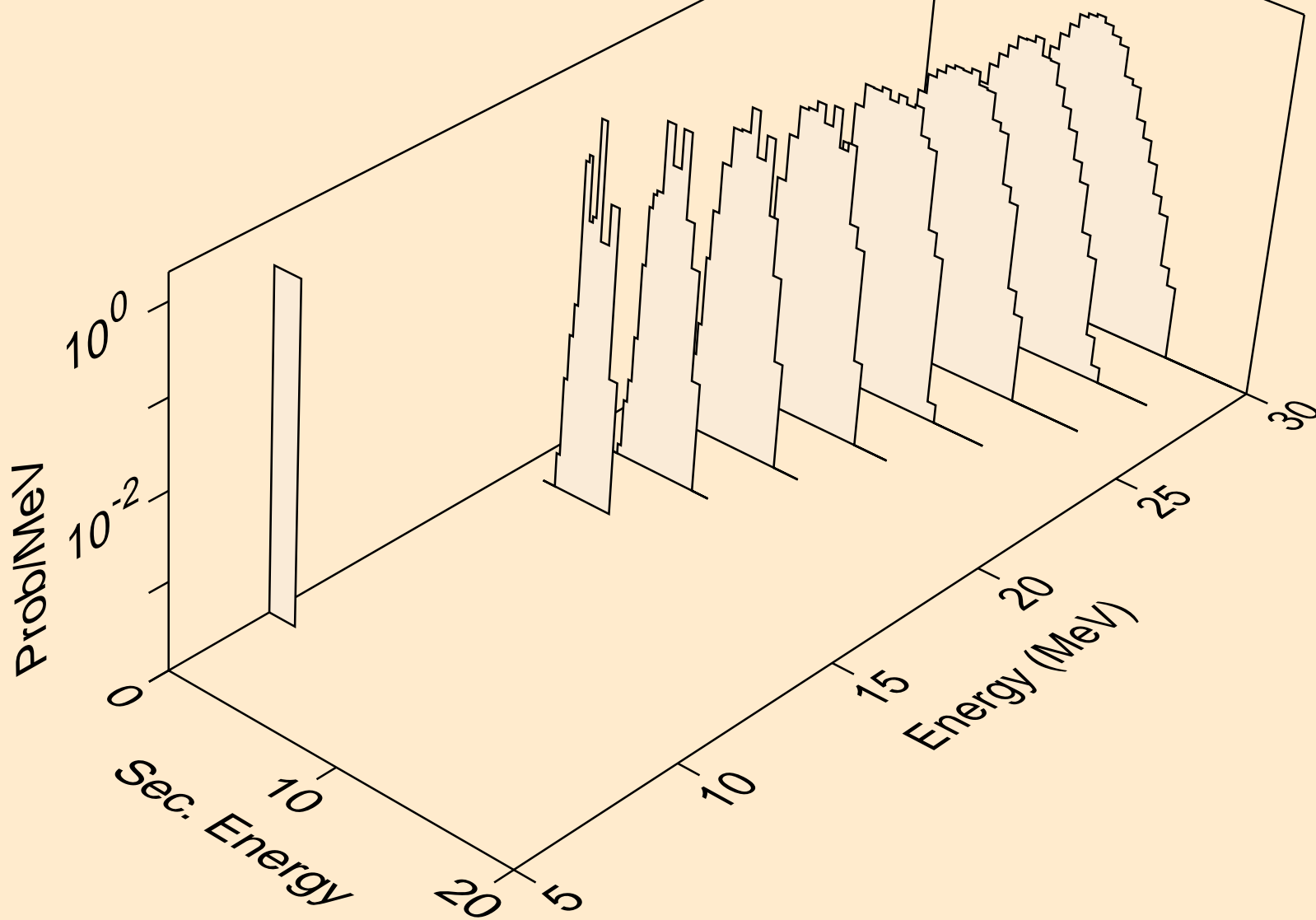

KR077 NEUTRON ACER TENDL-2019 LIBRARY; T=293.16K  
alphas from (n,2n)2a

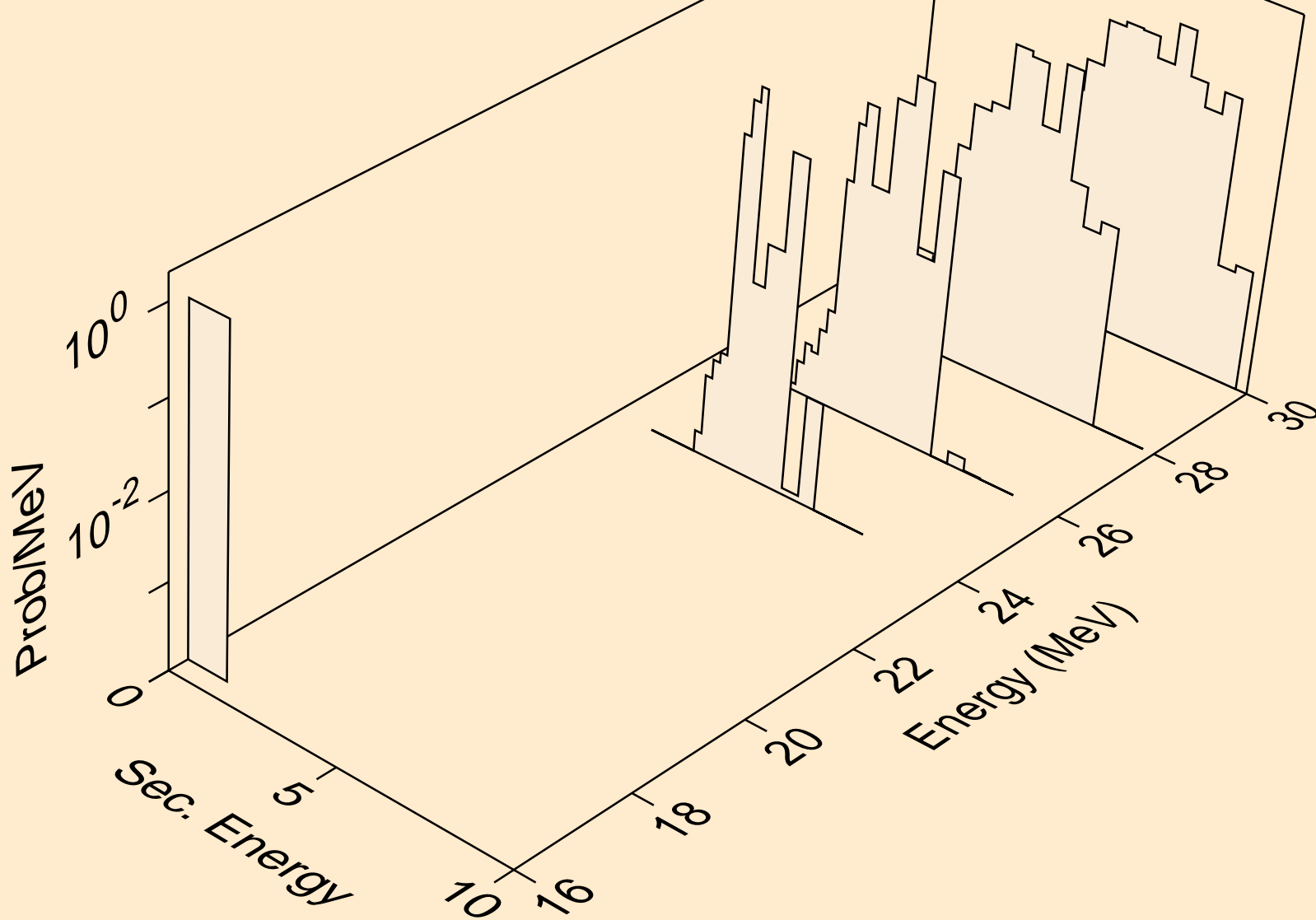

KR077 NEUTRON ACER TENDL-2019 LIBRARY; T=293.16K  
alphas from (n,npa)

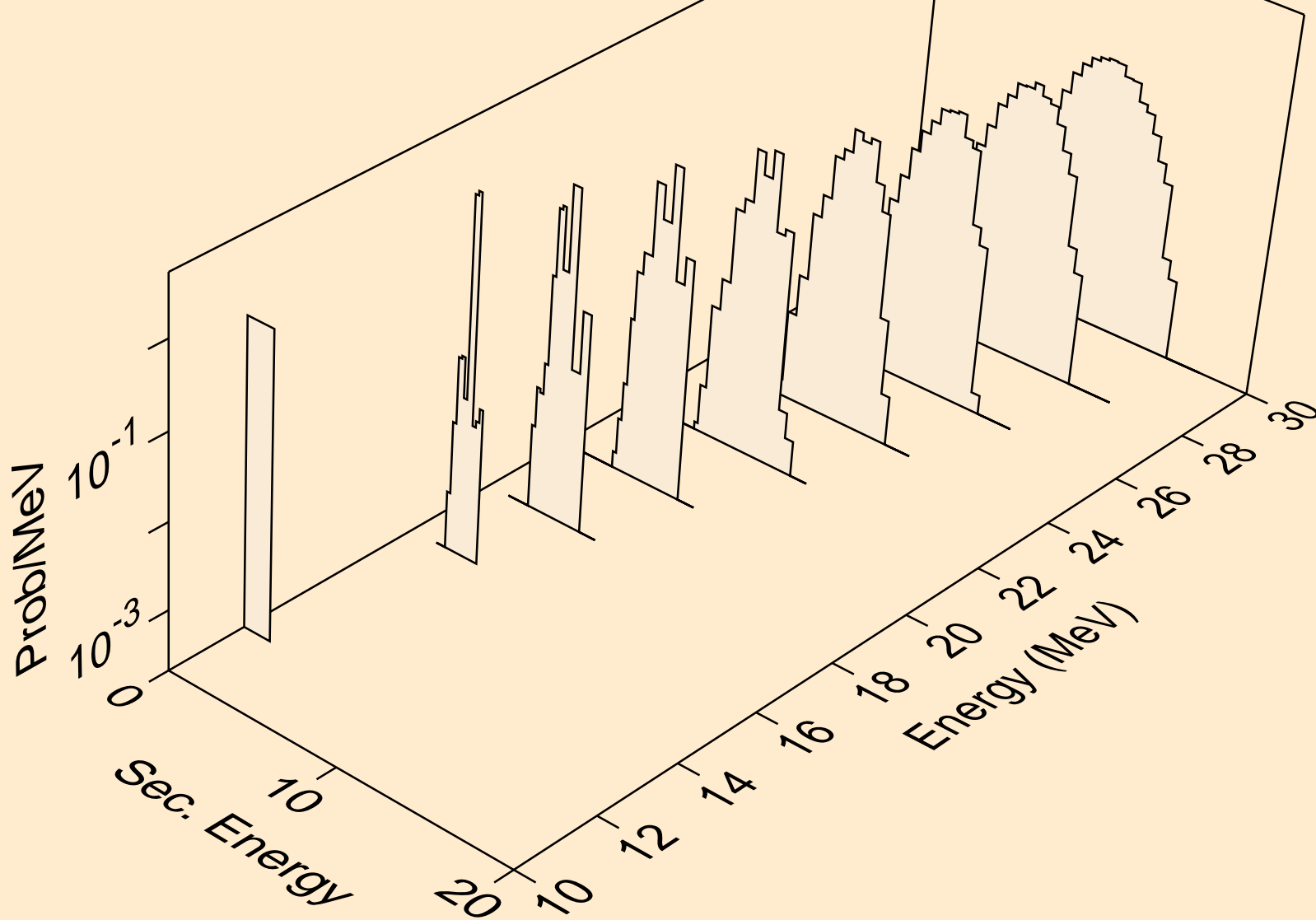

KR077 NEUTRON ACER TENDL-2019 LIBRARY; T=293.16K  
alphas from (n,a)

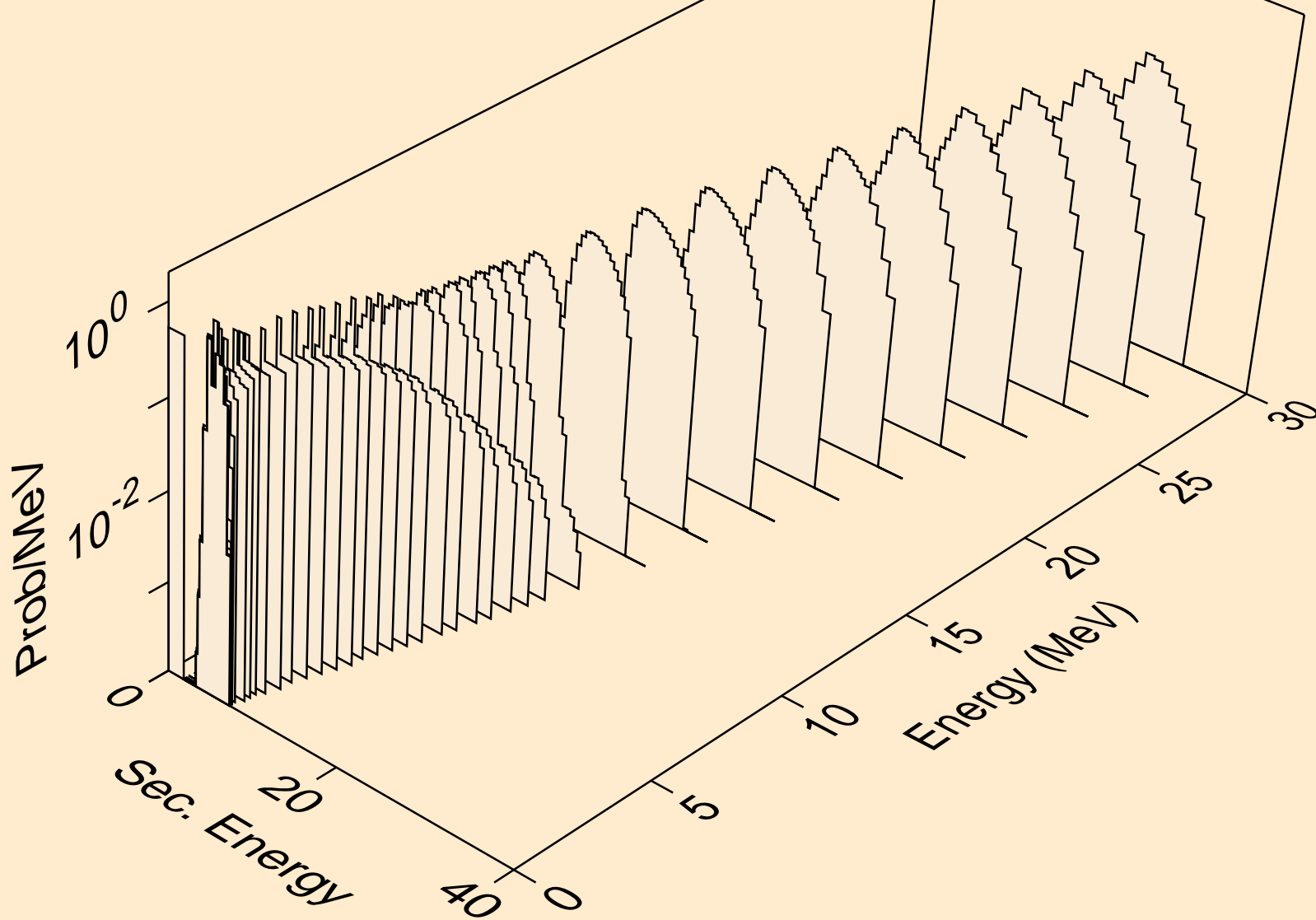

KR077 NEUTRON ACER TENDL-2019 LIBRARY; T=293.16K  
alphas from (n,2a)

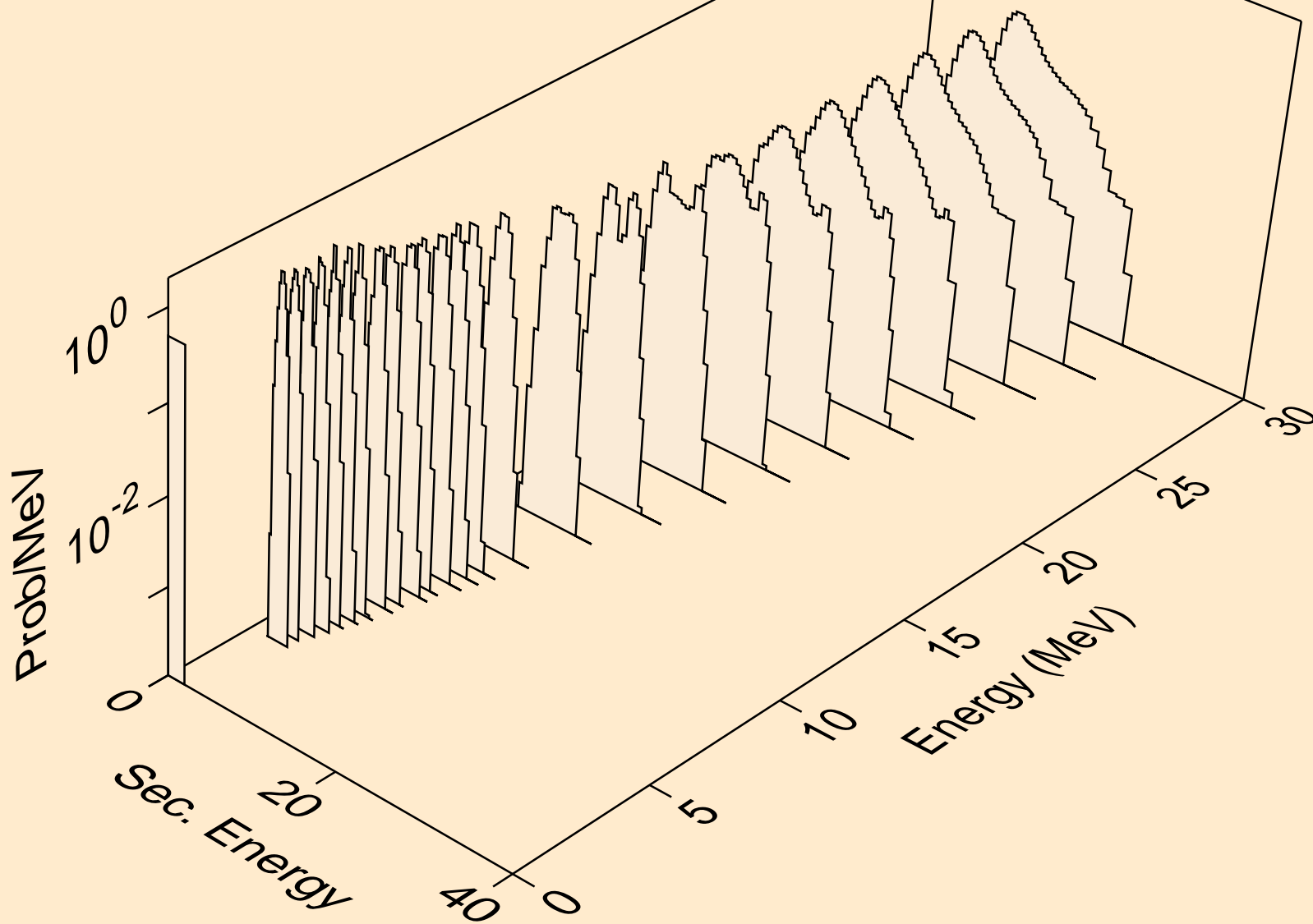

KR077 NEUTRON ACER TENDL-2019 LIBRARY; T=293.16K  
alphas from (n,3a)

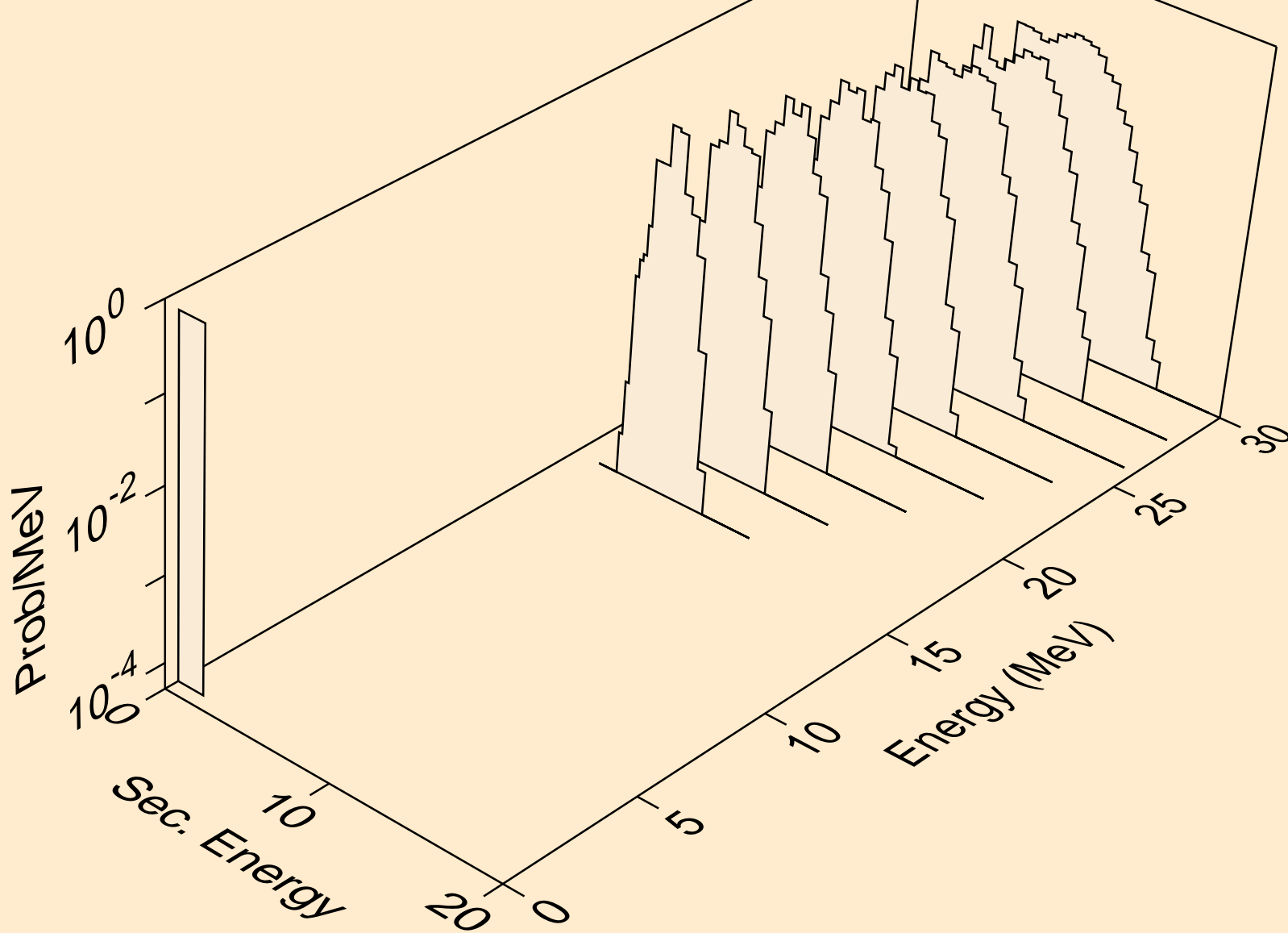

KR077 NEUTRON ACER TENDL-2019 LIBRARY; T=293.16K  
alphas from (n,pa)

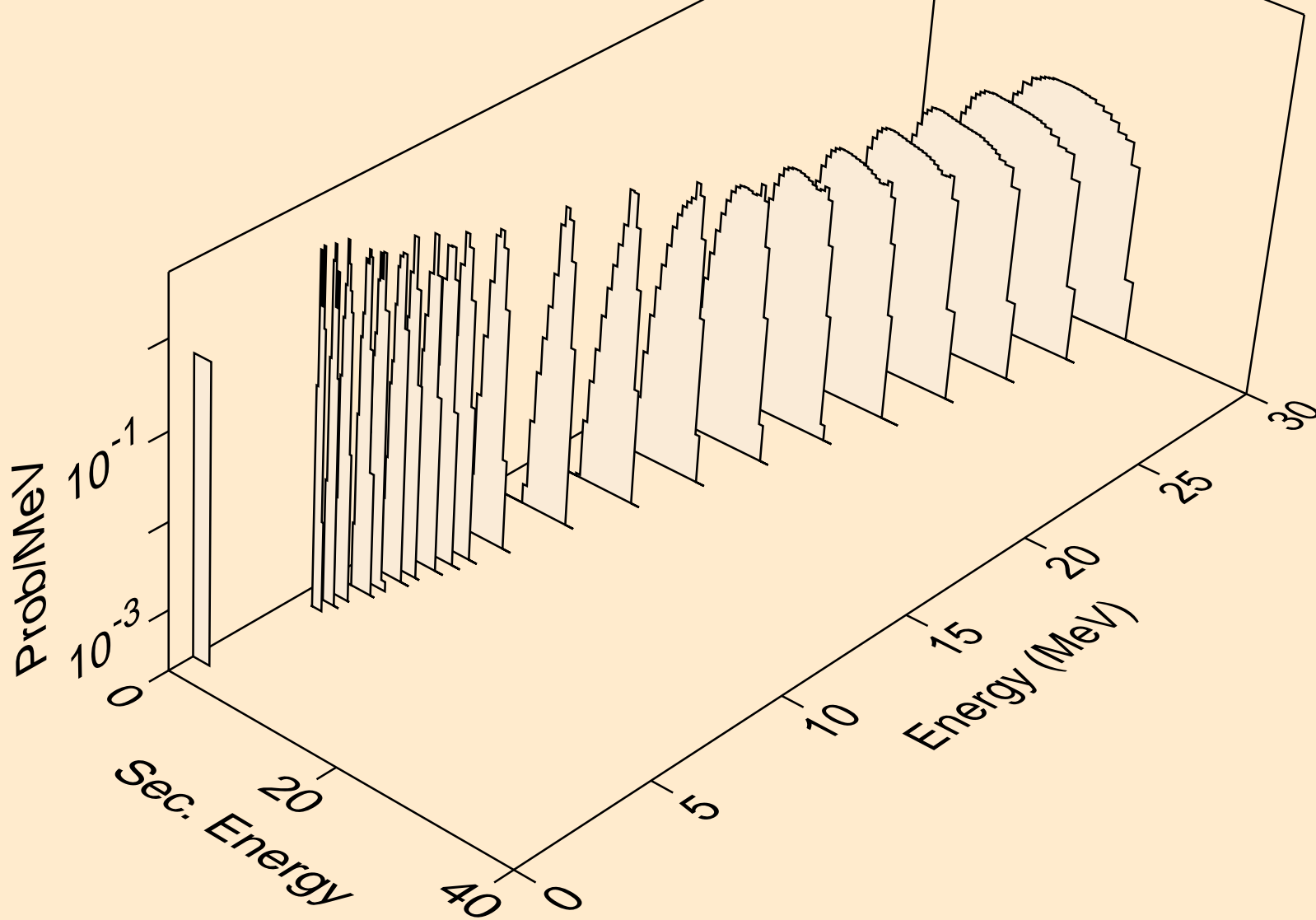

KR077 NEUTRON ACER TENDL-2019 LIBRARY; T=293.16K  
alphas from (n,da)

