

KR080 NEUTRON ACER TENDL-2019 LIBRARY; T=293.16K
Principal cross sections

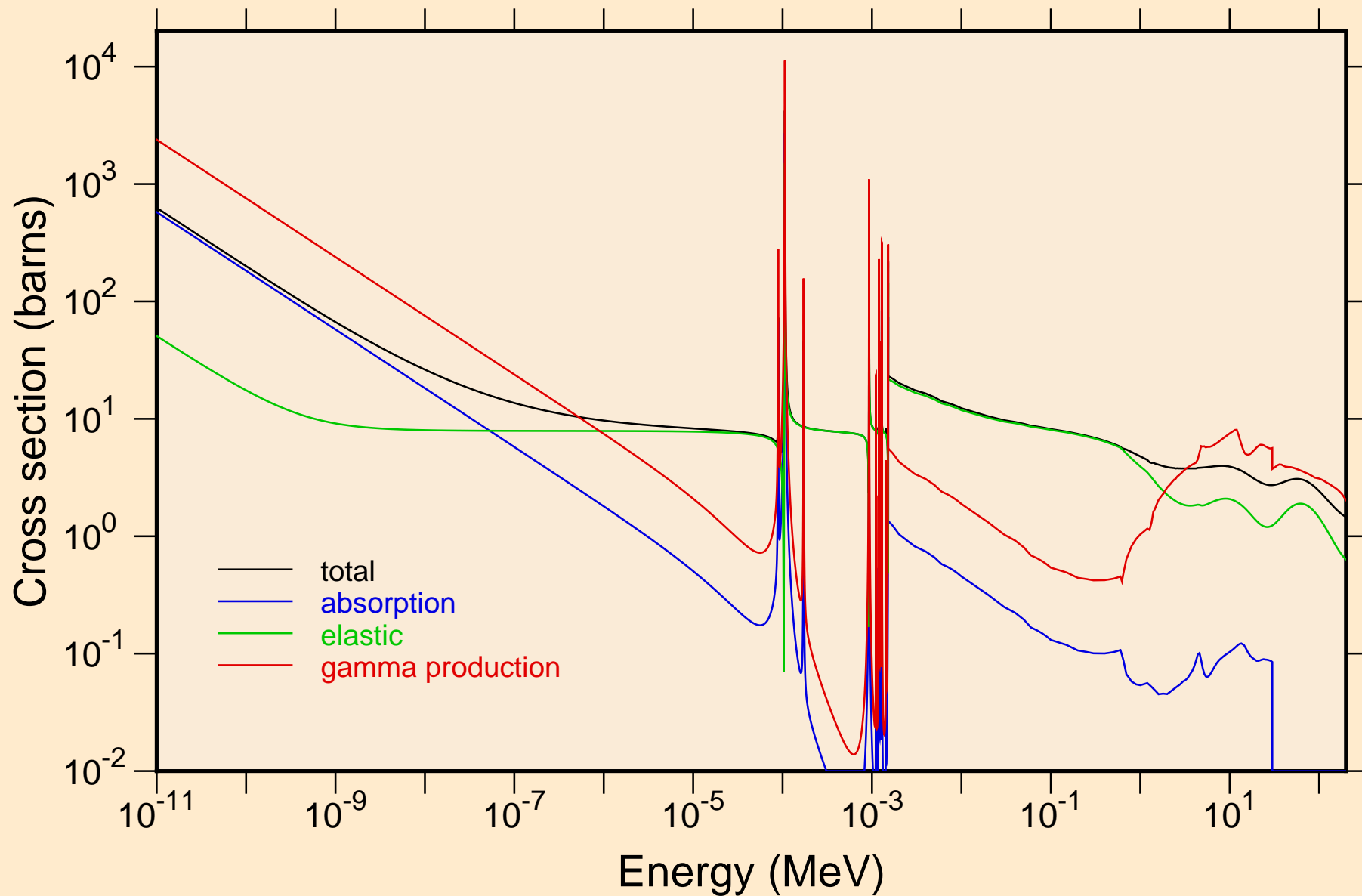

KR080 NEUTRON ACER TENDL-2019 LIBRARY; T=293.16K
resonance total cross section

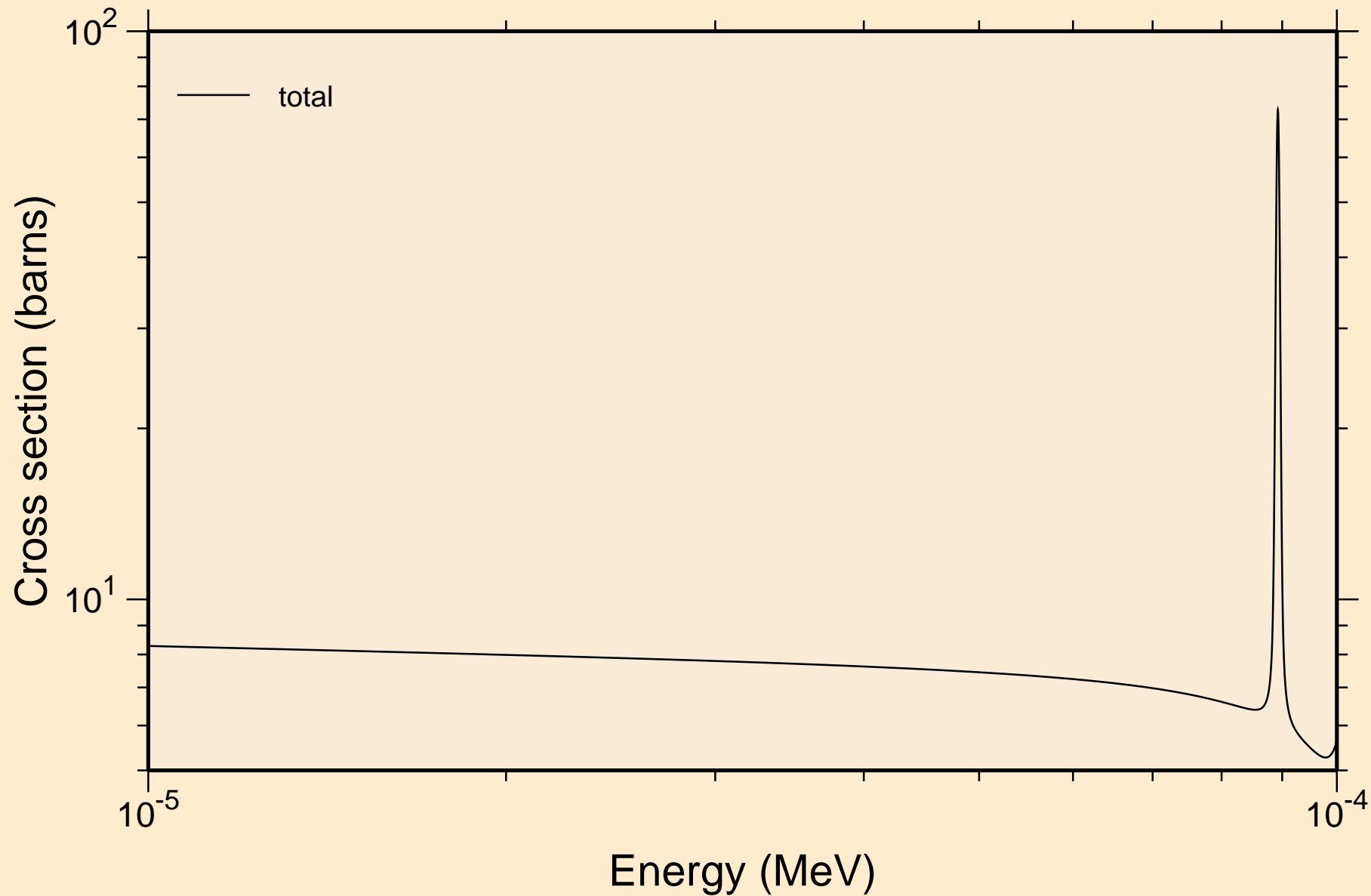

KR080 NEUTRON ACER TENDL-2019 LIBRARY; T=293.16K
resonance total cross section

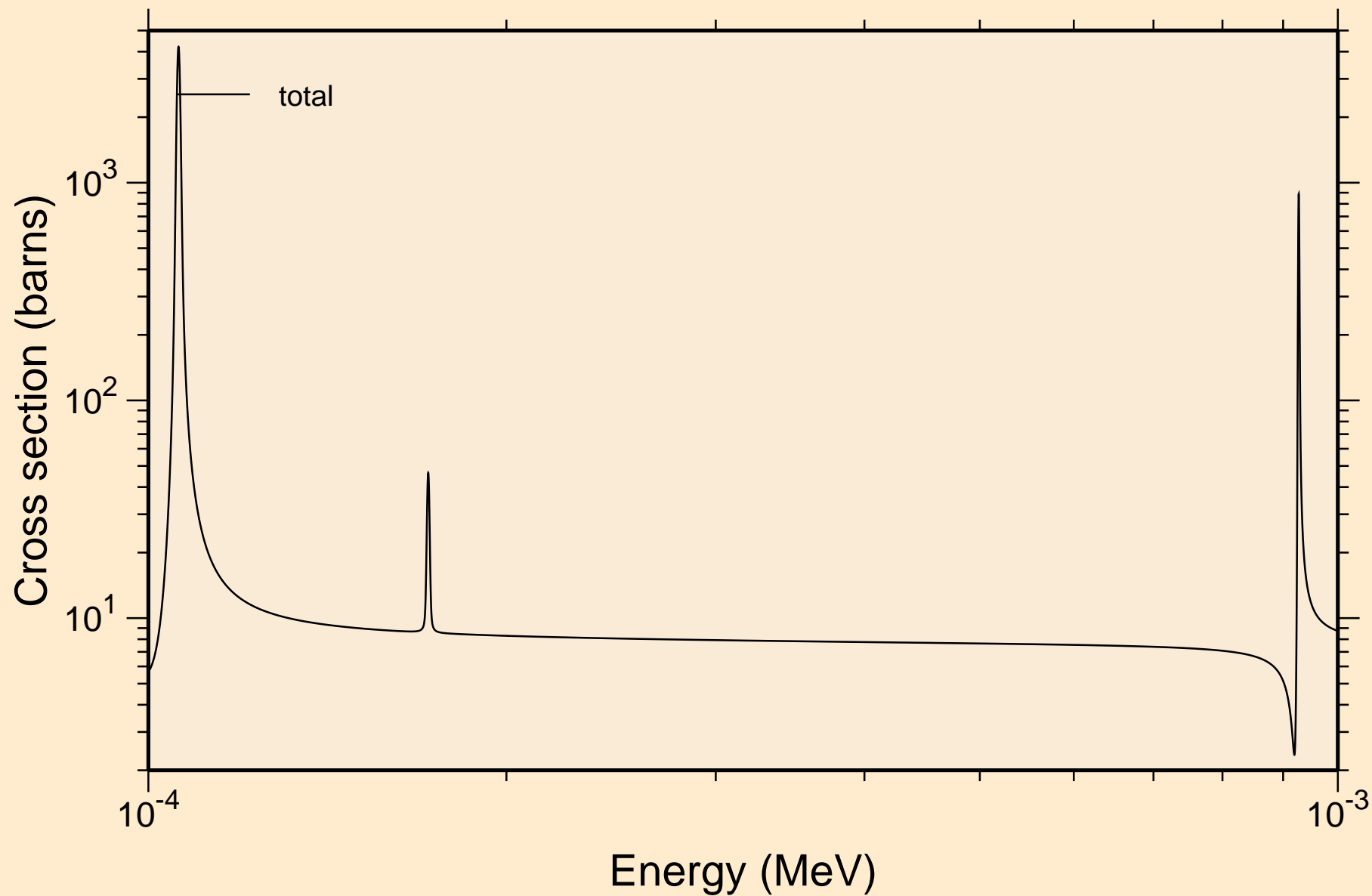

KR080 NEUTRON ACER TENDL-2019 LIBRARY; T=293.16K
resonance total cross section

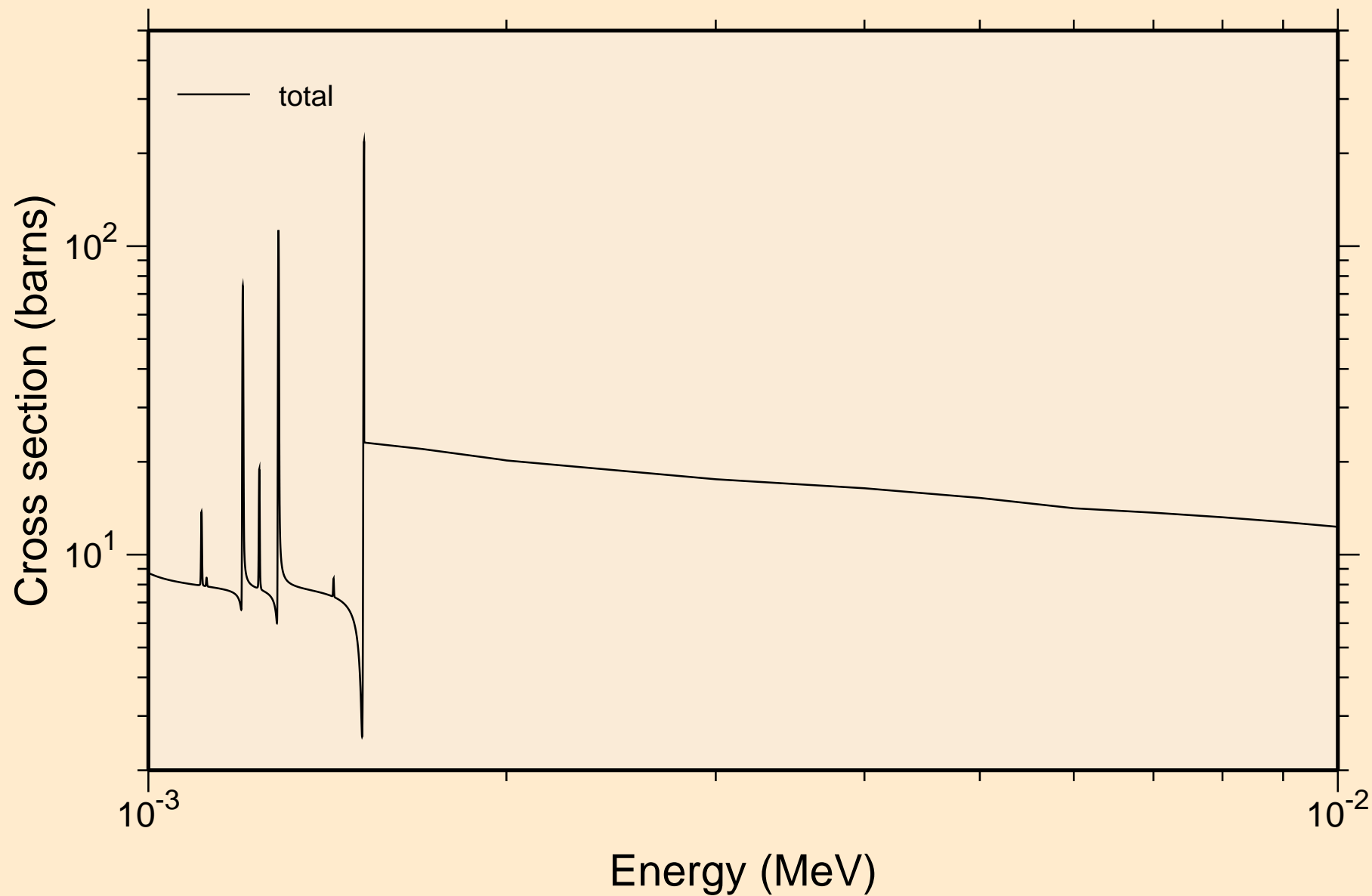

KR080 NEUTRON ACER TENDL-2019 LIBRARY; T=293.16K
resonance total cross section

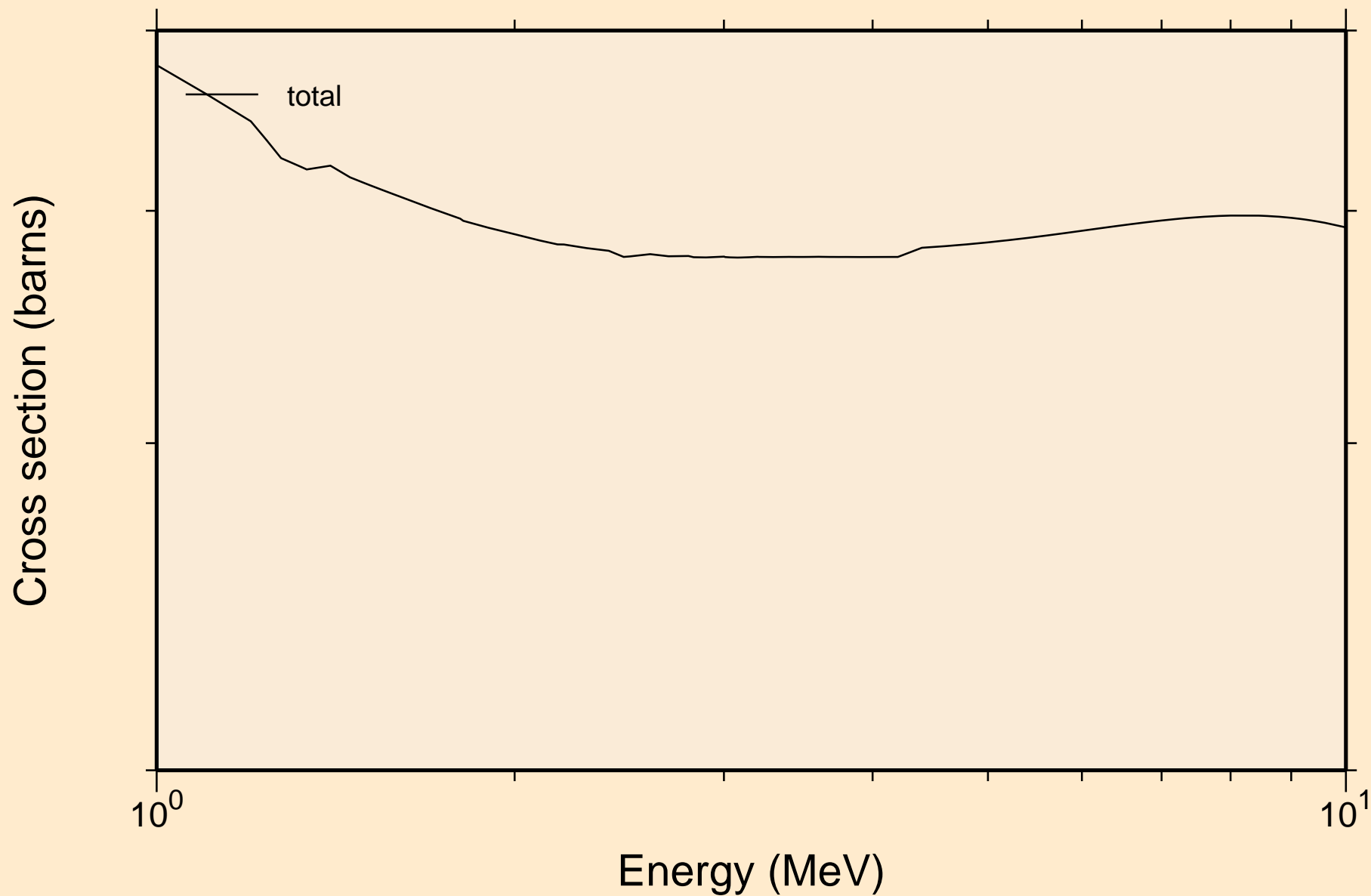

KR080 NEUTRON ACER TENDL-2019 LIBRARY; T=293.16K
resonance absorption cross sections

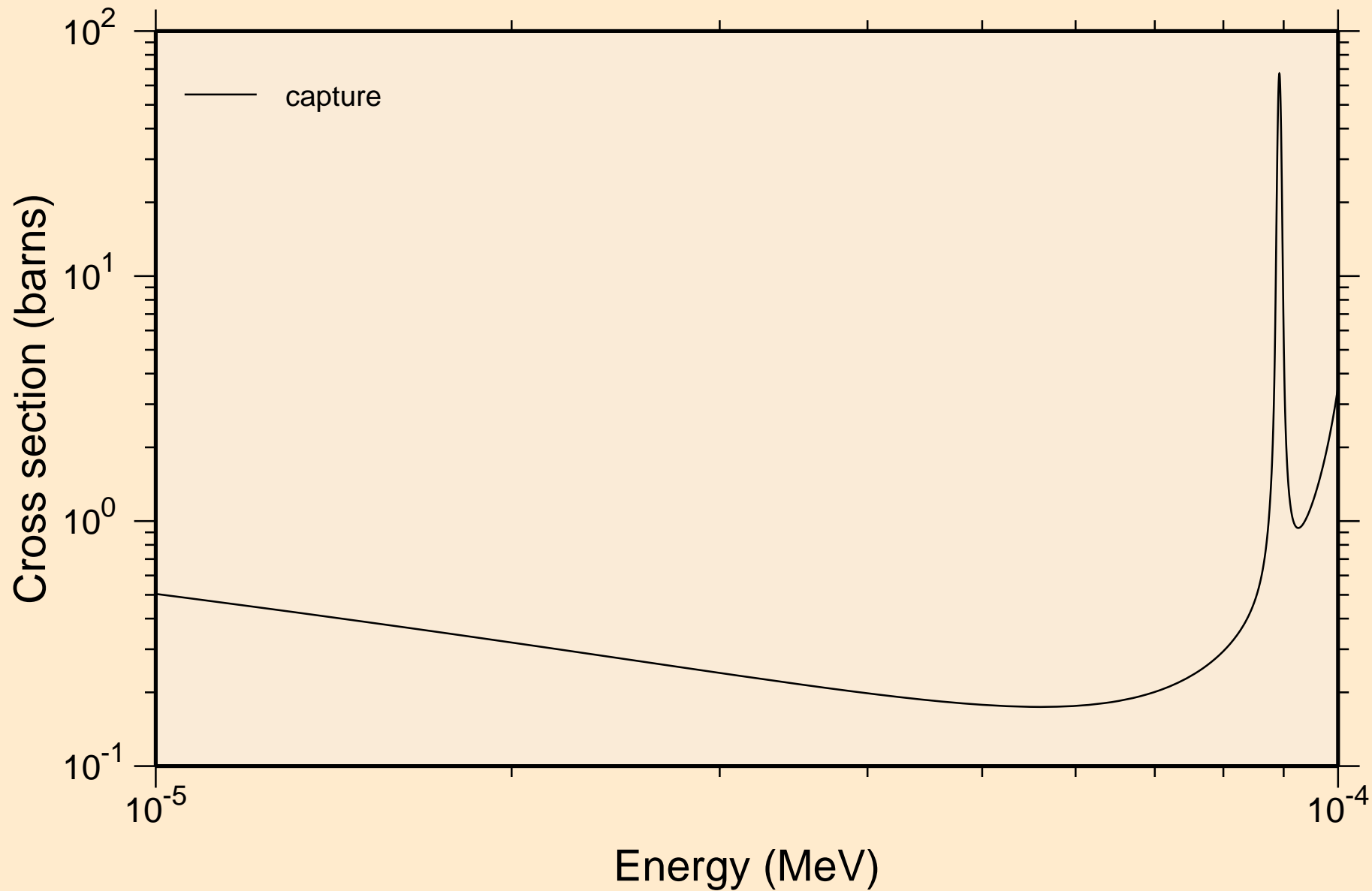

KR080 NEUTRON ACER TENDL-2019 LIBRARY; T=293.16K
resonance absorption cross sections

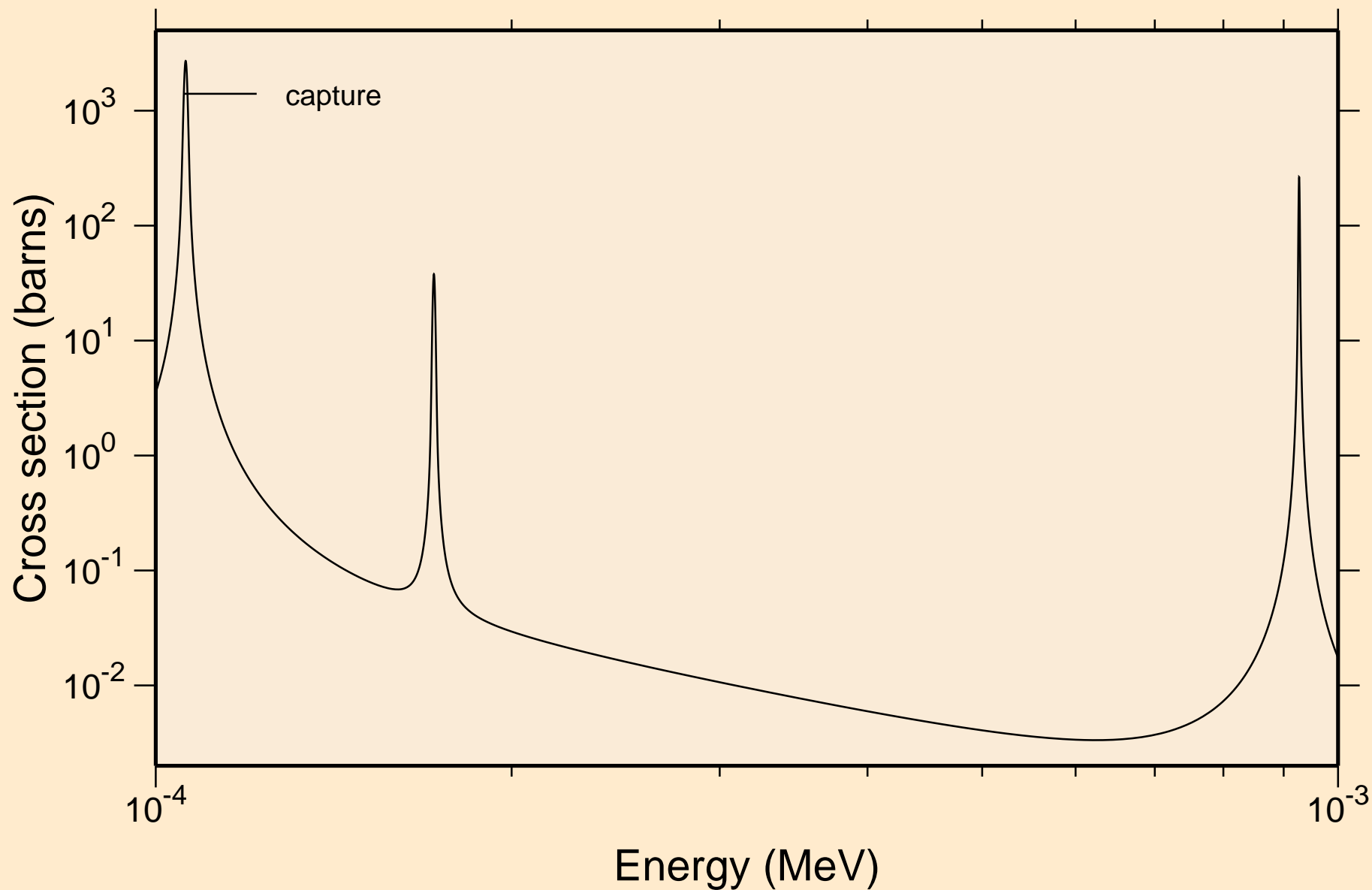

KR080 NEUTRON ACER TENDL-2019 LIBRARY; T=293.16K
resonance absorption cross sections

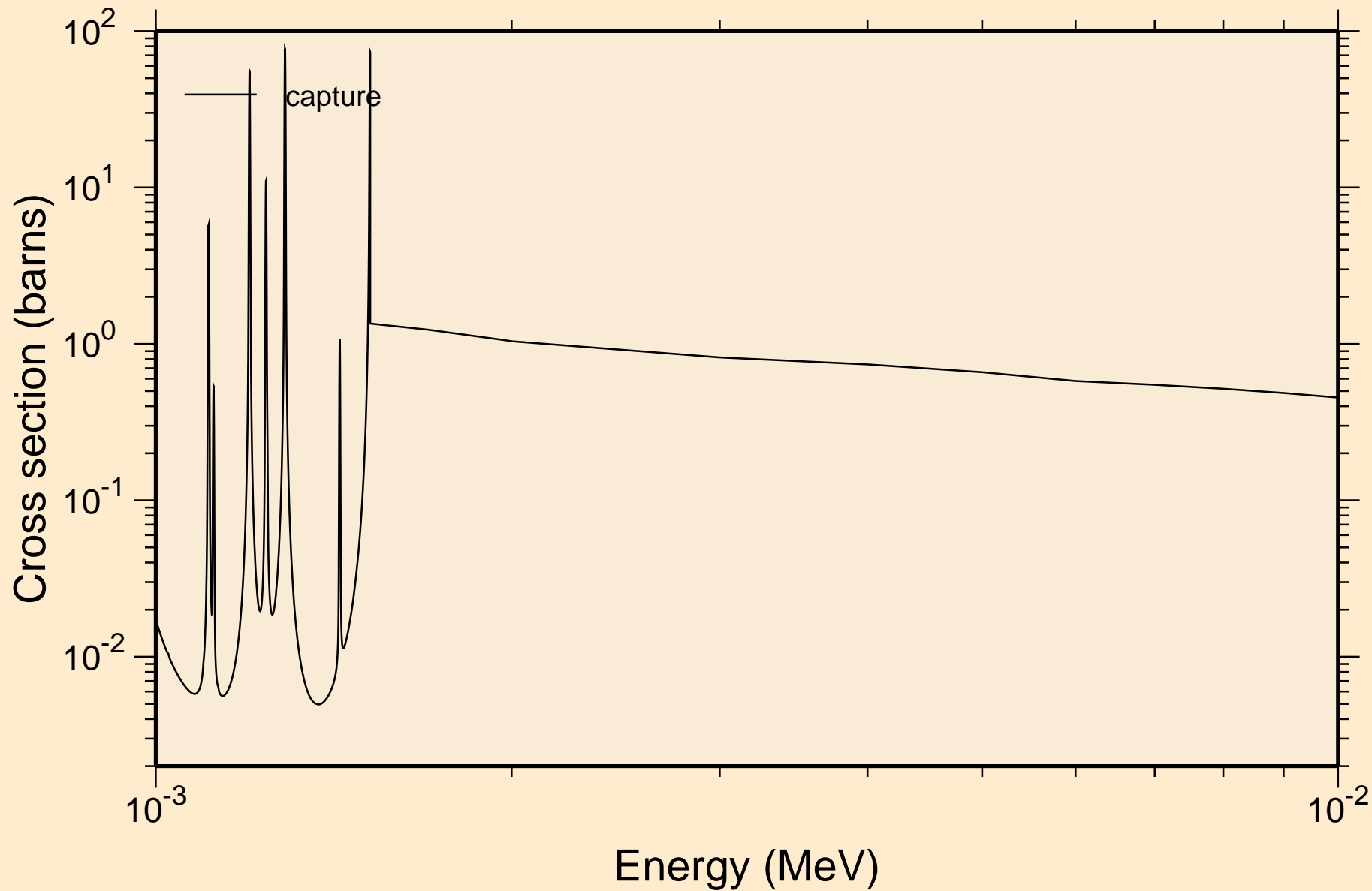

KR080 NEUTRON ACER TENDL-2019 LIBRARY; T=293.16K
resonance absorption cross sections

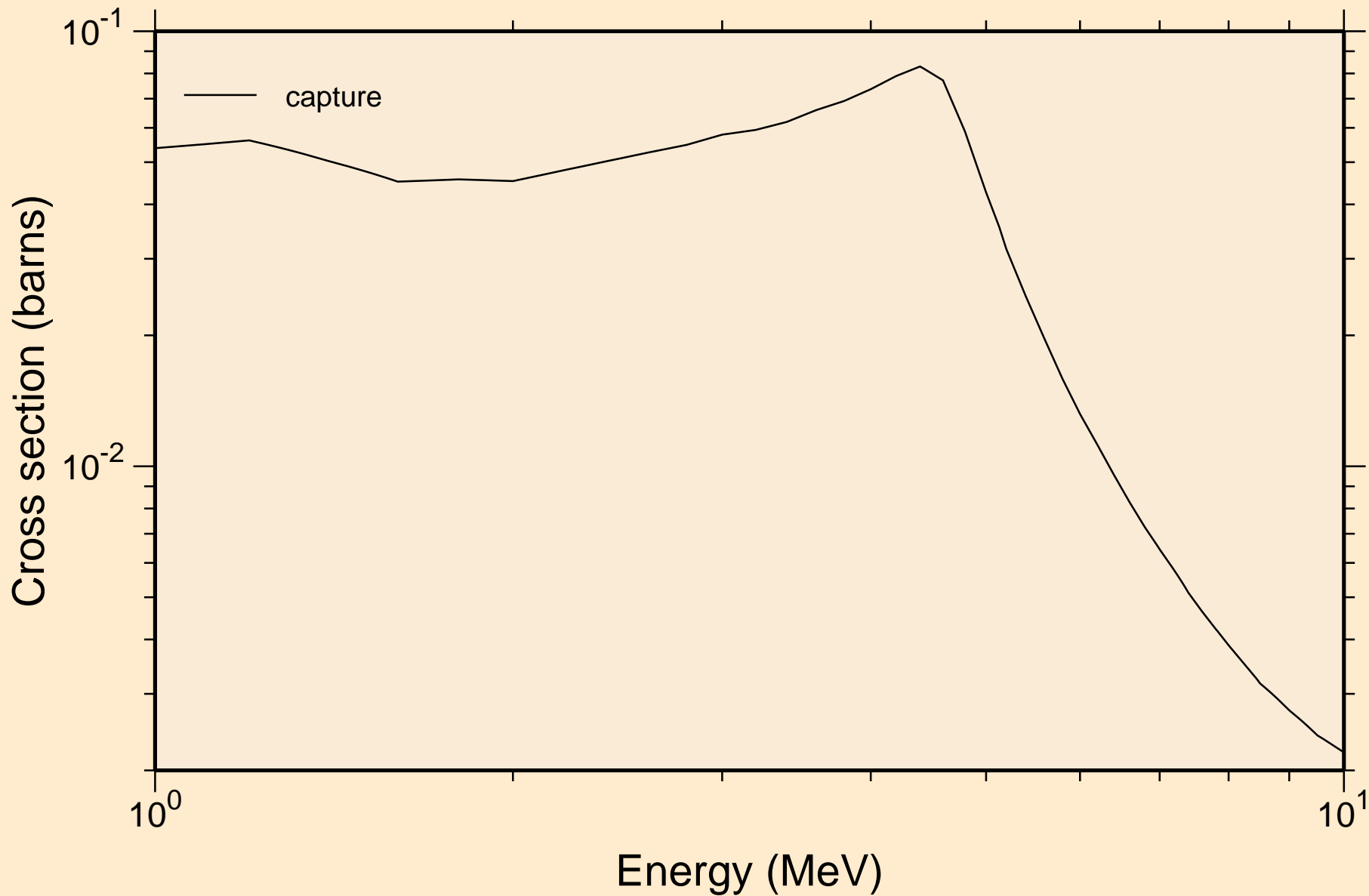

KR080 NEUTRON ACER TENDL-2019 LIBRARY; T=293.16K
Heating

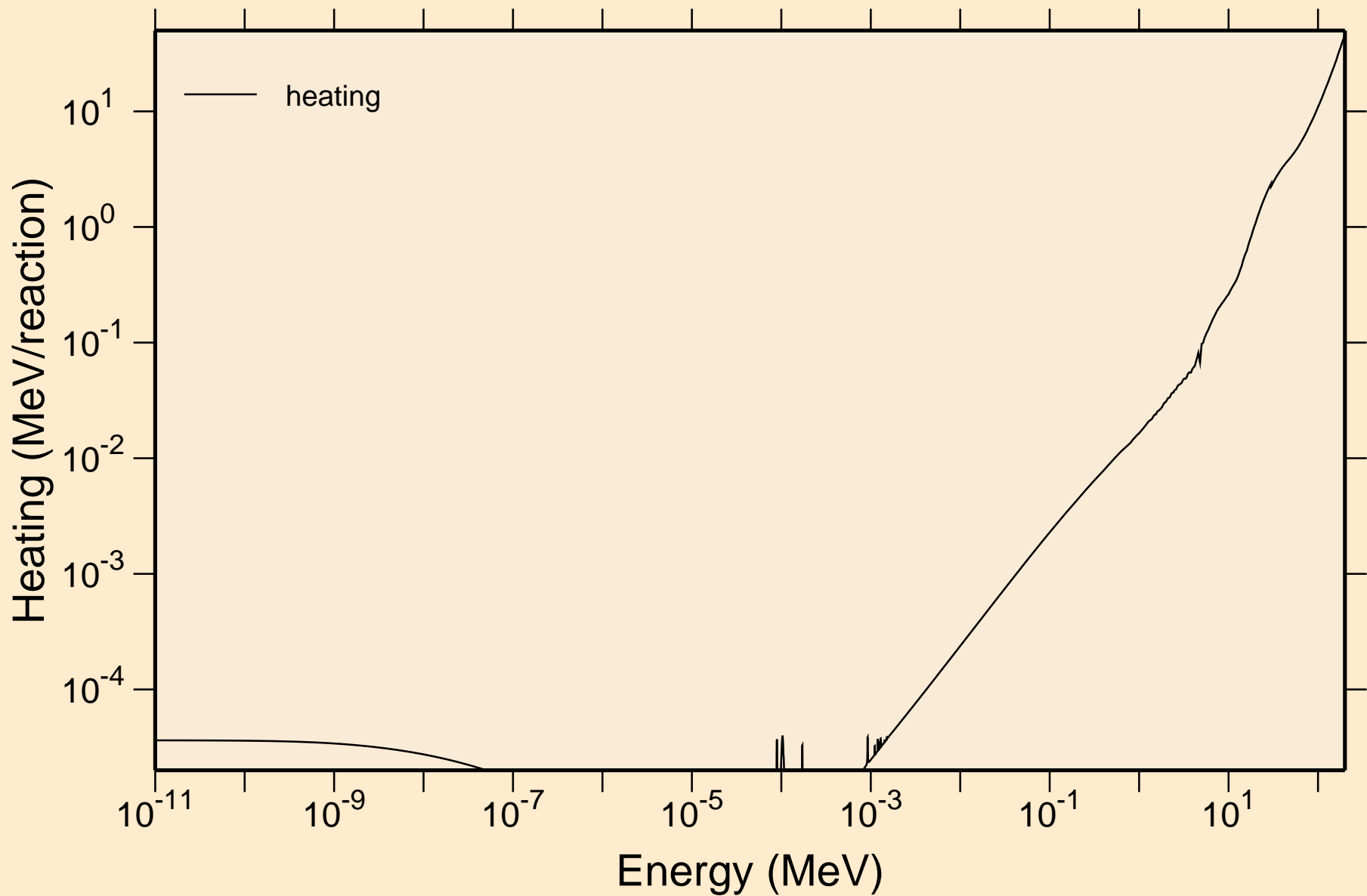

KR080 NEUTRON ACER TENDL-2019 LIBRARY; T=293.16K
Damage

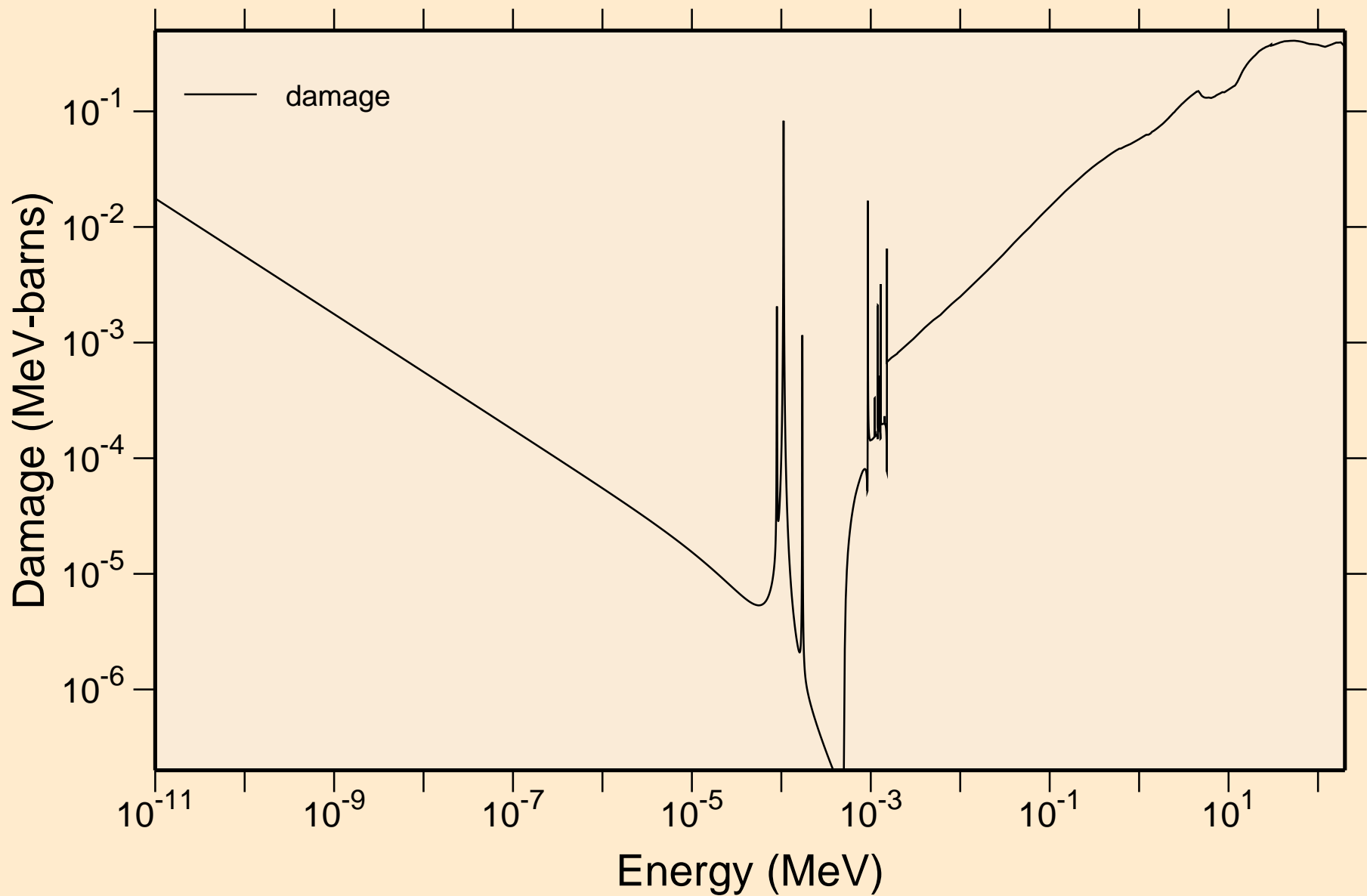

KR080 NEUTRON ACER TENDL-2019 LIBRARY; T=293.16K
Non-threshold reactions

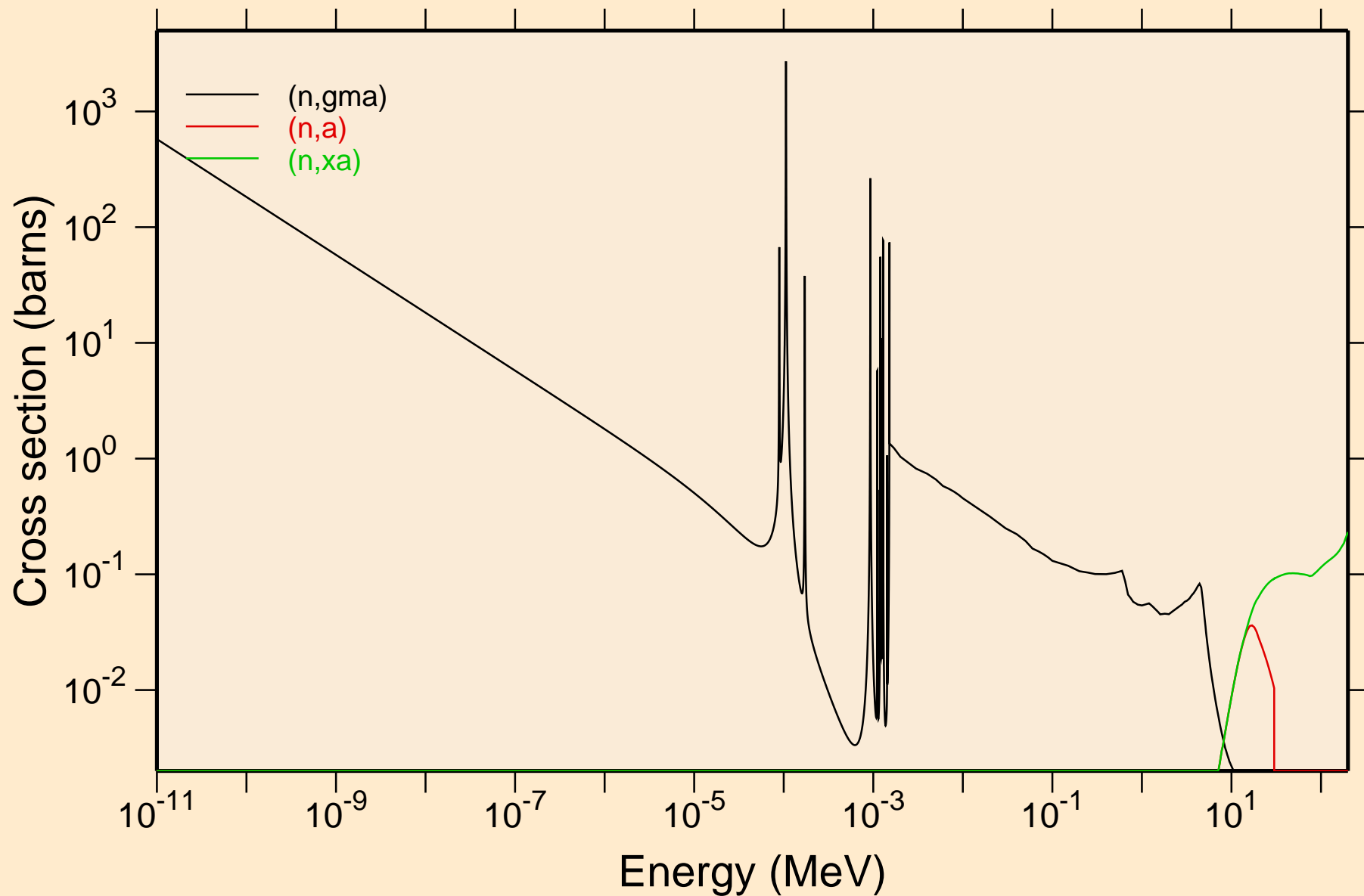

KR080 NEUTRON ACER TENDL-2019 LIBRARY; T=293.16K
Principal cross sections

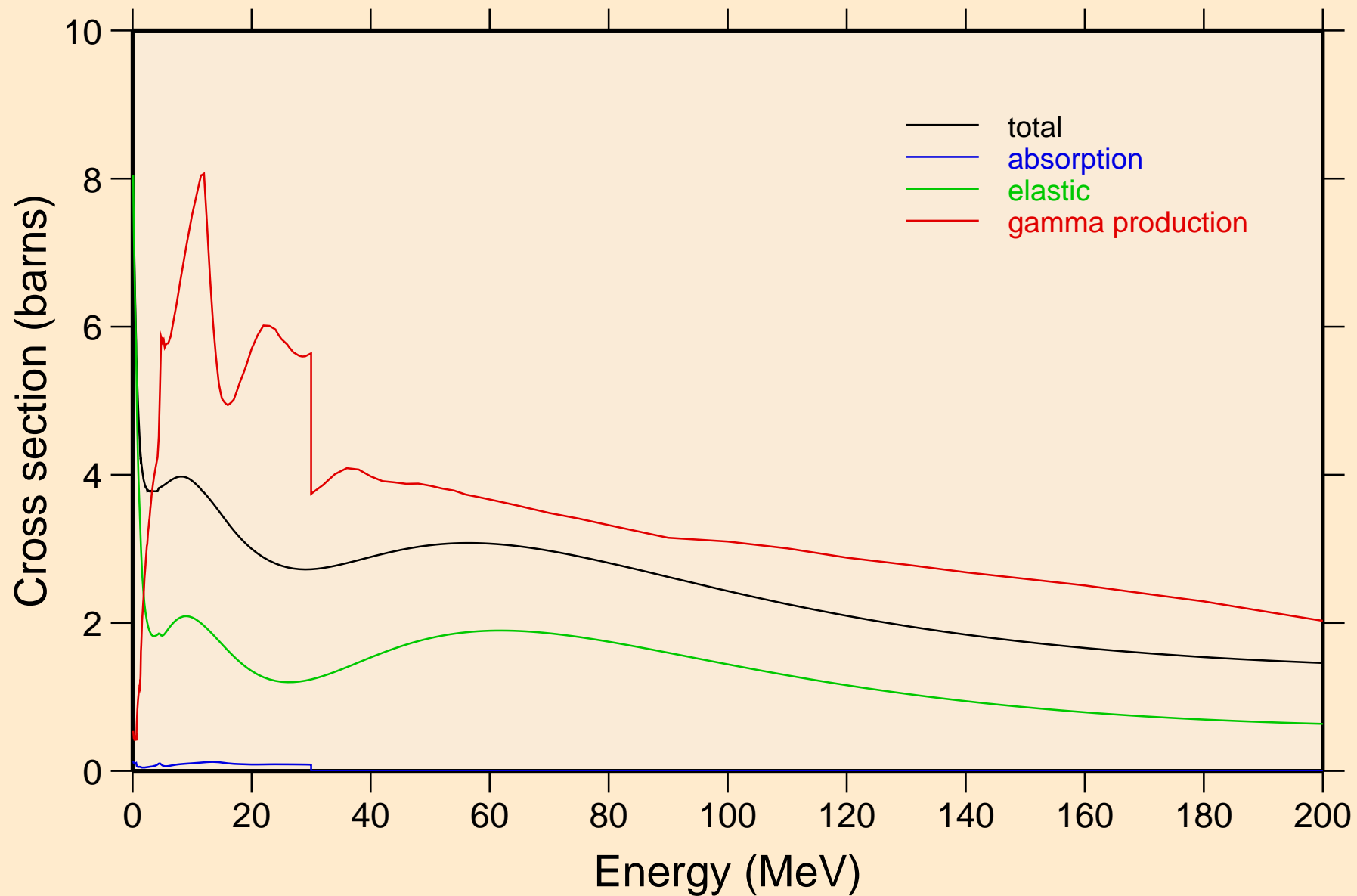

KR080 NEUTRON ACER TENDL-2019 LIBRARY; T=293.16K
Heating

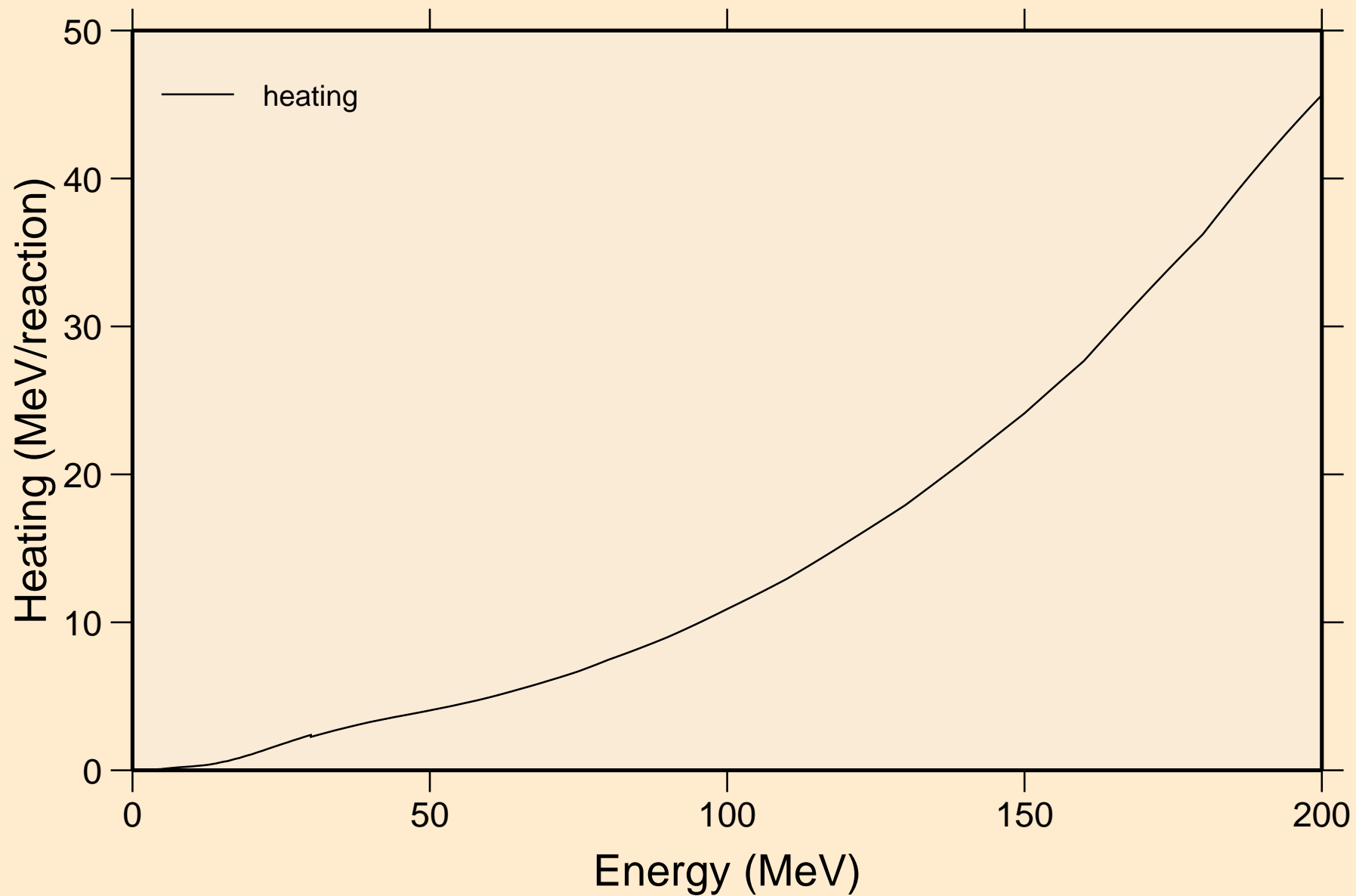

KR080 NEUTRON ACER TENDL-2019 LIBRARY; T=293.16K
Damage

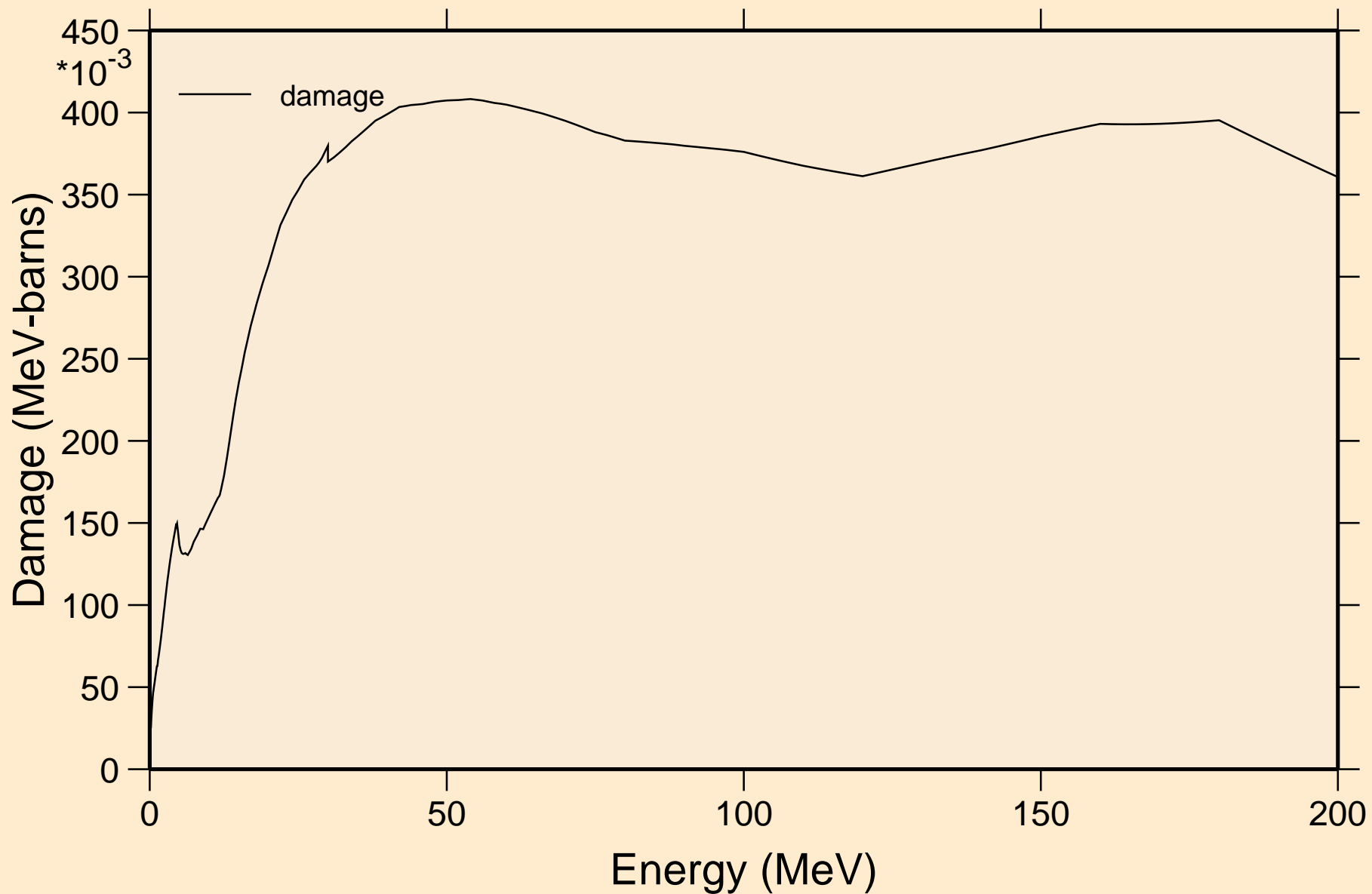

KR080 NEUTRON ACER TENDL-2019 LIBRARY; T=293.16K
Non-threshold reactions

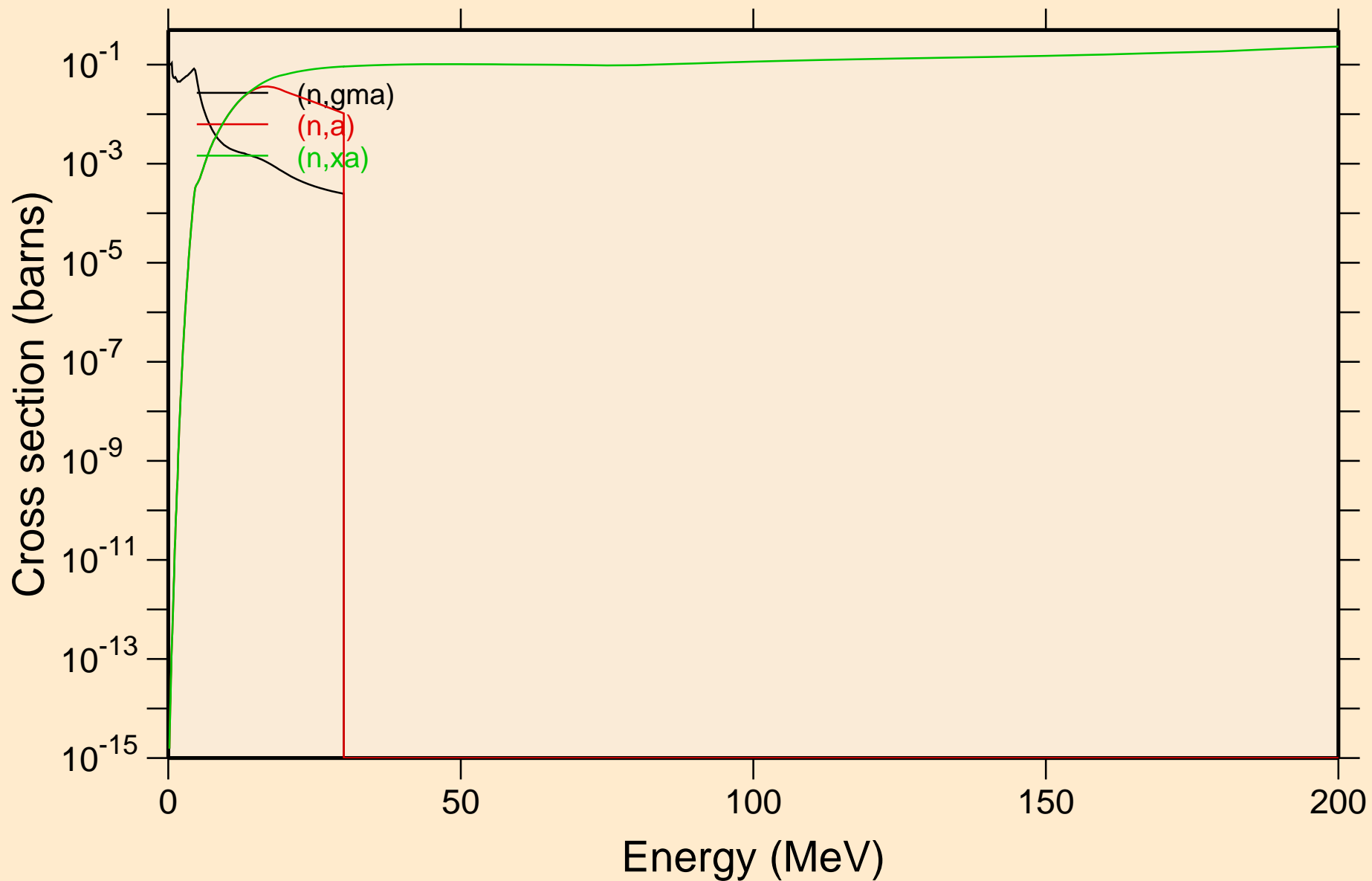

KR080 NEUTRON ACER TENDL-2019 LIBRARY; T=293.16K
Inelastic levels

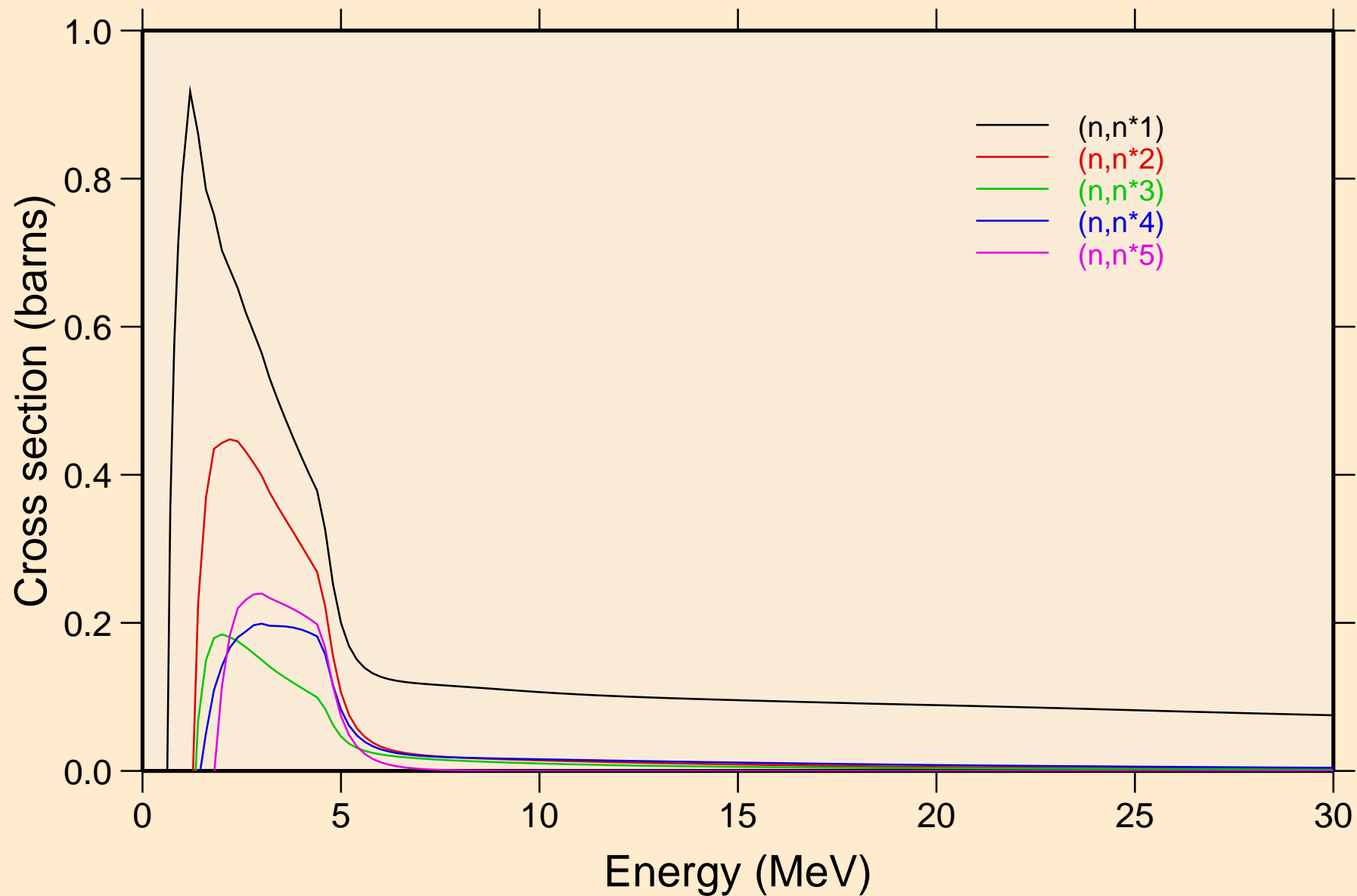

KR080 NEUTRON ACER TENDL-2019 LIBRARY; T=293.16K
Inelastic levels

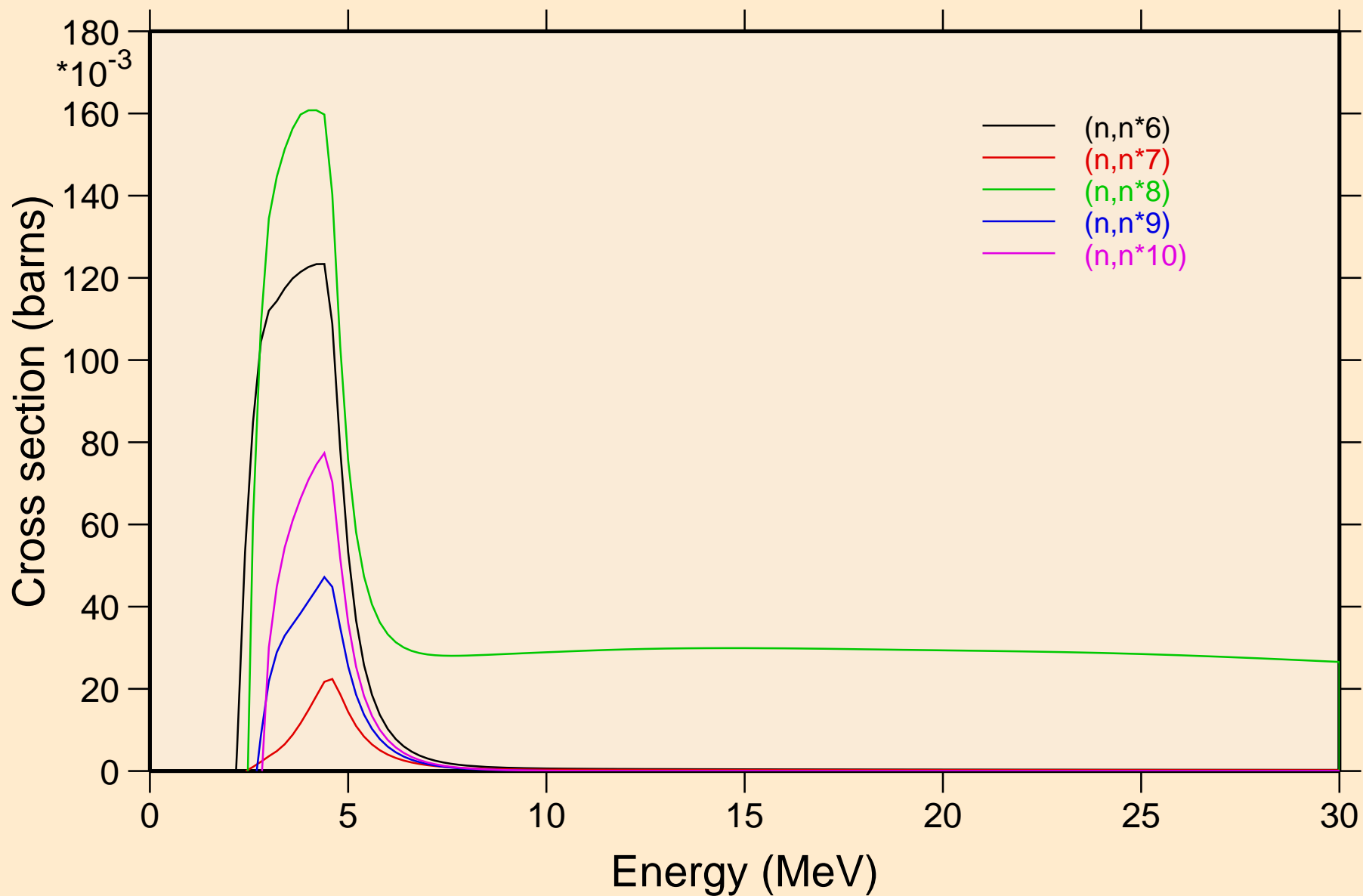

KR080 NEUTRON ACER TENDL-2019 LIBRARY; T=293.16K
Inelastic levels

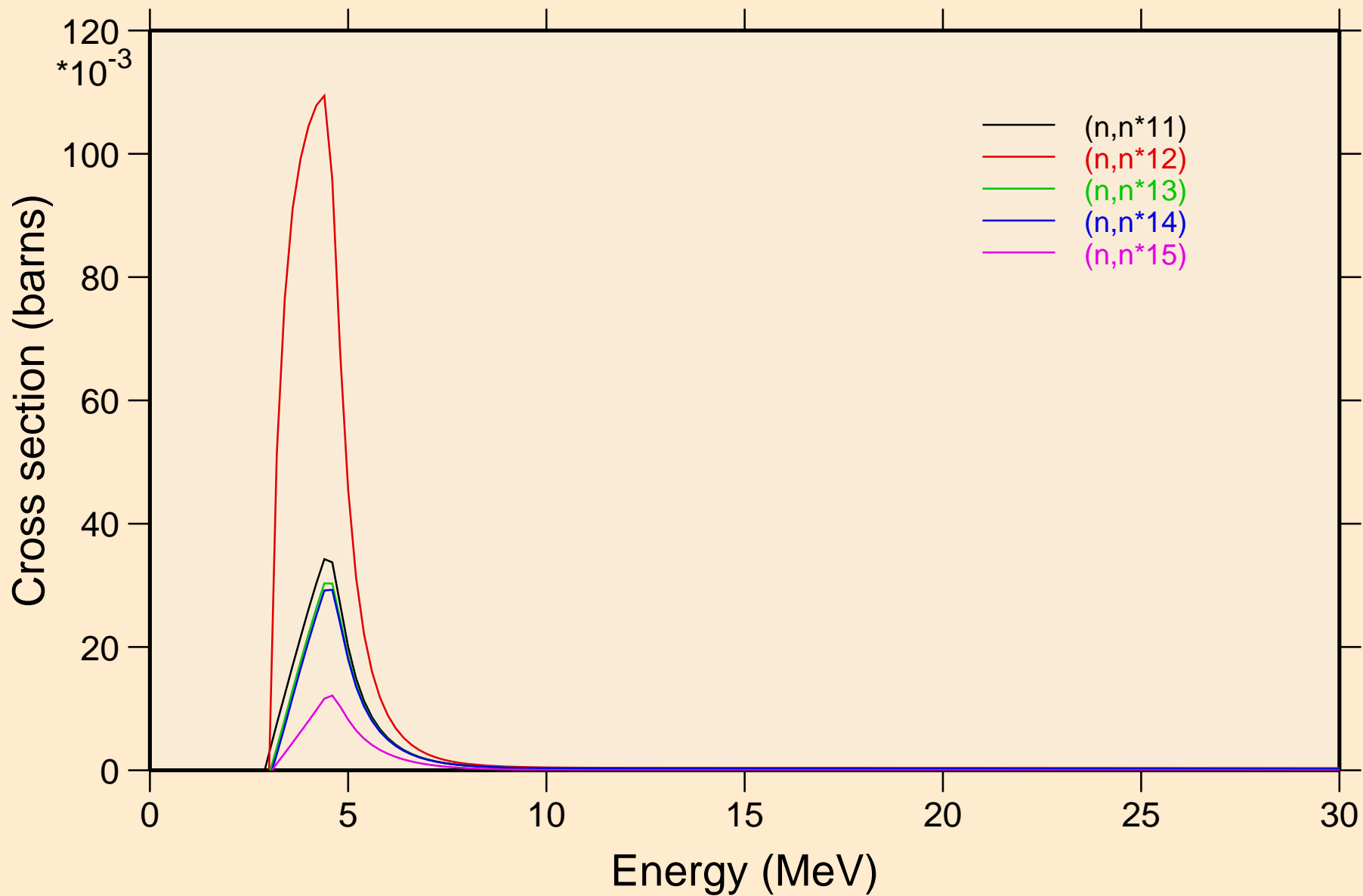

KR080 NEUTRON ACER TENDL-2019 LIBRARY; T=293.16K
Inelastic levels

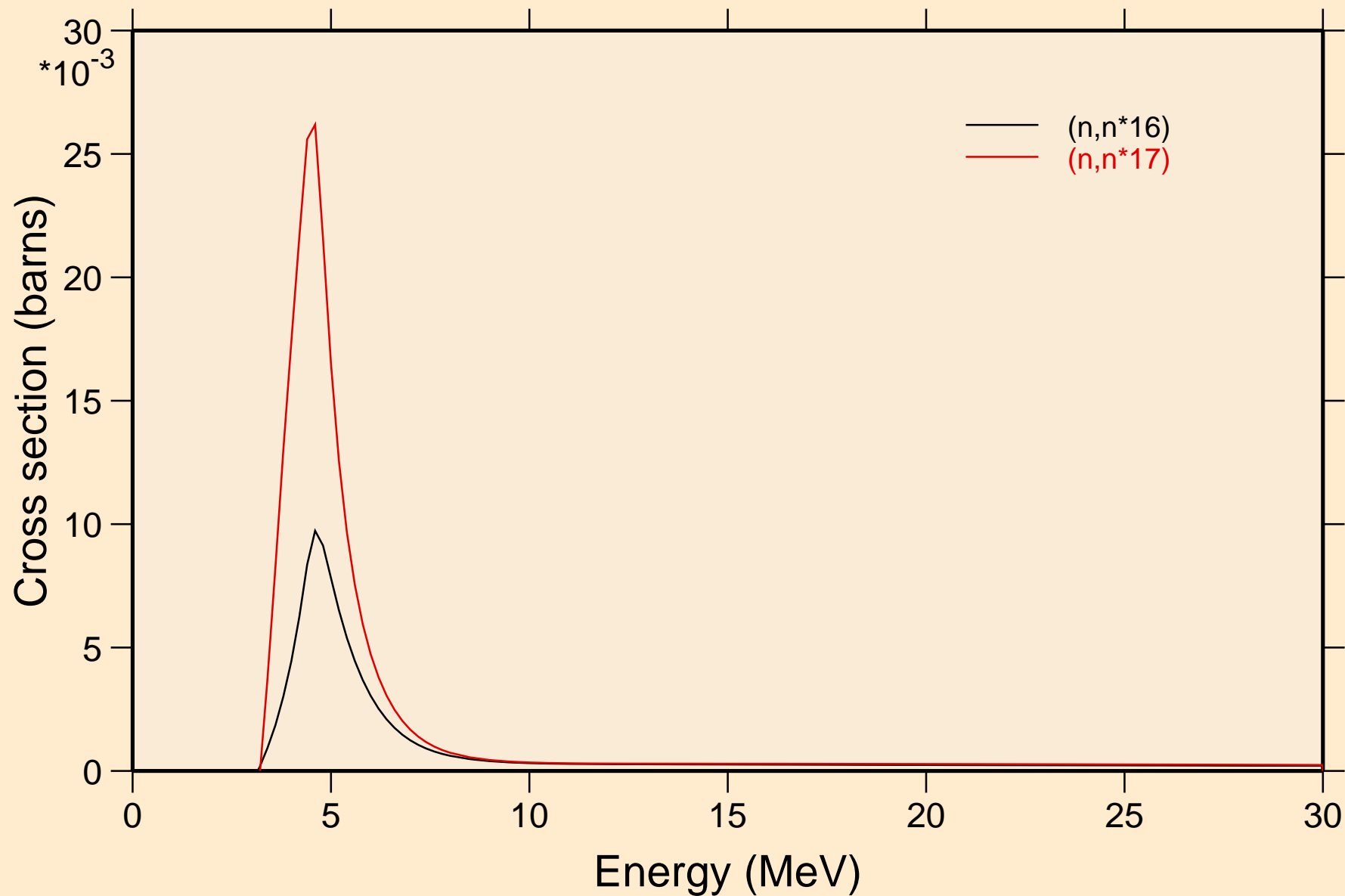

KR080 NEUTRON ACER TENDL-2019 LIBRARY; T=293.16K
Threshold reactions

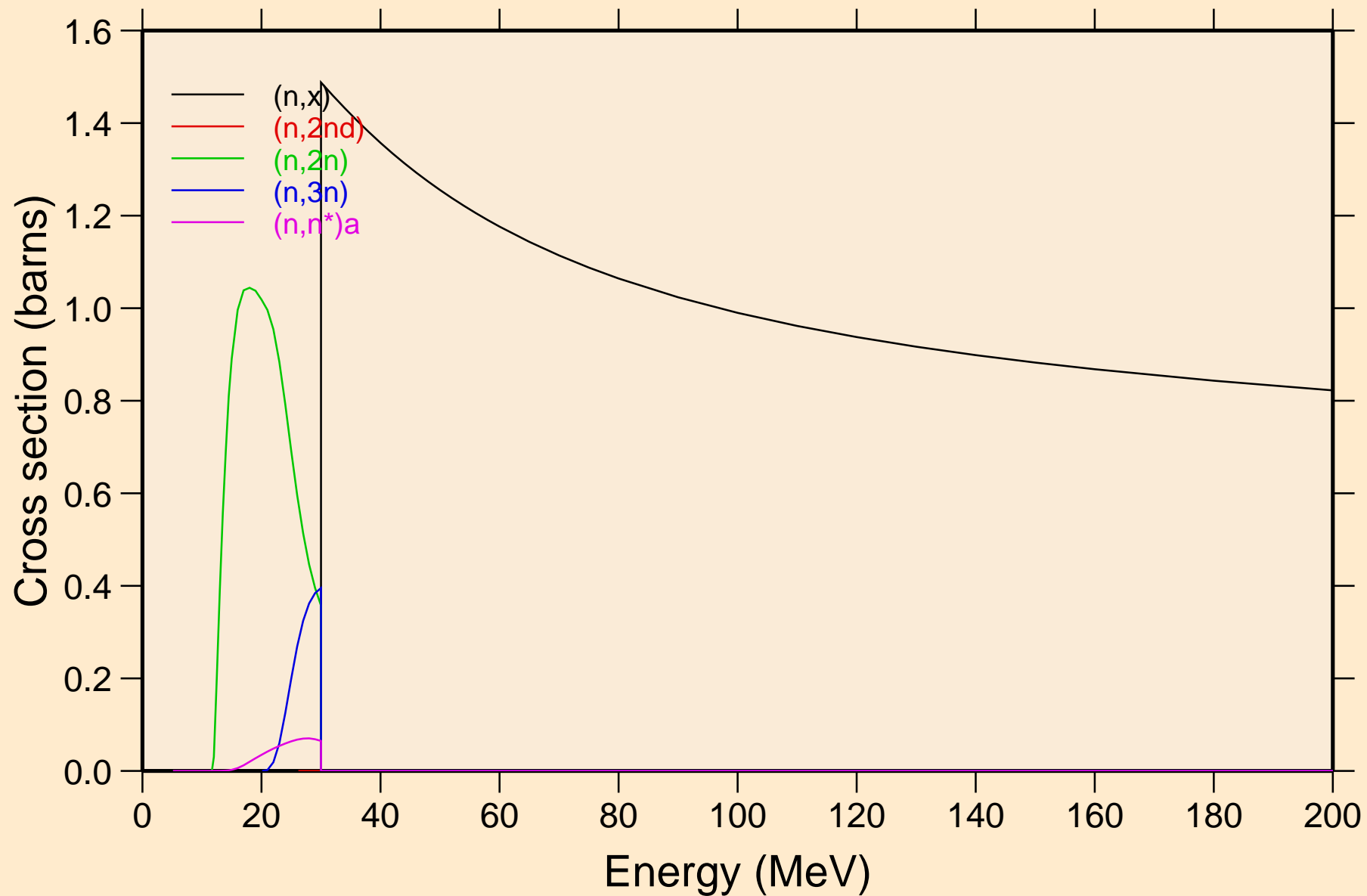

KR080 NEUTRON ACER TENDL-2019 LIBRARY; T=293.16K
Threshold reactions

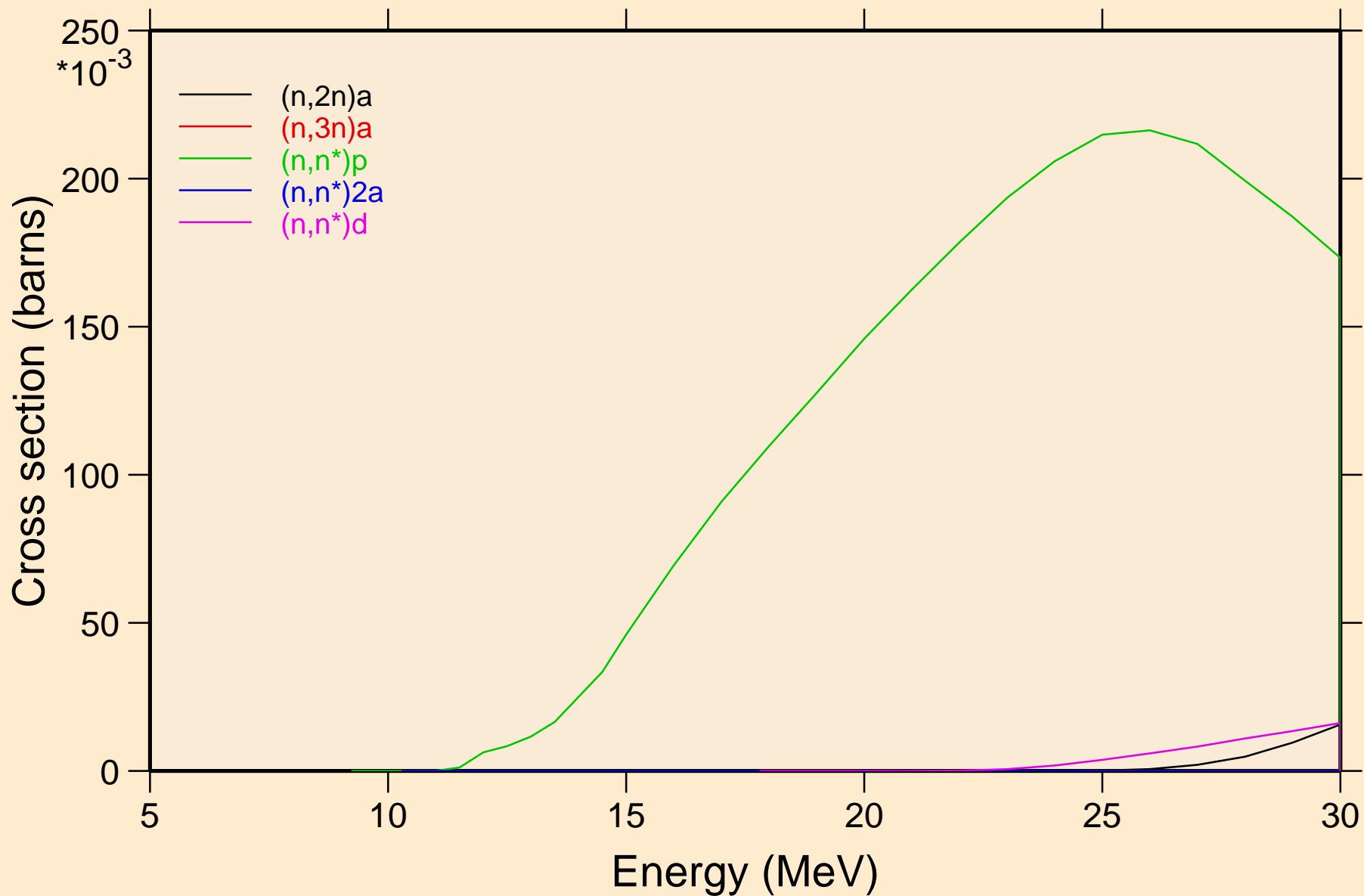

KR080 NEUTRON ACER TENDL-2019 LIBRARY; T=293.16K
Threshold reactions

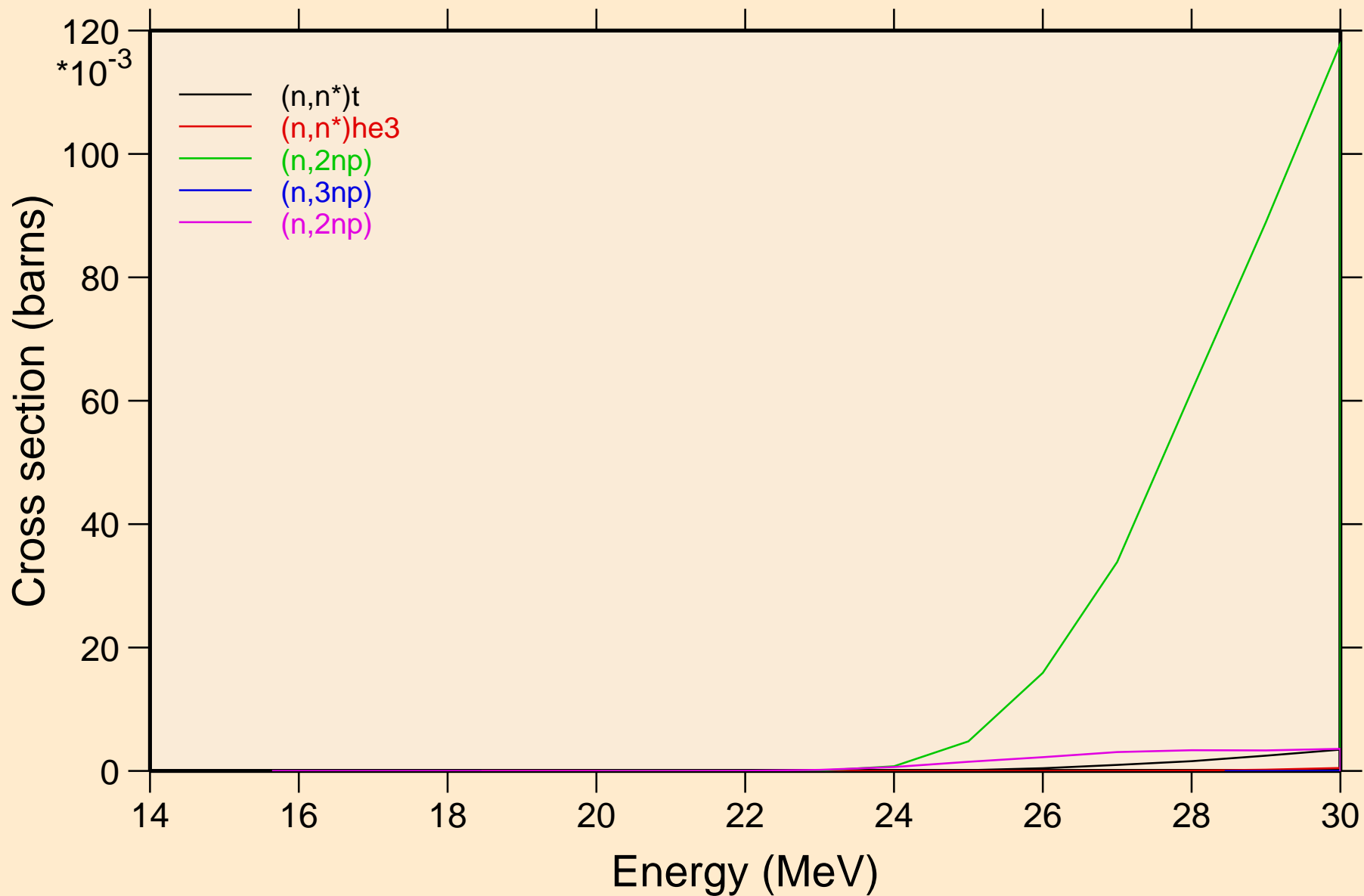

KR080 NEUTRON ACER TENDL-2019 LIBRARY; T=293.16K
Threshold reactions

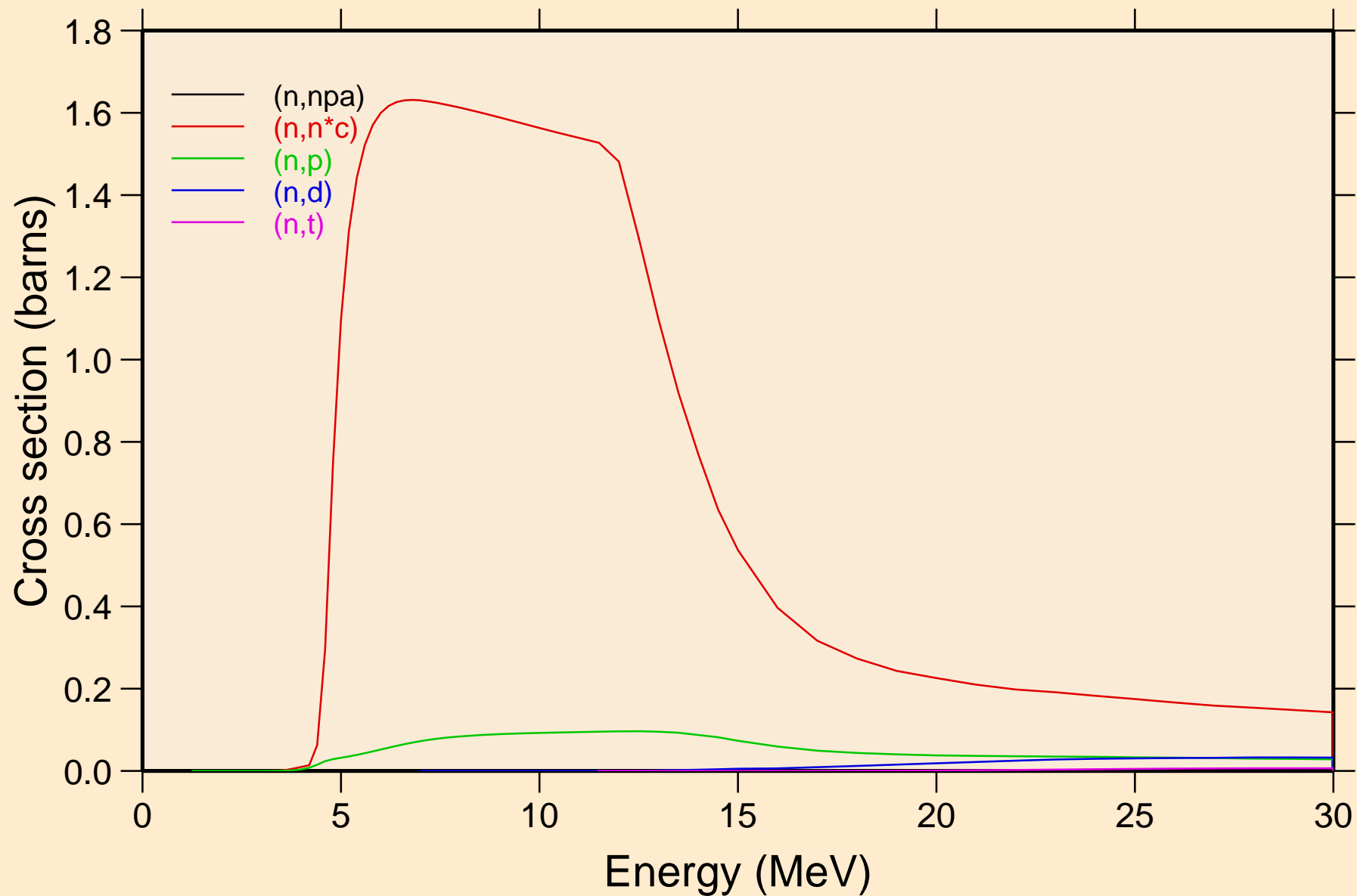

KR080 NEUTRON ACER TENDL-2019 LIBRARY; T=293.16K
Threshold reactions

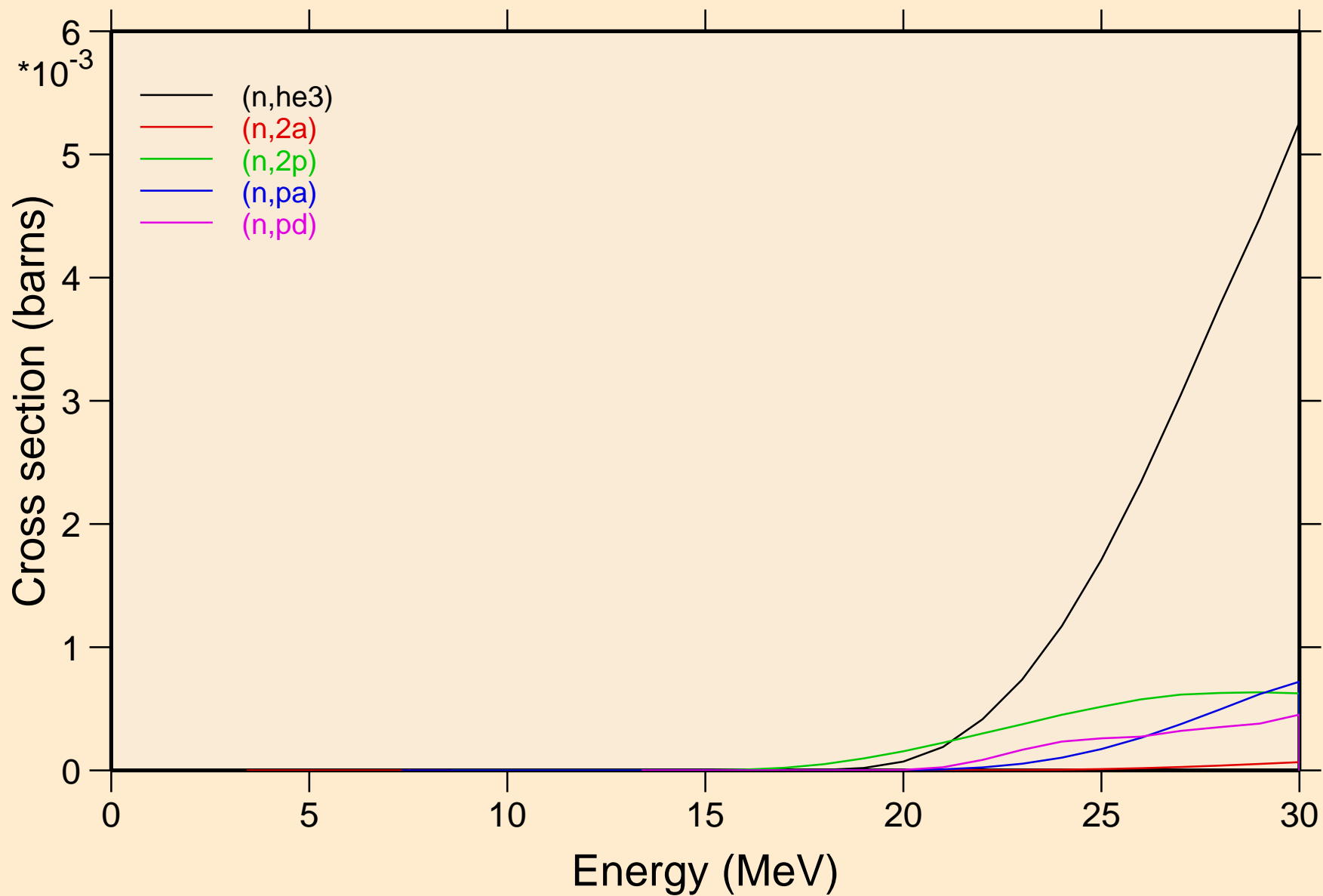

KR080 NEUTRON ACER TENDL-2019 LIBRARY; T=293.16K
Threshold reactions

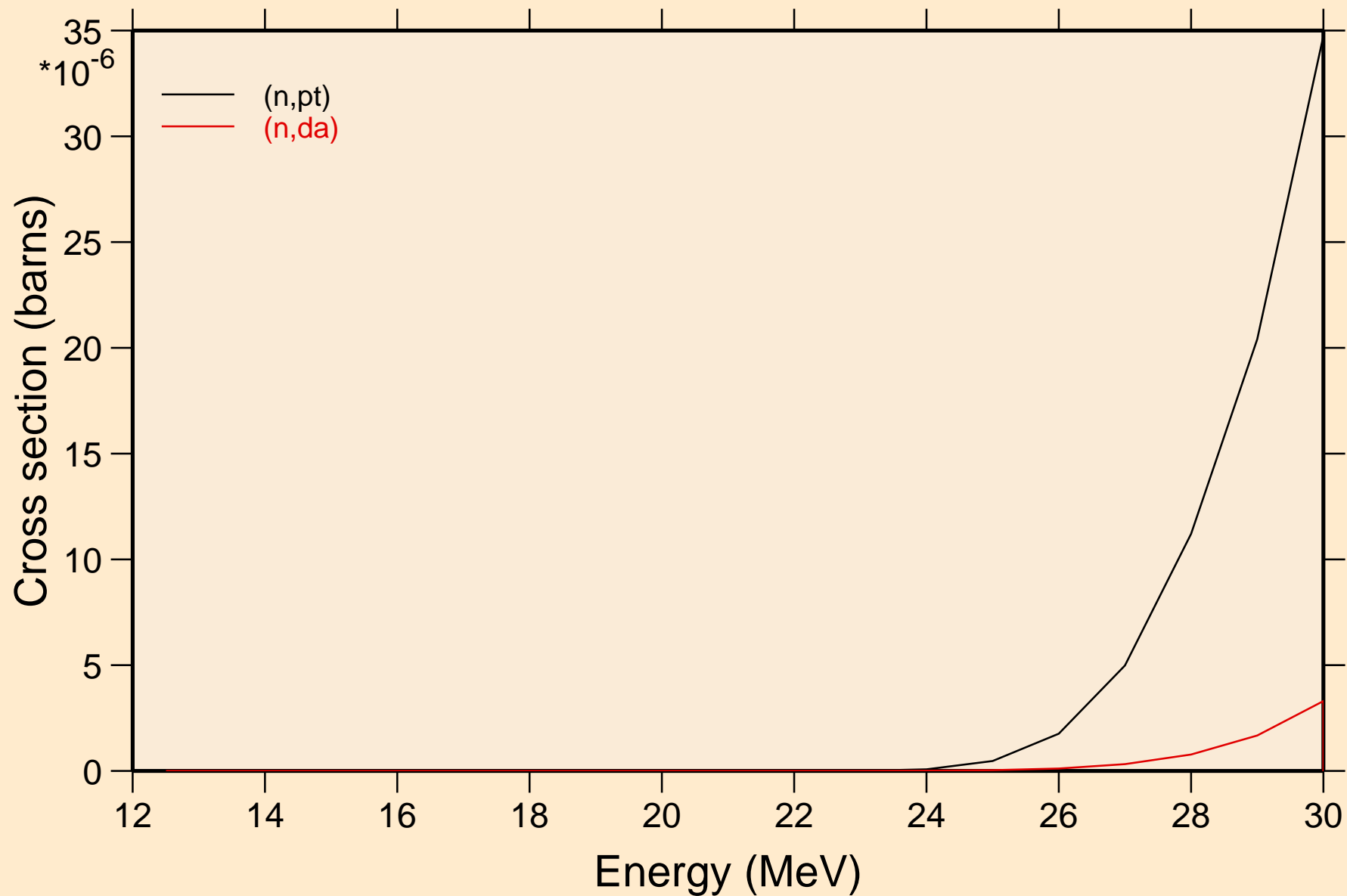

KR080 NEUTRON ACER TENDL-2019 LIBRARY; T=293.16K
Threshold reactions

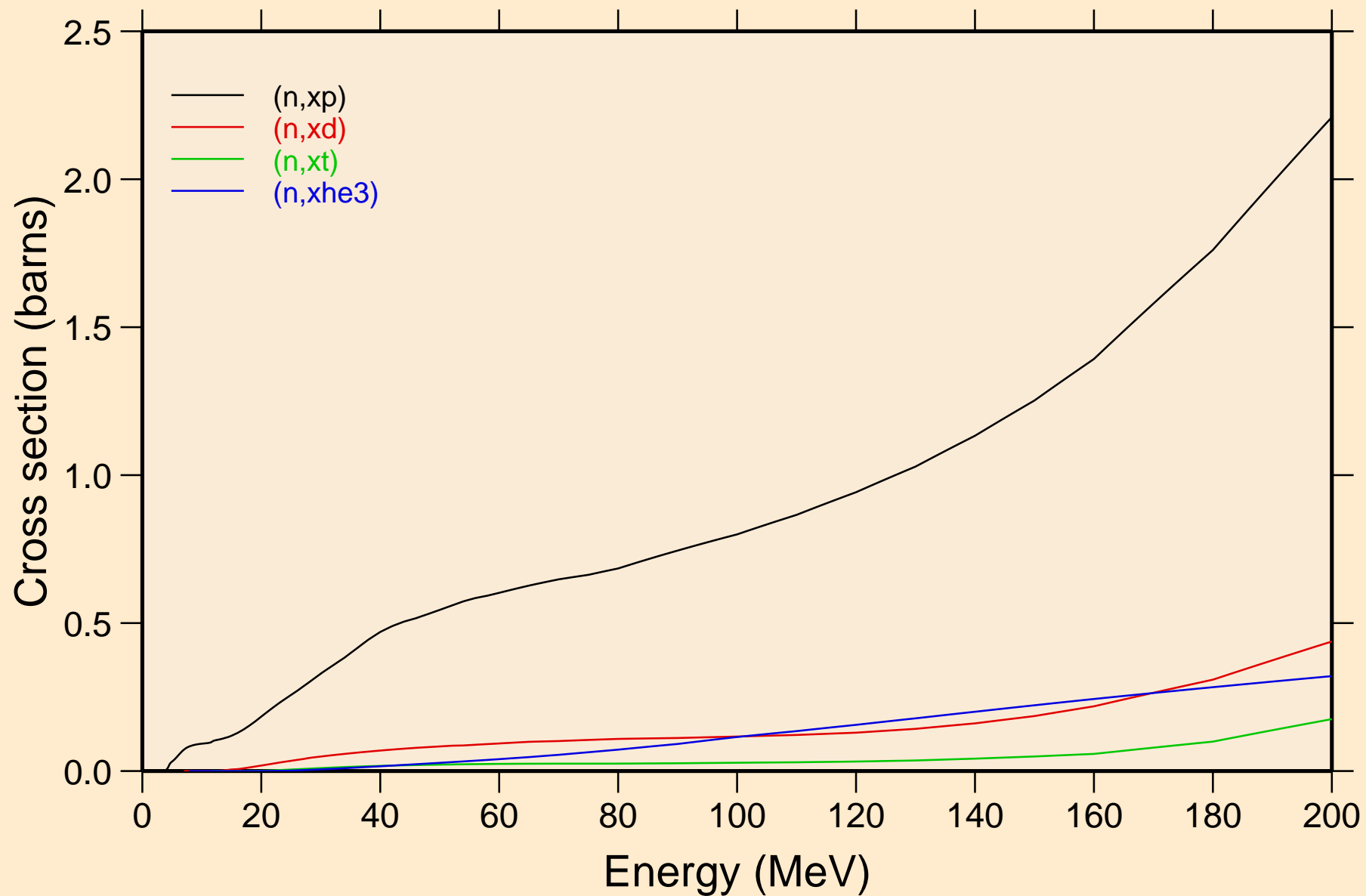

KR080 NEUTRON ACER TENDL-2019 LIBRARY; T=293.16K
angular distribution for elastic

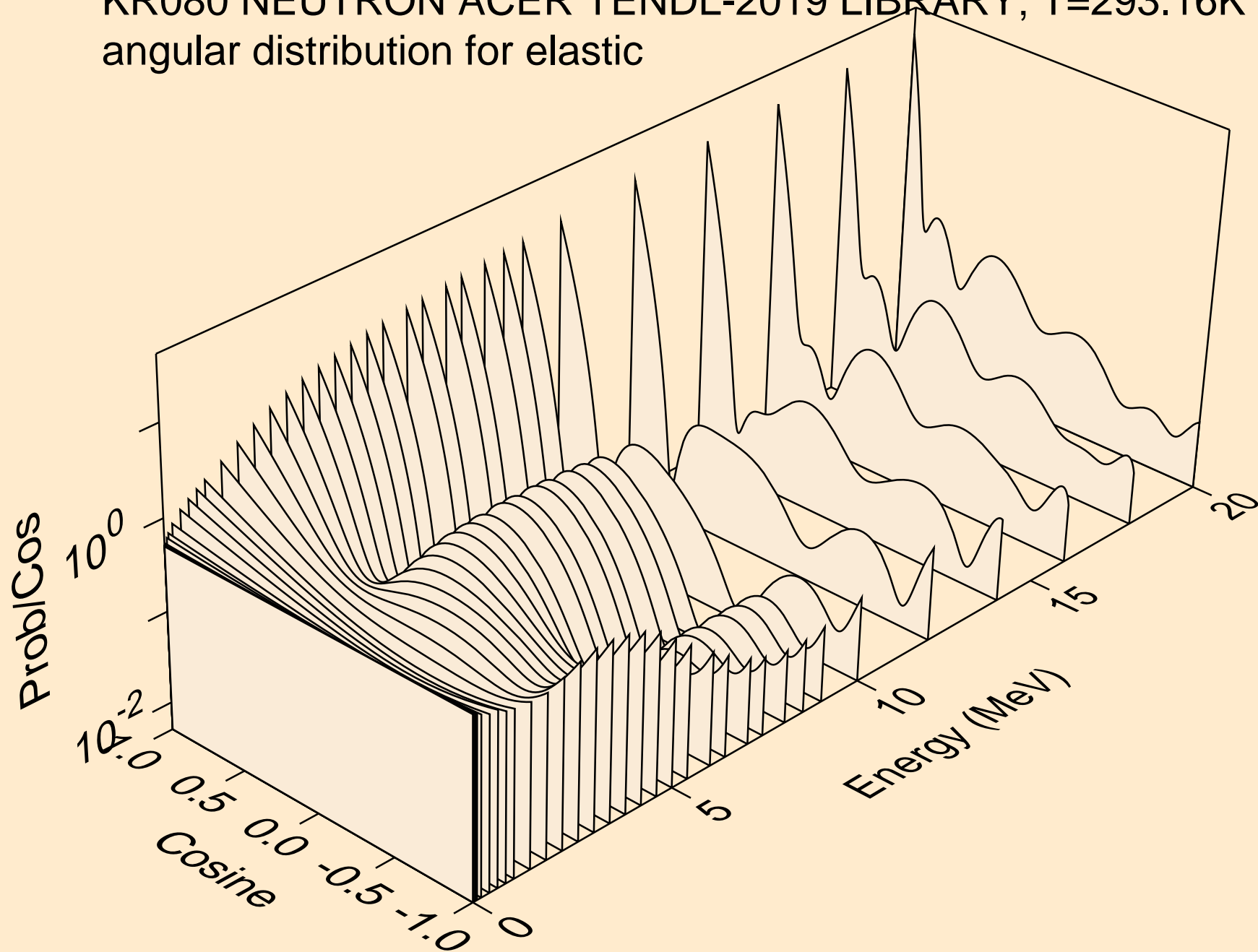

KR080 NEUTRON ACER TENDL-2019 LIBRARY; T=293.16K
angular distribution for elastic

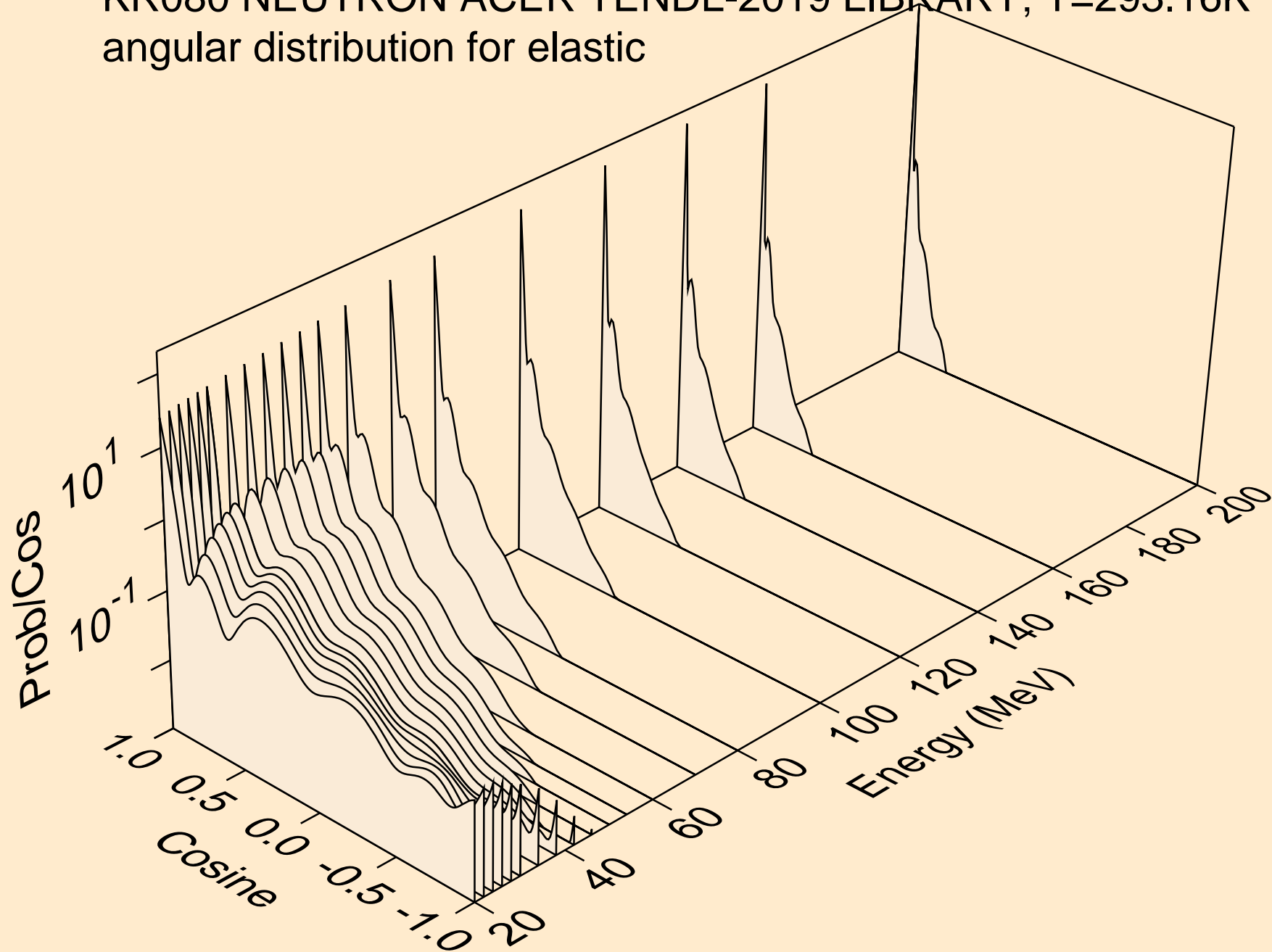

KR080 NEUTRON ACER TENDL-2019 LIBRARY; T=293.16K
angular distribution for (n,n*1)

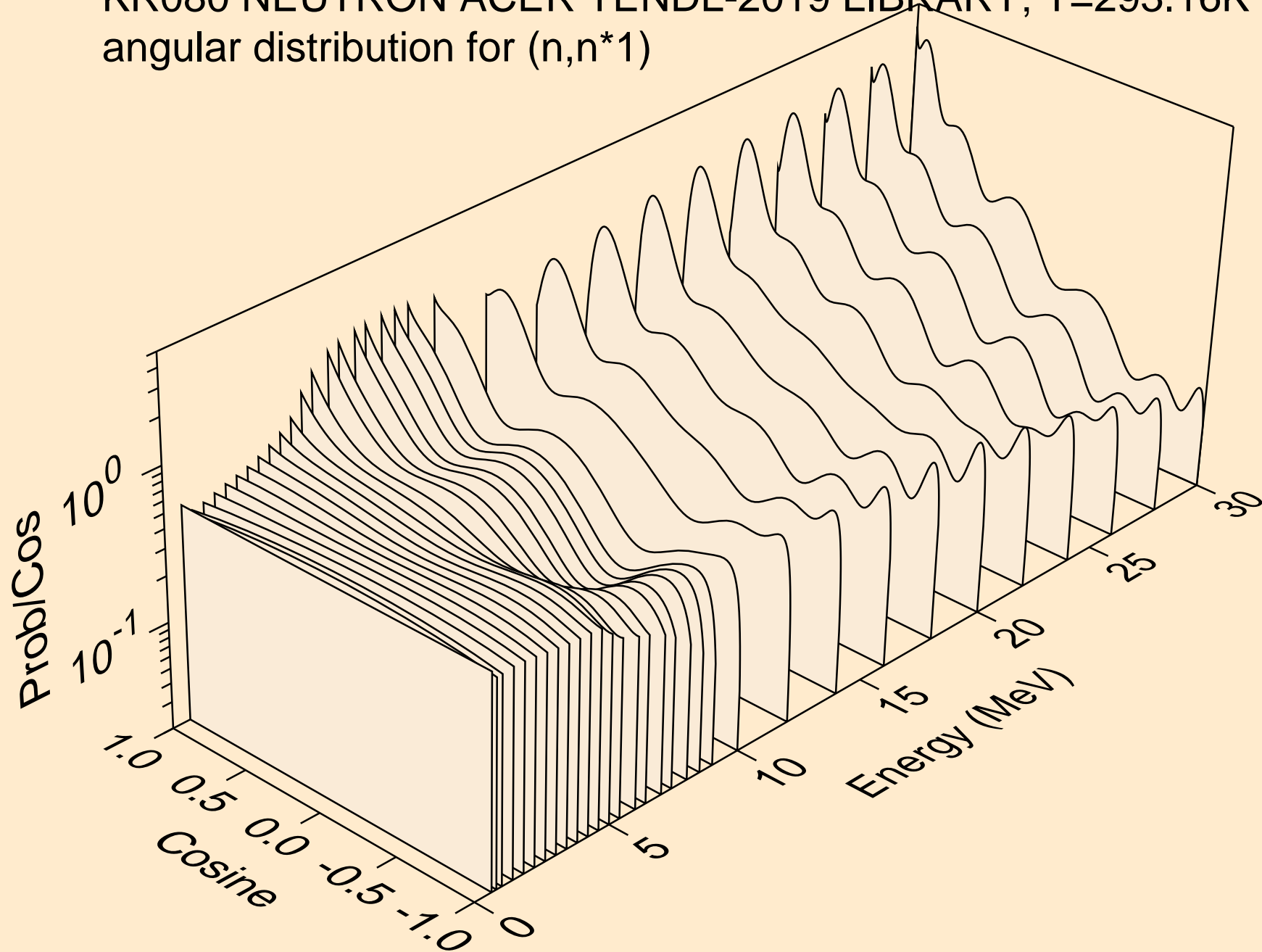

KR080 NEUTRON ACER TENDL-2019 LIBRARY; T=293.16K
angular distribution for (n,n*2)

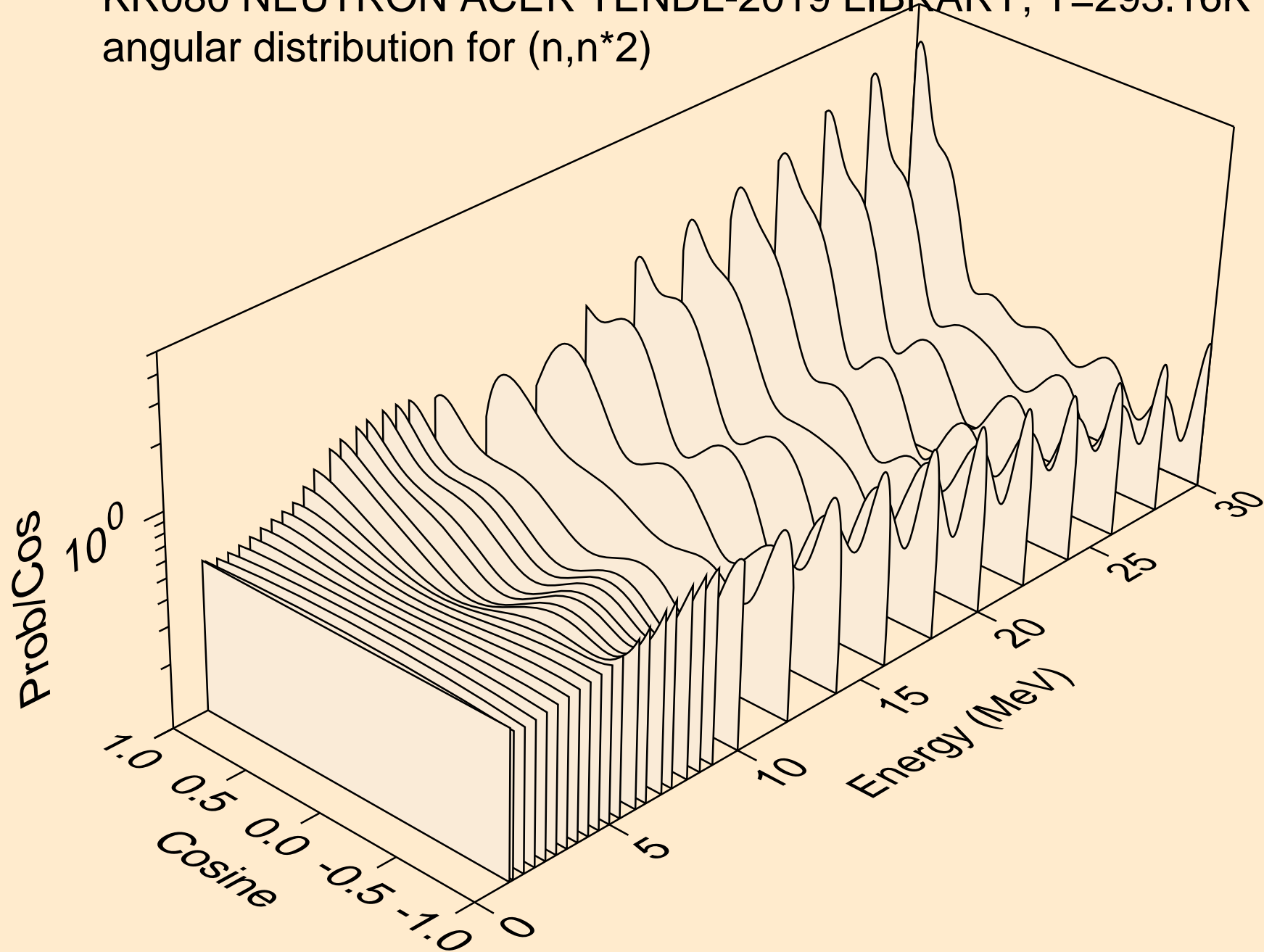

KR080 NEUTRON ACER TENDL-2019 LIBRARY; T=293.16K
angular distribution for (n,n*3)

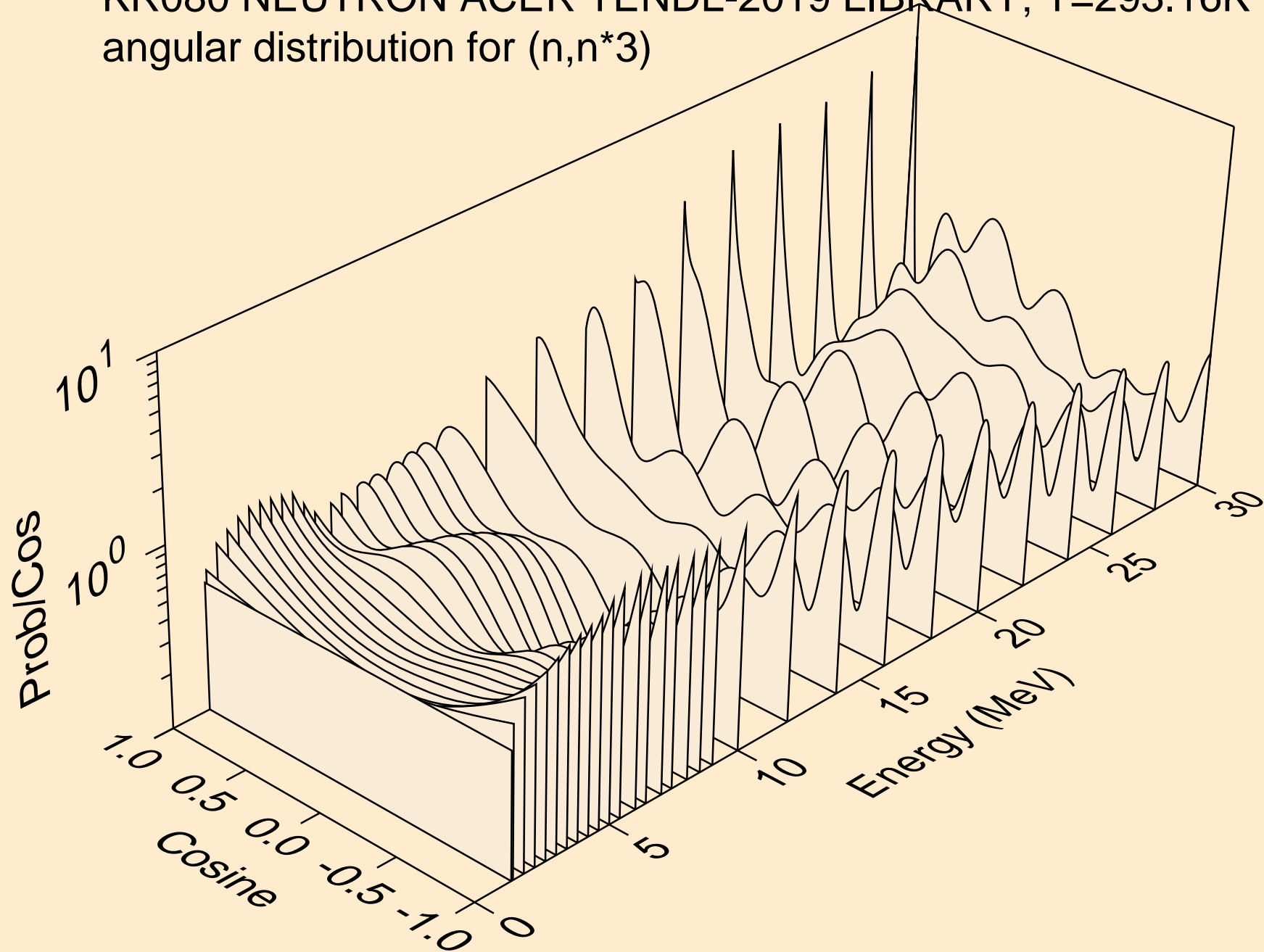

KR080 NEUTRON ACER TENDL-2019 LIBRARY; T=293.16K
angular distribution for (n,n*4)

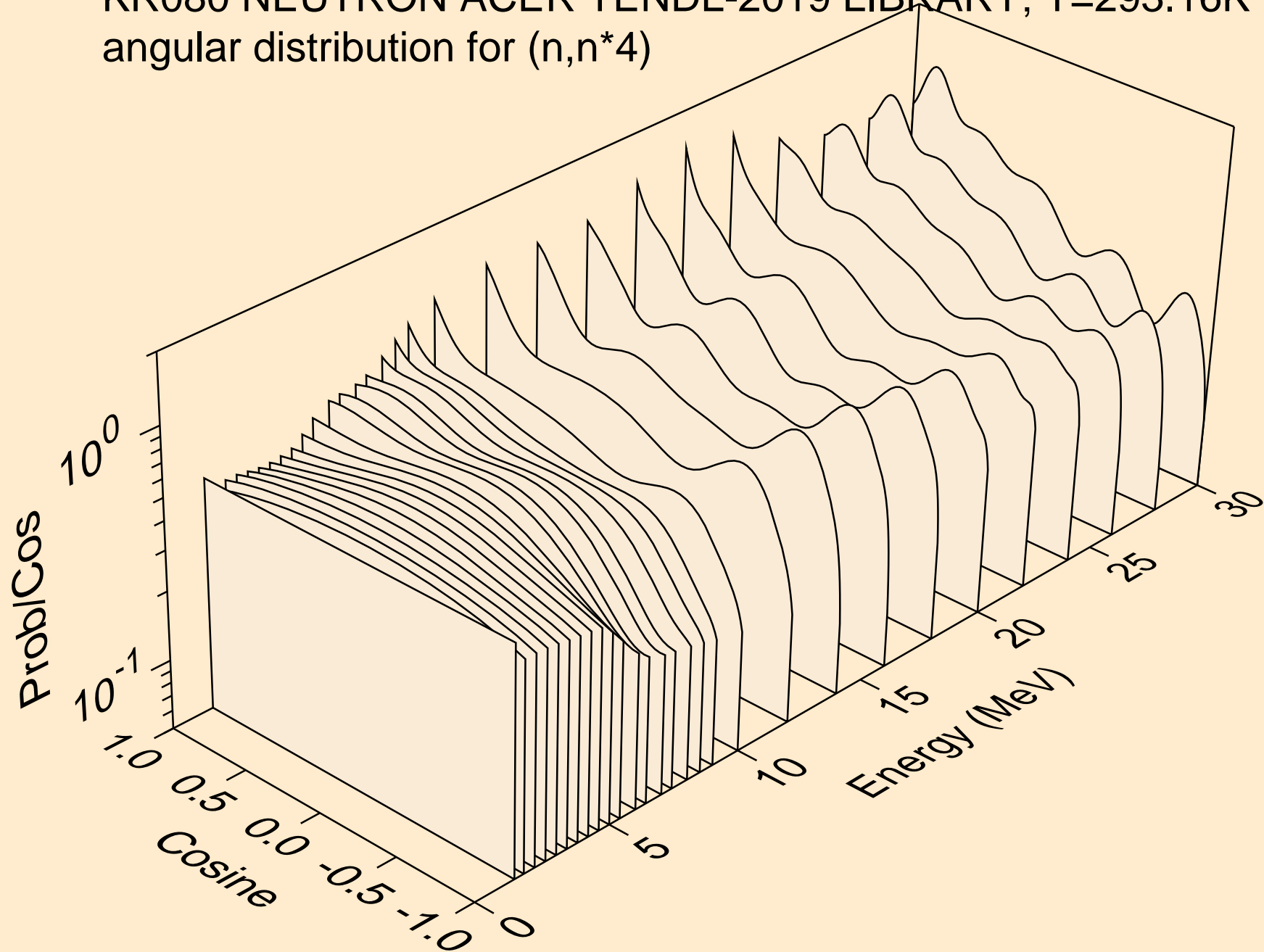

KR080 NEUTRON ACER TENDL-2019 LIBRARY; T=293.16K
angular distribution for (n,n*5)

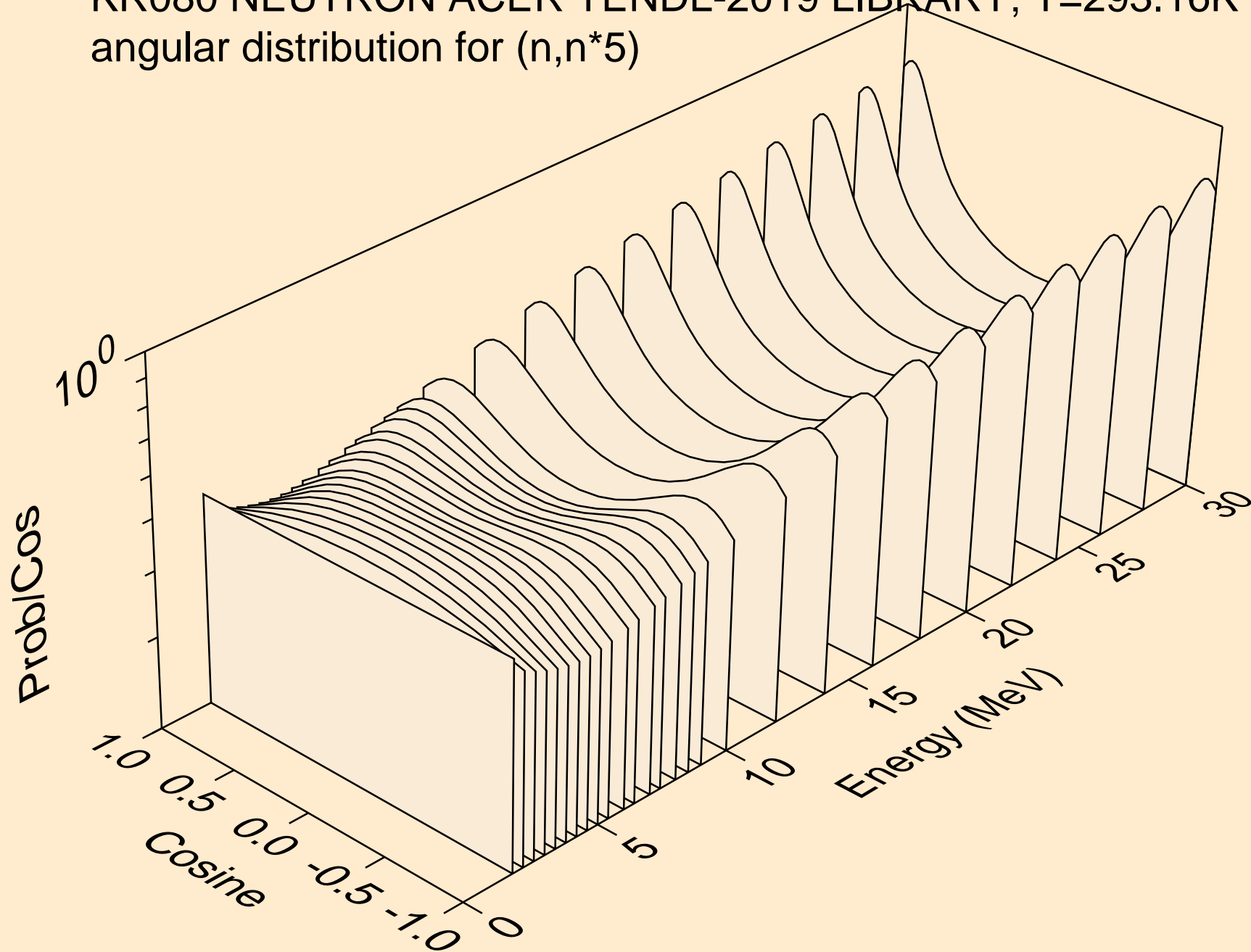

KR080 NEUTRON ACER TENDL-2019 LIBRARY; T=293.16K
angular distribution for (n,n*6)

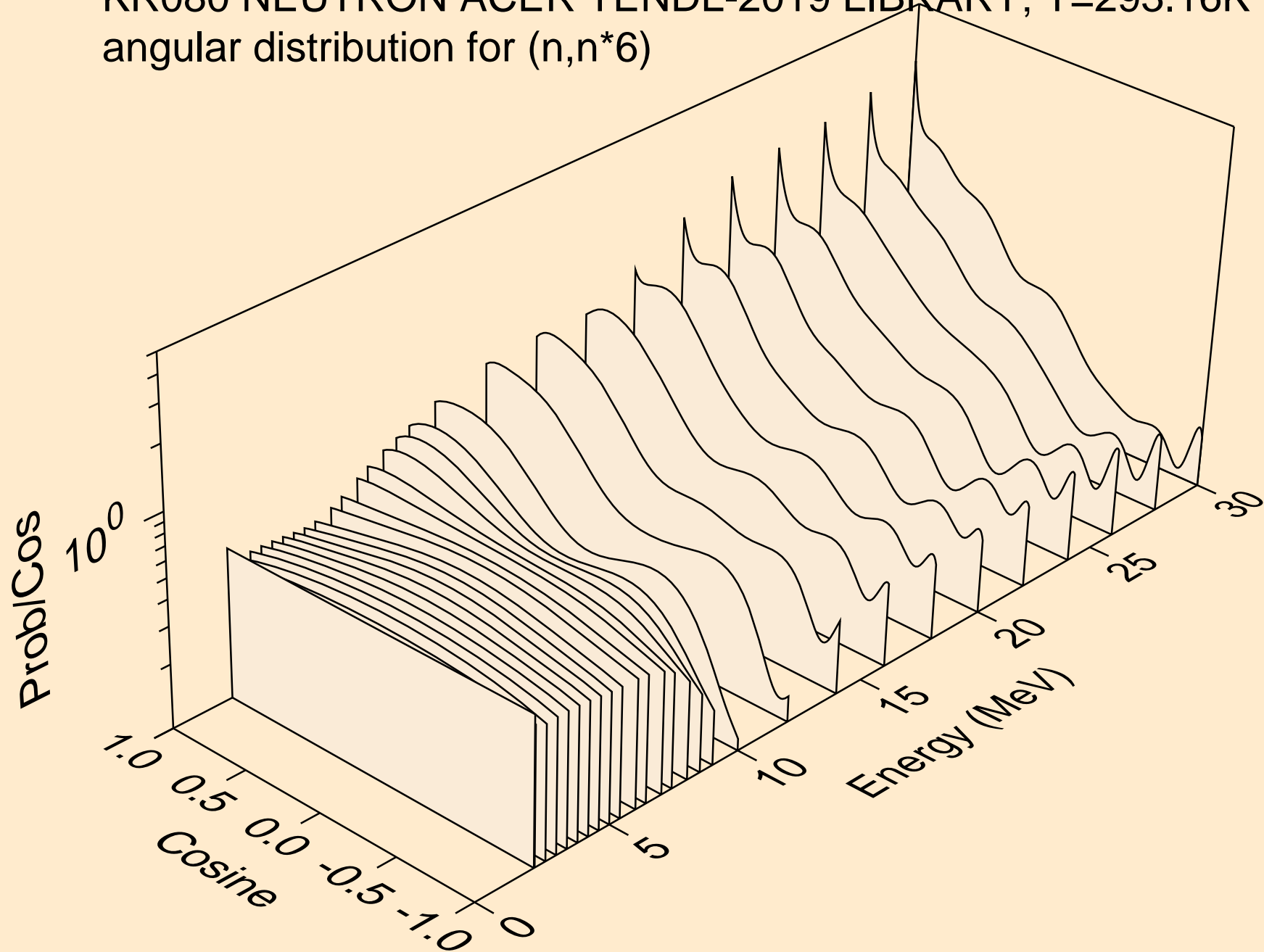

KR080 NEUTRON ACER TENDL-2019 LIBRARY; T=293.16K
angular distribution for (n,n*7)

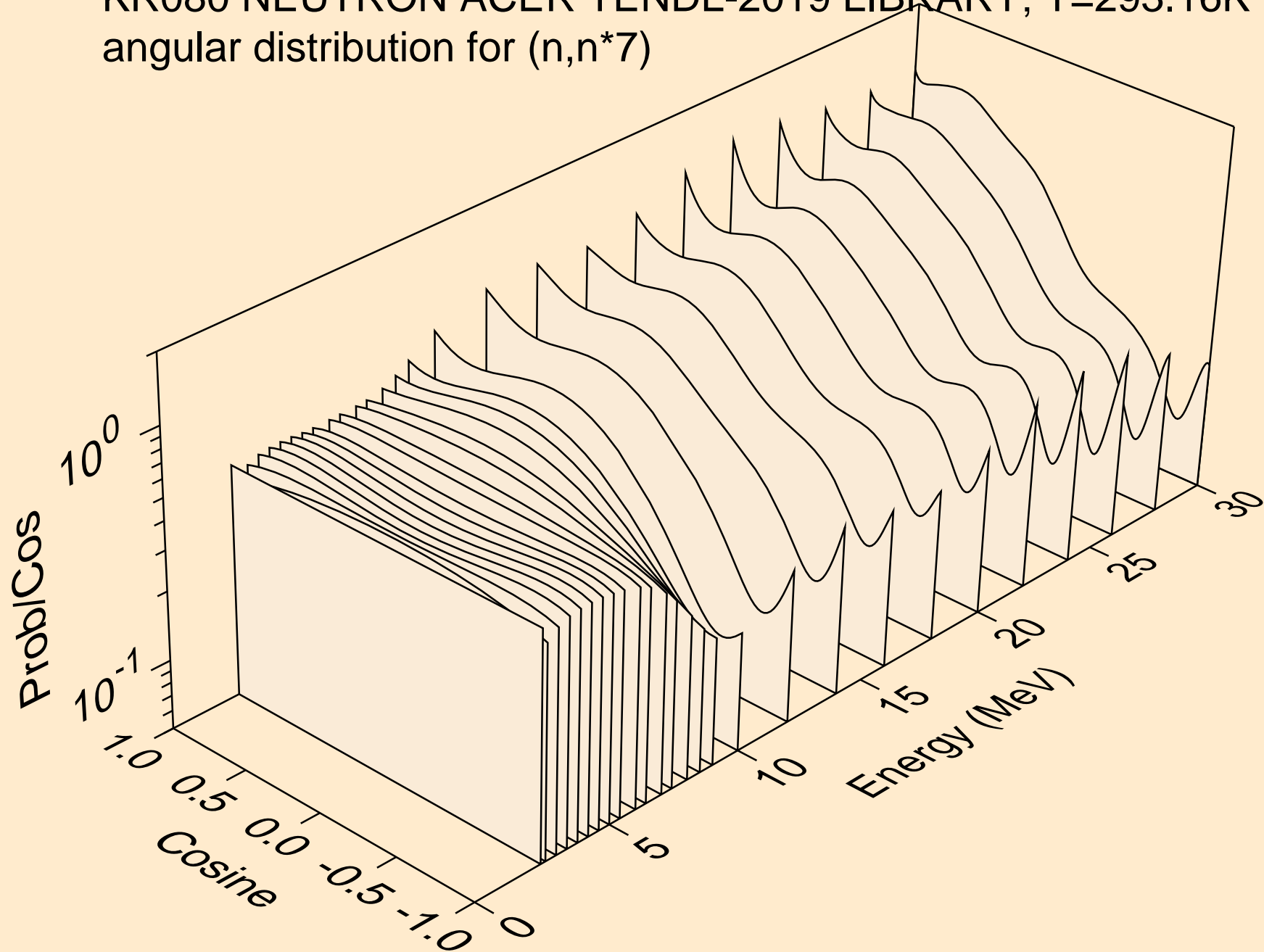

KR080 NEUTRON ACER TENDL-2019 LIBRARY; T=293.16K
angular distribution for (n,n*8)

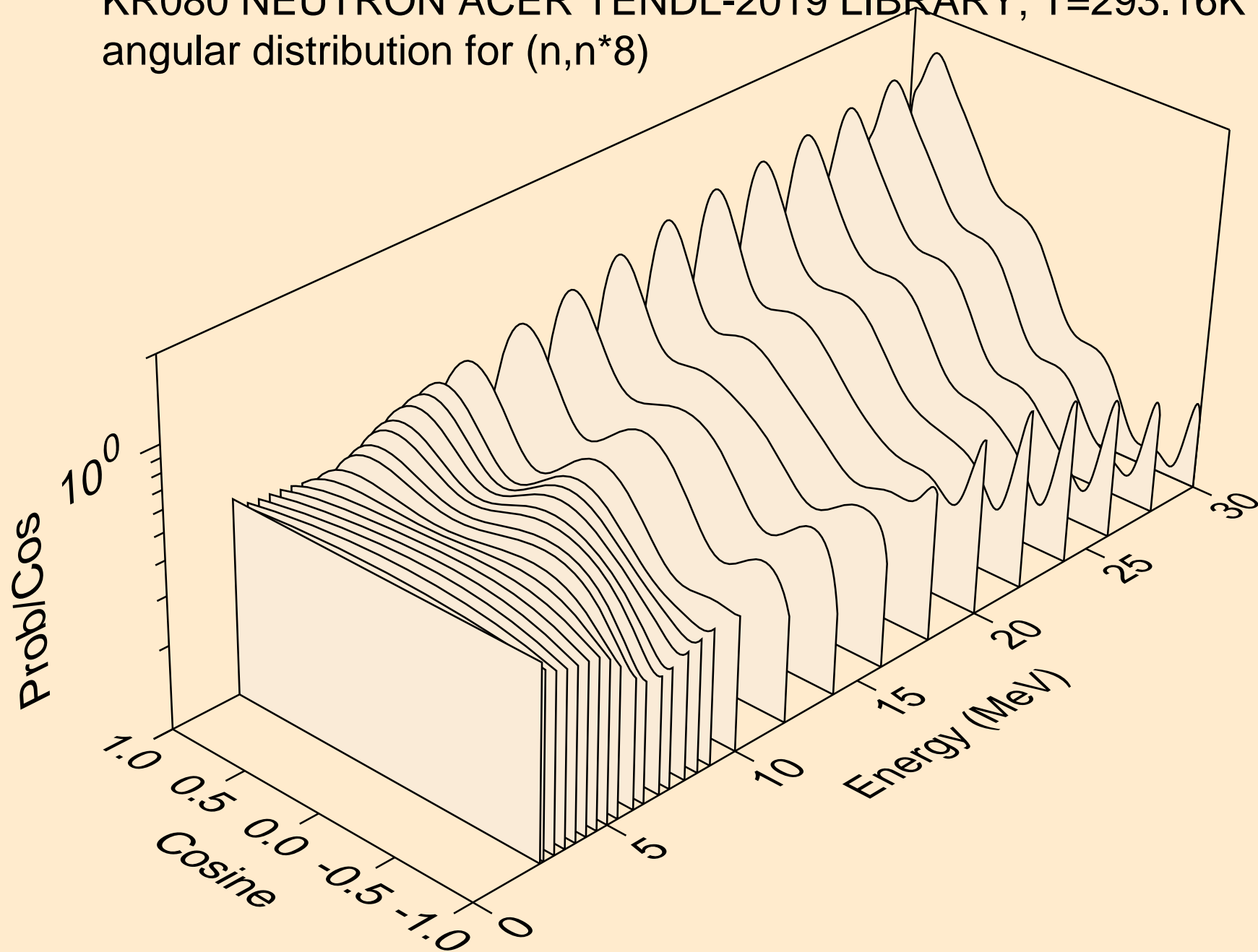

KR080 NEUTRON ACER TENDL-2019 LIBRARY; T=293.16K
angular distribution for (n,n*9)

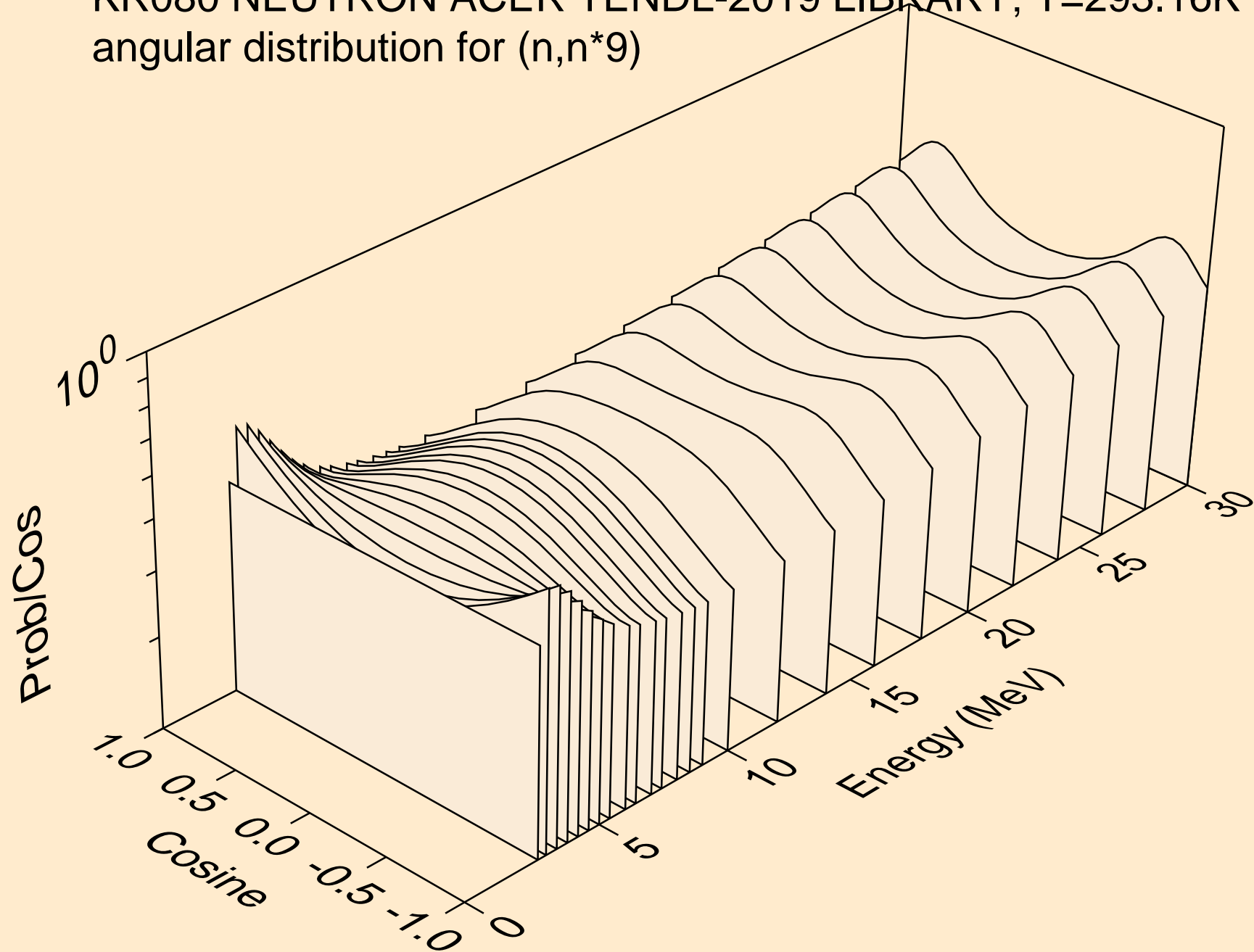

KR080 NEUTRON ACER TENDL-2019 LIBRARY; T=293.16K
angular distribution for (n,n*10)

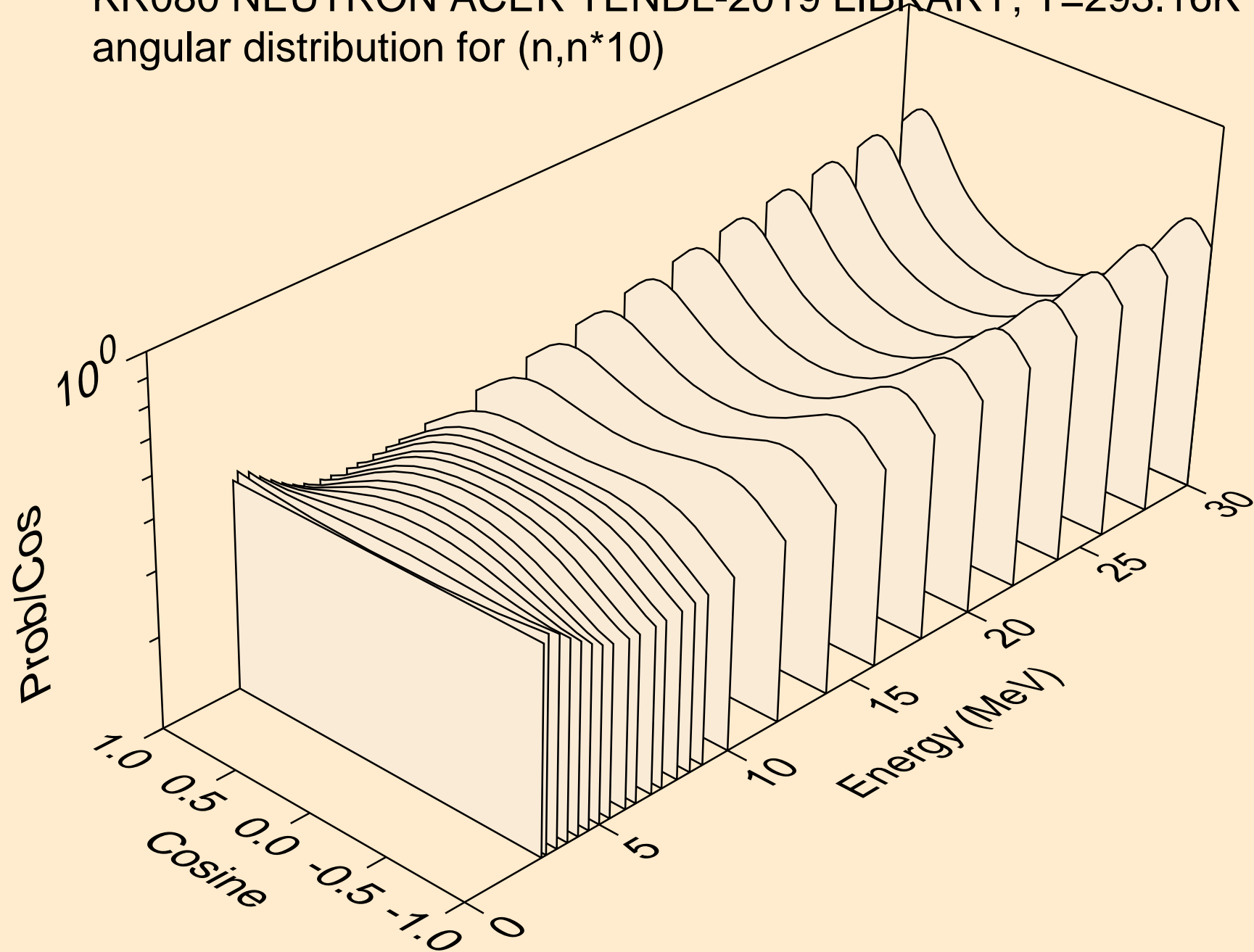

KR080 NEUTRON ACER TENDL-2019 LIBRARY; T=293.16K
angular distribution for (n,n*11)

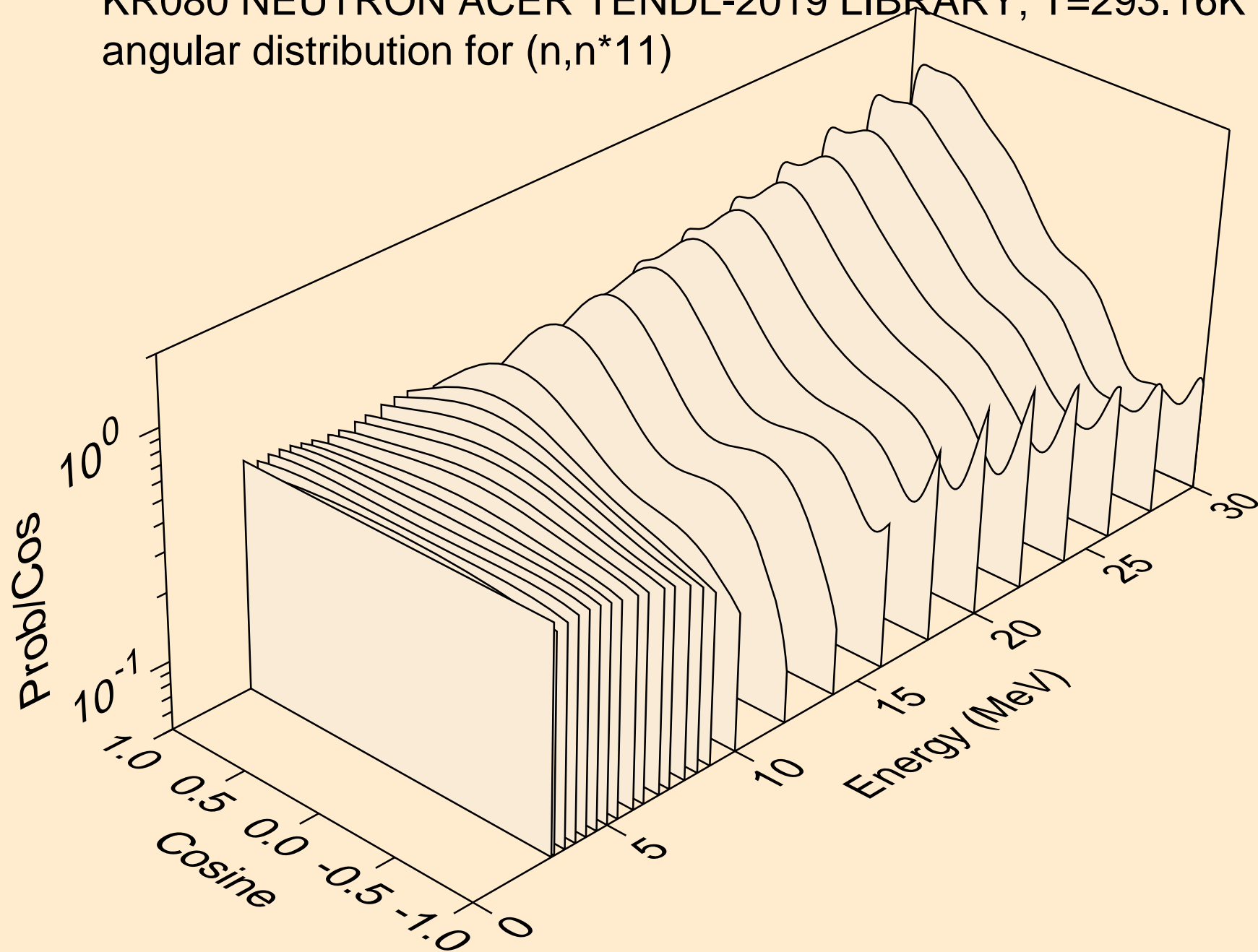

KR080 NEUTRON ACER TENDL-2019 LIBRARY; T=293.16K
angular distribution for (n,n*12)

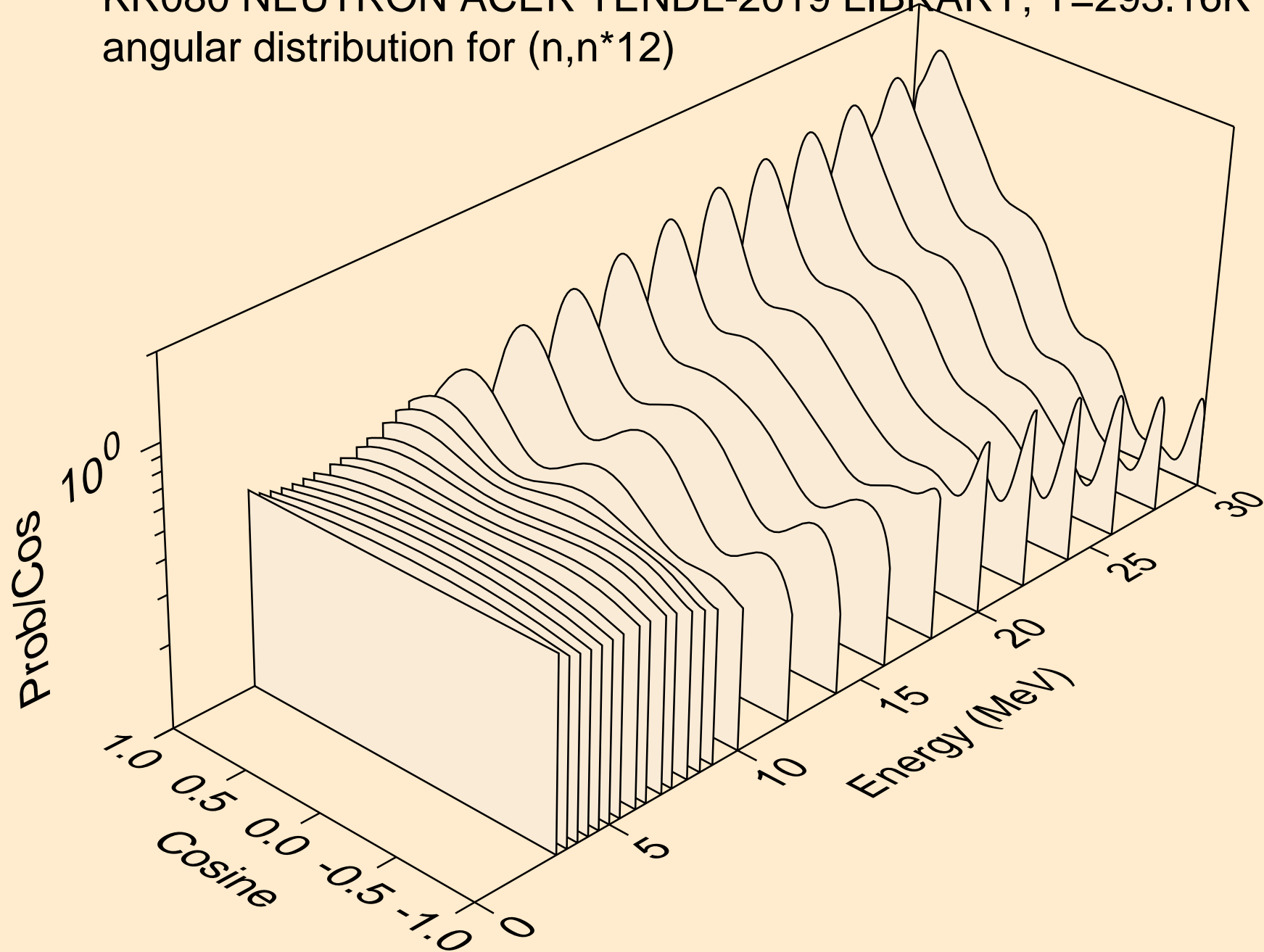

KR080 NEUTRON ACER TENDL-2019 LIBRARY; T=293.16K
angular distribution for (n,n*13)

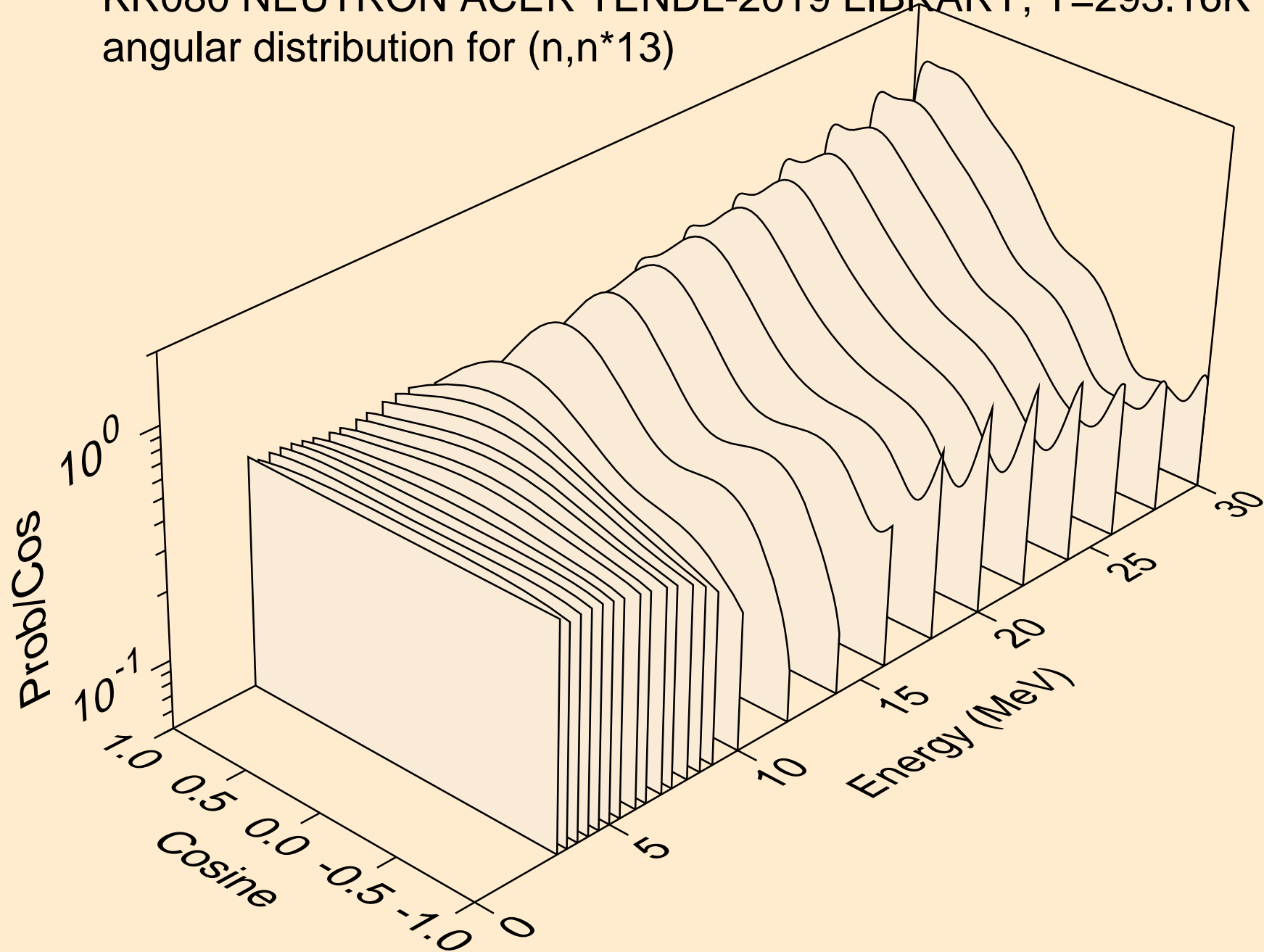

KR080 NEUTRON ACER TENDL-2019 LIBRARY; T=293.16K
angular distribution for (n,n*14)

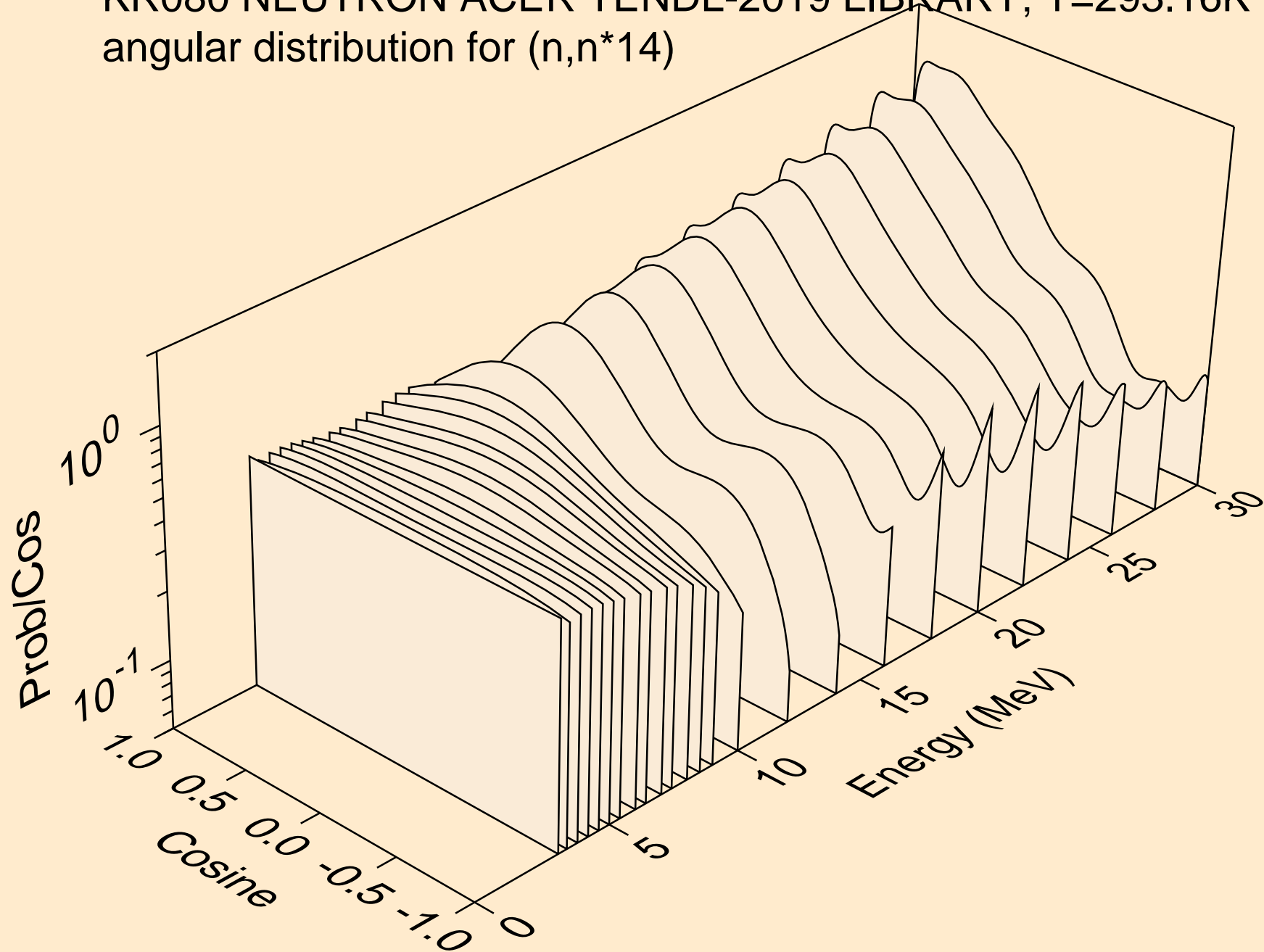

KR080 NEUTRON ACER TENDL-2019 LIBRARY; T=293.16K
angular distribution for (n,n*15)

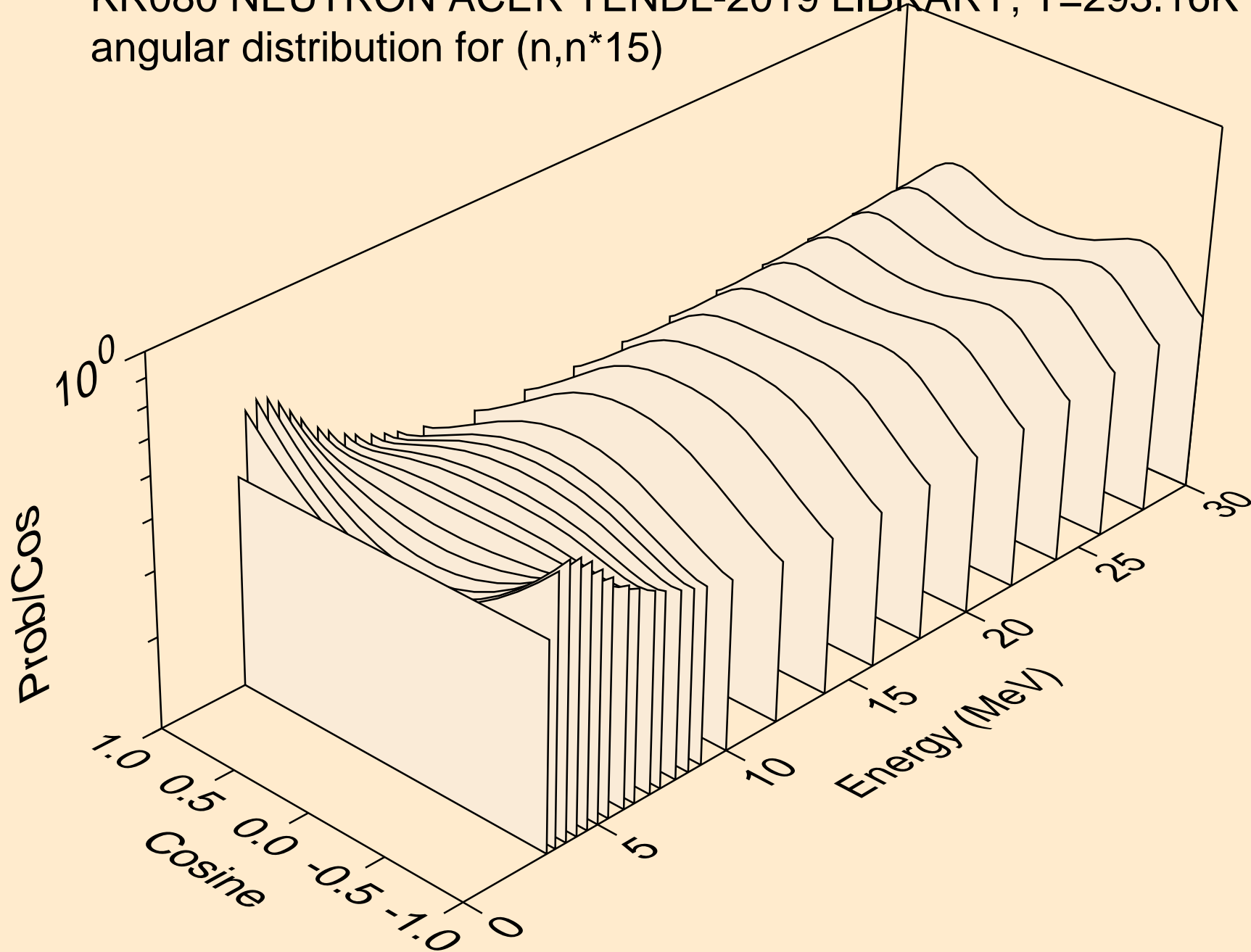

KR080 NEUTRON ACER TENDL-2019 LIBRARY; T=293.16K
angular distribution for (n,n*16)

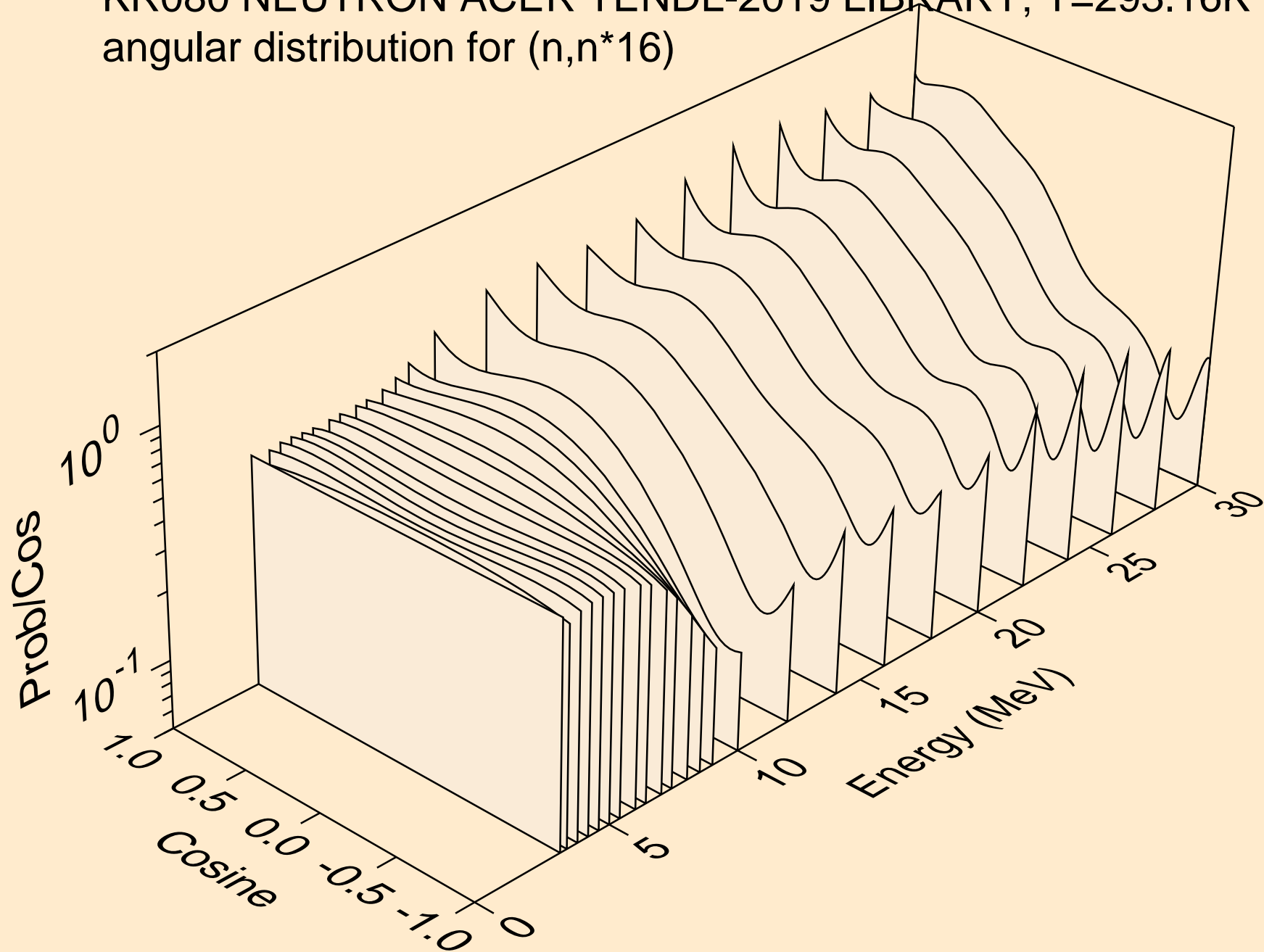

KR080 NEUTRON ACER TENDL-2019 LIBRARY; T=293.16K
angular distribution for (n,n*17)

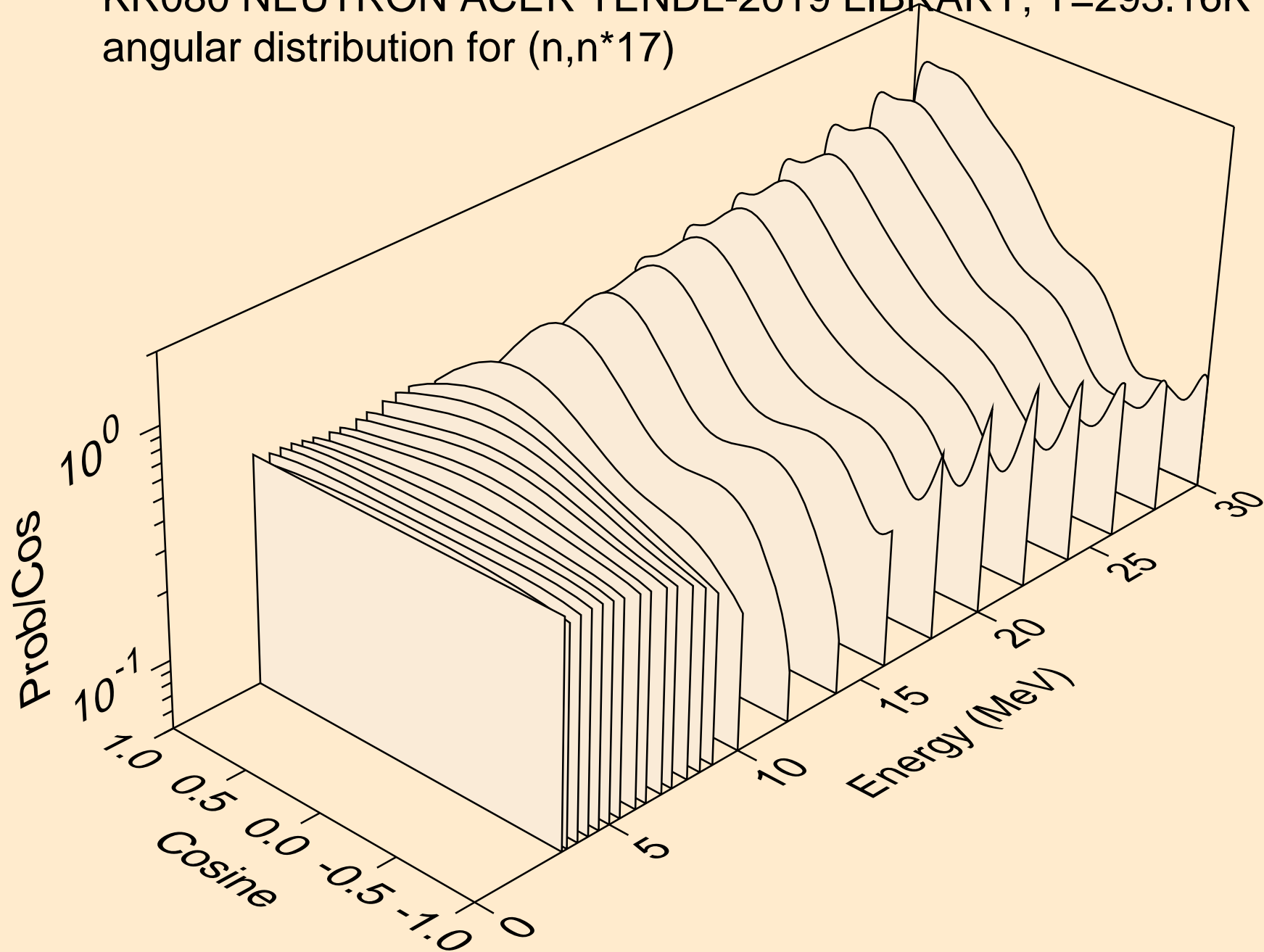

KR080 NEUTRON ACER TENDL-2019 LIBRARY; T=293.16K
Neutron emission for (n,x)

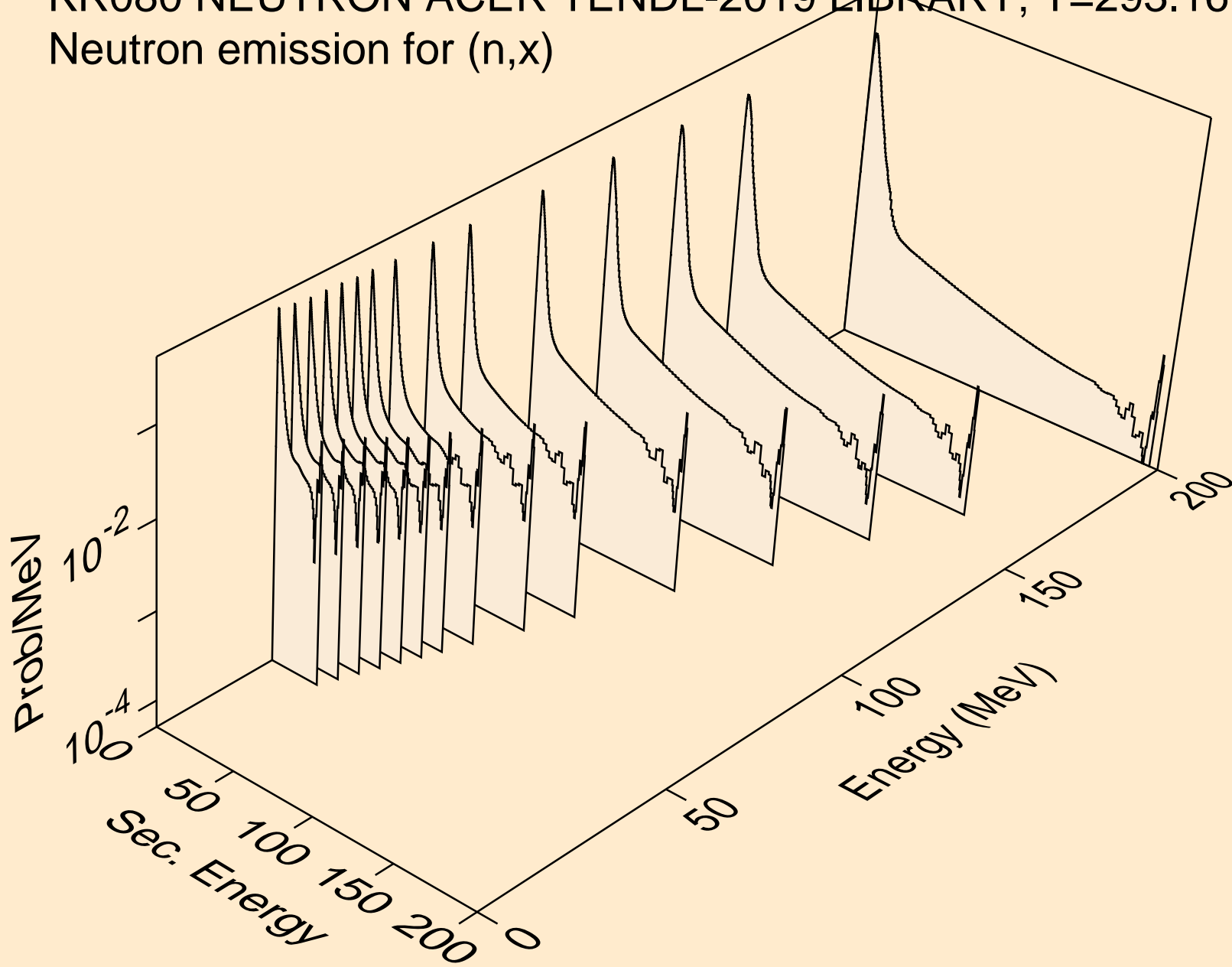

KR080 NEUTRON ACER TENDL-2019 LIBRARY; T=293.16K
Neutron emission for (n,2nd)

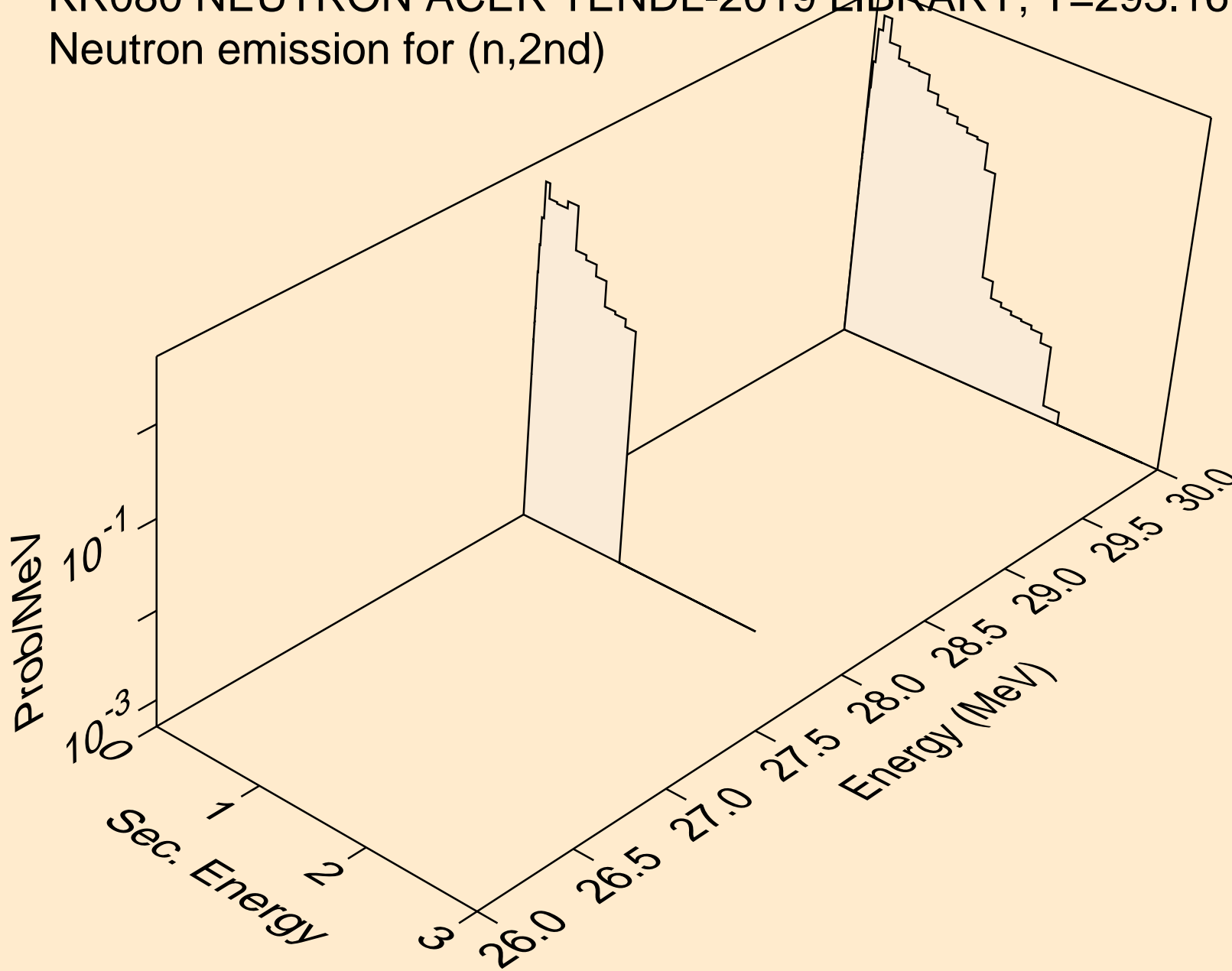

KR080 NEUTRON ACER TENDL-2019 LIBRARY; T=293.16K
Neutron emission for (n,2n)

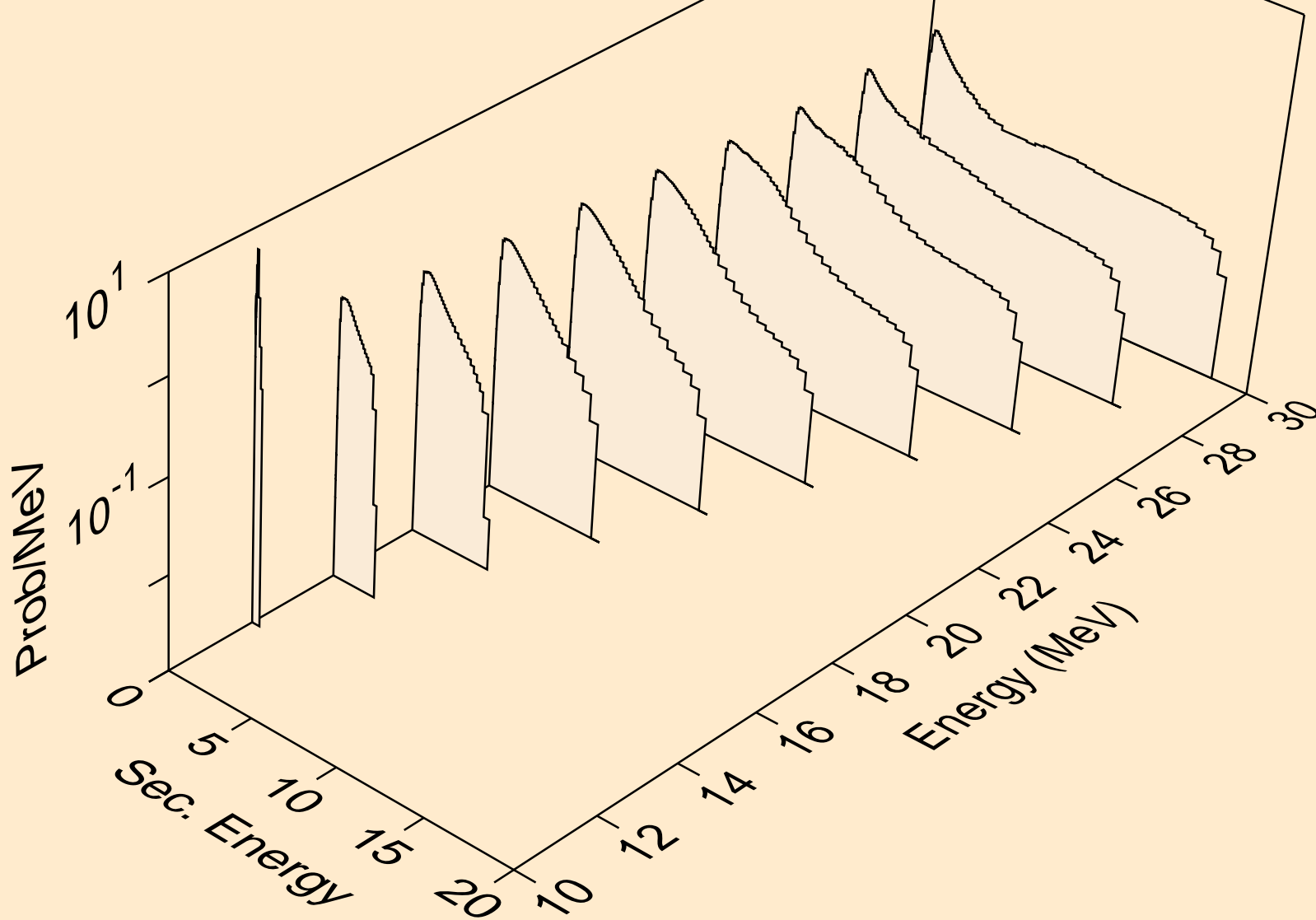

KR080 NEUTRON ACER TENDL-2019 LIBRARY; T=293.16K
Neutron emission for (n,3n)

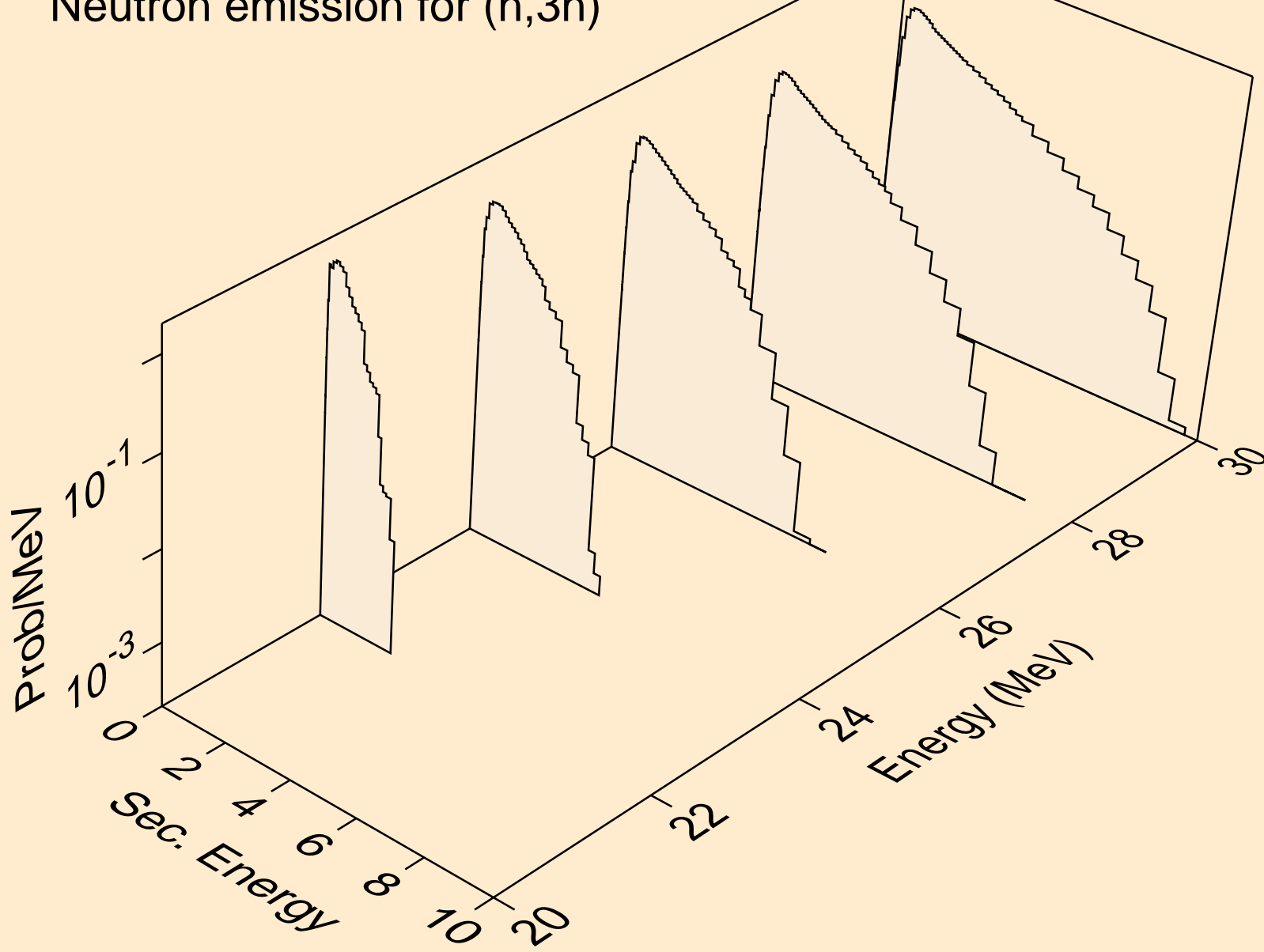

KR080 NEUTRON ACER TENDL-2019 LIBRARY; T=293.16K
Neutron emission for (n,n*)a

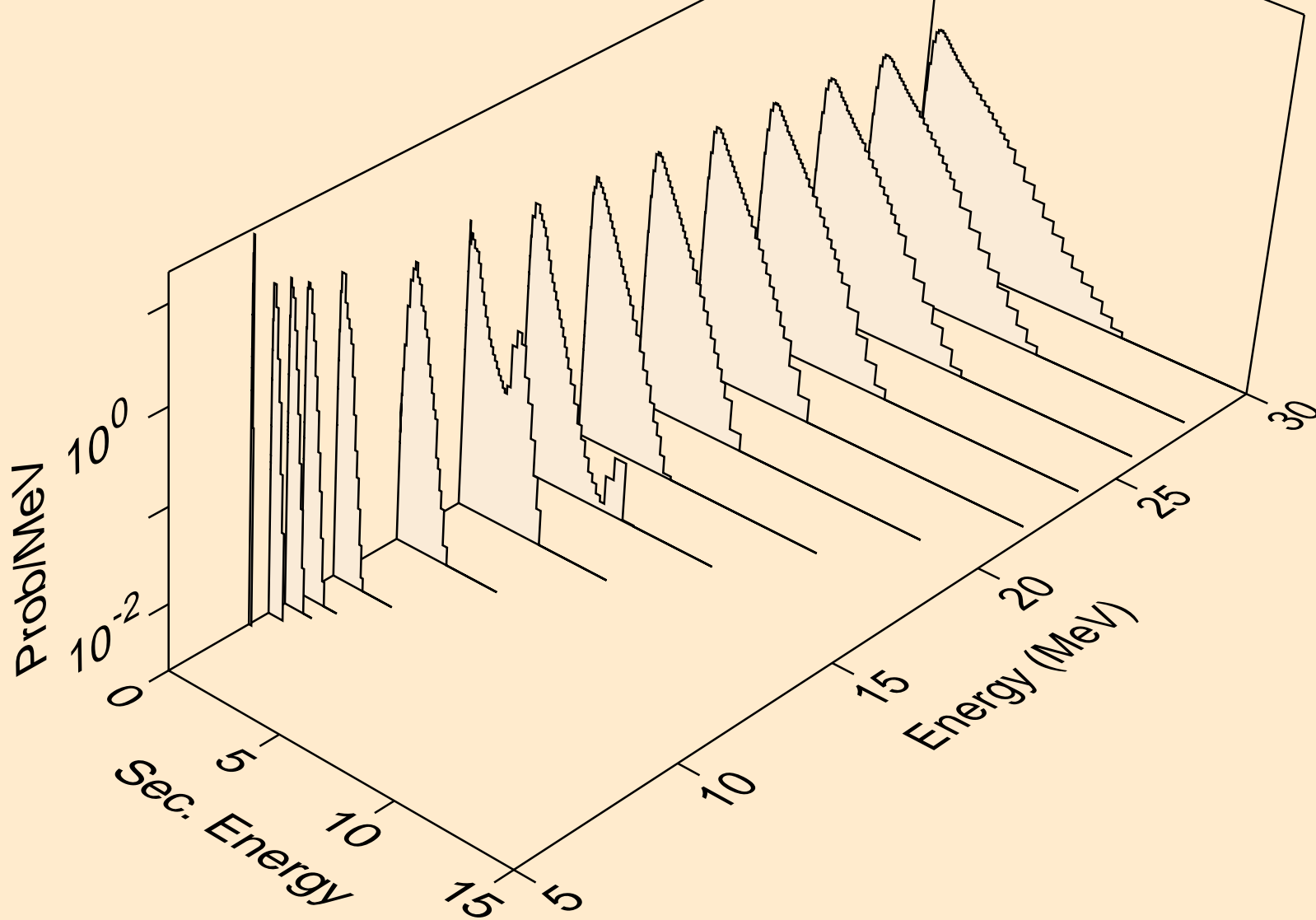

KR080 NEUTRON ACER TENDL-2019 LIBRARY; T=293.16K
Neutron emission for (n,2n)a

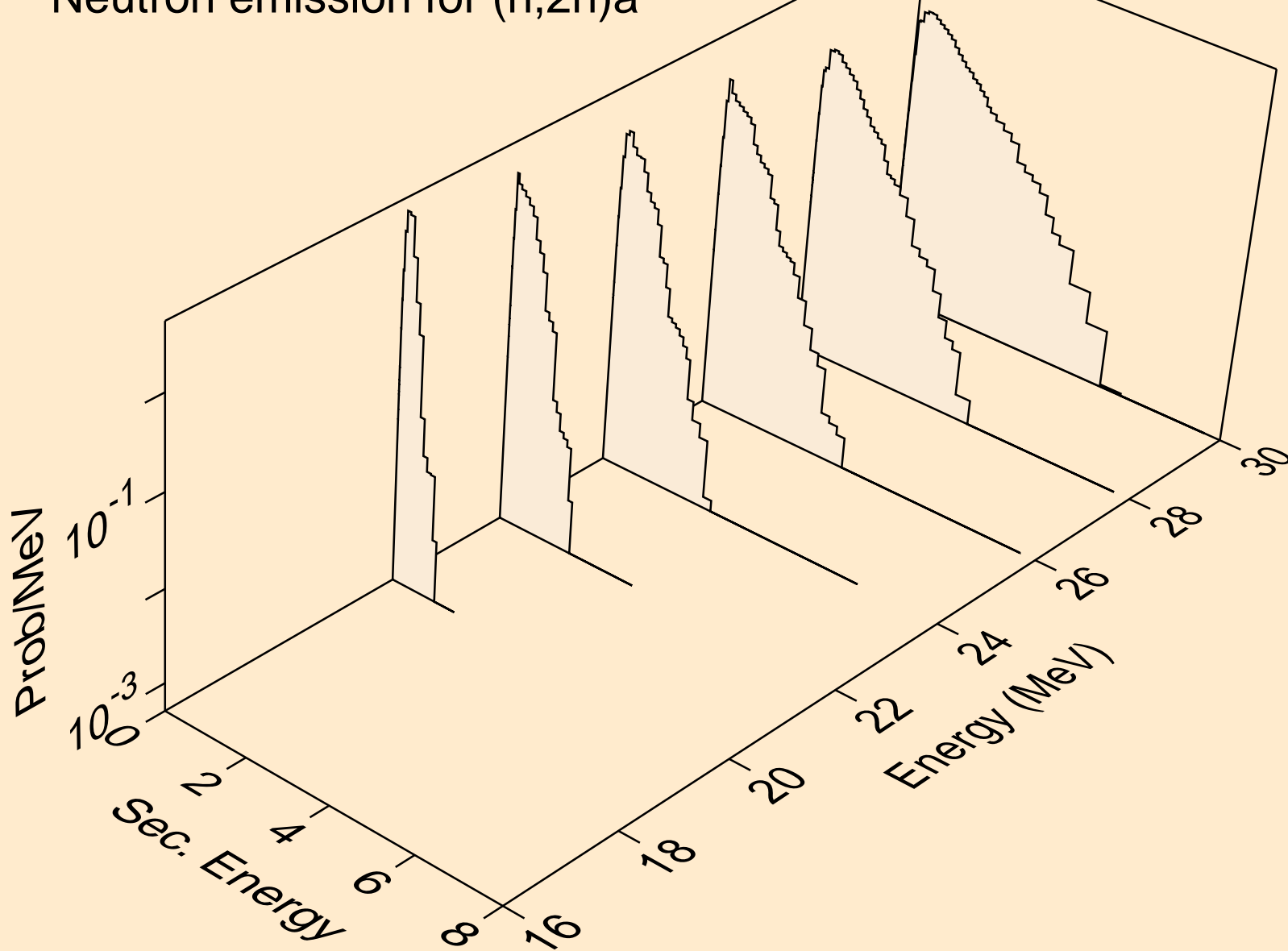

KR080 NEUTRON ACER TENDL-2019 LIBRARY; T=293.16K
Neutron emission for (n,3n)a

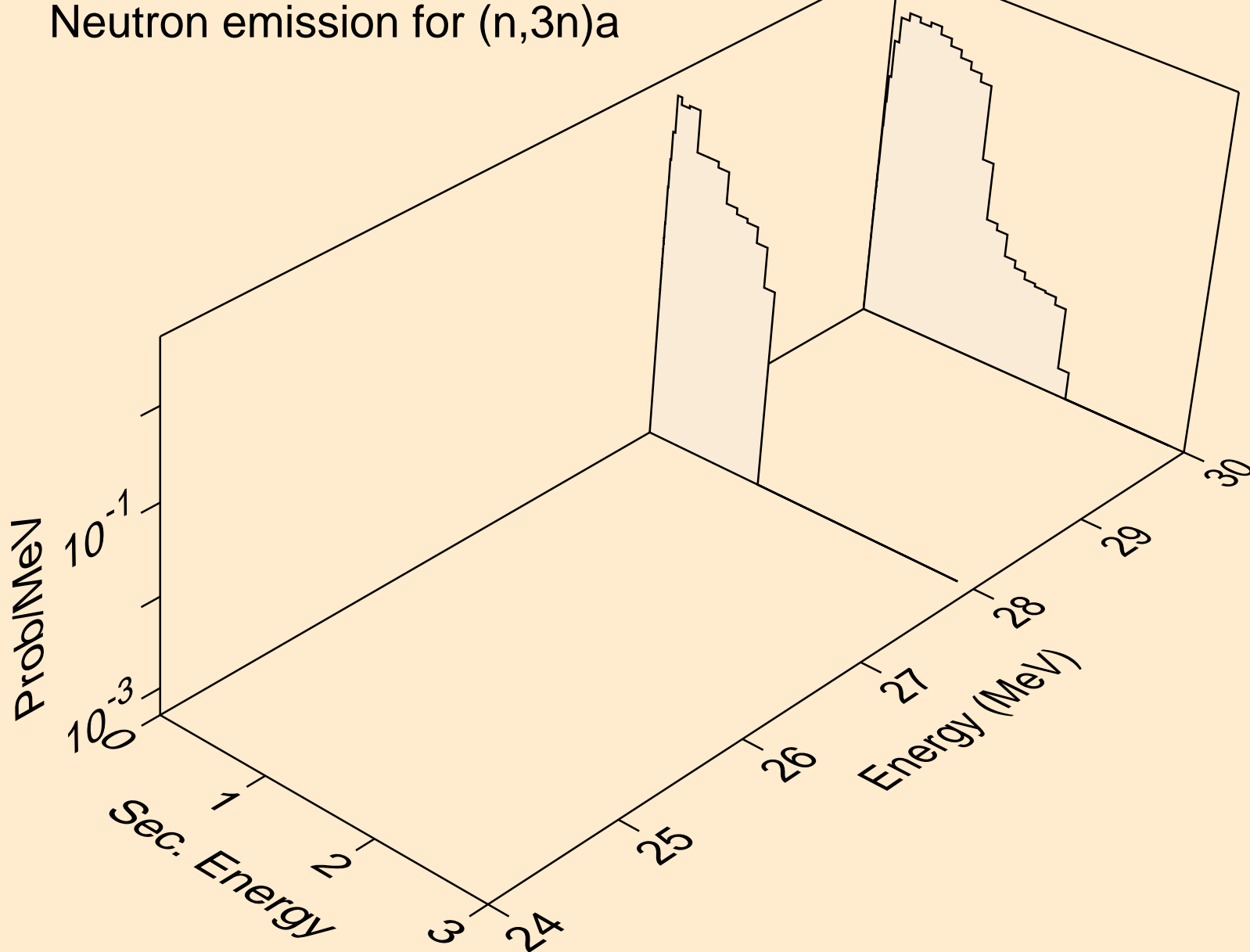

KR080 NEUTRON ACER TENDL-2019 LIBRARY; T=293.16K
Neutron emission for (n,n*)p

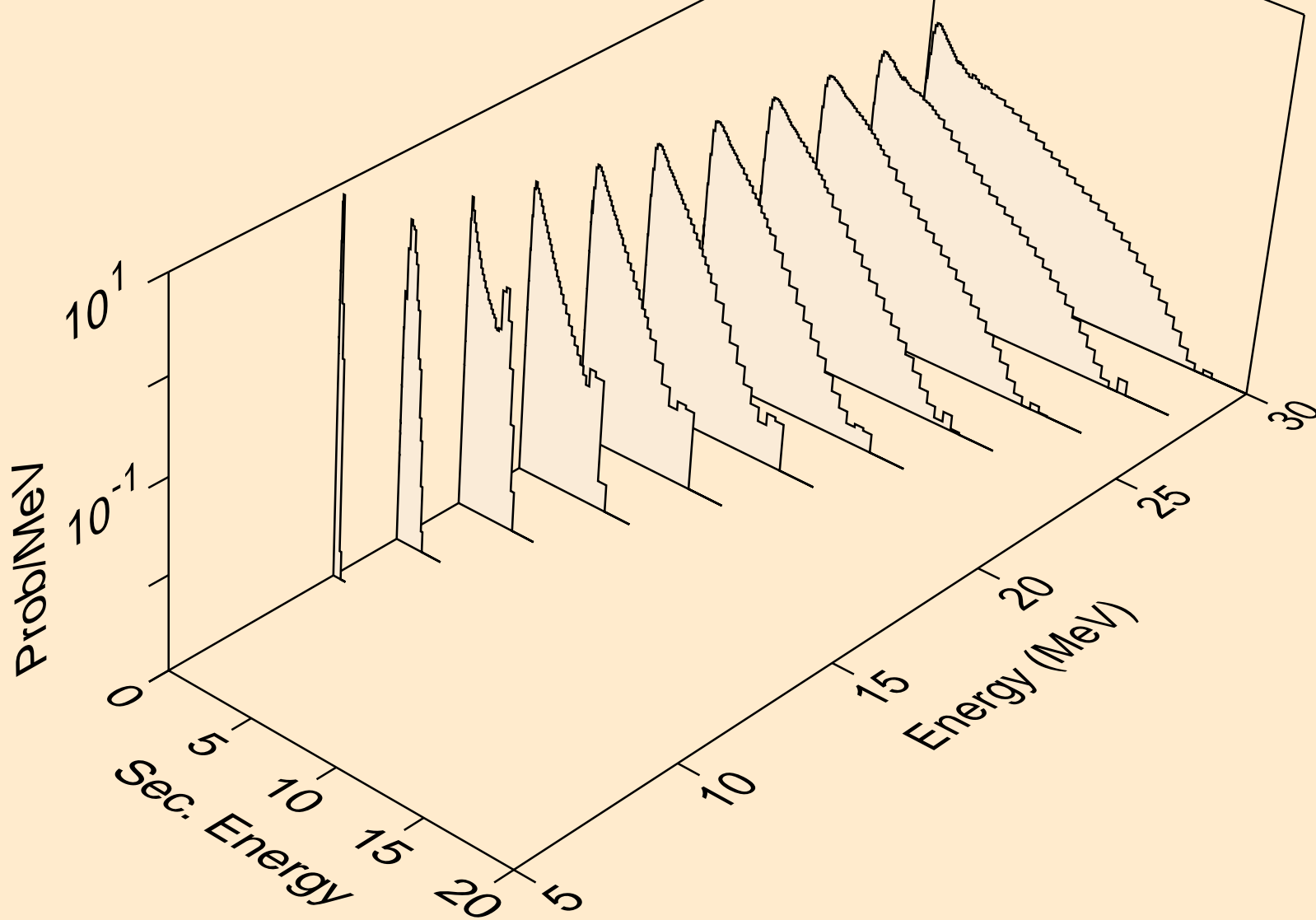

KR080 NEUTRON ACER TENDL-2019 LIBRARY; T=293.16K
Neutron emission for (n,n*)2a

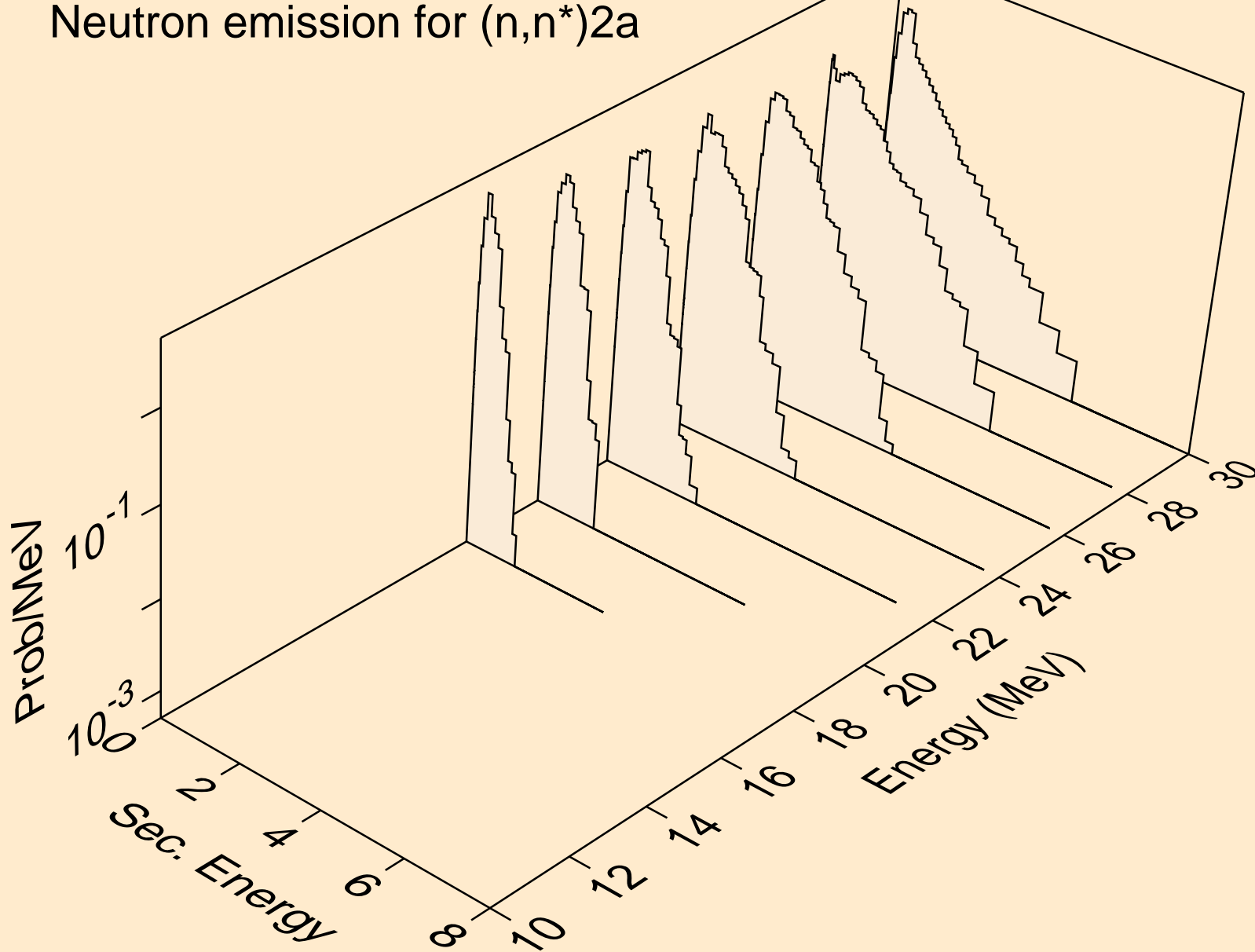

KR080 NEUTRON ACER TENDL-2019 LIBRARY; T=293.16K
Neutron emission for (n,n*)d

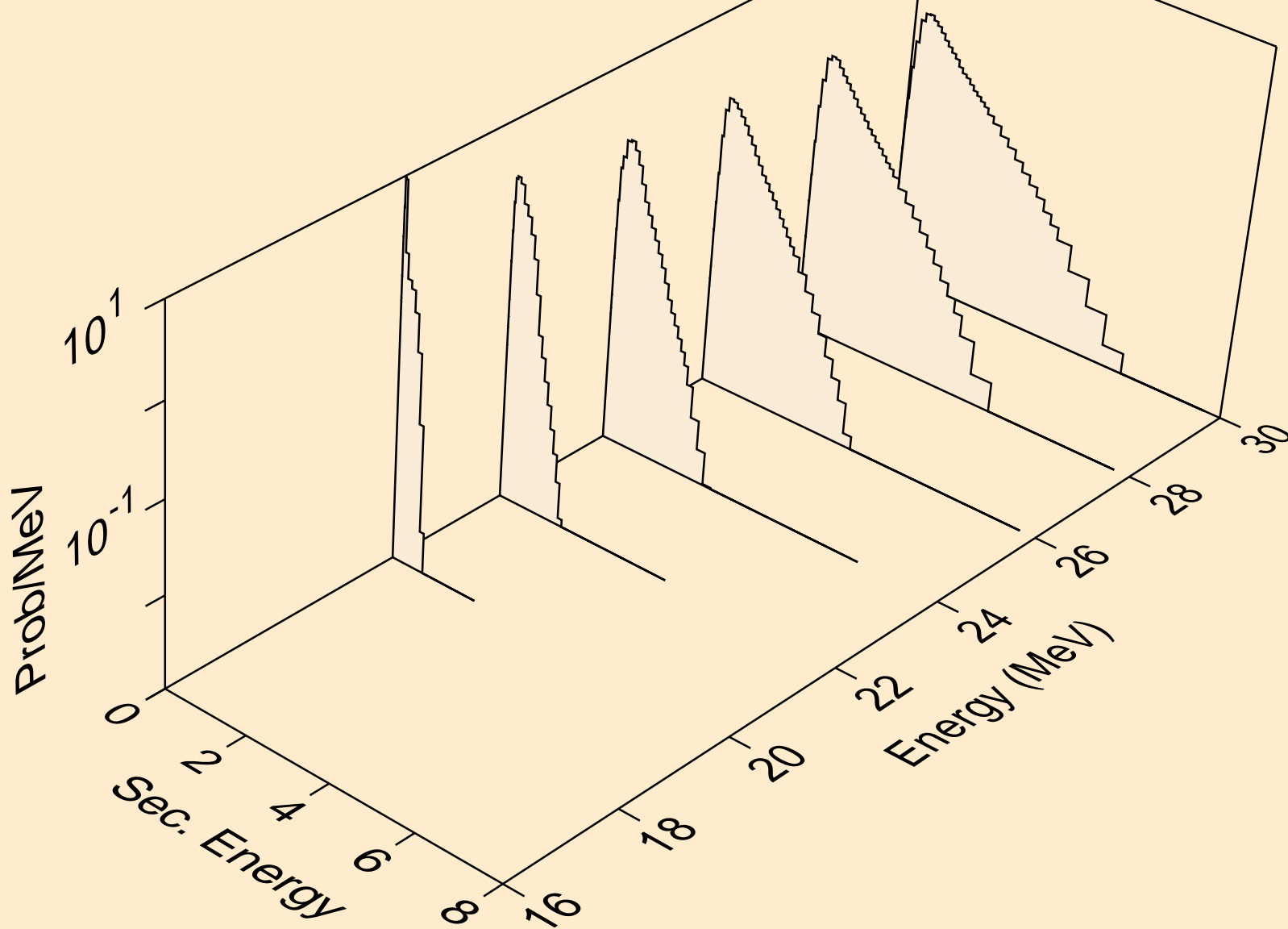

KR080 NEUTRON ACER TENDL-2019 LIBRARY; T=293.16K
Neutron emission for (n,n*)t

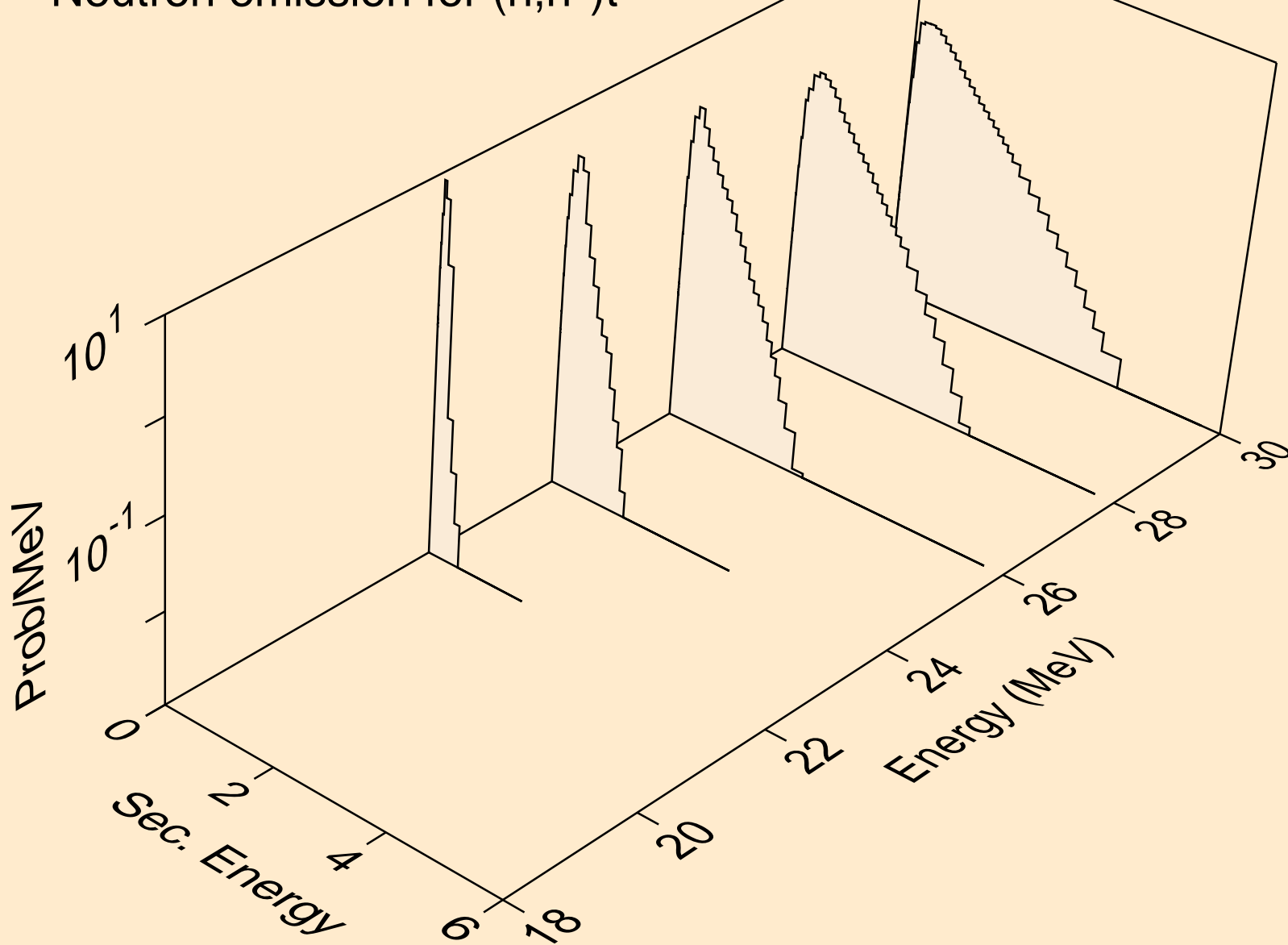

KR080 NEUTRON ACER TENDL-2019 LIBRARY; T=293.16K
Neutron emission for (n,n*)he3

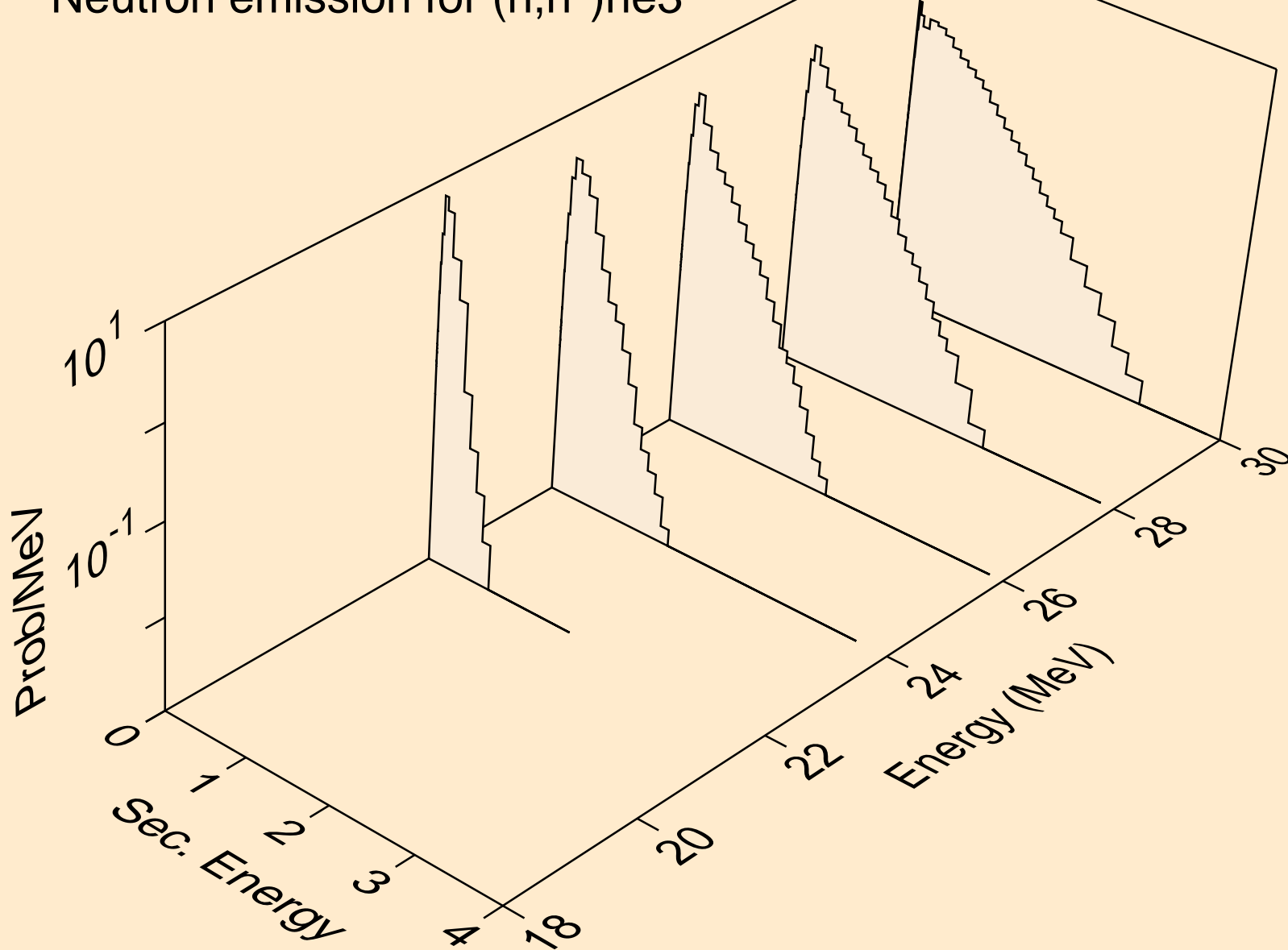

KR080 NEUTRON ACER TENDL-2019 LIBRARY; T=293.16K
Neutron emission for (n,2np)

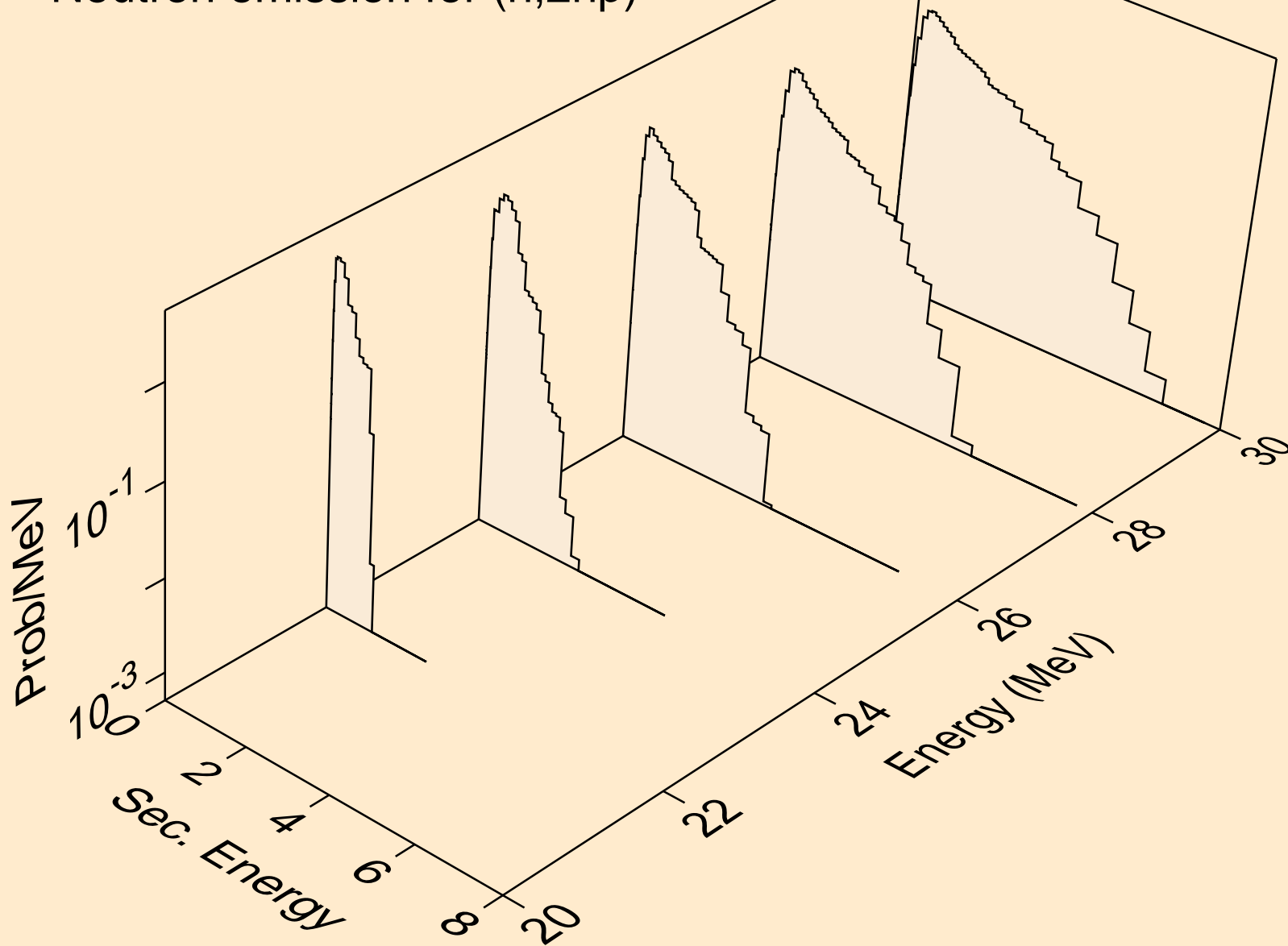

KR080 NEUTRON ACER TENDL-2019 LIBRARY; T=293.16K
Neutron emission for (n,3np)

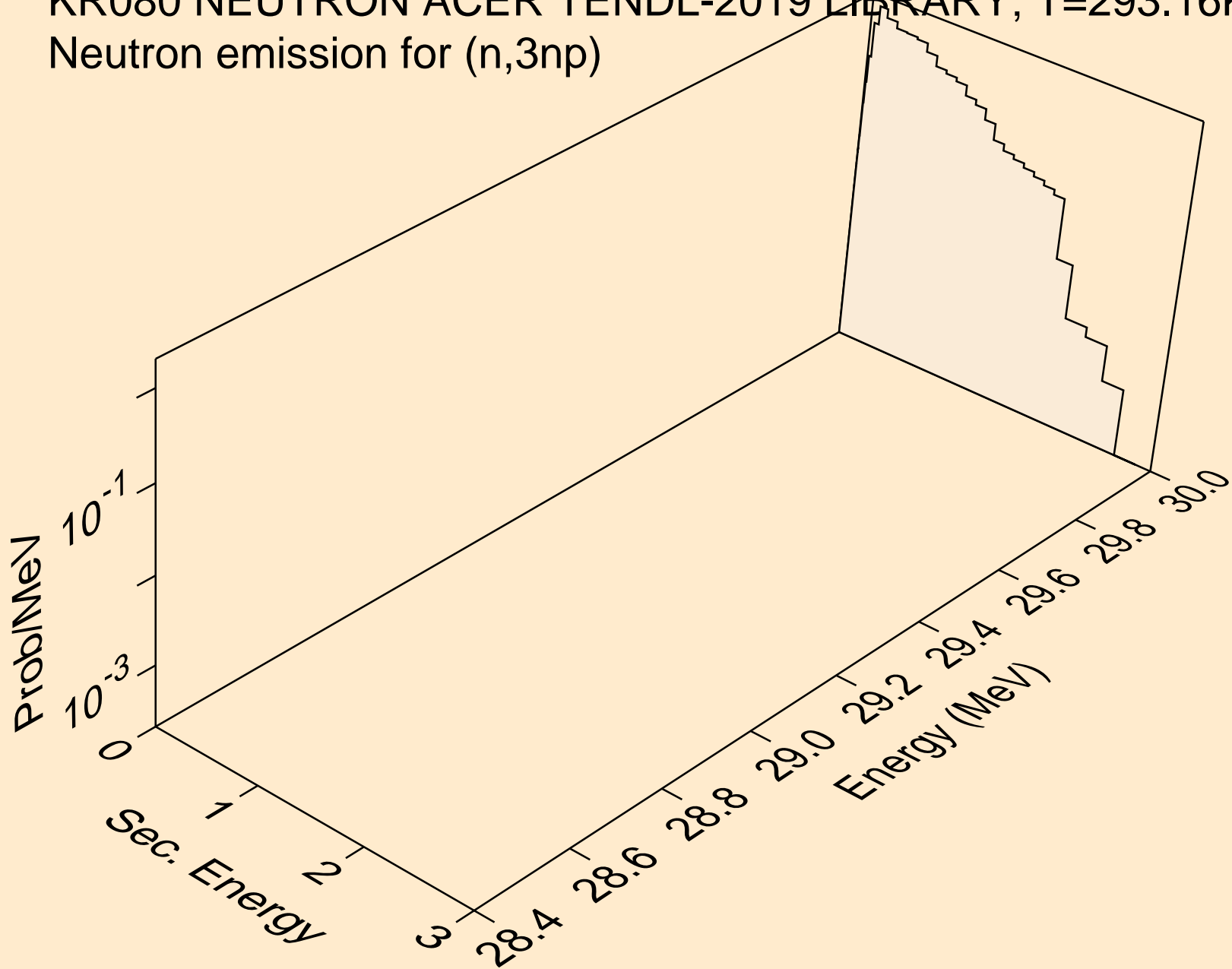

KR080 NEUTRON ACER TENDL-2019 LIBRARY; T=293.16K
Neutron emission for (n,2np)

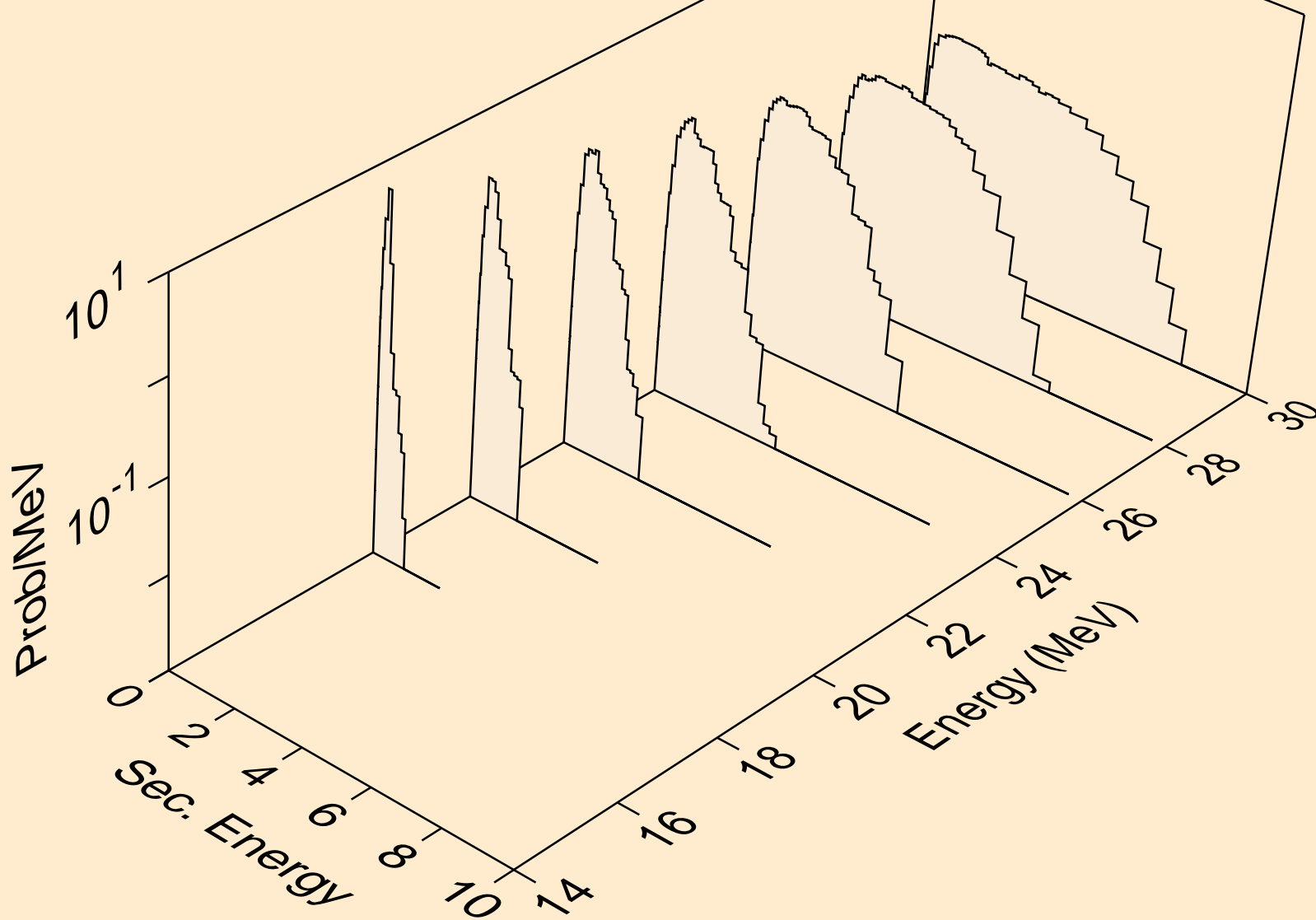

KR080 NEUTRON ACER TENDL-2019 LIBRARY; T=293.16K
Neutron emission for (n,npa)

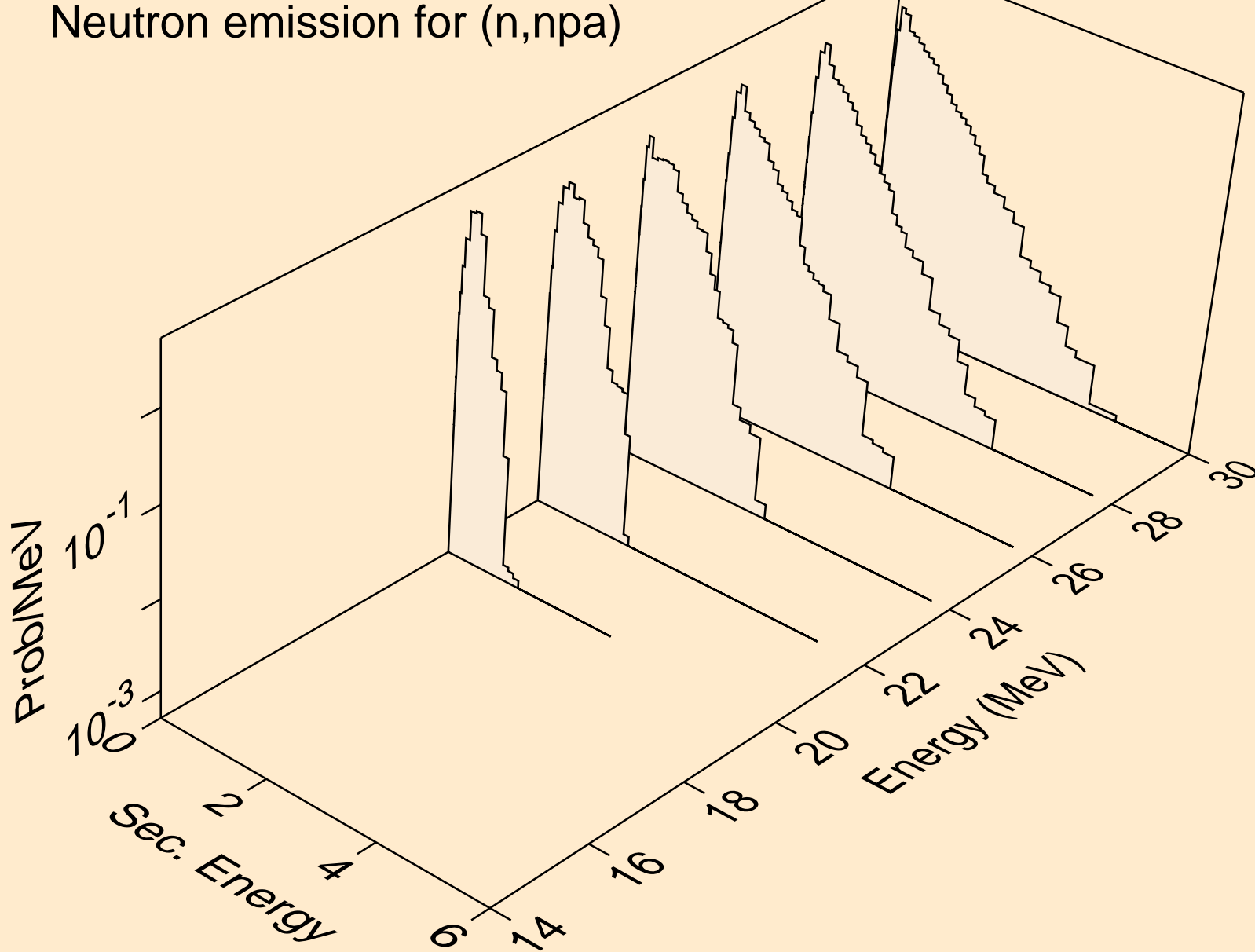

KR080 NEUTRON ACER TENDL-2019 LIBRARY; T=293.16K
Neutron emission for (n,n*c)

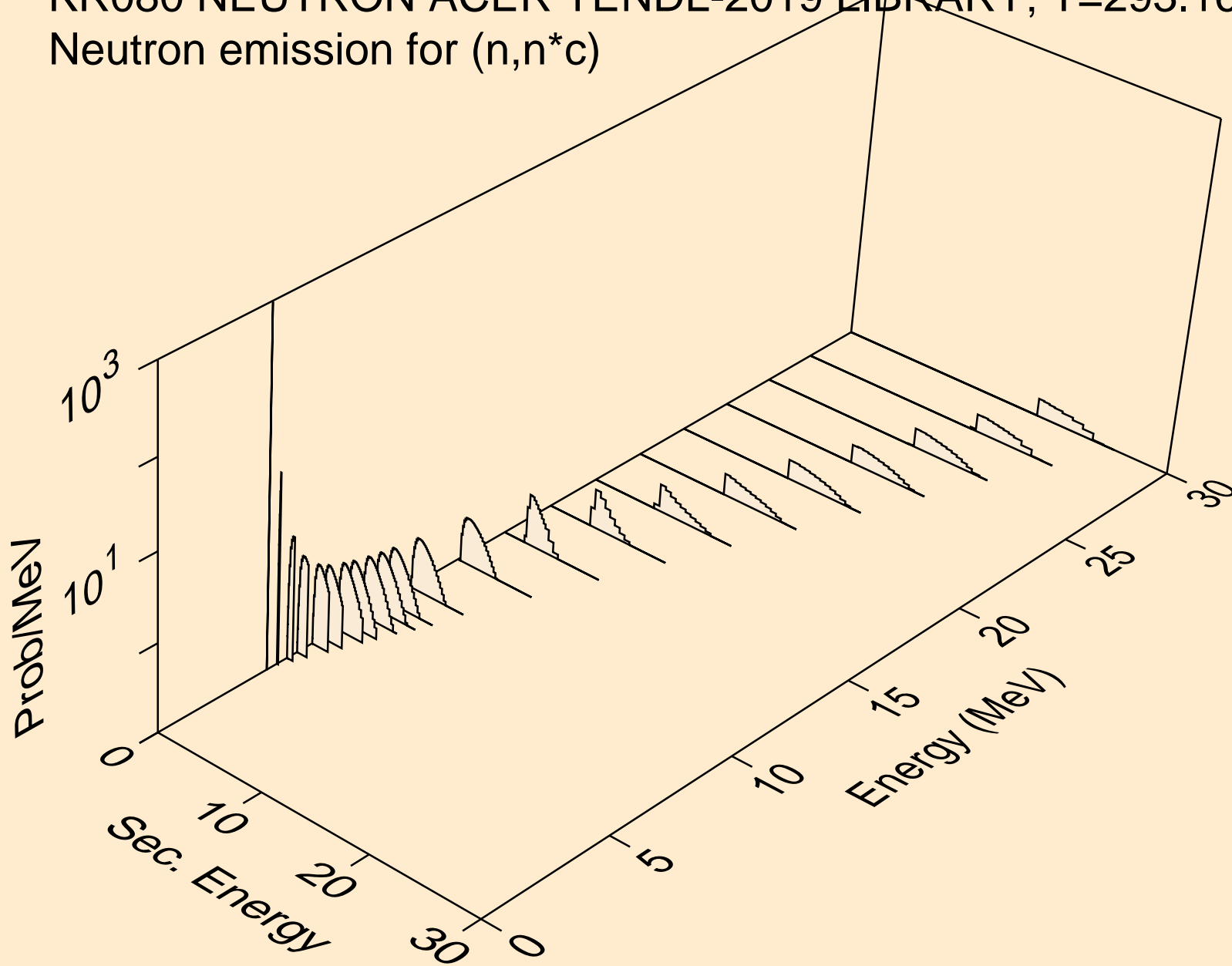

KR080 NEUTRON ACER TENDL-2019 LIBRARY; T=293.16K
Photon emission for (n,x)

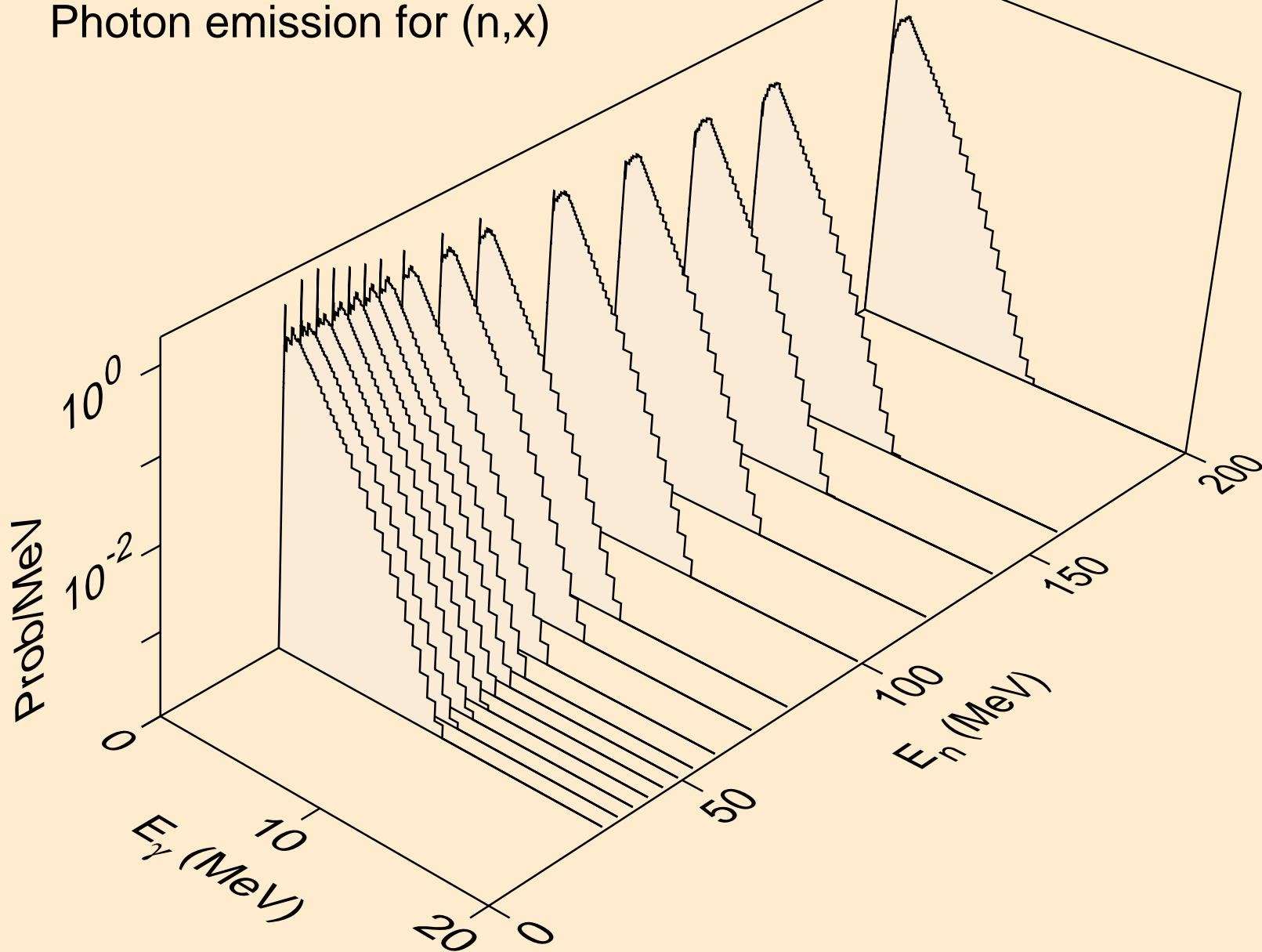

KR080 NEUTRON ACER TENDL-2019 LIBRARY; T=293.16K
Photon emission for (n,2nd)

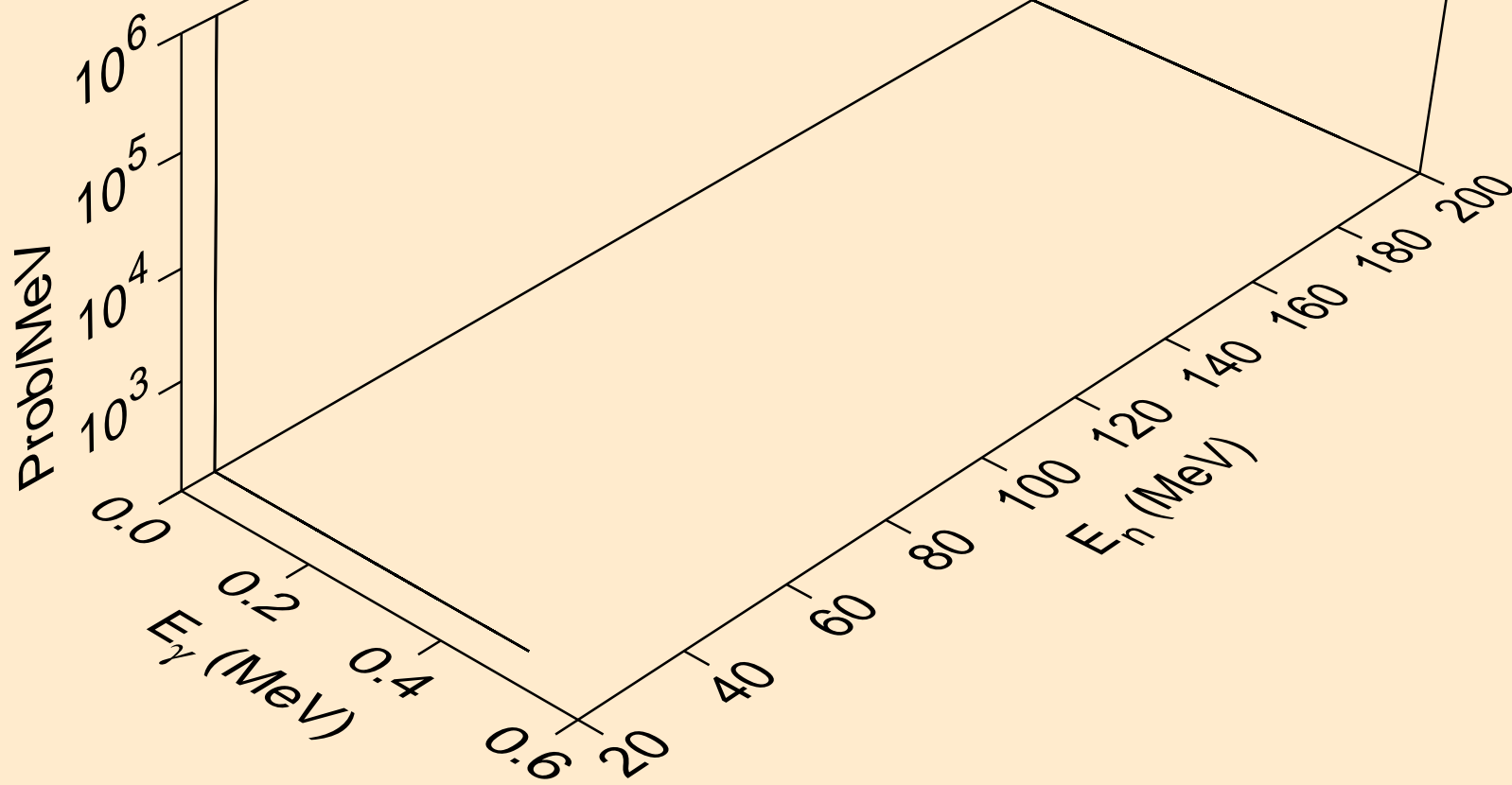

KR080 NEUTRON ACER TENDL-2019 LIBRARY; T=293.16K
Photon emission for (n,2n)

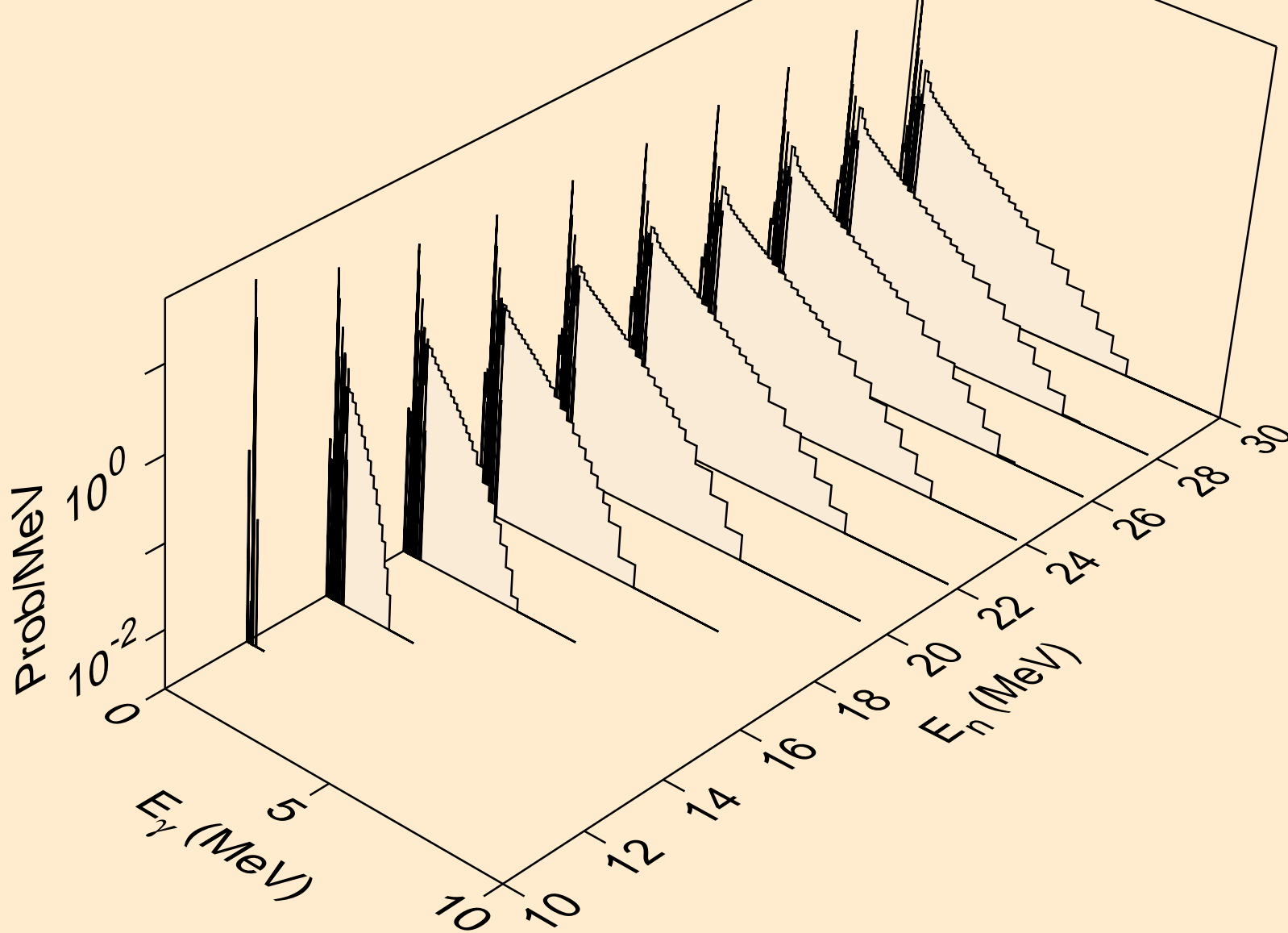

KR080 NEUTRON ACER TENDL-2019 LIBRARY; T=293.16K
Photon emission for (n,3n)

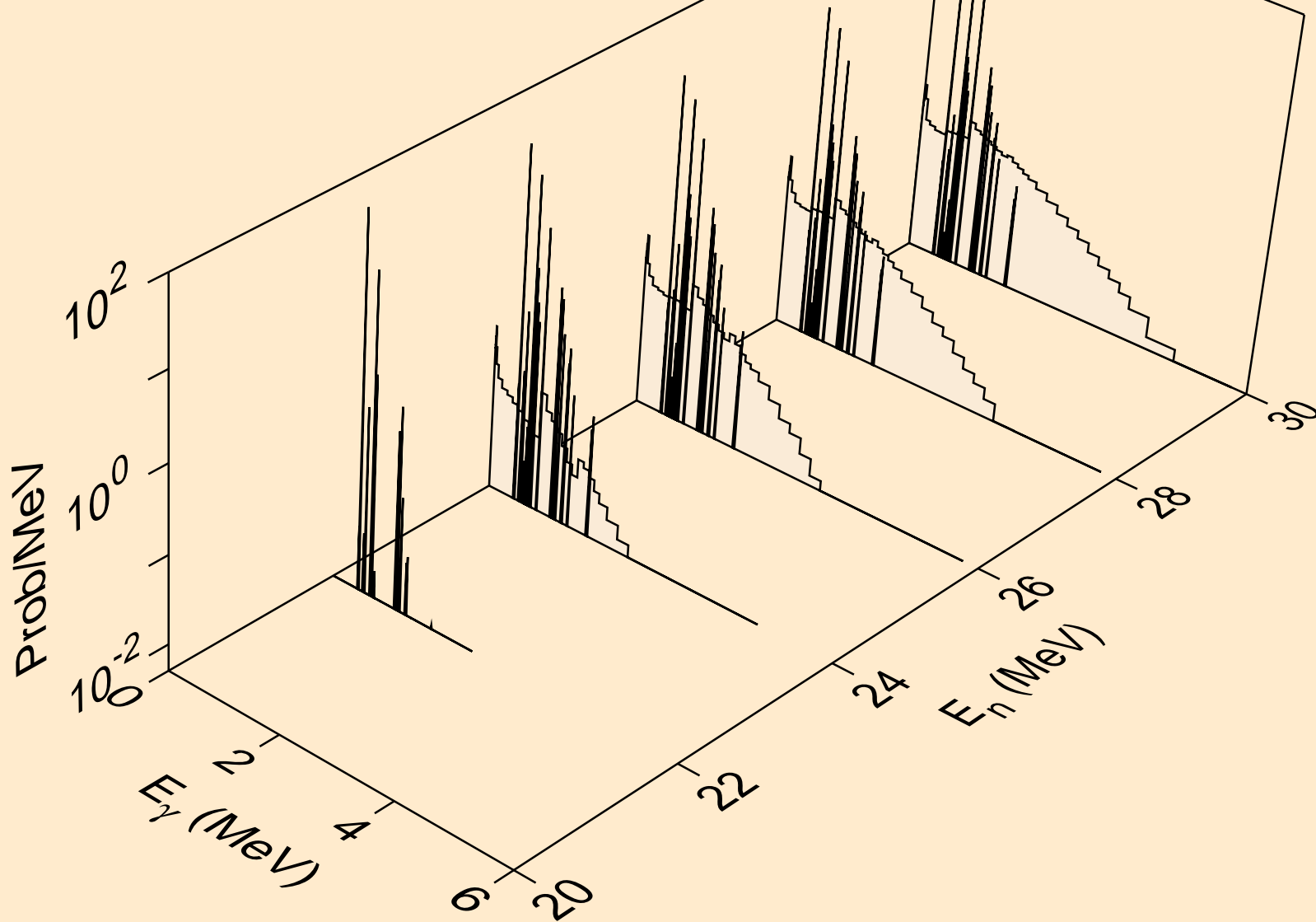

KR080 NEUTRON ACER TENDL-2019 LIBRARY; T=293.16K
Photon emission for (n,n*)a

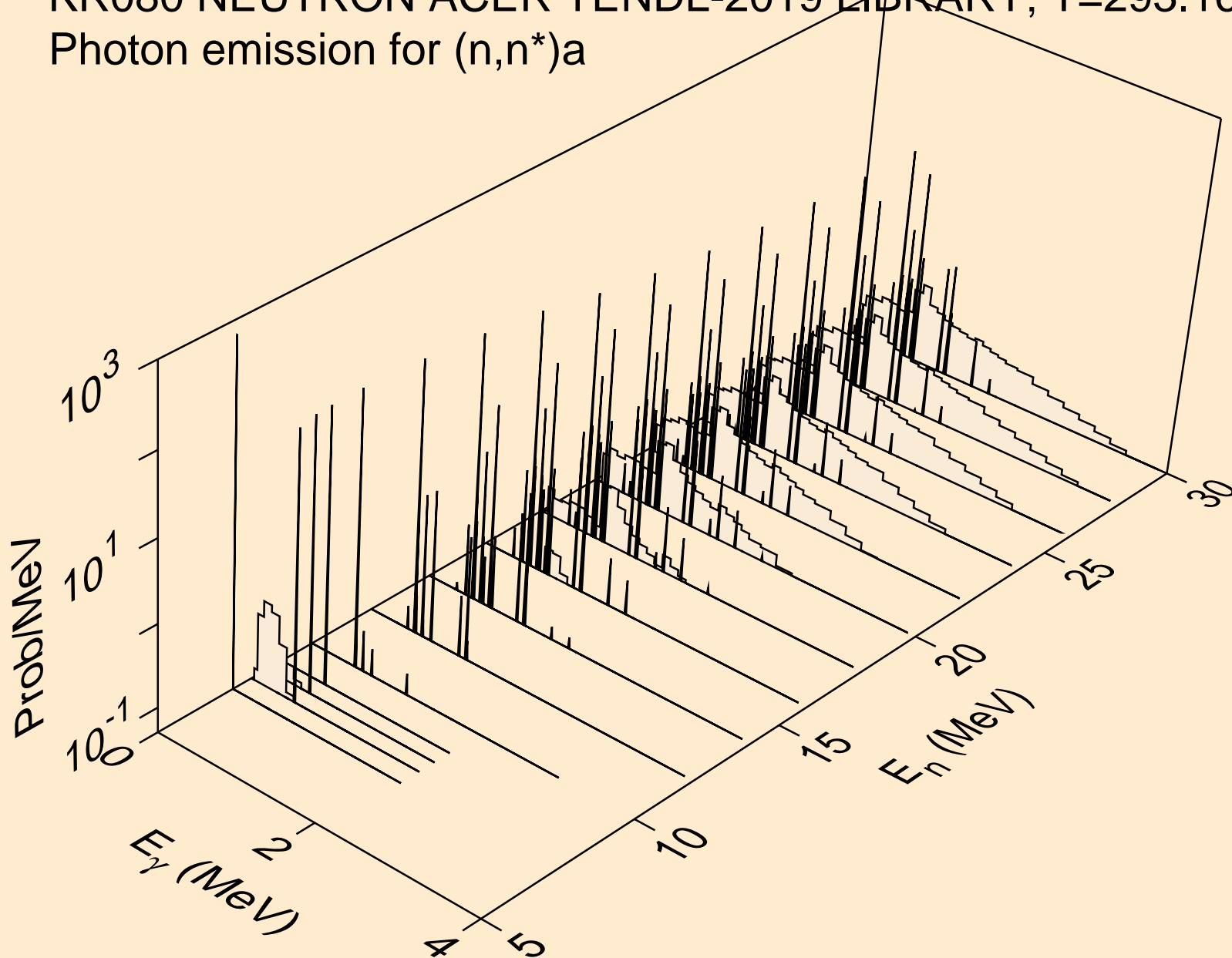

KR080 NEUTRON ACER TENDL-2019 LIBRARY; T=293.16K
Photon emission for (n,2n)a

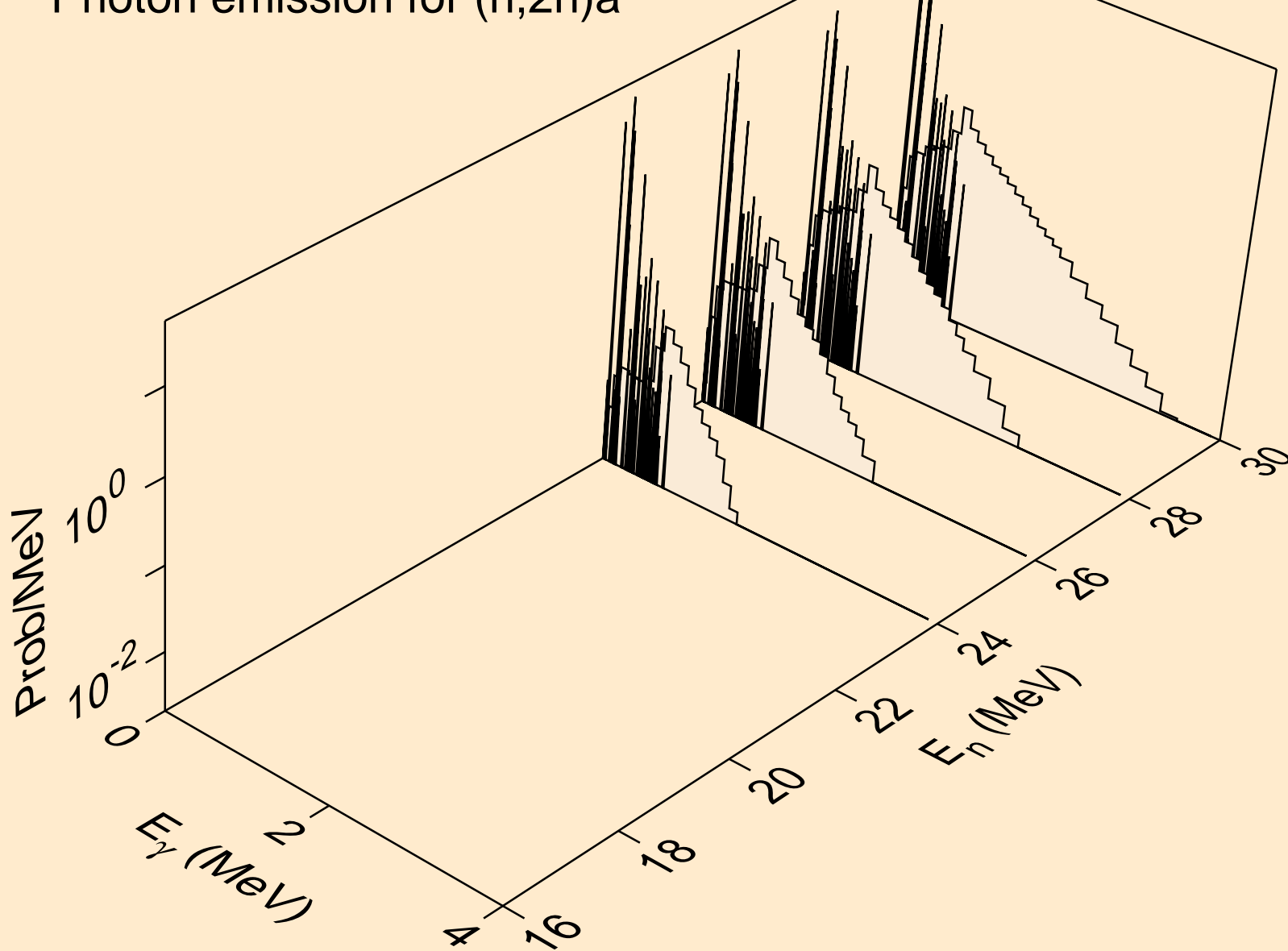

KR080 NEUTRON ACER TENDL-2019 LIBRARY; T=293.16K
Photon emission for (n,3n)a

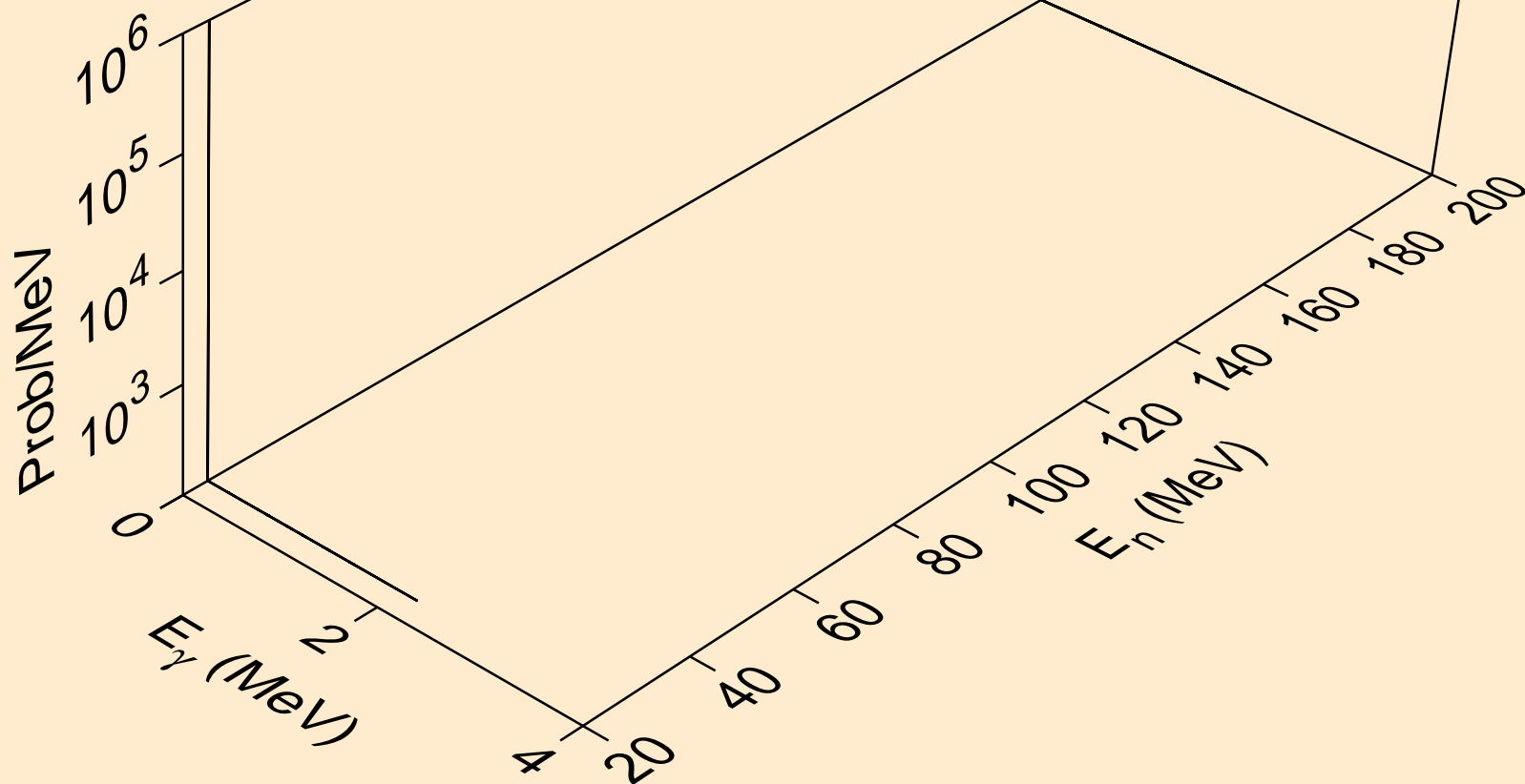

KR080 NEUTRON ACER TENDL-2019 LIBRARY; T=293.16K
Photon emission for (n,n*)p

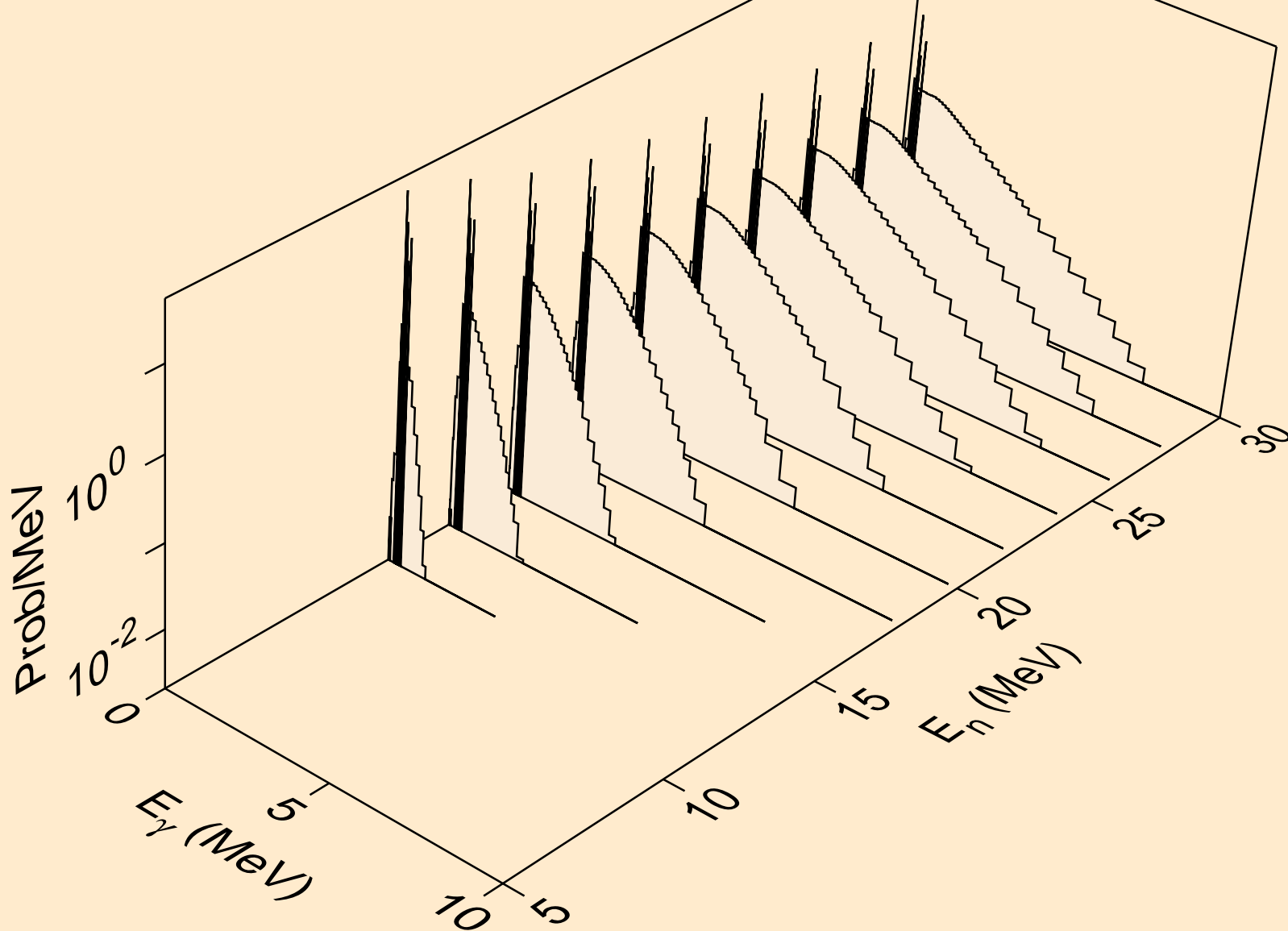

KR080 NEUTRON ACER TENDL-2019 LIBRARY; T=293.16K
Photon emission for (n,n*)2a

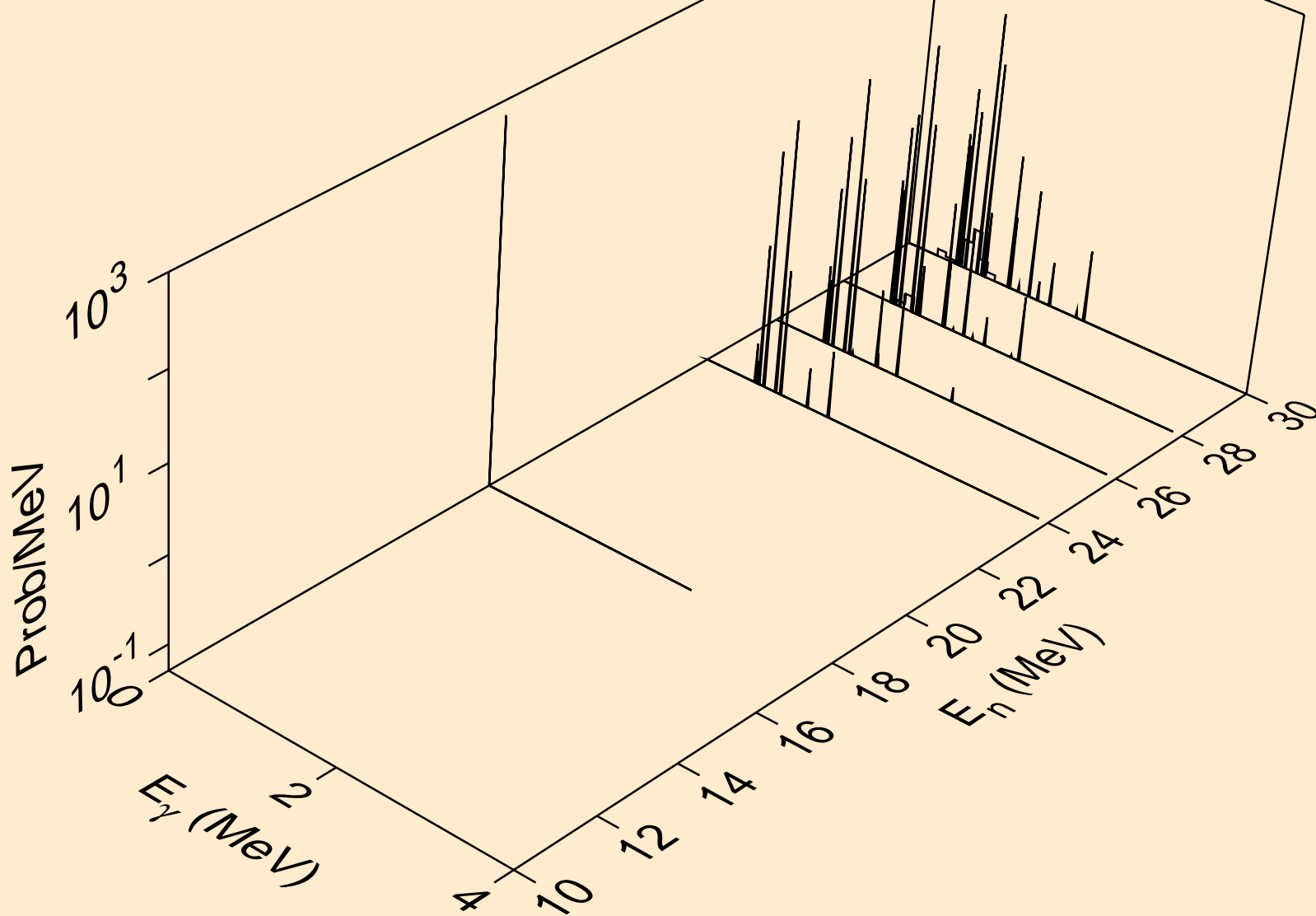

KR080 NEUTRON ACER TENDL-2019 LIBRARY; T=293.16K
Photon emission for (n,n*)d

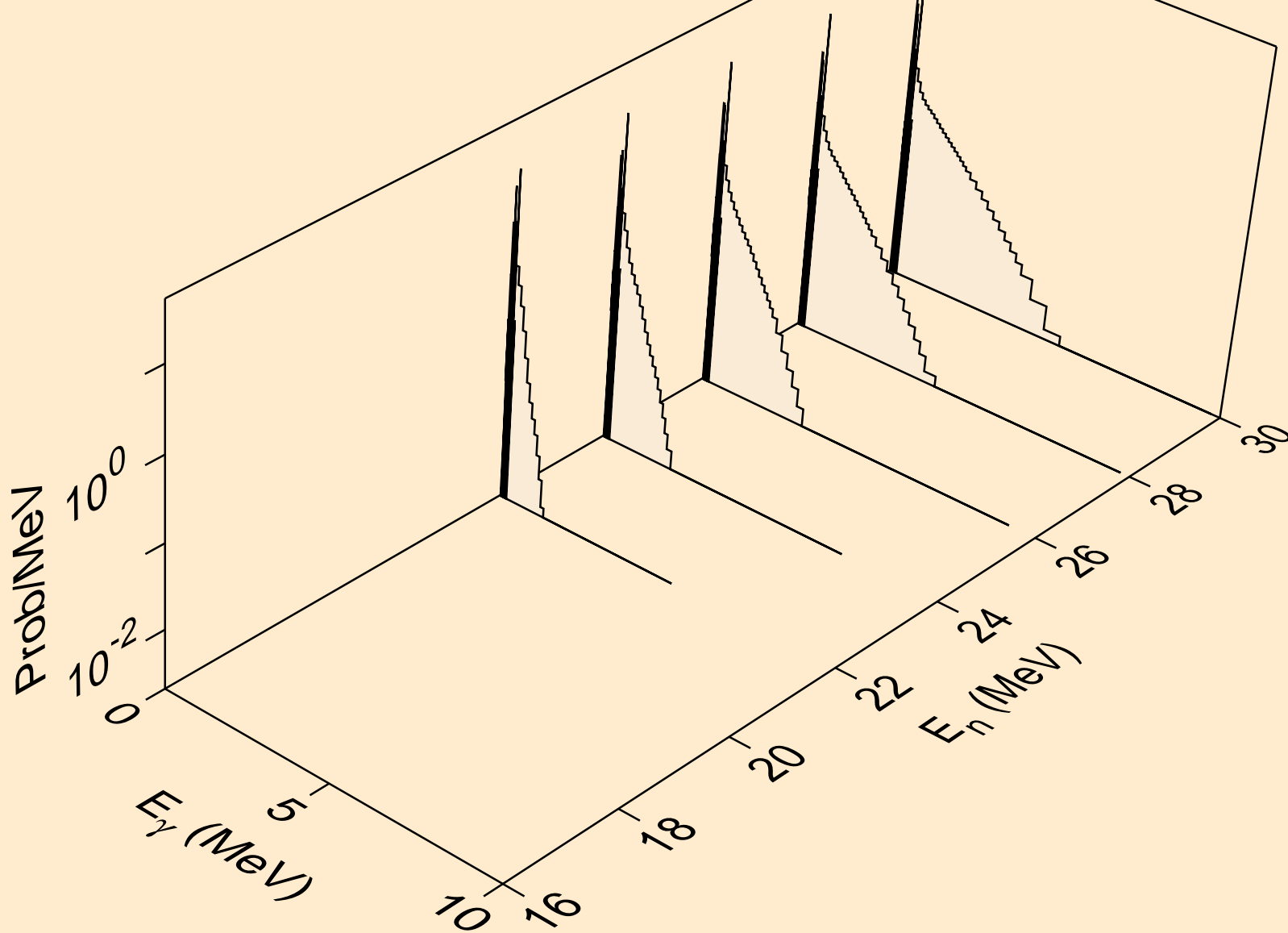

KR080 NEUTRON ACER TENDL-2019 LIBRARY; T=293.16K
Photon emission for (n,n*)t

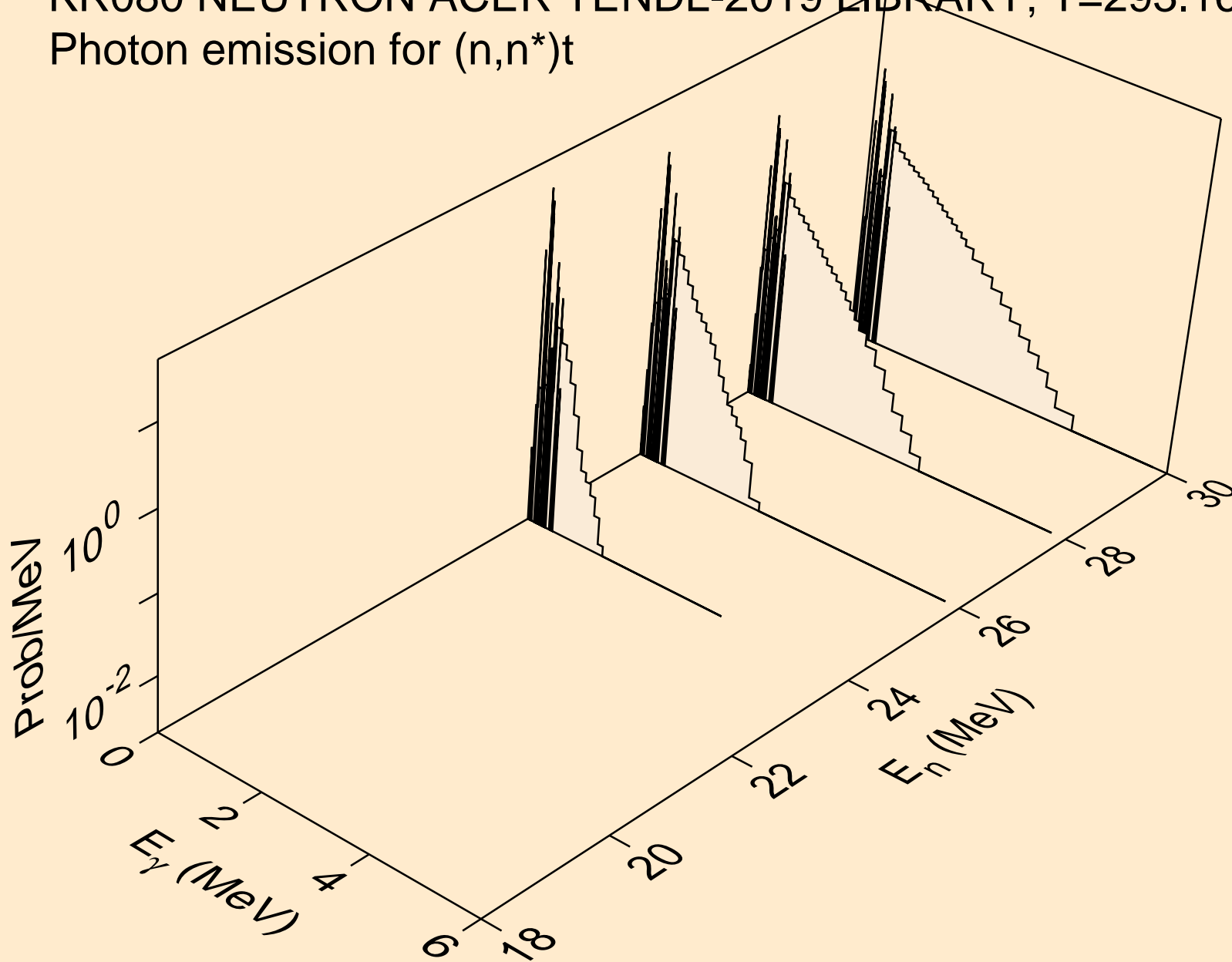

KR080 NEUTRON ACER TENDL-2019 LIBRARY; T=293.16K
Photon emission for (n,n*)he3

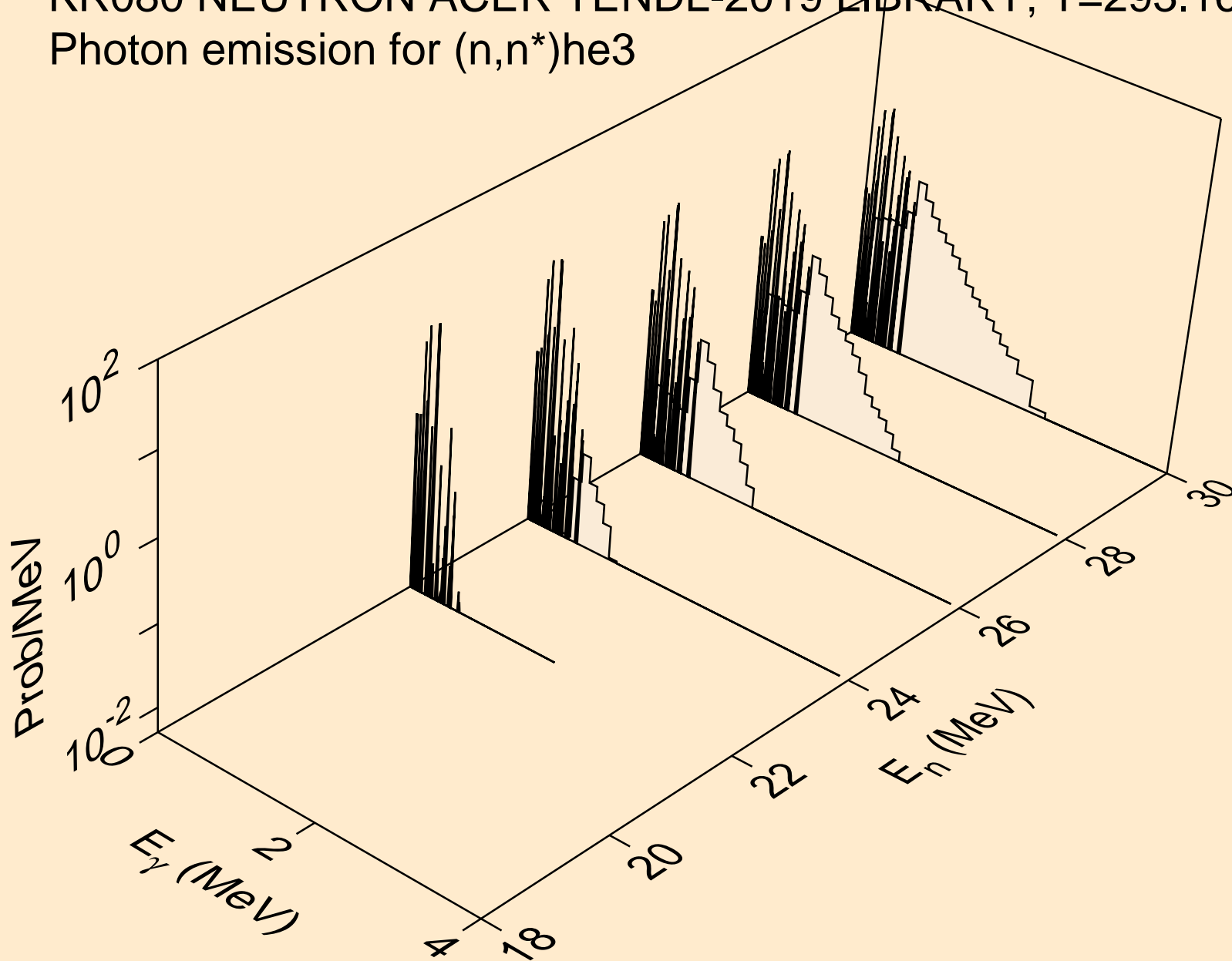

KR080 NEUTRON ACER TENDL-2019 LIBRARY; T=293.16K
Photon emission for (n,2np)

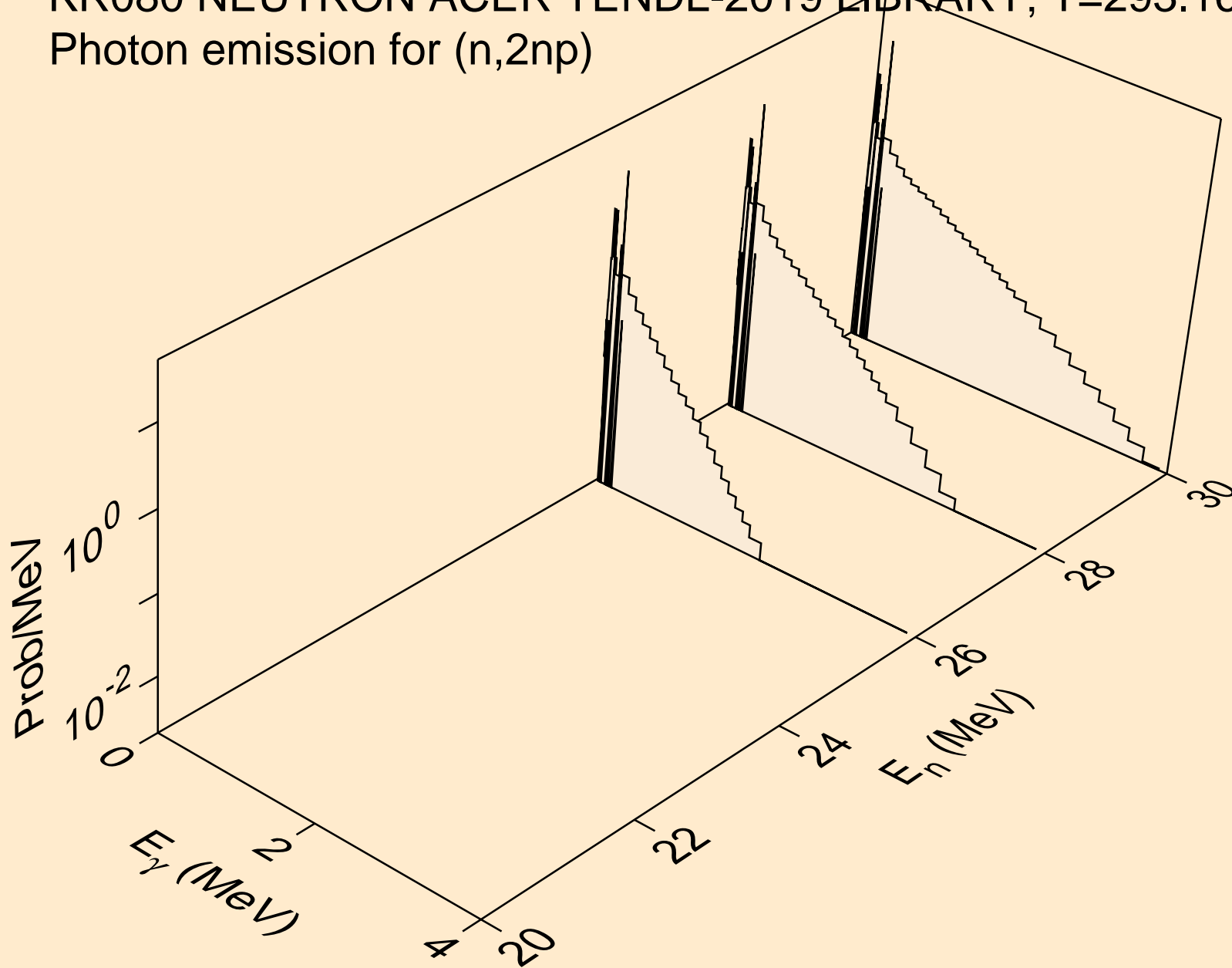

KR080 NEUTRON ACER TENDL-2019 LIBRARY; T=293.16K
Photon emission for (n,3np)

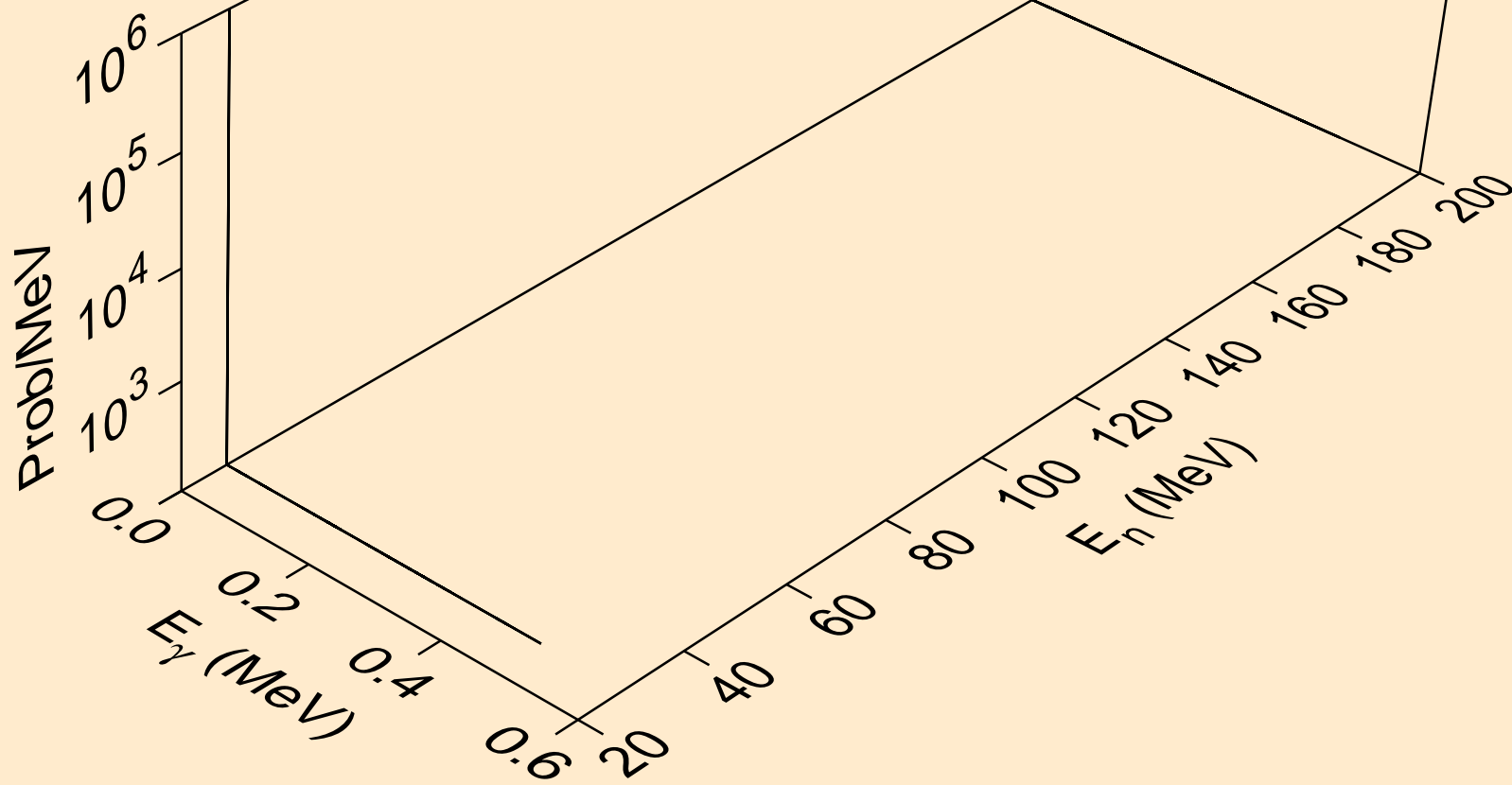

KR080 NEUTRON ACER TENDL-2019 LIBRARY; T=293.16K
Photon emission for (n,2np)

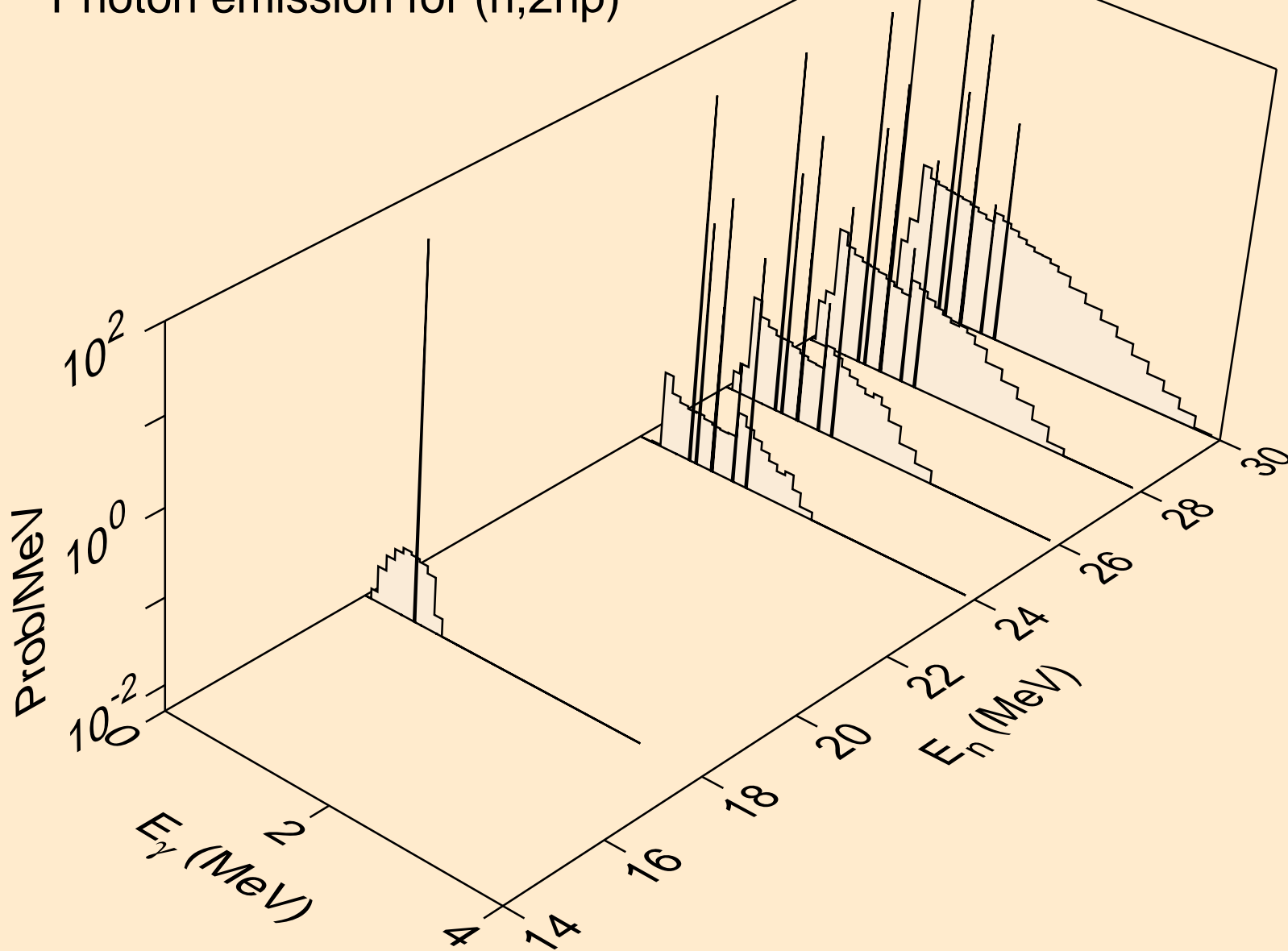

KR080 NEUTRON ACER TENDL-2019 LIBRARY; T=293.16K
Photon emission for (n,npa)

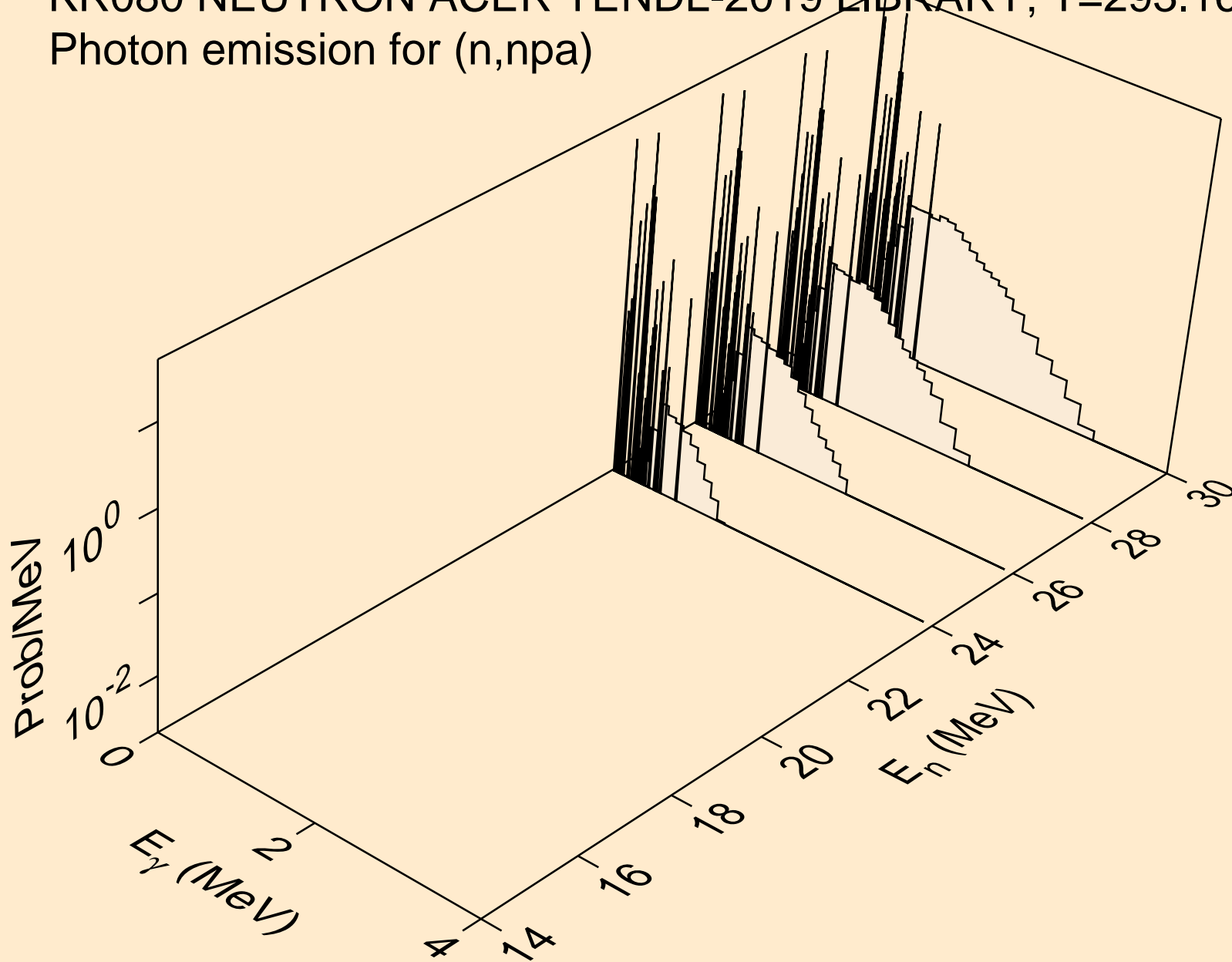

KR080 NEUTRON ACER TENDL-2019 LIBRARY; T=293.16K
Photon emission for (n,n*c)

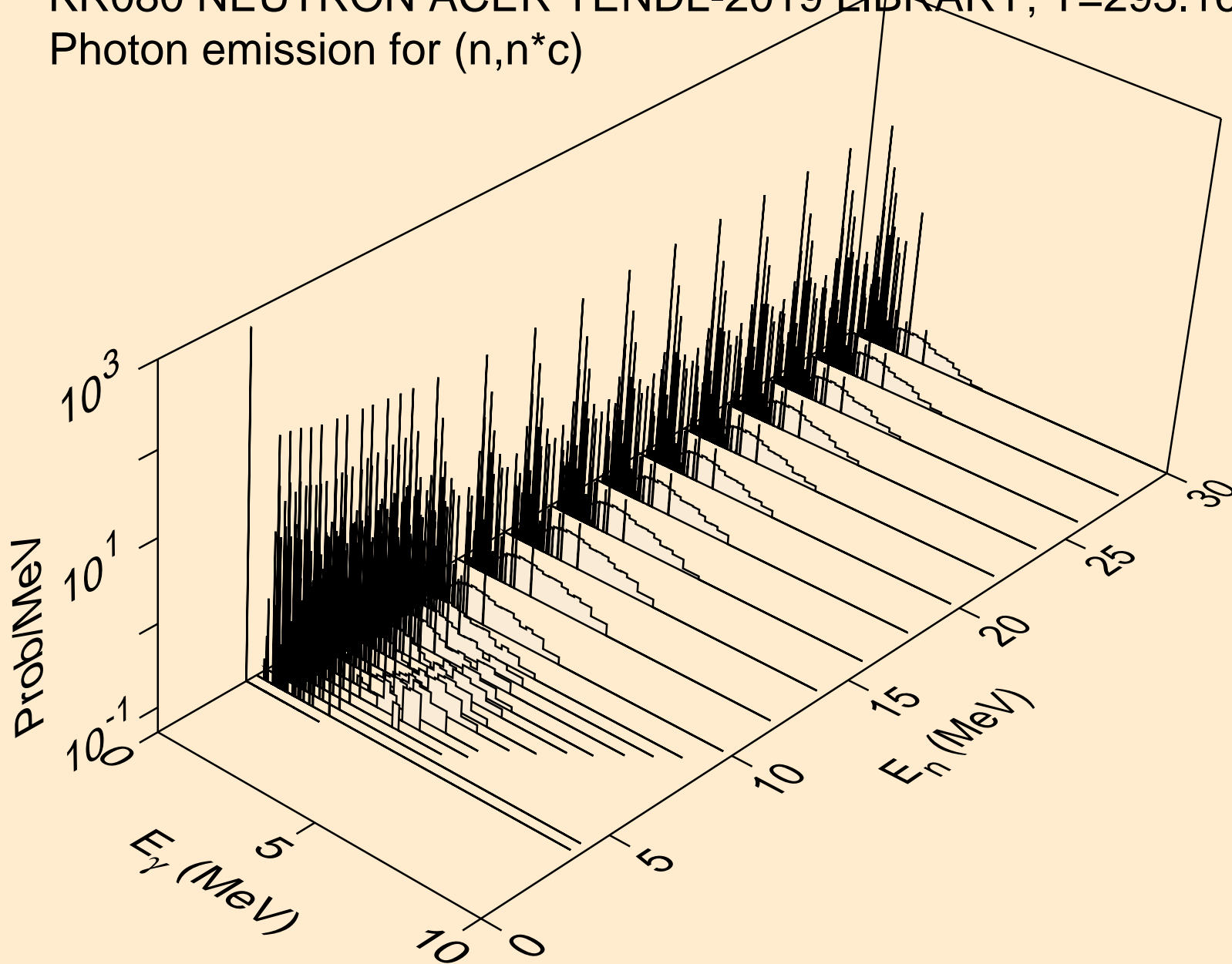

KR080 NEUTRON ACER TENDL-2019 LIBRARY; T=293.16K
Photon emission for (n,gma)

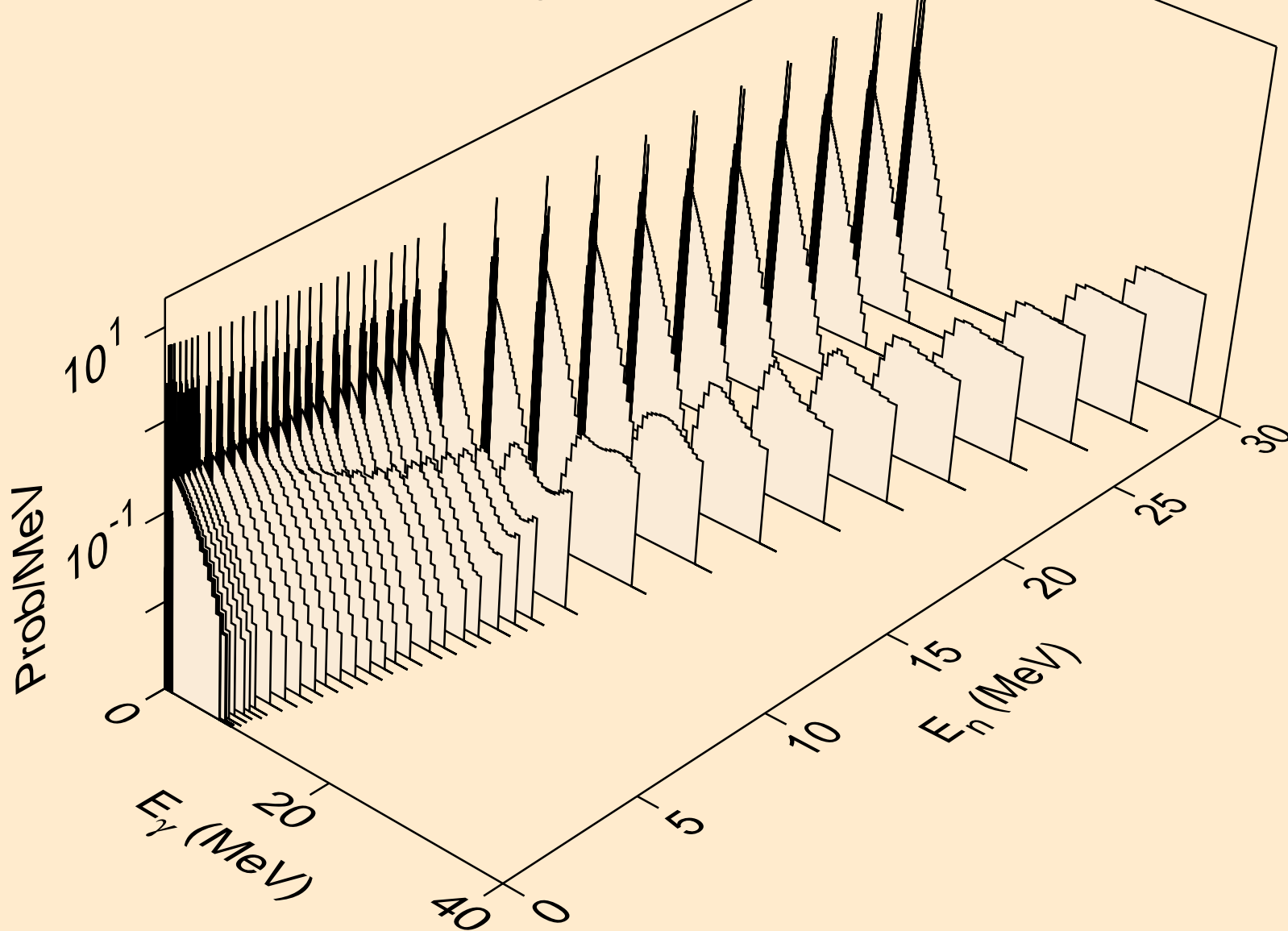

KR080 NEUTRON ACER TENDL-2019 LIBRARY; T=293.16K
Photon emission for (n,p)

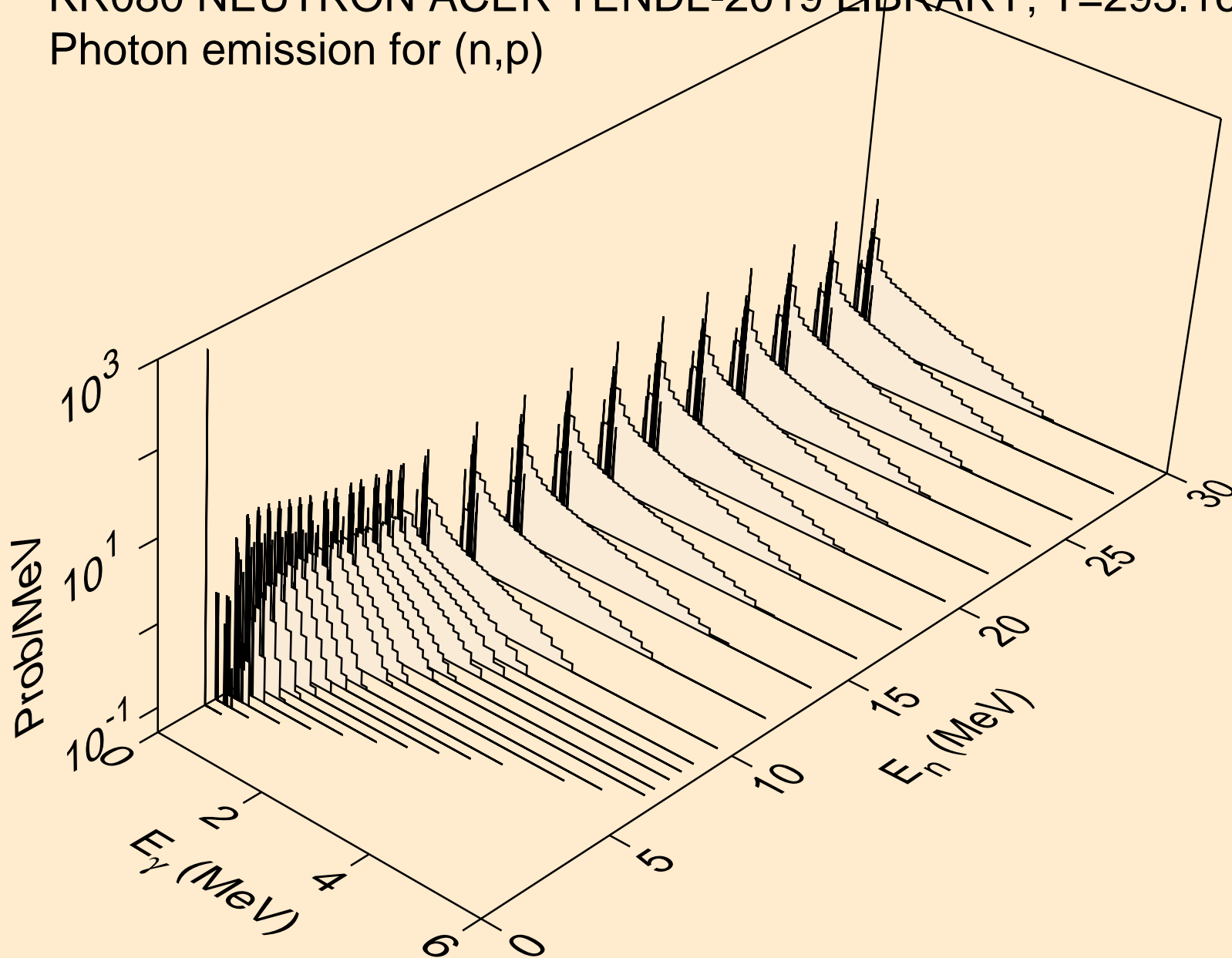

KR080 NEUTRON ACER TENDL-2019 LIBRARY; T=293.16K
Photon emission for (n,d)

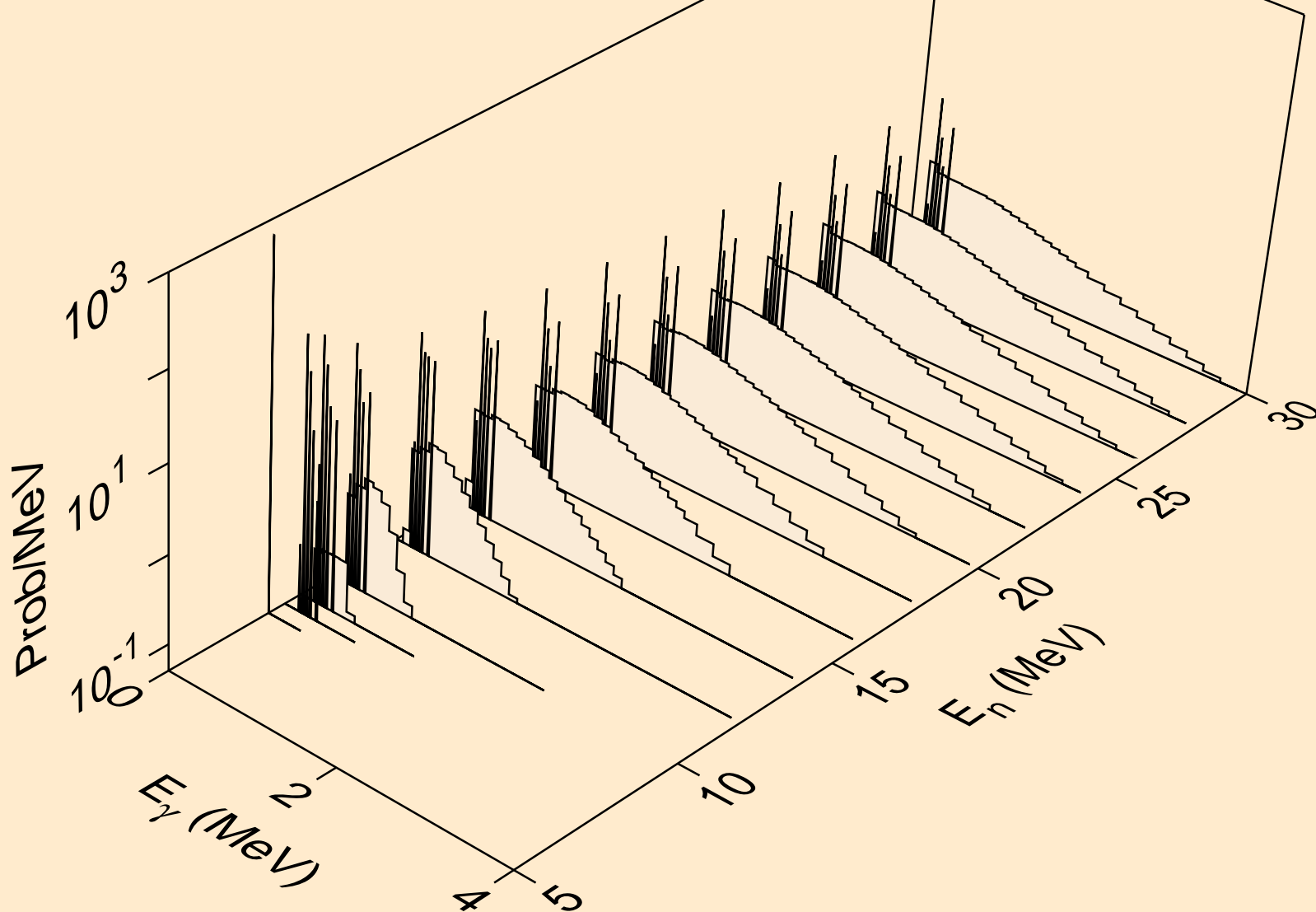

KR080 NEUTRON ACER TENDL-2019 LIBRARY; T=293.16K
Photon emission for (n,t)

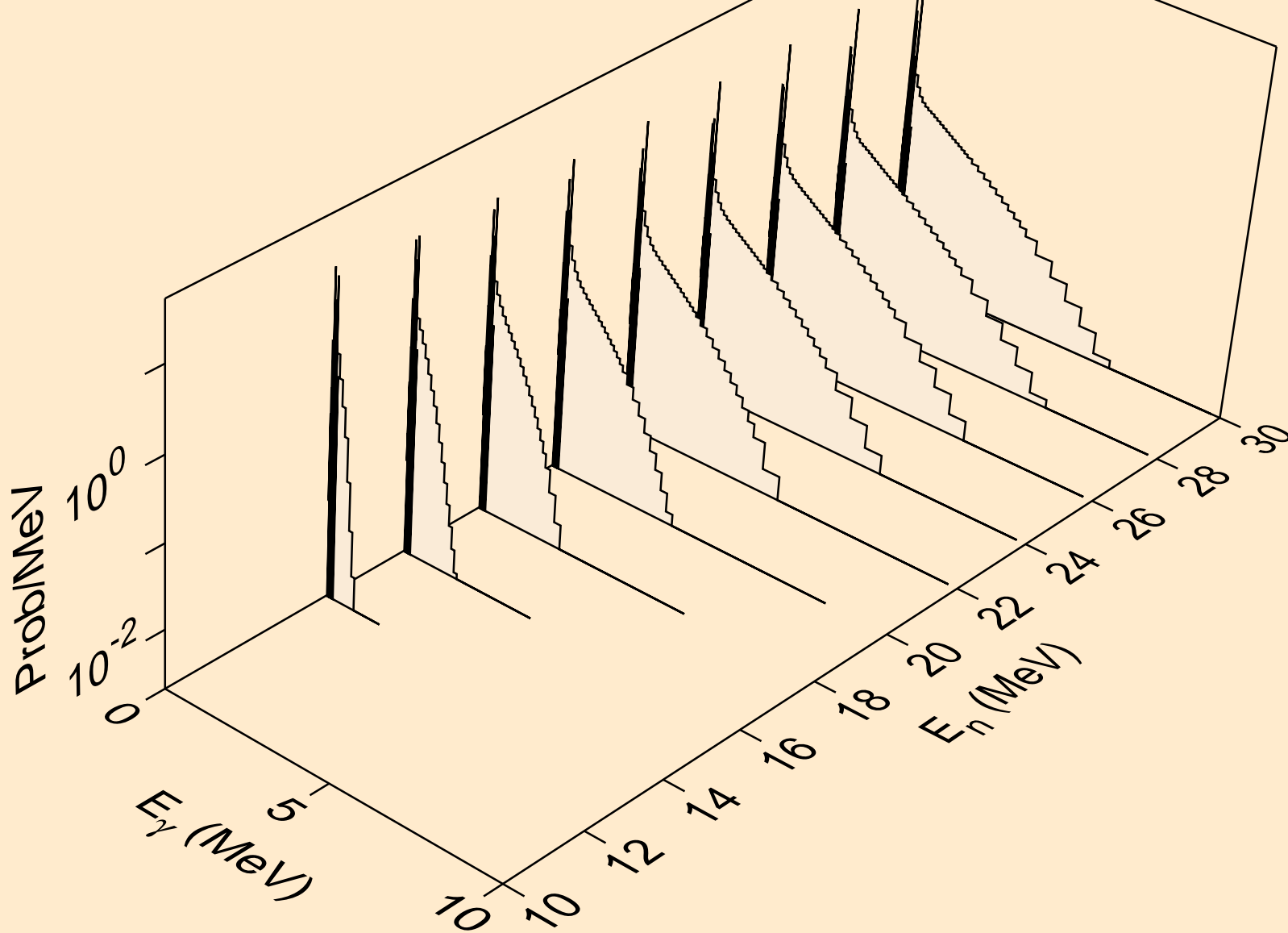

KR080 NEUTRON ACER TENDL-2019 LIBRARY; T=293.16K
Photon emission for (n,he3)

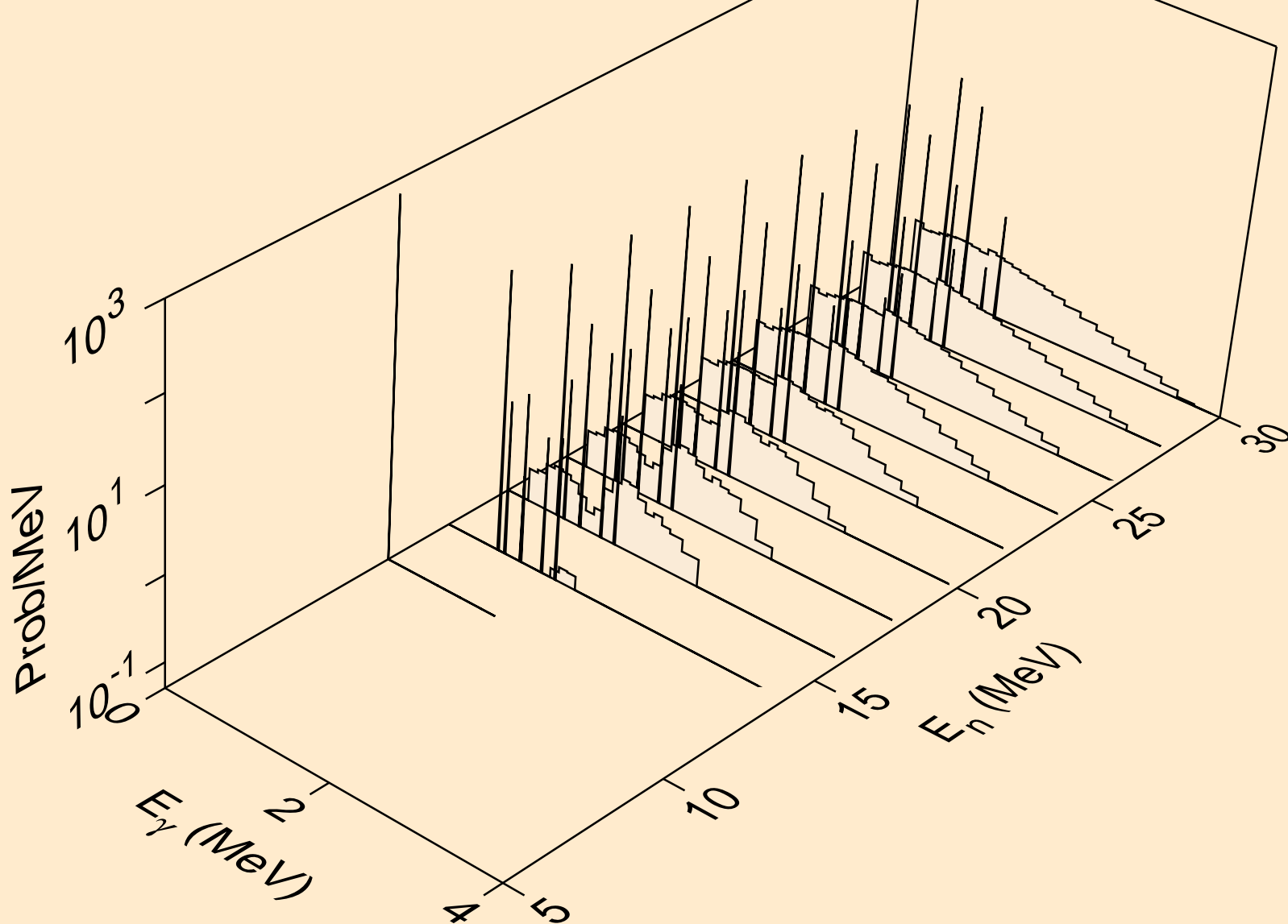

KR080 NEUTRON ACER TENDL-2019 LIBRARY; T=293.16K
Photon emission for (n,a)

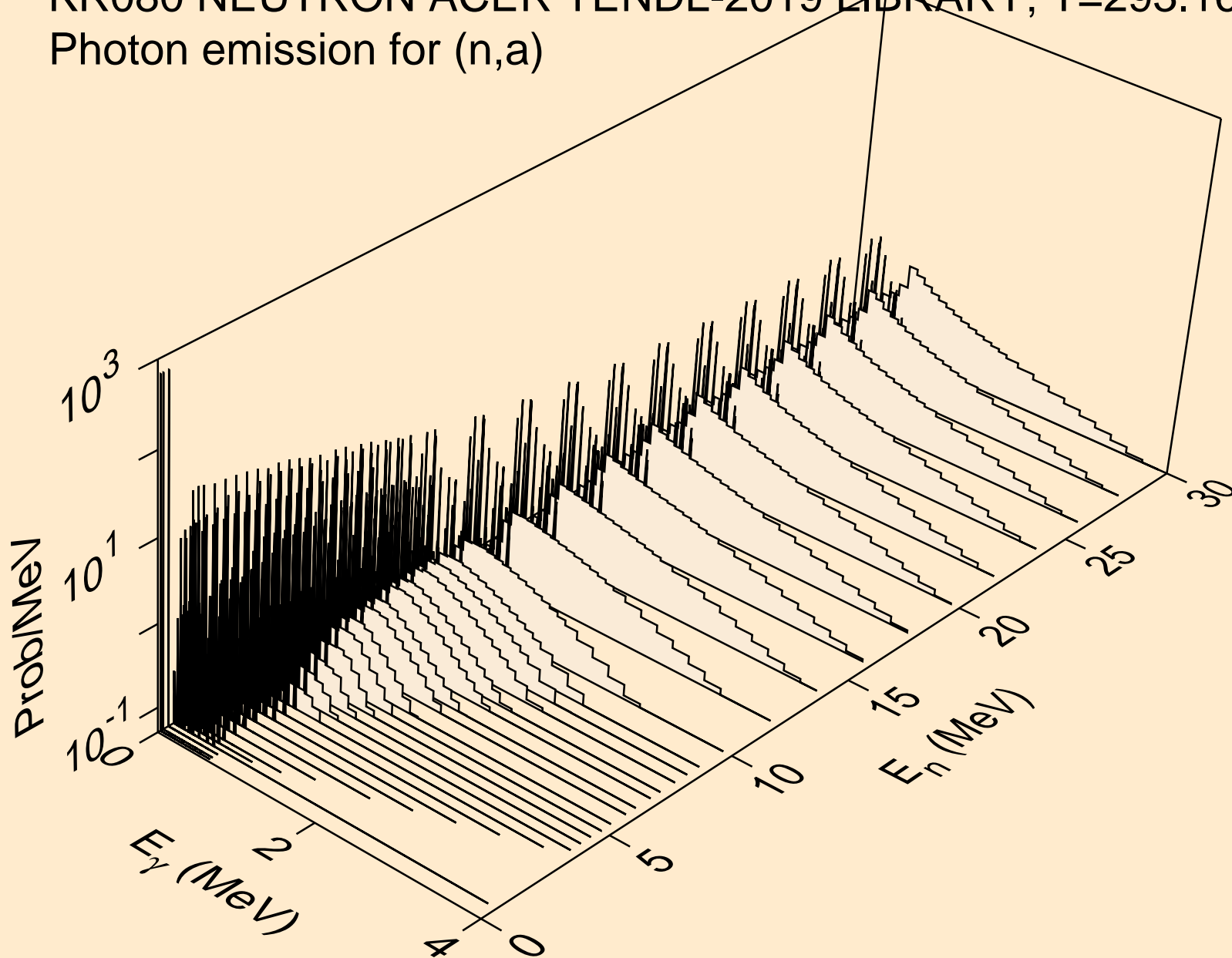

KR080 NEUTRON ACER TENDL-2019 LIBRARY; T=293.16K
Photon emission for (n,2a)

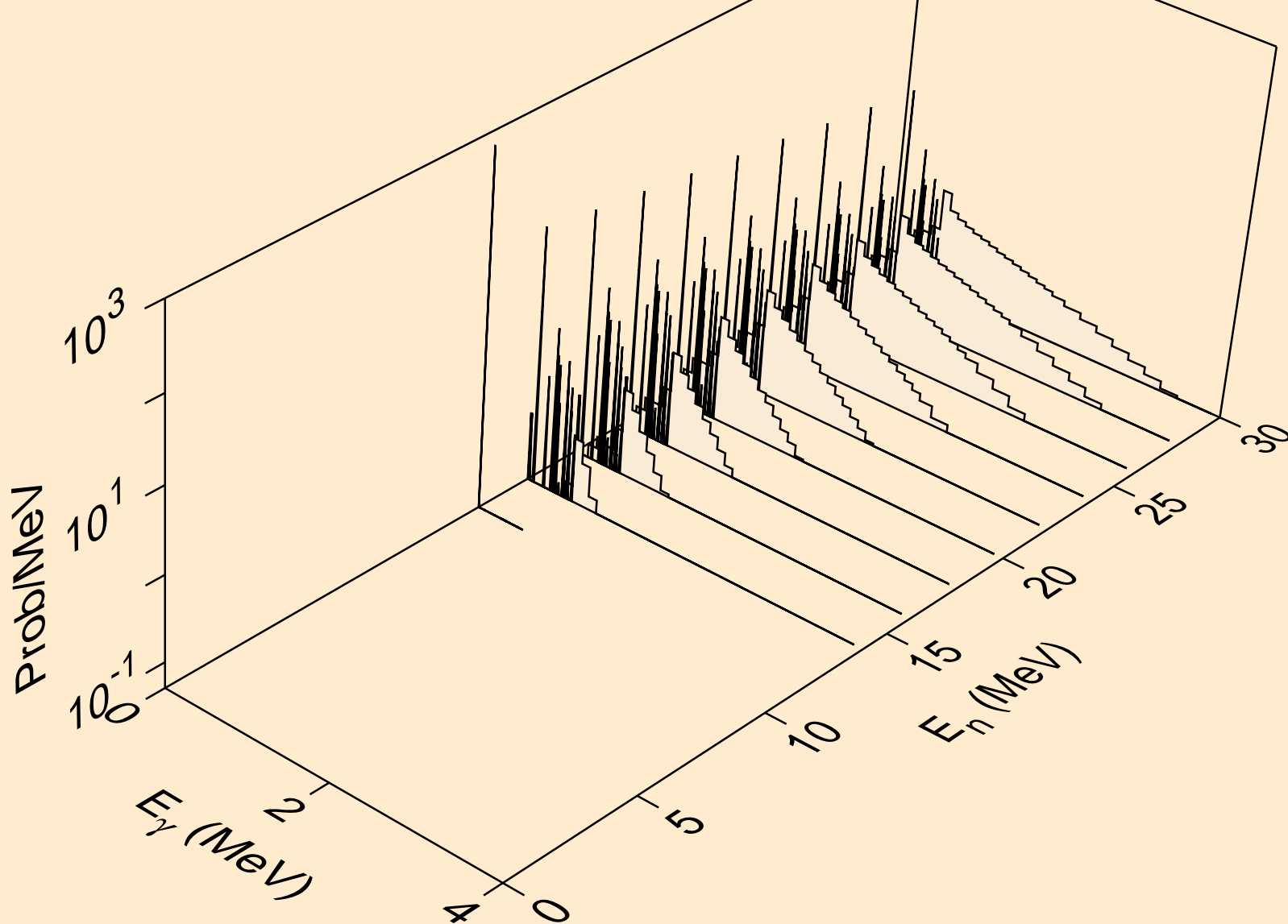

KR080 NEUTRON ACER TENDL-2019 LIBRARY; T=293.16K
Photon emission for (n,2p)

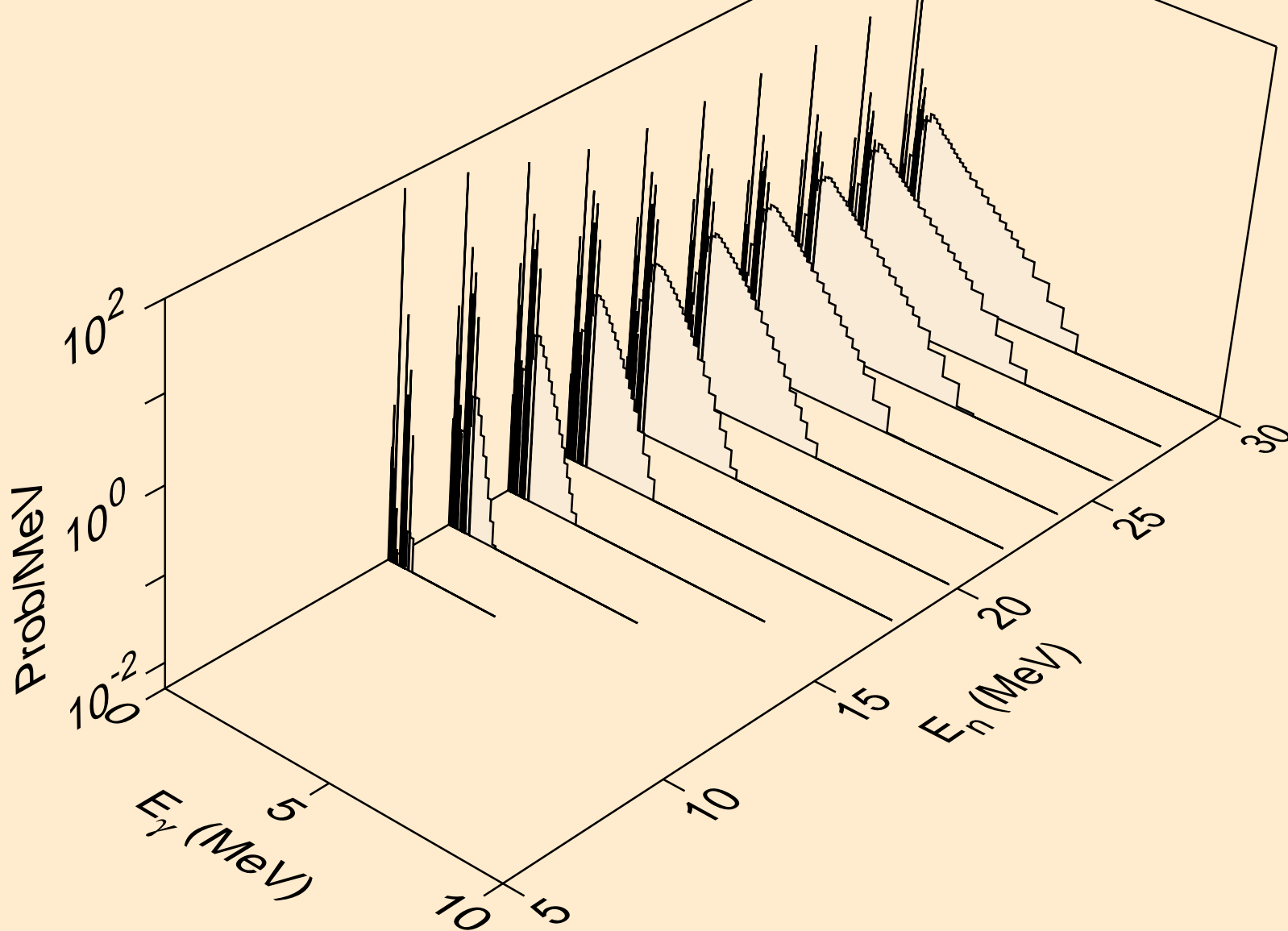

KR080 NEUTRON ACER TENDL-2019 LIBRARY; T=293.16K
Photon emission for (n,p α)

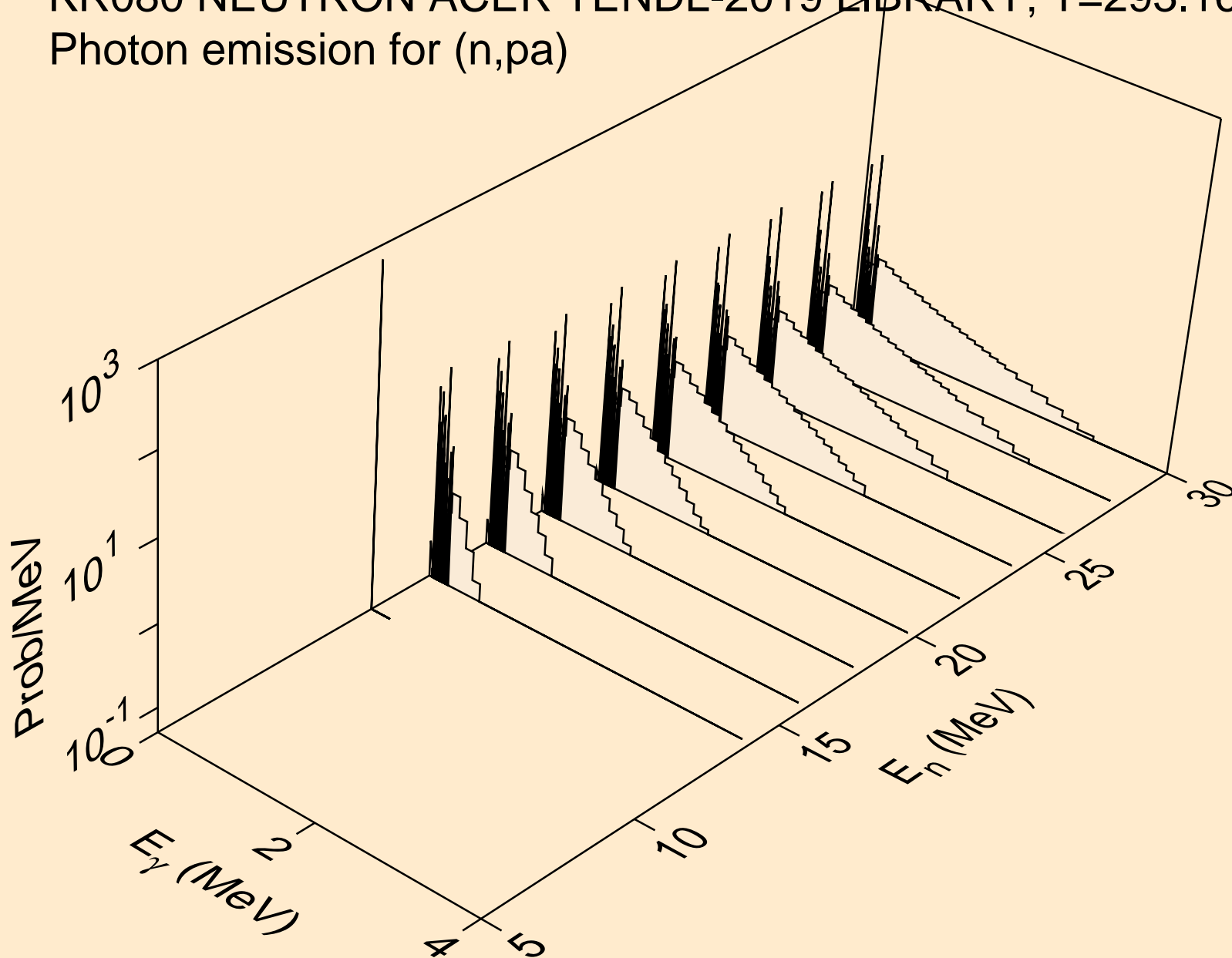

KR080 NEUTRON ACER TENDL-2019 LIBRARY; T=293.16K
Photon emission for (n,pd)

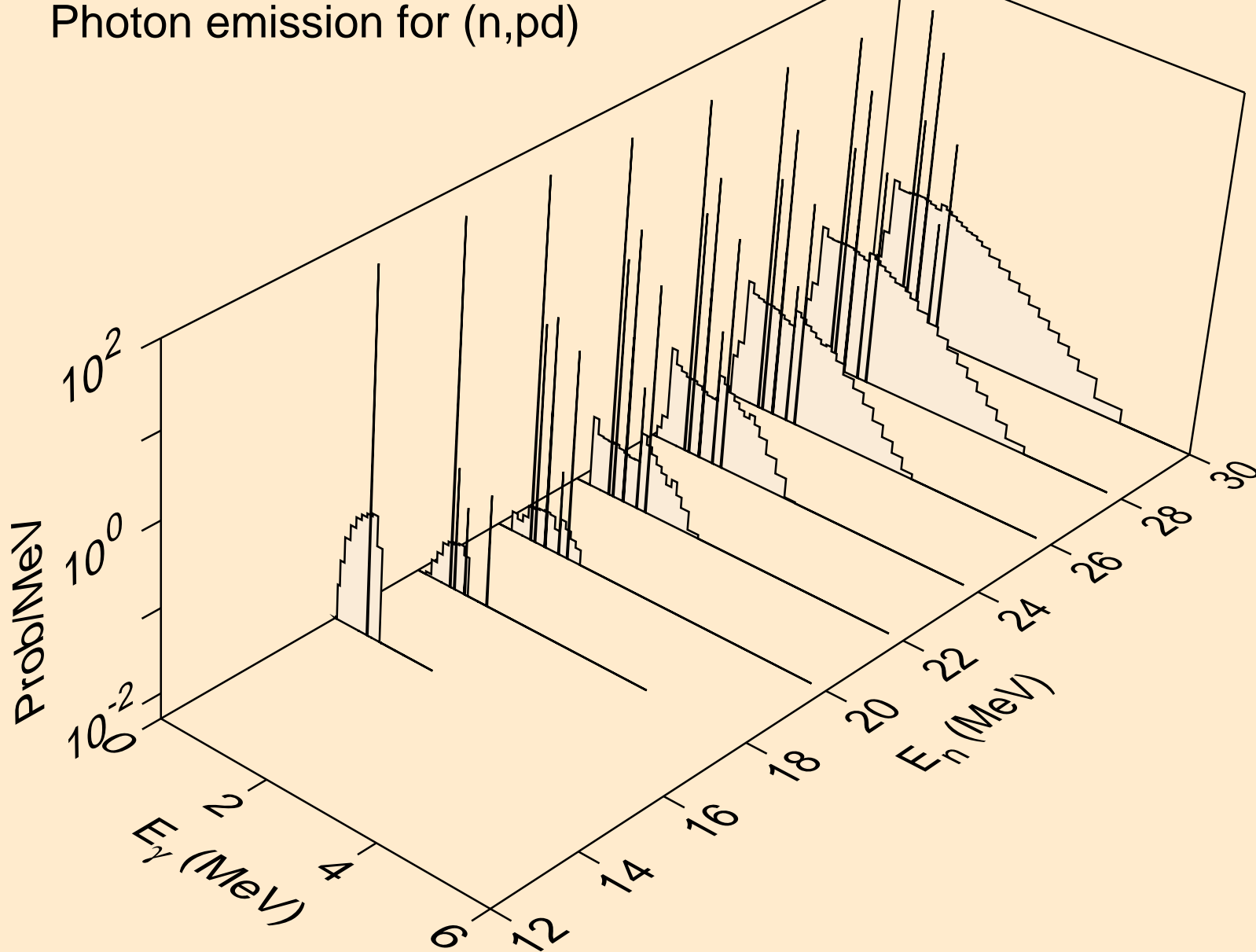

KR080 NEUTRON ACER TENDL-2019 LIBRARY; T=293.16K
Photon emission for (n,pt)

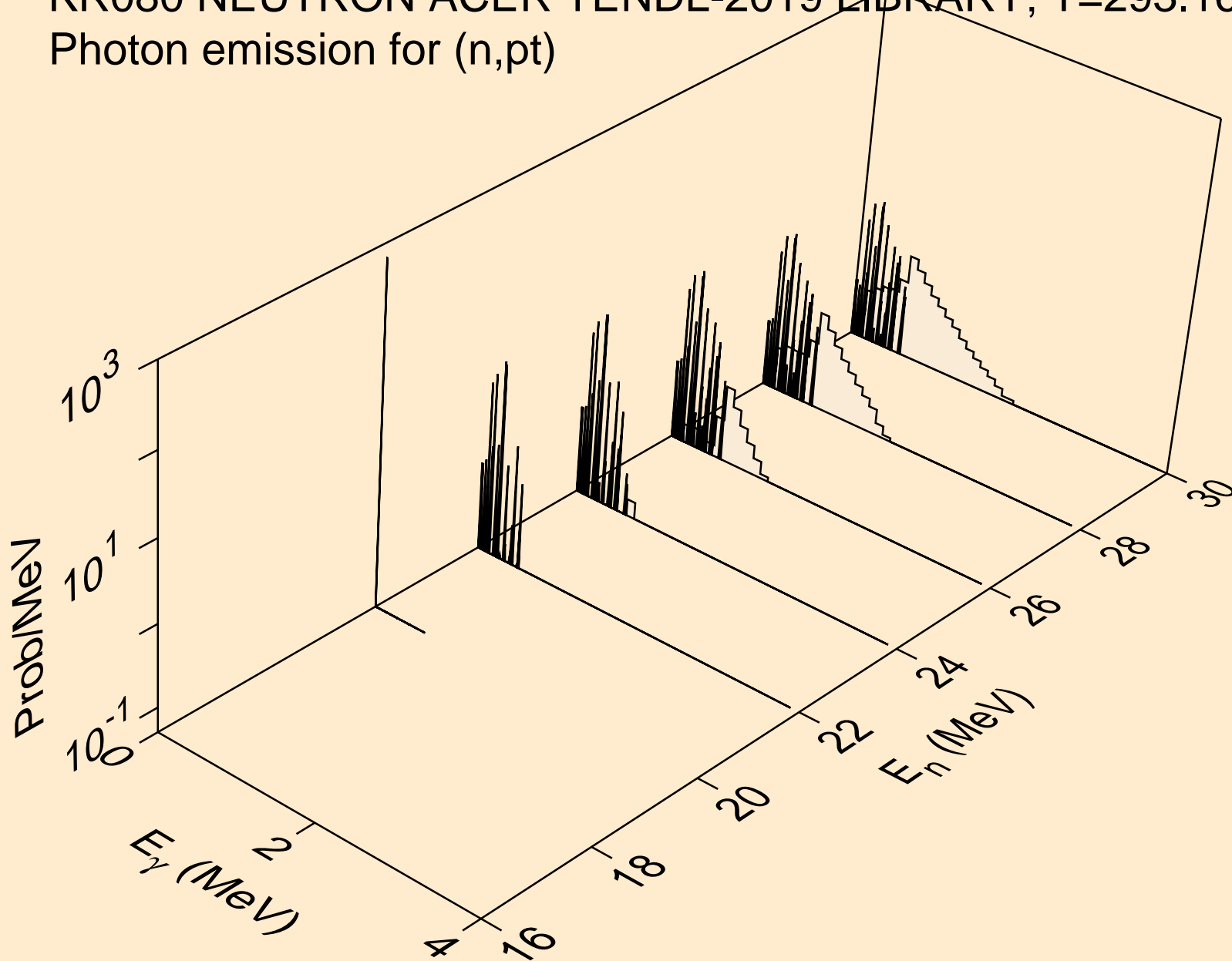

KR080 NEUTRON ACER TENDL-2019 LIBRARY; T=293.16K
Photon emission for (n,da)

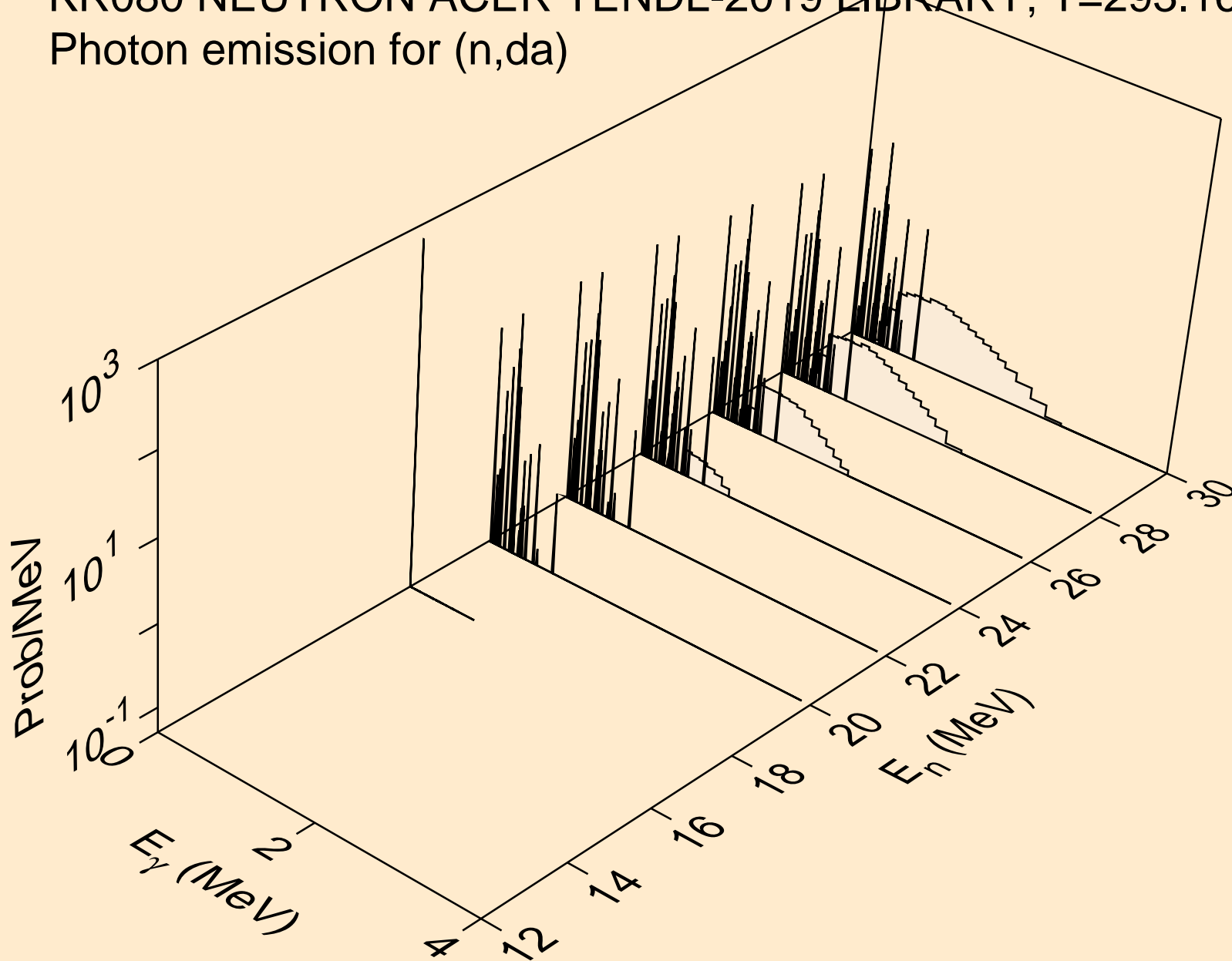

KR080 NEUTRON ACER TENDL-2019 LIBRARY; T=293.16K
thermal capture photon spectrum

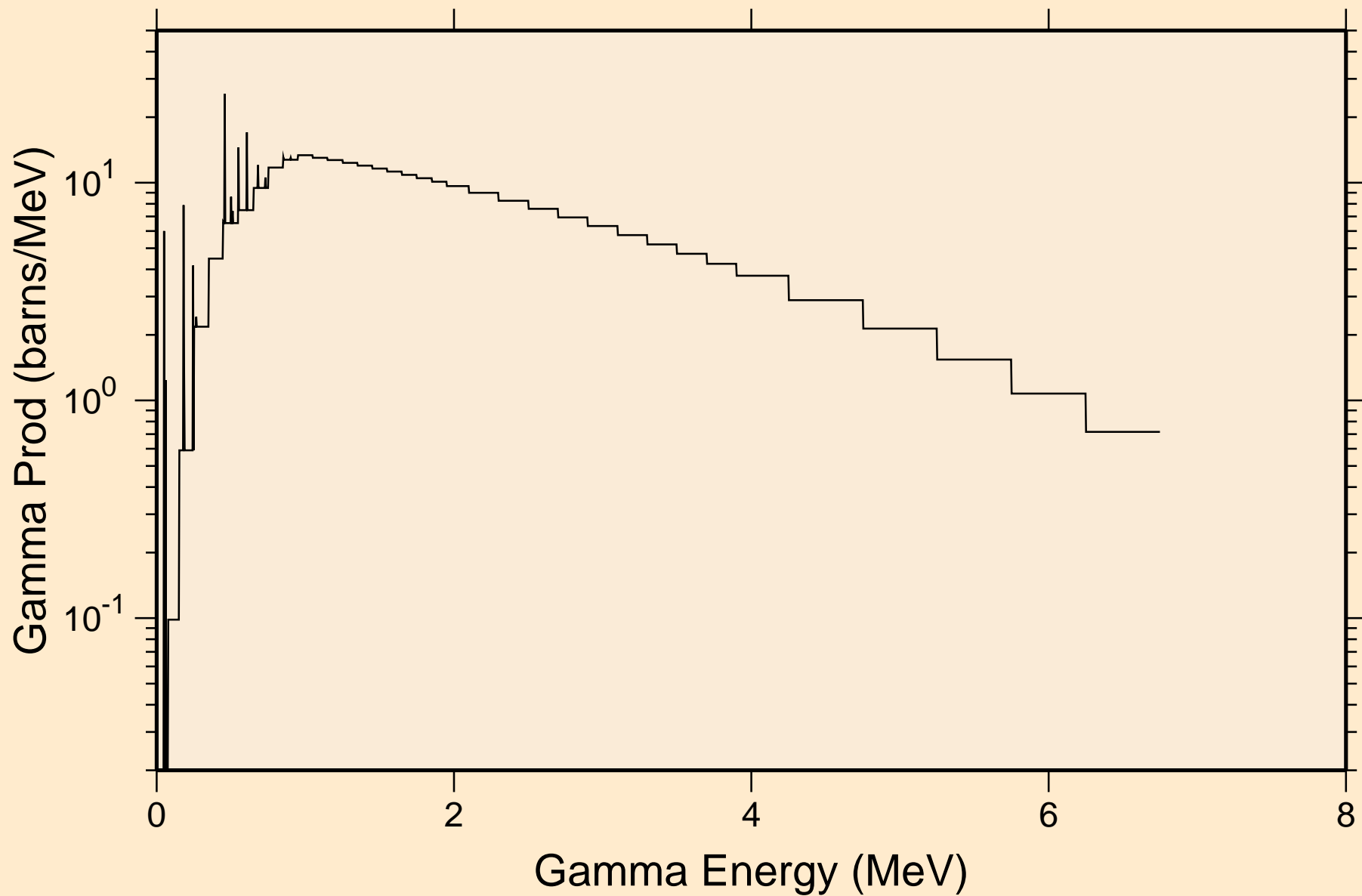

KR080 NEUTRON ACER TENDL-2019 LIBRARY; T=293.16K
14 MeV photon spectrum

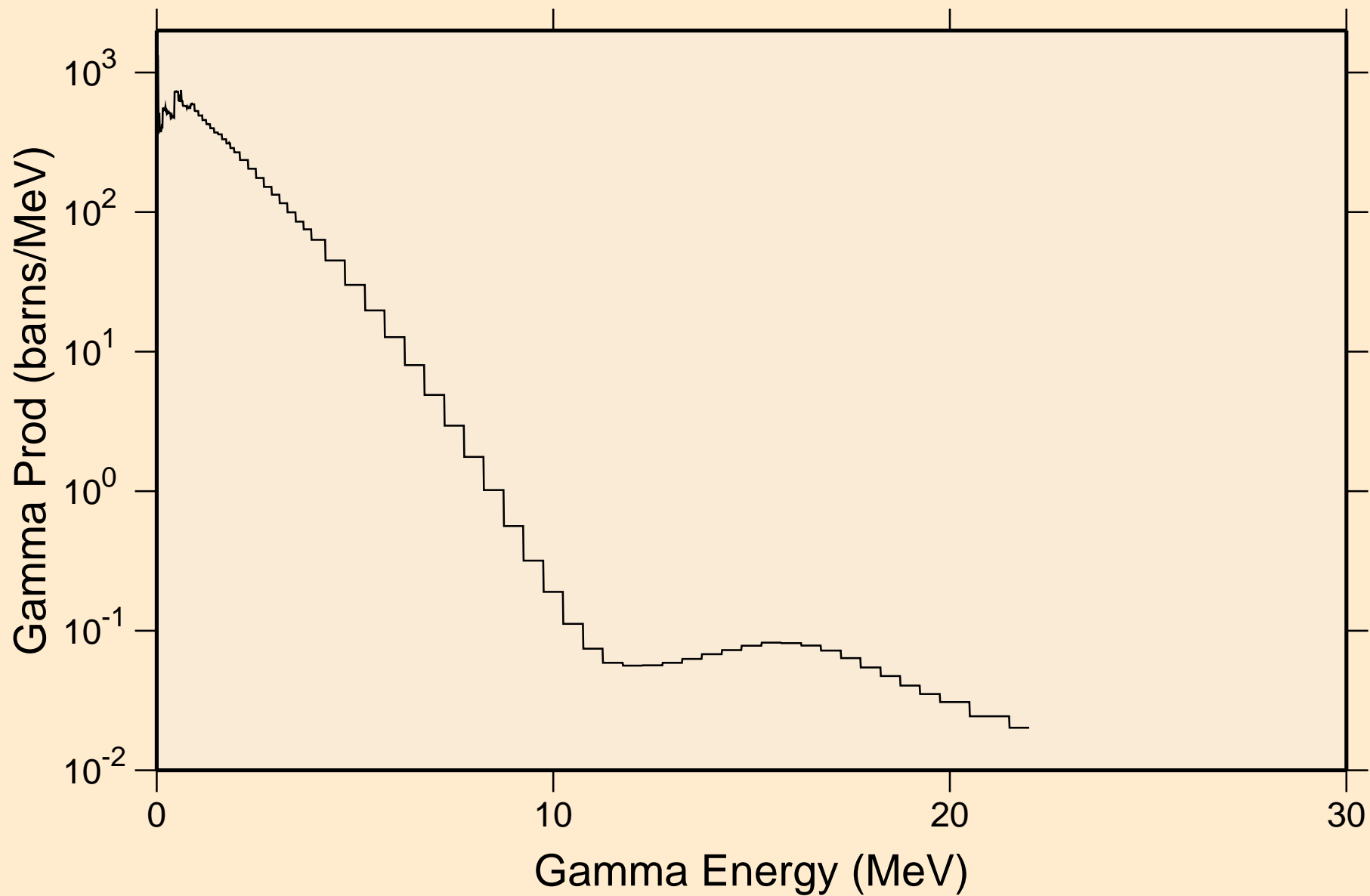

KR080 NEUTRON ACER TENDL-2019 LIBRARY; T=293.16K
Particle heating contributions

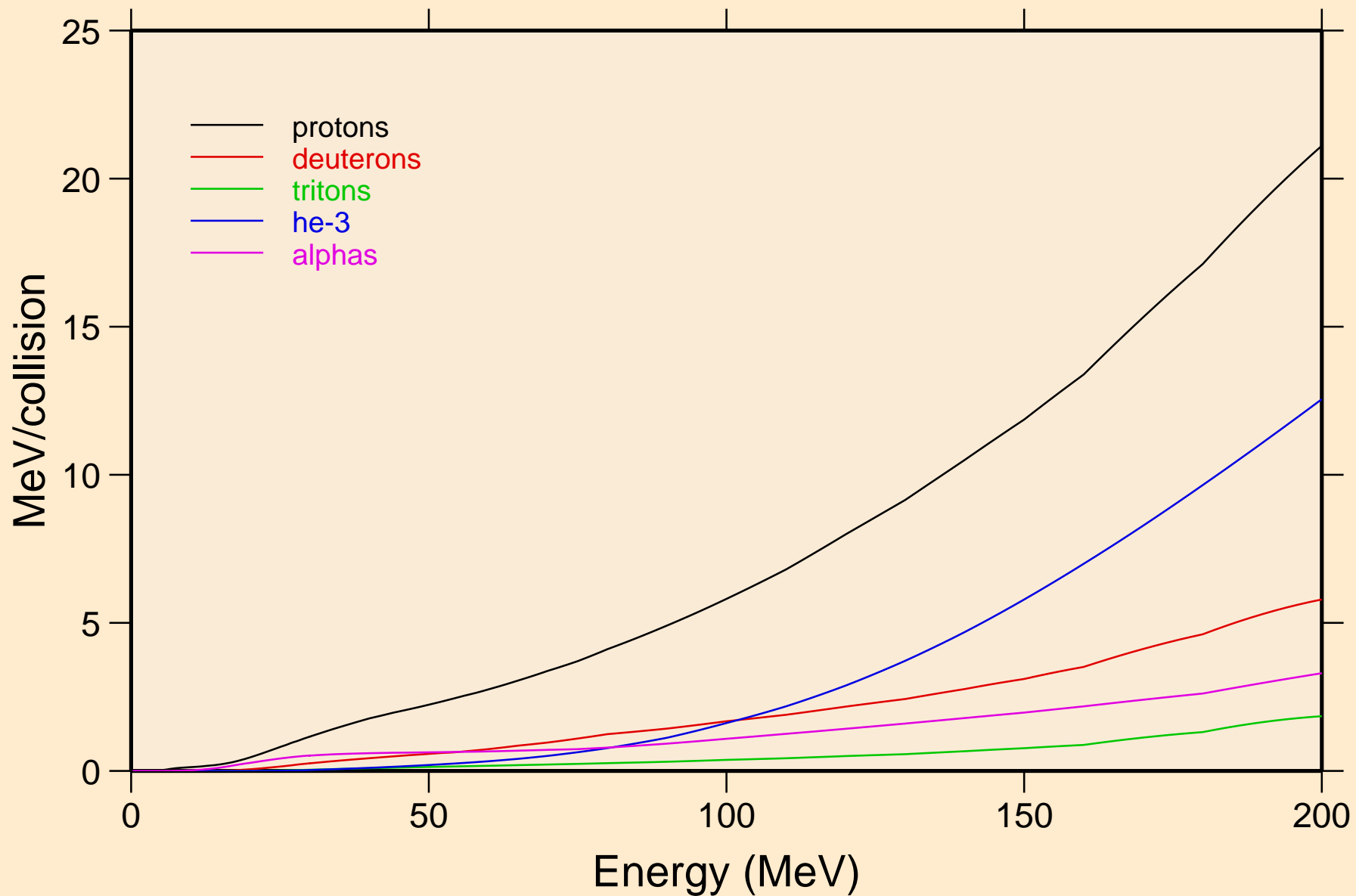

KR080 NEUTRON ACER TENDL-2019 LIBRARY; T=293.16K
Recoil Heating

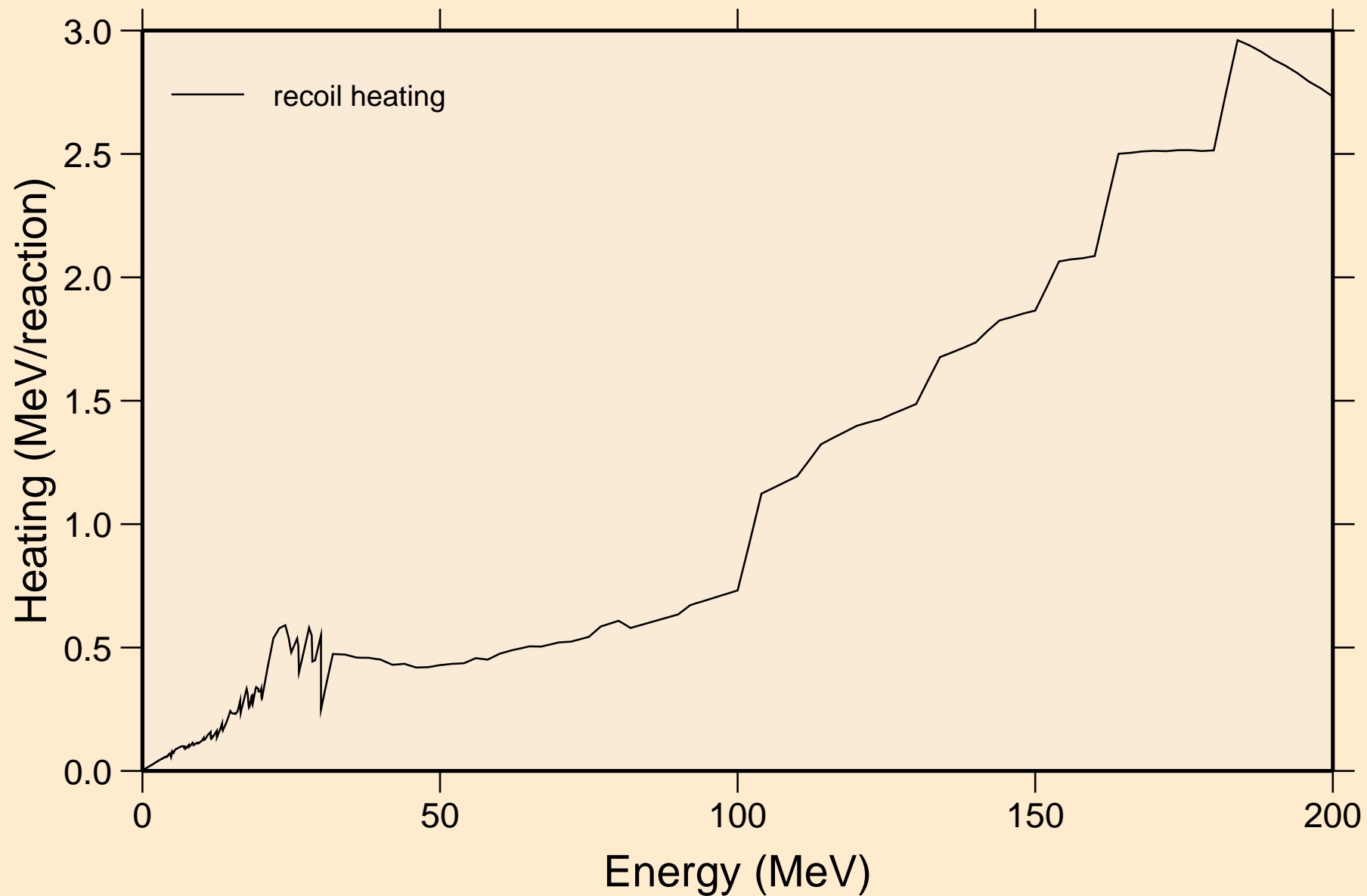

KR080 NEUTRON ACER TENDL-2019 LIBRARY; T=293.16K
Particle production cross sections

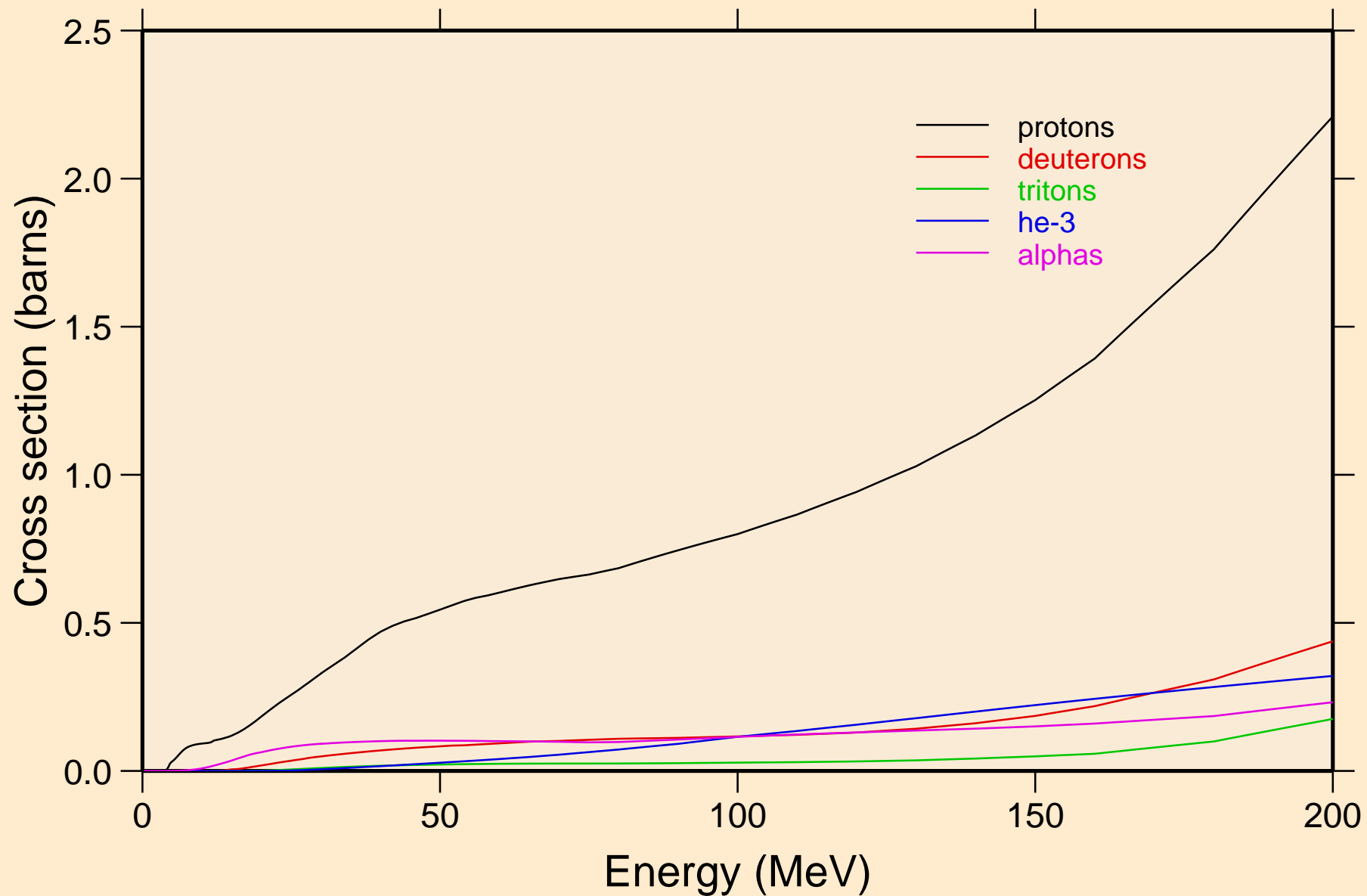

KR080 NEUTRON ACER TENDL-2019 LIBRARY; T=293.16K
protons from (n,x)

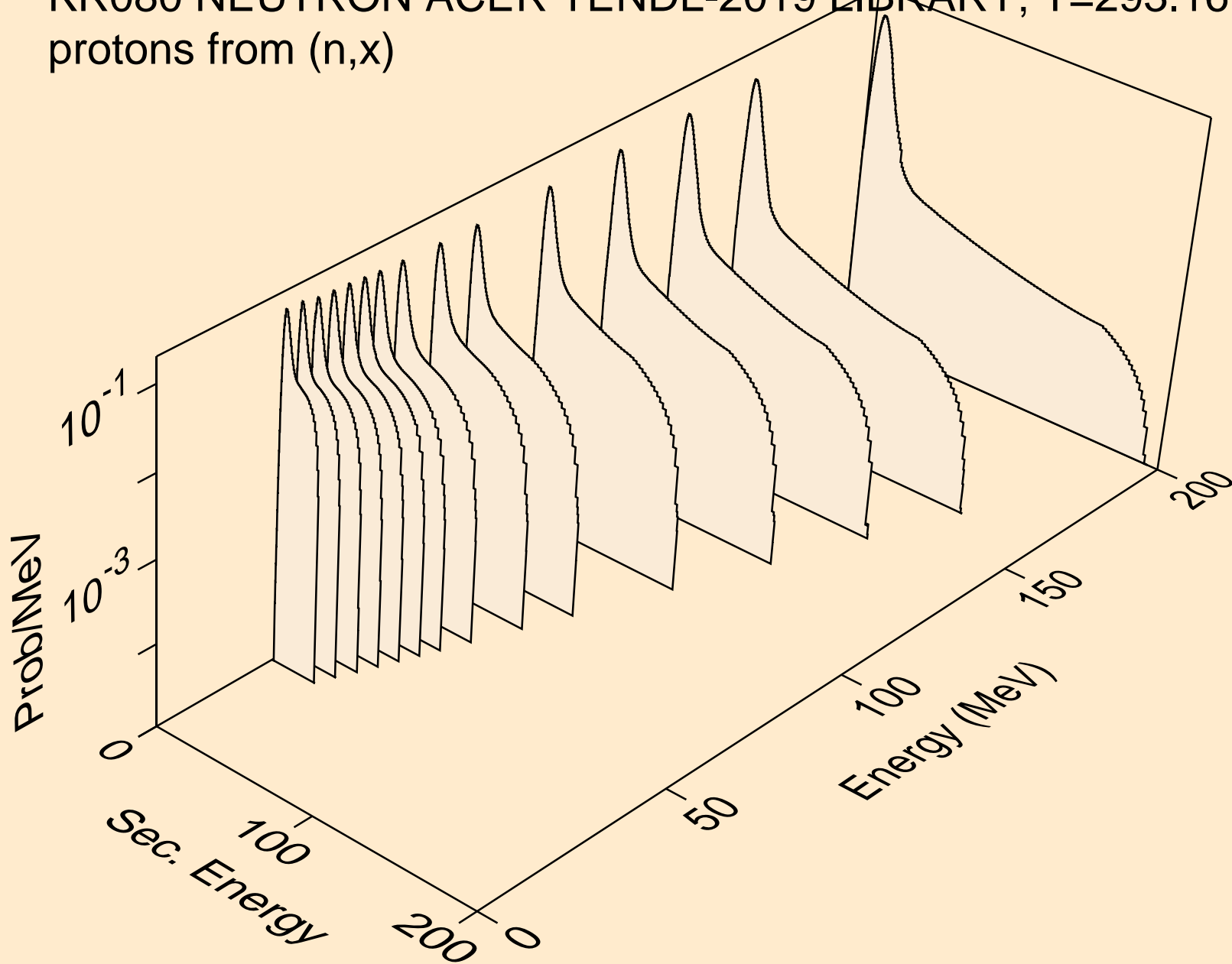

KR080 NEUTRON ACER TENDL-2019 LIBRARY; T=293.16K
protons from (n,n*)p

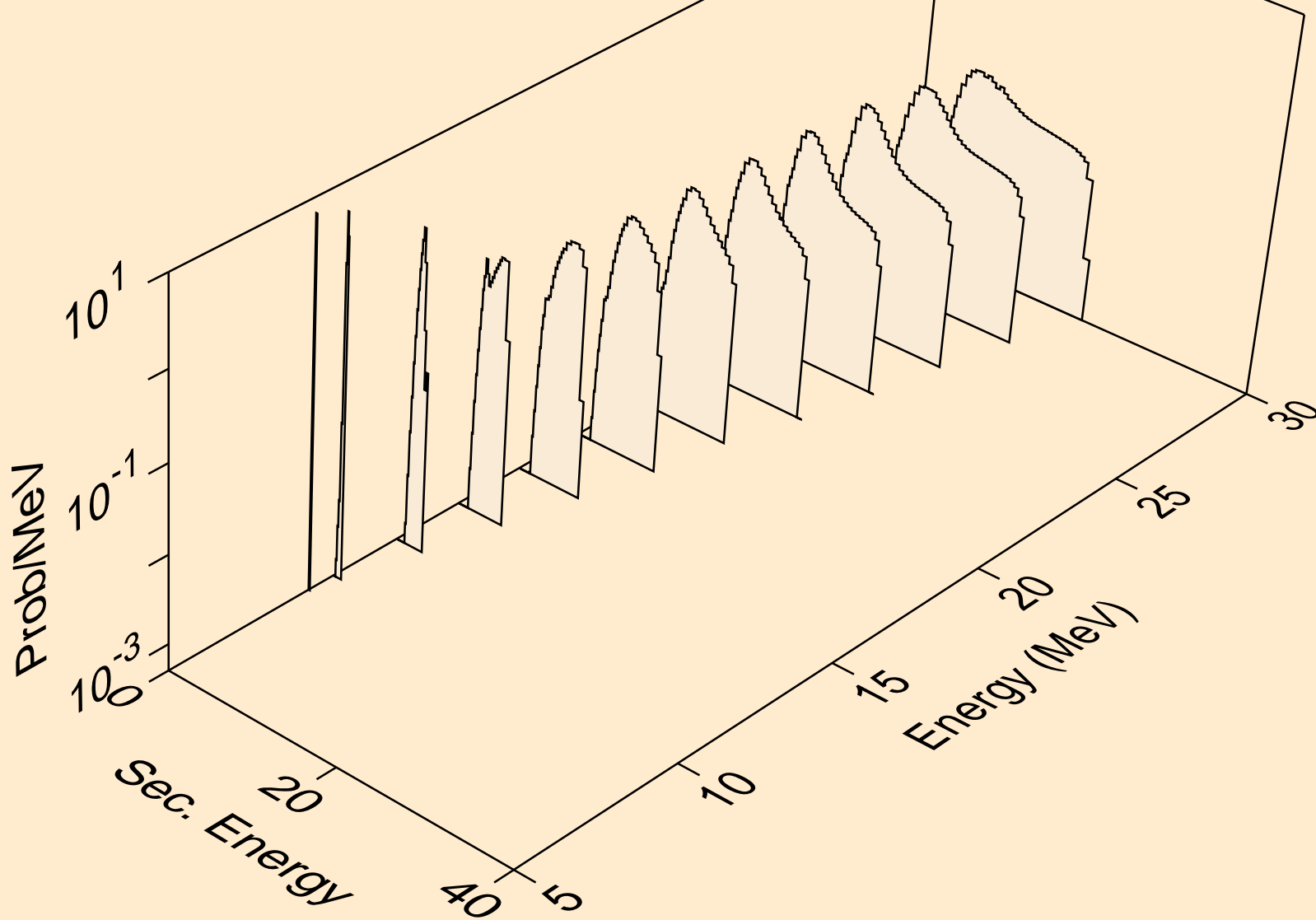

KR080 NEUTRON ACER TENDL-2019 LIBRARY; T=293.16K
protons from (n,2np)

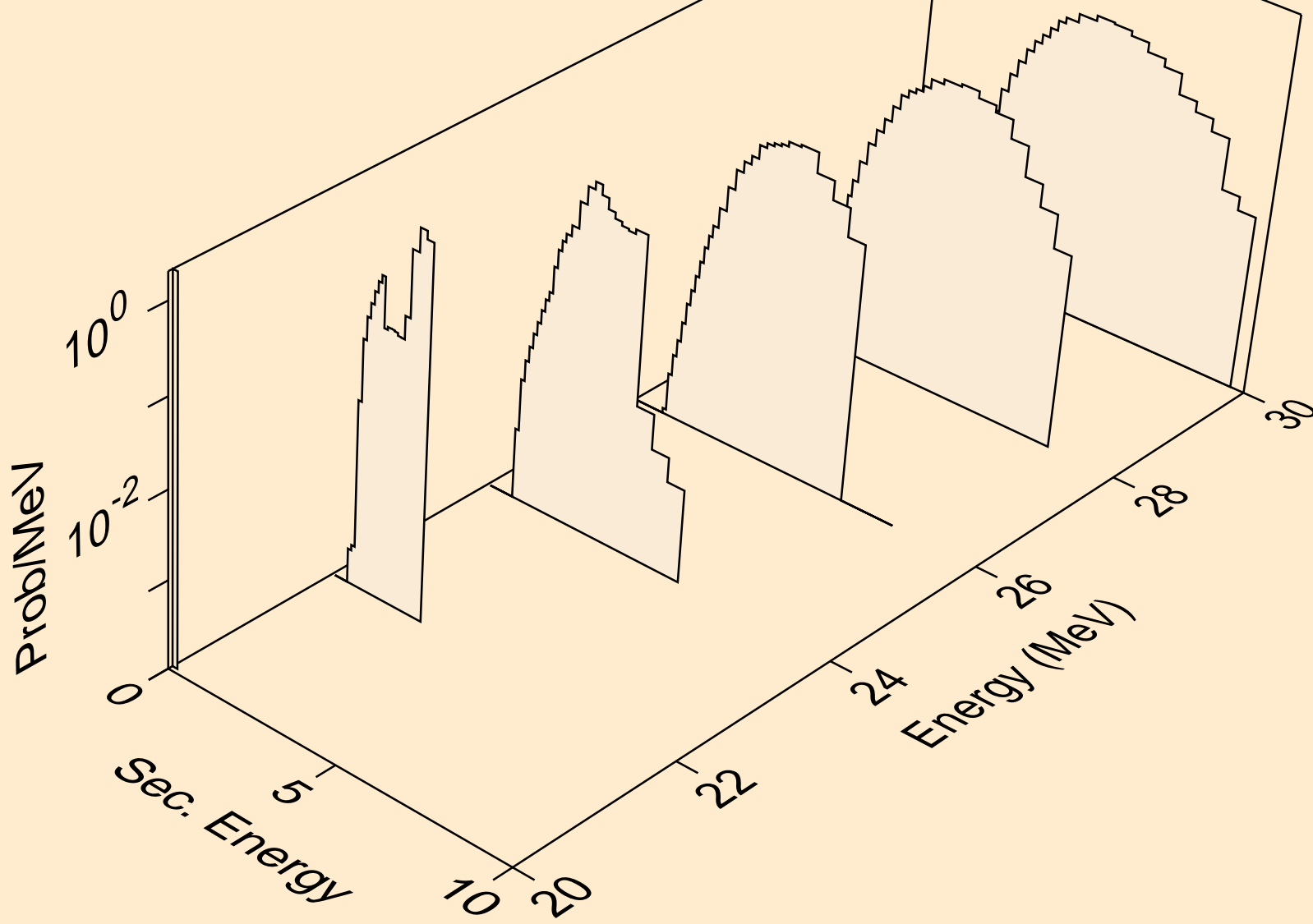

KR080 NEUTRON ACER TENDL-2019 LIBRARY; T=293.16K
protons from (n,3np)

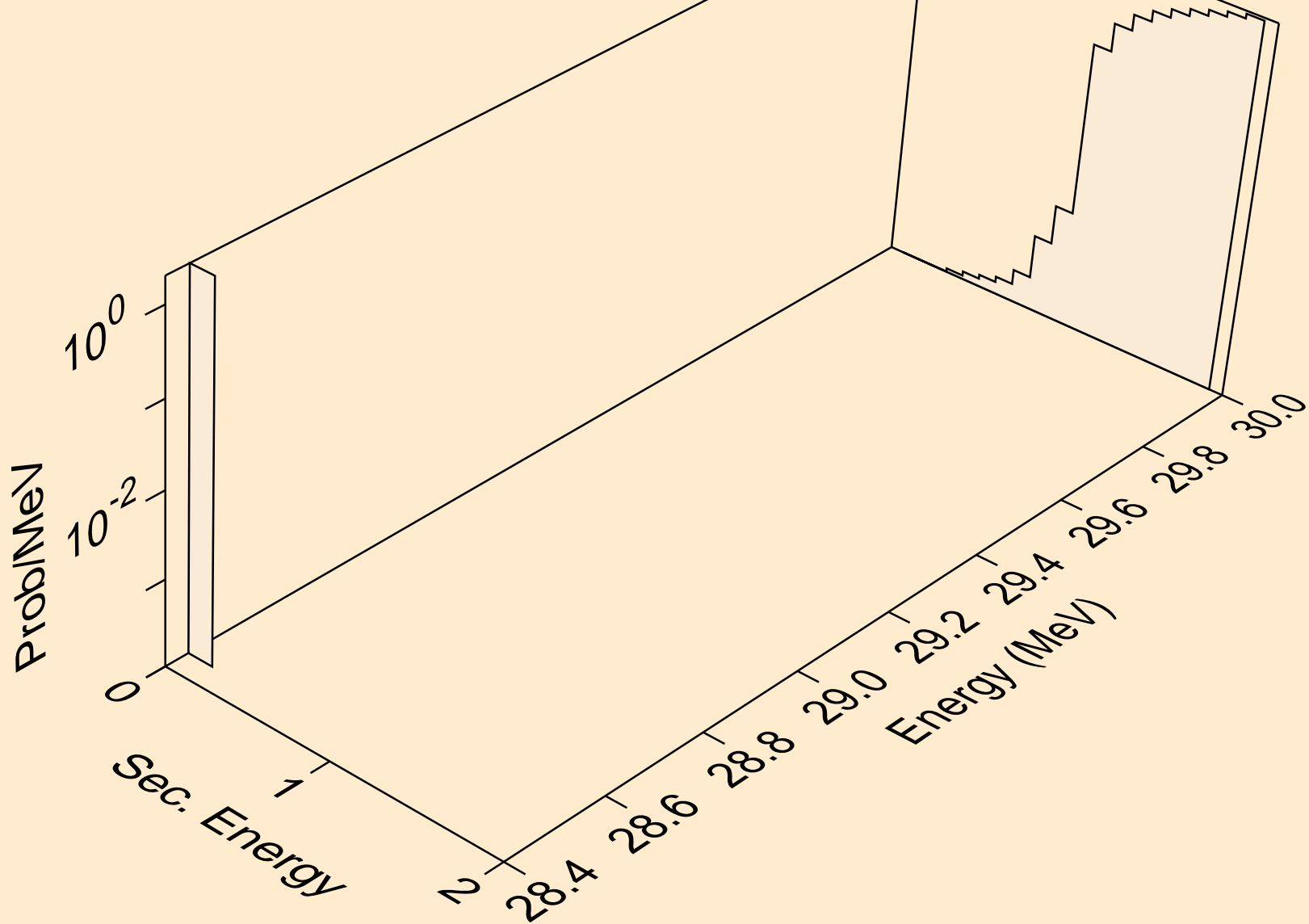

KR080 NEUTRON ACER TENDL-2019 LIBRARY; T=293.16K
protons from (n,2np)

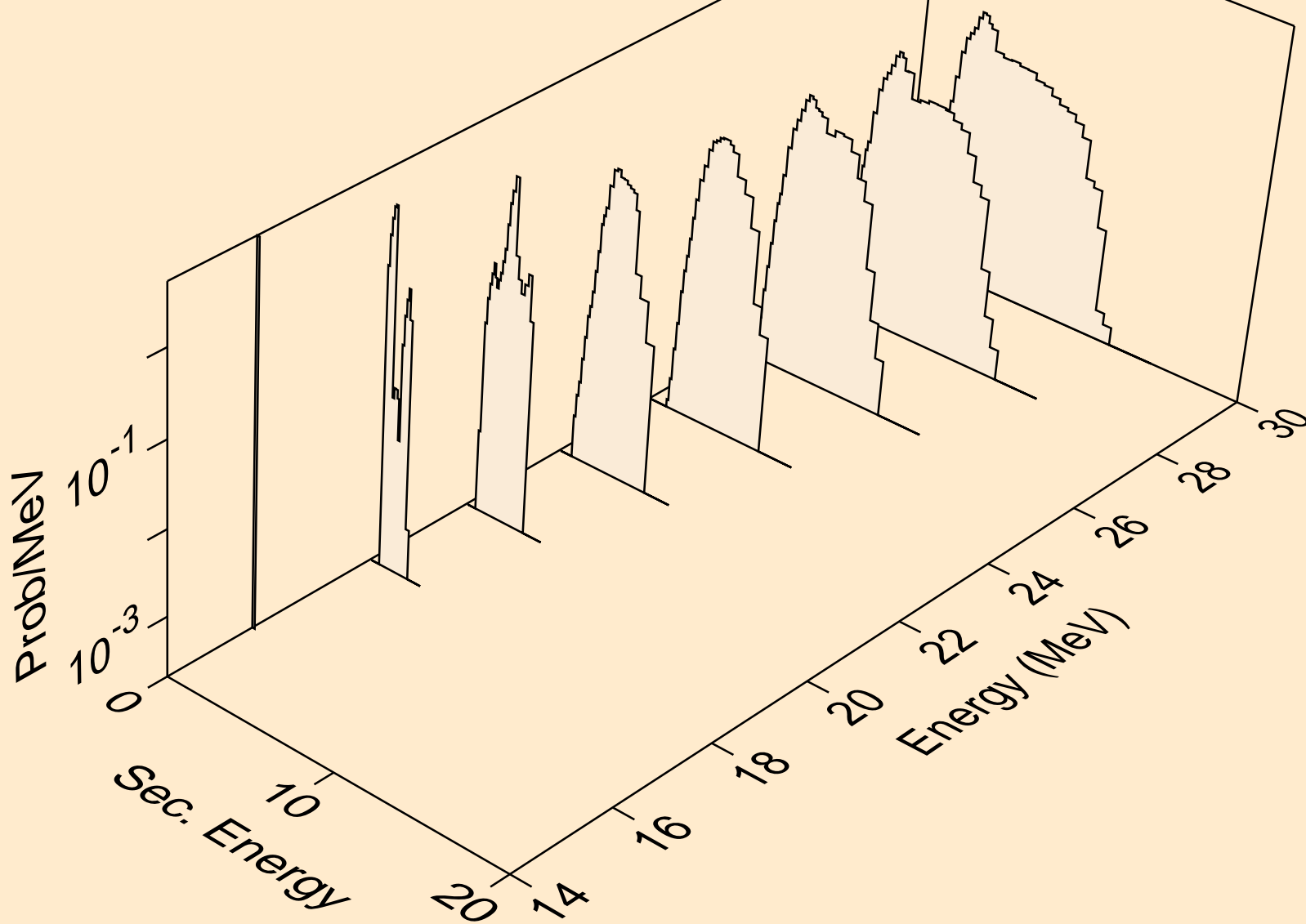

KR080 NEUTRON ACER TENDL-2019 LIBRARY; T=293.16K
protons from (n,npa)

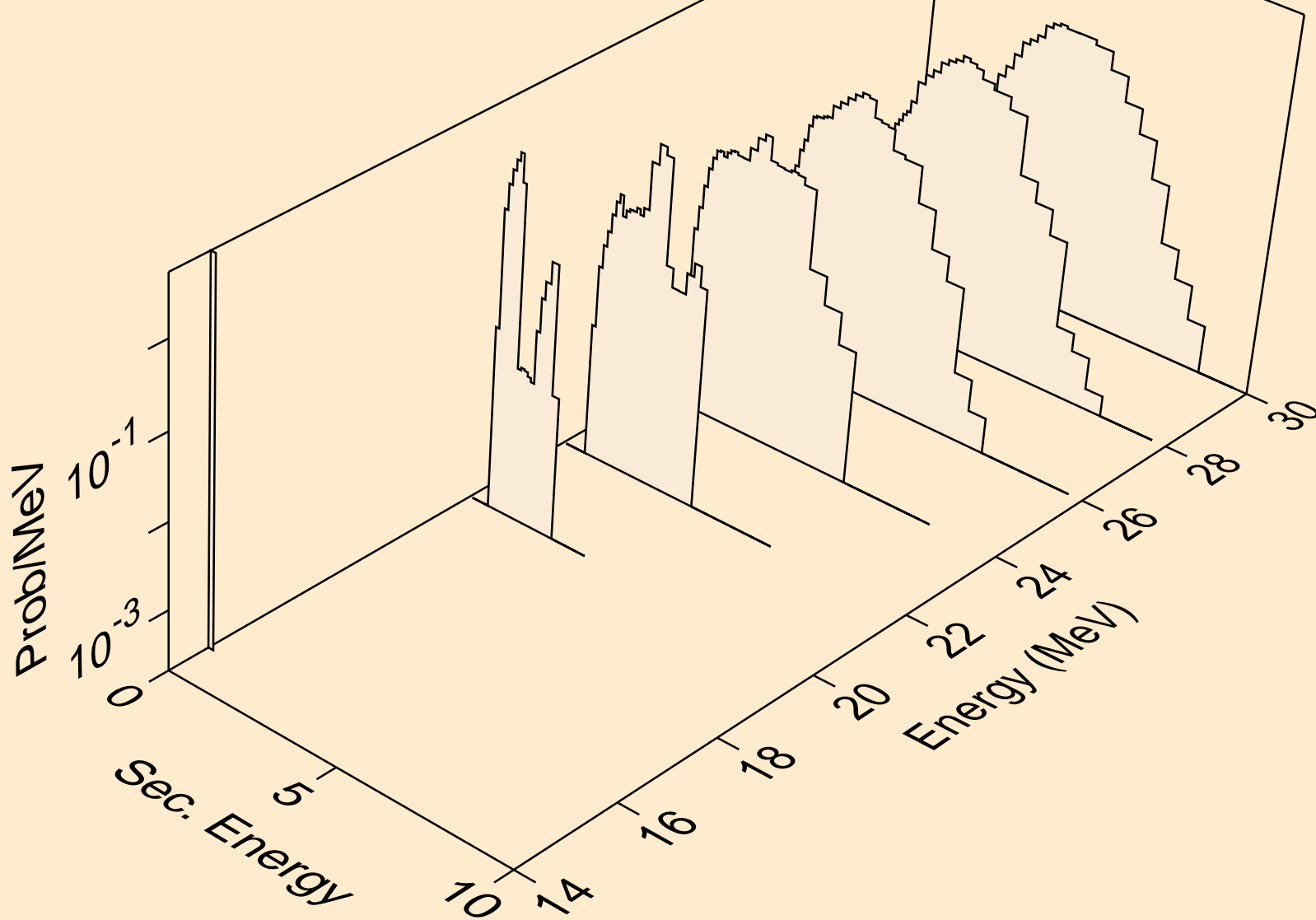

KR080 NEUTRON ACER TENDL-2019 LIBRARY; T=293.16K
protons from (n,p)

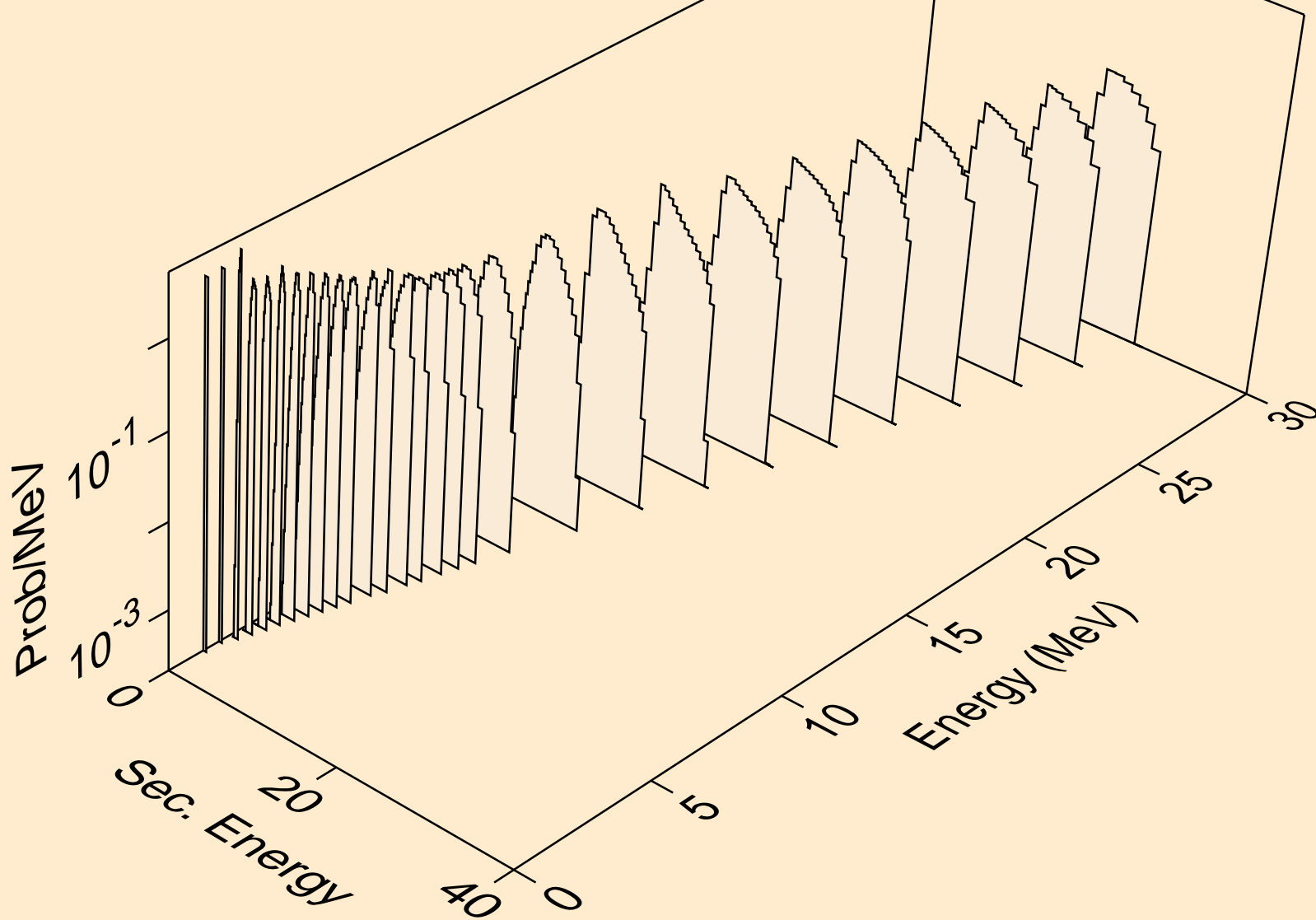

KR080 NEUTRON ACER TENDL-2019 LIBRARY; T=293.16K
protons from (n,2p)

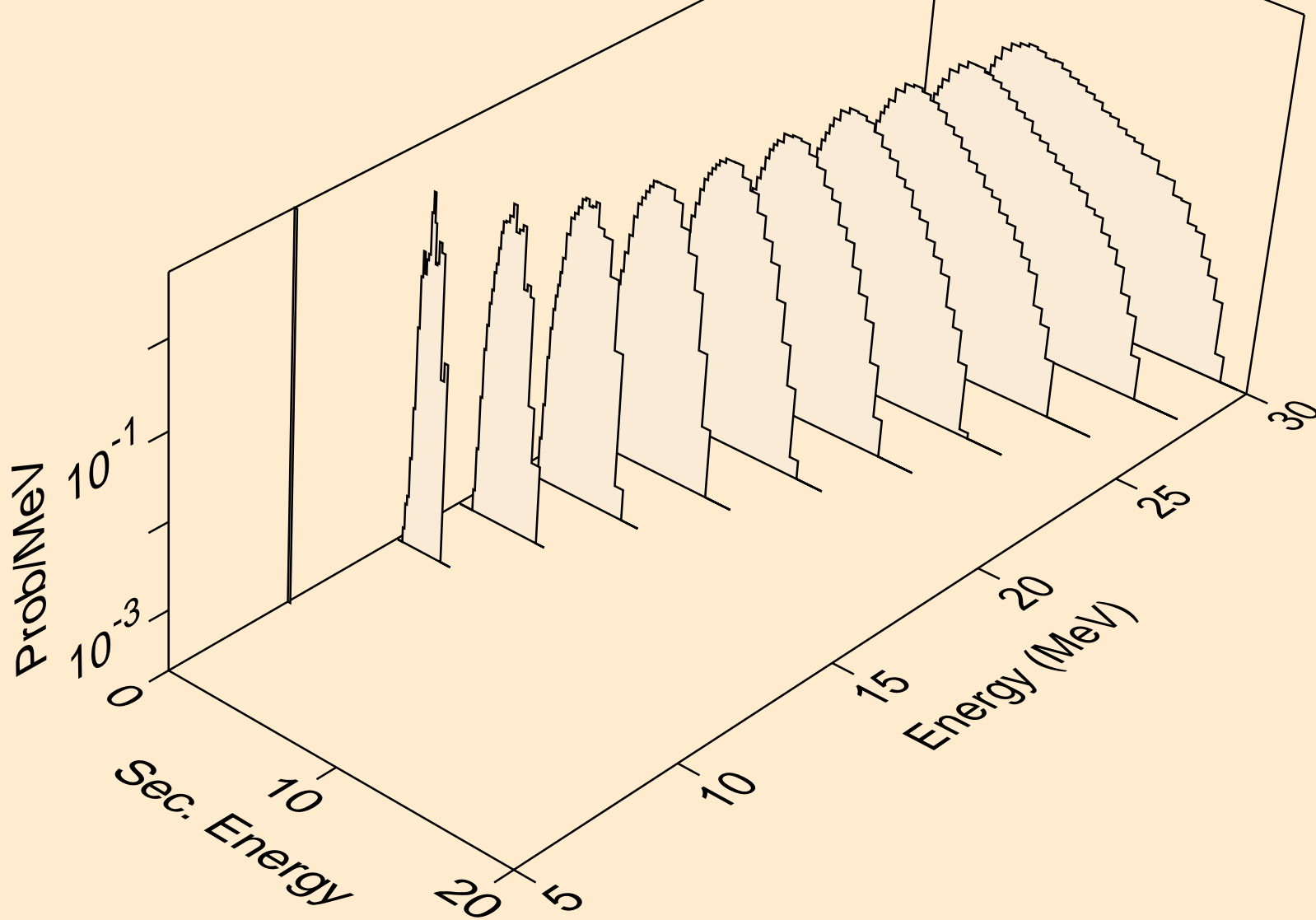

KR080 NEUTRON ACER TENDL-2019 LIBRARY; T=293.16K
protons from (n,p)

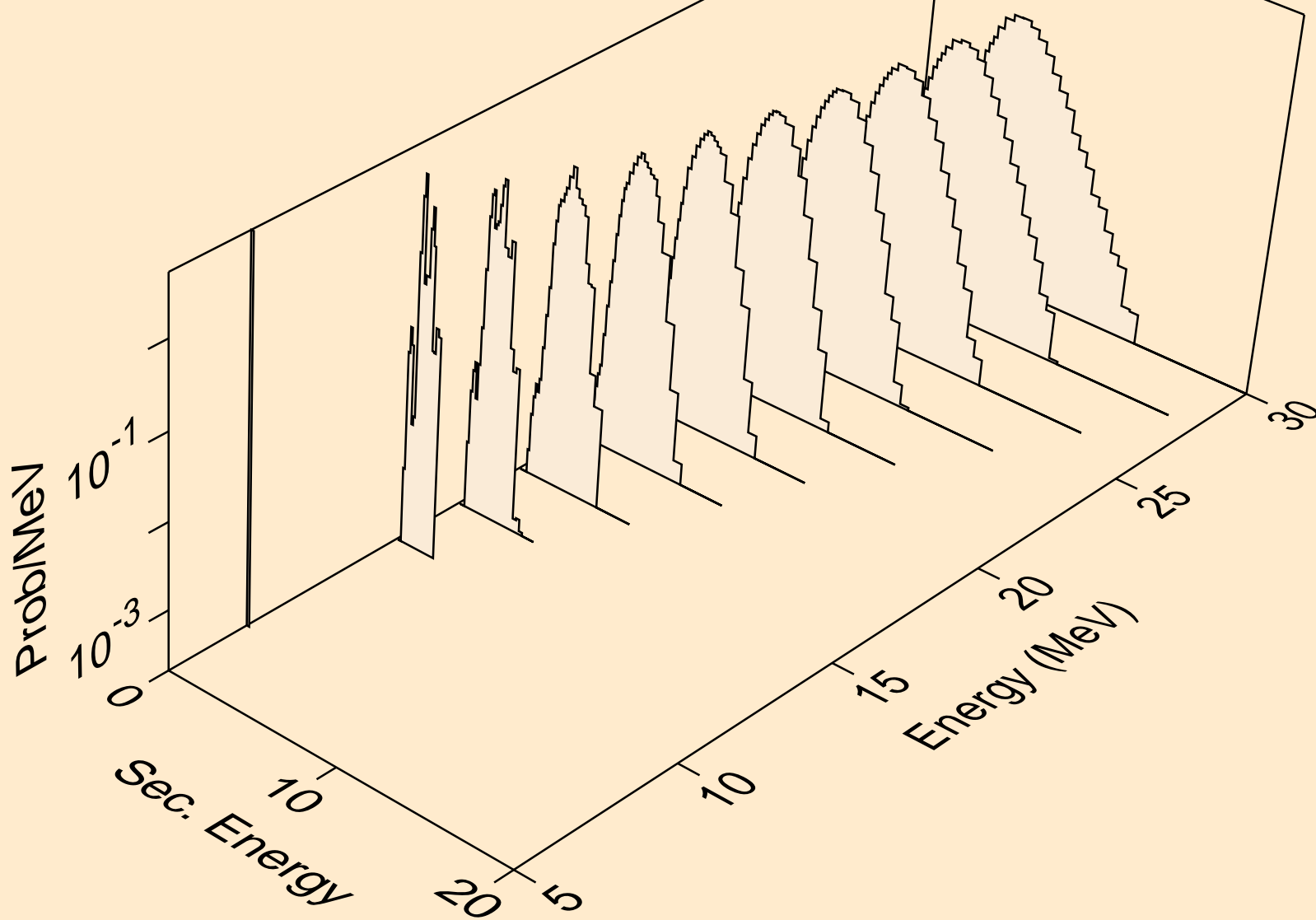

KR080 NEUTRON ACER TENDL-2019 LIBRARY; T=293.16K
protons from (n,pd)

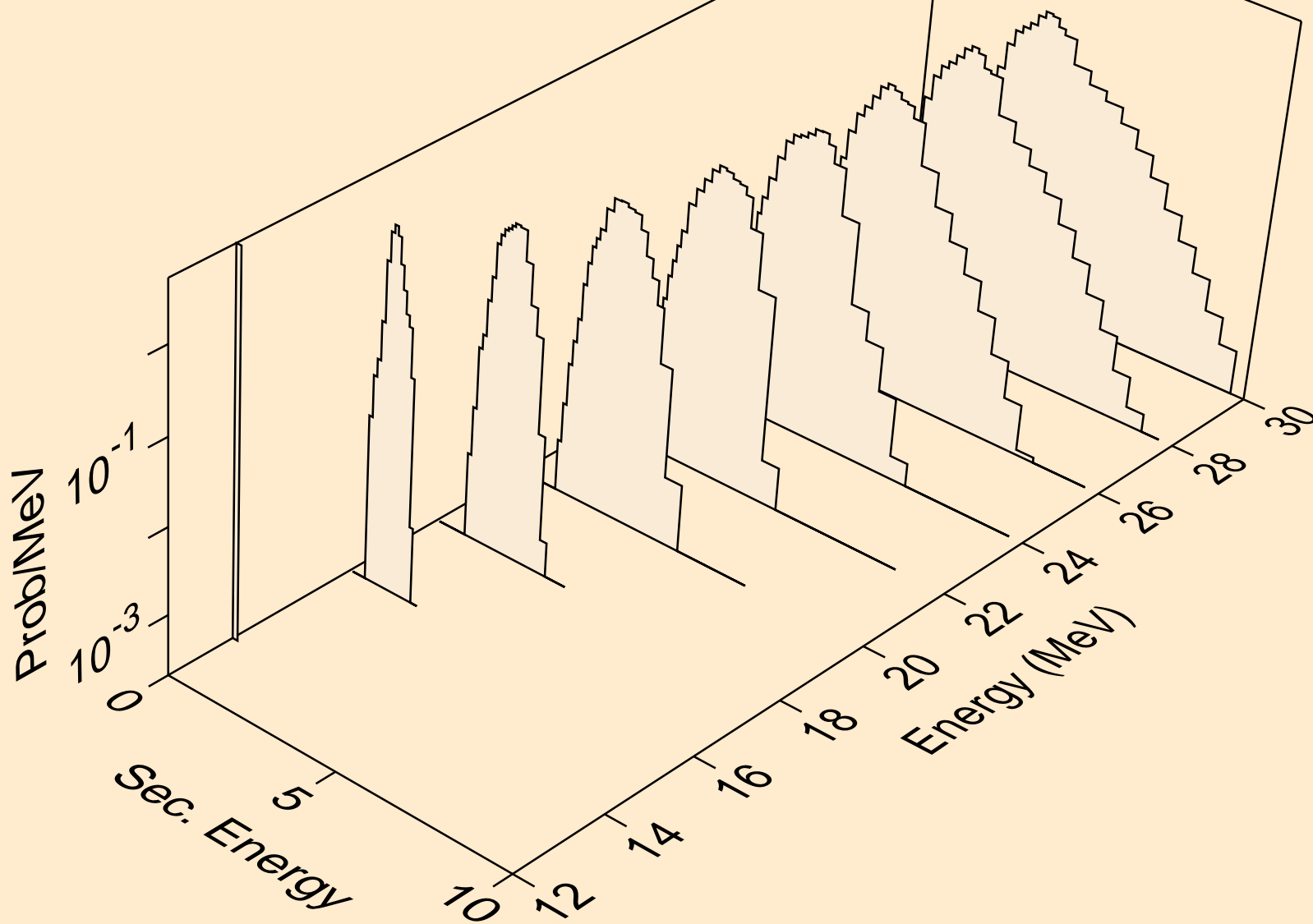

KR080 NEUTRON ACER TENDL-2019 LIBRARY; T=293.16K
protons from (n,pt)

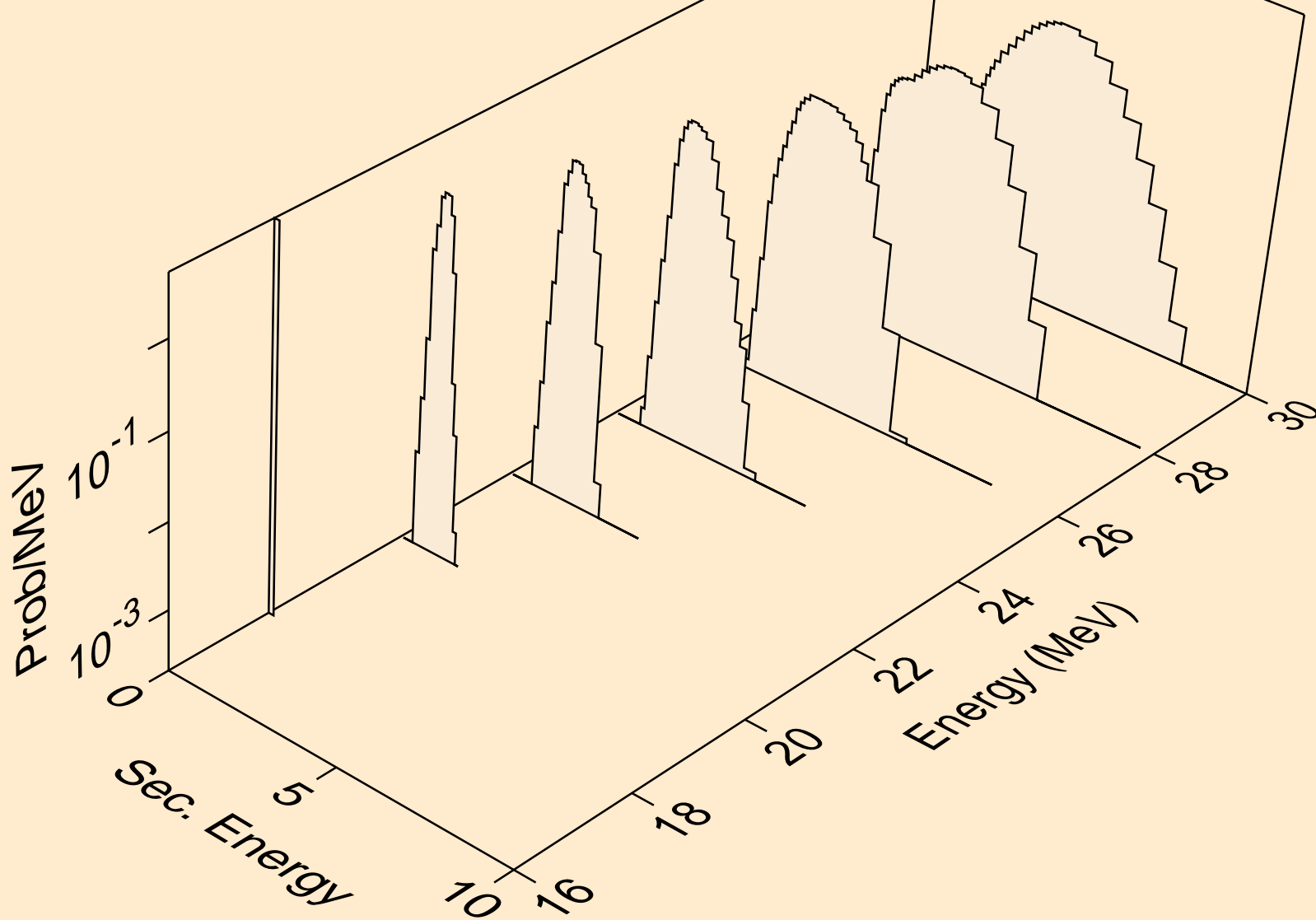

KR080 NEUTRON ACER TENDL-2019 LIBRARY; T=293.16K
deuterons from (n,x)

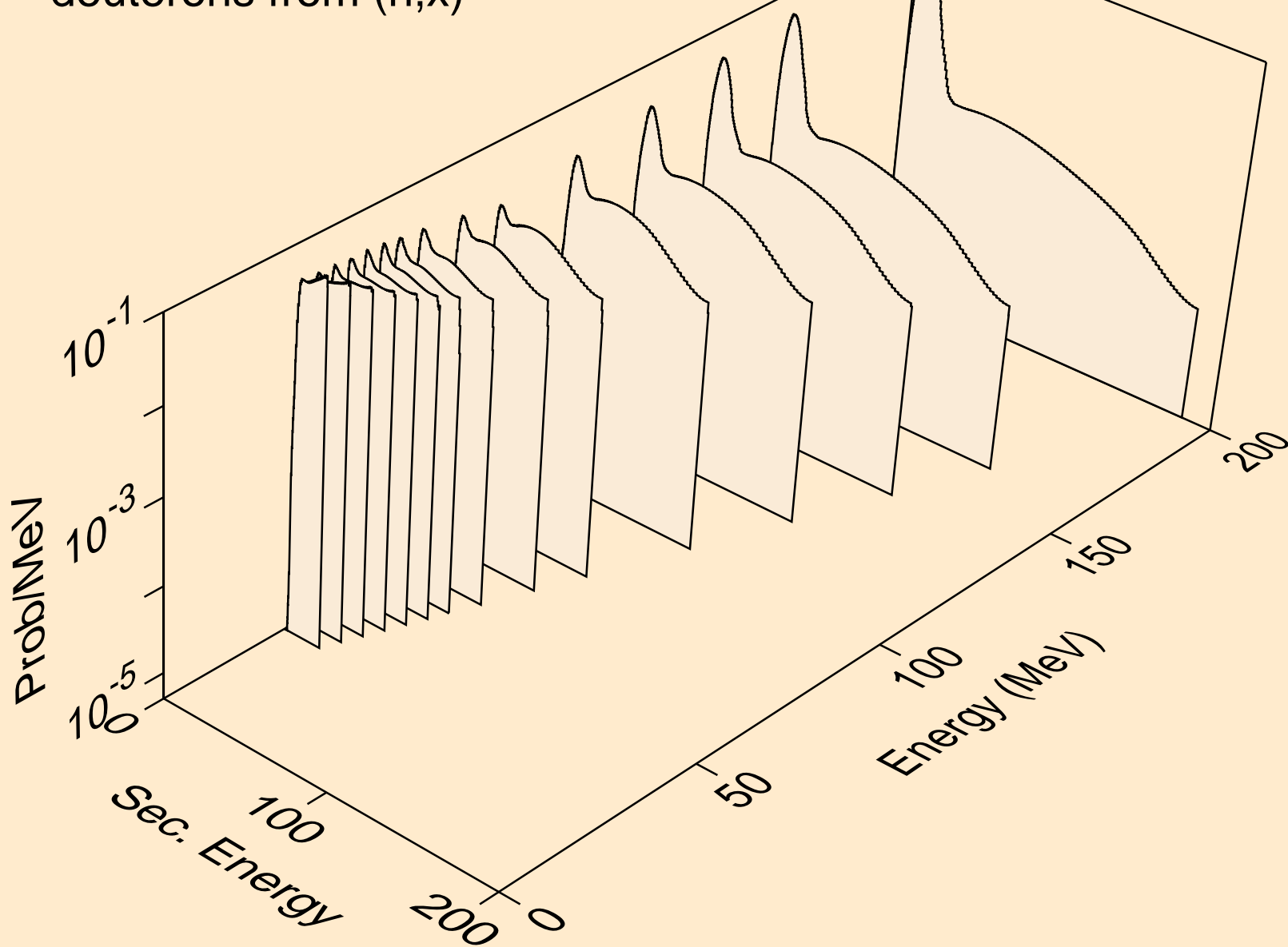

KR080 NEUTRON ACER TENDL-2019 LIBRARY; T=293.16K
deuterons from (n,2nd)

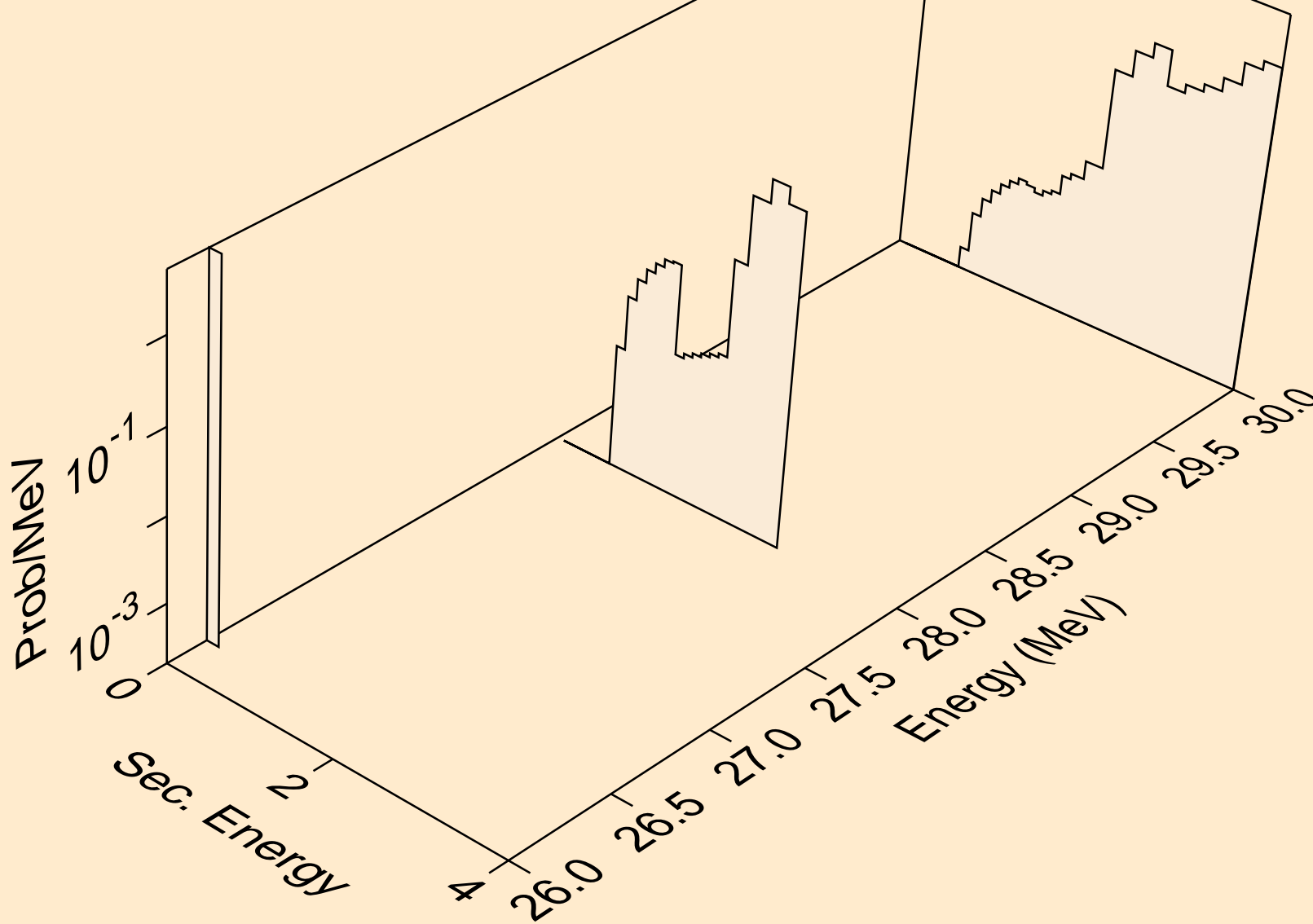

KR080 NEUTRON ACER TENDL-2019 LIBRARY; T=293.16K
deuterons from (n,n*)d

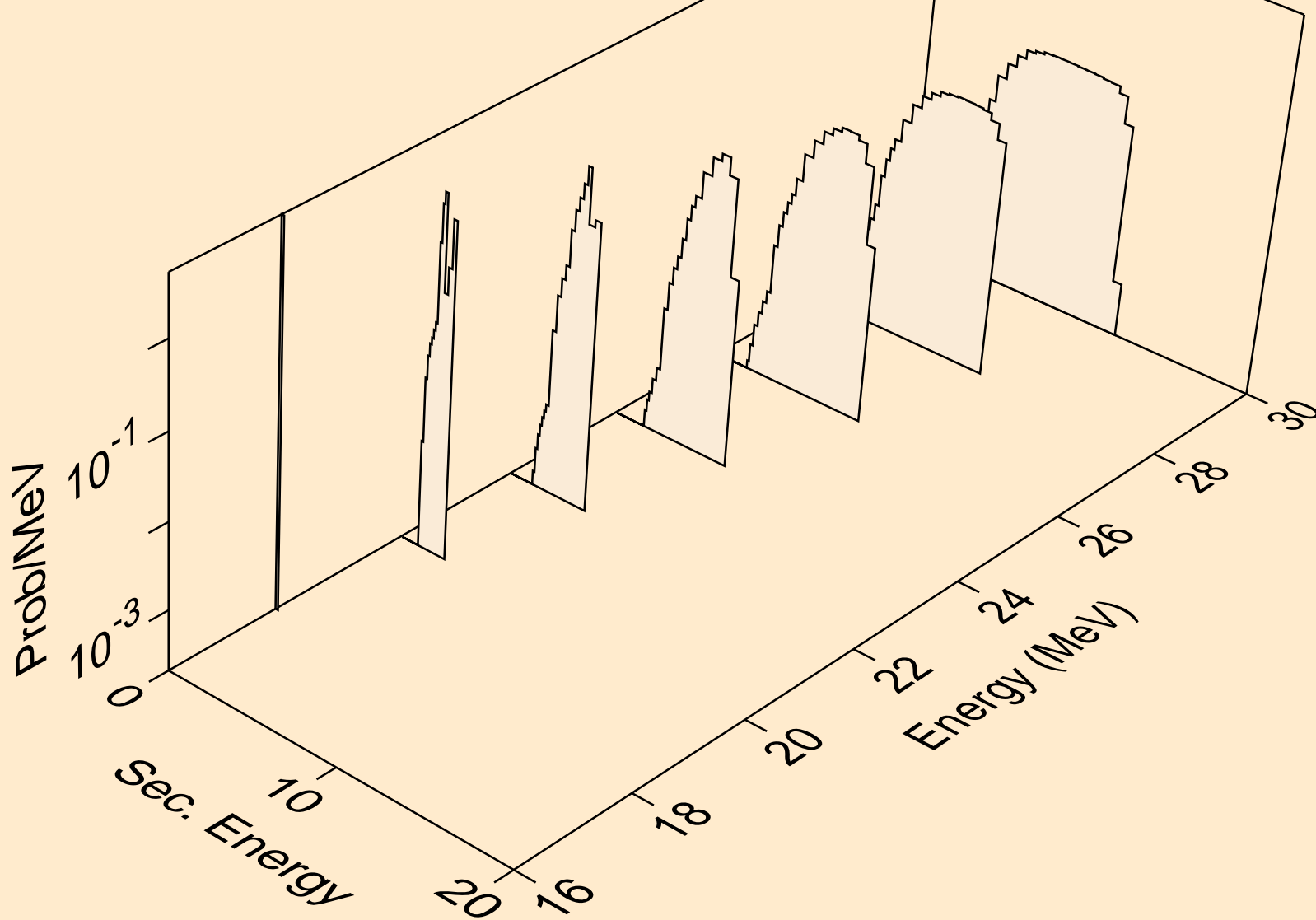

KR080 NEUTRON ACER TENDL-2019 LIBRARY; T=293.16K
deuterons from (n,d)

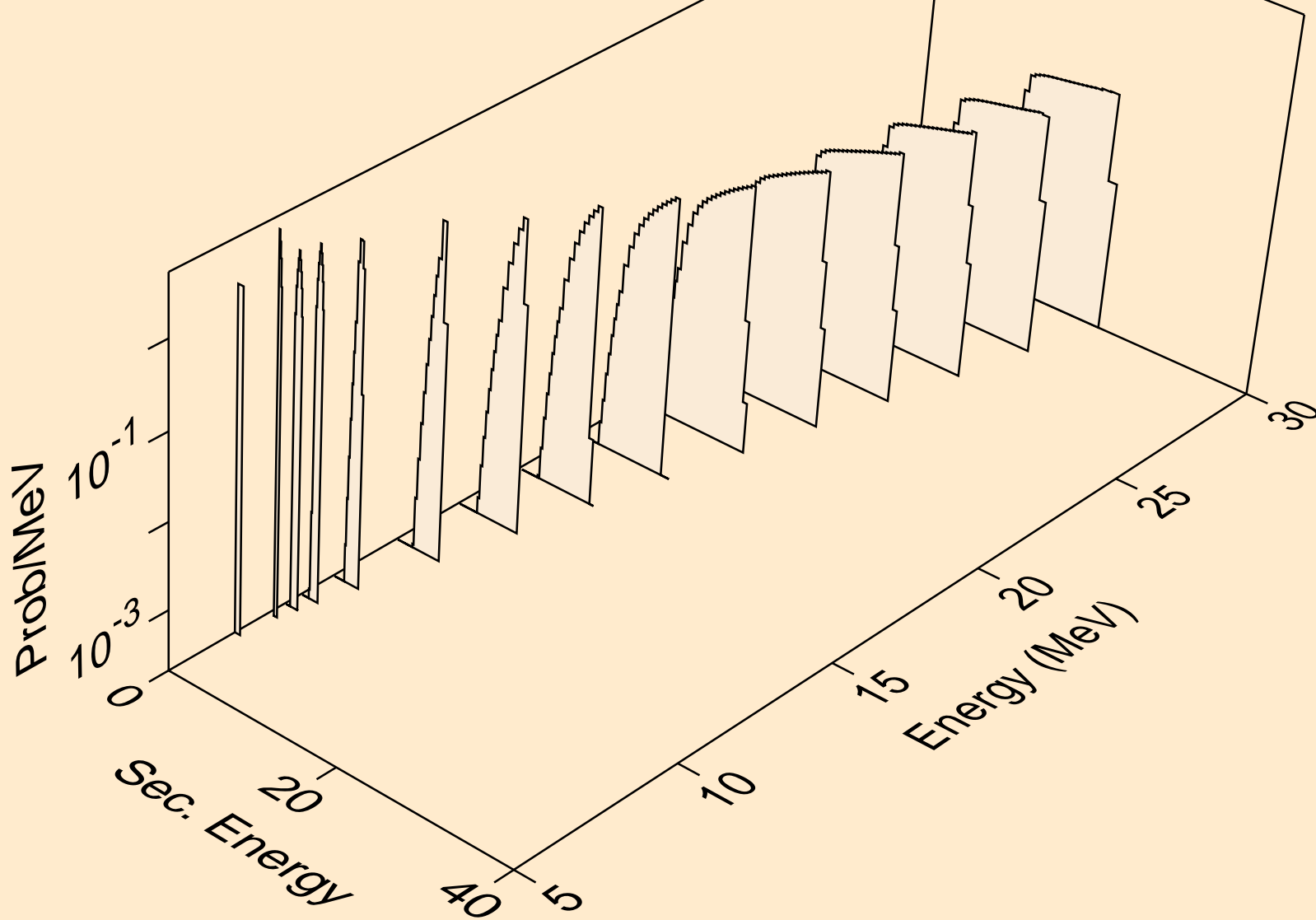

KR080 NEUTRON ACER TENDL-2019 LIBRARY; T=293.16K
deuterons from (n,pd)

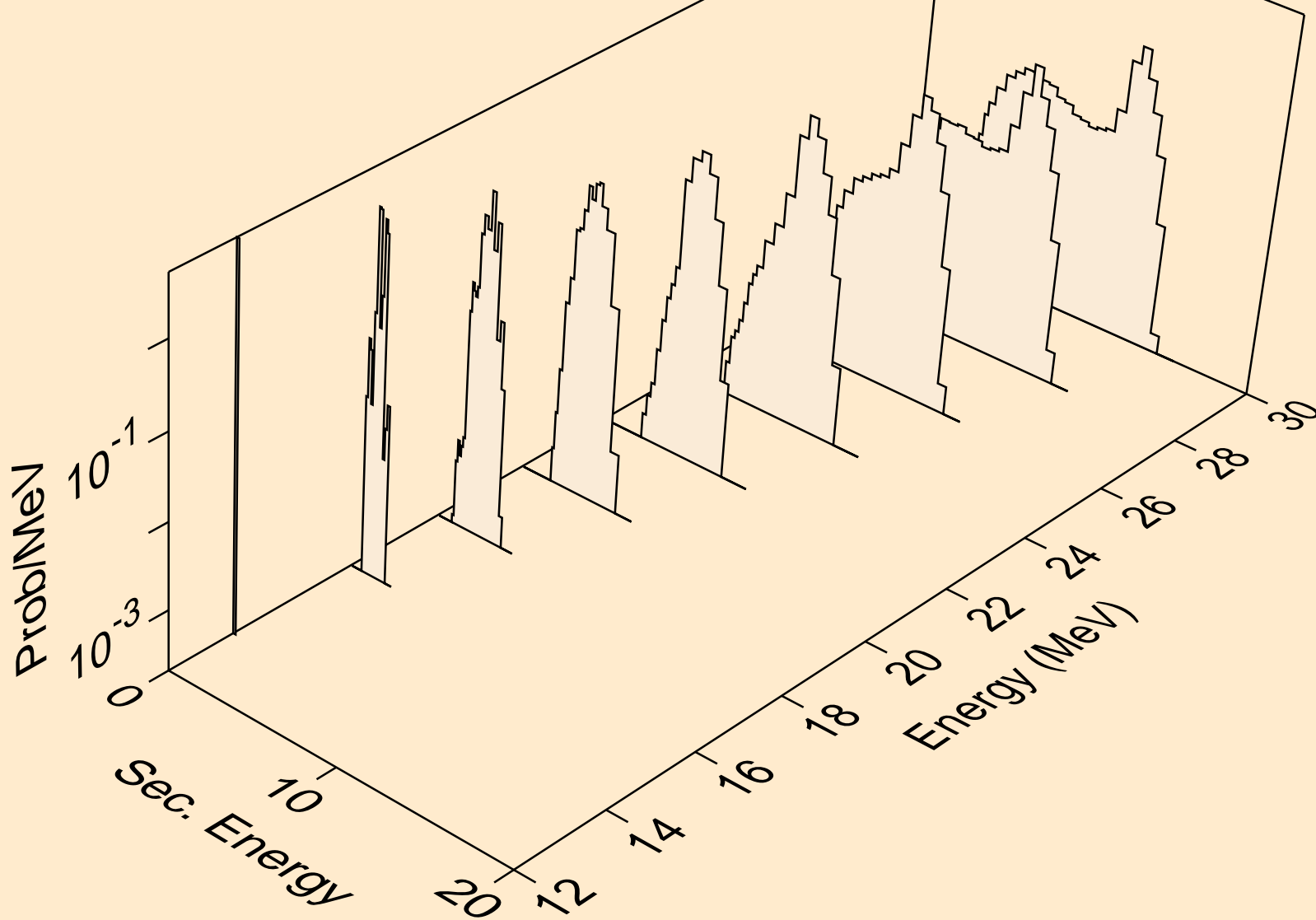

KR080 NEUTRON ACER TENDL-2019 LIBRARY; T=293.16K
deuterons from (n,da)

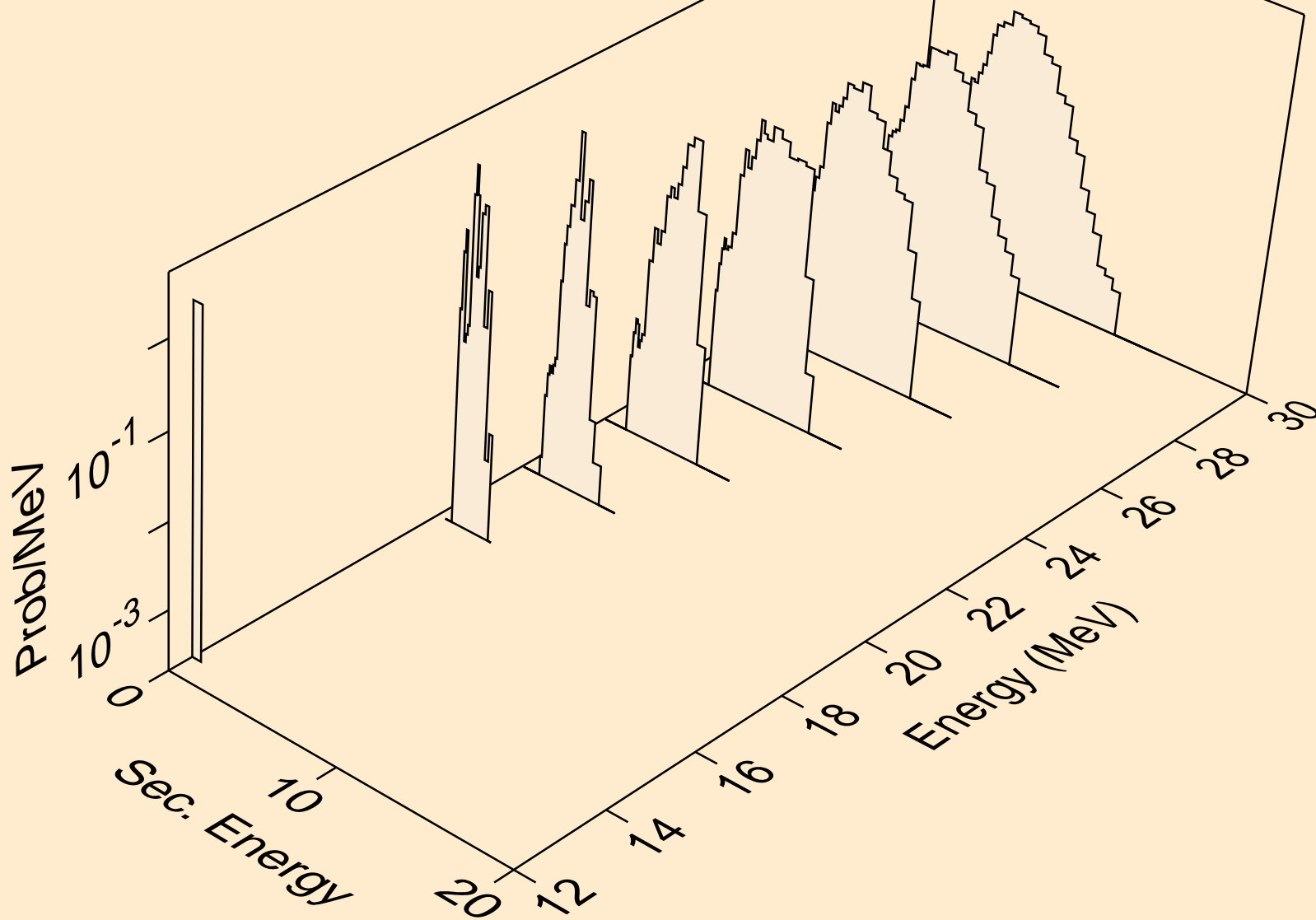

KR080 NEUTRON ACER TENDL-2019 LIBRARY; T=293.16K
tritons from (n,x)

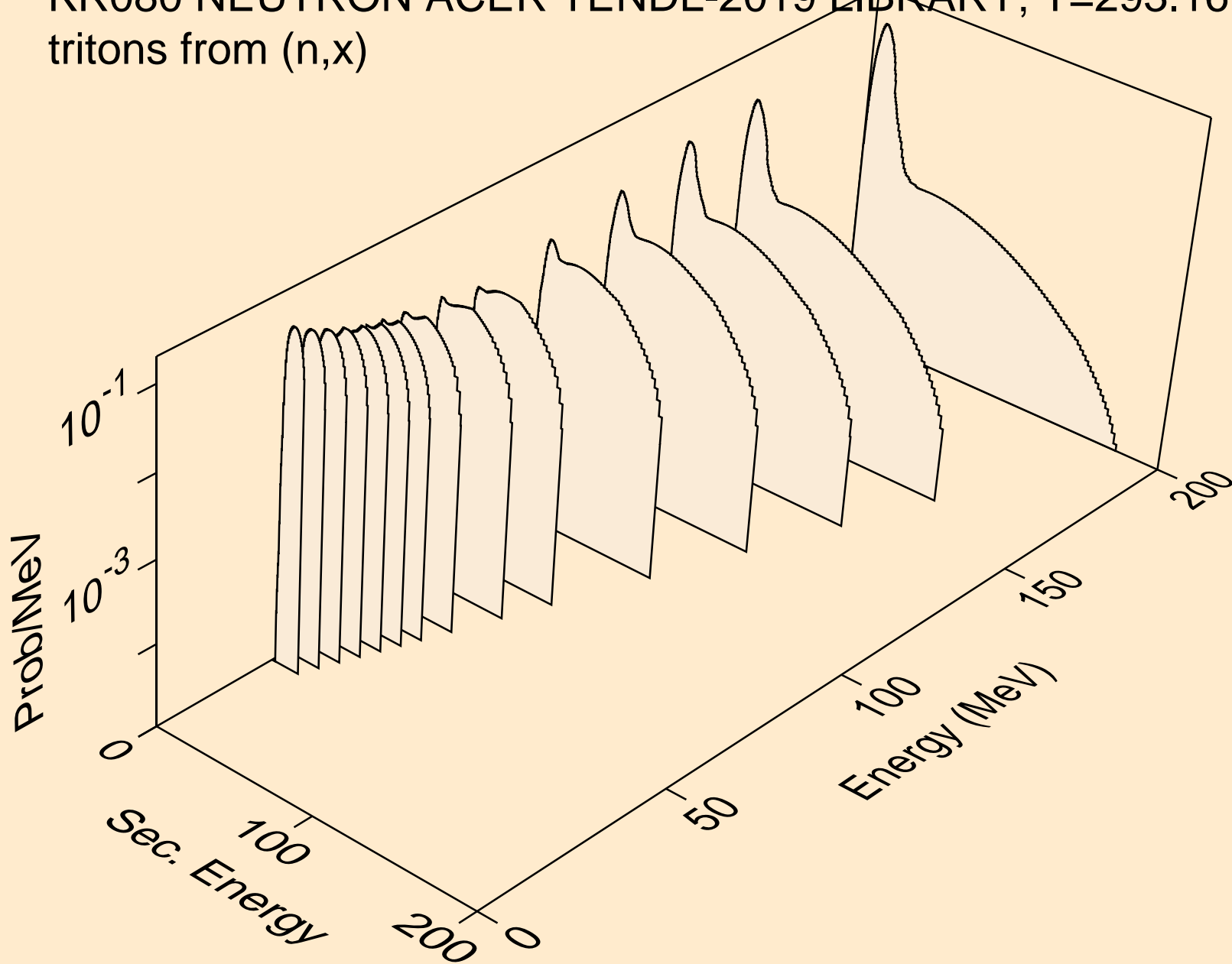

KR080 NEUTRON ACER TENDL-2019 LIBRARY; T=293.16K
tritons from (n,n*)t

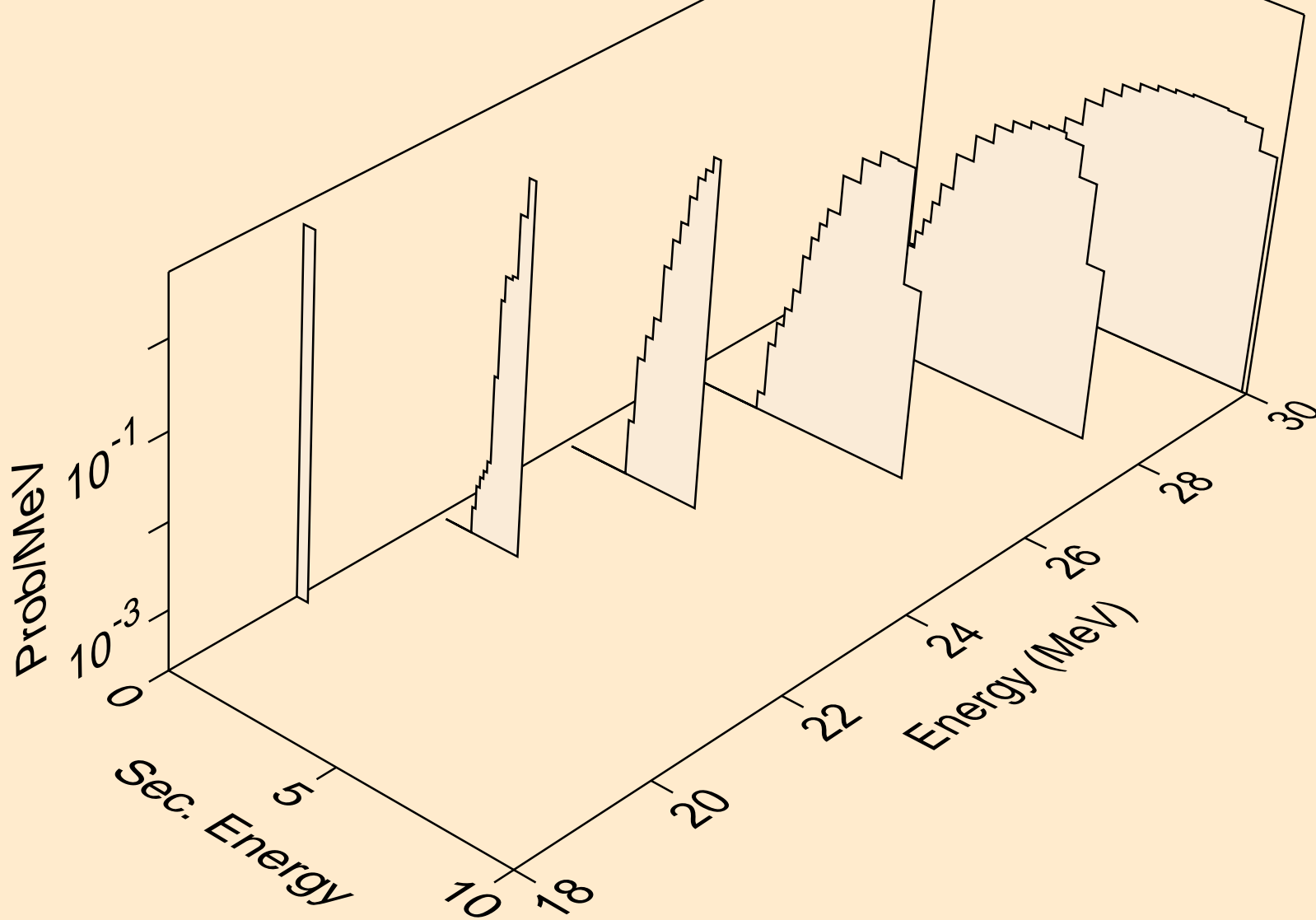

KR080 NEUTRON ACER TENDL-2019 LIBRARY; T=293.16K
tritons from (n,t)

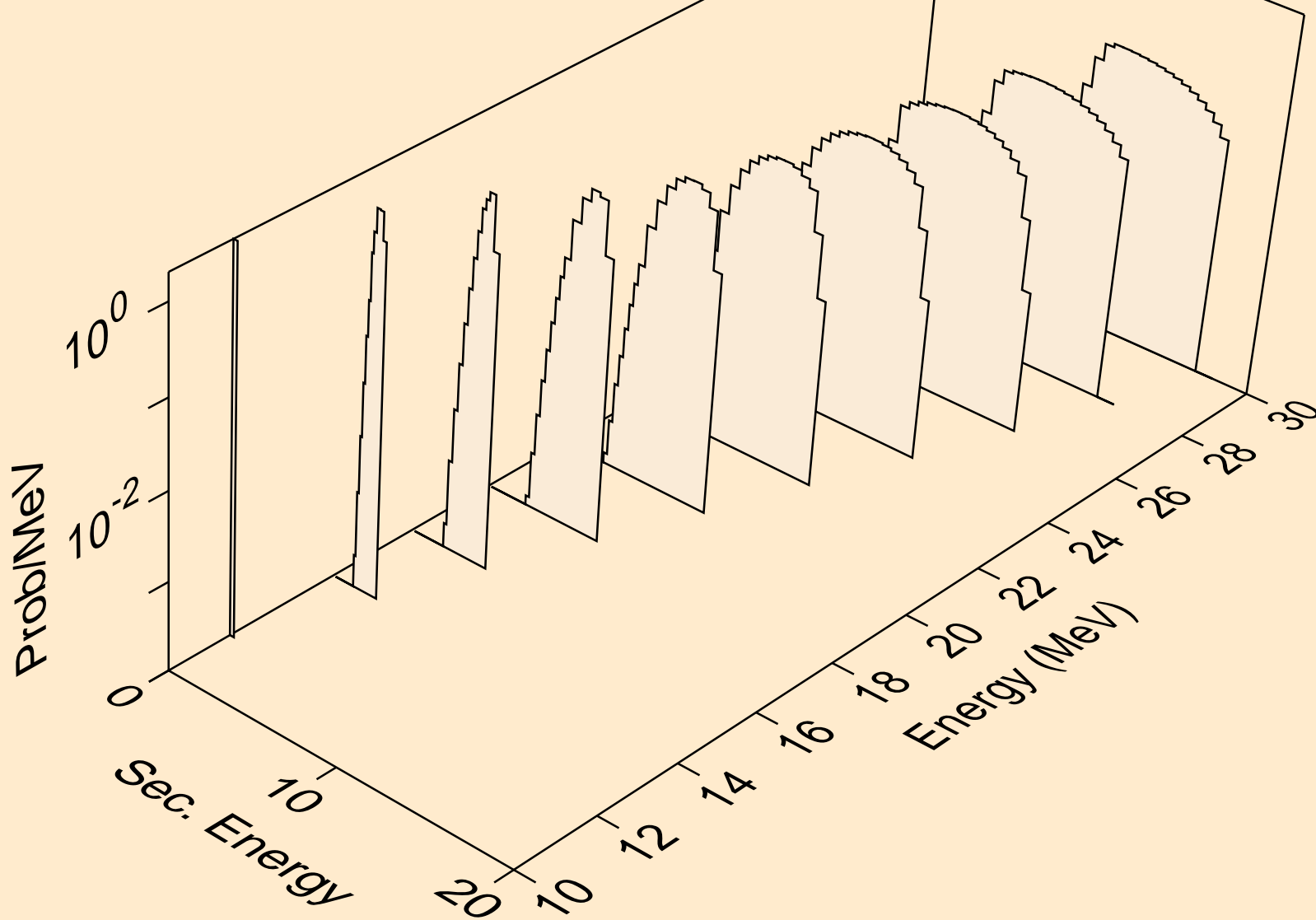

KR080 NEUTRON ACER TENDL-2019 LIBRARY; T=293.16K
tritons from (n,pt)

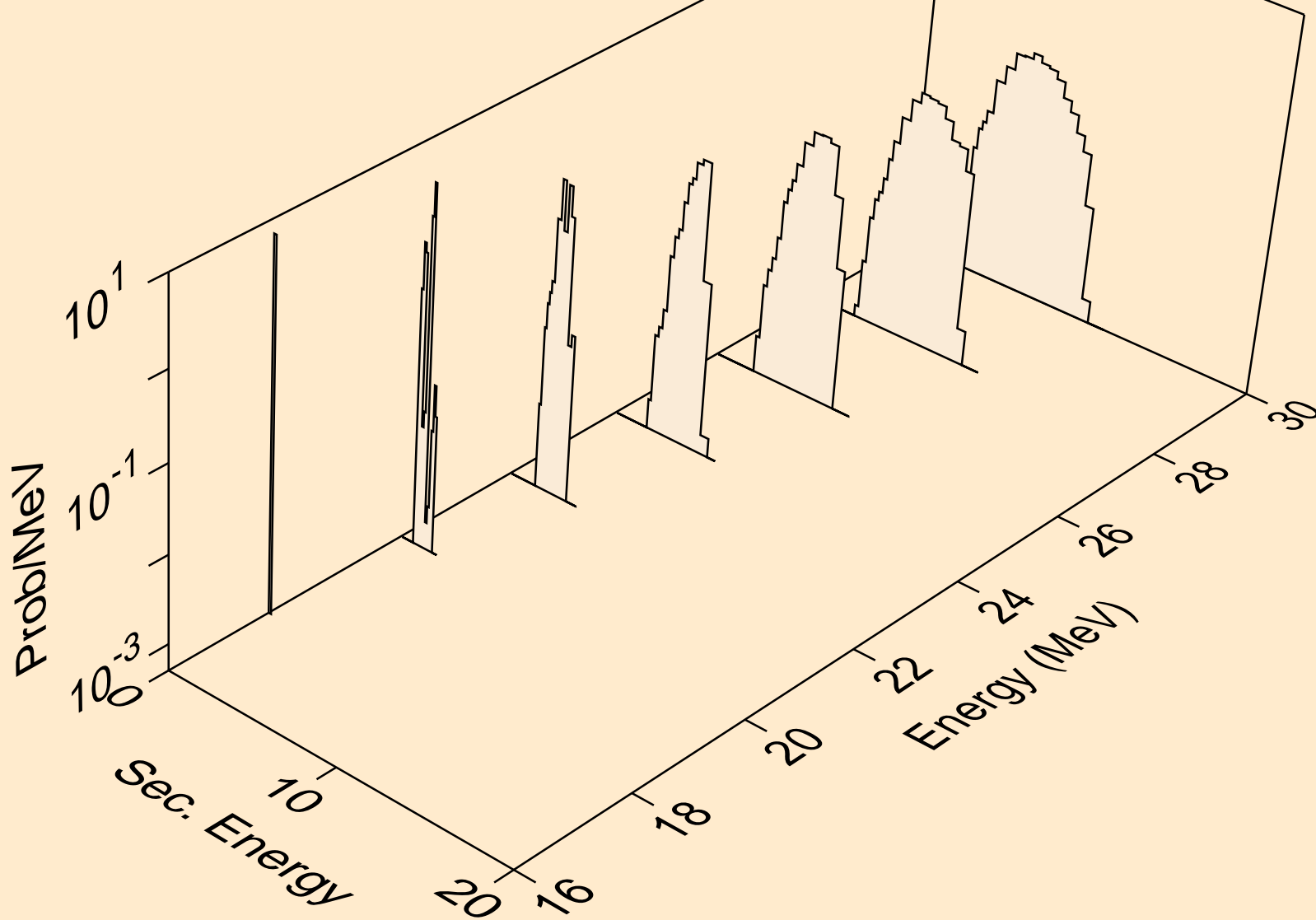

KR080 NEUTRON ACER TENDL-2019 LIBRARY; T=293.16K
he3s from (n,x)

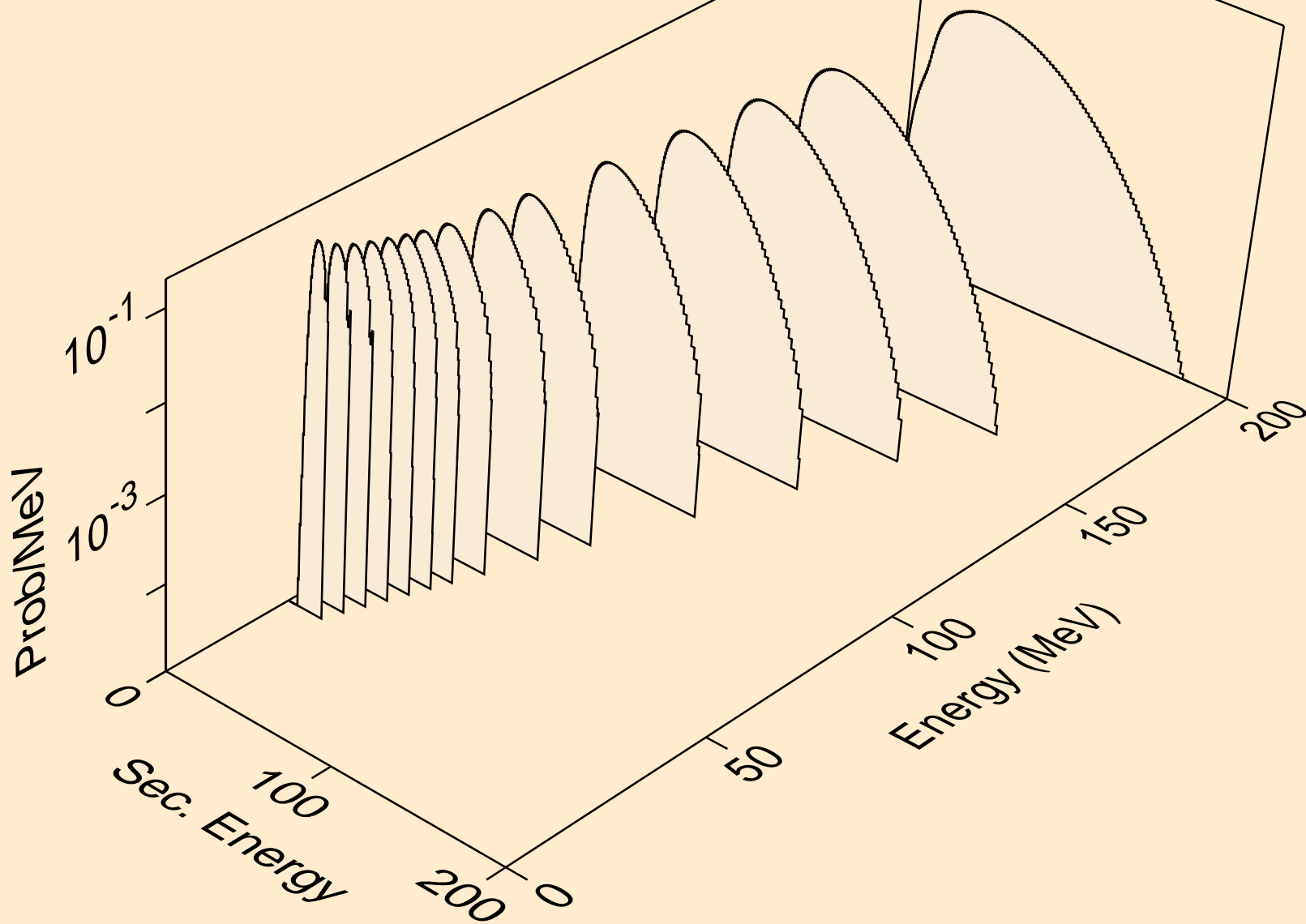

KR080 NEUTRON ACER TENDL-2019 LIBRARY; T=293.16K
he3s from (n,n*)he3

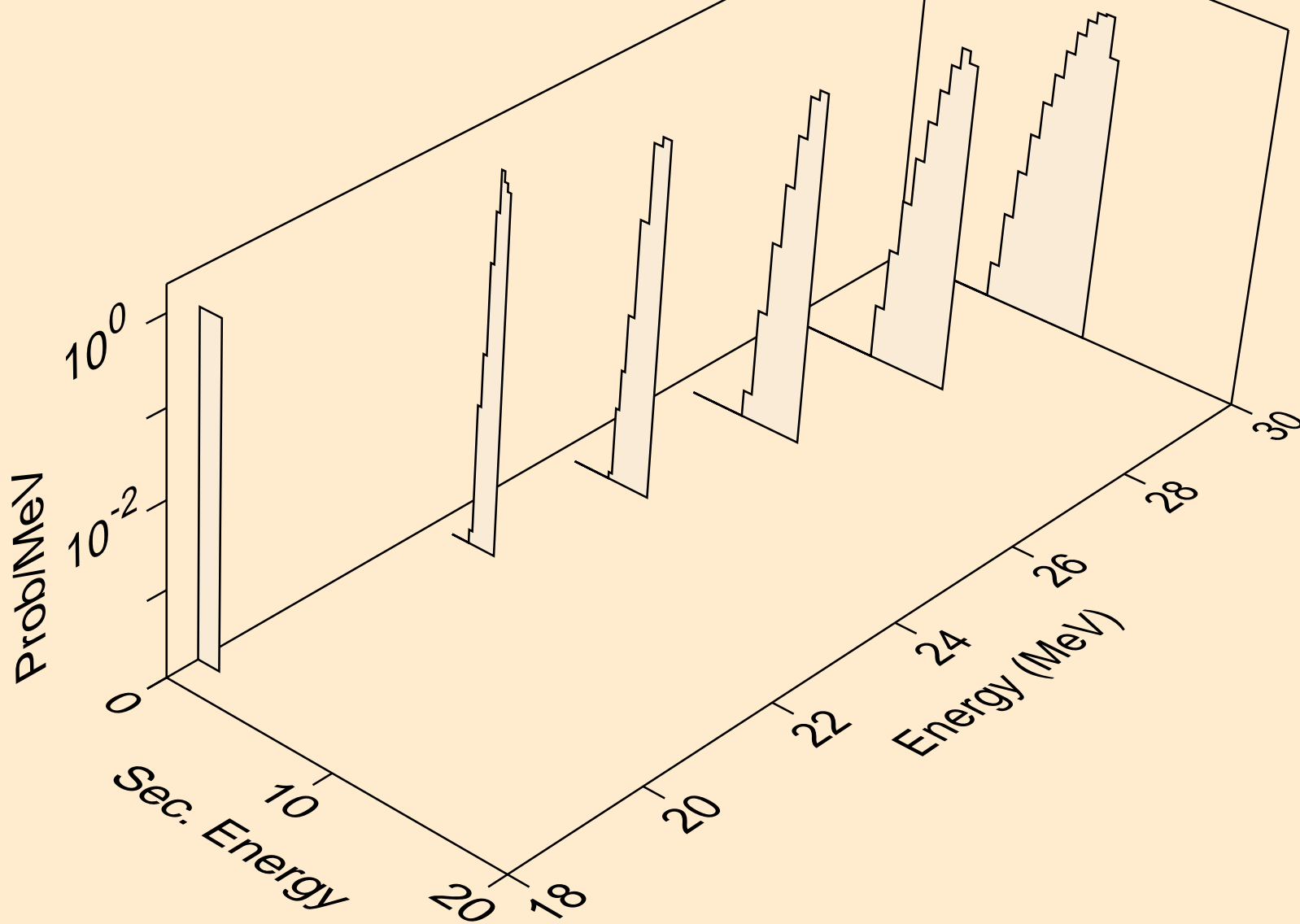

KR080 NEUTRON ACER TENDL-2019 LIBRARY; T=293.16K
he3s from (n,he3)

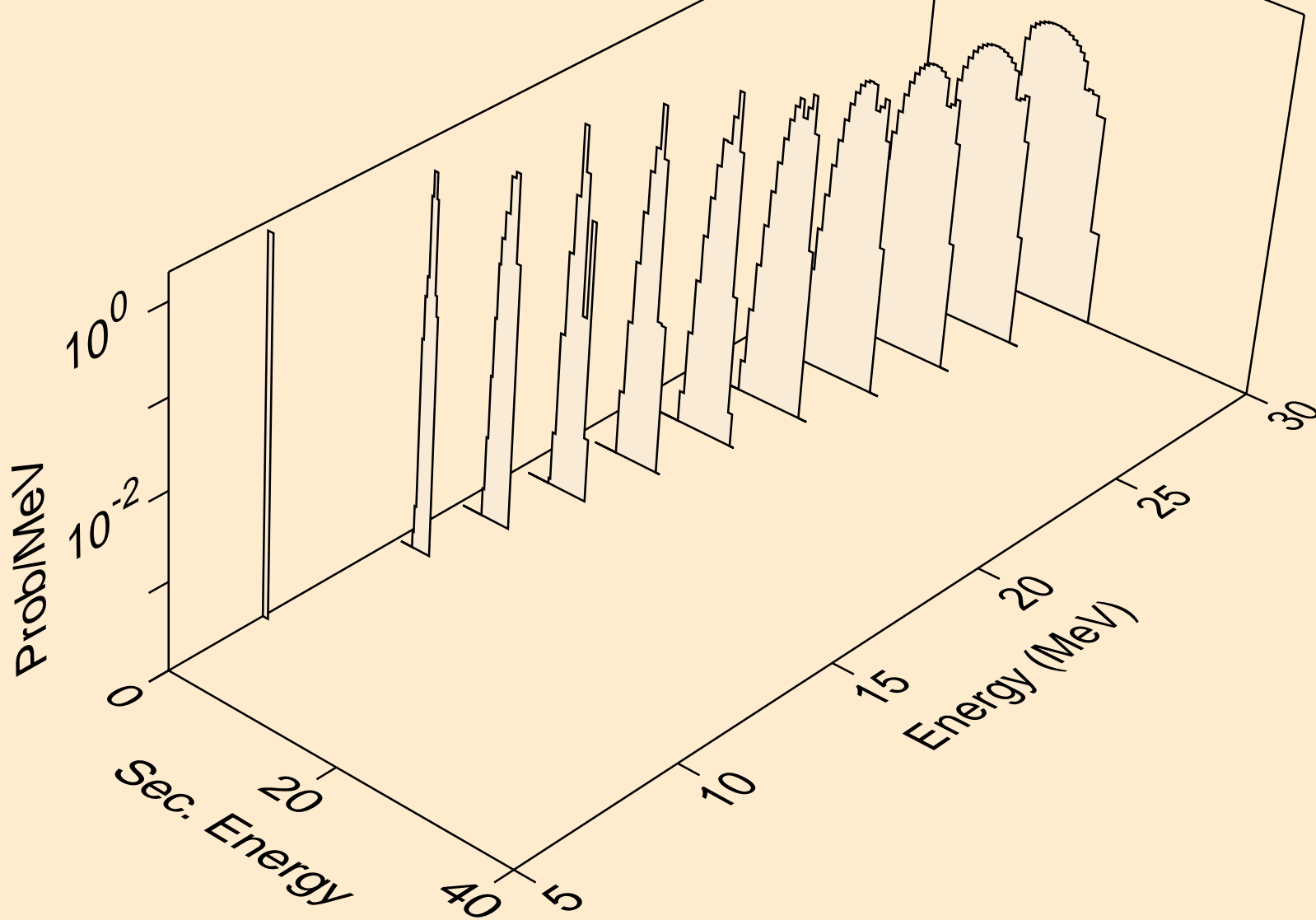

KR080 NEUTRON ACER TENDL-2019 LIBRARY; T=293.16K
alphas from (n,x)

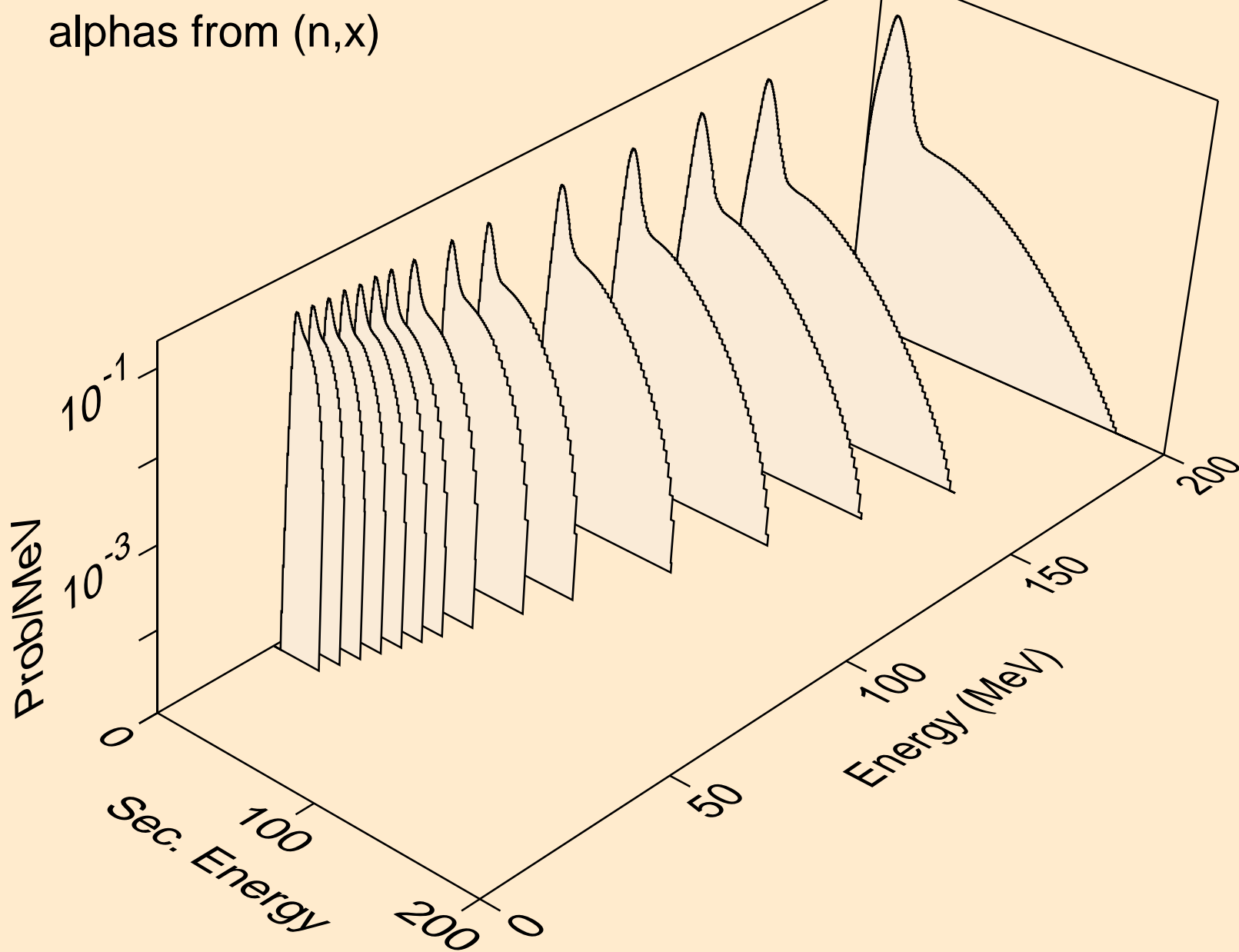

KR080 NEUTRON ACER TENDL-2019 LIBRARY; T=293.16K
alphas from (n,n*)a

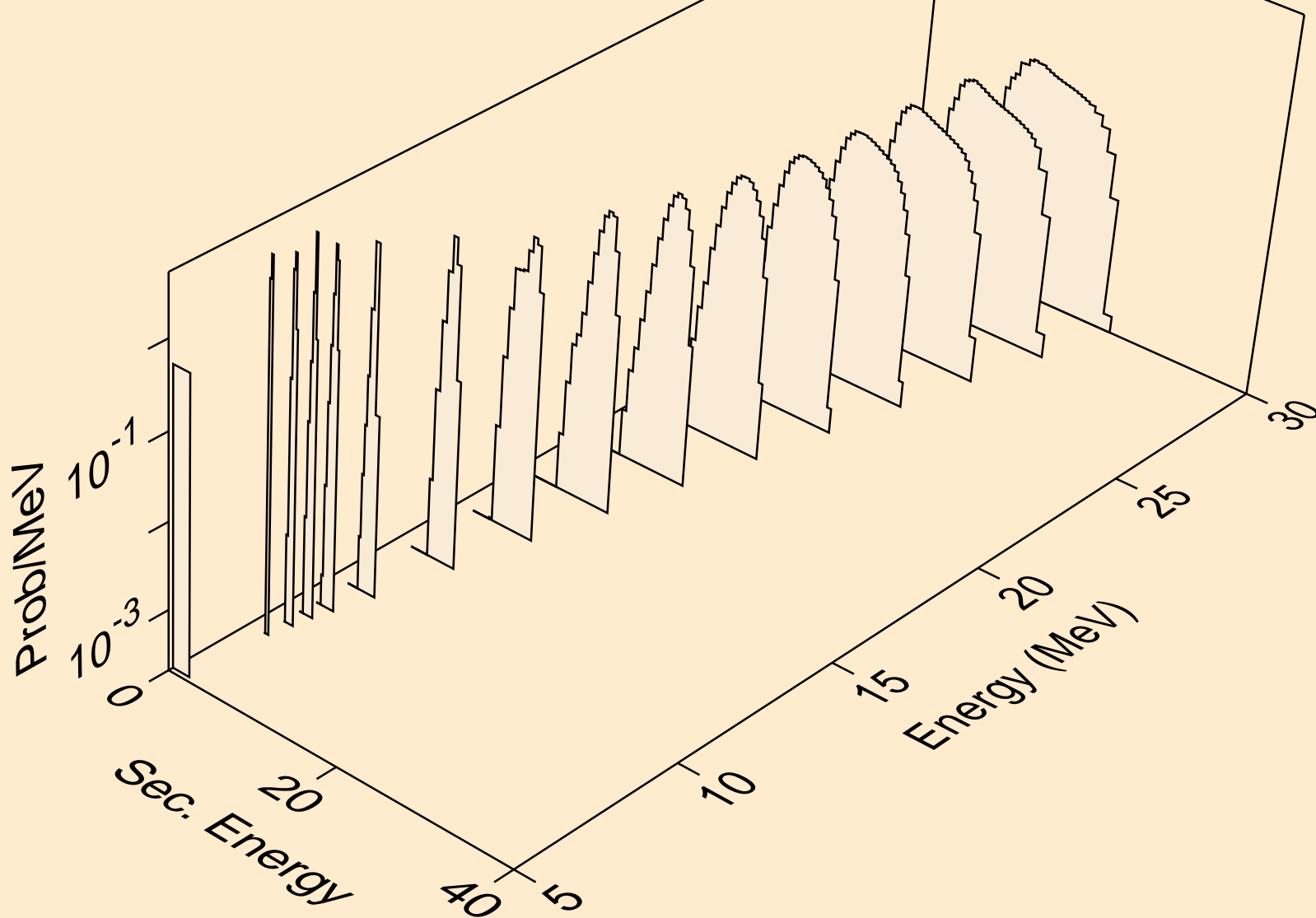

KR080 NEUTRON ACER TENDL-2019 LIBRARY; T=293.16K
alphas from (n,2n)a

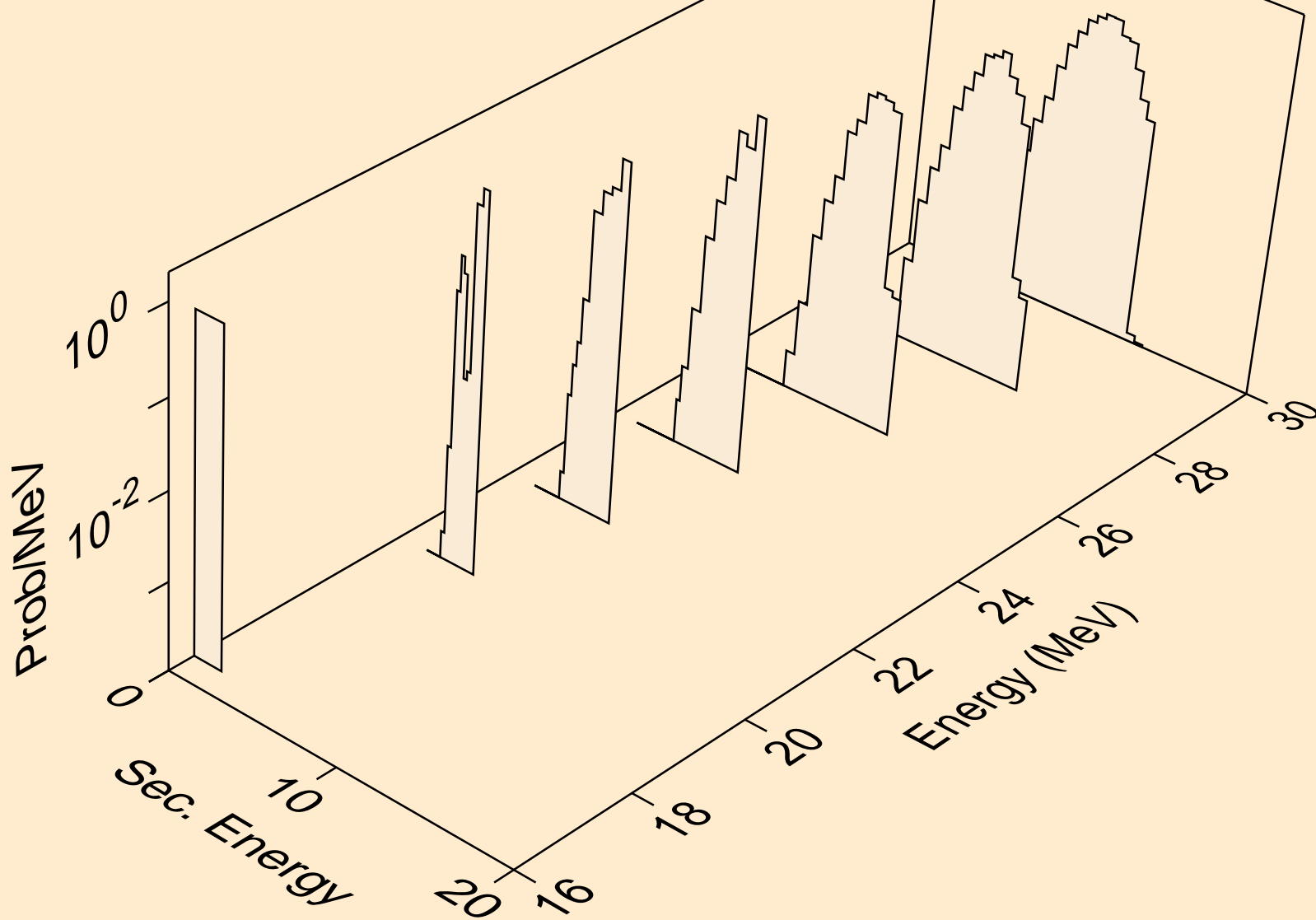

KR080 NEUTRON ACER TENDL-2019 LIBRARY; T=293.16K
alphas from (n,3n)a

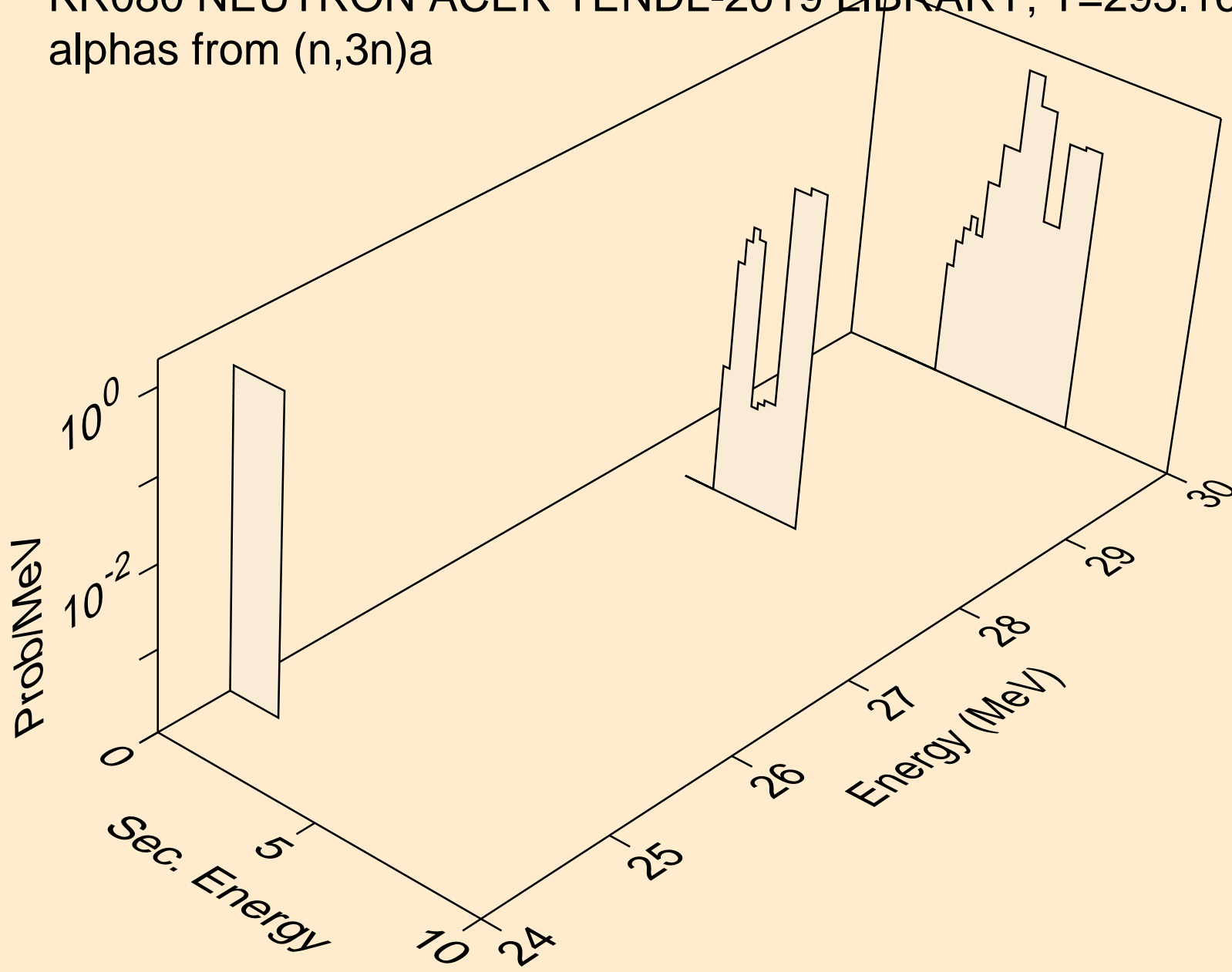

KR080 NEUTRON ACER TENDL-2019 LIBRARY; T=293.16K
alphas from (n,n*)2a

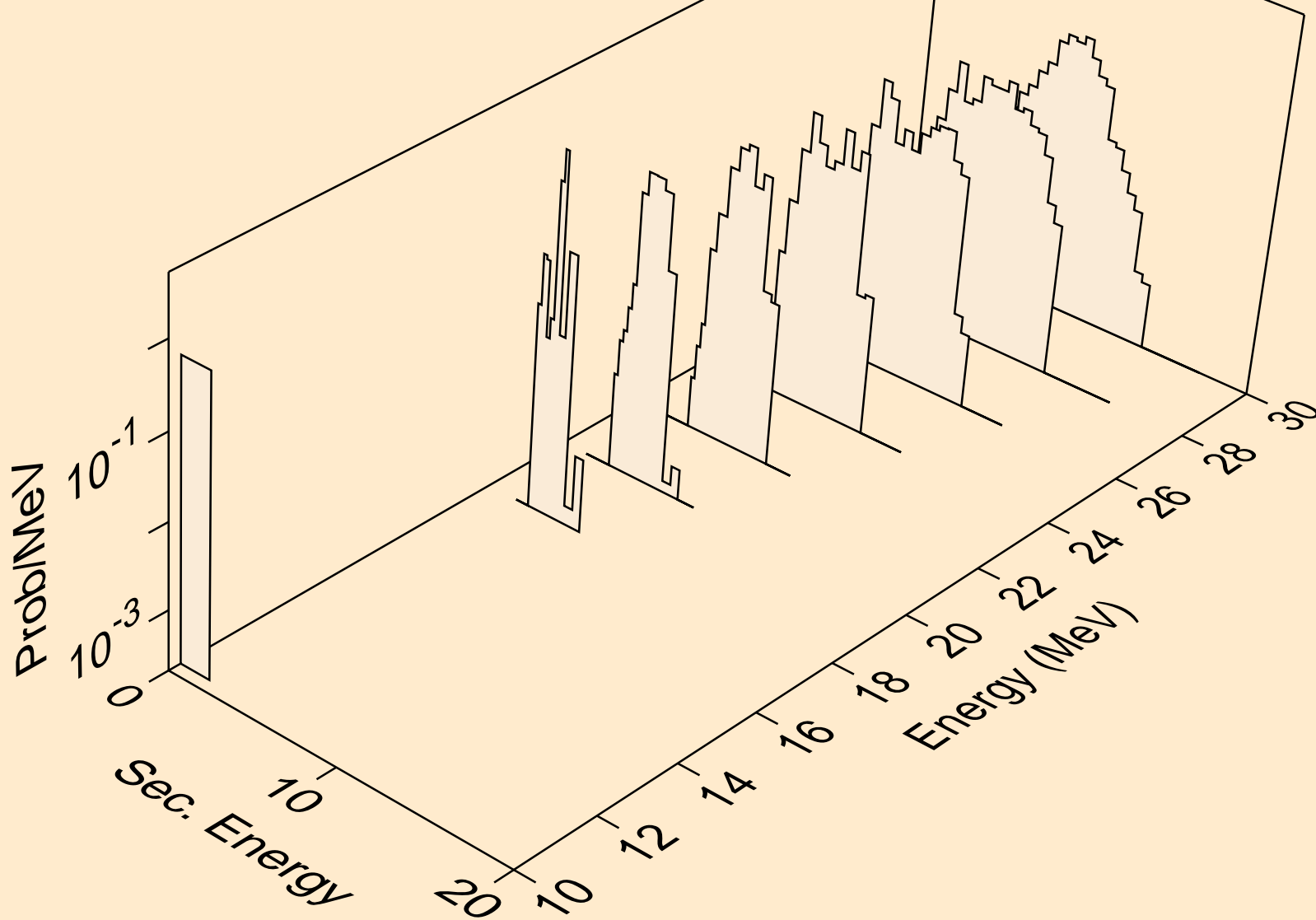

KR080 NEUTRON ACER TENDL-2019 LIBRARY; T=293.16K
alphas from (n,npa)

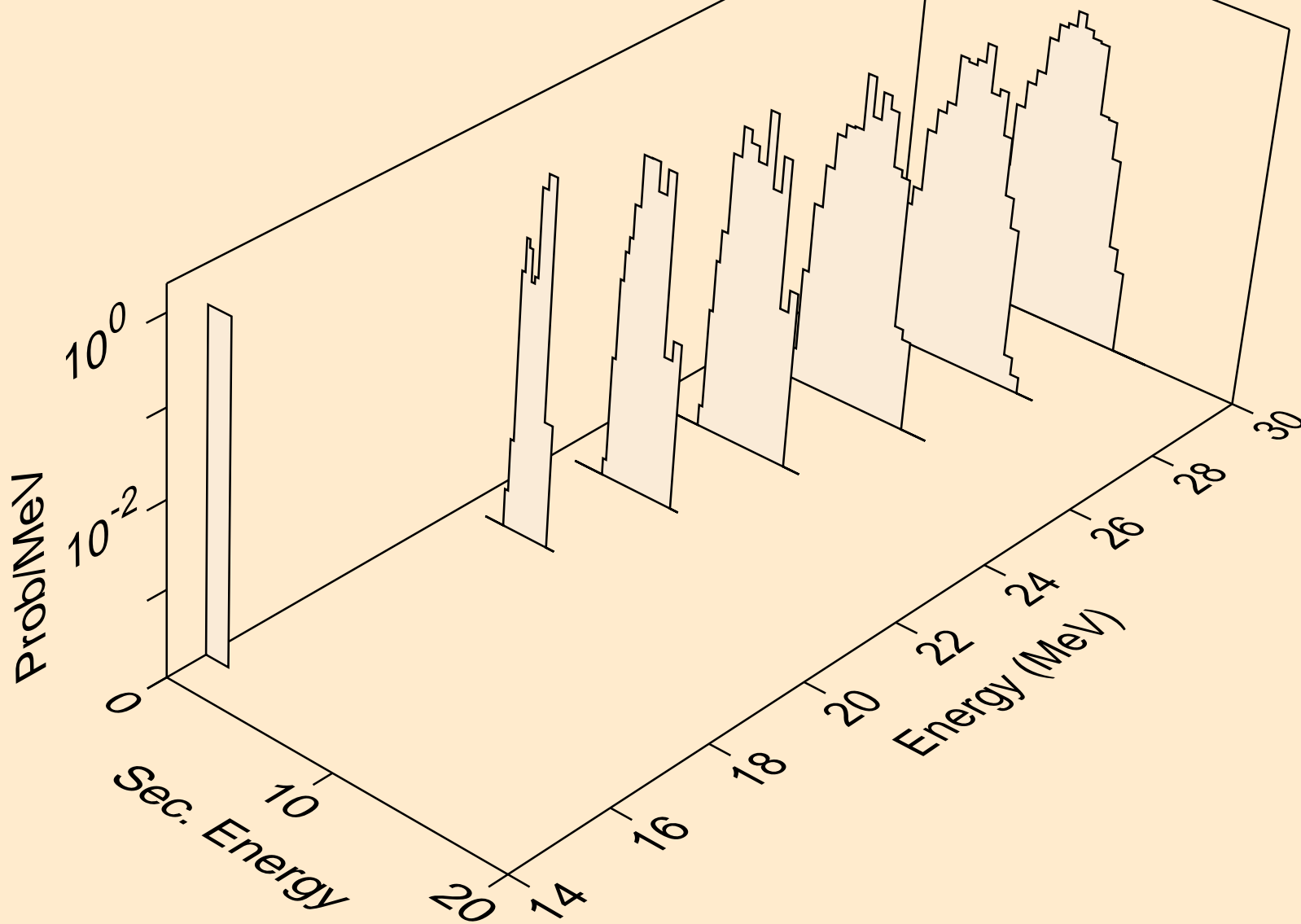

KR080 NEUTRON ACER TENDL-2019 LIBRARY; T=293.16K
alphas from (n,a)

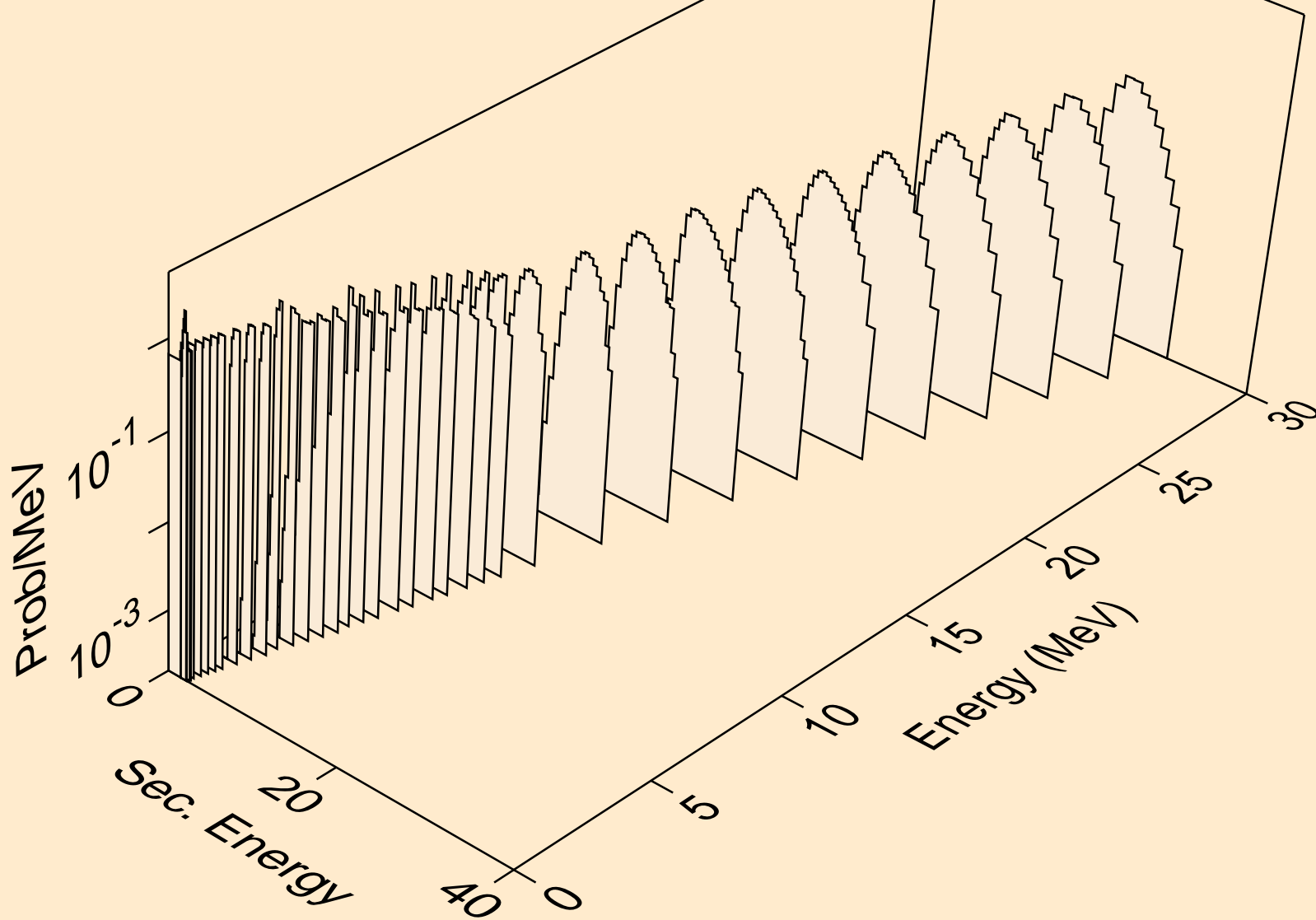

KR080 NEUTRON ACER TENDL-2019 LIBRARY; T=293.16K
alphas from (n,2a)

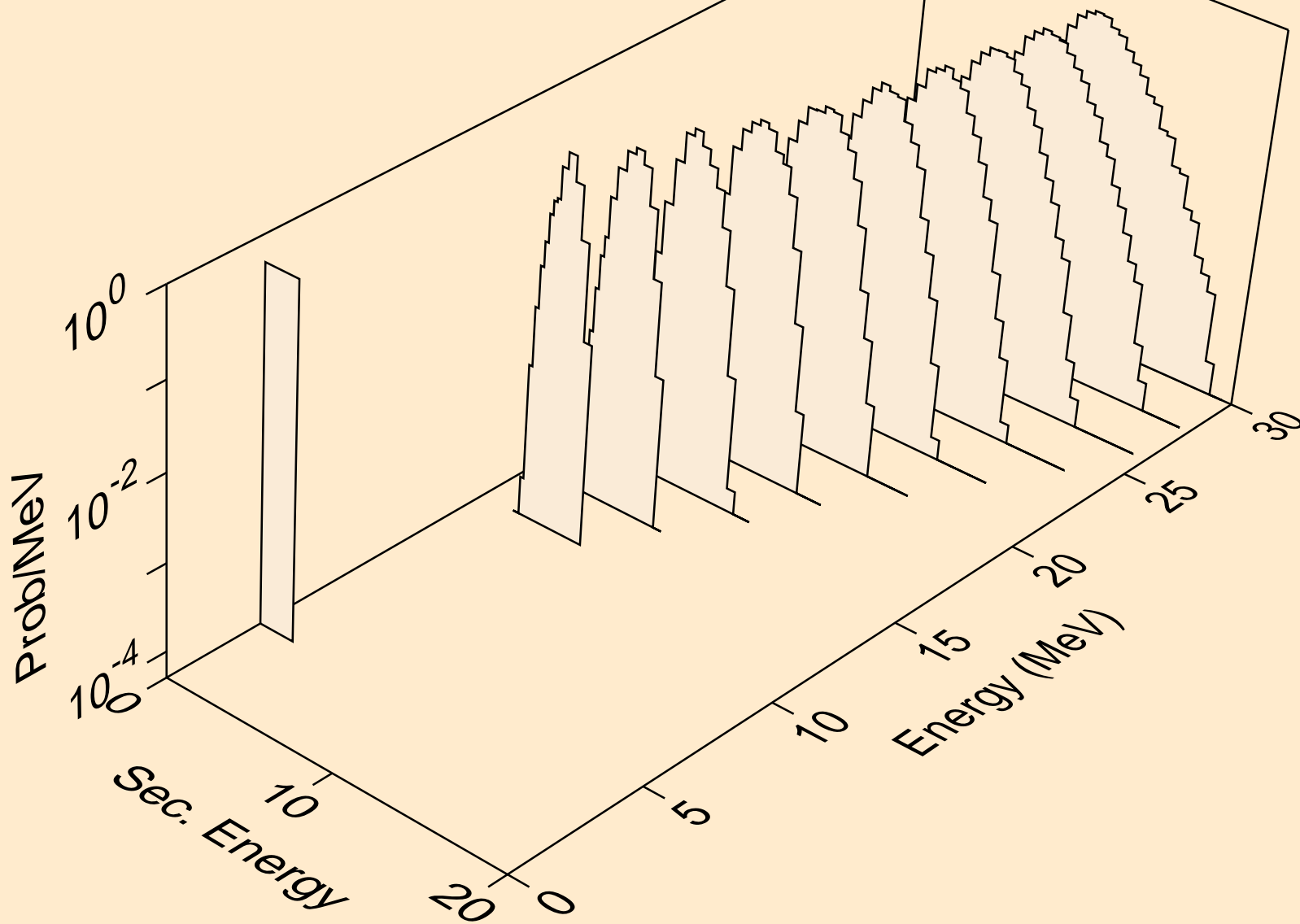

KR080 NEUTRON ACER TENDL-2019 LIBRARY; T=293.16K
alphas from (n,pa)

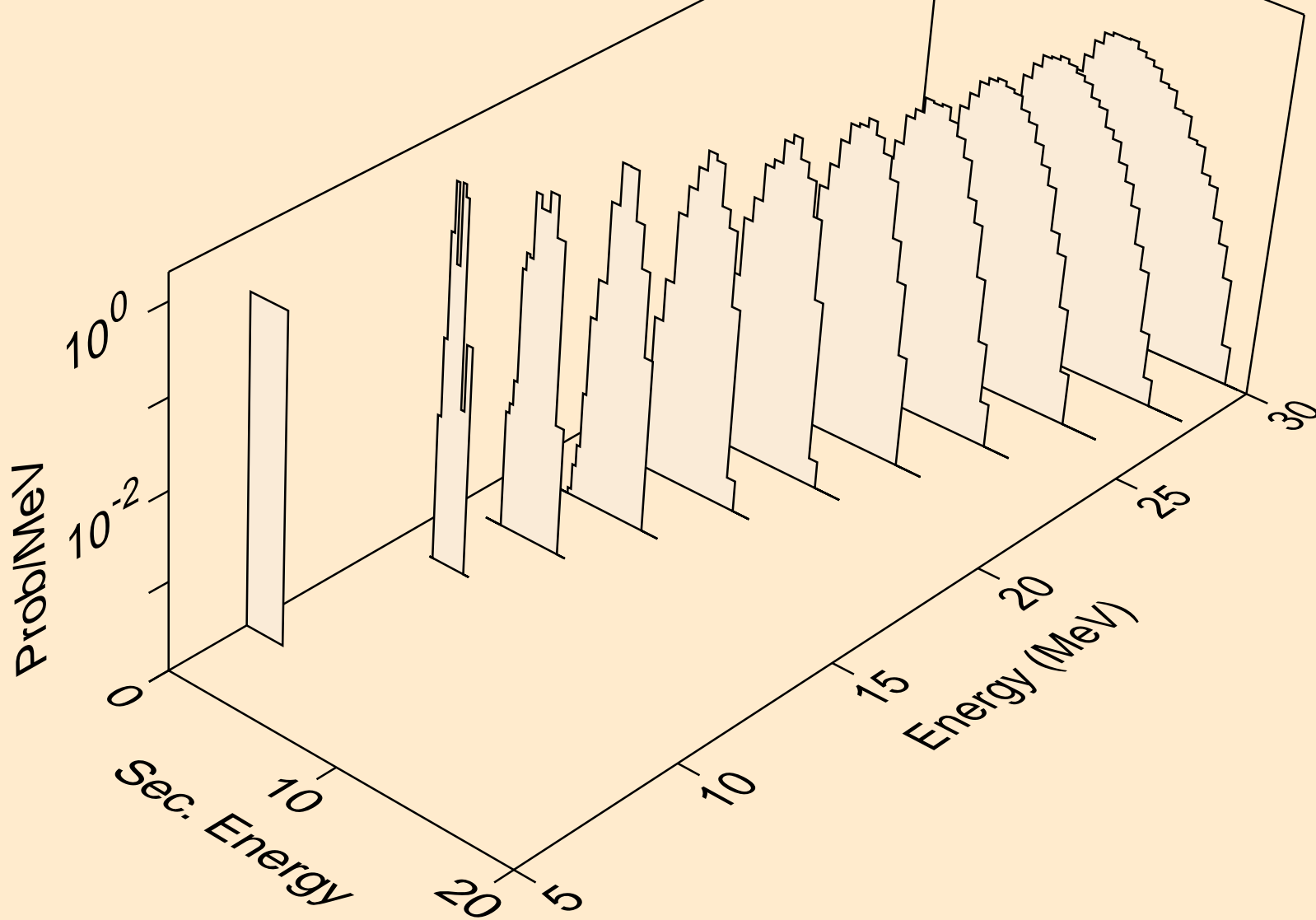

KR080 NEUTRON ACER TENDL-2019 LIBRARY; T=293.16K
alphas from (n,da)

