

MN051 NEUTRON ACER TENDL-2019 LIBRARY; T=293.16K
Principal cross sections

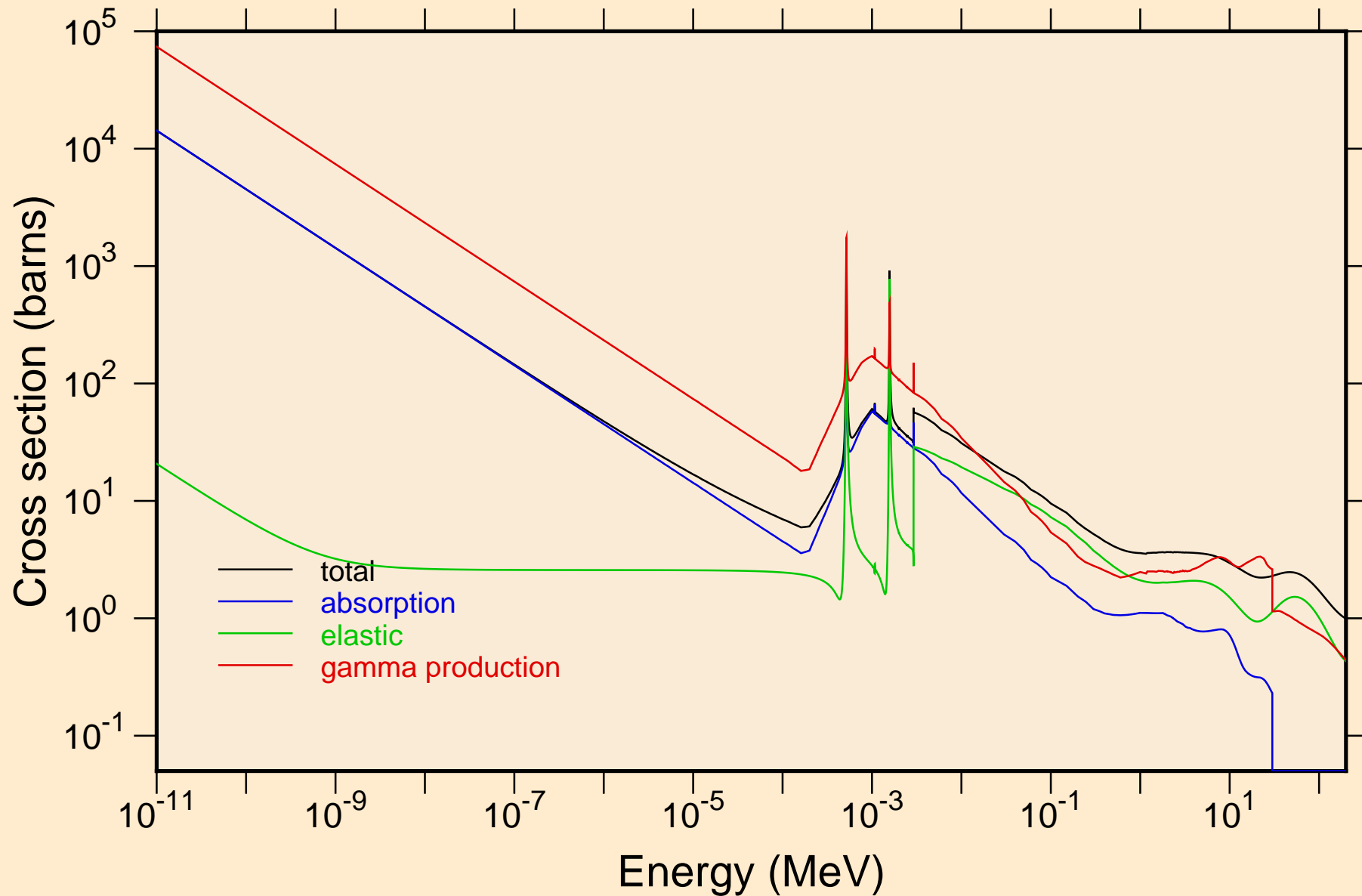

MN051 NEUTRON ACER TENDL-2019 LIBRARY; T=293.16K
resonance total cross section

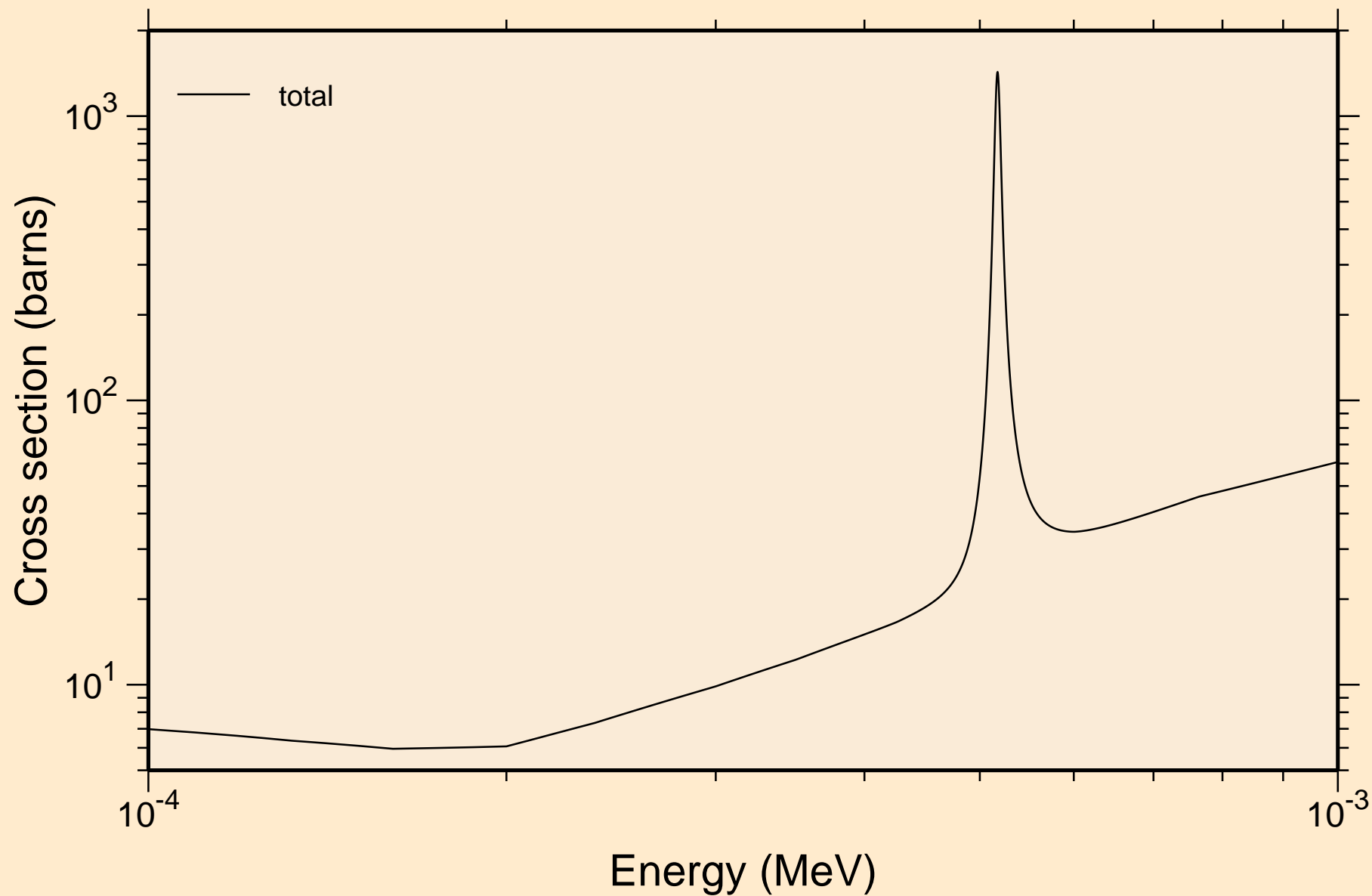

MN051 NEUTRON ACER TENDL-2019 LIBRARY; T=293.16K
resonance total cross section

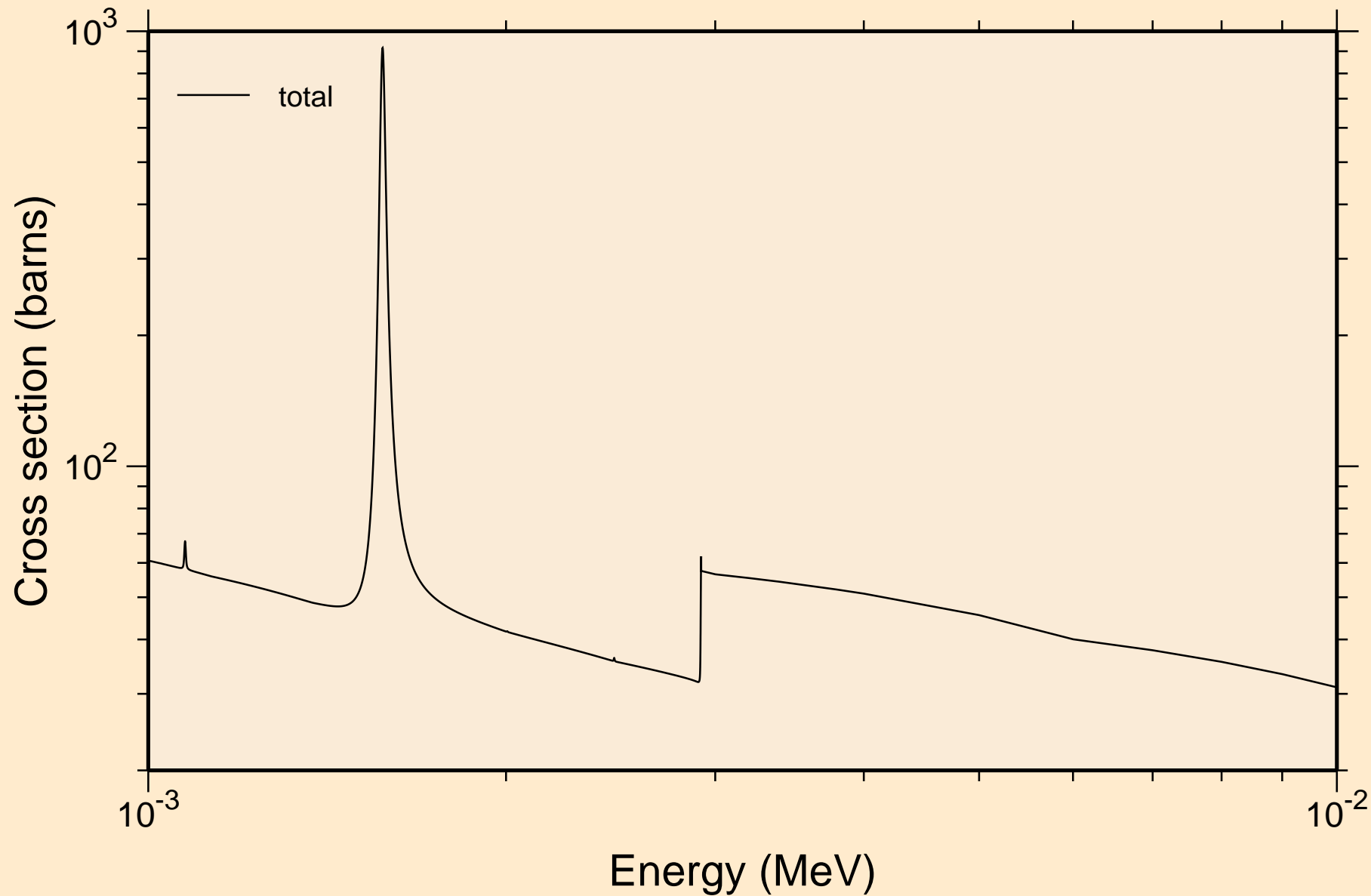

MN051 NEUTRON ACER TENDL-2019 LIBRARY; T=293.16K
resonance total cross section

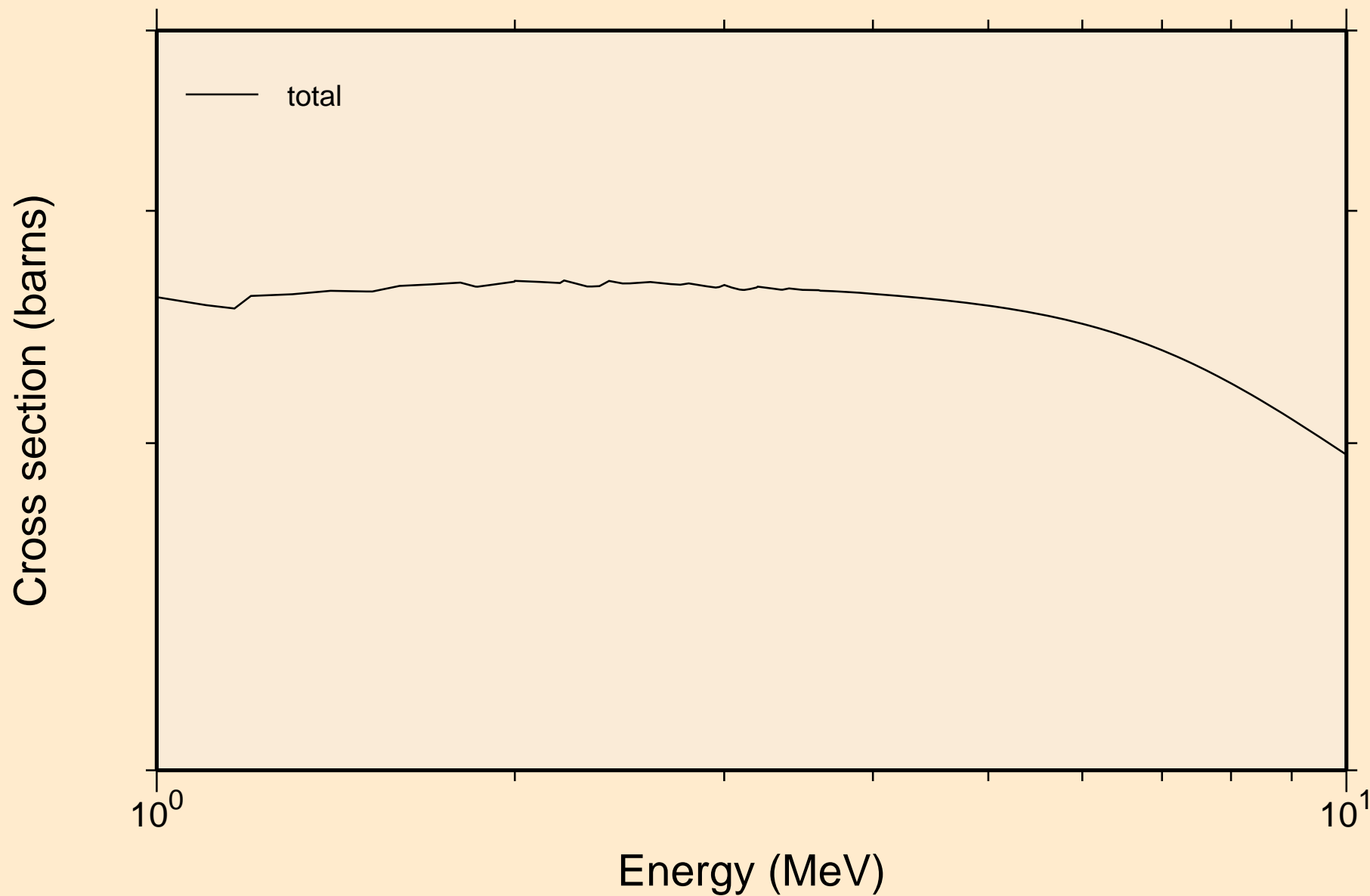

MN051 NEUTRON ACER TENDL-2019 LIBRARY; T=293.16K
resonance absorption cross sections

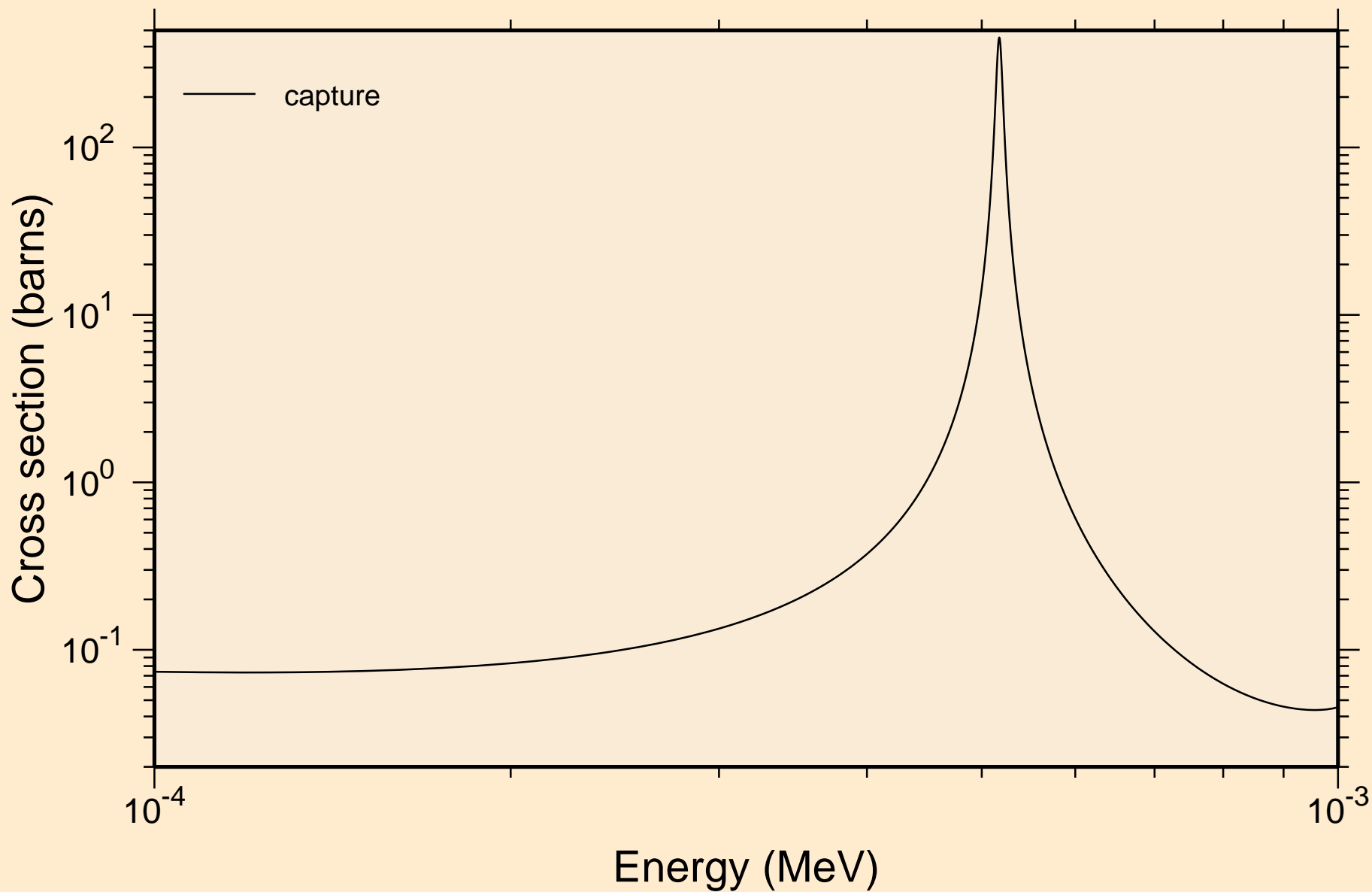

MN051 NEUTRON ACER TENDL-2019 LIBRARY; T=293.16K
resonance absorption cross sections

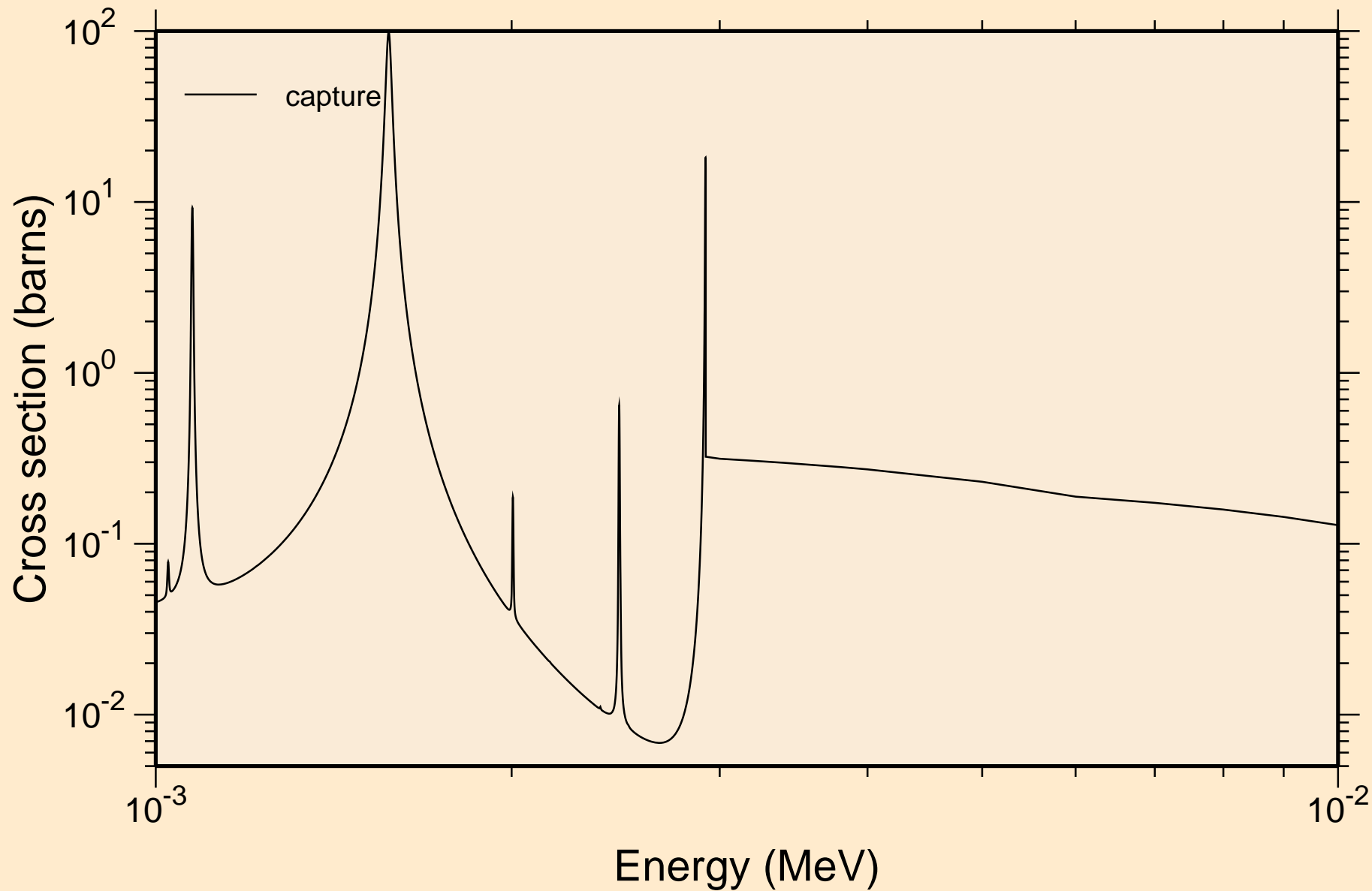

MN051 NEUTRON ACER TENDL-2019 LIBRARY; T=293.16K
resonance absorption cross sections

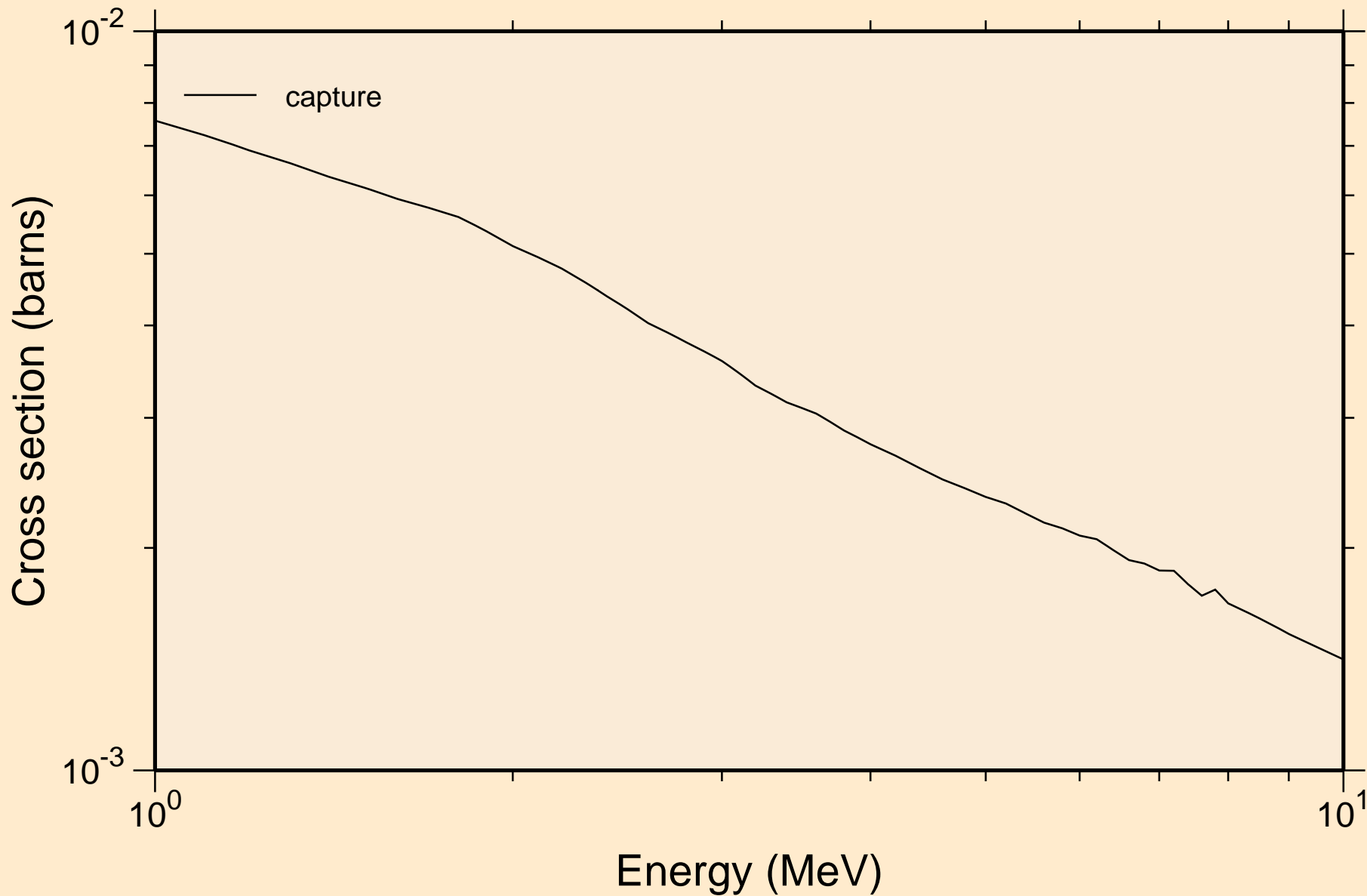

MN051 NEUTRON ACER TENDL-2019 LIBRARY; T=293.16K
Heating

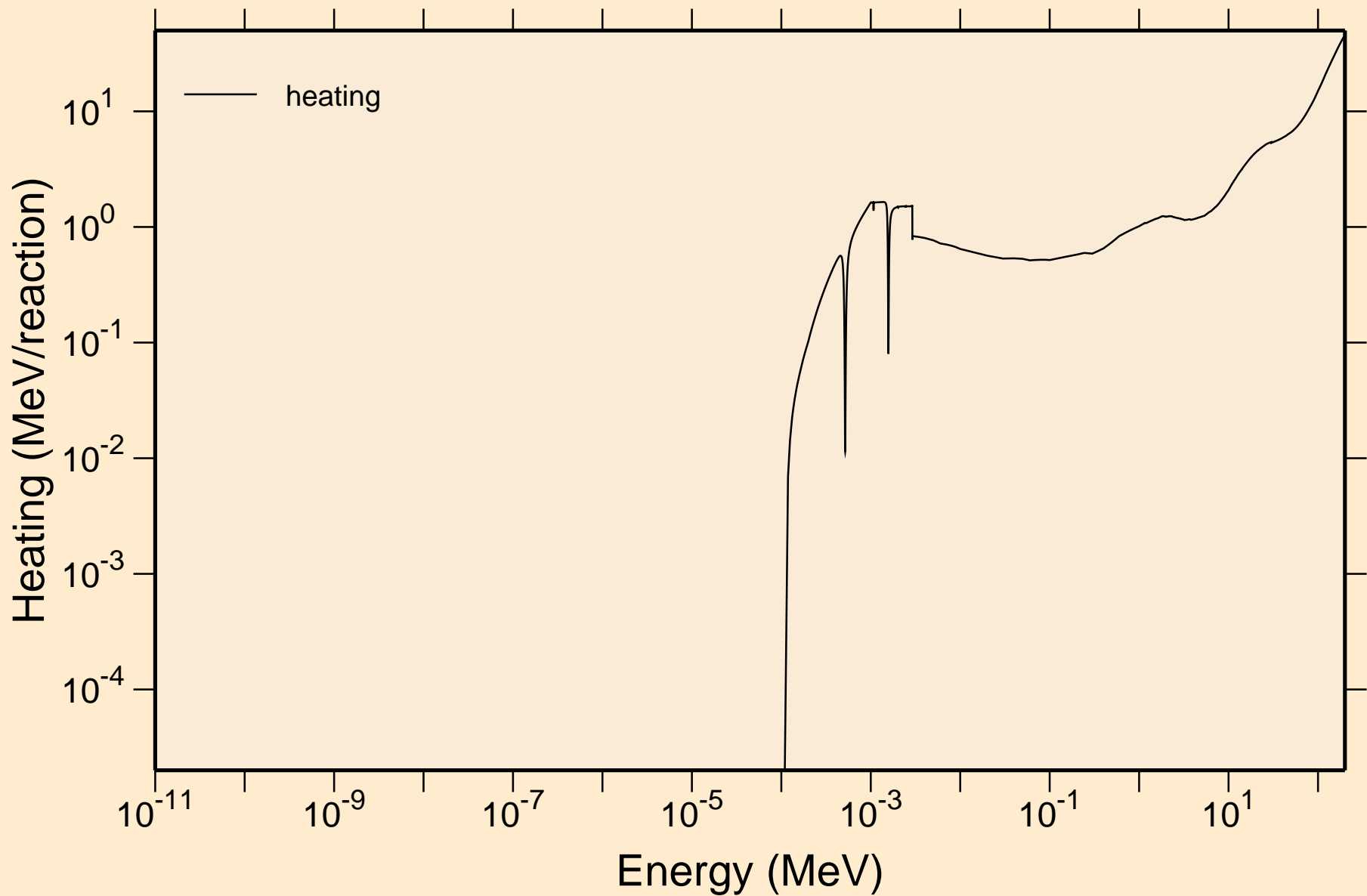

MN051 NEUTRON ACER TENDL-2019 LIBRARY; T=293.16K
Damage

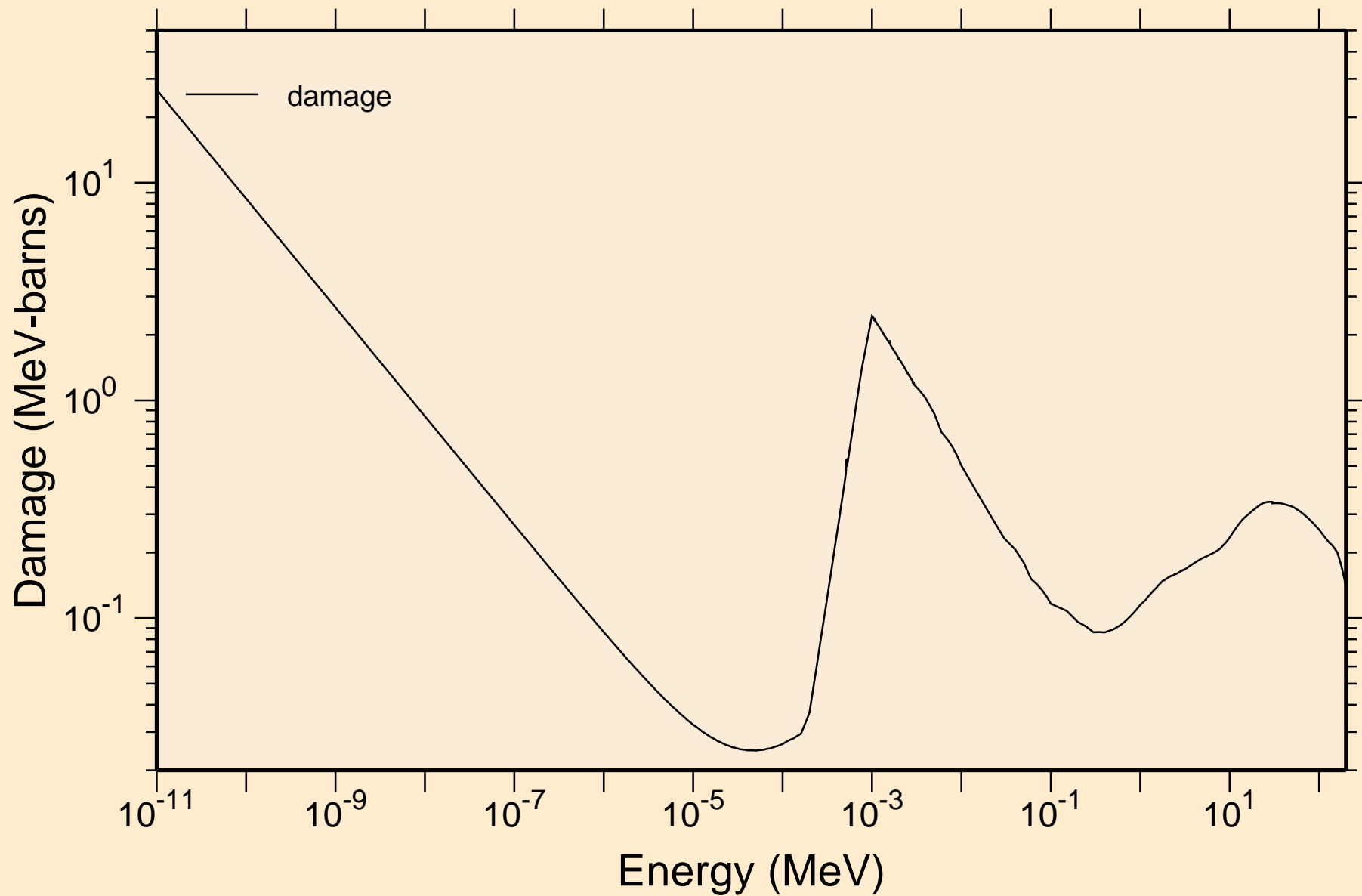

MN051 NEUTRON ACER TENDL-2019 LIBRARY; T=293.16K
Non-threshold reactions

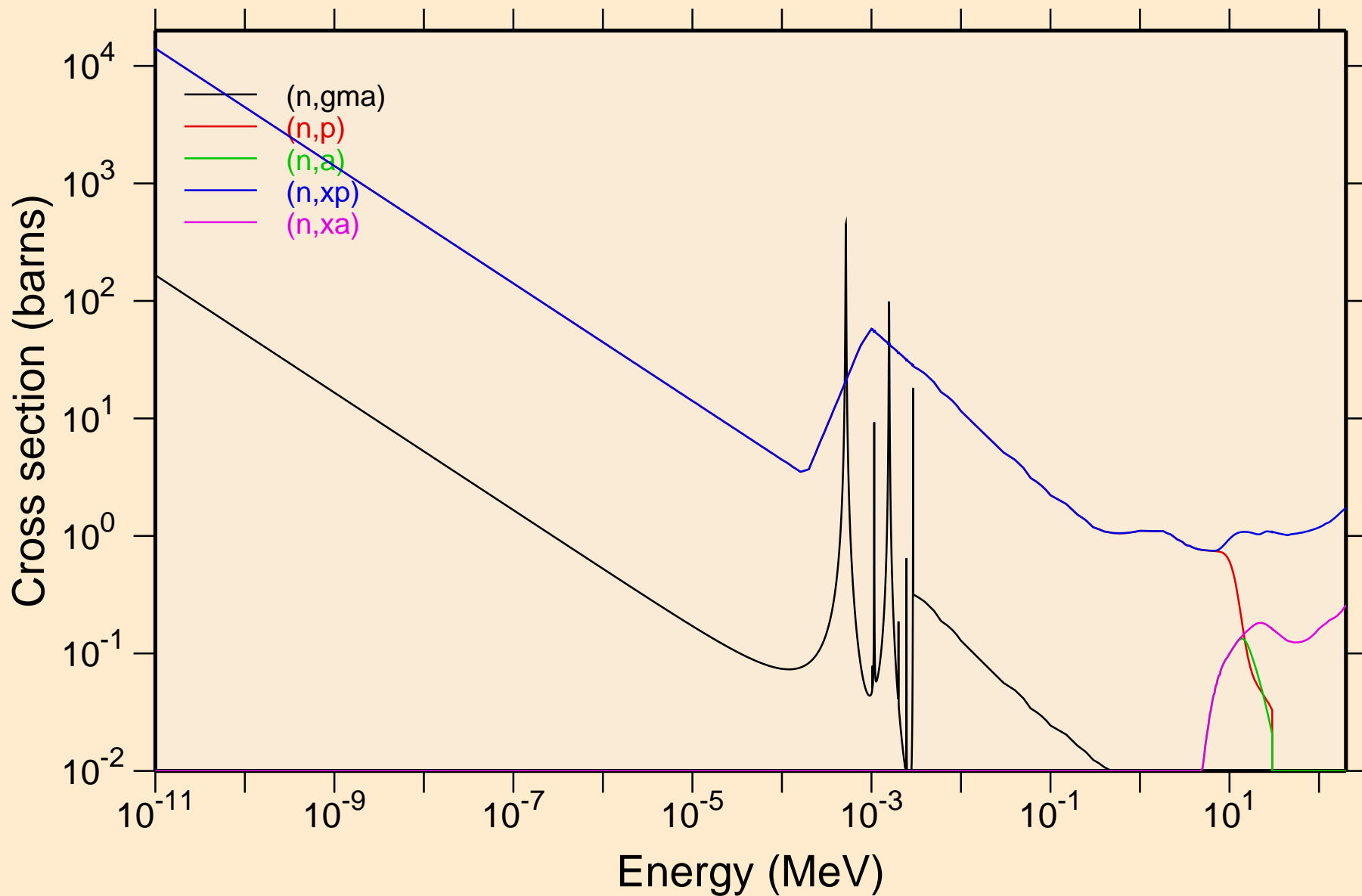

MN051 NEUTRON ACER TENDL-2019 LIBRARY; T=293.16K

Principal cross sections

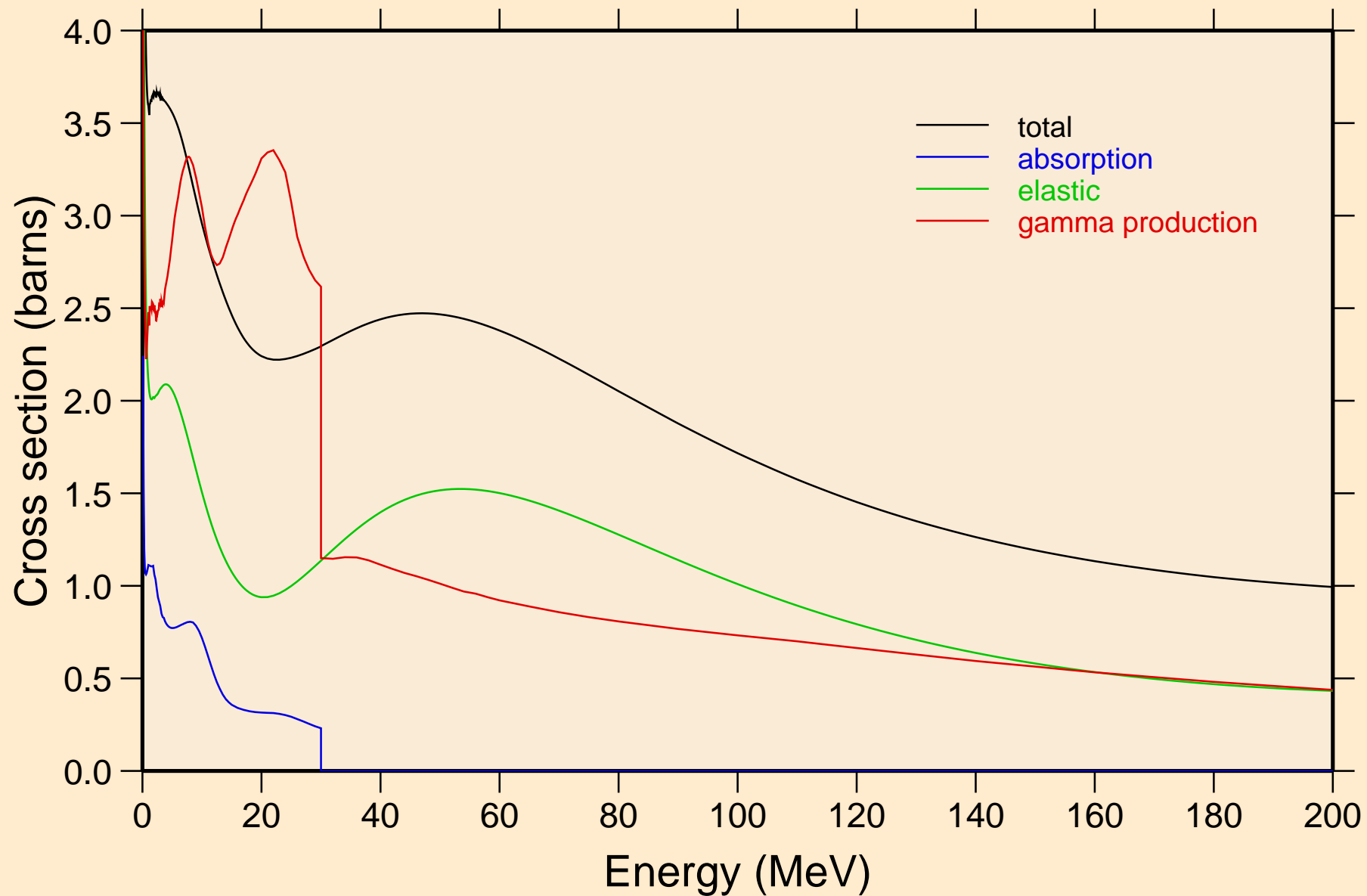

MN051 NEUTRON ACER TENDL-2019 LIBRARY; T=293.16K
Heating

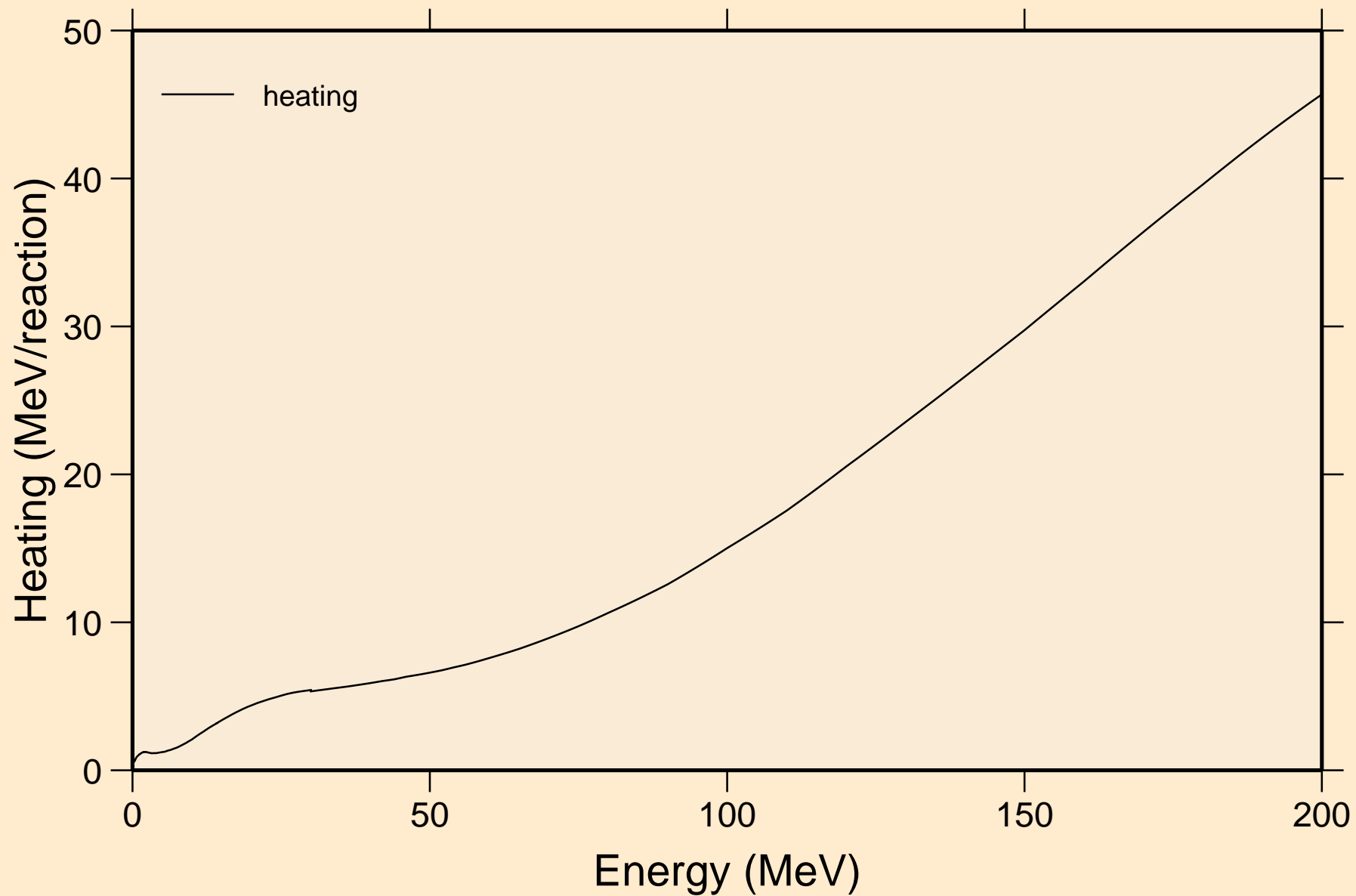

MN051 NEUTRON ACER TENDL-2019 LIBRARY; T=293.16K
Damage

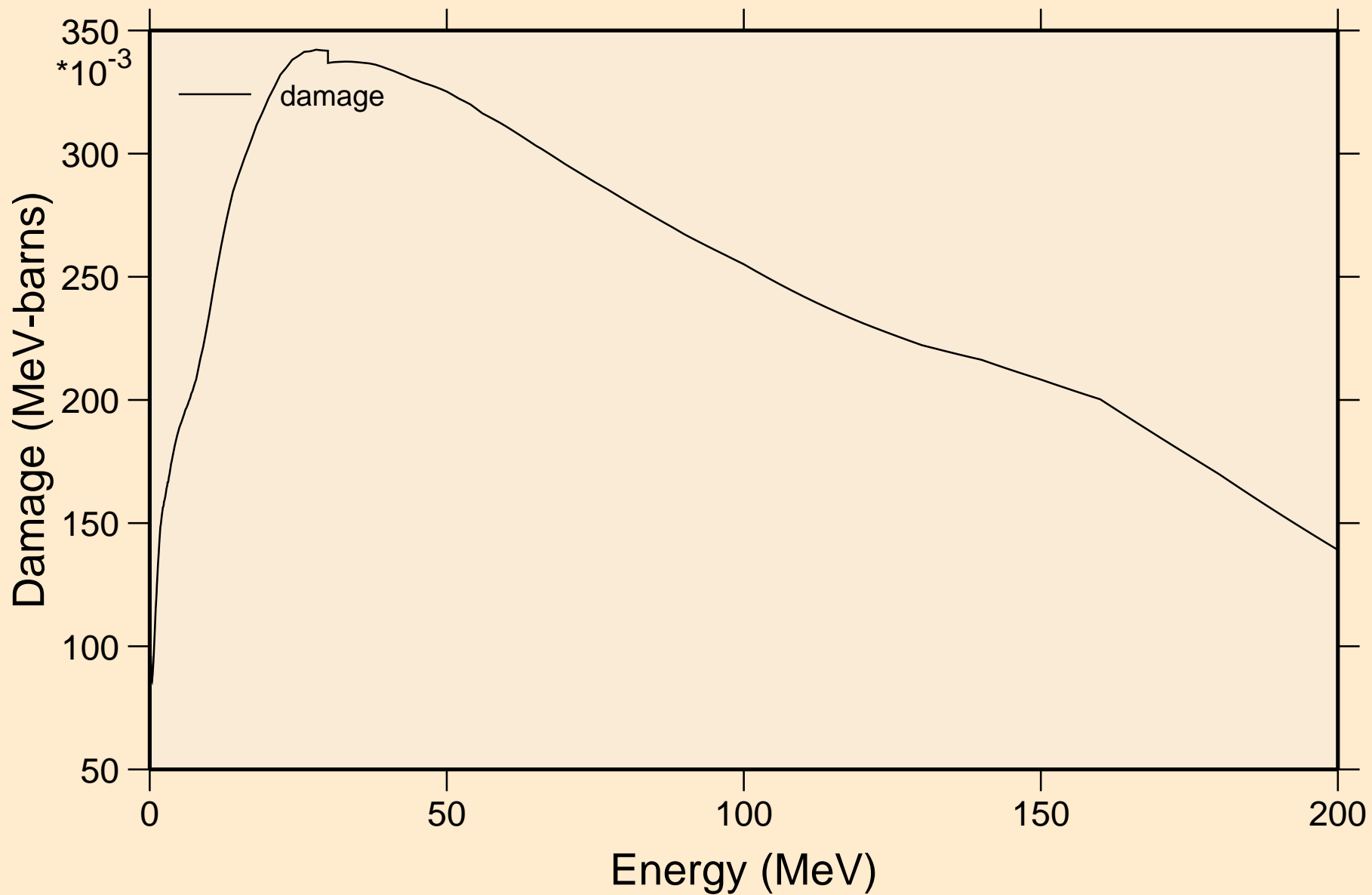

MN051 NEUTRON ACER TENDL-2019 LIBRARY; T=293.16K
Non-threshold reactions

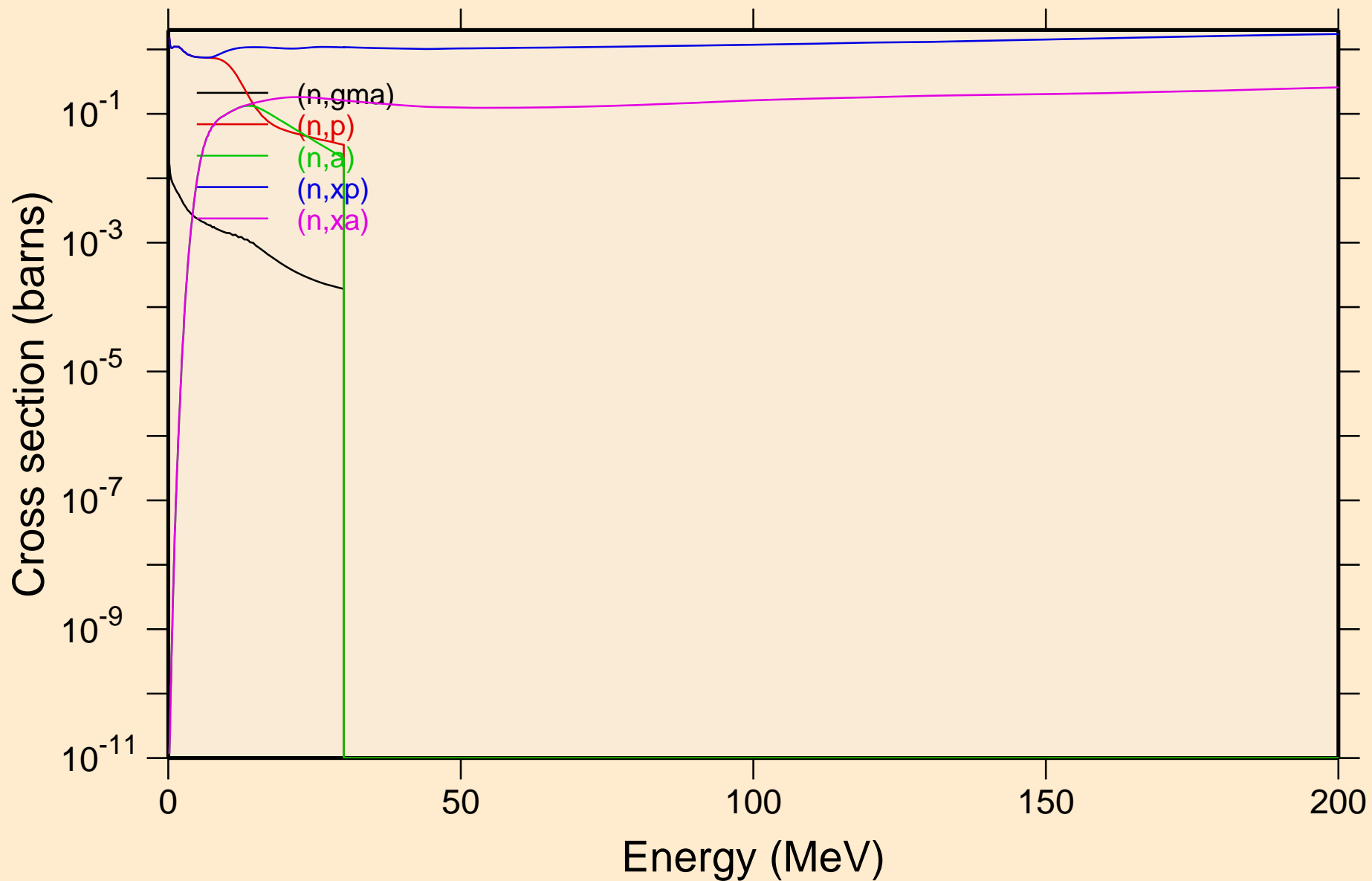

MN051 NEUTRON ACER TENDL-2019 LIBRARY; T=293.16K
Inelastic levels

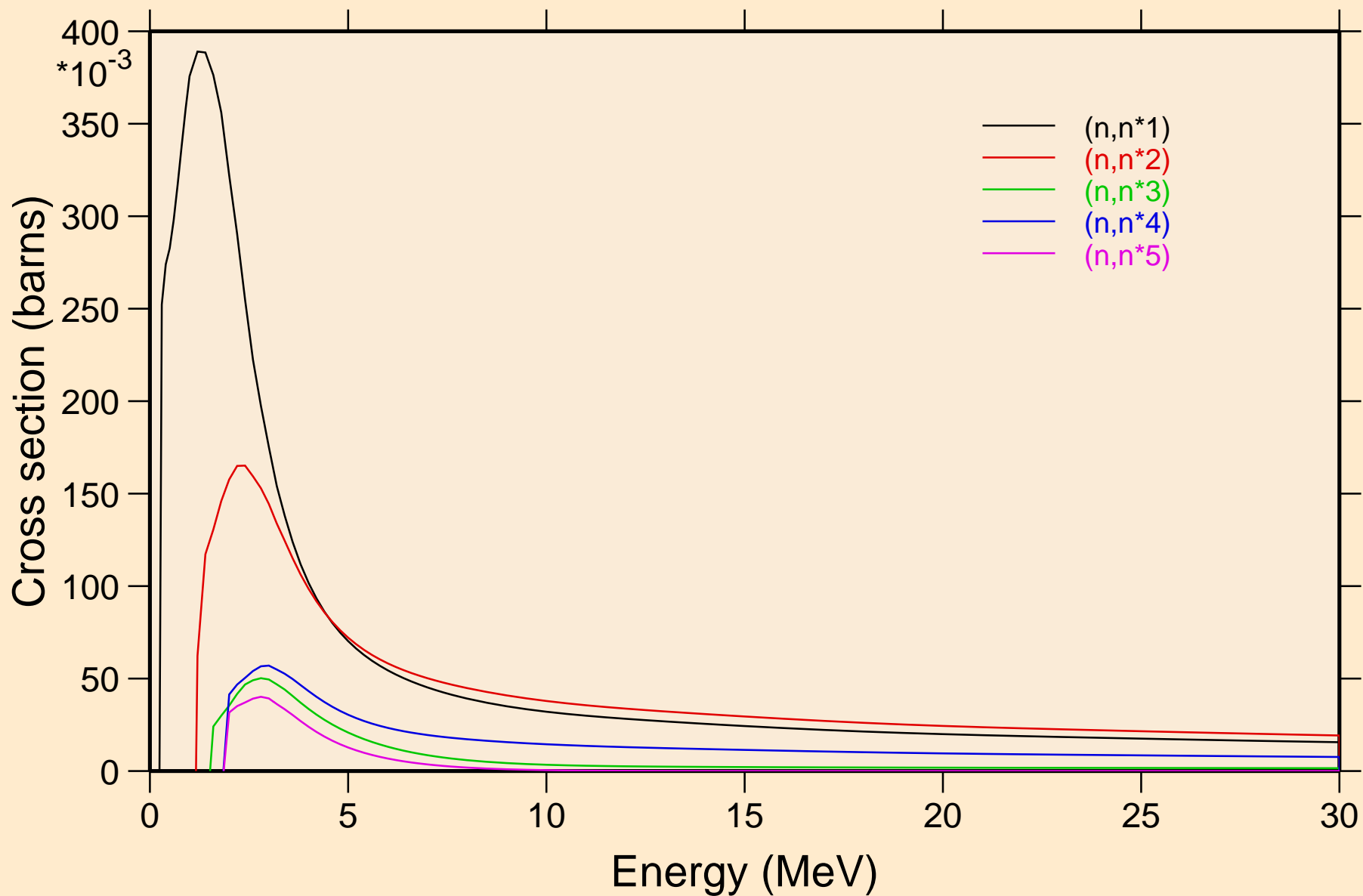

MN051 NEUTRON ACER TENDL-2019 LIBRARY; T=293.16K
Inelastic levels

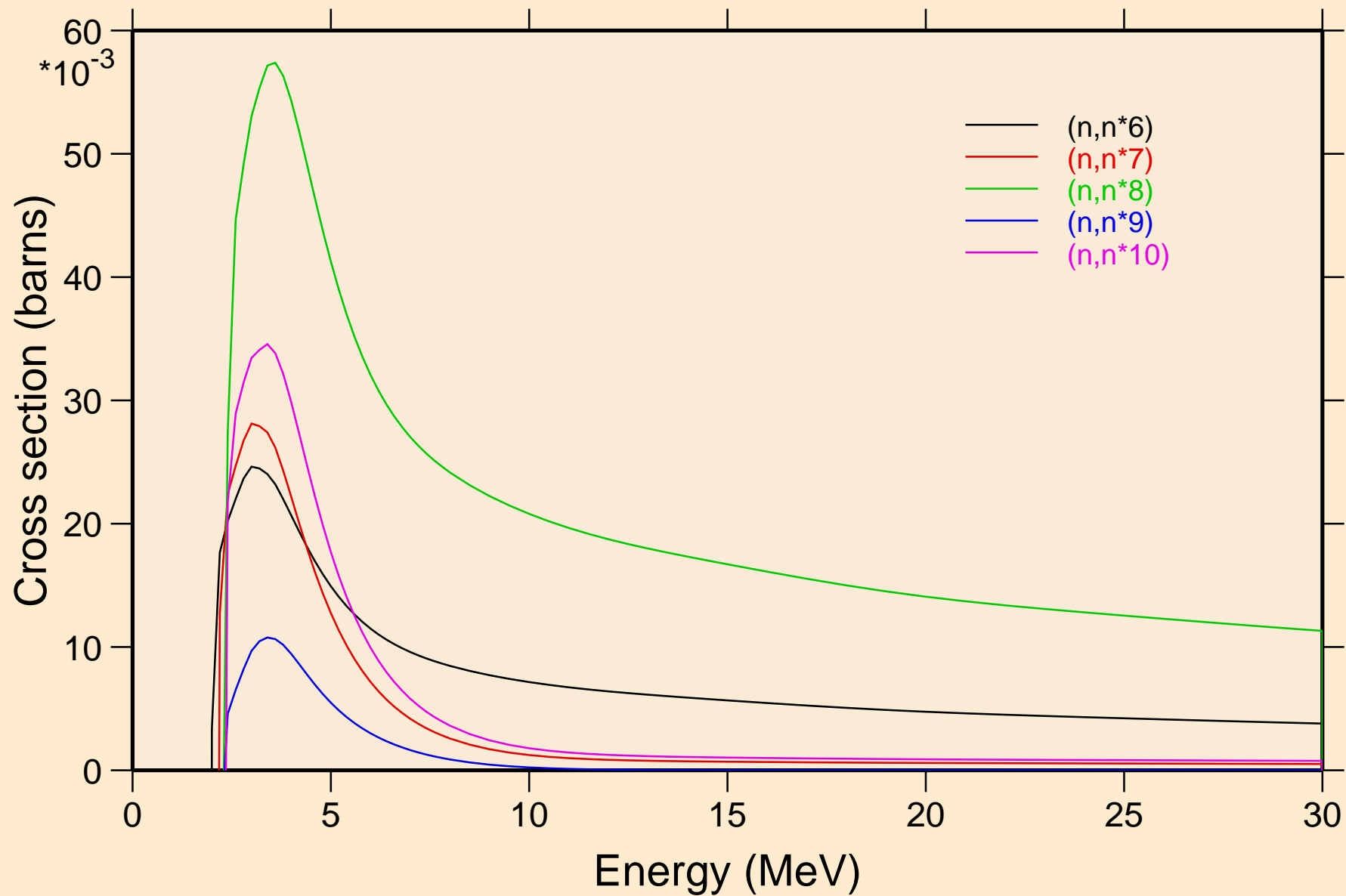

MN051 NEUTRON ACER TENDL-2019 LIBRARY; T=293.16K
Inelastic levels

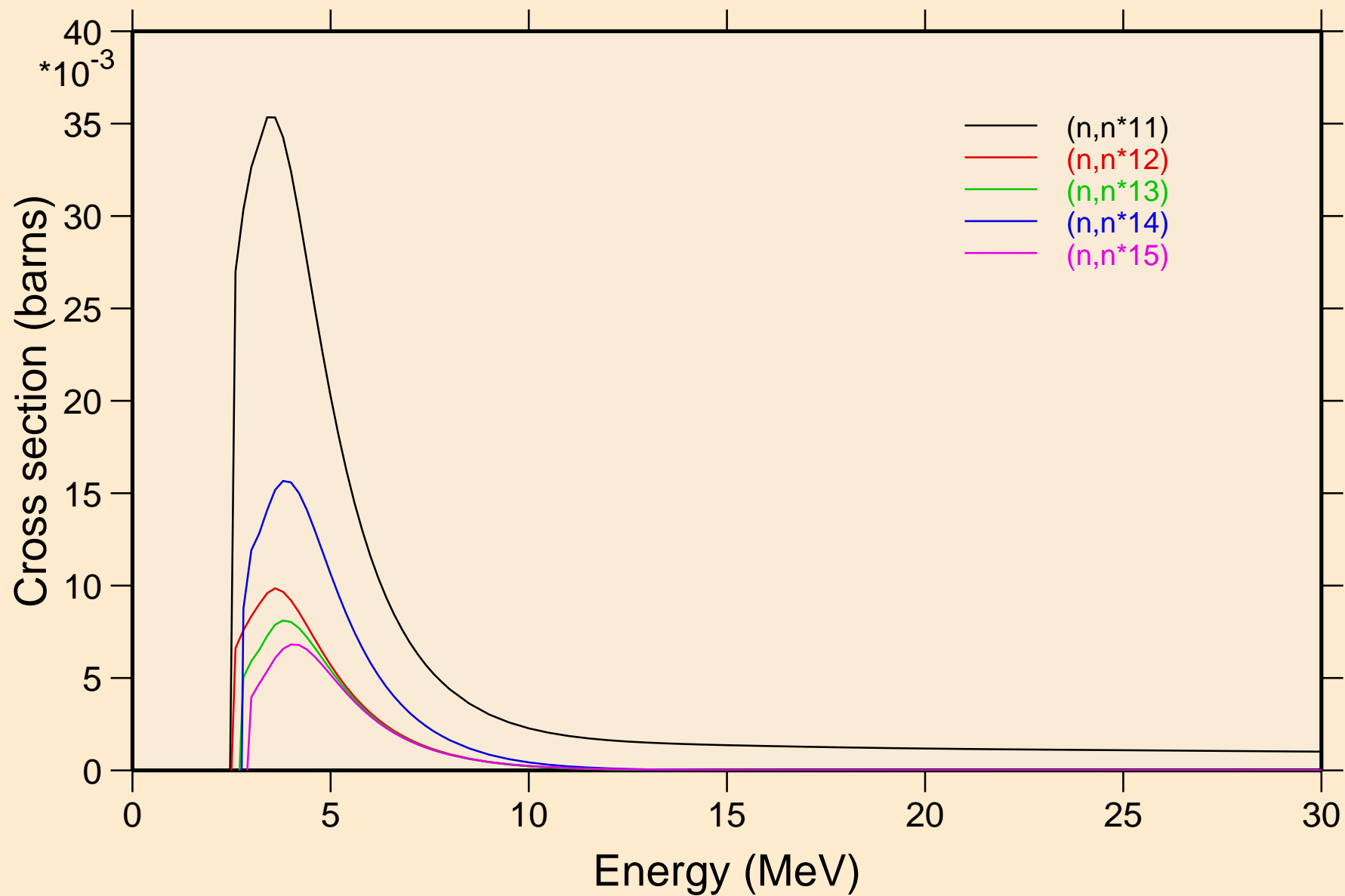

MN051 NEUTRON ACER TENDL-2019 LIBRARY; T=293.16K
Inelastic levels

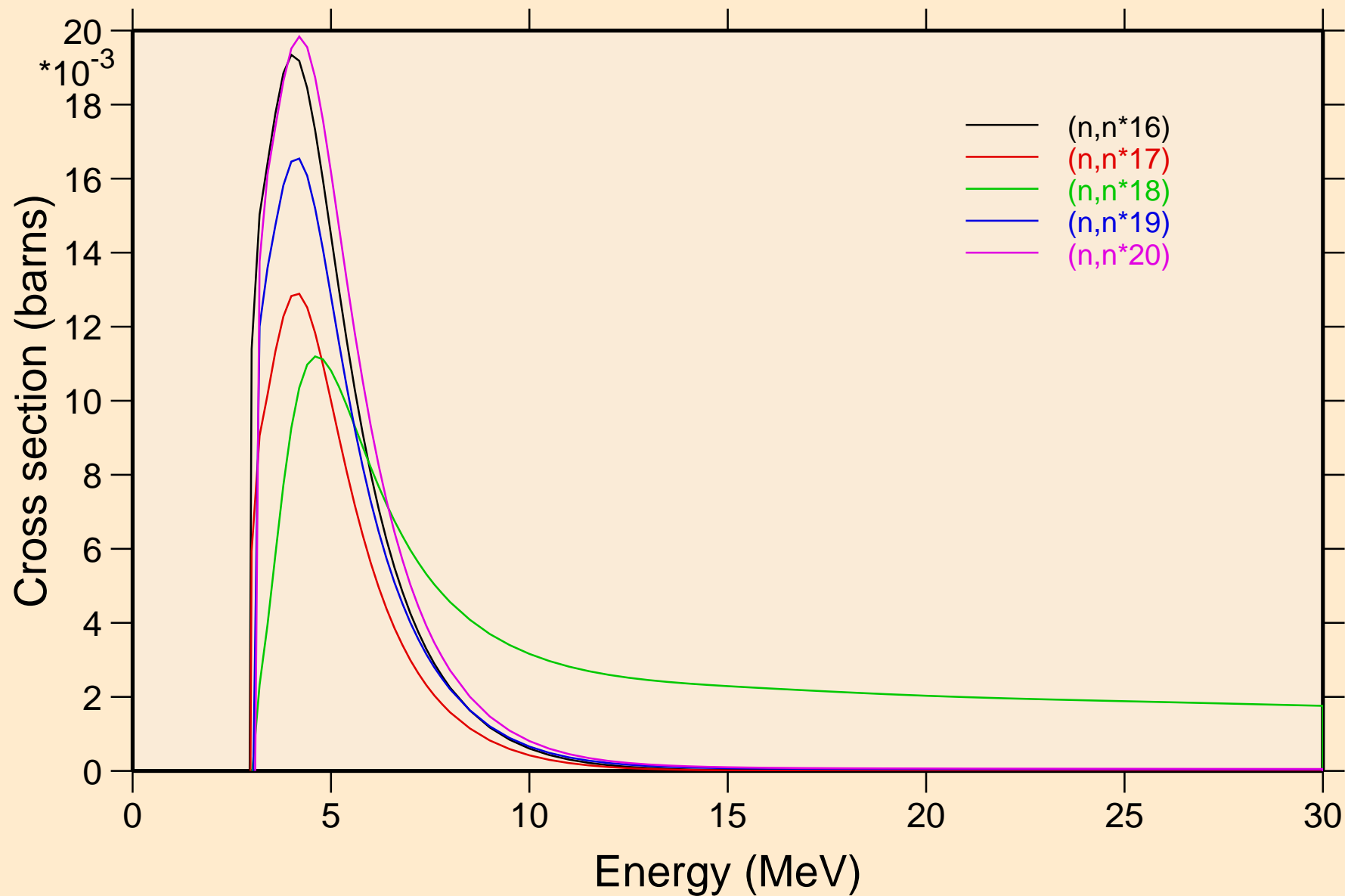

MN051 NEUTRON ACER TENDL-2019 LIBRARY; T=293.16K
Inelastic levels

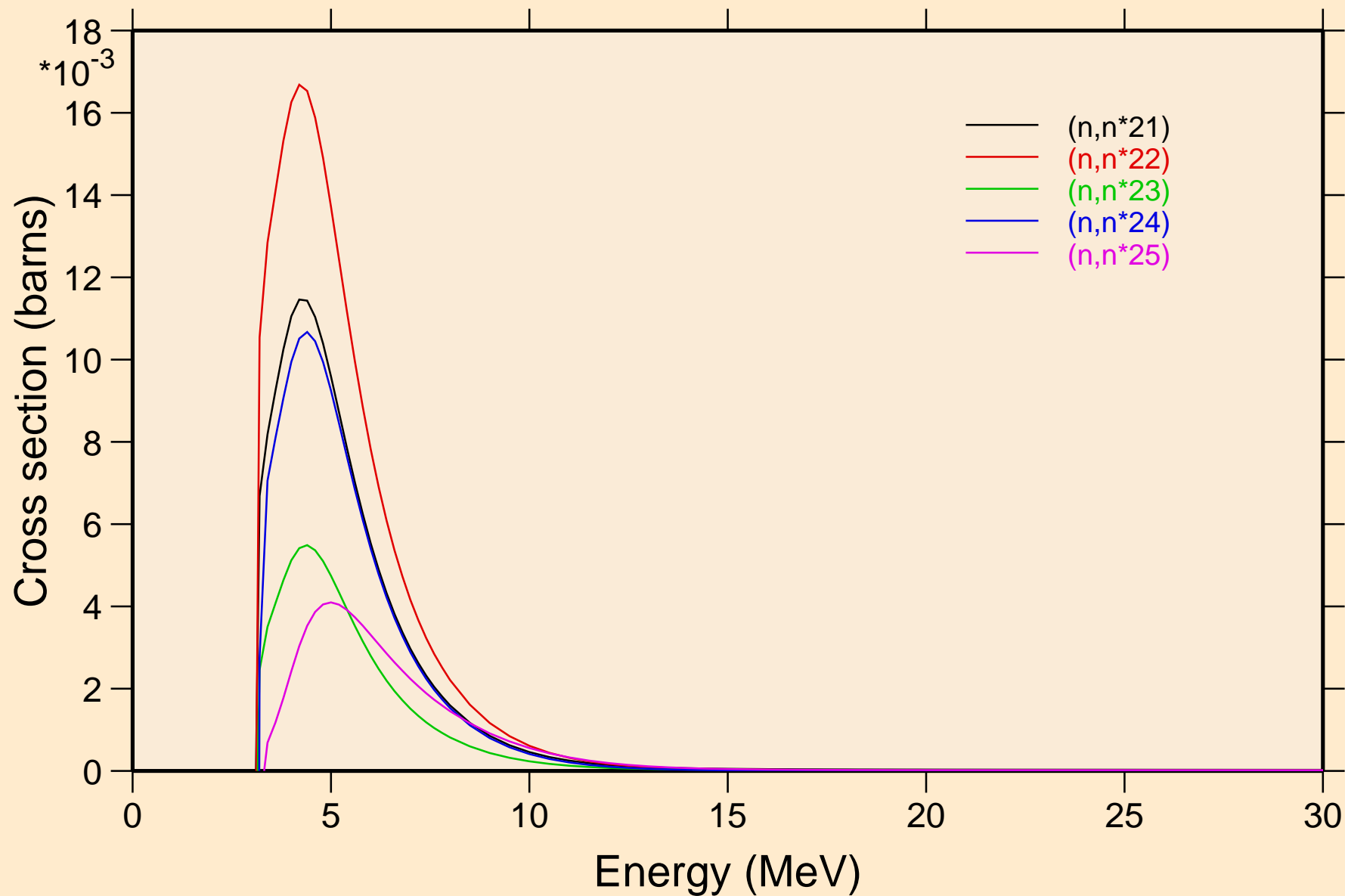

MN051 NEUTRON ACER TENDL-2019 LIBRARY; T=293.16K
Inelastic levels

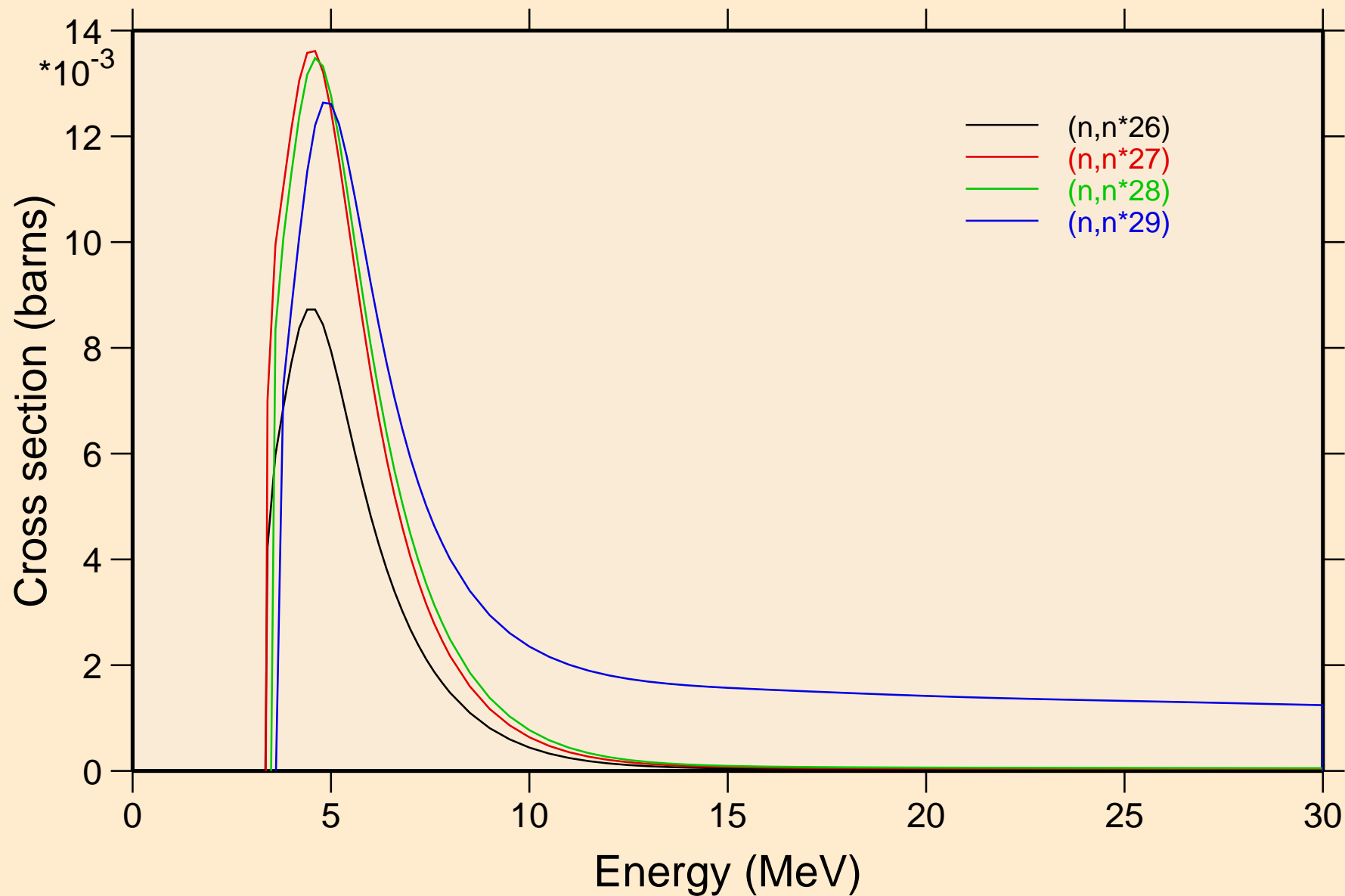

MN051 NEUTRON ACER TENDL-2019 LIBRARY; T=293.16K
Threshold reactions

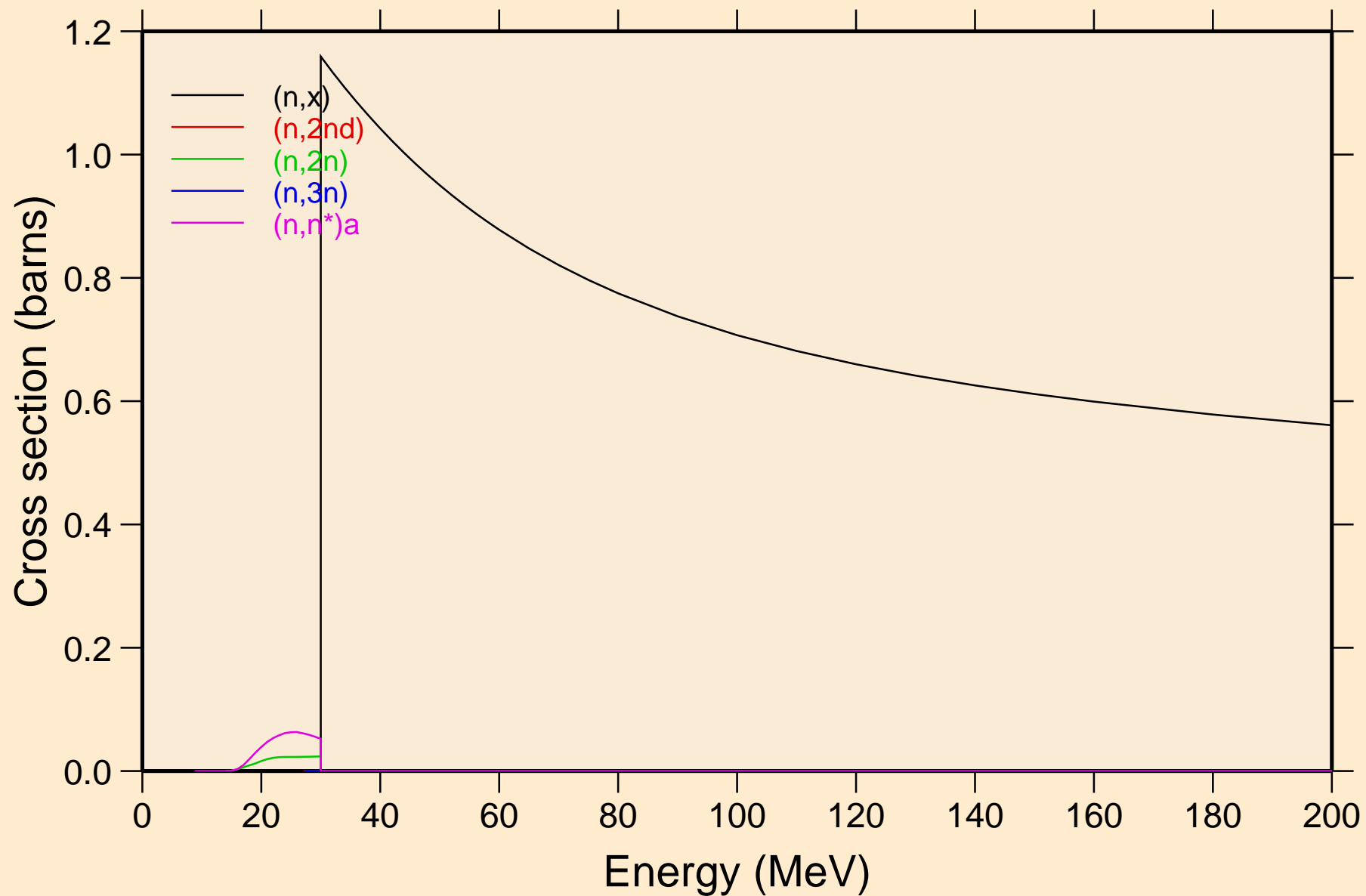

MN051 NEUTRON ACER TENDL-2019 LIBRARY; T=293.16K
Threshold reactions

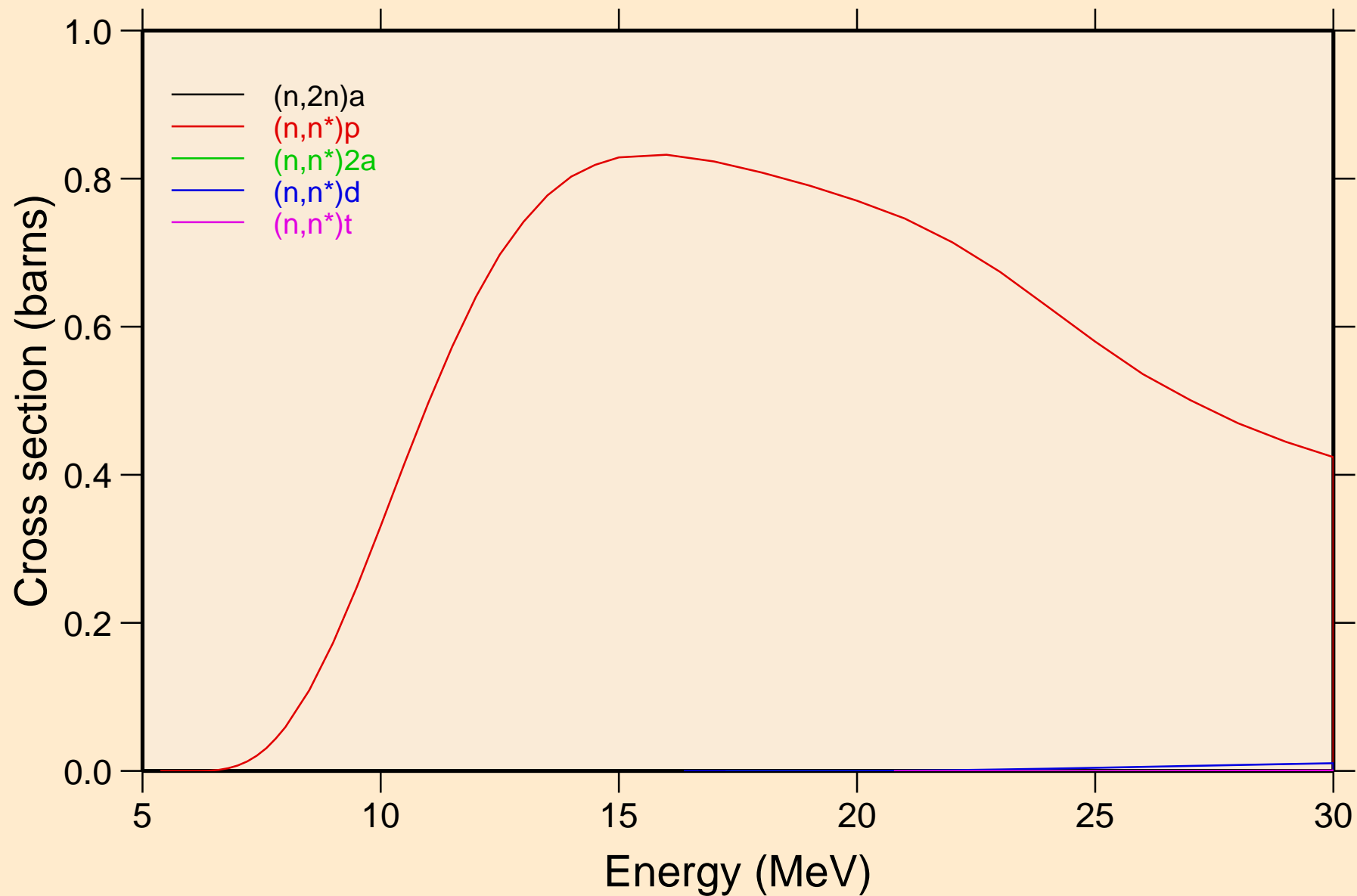

MN051 NEUTRON ACER TENDL-2019 LIBRARY; T=293.16K
Threshold reactions

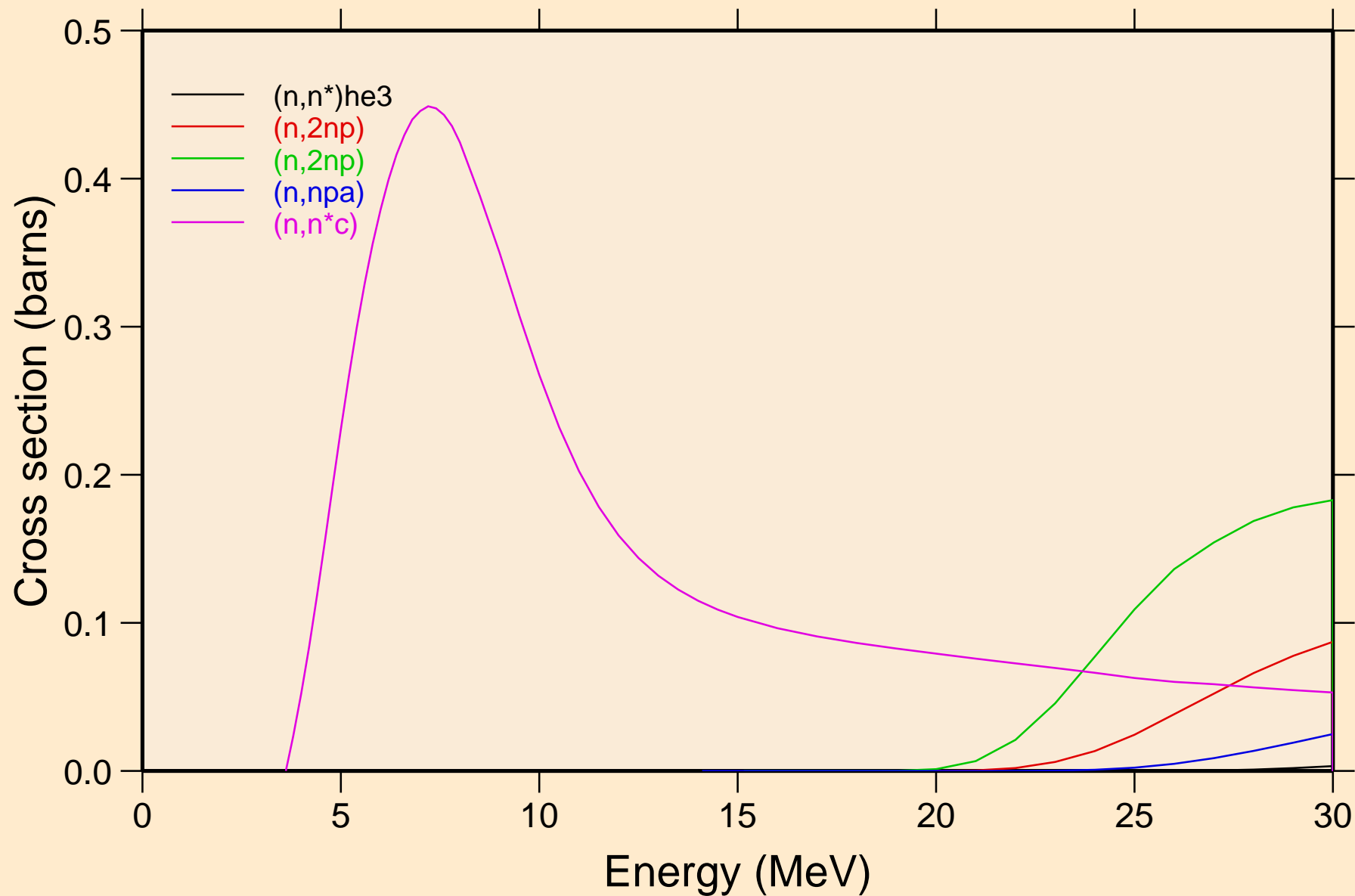

MN051 NEUTRON ACER TENDL-2019 LIBRARY; T=293.16K
Threshold reactions

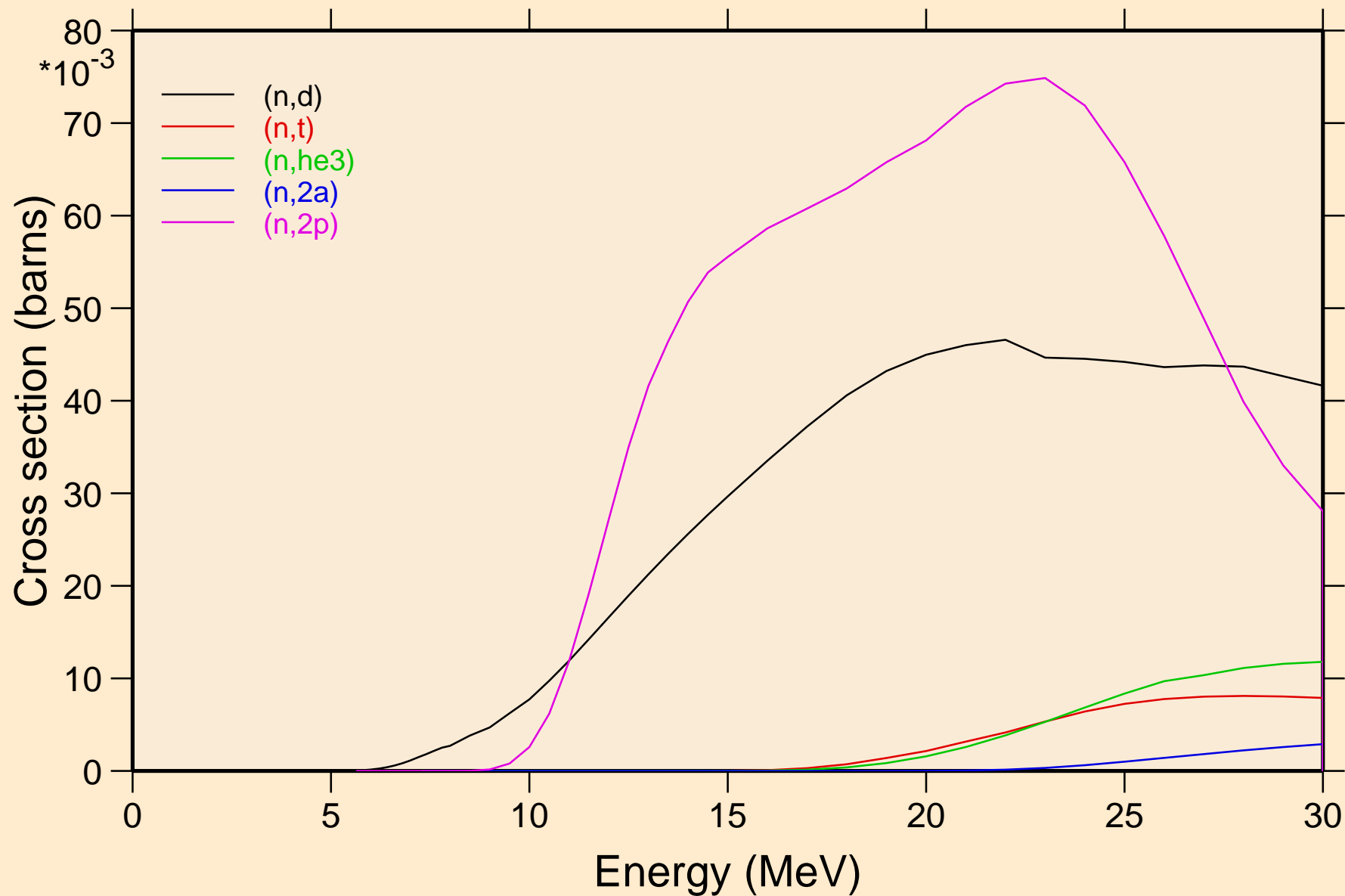

MN051 NEUTRON ACER TENDL-2019 LIBRARY; T=293.16K
Threshold reactions

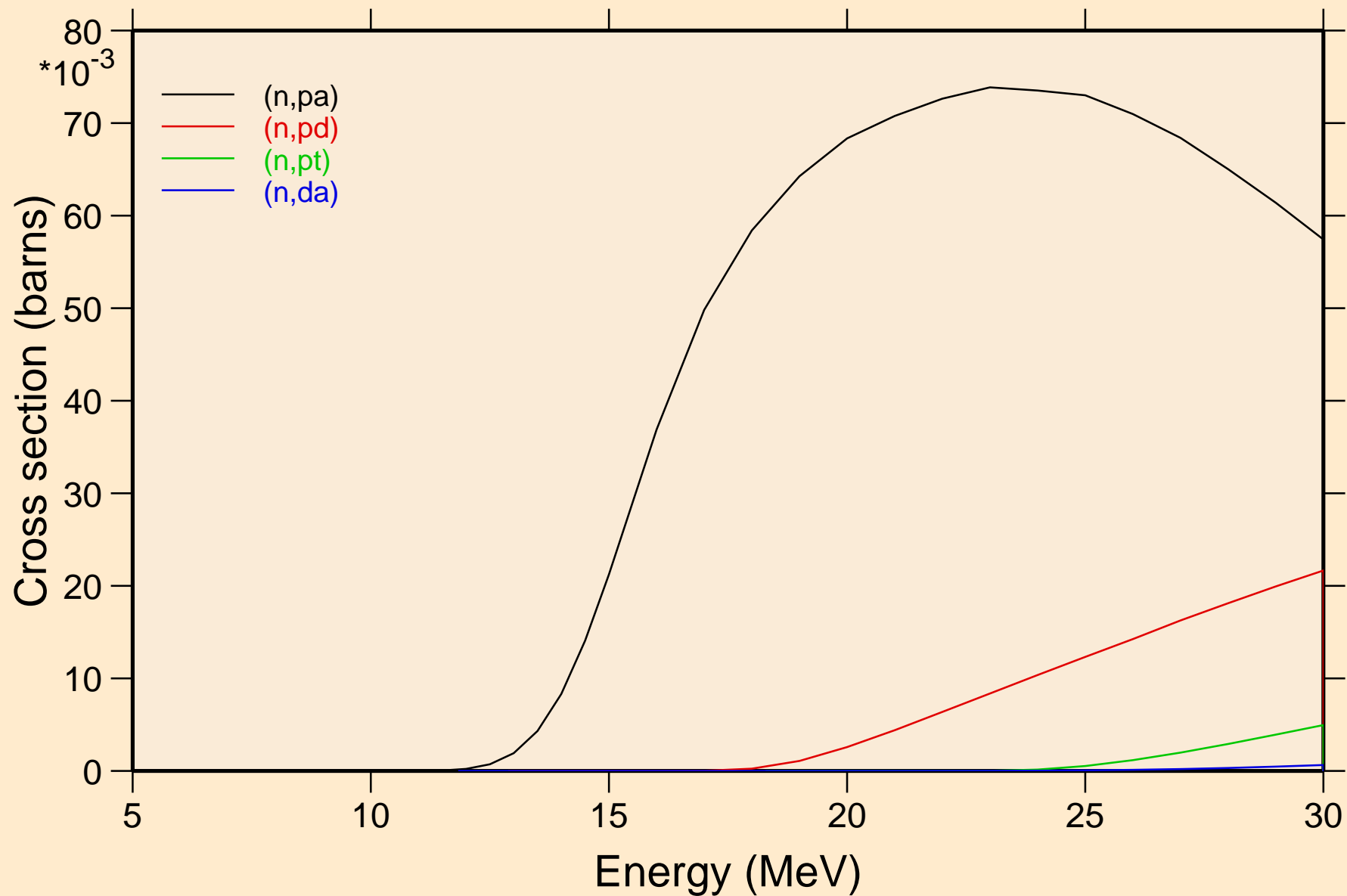

MN051 NEUTRON ACER TENDL-2019 LIBRARY; T=293.16K
Threshold reactions

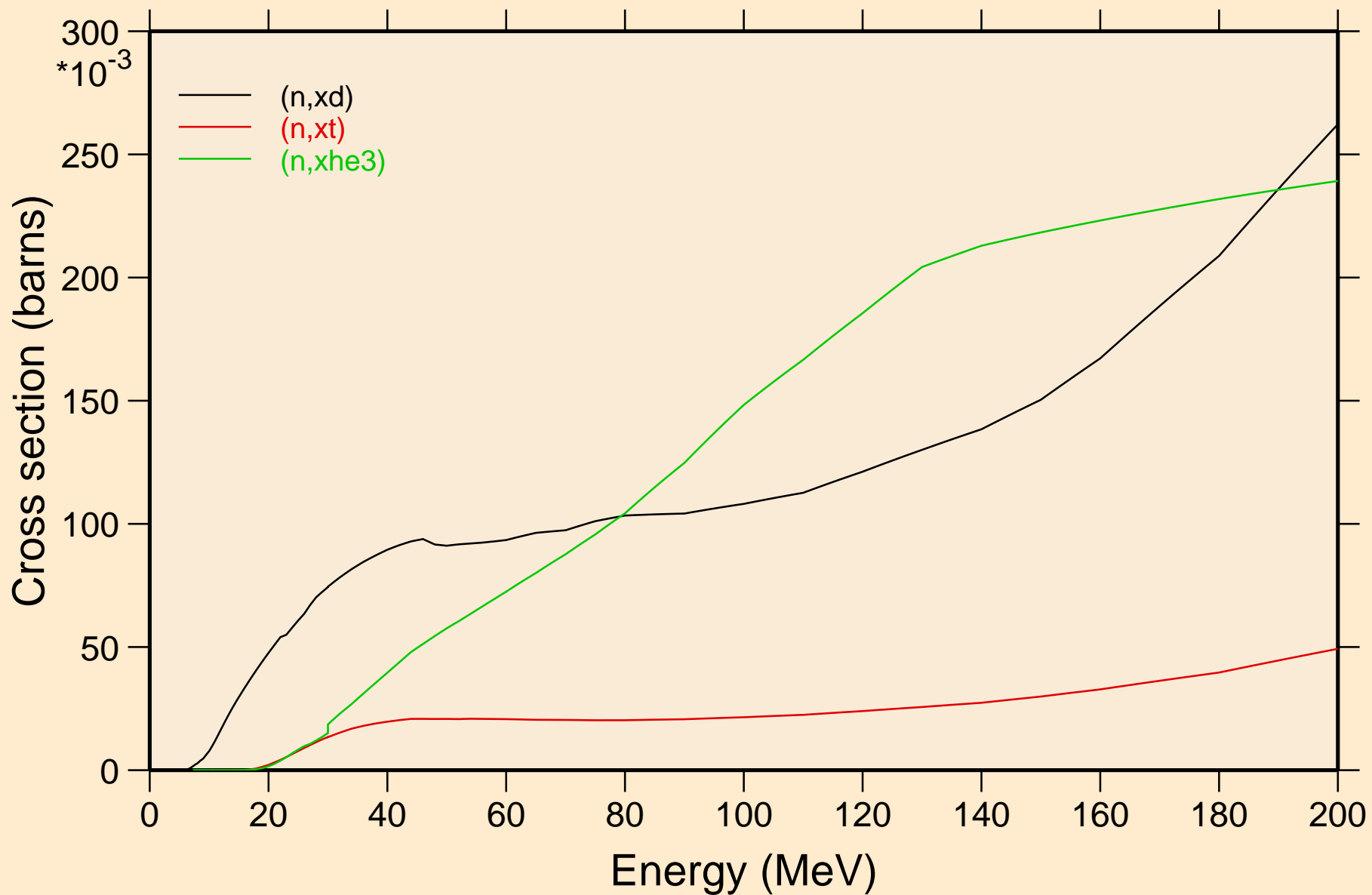

MN051 NEUTRON ACER TENDL-2019 LIBRARY; T=293.16K
angular distribution for elastic

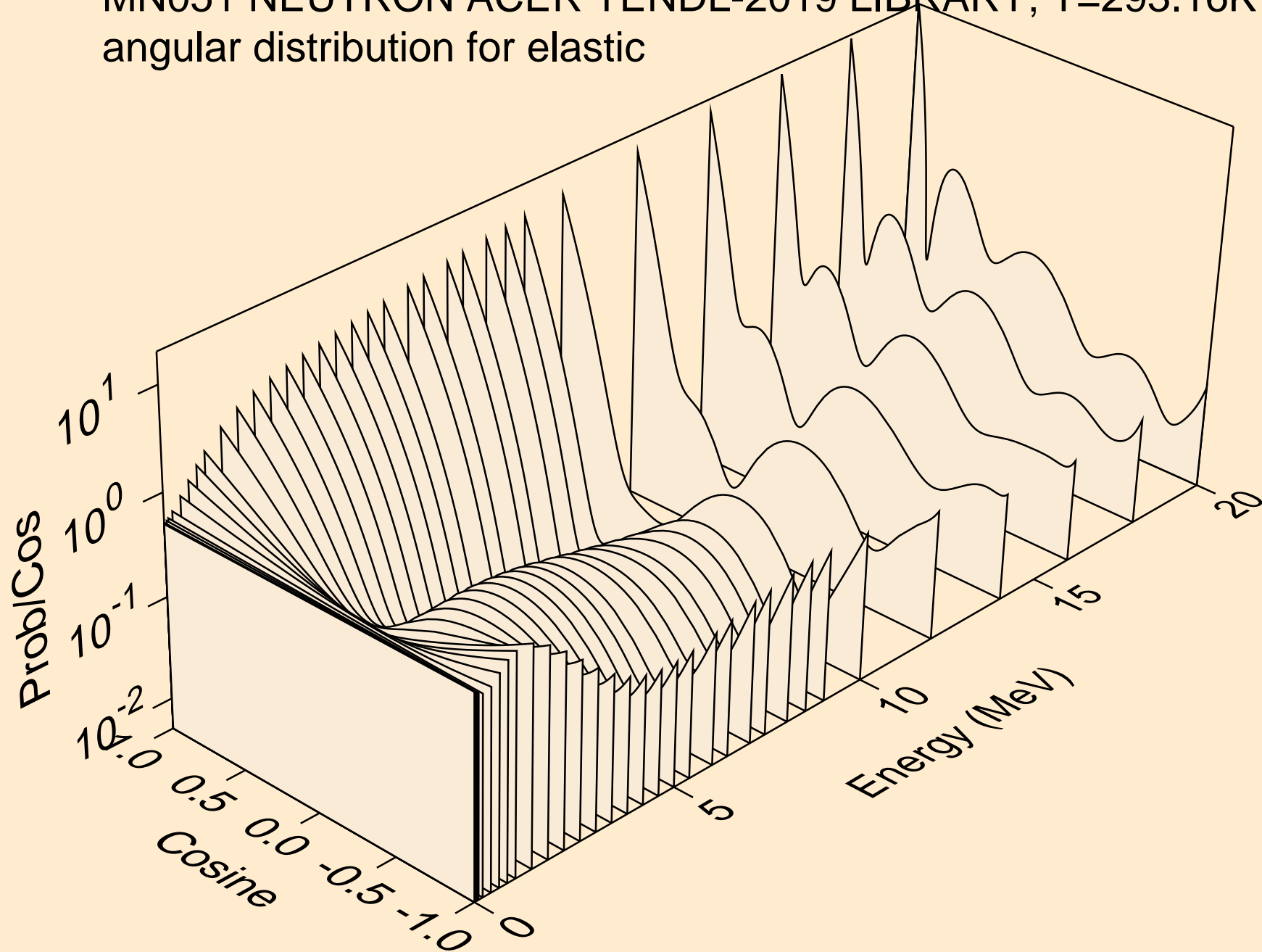

MN051 NEUTRON ACER TENDL-2019 LIBRARY; T=293.16K
angular distribution for elastic

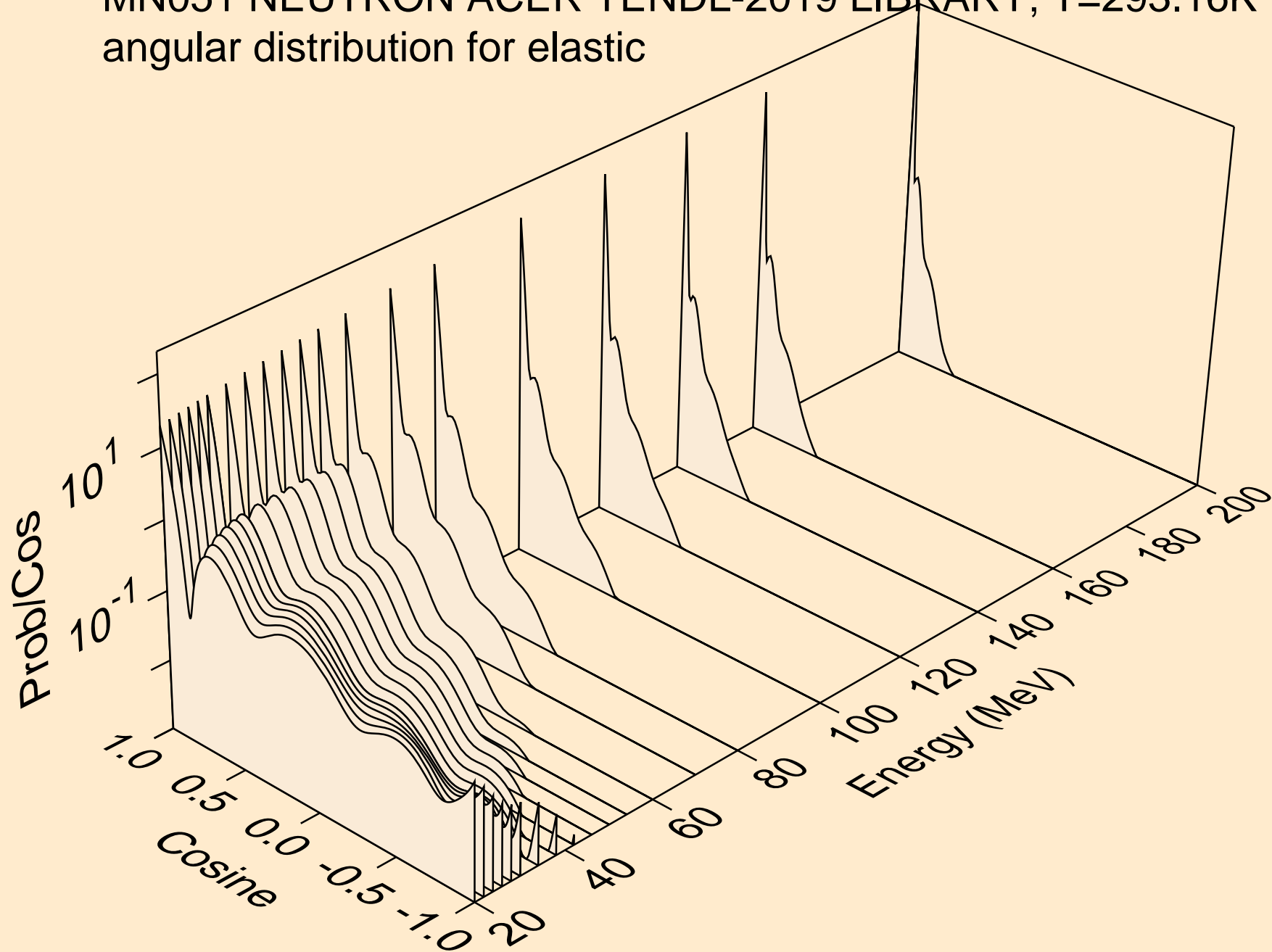

MN051 NEUTRON ACER TENDL-2019 LIBRARY; T=293.16K
angular distribution for (n,n*1)

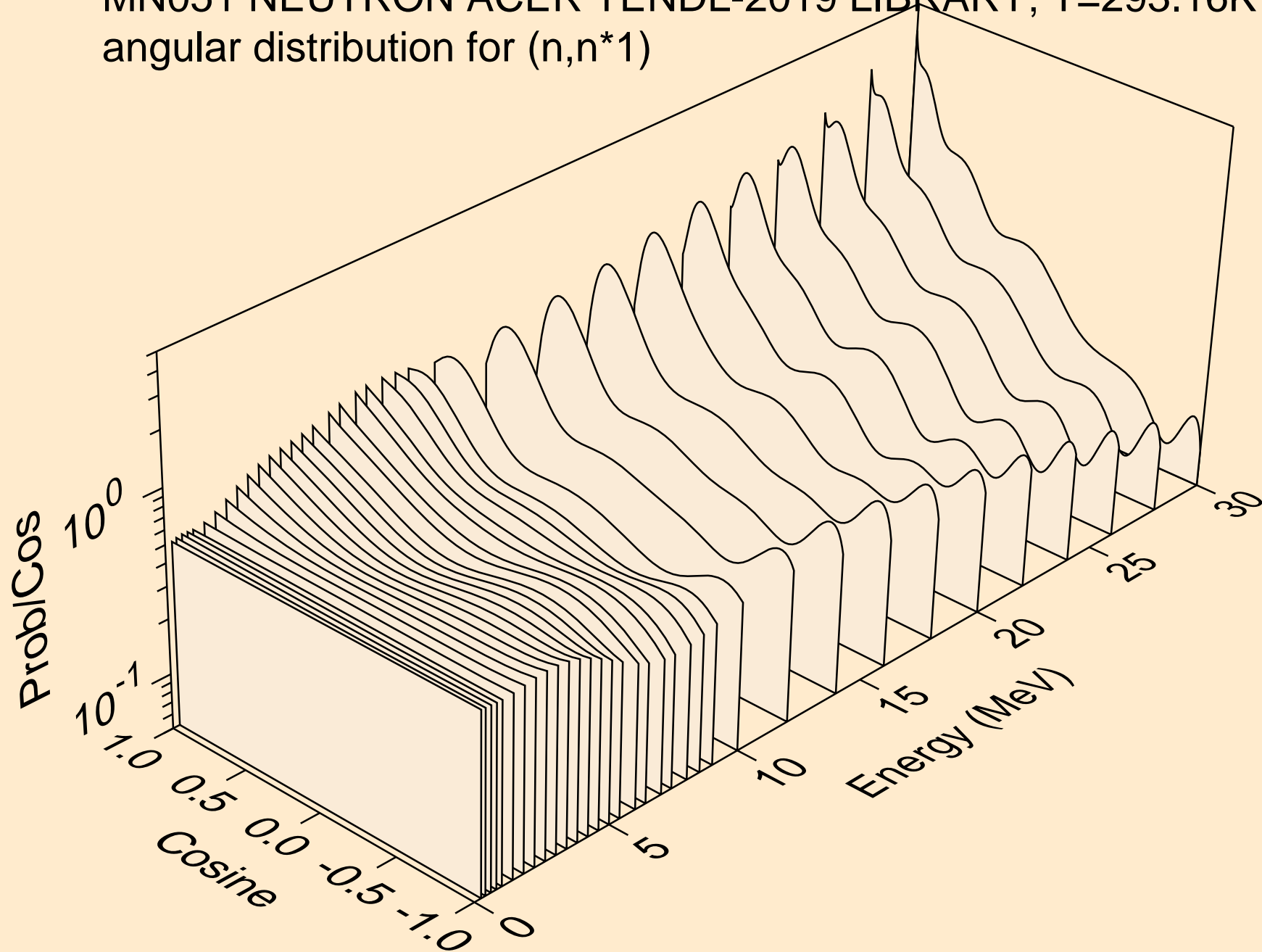

MN051 NEUTRON ACER TENDL-2019 LIBRARY; T=293.16K
angular distribution for (n,n*2)

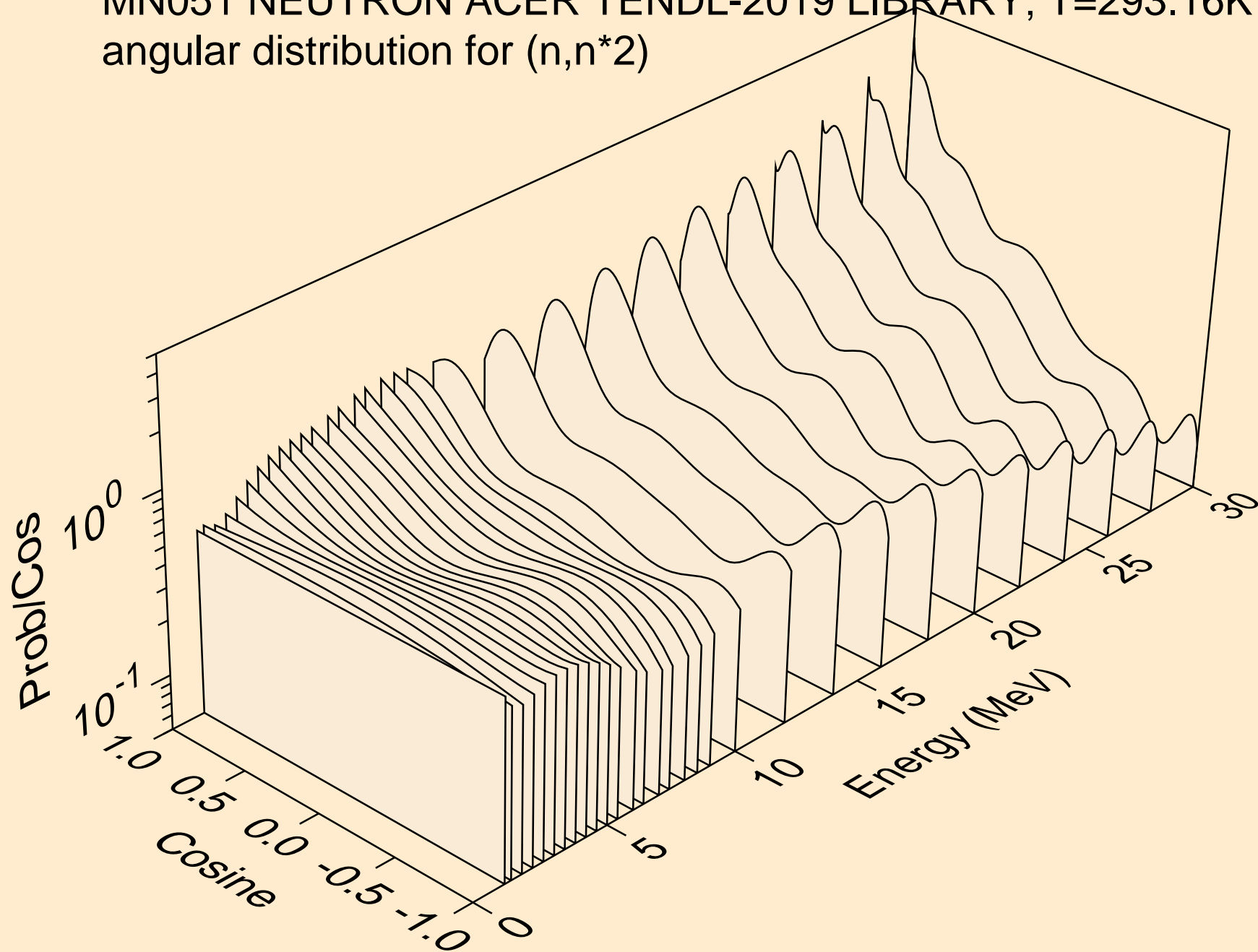

MN051 NEUTRON ACER TENDL-2019 LIBRARY; T=293.16K
angular distribution for (n,n*3)

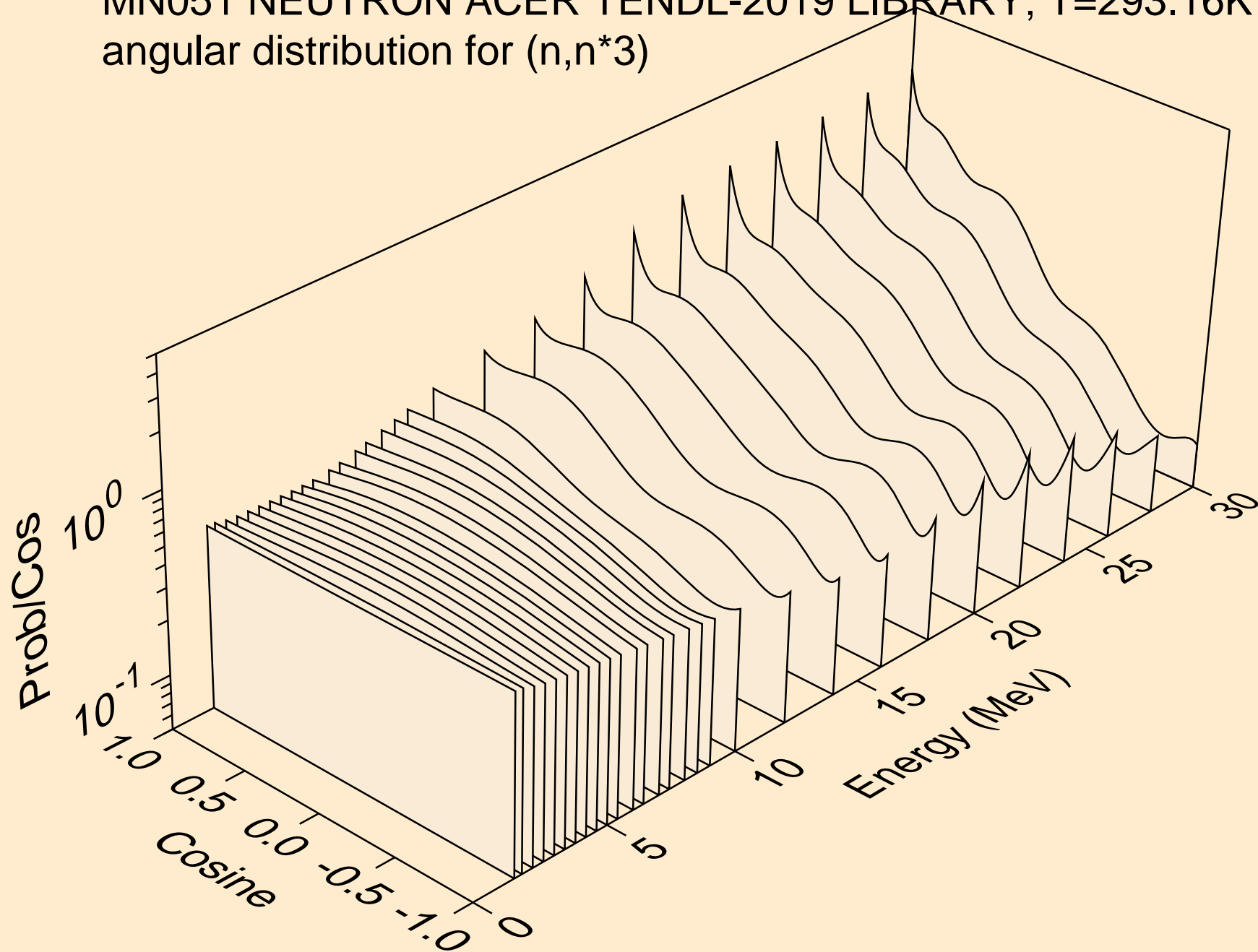

MN051 NEUTRON ACER TENDL-2019 LIBRARY; T=293.16K
angular distribution for (n,n*4)

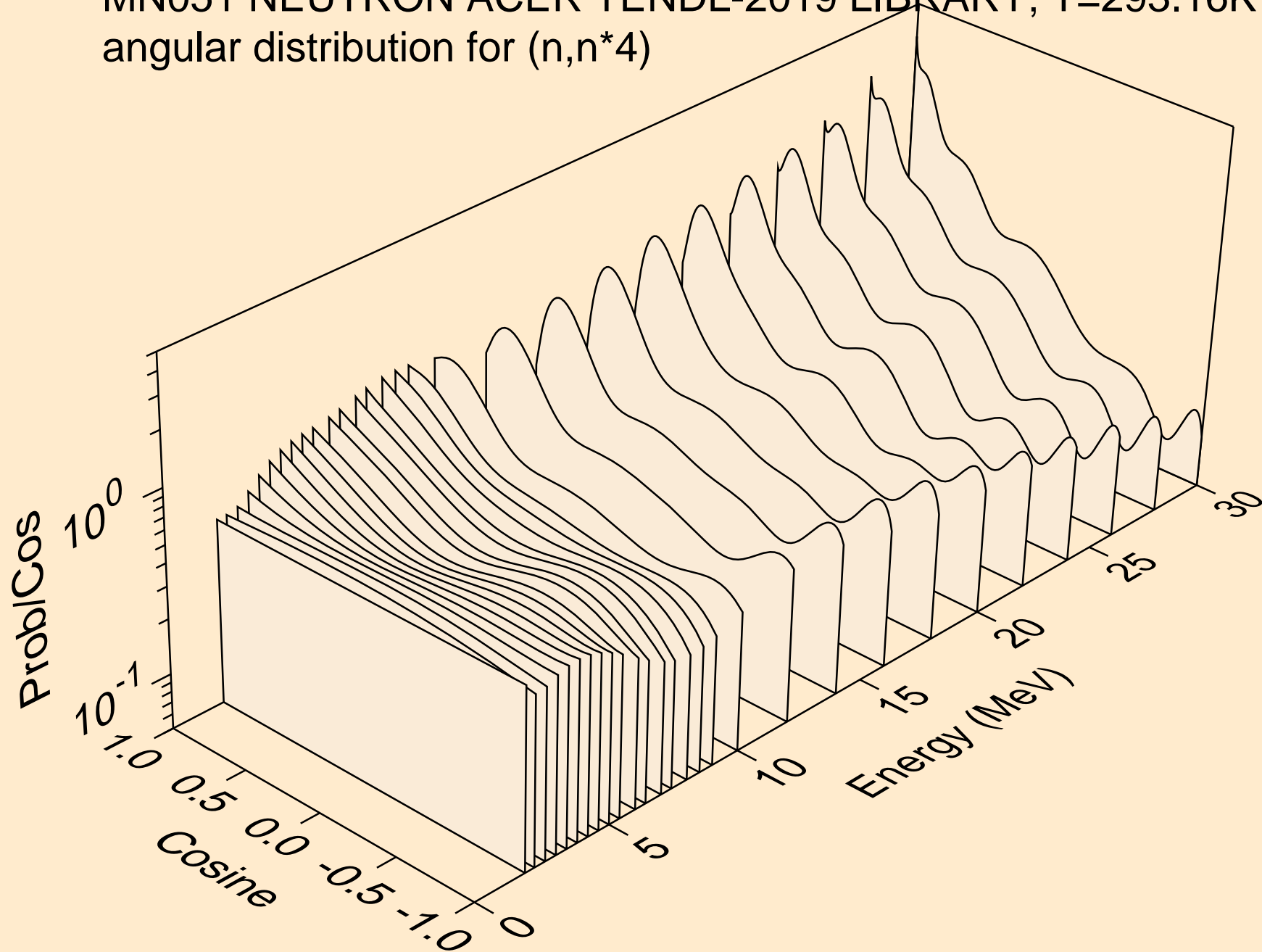

MN051 NEUTRON ACER TENDL-2019 LIBRARY; T=293.16K
angular distribution for (n,n*5)

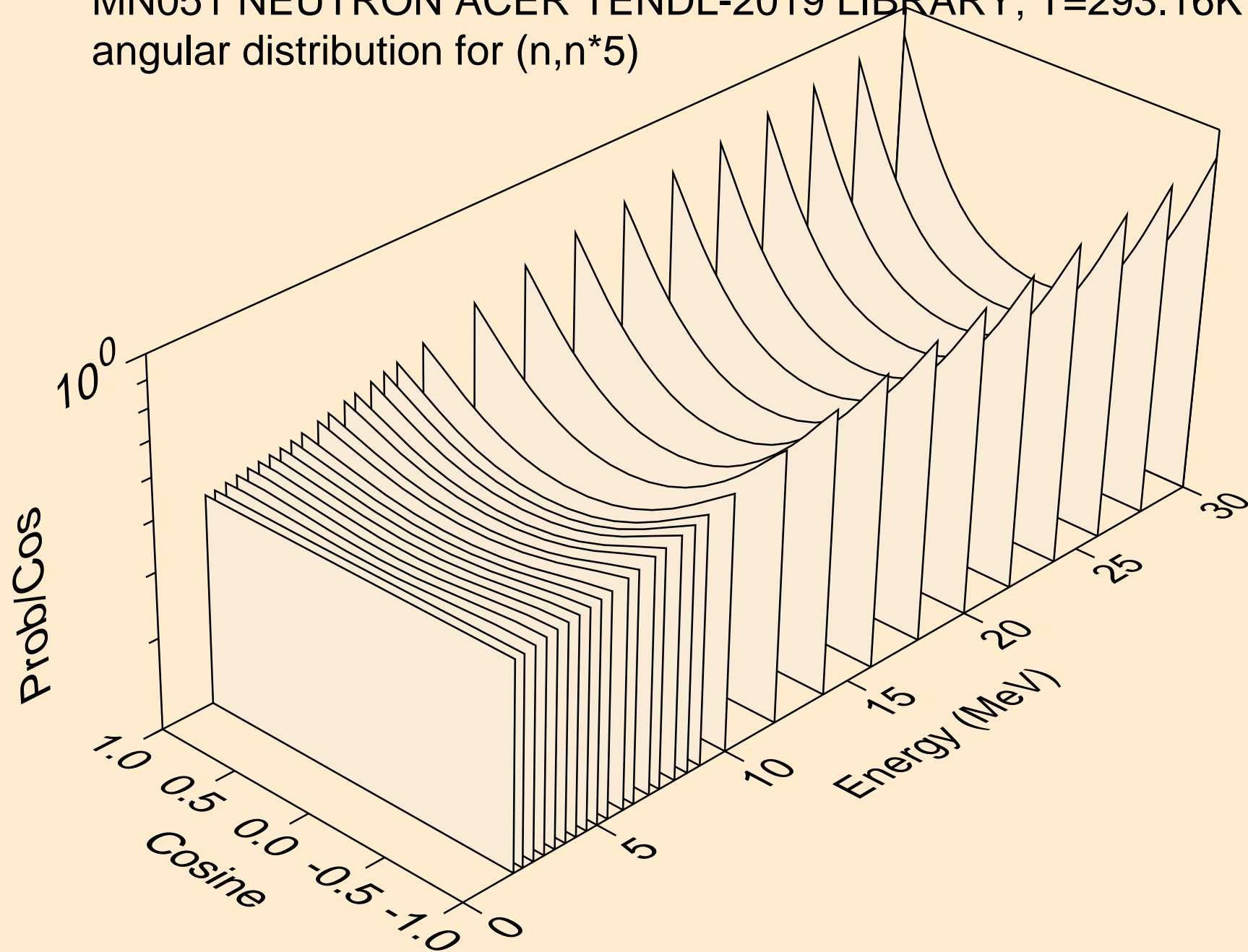

MN051 NEUTRON ACER TENDL-2019 LIBRARY; T=293.16K
angular distribution for (n,n*6)

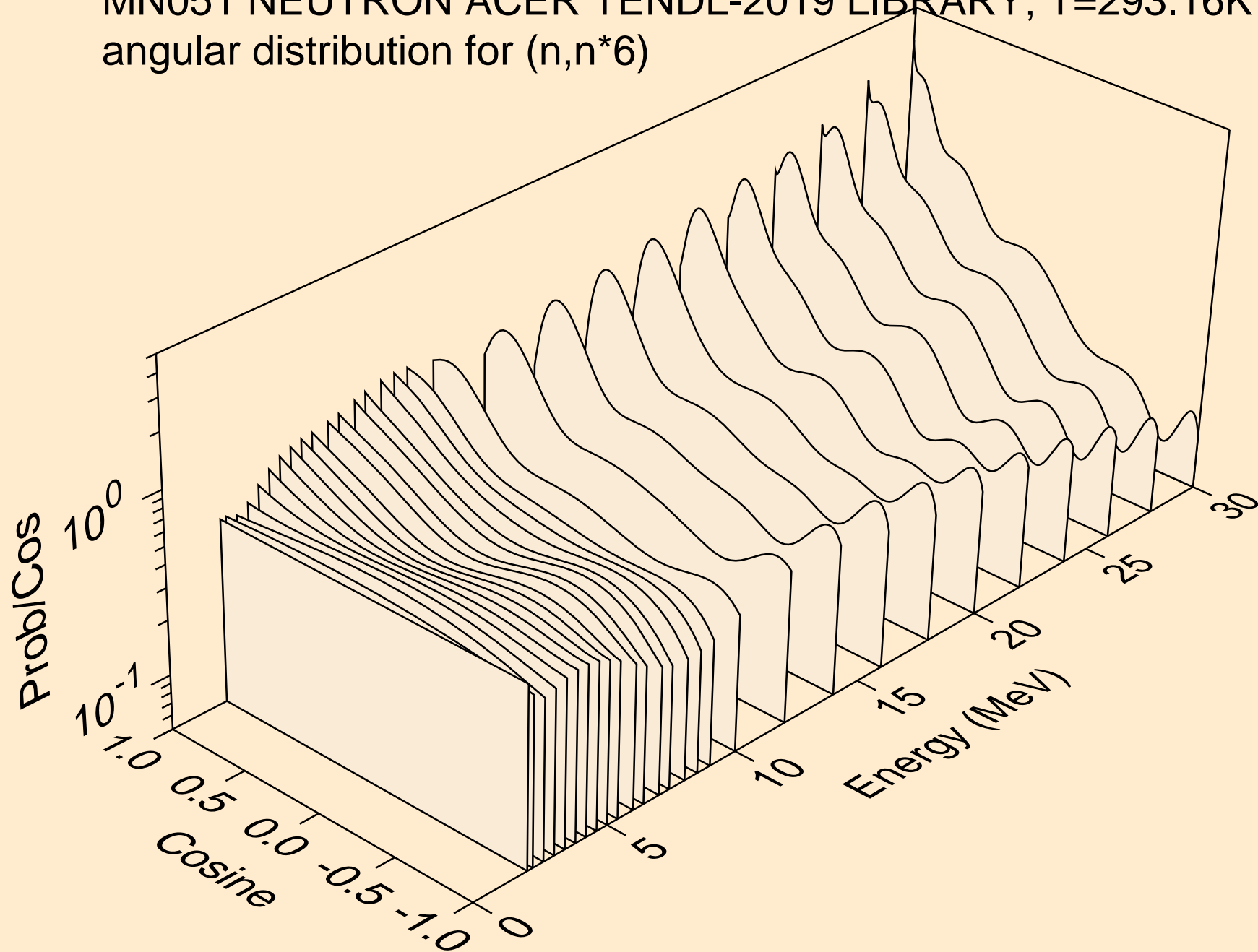

MN051 NEUTRON ACER TENDL-2019 LIBRARY; T=293.16K
angular distribution for (n,n*7)

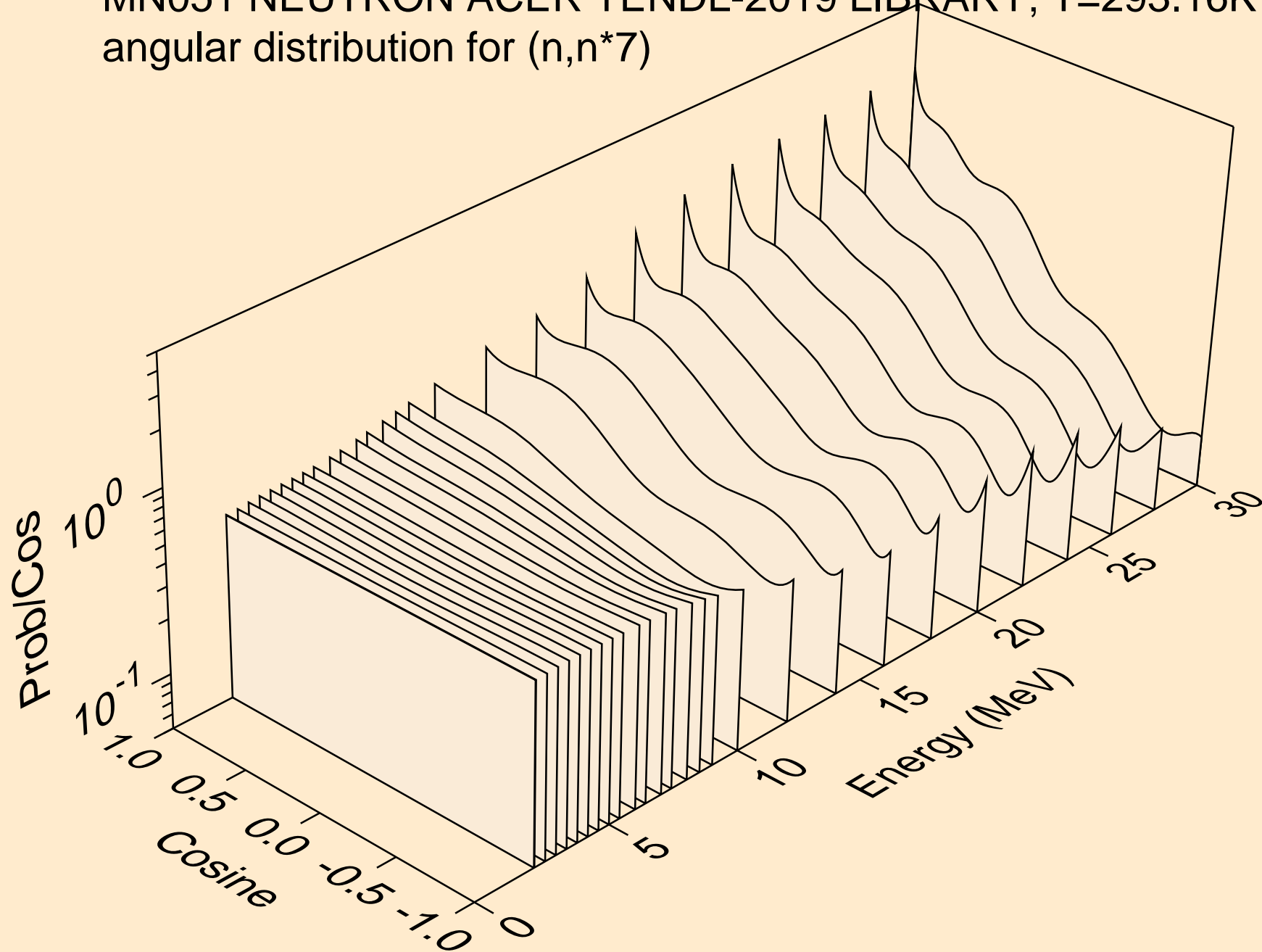

MN051 NEUTRON ACER TENDL-2019 LIBRARY; T=293.16K
angular distribution for (n,n*8)

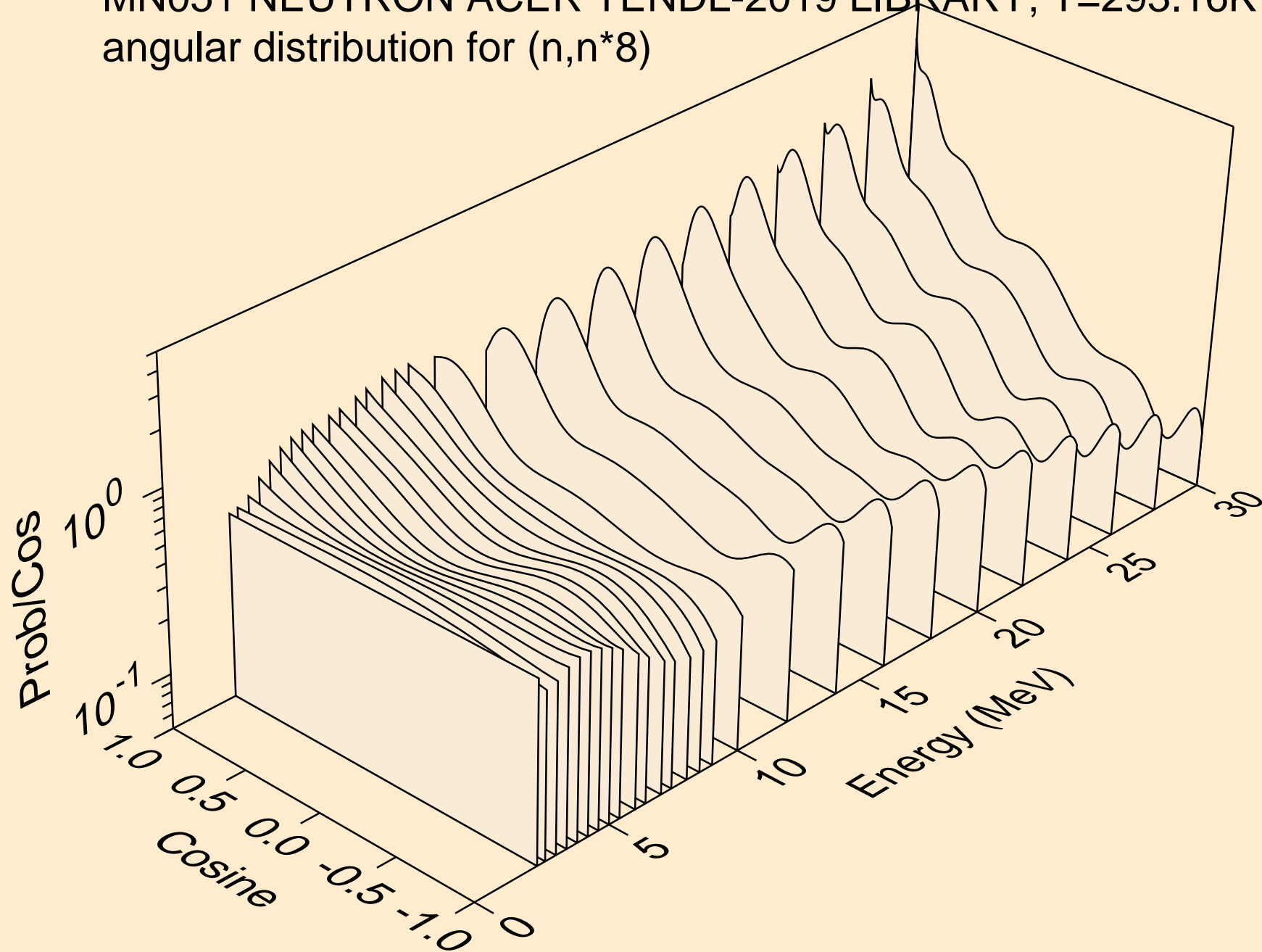

MN051 NEUTRON ACER TENDL-2019 LIBRARY; T=293.16K
angular distribution for (n,n*9)

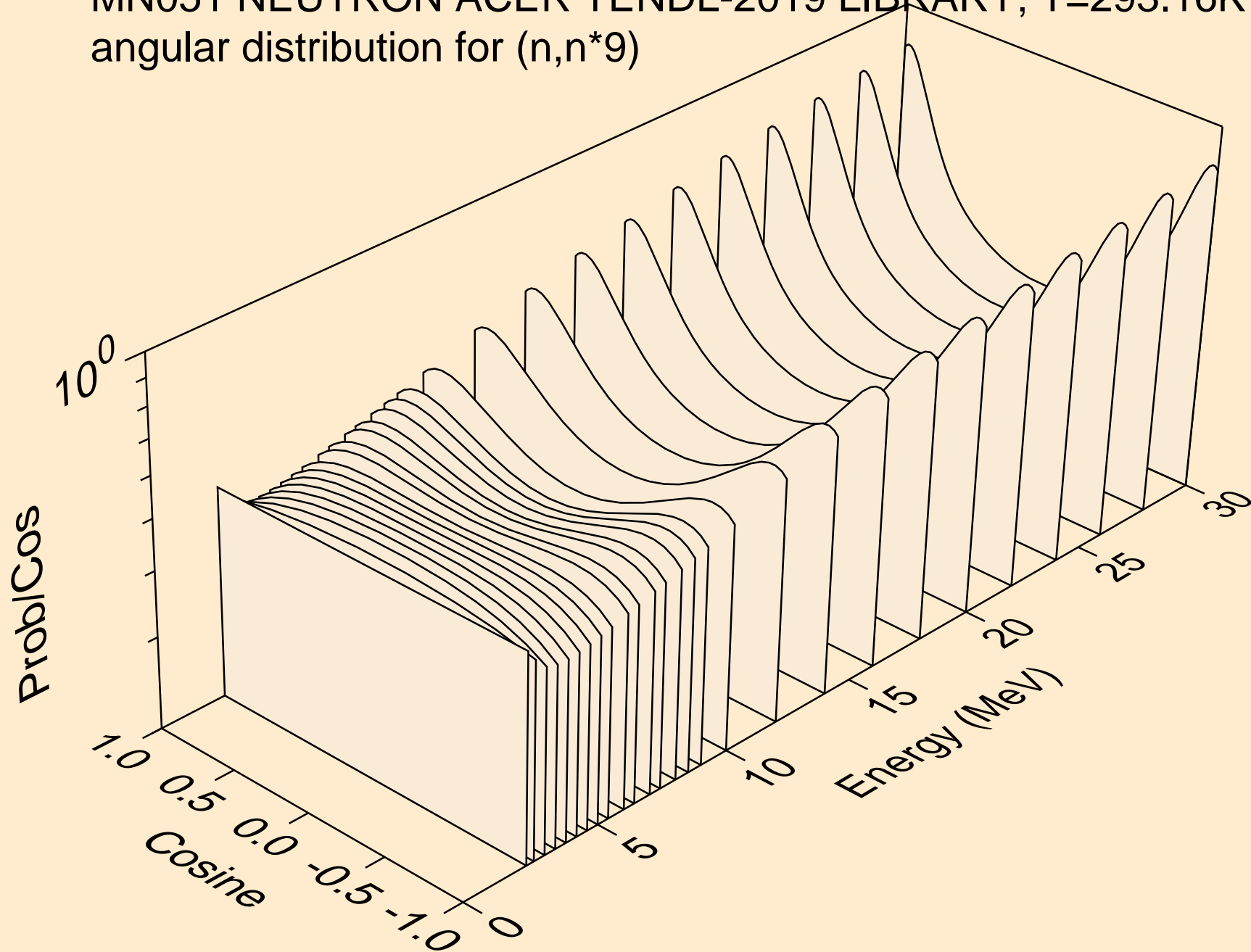

MN051 NEUTRON ACER TENDL-2019 LIBRARY; T=293.16K
angular distribution for (n,n*10)

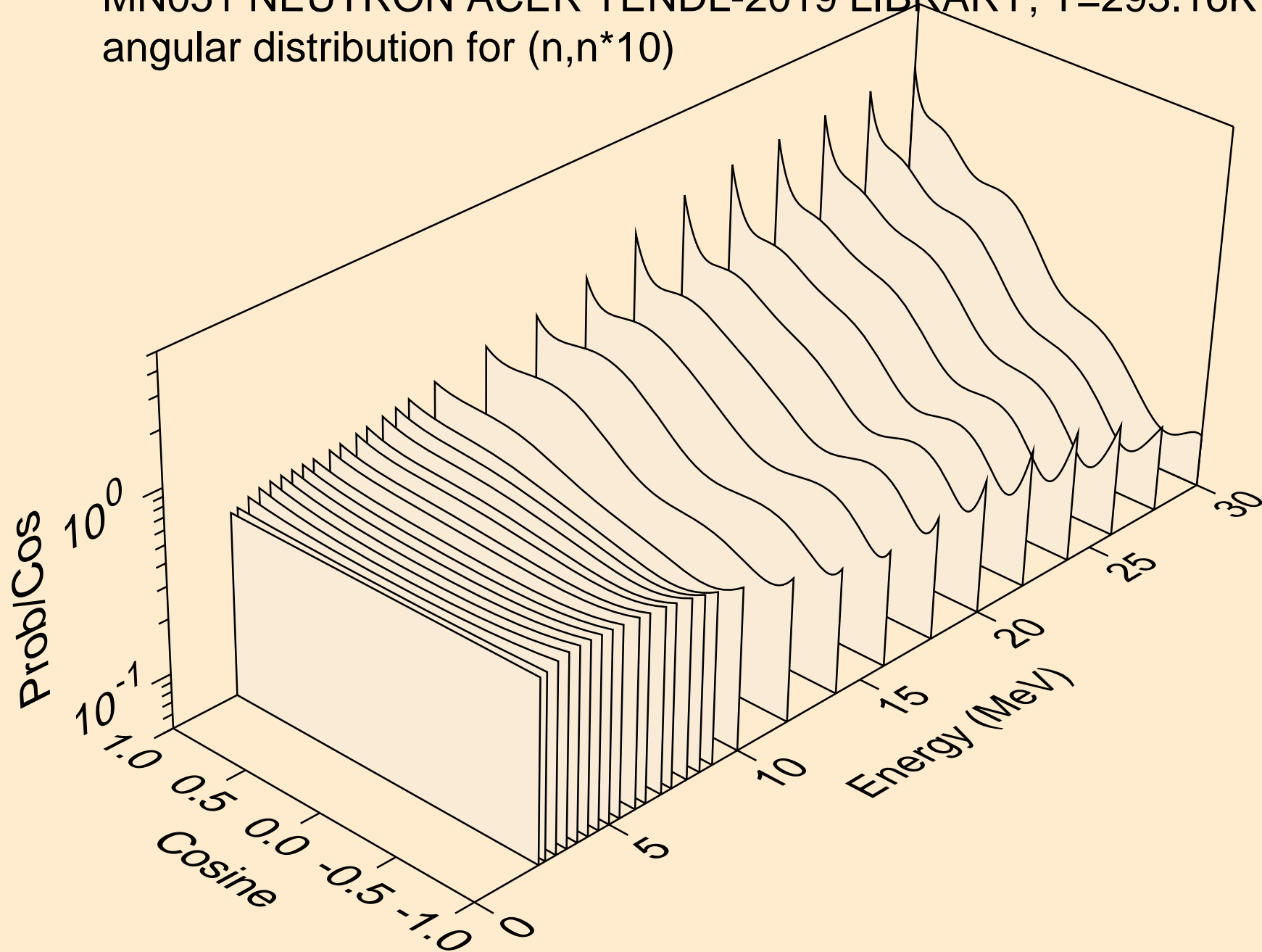

MN051 NEUTRON ACER TENDL-2019 LIBRARY; T=293.16K
angular distribution for (n,n*11)

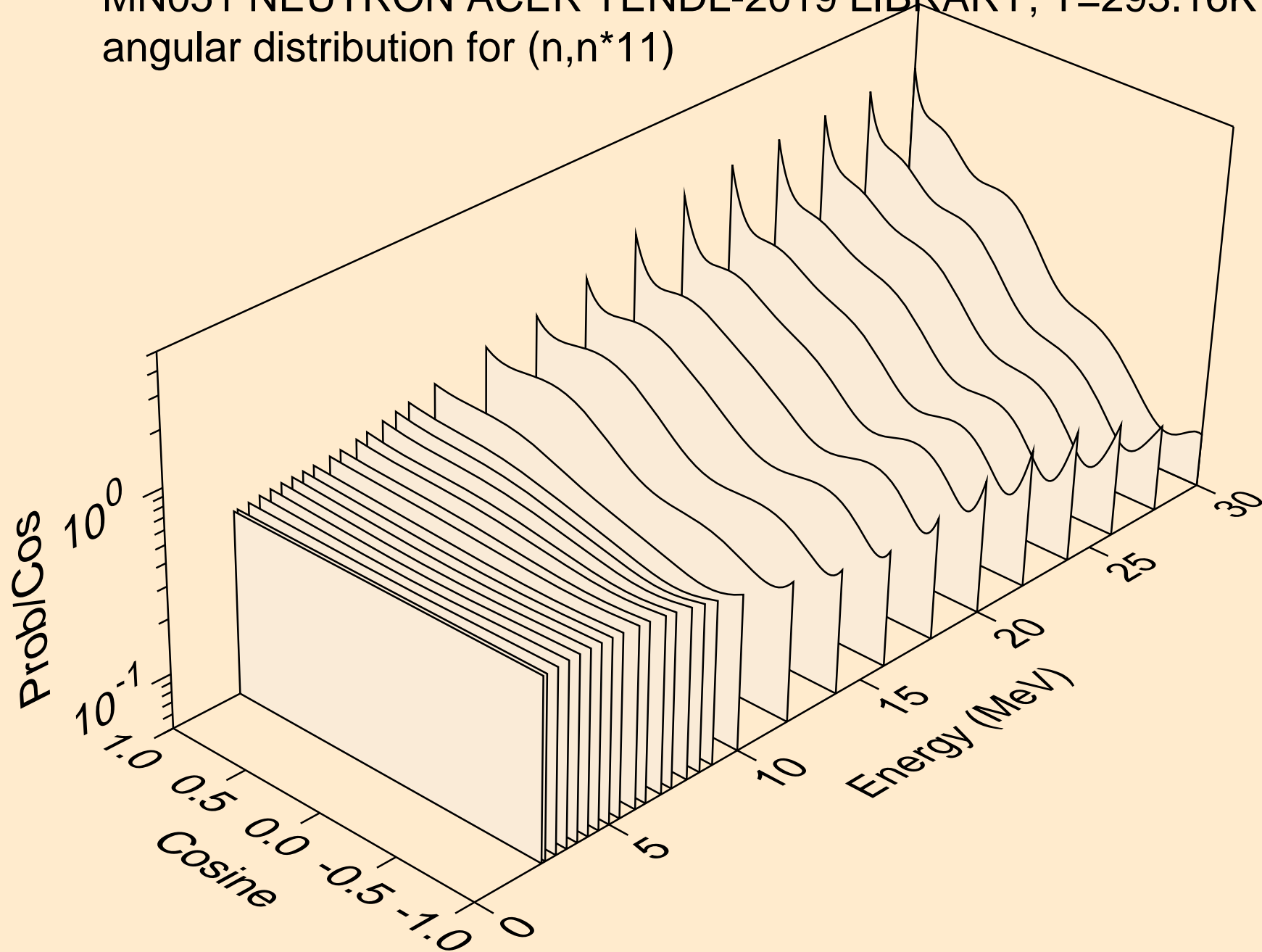

MN051 NEUTRON ACER TENDL-2019 LIBRARY; T=293.16K
angular distribution for (n,n*12)

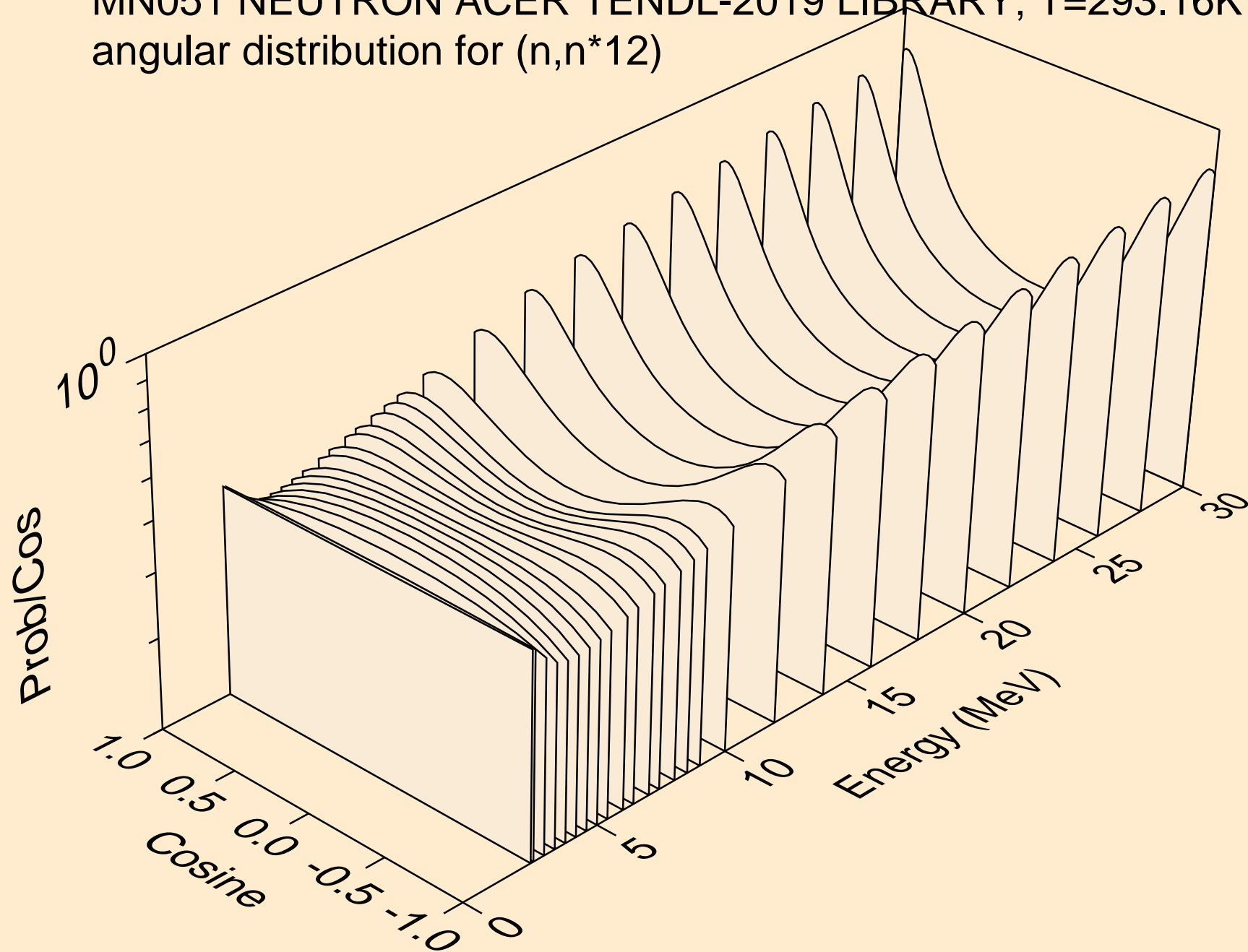

MN051 NEUTRON ACER TENDL-2019 LIBRARY; T=293.16K
angular distribution for (n,n*13)

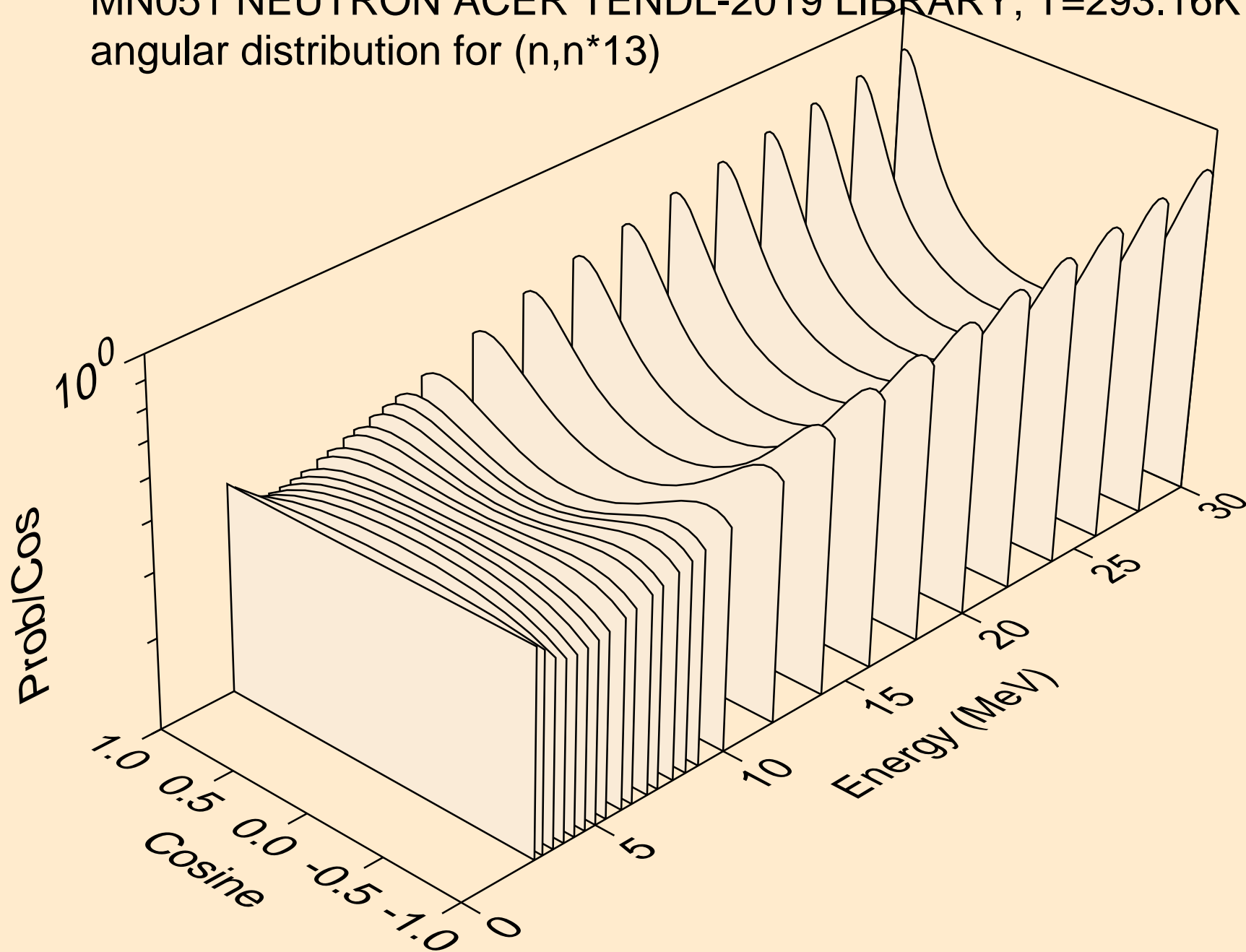

MN051 NEUTRON ACER TENDL-2019 LIBRARY; T=293.16K
angular distribution for (n,n*14)

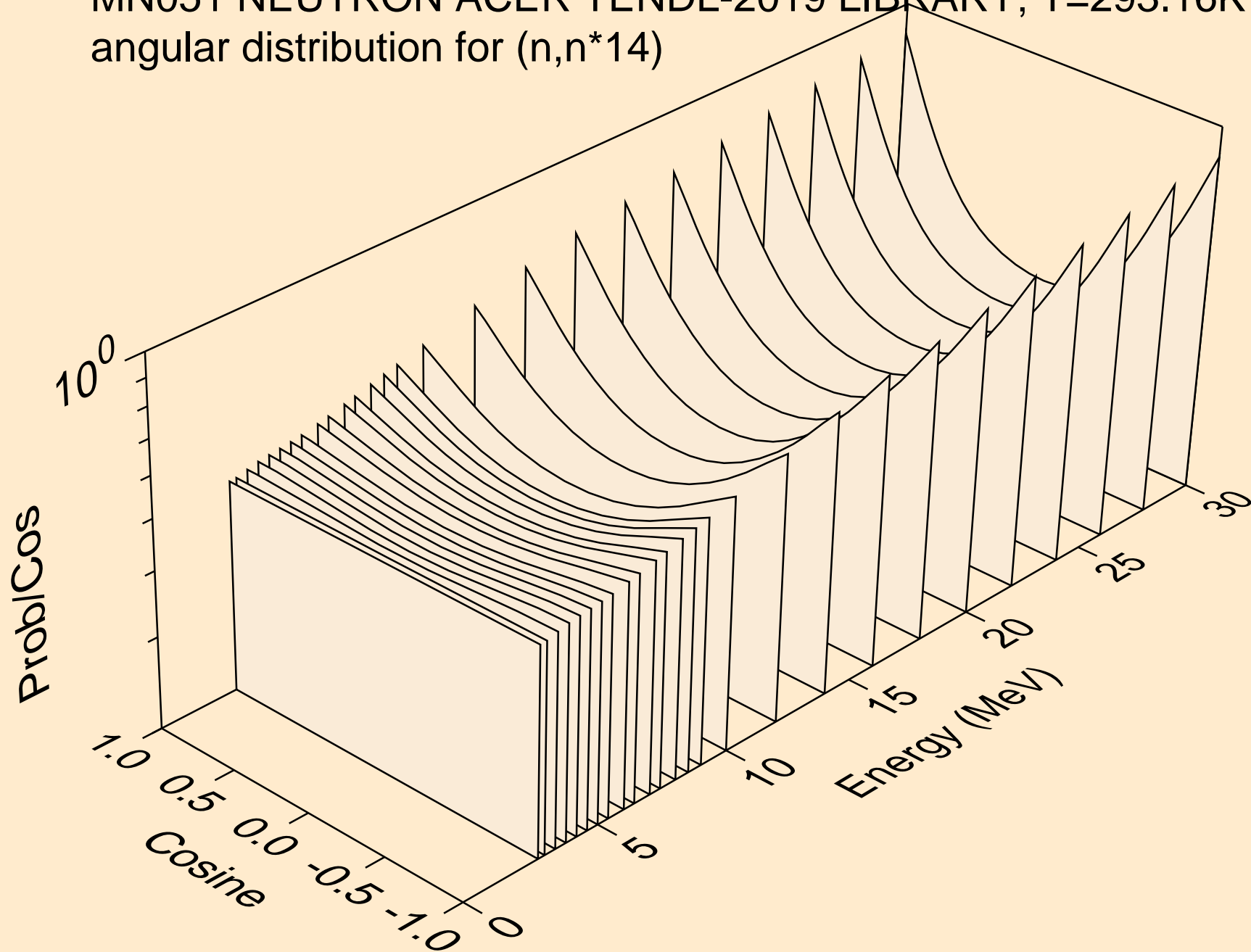

MN051 NEUTRON ACER TENDL-2019 LIBRARY; T=293.16K
angular distribution for (n,n*15)

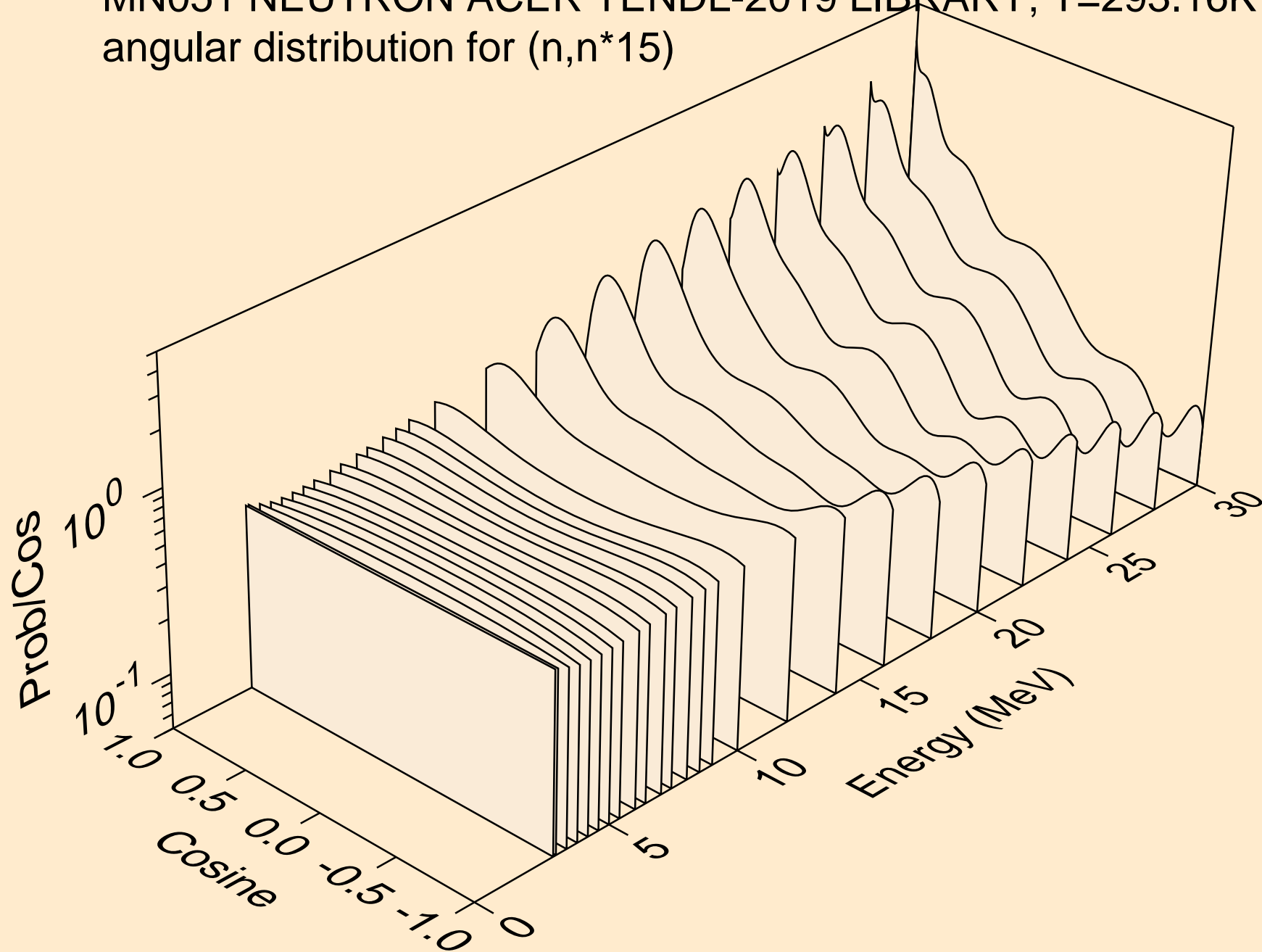

MN051 NEUTRON ACER TENDL-2019 LIBRARY; T=293.16K
angular distribution for (n,n*16)

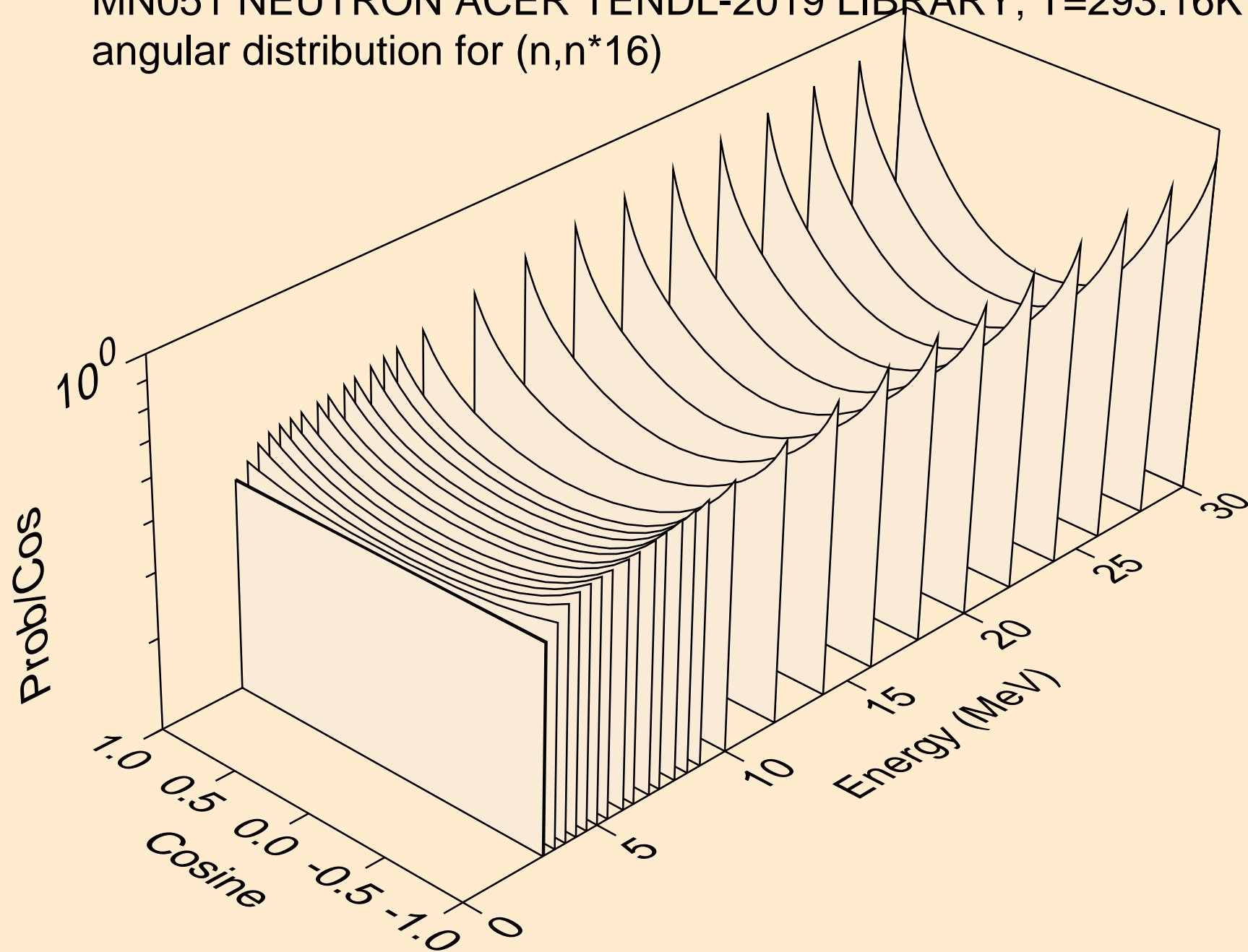

MN051 NEUTRON ACER TENDL-2019 LIBRARY; T=293.16K
angular distribution for (n,n*17)

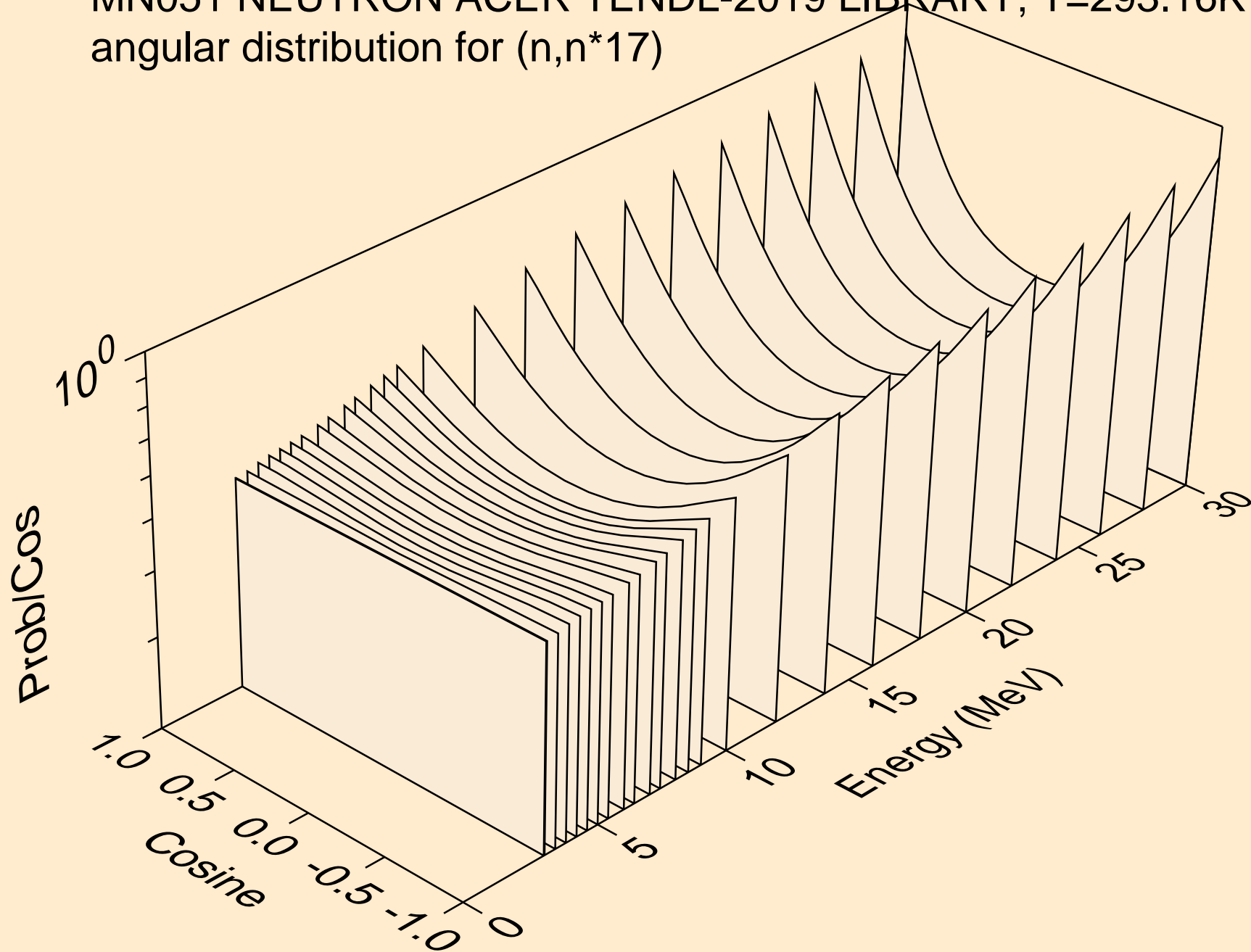

MN051 NEUTRON ACER TENDL-2019 LIBRARY; T=293.16K
angular distribution for (n,n*18)

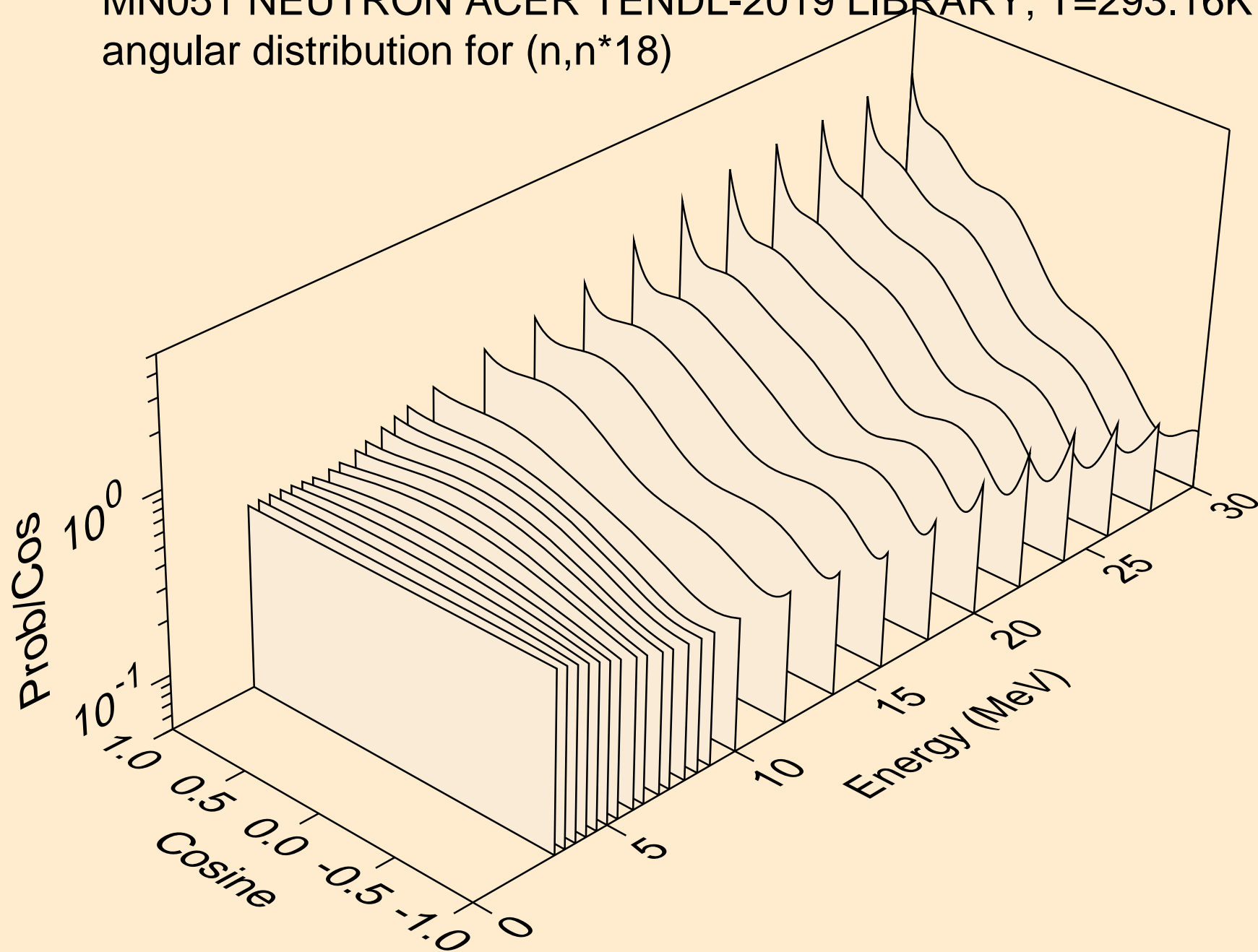

MN051 NEUTRON ACER TENDL-2019 LIBRARY; T=293.16K
angular distribution for (n,n*19)

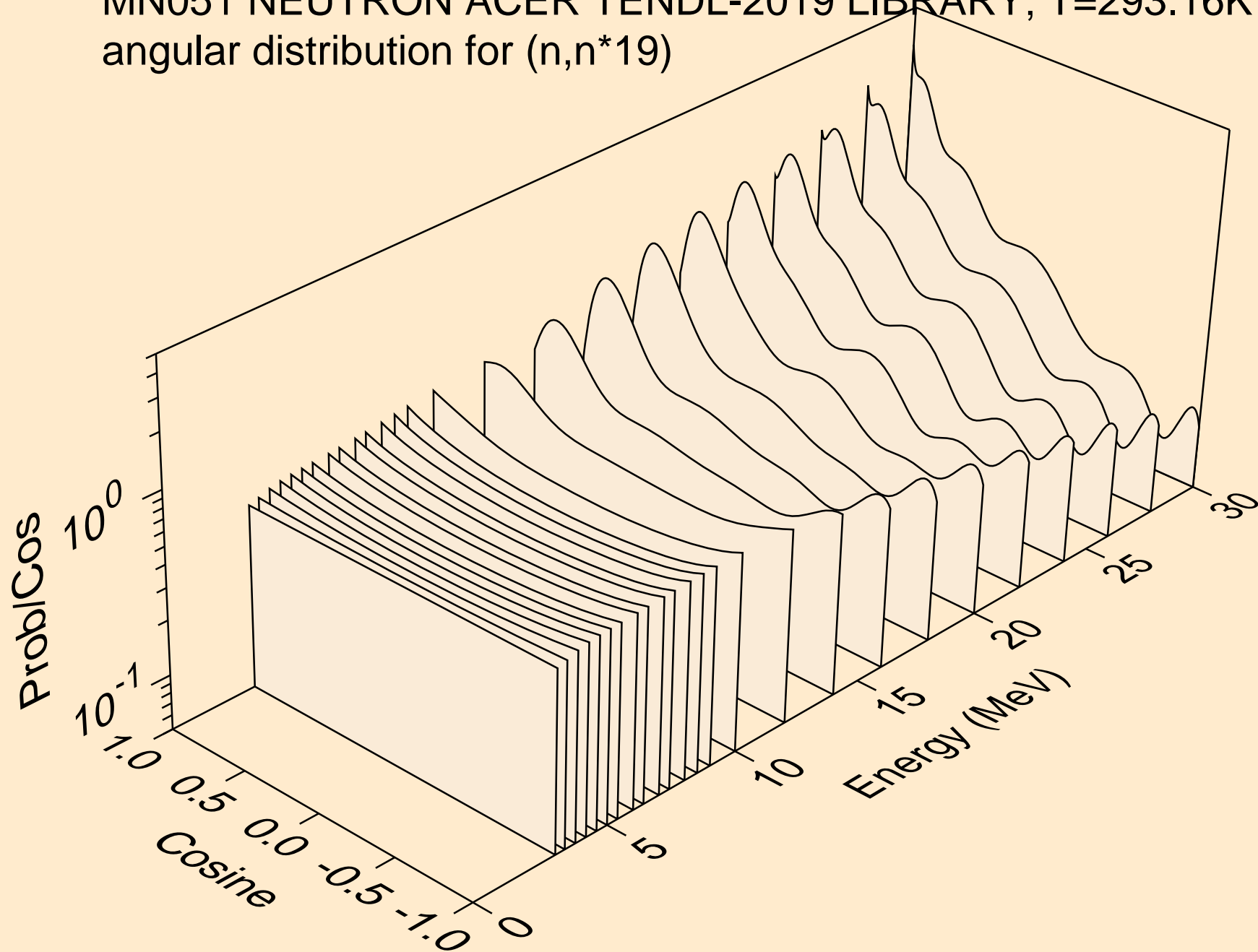

MN051 NEUTRON ACER TENDL-2019 LIBRARY; T=293.16K
angular distribution for (n,n*20)

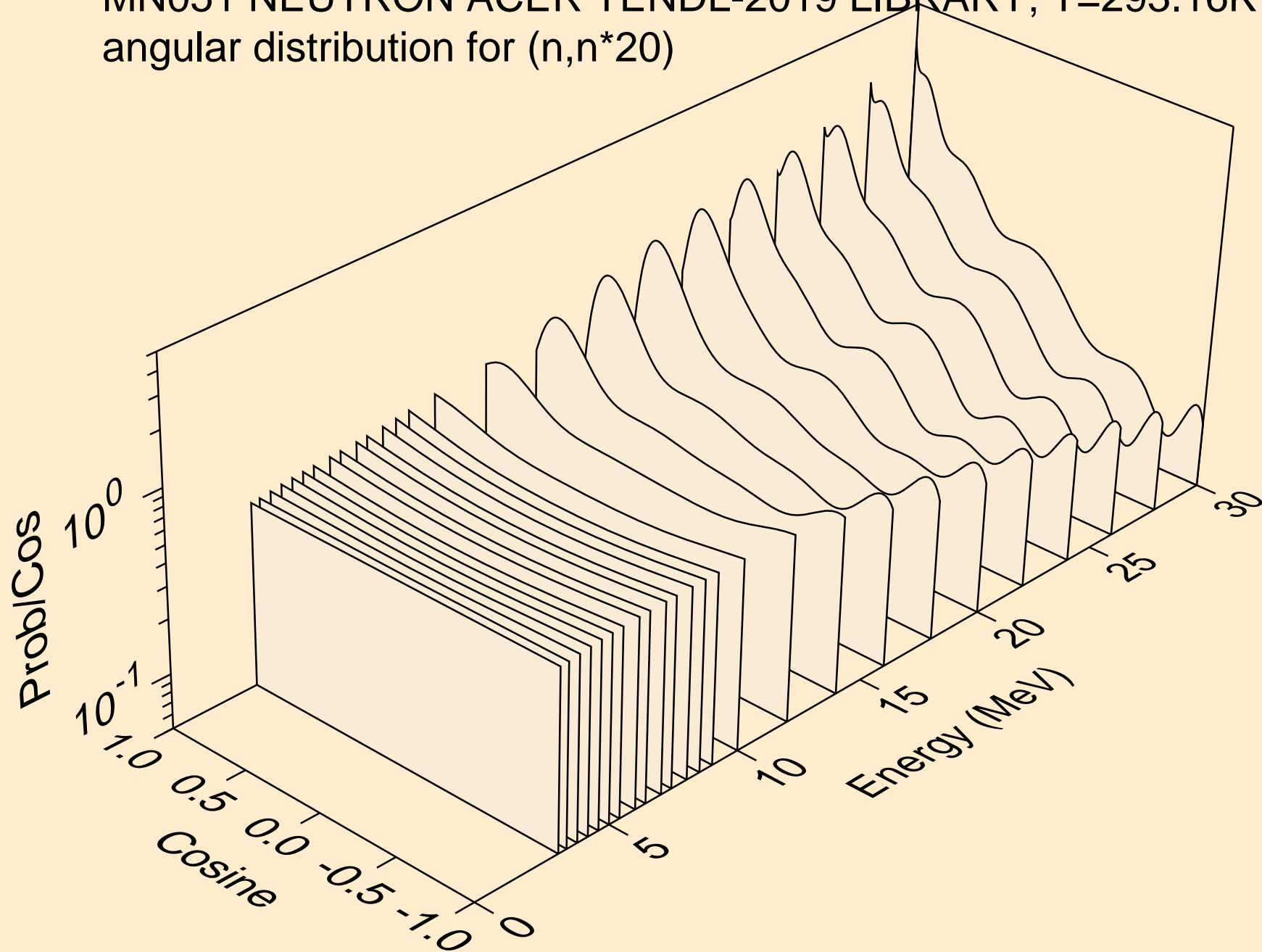

MN051 NEUTRON ACER TENDL-2019 LIBRARY; T=293.16K
angular distribution for (n,n*21)

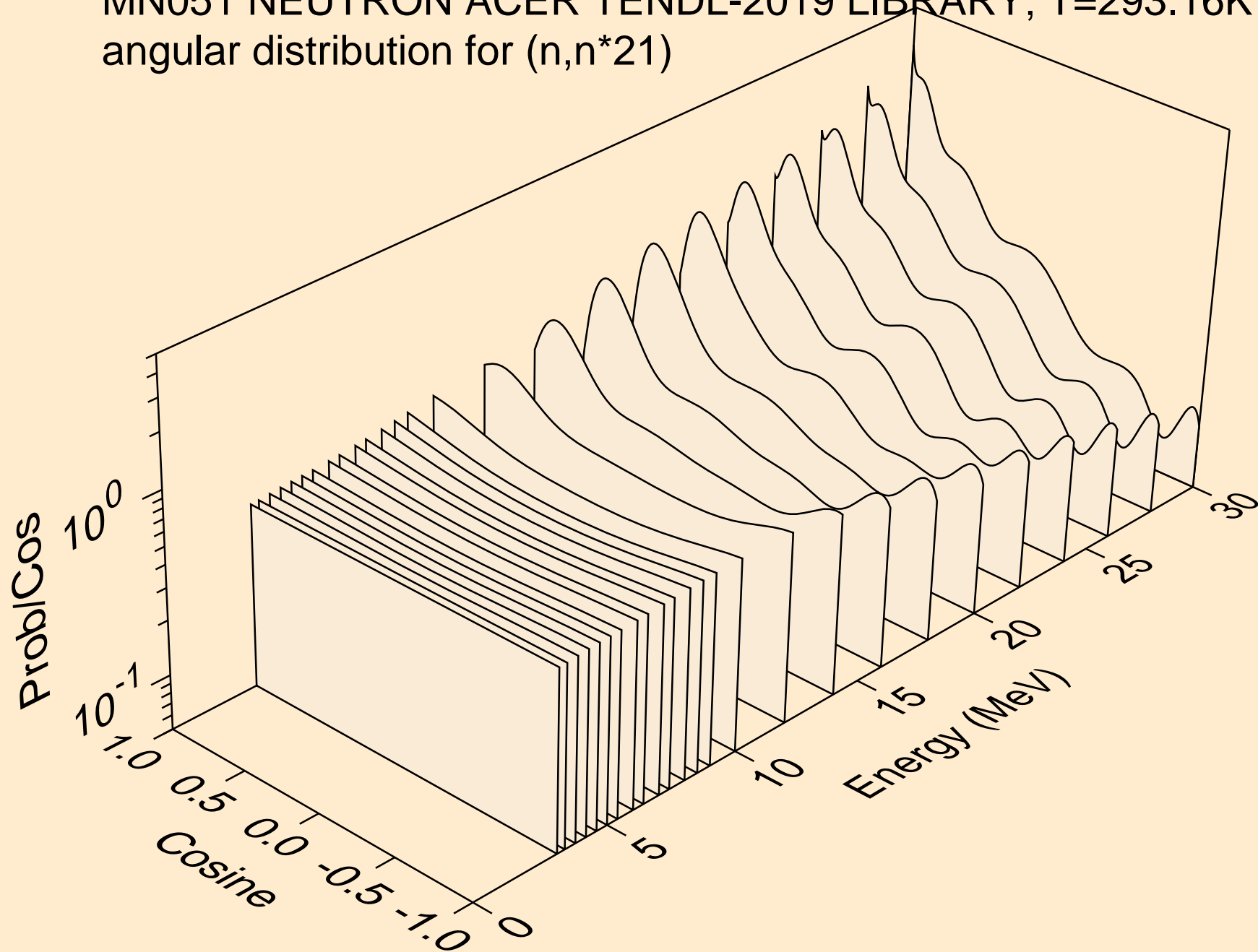

MN051 NEUTRON ACER TENDL-2019 LIBRARY; T=293.16K
angular distribution for (n,n*22)

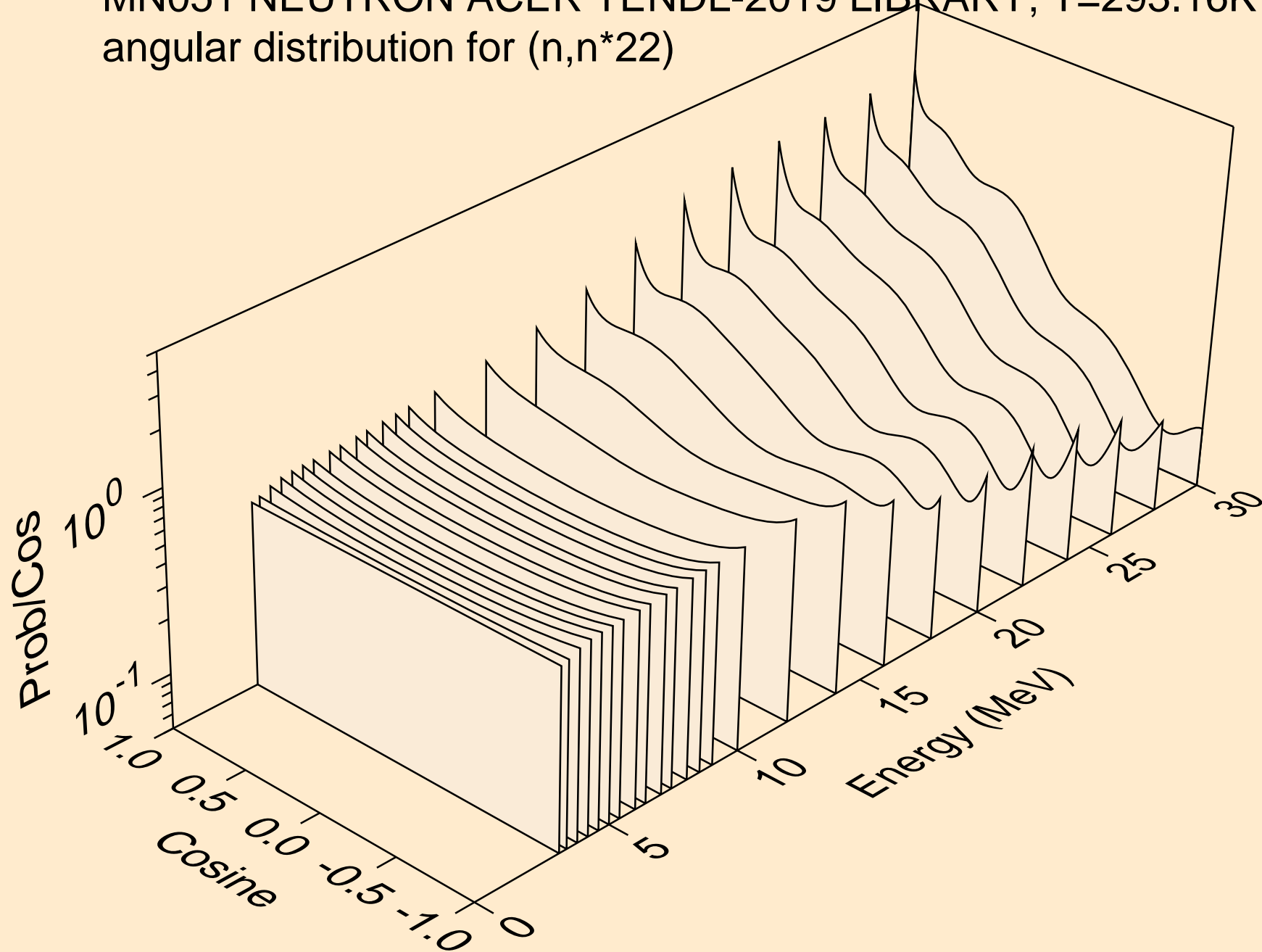

MN051 NEUTRON ACER TENDL-2019 LIBRARY; T=293.16K
angular distribution for (n,n*23)

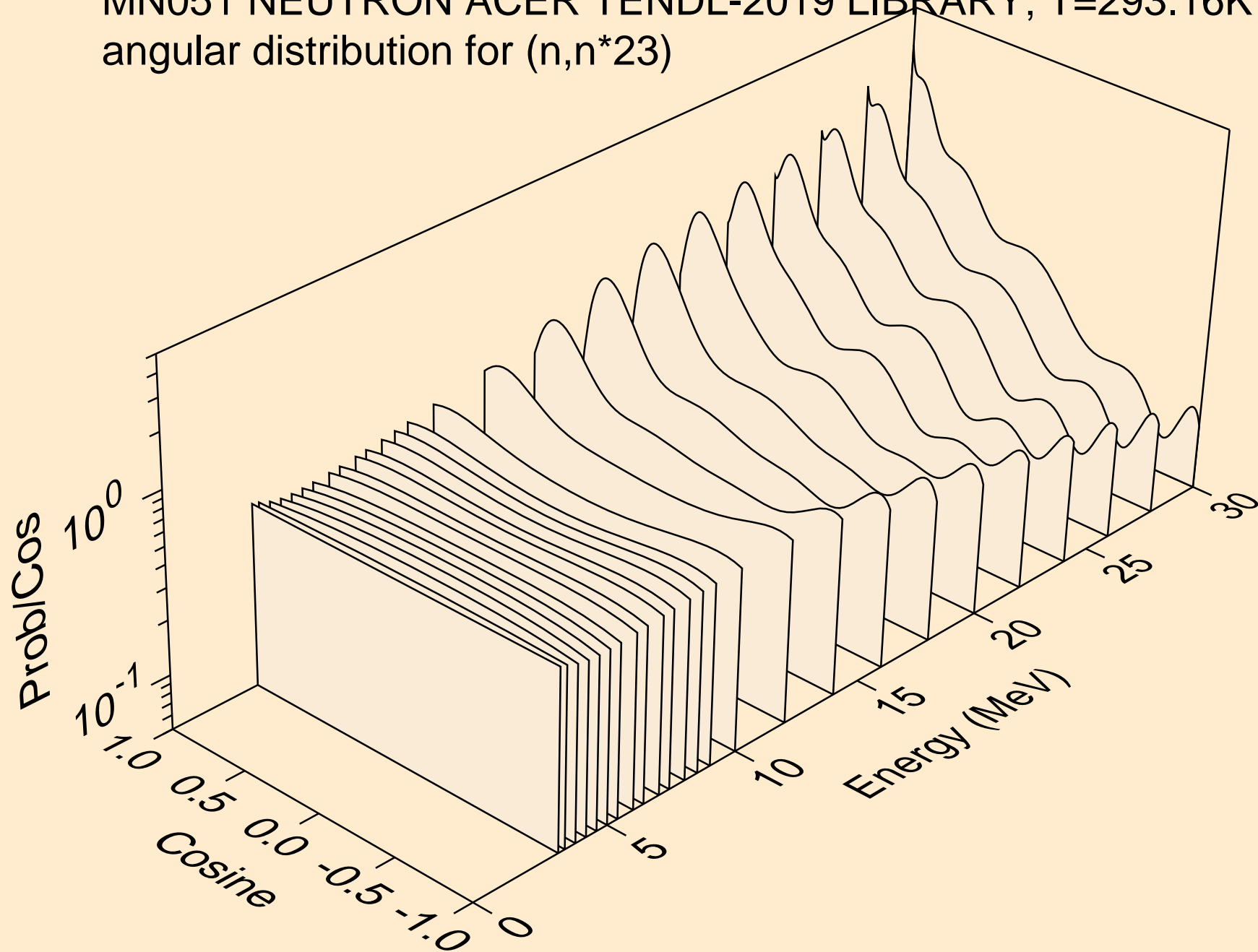

MN051 NEUTRON ACER TENDL-2019 LIBRARY; T=293.16K
angular distribution for (n,n*24)

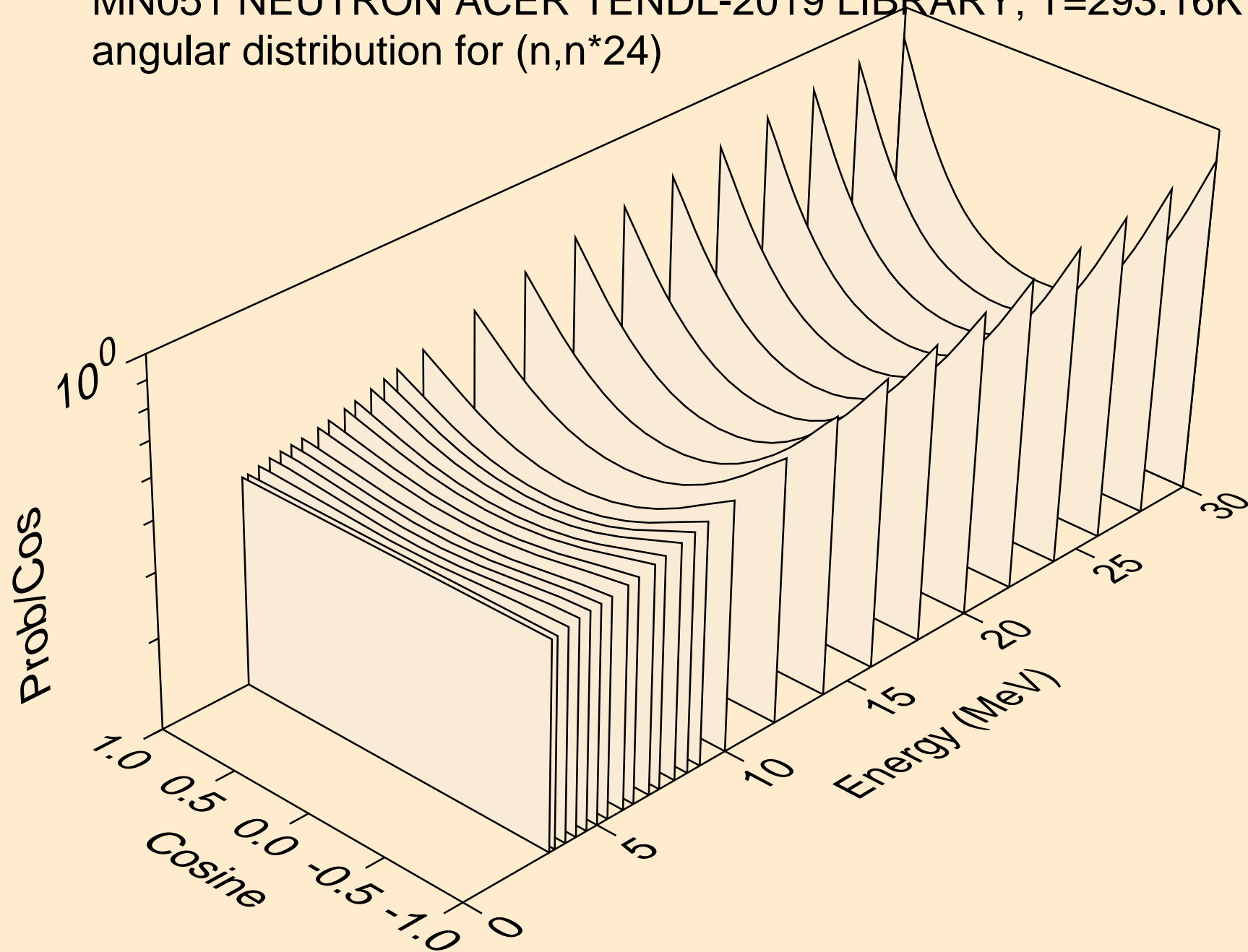

MN051 NEUTRON ACER TENDL-2019 LIBRARY; T=293.16K
angular distribution for (n,n*25)

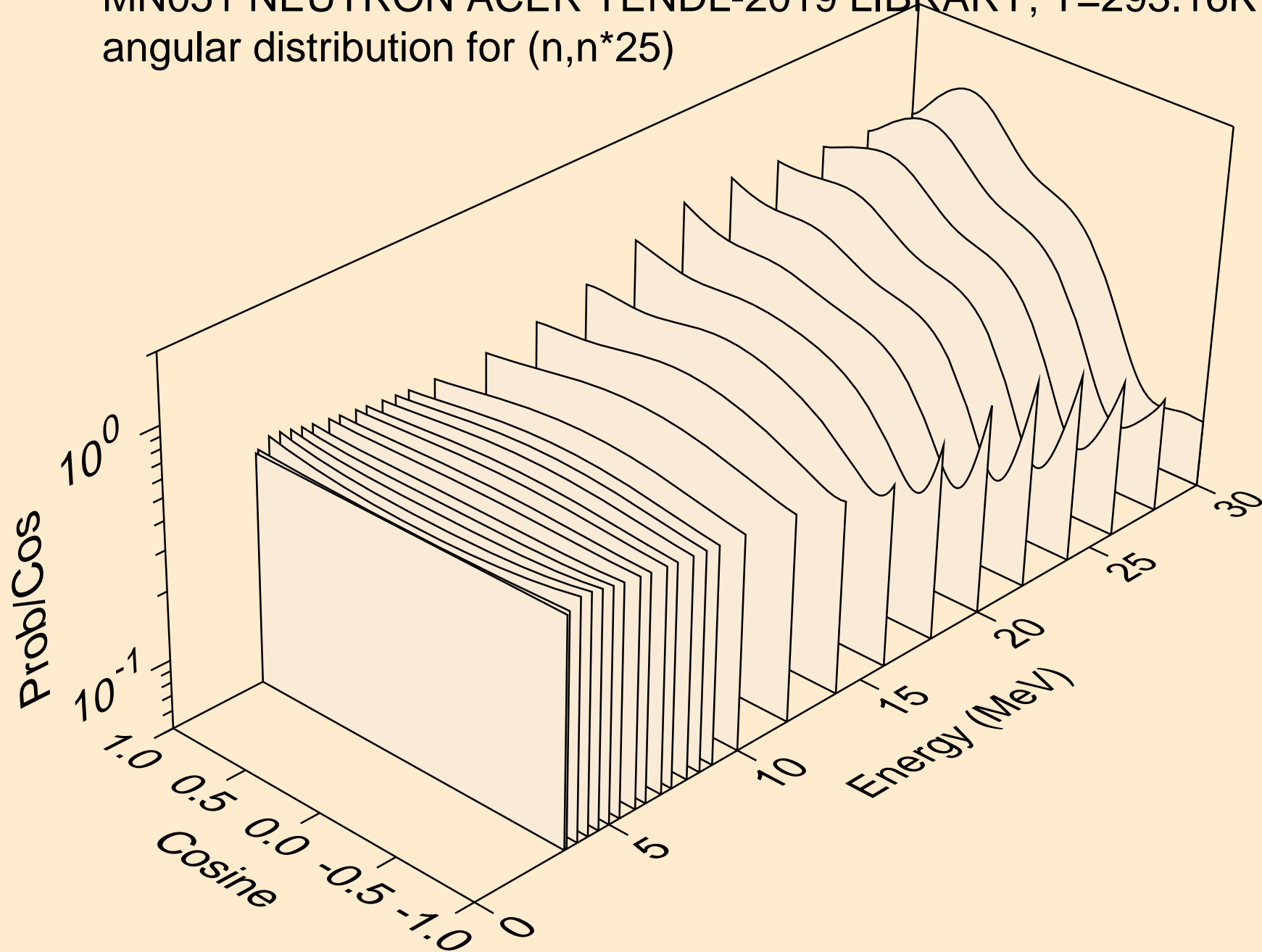

MN051 NEUTRON ACER TENDL-2019 LIBRARY; T=293.16K
angular distribution for (n,n*26)

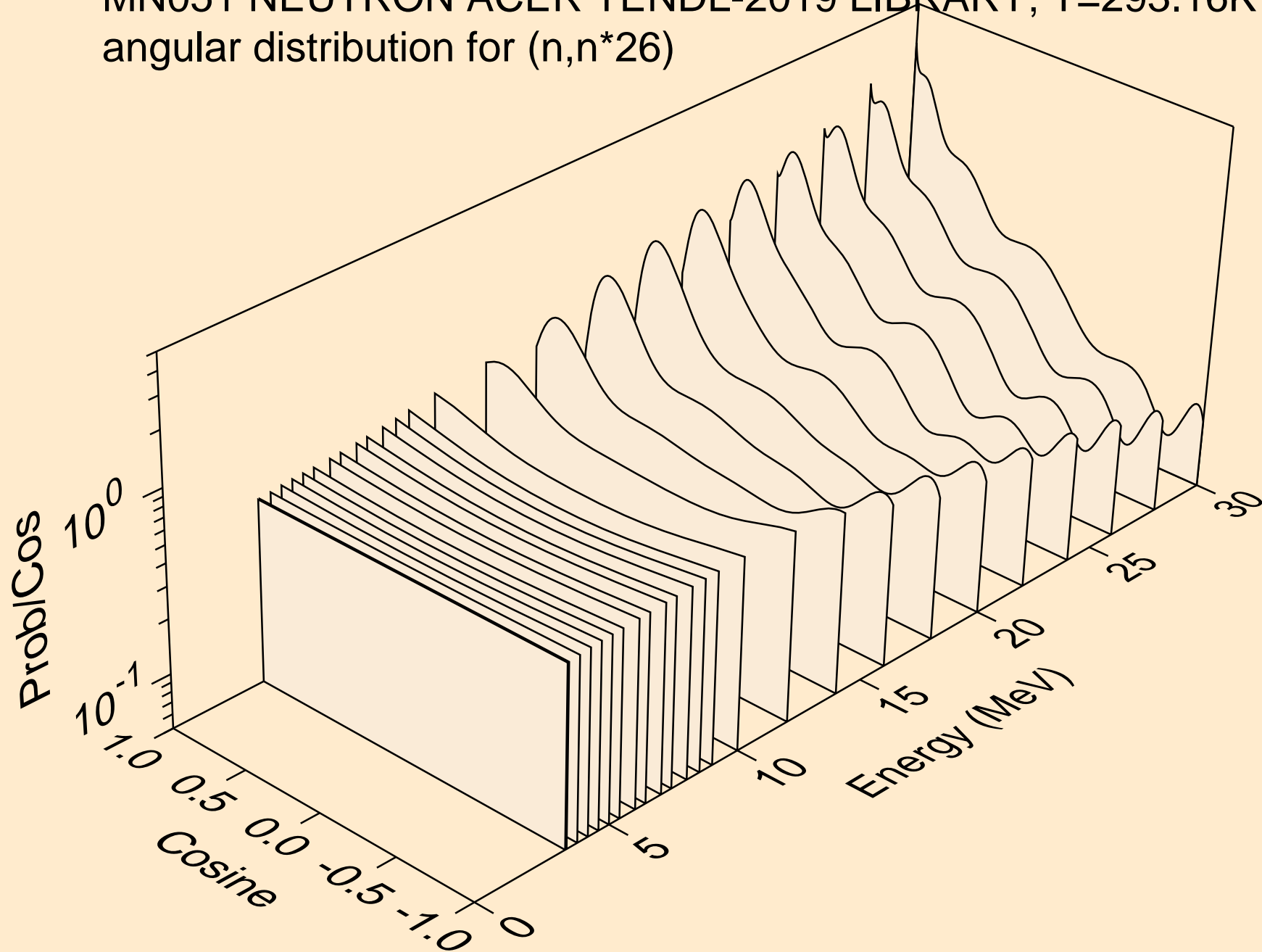

MN051 NEUTRON ACER TENDL-2019 LIBRARY; T=293.16K
angular distribution for (n,n*27)

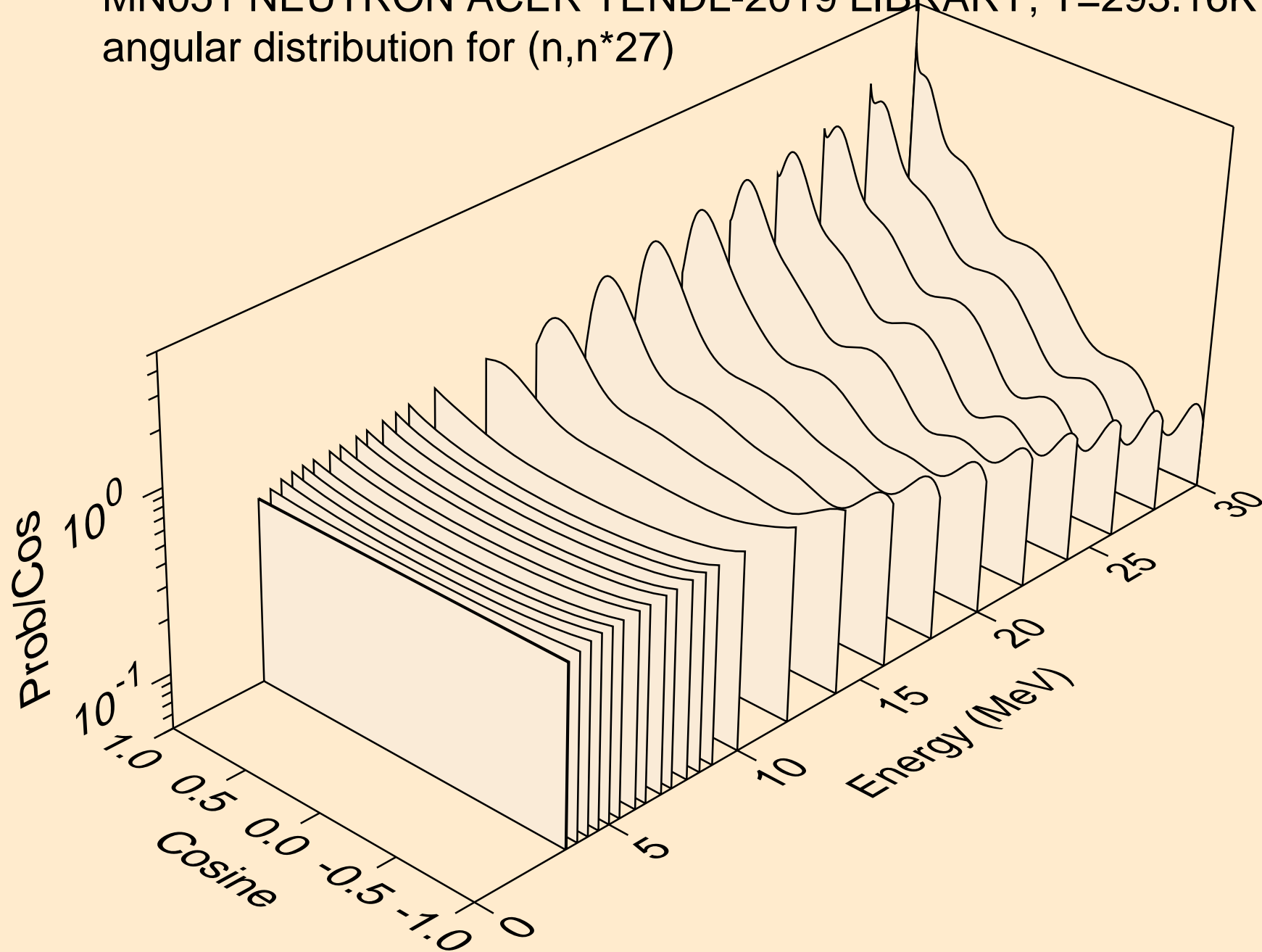

MN051 NEUTRON ACER TENDL-2019 LIBRARY; T=293.16K
angular distribution for (n,n*28)

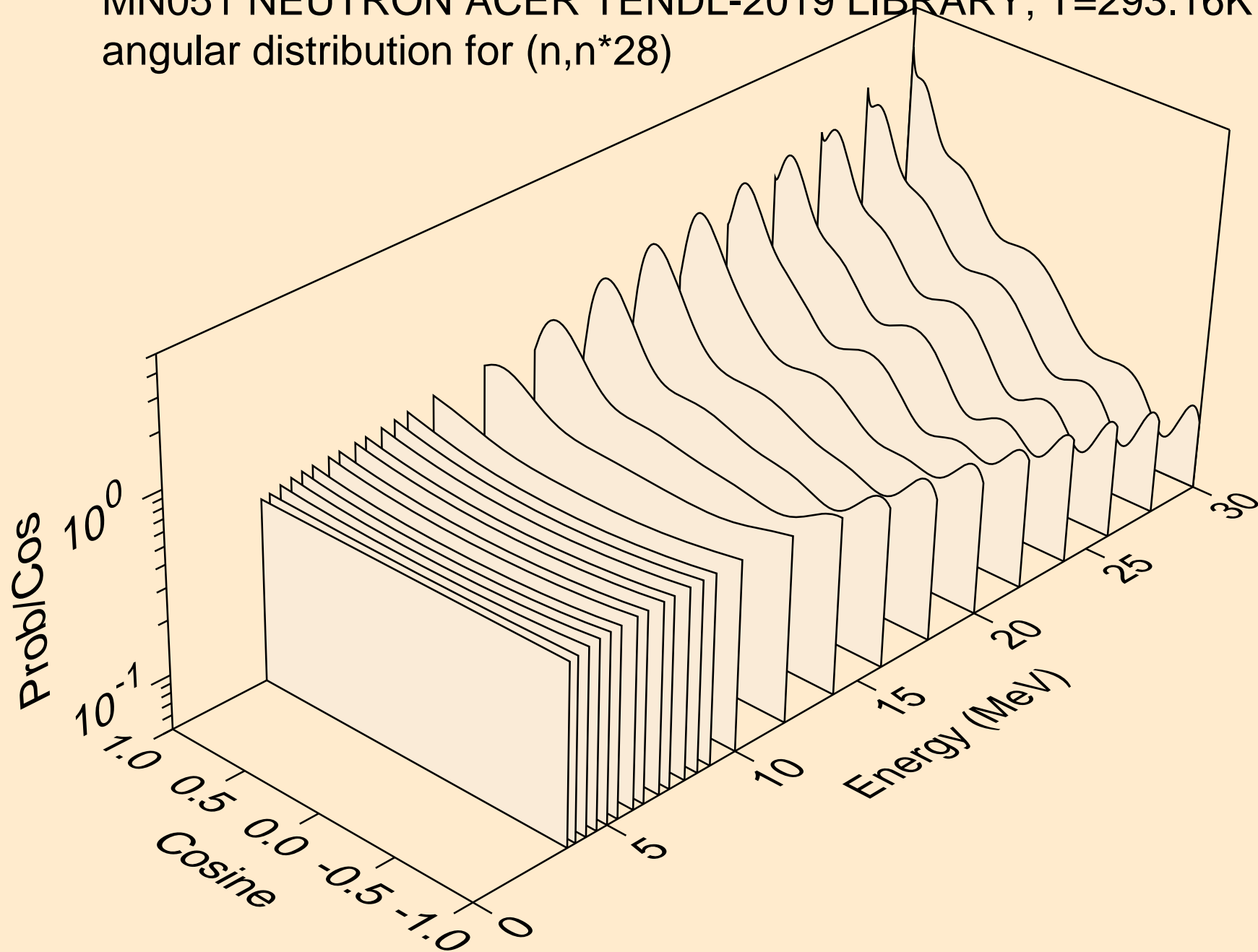

MN051 NEUTRON ACER TENDL-2019 LIBRARY; T=293.16K
angular distribution for (n,n*29)

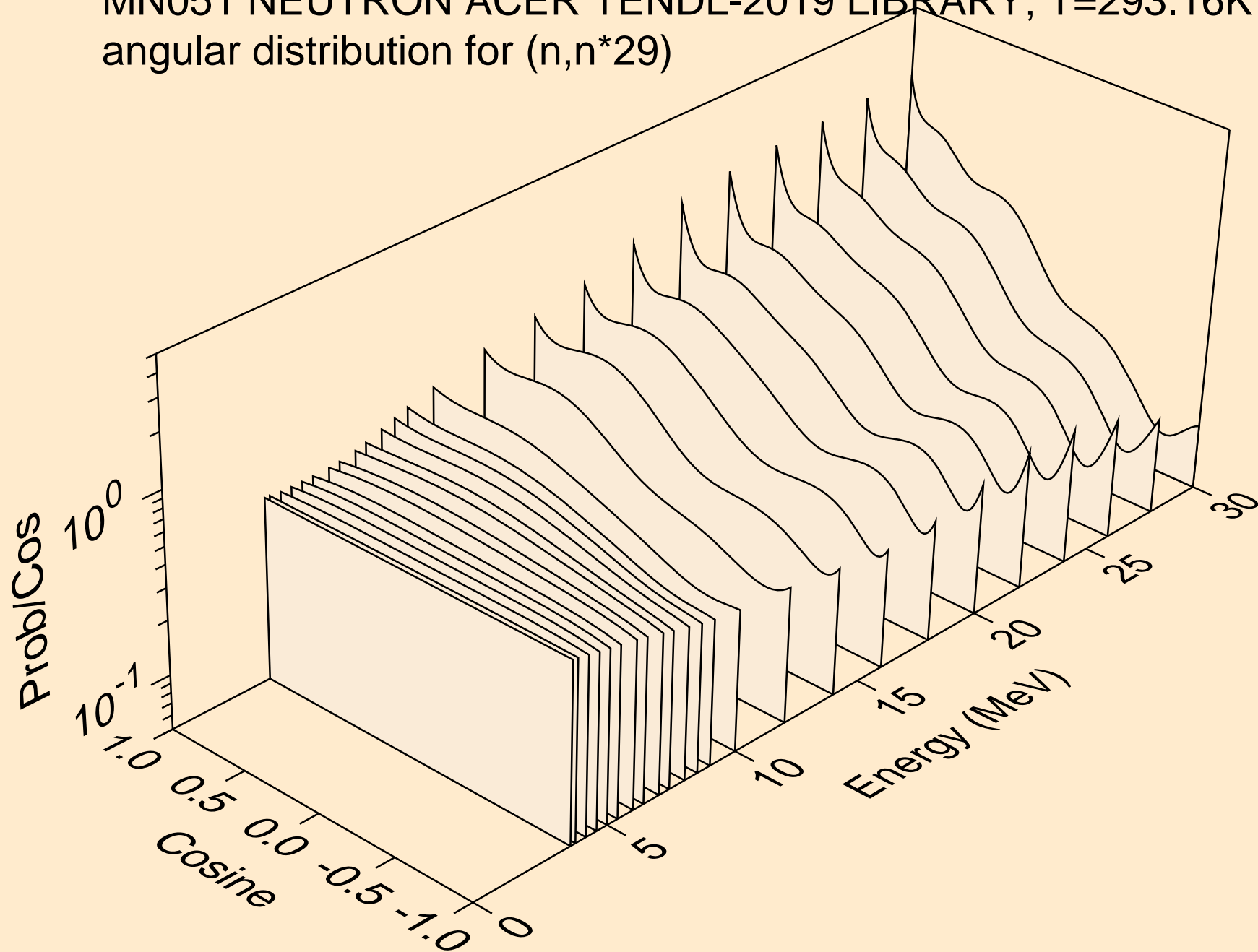

MN051 NEUTRON ACER TENDL-2019 LIBRARY; T=293.16K
Neutron emission for (n,x)

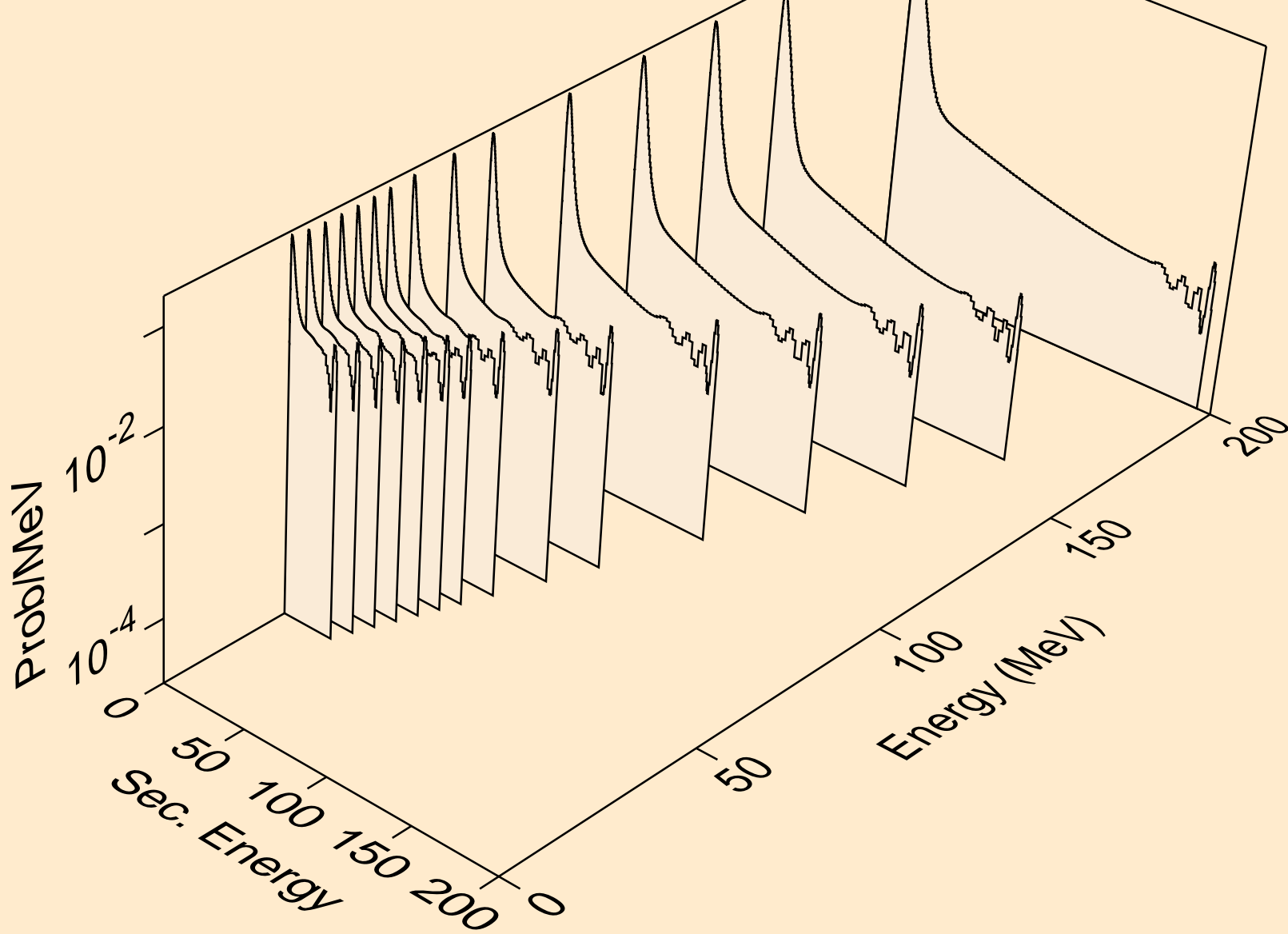

MN051 NEUTRON ACER TENDL-2019 LIBRARY; T=293.16K
Neutron emission for (n,2nd)

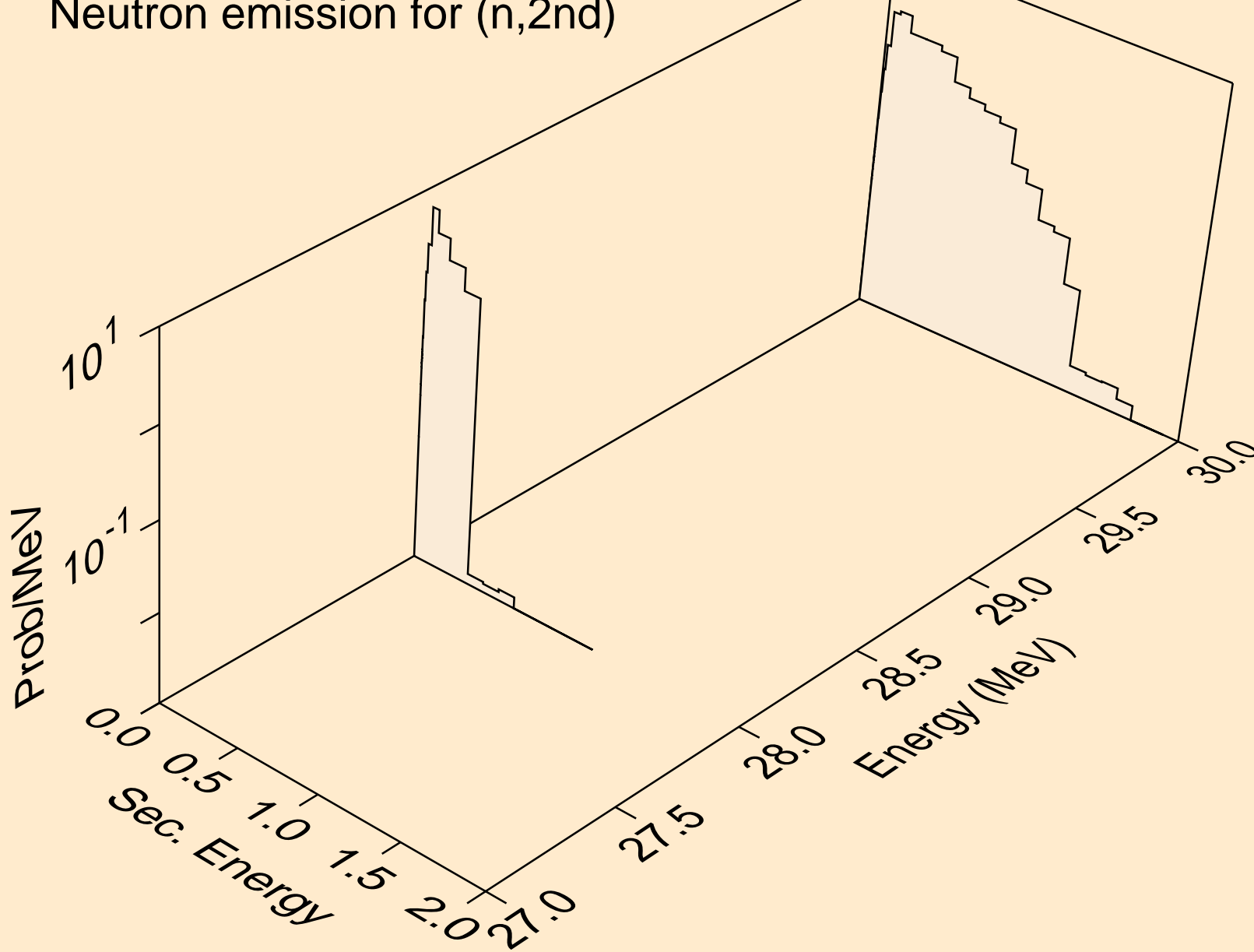

MN051 NEUTRON ACER TENDL-2019 LIBRARY; T=293.16K
Neutron emission for (n,2n)

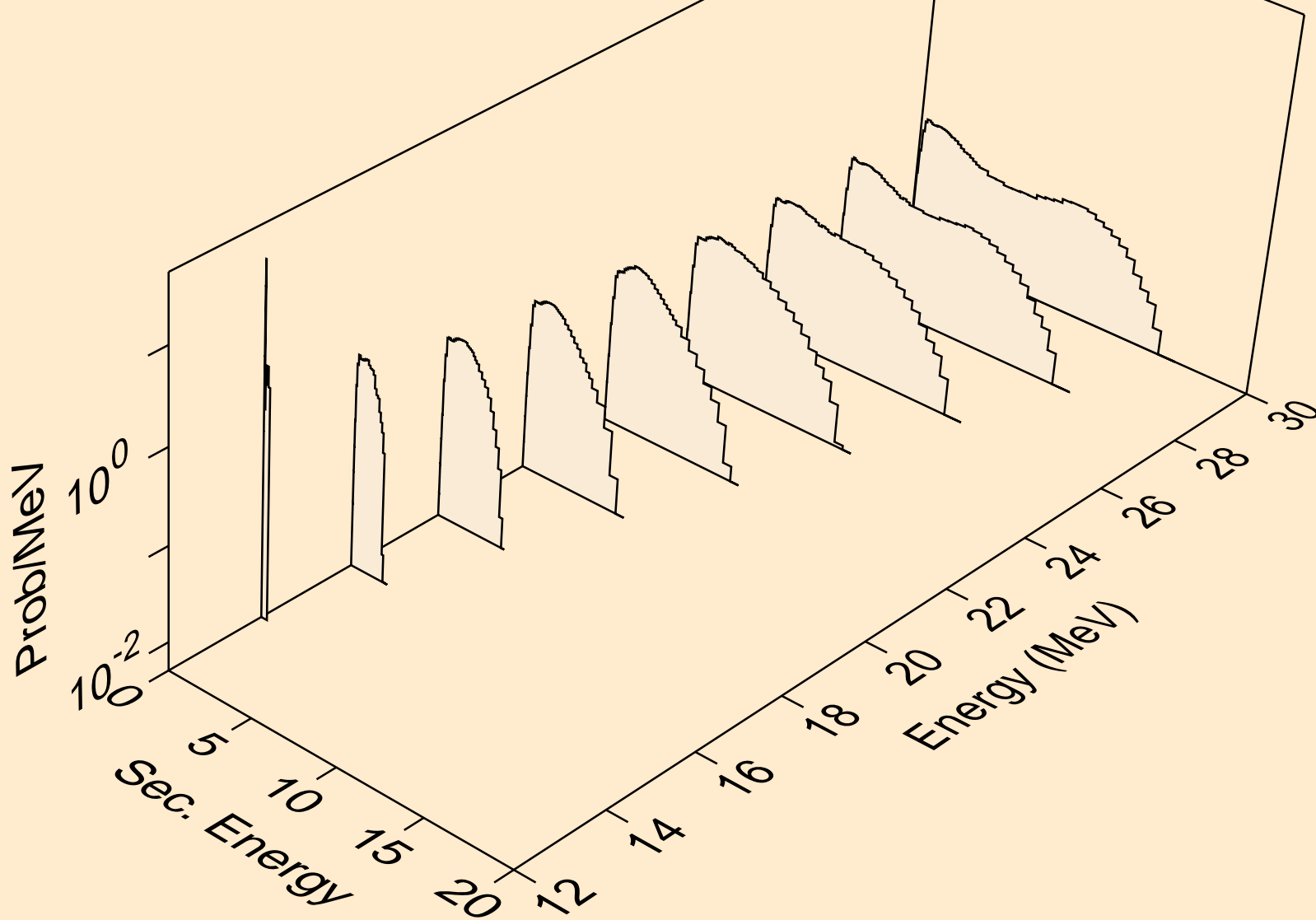

MN051 NEUTRON ACER TENDL-2019 LIBRARY; T=293.16K
Neutron emission for (n,3n)

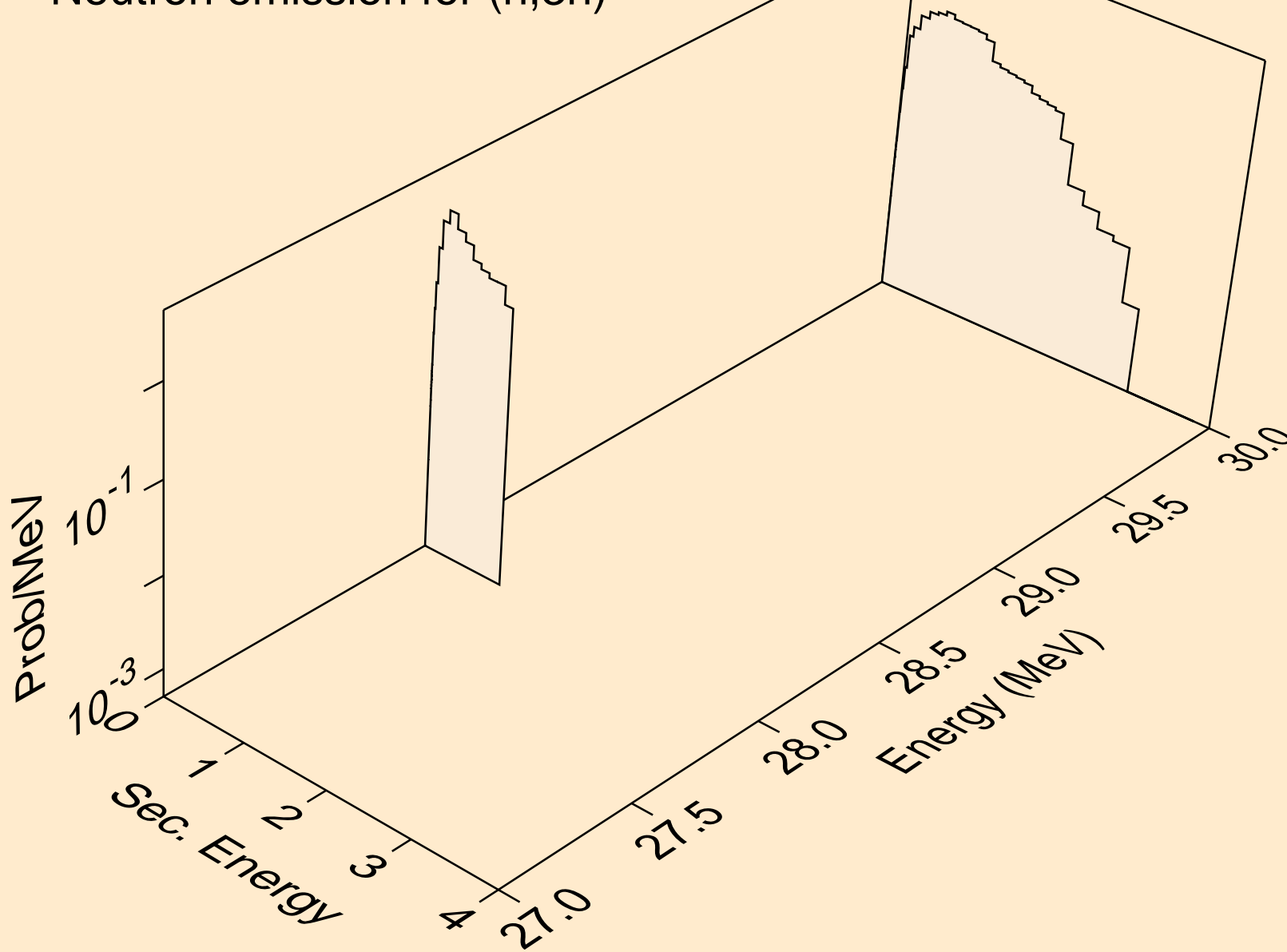

MN051 NEUTRON ACER TENDL-2019 LIBRARY; T=293.16K
Neutron emission for (n,n*)a

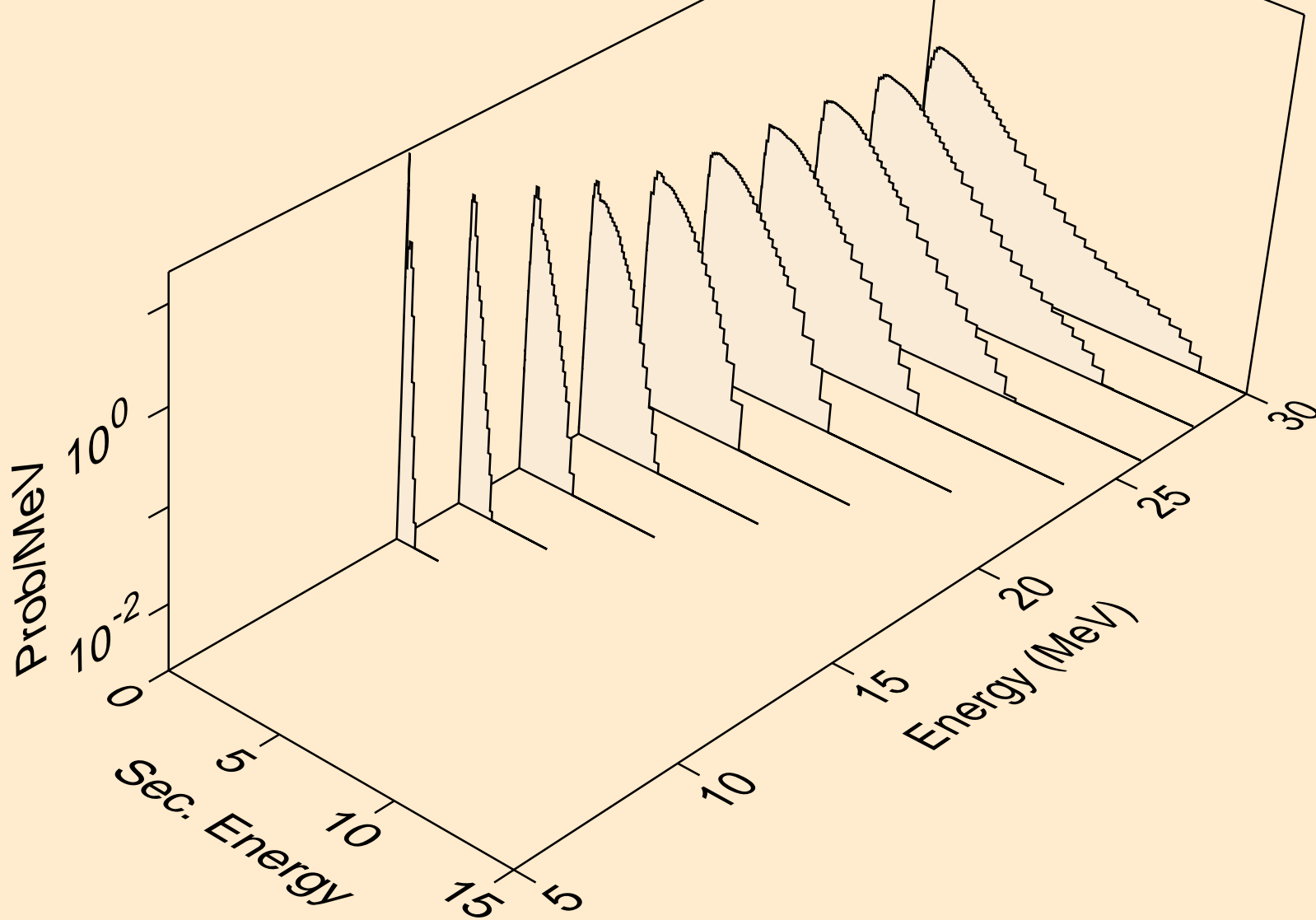

MN051 NEUTRON ACER TENDL-2019 LIBRARY; T=293.16K
Neutron emission for (n,2n)a

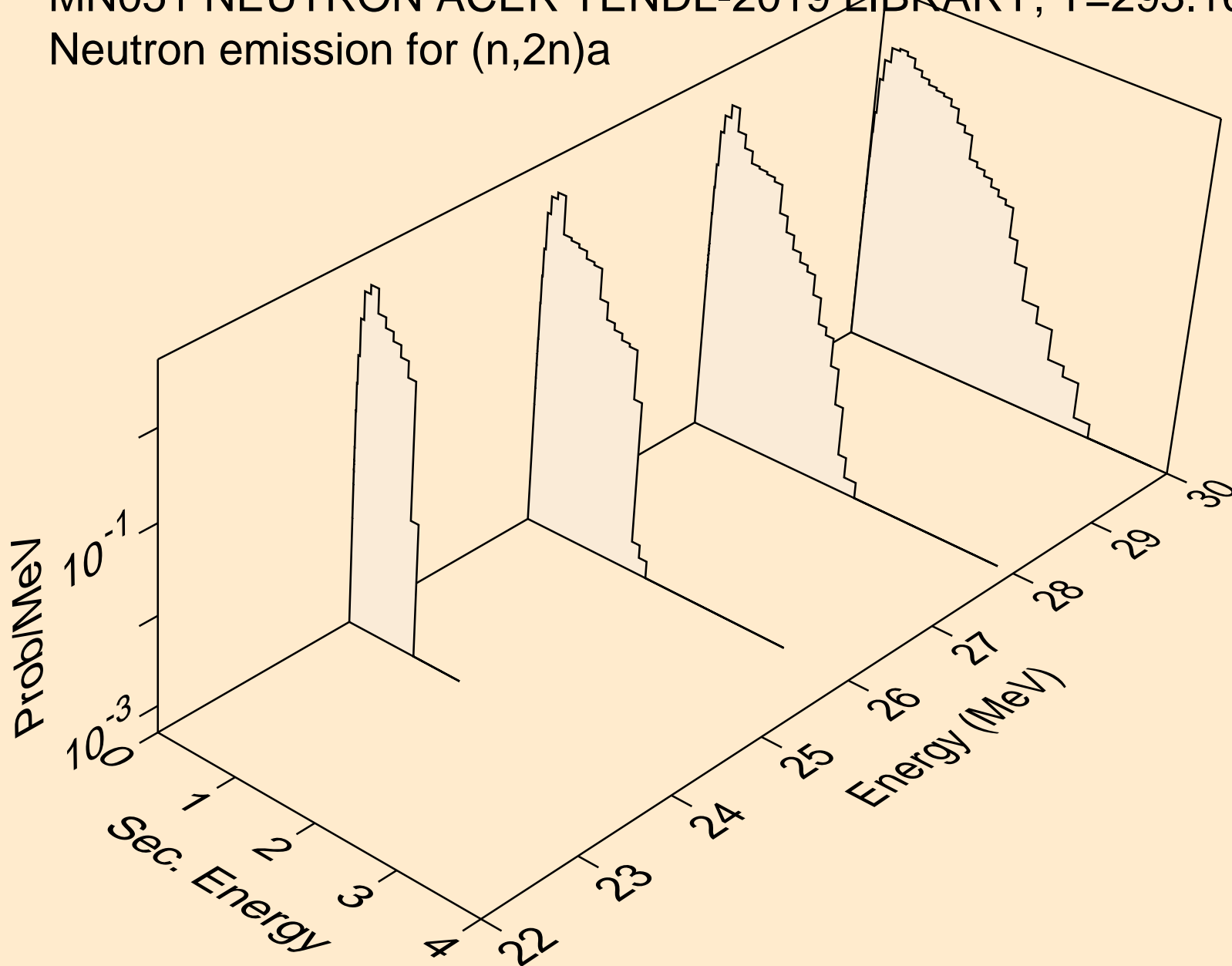

MN051 NEUTRON ACER TENDL-2019 LIBRARY; T=293.16K
Neutron emission for (n,n*)p

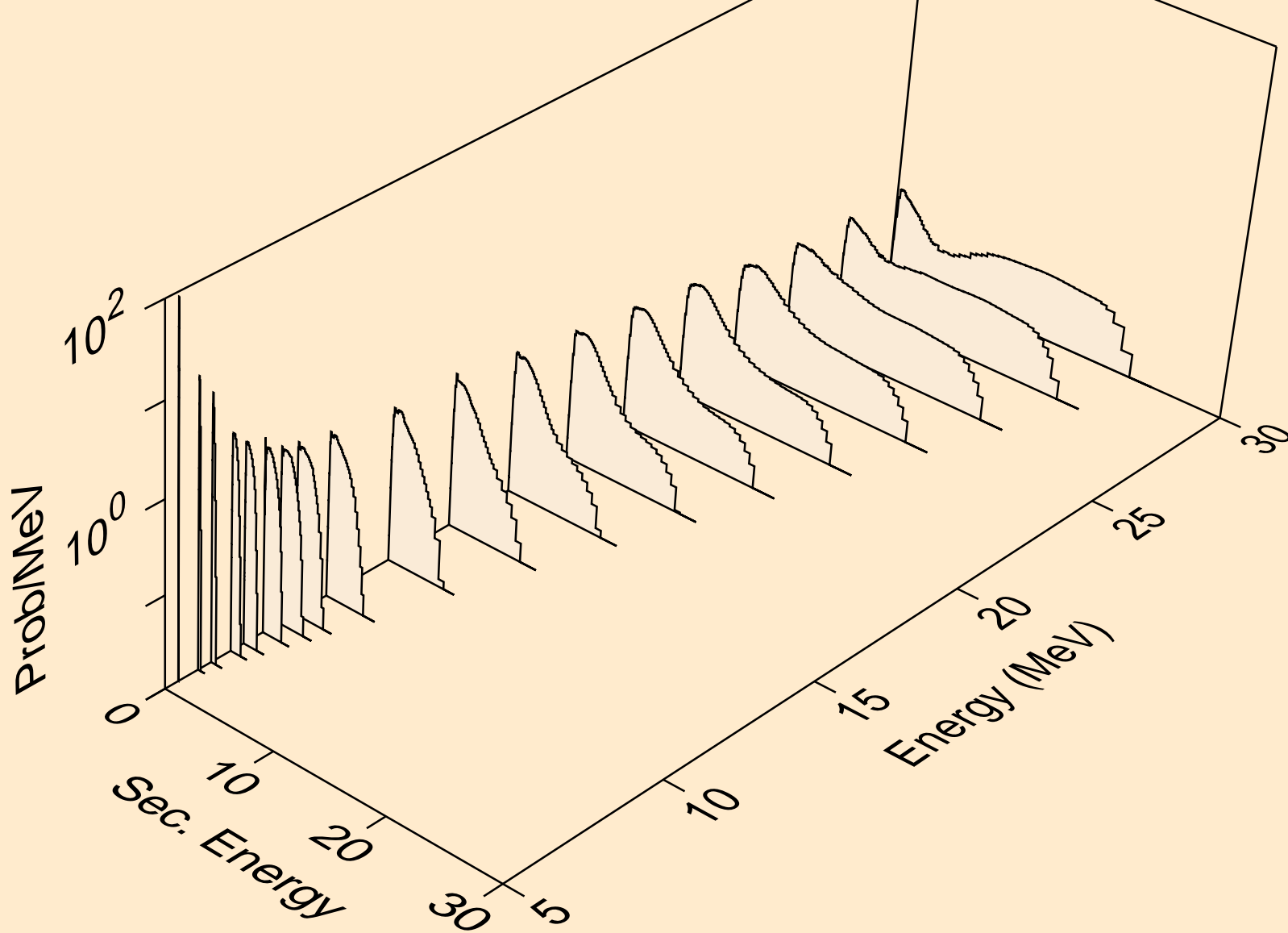

MN051 NEUTRON ACER TENDL-2019 LIBRARY; T=293.16K
Neutron emission for (n,n*)2a

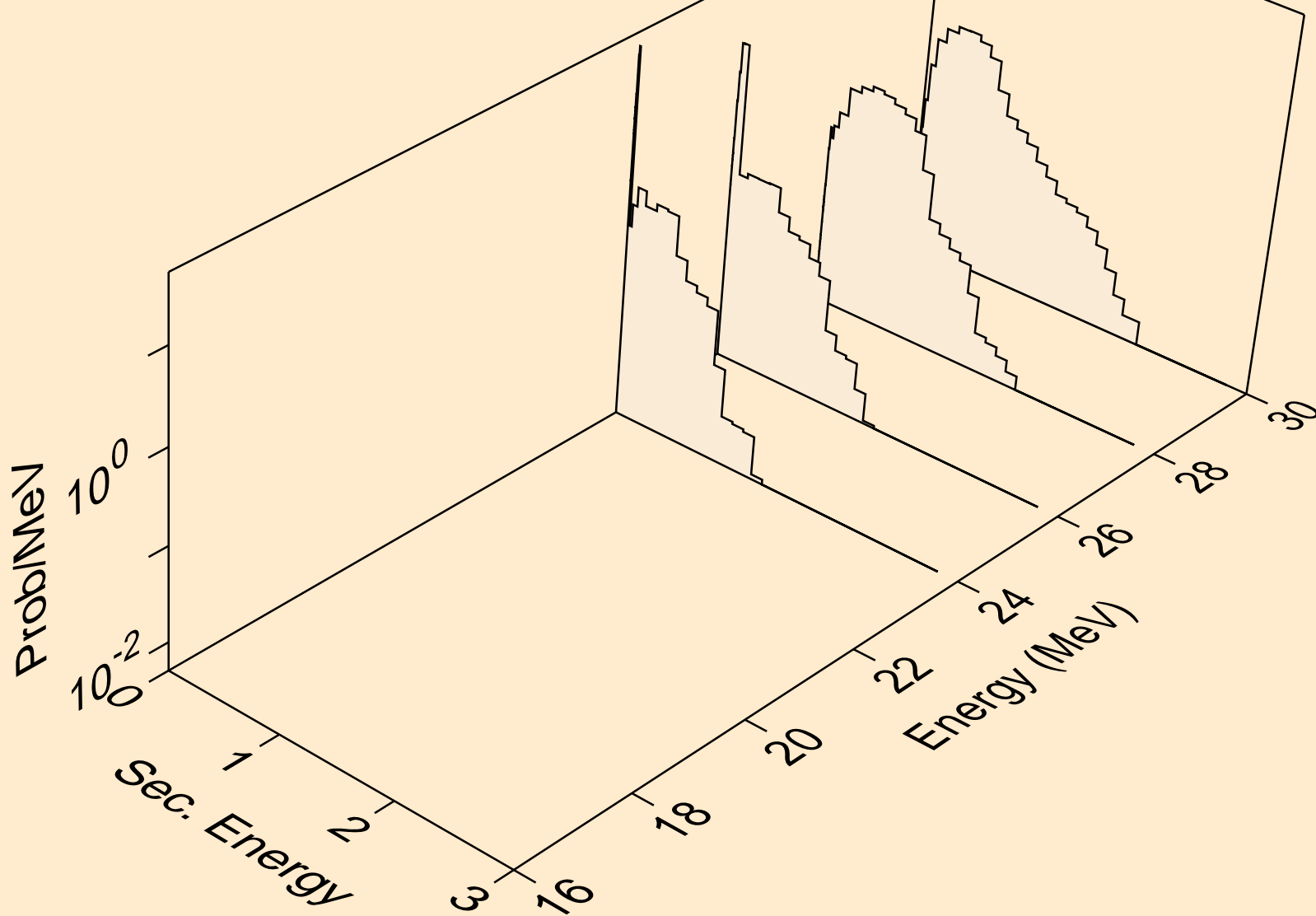

MN051 NEUTRON ACER TENDL-2019 LIBRARY; T=293.16K
Neutron emission for (n,n*)d

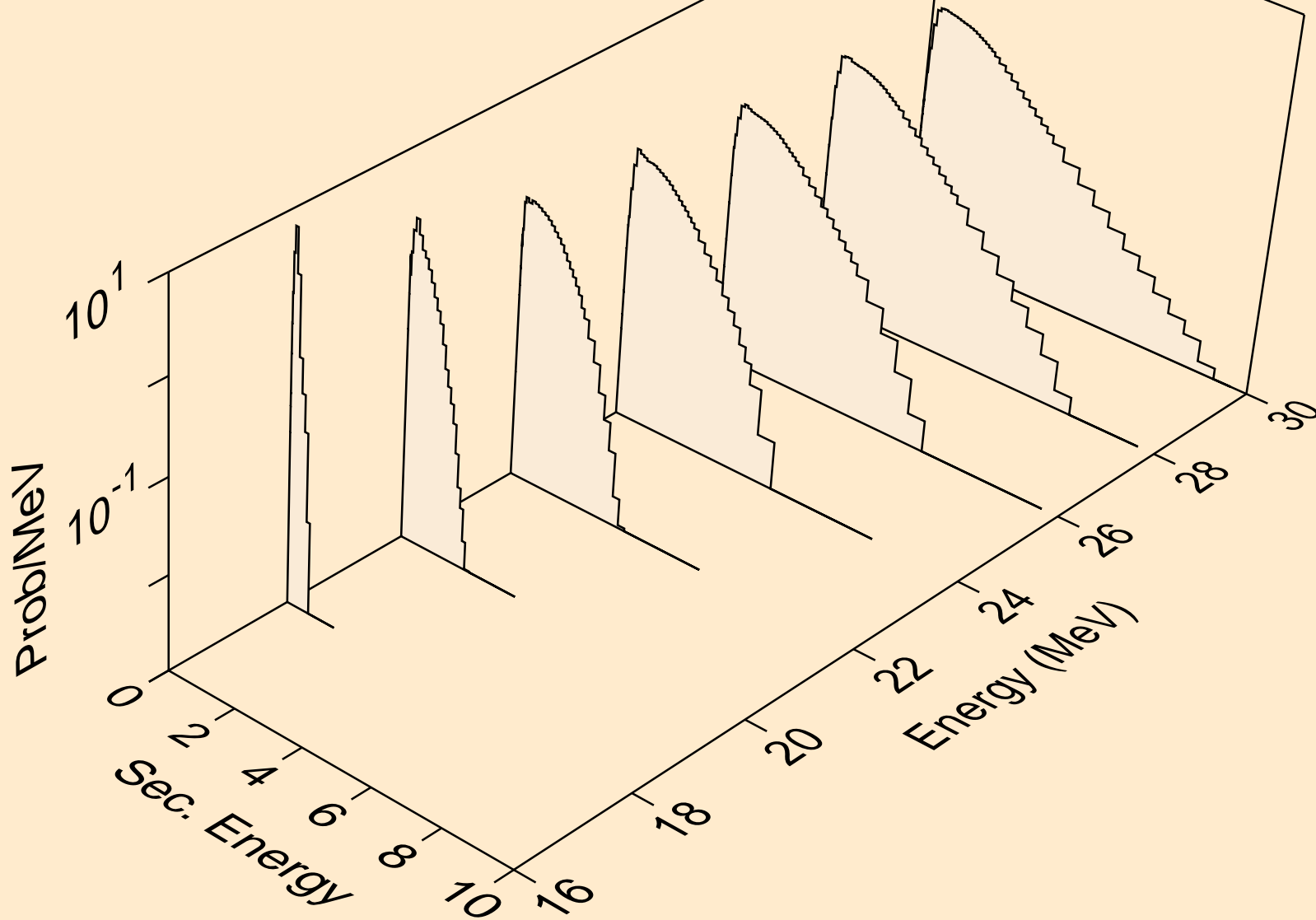

MN051 NEUTRON ACER TENDL-2019 LIBRARY; T=293.16K
Neutron emission for (n,n*)t

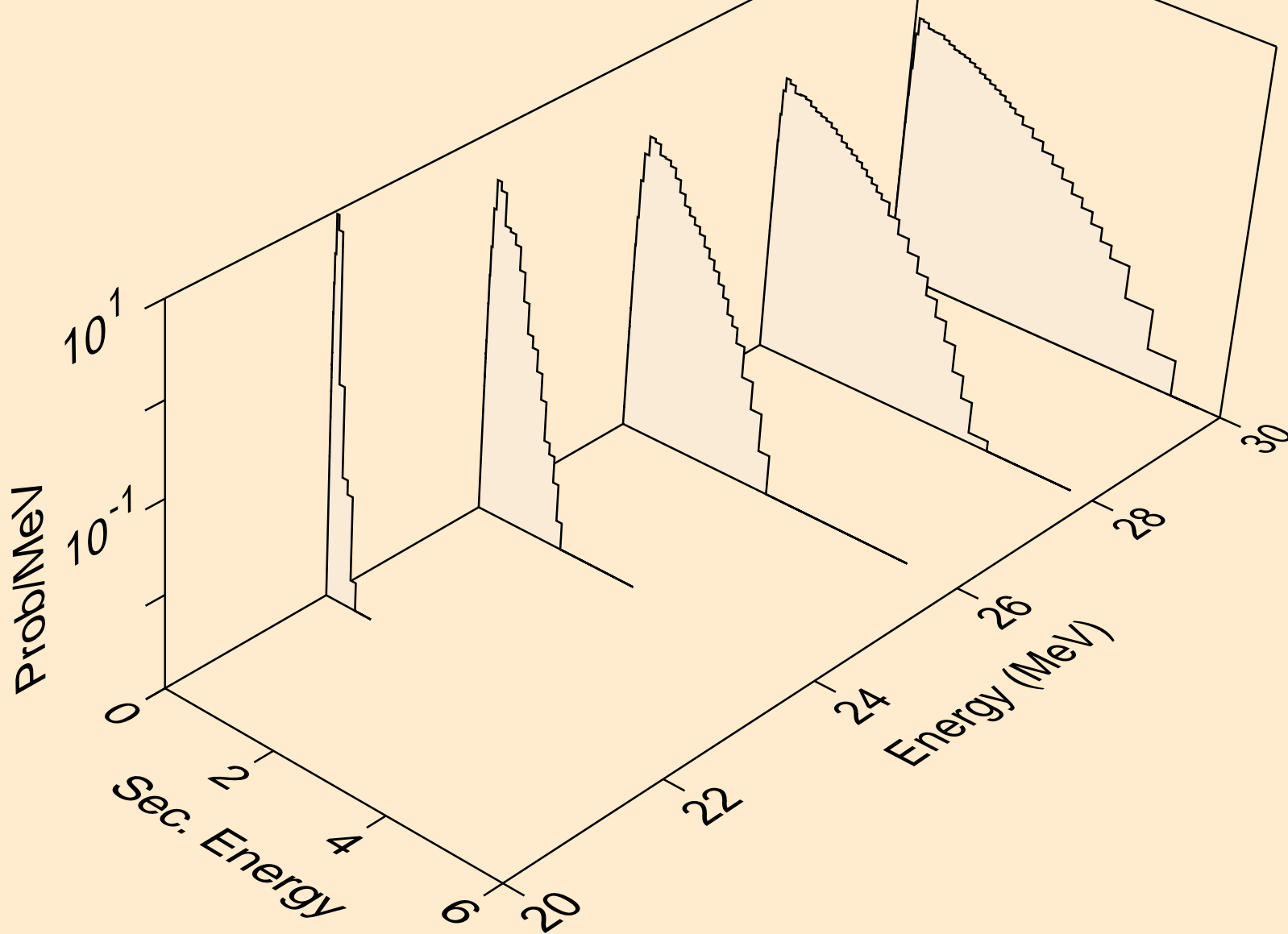

MN051 NEUTRON ACER TENDL-2019 LIBRARY; T=293.16K
Neutron emission for (n,n*)he3

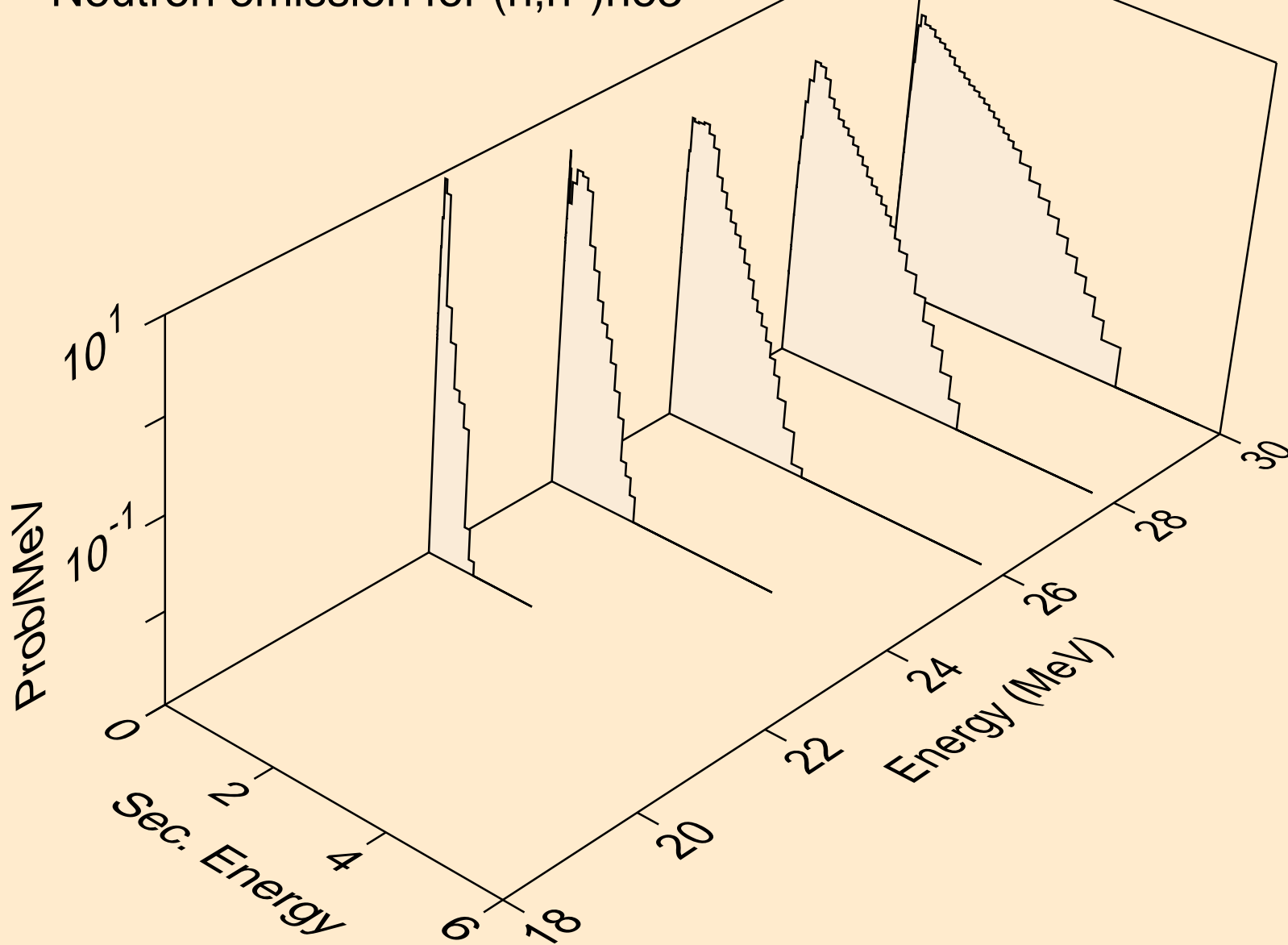

MN051 NEUTRON ACER TENDL-2019 LIBRARY; T=293.16K
Neutron emission for (n,2np)

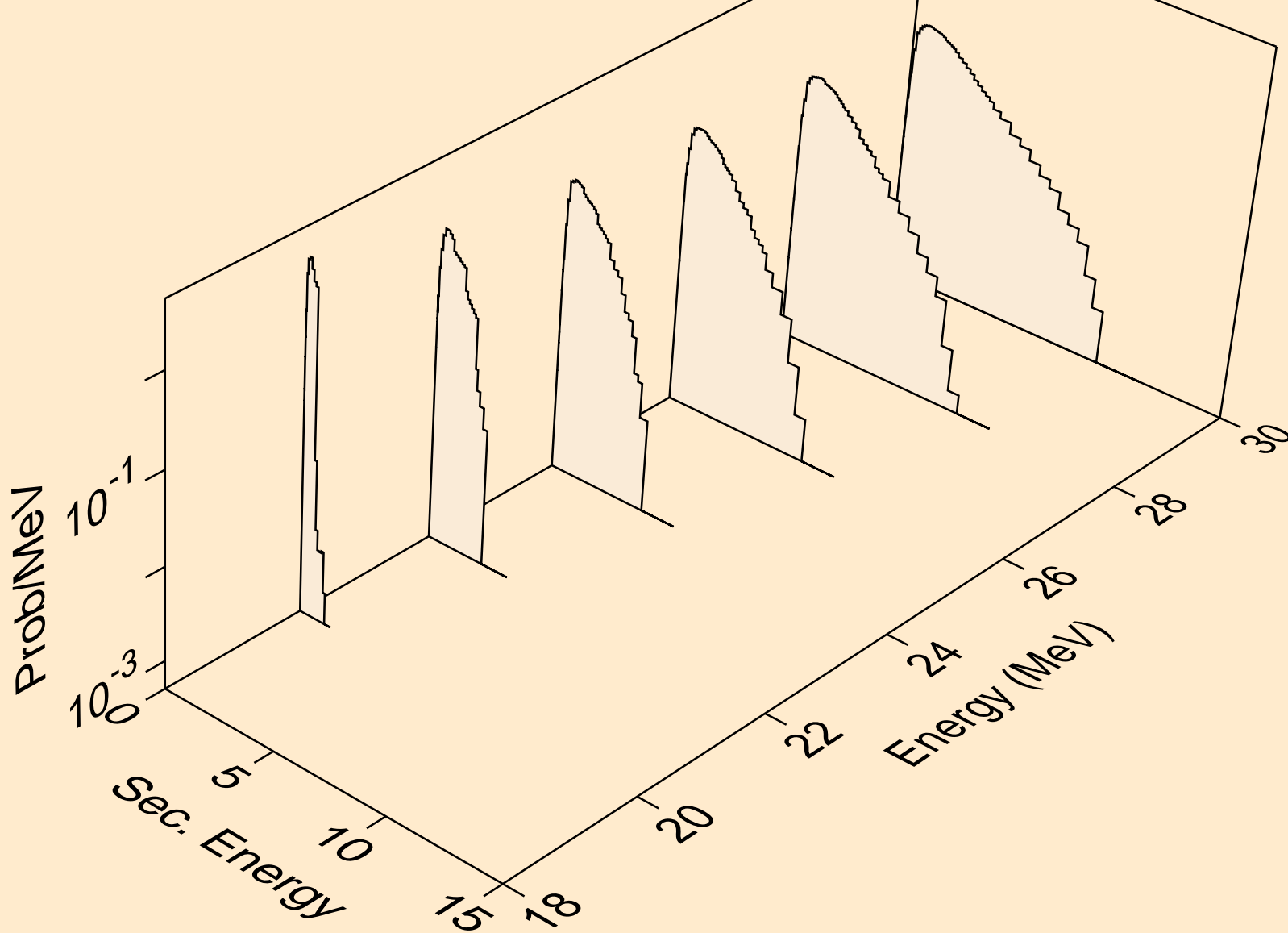

MN051 NEUTRON ACER TENDL-2019 LIBRARY; T=293.16K
Neutron emission for (n,2np)

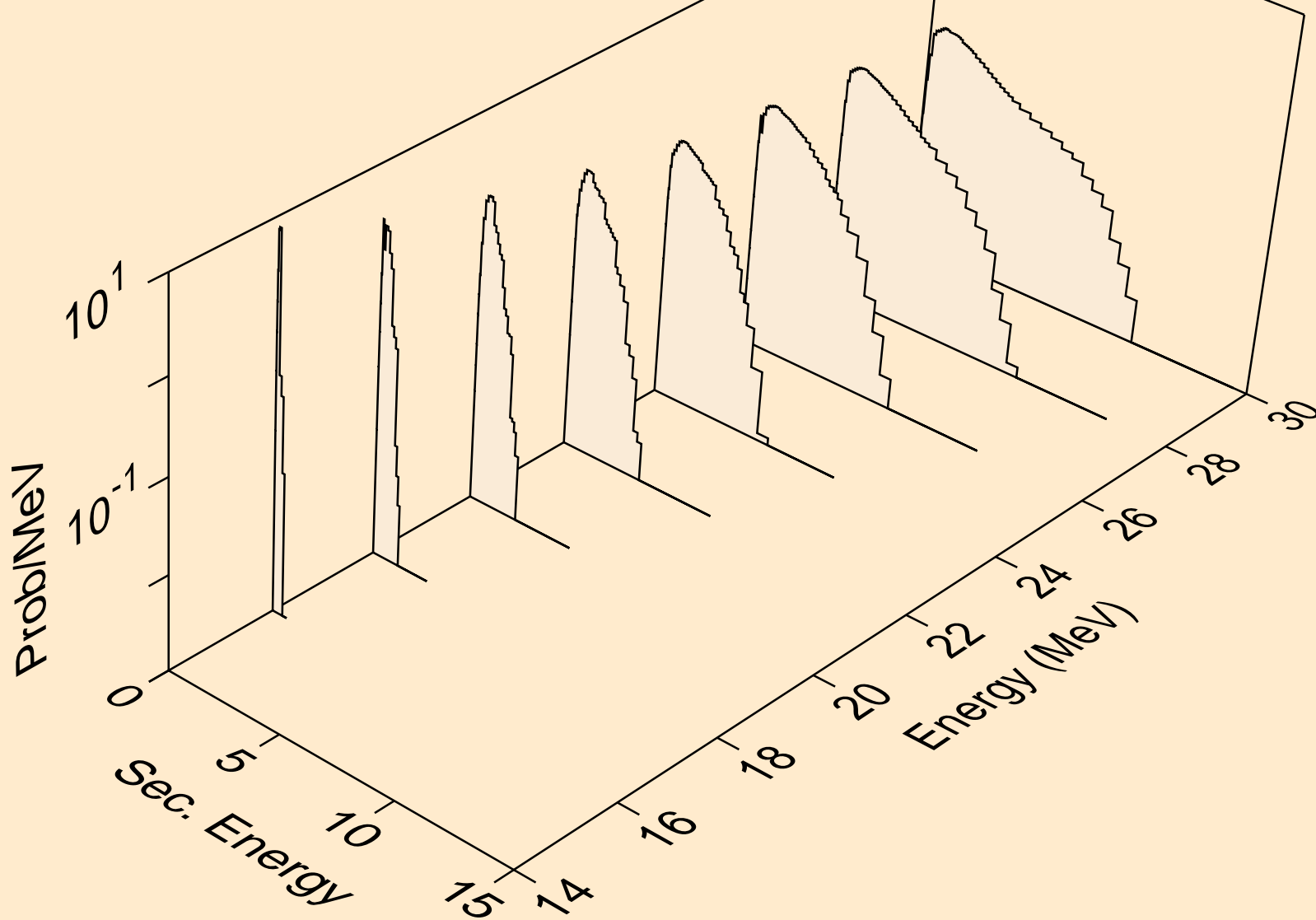

MN051 NEUTRON ACER TENDL-2019 LIBRARY; T=293.16K
Neutron emission for (n,npa)

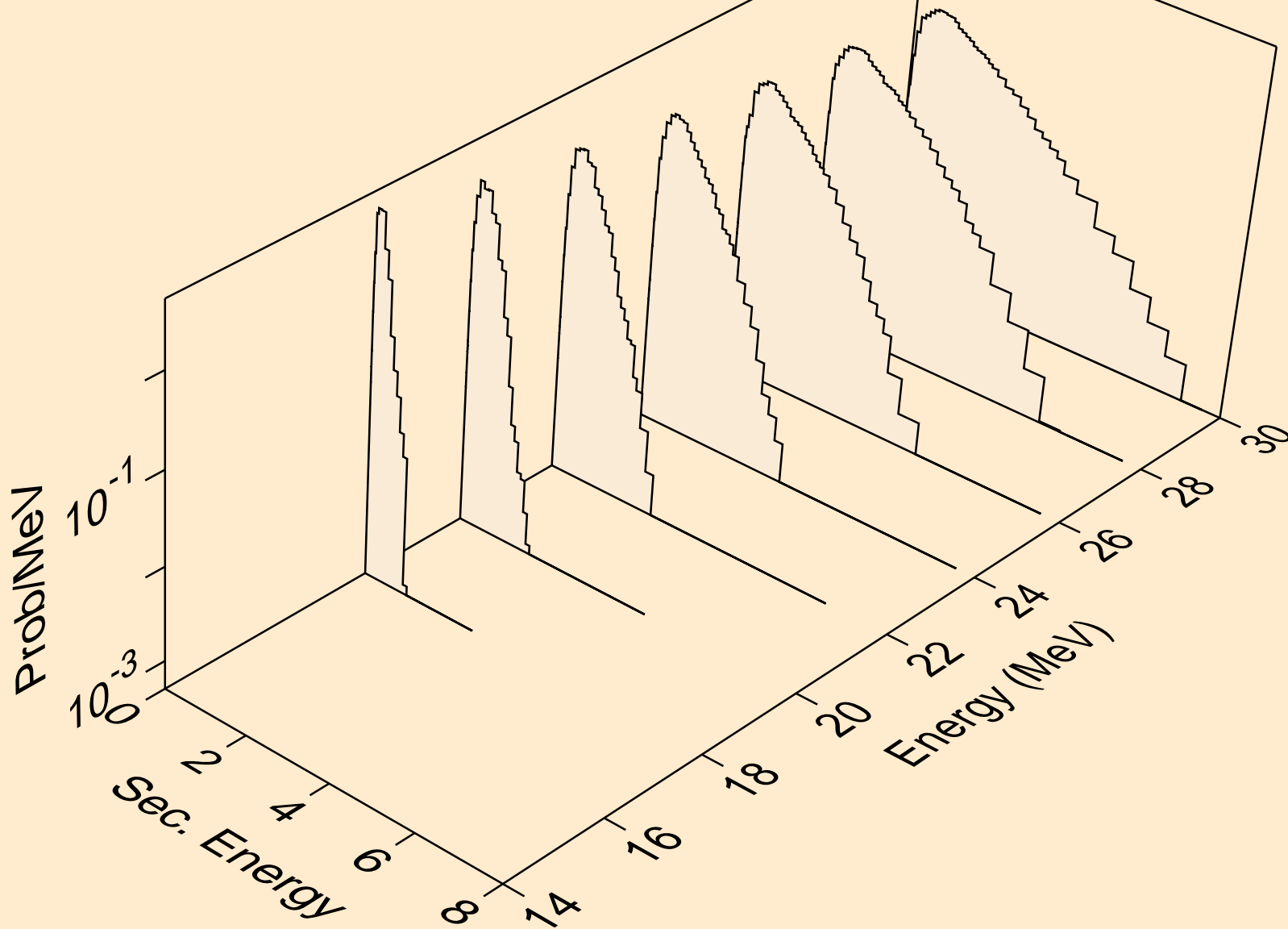

MN051 NEUTRON ACER TENDL-2019 LIBRARY; T=293.16K
Neutron emission for (n,n*c)

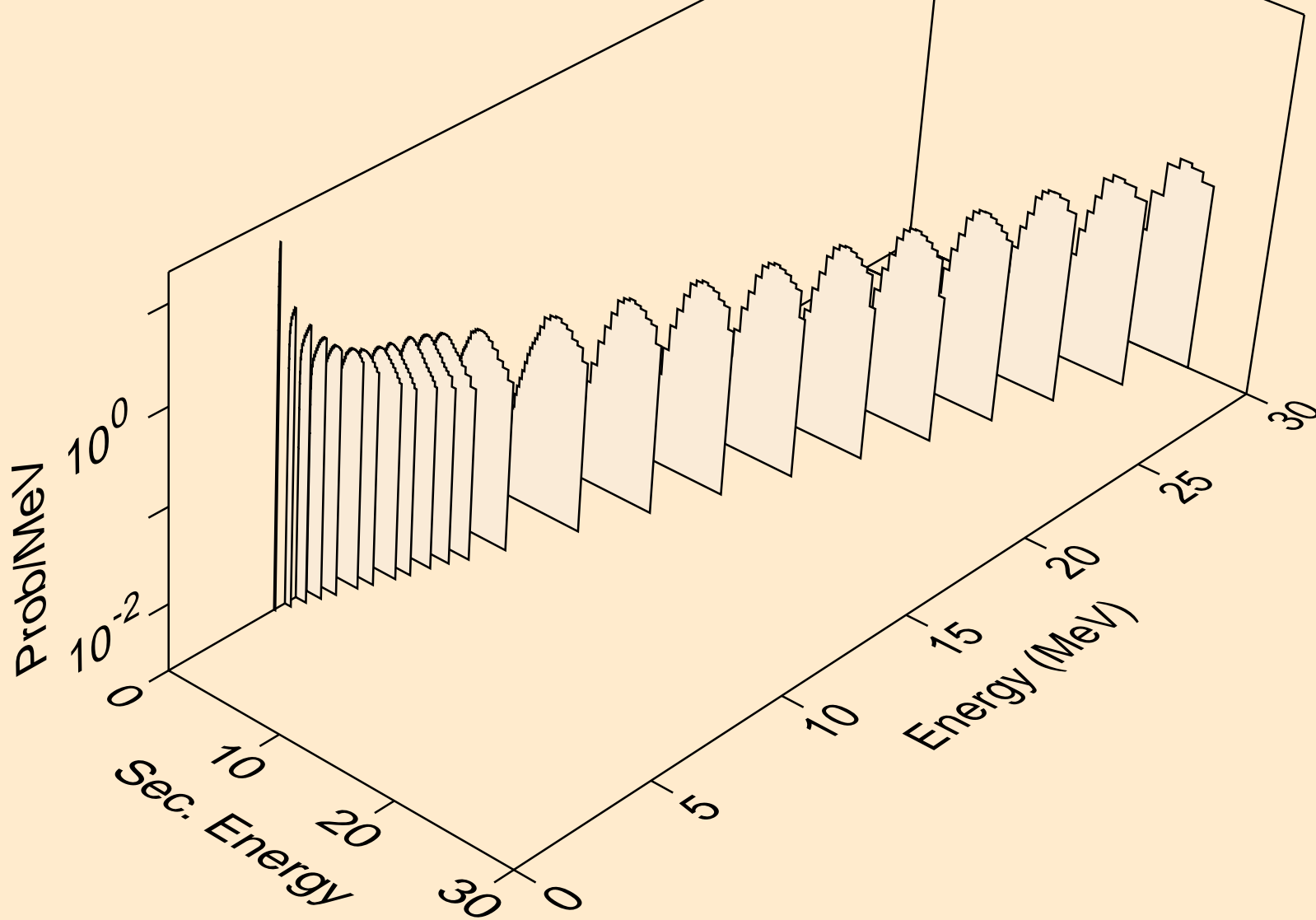

MN051 NEUTRON ACER TENDL-2019 LIBRARY; T=293.16K
Photon emission for (n,x)

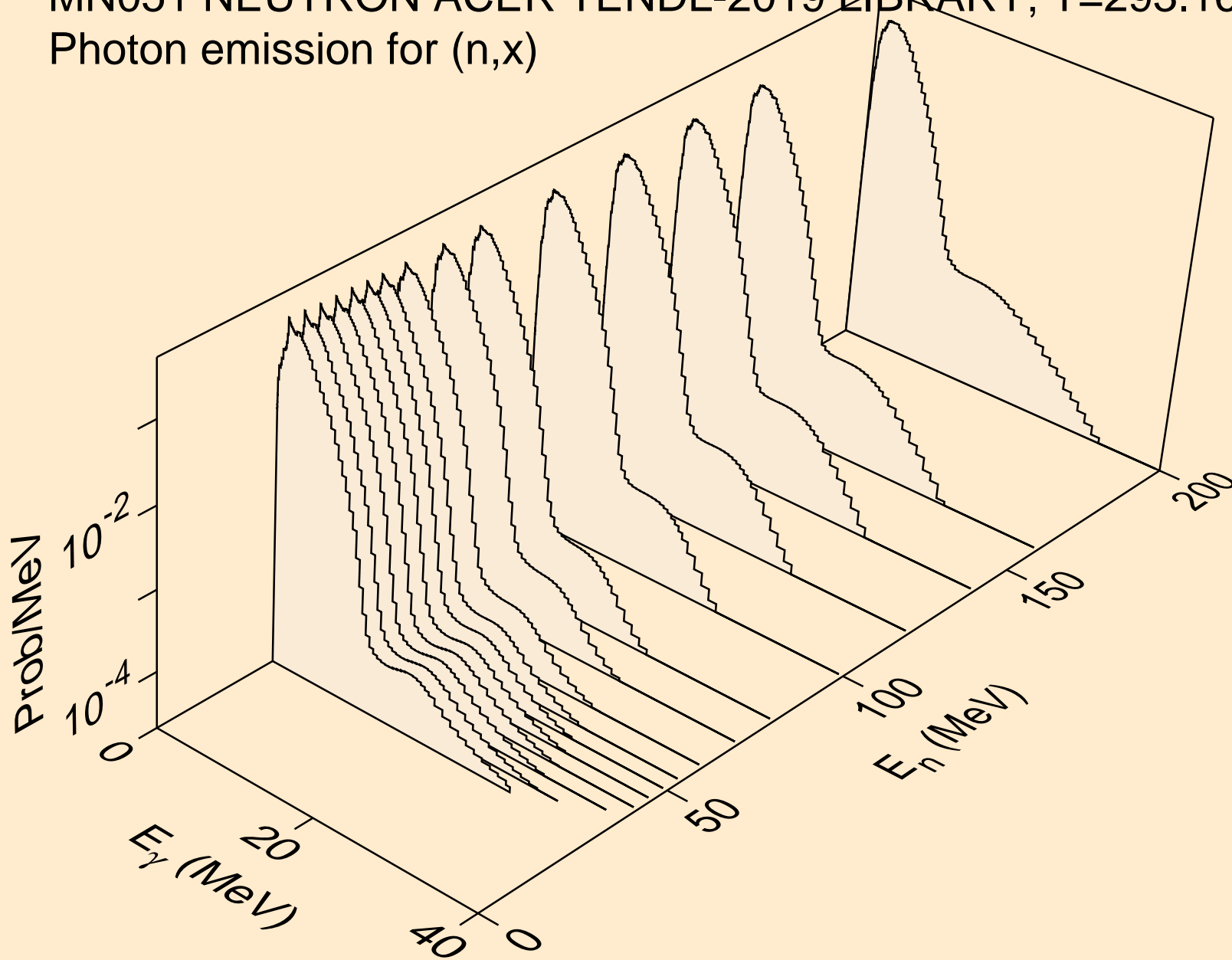

MN051 NEUTRON ACER TENDL-2019 LIBRARY; T=293.16K
Photon emission for (n,2nd)

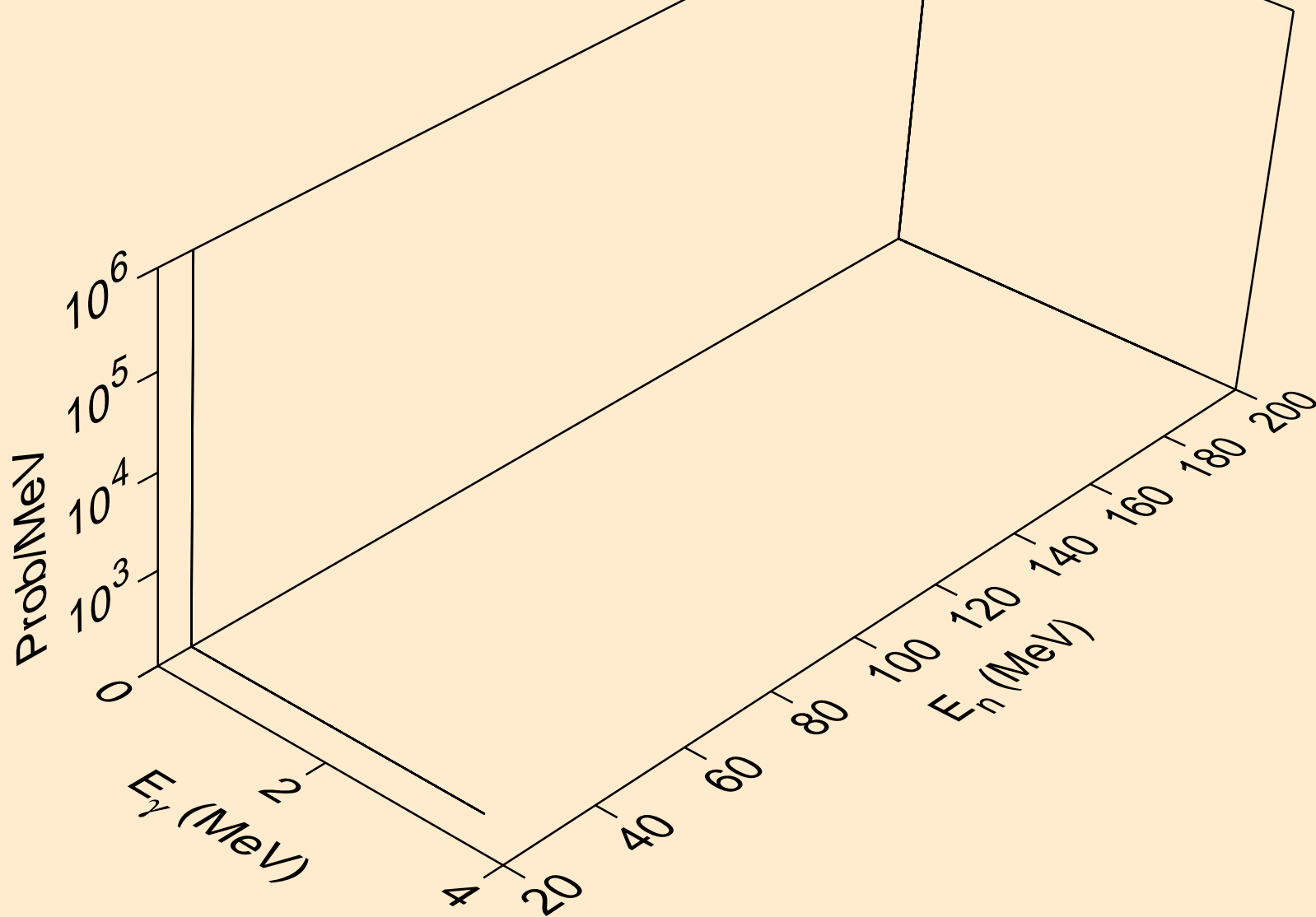

MN051 NEUTRON ACER TENDL-2019 LIBRARY; T=293.16K
Photon emission for (n,2n)

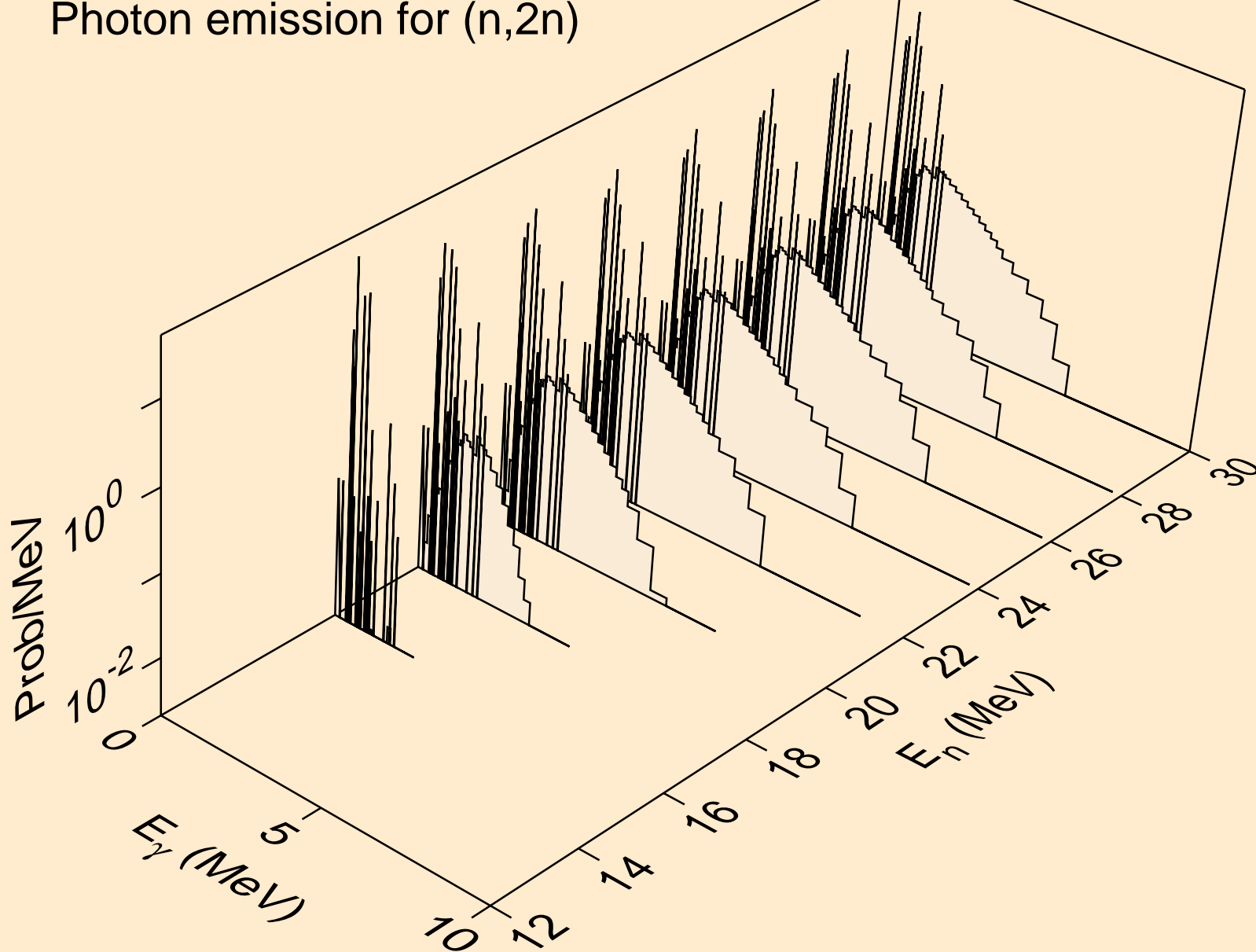

MN051 NEUTRON ACER TENDL-2019 LIBRARY; T=293.16K
Photon emission for (n,3n)

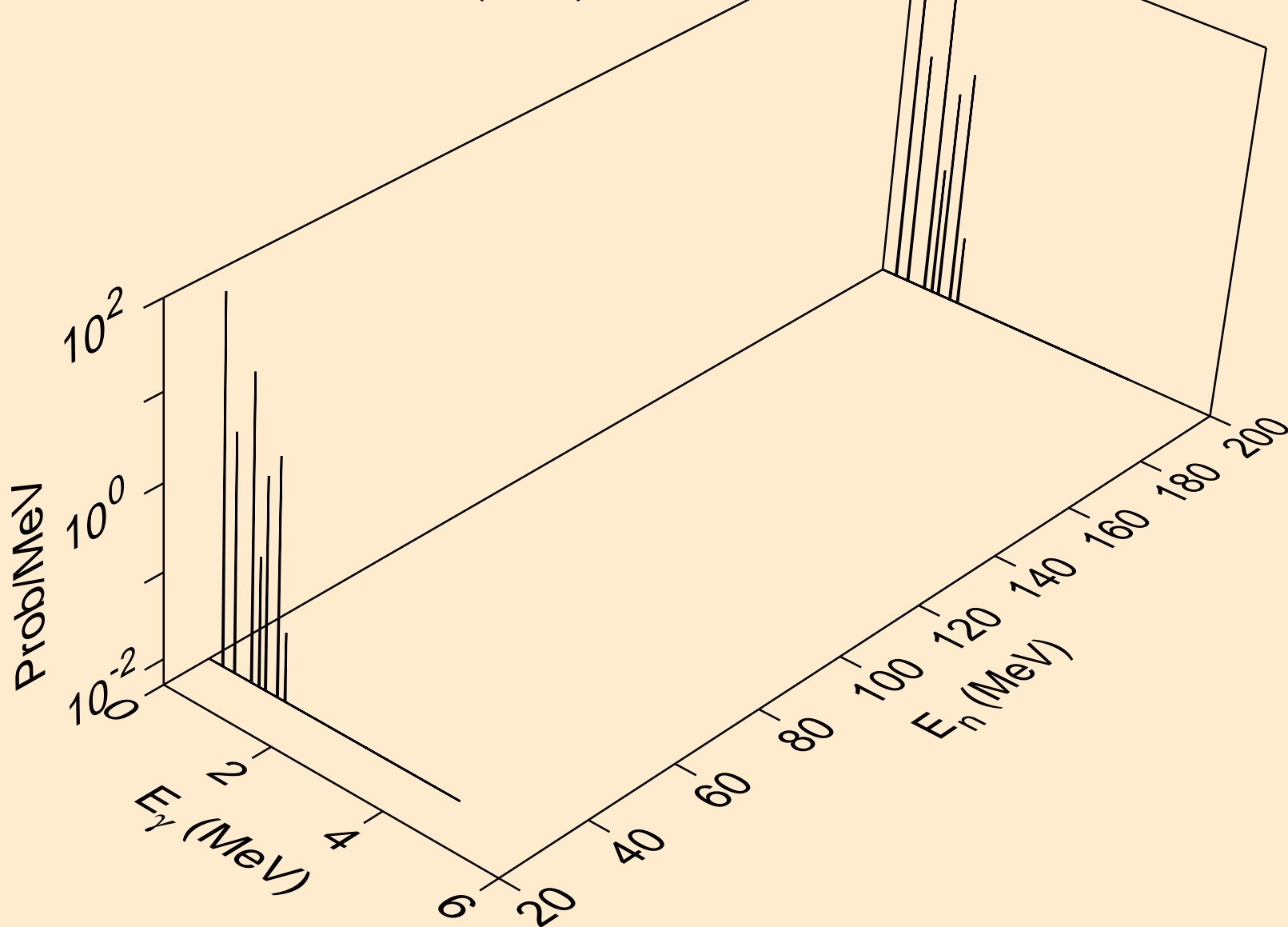

MN051 NEUTRON ACER TENDL-2019 LIBRARY; T=293.16K
Photon emission for (n,n*)a

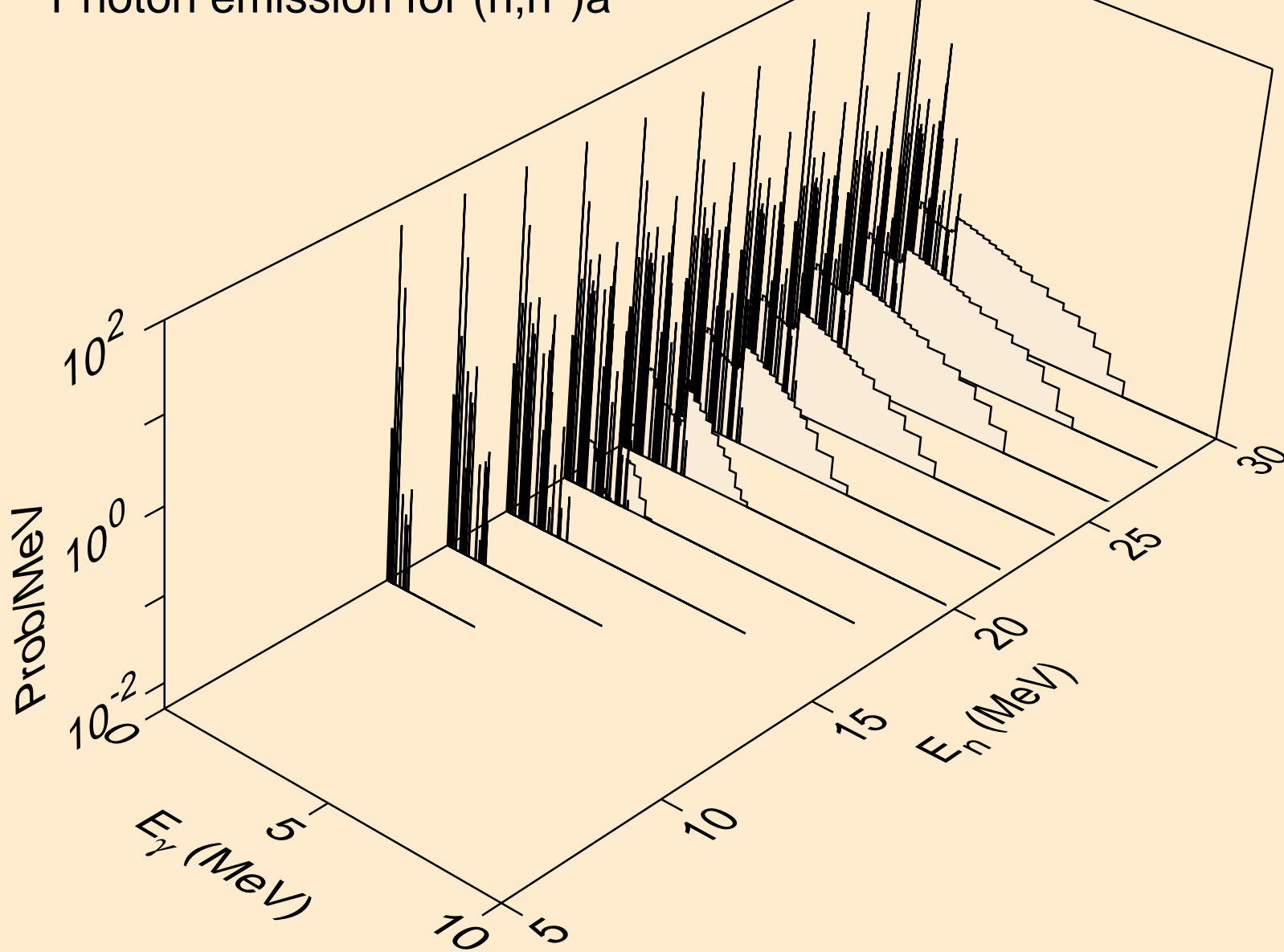

MN051 NEUTRON ACER TENDL-2019 LIBRARY; T=293.16K
Photon emission for (n,2n)a

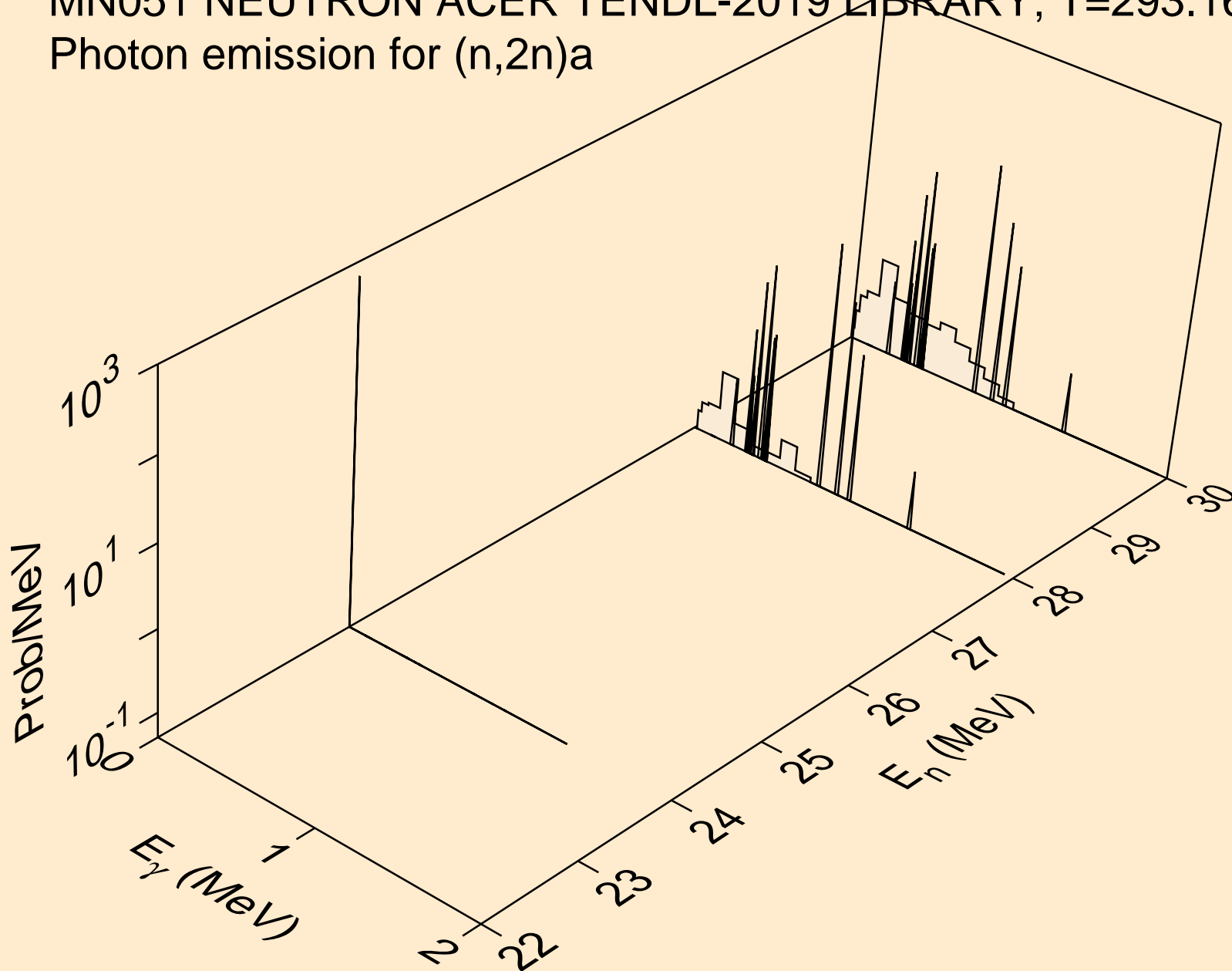

MN051 NEUTRON ACER TENDL-2019 LIBRARY; T=293.16K
Photon emission for (n,n*)p

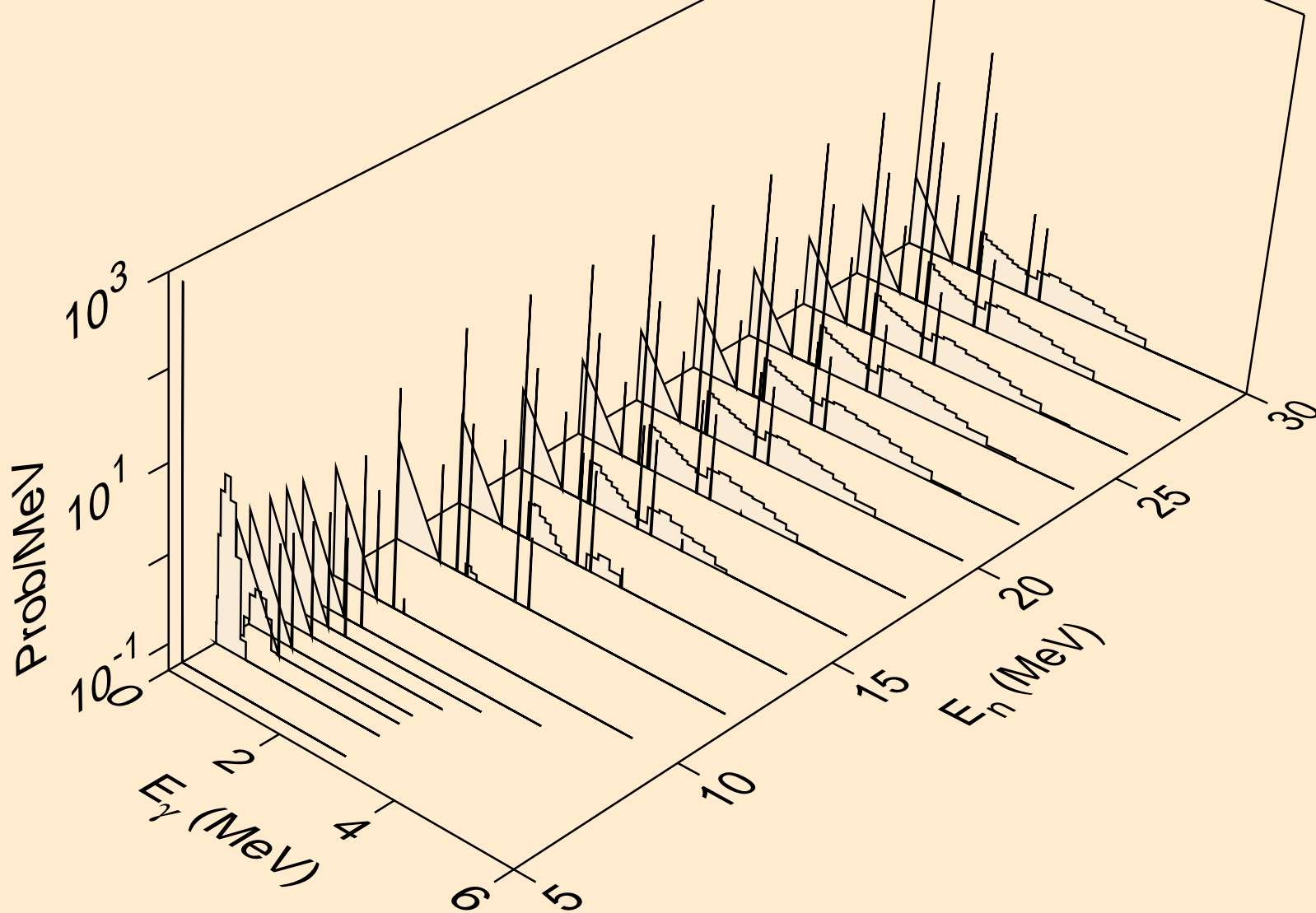

MN051 NEUTRON ACER TENDL-2019 LIBRARY; T=293.16K
Photon emission for (n,n*)2a

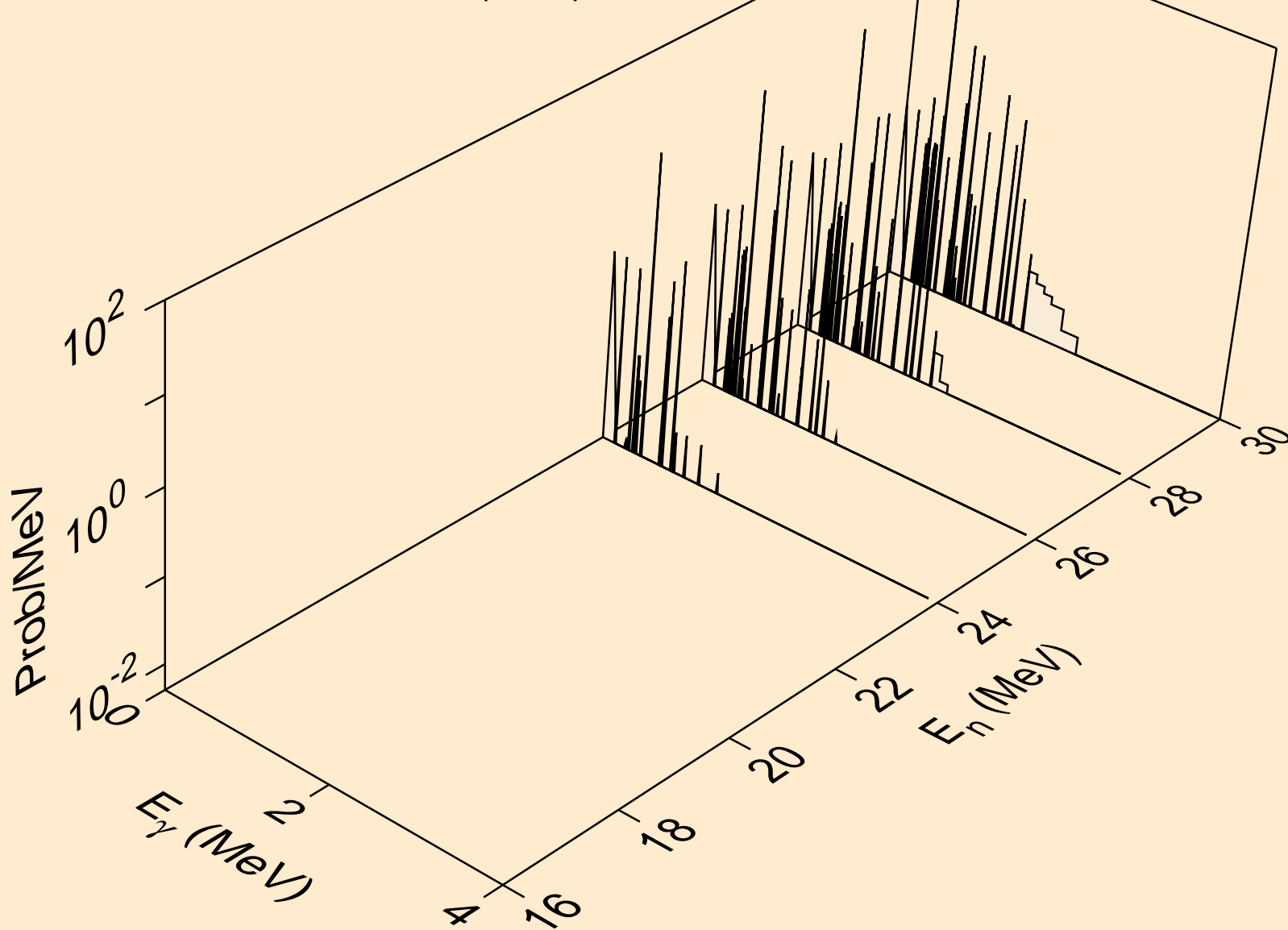

MN051 NEUTRON ACER TENDL-2019 LIBRARY; T=293.16K
Photon emission for (n,n*)d

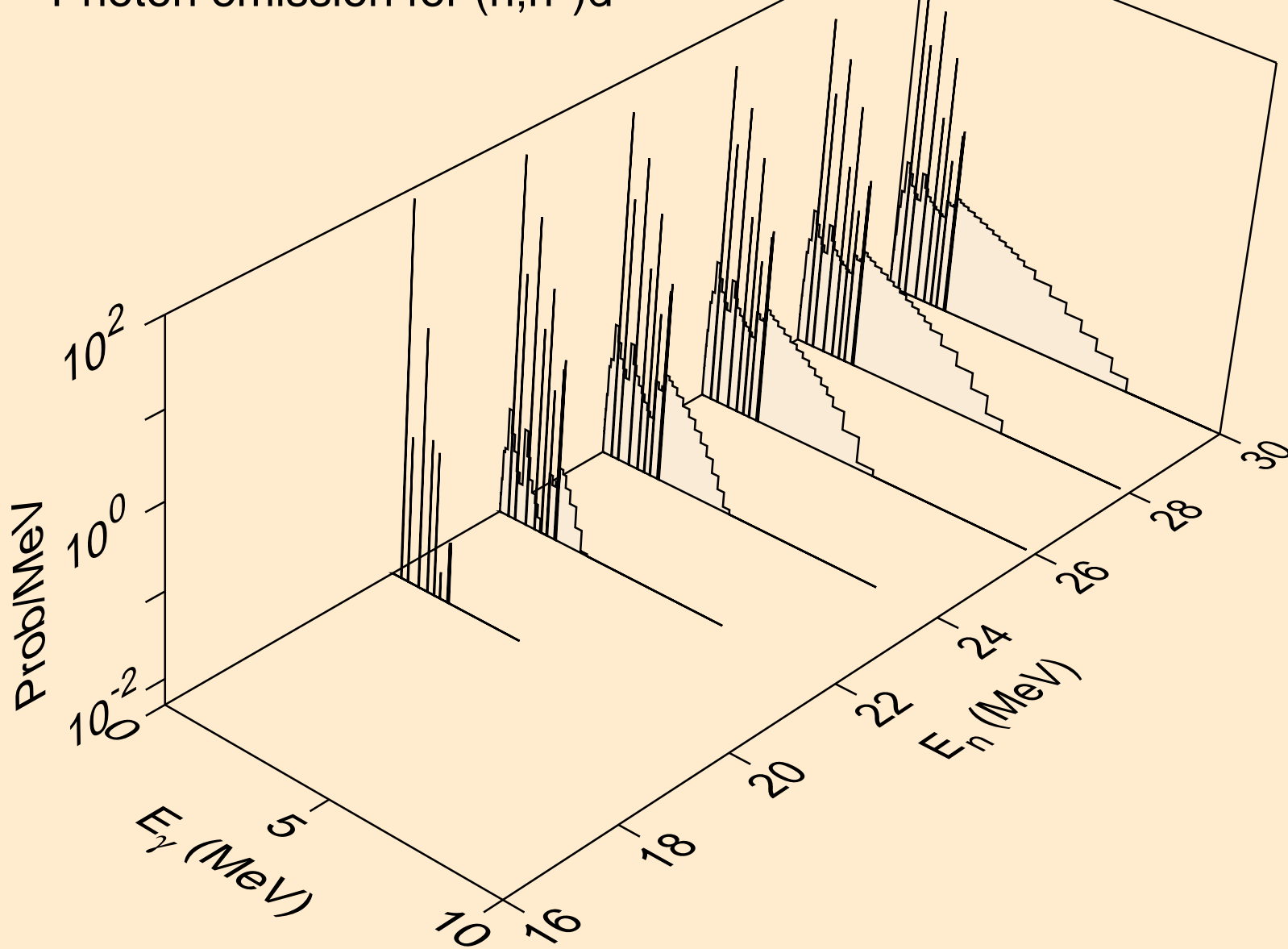

MN051 NEUTRON ACER TENDL-2019 LIBRARY; T=293.16K
Photon emission for (n,n*)t

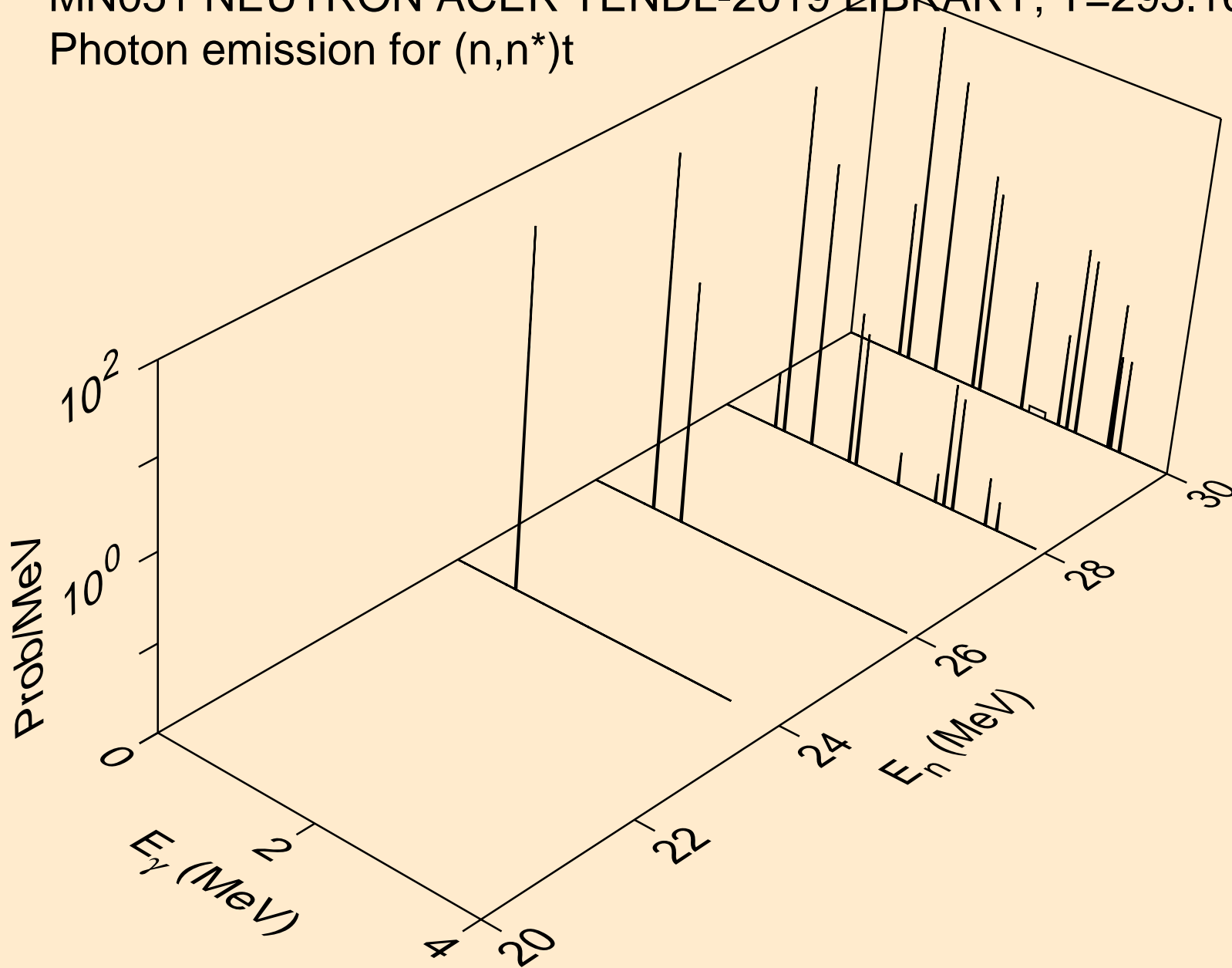

MN051 NEUTRON ACER TENDL-2019 LIBRARY; T=293.16K
Photon emission for (n,n*)he3

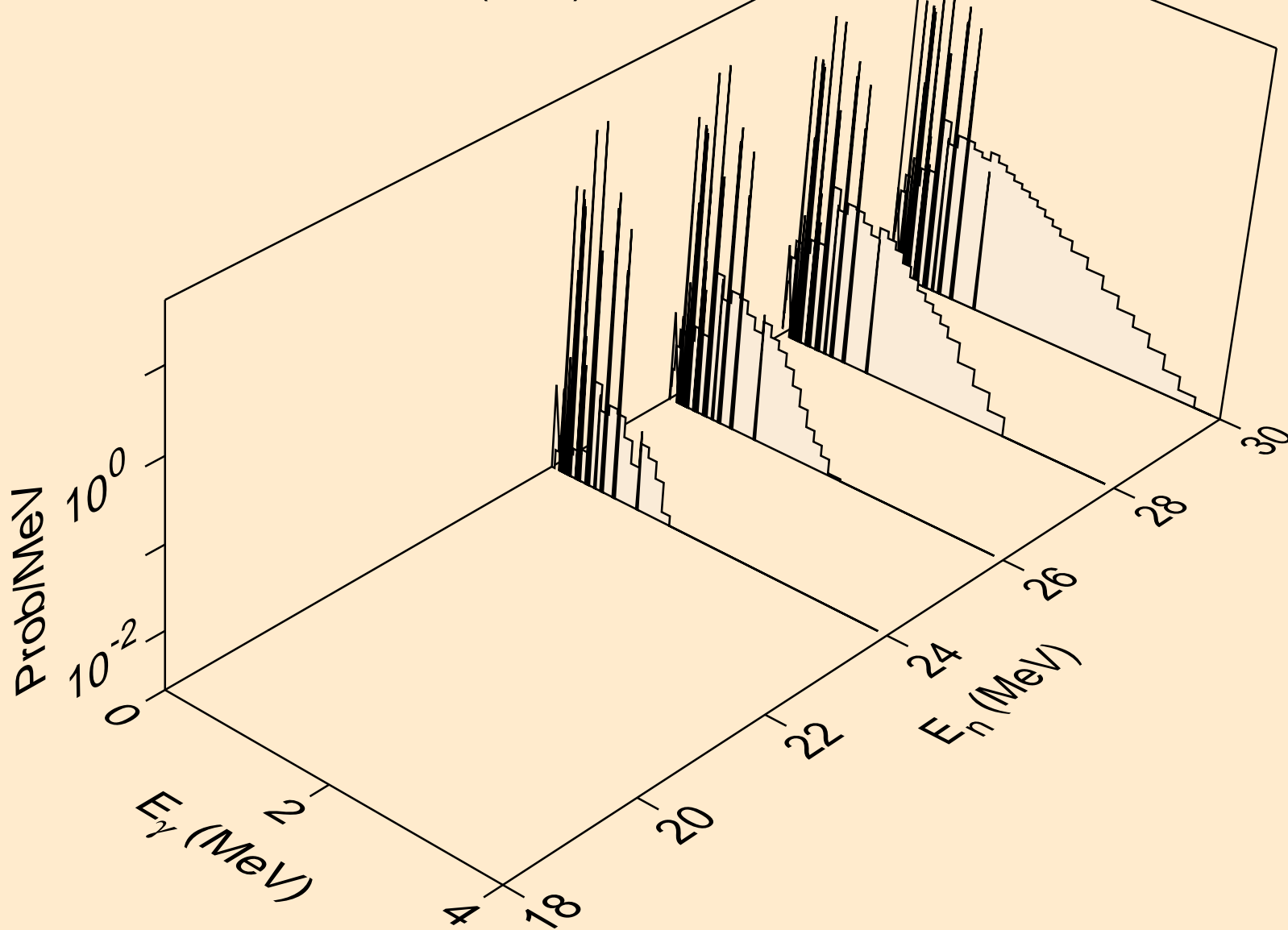

MN051 NEUTRON ACER TENDL-2019 LIBRARY; T=293.16K
Photon emission for (n,2np)

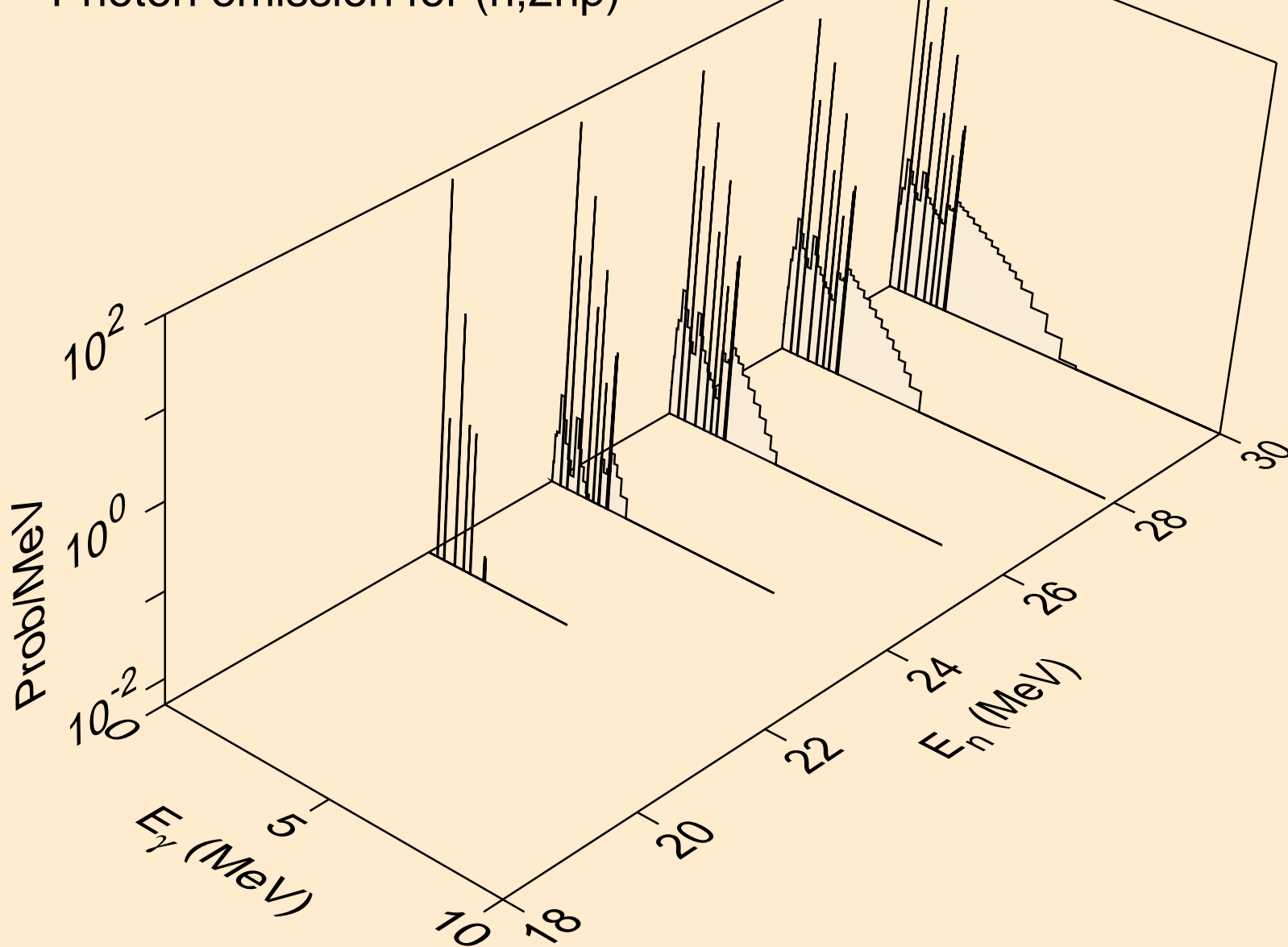

MN051 NEUTRON ACER TENDL-2019 LIBRARY; T=293.16K
Photon emission for (n,2np)

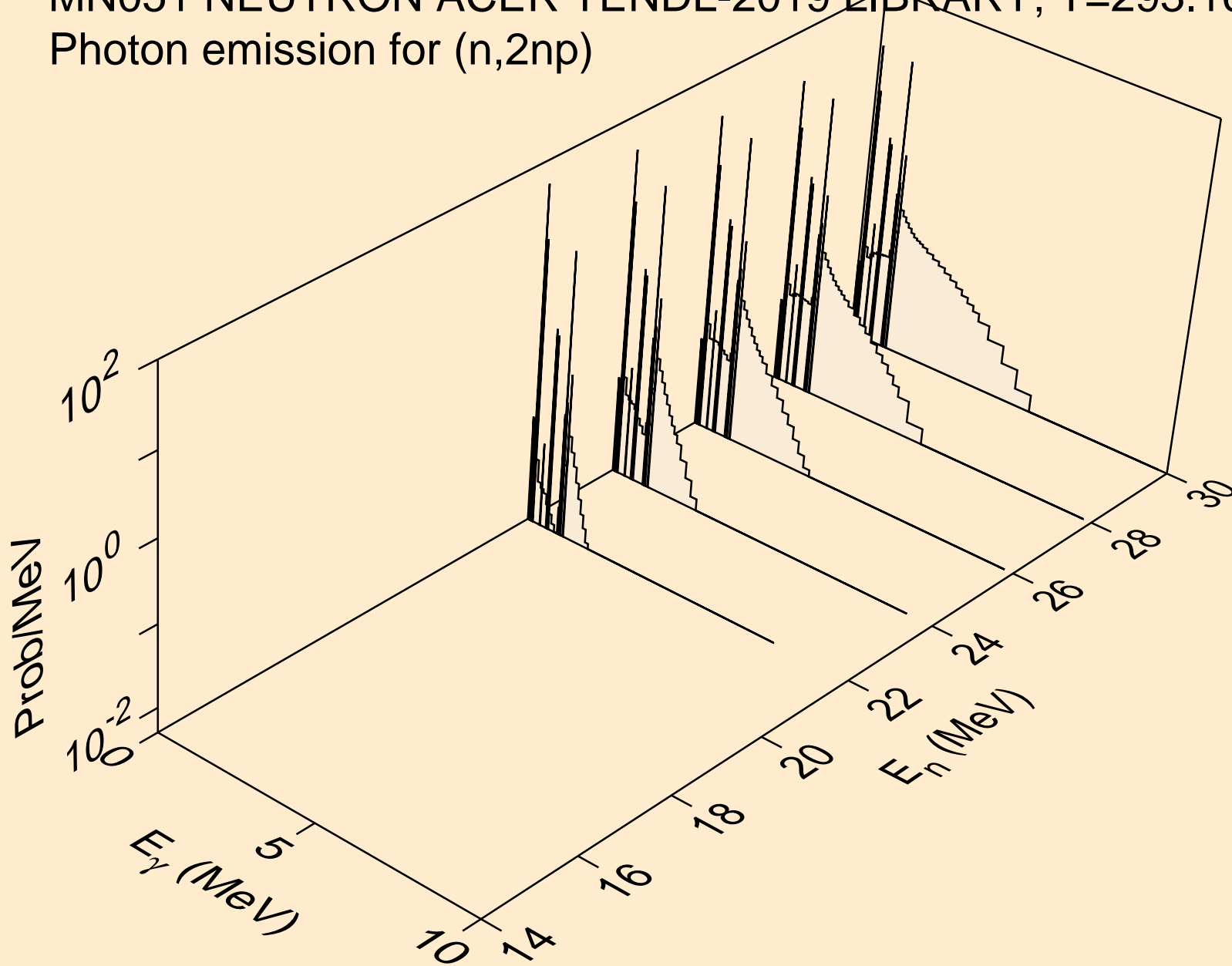

MN051 NEUTRON ACER TENDL-2019 LIBRARY; T=293.16K
Photon emission for (n,npa)

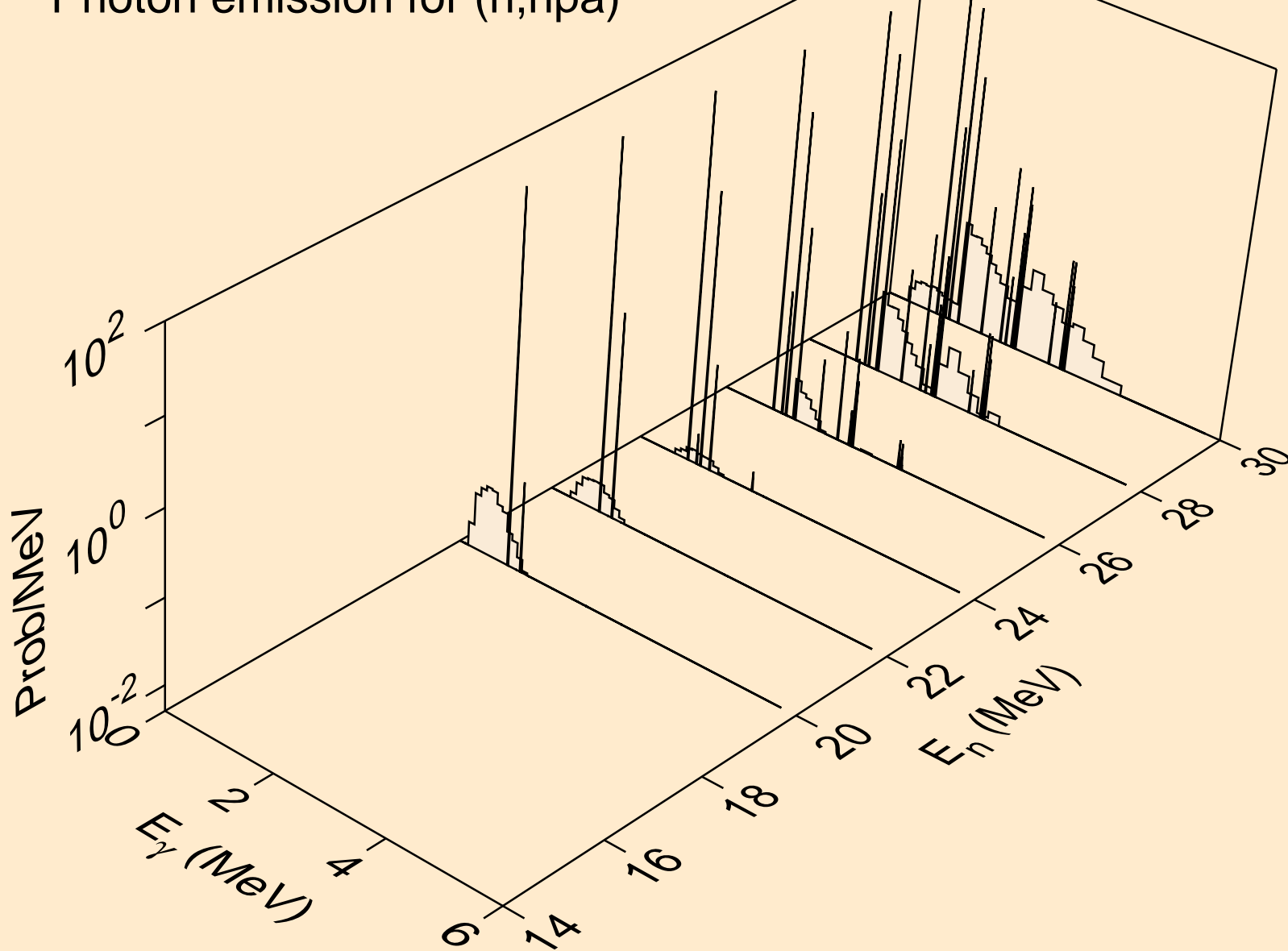

MN051 NEUTRON ACER TENDL-2019 LIBRARY; T=293.16K
Photon emission for (n,n*c)

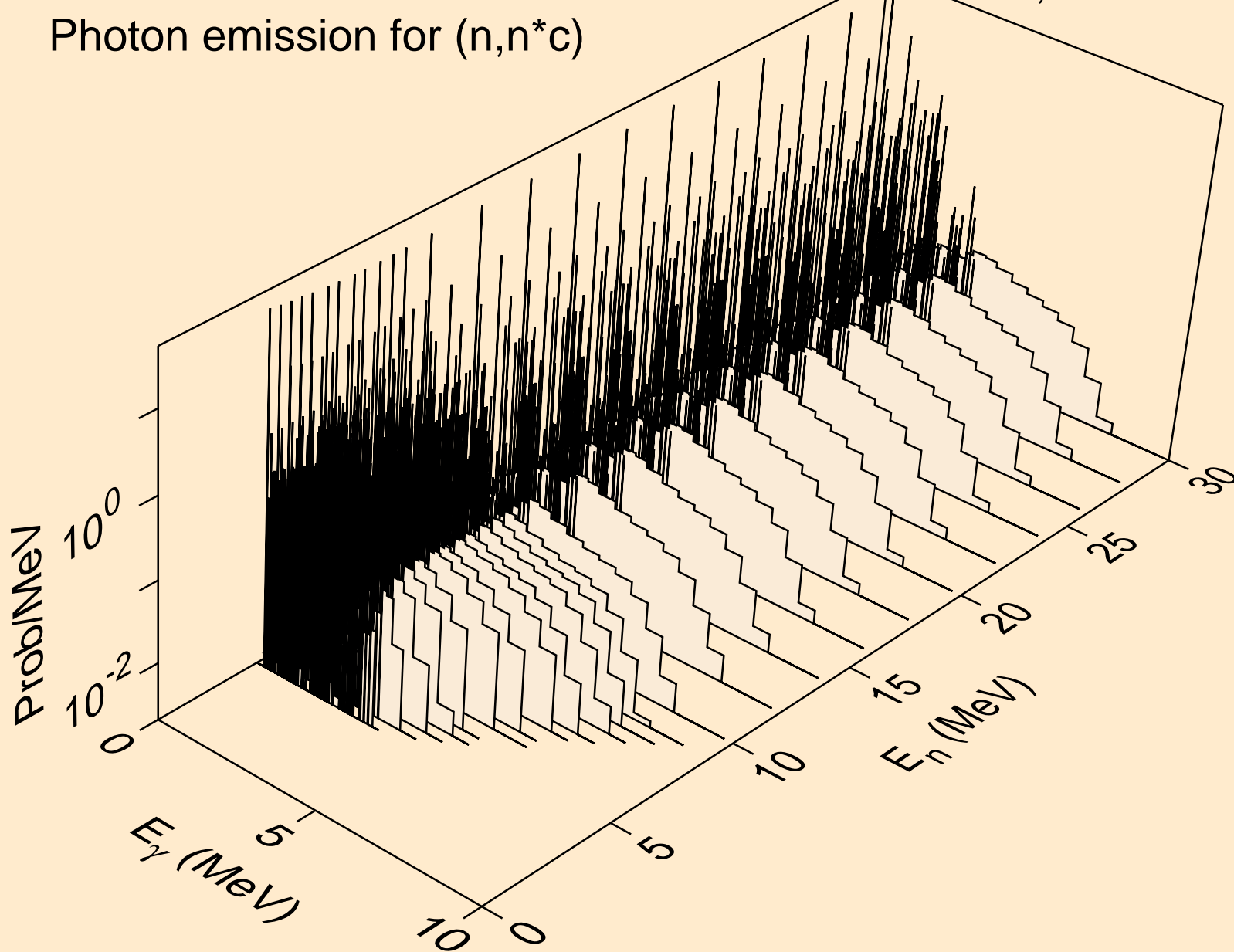

MN051 NEUTRON ACER TENDL-2019 LIBRARY; T=293.16K
Photon emission for (n,gma)

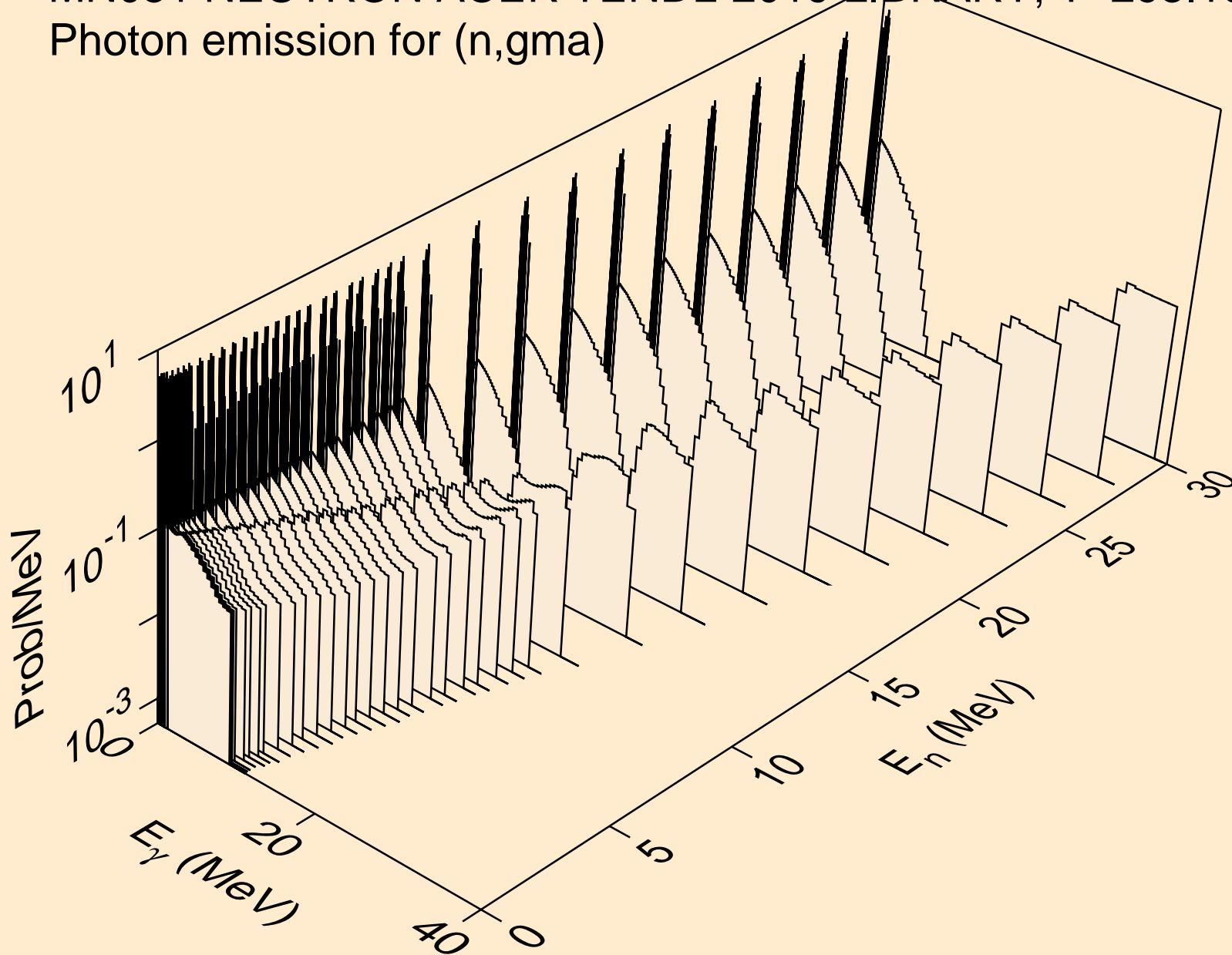

MN051 NEUTRON ACER TENDL-2019 LIBRARY; T=293.16K
Photon emission for (n,p)

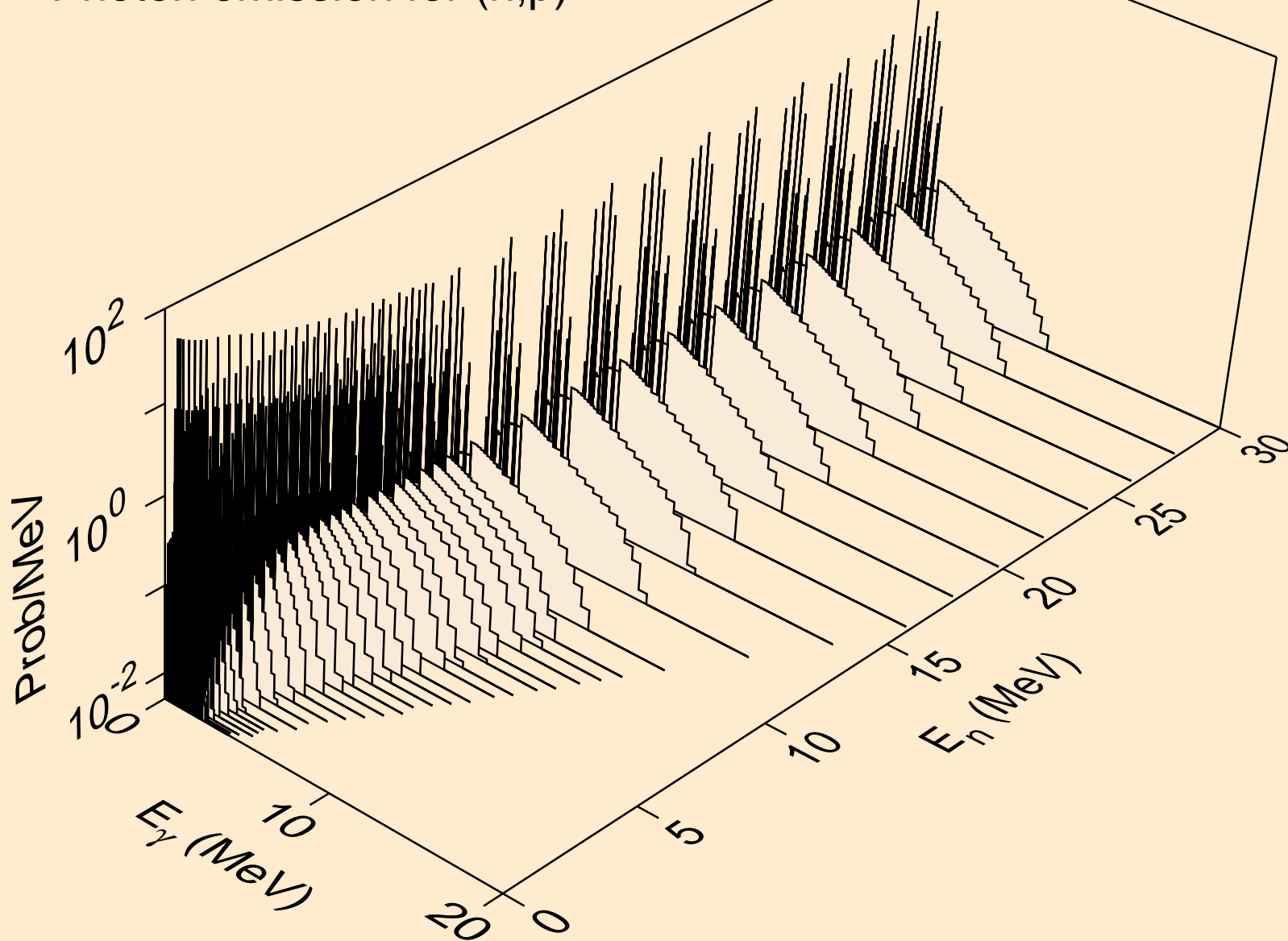

MN051 NEUTRON ACER TENDL-2019 LIBRARY; T=293.16K
Photon emission for (n,d)

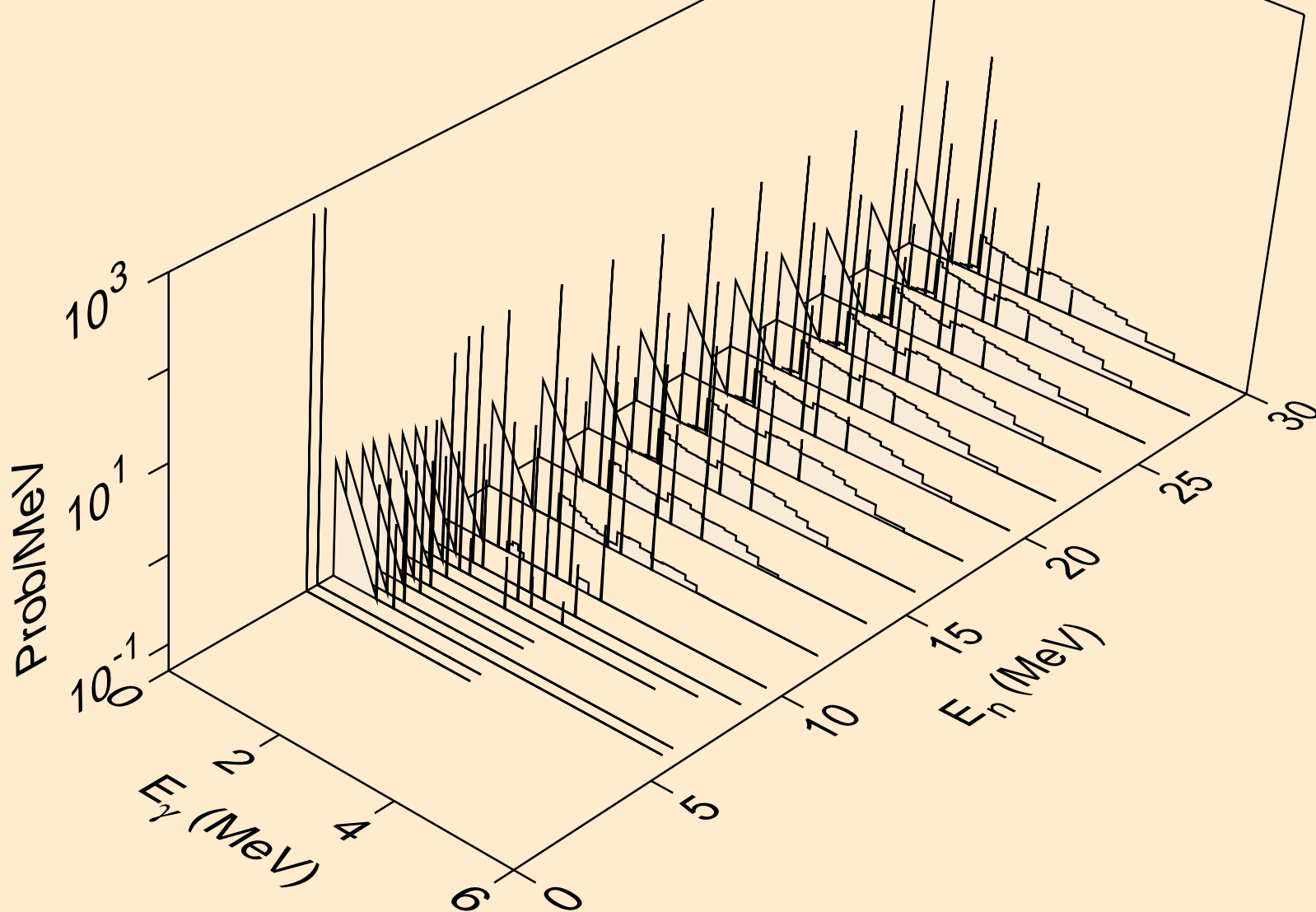

MN051 NEUTRON ACER TENDL-2019 LIBRARY; T=293.16K
Photon emission for (n,t)

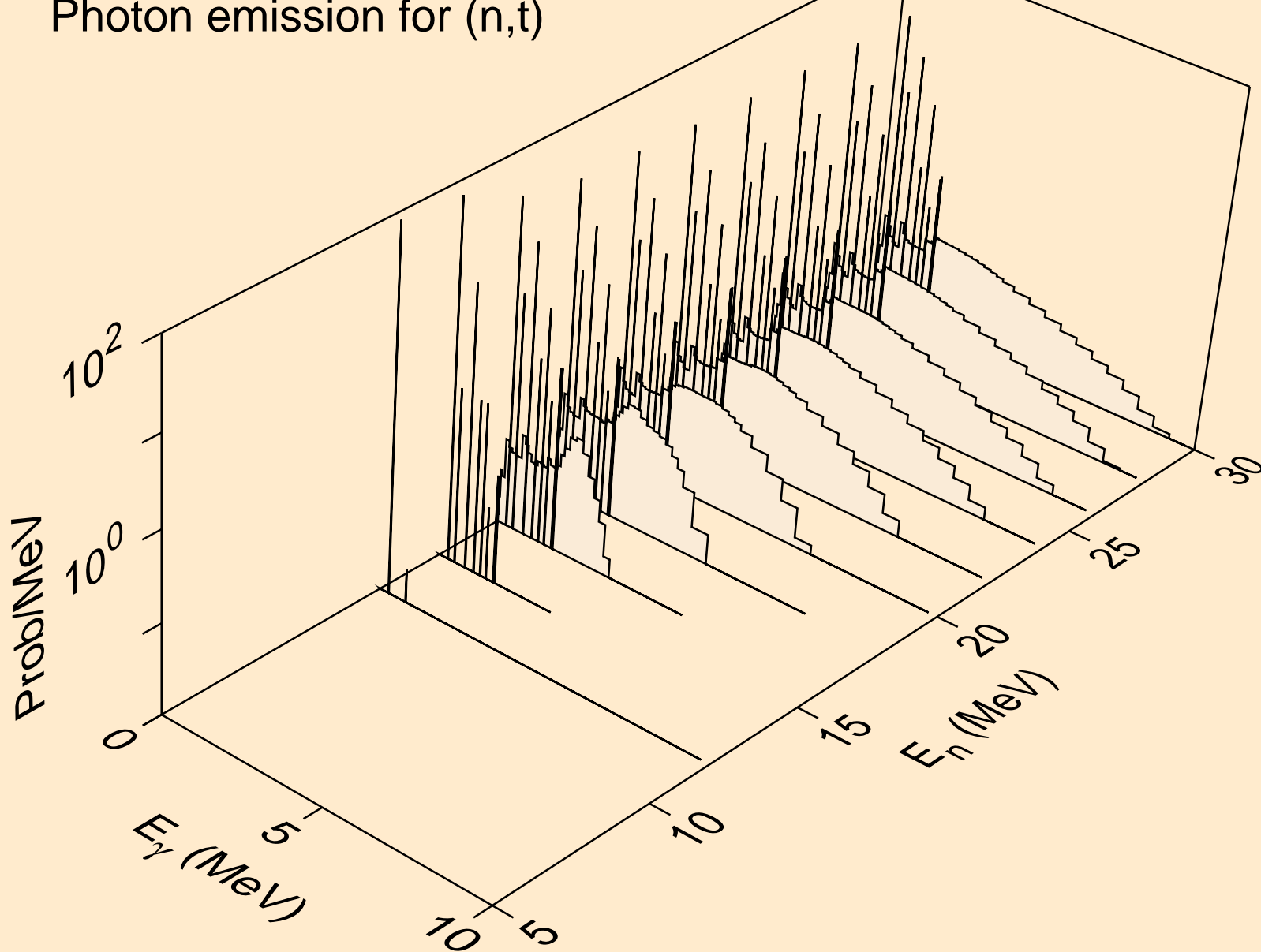

MN051 NEUTRON ACER TENDL-2019 LIBRARY; T=293.16K
Photon emission for (n,he3)

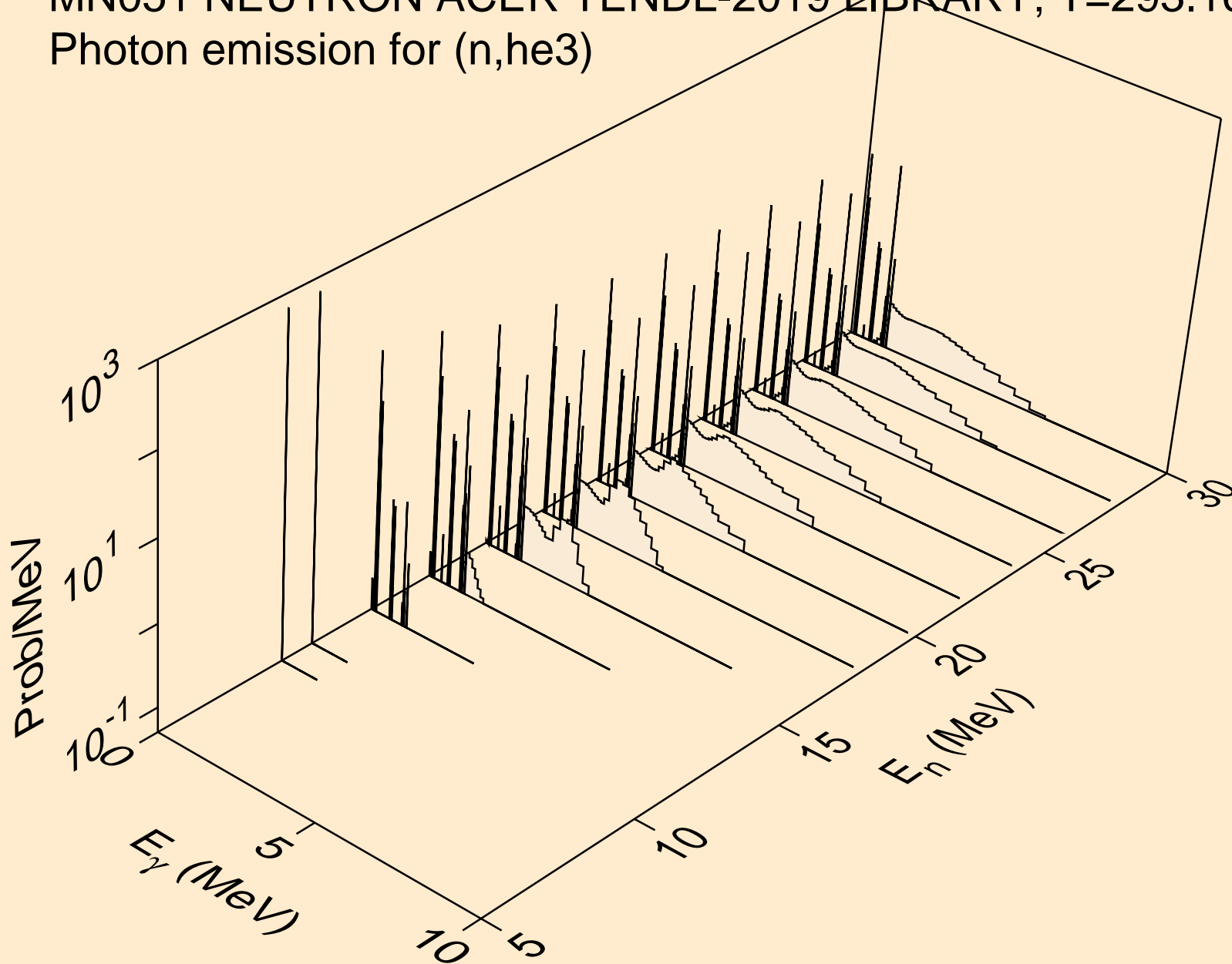

MN051 NEUTRON ACER TENDL-2019 LIBRARY; T=293.16K
Photon emission for (n,a)

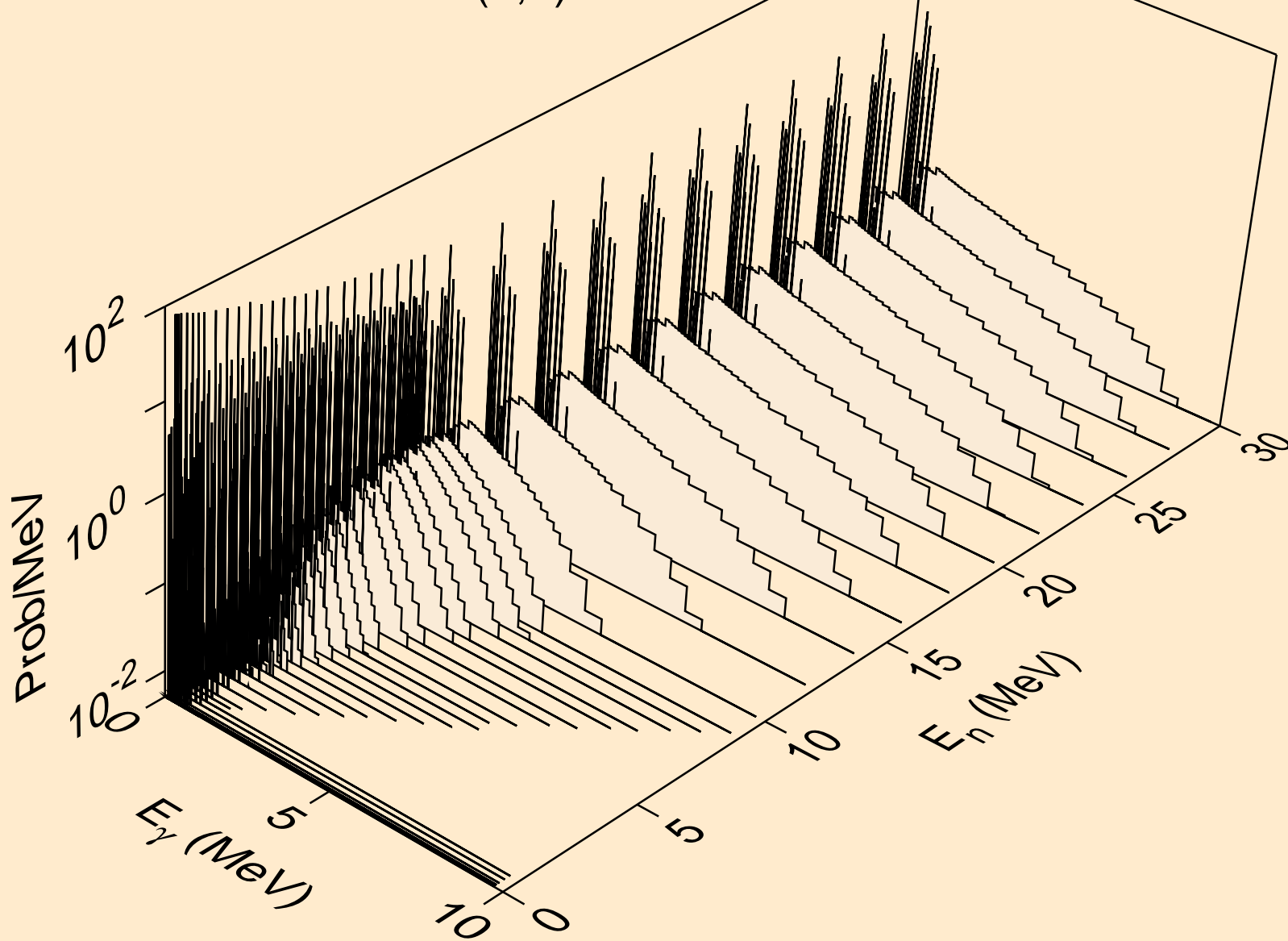

MN051 NEUTRON ACER TENDL-2019 LIBRARY; T=293.16K
Photon emission for (n,2a)

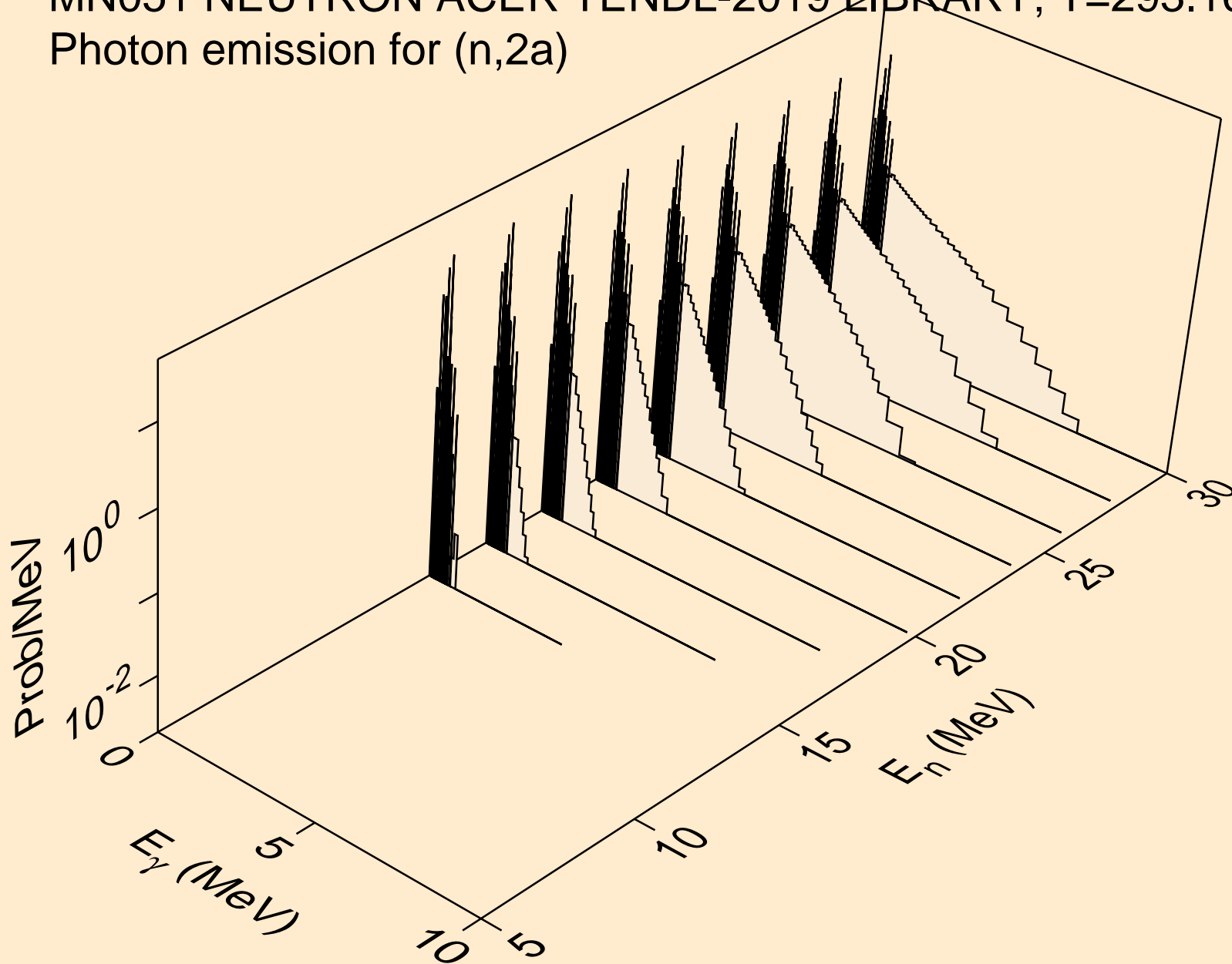

MN051 NEUTRON ACER TENDL-2019 LIBRARY; T=293.16K
Photon emission for (n,2p)

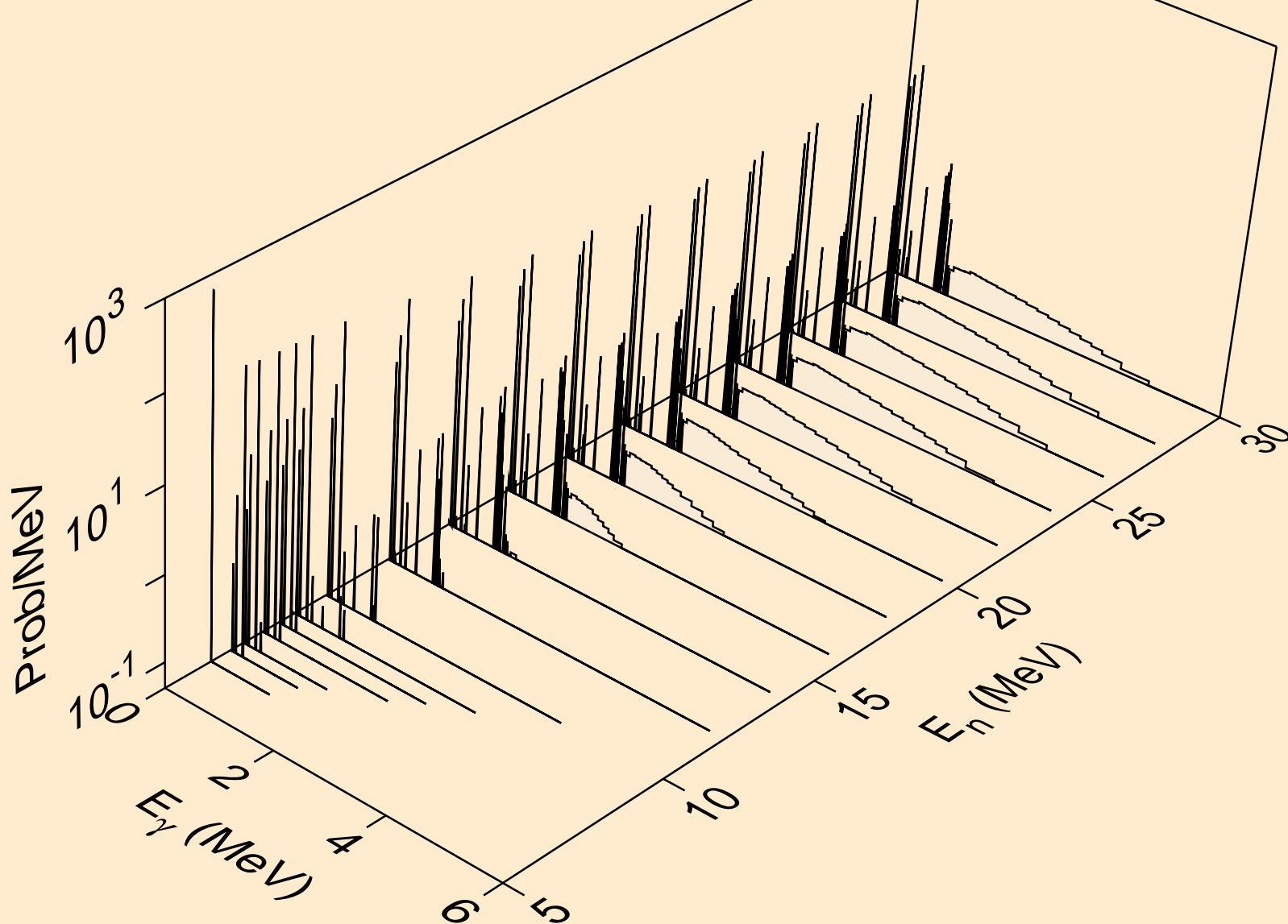

MN051 NEUTRON ACER TENDL-2019 LIBRARY; T=293.16K
Photon emission for (n,p α)

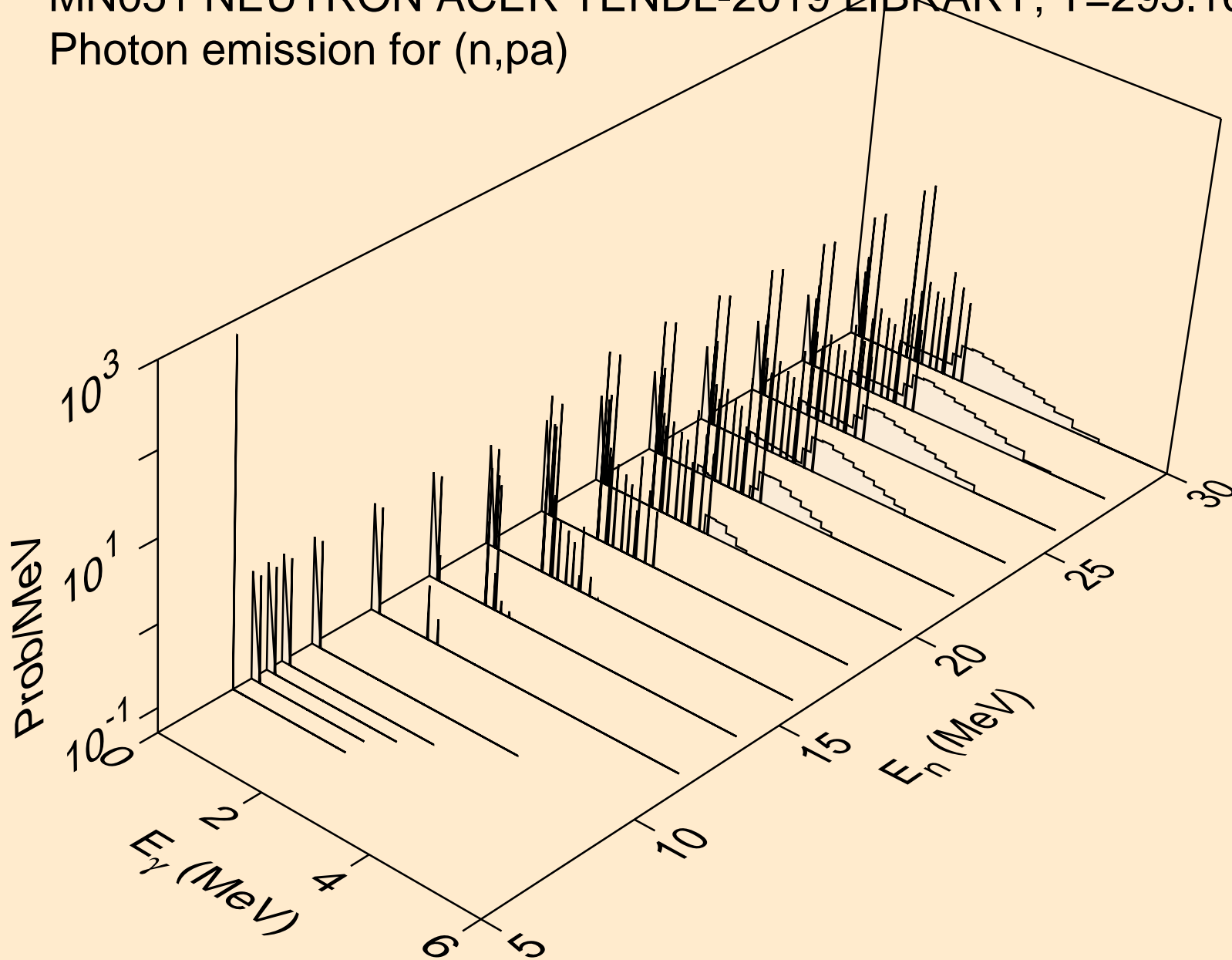

MN051 NEUTRON ACER TENDL-2019 LIBRARY; T=293.16K
Photon emission for (n,pd)

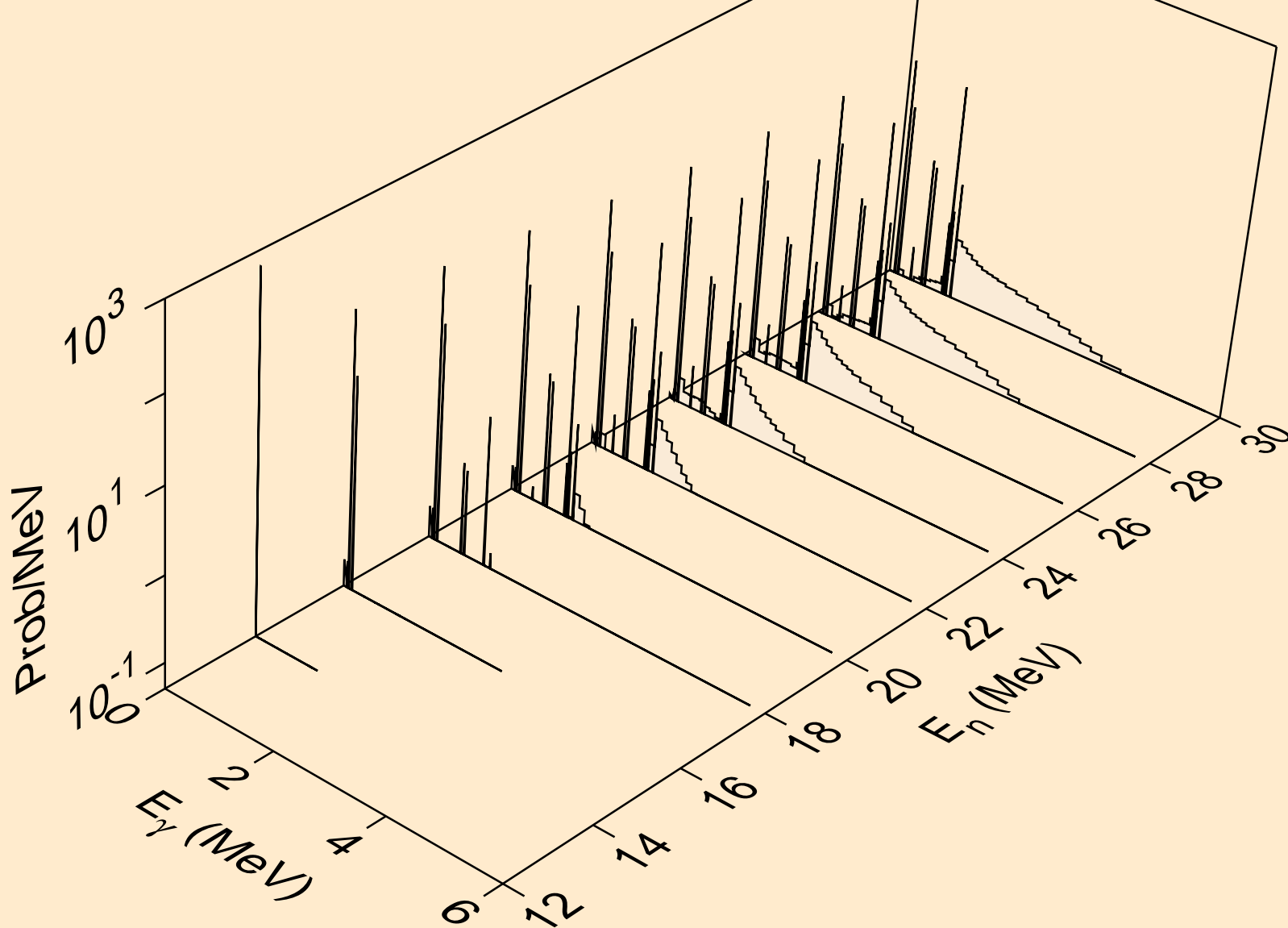

MN051 NEUTRON ACER TENDL-2019 LIBRARY; T=293.16K
Photon emission for (n,pt)

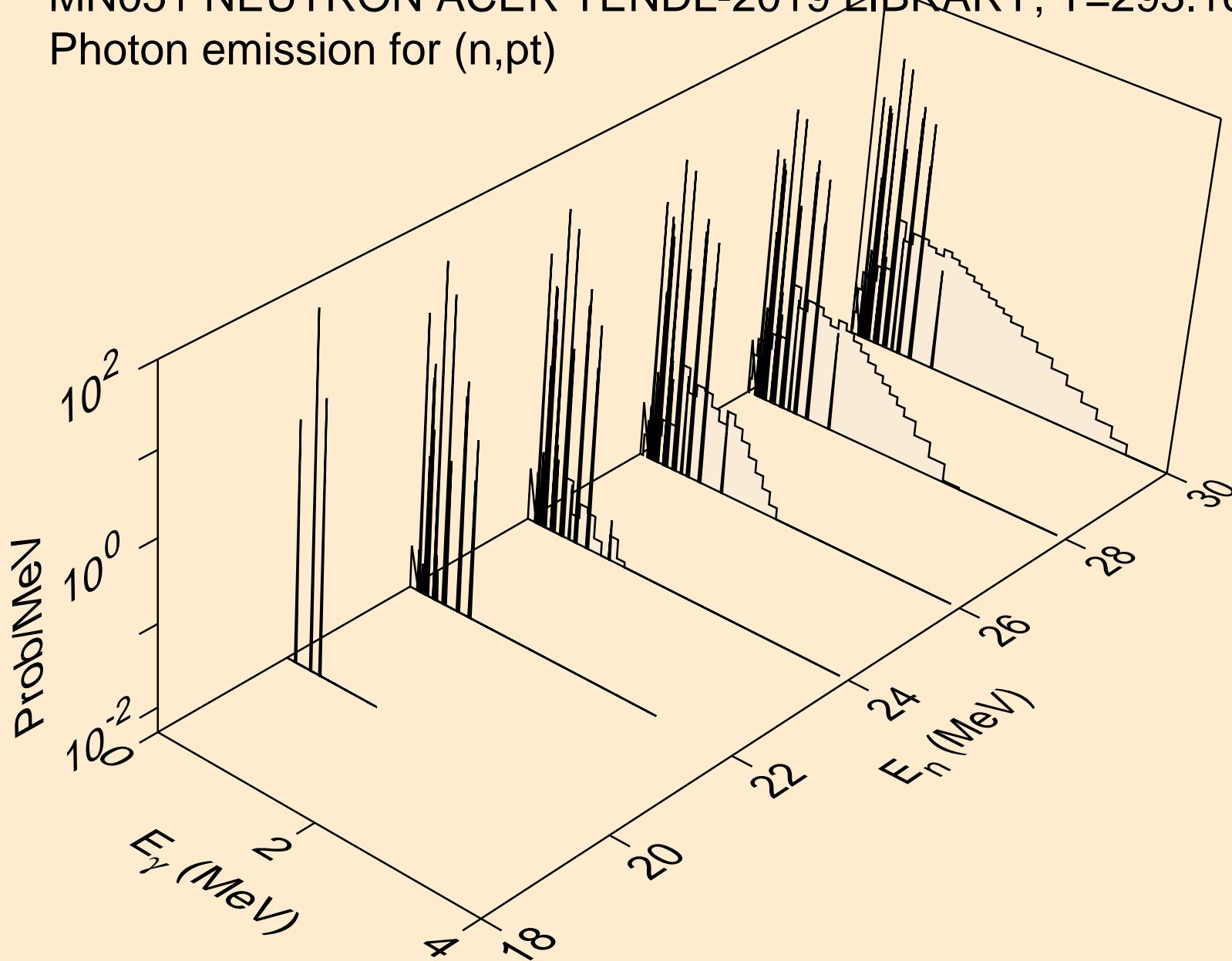

MN051 NEUTRON ACER TENDL-2019 LIBRARY; T=293.16K
Photon emission for (n,da)

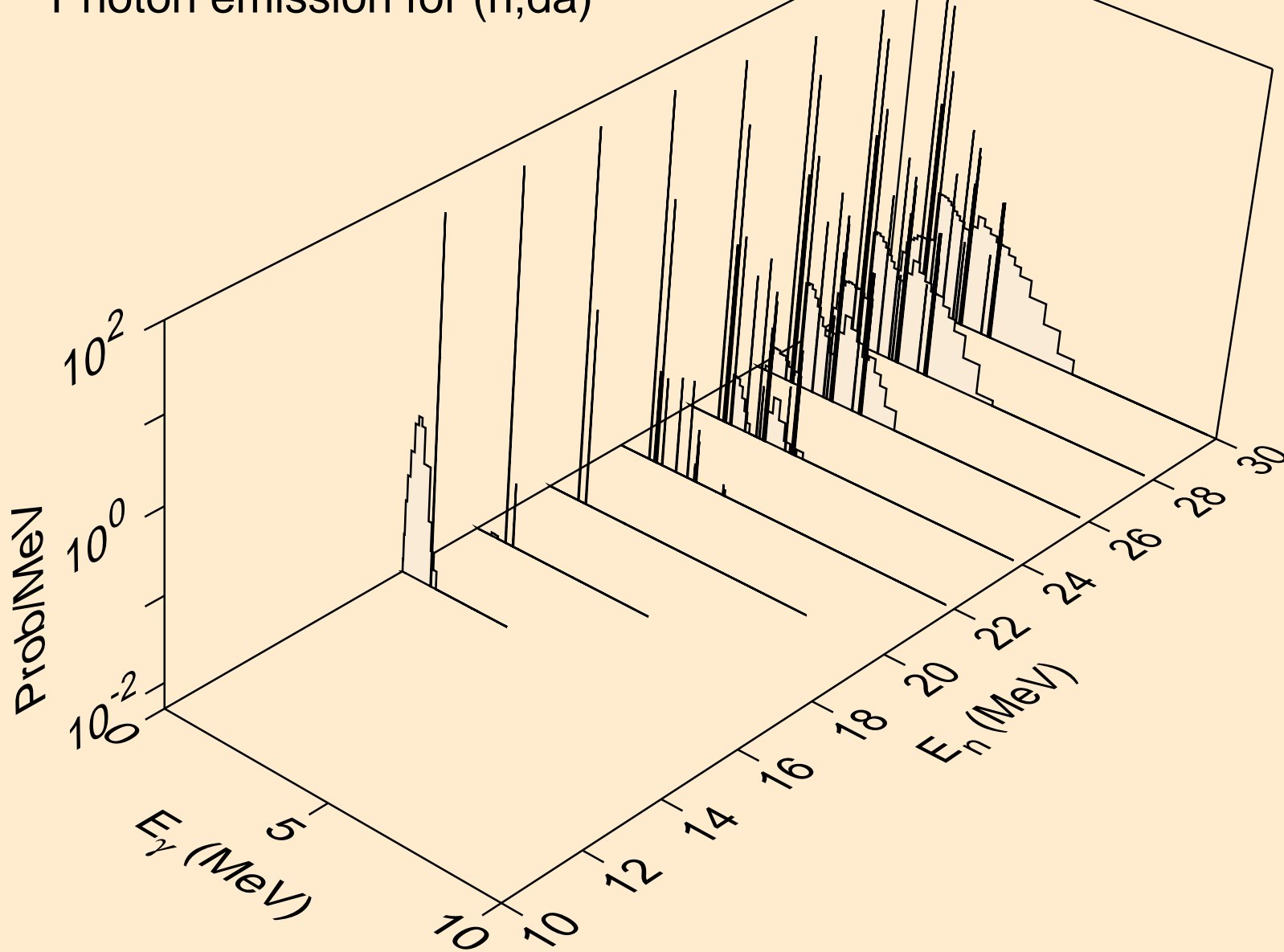

MN051 NEUTRON ACER TENDL-2019 LIBRARY; T=293.16K
thermal capture photon spectrum

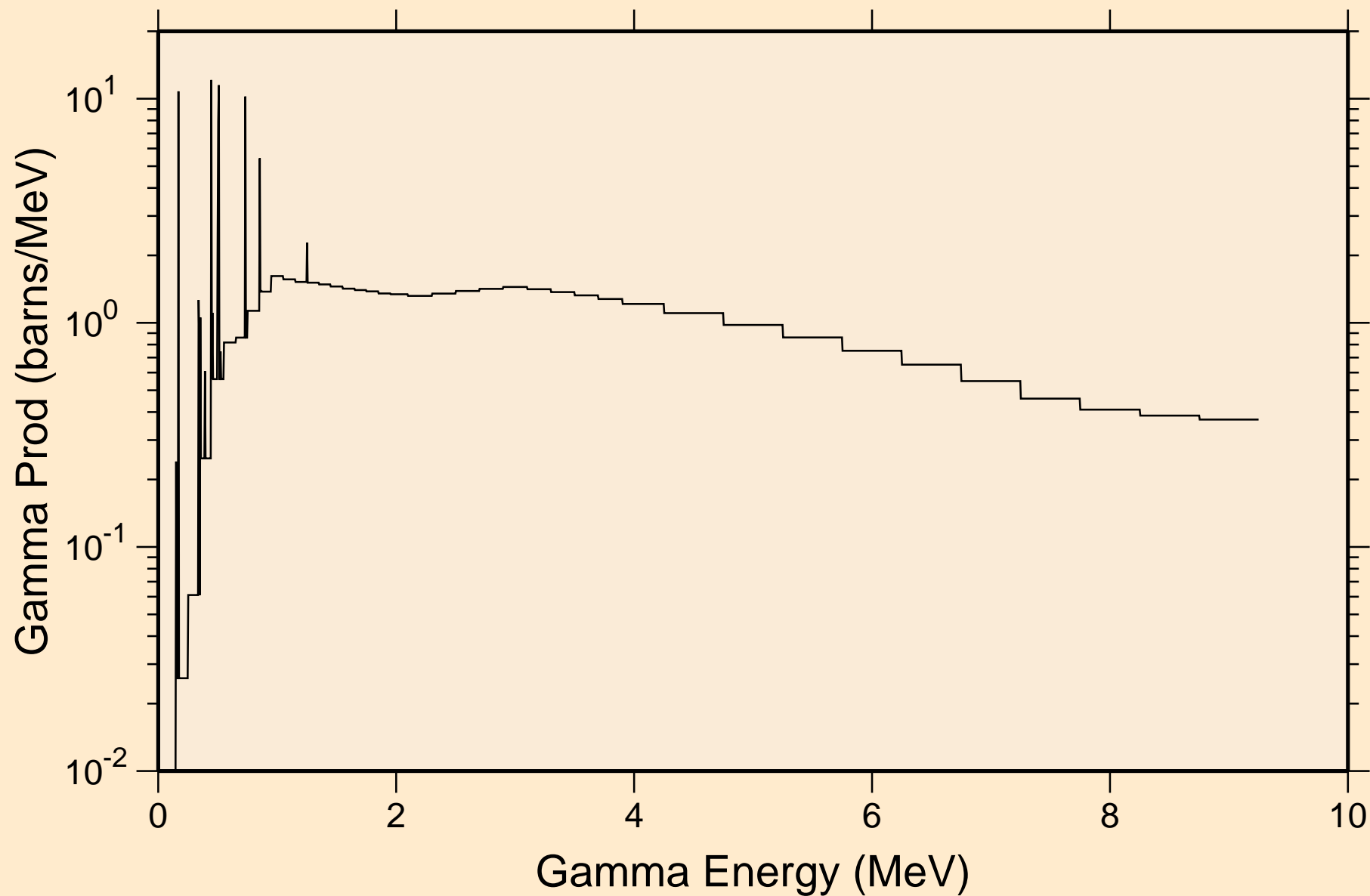

MN051 NEUTRON ACER TENDL-2019 LIBRARY; T=293.16K
14 MeV photon spectrum

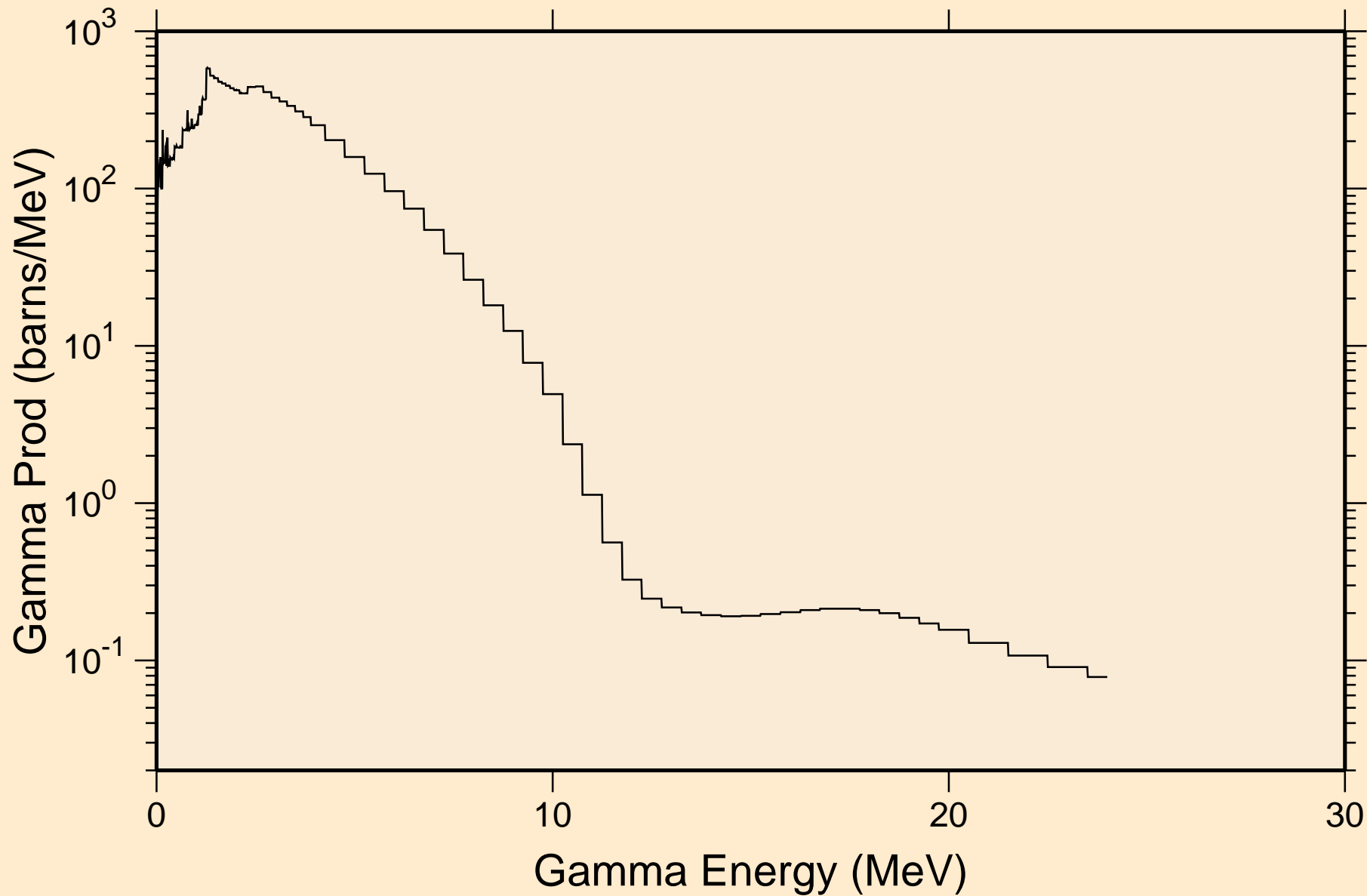

MN051 NEUTRON ACER TENDL-2019 LIBRARY; T=293.16K
Particle heating contributions

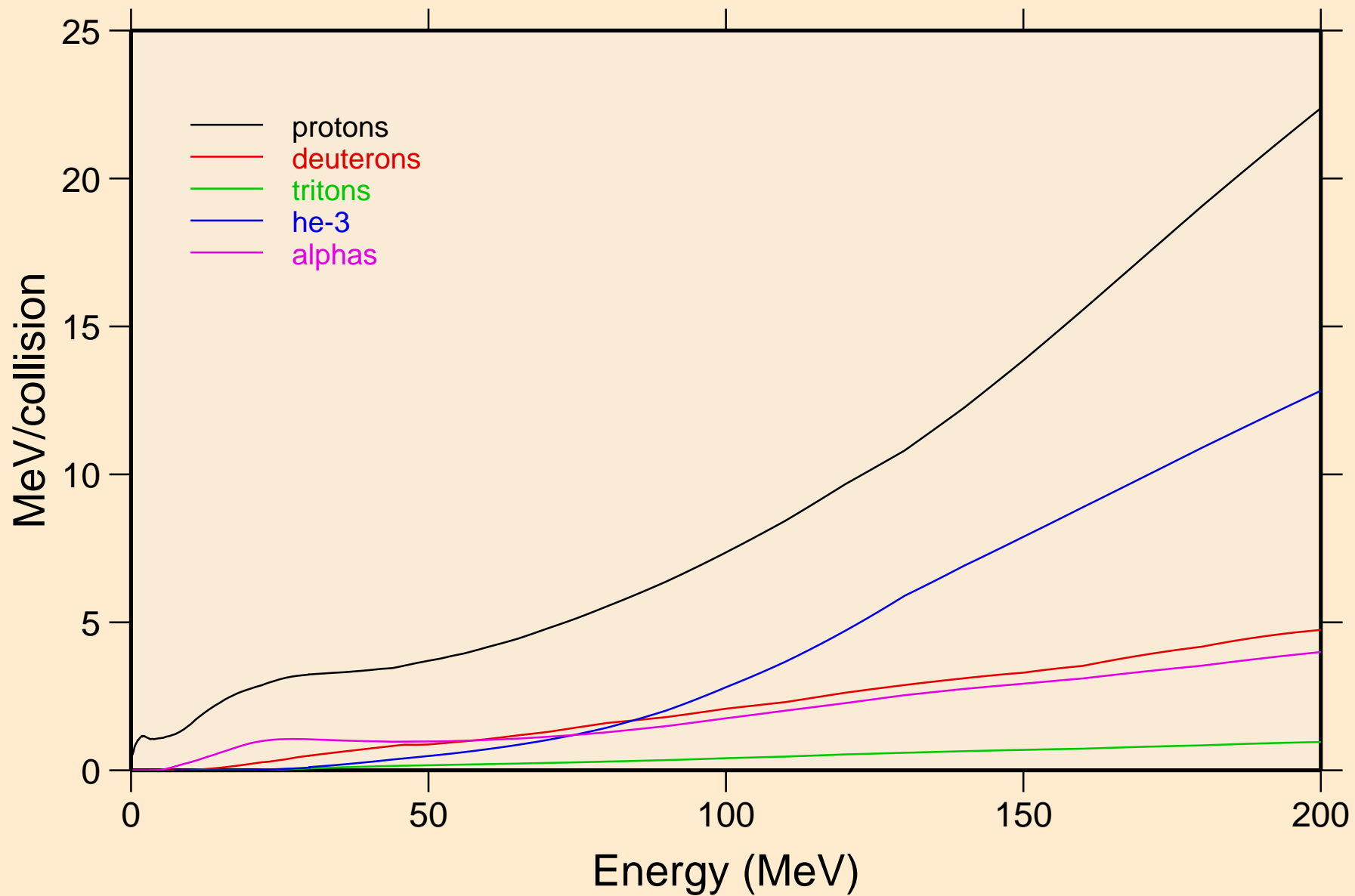

MN051 NEUTRON ACER TENDL-2019 LIBRARY; T=293.16K
Recoil Heating

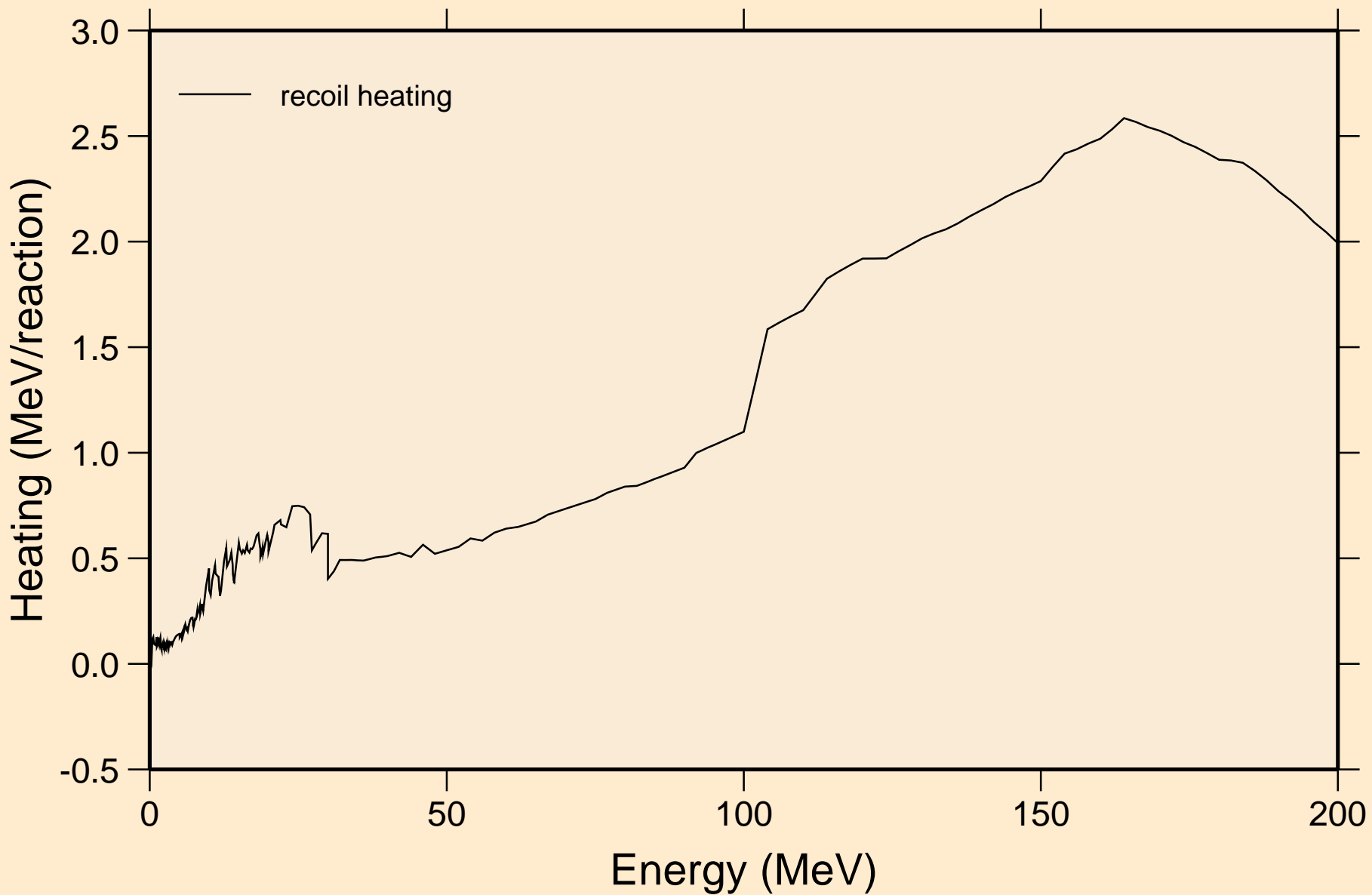

MN051 NEUTRON ACER TENDL-2019 LIBRARY; T=293.16K
Particle production cross sections

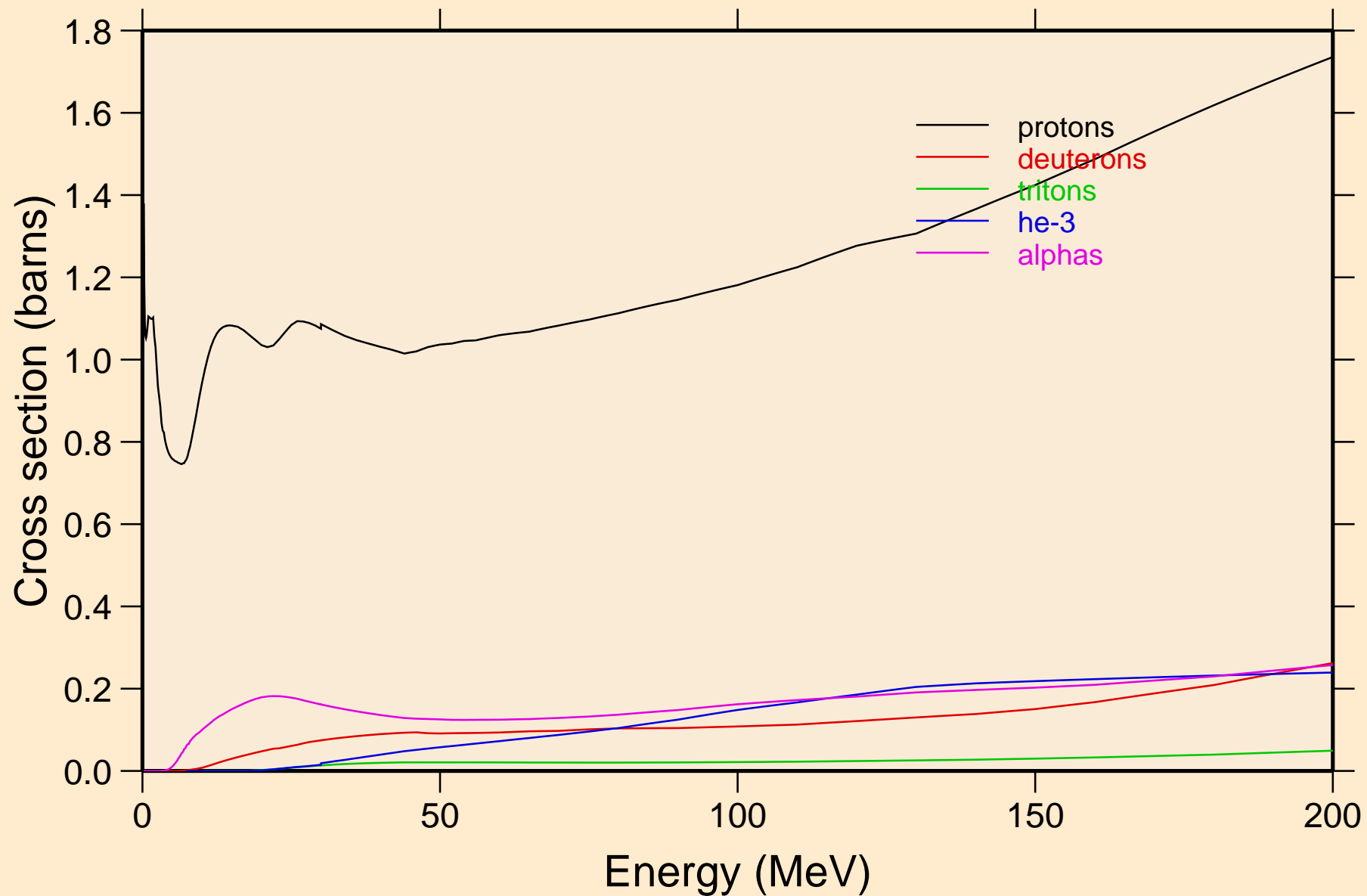

MN051 NEUTRON ACER TENDL-2019 LIBRARY; T=293.16K
protons from (n,x)

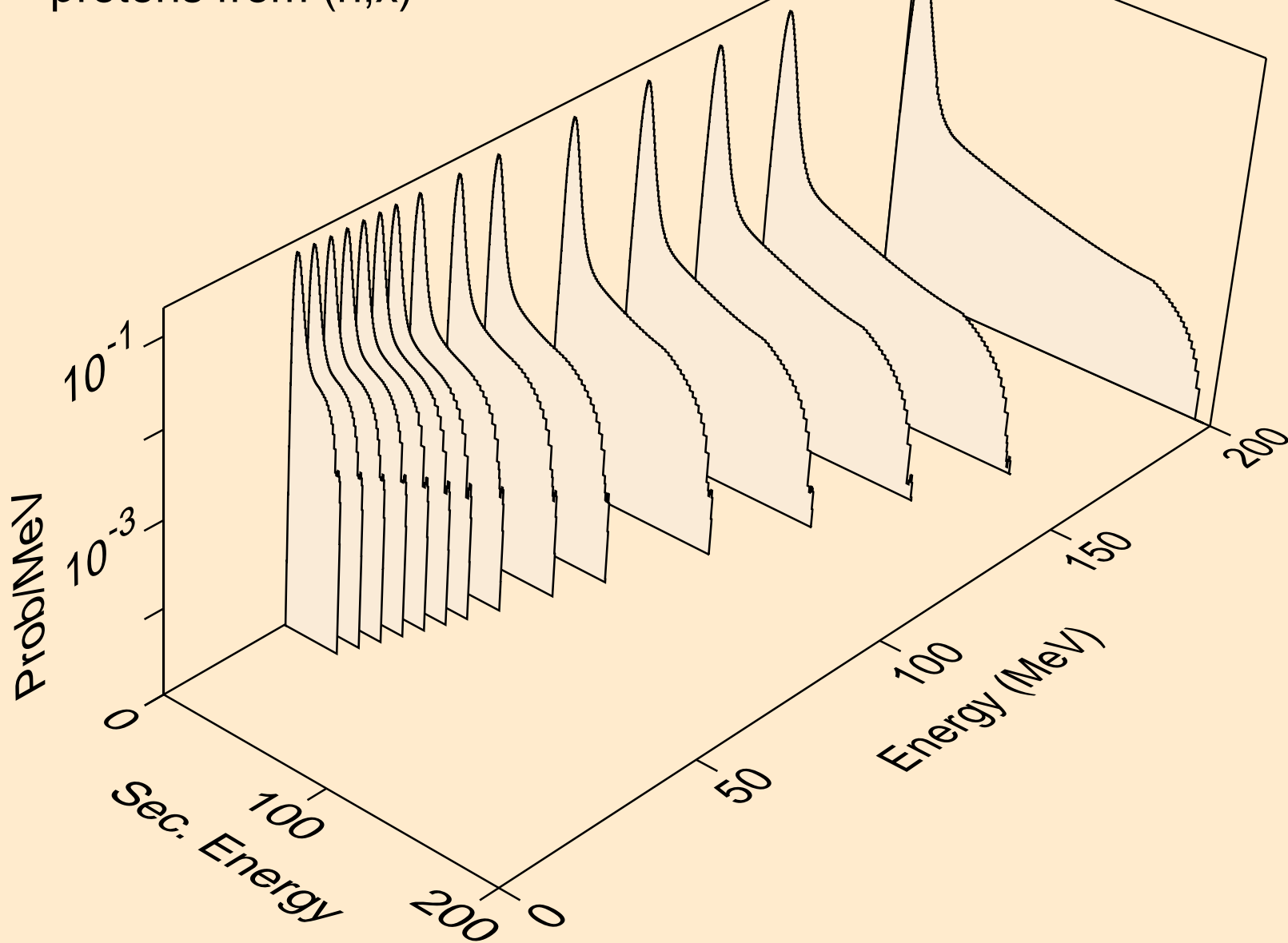

MN051 NEUTRON ACER TENDL-2019 LIBRARY; T=293.16K
protons from (n,n*)p

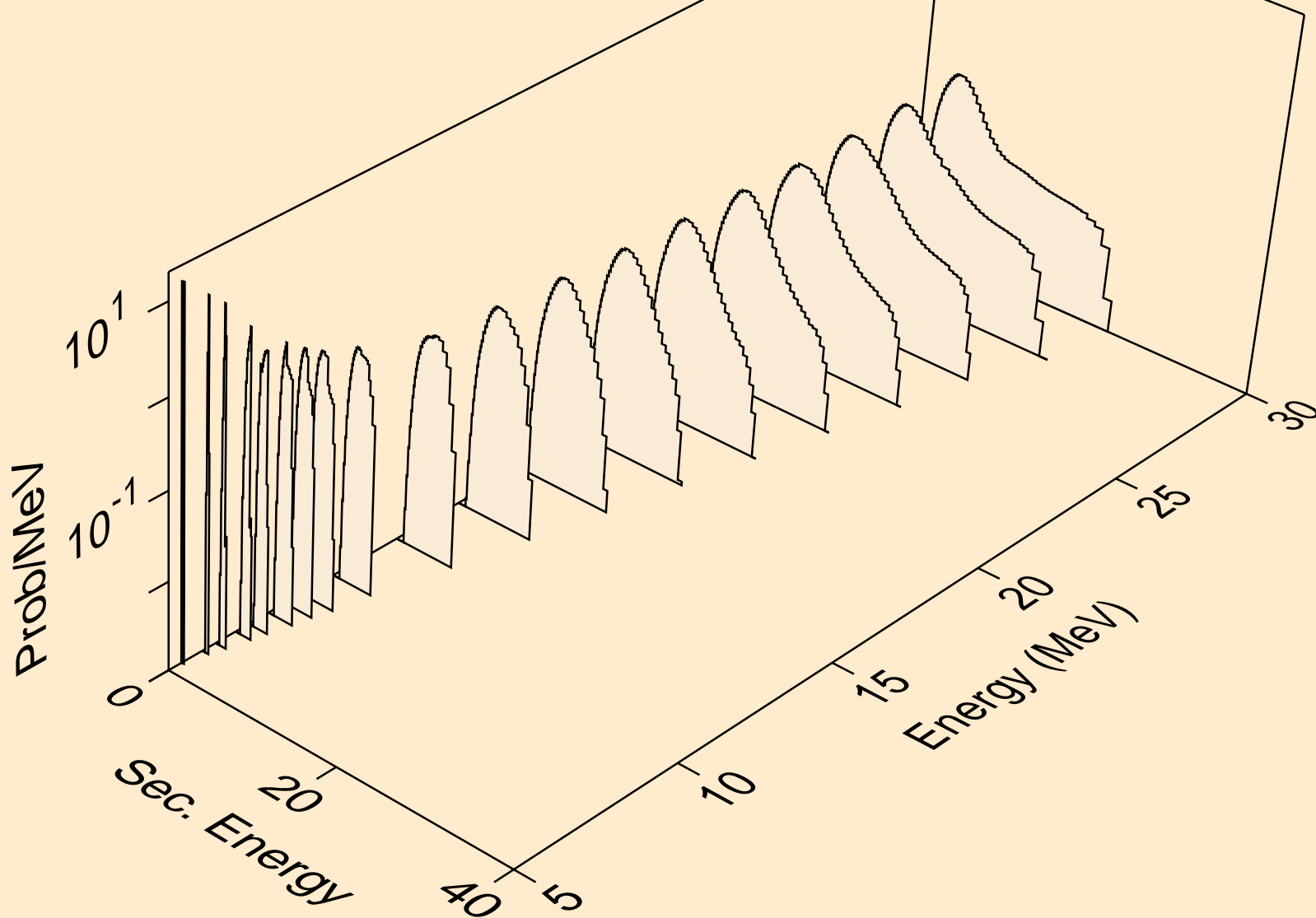

MN051 NEUTRON ACER TENDL-2019 LIBRARY; T=293.16K
protons from (n,2np)

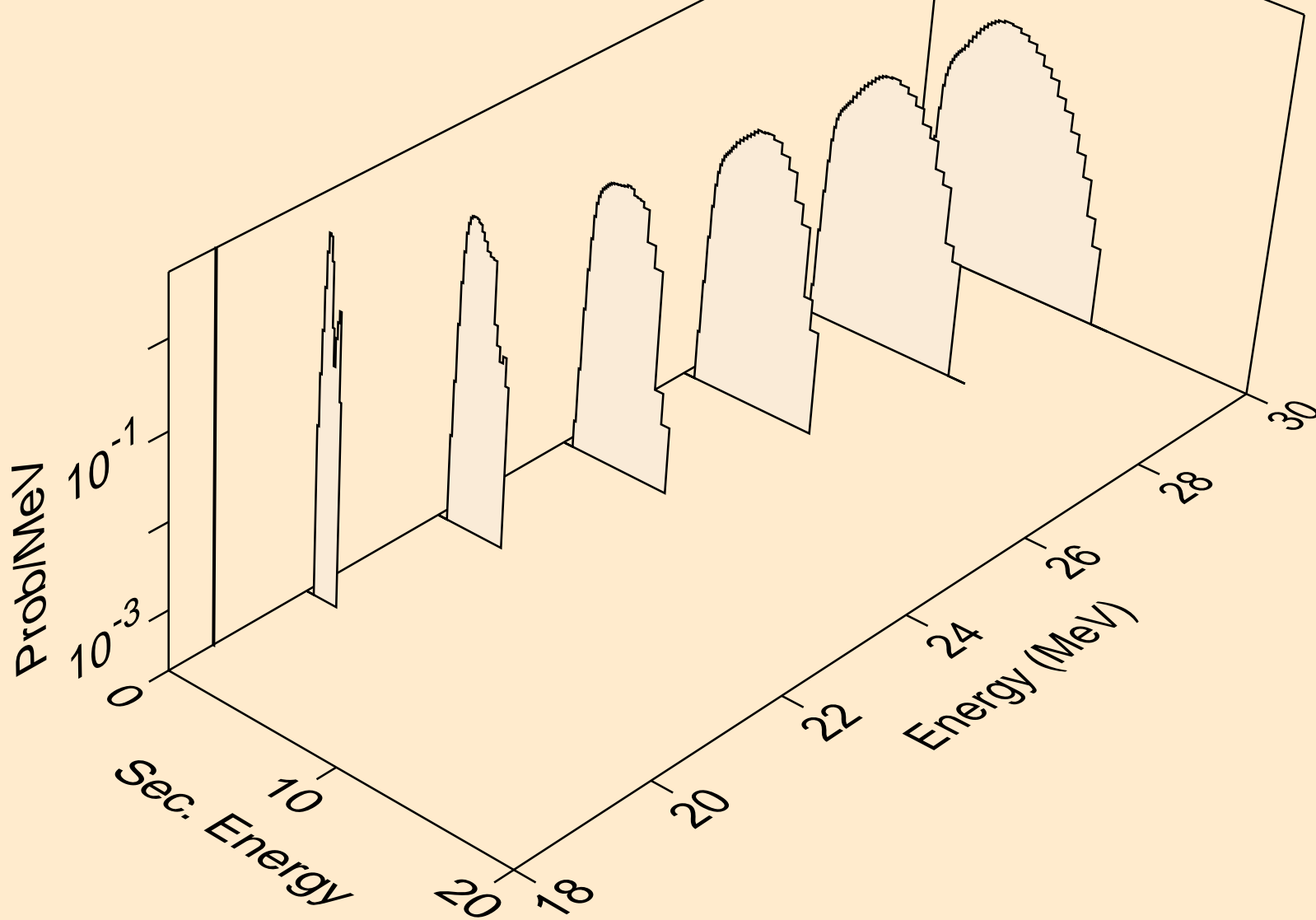

MN051 NEUTRON ACER TENDL-2019 LIBRARY; T=293.16K
protons from (n,2np)

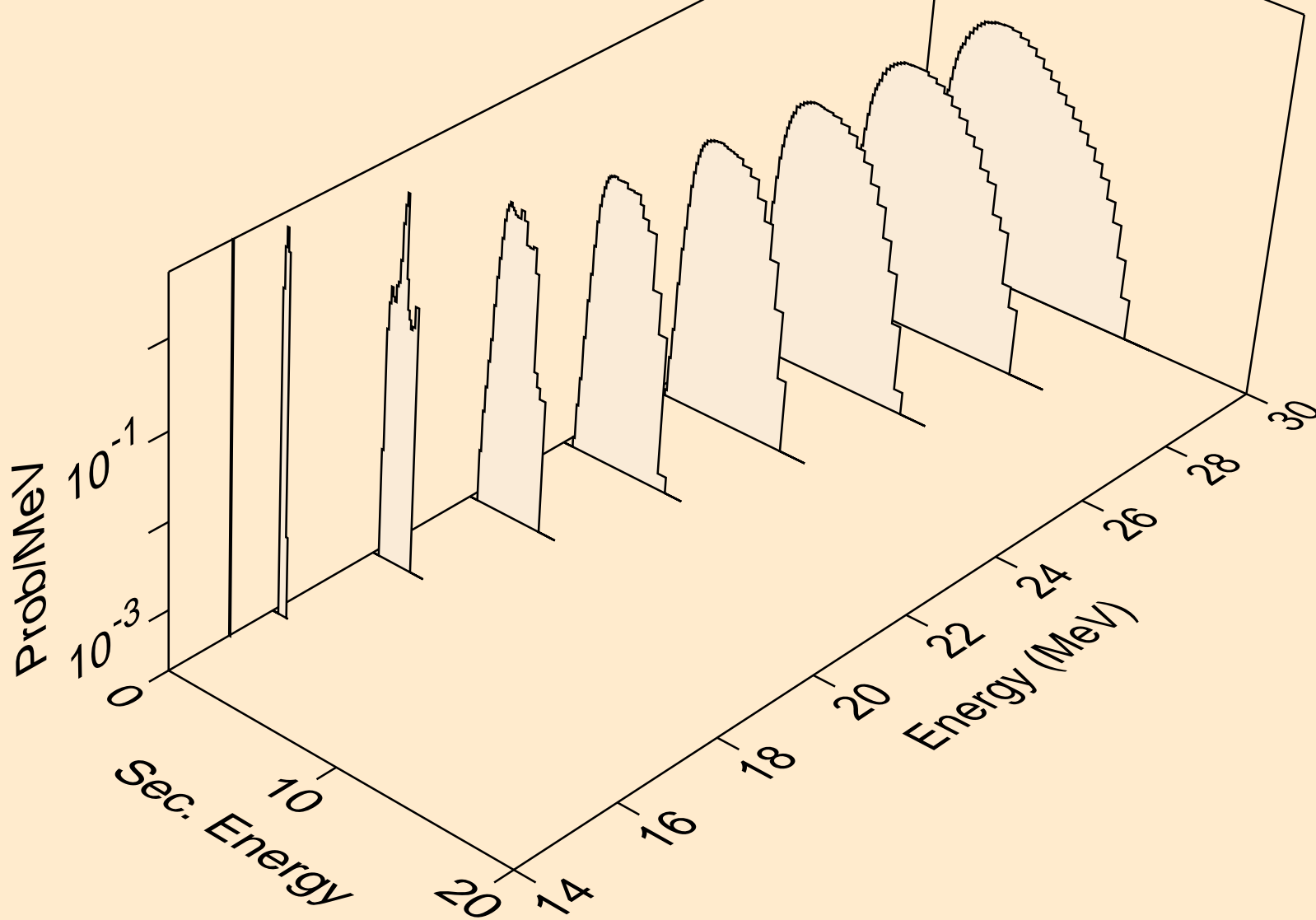

MN051 NEUTRON ACER TENDL-2019 LIBRARY; T=293.16K
protons from (n,npa)

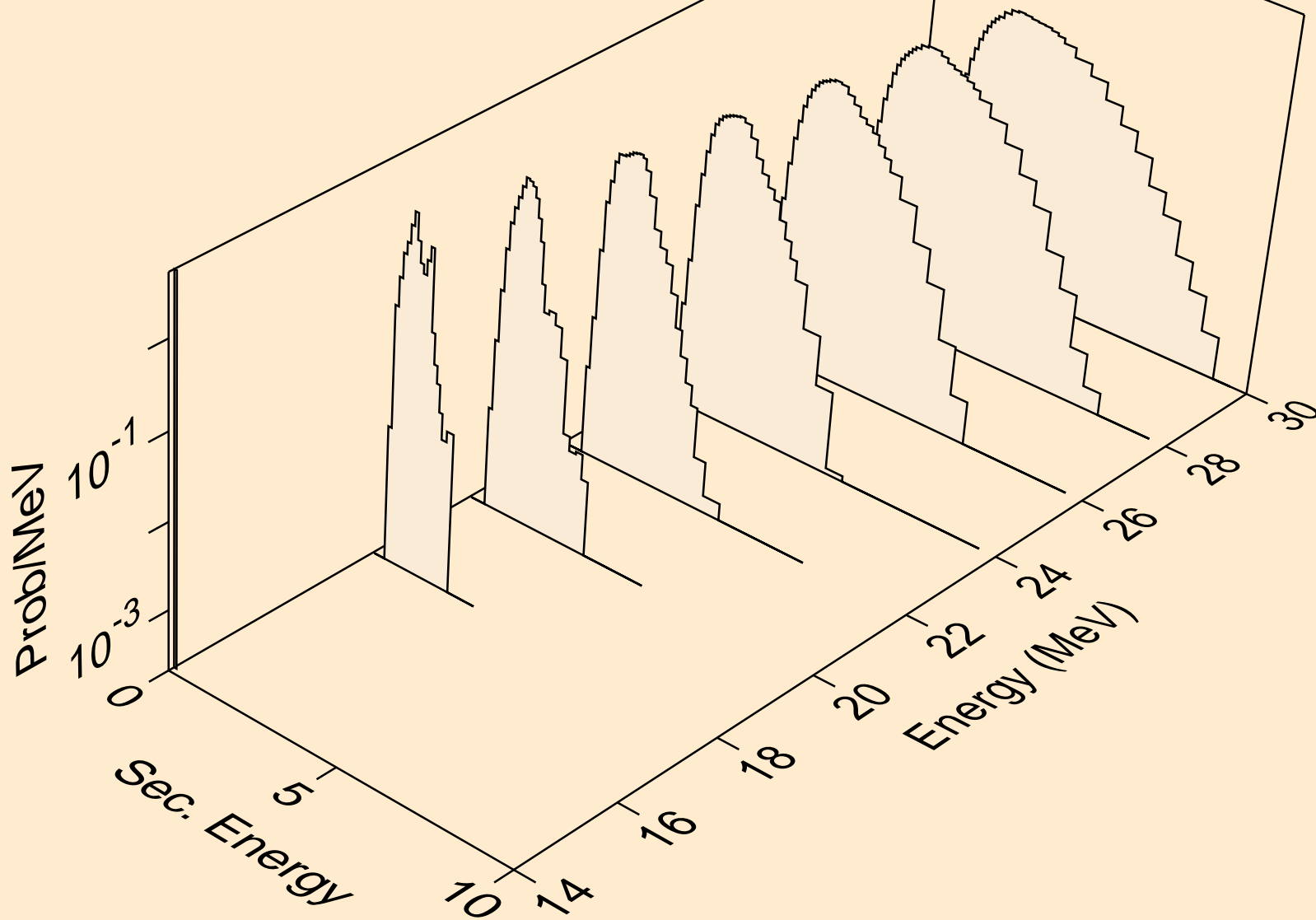

MN051 NEUTRON ACER TENDL-2019 LIBRARY; T=293.16K
protons from (n,p)

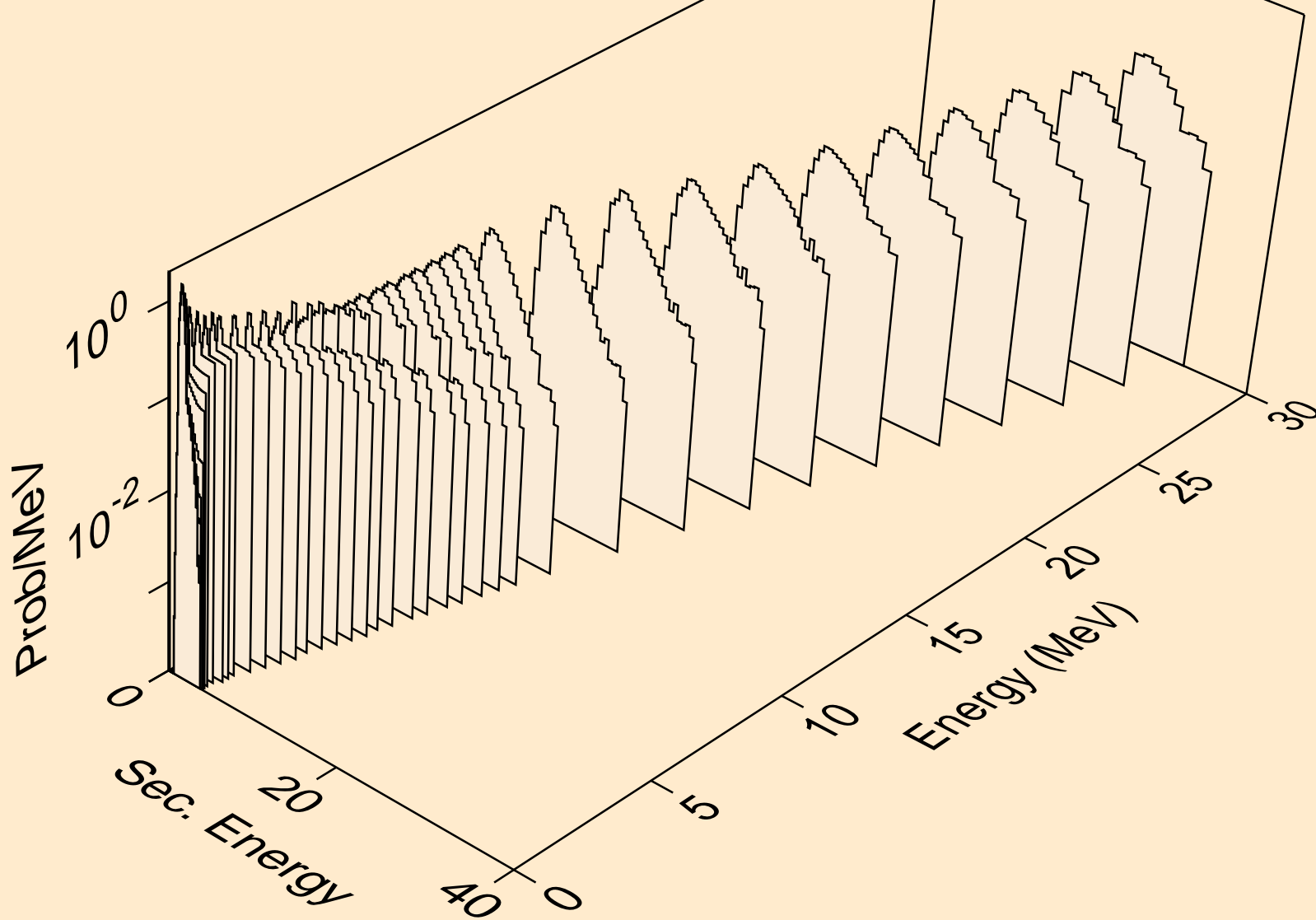

MN051 NEUTRON ACER TENDL-2019 LIBRARY; T=293.16K
protons from (n,2p)

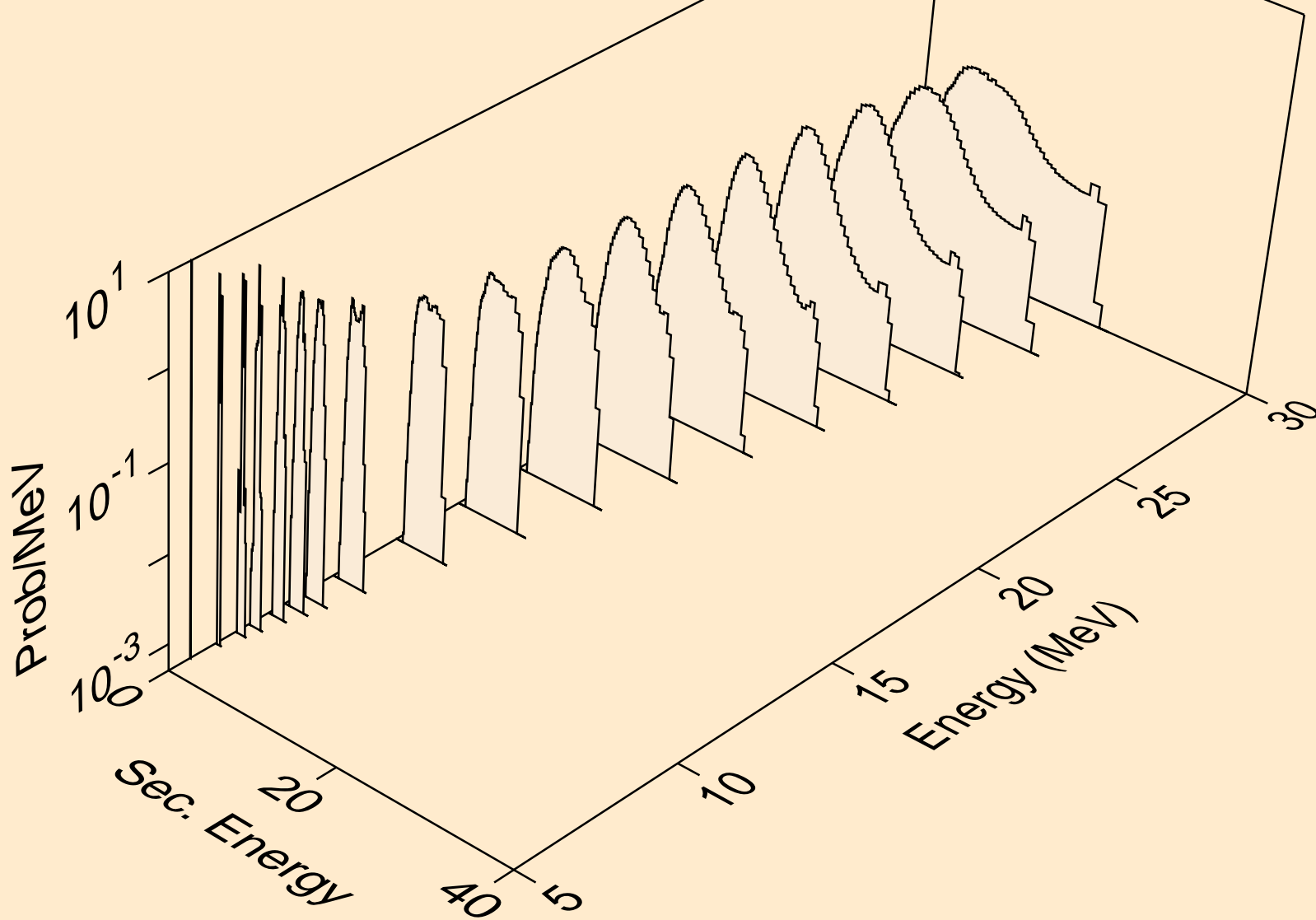

MN051 NEUTRON ACER TENDL-2019 LIBRARY; T=293.16K
protons from (n,p)

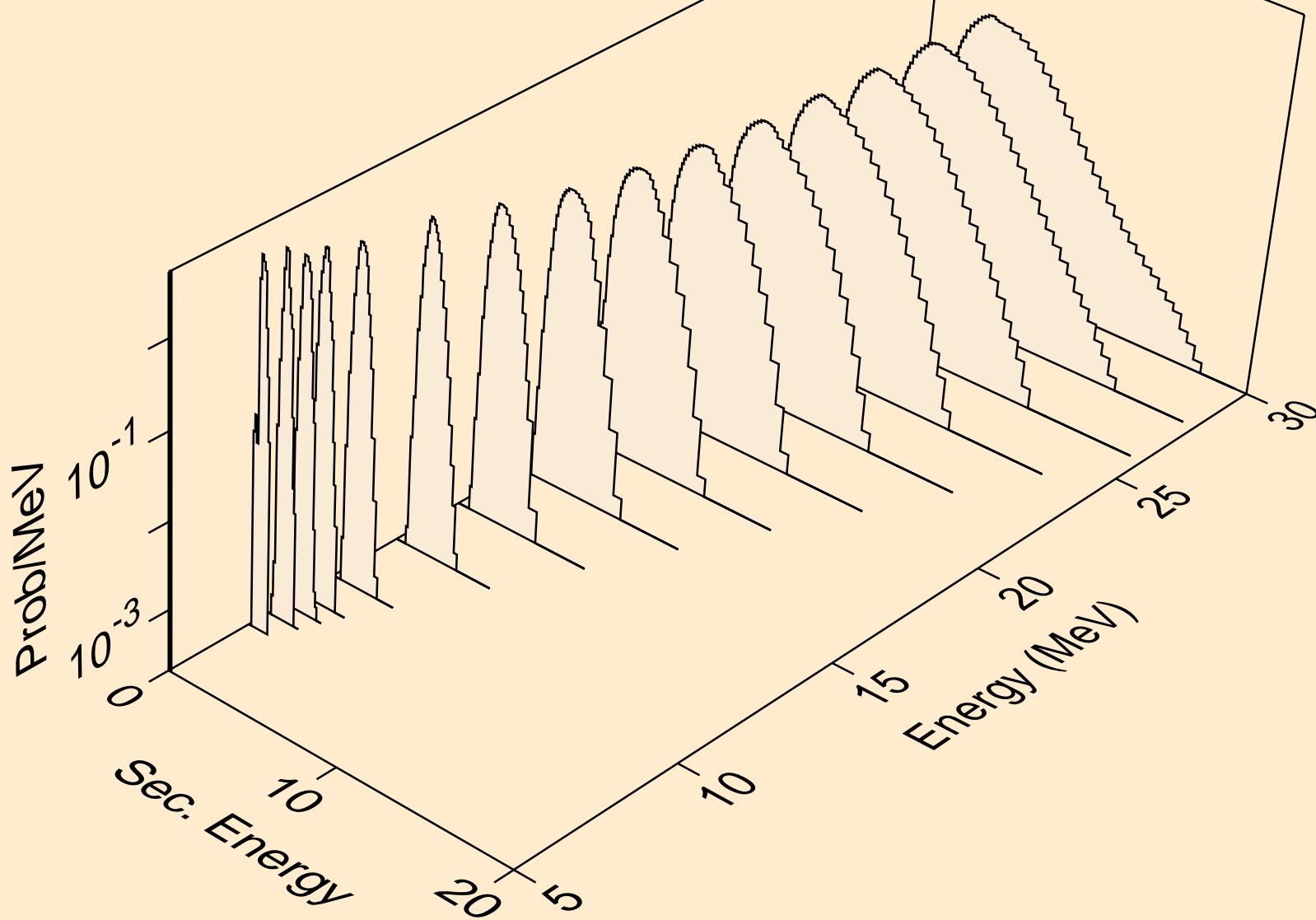

MN051 NEUTRON ACER TENDL-2019 LIBRARY; T=293.16K
protons from (n,pd)

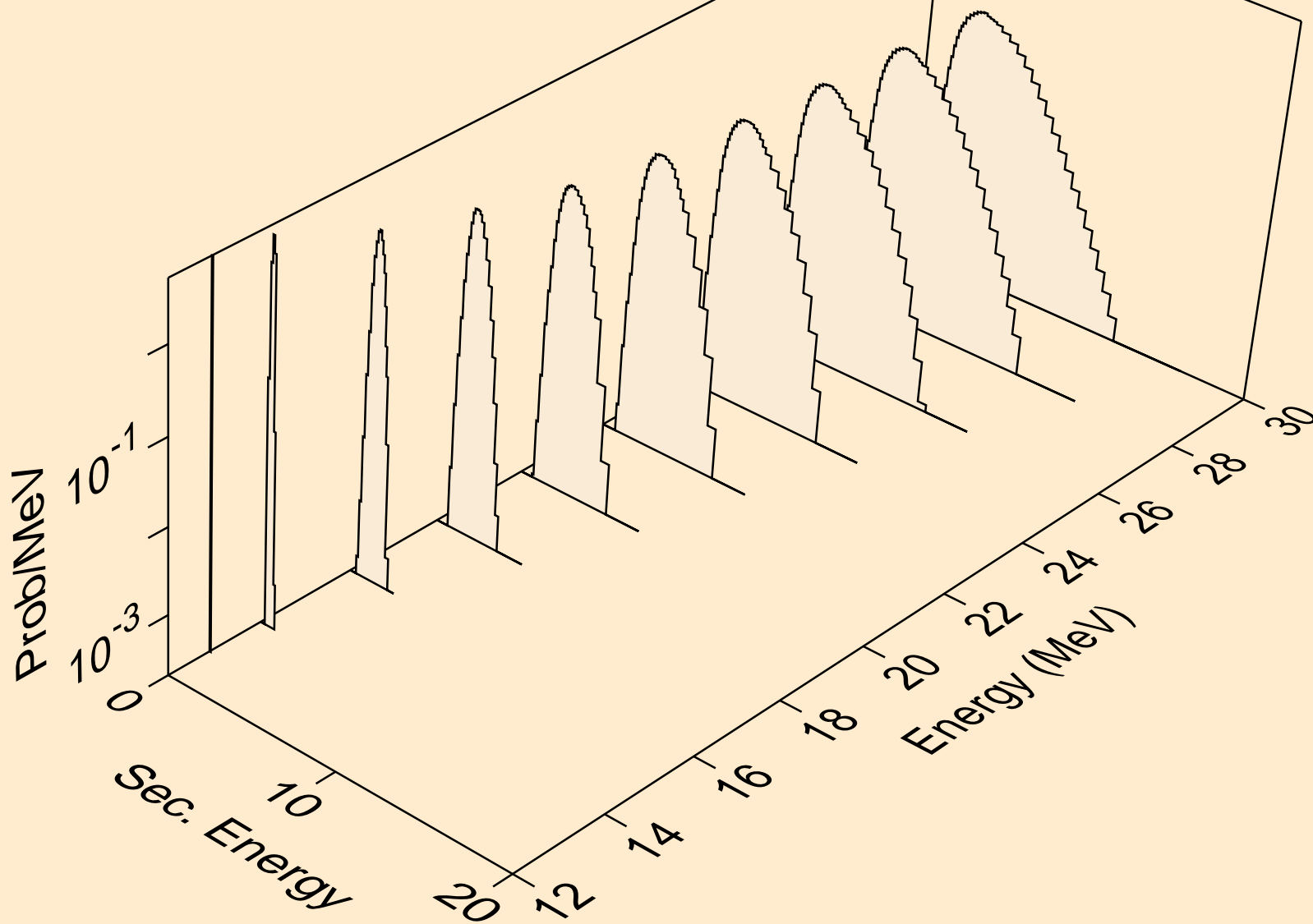

MN051 NEUTRON ACER TENDL-2019 LIBRARY; T=293.16K
protons from (n,pt)

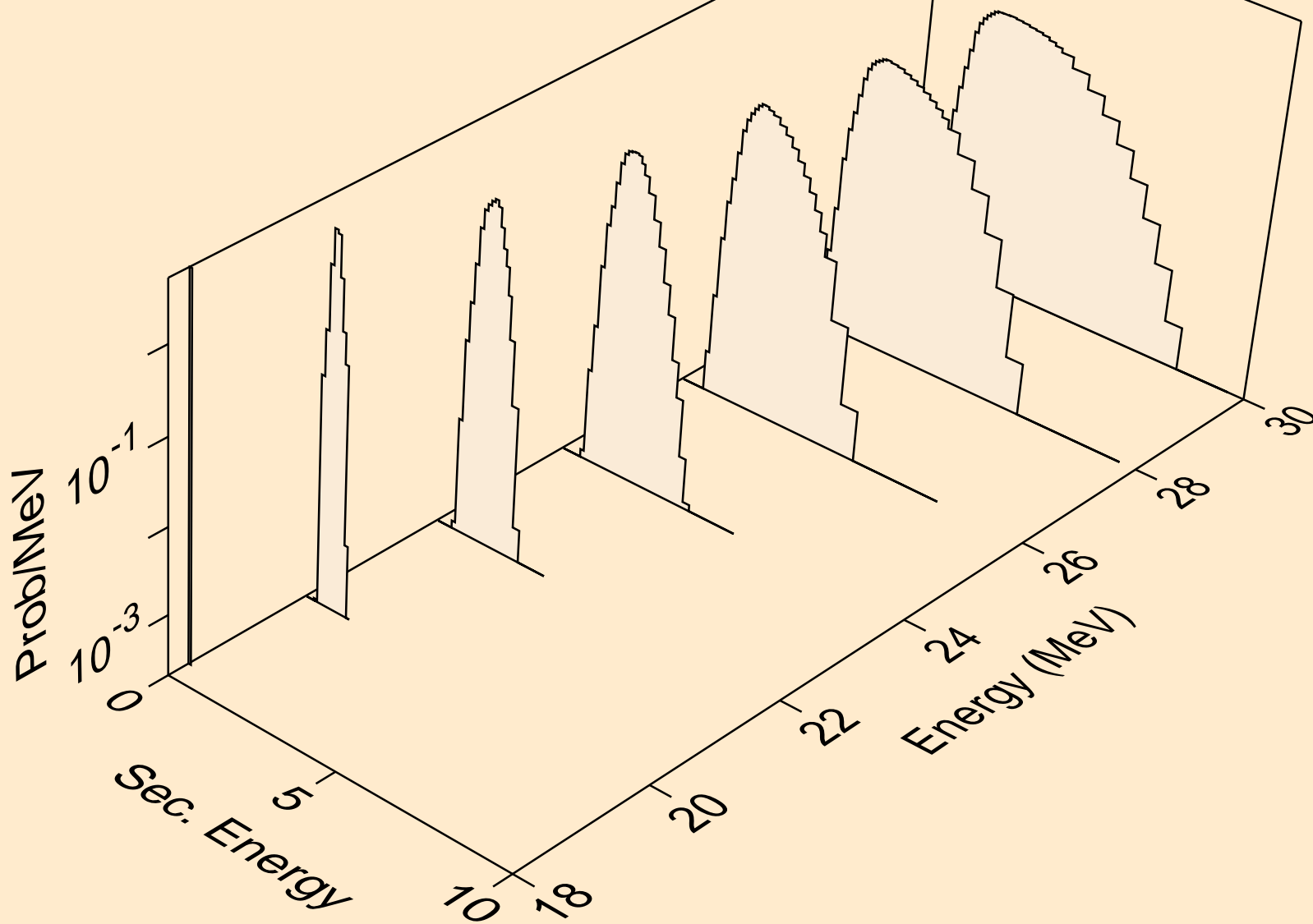

MN051 NEUTRON ACER TENDL-2019 LIBRARY; T=293.16K
deuterons from (n,x)

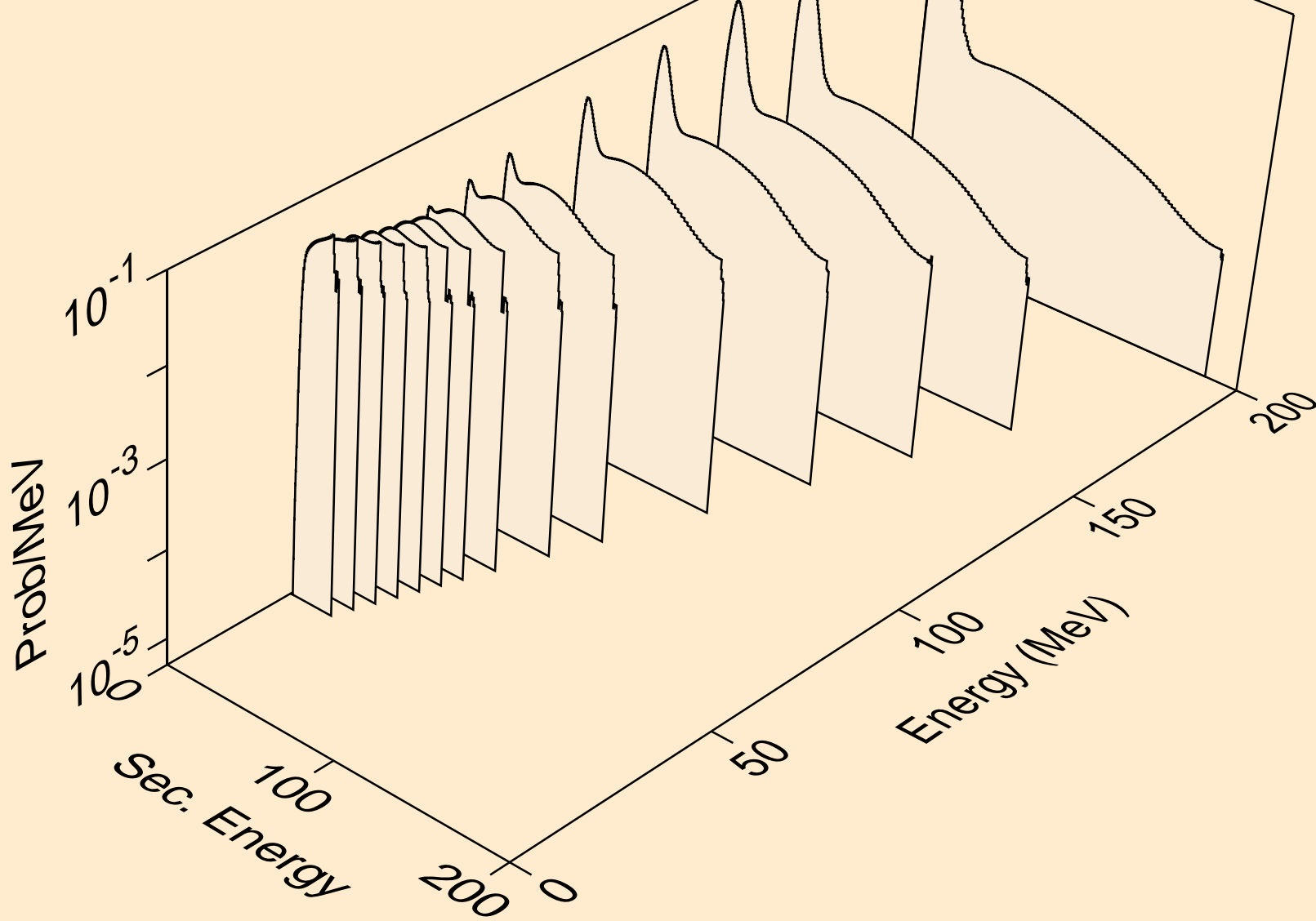

MN051 NEUTRON ACER TENDL-2019 LIBRARY; T=293.16K
deuterons from (n,2nd)

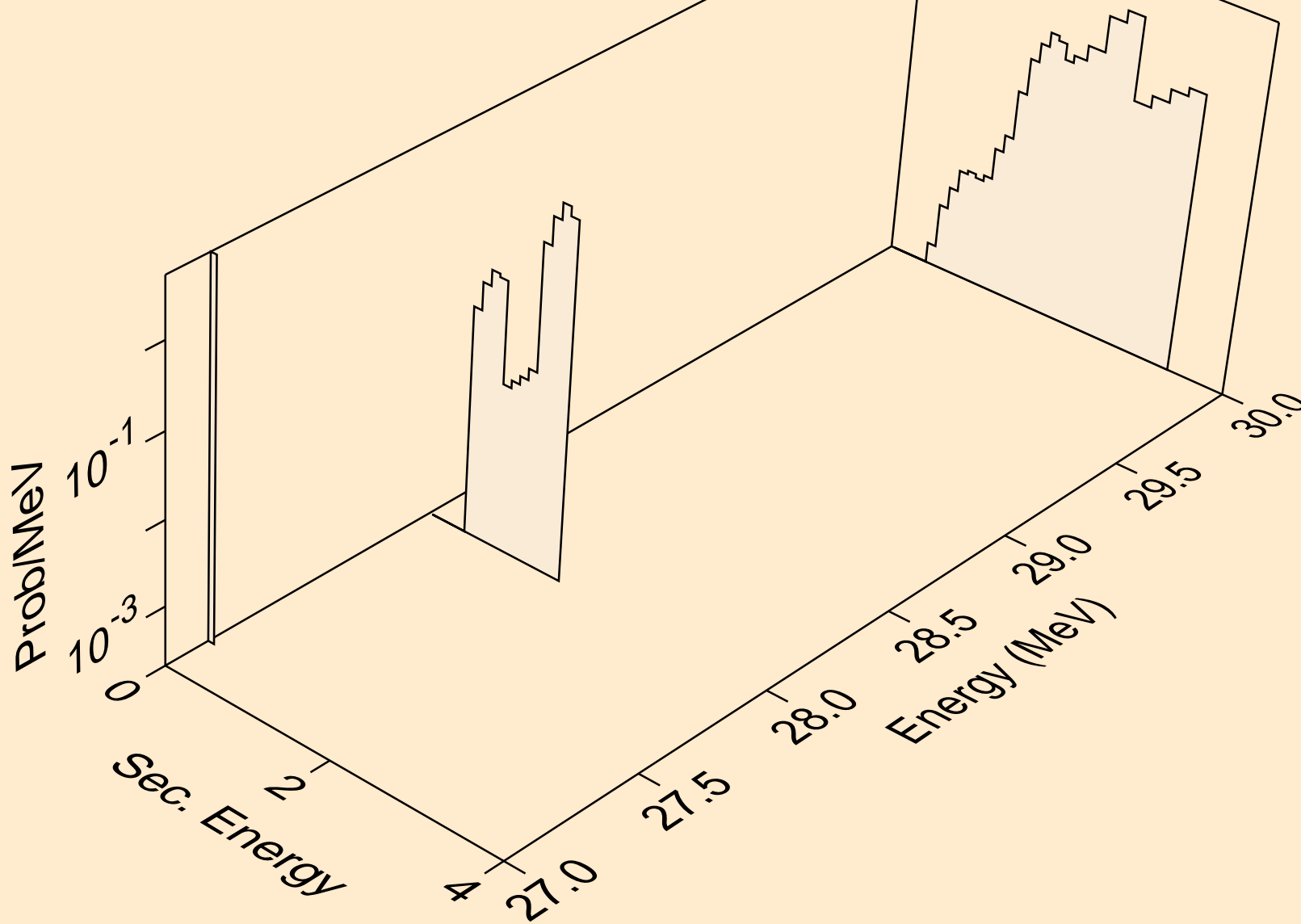

MN051 NEUTRON ACER TENDL-2019 LIBRARY; T=293.16K
deuterons from (n,n*)d

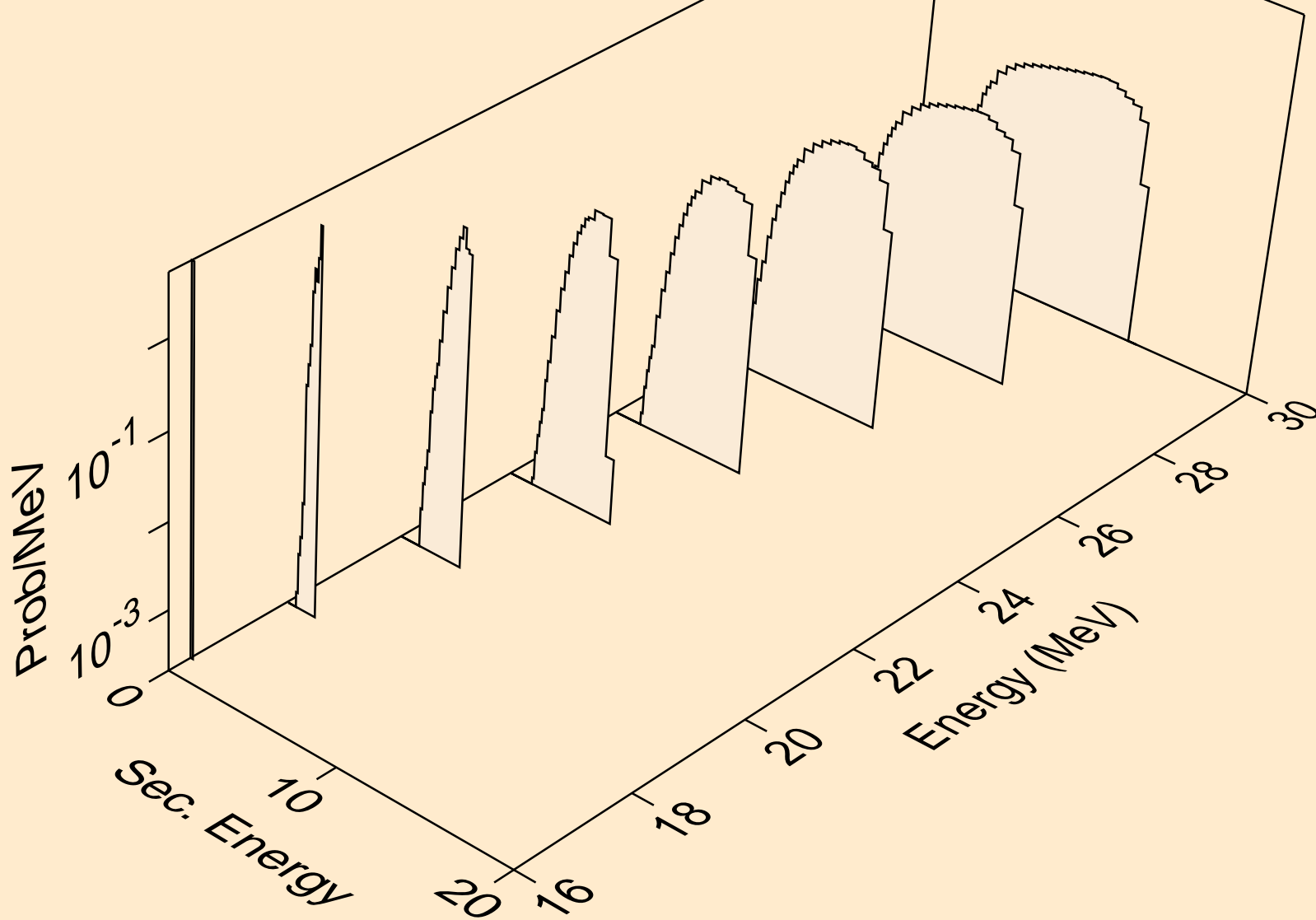

MN051 NEUTRON ACER TENDL-2019 LIBRARY; T=293.16K
deuterons from (n,d)

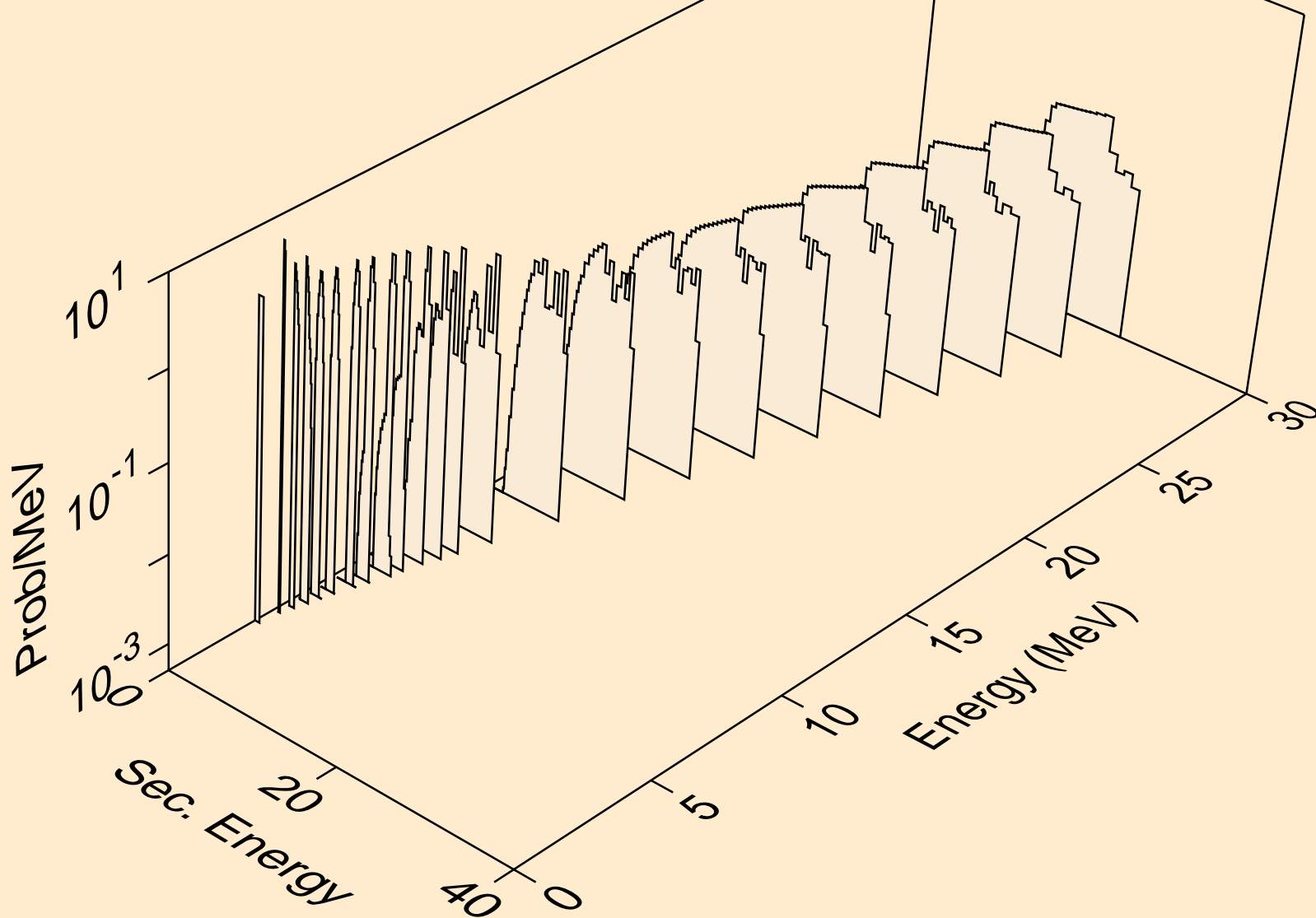

MN051 NEUTRON ACER TENDL-2019 LIBRARY; T=293.16K
deuterons from (n,pd)

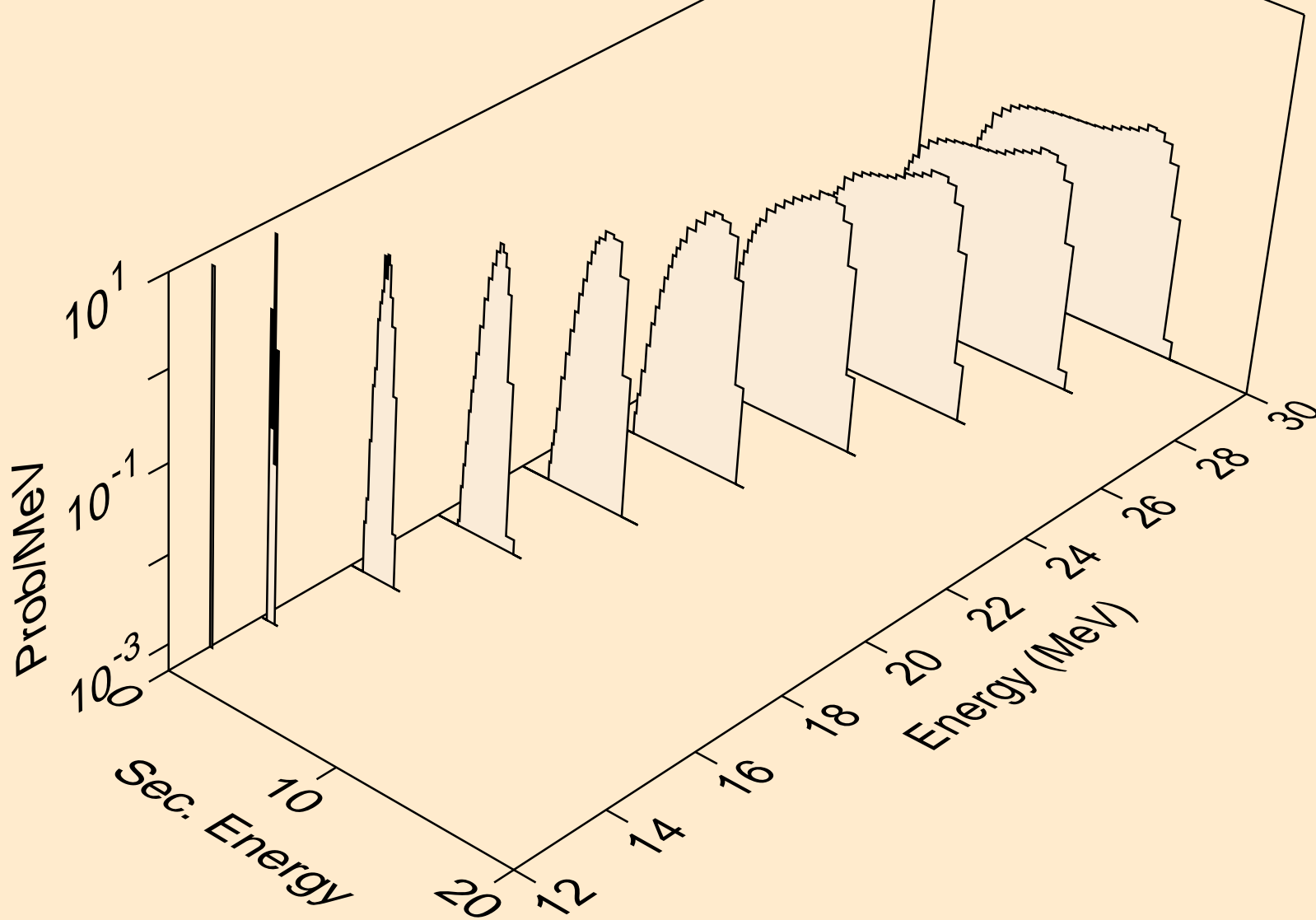

MN051 NEUTRON ACER TENDL-2019 LIBRARY; T=293.16K
deuterons from (n,da)

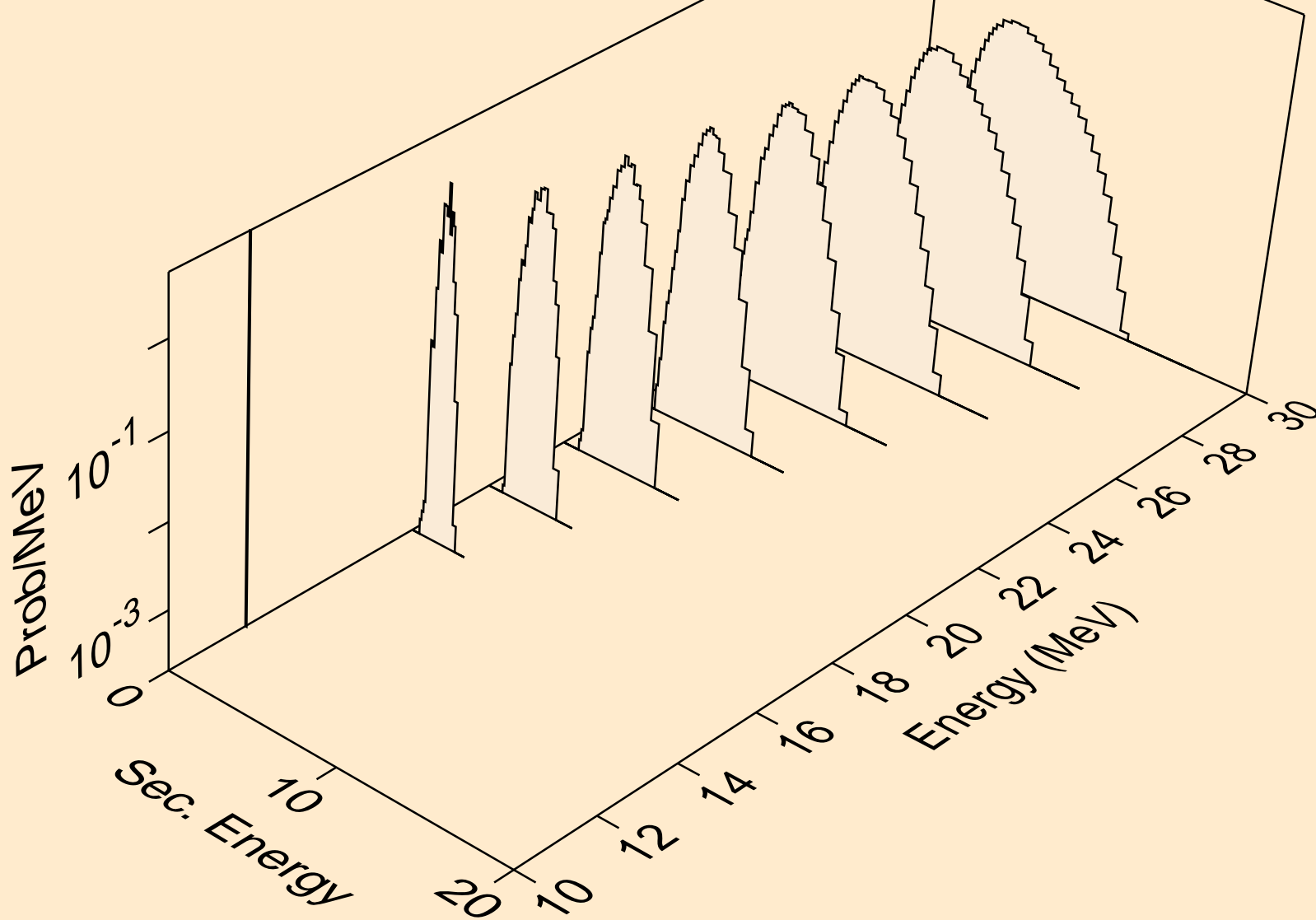

MN051 NEUTRON ACER TENDL-2019 LIBRARY; T=293.16K
tritons from (n,x)

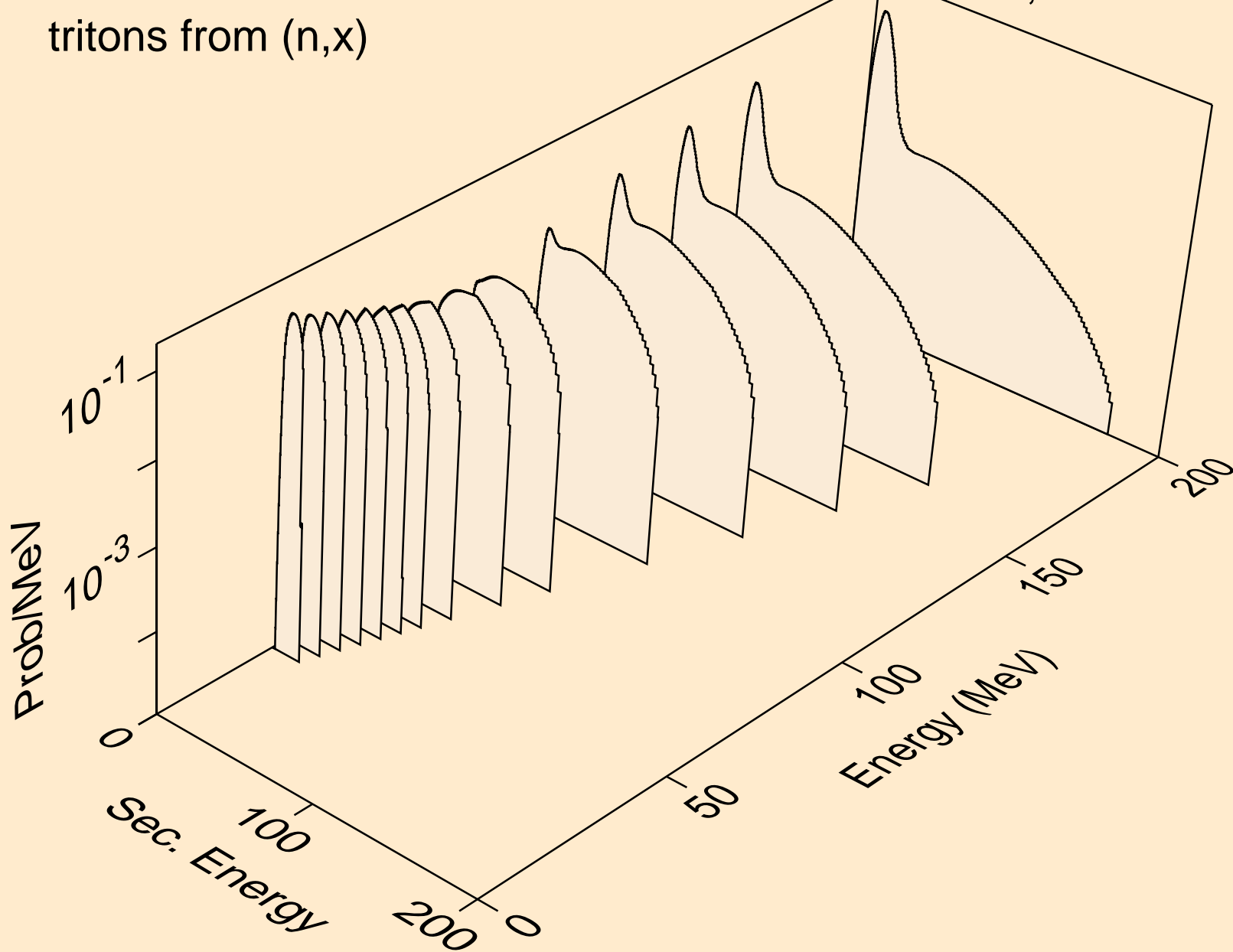

MN051 NEUTRON ACER TENDL-2019 LIBRARY; T=293.16K
tritons from (n,n*)t

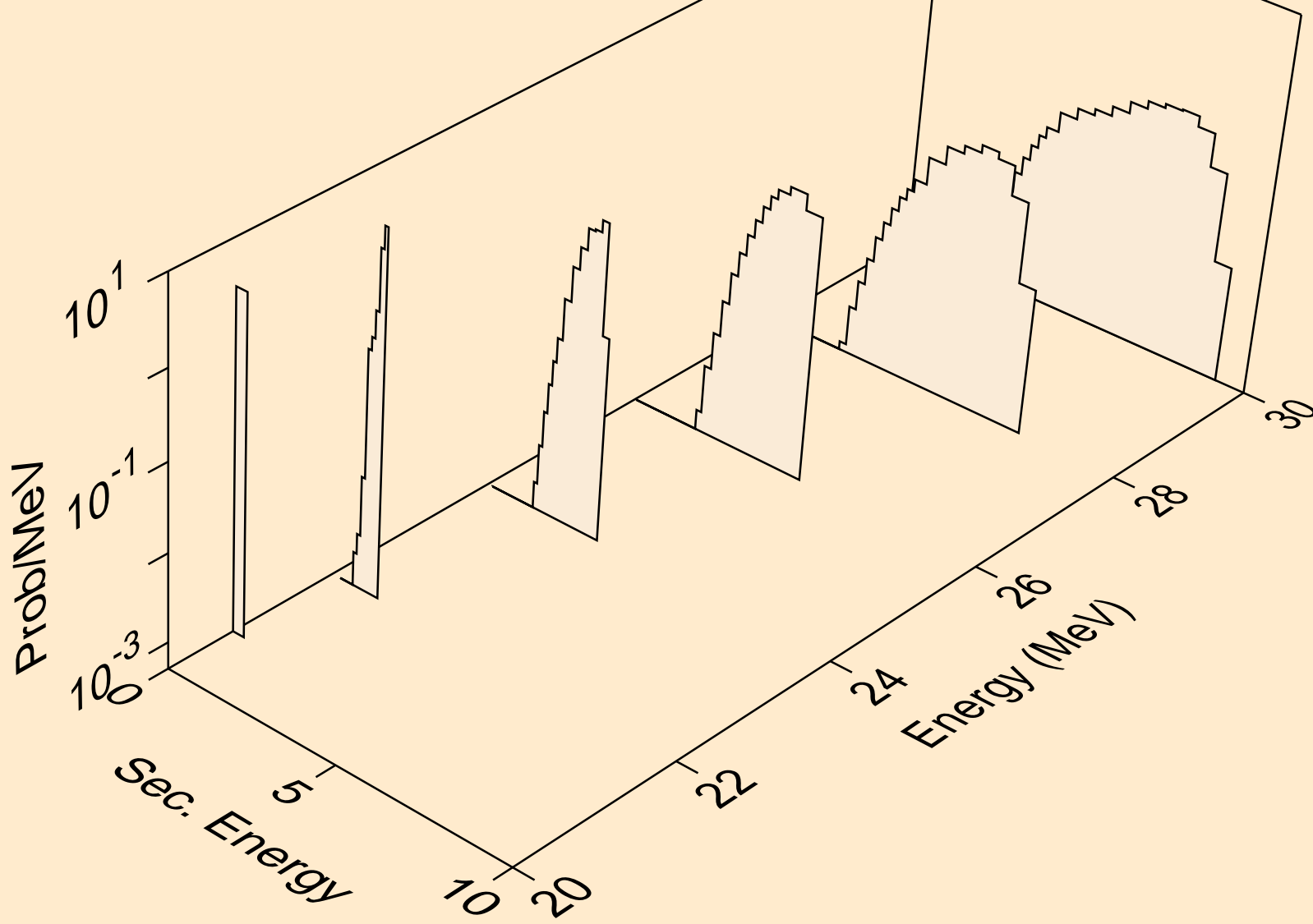

MN051 NEUTRON ACER TENDL-2019 LIBRARY; T=293.16K
tritons from (n,t)

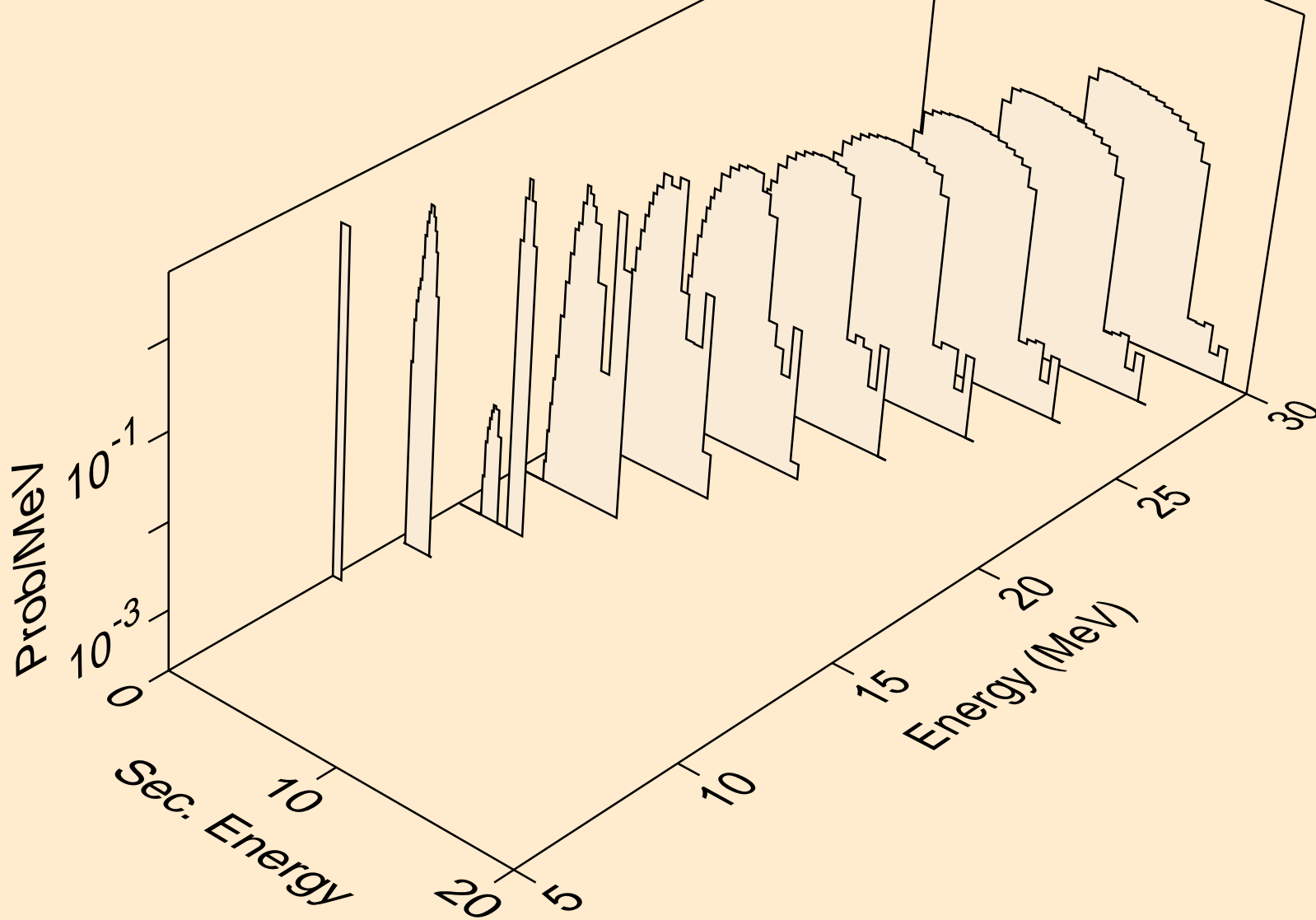

MN051 NEUTRON ACER TENDL-2019 LIBRARY; T=293.16K
tritons from (n,pt)

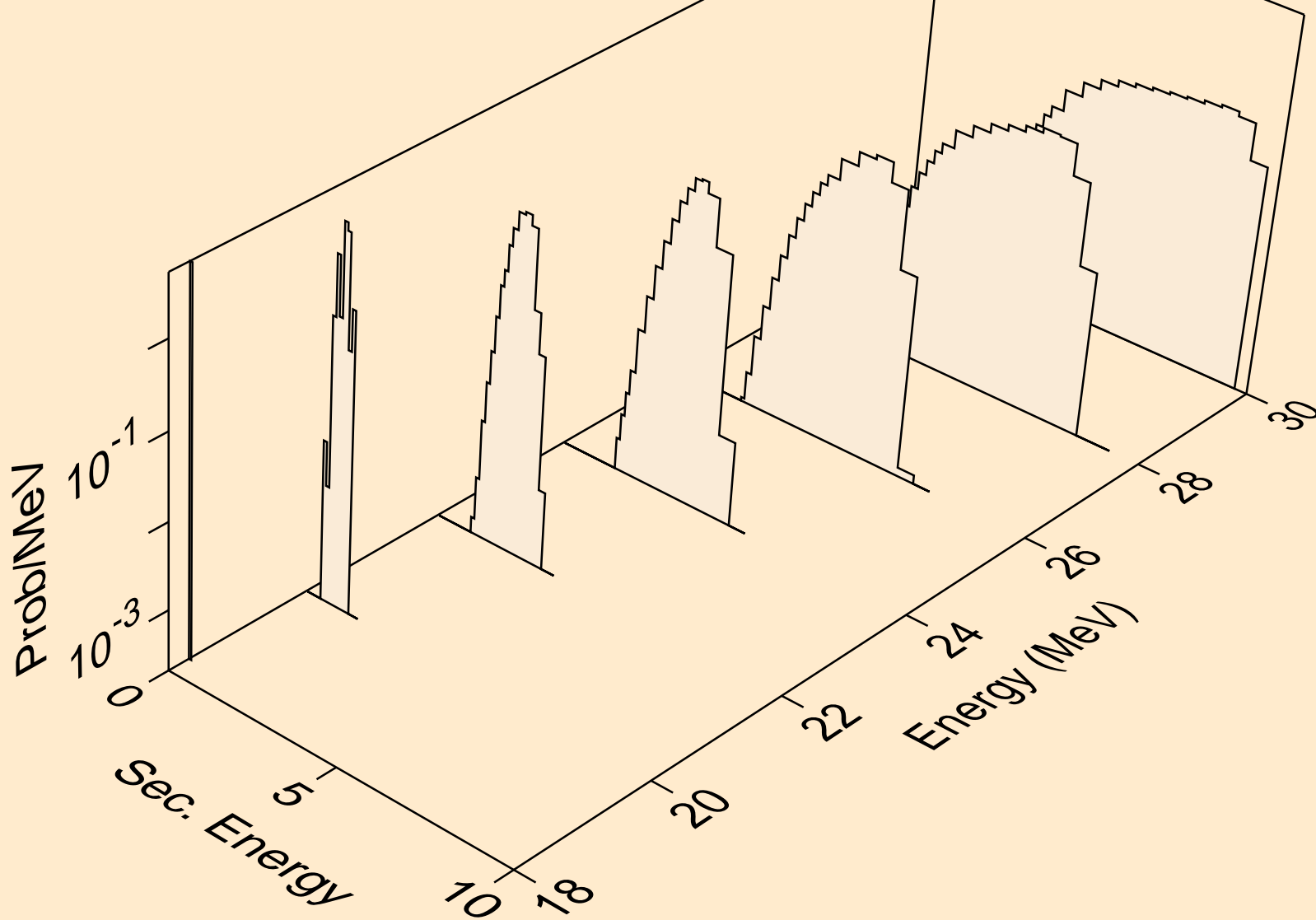

MN051 NEUTRON ACER TENDL-2019 LIBRARY; T=293.16K
he3s from (n,x)

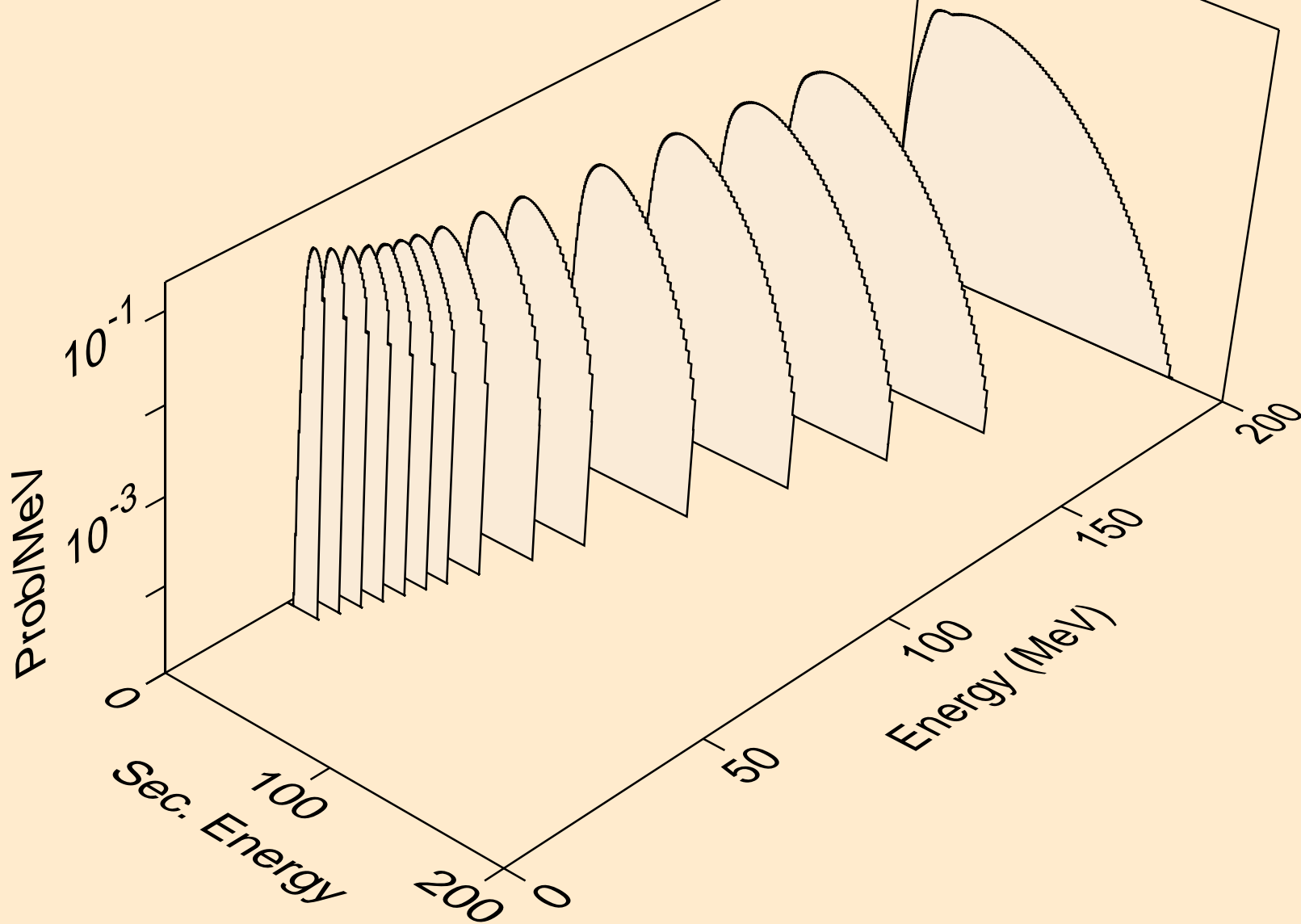

MN051 NEUTRON ACER TENDL-2019 LIBRARY; T=293.16K
he3s from (n,n*)he3

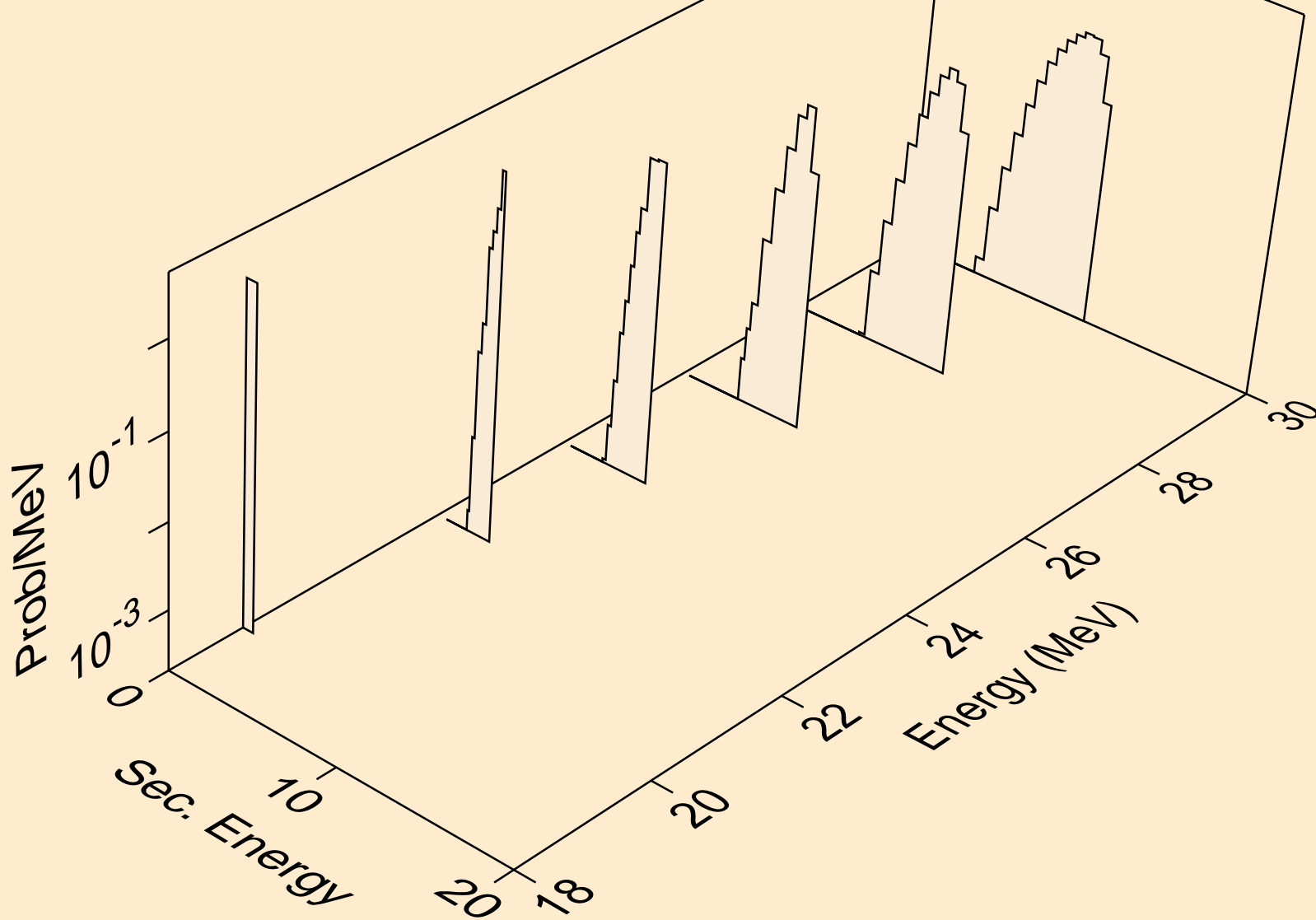

MN051 NEUTRON ACER TENDL-2019 LIBRARY; T=293.16K
he3s from (n,he3)

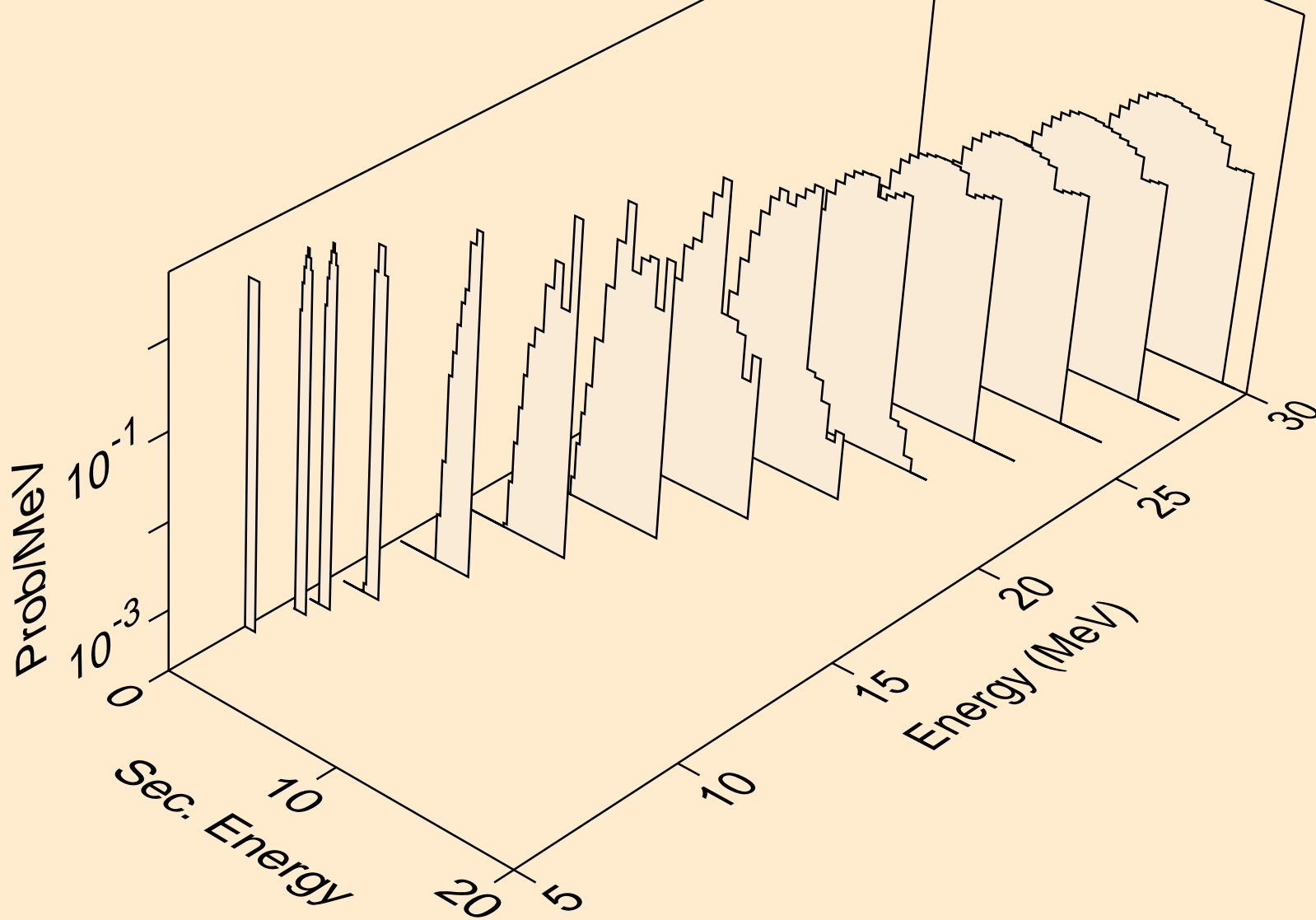

MN051 NEUTRON ACER TENDL-2019 LIBRARY; T=293.16K
alphas from (n,x)

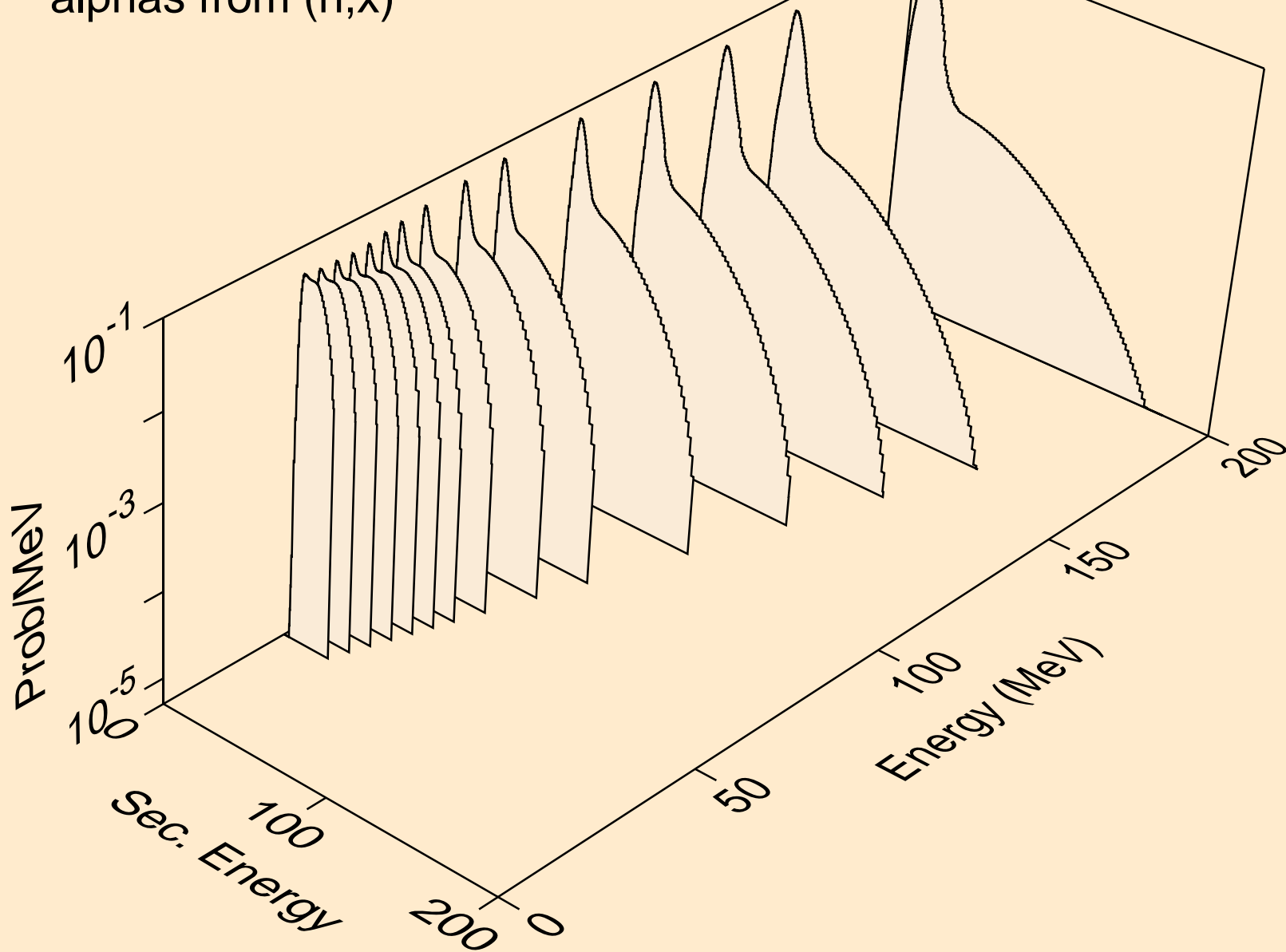

MN051 NEUTRON ACER TENDL-2019 LIBRARY; T=293.16K
alphas from (n,n*)a

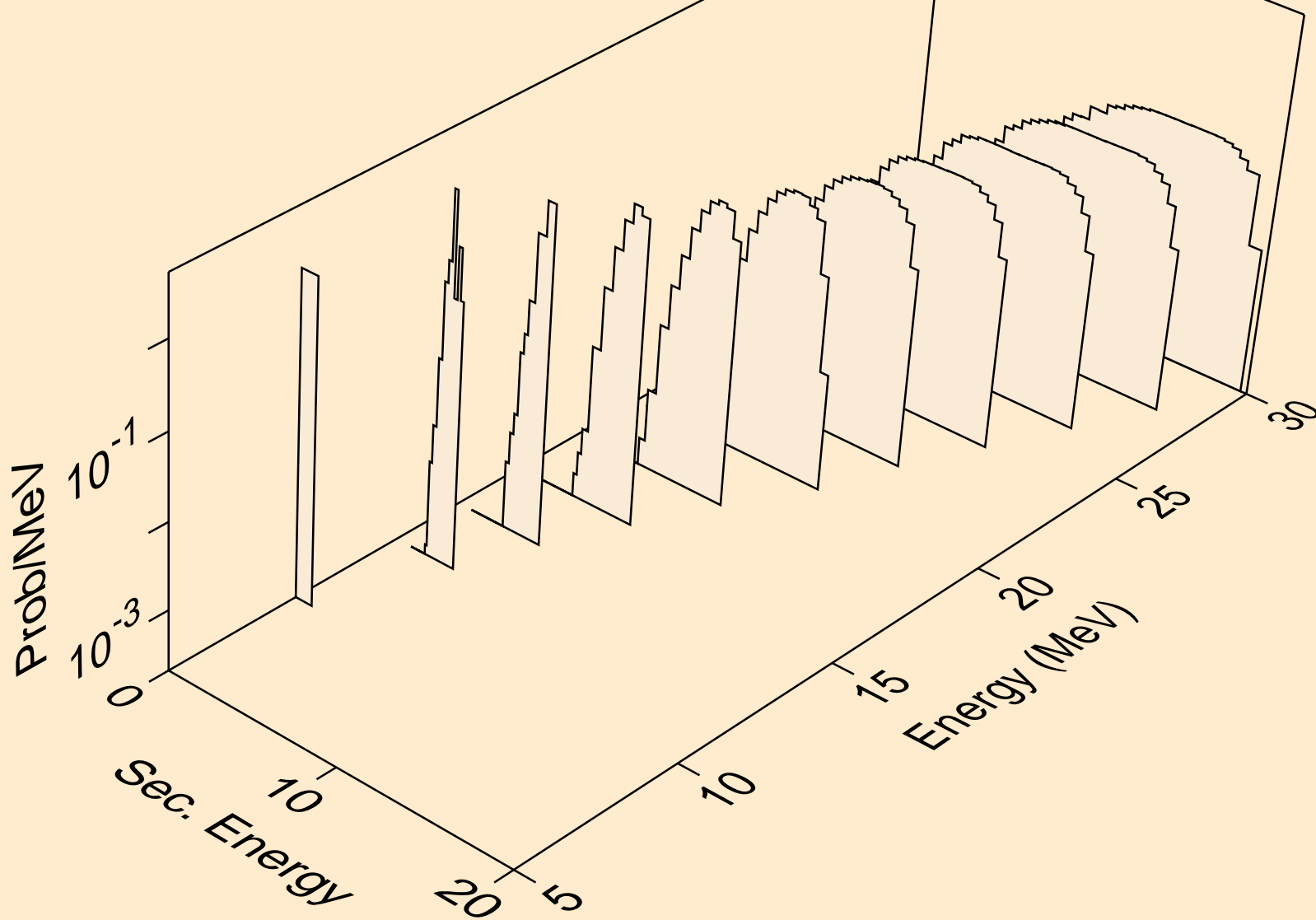

MN051 NEUTRON ACER TENDL-2019 LIBRARY; T=293.16K
alphas from (n,2n)a

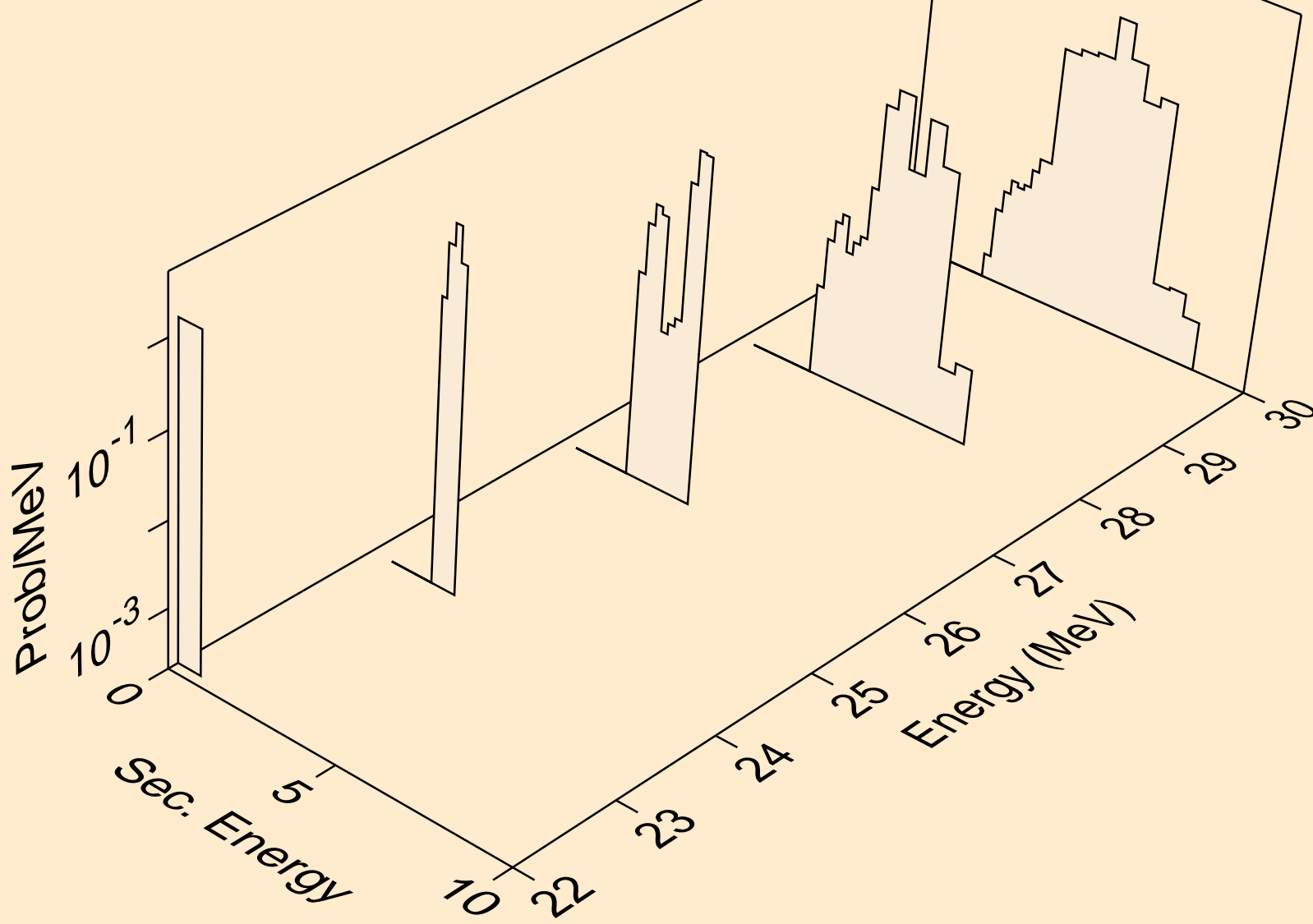

MN051 NEUTRON ACER TENDL-2019 LIBRARY; T=293.16K
alphas from (n,n*)2a

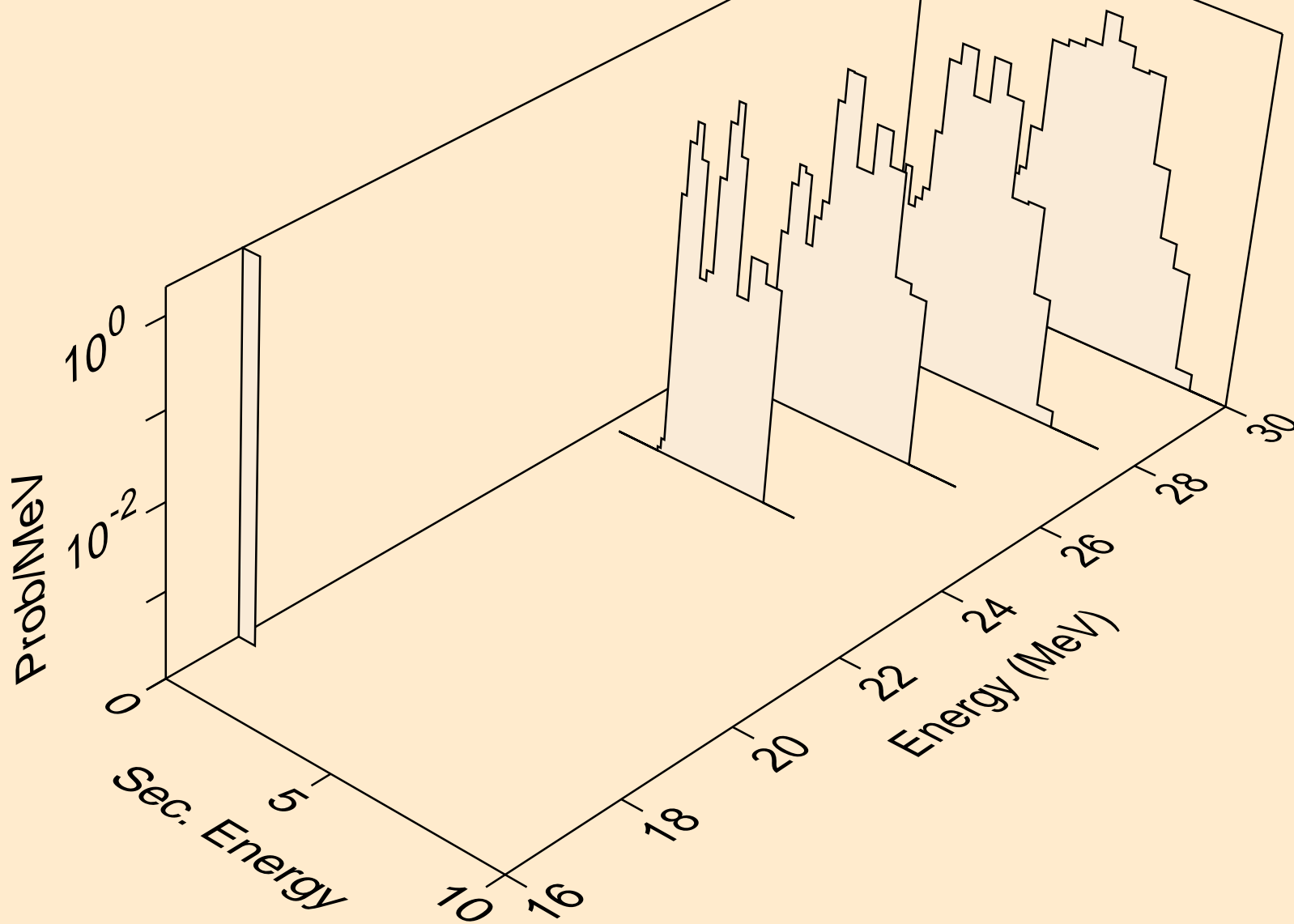

MN051 NEUTRON ACER TENDL-2019 LIBRARY; T=293.16K
alphas from (n,npa)

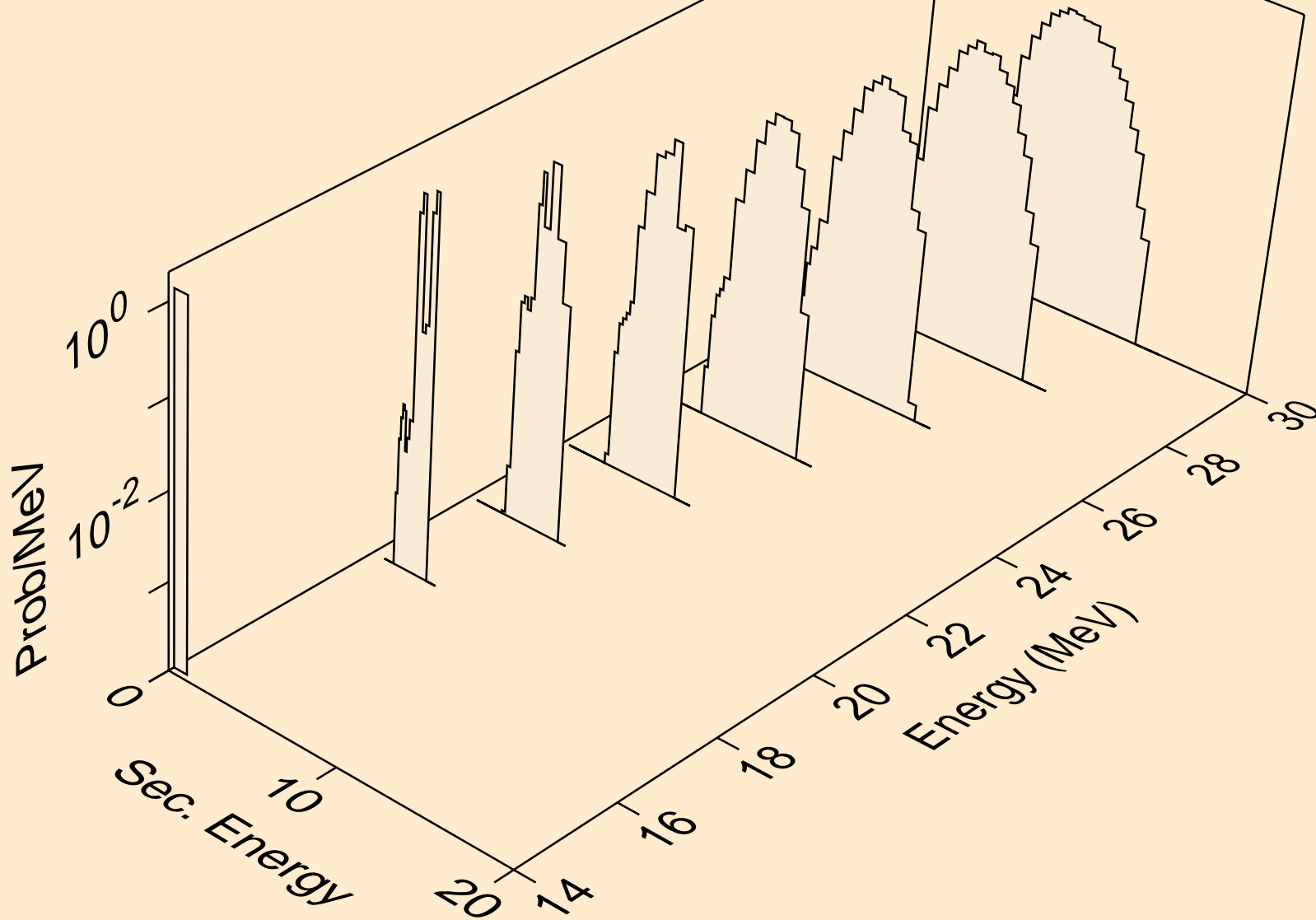

MN051 NEUTRON ACER TENDL-2019 LIBRARY; T=293.16K
alphas from (n,a)

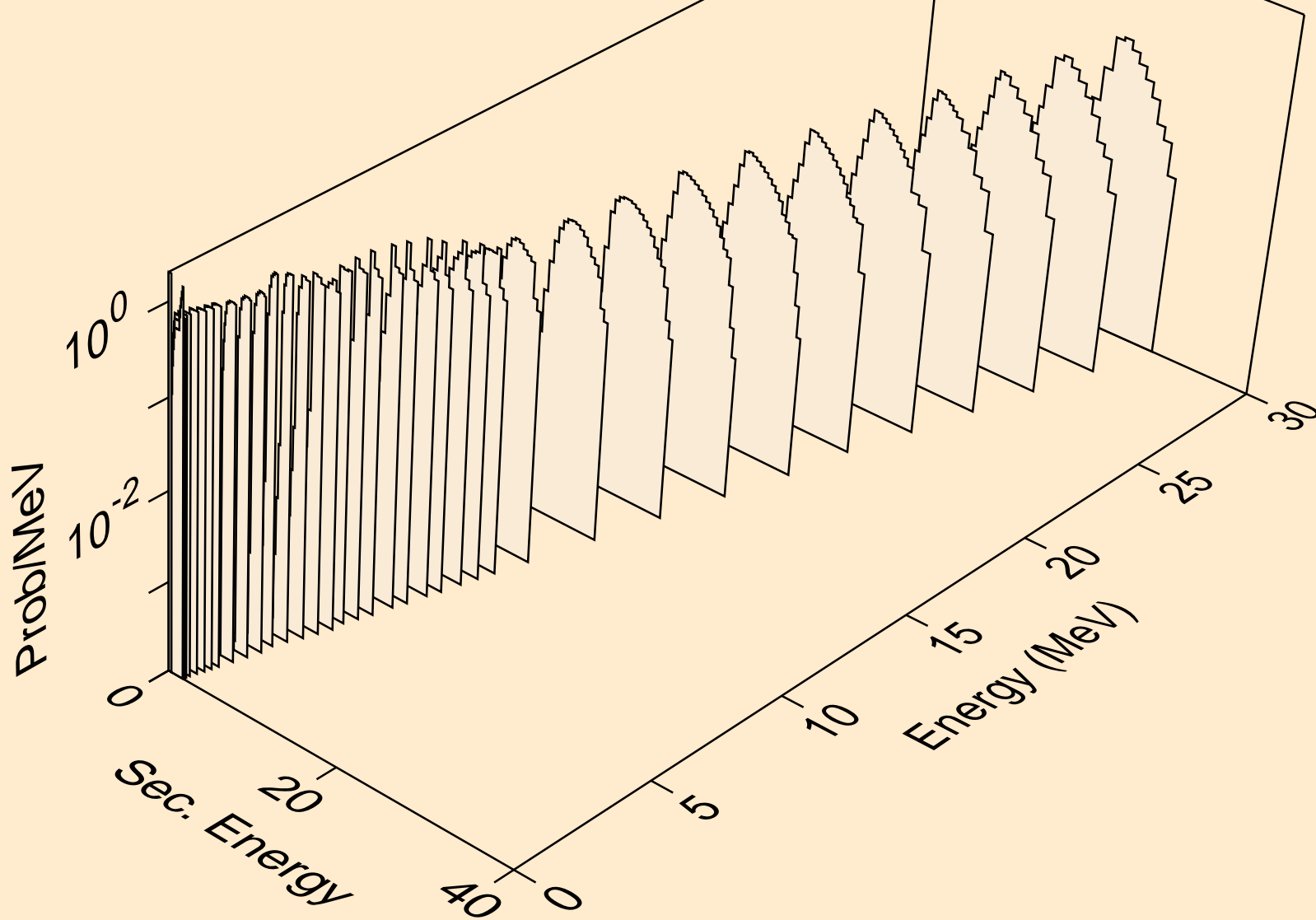

MN051 NEUTRON ACER TENDL-2019 LIBRARY; T=293.16K
alphas from (n,2a)

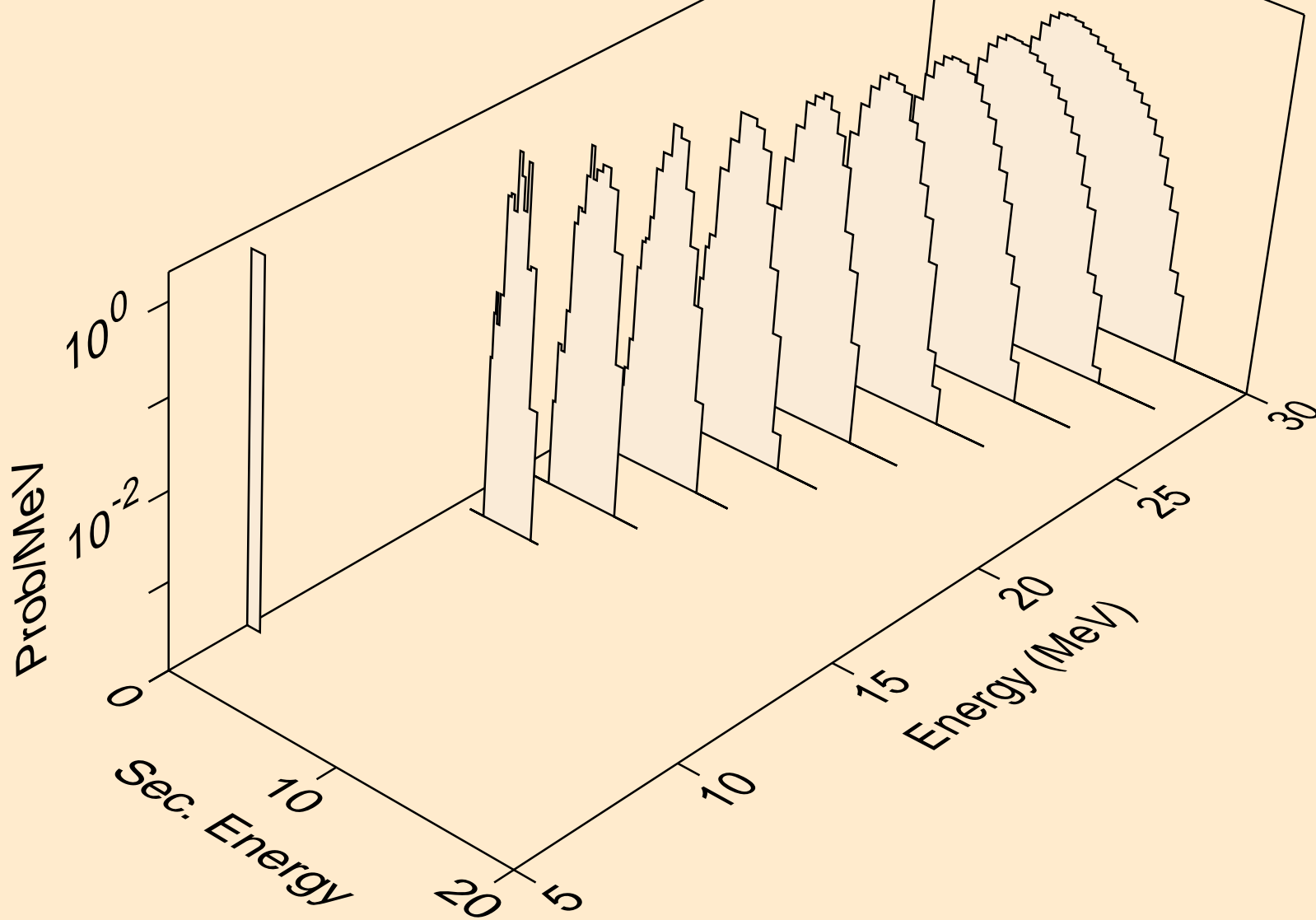

MN051 NEUTRON ACER TENDL-2019 LIBRARY; T=293.16K
alphas from (n,pa)

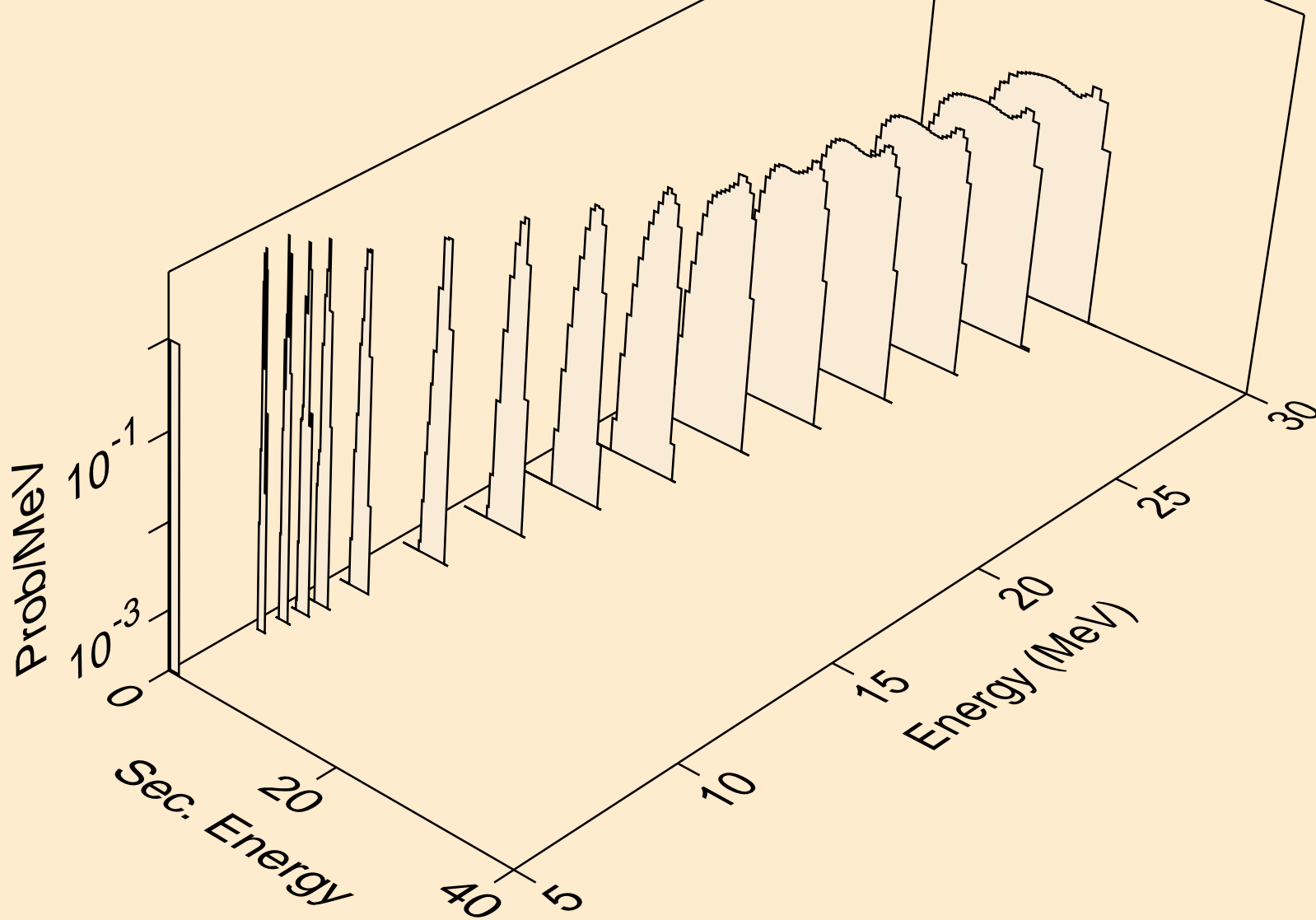

MN051 NEUTRON ACER TENDL-2019 LIBRARY; T=293.16K
alphas from (n,da)

