

MO085 NEUTRON ACER TENDL-2019 LIBRARY; T=293.16K
Principal cross sections

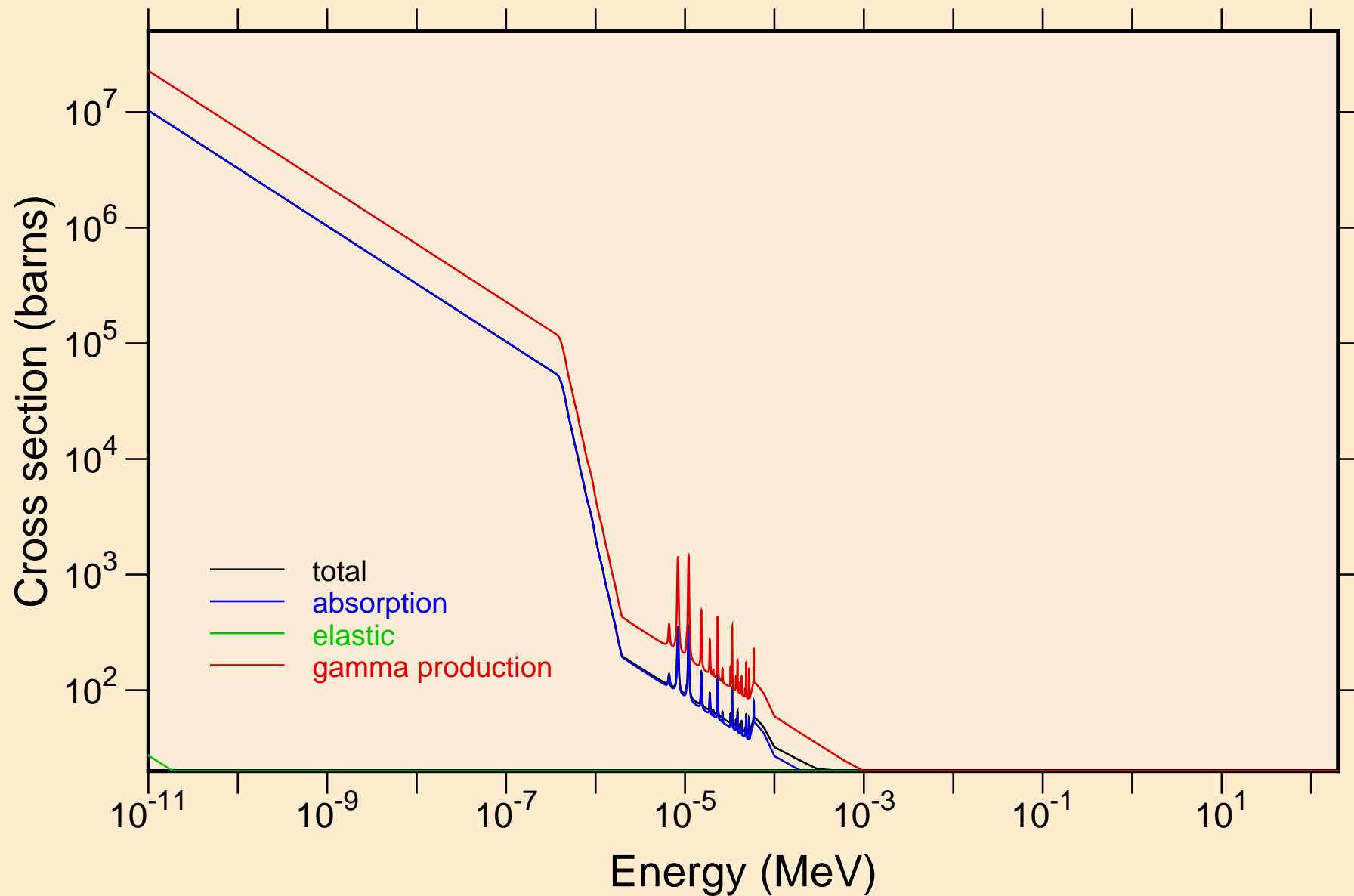

MO085 NEUTRON ACER TENDL-2019 LIBRARY; T=293.16K
resonance total cross section

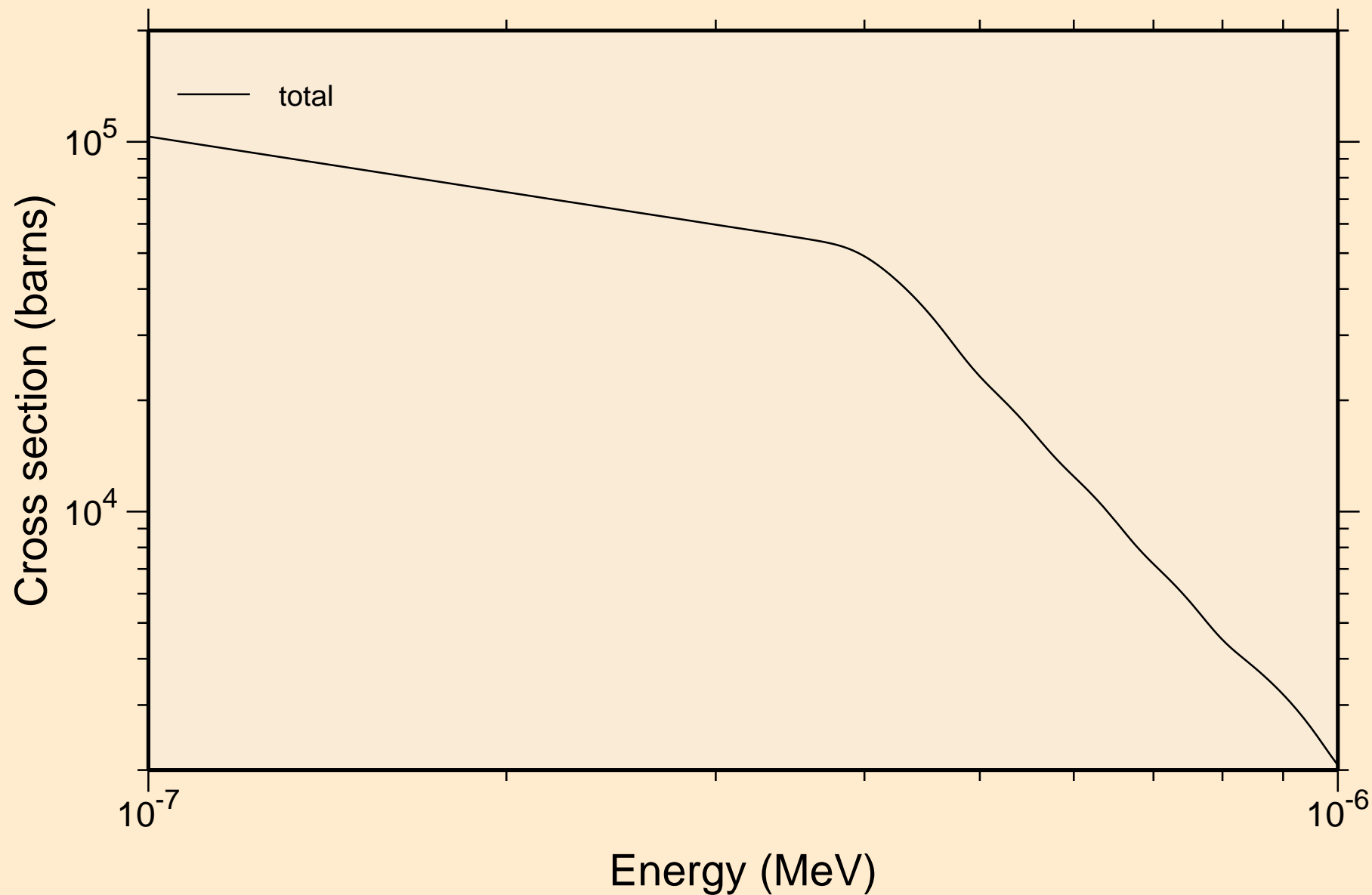

MO085 NEUTRON ACER TENDL-2019 LIBRARY; T=293.16K
resonance total cross section

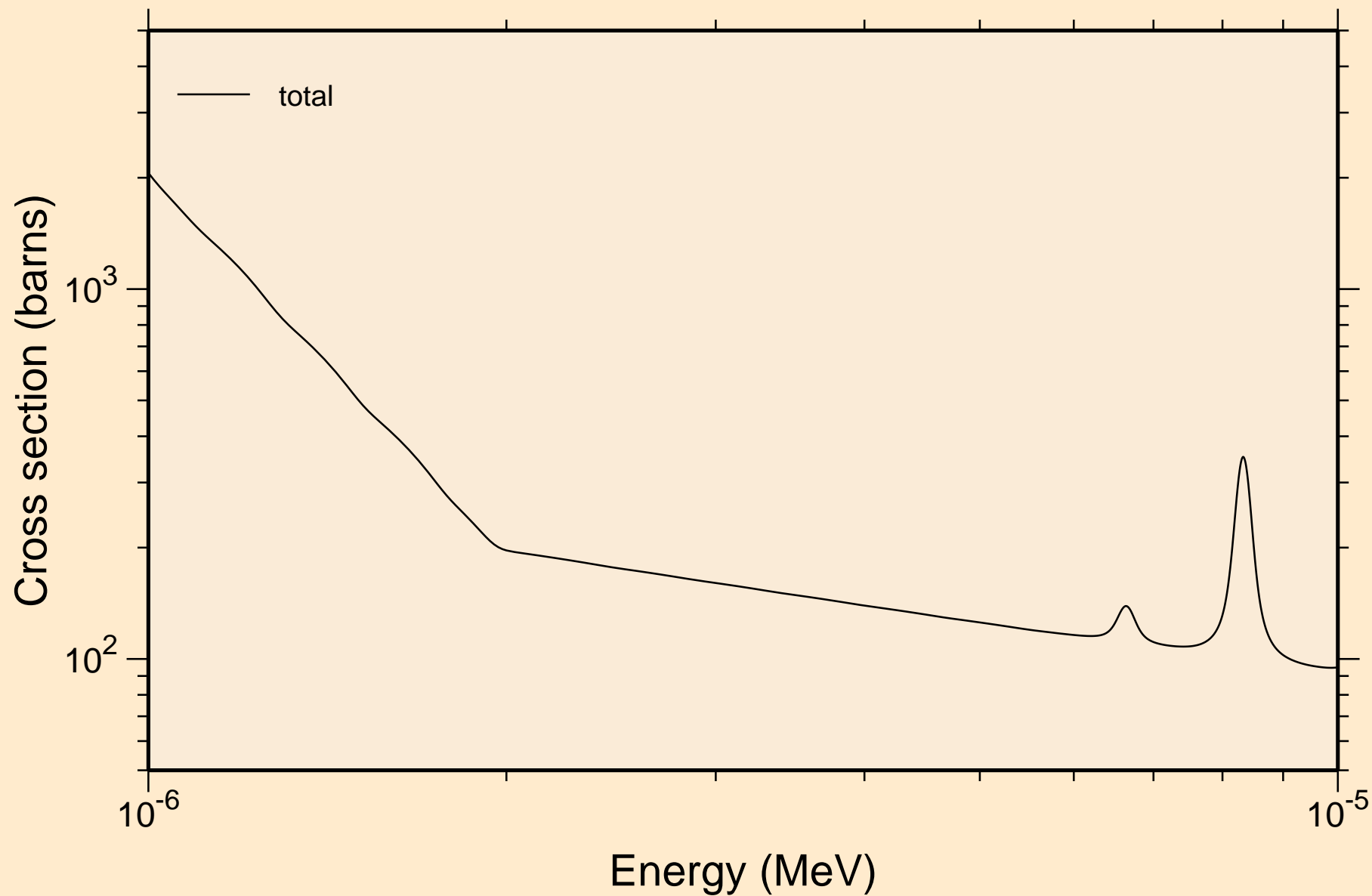

MO085 NEUTRON ACER TENDL-2019 LIBRARY; T=293.16K
resonance total cross section

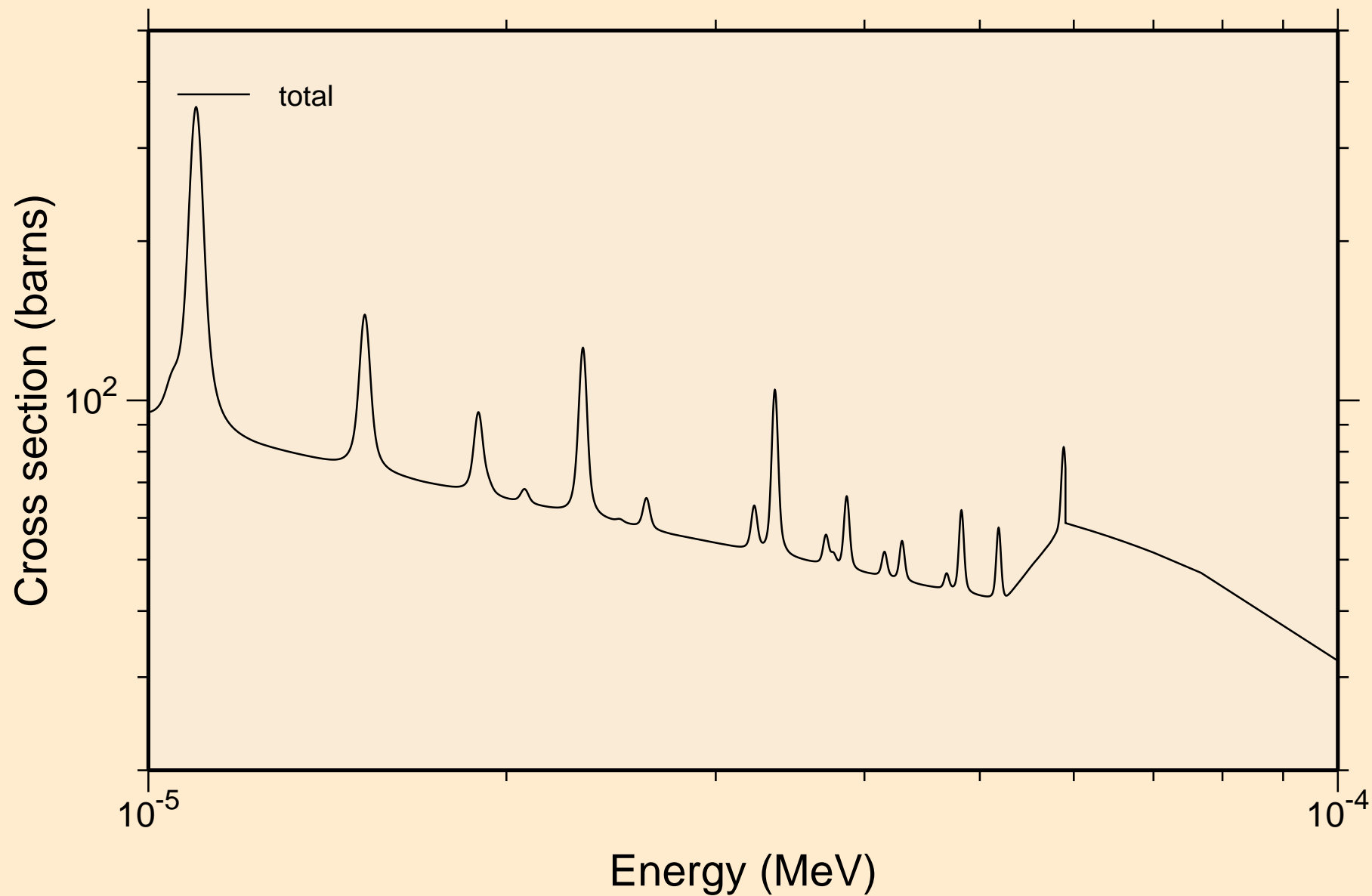

M0085 NEUTRON ACER TENDL-2019 LIBRARY; T=293.16K
resonance total cross section

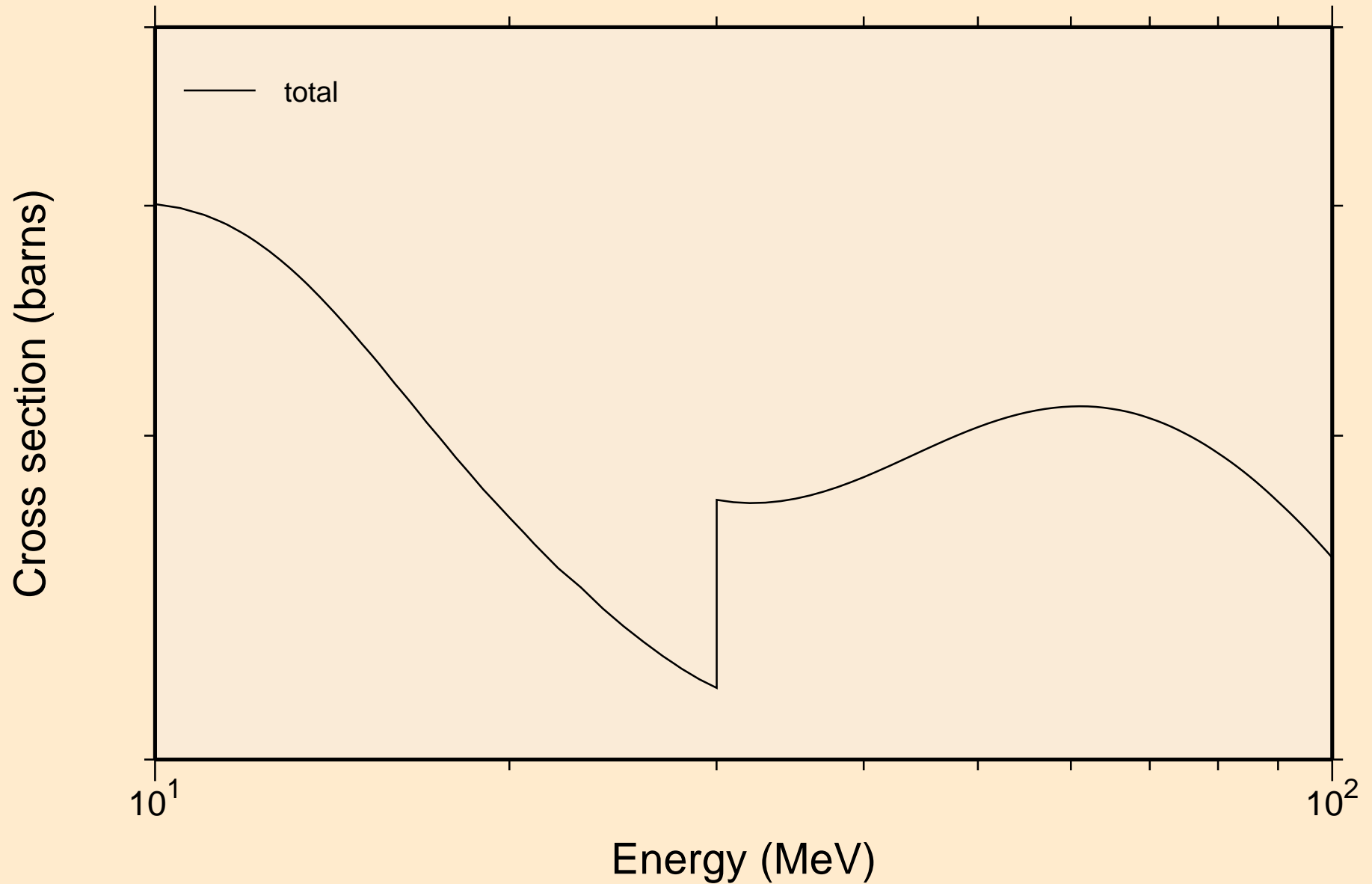

MO085 NEUTRON ACER TENDL-2019 LIBRARY; T=293.16K
resonance absorption cross sections

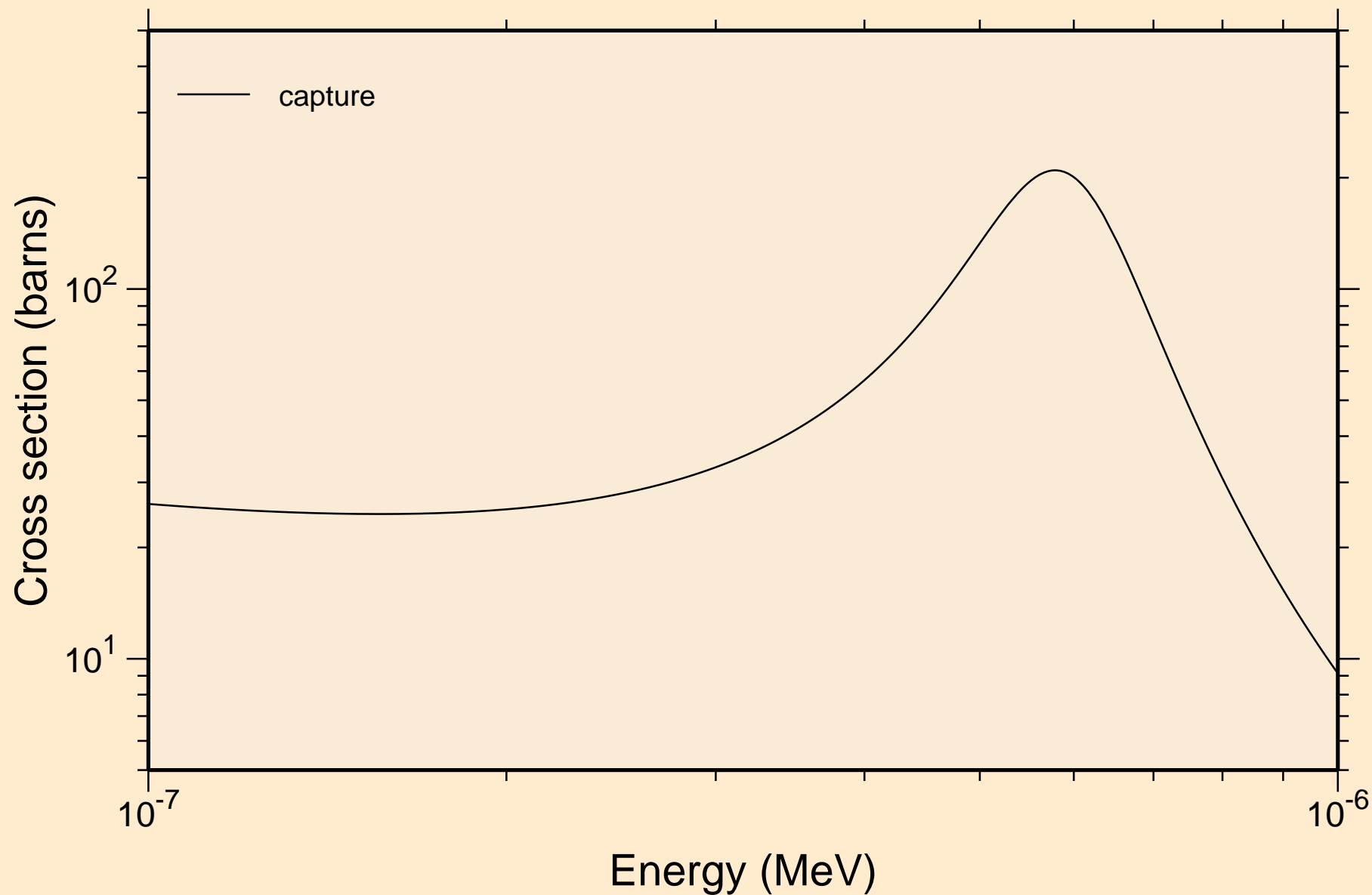

MO085 NEUTRON ACER TENDL-2019 LIBRARY; T=293.16K
resonance absorption cross sections

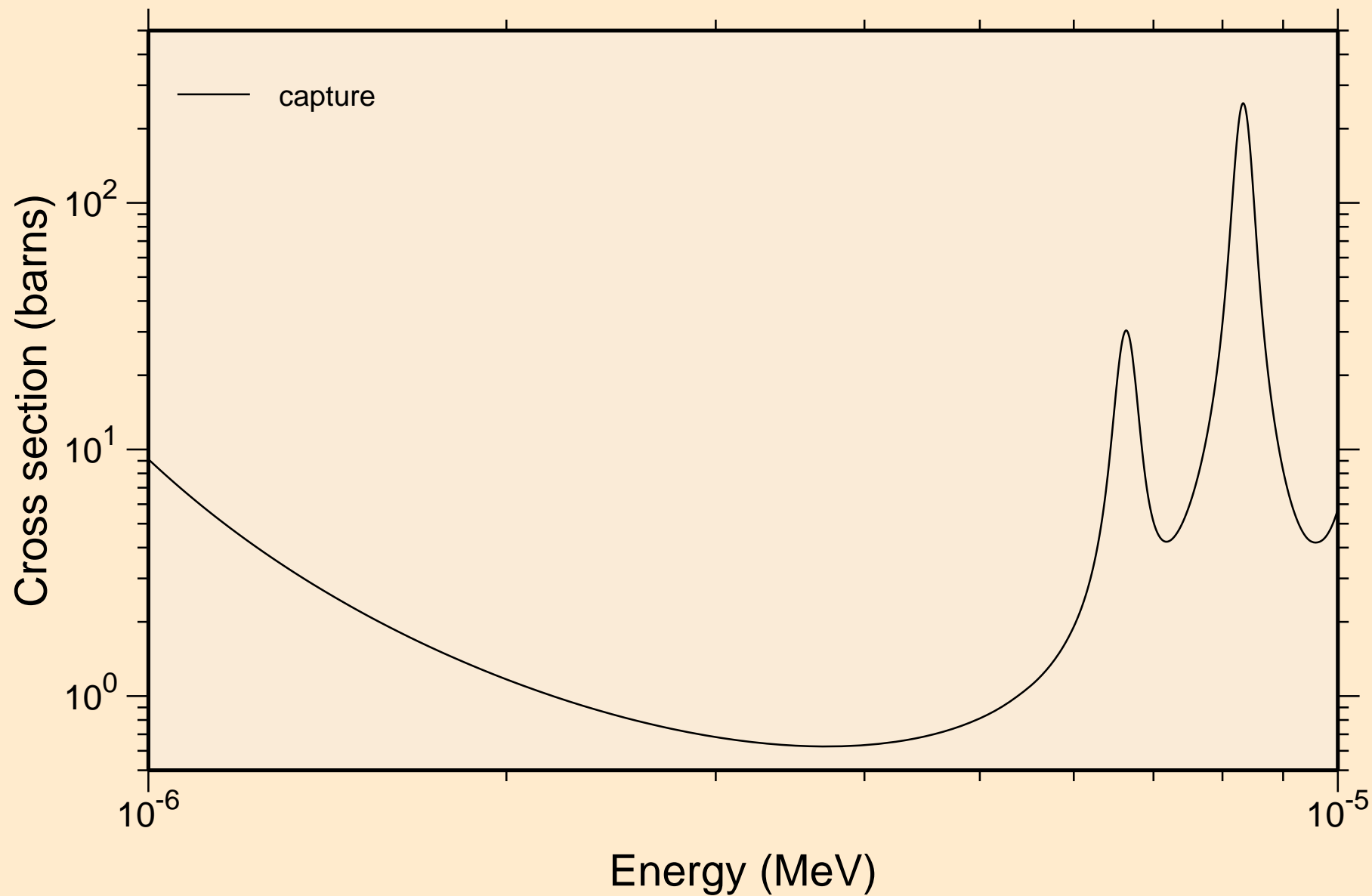

MO085 NEUTRON ACER TENDL-2019 LIBRARY; T=293.16K
resonance absorption cross sections

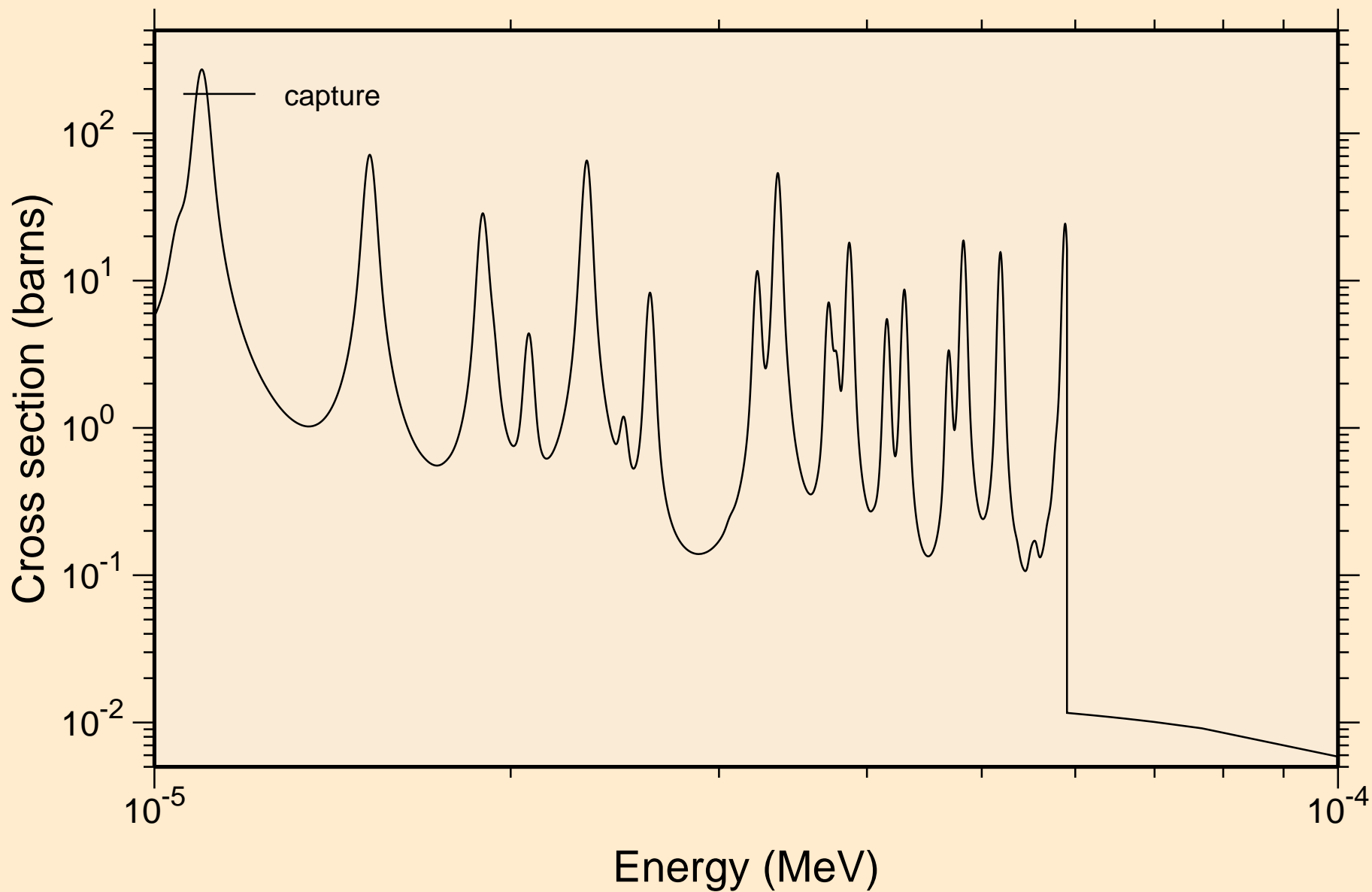

MO085 NEUTRON ACER TENDL-2019 LIBRARY; T=293.16K
resonance absorption cross sections

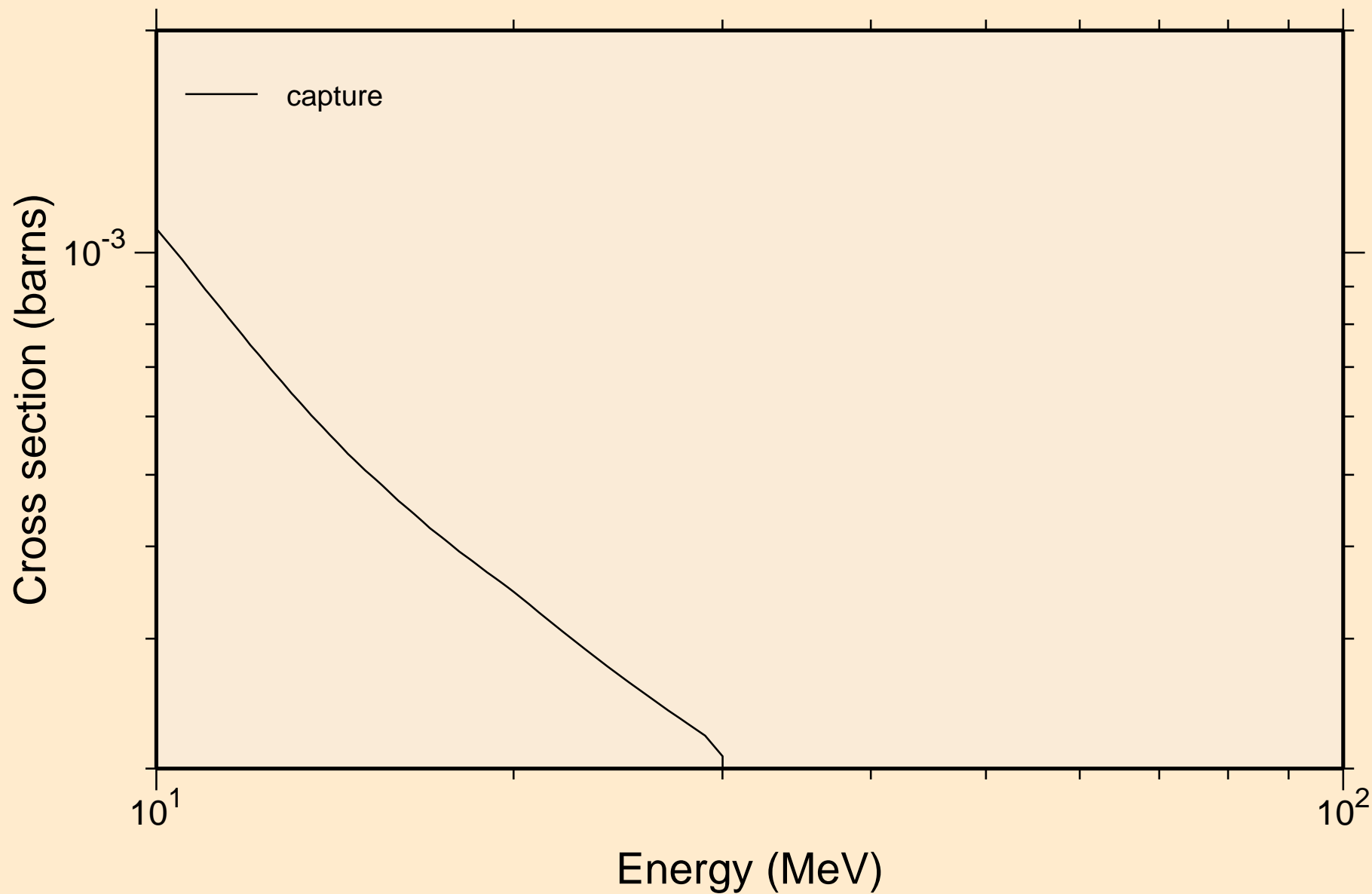

MO085 NEUTRON ACER TENDL-2019 LIBRARY; T=293.16K
Heating

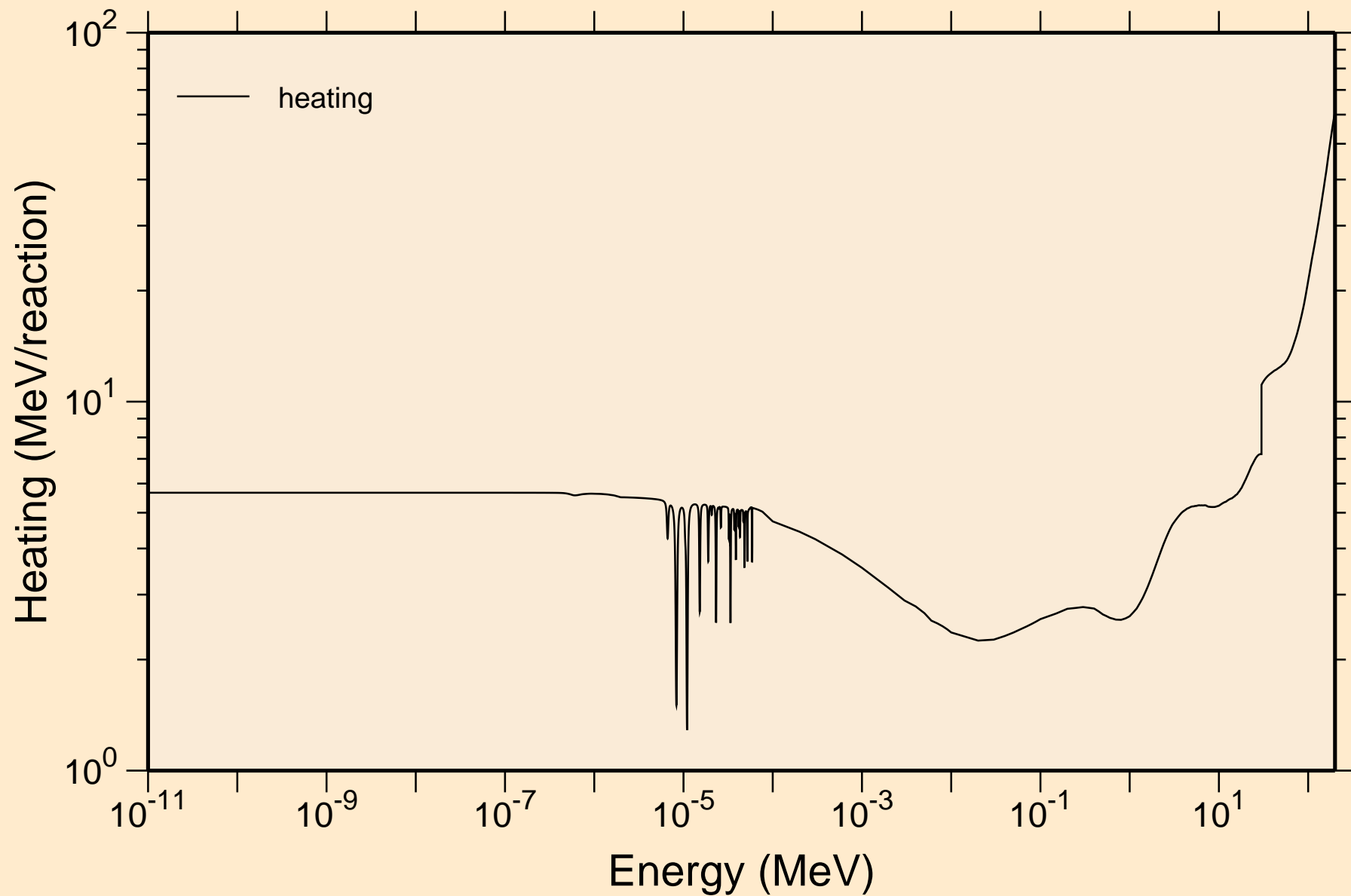

MO085 NEUTRON ACER TENDL-2019 LIBRARY; T=293.16K
Damage

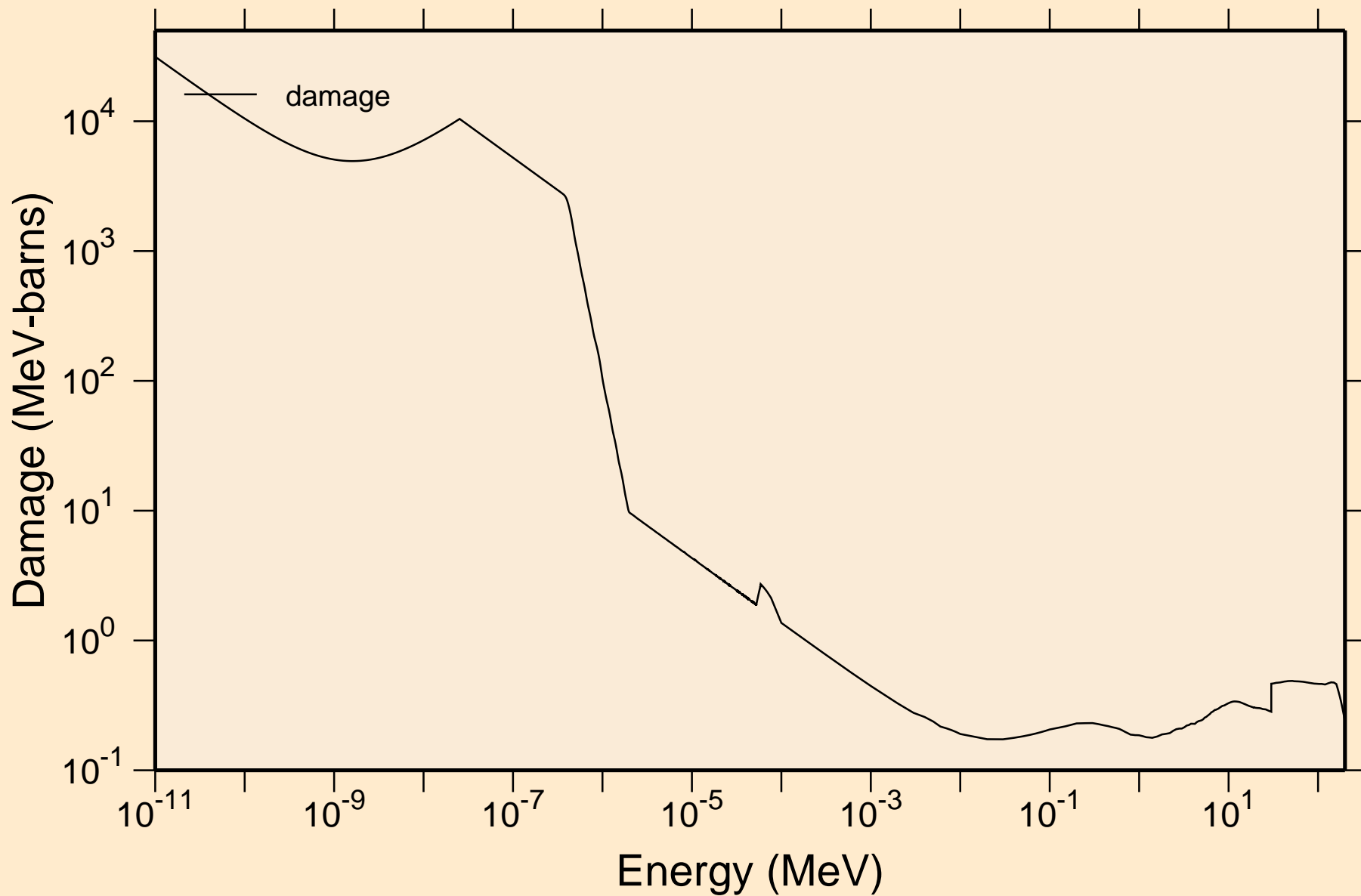

MO085 NEUTRON ACER TENDL-2019 LIBRARY; T=293.16K
Non-threshold reactions

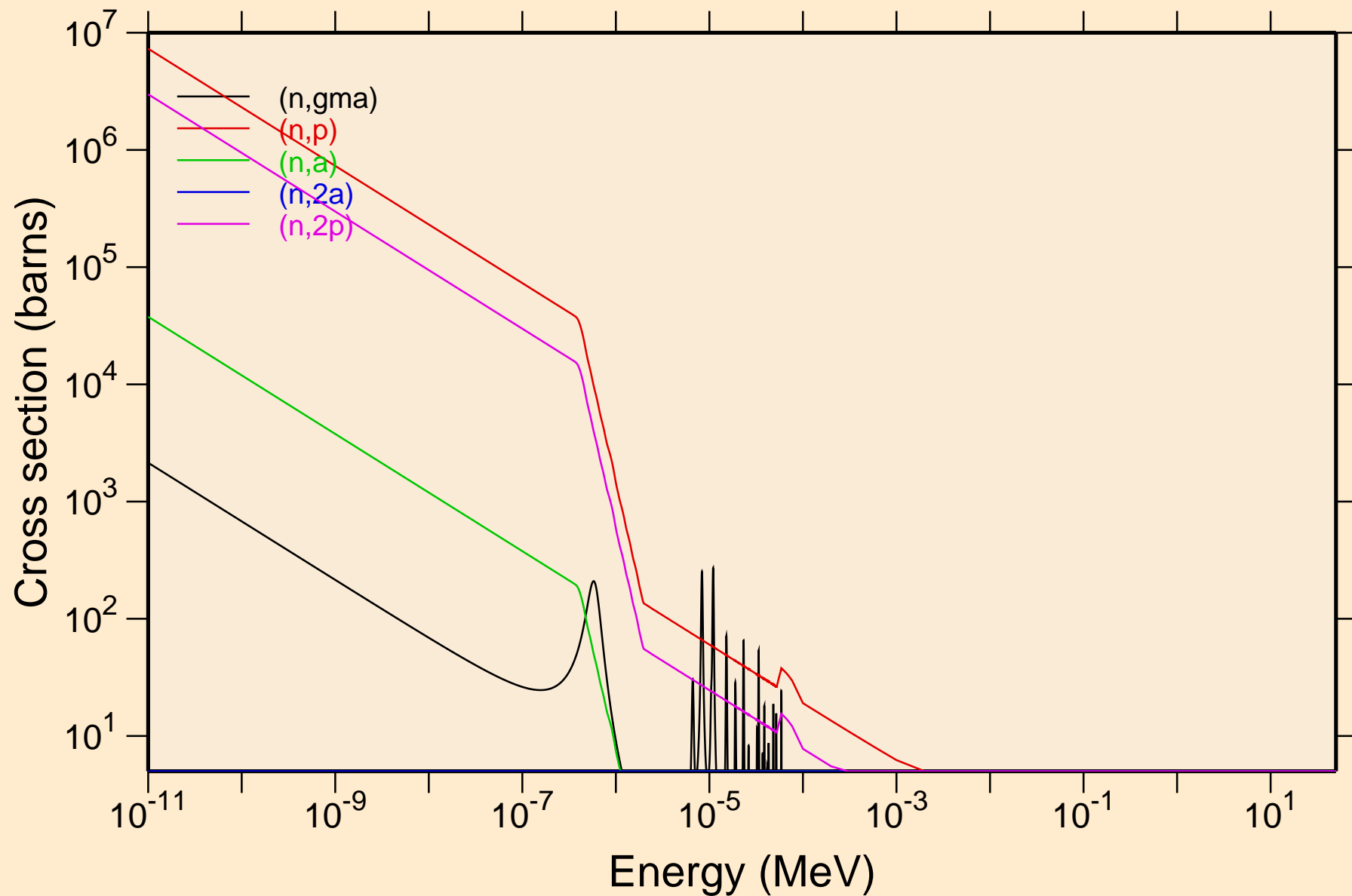

MO085 NEUTRON ACER TENDL-2019 LIBRARY; T=293.16K
Non-threshold reactions

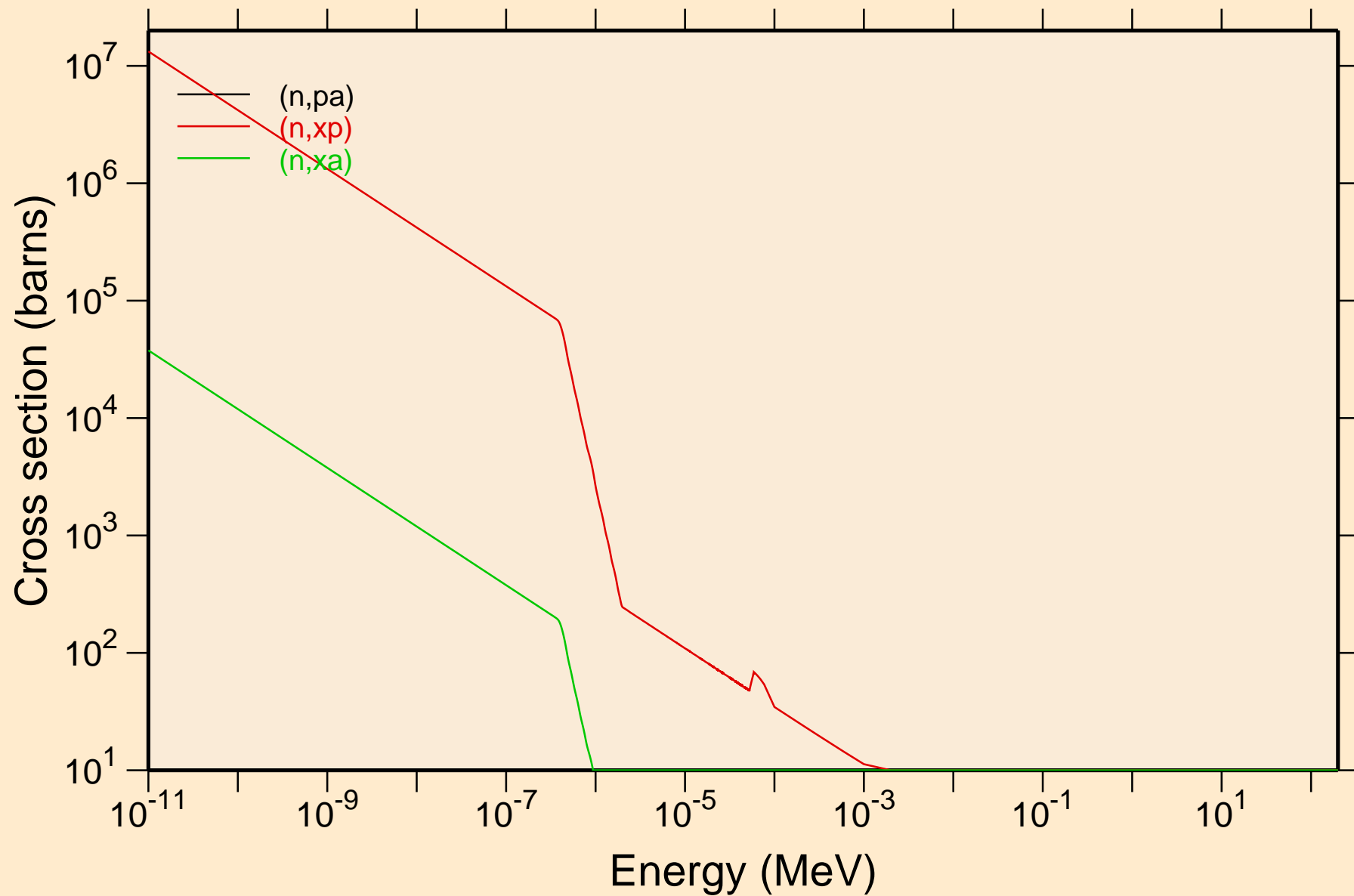

MO085 NEUTRON ACER TENDL-2019 LIBRARY; T=293.16K
Principal cross sections

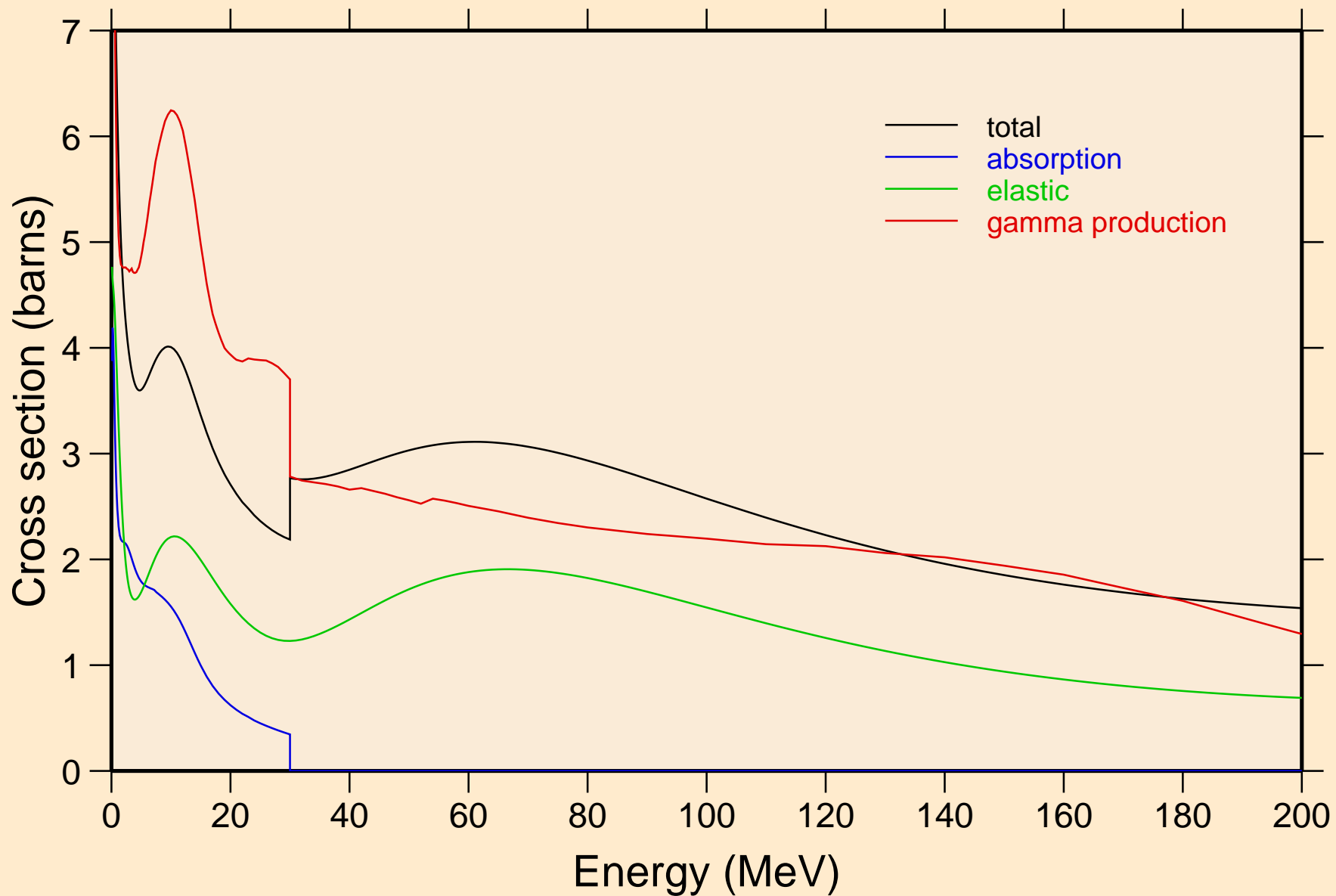

MO085 NEUTRON ACER TENDL-2019 LIBRARY; T=293.16K
Heating

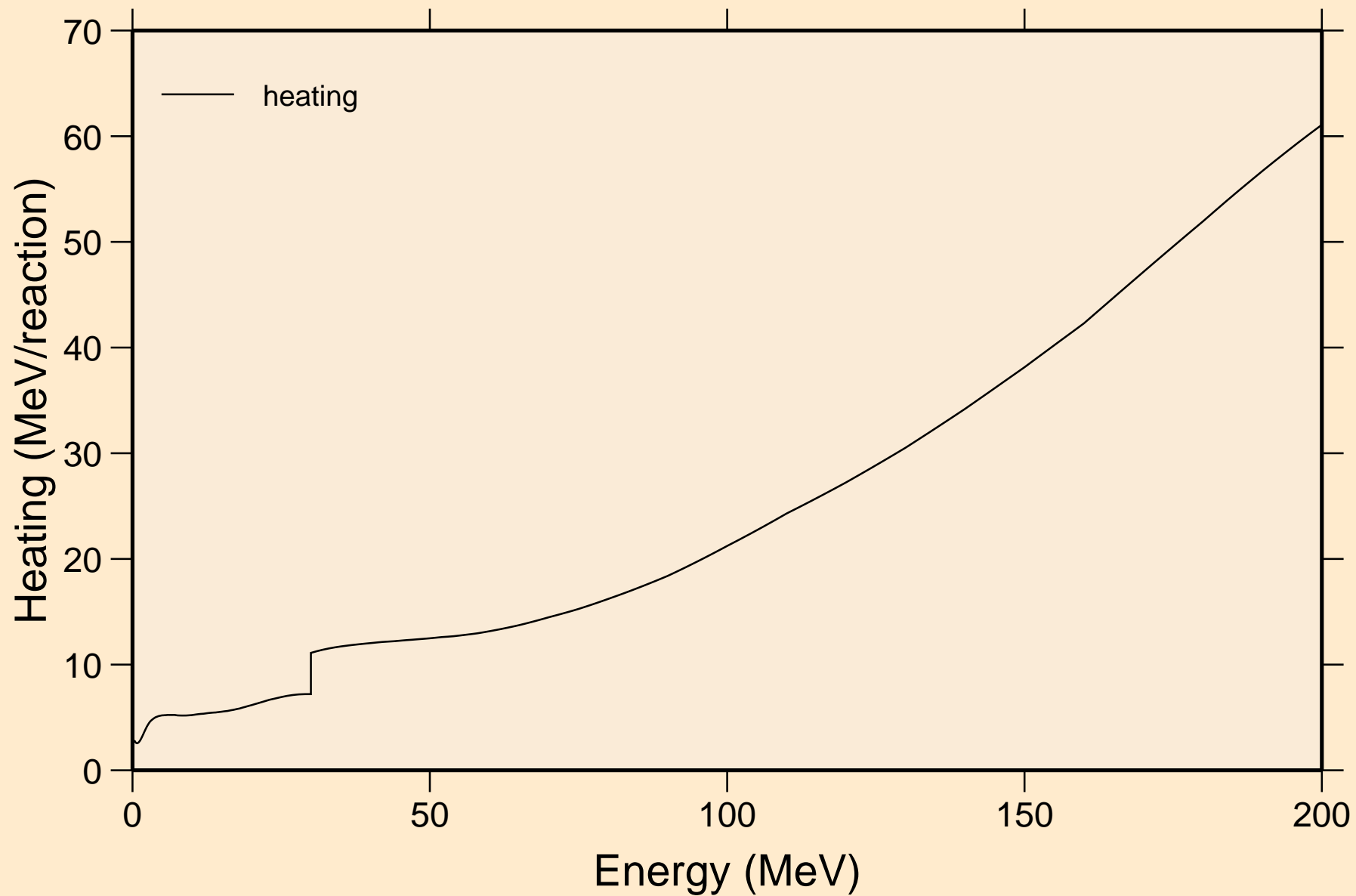

MO085 NEUTRON ACER TENDL-2019 LIBRARY; T=293.16K
Damage

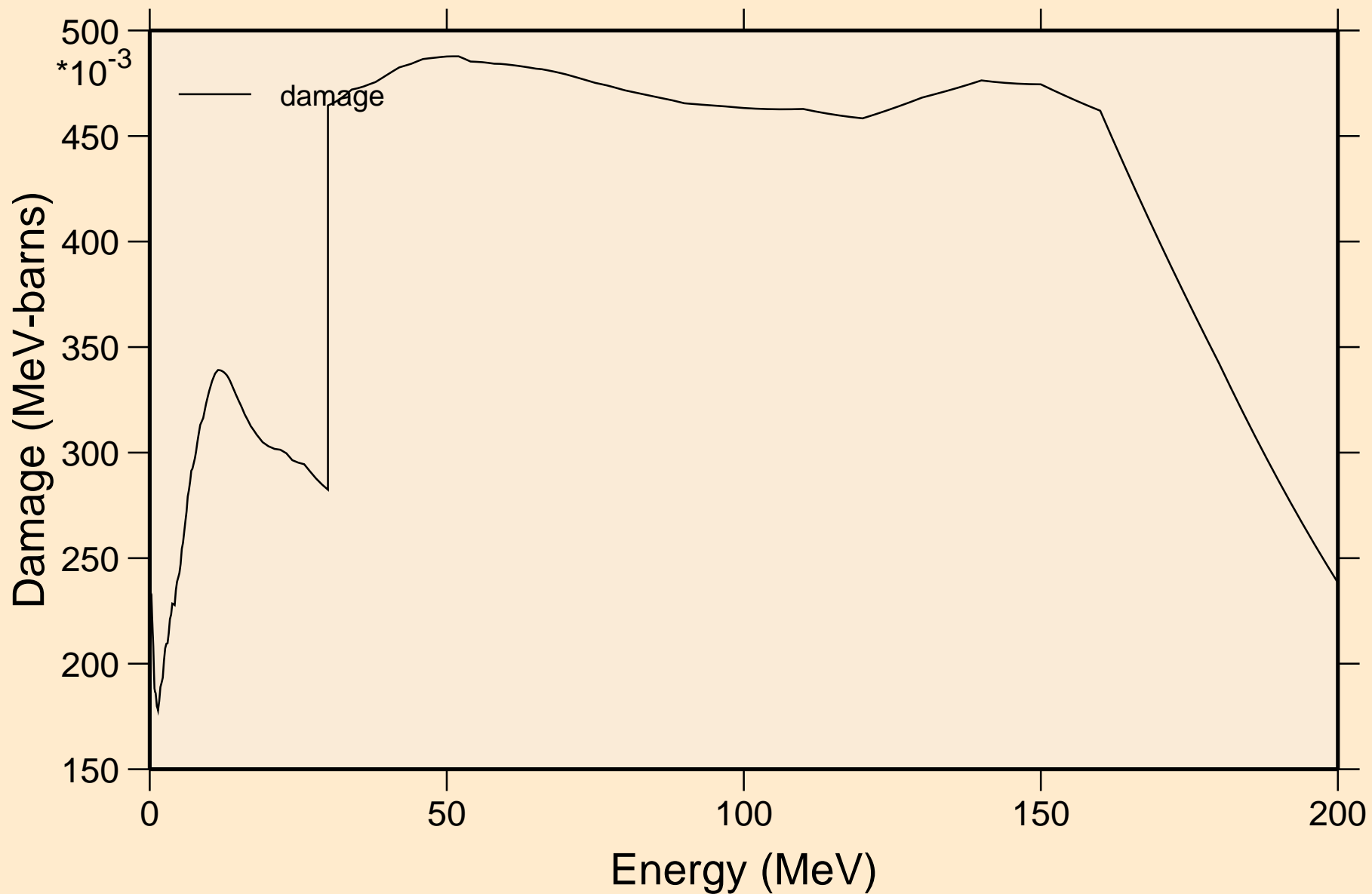

MO085 NEUTRON ACER TENDL-2019 LIBRARY; T=293.16K
Non-threshold reactions

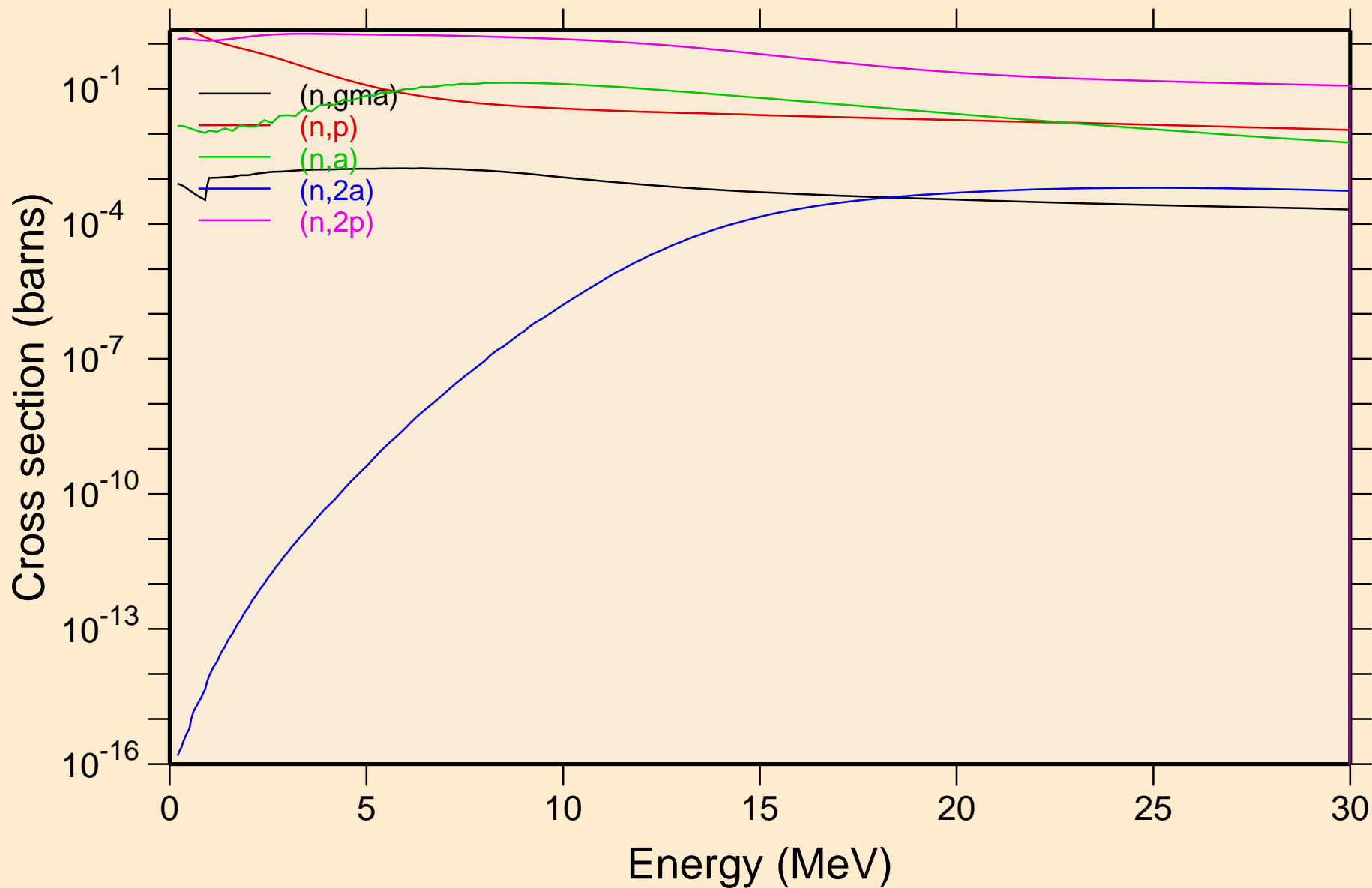

MO085 NEUTRON ACER TENDL-2019 LIBRARY; T=293.16K
Non-threshold reactions

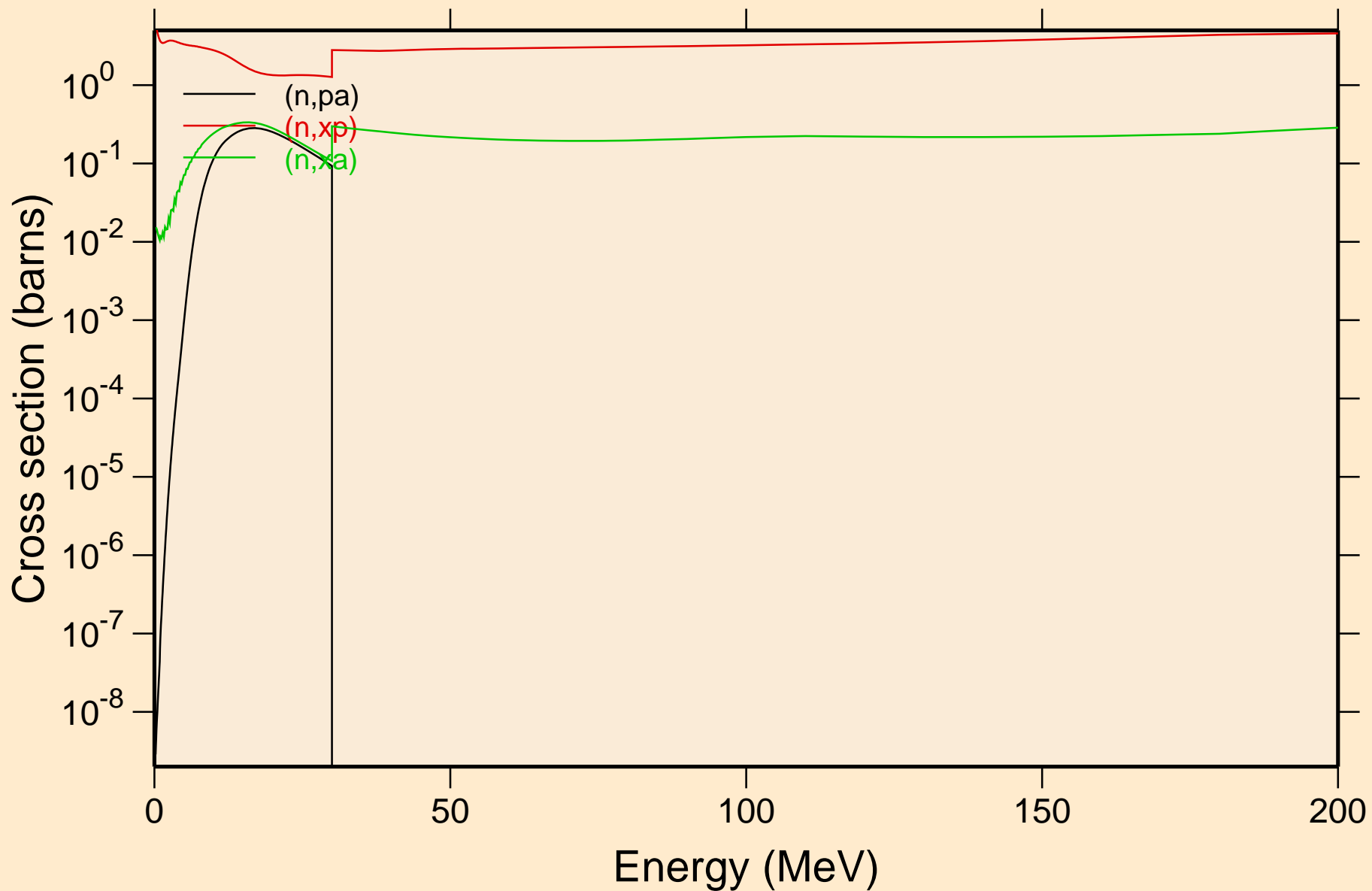

MO085 NEUTRON ACER TENDL-2019 LIBRARY; T=293.16K
Inelastic levels

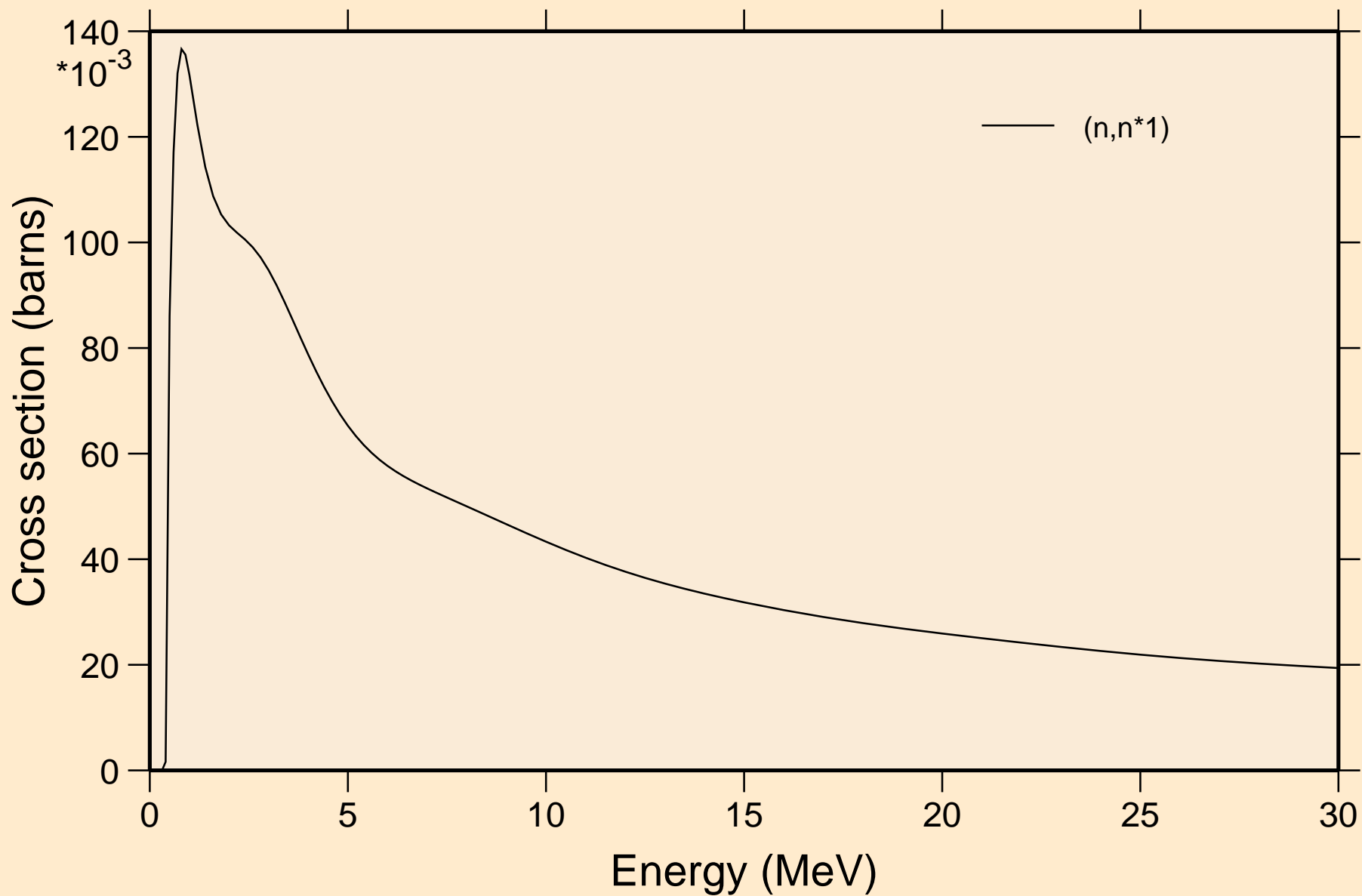

MO085 NEUTRON ACER TENDL-2019 LIBRARY; T=293.16K
Threshold reactions

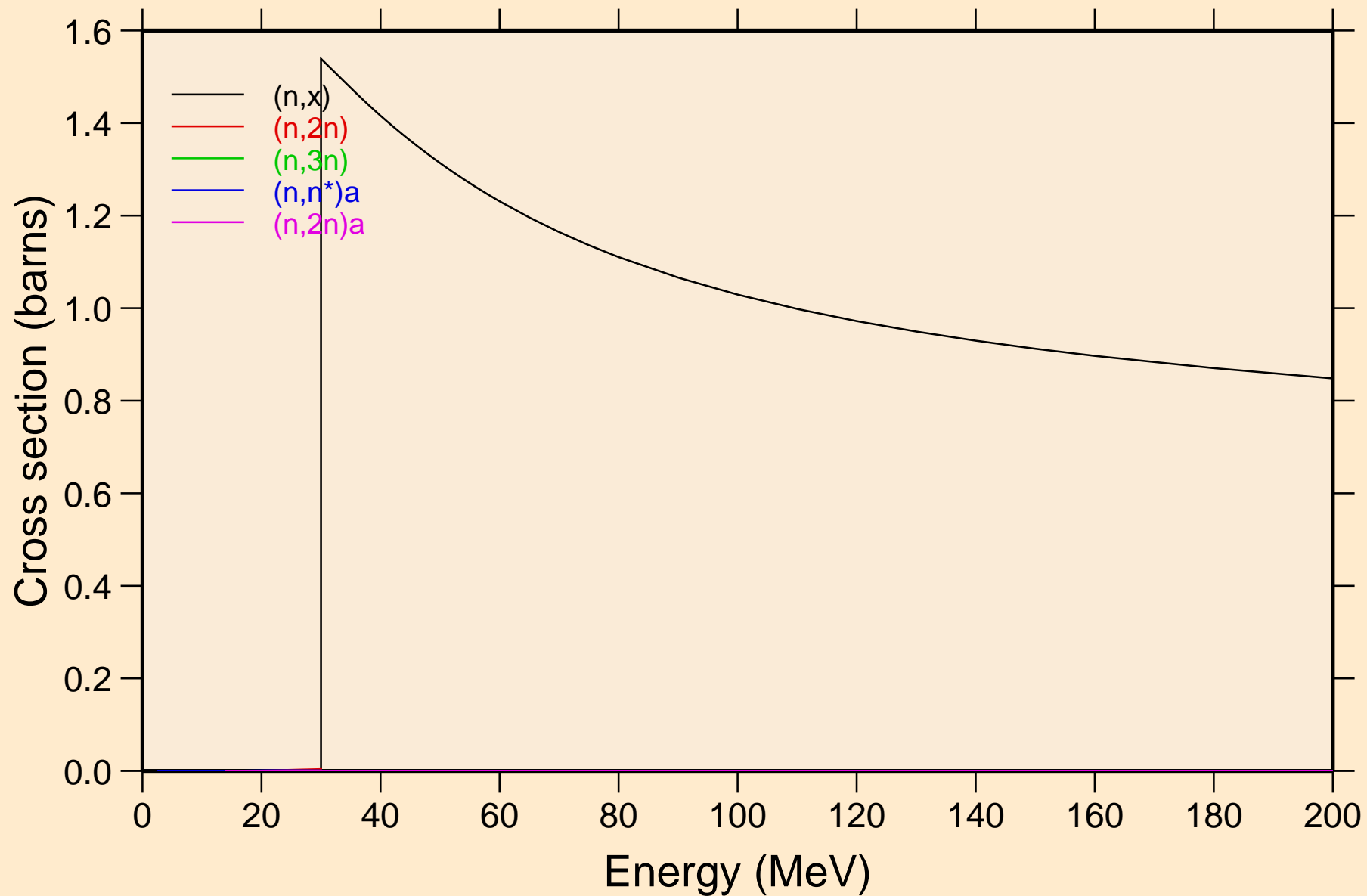

MO085 NEUTRON ACER TENDL-2019 LIBRARY; T=293.16K
Threshold reactions

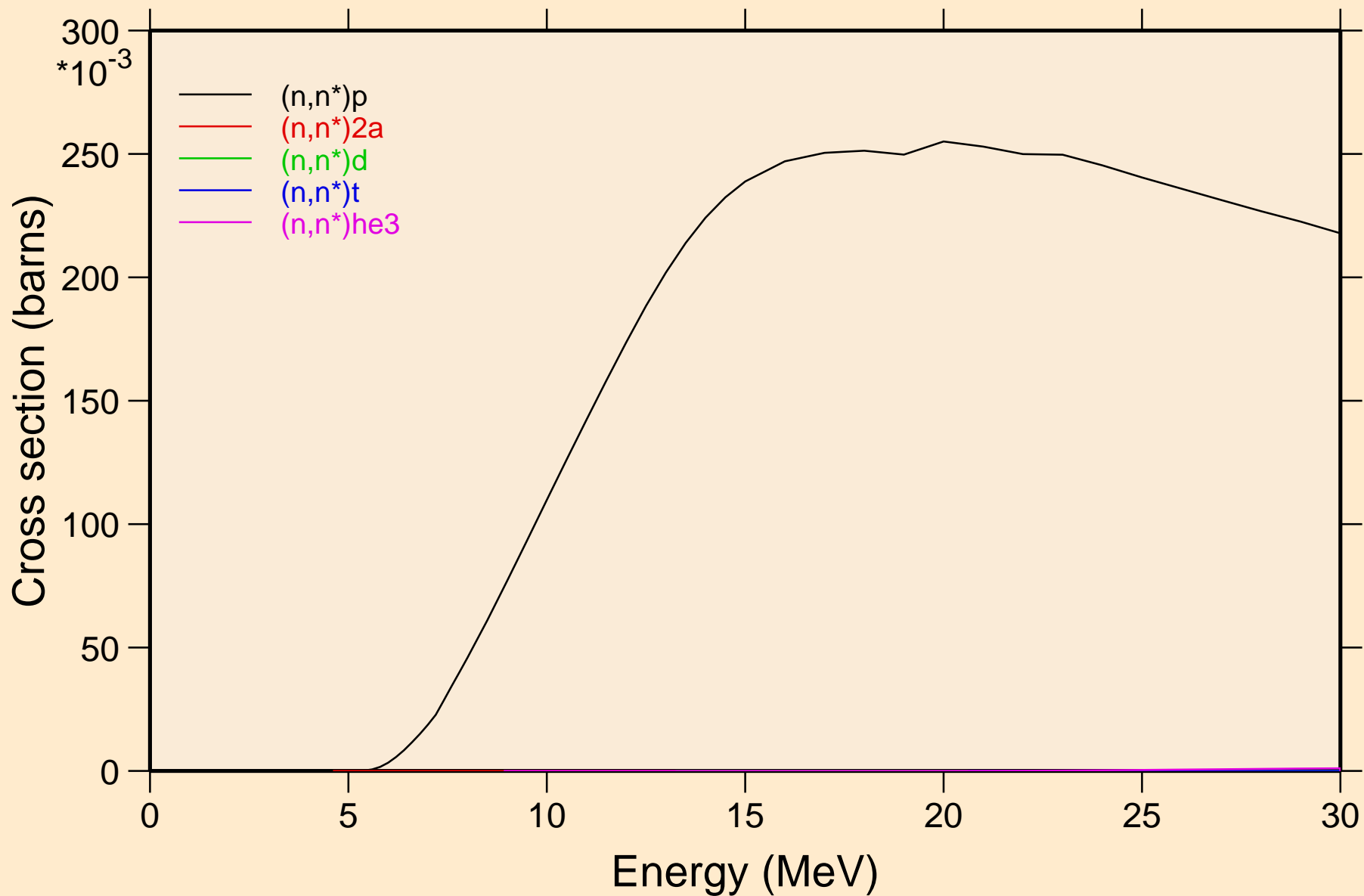

MO085 NEUTRON ACER TENDL-2019 LIBRARY; T=293.16K
Threshold reactions

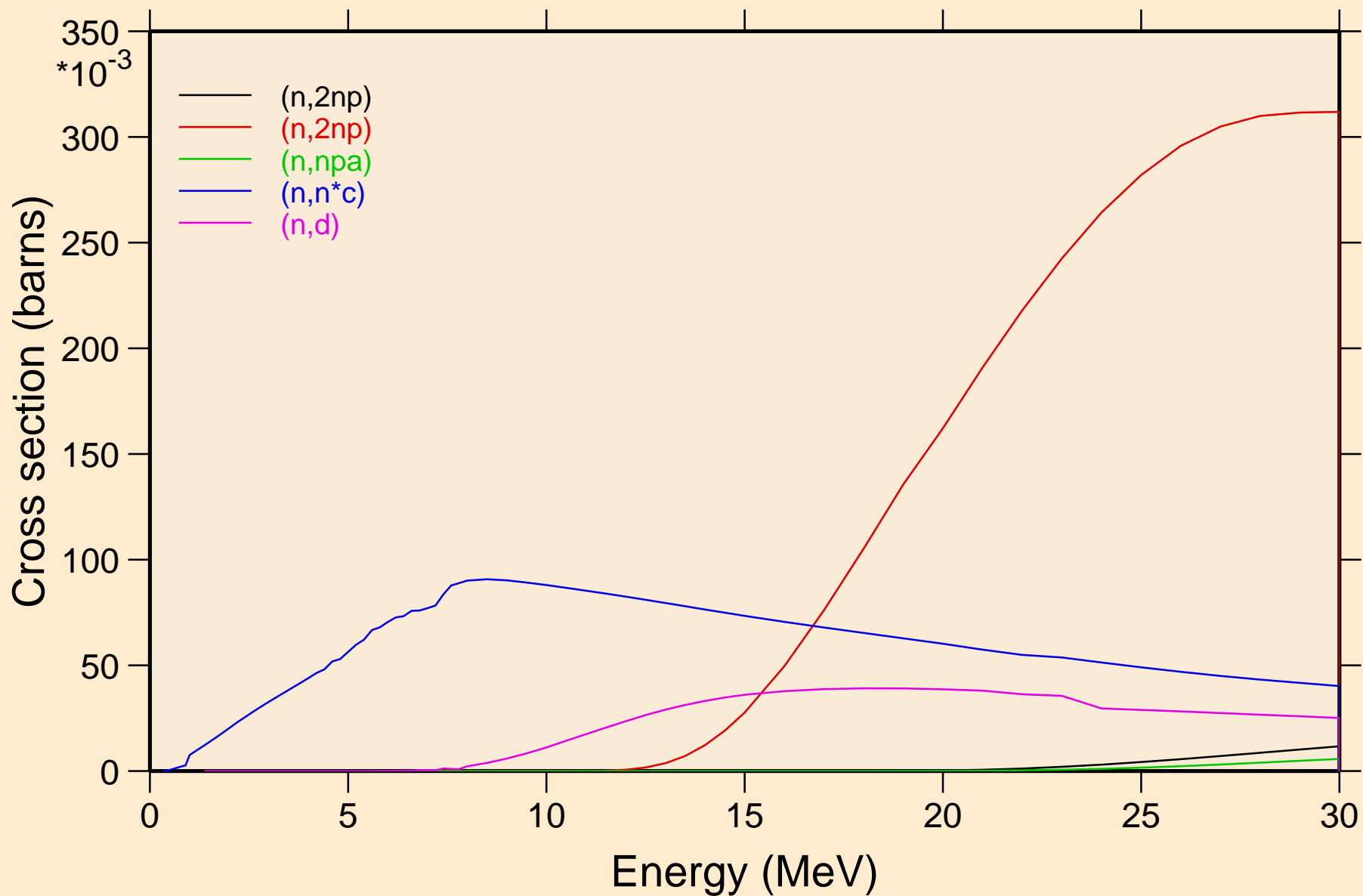

MO085 NEUTRON ACER TENDL-2019 LIBRARY; T=293.16K
Threshold reactions

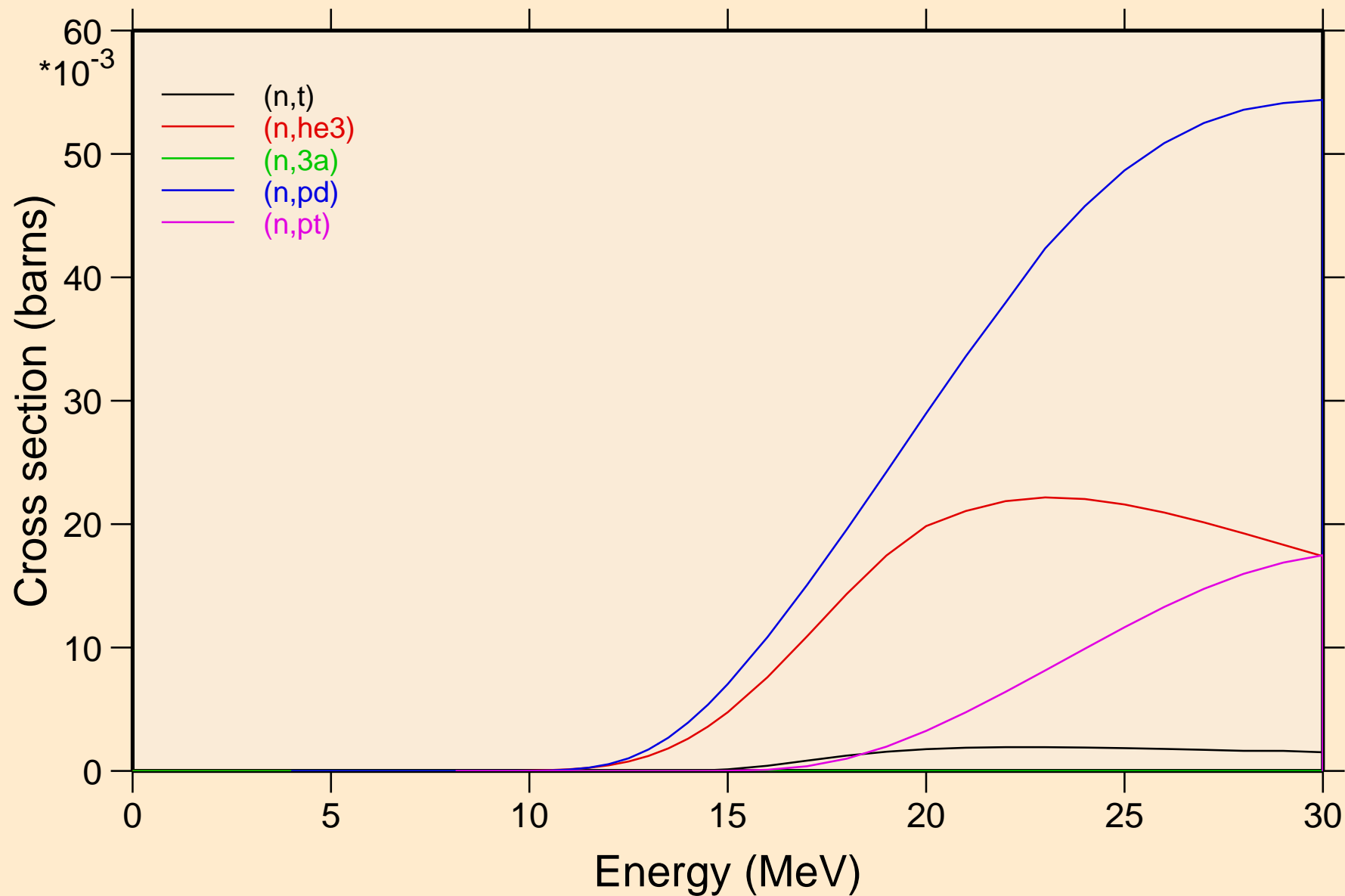

MO085 NEUTRON ACER TENDL-2019 LIBRARY; T=293.16K
Threshold reactions

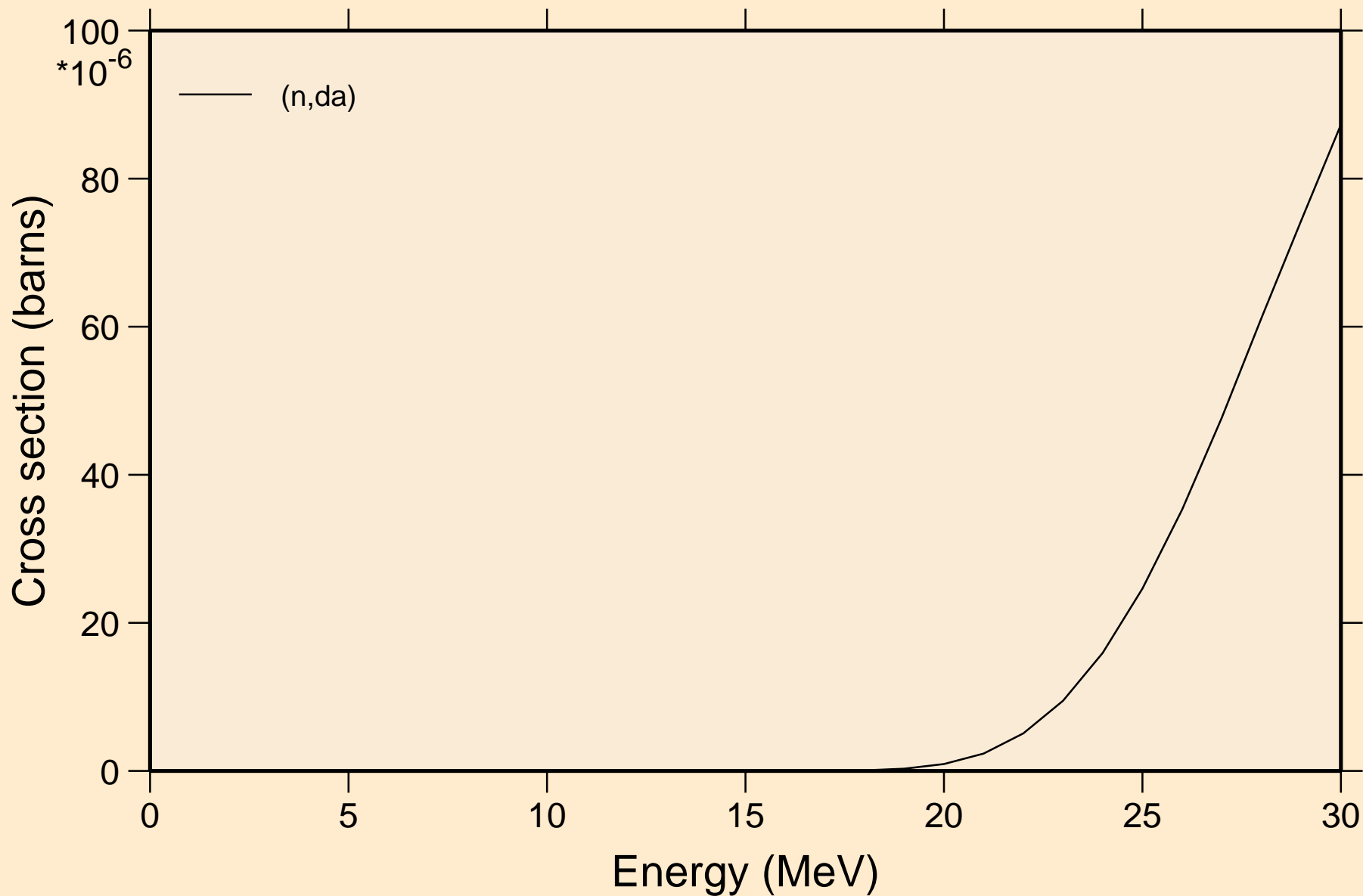

MO085 NEUTRON ACER TENDL-2019 LIBRARY; T=293.16K
Threshold reactions

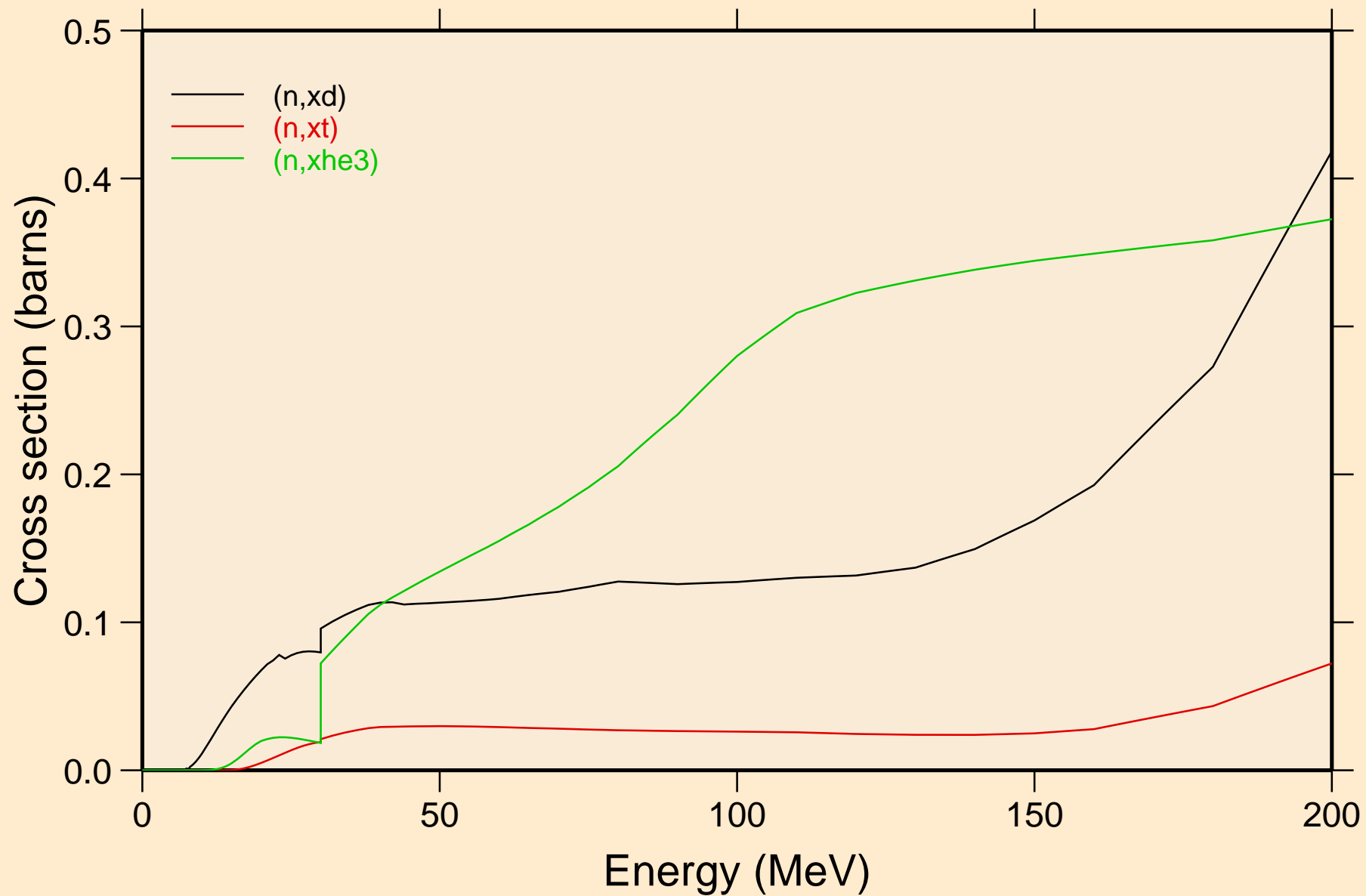

MO085 NEUTRON ACER TENDL-2019 LIBRARY; T=293.16K
angular distribution for elastic

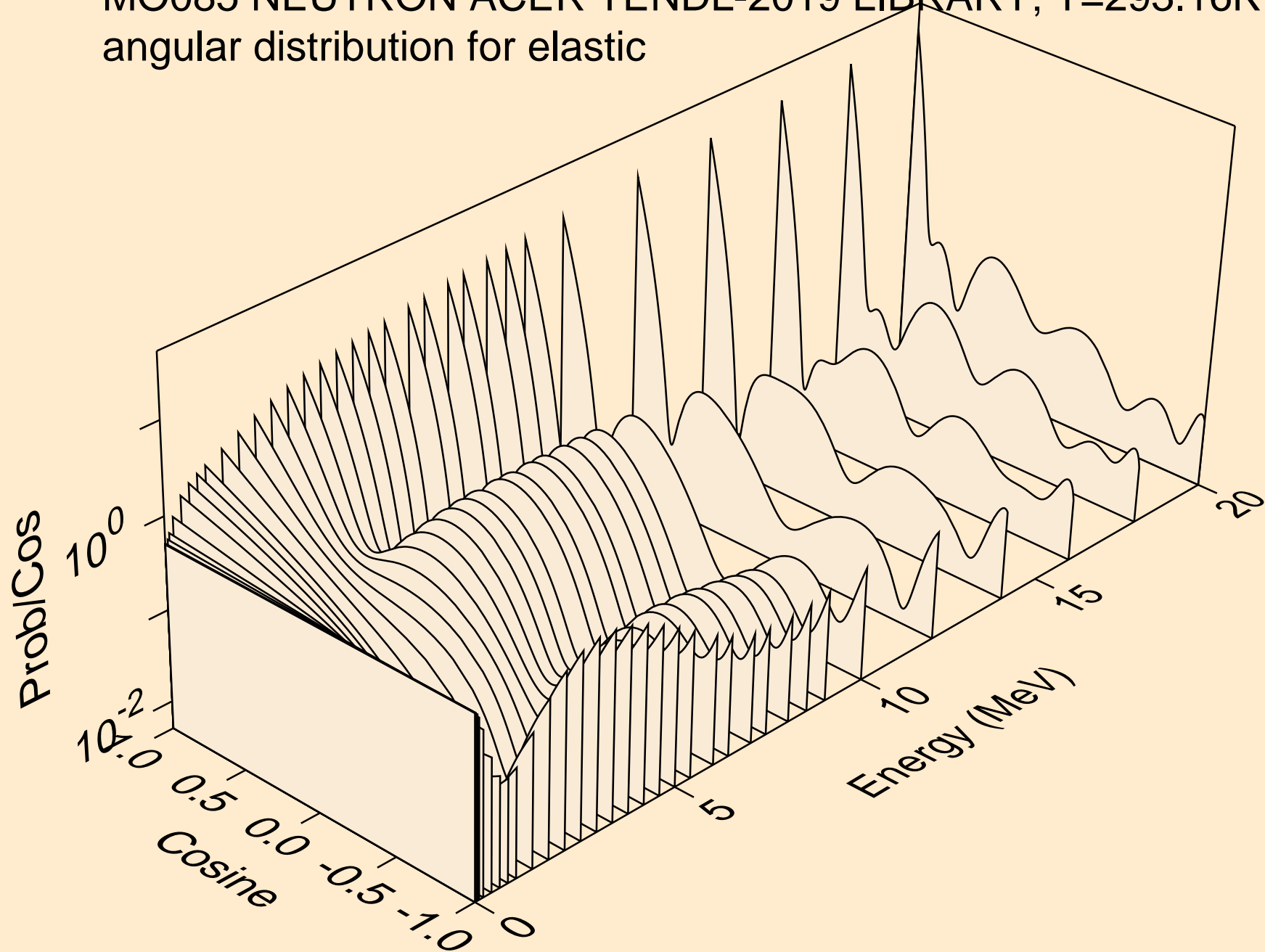

MO085 NEUTRON ACER TENDL-2019 LIBRARY; T=293.16K
angular distribution for elastic

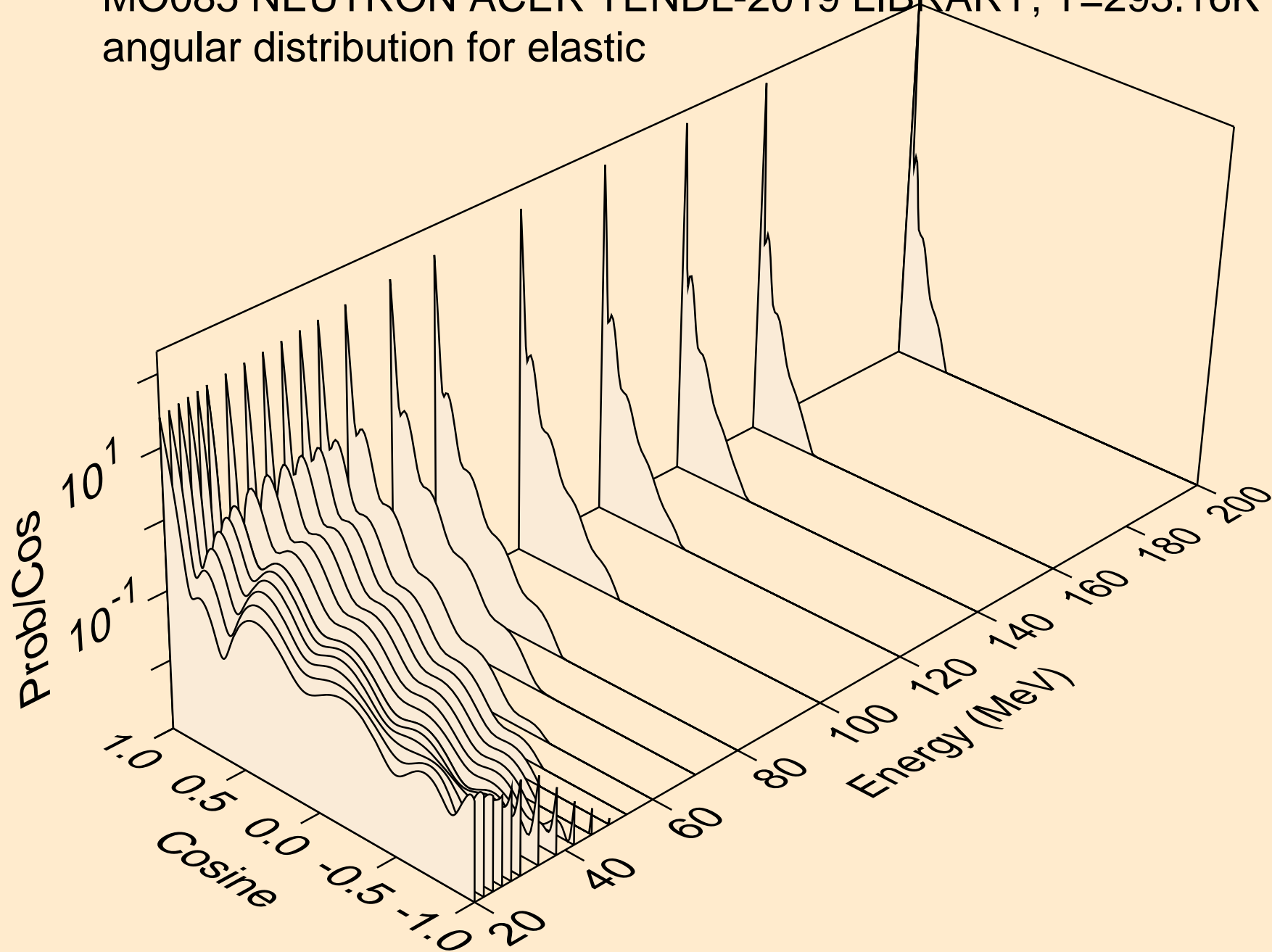

MO085 NEUTRON ACER TENDL-2019 LIBRARY; T=293.16K
angular distribution for (n,n*1)

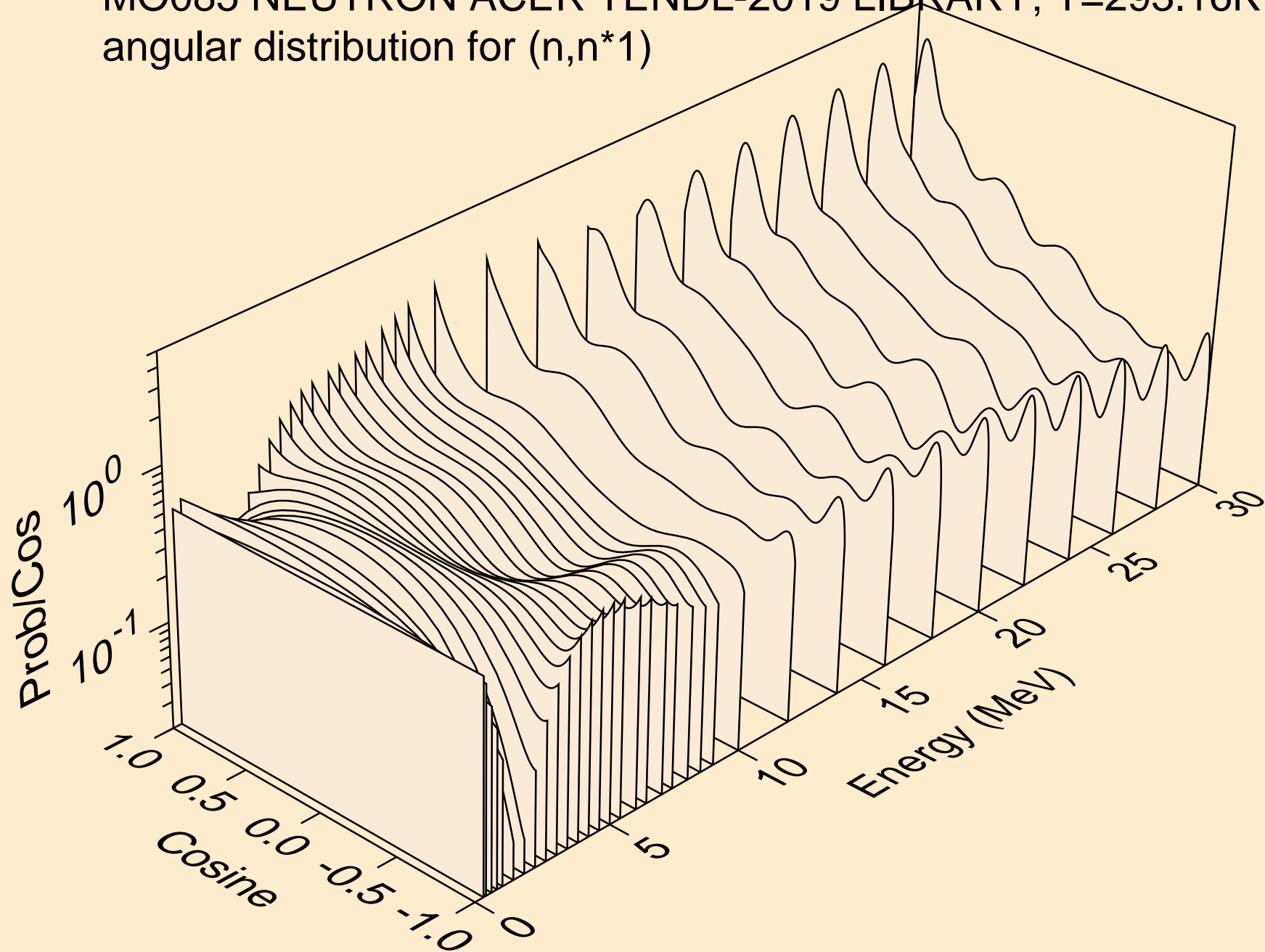

MO085 NEUTRON ACER TENDL-2019 LIBRARY; T=293.16K
Neutron emission for (n,x)

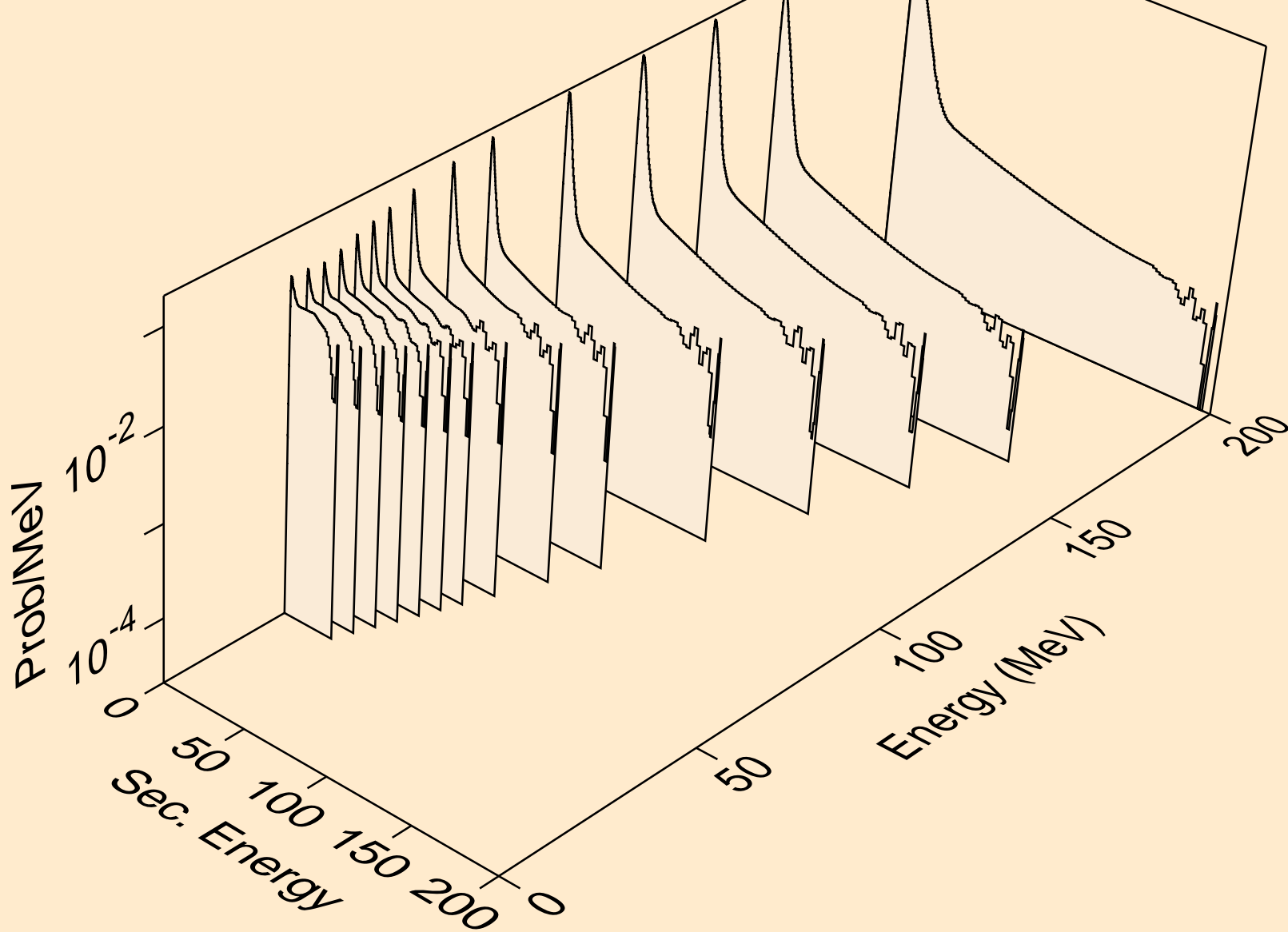

MO085 NEUTRON ACER TENDL-2019 LIBRARY; T=293.16K
Neutron emission for (n,2n)

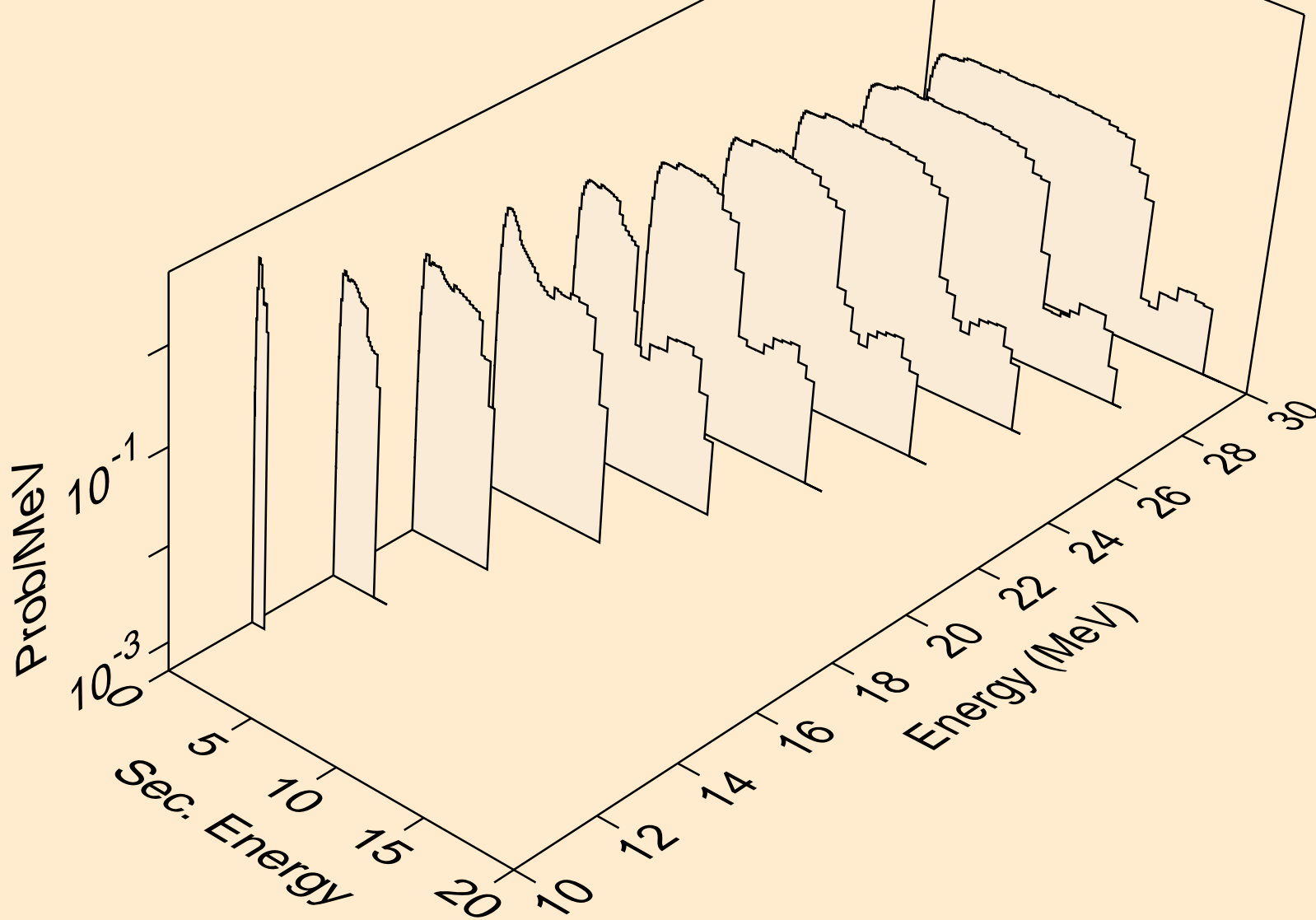

MO085 NEUTRON ACER TENDL-2019 LIBRARY; T=293.16K
Neutron emission for (n,3n)

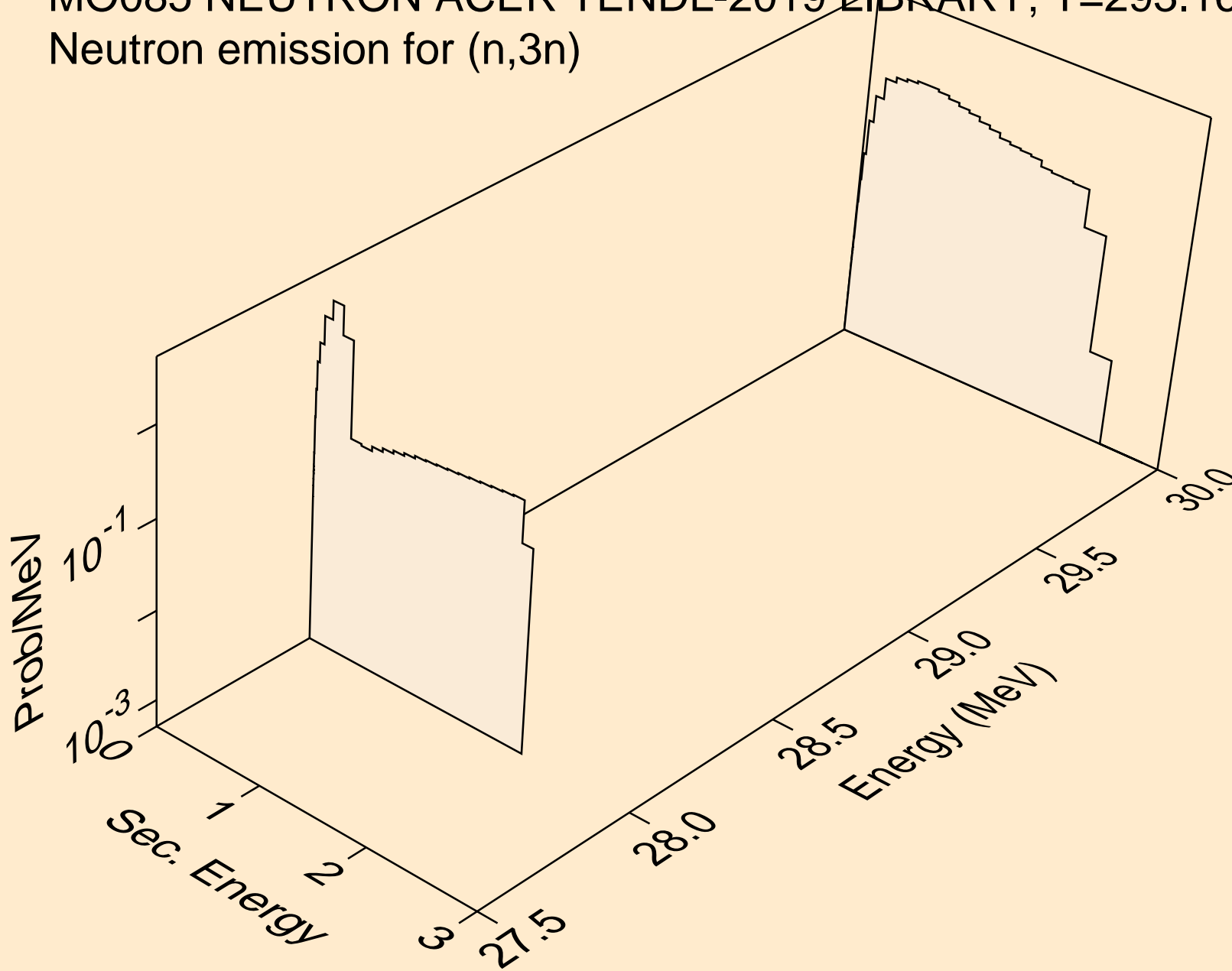

MO085 NEUTRON ACER TENDL-2019 LIBRARY; T=293.16K
Neutron emission for (n,n*)a

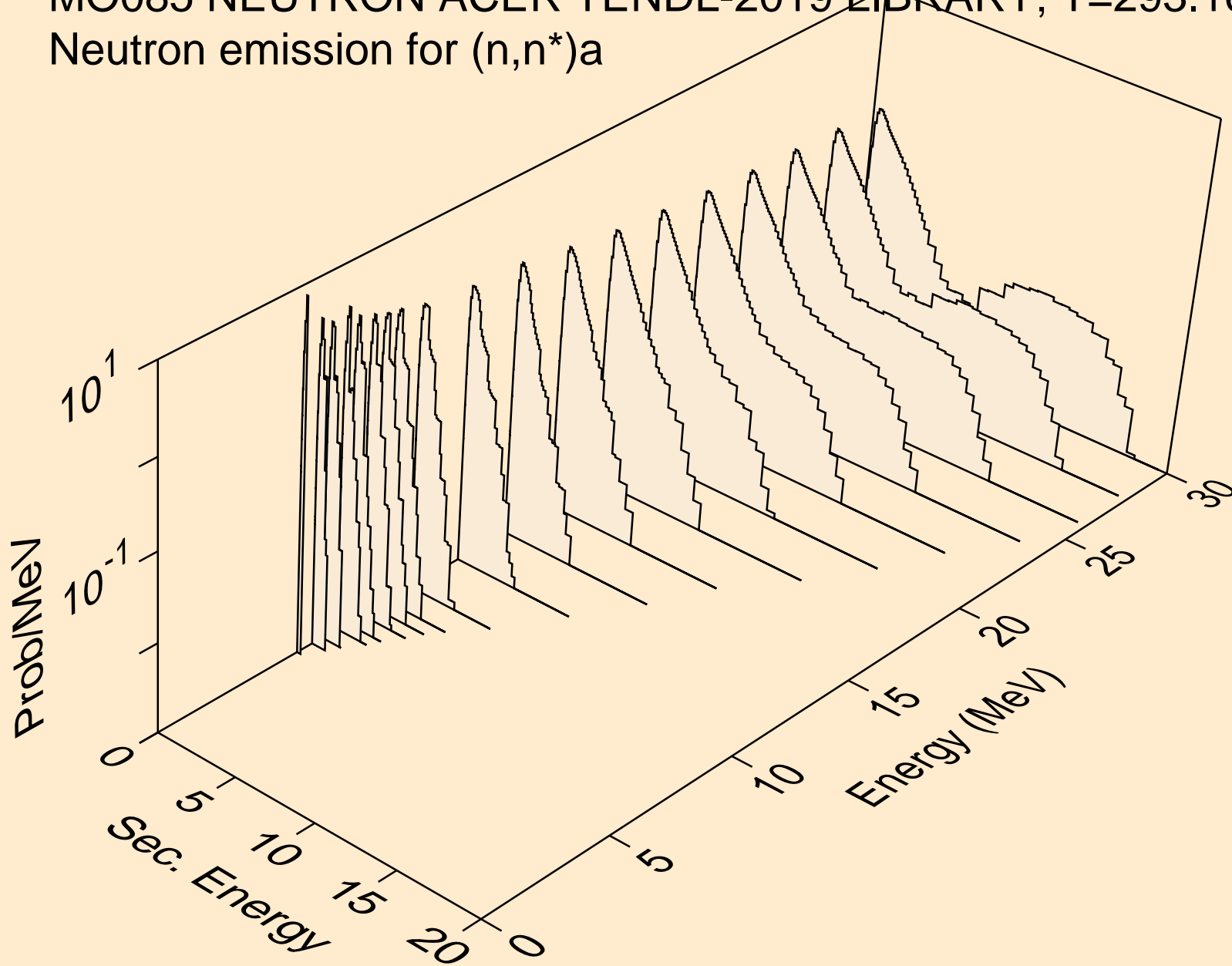

MO085 NEUTRON ACER TENDL-2019 LIBRARY; T=293.16K
Neutron emission for (n,2n)a

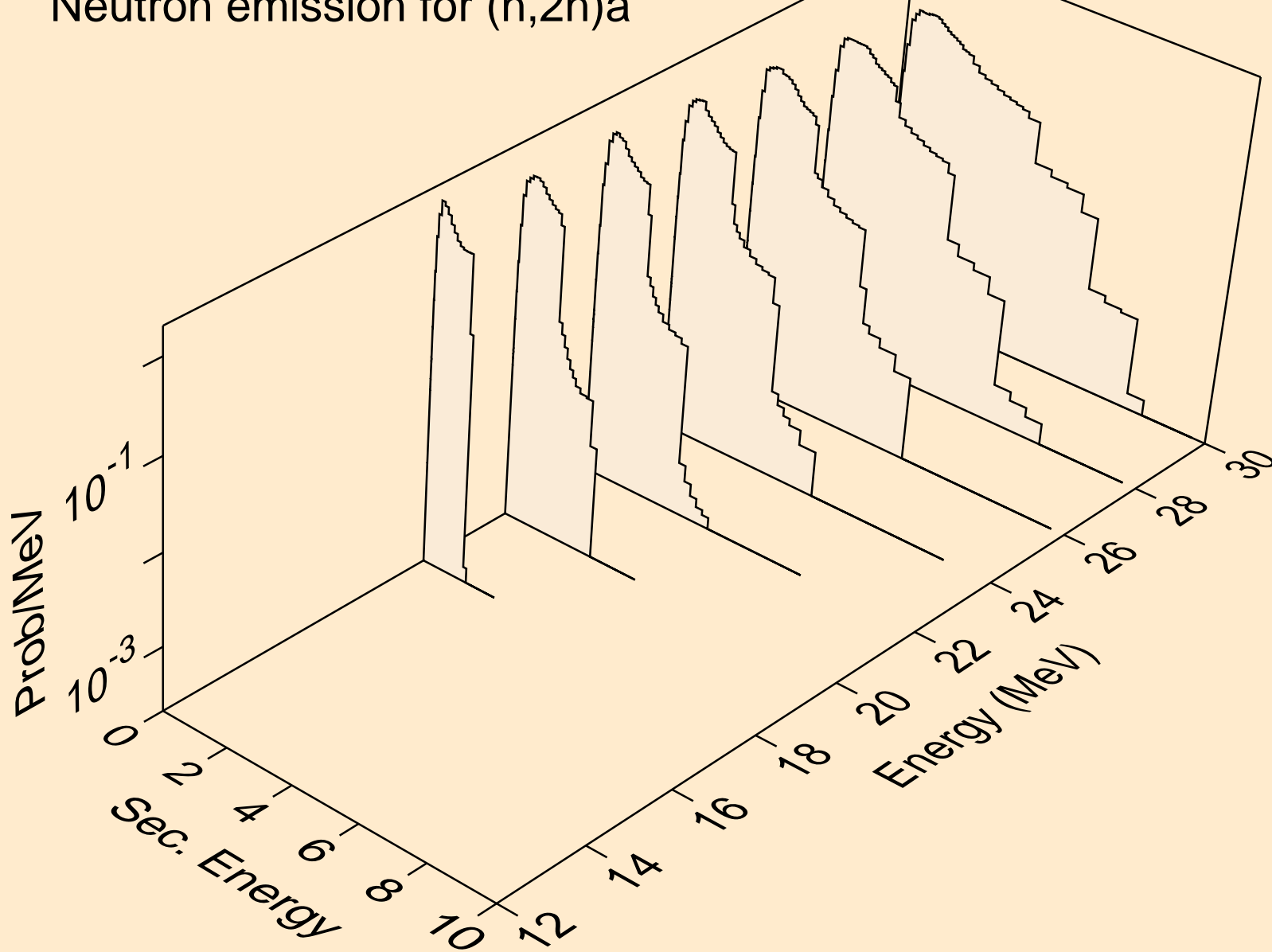

MO085 NEUTRON ACER TENDL-2019 LIBRARY; T=293.16K
Neutron emission for (n,n*)p

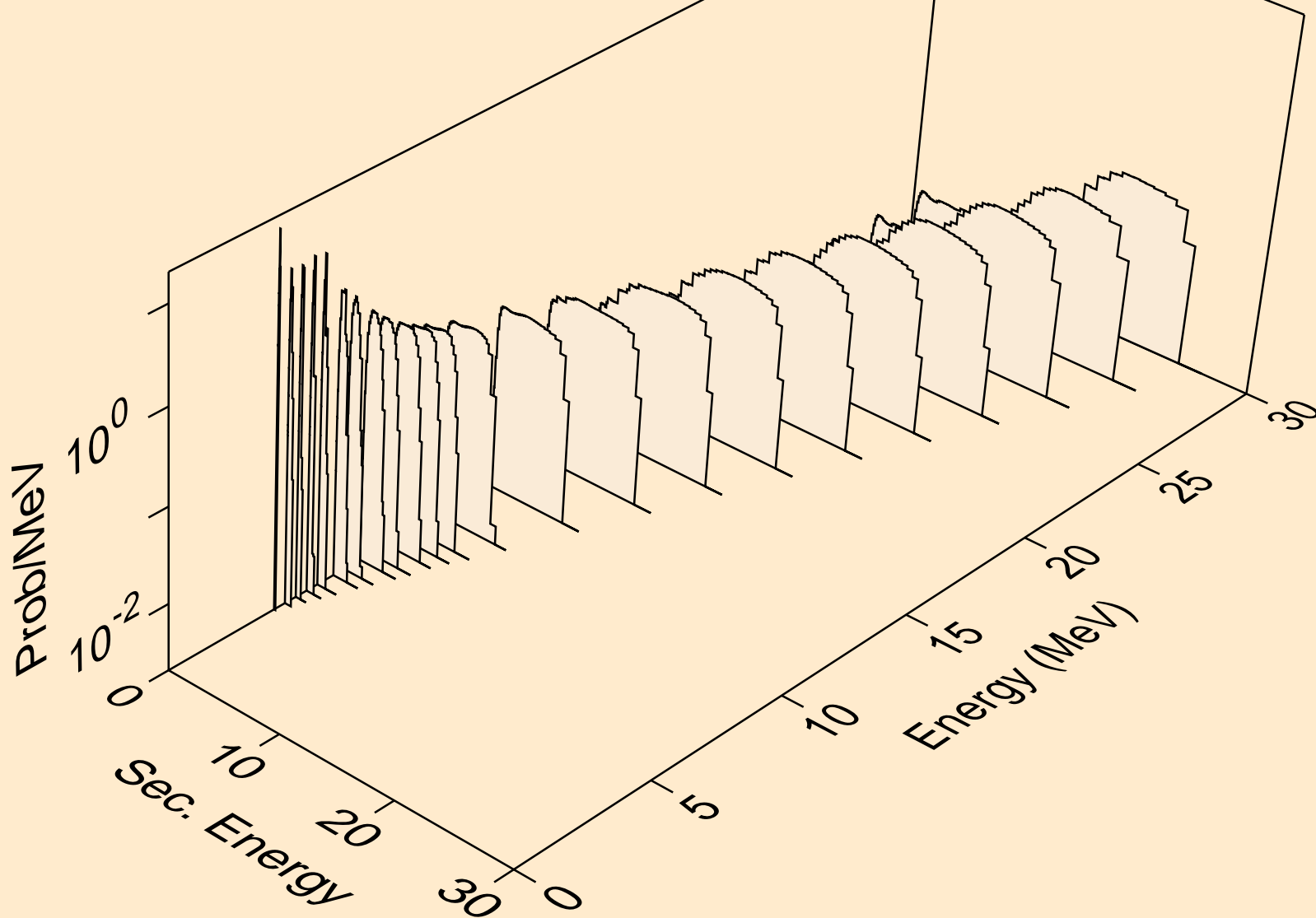

MO085 NEUTRON ACER TENDL-2019 LIBRARY; T=293.16K
Neutron emission for (n,n*)2a

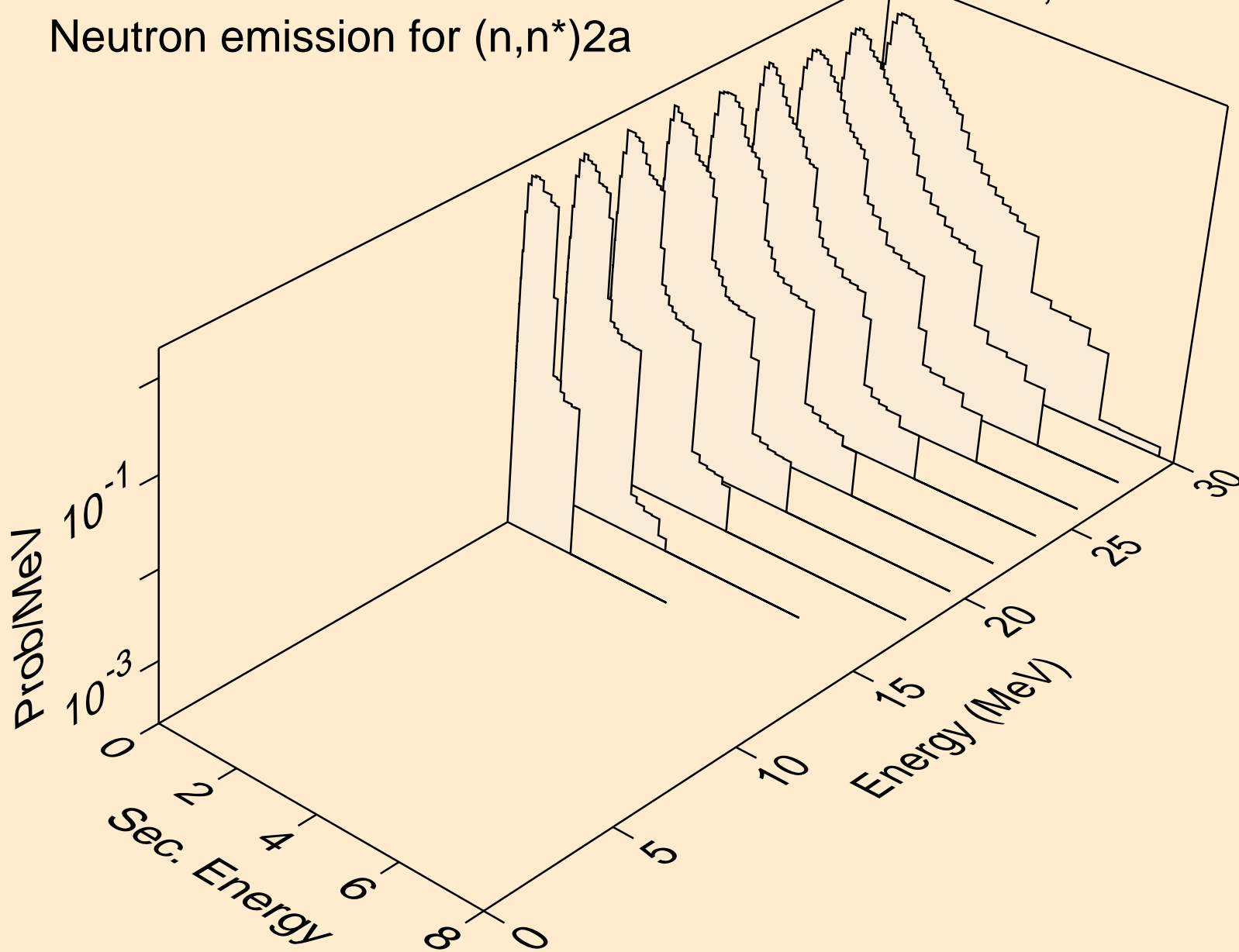

MO085 NEUTRON ACER TENDL-2019 LIBRARY; T=293.16K
Neutron emission for (n,n*)d

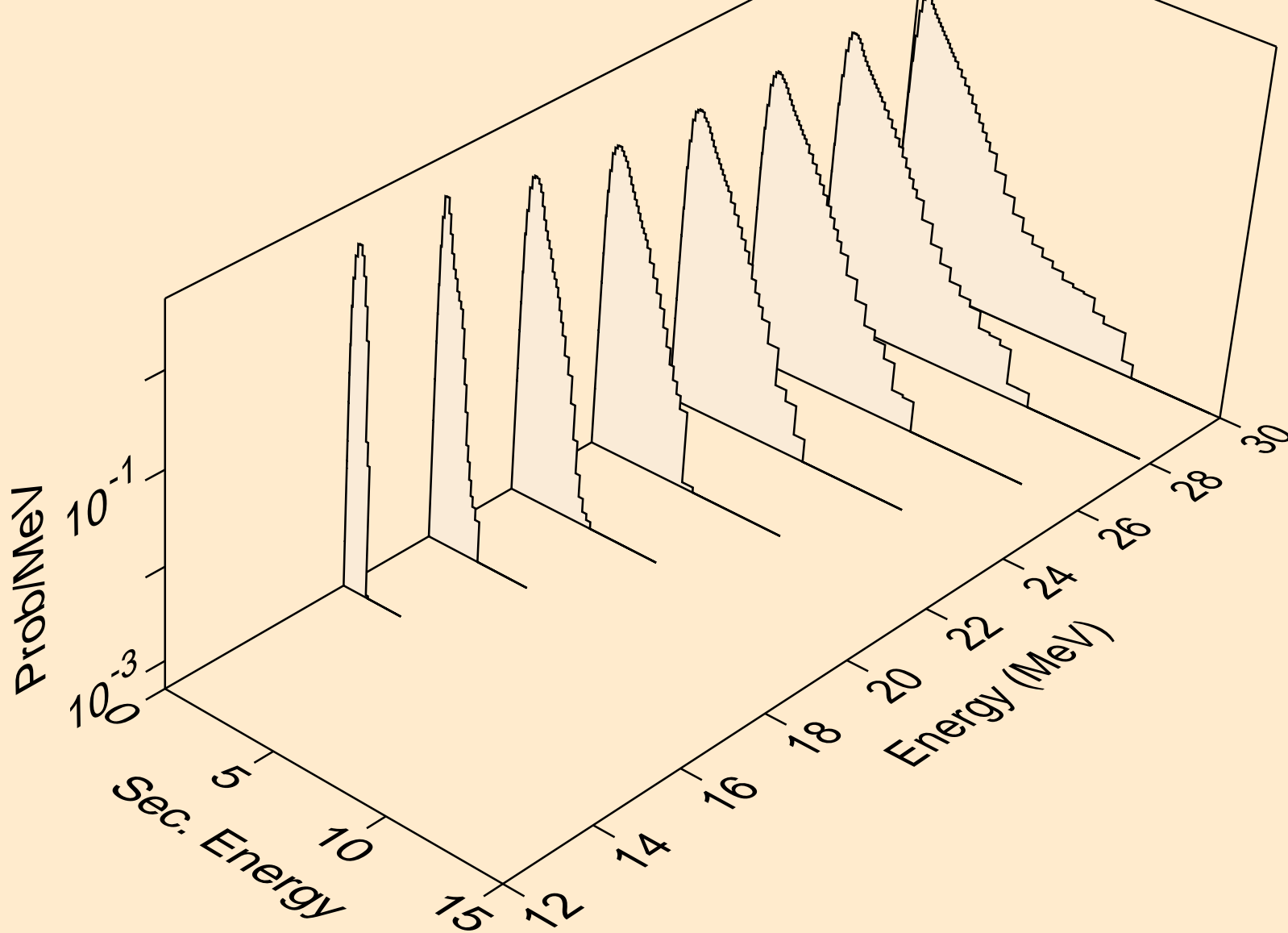

MO085 NEUTRON ACER TENDL-2019 LIBRARY; T=293.16K
Neutron emission for (n,n*)t

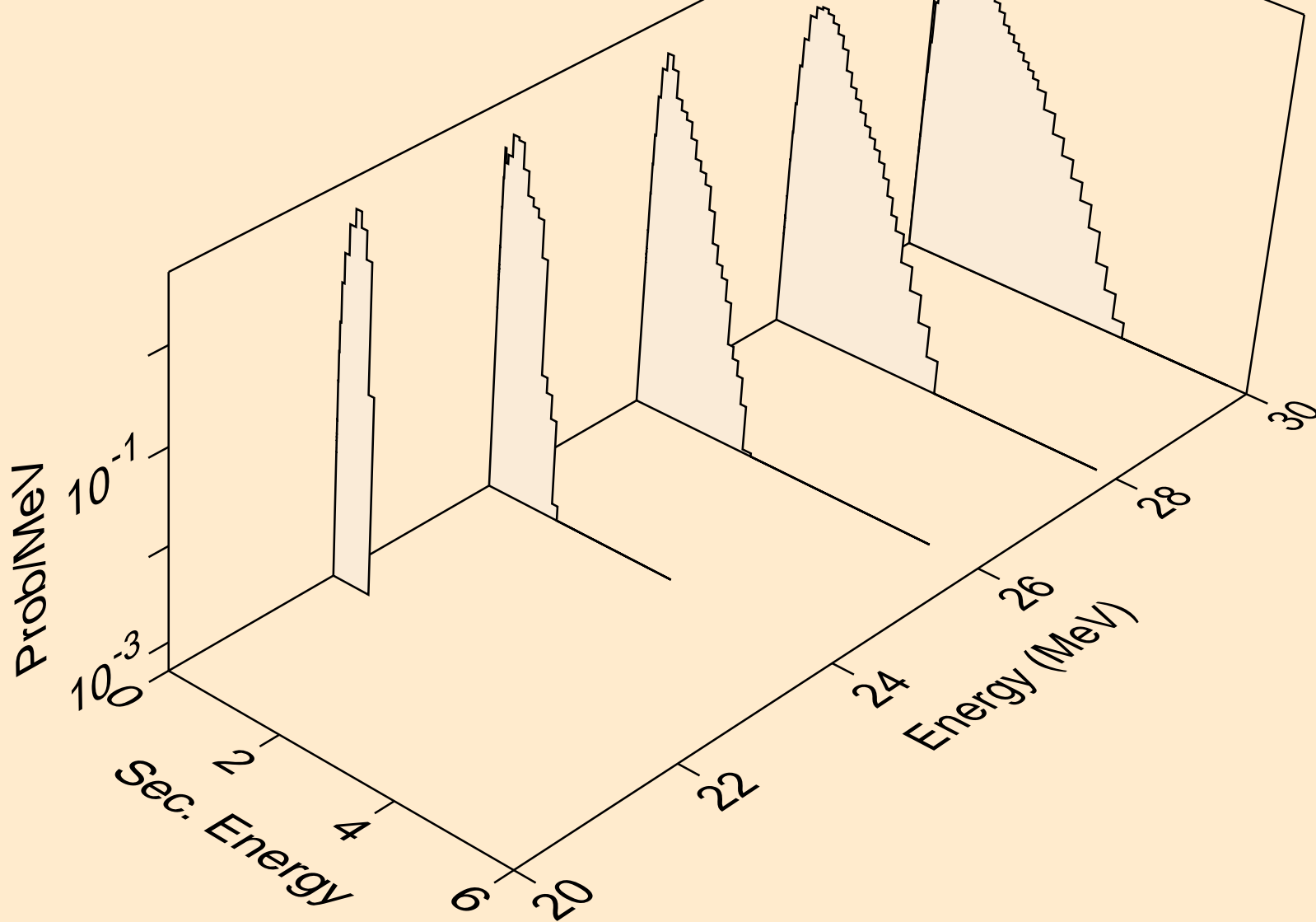

MO085 NEUTRON ACER TENDL-2019 LIBRARY; T=293.16K
Neutron emission for (n,n*)he3

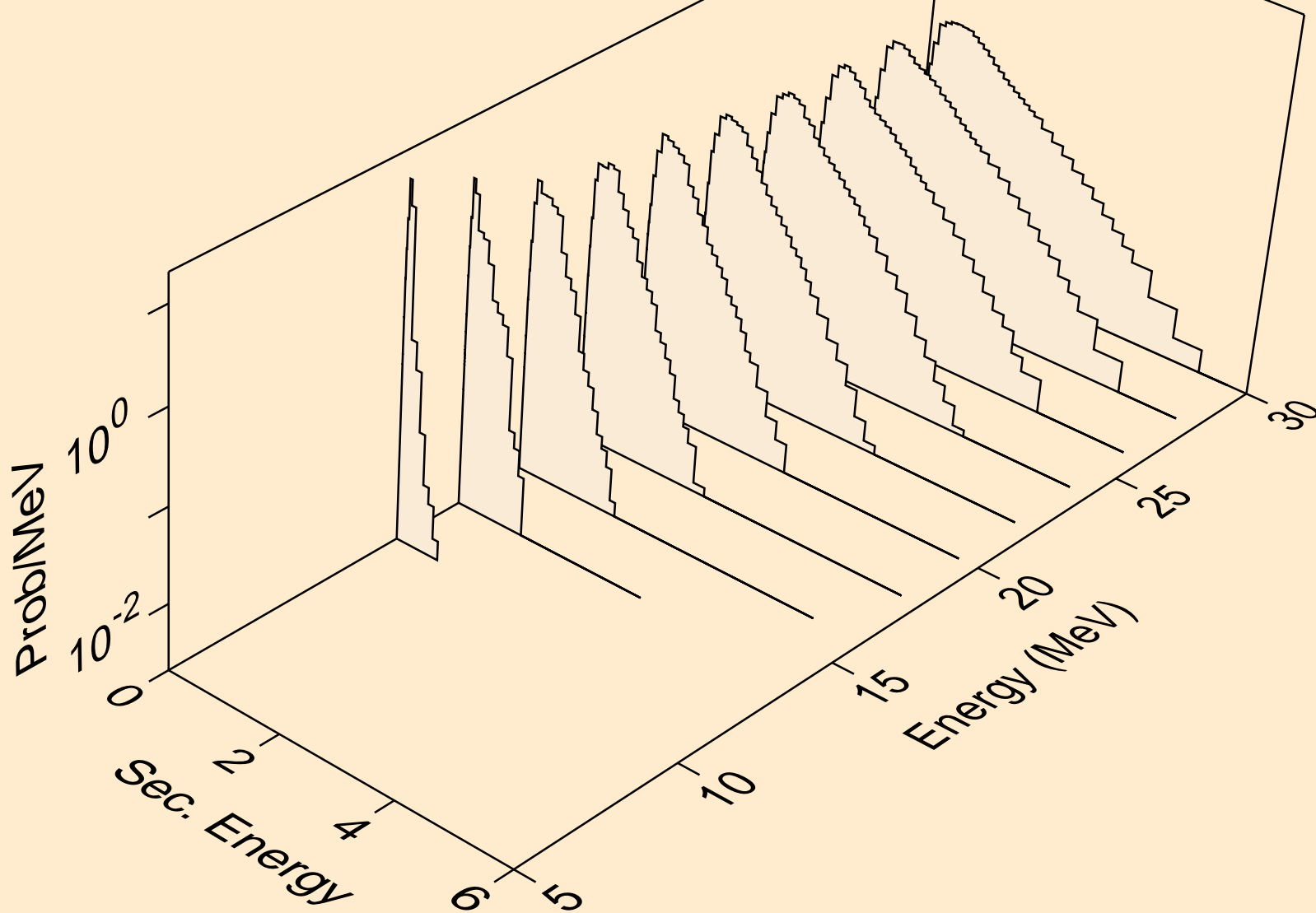

MO085 NEUTRON ACER TENDL-2019 LIBRARY; T=293.16K
Neutron emission for (n,2np)

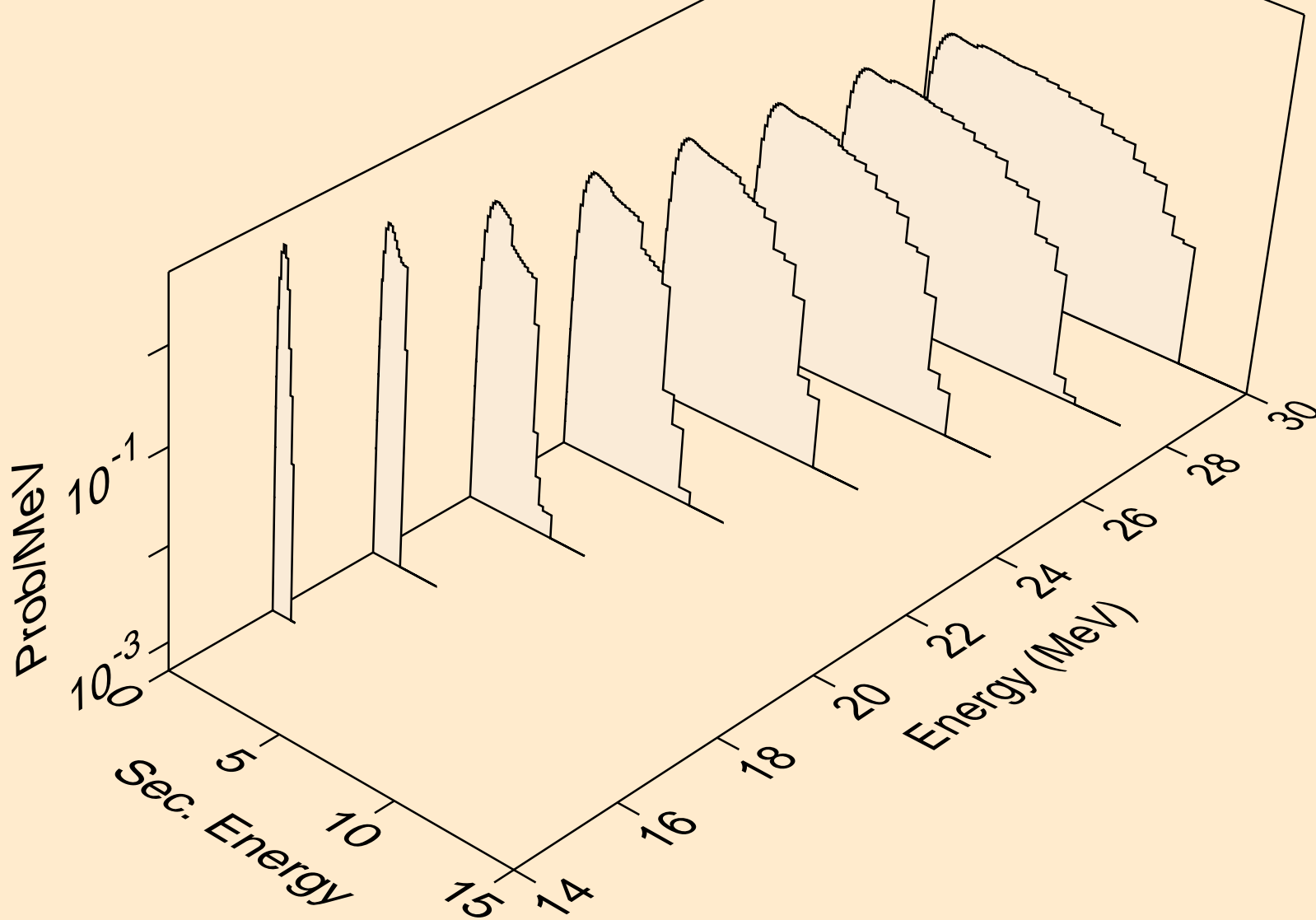

MO085 NEUTRON ACER TENDL-2019 LIBRARY; T=293.16K
Neutron emission for (n,2np)

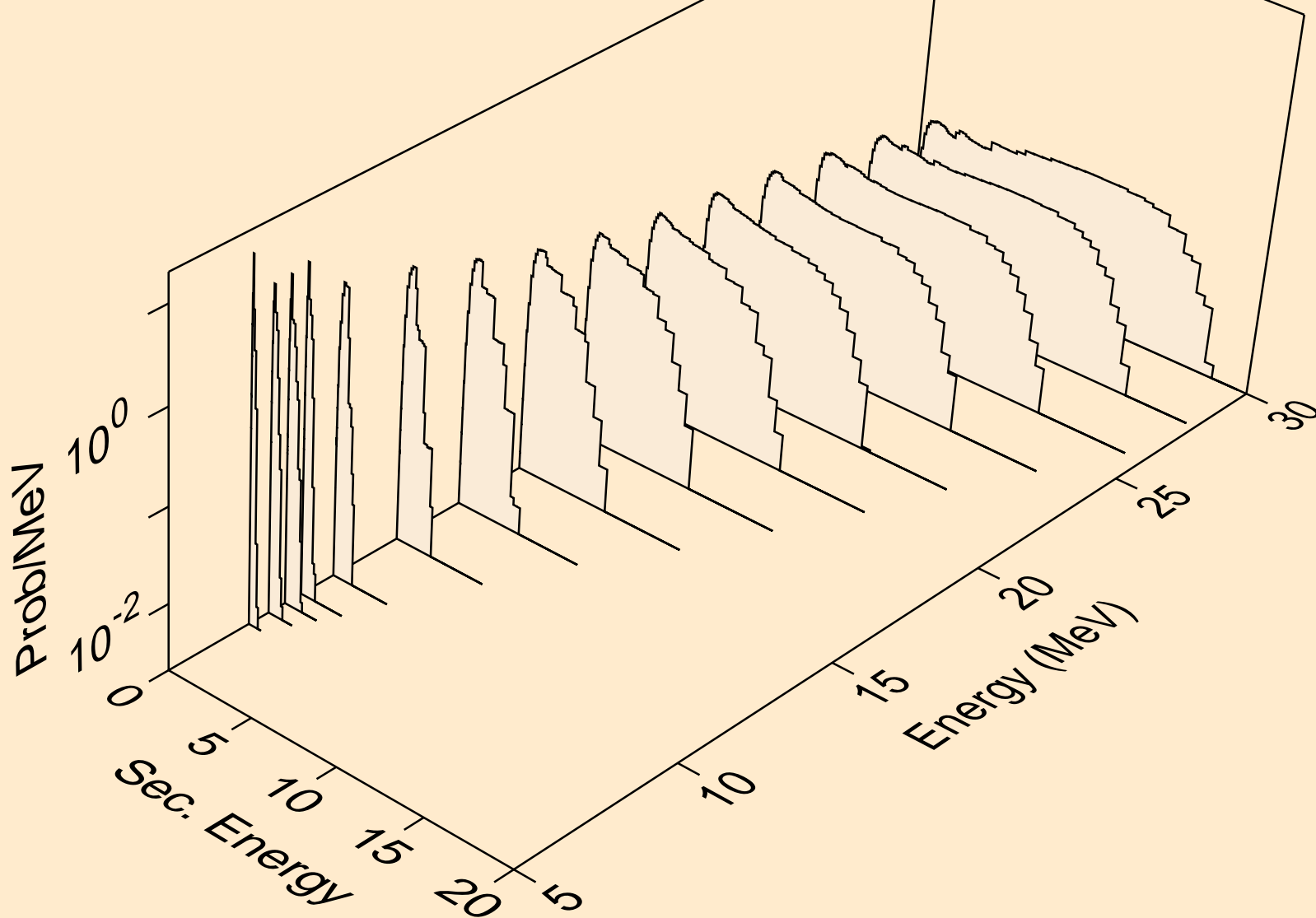

MO085 NEUTRON ACER TENDL-2019 LIBRARY; T=293.16K
Neutron emission for (n,npa)

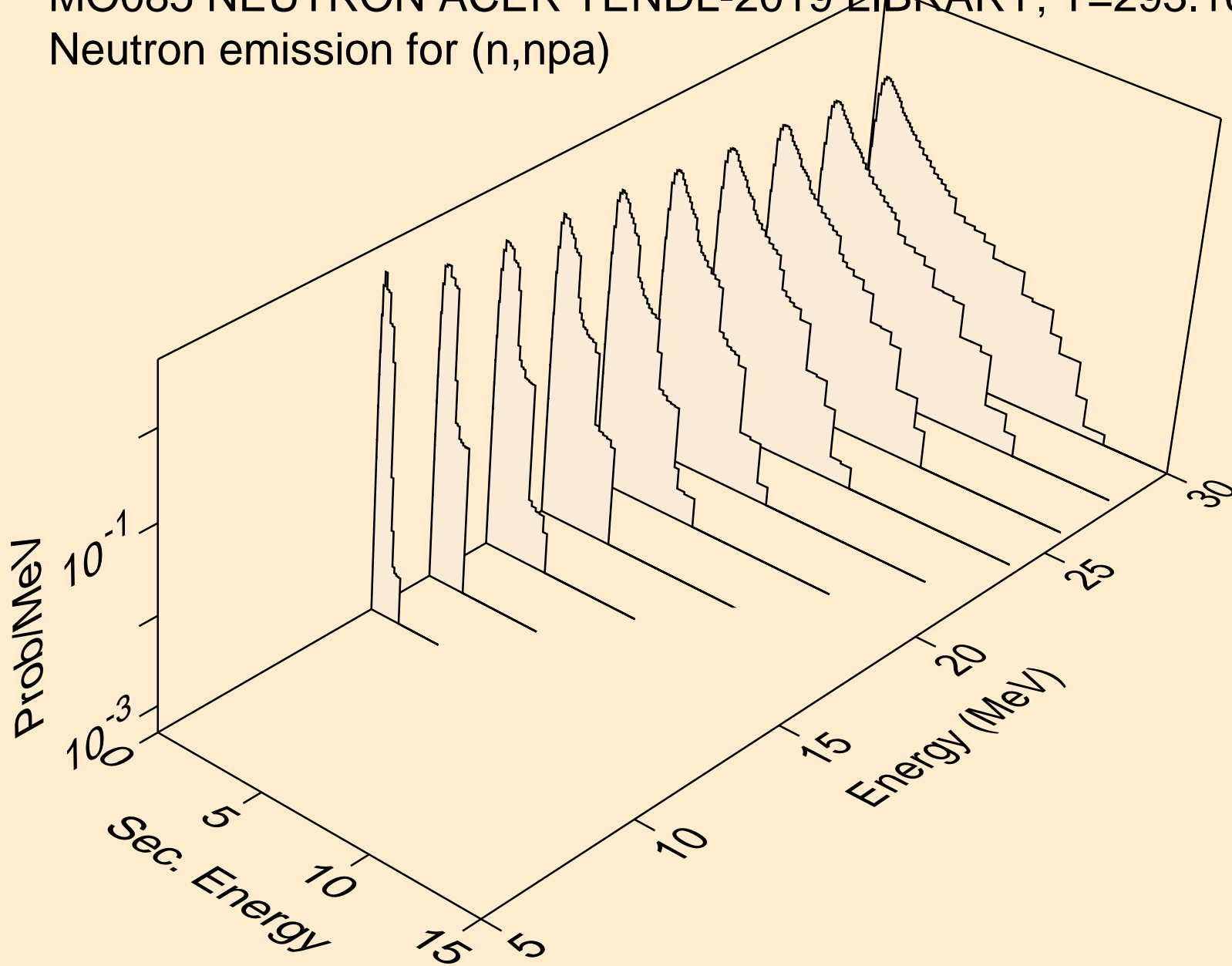

MO085 NEUTRON ACER TENDL-2019 LIBRARY; T=293.16K
Neutron emission for (n,n*c)

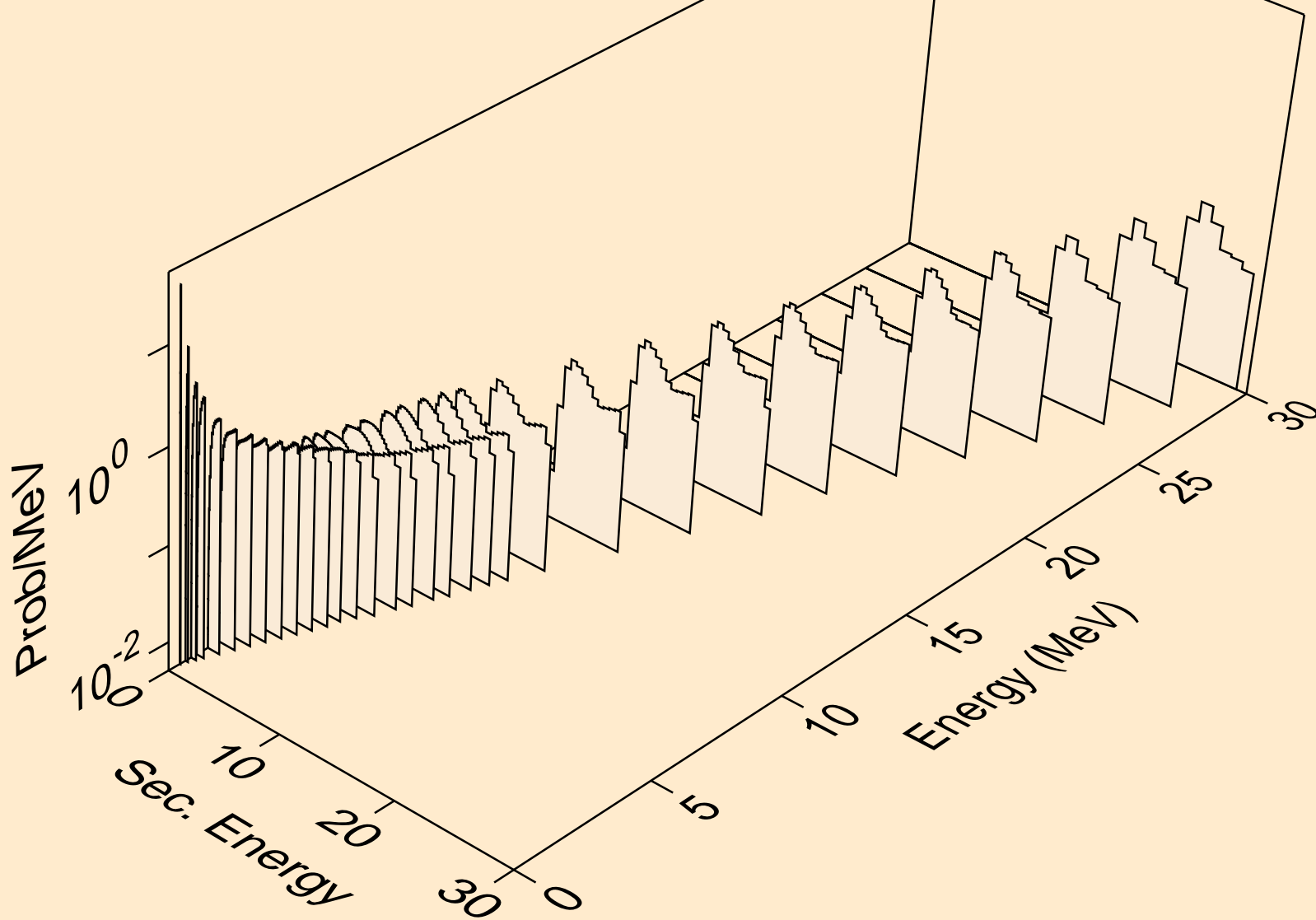

MO085 NEUTRON ACER TENDL-2019 LIBRARY; T=293.16K
Photon emission for (n,x)

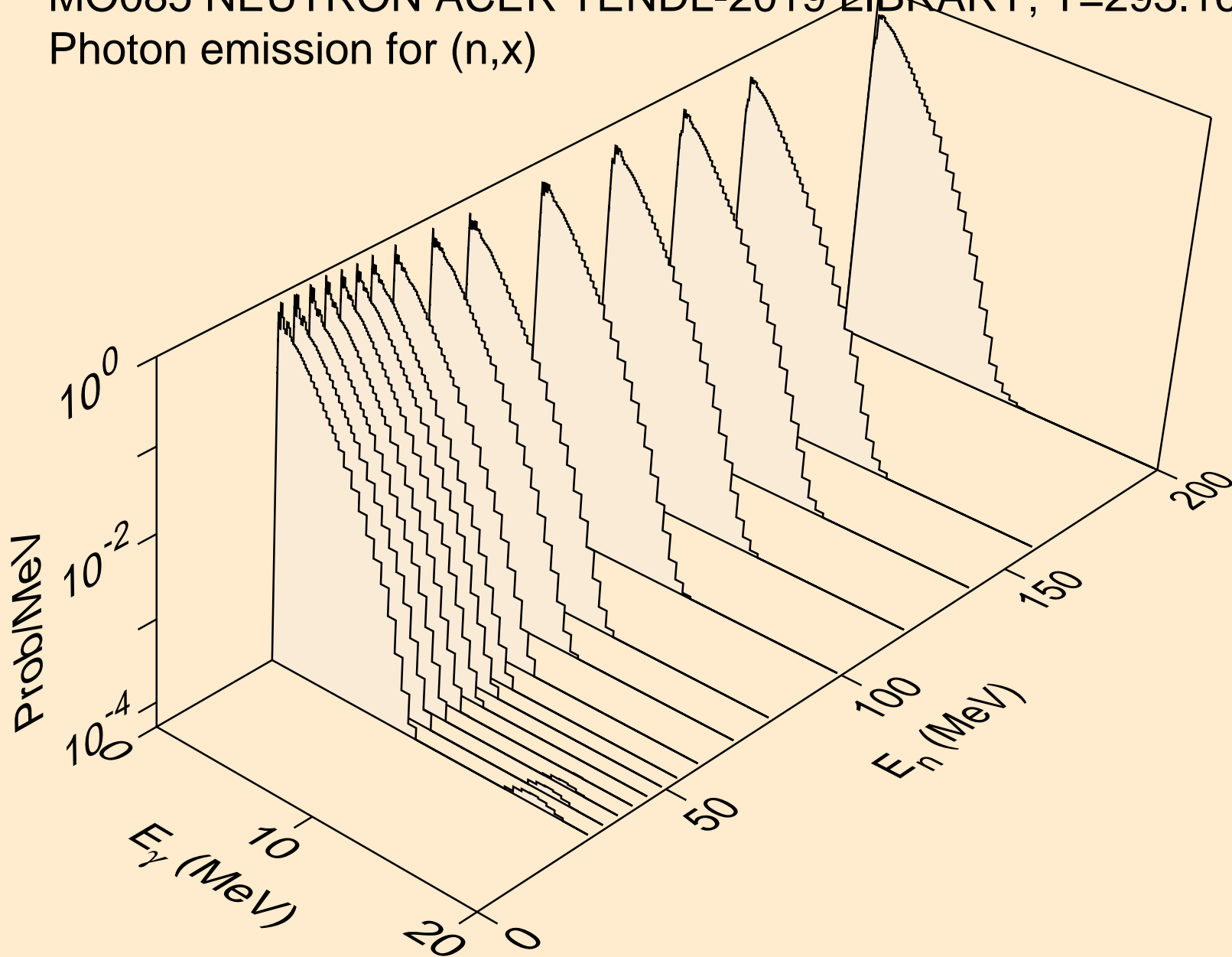

MO085 NEUTRON ACER TENDL-2019 LIBRARY; T=293.16K
Photon emission for (n,2n)

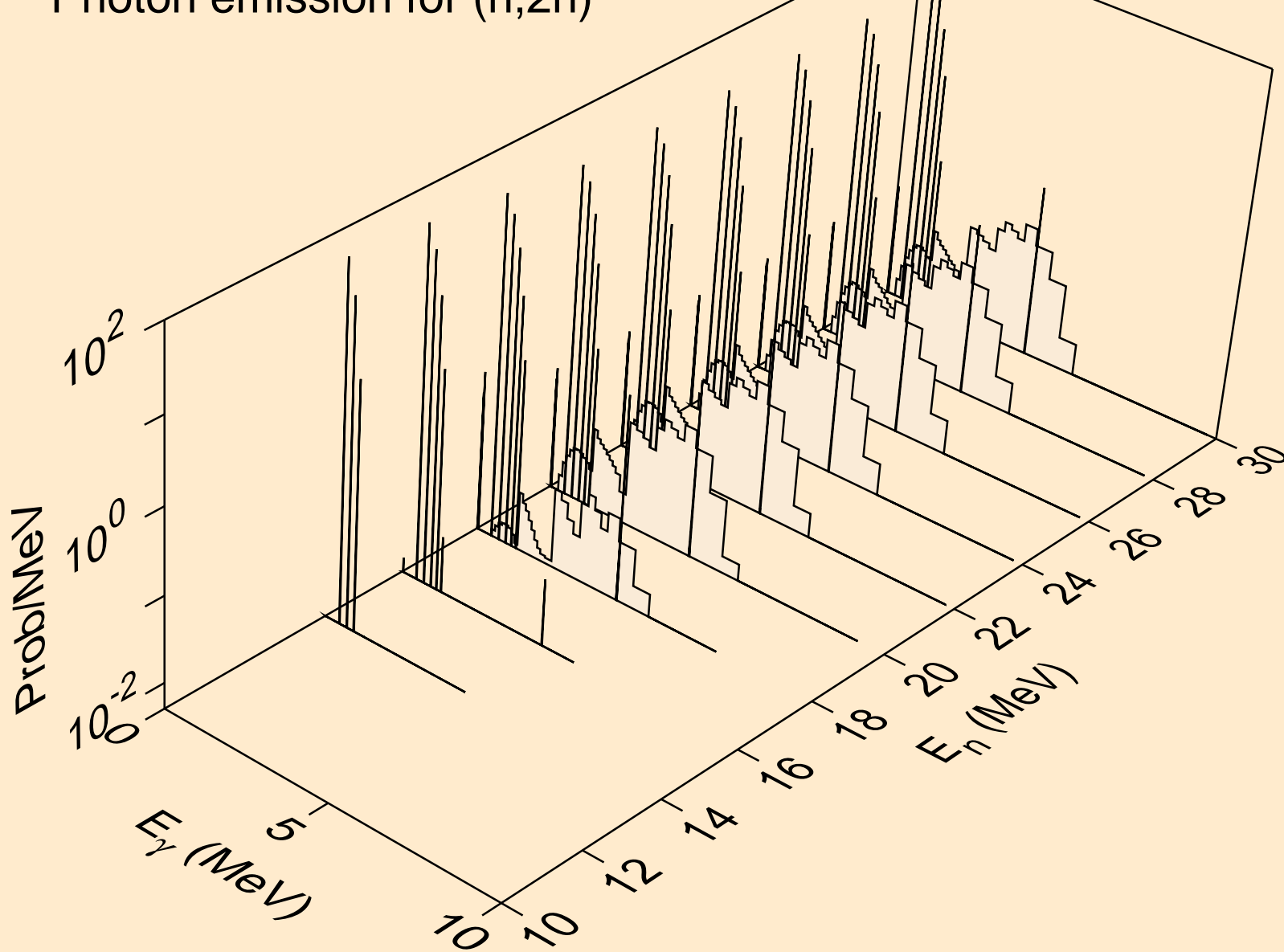

MO085 NEUTRON ACER TENDL-2019 LIBRARY; T=293.16K
Photon emission for (n,3n)

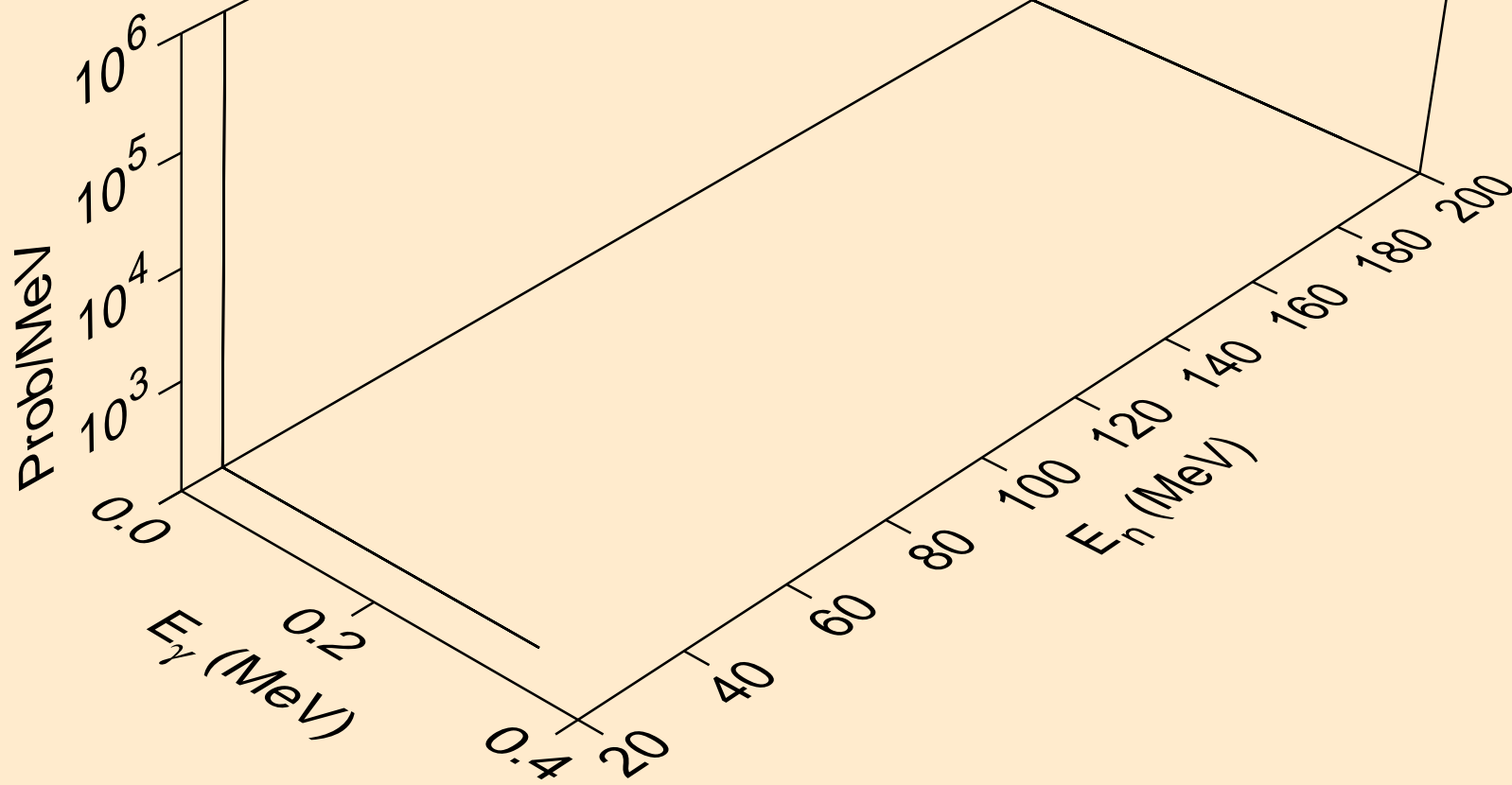

MO085 NEUTRON ACER TENDL-2019 LIBRARY; T=293.16K
Photon emission for (n,n*)a

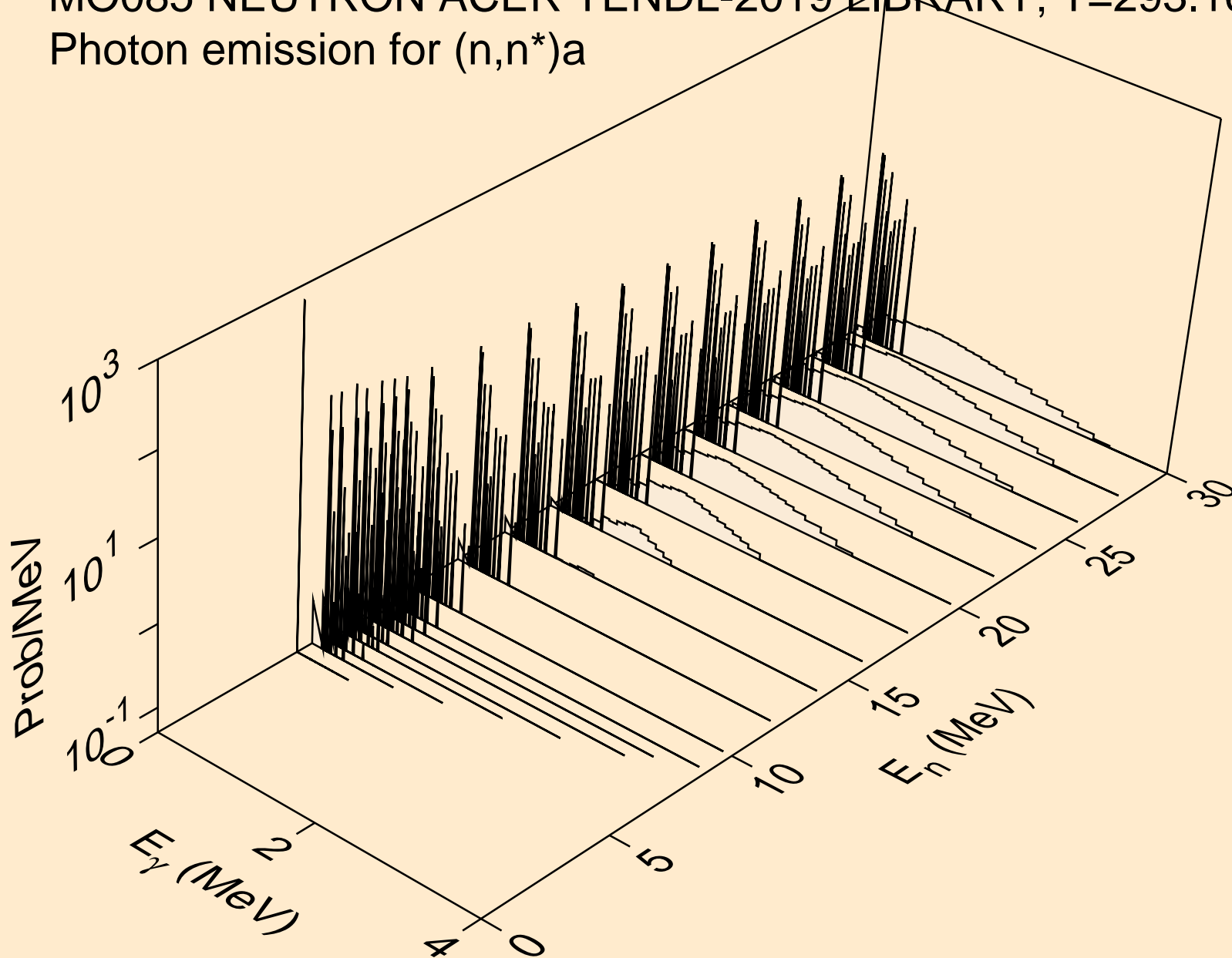

MO085 NEUTRON ACER TENDL-2019 LIBRARY; T=293.16K
Photon emission for (n,2n)a

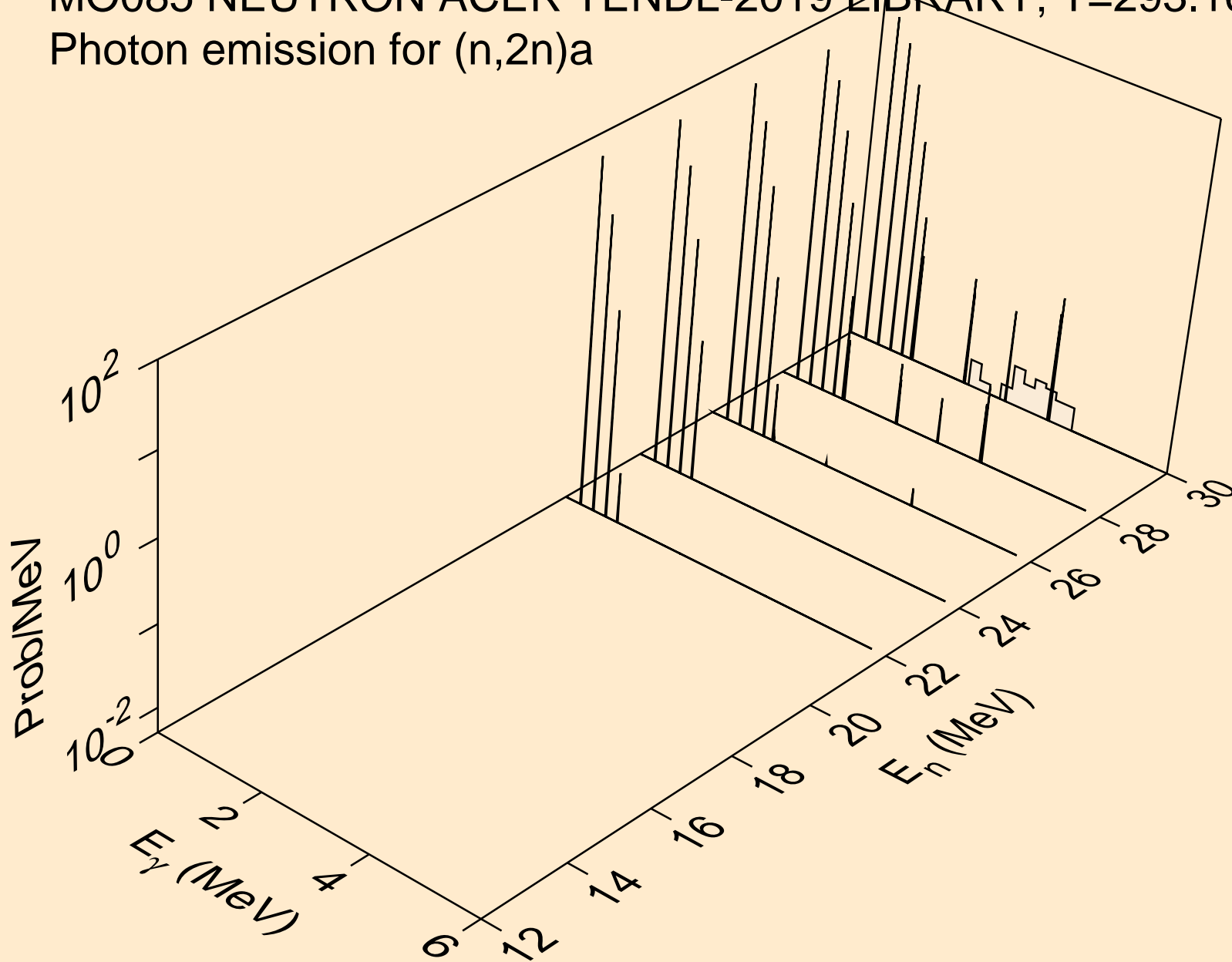

MO085 NEUTRON ACER TENDL-2019 LIBRARY; T=293.16K
Photon emission for (n,n*)p

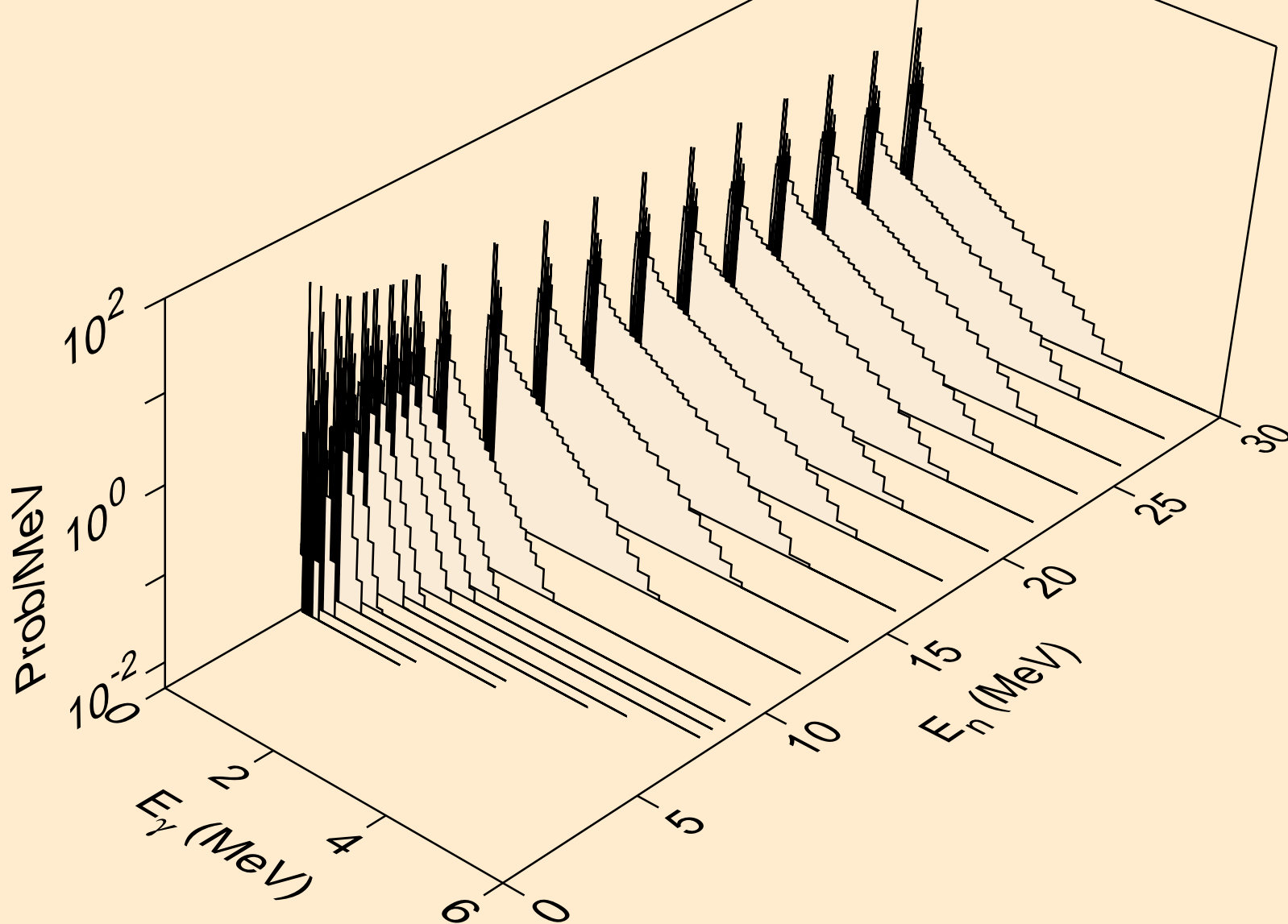

MO085 NEUTRON ACER TENDL-2019 LIBRARY; T=293.16K
Photon emission for (n,n*)2a

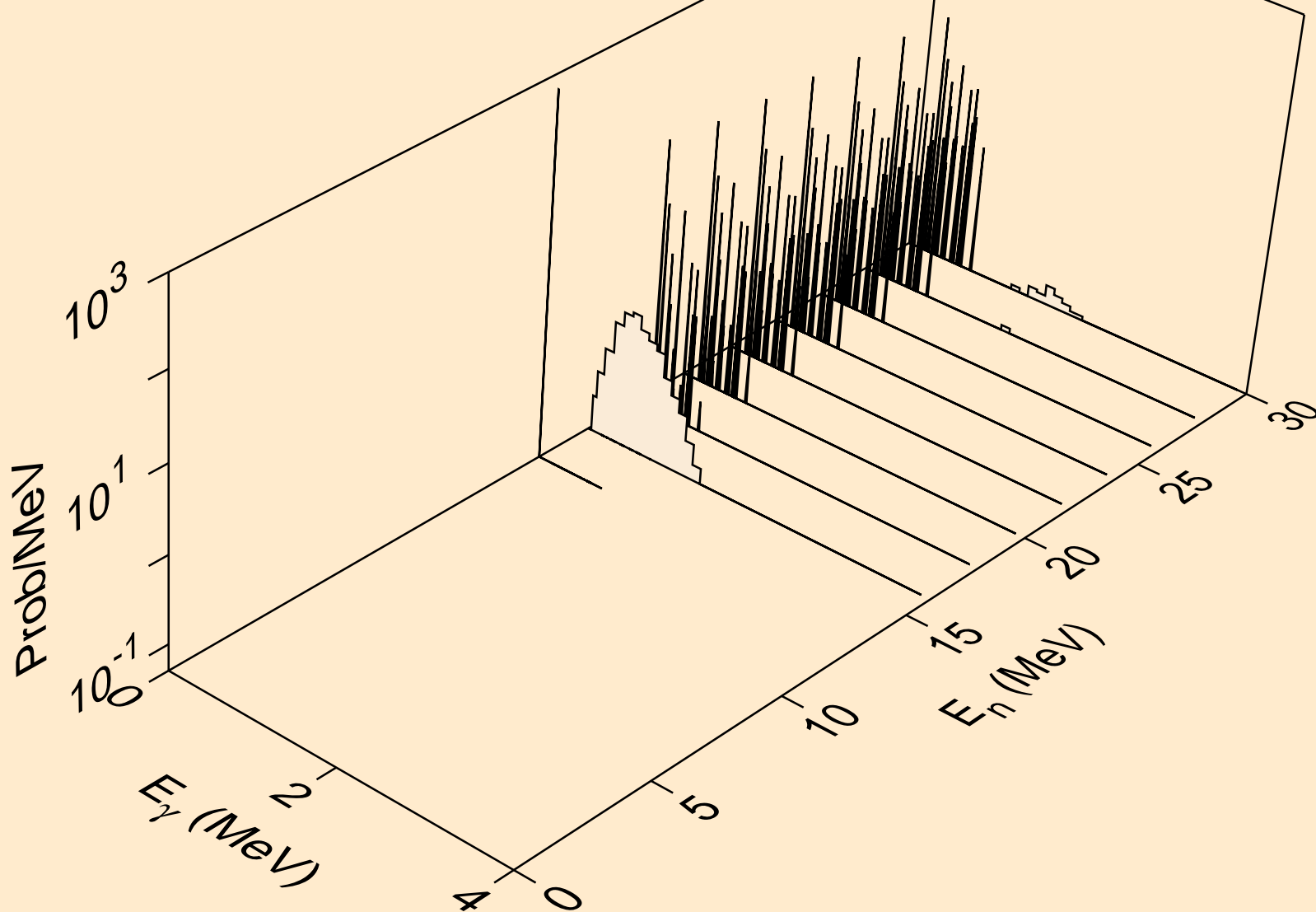

MO085 NEUTRON ACER TENDL-2019 LIBRARY; T=293.16K
Photon emission for (n,n*)d

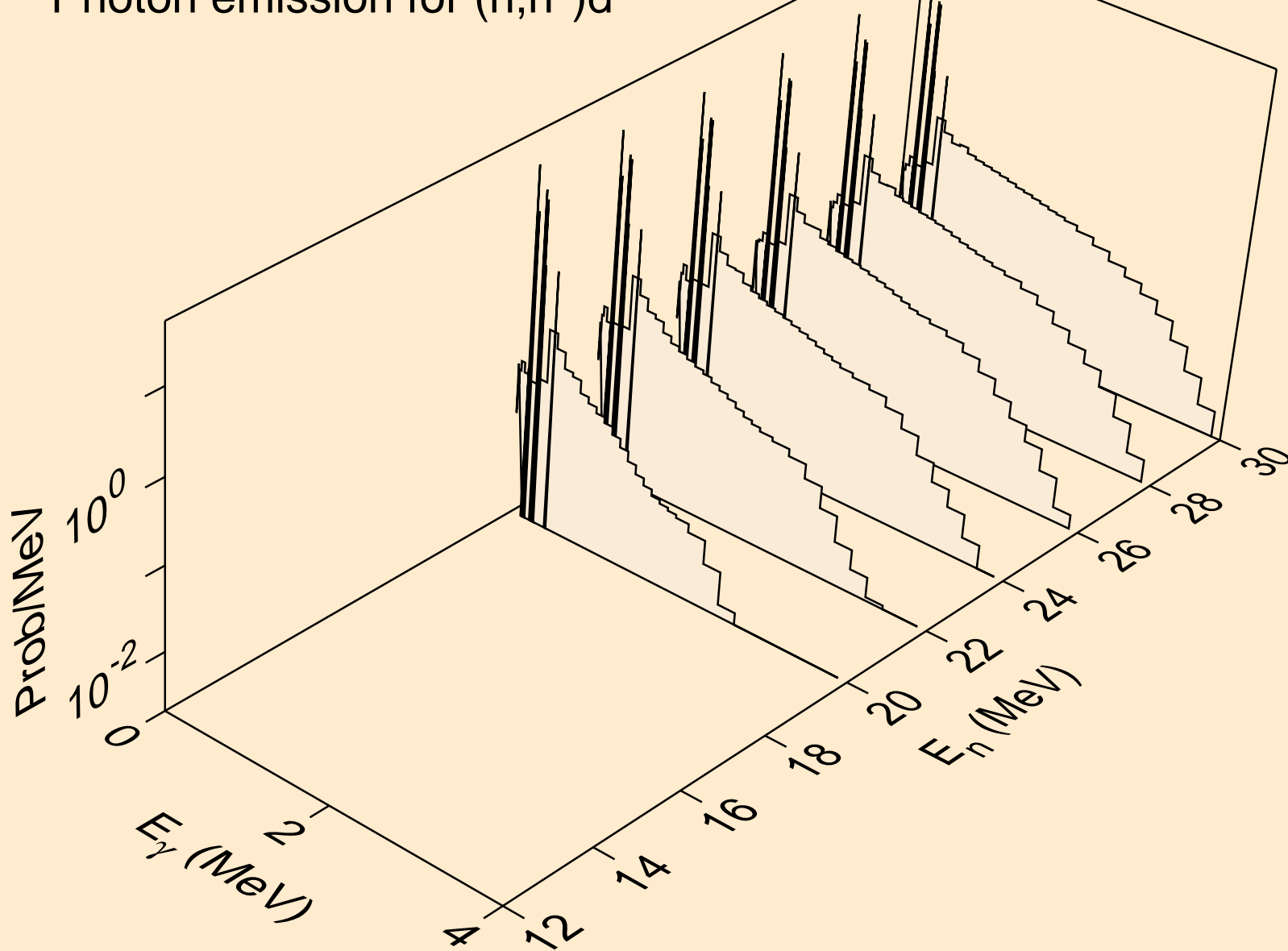

MO085 NEUTRON ACER TENDL-2019 LIBRARY; T=293.16K
Photon emission for (n,n*)t

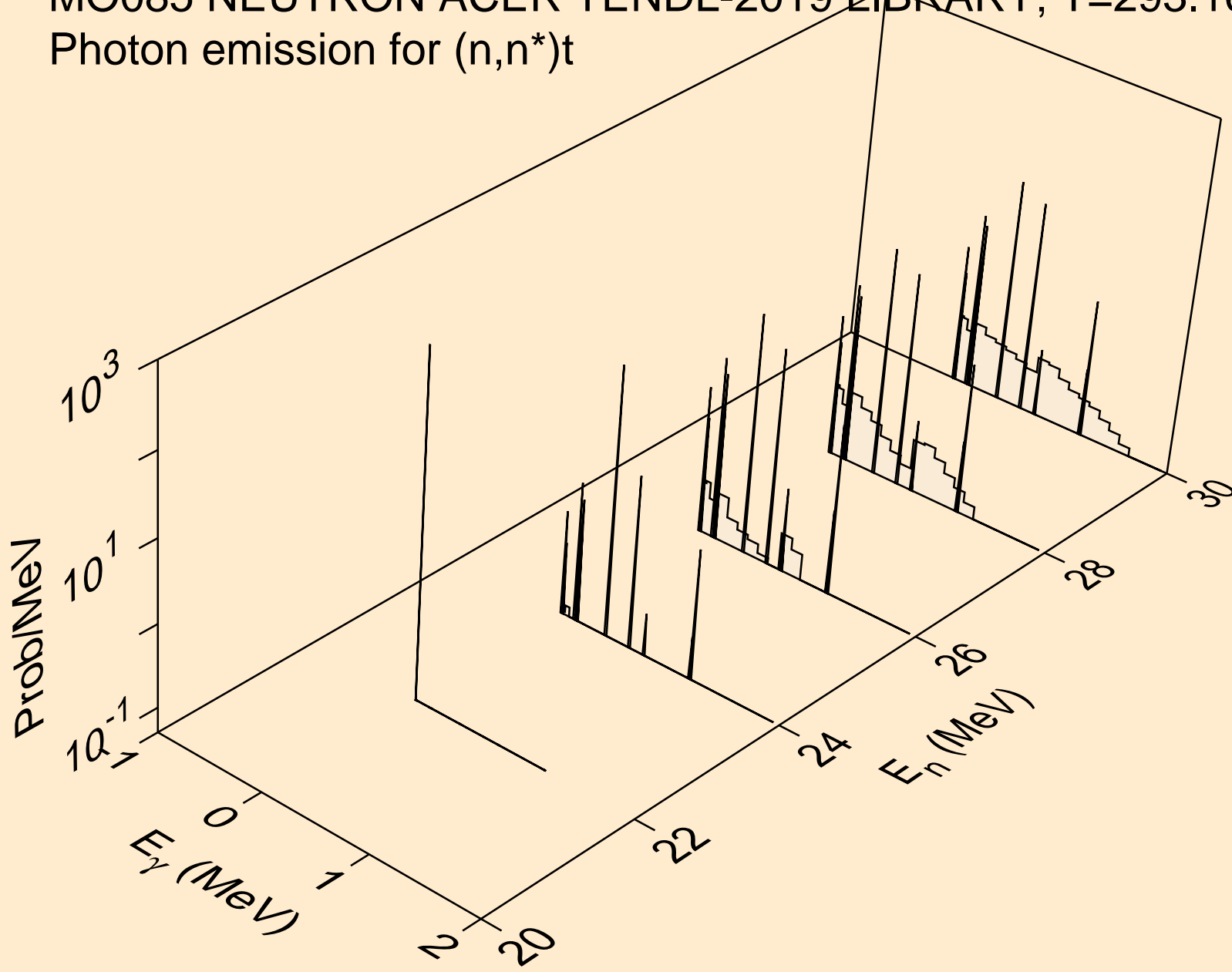

MO085 NEUTRON ACER TENDL-2019 LIBRARY; T=293.16K
Photon emission for (n,n*)he3

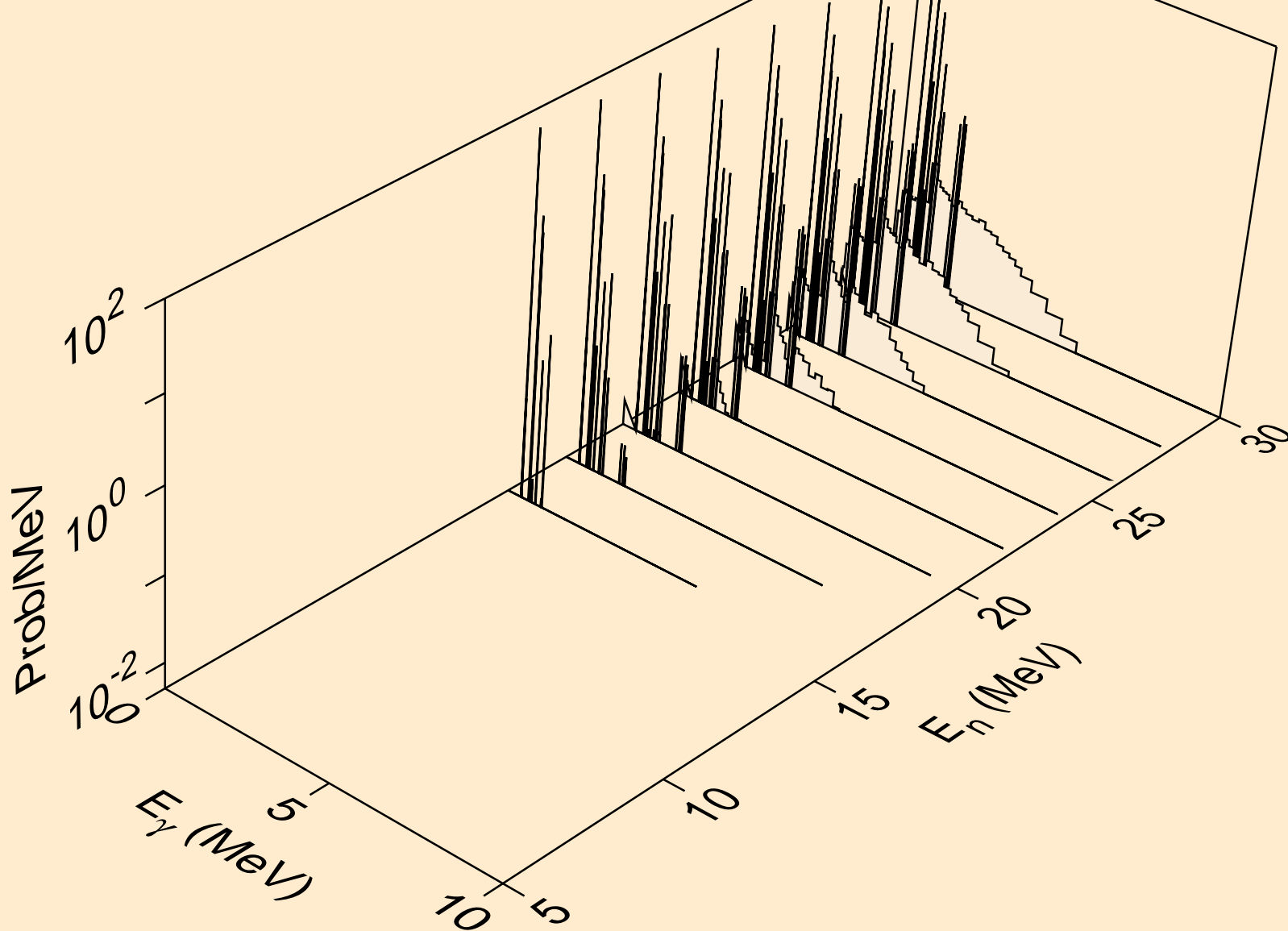

MO085 NEUTRON ACER TENDL-2019 LIBRARY; T=293.16K
Photon emission for (n,2np)

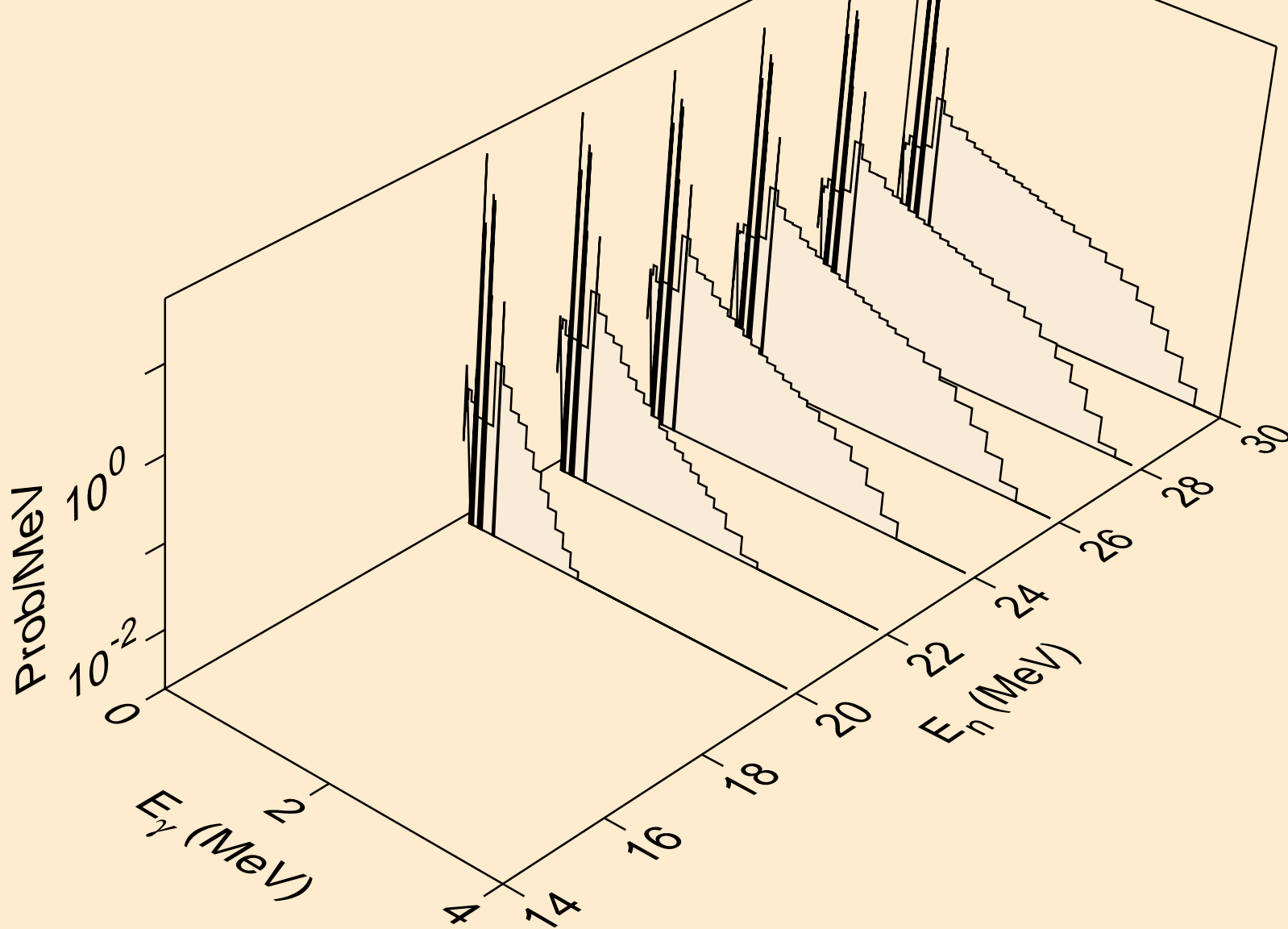

MO085 NEUTRON ACER TENDL-2019 LIBRARY; T=293.16K
Photon emission for (n,2np)

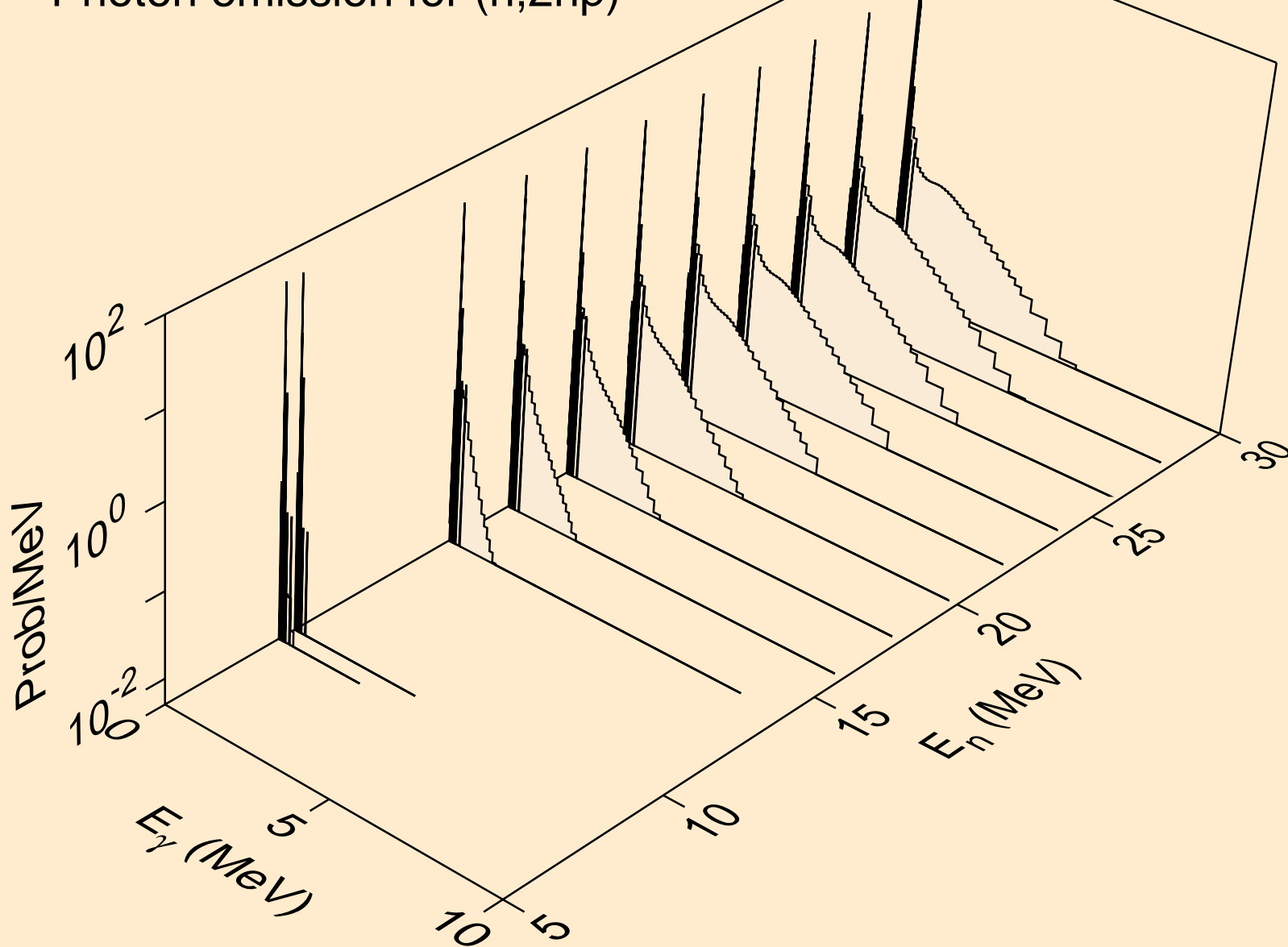

MO085 NEUTRON ACER TENDL-2019 LIBRARY; T=293.16K
Photon emission for (n,npa)

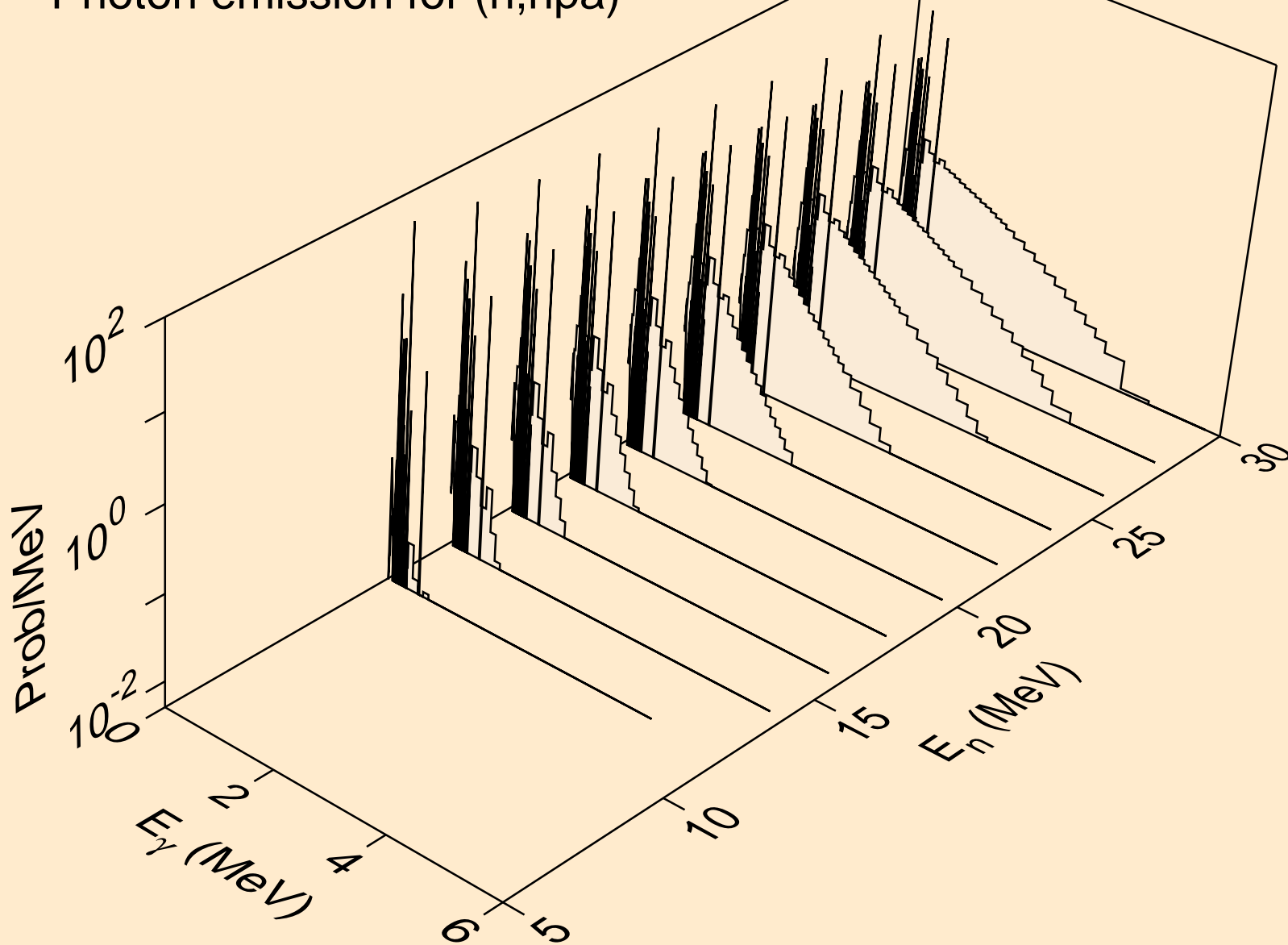

MO085 NEUTRON ACER TENDL-2019 LIBRARY; T=293.16K
Photon emission for (n,n*c)

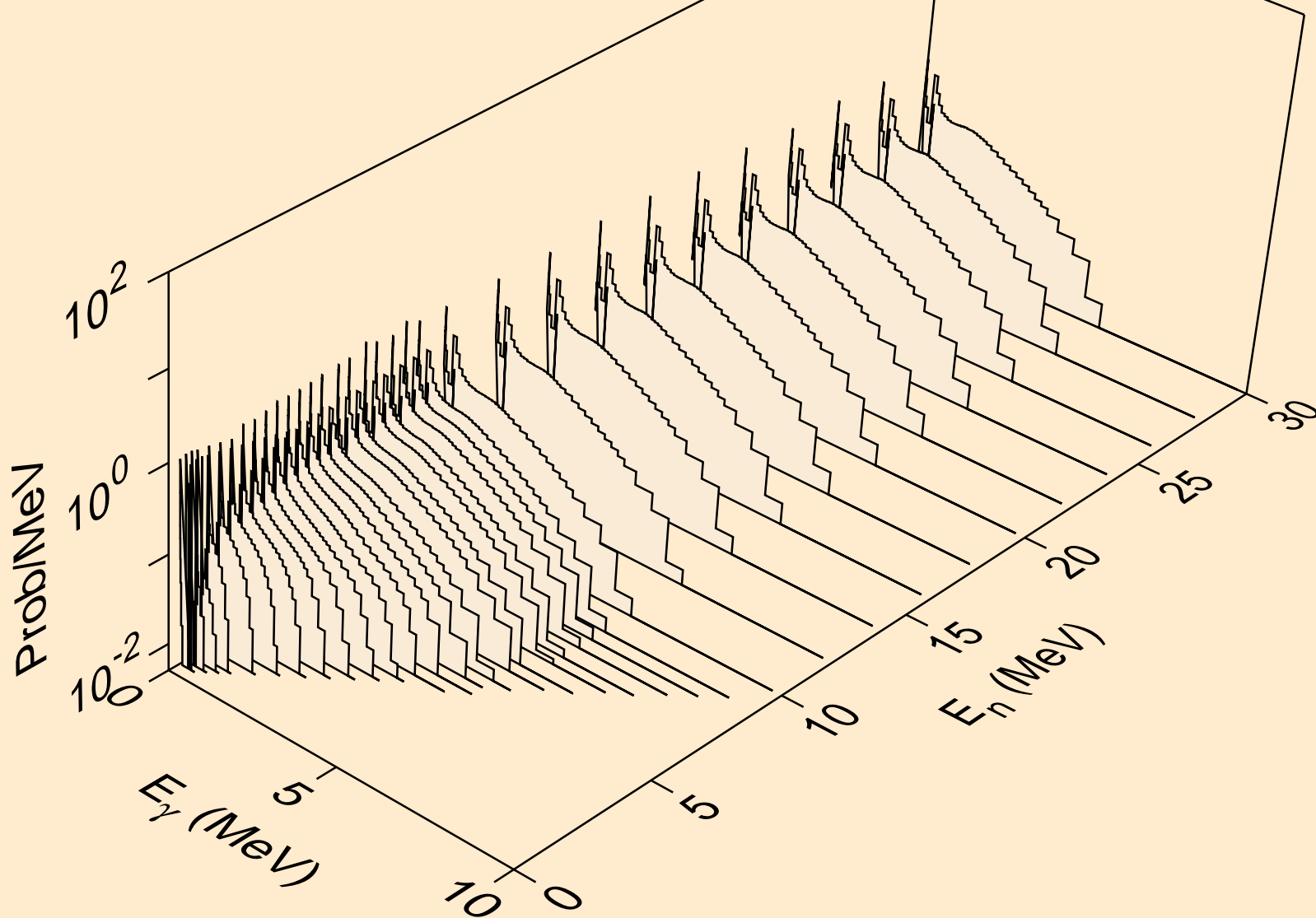

MO085 NEUTRON ACER TENDL-2019 LIBRARY; T=293.16K
Photon emission for (n,gma)

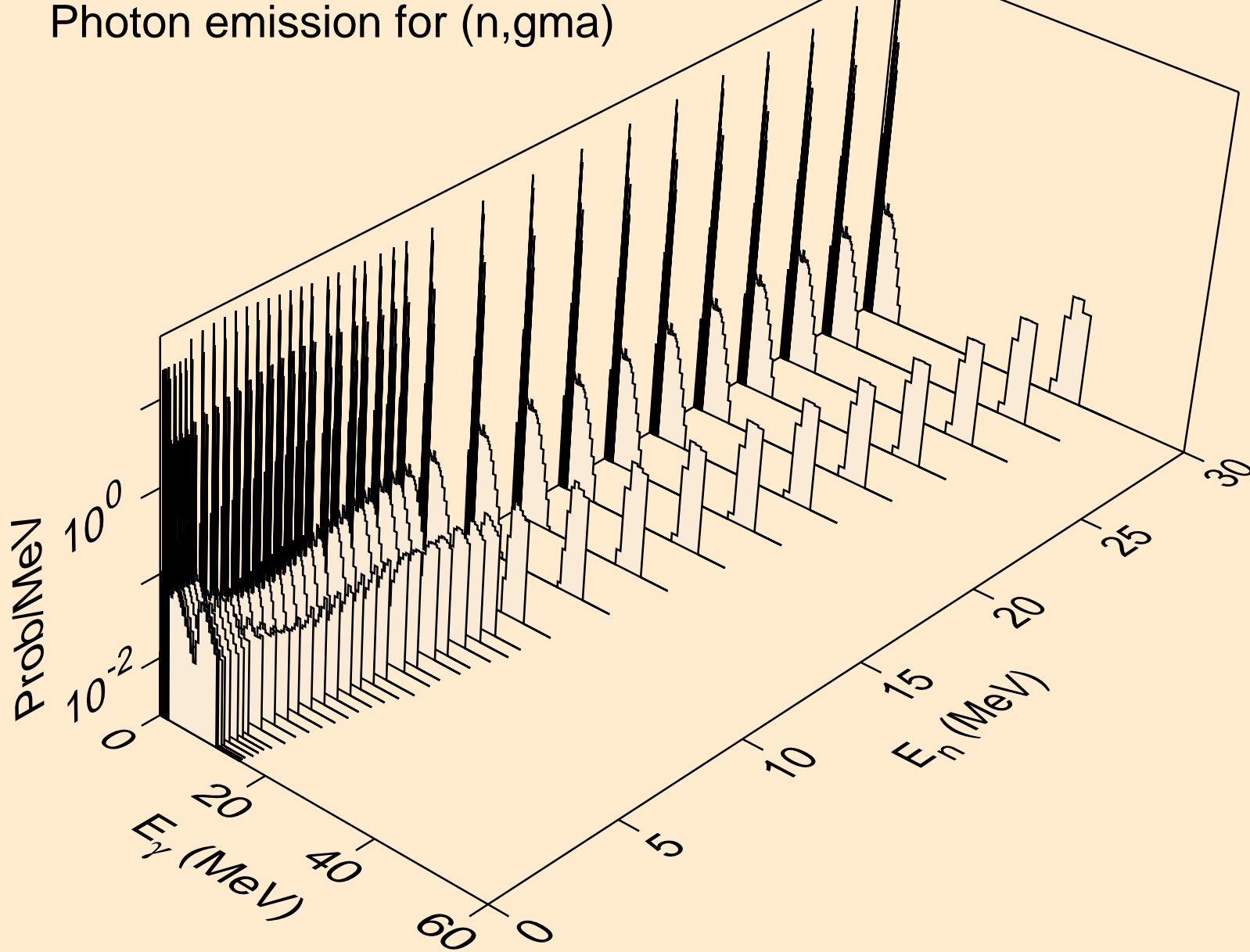

MO085 NEUTRON ACER TENDL-2019 LIBRARY; T=293.16K
Photon emission for (n,p)

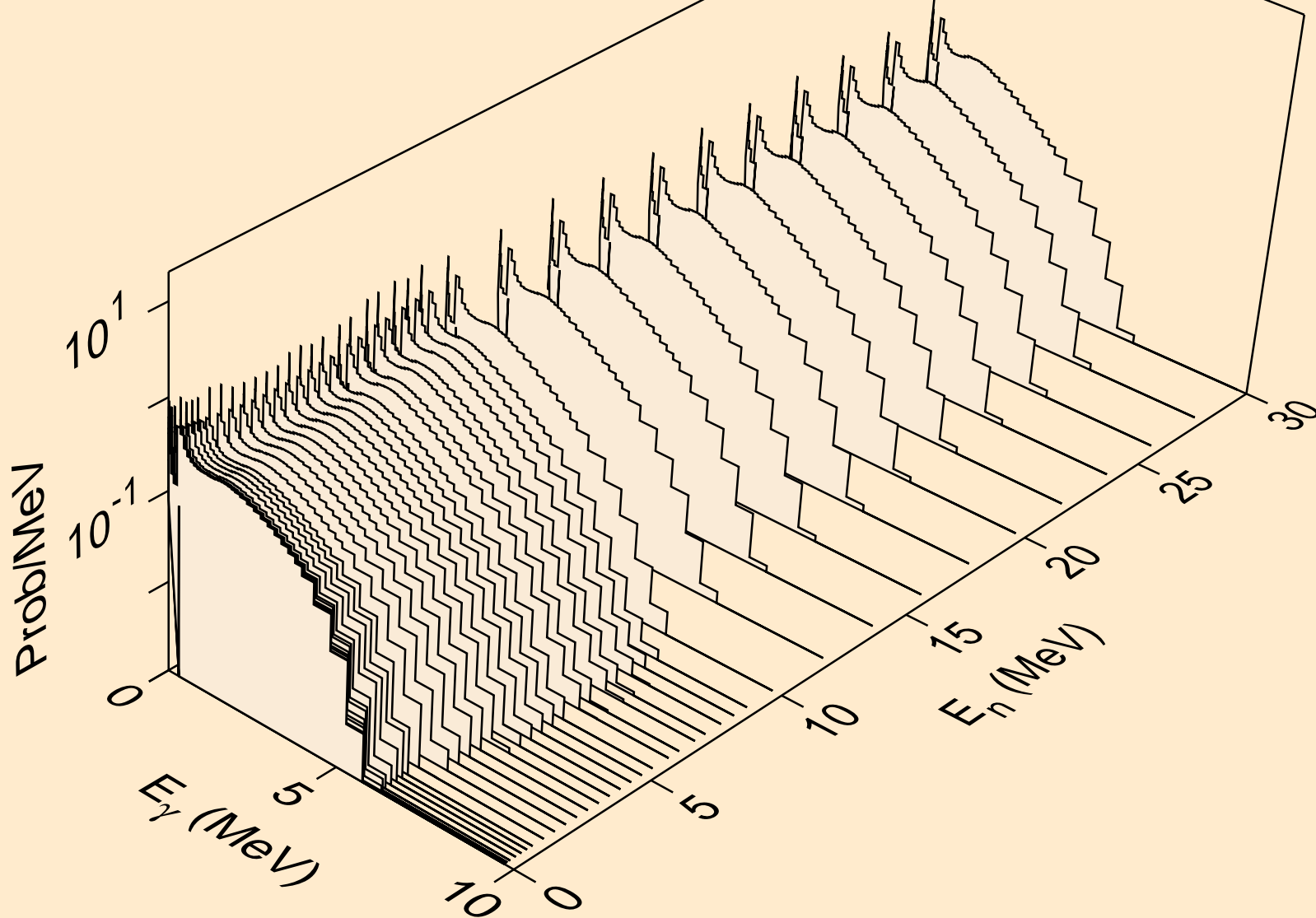

MO085 NEUTRON ACER TENDL-2019 LIBRARY; T=293.16K
Photon emission for (n,d)

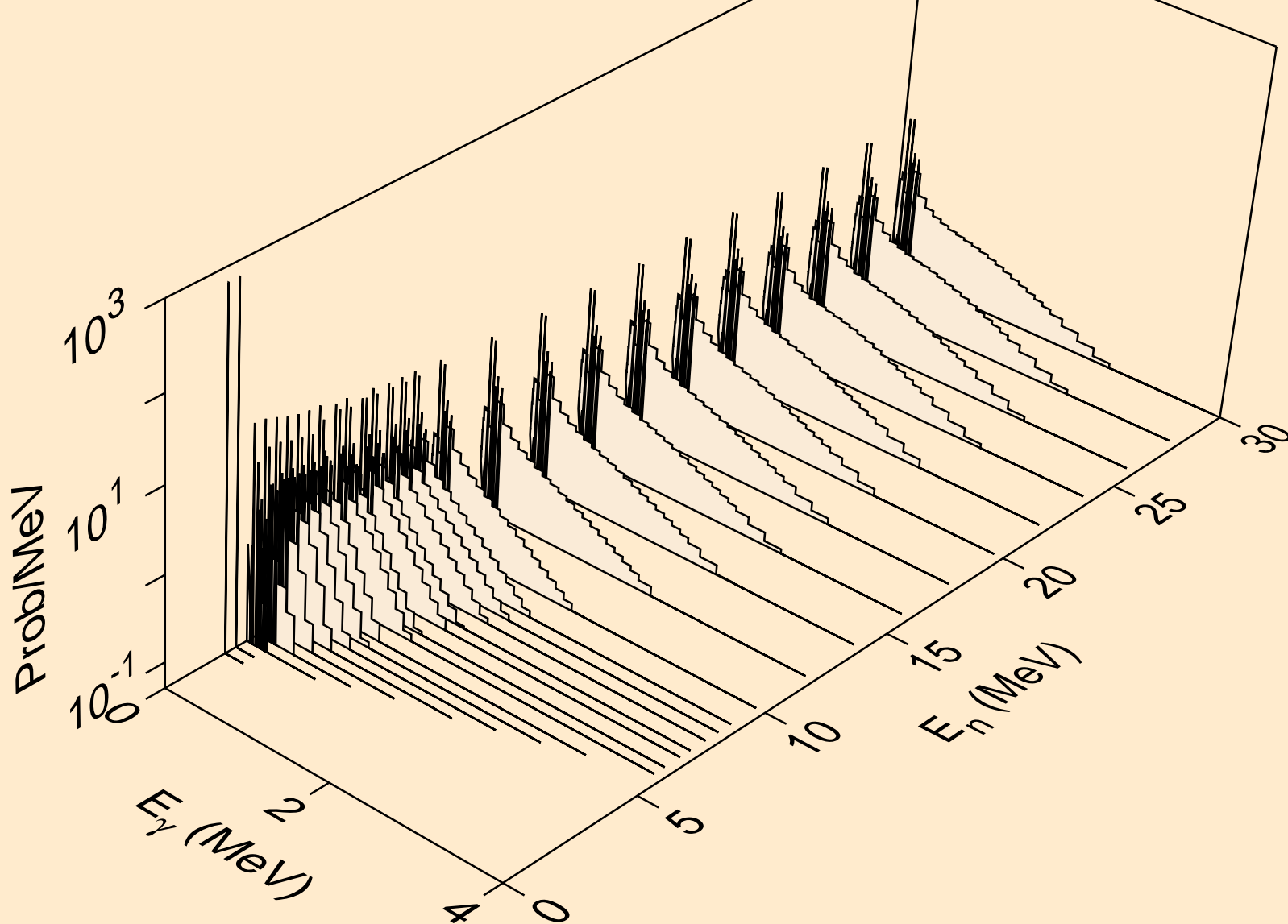

MO085 NEUTRON ACER TENDL-2019 LIBRARY; T=293.16K
Photon emission for (n,t)

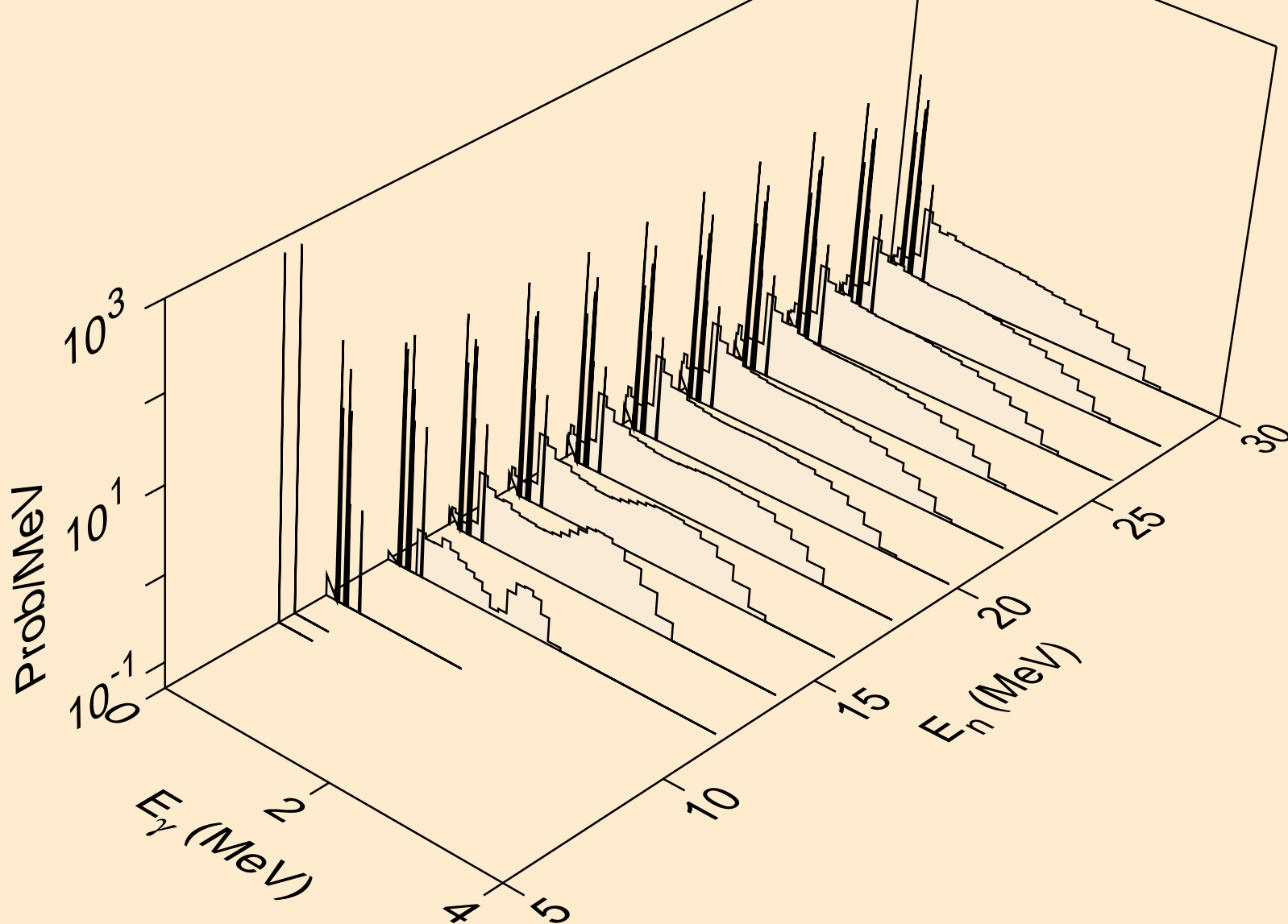

MO085 NEUTRON ACER TENDL-2019 LIBRARY; T=293.16K
Photon emission for (n,he3)

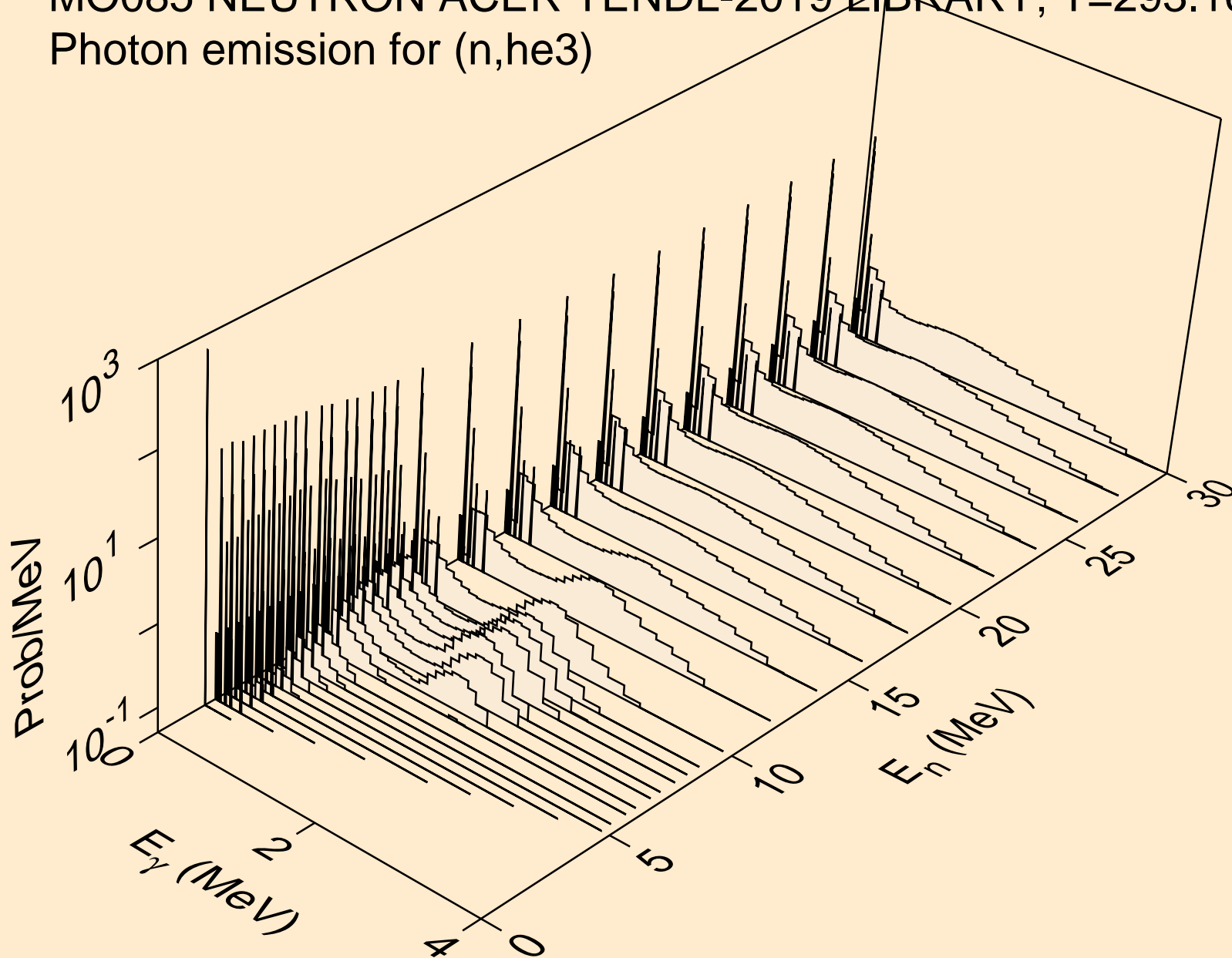

MO085 NEUTRON ACER TENDL-2019 LIBRARY; T=293.16K
Photon emission for (n,a)

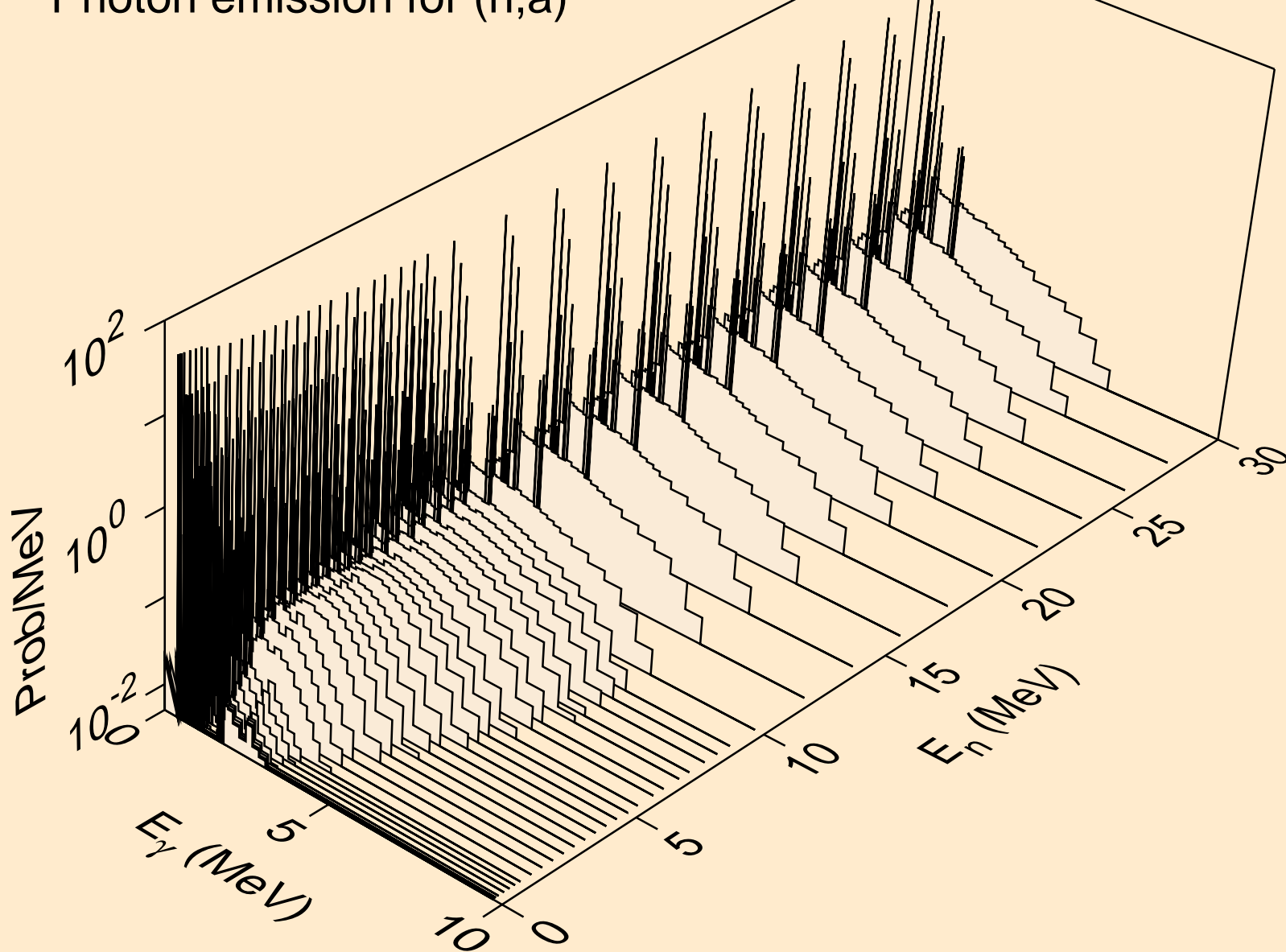

MO085 NEUTRON ACER TENDL-2019 LIBRARY; T=293.16K
Photon emission for (n,2a)

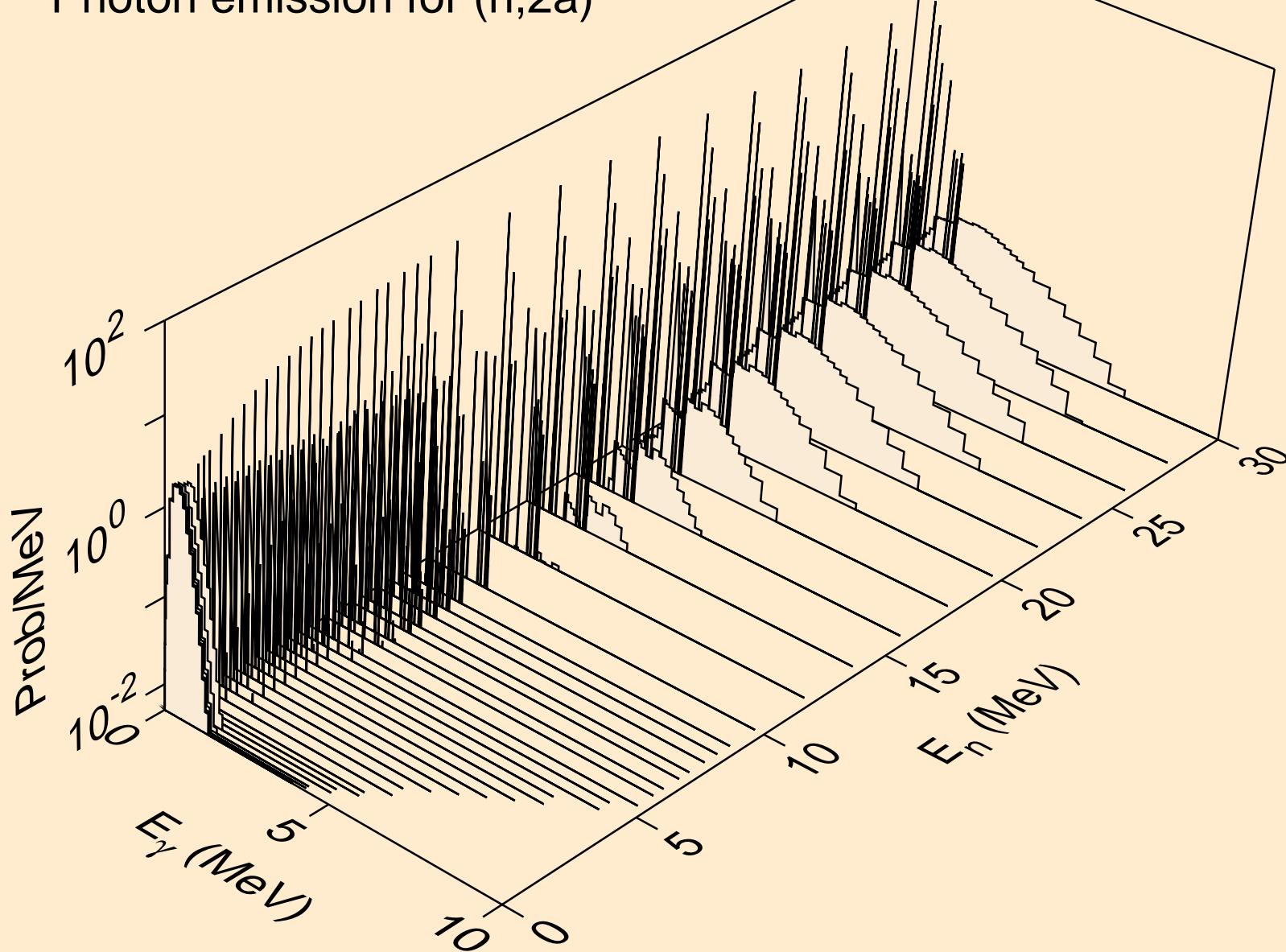

MO085 NEUTRON ACER TENDL-2019 LIBRARY; T=293.16K
Photon emission for (n,3a)

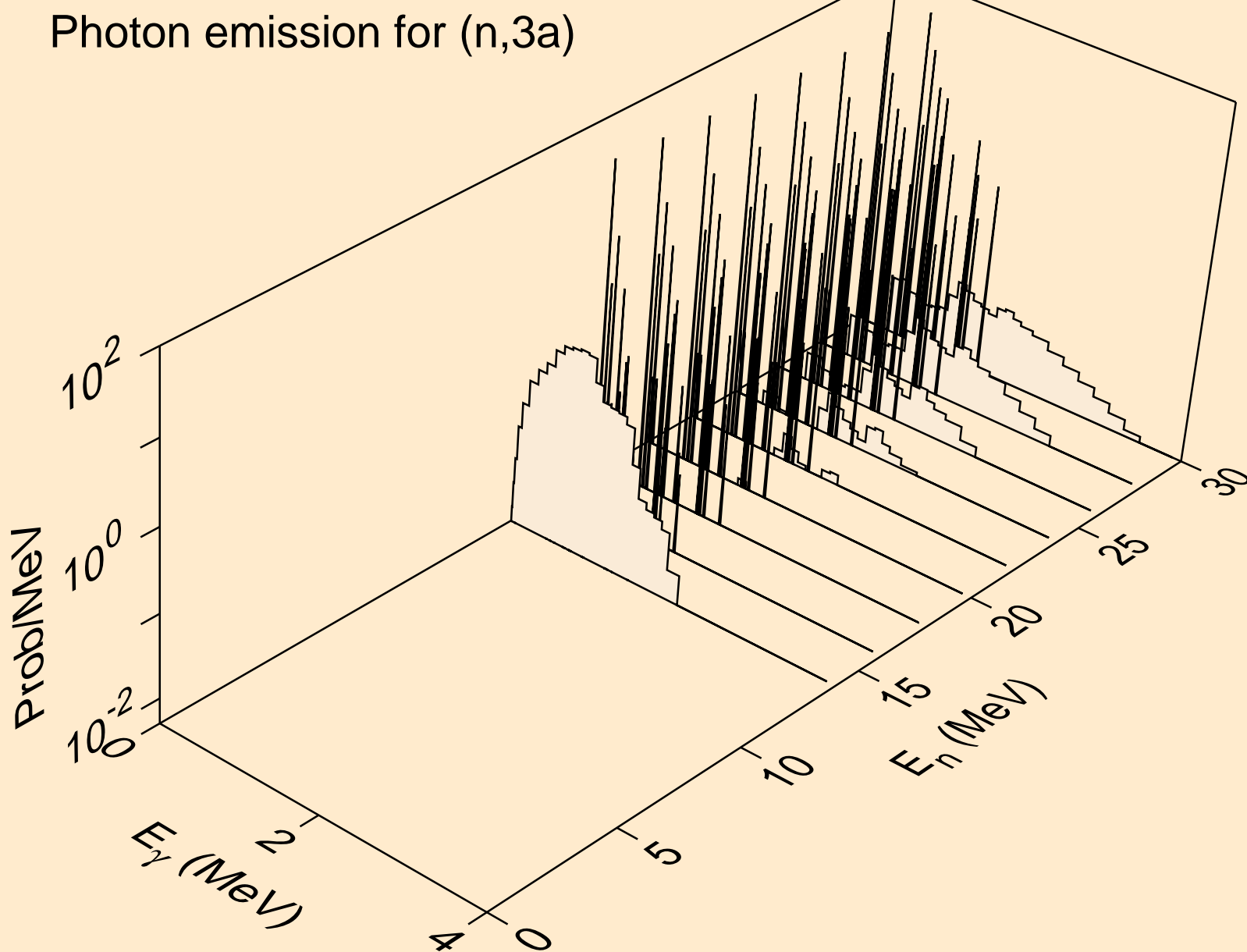

MO085 NEUTRON ACER TENDL-2019 LIBRARY; T=293.16K
Photon emission for (n,2p)

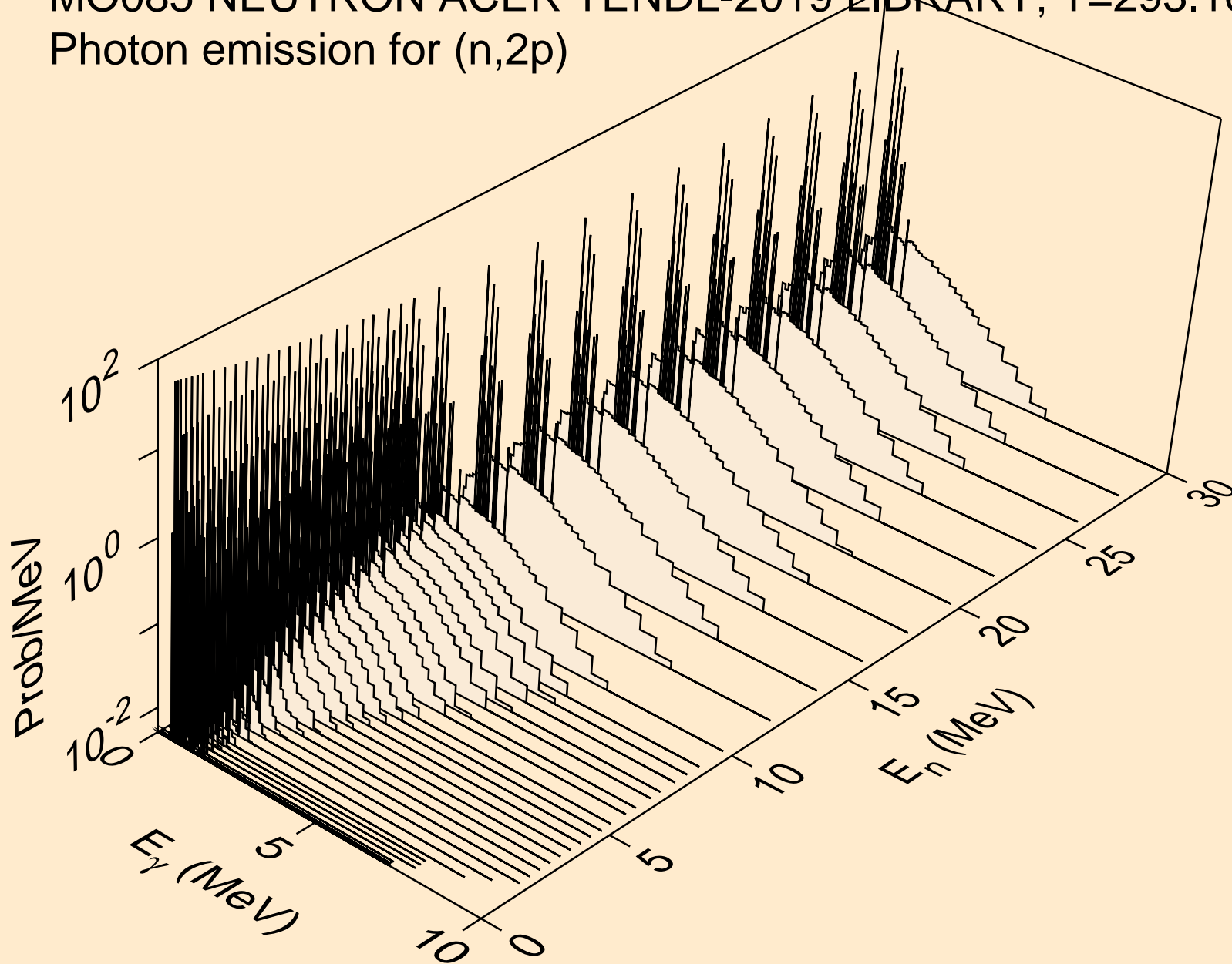

MO085 NEUTRON ACER TENDL-2019 LIBRARY; T=293.16K
Photon emission for (n,p α)

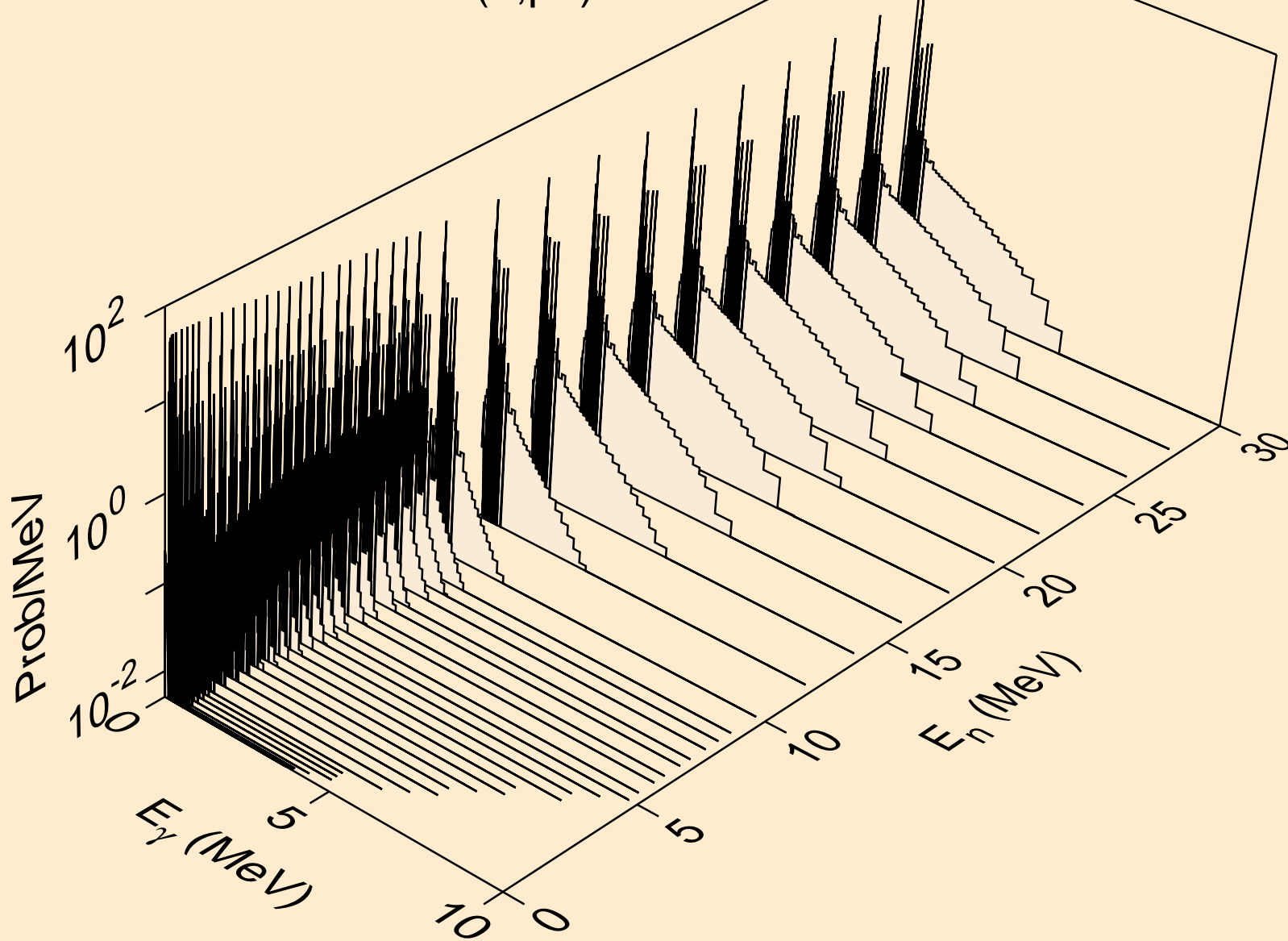

MO085 NEUTRON ACER TENDL-2019 LIBRARY; T=293.16K
Photon emission for (n,pd)

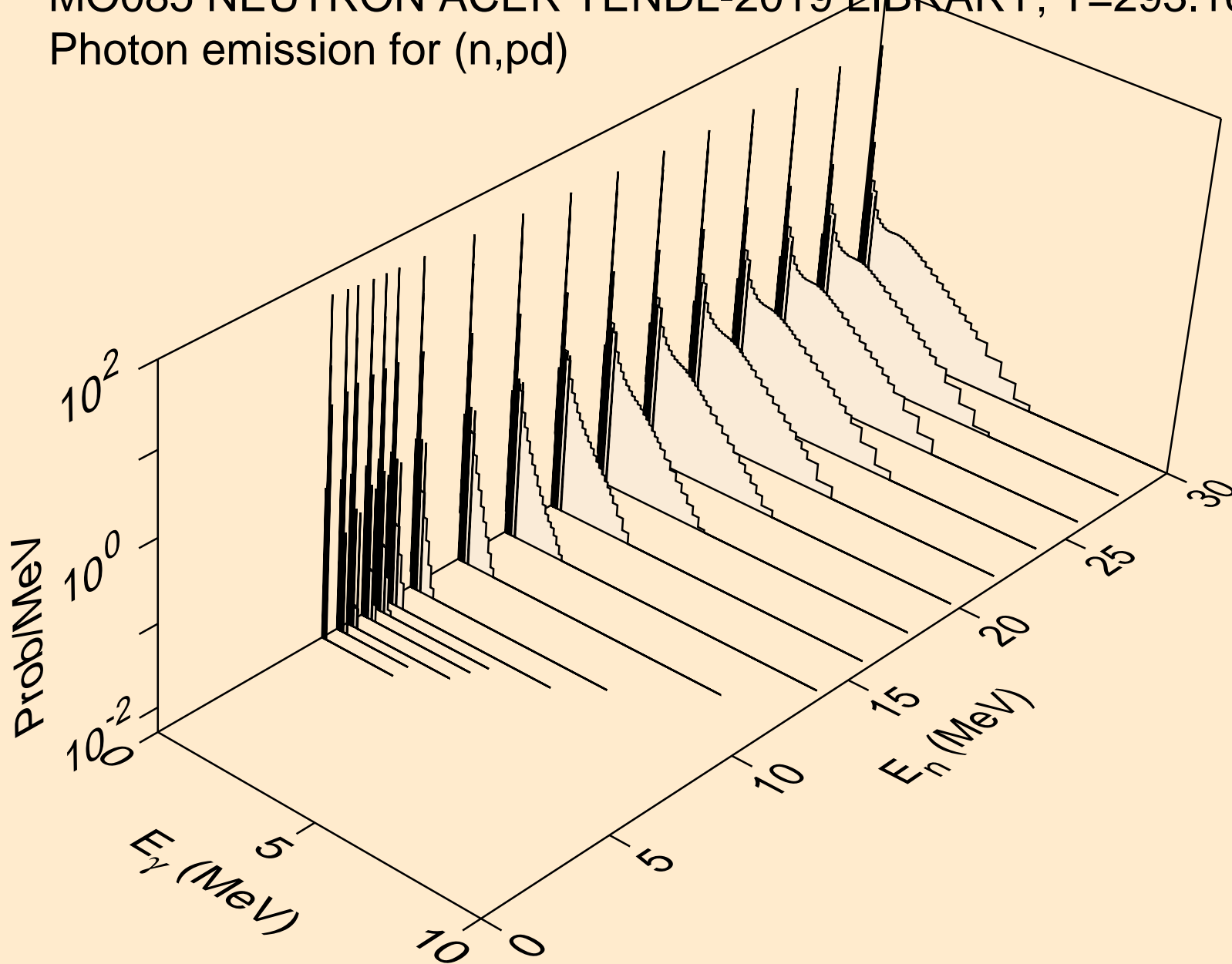

MO085 NEUTRON ACER TENDL-2019 LIBRARY; T=293.16K
Photon emission for (n,pt)

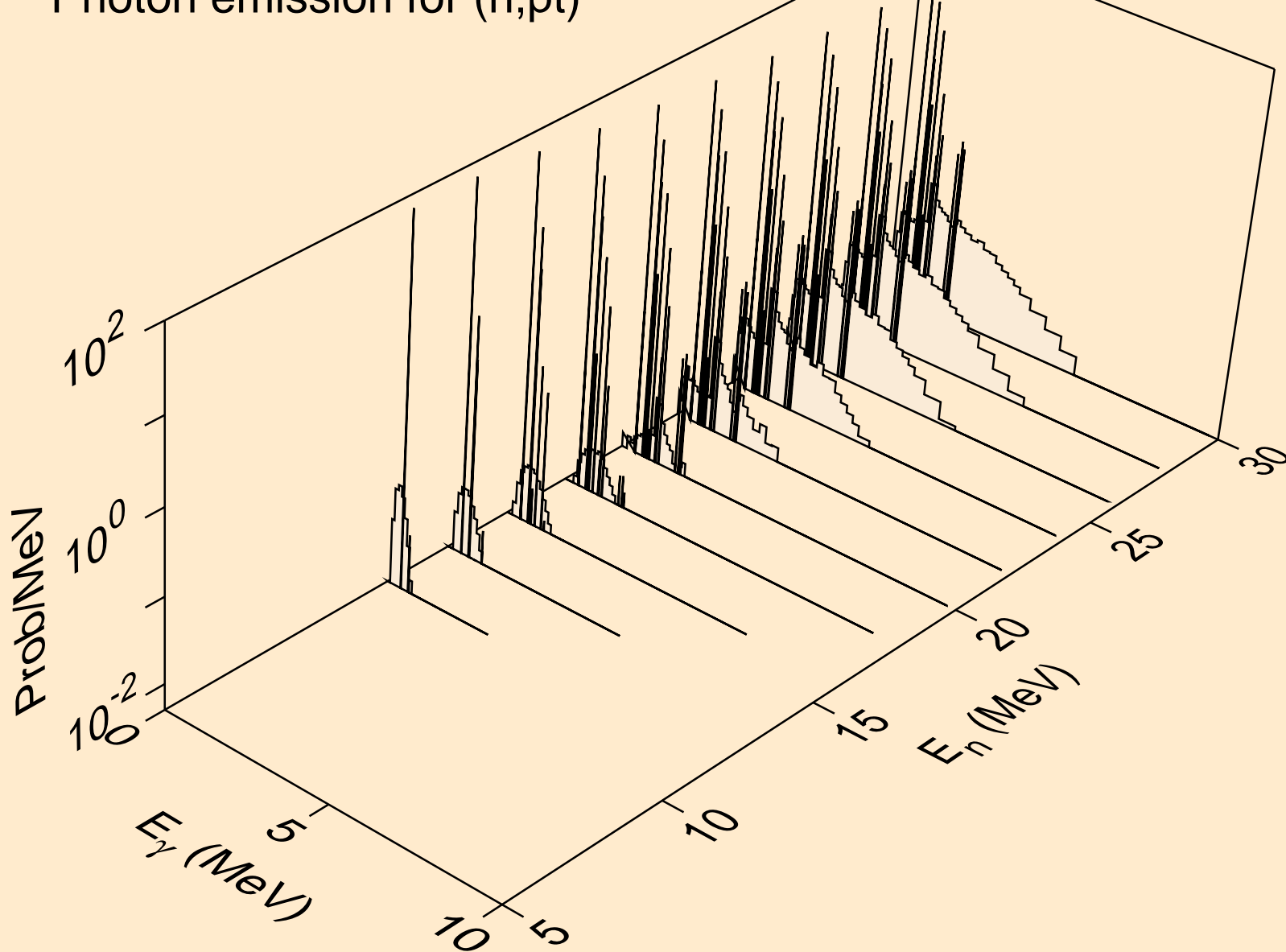

MO085 NEUTRON ACER TENDL-2019 LIBRARY; T=293.16K
Photon emission for (n,da)

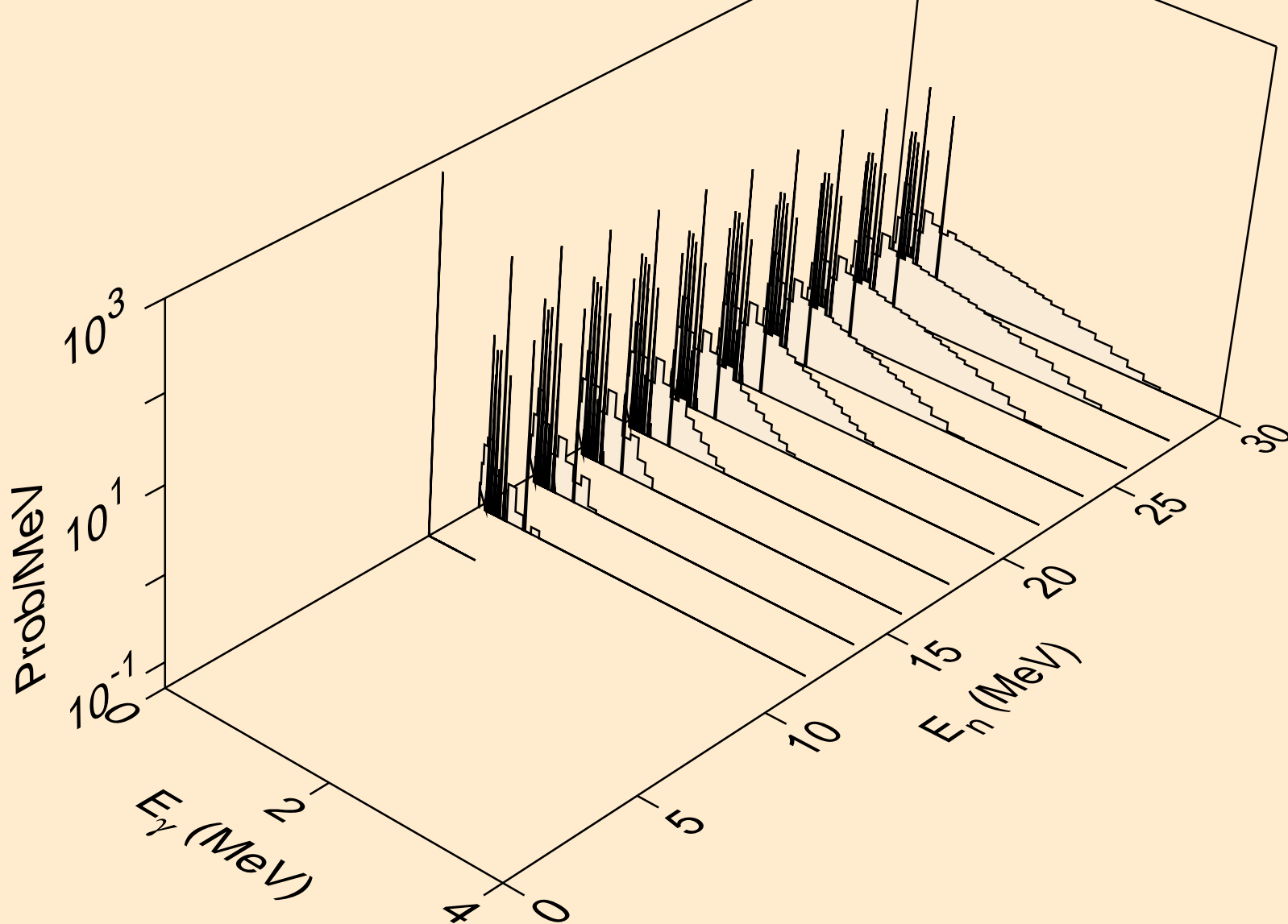

MO085 NEUTRON ACER TENDL-2019 LIBRARY; T=293.16K
thermal capture photon spectrum

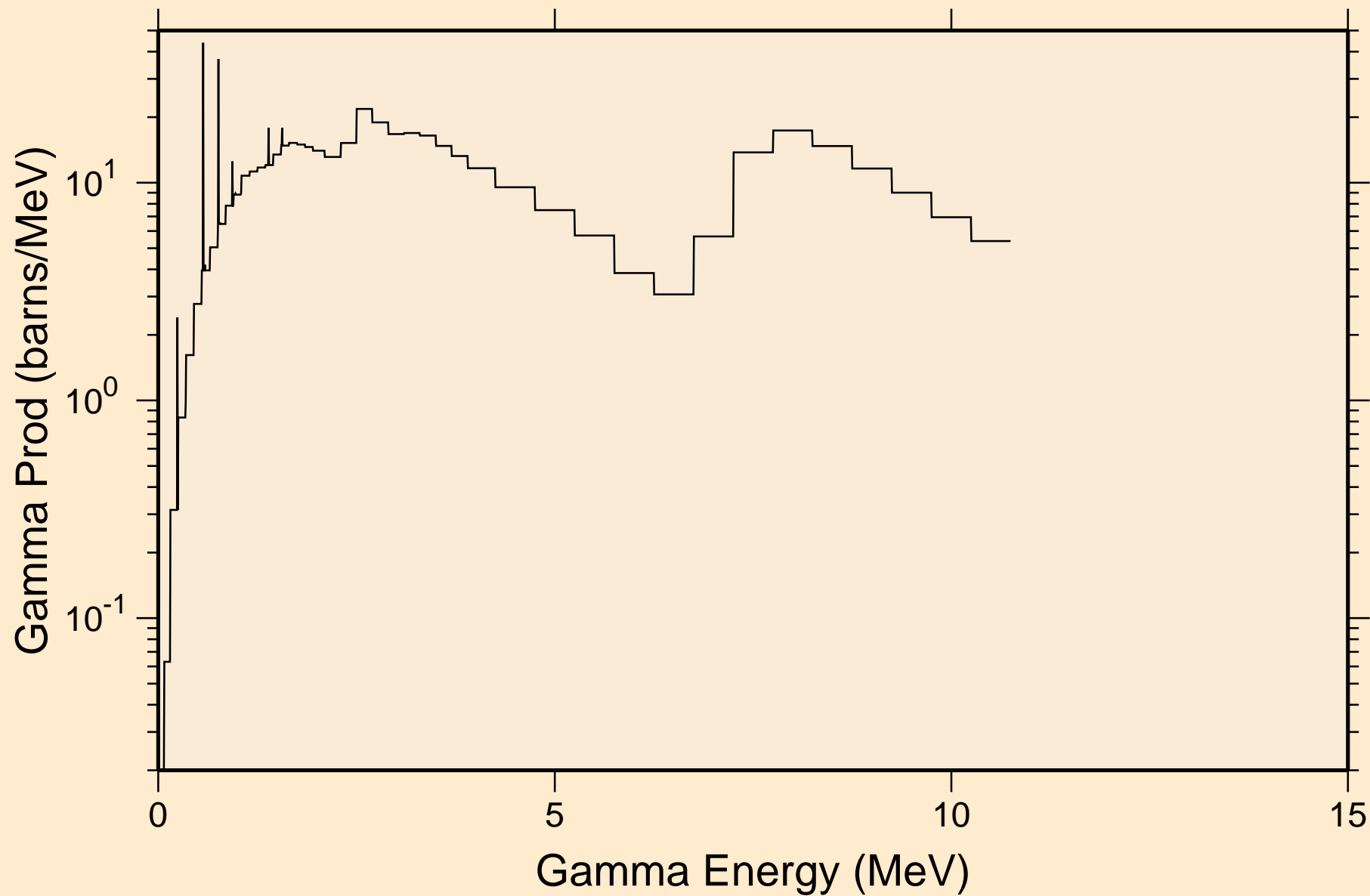

MO085 NEUTRON ACER TENDL-2019 LIBRARY; T=293.16K
14 MeV photon spectrum

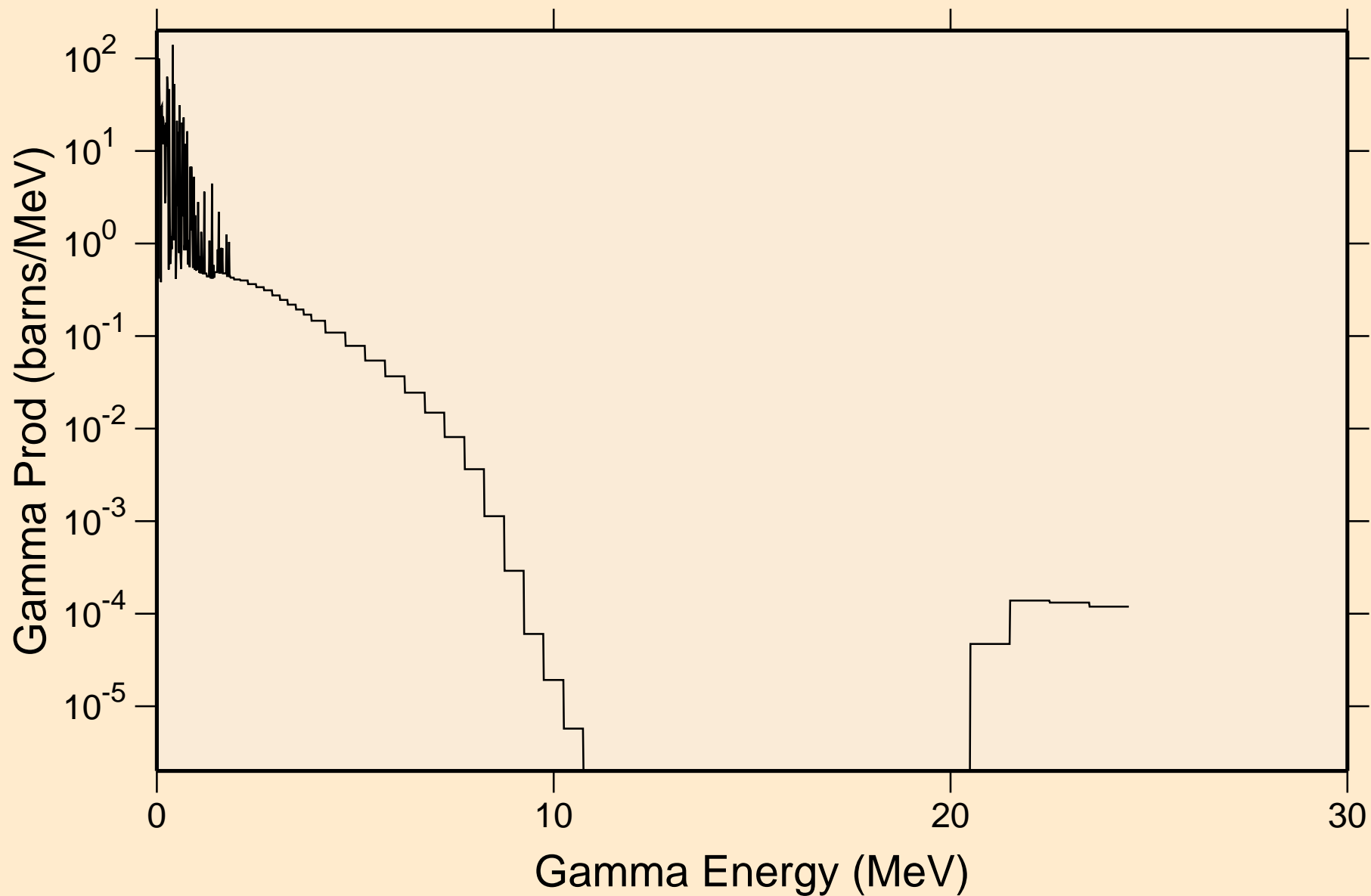

MO085 NEUTRON ACER TENDL-2019 LIBRARY; T=293.16K

Particle heating contributions

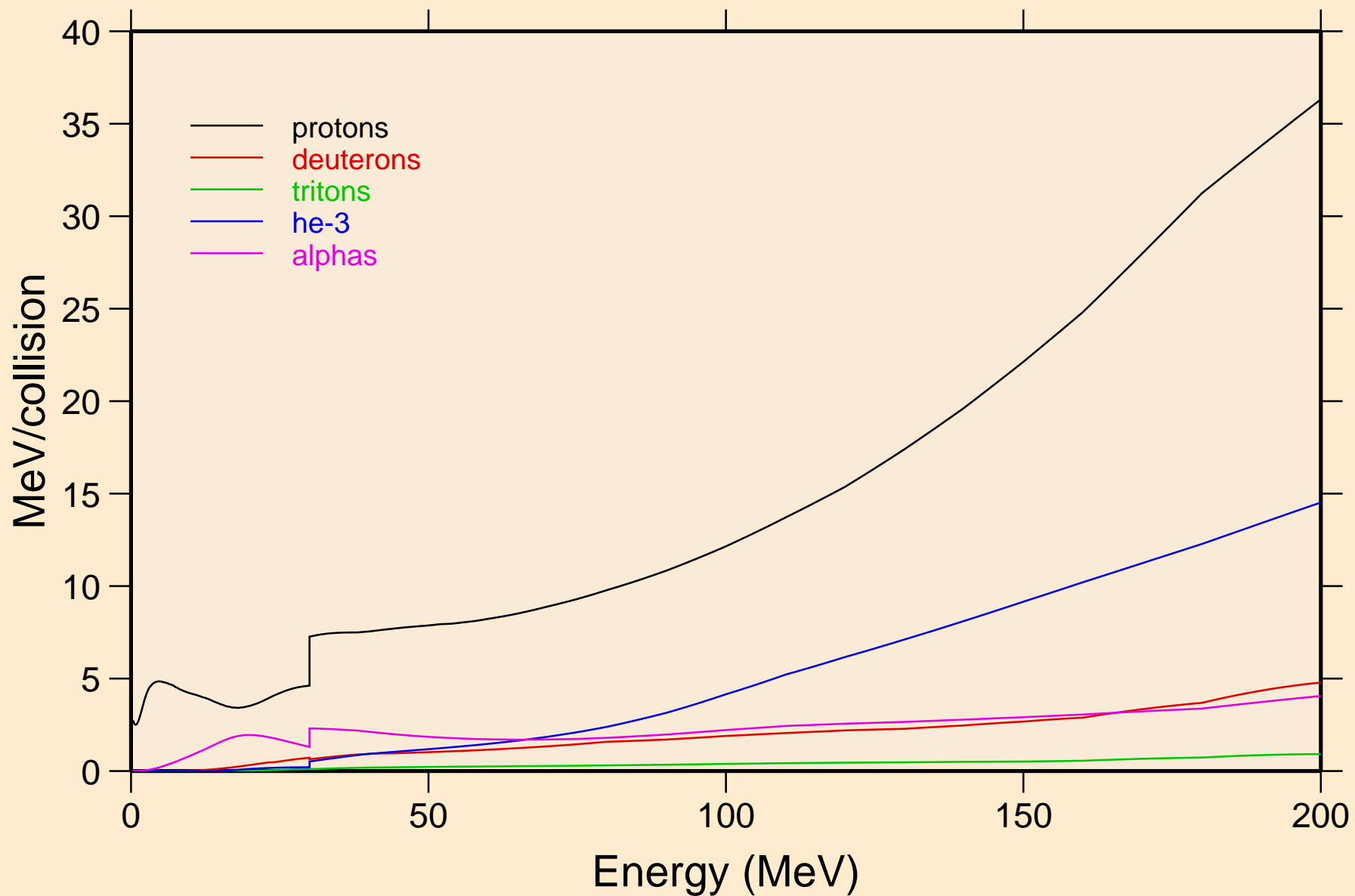

MO085 NEUTRON ACER TENDL-2019 LIBRARY; T=293.16K
Recoil Heating

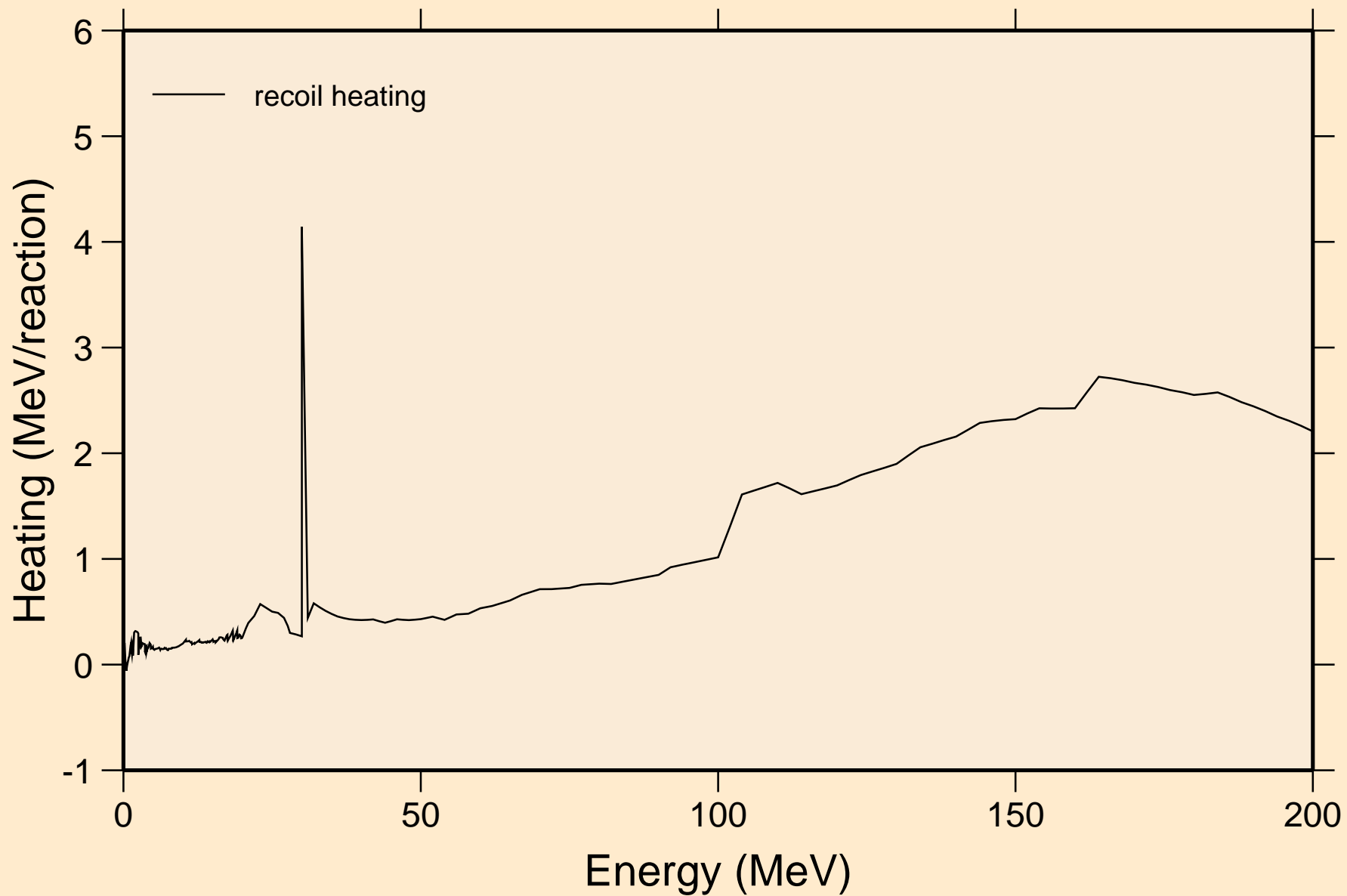

MO085 NEUTRON ACER TENDL-2019 LIBRARY; T=293.16K
Particle production cross sections

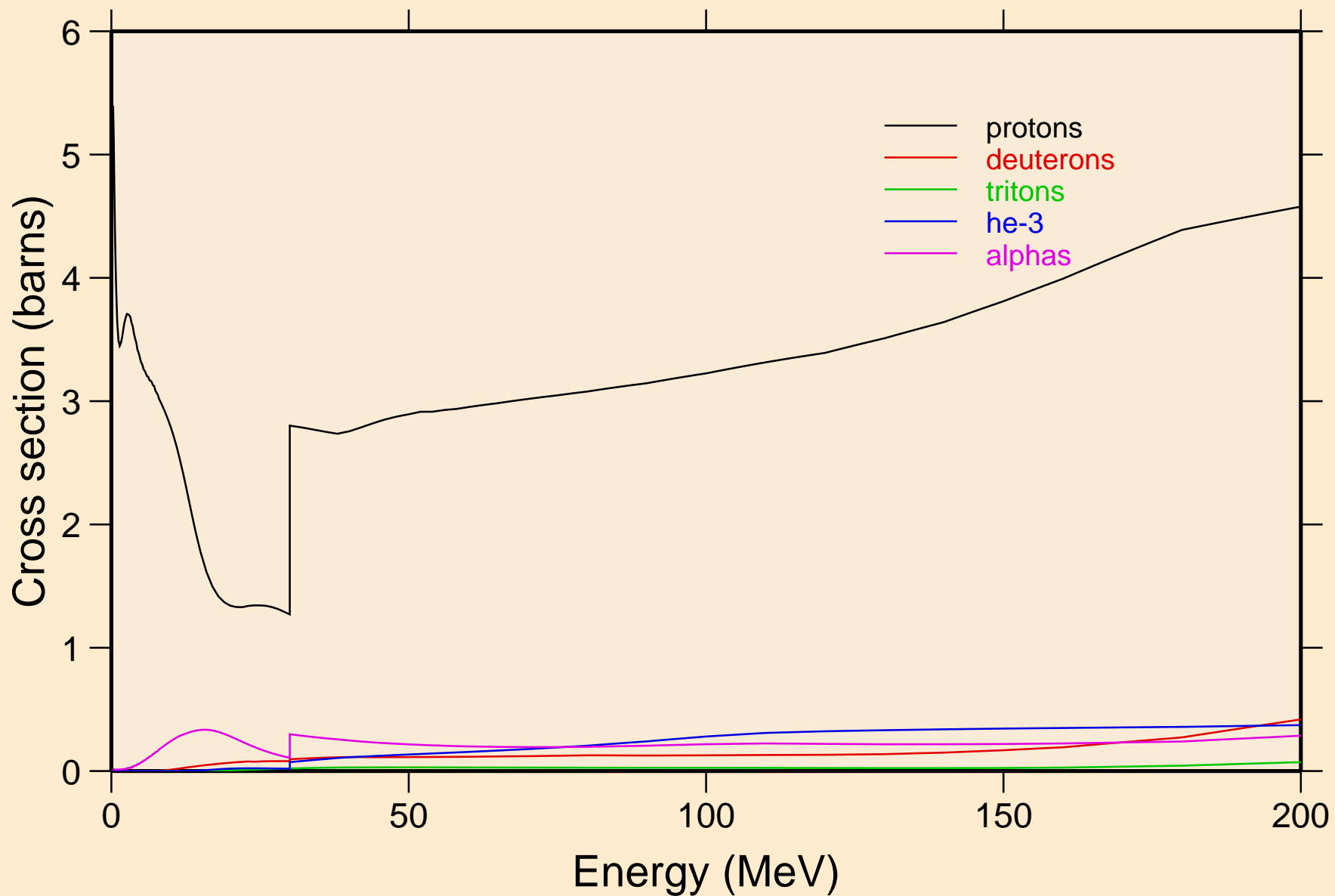

MO085 NEUTRON ACER TENDL-2019 LIBRARY; T=293.16K
protons from (n,x)

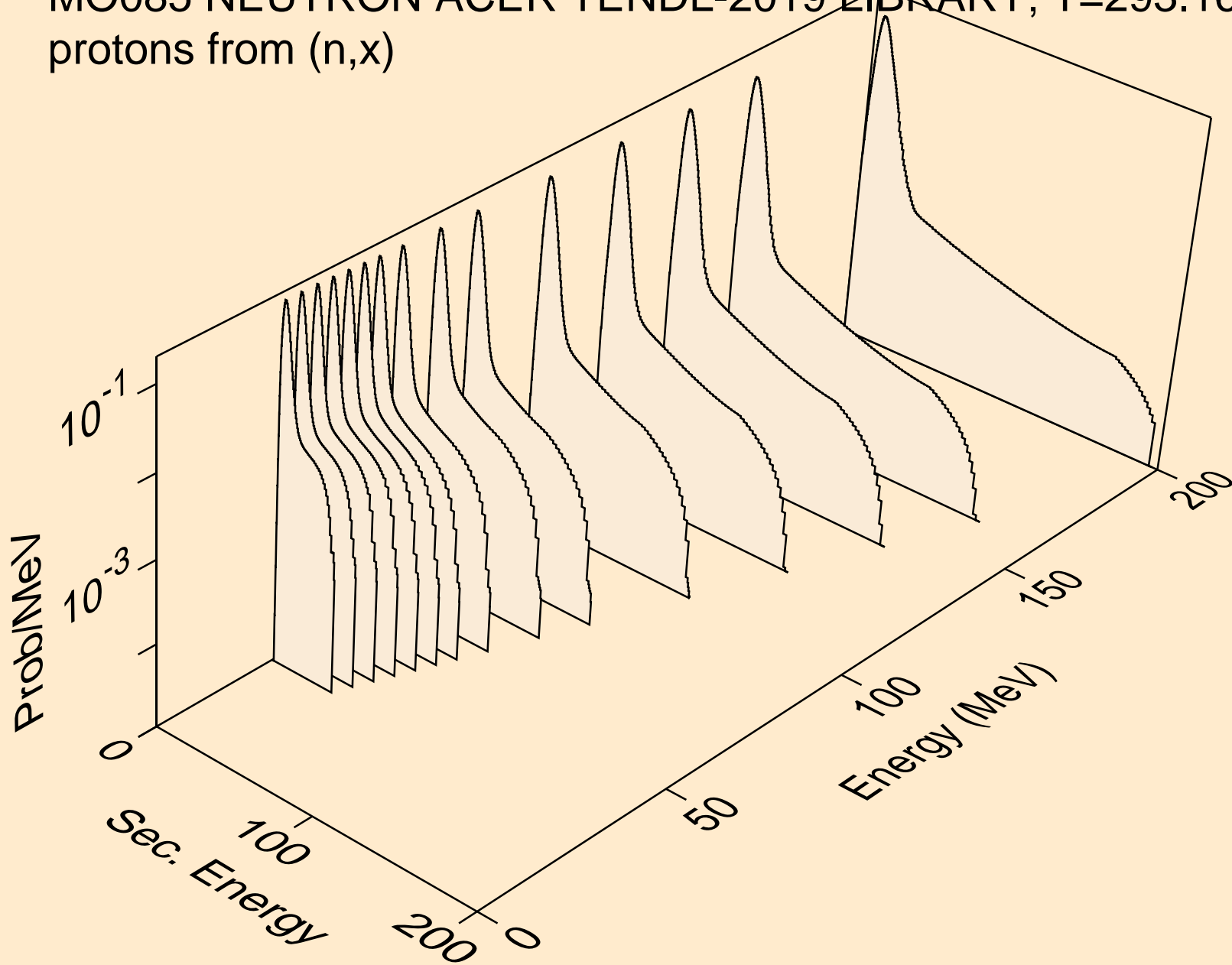

MO085 NEUTRON ACER TENDL-2019 LIBRARY; T=293.16K
protons from (n,n*)p

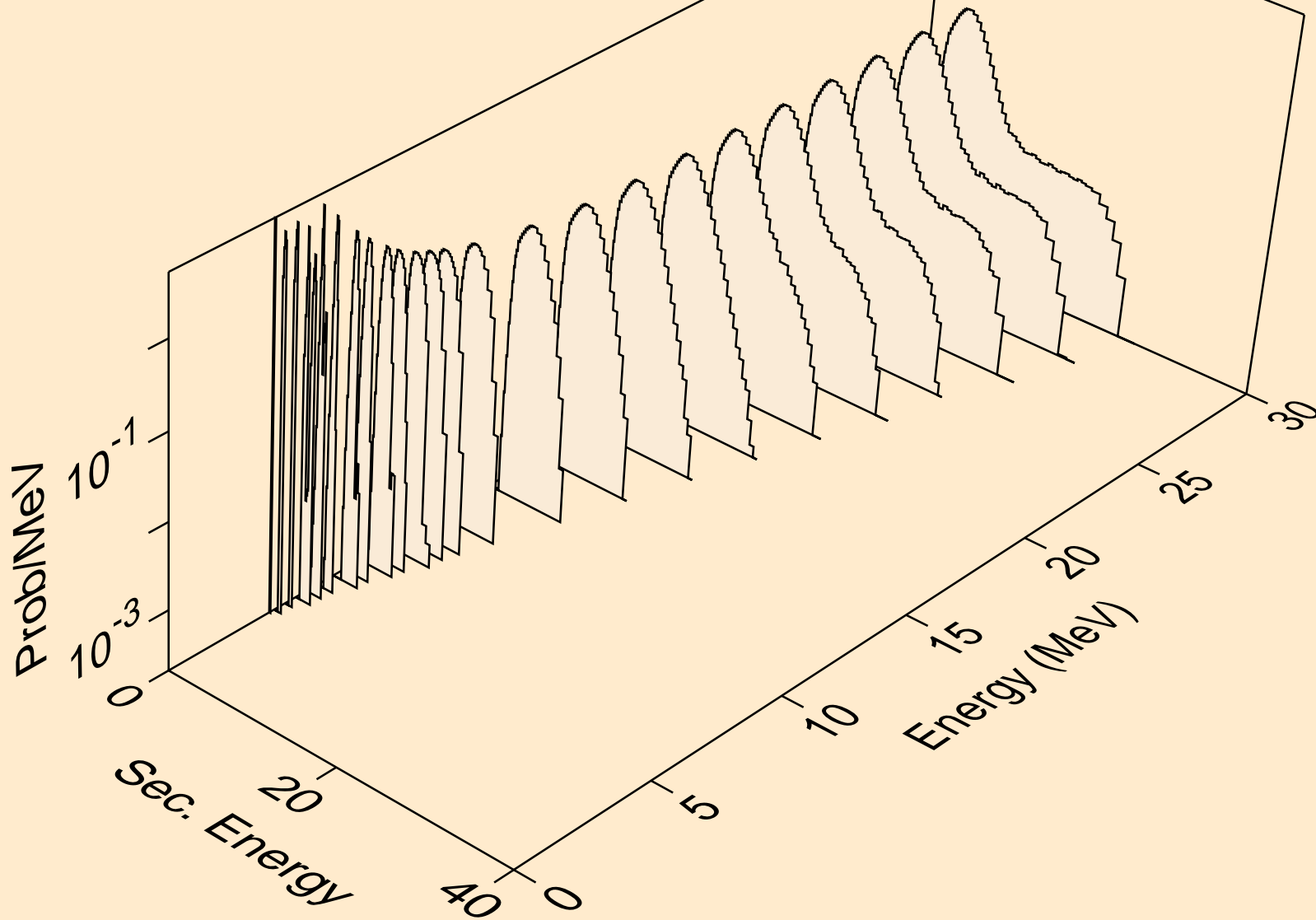

MO085 NEUTRON ACER TENDL-2019 LIBRARY; T=293.16K
protons from (n,2np)

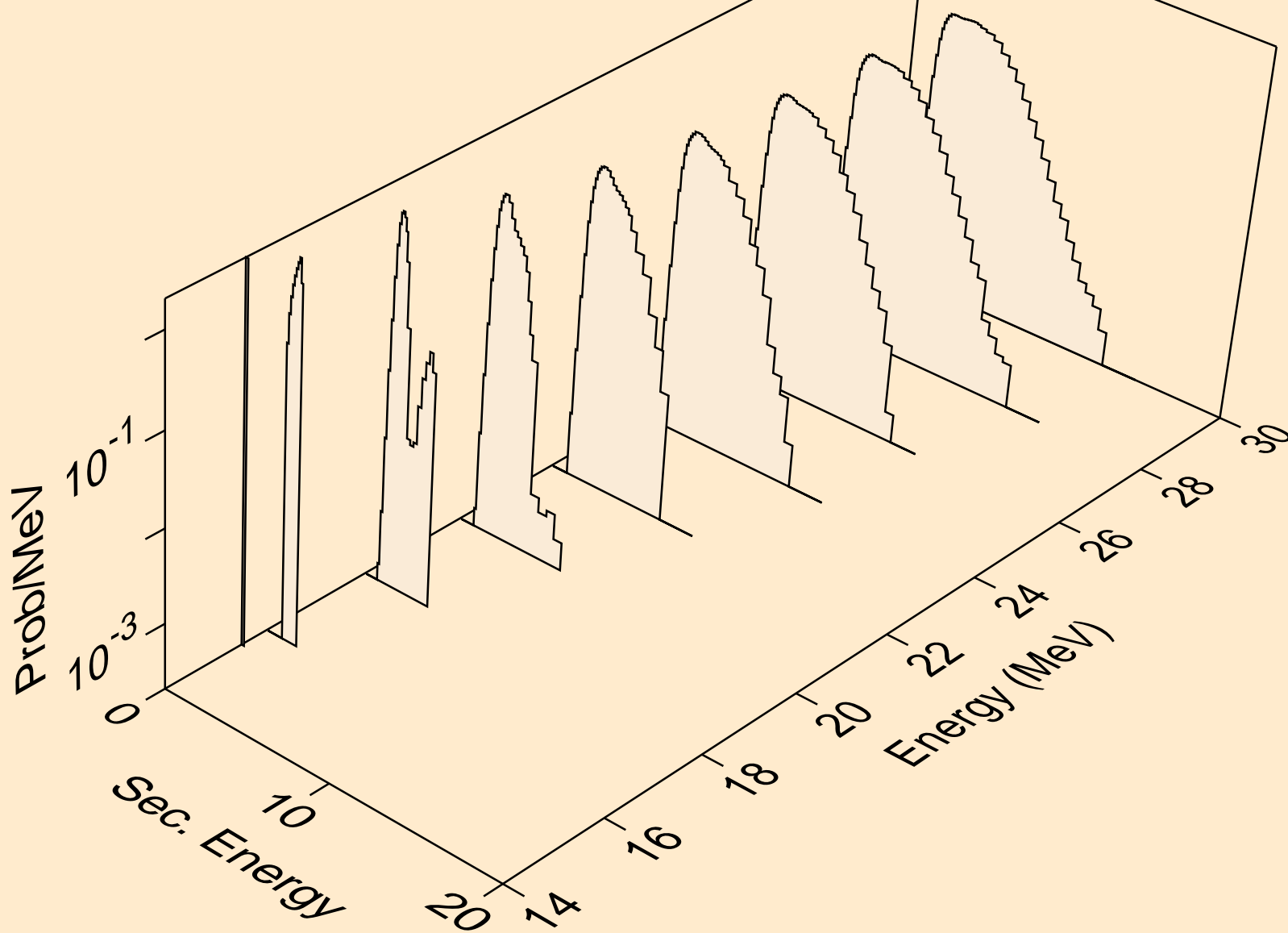

MO085 NEUTRON ACER TENDL-2019 LIBRARY; T=293.16K
protons from (n,2np)

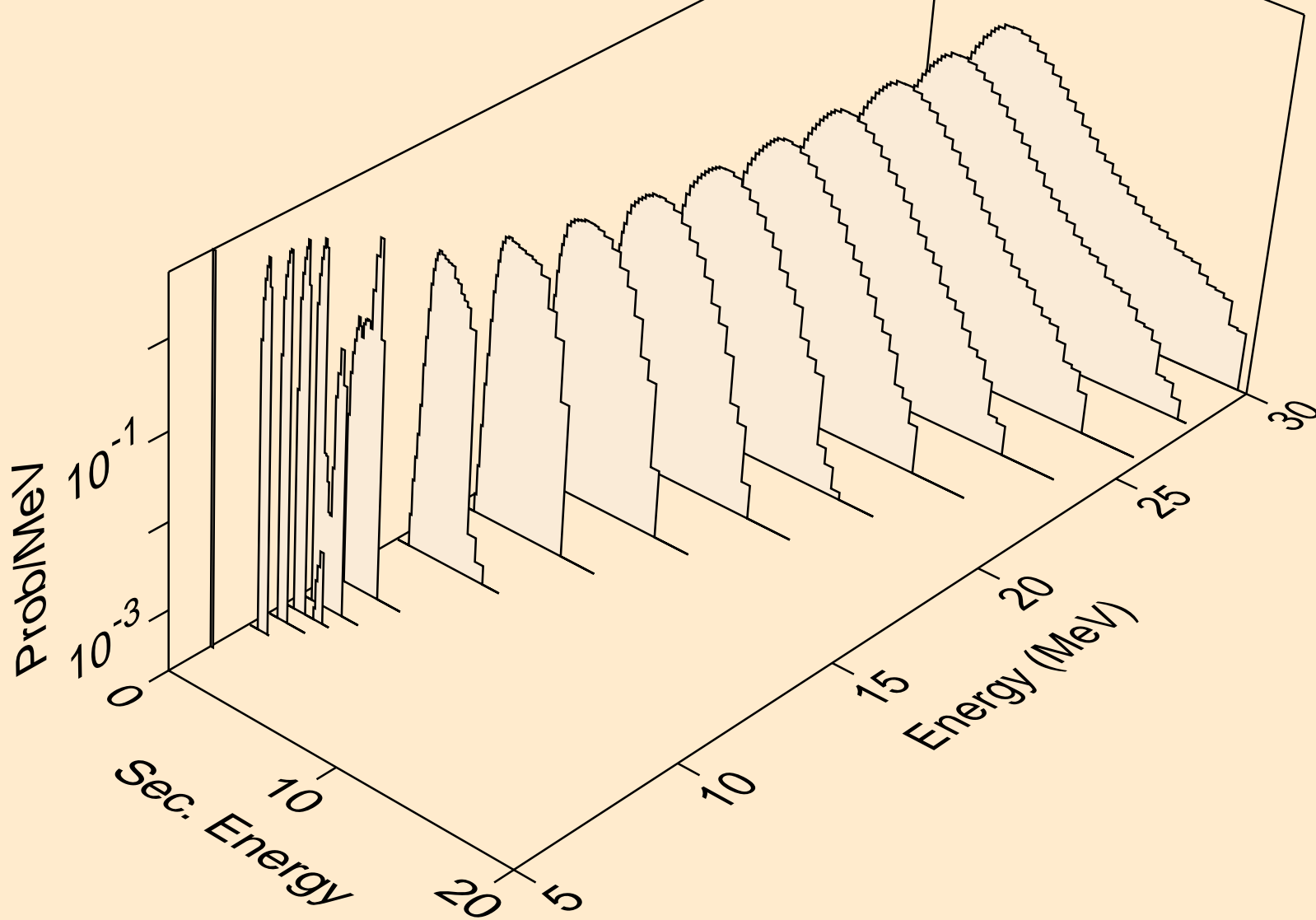

MO085 NEUTRON ACER TENDL-2019 LIBRARY; T=293.16K
protons from (n,npa)

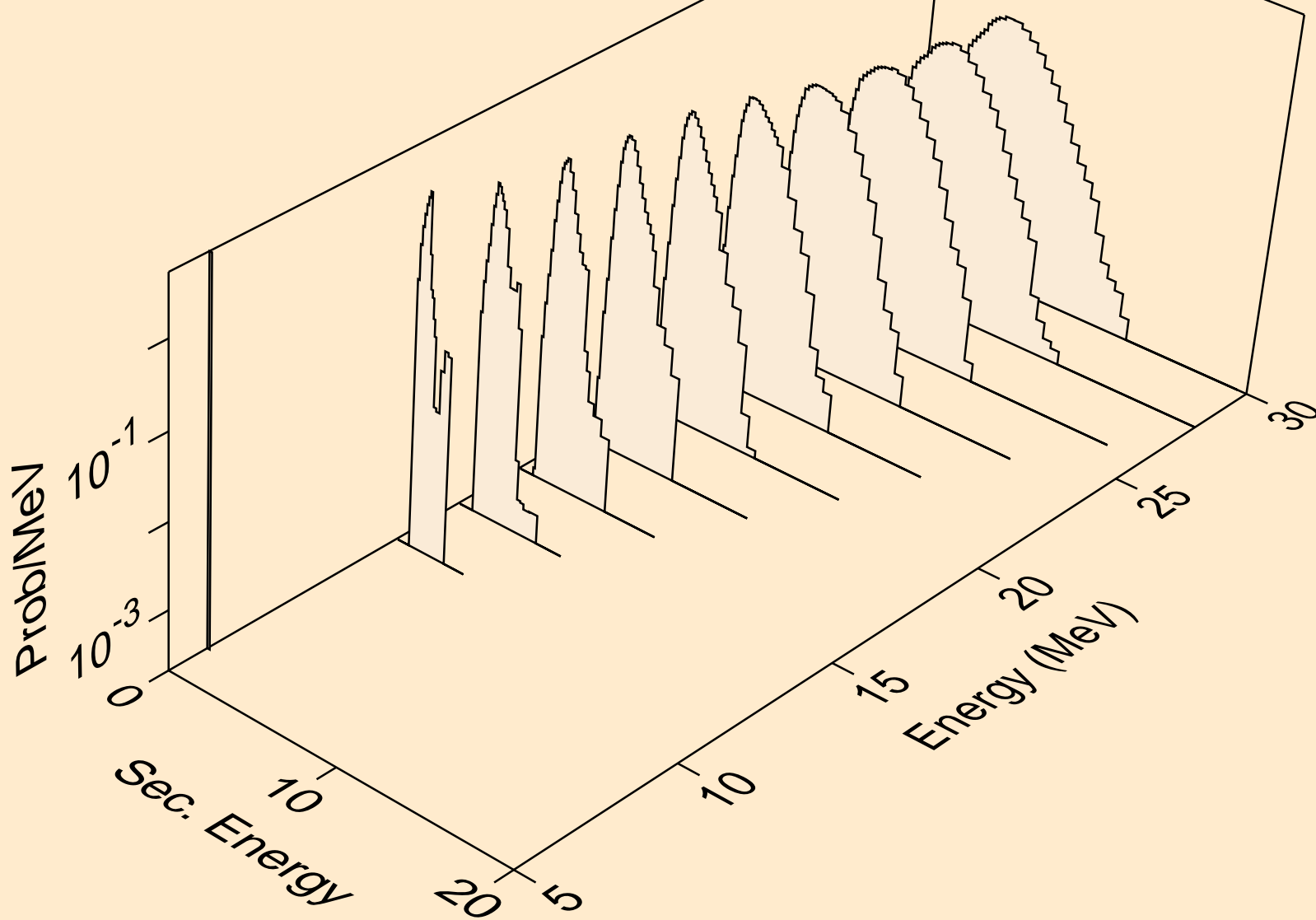

MO085 NEUTRON ACER TENDL-2019 LIBRARY; T=293.16K
protons from (n,p)

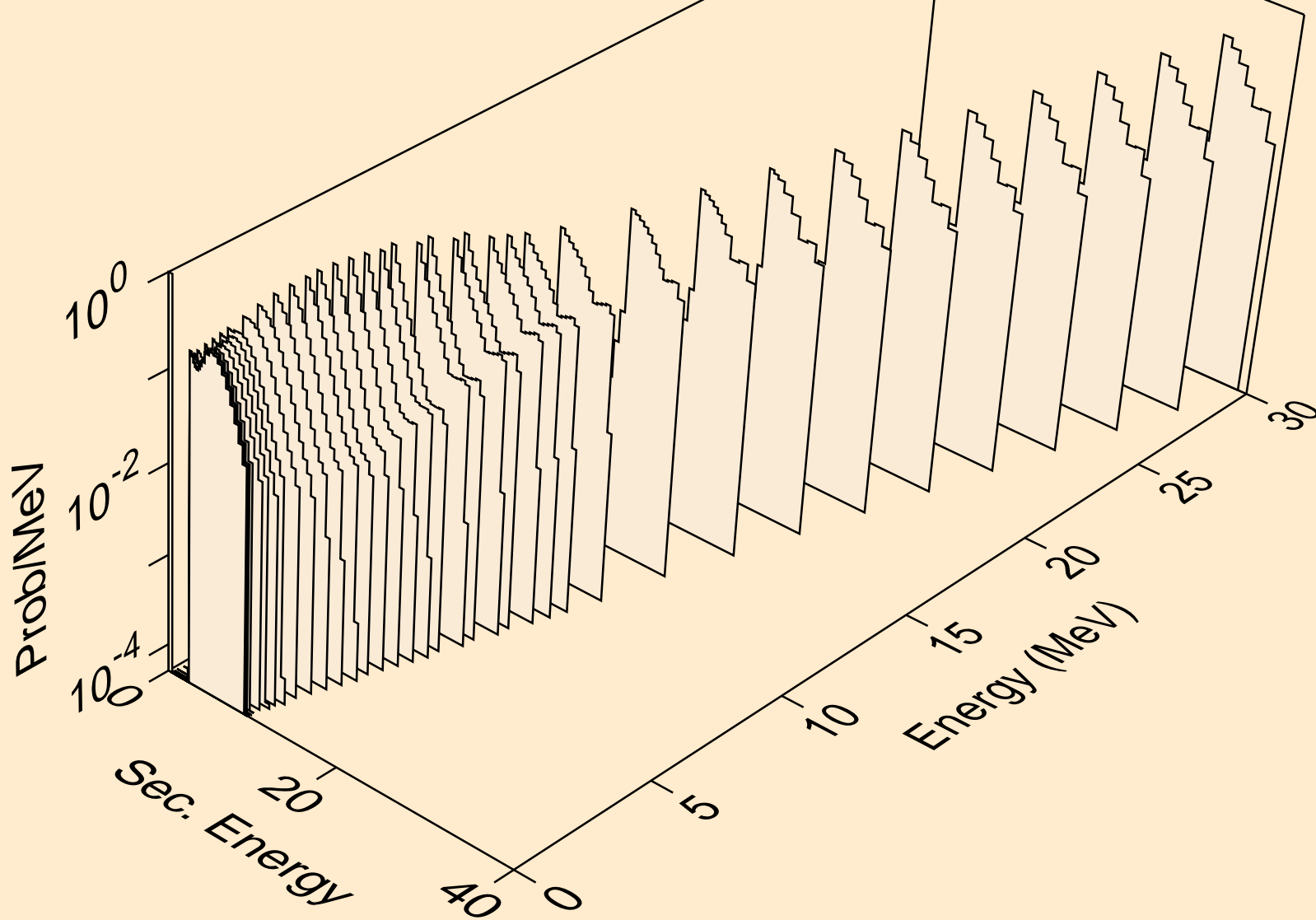

MO085 NEUTRON ACER TENDL-2019 LIBRARY; T=293.16K
protons from (n,2p)

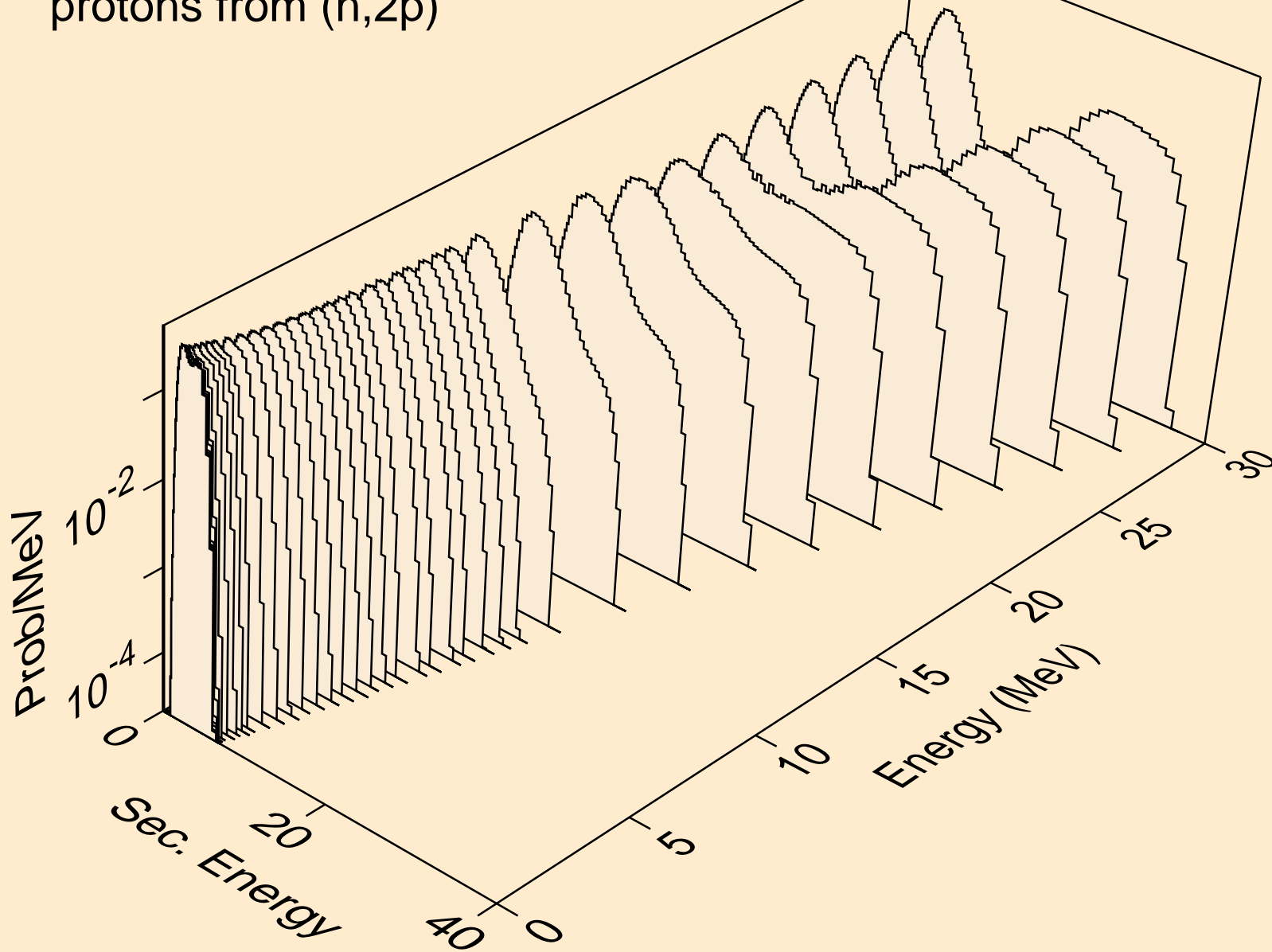

MO085 NEUTRON ACER TENDL-2019 LIBRARY; T=293.16K
protons from (n,p)

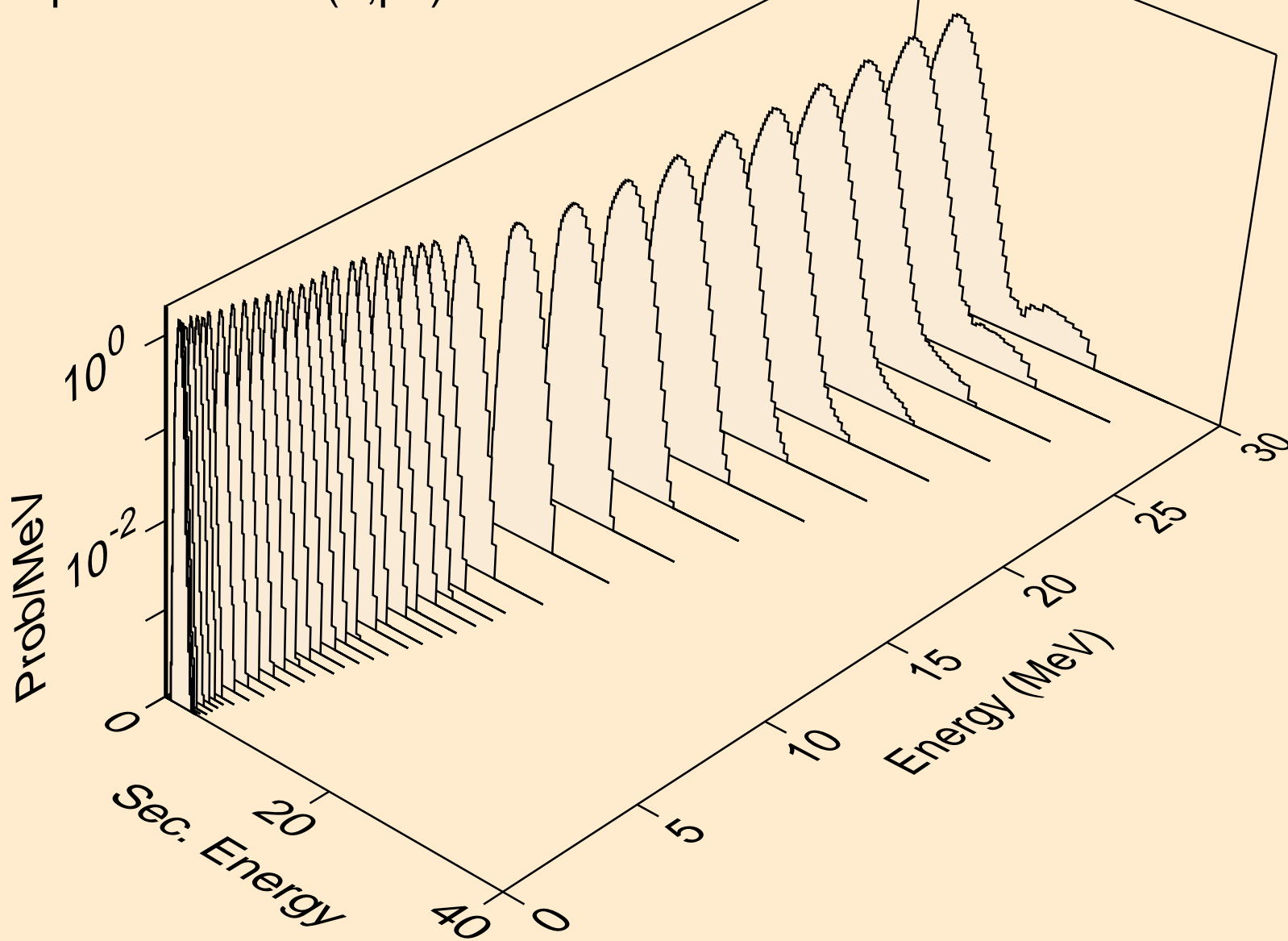

MO085 NEUTRON ACER TENDL-2019 LIBRARY; T=293.16K
protons from (n,pd)

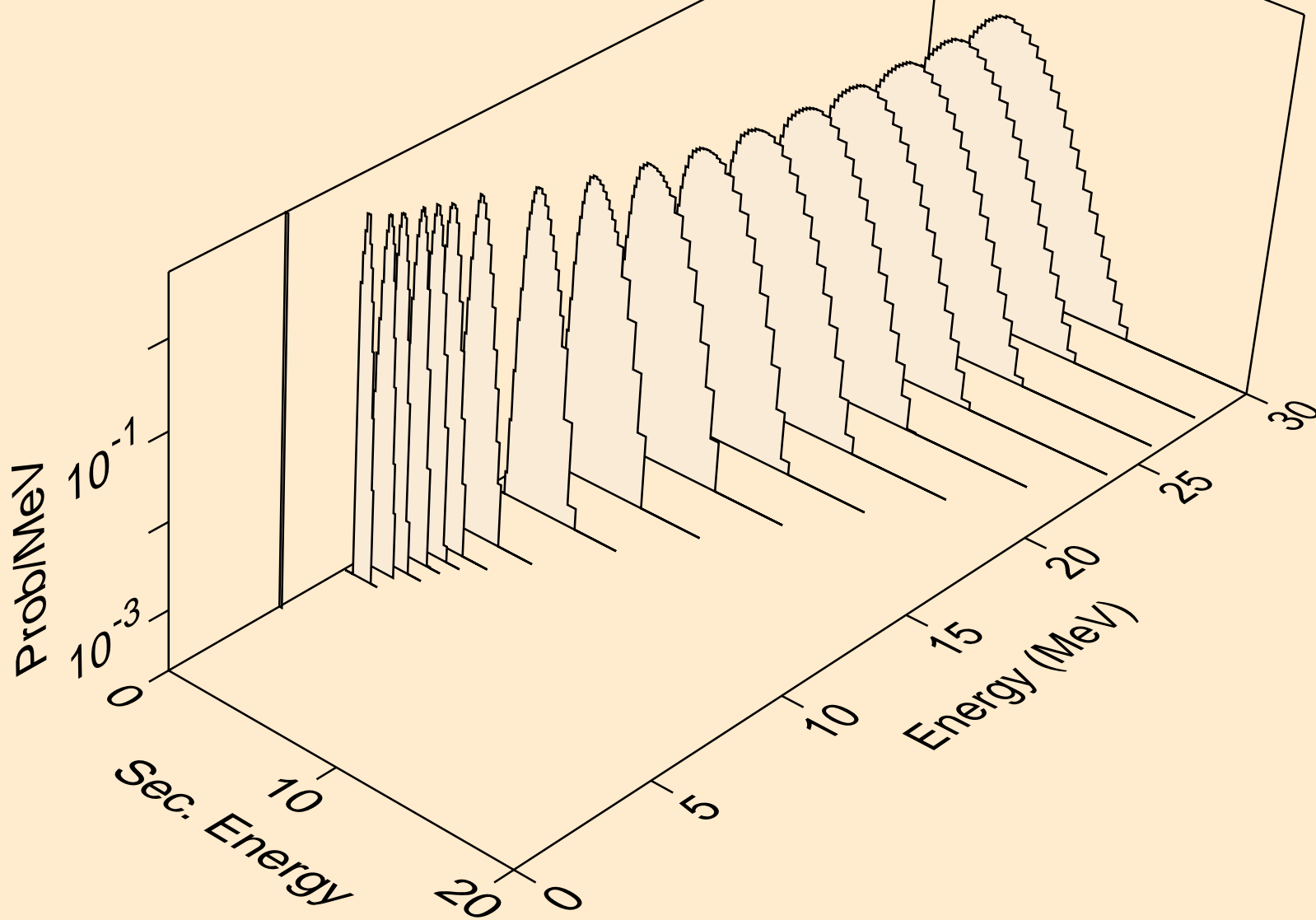

MO085 NEUTRON ACER TENDL-2019 LIBRARY; T=293.16K
protons from (n,pt)

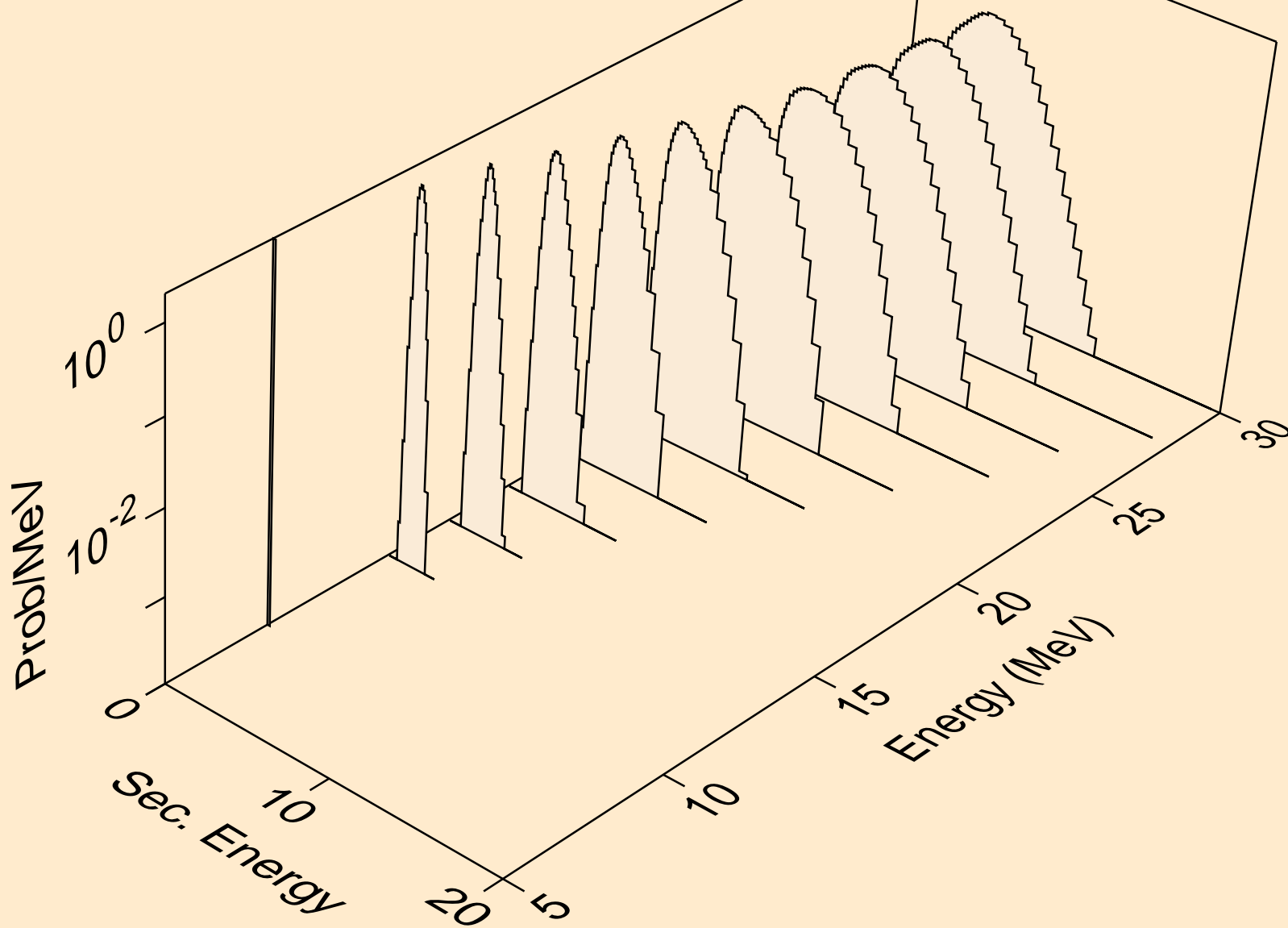

MO085 NEUTRON ACER TENDL-2019 LIBRARY; T=293.16K
deuterons from (n,x)

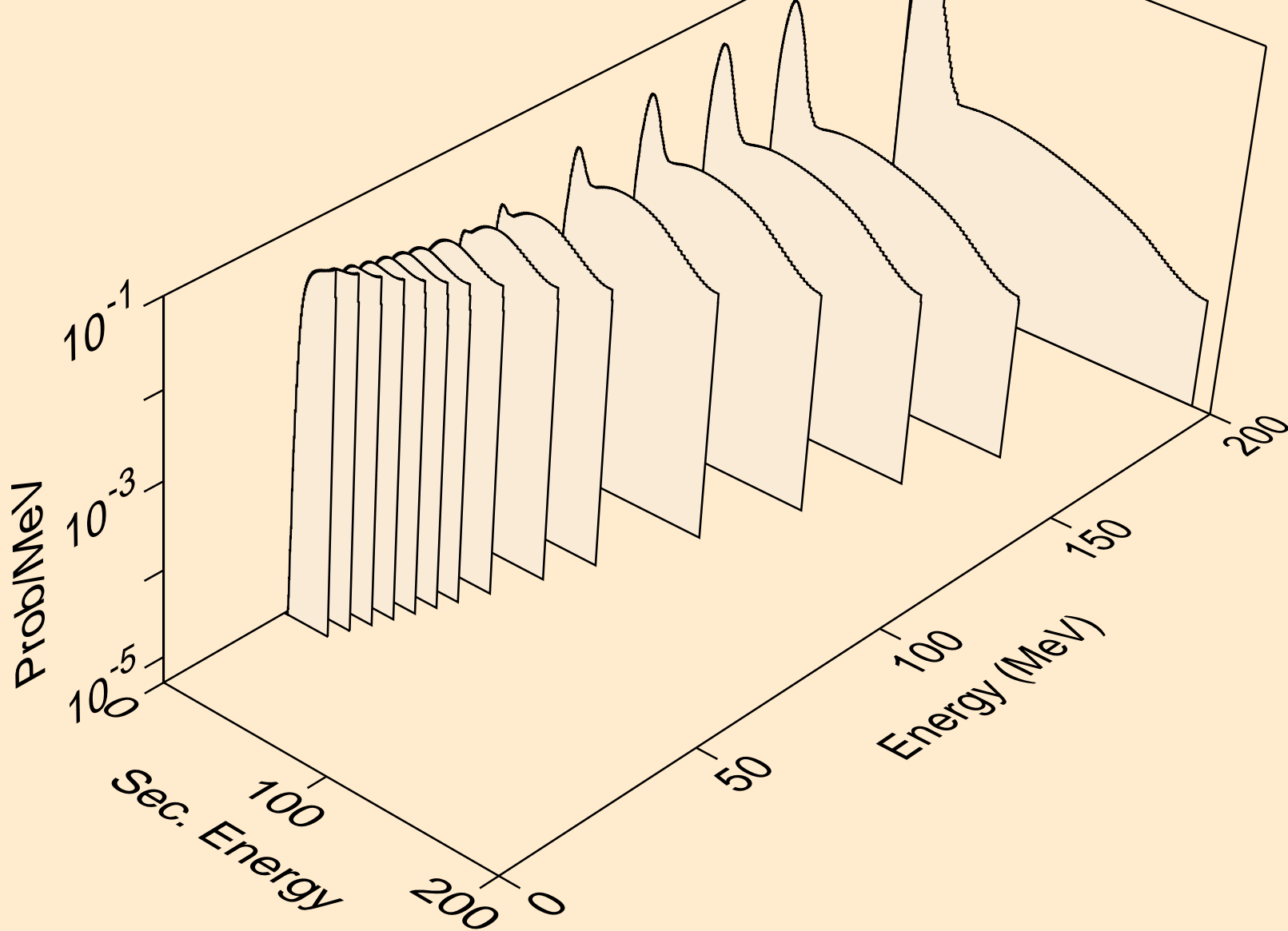

MO085 NEUTRON ACER TENDL-2019 LIBRARY; T=293.16K
deuterons from (n,n*)d

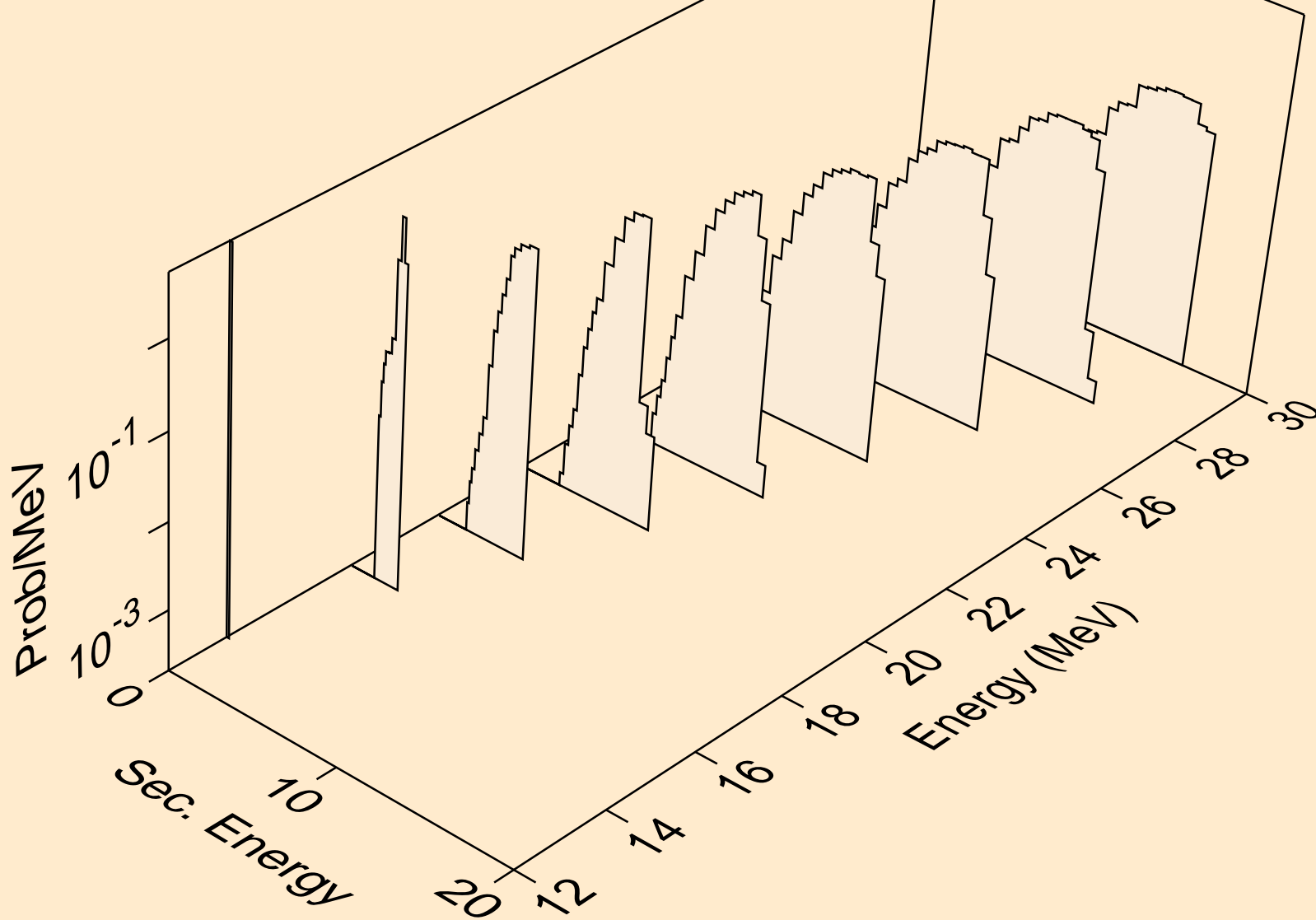

MO085 NEUTRON ACER TENDL-2019 LIBRARY; T=293.16K
deuterons from (n,d)

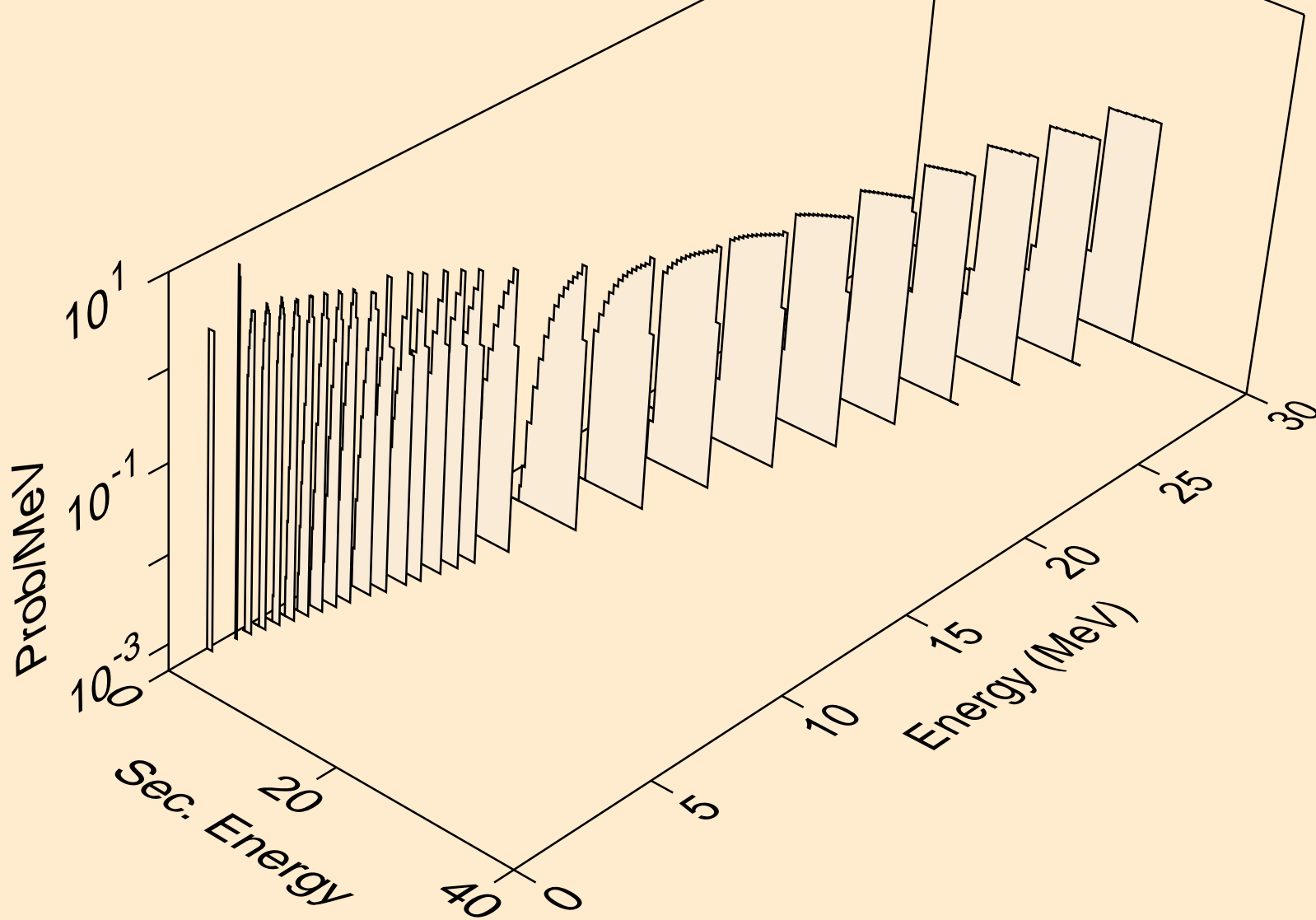

MO085 NEUTRON ACER TENDL-2019 LIBRARY; T=293.16K
deuterons from (n,pd)

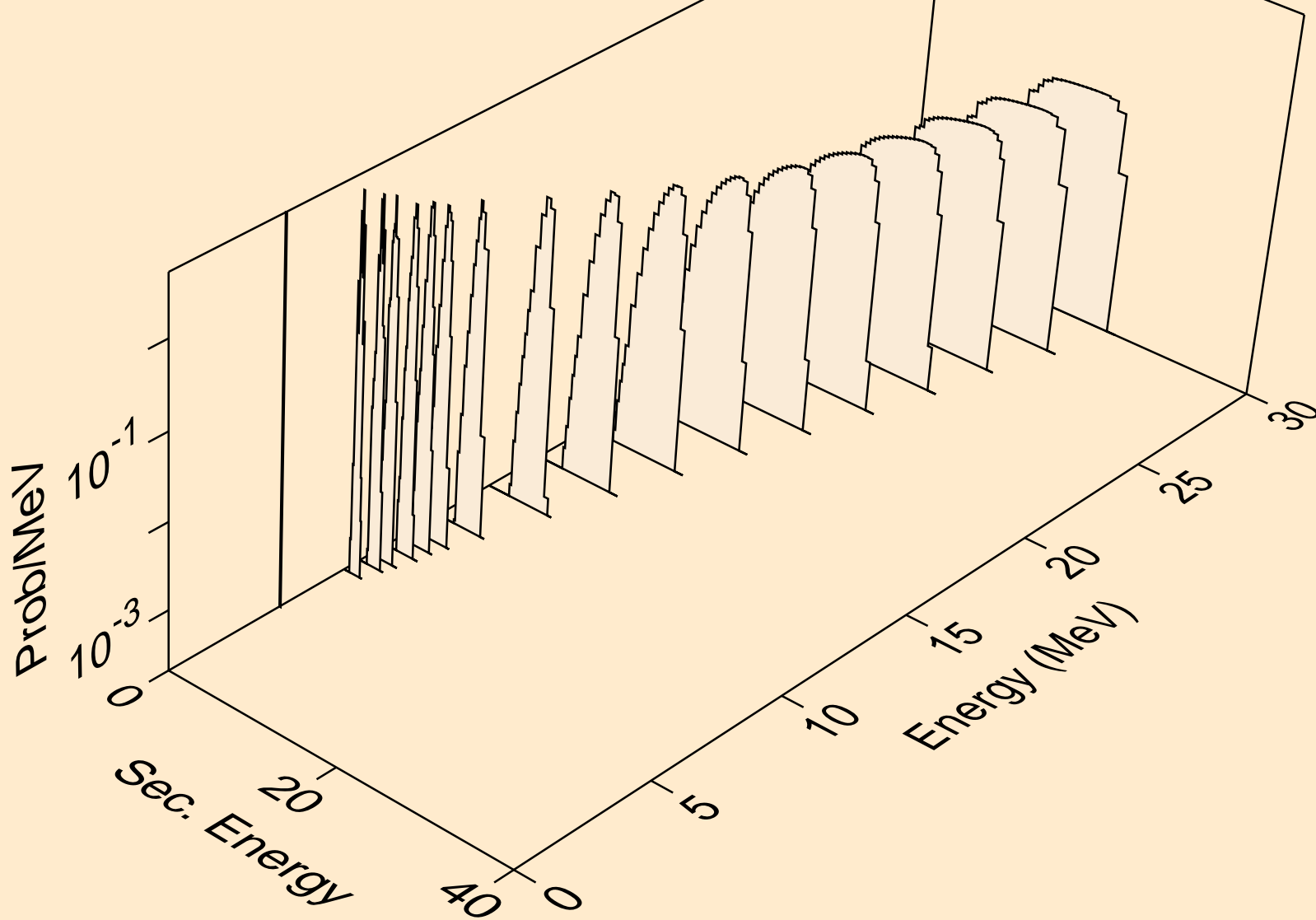

MO085 NEUTRON ACER TENDL-2019 LIBRARY; T=293.16K
deuterons from (n,da)

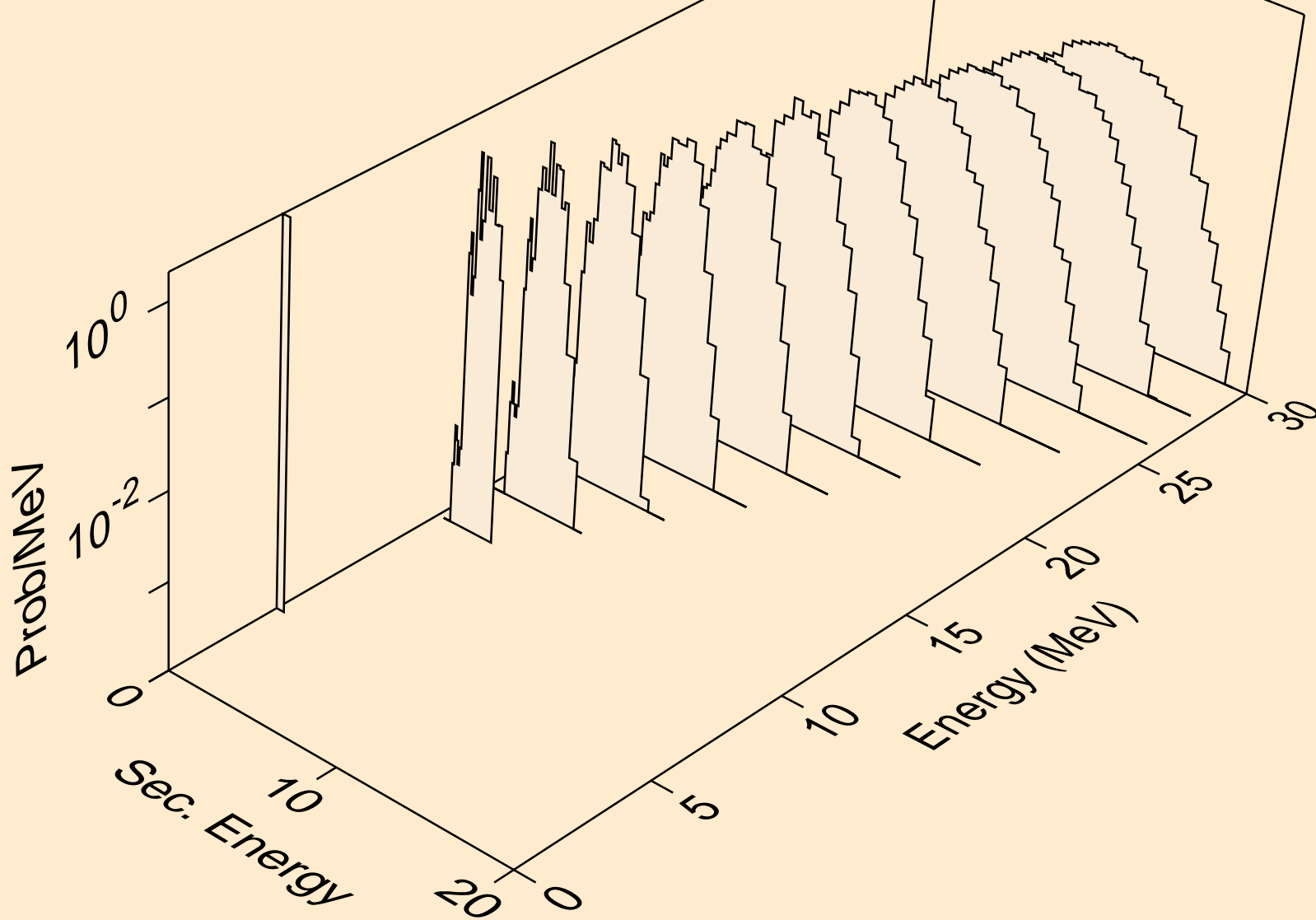

MO085 NEUTRON ACER TENDL-2019 LIBRARY; T=293.16K
tritons from (n,x)

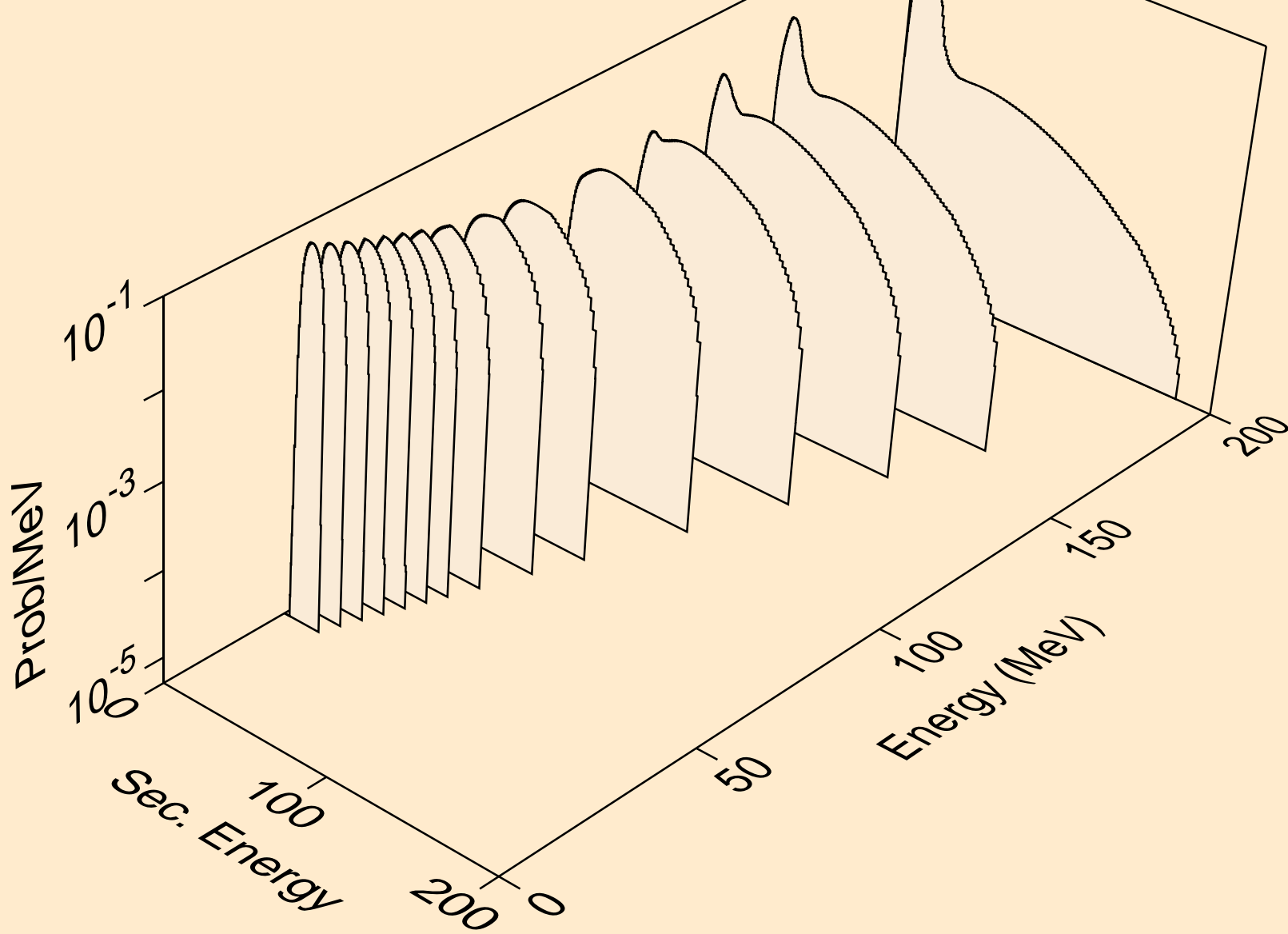

MO085 NEUTRON ACER TENDL-2019 LIBRARY; T=293.16K
tritons from (n,n*)t

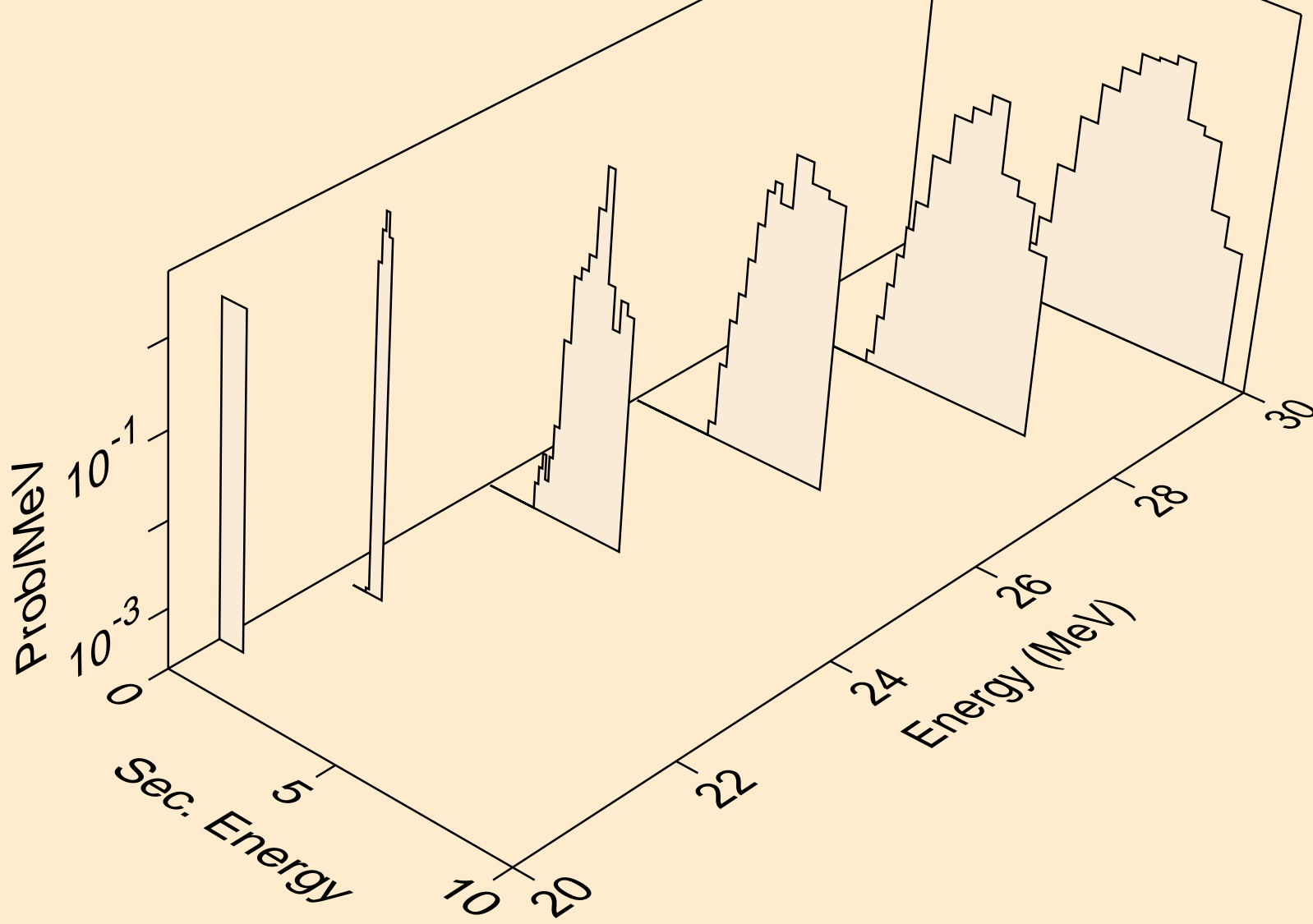

MO085 NEUTRON ACER TENDL-2019 LIBRARY; T=293.16K
tritons from (n,t)

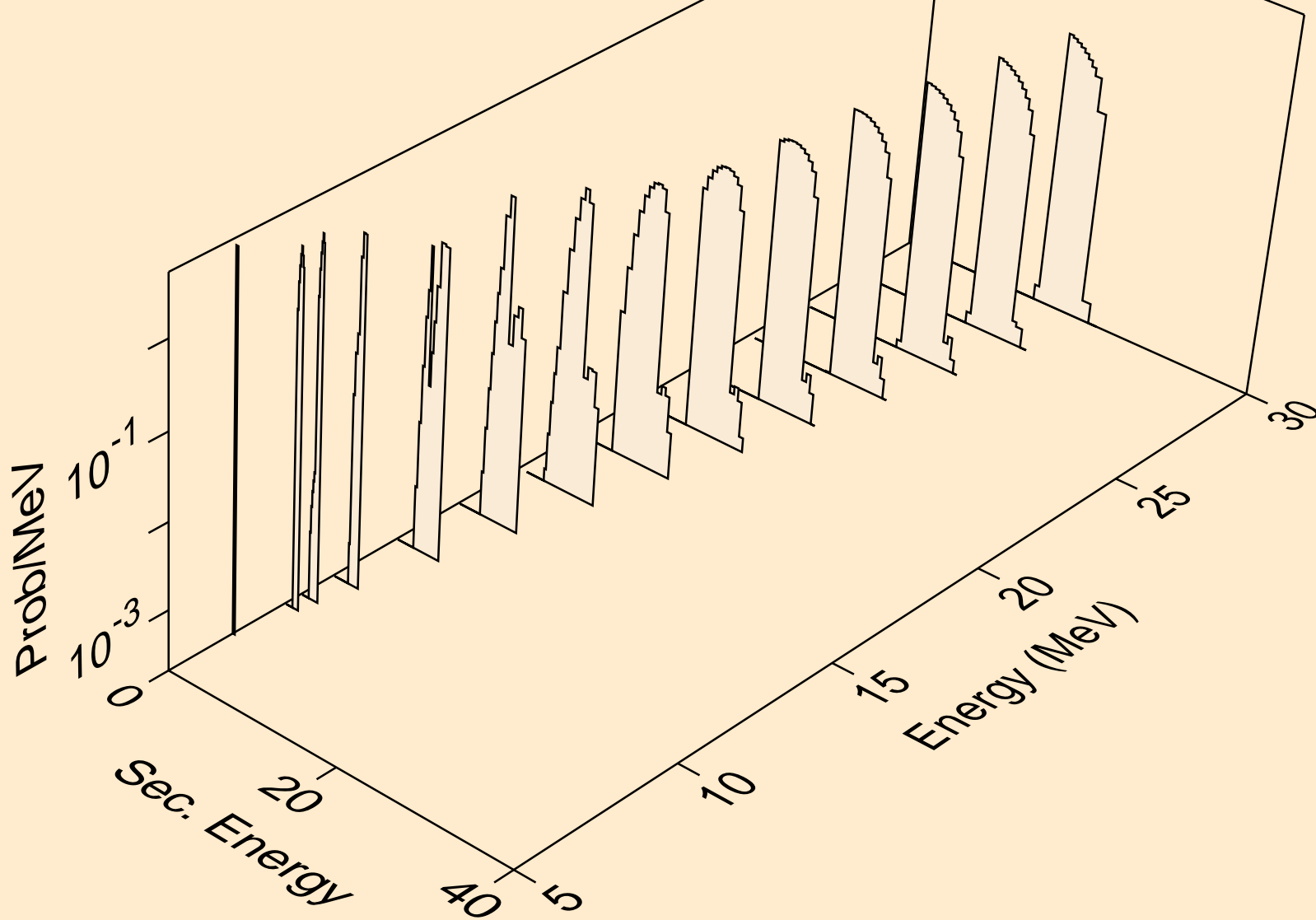

MO085 NEUTRON ACER TENDL-2019 LIBRARY; T=293.16K
tritons from (n,pt)

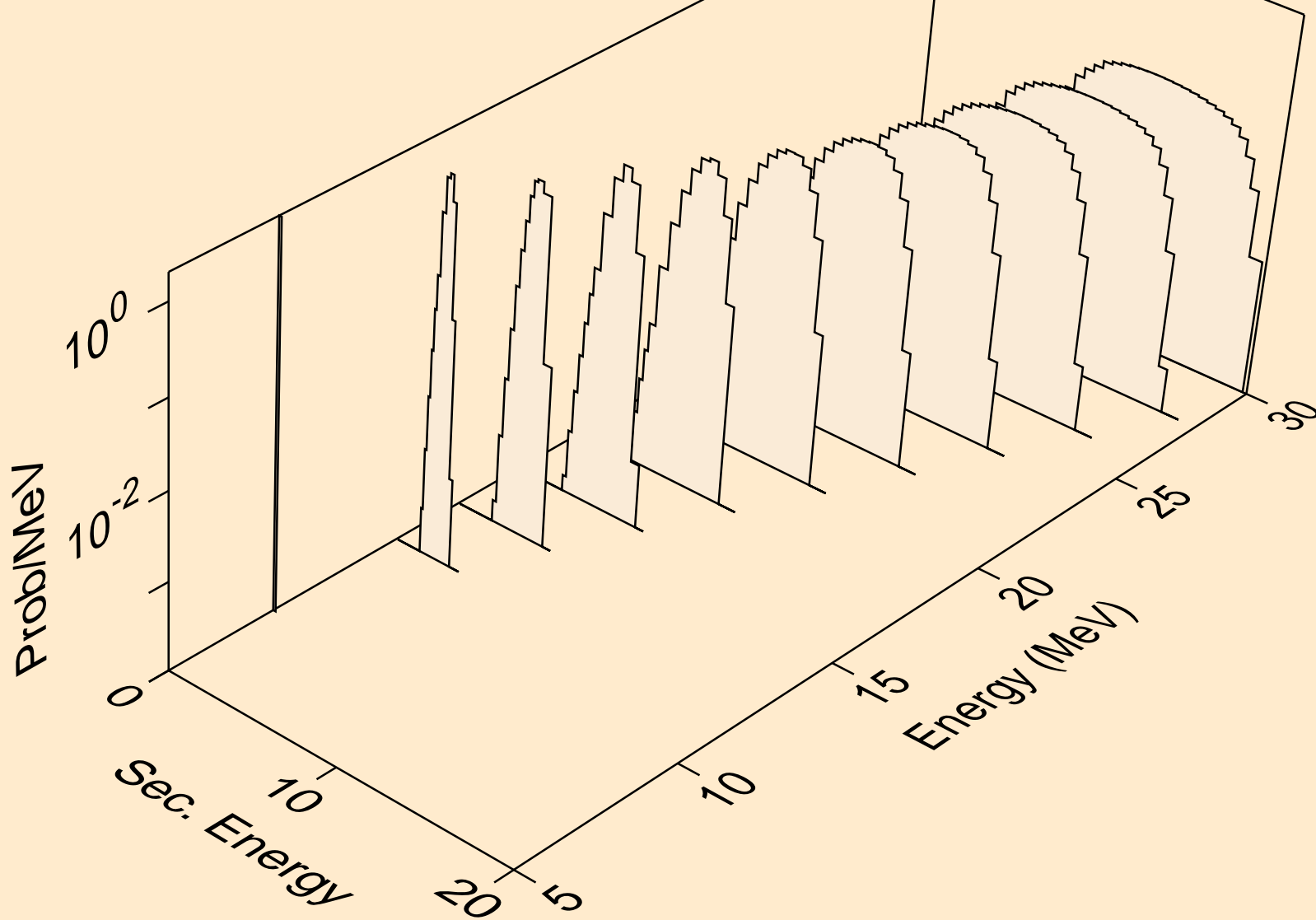

MO085 NEUTRON ACER TENDL-2019 LIBRARY; T=293.16K
he3s from (n,x)

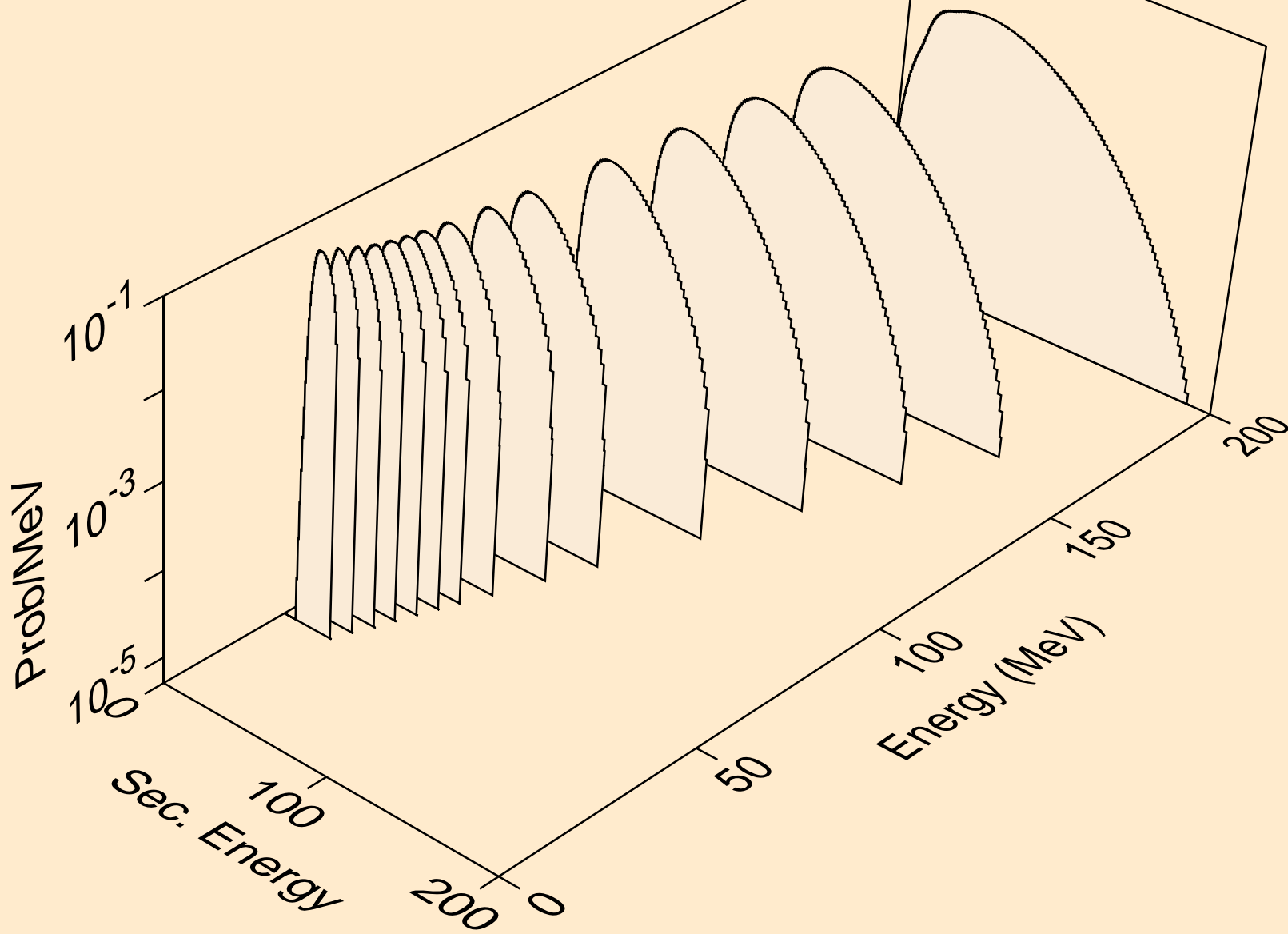

MO085 NEUTRON ACER TENDL-2019 LIBRARY; T=293.16K
he3s from (n,n*)he3

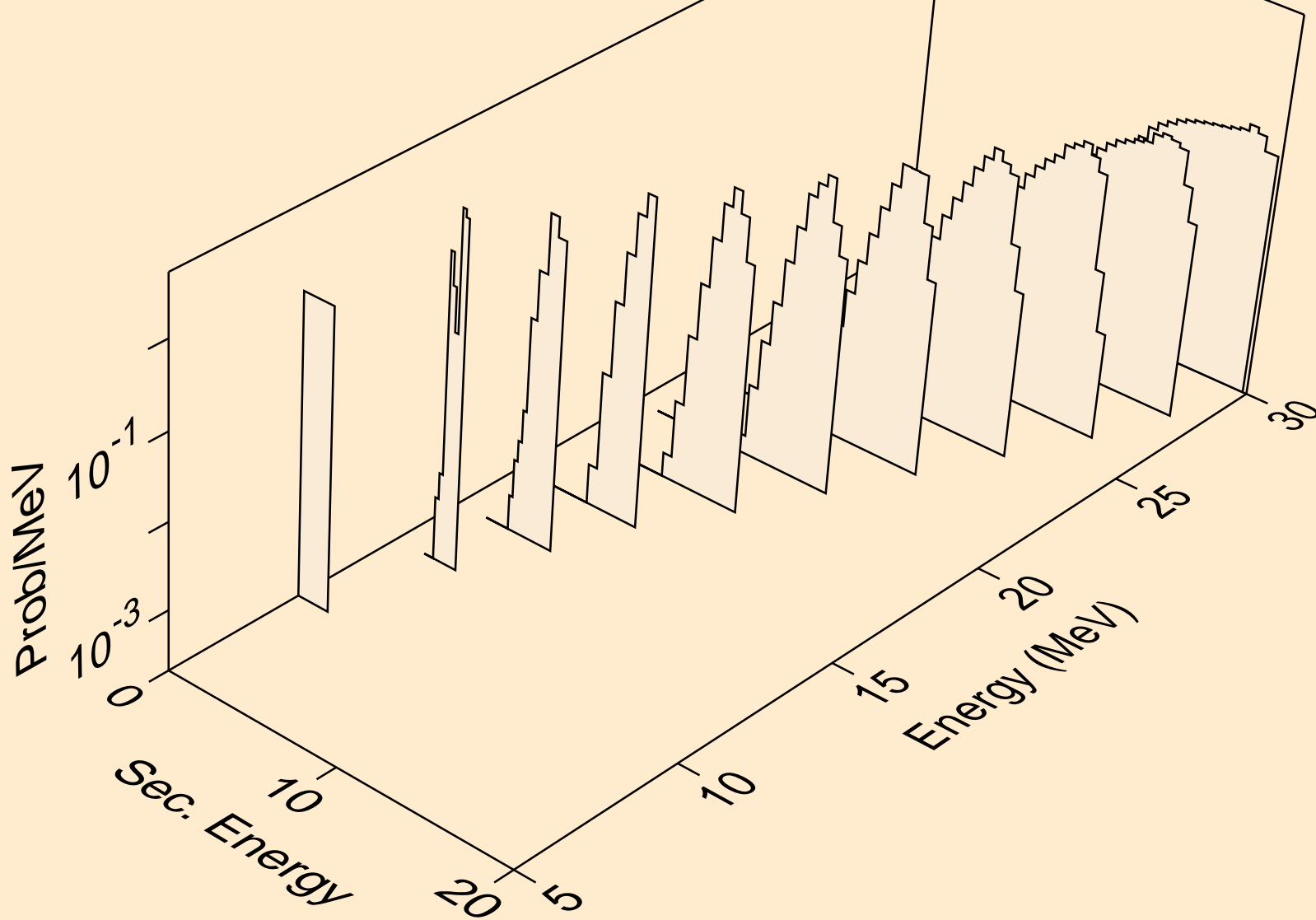

MO085 NEUTRON ACER TENDL-2019 LIBRARY; T=293.16K
he3s from (n,he3)

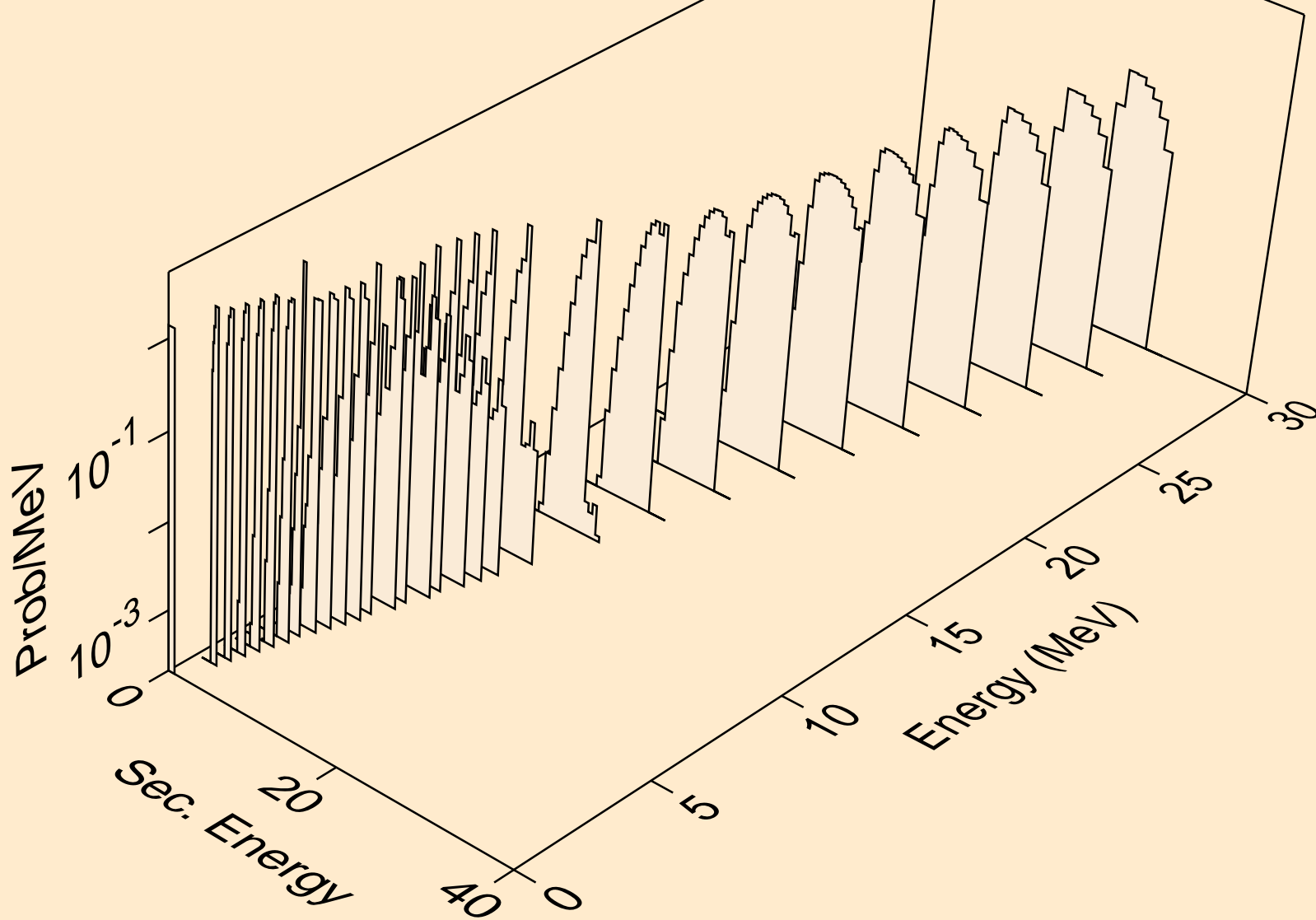

MO085 NEUTRON ACER TENDL-2019 LIBRARY; T=293.16K
alphas from (n,x)

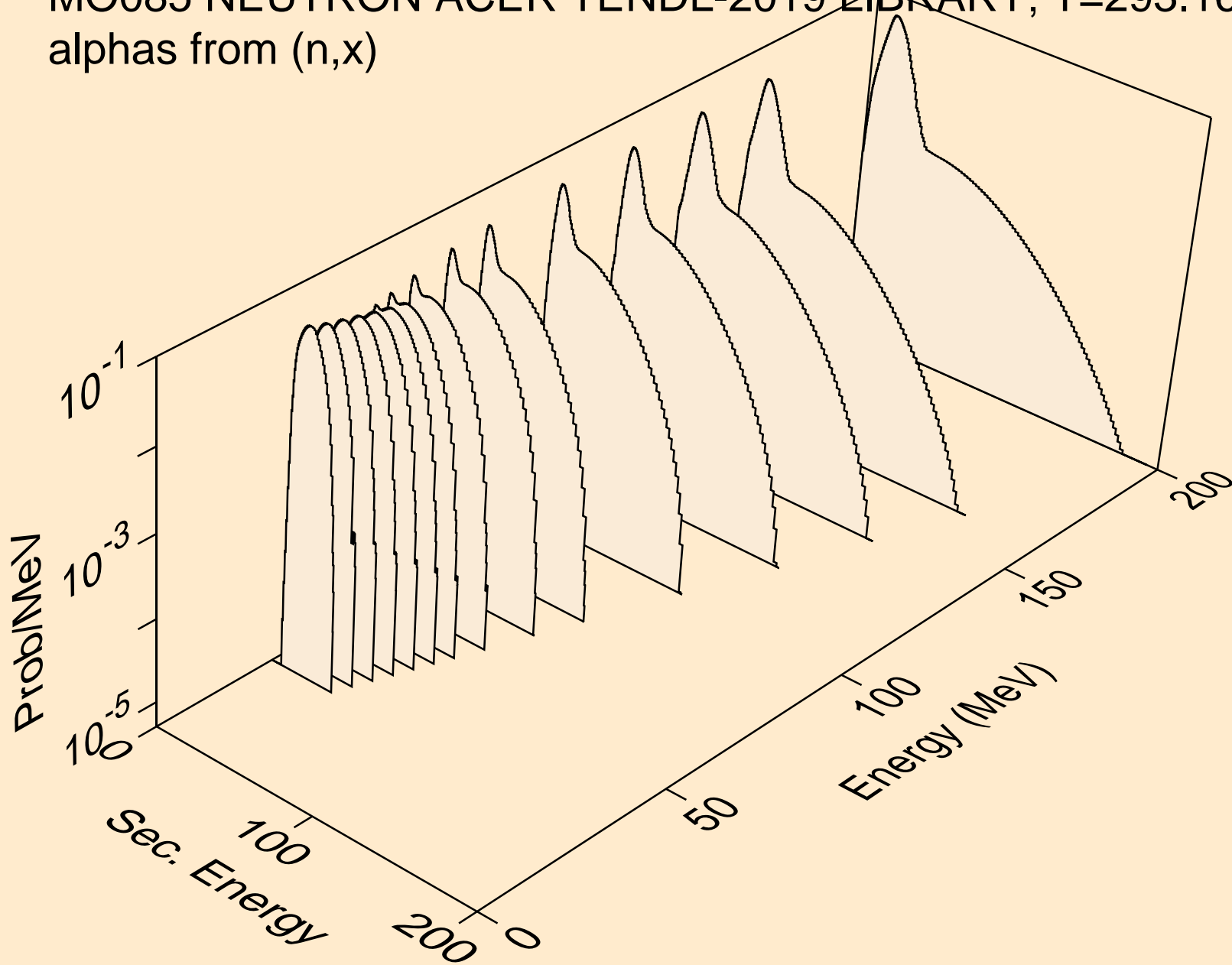

MO085 NEUTRON ACER TENDL-2019 LIBRARY; T=293.16K
alphas from (n,n*)a

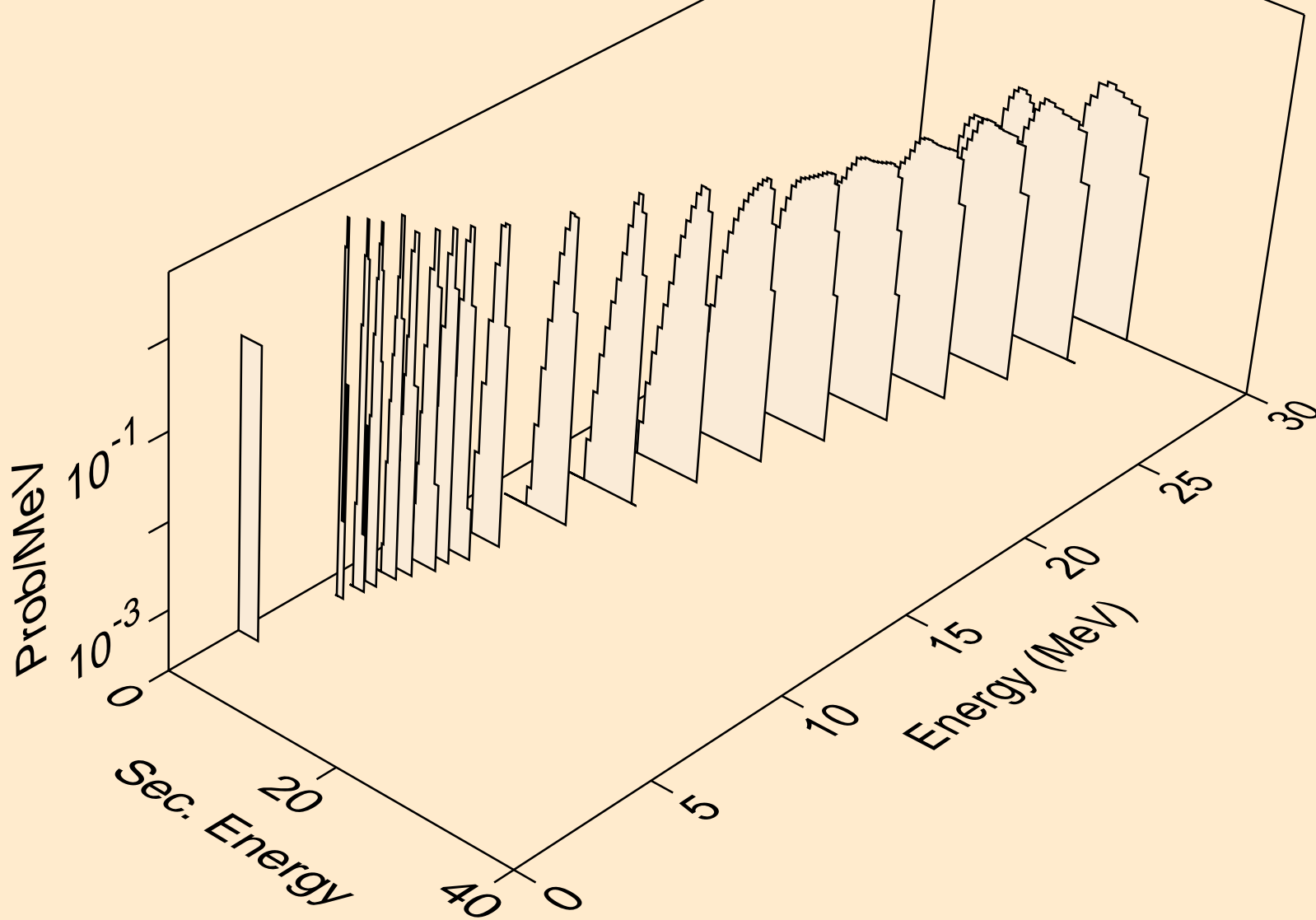

MO085 NEUTRON ACER TENDL-2019 LIBRARY; T=293.16K
alphas from (n,2n)a

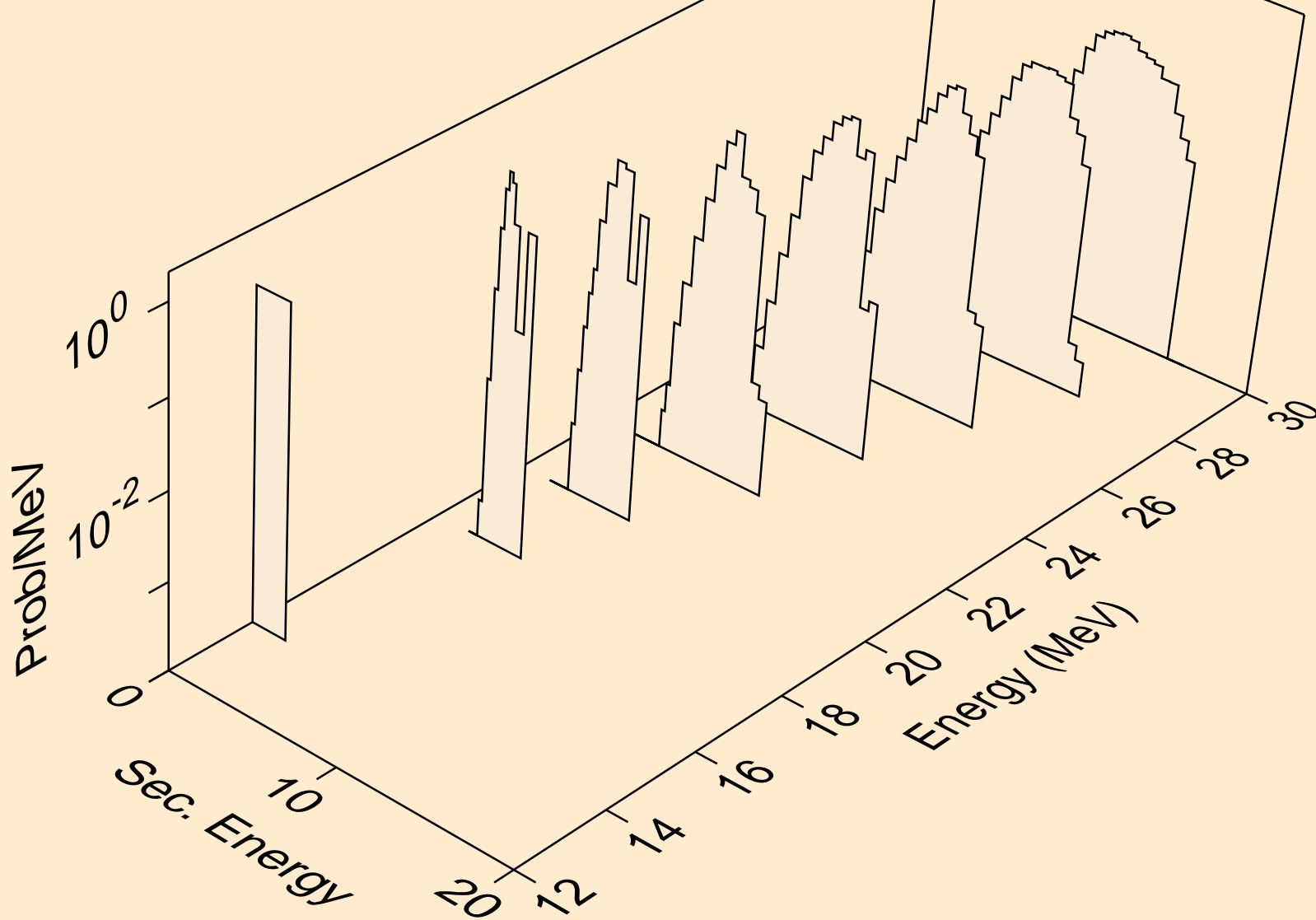

MO085 NEUTRON ACER TENDL-2019 LIBRARY; T=293.16K
alphas from (n,n*)2a

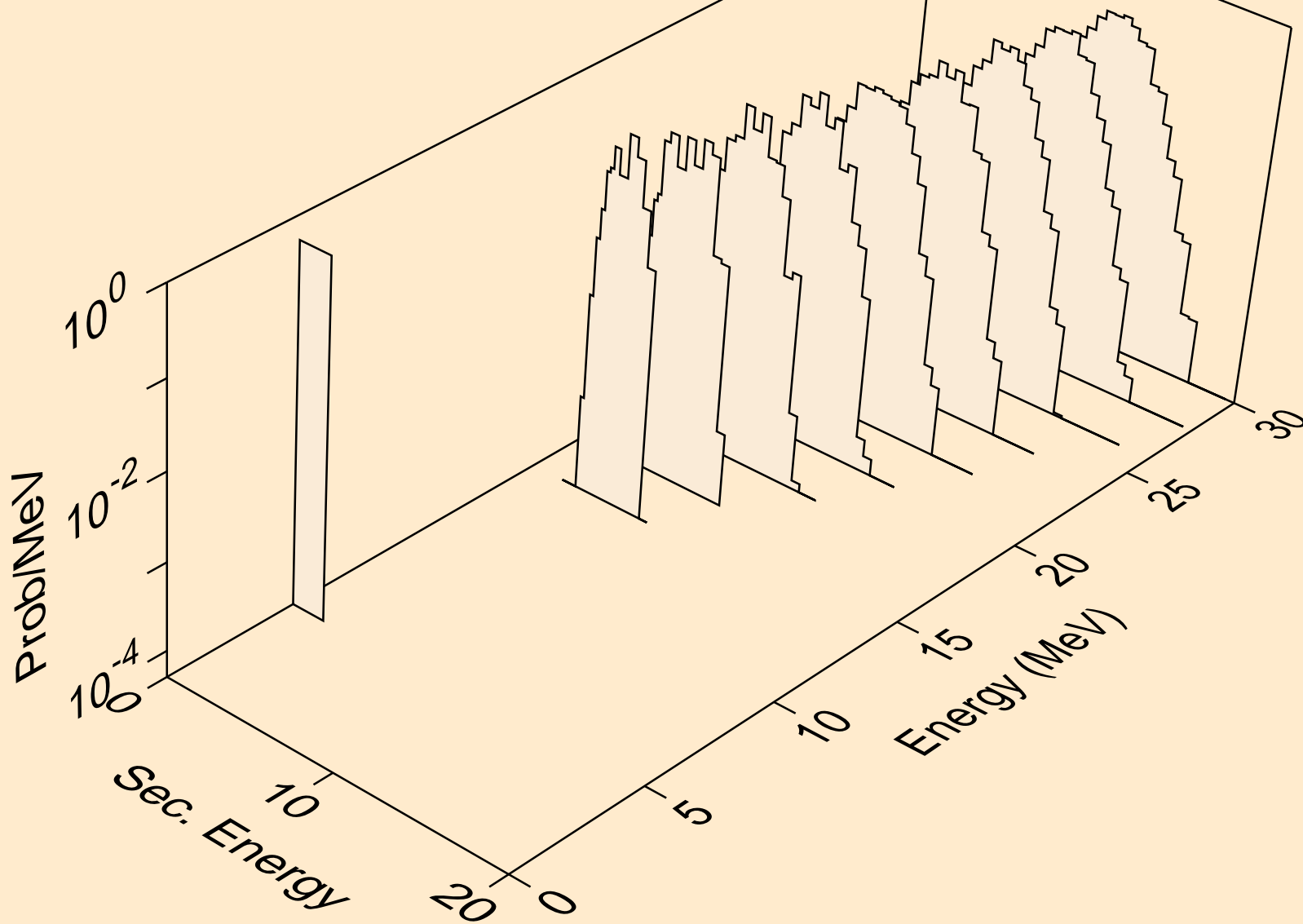

MO085 NEUTRON ACER TENDL-2019 LIBRARY; T=293.16K
alphas from (n,npa)

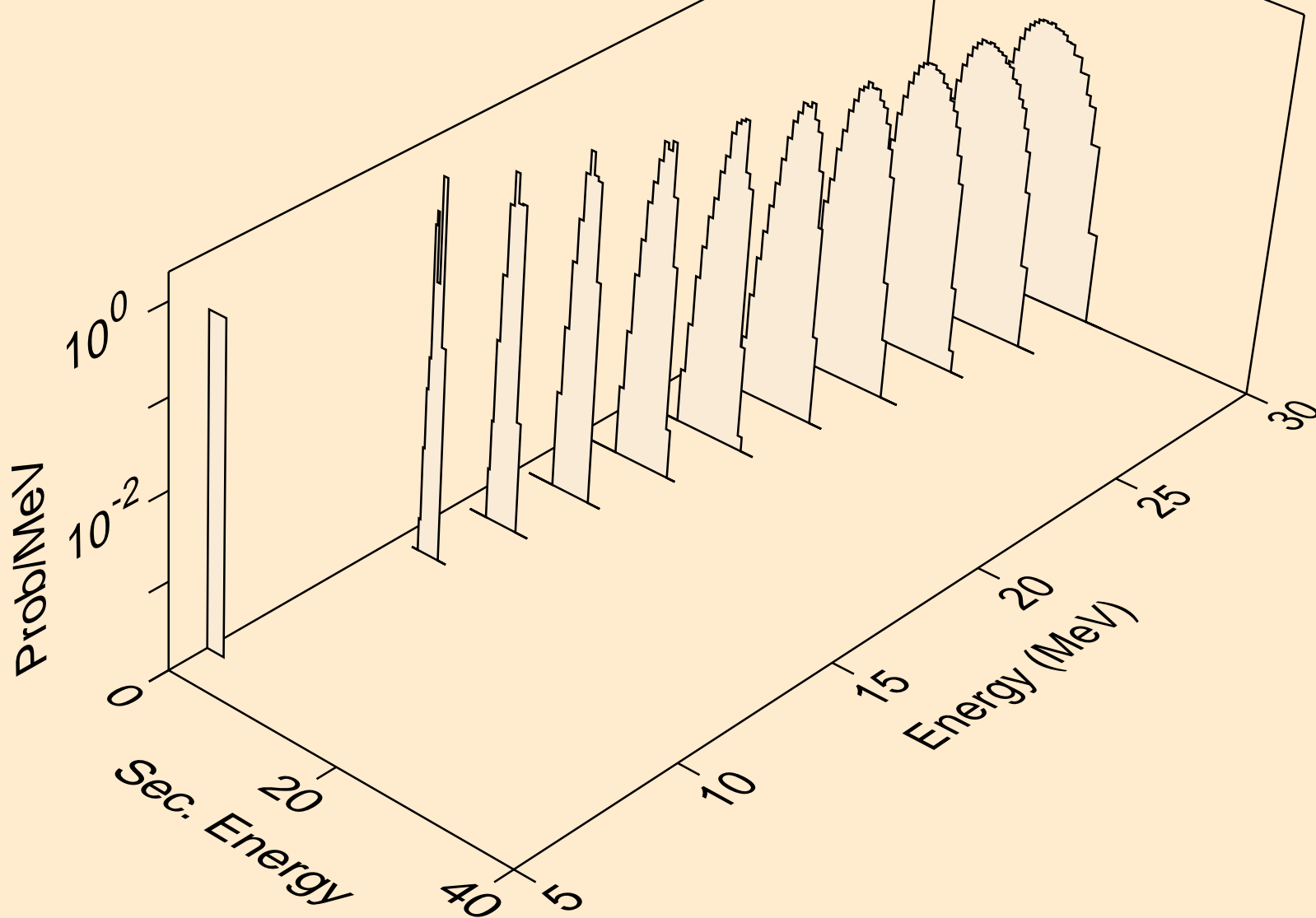

MO085 NEUTRON ACER TENDL-2019 LIBRARY; T=293.16K
alphas from (n,a)

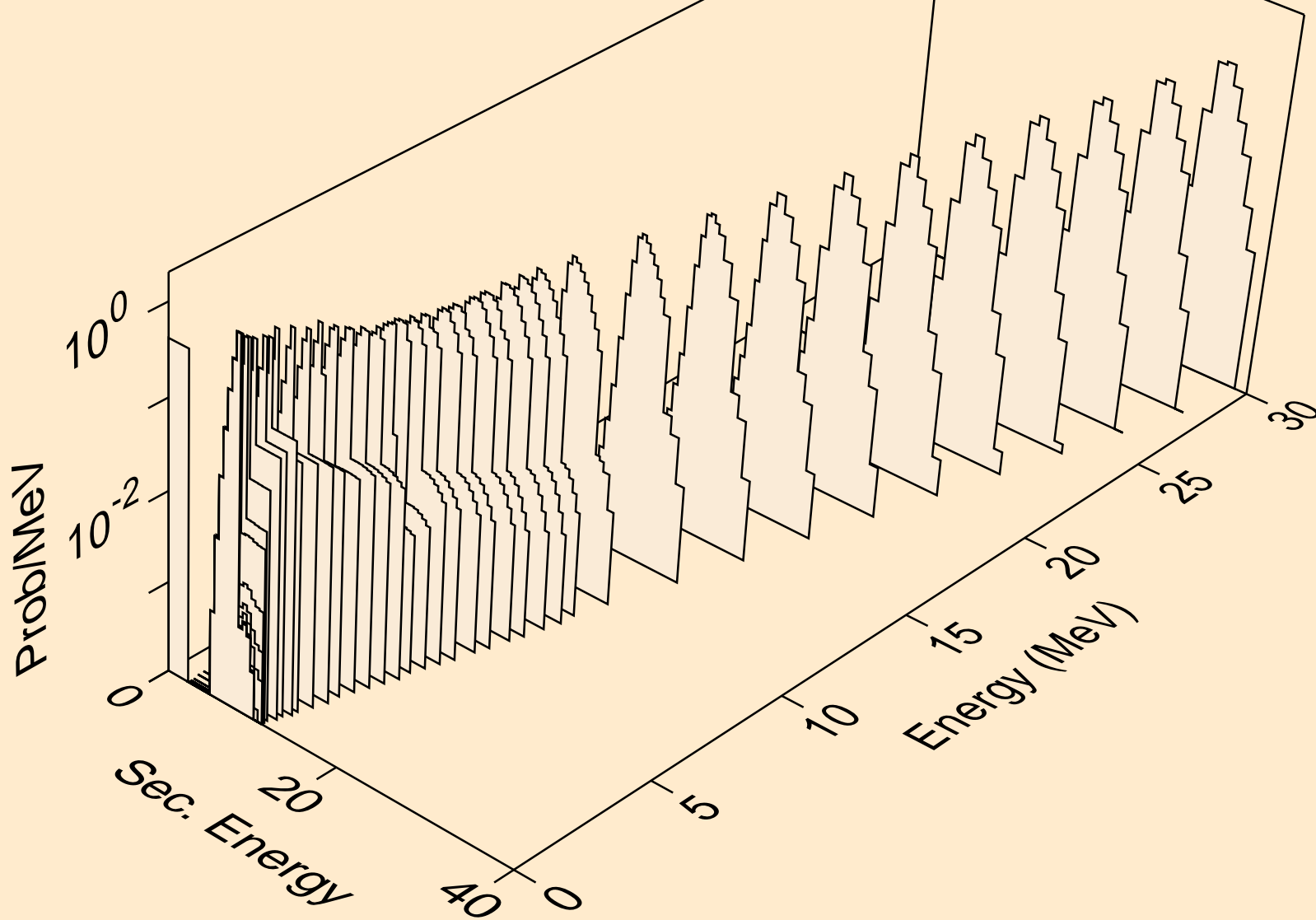

MO085 NEUTRON ACER TENDL-2019 LIBRARY; T=293.16K
alphas from (n,2a)

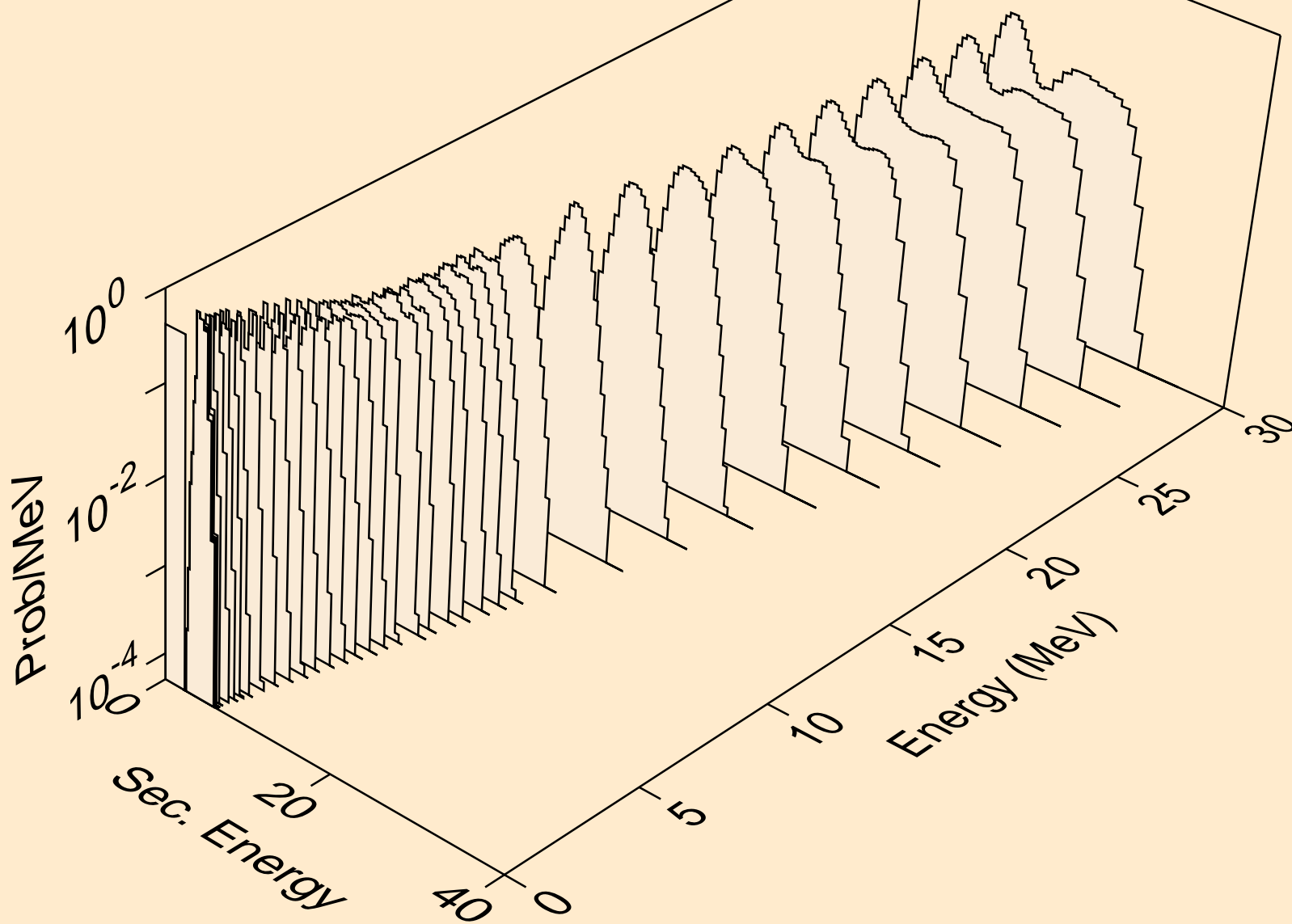

MO085 NEUTRON ACER TENDL-2019 LIBRARY; T=293.16K
alphas from (n,3a)

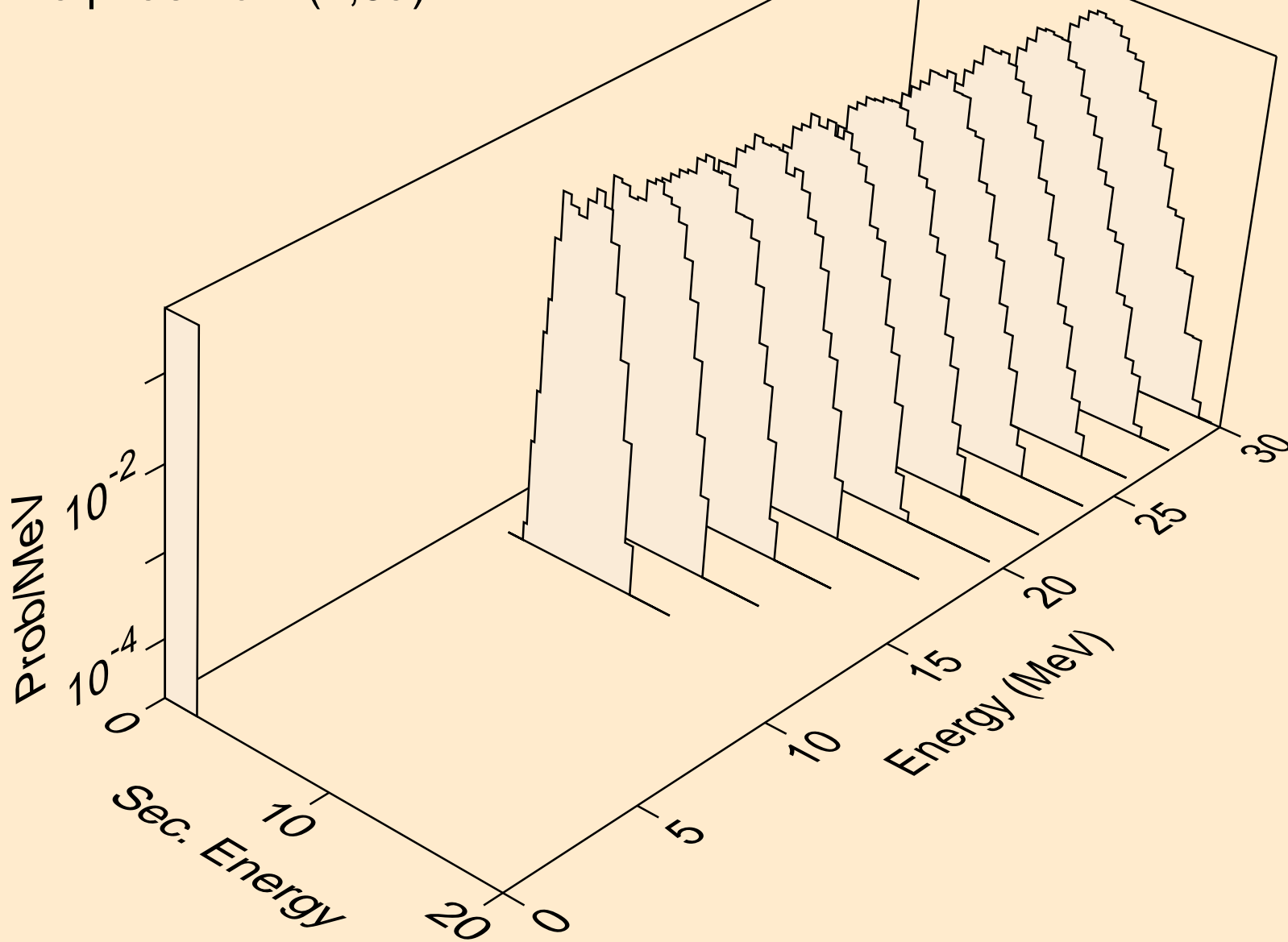

MO085 NEUTRON ACER TENDL-2019 LIBRARY; T=293.16K
alphas from (n,pa)

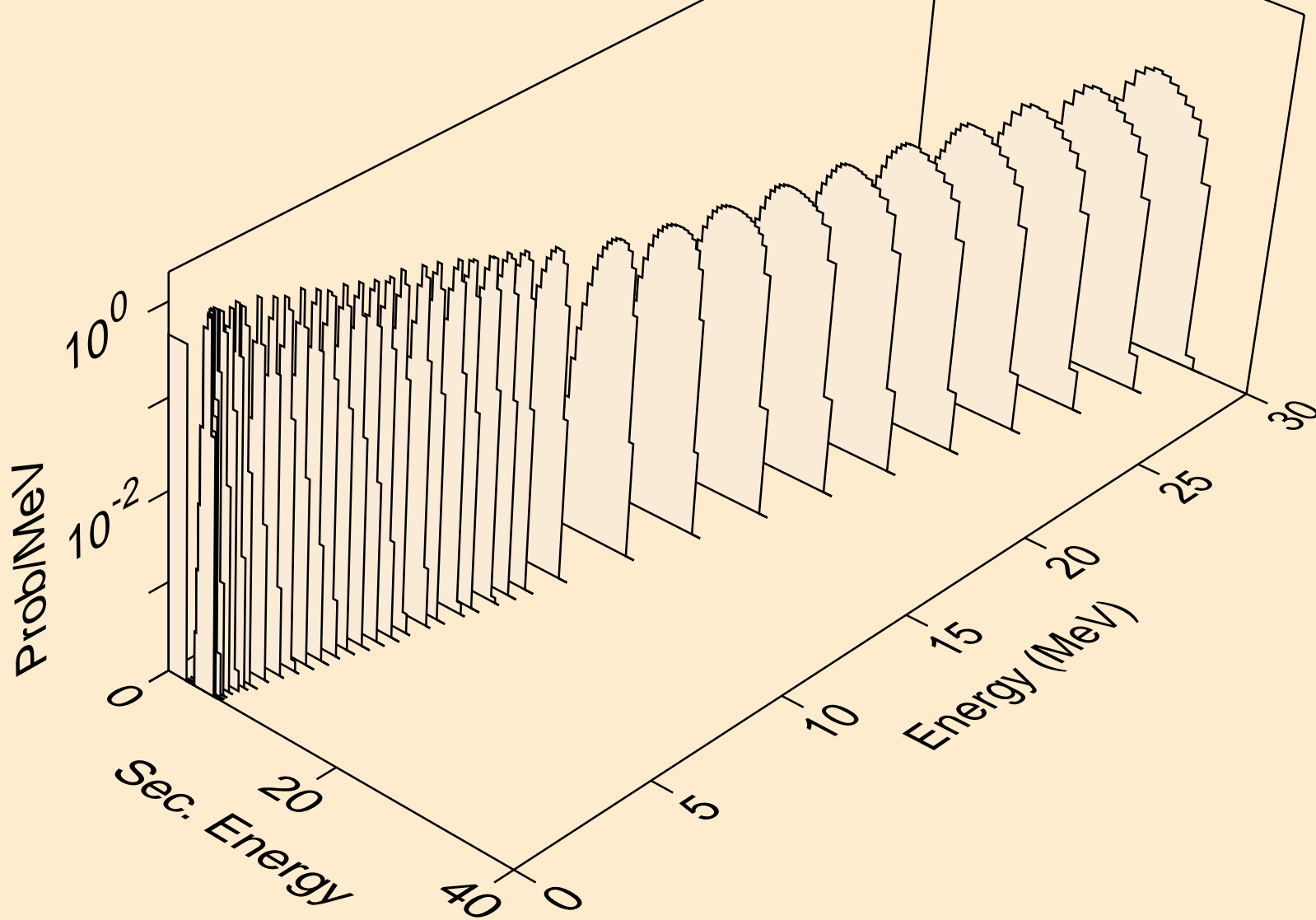

MO085 NEUTRON ACER TENDL-2019 LIBRARY; T=293.16K
alphas from (n,da)

