

PB189M NEUTRON ACER TENDL-2019 LIBRARY; T=293.16K
Principal cross sections

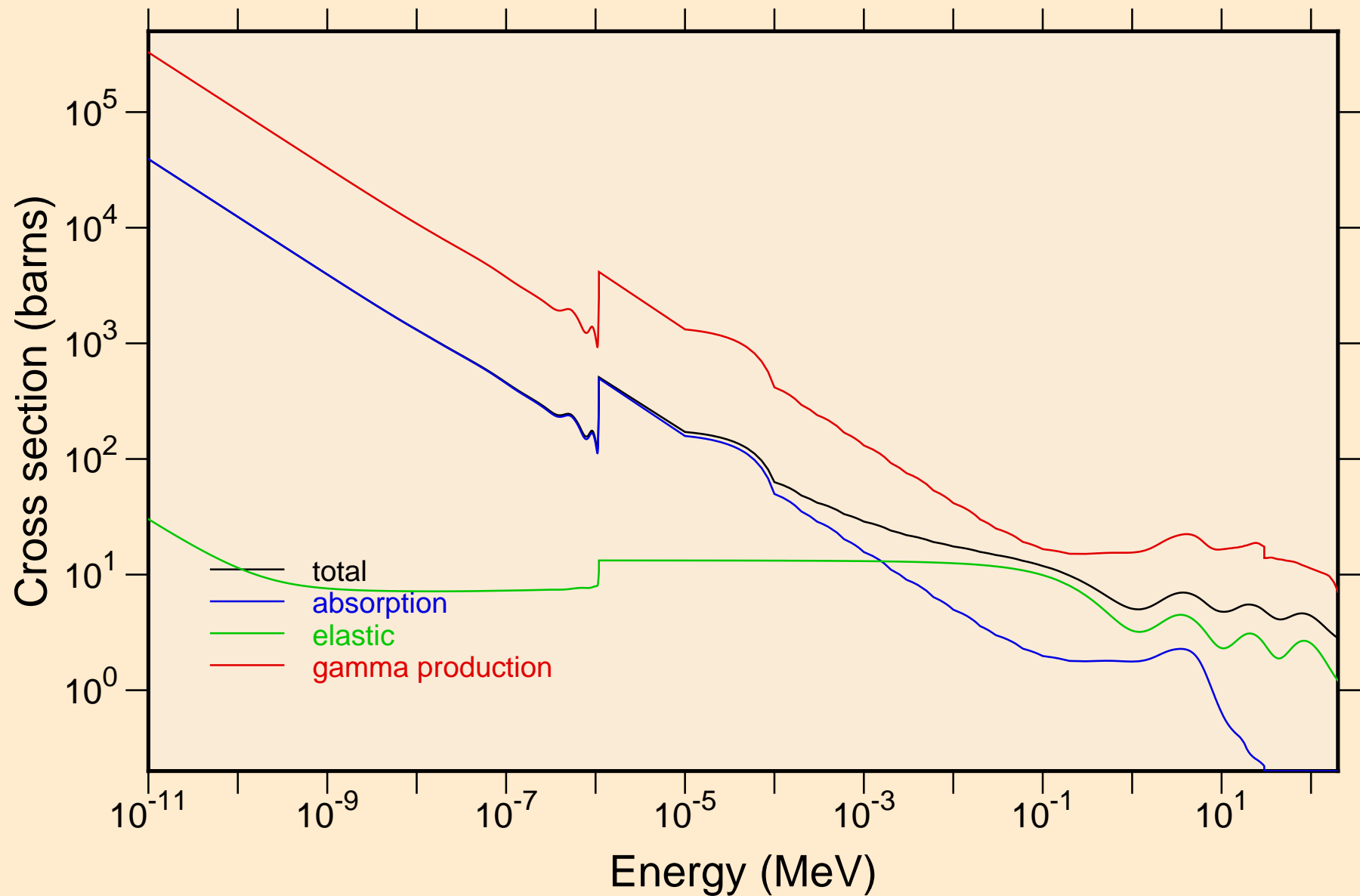

PB189M NEUTRON ACER TENDL-2019 LIBRARY; T=293.16K
Heating

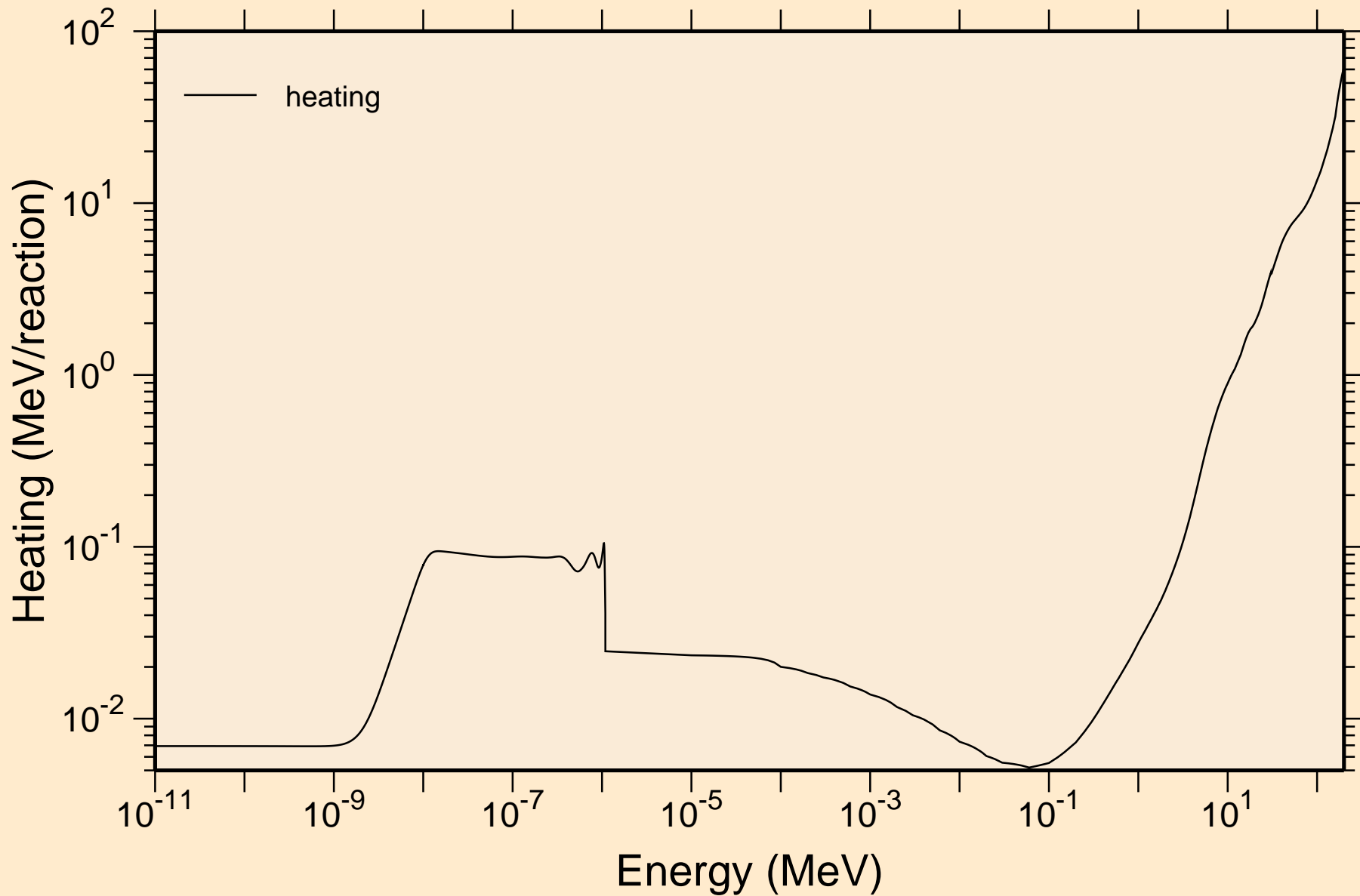

PB189M NEUTRON ACER TENDL-2019 LIBRARY; T=293.16K
Damage

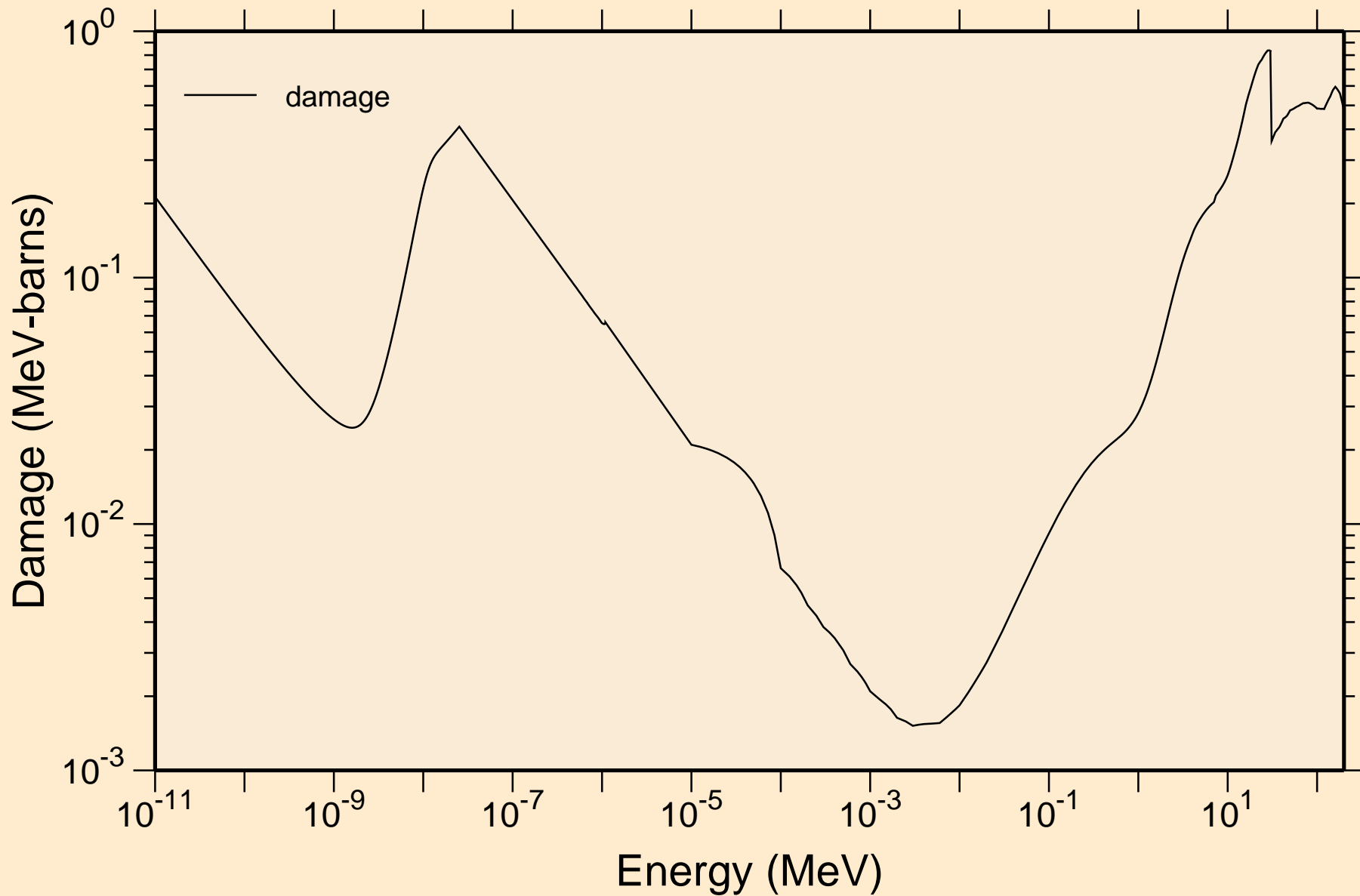

PB189M NEUTRON ACER TENDL-2019 LIBRARY; T=293.16K
Non-threshold reactions

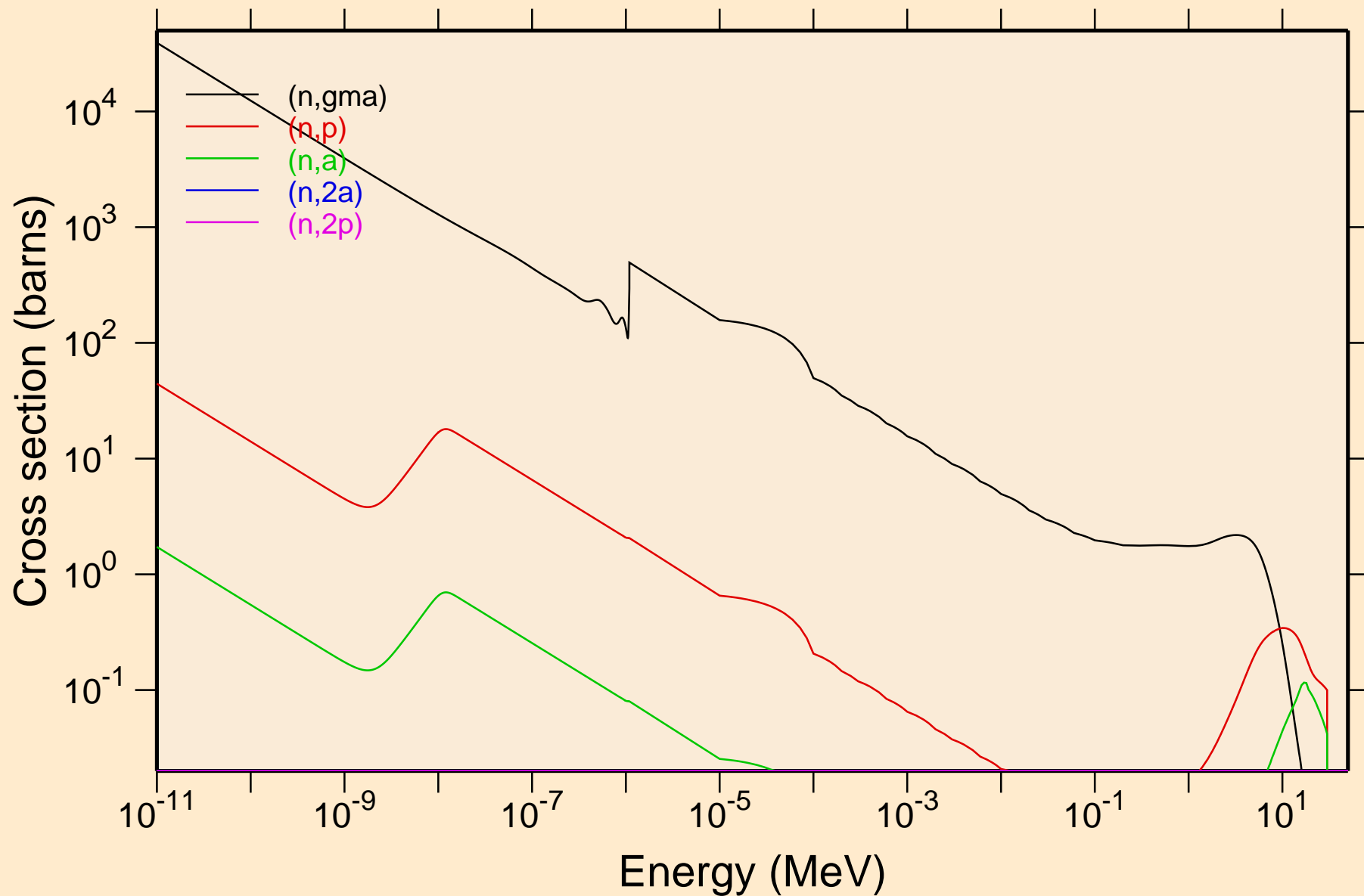

PB189M NEUTRON ACER TENDL-2019 LIBRARY; T=293.16K
Non-threshold reactions

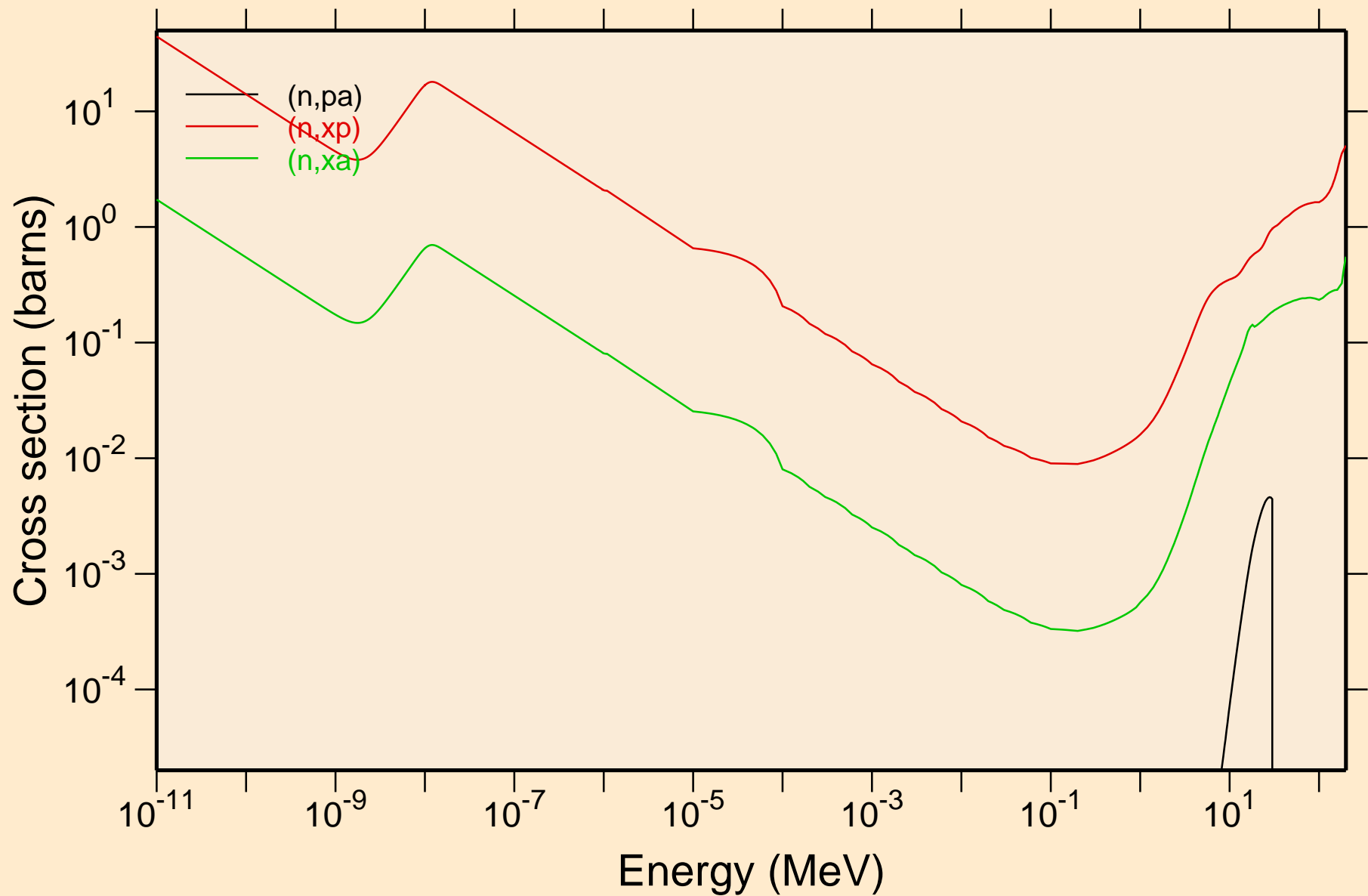

PB189M NEUTRON ACER TENDL-2019 LIBRARY; T=293.16K
Principal cross sections

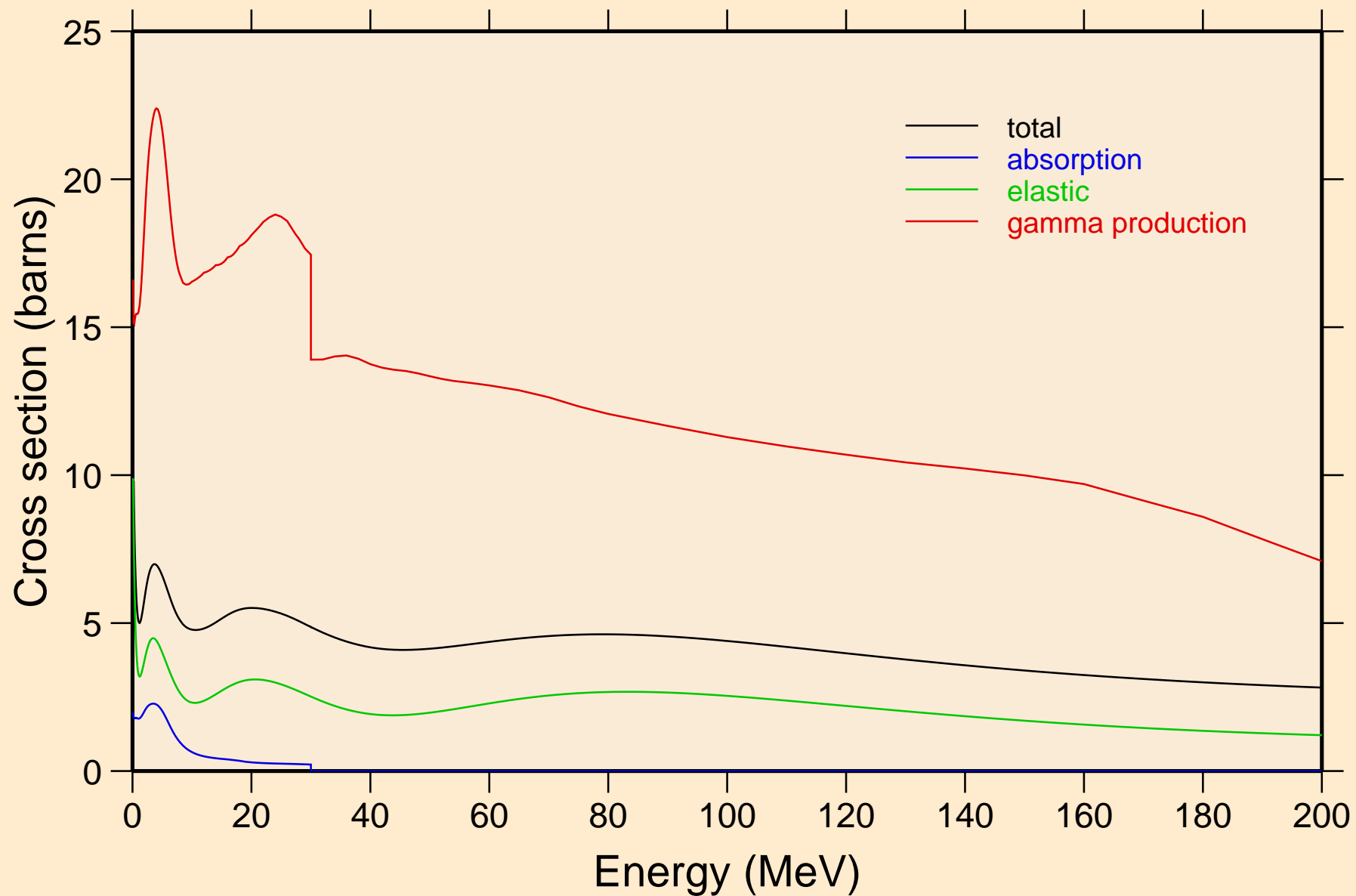

PB189M NEUTRON ACER TENDL-2019 LIBRARY; T=293.16K
Heating

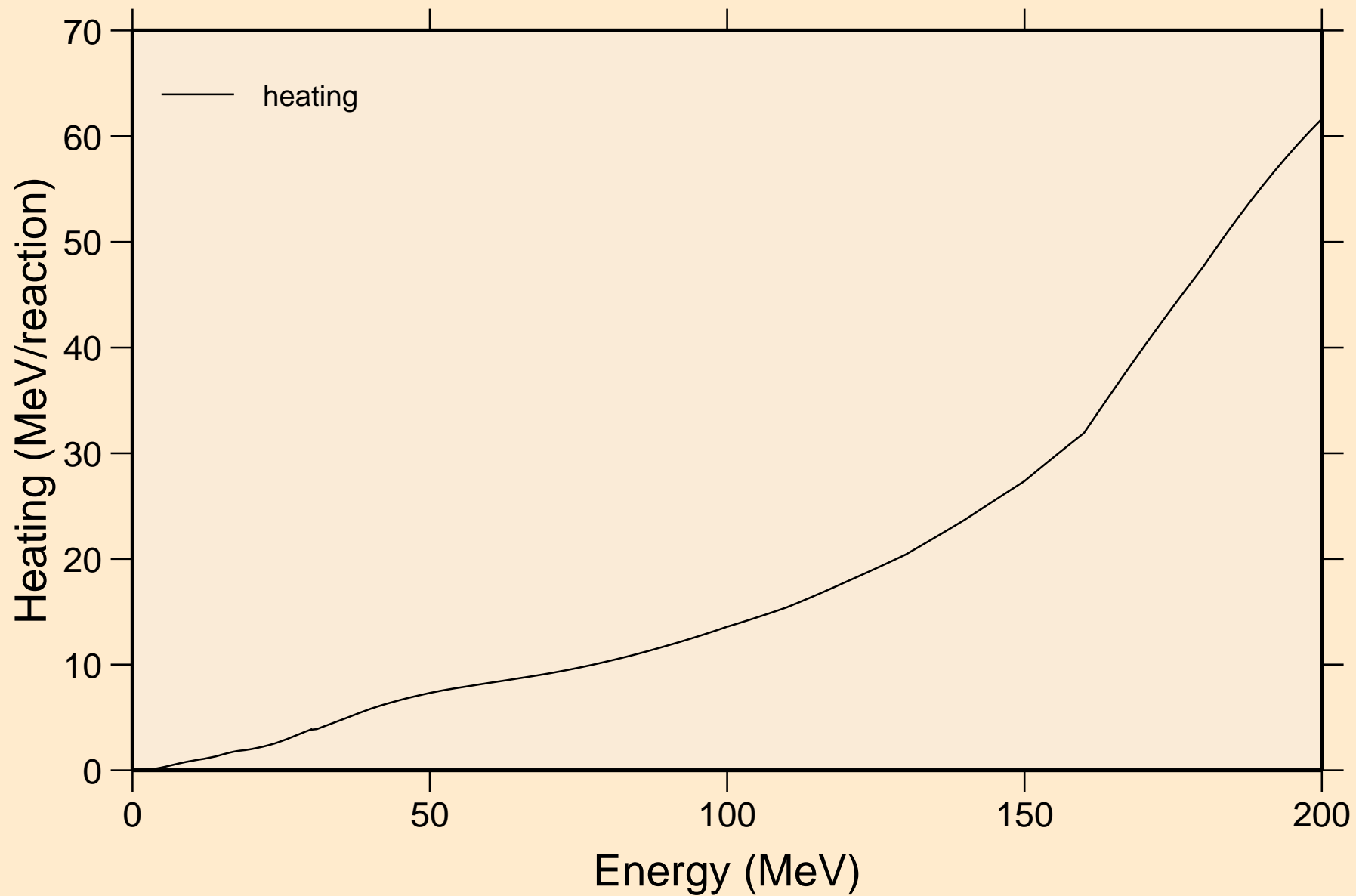

PB189M NEUTRON ACER TENDL-2019 LIBRARY; T=293.16K
Damage

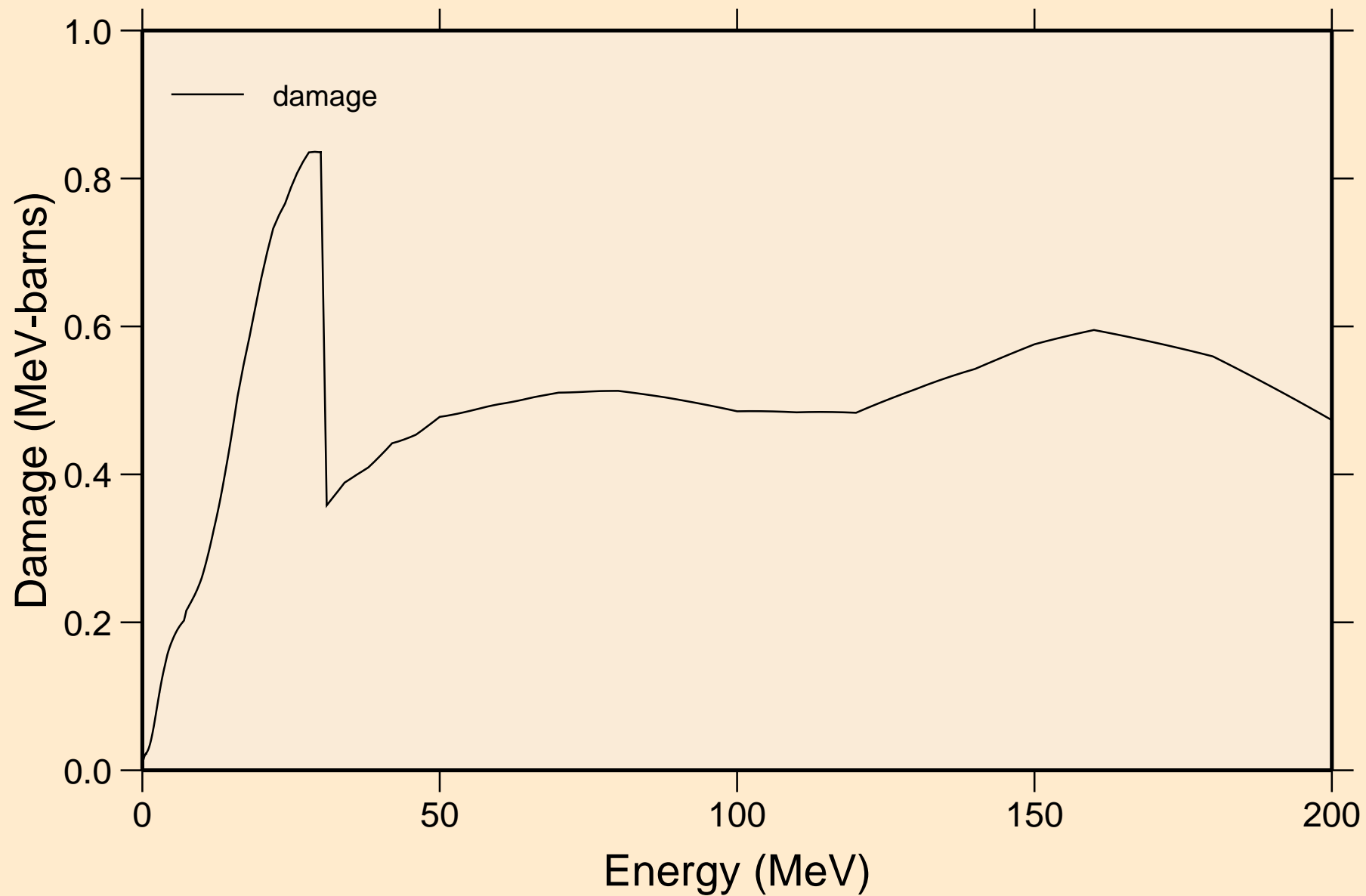

PB189M NEUTRON ACER TENDL-2019 LIBRARY; T=293.16K
Non-threshold reactions

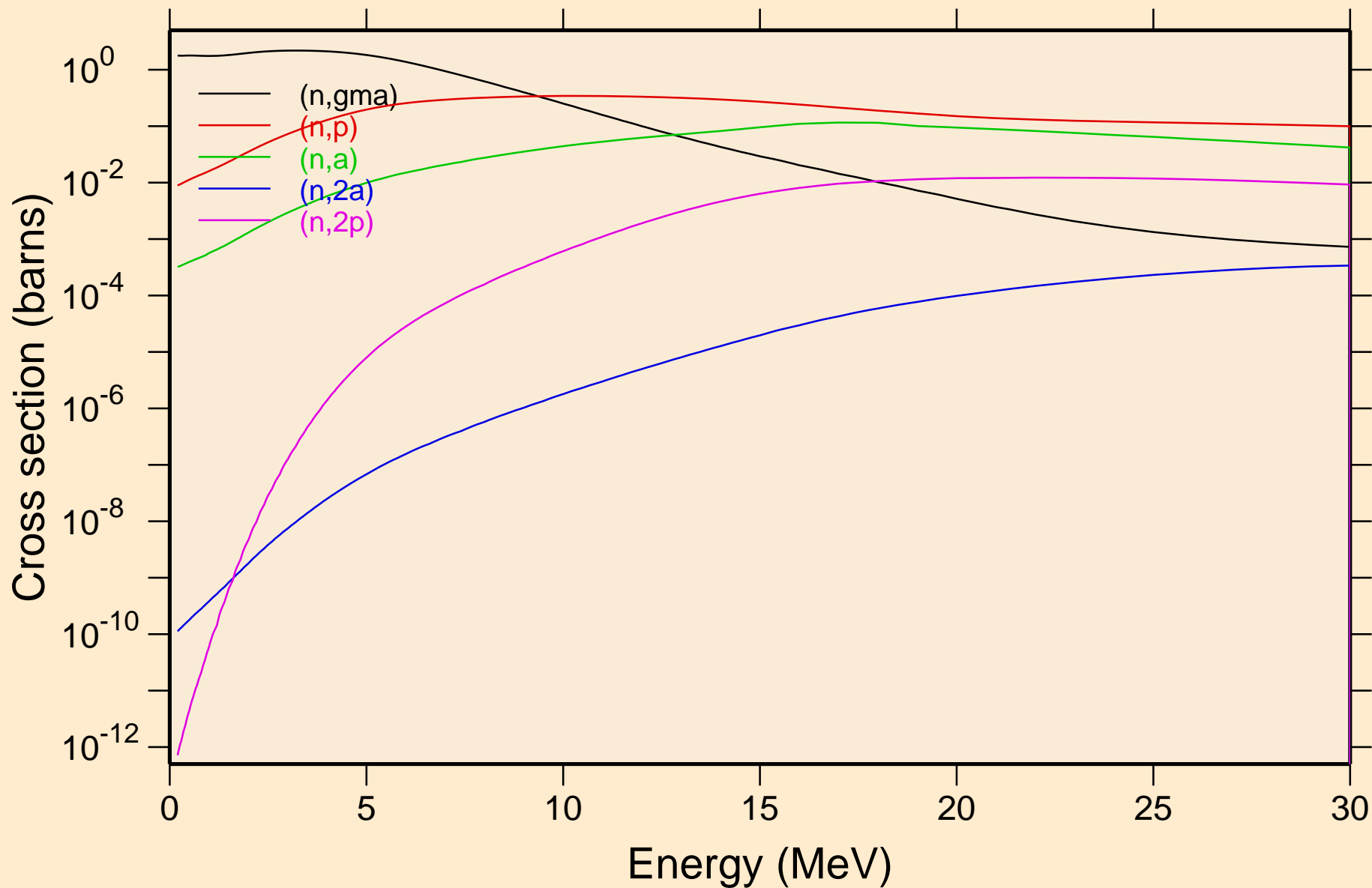

PB189M NEUTRON ACER TENDL-2019 LIBRARY; T=293.16K
Non-threshold reactions

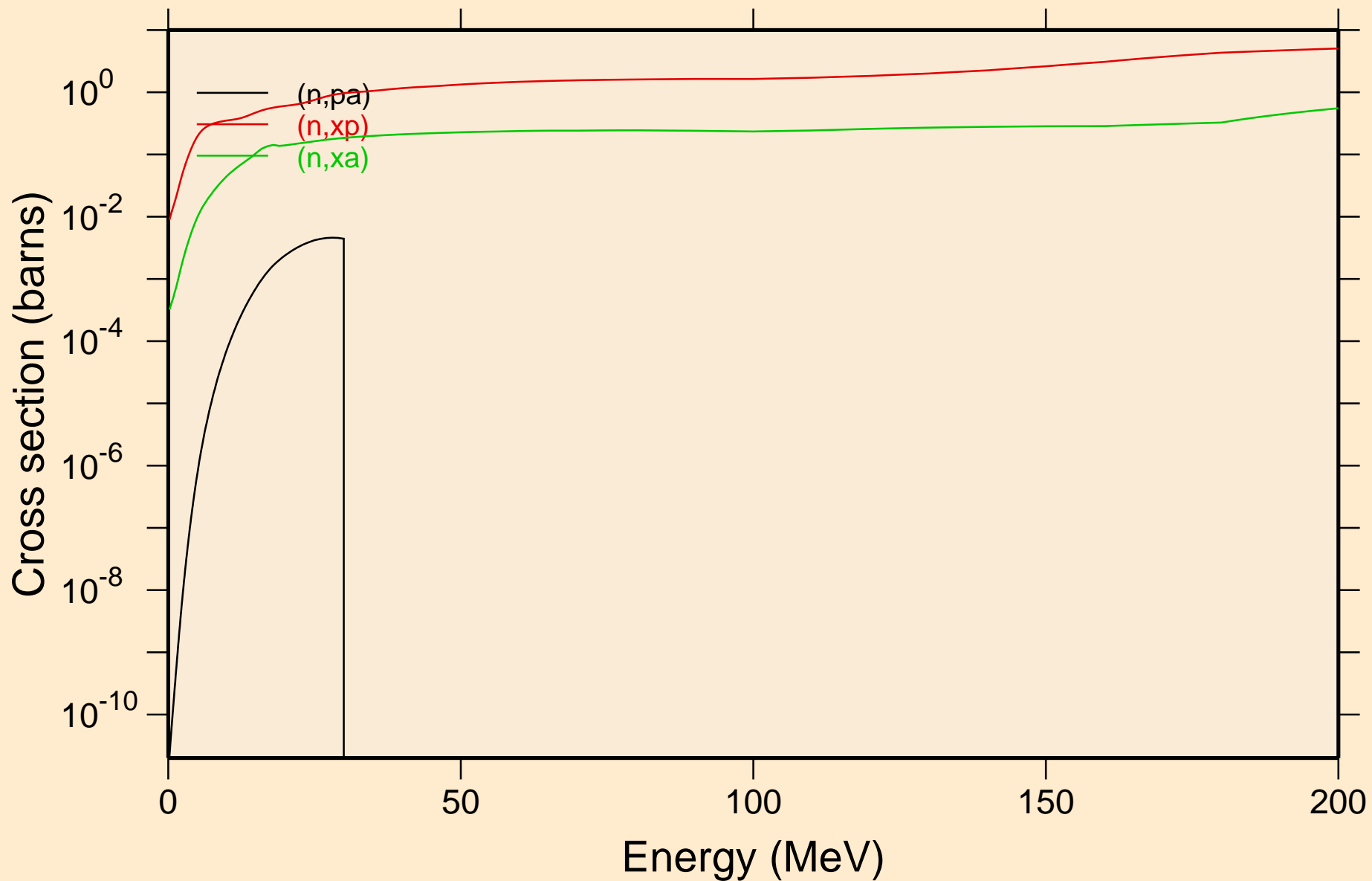

PB189M NEUTRON ACER TENDL-2019 LIBRARY; T=293.16K
Inelastic levels

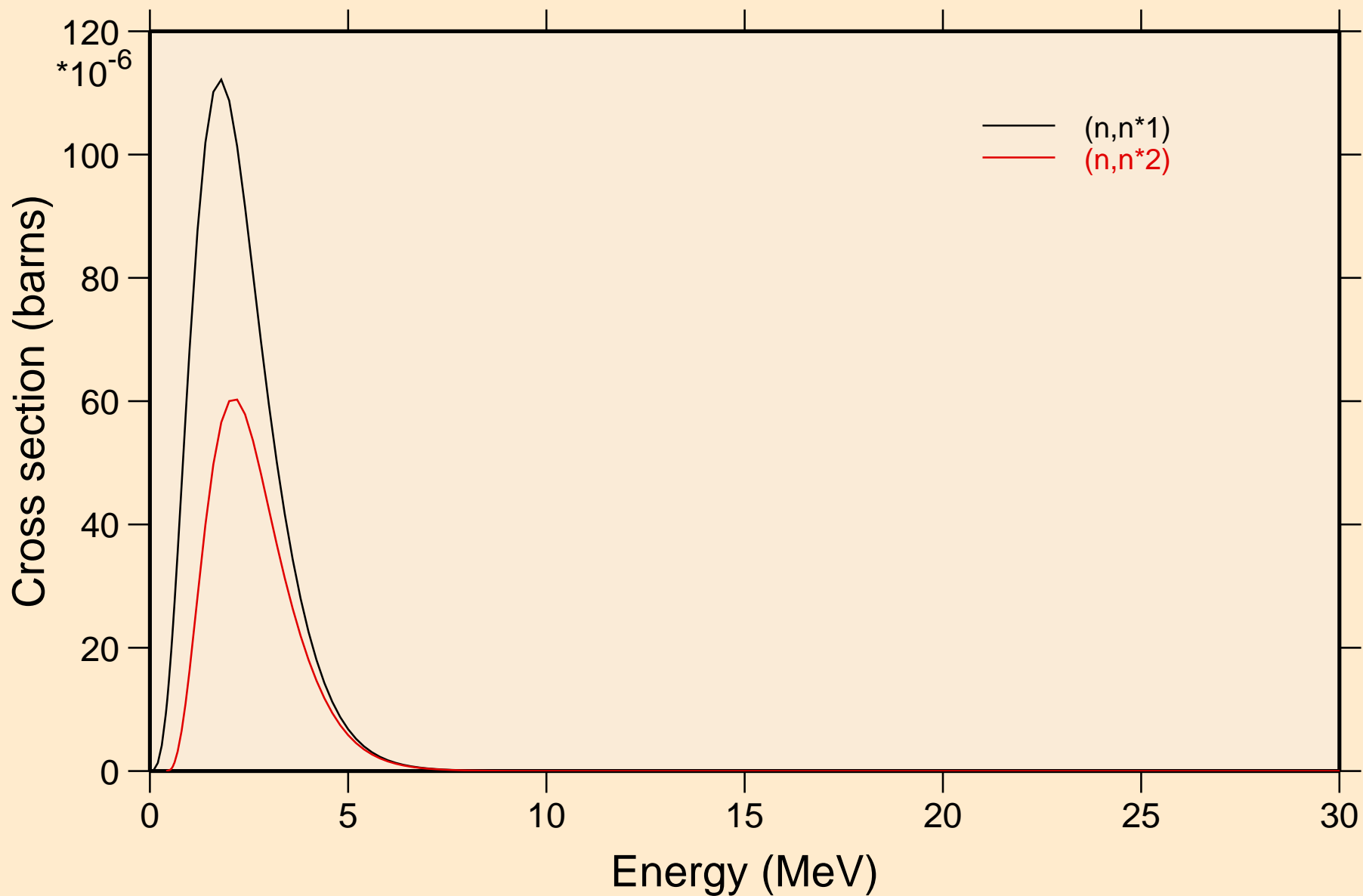

PB189M NEUTRON ACER TENDL-2019 LIBRARY; T=293.16K
Threshold reactions

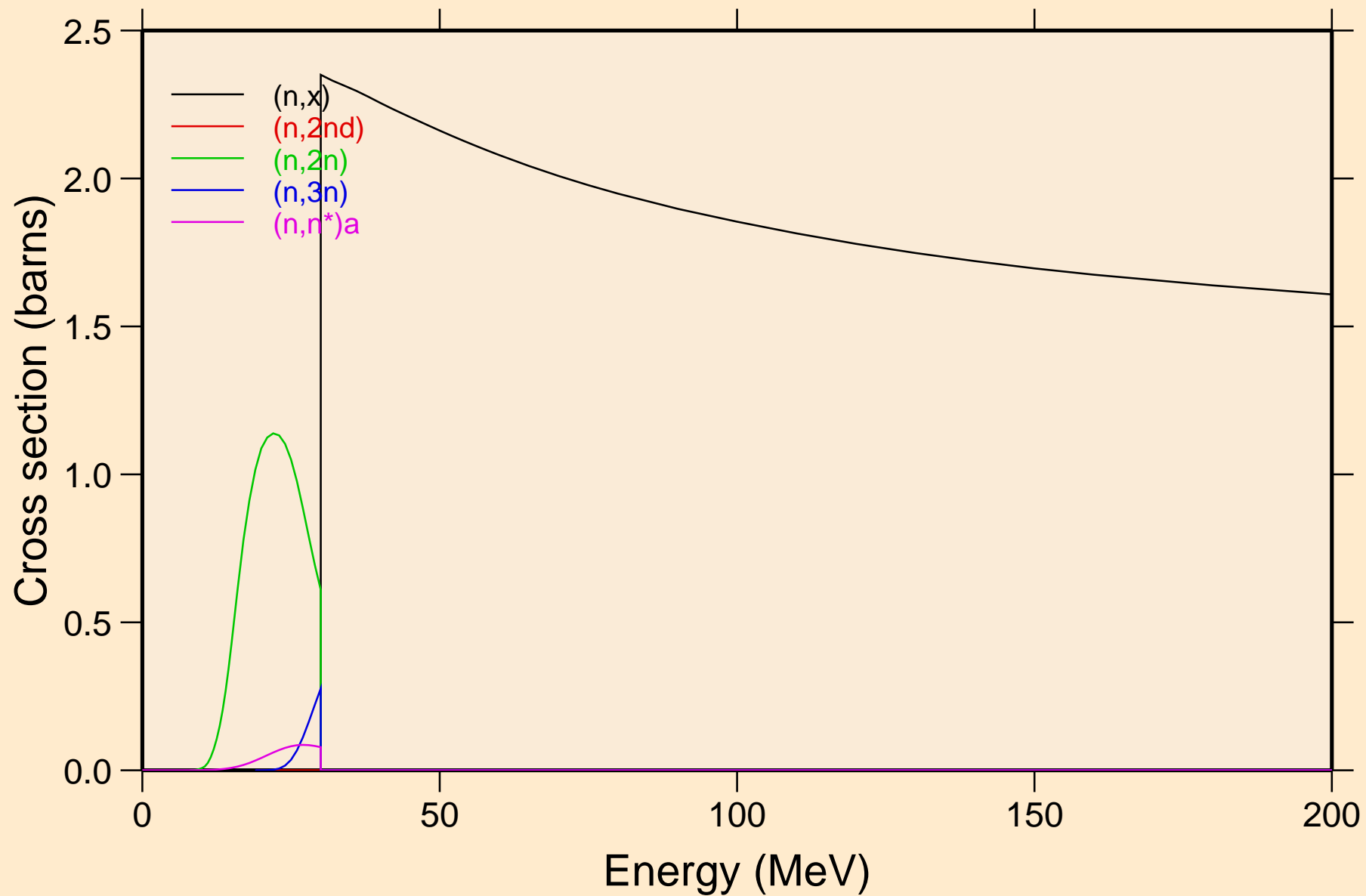

PB189M NEUTRON ACER TENDL-2019 LIBRARY; T=293.16K
Threshold reactions

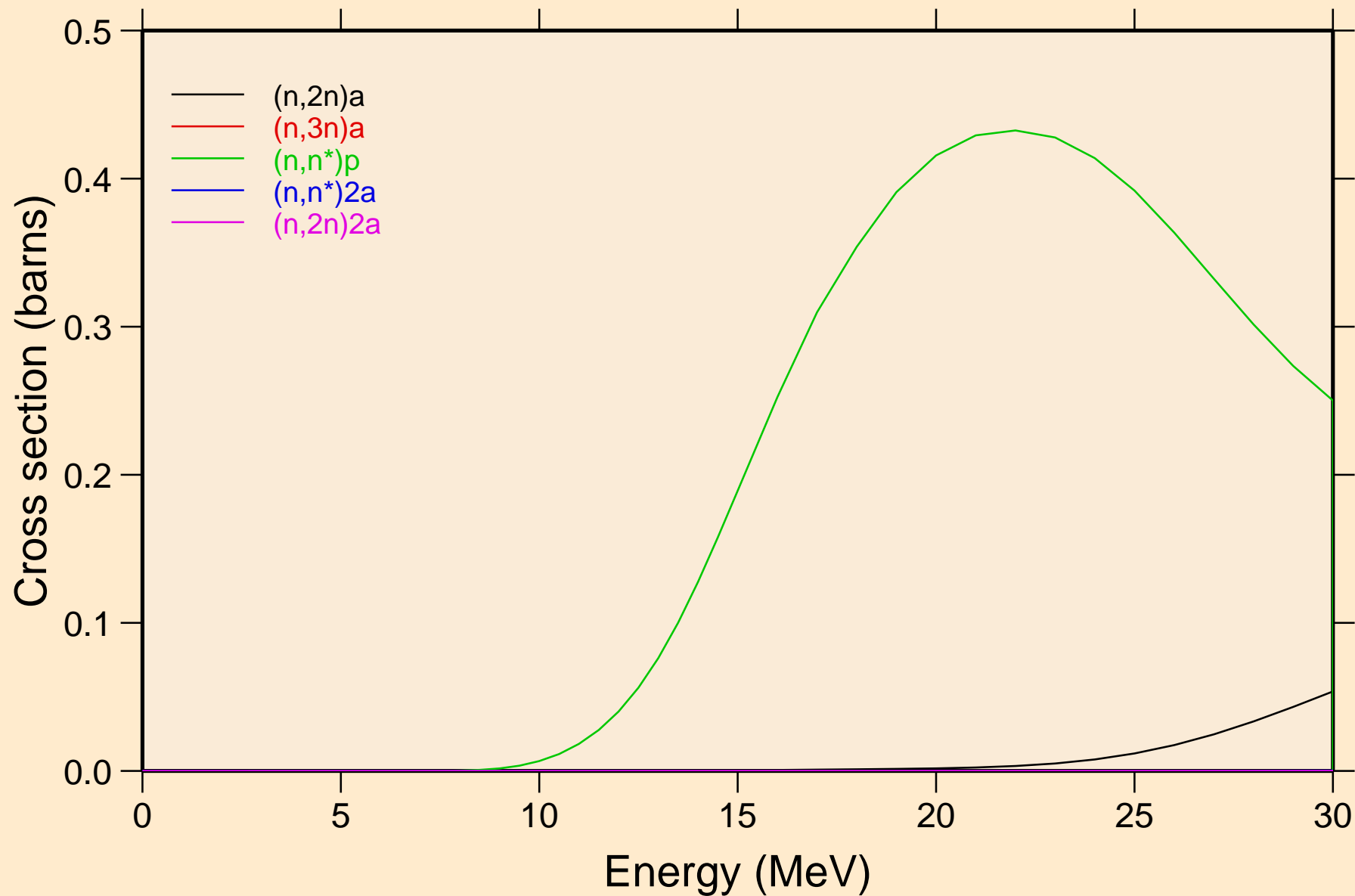

PB189M NEUTRON ACER TENDL-2019 LIBRARY; T=293.16K
Threshold reactions

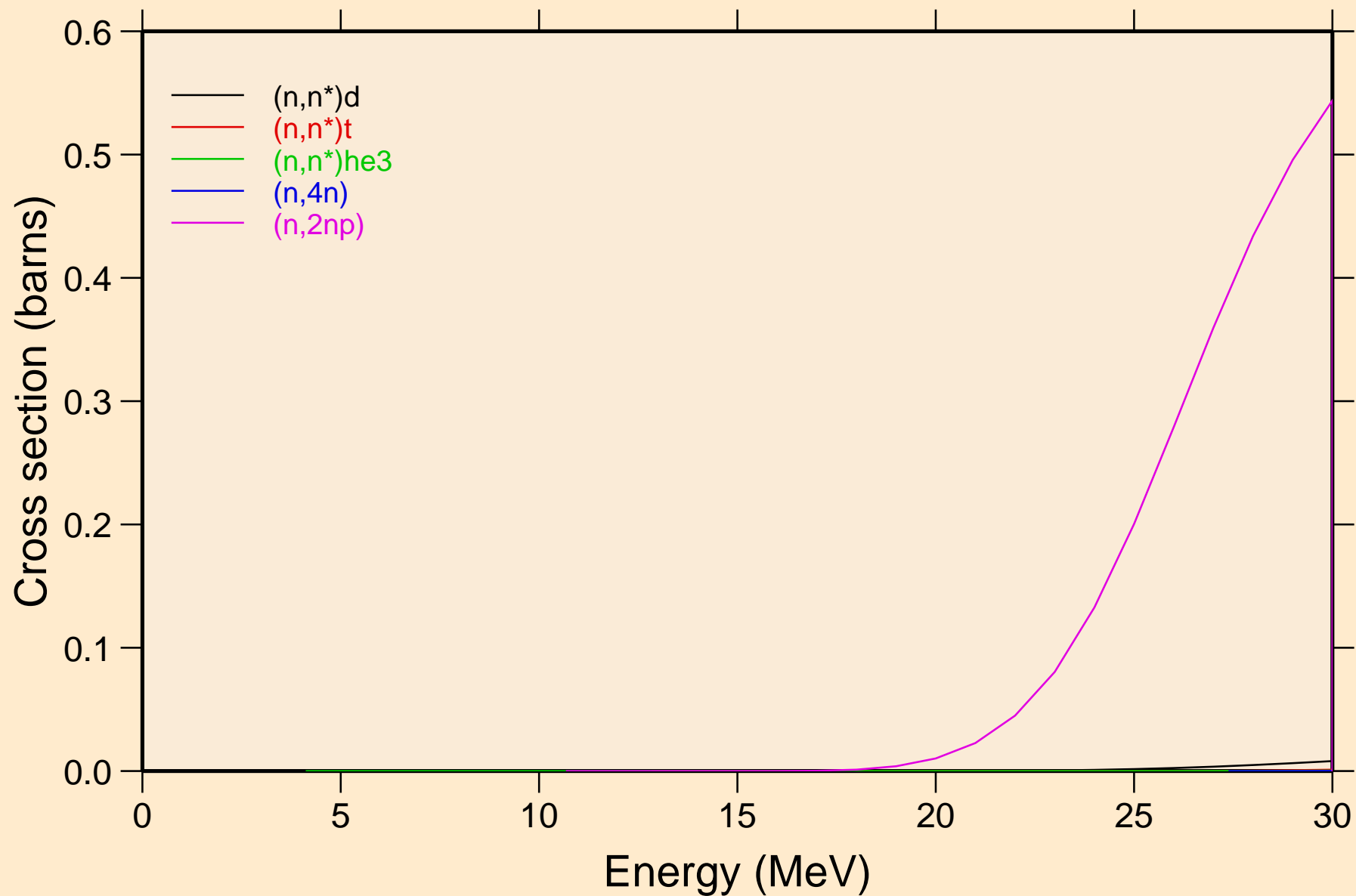

PB189M NEUTRON ACER TENDL-2019 LIBRARY; T=293.16K
Threshold reactions

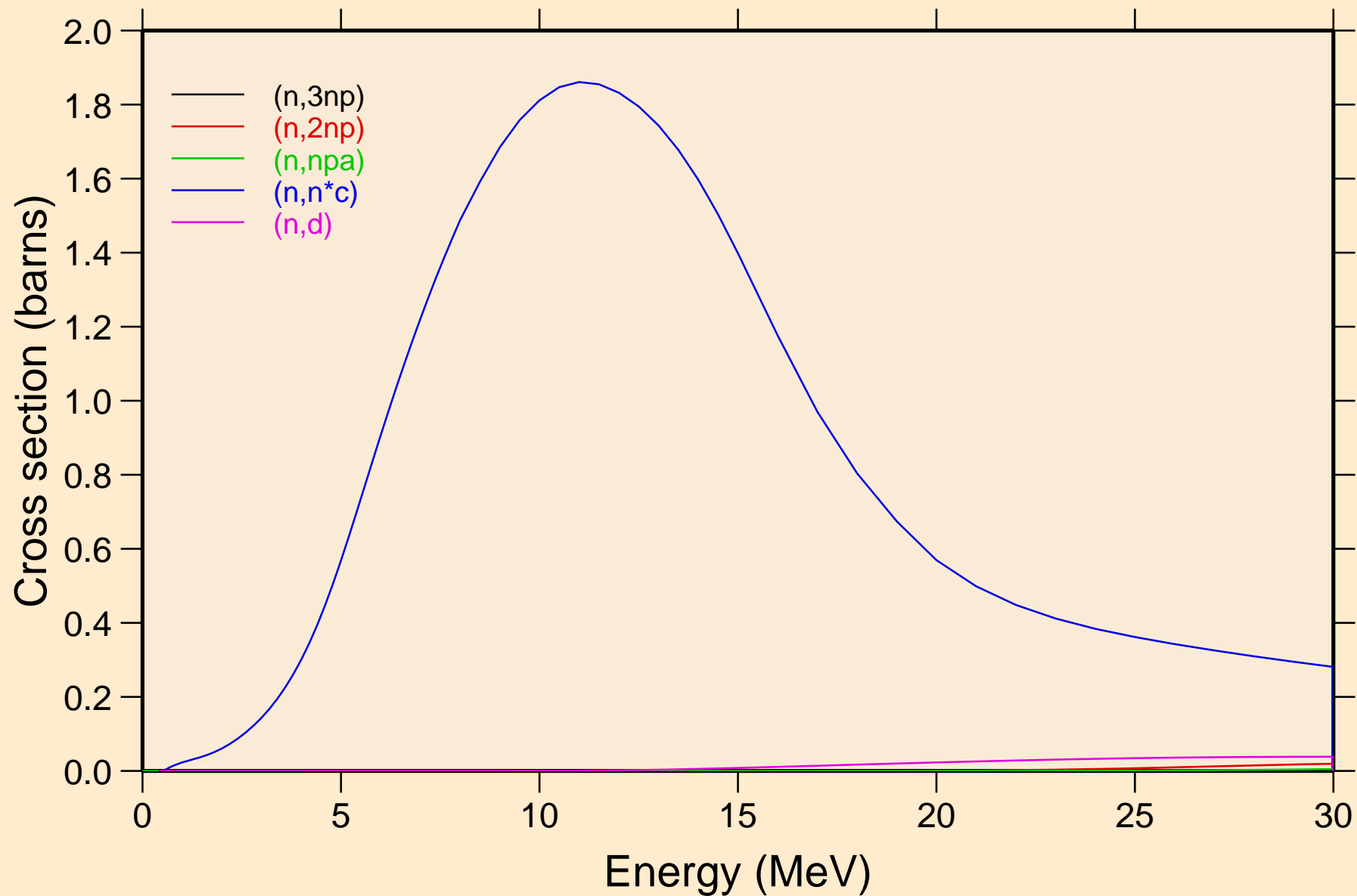

PB189M NEUTRON ACER TENDL-2019 LIBRARY; T=293.16K
Threshold reactions

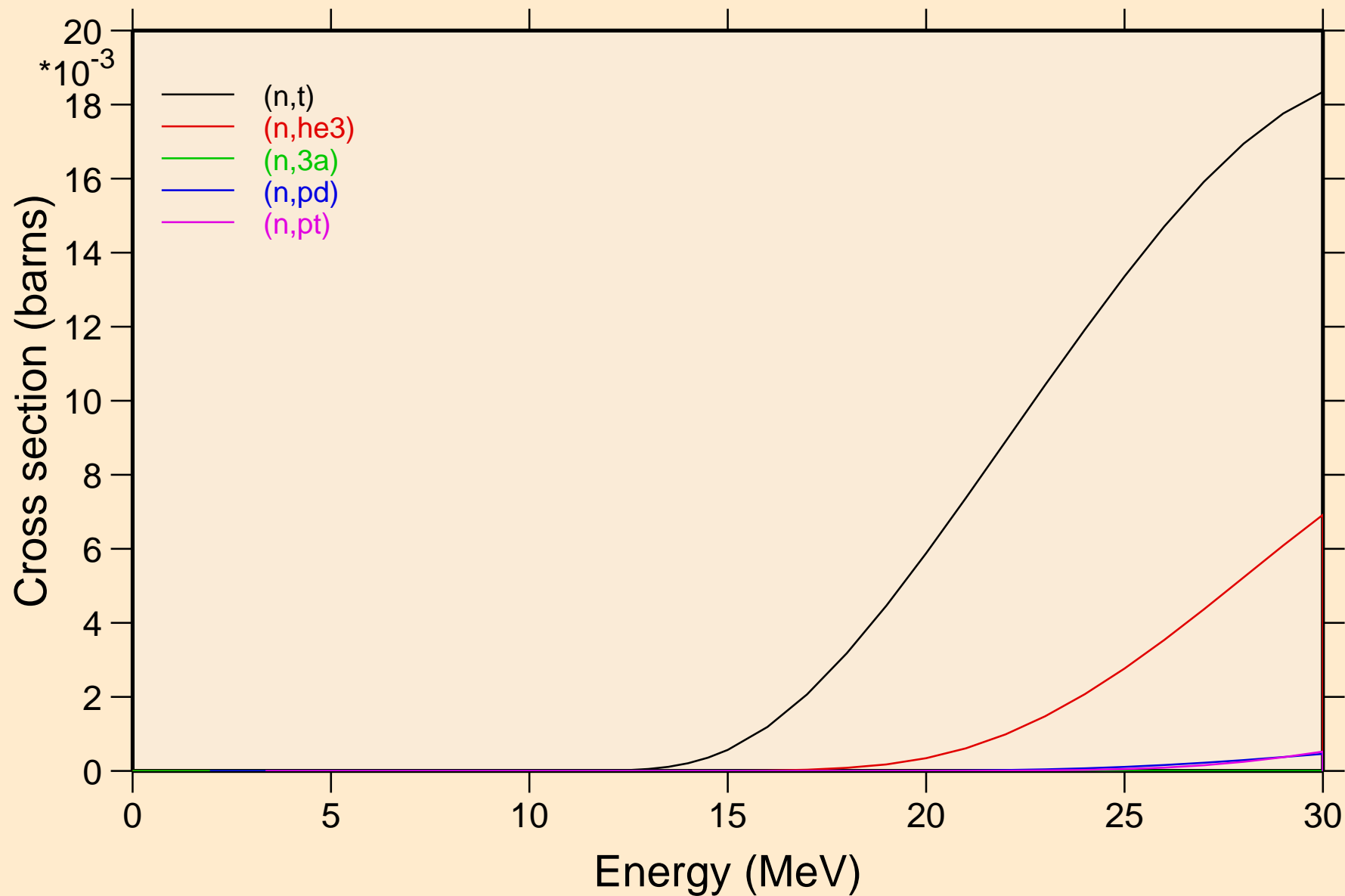

PB189M NEUTRON ACER TENDL-2019 LIBRARY; T=293.16K
Threshold reactions

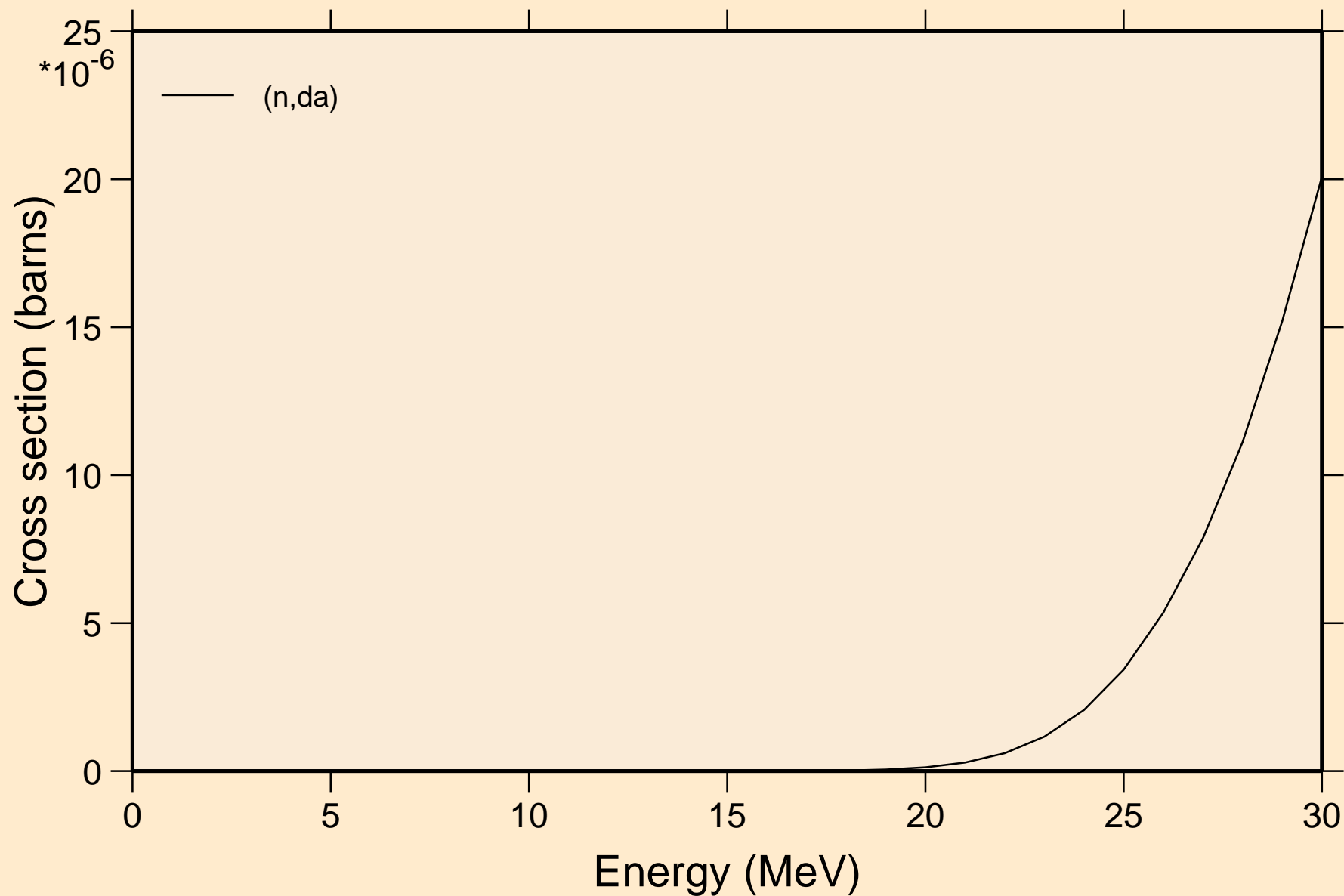

PB189M NEUTRON ACER TENDL-2019 LIBRARY; T=293.16K
Threshold reactions

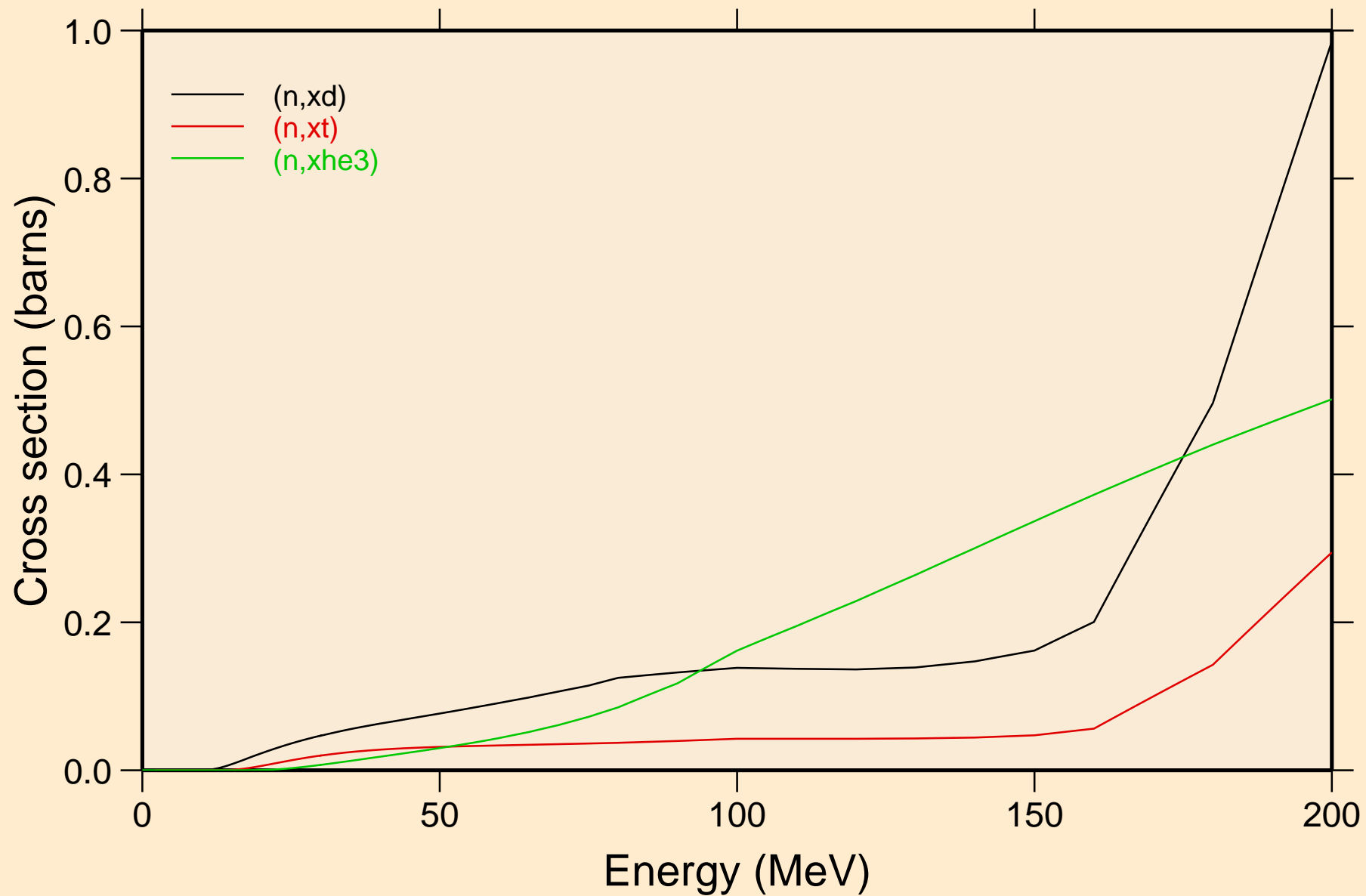

PB189M NEUTRON ACER TENDL-2019 LIBRARY; T=293.16K
angular distribution for elastic

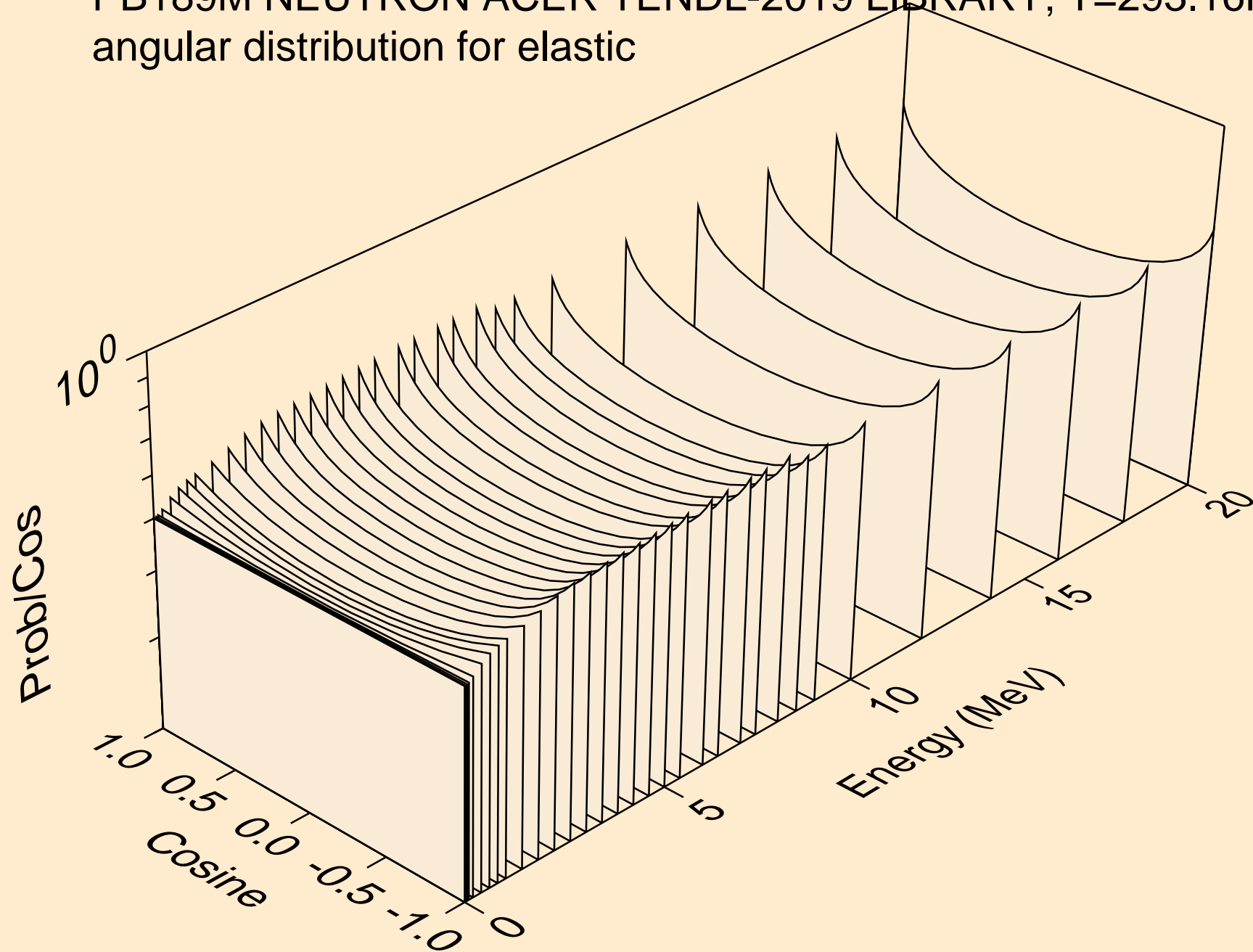

PB189M NEUTRON ACER TENDL-2019 LIBRARY; T=293.16K
angular distribution for elastic

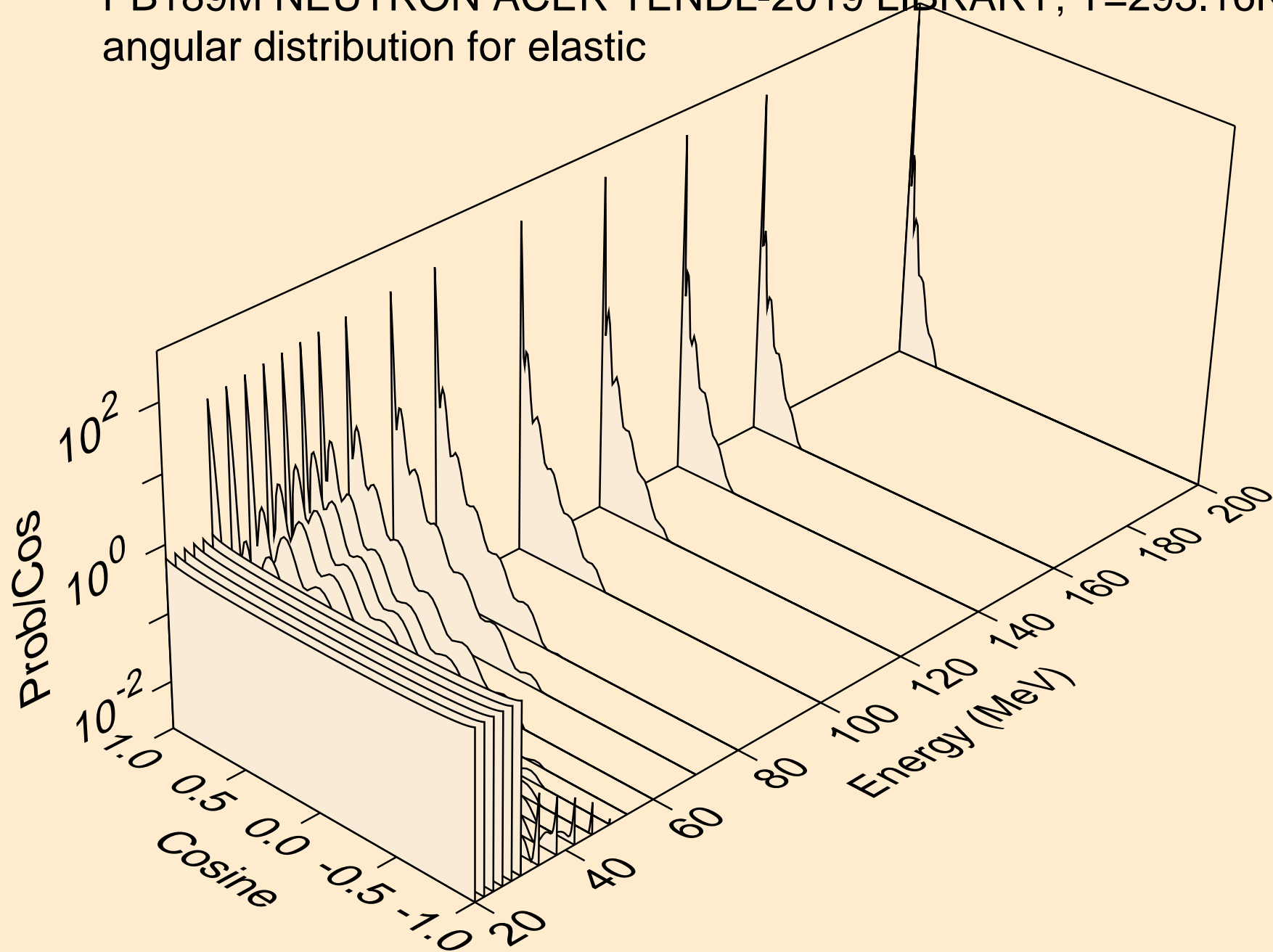

PB189M NEUTRON ACER TENDL-2019 LIBRARY; T=293.16K
angular distribution for (n,n*1)

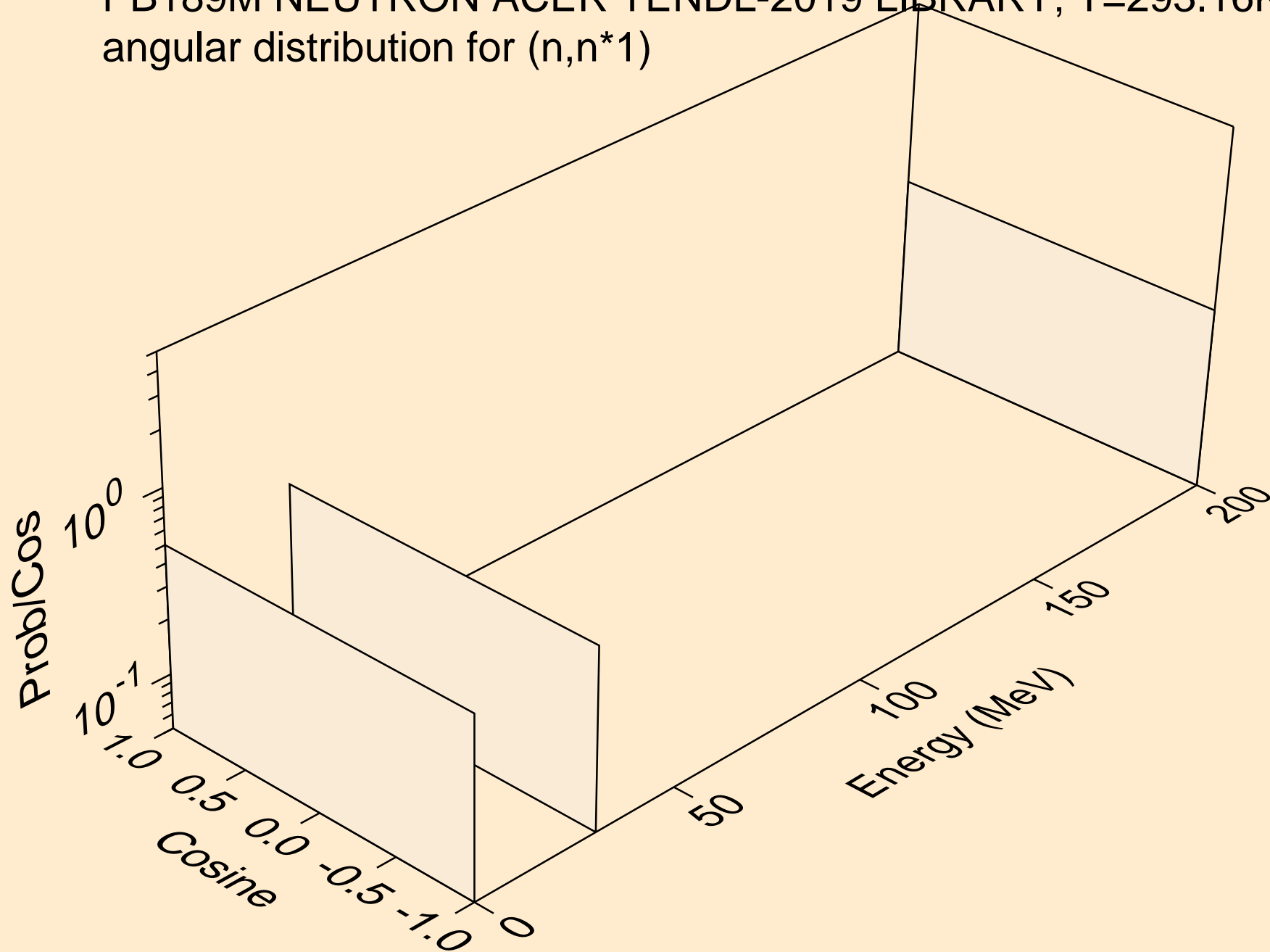

PB189M NEUTRON ACER TENDL-2019 LIBRARY; T=293.16K
angular distribution for (n,n*2)

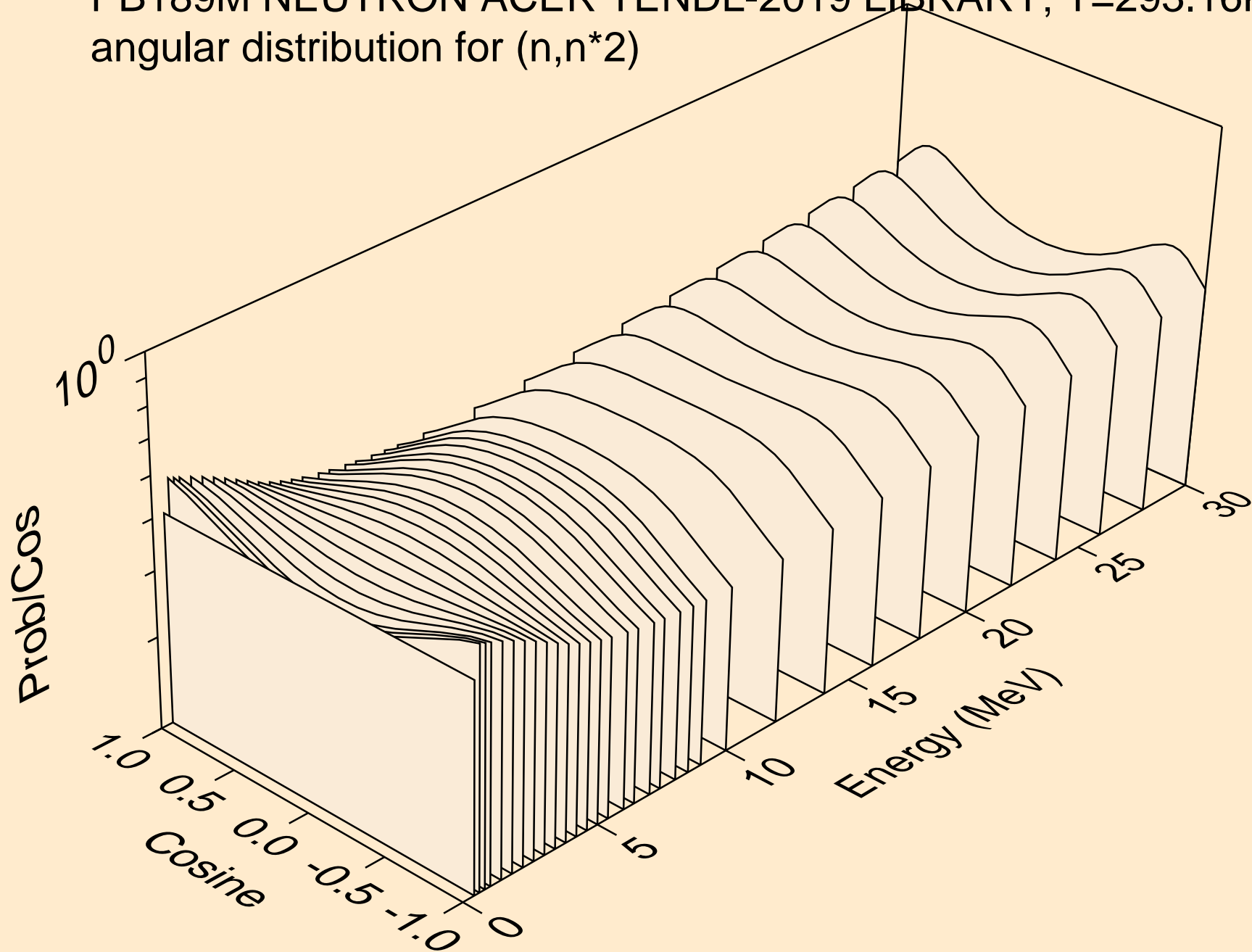

PB189M NEUTRON ACER TENDL-2019 LIBRARY; T=293.16K
Neutron emission for (n,x)

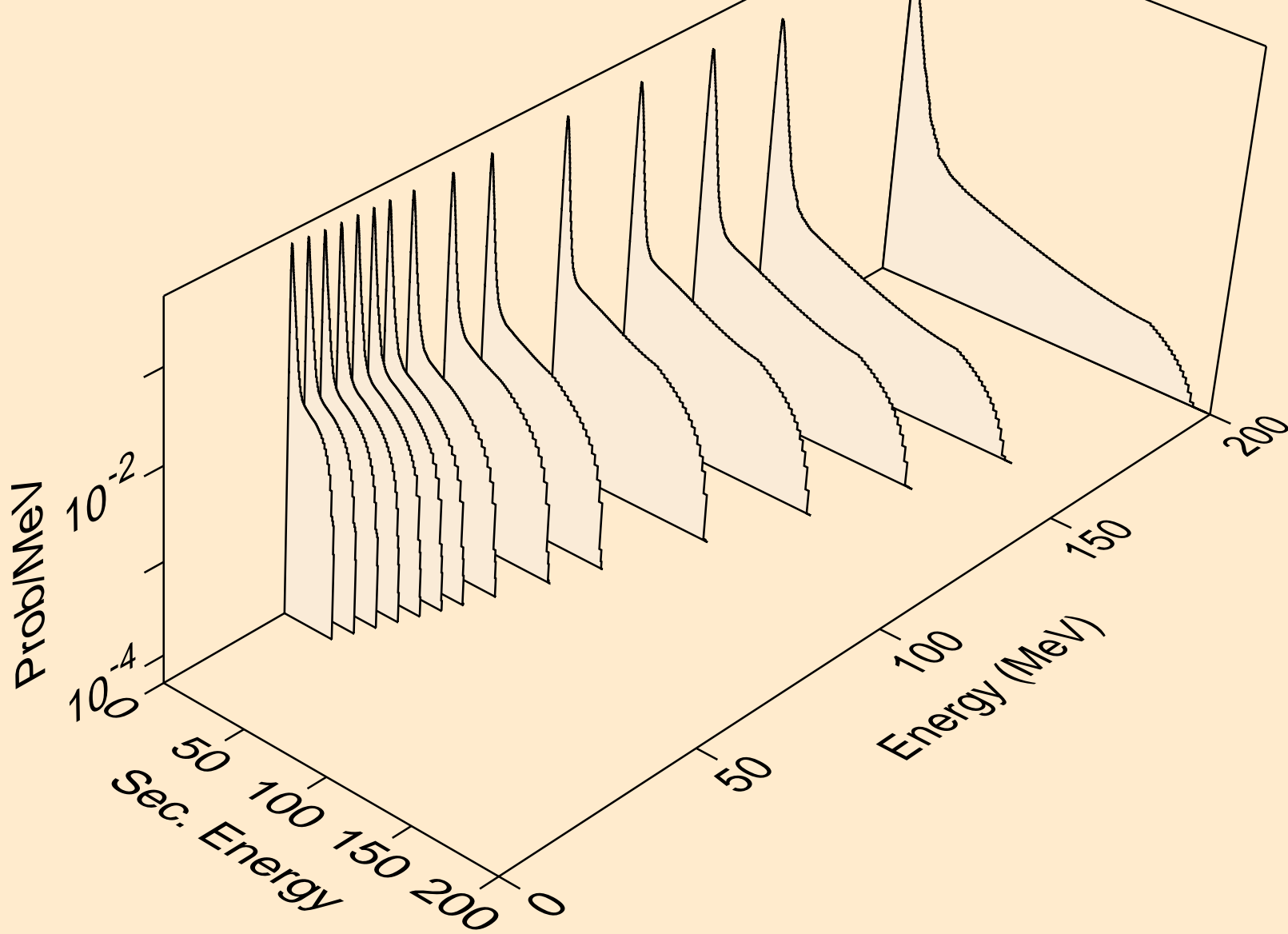

PB189M NEUTRON ACER TENDL-2019 LIBRARY; T=293.16K
Neutron emission for (n,2nd)

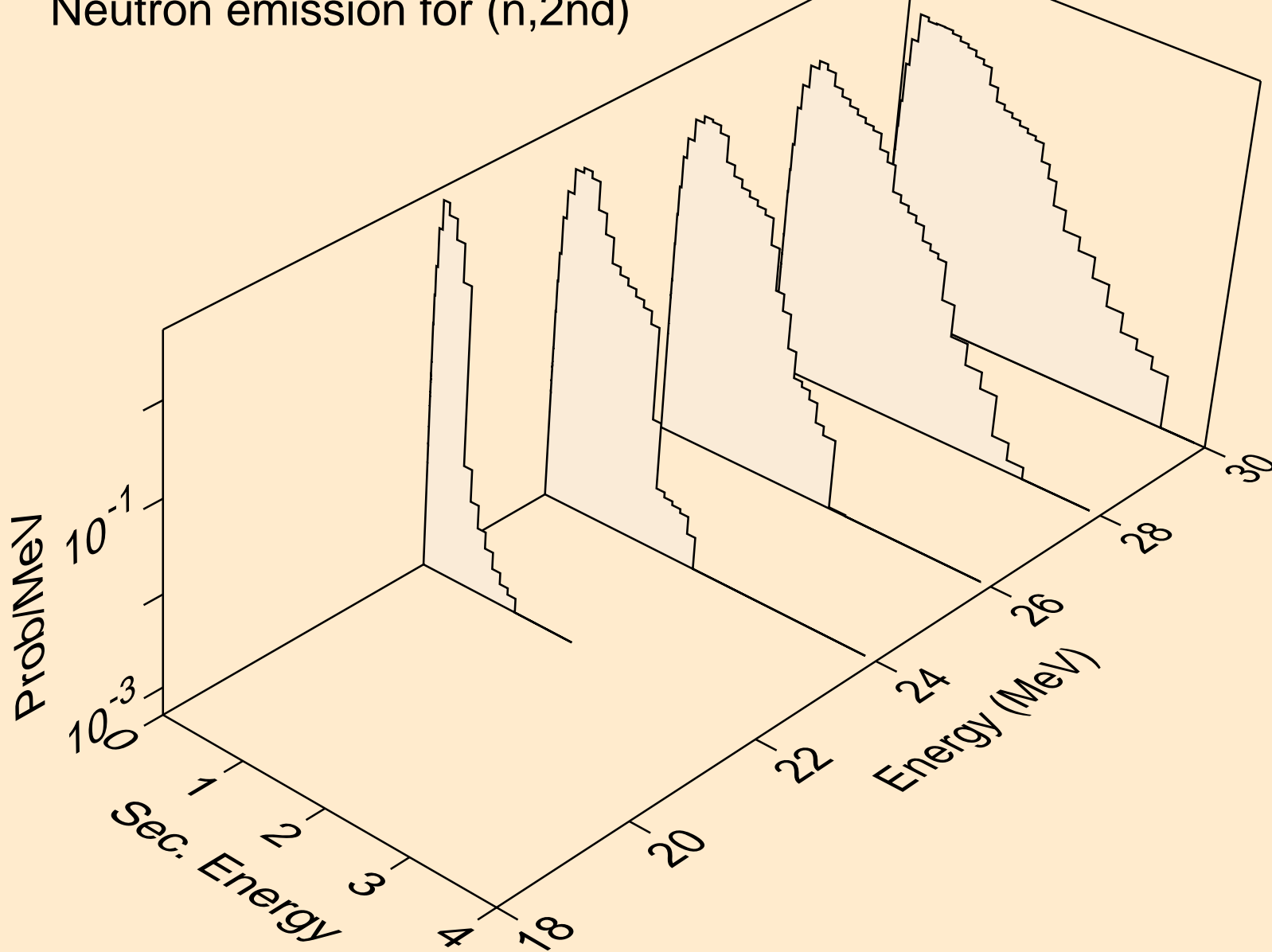

PB189M NEUTRON ACER TENDL-2019 LIBRARY; T=293.16K
Neutron emission for (n,2n)

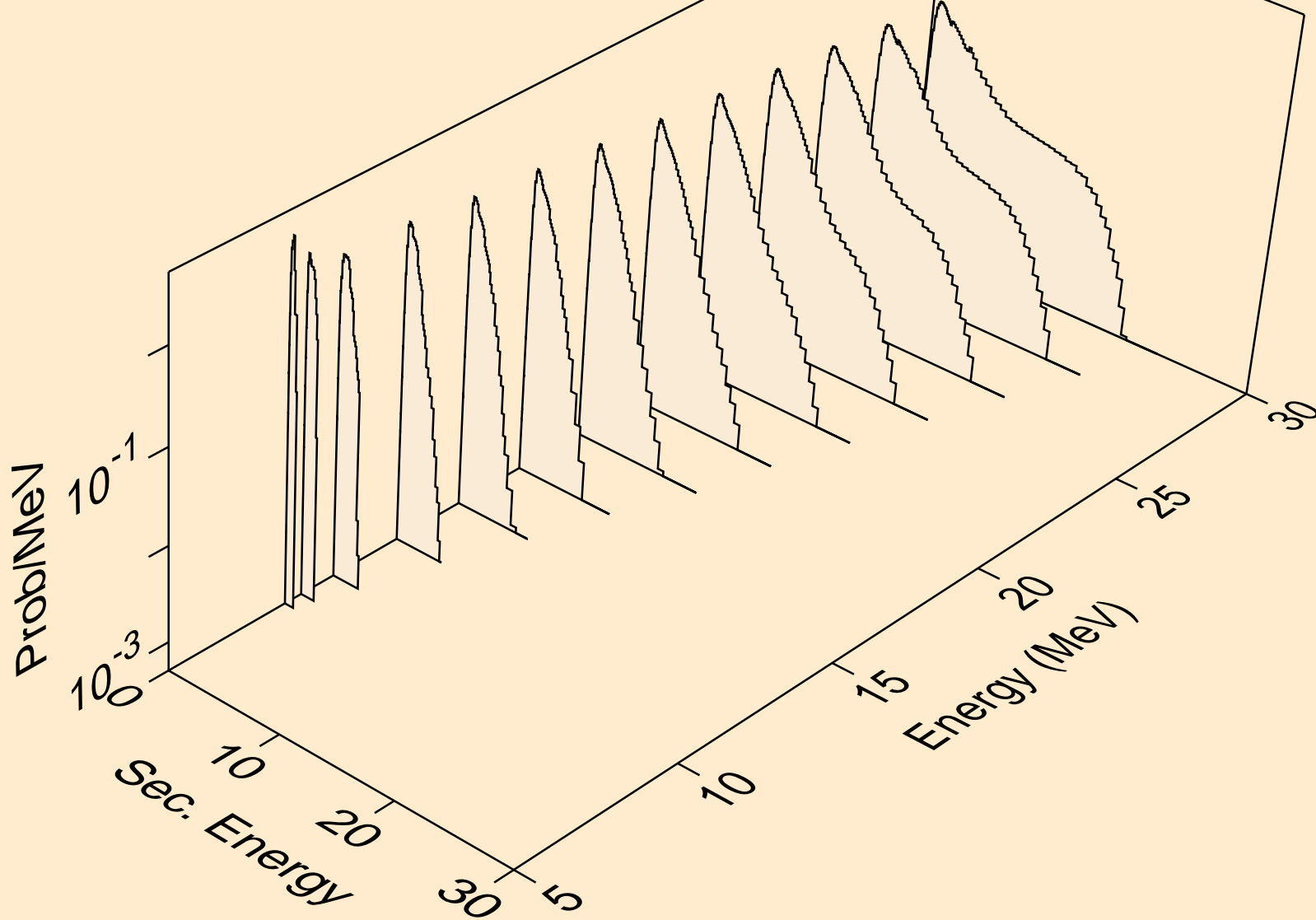

PB189M NEUTRON ACER TENDL-2019 LIBRARY; T=293.16K
Neutron emission for (n,3n)

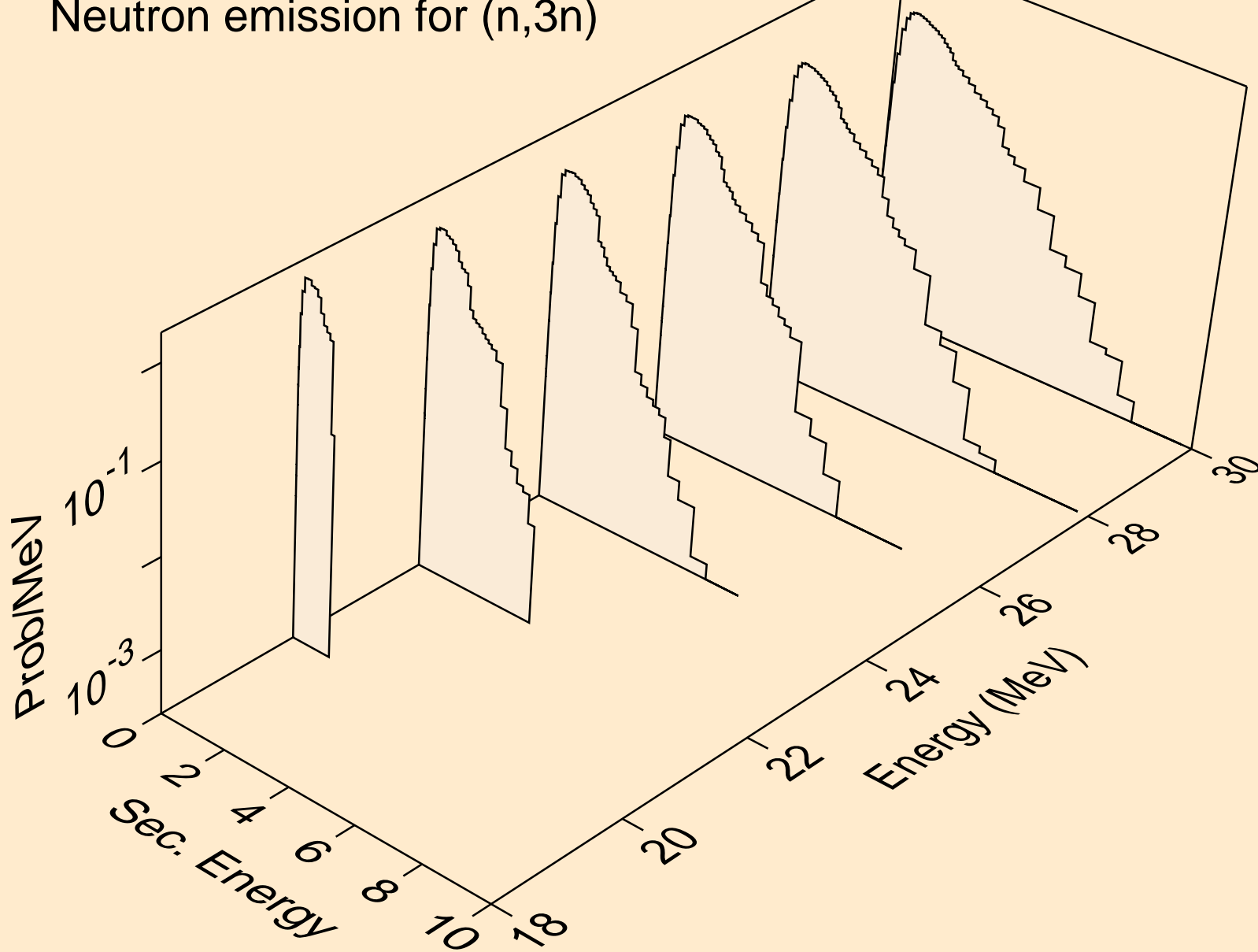

PB189M NEUTRON ACER TENDL-2019 LIBRARY; T=293.16K
Neutron emission for (n,n*)a

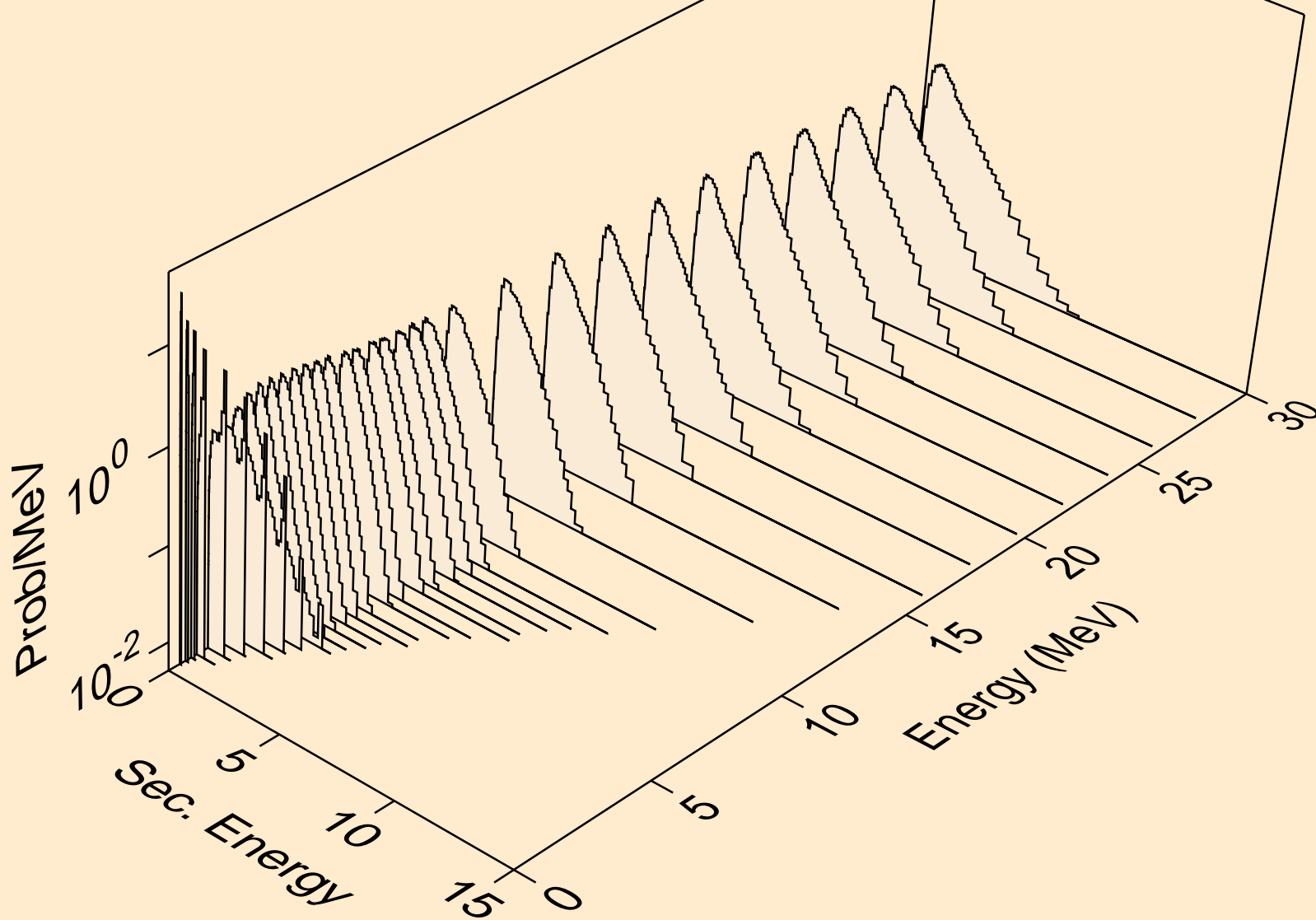

PB189M NEUTRON ACER TENDL-2019 LIBRARY; T=293.16K
Neutron emission for (n,2n)a

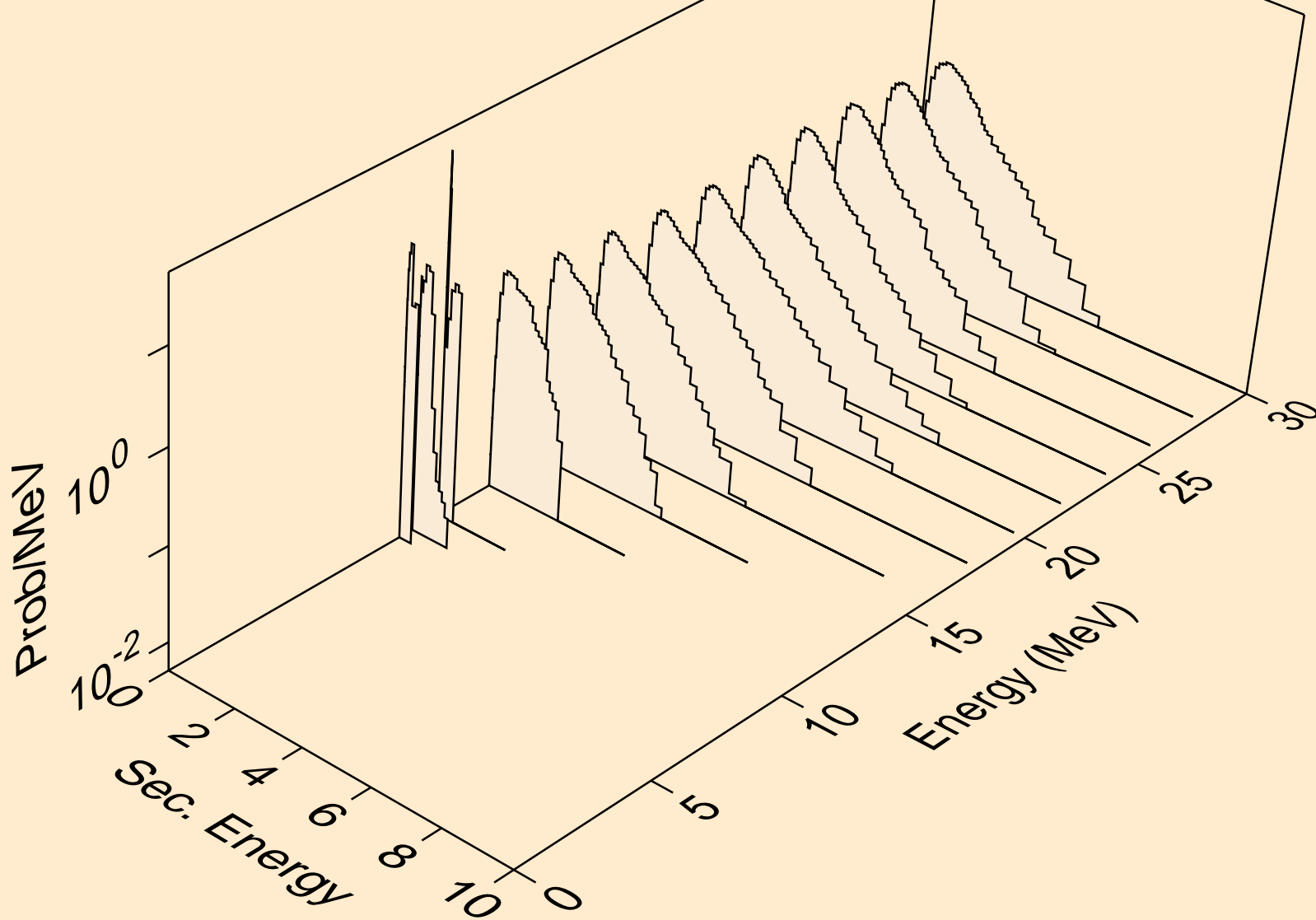

PB189M NEUTRON ACER TENDL-2019 LIBRARY; T=293.16K
Neutron emission for (n,3n)a

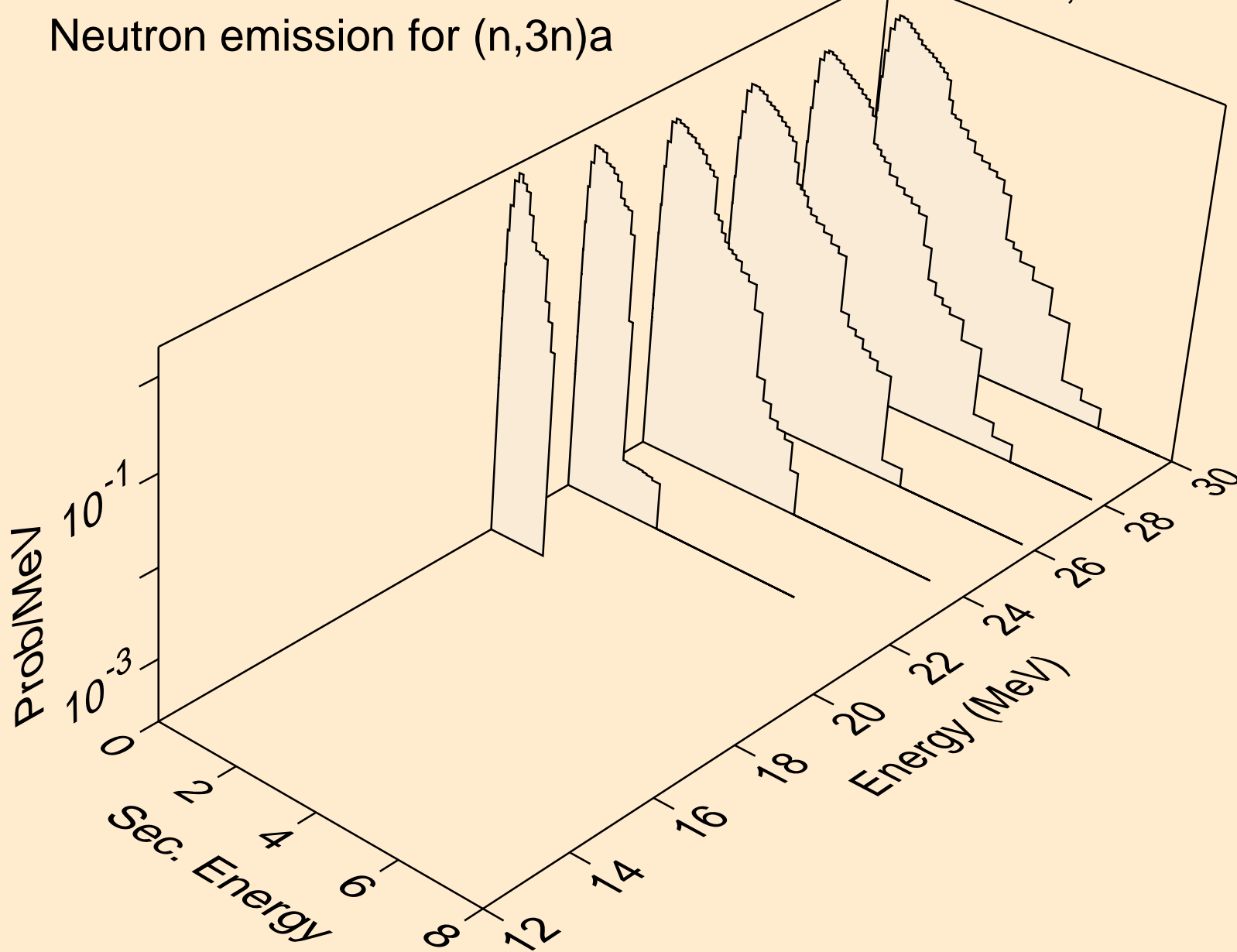

PB189M NEUTRON ACER TENDL-2019 LIBRARY; T=293.16K
Neutron emission for (n,n*)p

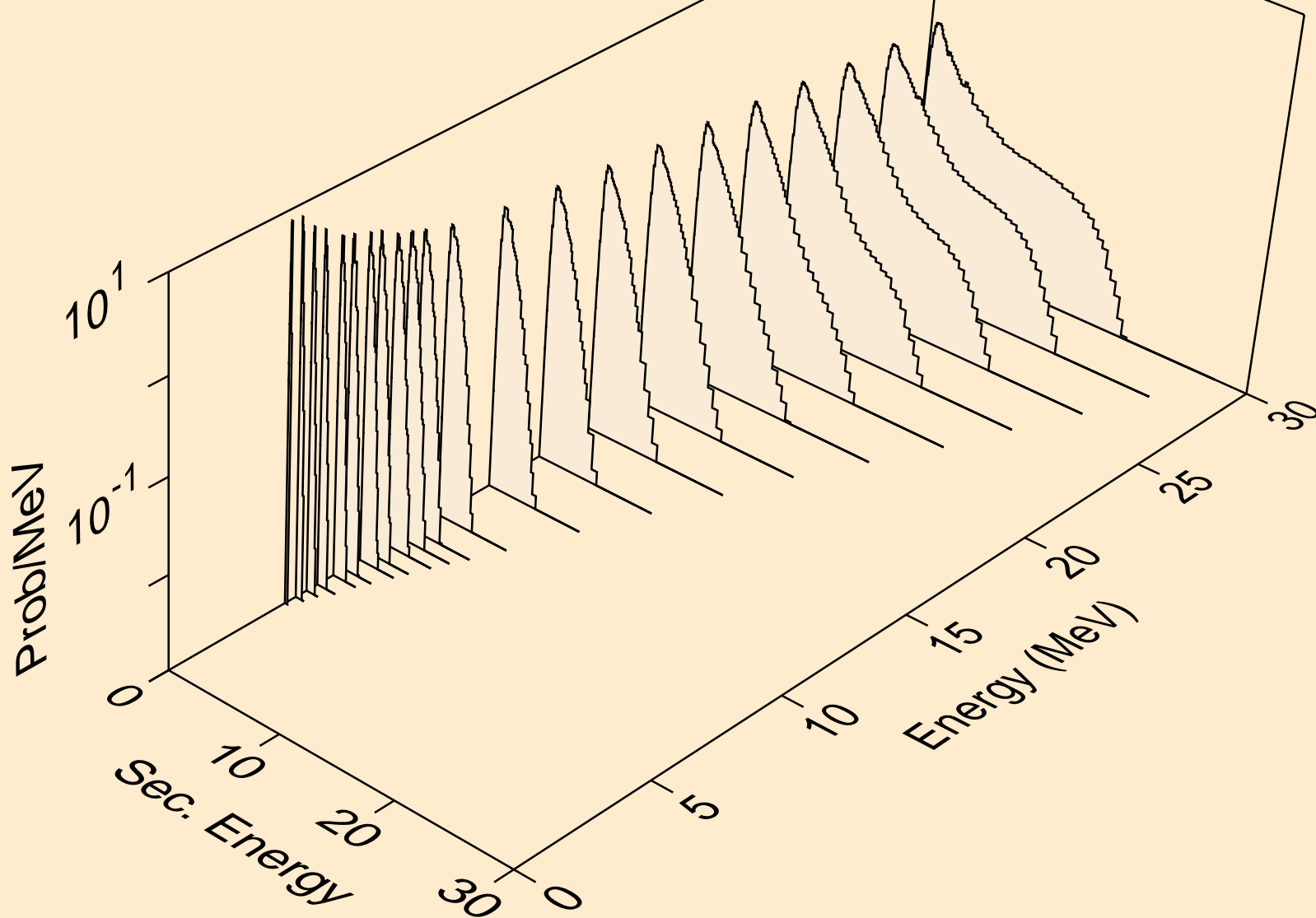

PB189M NEUTRON ACER TENDL-2019 LIBRARY; T=293.16K
Neutron emission for (n,n*)2a

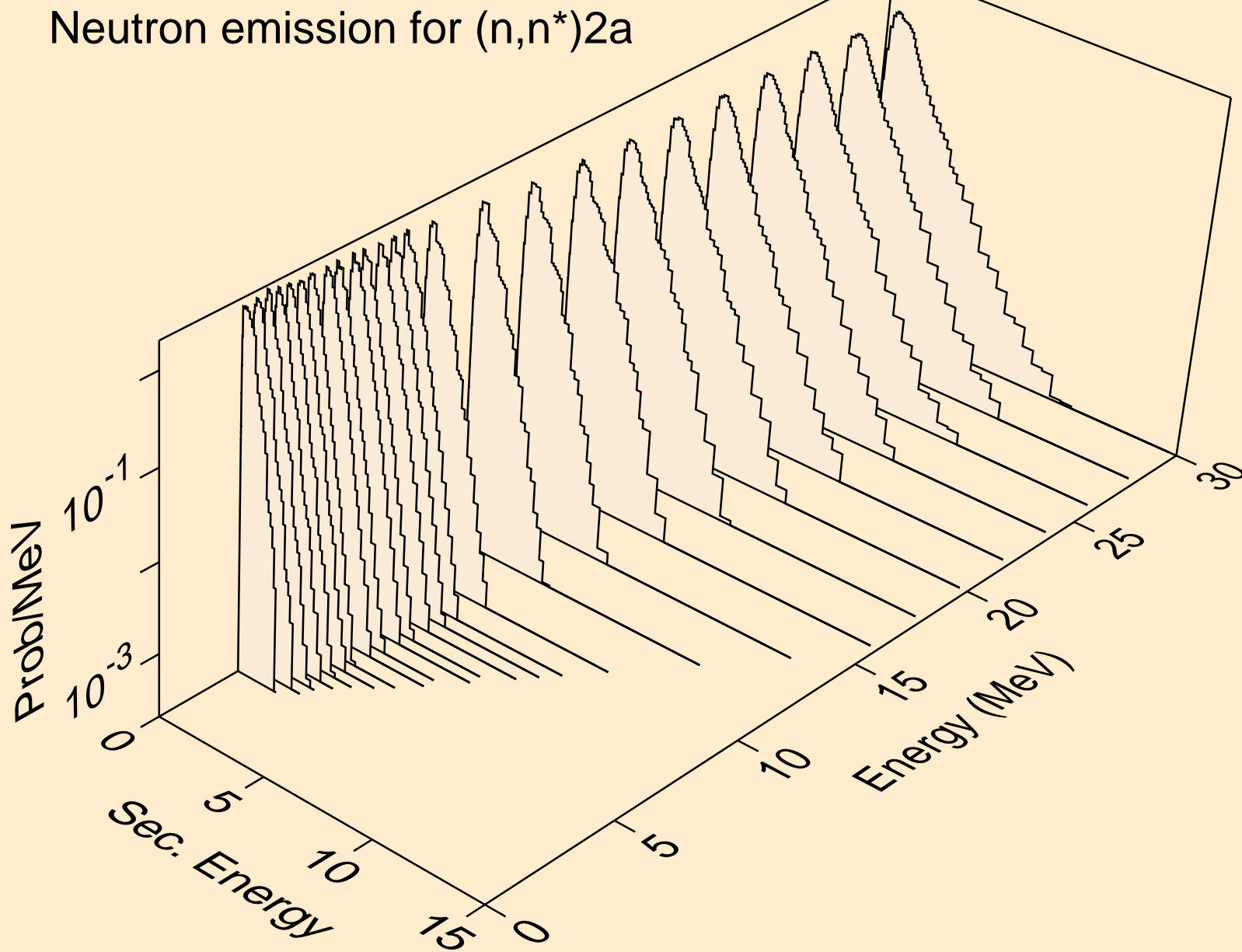

PB189M NEUTRON ACER TENDL-2019 LIBRARY; T=293.16K
Neutron emission for (n,2n)2a

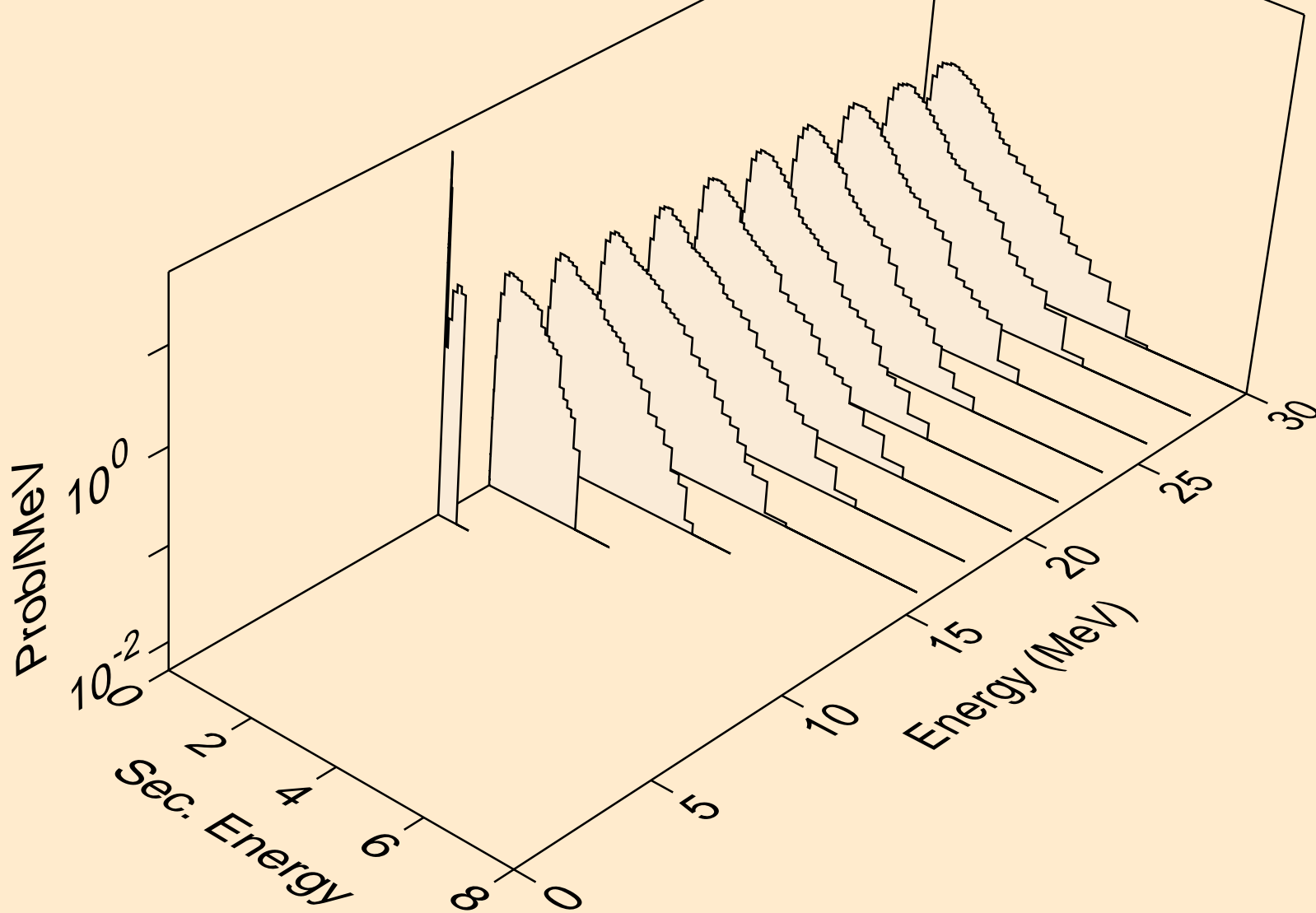

PB189M NEUTRON ACER TENDL-2019 LIBRARY; T=293.16K
Neutron emission for (n,n*)d

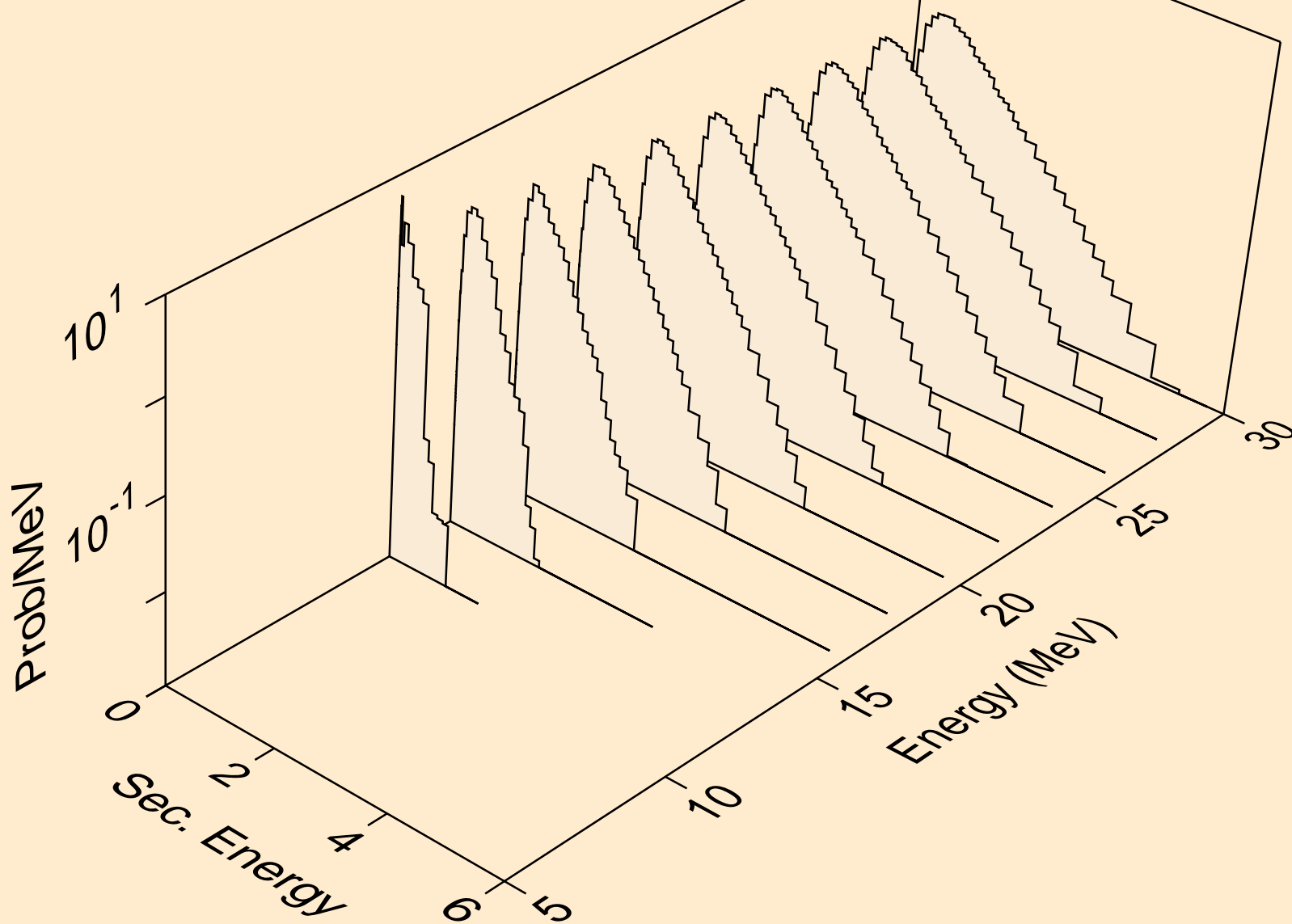

PB189M NEUTRON ACER TENDL-2019 LIBRARY; T=293.16K
Neutron emission for (n,n*)t

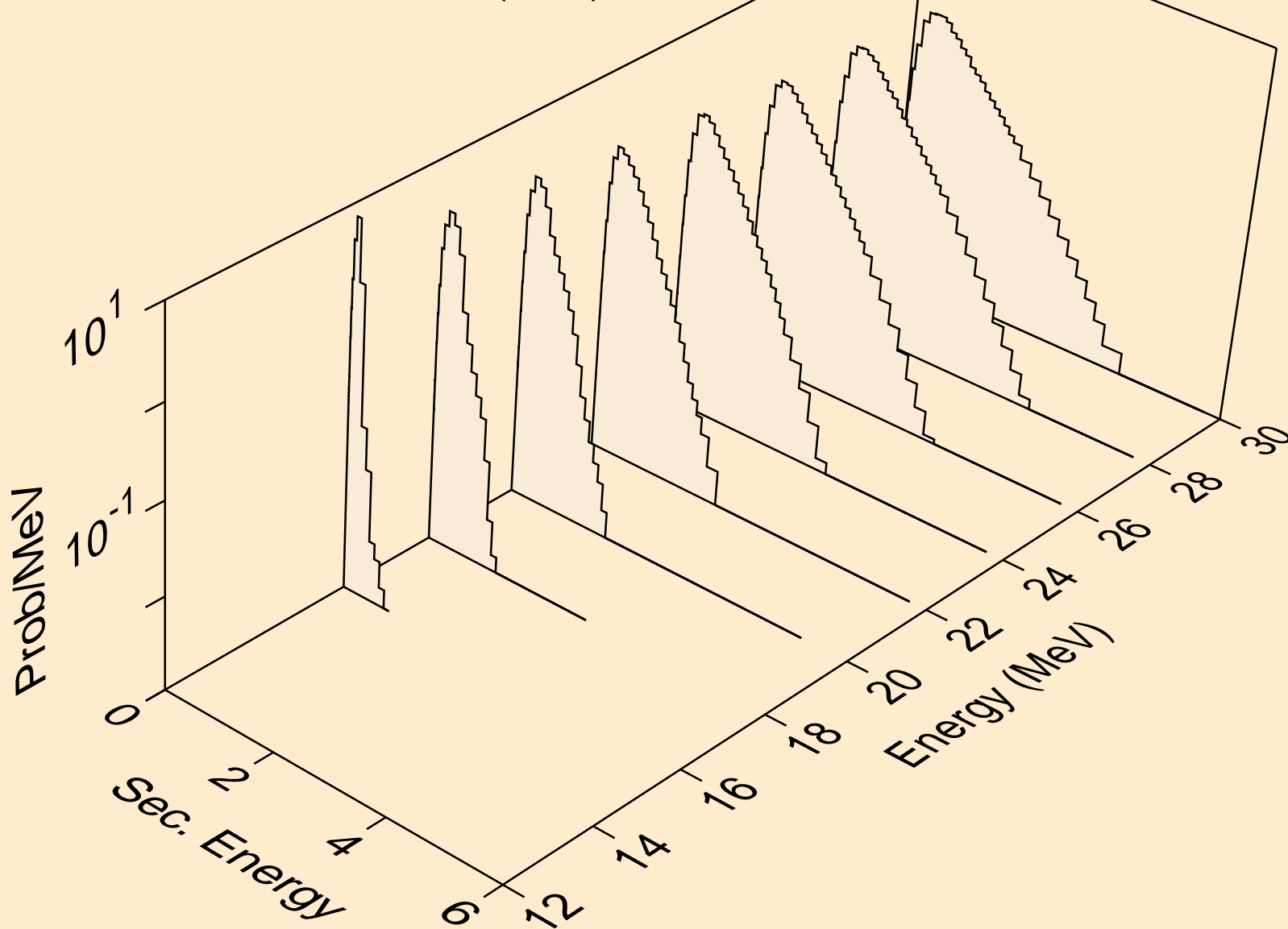

PB189M NEUTRON ACER TENDL-2019 LIBRARY; T=293.16K
Neutron emission for (n,n*)he3

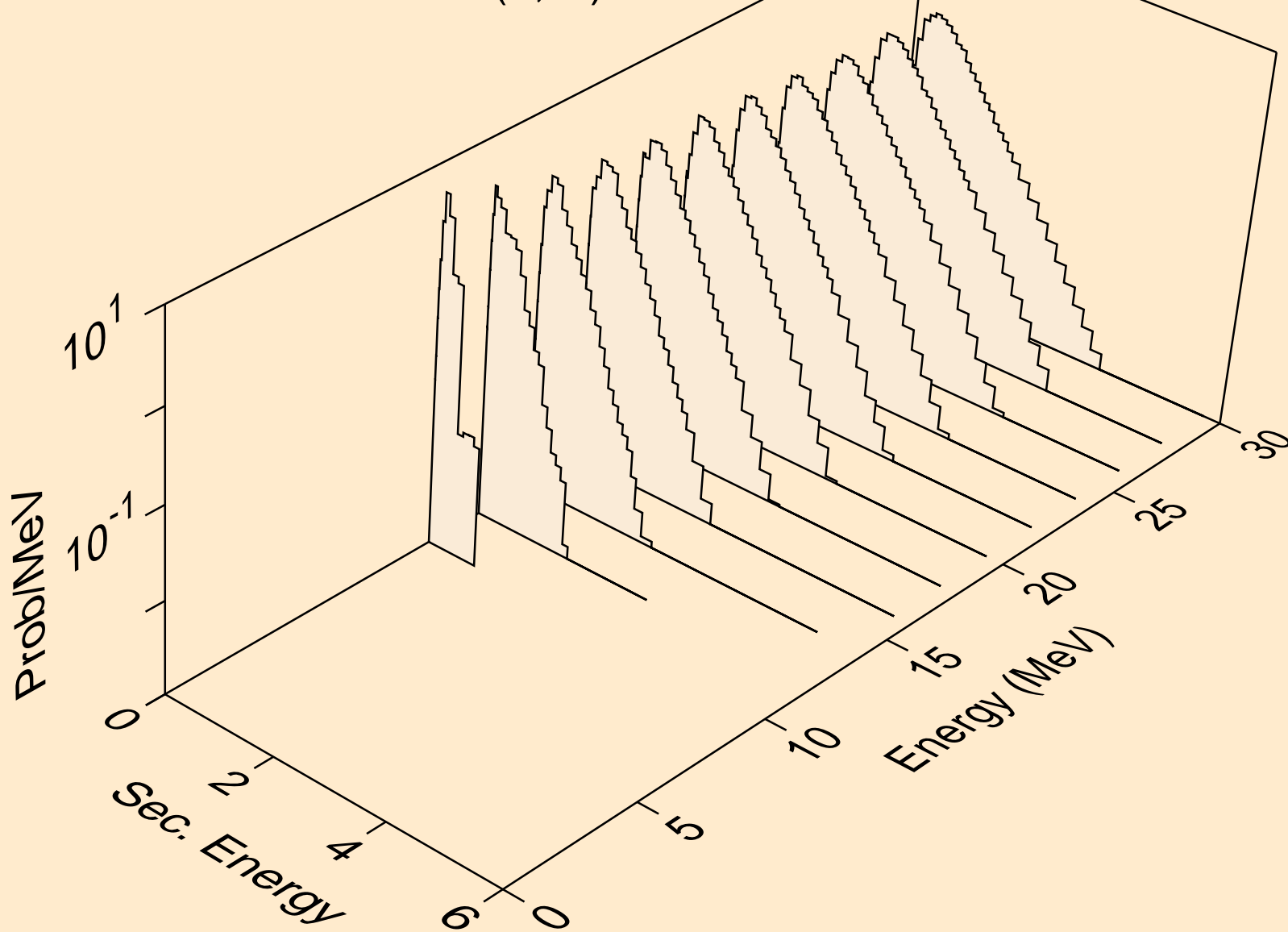

PB189M NEUTRON ACER TENDL-2019 LIBRARY; T=293.16K
Neutron emission for (n,4n)

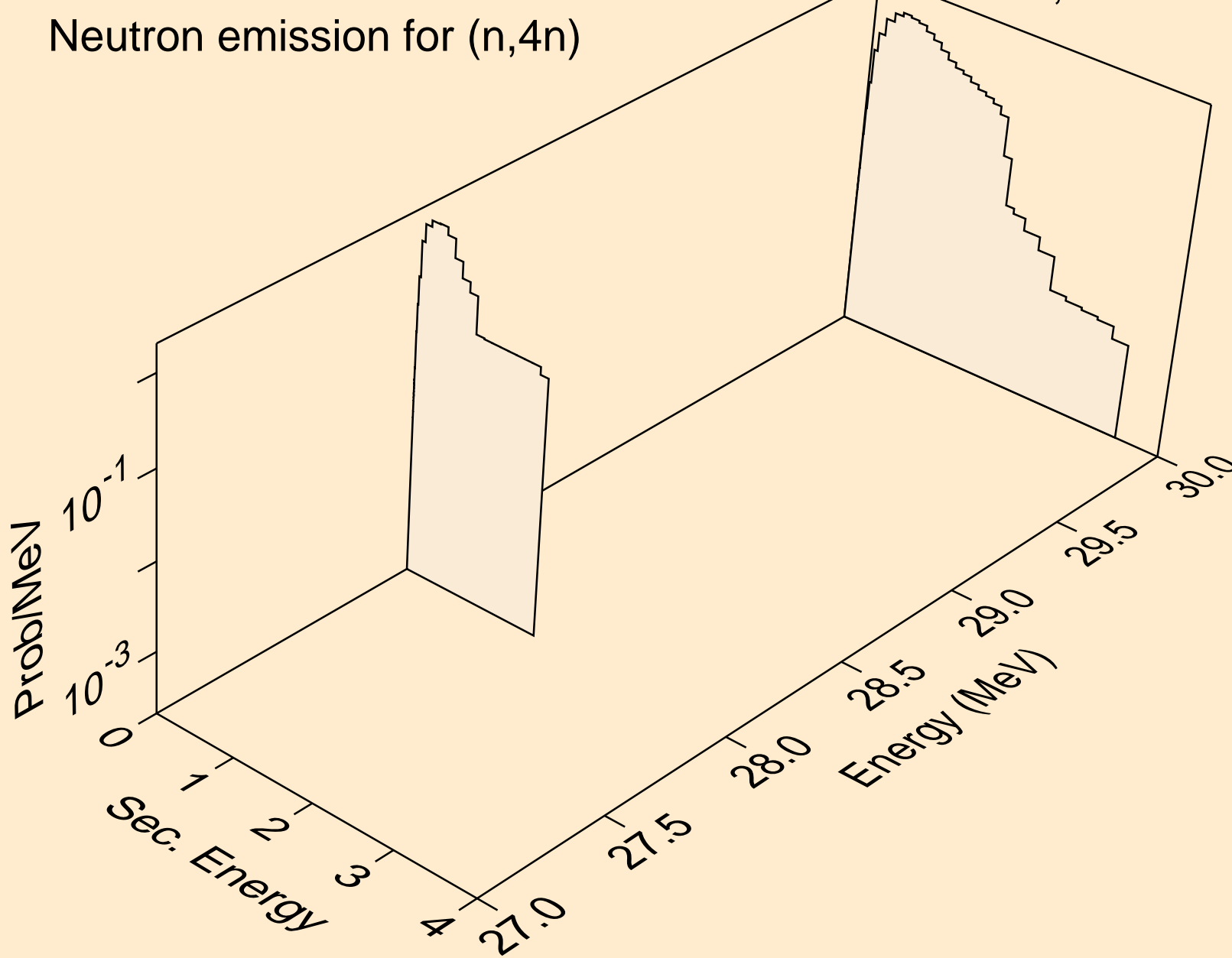

PB189M NEUTRON ACER TENDL-2019 LIBRARY; T=293.16K
Neutron emission for (n,2np)

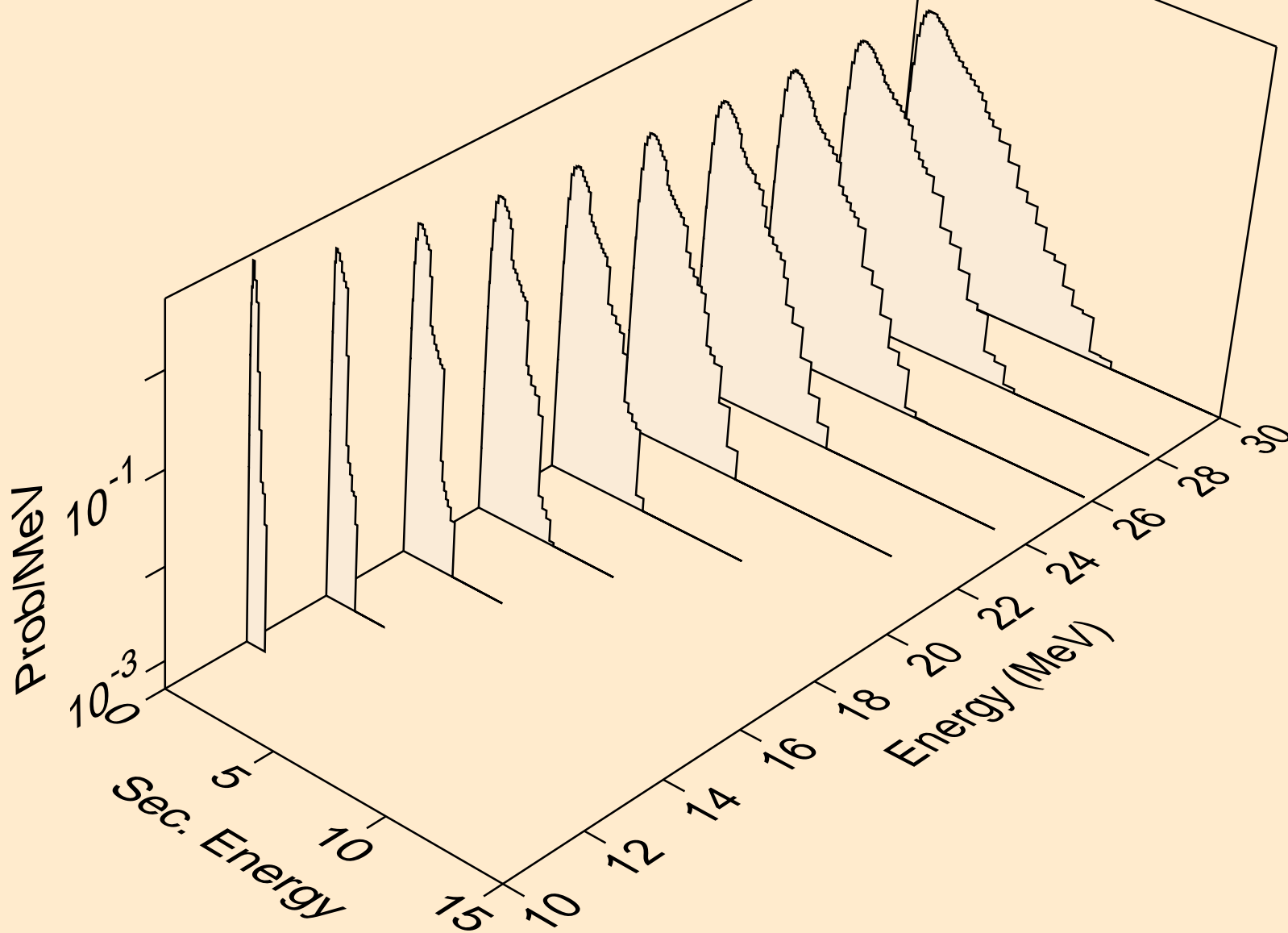

PB189M NEUTRON ACER TENDL-2019 LIBRARY; T=293.16K
Neutron emission for (n,3np)

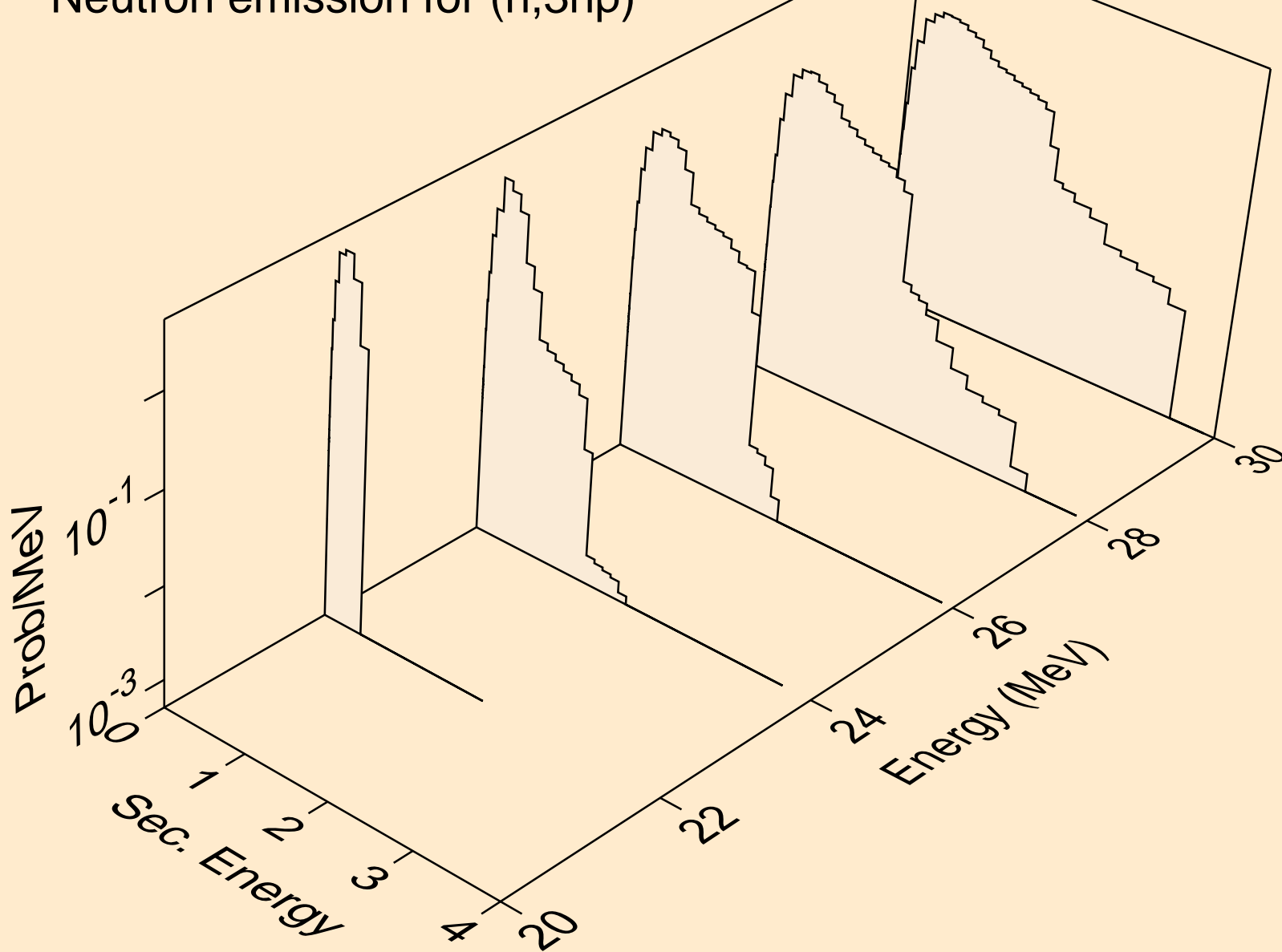

PB189M NEUTRON ACER TENDL-2019 LIBRARY; T=293.16K
Neutron emission for (n,2np)

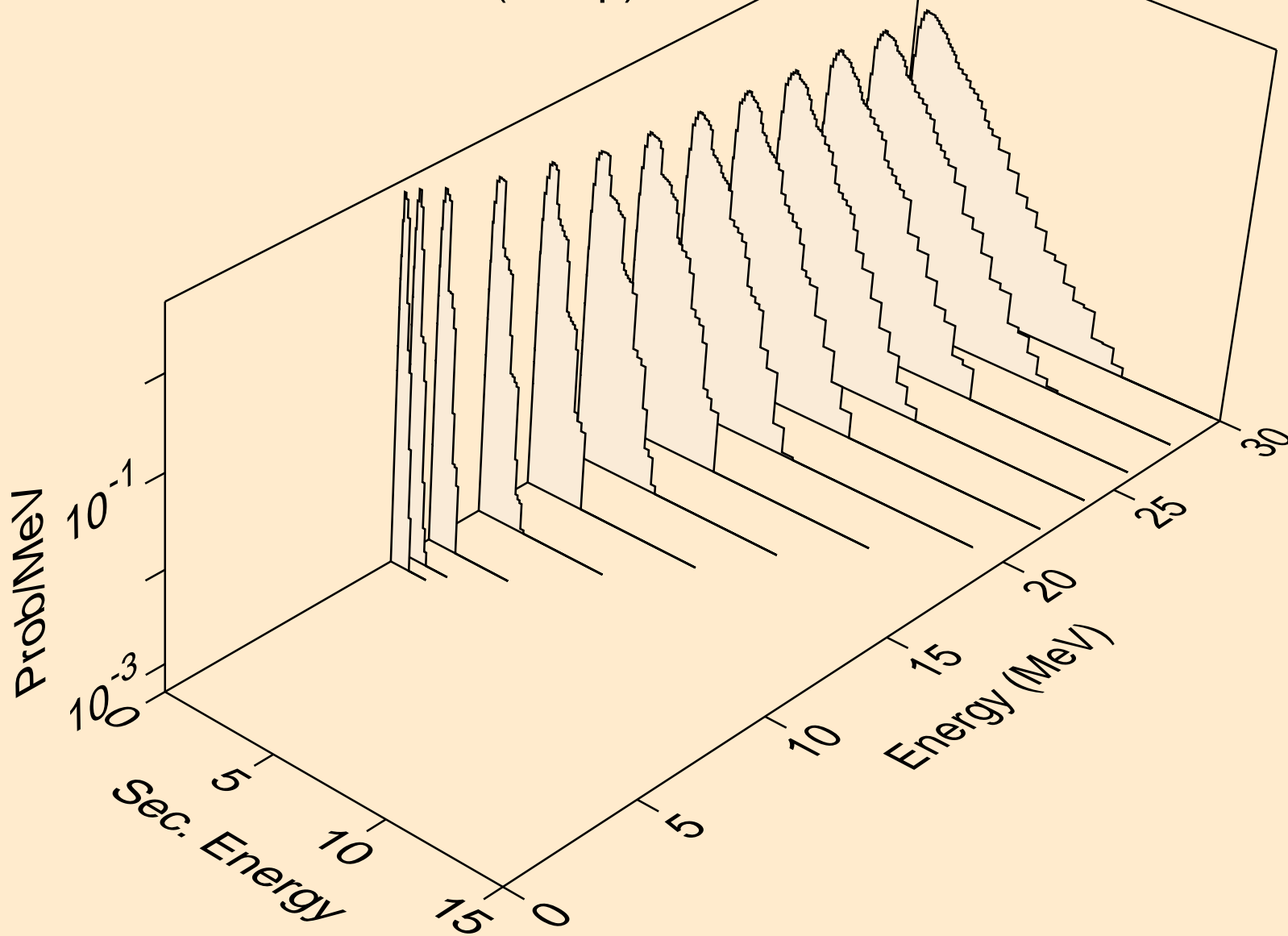

PB189M NEUTRON ACER TENDL-2019 LIBRARY; T=293.16K
Neutron emission for (n,npa)

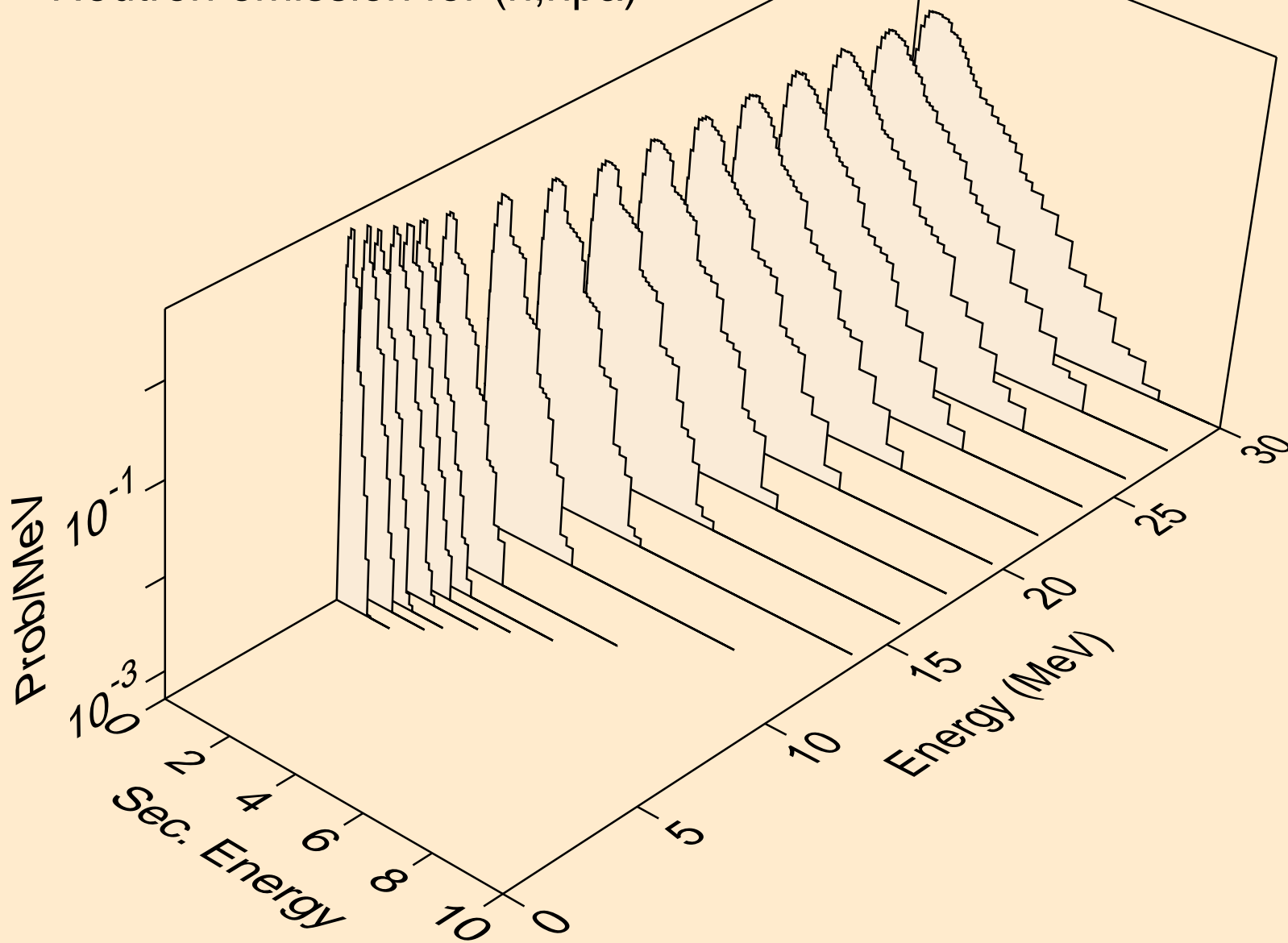

PB189M NEUTRON ACER TENDL-2019 LIBRARY; T=293.16K
Neutron emission for (n,n*c)

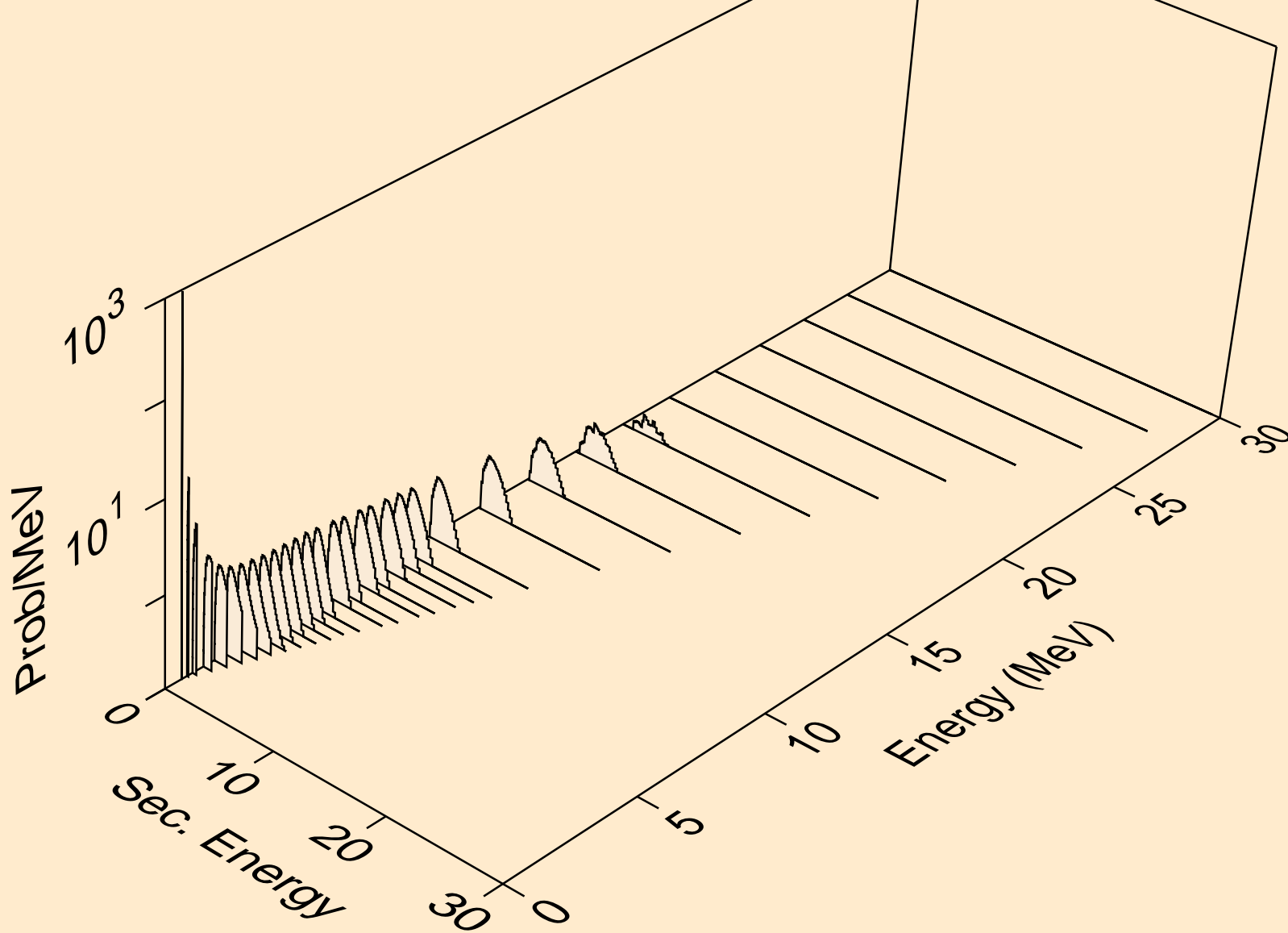

PB189M NEUTRON ACER TENDL-2019 LIBRARY; T=293.16K
Photon emission for (n,x)

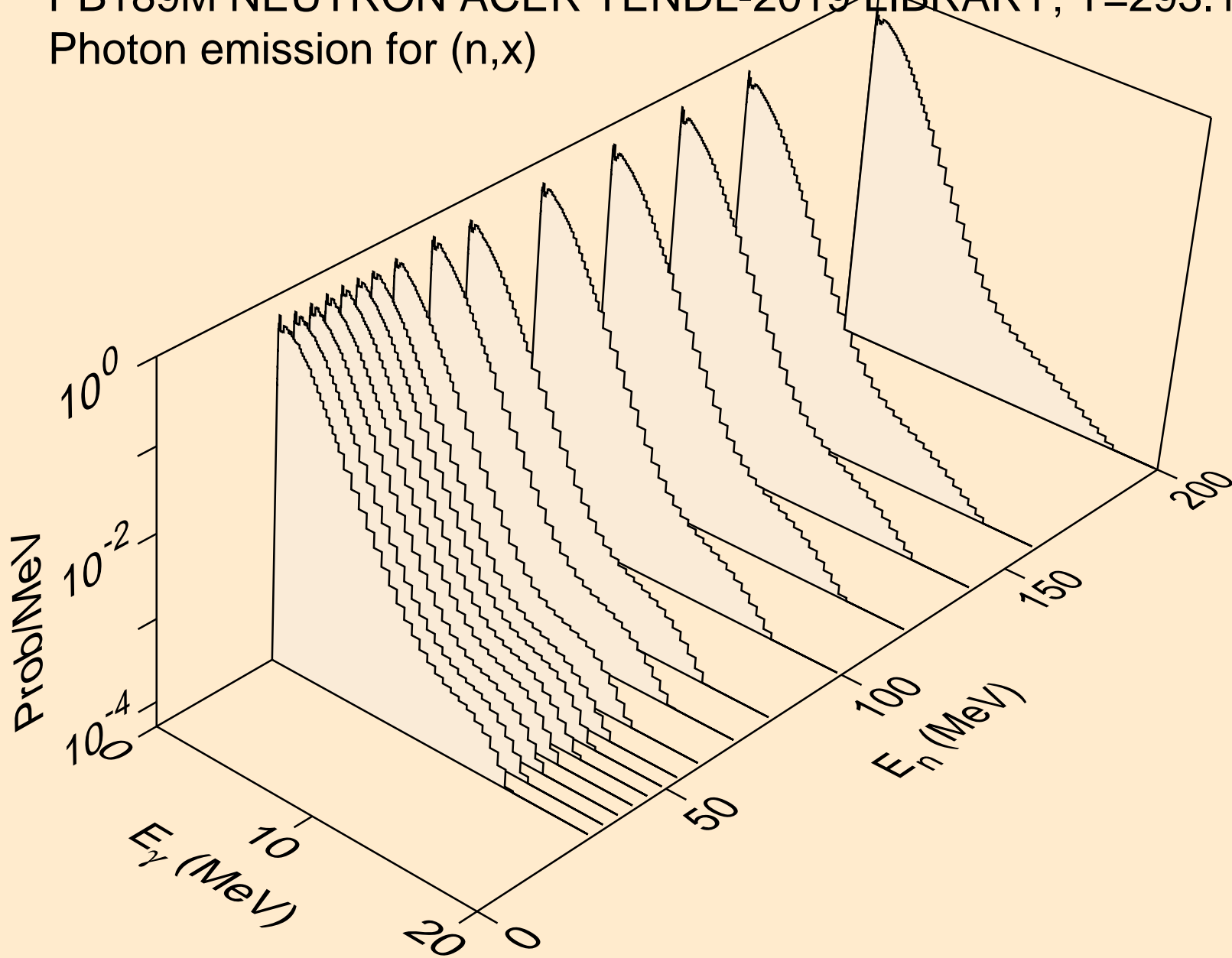

PB189M NEUTRON ACER TENDL-2019 LIBRARY; T=293.16K
Photon emission for (n,2nd)

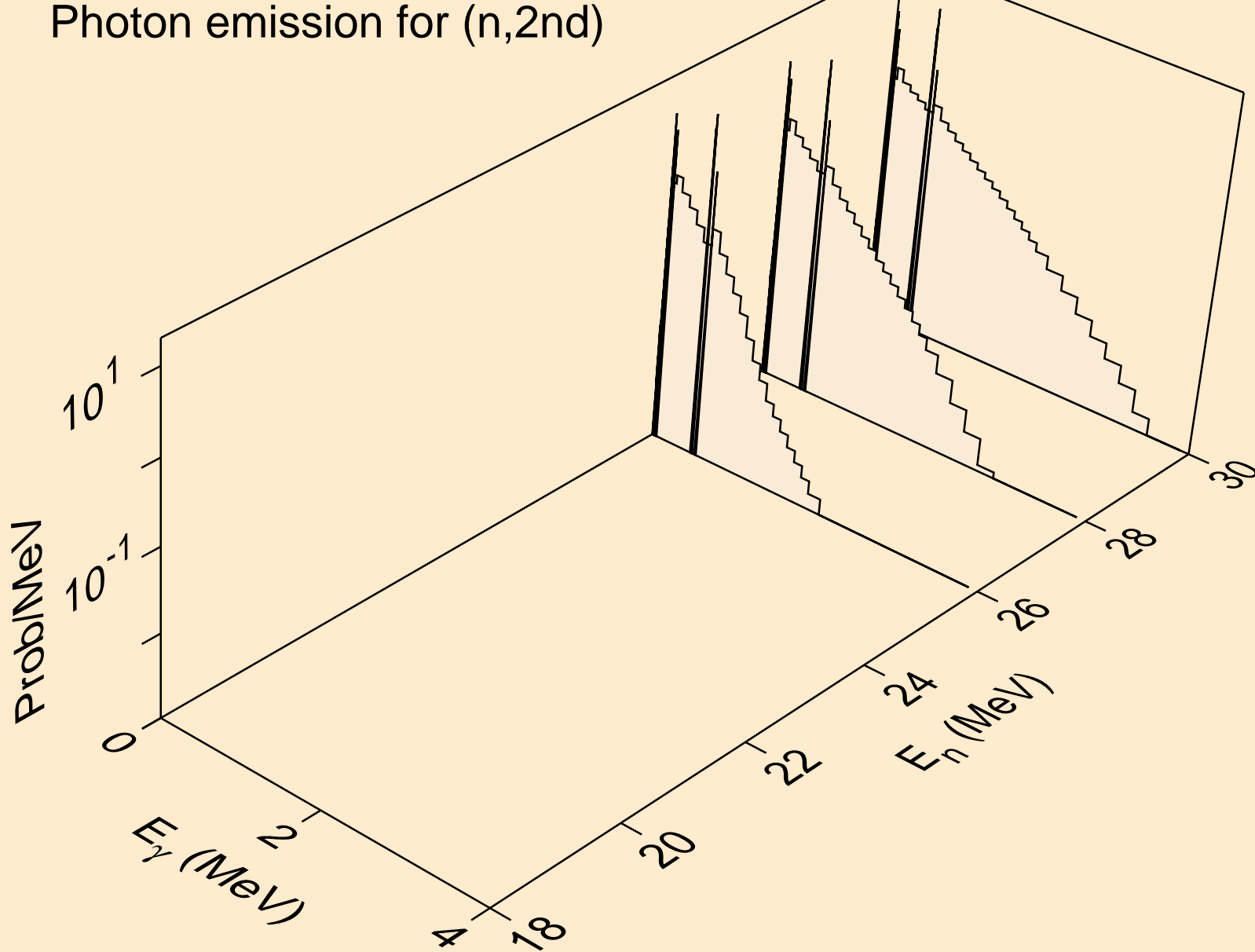

PB189M NEUTRON ACER TENDL-2019 LIBRARY; T=293.16K
Photon emission for (n,2n)

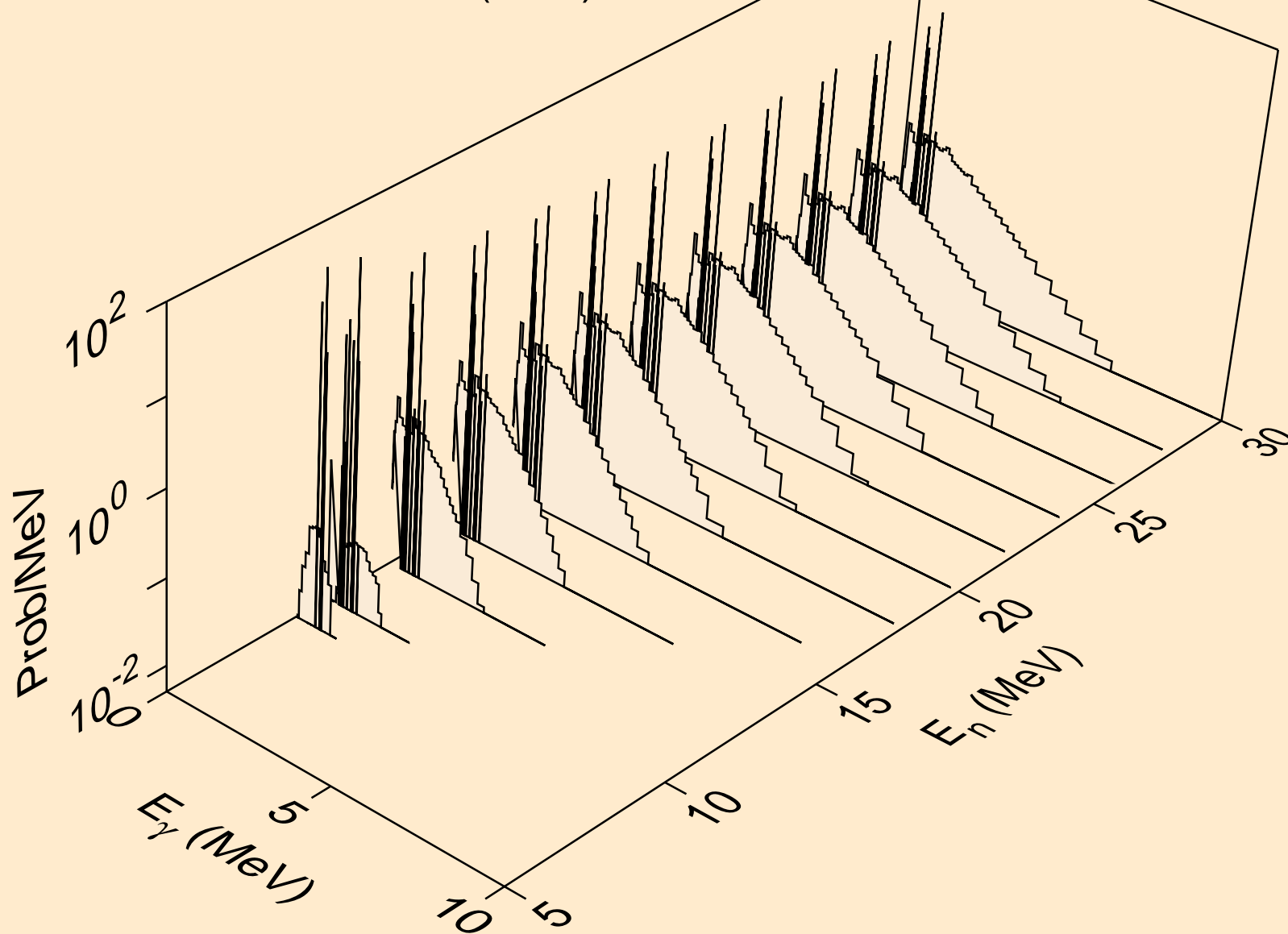

PB189M NEUTRON ACER TENDL-2019 LIBRARY; T=293.16K
Photon emission for (n,3n)

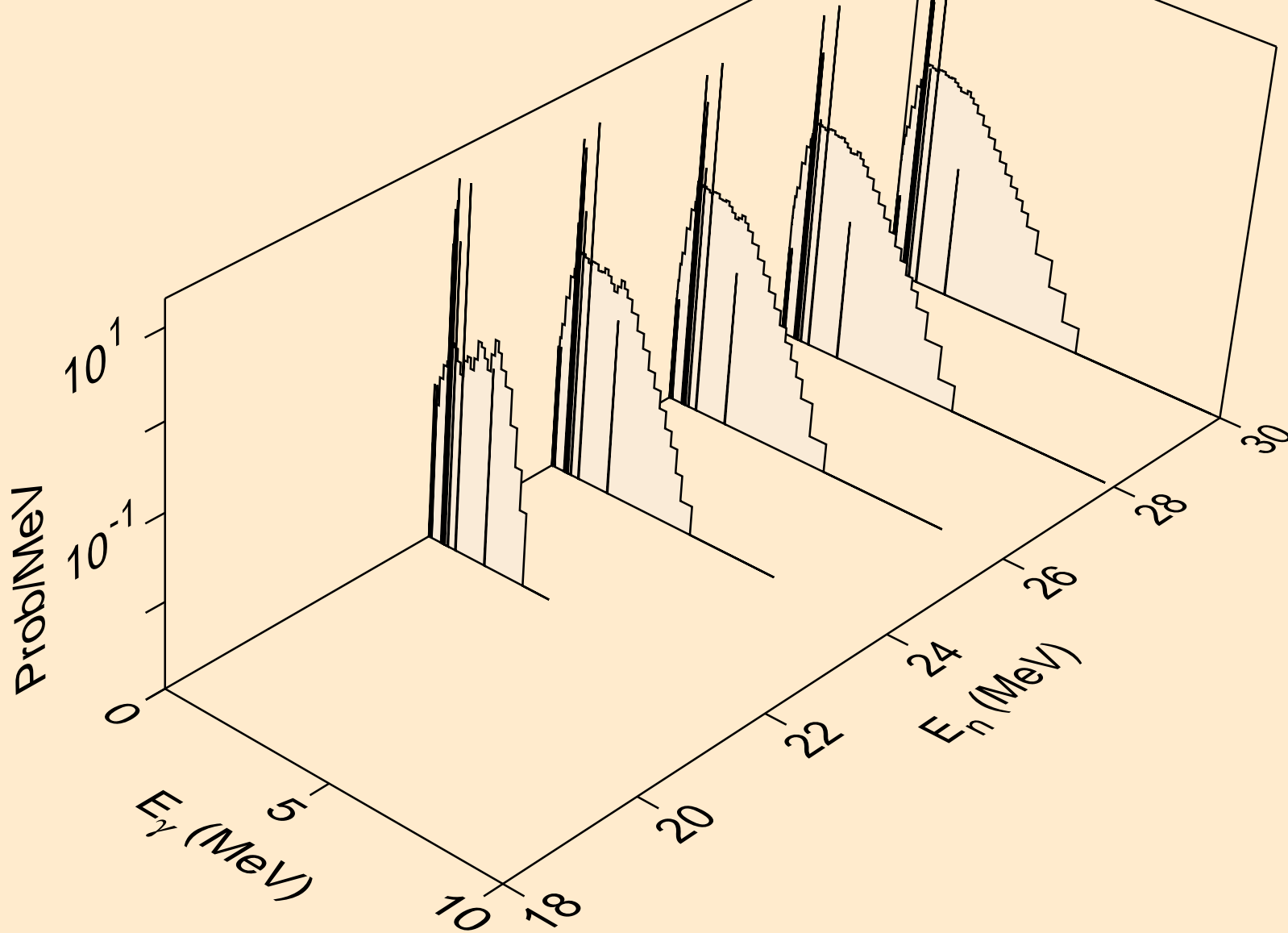

PB189M NEUTRON ACER TENDL-2019 LIBRARY; T=293.16K
Photon emission for (n,n*)a

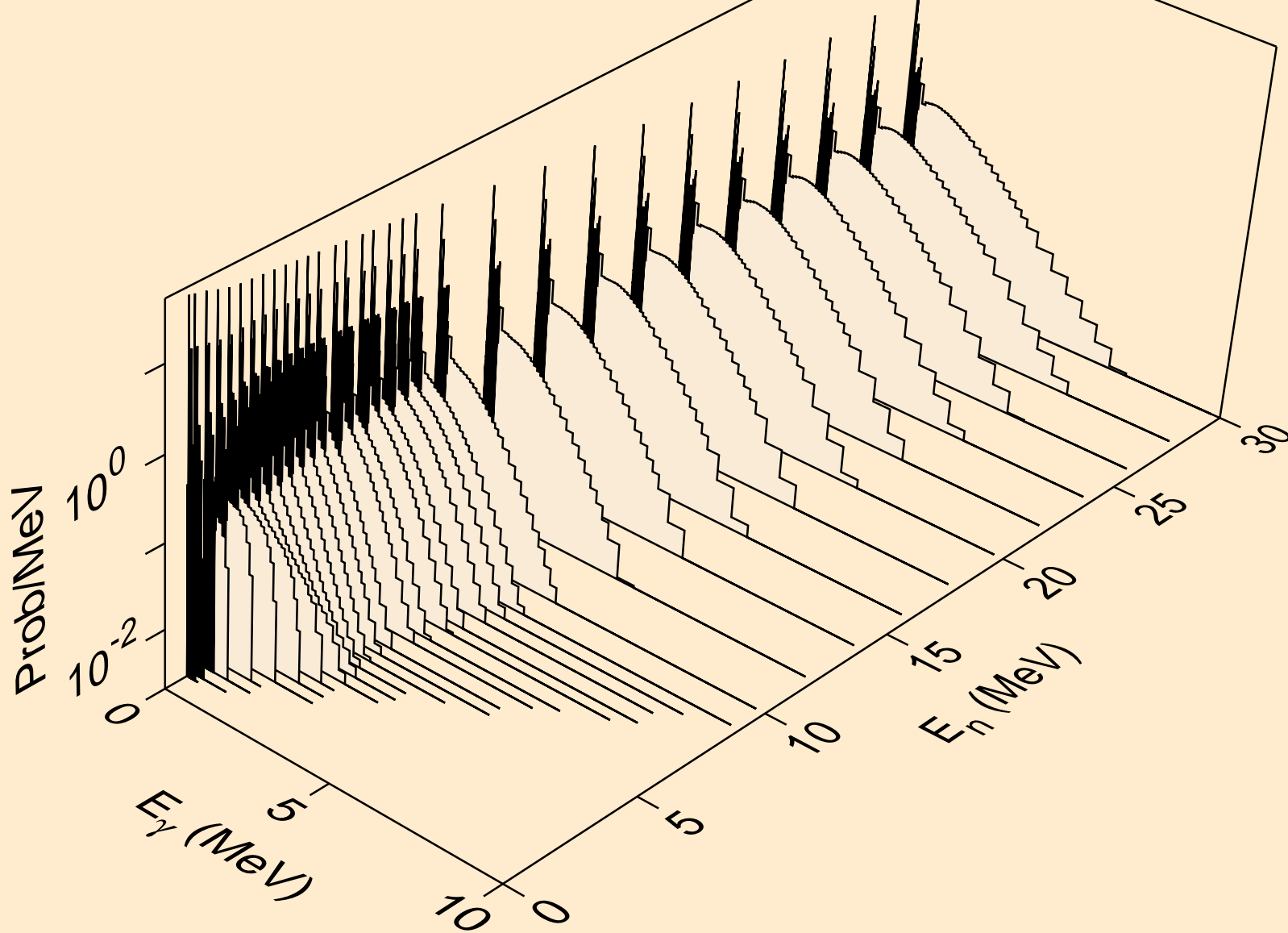

PB189M NEUTRON ACER TENDL-2019 LIBRARY; T=293.16K
Photon emission for (n,2n)a

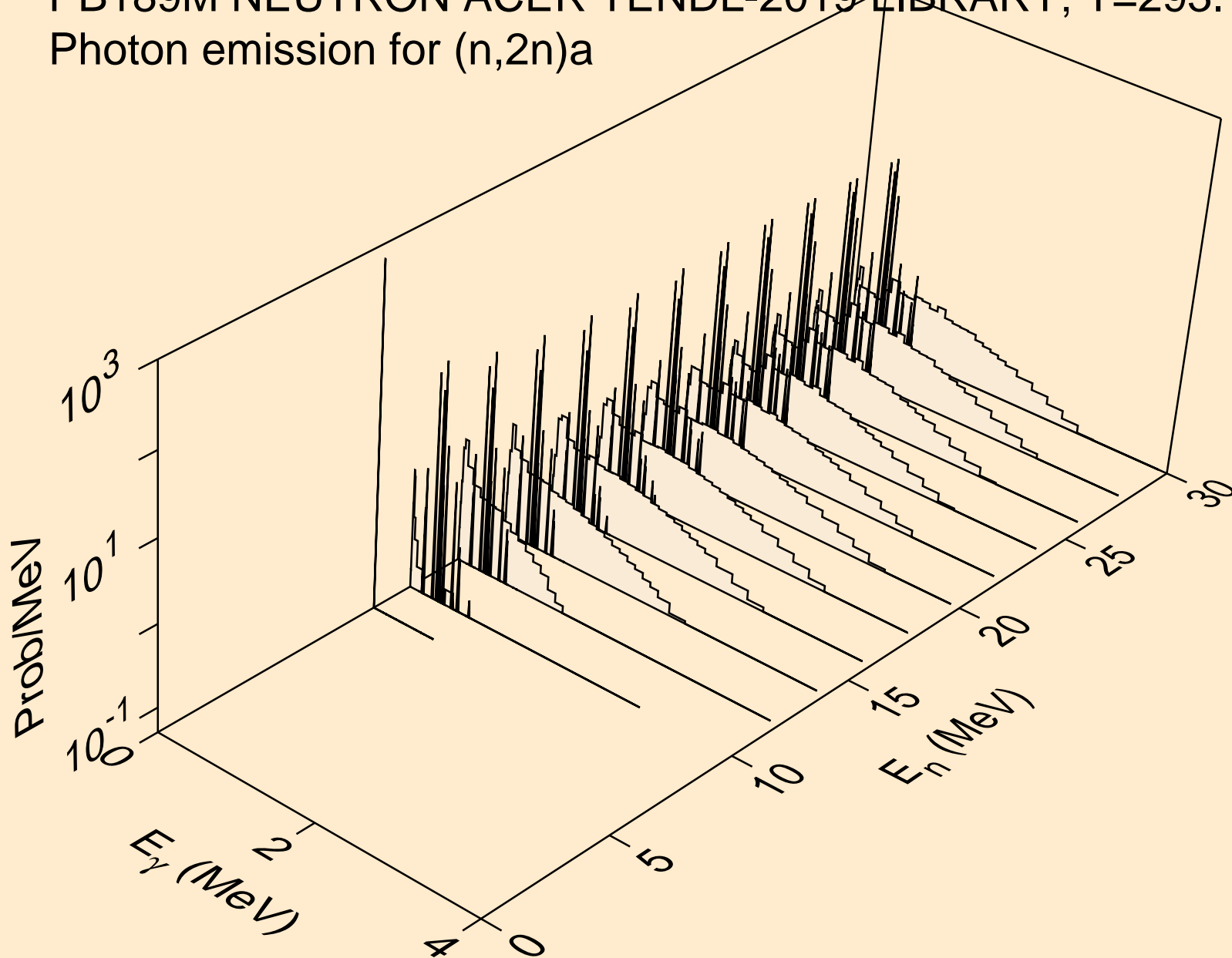

PB189M NEUTRON ACER TENDL-2019 LIBRARY; T=293.16K
Photon emission for (n,3n)a

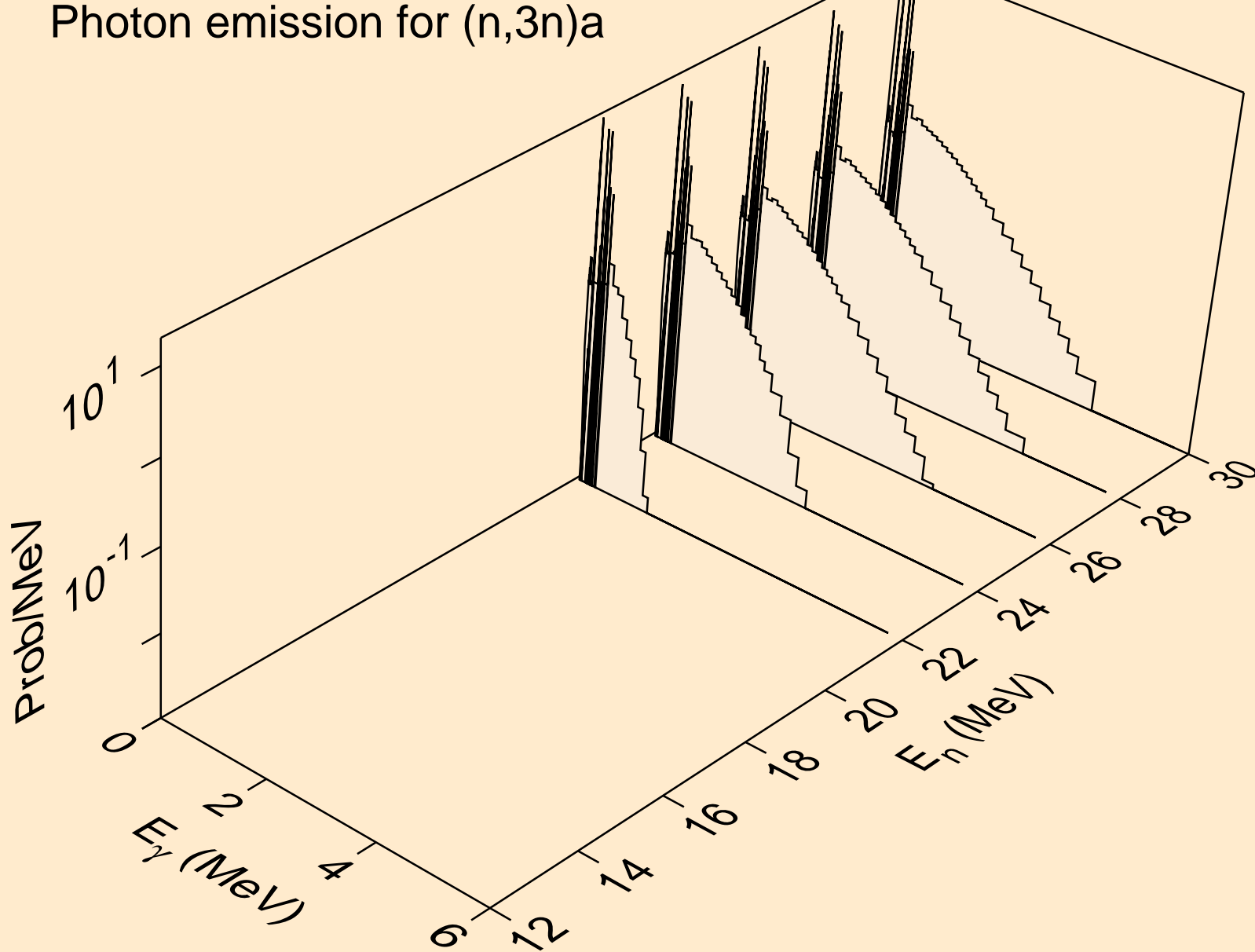

PB189M NEUTRON ACER TENDL-2019 LIBRARY; T=293.16K
Photon emission for (n,n*)p

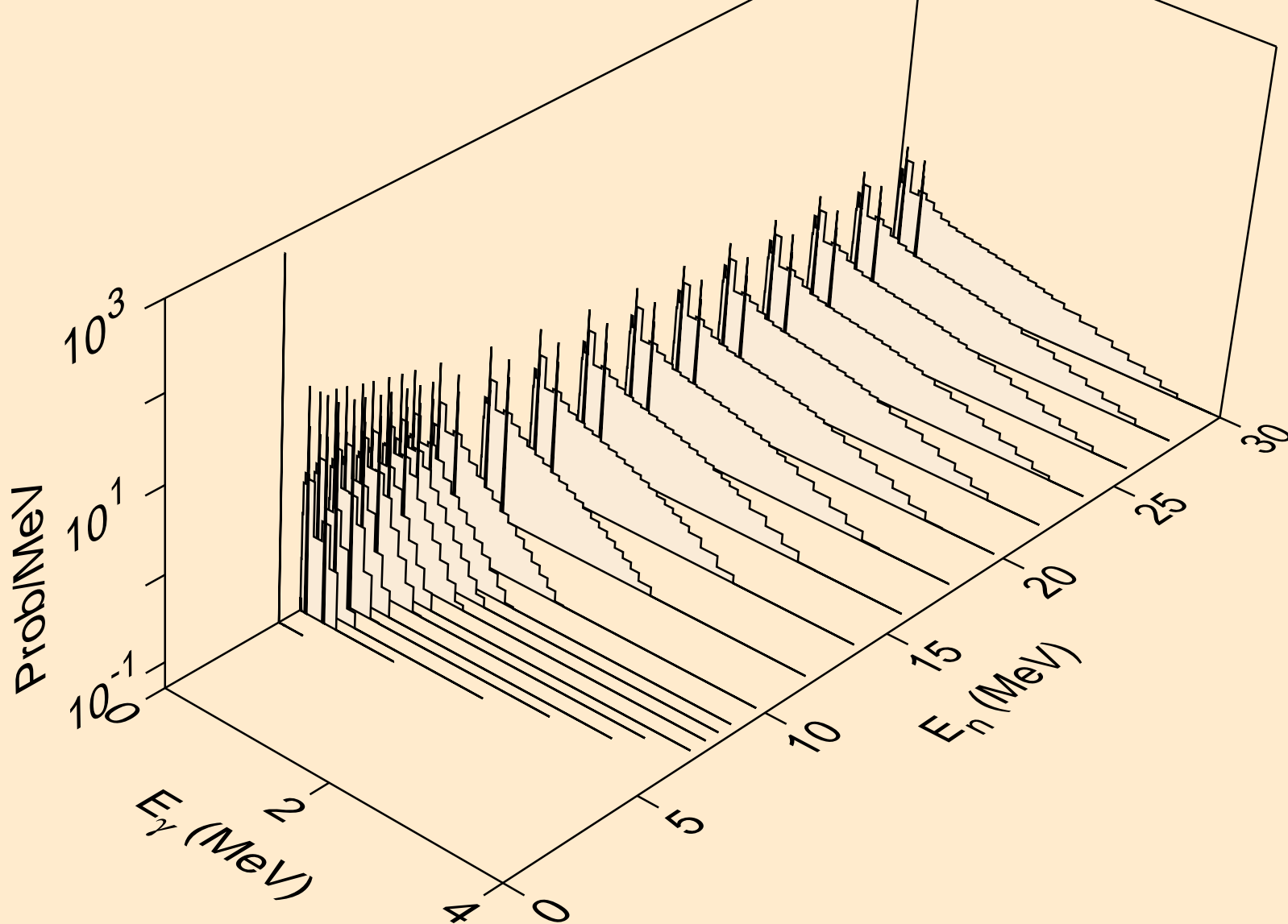

PB189M NEUTRON ACER TENDL-2019 LIBRARY; T=293.16K
Photon emission for (n,n*)2a

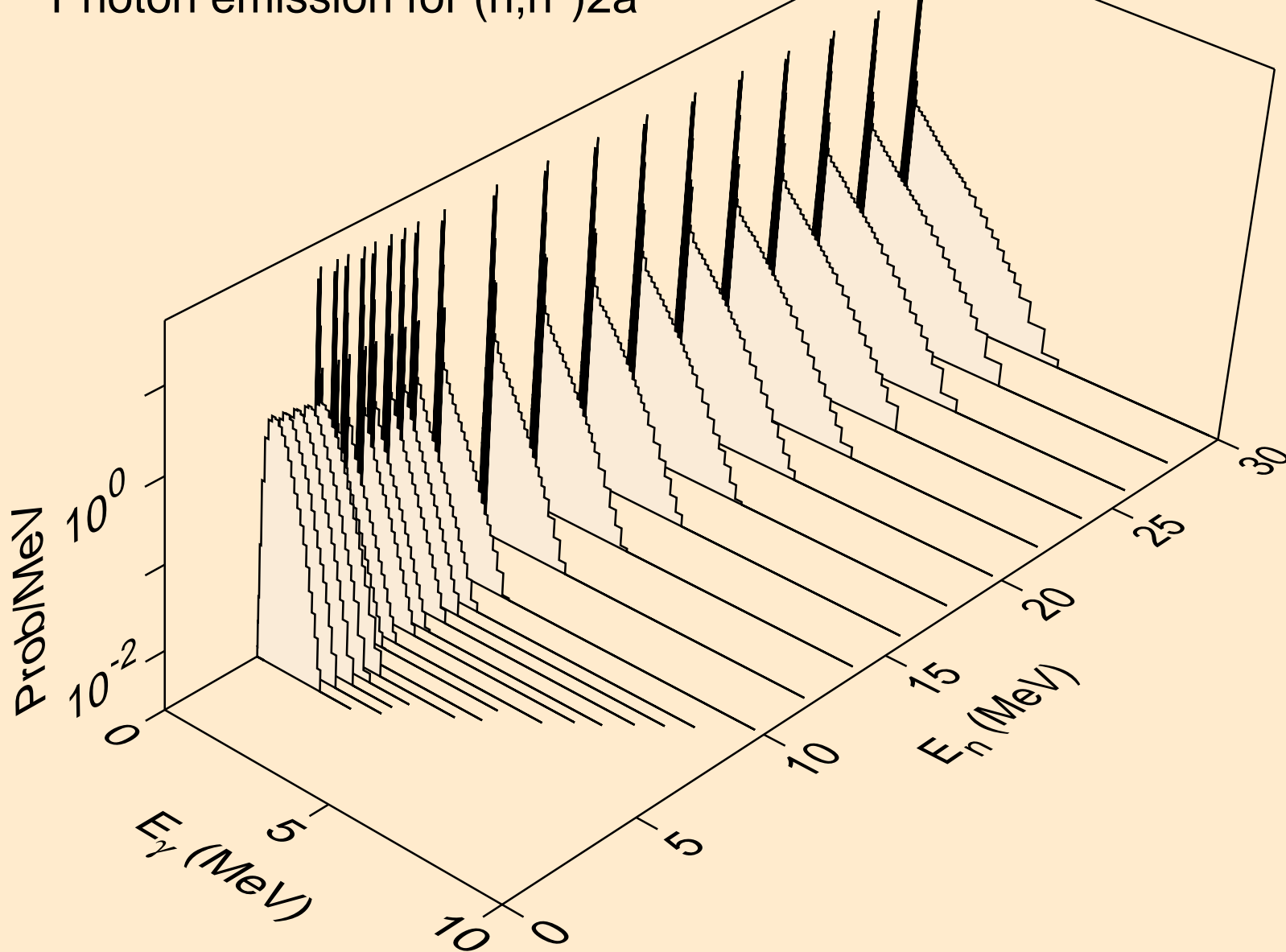

PB189M NEUTRON ACER TENDL-2019 LIBRARY; T=293.16K
Photon emission for (n,2n)2a

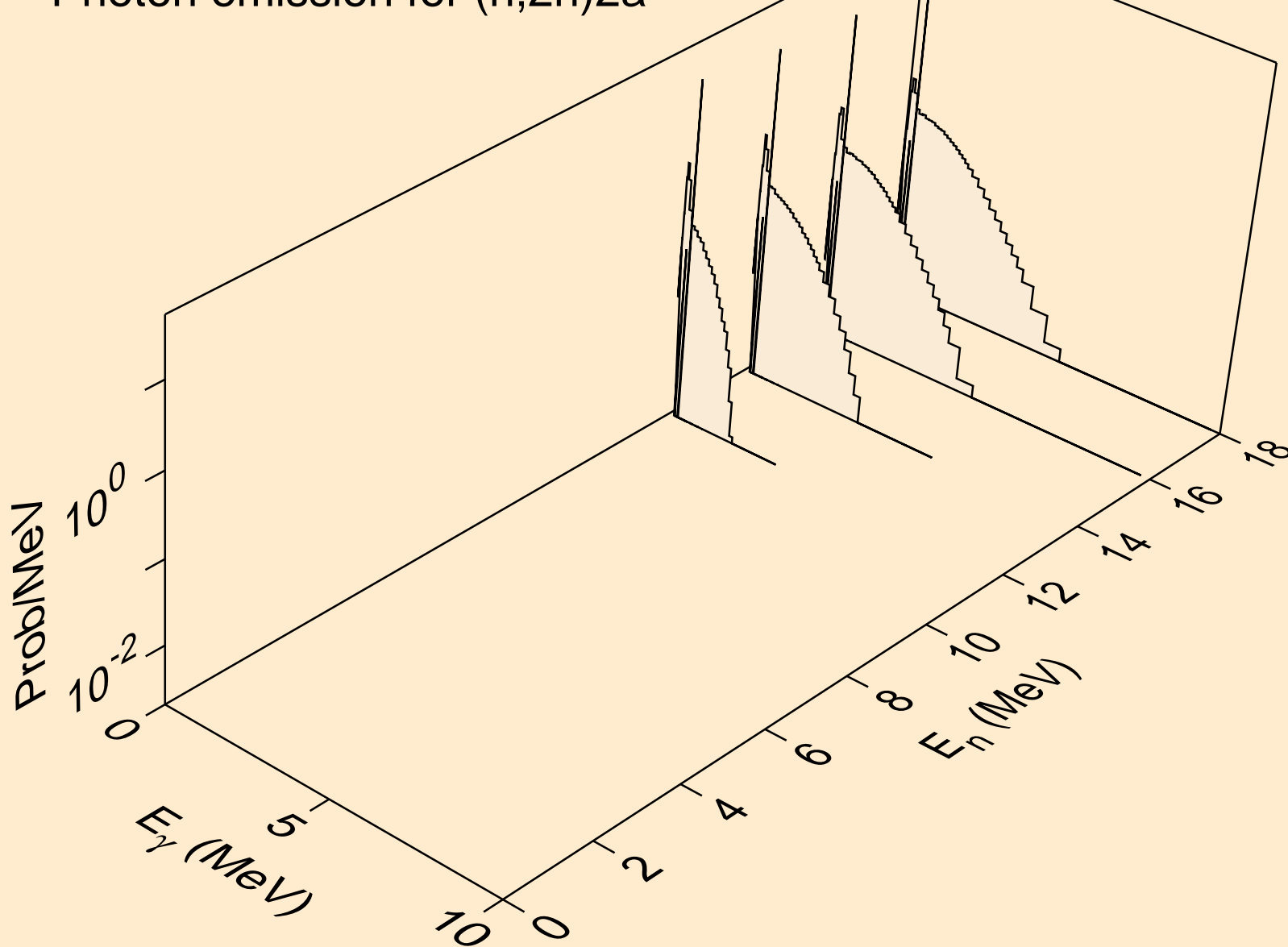

PB189M NEUTRON ACER TENDL-2019 LIBRARY; T=293.16K
Photon emission for (n,n*)d

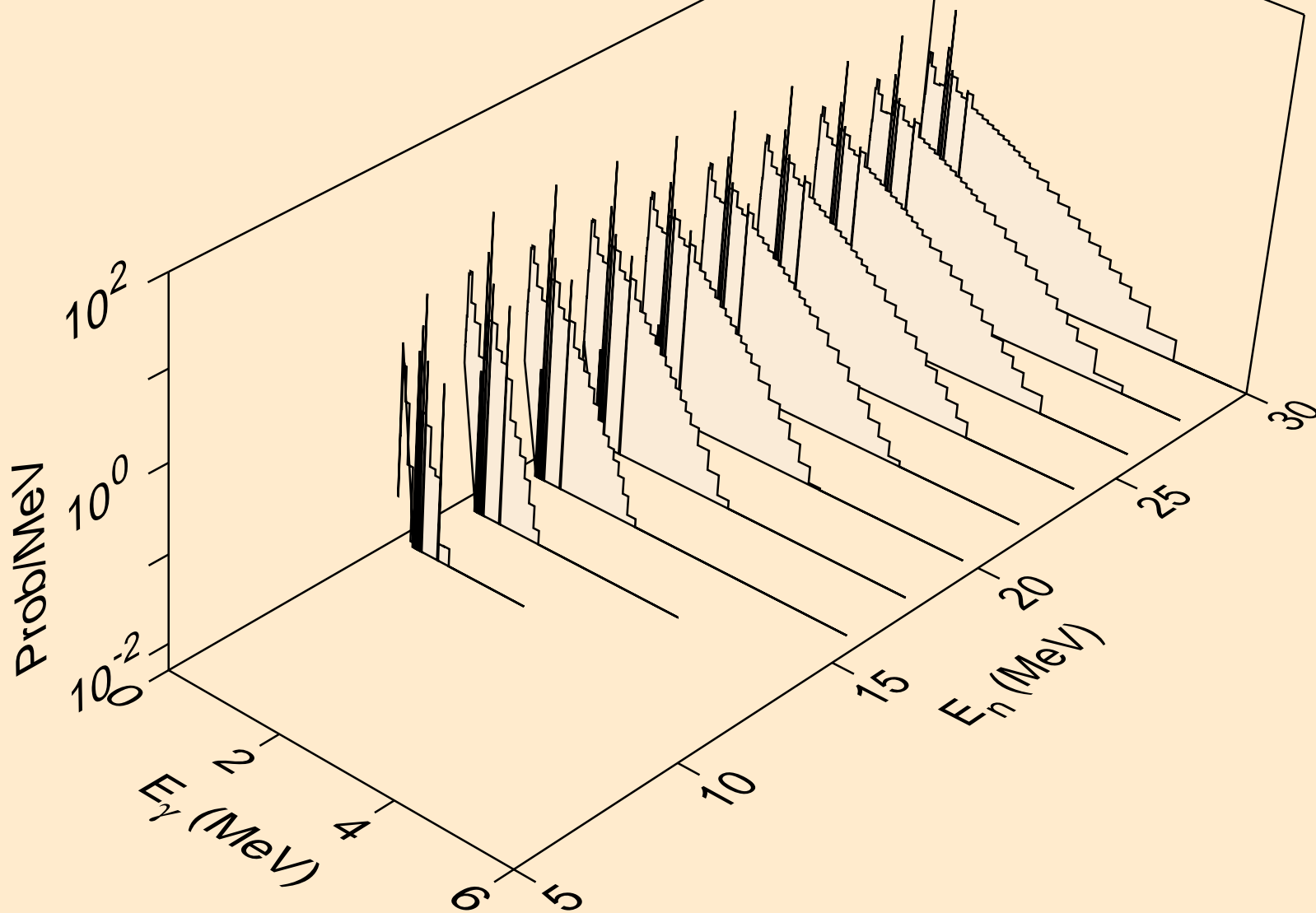

PB189M NEUTRON ACER TENDL-2019 LIBRARY; T=293.16K
Photon emission for (n,n*)t

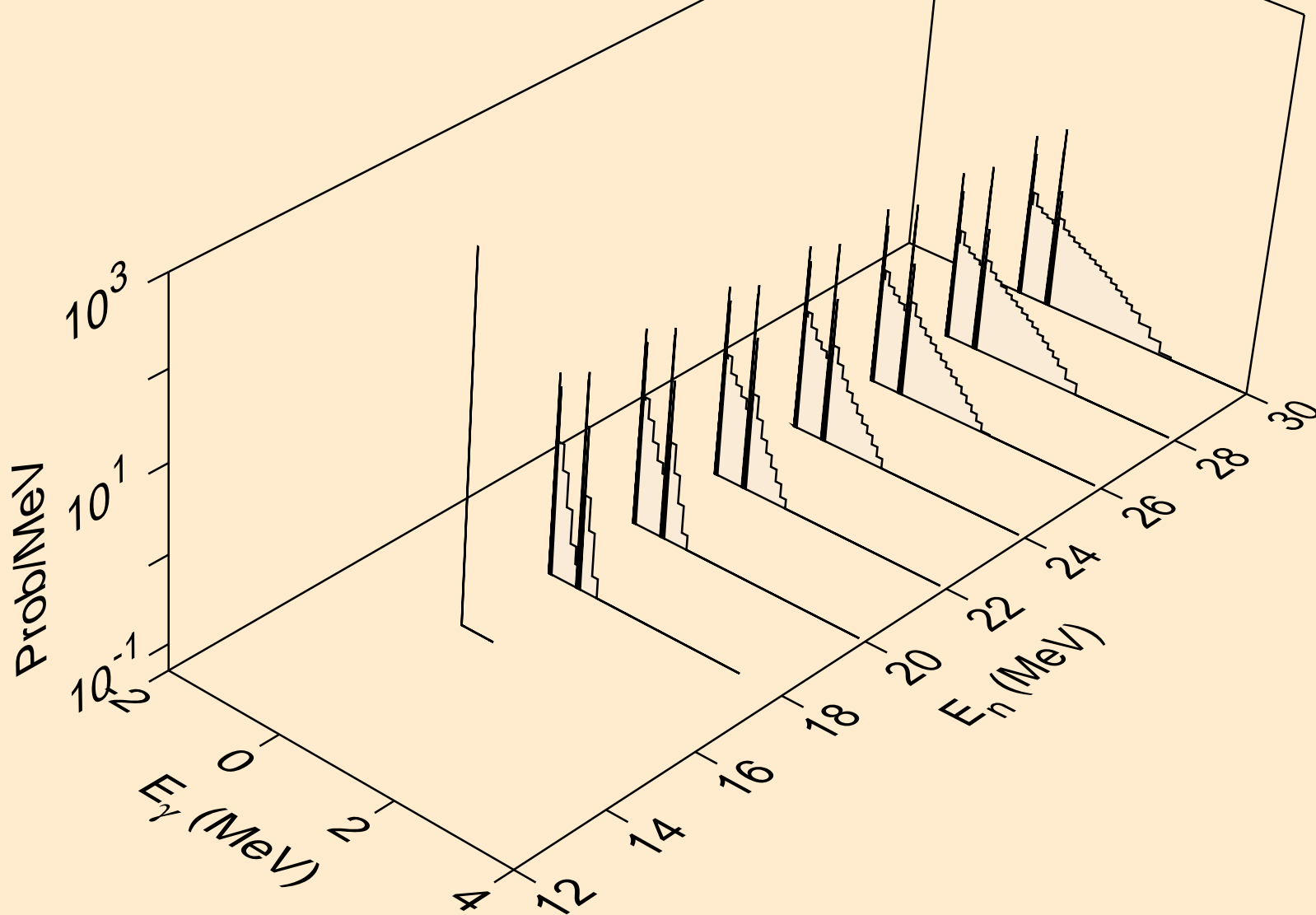

PB189M NEUTRON ACER TENDL-2019 LIBRARY; T=293.16K
Photon emission for (n,n*)he3

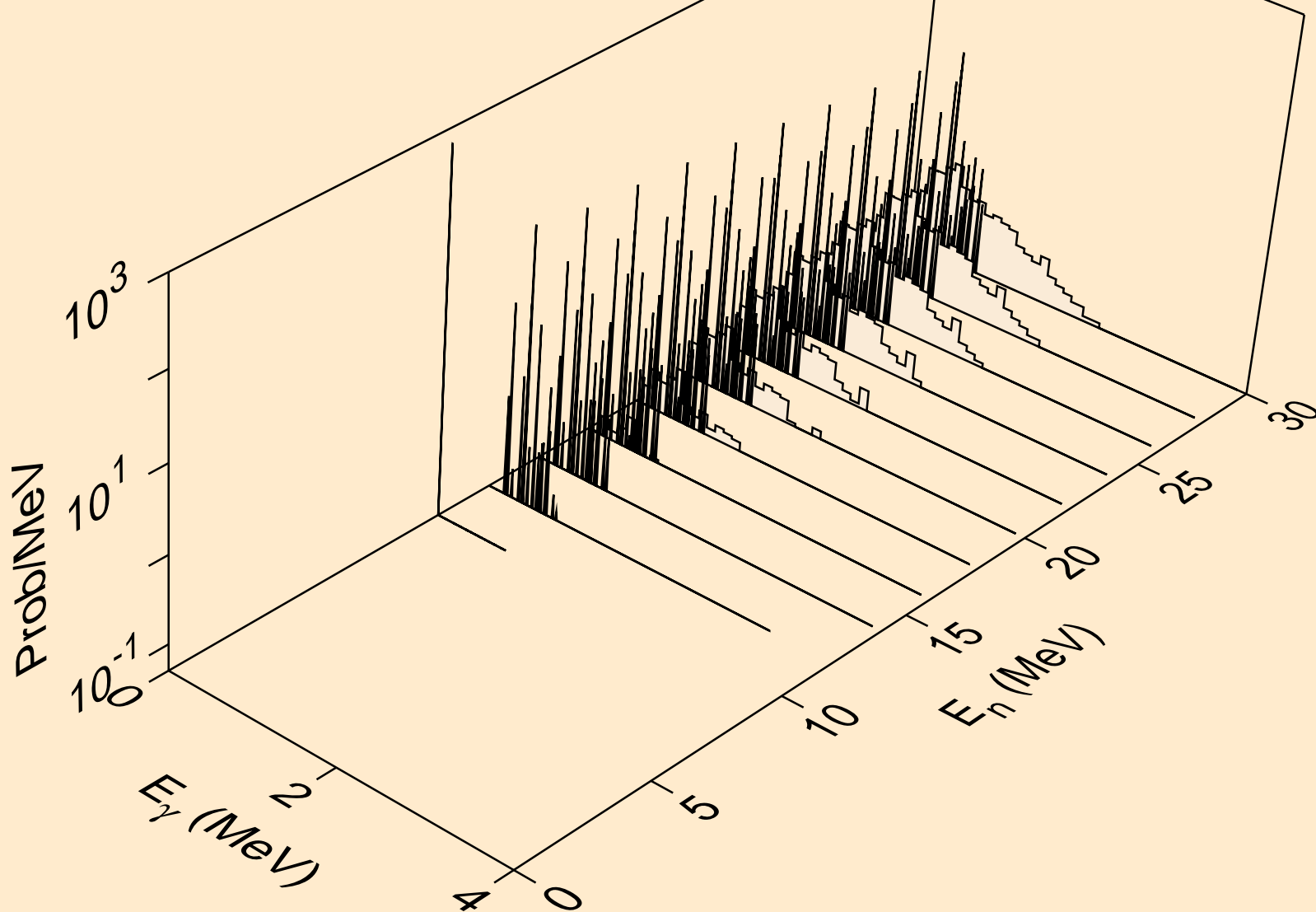

PB189M NEUTRON ACER TENDL-2019 LIBRARY; T=293.16K
Photon emission for (n,4n)

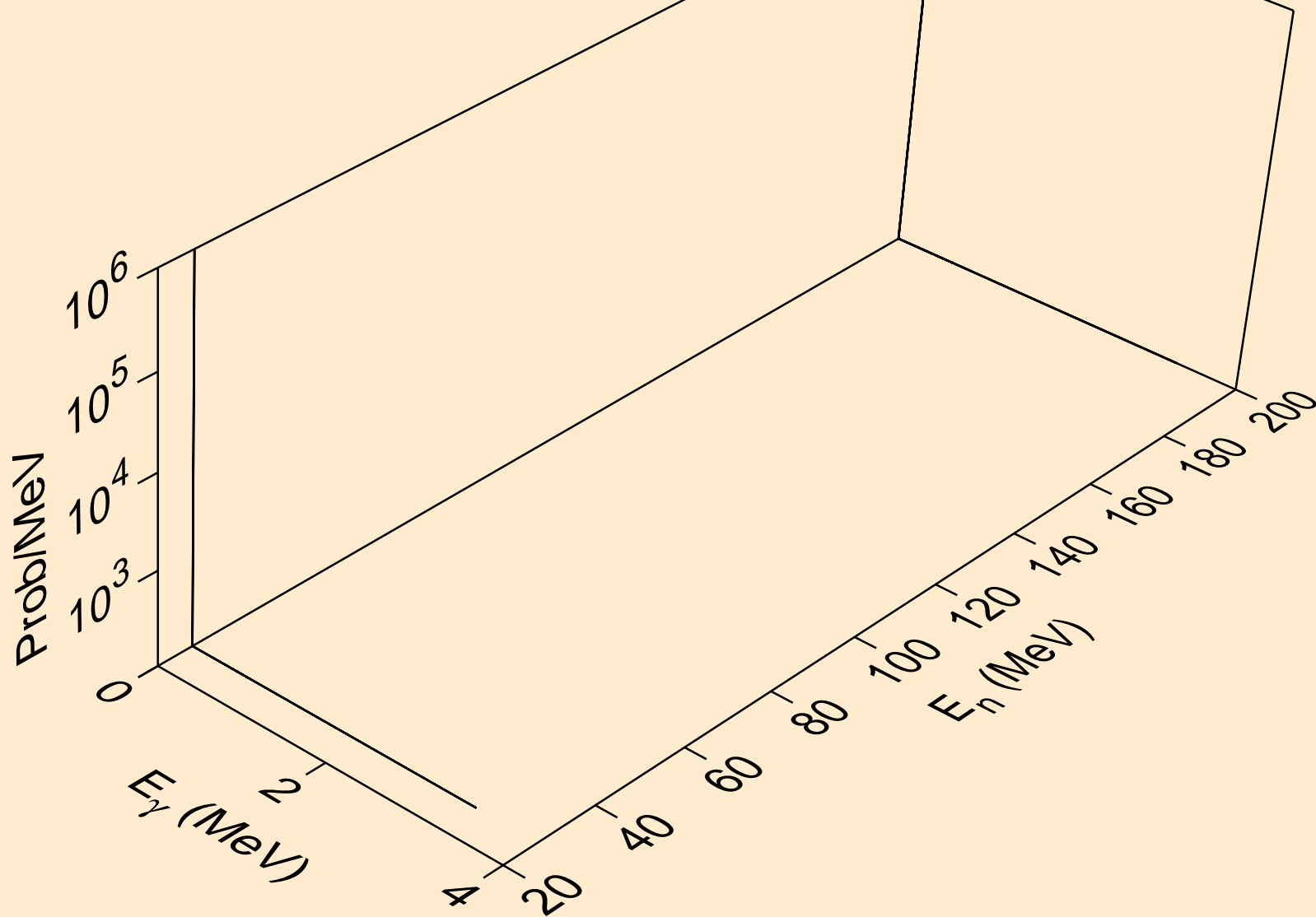

PB189M NEUTRON ACER TENDL-2019 LIBRARY; T=293.16K
Photon emission for (n,2np)

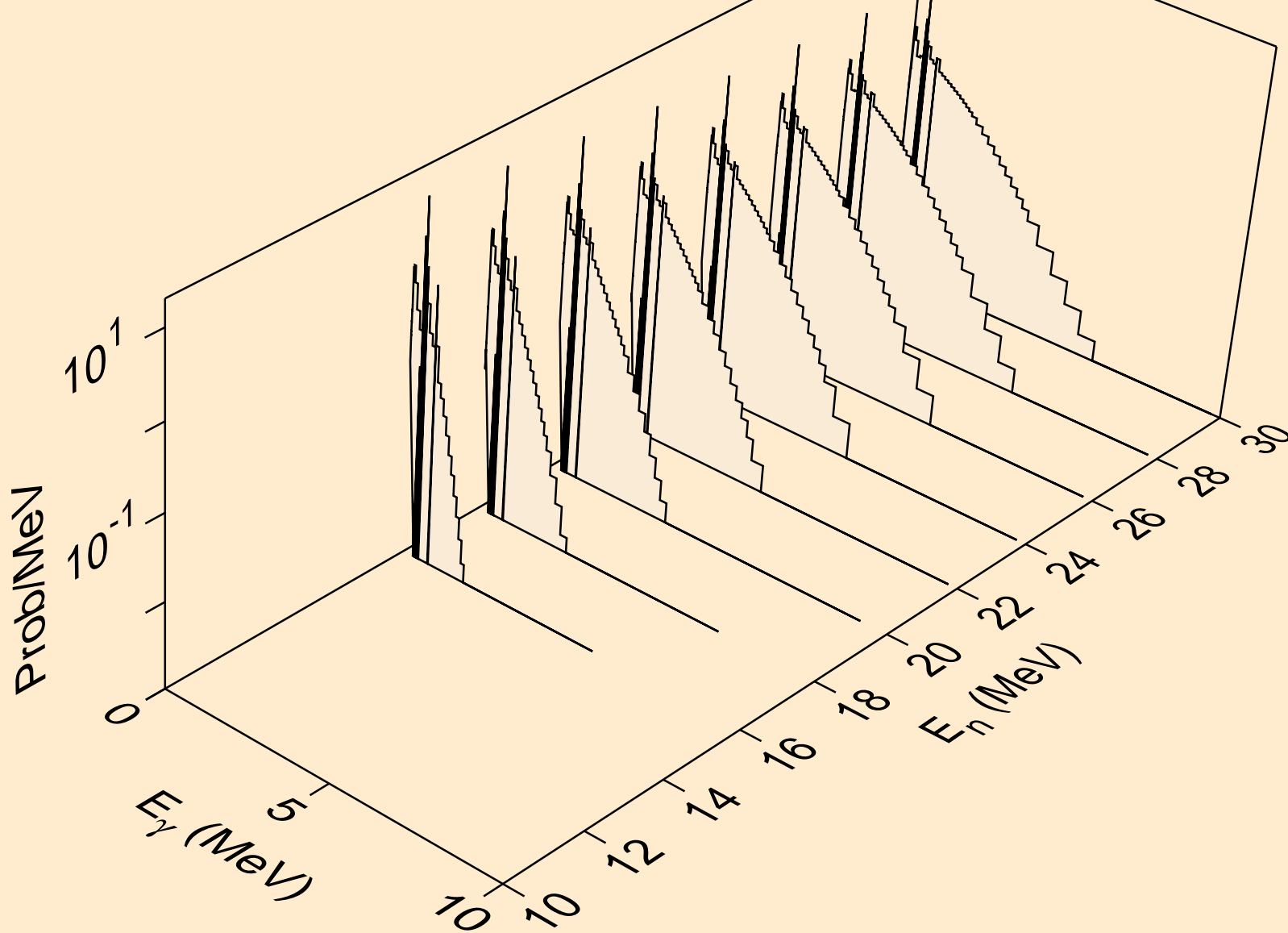

PB189M NEUTRON ACER TENDL-2019 LIBRARY; T=293.16K
Photon emission for (n,3np)

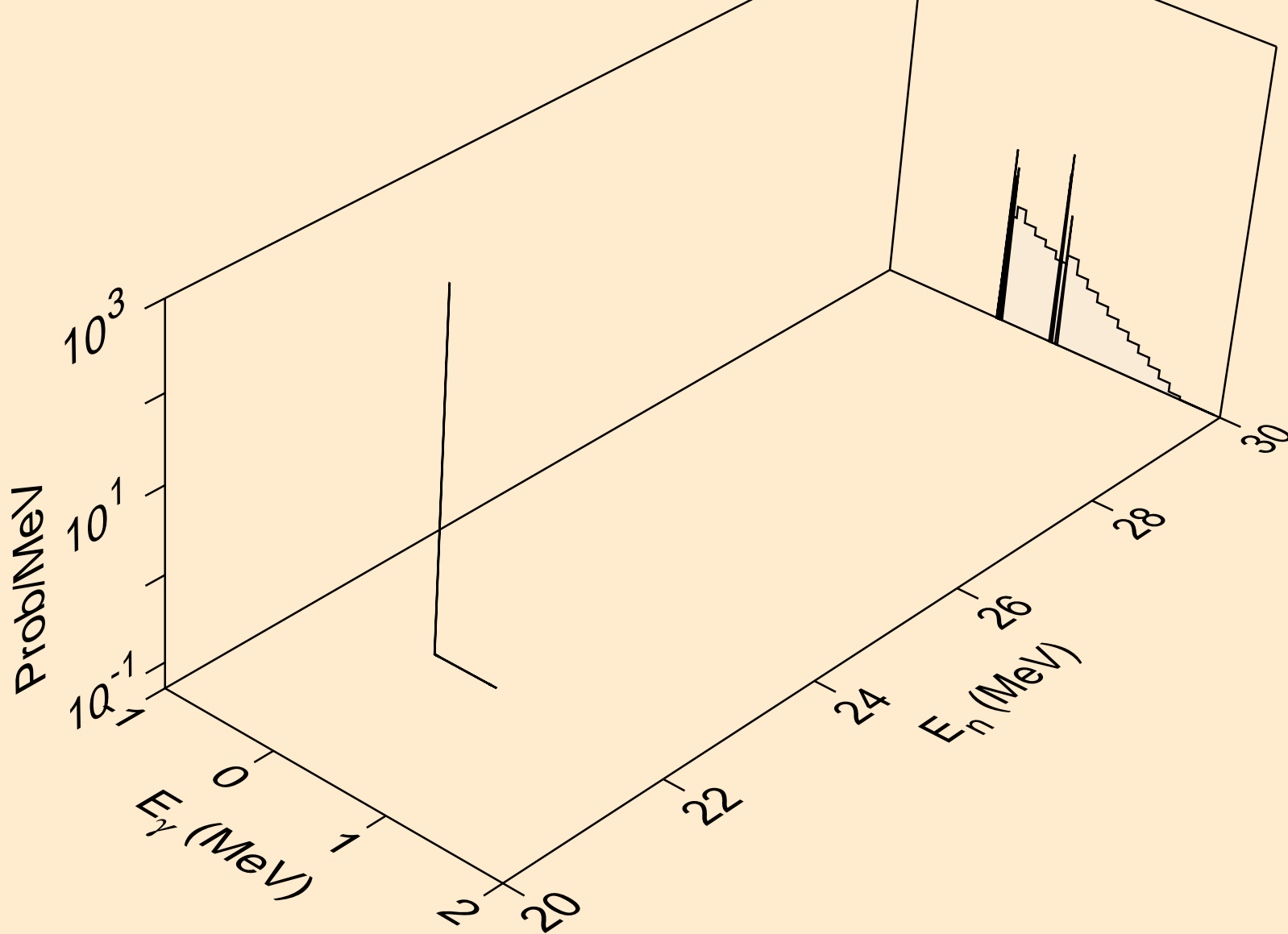

PB189M NEUTRON ACER TENDL-2019 LIBRARY; T=293.16K
Photon emission for (n,2np)

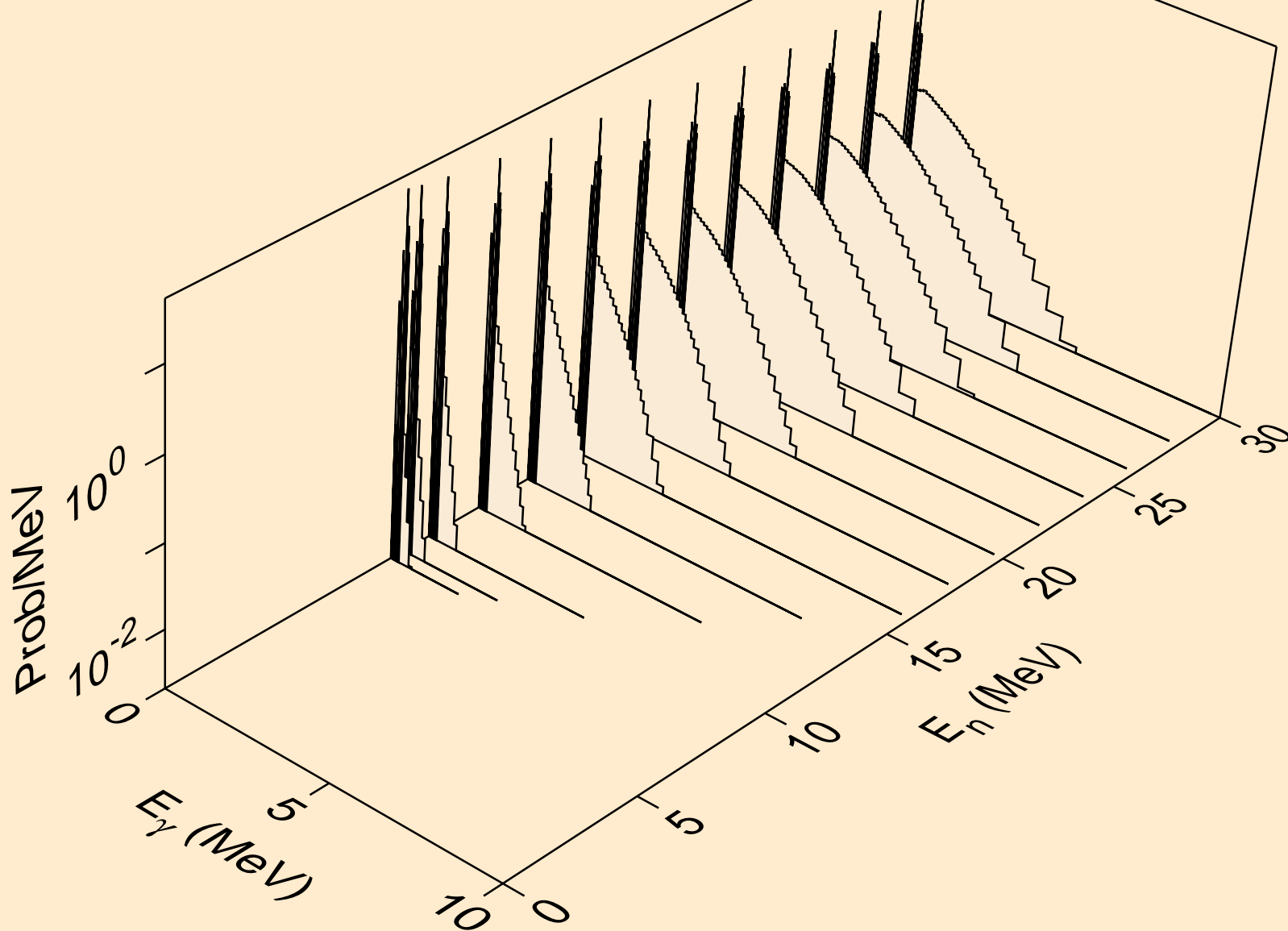

PB189M NEUTRON ACER TENDL-2019 LIBRARY; T=293.16K
Photon emission for (n,npa)

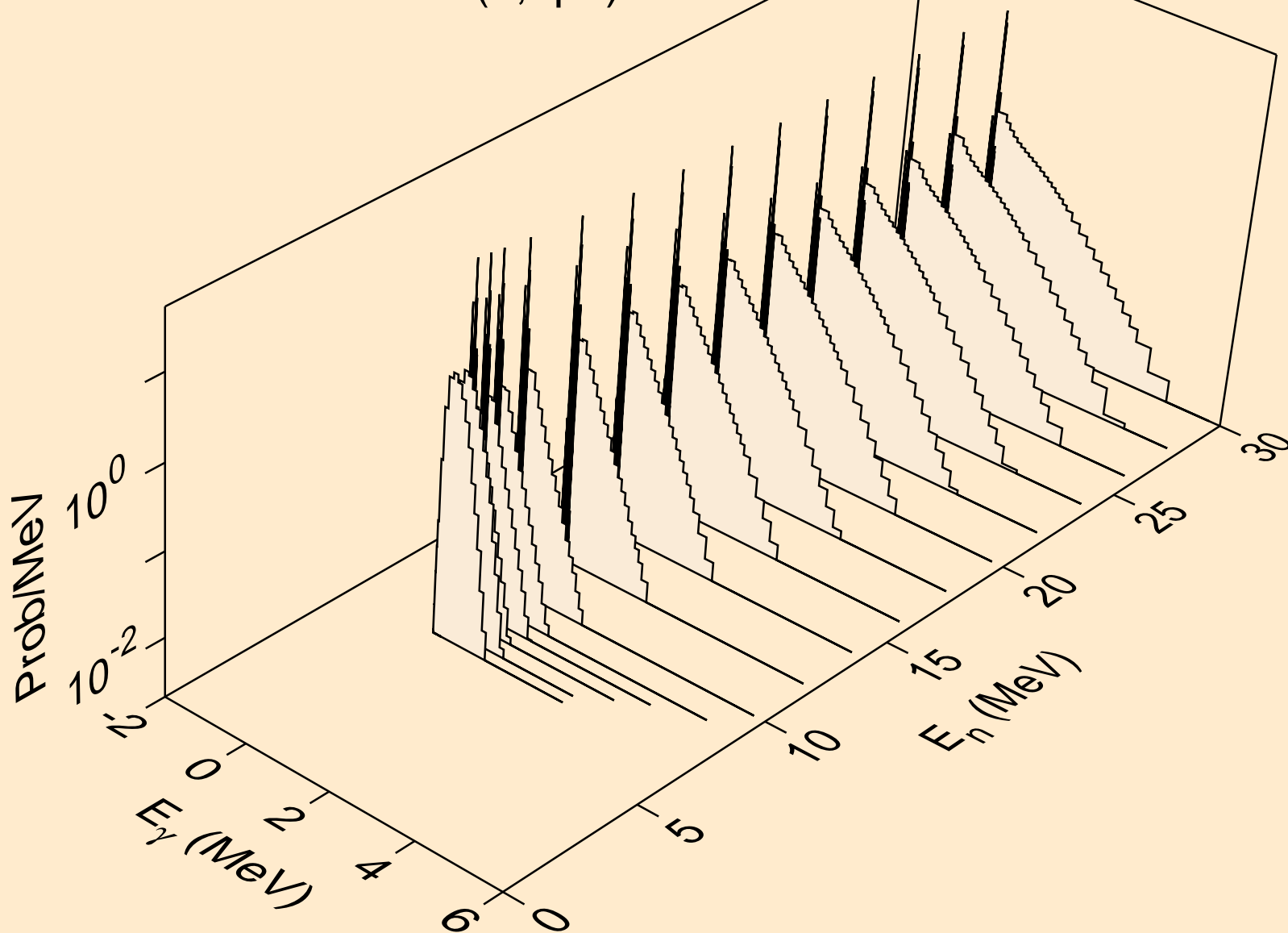

PB189M NEUTRON ACER TENDL-2019 LIBRARY; T=293.16K
Photon emission for (n,n*2)

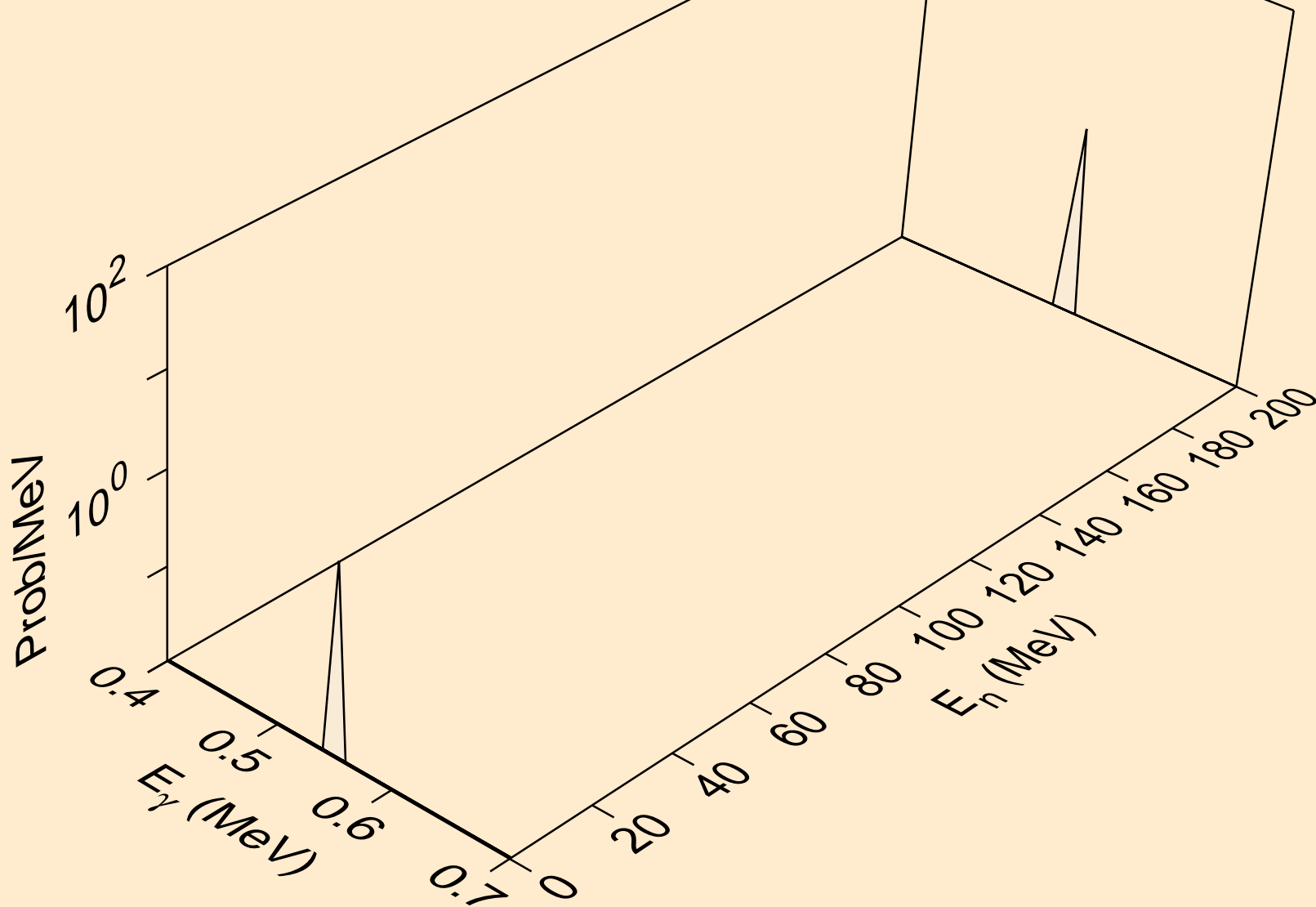

PB189M NEUTRON ACER TENDL-2019 LIBRARY; T=293.16K
Photon emission for (n,n*c)

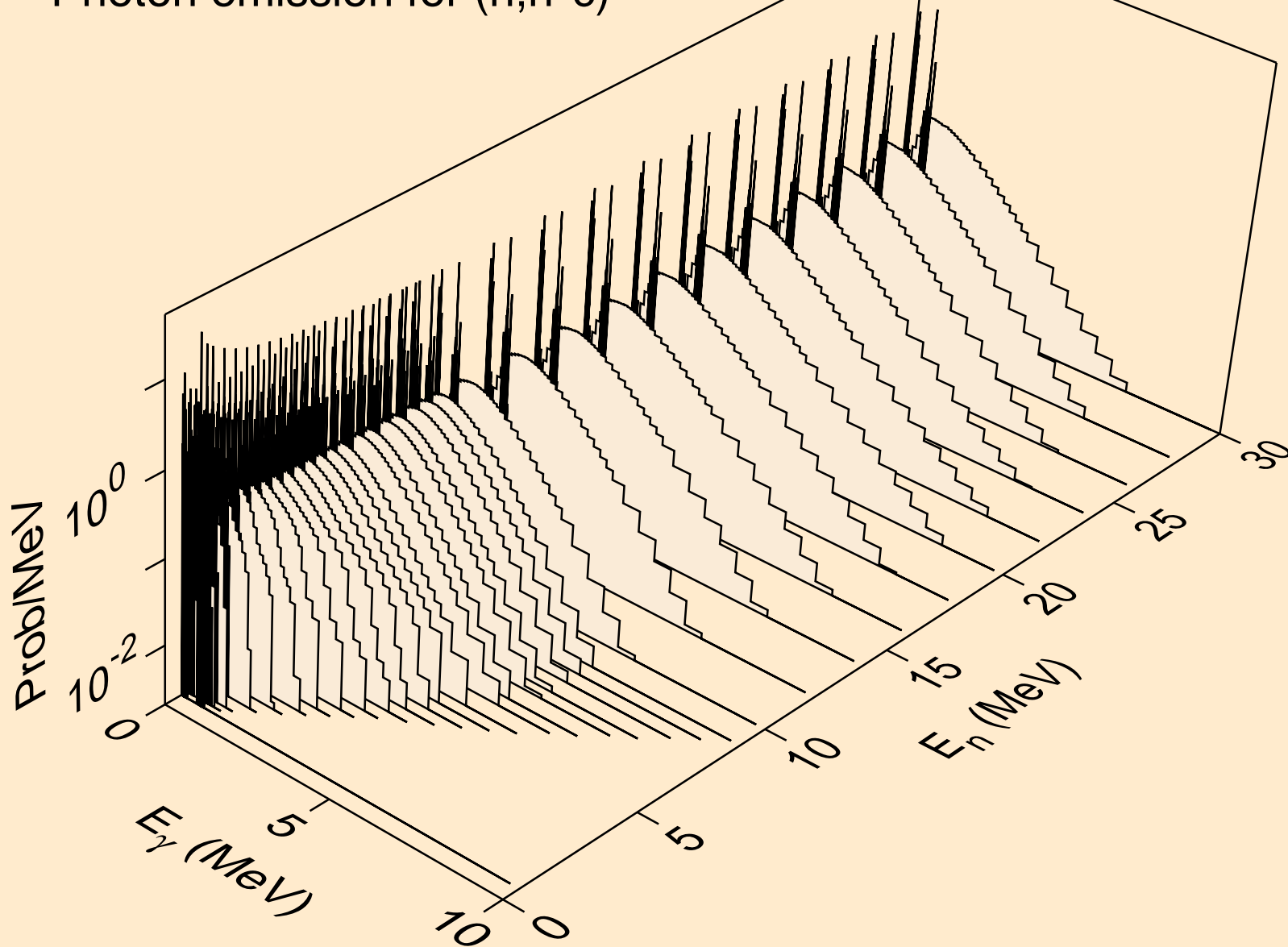

PB189M NEUTRON ACER TENDL-2019 LIBRARY; T=293.16K
Photon emission for (n,gma)

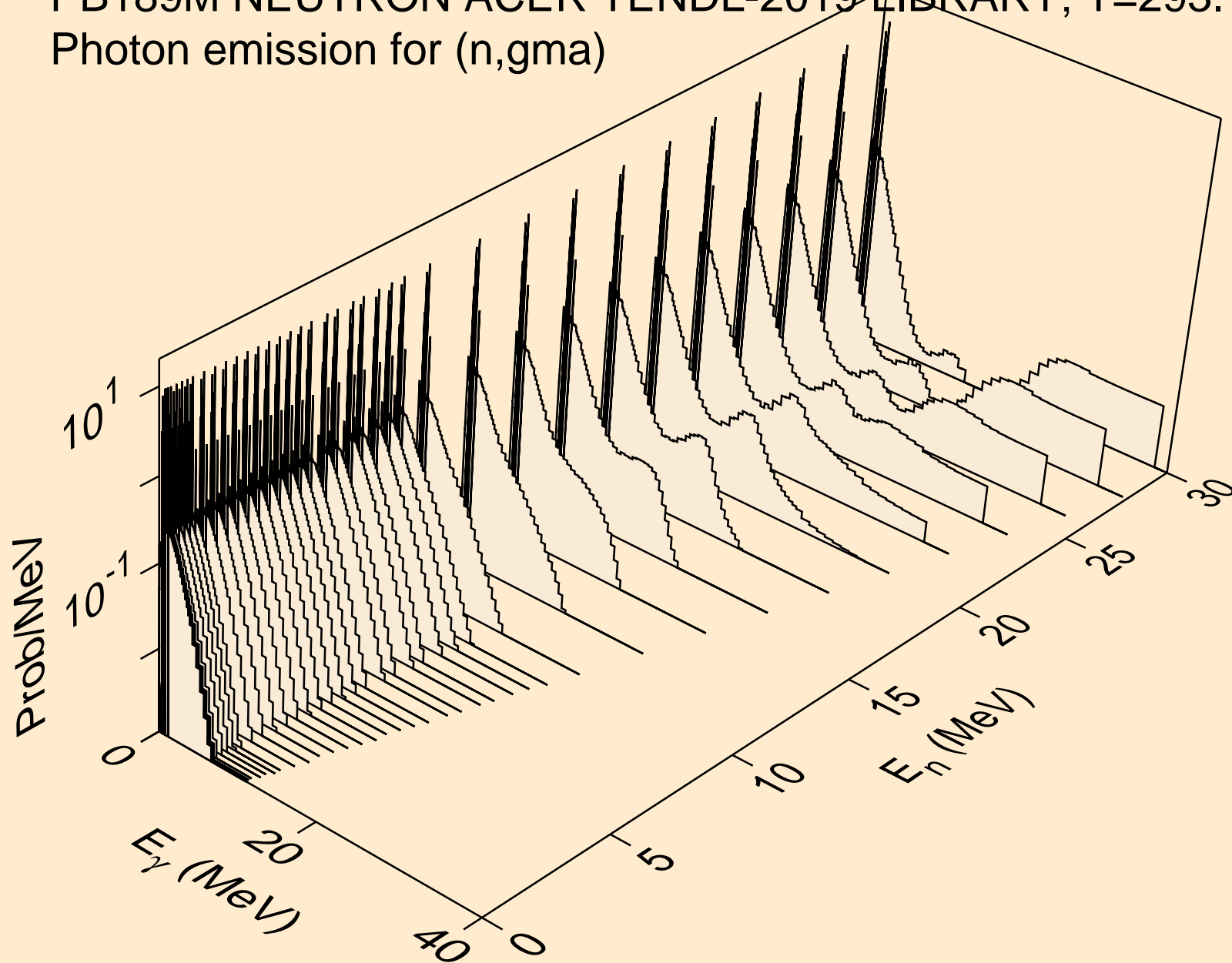

PB189M NEUTRON ACER TENDL-2019 LIBRARY; T=293.16K
Photon emission for (n,p)

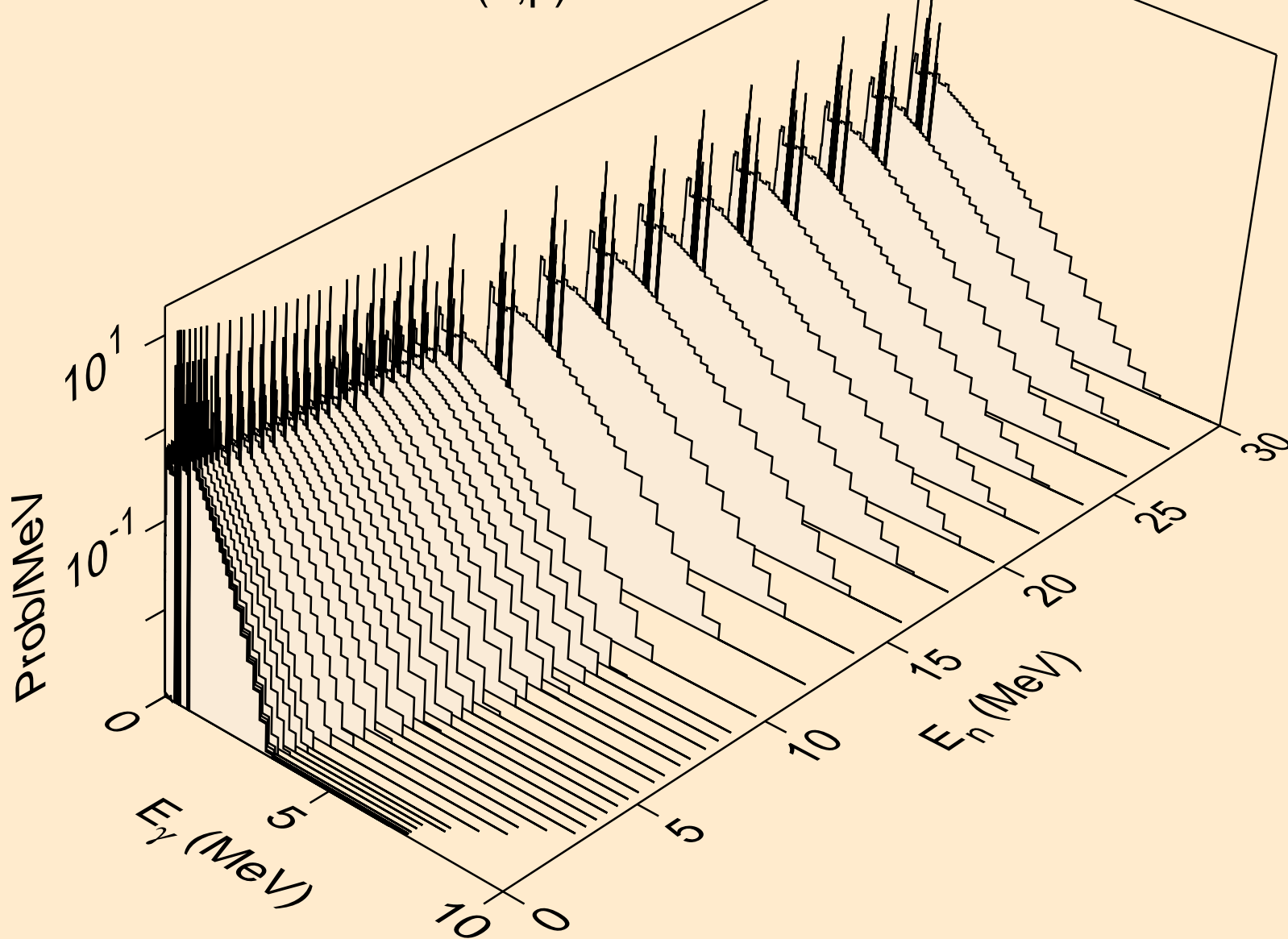

PB189M NEUTRON ACER TENDL-2019 LIBRARY; T=293.16K
Photon emission for (n,d)

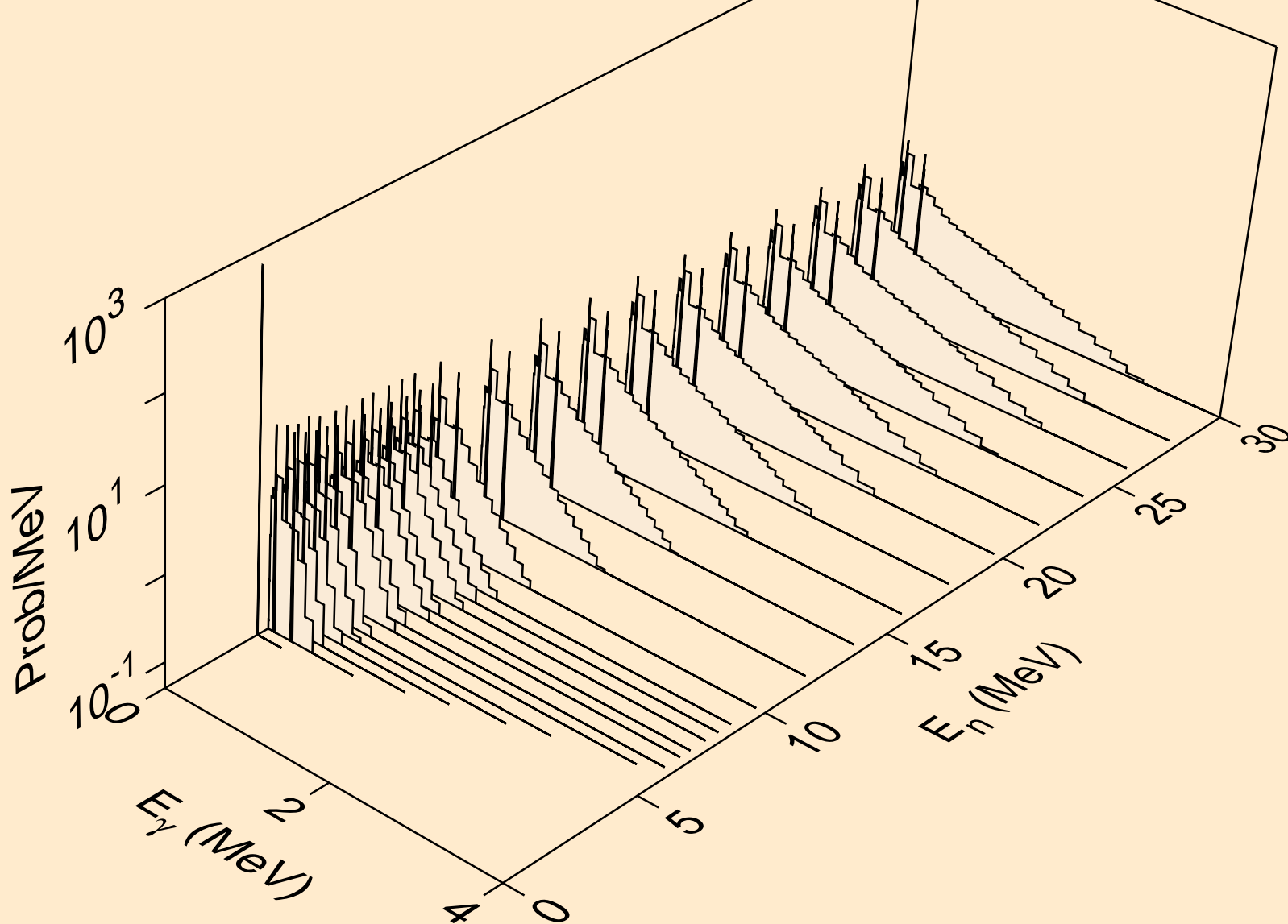

PB189M NEUTRON ACER TENDL-2019 LIBRARY; T=293.16K
Photon emission for (n,t)

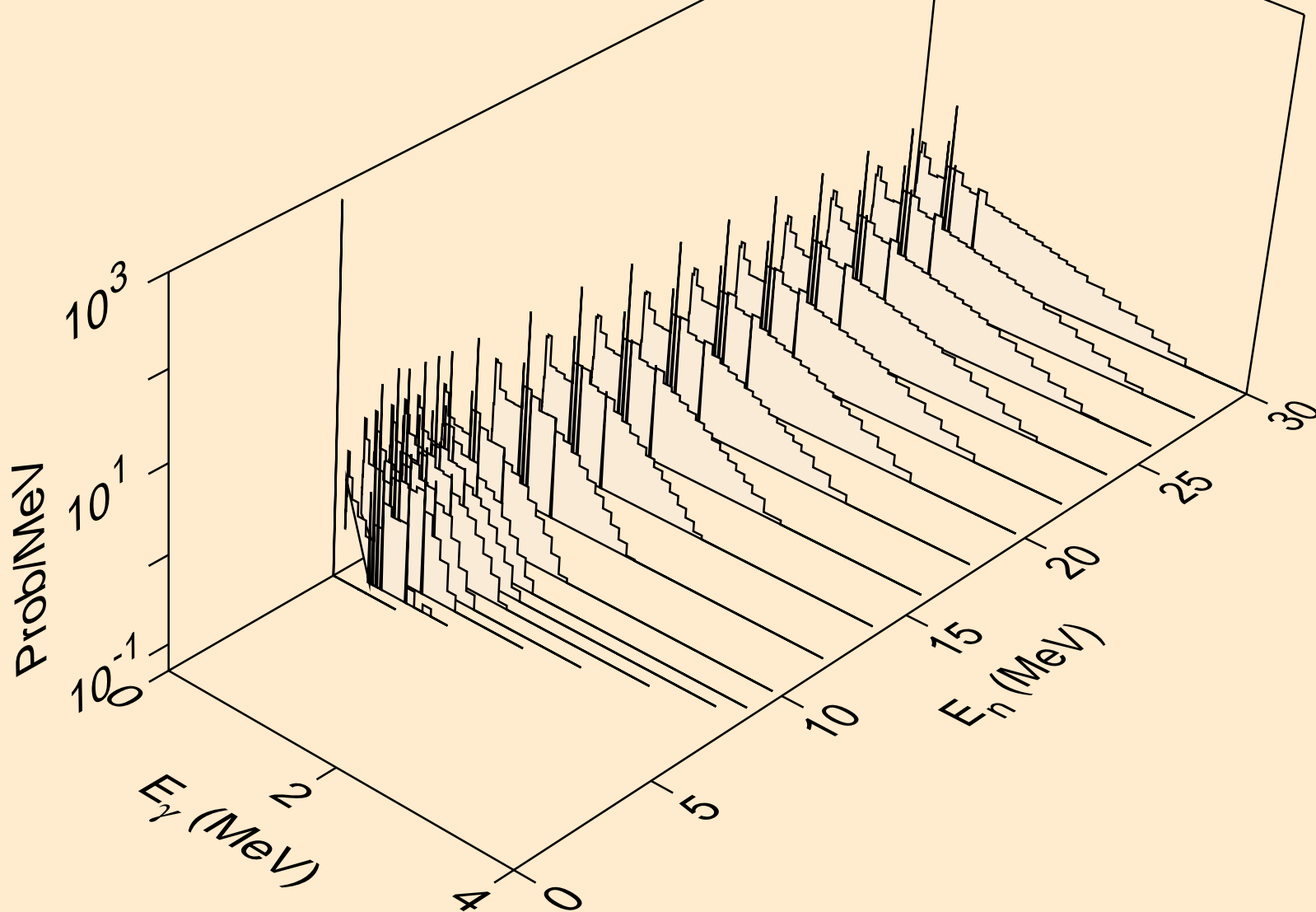

PB189M NEUTRON ACER TENDL-2019 LIBRARY; T=293.16K
Photon emission for (n,he3)

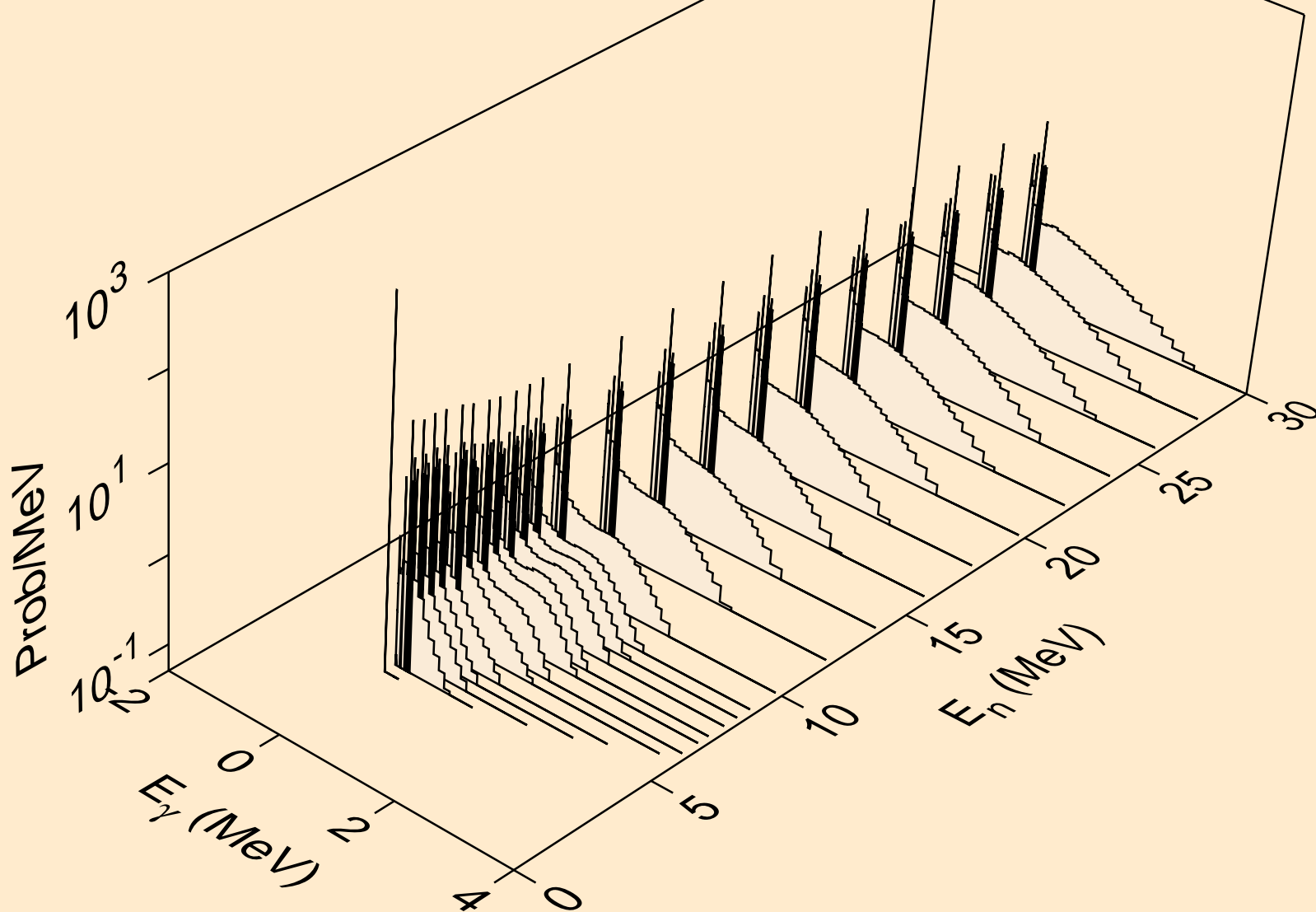

PB189M NEUTRON ACER TENDL-2019 LIBRARY; T=293.16K
Photon emission for (n,a)

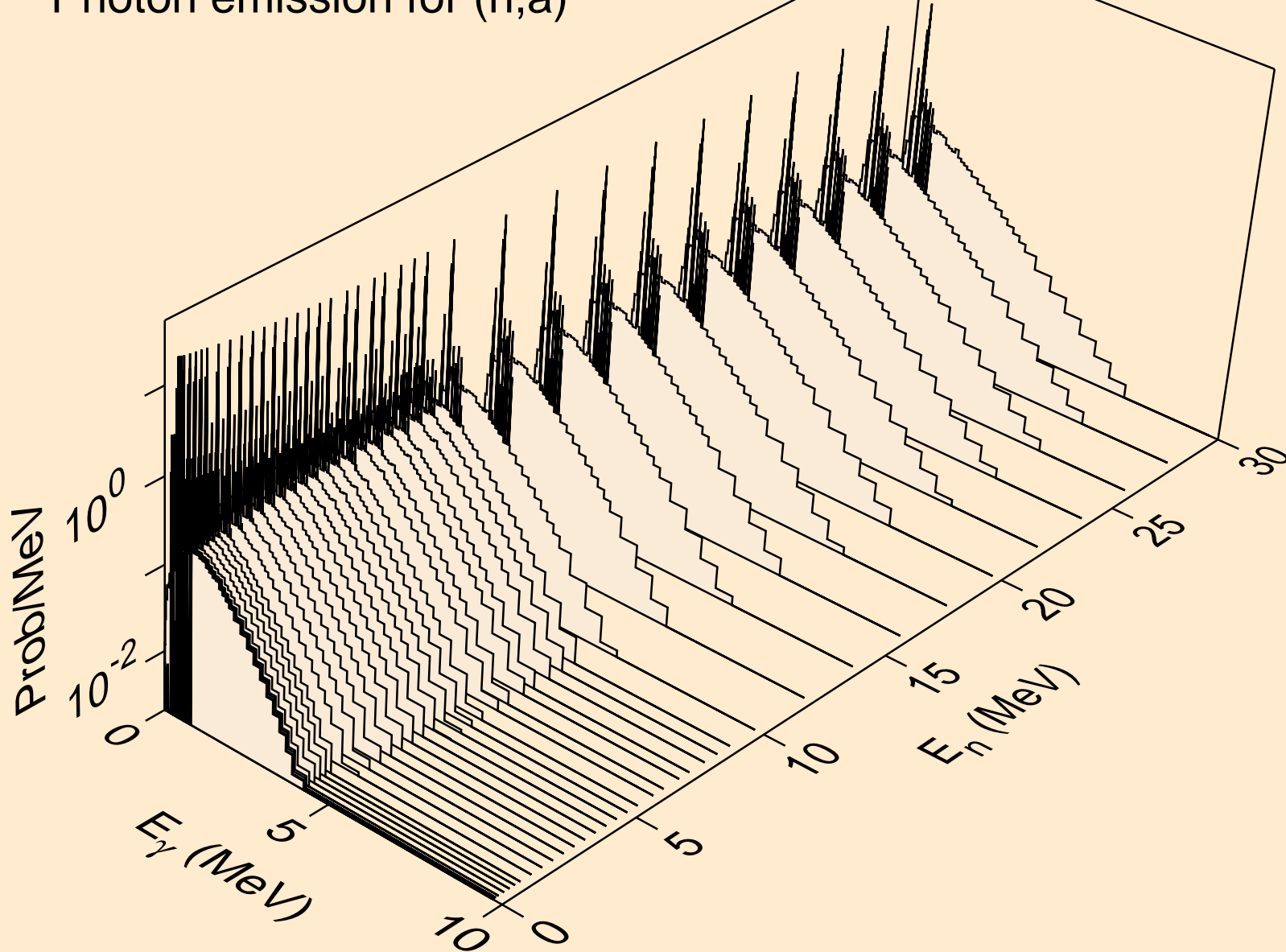

PB189M NEUTRON ACER TENDL-2019 LIBRARY; T=293.16K
Photon emission for (n,2a)

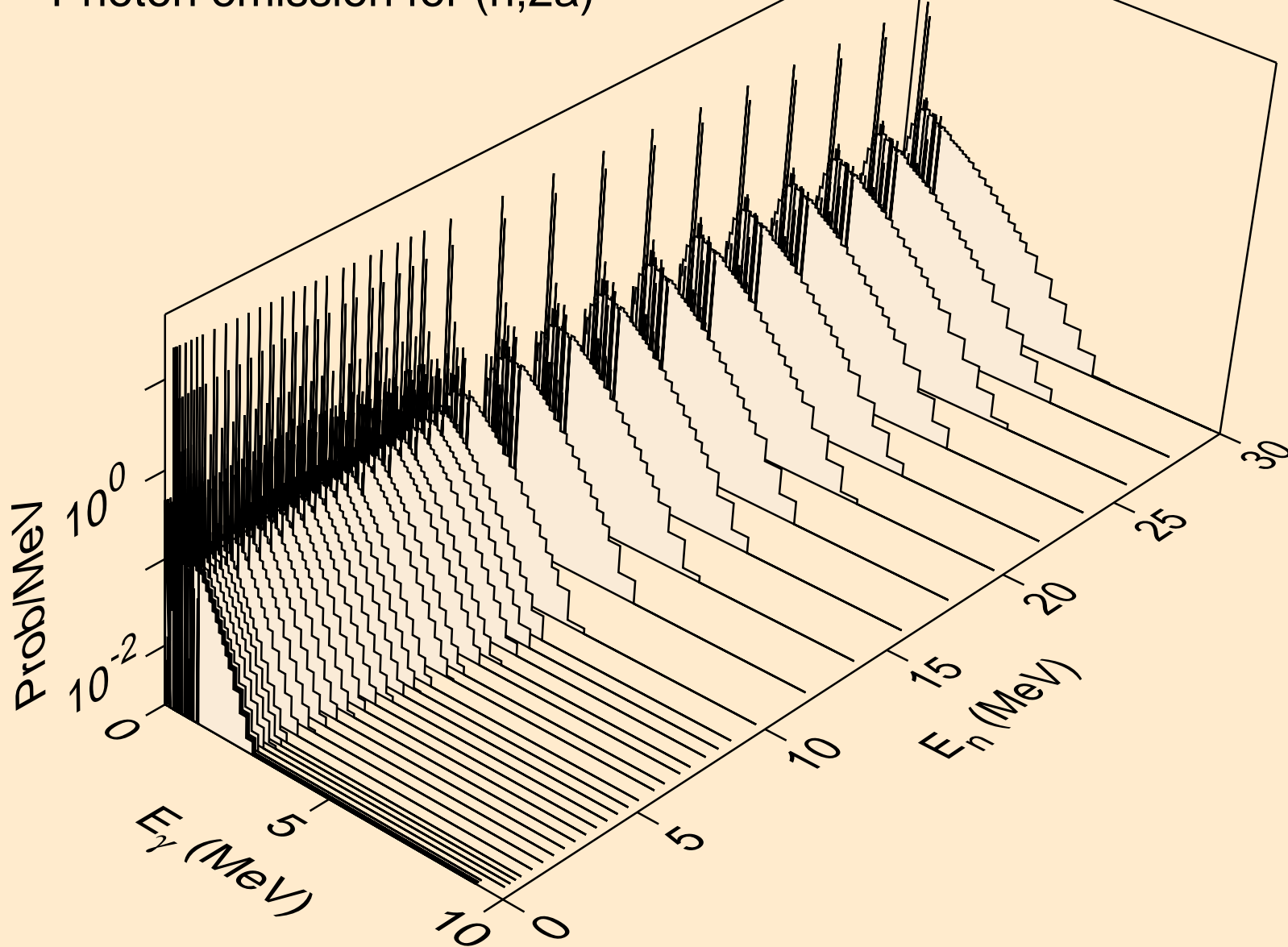

PB189M NEUTRON ACER TENDL-2019 LIBRARY; T=293.16K
Photon emission for (n,3a)

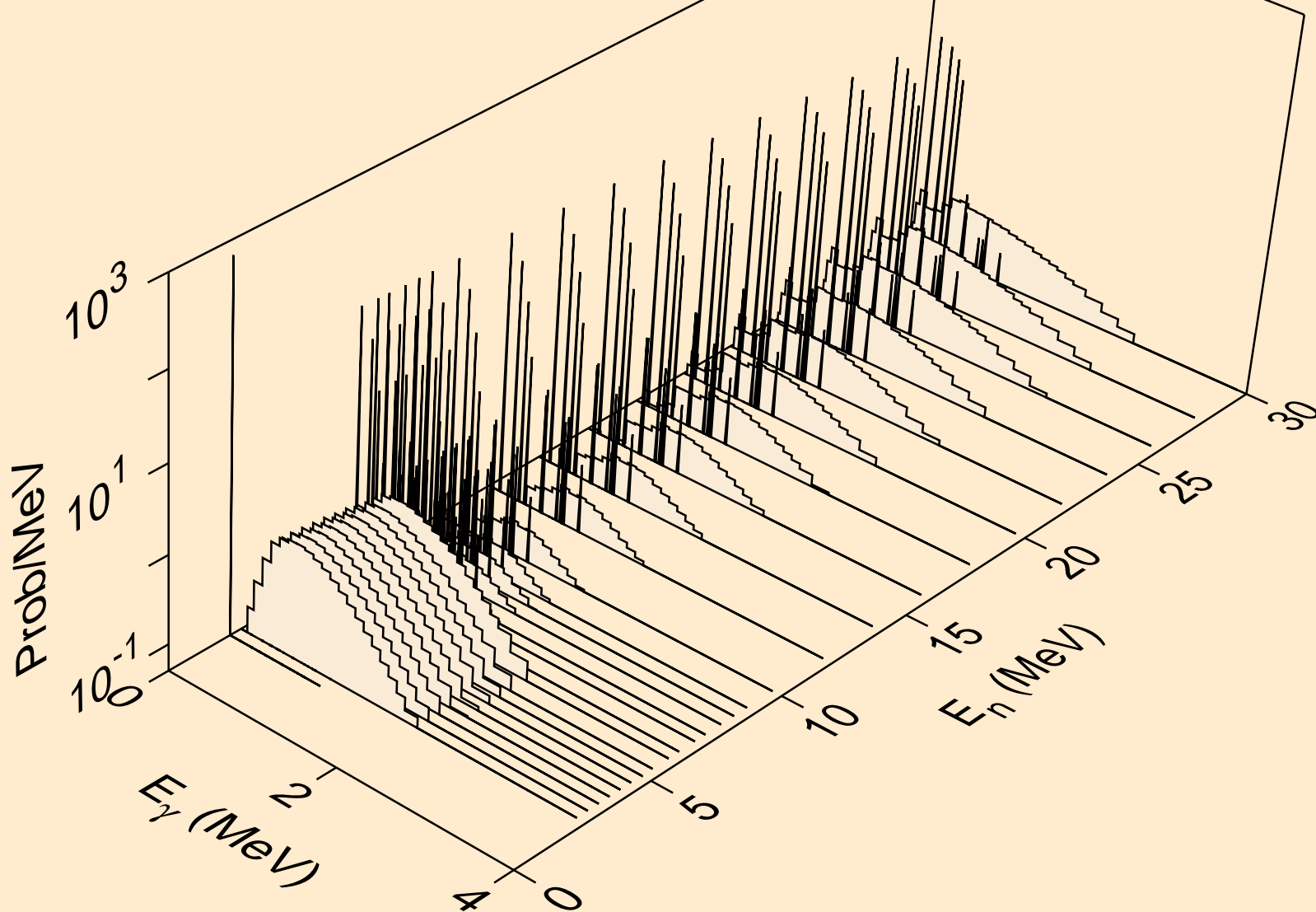

PB189M NEUTRON ACER TENDL-2019 LIBRARY; T=293.16K
Photon emission for (n,2p)

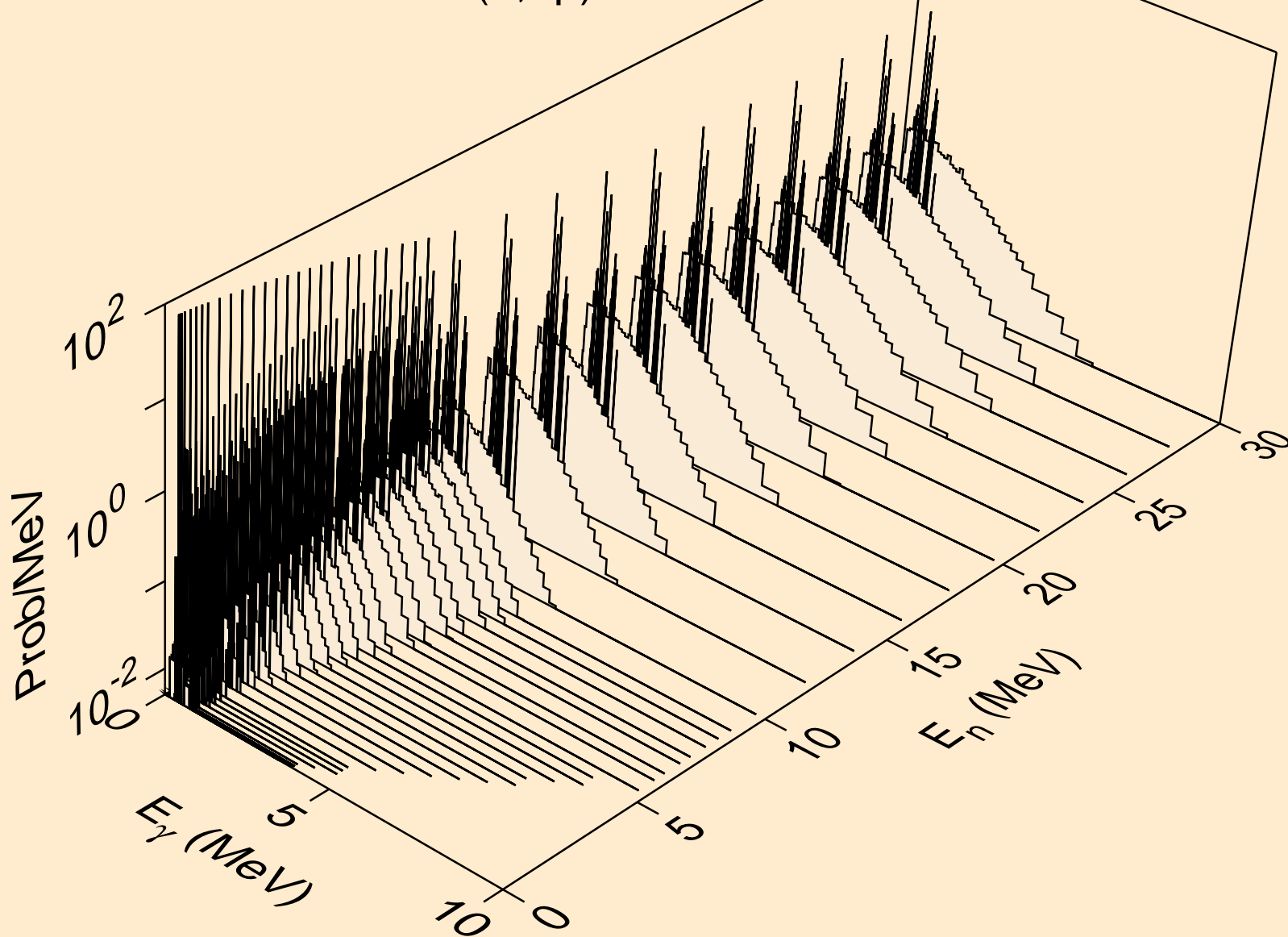

PB189M NEUTRON ACER TENDL-2019 LIBRARY; T=293.16K
Photon emission for (n,p α)

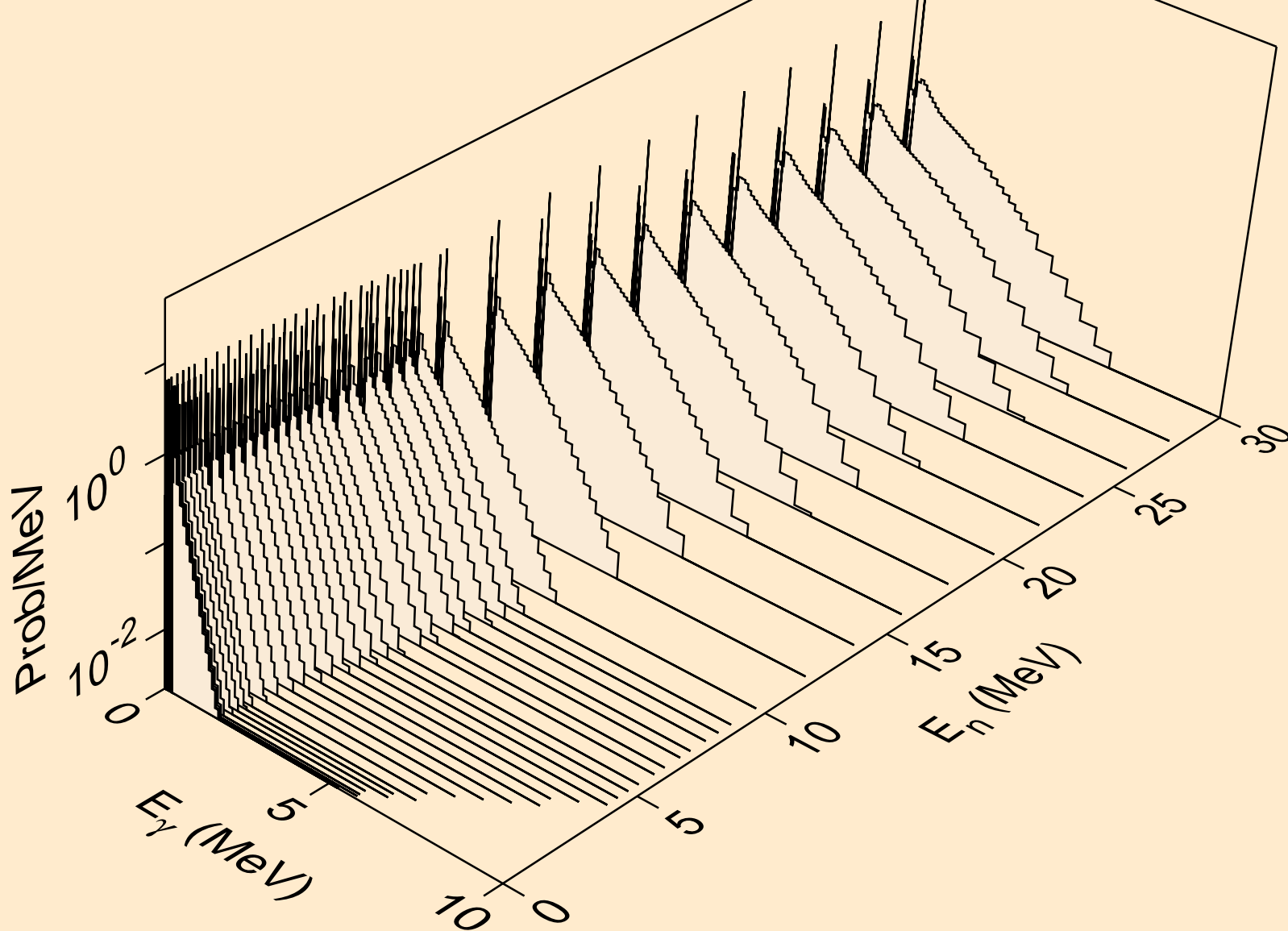

PB189M NEUTRON ACER TENDL-2019 LIBRARY; T=293.16K
Photon emission for (n,pd)

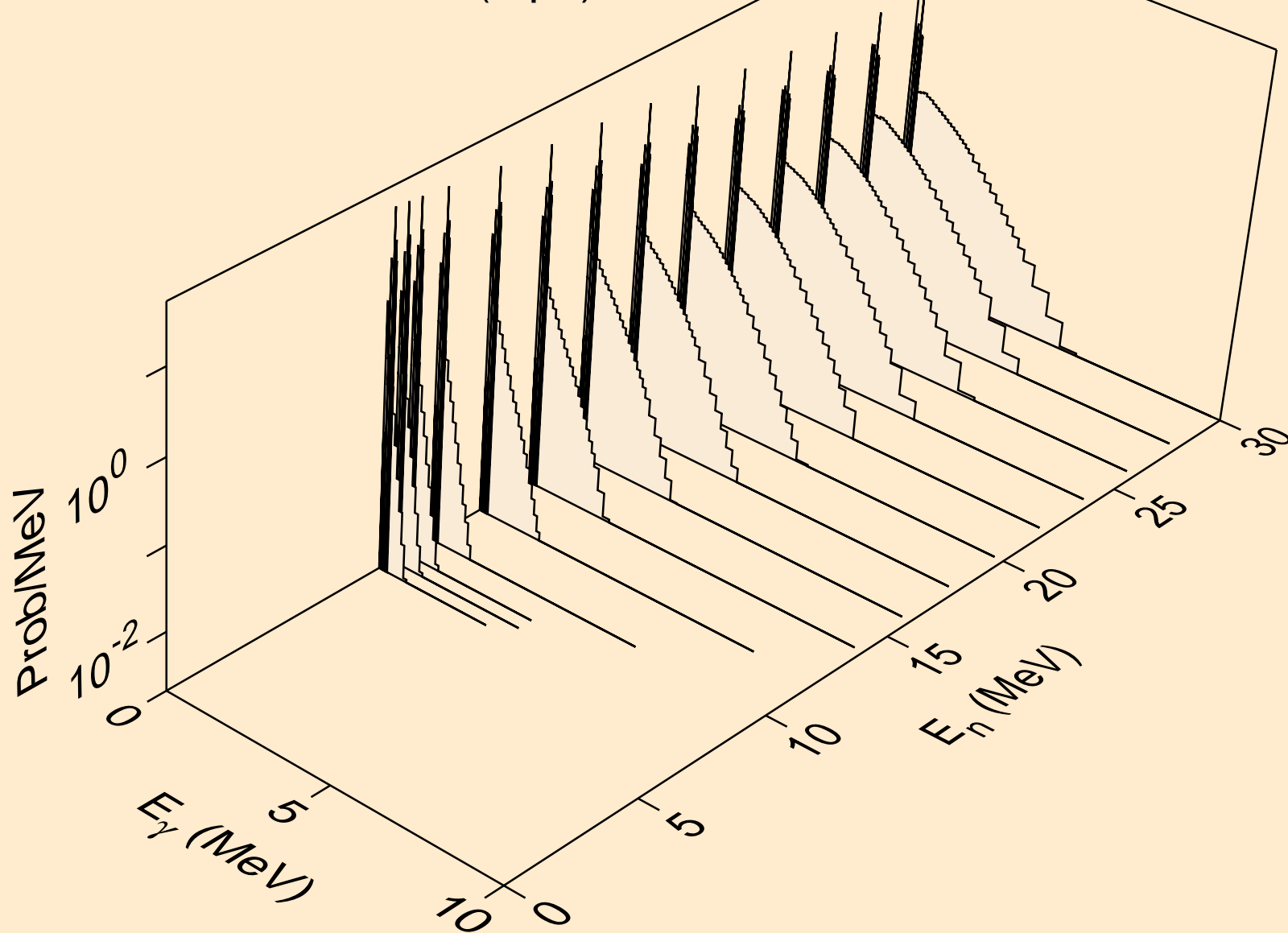

PB189M NEUTRON ACER TENDL-2019 LIBRARY; T=293.16K
Photon emission for (n,pt)

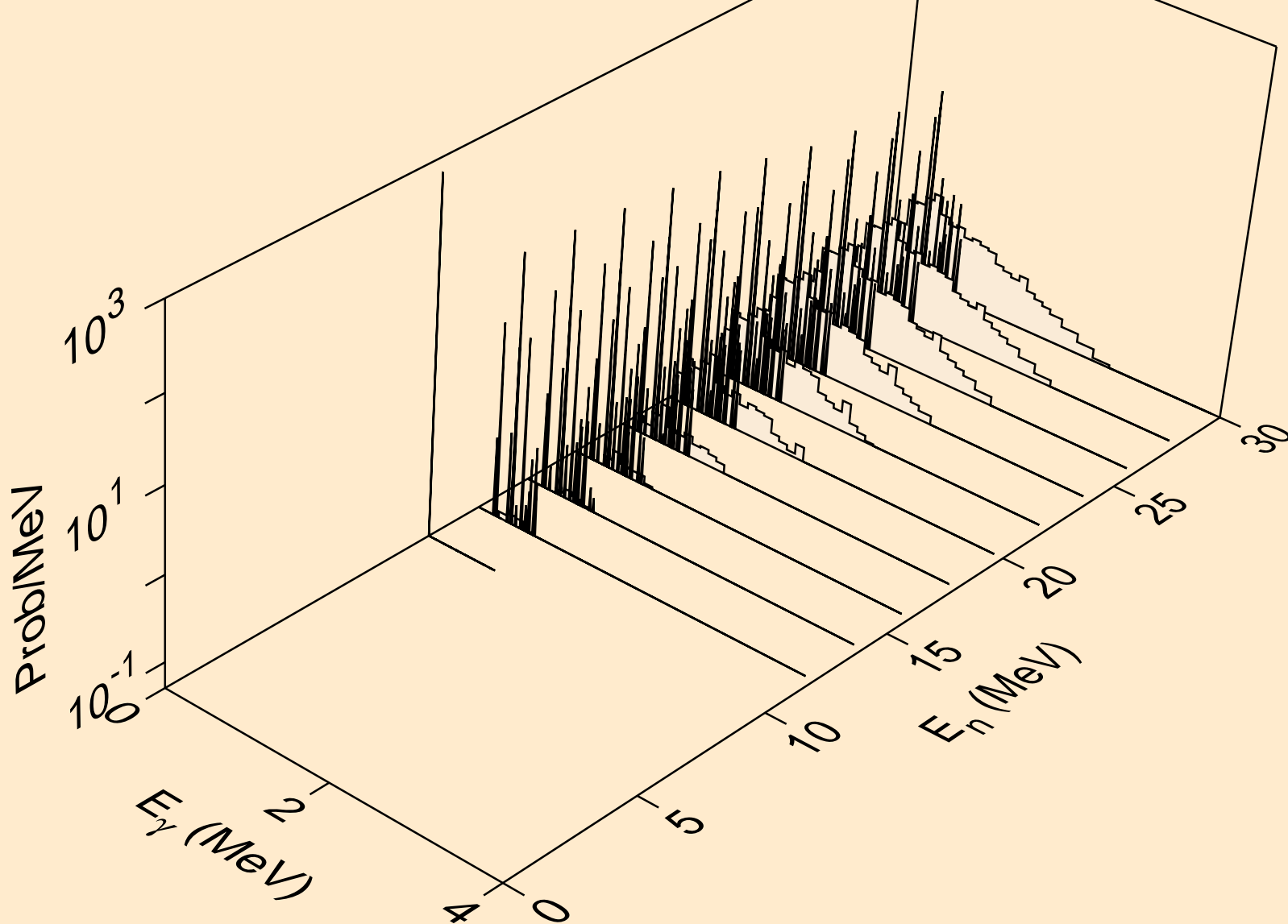

PB189M NEUTRON ACER TENDL-2019 LIBRARY; T=293.16K
Photon emission for (n,da)

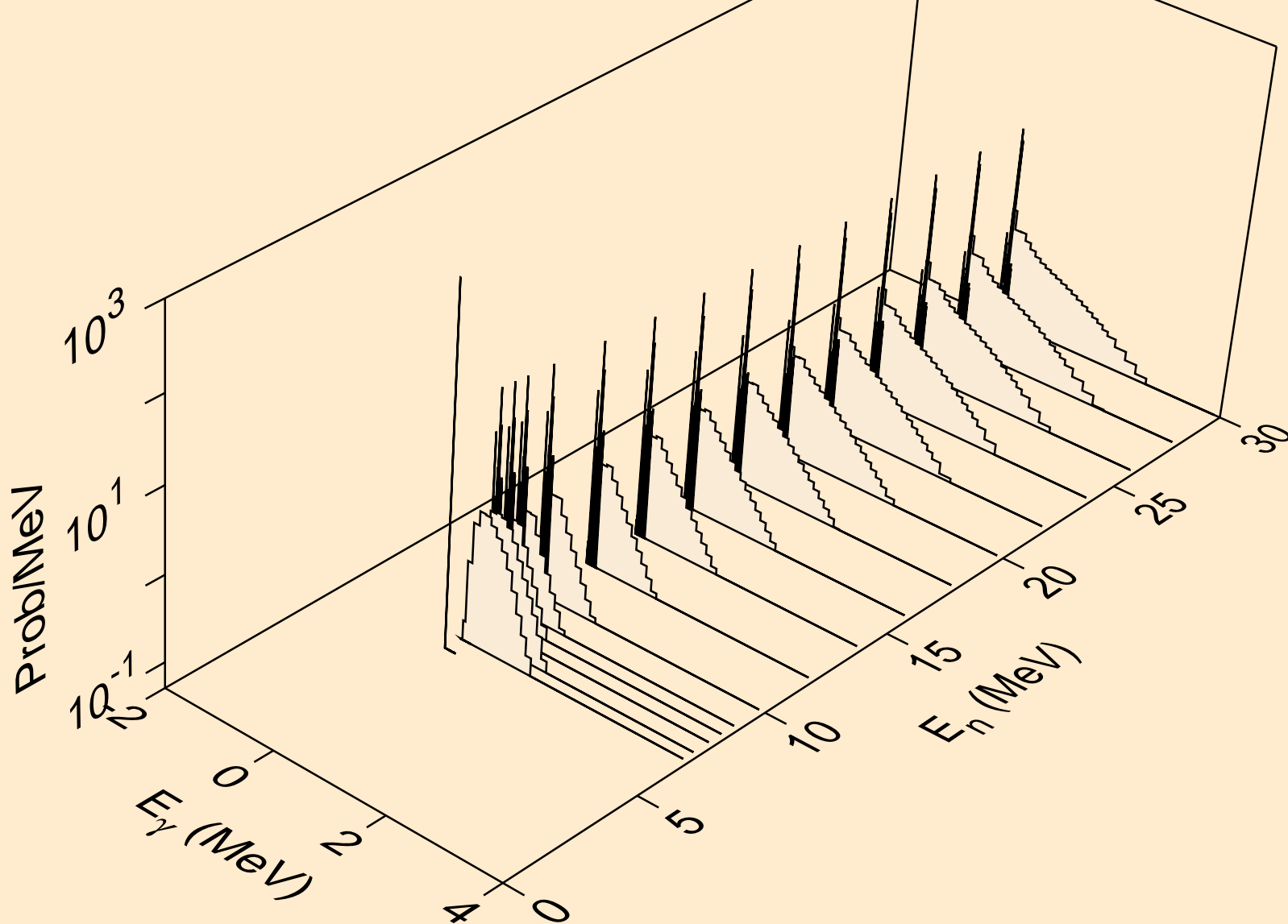

PB189M NEUTRON ACER TENDL-2019 LIBRARY; T=293.16K
thermal capture photon spectrum

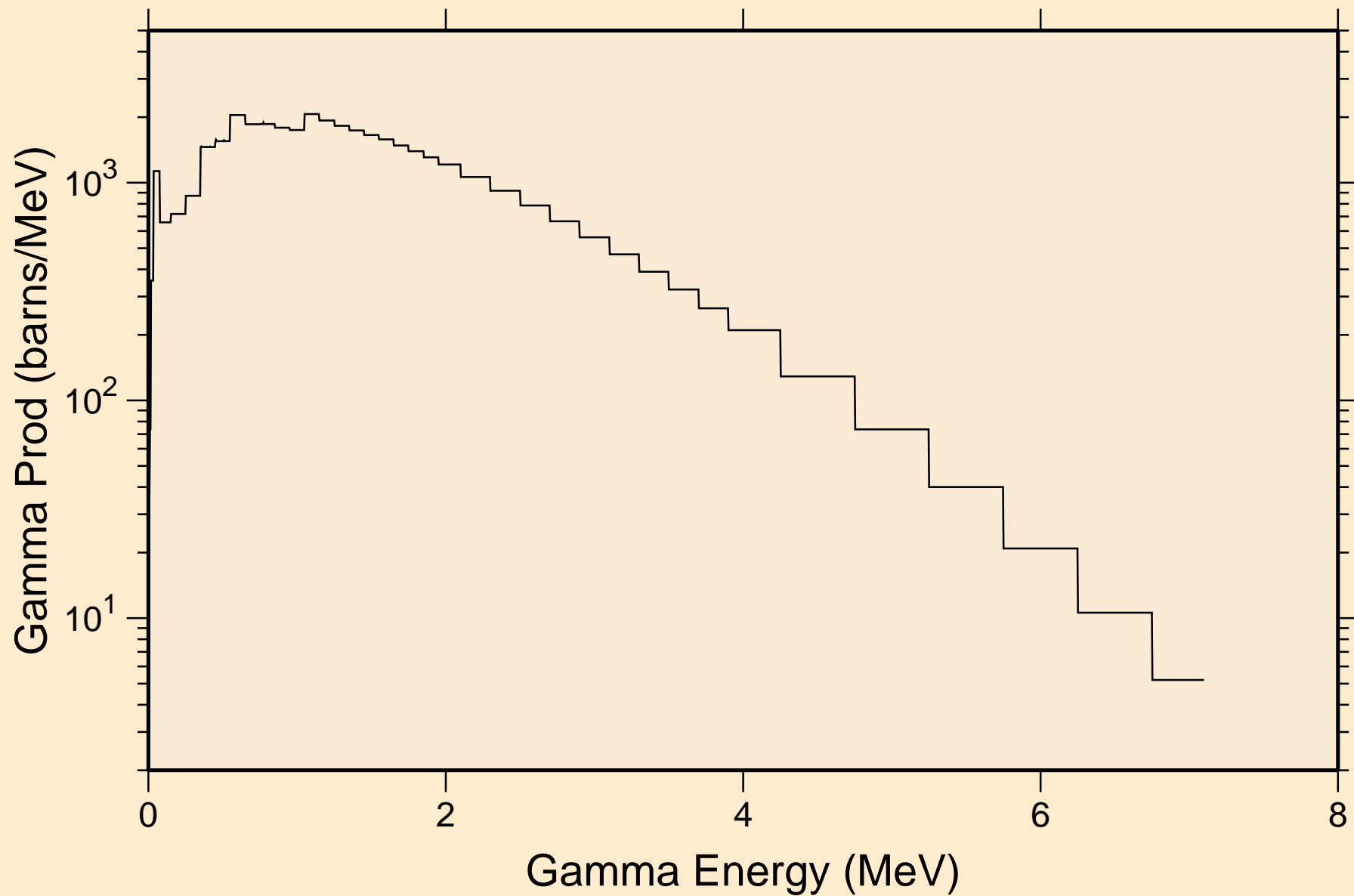

PB189M NEUTRON ACER TENDL-2019 LIBRARY; T=293.16K
14 MeV photon spectrum

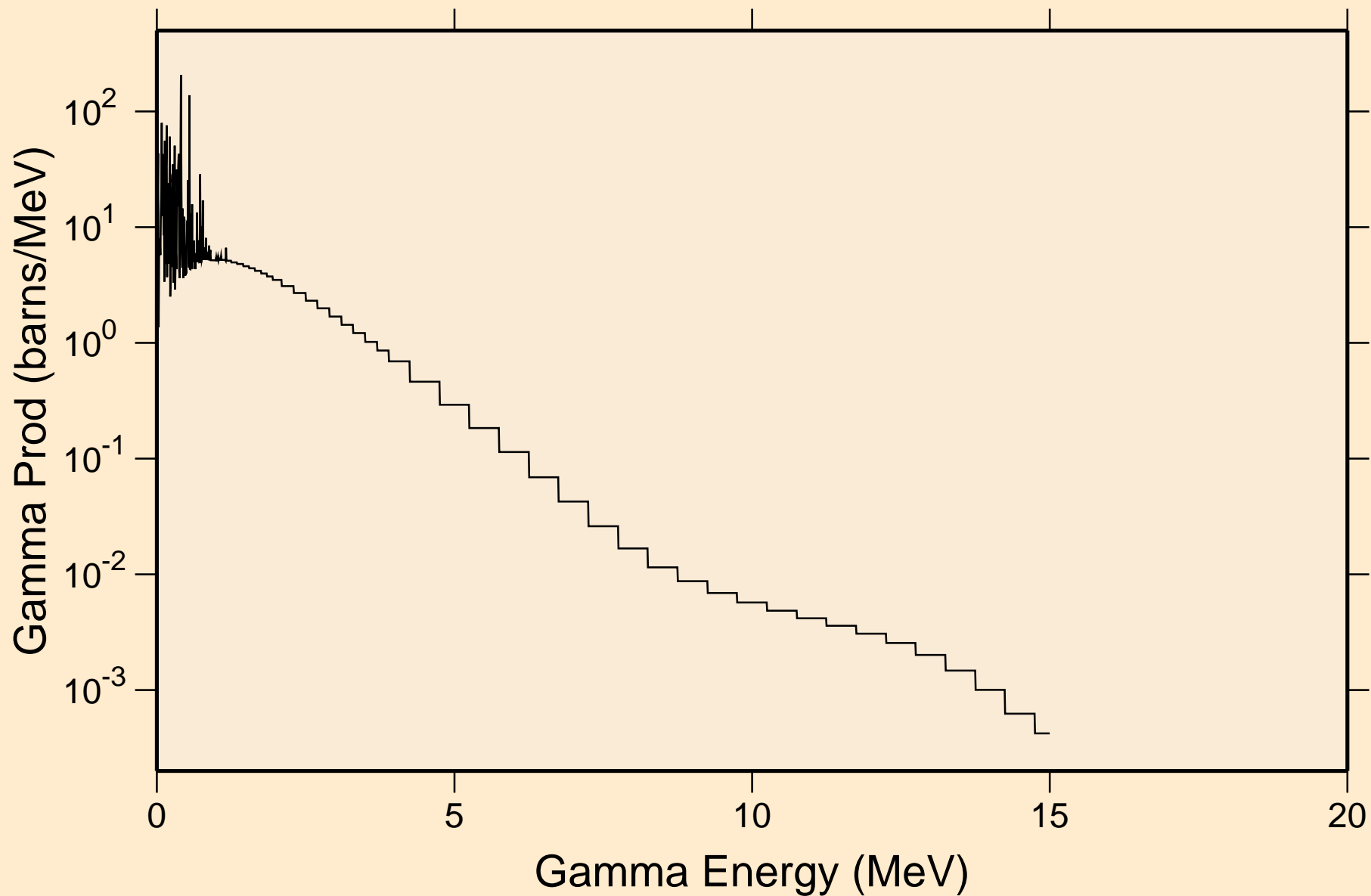

PB189M NEUTRON ACER TENDL-2019 LIBRARY; T=293.16K
Particle heating contributions

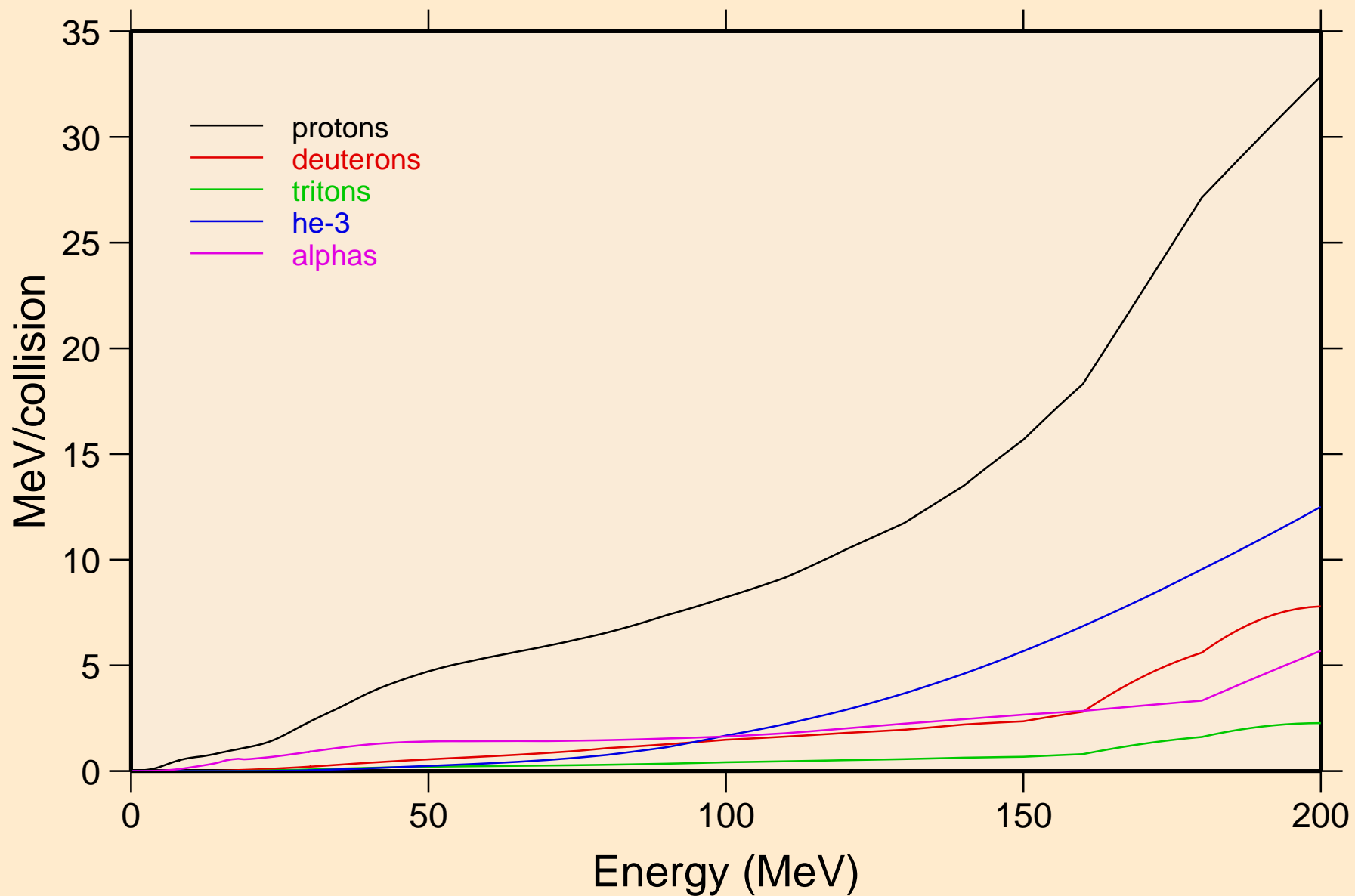

PB189M NEUTRON ACER TENDL-2019 LIBRARY; T=293.16K
Recoil Heating

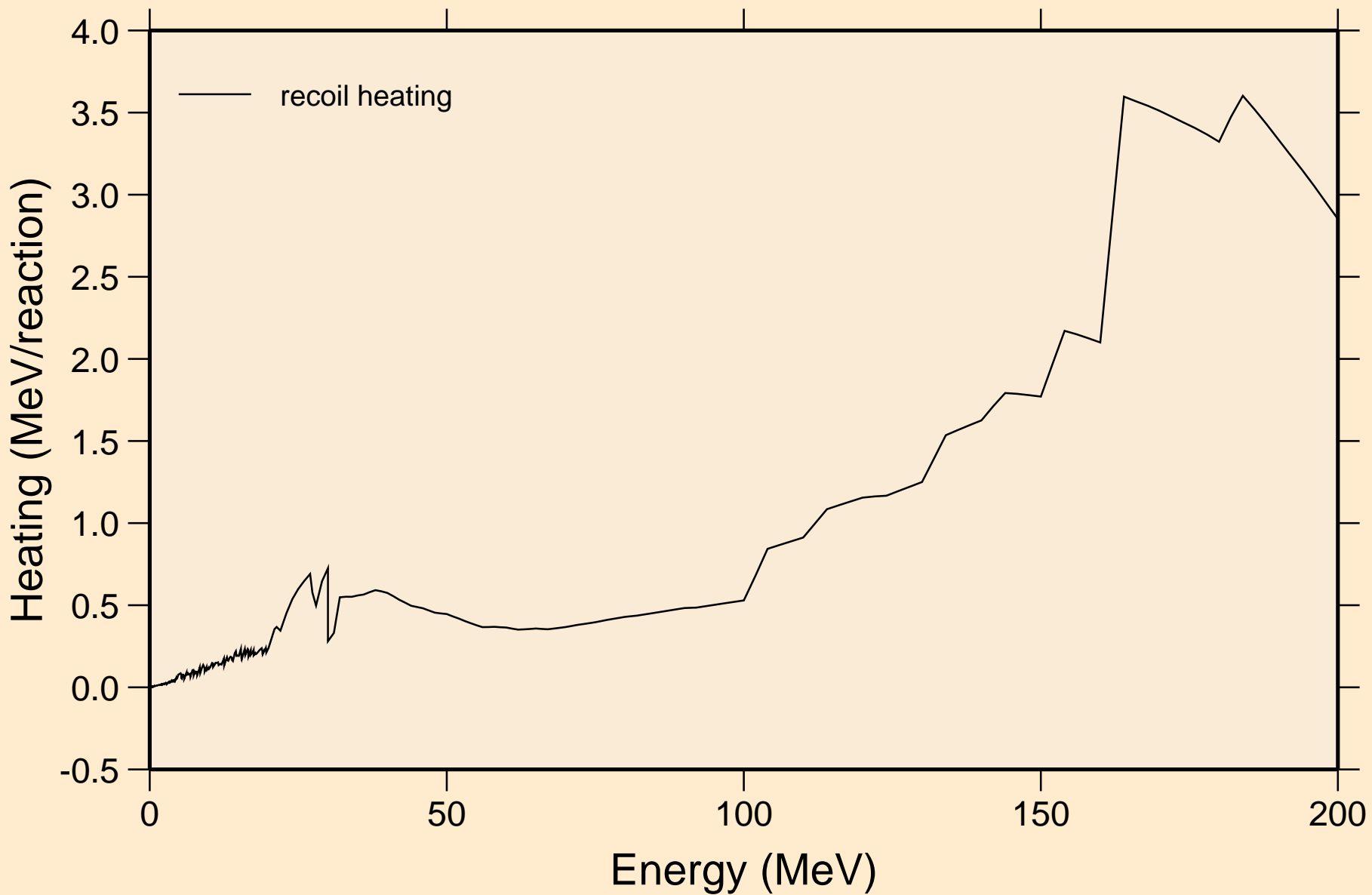

PB189M NEUTRON ACER TENDL-2019 LIBRARY; T=293.16K
Particle production cross sections

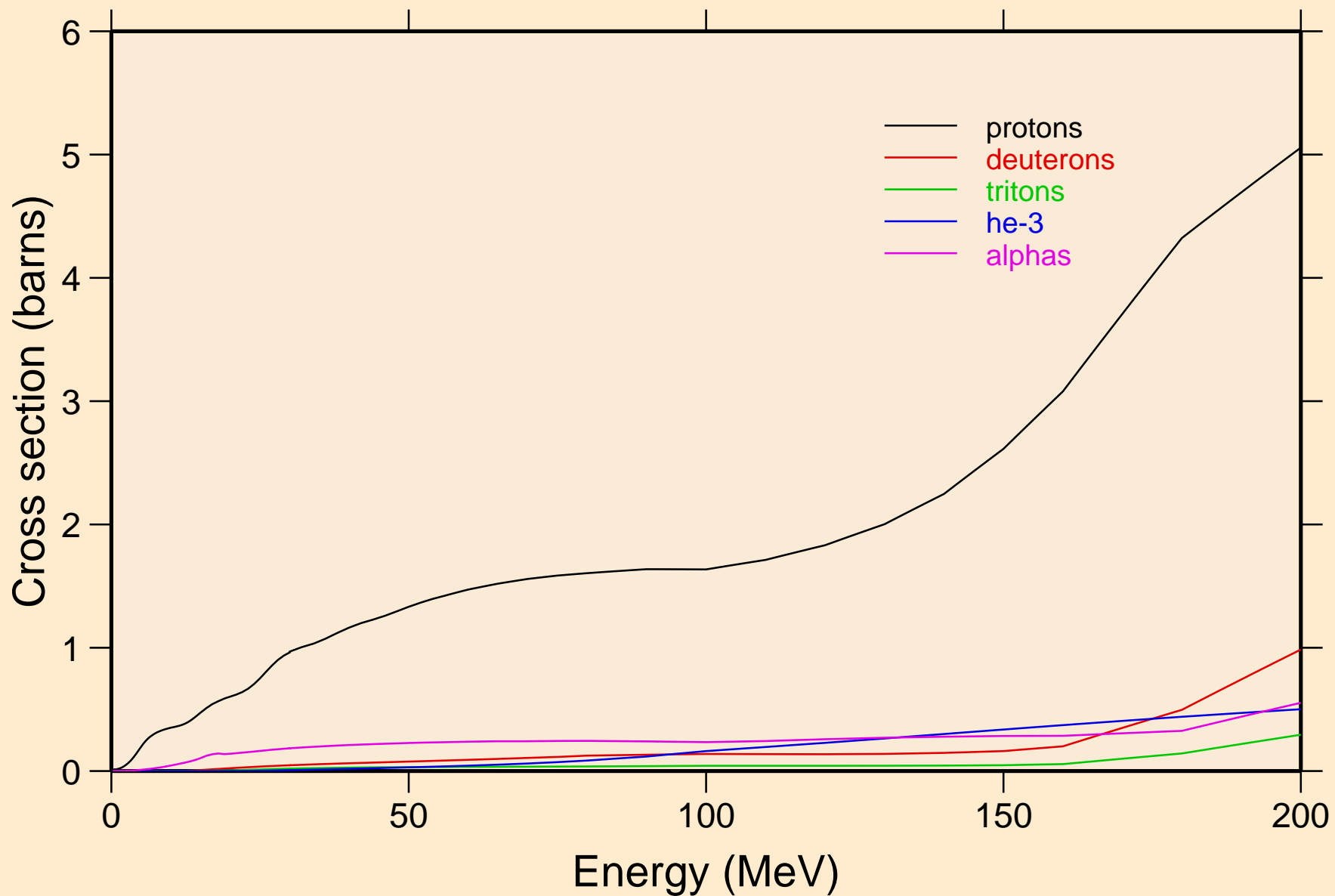

PB189M NEUTRON ACER TENDL-2019 LIBRARY; T=293.16K
protons from (n,x)

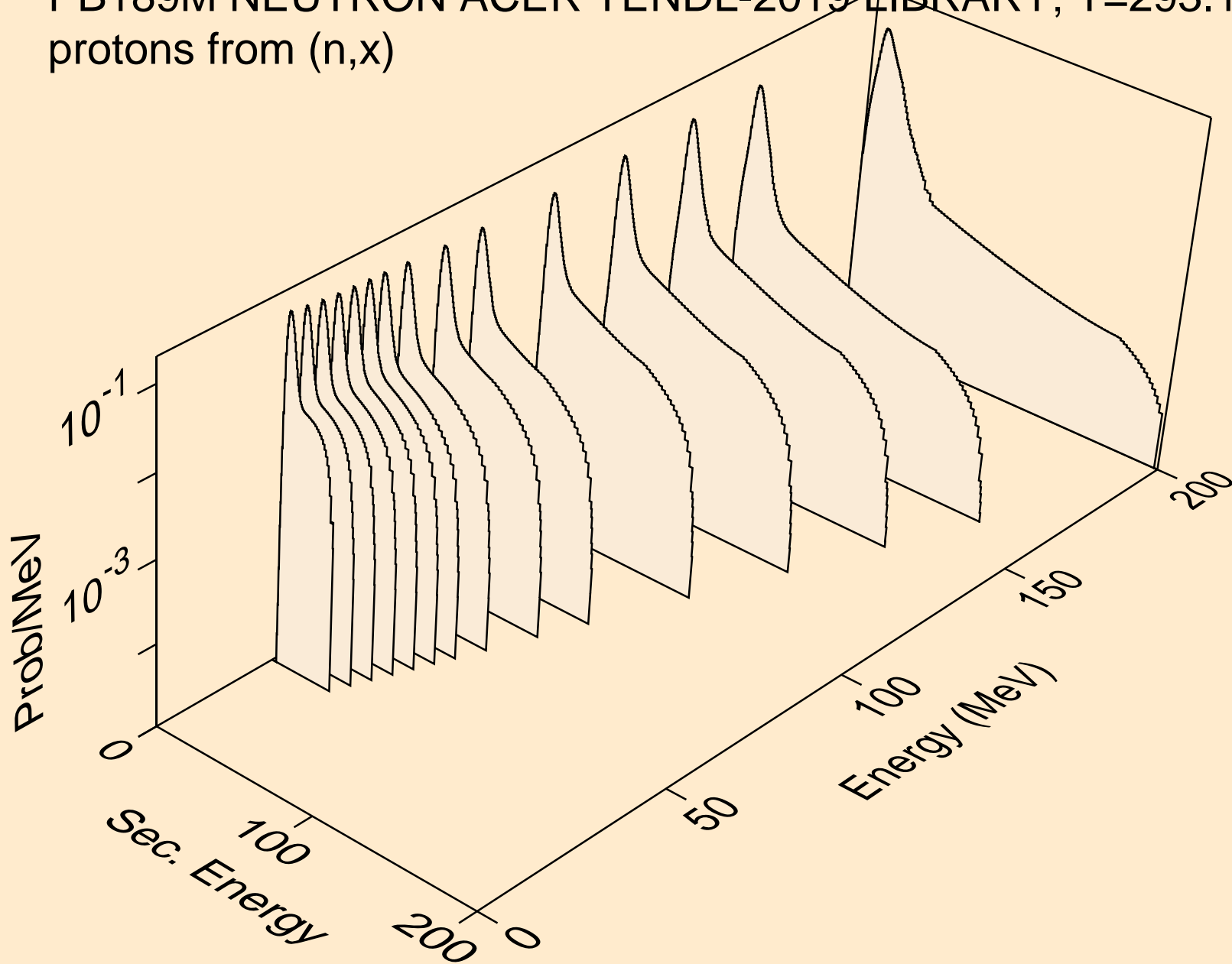

PB189M NEUTRON ACER TENDL-2019 LIBRARY; T=293.16K
protons from (n,n*)p

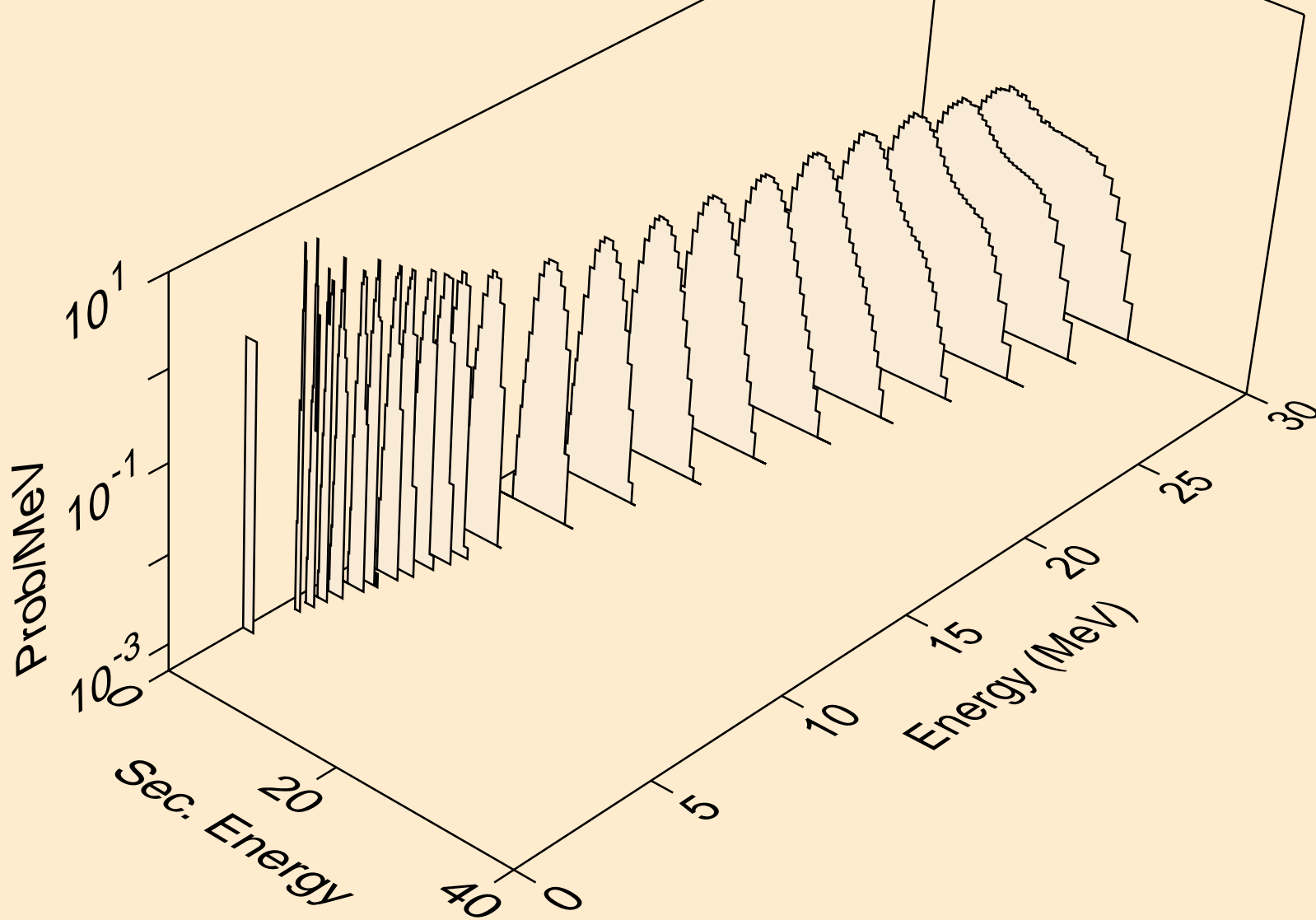

PB189M NEUTRON ACER TENDL-2019 LIBRARY; T=293.16K
protons from (n,2np)

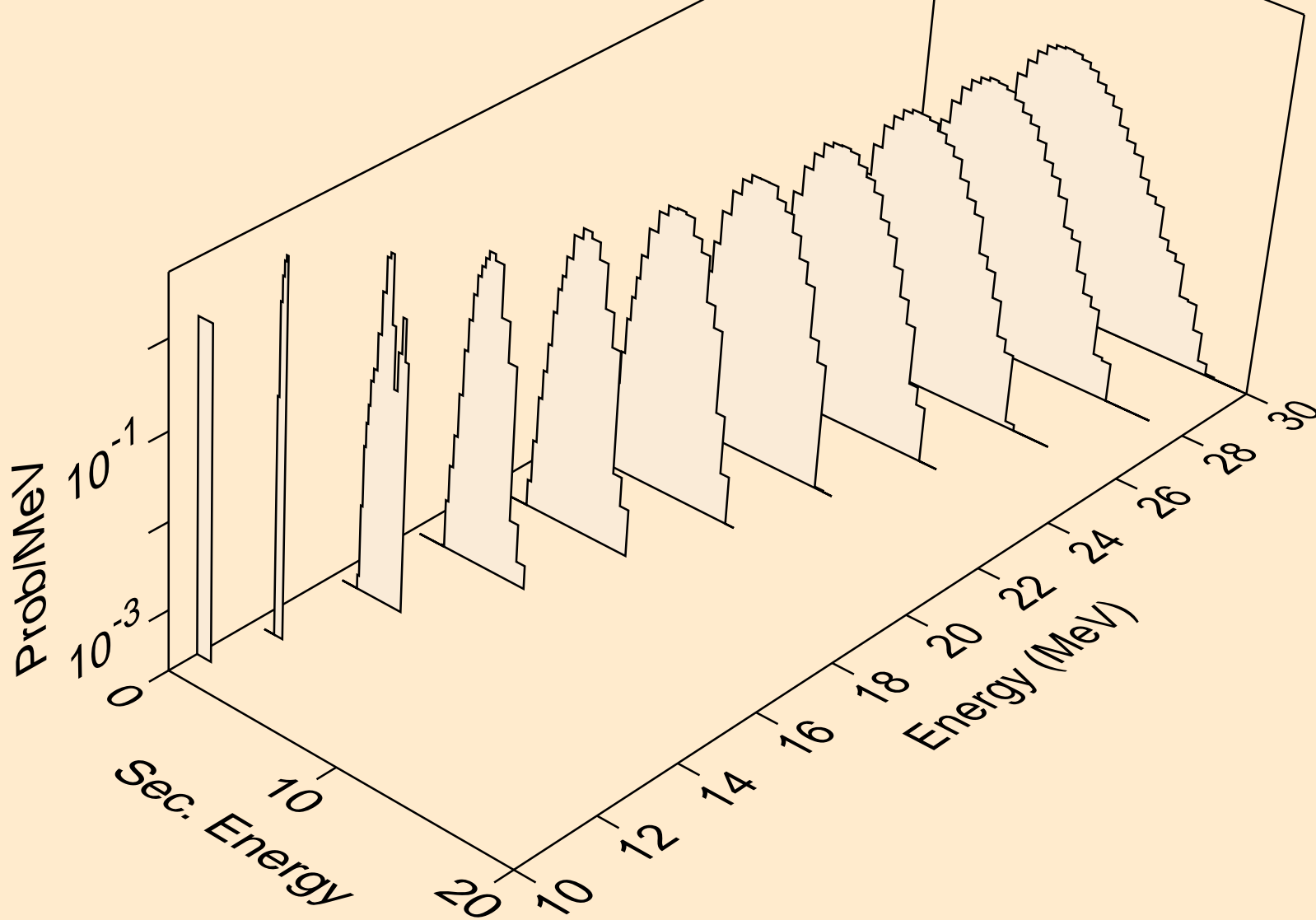

PB189M NEUTRON ACER TENDL-2019 LIBRARY; T=293.16K
protons from (n,3np)

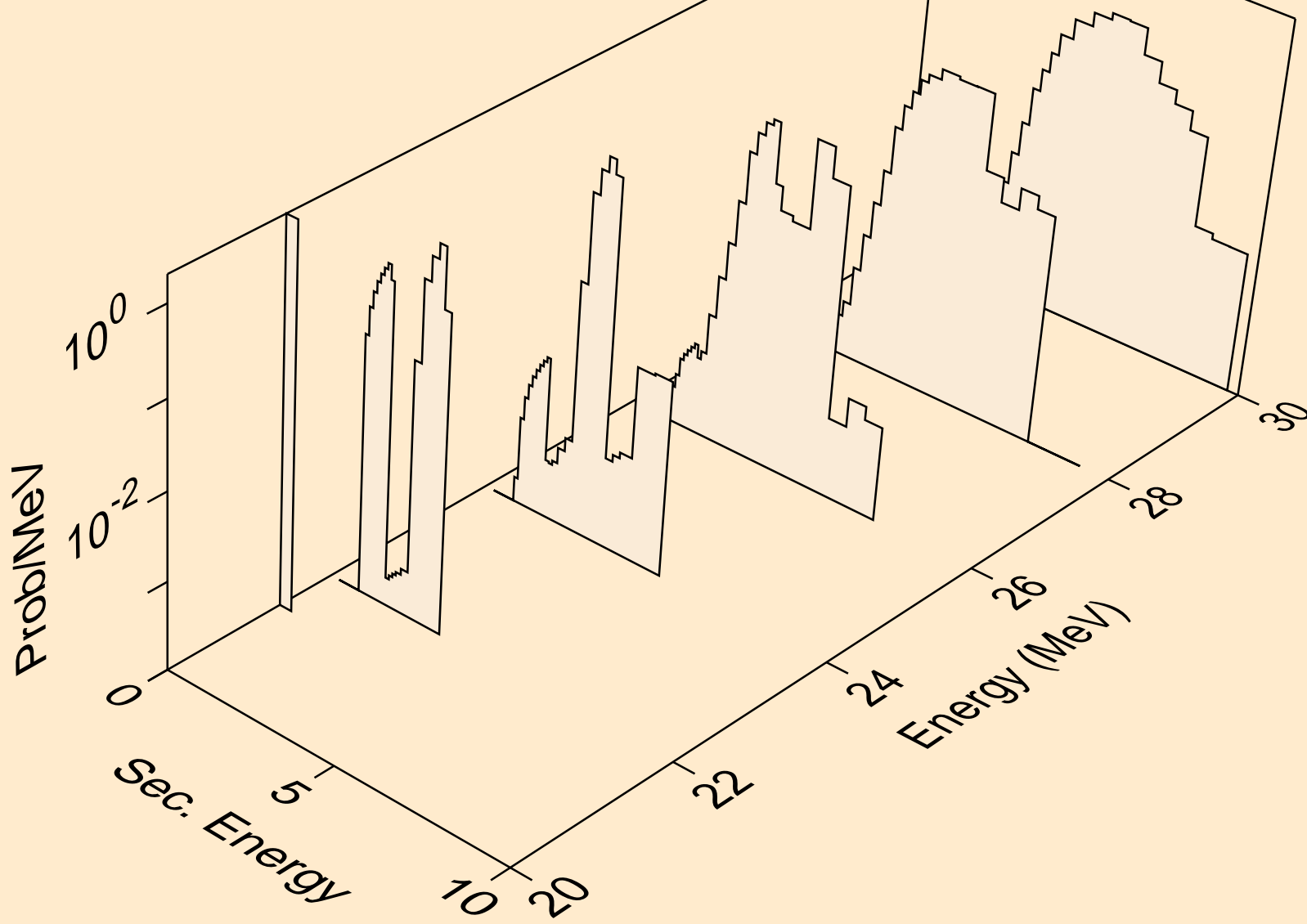

PB189M NEUTRON ACER TENDL-2019 LIBRARY; T=293.16K
protons from (n,2np)

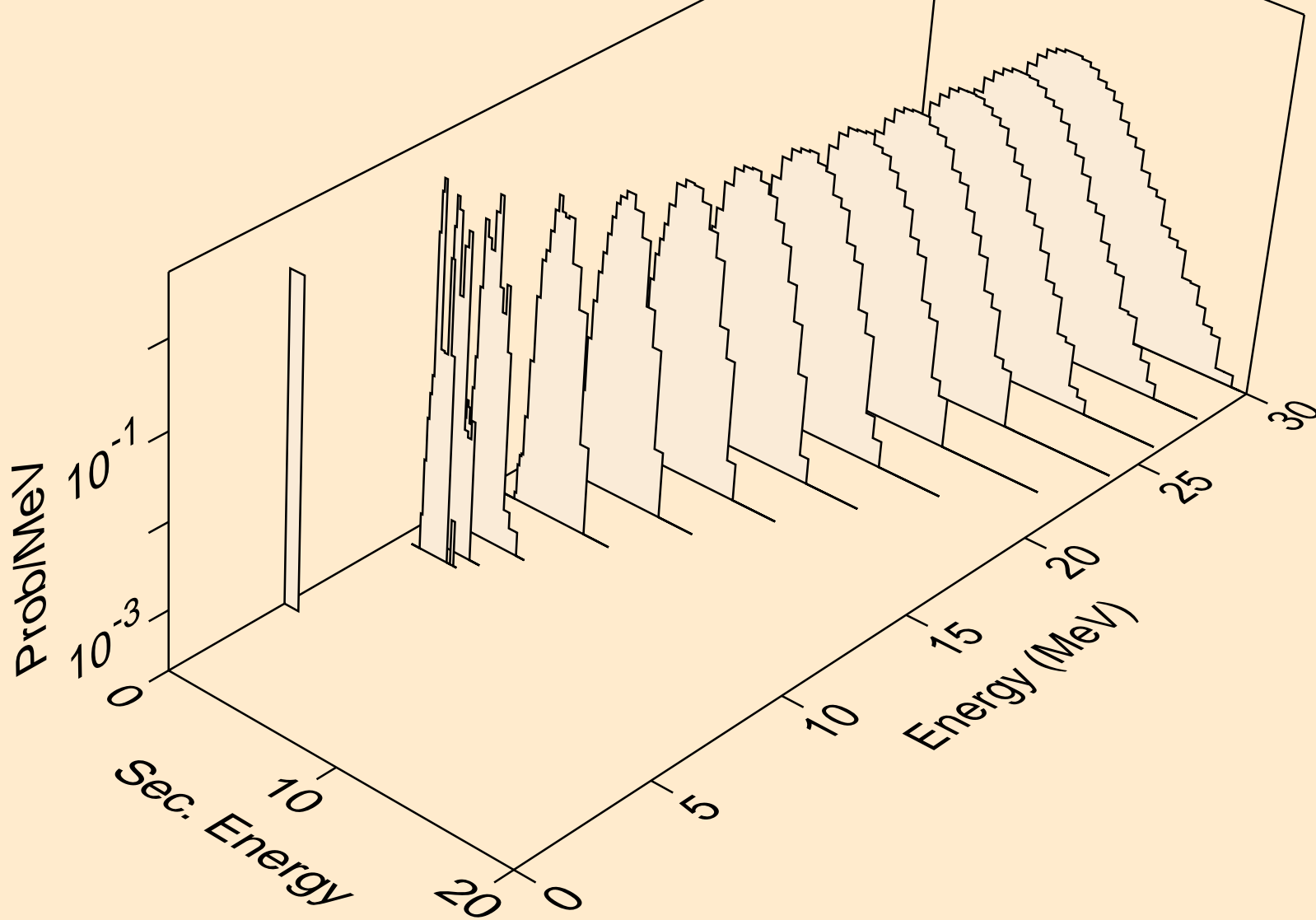

PB189M NEUTRON ACER TENDL-2019 LIBRARY; T=293.16K
protons from (n,npa)

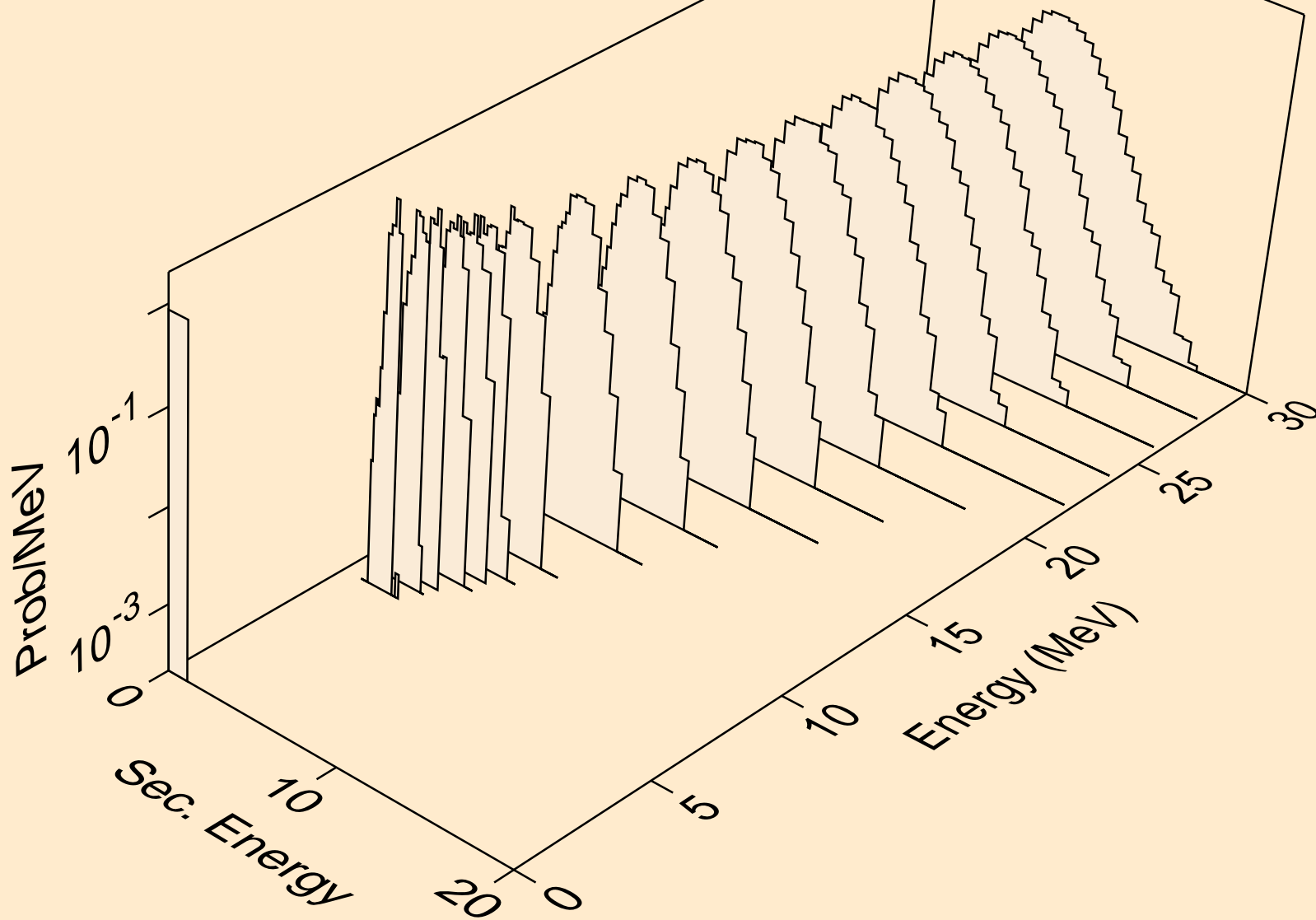

PB189M NEUTRON ACER TENDL-2019 LIBRARY; T=293.16K
protons from (n,p)

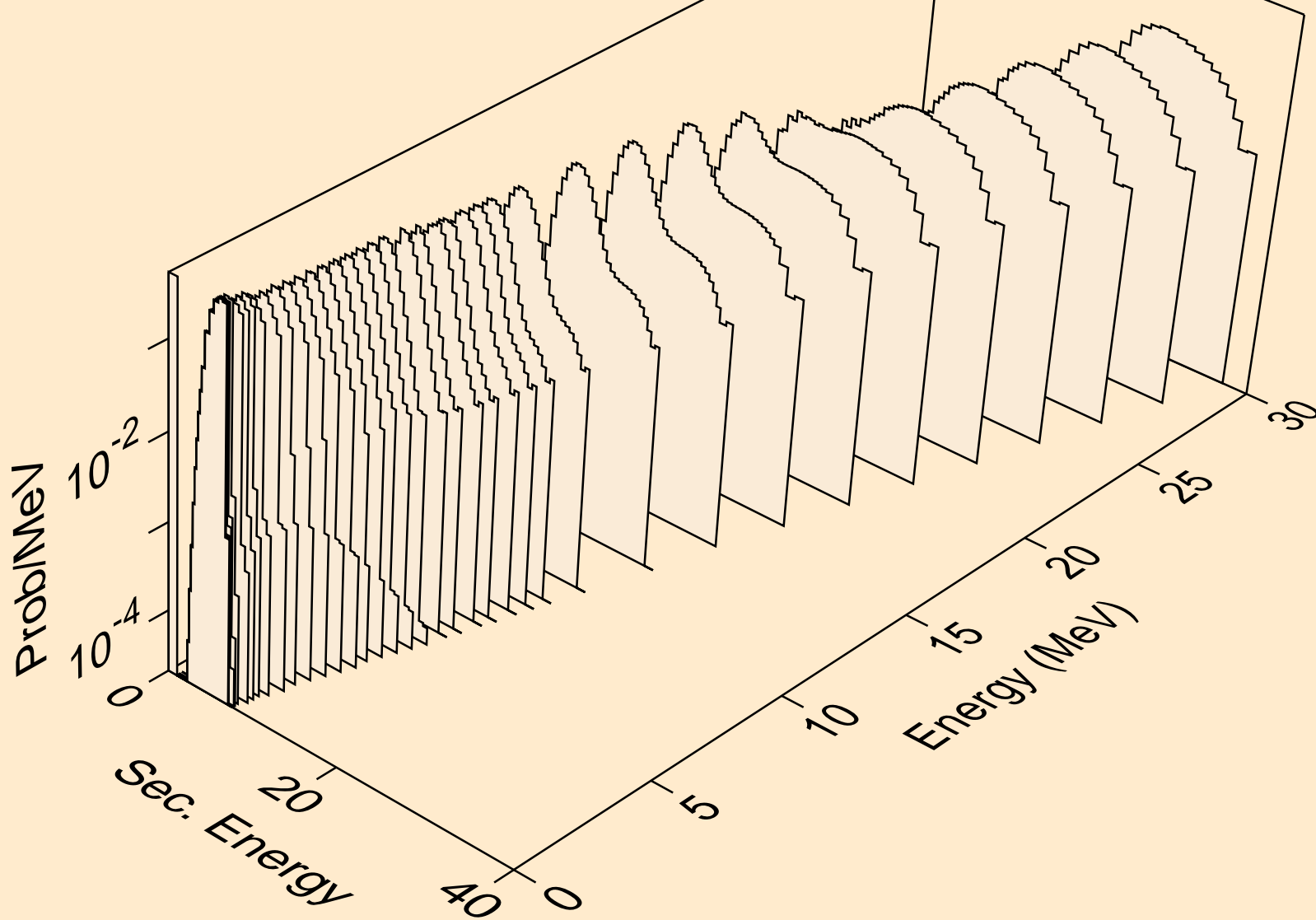

PB189M NEUTRON ACER TENDL-2019 LIBRARY; T=293.16K
protons from (n,2p)

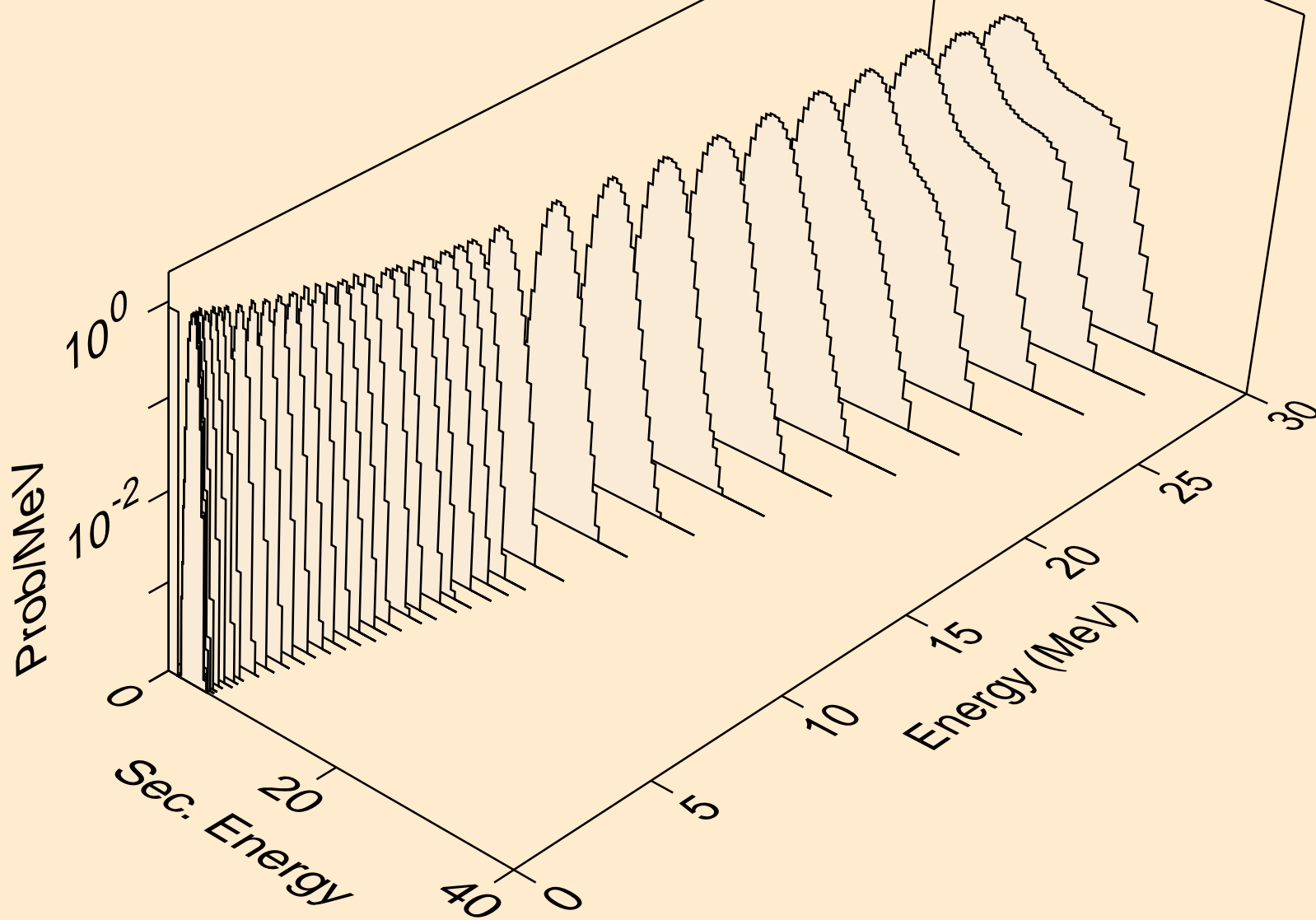

PB189M NEUTRON ACER TENDL-2019 LIBRARY; T=293.16K
protons from (n,p)

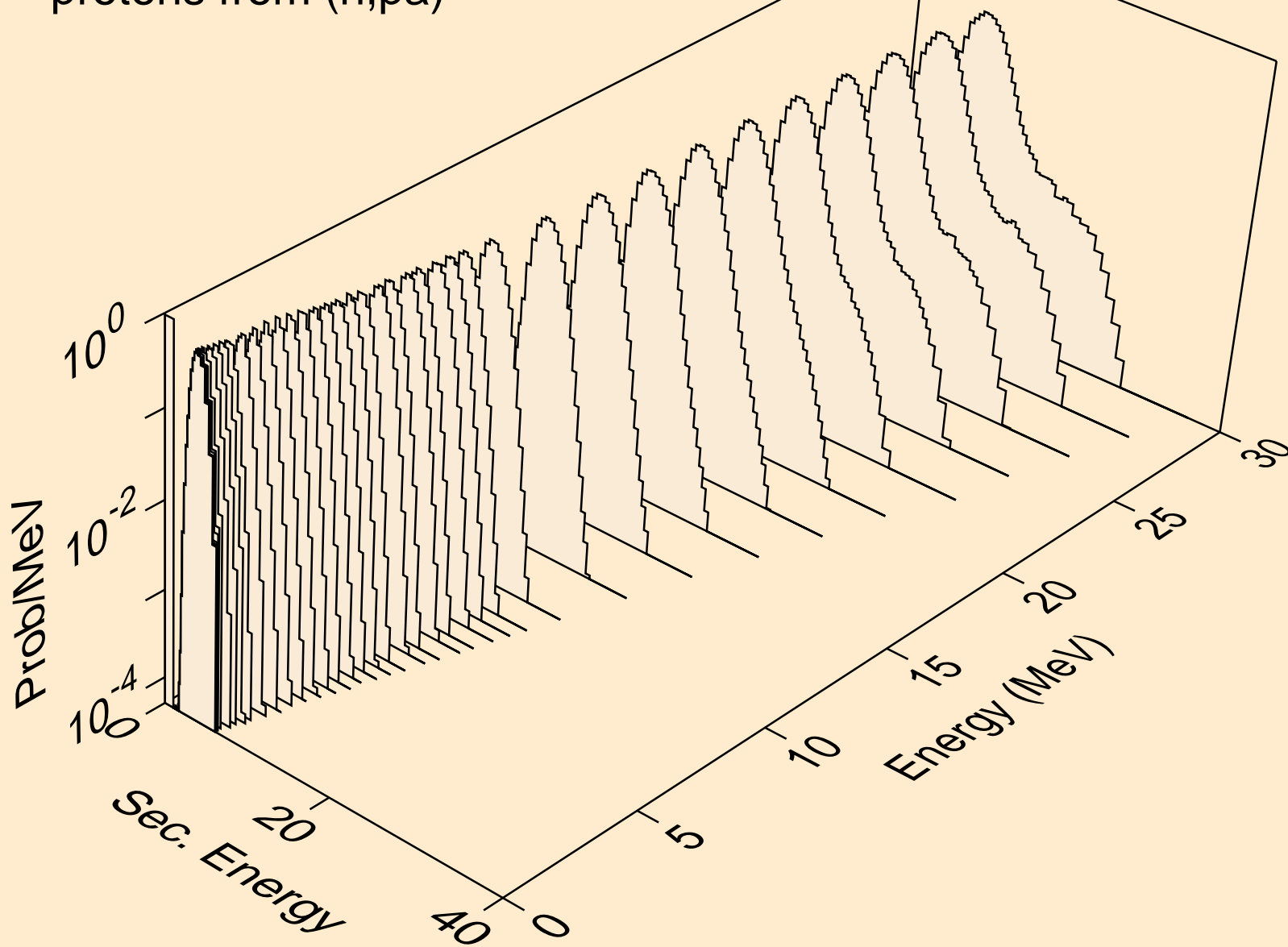

PB189M NEUTRON ACER TENDL-2019 LIBRARY; T=293.16K
protons from (n,pd)

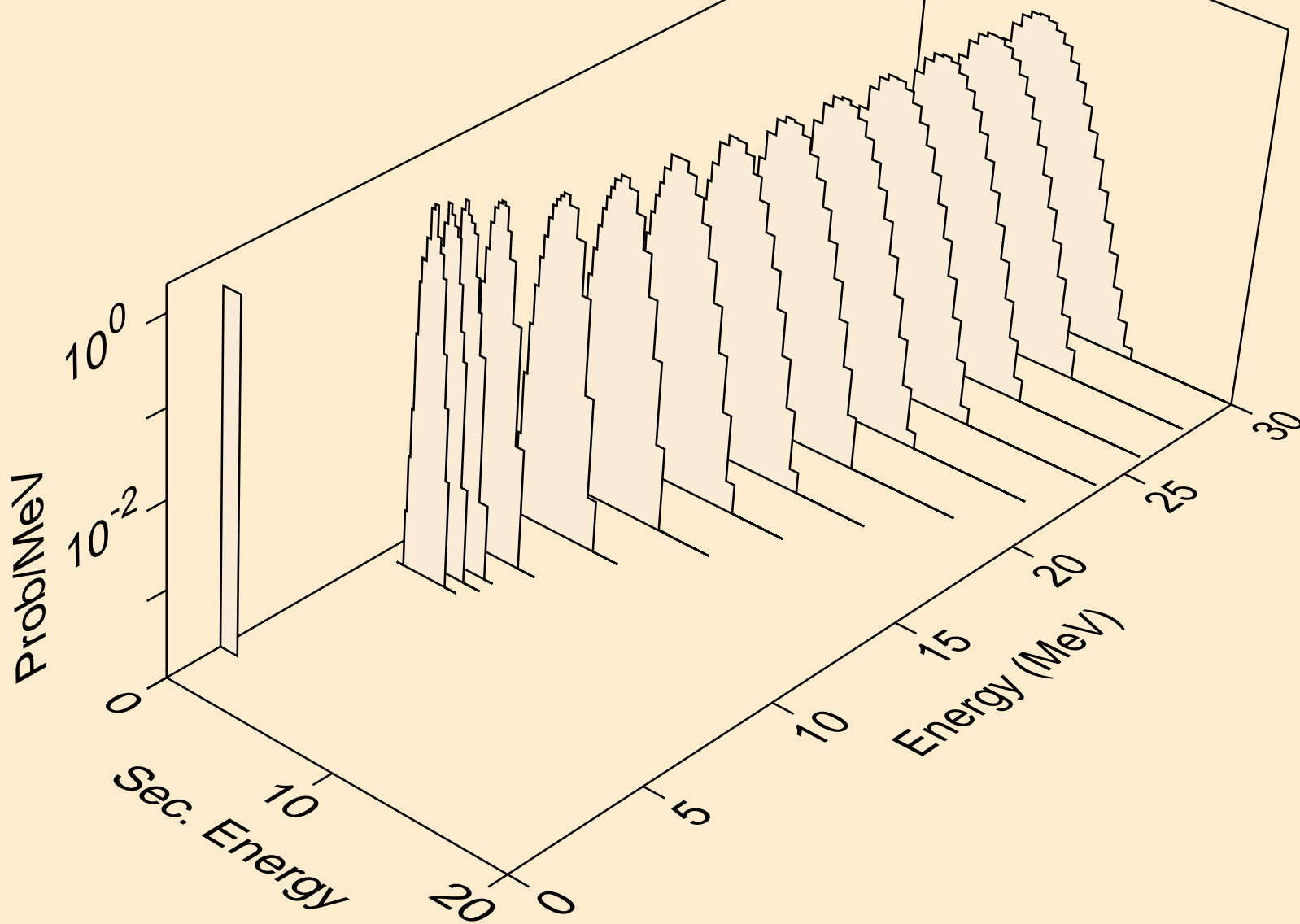

PB189M NEUTRON ACER TENDL-2019 LIBRARY; T=293.16K
protons from (n,pt)

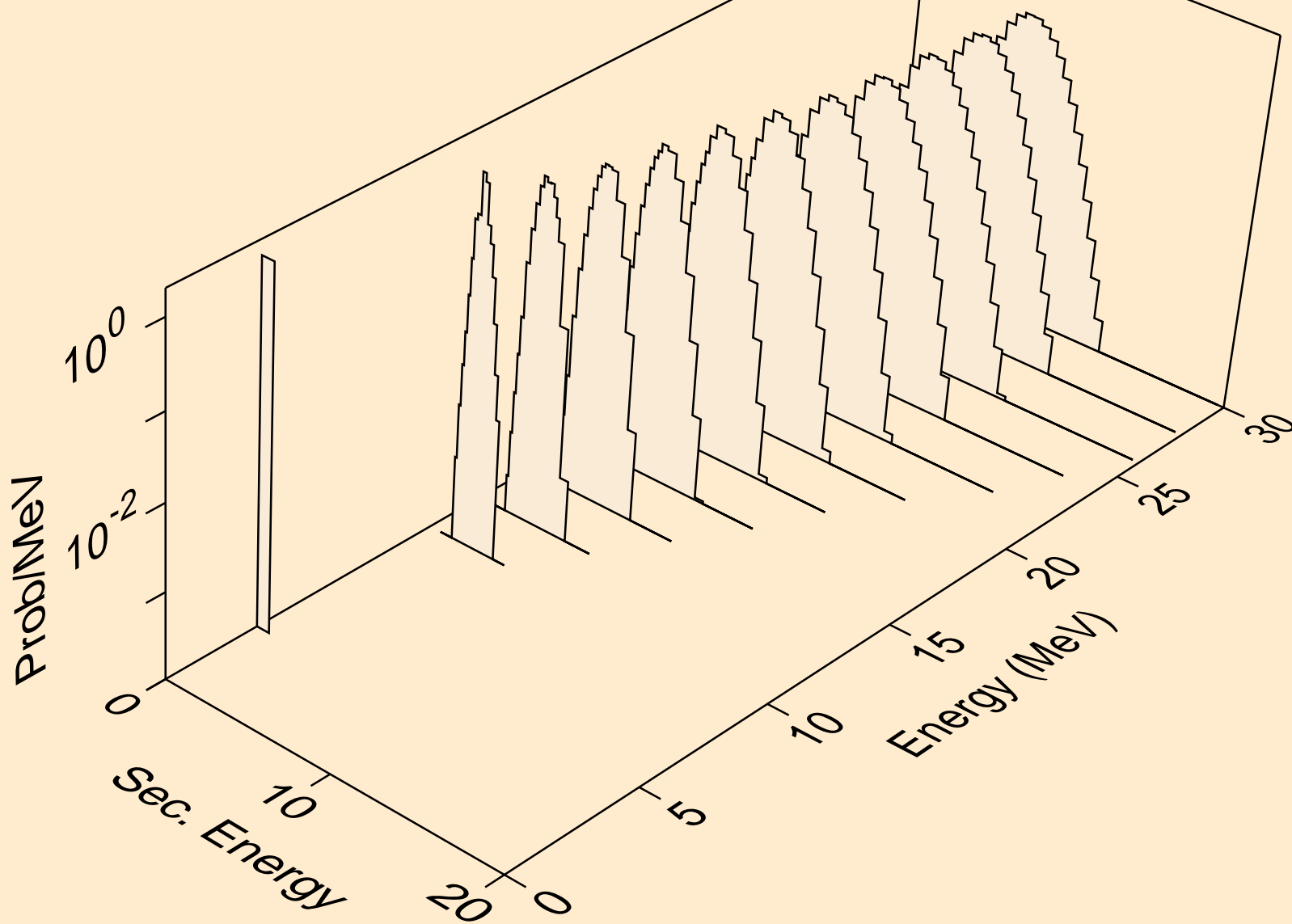

PB189M NEUTRON ACER TENDL-2019 LIBRARY; T=293.16K
deuterons from (n,x)

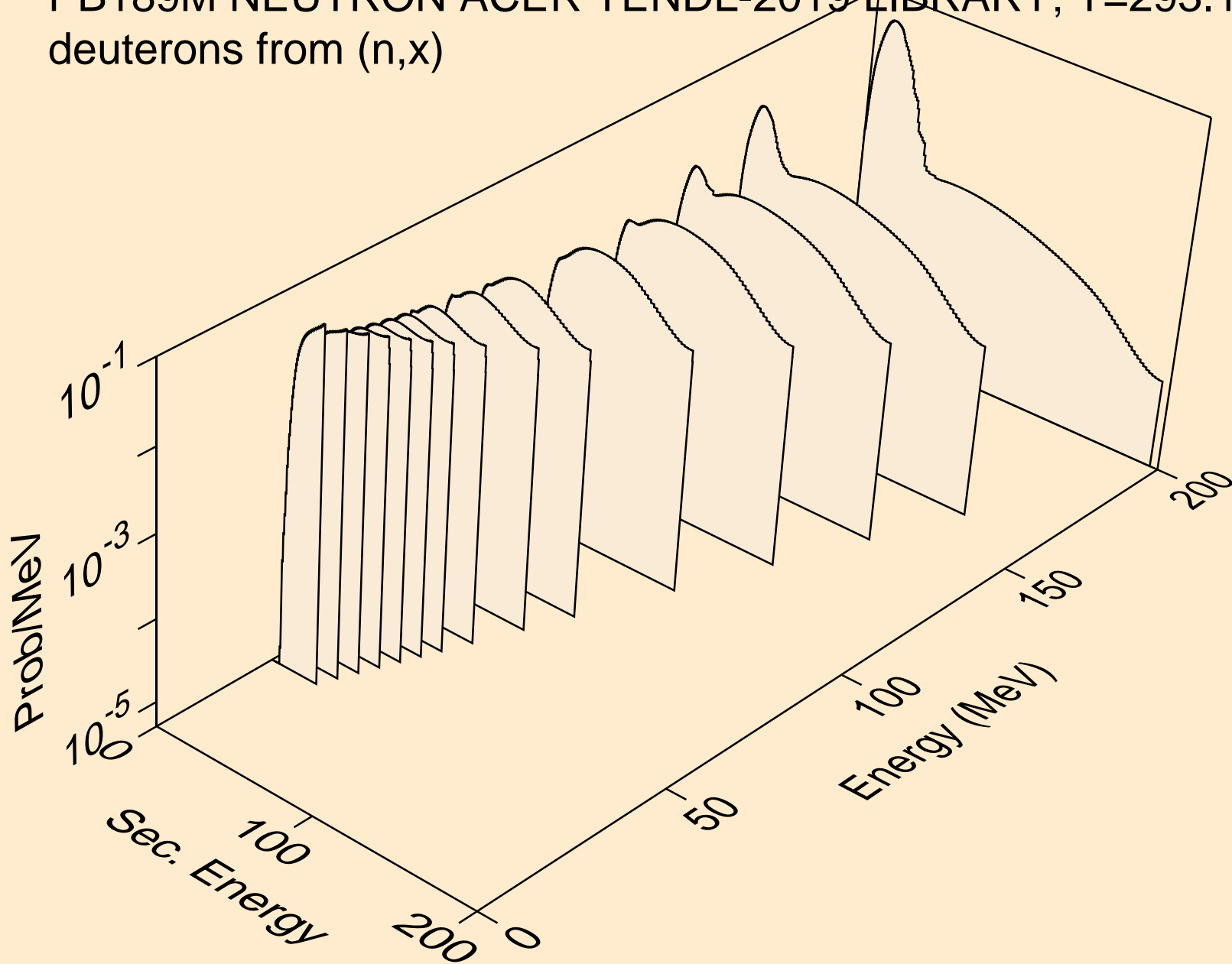

PB189M NEUTRON ACER TENDL-2019 LIBRARY; T=293.16K
deuterons from (n,2nd)

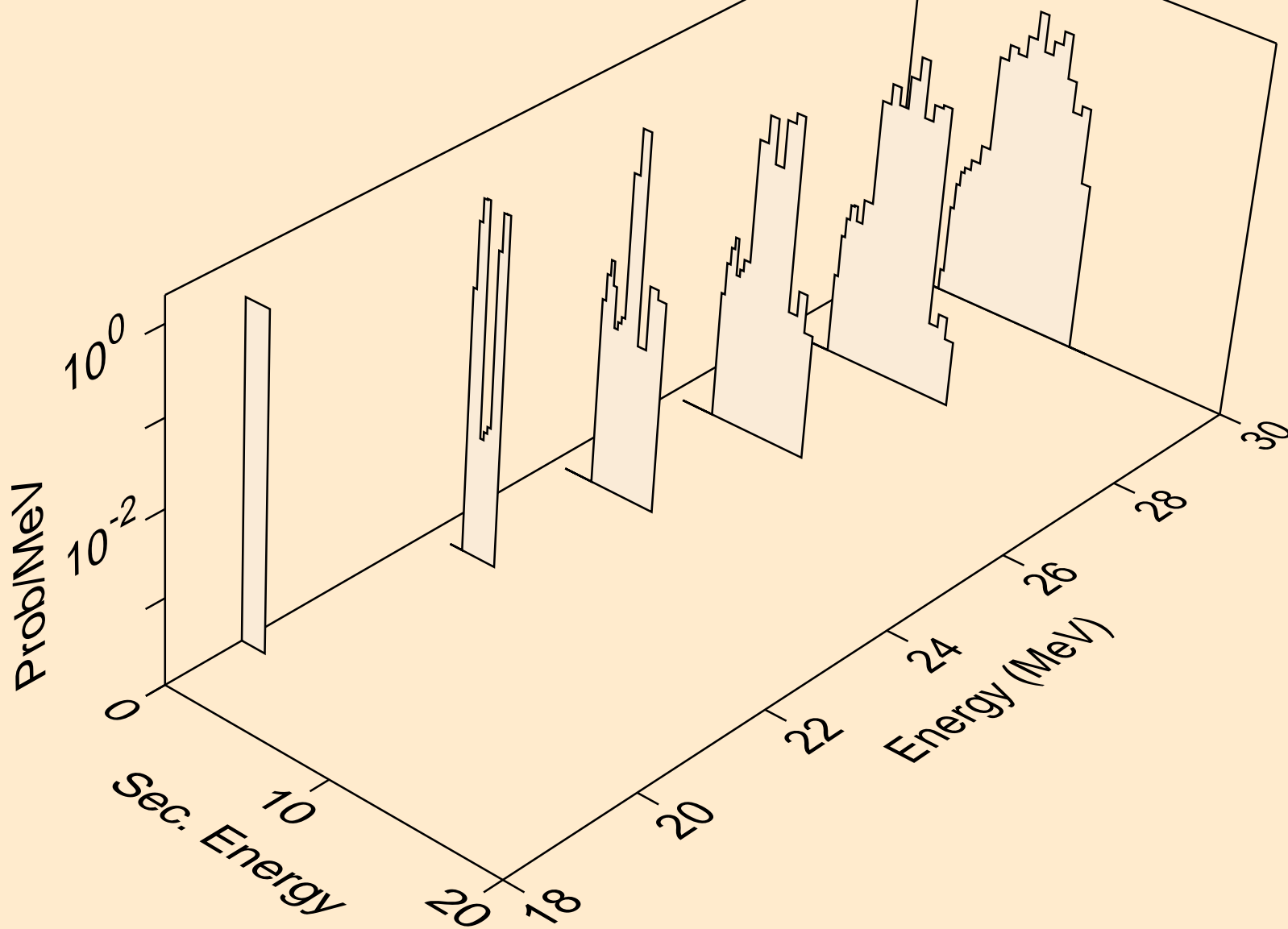

PB189M NEUTRON ACER TENDL-2019 LIBRARY; T=293.16K
deuterons from (n,n*)d

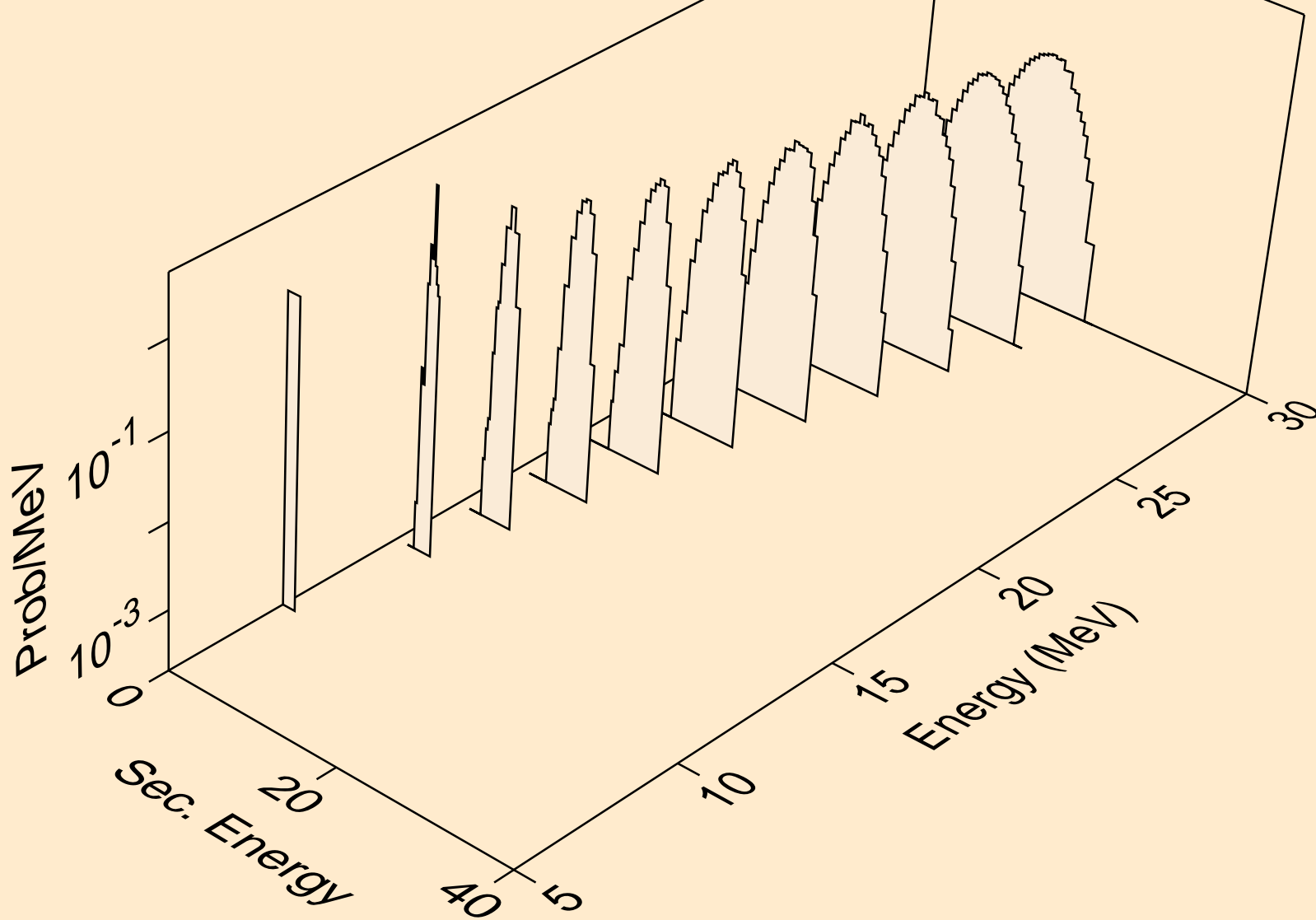

PB189M NEUTRON ACER TENDL-2019 LIBRARY; T=293.16K
deuterons from (n,d)

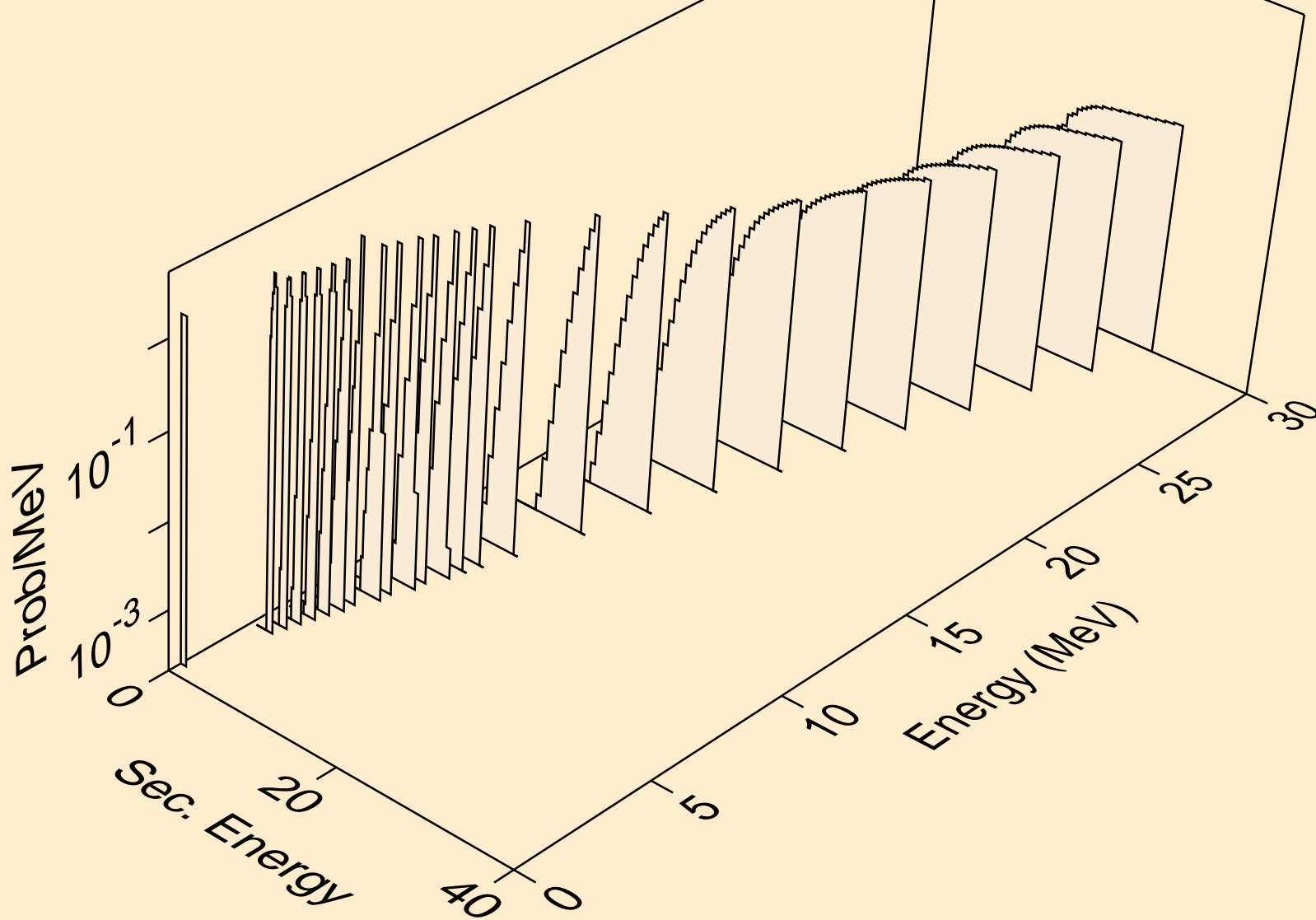

PB189M NEUTRON ACER TENDL-2019 LIBRARY; T=293.16K
deuterons from (n,pd)

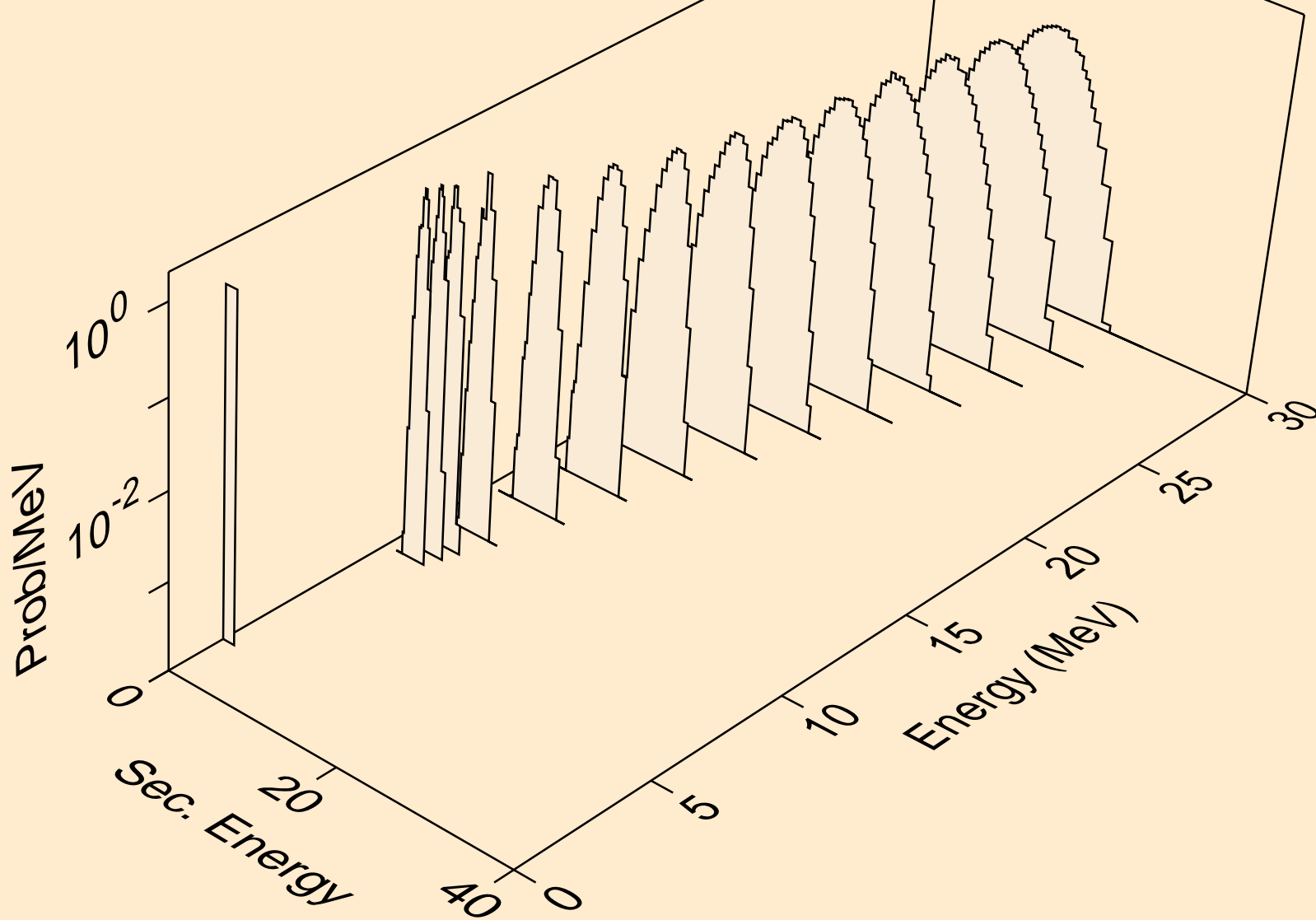

PB189M NEUTRON ACER TENDL-2019 LIBRARY; T=293.16K
deuterons from (n,da)

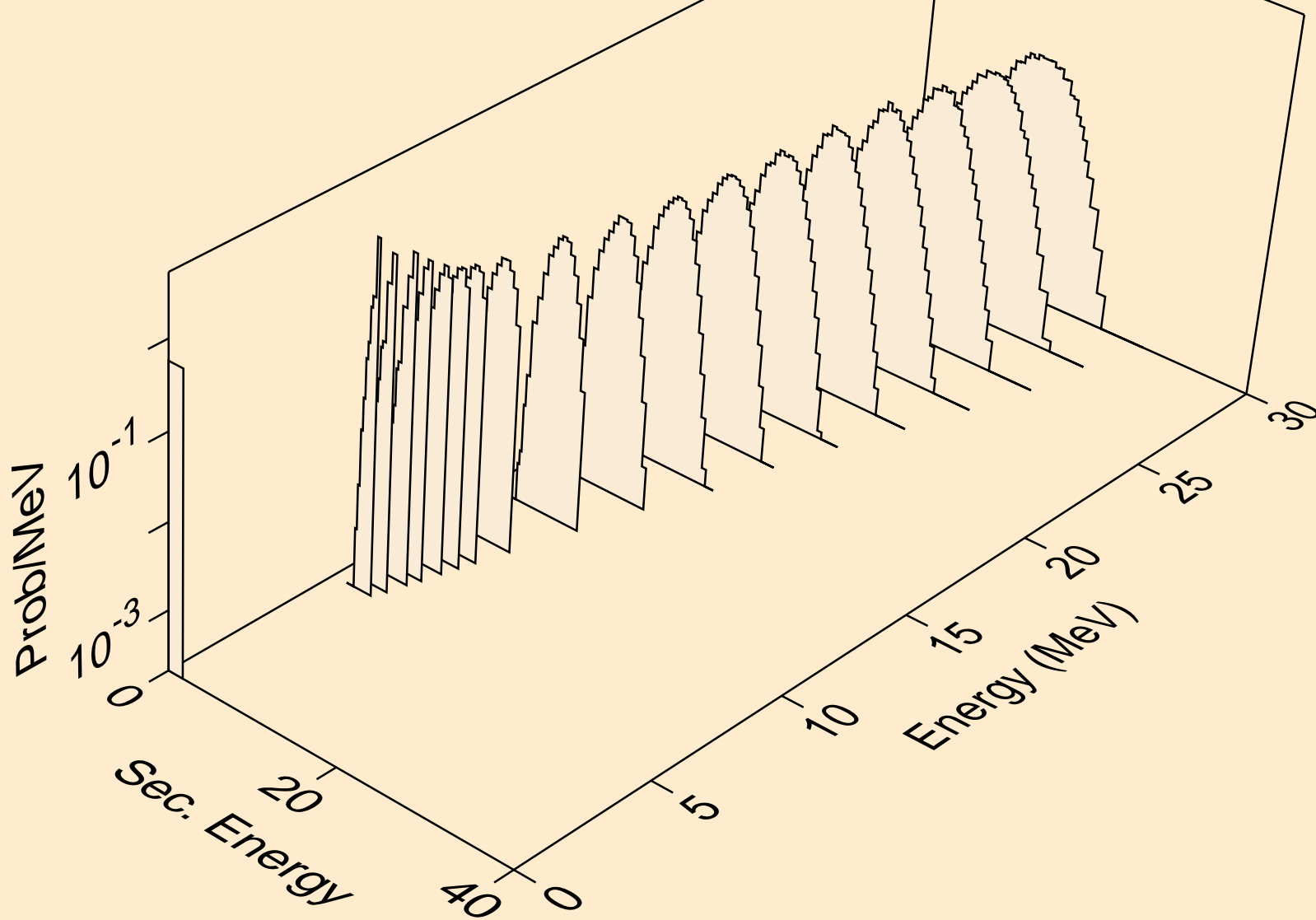

PB189M NEUTRON ACER TENDL-2019 LIBRARY; T=293.16K
tritons from (n,x)

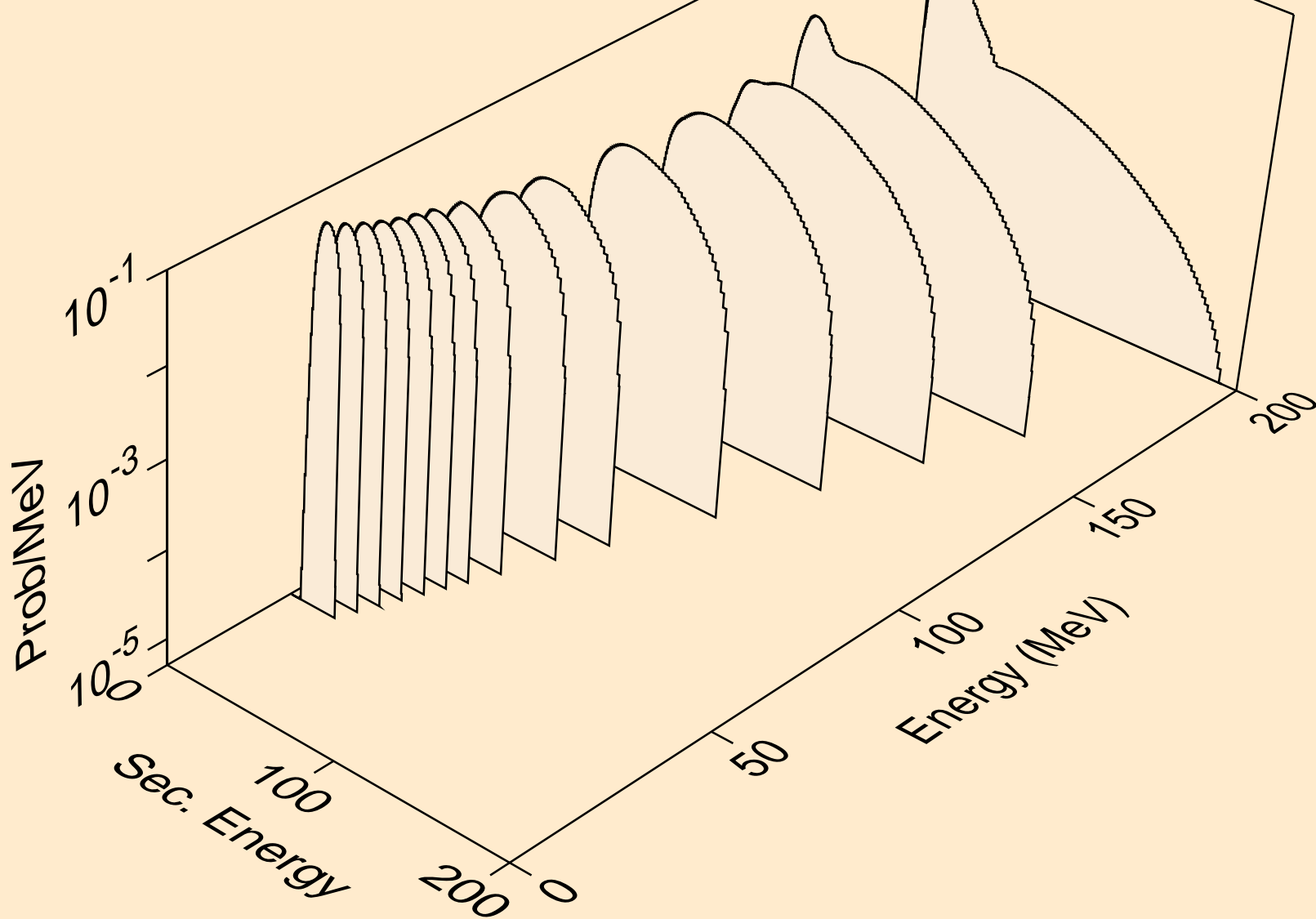

PB189M NEUTRON ACER TENDL-2019 LIBRARY; T=293.16K
tritons from (n,n*)t

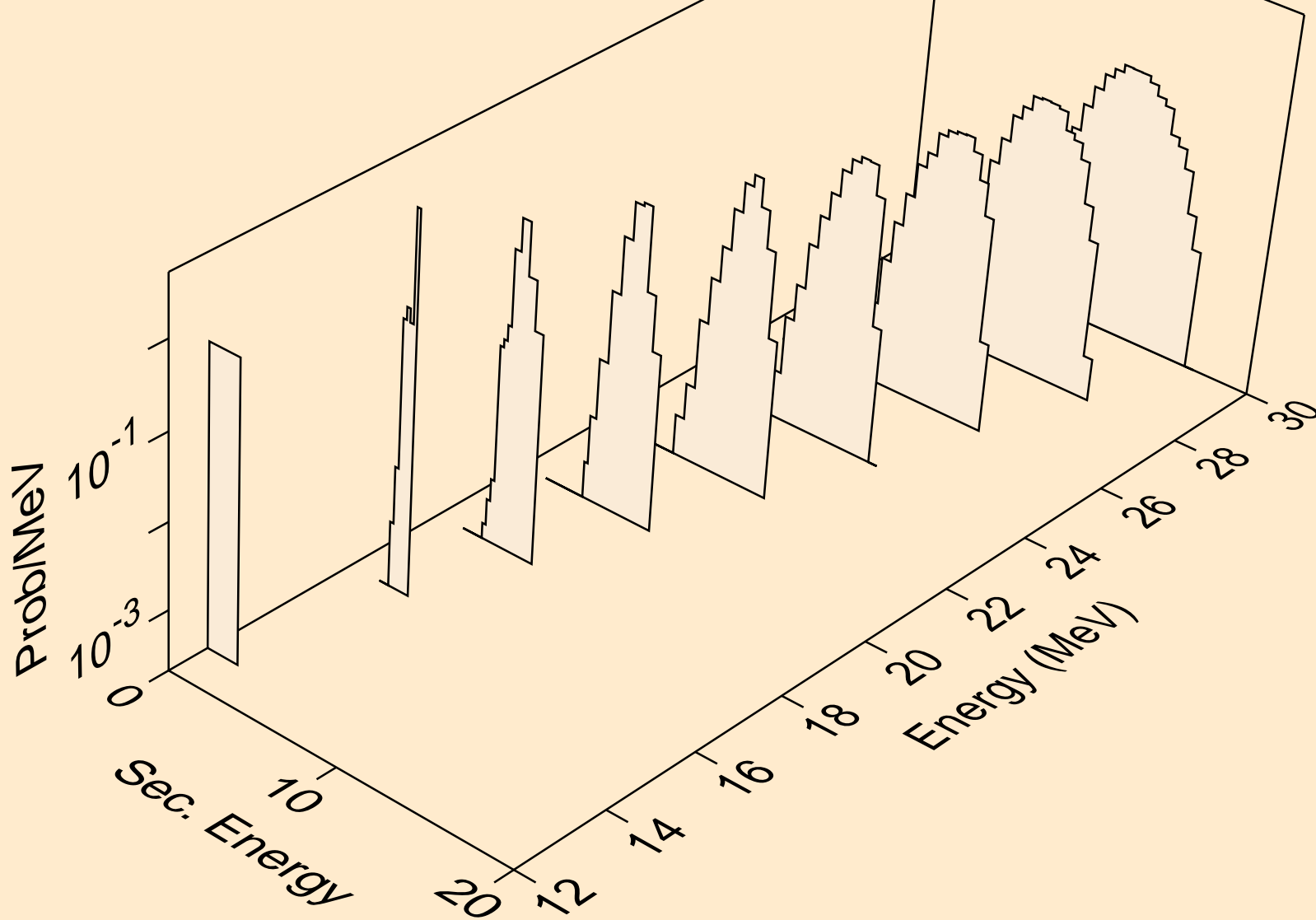

PB189M NEUTRON ACER TENDL-2019 LIBRARY; T=293.16K
tritons from (n,t)

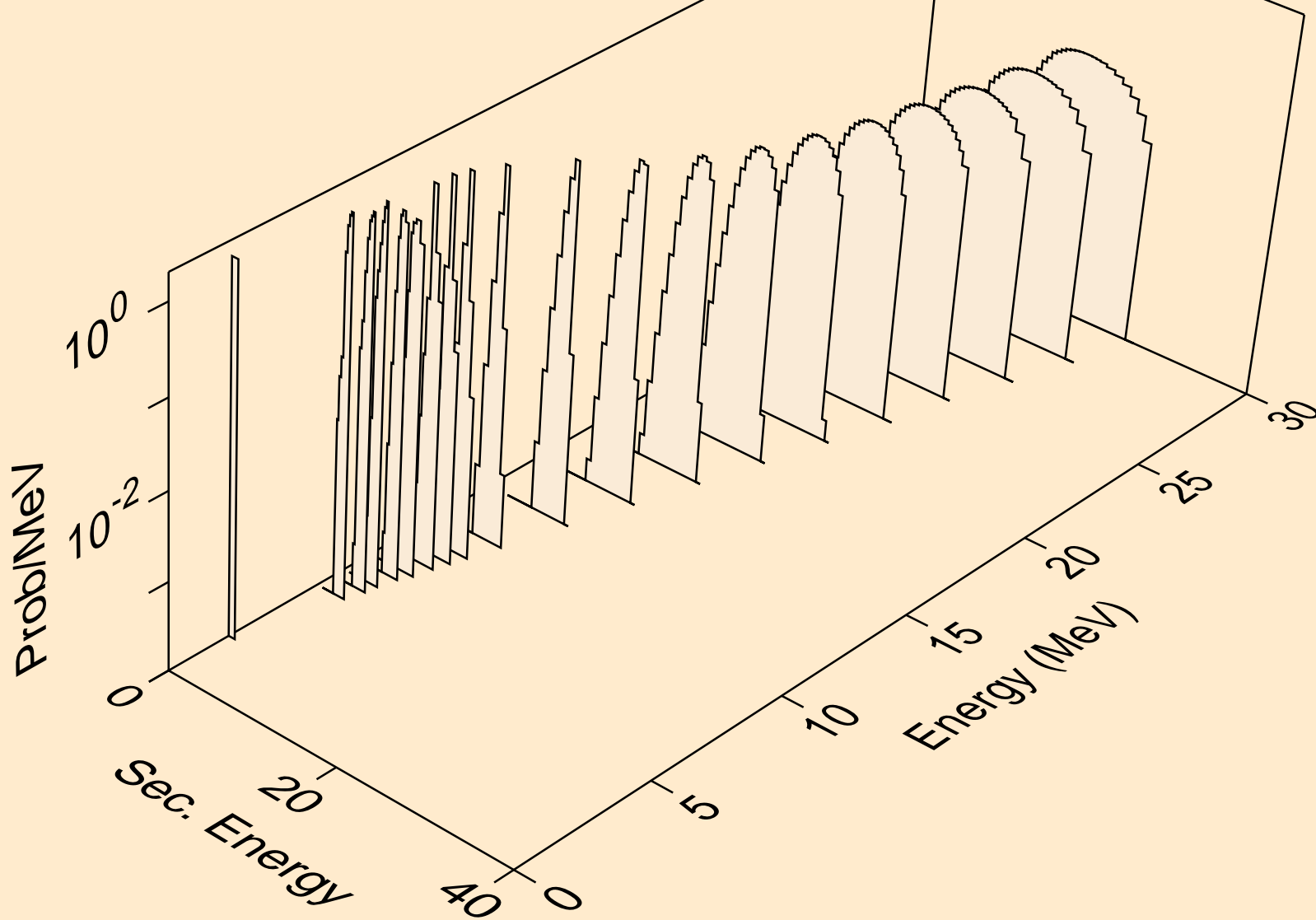

PB189M NEUTRON ACER TENDL-2019 LIBRARY; T=293.16K
tritons from (n,pt)

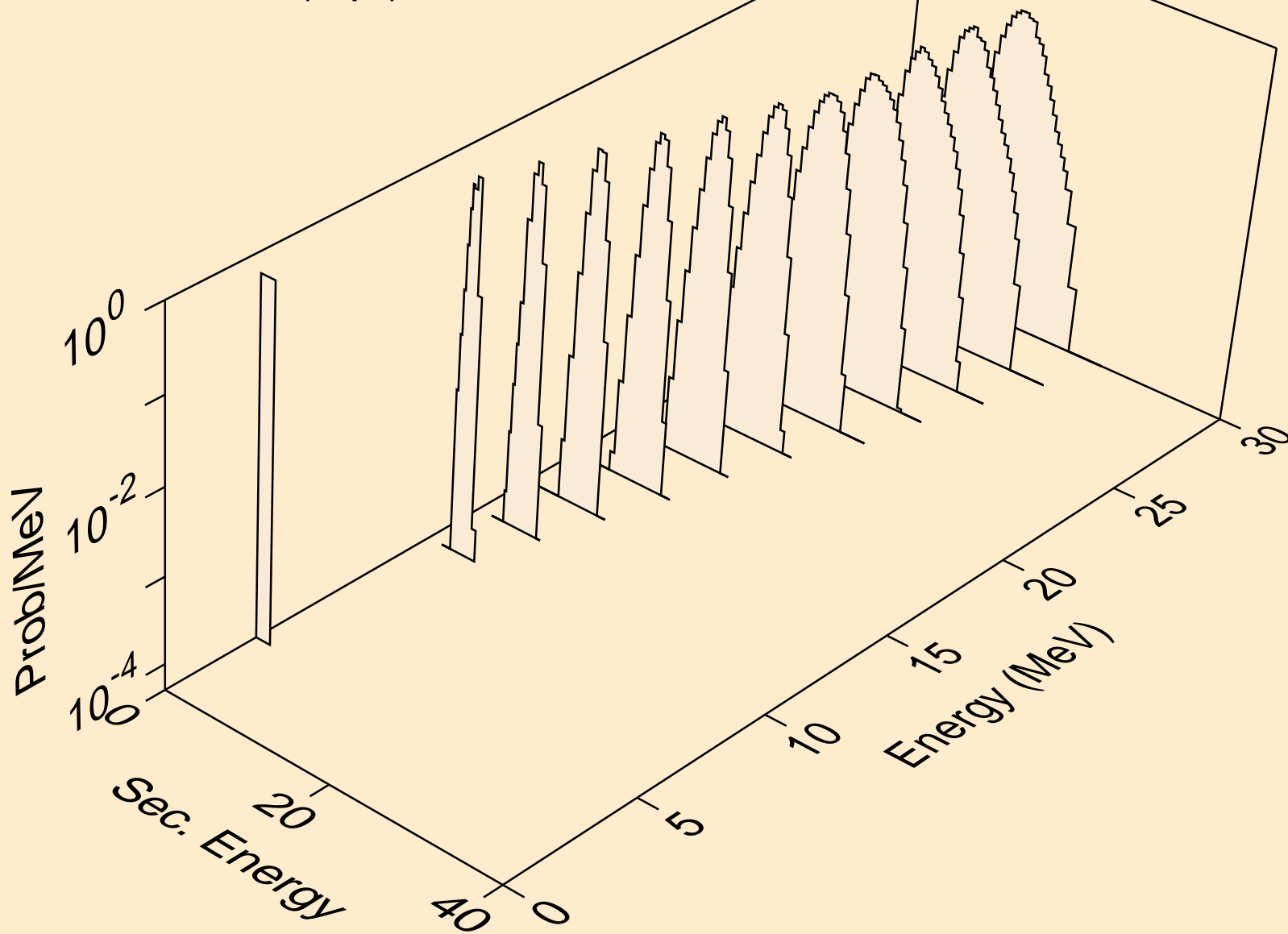

PB189M NEUTRON ACER TENDL-2019 LIBRARY; T=293.16K
he3s from (n,x)

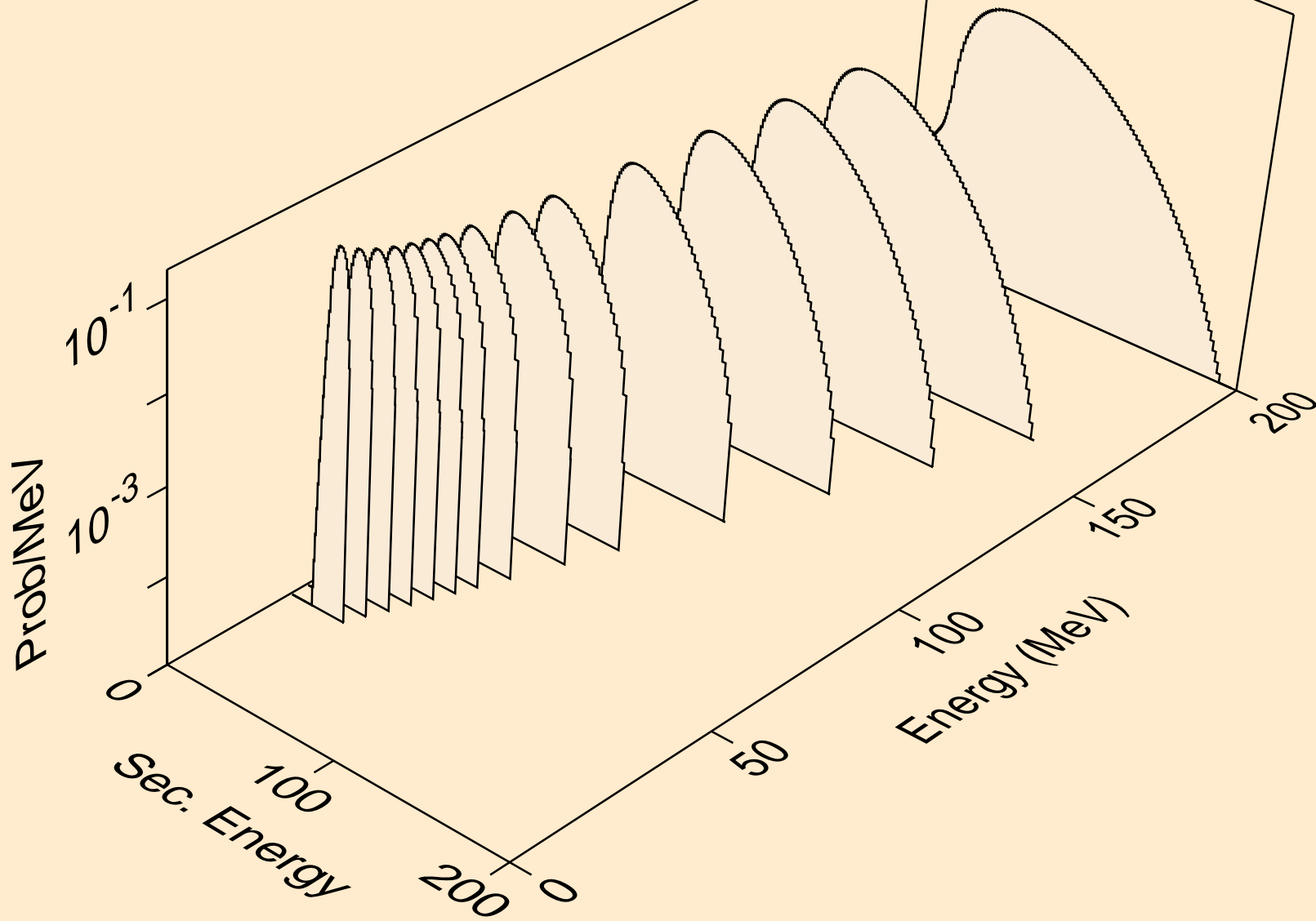

PB189M NEUTRON ACER TENDL-2019 LIBRARY; T=293.16K
he3s from (n,n*)he3

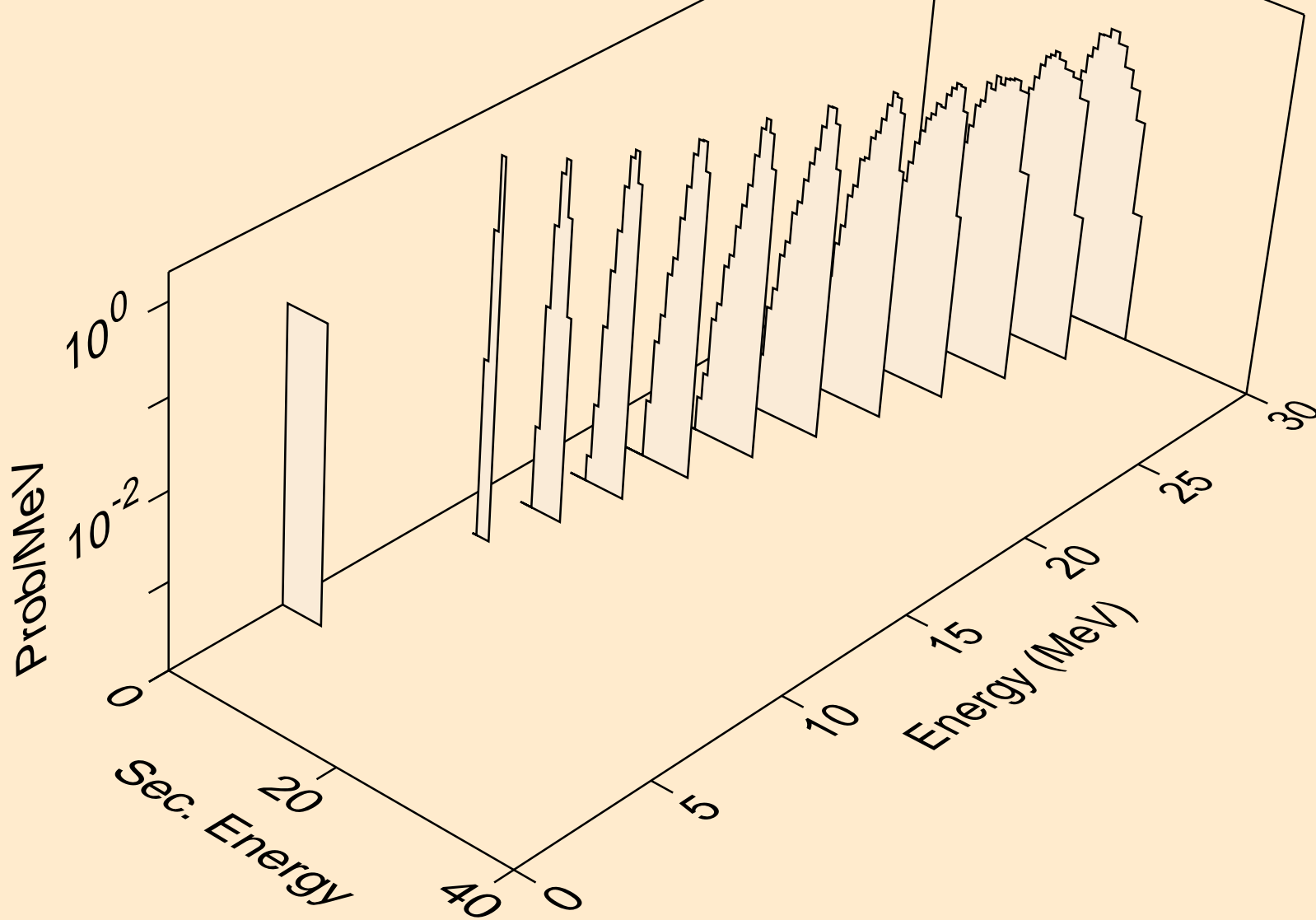

PB189M NEUTRON ACER TENDL-2019 LIBRARY; T=293.16K
he3s from (n,he3)

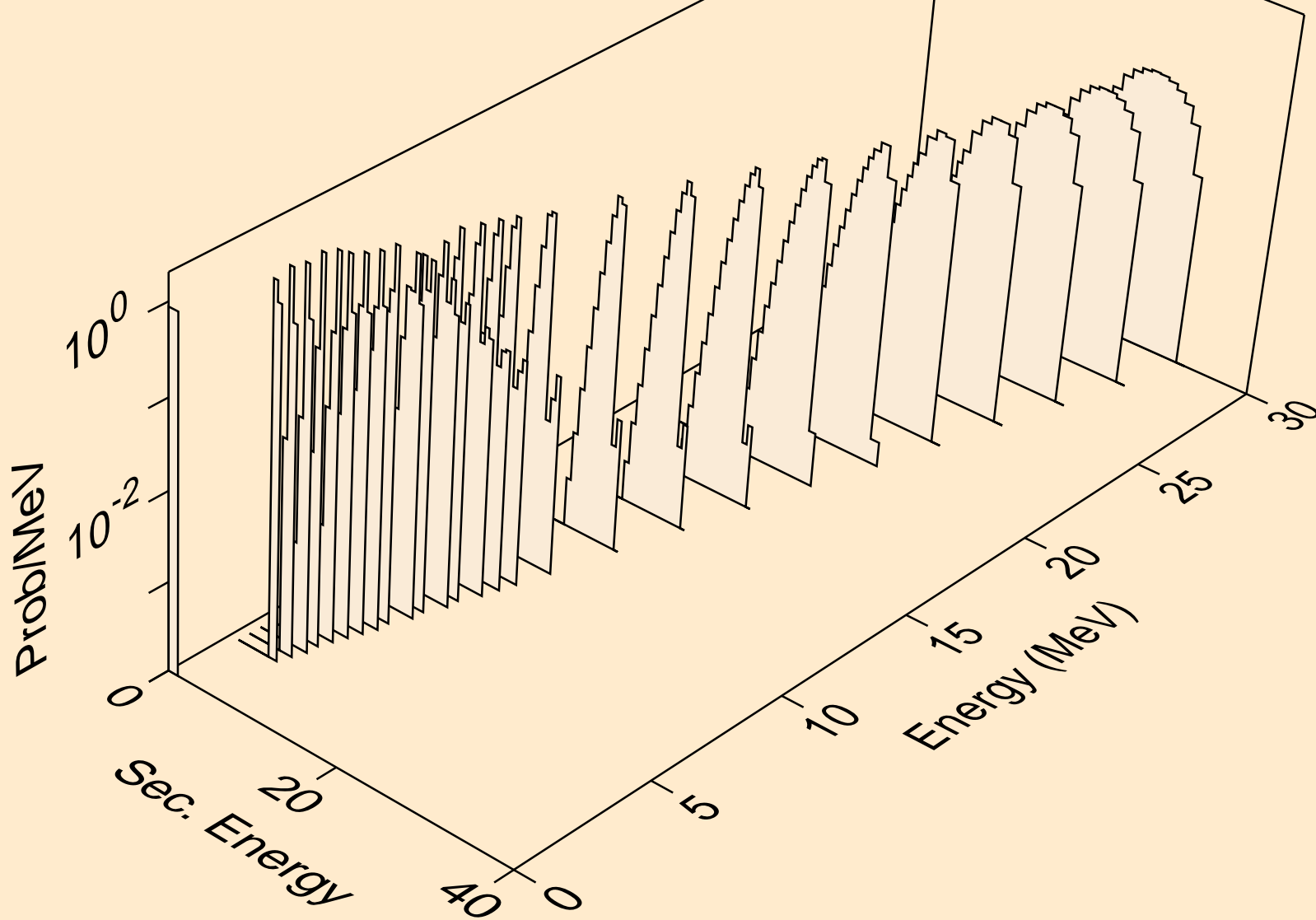

PB189M NEUTRON ACER TENDL-2019 LIBRARY; T=293.16K
alphas from (n,x)

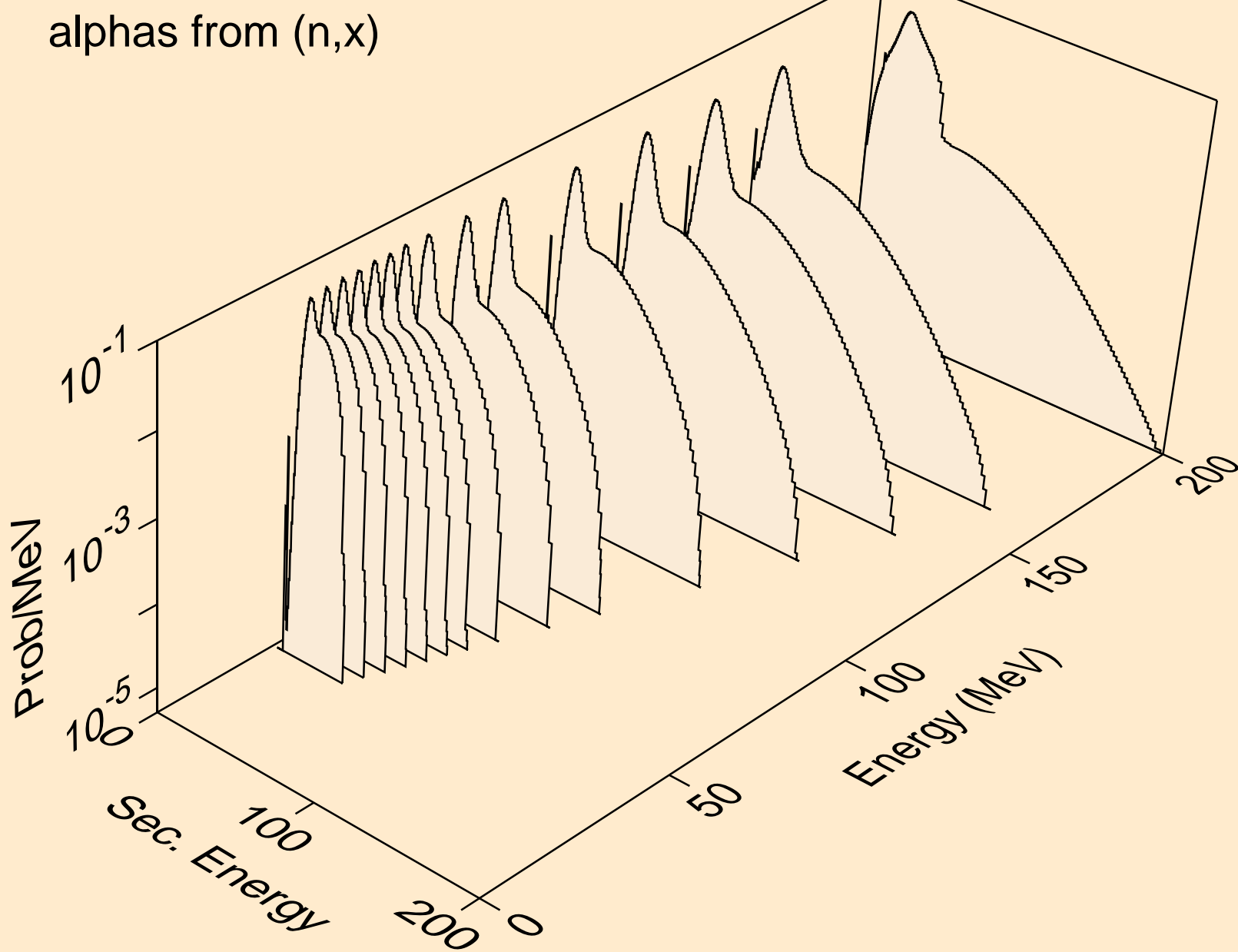

PB189M NEUTRON ACER TENDL-2019 LIBRARY; T=293.16K
alphas from (n,n*)a

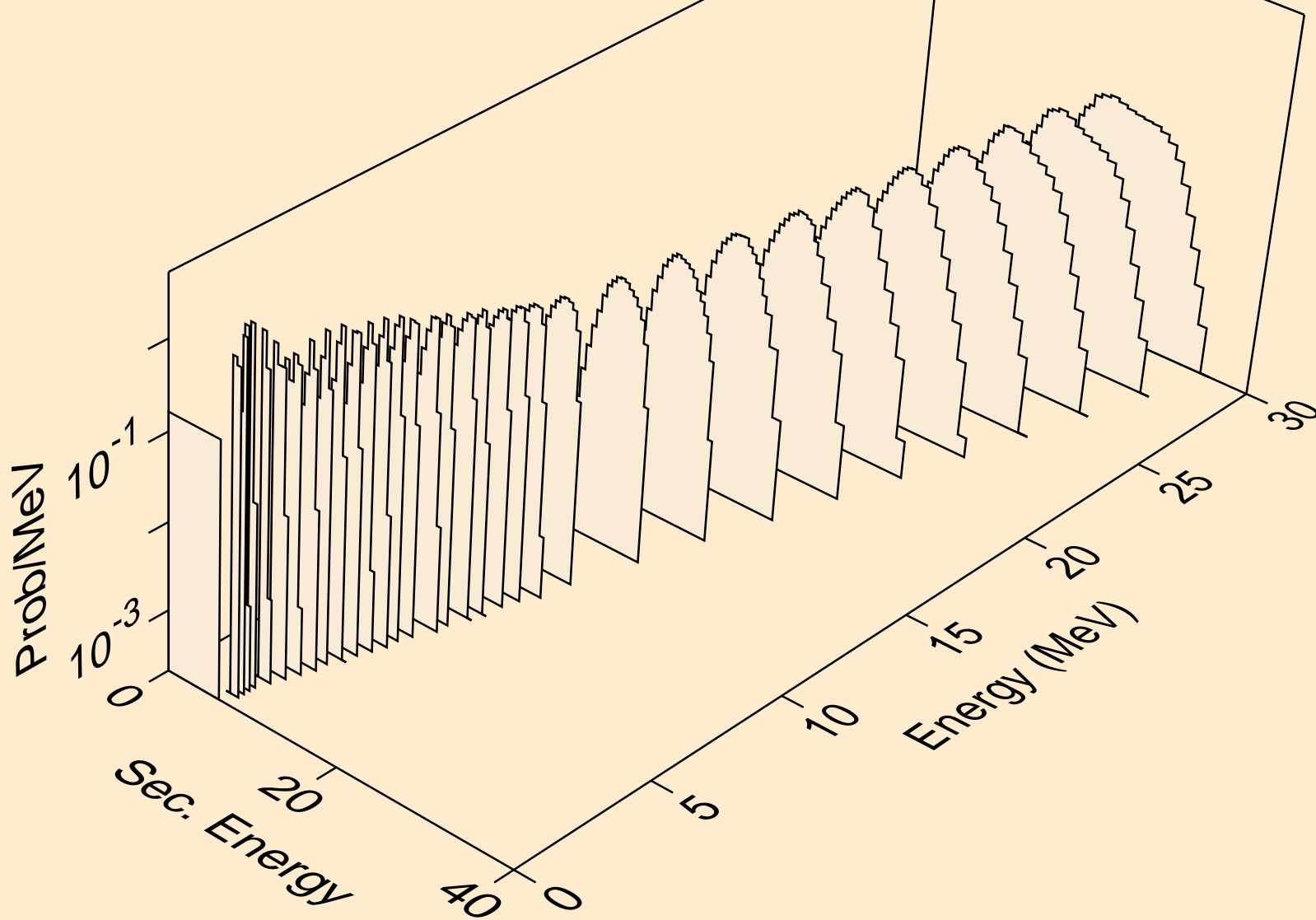

PB189M NEUTRON ACER TENDL-2019 LIBRARY; T=293.16K
alphas from (n,2n)a

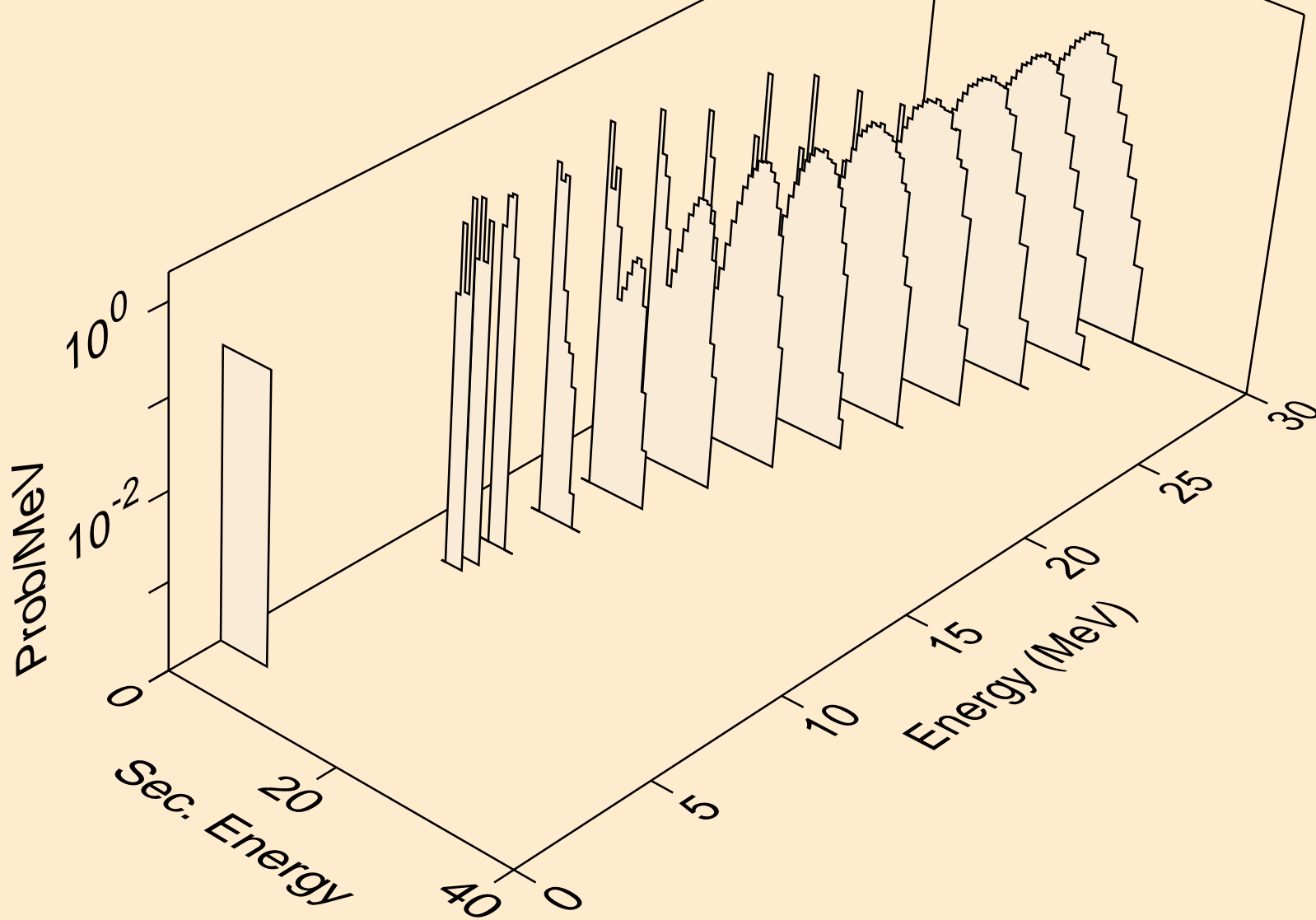

PB189M NEUTRON ACER TENDL-2019 LIBRARY; T=293.16K
alphas from (n,3n)a

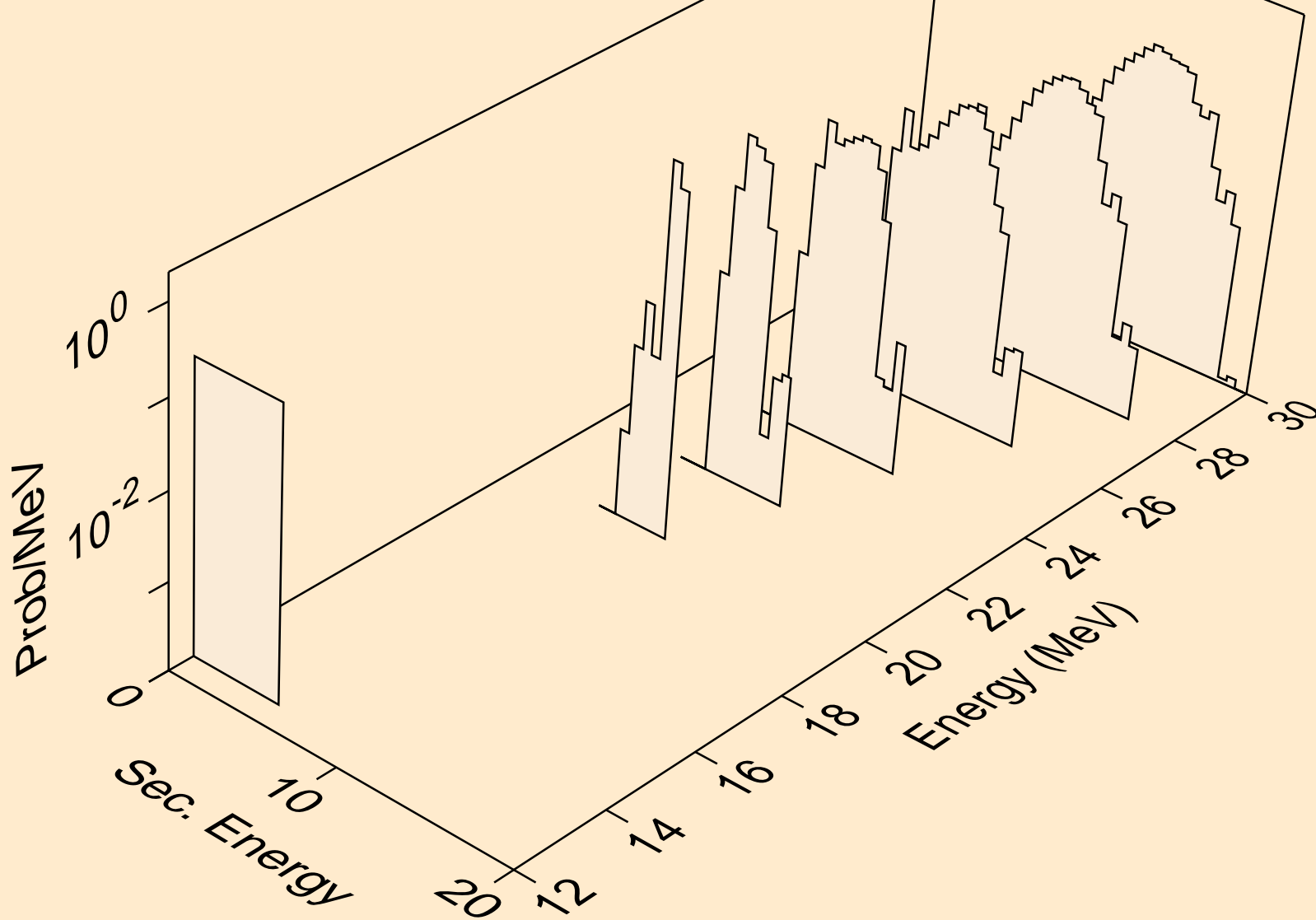

PB189M NEUTRON ACER TENDL-2019 LIBRARY; T=293.16K
alphas from (n,n*)2a

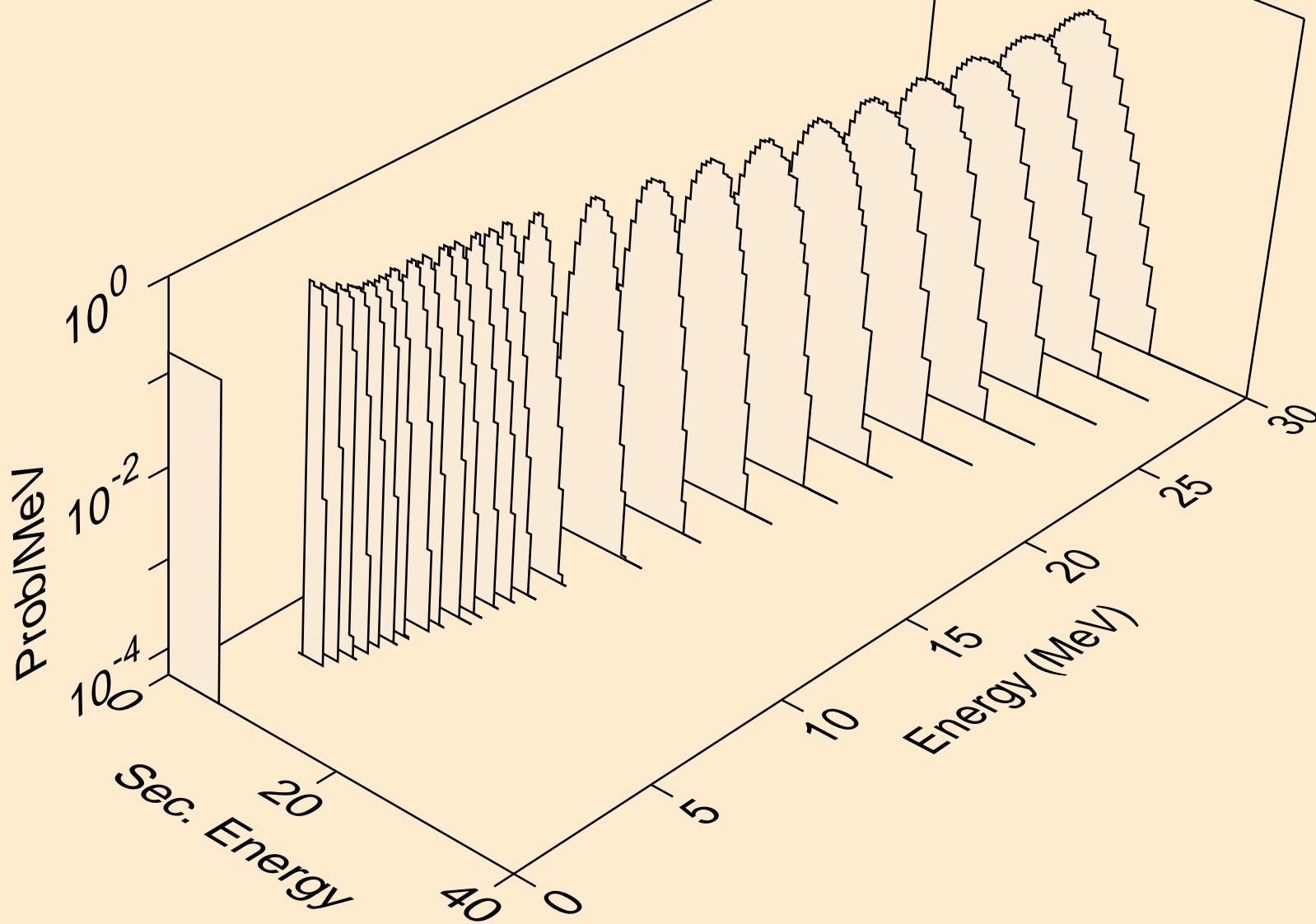

PB189M NEUTRON ACER TENDL-2019 LIBRARY; T=293.16K
alphas from (n,2n)2a

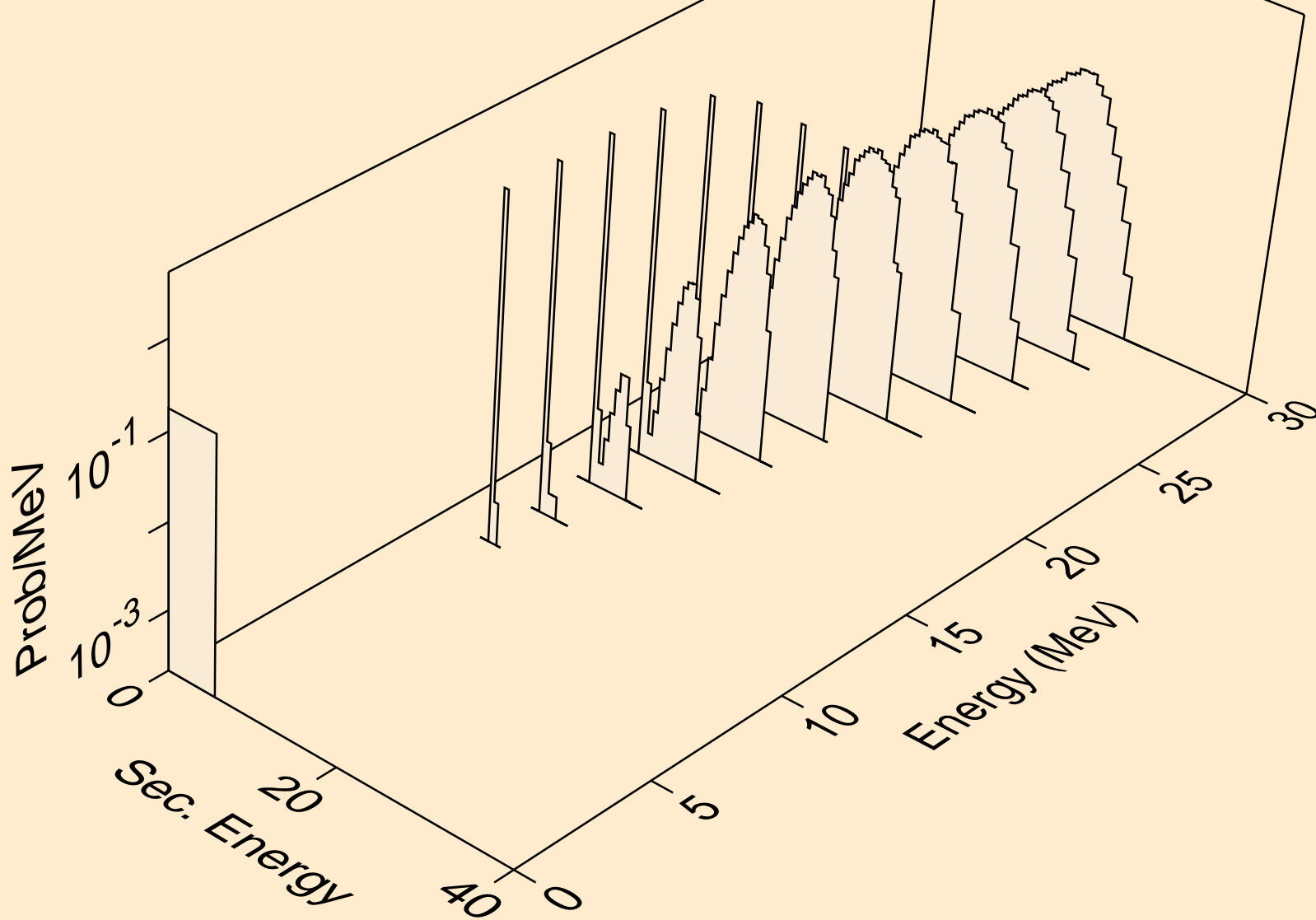

PB189M NEUTRON ACER TENDL-2019 LIBRARY; T=293.16K
alphas from (n,npa)

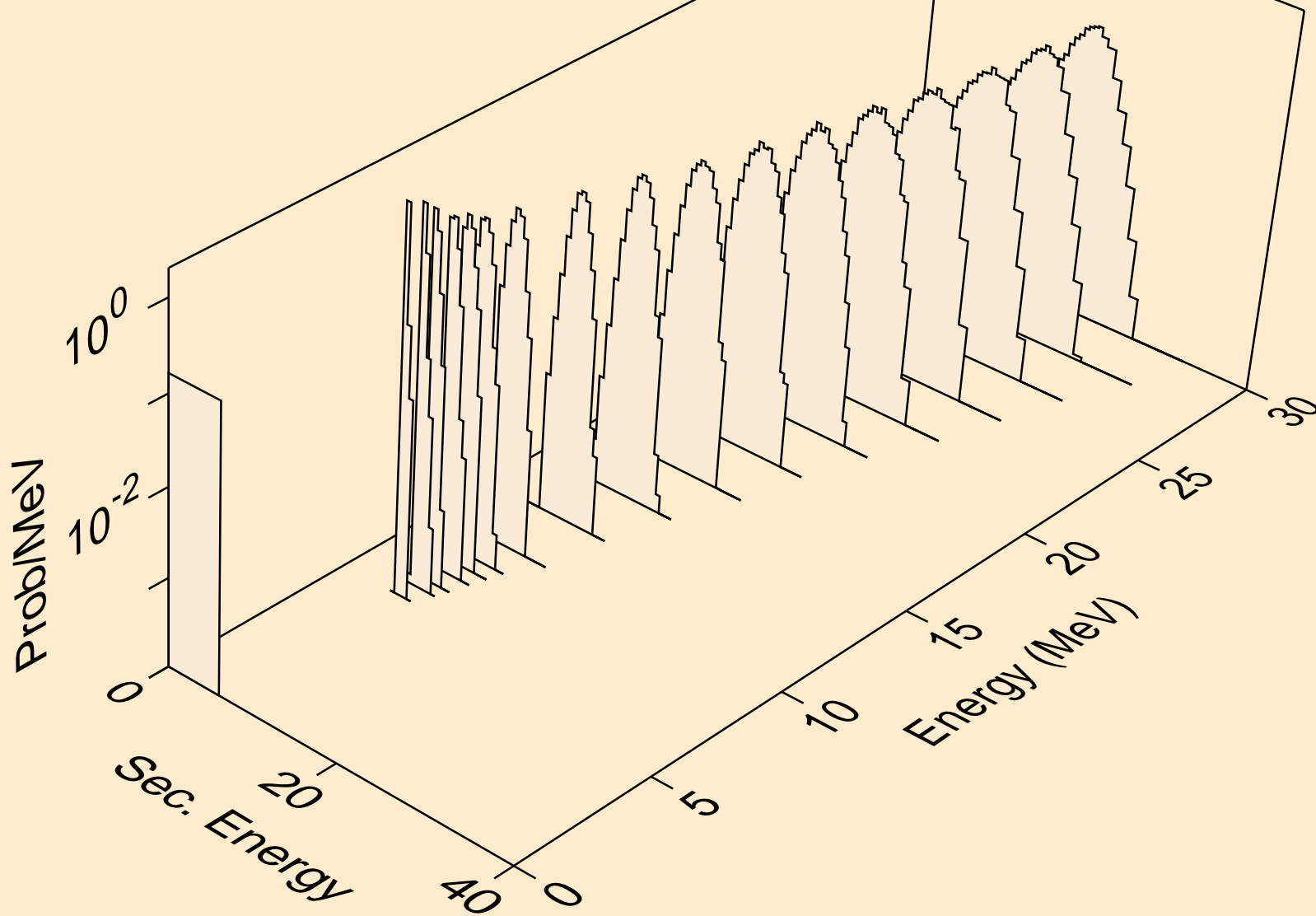

PB189M NEUTRON ACER TENDL-2019 LIBRARY; T=293.16K
alphas from (n,a)

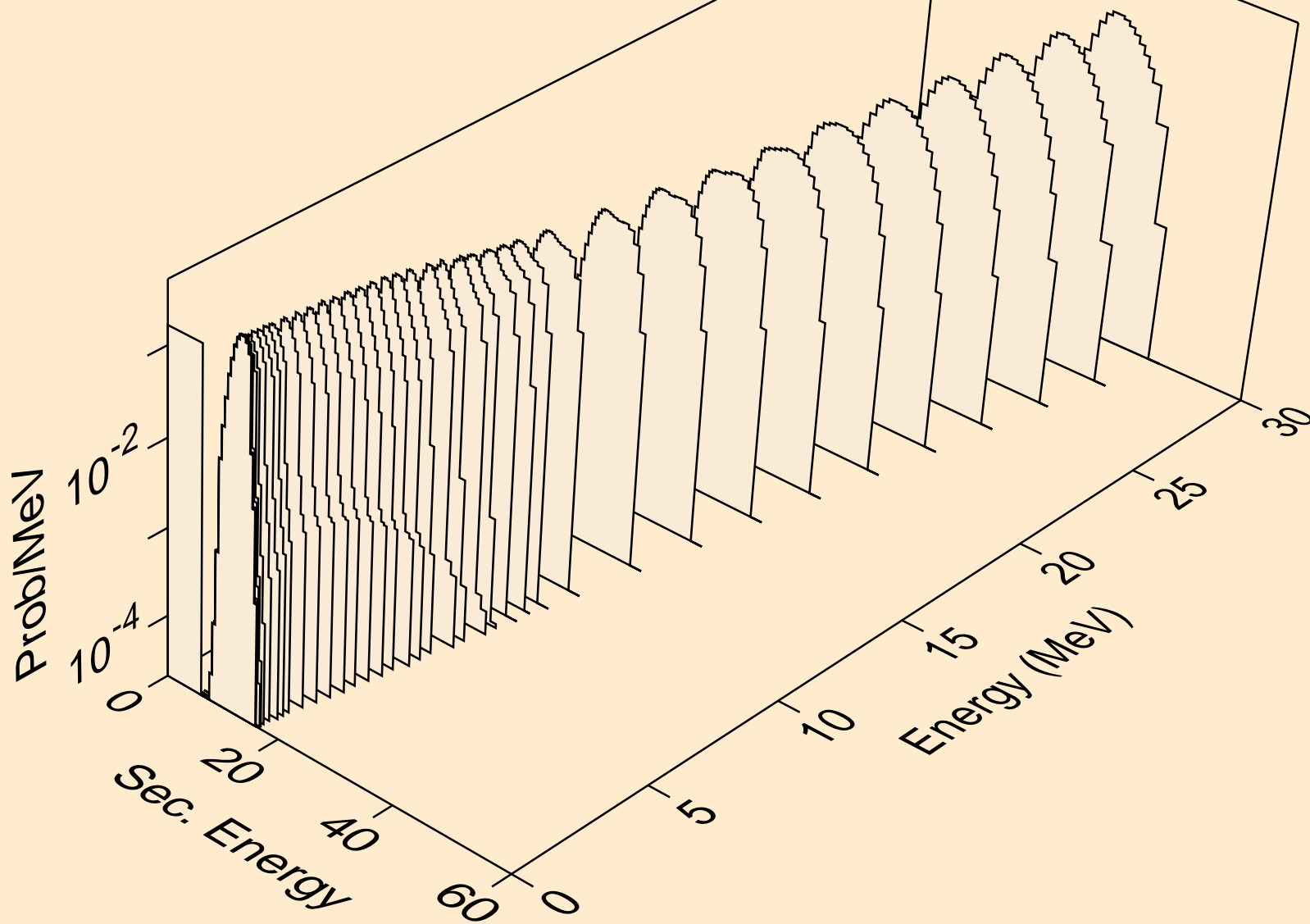

PB189M NEUTRON ACER TENDL-2019 LIBRARY; T=293.16K
alphas from (n,2a)

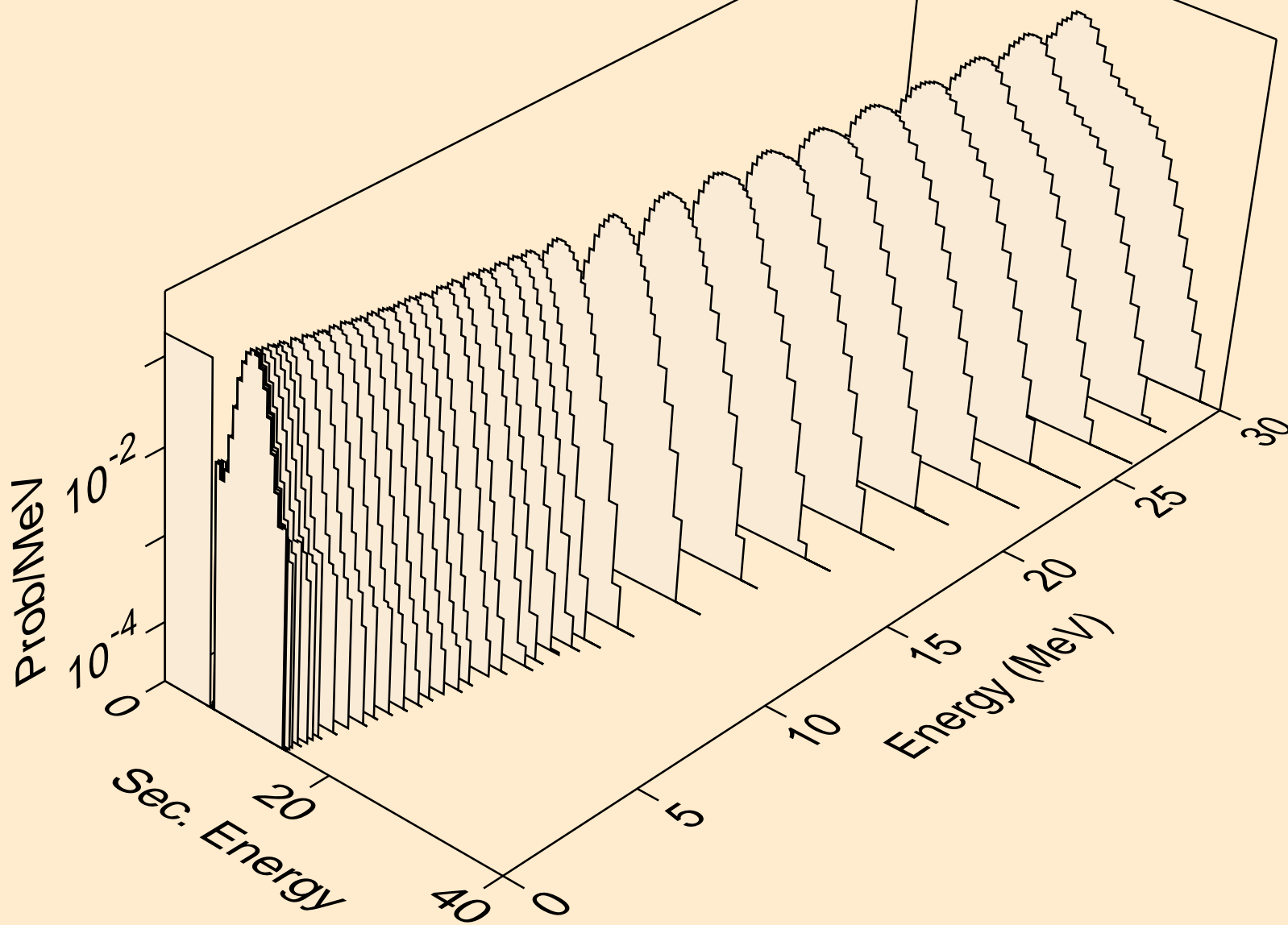

PB189M NEUTRON ACER TENDL-2019 LIBRARY; T=293.16K
alphas from (n,3a)

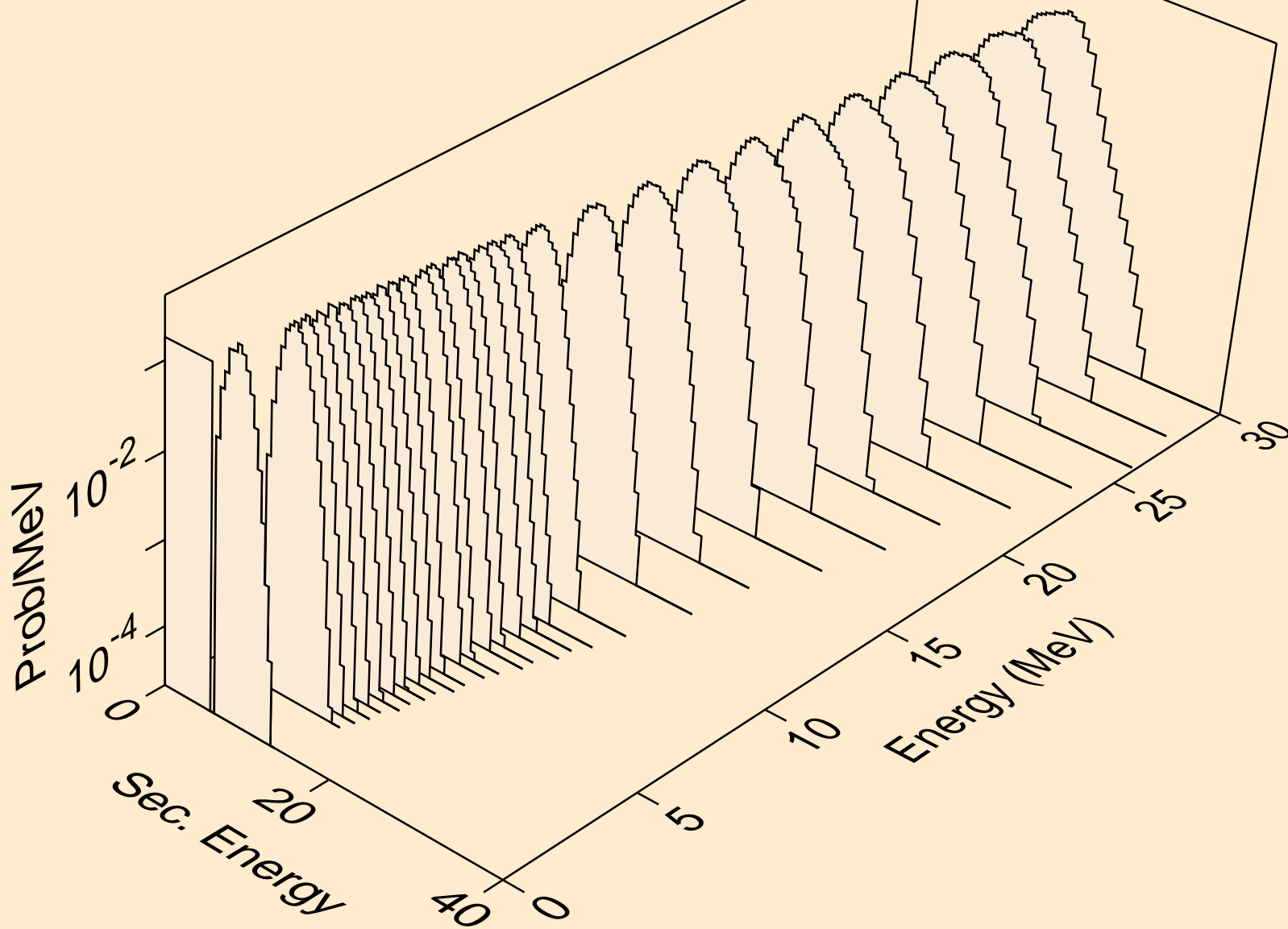

PB189M NEUTRON ACER TENDL-2019 LIBRARY; T=293.16K
alphas from (n,pa)

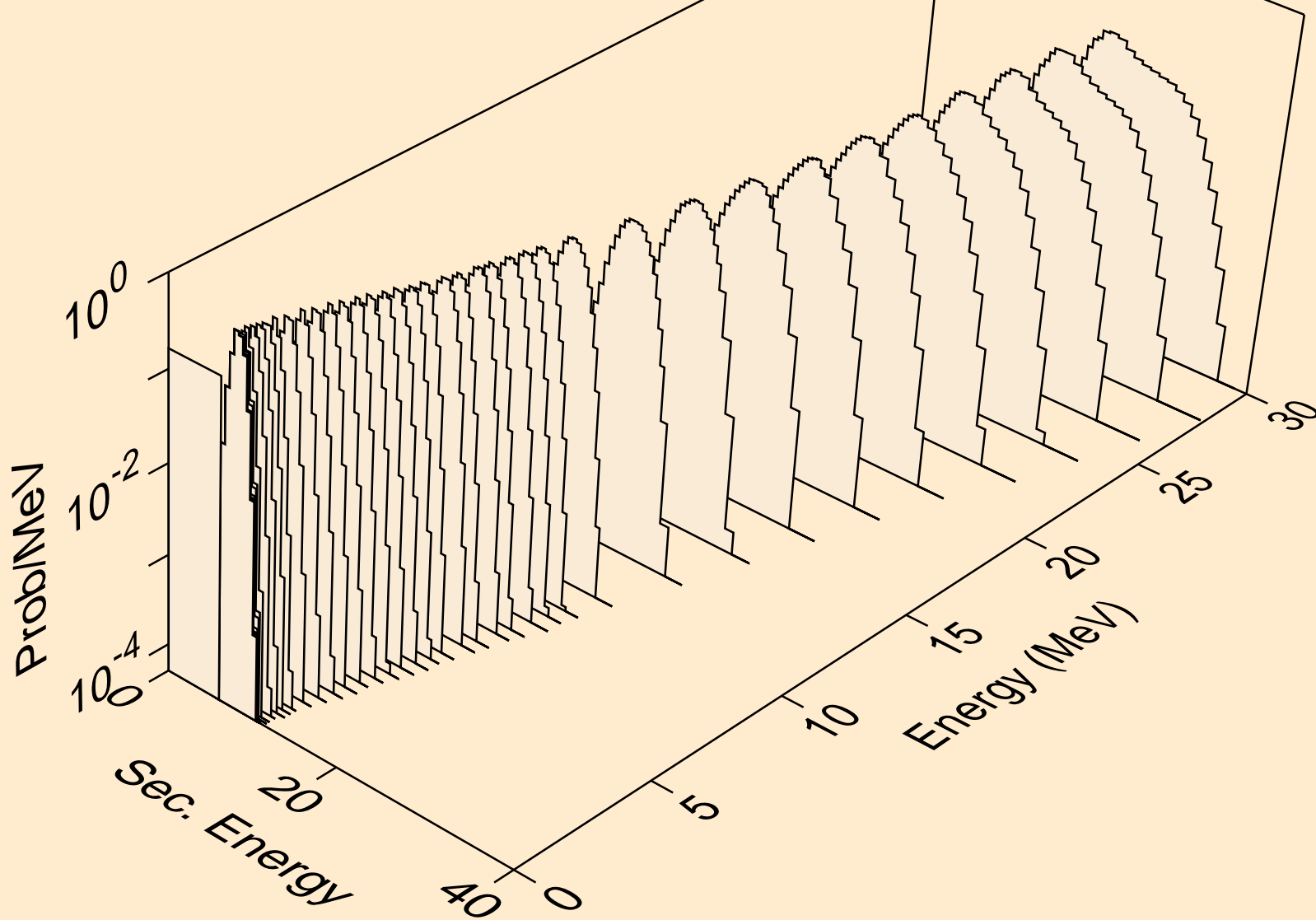

PB189M NEUTRON ACER TENDL-2019 LIBRARY; T=293.16K
alphas from (n,da)

