

RH092 NEUTRON ACER TENDL-2019 LIBRARY; T=293.16K  
Principal cross sections

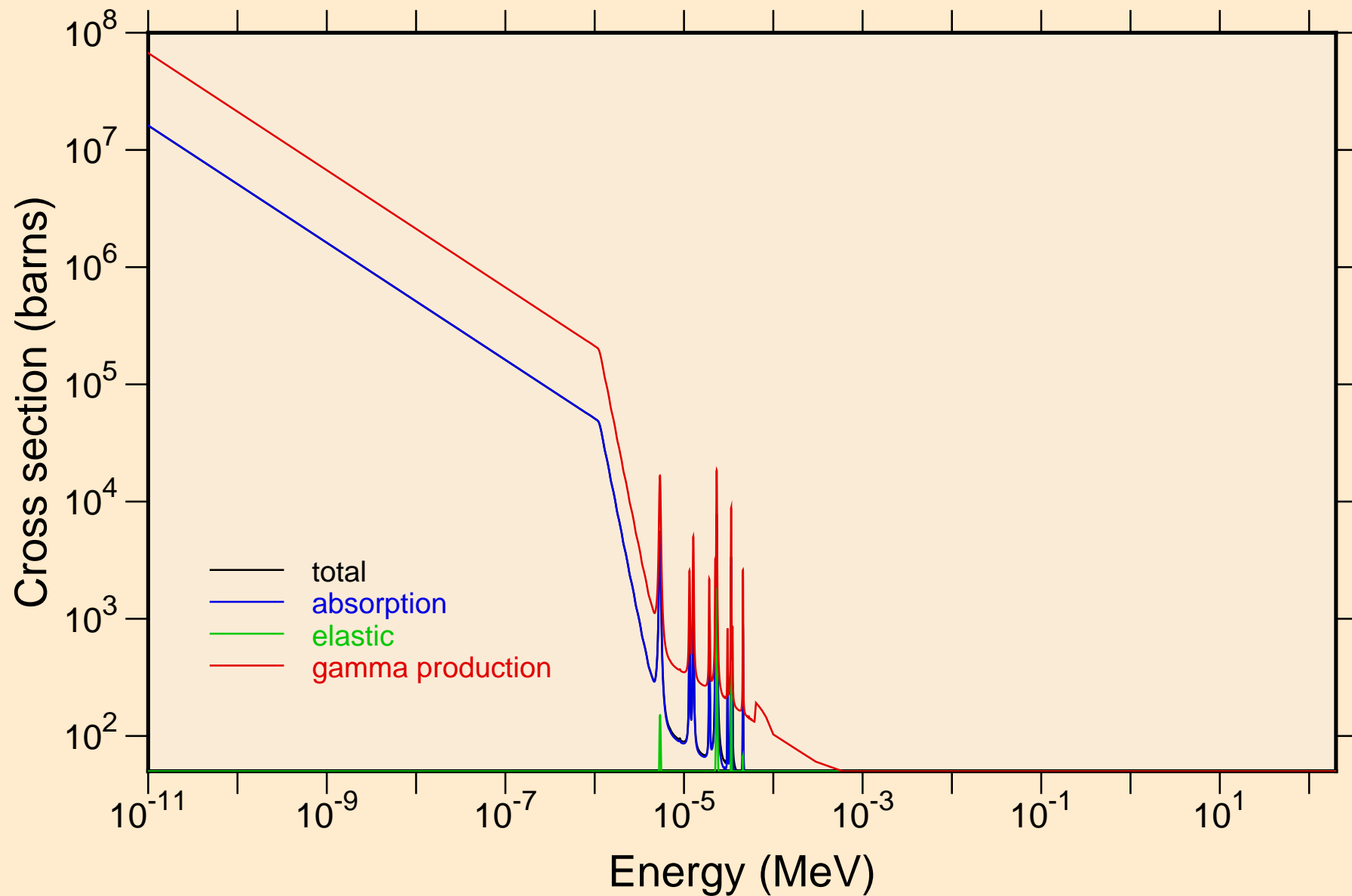

RH092 NEUTRON ACER TENDL-2019 LIBRARY; T=293.16K  
resonance total cross section

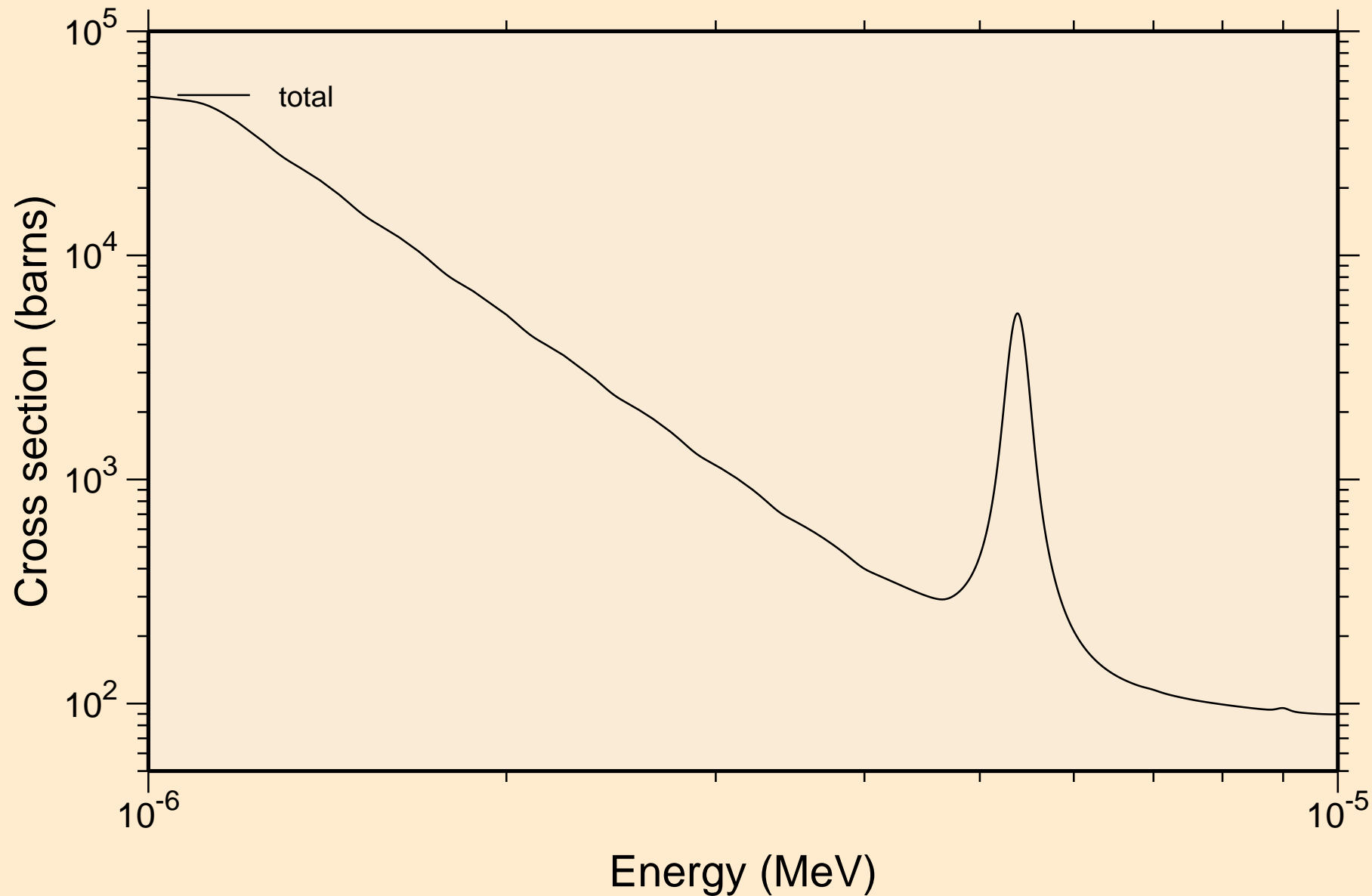

RH092 NEUTRON ACER TENDL-2019 LIBRARY; T=293.16K  
resonance total cross section

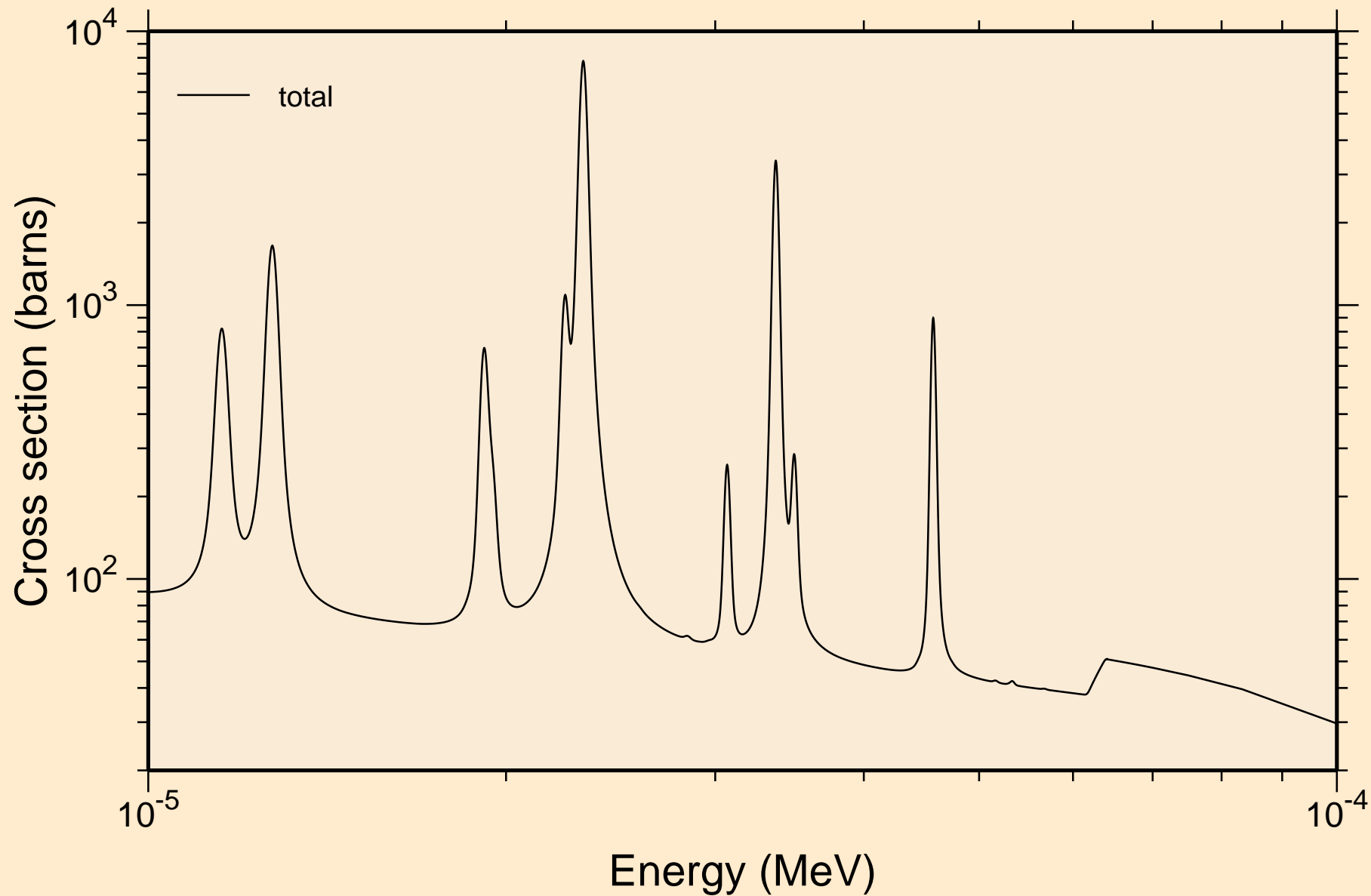

RH092 NEUTRON ACER TENDL-2019 LIBRARY; T=293.16K  
resonance total cross section

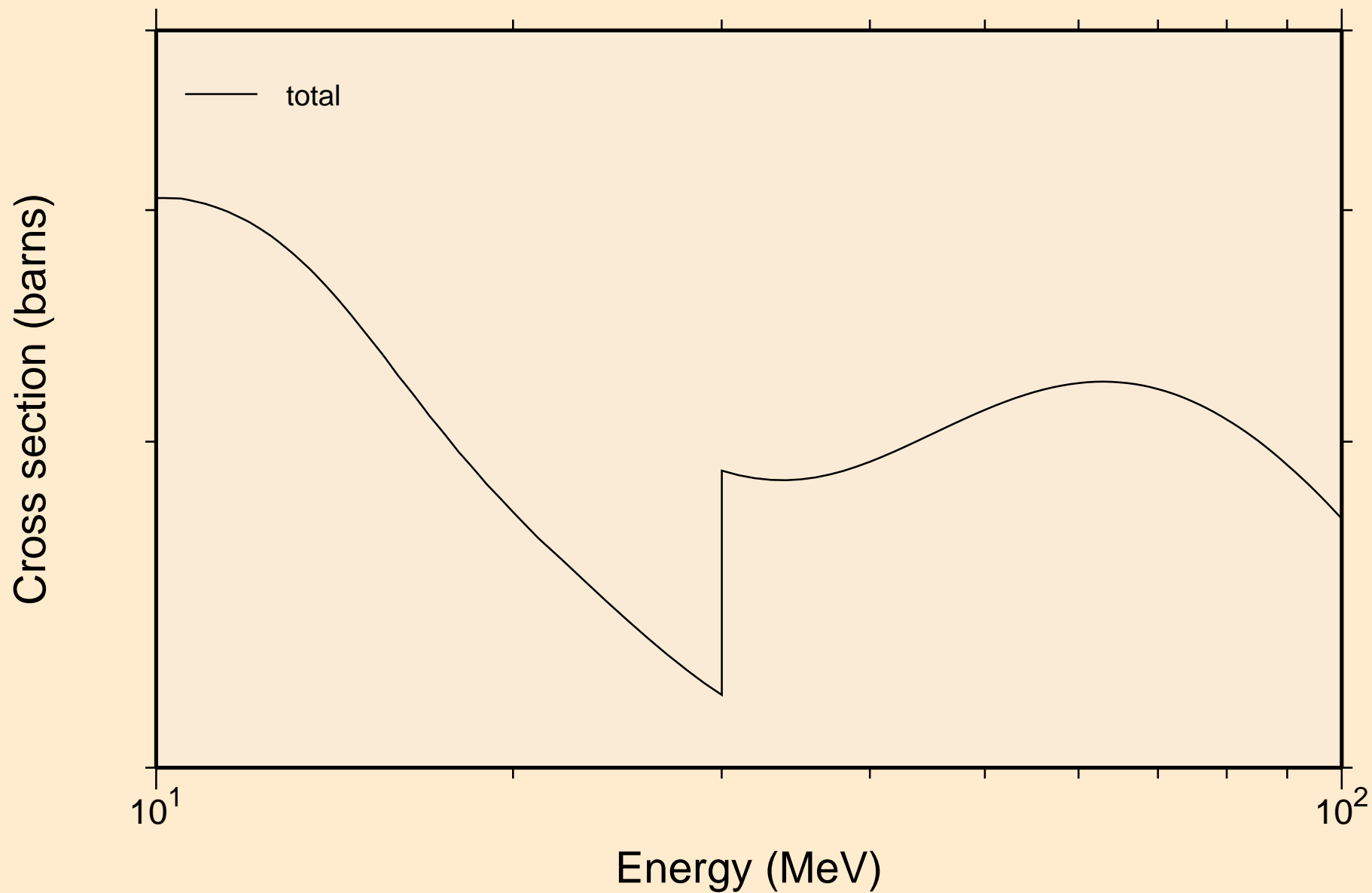

RH092 NEUTRON ACER TENDL-2019 LIBRARY; T=293.16K  
resonance absorption cross sections

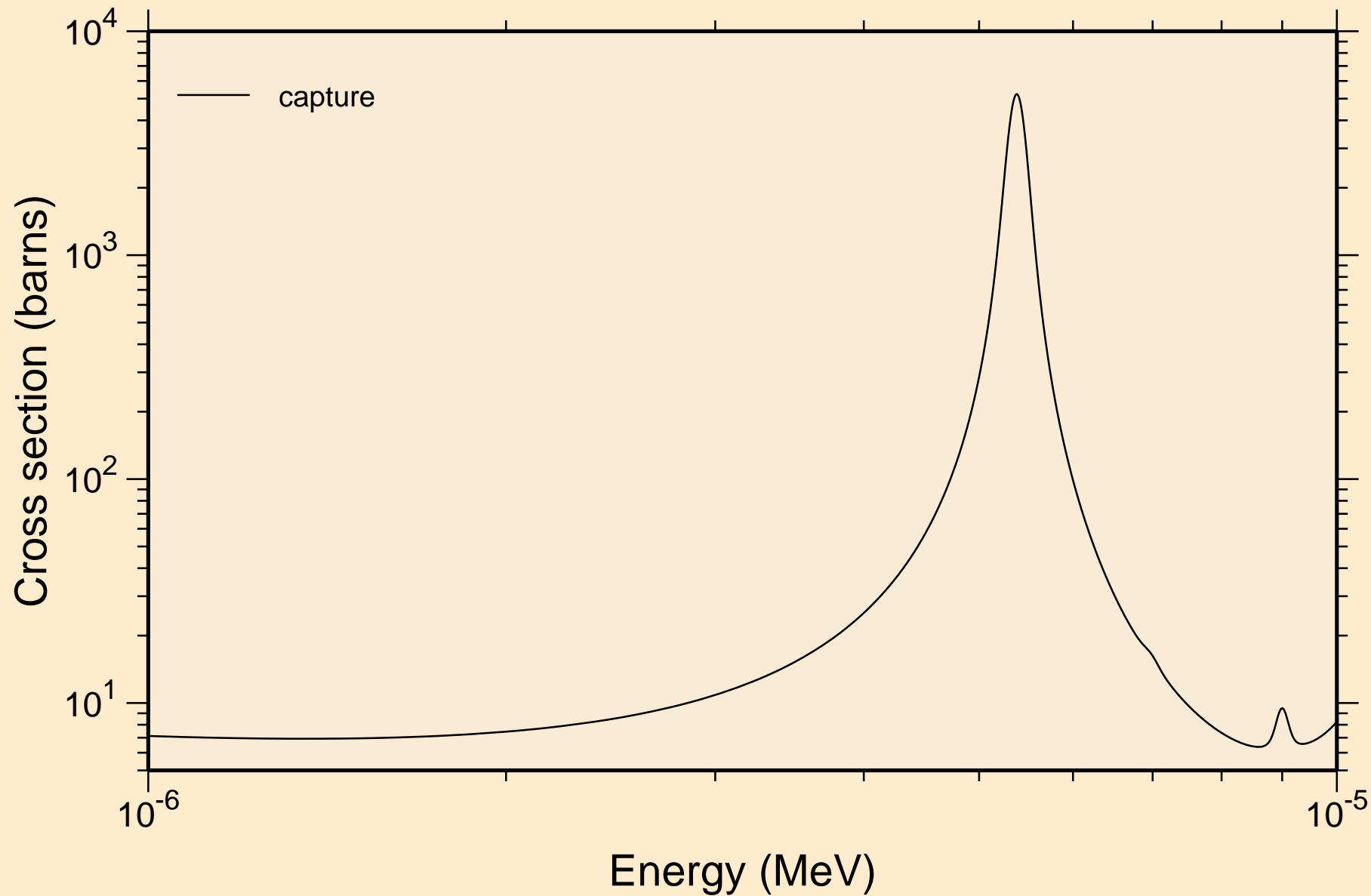

RH092 NEUTRON ACER TENDL-2019 LIBRARY; T=293.16K  
resonance absorption cross sections

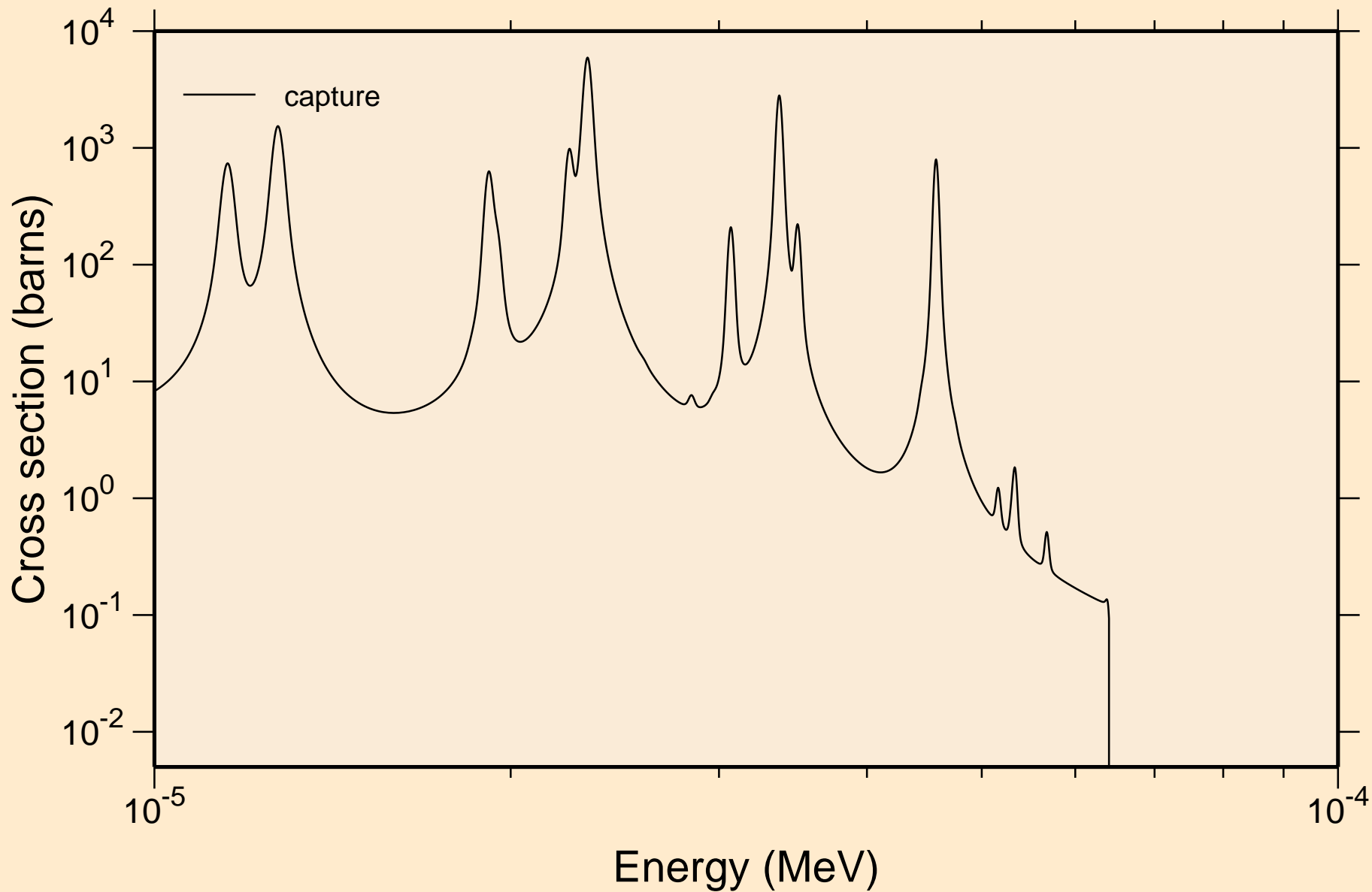

RH092 NEUTRON ACER TENDL-2019 LIBRARY; T=293.16K  
resonance absorption cross sections

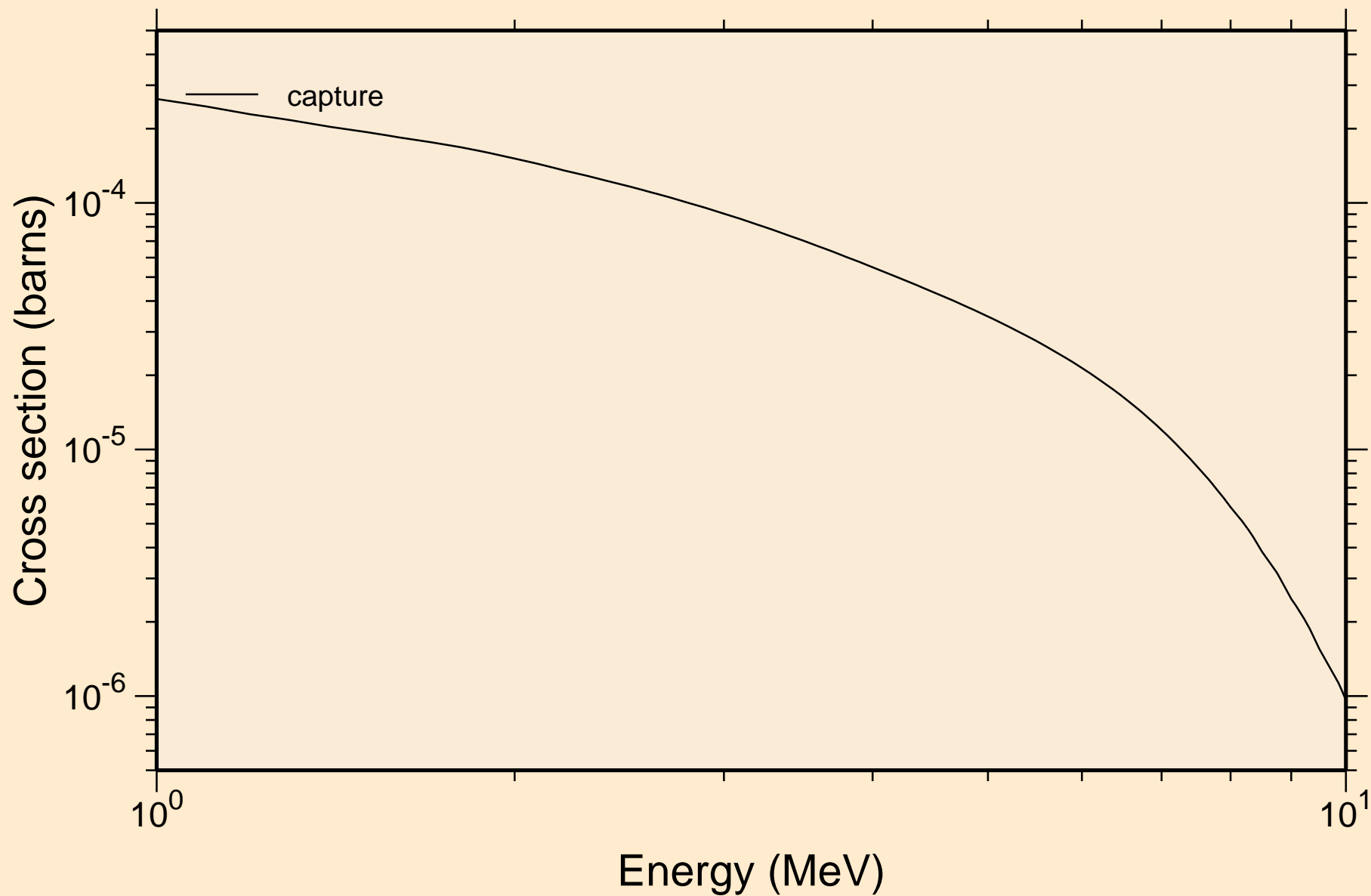

RH092 NEUTRON ACER TENDL-2019 LIBRARY; T=293.16K  
Heating

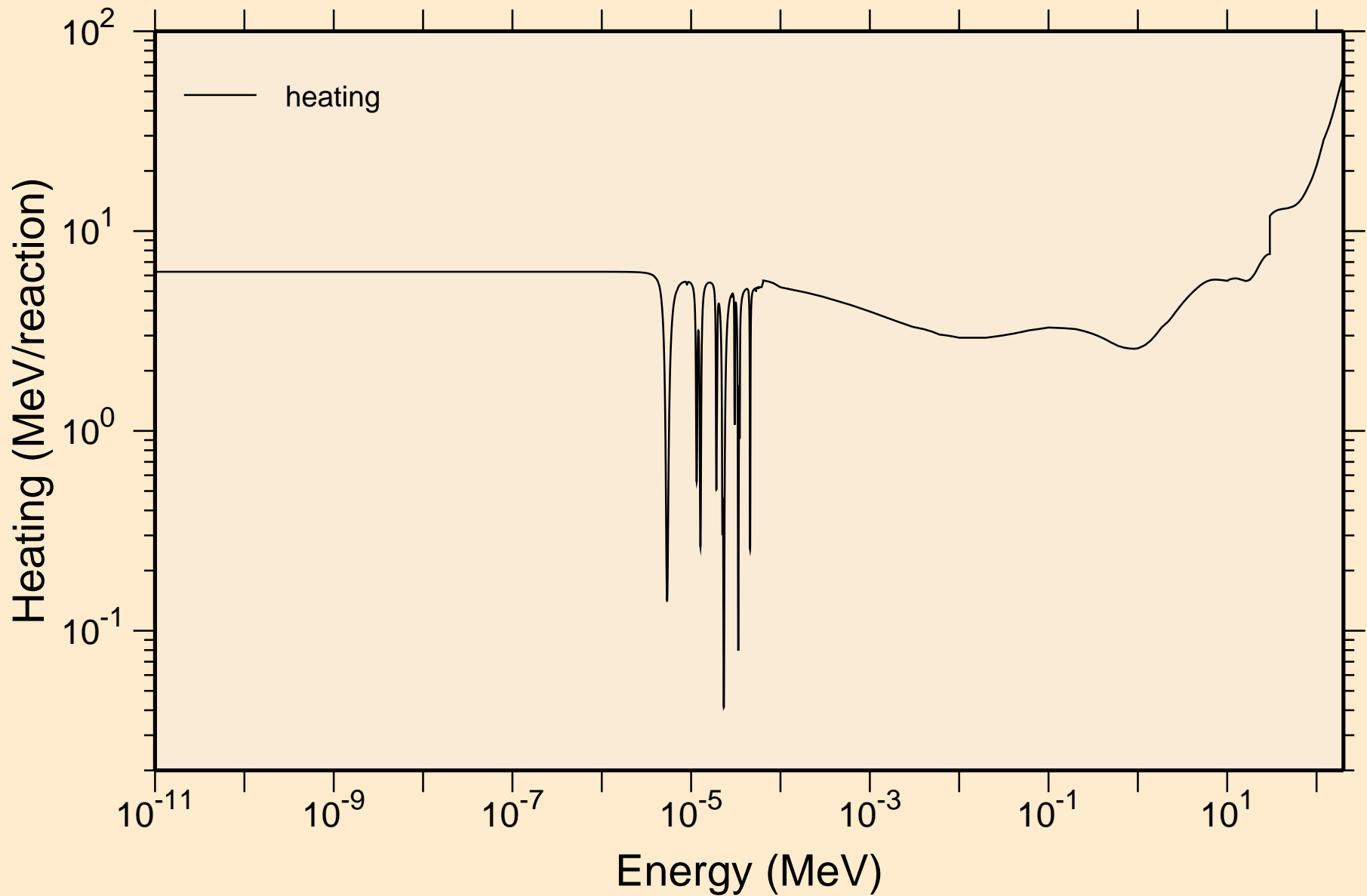

RH092 NEUTRON ACER TENDL-2019 LIBRARY; T=293.16K  
Damage

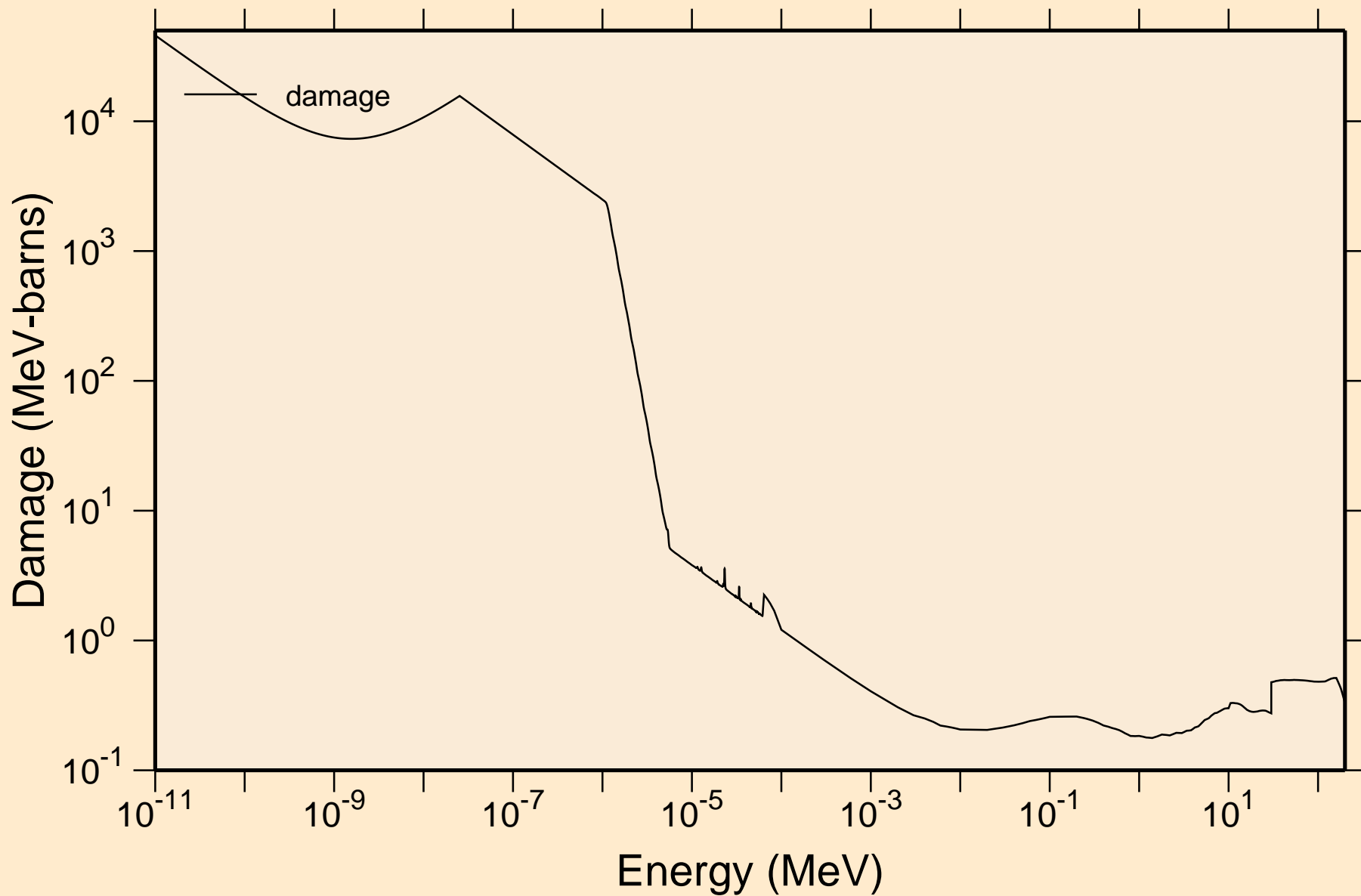

RH092 NEUTRON ACER TENDL-2019 LIBRARY; T=293.16K  
Non-threshold reactions

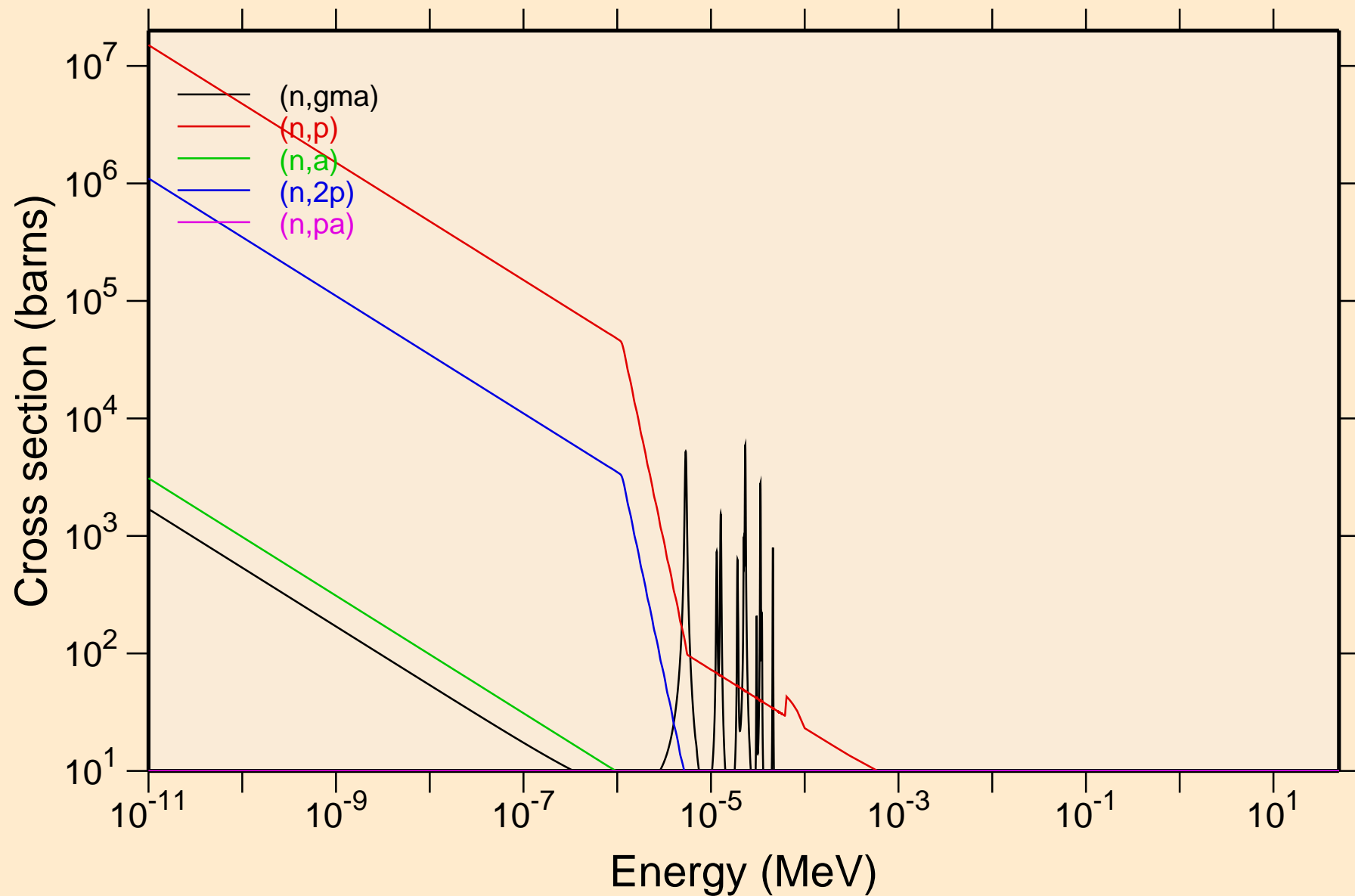

RH092 NEUTRON ACER TENDL-2019 LIBRARY; T=293.16K  
Non-threshold reactions

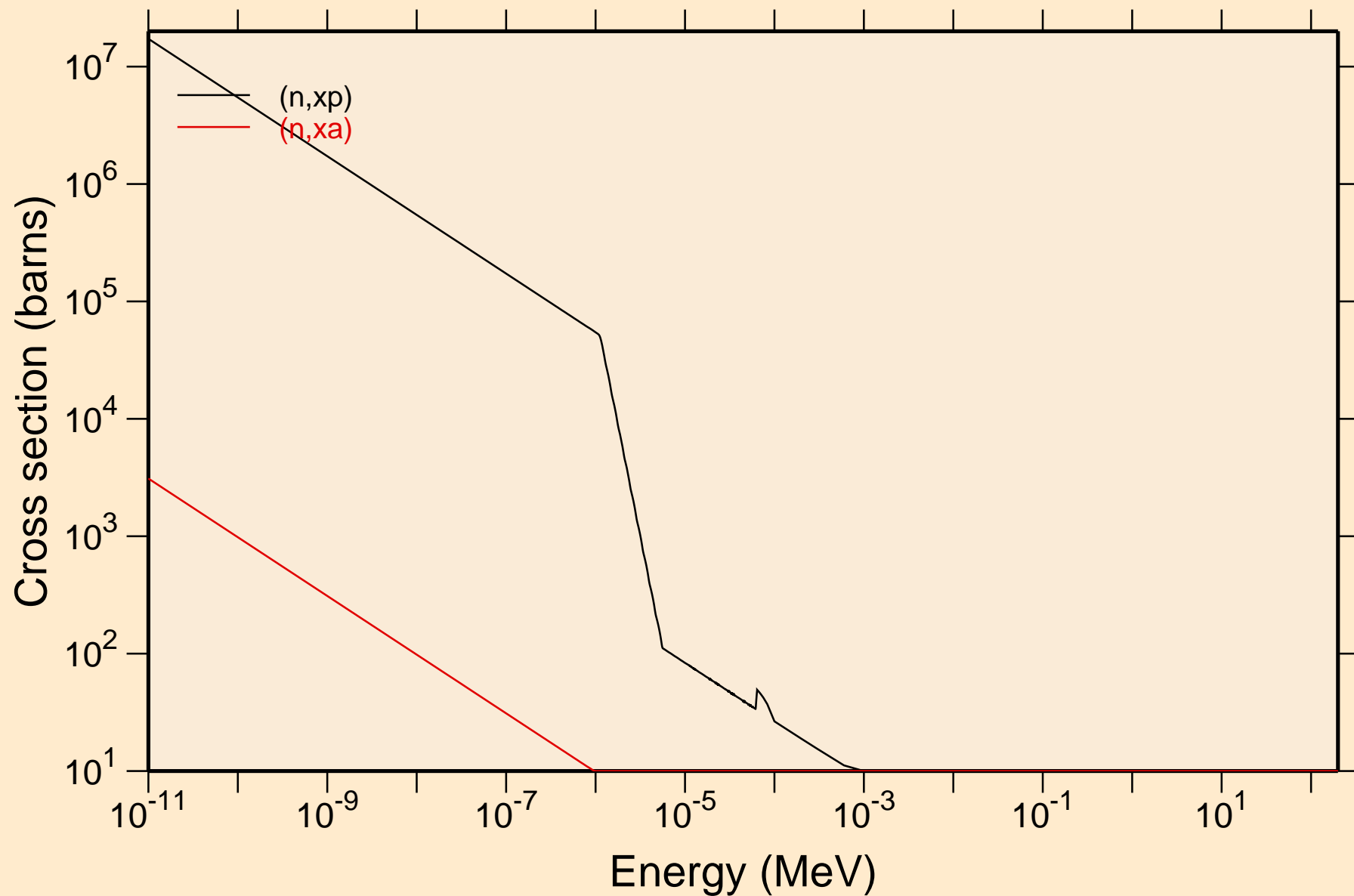

RH092 NEUTRON ACER TENDL-2019 LIBRARY; T=293.16K  
Principal cross sections

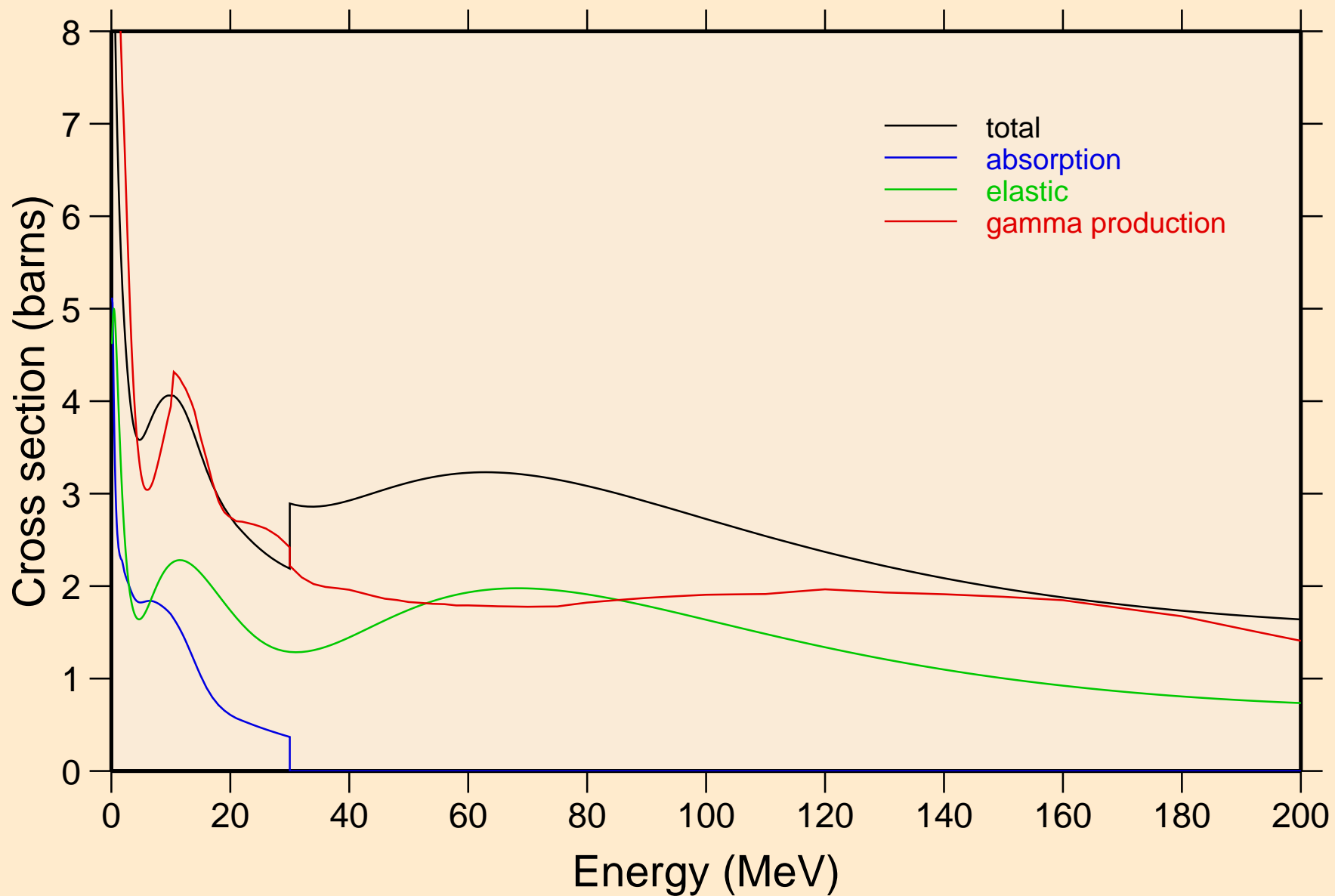

RH092 NEUTRON ACER TENDL-2019 LIBRARY; T=293.16K  
Heating

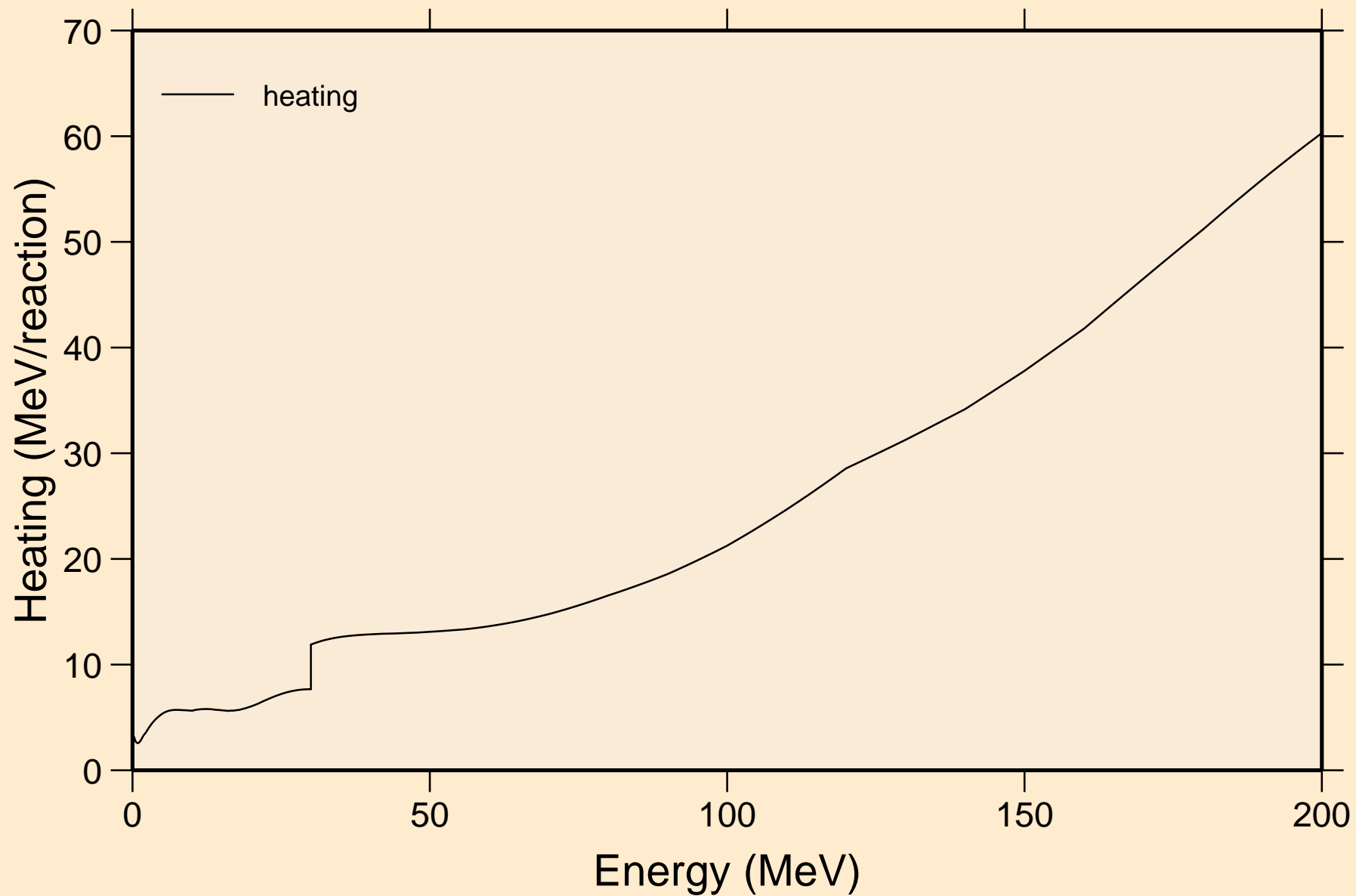

RH092 NEUTRON ACER TENDL-2019 LIBRARY; T=293.16K  
Damage

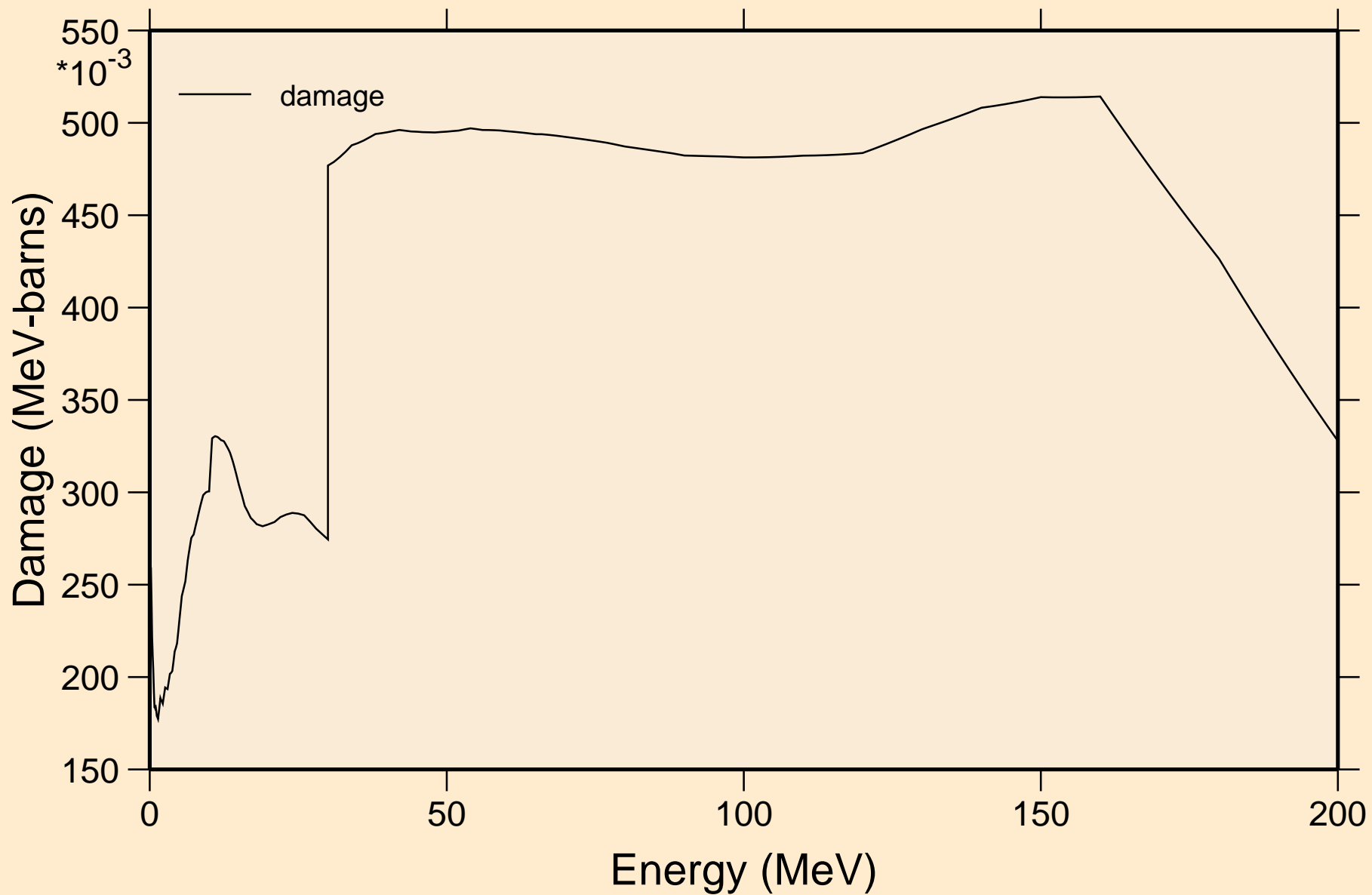

RH092 NEUTRON ACER TENDL-2019 LIBRARY; T=293.16K  
Non-threshold reactions

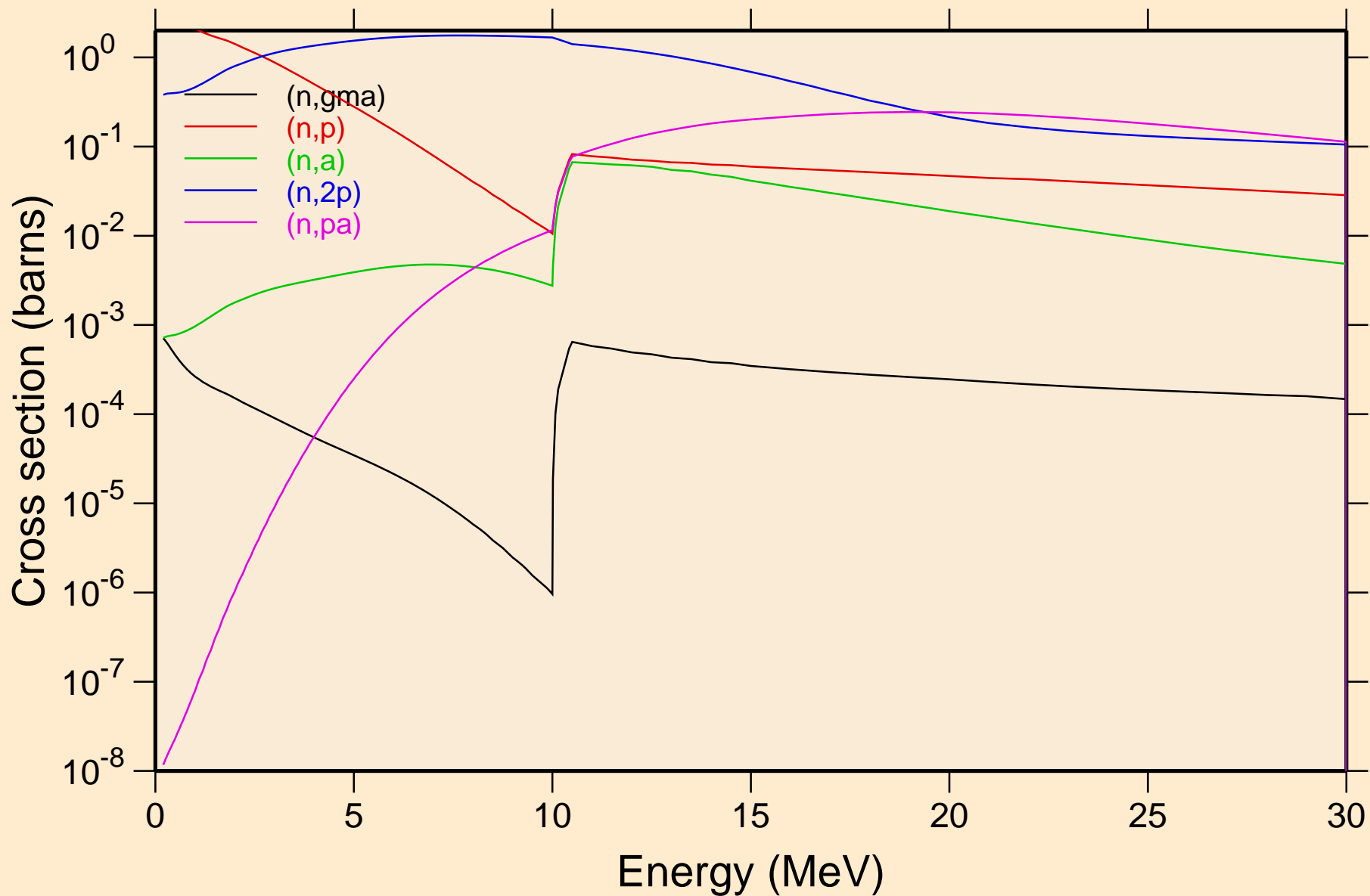

RH092 NEUTRON ACER TENDL-2019 LIBRARY; T=293.16K  
Non-threshold reactions

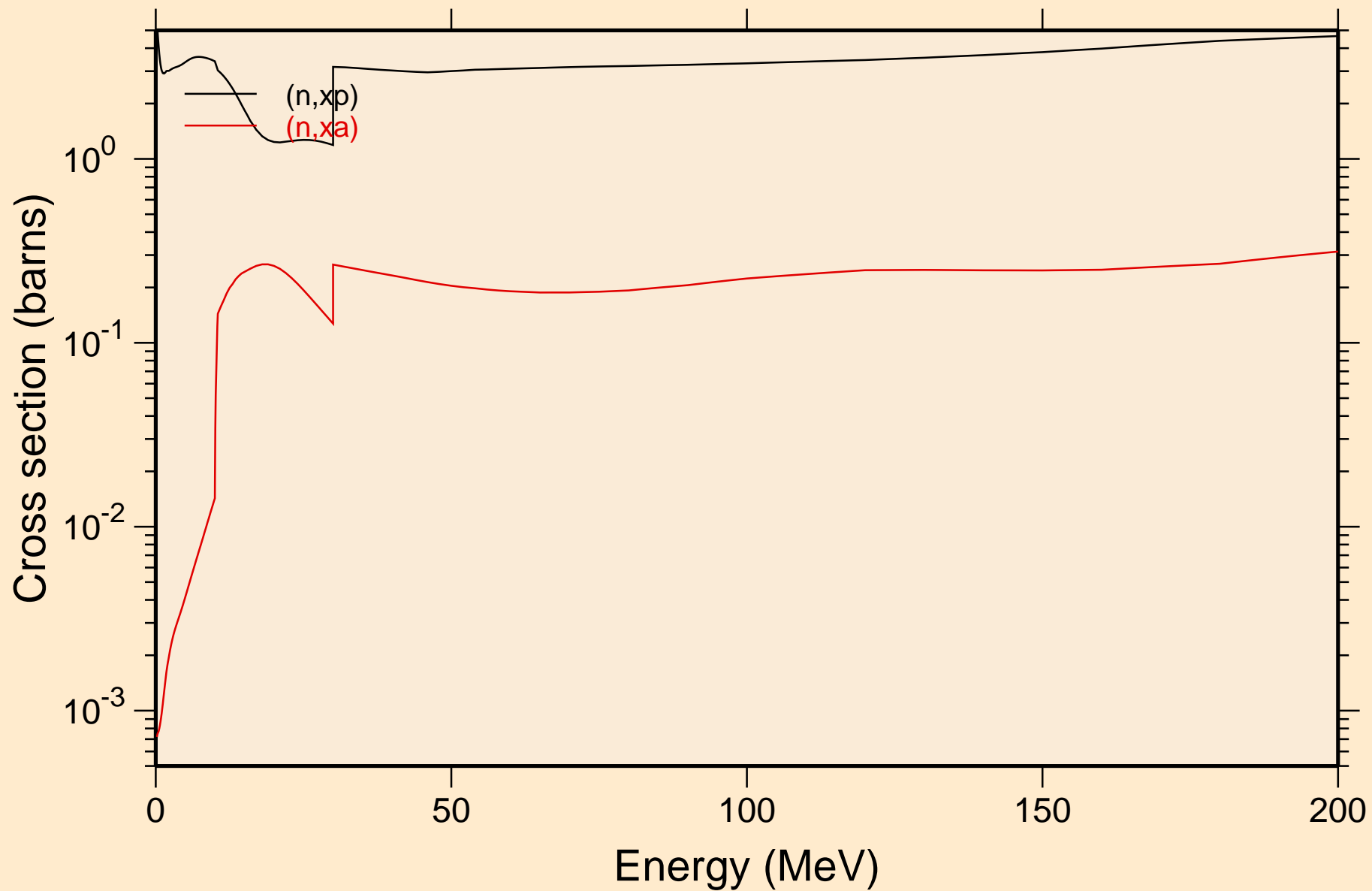

RH092 NEUTRON ACER TENDL-2019 LIBRARY; T=293.16K  
Inelastic levels

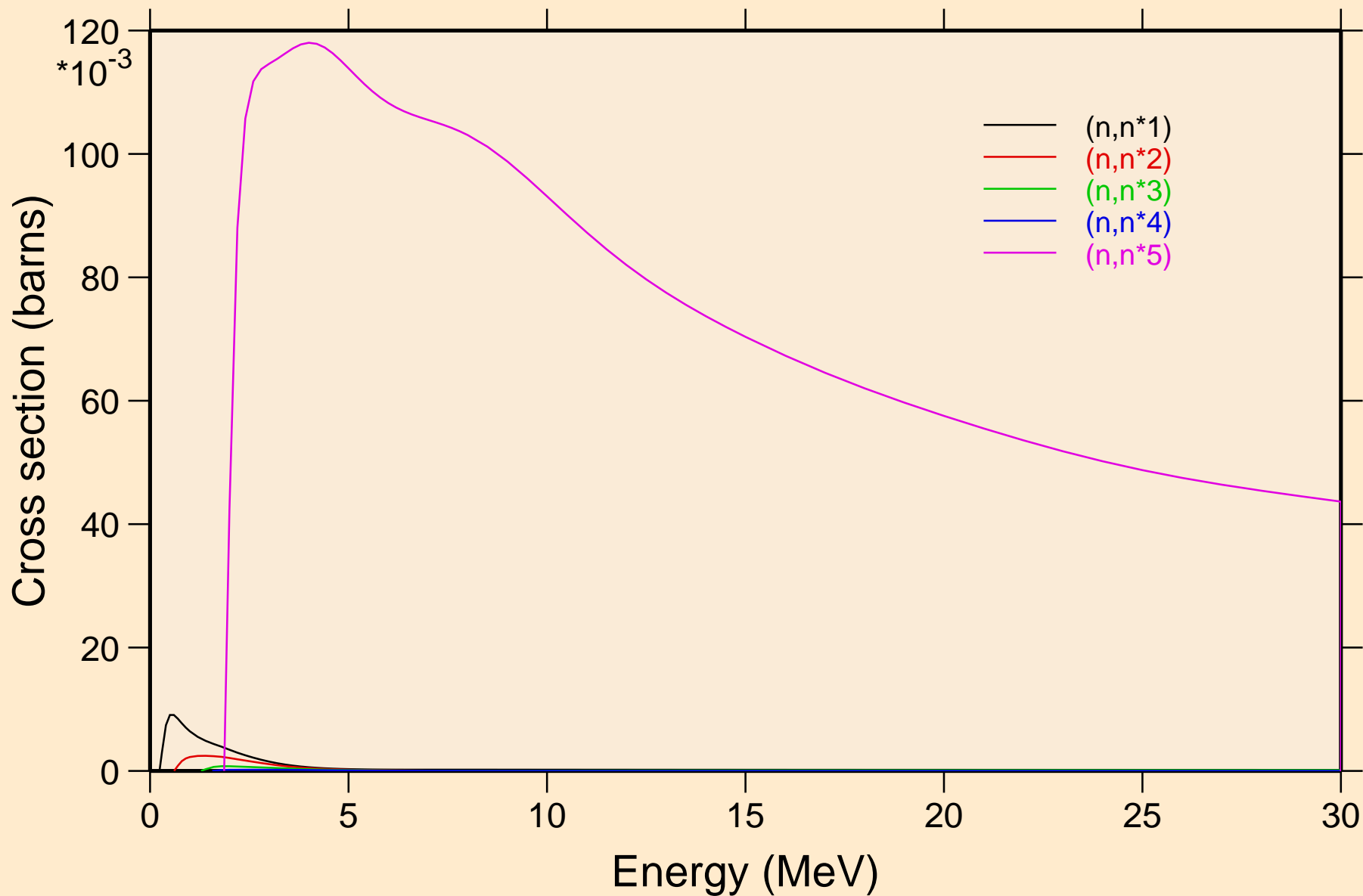

RH092 NEUTRON ACER TENDL-2019 LIBRARY; T=293.16K  
Threshold reactions

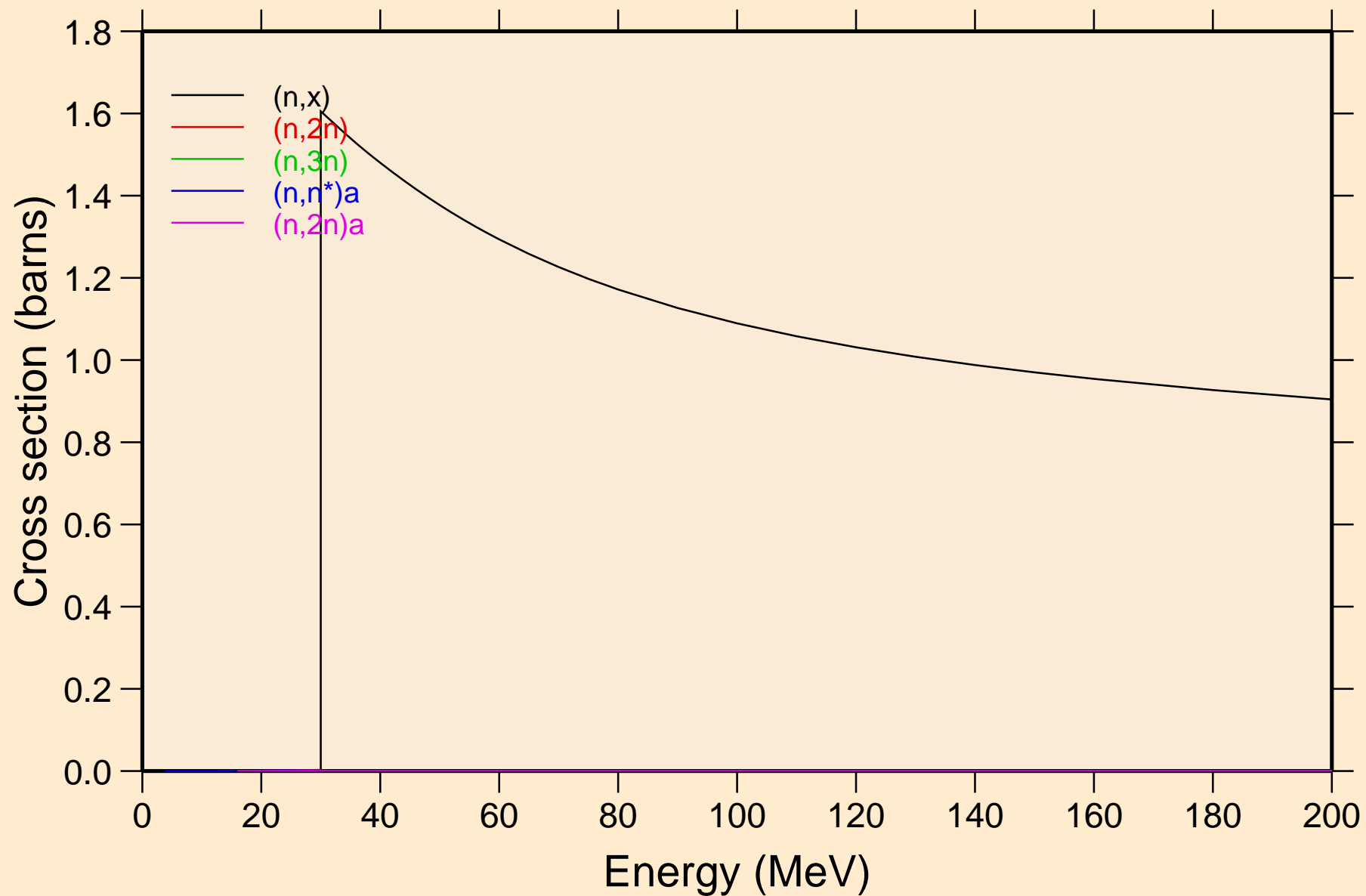

RH092 NEUTRON ACER TENDL-2019 LIBRARY; T=293.16K  
Threshold reactions

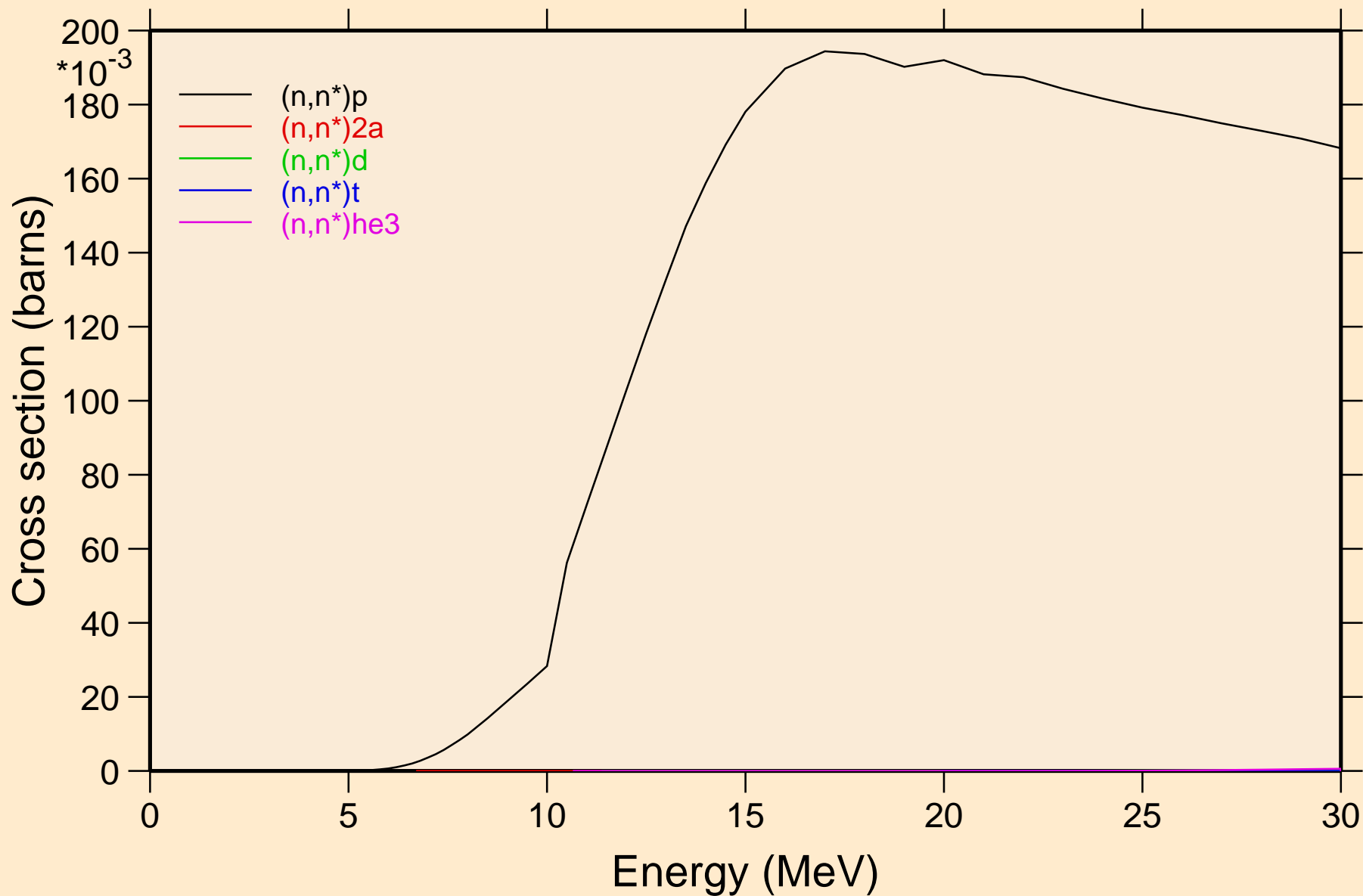

RH092 NEUTRON ACER TENDL-2019 LIBRARY; T=293.16K  
Threshold reactions

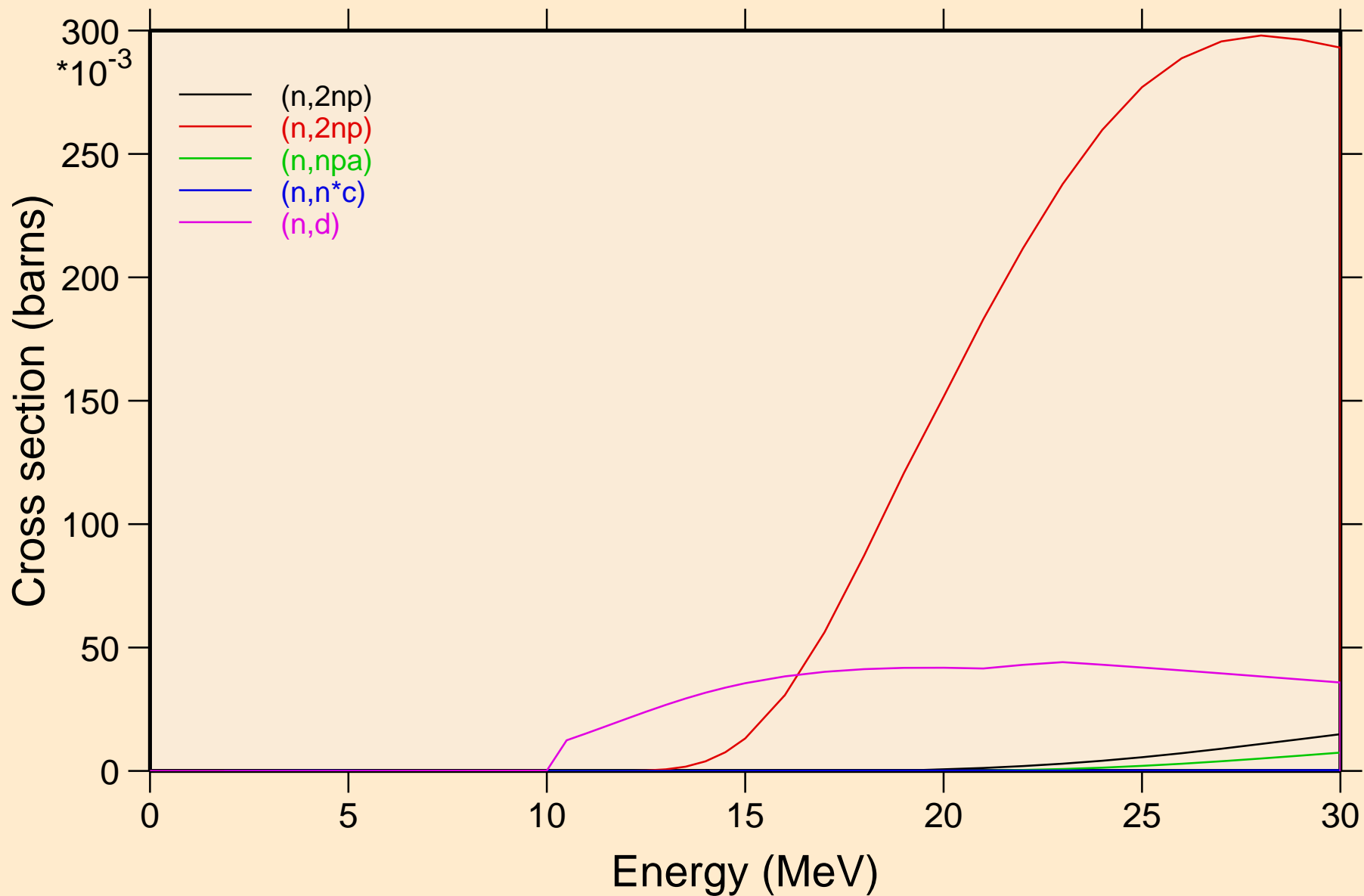

RH092 NEUTRON ACER TENDL-2019 LIBRARY; T=293.16K  
Threshold reactions

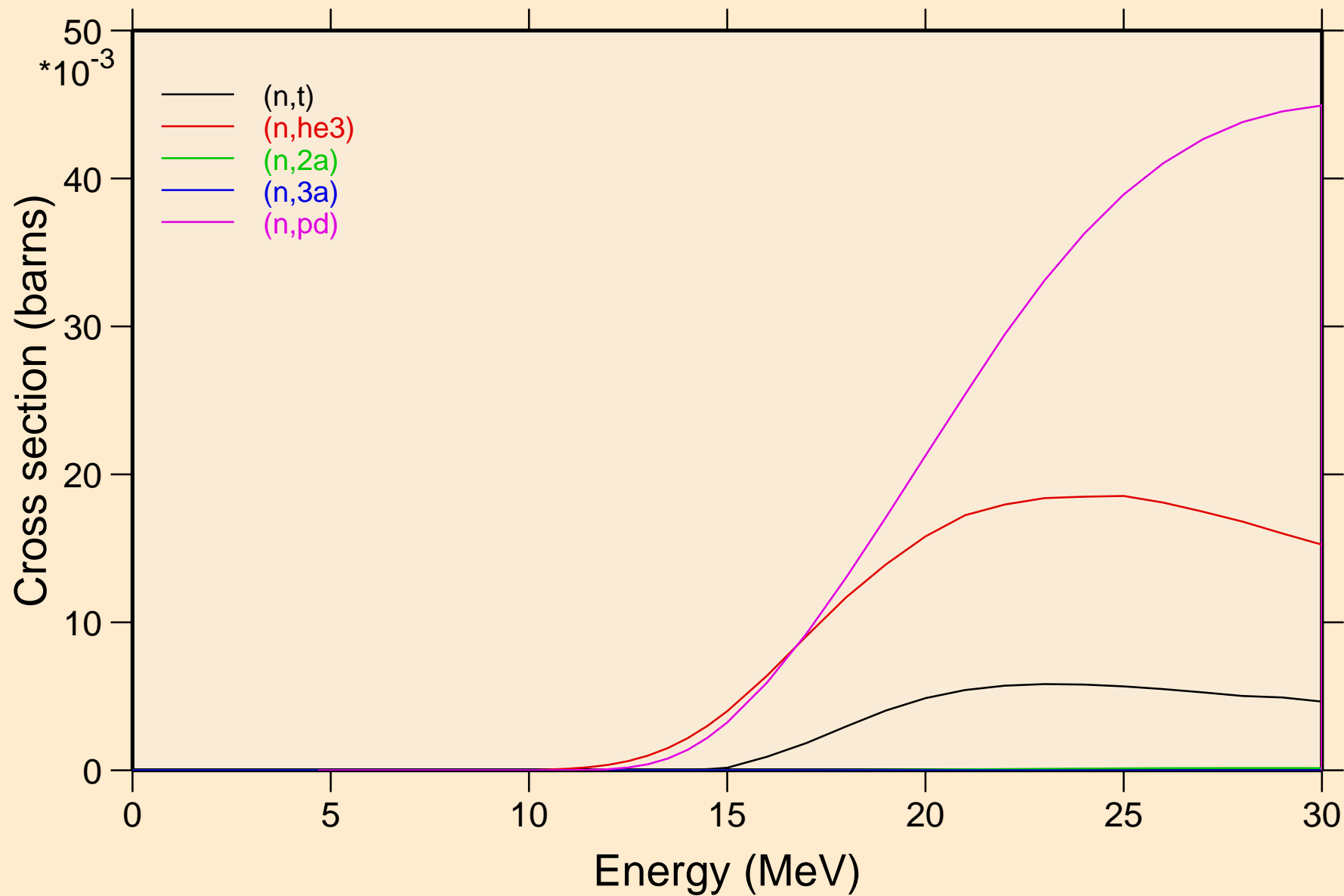

RH092 NEUTRON ACER TENDL-2019 LIBRARY; T=293.16K  
Threshold reactions

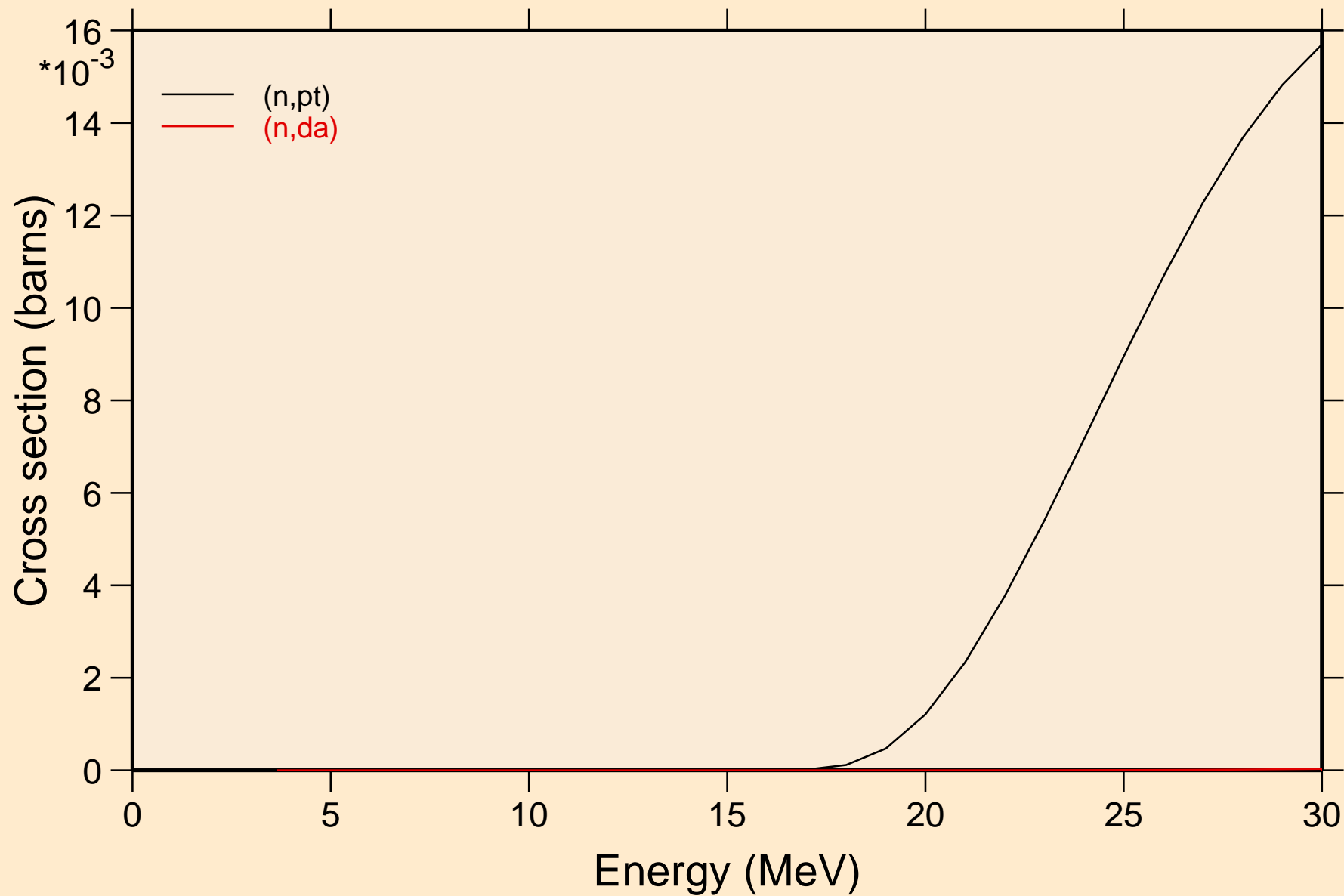

RH092 NEUTRON ACER TENDL-2019 LIBRARY; T=293.16K  
Threshold reactions

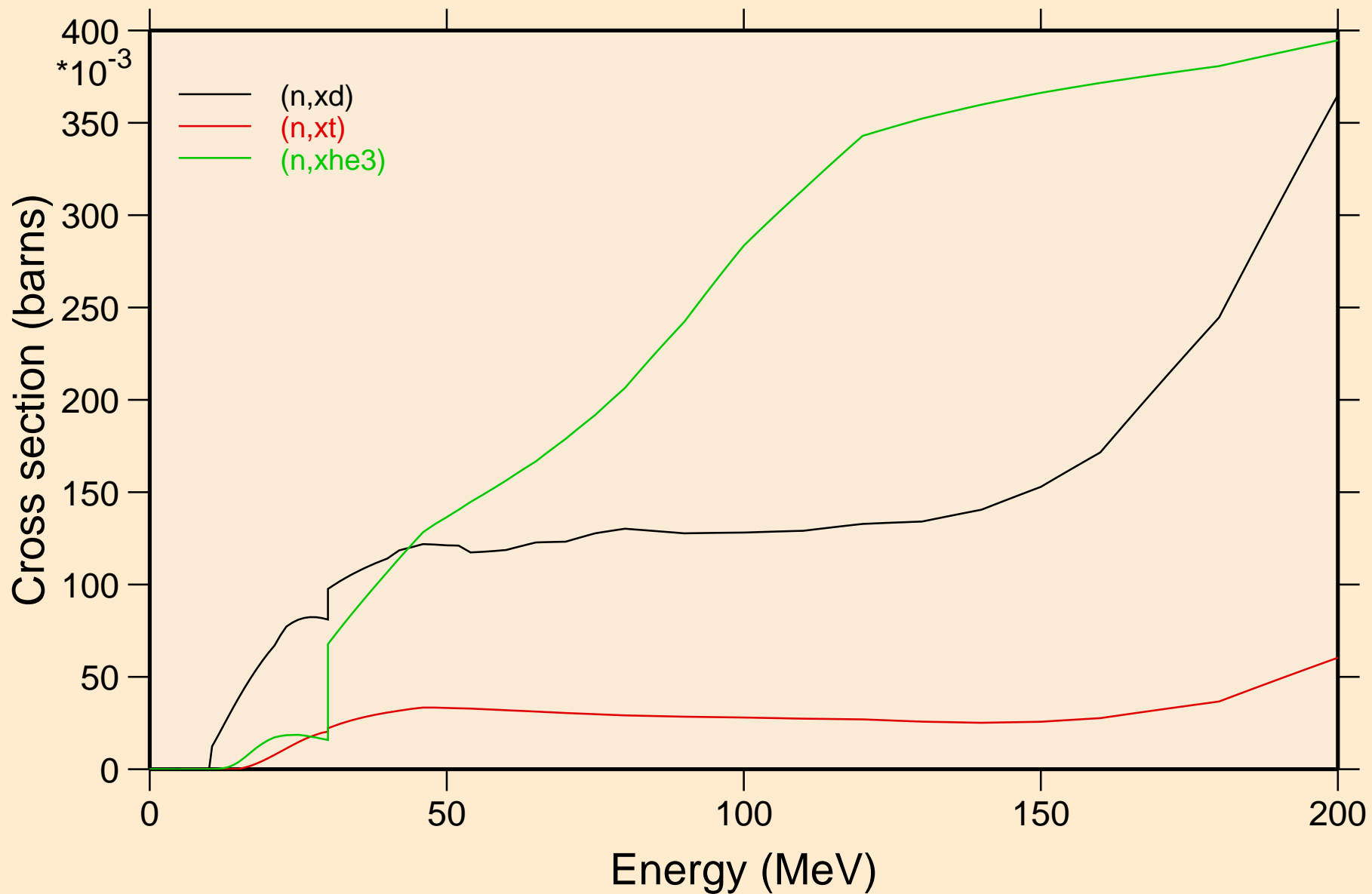

RH092 NEUTRON ACER TENDL-2019 LIBRARY; T=293.16K  
angular distribution for elastic

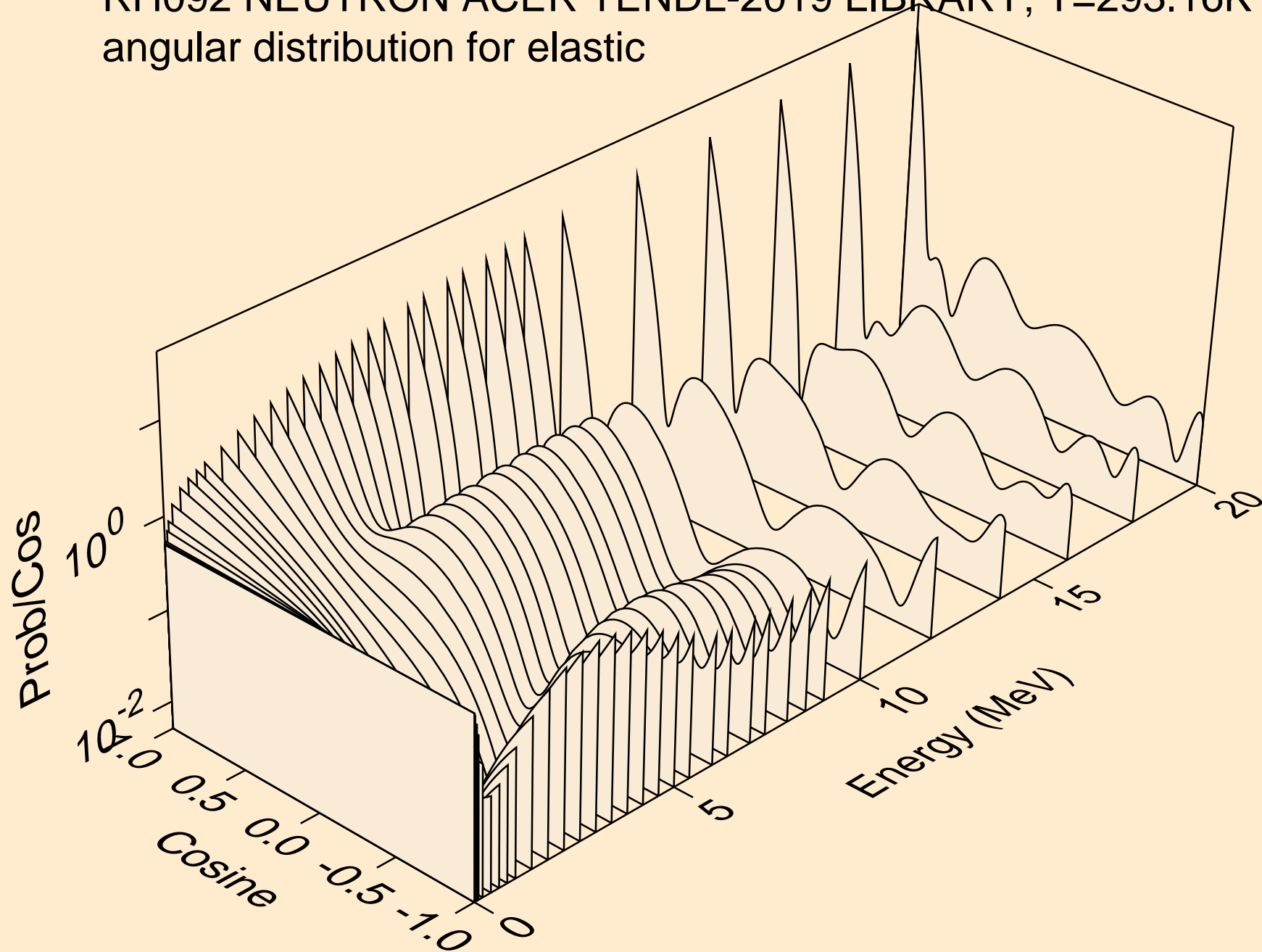

RH092 NEUTRON ACER TENDL-2019 LIBRARY; T=293.16K  
angular distribution for elastic

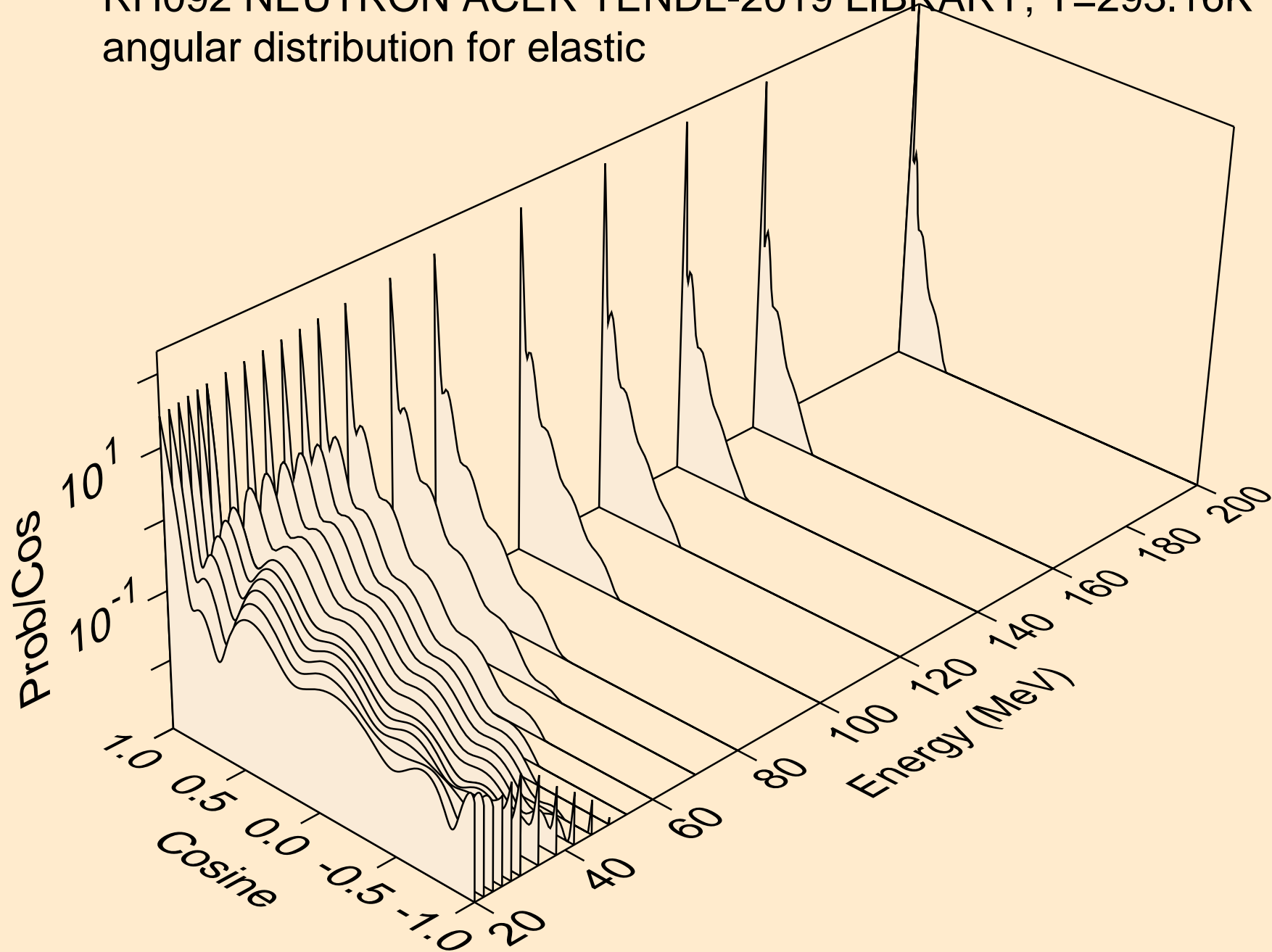

RH092 NEUTRON ACER TENDL-2019 LIBRARY; T=293.16K  
angular distribution for (n,n\*1)

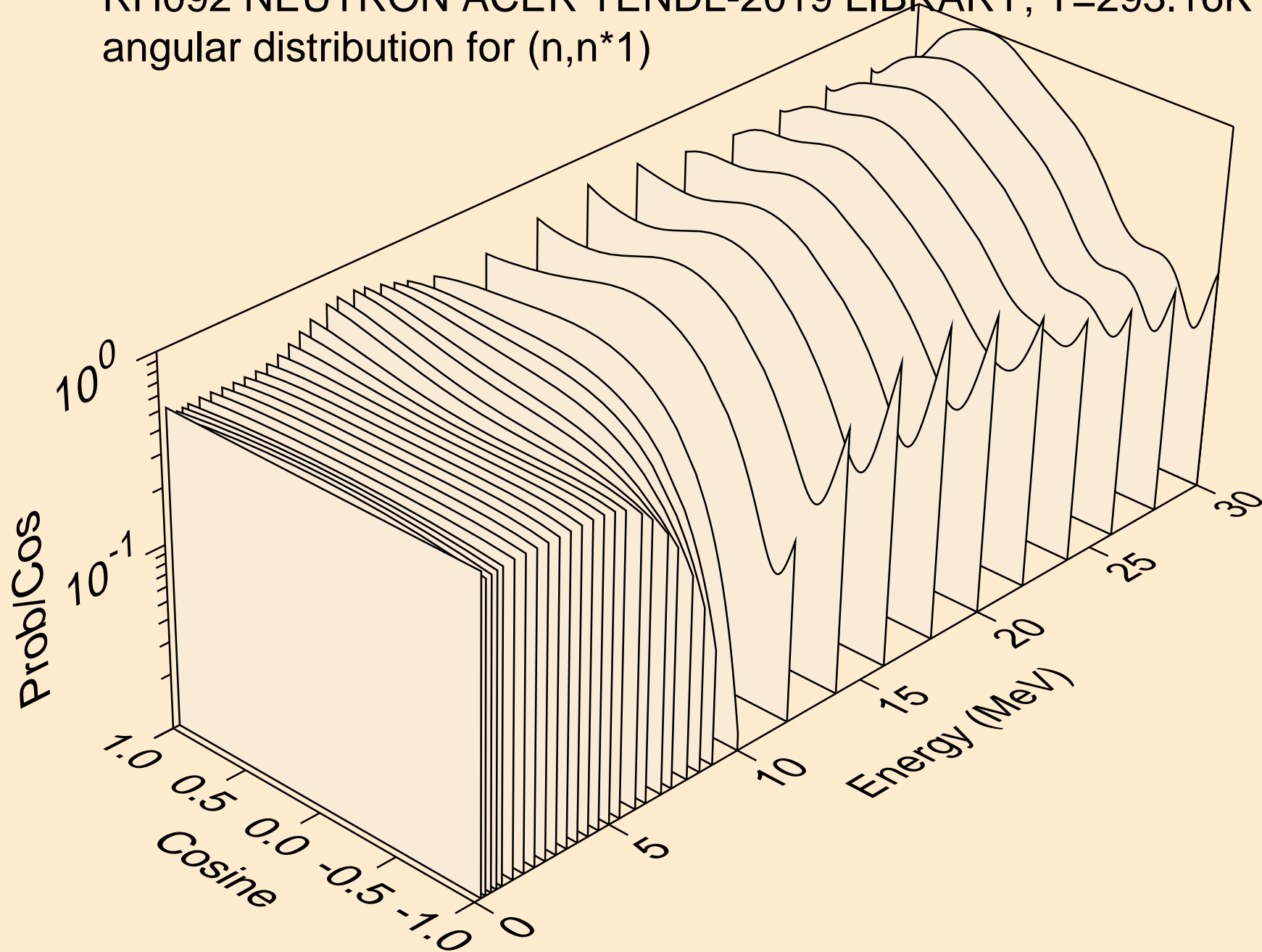

RH092 NEUTRON ACER TENDL-2019 LIBRARY; T=293.16K  
angular distribution for (n,n\*2)

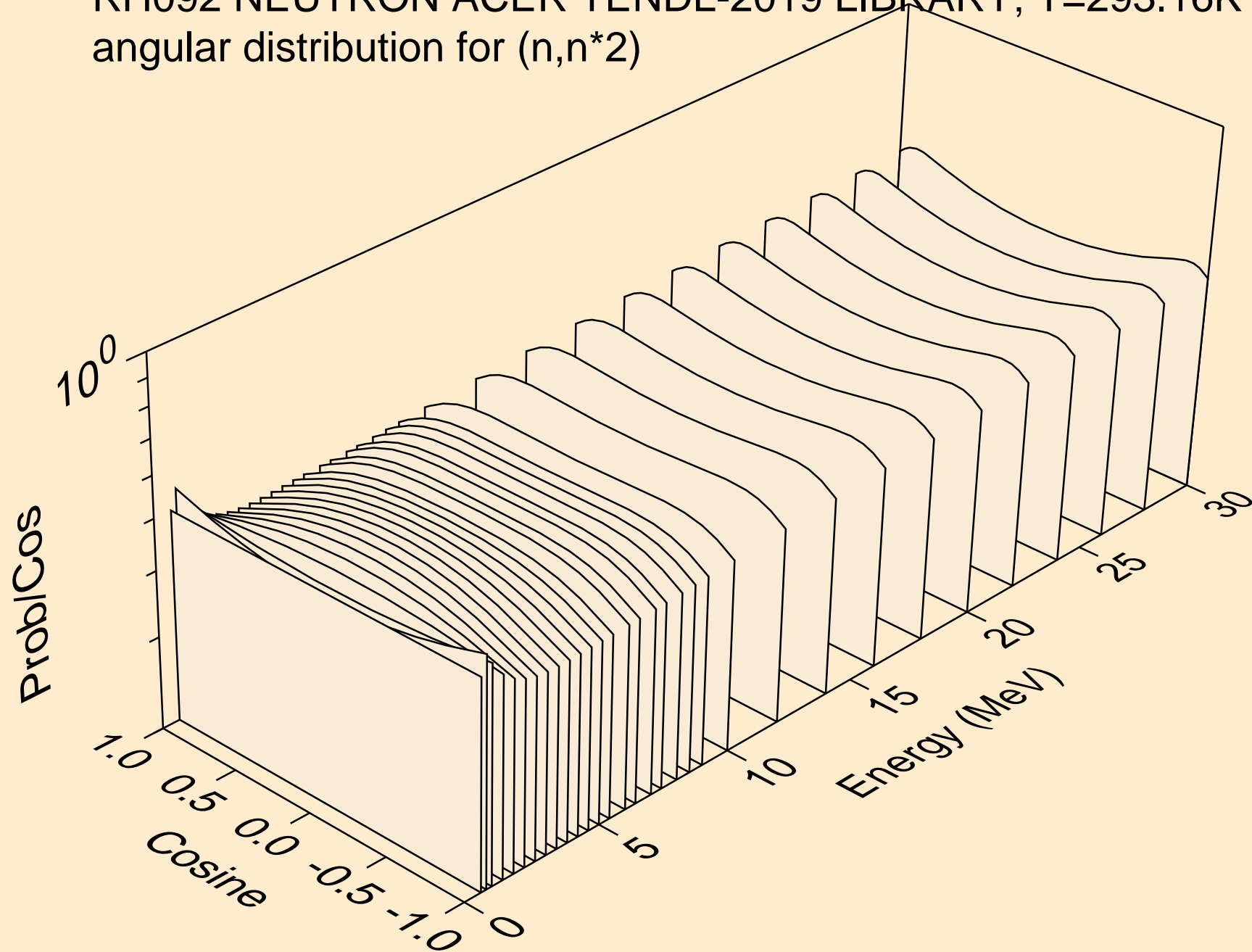

RH092 NEUTRON ACER TENDL-2019 LIBRARY; T=293.16K  
angular distribution for (n,n\*3)

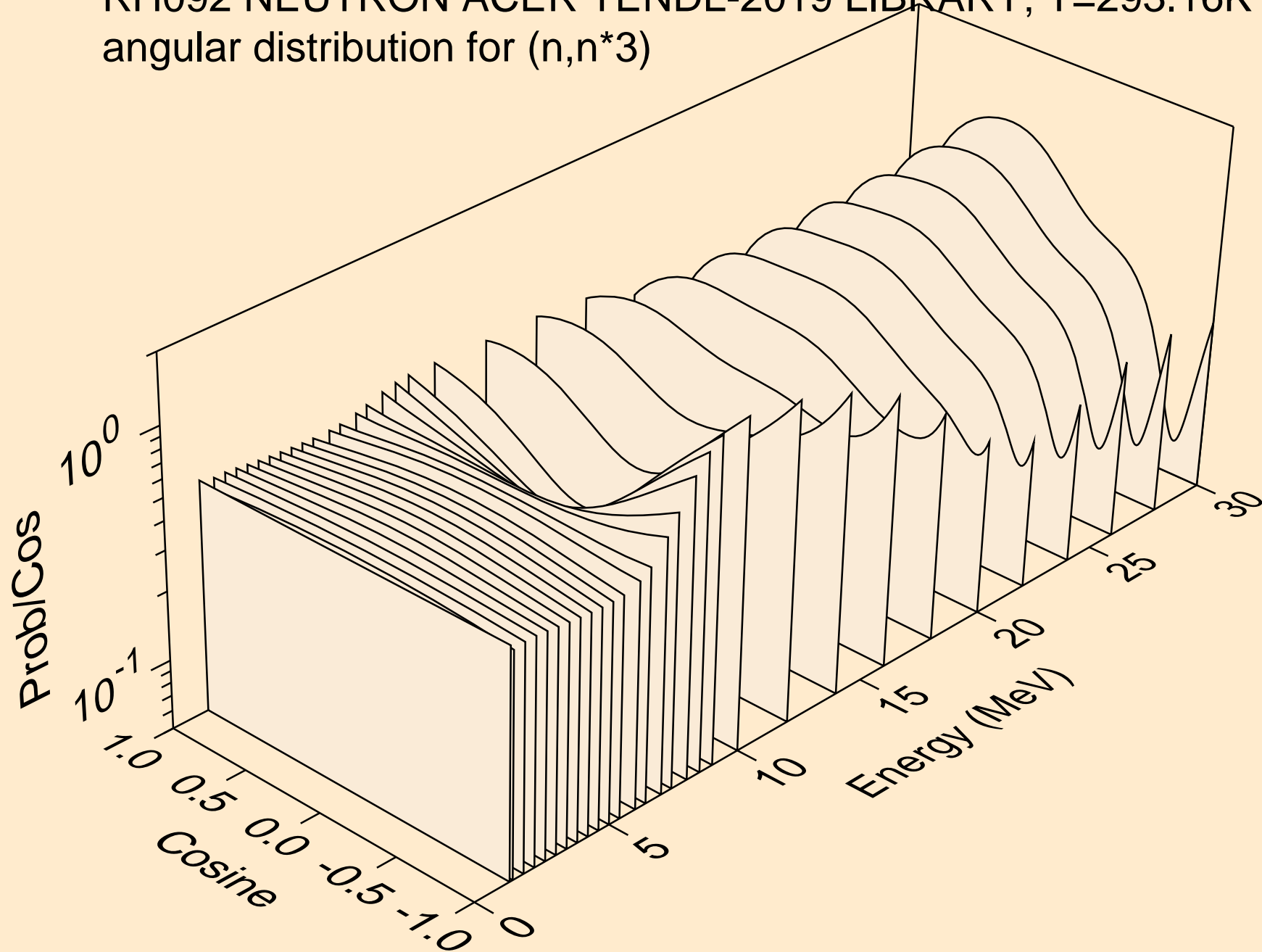

RH092 NEUTRON ACER TENDL-2019 LIBRARY; T=293.16K  
angular distribution for (n,n\*4)

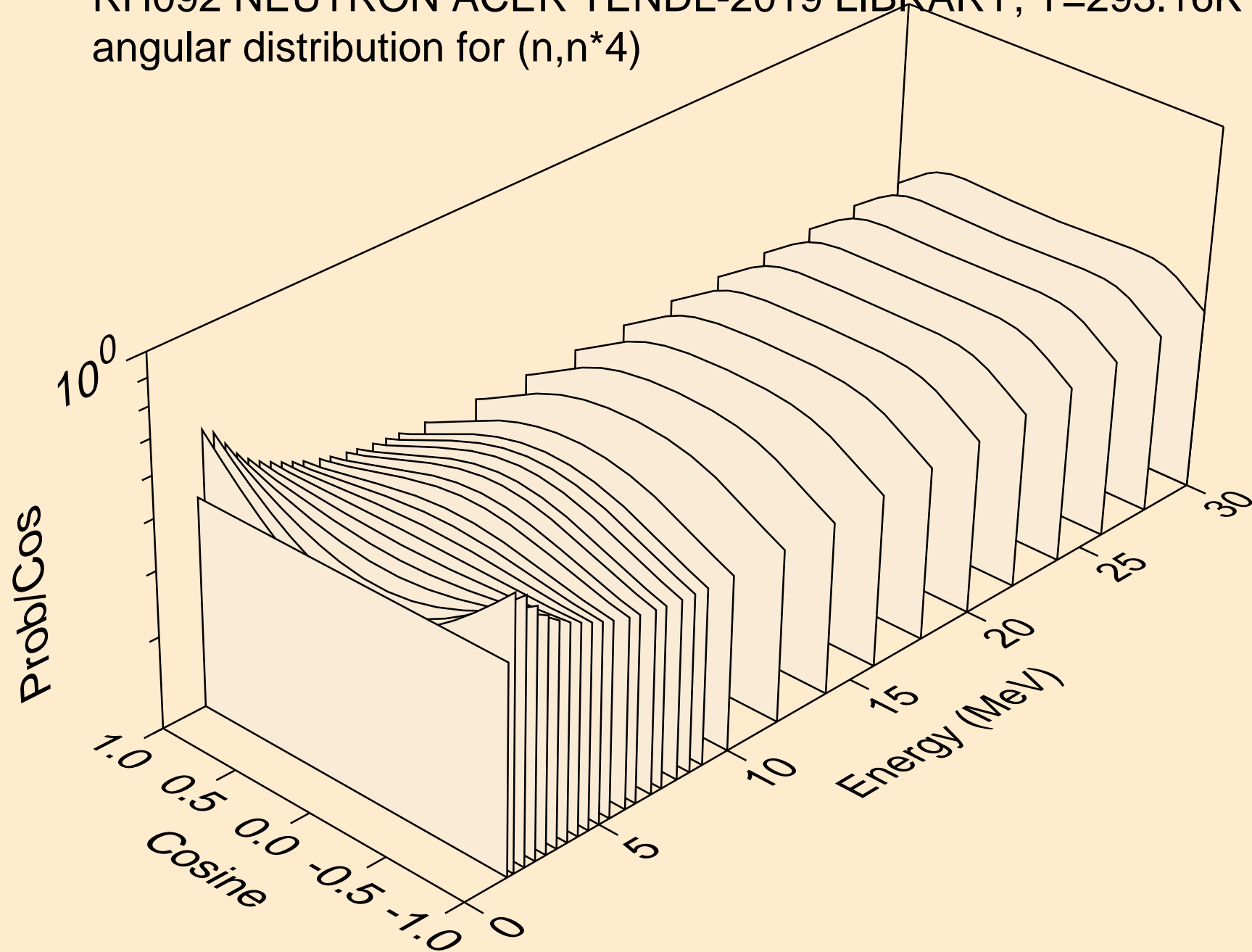

RH092 NEUTRON ACER TENDL-2019 LIBRARY; T=293.16K  
angular distribution for (n,n\*5)

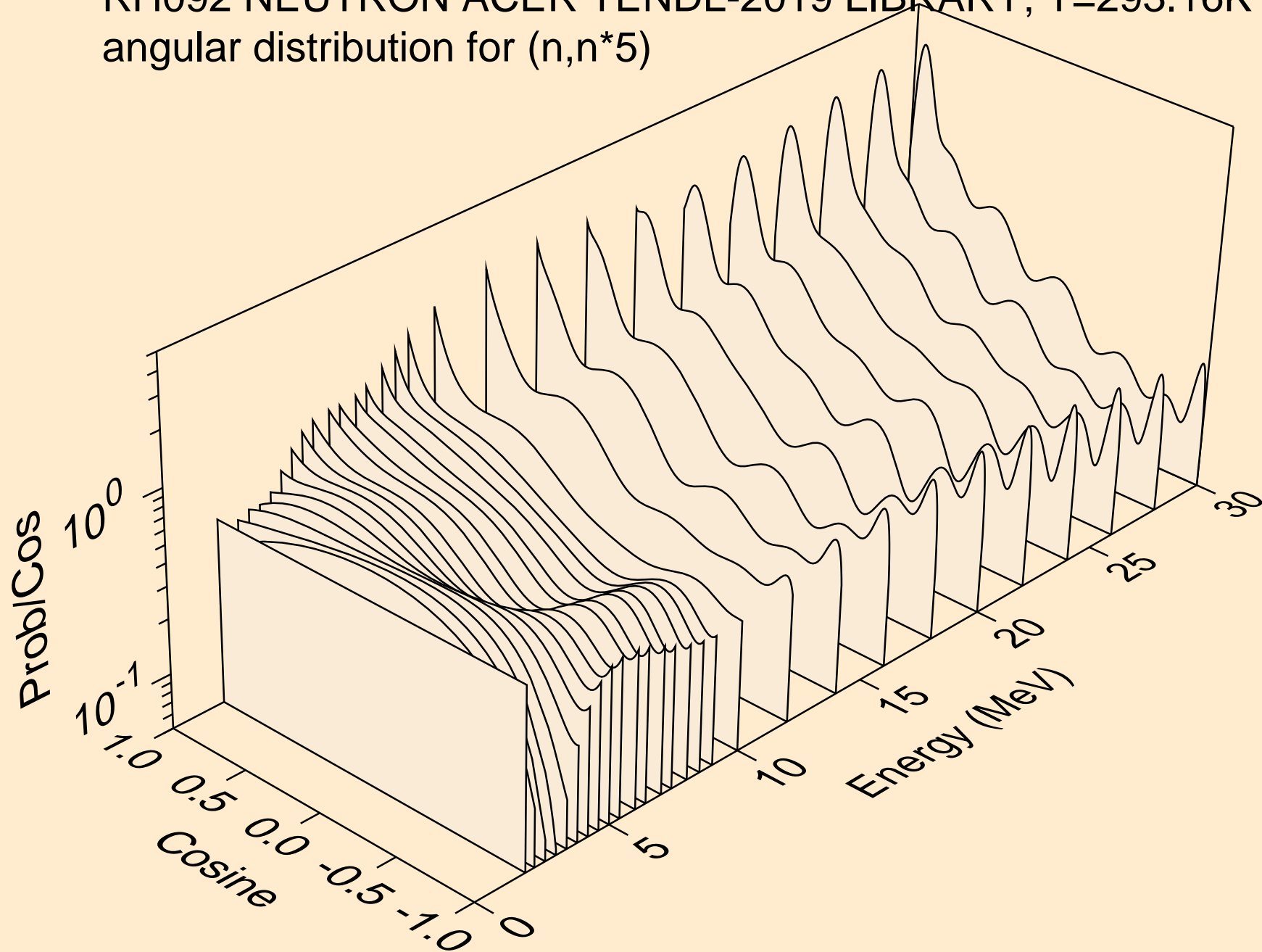

RH092 NEUTRON ACER TENDL-2019 LIBRARY; T=293.16K  
Neutron emission for (n,x)

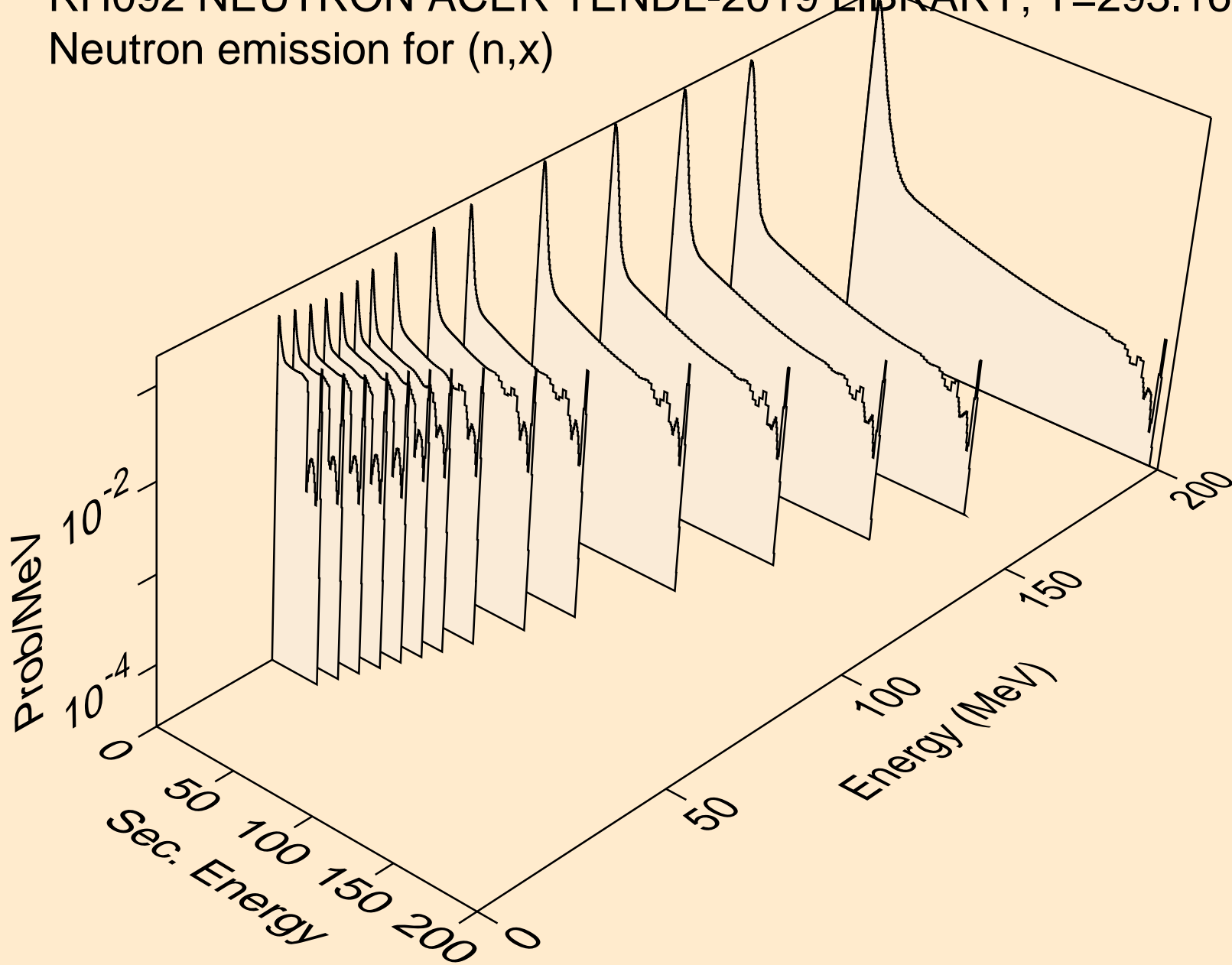

RH092 NEUTRON ACER TENDL-2019 LIBRARY; T=293.16K  
Neutron emission for (n,2n)

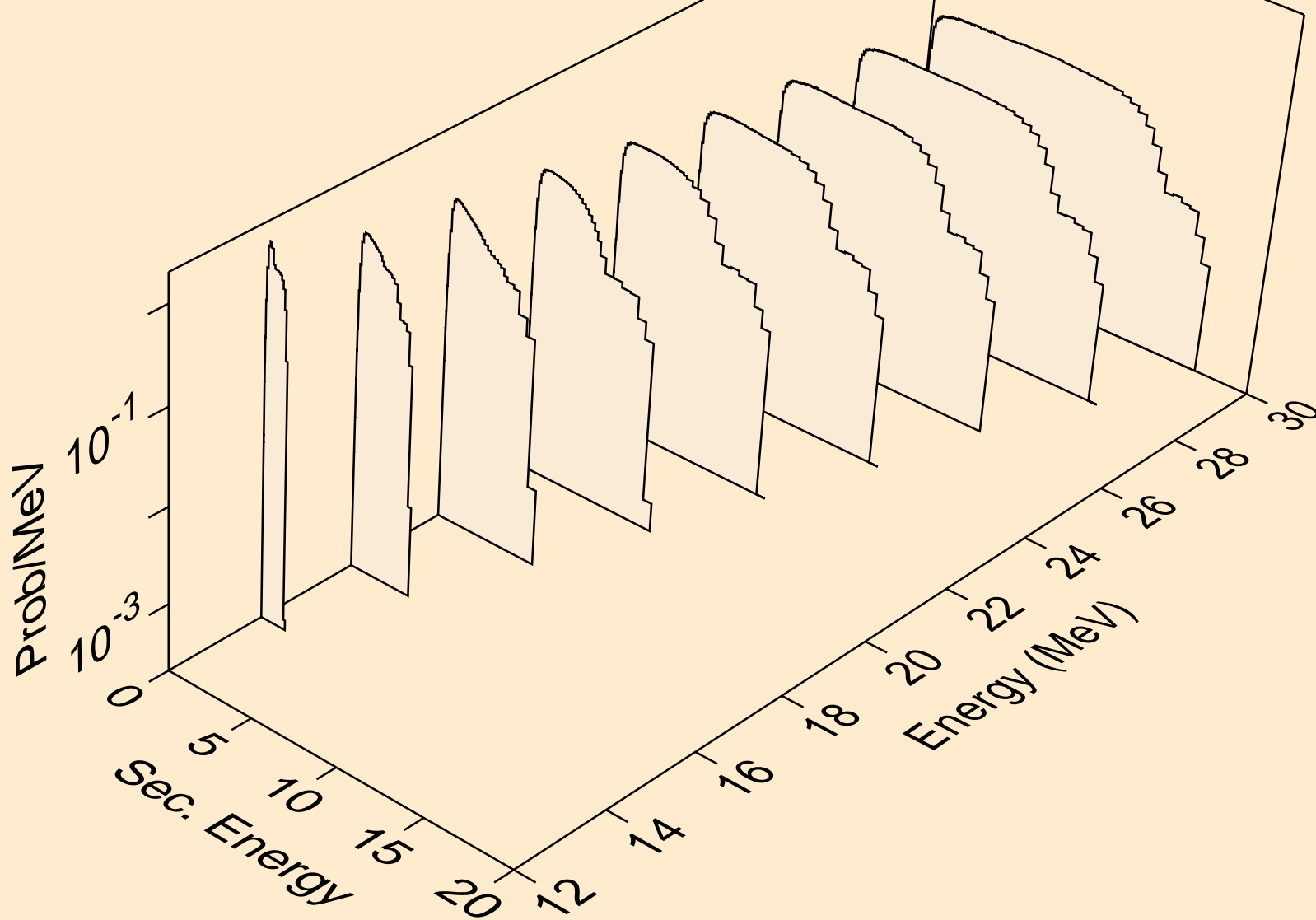

RH092 NEUTRON ACER TENDL-2019 LIBRARY; T=293.16K  
Neutron emission for (n,3n)

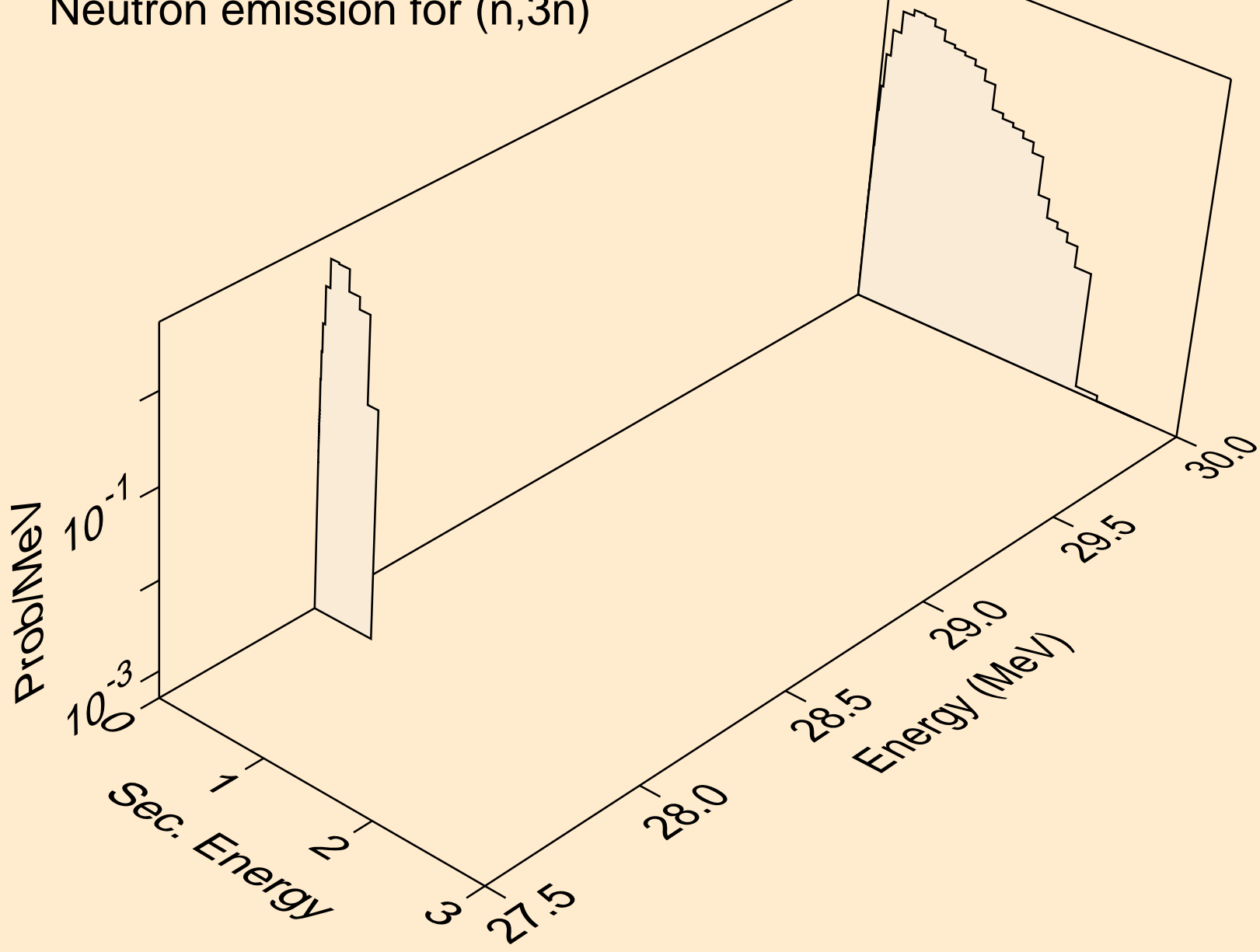

RH092 NEUTRON ACER TENDL-2019 LIBRARY; T=293.16K  
Neutron emission for (n,n\*)a

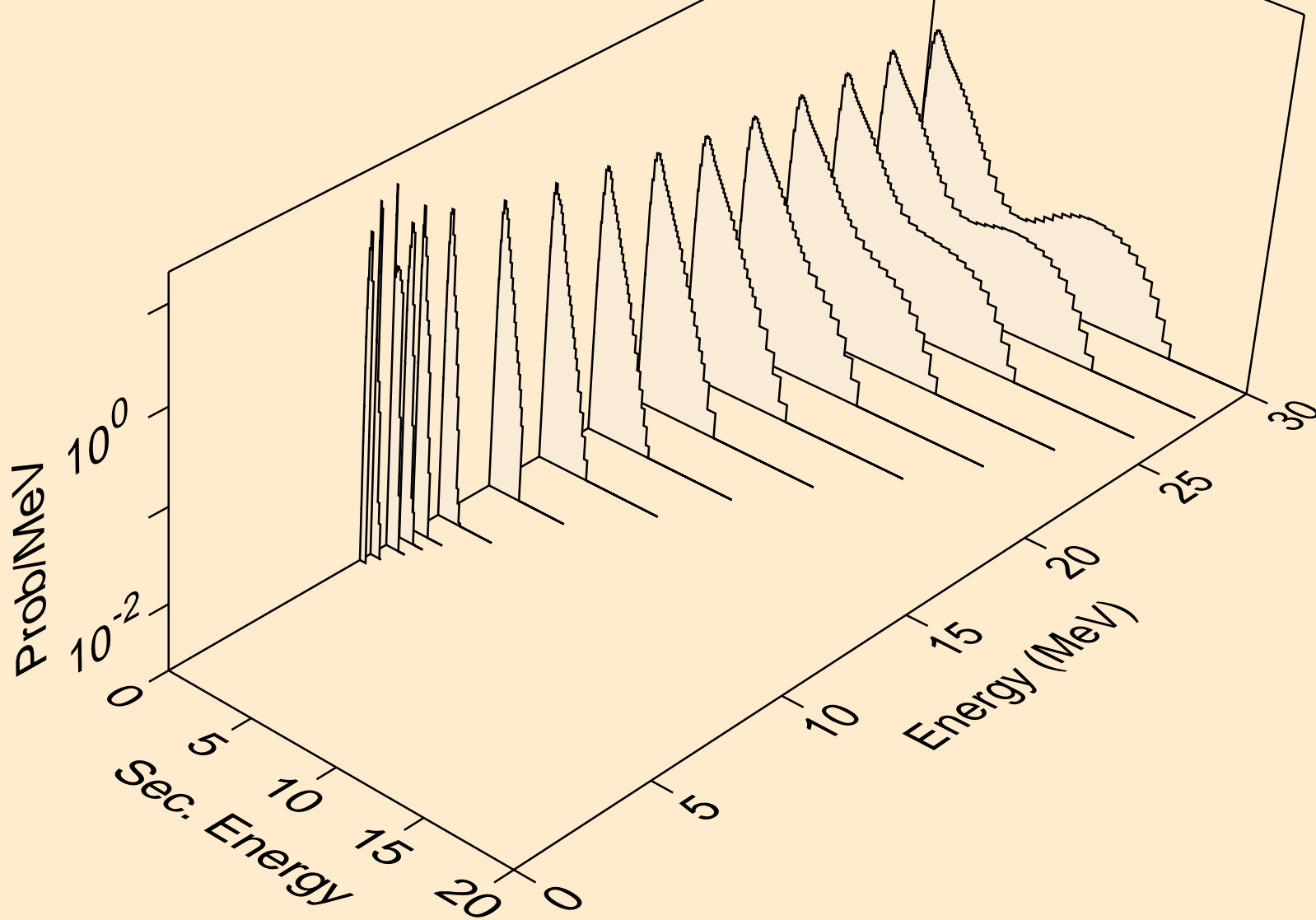

RH092 NEUTRON ACER TENDL-2019 LIBRARY; T=293.16K  
Neutron emission for (n,2n)a

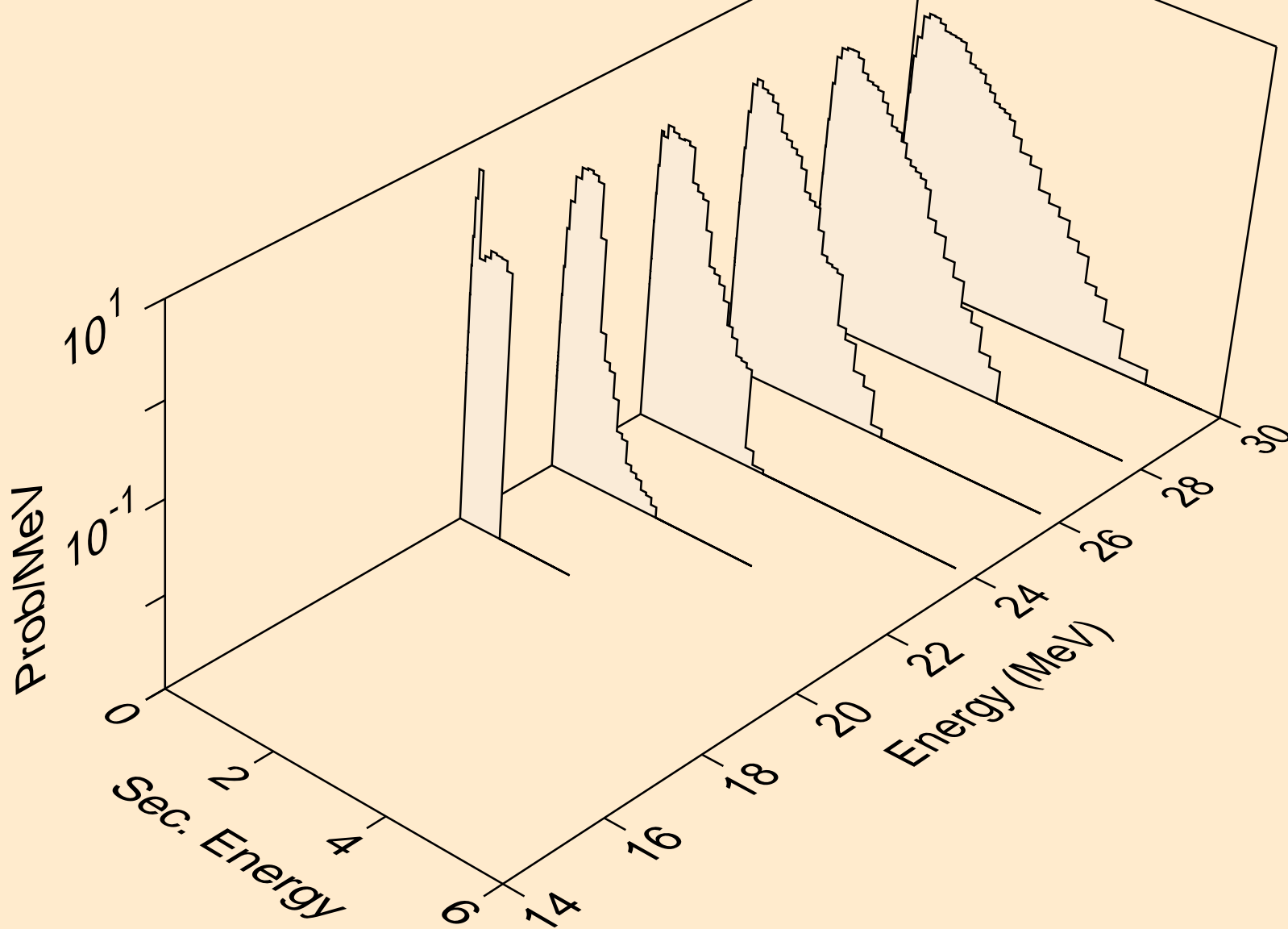

RH092 NEUTRON ACER TENDL-2019 LIBRARY; T=293.16K  
Neutron emission for (n,n\*)p

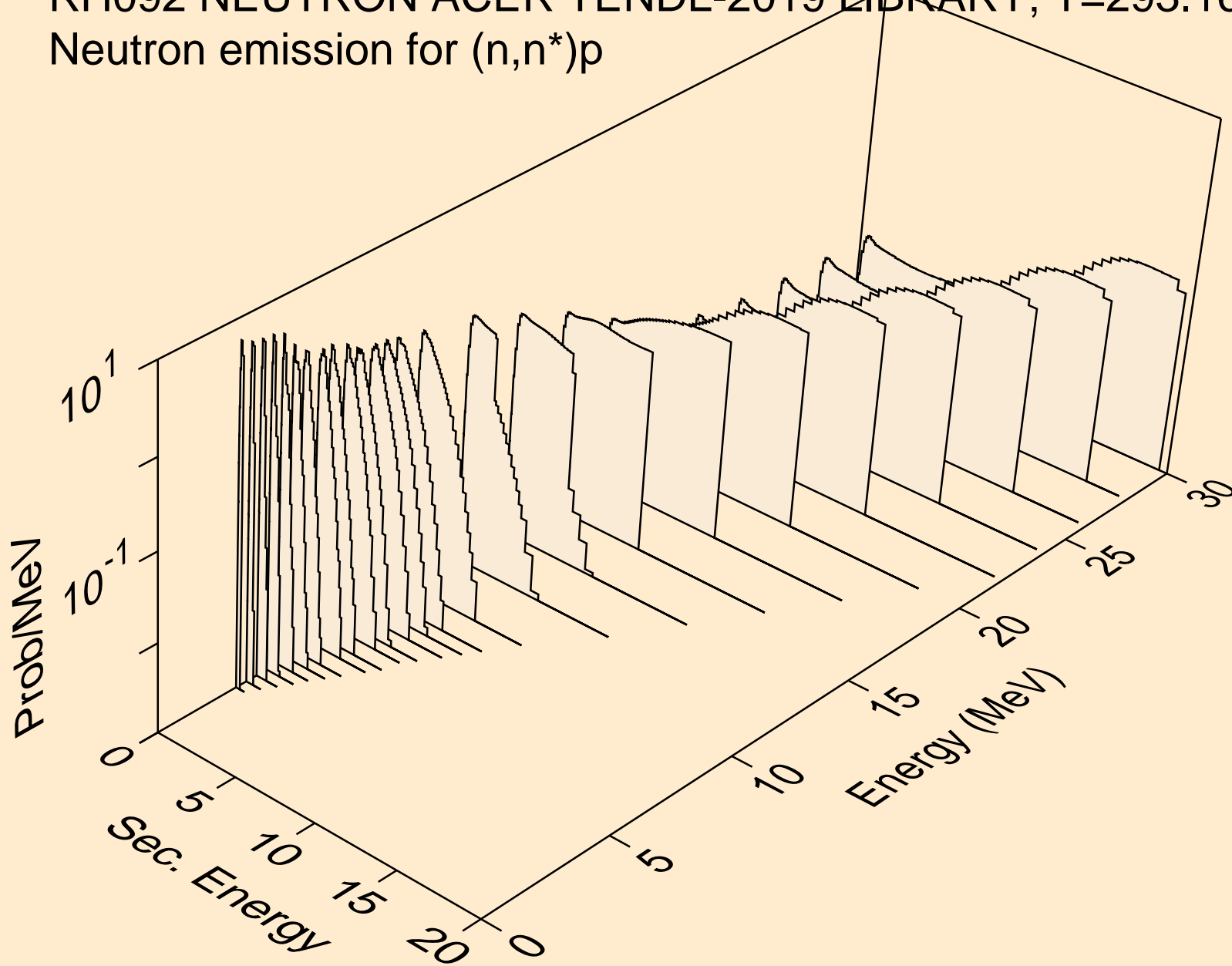

RH092 NEUTRON ACER TENDL-2019 LIBRARY; T=293.16K  
Neutron emission for (n,n\*)2a

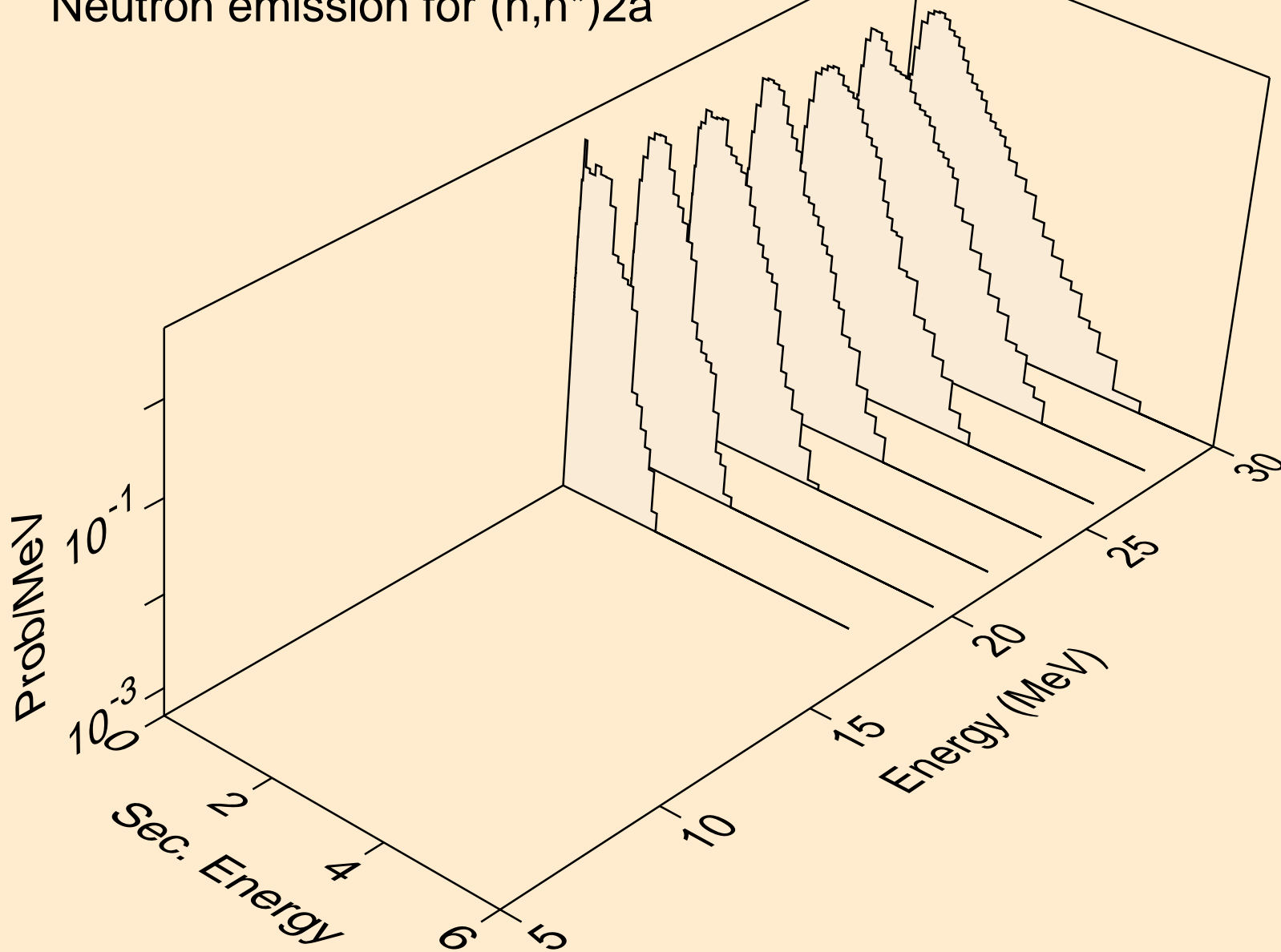

RH092 NEUTRON ACER TENDL-2019 LIBRARY; T=293.16K  
Neutron emission for (n,n\*)d

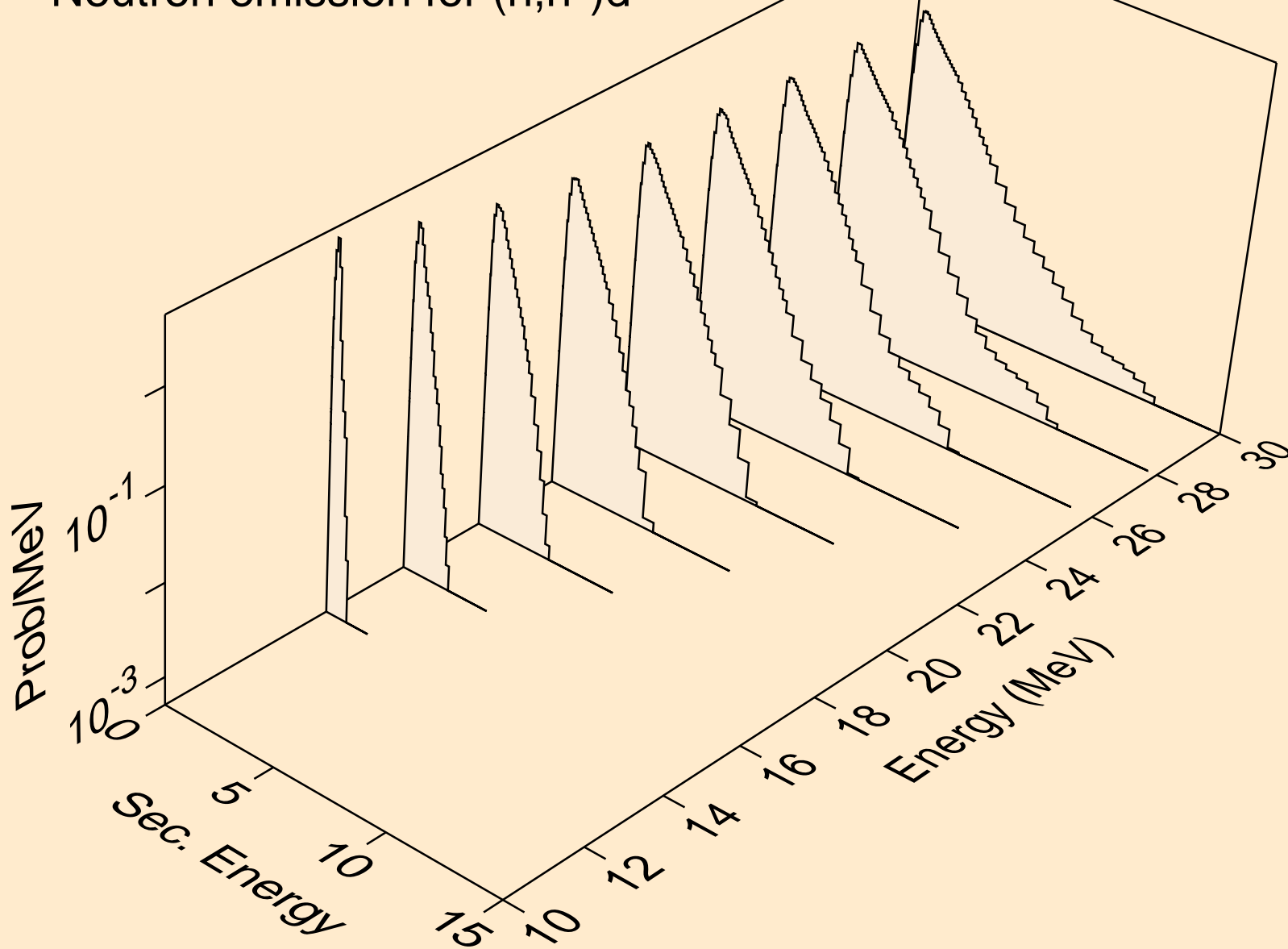

RH092 NEUTRON ACER TENDL-2019 LIBRARY; T=293.16K  
Neutron emission for (n,n\*)t

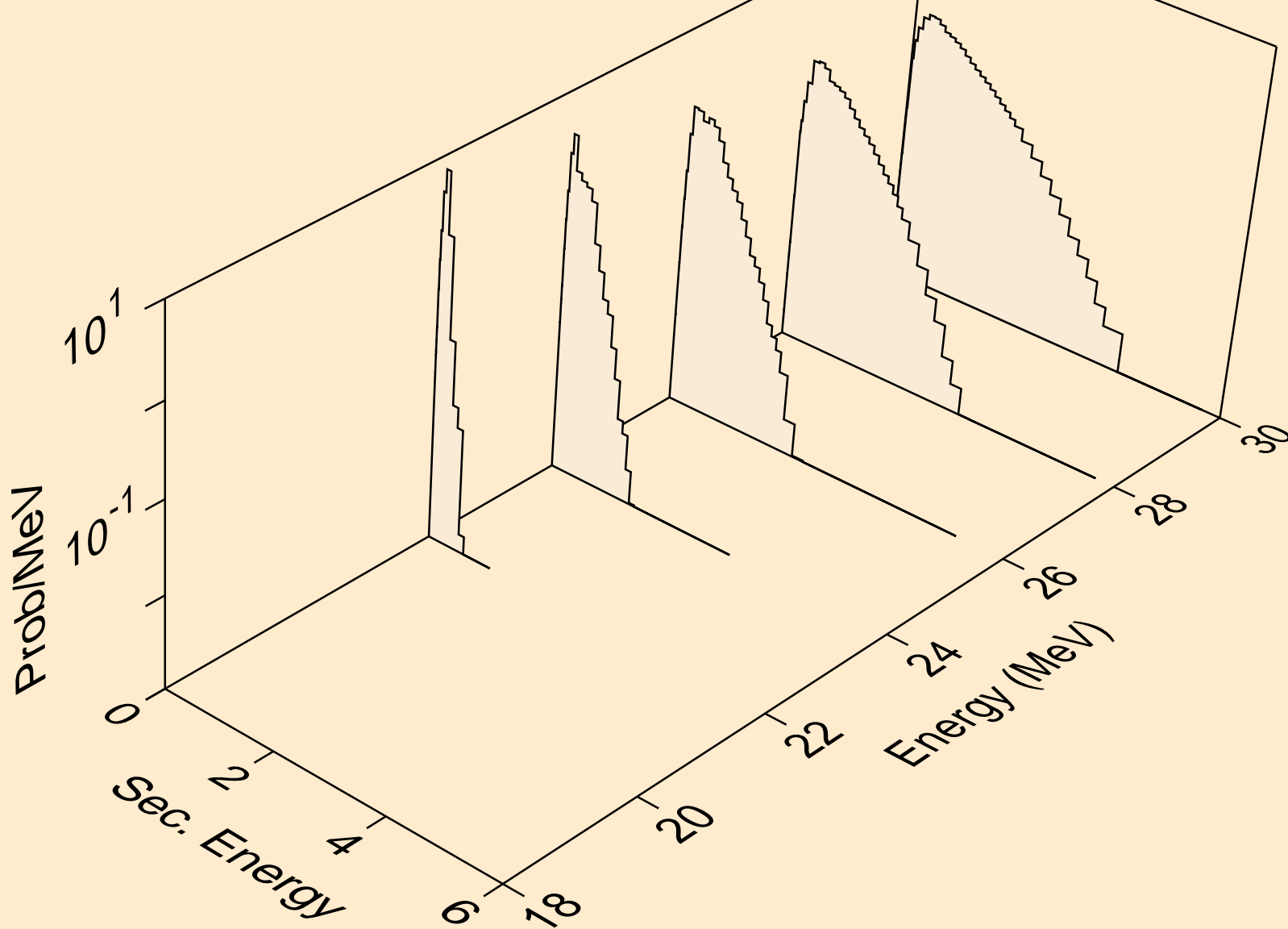

RH092 NEUTRON ACER TENDL-2019 LIBRARY; T=293.16K  
Neutron emission for (n,n\*)he3

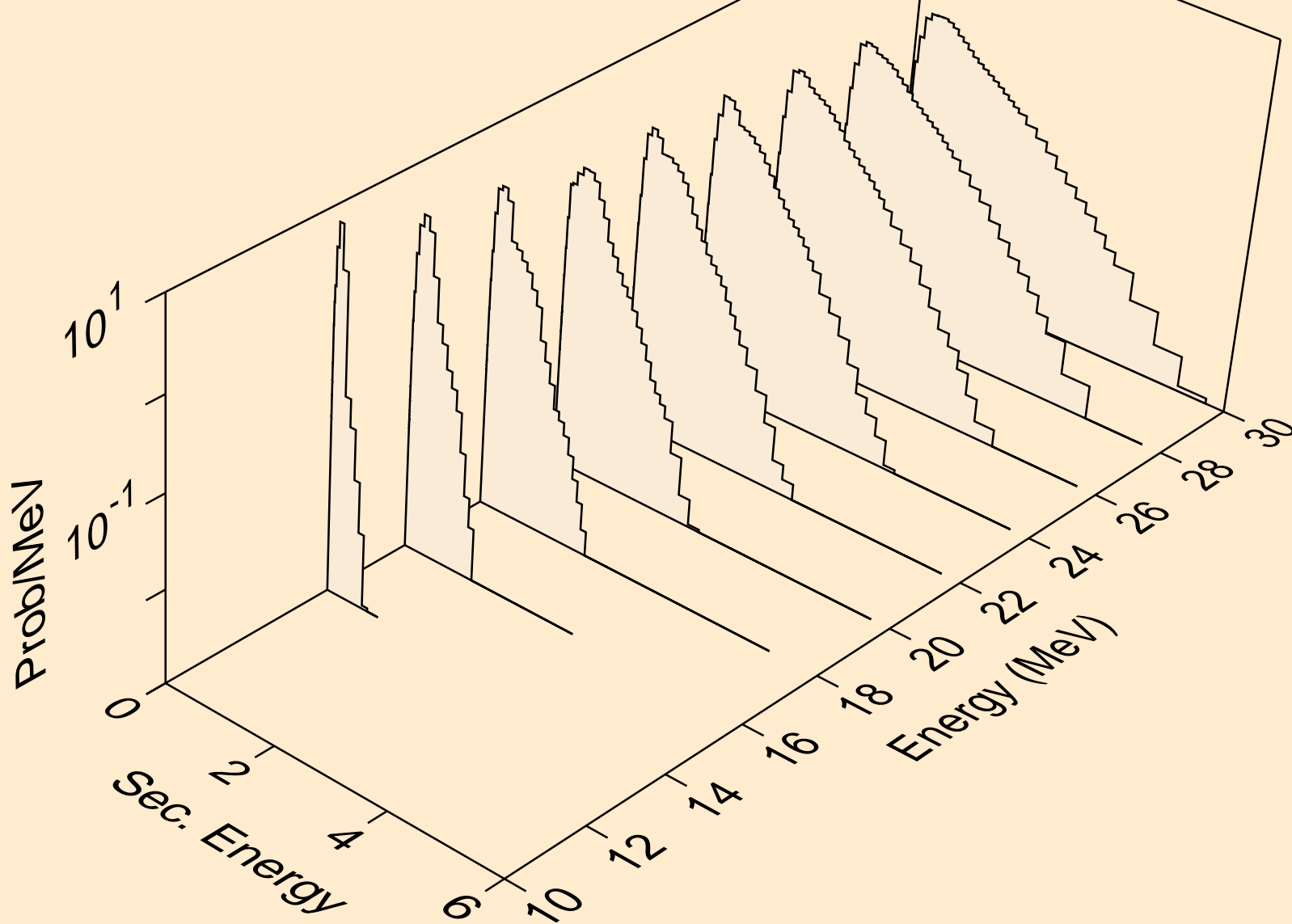

RH092 NEUTRON ACER TENDL-2019 LIBRARY; T=293.16K  
Neutron emission for (n,2np)

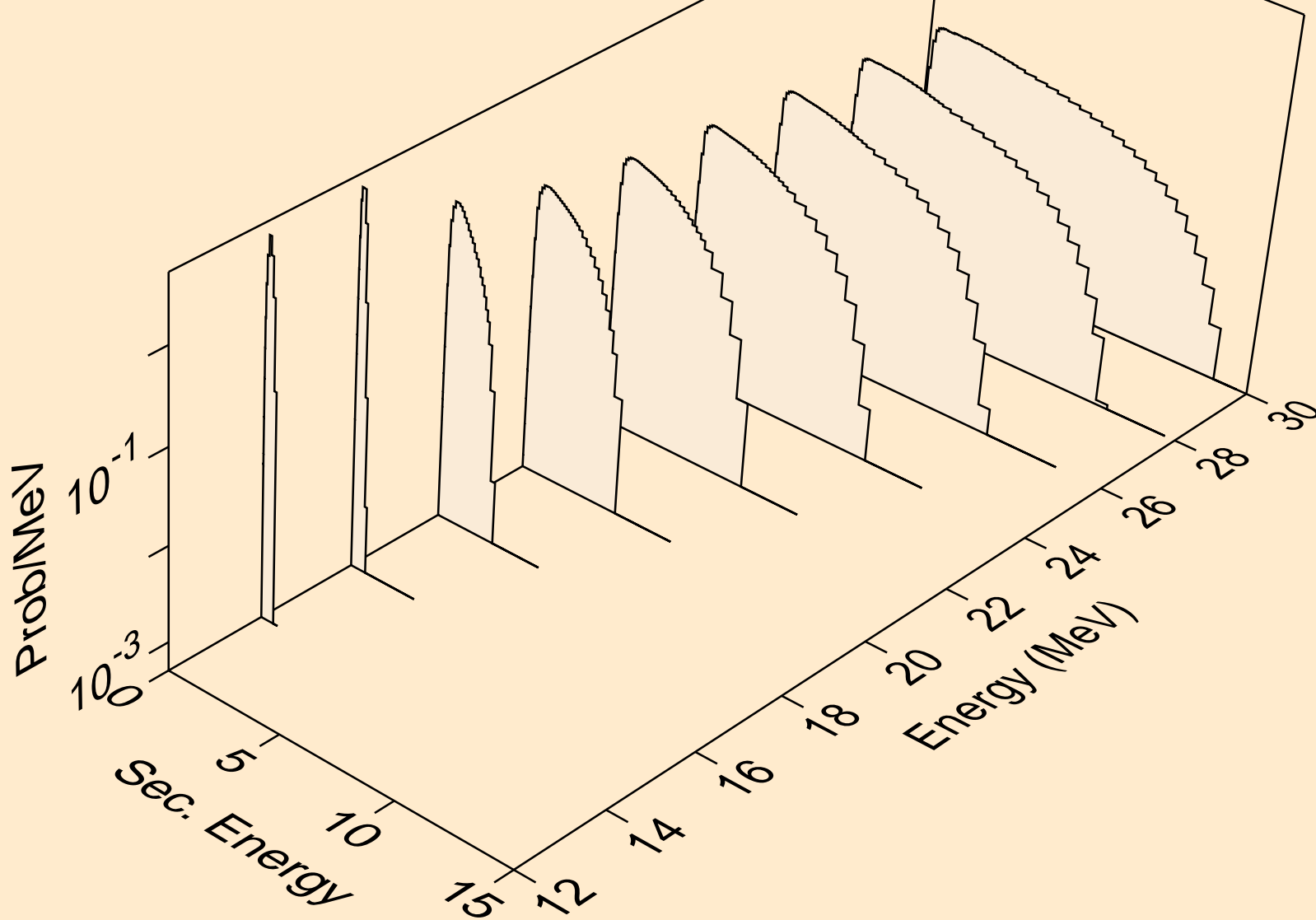

RH092 NEUTRON ACER TENDL-2019 LIBRARY; T=293.16K  
Neutron emission for (n,2np)

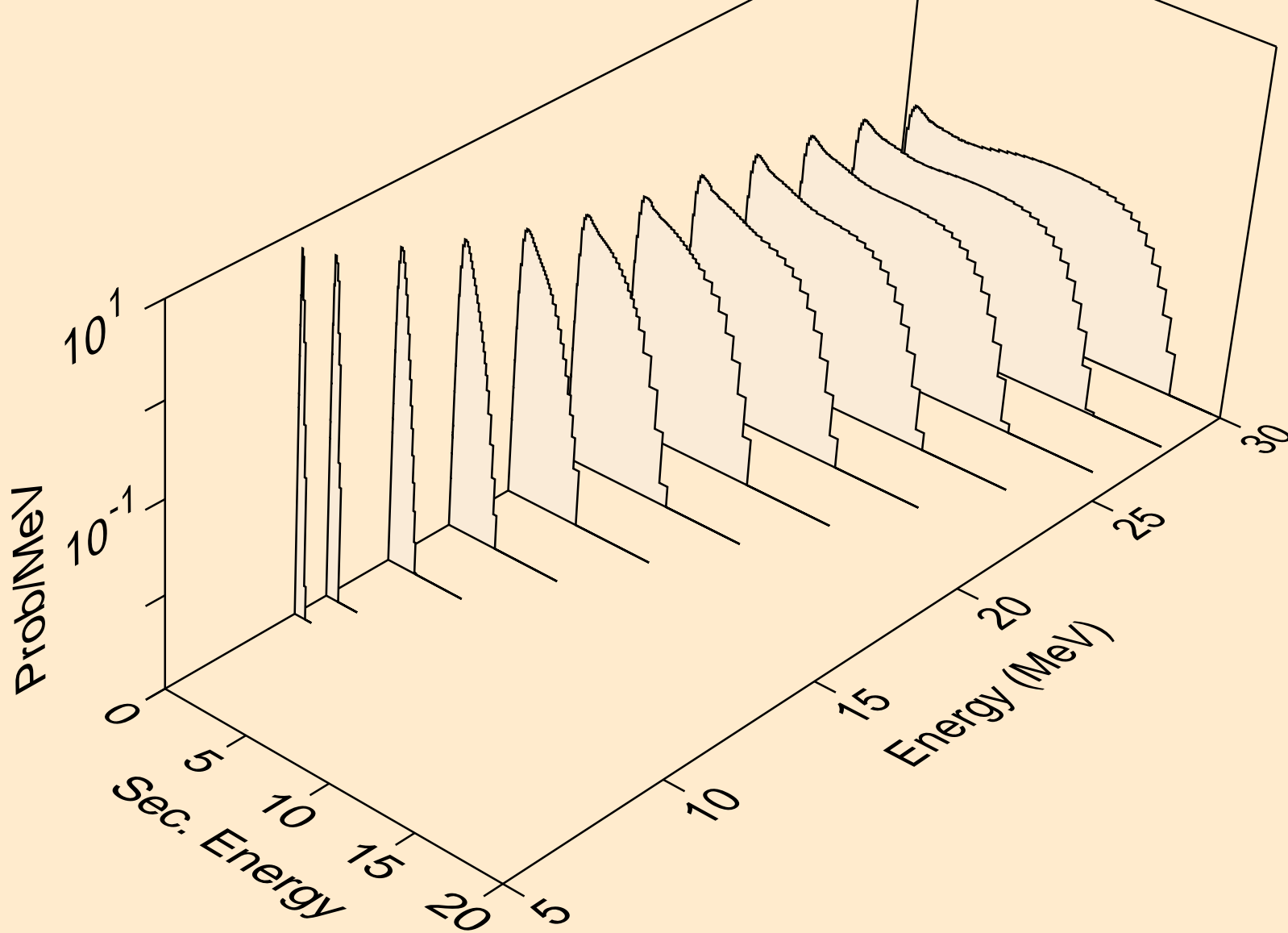

RH092 NEUTRON ACER TENDL-2019 LIBRARY; T=293.16K  
Neutron emission for (n,npa)

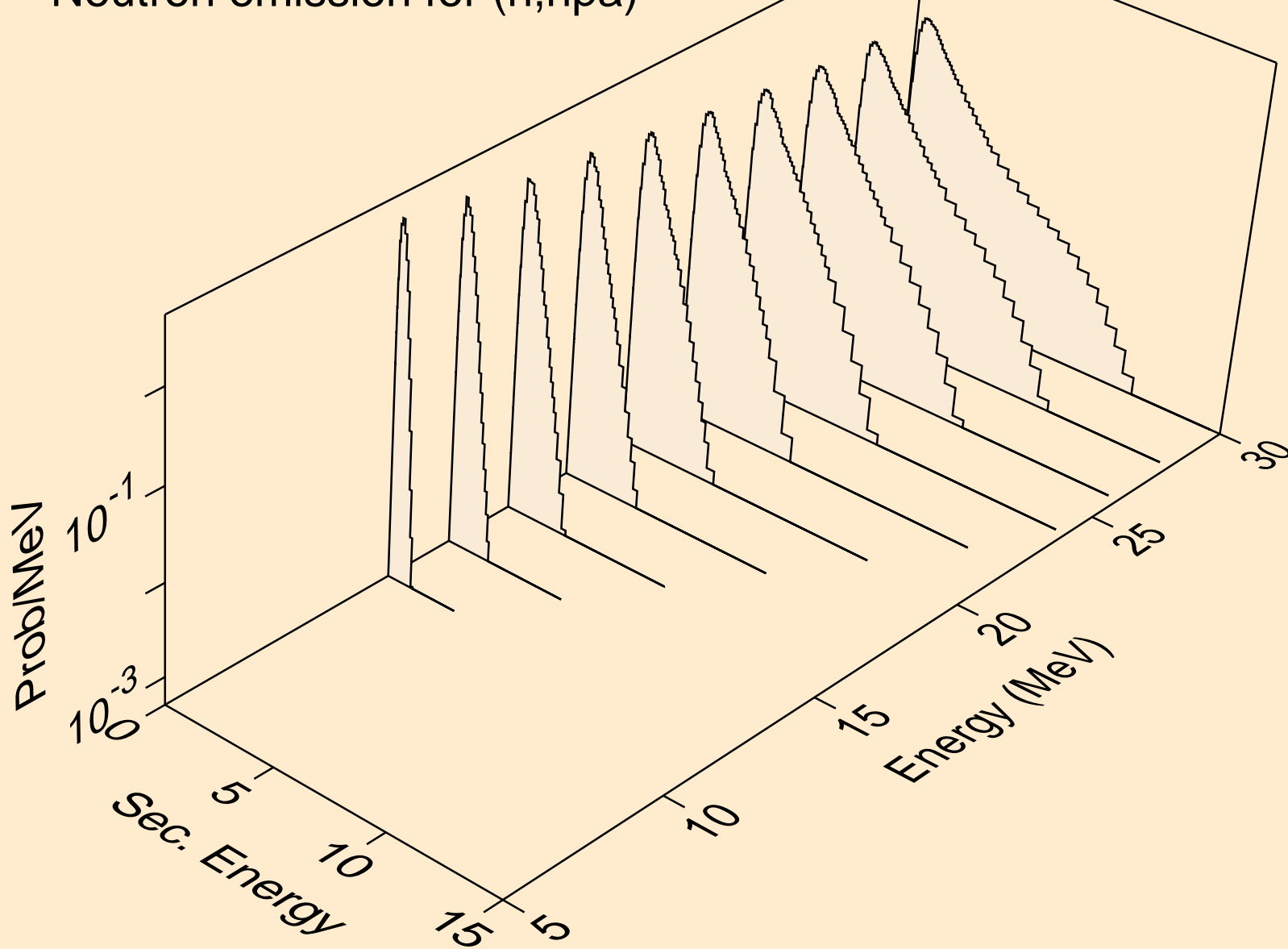

RH092 NEUTRON ACER TENDL-2019 LIBRARY; T=293.16K  
Neutron emission for (n,n\*c)

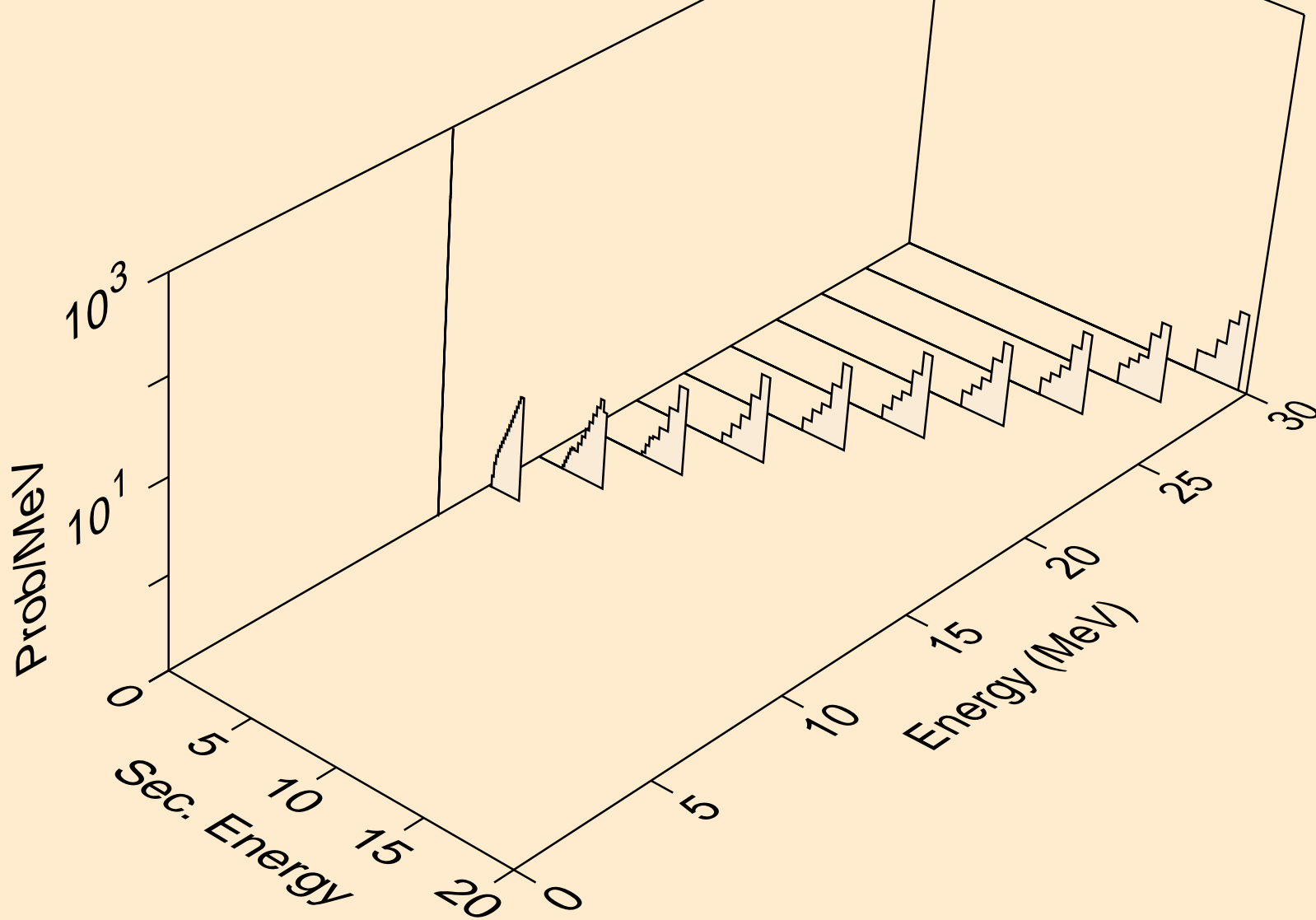

RH092 NEUTRON ACER TENDL-2019 LIBRARY; T=293.16K  
Photon emission for (n,x)

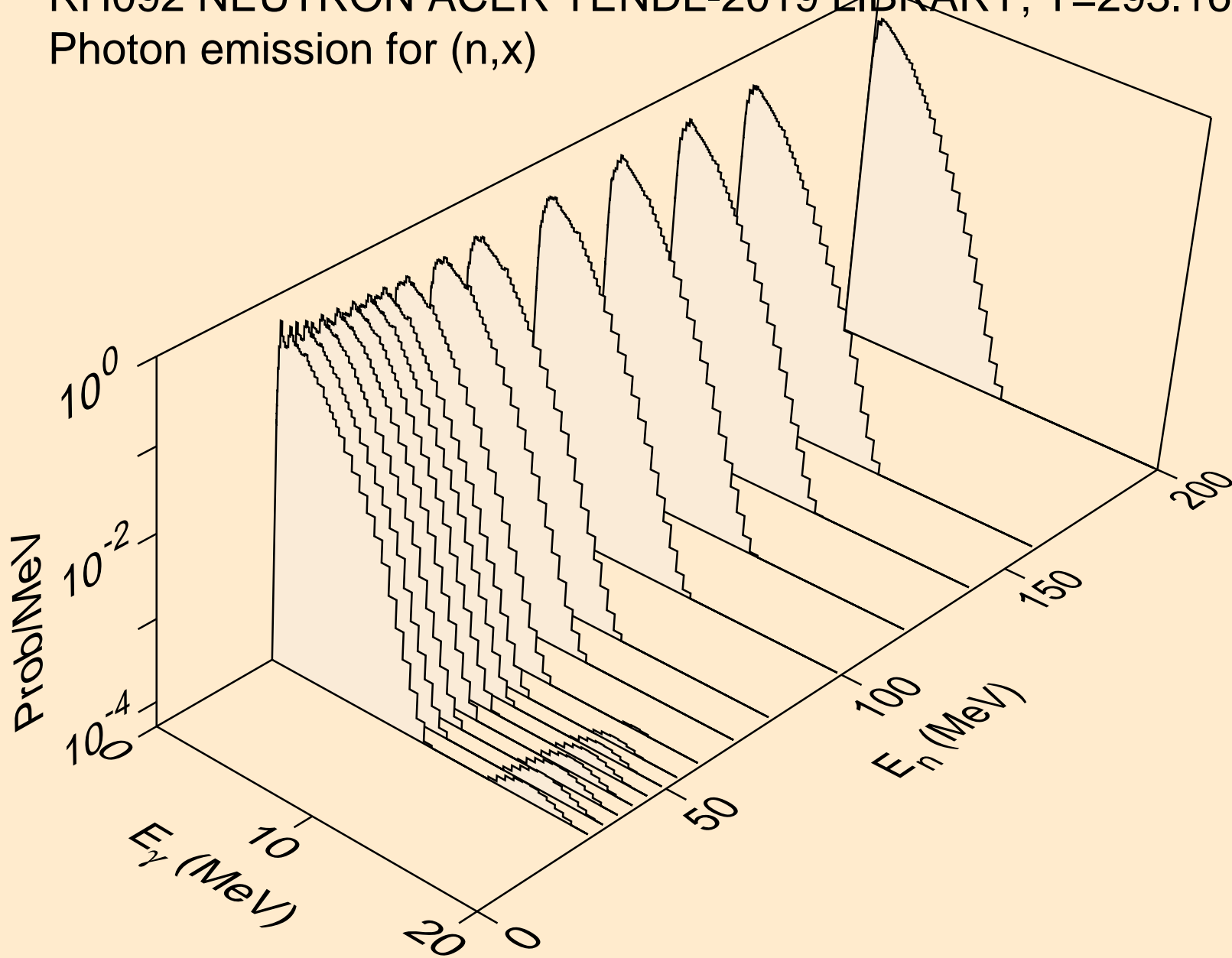

RH092 NEUTRON ACER TENDL-2019 LIBRARY; T=293.16K  
Photon emission for (n,2n)

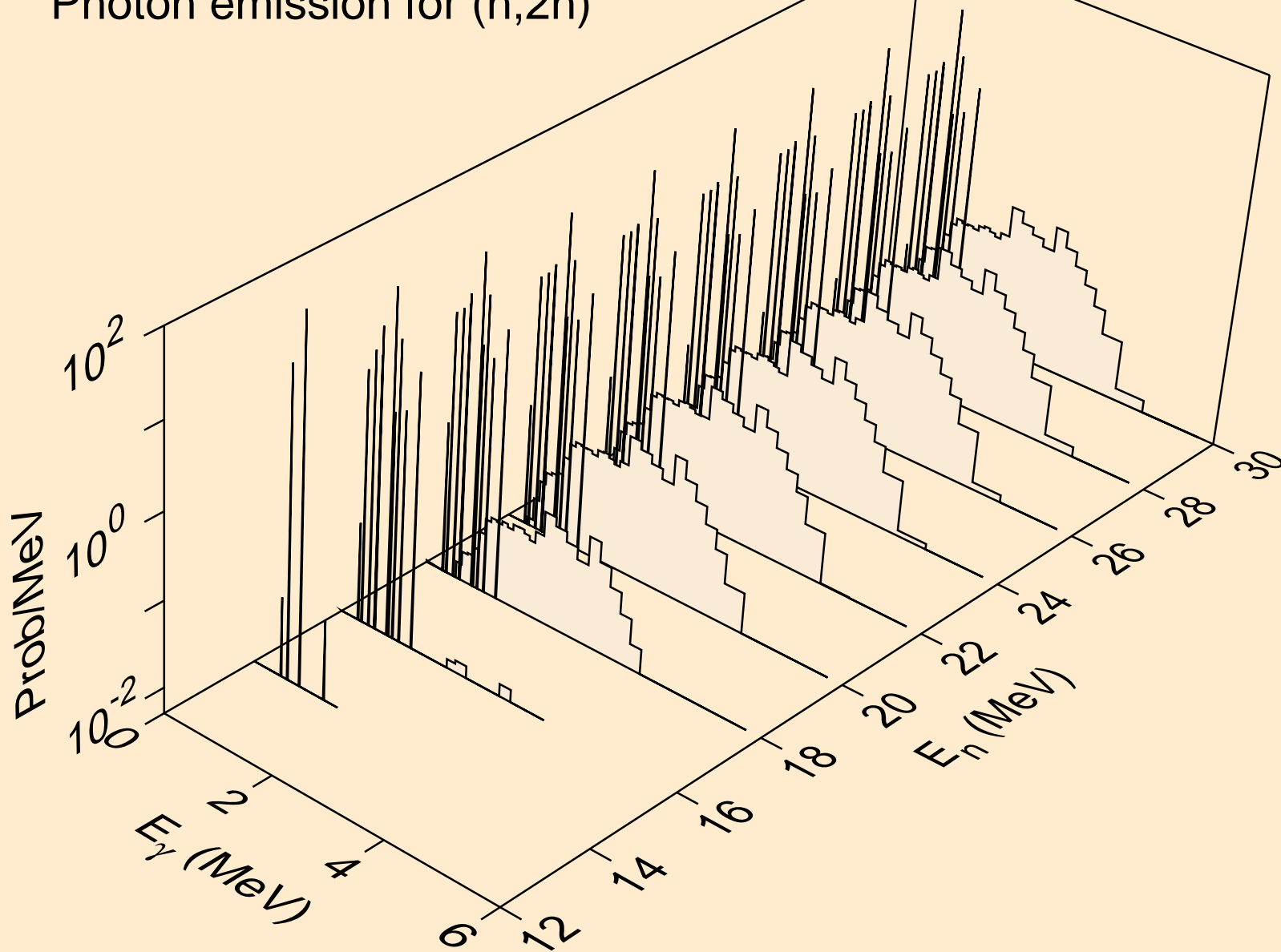

RH092 NEUTRON ACER TENDL-2019 LIBRARY; T=293.16K  
Photon emission for (n,3n)

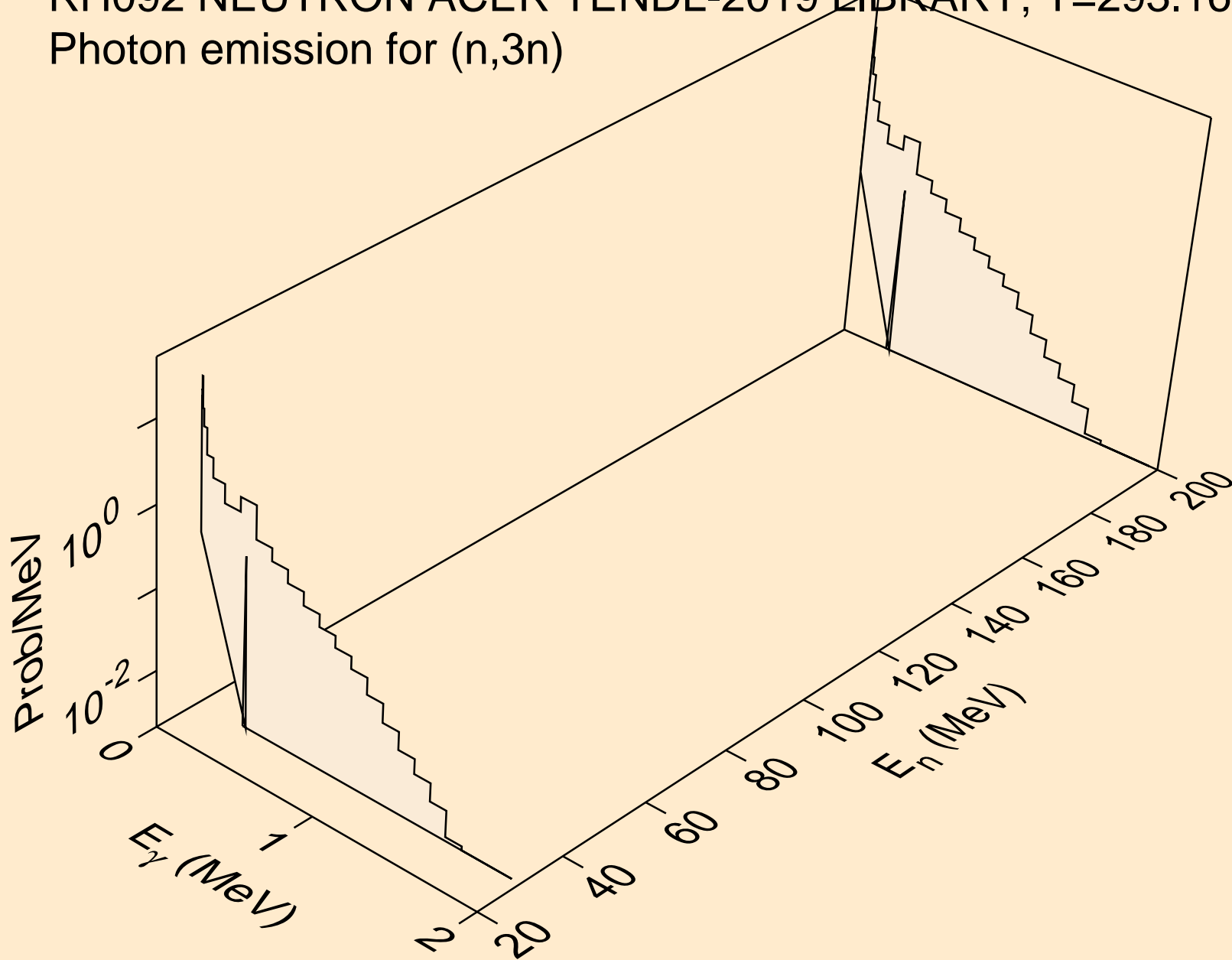

RH092 NEUTRON ACER TENDL-2019 LIBRARY; T=293.16K  
Photon emission for (n,n\*)a

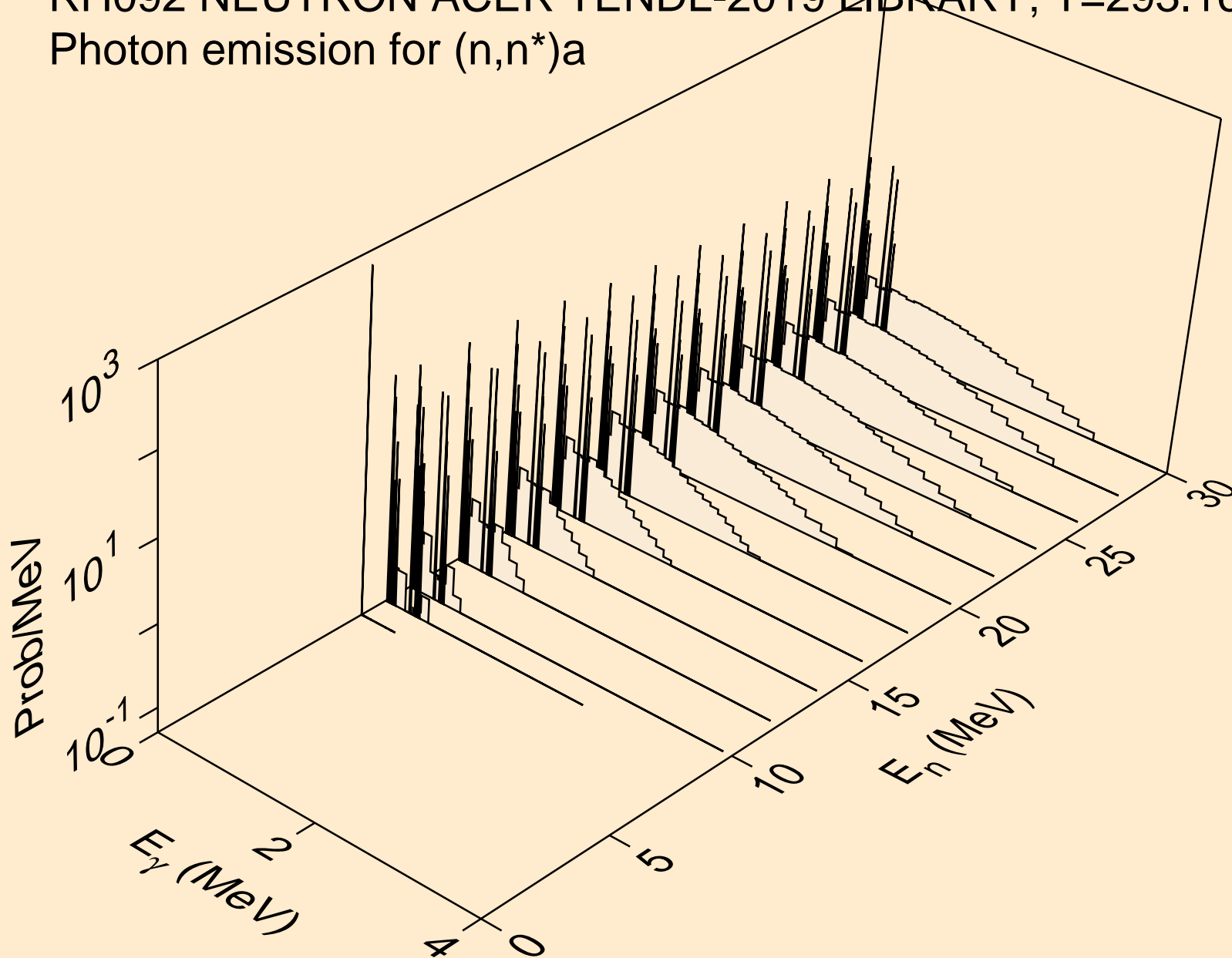

RH092 NEUTRON ACER TENDL-2019 LIBRARY; T=293.16K  
Photon emission for (n,2n)a

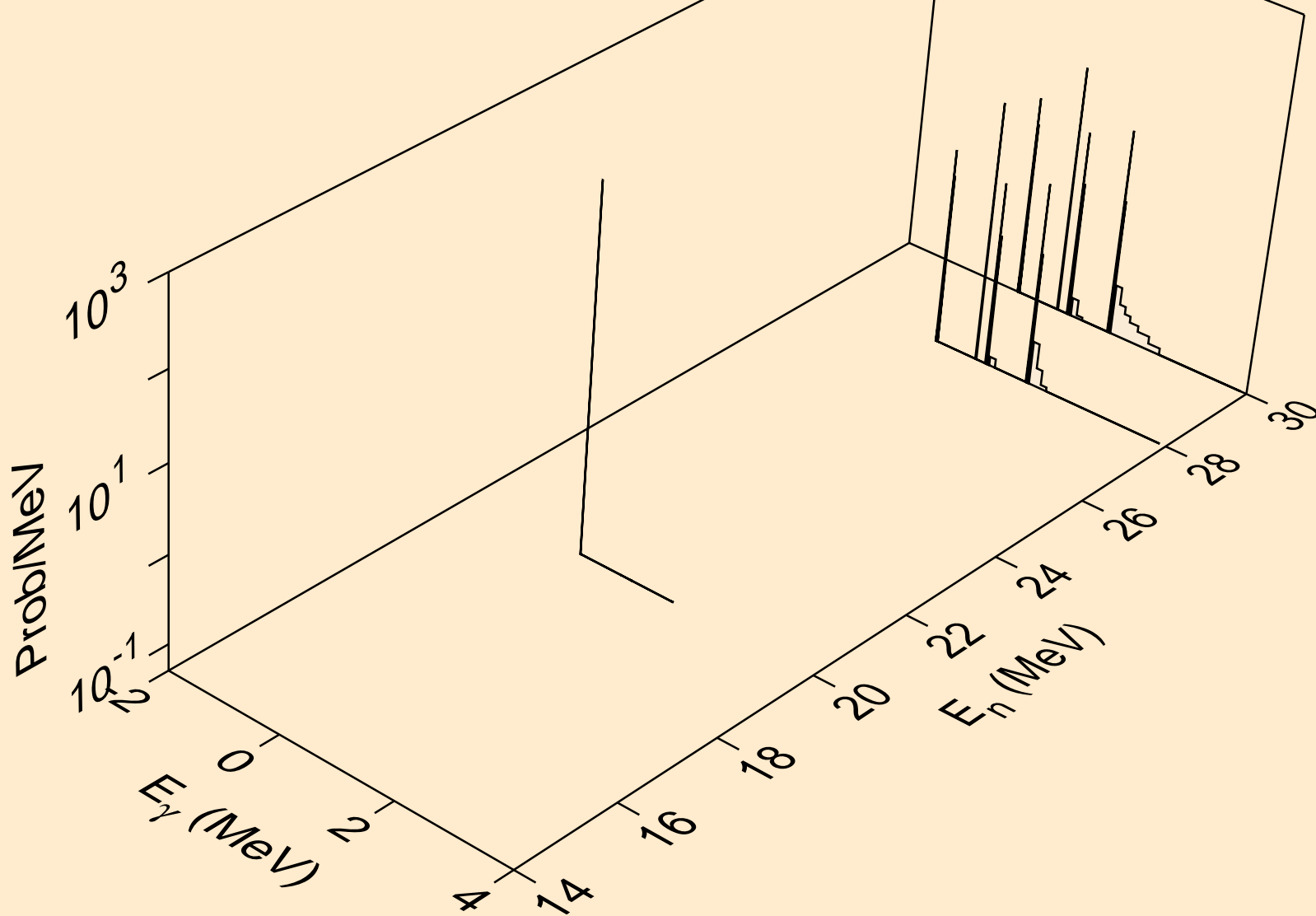

RH092 NEUTRON ACER TENDL-2019 LIBRARY; T=293.16K  
Photon emission for (n,n\*)p

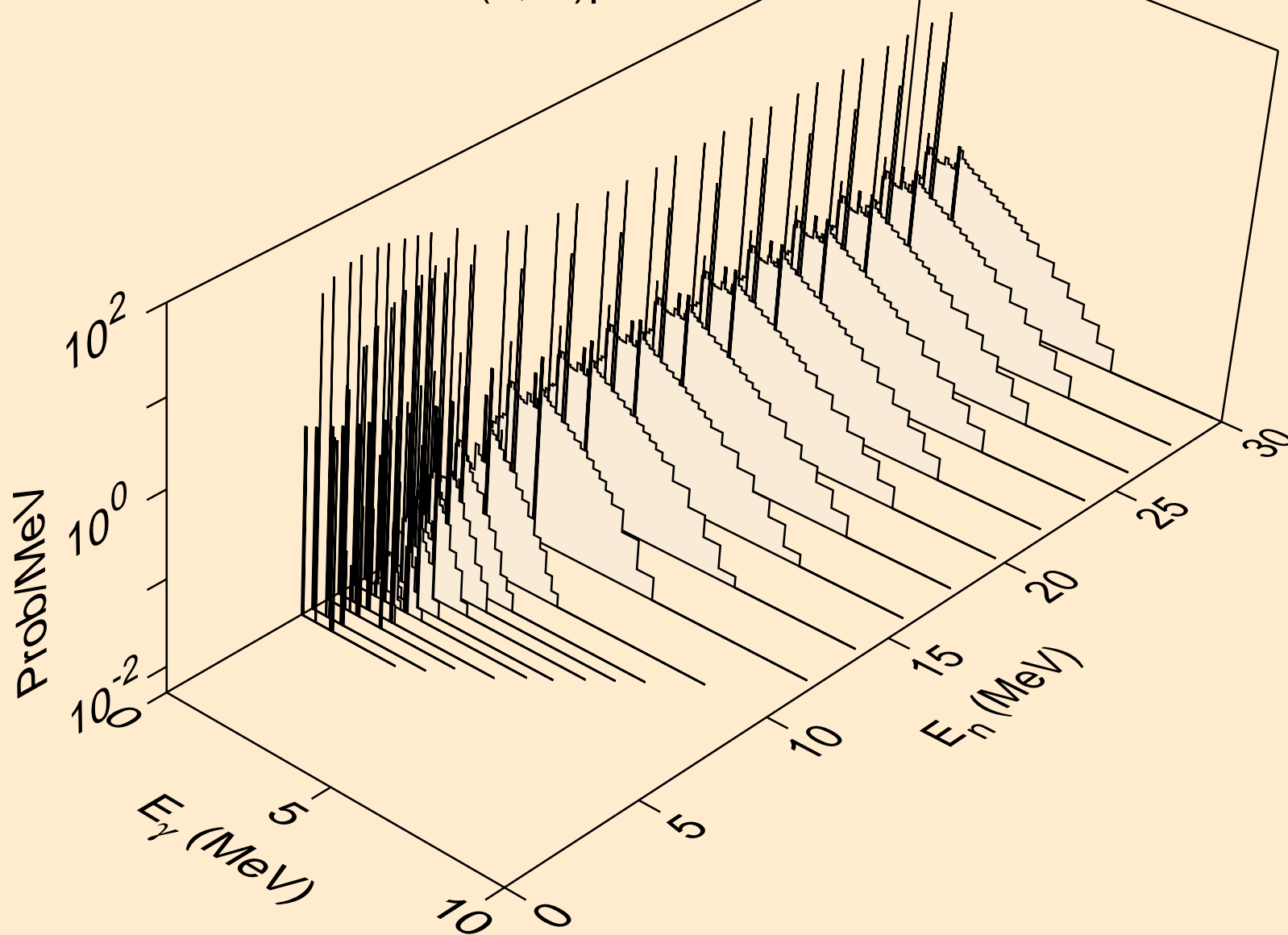

RH092 NEUTRON ACER TENDL-2019 LIBRARY; T=293.16K  
Photon emission for (n,n\*)2a

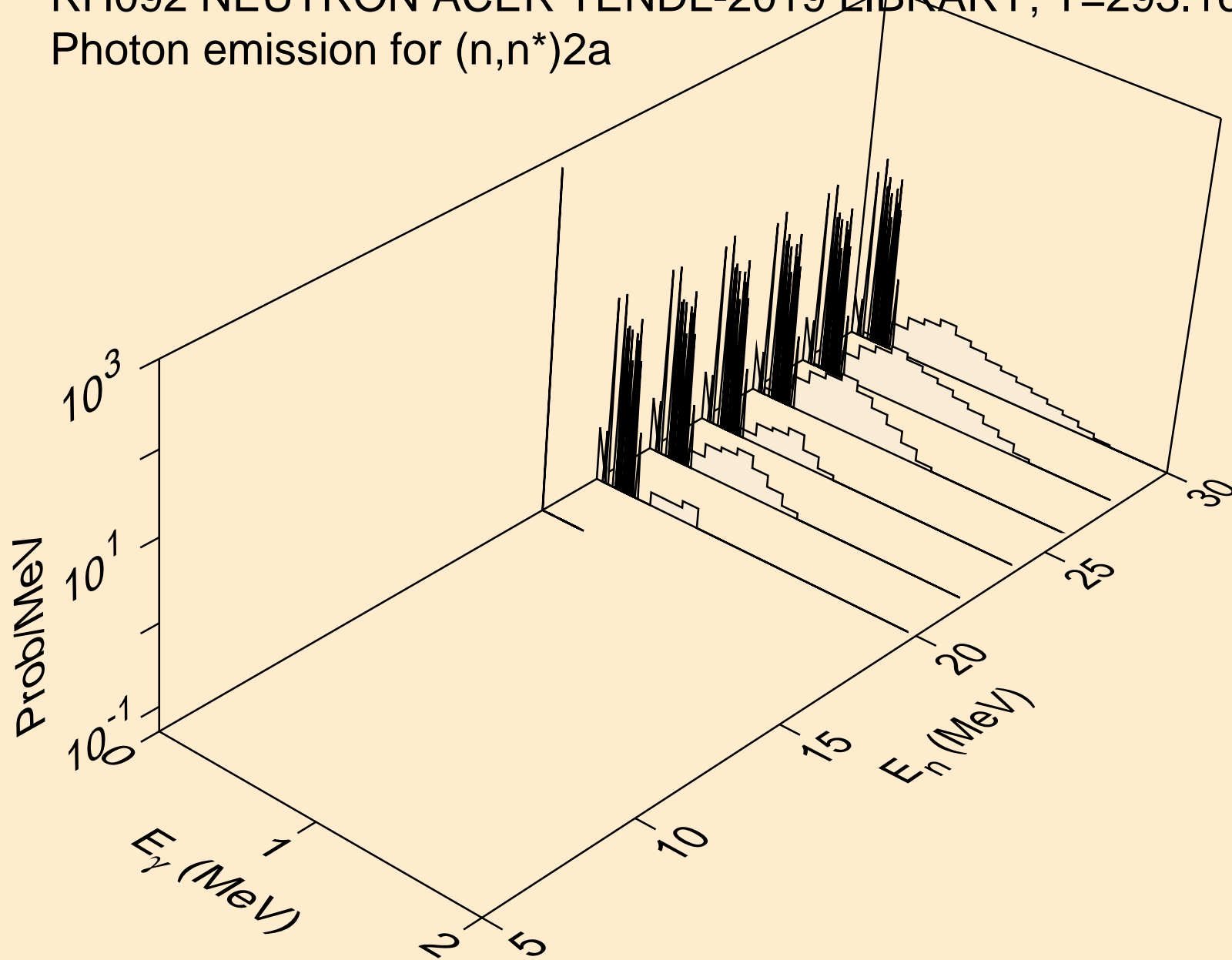

RH092 NEUTRON ACER TENDL-2019 LIBRARY; T=293.16K  
Photon emission for (n,n\*)d

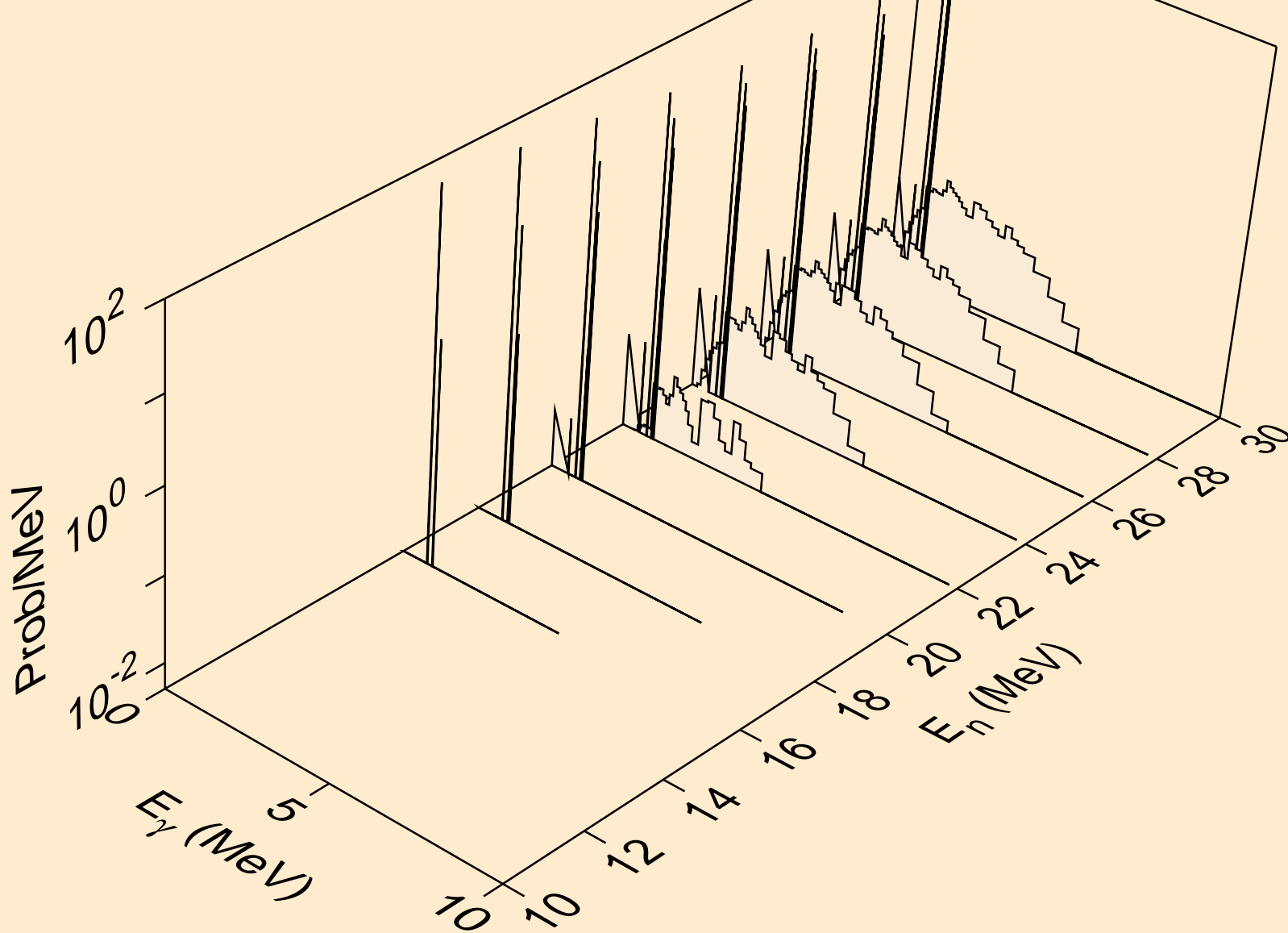

RH092 NEUTRON ACER TENDL-2019 LIBRARY; T=293.16K  
Photon emission for (n,n\*)t

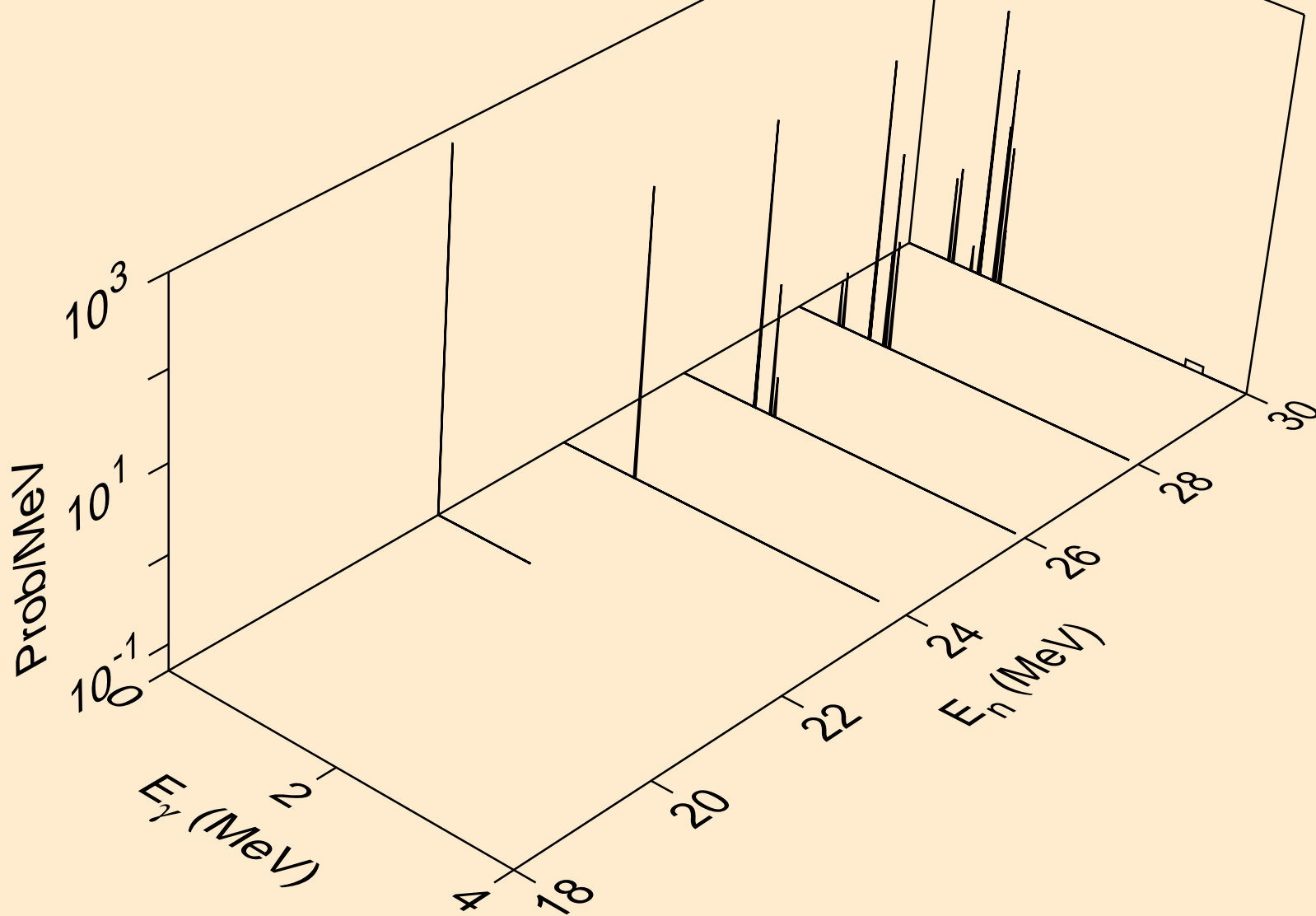

RH092 NEUTRON ACER TENDL-2019 LIBRARY; T=293.16K  
Photon emission for (n,n\*)he3

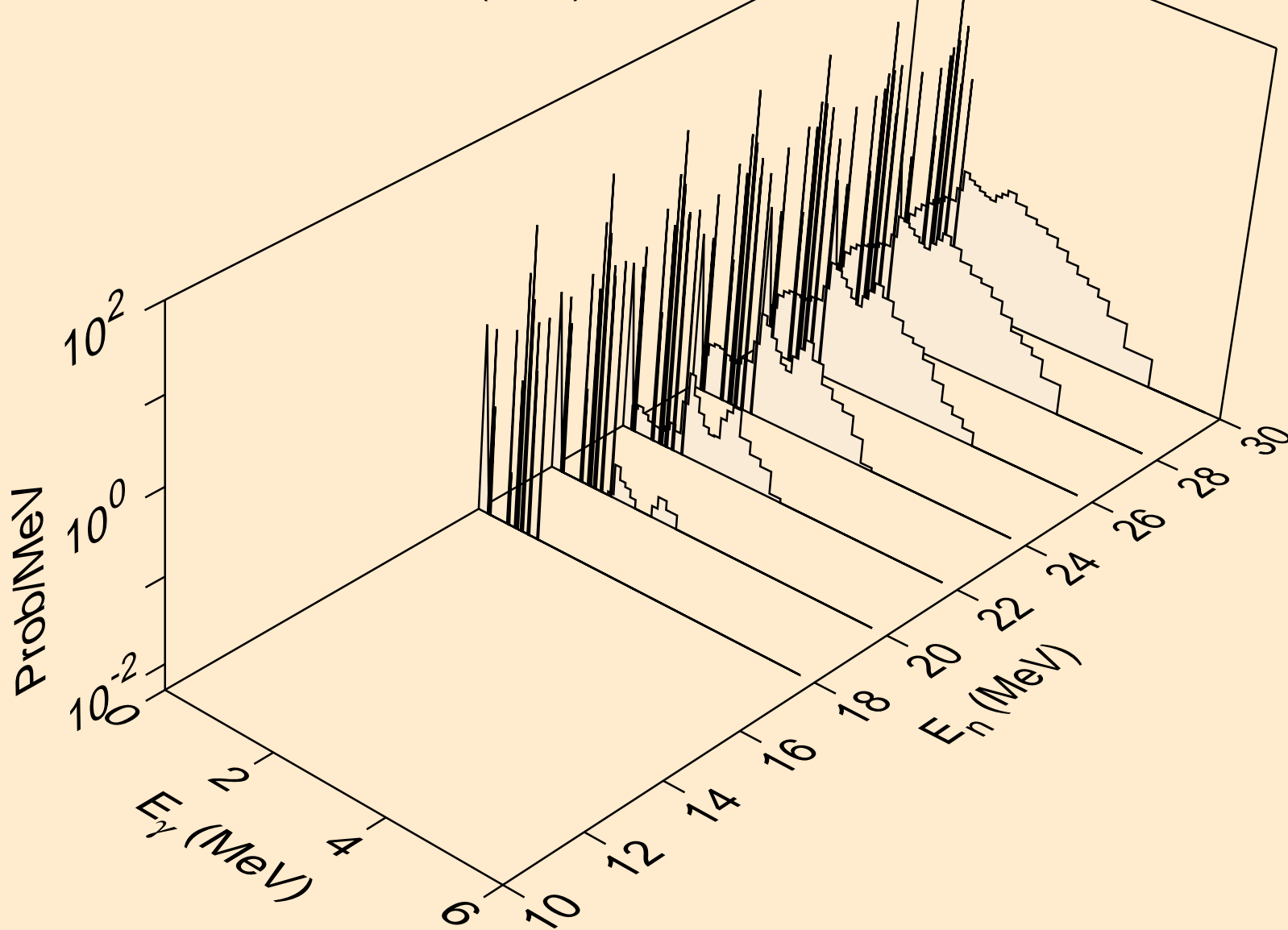

RH092 NEUTRON ACER TENDL-2019 LIBRARY; T=293.16K  
Photon emission for (n,2np)

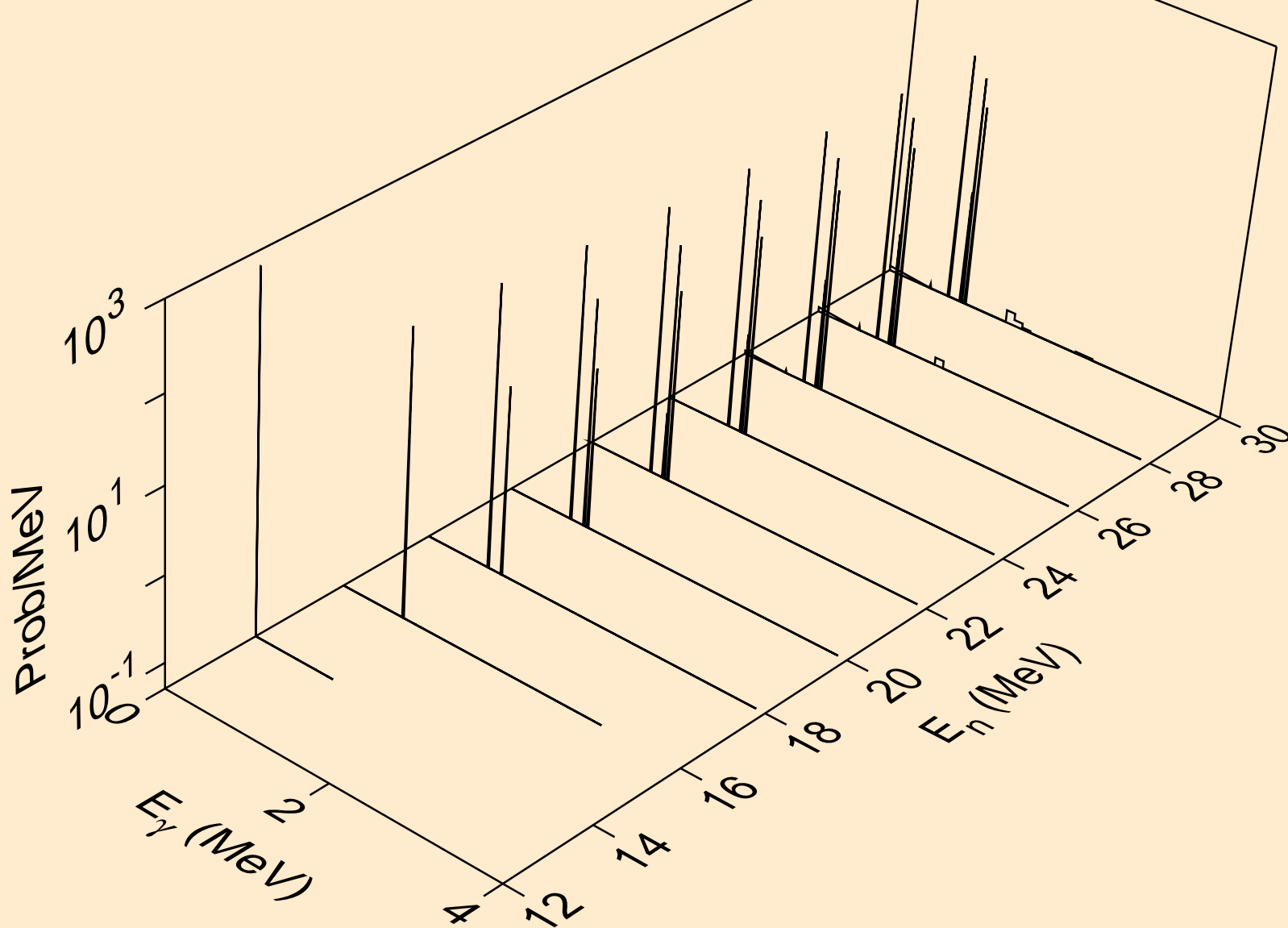

RH092 NEUTRON ACER TENDL-2019 LIBRARY; T=293.16K  
Photon emission for (n,2np)

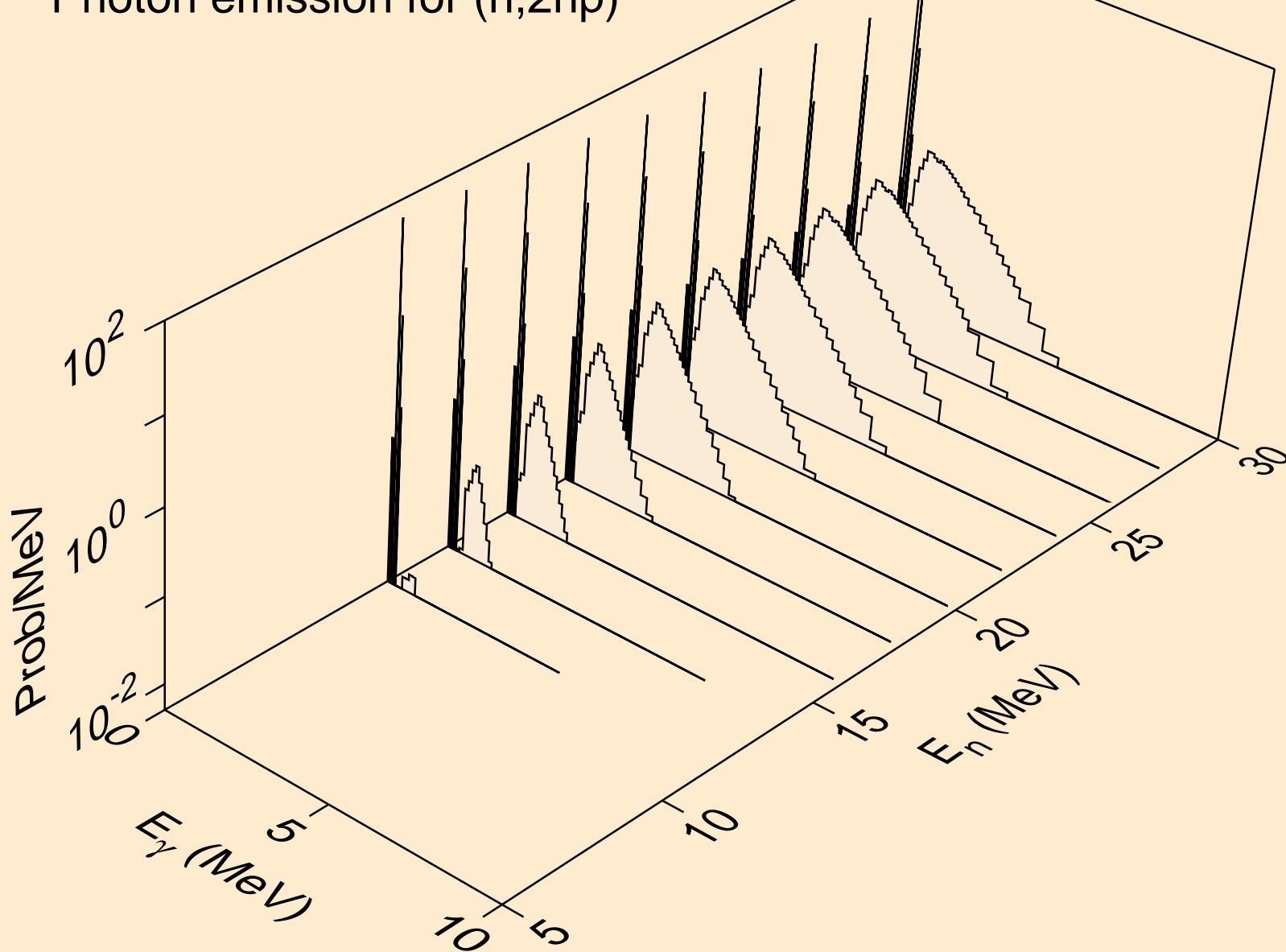

RH092 NEUTRON ACER TENDL-2019 LIBRARY; T=293.16K  
Photon emission for (n,npa)

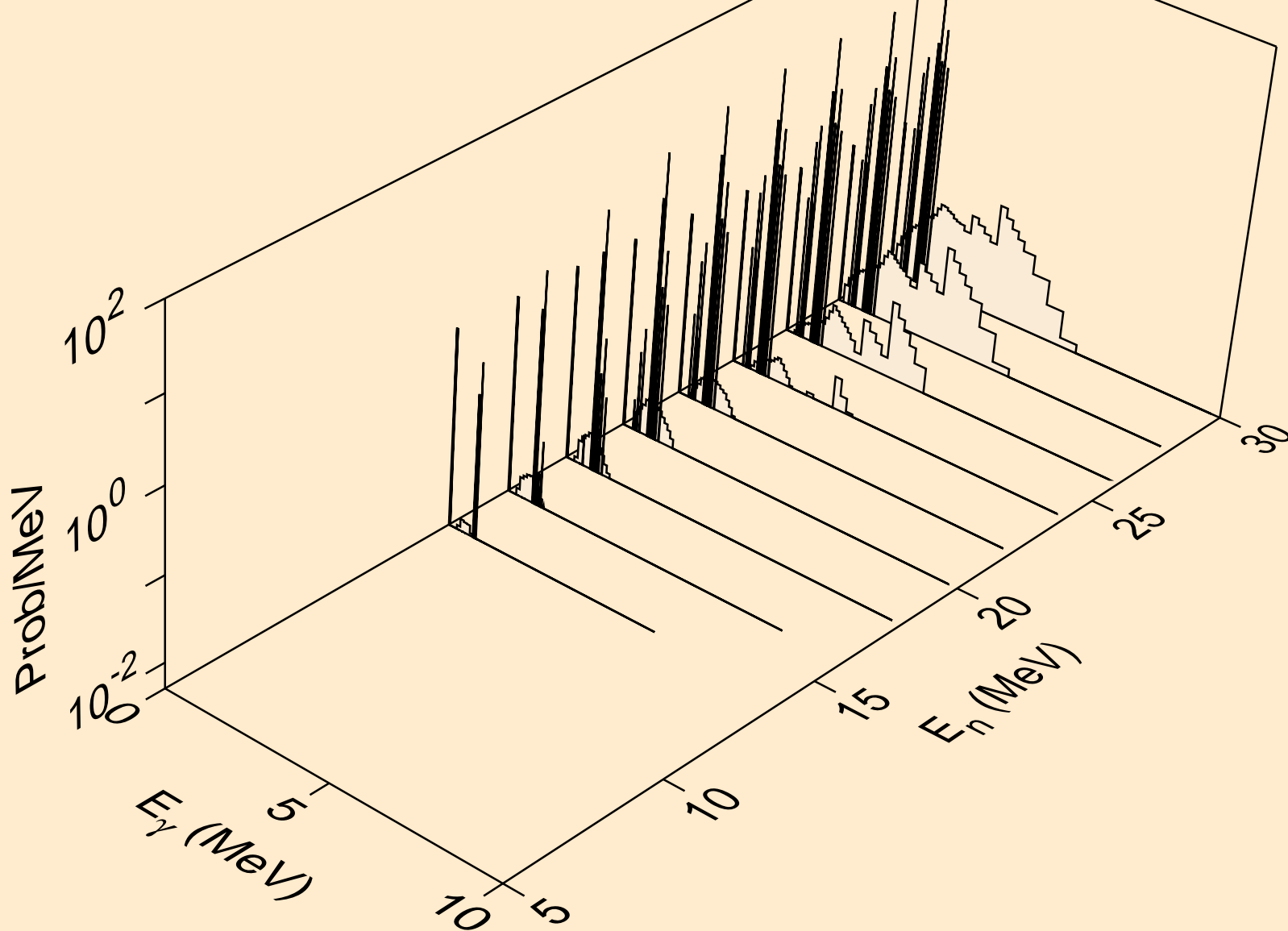

RH092 NEUTRON ACER TENDL-2019 LIBRARY; T=293.16K  
Photon emission for (n,n\*c)

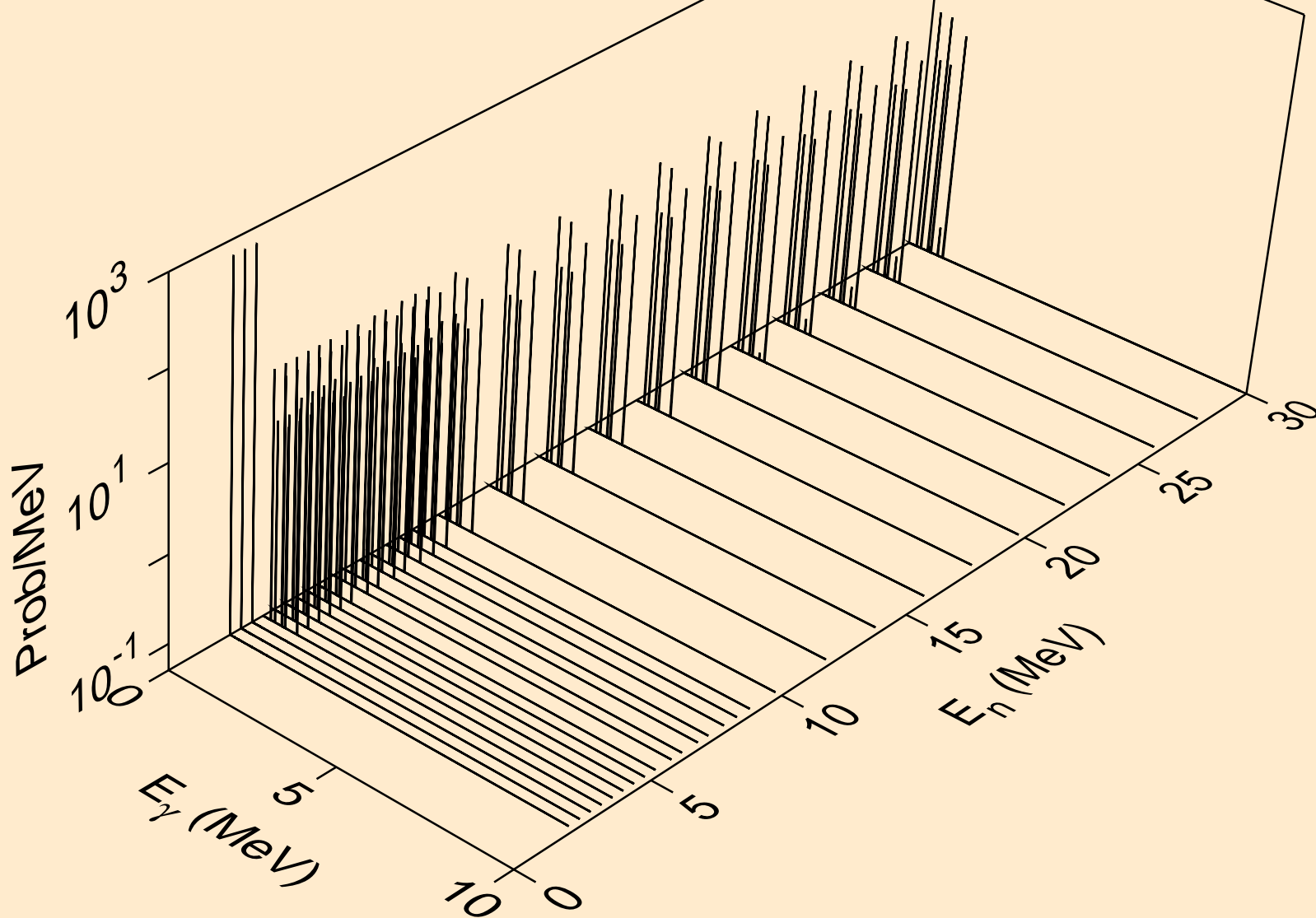

RH092 NEUTRON ACER TENDL-2019 LIBRARY; T=293.16K  
Photon emission for (n,gma)

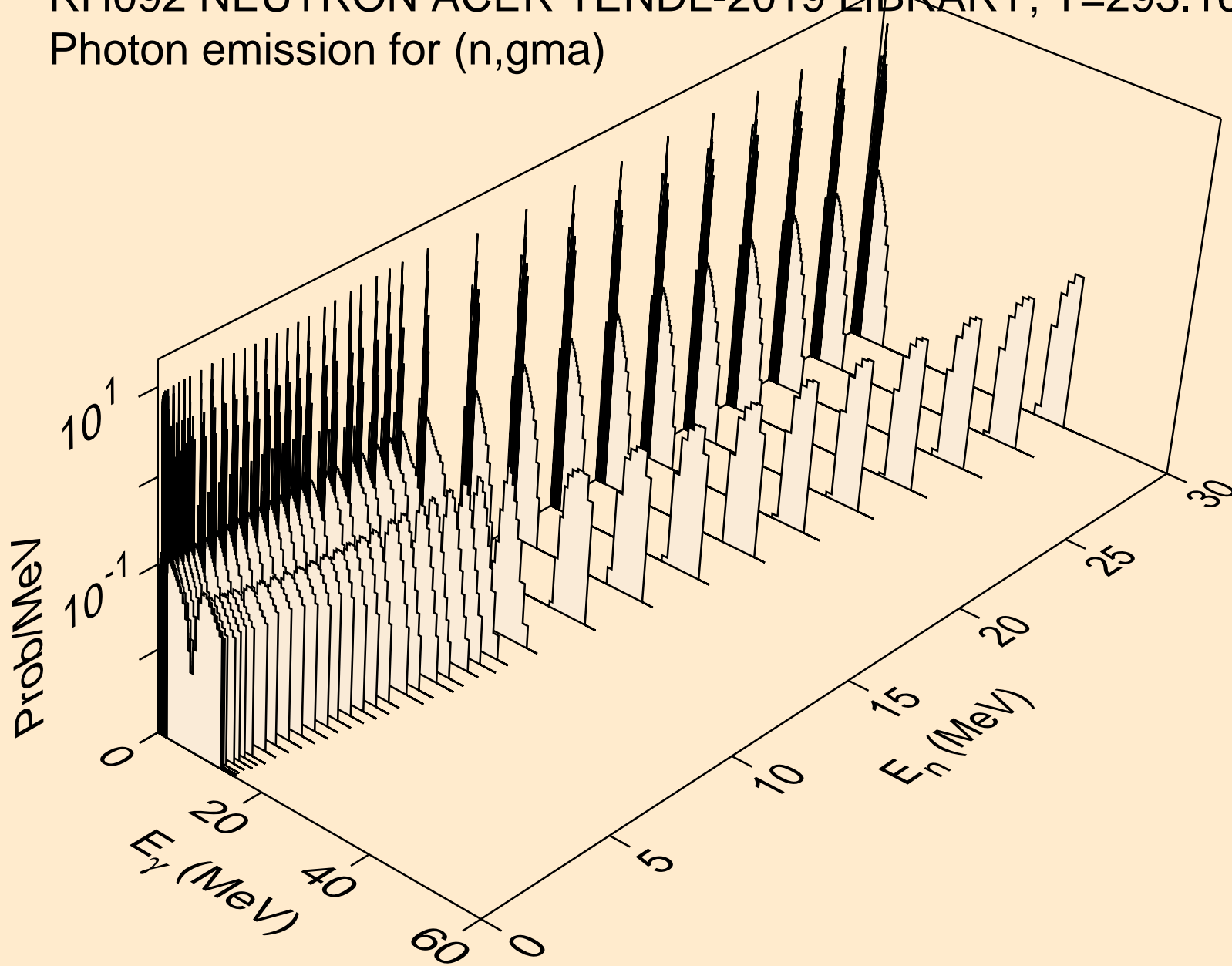

RH092 NEUTRON ACER TENDL-2019 LIBRARY; T=293.16K  
Photon emission for (n,p)

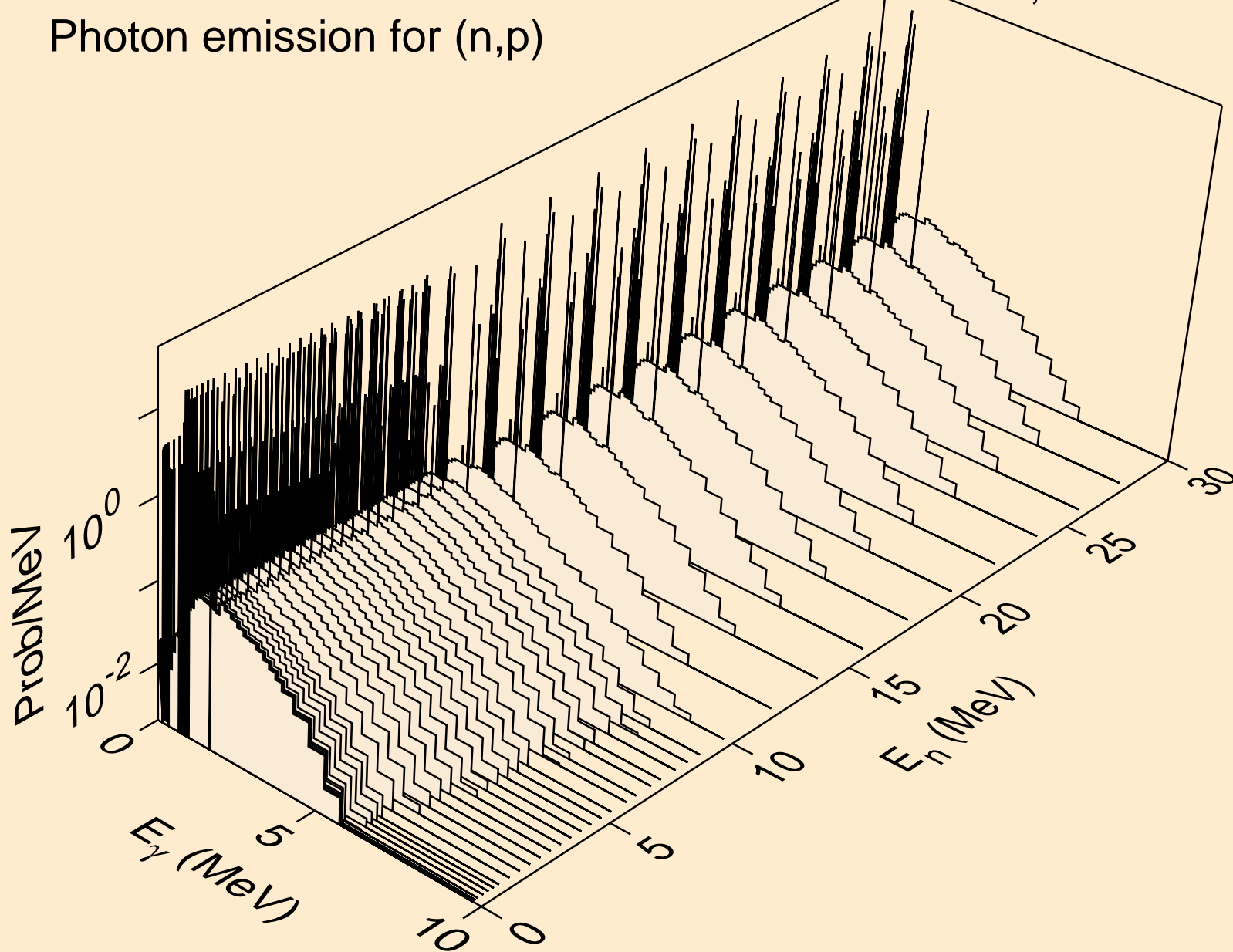

RH092 NEUTRON ACER TENDL-2019 LIBRARY; T=293.16K  
Photon emission for (n,d)

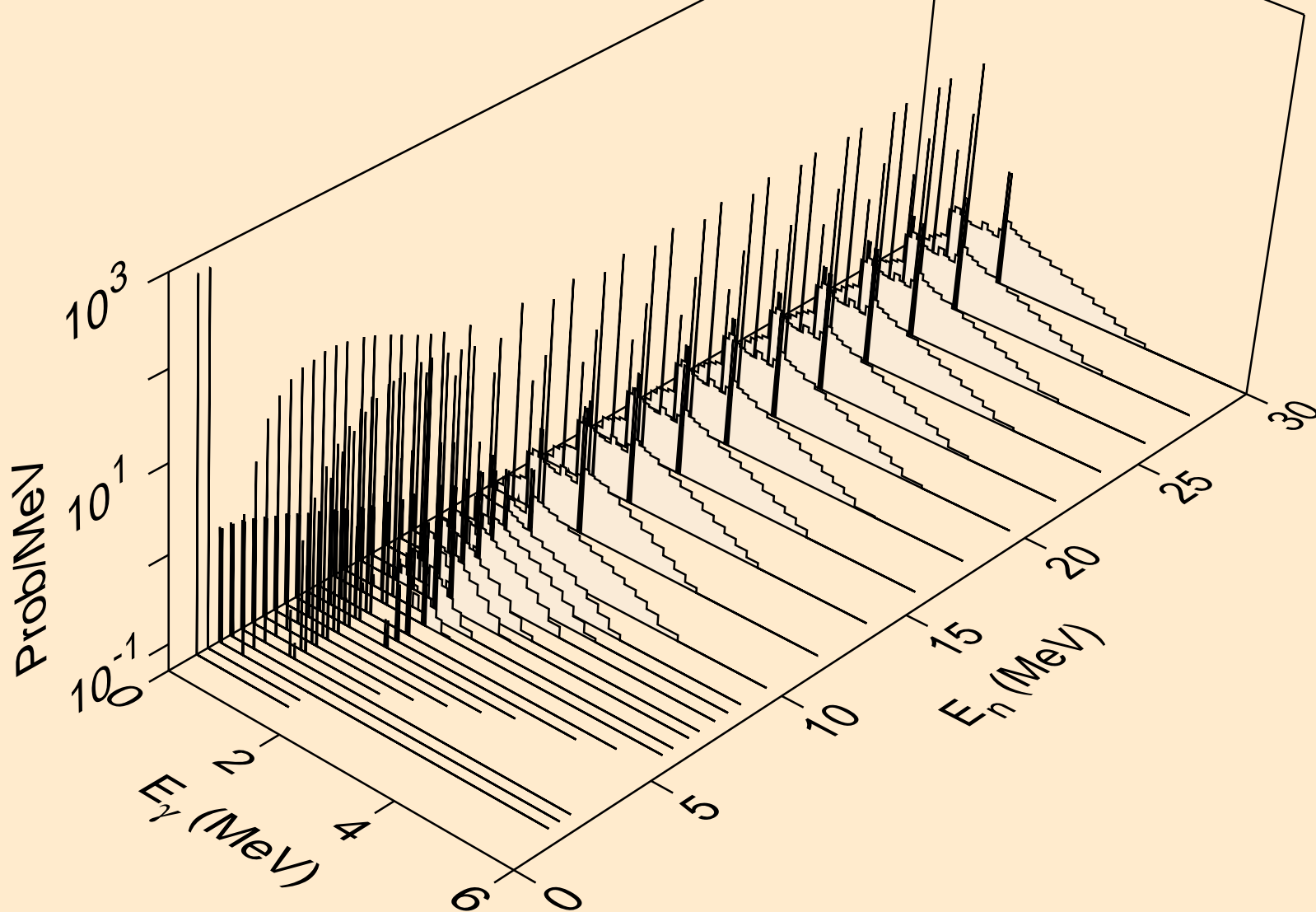

RH092 NEUTRON ACER TENDL-2019 LIBRARY; T=293.16K  
Photon emission for (n,t)

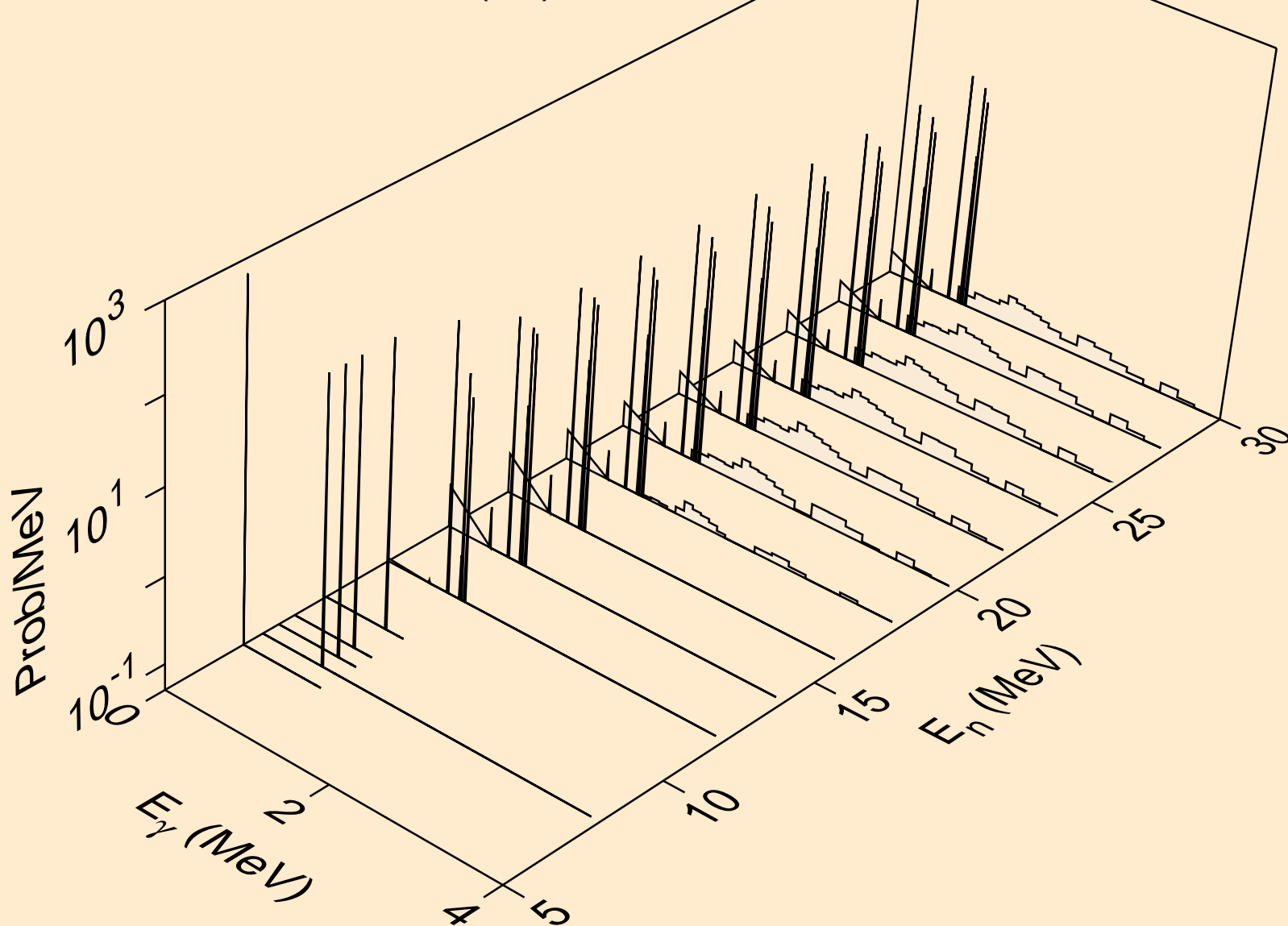

RH092 NEUTRON ACER TENDL-2019 LIBRARY; T=293.16K  
Photon emission for (n,he3)

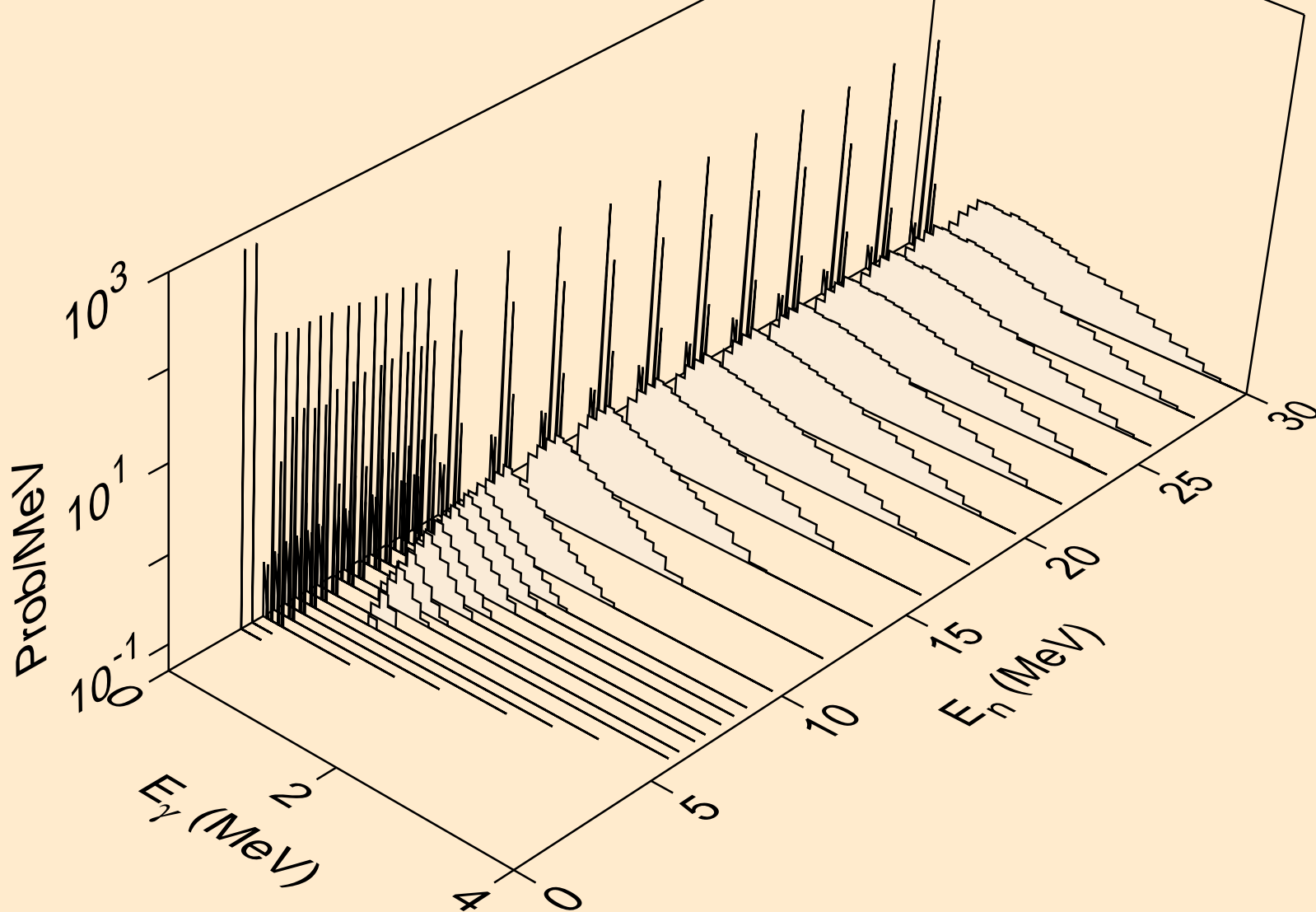

RH092 NEUTRON ACER TENDL-2019 LIBRARY; T=293.16K  
Photon emission for (n,a)

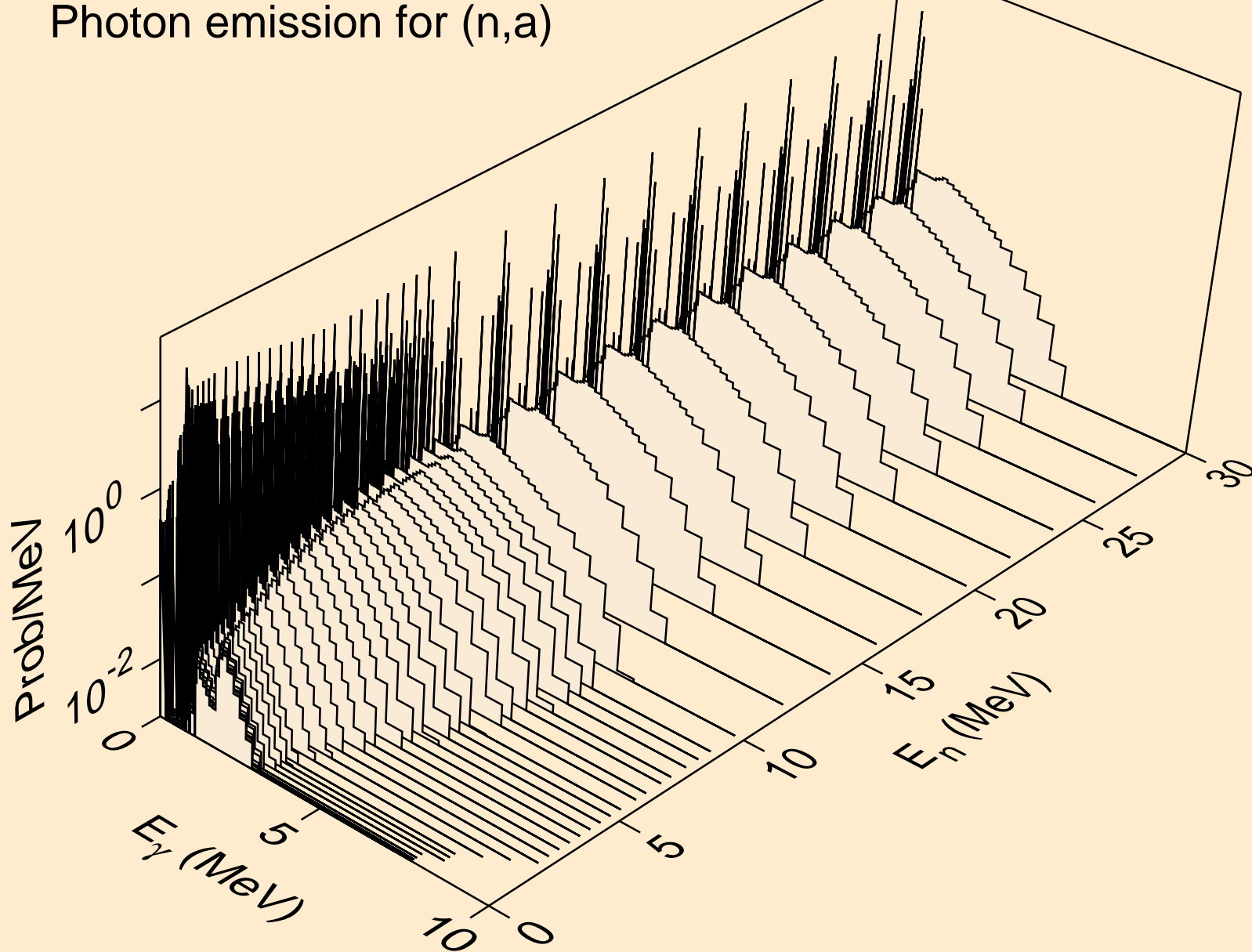

RH092 NEUTRON ACER TENDL-2019 LIBRARY; T=293.16K  
Photon emission for (n,2a)

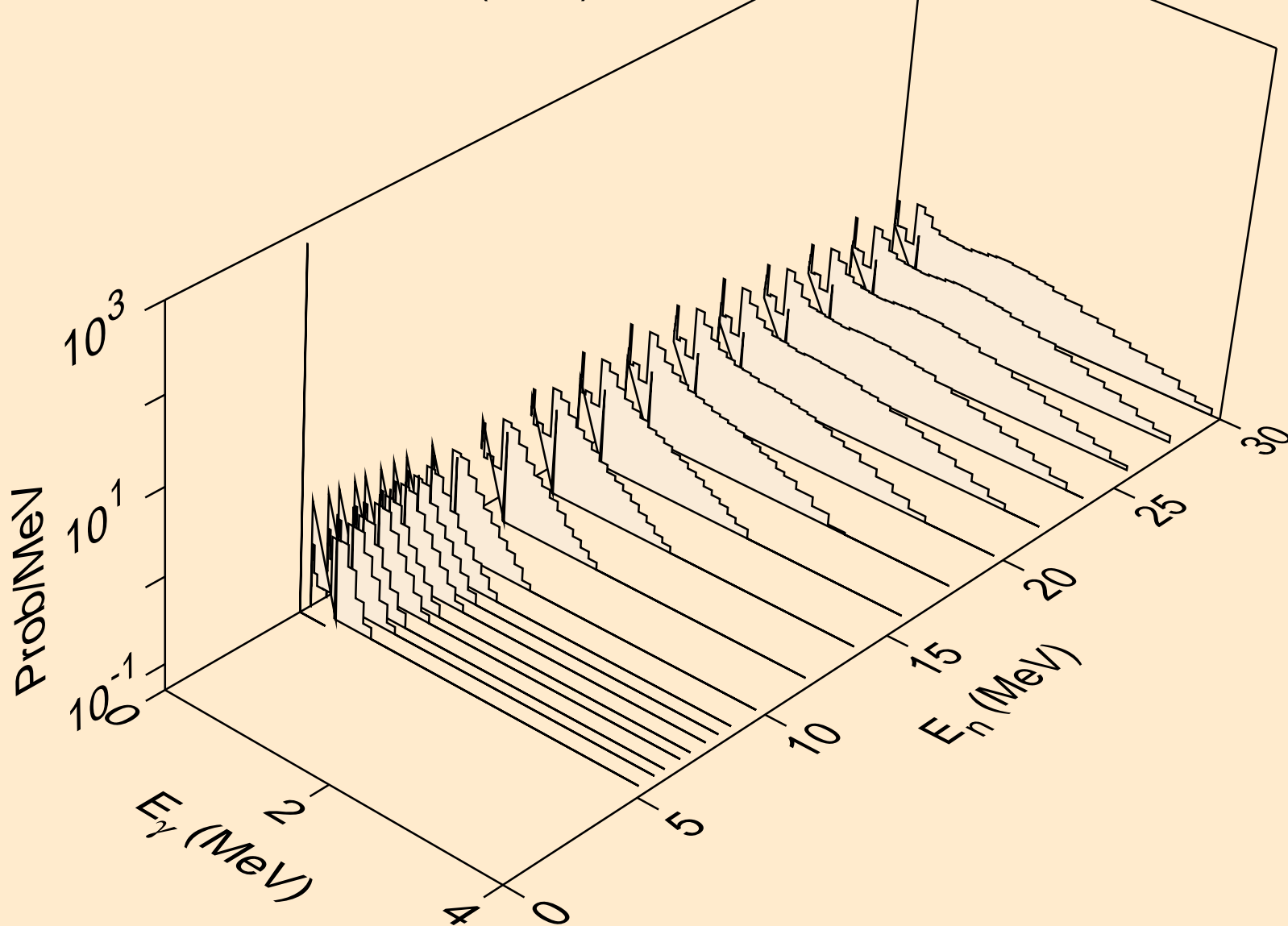

RH092 NEUTRON ACER TENDL-2019 LIBRARY; T=293.16K  
Photon emission for (n,3a)

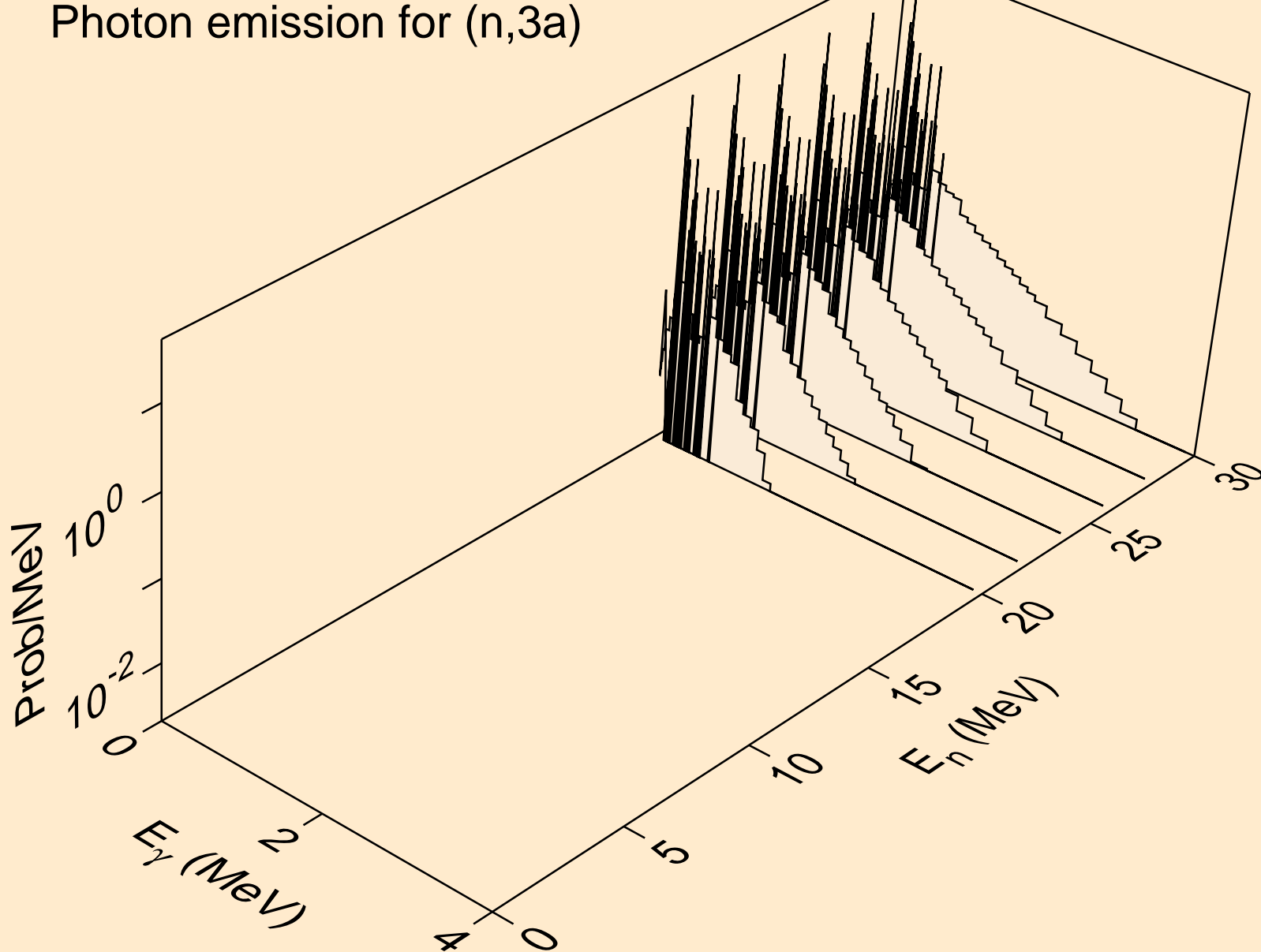

RH092 NEUTRON ACER TENDL-2019 LIBRARY; T=293.16K  
Photon emission for (n,2p)

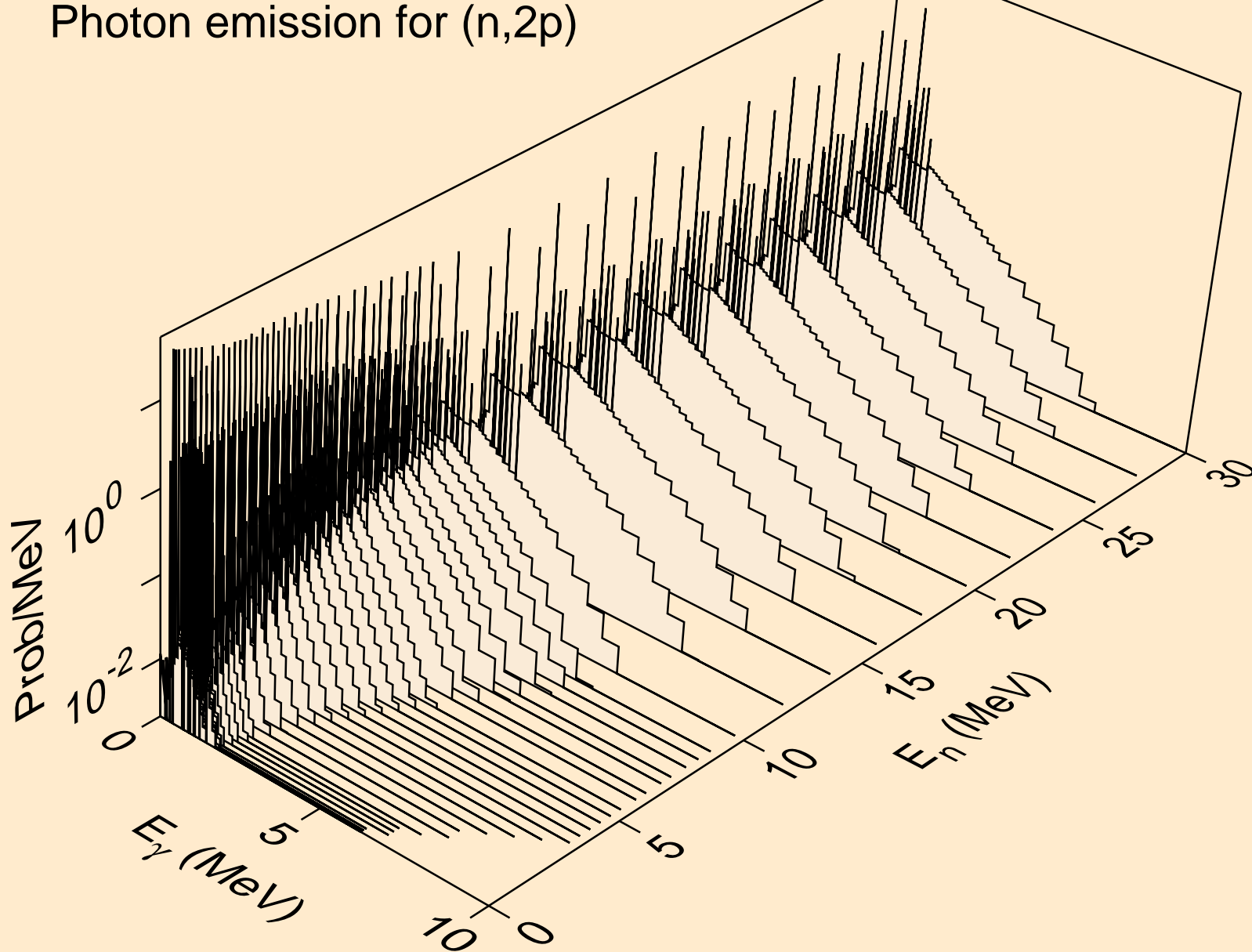

RH092 NEUTRON ACER TENDL-2019 LIBRARY; T=293.16K  
Photon emission for (n,p $\alpha$ )

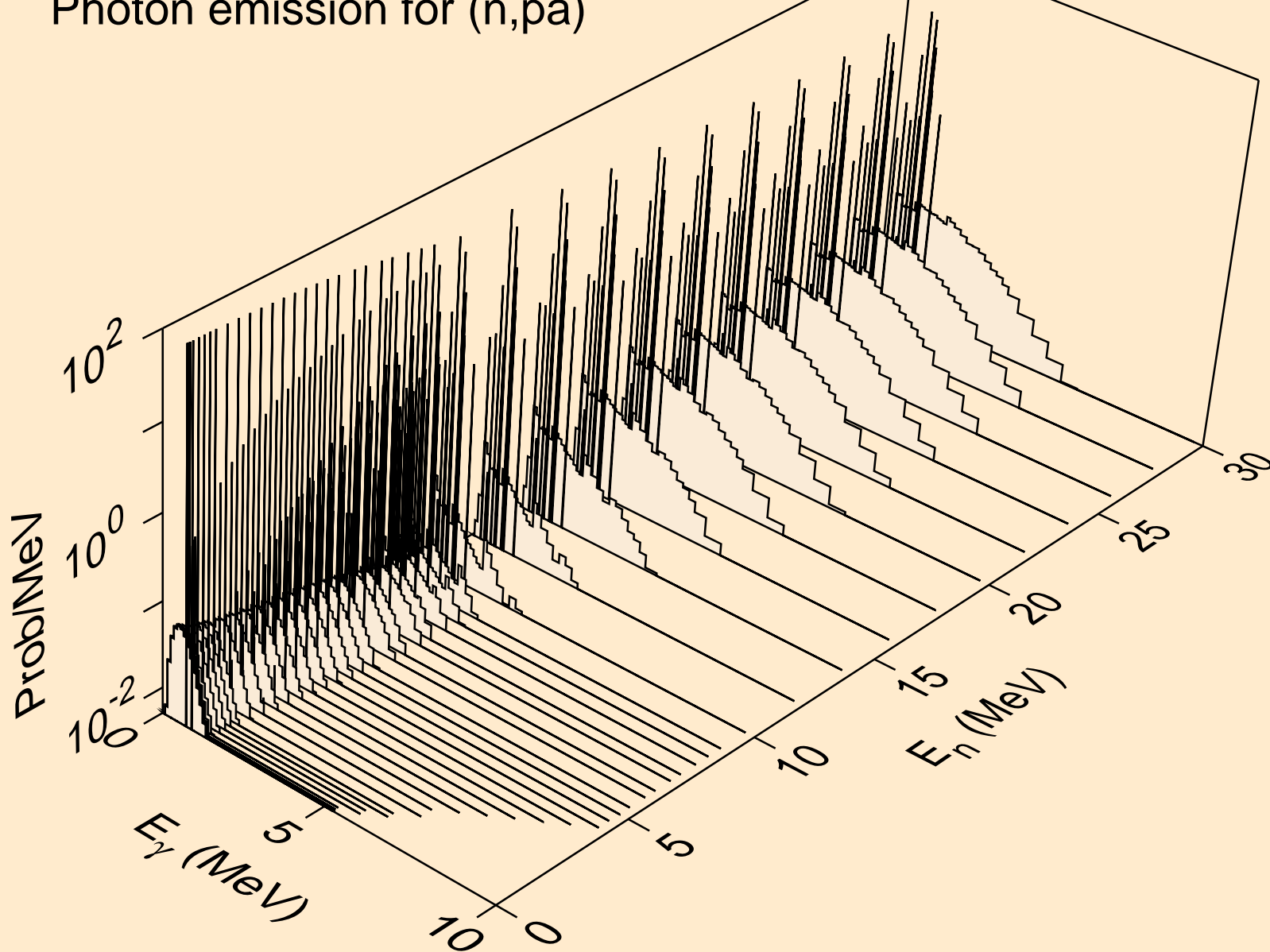

RH092 NEUTRON ACER TENDL-2019 LIBRARY; T=293.16K  
Photon emission for (n,pd)

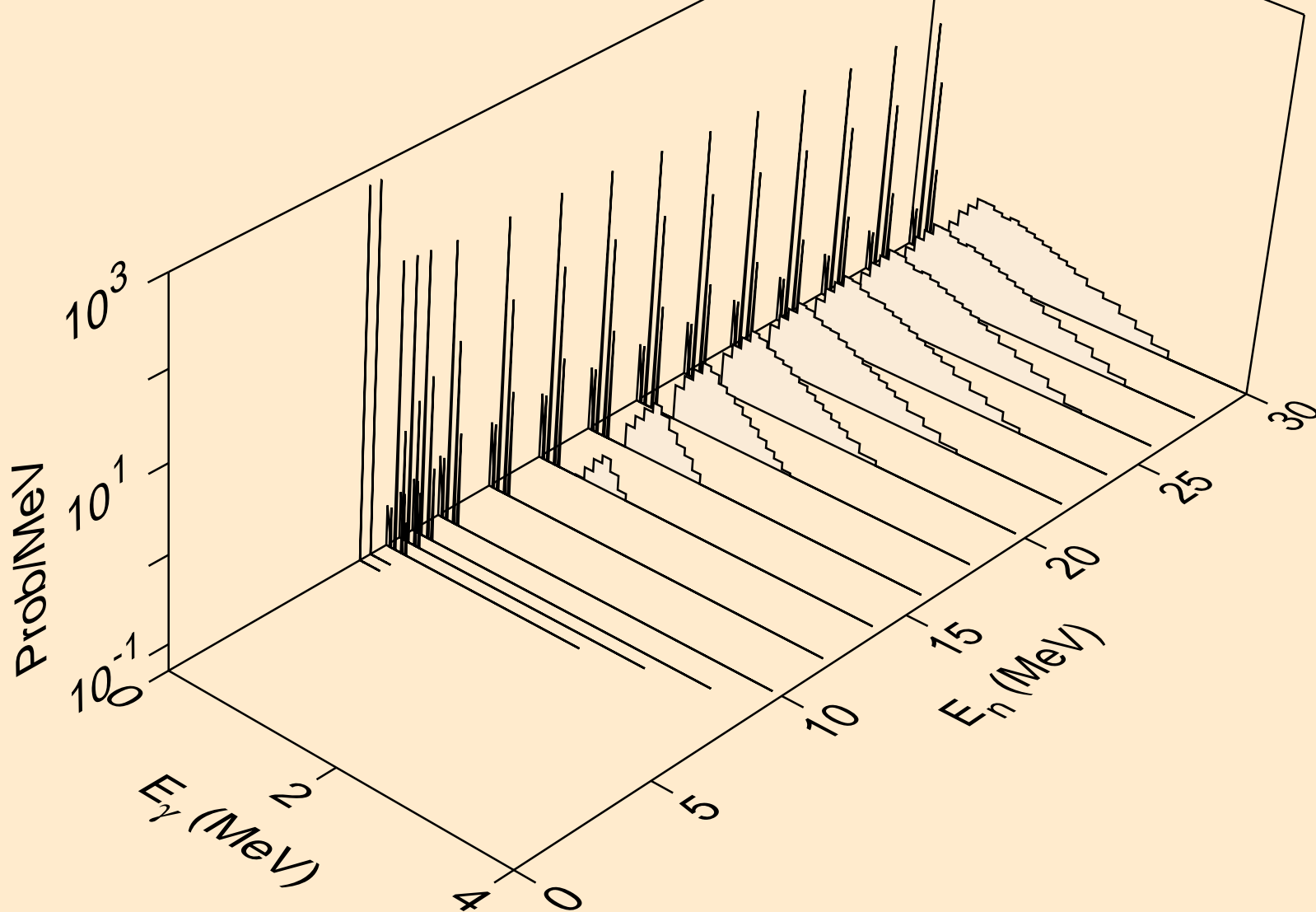

RH092 NEUTRON ACER TENDL-2019 LIBRARY; T=293.16K  
Photon emission for (n,pt)

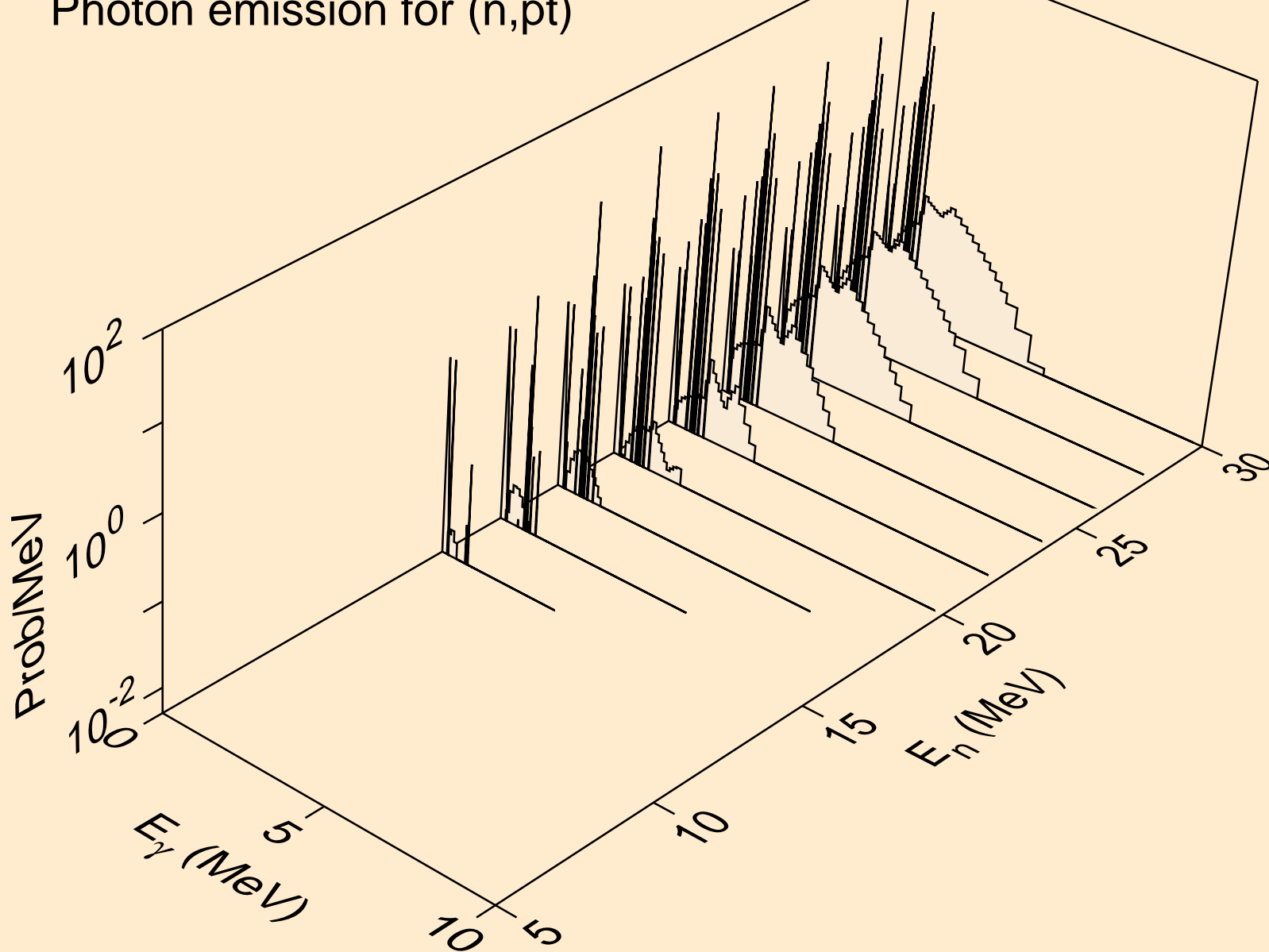

RH092 NEUTRON ACER TENDL-2019 LIBRARY; T=293.16K  
Photon emission for (n,da)

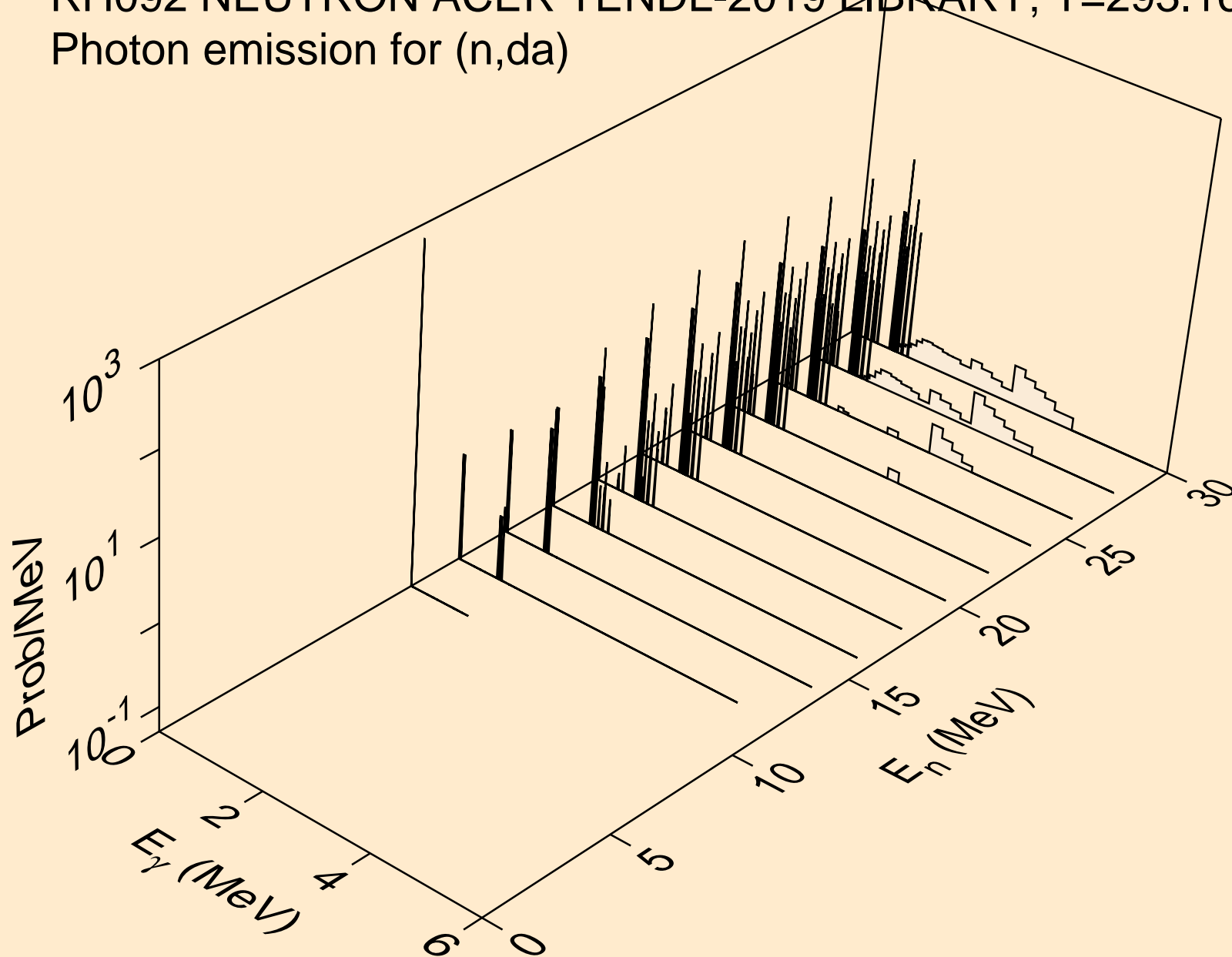

RH092 NEUTRON ACER TENDL-2019 LIBRARY; T=293.16K  
thermal capture photon spectrum

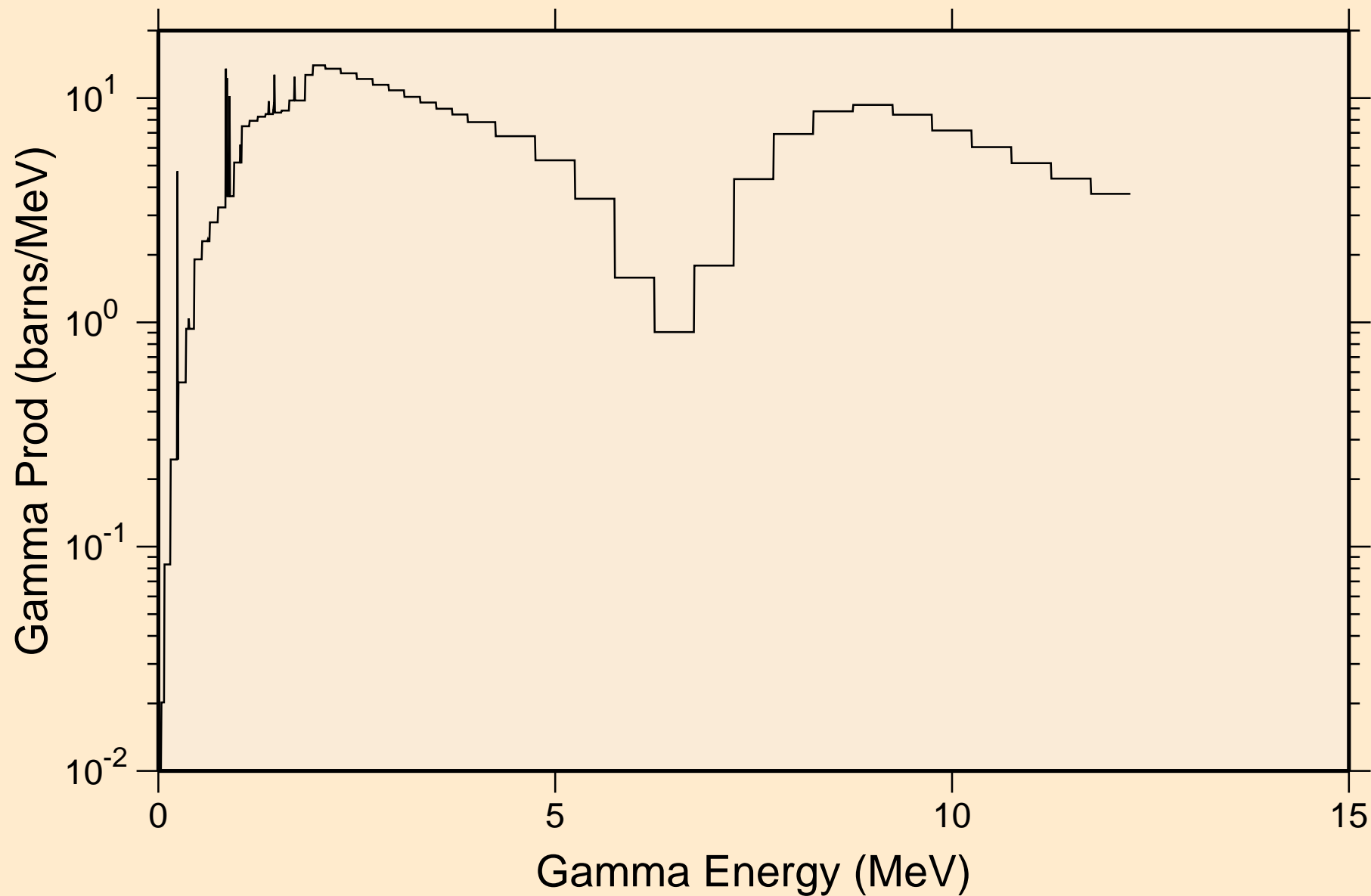

RH092 NEUTRON ACER TENDL-2019 LIBRARY; T=293.16K  
14 MeV photon spectrum

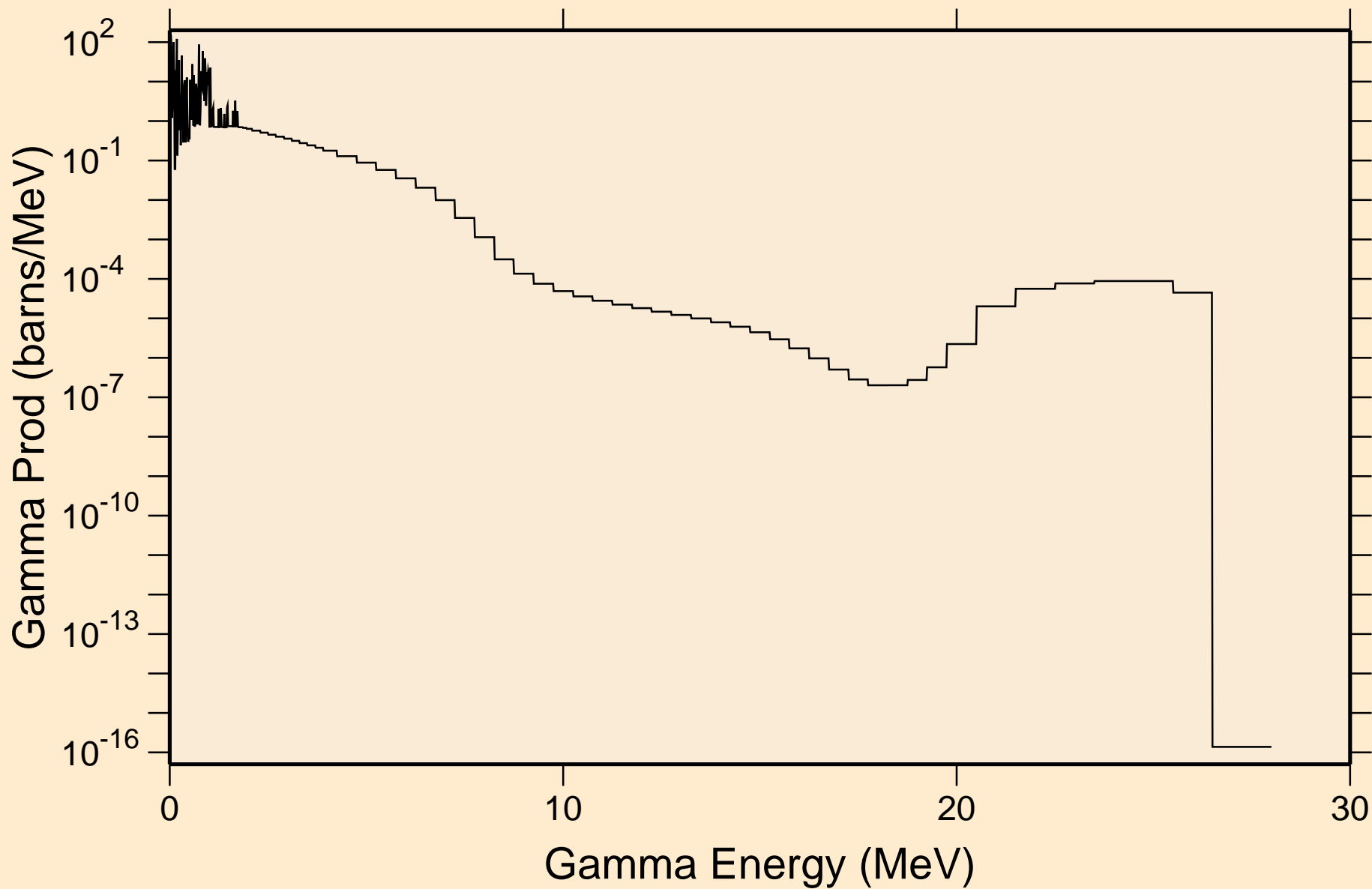

# RH092 NEUTRON ACER TENDL-2019 LIBRARY; T=293.16K

## Particle heating contributions

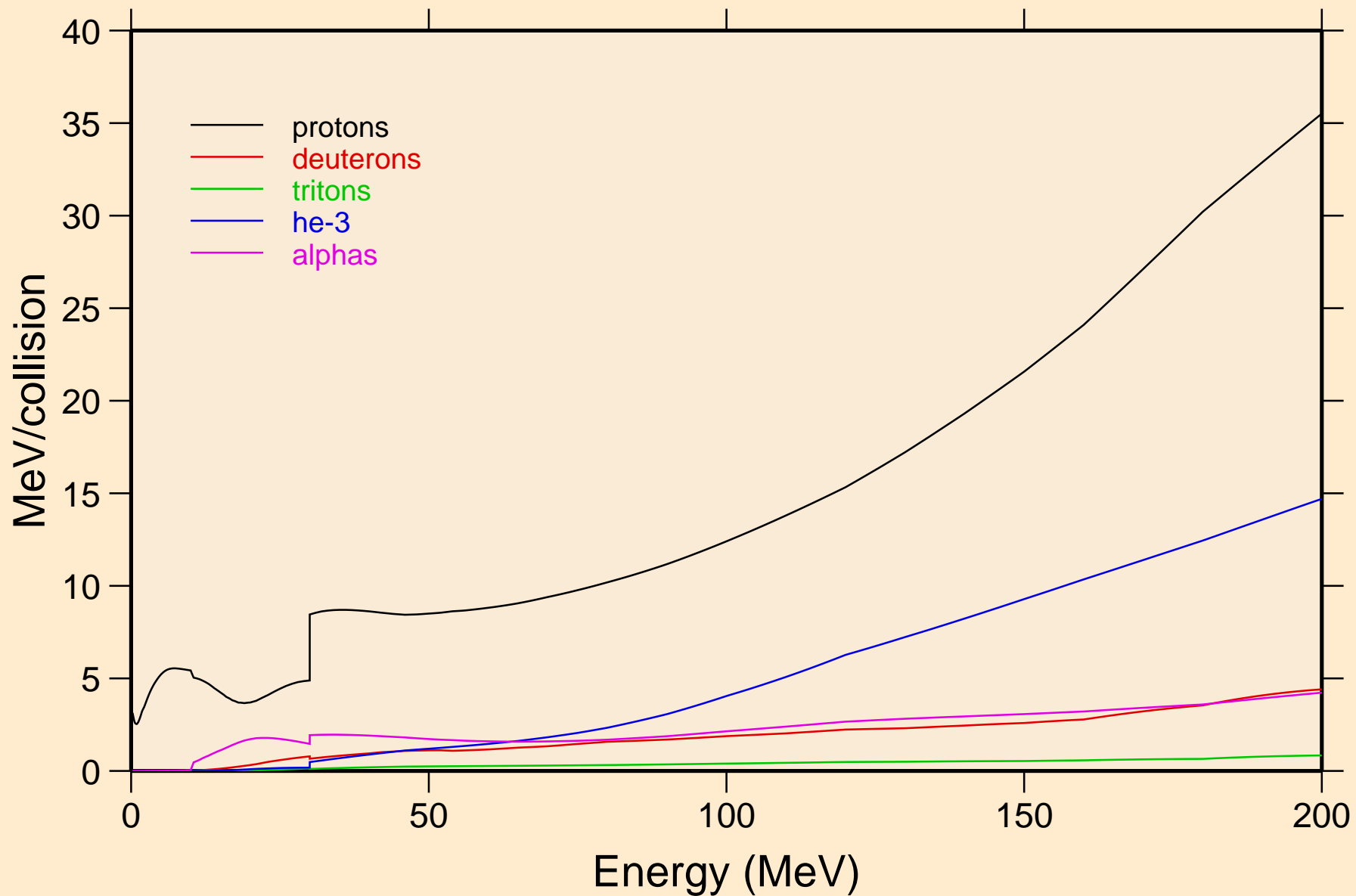

RH092 NEUTRON ACER TENDL-2019 LIBRARY; T=293.16K  
Recoil Heating

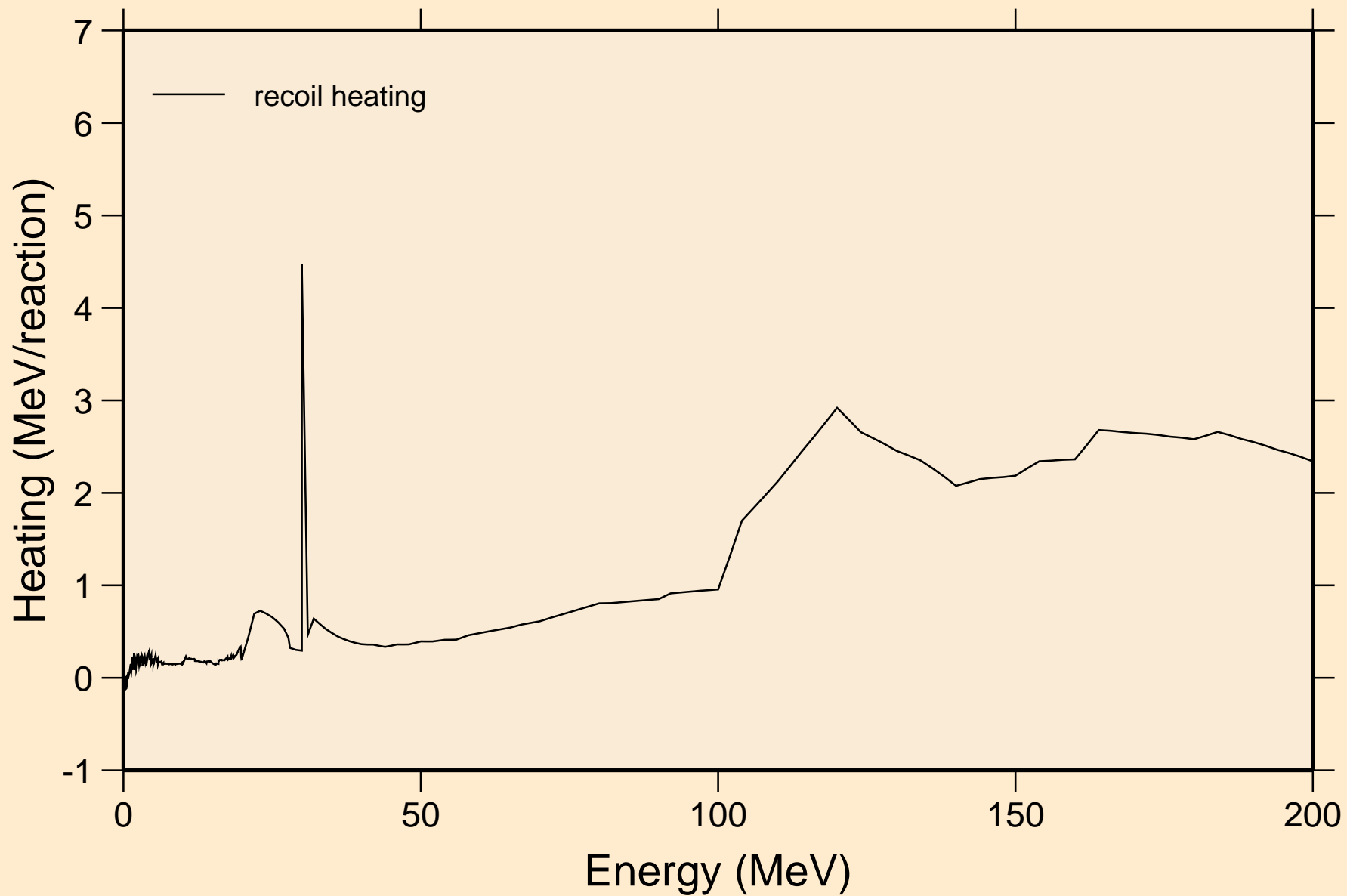

RH092 NEUTRON ACER TENDL-2019 LIBRARY; T=293.16K  
Particle production cross sections

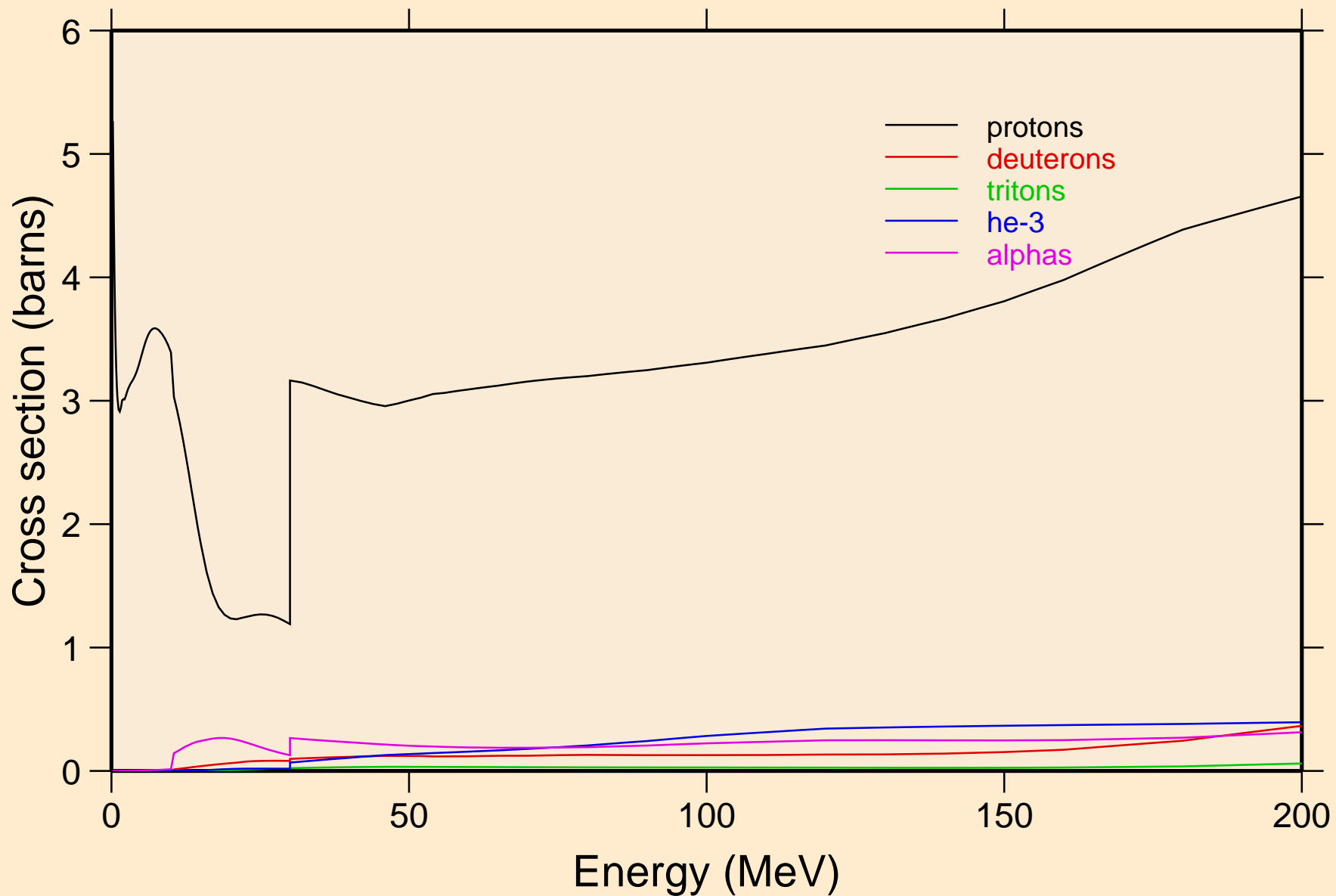

RH092 NEUTRON ACER TENDL-2019 LIBRARY; T=293.16K  
protons from (n,x)

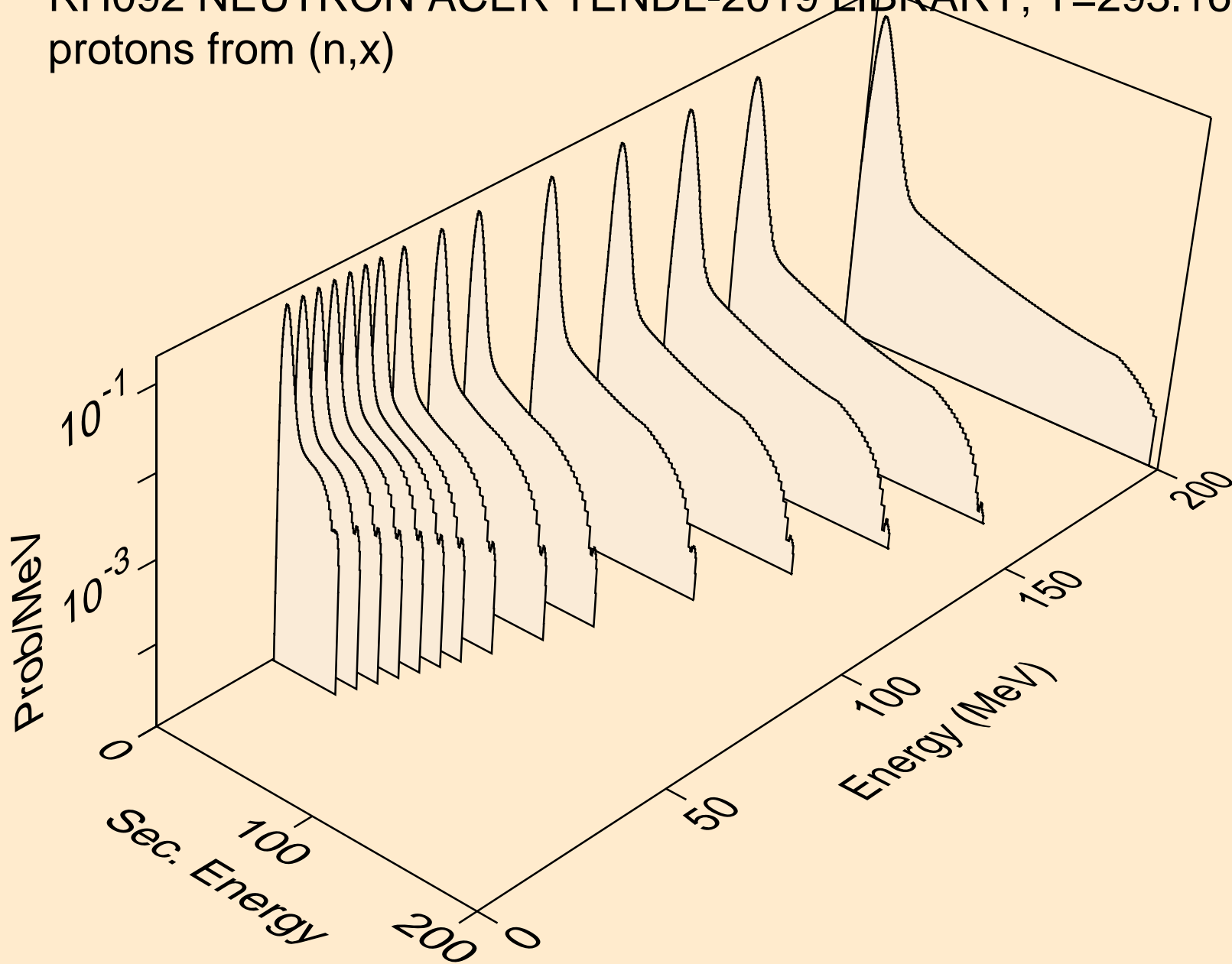

RH092 NEUTRON ACER TENDL-2019 LIBRARY; T=293.16K  
protons from (n,n\*)p

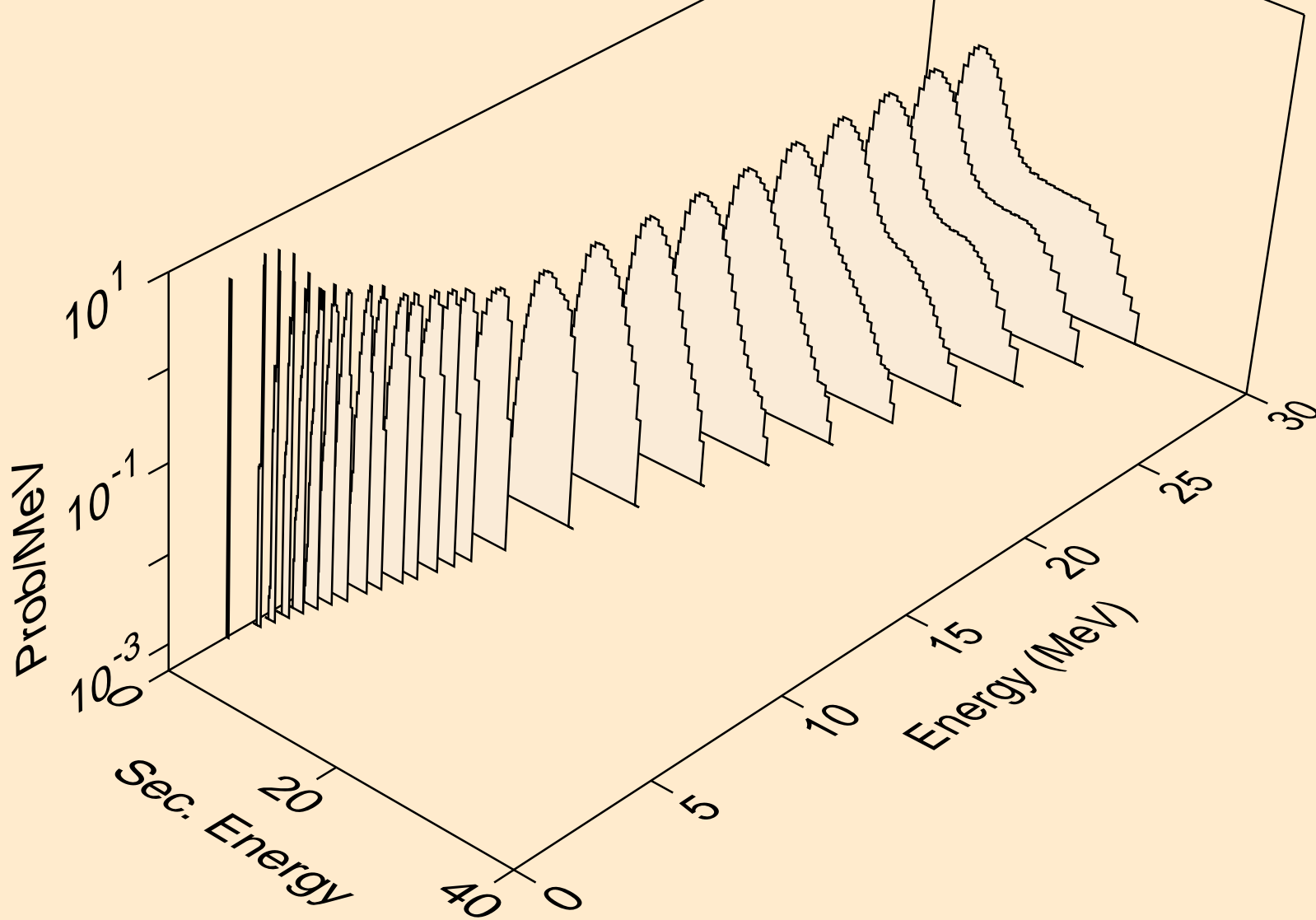

RH092 NEUTRON ACER TENDL-2019 LIBRARY; T=293.16K  
protons from (n,2np)

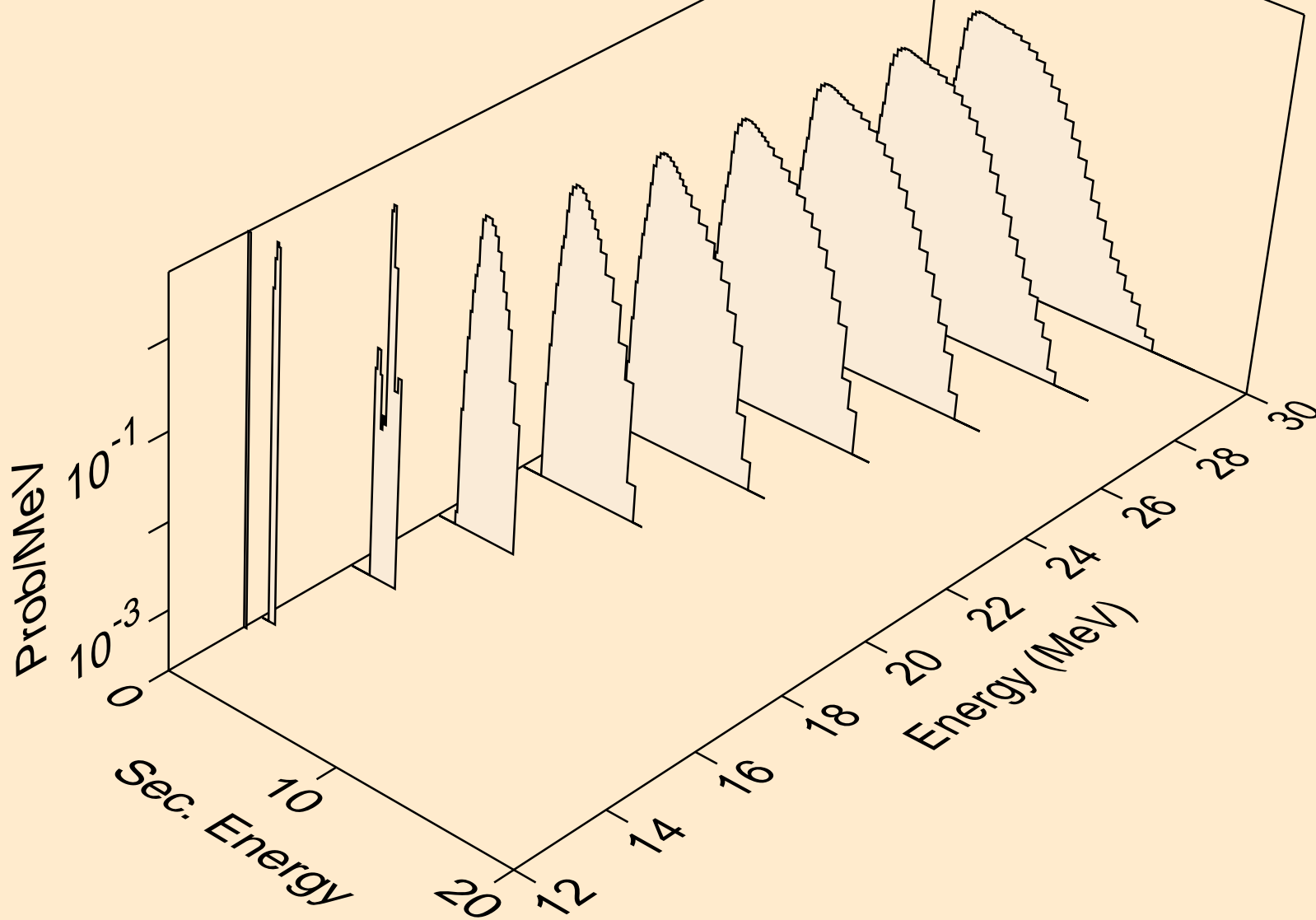

RH092 NEUTRON ACER TENDL-2019 LIBRARY; T=293.16K  
protons from (n,2np)

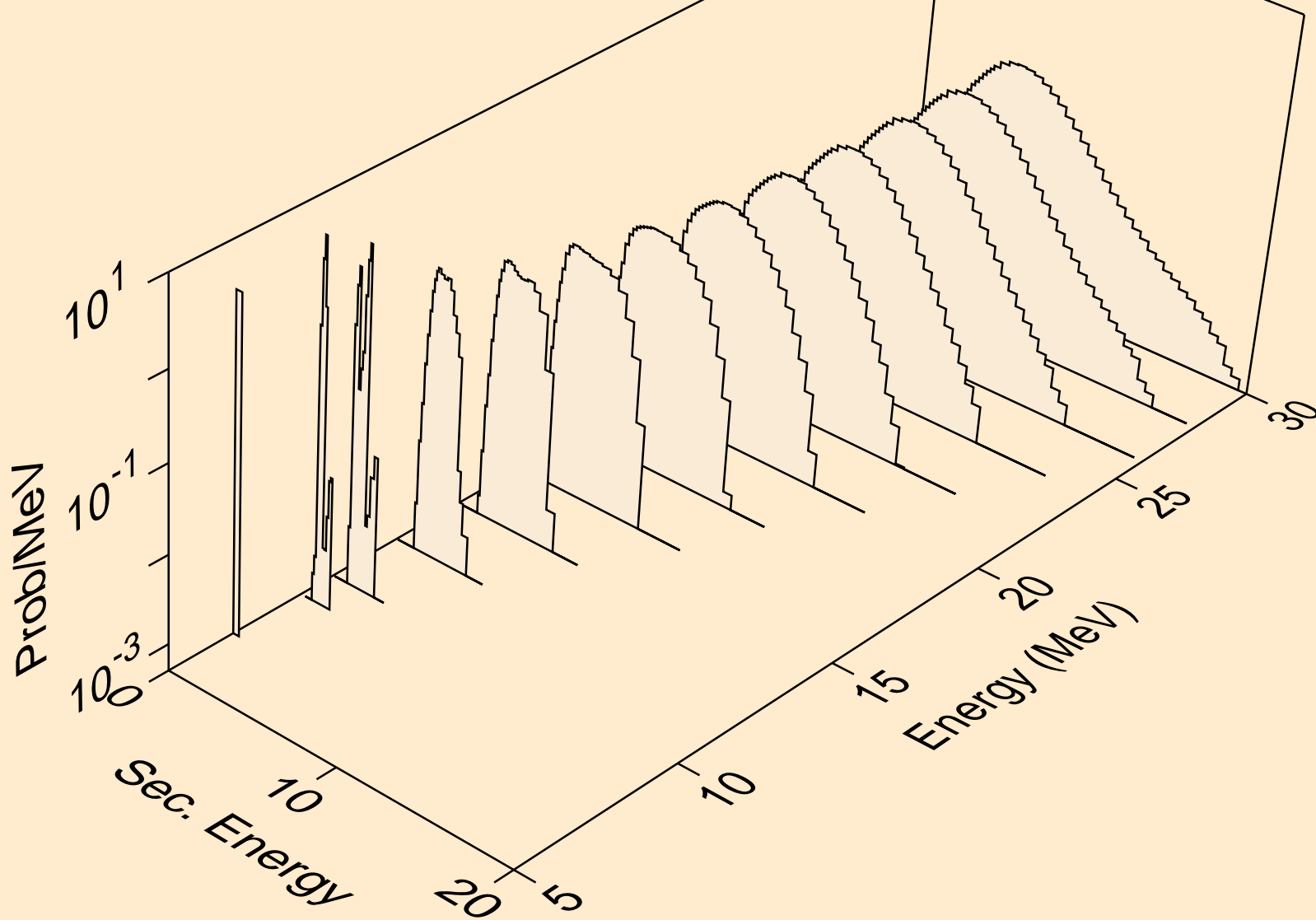

RH092 NEUTRON ACER TENDL-2019 LIBRARY; T=293.16K  
protons from (n,npa)

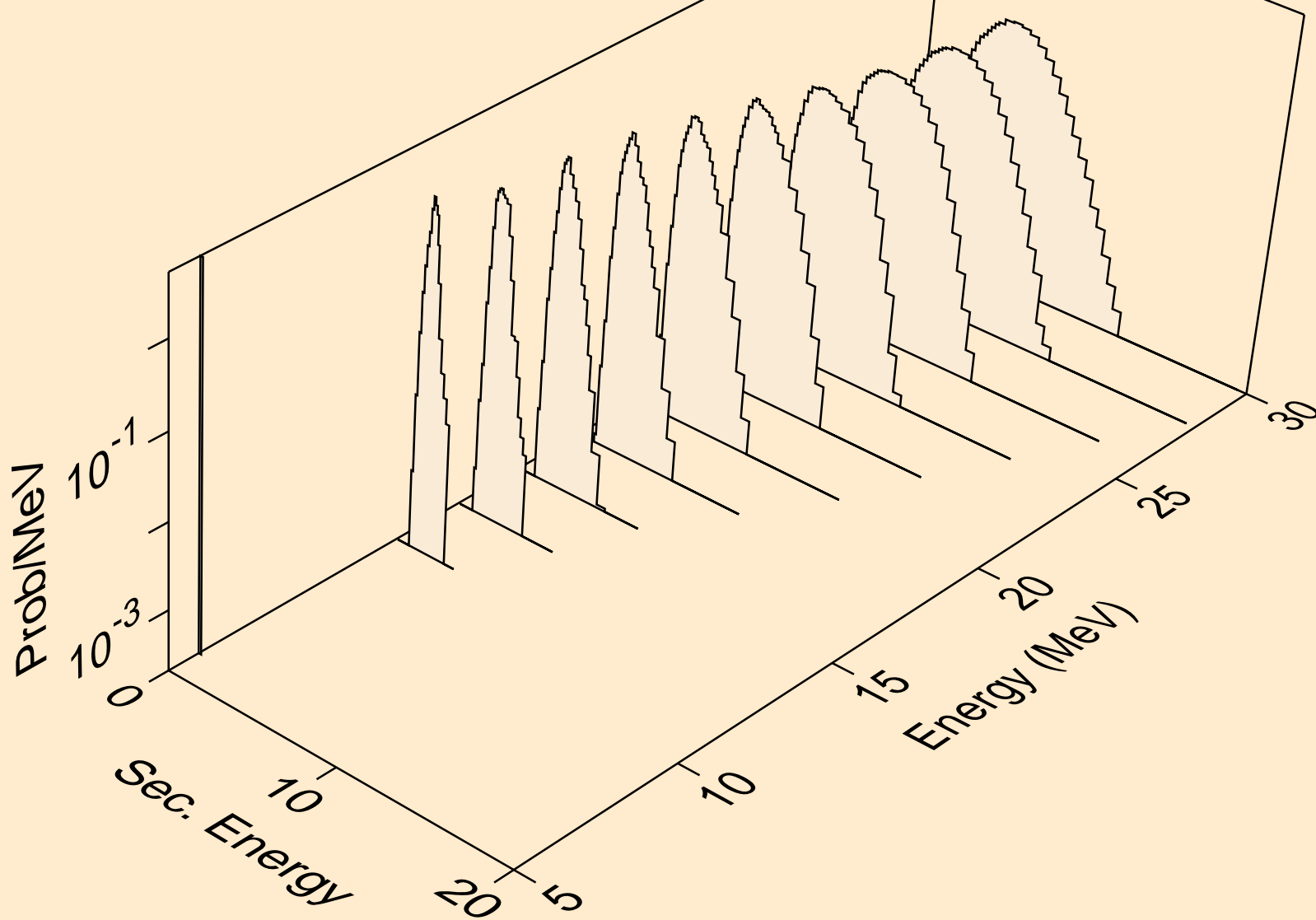

RH092 NEUTRON ACER TENDL-2019 LIBRARY; T=293.16K  
protons from (n,p)

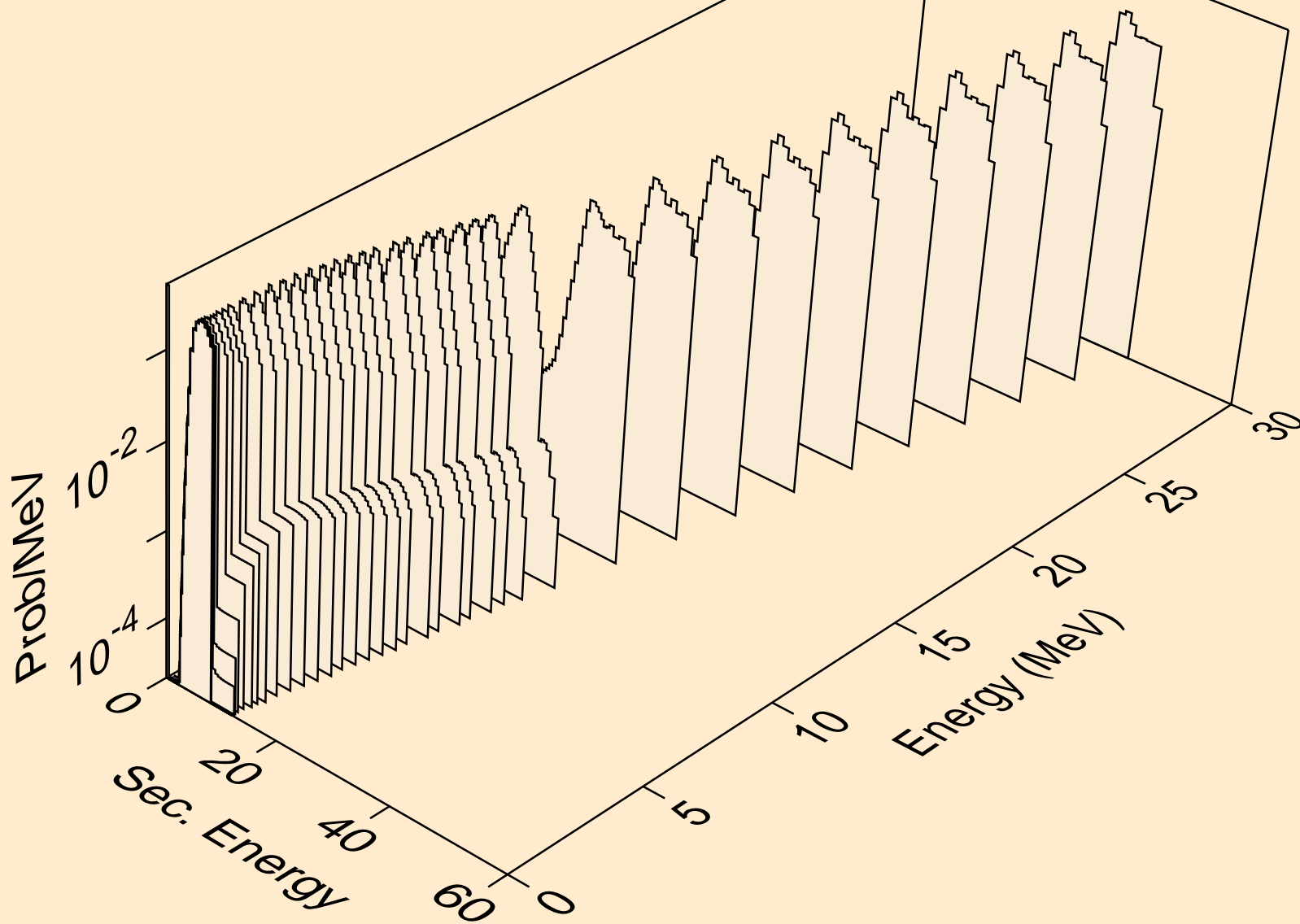

RH092 NEUTRON ACER TENDL-2019 LIBRARY; T=293.16K  
protons from (n,2p)

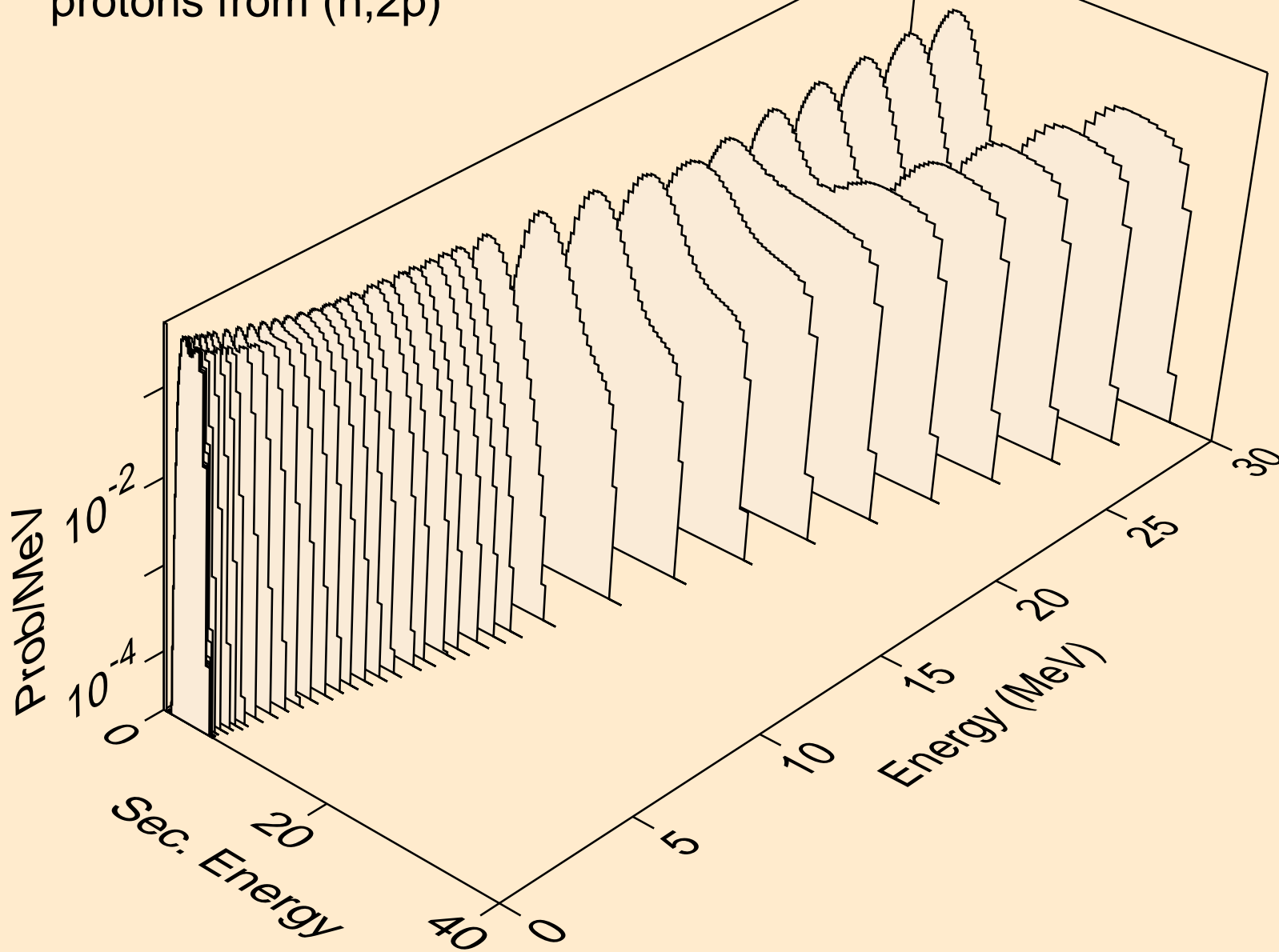

RH092 NEUTRON ACER TENDL-2019 LIBRARY; T=293.16K  
protons from (n,p)

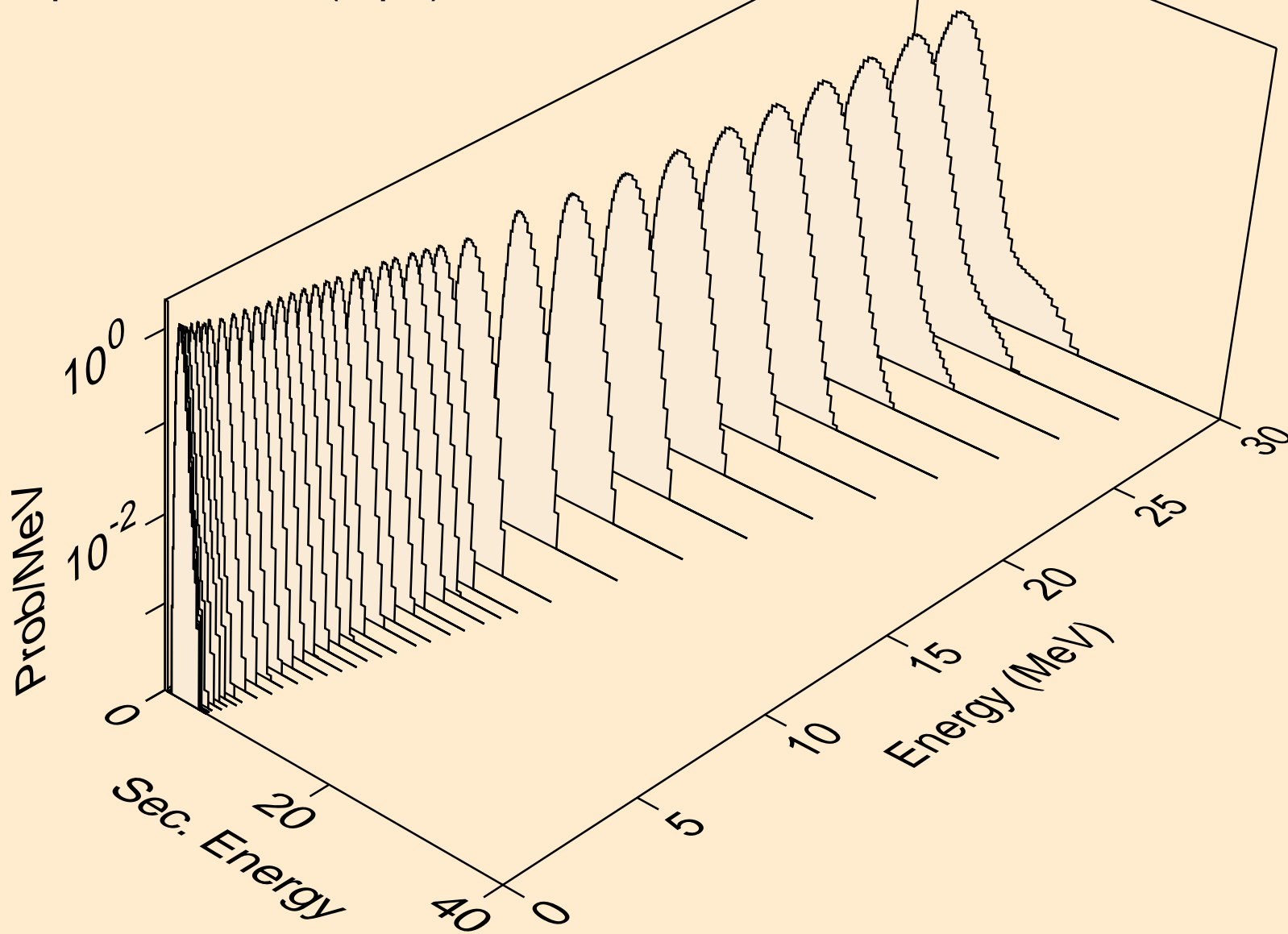

RH092 NEUTRON ACER TENDL-2019 LIBRARY; T=293.16K  
protons from (n,pd)

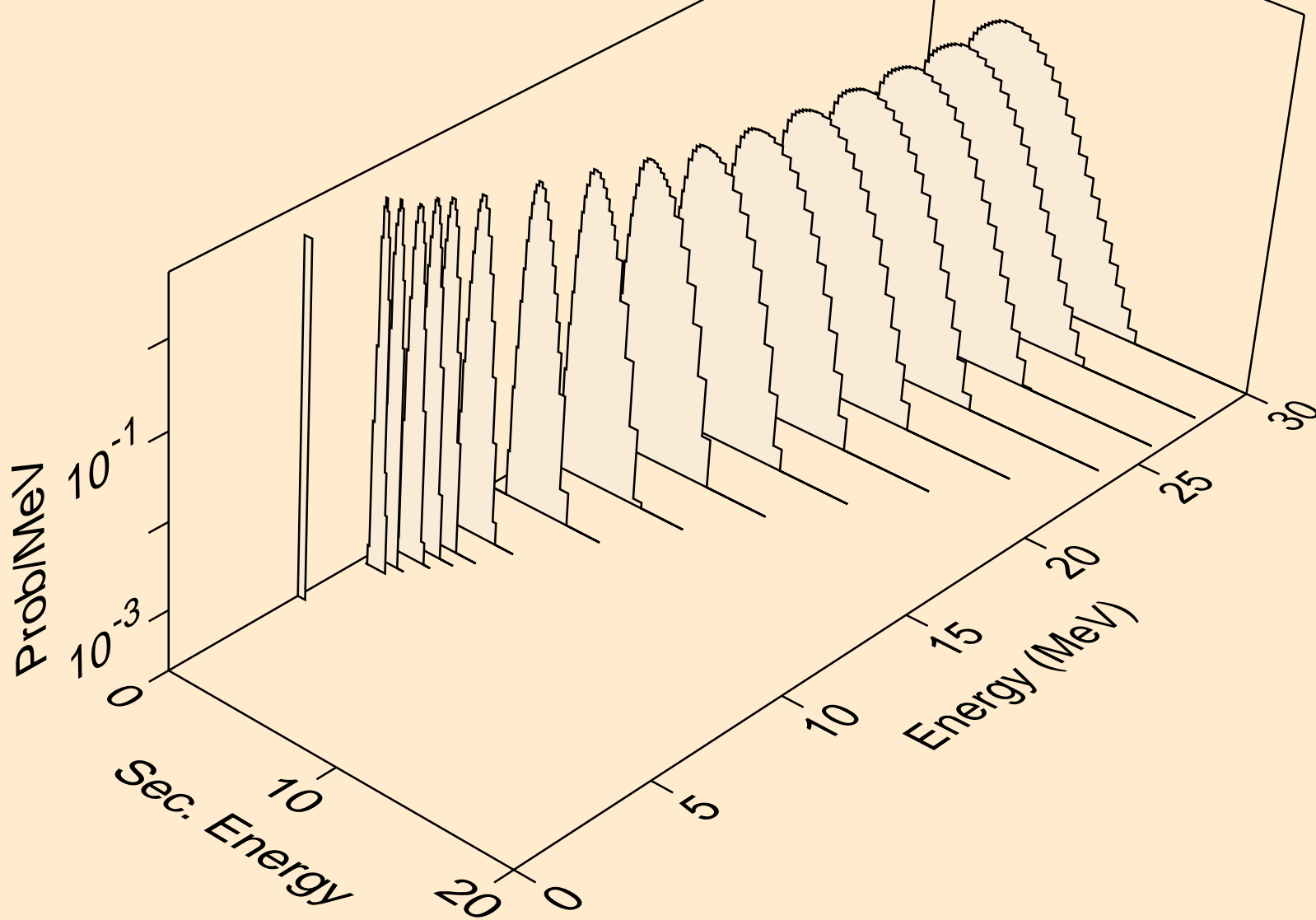

RH092 NEUTRON ACER TENDL-2019 LIBRARY; T=293.16K  
protons from (n,pt)

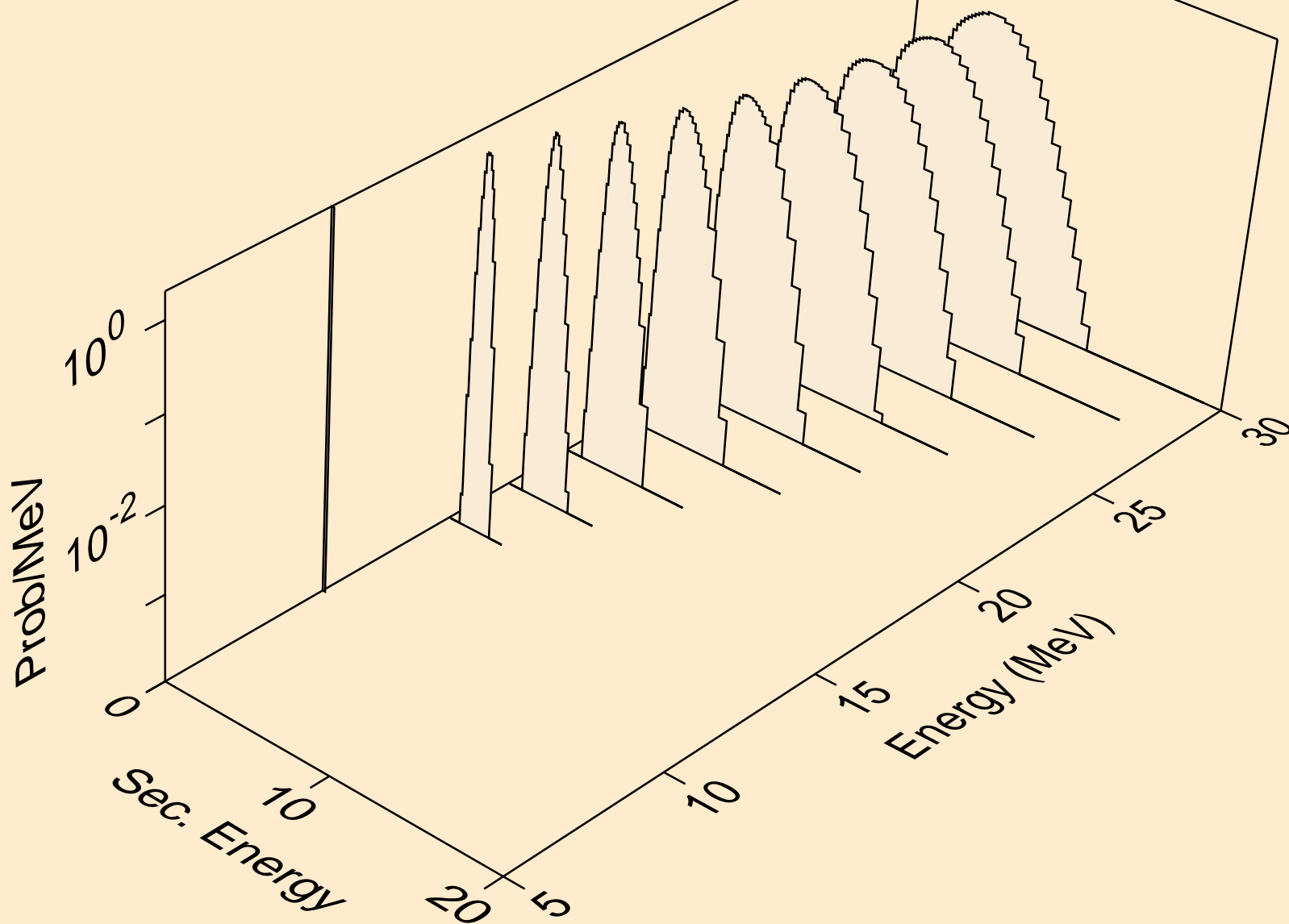

RH092 NEUTRON ACER TENDL-2019 LIBRARY; T=293.16K  
deuterons from (n,x)

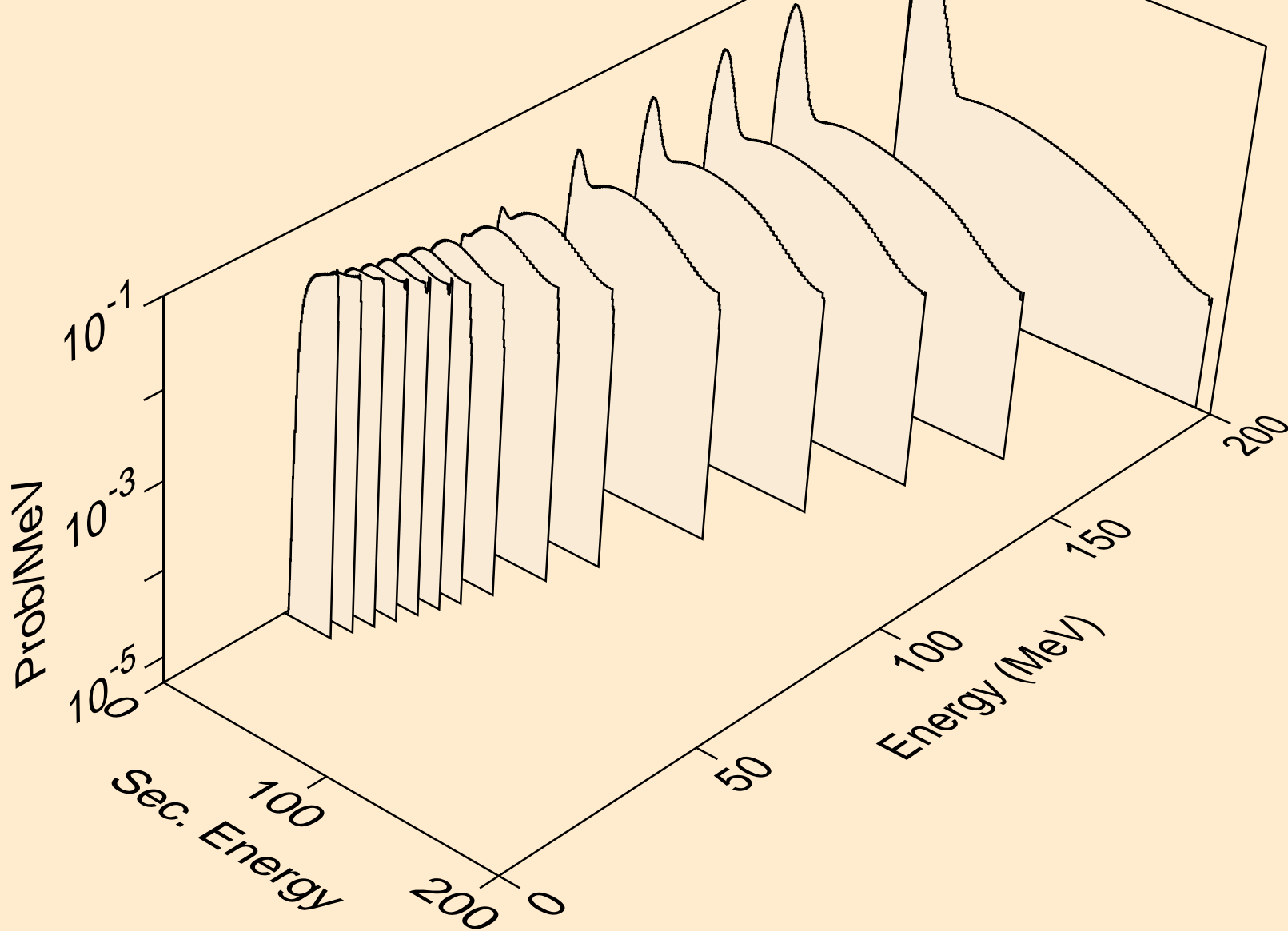

RH092 NEUTRON ACER TENDL-2019 LIBRARY; T=293.16K  
deuterons from (n,n\*)d

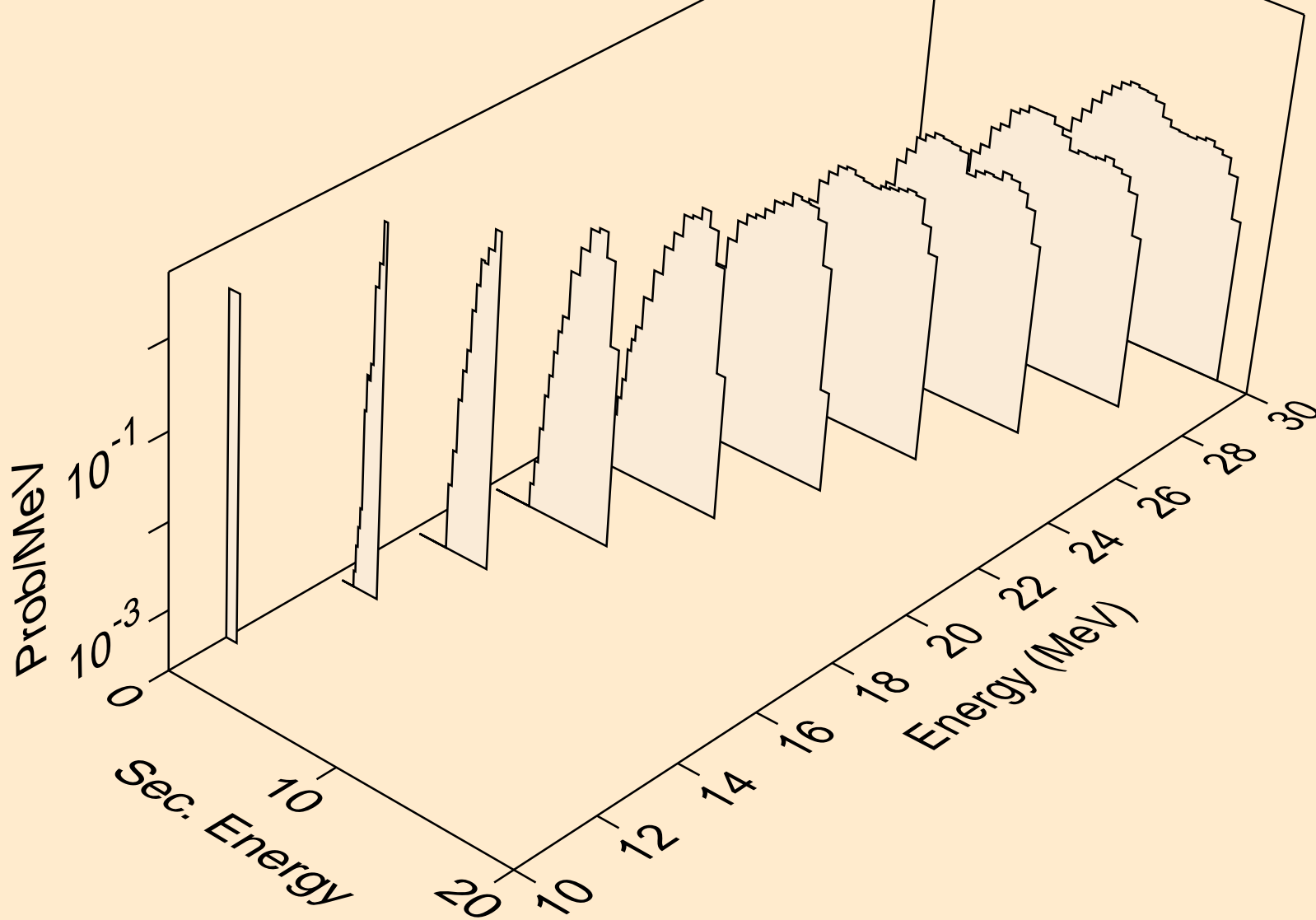

RH092 NEUTRON ACER TENDL-2019 LIBRARY; T=293.16K  
deuterons from (n,d)

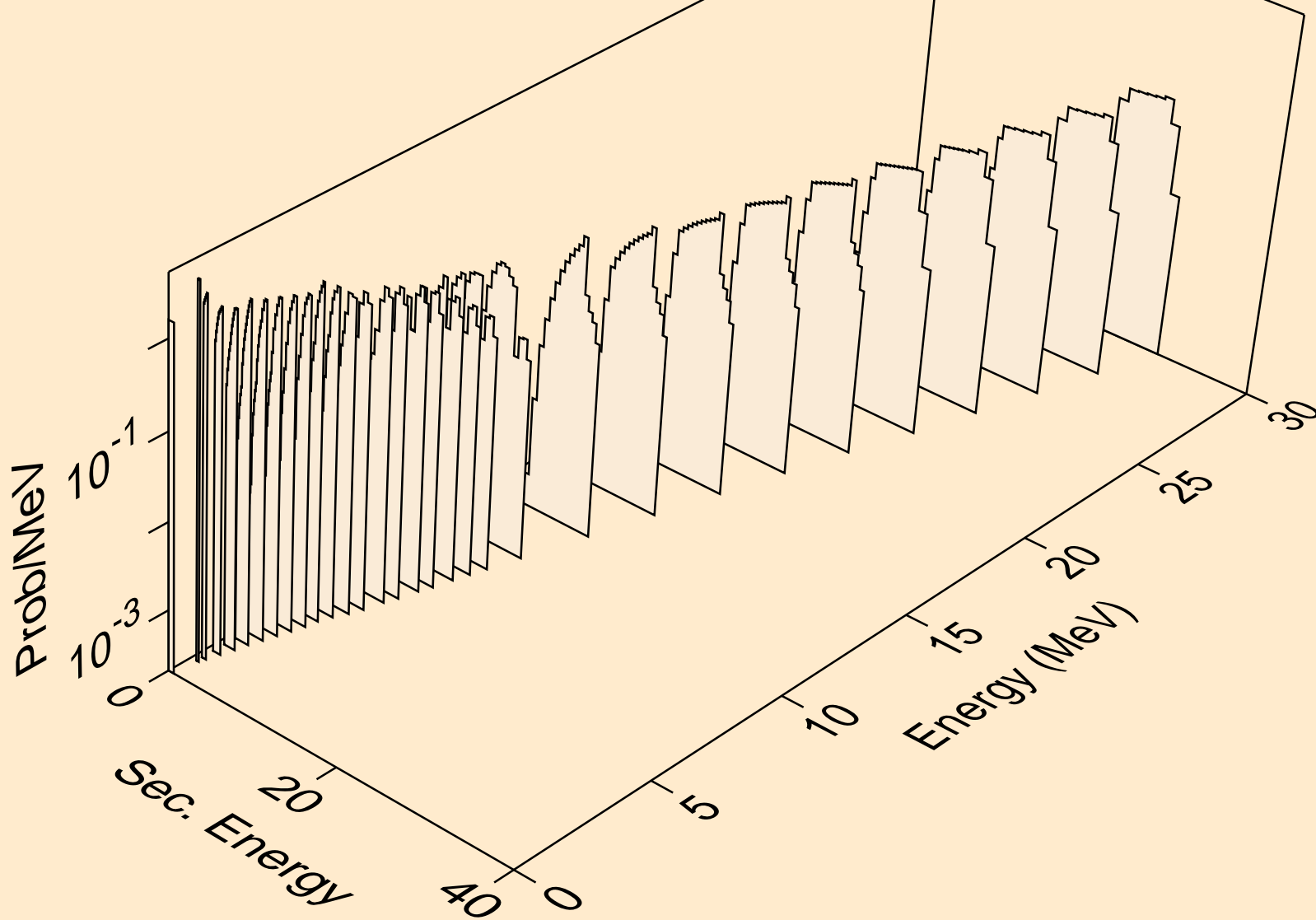

RH092 NEUTRON ACER TENDL-2019 LIBRARY; T=293.16K  
deuterons from (n,pd)

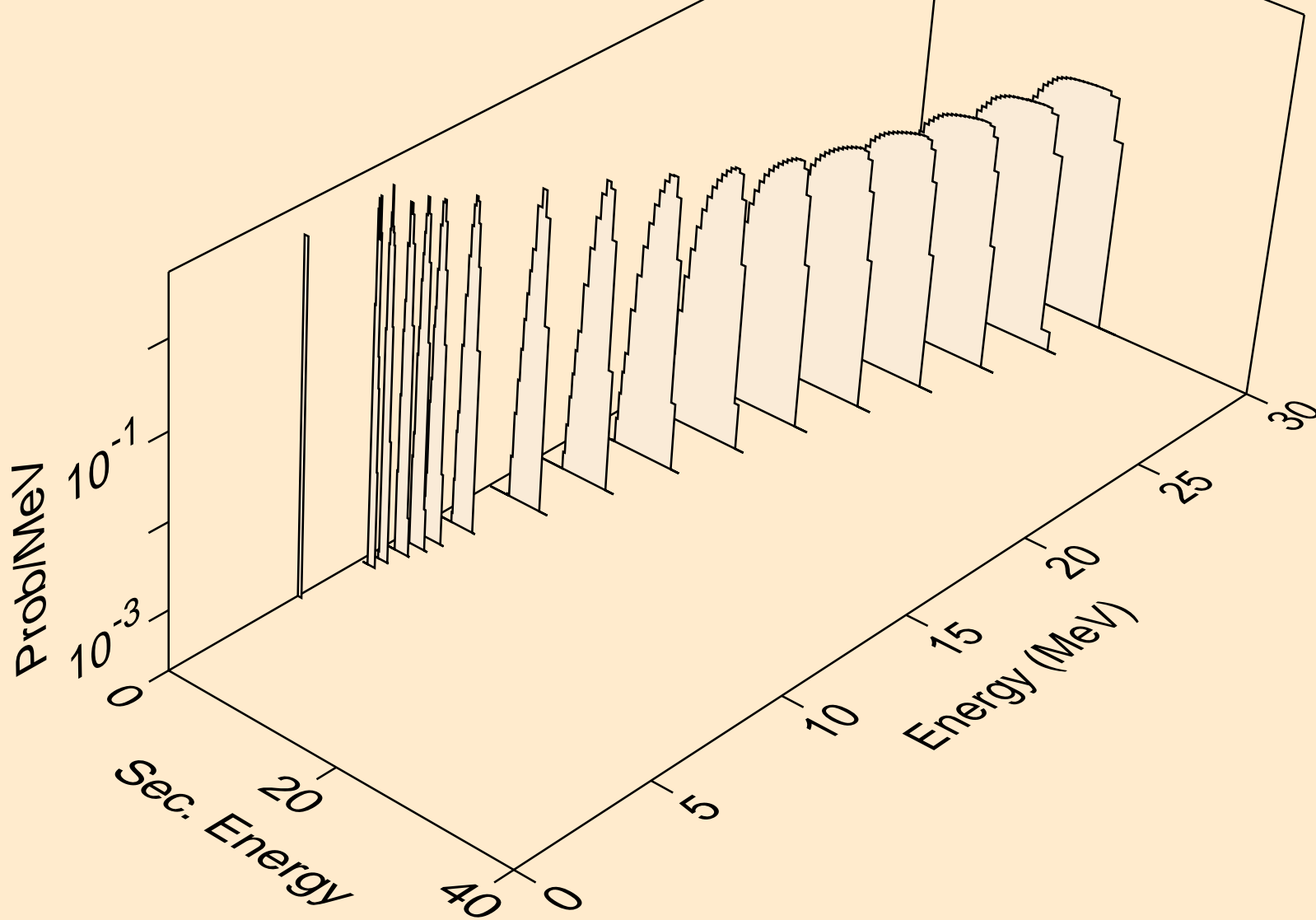

RH092 NEUTRON ACER TENDL-2019 LIBRARY; T=293.16K  
deuterons from (n,da)

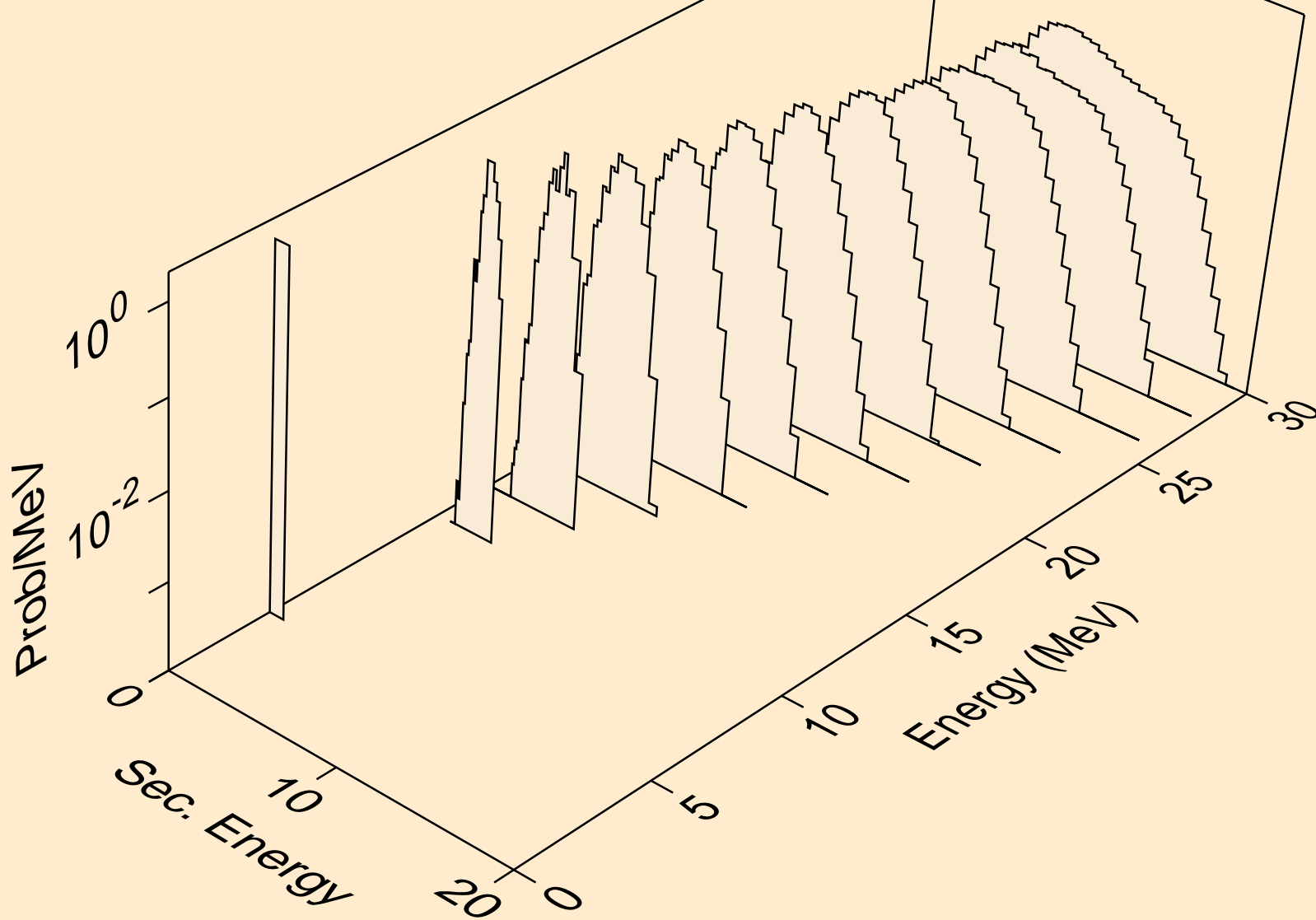

RH092 NEUTRON ACER TENDL-2019 LIBRARY; T=293.16K  
tritons from (n,x)

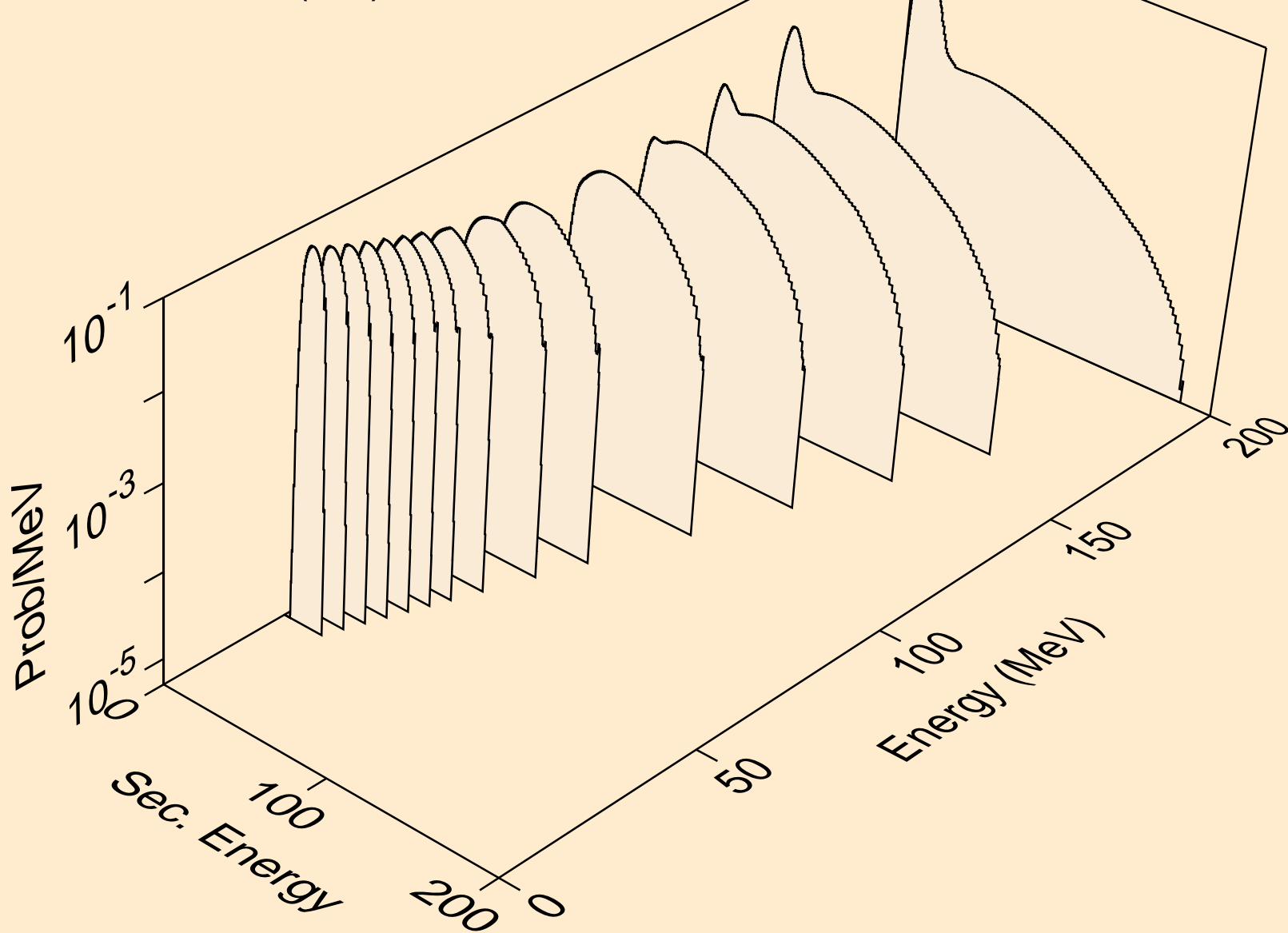

RH092 NEUTRON ACER TENDL-2019 LIBRARY; T=293.16K  
tritons from (n,n\*)t

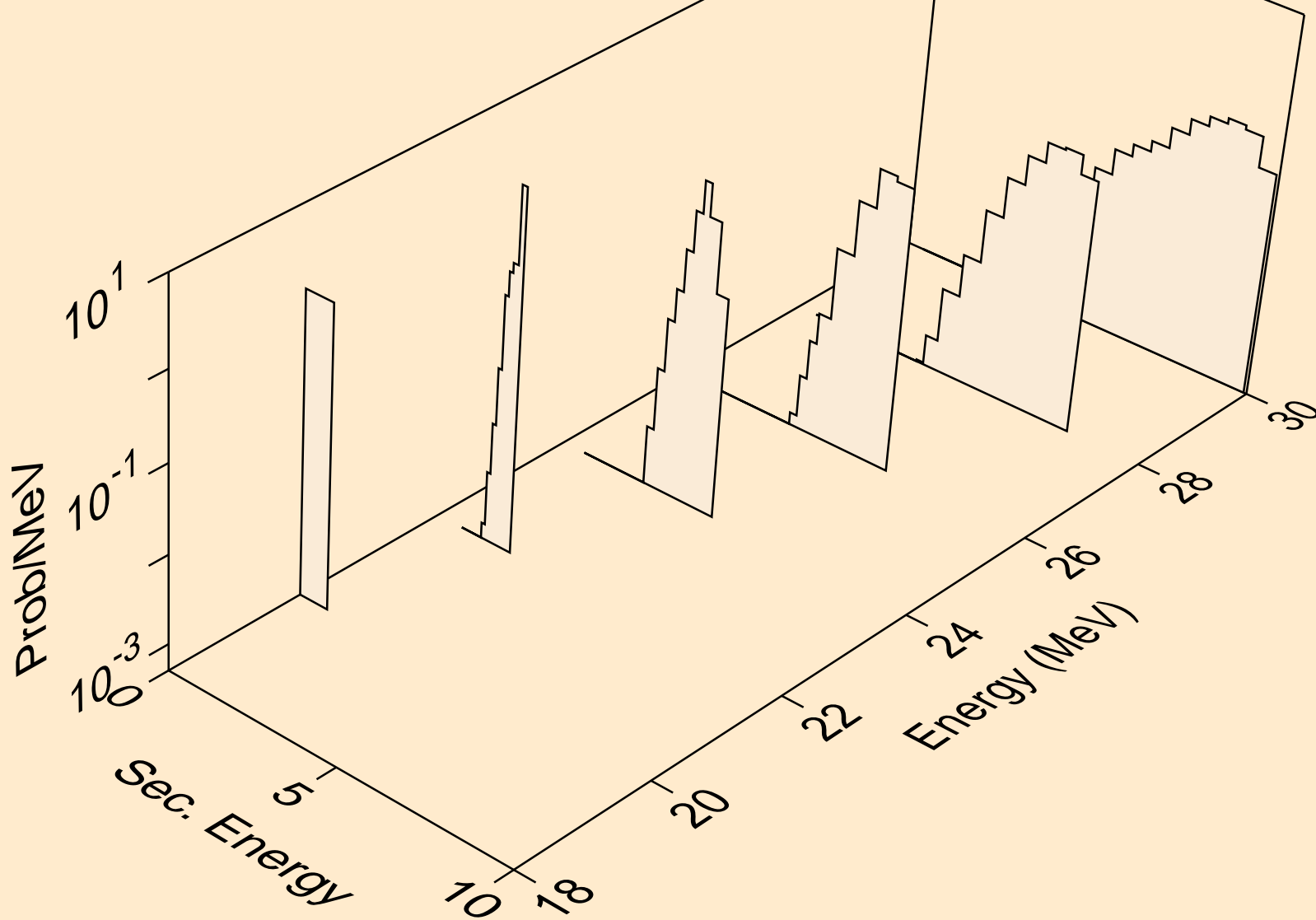

RH092 NEUTRON ACER TENDL-2019 LIBRARY; T=293.16K  
tritons from (n,t)

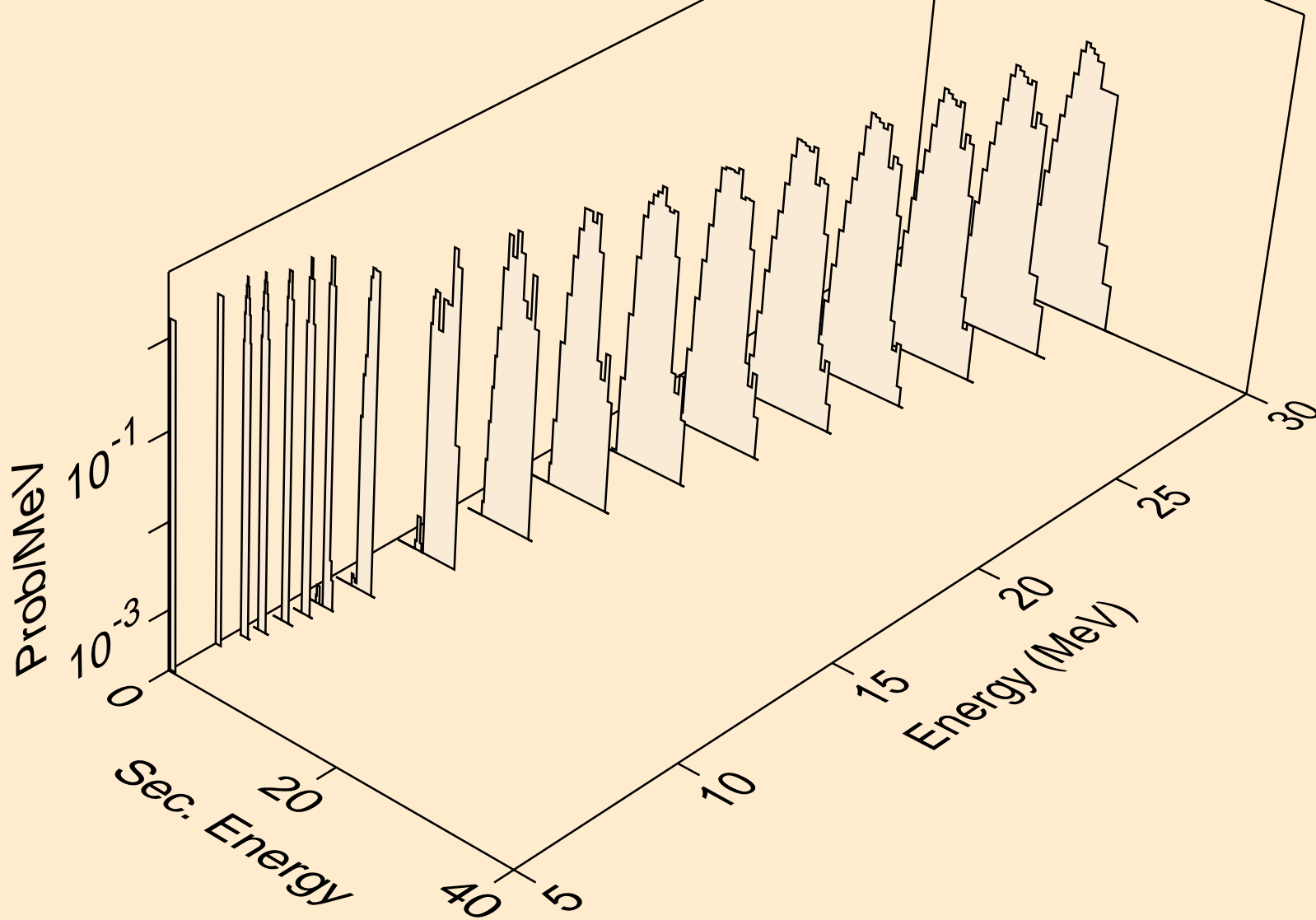

RH092 NEUTRON ACER TENDL-2019 LIBRARY; T=293.16K  
tritons from (n,pt)

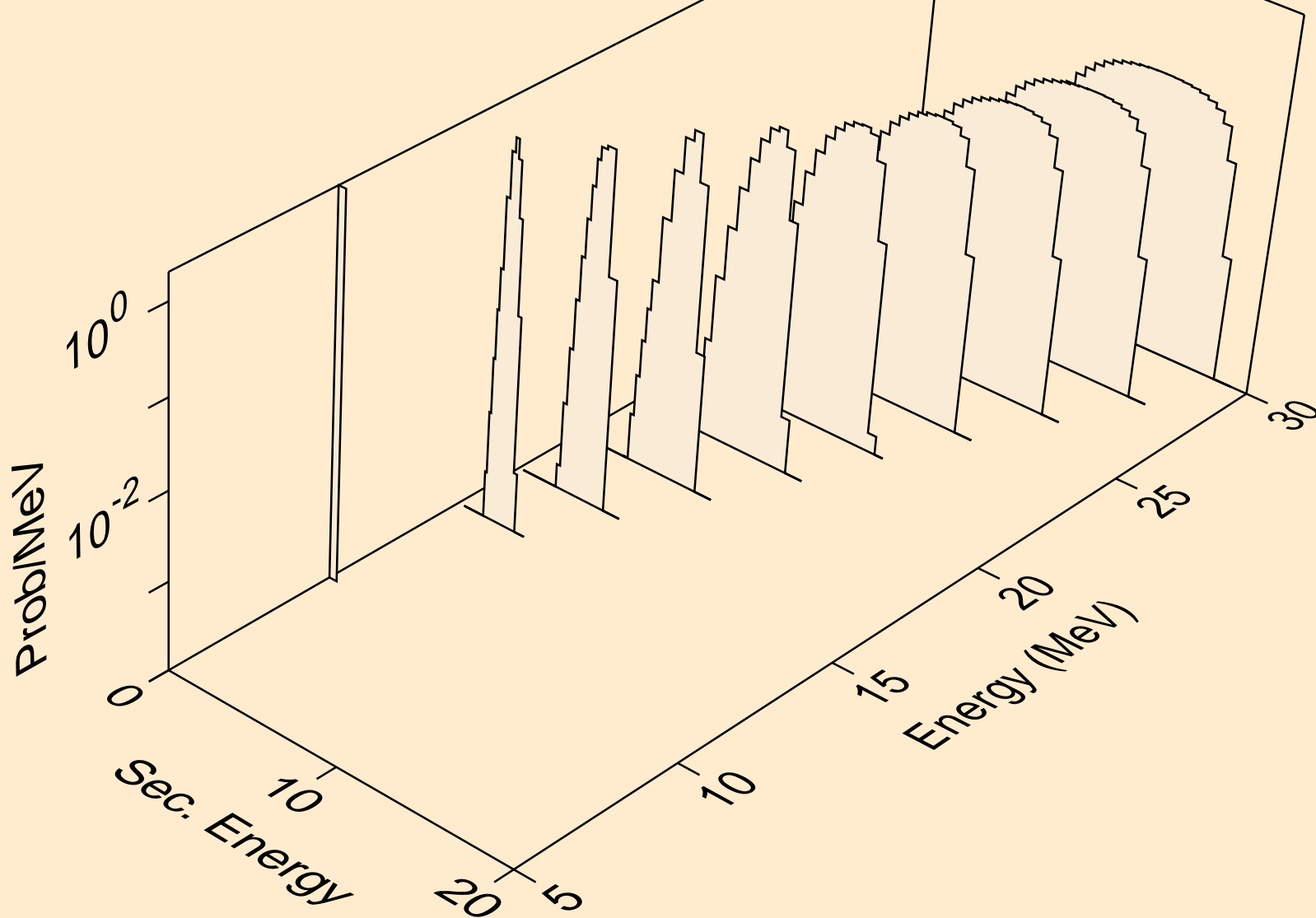

RH092 NEUTRON ACER TENDL-2019 LIBRARY; T=293.16K  
he3s from (n,x)

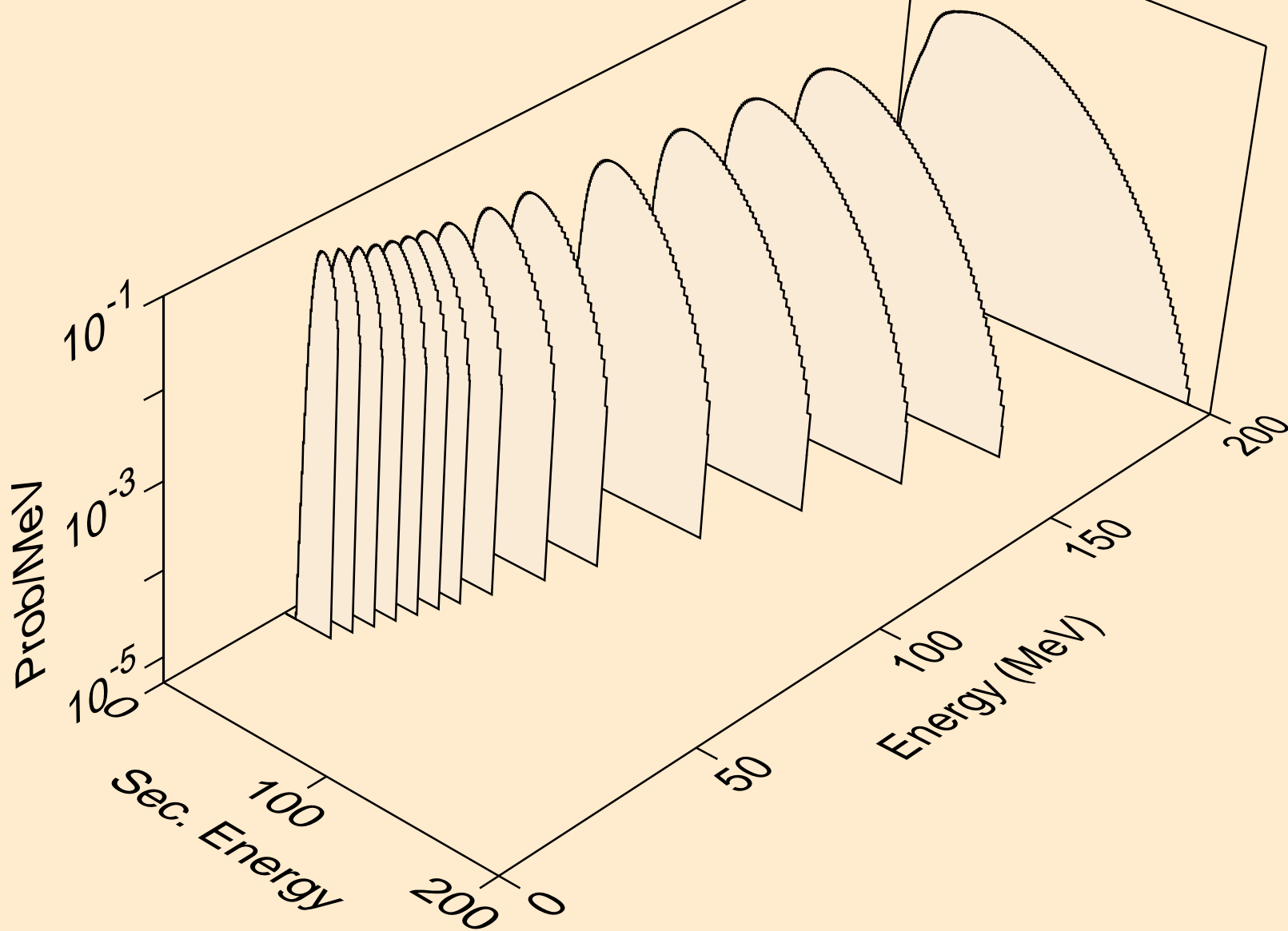

RH092 NEUTRON ACER TENDL-2019 LIBRARY; T=293.16K  
he3s from (n,n\*)he3

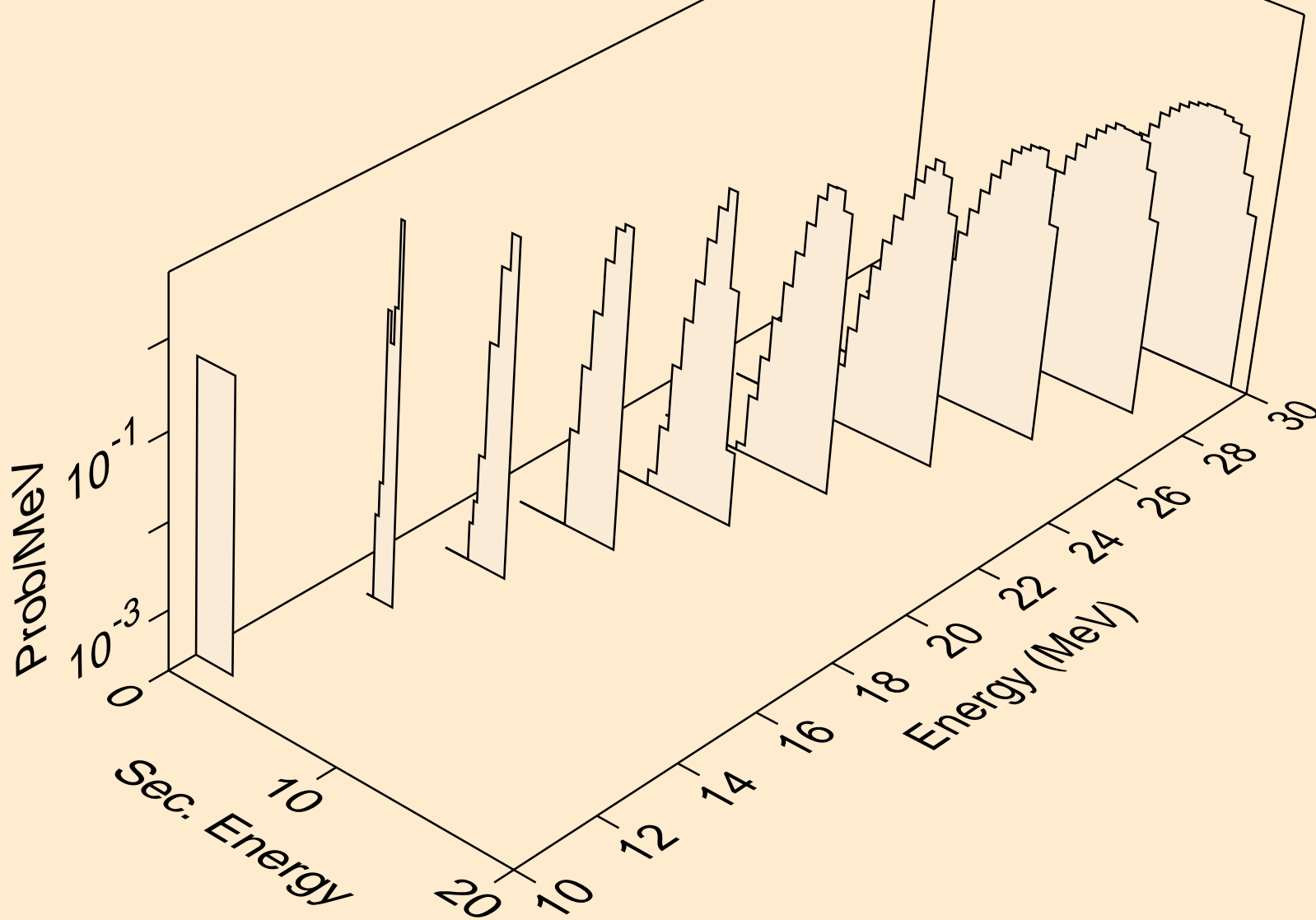

RH092 NEUTRON ACER TENDL-2019 LIBRARY; T=293.16K  
he3s from (n,he3)

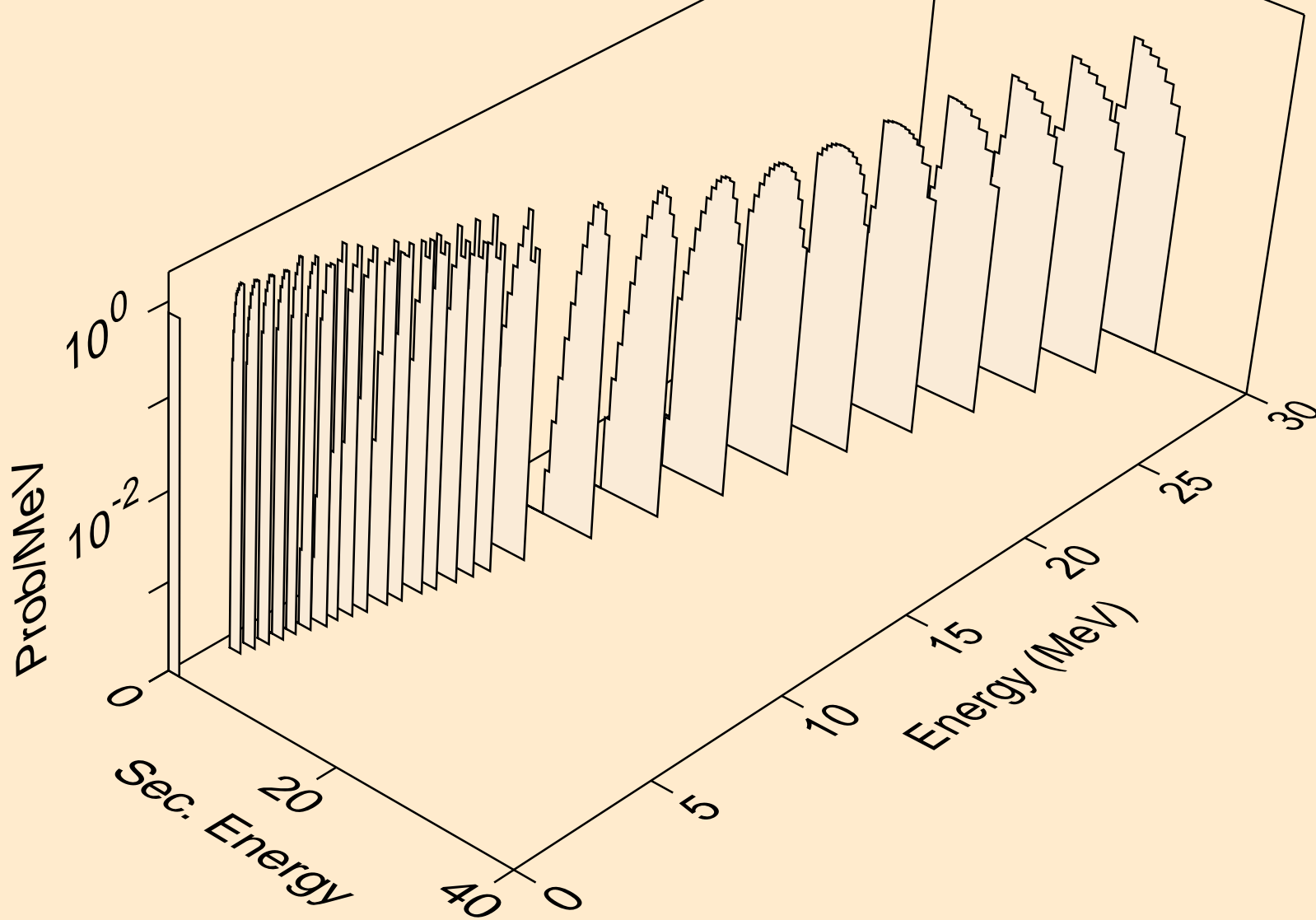

RH092 NEUTRON ACER TENDL-2019 LIBRARY; T=293.16K  
alphas from (n,x)

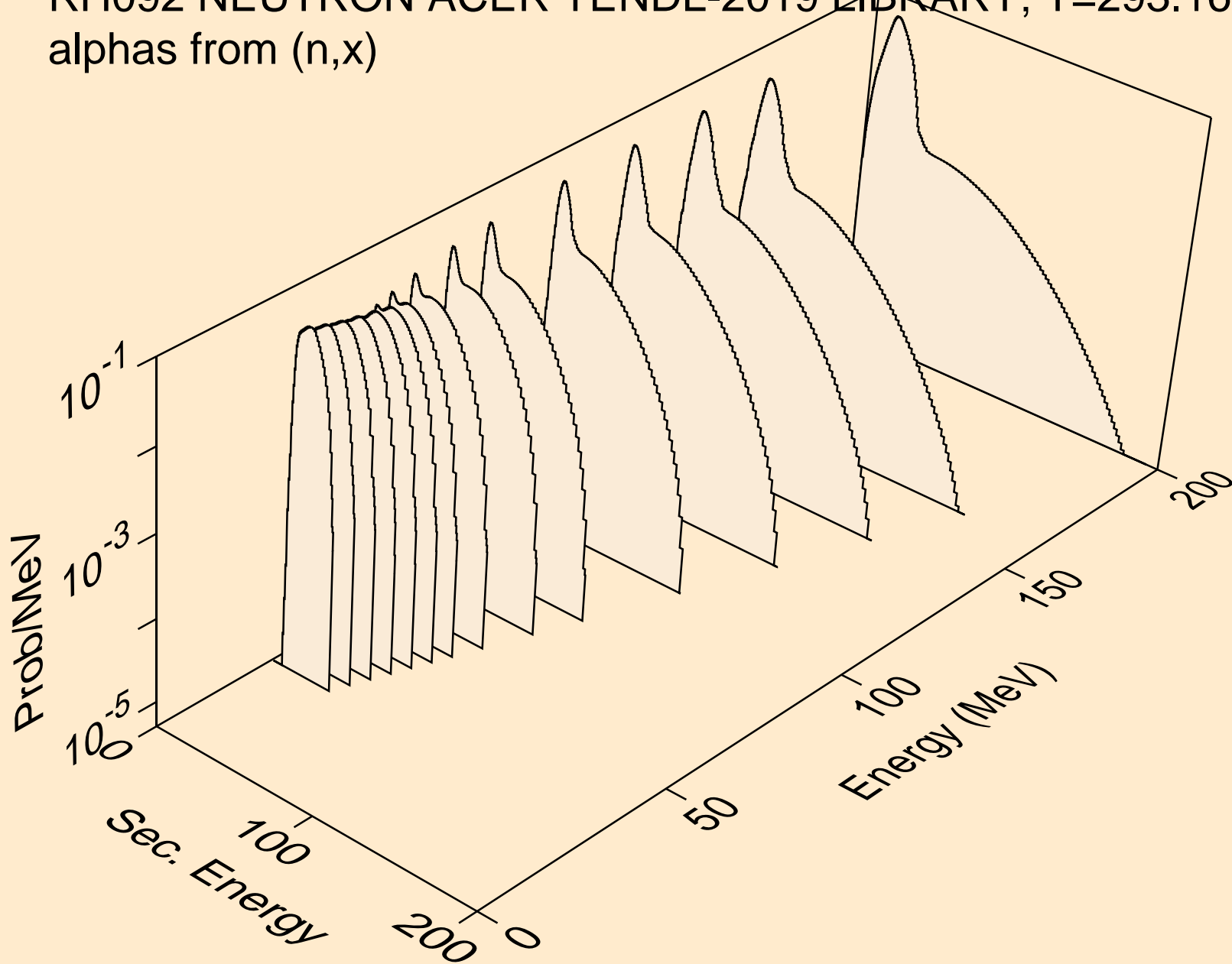

RH092 NEUTRON ACER TENDL-2019 LIBRARY; T=293.16K  
alphas from (n,n\*)a

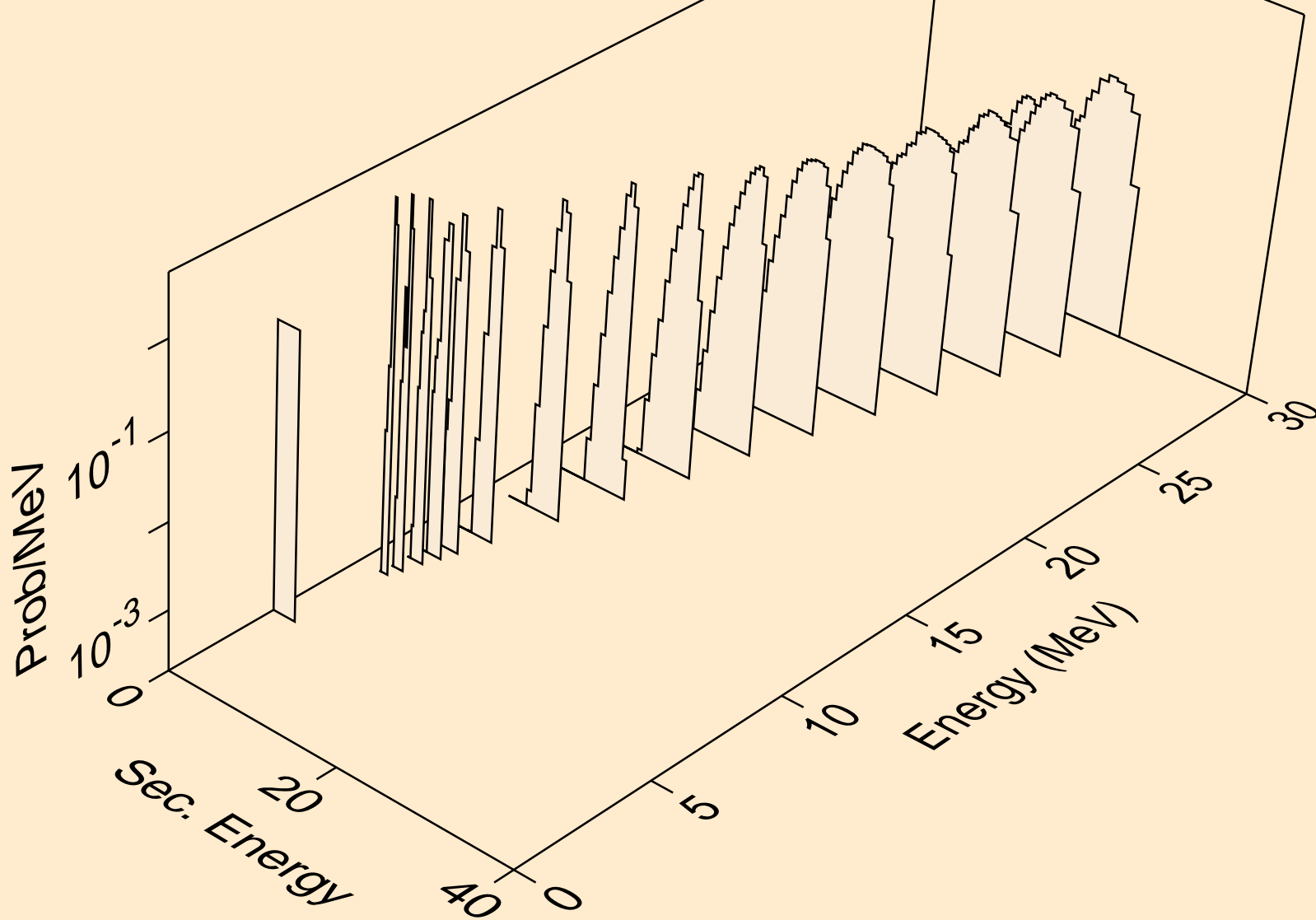

RH092 NEUTRON ACER TENDL-2019 LIBRARY; T=293.16K  
alphas from (n,2n)a

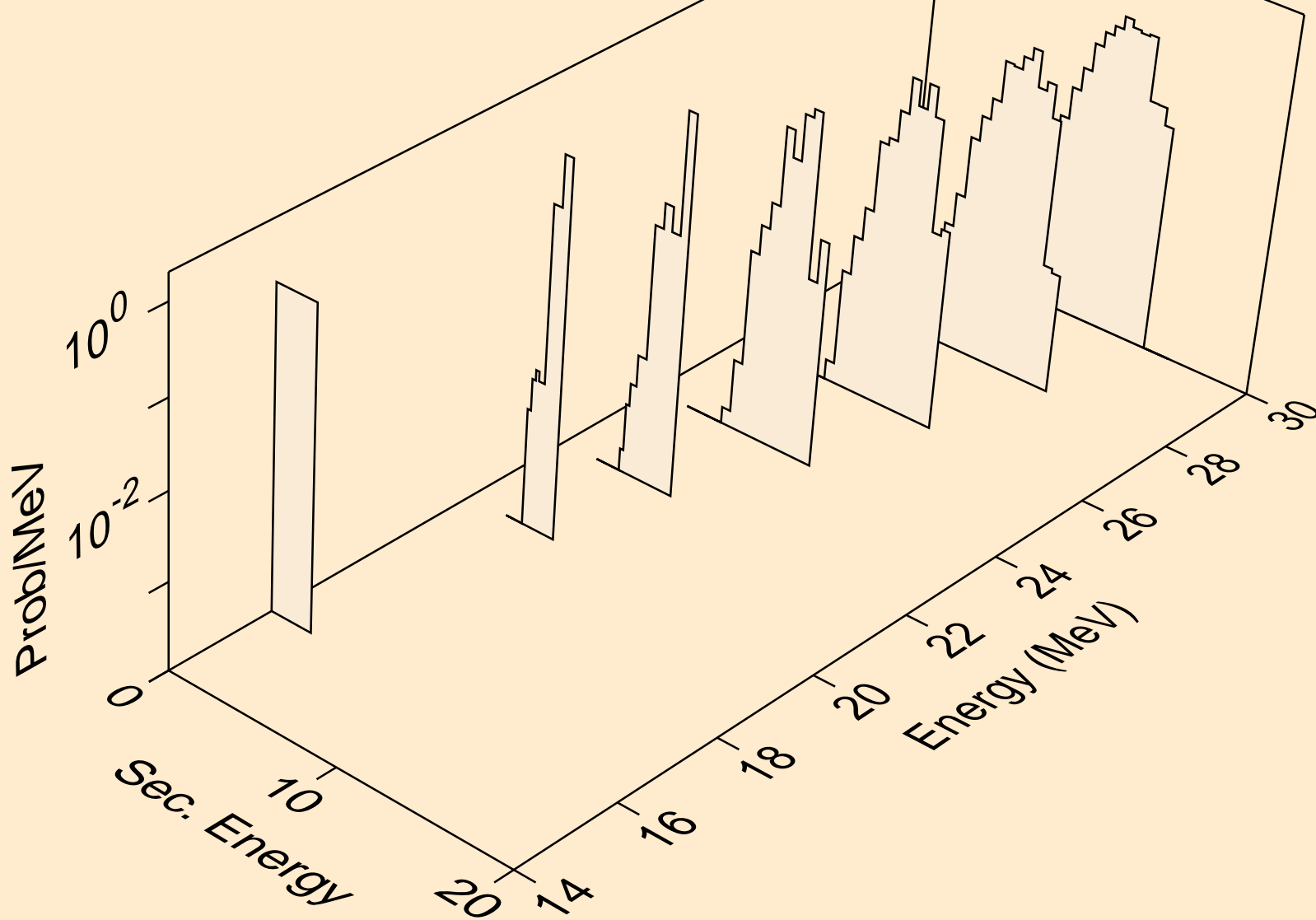

RH092 NEUTRON ACER TENDL-2019 LIBRARY; T=293.16K  
alphas from (n,n\*)2a

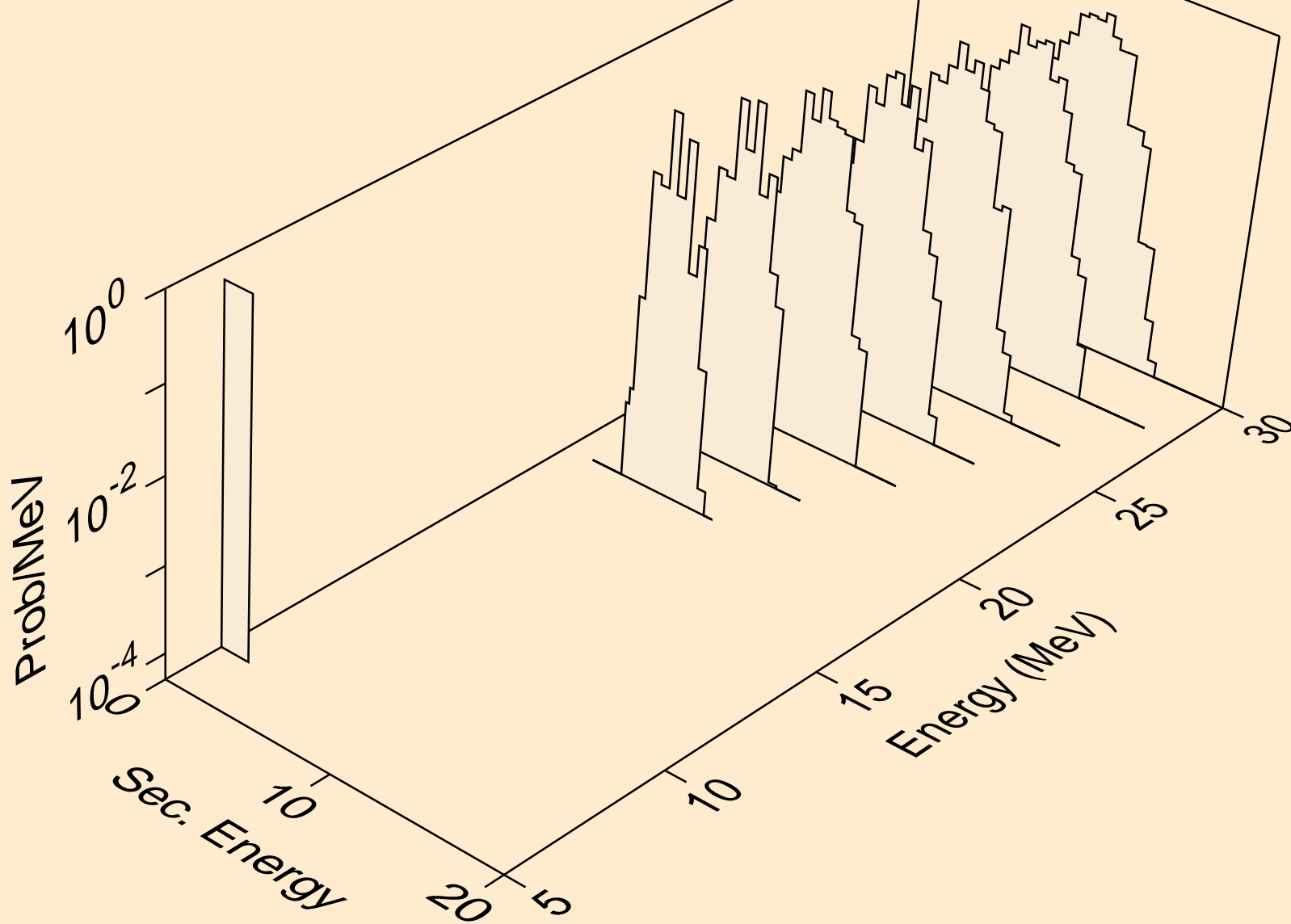

RH092 NEUTRON ACER TENDL-2019 LIBRARY; T=293.16K  
alphas from (n,npa)

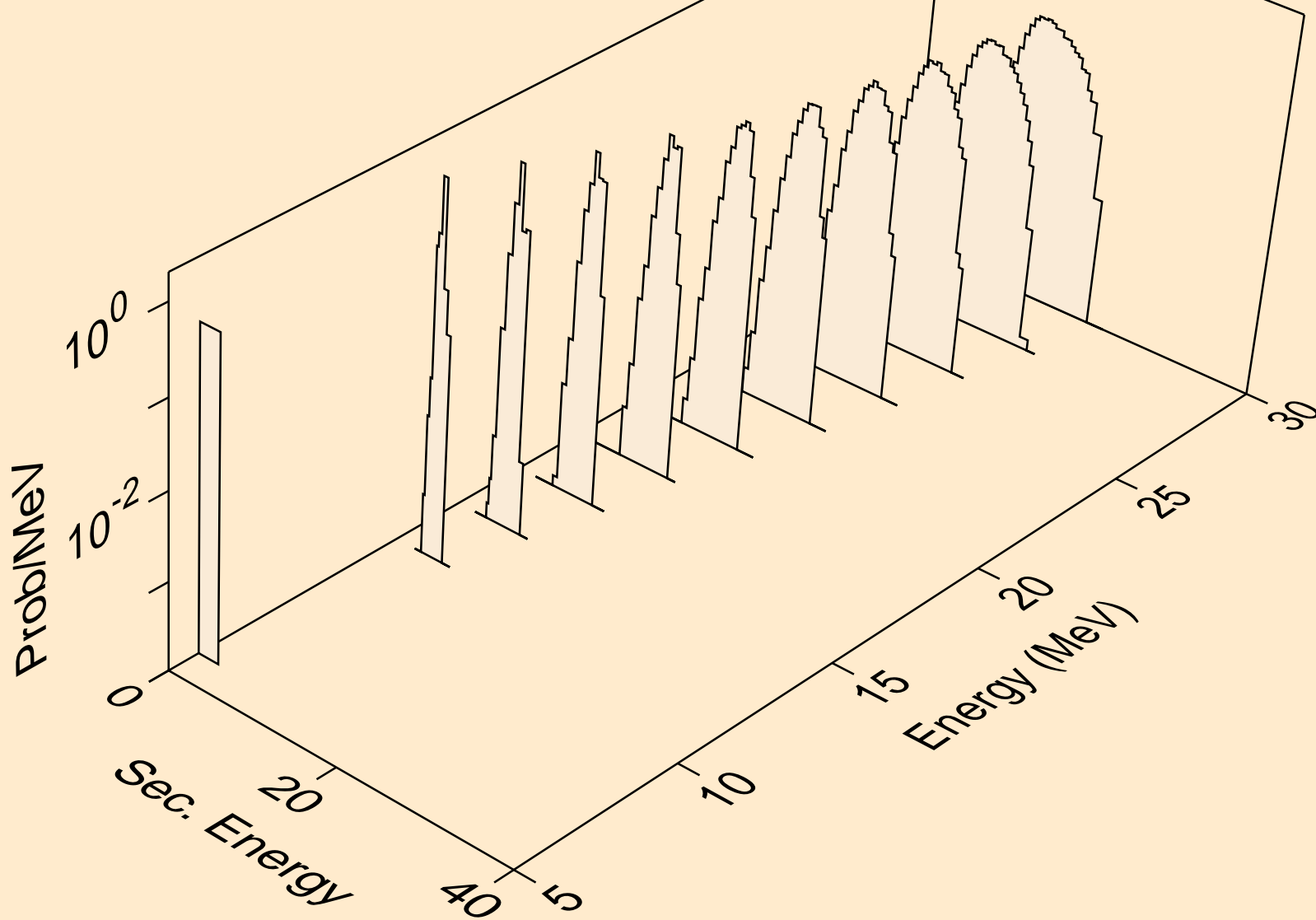

RH092 NEUTRON ACER TENDL-2019 LIBRARY; T=293.16K  
alphas from (n,a)

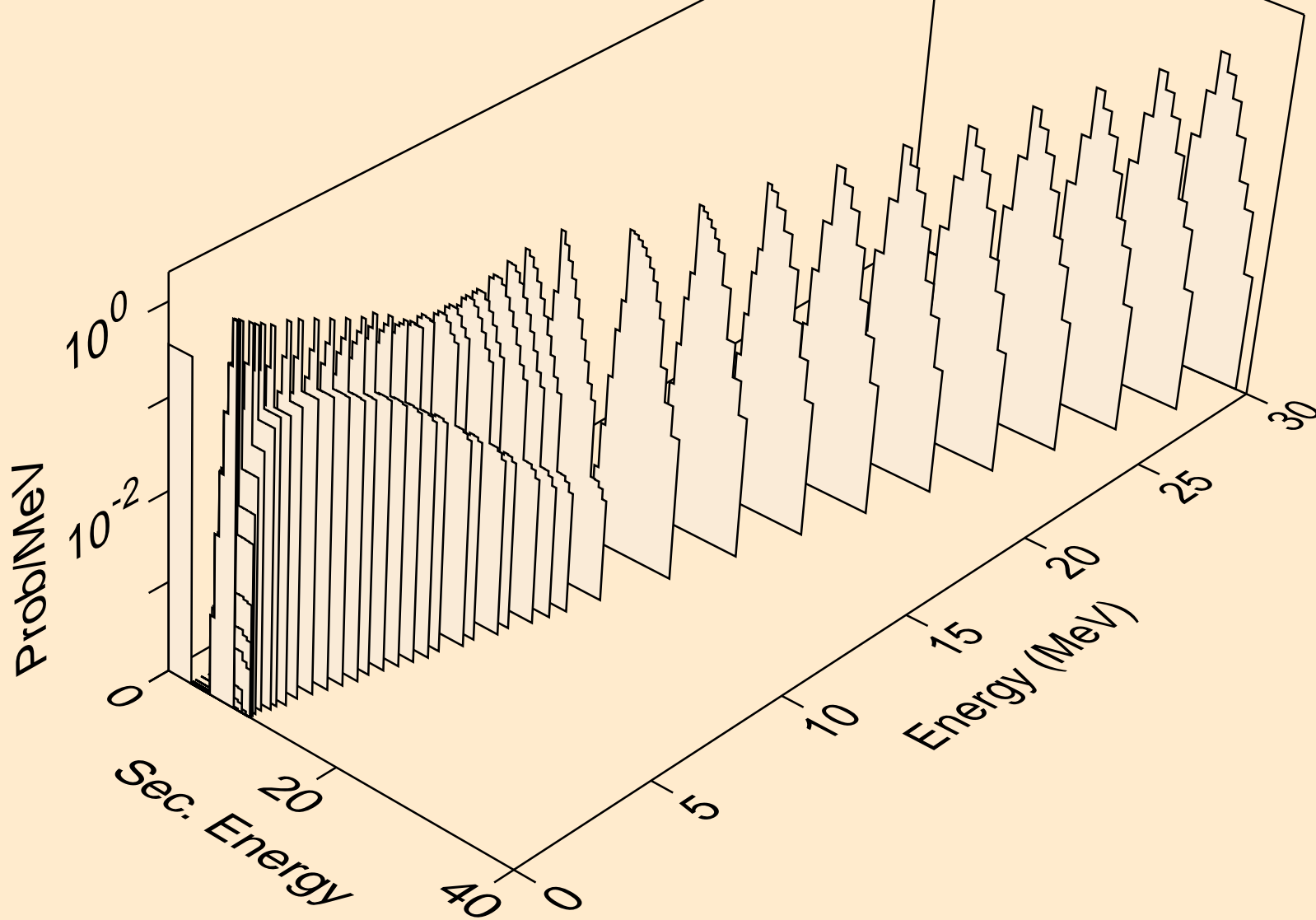

RH092 NEUTRON ACER TENDL-2019 LIBRARY; T=293.16K  
alphas from (n,2a)

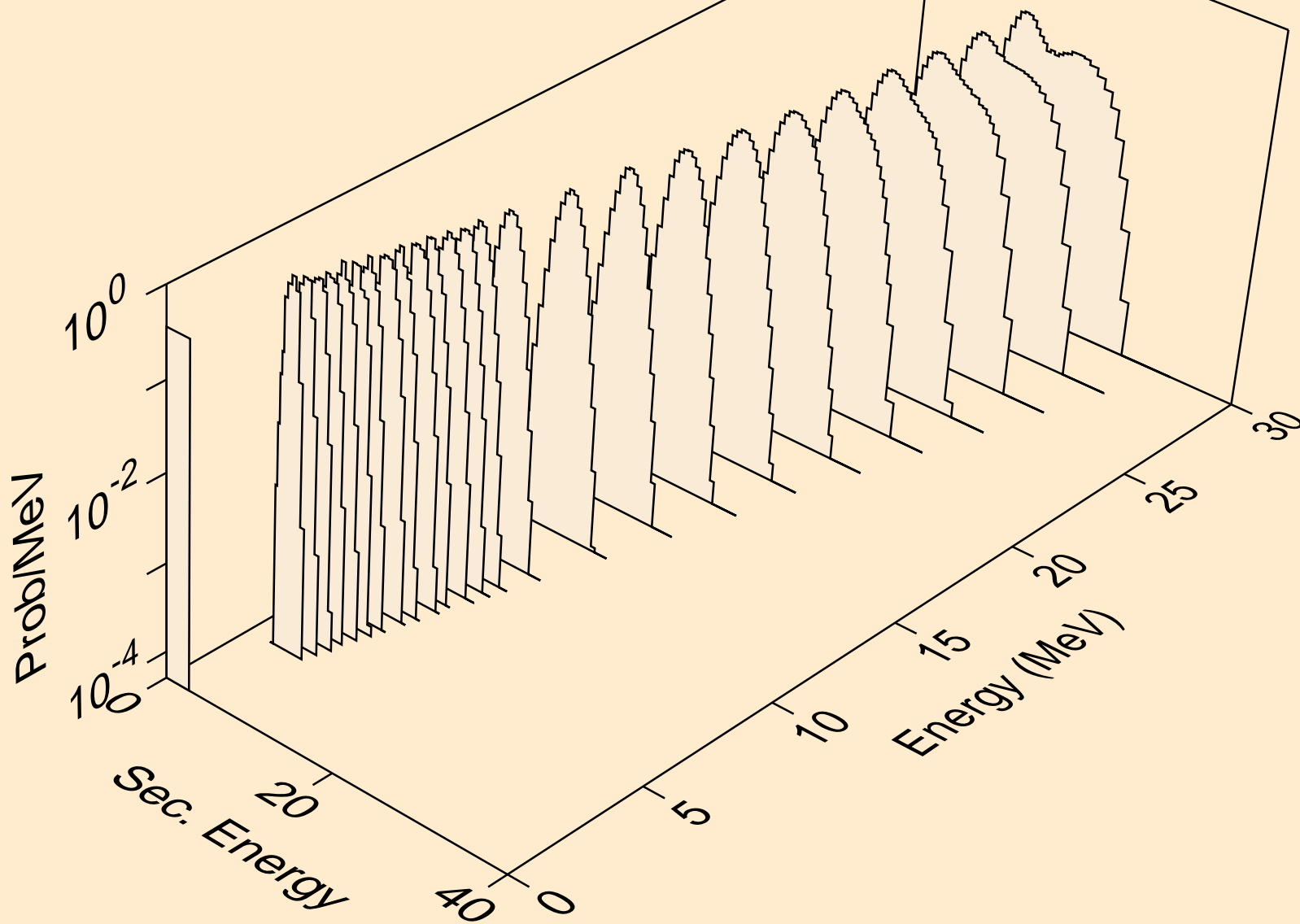

RH092 NEUTRON ACER TENDL-2019 LIBRARY; T=293.16K  
alphas from (n,3a)

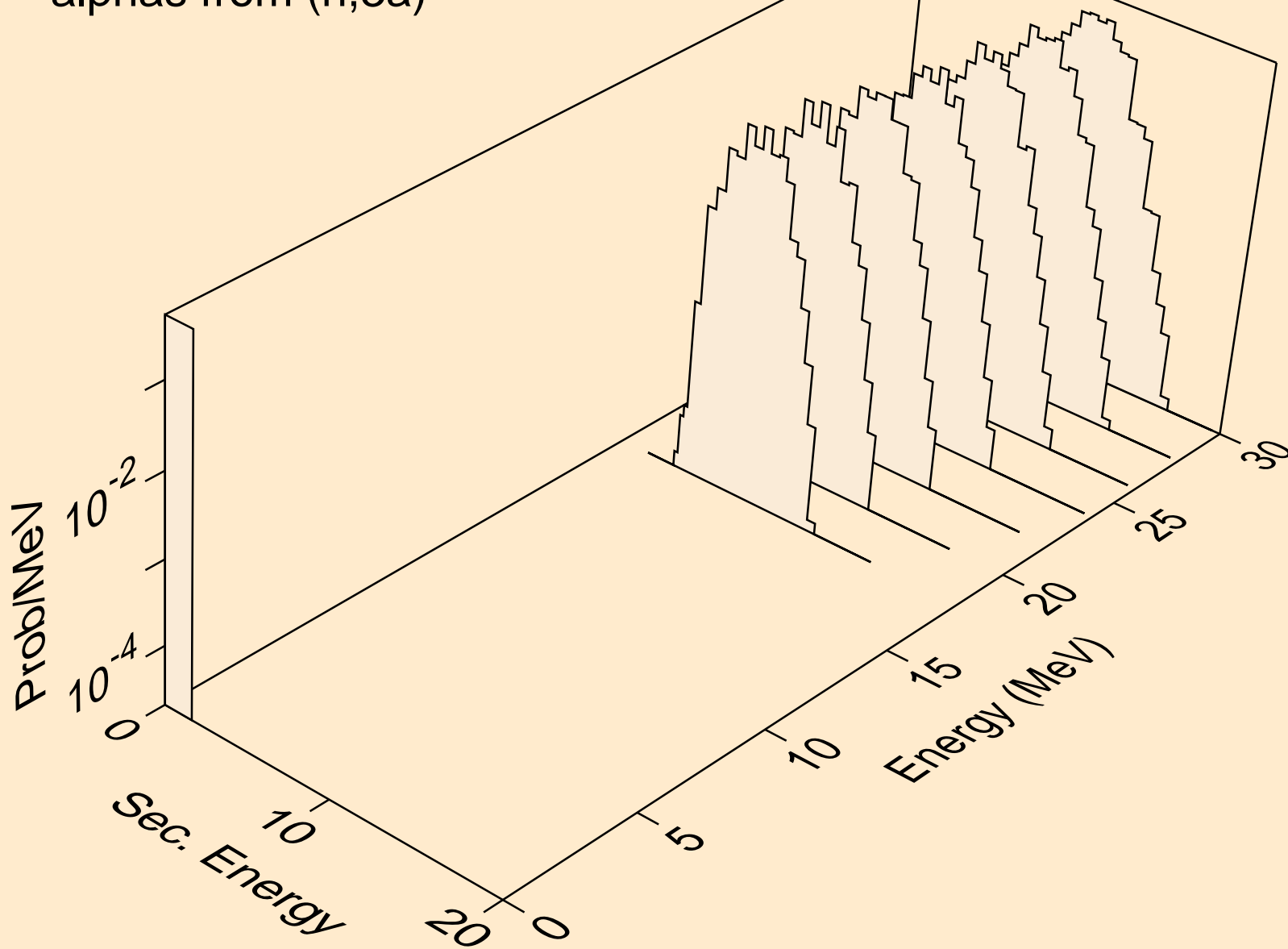

RH092 NEUTRON ACER TENDL-2019 LIBRARY; T=293.16K  
alphas from (n,pa)

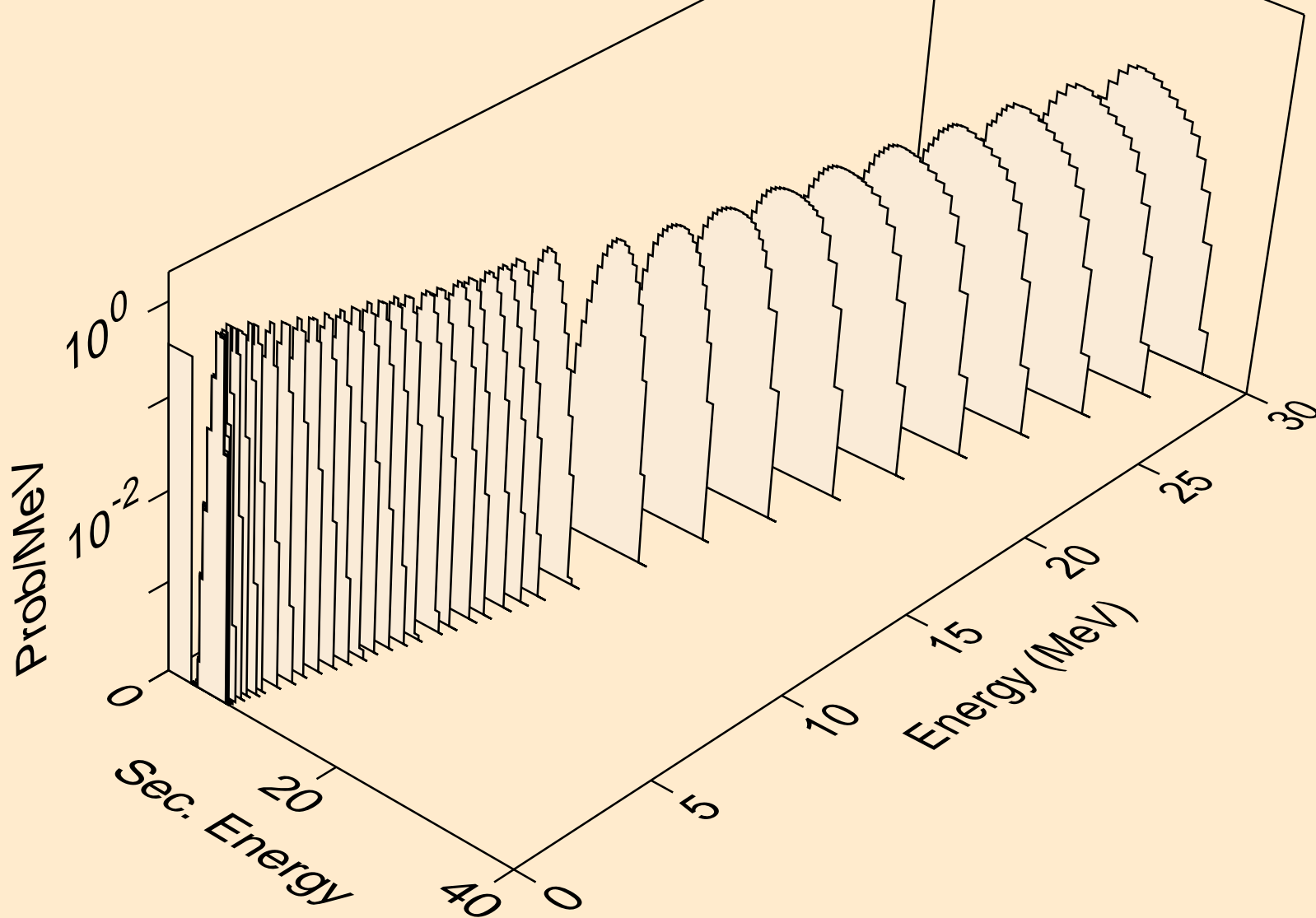

RH092 NEUTRON ACER TENDL-2019 LIBRARY; T=293.16K  
alphas from (n,da)

