

SC049 NEUTRON ACER TENDL-2019 LIBRARY; T=293.16K  
Principal cross sections

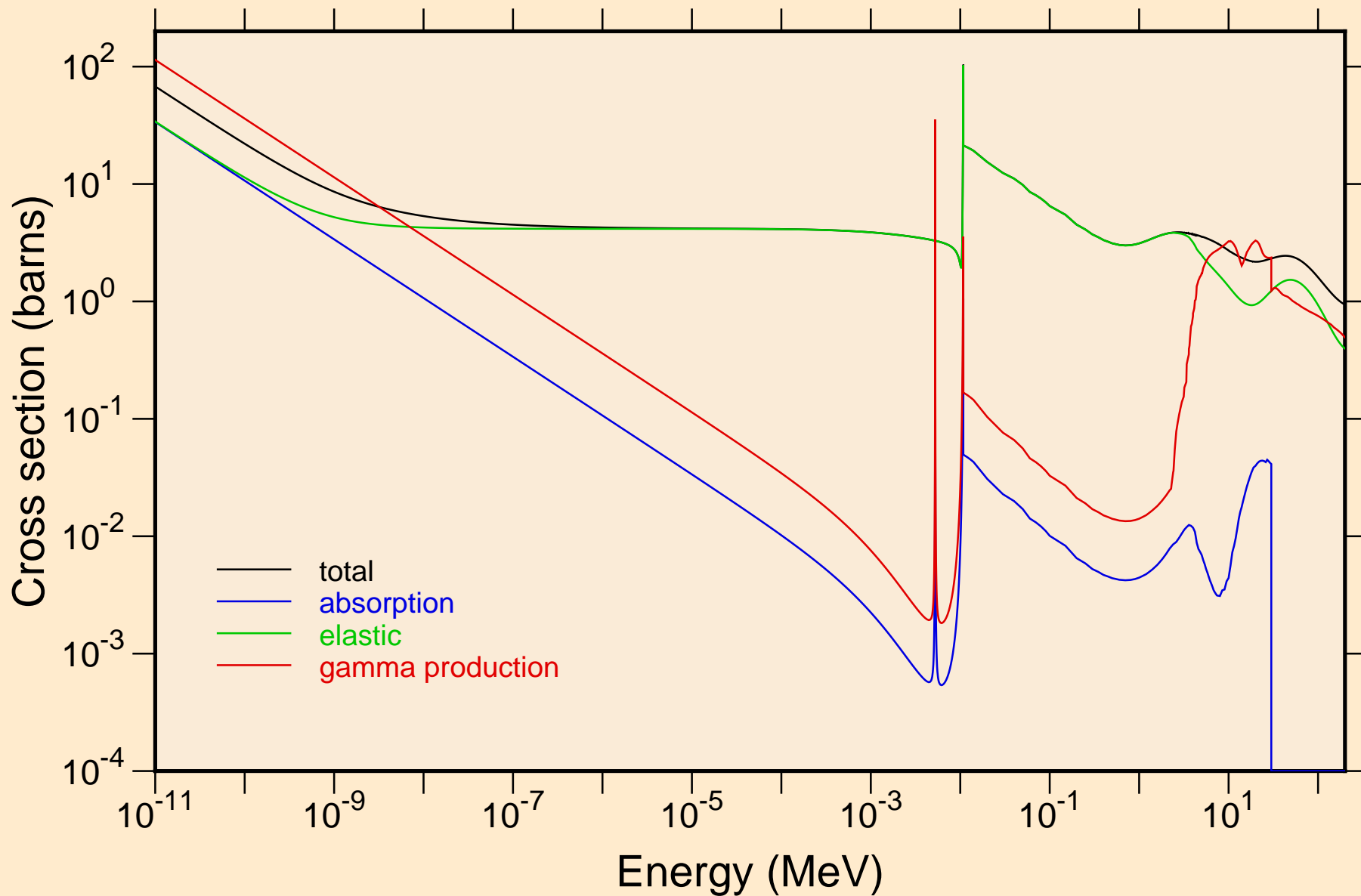

SC049 NEUTRON ACER TENDL-2019 LIBRARY; T=293.16K  
Heating

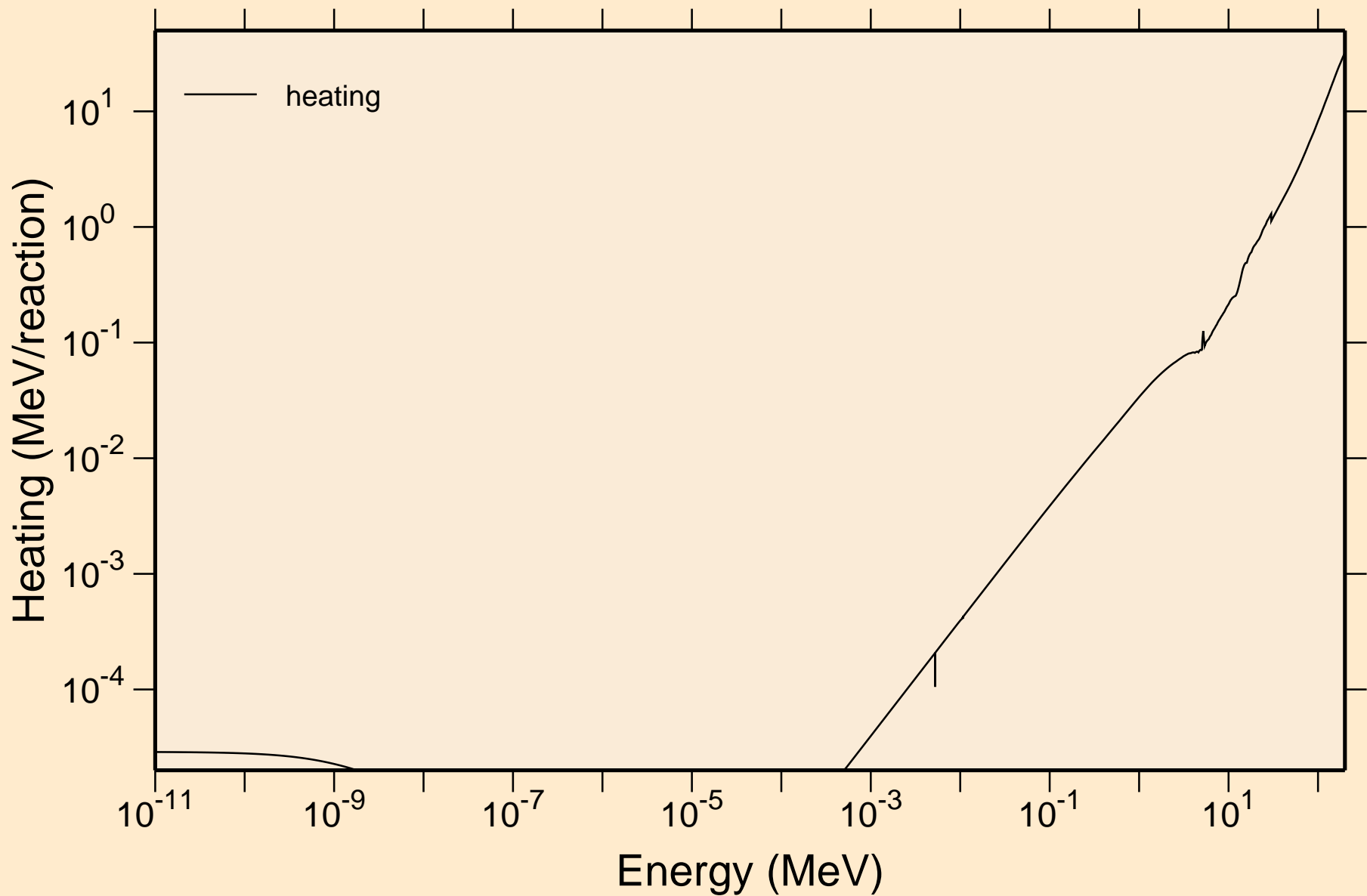

SC049 NEUTRON ACER TENDL-2019 LIBRARY; T=293.16K  
Damage

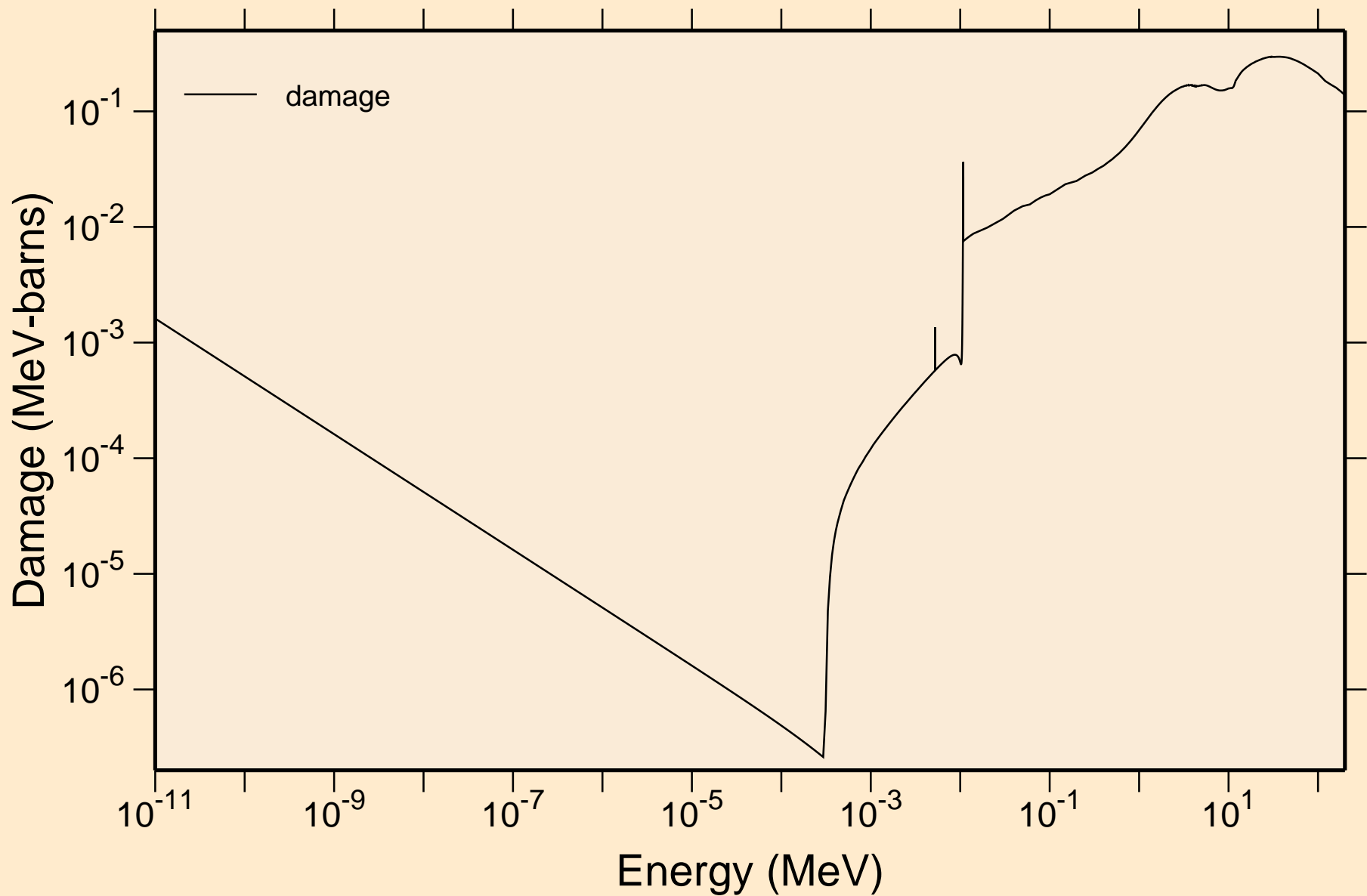

SC049 NEUTRON ACER TENDL-2019 LIBRARY; T=293.16K  
Non-threshold reactions

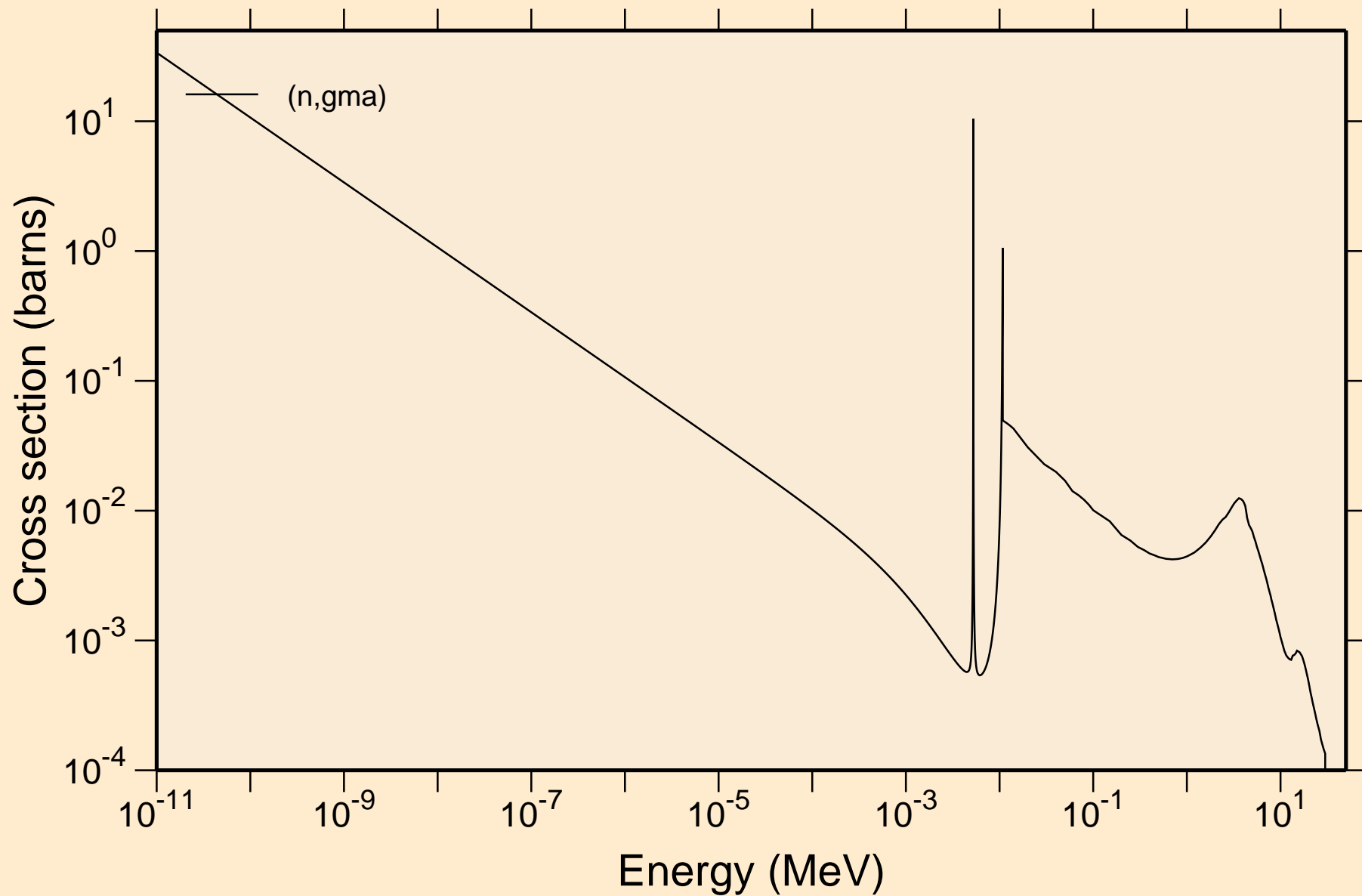

# SC049 NEUTRON ACER TENDL-2019 LIBRARY; T=293.16K

## Principal cross sections

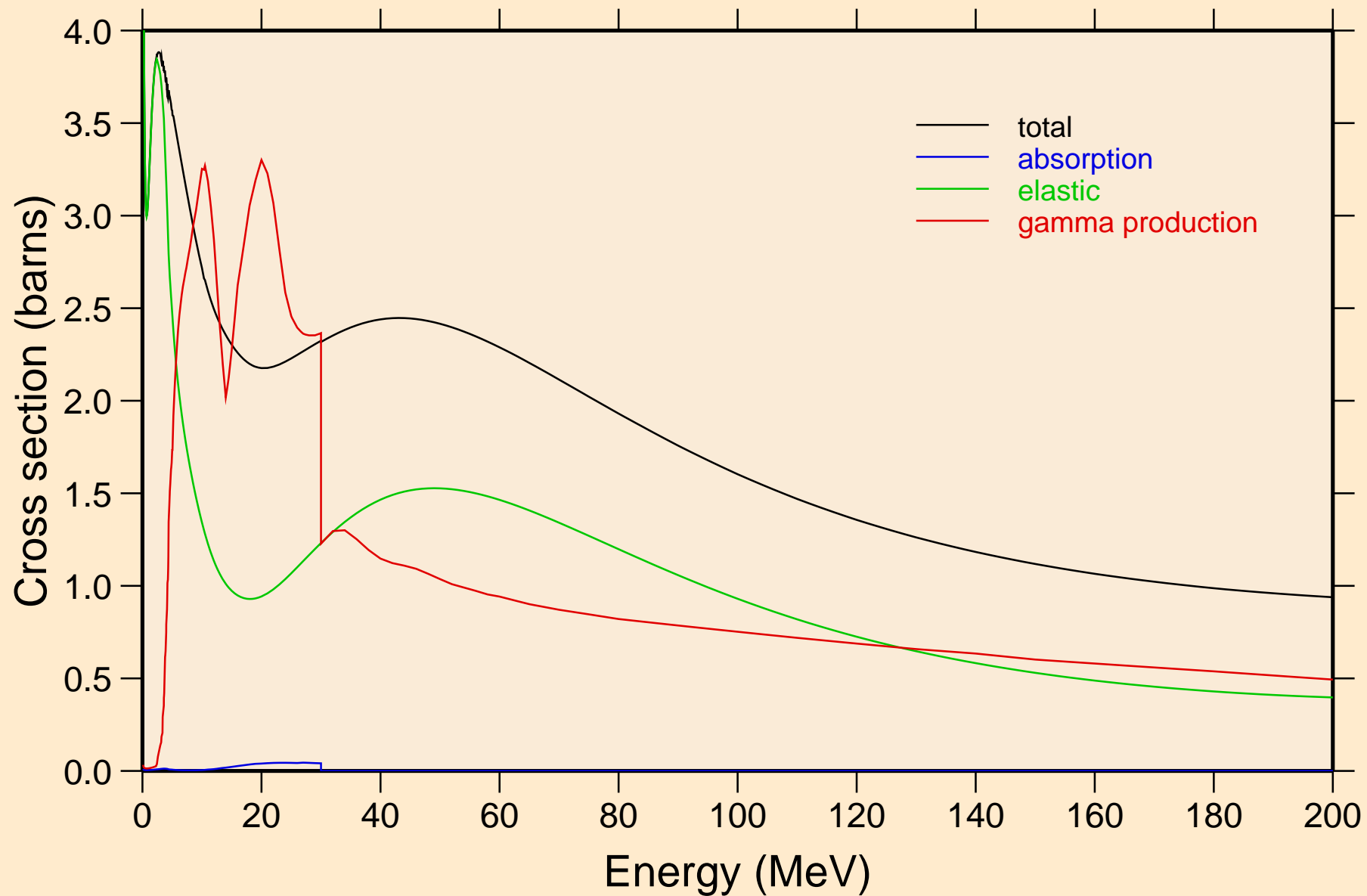

SC049 NEUTRON ACER TENDL-2019 LIBRARY; T=293.16K  
Heating

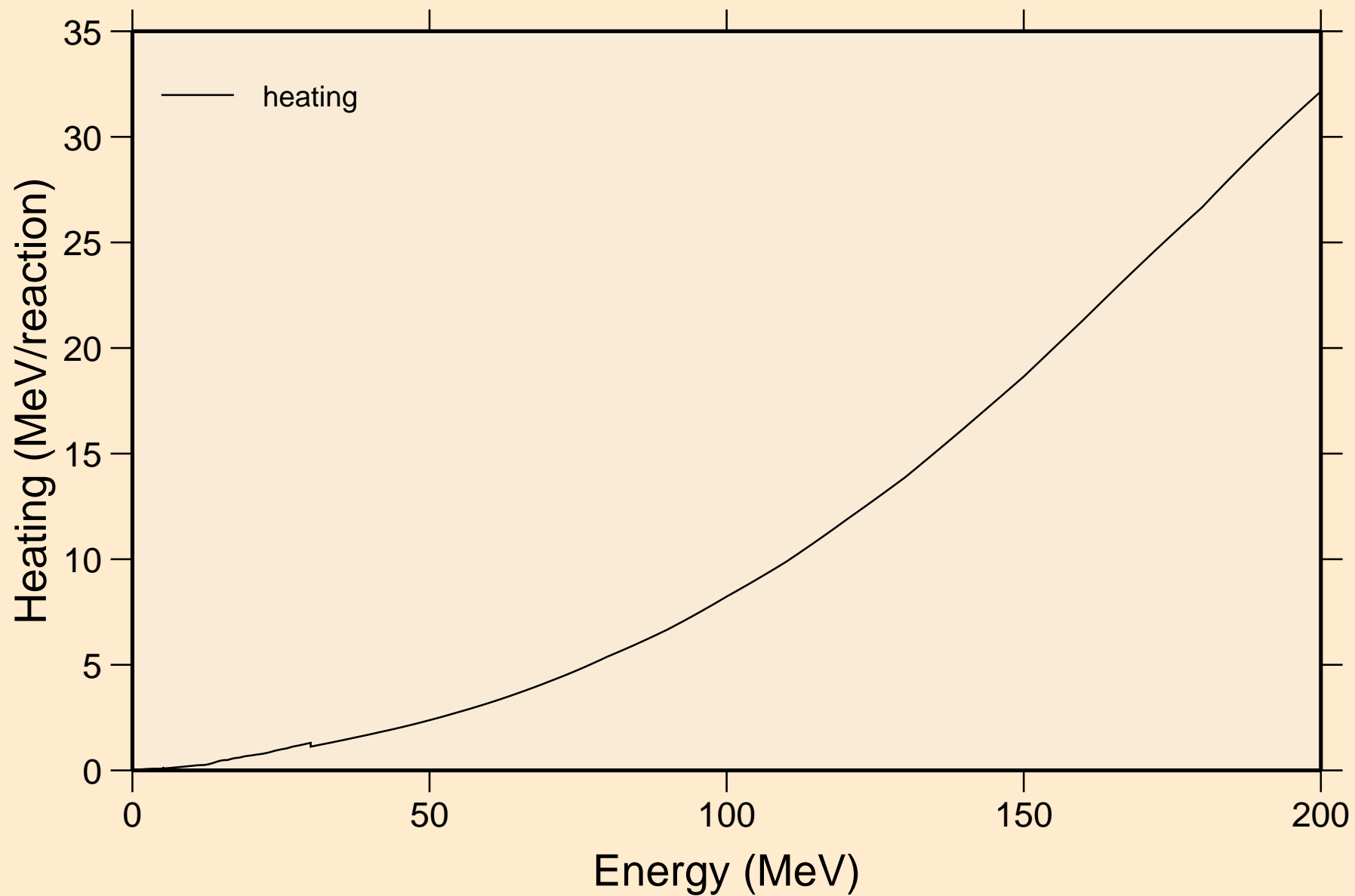

SC049 NEUTRON ACER TENDL-2019 LIBRARY; T=293.16K  
Damage

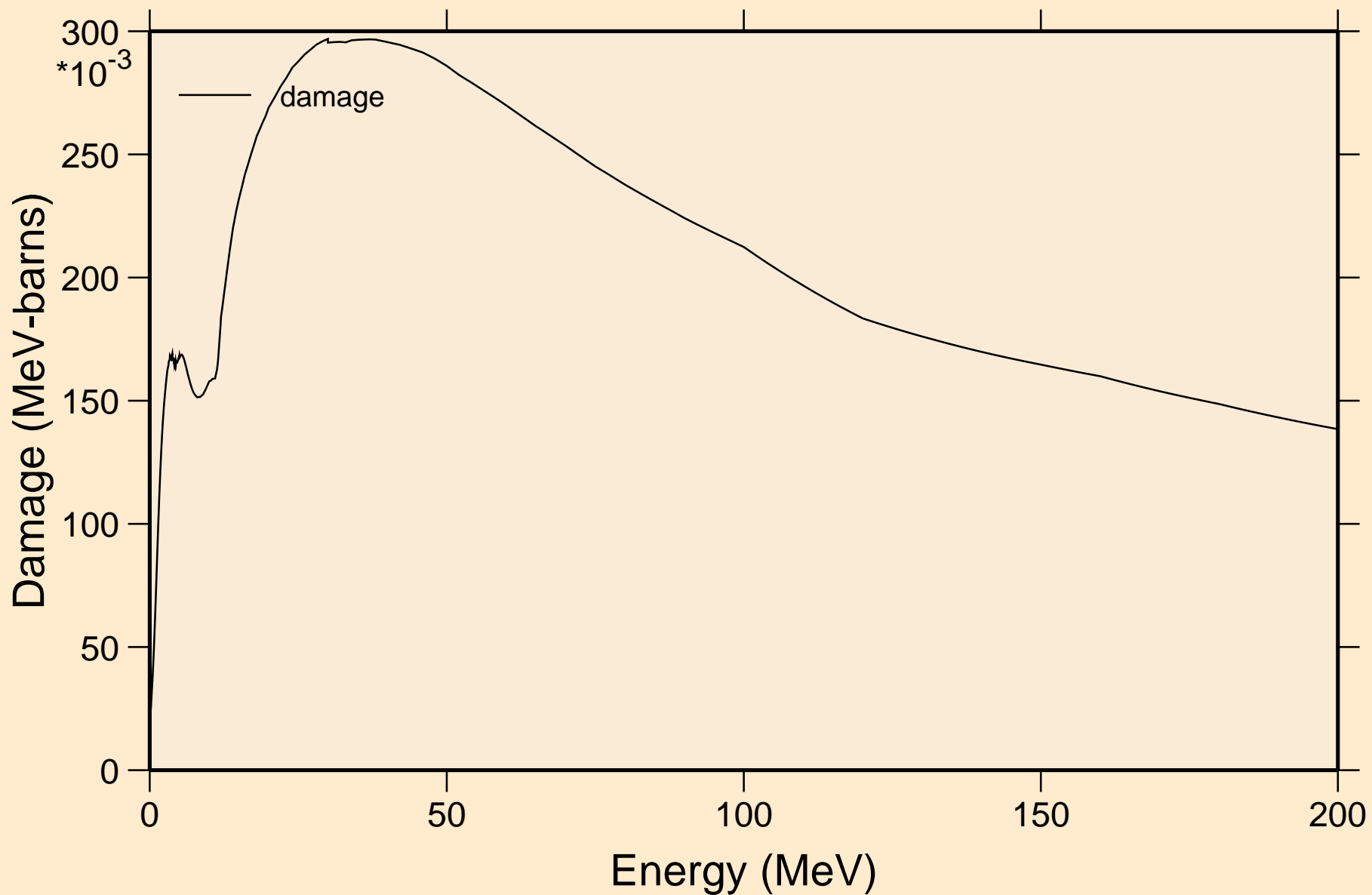

SC049 NEUTRON ACER TENDL-2019 LIBRARY; T=293.16K  
Non-threshold reactions

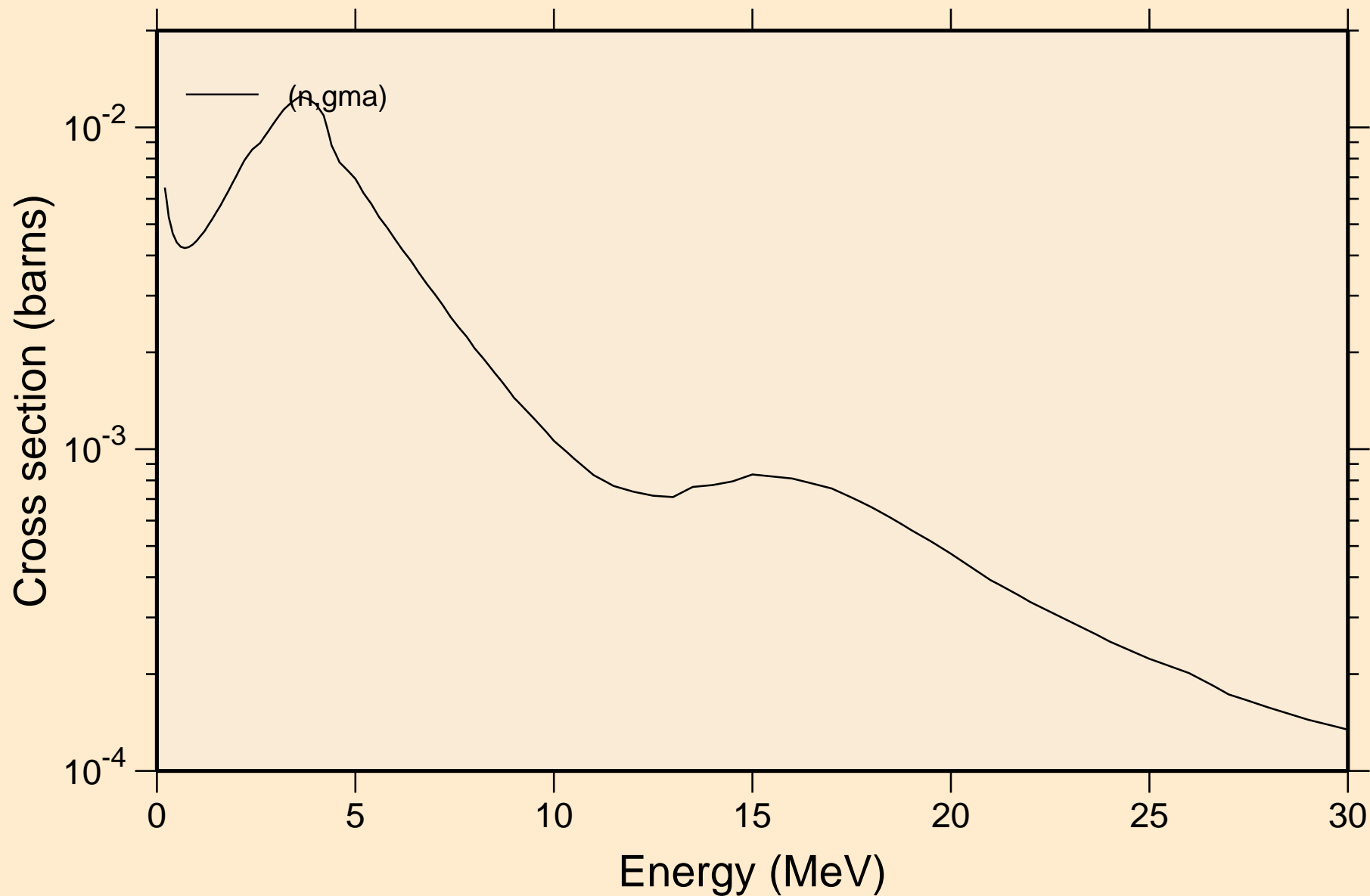

SC049 NEUTRON ACER TENDL-2019 LIBRARY; T=293.16K  
Inelastic levels

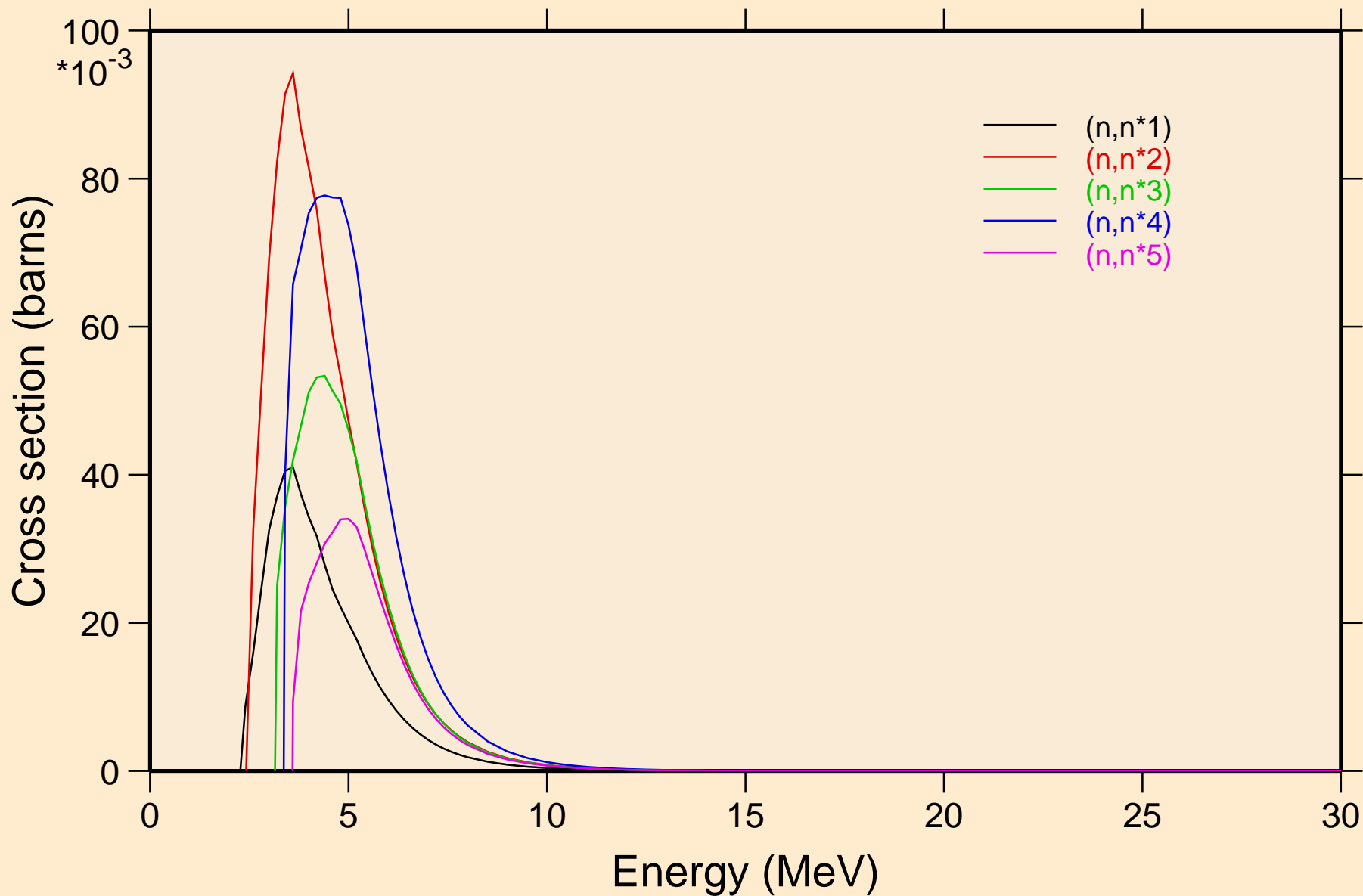

SC049 NEUTRON ACER TENDL-2019 LIBRARY; T=293.16K  
Inelastic levels

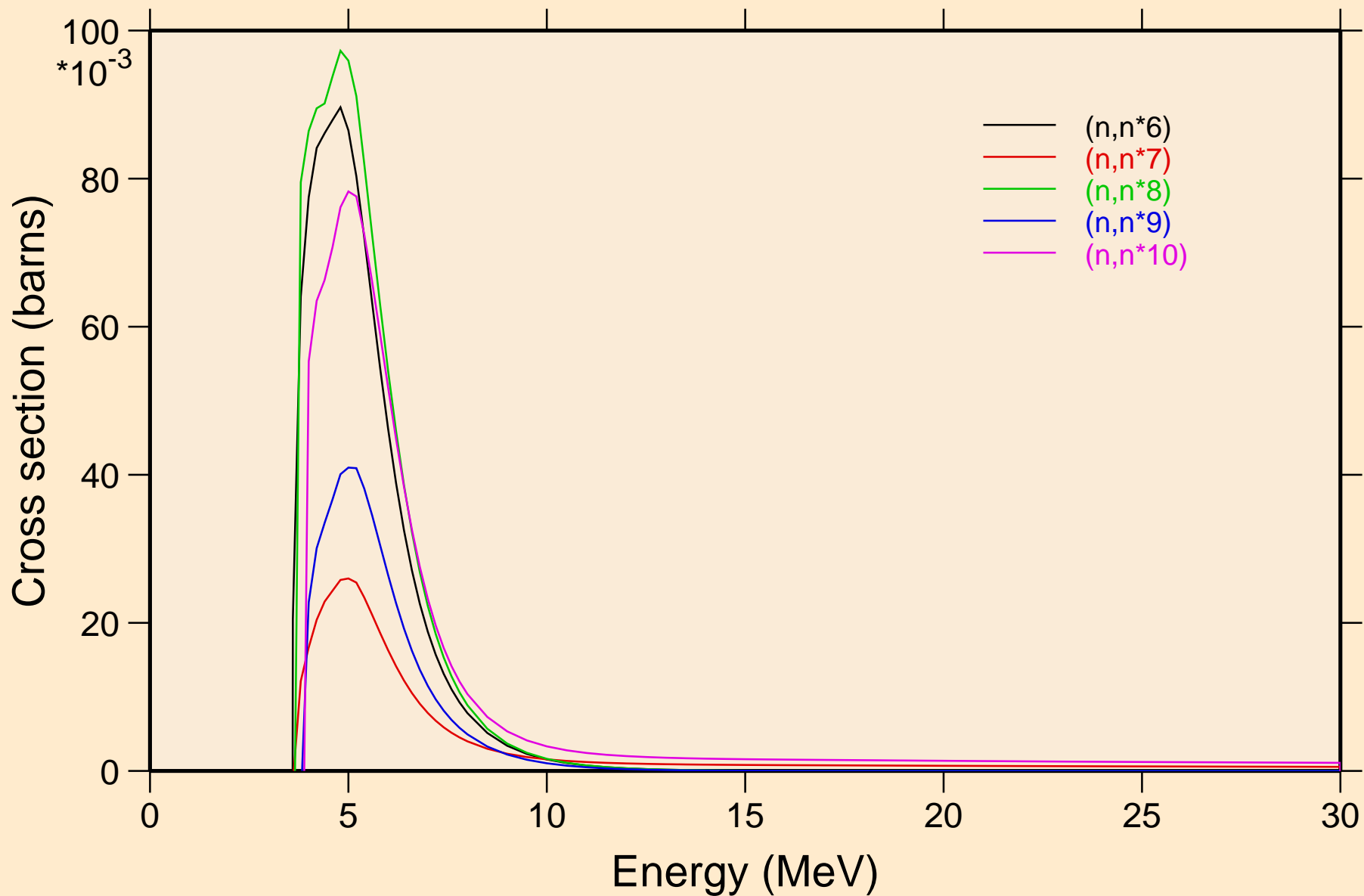

SC049 NEUTRON ACER TENDL-2019 LIBRARY; T=293.16K  
Inelastic levels

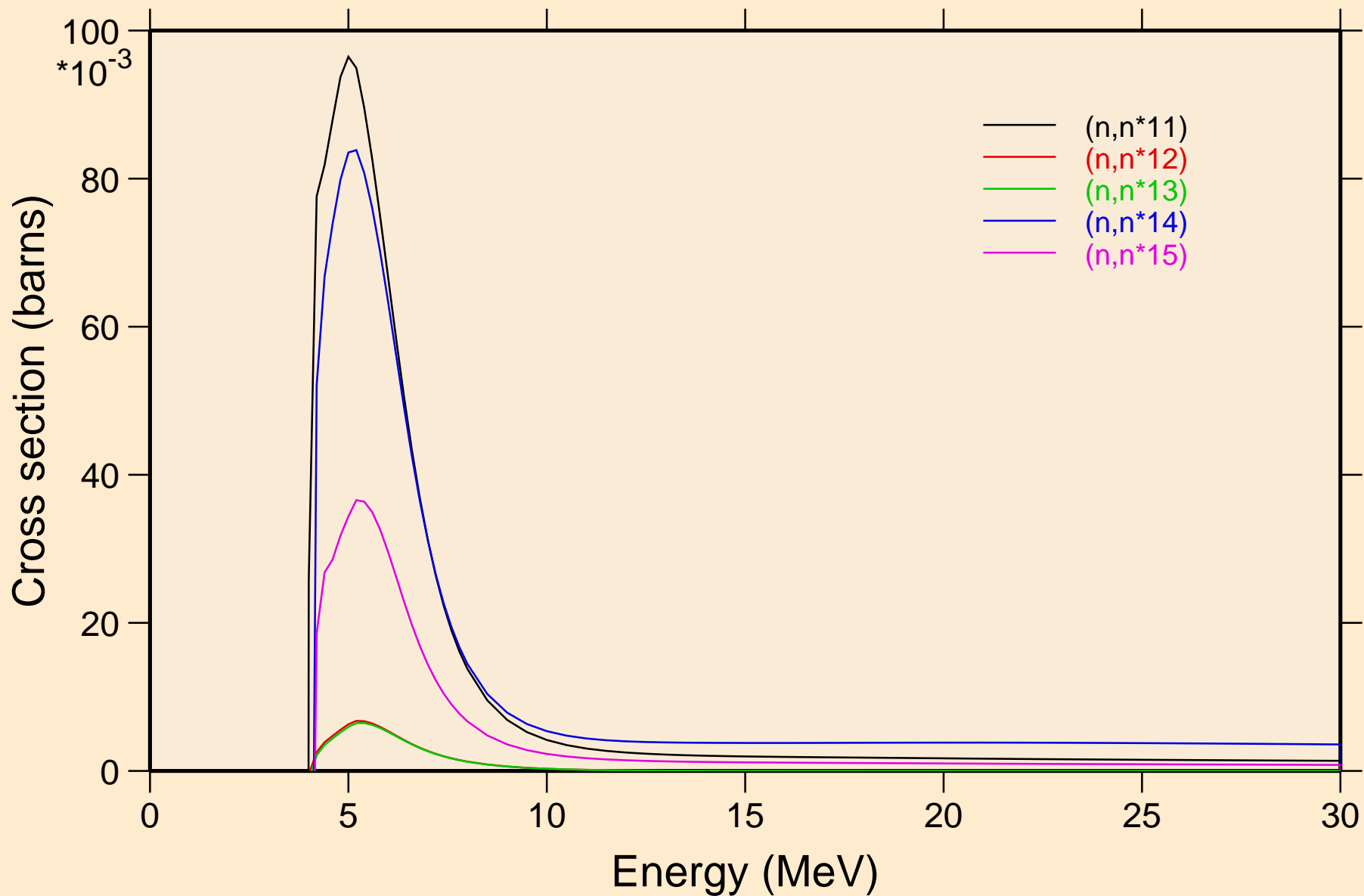

SC049 NEUTRON ACER TENDL-2019 LIBRARY; T=293.16K  
Inelastic levels

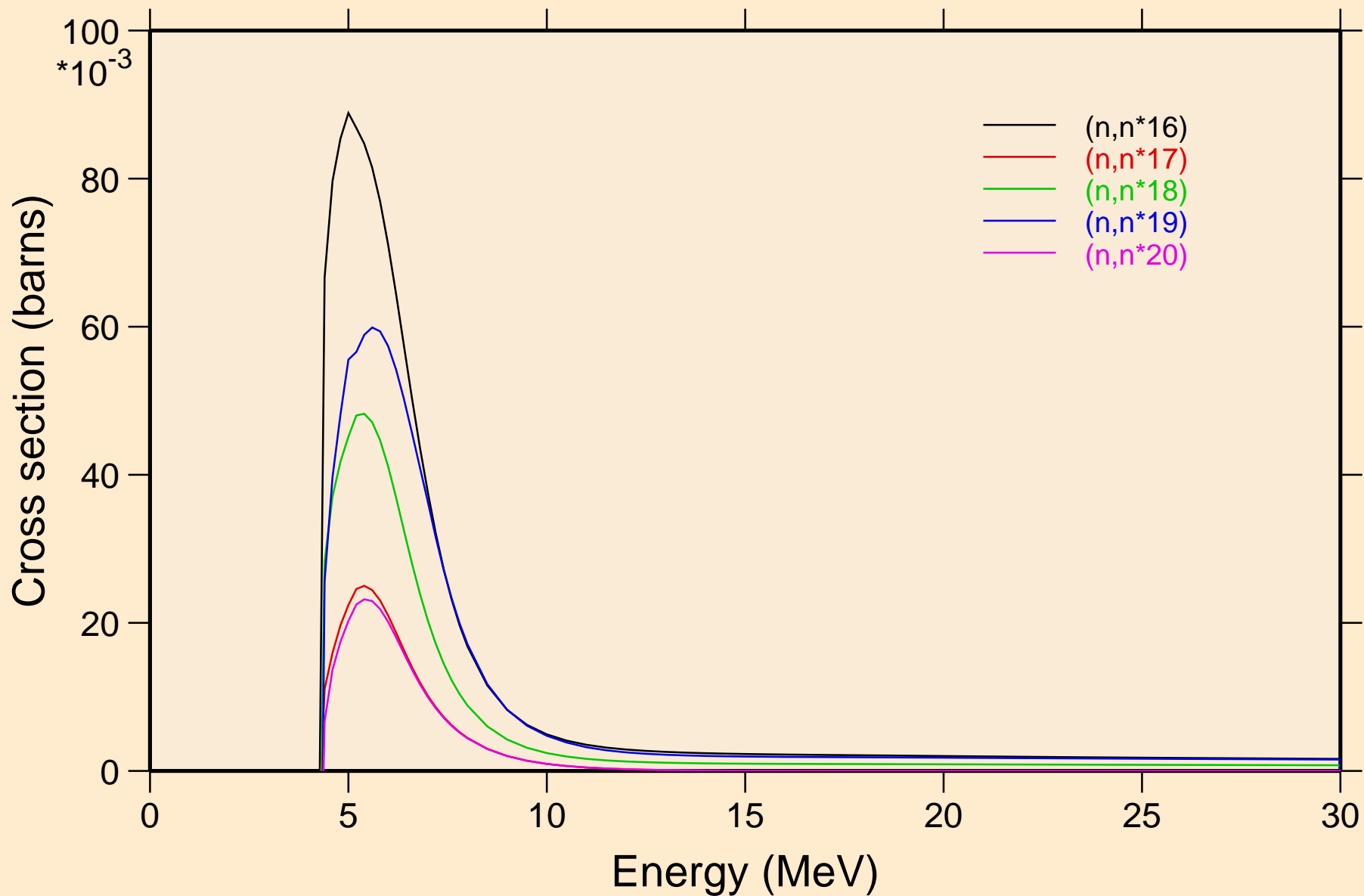

SC049 NEUTRON ACER TENDL-2019 LIBRARY; T=293.16K  
Inelastic levels

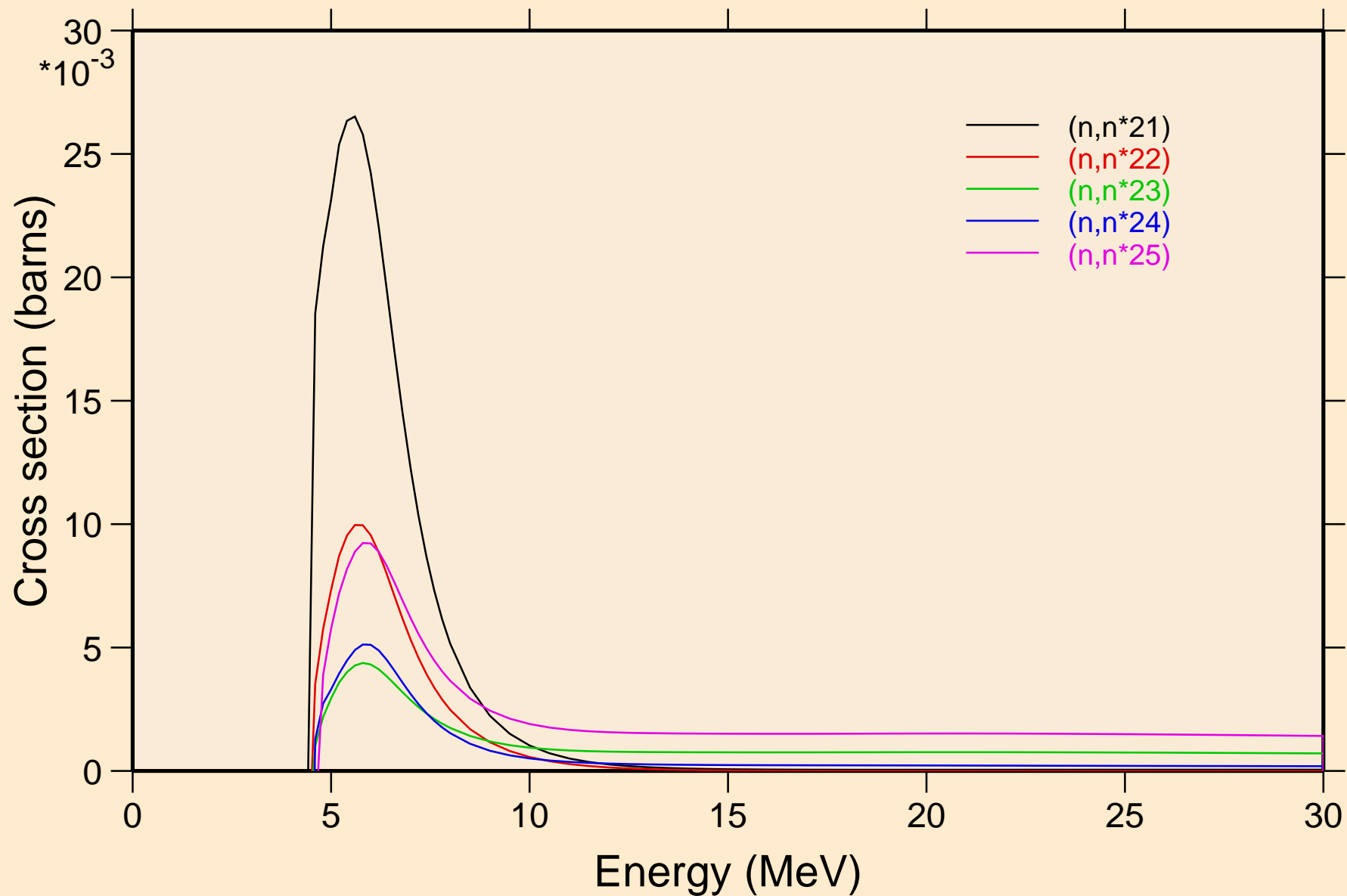

SC049 NEUTRON ACER TENDL-2019 LIBRARY; T=293.16K  
Inelastic levels

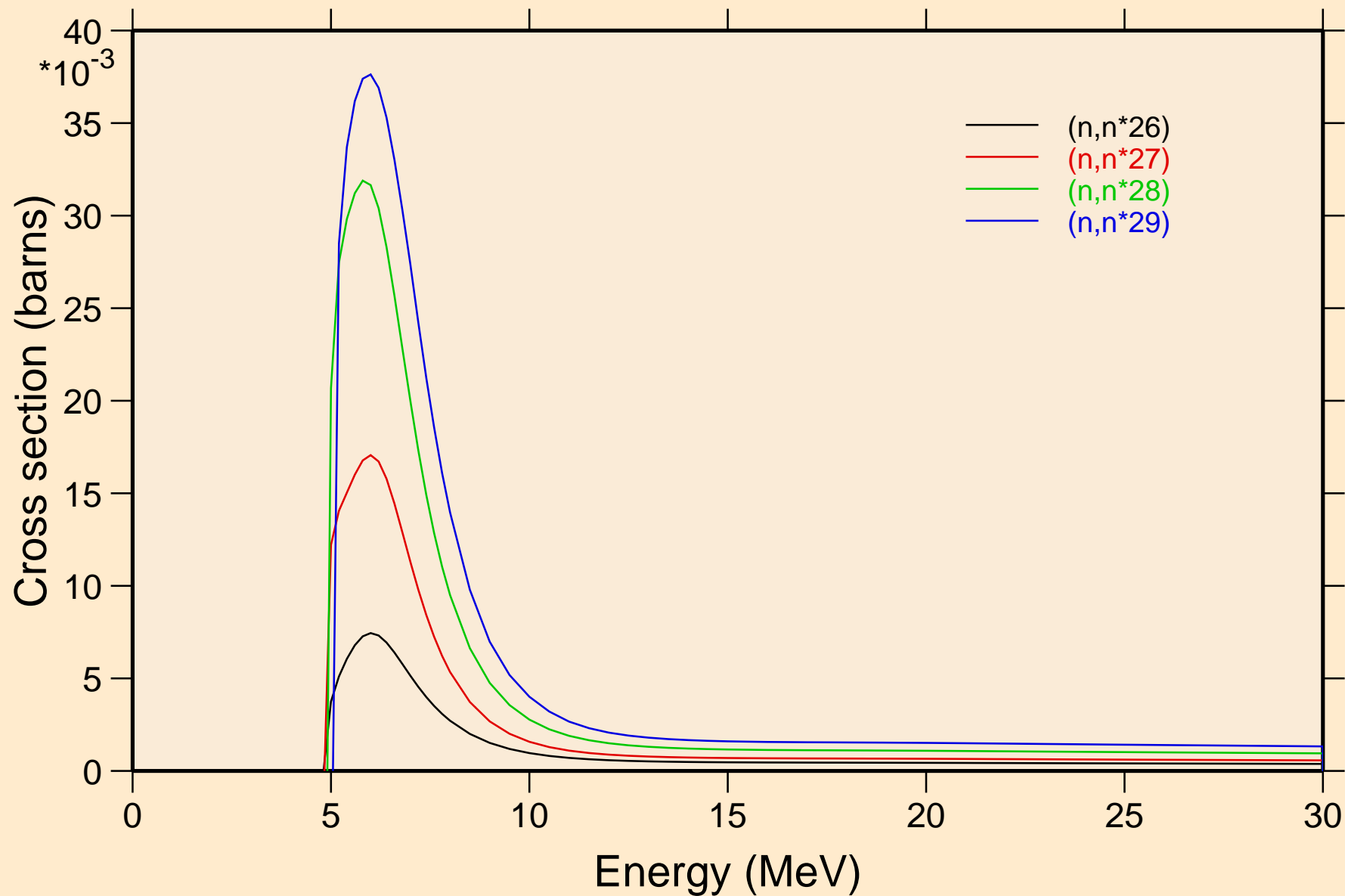

SC049 NEUTRON ACER TENDL-2019 LIBRARY; T=293.16K  
Threshold reactions

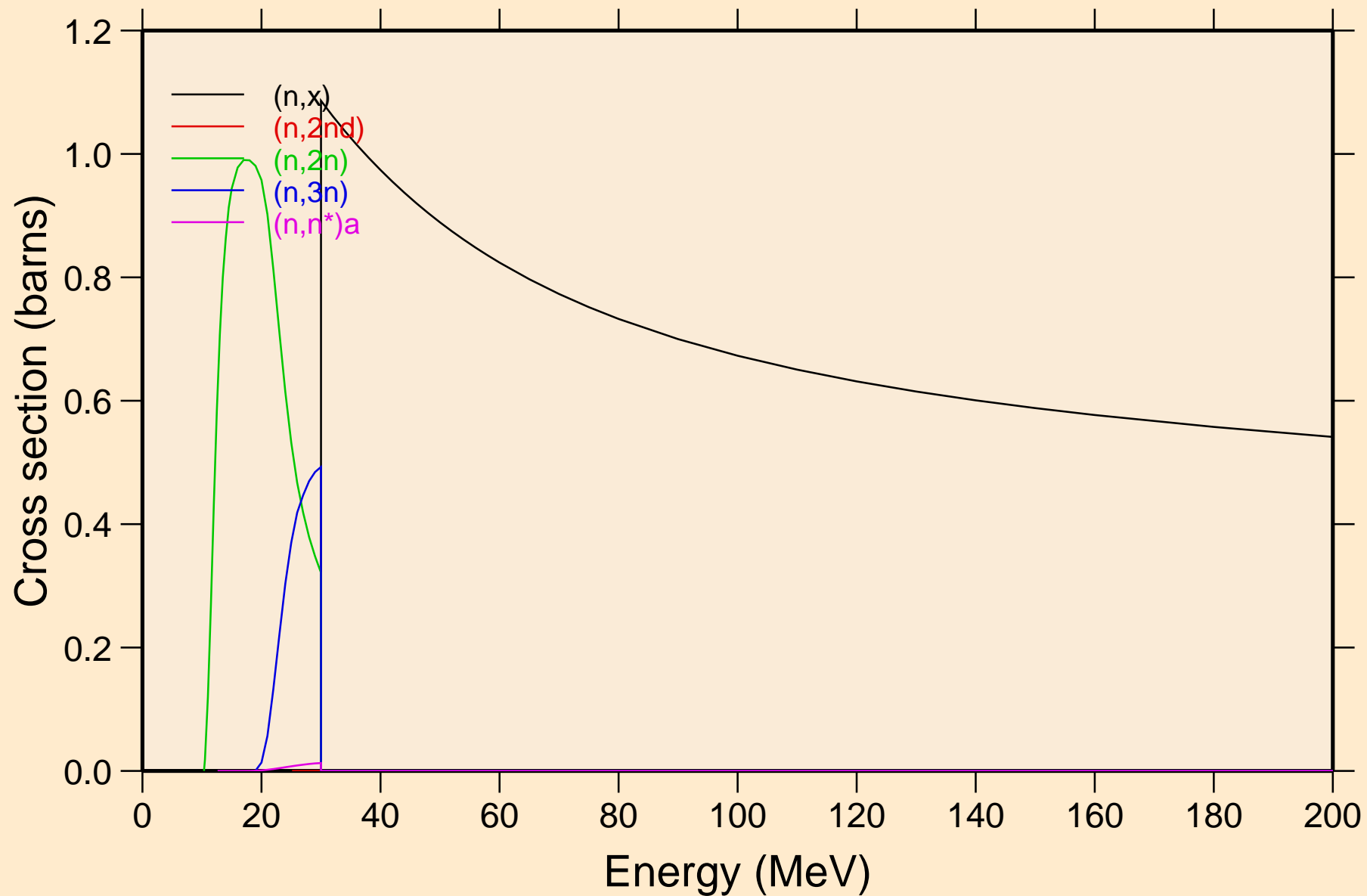

SC049 NEUTRON ACER TENDL-2019 LIBRARY; T=293.16K  
Threshold reactions

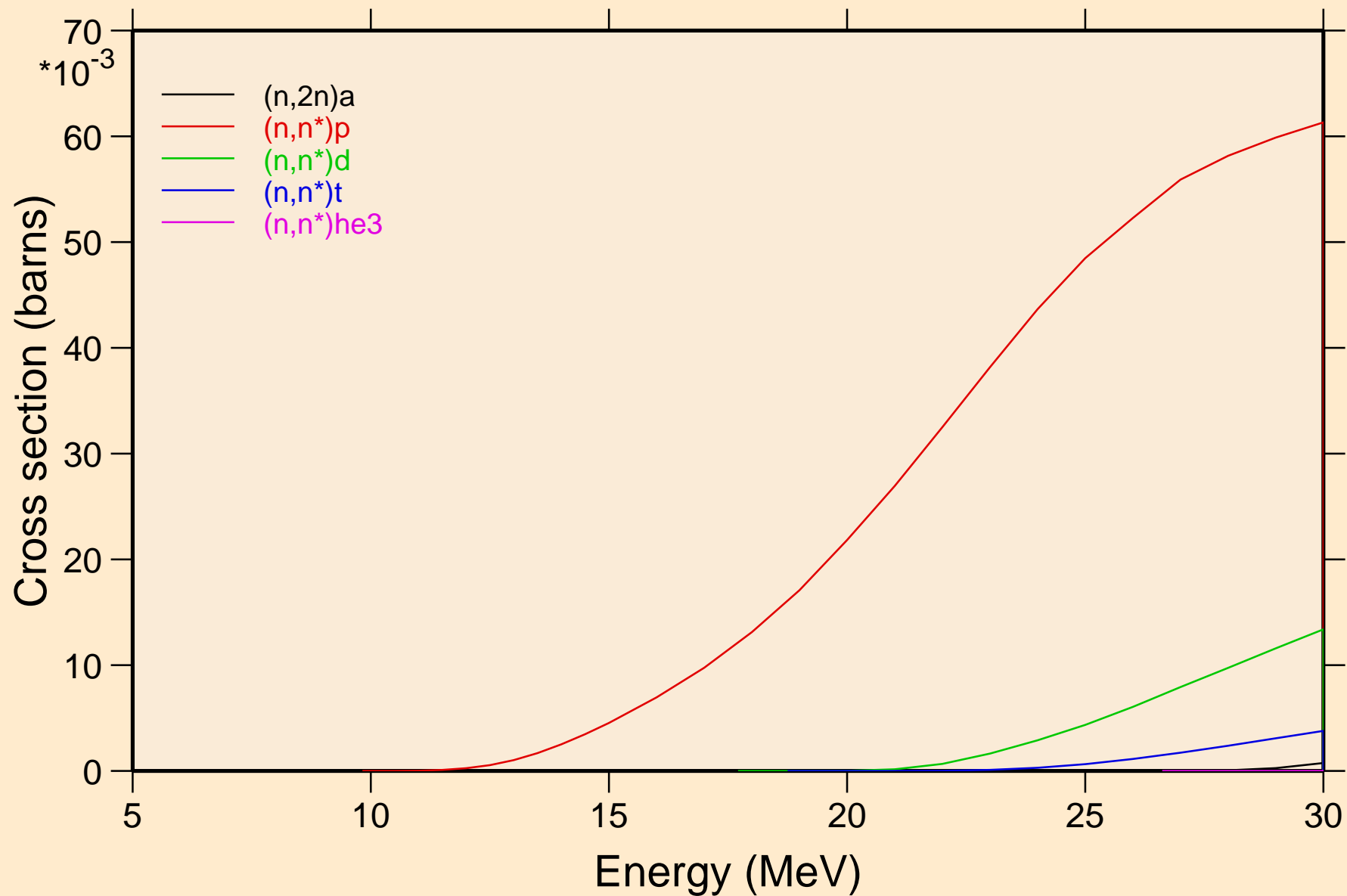

SC049 NEUTRON ACER TENDL-2019 LIBRARY; T=293.16K  
Threshold reactions

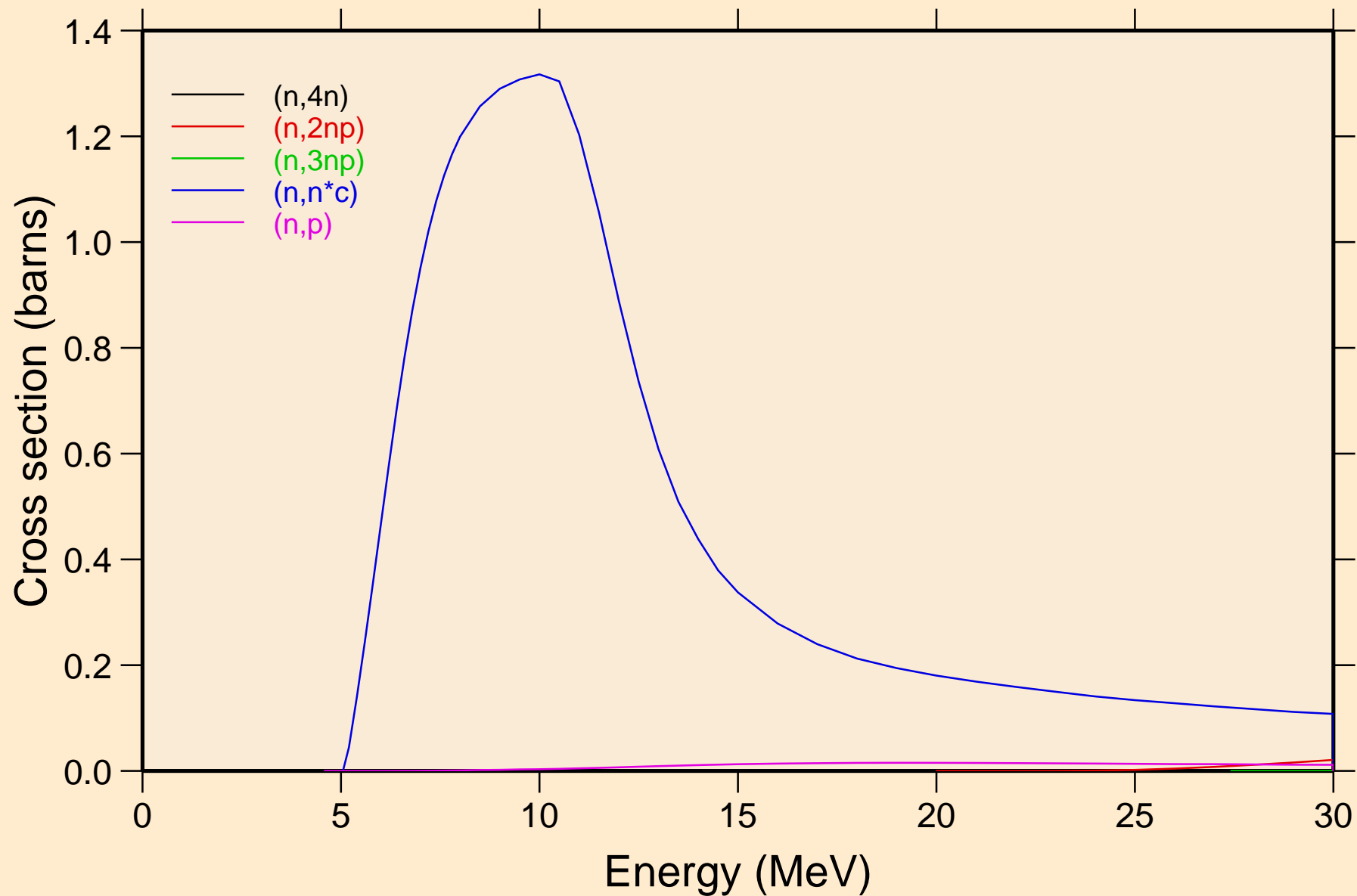

SC049 NEUTRON ACER TENDL-2019 LIBRARY; T=293.16K  
Threshold reactions

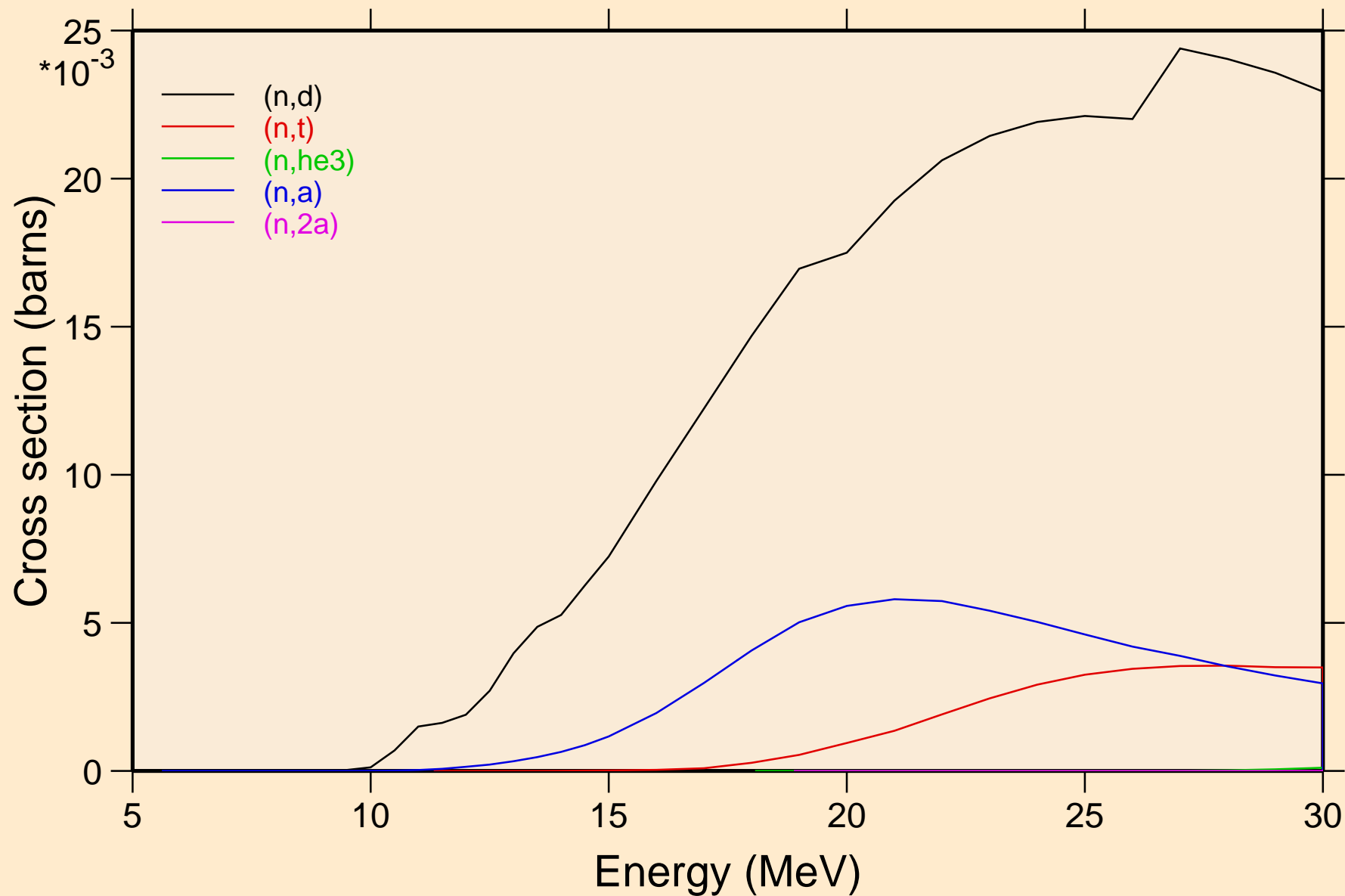

SC049 NEUTRON ACER TENDL-2019 LIBRARY; T=293.16K  
Threshold reactions

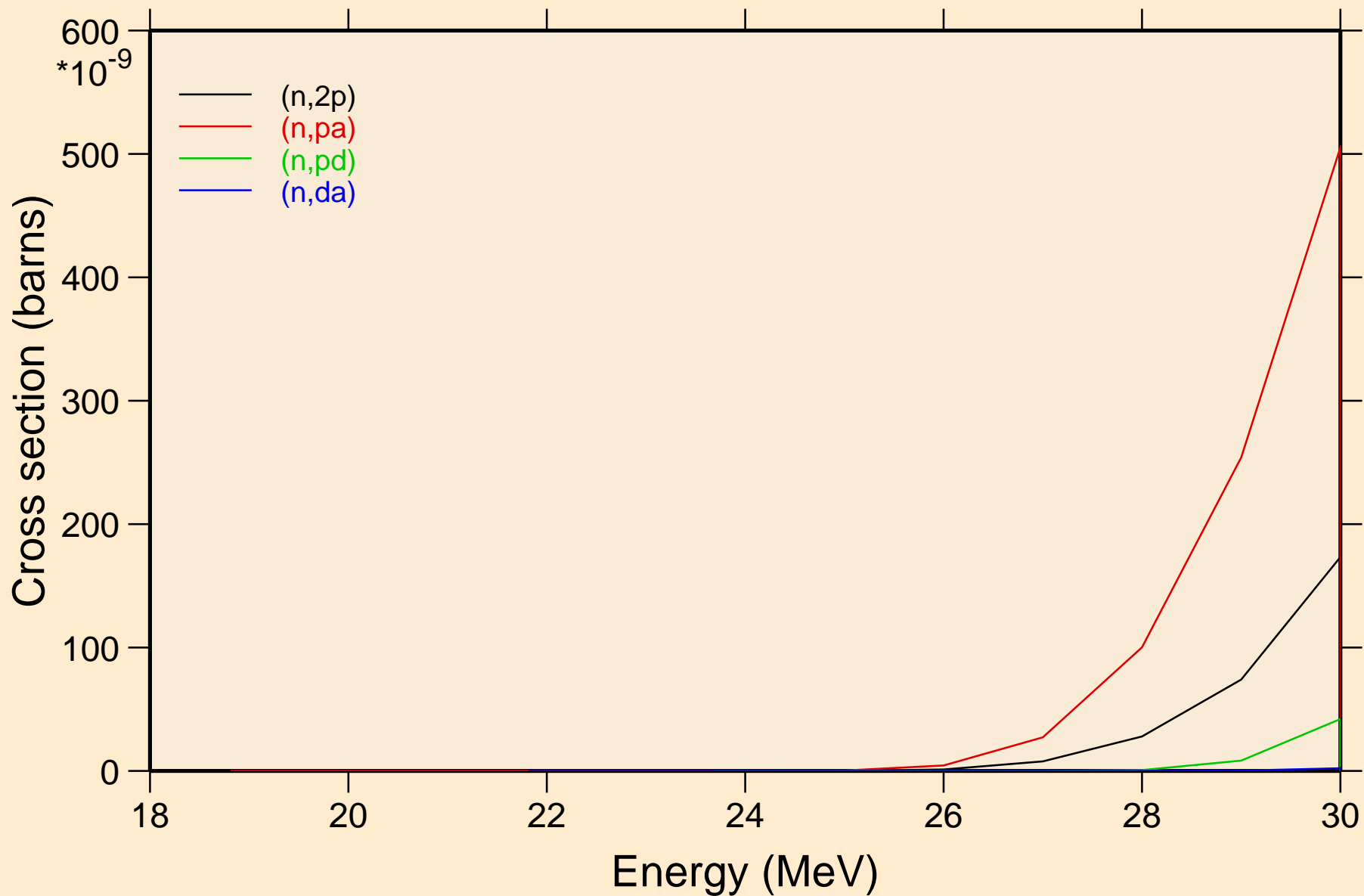

SC049 NEUTRON ACER TENDL-2019 LIBRARY; T=293.16K  
Threshold reactions

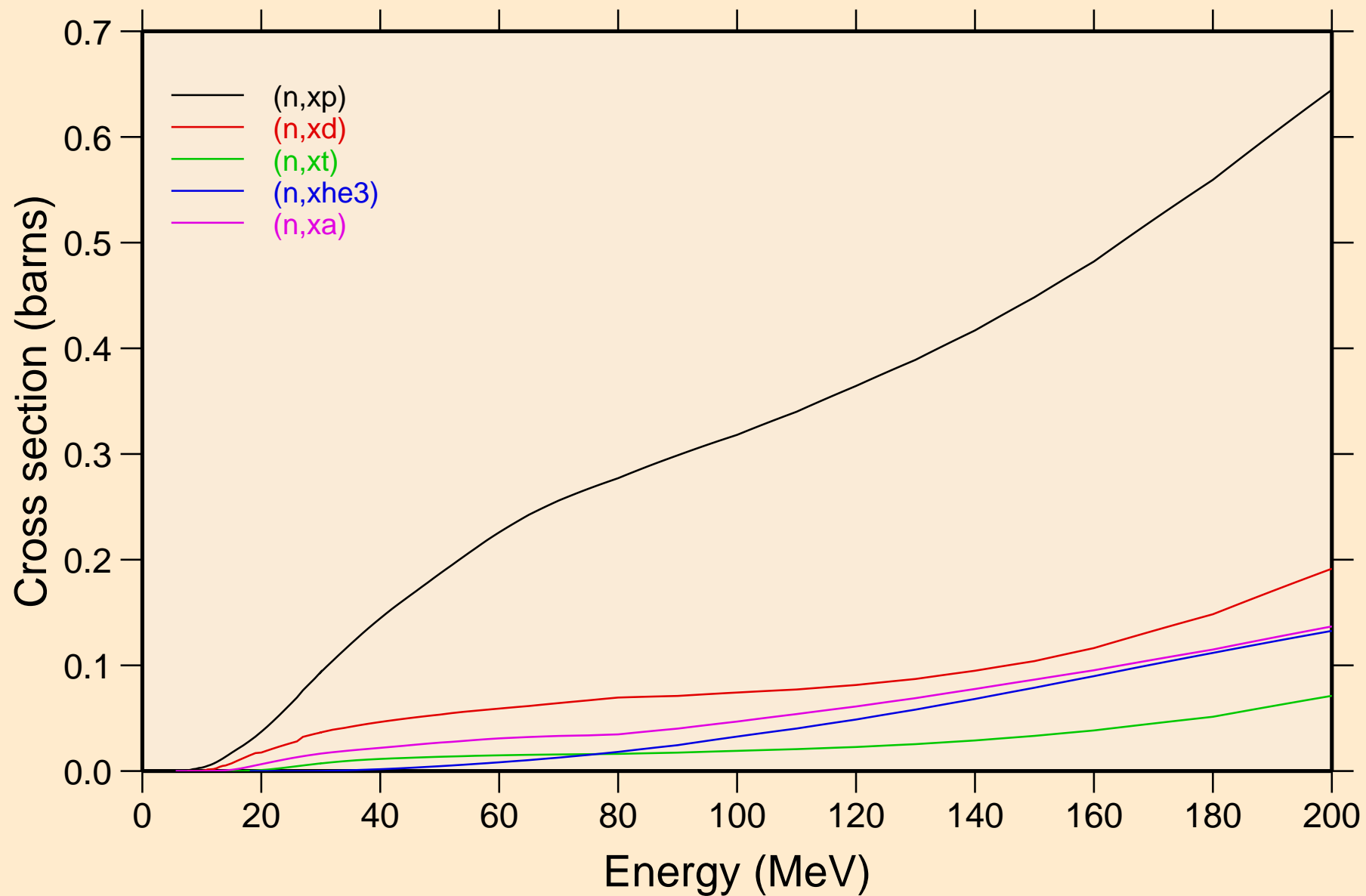

SC049 NEUTRON ACER TENDL-2019 LIBRARY; T=293.16K  
angular distribution for elastic

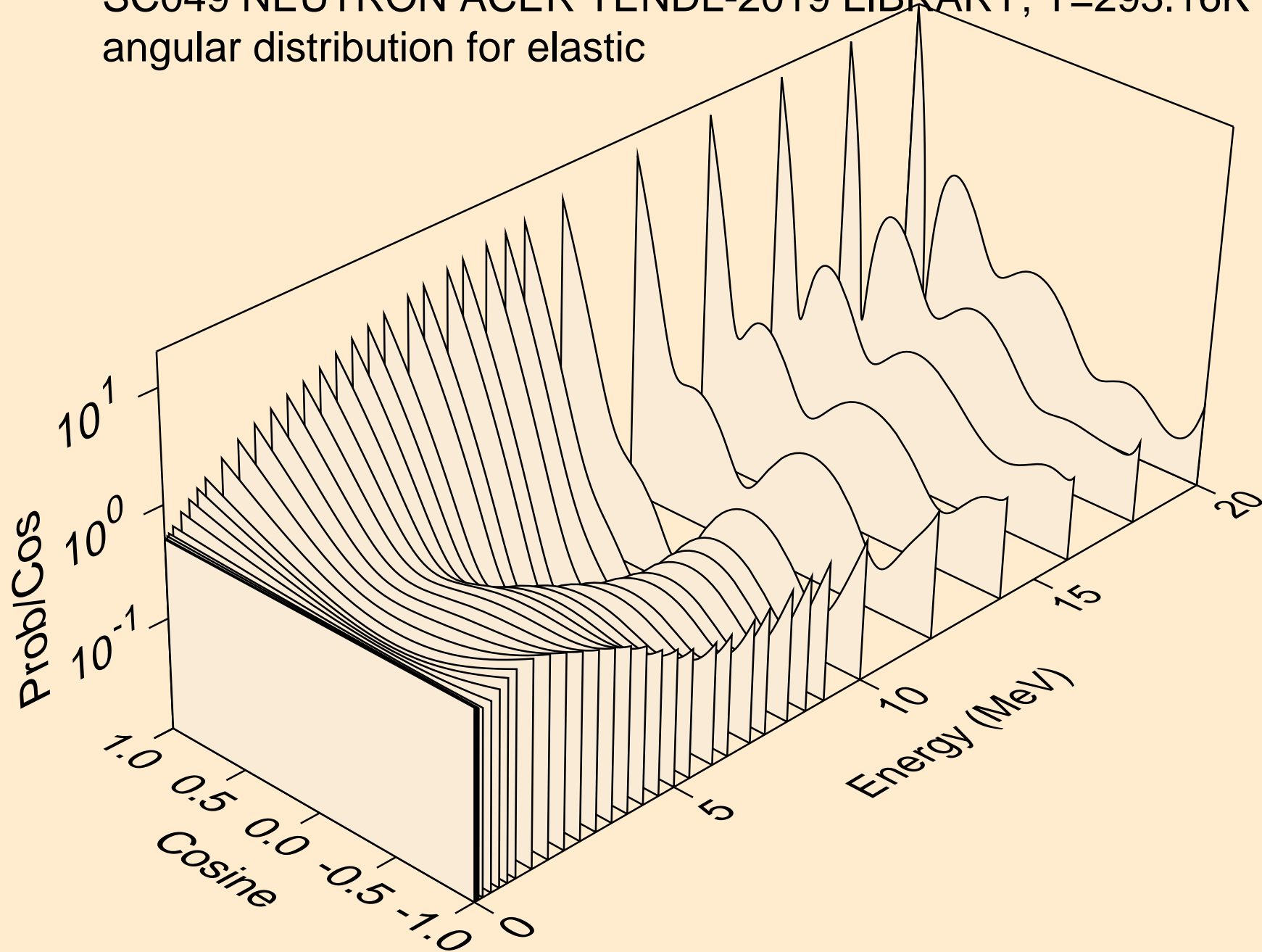

SC049 NEUTRON ACER TENDL-2019 LIBRARY; T=293.16K  
angular distribution for elastic

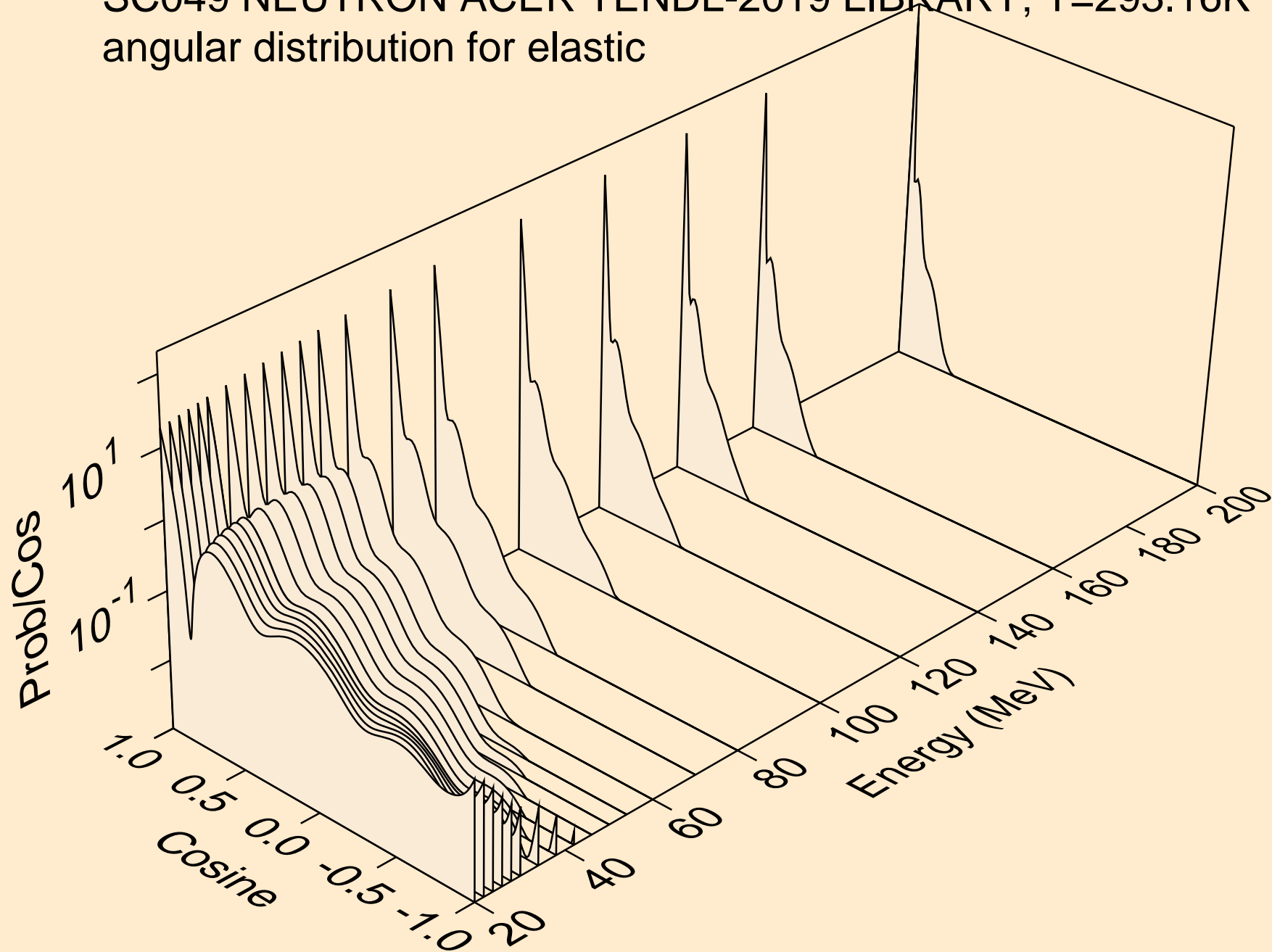

SC049 NEUTRON ACER TENDL-2019 LIBRARY; T=293.16K  
angular distribution for (n,n\*1)

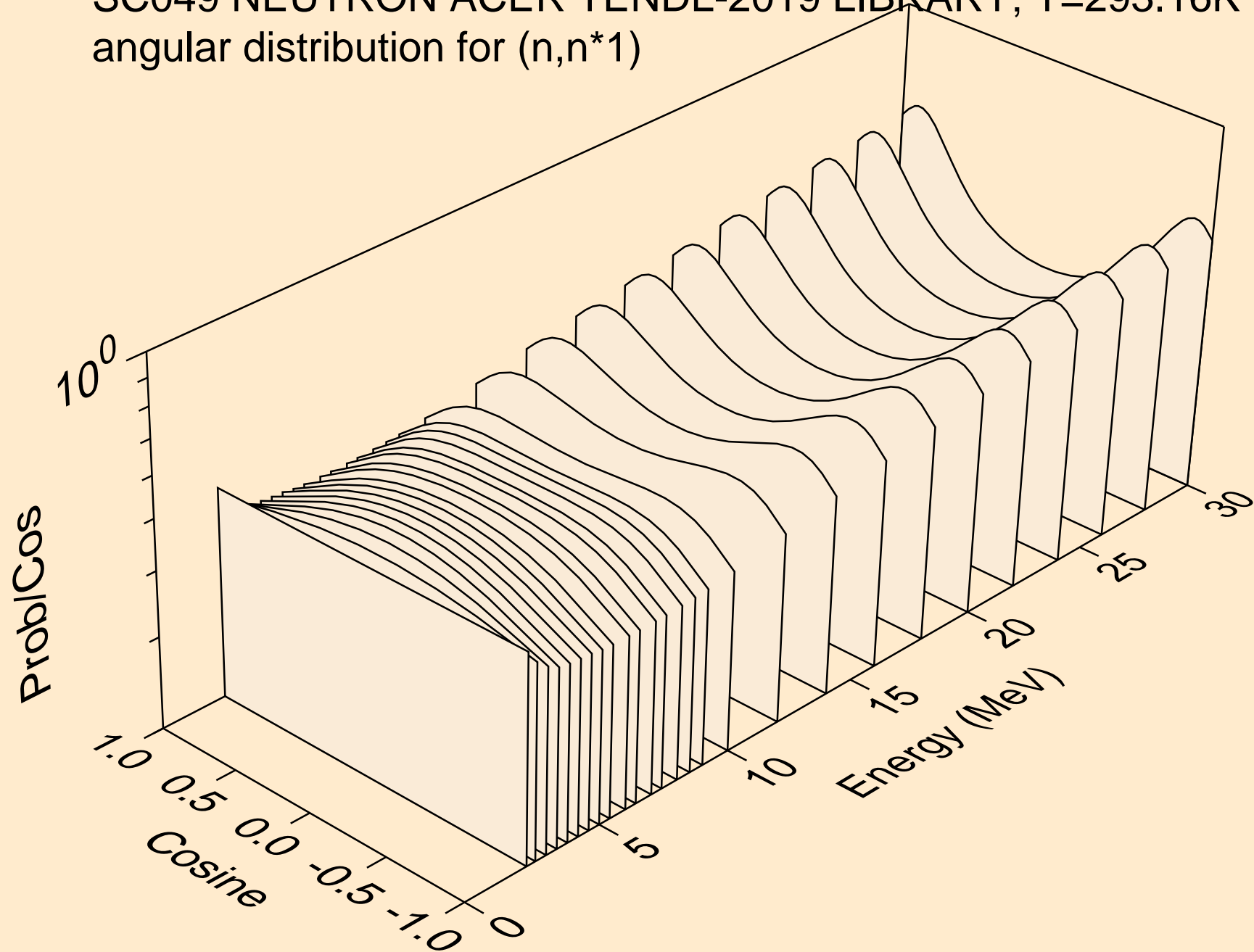

SC049 NEUTRON ACER TENDL-2019 LIBRARY; T=293.16K  
angular distribution for (n,n\*2)

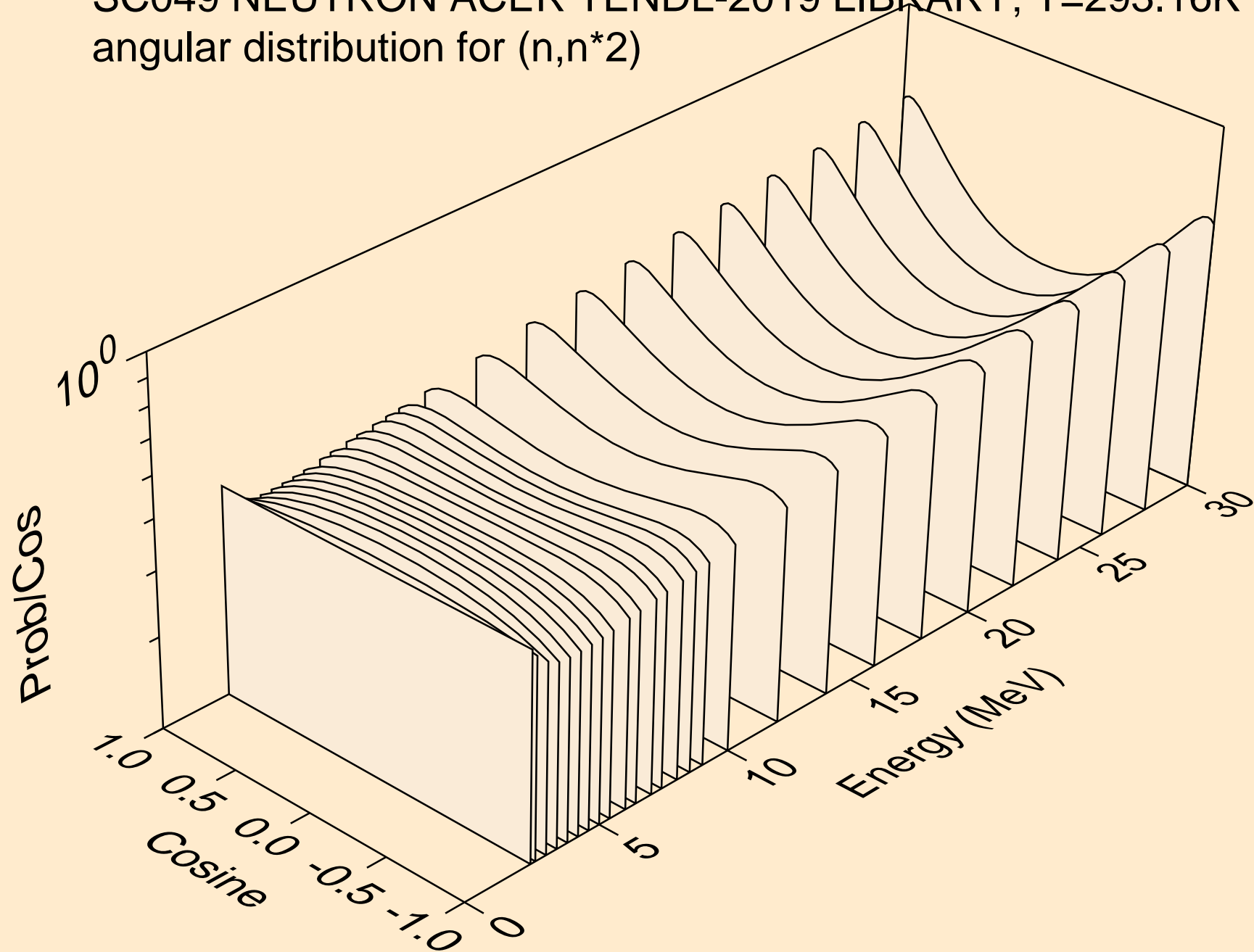

SC049 NEUTRON ACER TENDL-2019 LIBRARY; T=293.16K  
angular distribution for (n,n\*3)

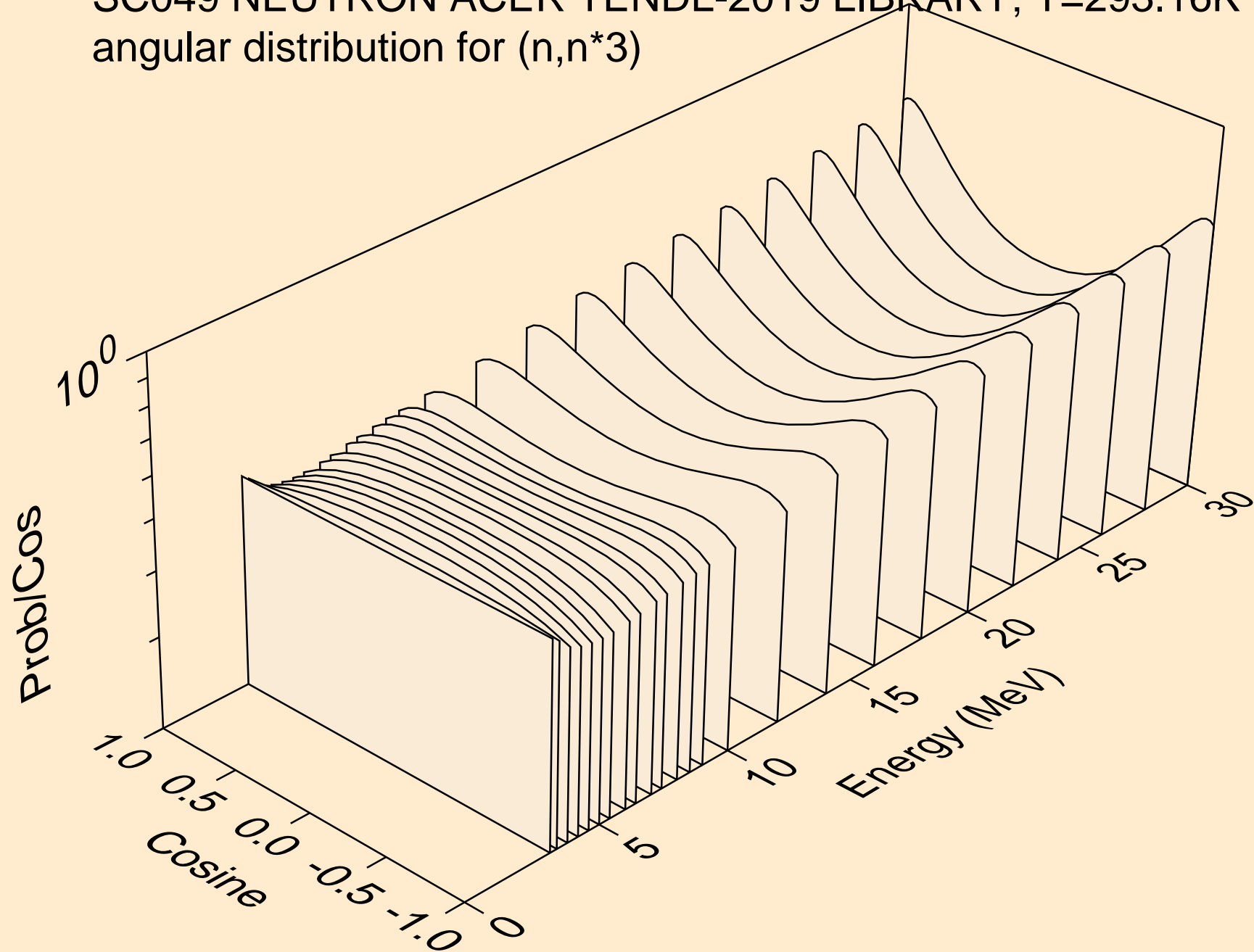

SC049 NEUTRON ACER TENDL-2019 LIBRARY; T=293.16K  
angular distribution for (n,n\*4)

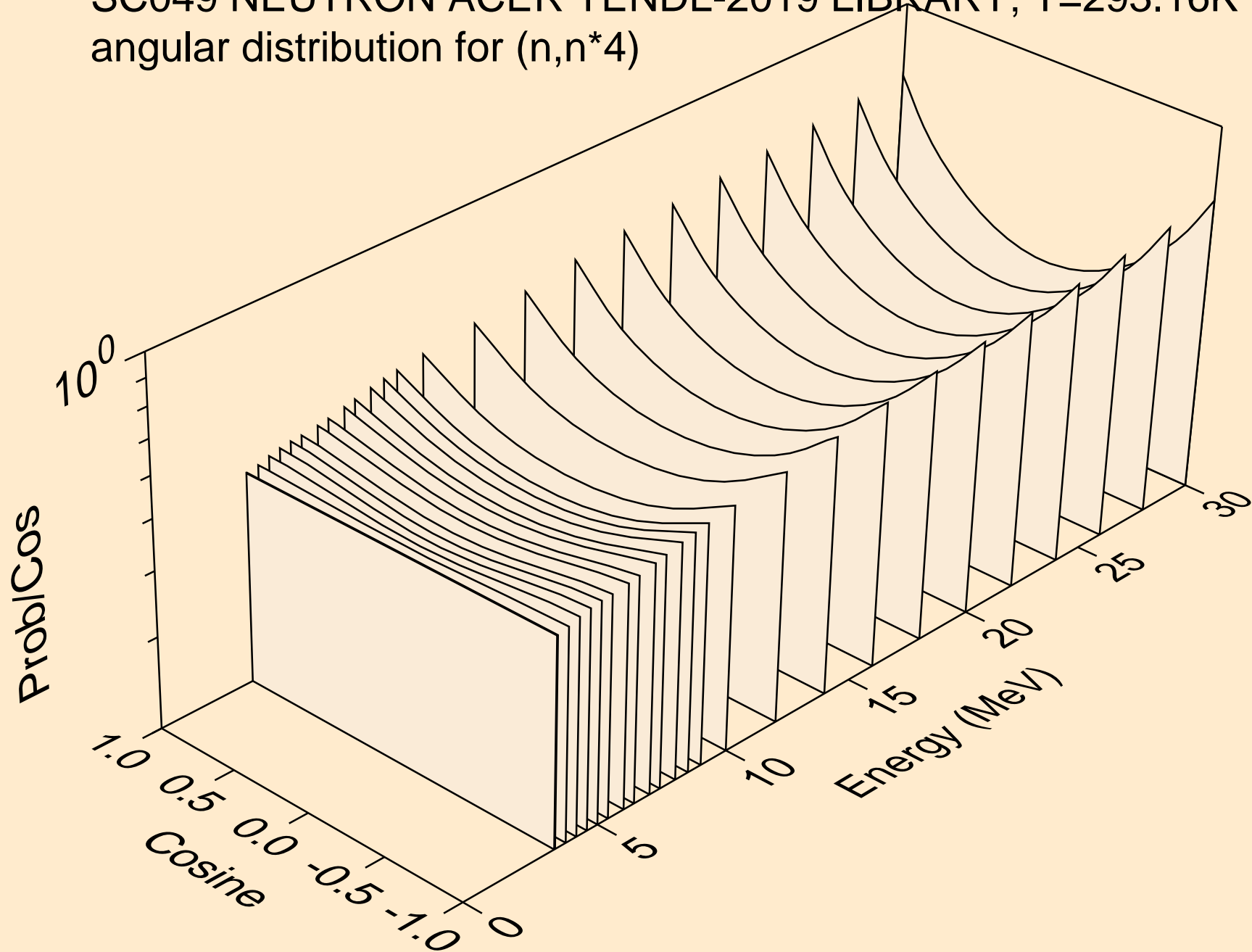

SC049 NEUTRON ACER TENDL-2019 LIBRARY; T=293.16K  
angular distribution for (n,n\*5)

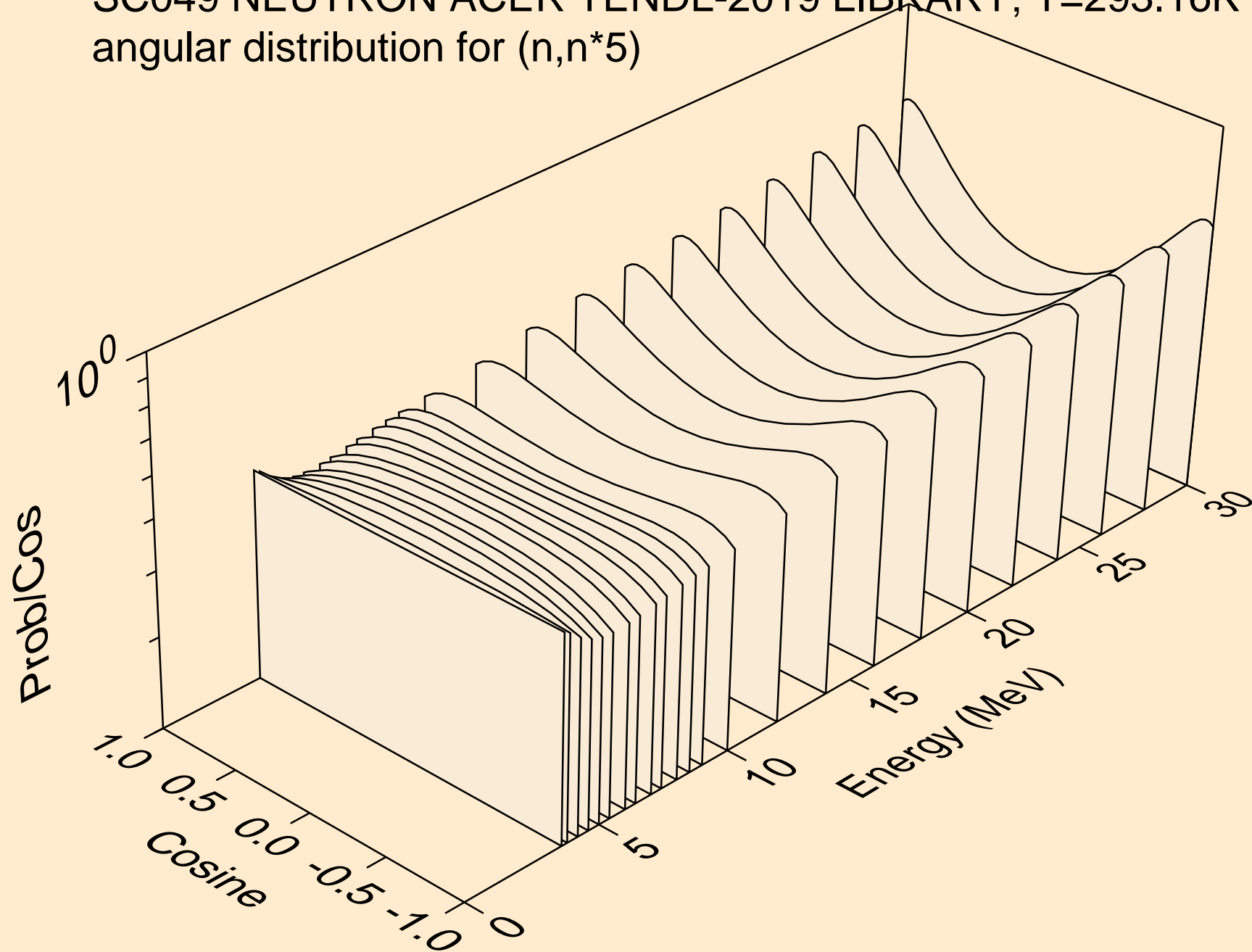

SC049 NEUTRON ACER TENDL-2019 LIBRARY; T=293.16K  
angular distribution for (n,n\*6)

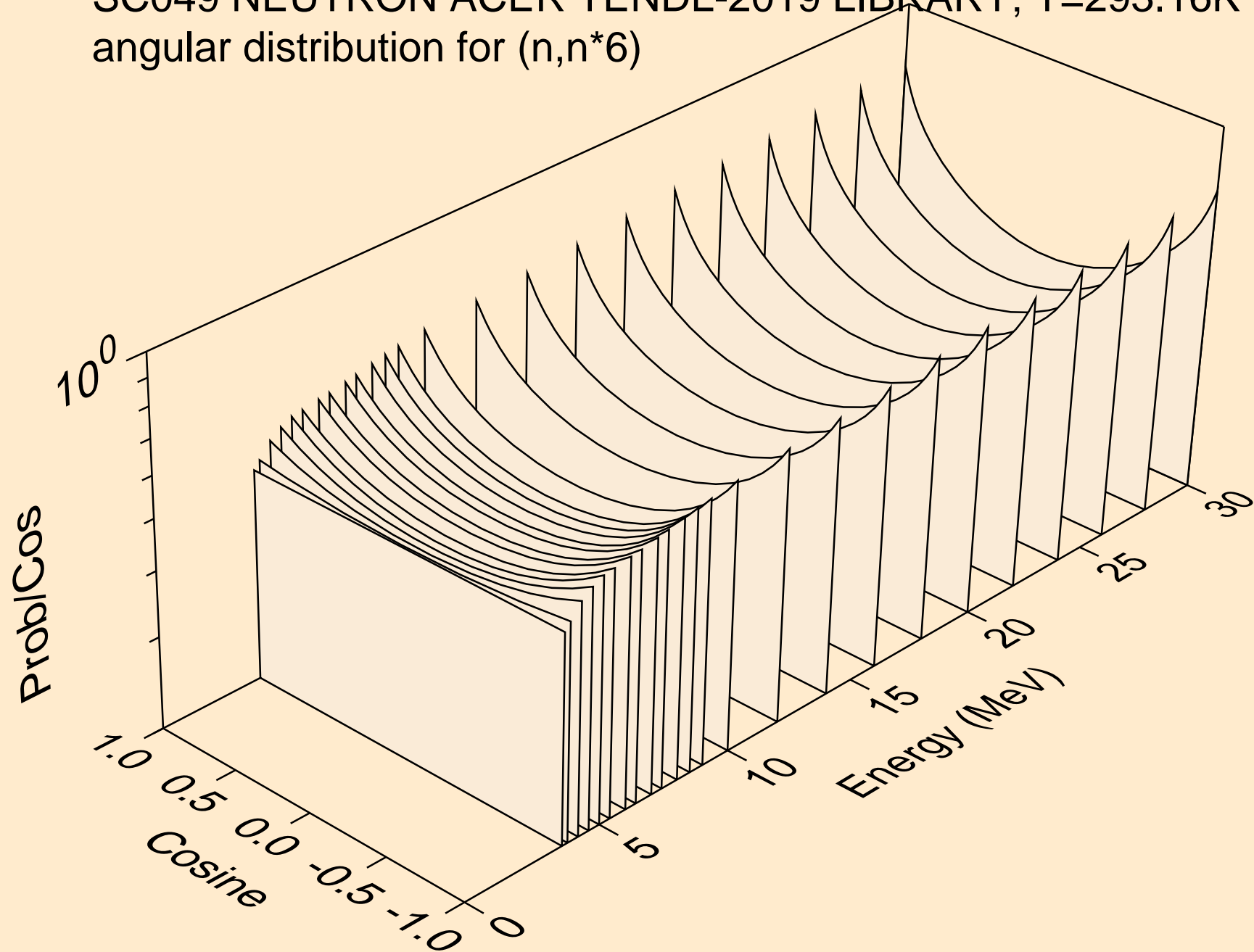

SC049 NEUTRON ACER TENDL-2019 LIBRARY; T=293.16K  
angular distribution for (n,n\*7)

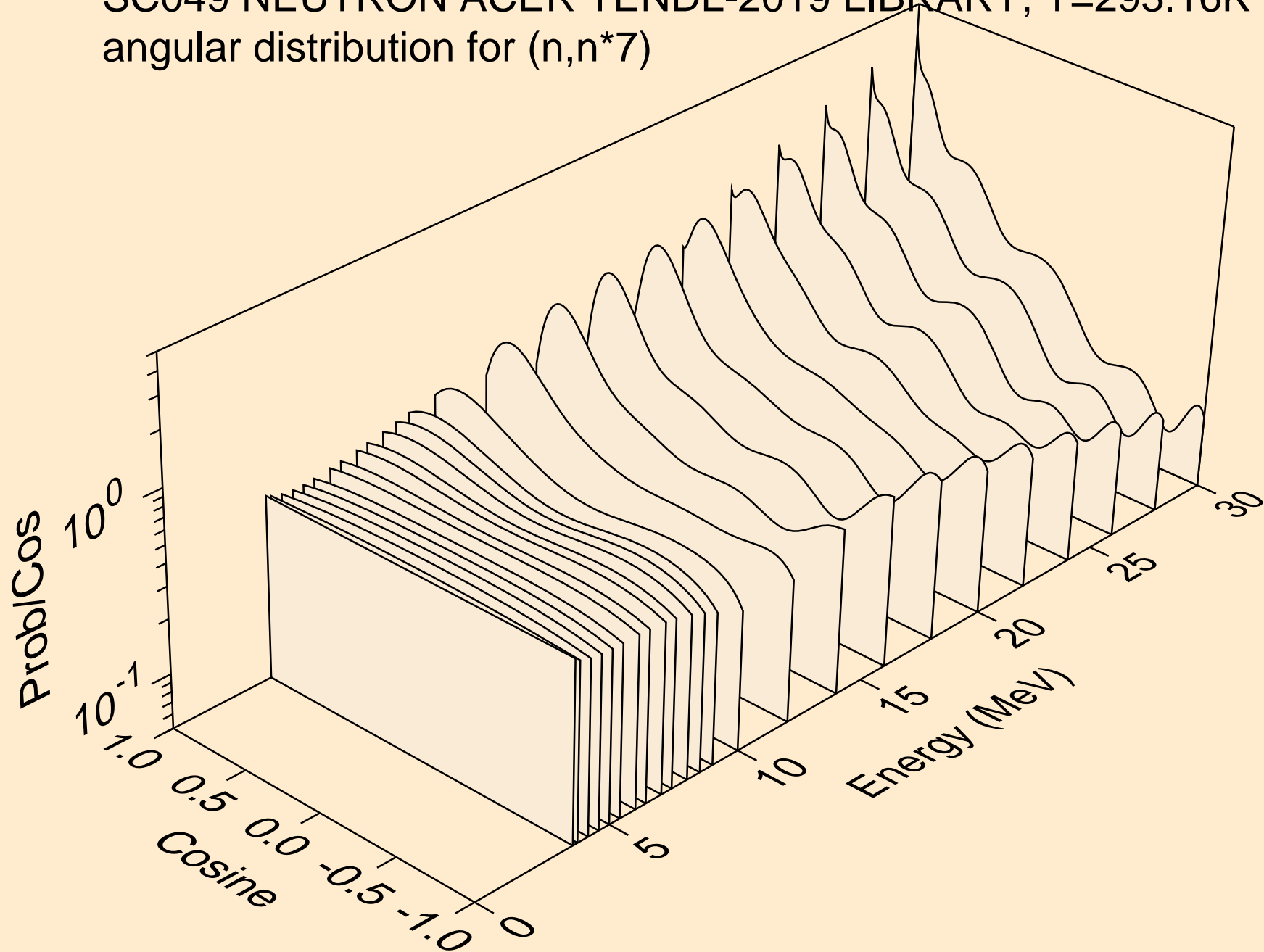

SC049 NEUTRON ACER TENDL-2019 LIBRARY; T=293.16K  
angular distribution for (n,n\*8)

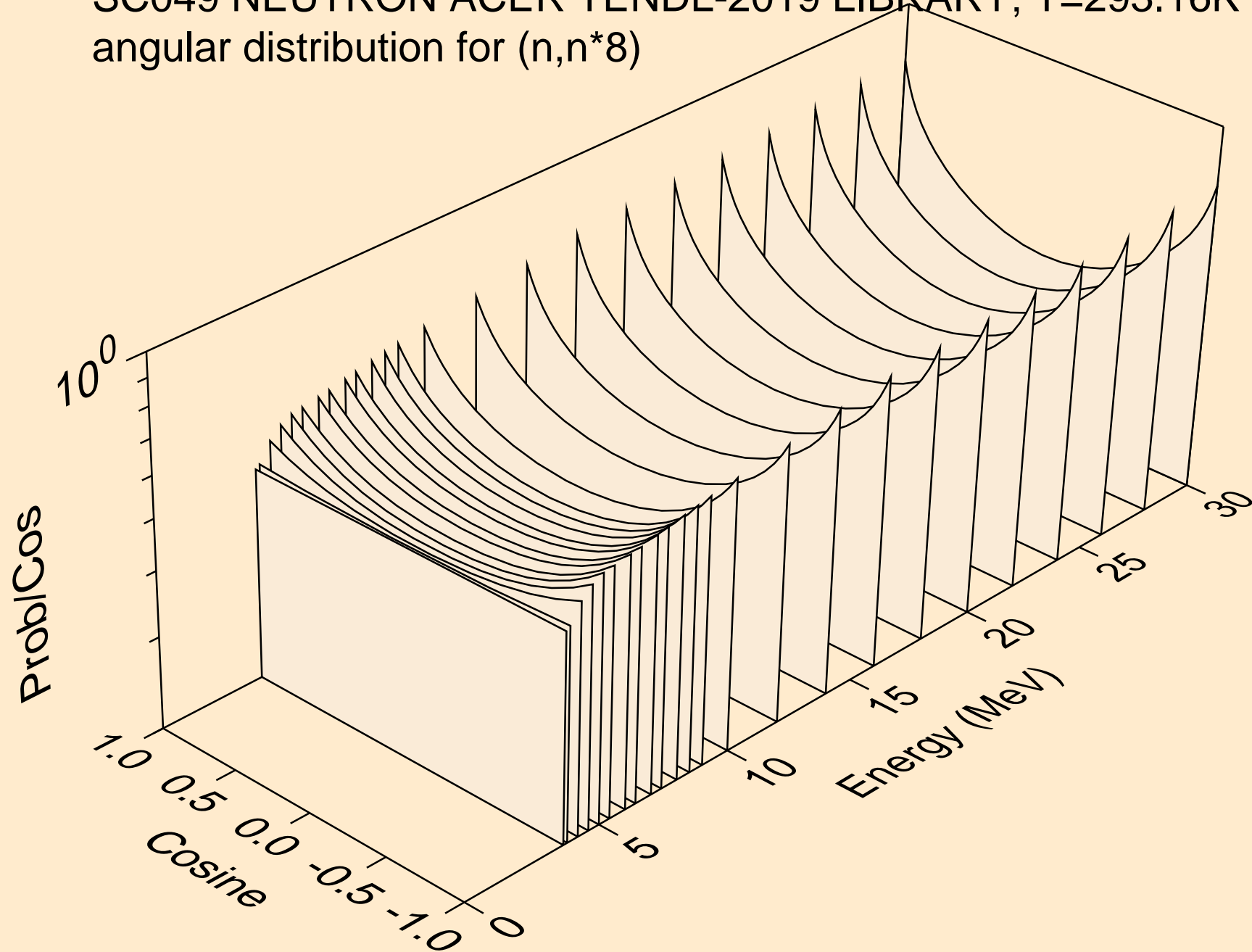

SC049 NEUTRON ACER TENDL-2019 LIBRARY; T=293.16K  
angular distribution for (n,n\*9)

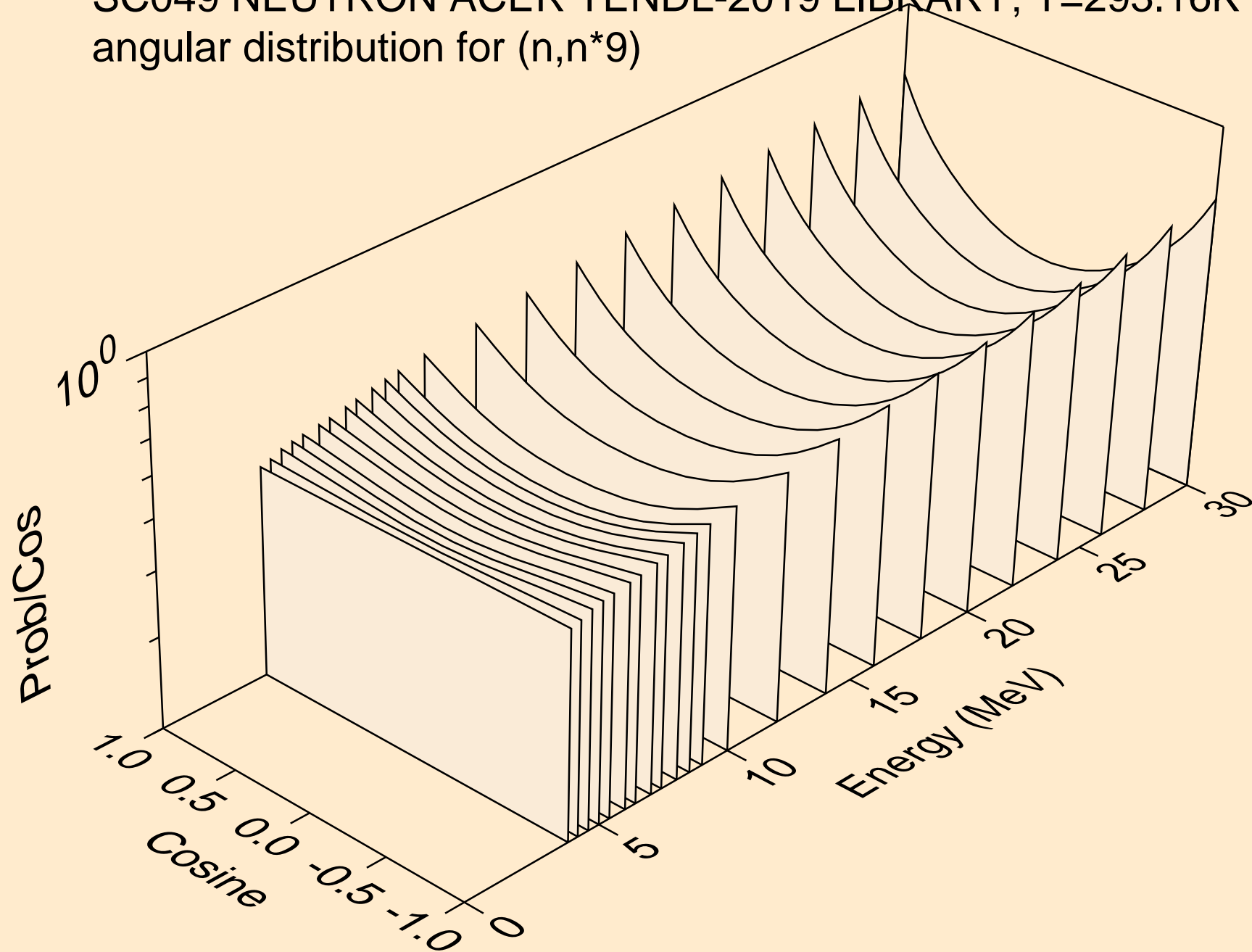

SC049 NEUTRON ACER TENDL-2019 LIBRARY; T=293.16K  
angular distribution for (n,n\*10)

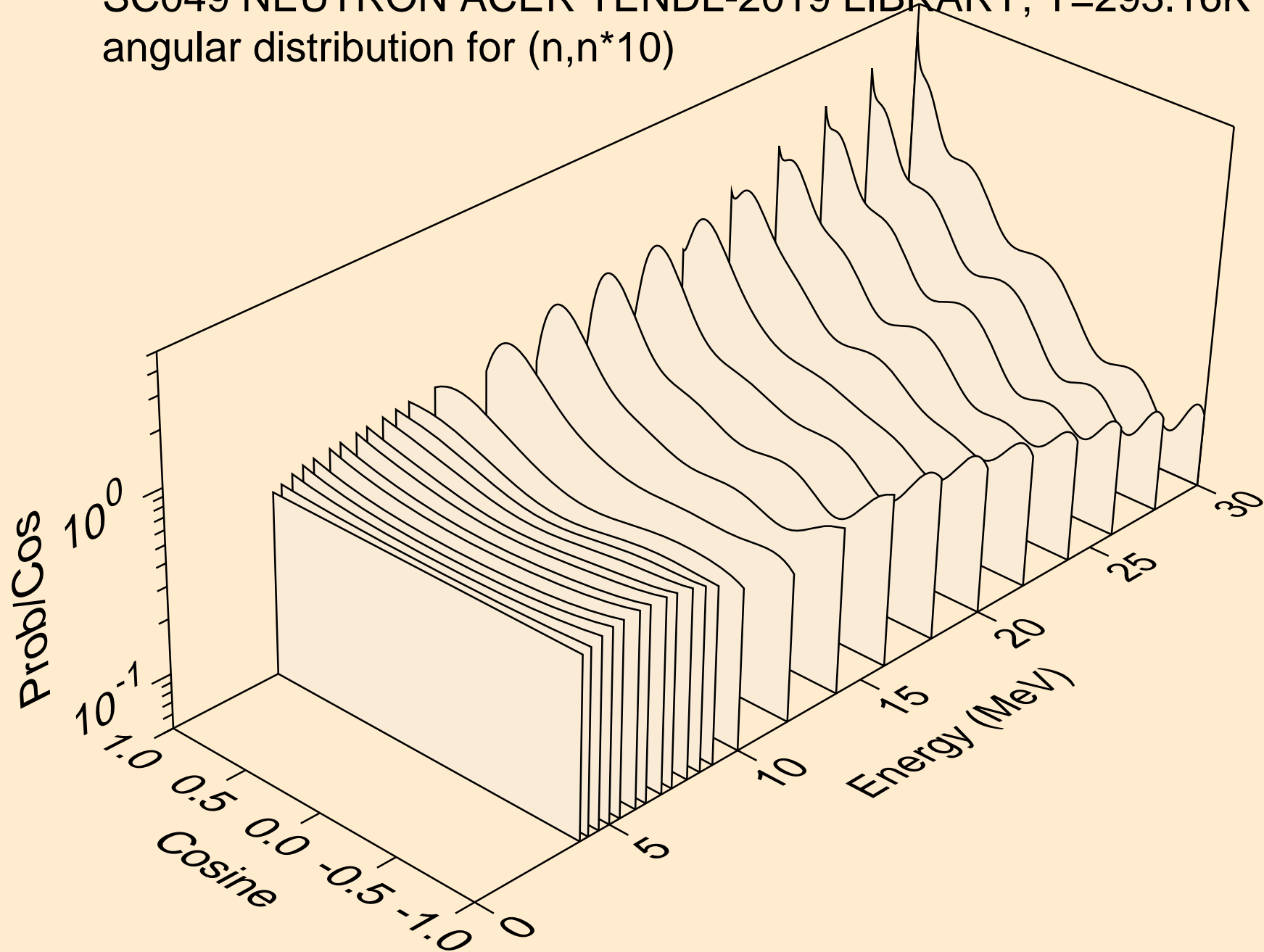

SC049 NEUTRON ACER TENDL-2019 LIBRARY; T=293.16K  
angular distribution for (n,n\*11)

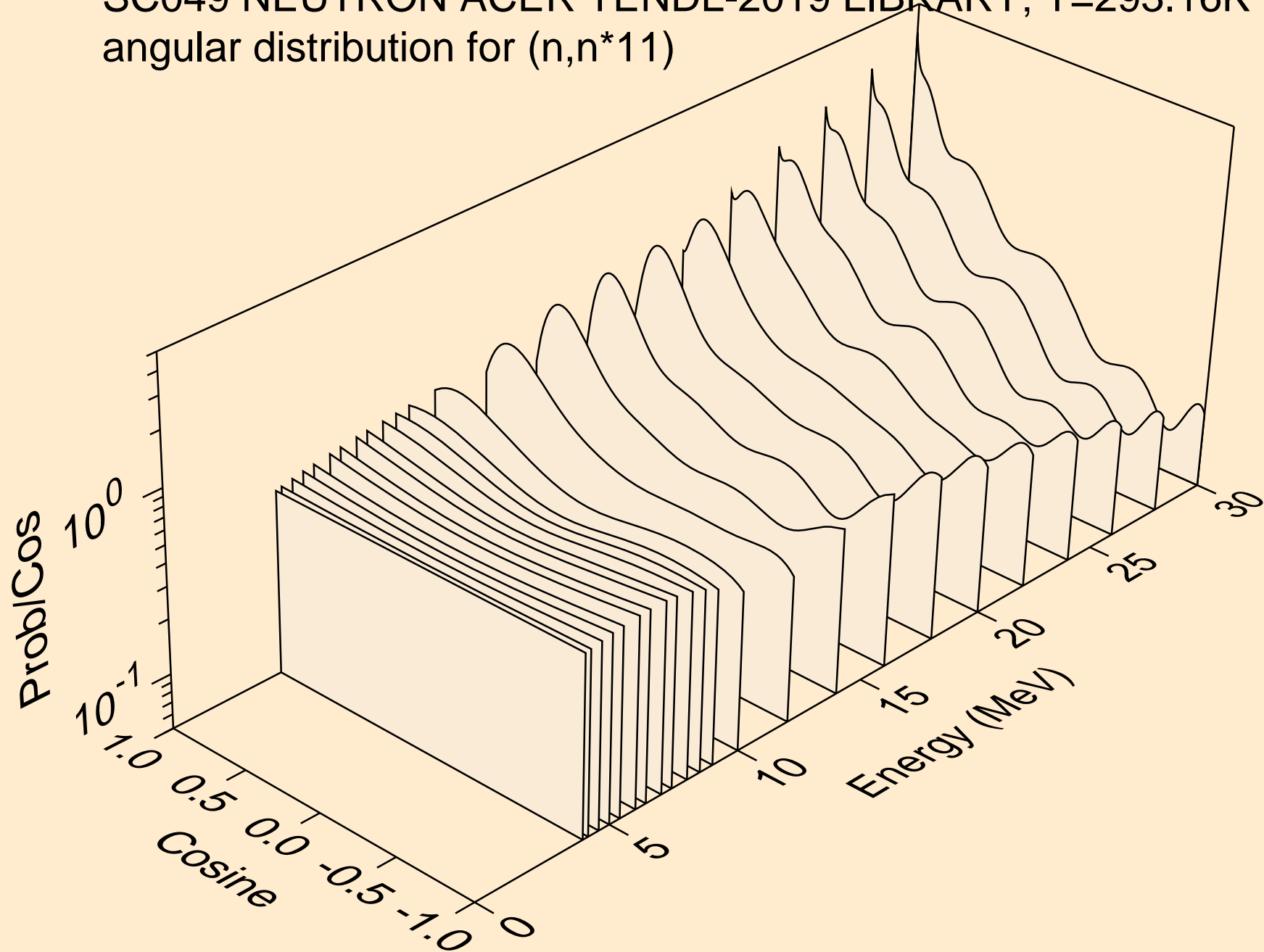

SC049 NEUTRON ACER TENDL-2019 LIBRARY; T=293.16K  
angular distribution for (n,n\*12)

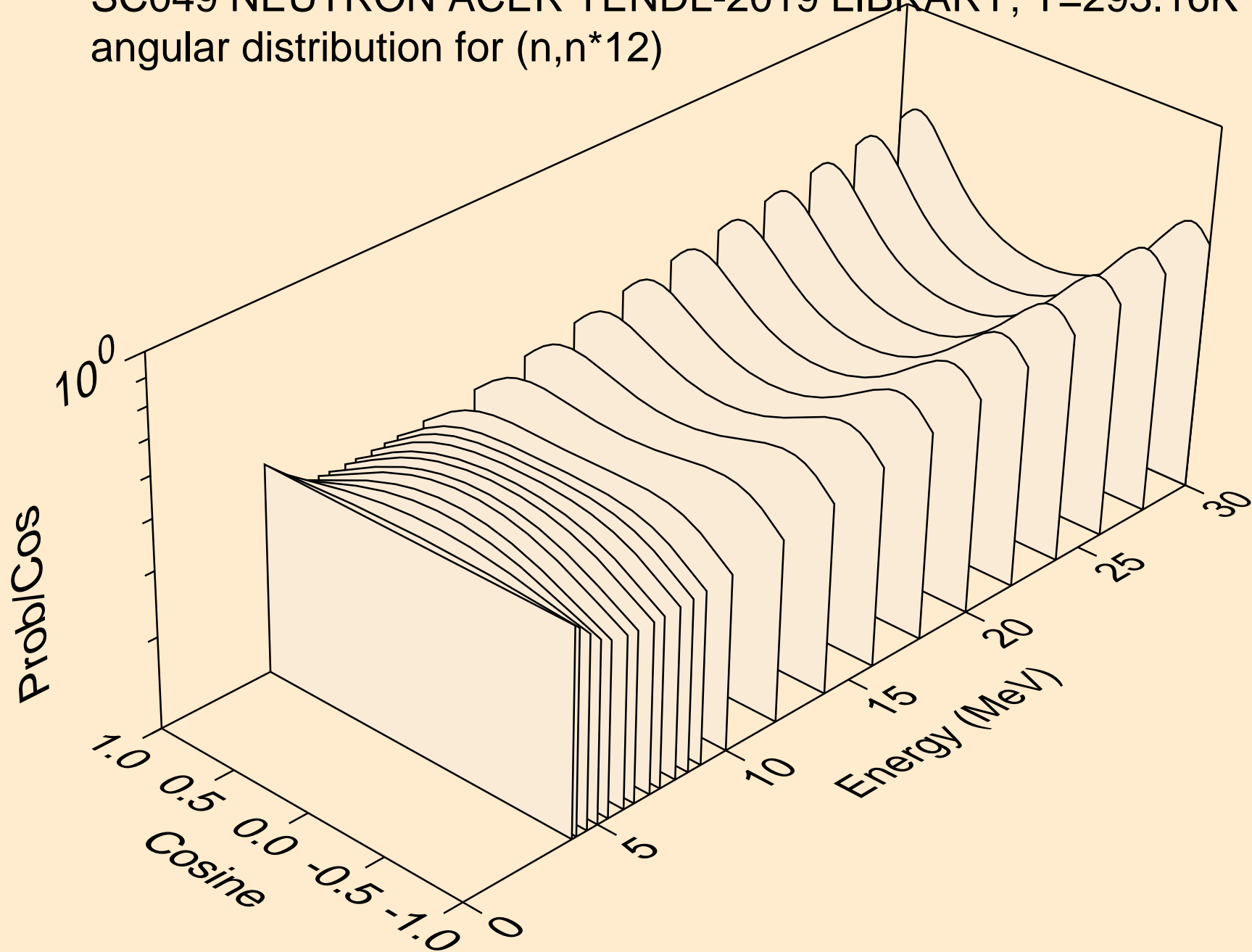

SC049 NEUTRON ACER TENDL-2019 LIBRARY; T=293.16K  
angular distribution for (n,n\*13)

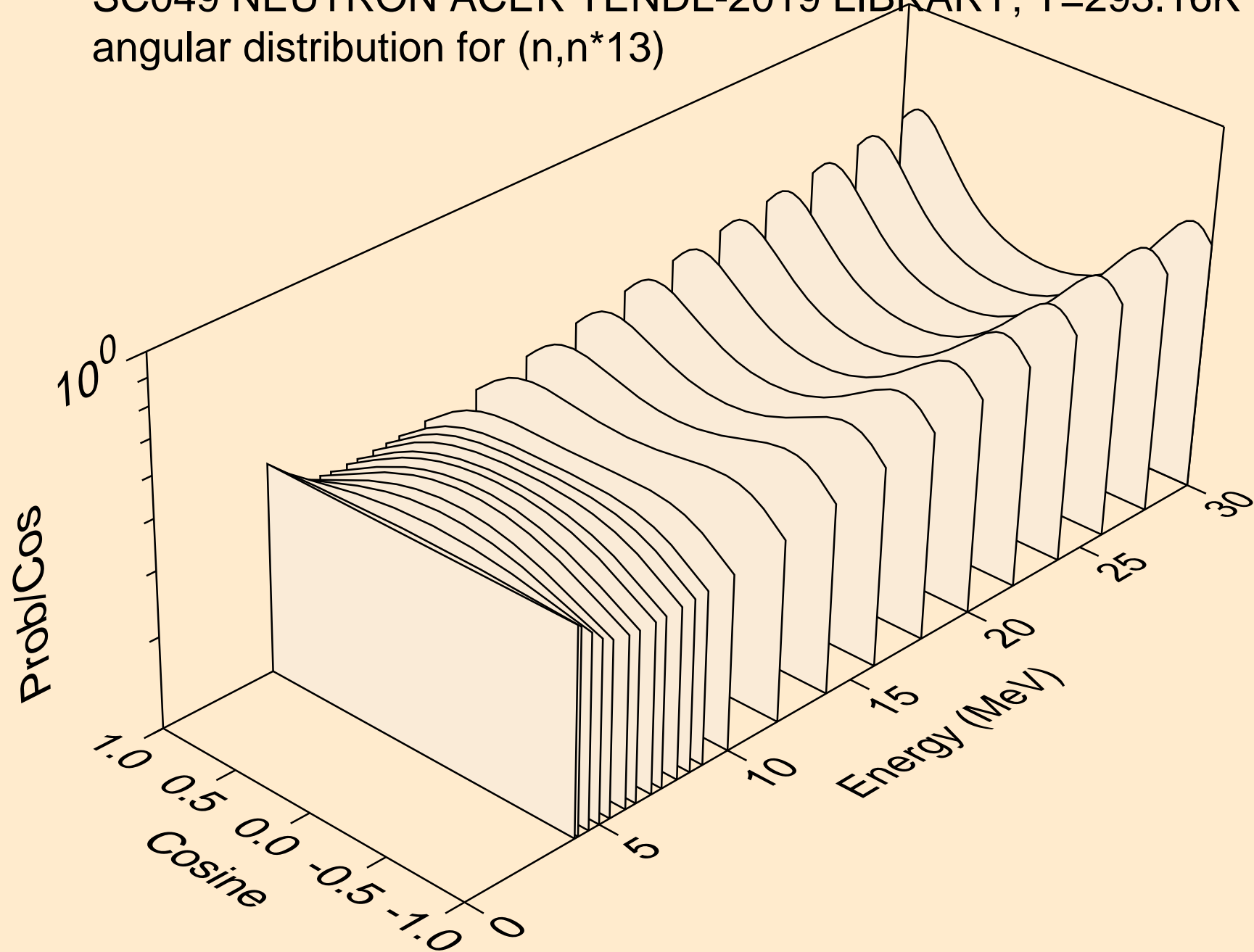

SC049 NEUTRON ACER TENDL-2019 LIBRARY; T=293.16K  
angular distribution for (n,n\*14)

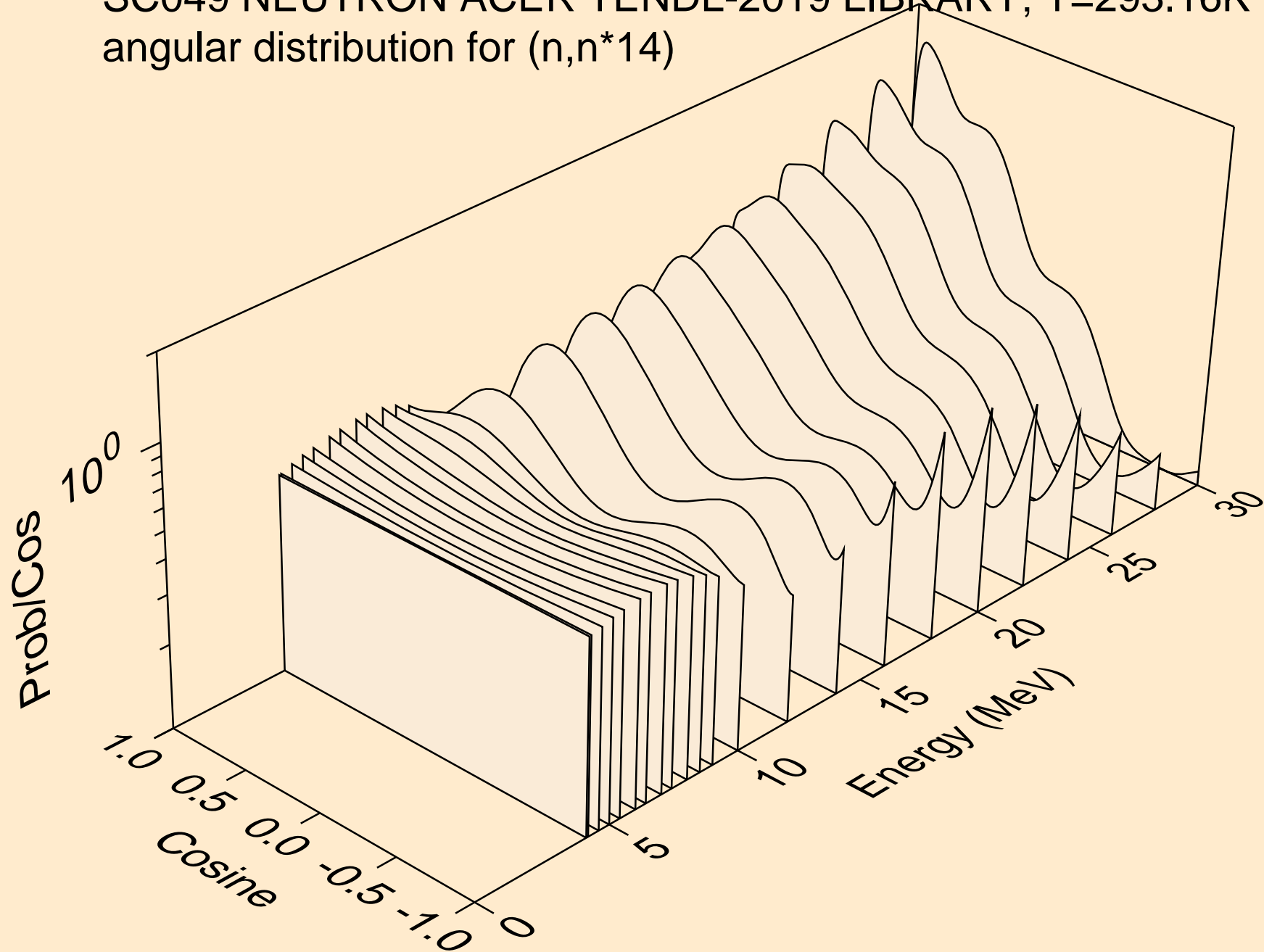

SC049 NEUTRON ACER TENDL-2019 LIBRARY; T=293.16K  
angular distribution for (n,n\*15)

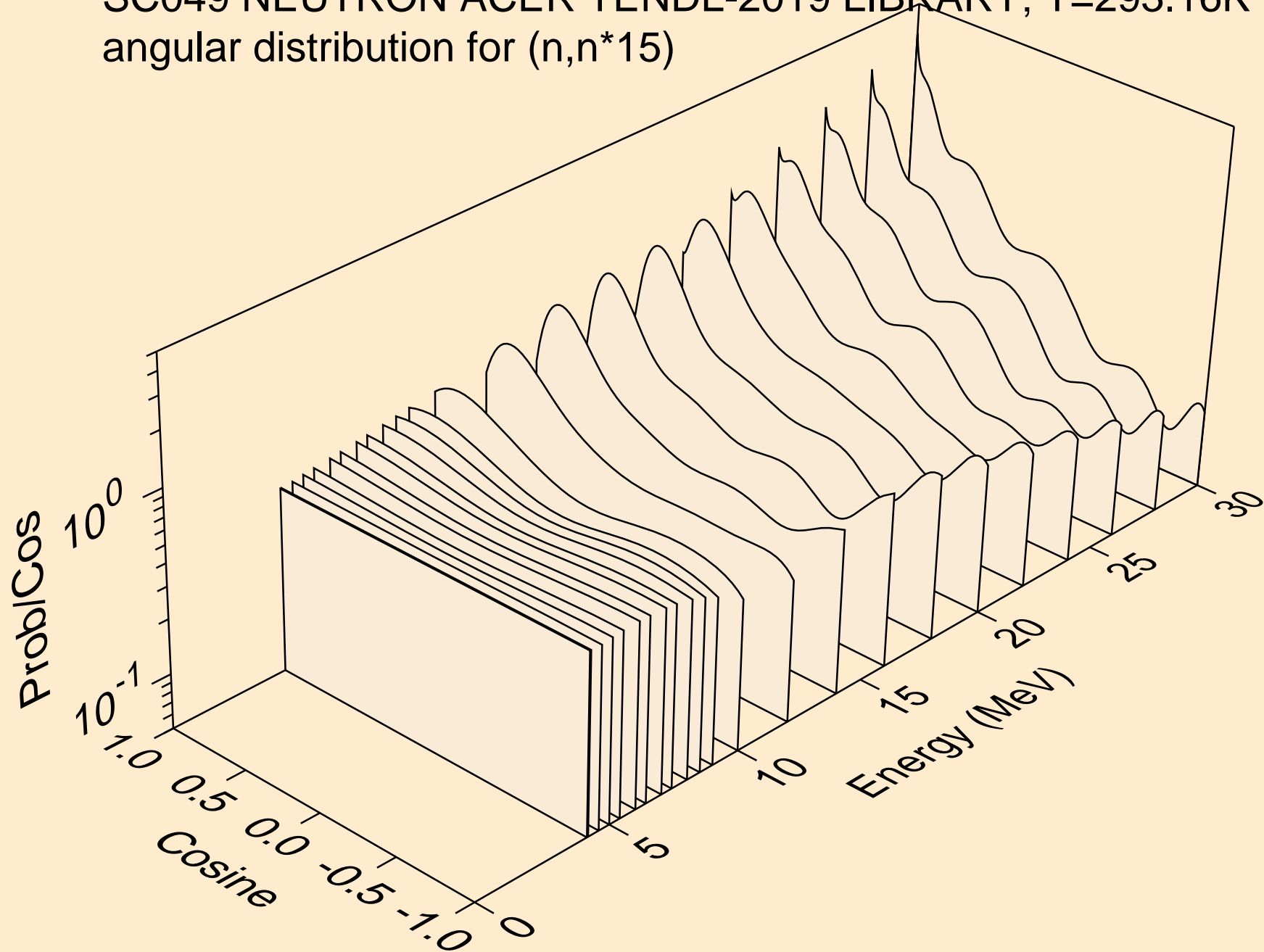

SC049 NEUTRON ACER TENDL-2019 LIBRARY; T=293.16K  
angular distribution for (n,n\*16)

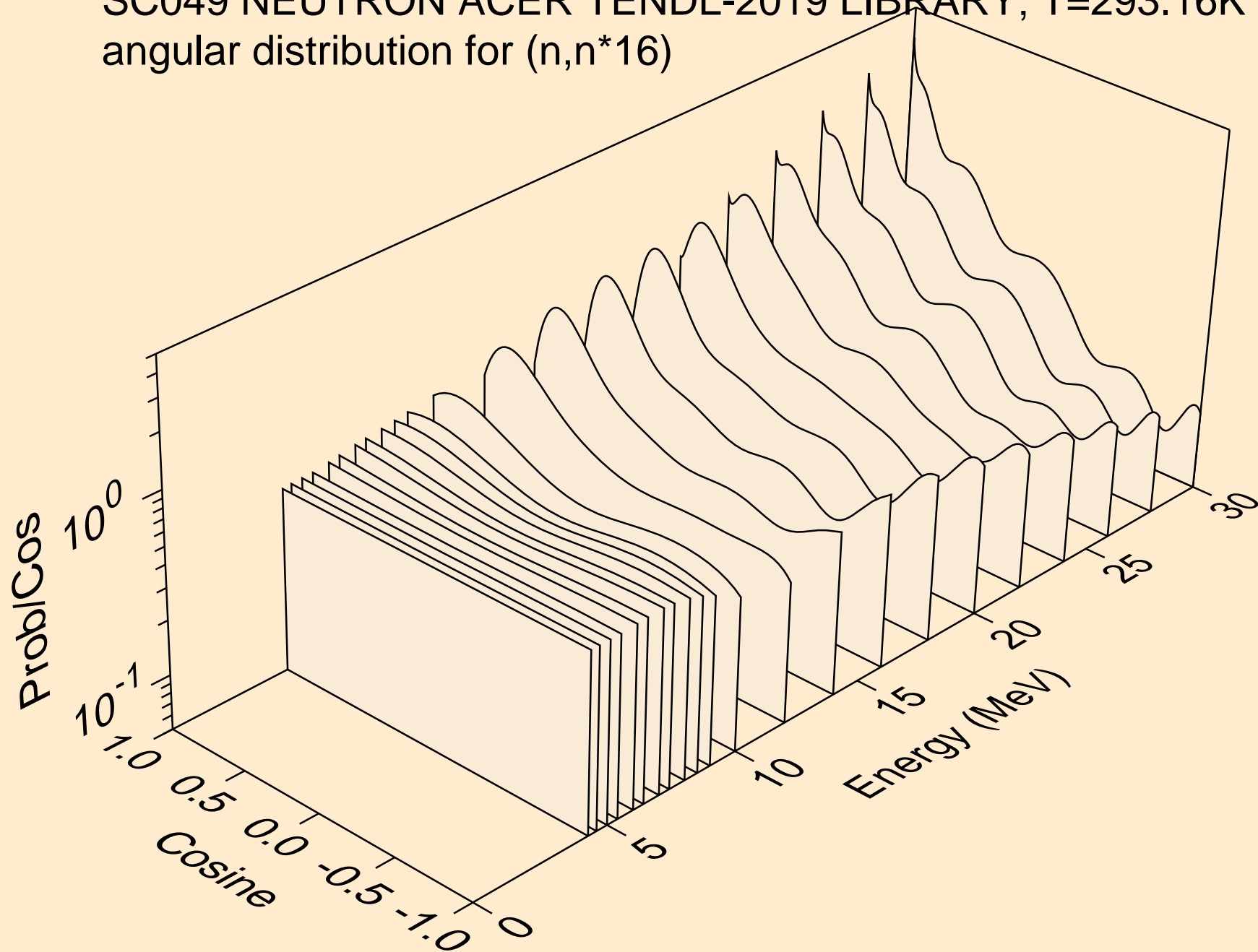

SC049 NEUTRON ACER TENDL-2019 LIBRARY; T=293.16K  
angular distribution for (n,n\*17)

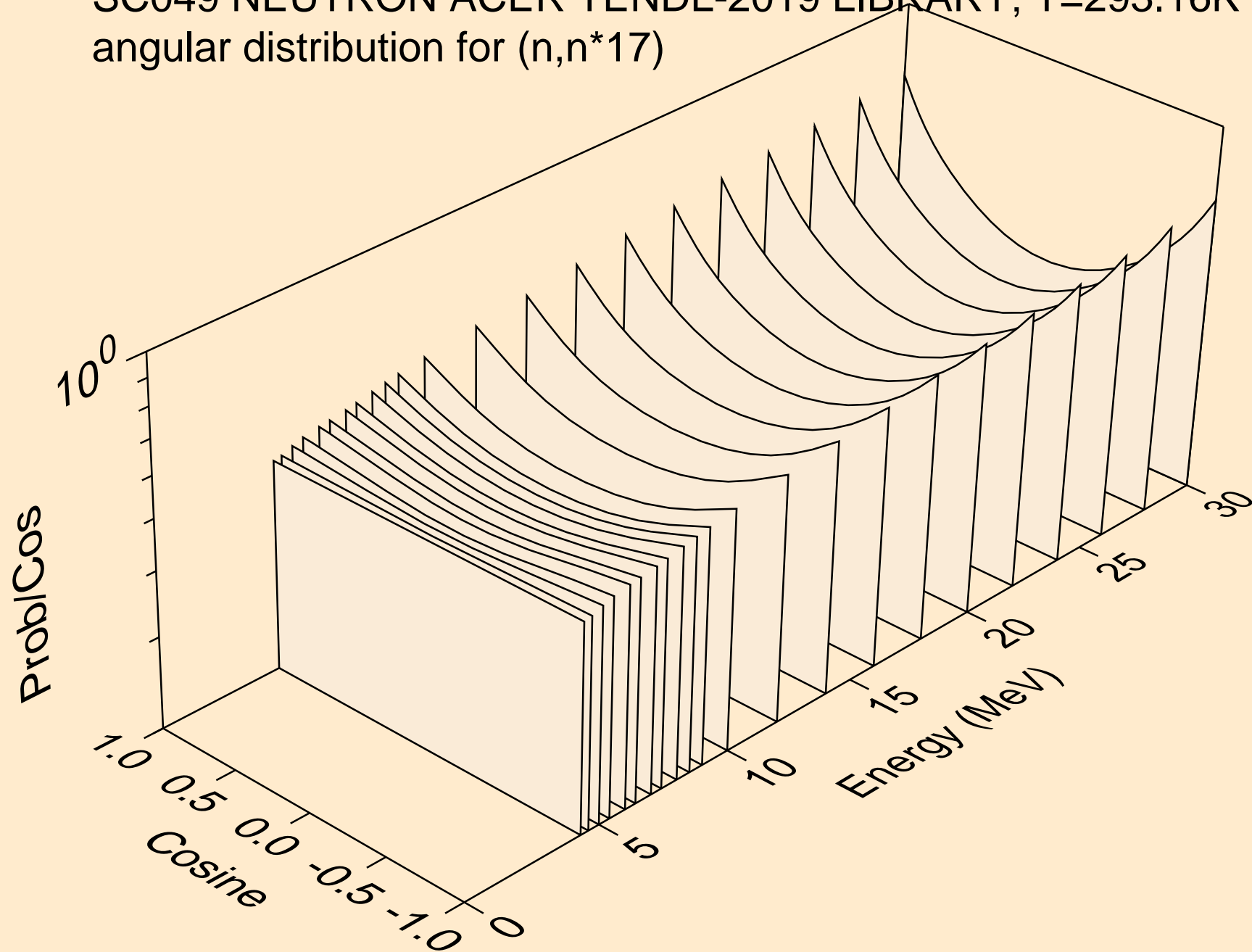

SC049 NEUTRON ACER TENDL-2019 LIBRARY; T=293.16K  
angular distribution for (n,n\*18)

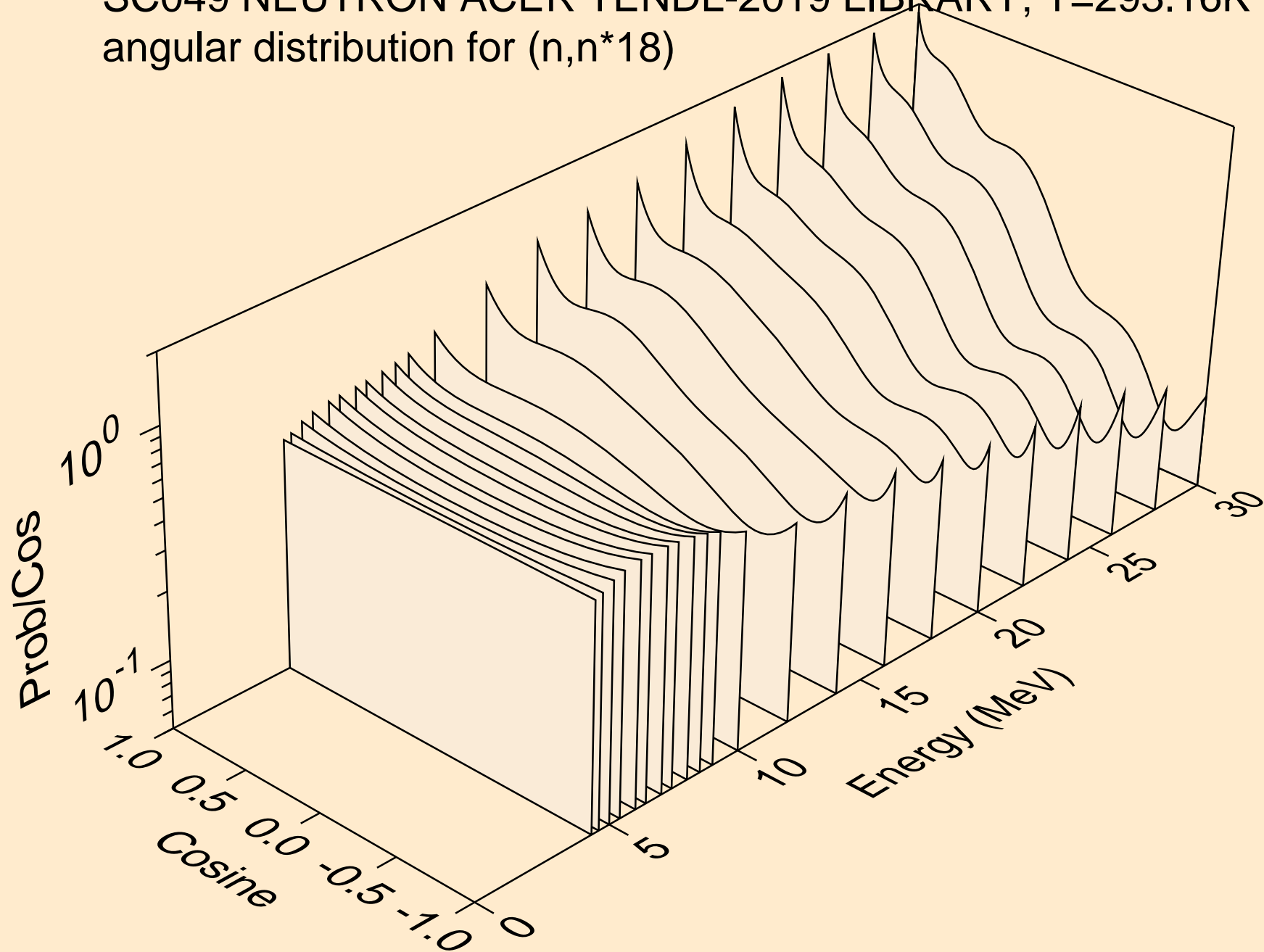

SC049 NEUTRON ACER TENDL-2019 LIBRARY; T=293.16K  
angular distribution for (n,n\*19)

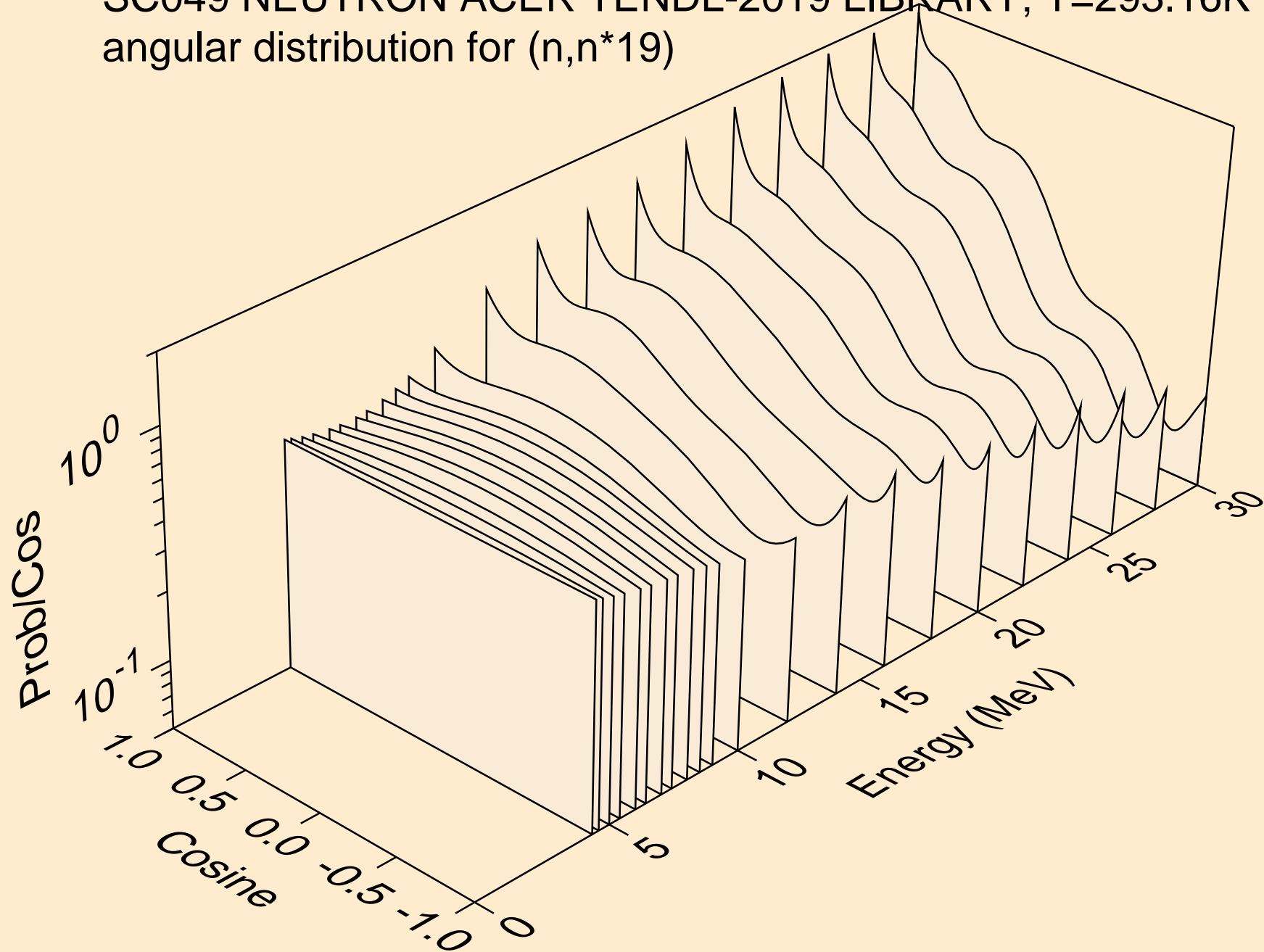

SC049 NEUTRON ACER TENDL-2019 LIBRARY; T=293.16K  
angular distribution for (n,n\*20)

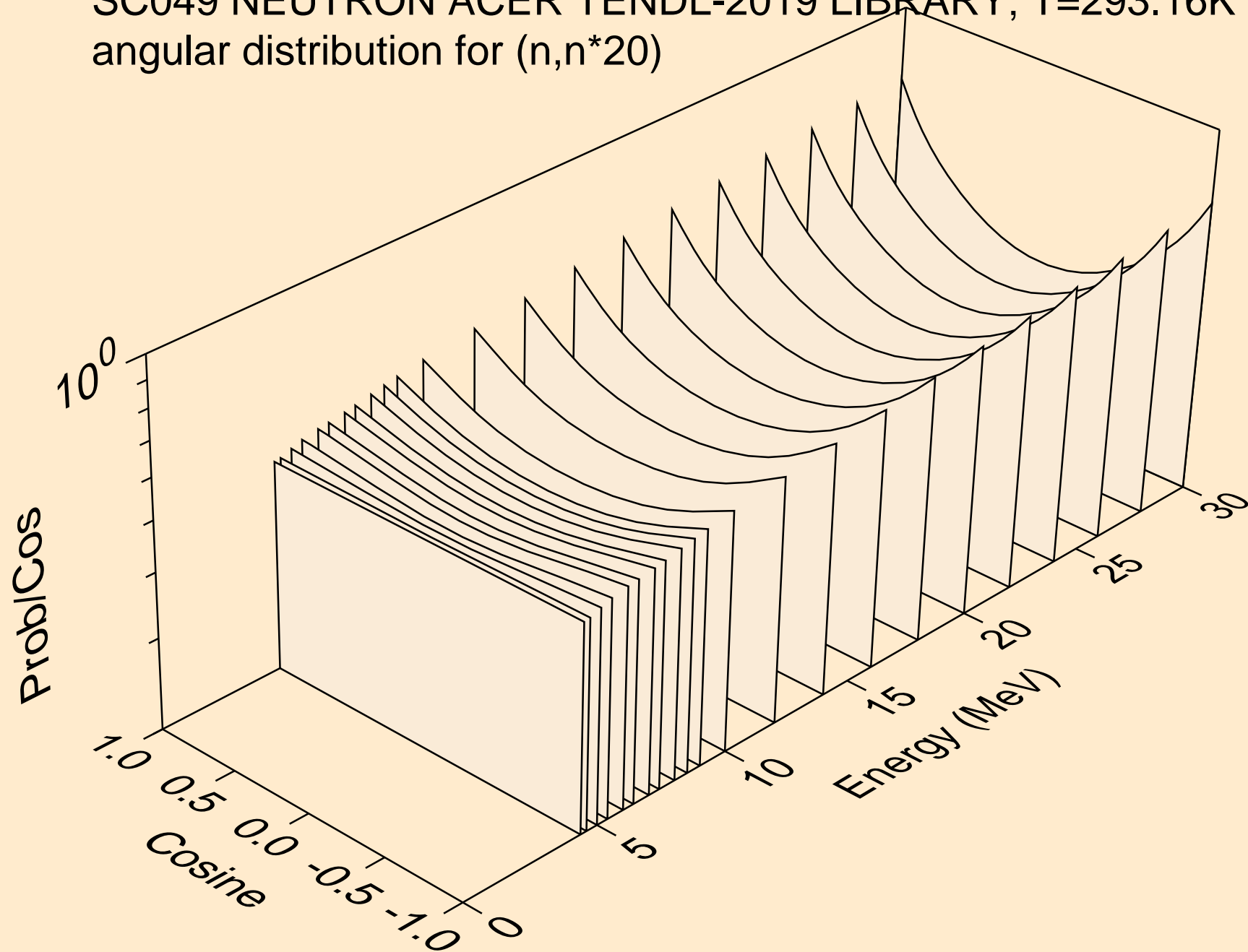

SC049 NEUTRON ACER TENDL-2019 LIBRARY; T=293.16K  
angular distribution for (n,n\*21)

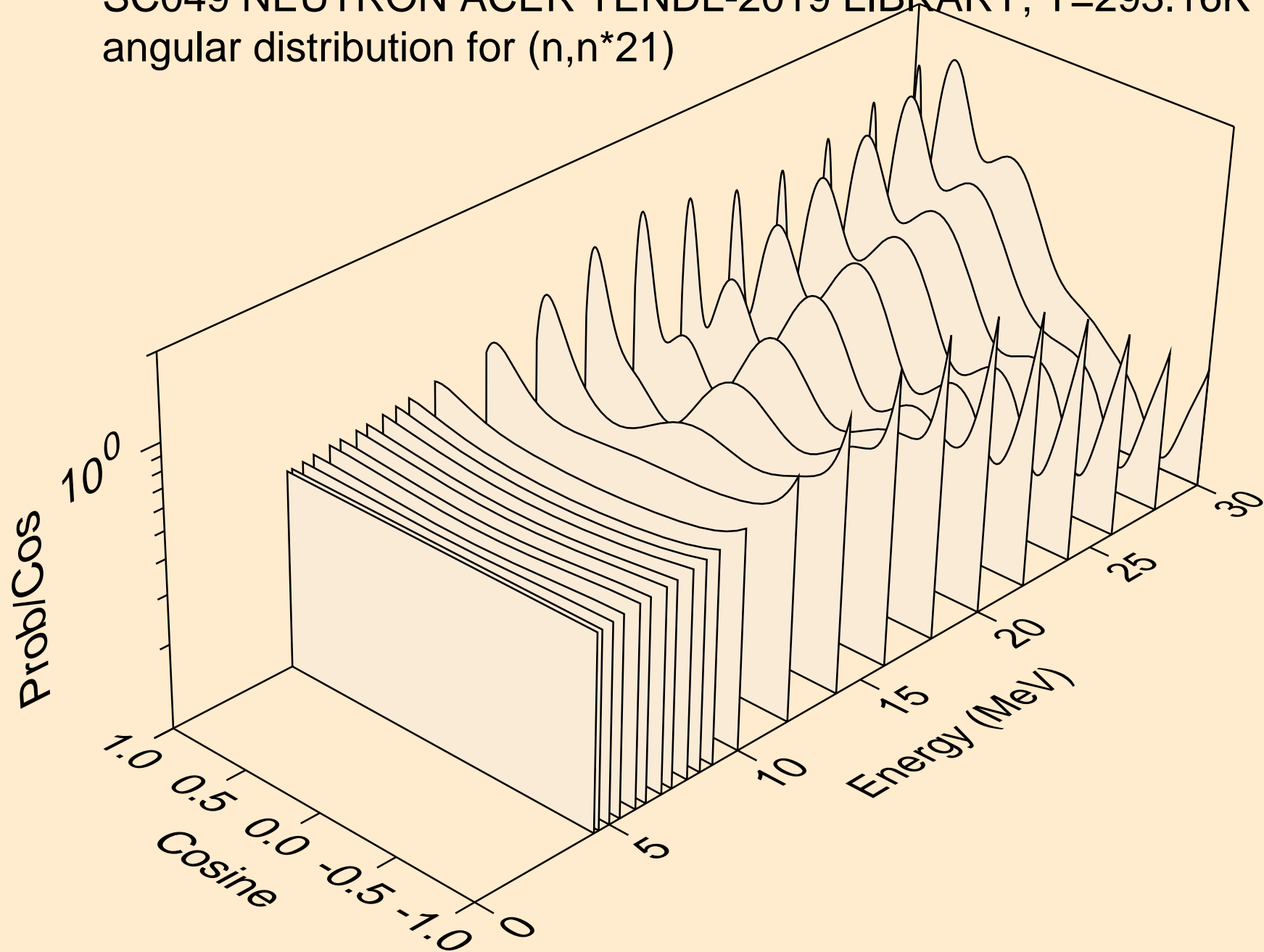

SC049 NEUTRON ACER TENDL-2019 LIBRARY; T=293.16K  
angular distribution for (n,n\*22)

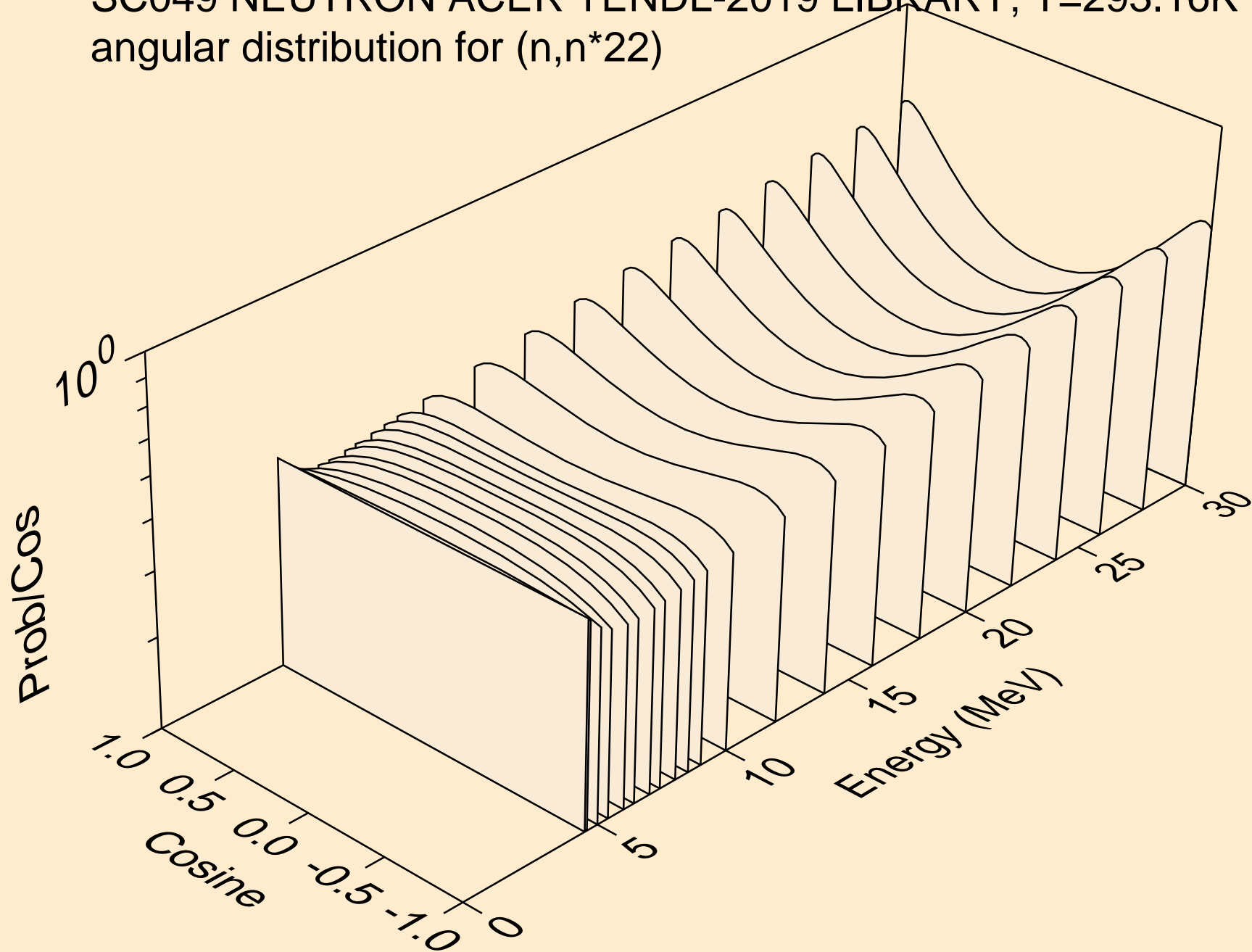

SC049 NEUTRON ACER TENDL-2019 LIBRARY; T=293.16K  
angular distribution for (n,n\*23)

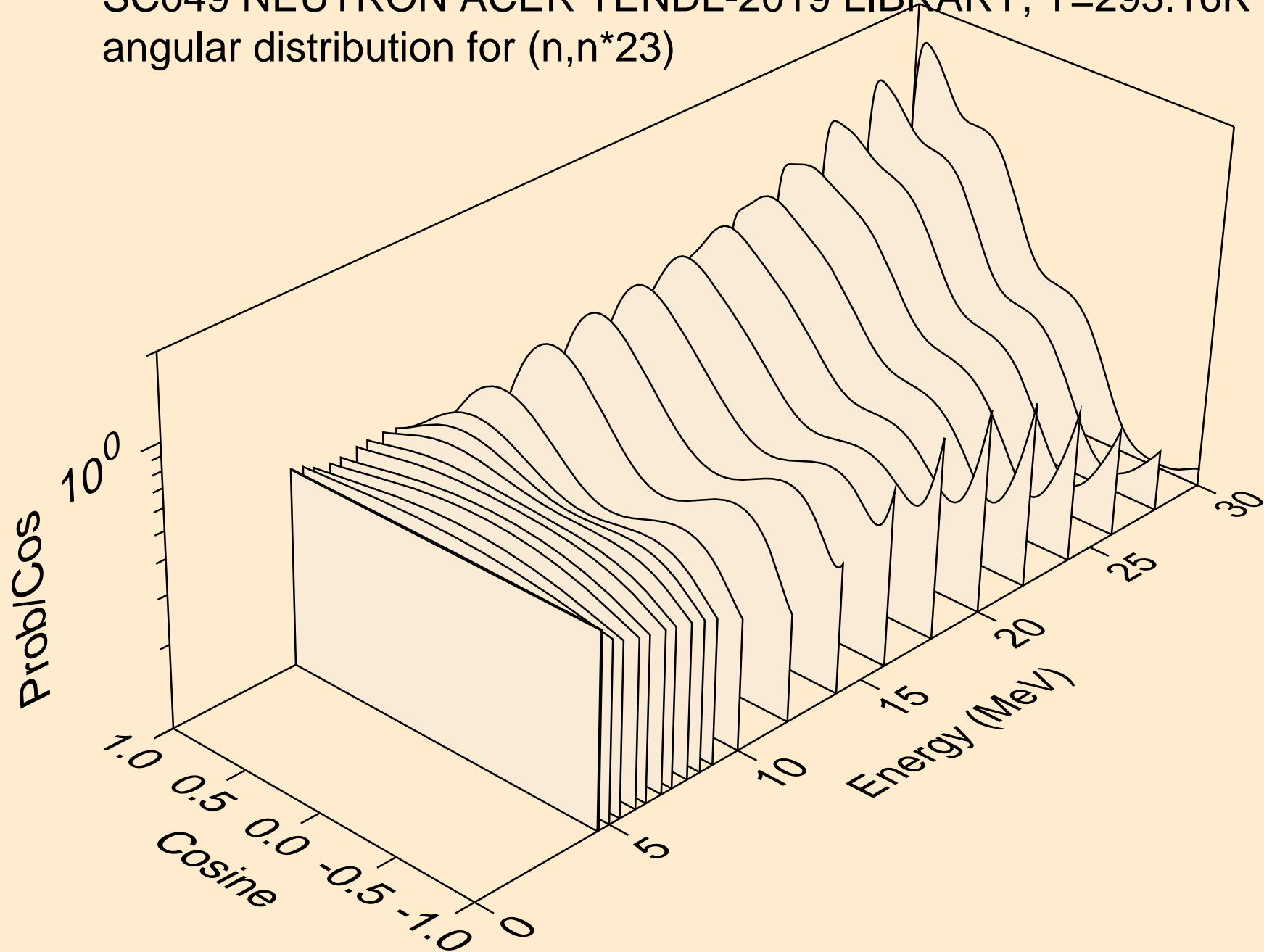

SC049 NEUTRON ACER TENDL-2019 LIBRARY; T=293.16K  
angular distribution for (n,n\*24)

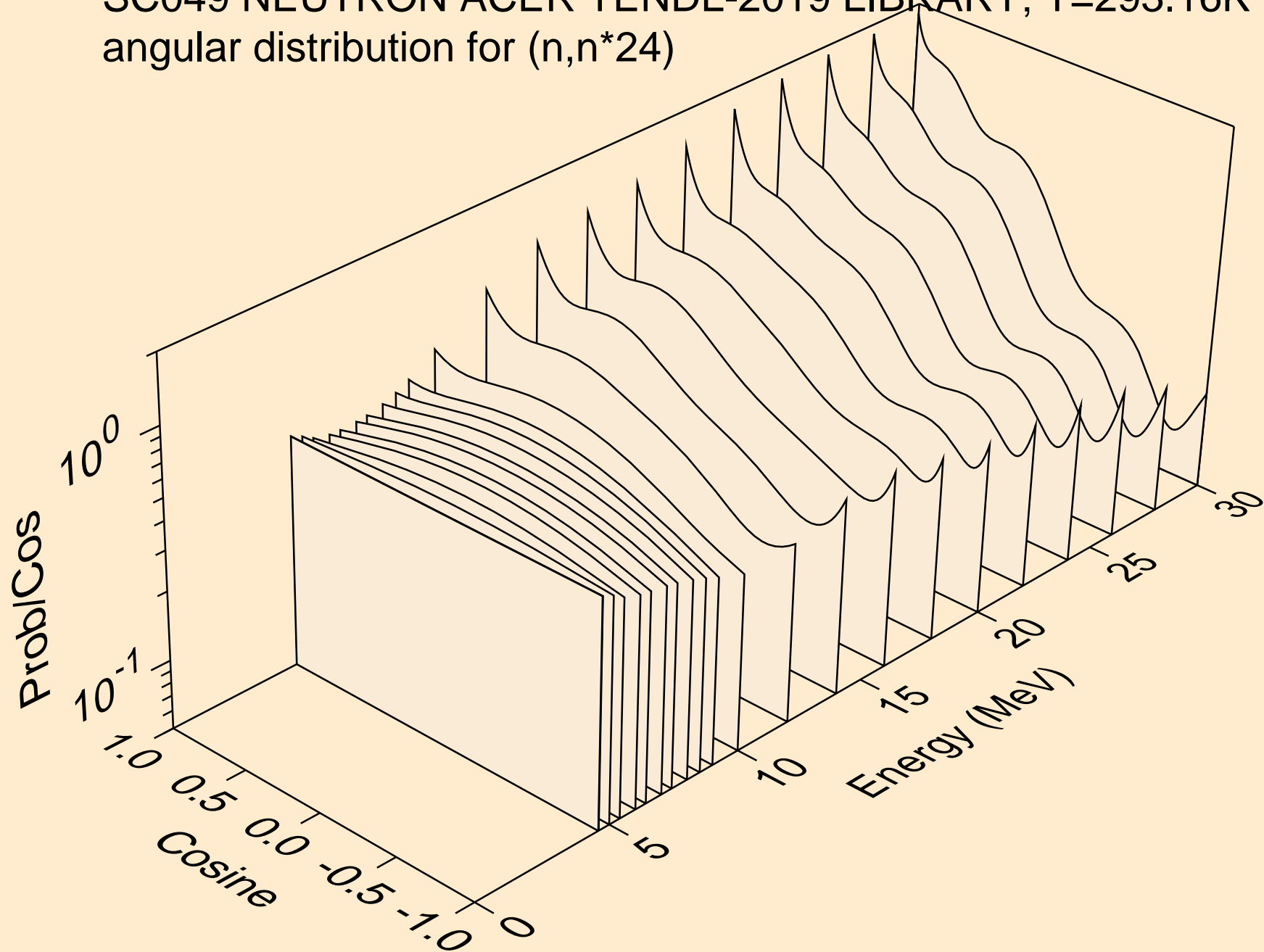

SC049 NEUTRON ACER TENDL-2019 LIBRARY; T=293.16K  
angular distribution for (n,n\*25)

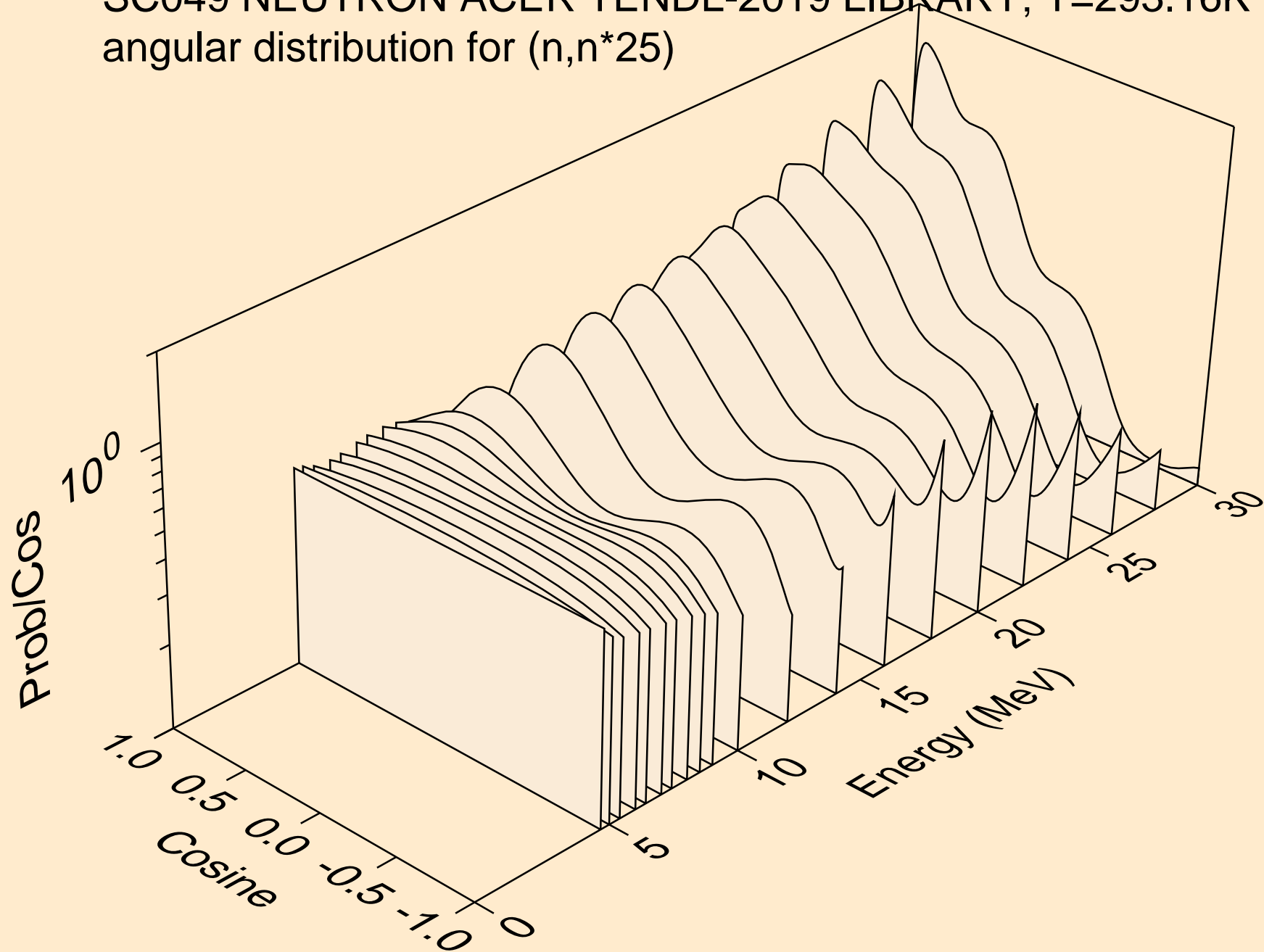

SC049 NEUTRON ACER TENDL-2019 LIBRARY; T=293.16K  
angular distribution for (n,n\*26)

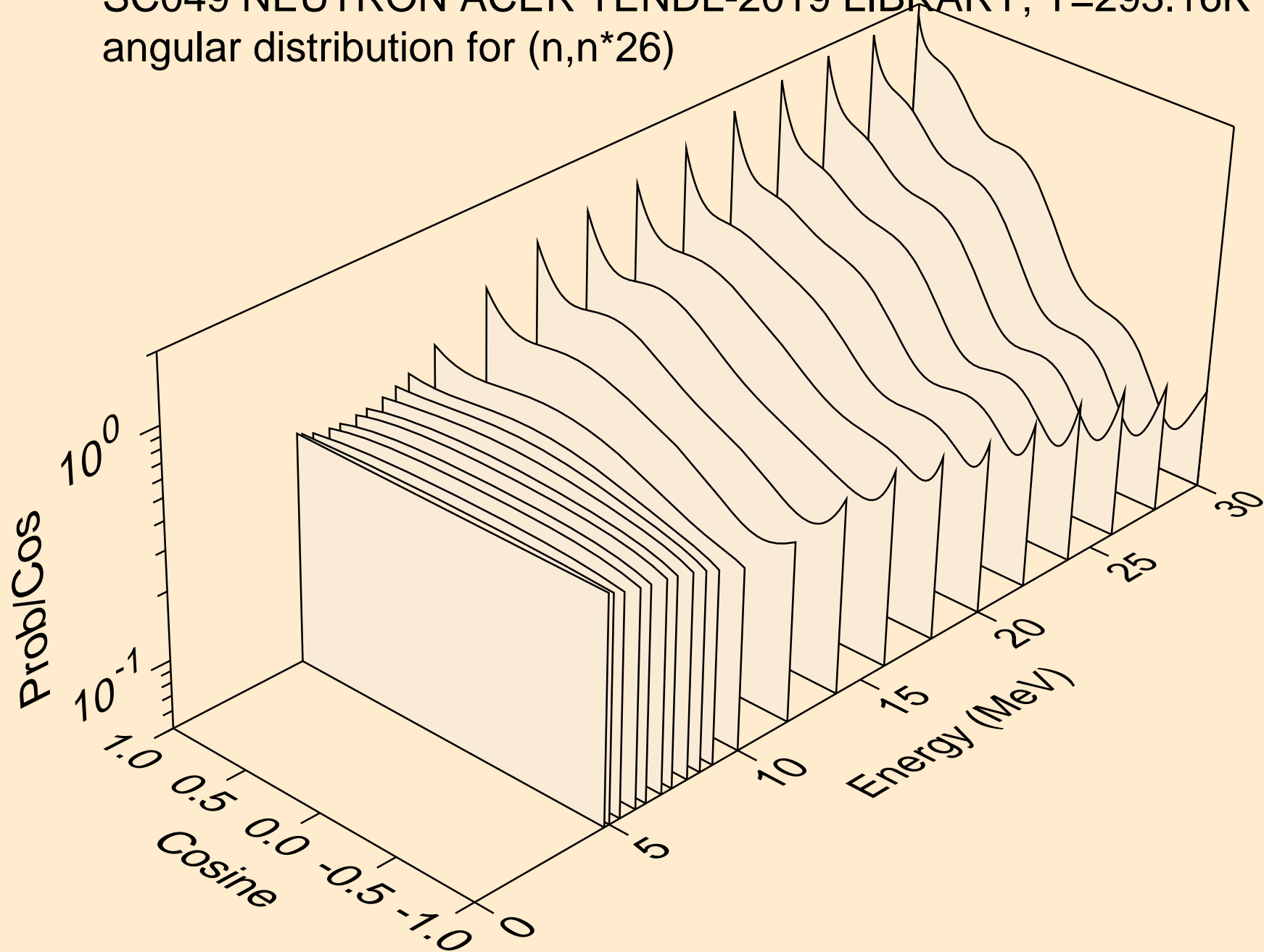

SC049 NEUTRON ACER TENDL-2019 LIBRARY; T=293.16K  
angular distribution for (n,n\*27)

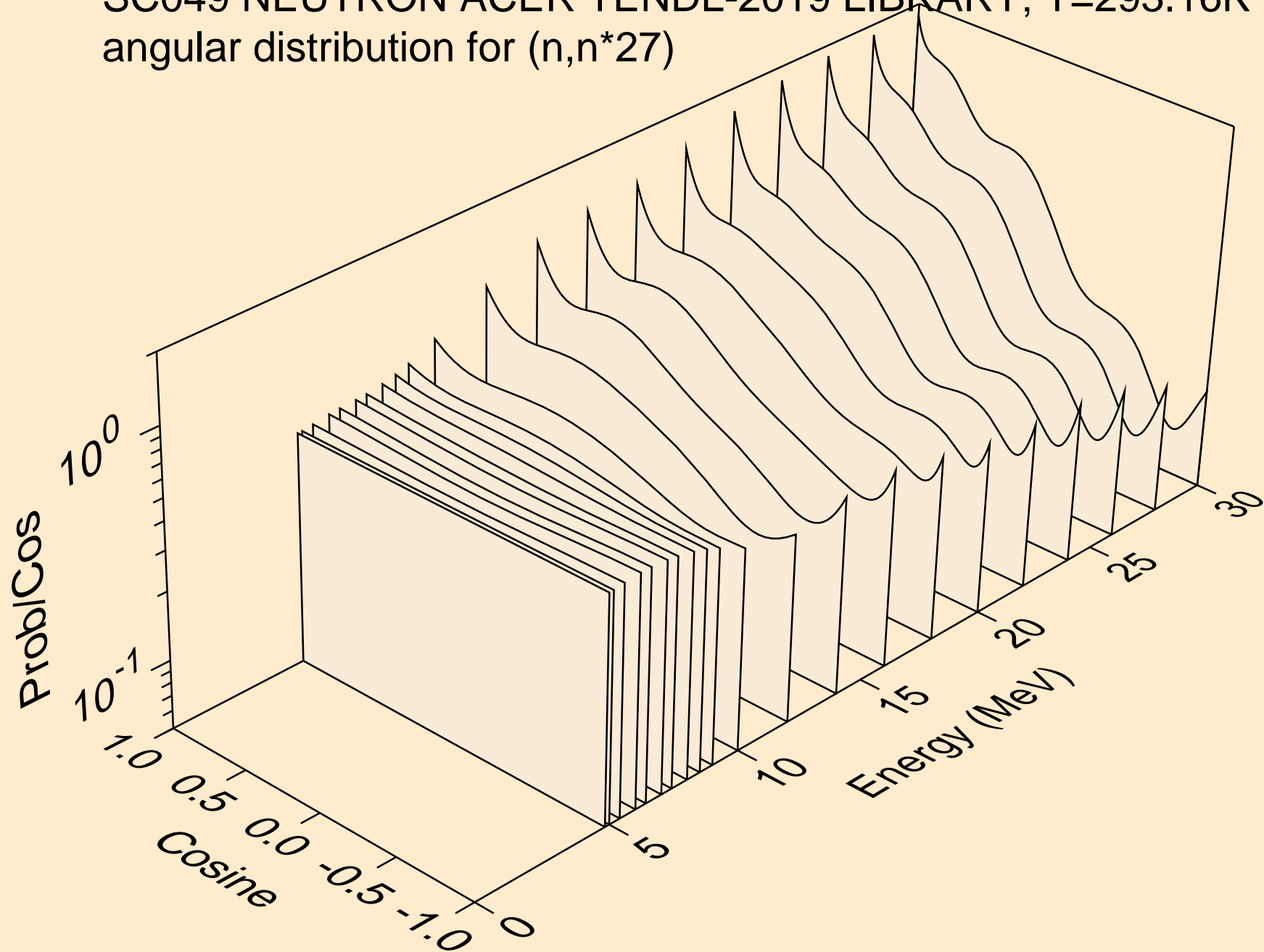

SC049 NEUTRON ACER TENDL-2019 LIBRARY; T=293.16K  
angular distribution for (n,n\*28)

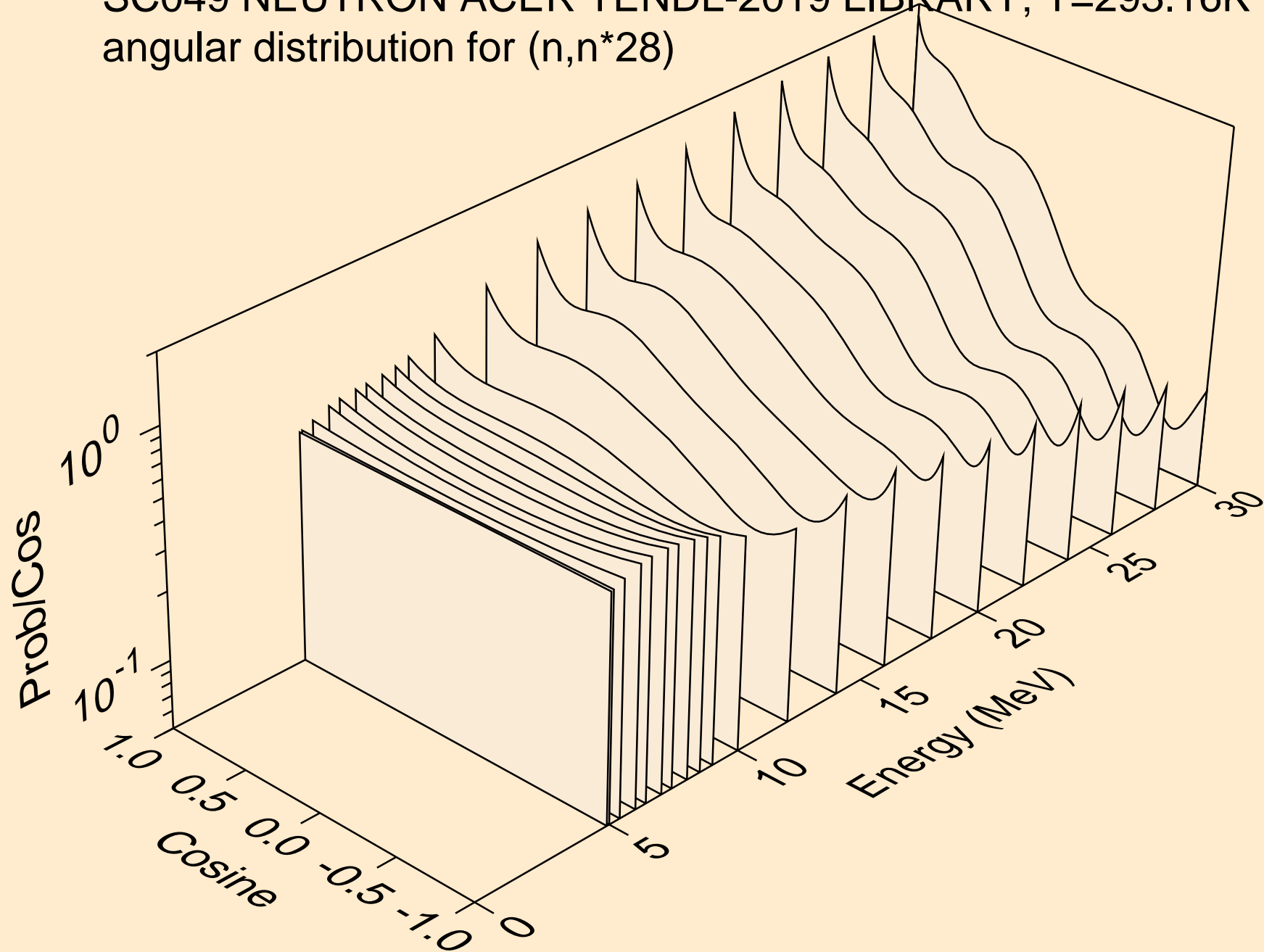

SC049 NEUTRON ACER TENDL-2019 LIBRARY; T=293.16K  
angular distribution for (n,n\*29)

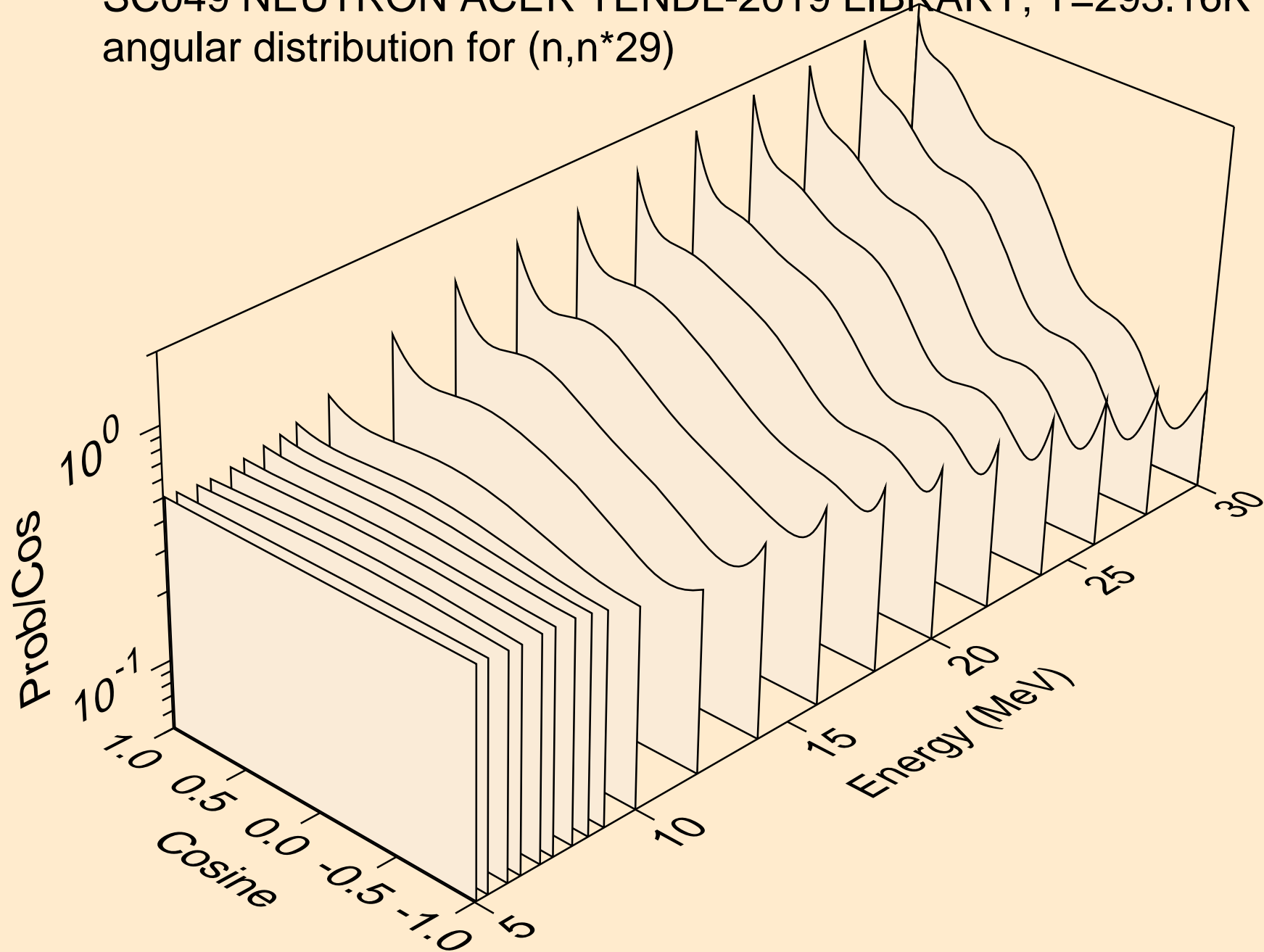

SC049 NEUTRON ACER TENDL-2019 LIBRARY; T=293.16K  
Neutron emission for (n,x)

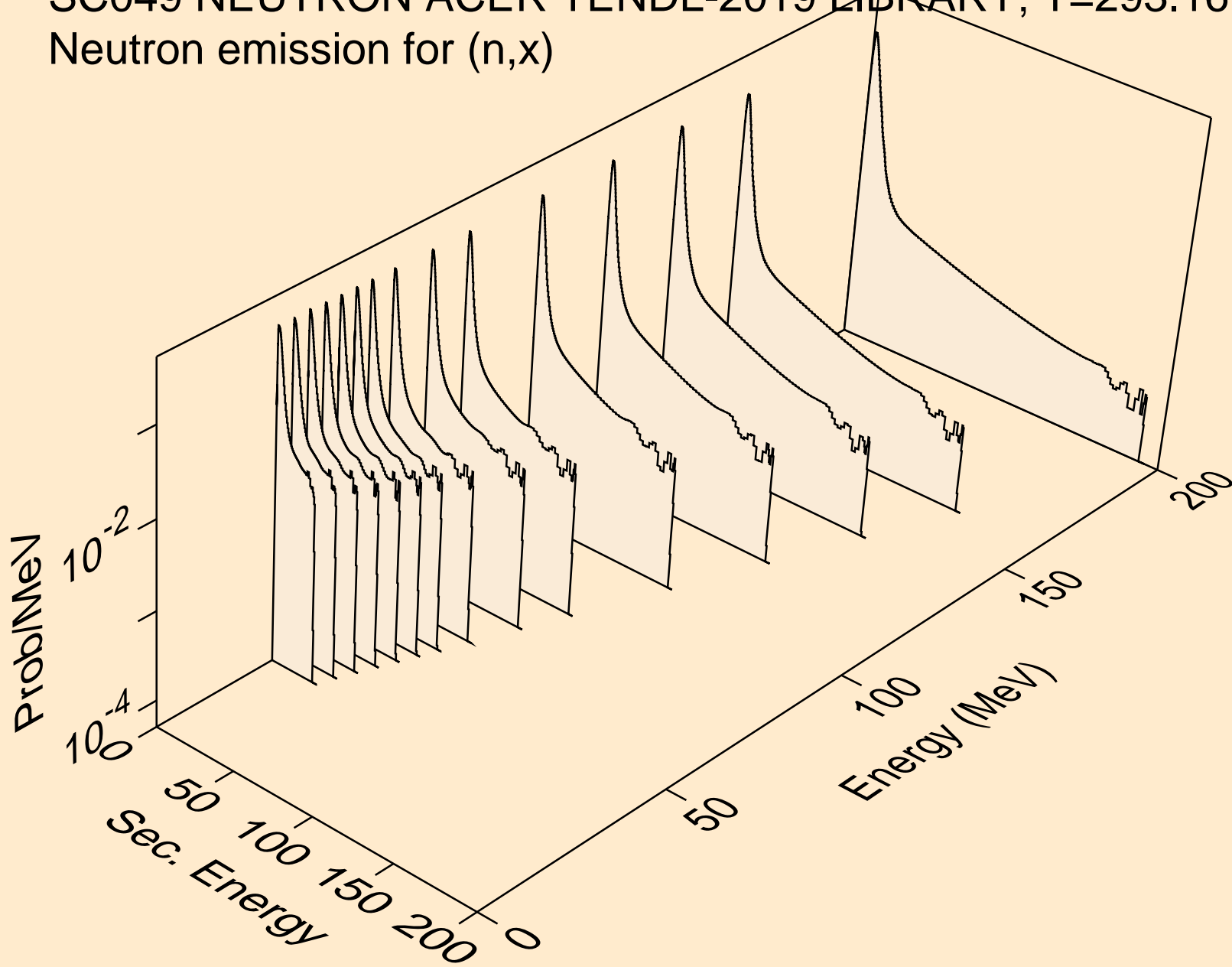

SC049 NEUTRON ACER TENDL-2019 LIBRARY; T=293.16K  
Neutron emission for (n,2nd)

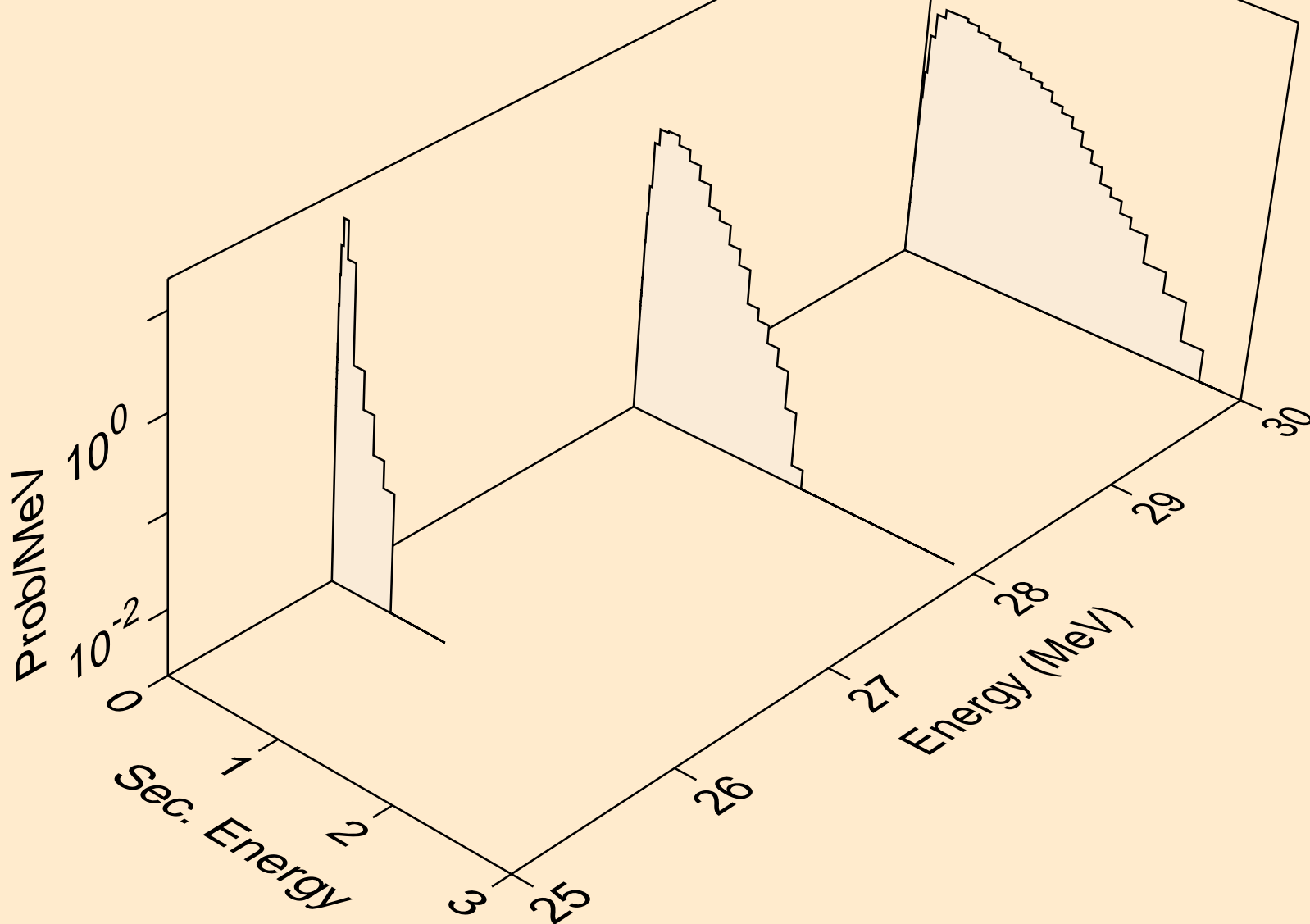

SC049 NEUTRON ACER TENDL-2019 LIBRARY; T=293.16K  
Neutron emission for (n,2n)

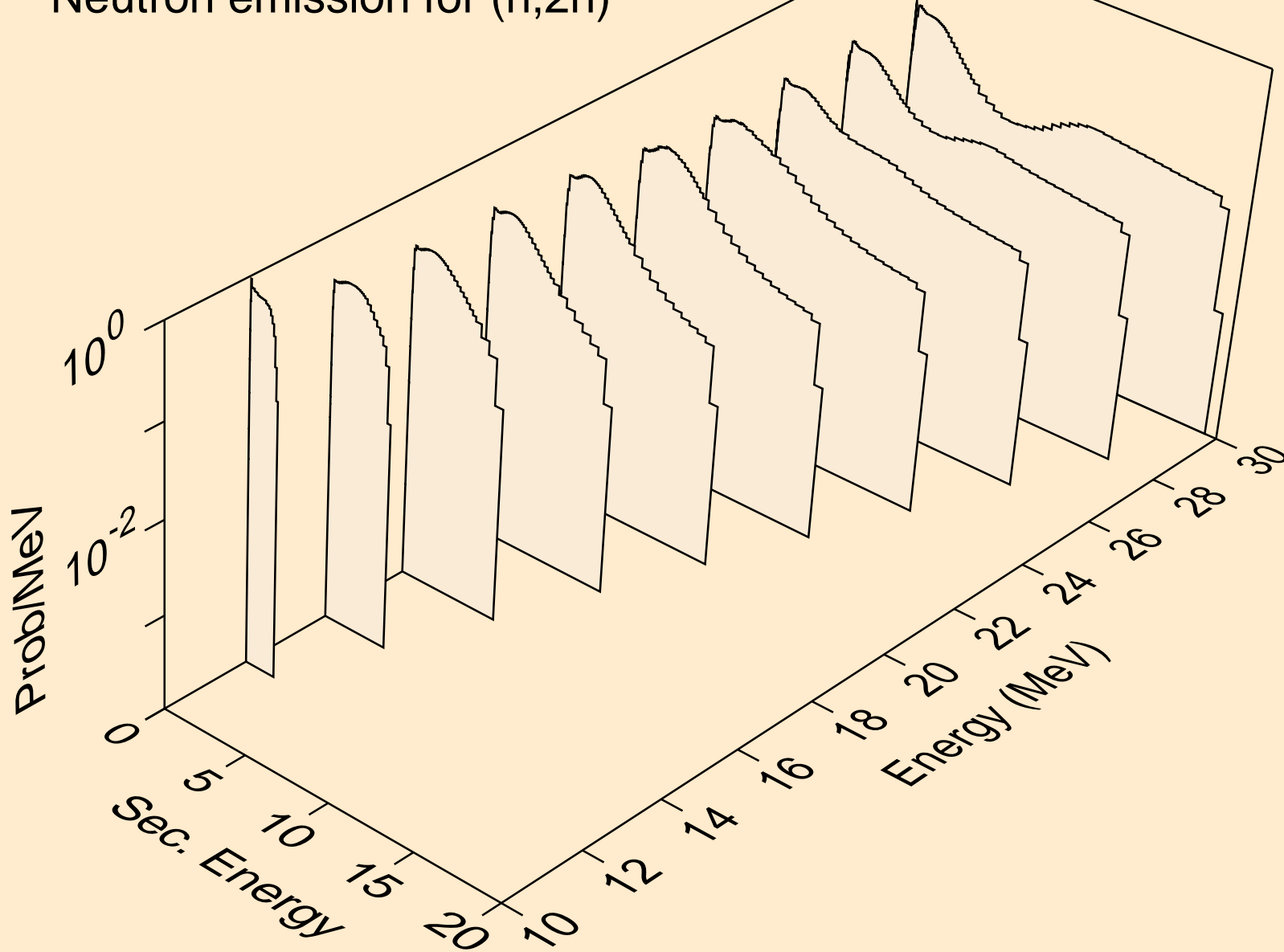

SC049 NEUTRON ACER TENDL-2019 LIBRARY; T=293.16K  
Neutron emission for (n,3n)

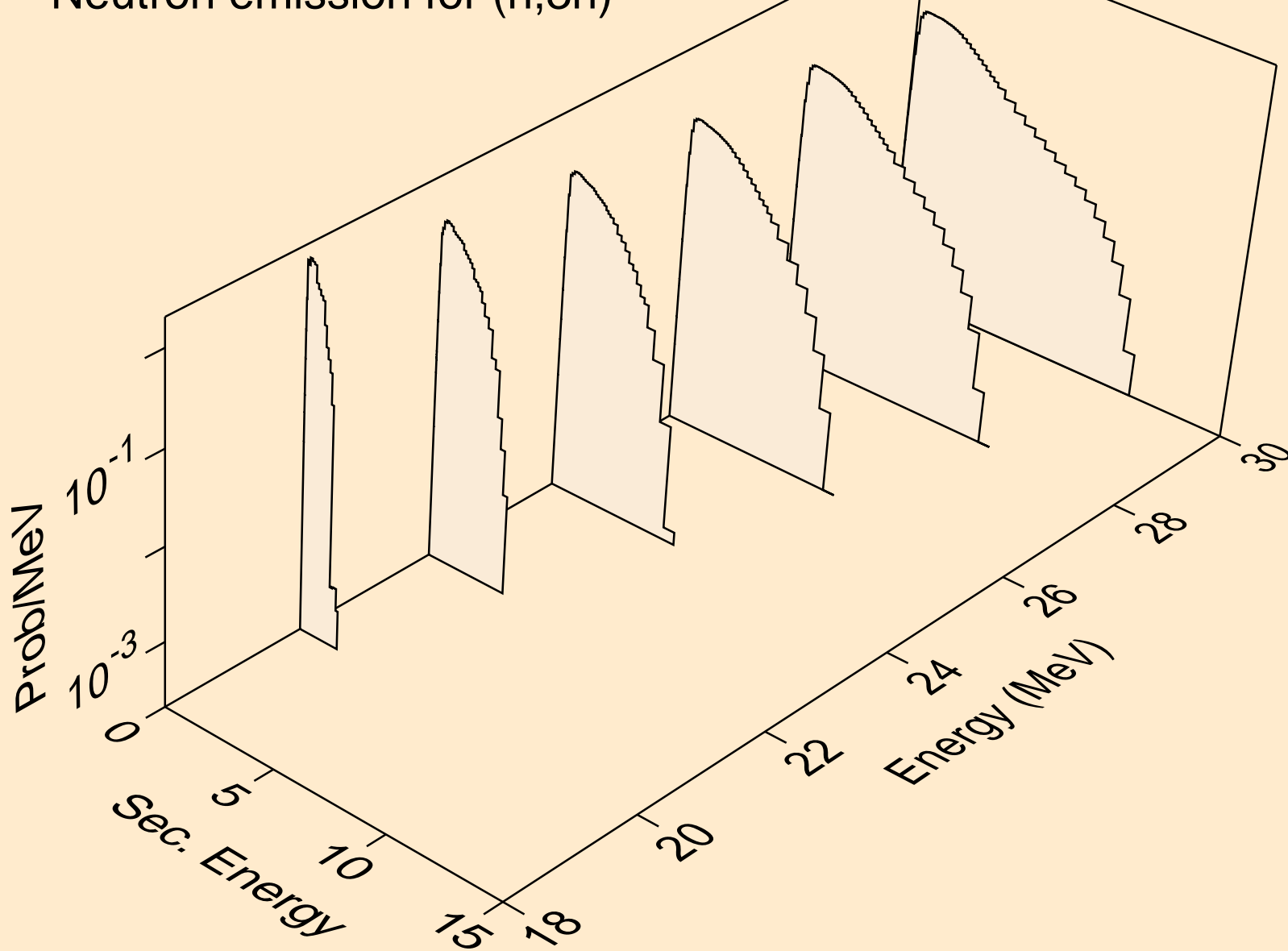

SC049 NEUTRON ACER TENDL-2019 LIBRARY; T=293.16K  
Neutron emission for (n,n\*)a

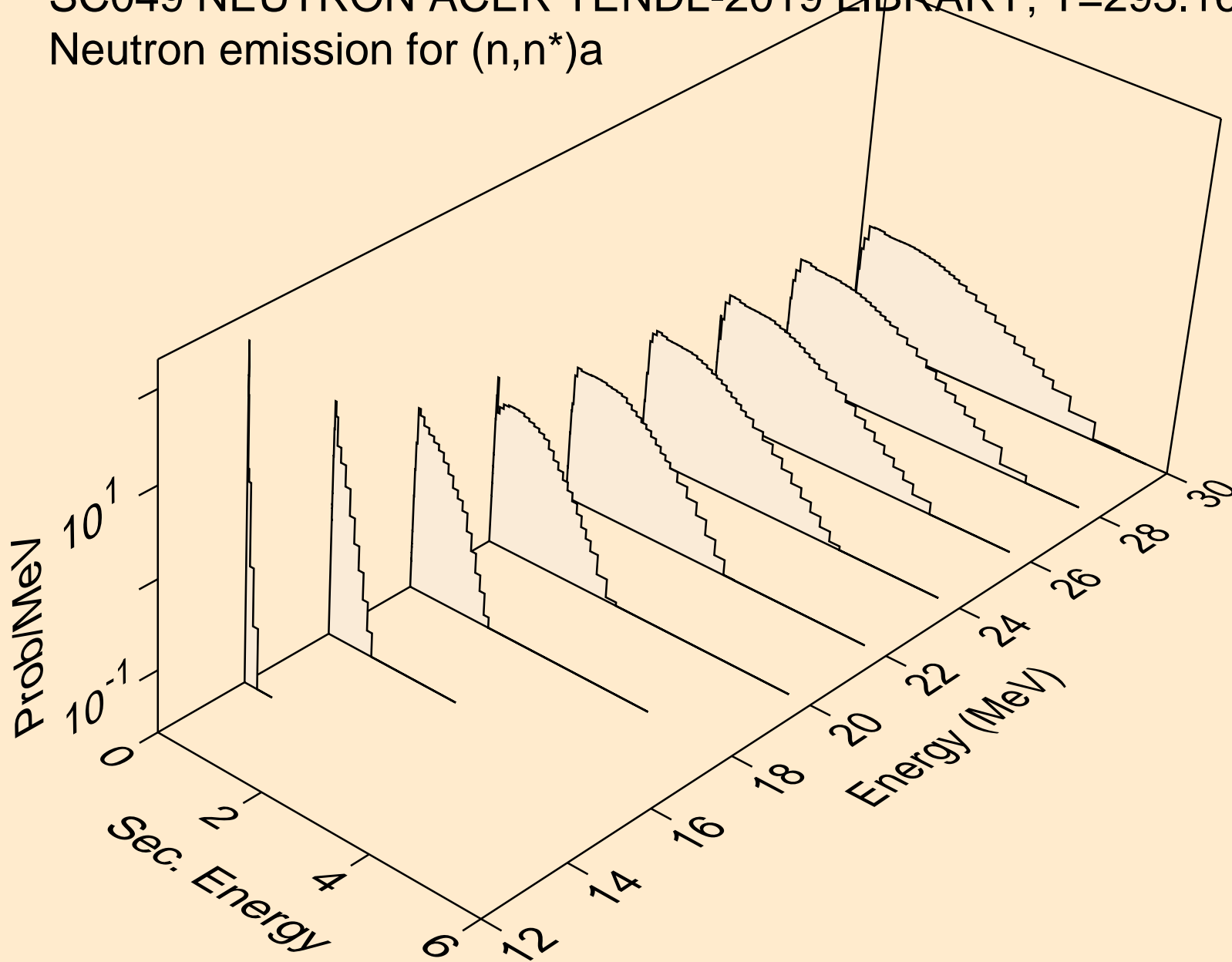

SC049 NEUTRON ACER TENDL-2019 LIBRARY; T=293.16K  
Neutron emission for (n,2n)a

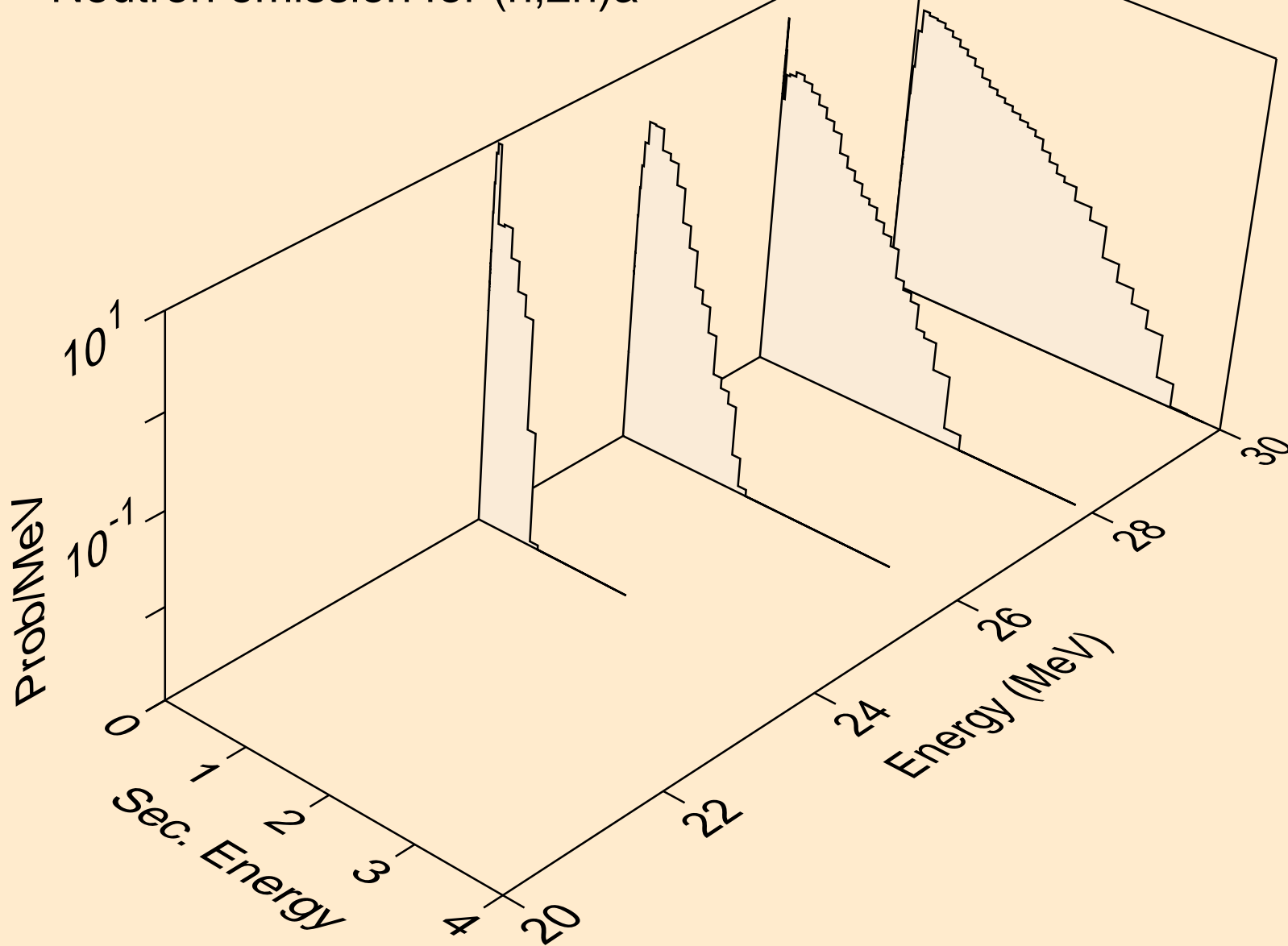

SC049 NEUTRON ACER TENDL-2019 LIBRARY; T=293.16K  
Neutron emission for (n,n\*)p

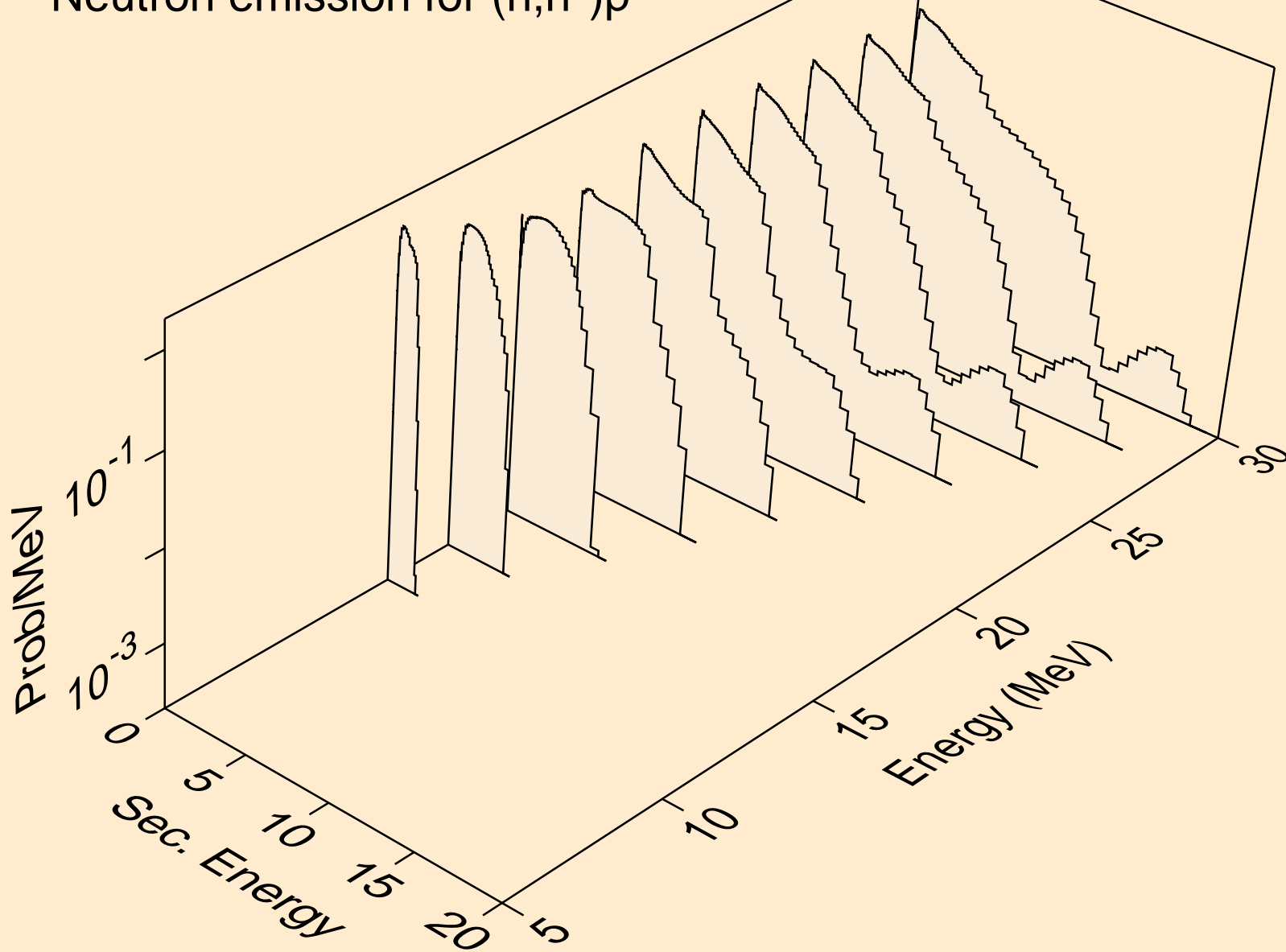

SC049 NEUTRON ACER TENDL-2019 LIBRARY; T=293.16K  
Neutron emission for (n,n\*)d

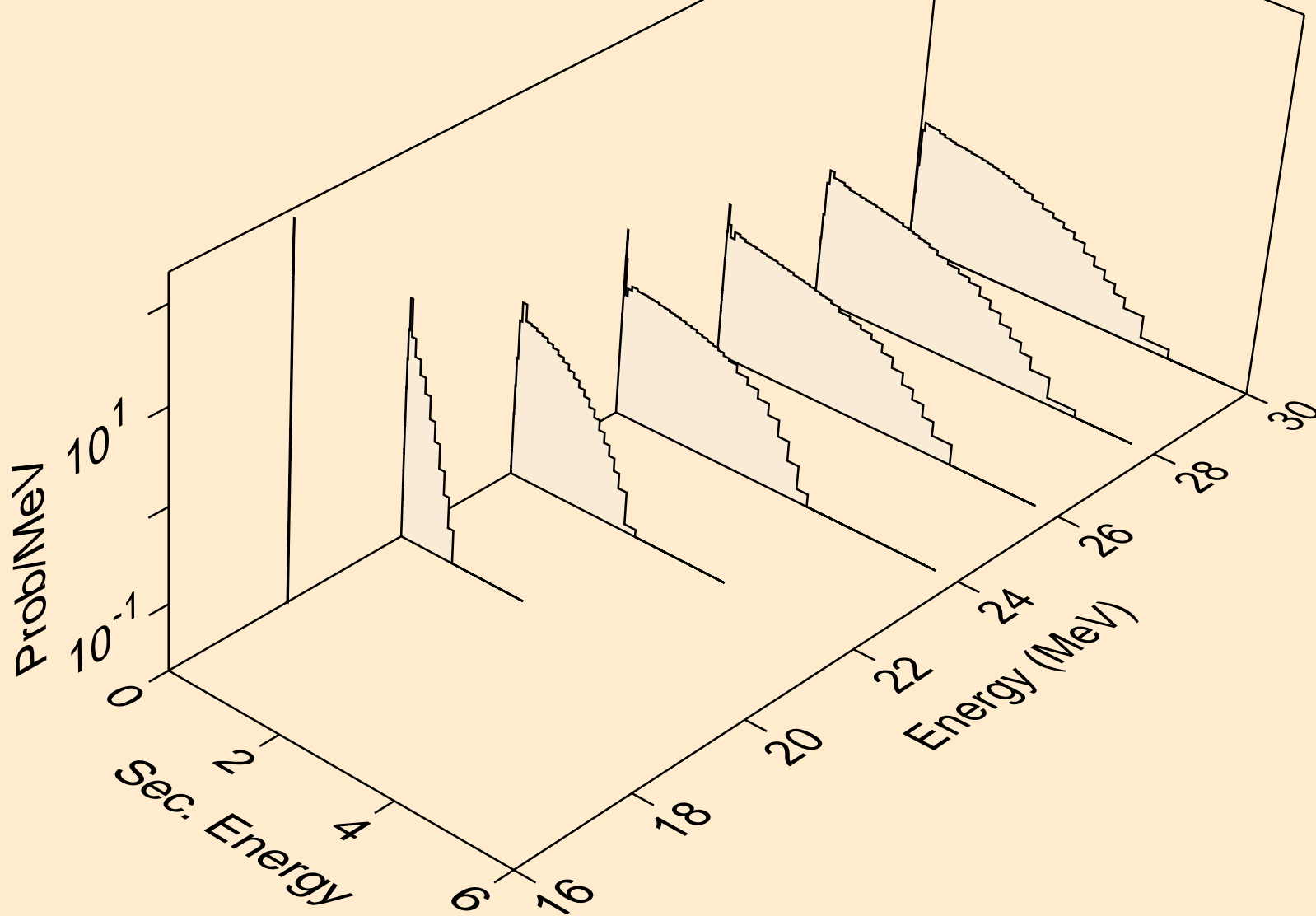

SC049 NEUTRON ACER TENDL-2019 LIBRARY; T=293.16K  
Neutron emission for (n,n\*)t

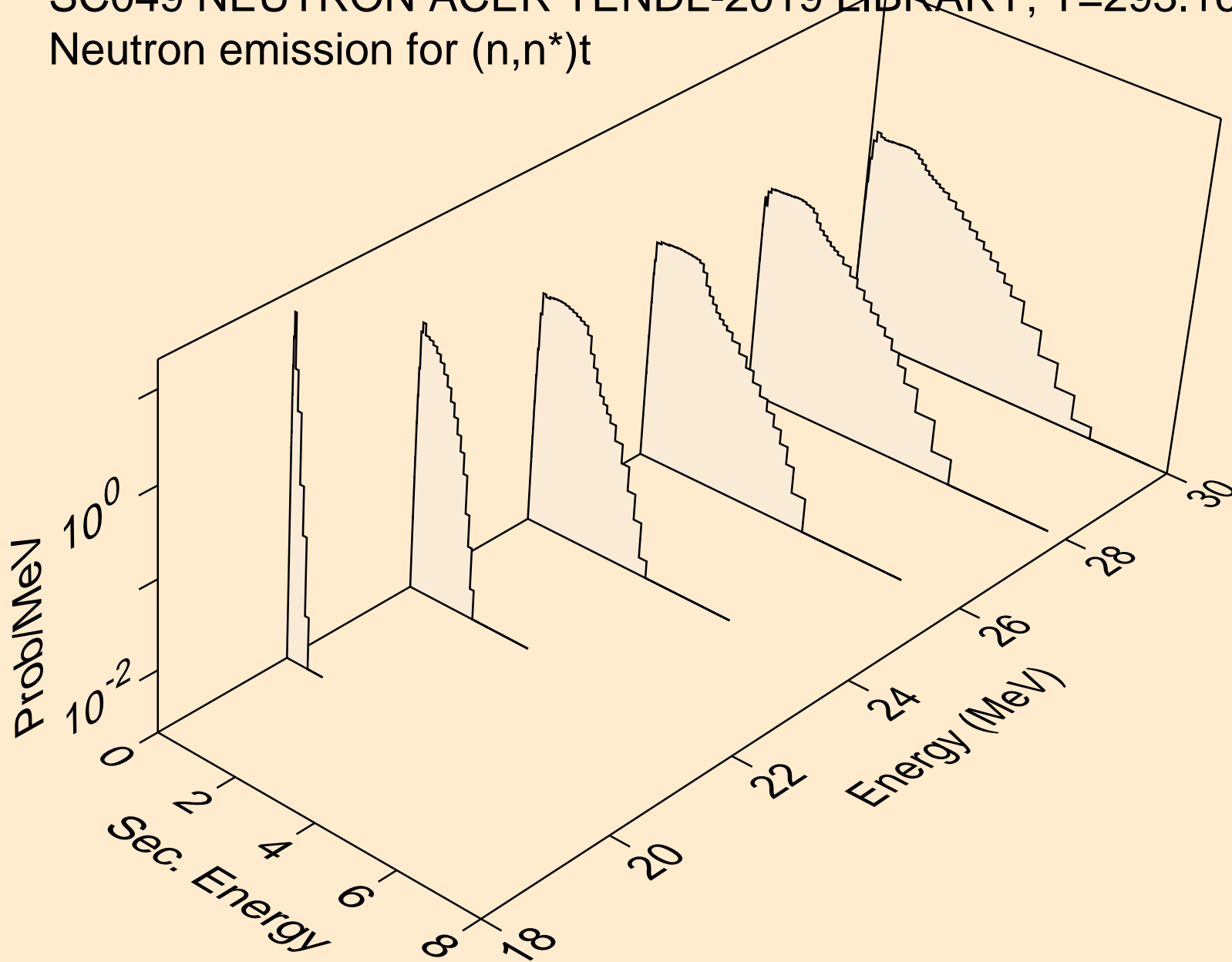

SC049 NEUTRON ACER TENDL-2019 LIBRARY; T=293.16K  
Neutron emission for (n,n\*)he3

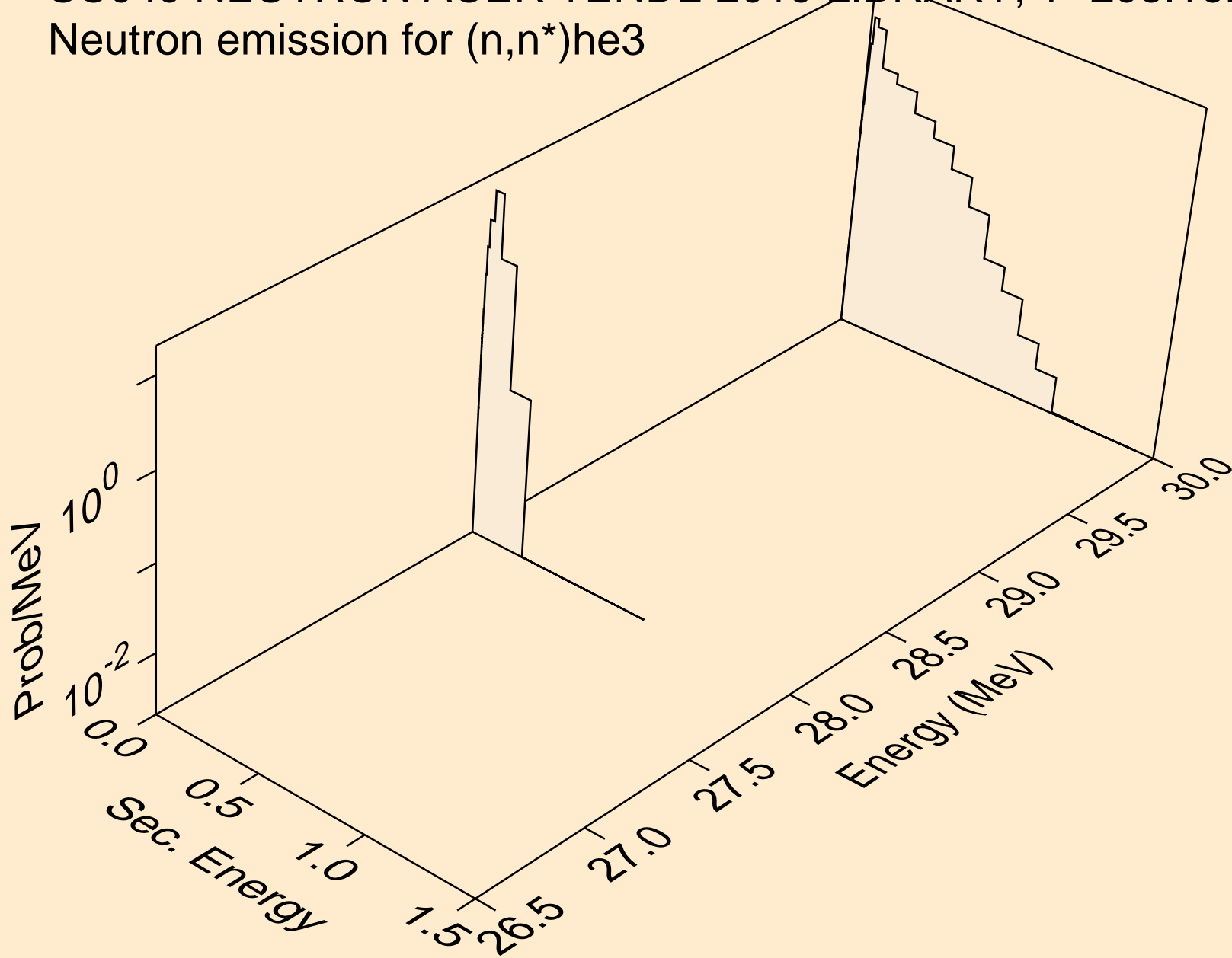

SC049 NEUTRON ACER TENDL-2019 LIBRARY; T=293.16K  
Neutron emission for (n,4n)

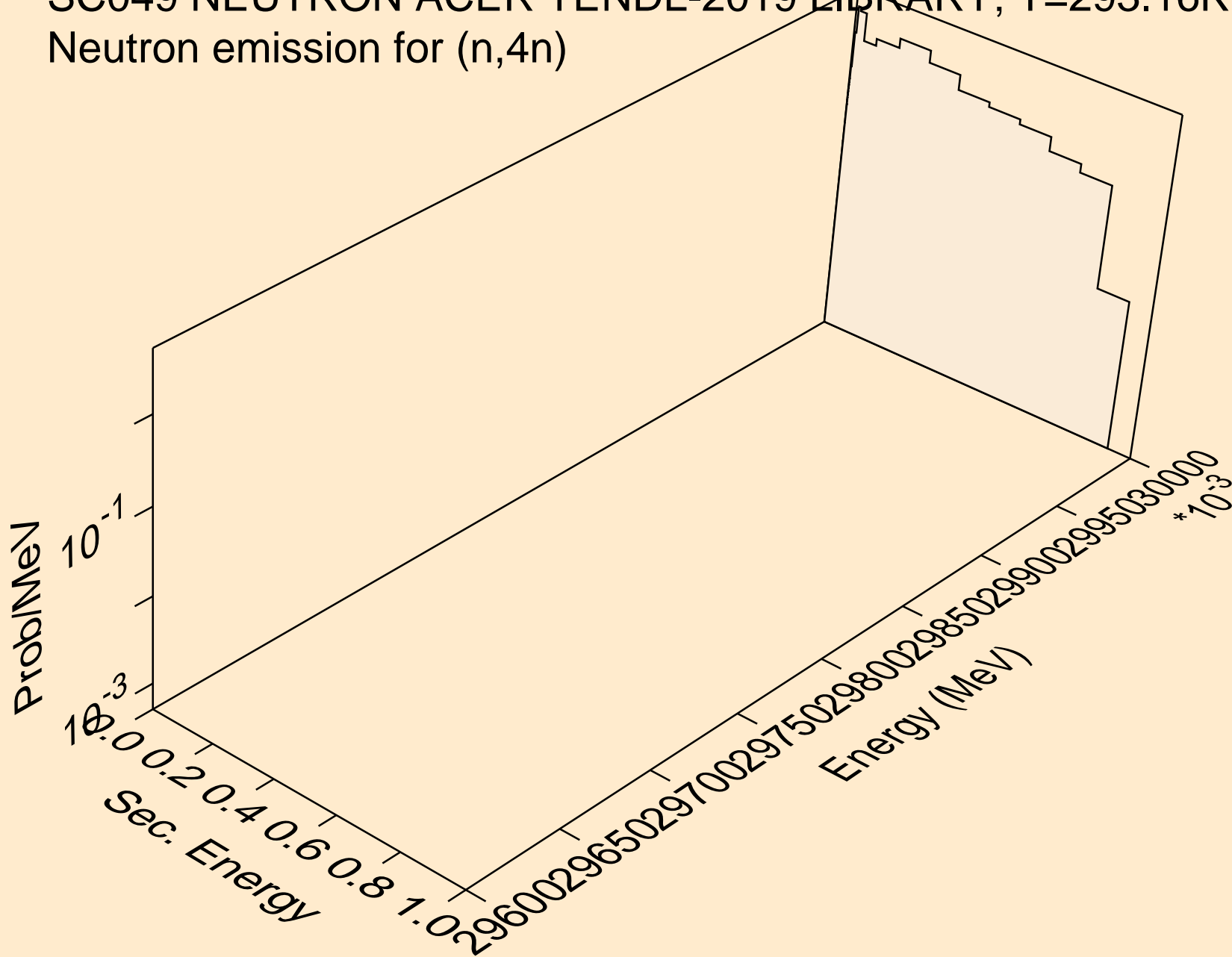

SC049 NEUTRON ACER TENDL-2019 LIBRARY; T=293.16K  
Neutron emission for (n,2np)

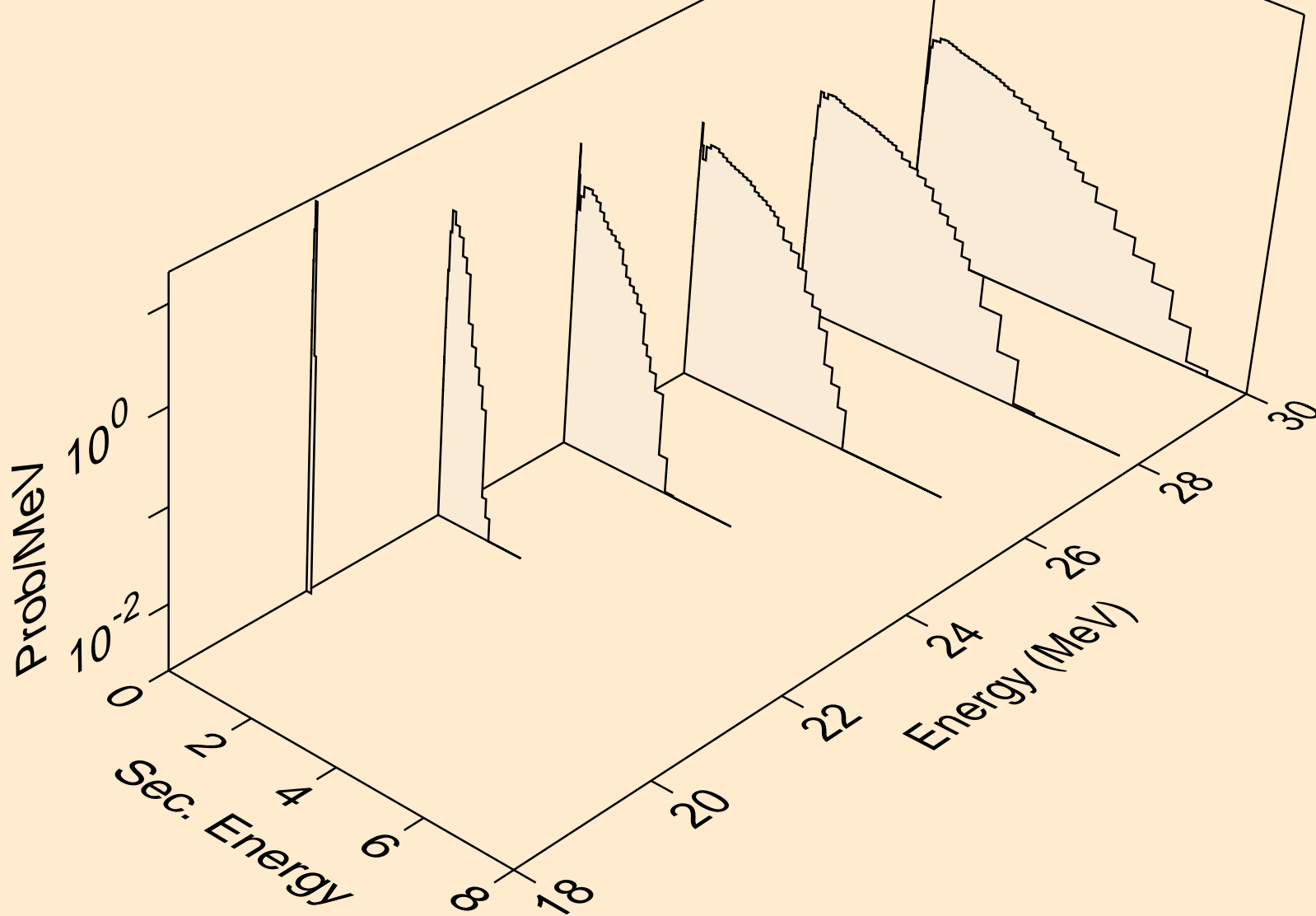

SC049 NEUTRON ACER TENDL-2019 LIBRARY; T=293.16K  
Neutron emission for (n,3np)

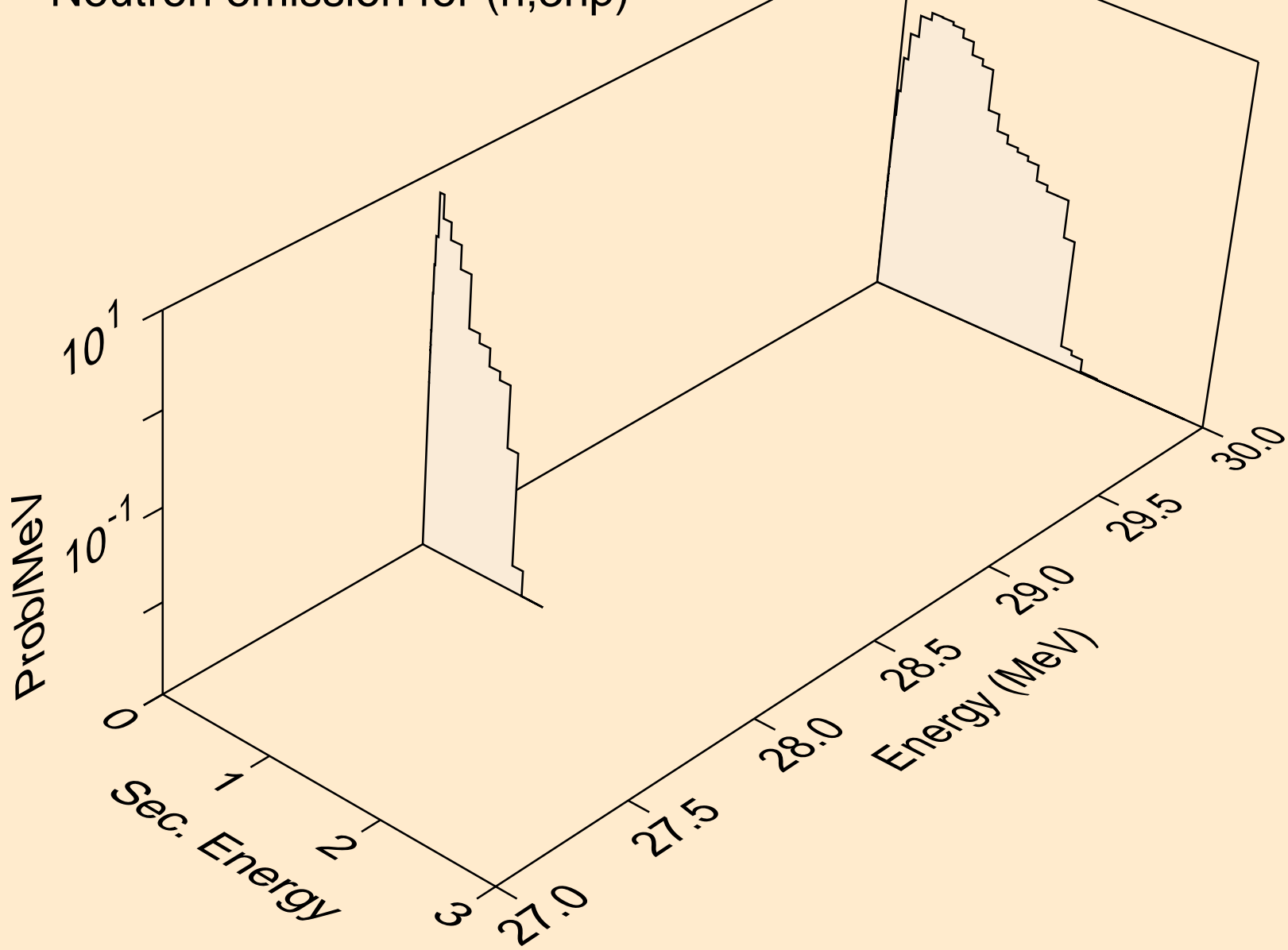

SC049 NEUTRON ACER TENDL-2019 LIBRARY; T=293.16K  
Neutron emission for (n,n\*c)

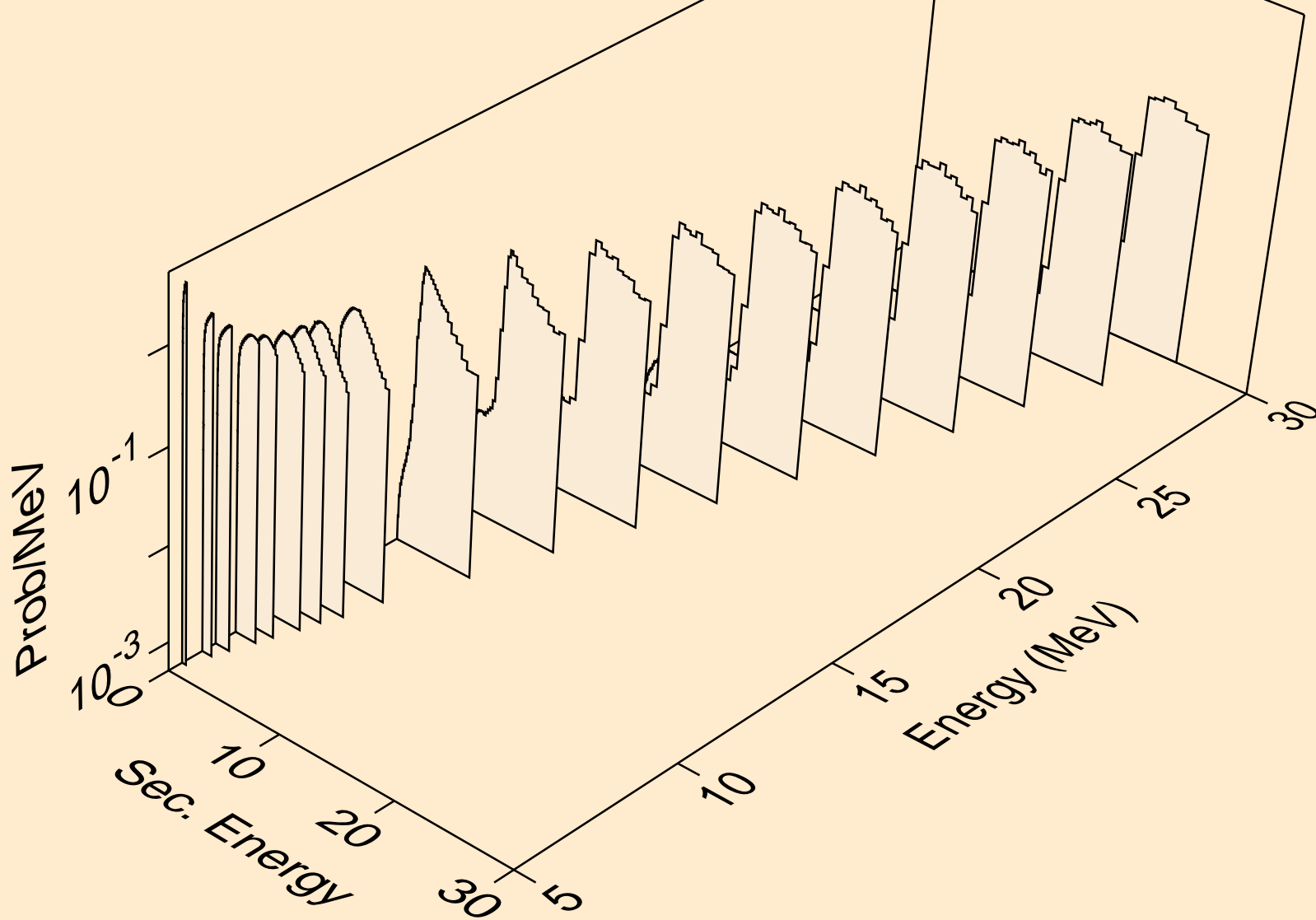

SC049 NEUTRON ACER TENDL-2019 LIBRARY; T=293.16K  
Photon emission for (n,x)

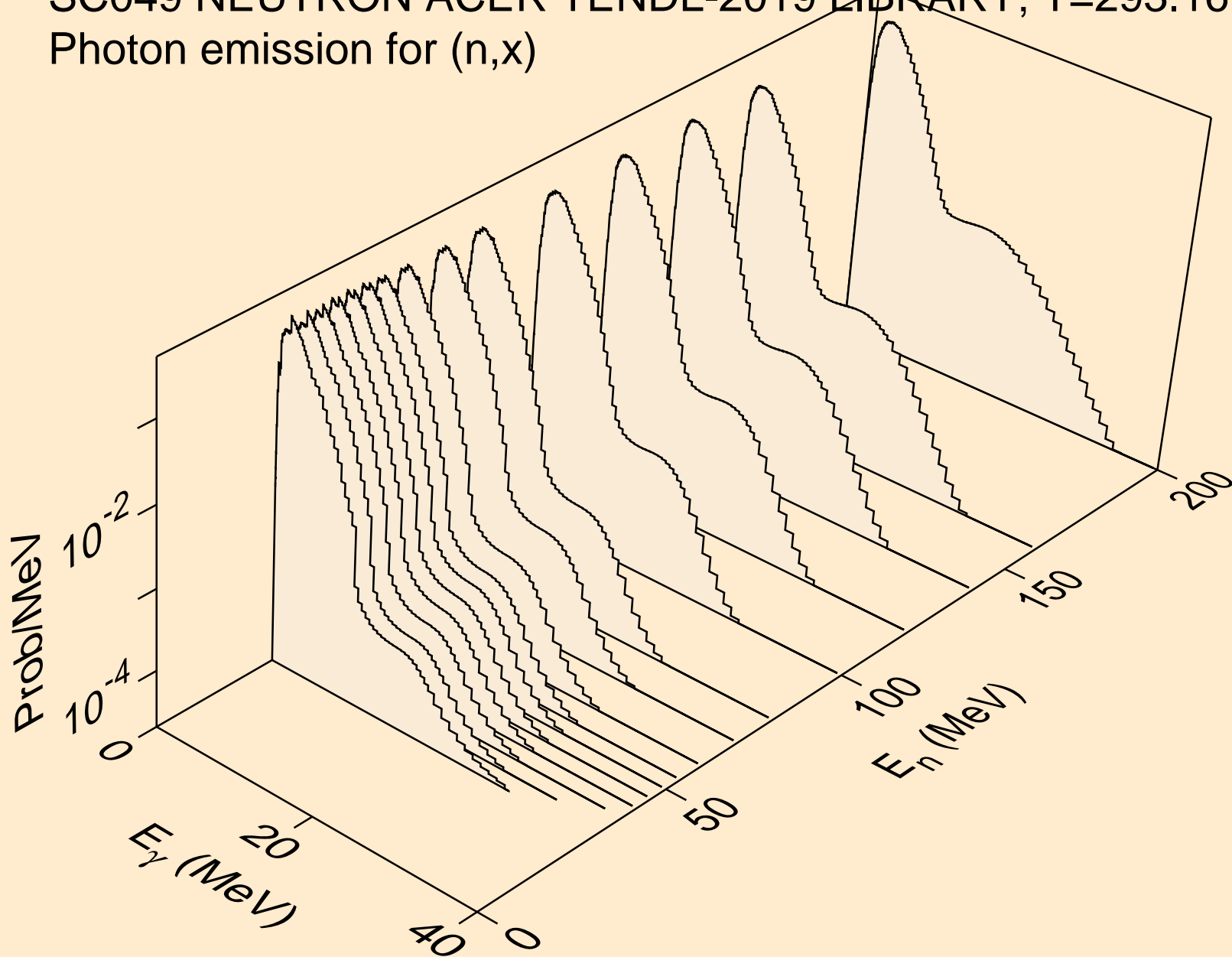

SC049 NEUTRON ACER TENDL-2019 LIBRARY; T=293.16K  
Photon emission for (n,2nd)

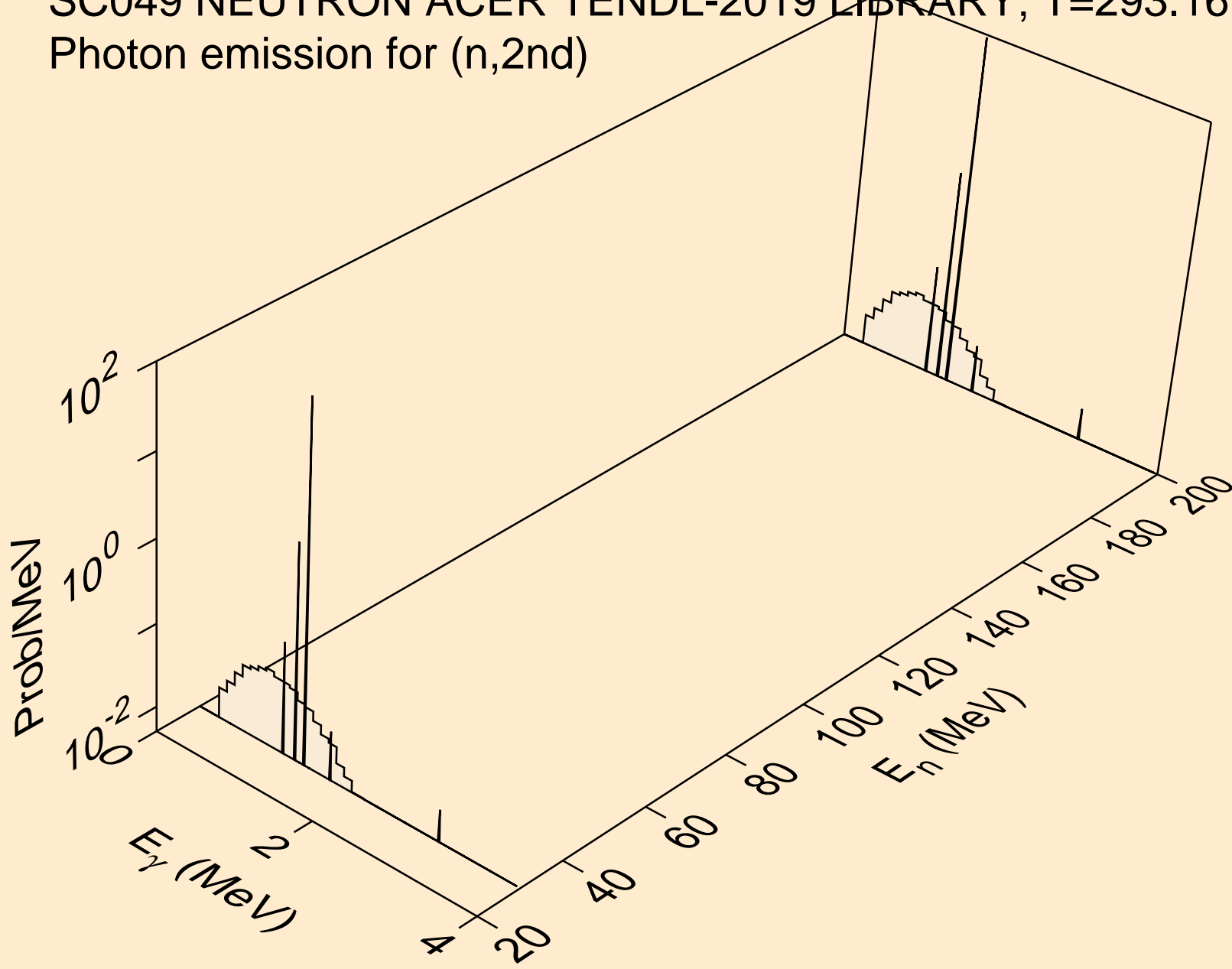

SC049 NEUTRON ACER TENDL-2019 LIBRARY; T=293.16K  
Photon emission for (n,2n)

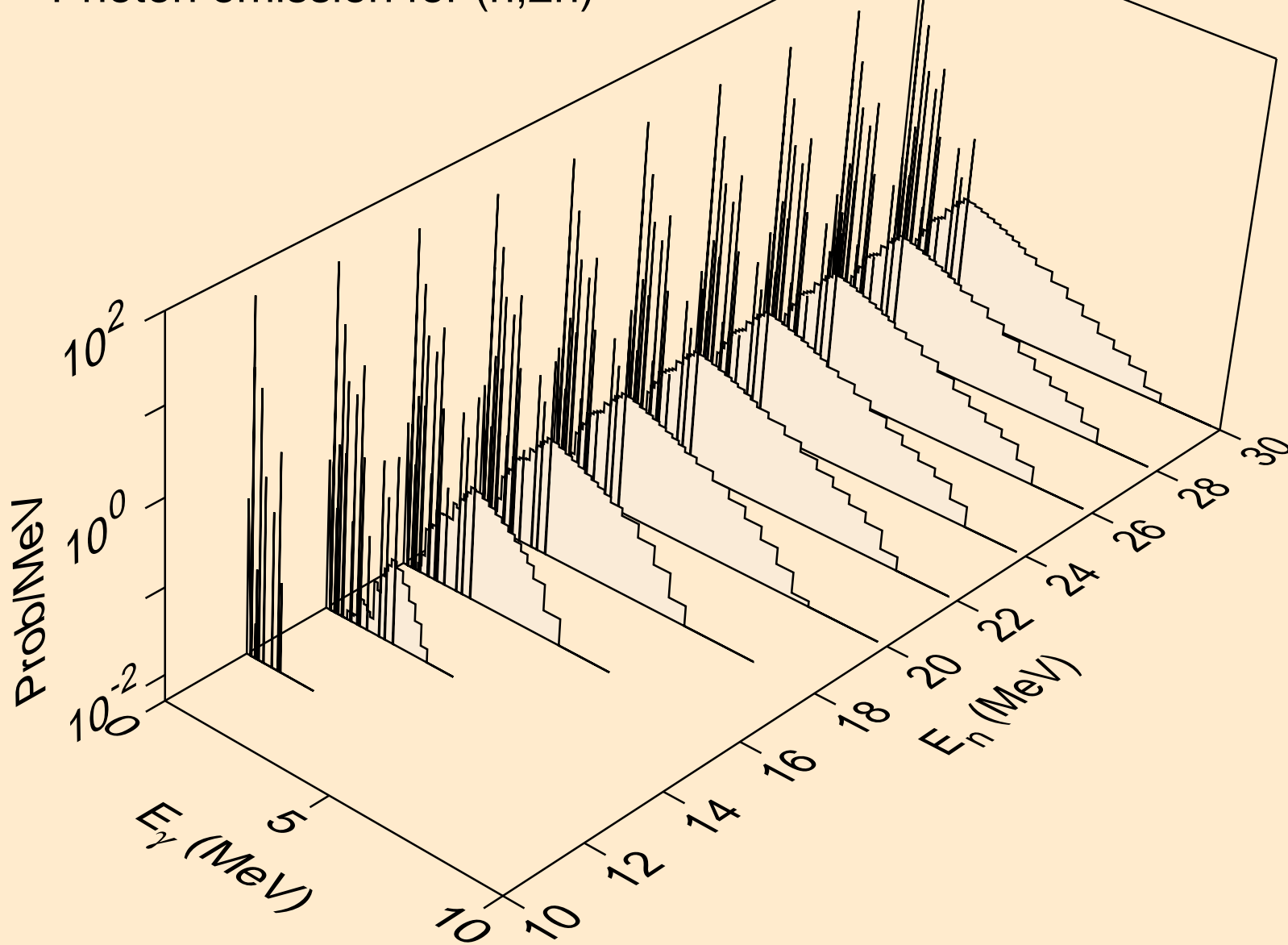

SC049 NEUTRON ACER TENDL-2019 LIBRARY; T=293.16K  
Photon emission for (n,3n)

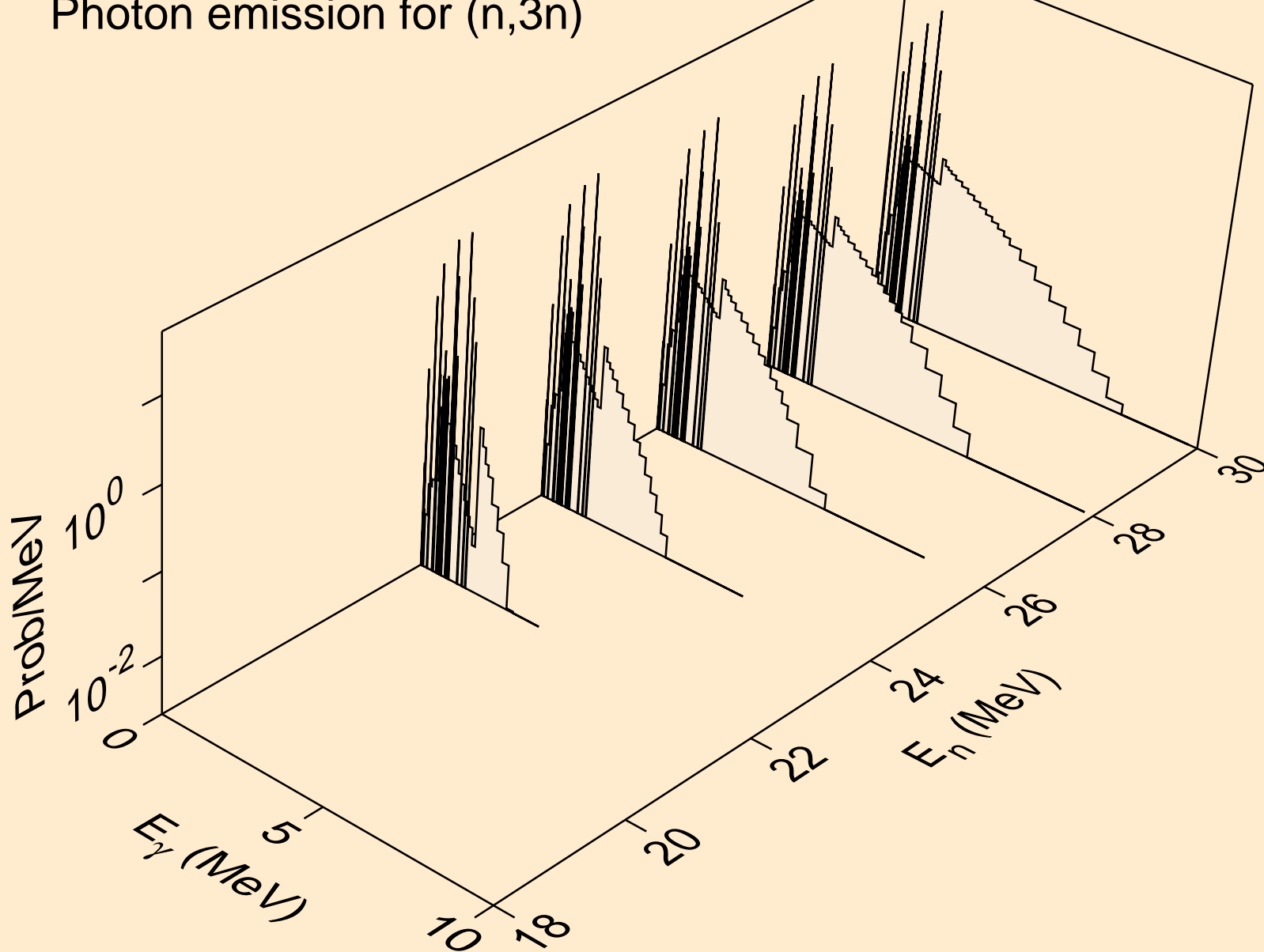

SC049 NEUTRON ACER TENDL-2019 LIBRARY; T=293.16K  
Photon emission for (n,n\*)a

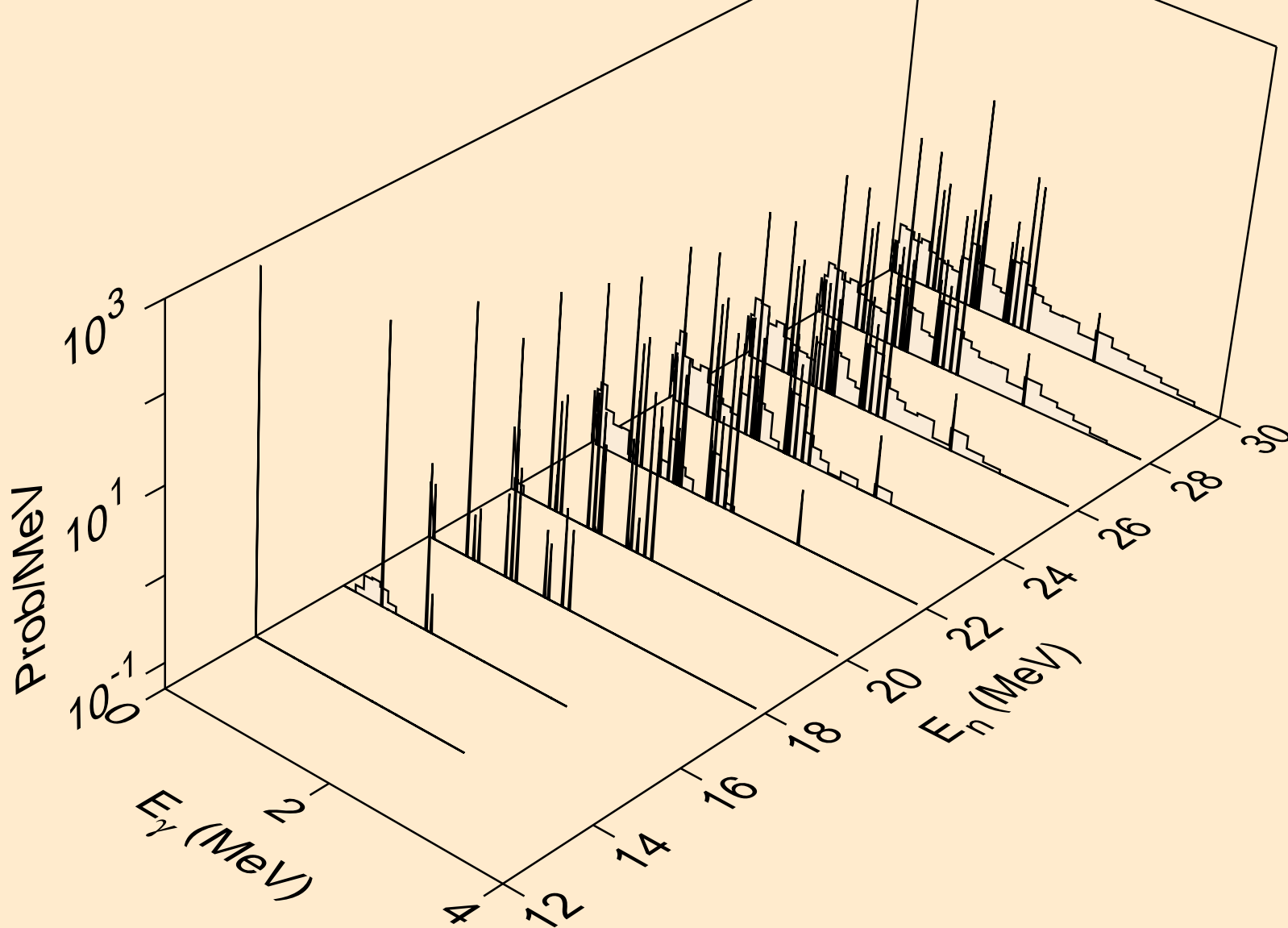

SC049 NEUTRON ACER TENDL-2019 LIBRARY; T=293.16K  
Photon emission for (n,2n)a

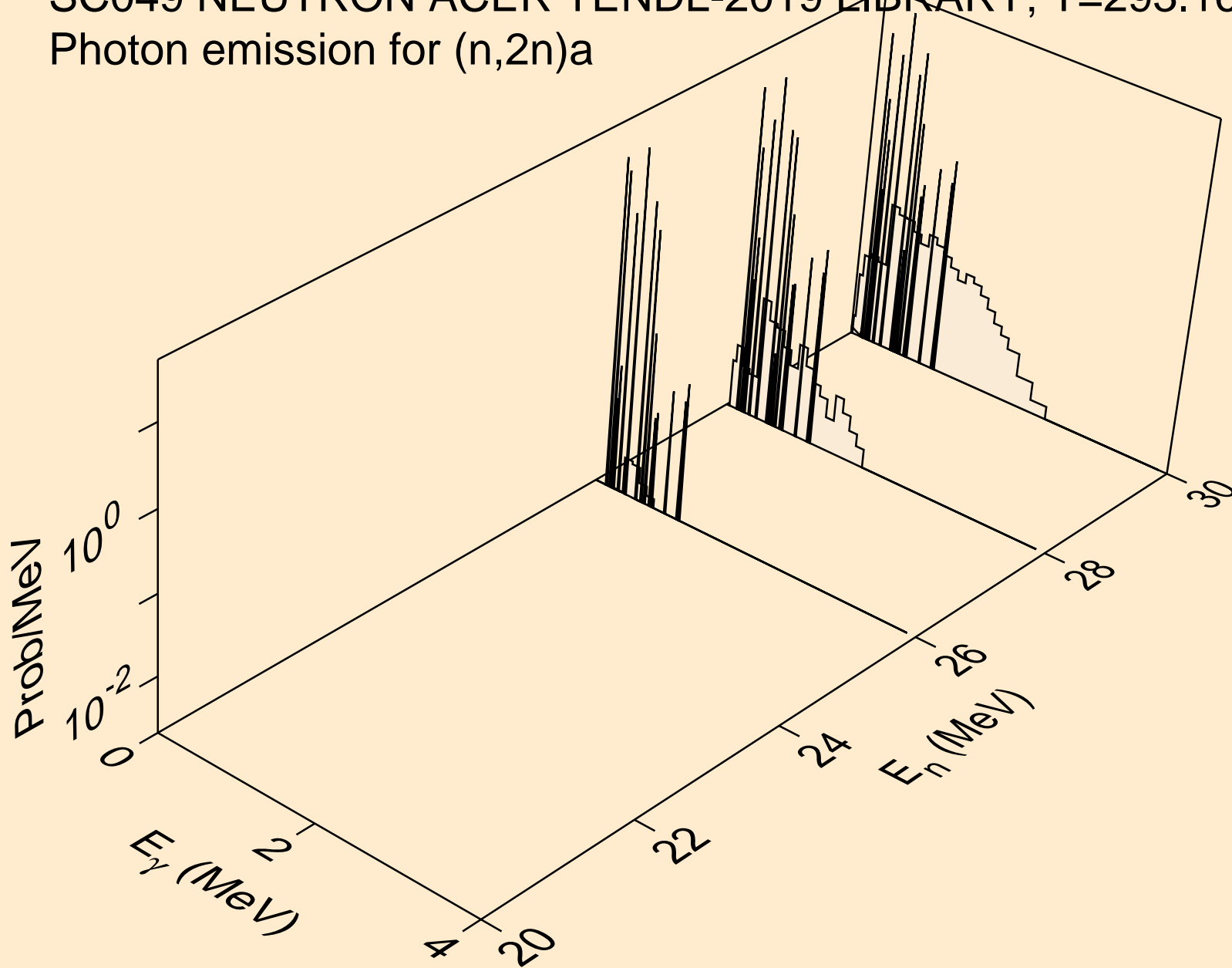

SC049 NEUTRON ACER TENDL-2019 LIBRARY; T=293.16K  
Photon emission for (n,n\*)p

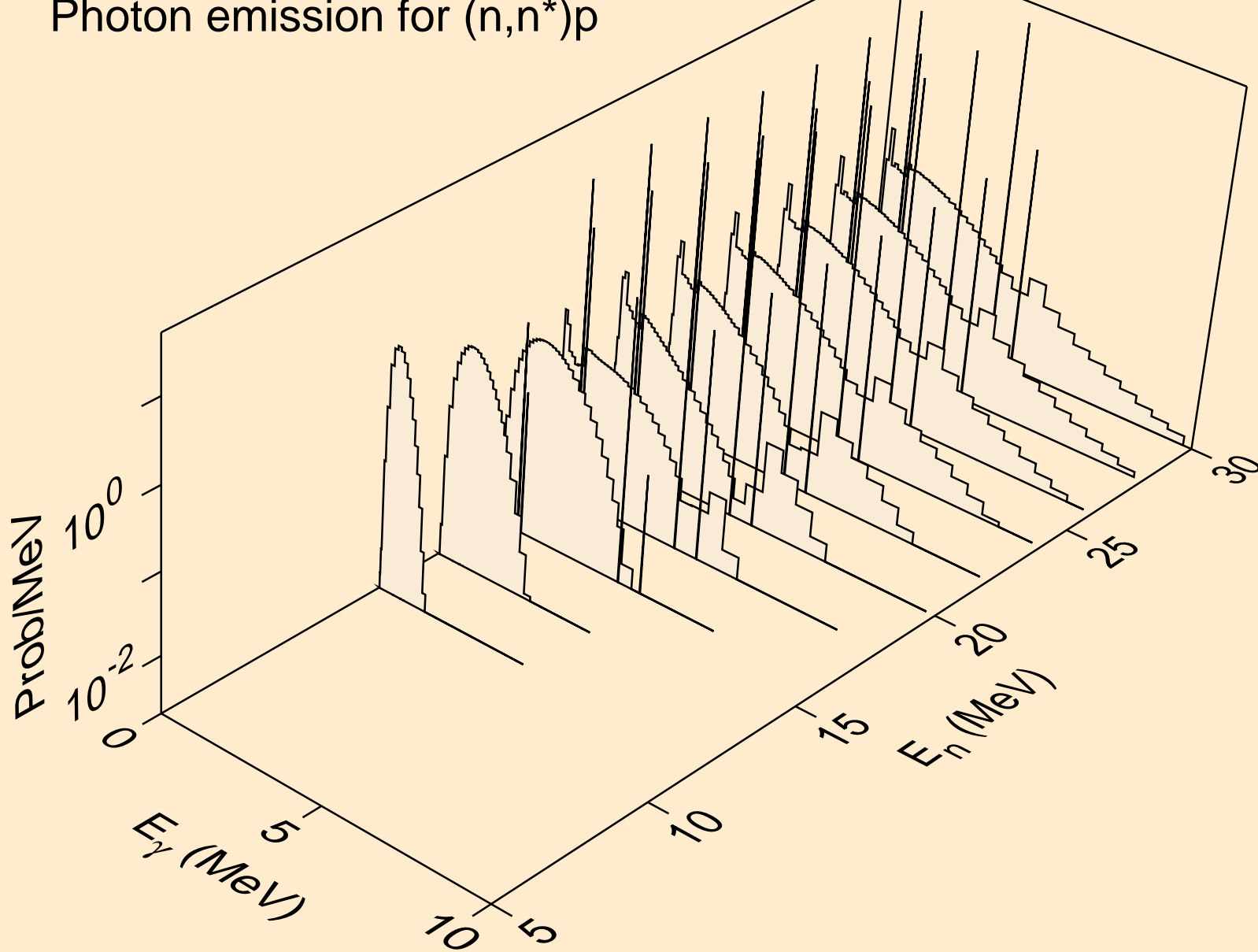

SC049 NEUTRON ACER TENDL-2019 LIBRARY; T=293.16K  
Photon emission for (n,n\*)d

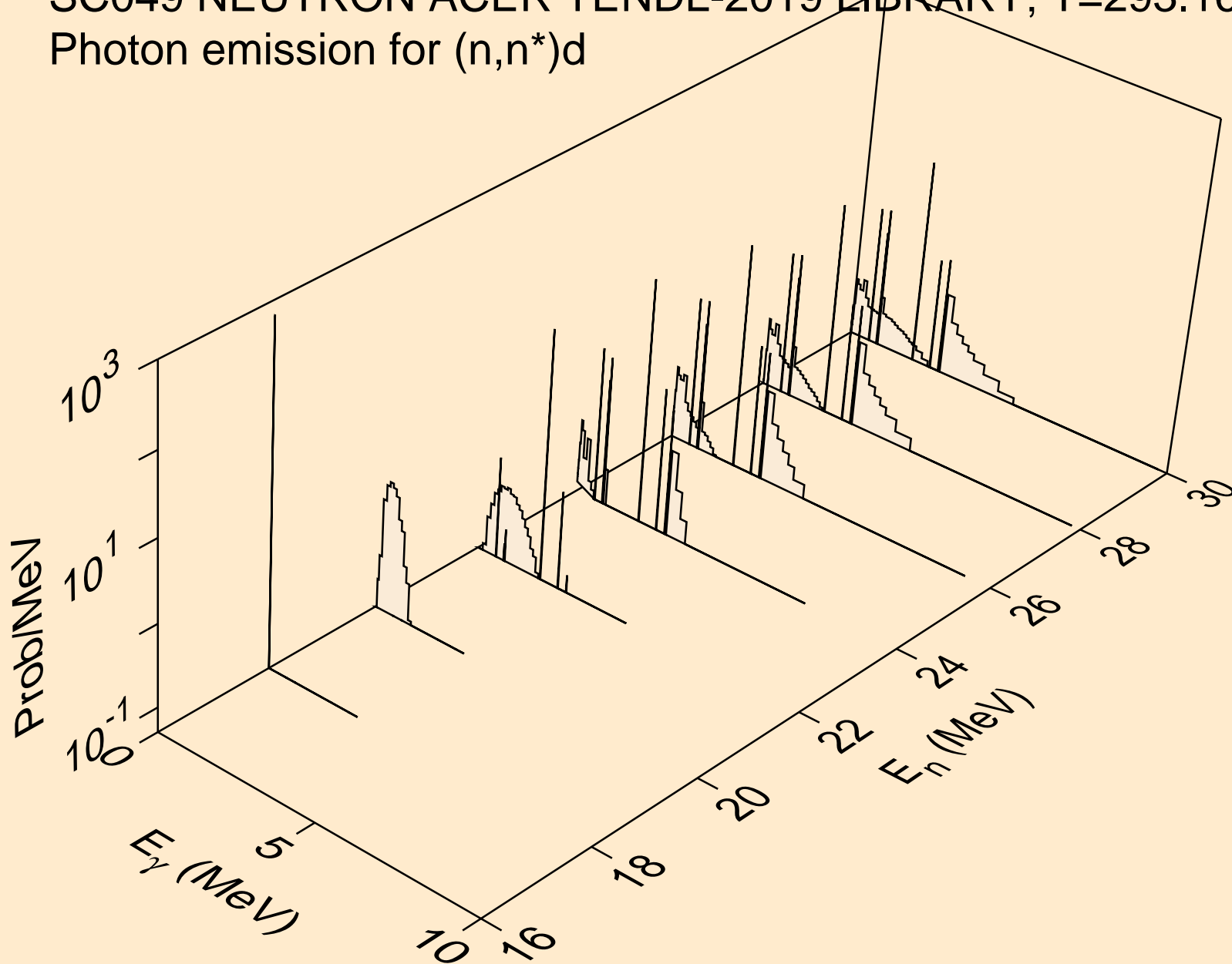

SC049 NEUTRON ACER TENDL-2019 LIBRARY; T=293.16K  
Photon emission for (n,n\*)t

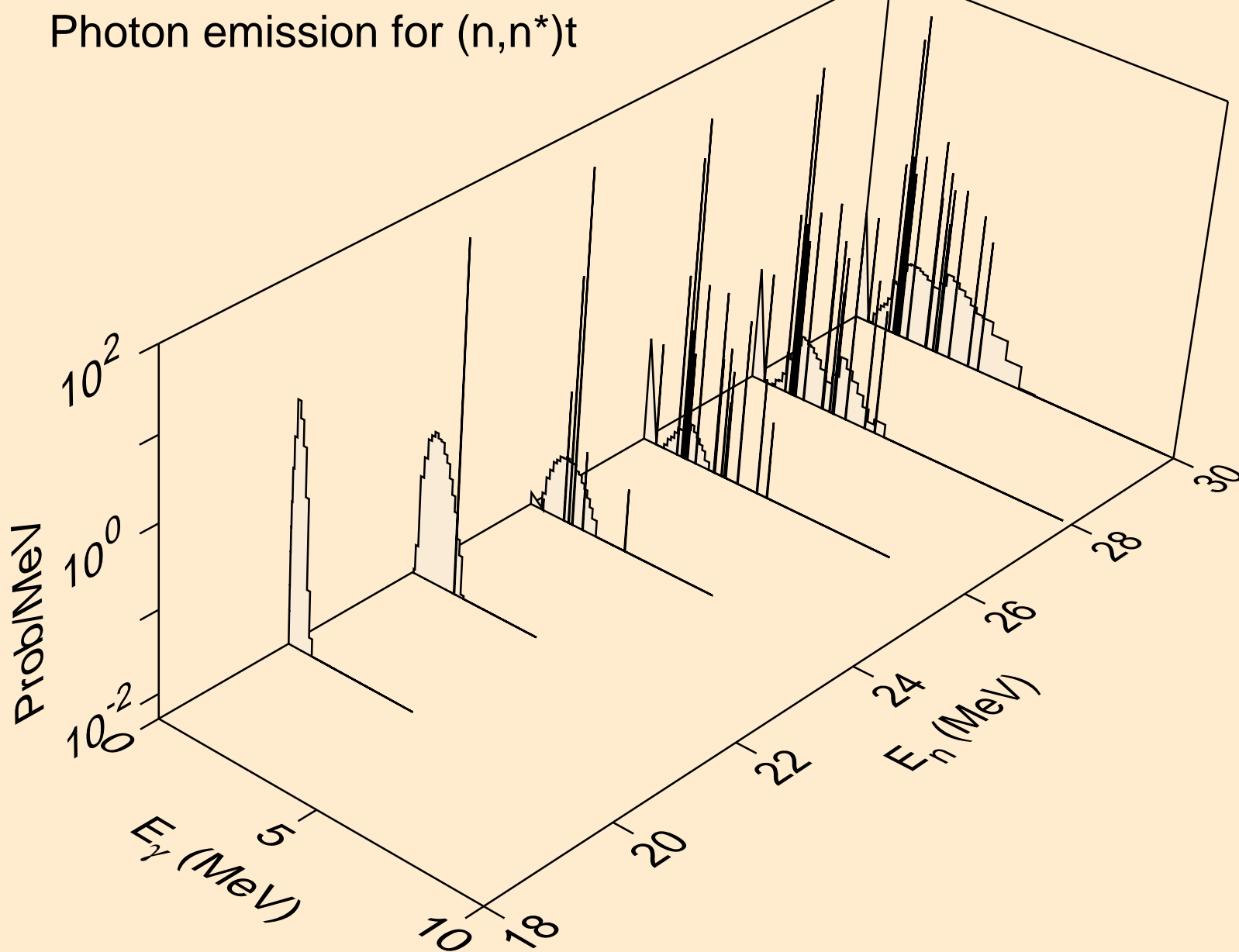

SC049 NEUTRON ACER TENDL-2019 LIBRARY; T=293.16K  
Photon emission for (n,n\*)he3

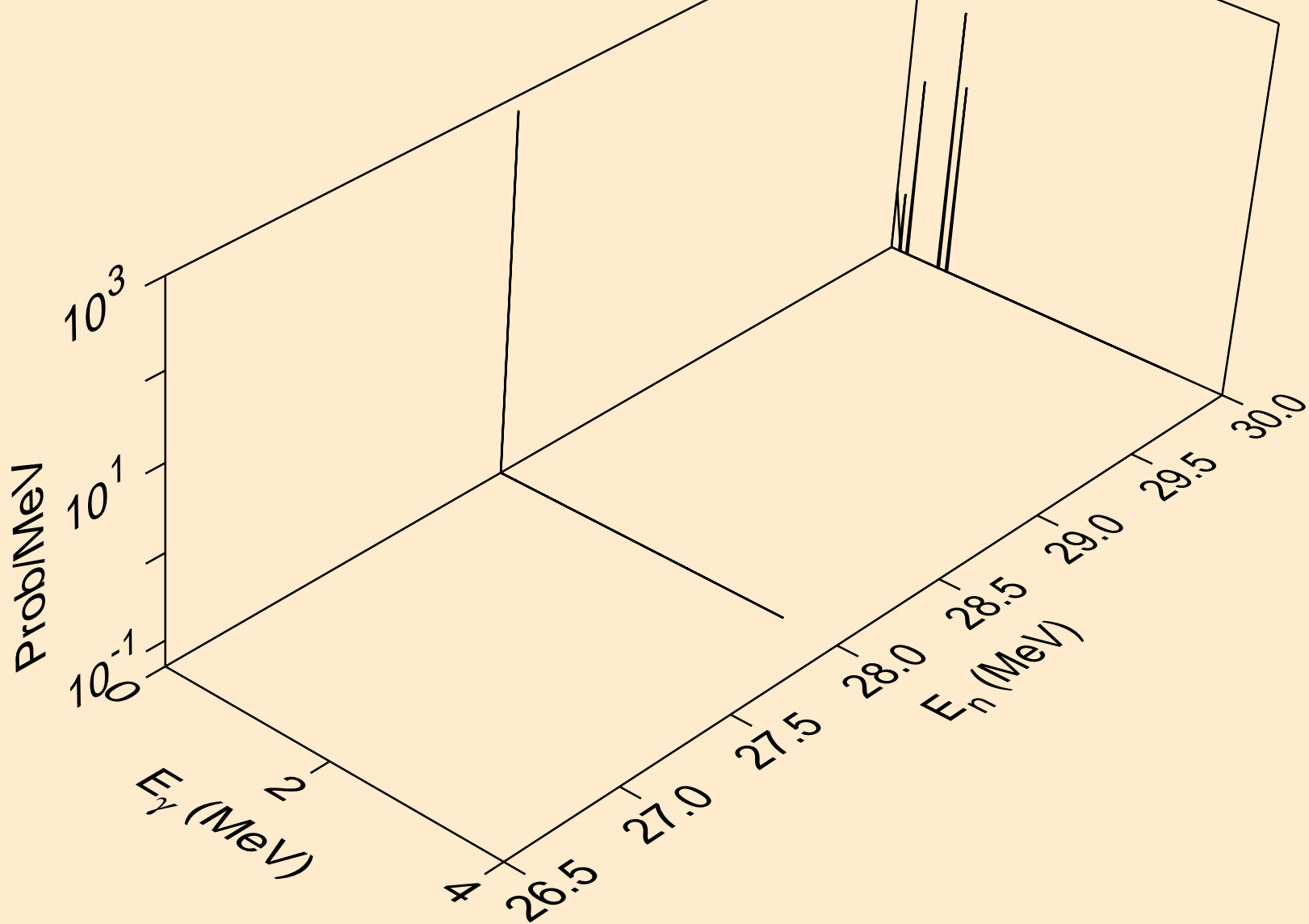

SC049 NEUTRON ACER TENDL-2019 LIBRARY; T=293.16K  
Photon emission for (n,4n)

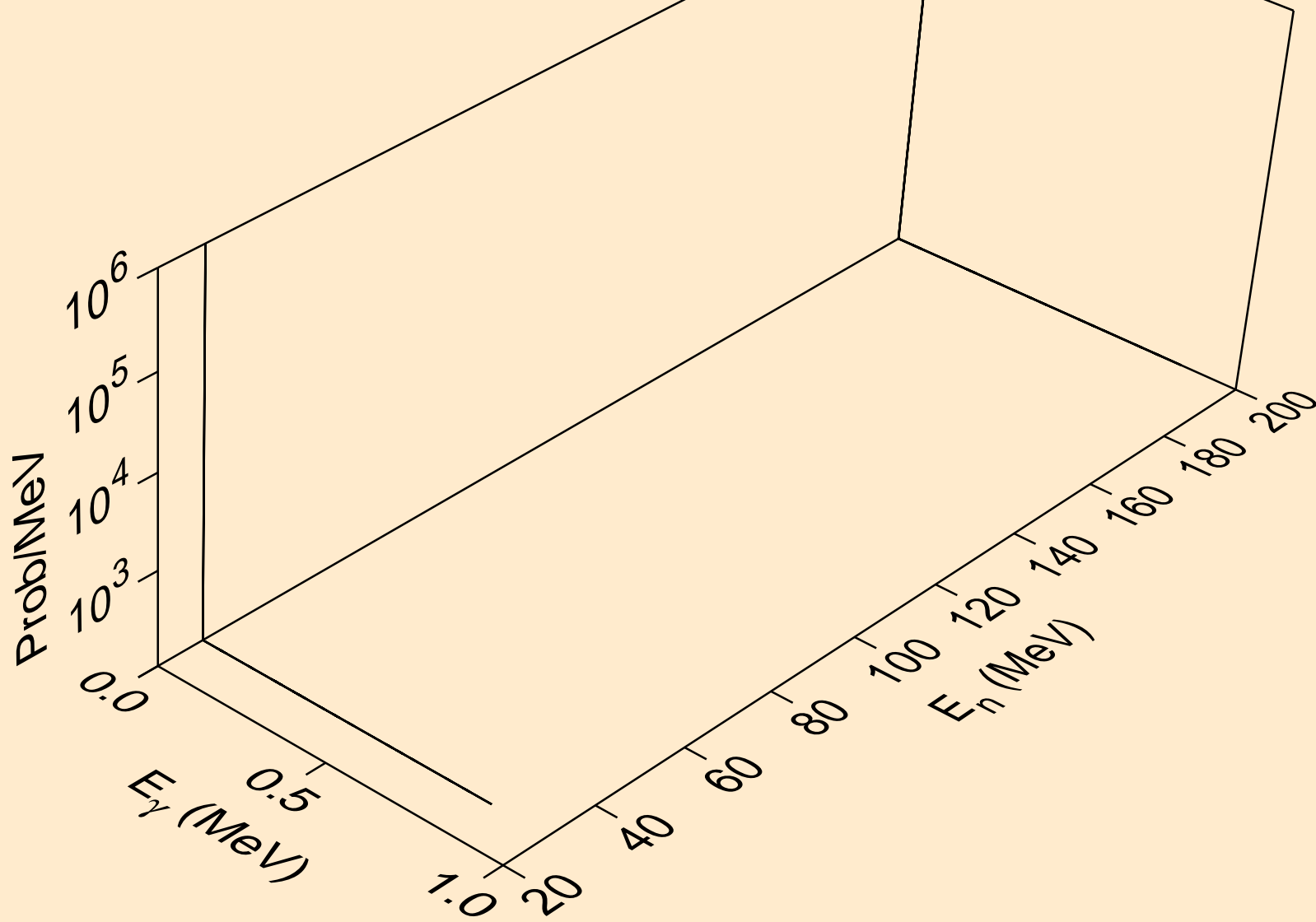

SC049 NEUTRON ACER TENDL-2019 LIBRARY; T=293.16K  
Photon emission for (n,2np)

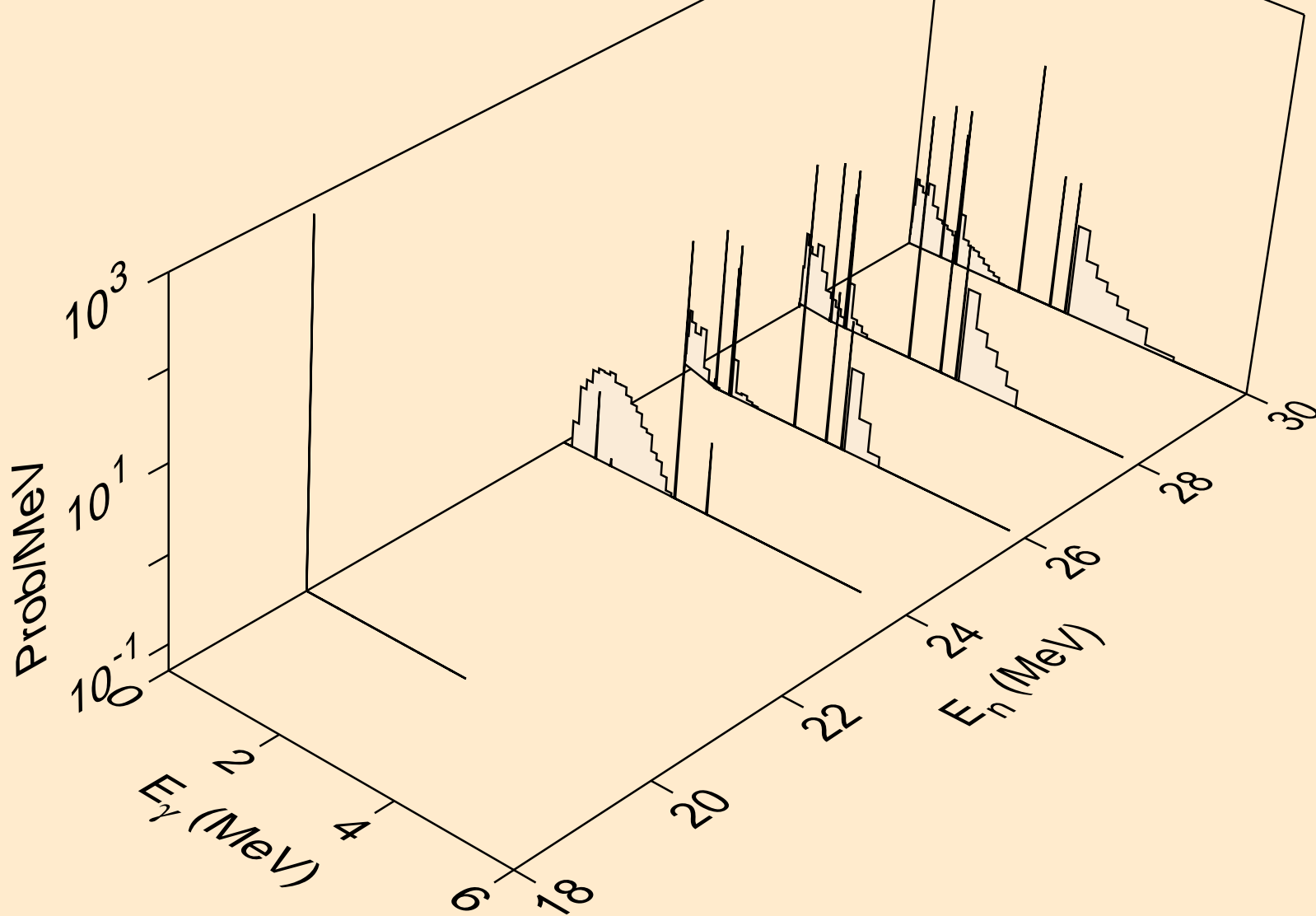

SC049 NEUTRON ACER TENDL-2019 LIBRARY; T=293.16K  
Photon emission for (n,3np)

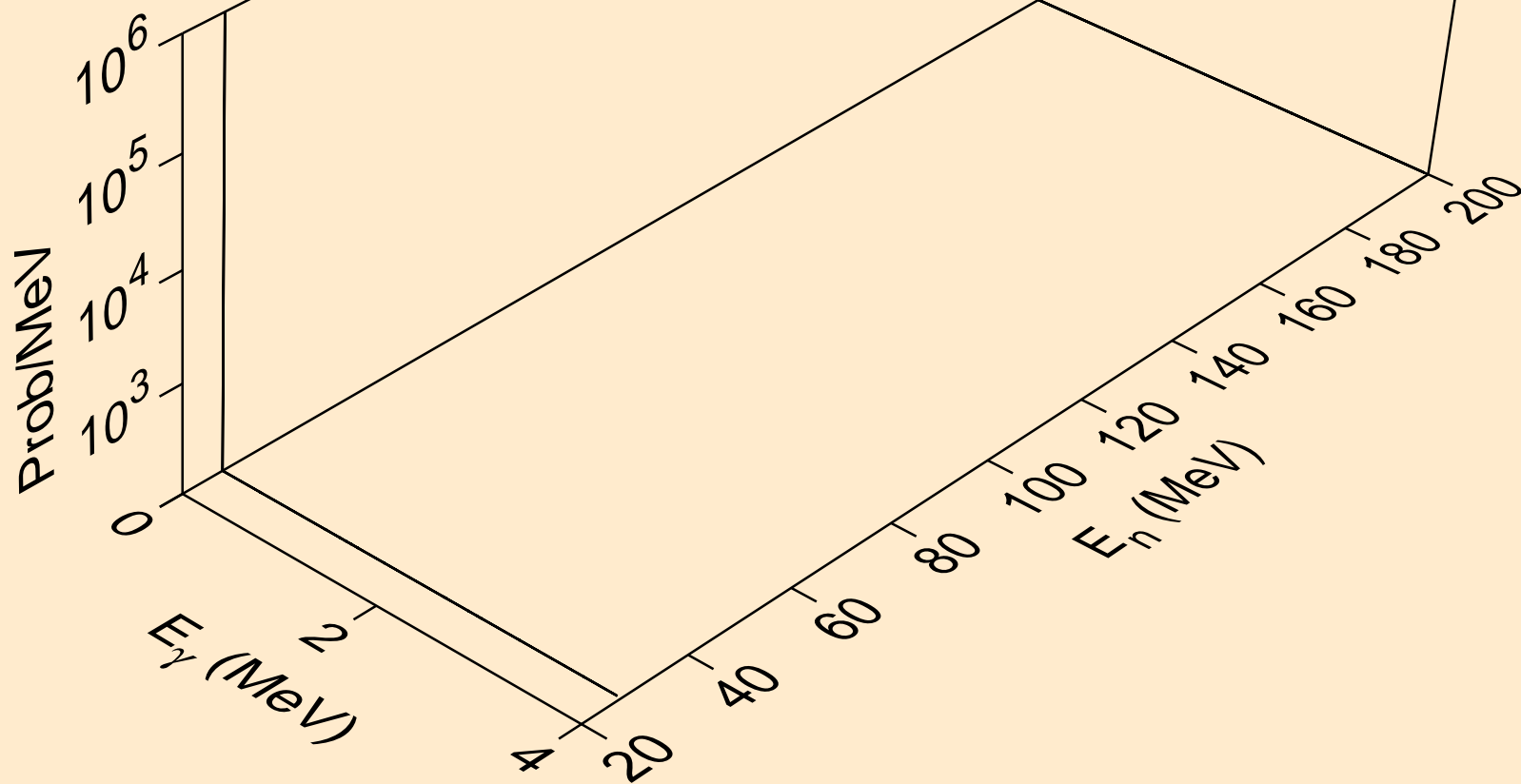

SC049 NEUTRON ACER TENDL-2019 LIBRARY; T=293.16K  
Photon emission for (n,n\*c)

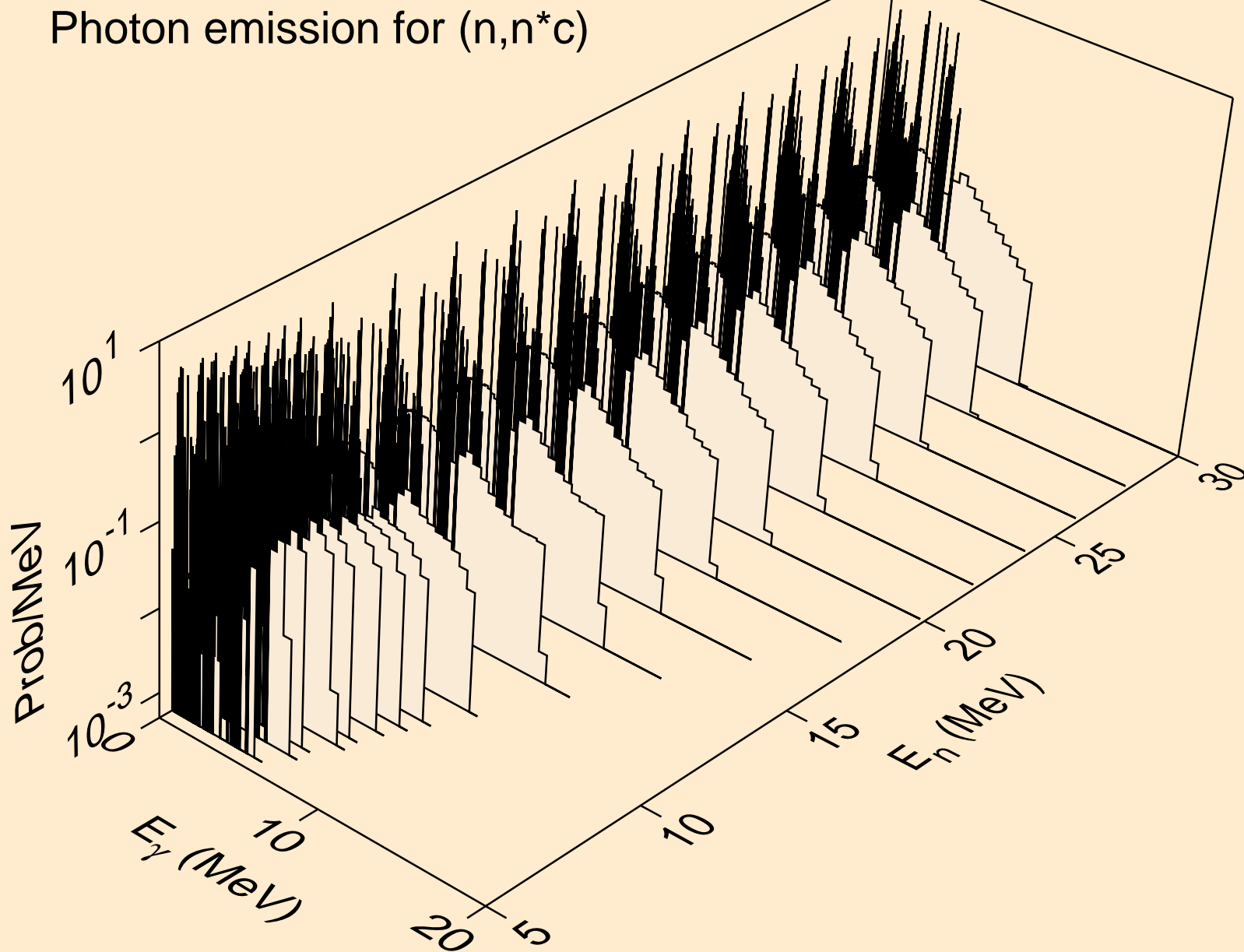

SC049 NEUTRON ACER TENDL-2019 LIBRARY; T=293.16K  
Photon emission for (n,gma)

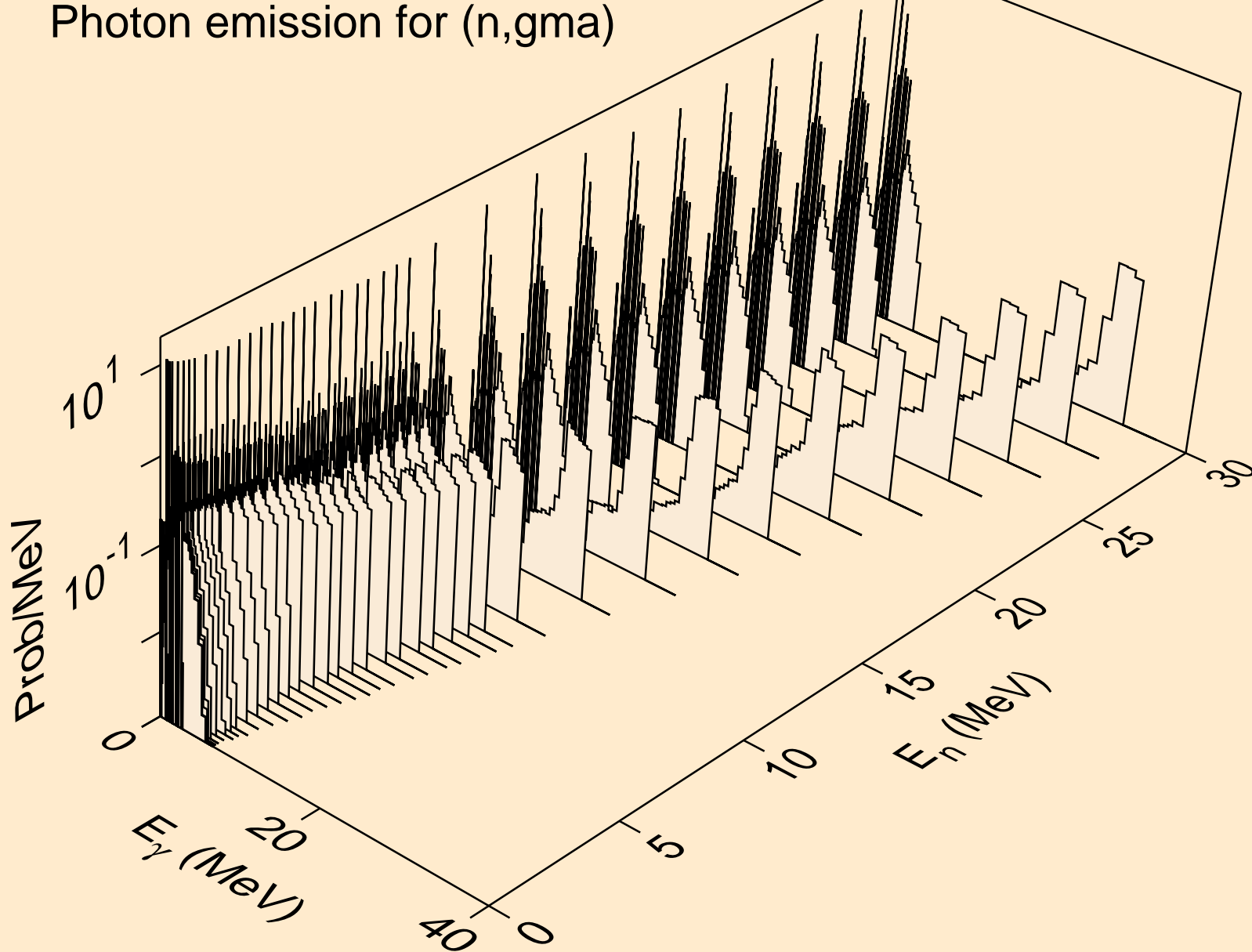

SC049 NEUTRON ACER TENDL-2019 LIBRARY; T=293.16K  
Photon emission for (n,p)

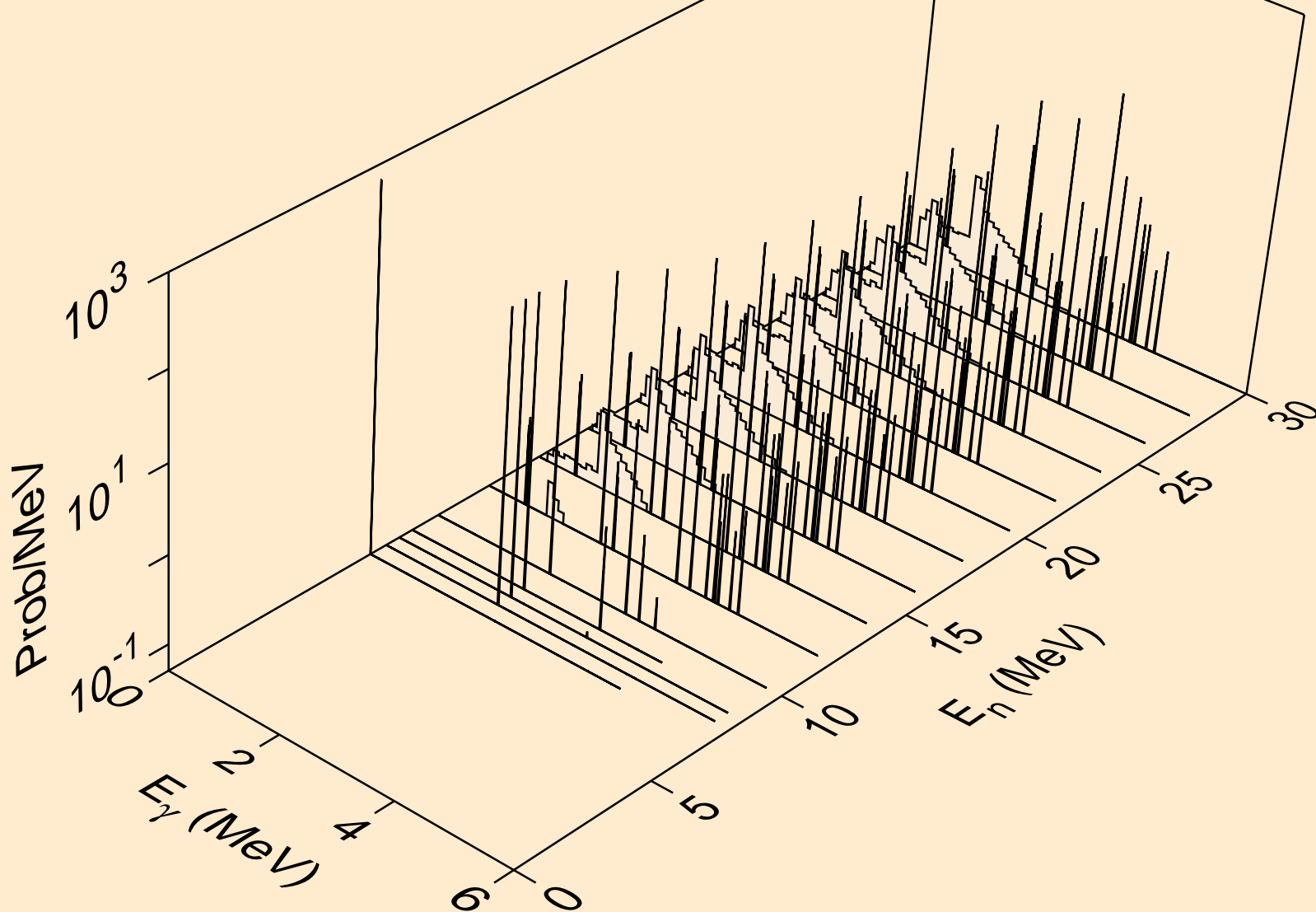

SC049 NEUTRON ACER TENDL-2019 LIBRARY; T=293.16K  
Photon emission for (n,d)

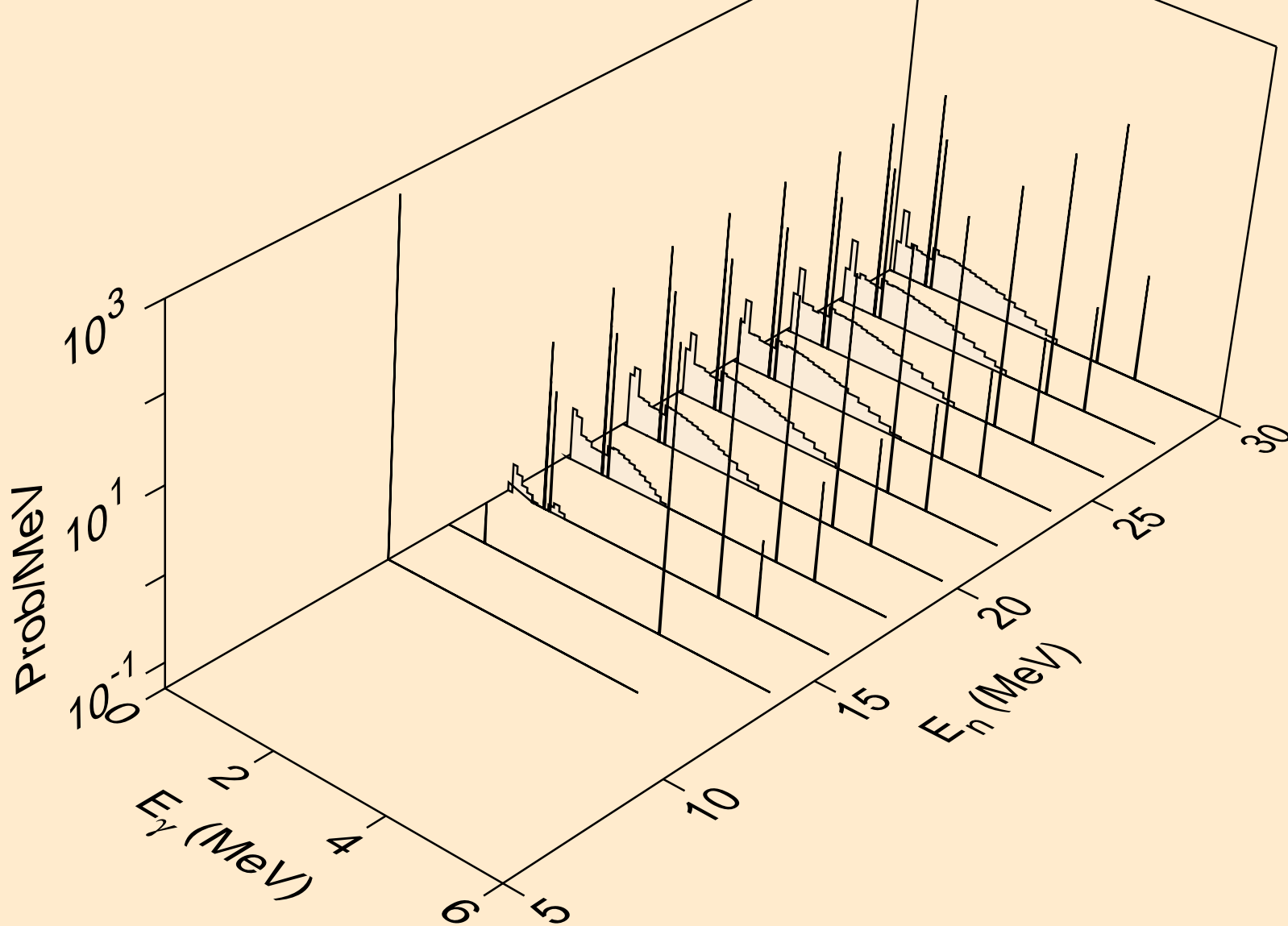

SC049 NEUTRON ACER TENDL-2019 LIBRARY; T=293.16K  
Photon emission for (n,t)

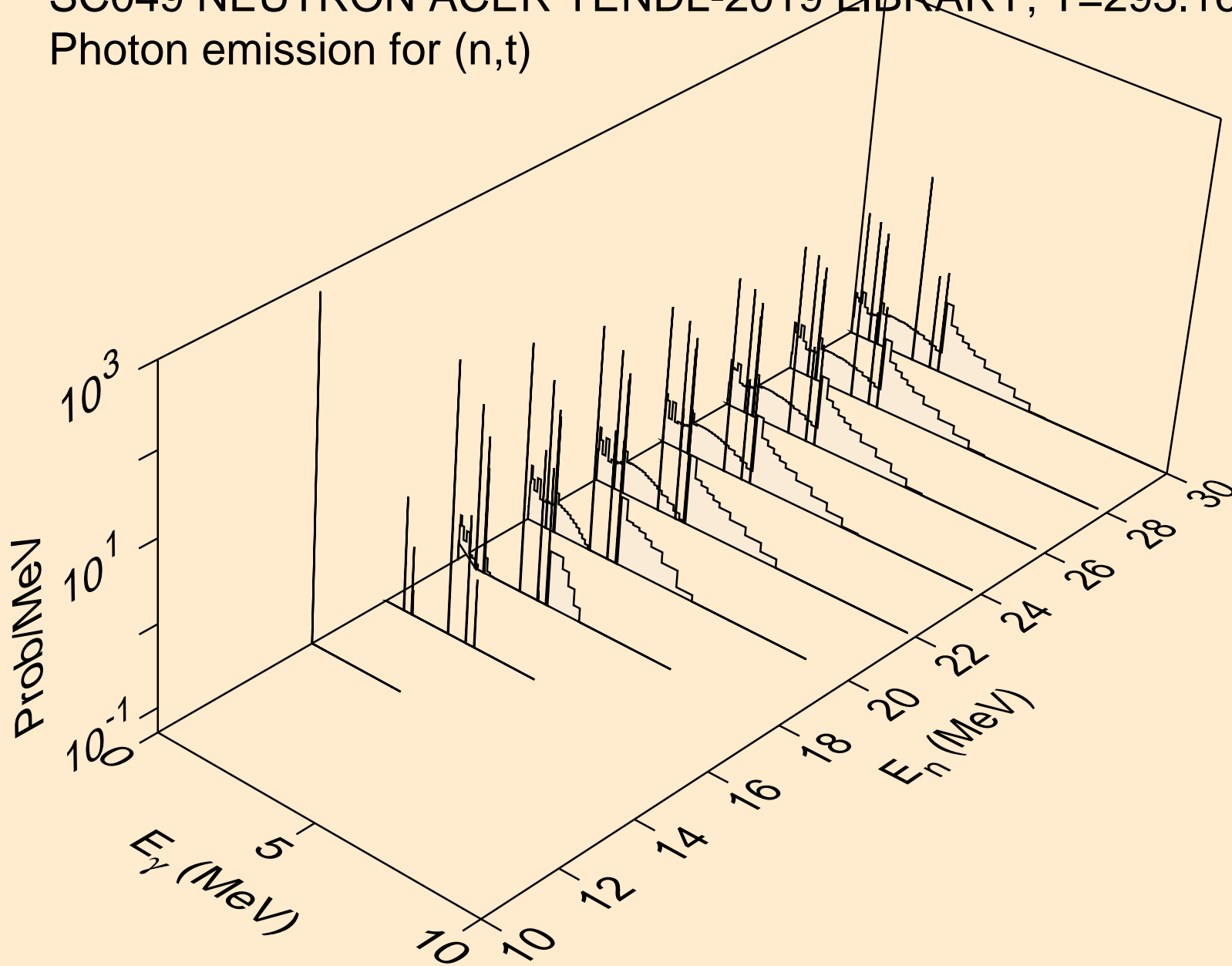

SC049 NEUTRON ACER TENDL-2019 LIBRARY; T=293.16K  
Photon emission for (n,he3)

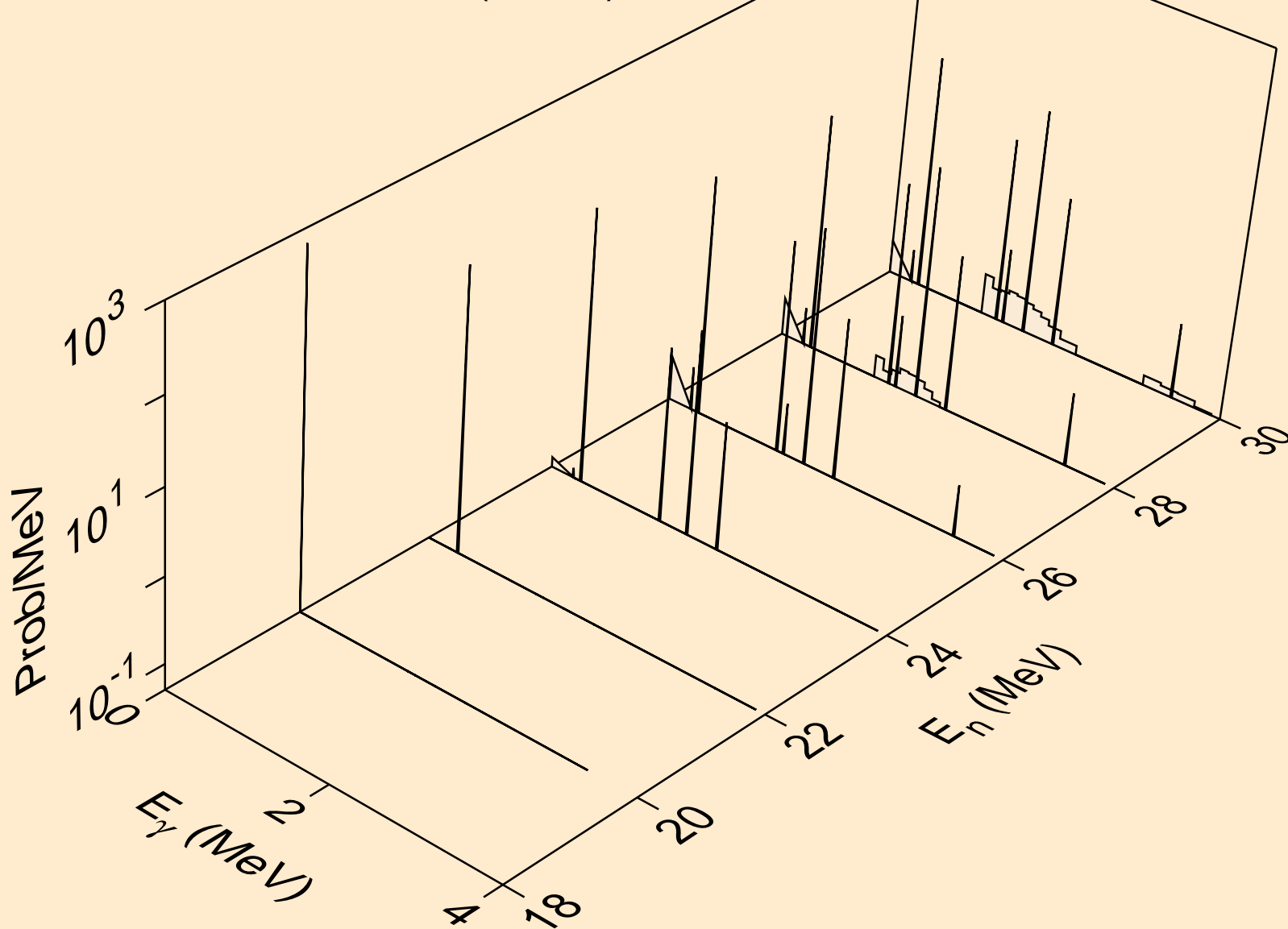

SC049 NEUTRON ACER TENDL-2019 LIBRARY; T=293.16K  
Photon emission for (n,a)

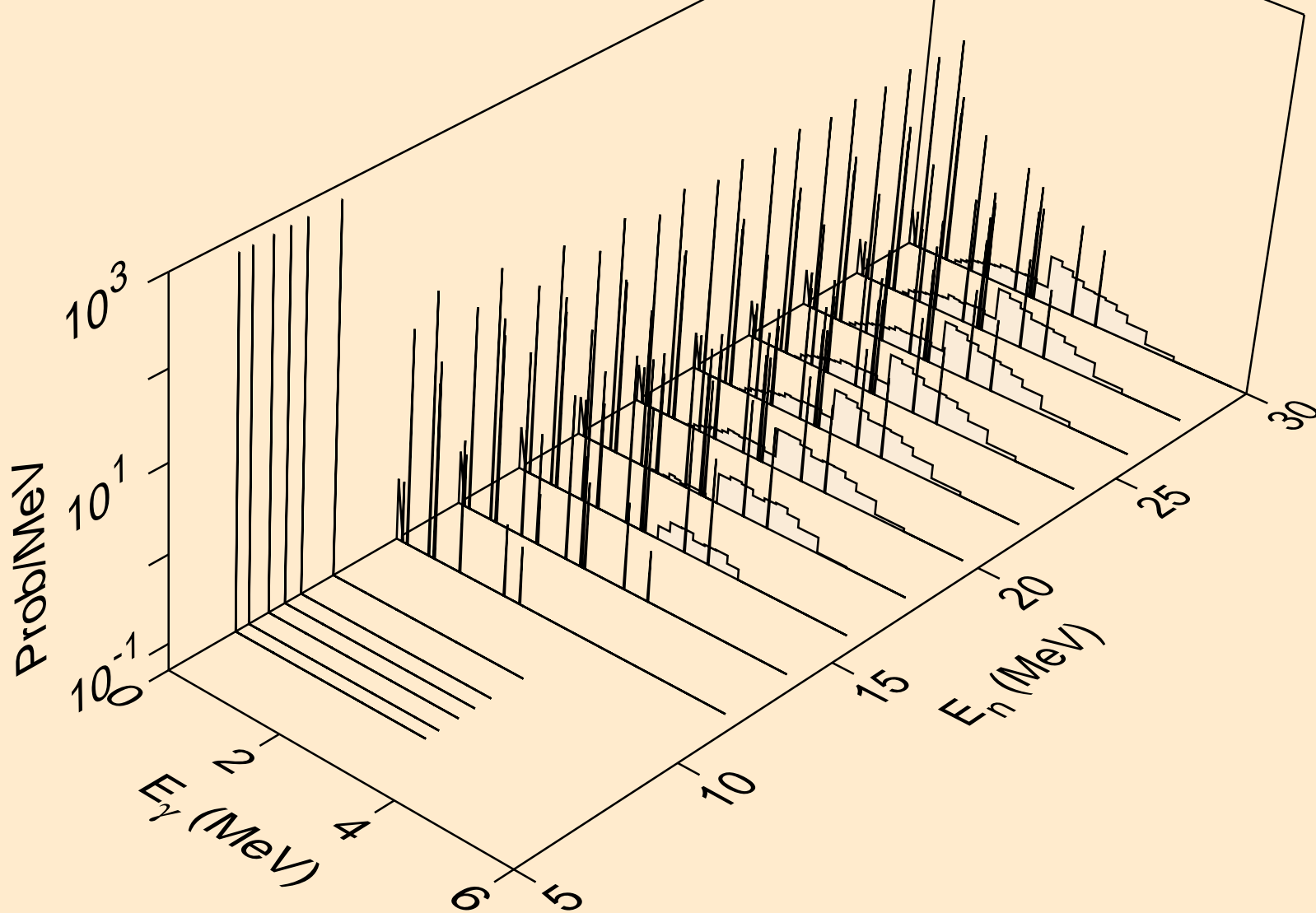

SC049 NEUTRON ACER TENDL-2019 LIBRARY; T=293.16K  
Photon emission for (n,2a)

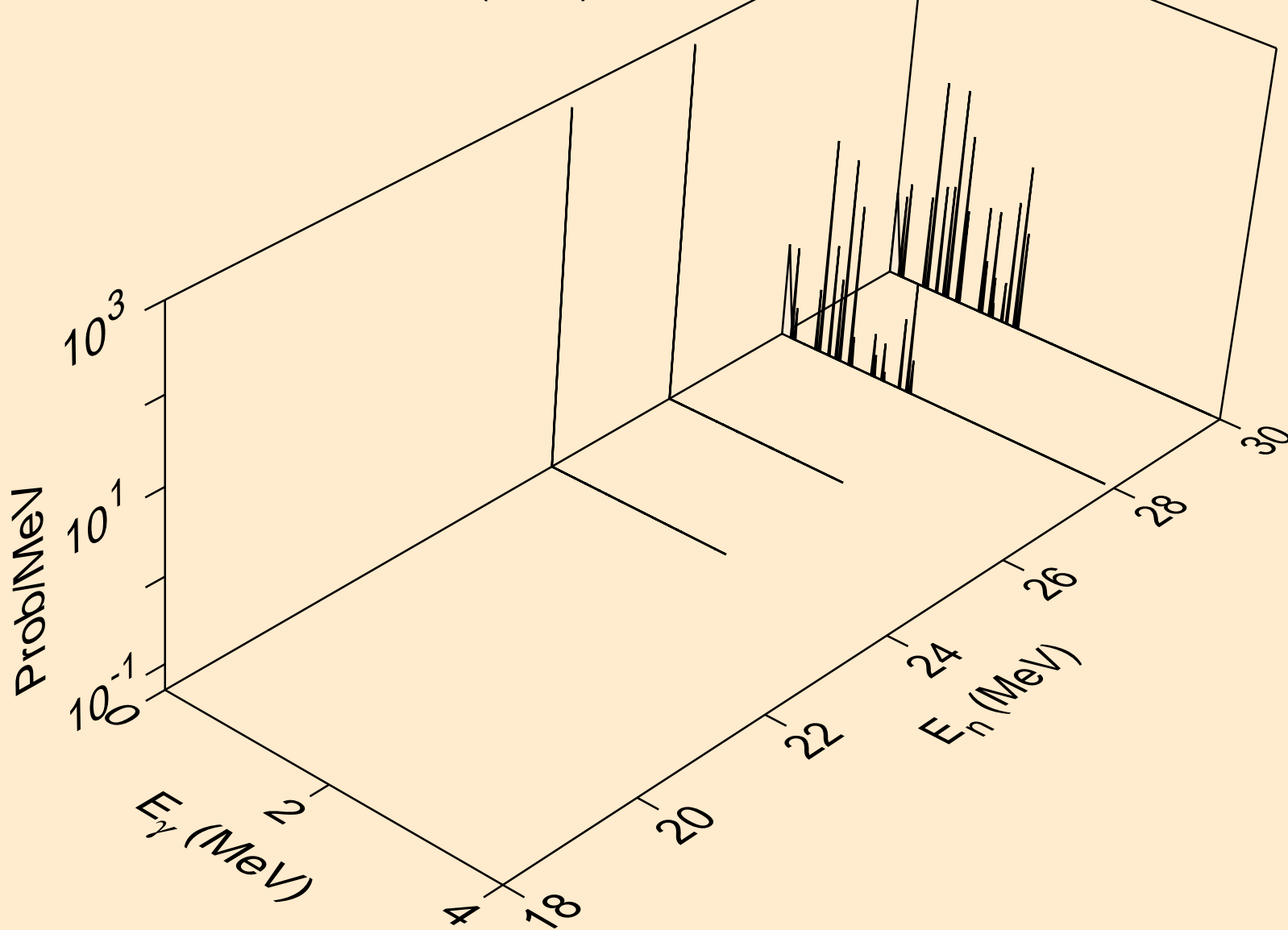

SC049 NEUTRON ACER TENDL-2019 LIBRARY; T=293.16K  
Photon emission for (n,2p)

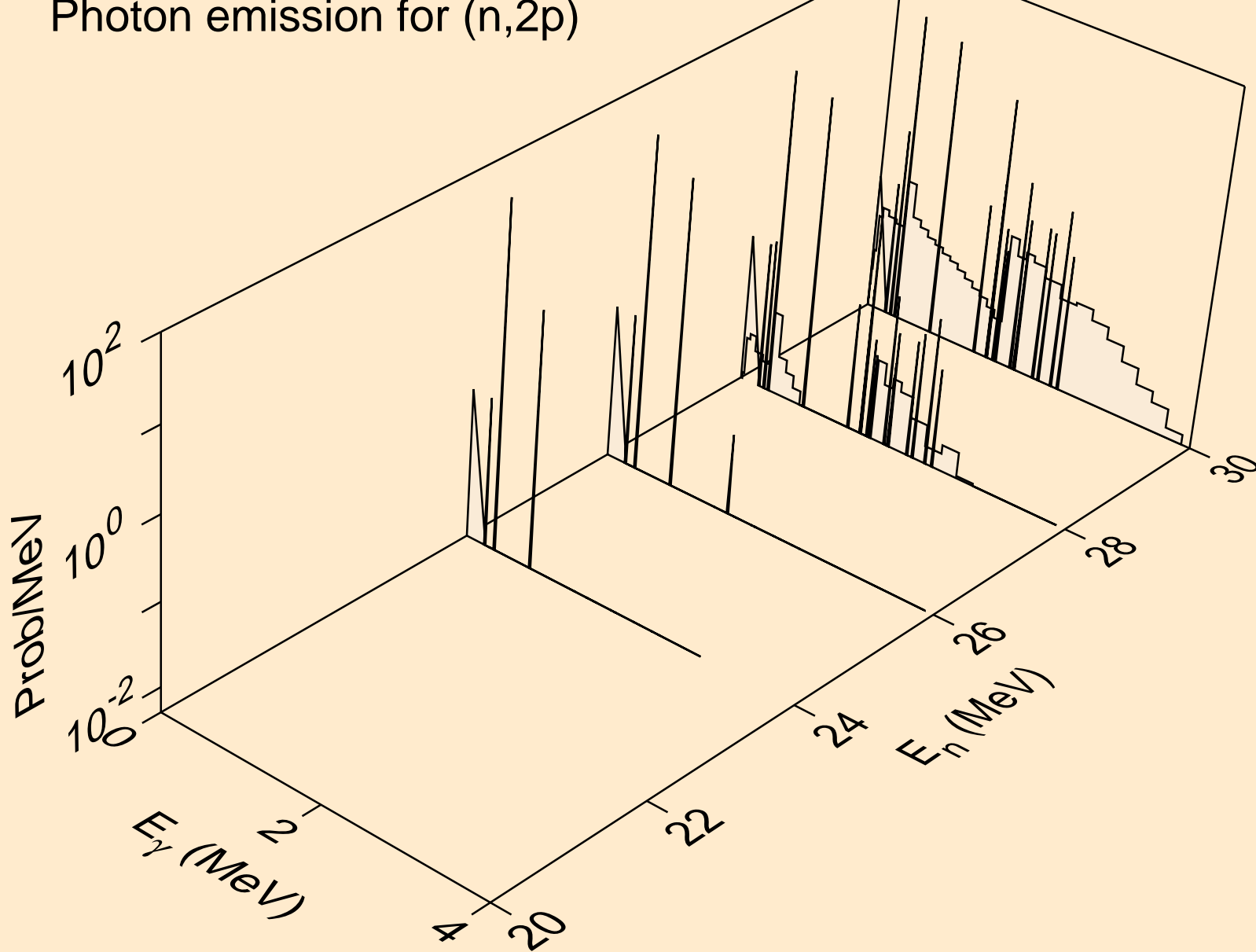

SC049 NEUTRON ACER TENDL-2019 LIBRARY; T=293.16K  
Photon emission for (n,p $\alpha$ )

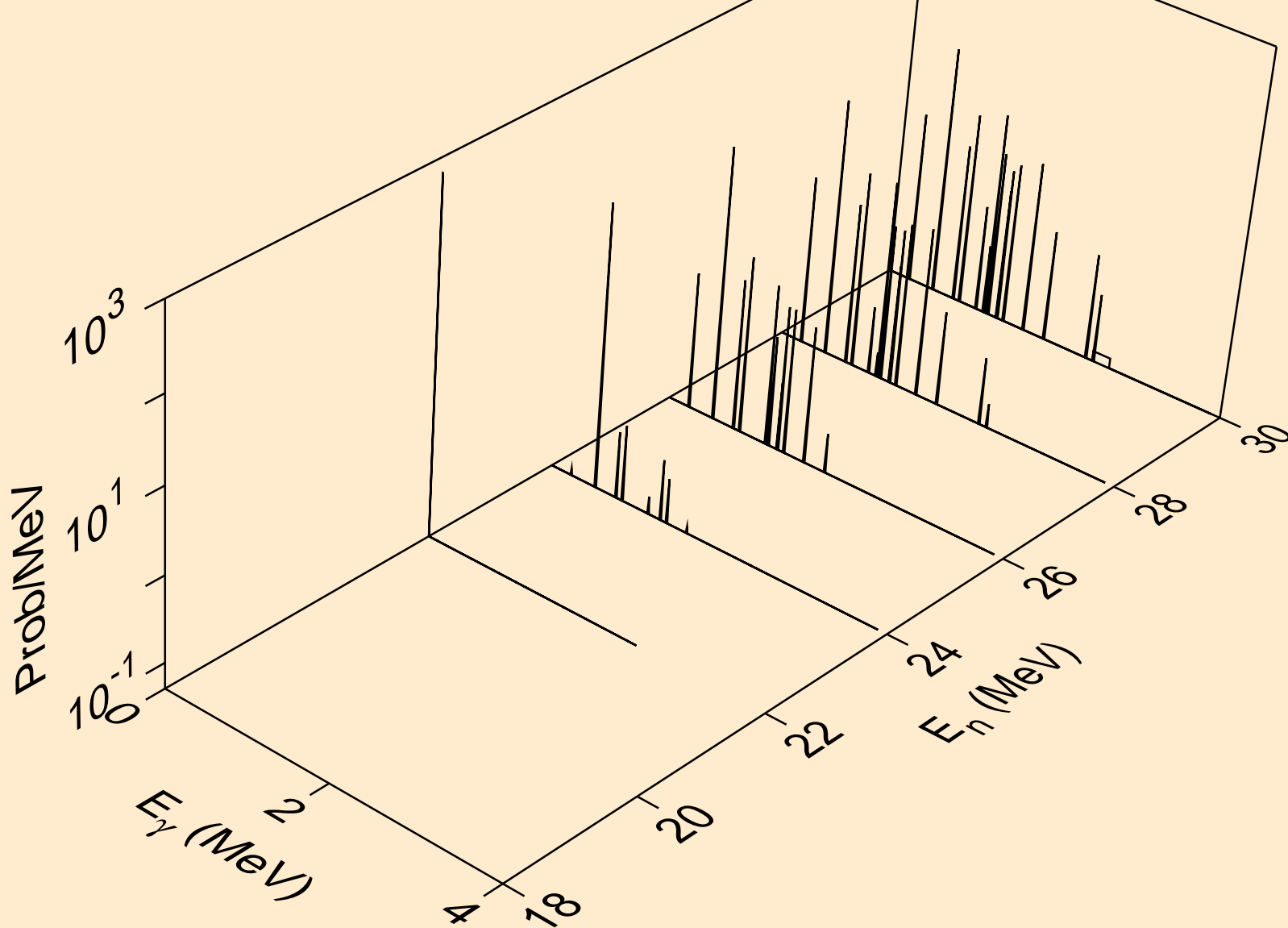

SC049 NEUTRON ACER TENDL-2019 LIBRARY; T=293.16K  
Photon emission for (n,pd)

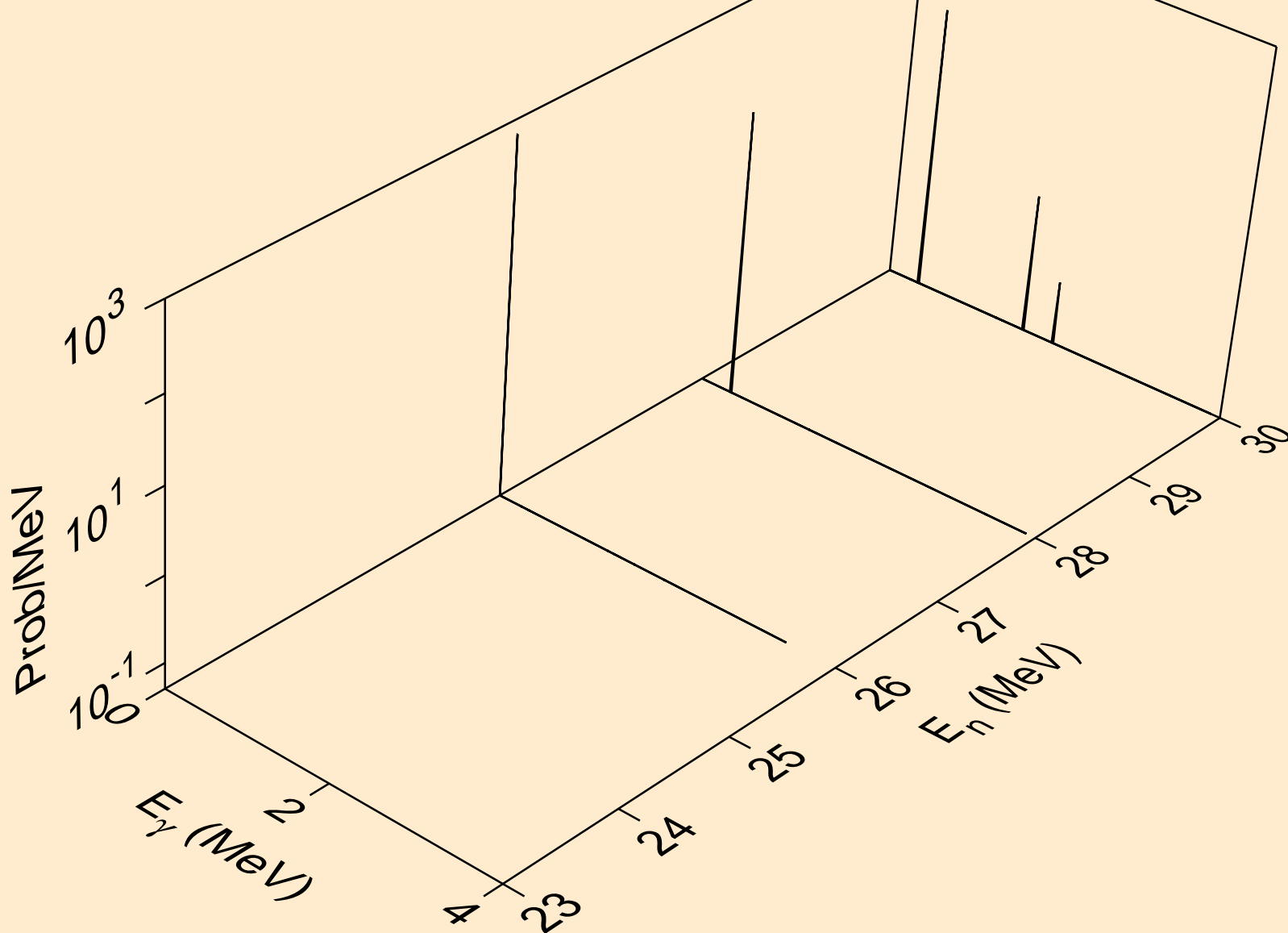

SC049 NEUTRON ACER TENDL-2019 LIBRARY; T=293.16K  
Photon emission for (n,da)

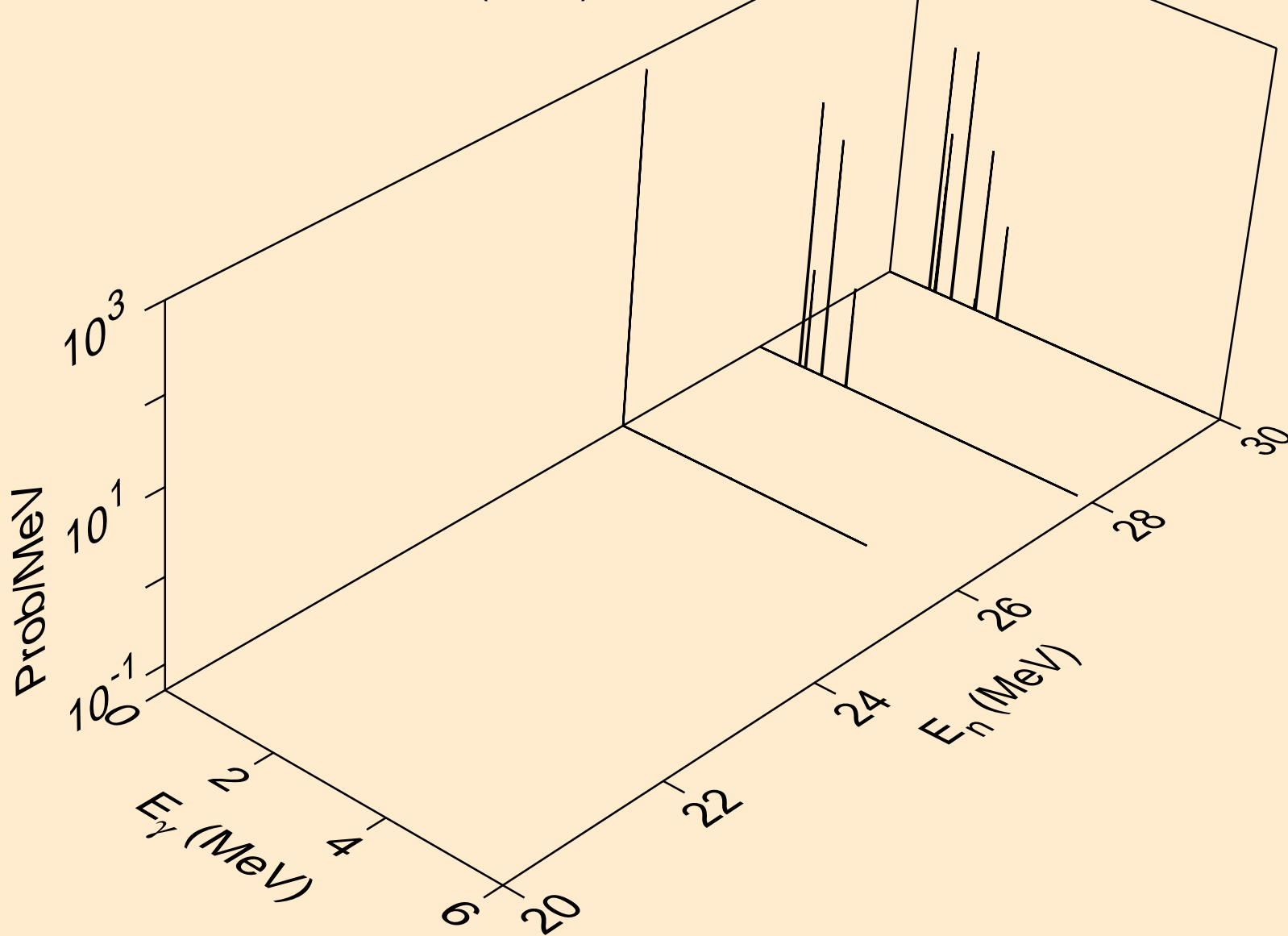

SC049 NEUTRON ACER TENDL-2019 LIBRARY; T=293.16K  
thermal capture photon spectrum

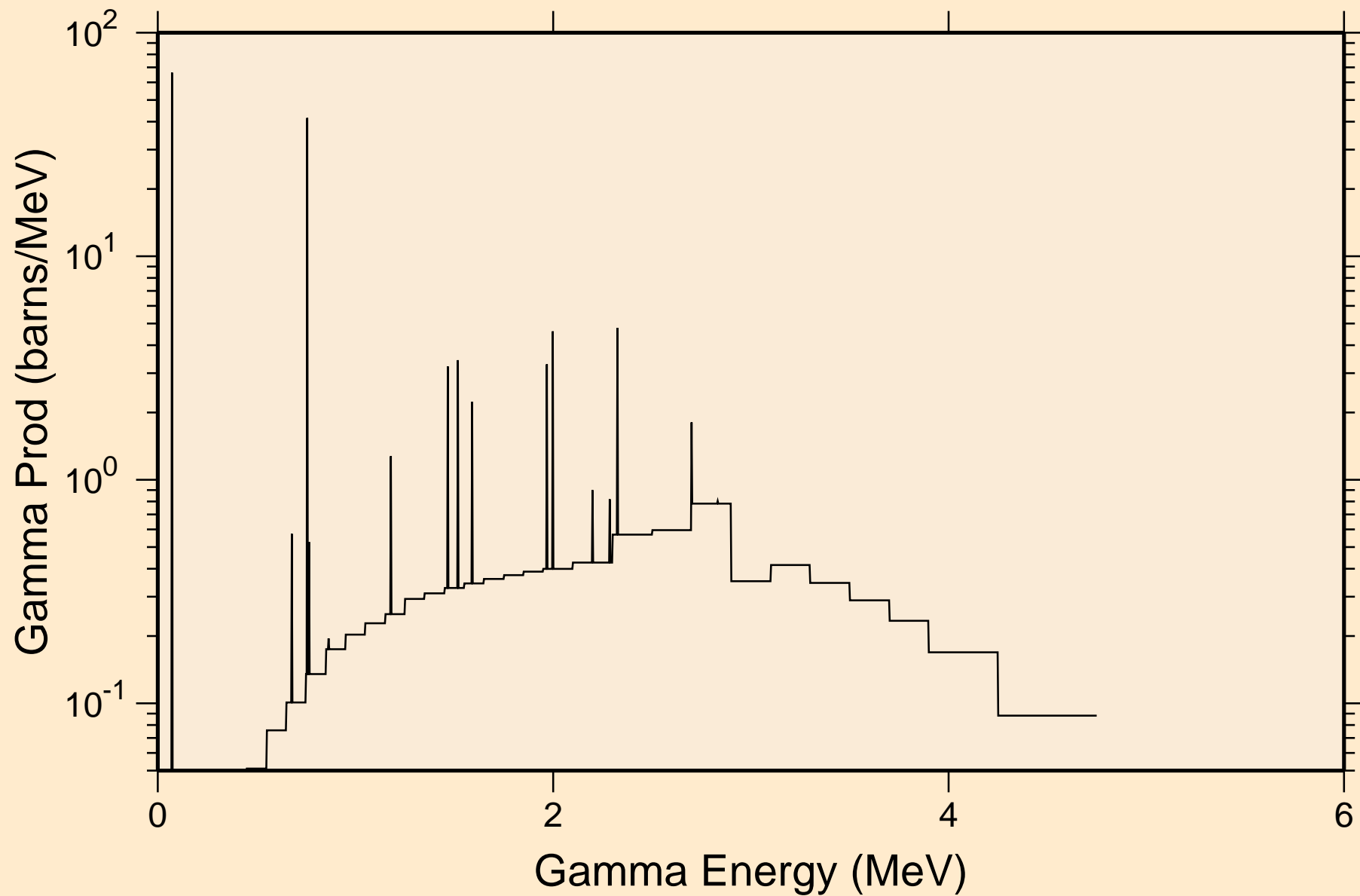

SC049 NEUTRON ACER TENDL-2019 LIBRARY; T=293.16K  
14 MeV photon spectrum

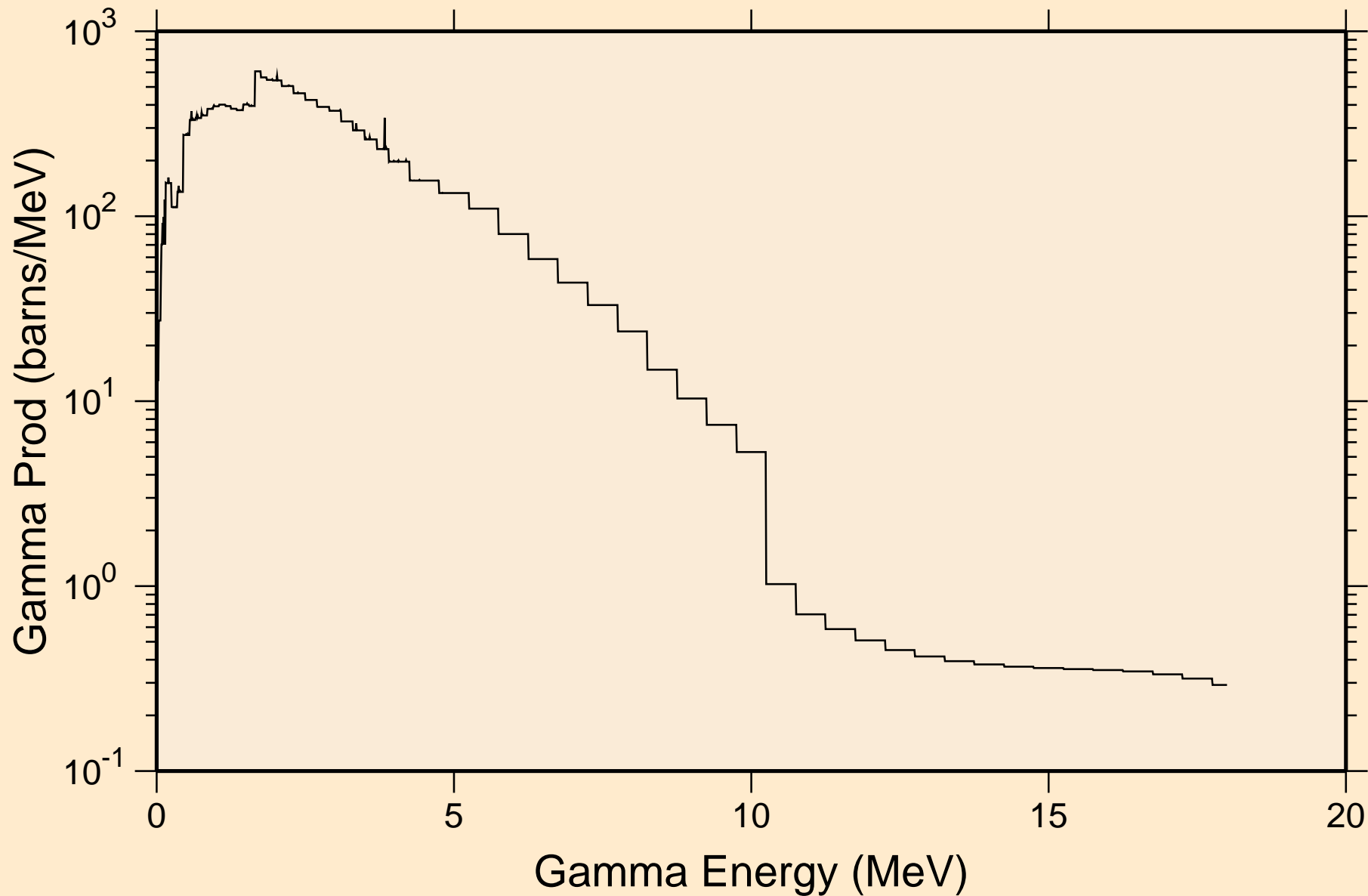

# SC049 NEUTRON ACER TENDL-2019 LIBRARY; T=293.16K

## Particle heating contributions

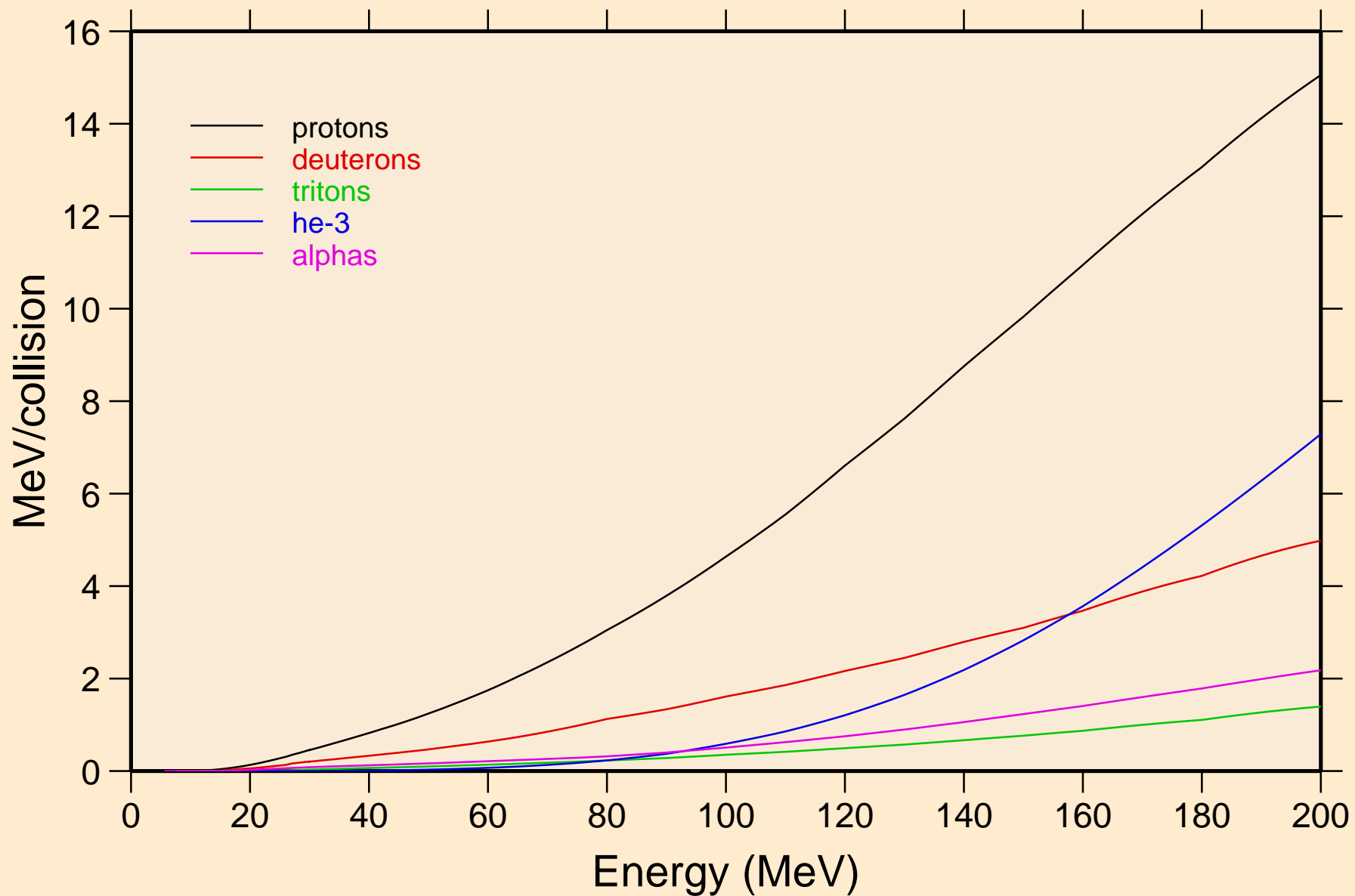

SC049 NEUTRON ACER TENDL-2019 LIBRARY; T=293.16K  
Recoil Heating

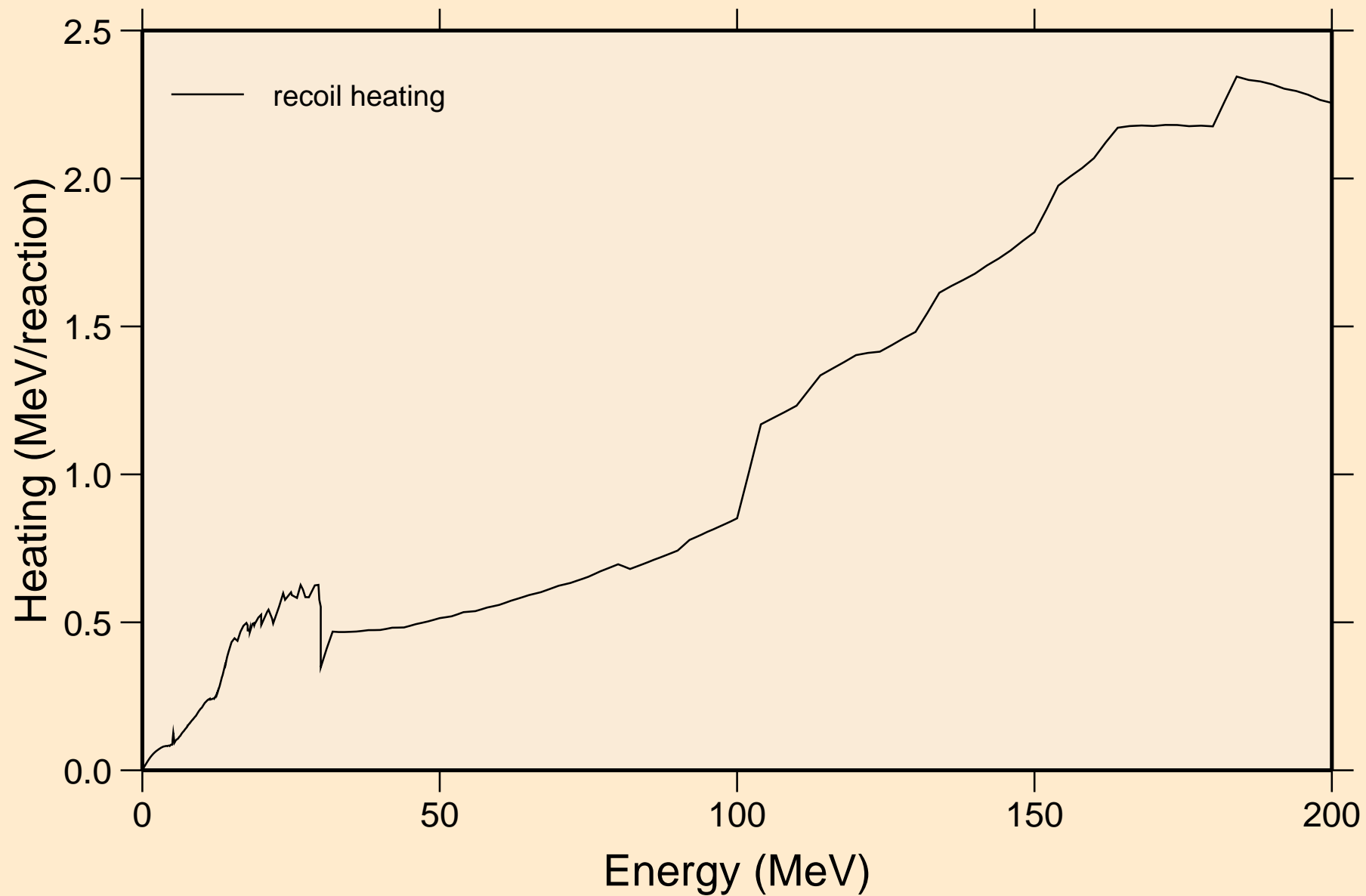

SC049 NEUTRON ACER TENDL-2019 LIBRARY; T=293.16K  
Particle production cross sections

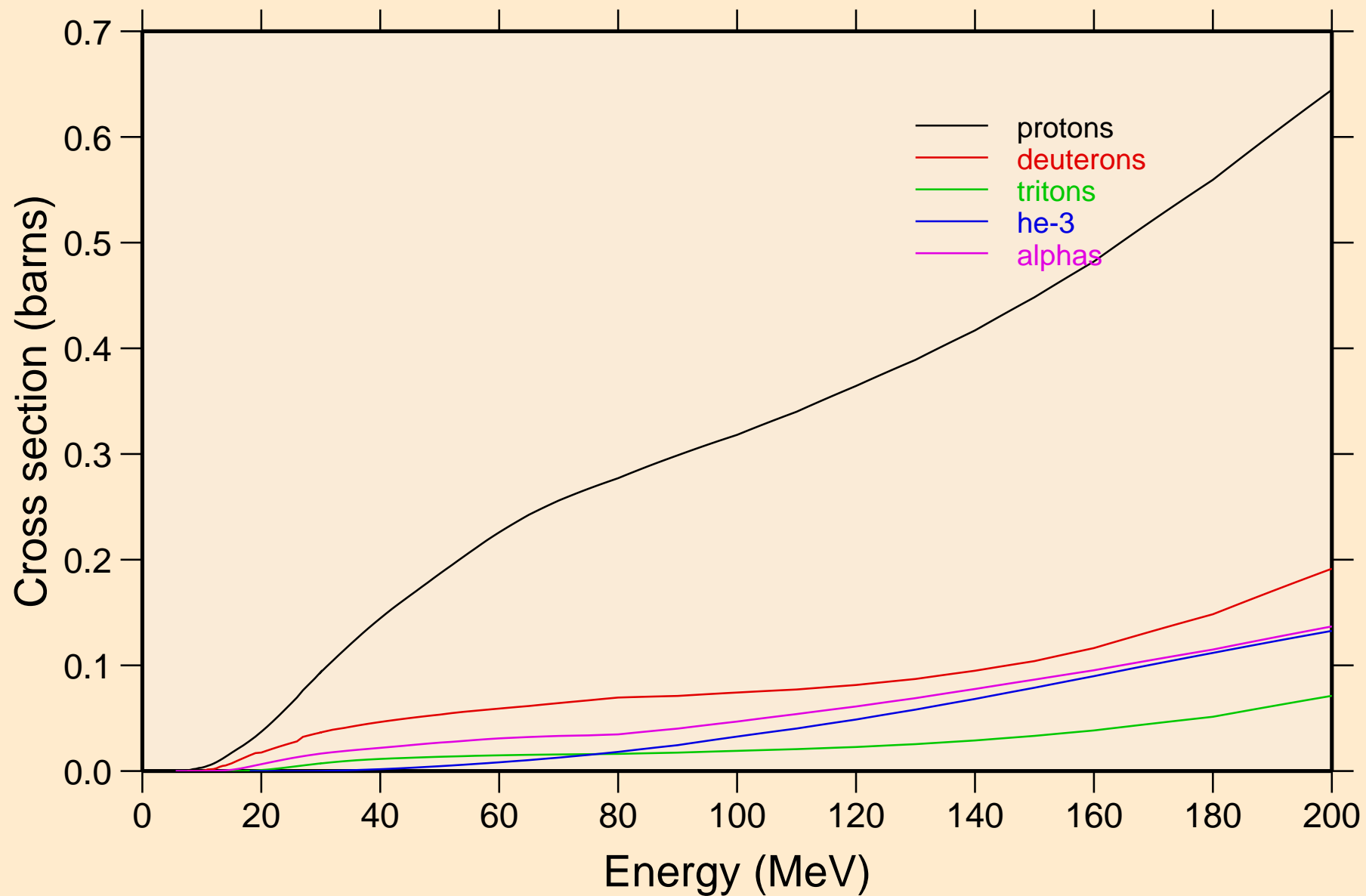

SC049 NEUTRON ACER TENDL-2019 LIBRARY; T=293.16K  
protons from (n,x)

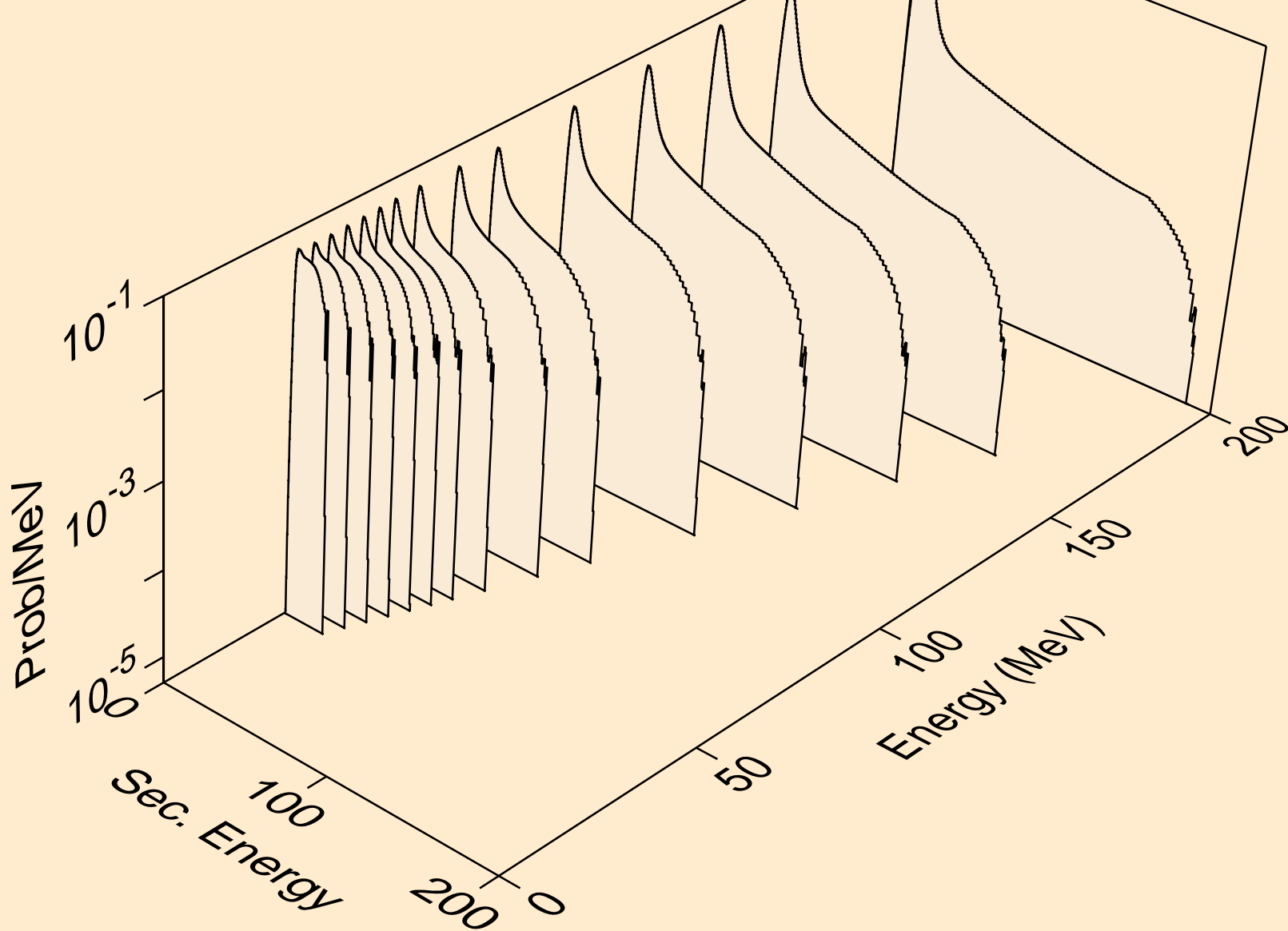

SC049 NEUTRON ACER TENDL-2019 LIBRARY; T=293.16K  
protons from (n,n\*)p

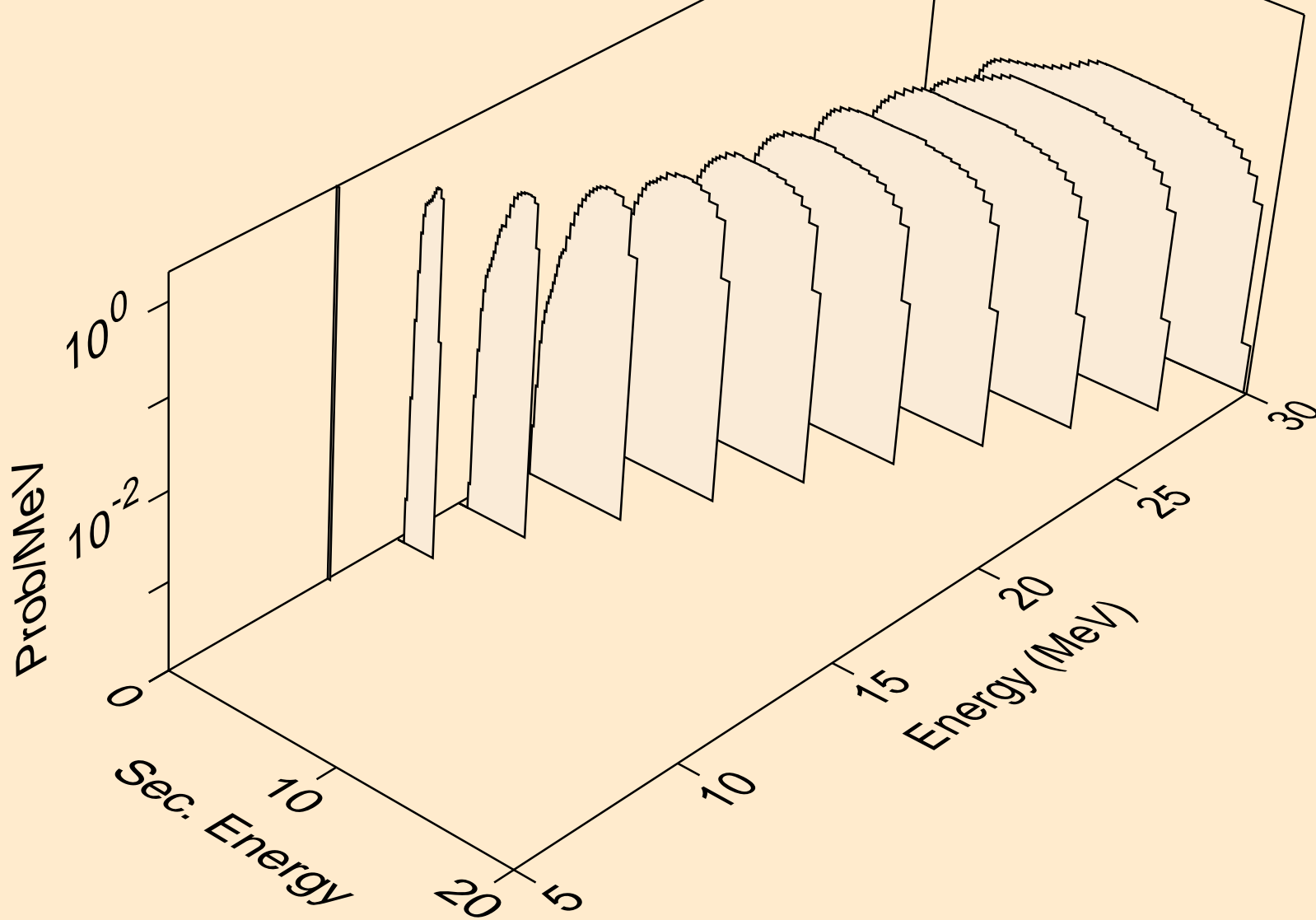

SC049 NEUTRON ACER TENDL-2019 LIBRARY; T=293.16K  
protons from (n,2np)

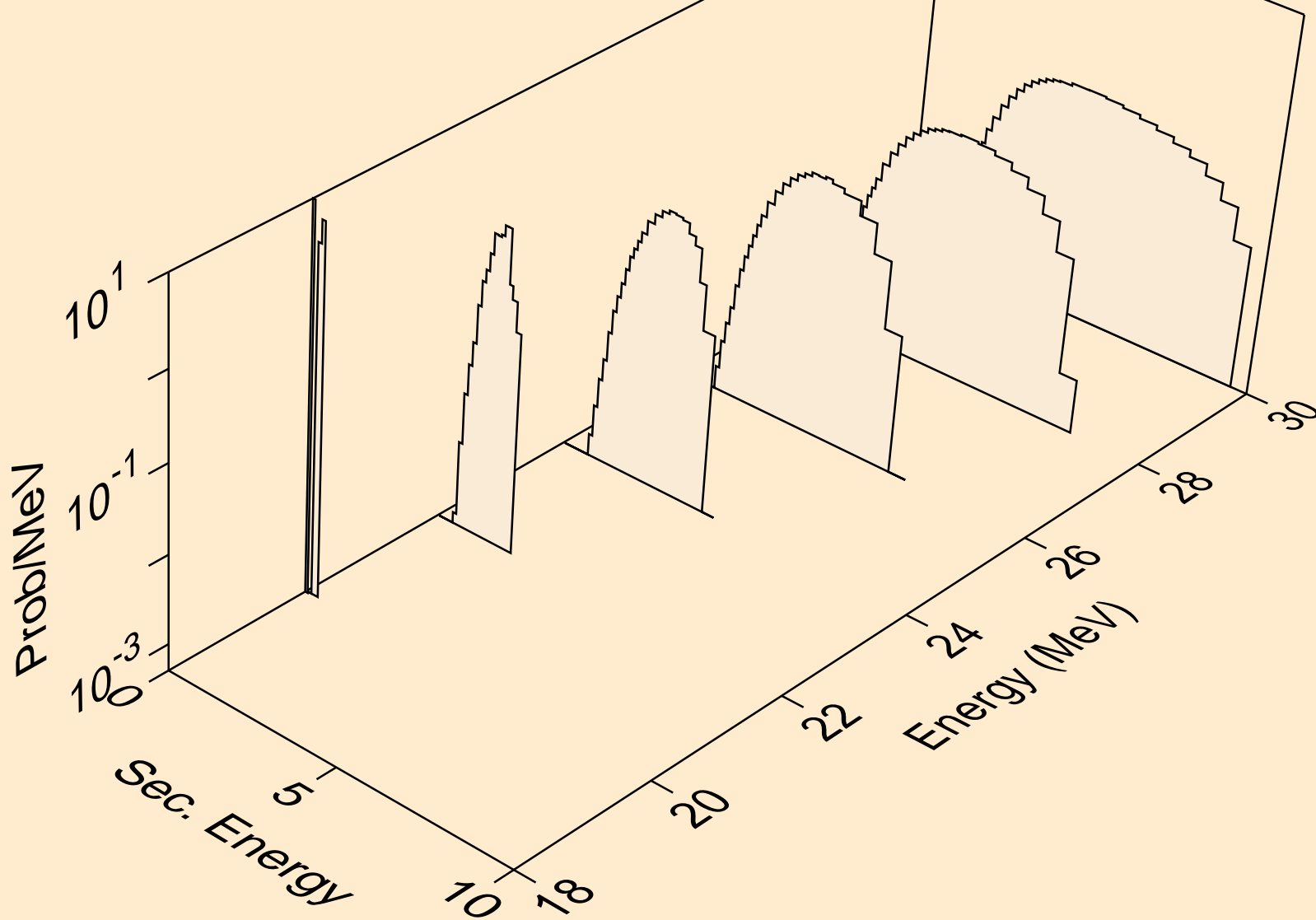

SC049 NEUTRON ACER TENDL-2019 LIBRARY; T=293.16K  
protons from (n,3np)

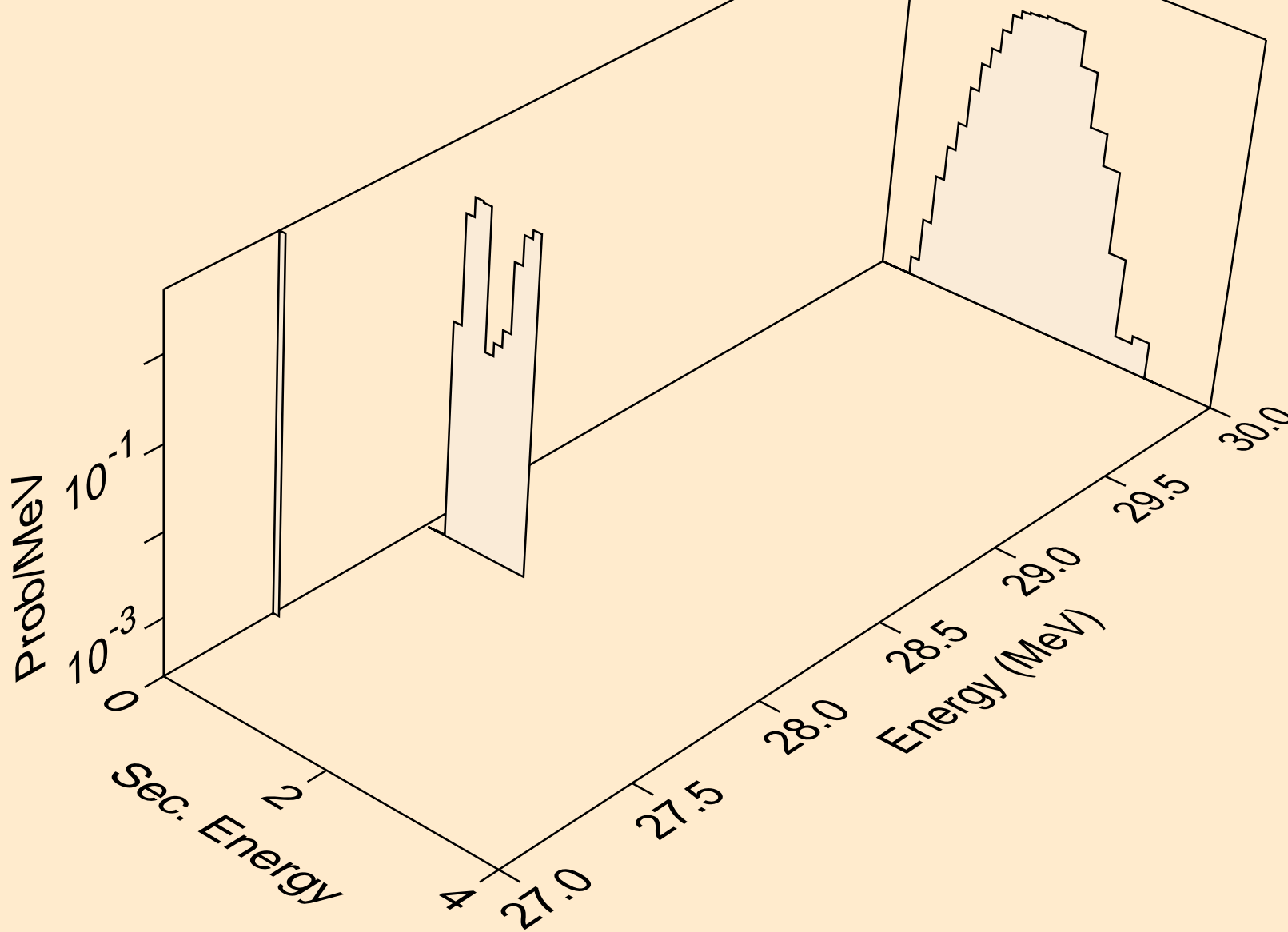

SC049 NEUTRON ACER TENDL-2019 LIBRARY; T=293.16K  
protons from (n,p)

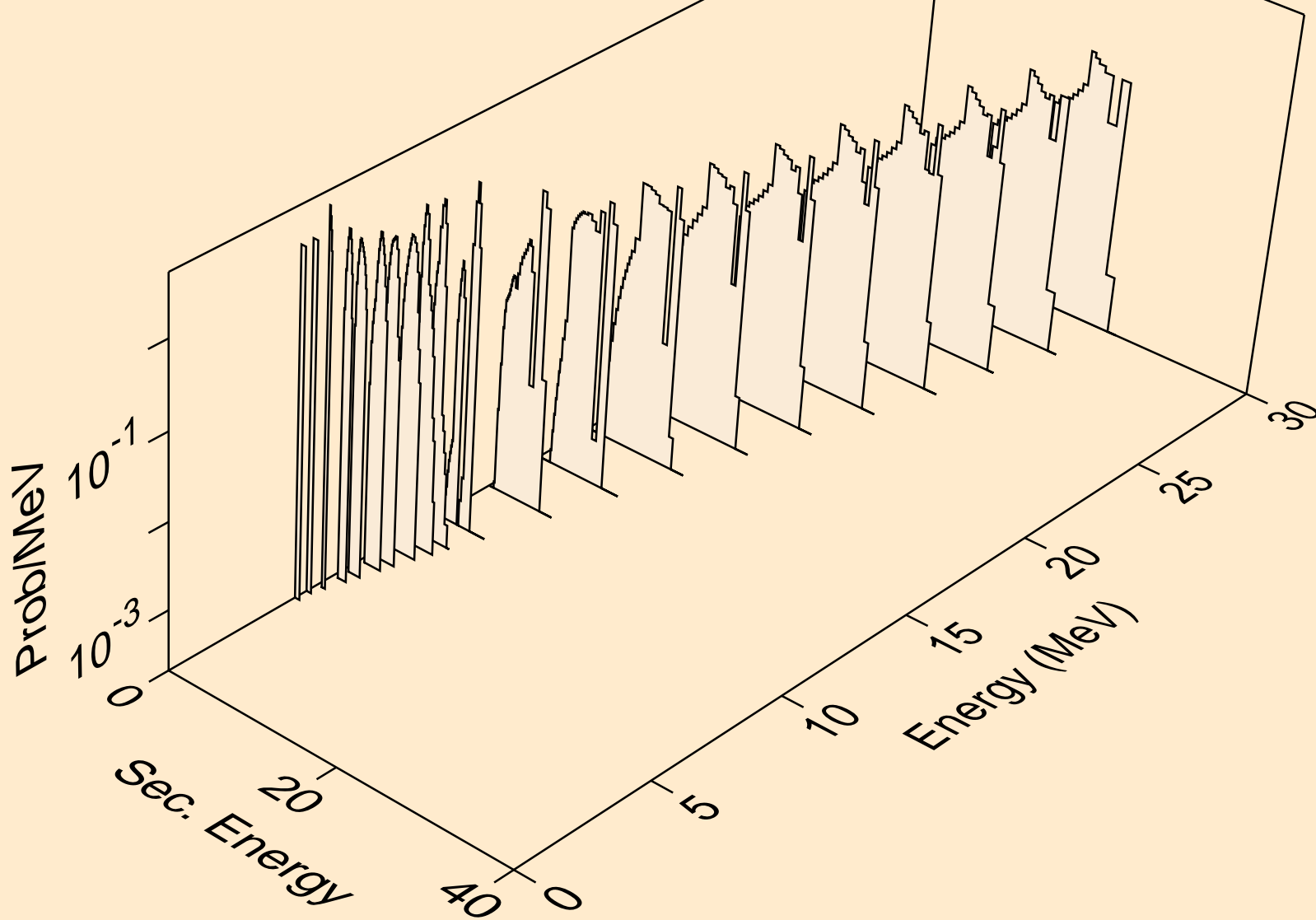

SC049 NEUTRON ACER TENDL-2019 LIBRARY; T=293.16K  
protons from (n,2p)

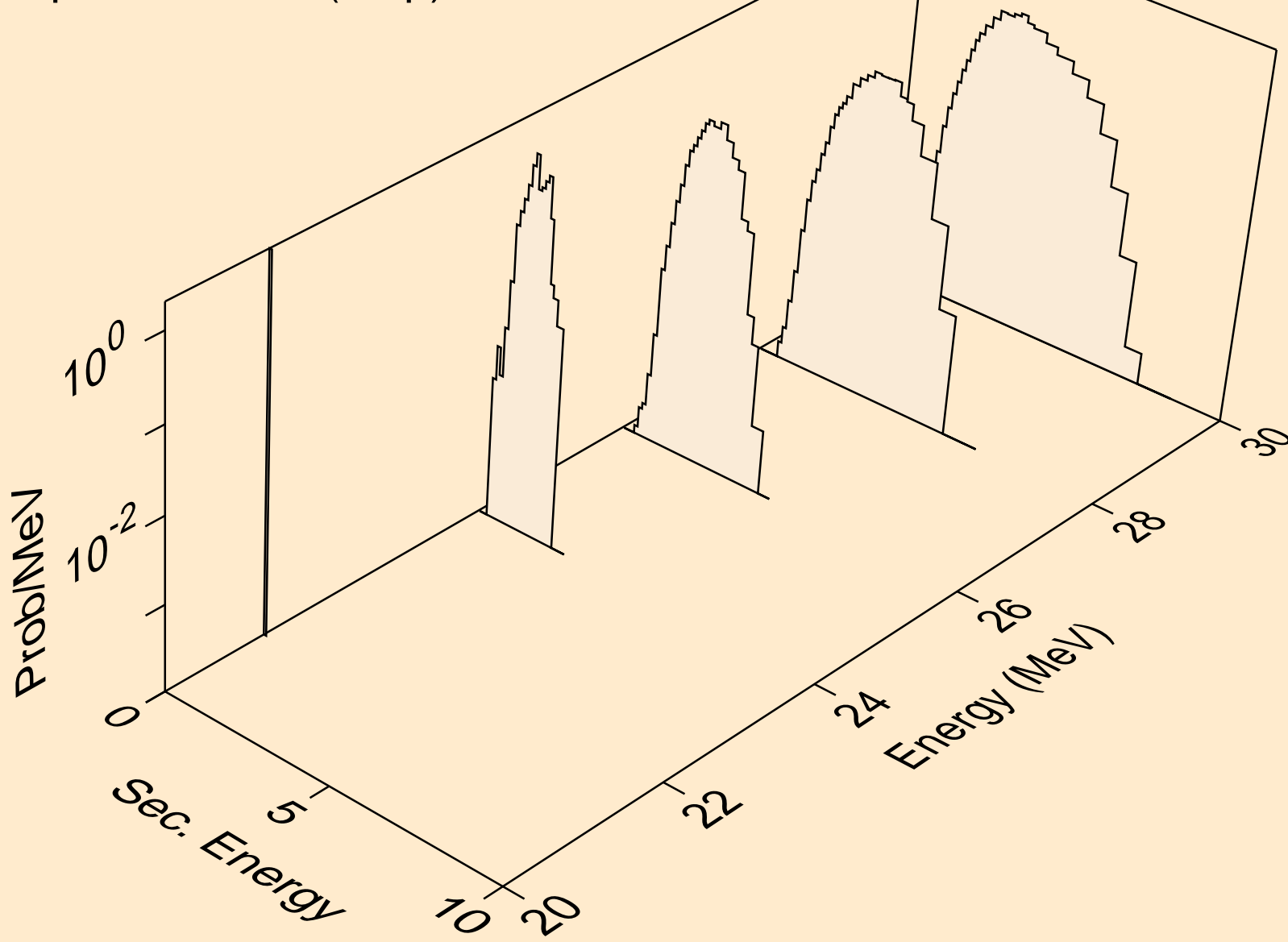

SC049 NEUTRON ACER TENDL-2019 LIBRARY; T=293.16K  
protons from (n,p)

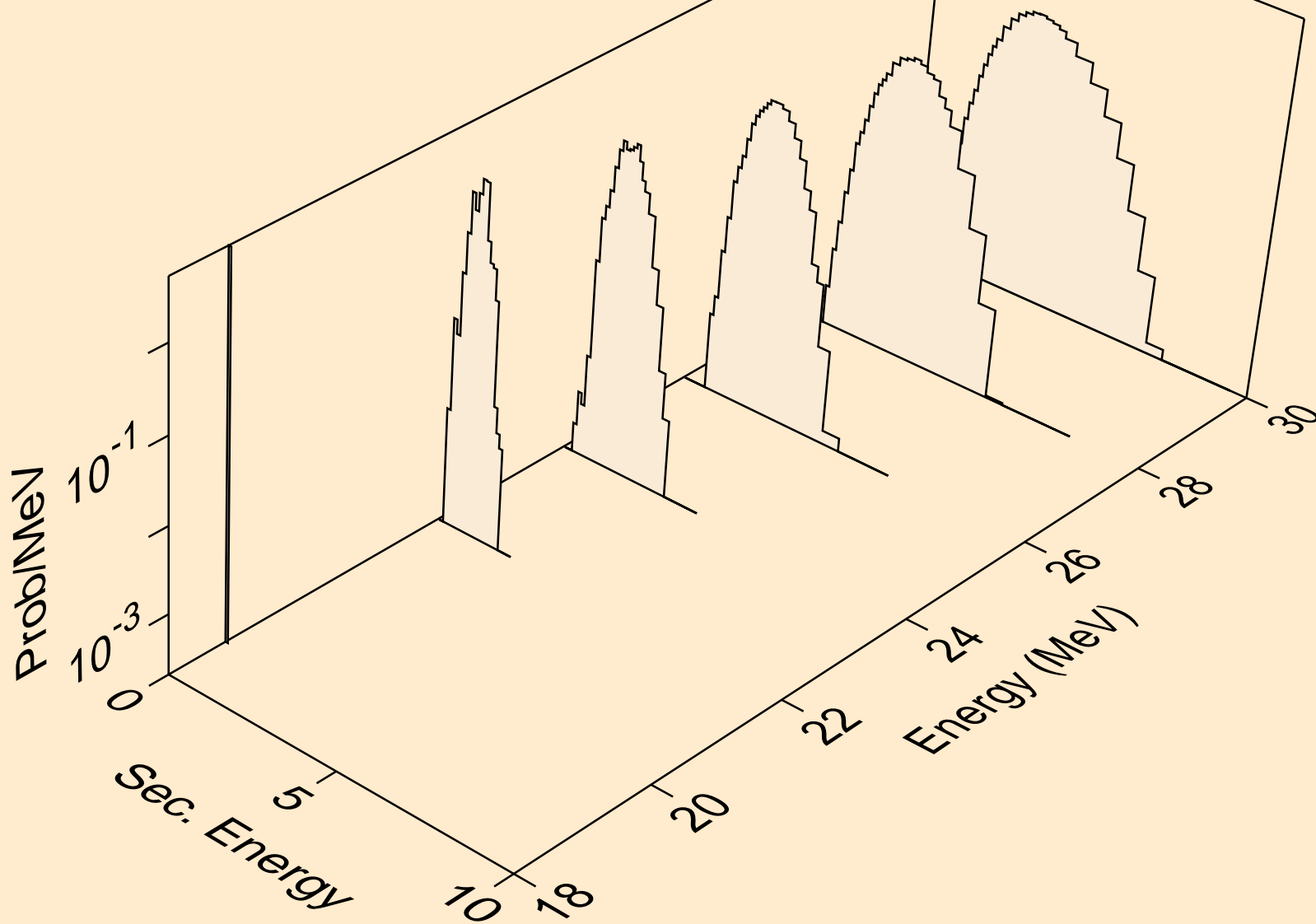

SC049 NEUTRON ACER TENDL-2019 LIBRARY; T=293.16K  
protons from (n,pd)

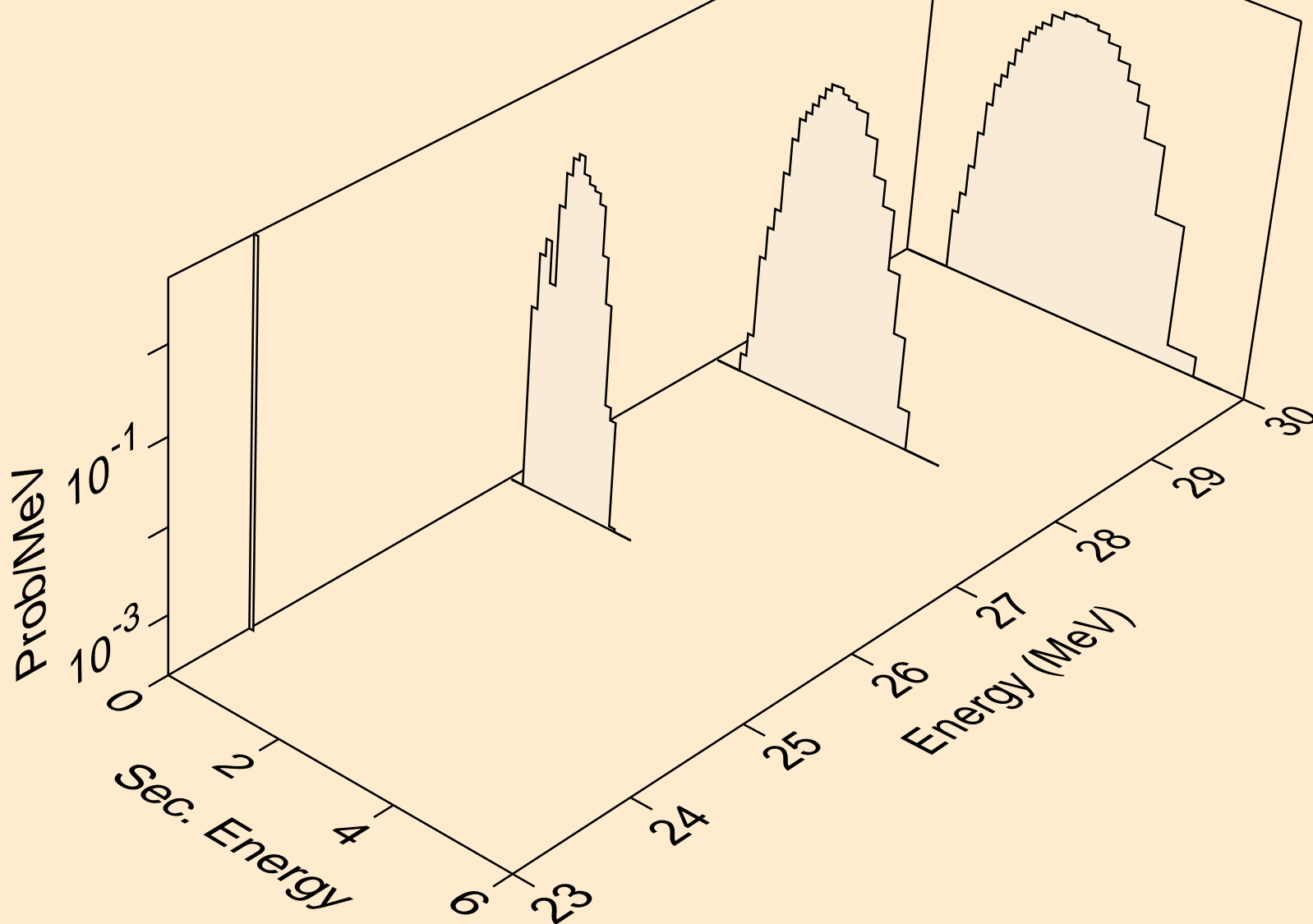

SC049 NEUTRON ACER TENDL-2019 LIBRARY; T=293.16K  
deuterons from (n,x)

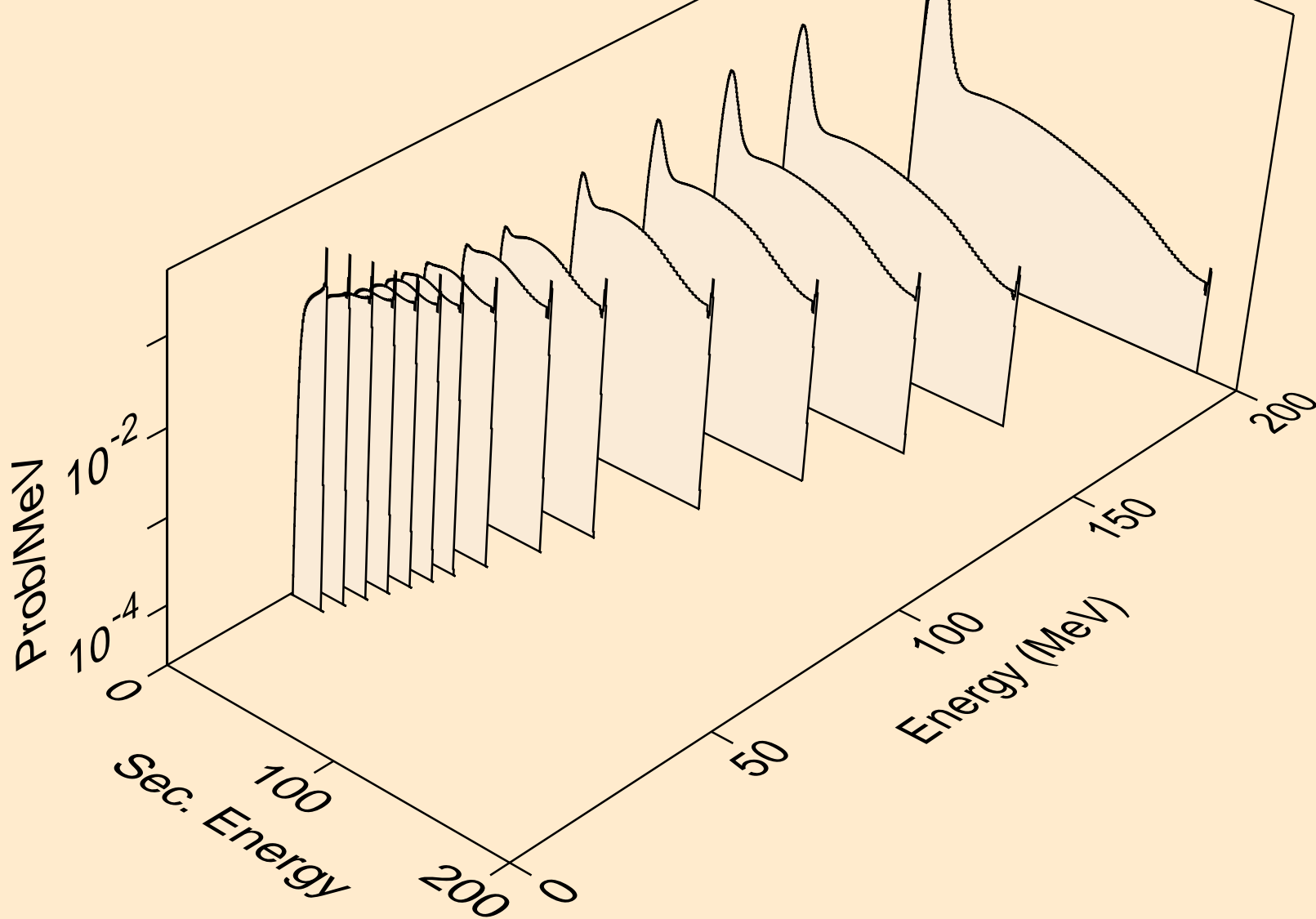

SC049 NEUTRON ACER TENDL-2019 LIBRARY; T=293.16K  
deuterons from (n,2nd)

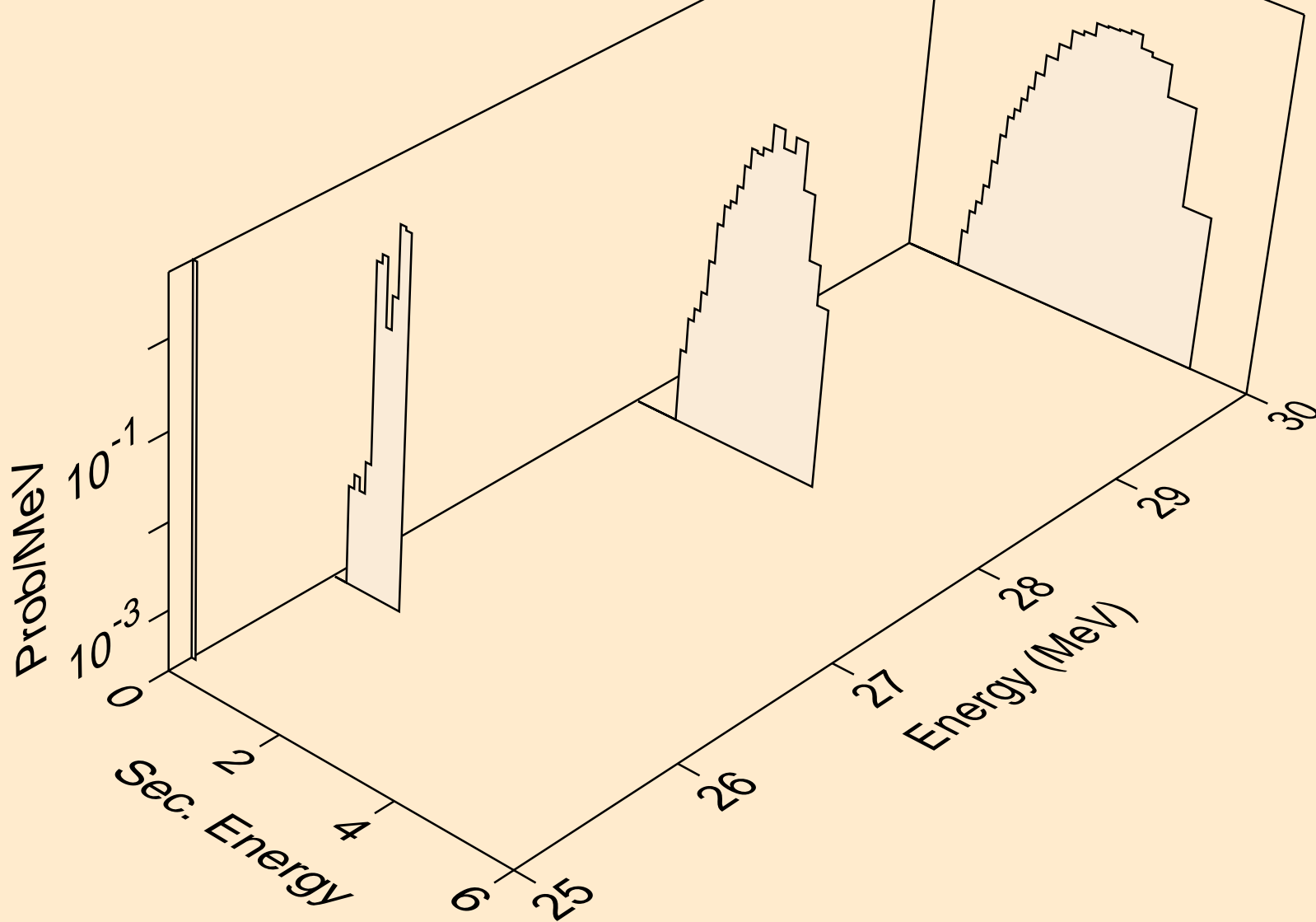

SC049 NEUTRON ACER TENDL-2019 LIBRARY; T=293.16K  
deuterons from (n,n\*)d

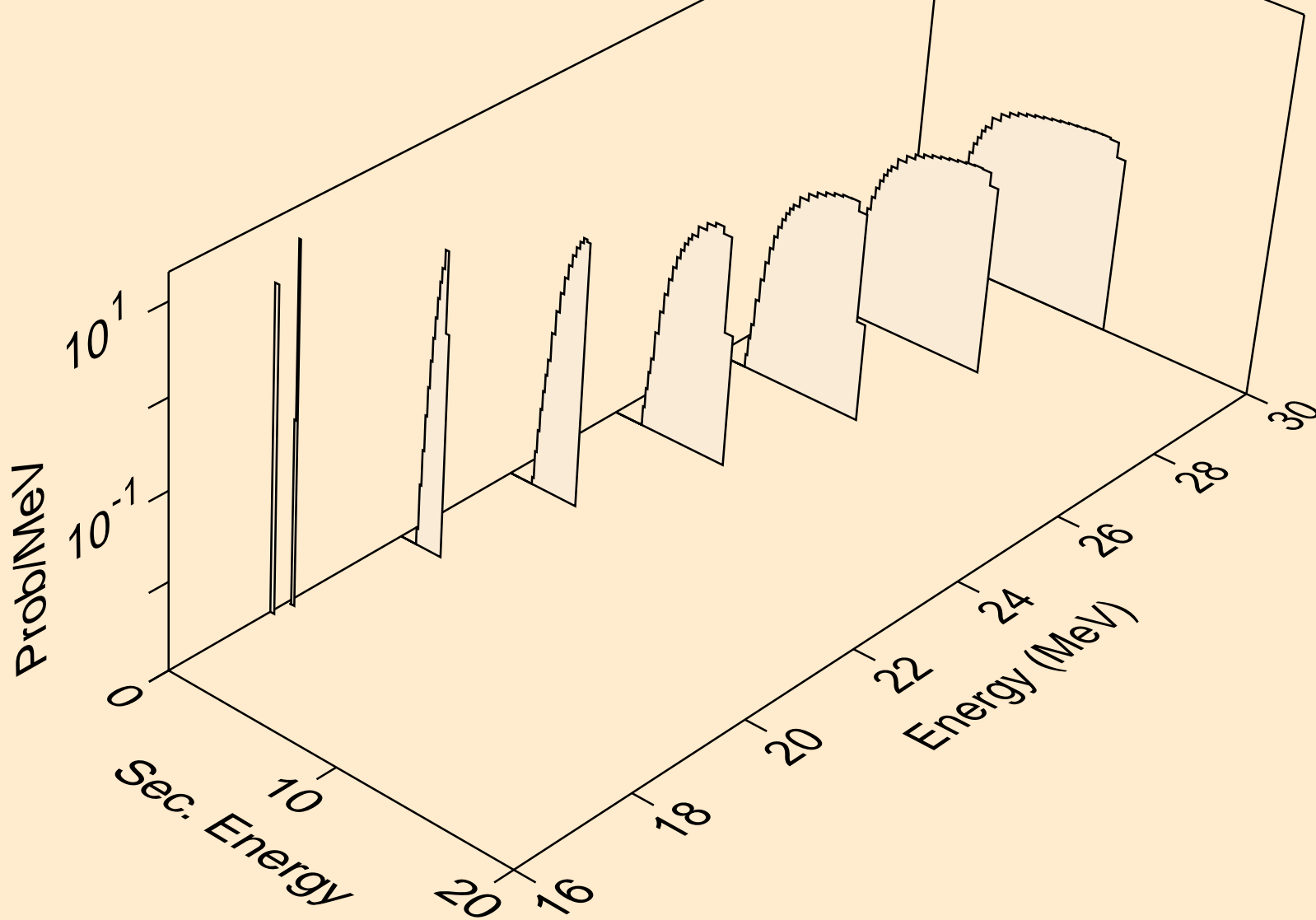

SC049 NEUTRON ACER TENDL-2019 LIBRARY; T=293.16K  
deuterons from (n,d)

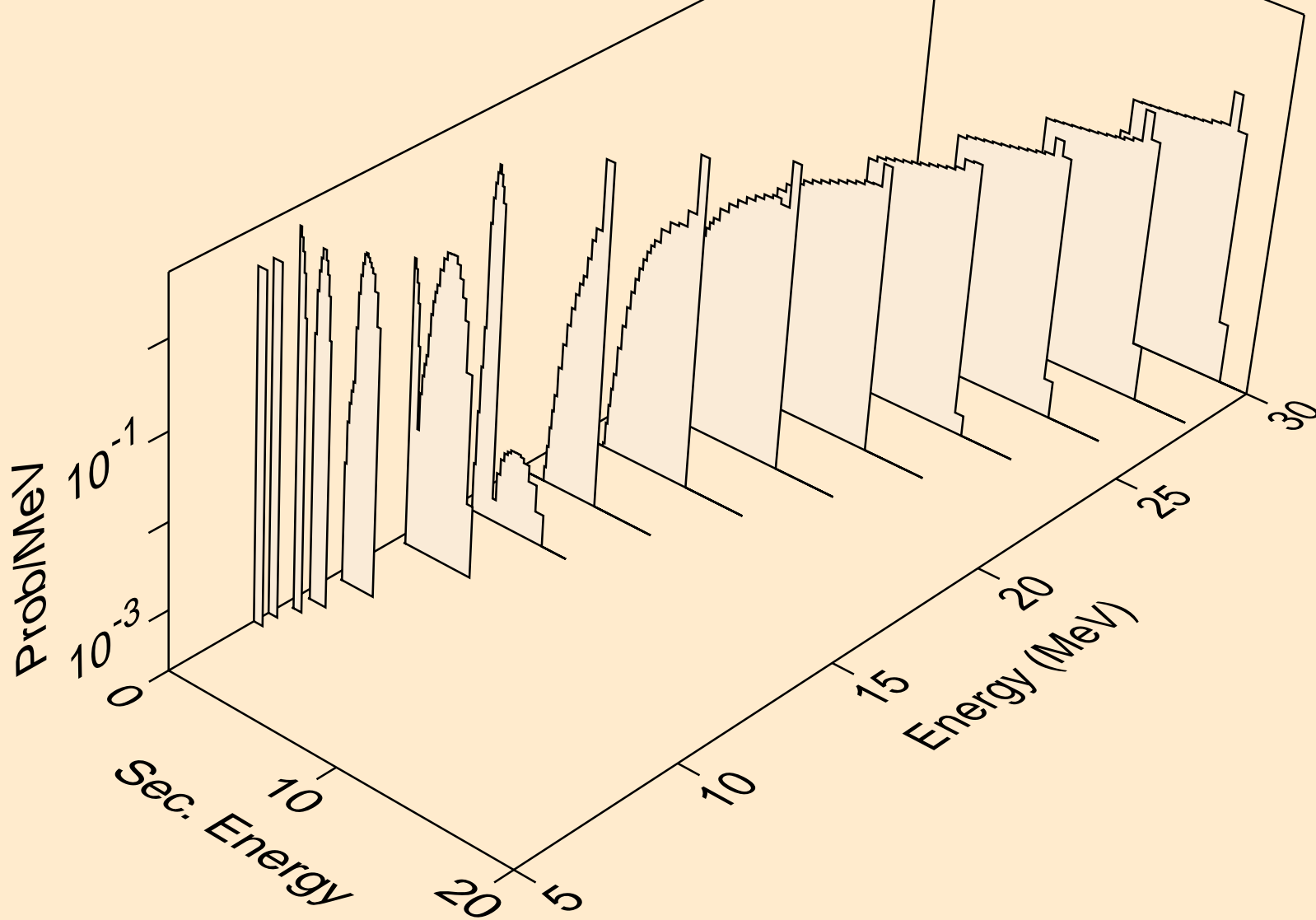

SC049 NEUTRON ACER TENDL-2019 LIBRARY; T=293.16K  
deuterons from (n,pd)

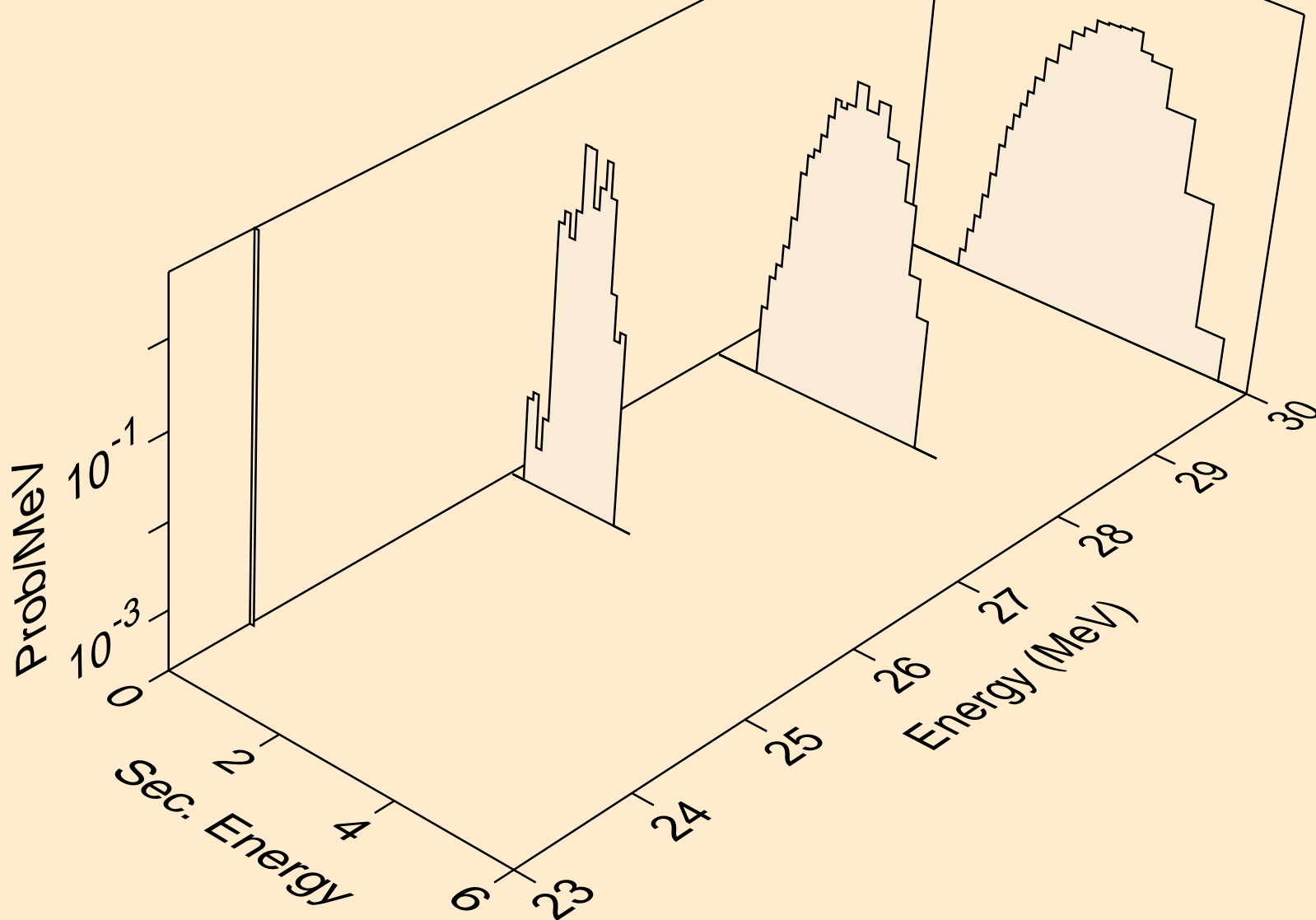

SC049 NEUTRON ACER TENDL-2019 LIBRARY; T=293.16K  
deuterons from (n,da)

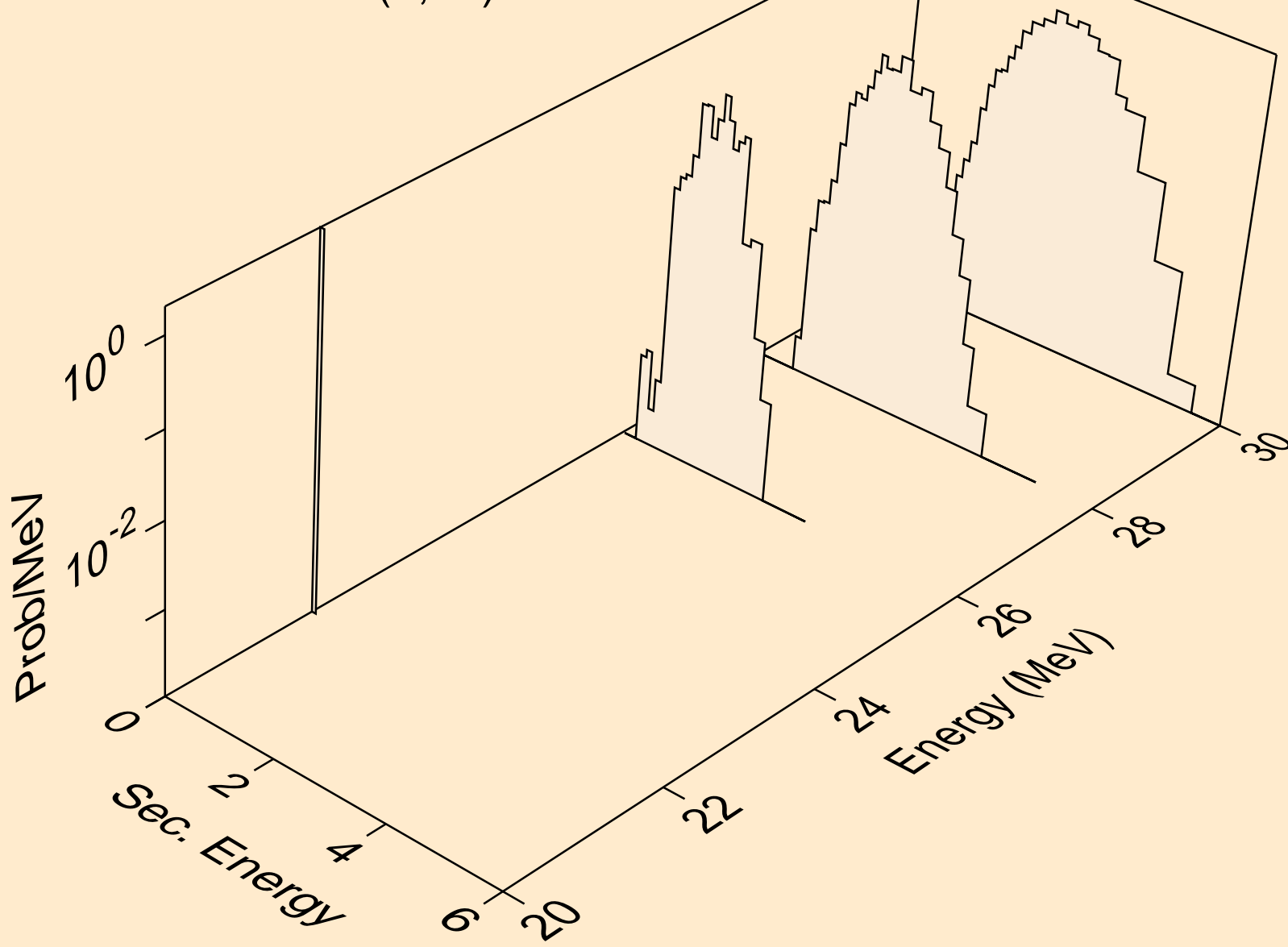

SC049 NEUTRON ACER TENDL-2019 LIBRARY; T=293.16K  
tritons from (n,x)

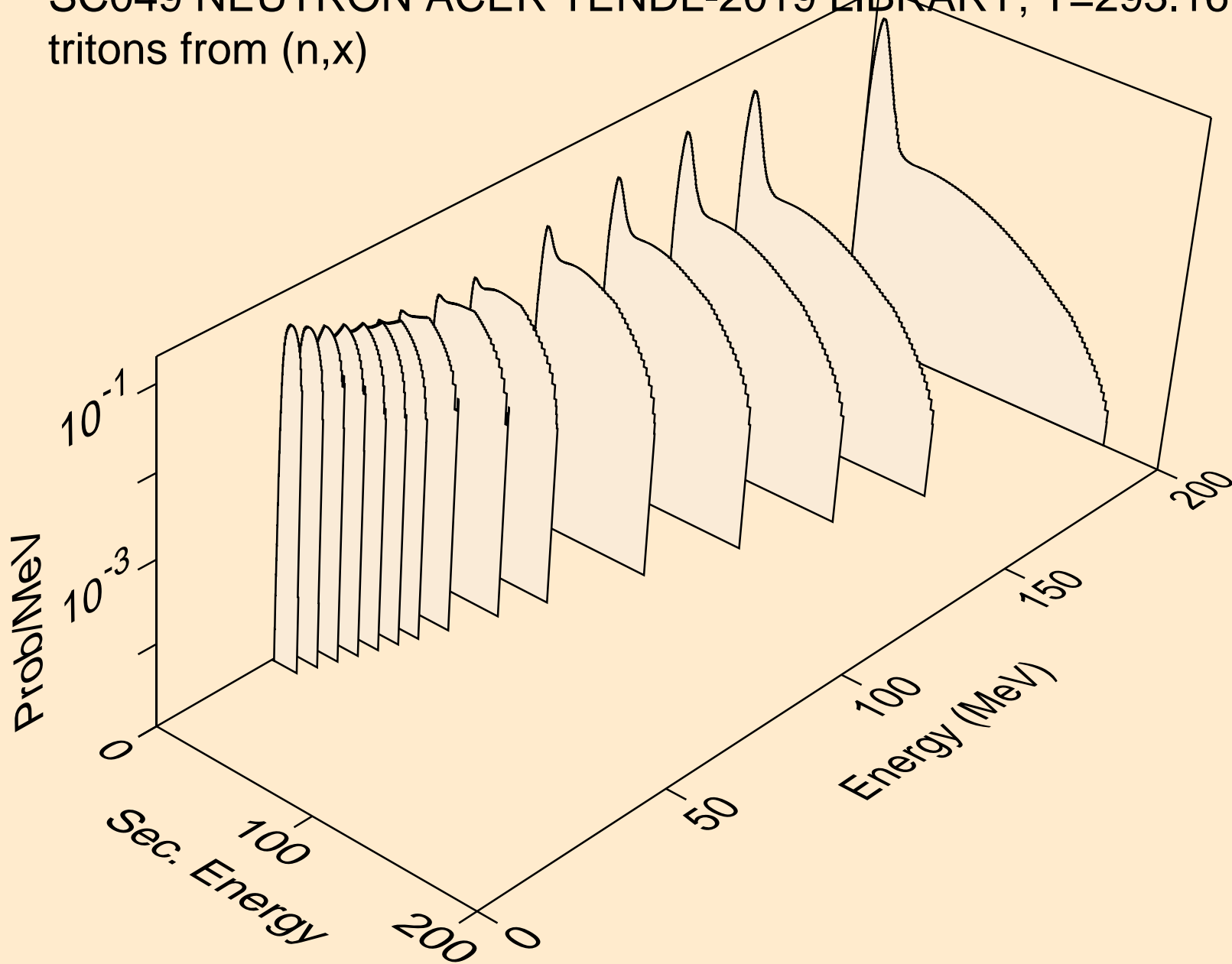

SC049 NEUTRON ACER TENDL-2019 LIBRARY; T=293.16K  
tritons from (n,n\*)t

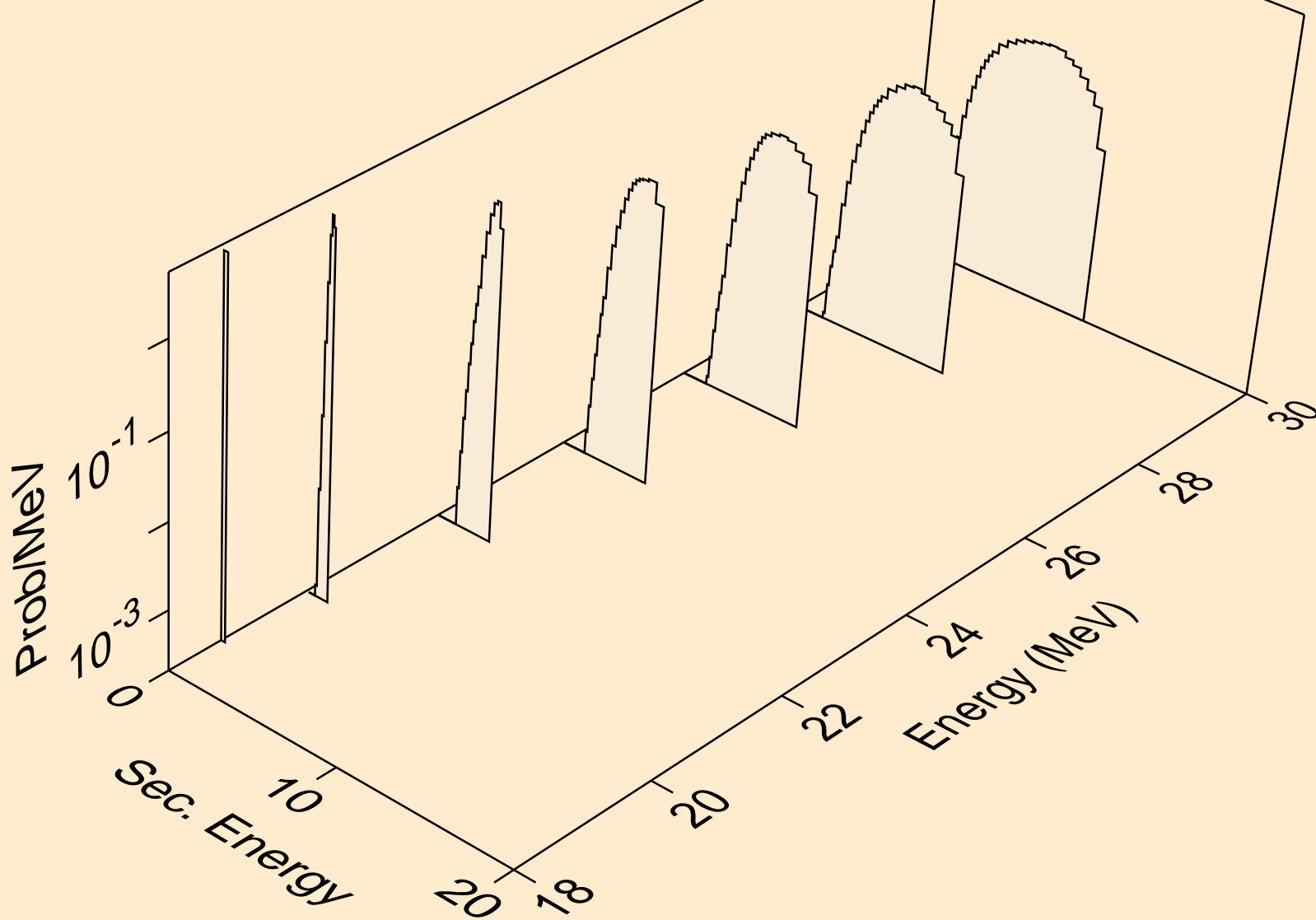

SC049 NEUTRON ACER TENDL-2019 LIBRARY; T=293.16K  
tritons from (n,t)

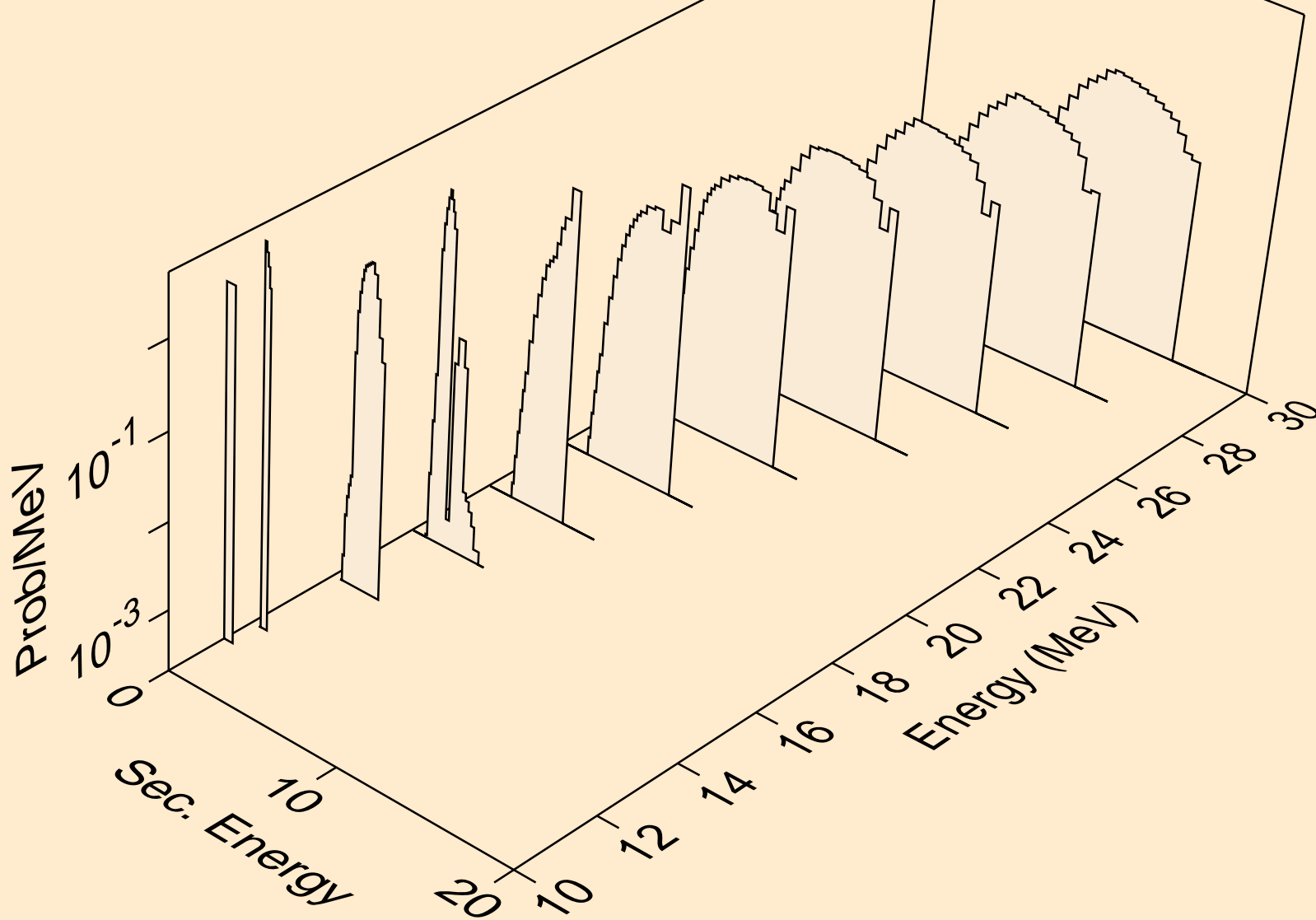

SC049 NEUTRON ACER TENDL-2019 LIBRARY; T=293.16K  
he3s from (n,x)

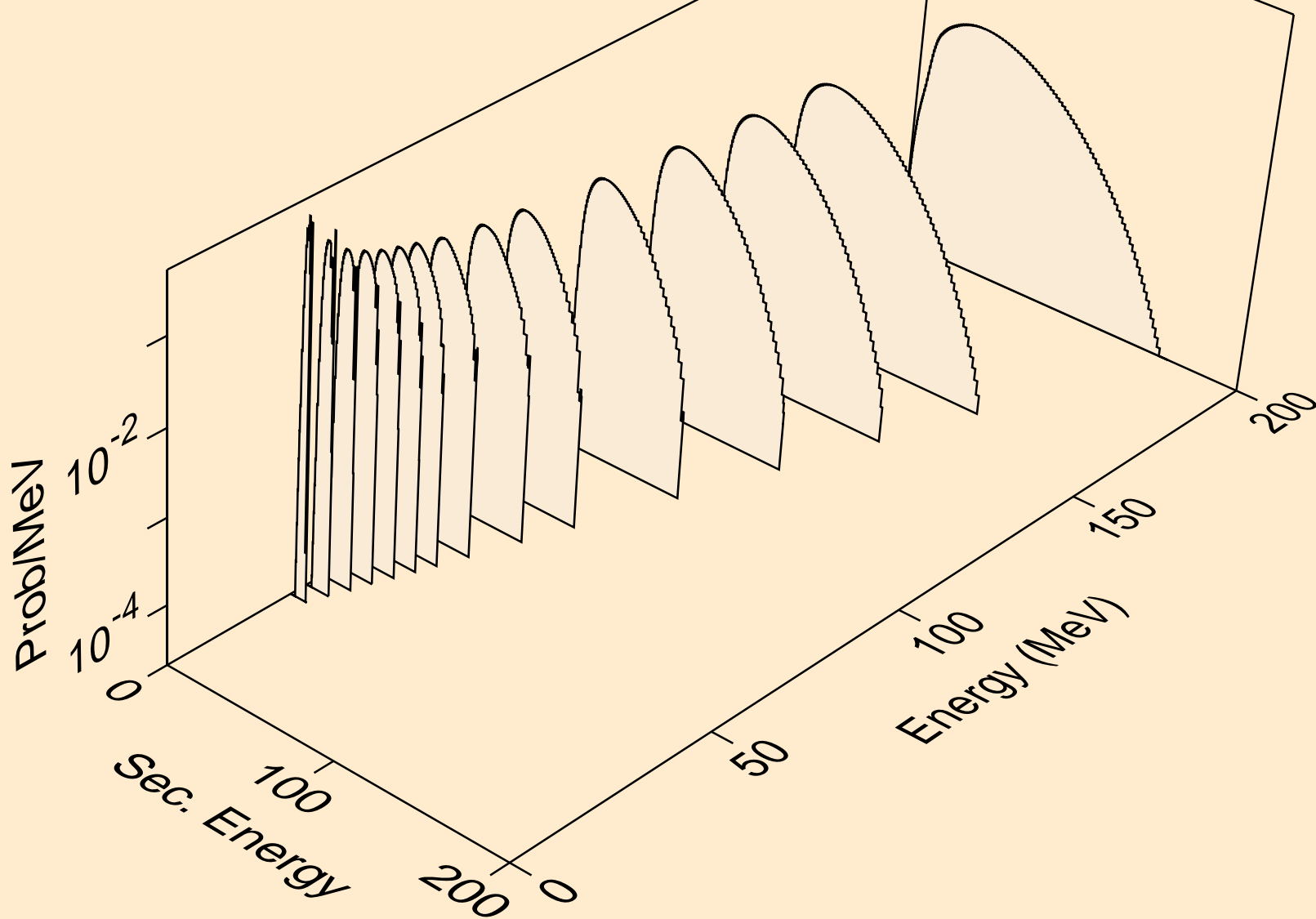

SC049 NEUTRON ACER TENDL-2019 LIBRARY; T=293.16K  
he3s from (n,n\*)he3

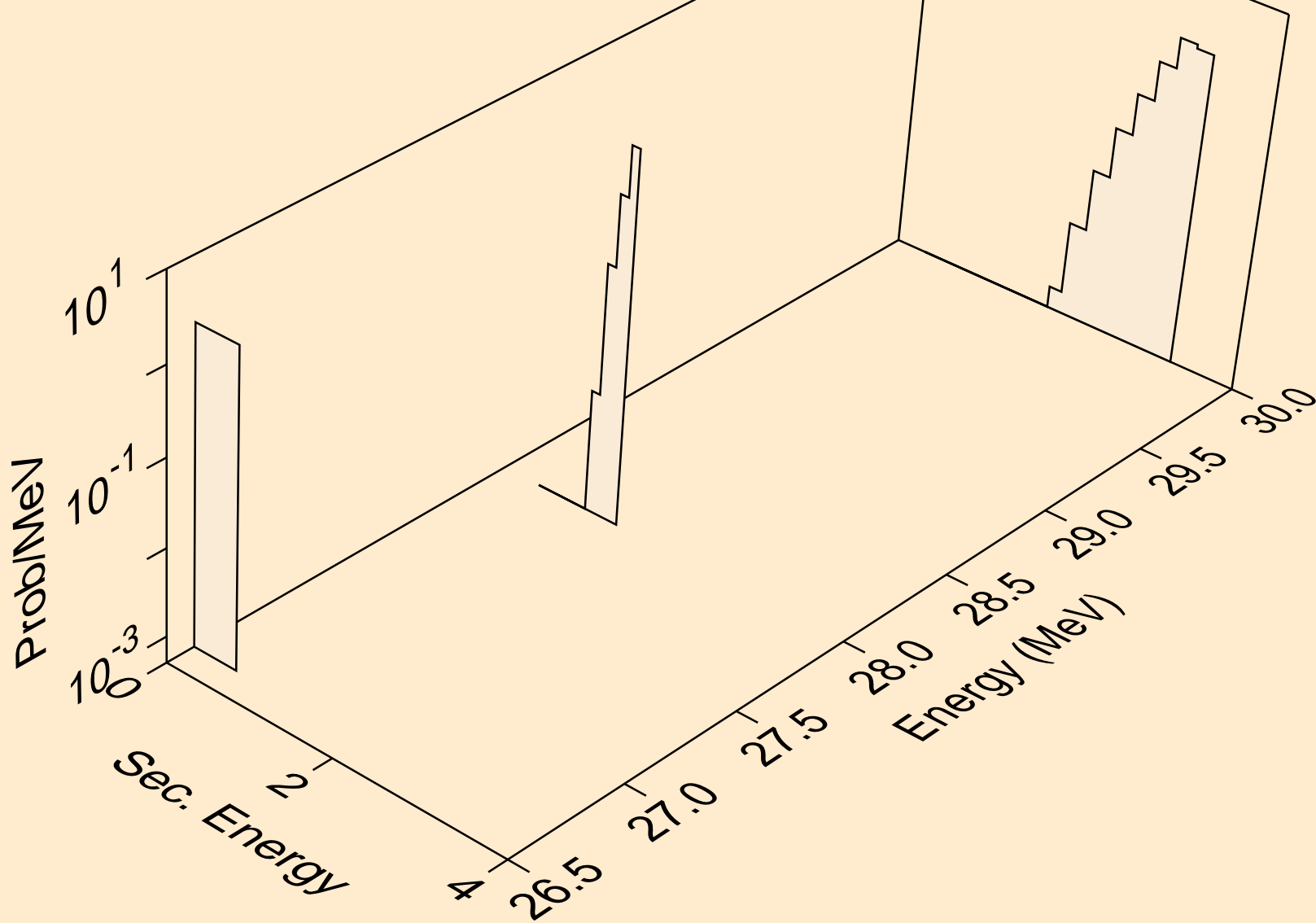

SC049 NEUTRON ACER TENDL-2019 LIBRARY; T=293.16K  
he3s from (n,he3)

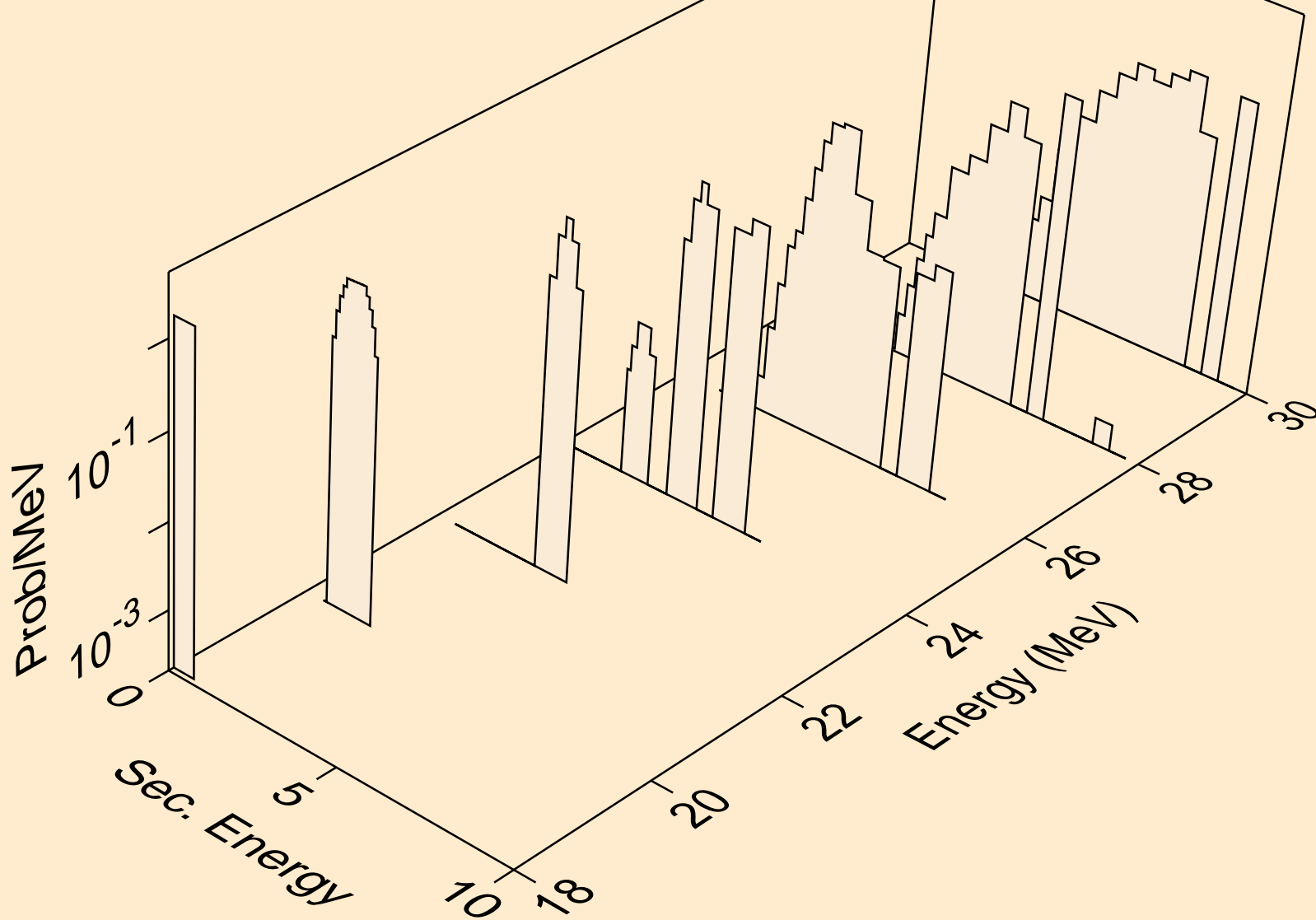

SC049 NEUTRON ACER TENDL-2019 LIBRARY; T=293.16K  
alphas from (n,x)

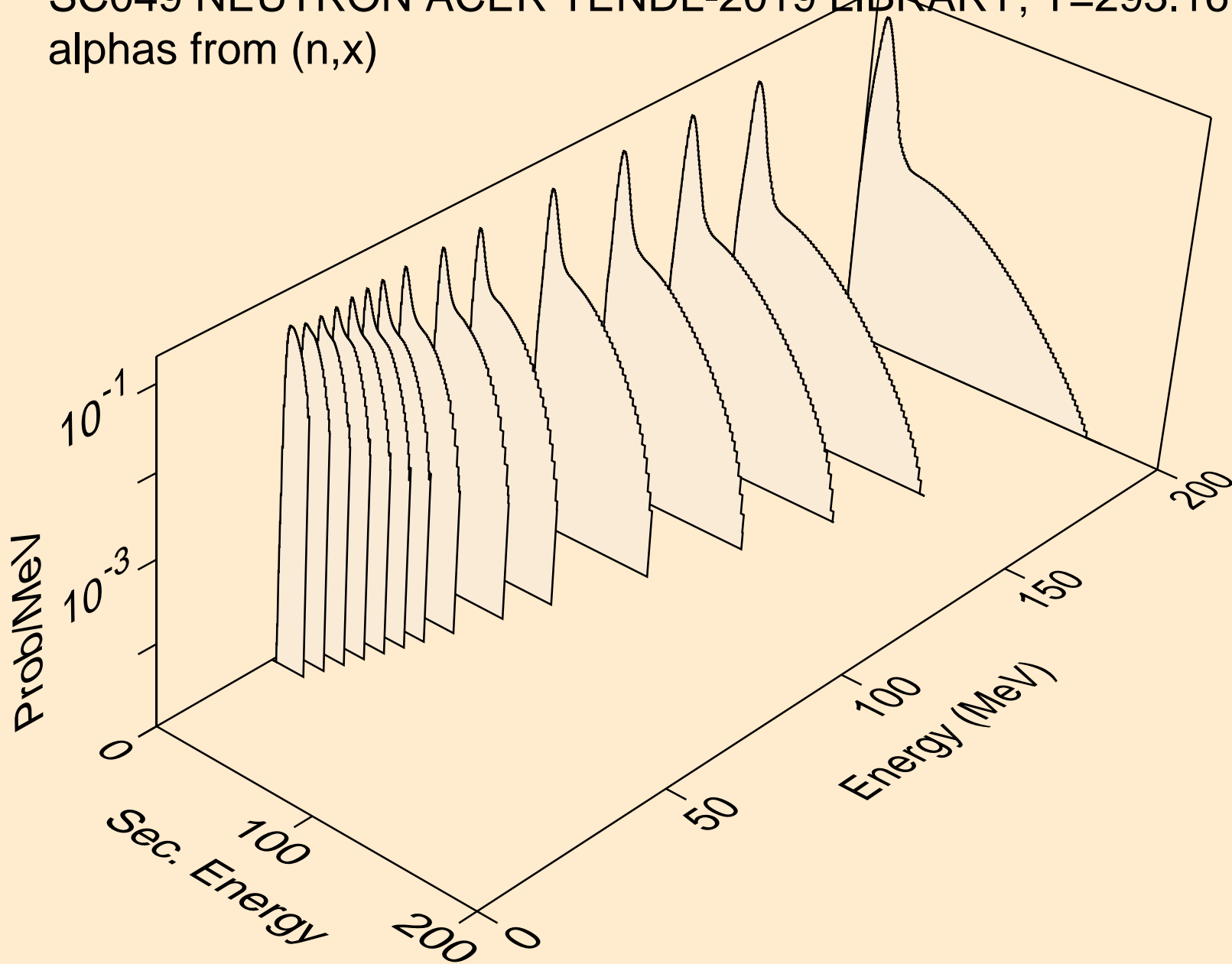

SC049 NEUTRON ACER TENDL-2019 LIBRARY; T=293.16K  
alphas from (n,n\*)a

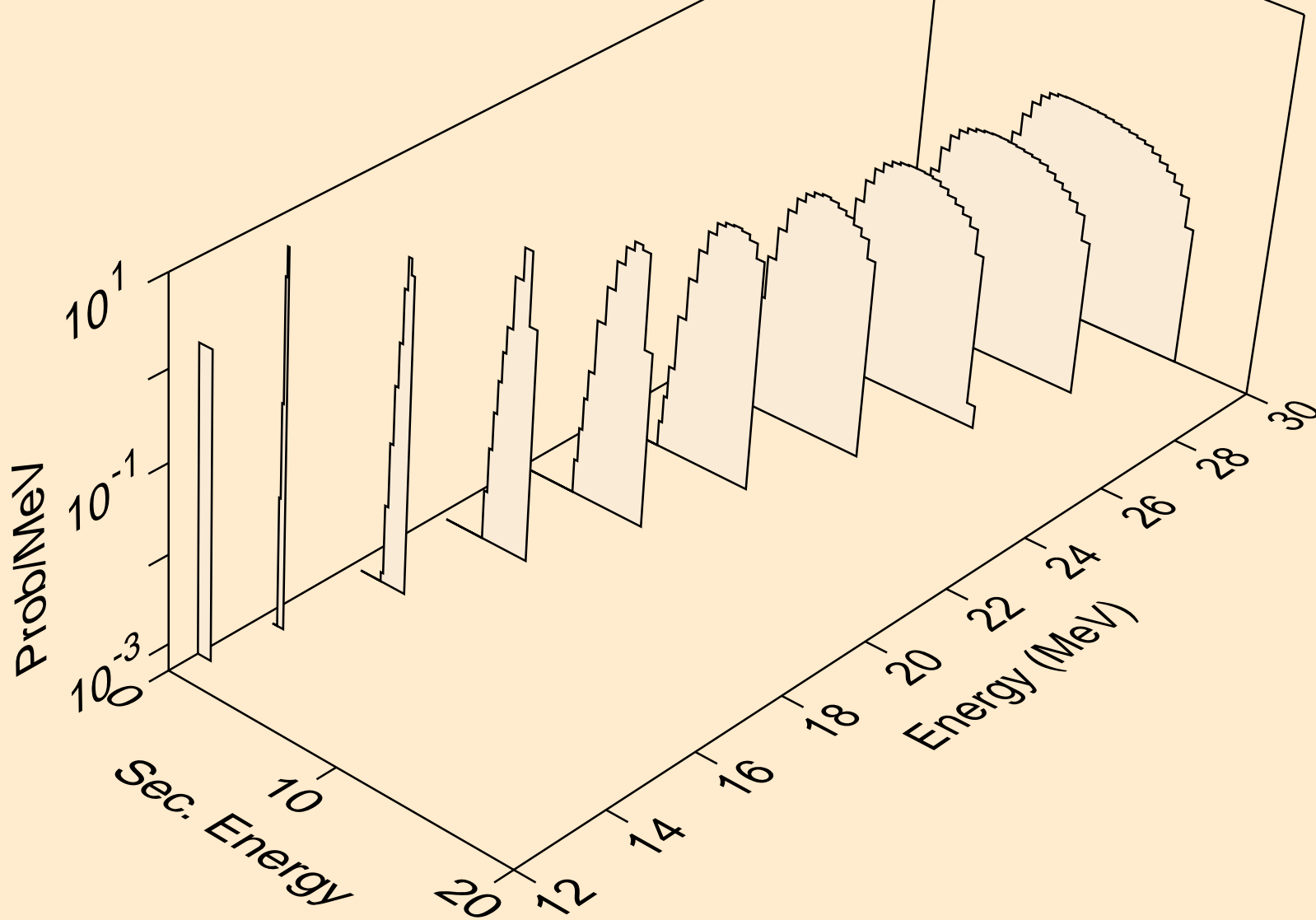

SC049 NEUTRON ACER TENDL-2019 LIBRARY; T=293.16K  
alphas from (n,2n)a

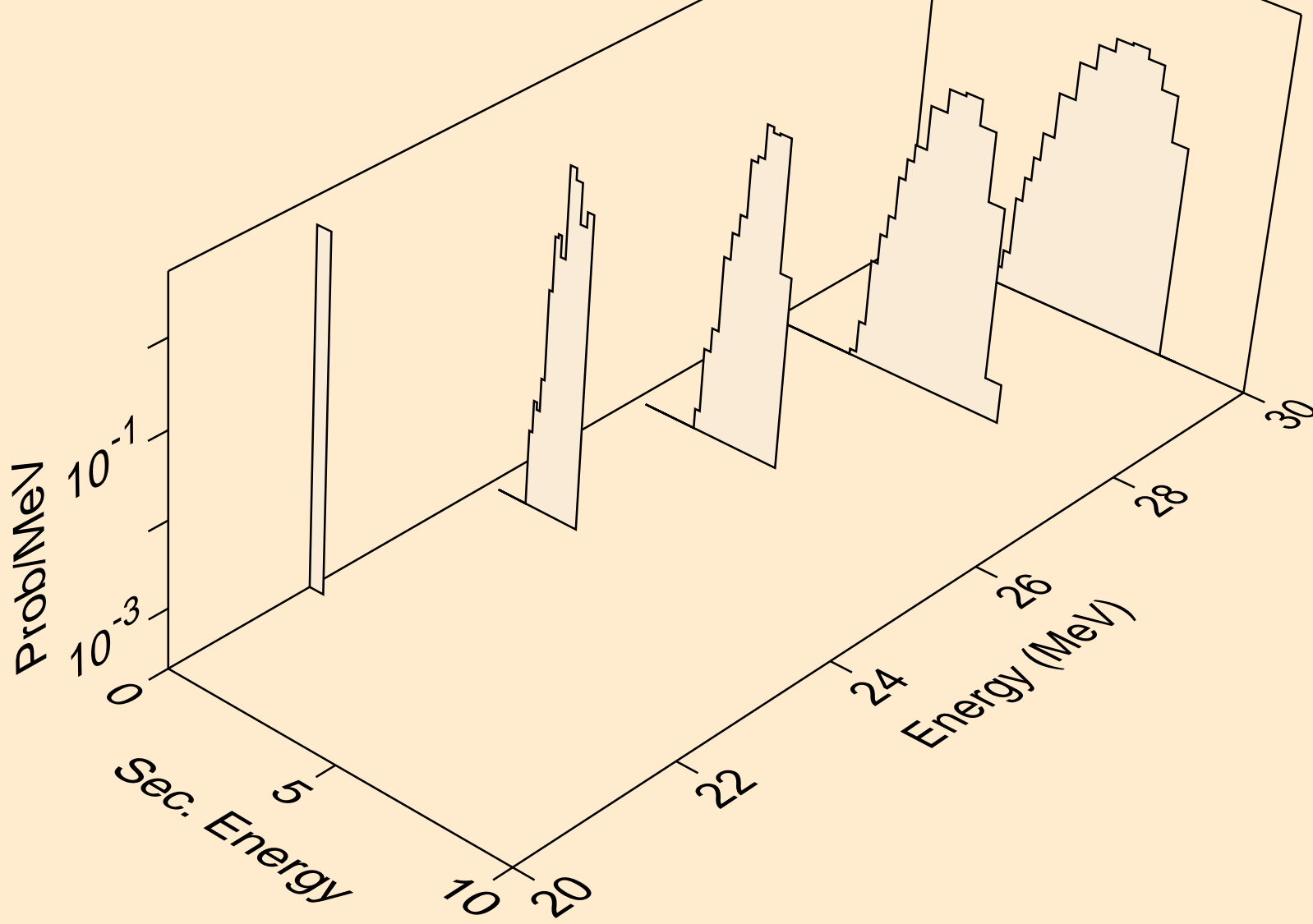

SC049 NEUTRON ACER TENDL-2019 LIBRARY; T=293.16K  
alphas from (n,a)

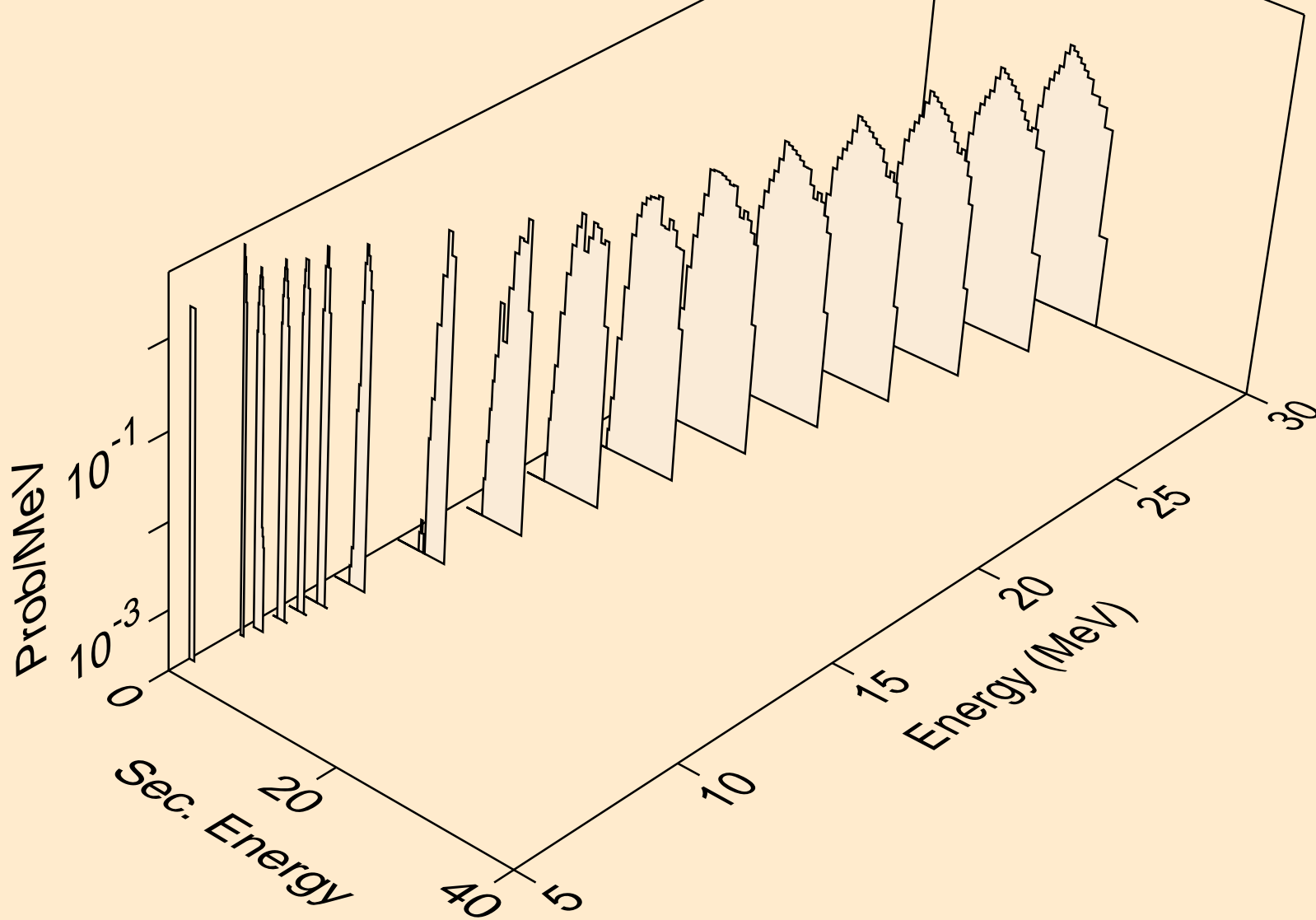

SC049 NEUTRON ACER TENDL-2019 LIBRARY; T=293.16K  
alphas from (n,2a)

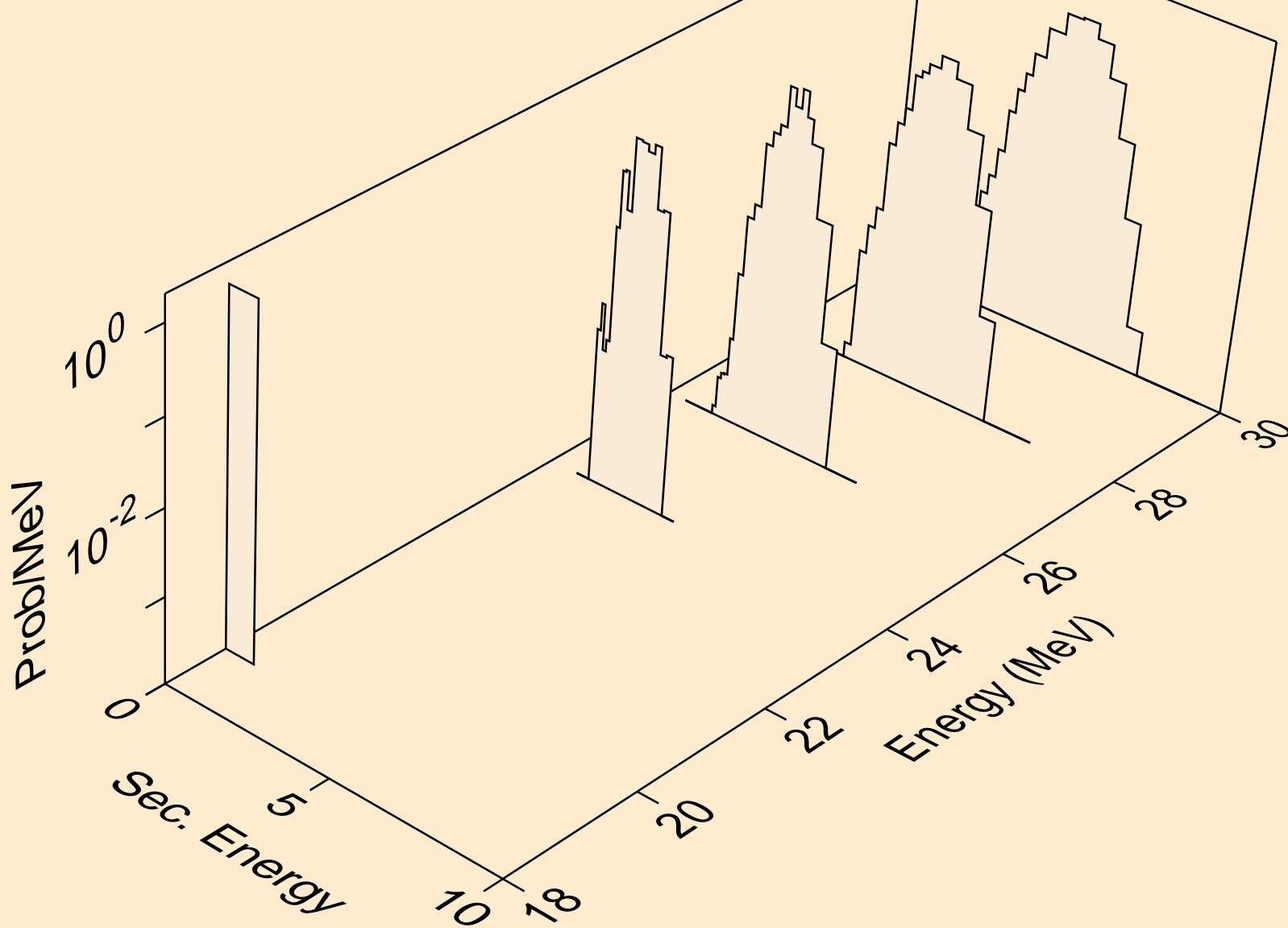

SC049 NEUTRON ACER TENDL-2019 LIBRARY; T=293.16K  
alphas from (n,pa)

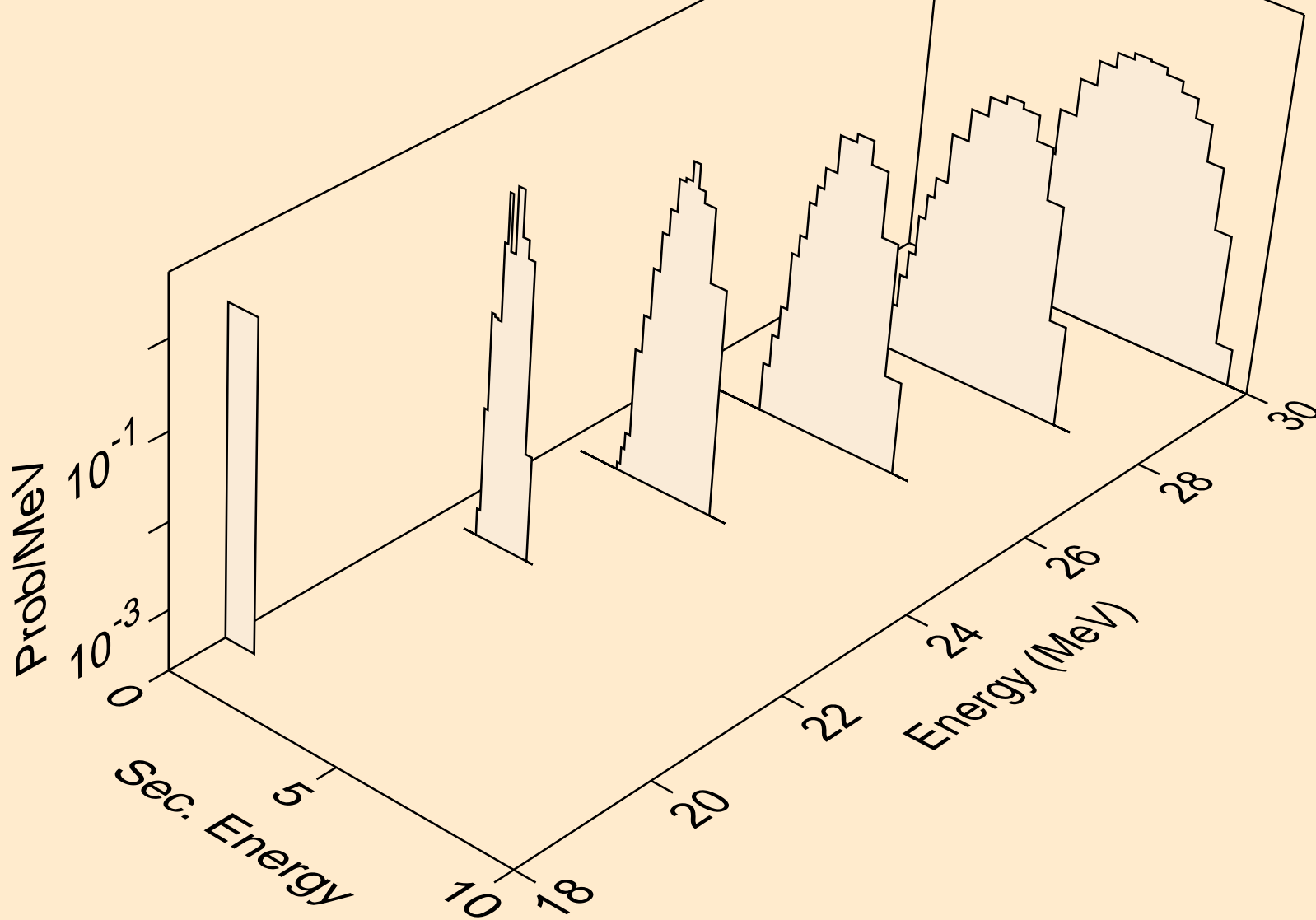

SC049 NEUTRON ACER TENDL-2019 LIBRARY; T=293.16K  
alphas from (n,da)

