

SE083 NEUTRON ACER TENDL-2019 LIBRARY; T=293.16K
Principal cross sections

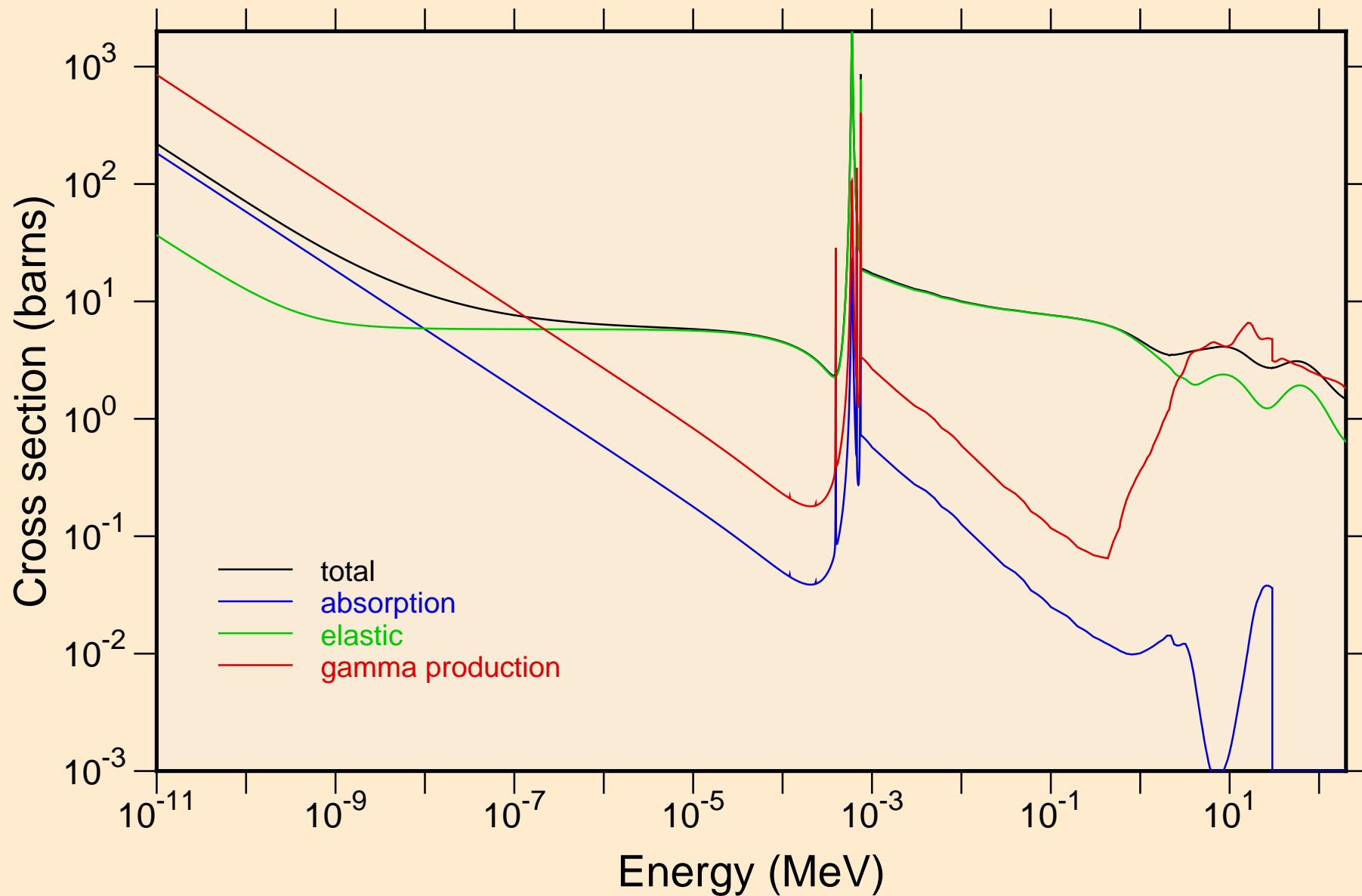

SE083 NEUTRON ACER TENDL-2019 LIBRARY; T=293.16K
resonance total cross section

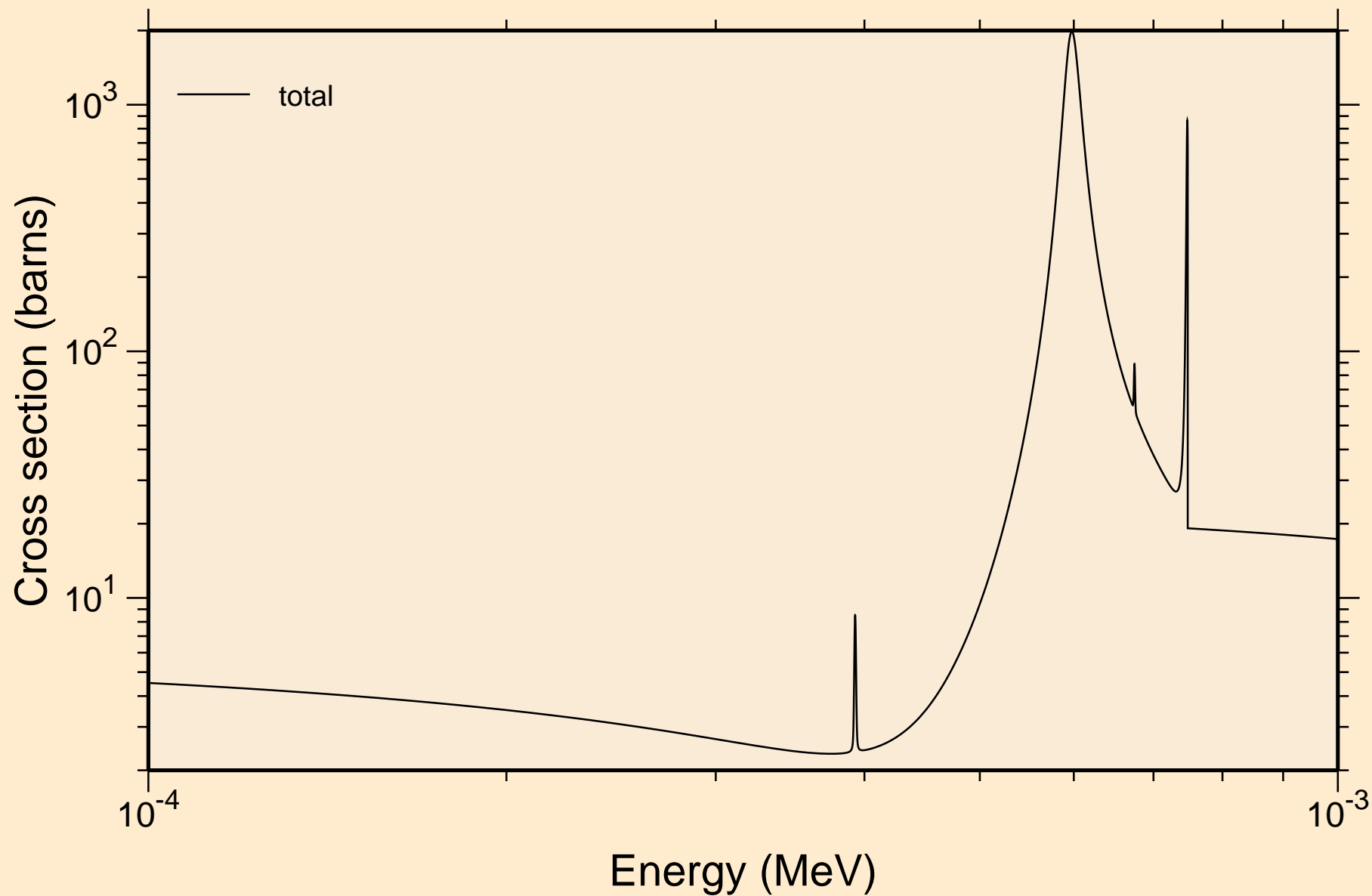

S \bar{E} 083 NEUTRON ACER TENDL-2019 LIBRARY; T=293.16K
resonance total cross section

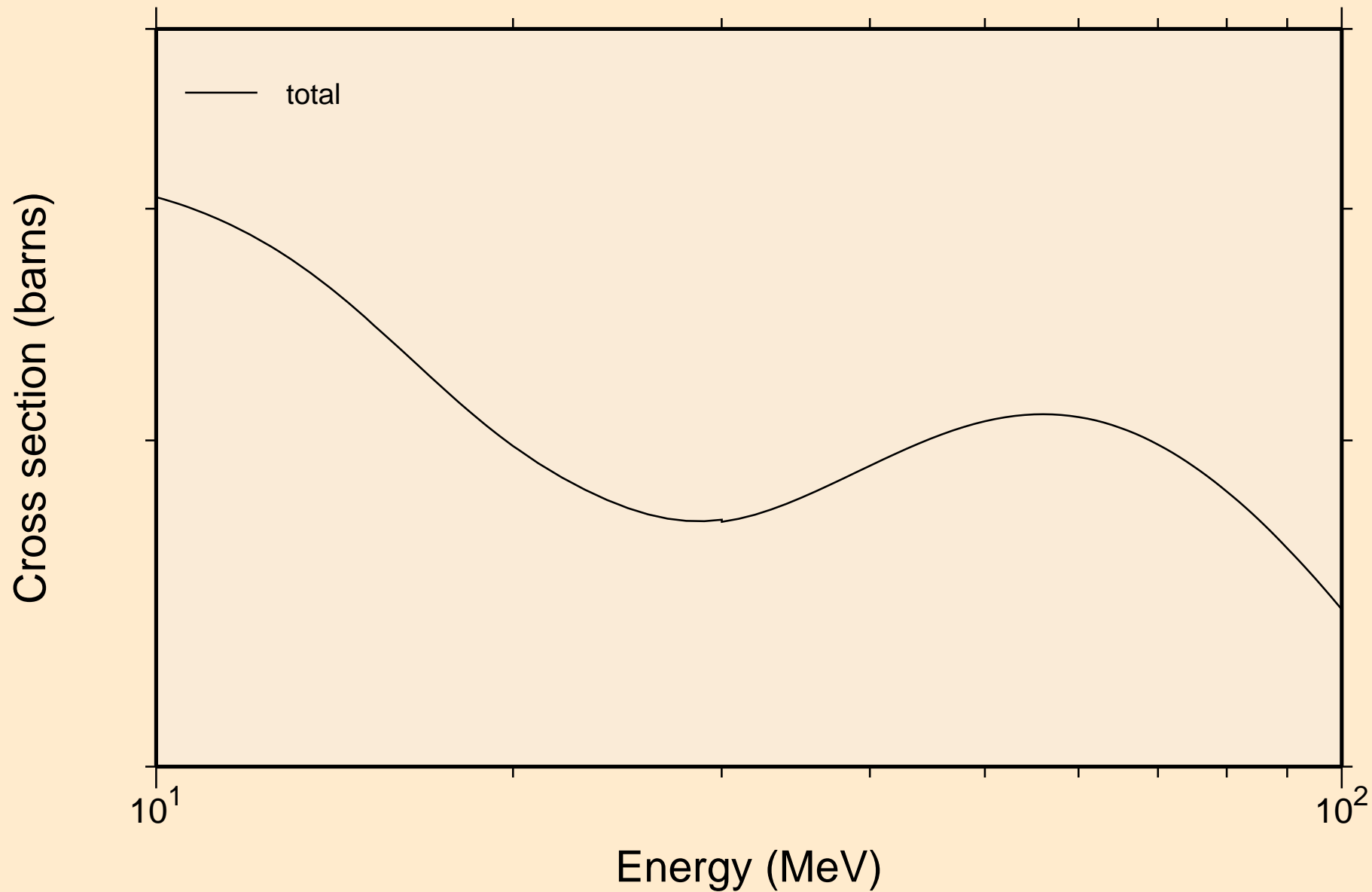

SE083 NEUTRON ACER TENDL-2019 LIBRARY; T=293.16K
resonance absorption cross sections

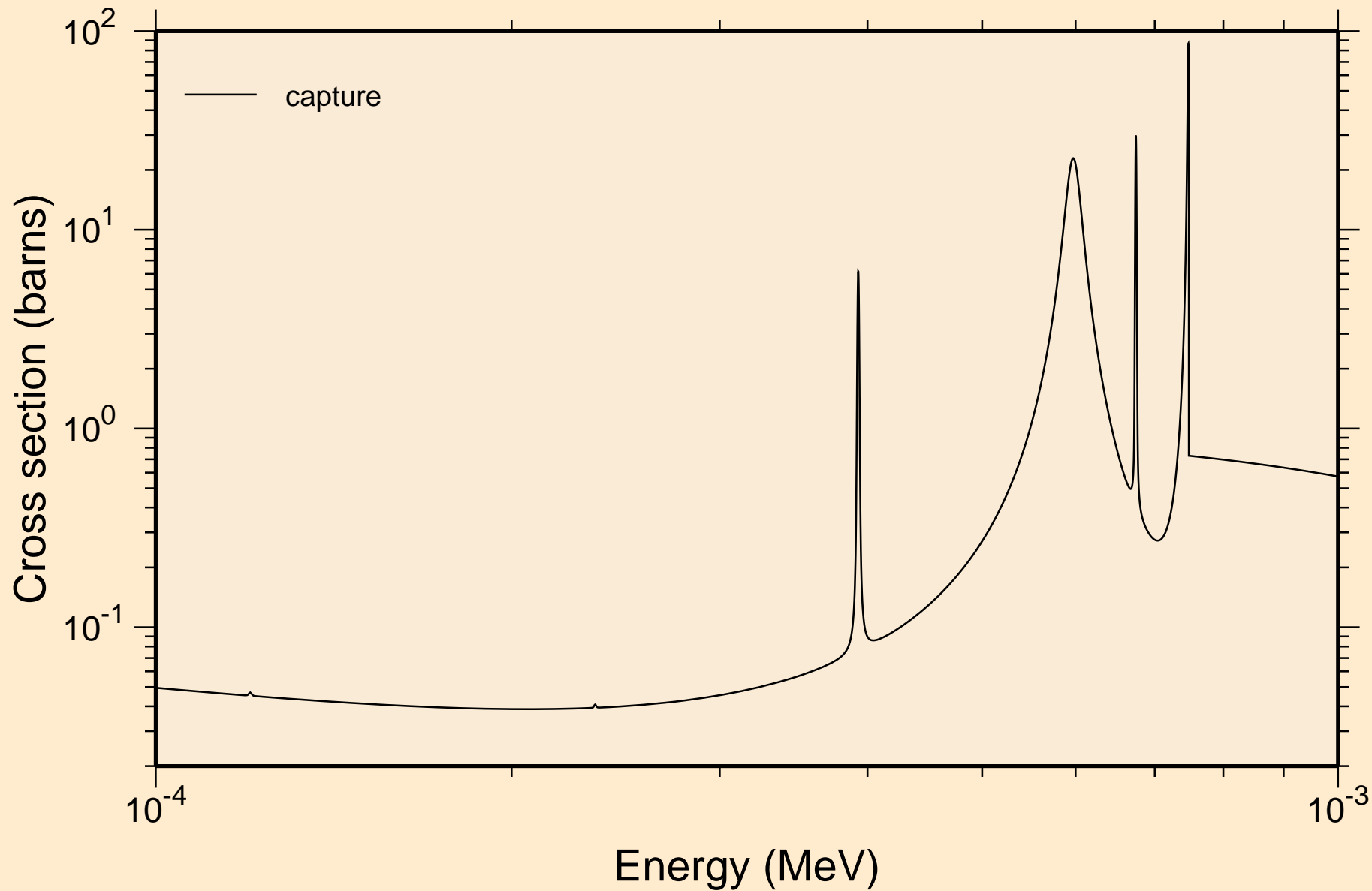

SE083 NEUTRON ACER TENDL-2019 LIBRARY; T=293.16K
resonance absorption cross sections

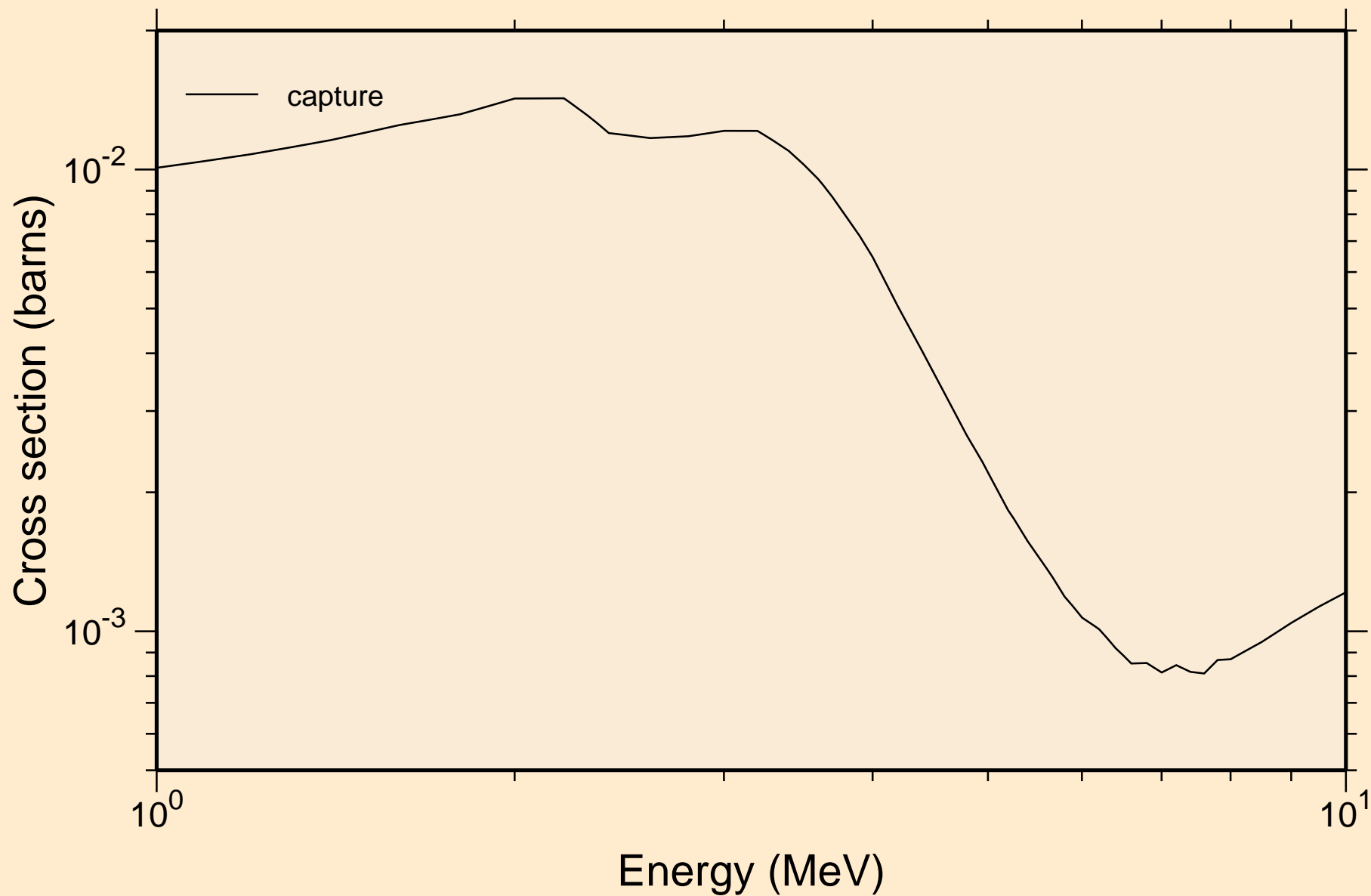

SE083 NEUTRON ACER TENDL-2019 LIBRARY; T=293.16K
Heating

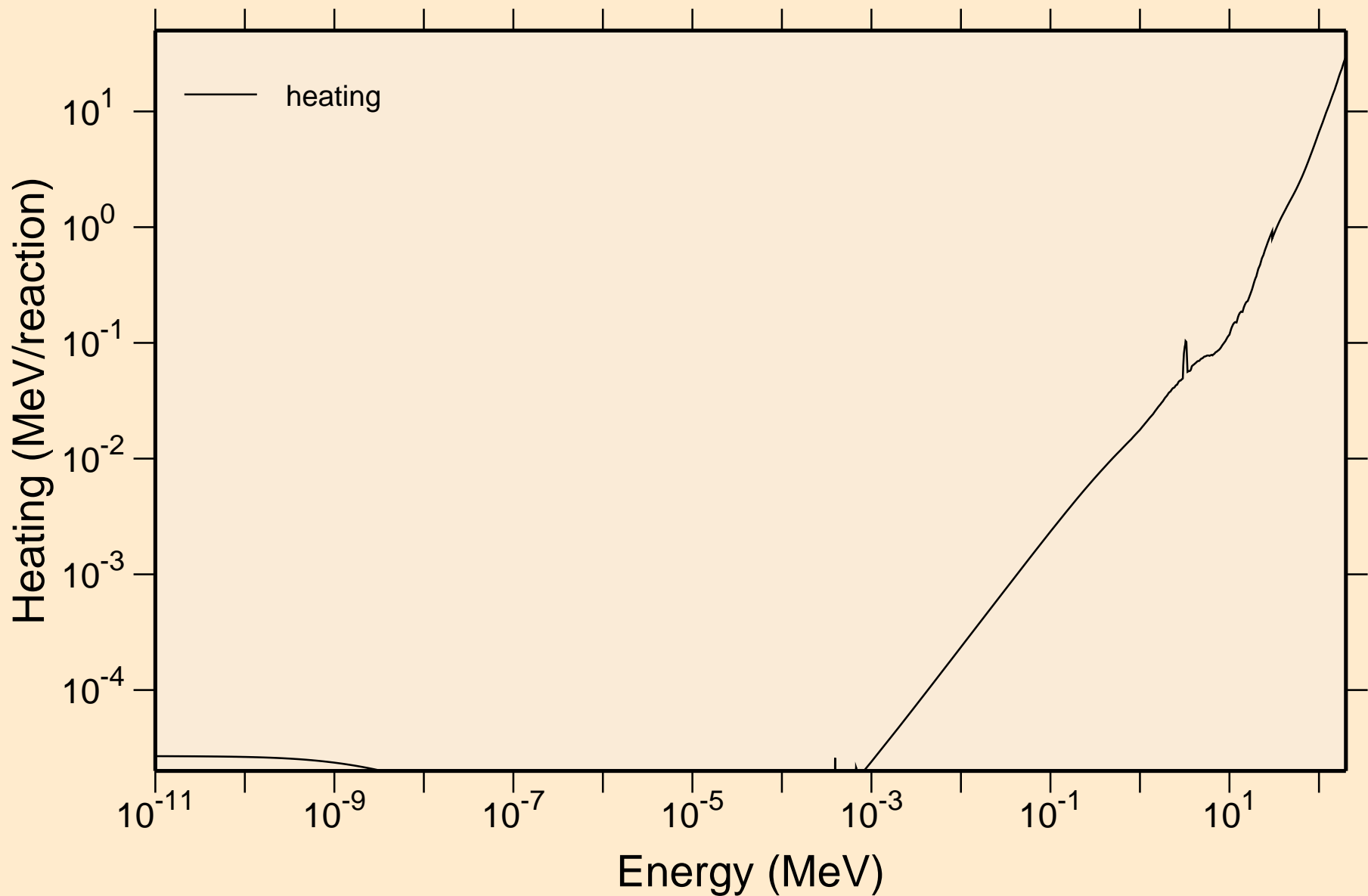

SE083 NEUTRON ACER TENDL-2019 LIBRARY; T=293.16K
Damage

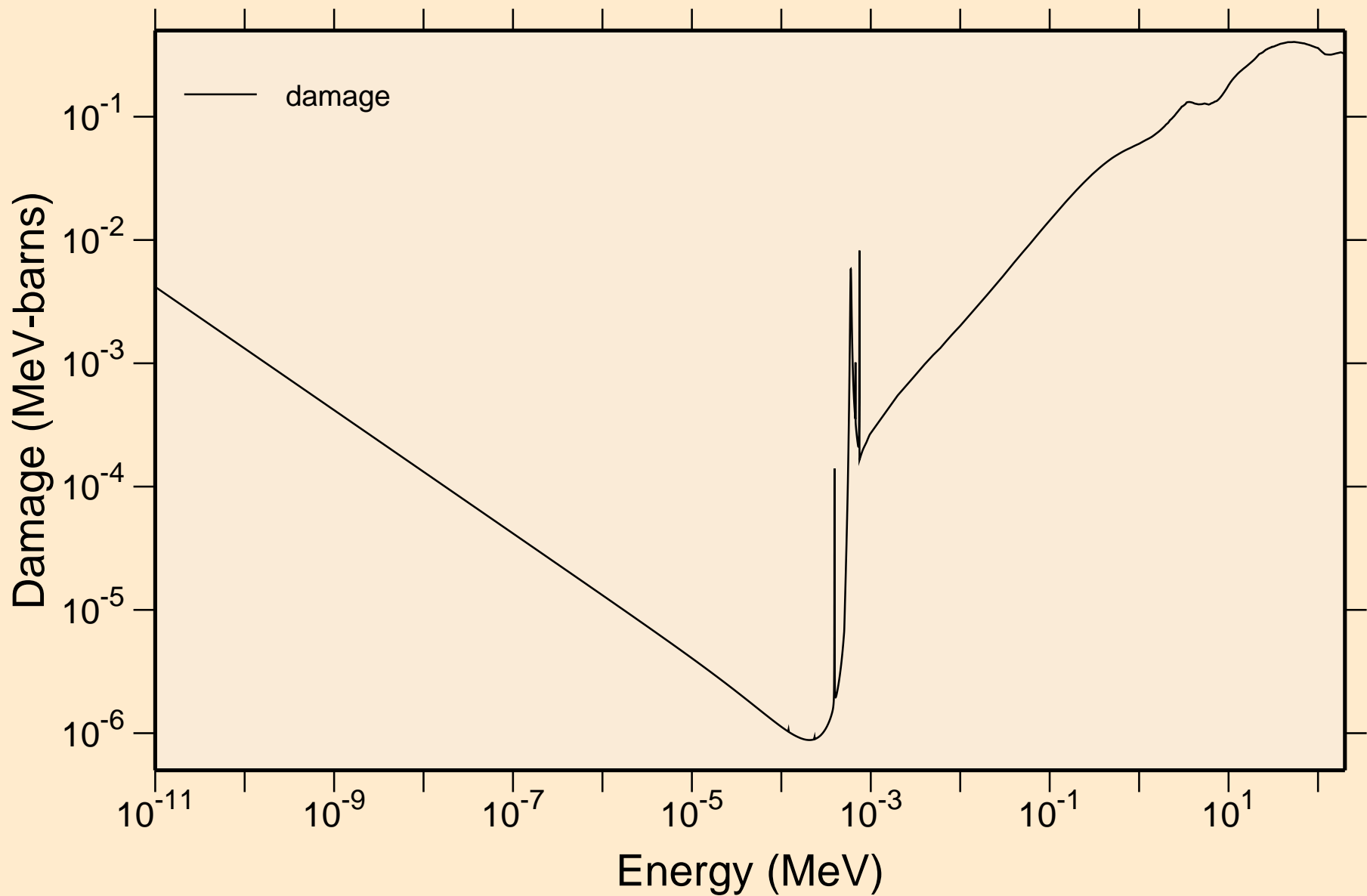

SE083 NEUTRON ACER TENDL-2019 LIBRARY; T=293.16K
Non-threshold reactions

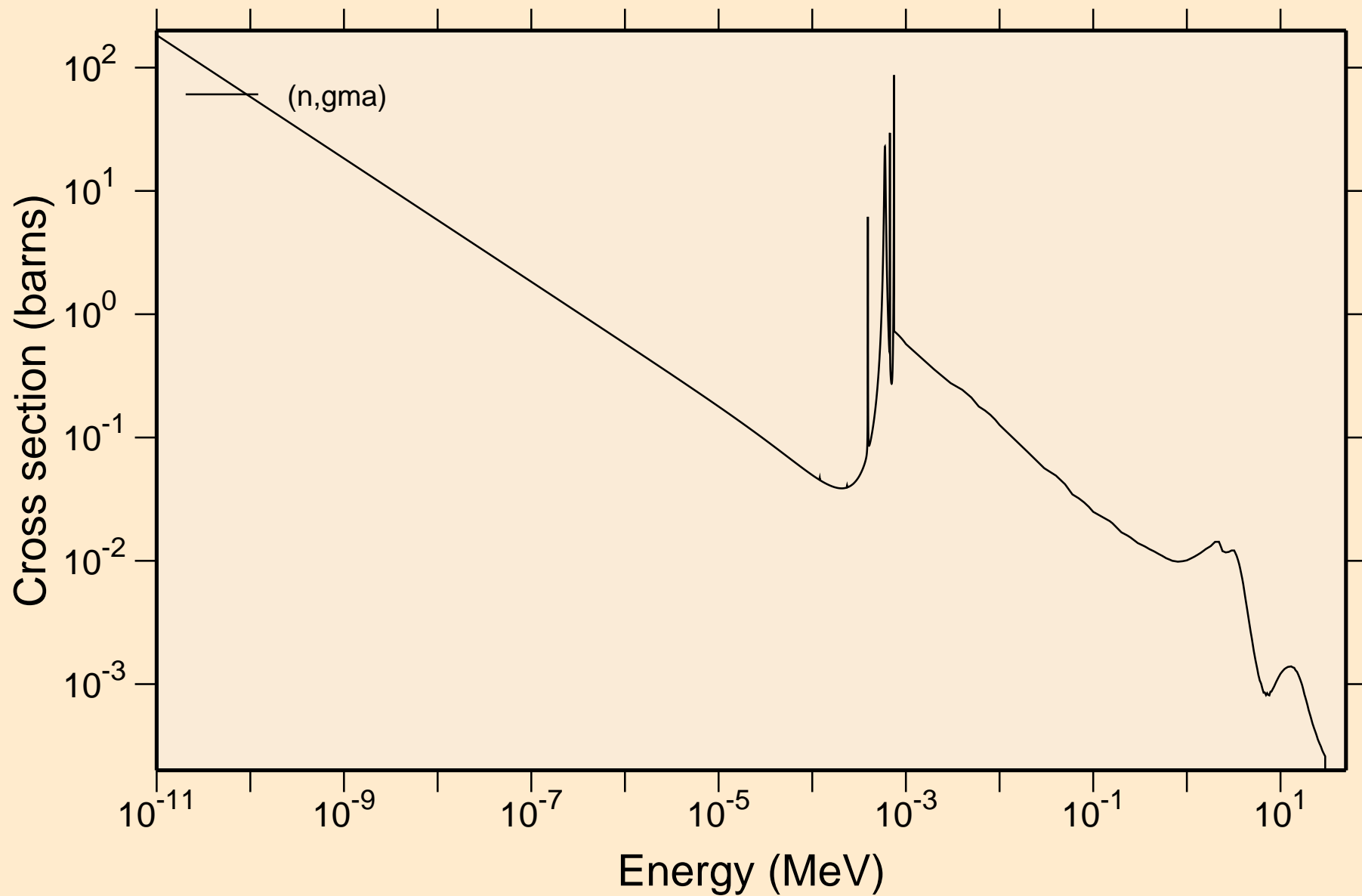

SE083 NEUTRON ACER TENDL-2019 LIBRARY; T=293.16K
Principal cross sections

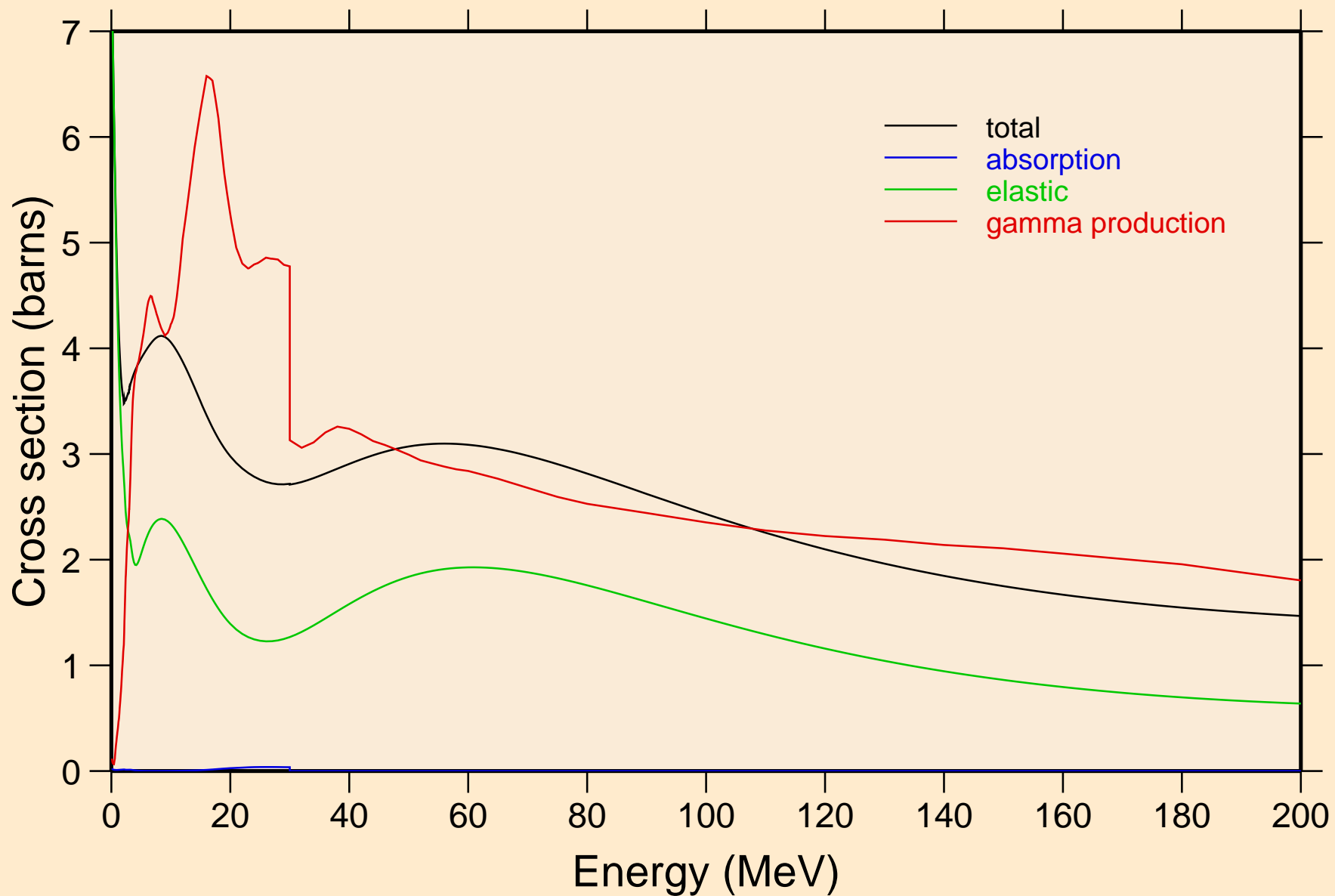

SE083 NEUTRON ACER TENDL-2019 LIBRARY; T=293.16K
Heating

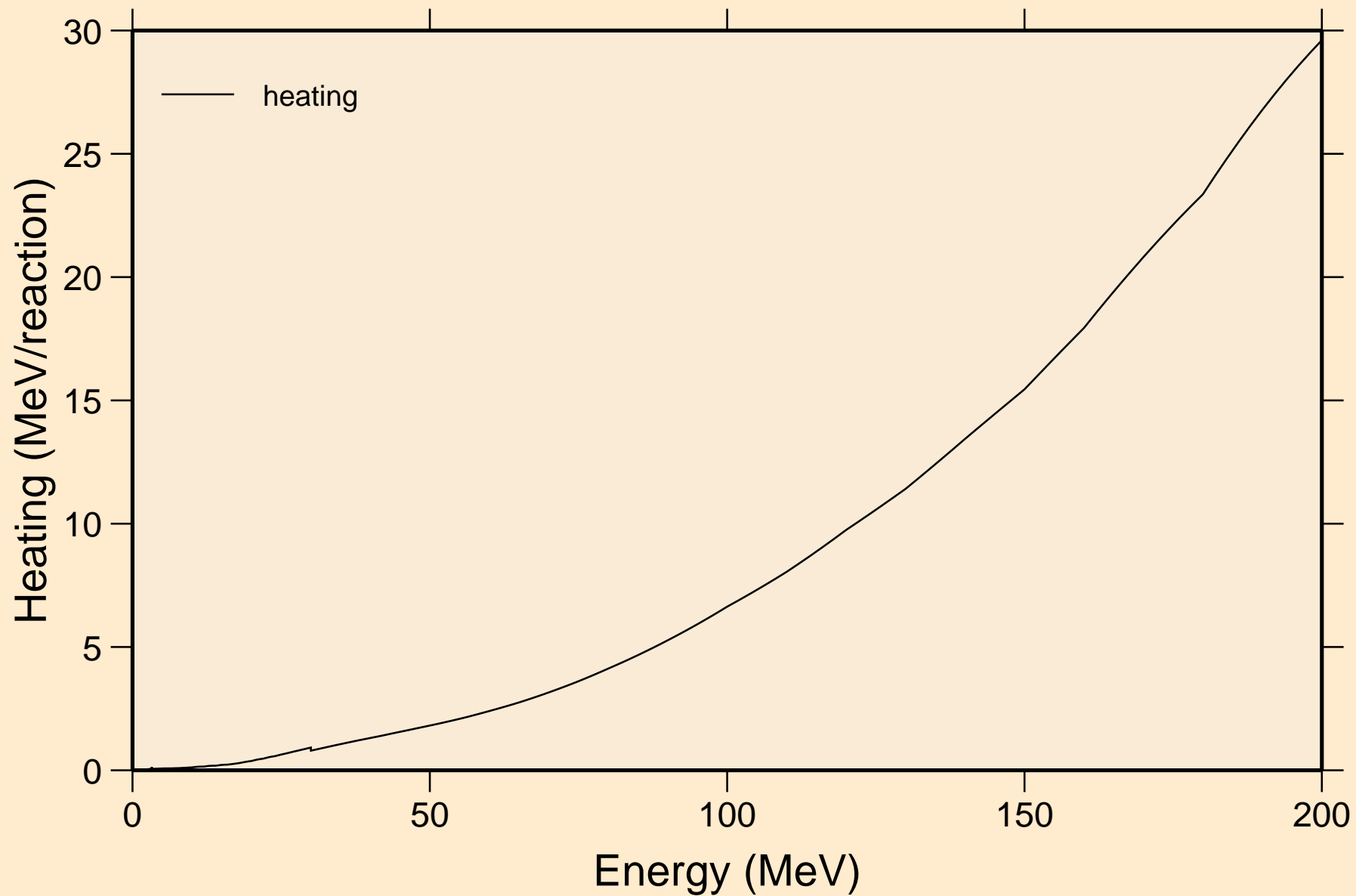

SE083 NEUTRON ACER TENDL-2019 LIBRARY; T=293.16K
Damage

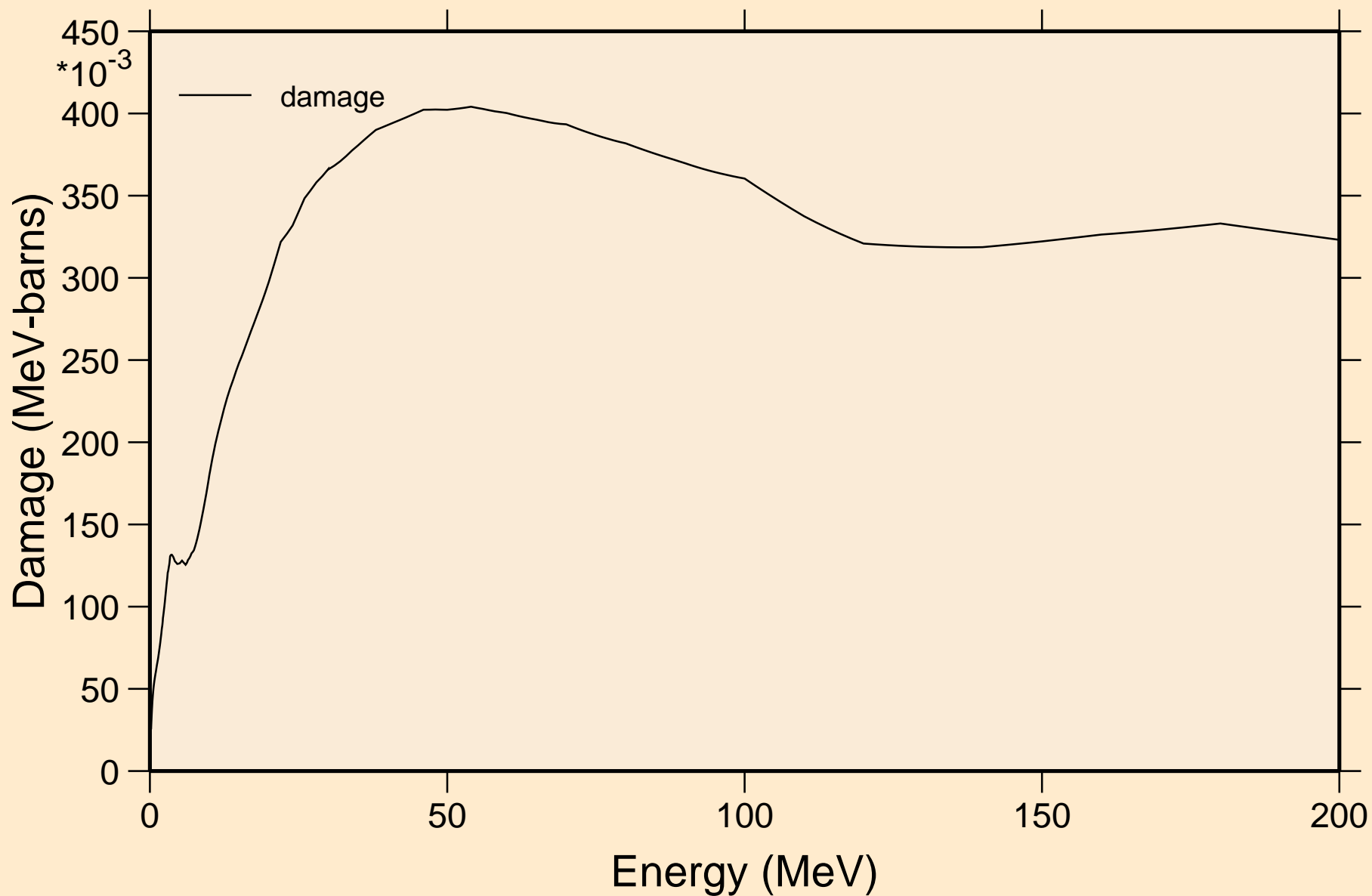

SE083 NEUTRON ACER TENDL-2019 LIBRARY; T=293.16K
Non-threshold reactions

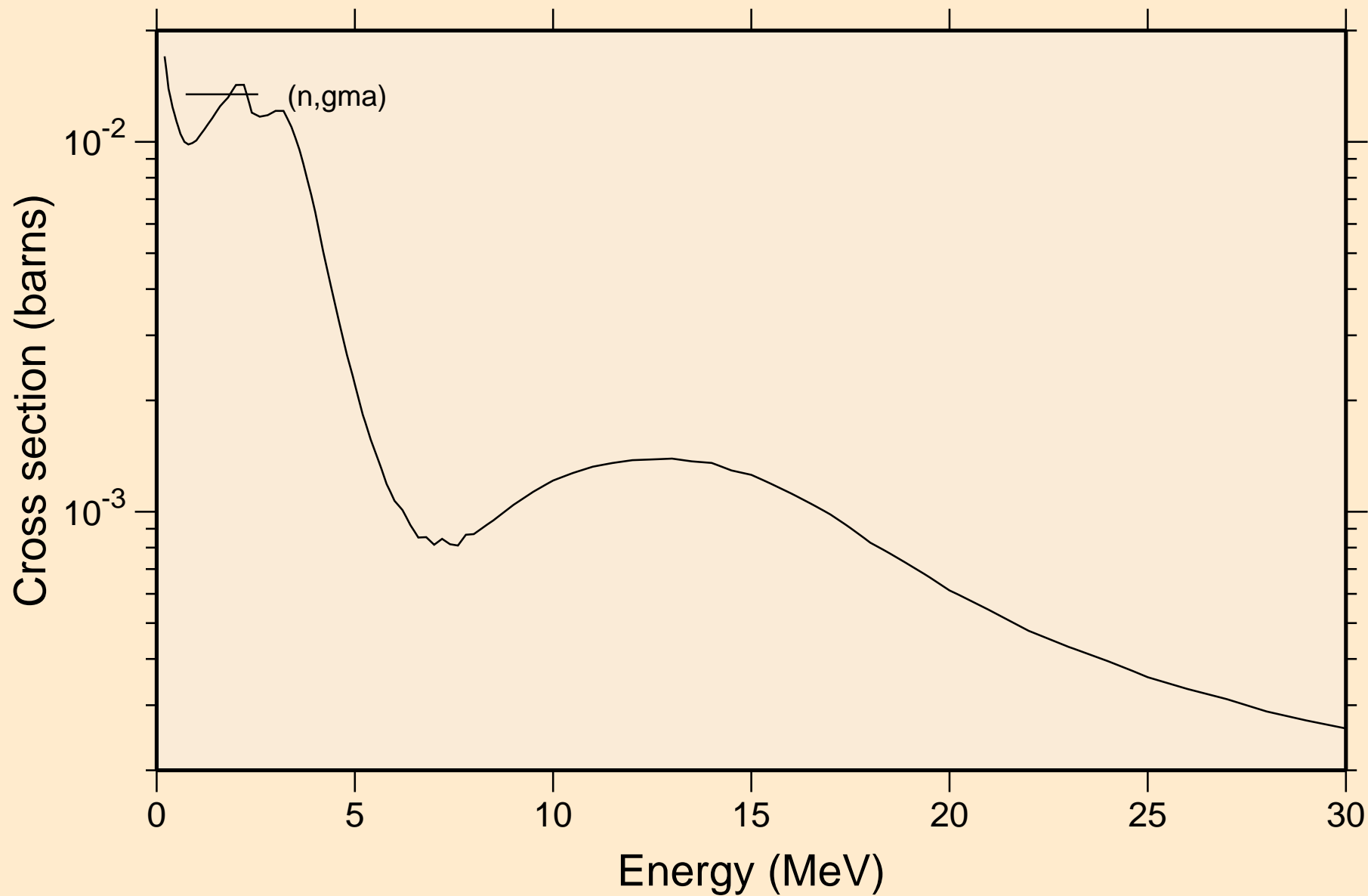

SE083 NEUTRON ACER TENDL-2019 LIBRARY; T=293.16K
Inelastic levels

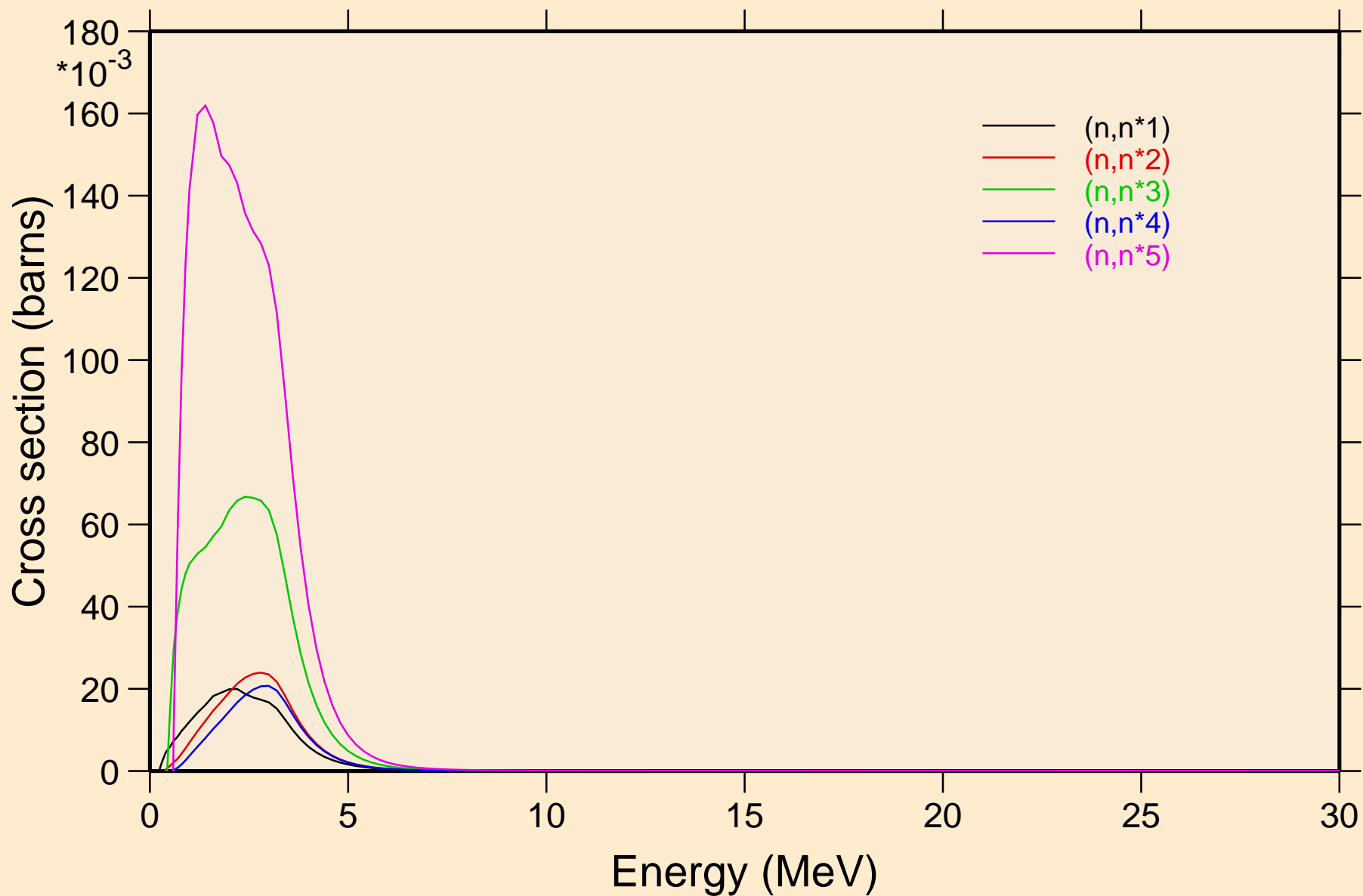

SE083 NEUTRON ACER TENDL-2019 LIBRARY; T=293.16K
Inelastic levels

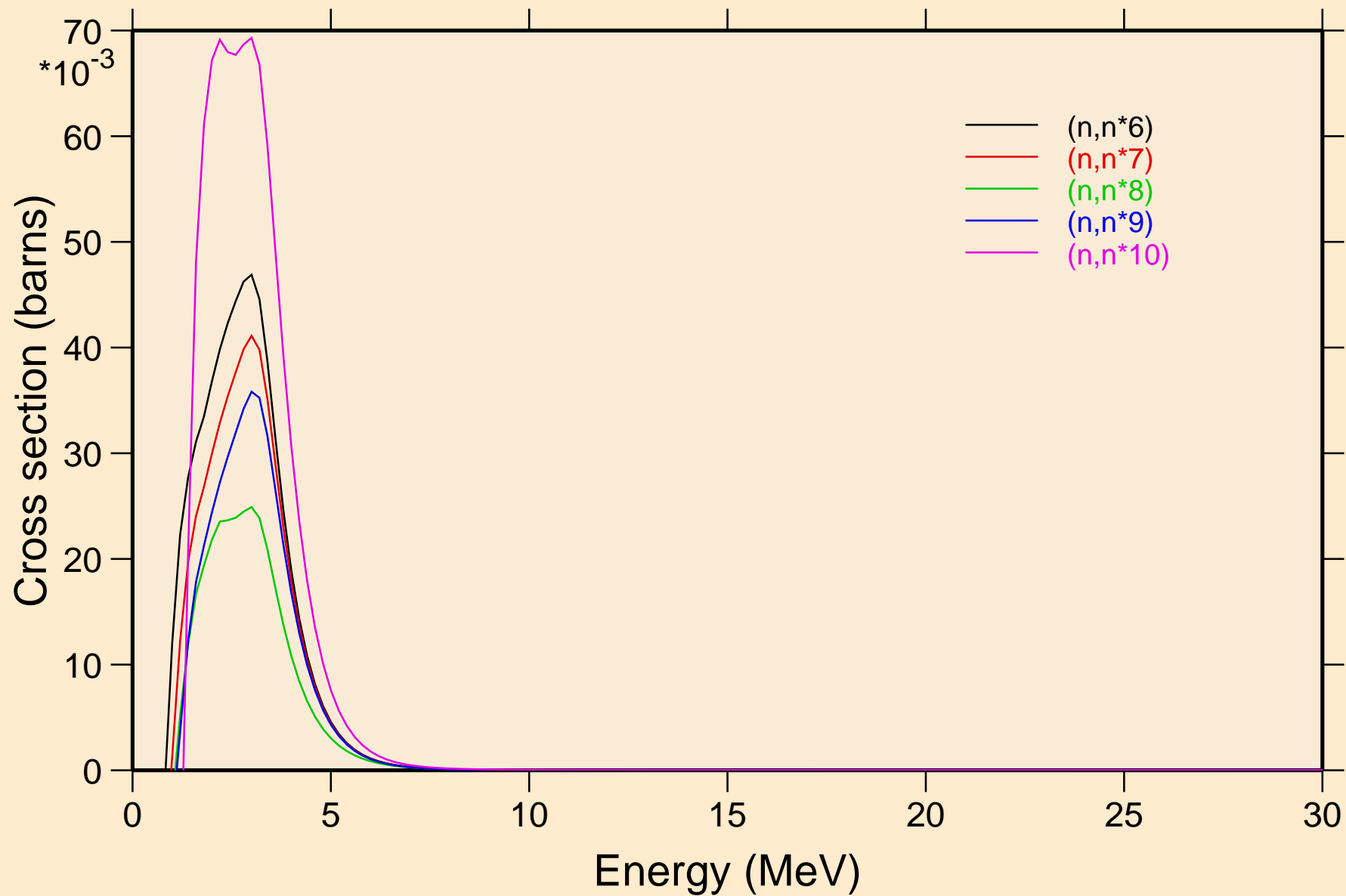

SE083 NEUTRON ACER TENDL-2019 LIBRARY; T=293.16K
Inelastic levels

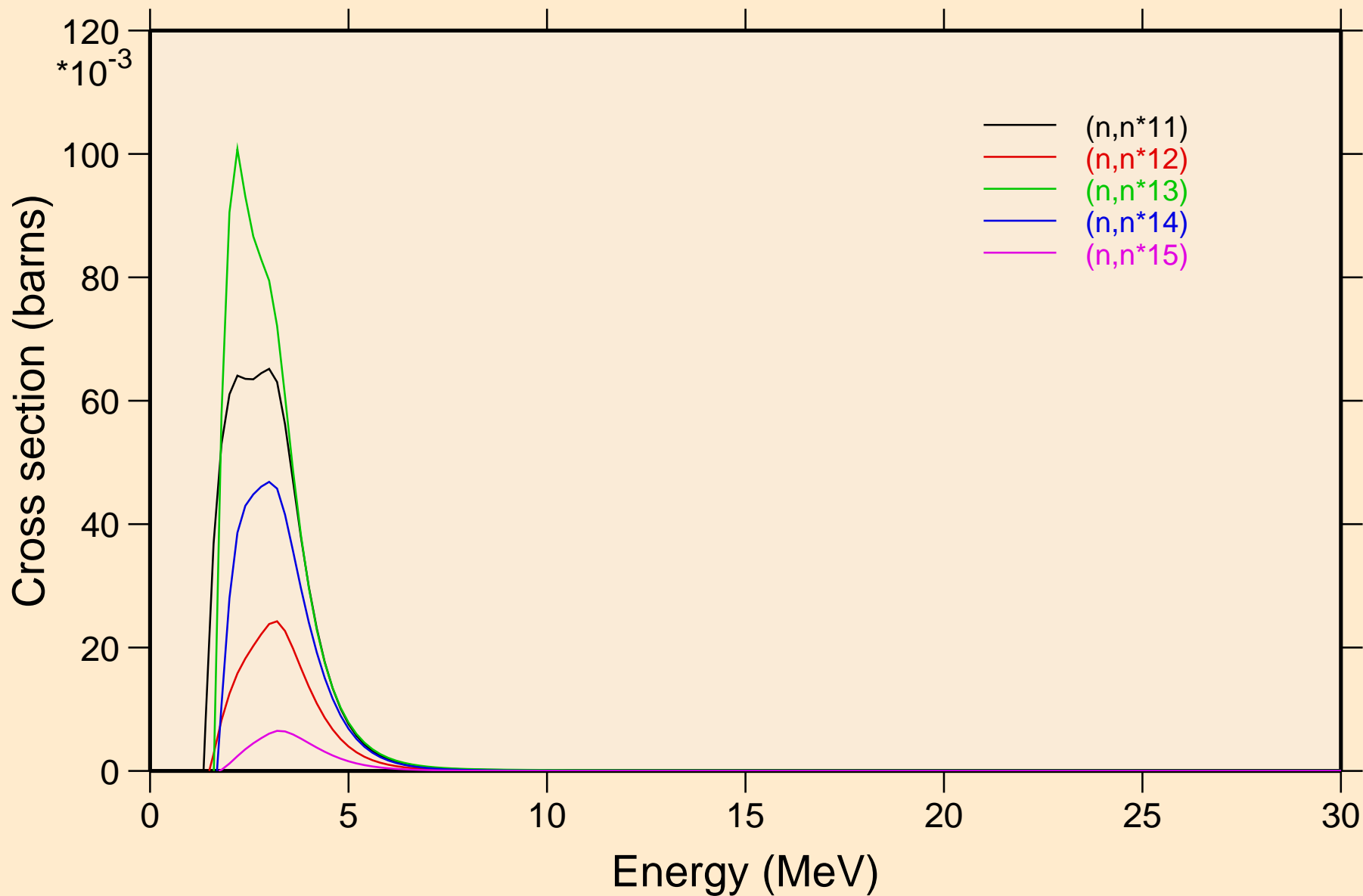

SE083 NEUTRON ACER TENDL-2019 LIBRARY; T=293.16K
Inelastic levels

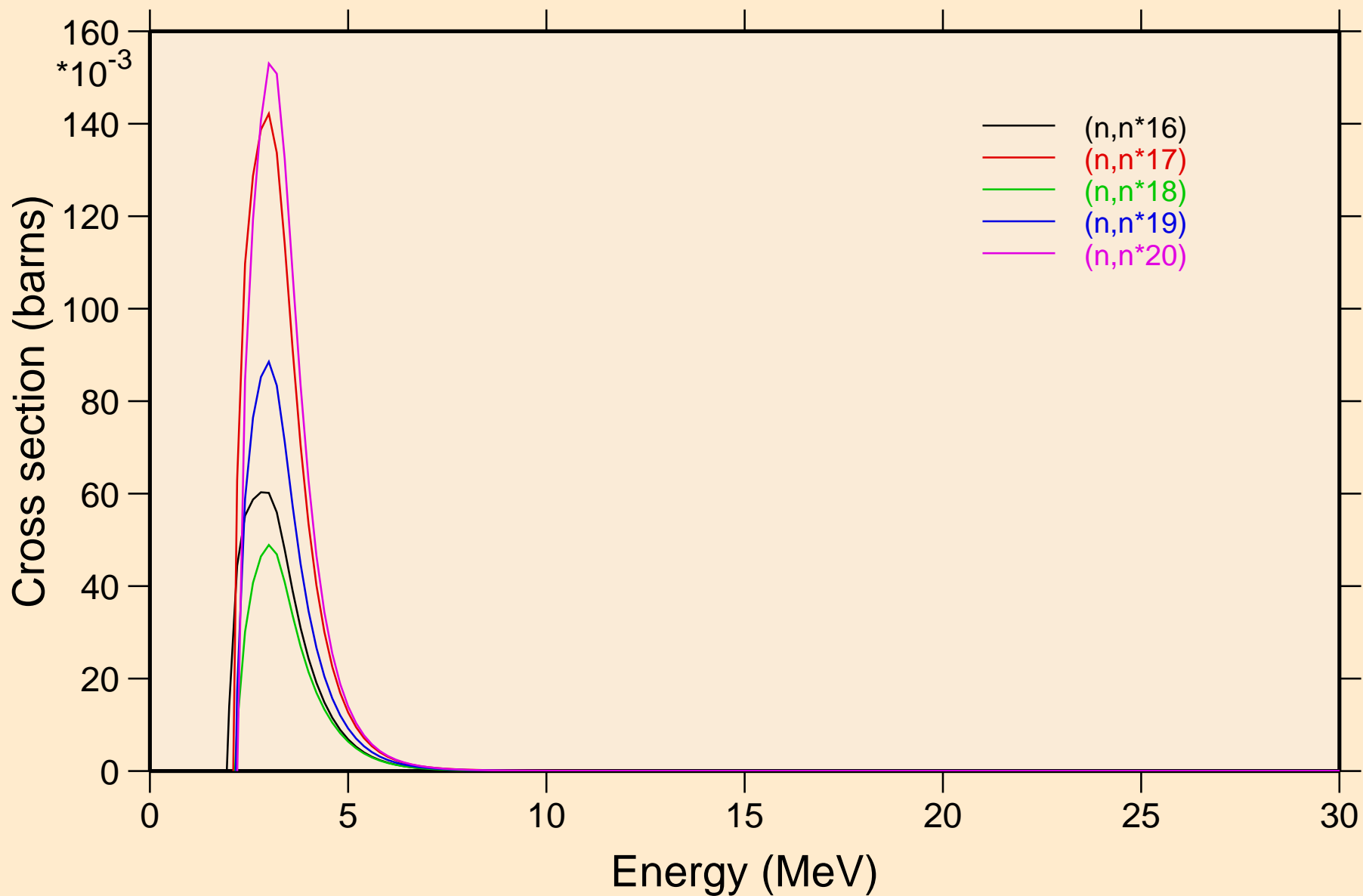

SE083 NEUTRON ACER TENDL-2019 LIBRARY; T=293.16K
Inelastic levels

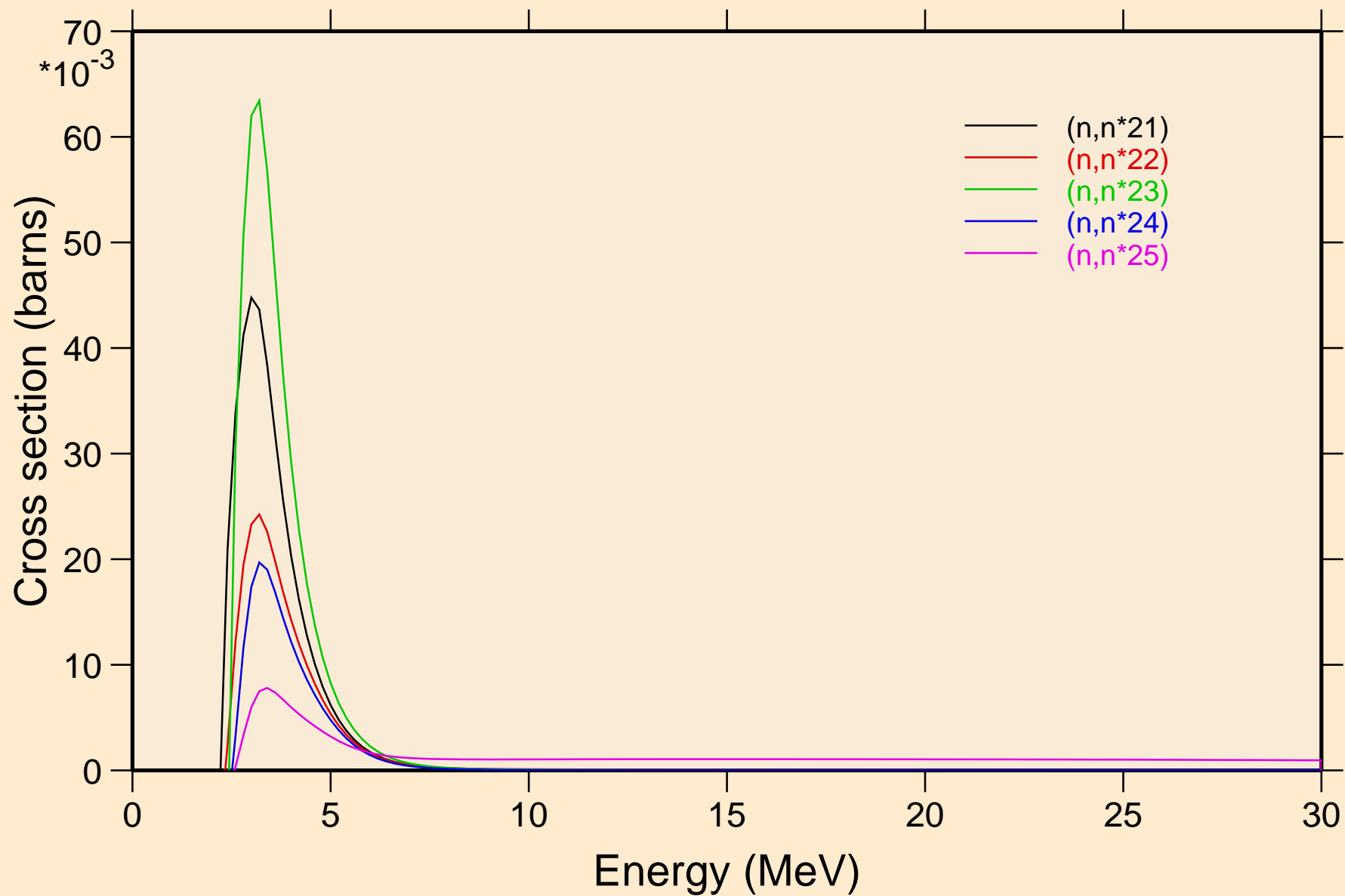

SE083 NEUTRON ACER TENDL-2019 LIBRARY; T=293.16K
Inelastic levels

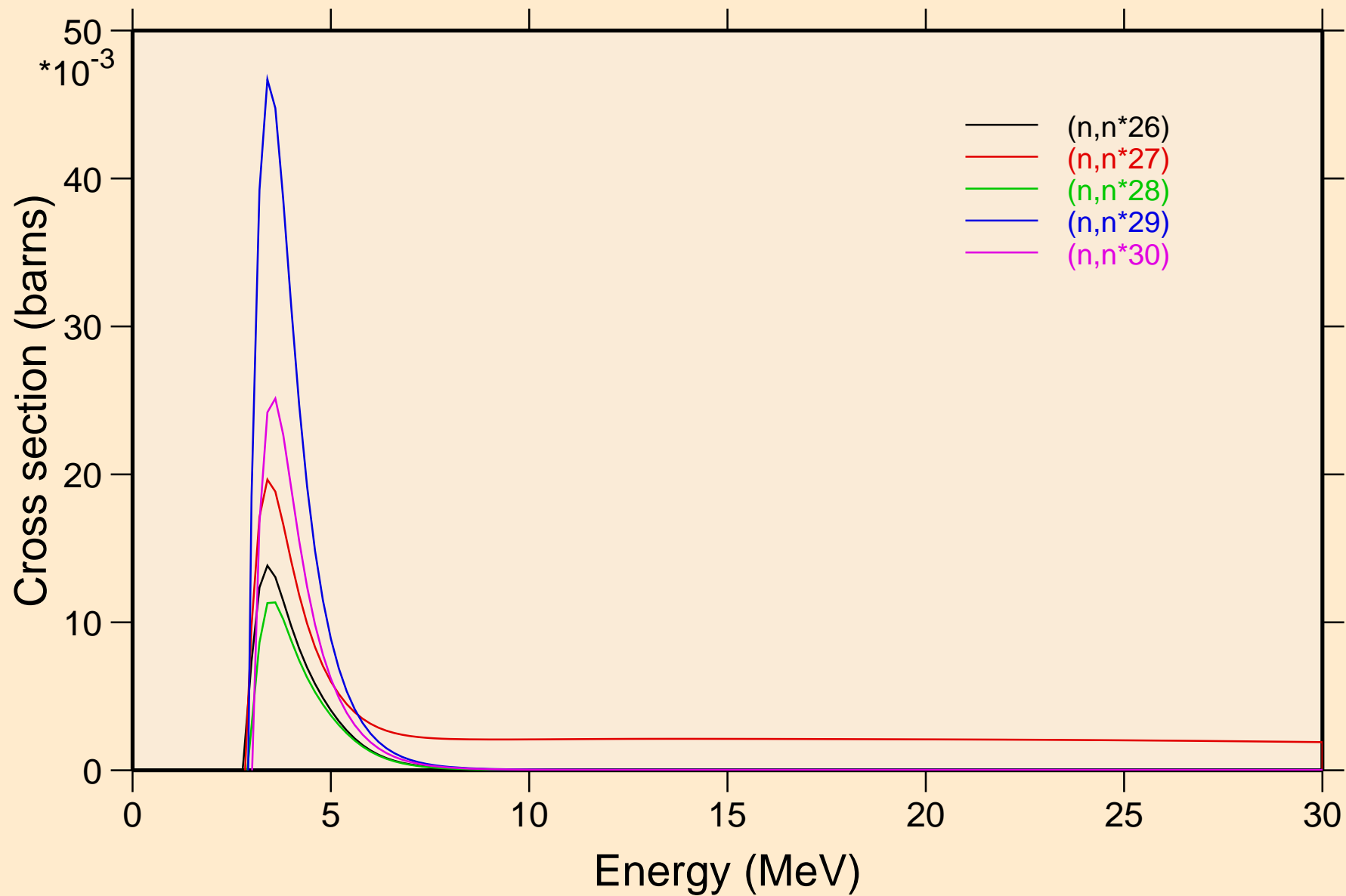

SE083 NEUTRON ACER TENDL-2019 LIBRARY; T=293.16K
Threshold reactions

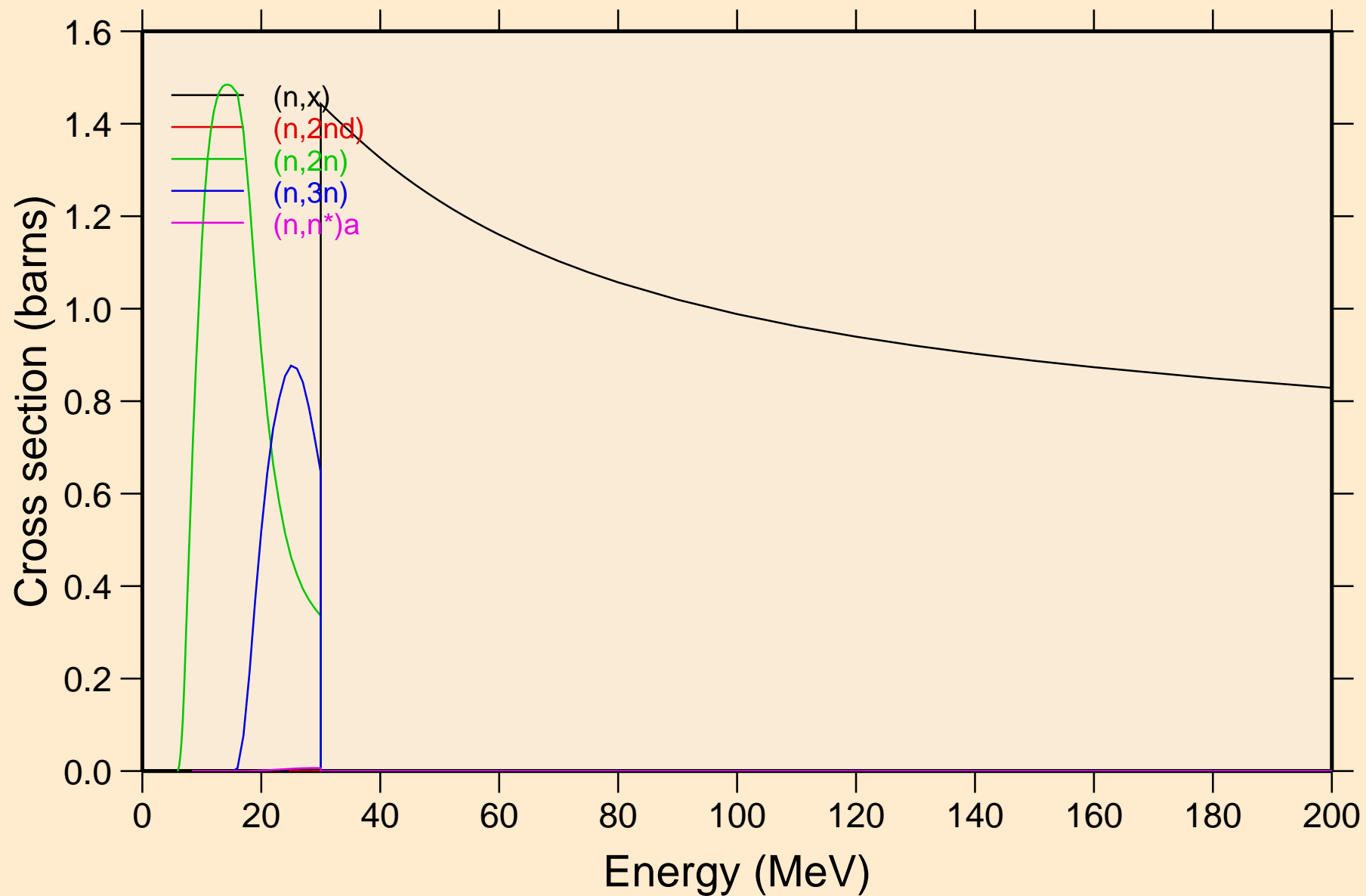

SE083 NEUTRON ACER TENDL-2019 LIBRARY; T=293.16K
Threshold reactions

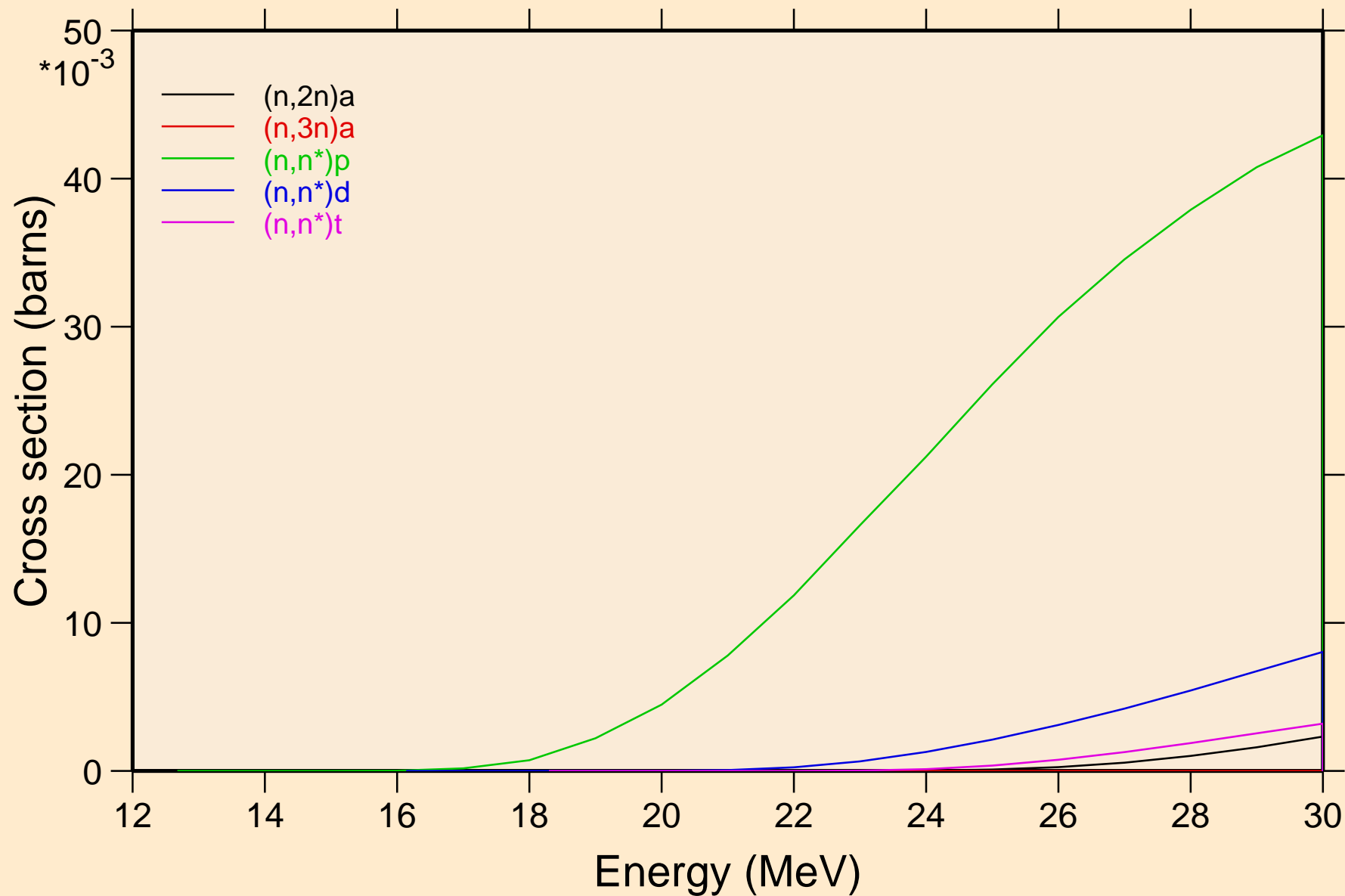

SE083 NEUTRON ACER TENDL-2019 LIBRARY; T=293.16K
Threshold reactions

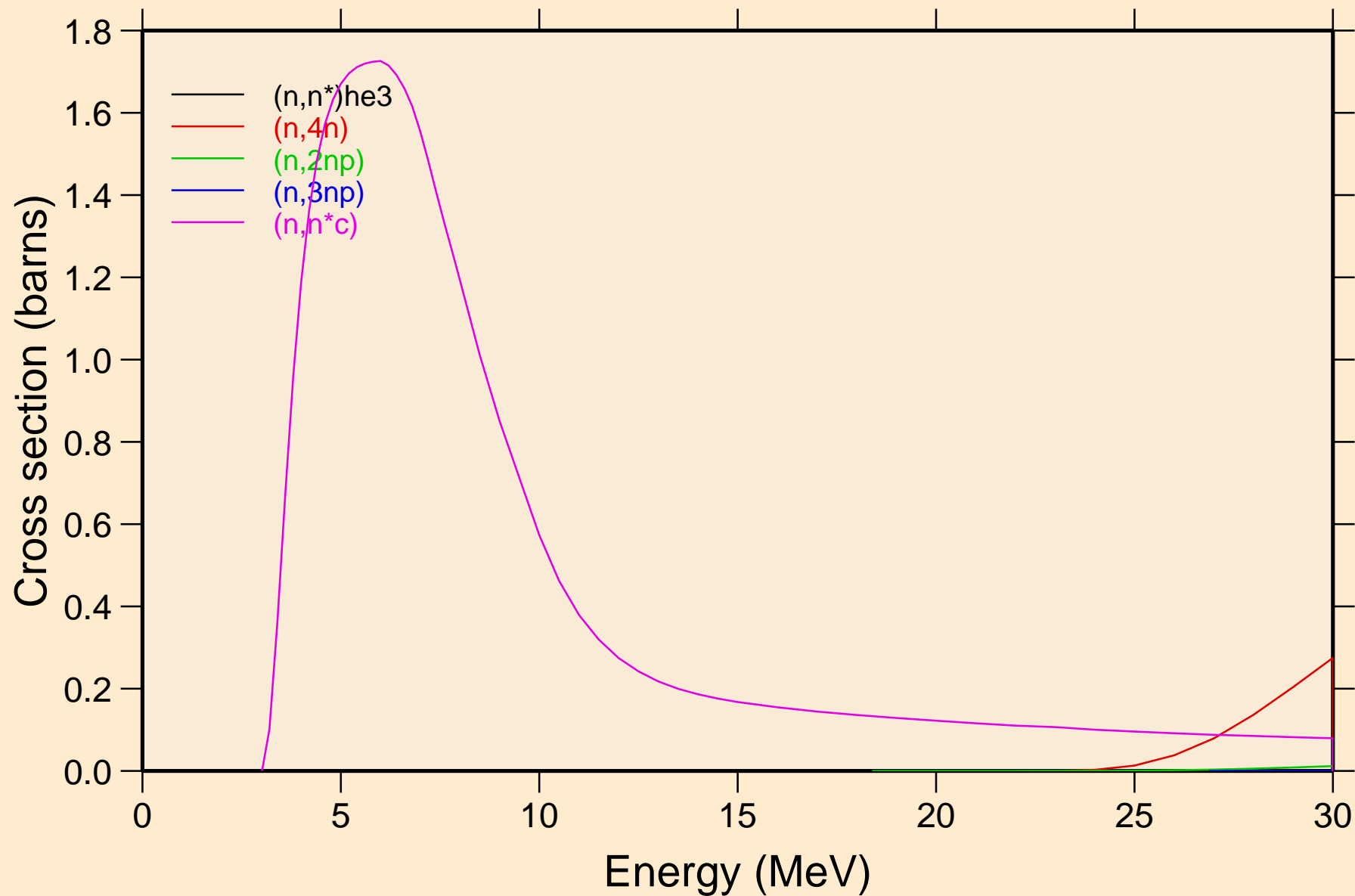

SE083 NEUTRON ACER TENDL-2019 LIBRARY; T=293.16K

Threshold reactions

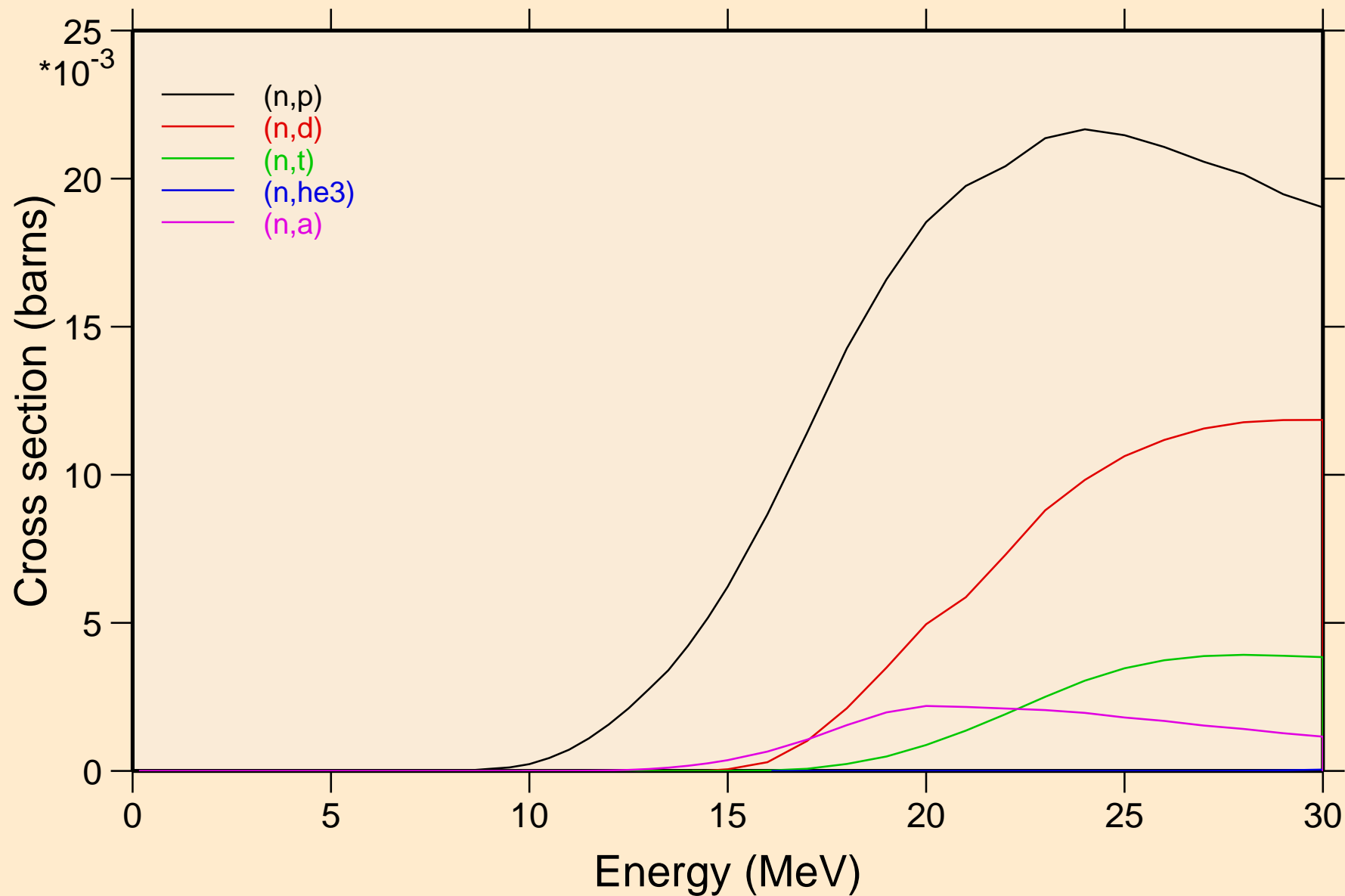

SE083 NEUTRON ACER TENDL-2019 LIBRARY; T=293.16K
Threshold reactions

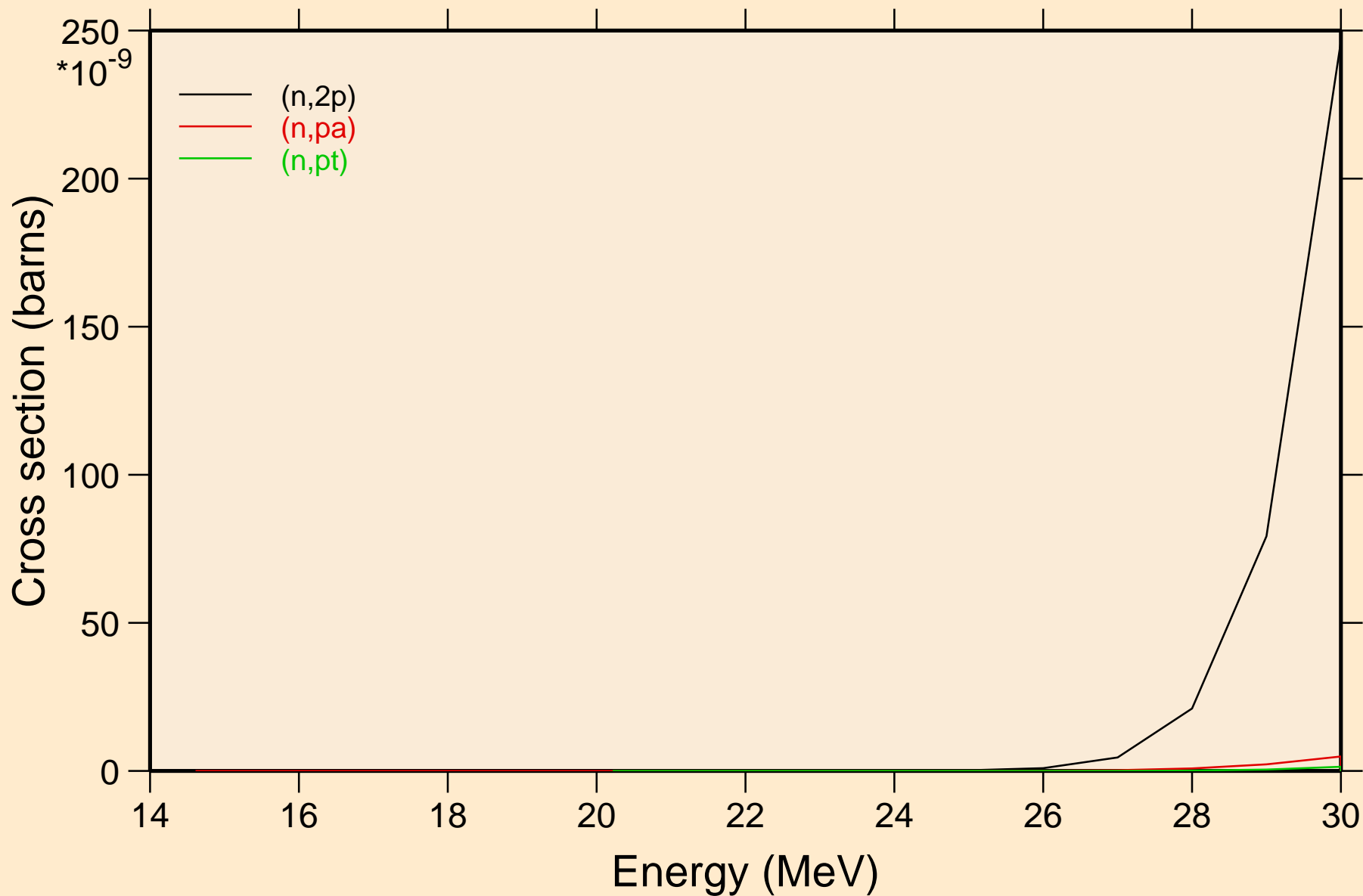

SE083 NEUTRON ACER TENDL-2019 LIBRARY; T=293.16K
Threshold reactions

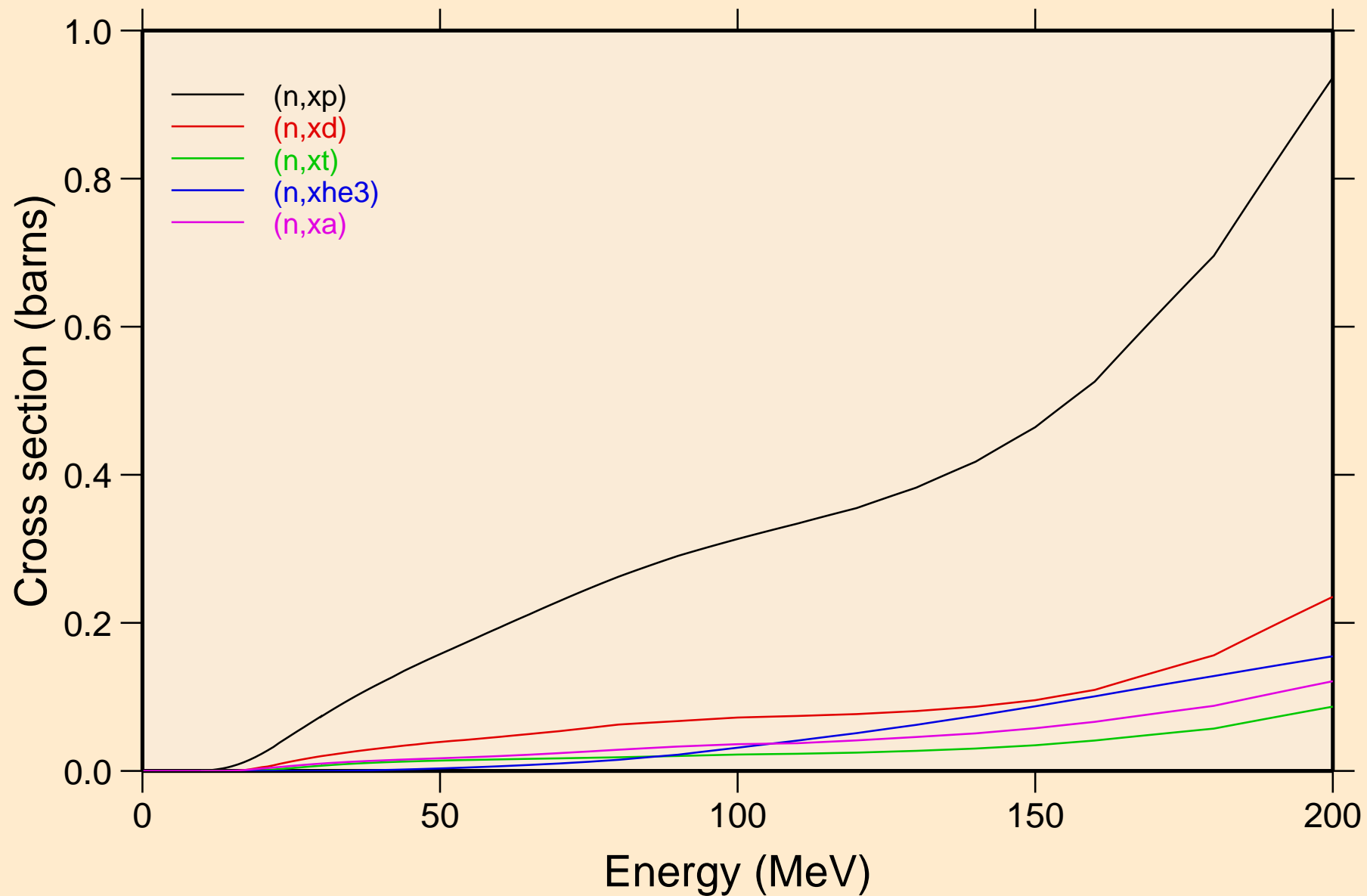

SE083 NEUTRON ACER TENDL-2019 LIBRARY; T=293.16K
angular distribution for elastic

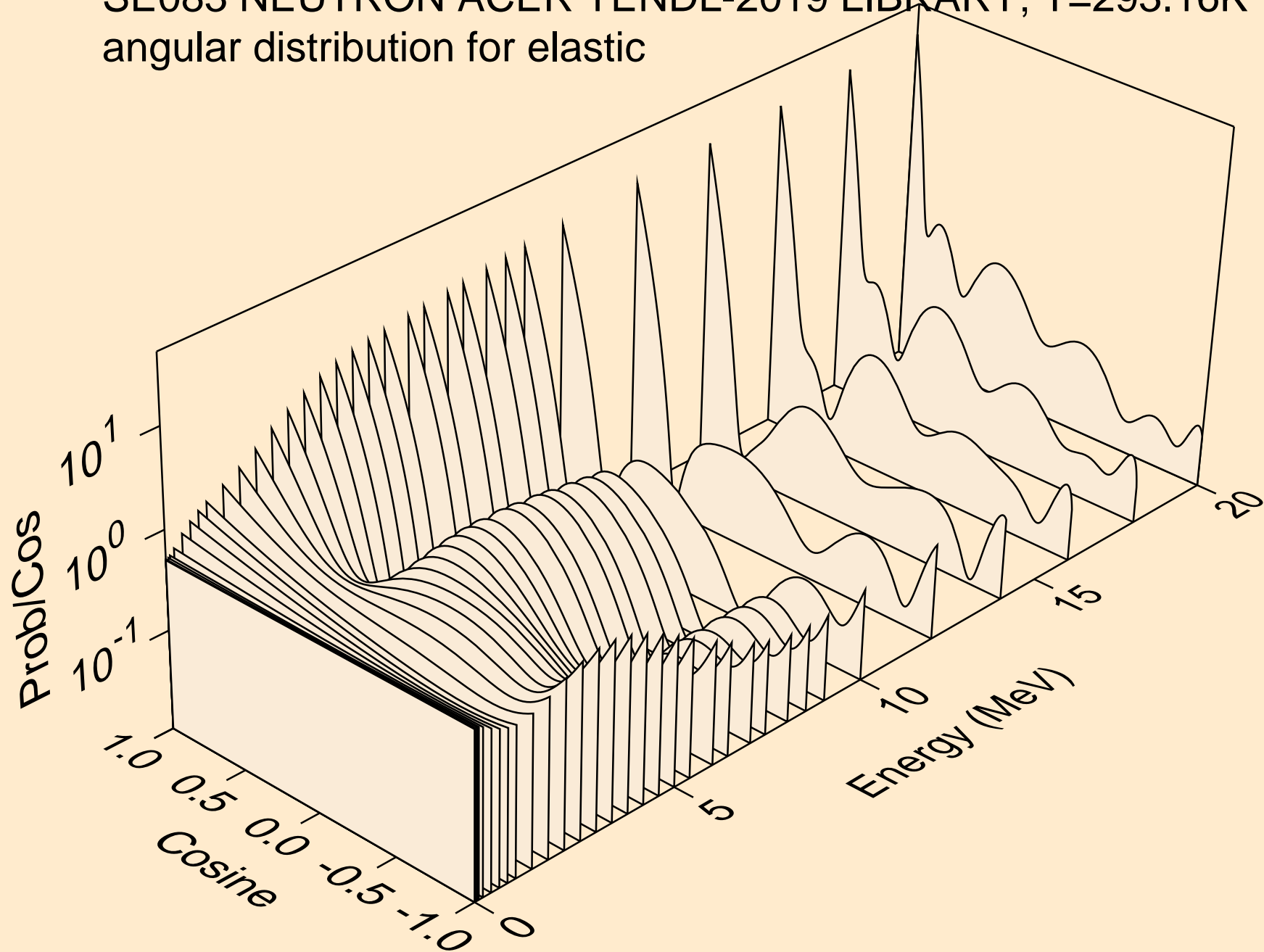

SE083 NEUTRON ACER TENDL-2019 LIBRARY; T=293.16K
angular distribution for elastic

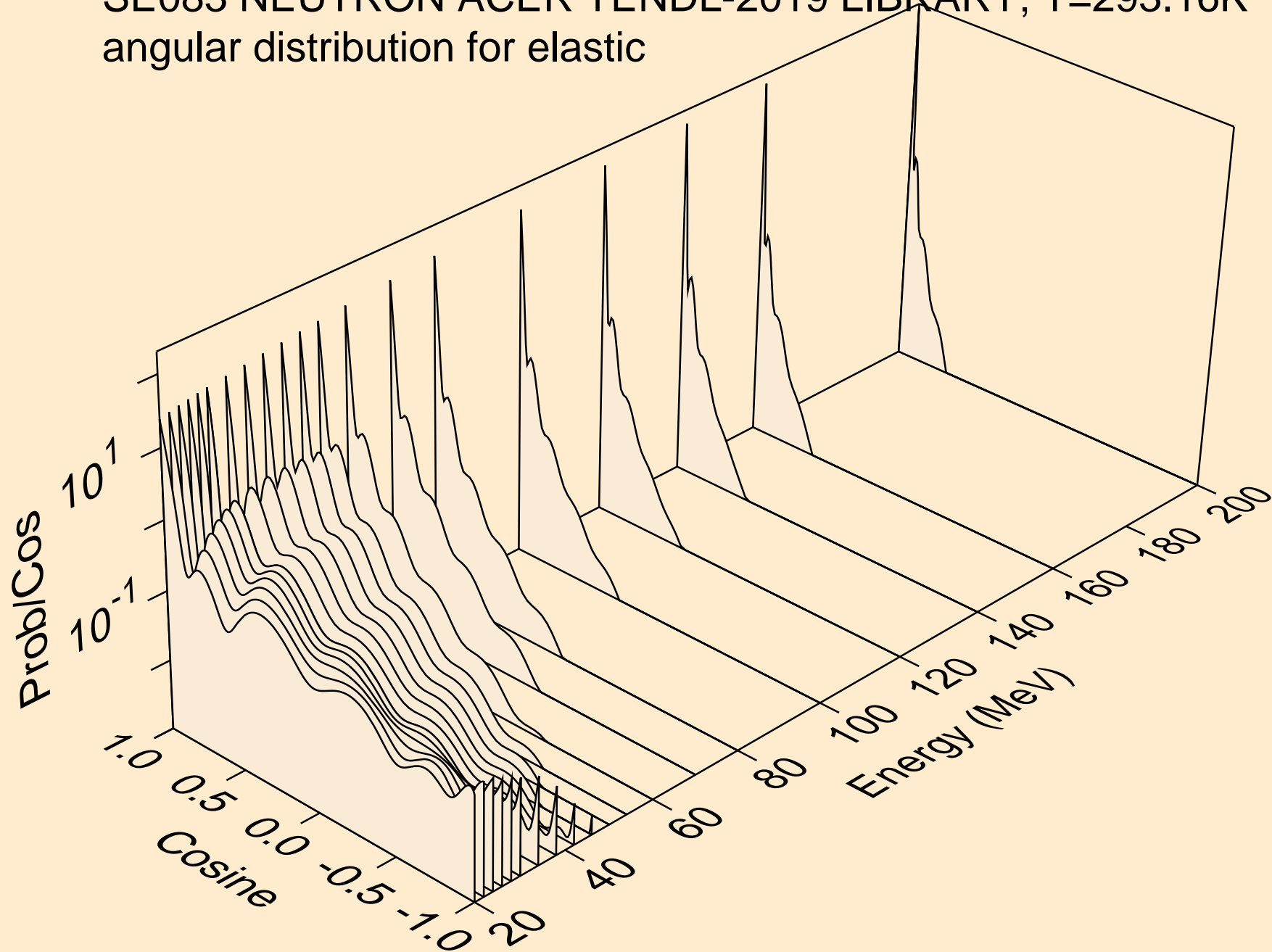

SE083 NEUTRON ACER TENDL-2019 LIBRARY; T=293.16K
angular distribution for (n,n*1)

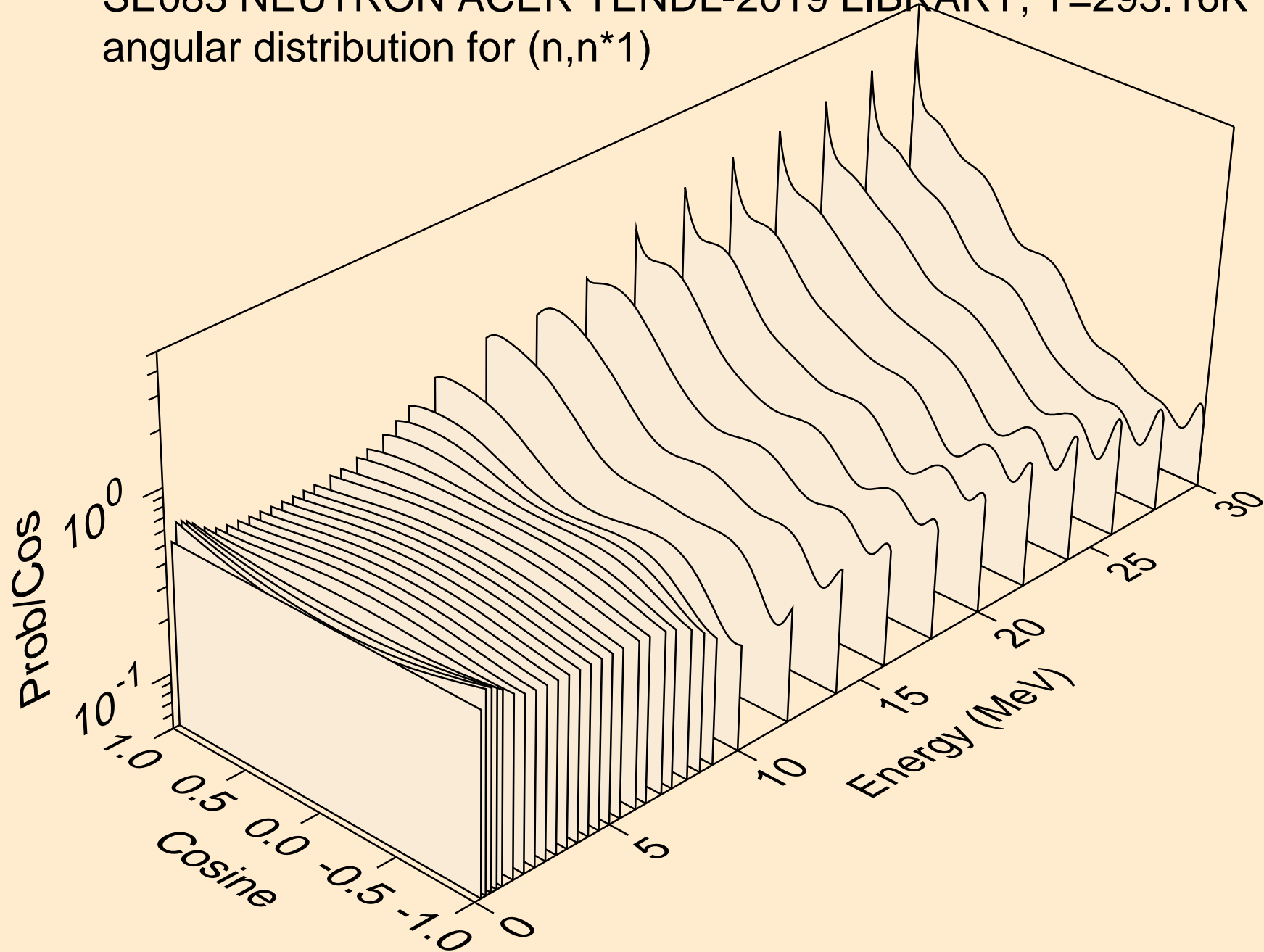

SE083 NEUTRON ACER TENDL-2019 LIBRARY; T=293.16K
angular distribution for (n,n*2)

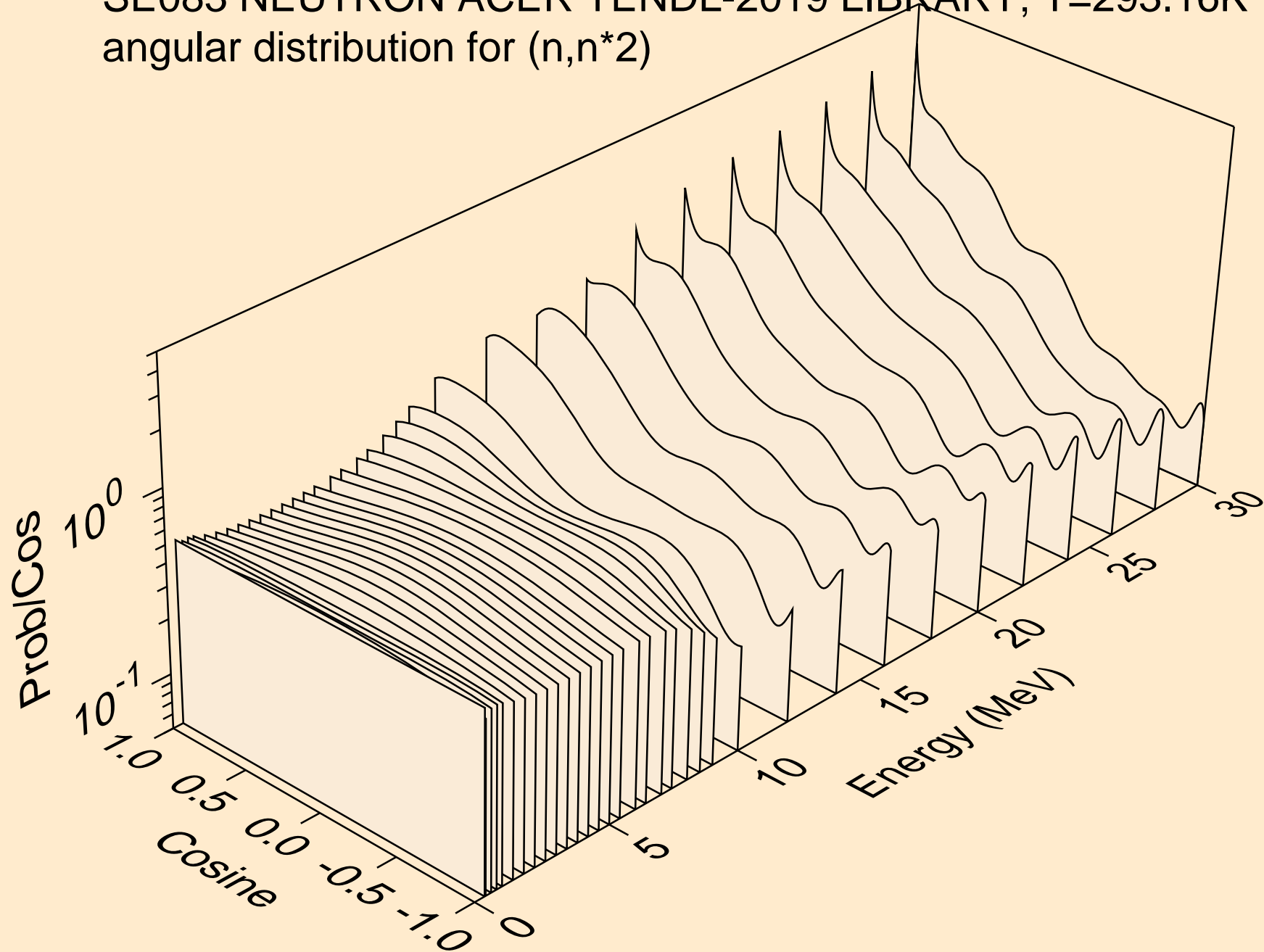

SE083 NEUTRON ACER TENDL-2019 LIBRARY; T=293.16K
angular distribution for (n,n*3)

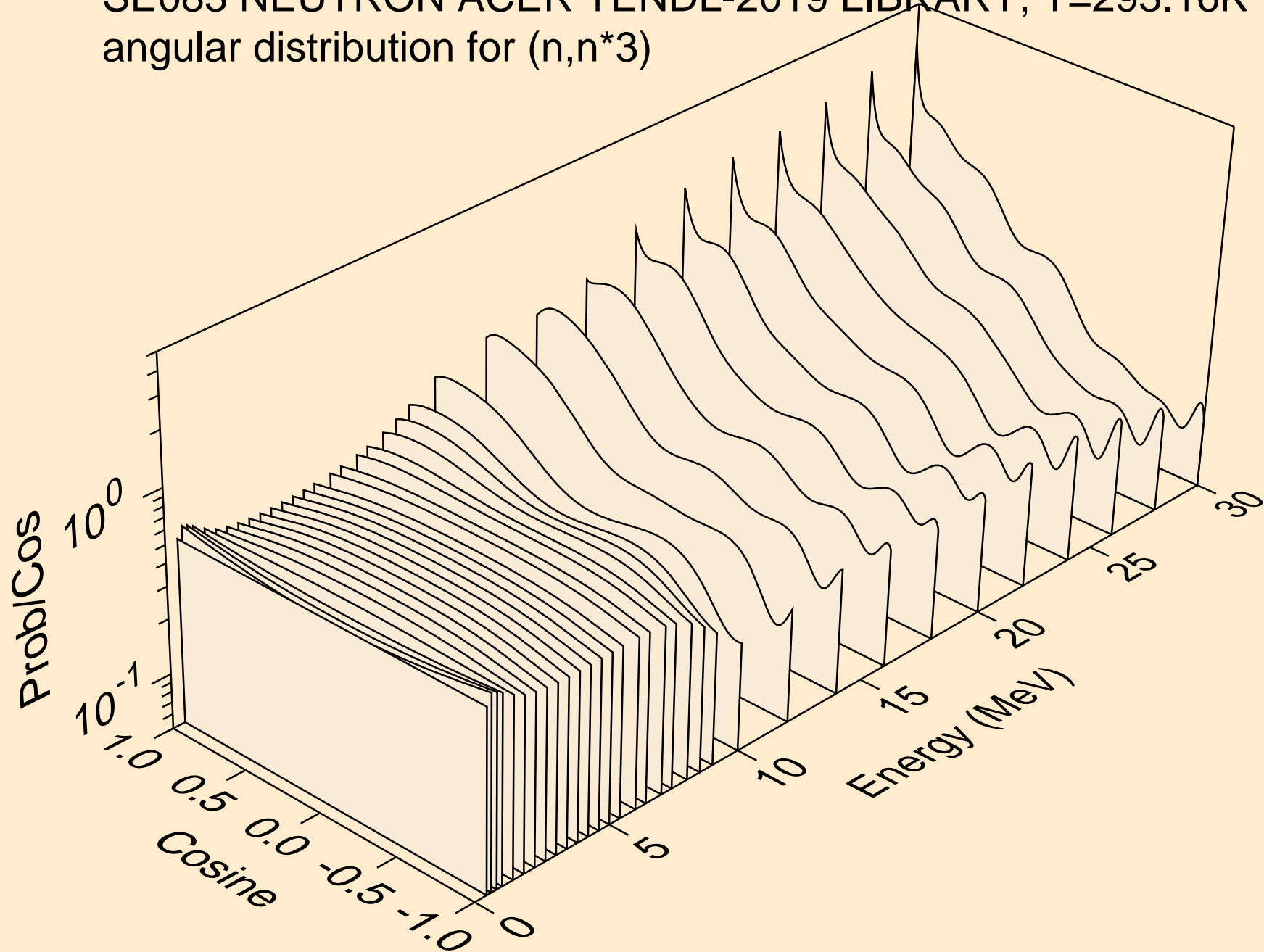

SE083 NEUTRON ACER TENDL-2019 LIBRARY; T=293.16K
angular distribution for (n,n*4)

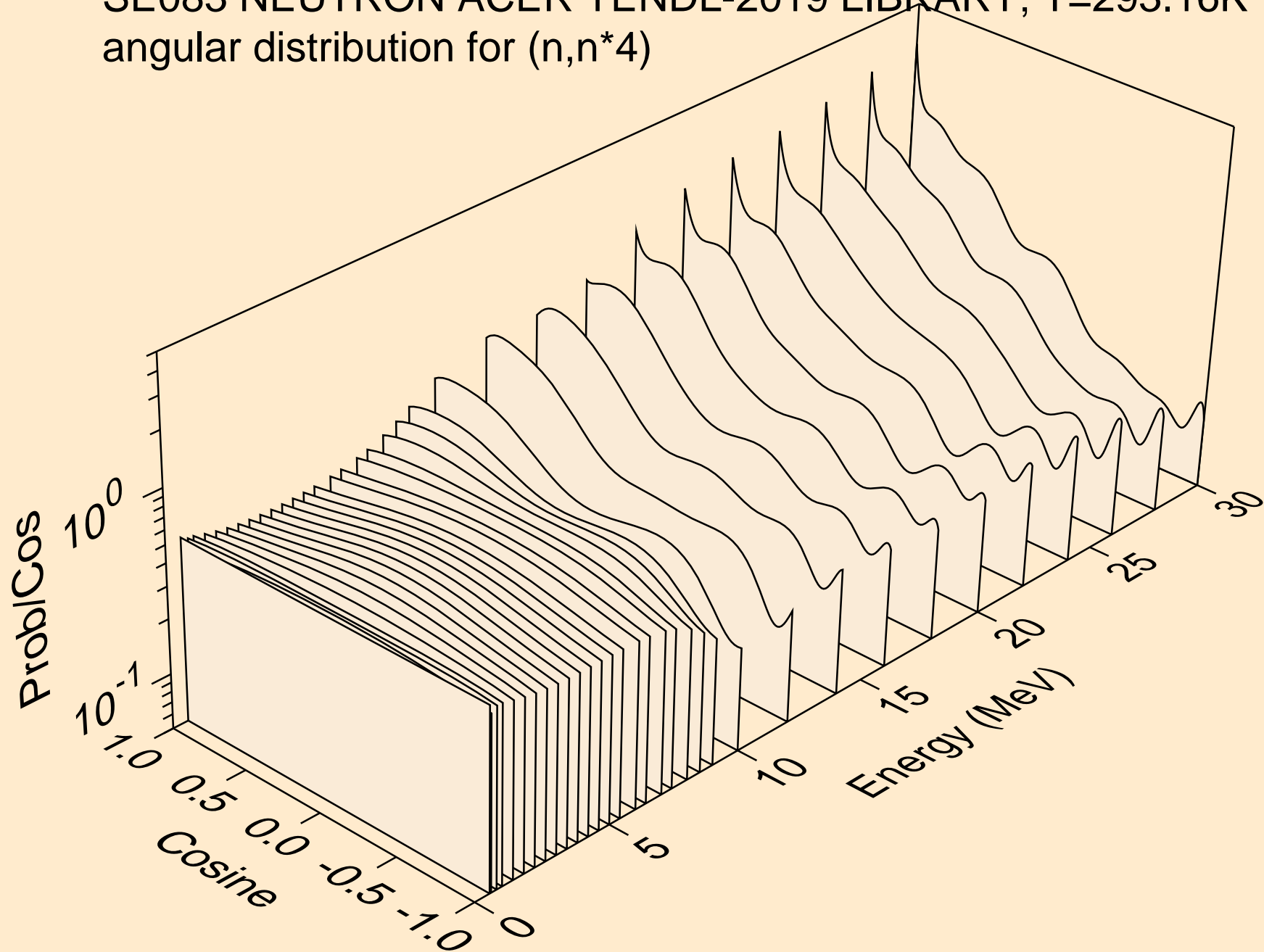

SE083 NEUTRON ACER TENDL-2019 LIBRARY; T=293.16K
angular distribution for (n,n*5)

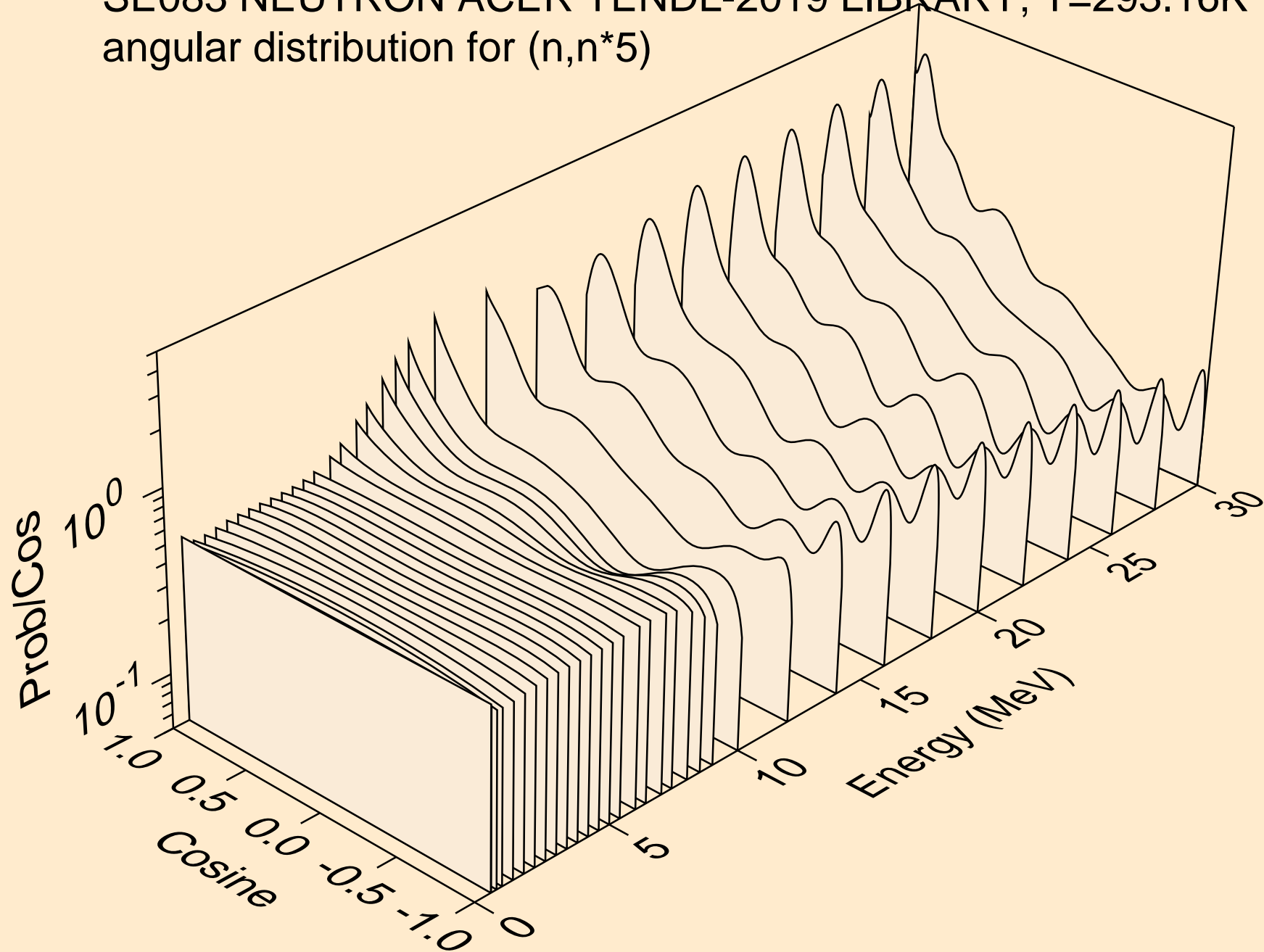

SE083 NEUTRON ACER TENDL-2019 LIBRARY; T=293.16K
angular distribution for (n,n*6)

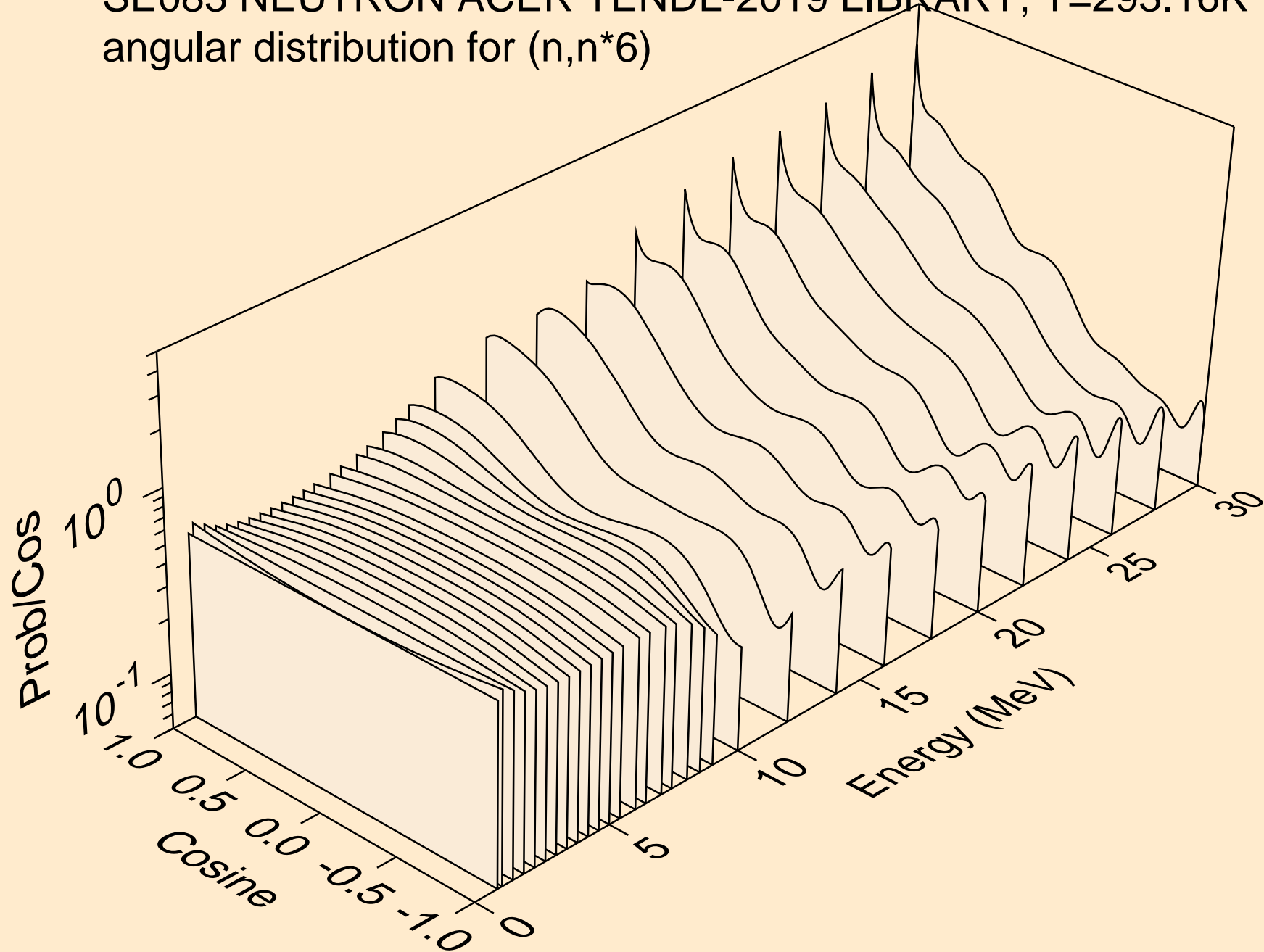

SE083 NEUTRON ACER TENDL-2019 LIBRARY; T=293.16K
angular distribution for (n,n*7)

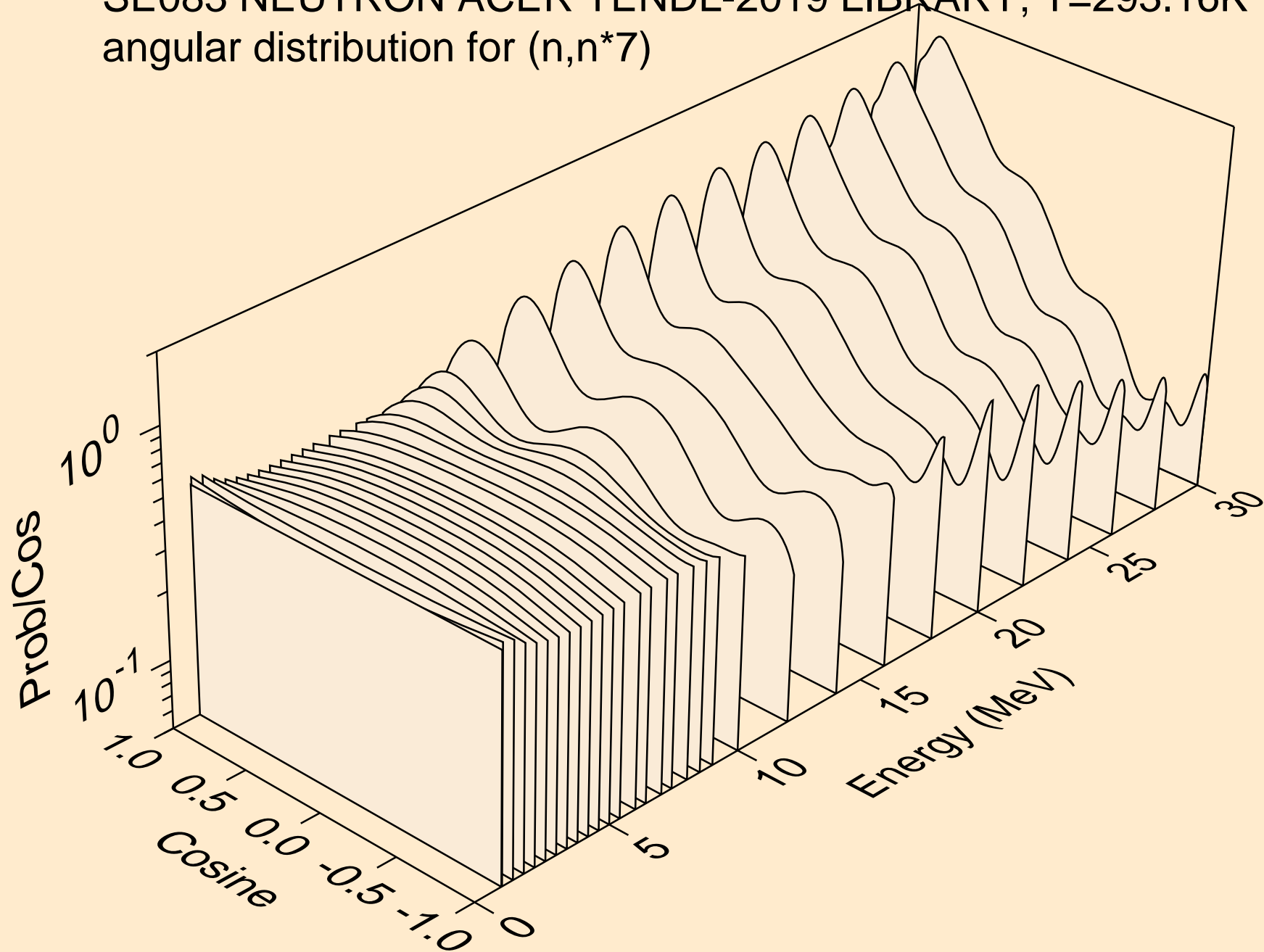

SE083 NEUTRON ACER TENDL-2019 LIBRARY; T=293.16K
angular distribution for (n,n*8)

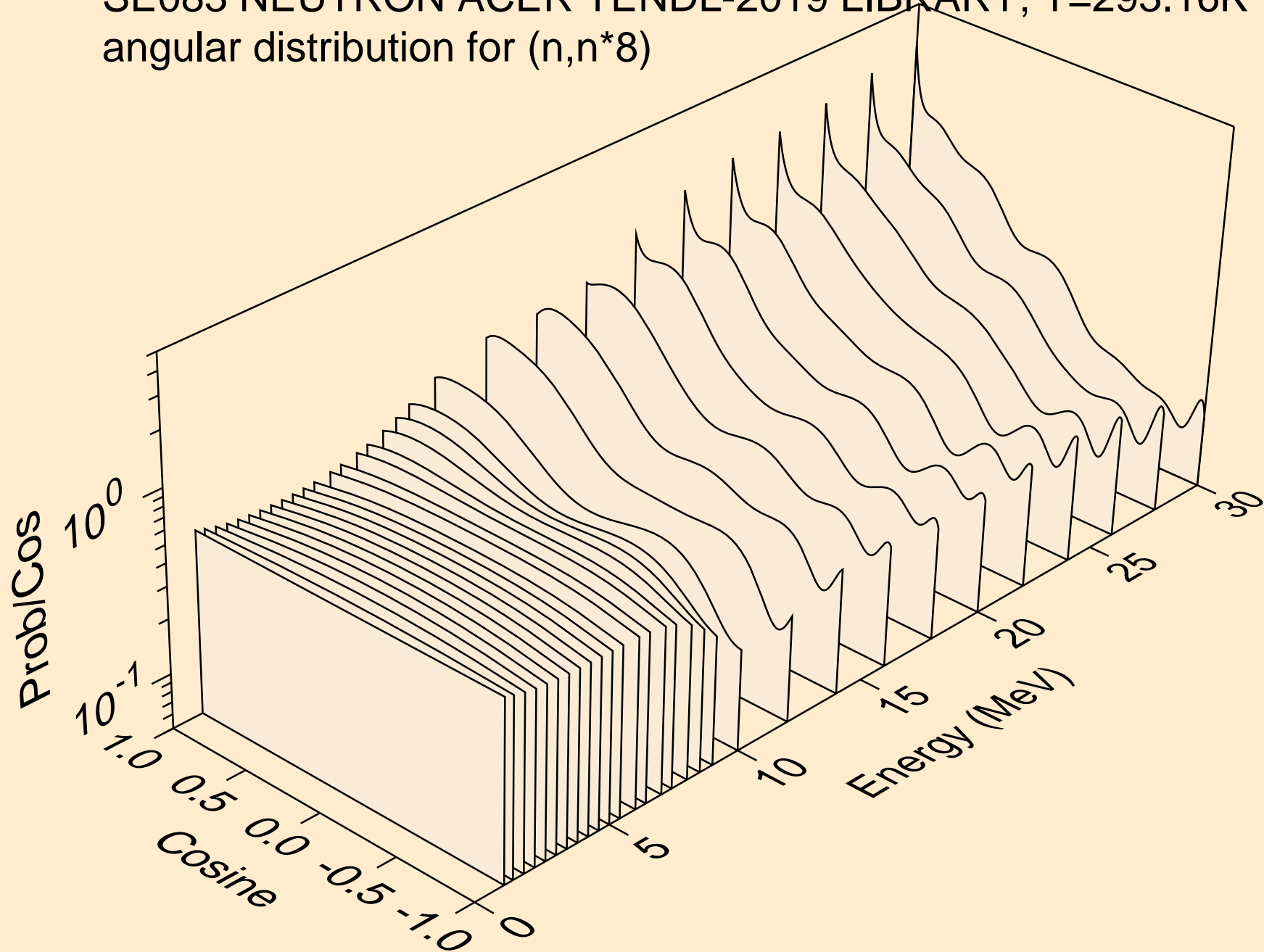

SE083 NEUTRON ACER TENDL-2019 LIBRARY; T=293.16K
angular distribution for (n,n*9)

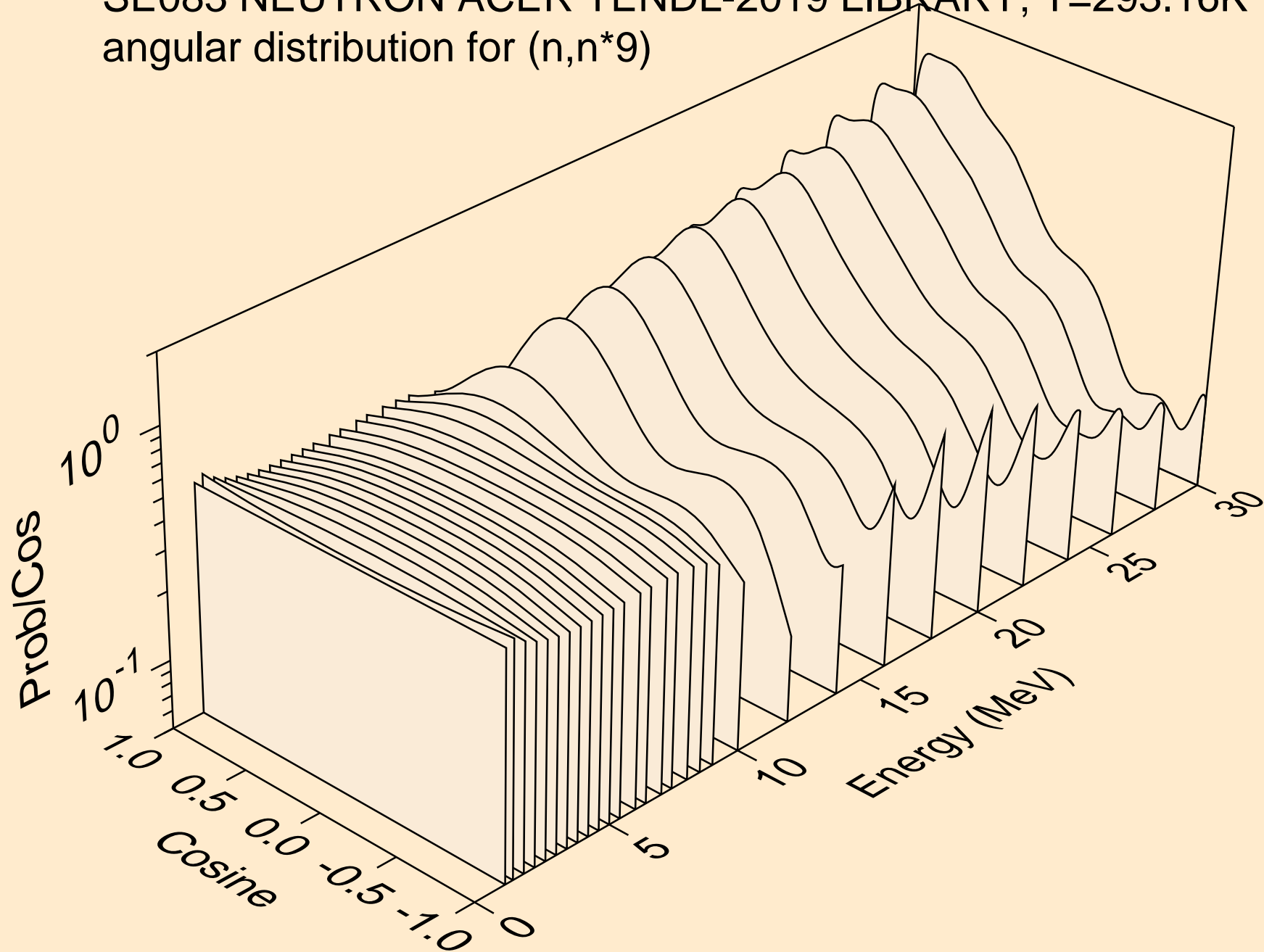

SE083 NEUTRON ACER TENDL-2019 LIBRARY; T=293.16K
angular distribution for (n,n*10)

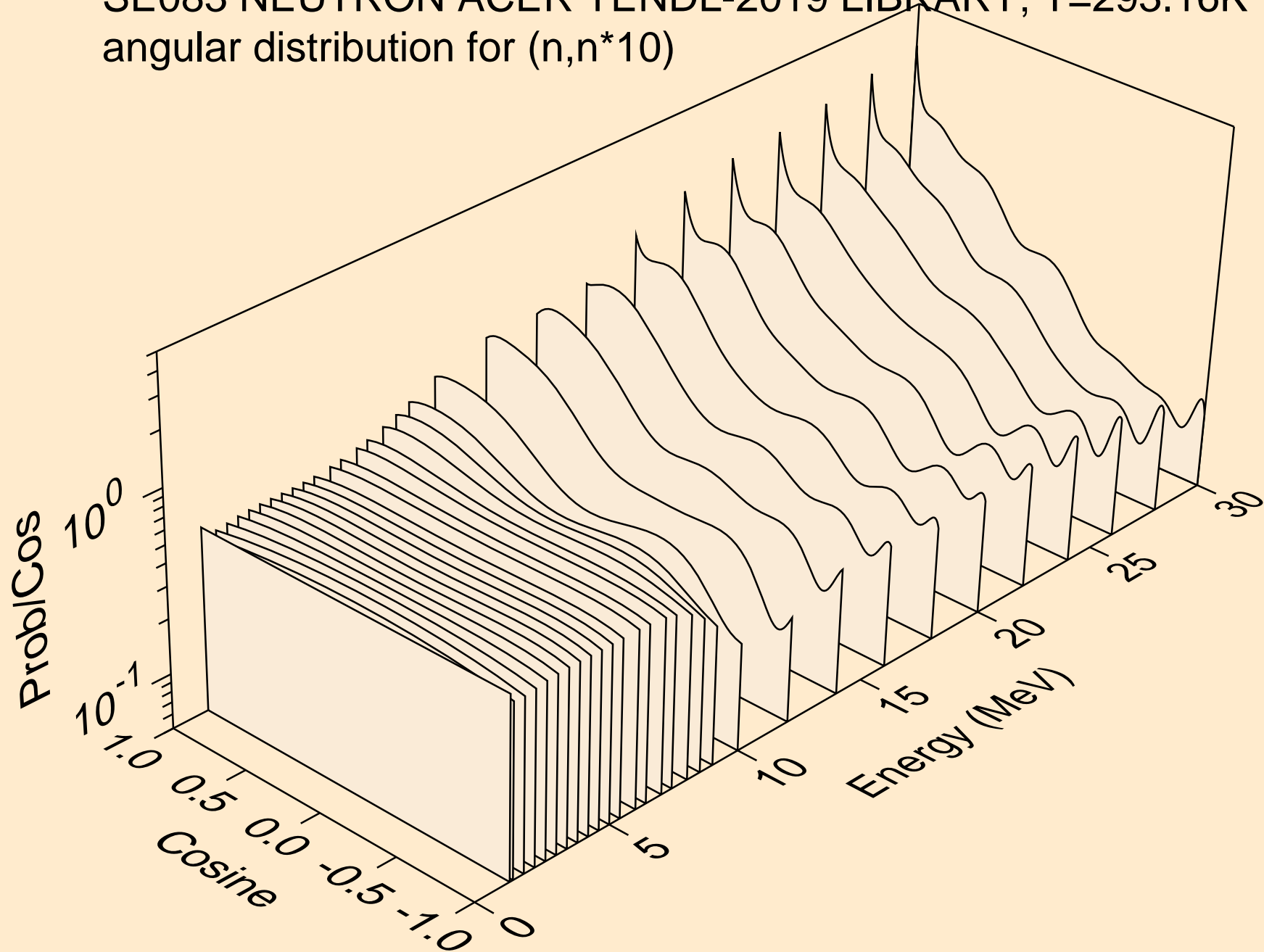

SE083 NEUTRON ACER TENDL-2019 LIBRARY; T=293.16K
angular distribution for (n,n*11)

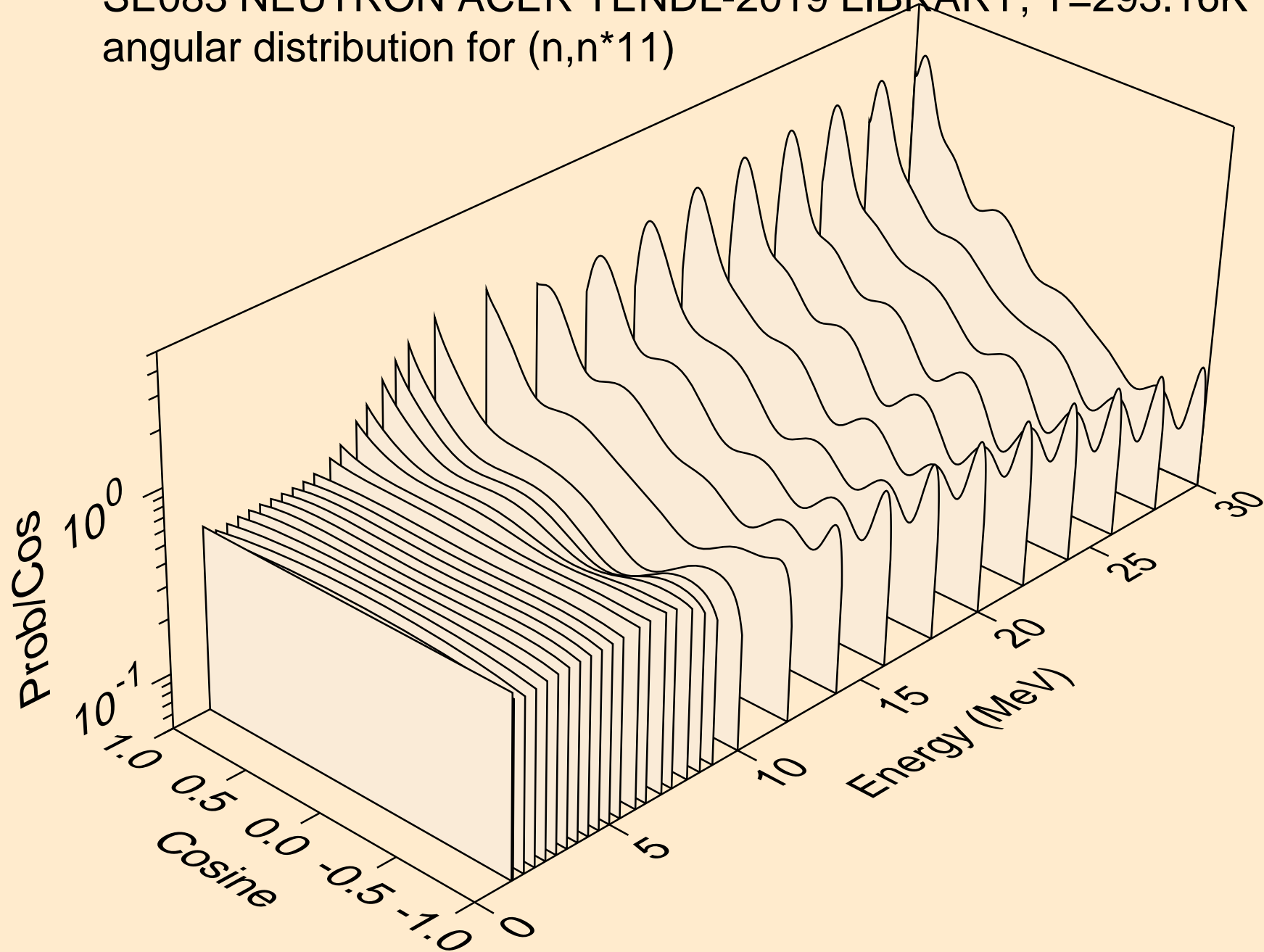

SE083 NEUTRON ACER TENDL-2019 LIBRARY; T=293.16K
angular distribution for (n,n*12)

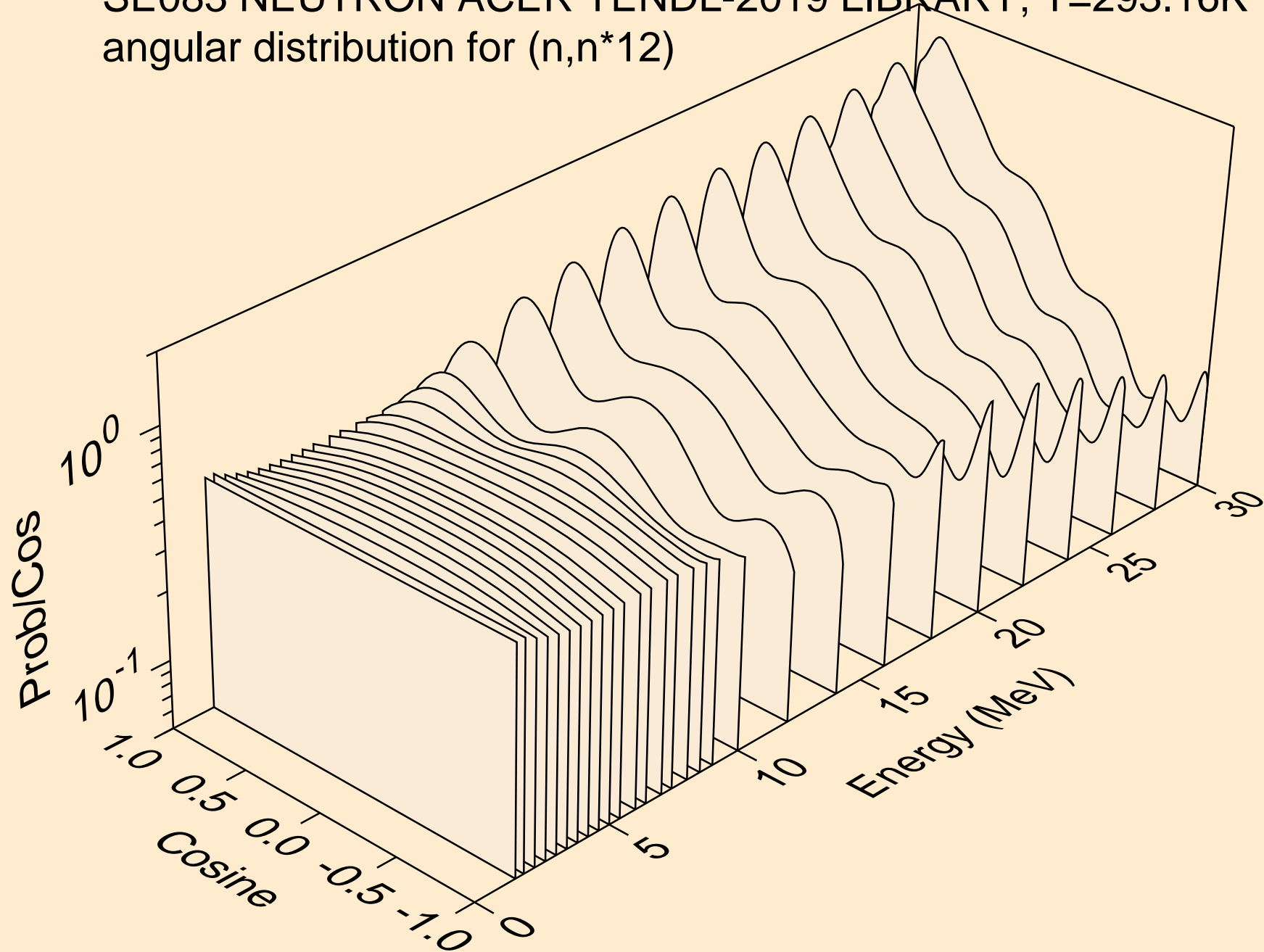

SE083 NEUTRON ACER TENDL-2019 LIBRARY; T=293.16K
angular distribution for (n,n*13)

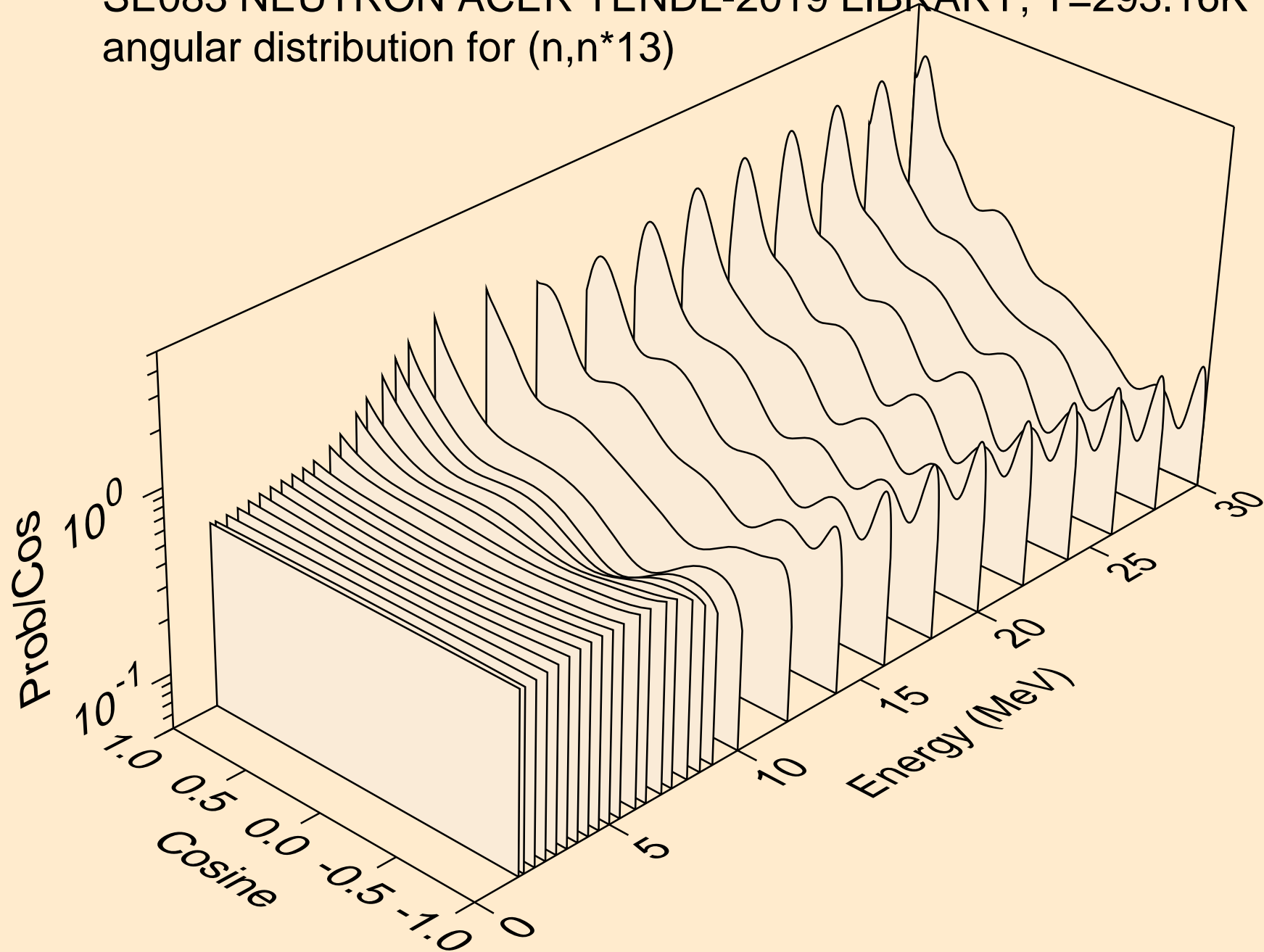

SE083 NEUTRON ACER TENDL-2019 LIBRARY; T=293.16K
angular distribution for (n,n*14)

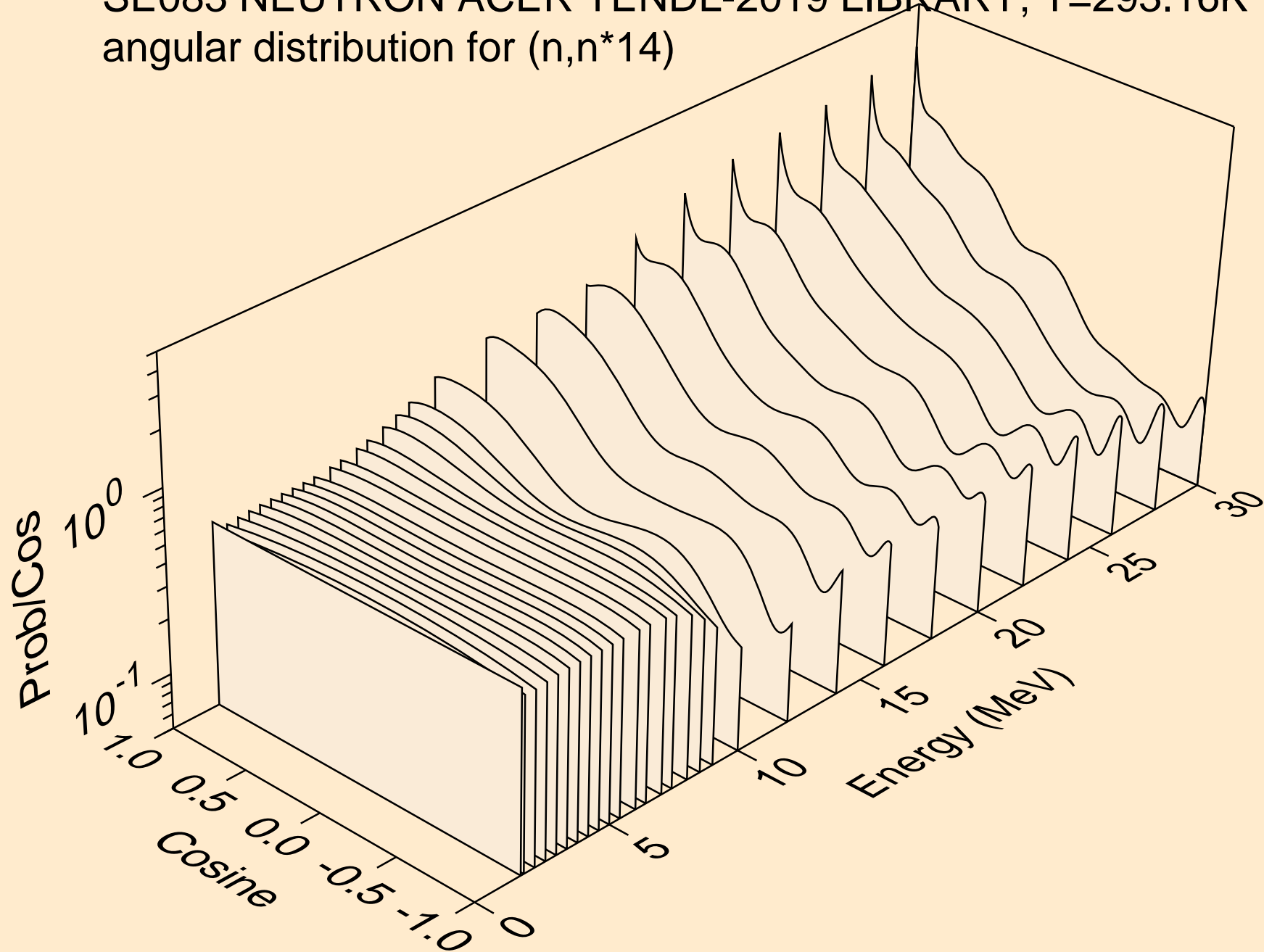

SE083 NEUTRON ACER TENDL-2019 LIBRARY; T=293.16K
angular distribution for (n,n*15)

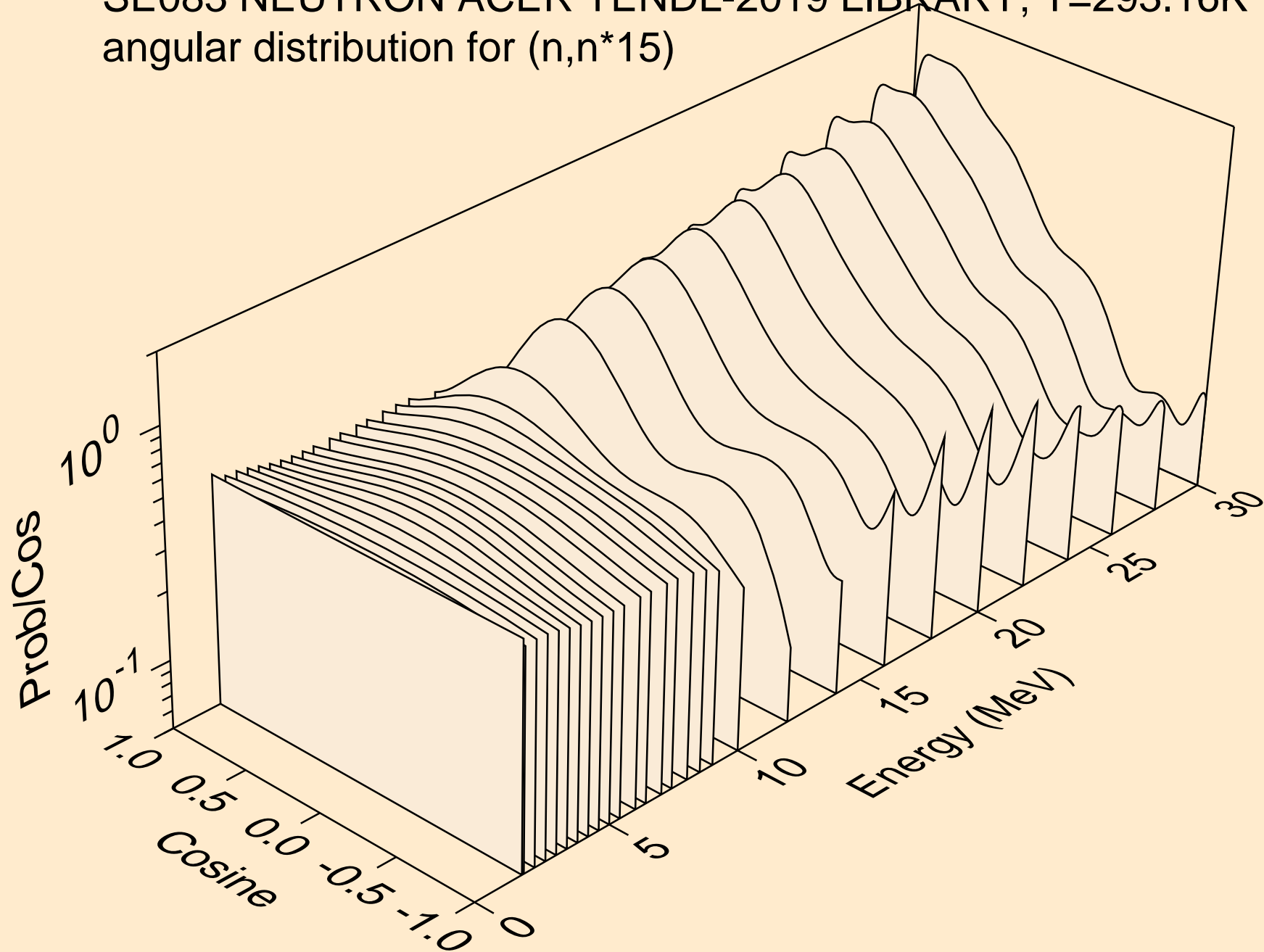

SE083 NEUTRON ACER TENDL-2019 LIBRARY; T=293.16K
angular distribution for (n,n*16)

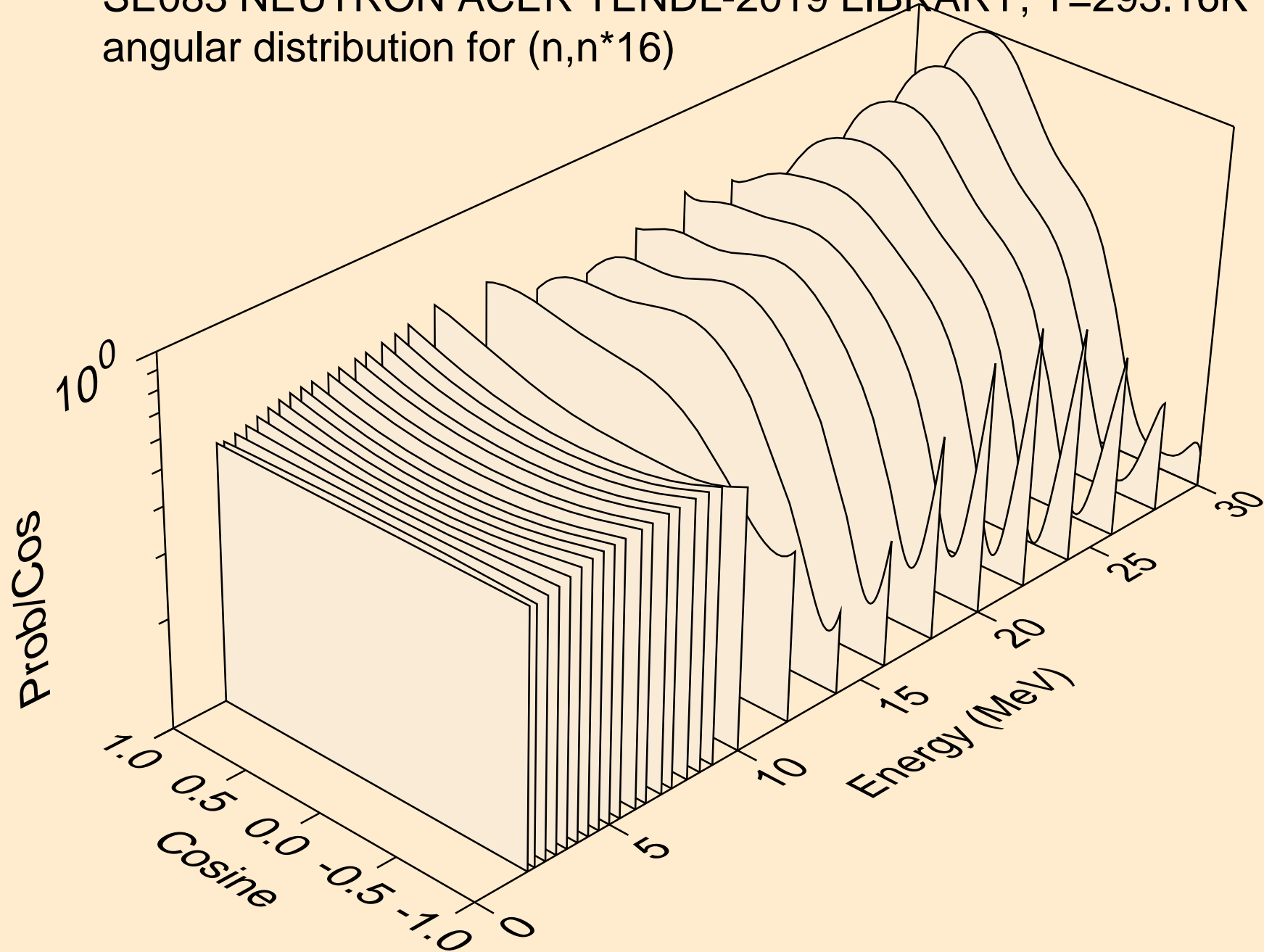

SE083 NEUTRON ACER TENDL-2019 LIBRARY; T=293.16K
angular distribution for (n,n*17)

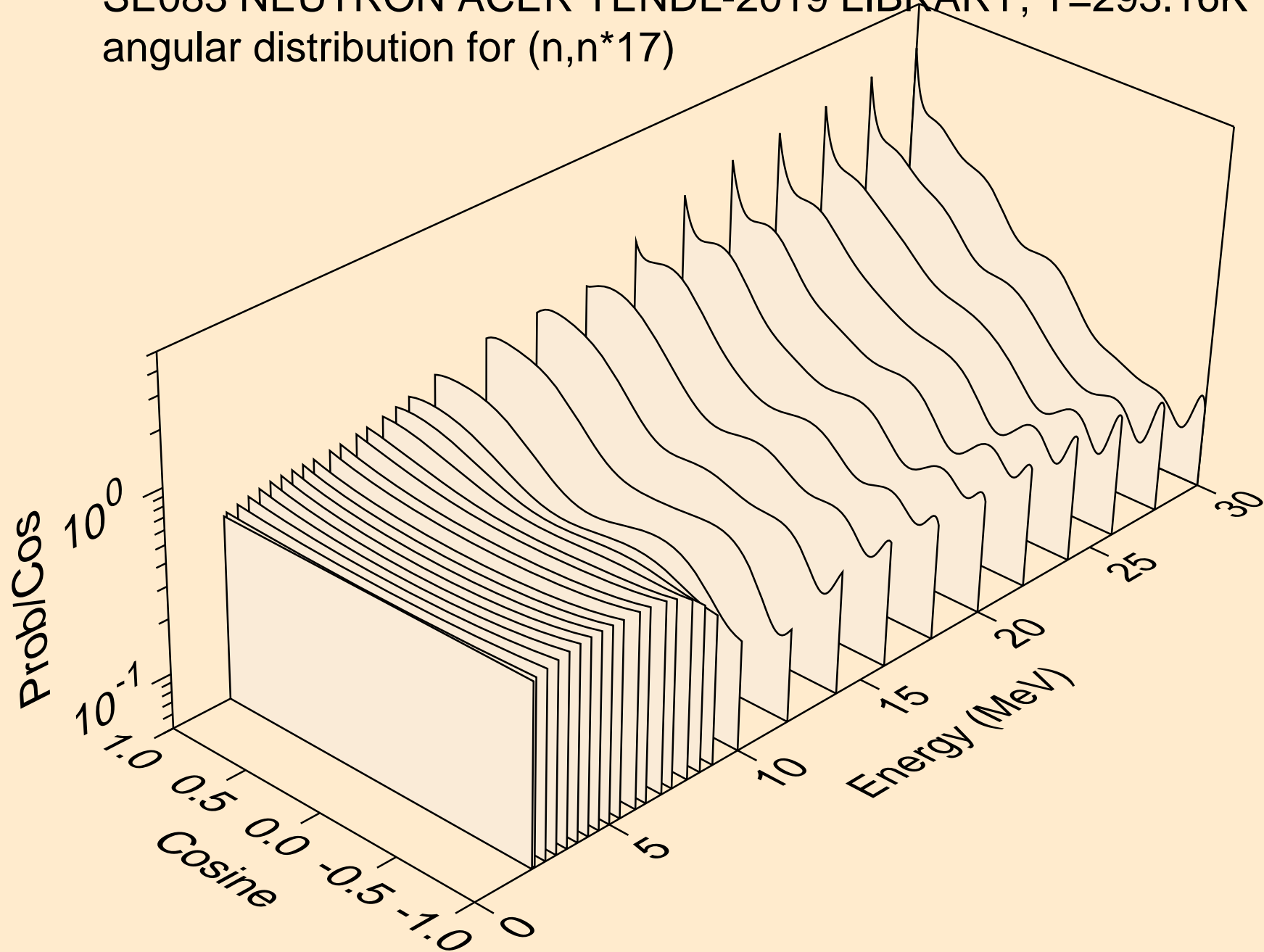

SE083 NEUTRON ACER TENDL-2019 LIBRARY; T=293.16K
angular distribution for (n,n*18)

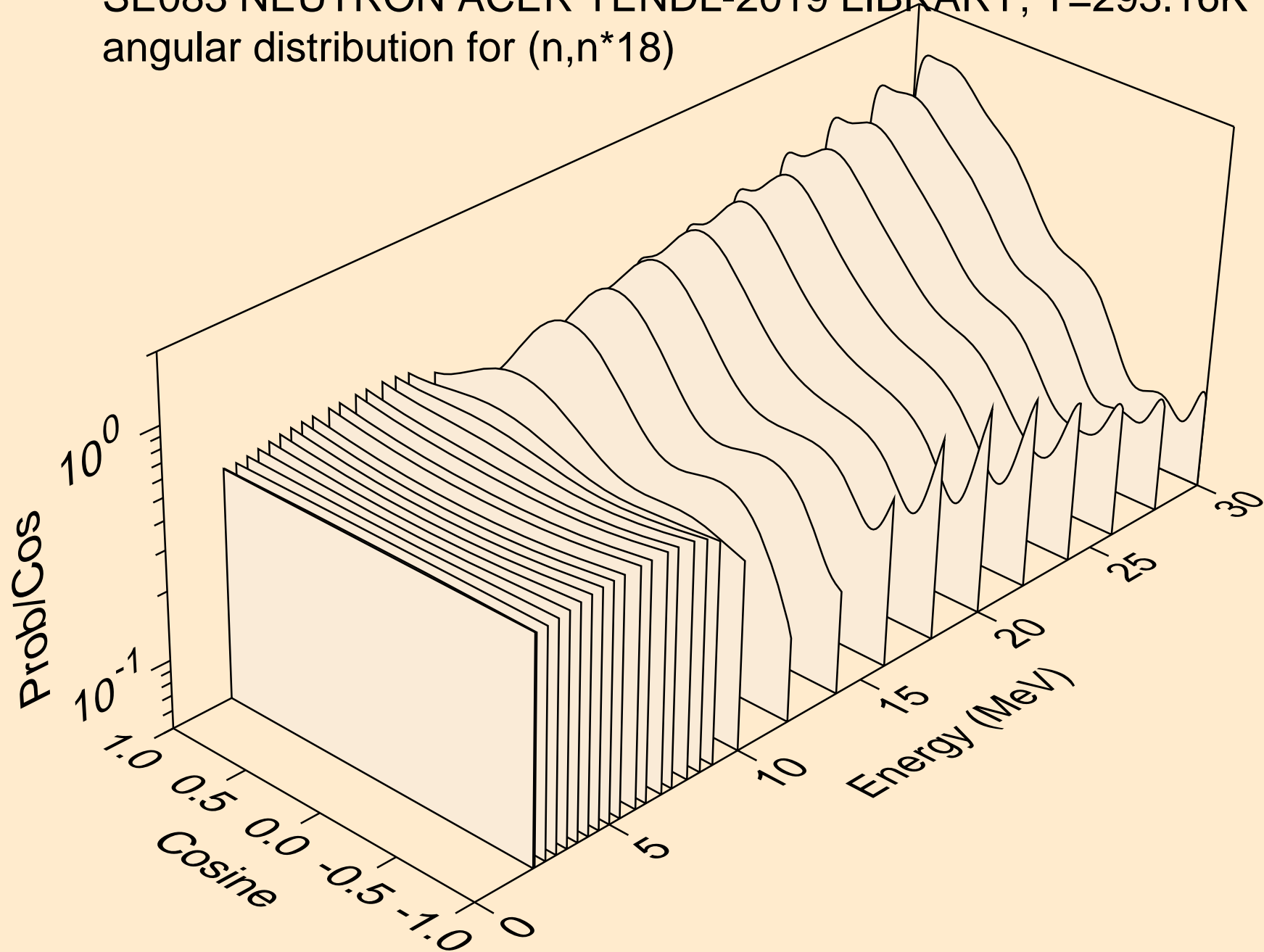

SE083 NEUTRON ACER TENDL-2019 LIBRARY; T=293.16K
angular distribution for (n,n*19)

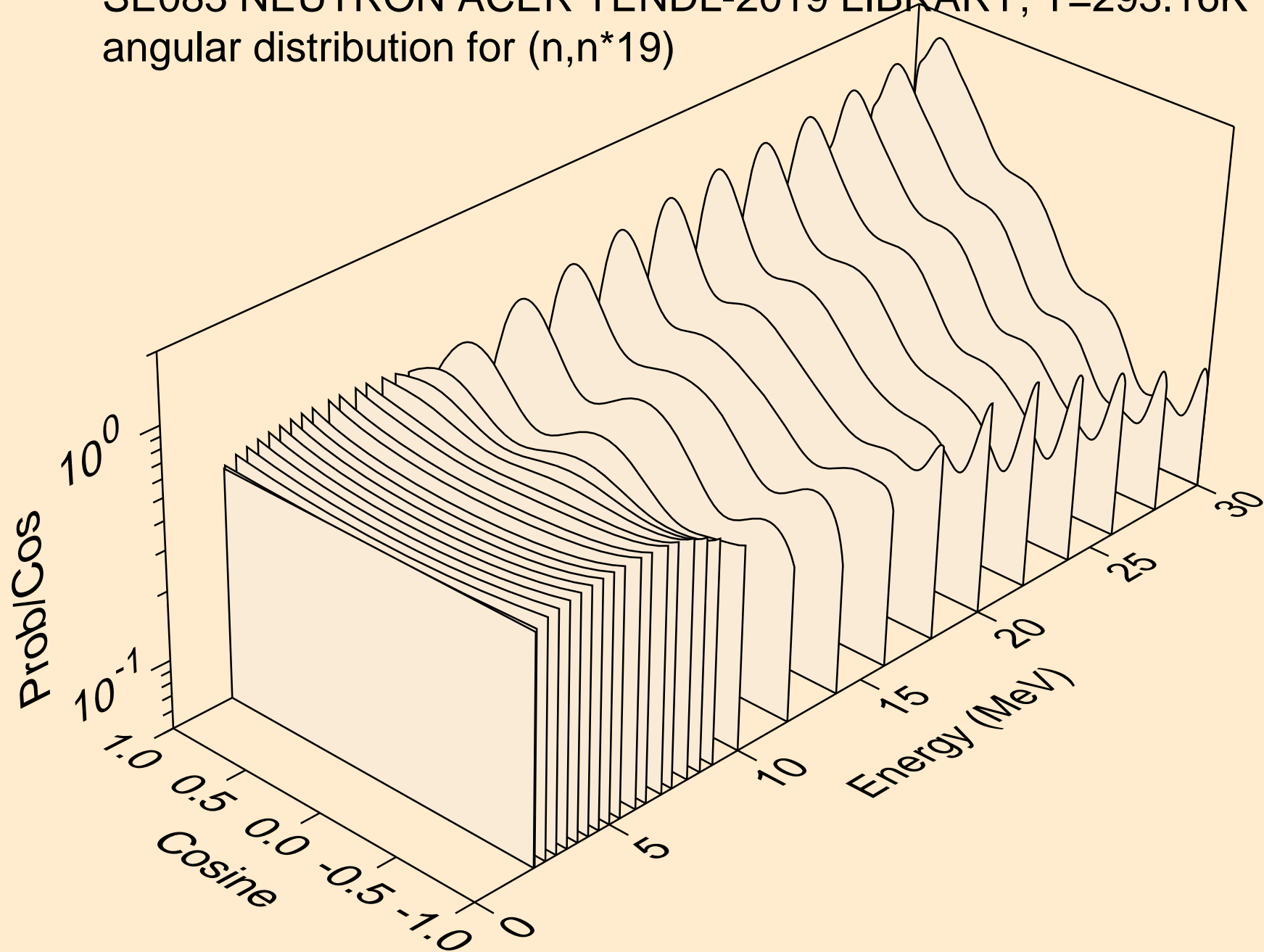

SE083 NEUTRON ACER TENDL-2019 LIBRARY; T=293.16K
angular distribution for (n,n*20)

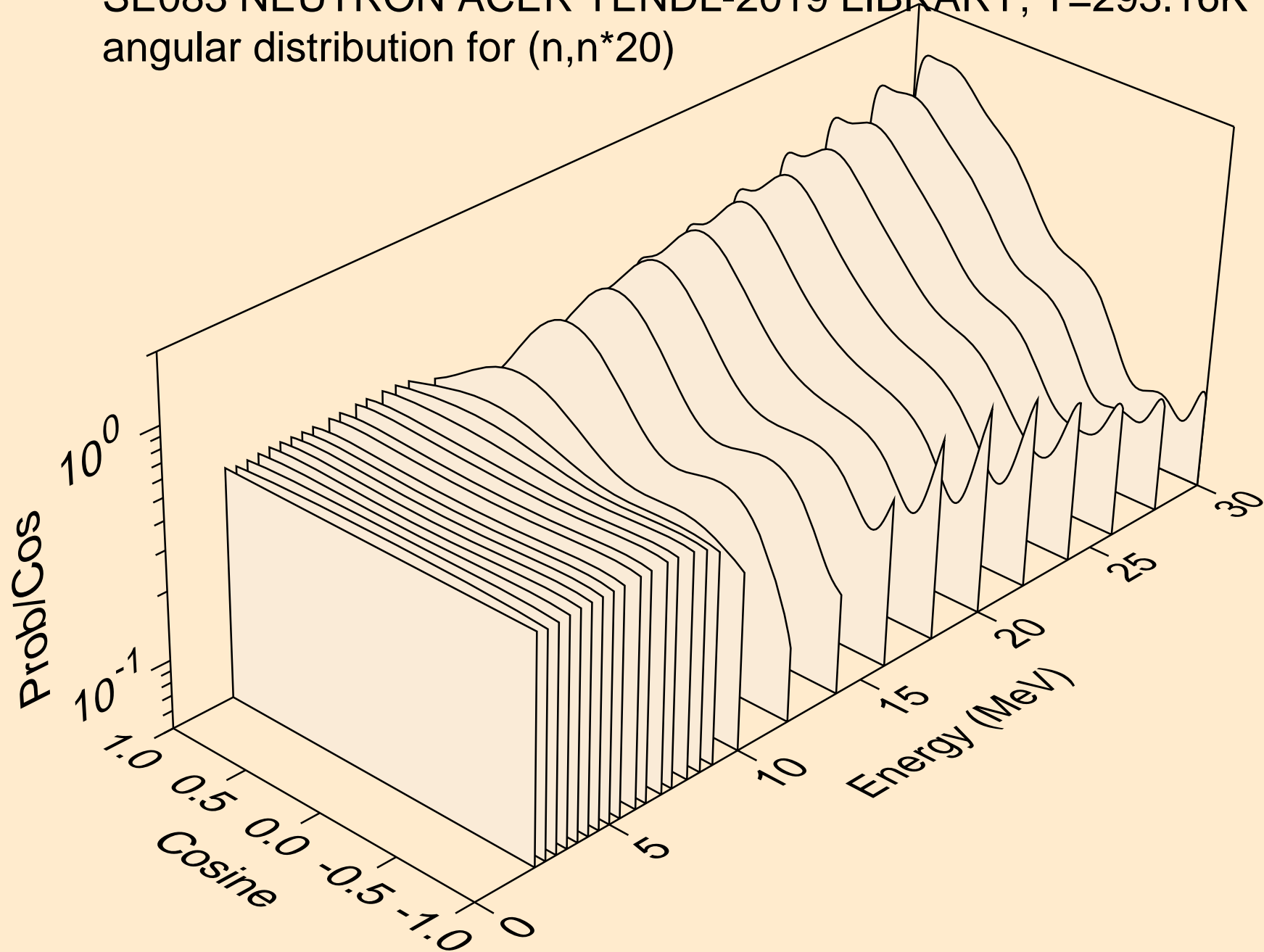

SE083 NEUTRON ACER TENDL-2019 LIBRARY; T=293.16K
angular distribution for (n,n*21)

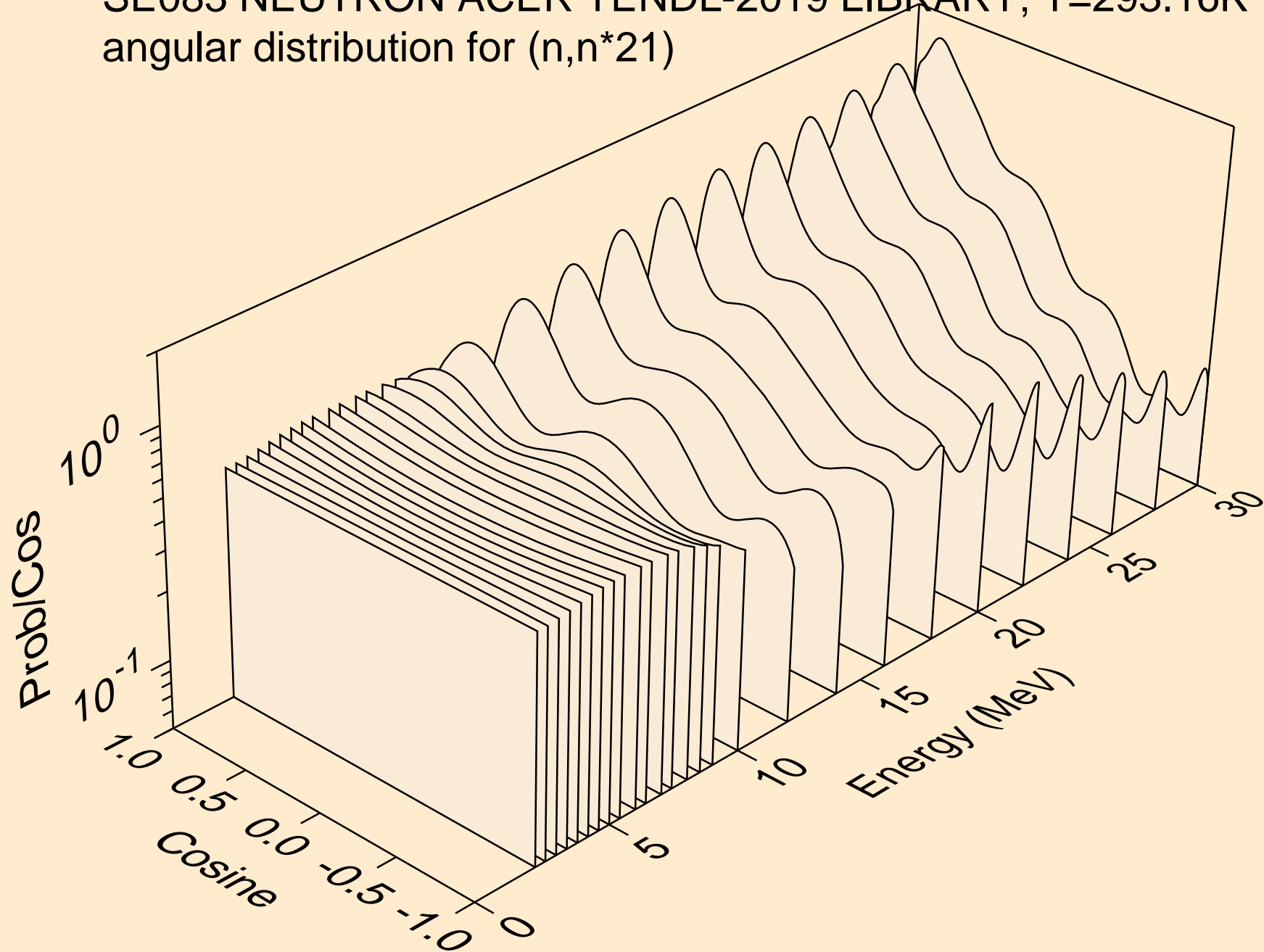

SE083 NEUTRON ACER TENDL-2019 LIBRARY; T=293.16K
angular distribution for (n,n*22)

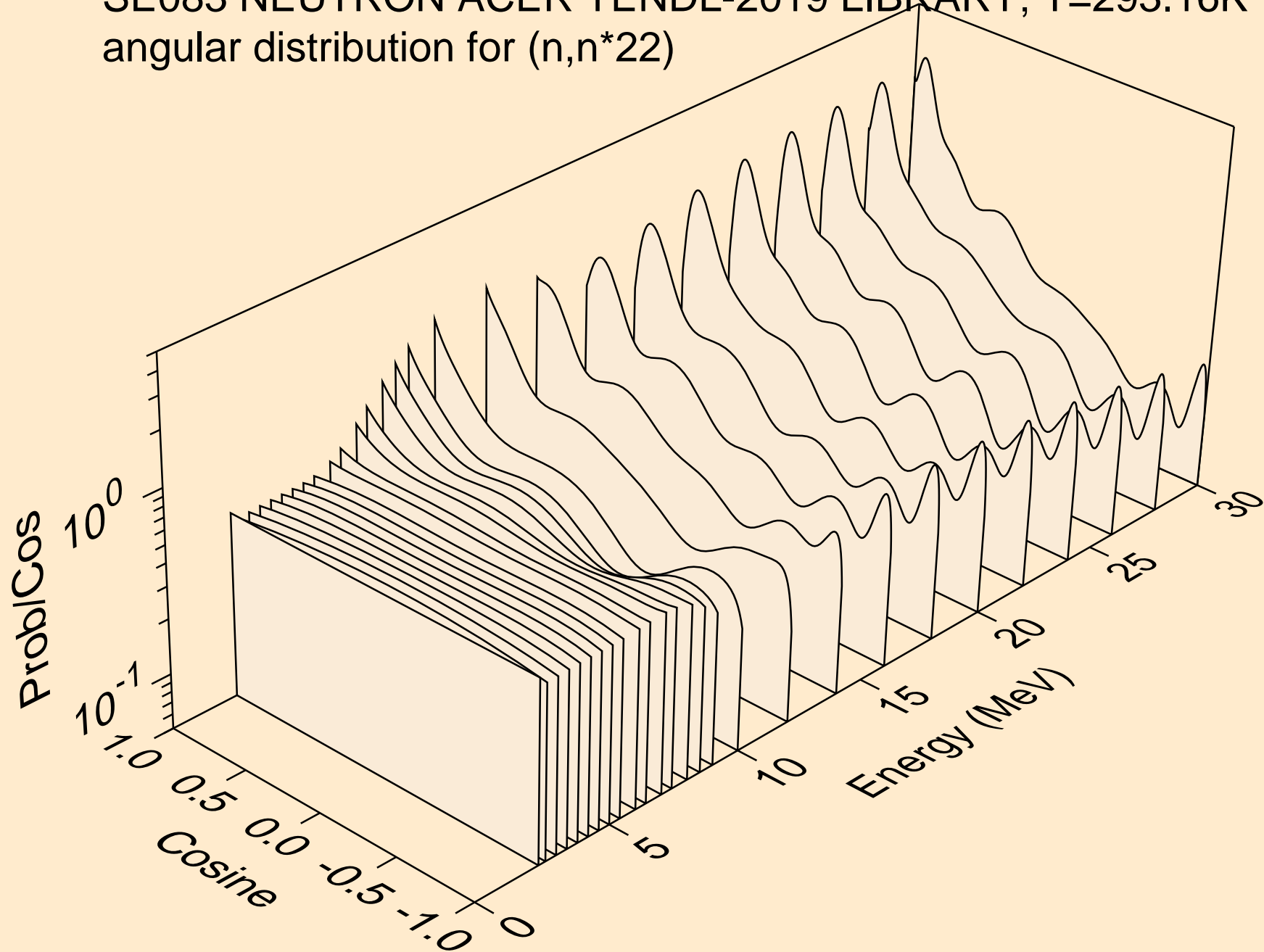

SE083 NEUTRON ACER TENDL-2019 LIBRARY; T=293.16K
angular distribution for (n,n*23)

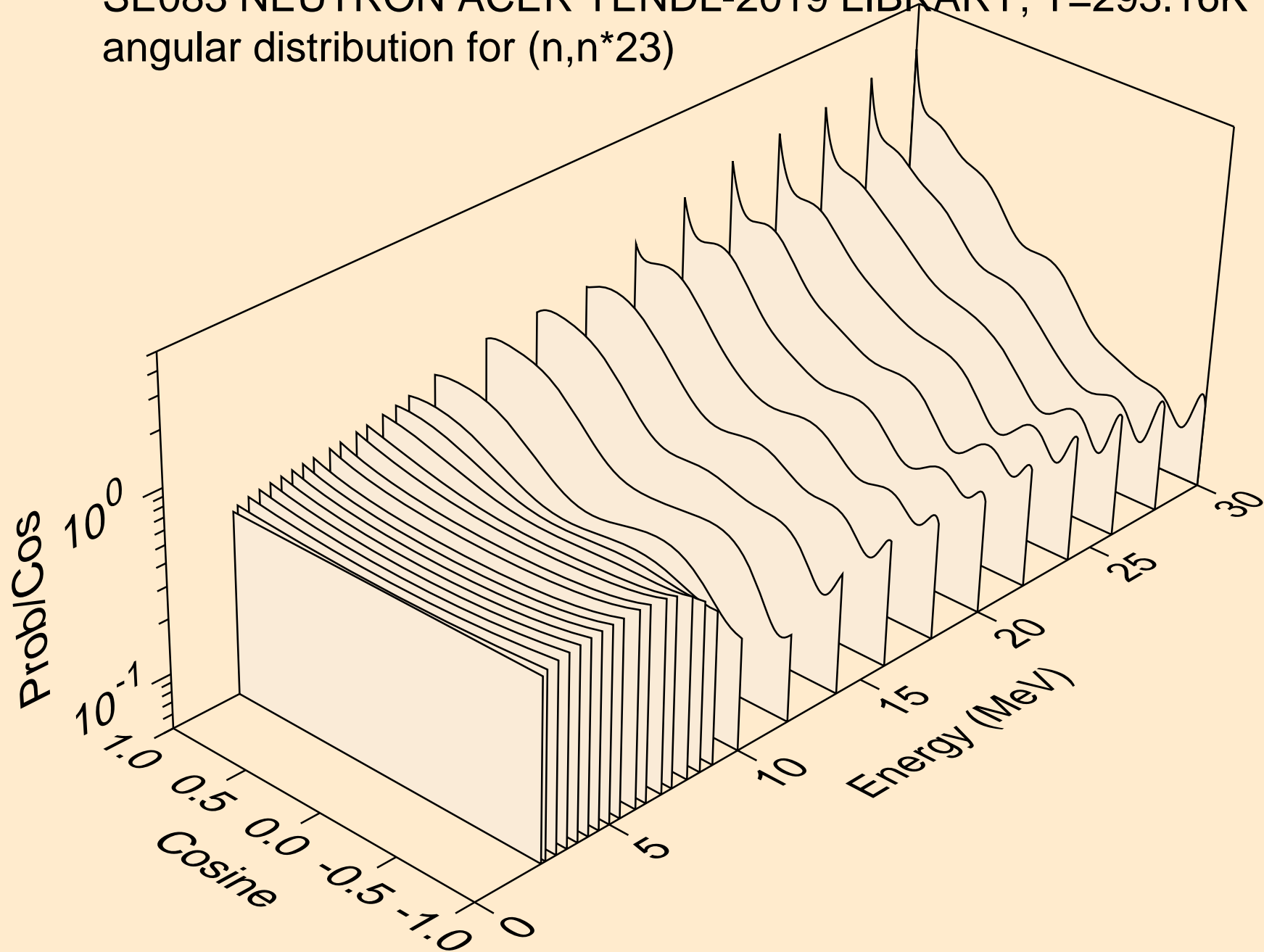

SE083 NEUTRON ACER TENDL-2019 LIBRARY; T=293.16K
angular distribution for (n,n*24)

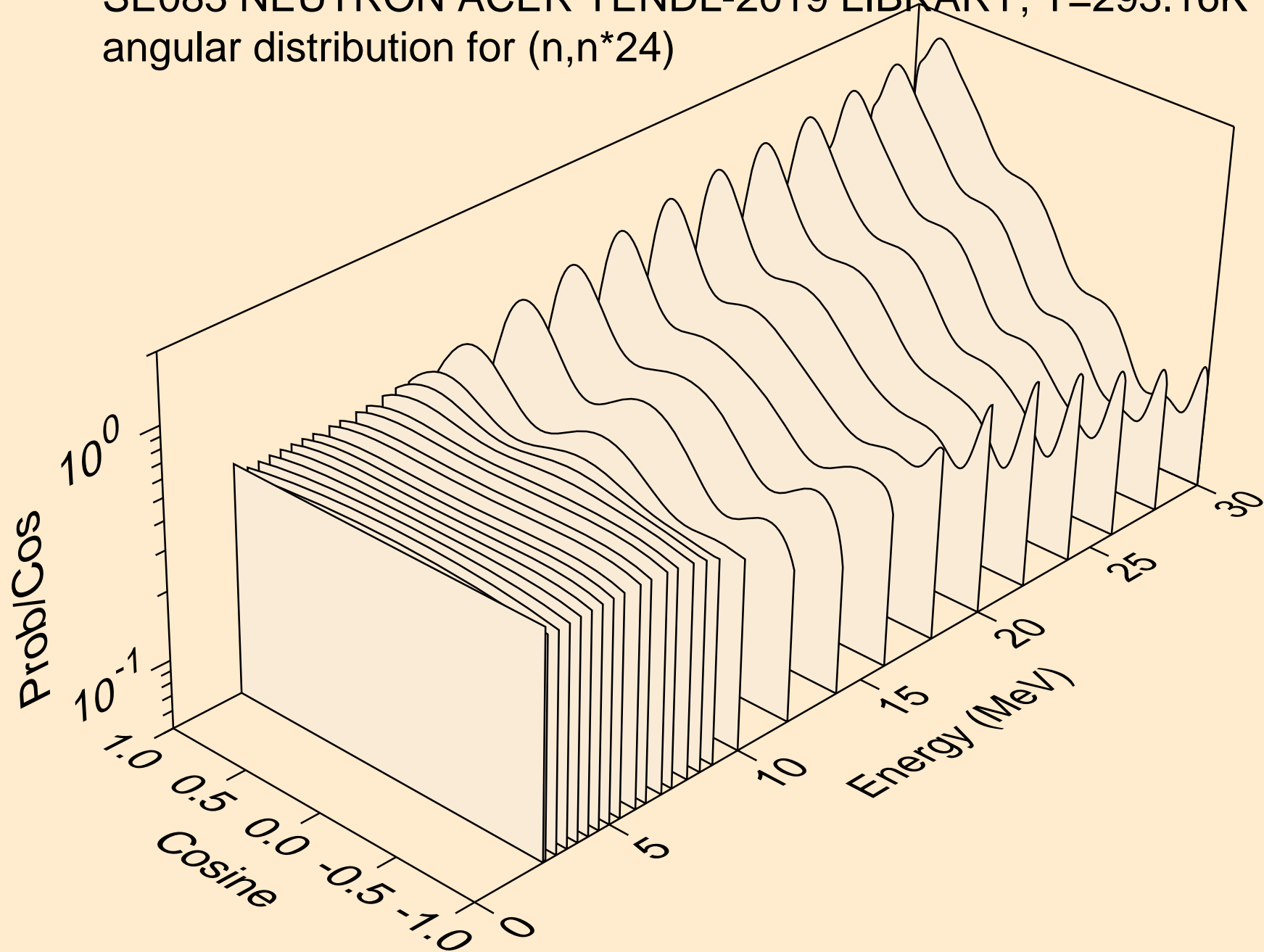

SE083 NEUTRON ACER TENDL-2019 LIBRARY; T=293.16K
angular distribution for (n,n*25)

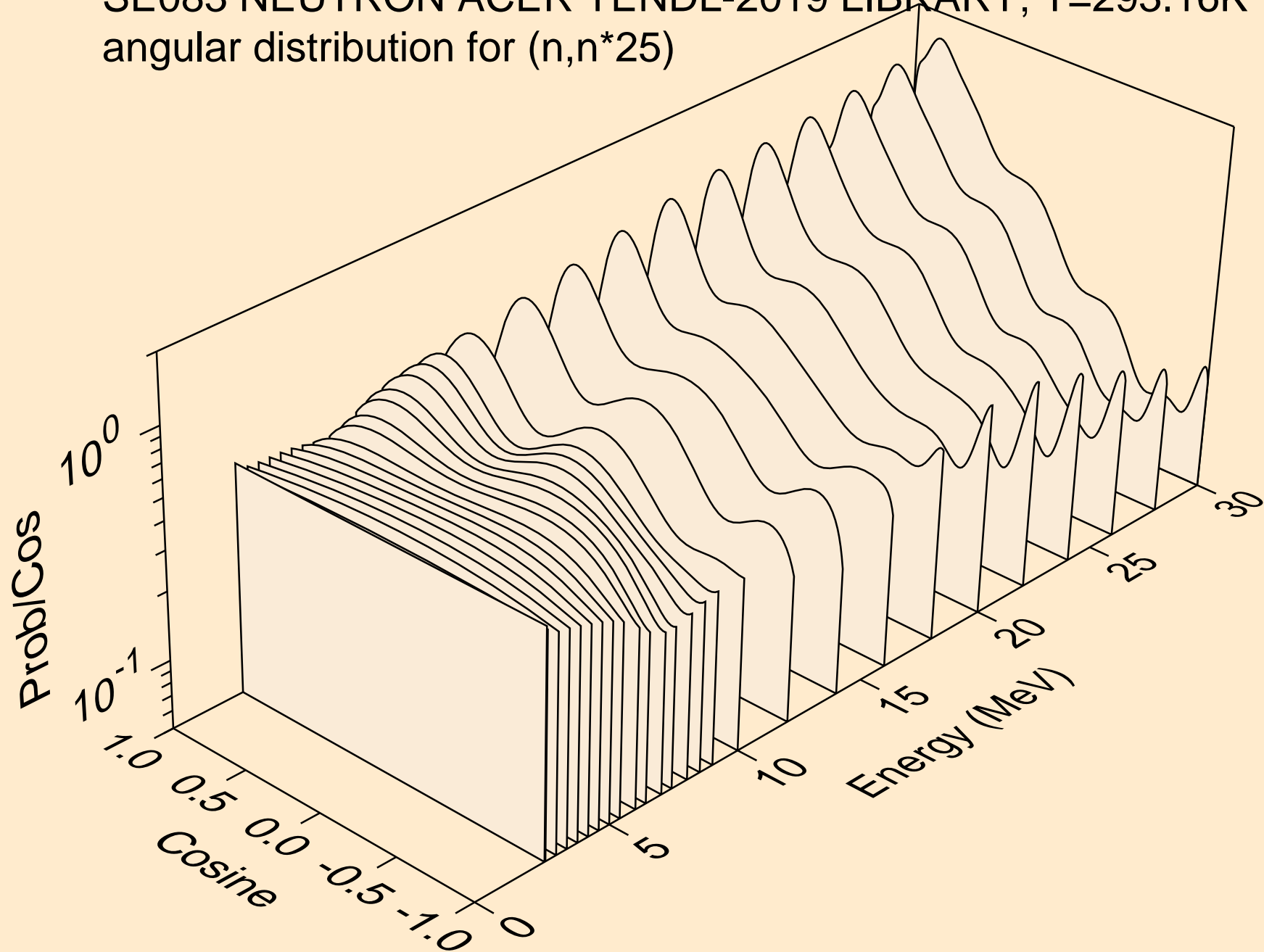

SE083 NEUTRON ACER TENDL-2019 LIBRARY; T=293.16K
angular distribution for (n,n*26)

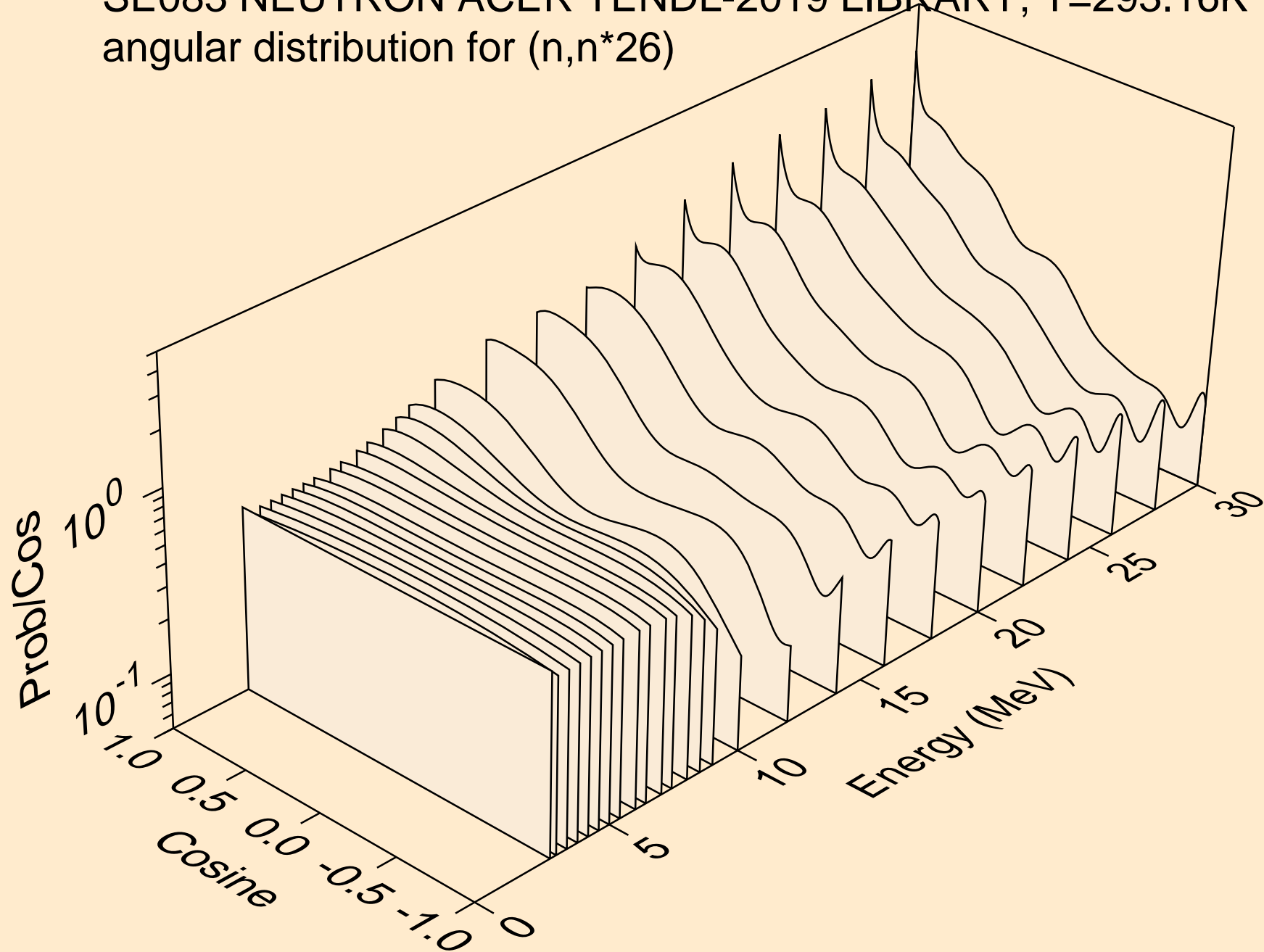

SE083 NEUTRON ACER TENDL-2019 LIBRARY; T=293.16K
angular distribution for (n,n*27)

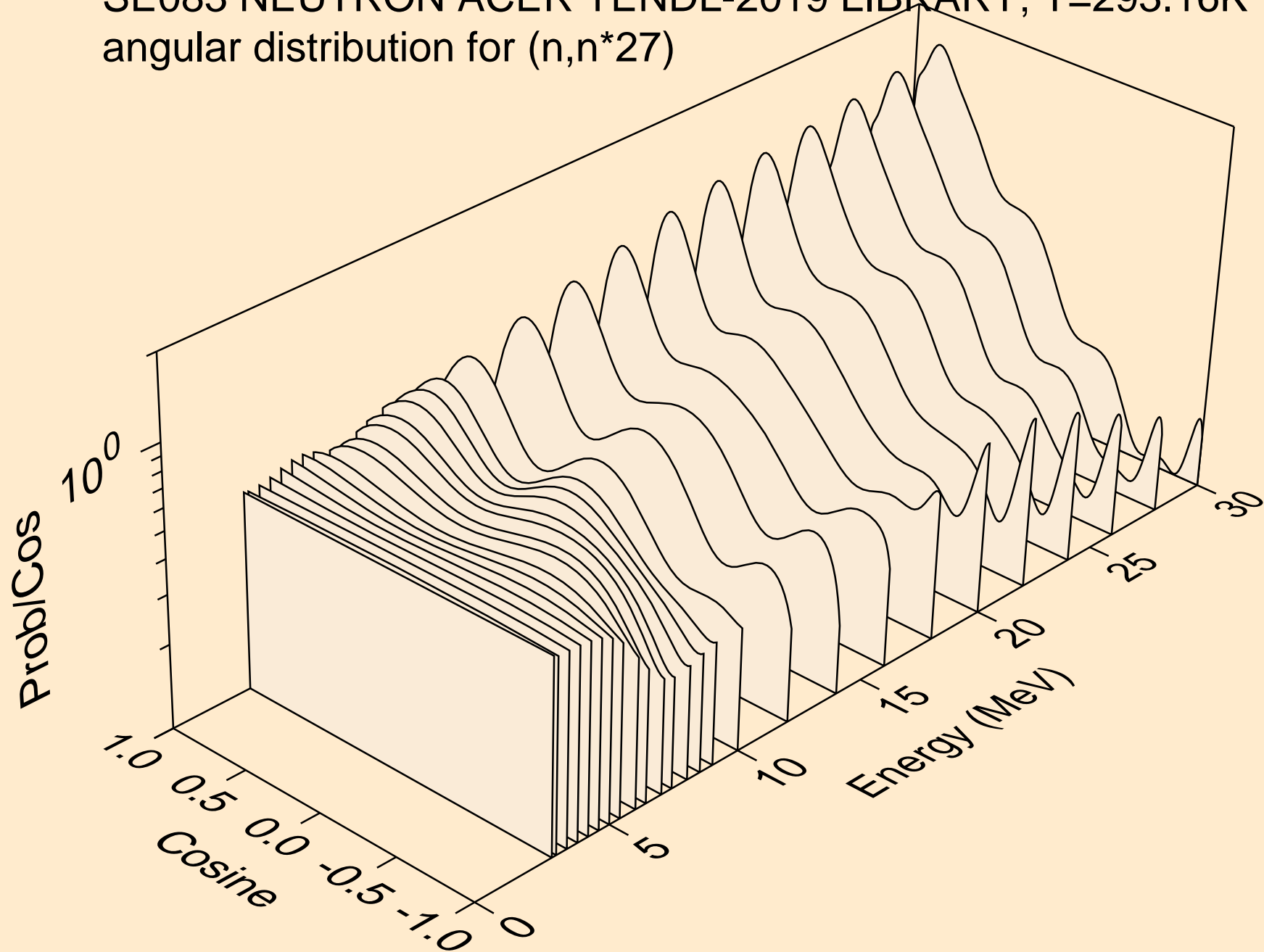

SE083 NEUTRON ACER TENDL-2019 LIBRARY; T=293.16K
angular distribution for (n,n*28)

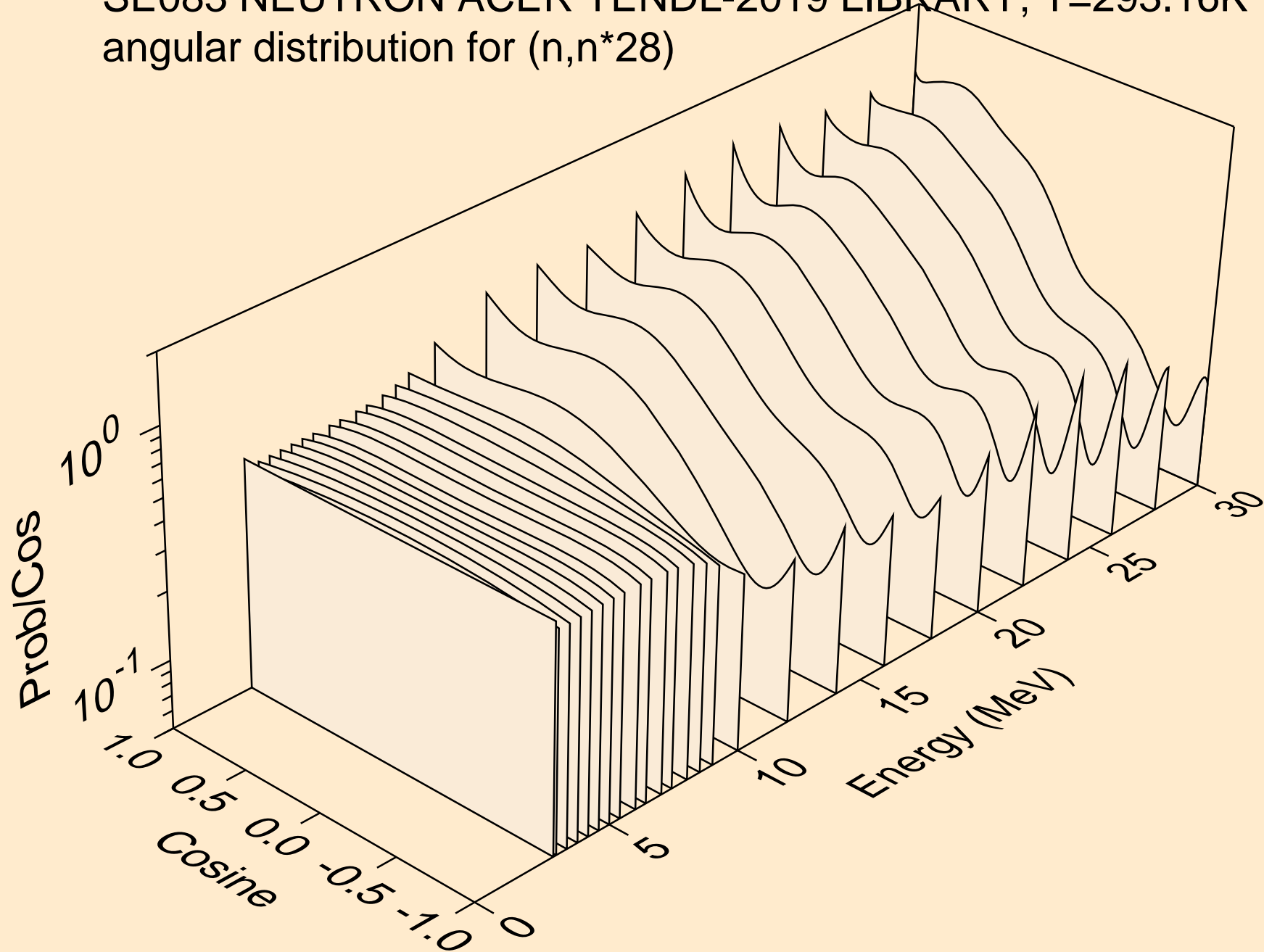

SE083 NEUTRON ACER TENDL-2019 LIBRARY; T=293.16K
angular distribution for (n,n*29)

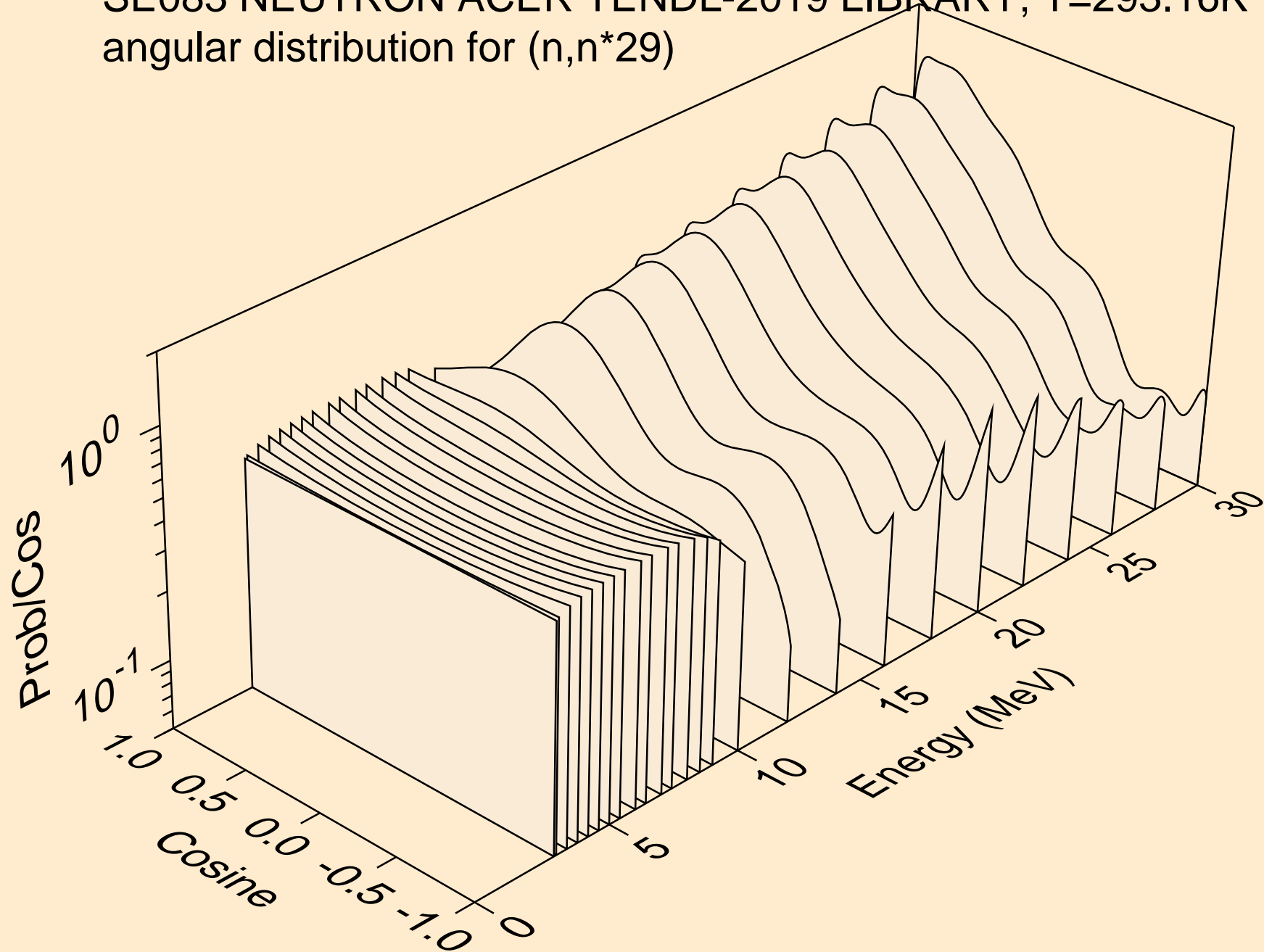

SE083 NEUTRON ACER TENDL-2019 LIBRARY; T=293.16K
angular distribution for (n,n*30)

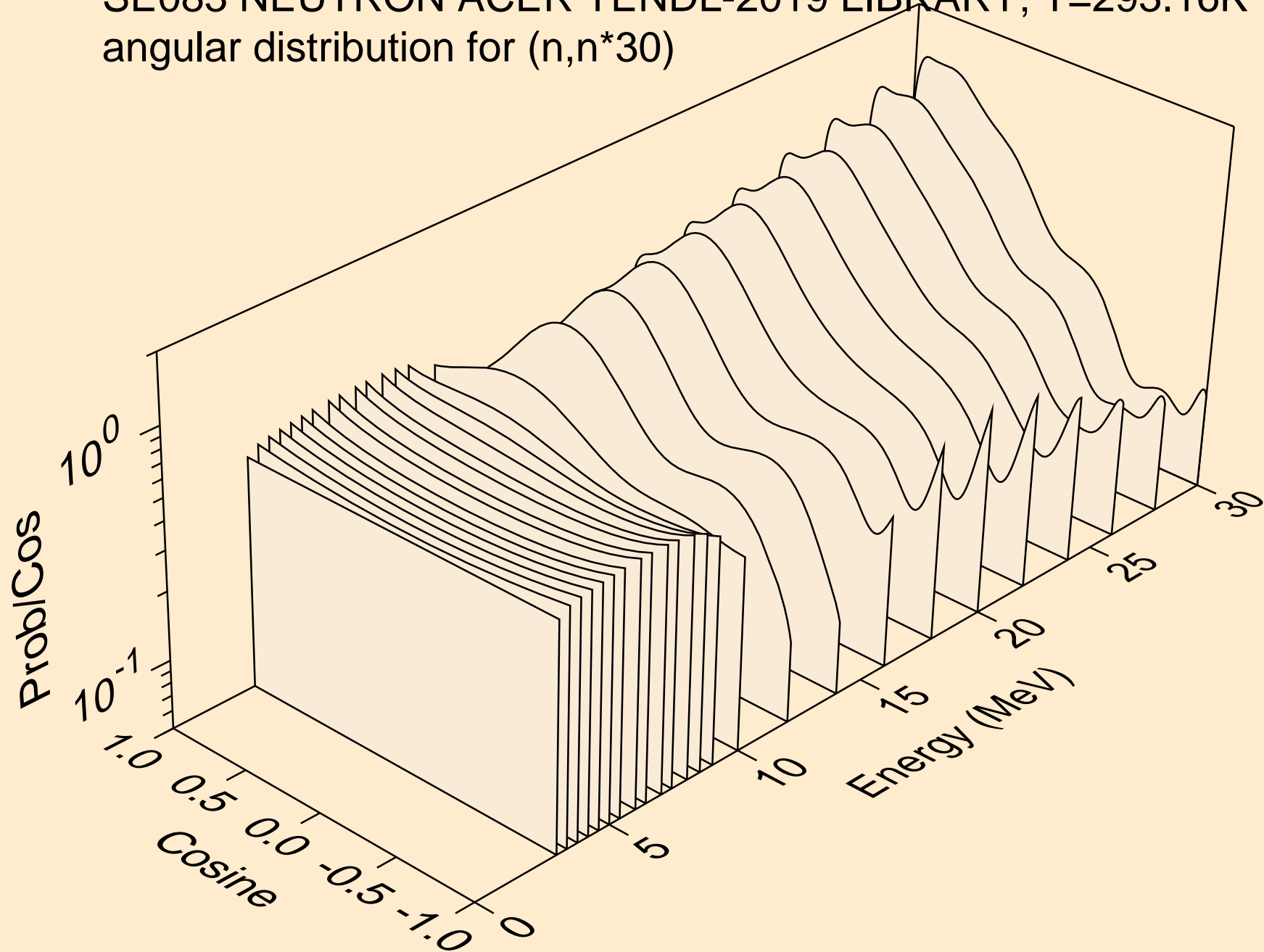

SE083 NEUTRON ACER TENDL-2019 LIBRARY; T=293.16K
Neutron emission for (n,x)

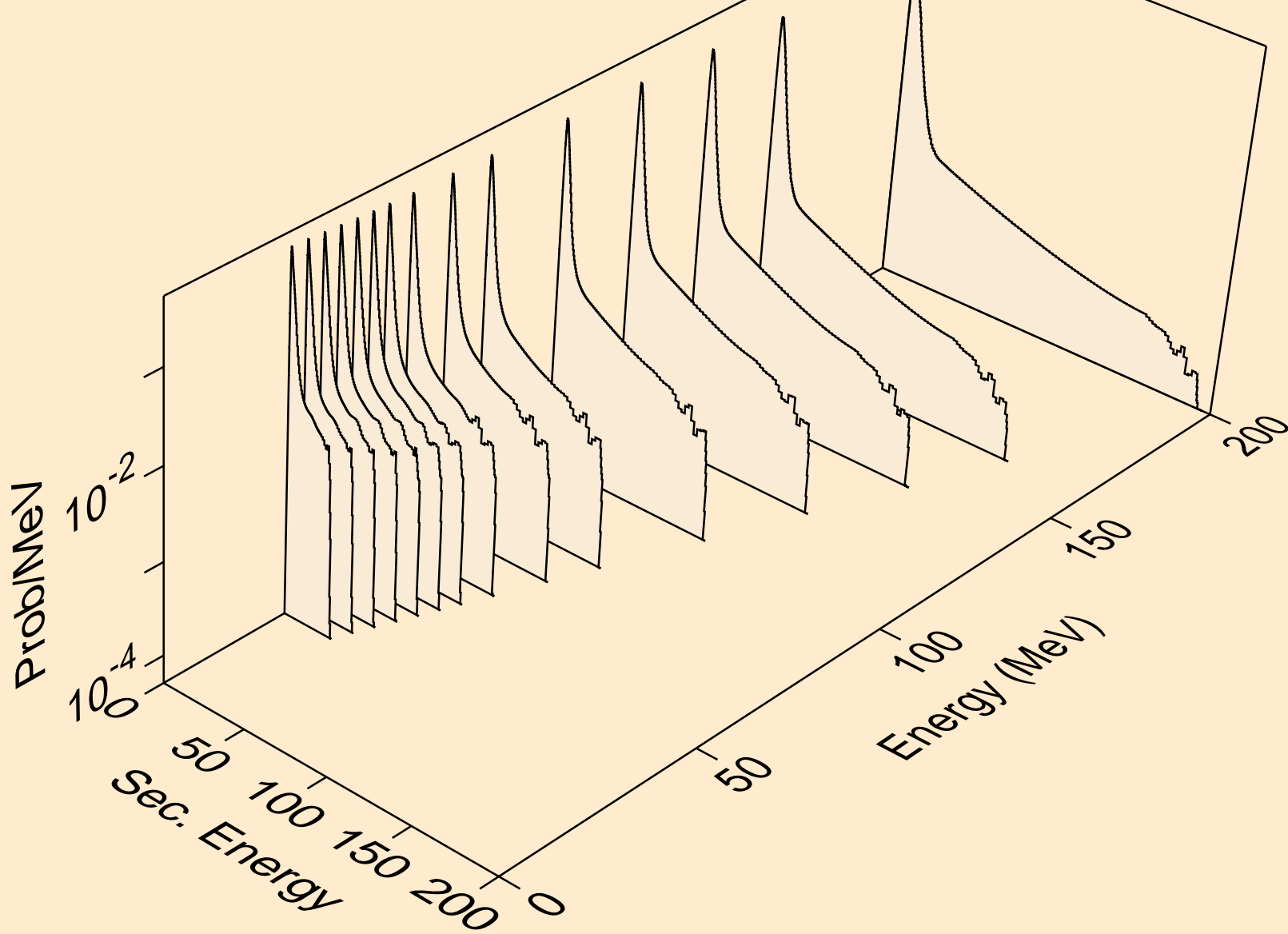

SE083 NEUTRON ACER TENDL-2019 LIBRARY; T=293.16K
Neutron emission for (n,2nd)

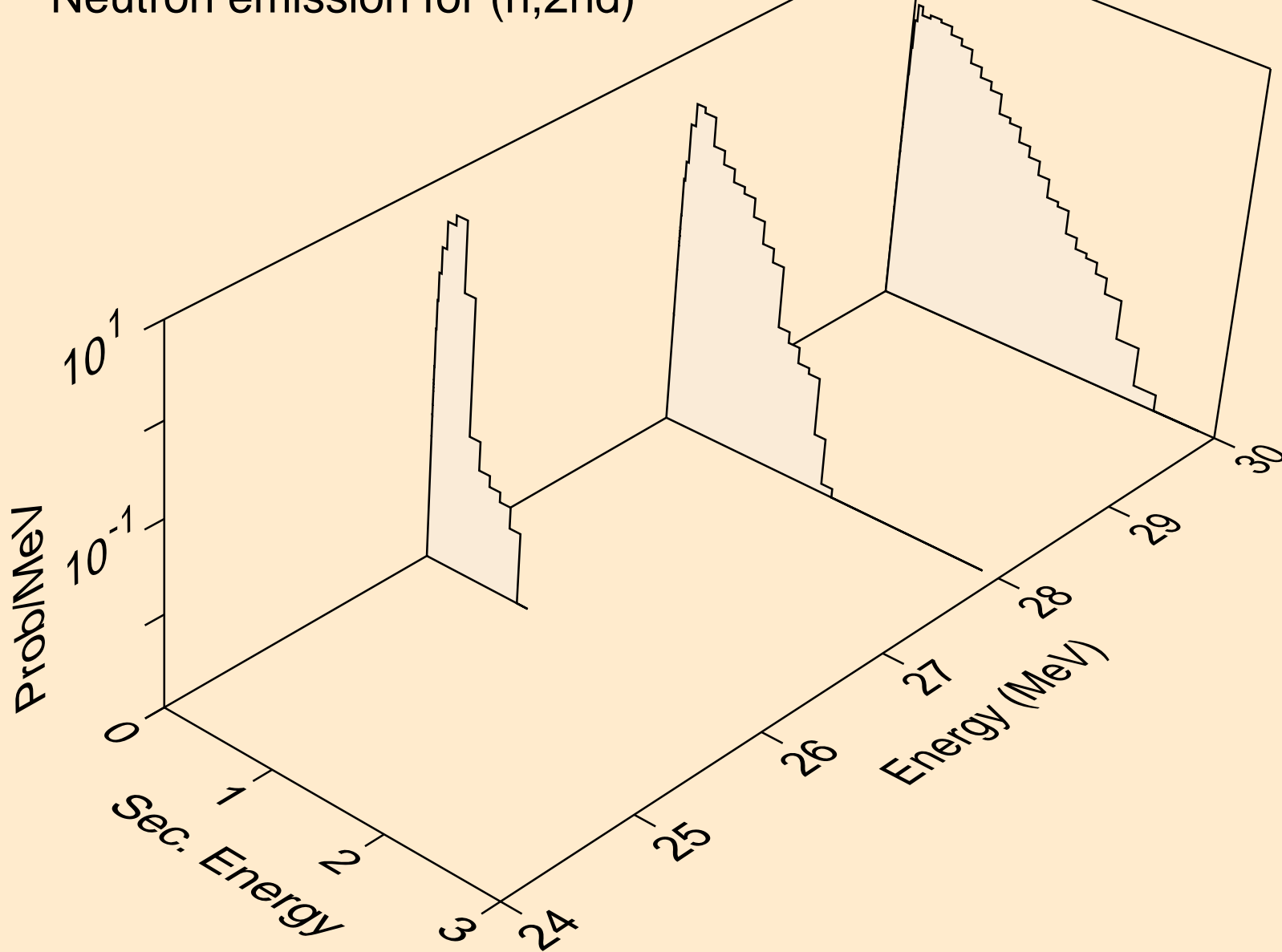

SE083 NEUTRON ACER TENDL-2019 LIBRARY; T=293.16K
Neutron emission for (n,2n)

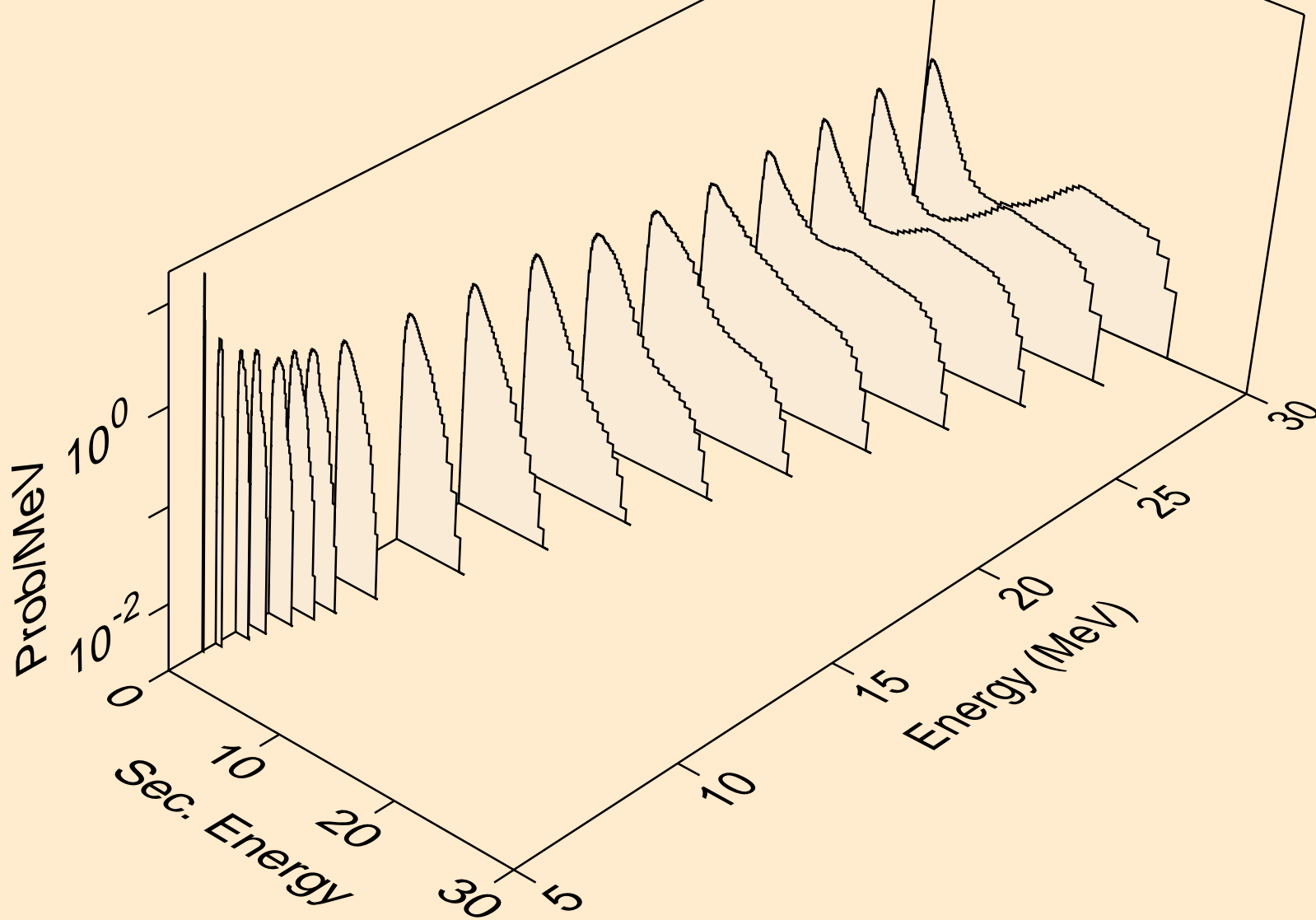

SE083 NEUTRON ACER TENDL-2019 LIBRARY; T=293.16K
Neutron emission for (n,3n)

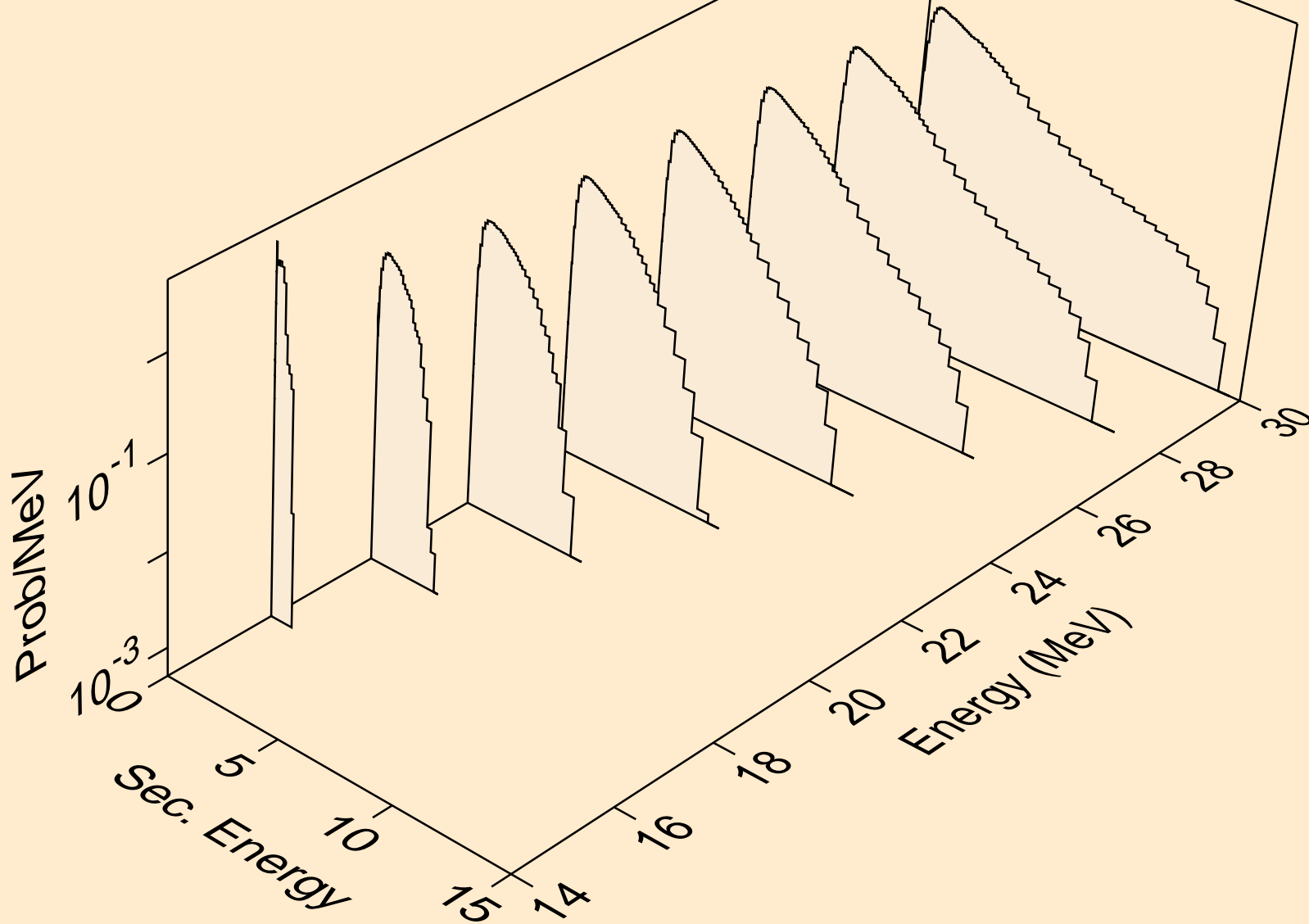

SE083 NEUTRON ACER TENDL-2019 LIBRARY; T=293.16K
Neutron emission for (n,n*)a

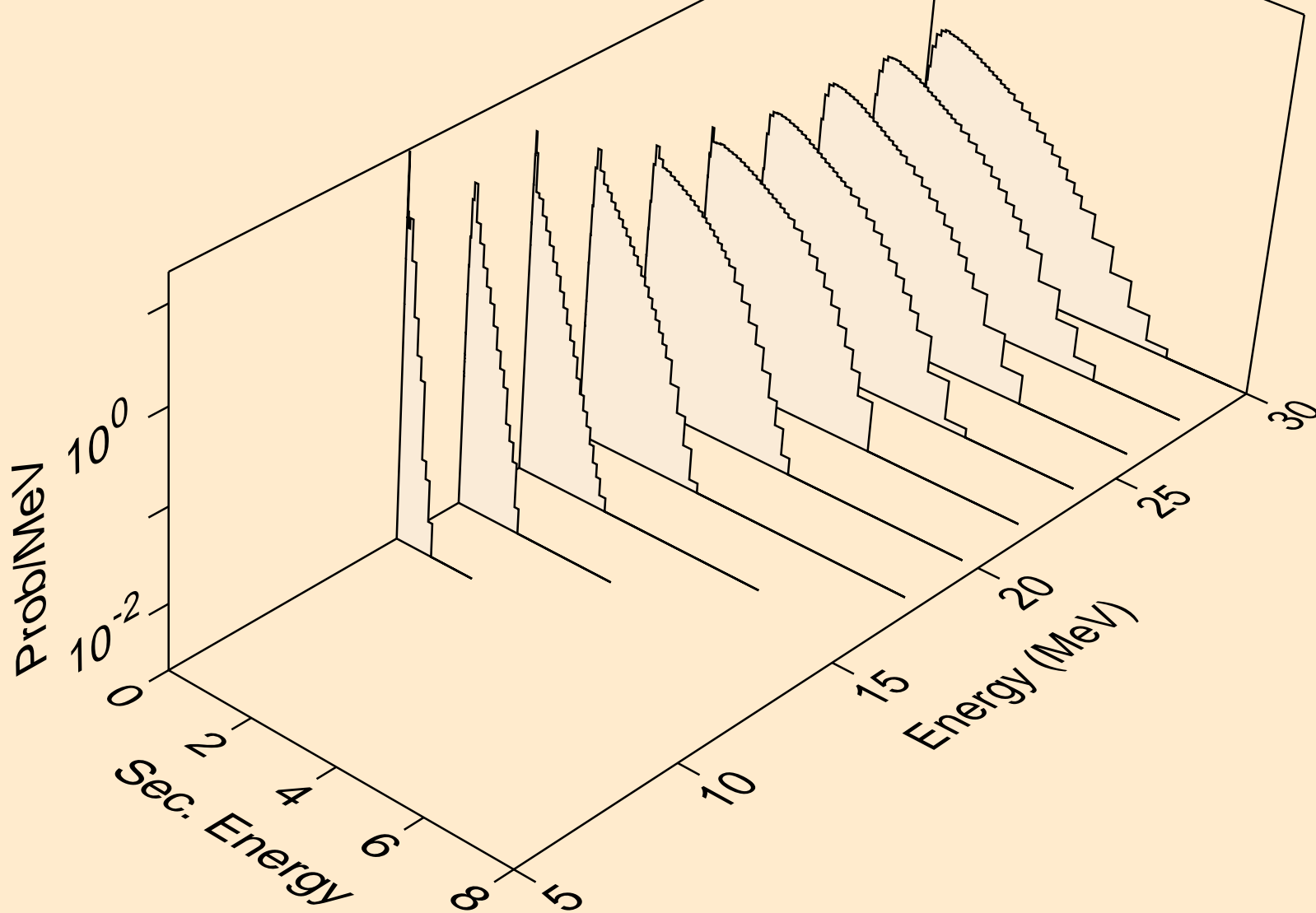

SE083 NEUTRON ACER TENDL-2019 LIBRARY; T=293.16K
Neutron emission for (n,2n)a

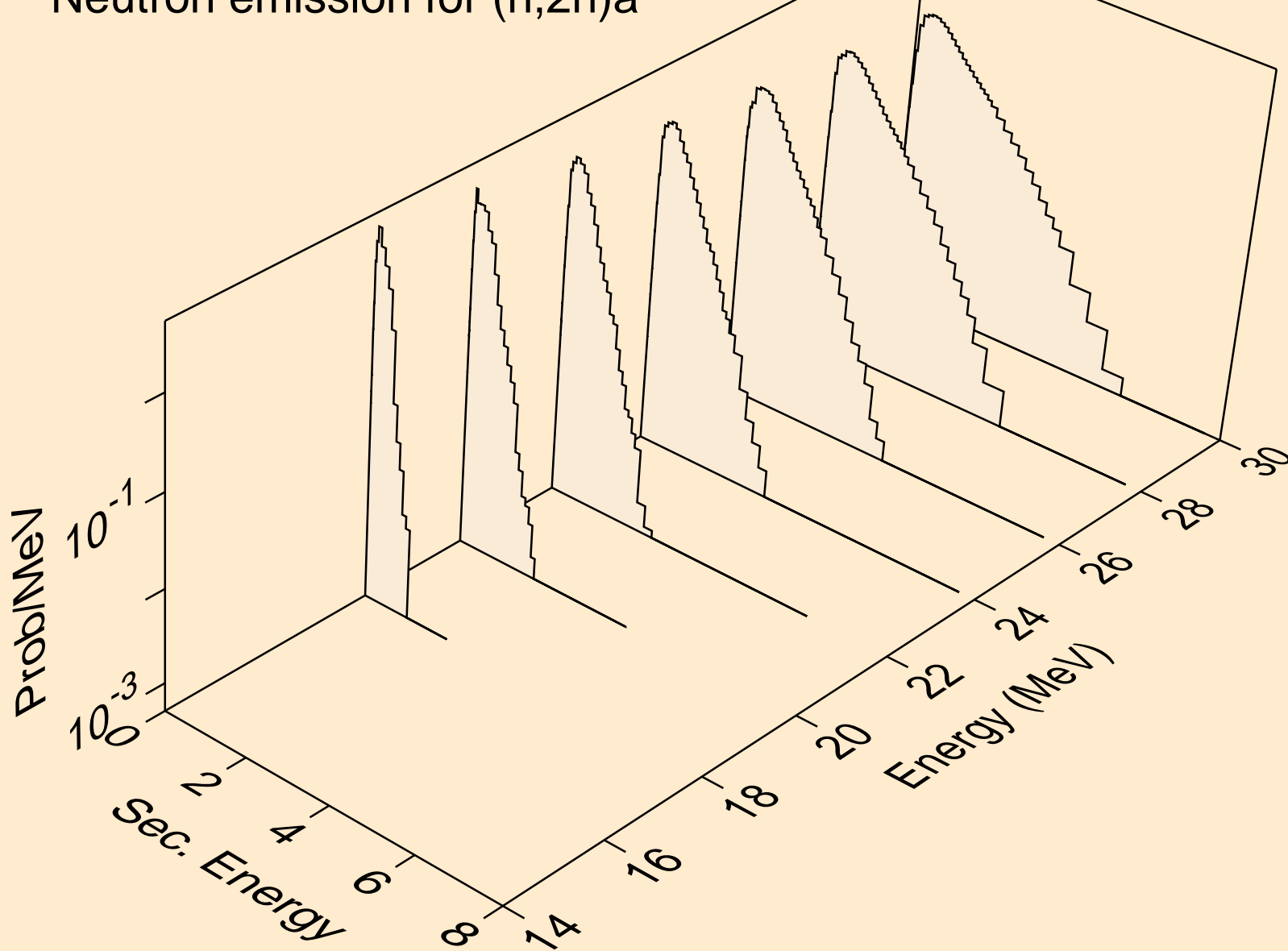

SE083 NEUTRON ACER TENDL-2019 LIBRARY; T=293.16K
Neutron emission for (n,3n)a

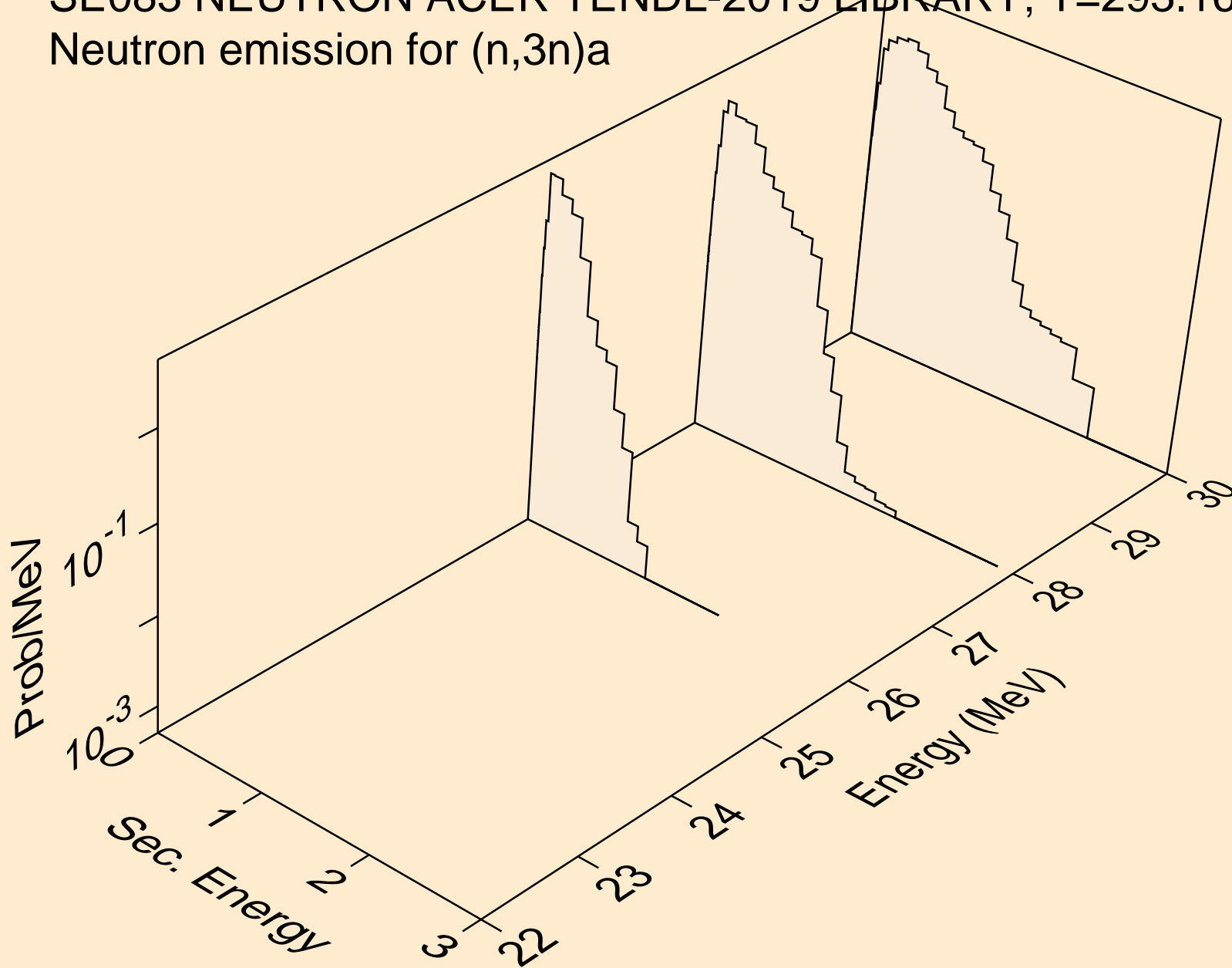

SE083 NEUTRON ACER TENDL-2019 LIBRARY; T=293.16K
Neutron emission for (n,n*)p

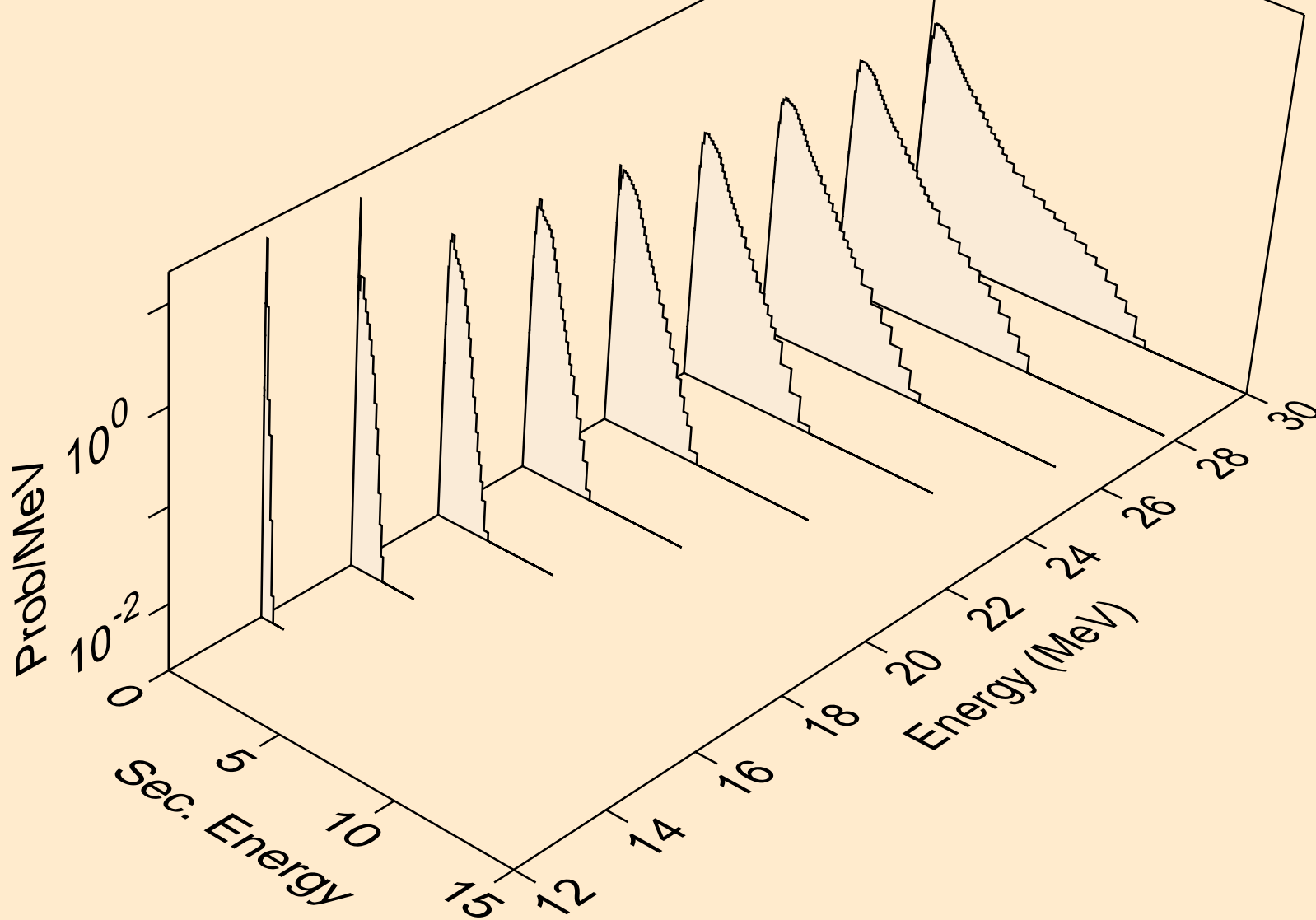

SE083 NEUTRON ACER TENDL-2019 LIBRARY; T=293.16K
Neutron emission for (n,n*)d

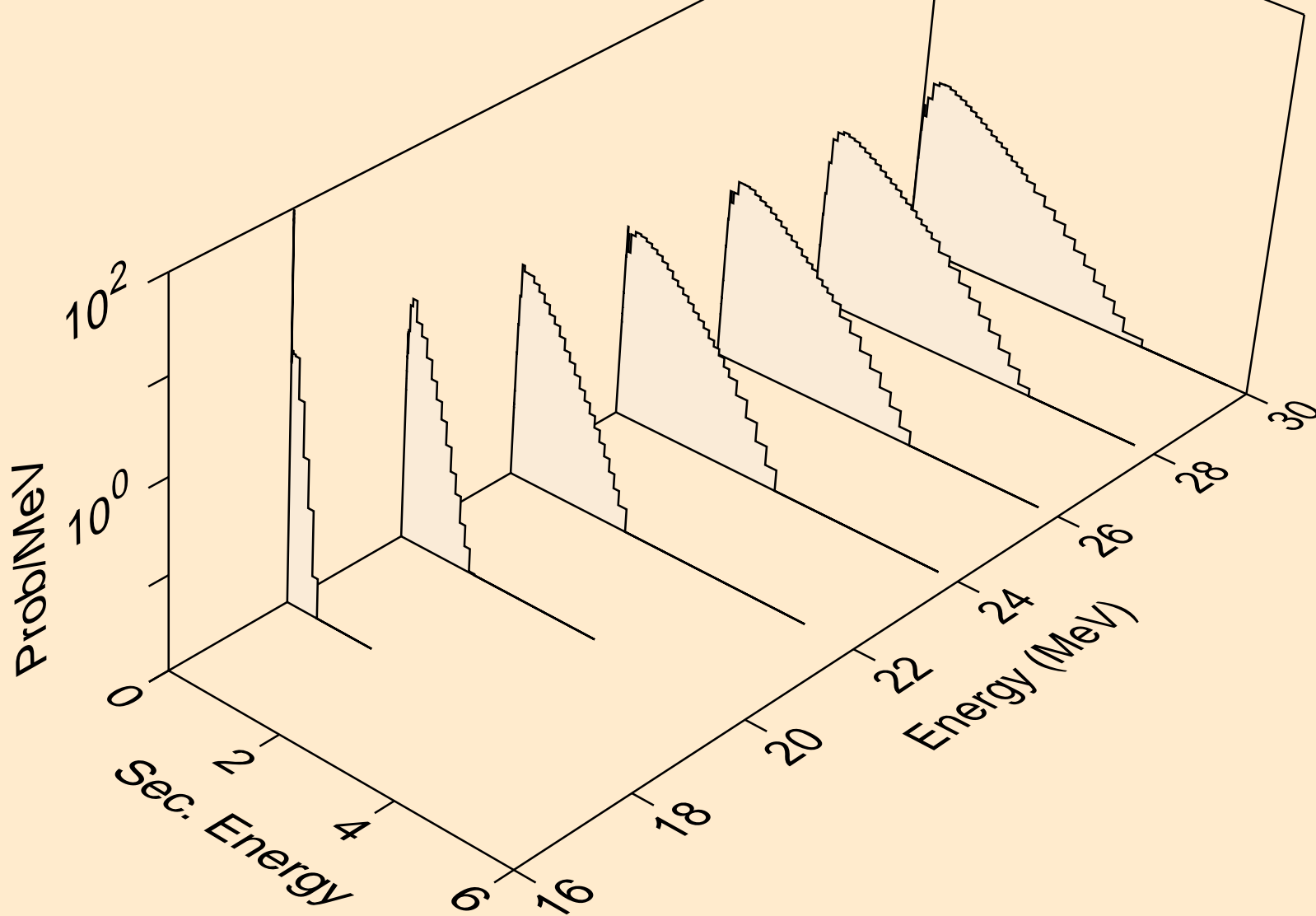

SE083 NEUTRON ACER TENDL-2019 LIBRARY; T=293.16K
Neutron emission for (n,n*)t

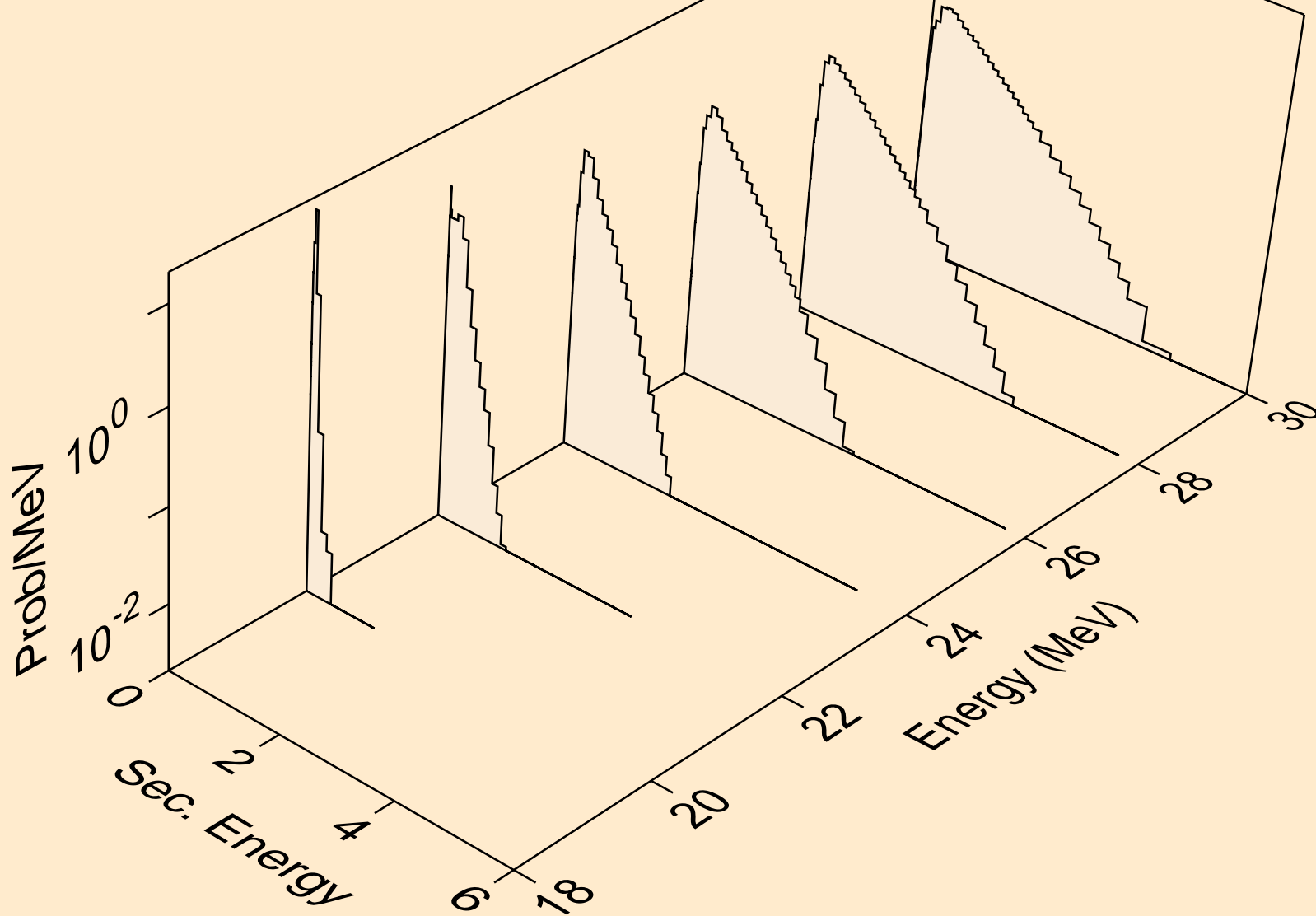

SE083 NEUTRON ACER TENDL-2019 LIBRARY; T=293.16K
Neutron emission for (n,n*)he3

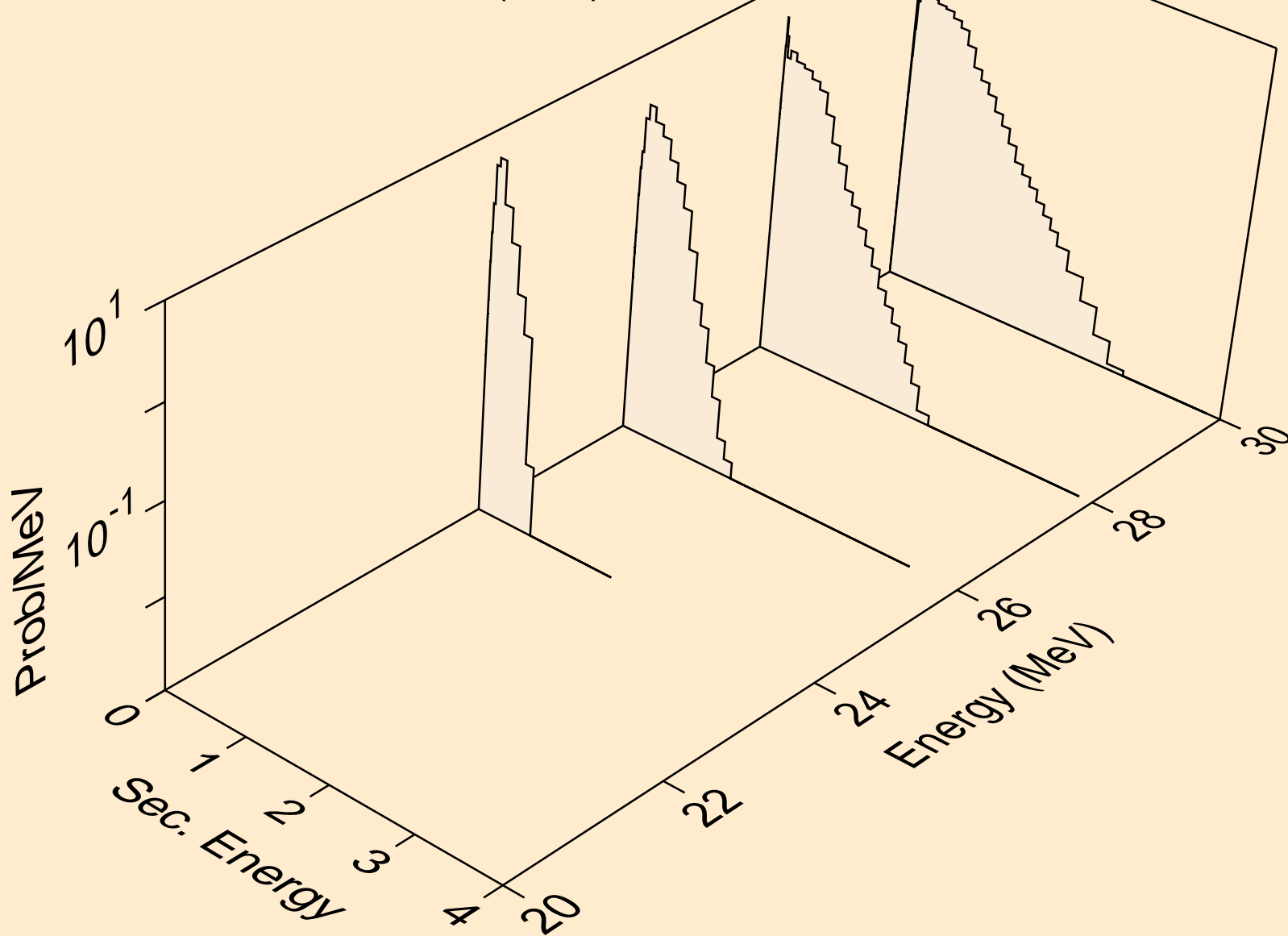

SE083 NEUTRON ACER TENDL-2019 LIBRARY; T=293.16K
Neutron emission for (n,4n)

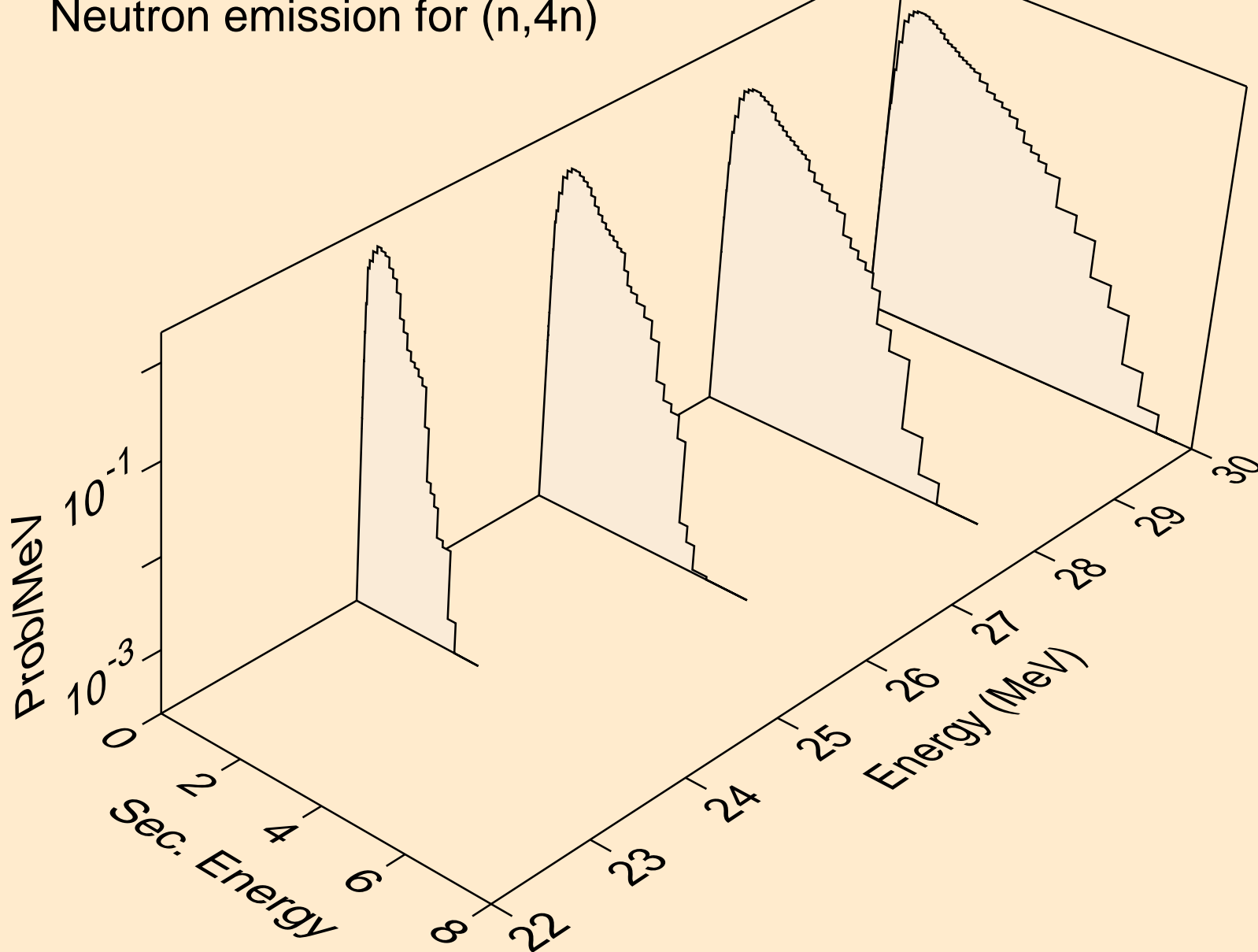

SE083 NEUTRON ACER TENDL-2019 LIBRARY; T=293.16K
Neutron emission for (n,2np)

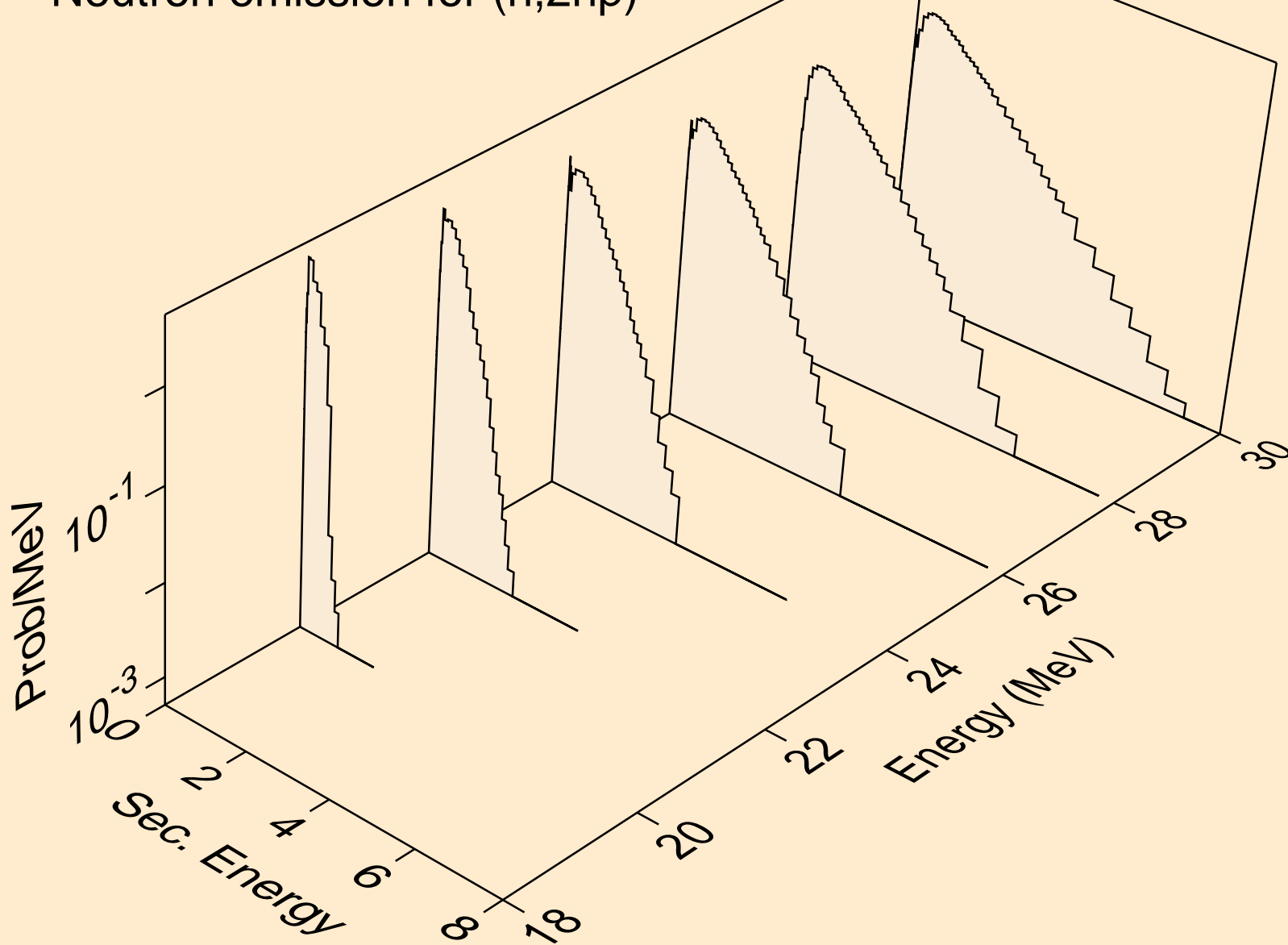

SE083 NEUTRON ACER TENDL-2019 LIBRARY; T=293.16K
Neutron emission for (n,3np)

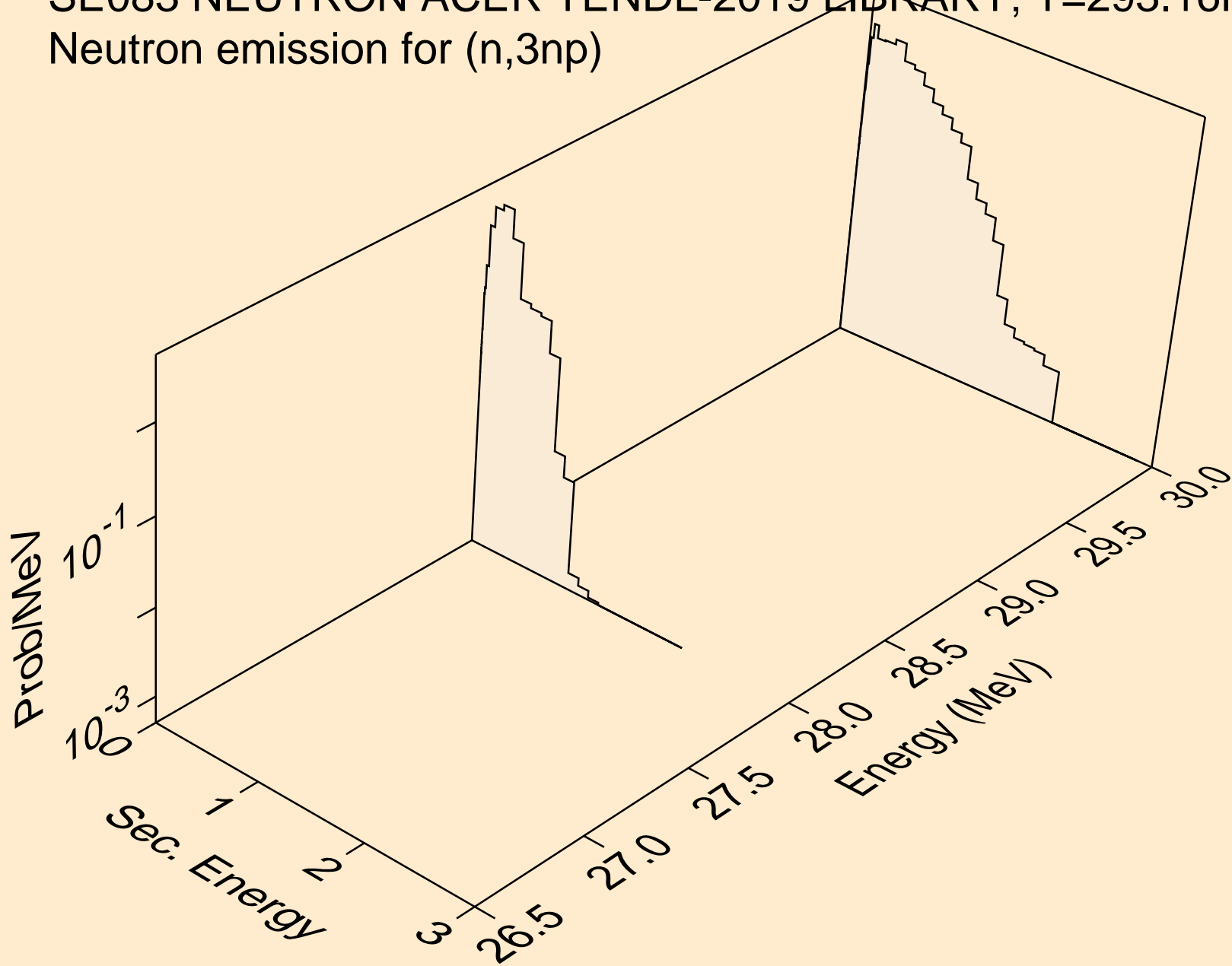

SE083 NEUTRON ACER TENDL-2019 LIBRARY; T=293.16K
Neutron emission for (n,n*c)

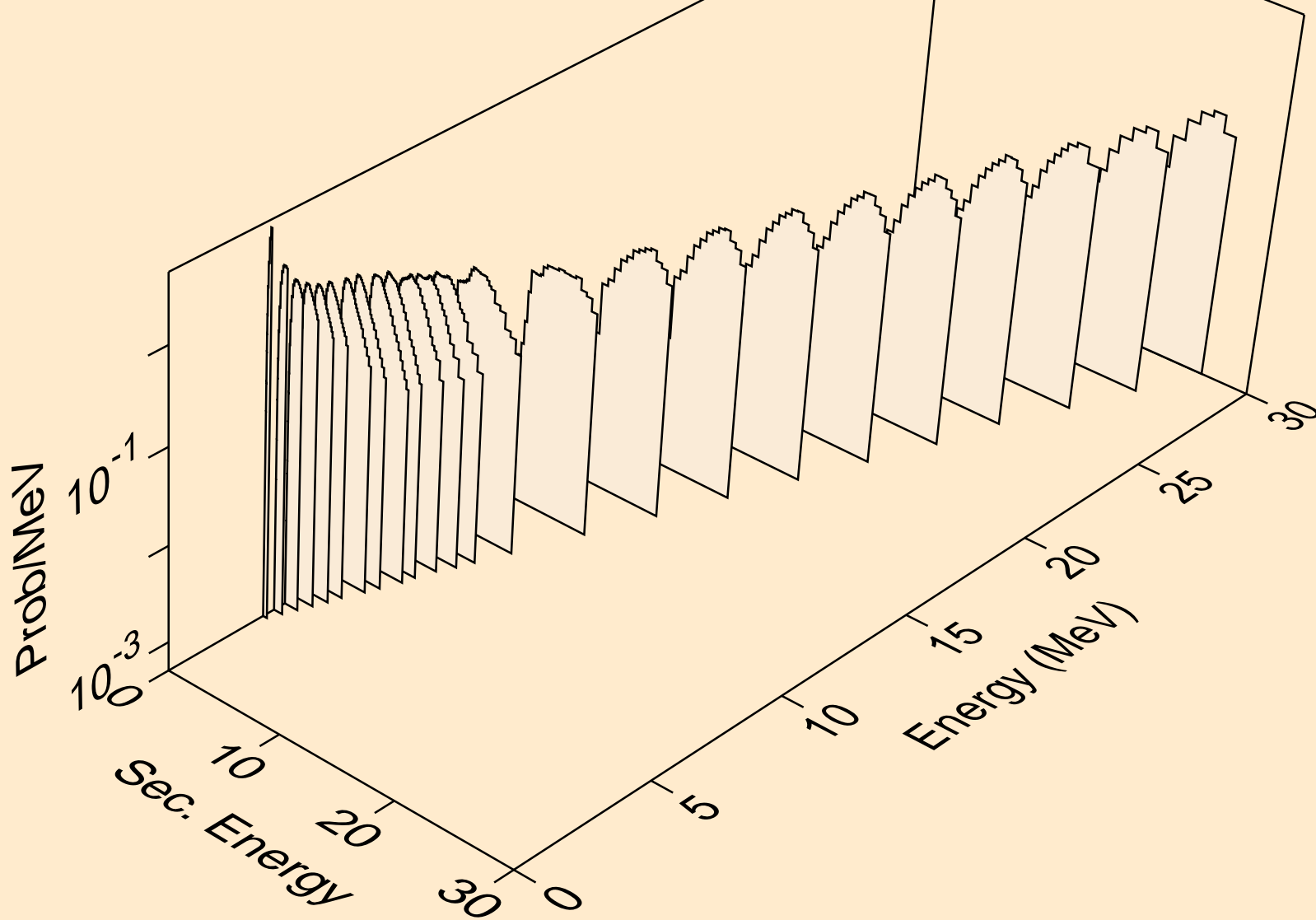

SE083 NEUTRON ACER TENDL-2019 LIBRARY; T=293.16K
Photon emission for (n,x)

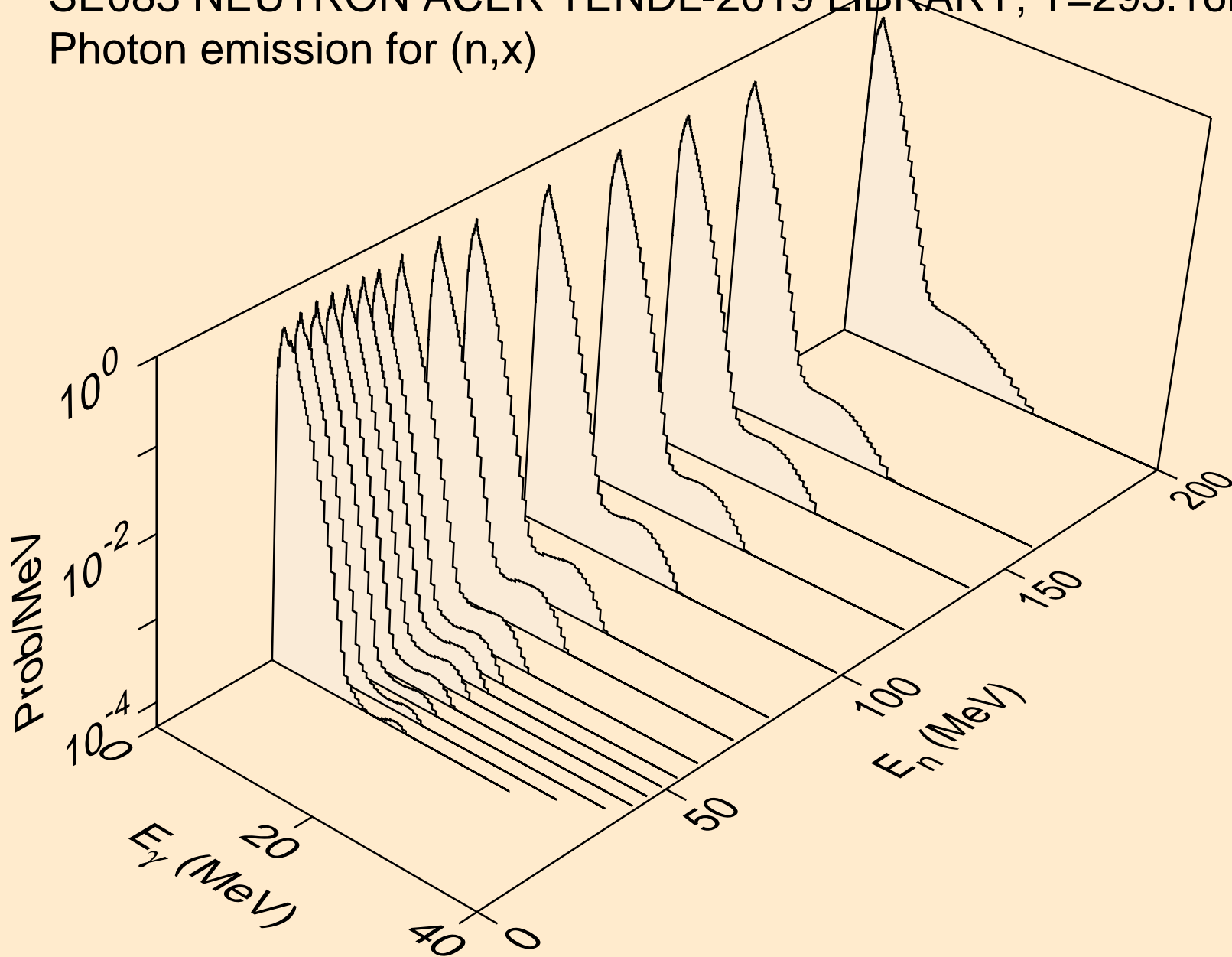

SE083 NEUTRON ACER TENDL-2019 LIBRARY; T=293.16K
Photon emission for (n,2nd)

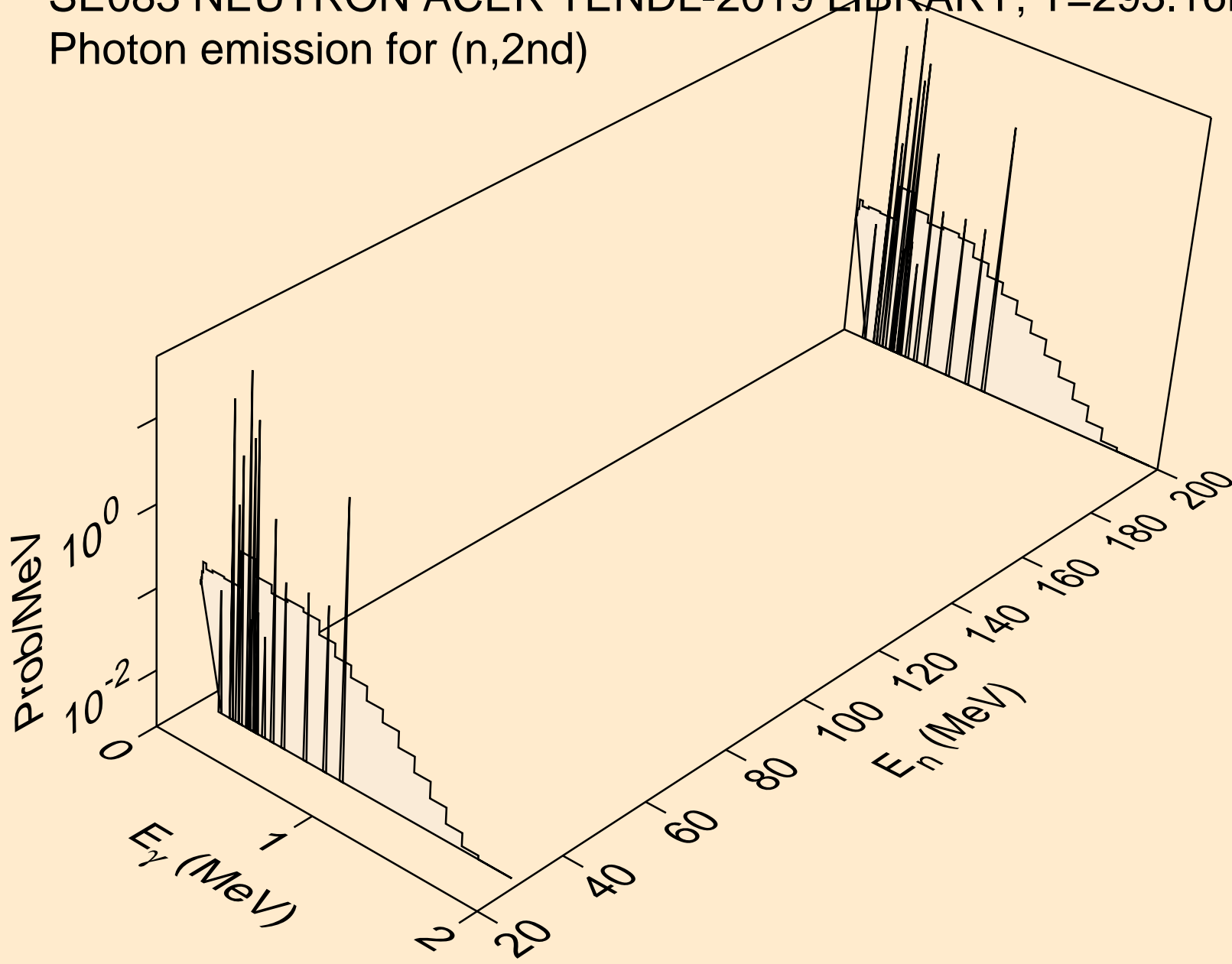

SE083 NEUTRON ACER TENDL-2019 LIBRARY; T=293.16K
Photon emission for (n,2n)

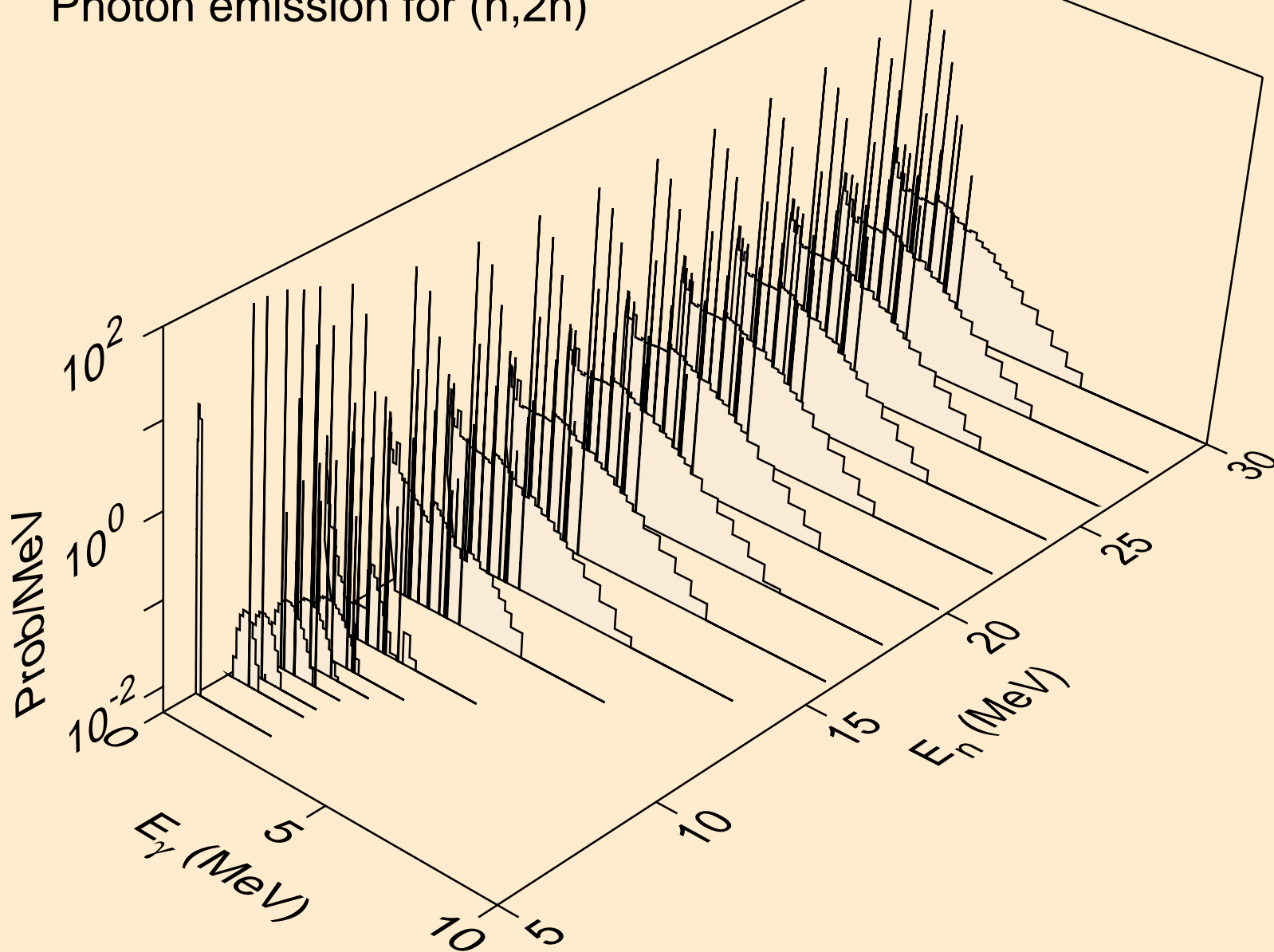

SE083 NEUTRON ACER TENDL-2019 LIBRARY; T=293.16K
Photon emission for (n,3n)

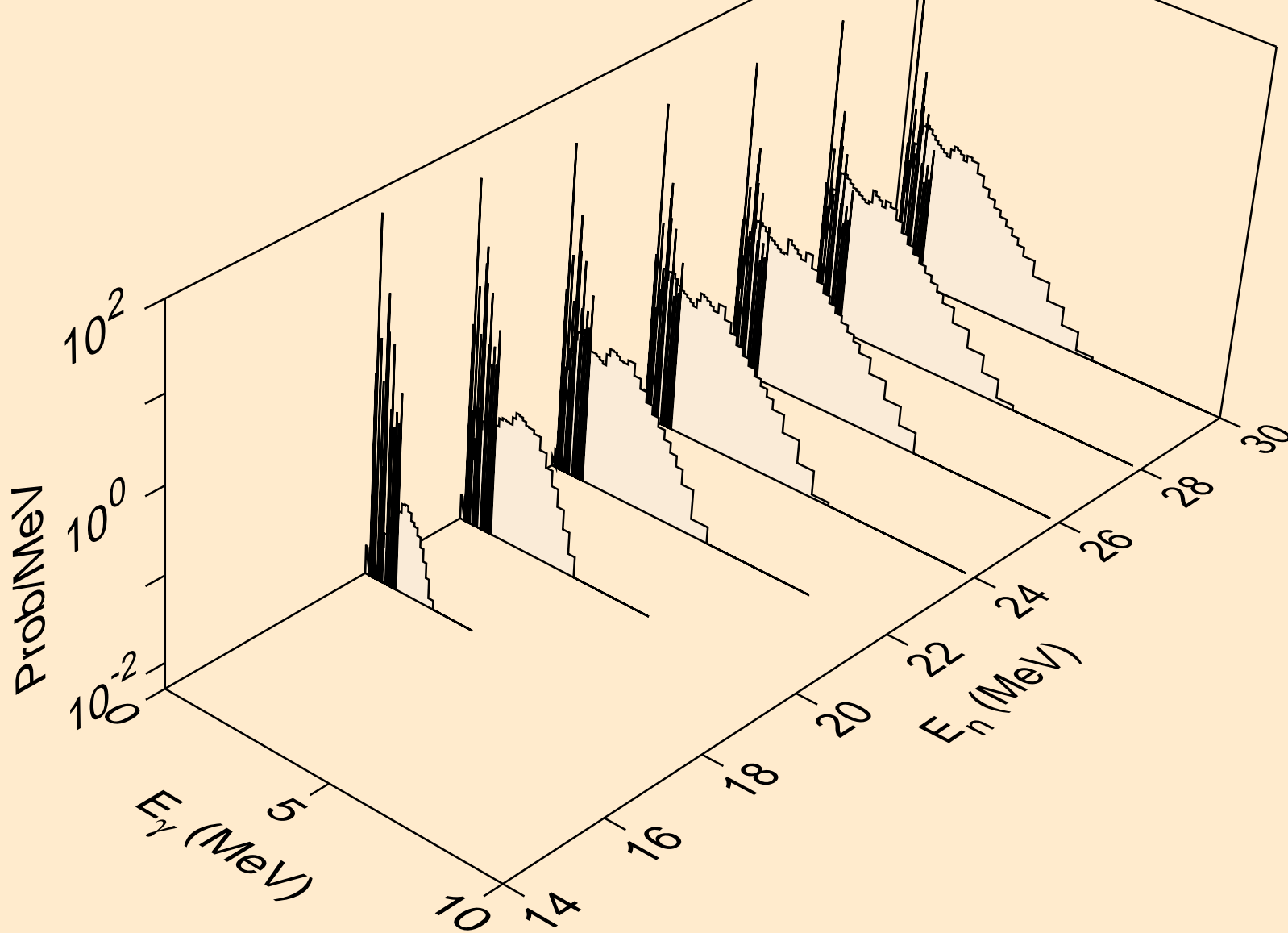

SE083 NEUTRON ACER TENDL-2019 LIBRARY; T=293.16K
Photon emission for (n,n*)a

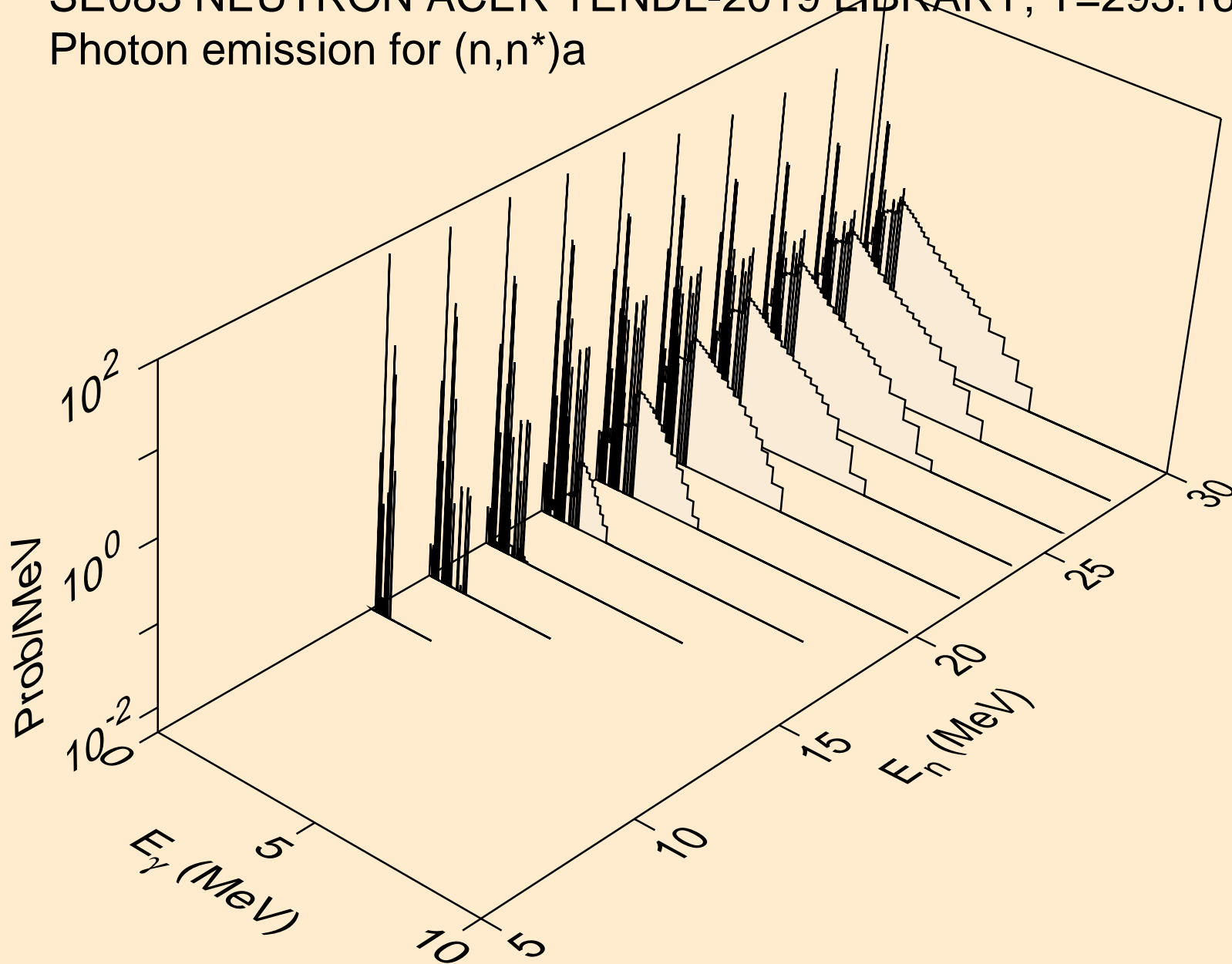

SE083 NEUTRON ACER TENDL-2019 LIBRARY; T=293.16K
Photon emission for (n,2n)a

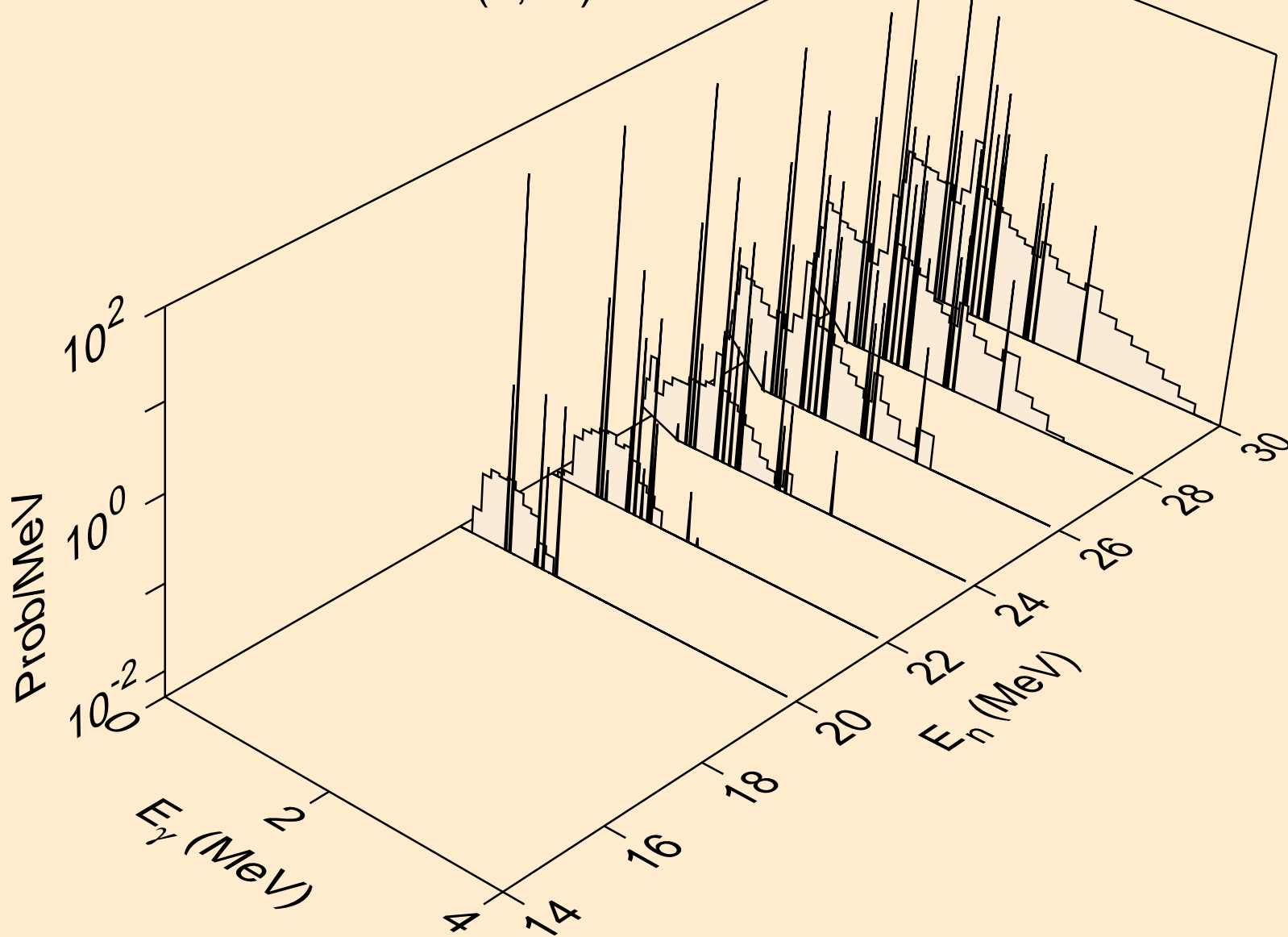

SE083 NEUTRON ACER TENDL-2019 LIBRARY; T=293.16K
Photon emission for (n,3n)a

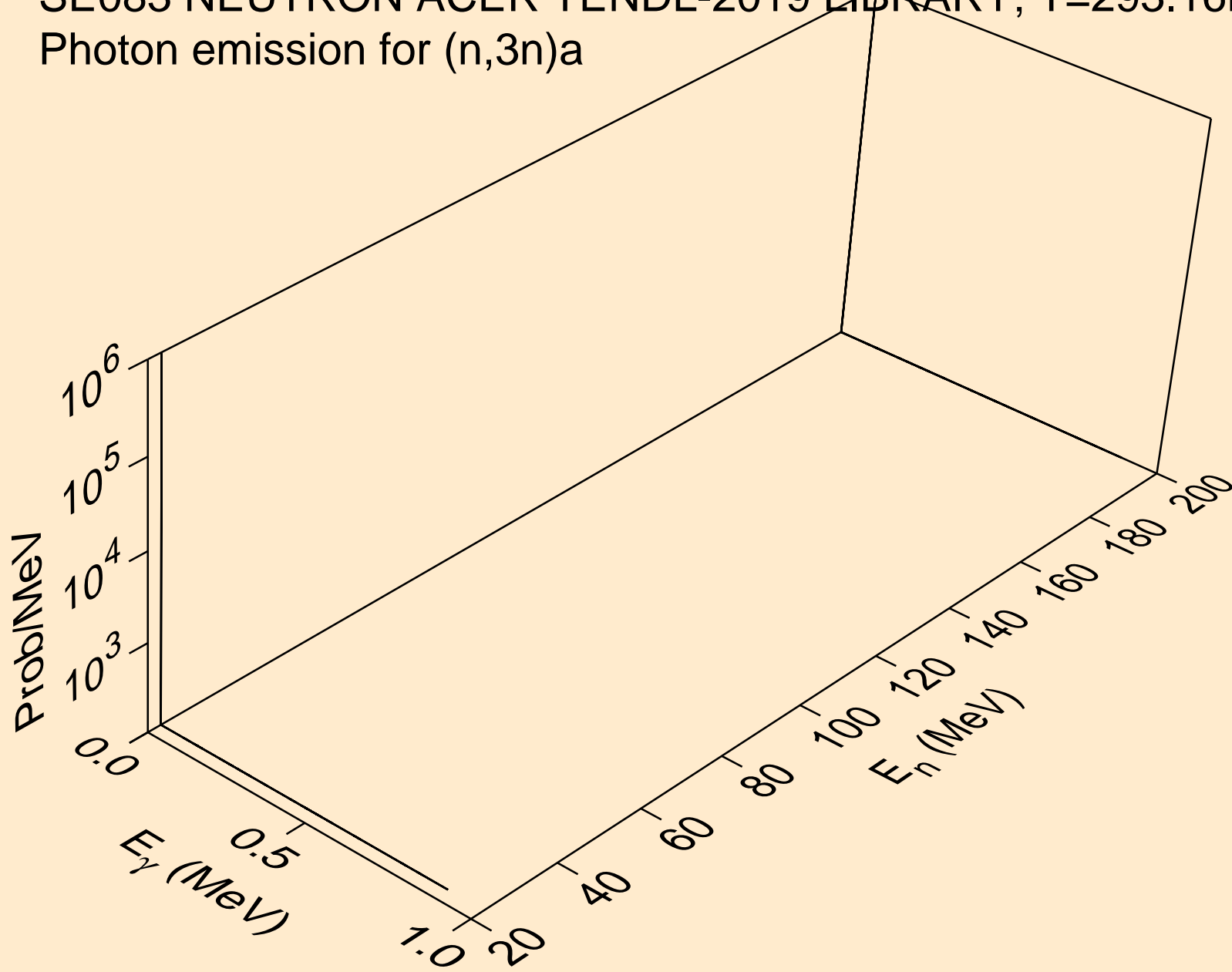

SE083 NEUTRON ACER TENDL-2019 LIBRARY; T=293.16K
Photon emission for (n,n*)p

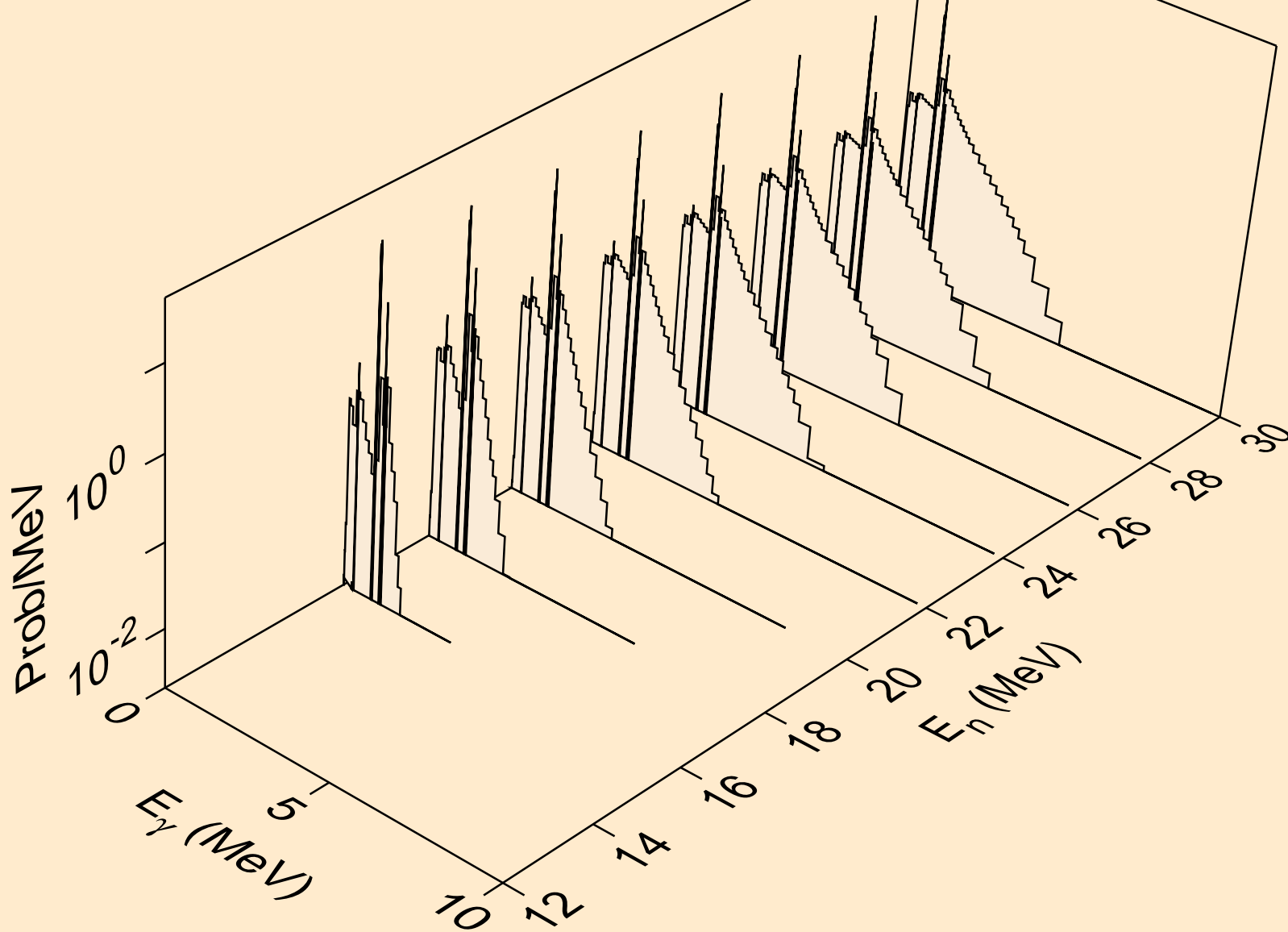

SE083 NEUTRON ACER TENDL-2019 LIBRARY; T=293.16K
Photon emission for (n,n*)d

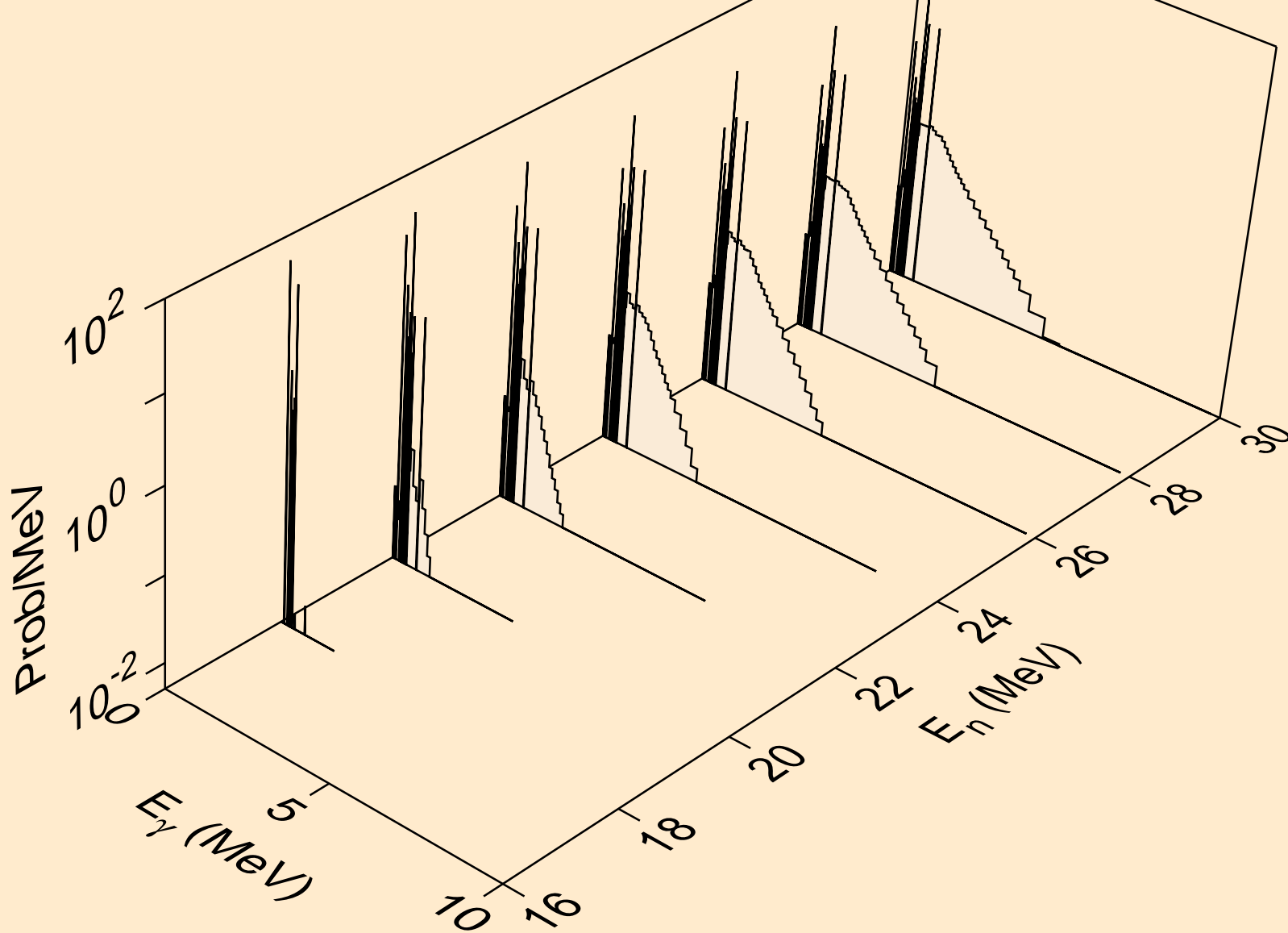

SE083 NEUTRON ACER TENDL-2019 LIBRARY; T=293.16K
Photon emission for (n,n*)t

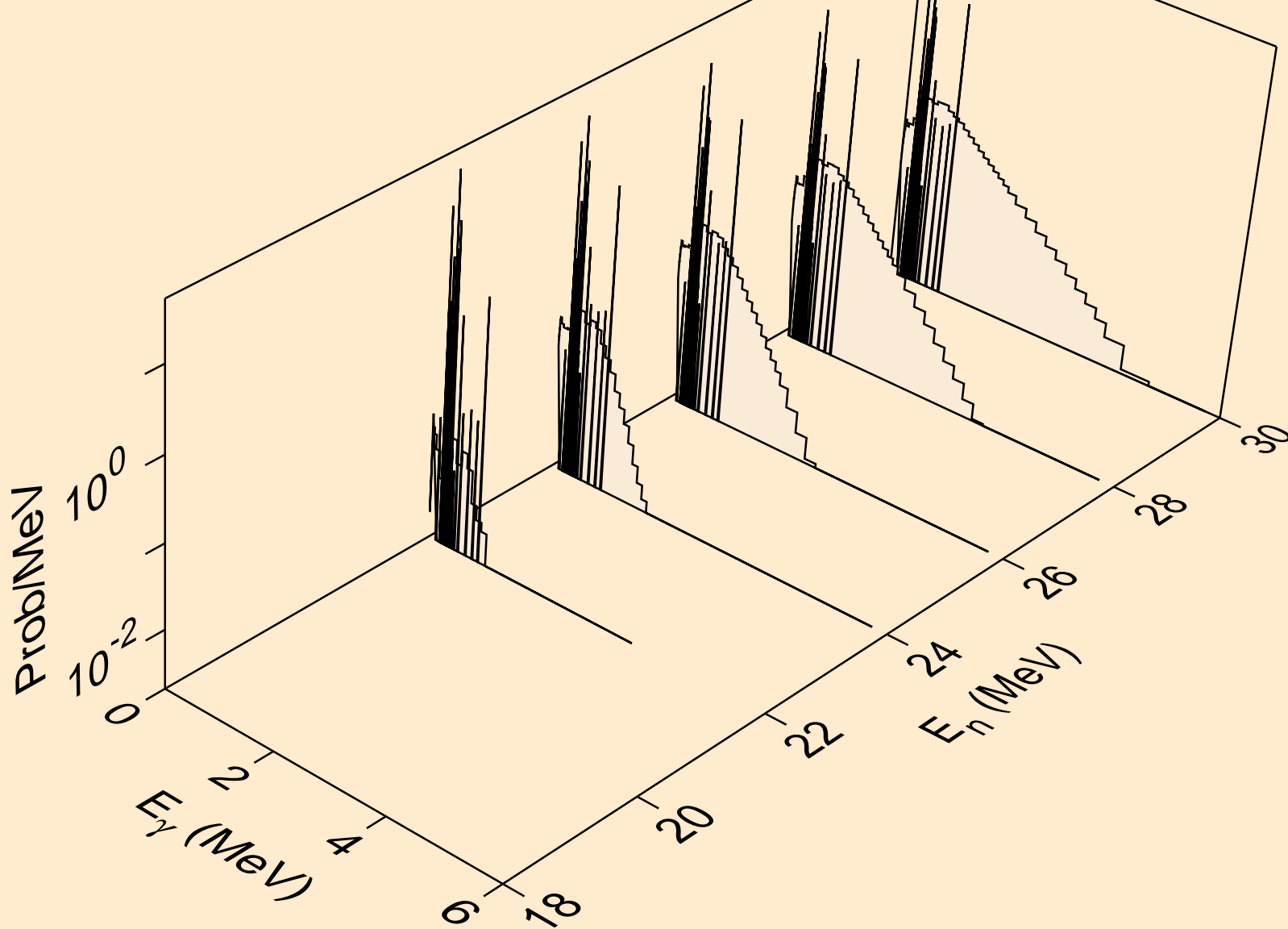

SE083 NEUTRON ACER TENDL-2019 LIBRARY; T=293.16K
Photon emission for (n,n*)he3

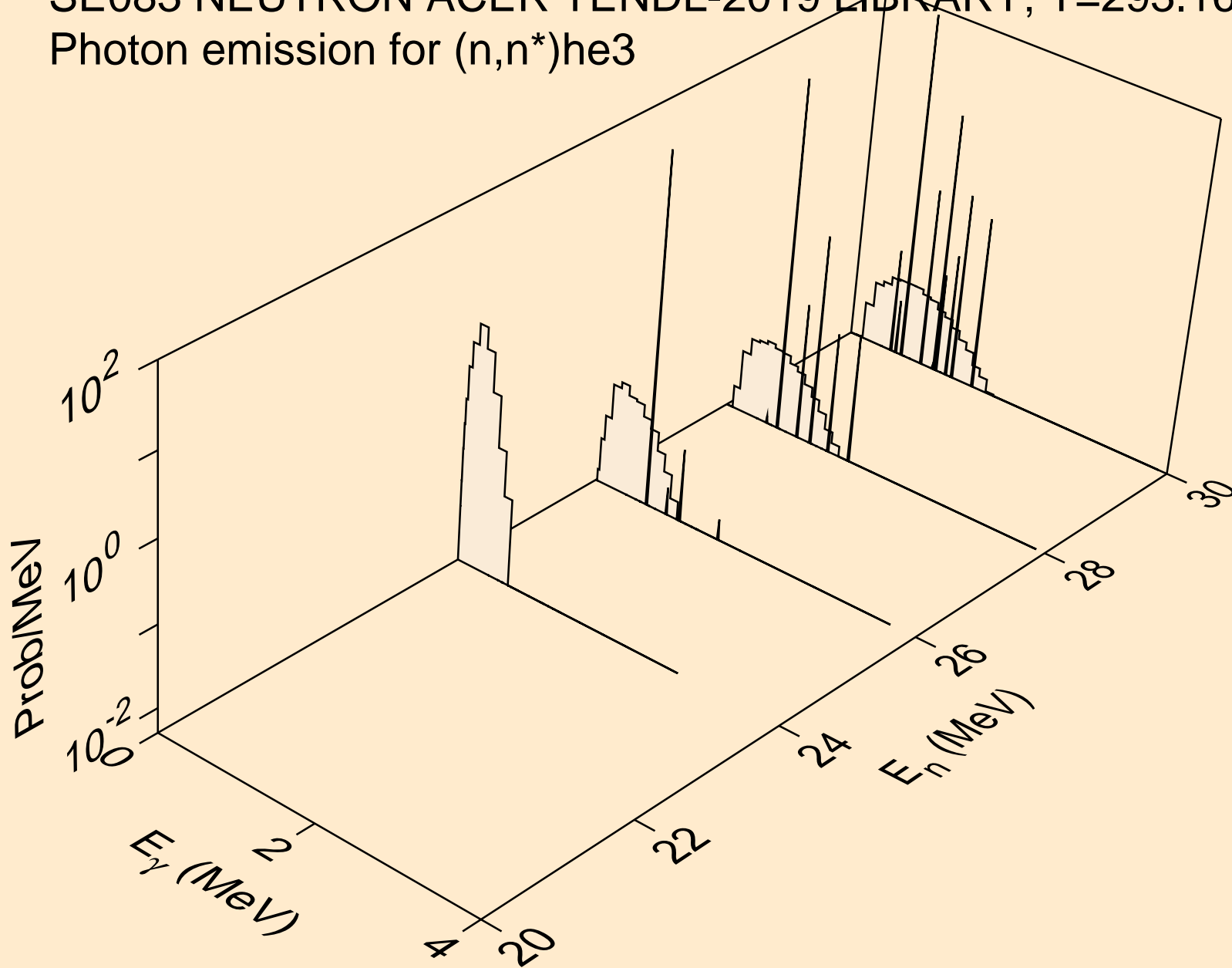

SE083 NEUTRON ACER TENDL-2019 LIBRARY; T=293.16K
Photon emission for (n,4n)

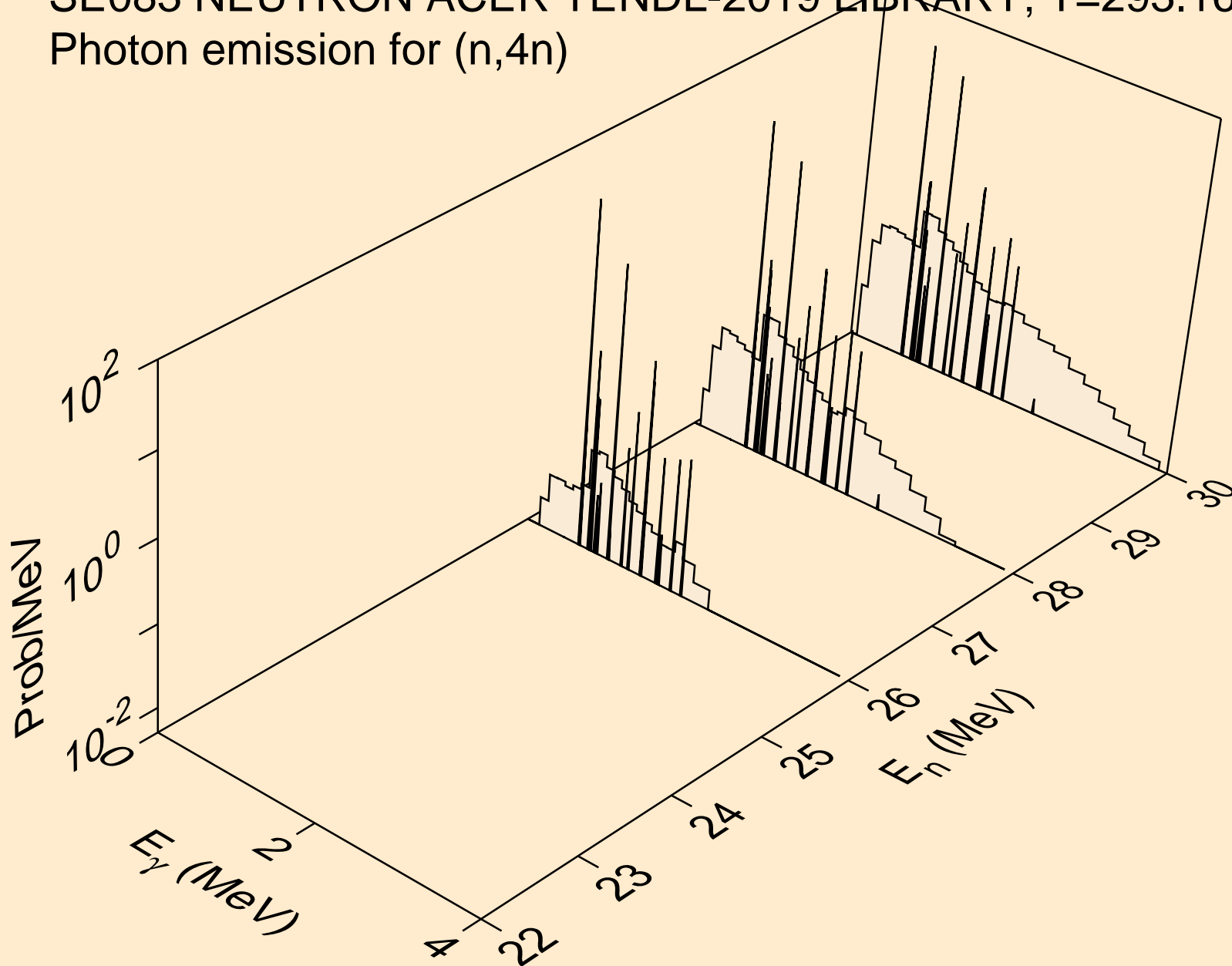

SE083 NEUTRON ACER TENDL-2019 LIBRARY; T=293.16K
Photon emission for (n,2np)

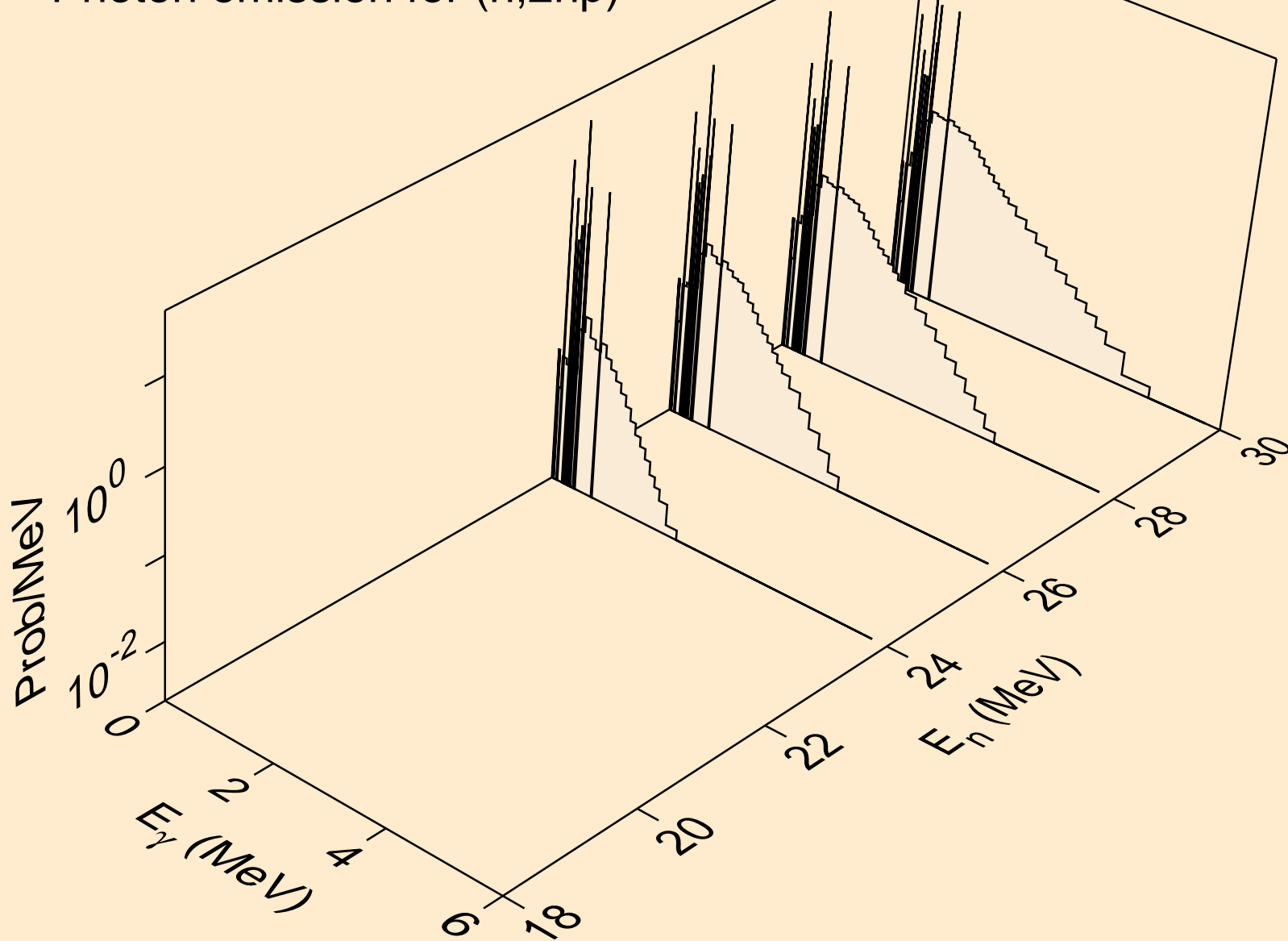

SE083 NEUTRON ACER TENDL-2019 LIBRARY; T=293.16K
Photon emission for (n,3np)

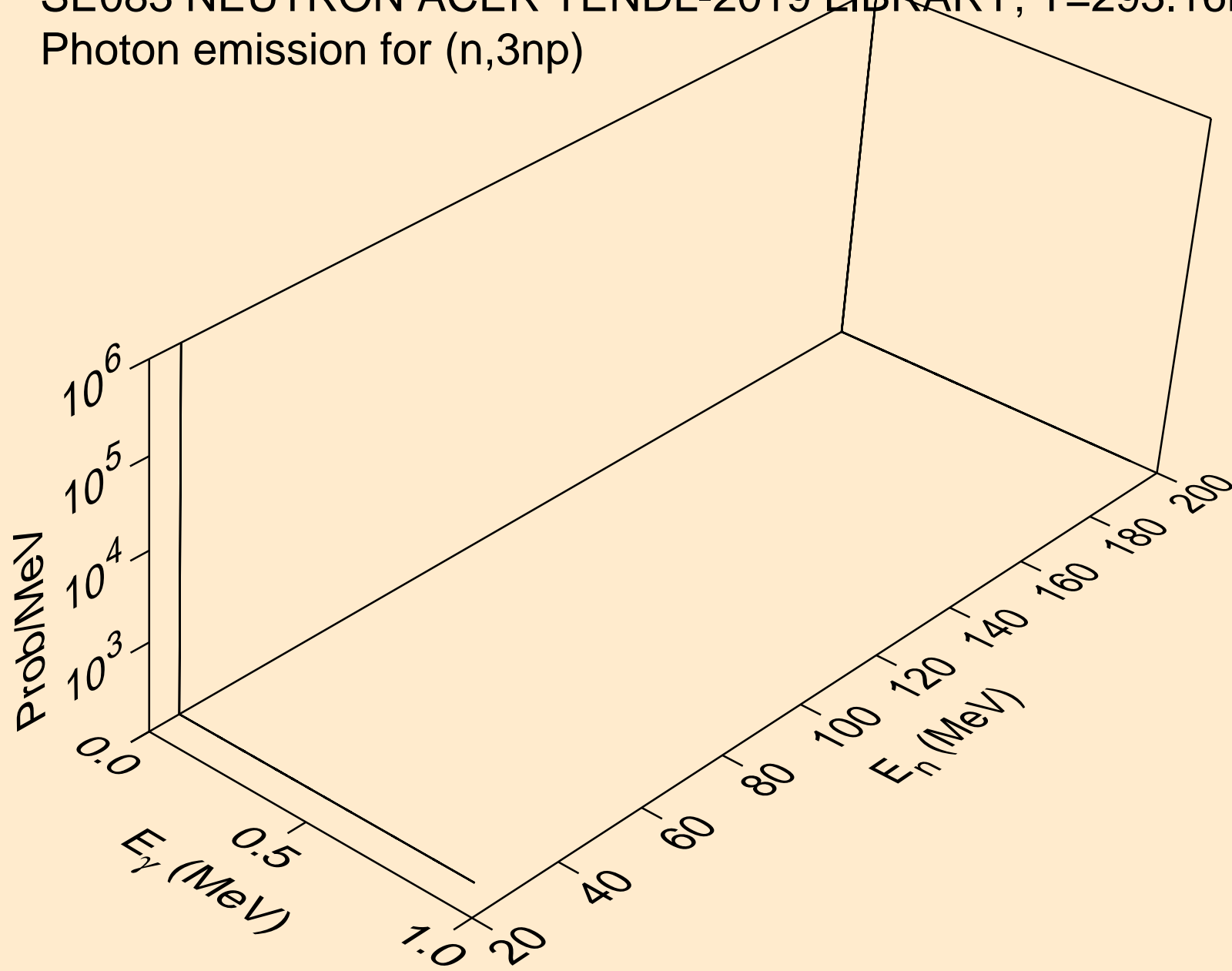

SE083 NEUTRON ACER TENDL-2019 LIBRARY; T=293.16K
Photon emission for (n,n*c)

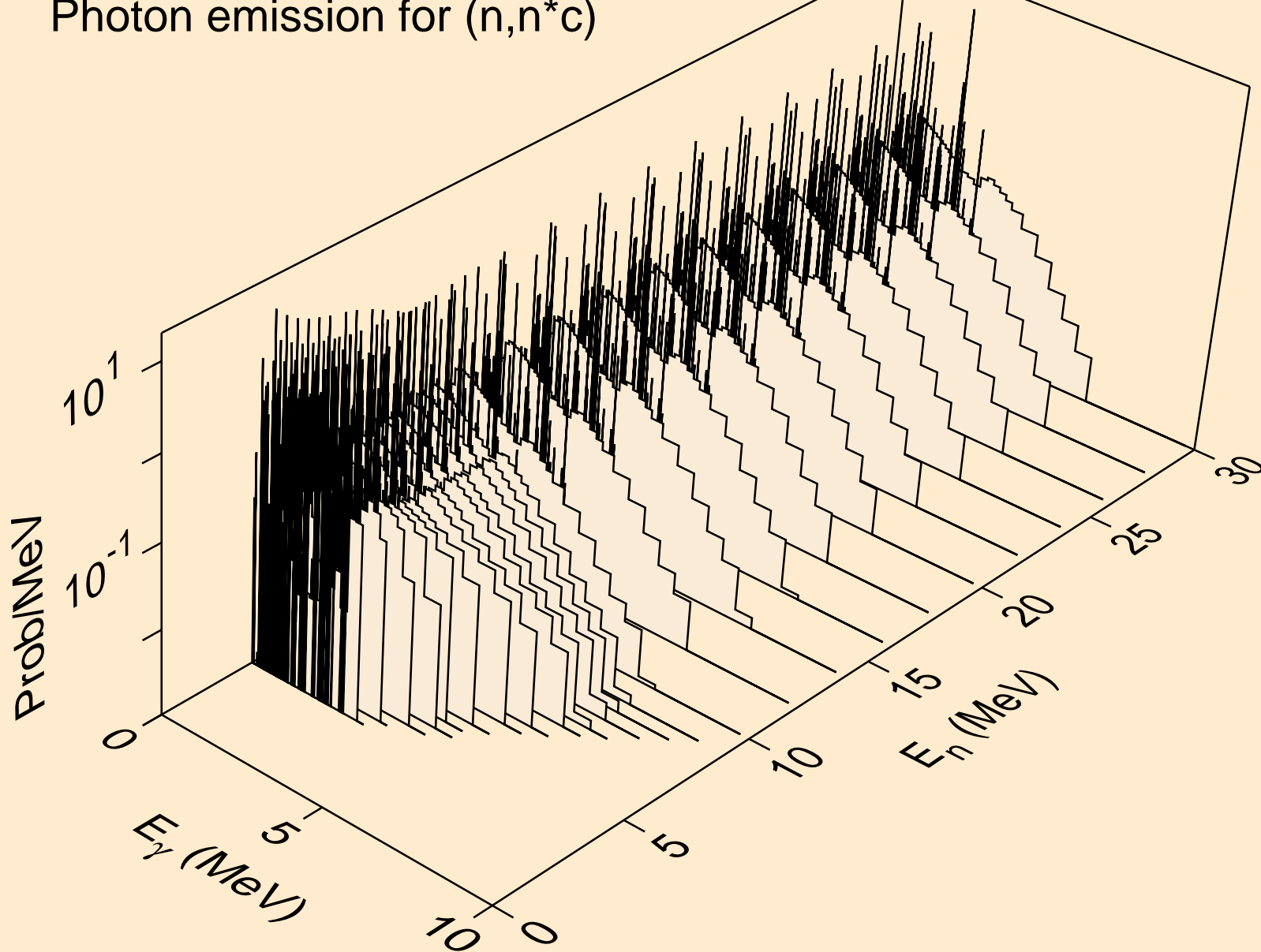

SE083 NEUTRON ACER TENDL-2019 LIBRARY; T=293.16K
Photon emission for (n,gma)

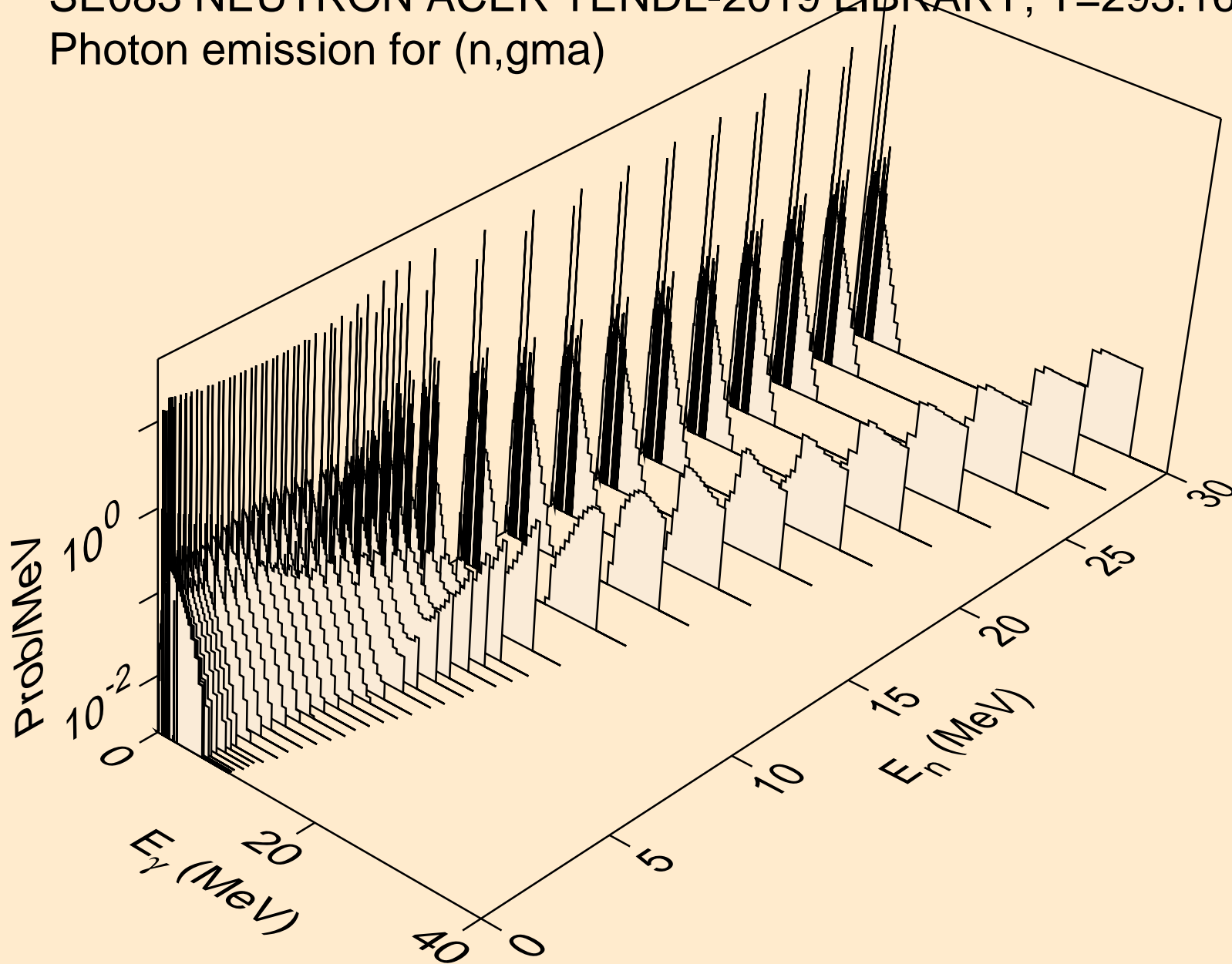

SE083 NEUTRON ACER TENDL-2019 LIBRARY; T=293.16K
Photon emission for (n,p)

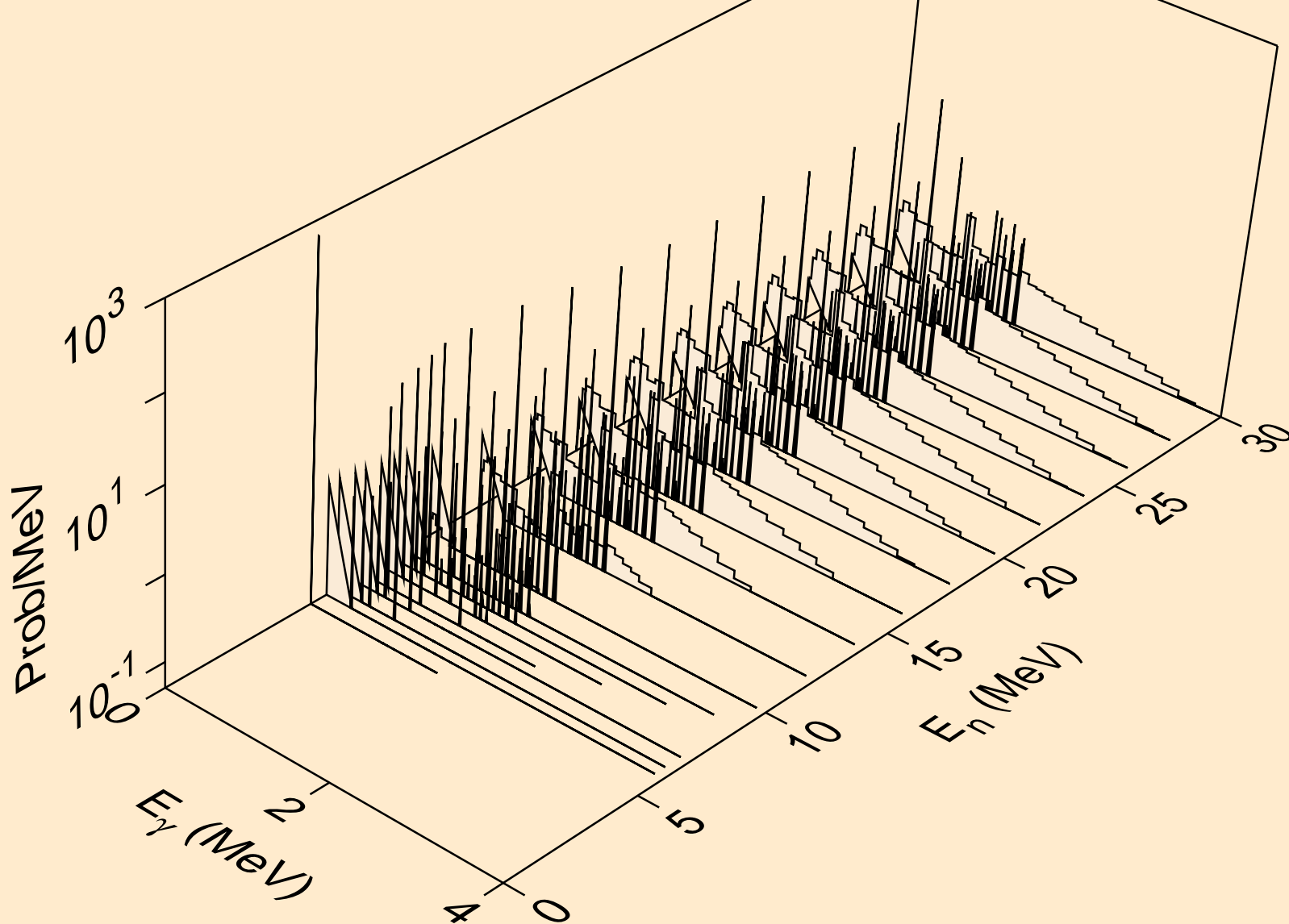

SE083 NEUTRON ACER TENDL-2019 LIBRARY; T=293.16K
Photon emission for (n,d)

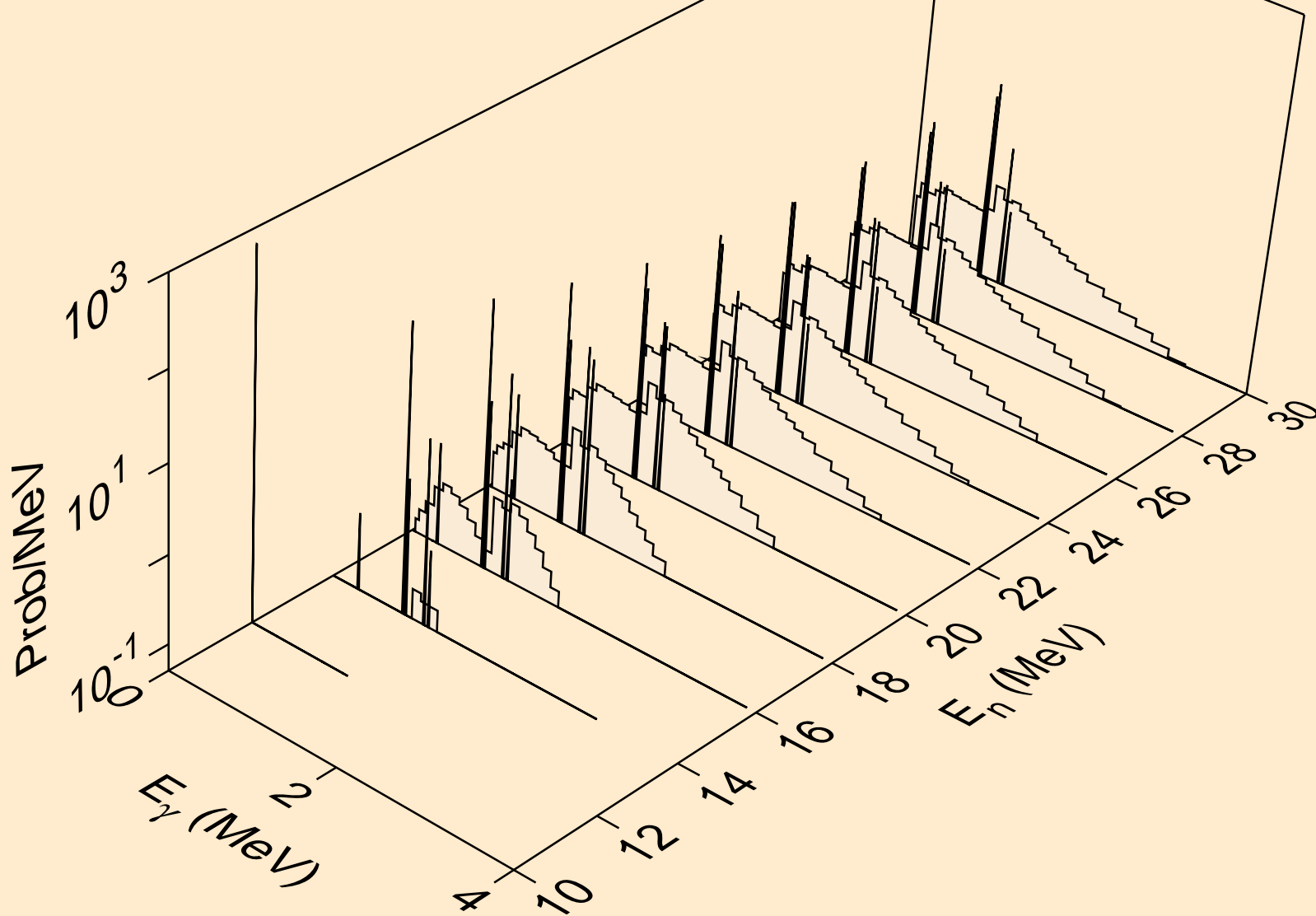

SE083 NEUTRON ACER TENDL-2019 LIBRARY; T=293.16K
Photon emission for (n,t)

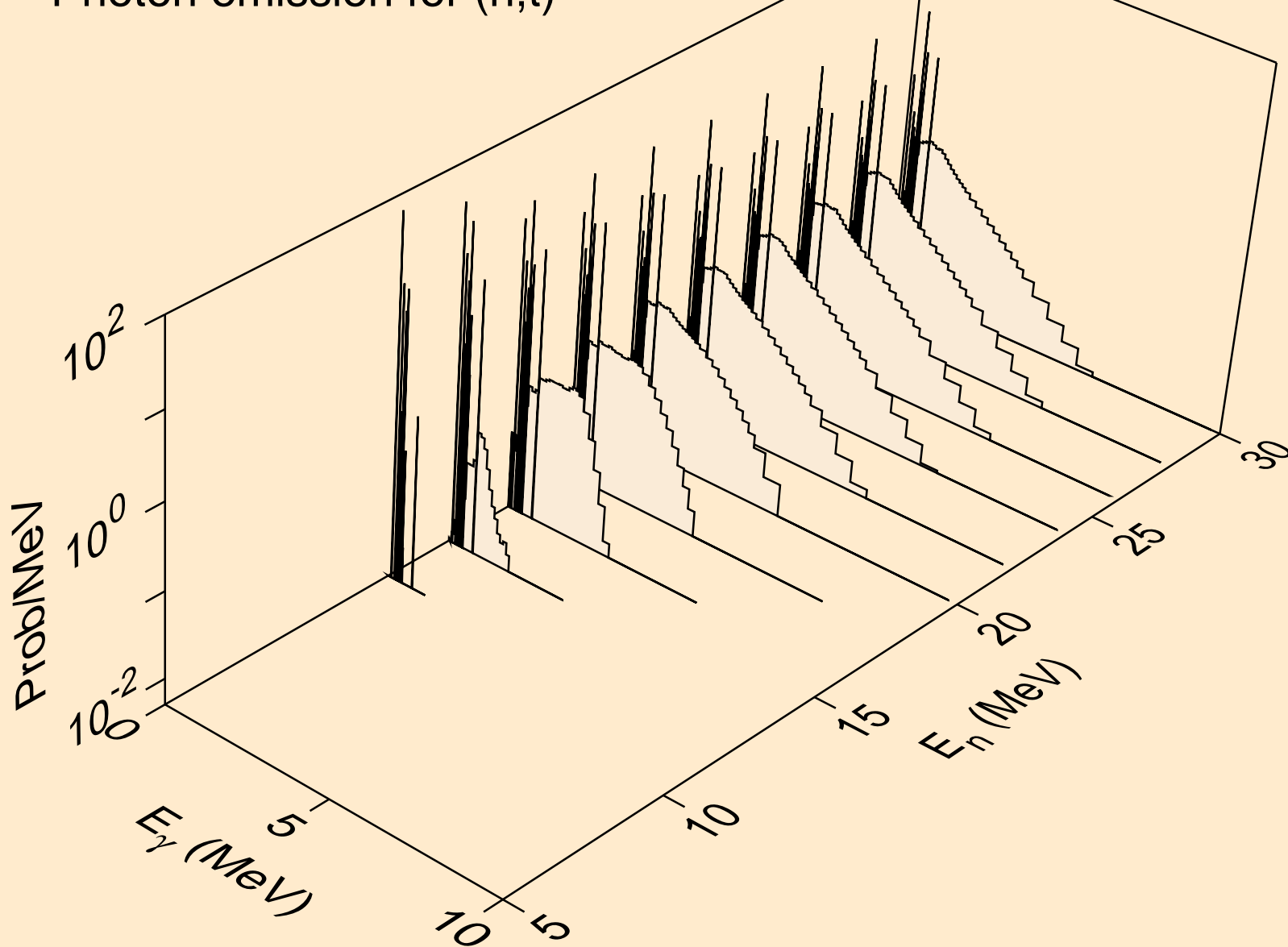

SE083 NEUTRON ACER TENDL-2019 LIBRARY; T=293.16K
Photon emission for (n,he3)

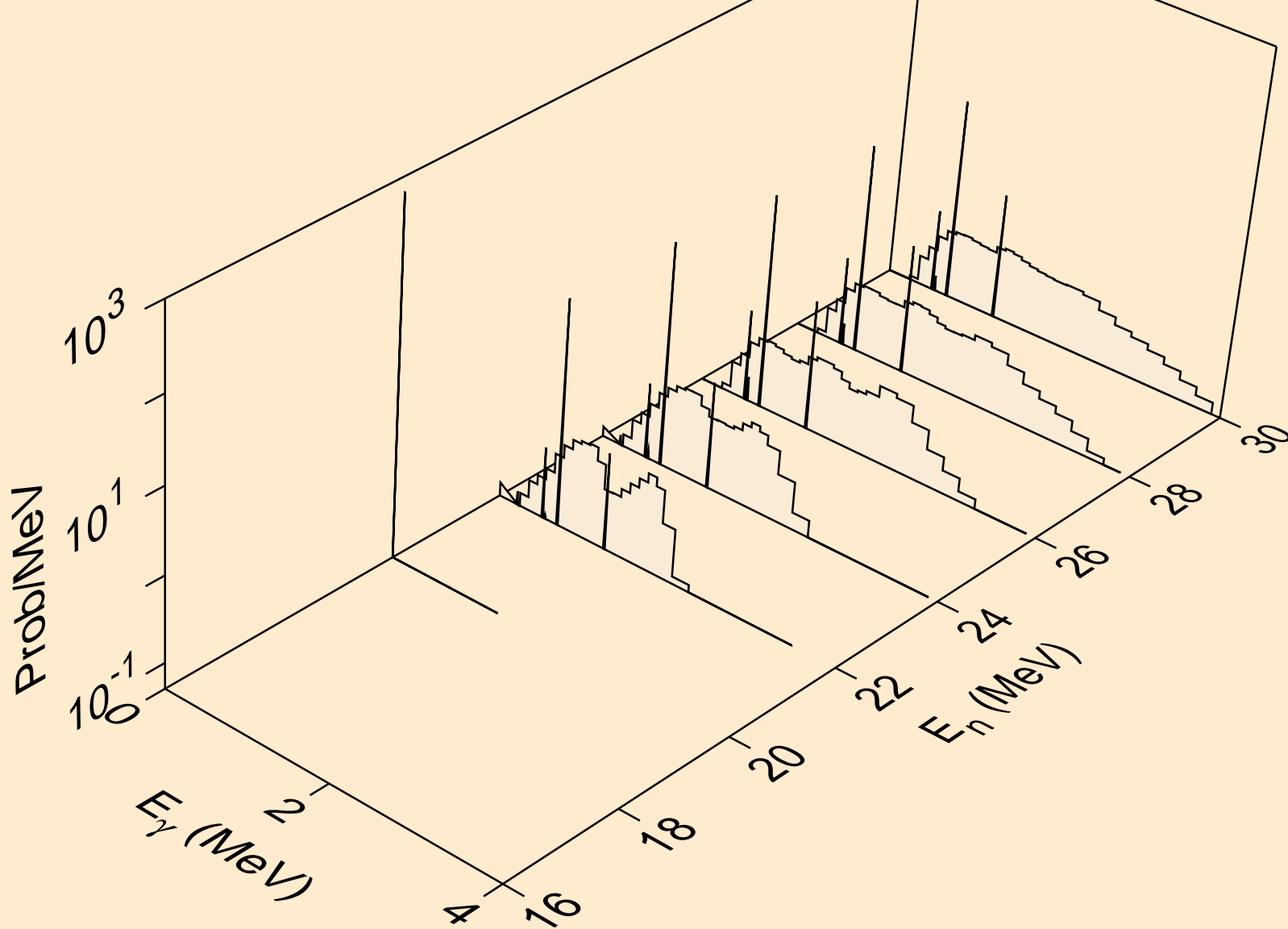

SE083 NEUTRON ACER TENDL-2019 LIBRARY; T=293.16K
Photon emission for (n,a)

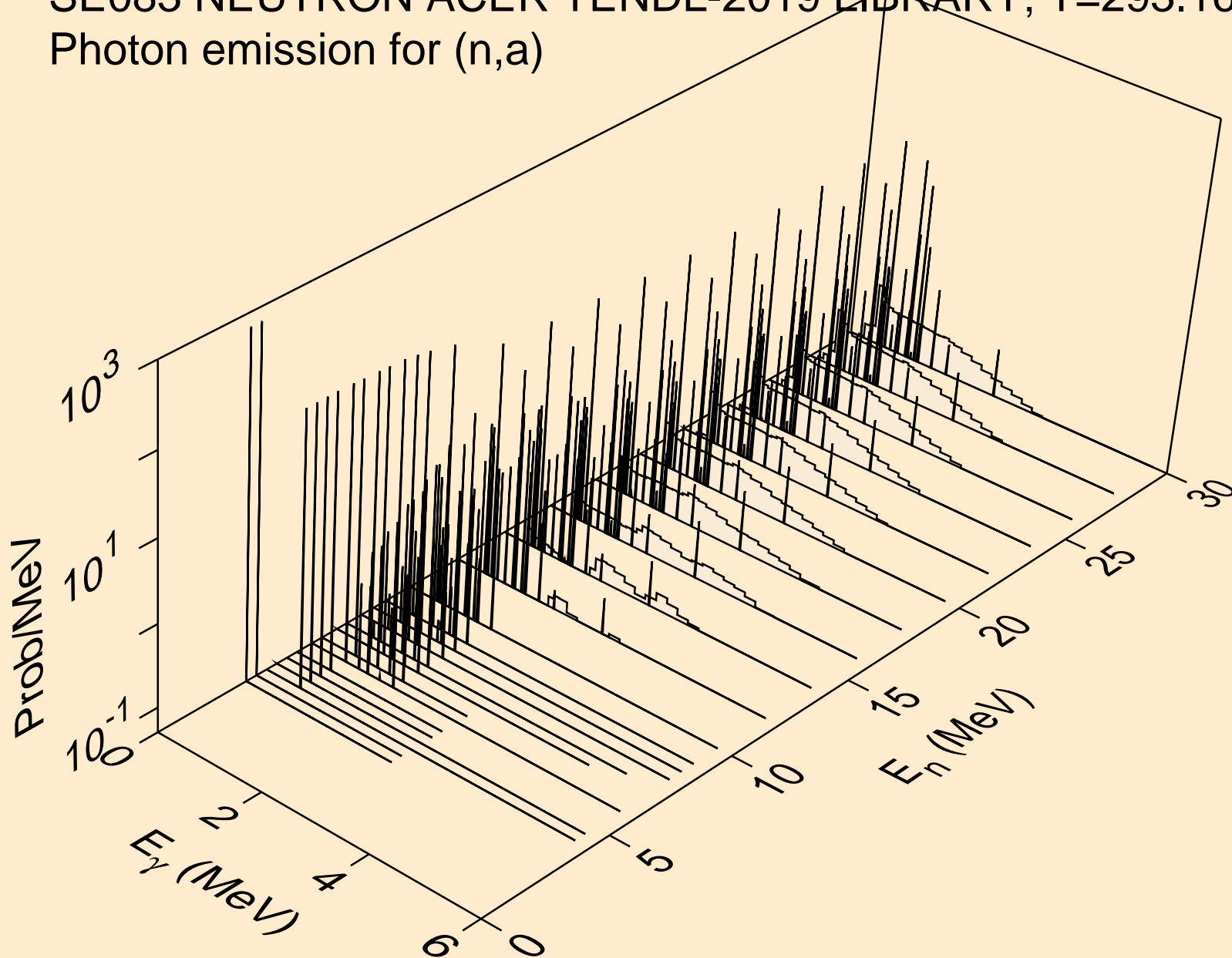

SE083 NEUTRON ACER TENDL-2019 LIBRARY; T=293.16K
Photon emission for (n,2p)

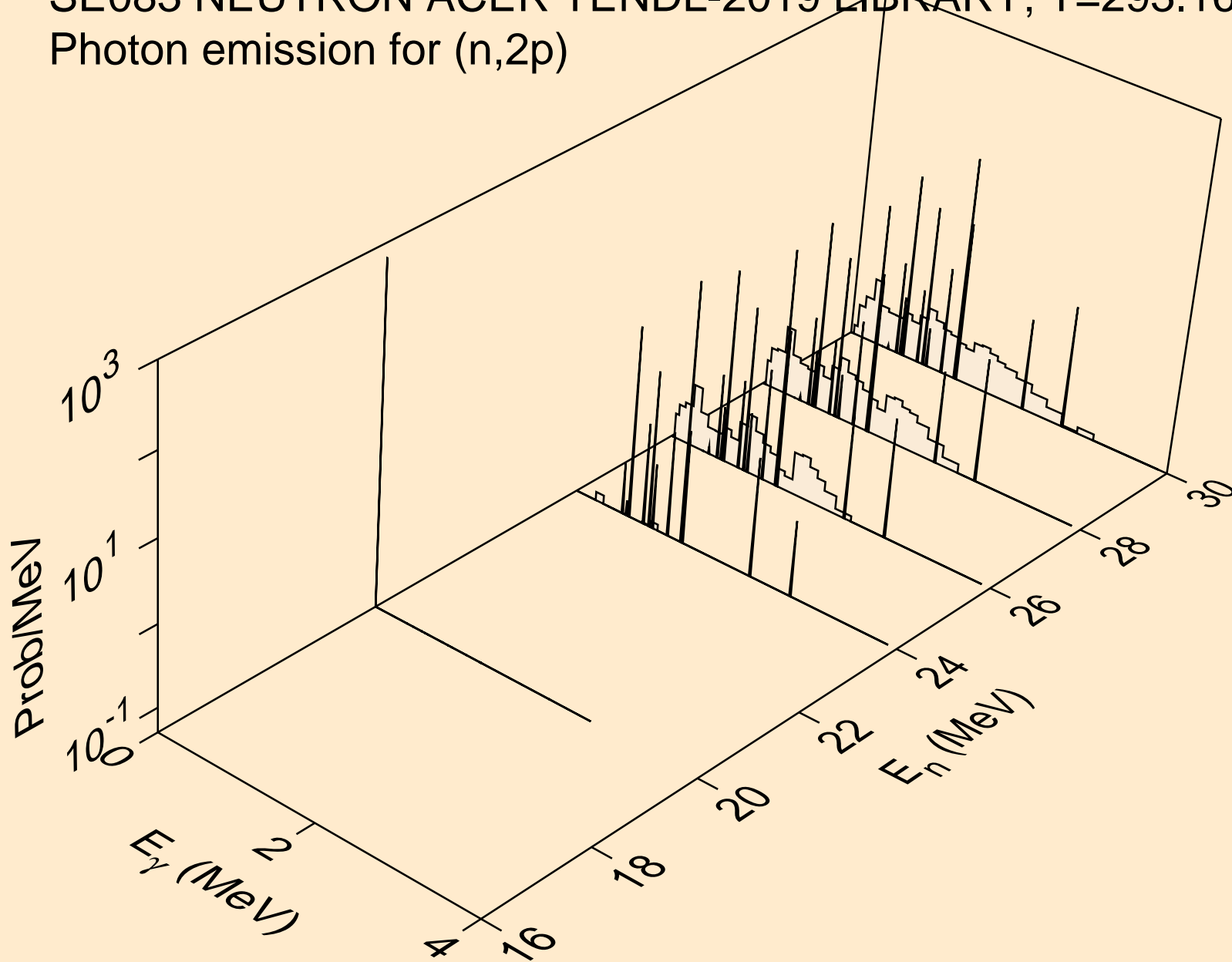

SE083 NEUTRON ACER TENDL-2019 LIBRARY; T=293.16K
Photon emission for (n,p α)

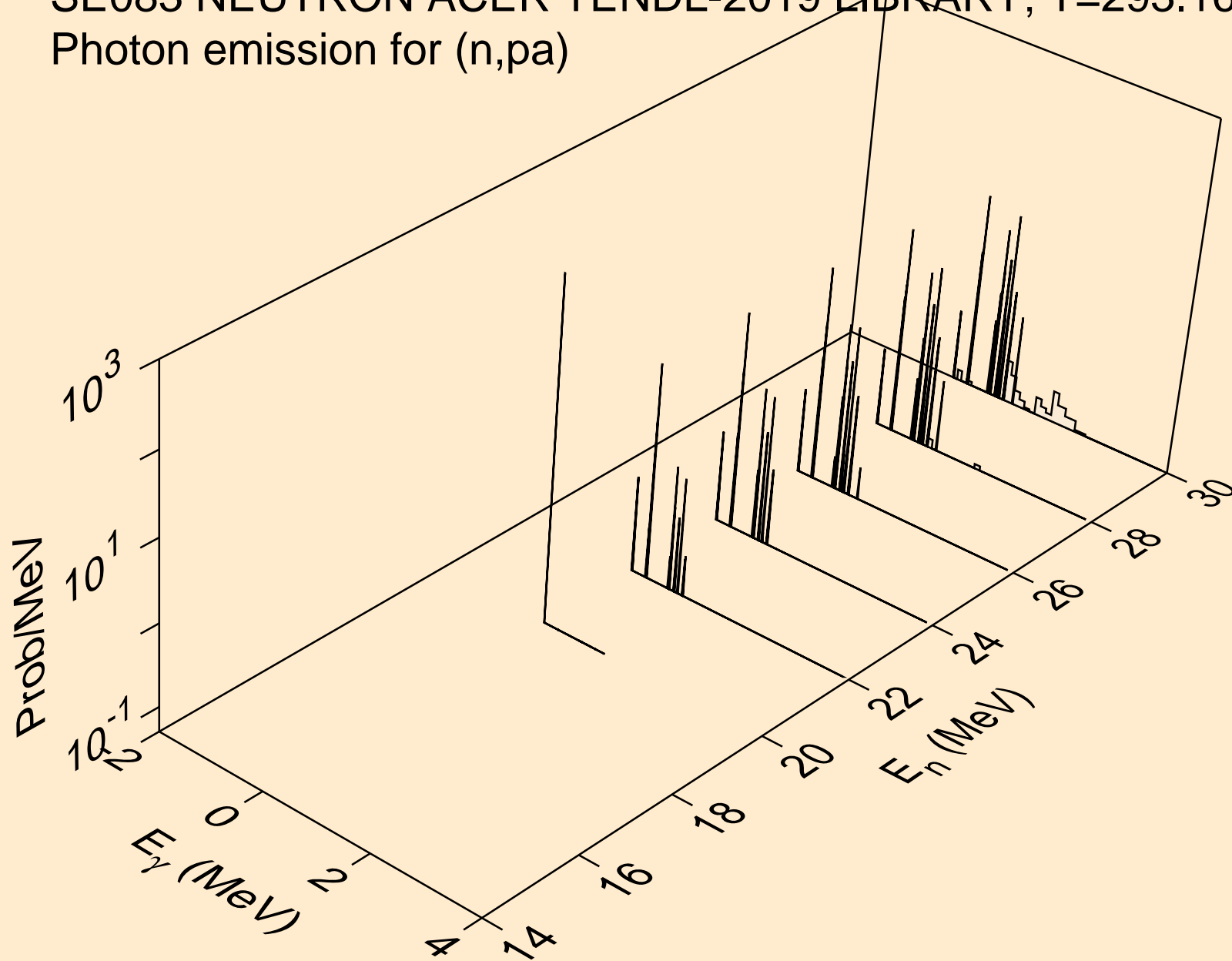

SE083 NEUTRON ACER TENDL-2019 LIBRARY; T=293.16K
Photon emission for (n,pt)

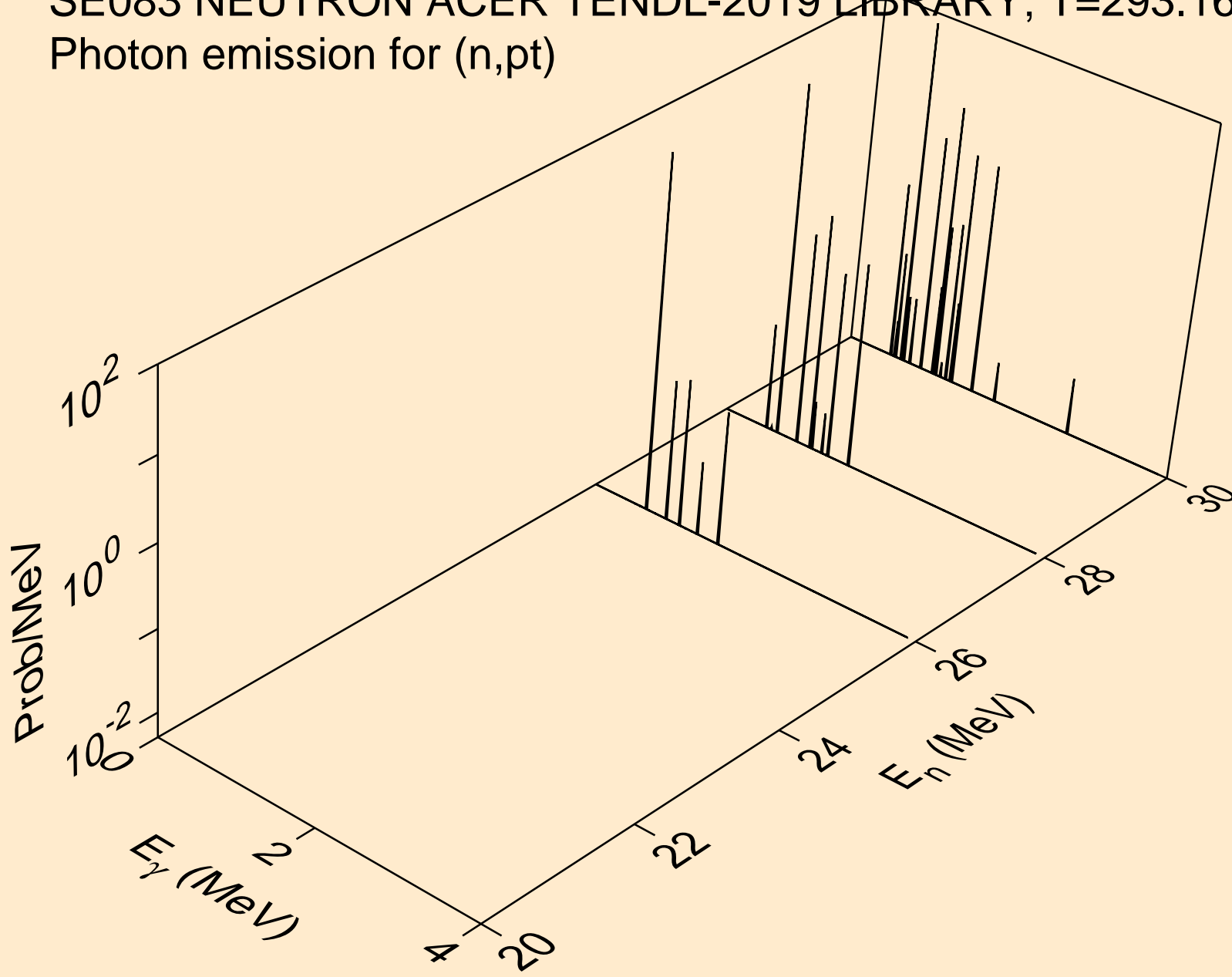

SE083 NEUTRON ACER TENDL-2019 LIBRARY; T=293.16K
thermal capture photon spectrum

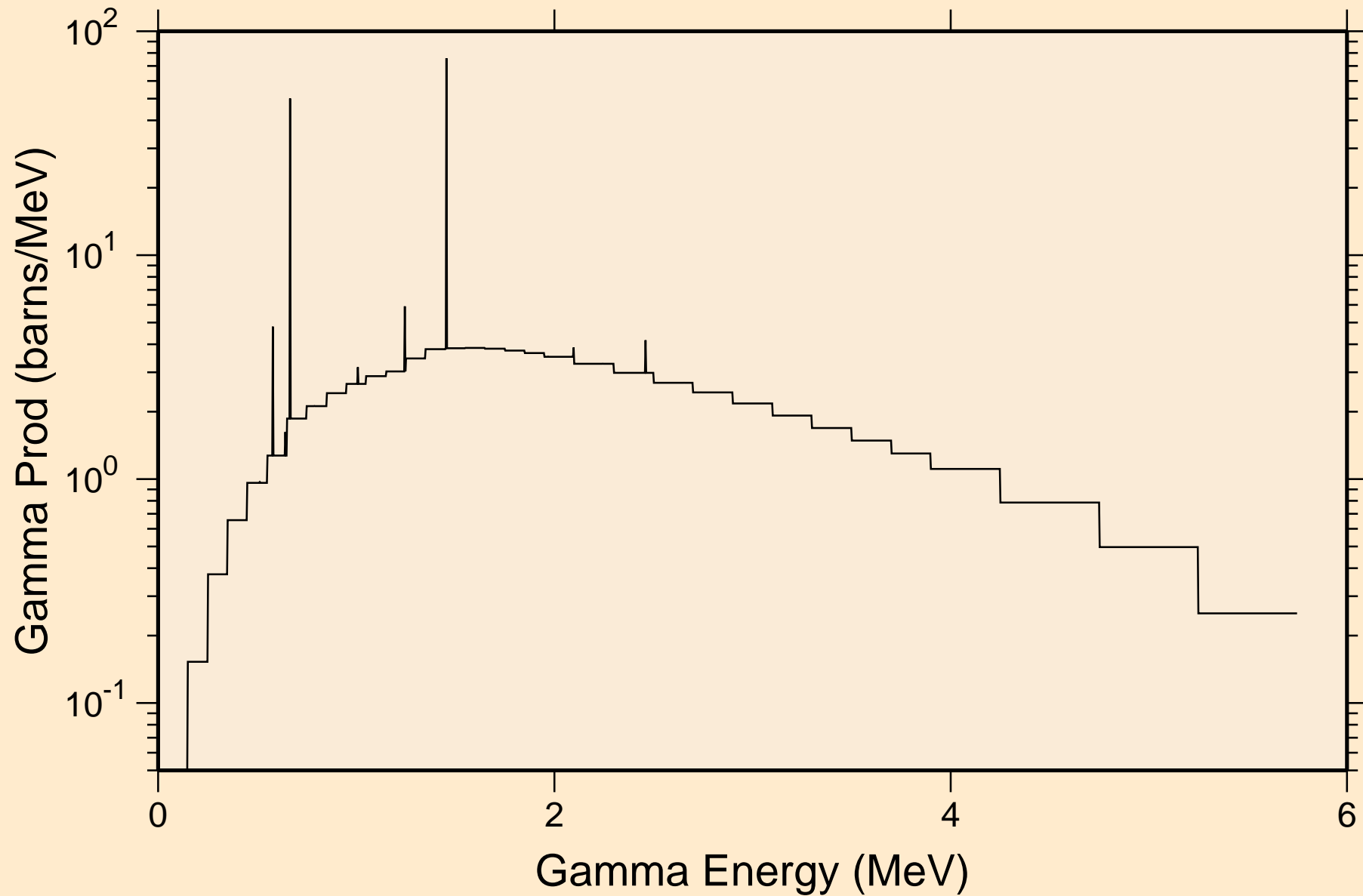

SE083 NEUTRON ACER TENDL-2019 LIBRARY; T=293.16K
14 MeV photon spectrum

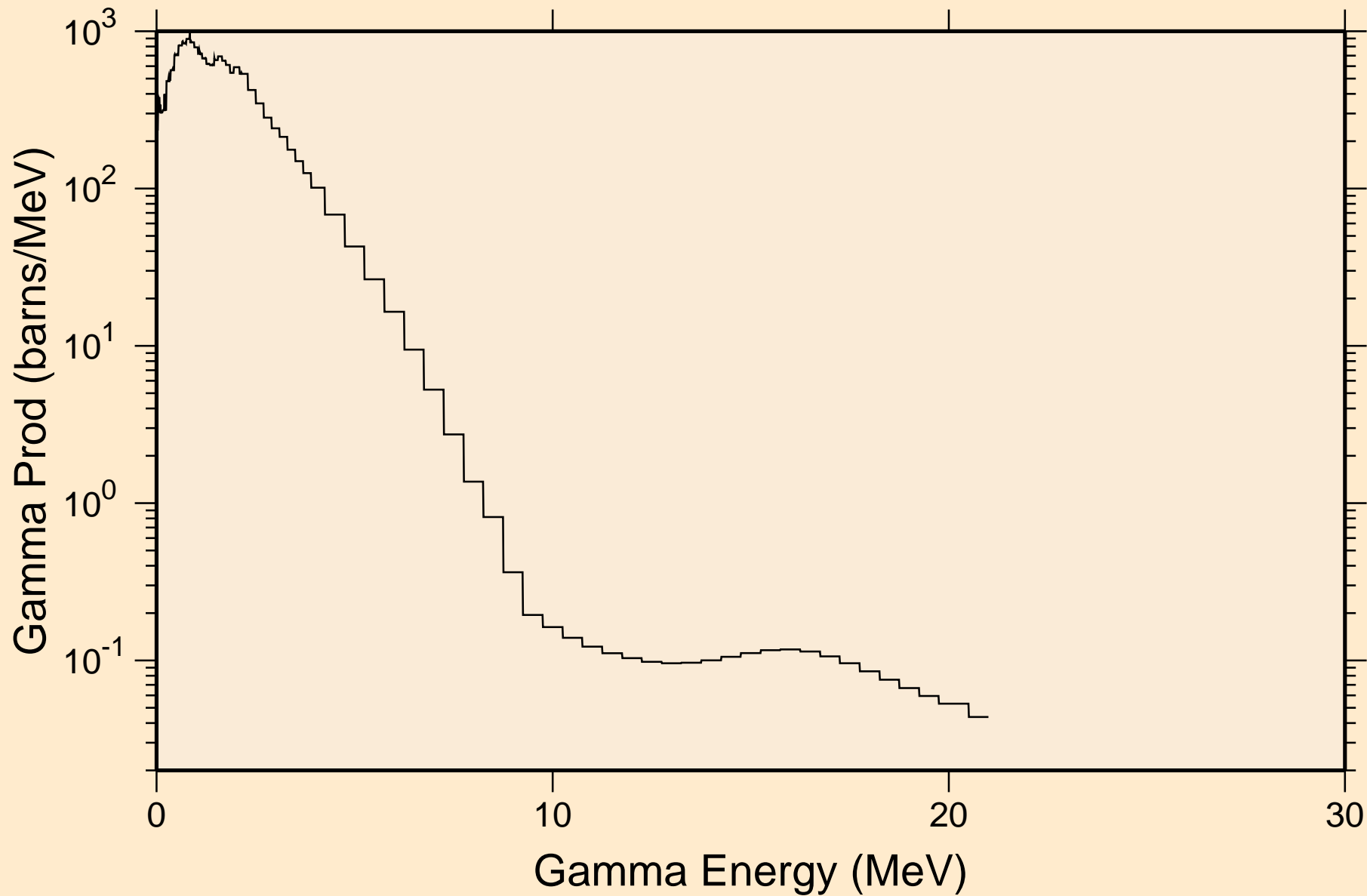

SE083 NEUTRON ACER TENDL-2019 LIBRARY; T=293.16K

Particle heating contributions

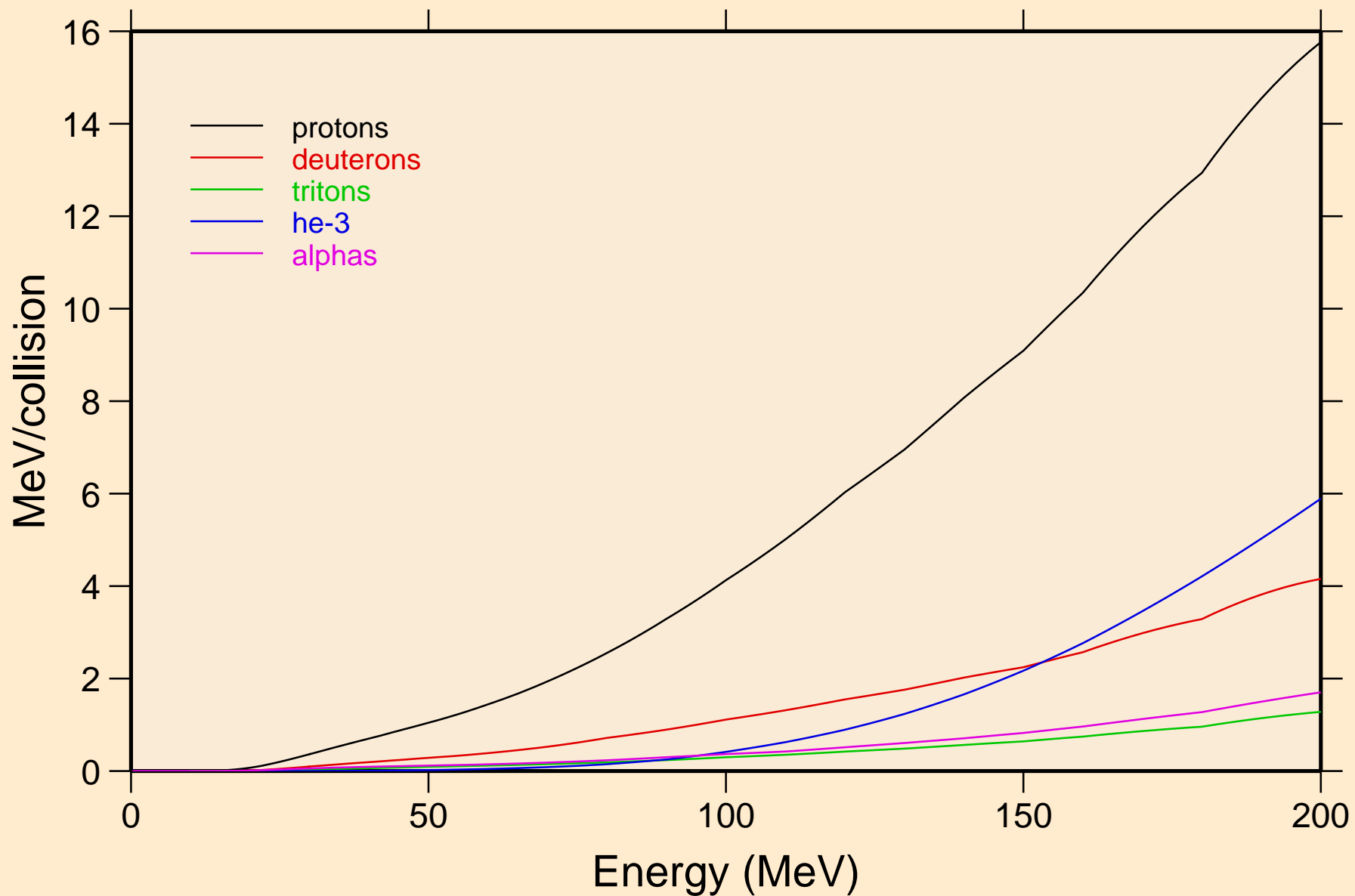

SE083 NEUTRON ACER TENDL-2019 LIBRARY; T=293.16K
Recoil Heating

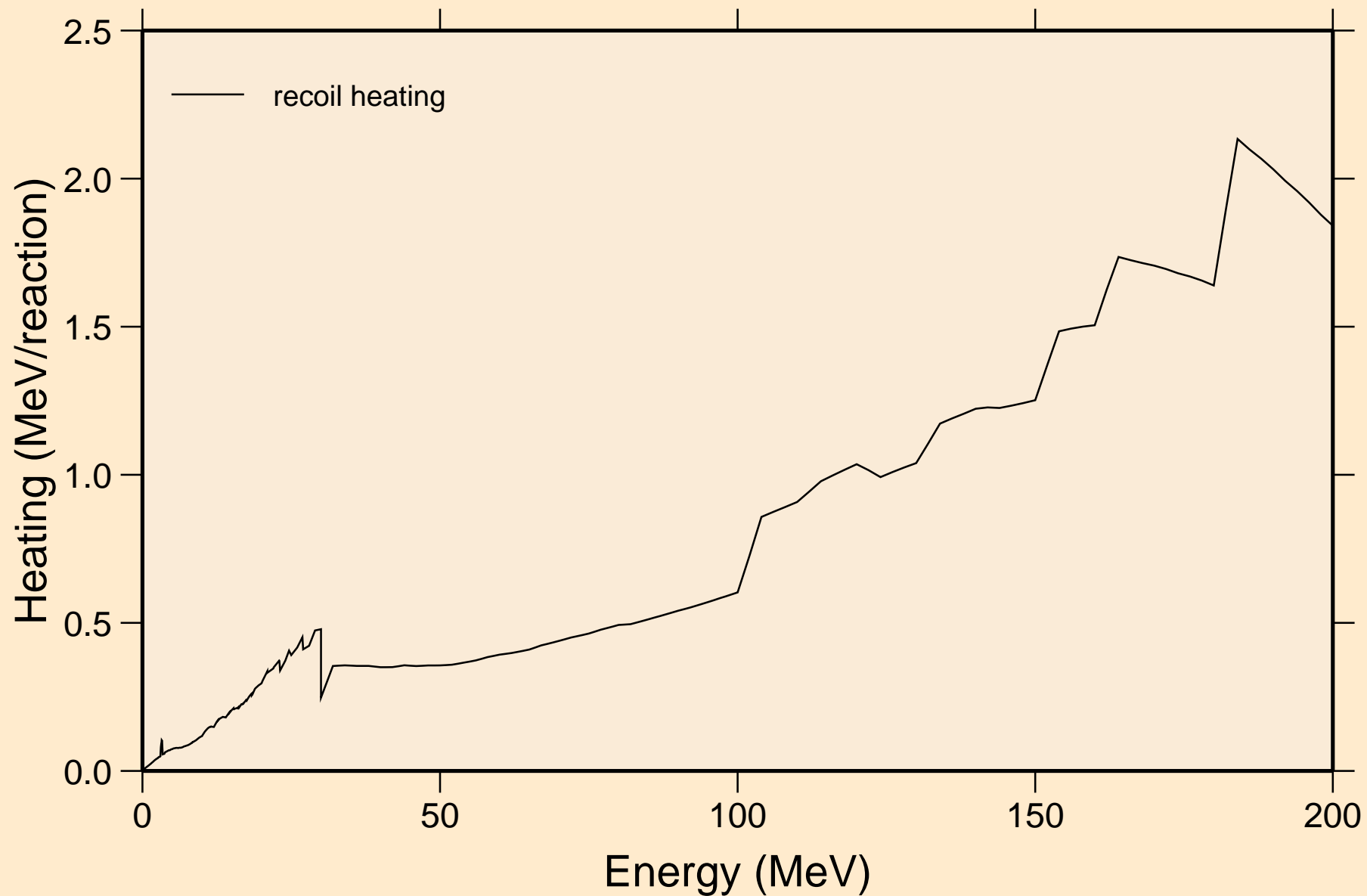

SE083 NEUTRON ACER TENDL-2019 LIBRARY; T=293.16K
Particle production cross sections

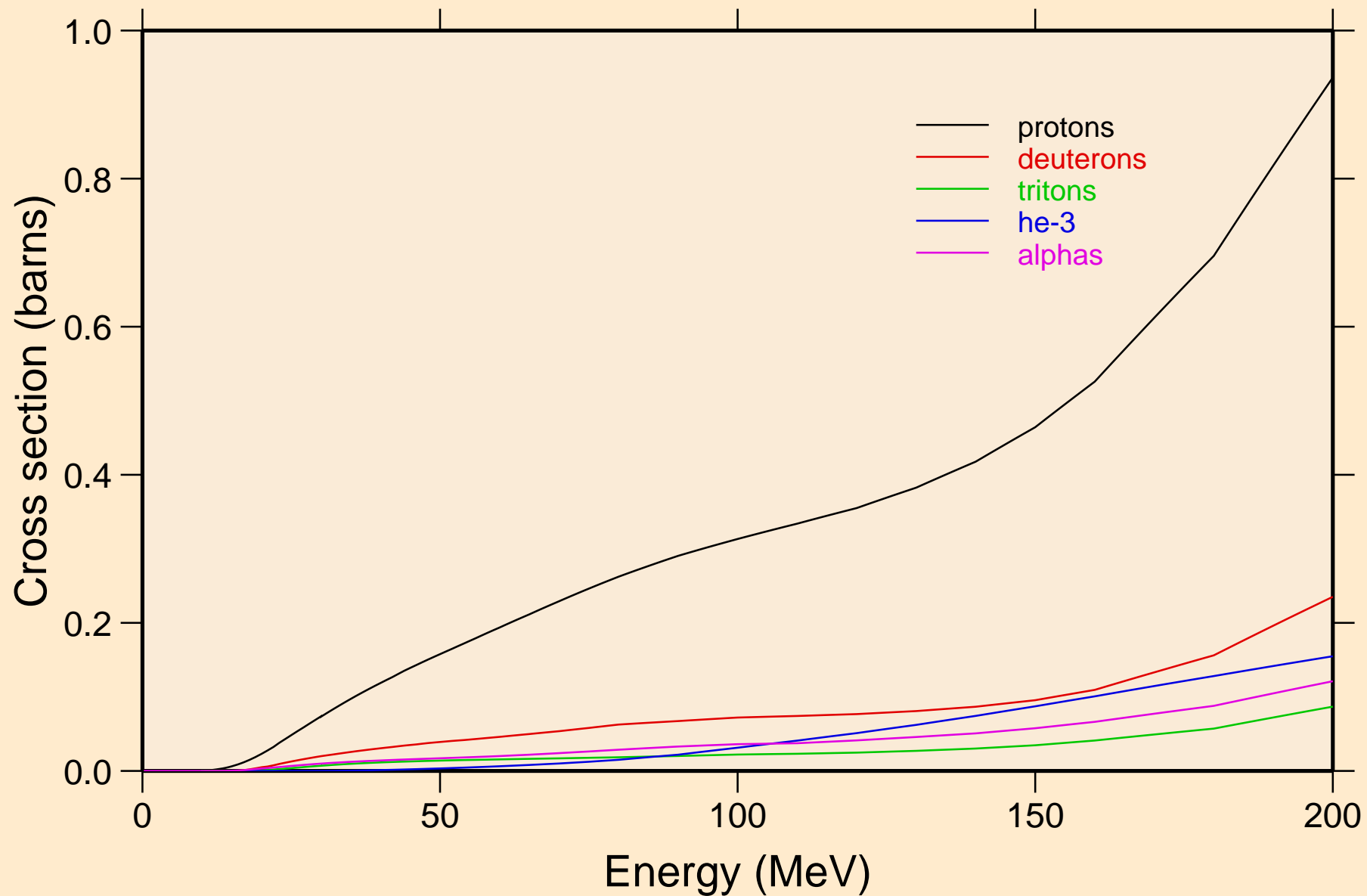

SE083 NEUTRON ACER TENDL-2019 LIBRARY; T=293.16K
protons from (n,x)

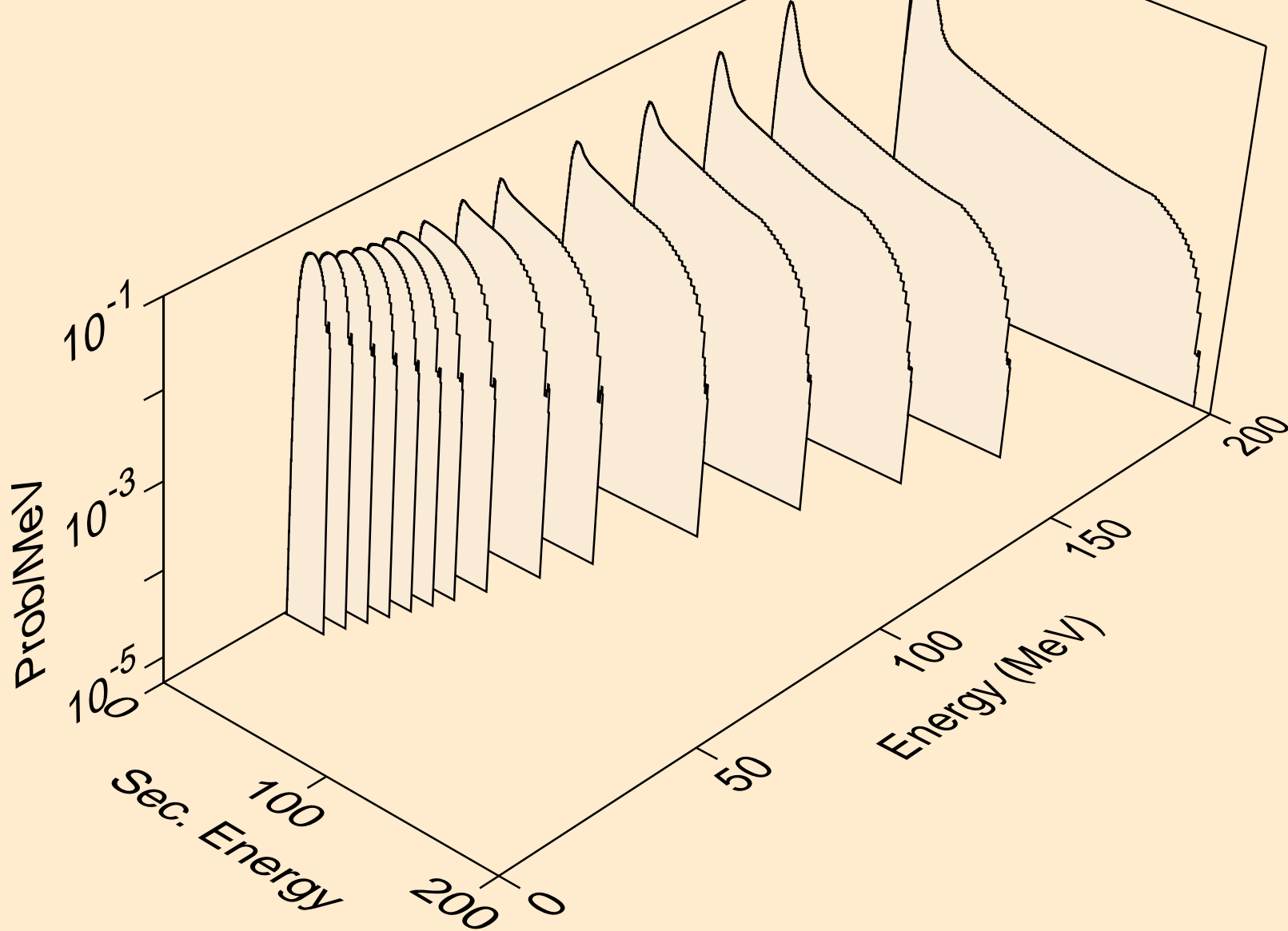

SE083 NEUTRON ACER TENDL-2019 LIBRARY; T=293.16K
protons from (n,n*)p

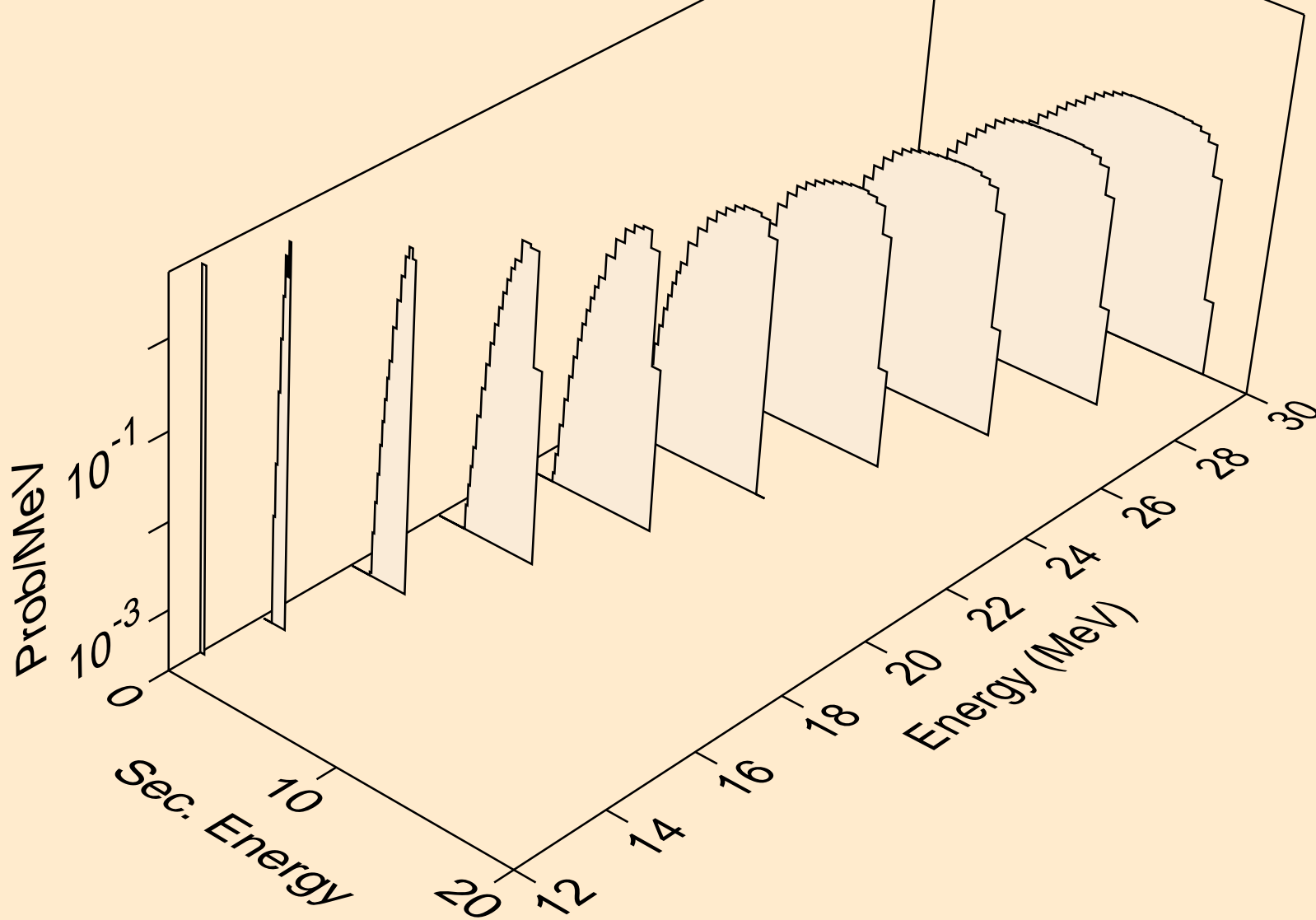

SE083 NEUTRON ACER TENDL-2019 LIBRARY; T=293.16K
protons from (n,2np)

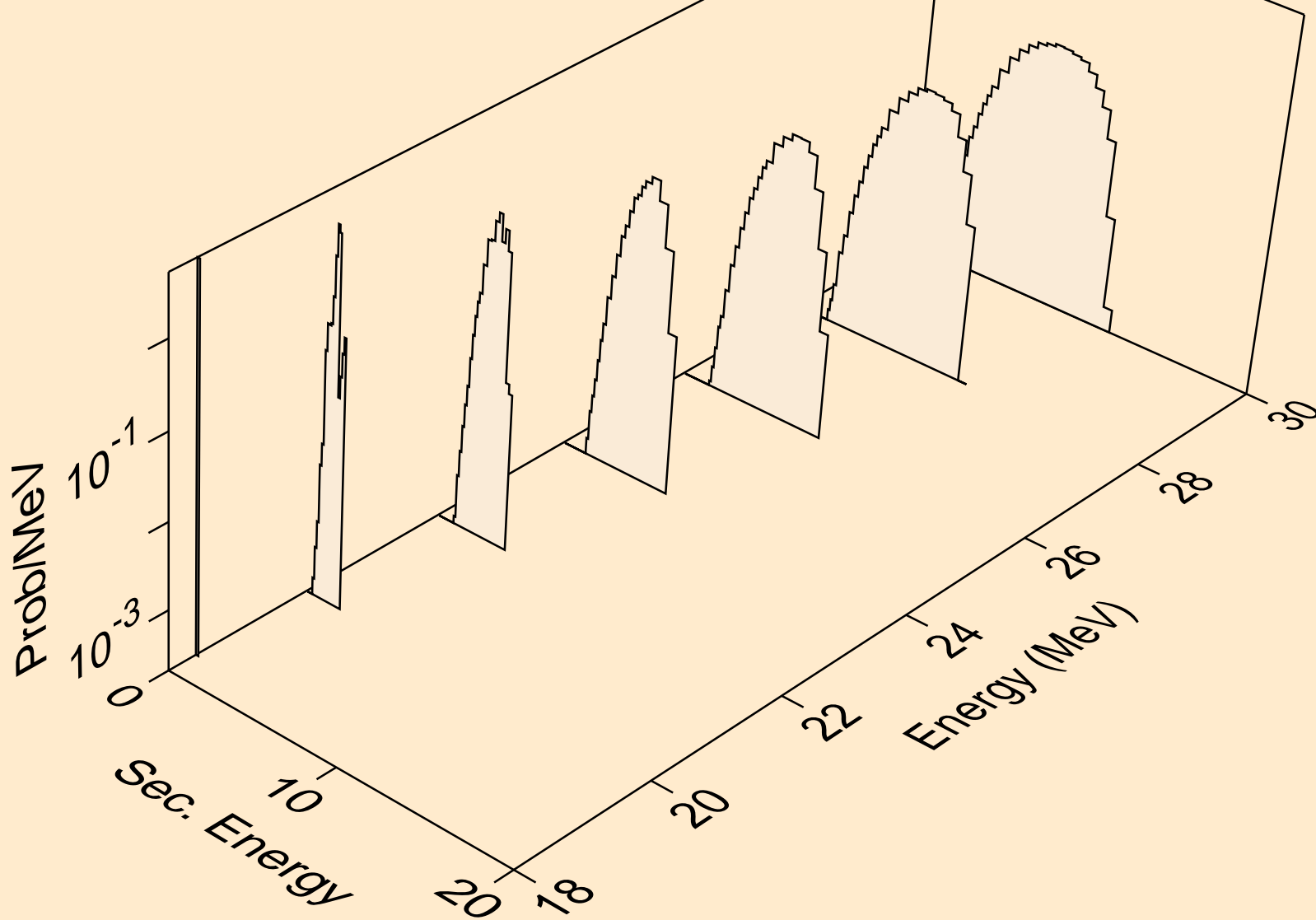

SE083 NEUTRON ACER TENDL-2019 LIBRARY; T=293.16K
protons from (n,3np)

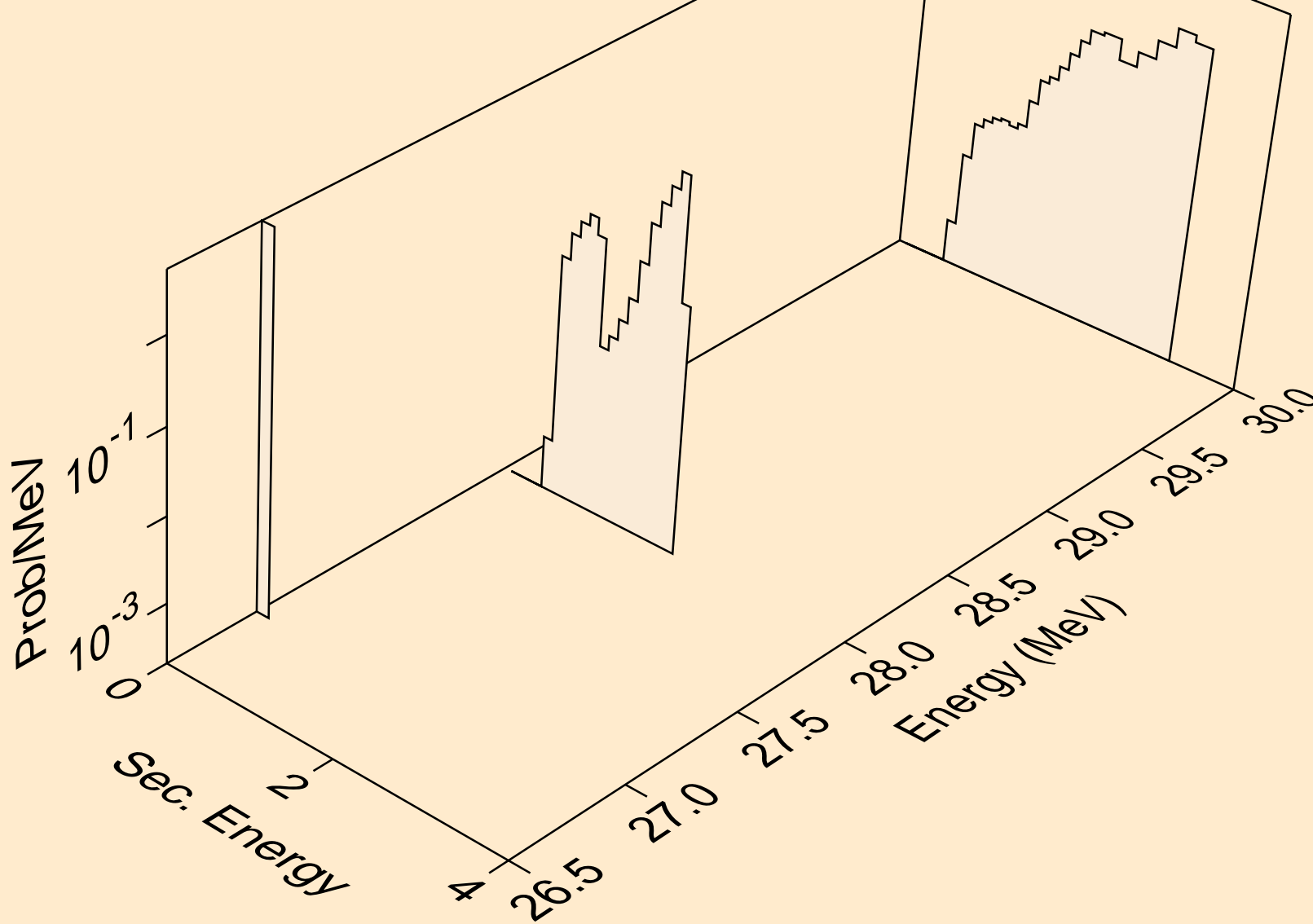

SE083 NEUTRON ACER TENDL-2019 LIBRARY; T=293.16K
protons from (n,p)

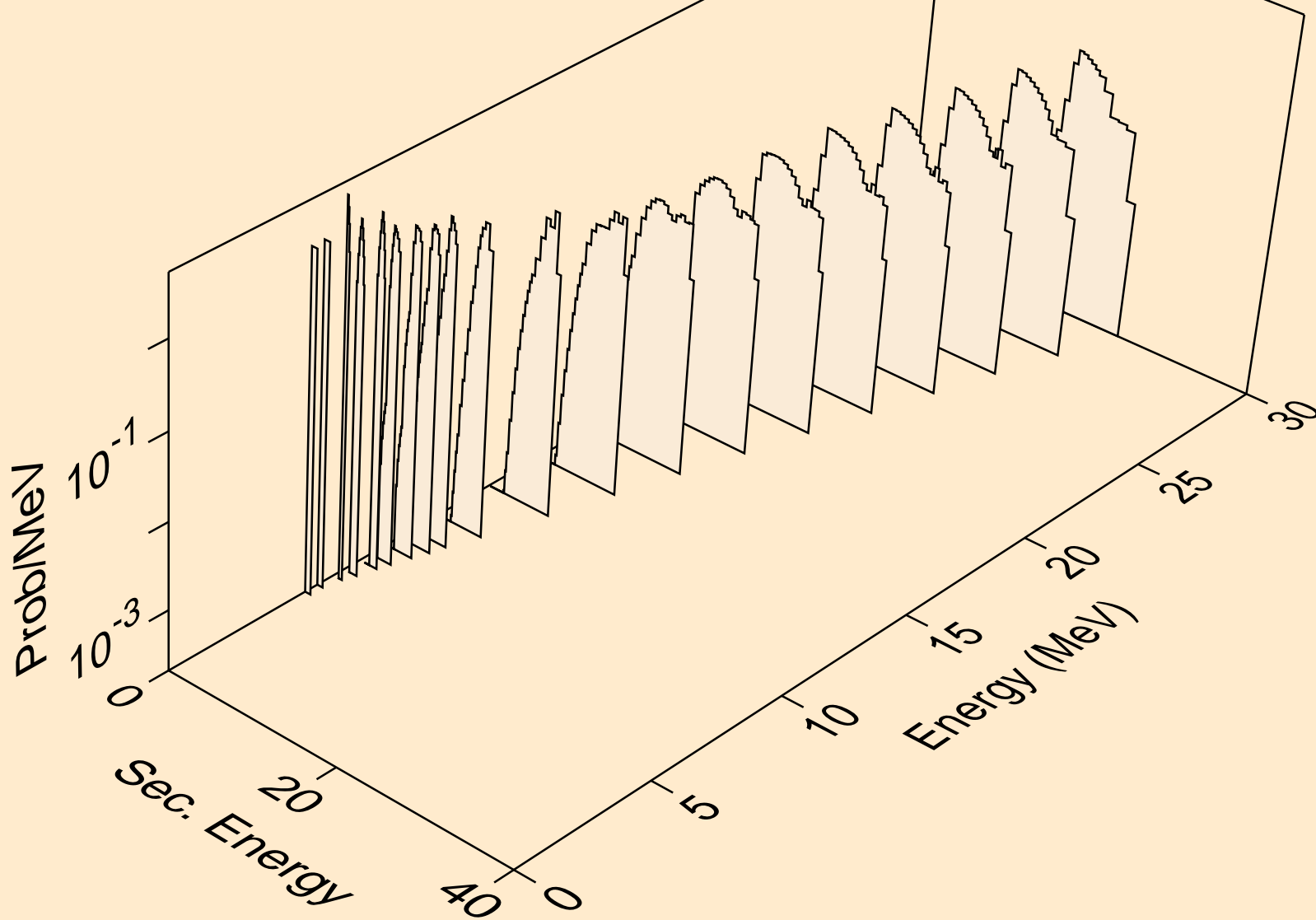

SE083 NEUTRON ACER TENDL-2019 LIBRARY; T=293.16K
protons from (n,2p)

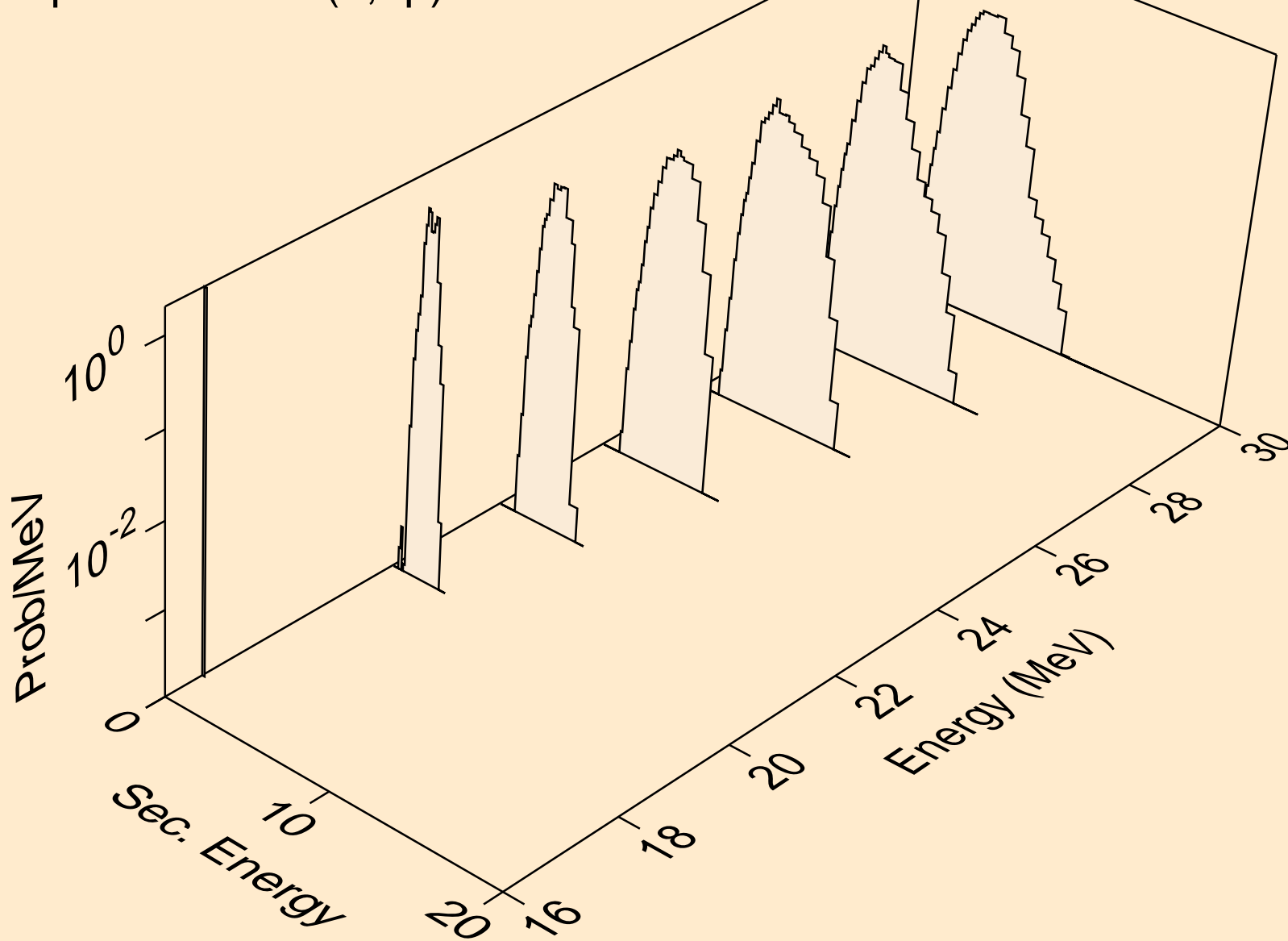

SE083 NEUTRON ACER TENDL-2019 LIBRARY; T=293.16K
protons from (n,p)

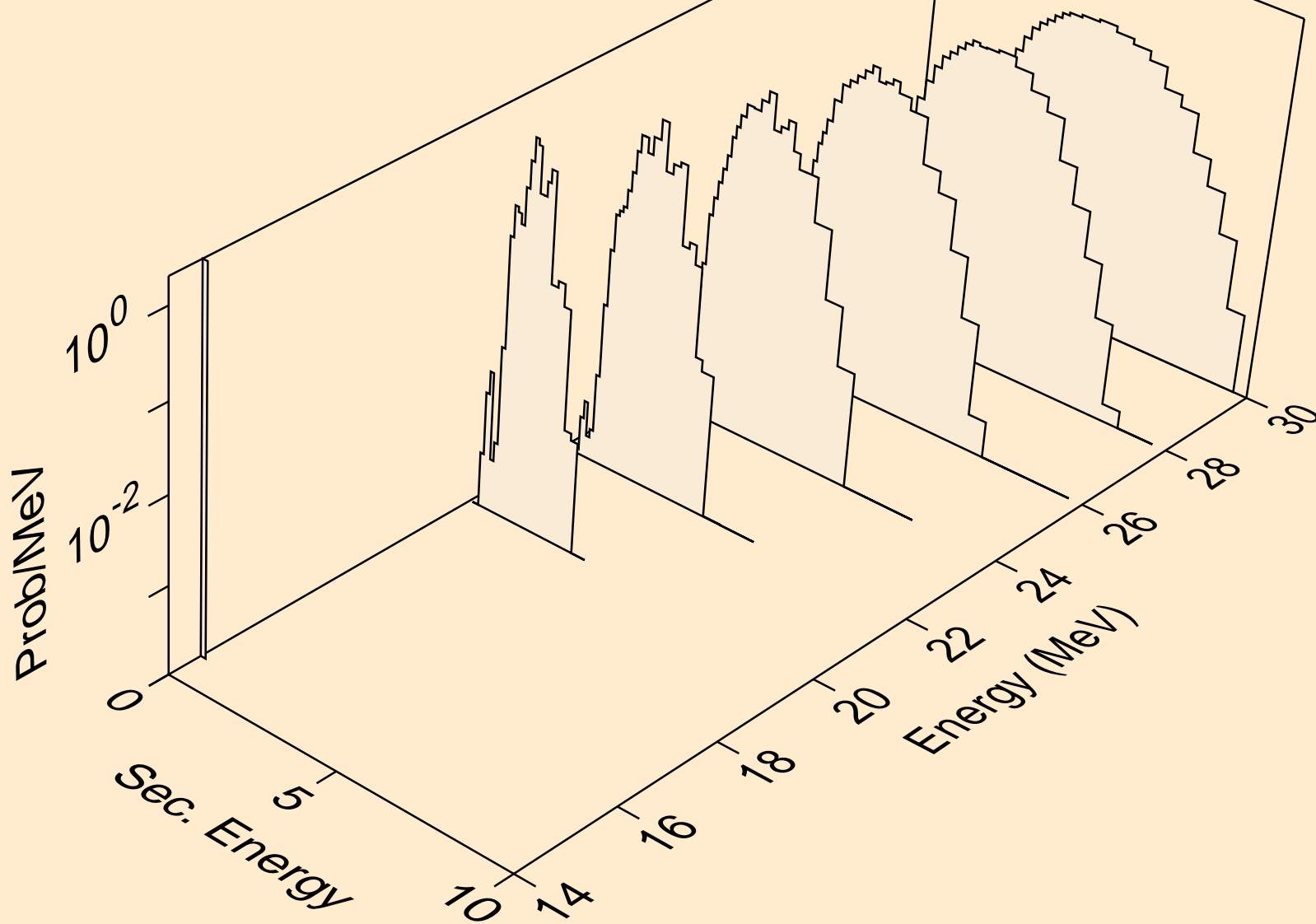

SE083 NEUTRON ACER TENDL-2019 LIBRARY; T=293.16K
protons from (n,pt)

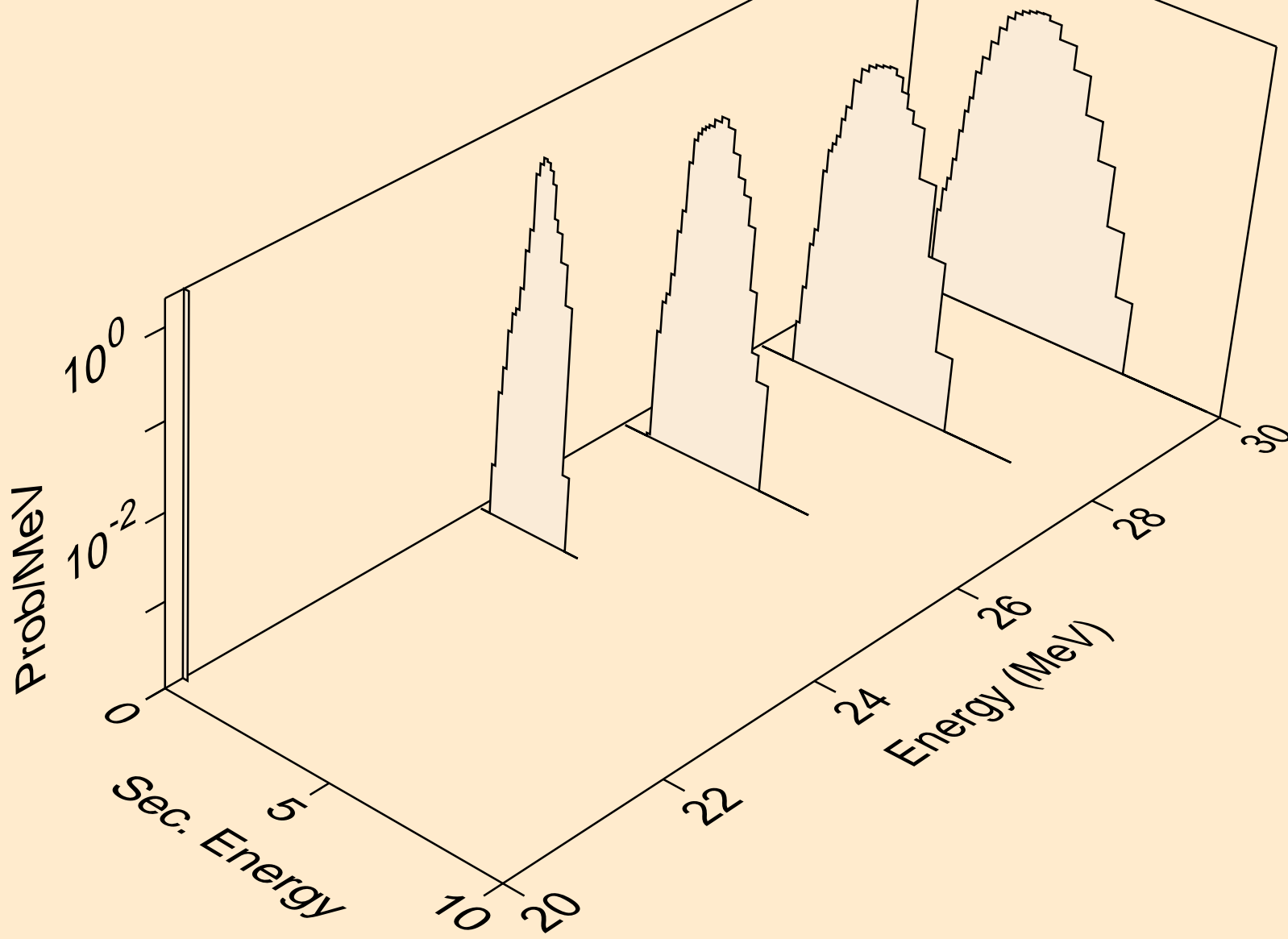

SE083 NEUTRON ACER TENDL-2019 LIBRARY; T=293.16K
deuterons from (n,x)

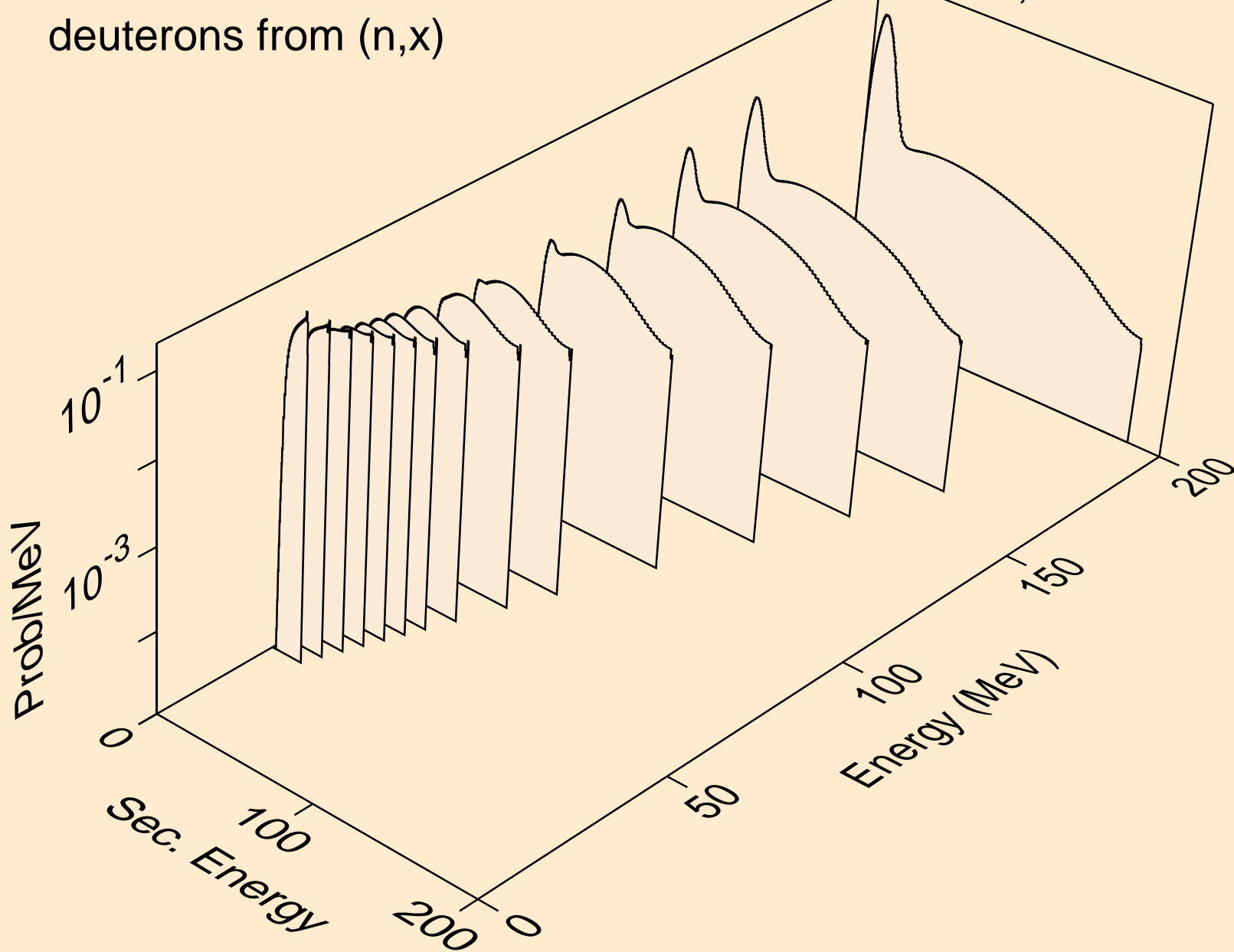

SE083 NEUTRON ACER TENDL-2019 LIBRARY; T=293.16K
deuterons from (n,2nd)

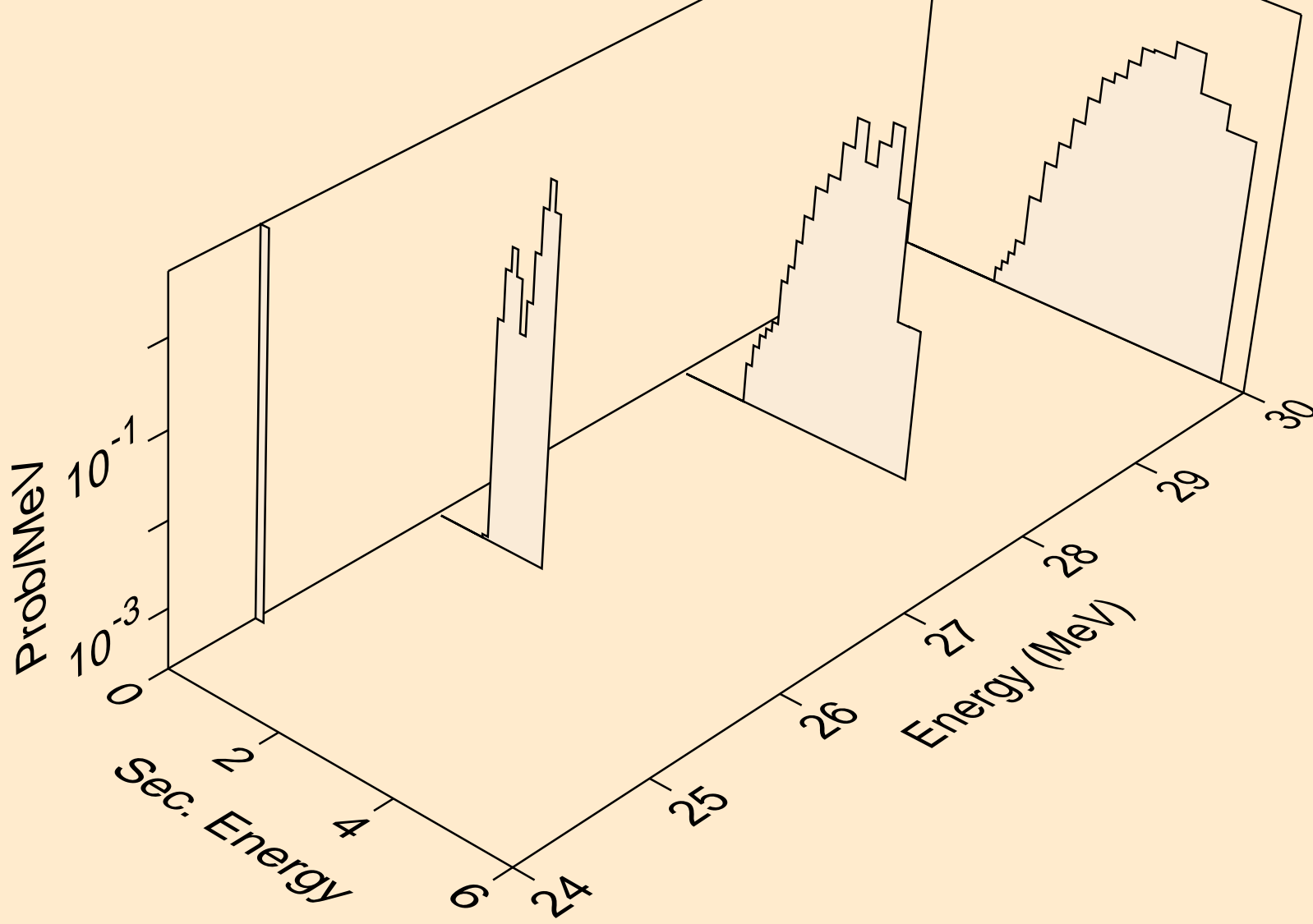

SE083 NEUTRON ACER TENDL-2019 LIBRARY; T=293.16K
deuterons from (n,n*)d

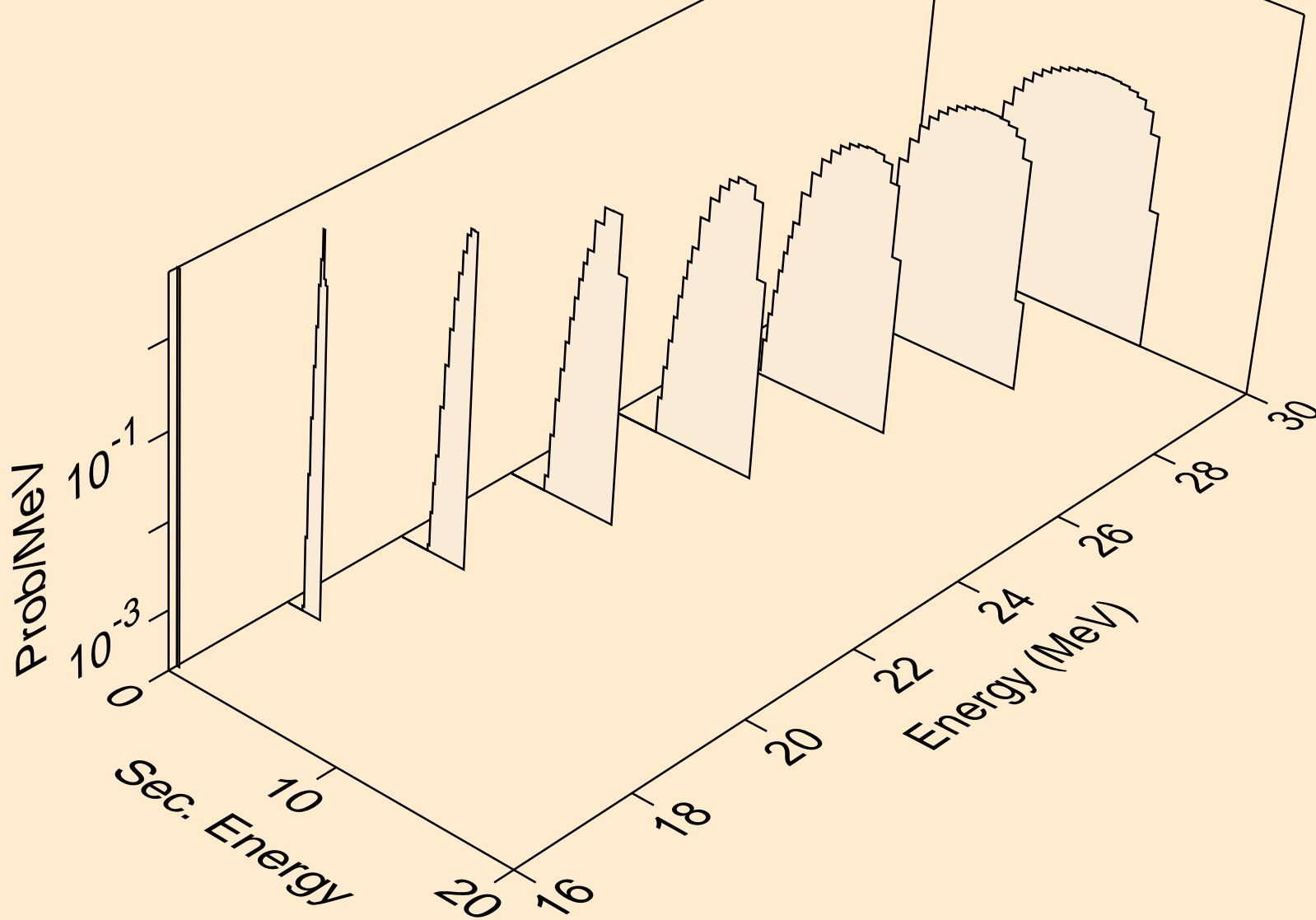

SE083 NEUTRON ACER TENDL-2019 LIBRARY; T=293.16K
deuterons from (n,d)

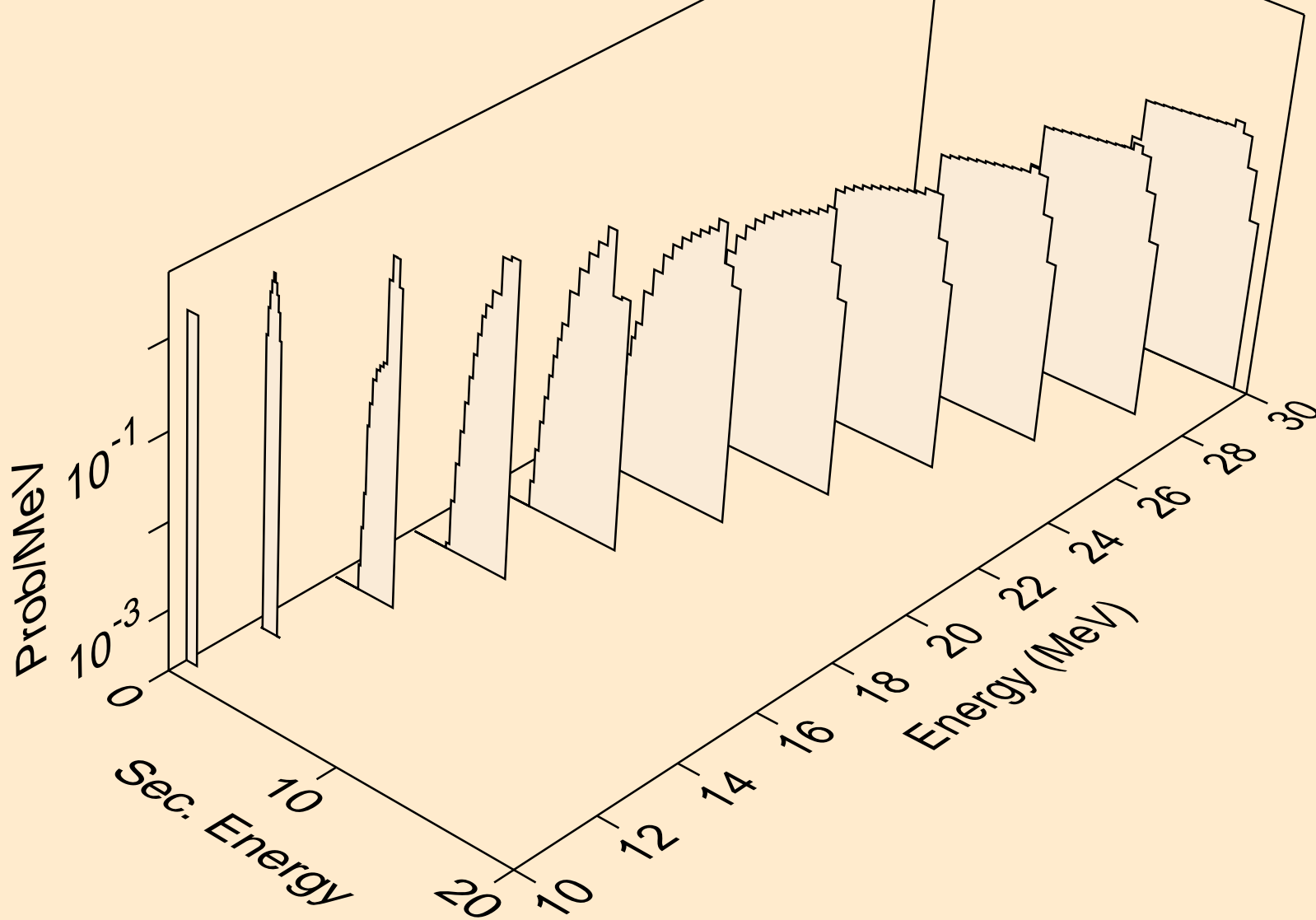

SE083 NEUTRON ACER TENDL-2019 LIBRARY; T=293.16K
tritons from (n,x)

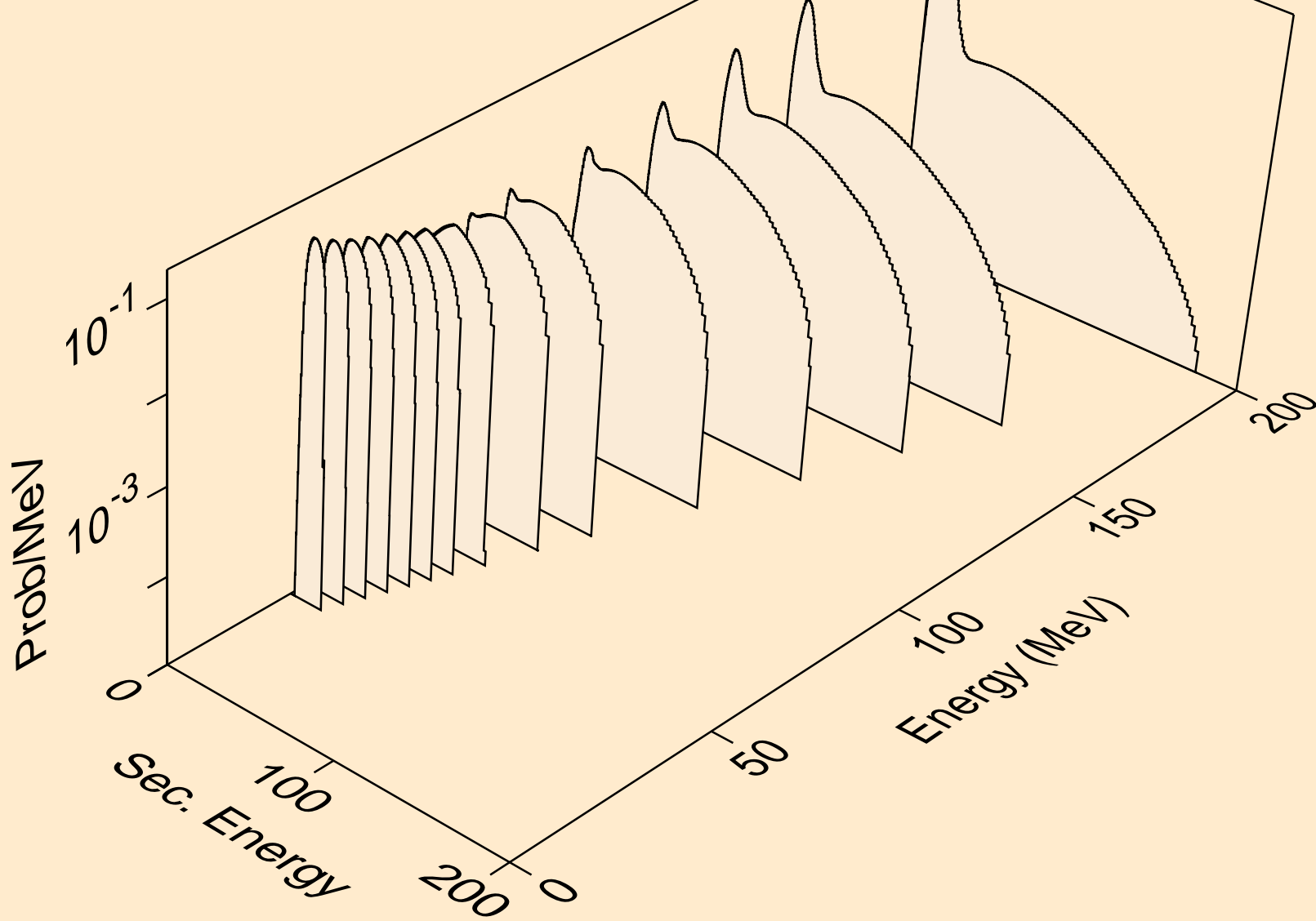

SE083 NEUTRON ACER TENDL-2019 LIBRARY; T=293.16K
tritons from (n,n*)t

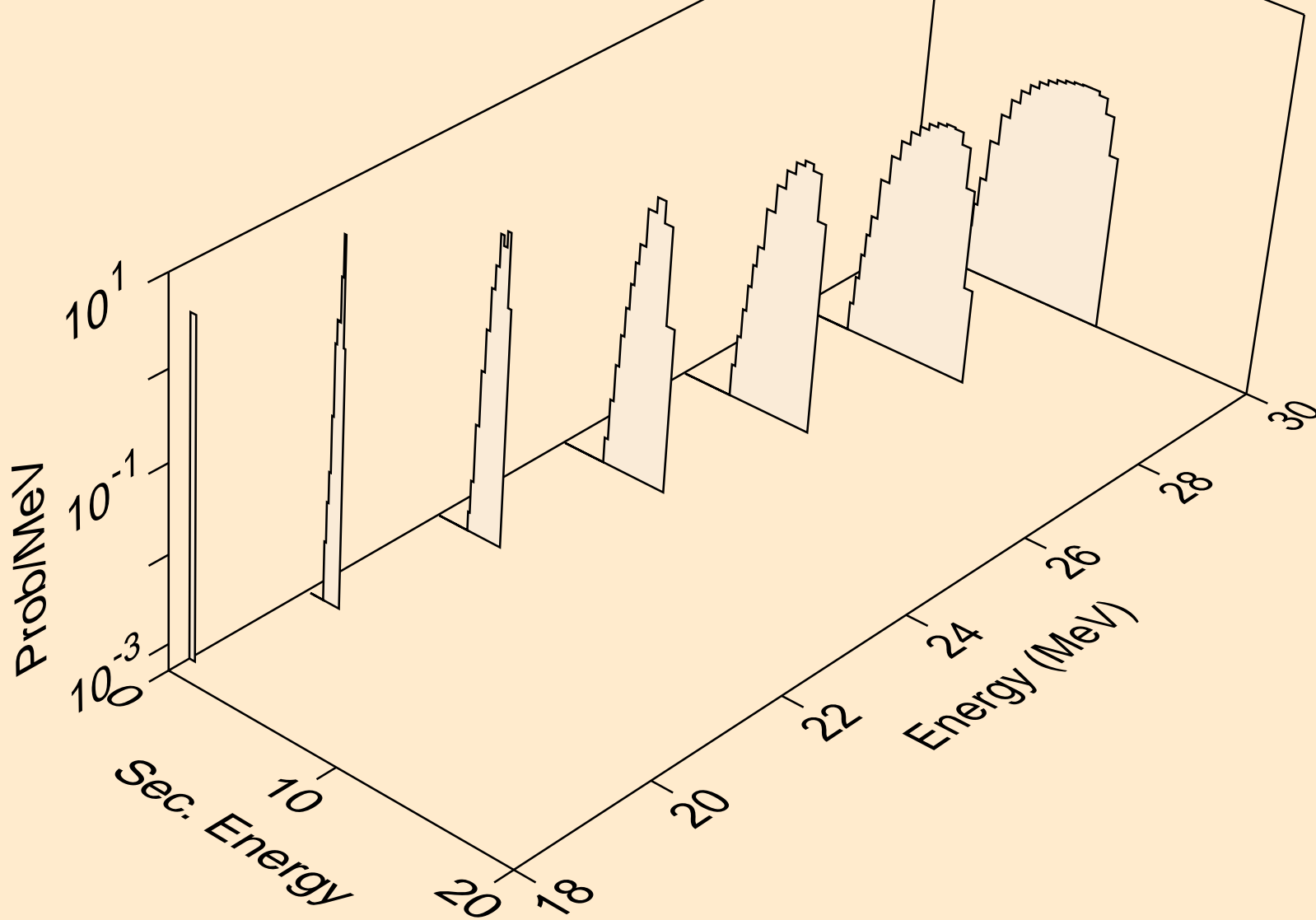

SE083 NEUTRON ACER TENDL-2019 LIBRARY; T=293.16K
tritons from (n,t)

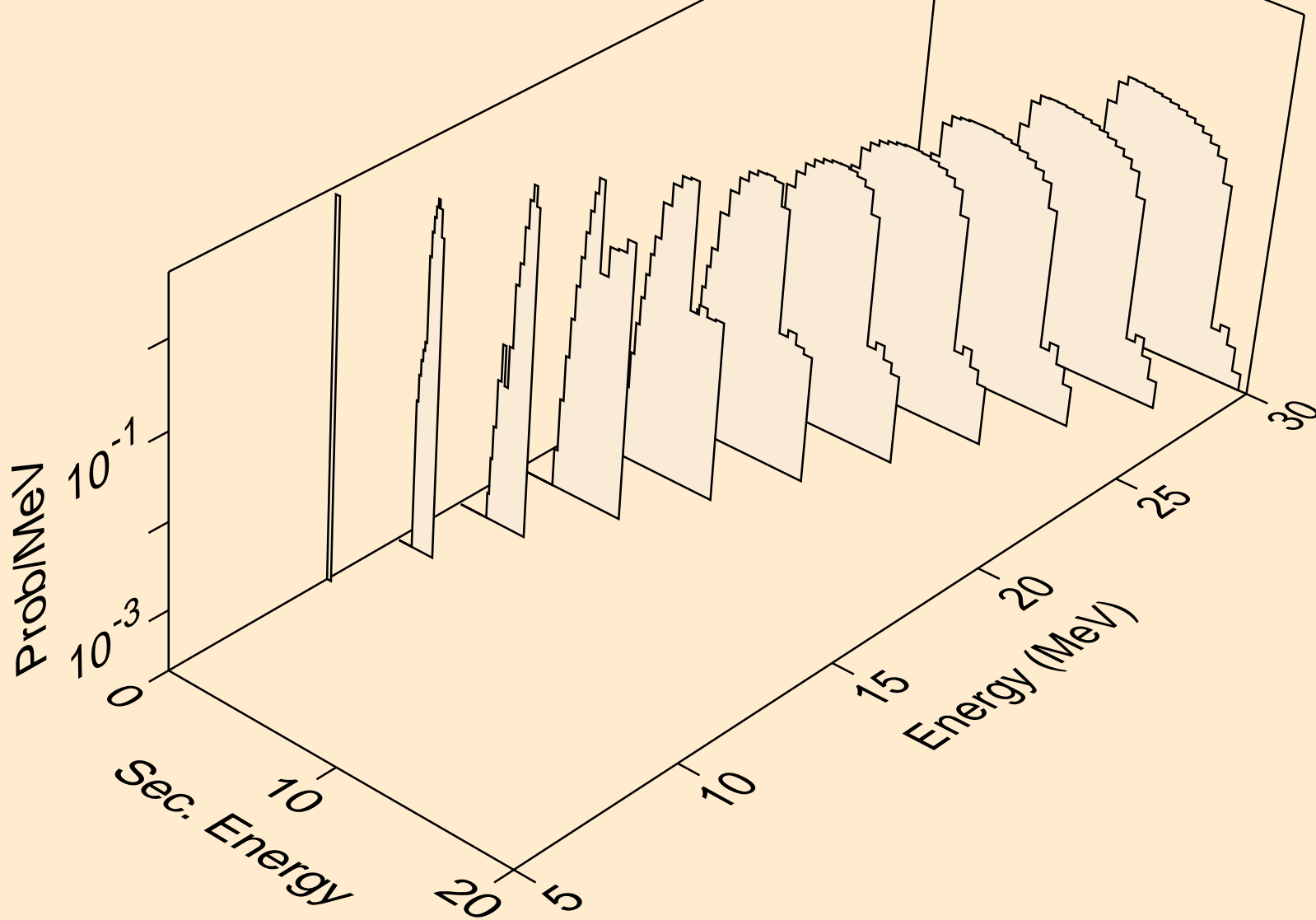

SE083 NEUTRON ACER TENDL-2019 LIBRARY; T=293.16K
tritons from (n,pt)

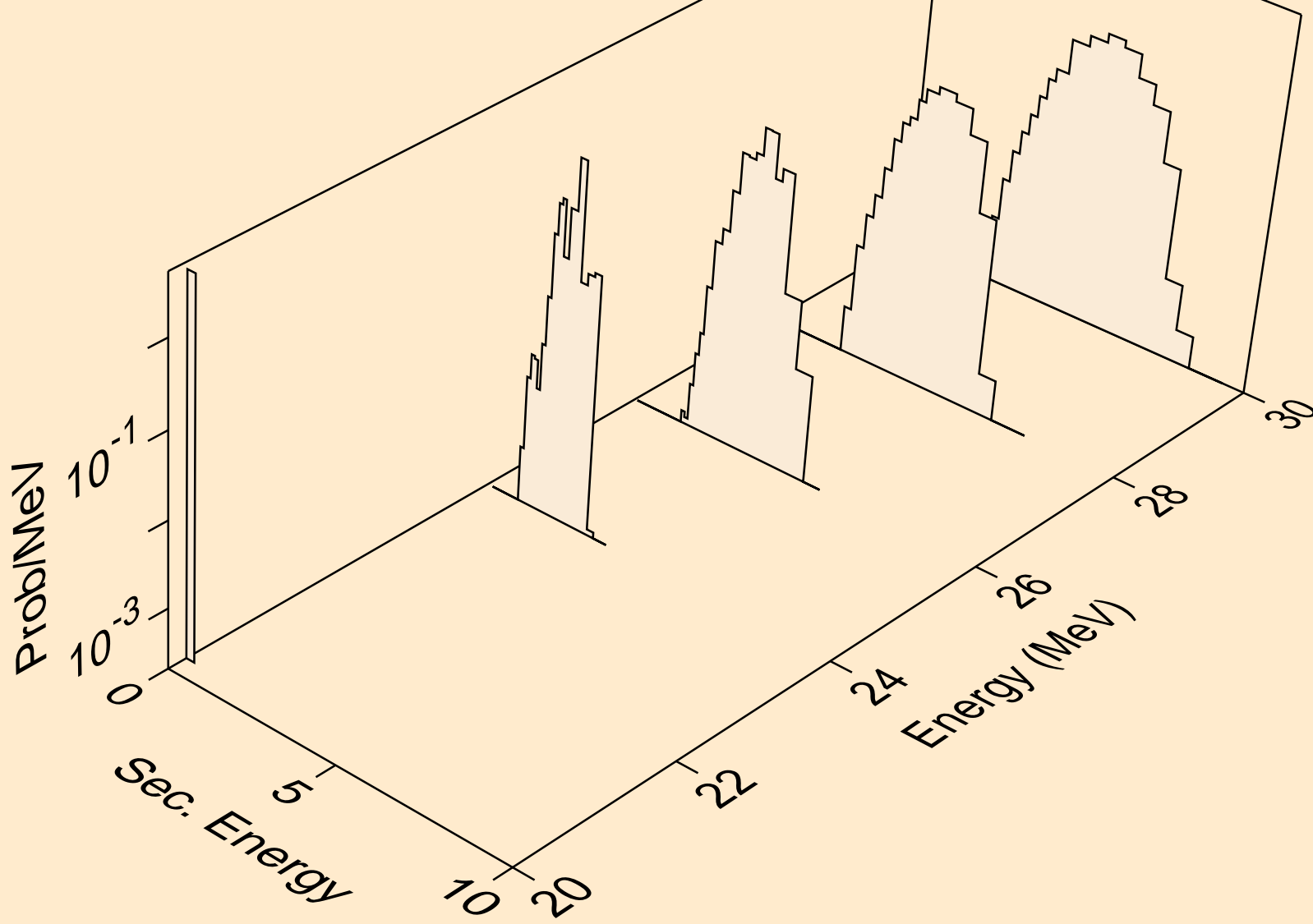

SE083 NEUTRON ACER TENDL-2019 LIBRARY; T=293.16K
he3s from (n,x)

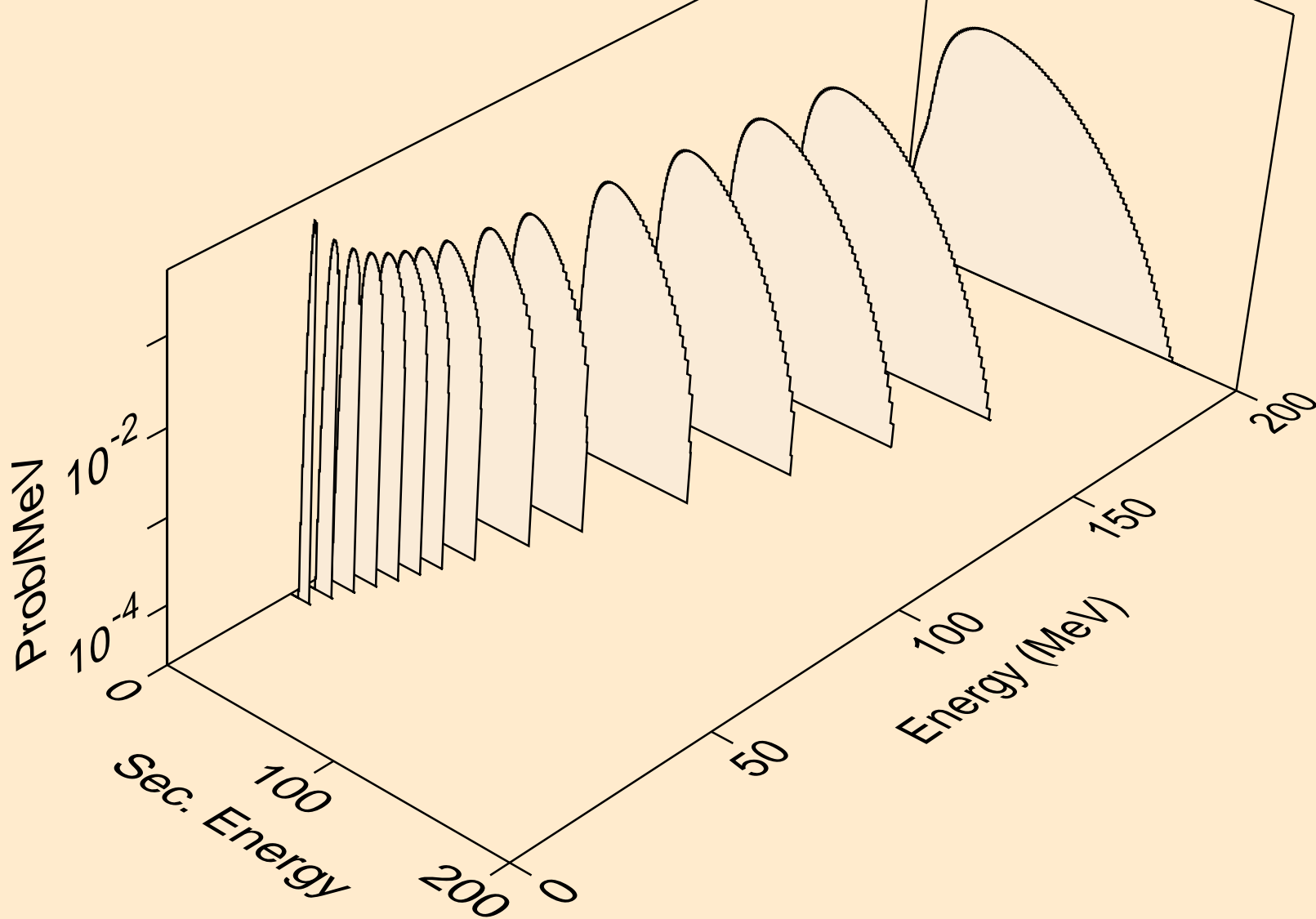

SE083 NEUTRON ACER TENDL-2019 LIBRARY; T=293.16K
he3s from (n,n*)he3

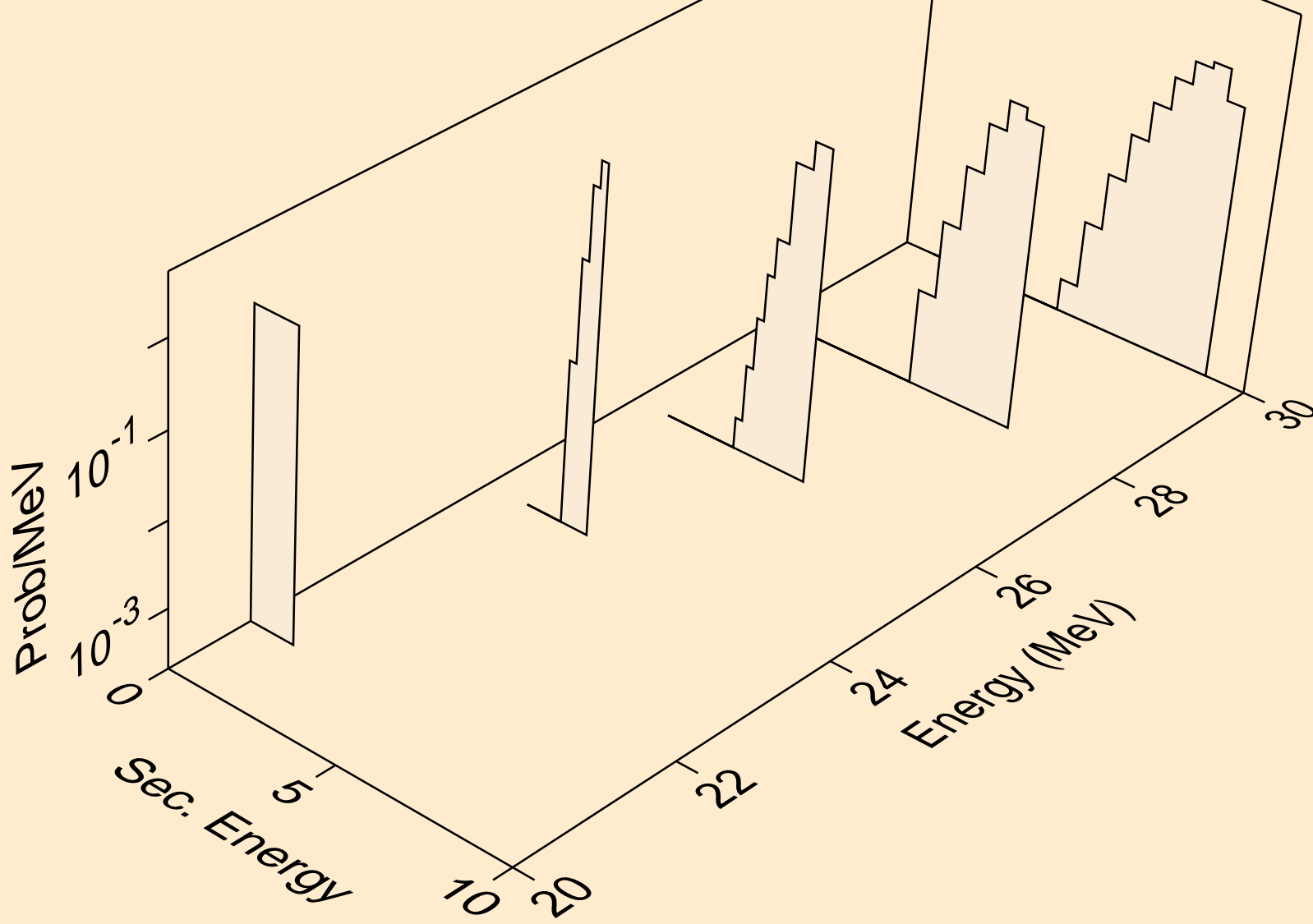

SE083 NEUTRON ACER TENDL-2019 LIBRARY; T=293.16K
he3s from (n,he3)

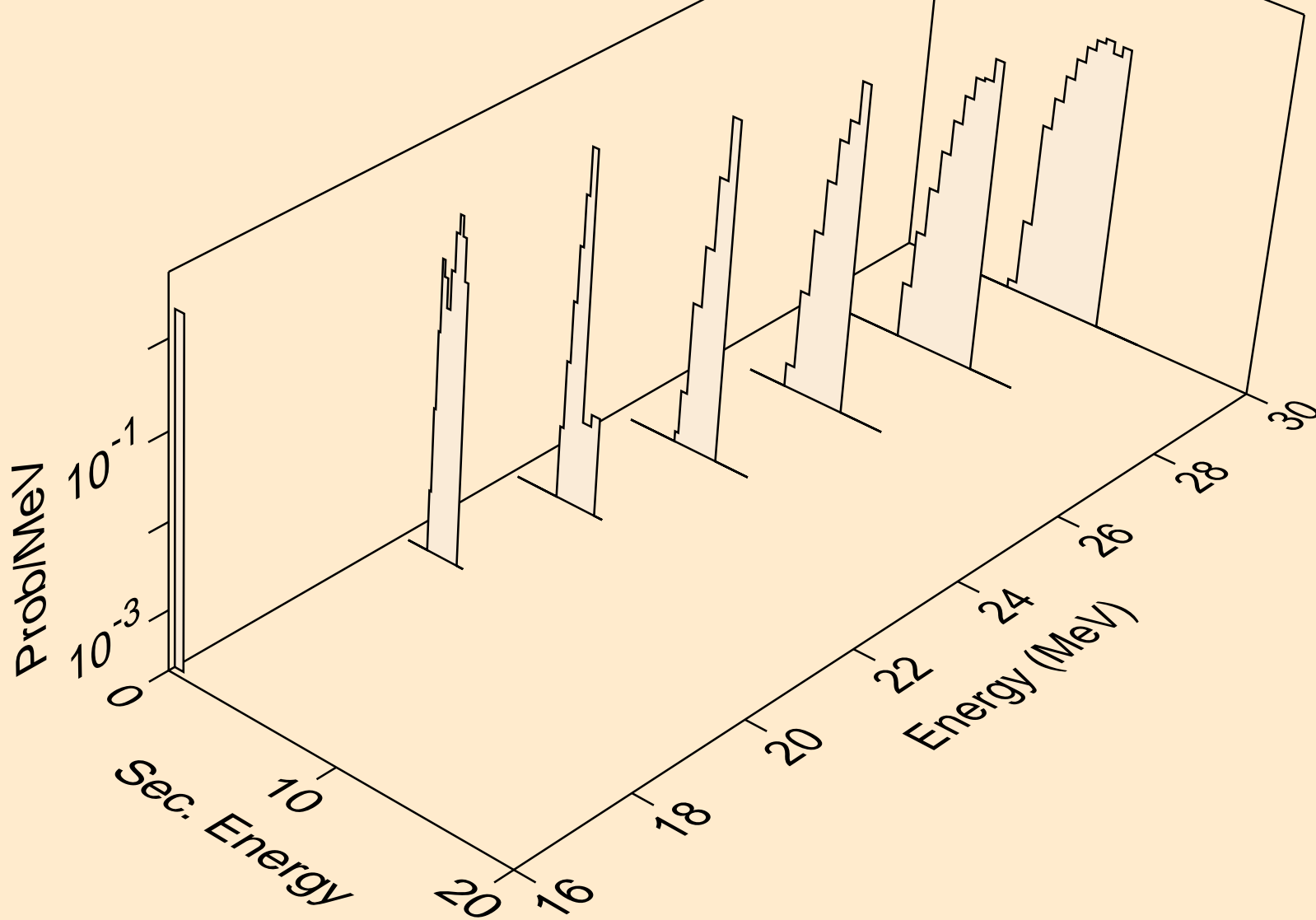

SE083 NEUTRON ACER TENDL-2019 LIBRARY; T=293.16K
alphas from (n,x)

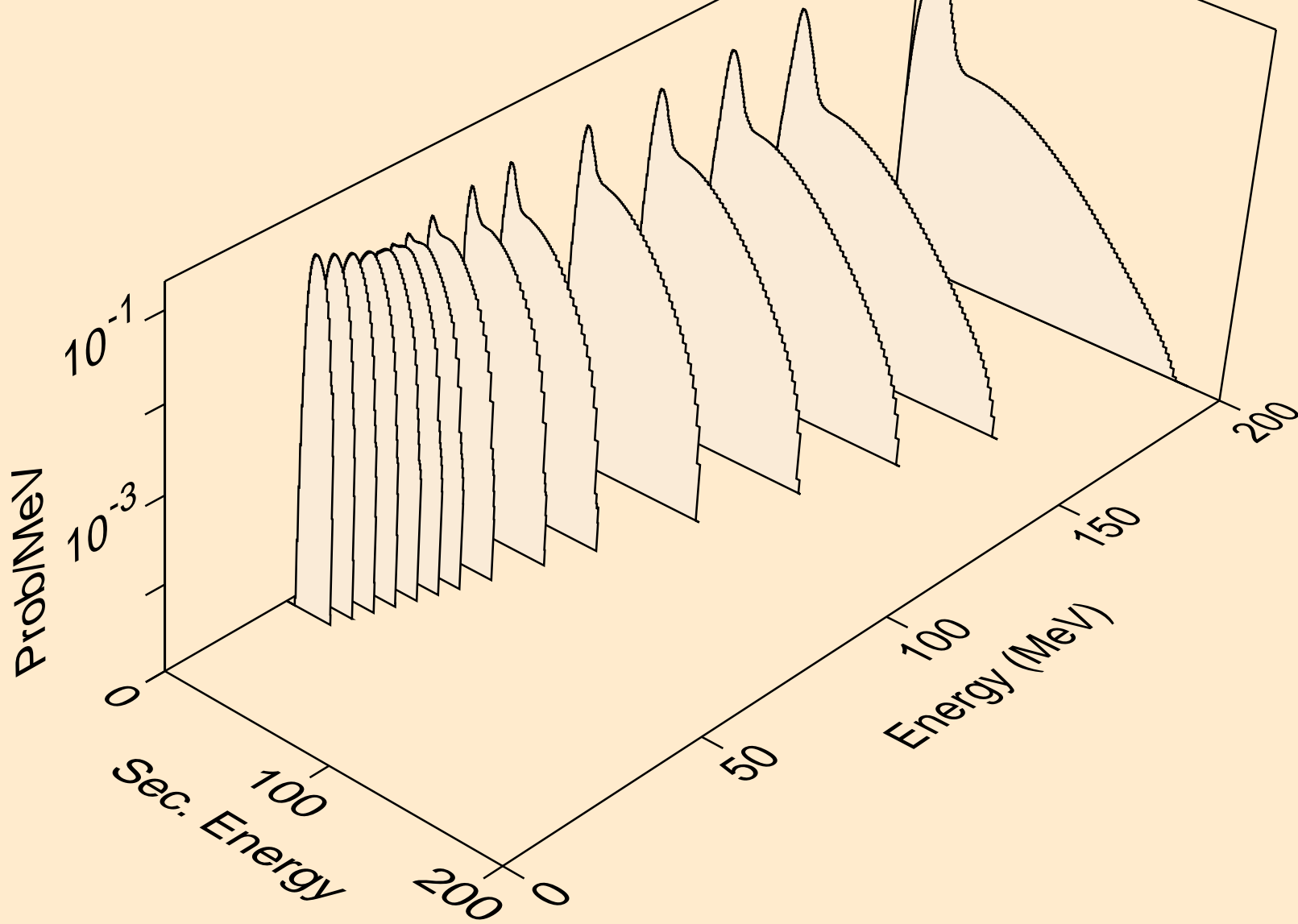

SE083 NEUTRON ACER TENDL-2019 LIBRARY; T=293.16K
alphas from (n,n*)a

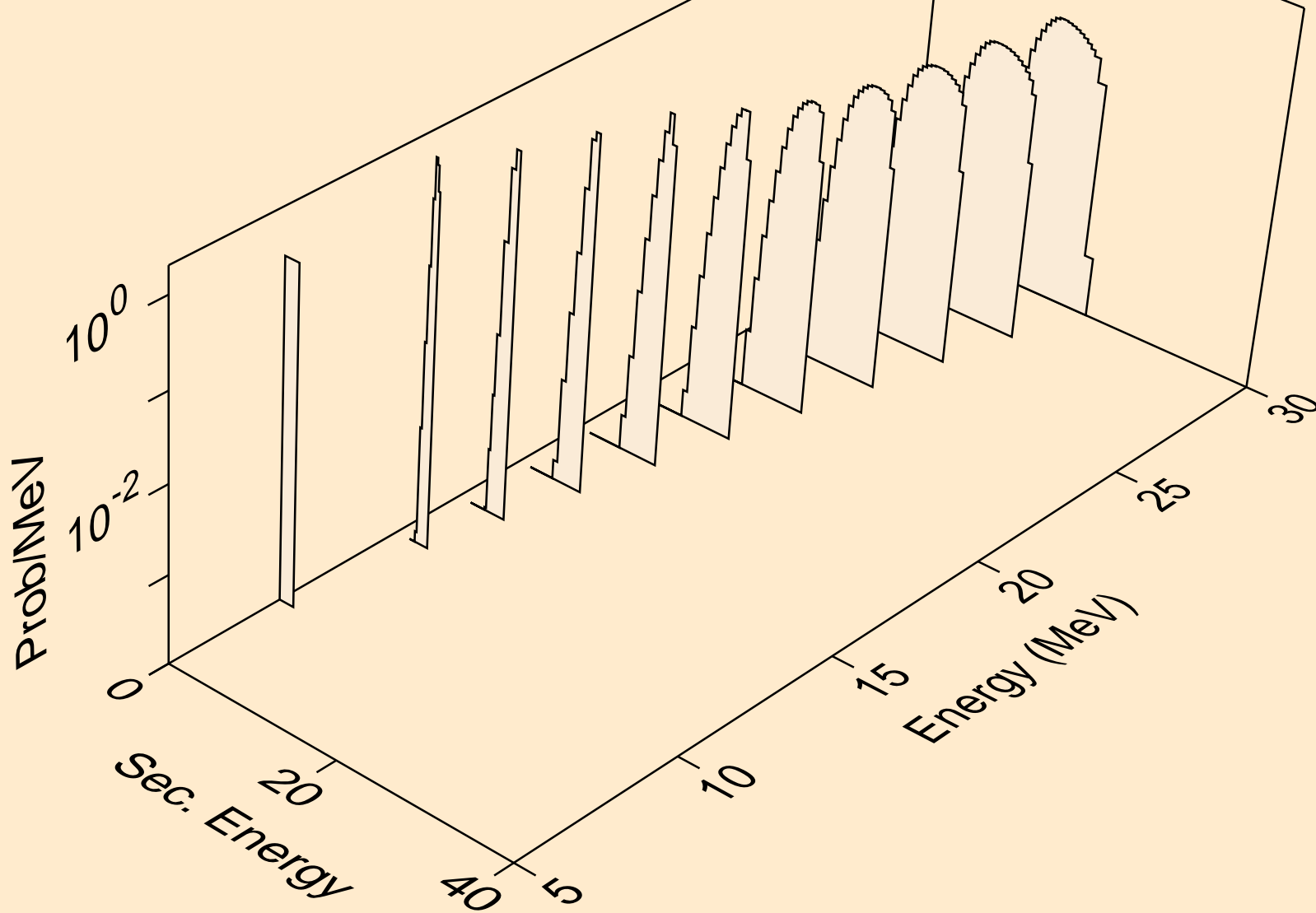

SE083 NEUTRON ACER TENDL-2019 LIBRARY; T=293.16K
alphas from (n,2n)a

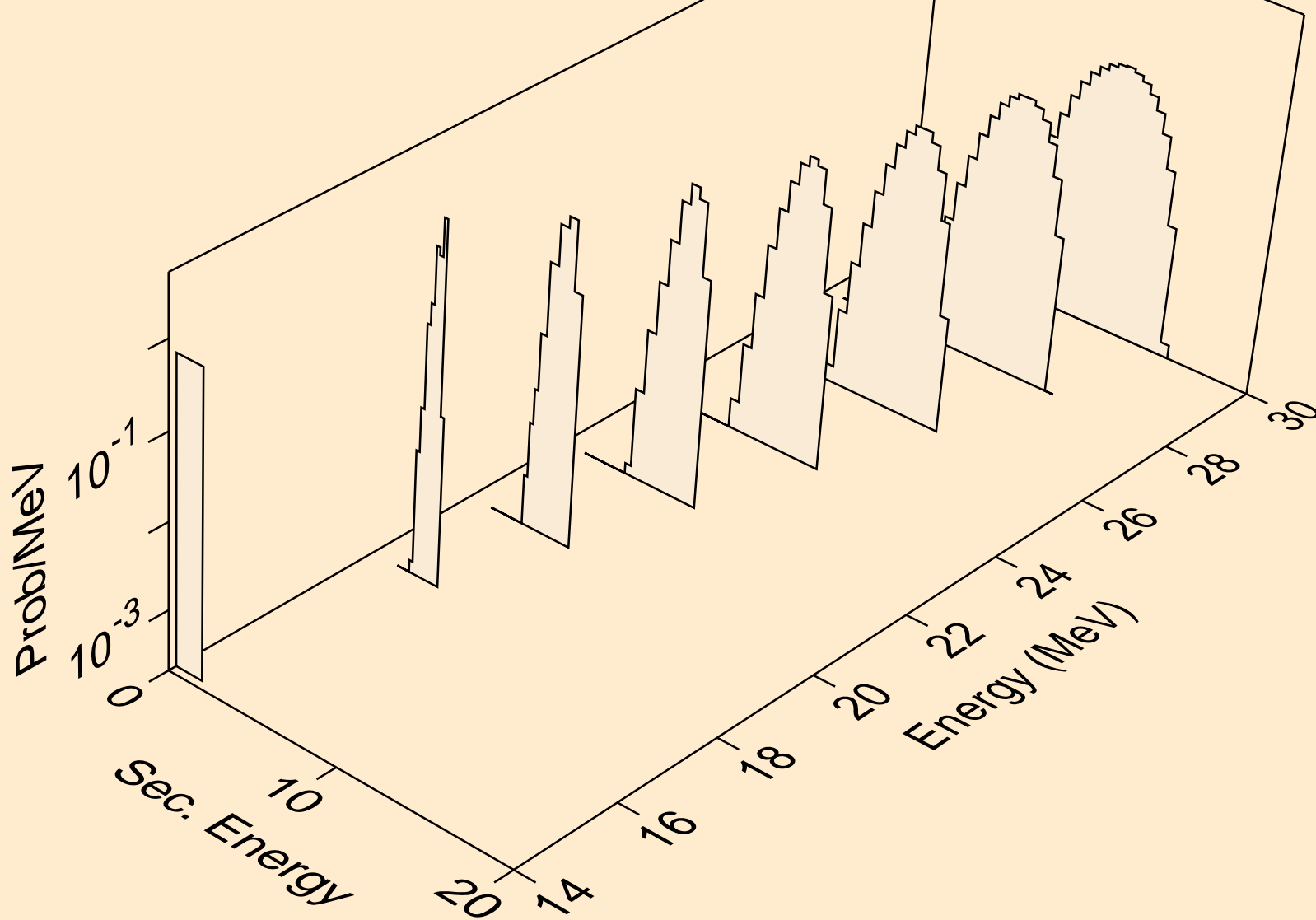

SE083 NEUTRON ACER TENDL-2019 LIBRARY; T=293.16K
alphas from (n,3n)a

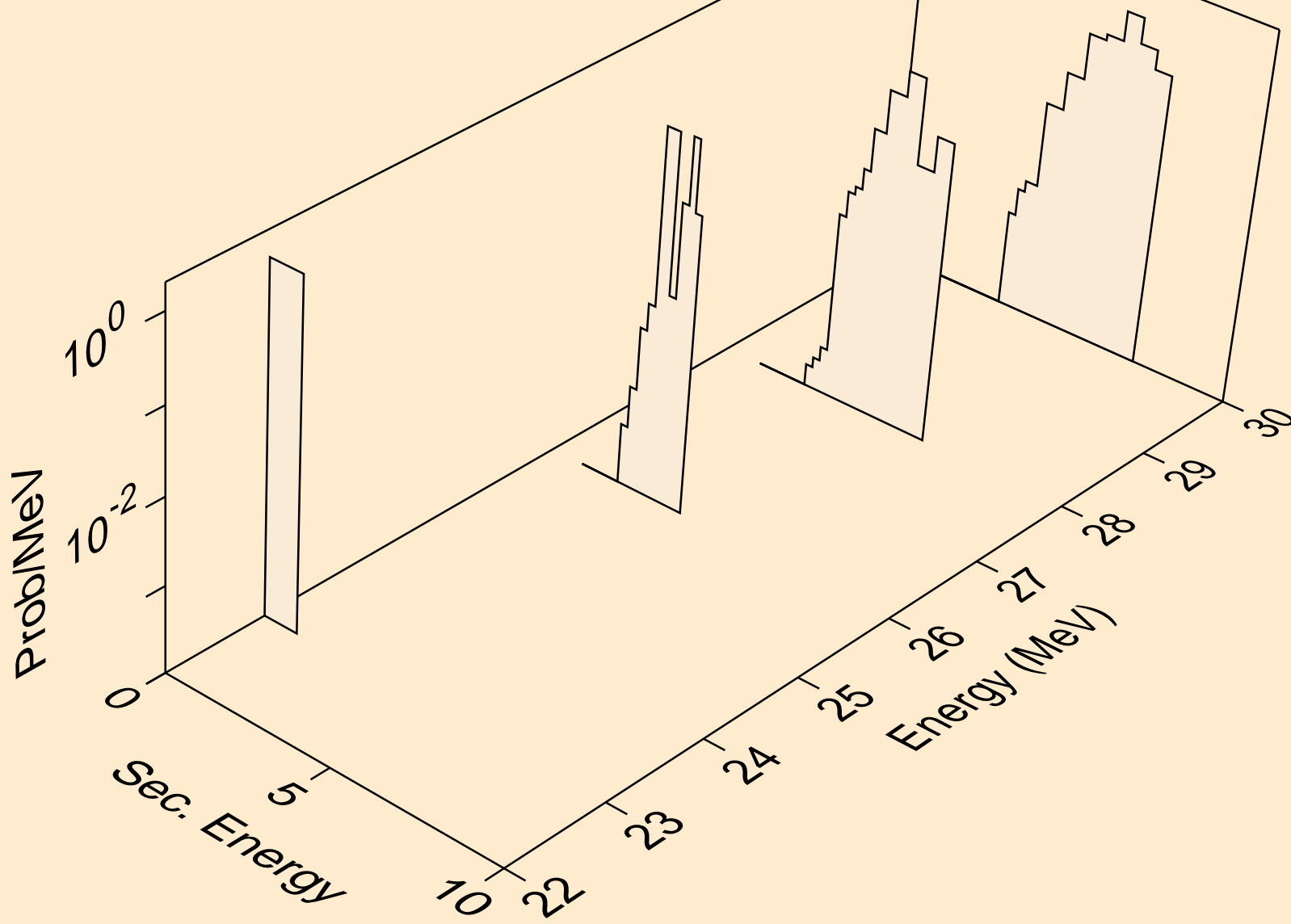

SE083 NEUTRON ACER TENDL-2019 LIBRARY; T=293.16K
alphas from (n,a)

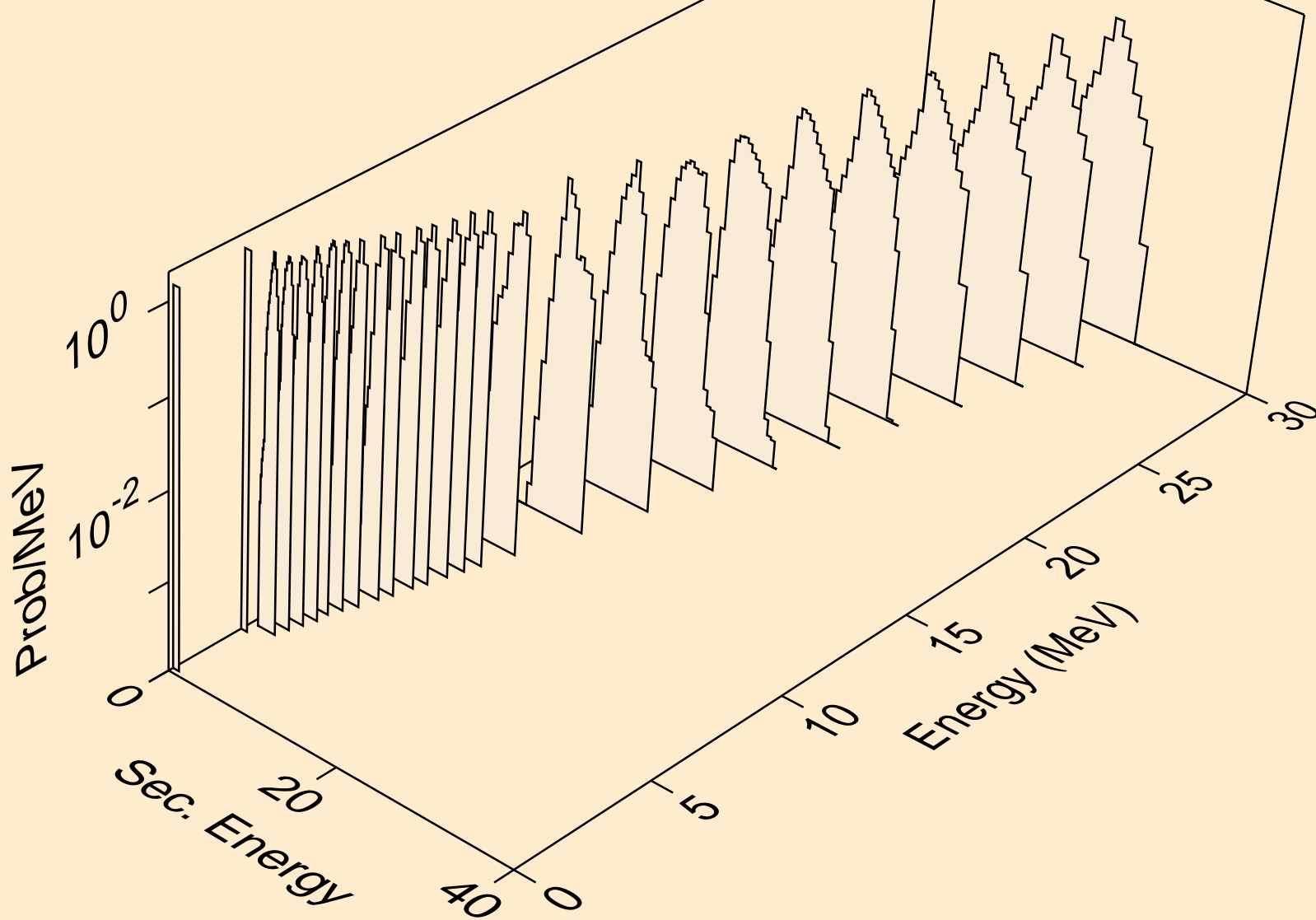

SE083 NEUTRON ACER TENDL-2019 LIBRARY; T=293.16K
alphas from (n,pa)

