

SE085 NEUTRON ACER TENDL-2019 LIBRARY; T=293.16K
Principal cross sections

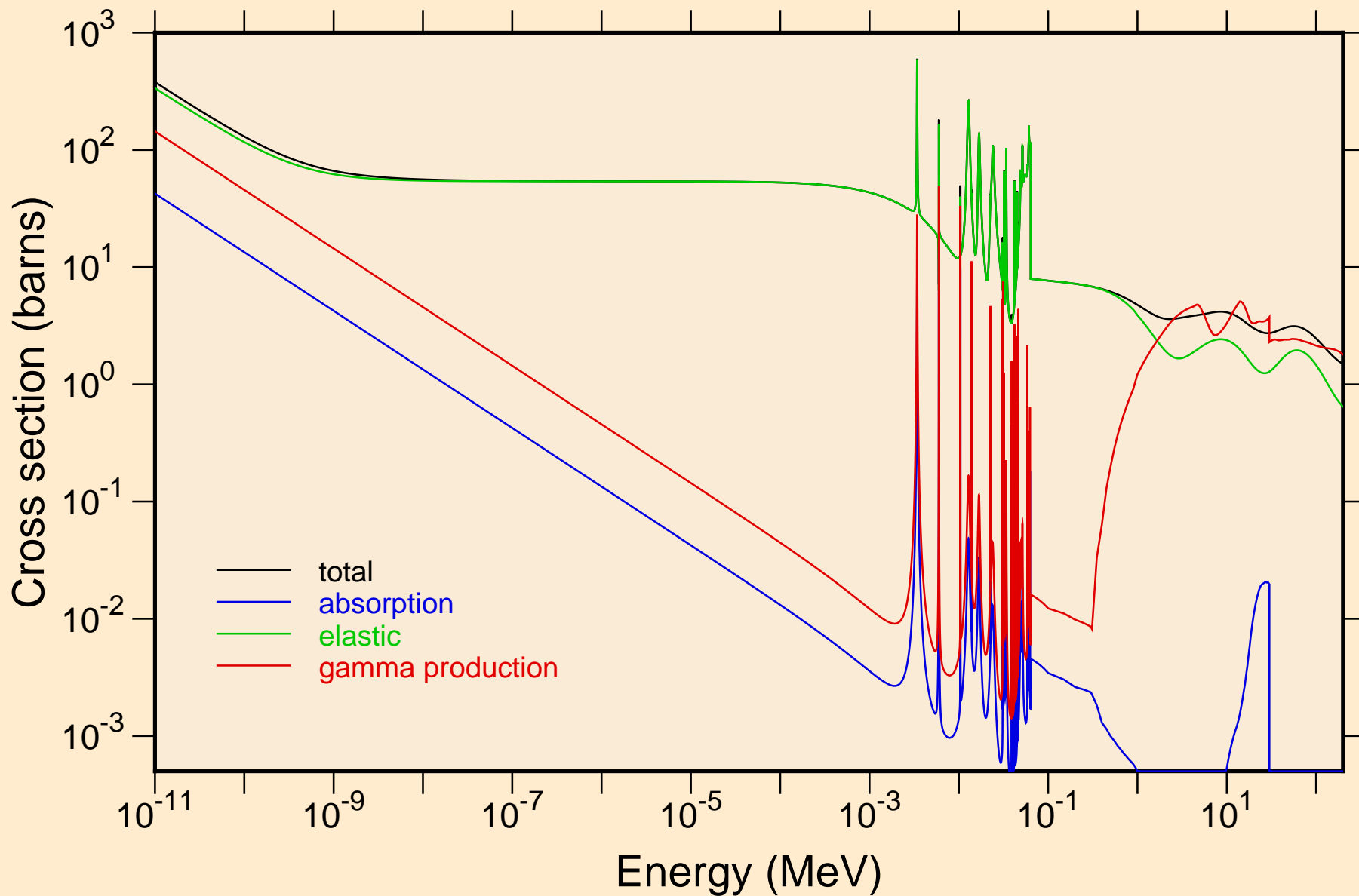

SE085 NEUTRON ACER TENDL-2019 LIBRARY; T=293.16K
resonance total cross section

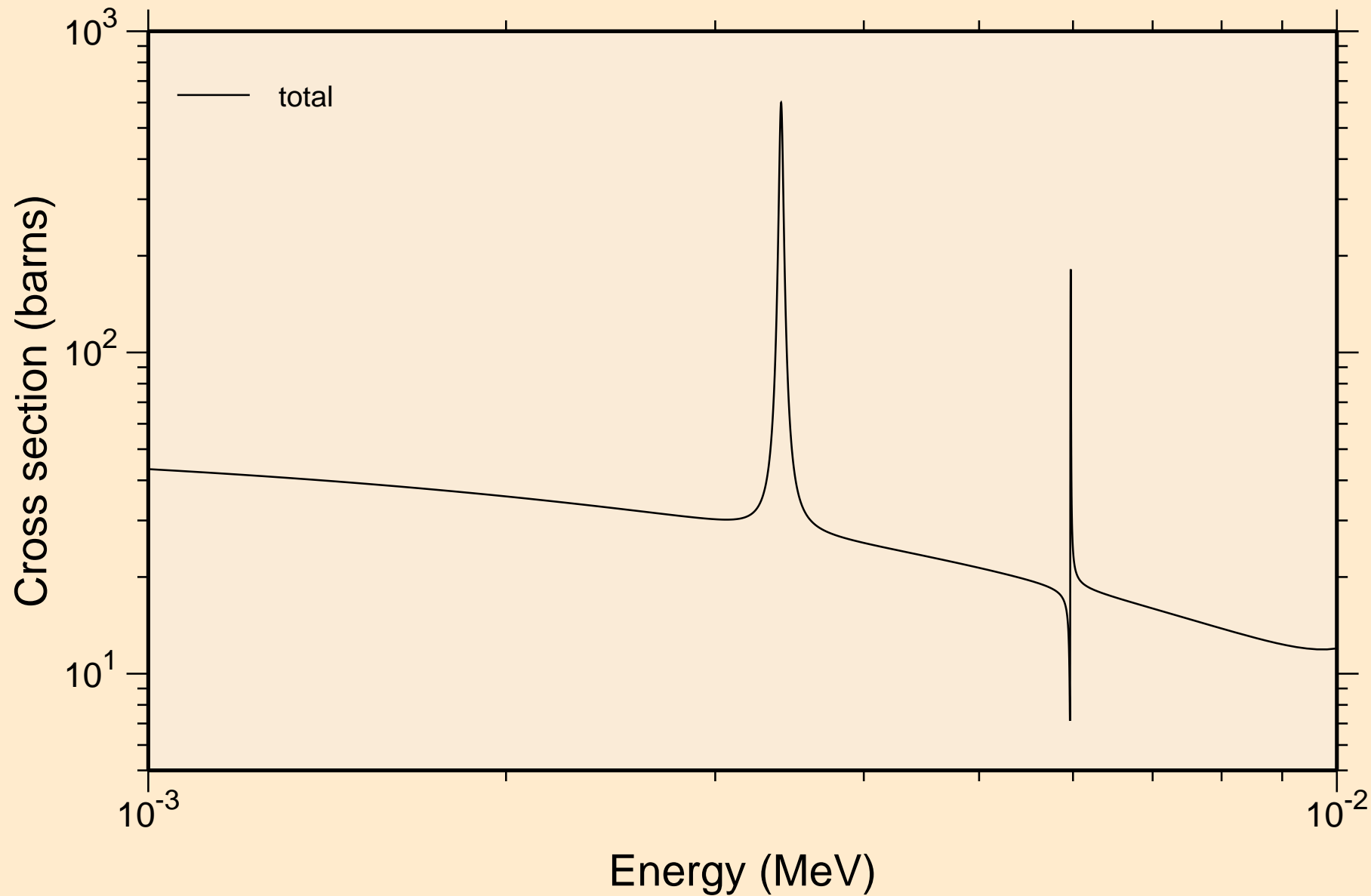

SE085 NEUTRON ACER TENDL-2019 LIBRARY; T=293.16K
resonance total cross section

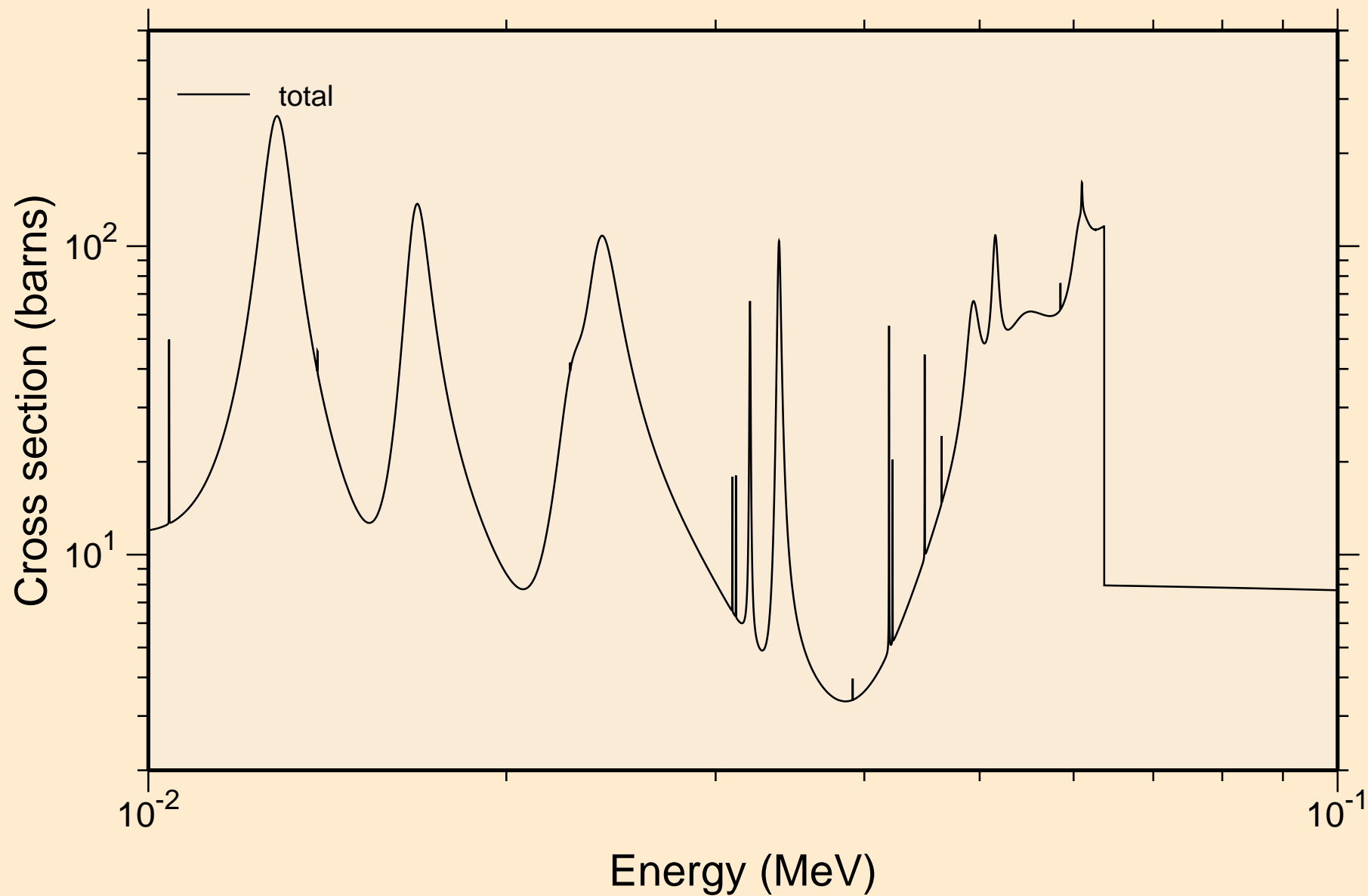

S \bar{E} 085 NEUTRON ACER TENDL-2019 LIBRARY; T=293.16K
resonance total cross section

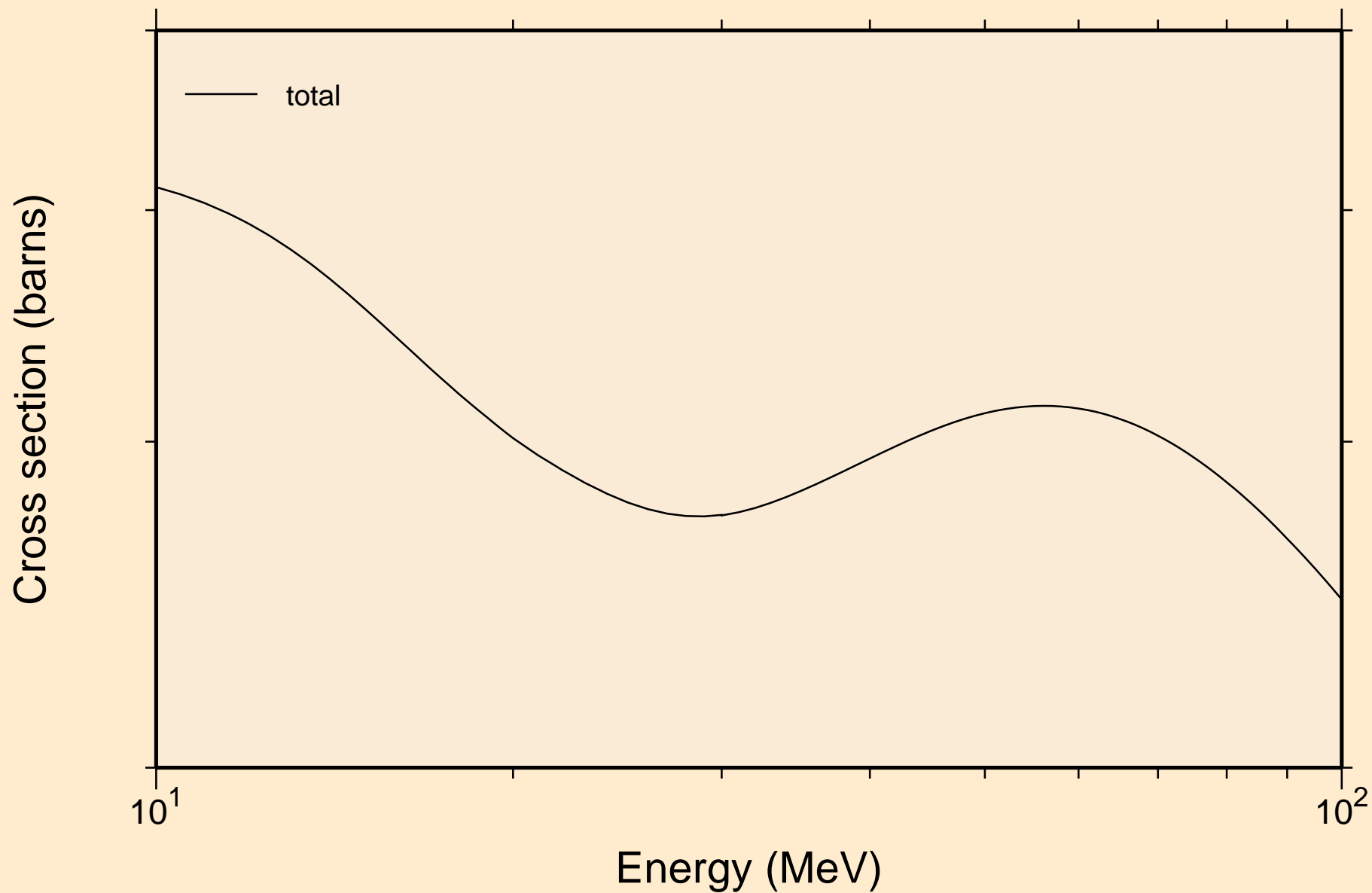

SE085 NEUTRON ACER TENDL-2019 LIBRARY; T=293.16K
resonance absorption cross sections

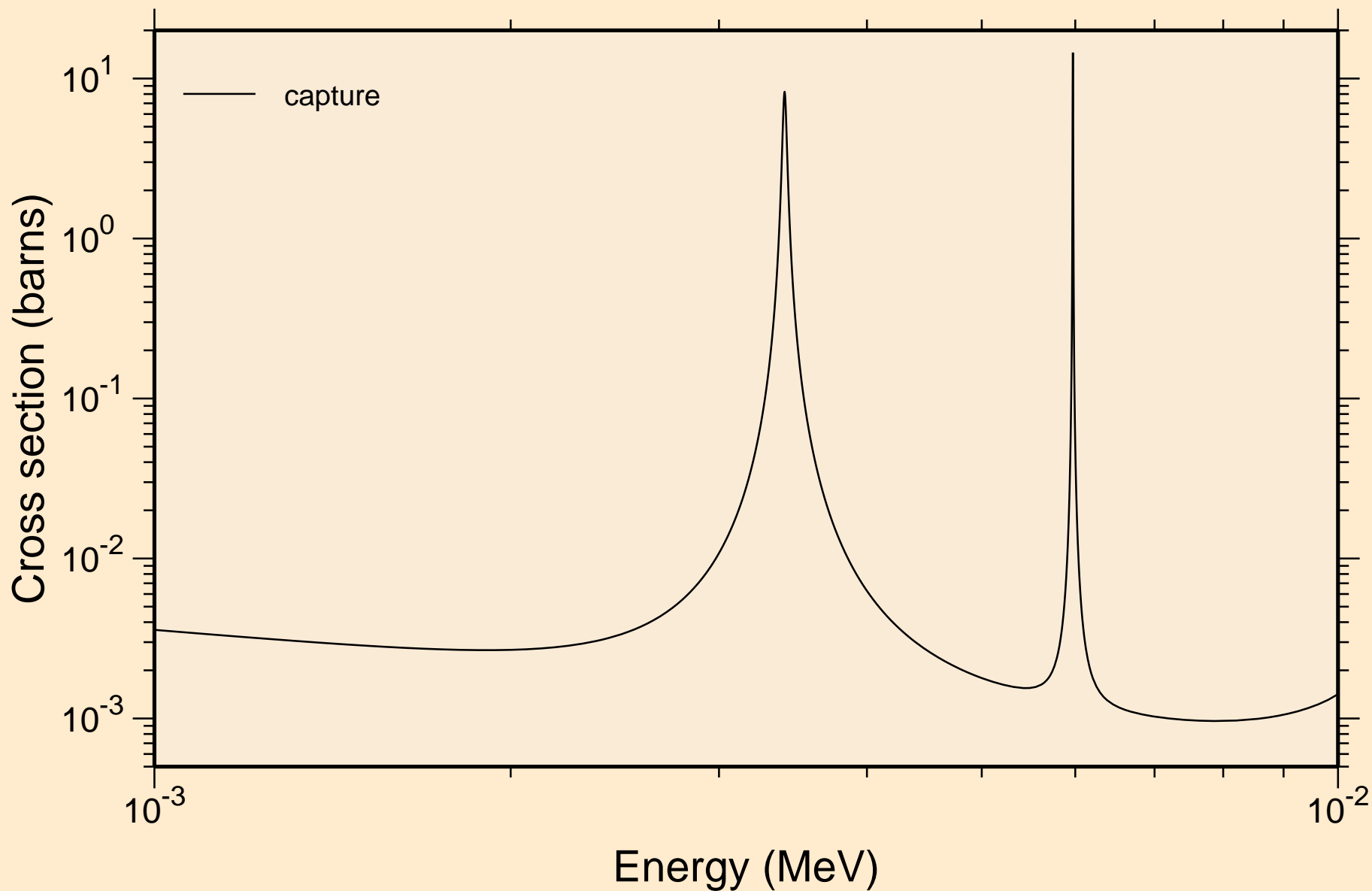

SE085 NEUTRON ACER TENDL-2019 LIBRARY; T=293.16K
resonance absorption cross sections

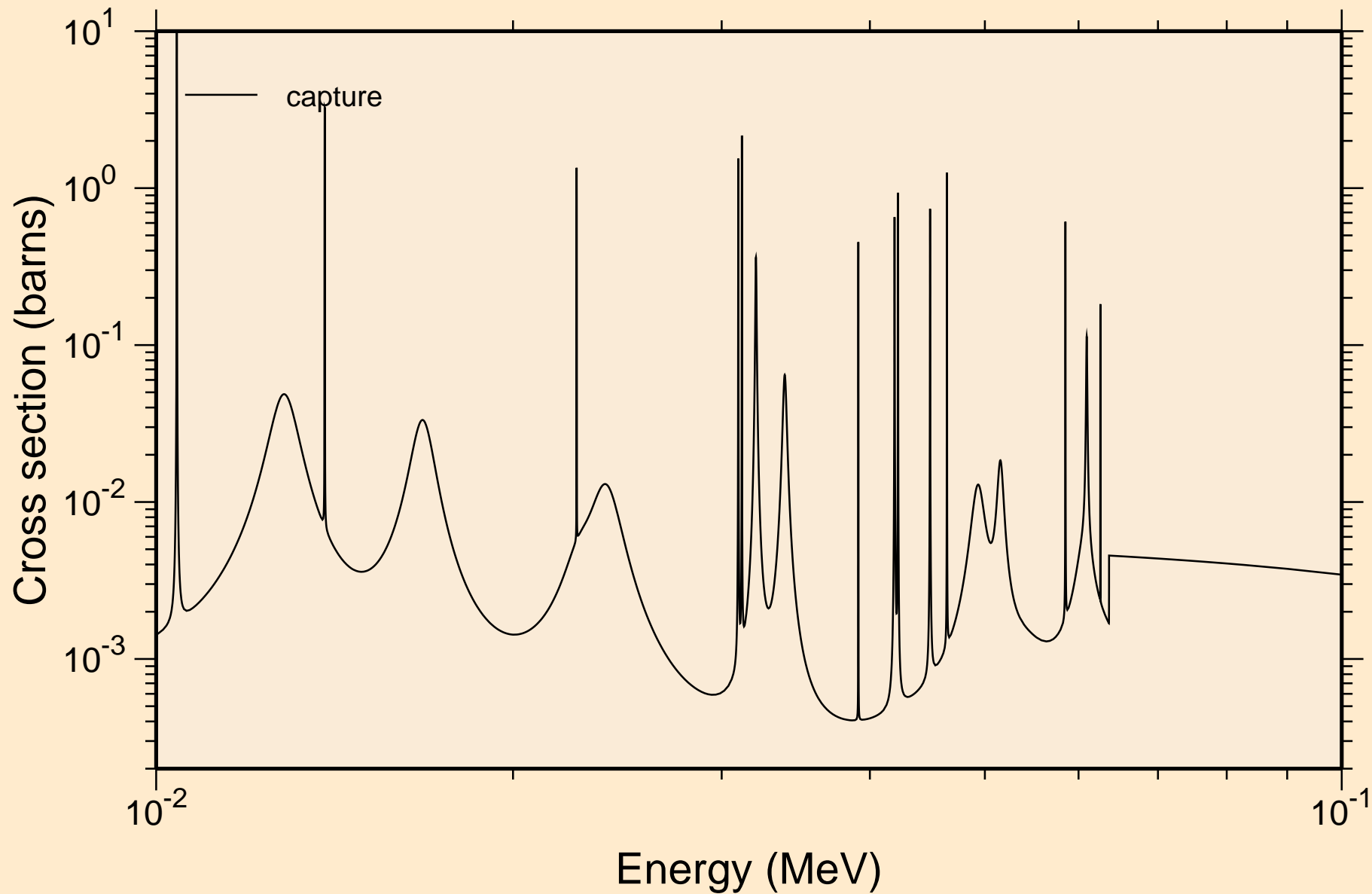

SE085 NEUTRON ACER TENDL-2019 LIBRARY; T=293.16K
resonance absorption cross sections

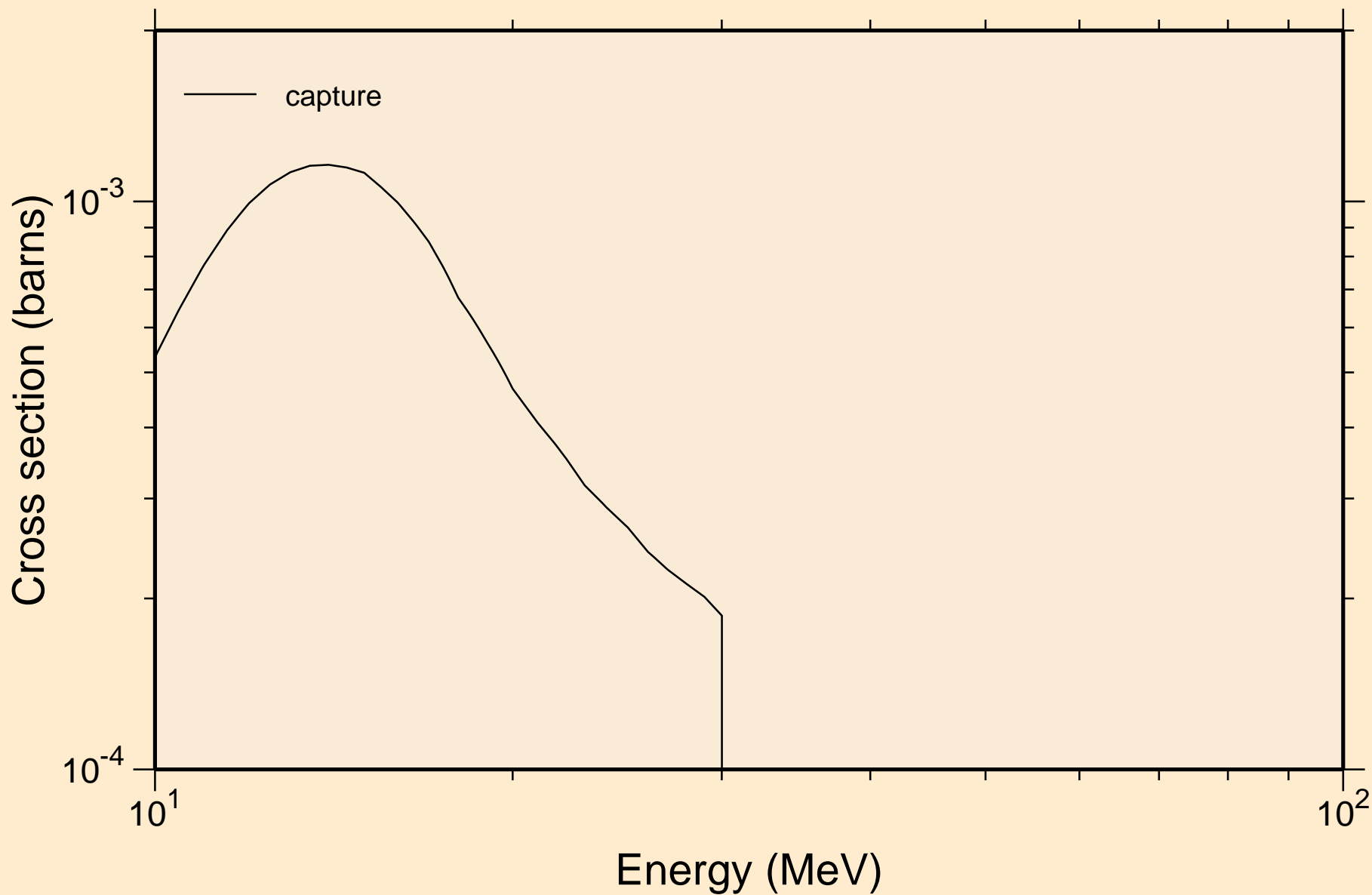

SE085 NEUTRON ACER TENDL-2019 LIBRARY; T=293.16K
Heating

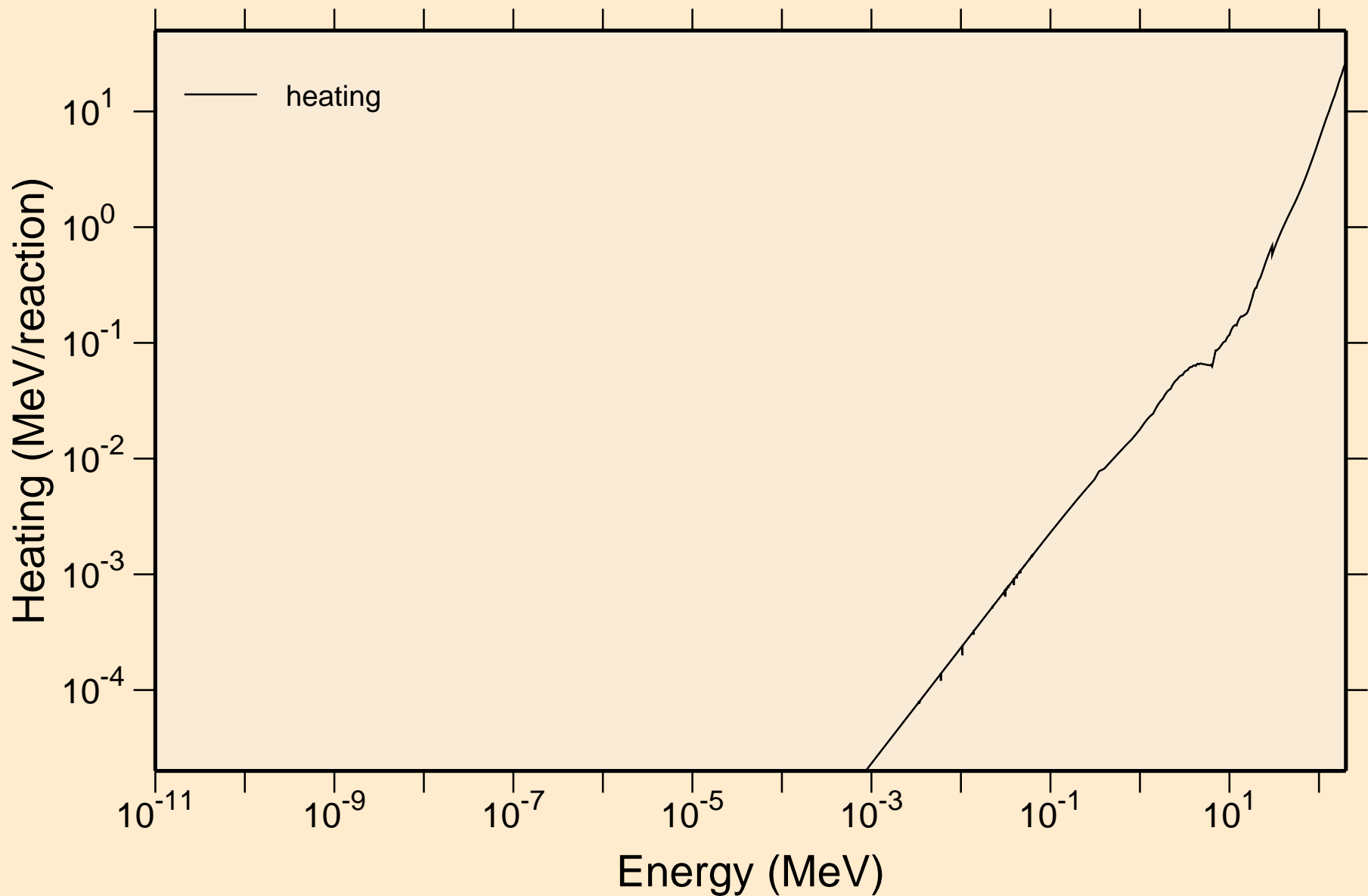

SE085 NEUTRON ACER TENDL-2019 LIBRARY; T=293.16K
Damage

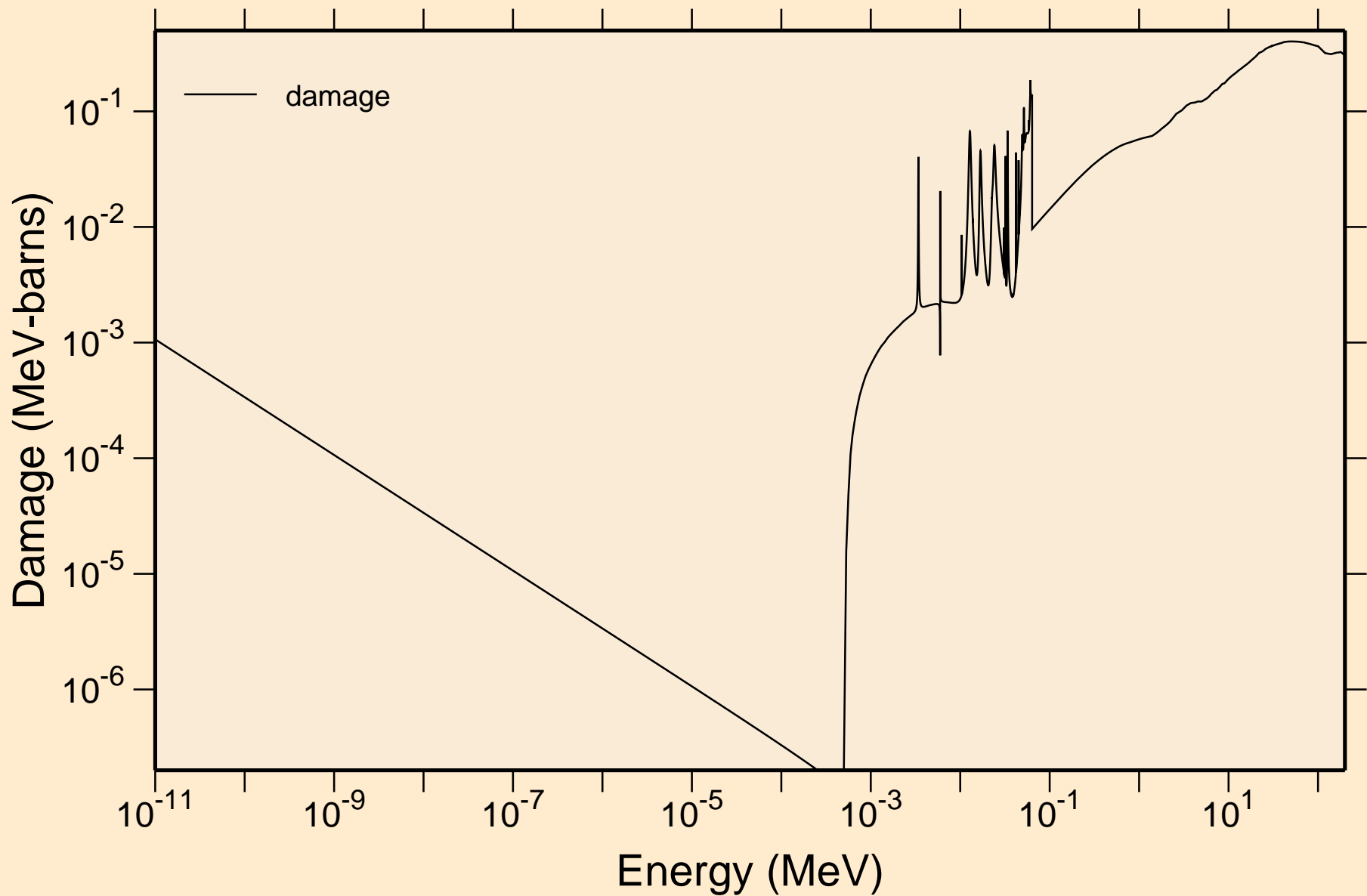

SE085 NEUTRON ACER TENDL-2019 LIBRARY; T=293.16K
Non-threshold reactions

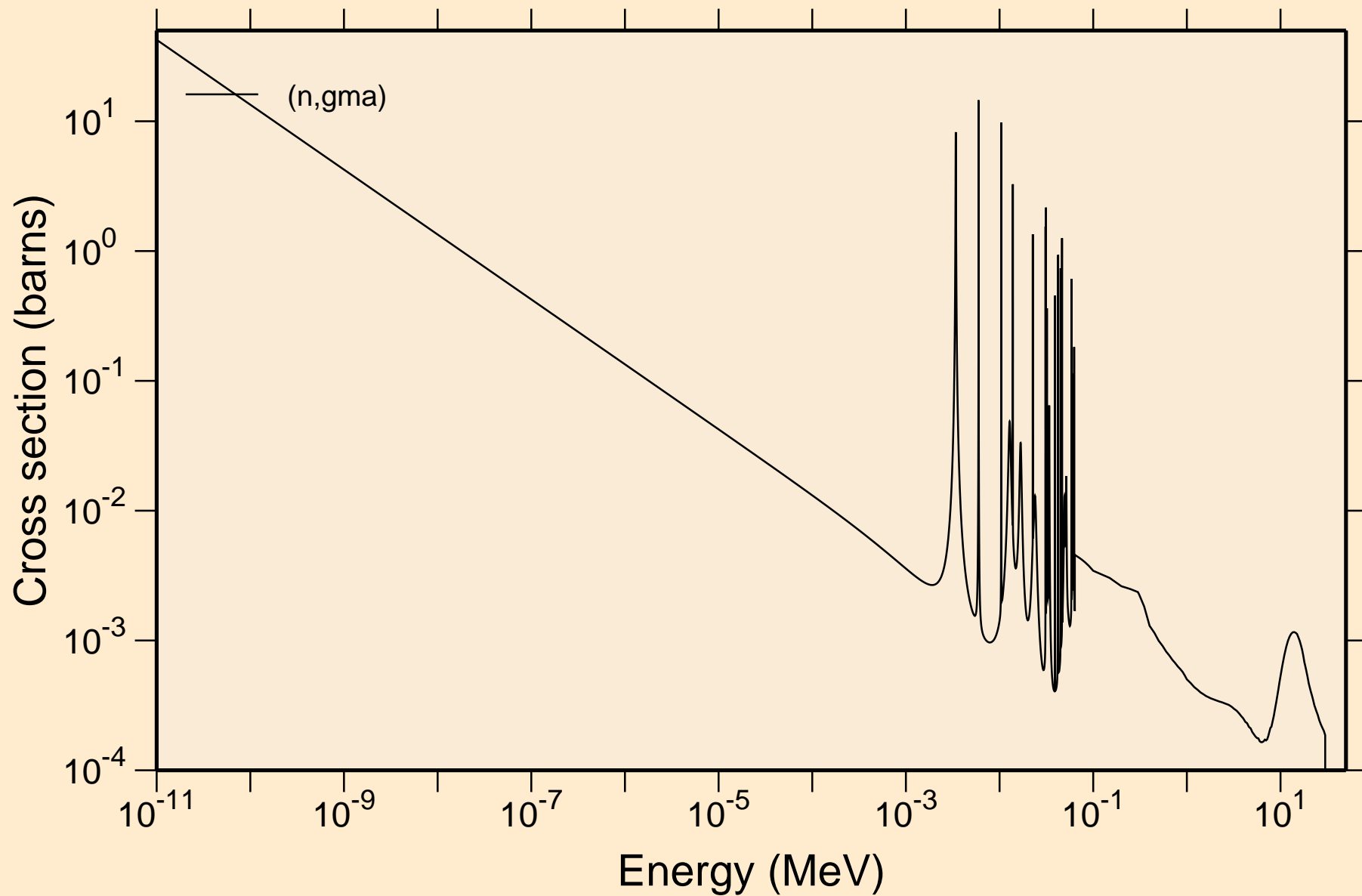

SE085 NEUTRON ACER TENDL-2019 LIBRARY; T=293.16K

Principal cross sections

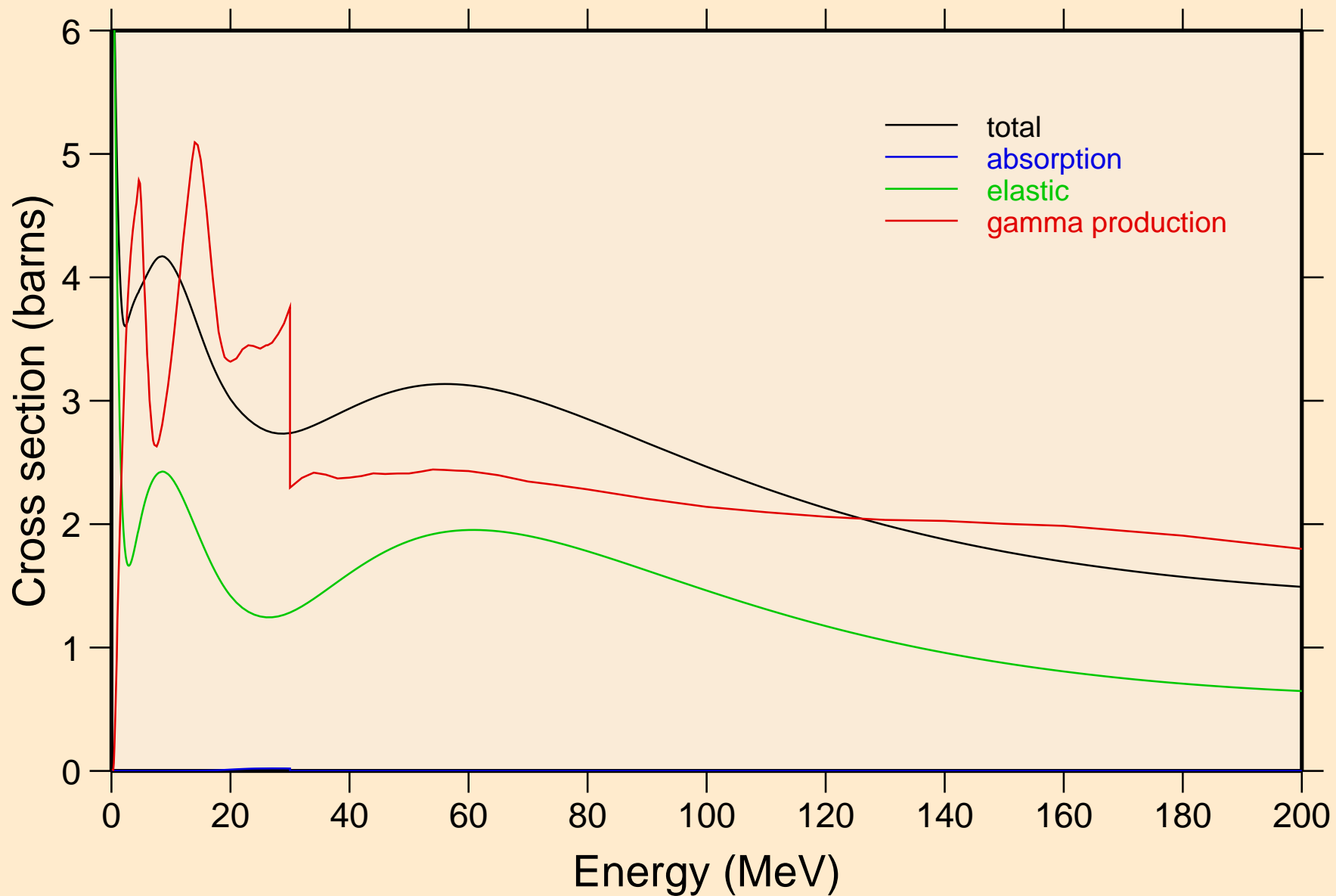

SE085 NEUTRON ACER TENDL-2019 LIBRARY; T=293.16K
Heating

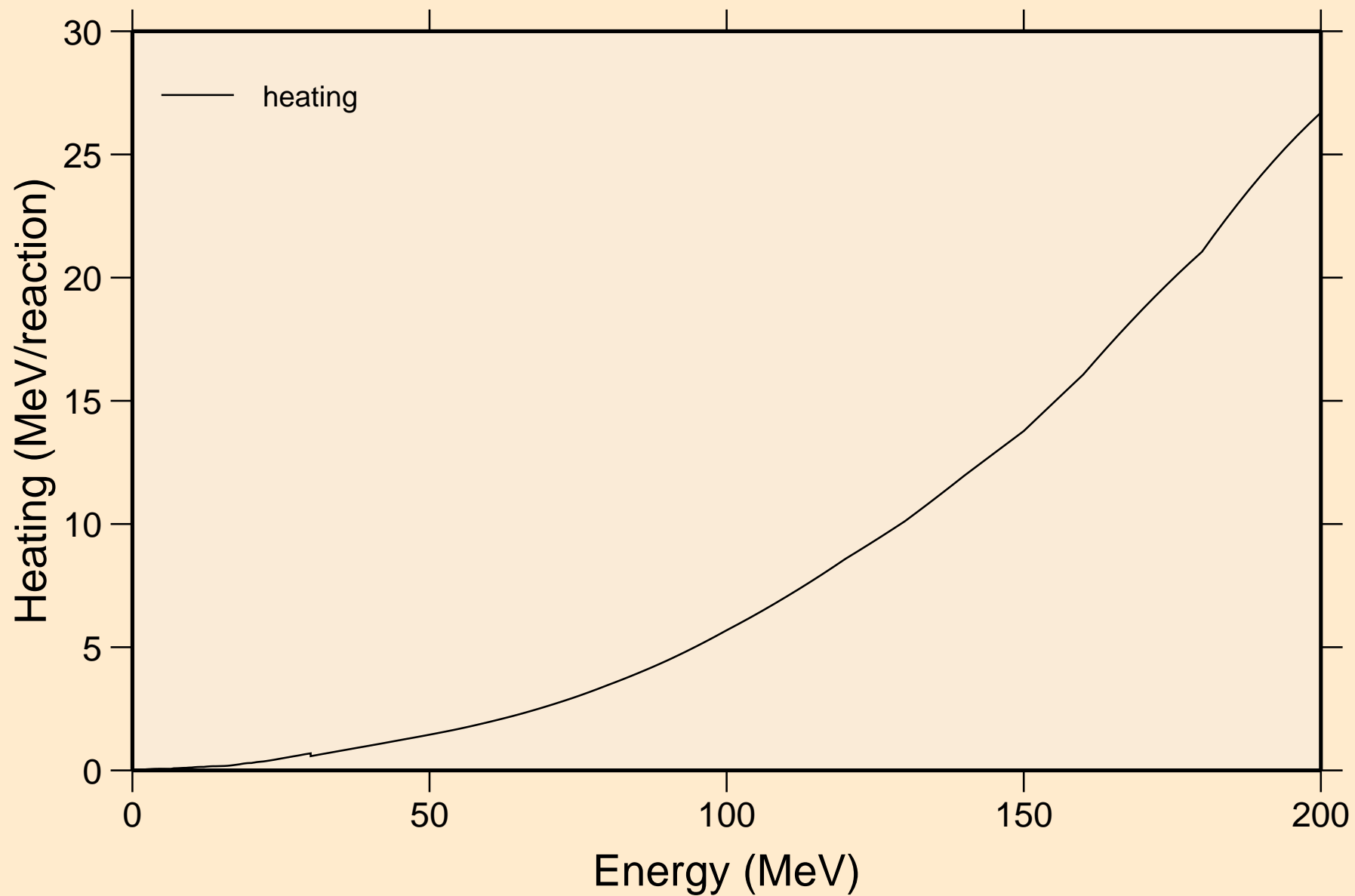

SE085 NEUTRON ACER TENDL-2019 LIBRARY; T=293.16K
Damage

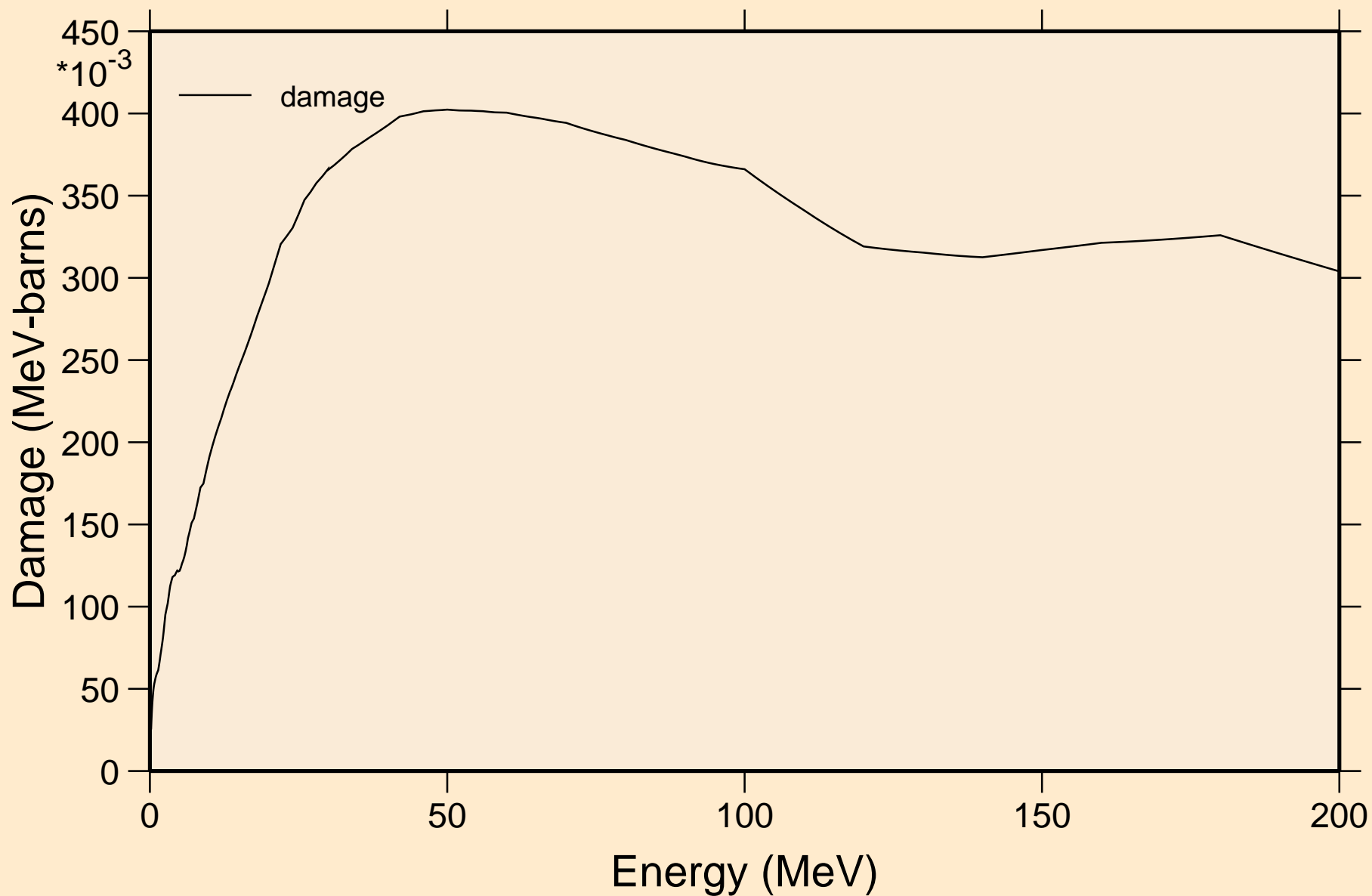

SE085 NEUTRON ACER TENDL-2019 LIBRARY; T=293.16K
Non-threshold reactions

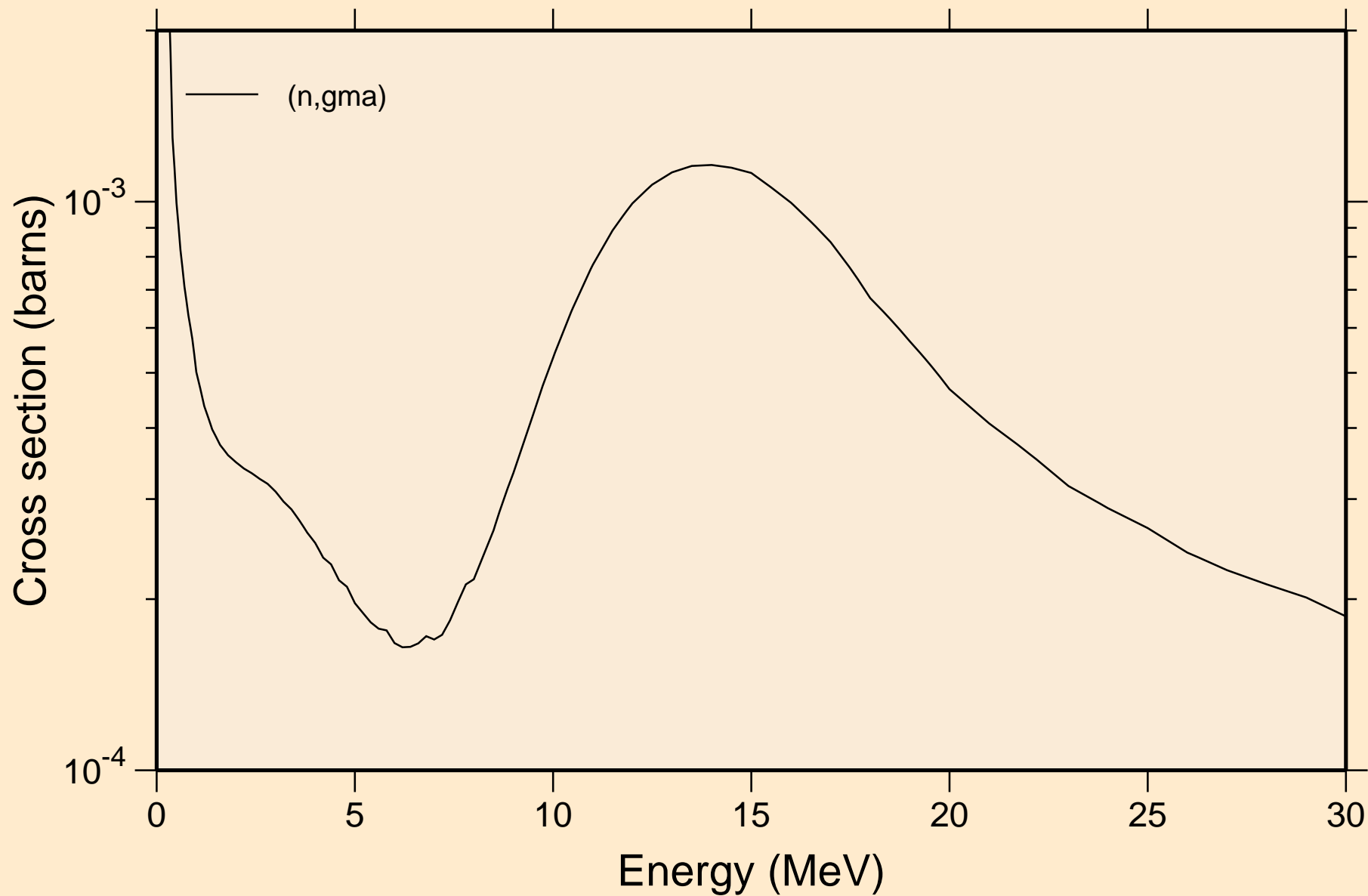

SE085 NEUTRON ACER TENDL-2019 LIBRARY; T=293.16K
Inelastic levels

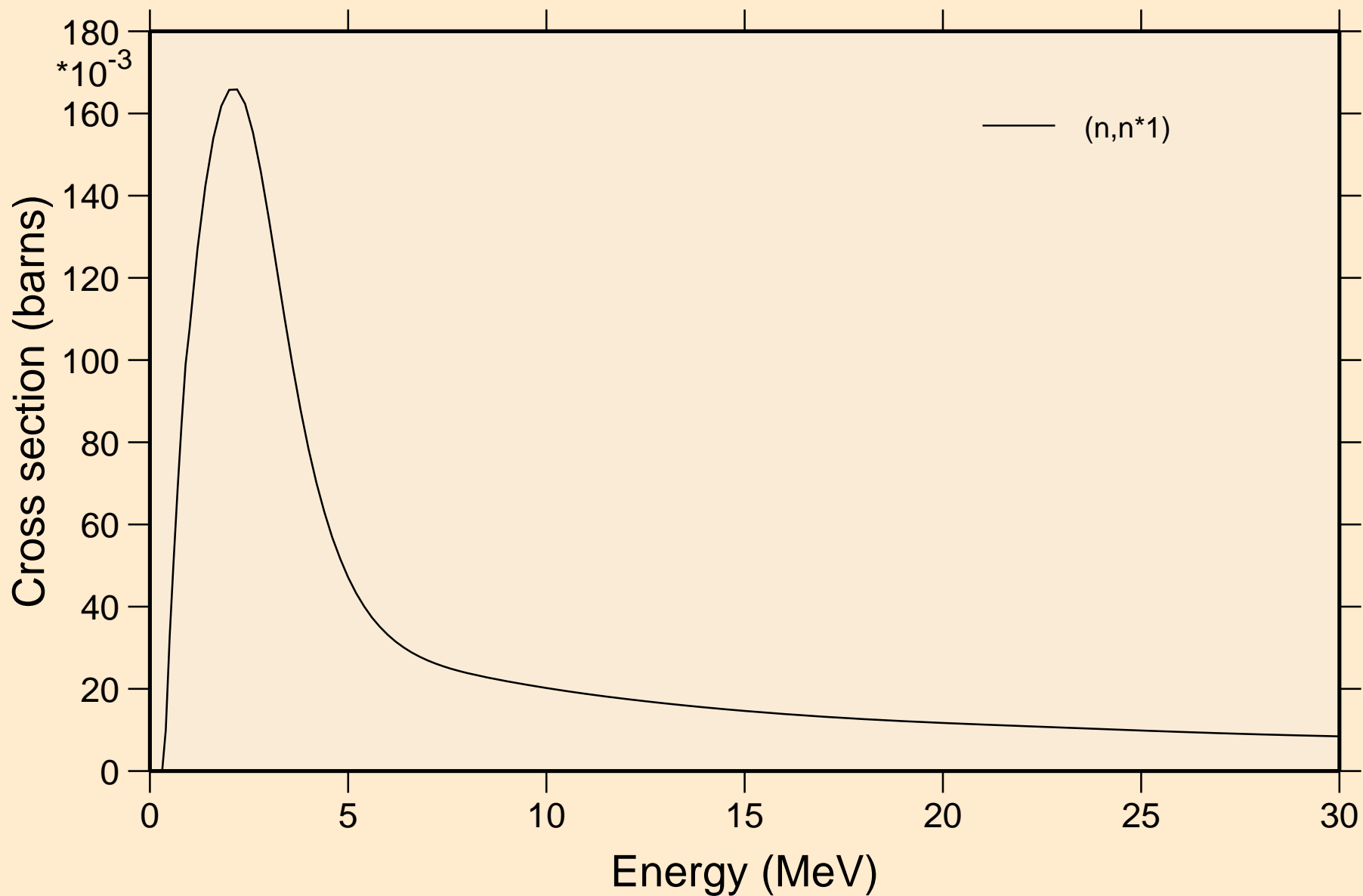

SE085 NEUTRON ACER TENDL-2019 LIBRARY; T=293.16K
Threshold reactions

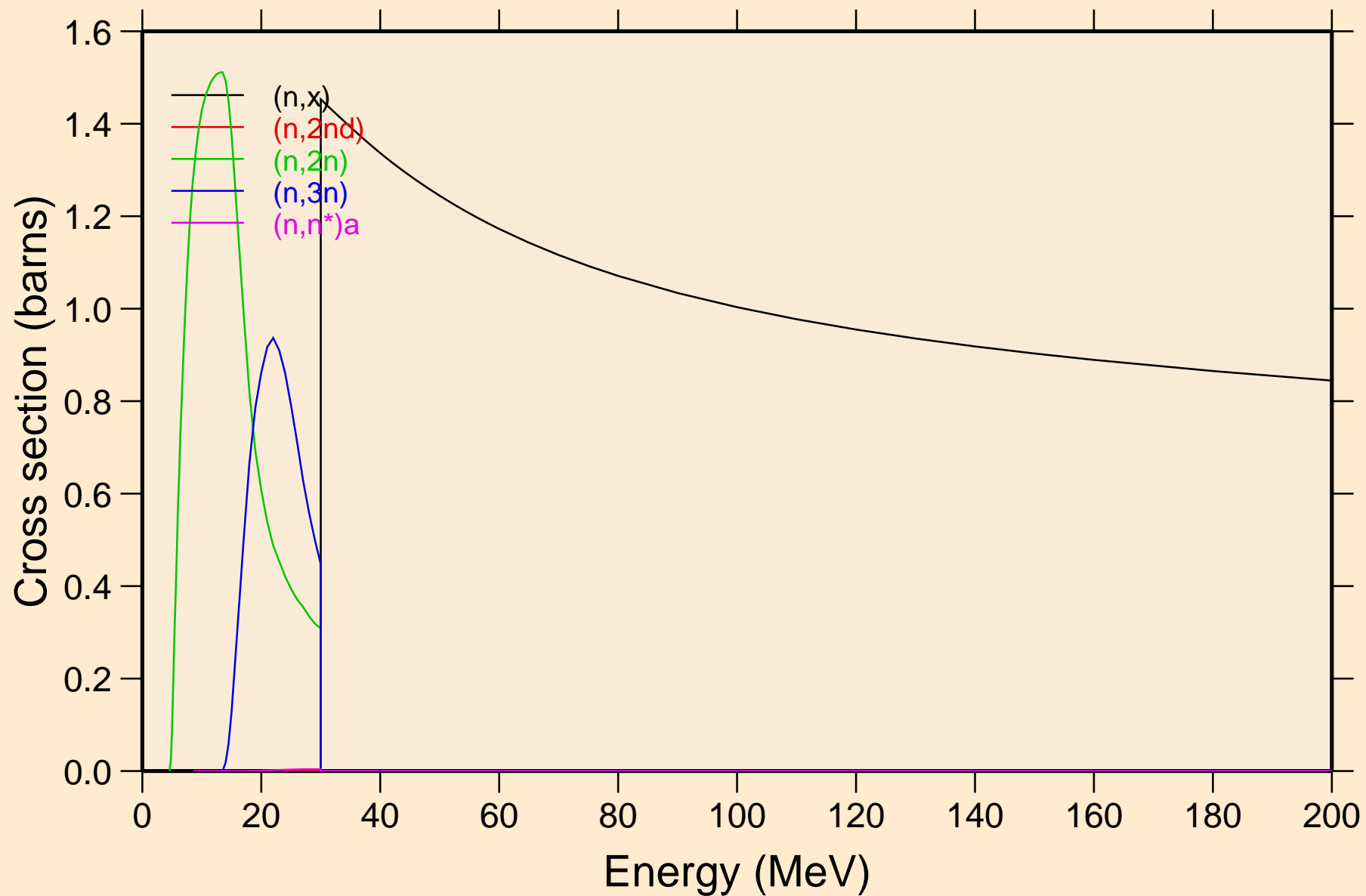

SE085 NEUTRON ACER TENDL-2019 LIBRARY; T=293.16K
Threshold reactions

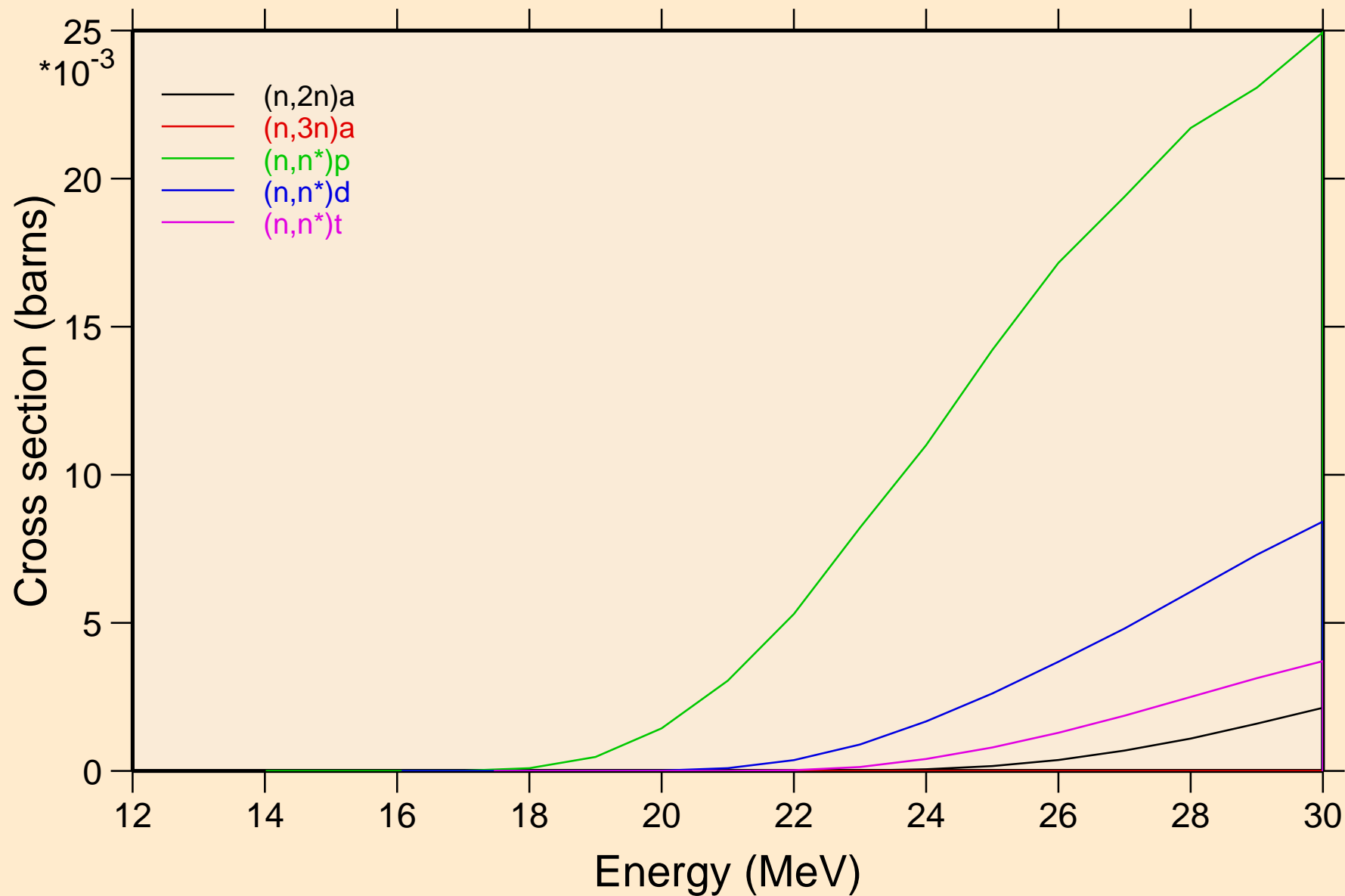

SE085 NEUTRON ACER TENDL-2019 LIBRARY; T=293.16K
Threshold reactions

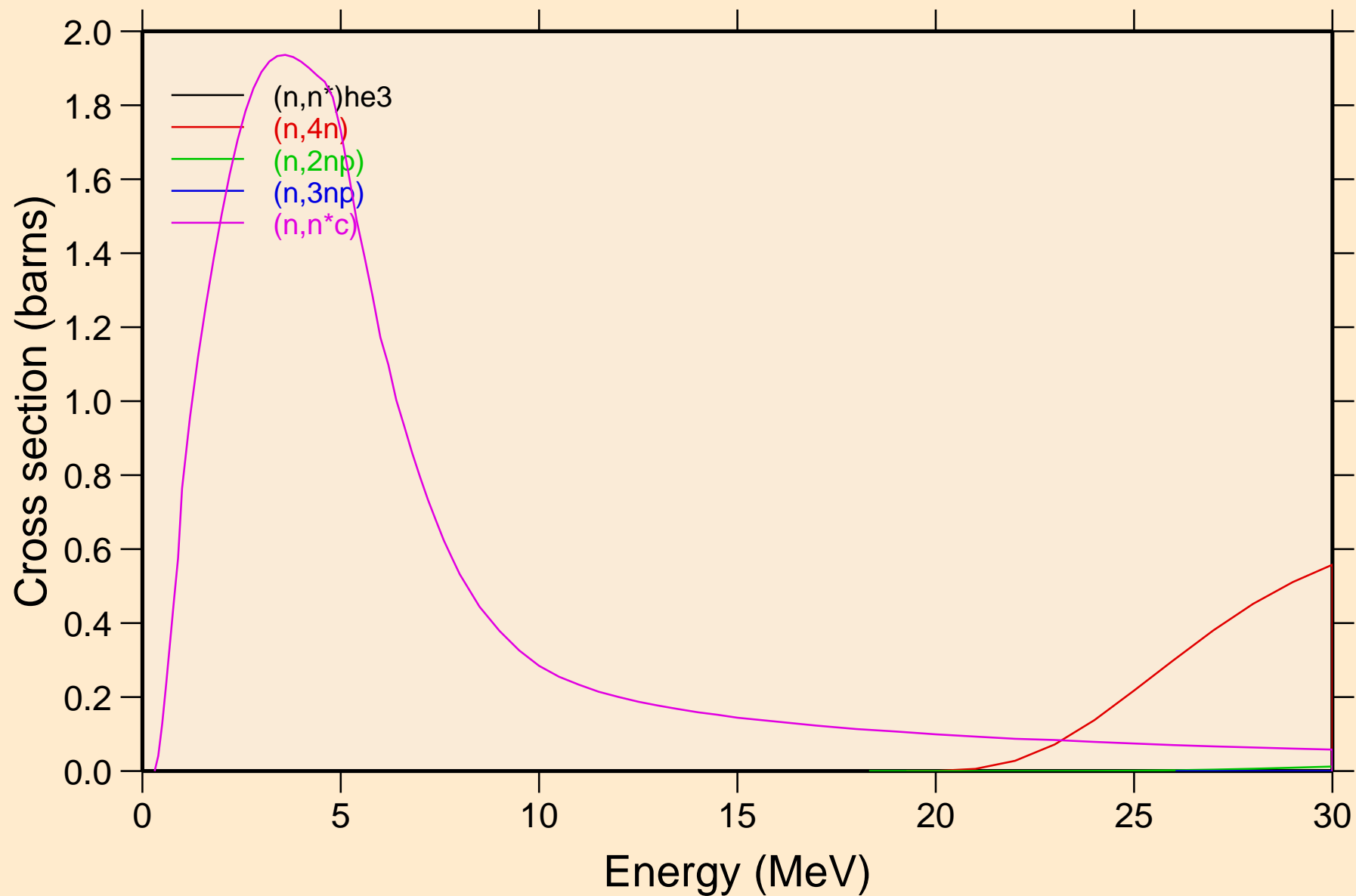

SE085 NEUTRON ACER TENDL-2019 LIBRARY; T=293.16K
Threshold reactions

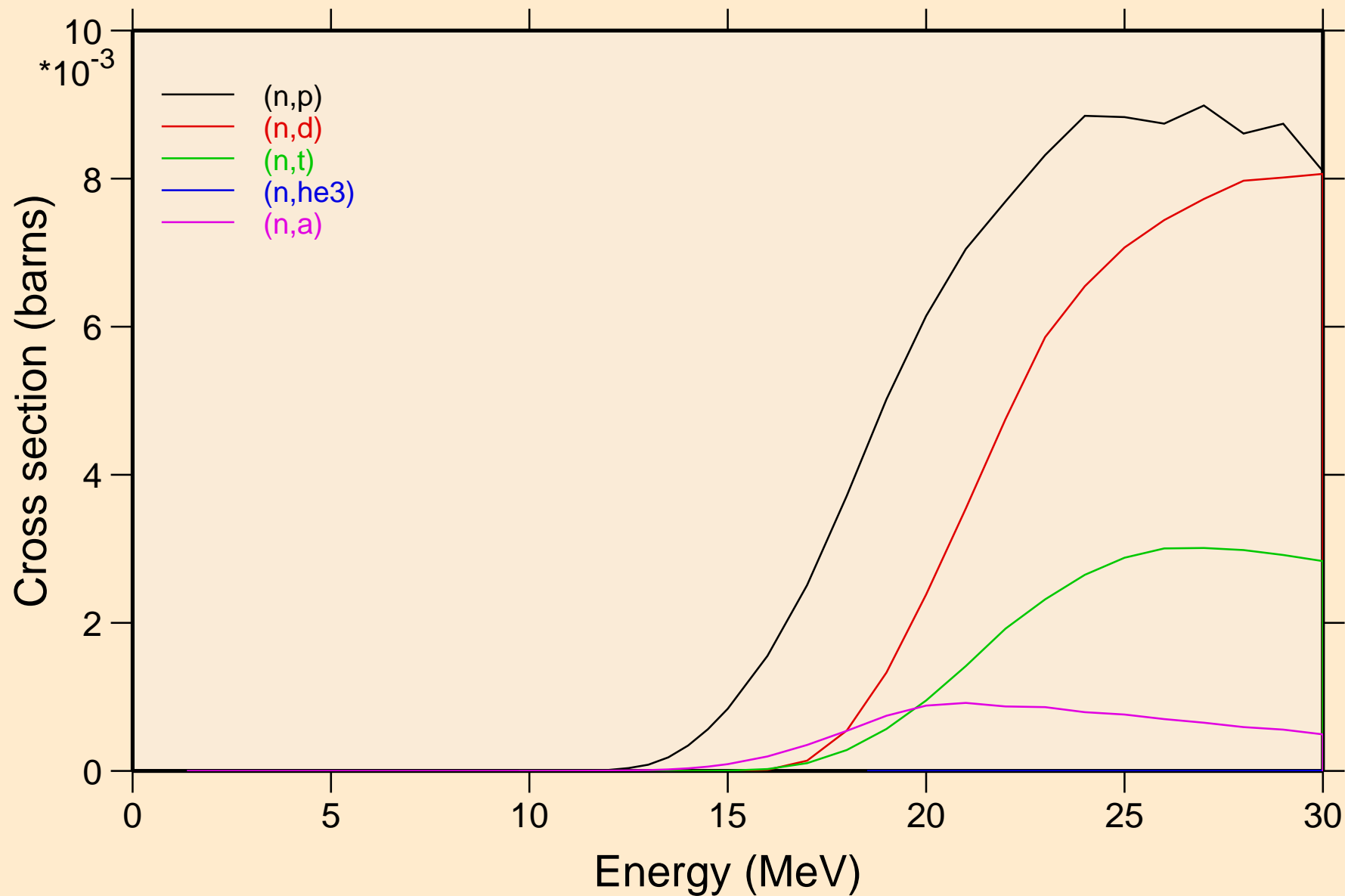

SE085 NEUTRON ACER TENDL-2019 LIBRARY; T=293.16K
Threshold reactions

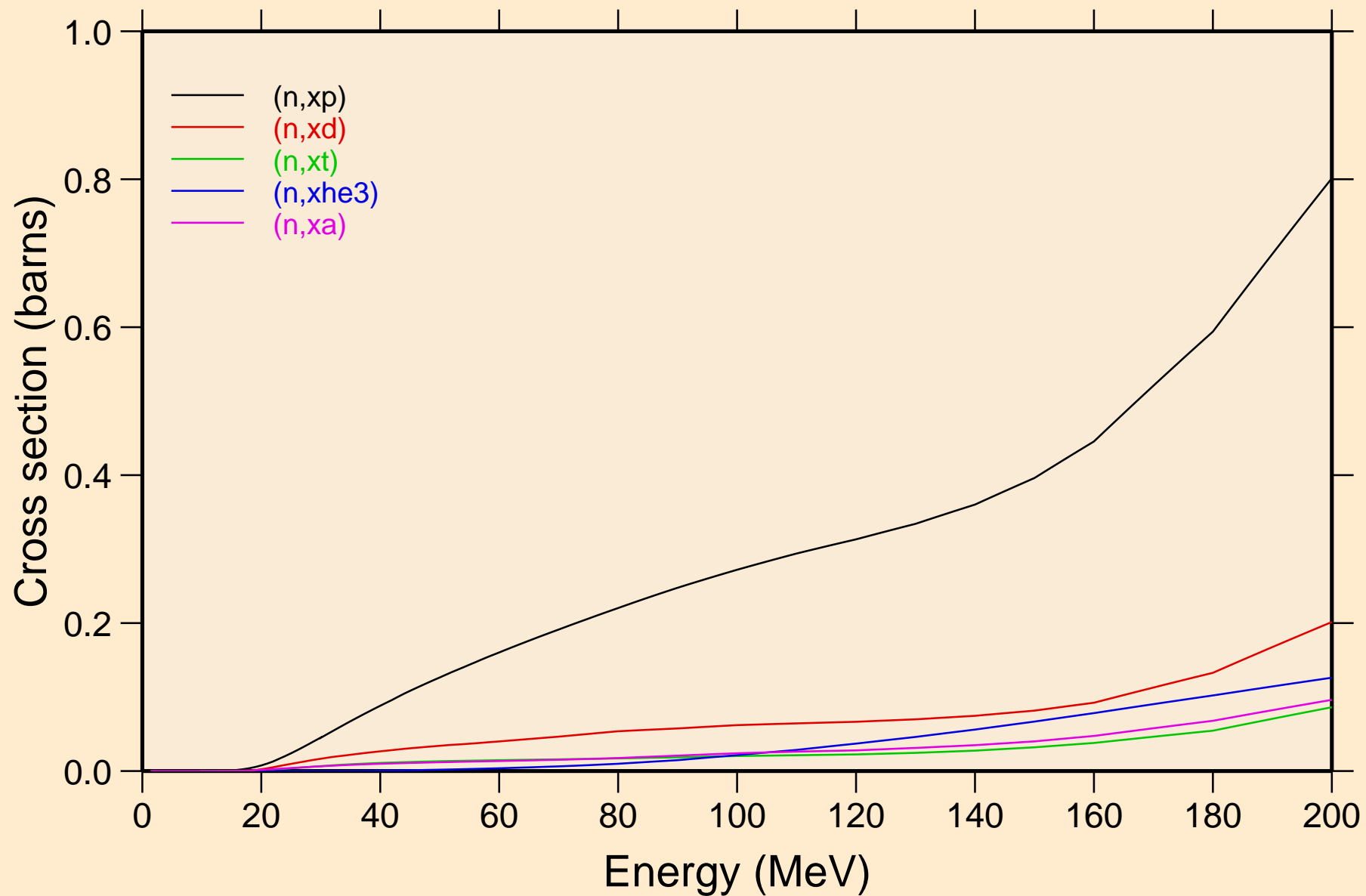

SE085 NEUTRON ACER TENDL-2019 LIBRARY; T=293.16K
angular distribution for elastic

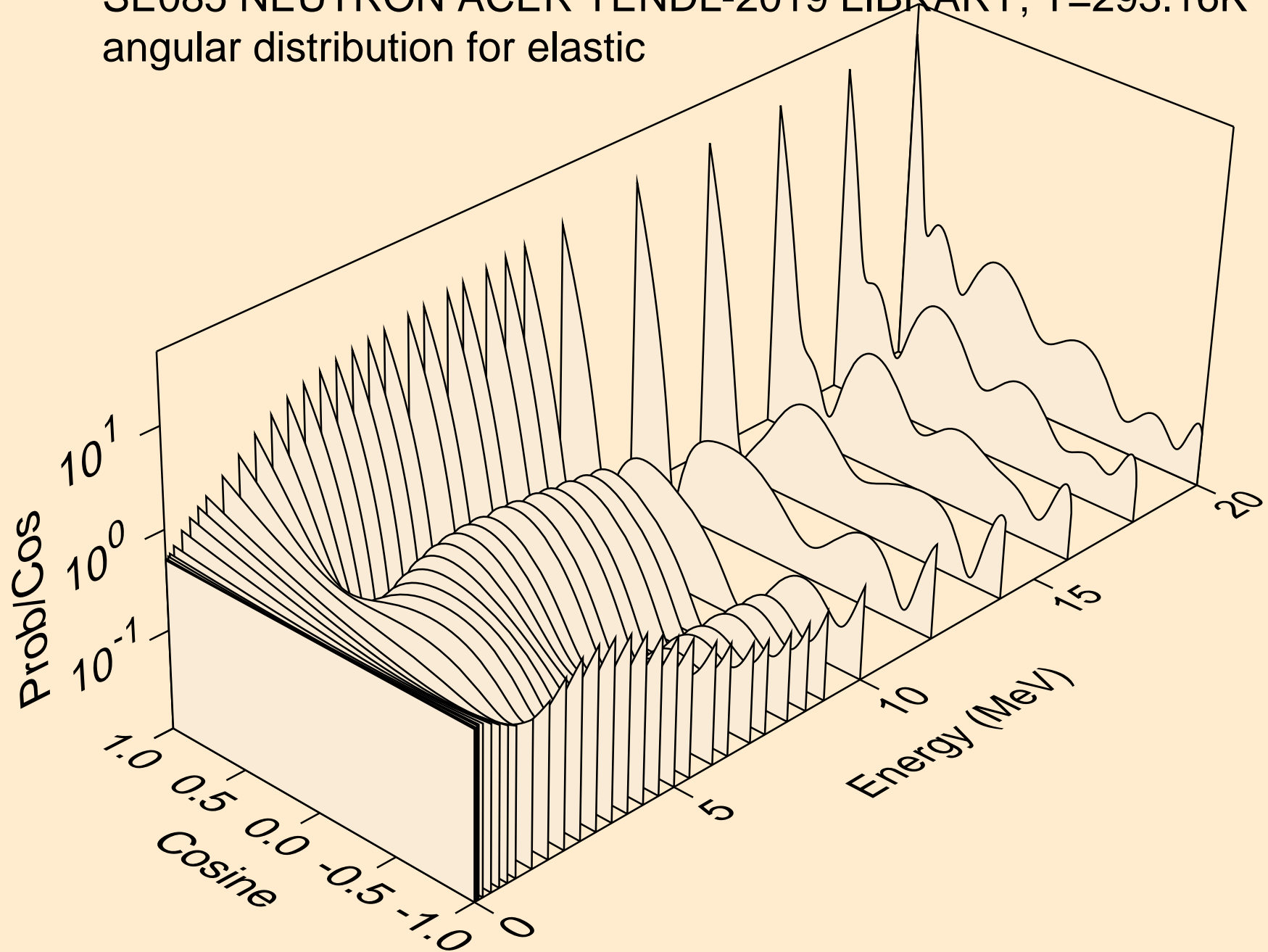

SE085 NEUTRON ACER TENDL-2019 LIBRARY; T=293.16K
angular distribution for elastic

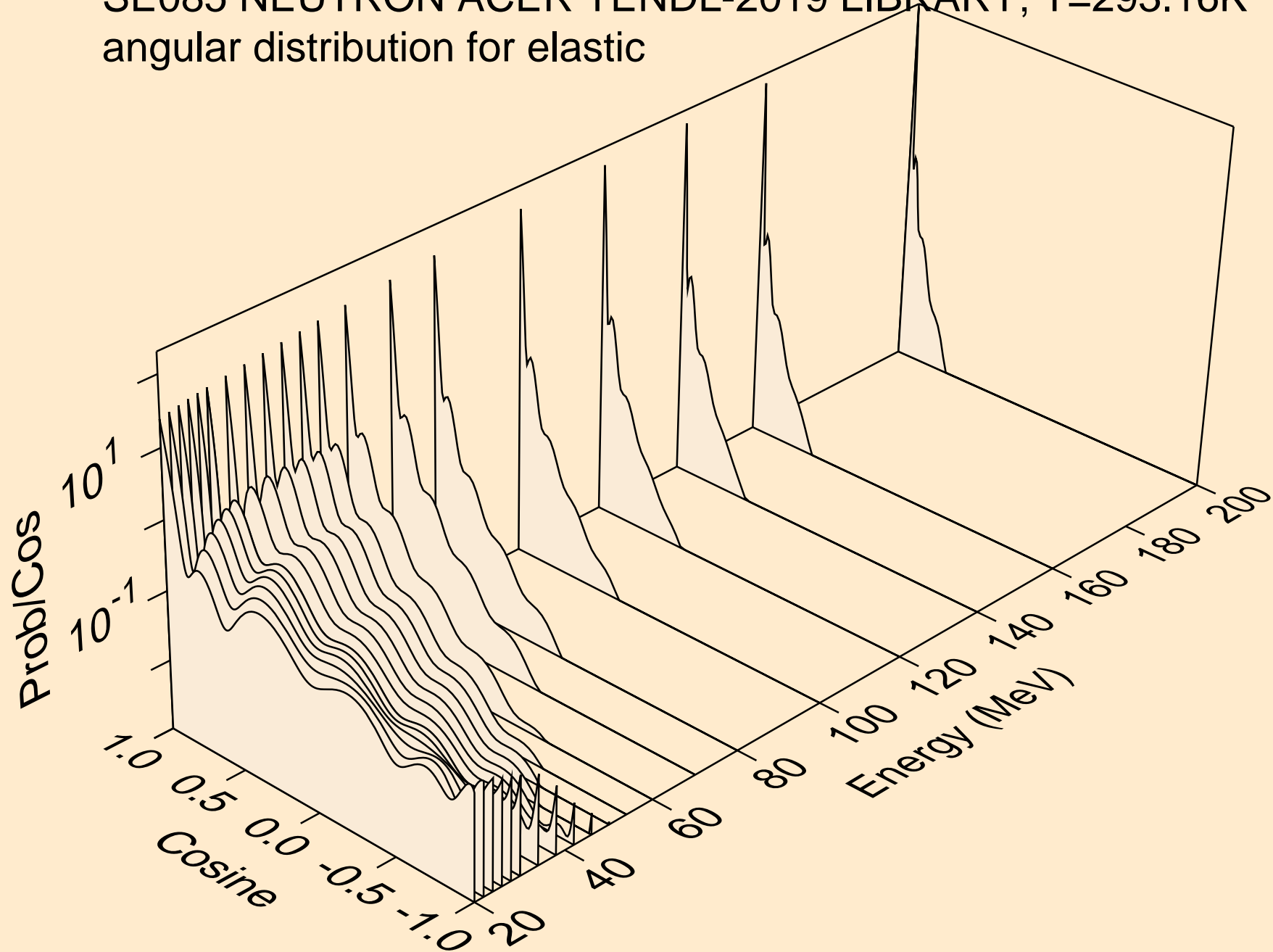

SE085 NEUTRON ACER TENDL-2019 LIBRARY; T=293.16K
angular distribution for (n,n*1)

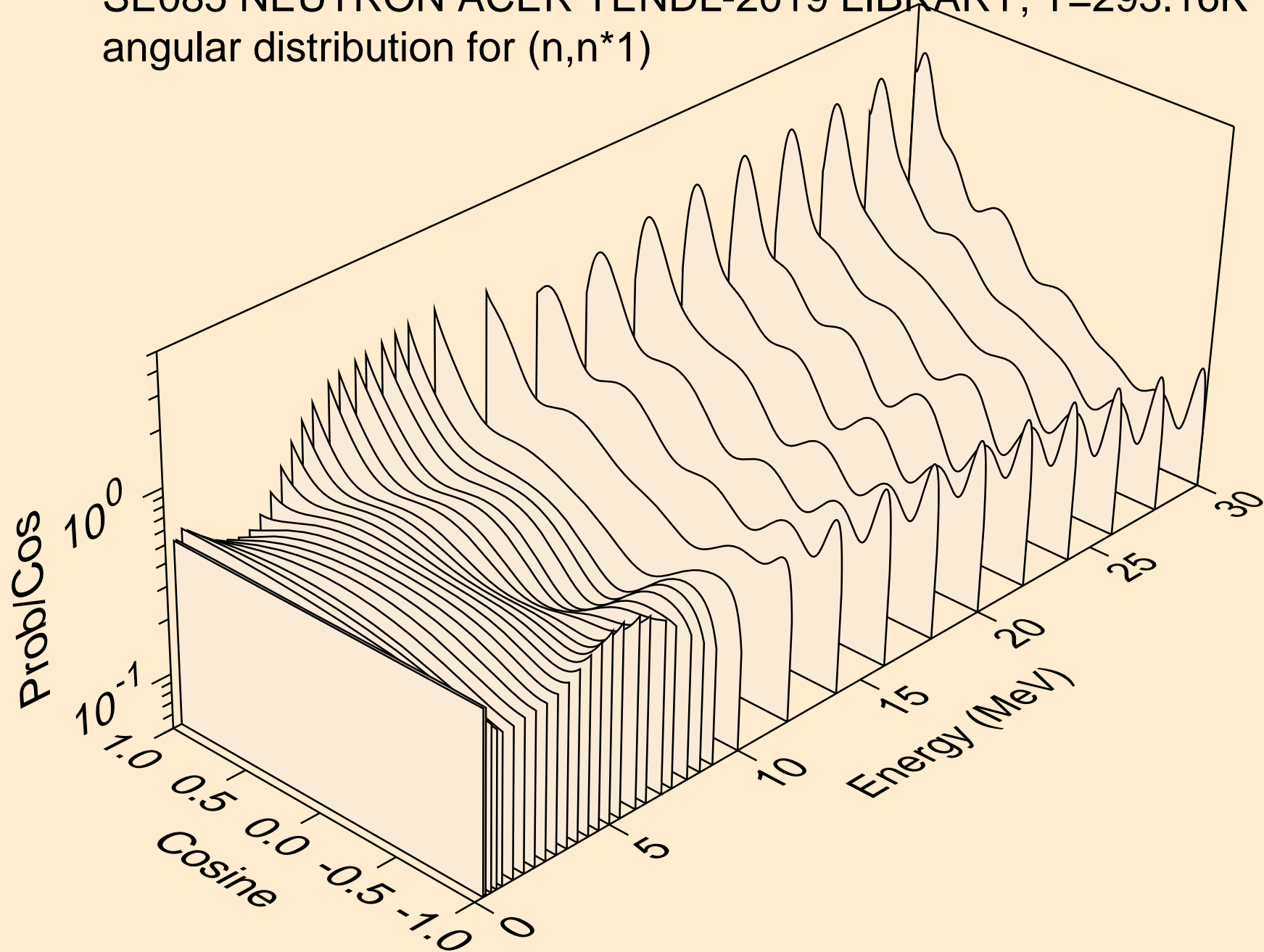

SE085 NEUTRON ACER TENDL-2019 LIBRARY; T=293.16K
Neutron emission for (n,x)

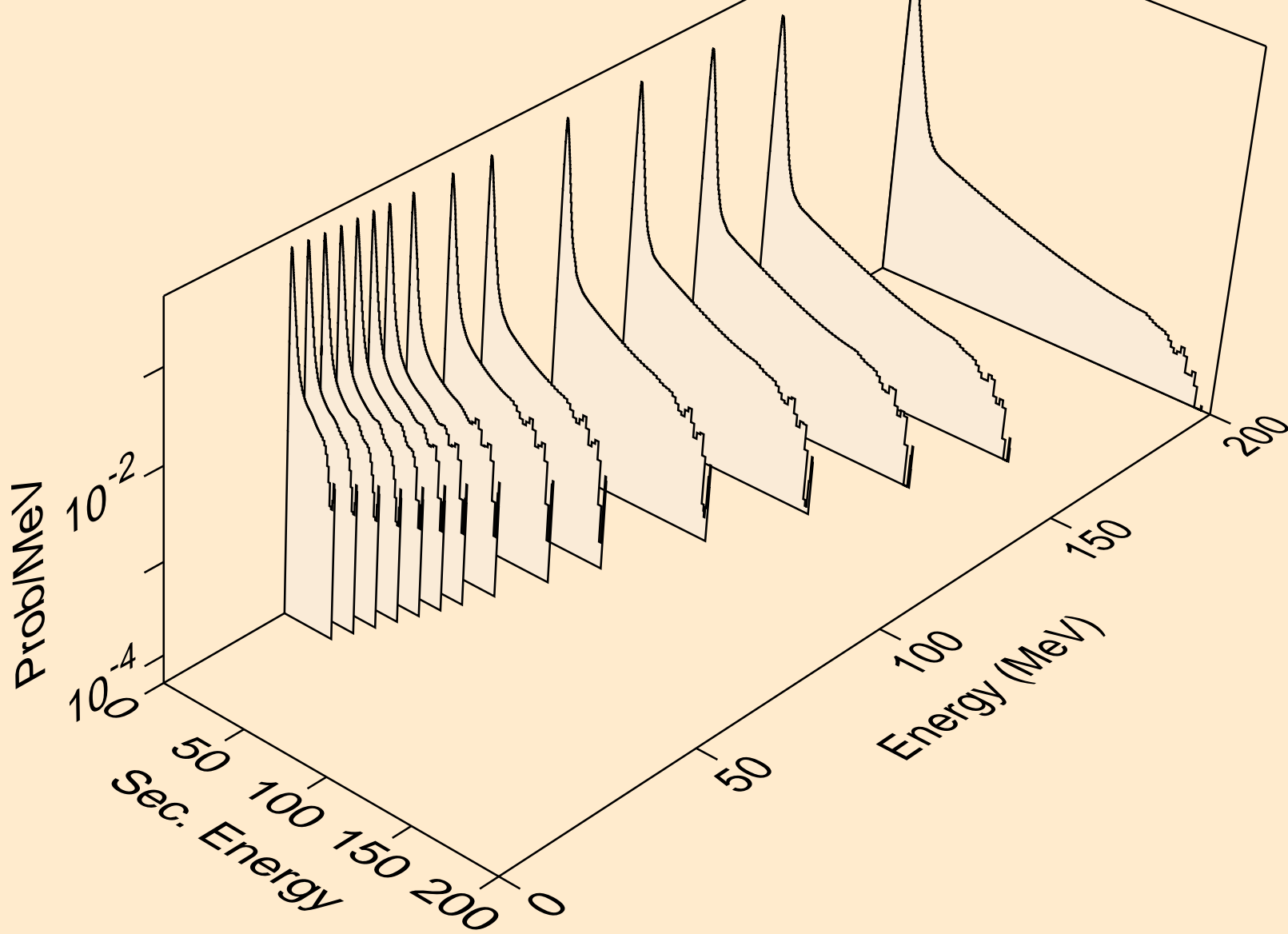

SE085 NEUTRON ACER TENDL-2019 LIBRARY; T=293.16K
Neutron emission for (n,2nd)

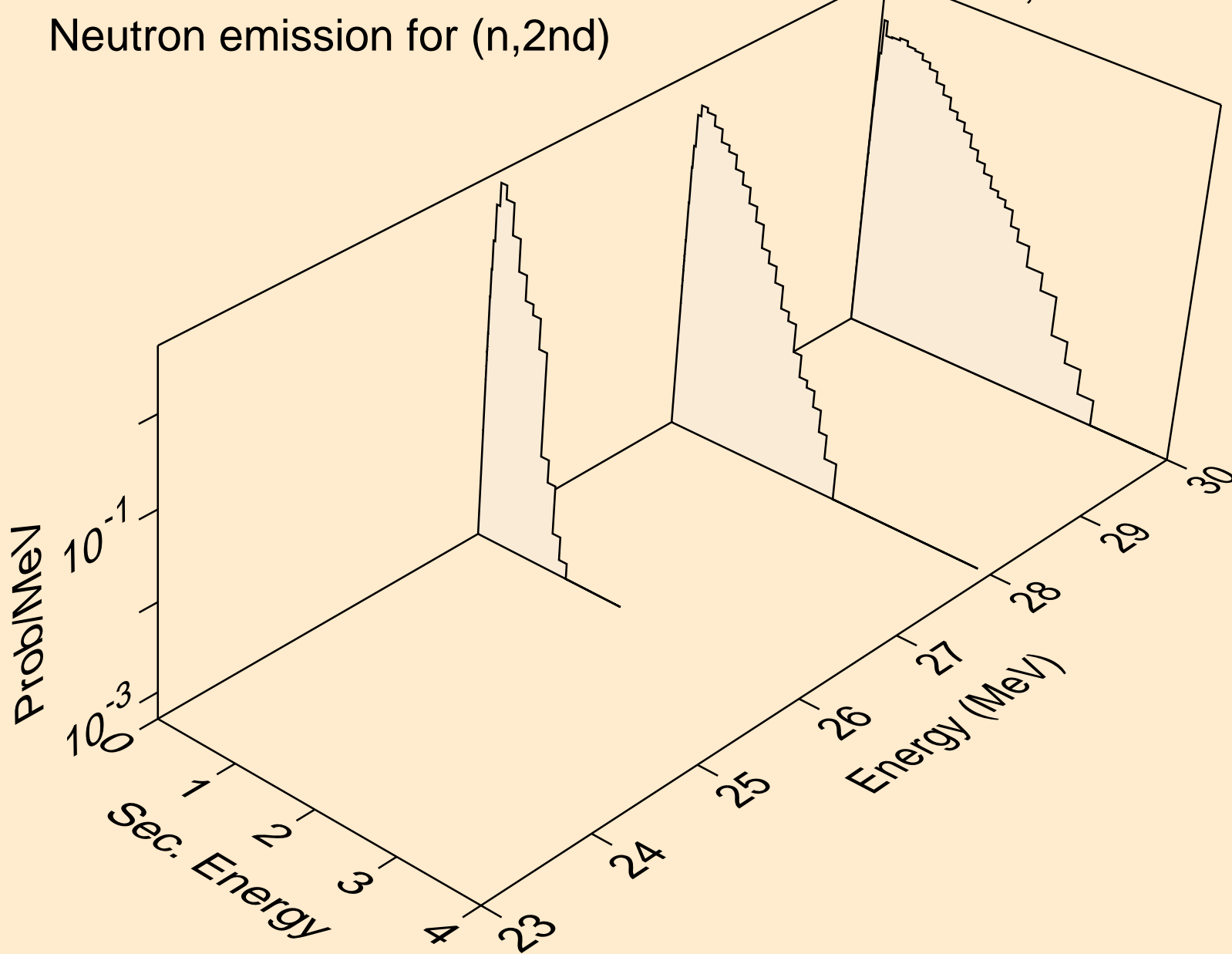

SE085 NEUTRON ACER TENDL-2019 LIBRARY; T=293.16K
Neutron emission for (n,2n)

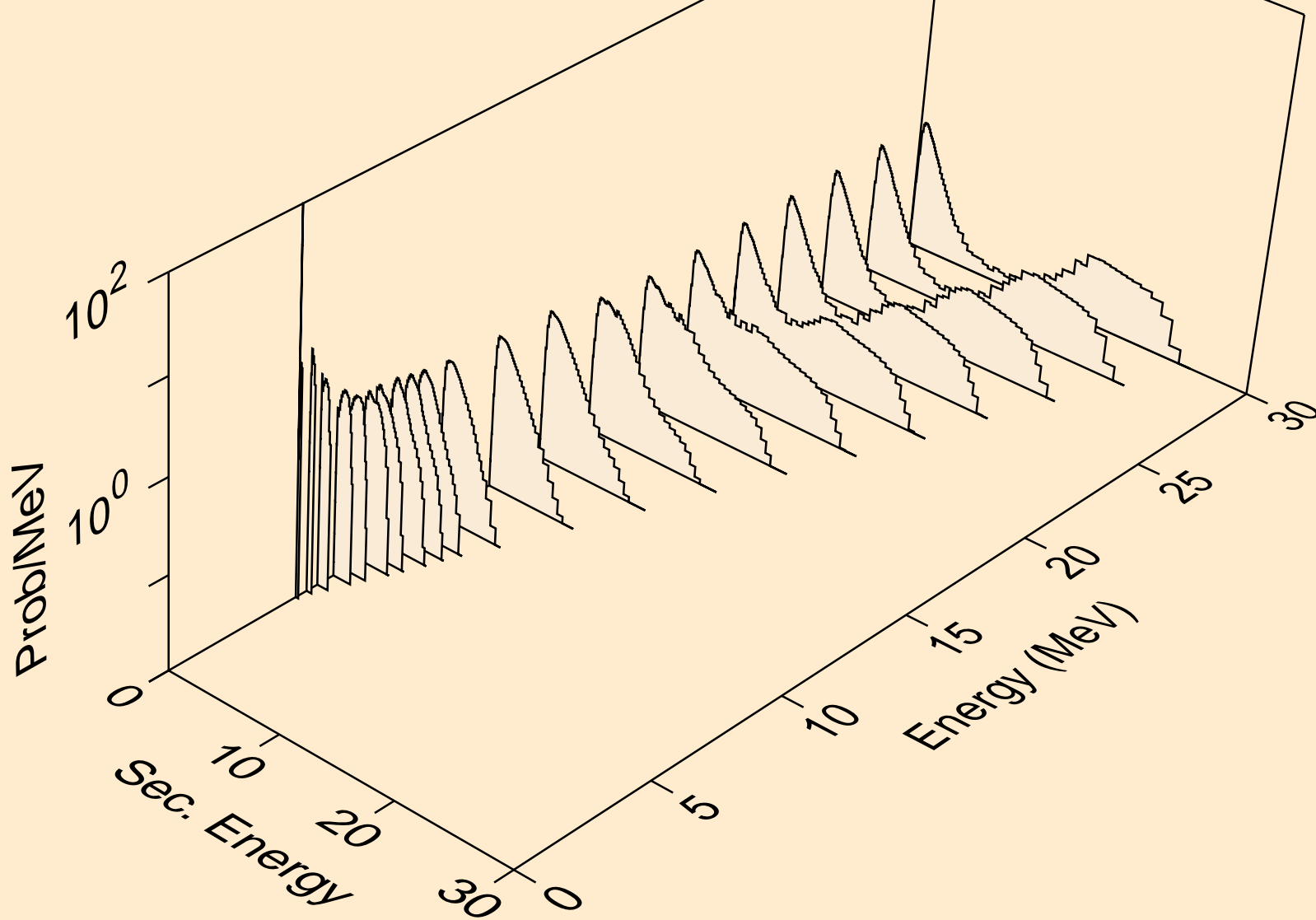

SE085 NEUTRON ACER TENDL-2019 LIBRARY; T=293.16K
Neutron emission for (n,3n)

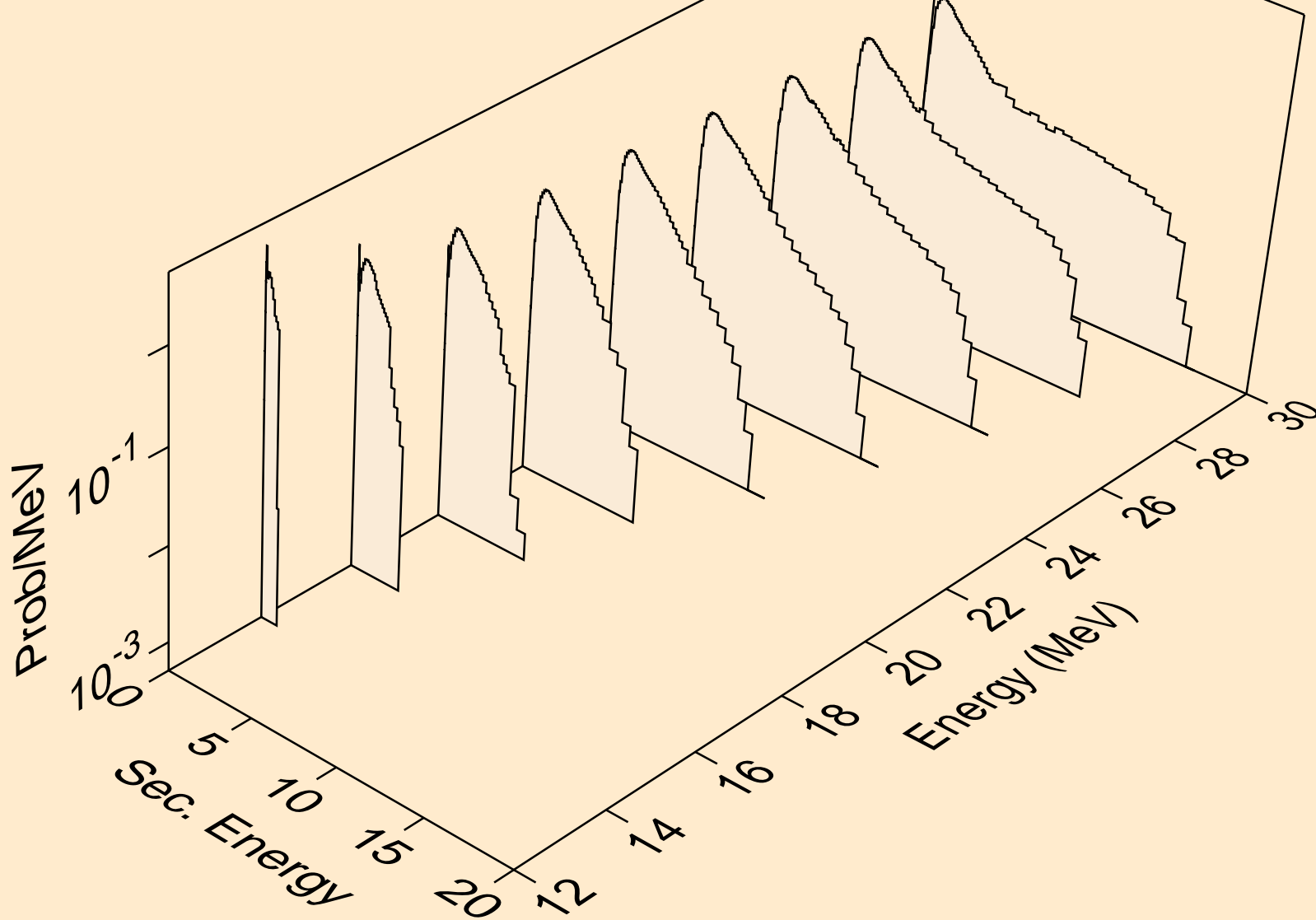

SE085 NEUTRON ACER TENDL-2019 LIBRARY; T=293.16K
Neutron emission for (n,n*)a

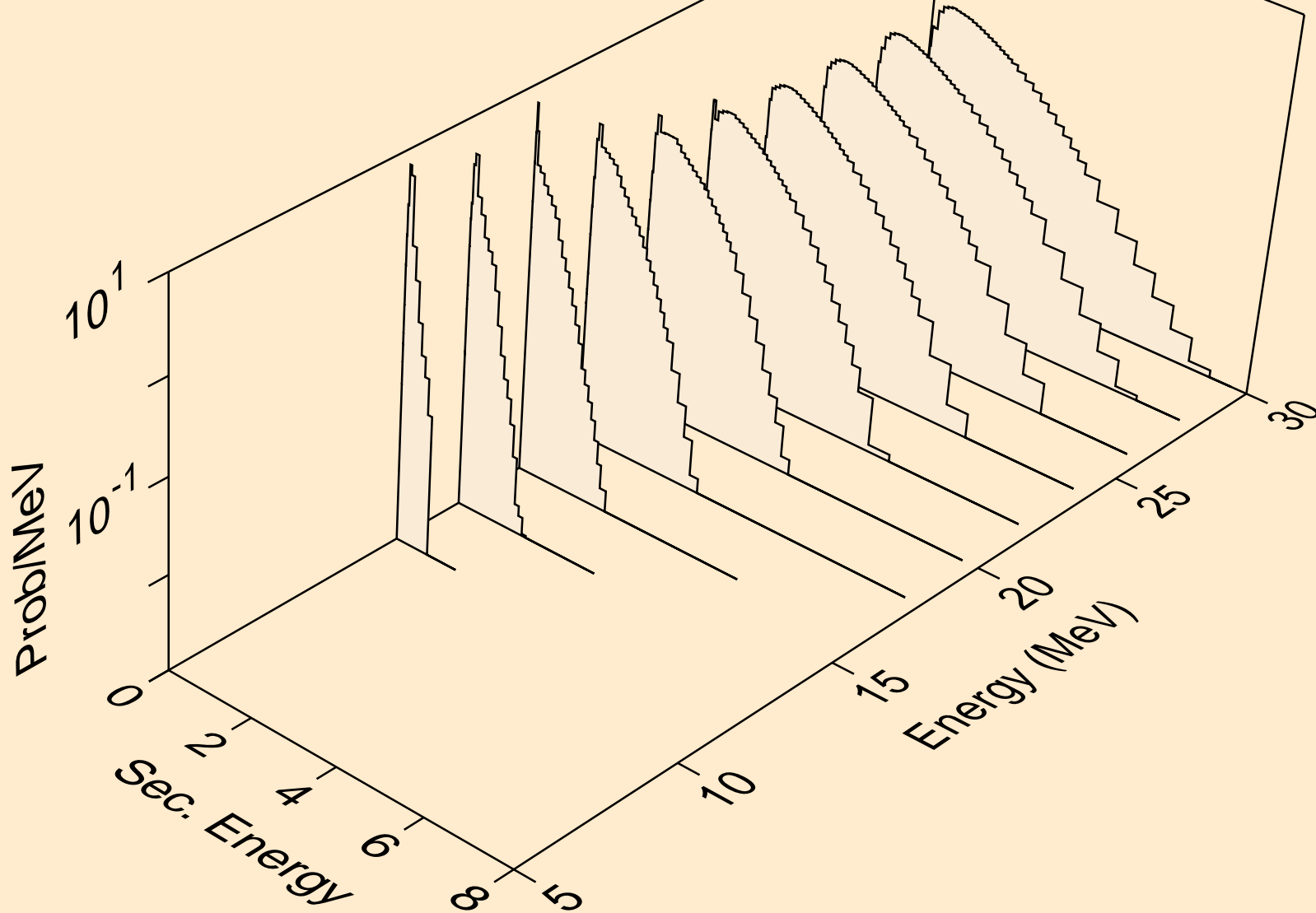

SE085 NEUTRON ACER TENDL-2019 LIBRARY; T=293.16K
Neutron emission for (n,2n)a

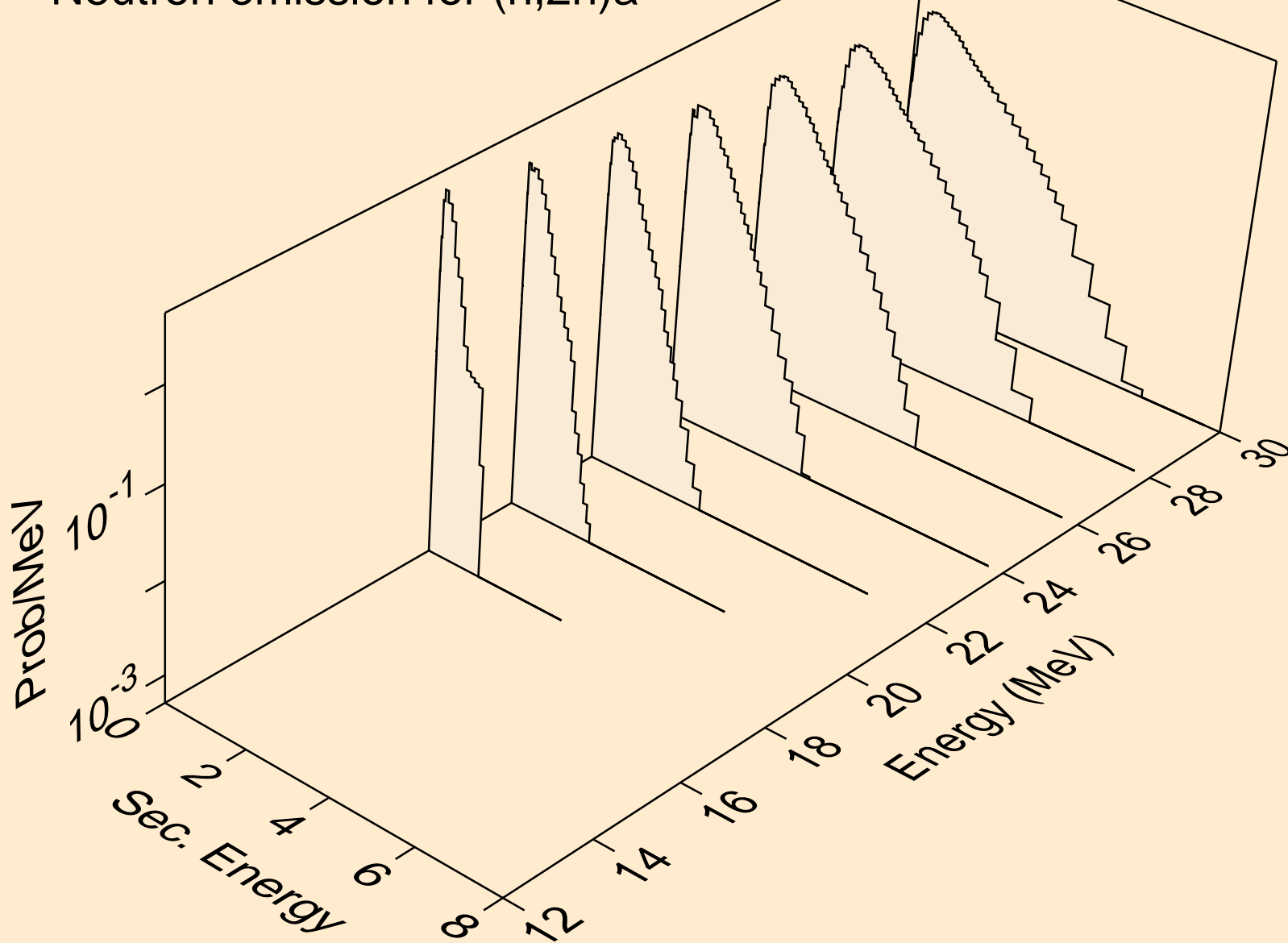

SE085 NEUTRON ACER TENDL-2019 LIBRARY; T=293.16K
Neutron emission for (n,3n)a

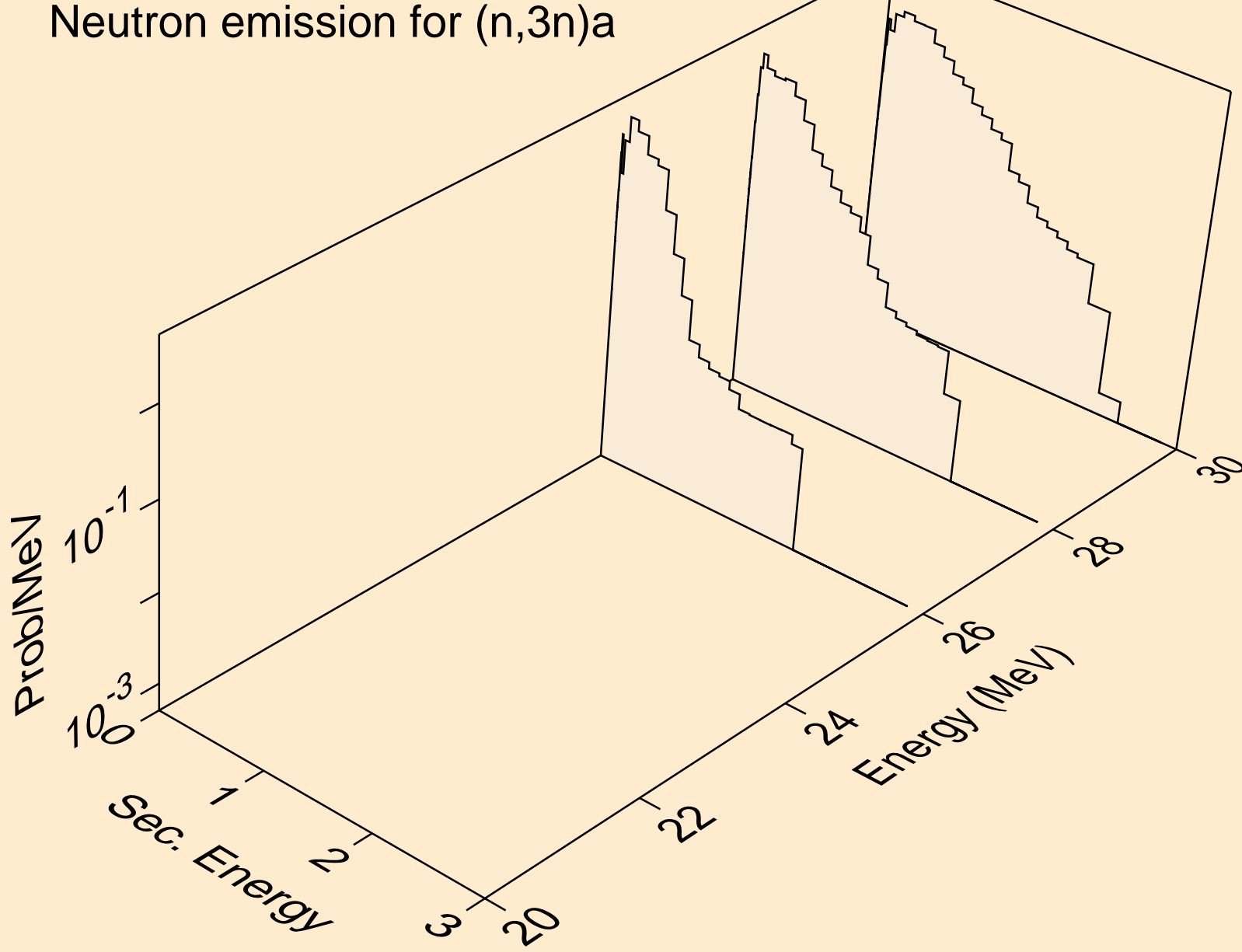

SE085 NEUTRON ACER TENDL-2019 LIBRARY; T=293.16K
Neutron emission for (n,n*)p

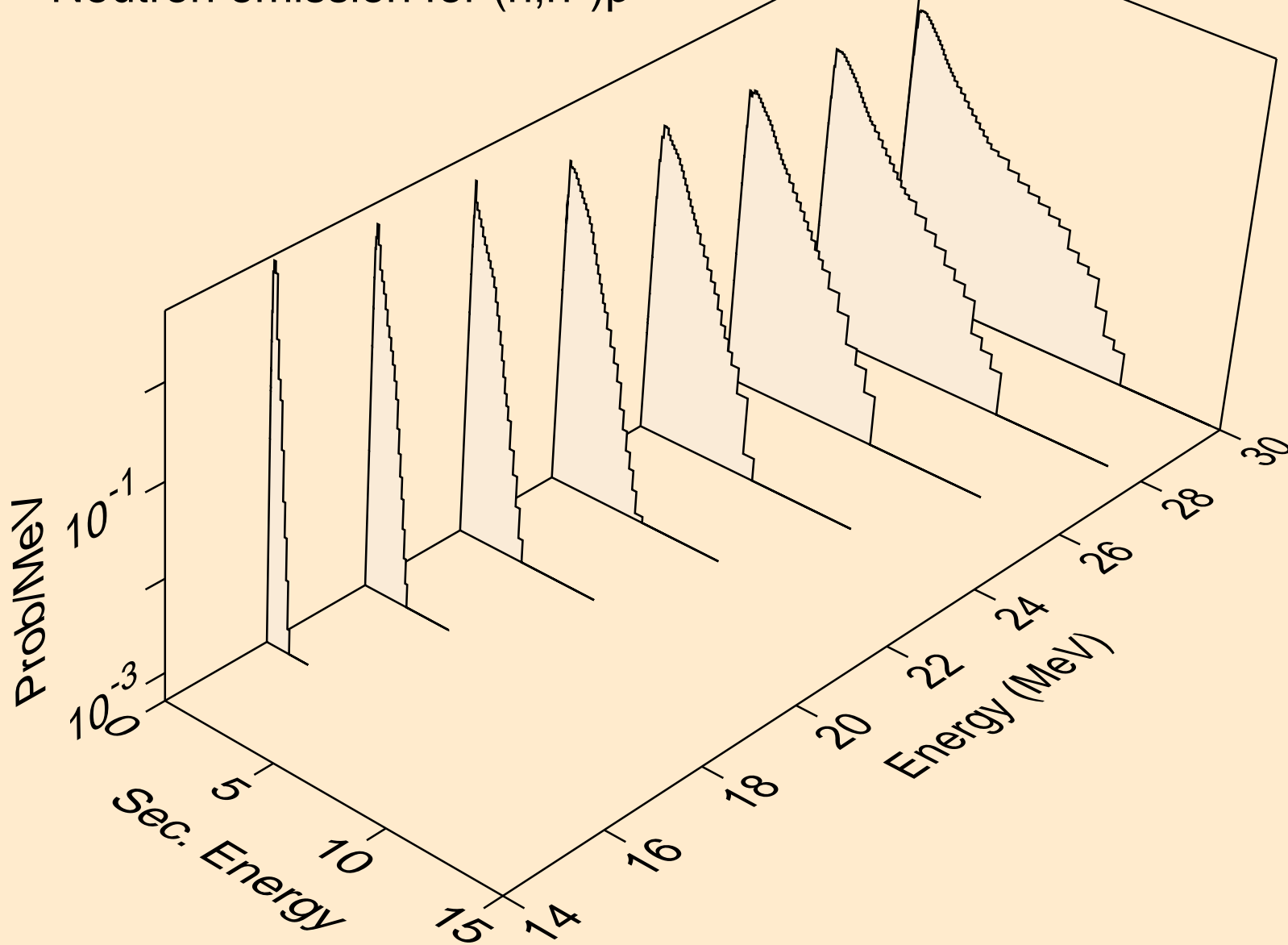

SE085 NEUTRON ACER TENDL-2019 LIBRARY; T=293.16K
Neutron emission for (n,n*)d

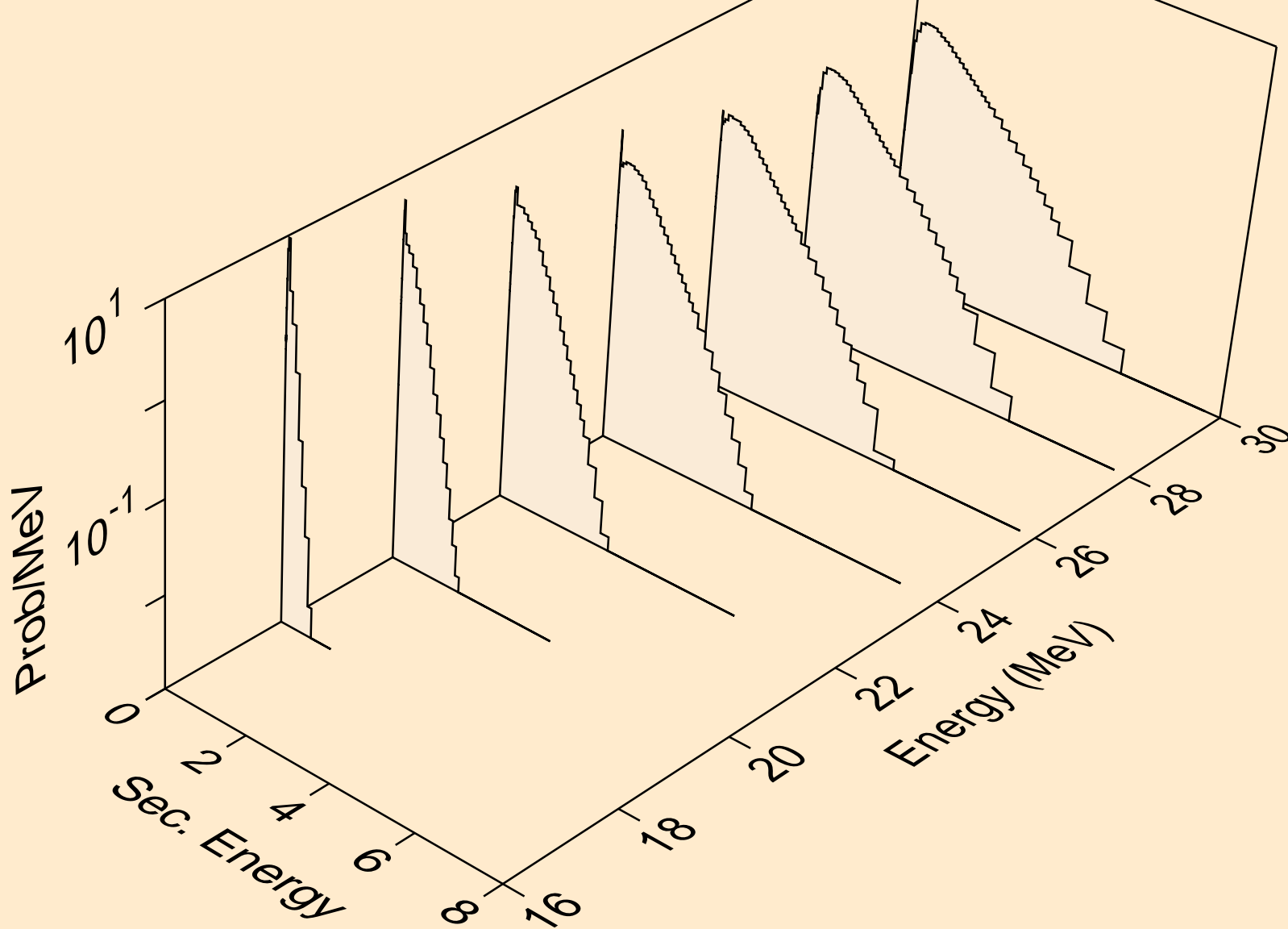

SE085 NEUTRON ACER TENDL-2019 LIBRARY; T=293.16K
Neutron emission for (n,n*)t

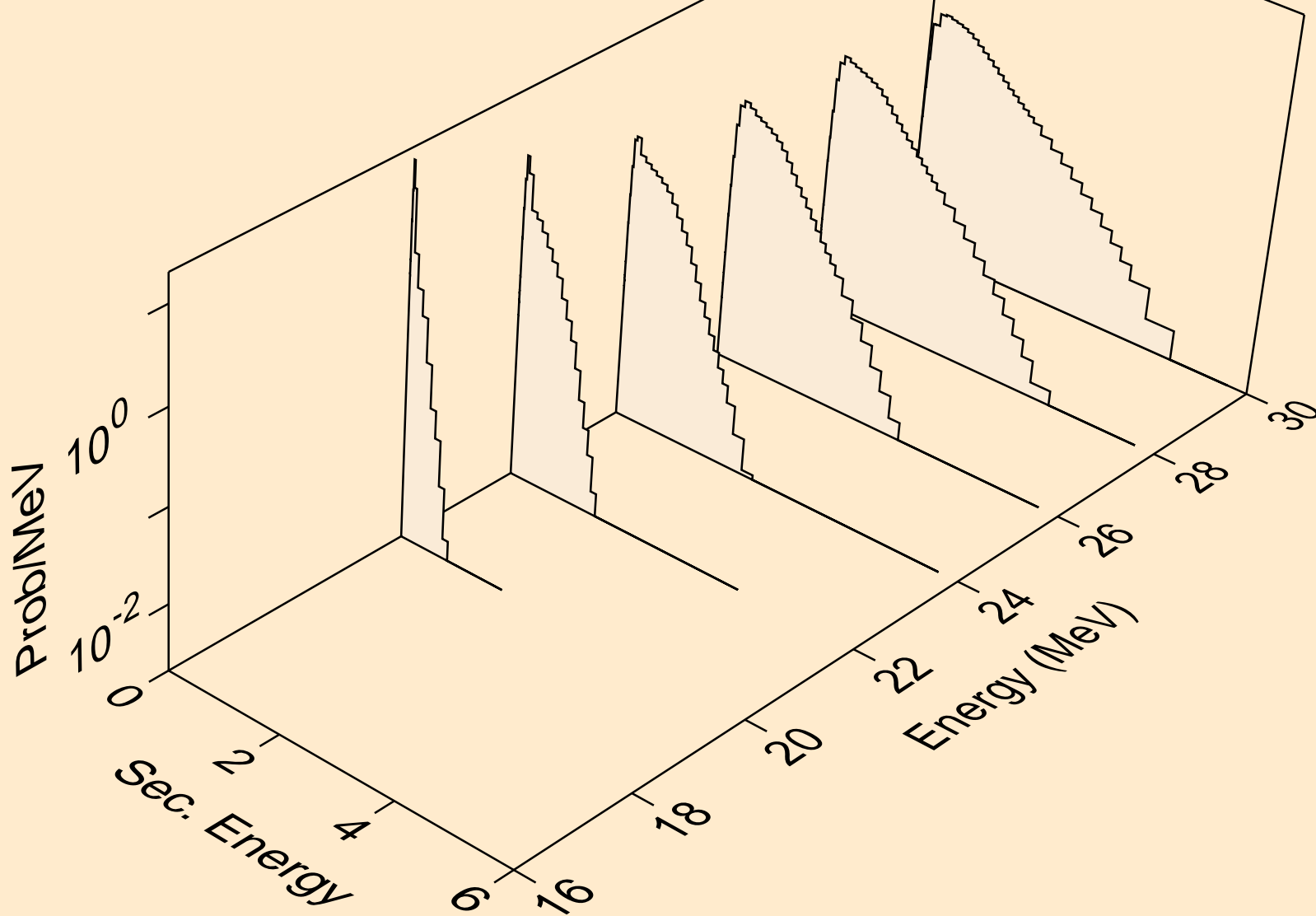

SE085 NEUTRON ACER TENDL-2019 LIBRARY; T=293.16K
Neutron emission for (n,n*)he3

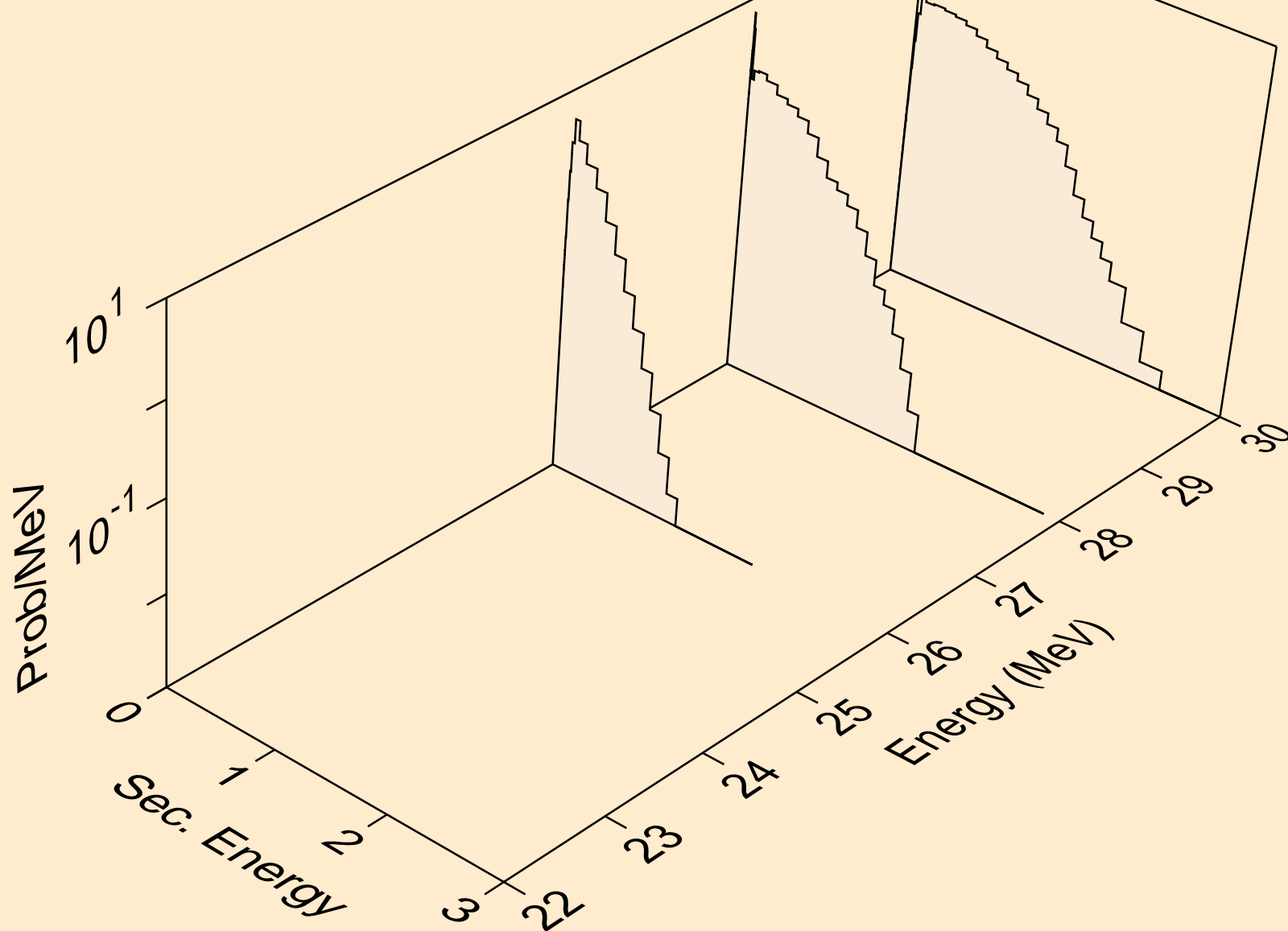

SE085 NEUTRON ACER TENDL-2019 LIBRARY; T=293.16K
Neutron emission for (n,4n)

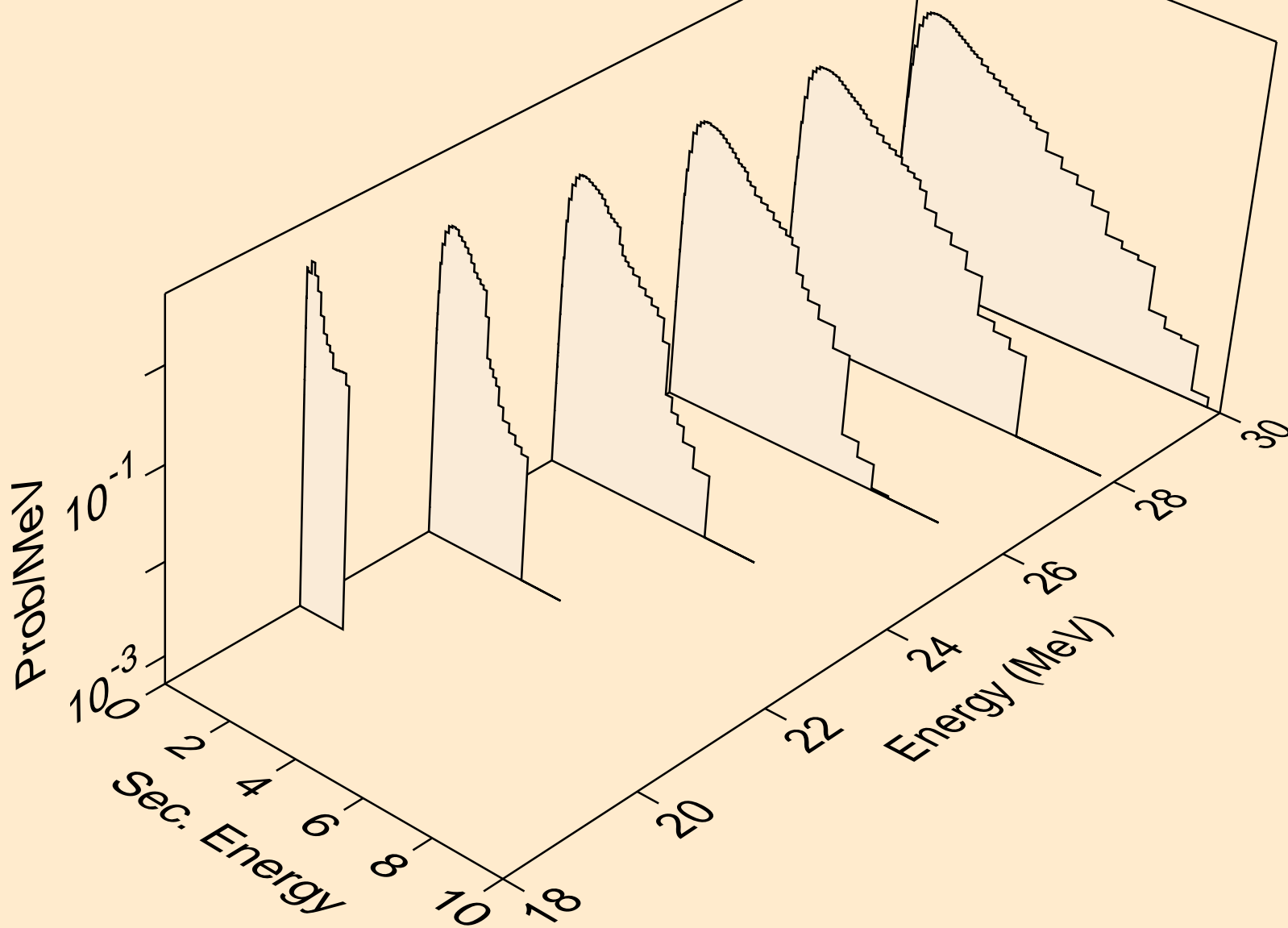

SE085 NEUTRON ACER TENDL-2019 LIBRARY; T=293.16K
Neutron emission for (n,2np)

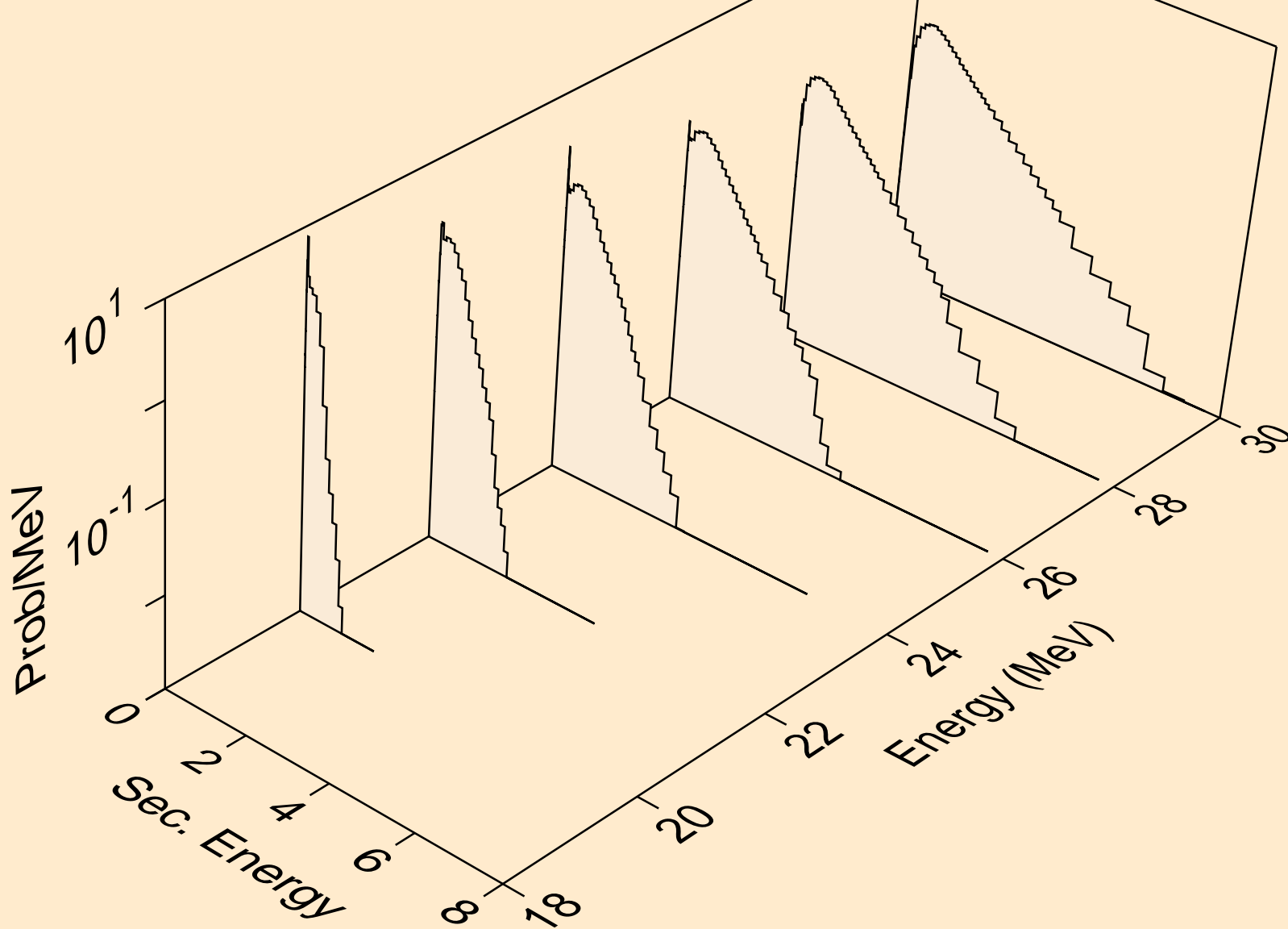

SE085 NEUTRON ACER TENDL-2019 LIBRARY; T=293.16K
Neutron emission for (n,3np)

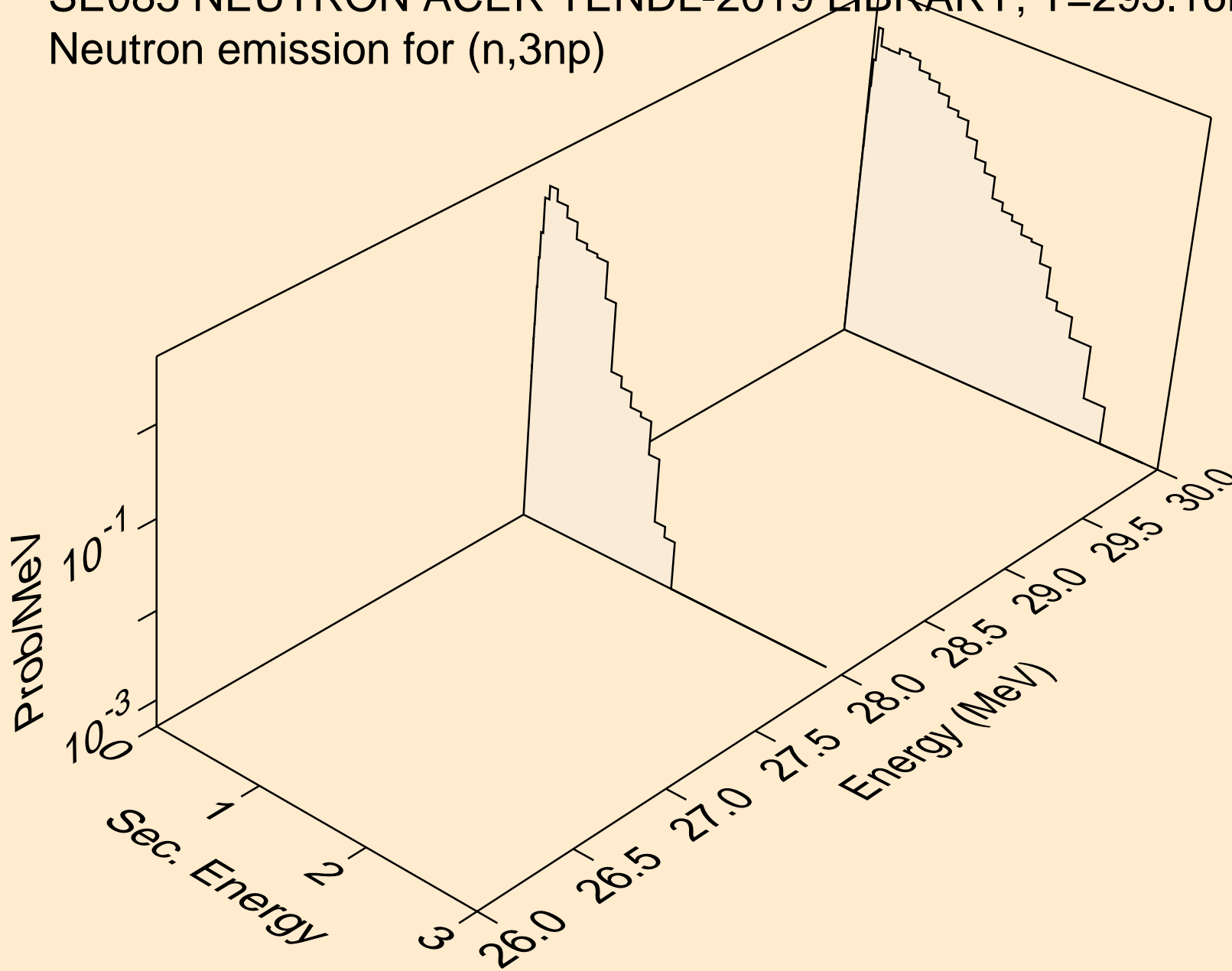

SE085 NEUTRON ACER TENDL-2019 LIBRARY; T=293.16K
Neutron emission for (n,n*c)

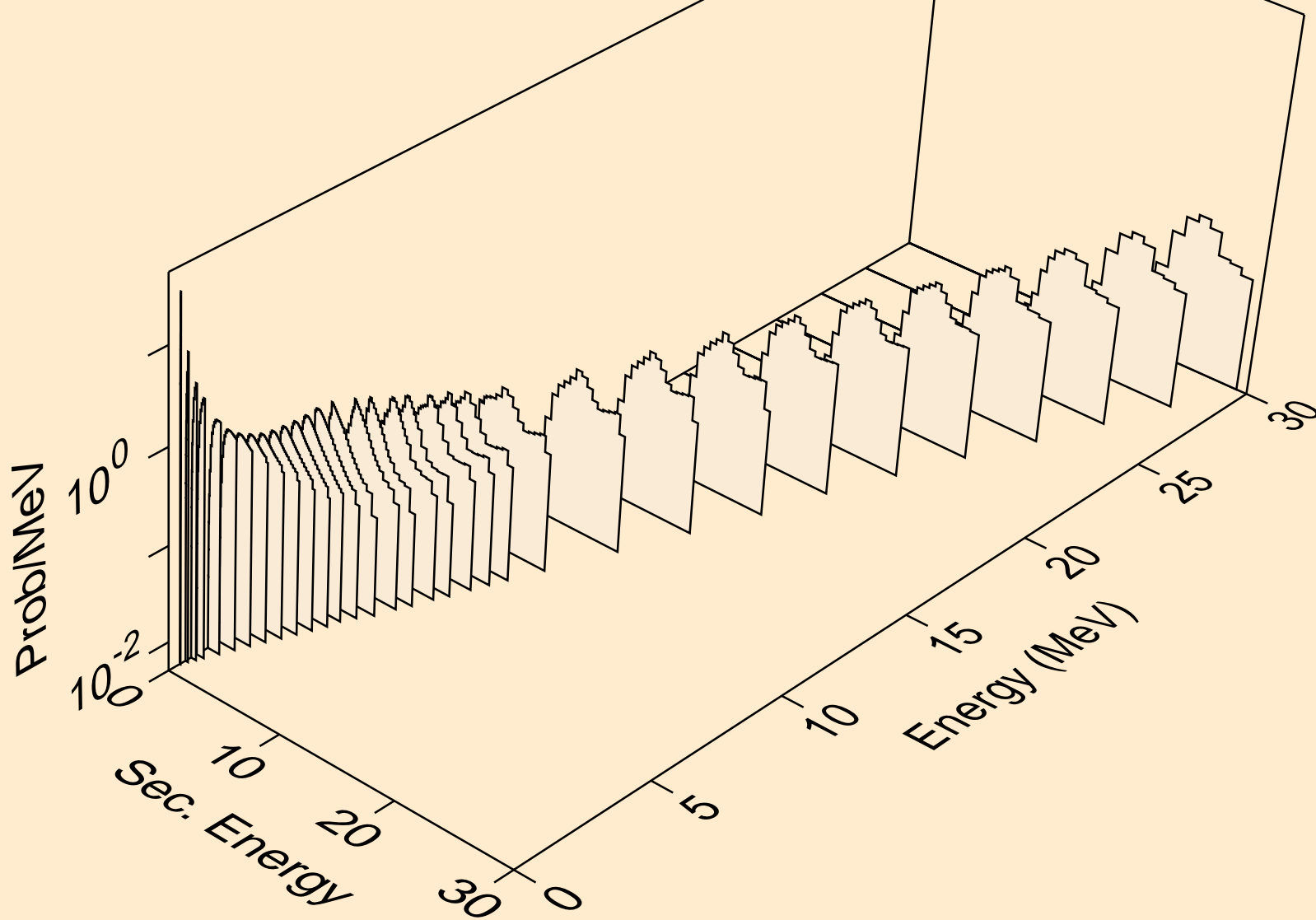

SE085 NEUTRON ACER TENDL-2019 LIBRARY; T=293.16K
Photon emission for (n,x)

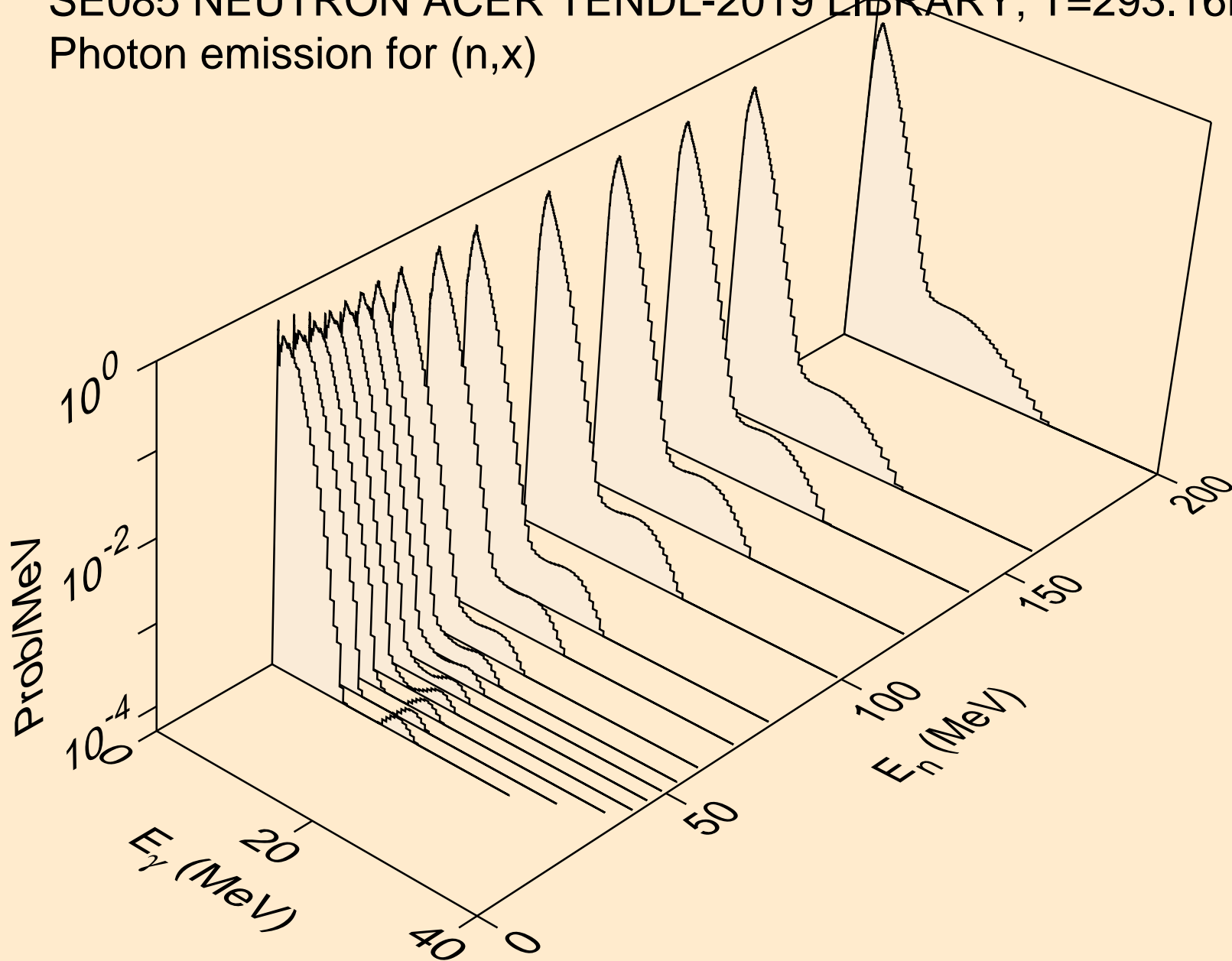

SE085 NEUTRON ACER TENDL-2019 LIBRARY; T=293.16K
Photon emission for (n,2nd)

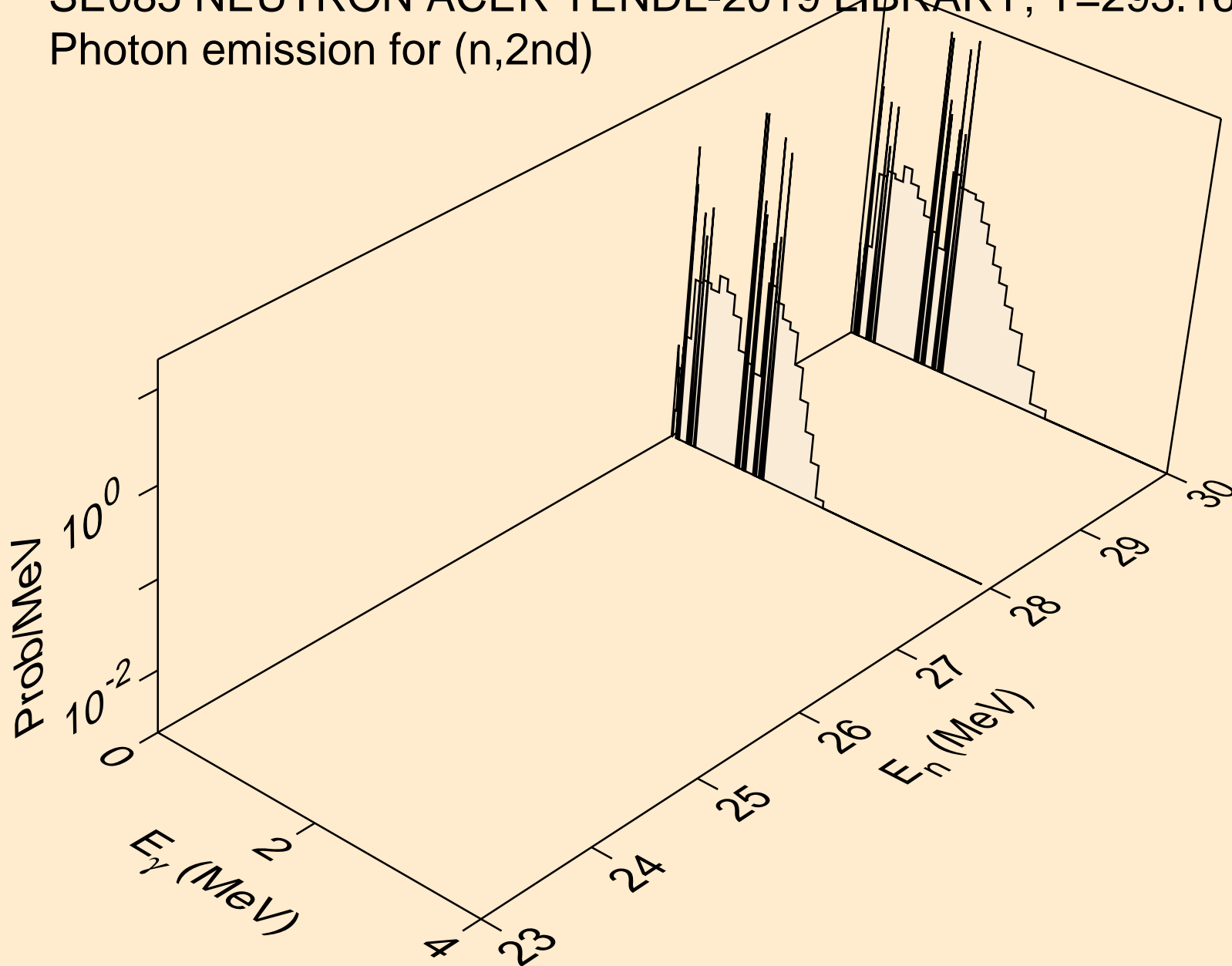

SE085 NEUTRON ACER TENDL-2019 LIBRARY; T=293.16K
Photon emission for (n,2n)

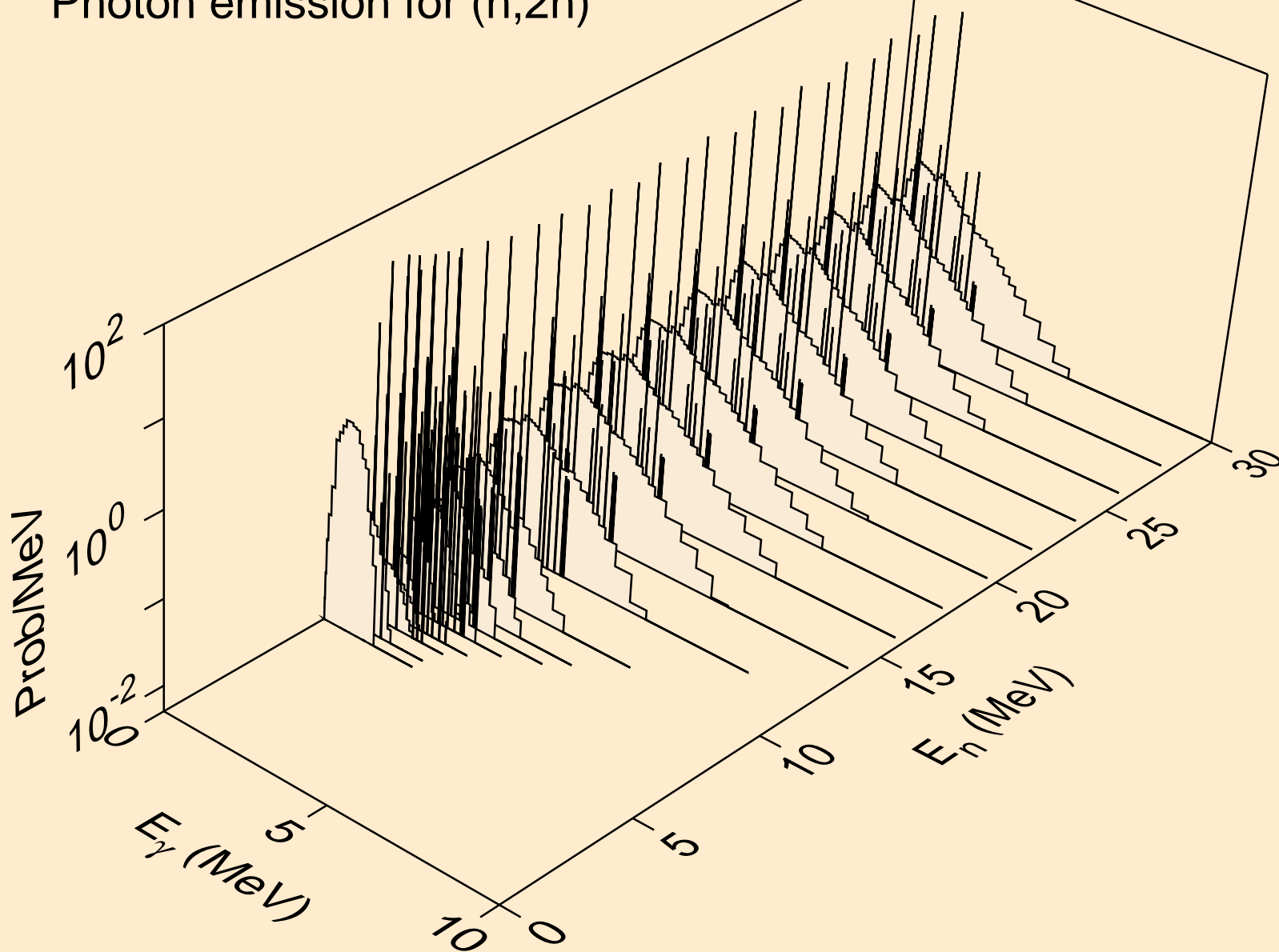

SE085 NEUTRON ACER TENDL-2019 LIBRARY; T=293.16K
Photon emission for (n,3n)

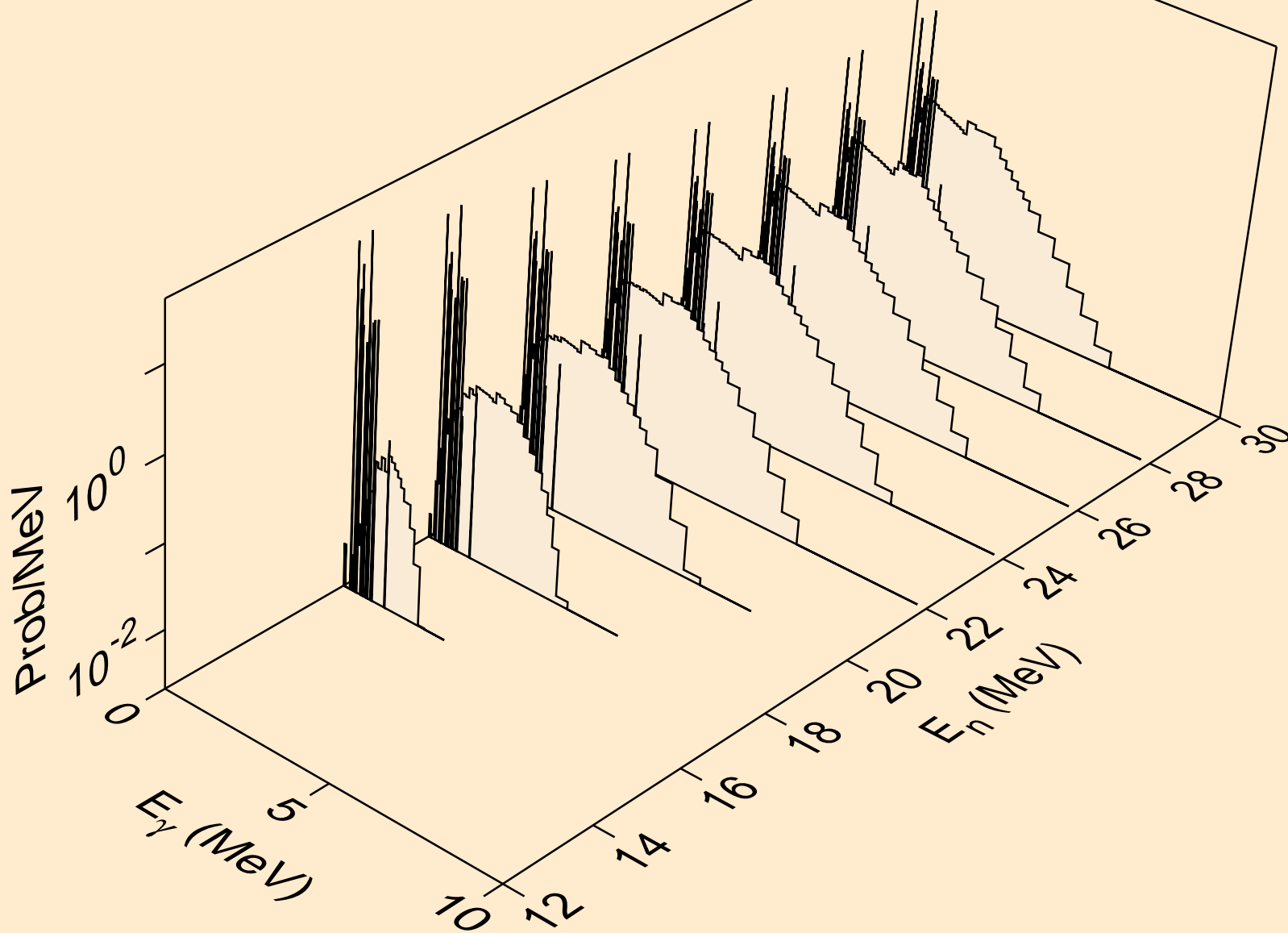

SE085 NEUTRON ACER TENDL-2019 LIBRARY; T=293.16K
Photon emission for (n,n*)a

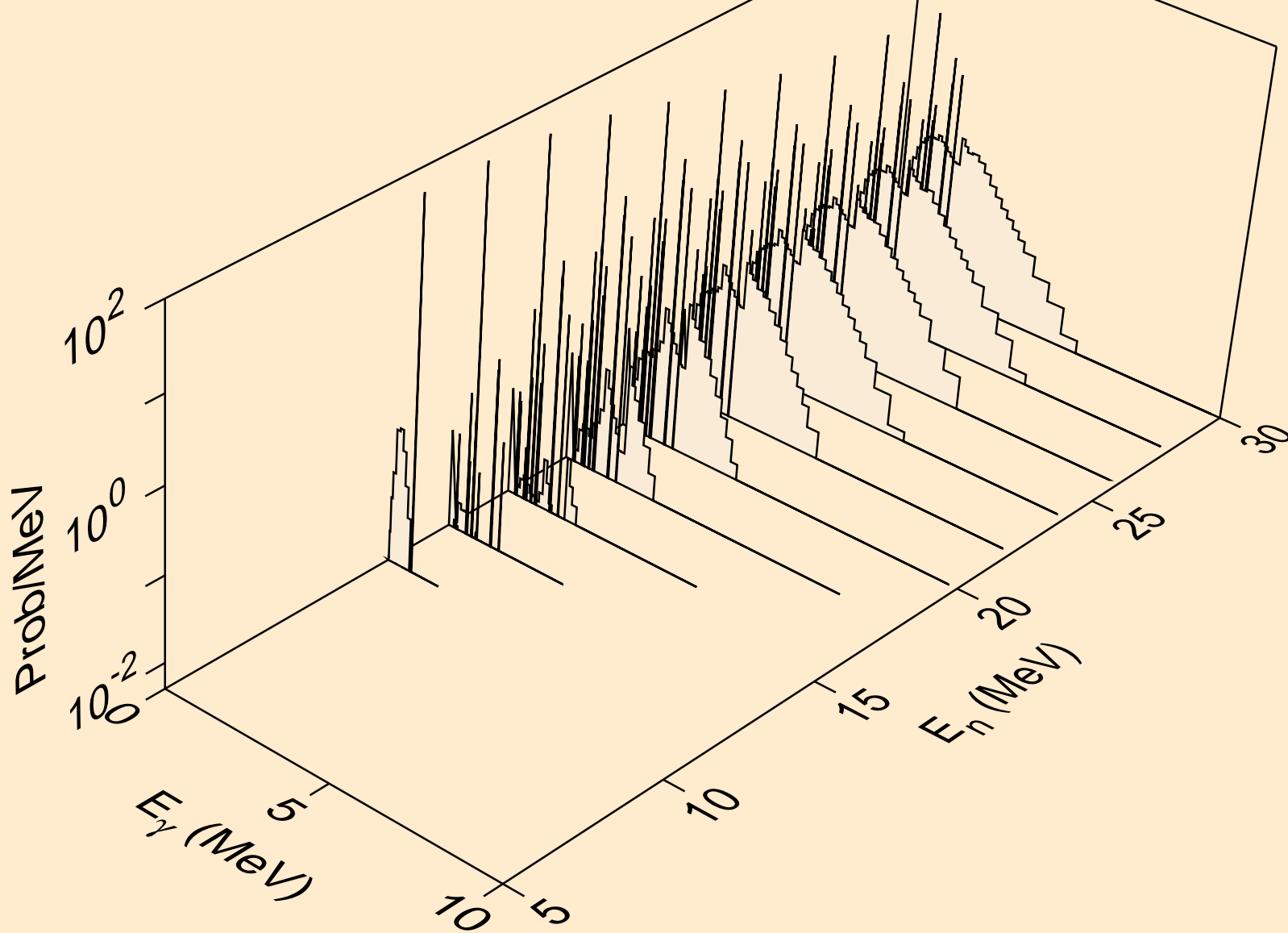

SE085 NEUTRON ACER TENDL-2019 LIBRARY; T=293.16K
Photon emission for (n,2n)a

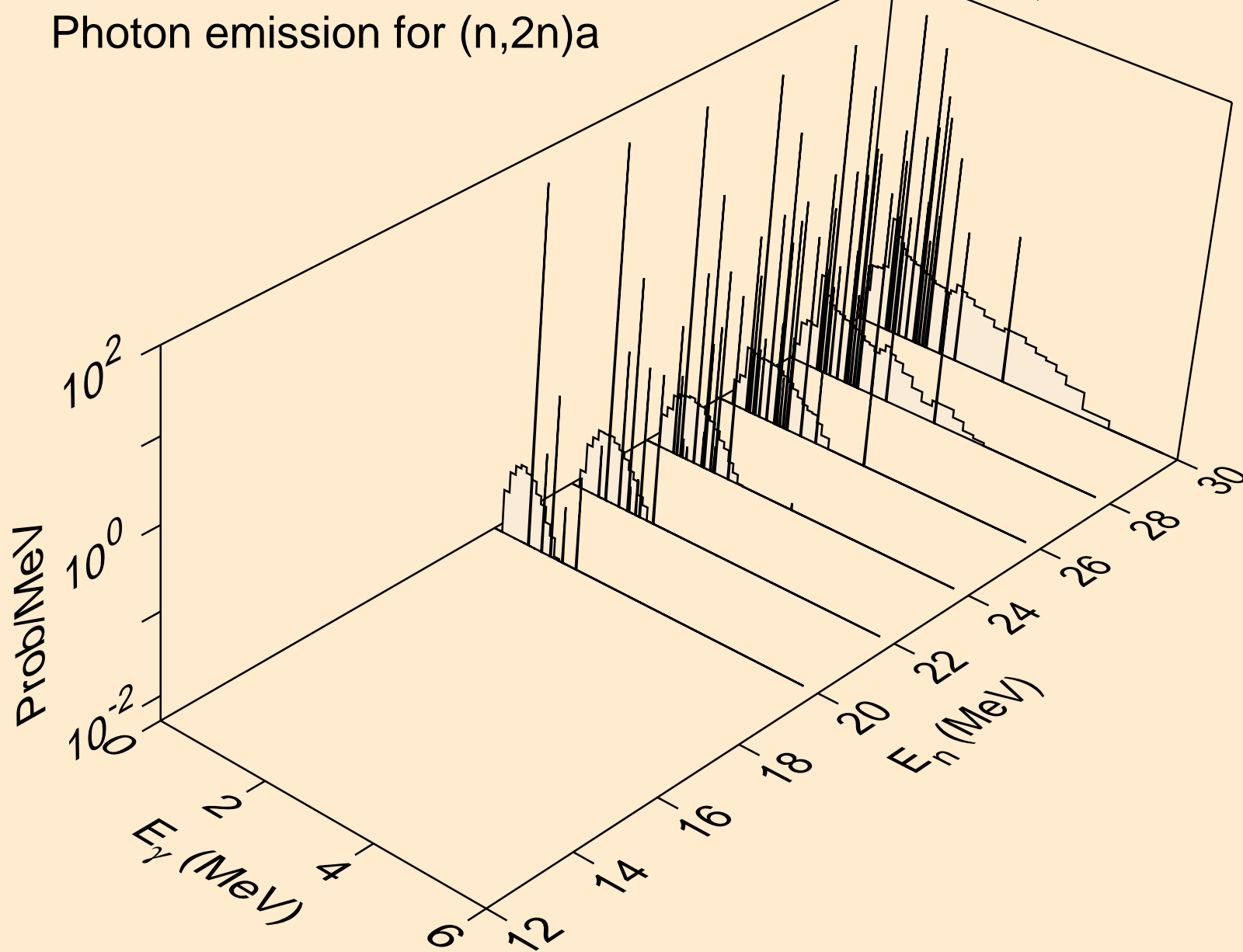

SE085 NEUTRON ACER TENDL-2019 LIBRARY; T=293.16K
Photon emission for (n,3n)a

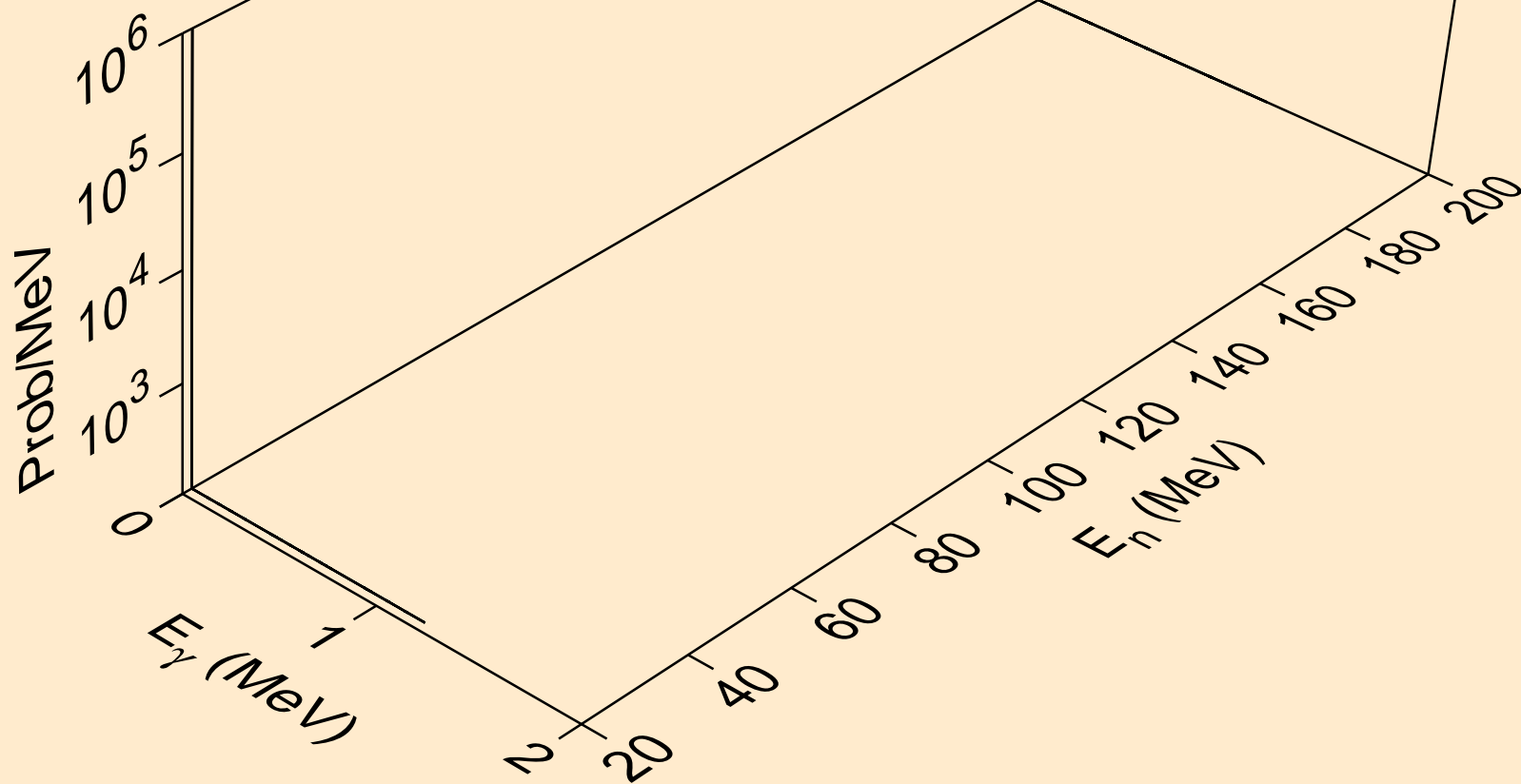

SE085 NEUTRON ACER TENDL-2019 LIBRARY; T=293.16K
Photon emission for (n,n*)p

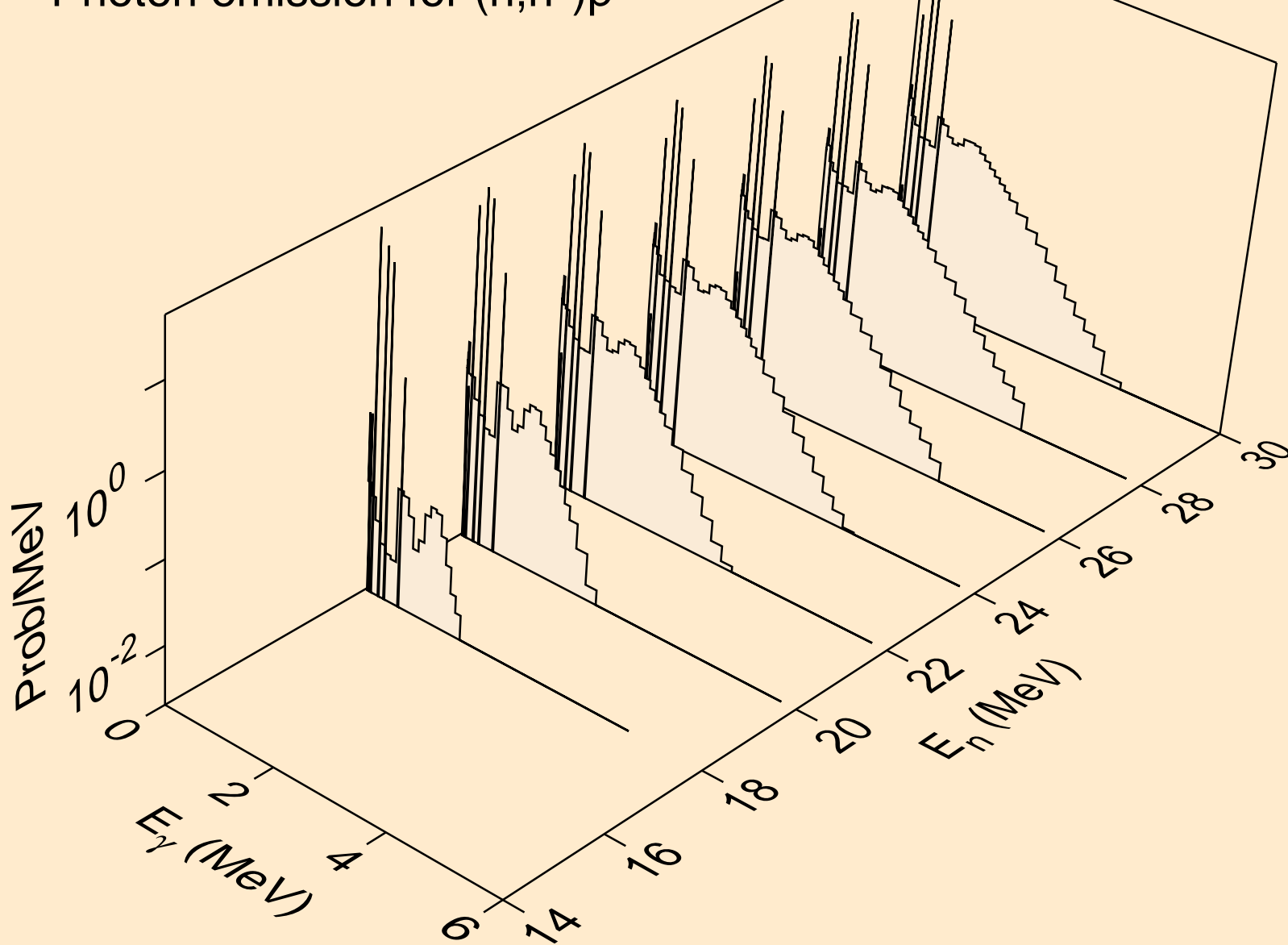

SE085 NEUTRON ACER TENDL-2019 LIBRARY; T=293.16K
Photon emission for (n,n*)d

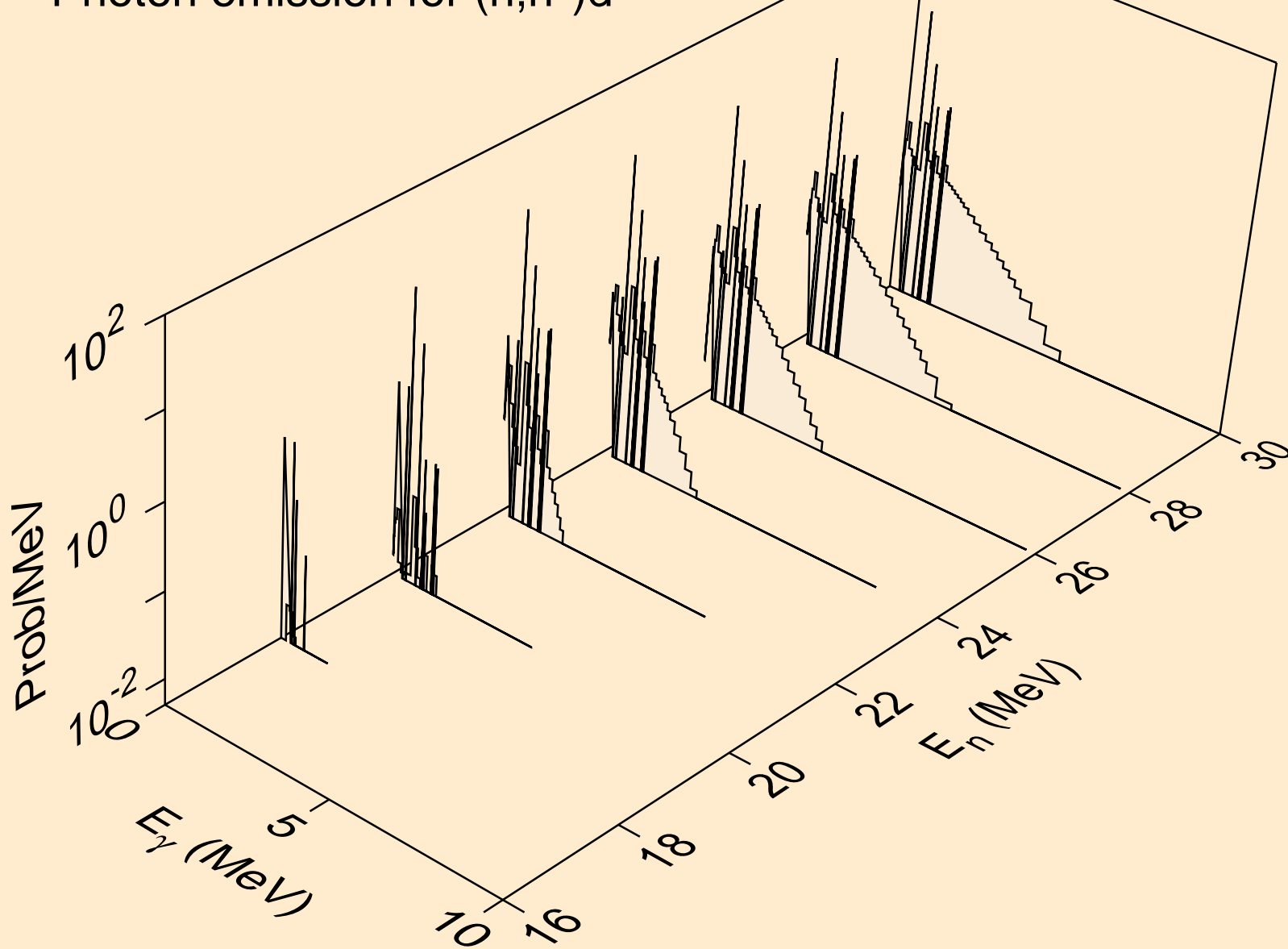

SE085 NEUTRON ACER TENDL-2019 LIBRARY; T=293.16K
Photon emission for (n,n*)t

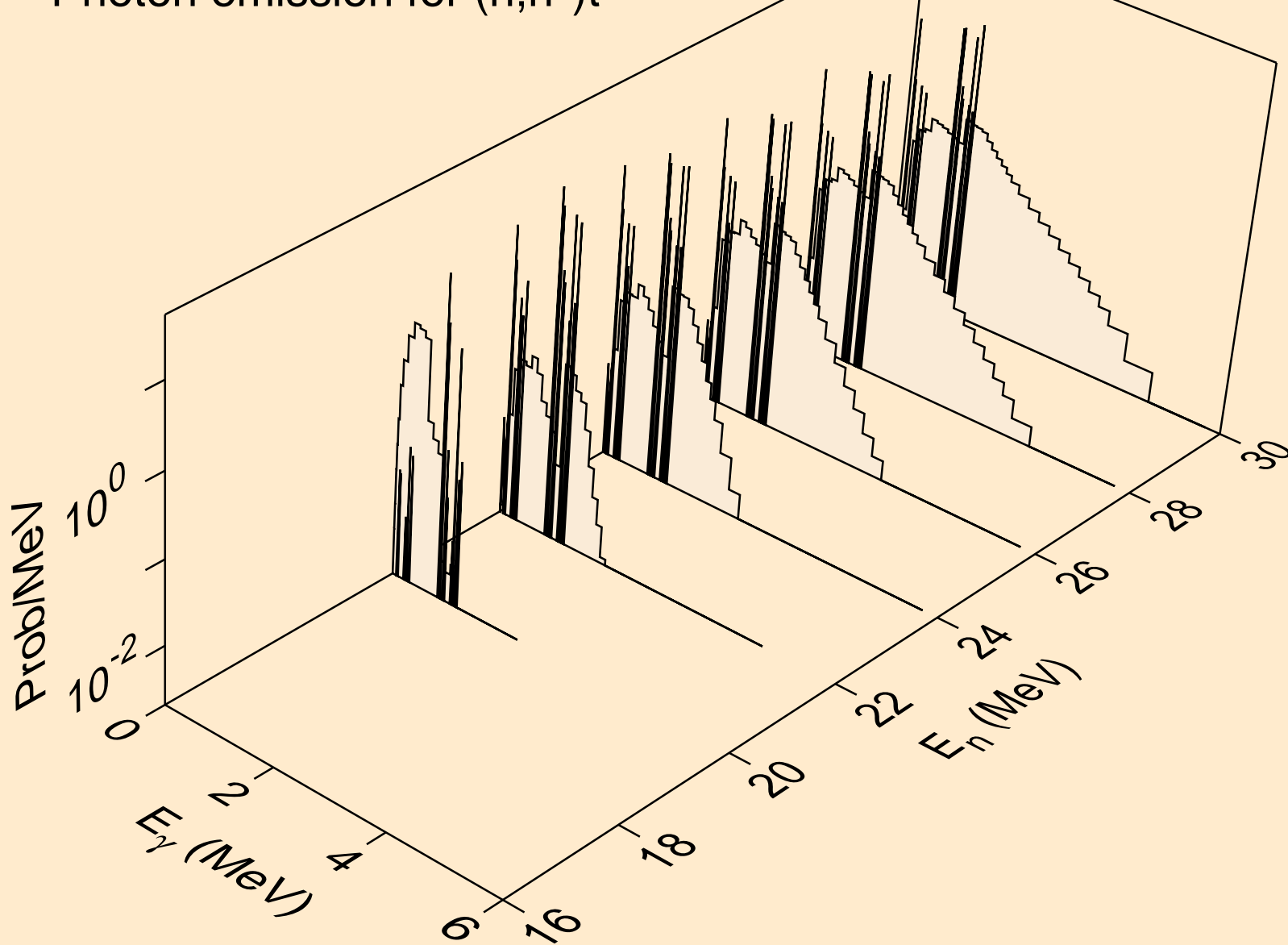

SE085 NEUTRON ACER TENDL-2019 LIBRARY; T=293.16K
Photon emission for (n,n*)he3

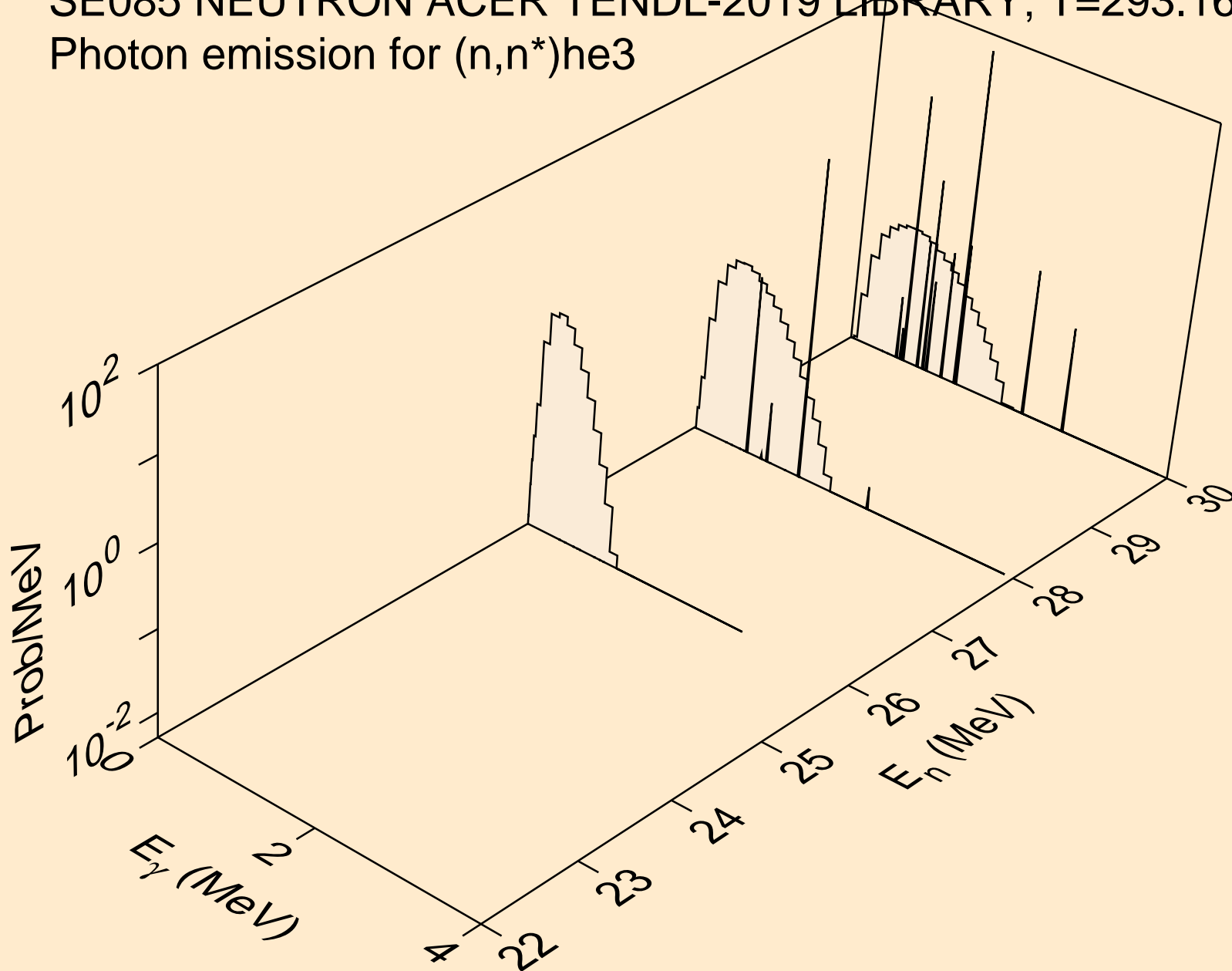

SE085 NEUTRON ACER TENDL-2019 LIBRARY; T=293.16K
Photon emission for (n,4n)

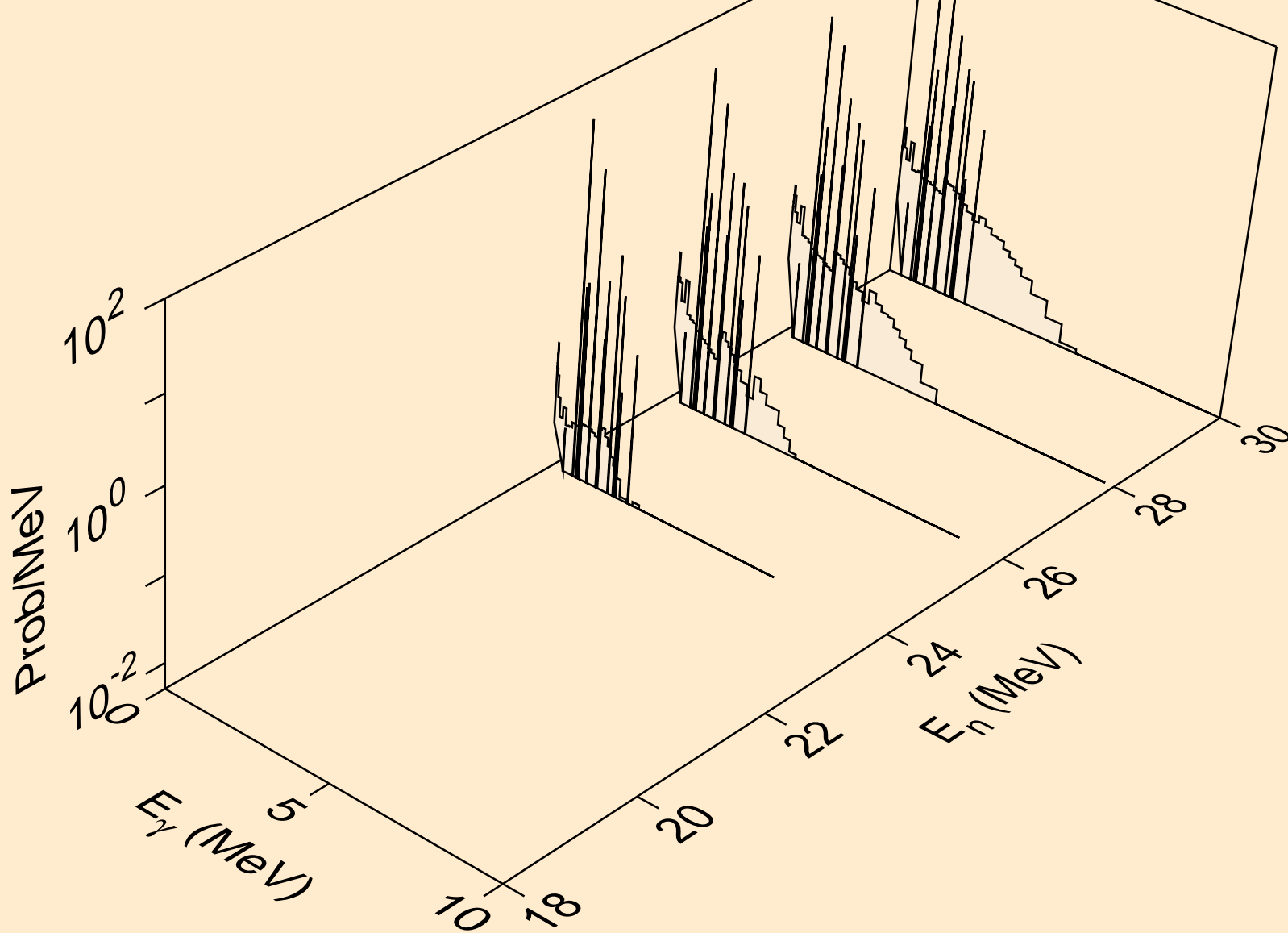

SE085 NEUTRON ACER TENDL-2019 LIBRARY; T=293.16K
Photon emission for (n,2np)

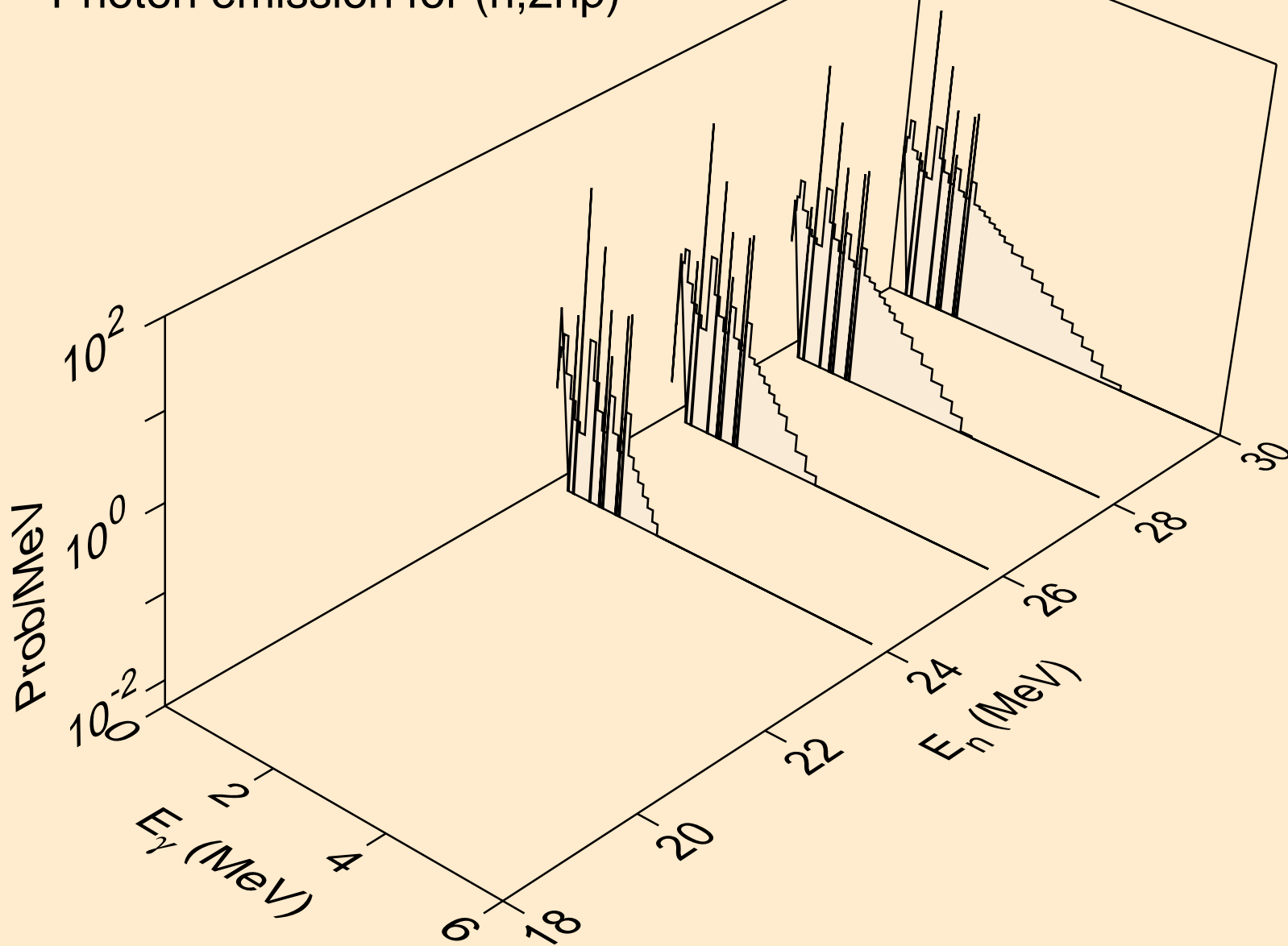

SE085 NEUTRON ACER TENDL-2019 LIBRARY; T=293.16K
Photon emission for (n,3np)

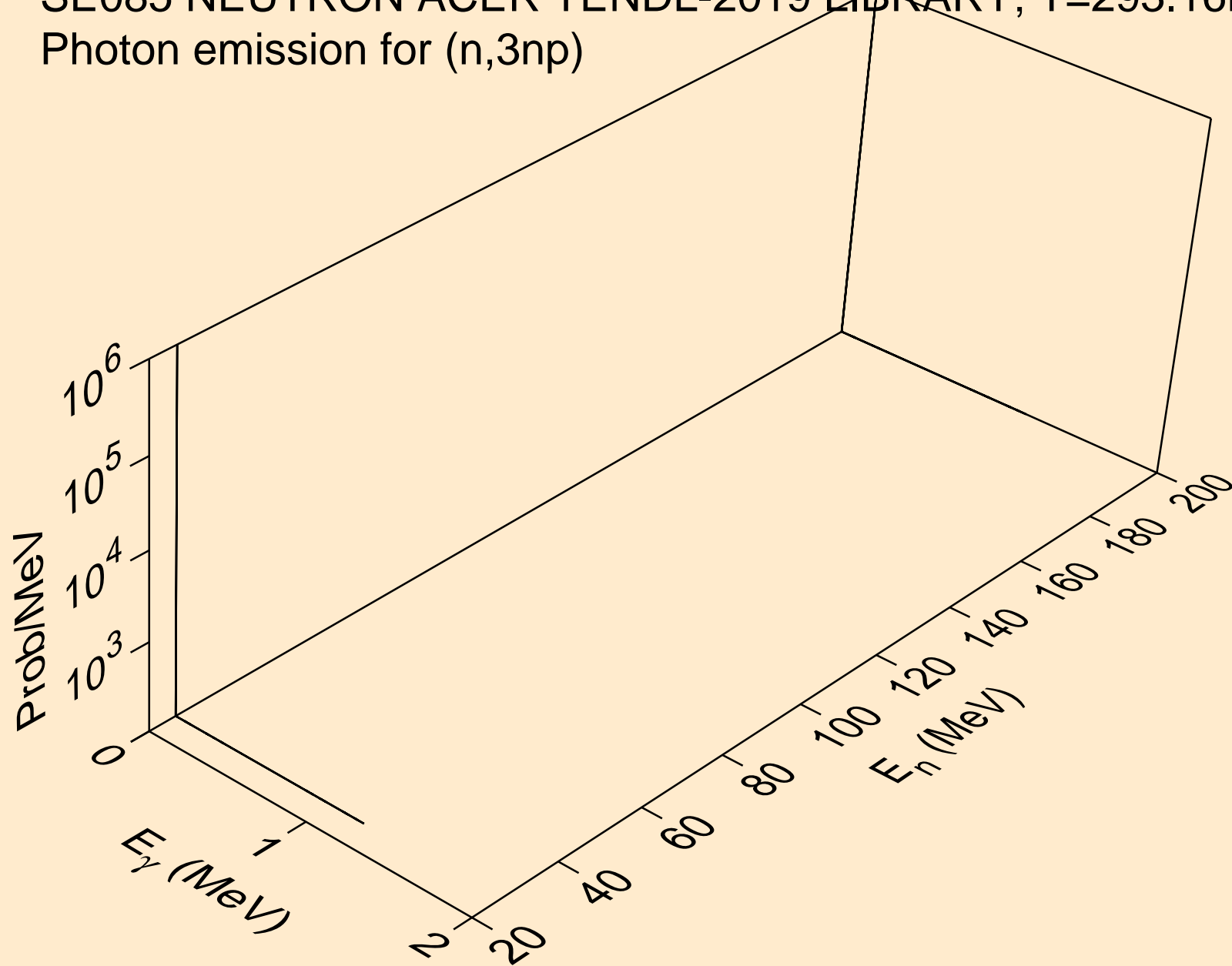

SE085 NEUTRON ACER TENDL-2019 LIBRARY; T=293.16K
Photon emission for (n,n*c)

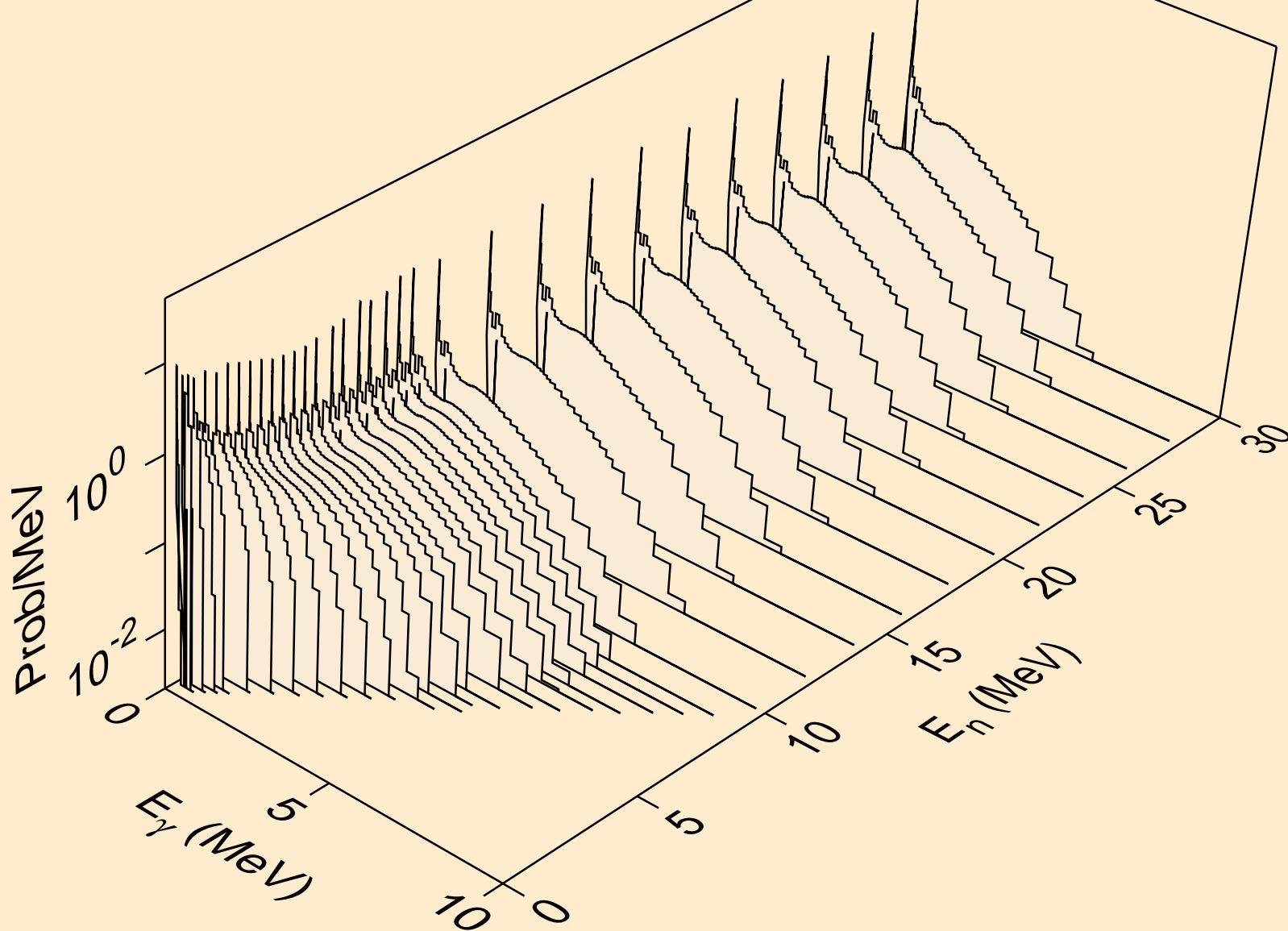

SE085 NEUTRON ACER TENDL-2019 LIBRARY; T=293.16K
Photon emission for (n,gma)

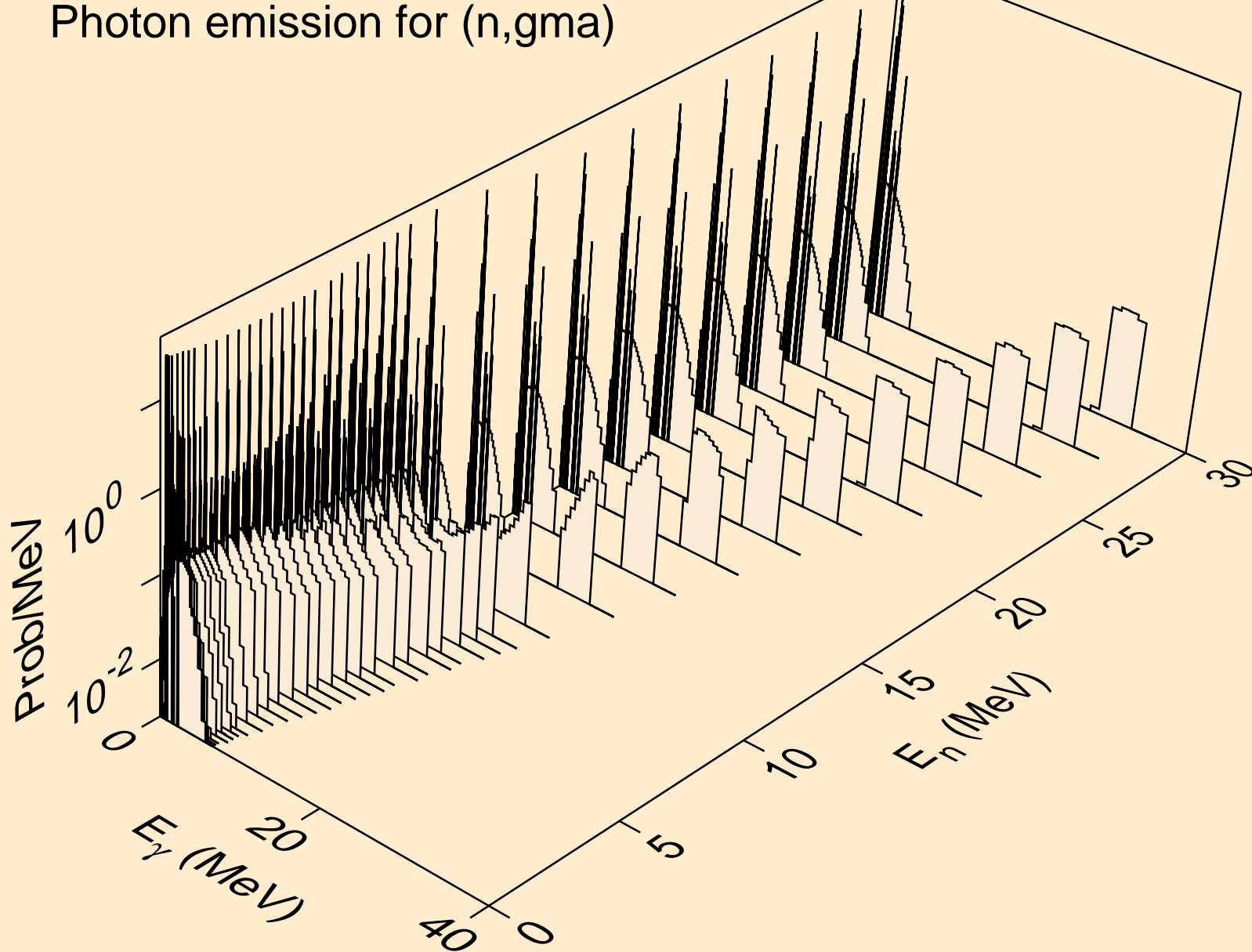

SE085 NEUTRON ACER TENDL-2019 LIBRARY; T=293.16K
Photon emission for (n,p)

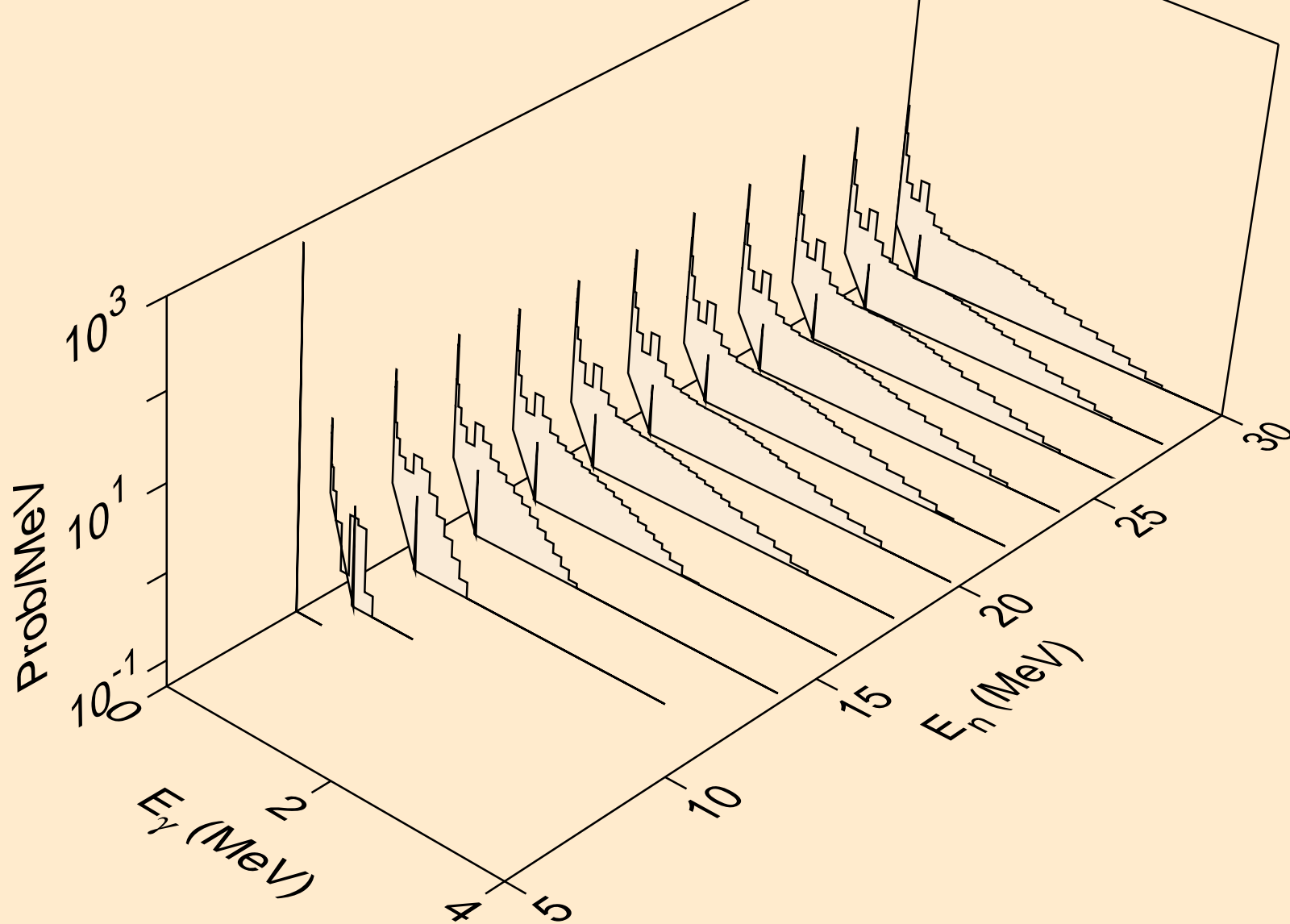

SE085 NEUTRON ACER TENDL-2019 LIBRARY; T=293.16K
Photon emission for (n,d)

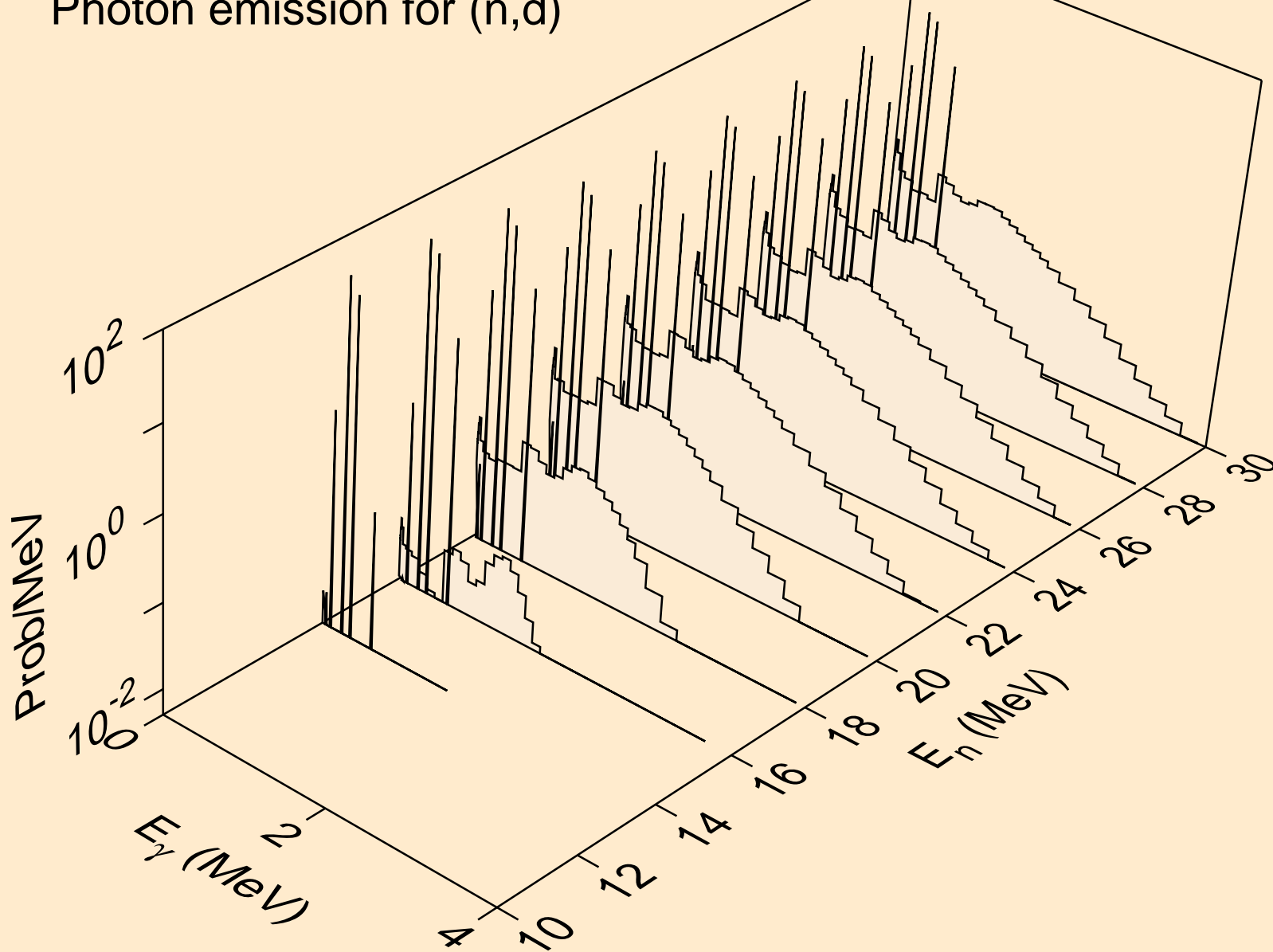

SE085 NEUTRON ACER TENDL-2019 LIBRARY; T=293.16K
Photon emission for (n,t)

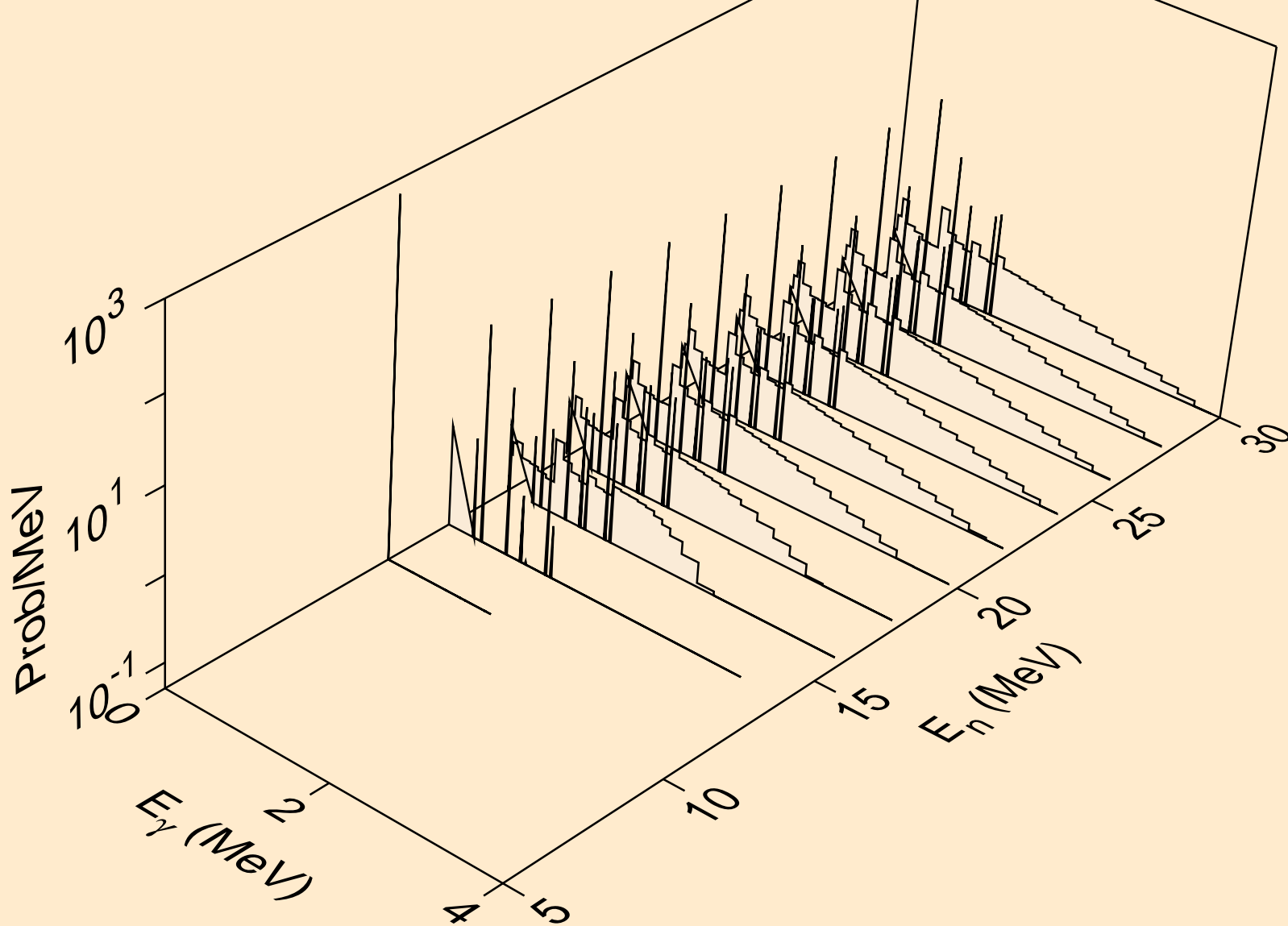

SE085 NEUTRON ACER TENDL-2019 LIBRARY; T=293.16K
Photon emission for (n,he3)

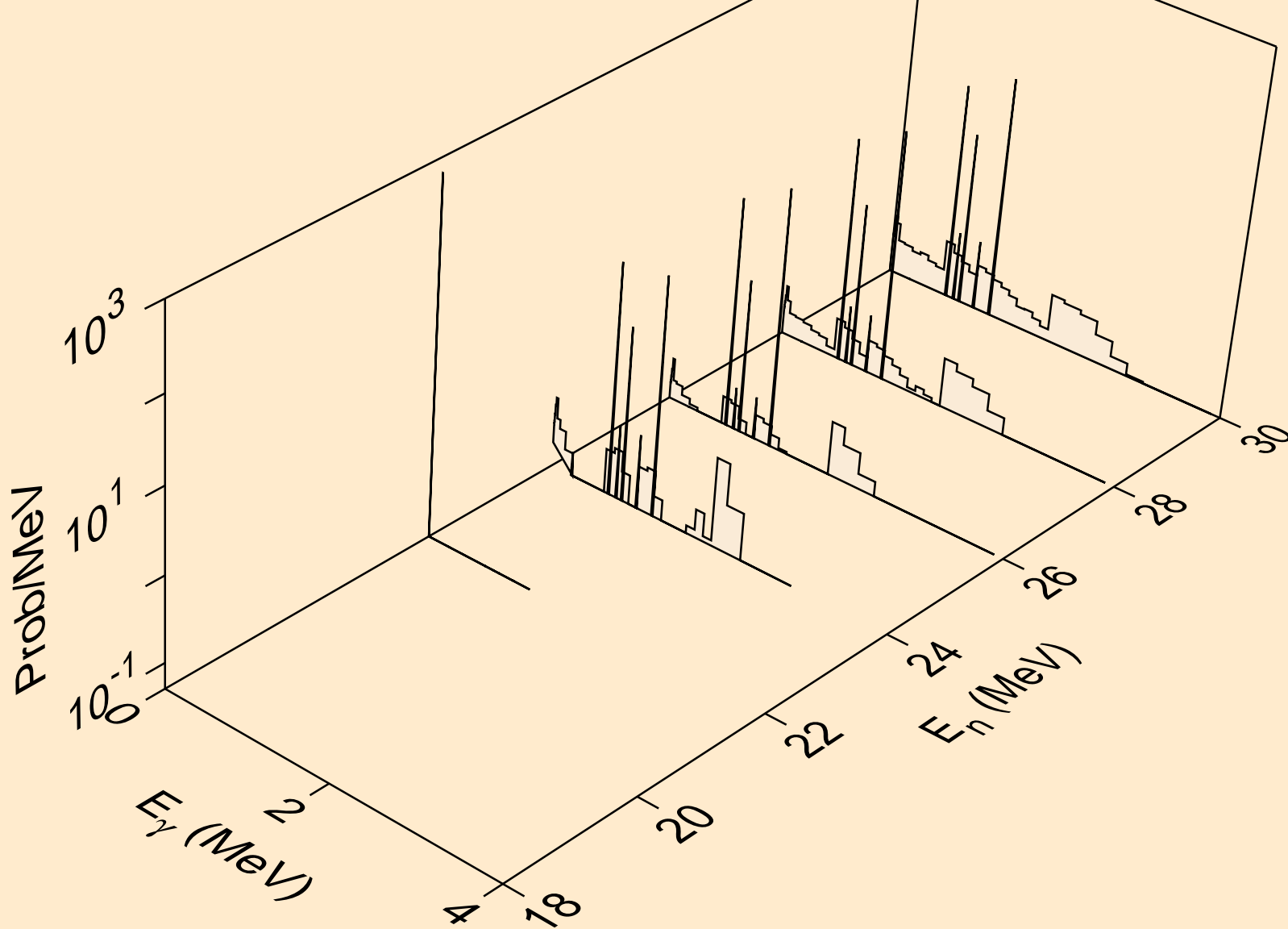

SE085 NEUTRON ACER TENDL-2019 LIBRARY; T=293.16K
Photon emission for (n,a)

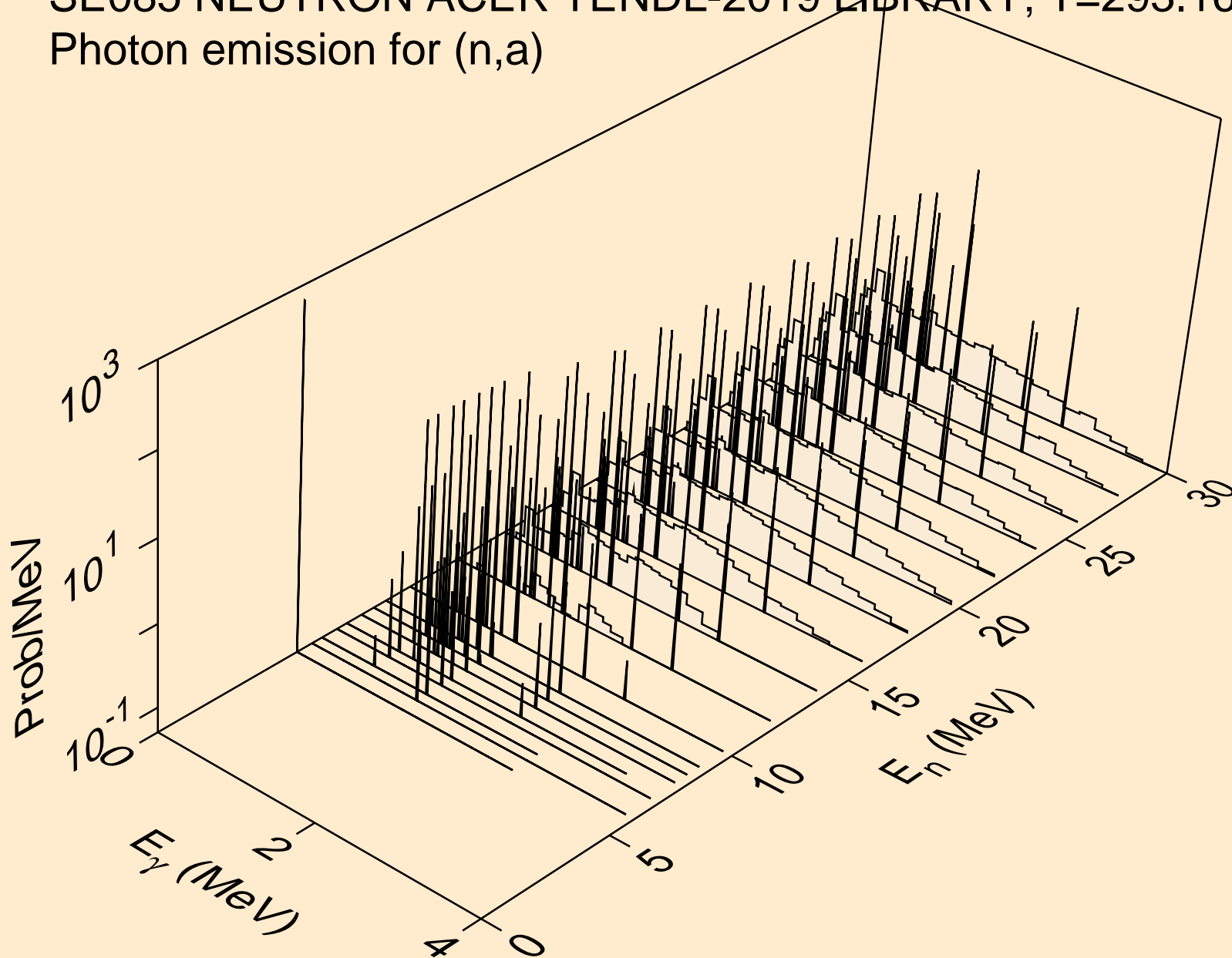

SE085 NEUTRON ACER TENDL-2019 LIBRARY; T=293.16K
thermal capture photon spectrum

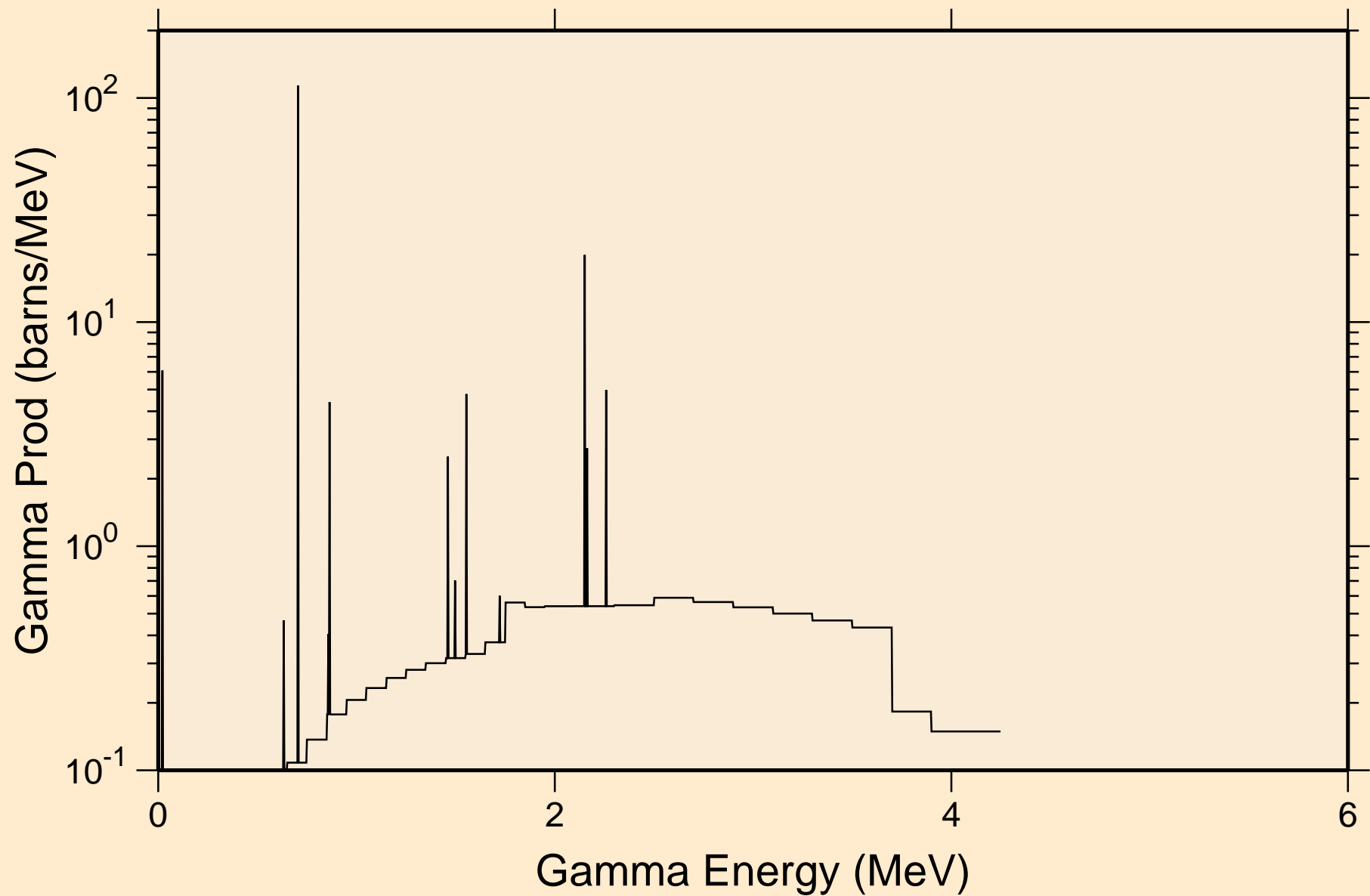

SE085 NEUTRON ACER TENDL-2019 LIBRARY; T=293.16K
14 MeV photon spectrum

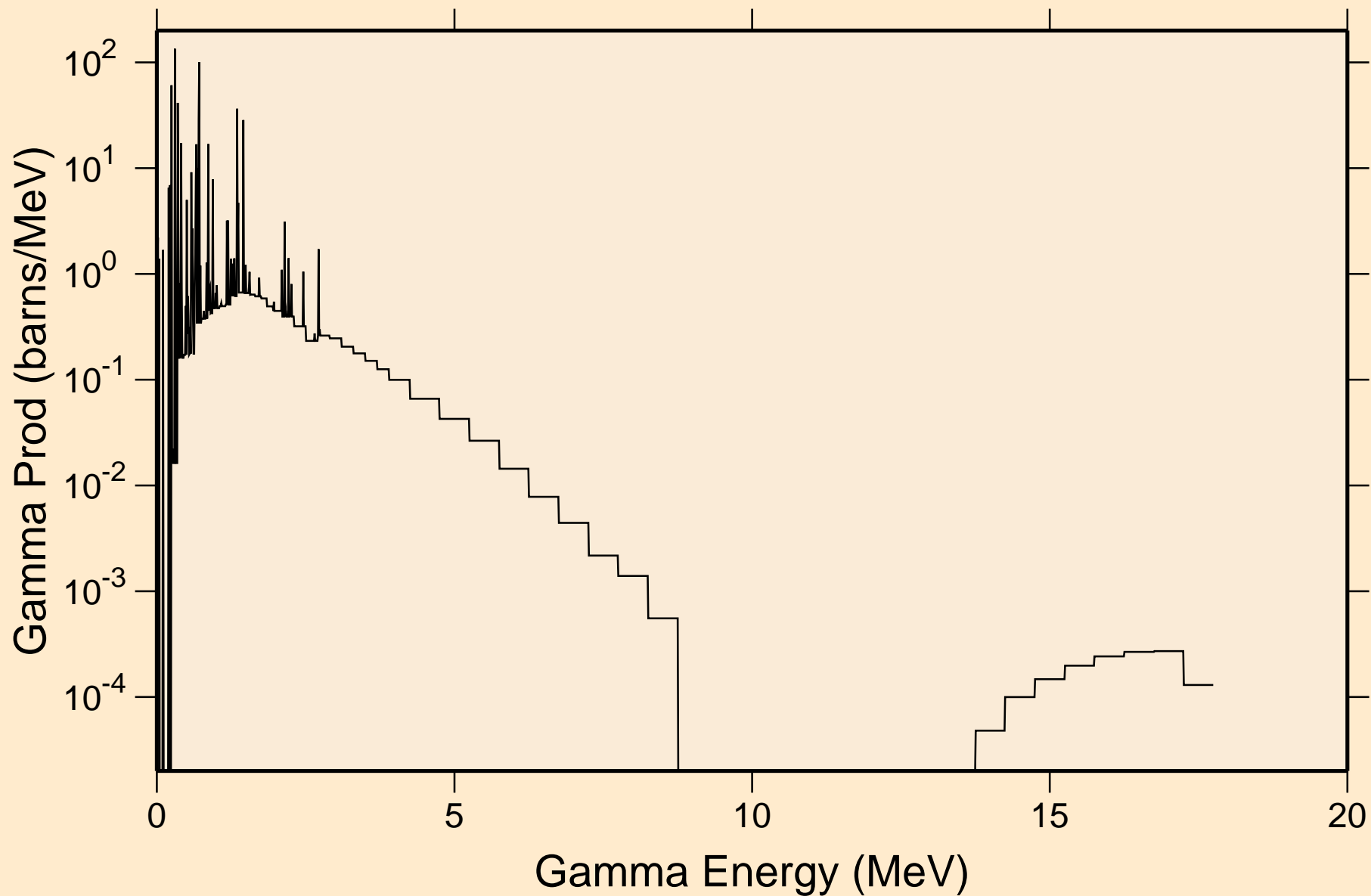

SE085 NEUTRON ACER TENDL-2019 LIBRARY; T=293.16K
Particle heating contributions

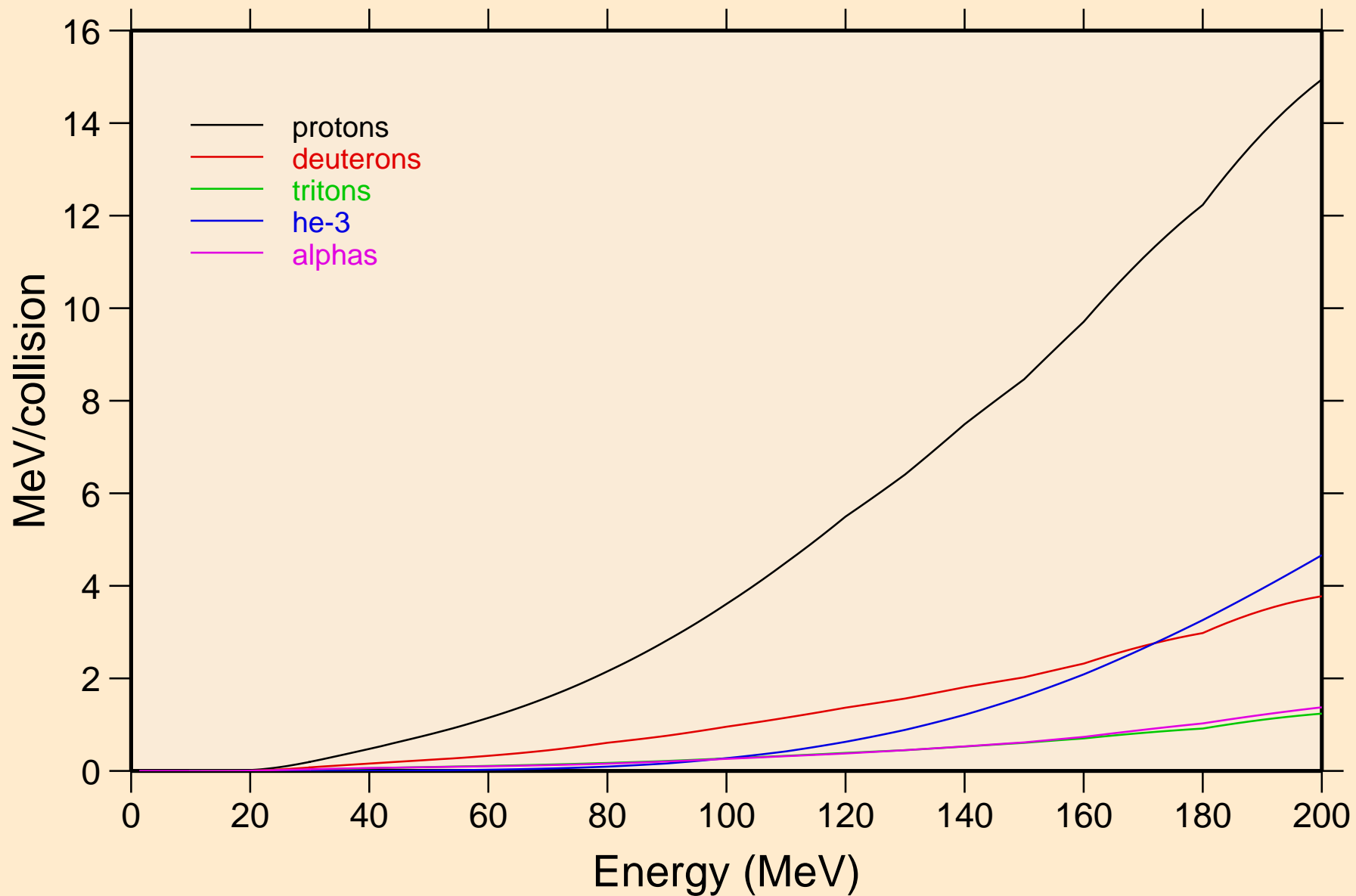

SE085 NEUTRON ACER TENDL-2019 LIBRARY; T=293.16K
Recoil Heating

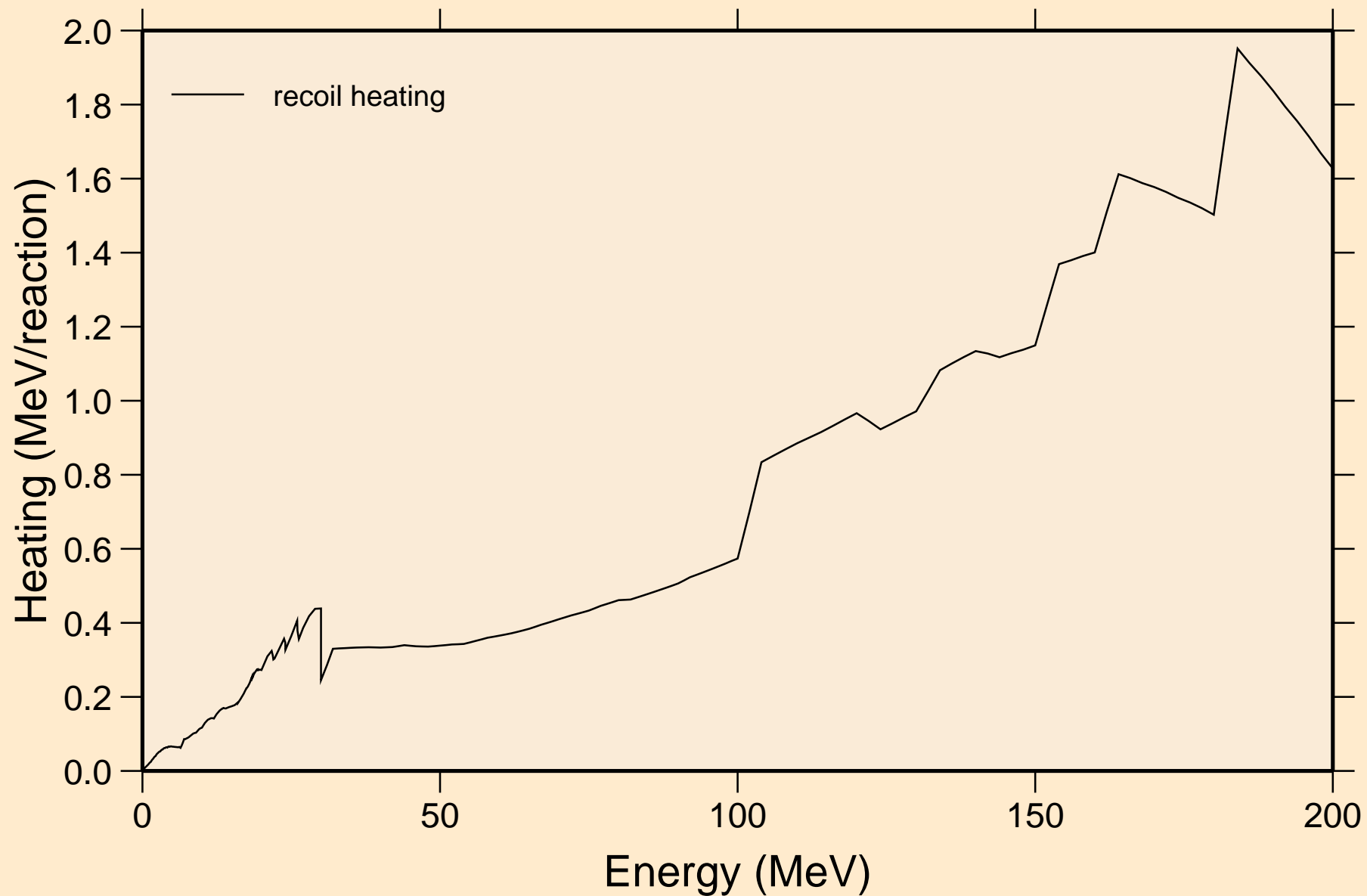

SE085 NEUTRON ACER TENDL-2019 LIBRARY; T=293.16K
Particle production cross sections

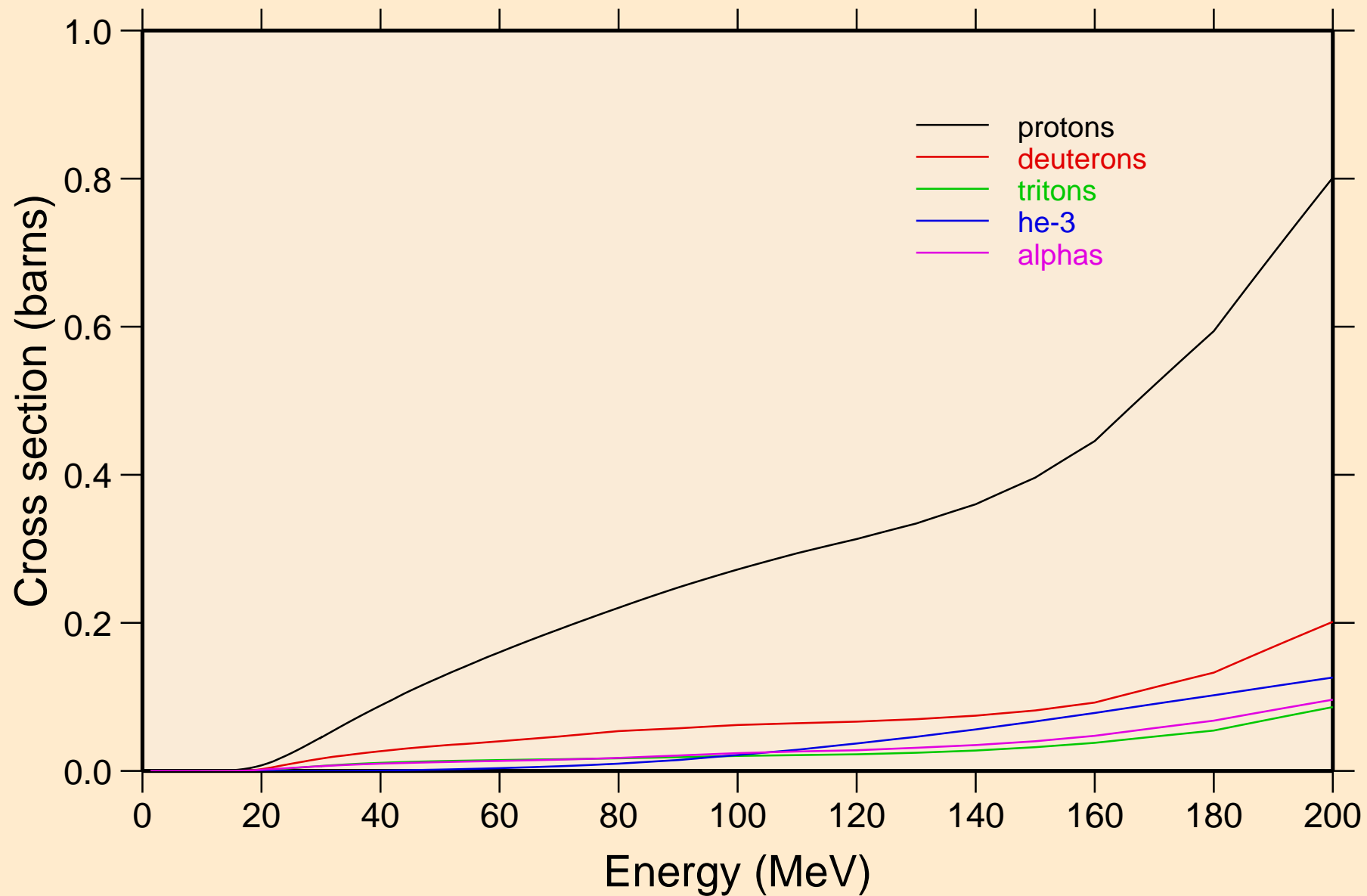

SE085 NEUTRON ACER TENDL-2019 LIBRARY; T=293.16K
protons from (n,x)

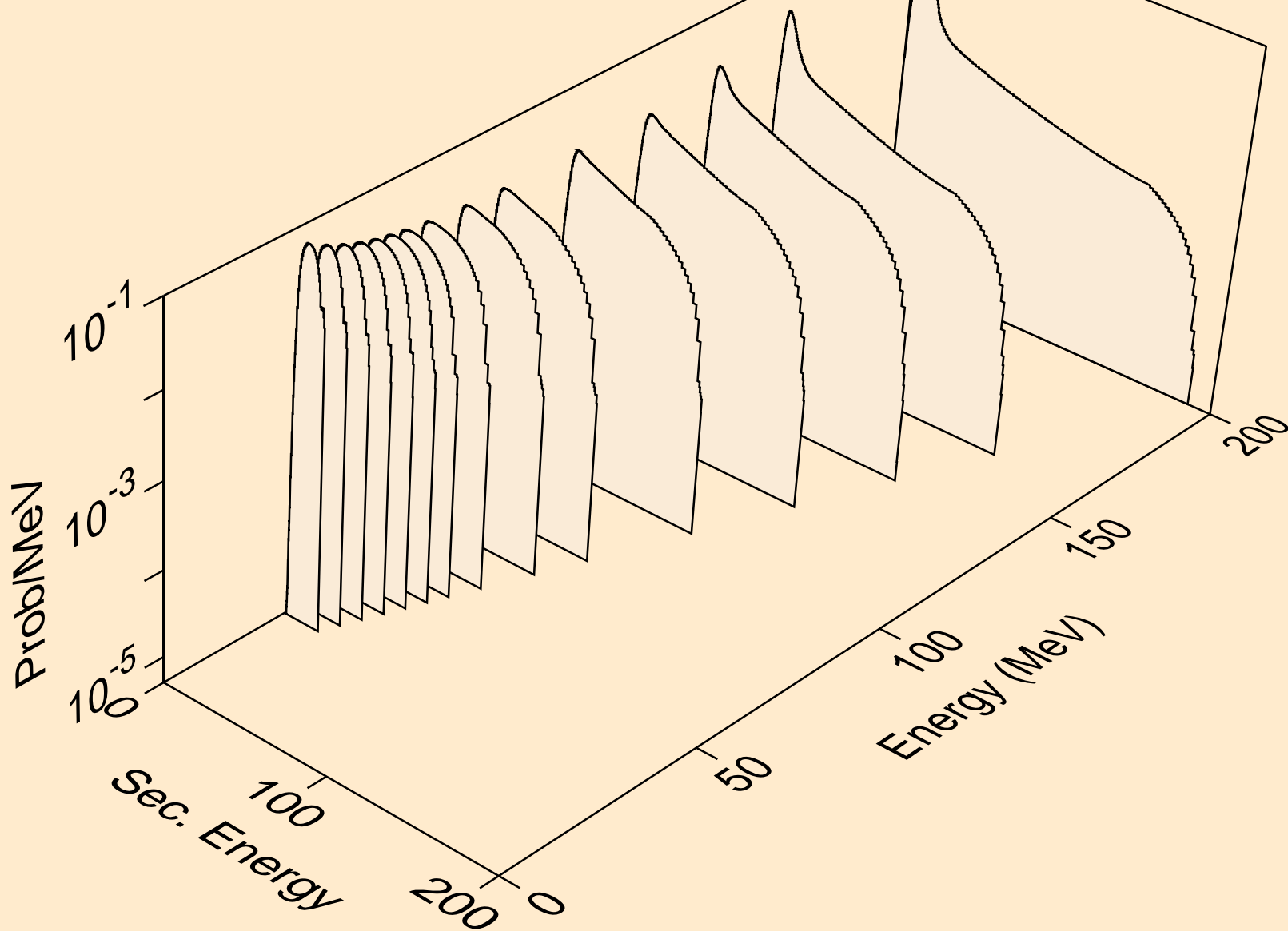

SE085 NEUTRON ACER TENDL-2019 LIBRARY; T=293.16K
protons from (n,n*)p

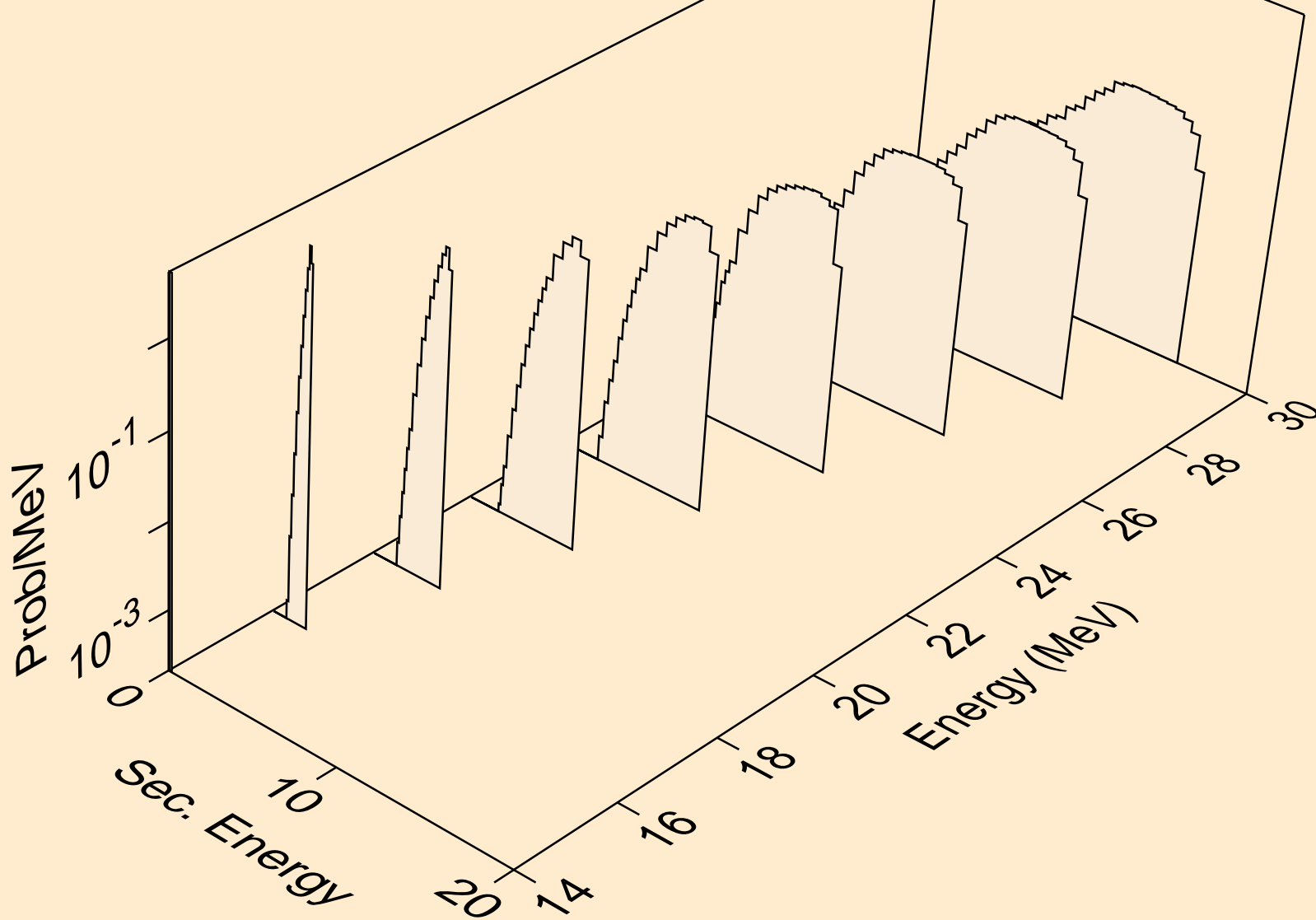

SE085 NEUTRON ACER TENDL-2019 LIBRARY; T=293.16K
protons from (n,2np)

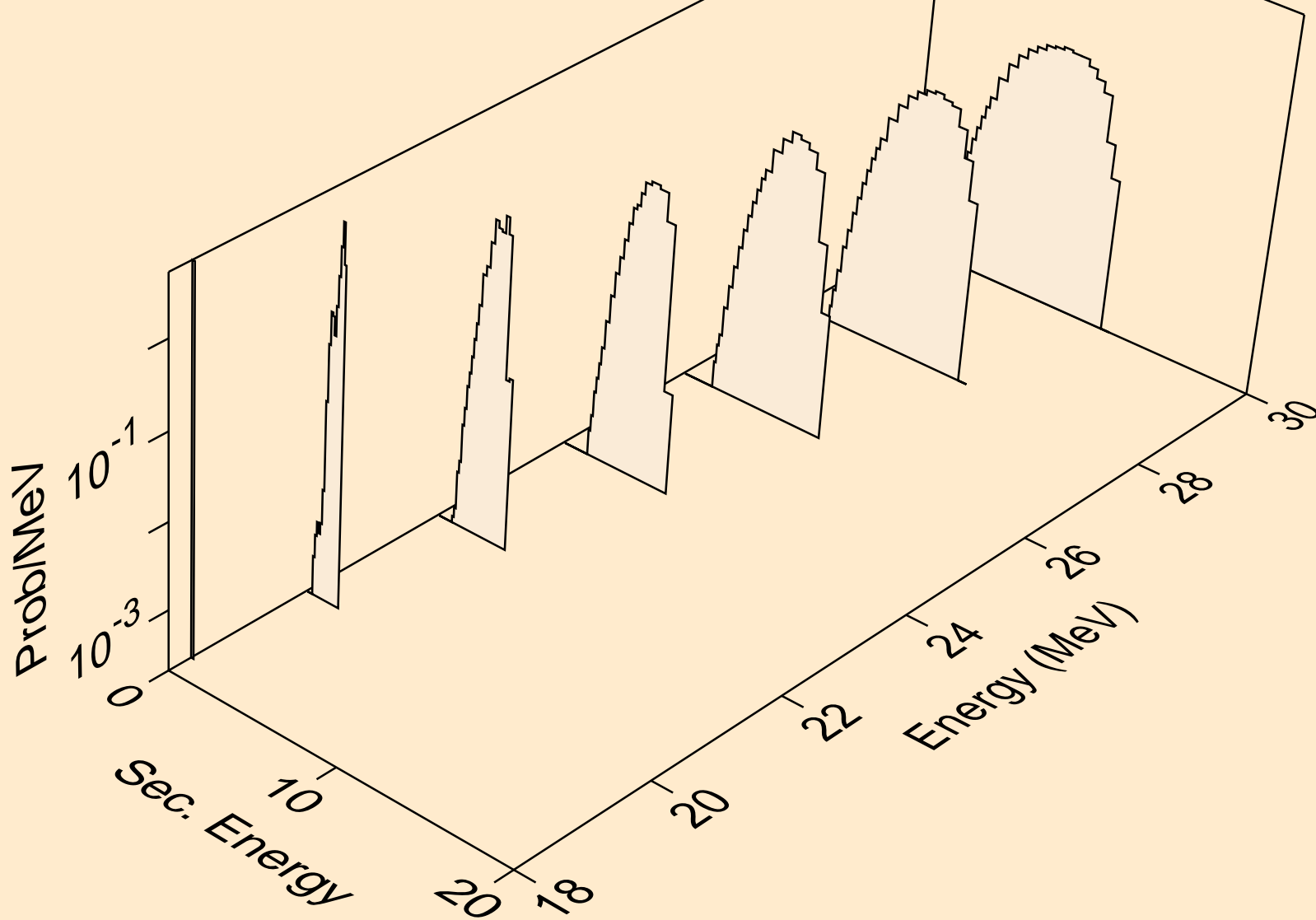

SE085 NEUTRON ACER TENDL-2019 LIBRARY; T=293.16K
protons from (n,3np)

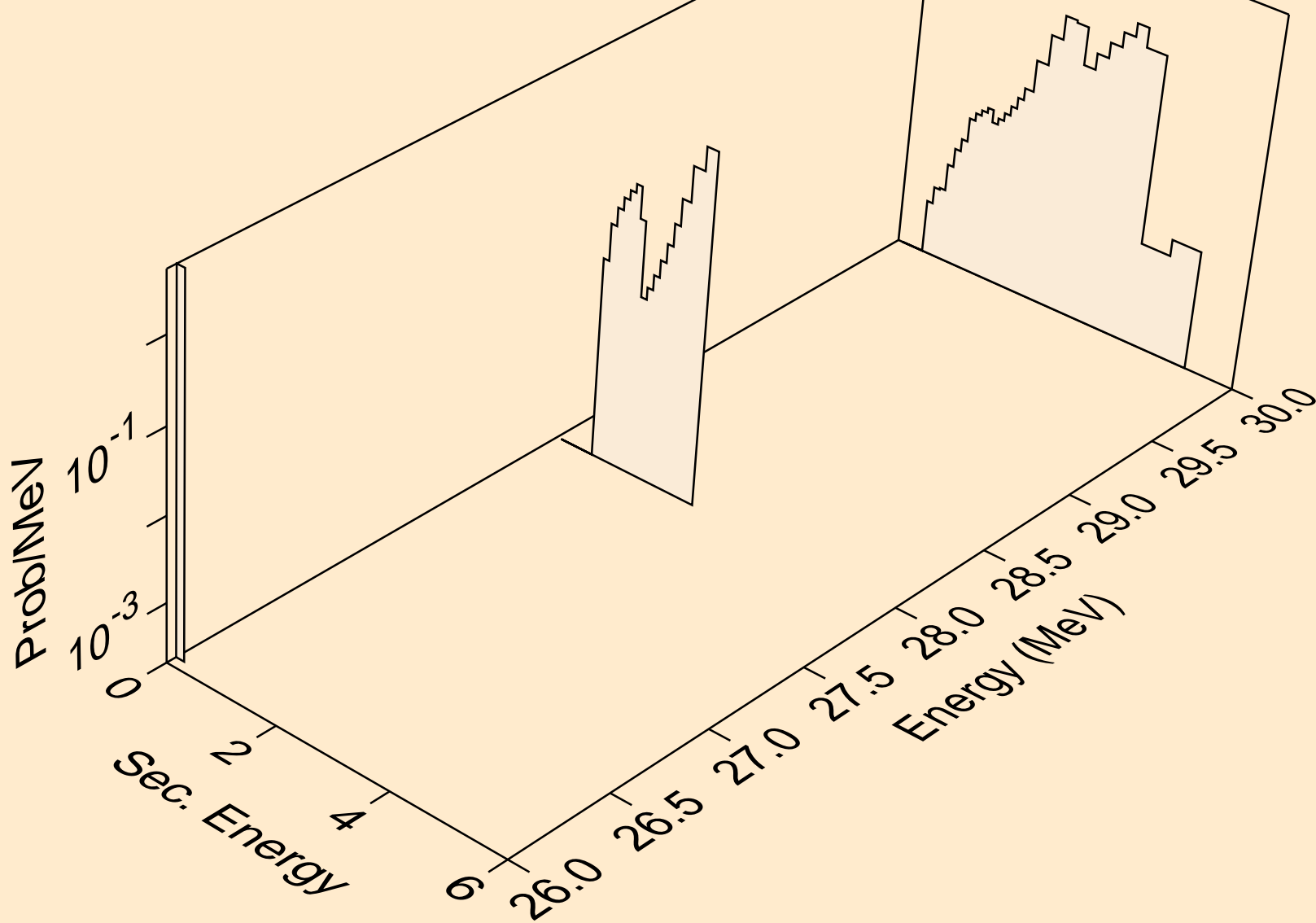

SE085 NEUTRON ACER TENDL-2019 LIBRARY; T=293.16K
protons from (n,p)

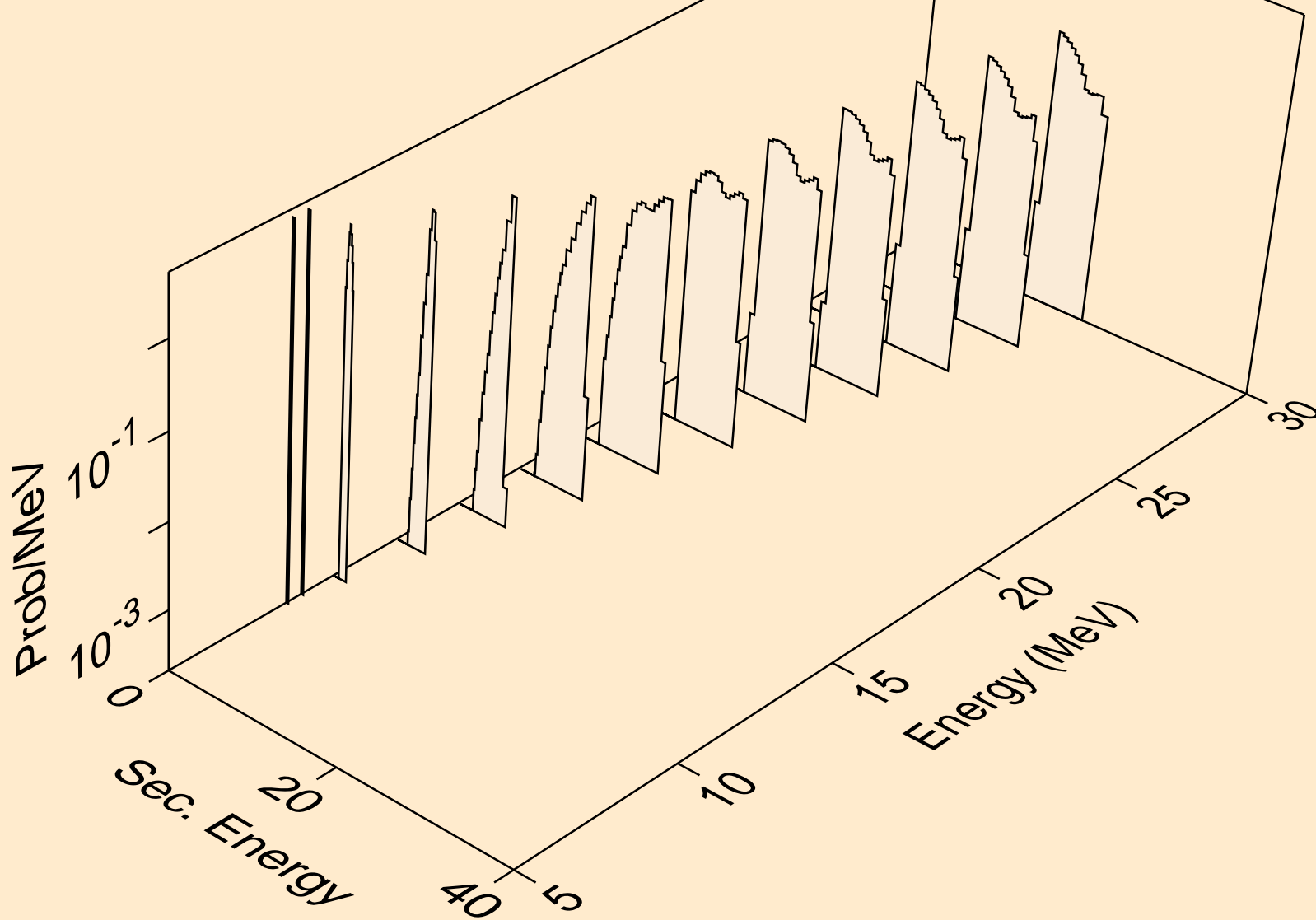

SE085 NEUTRON ACER TENDL-2019 LIBRARY; T=293.16K
deuterons from (n,x)

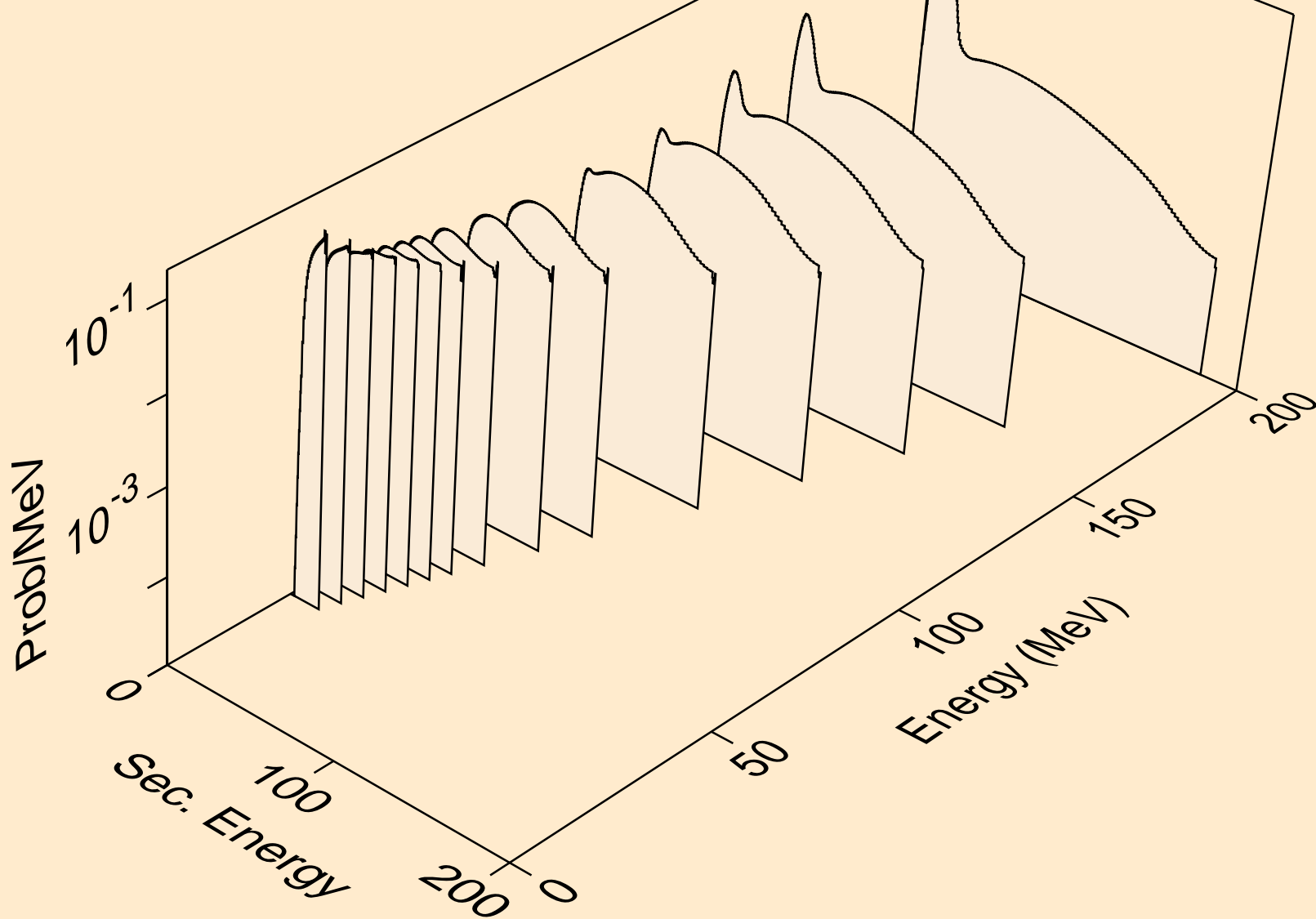

SE085 NEUTRON ACER TENDL-2019 LIBRARY; T=293.16K
deuterons from (n,2nd)

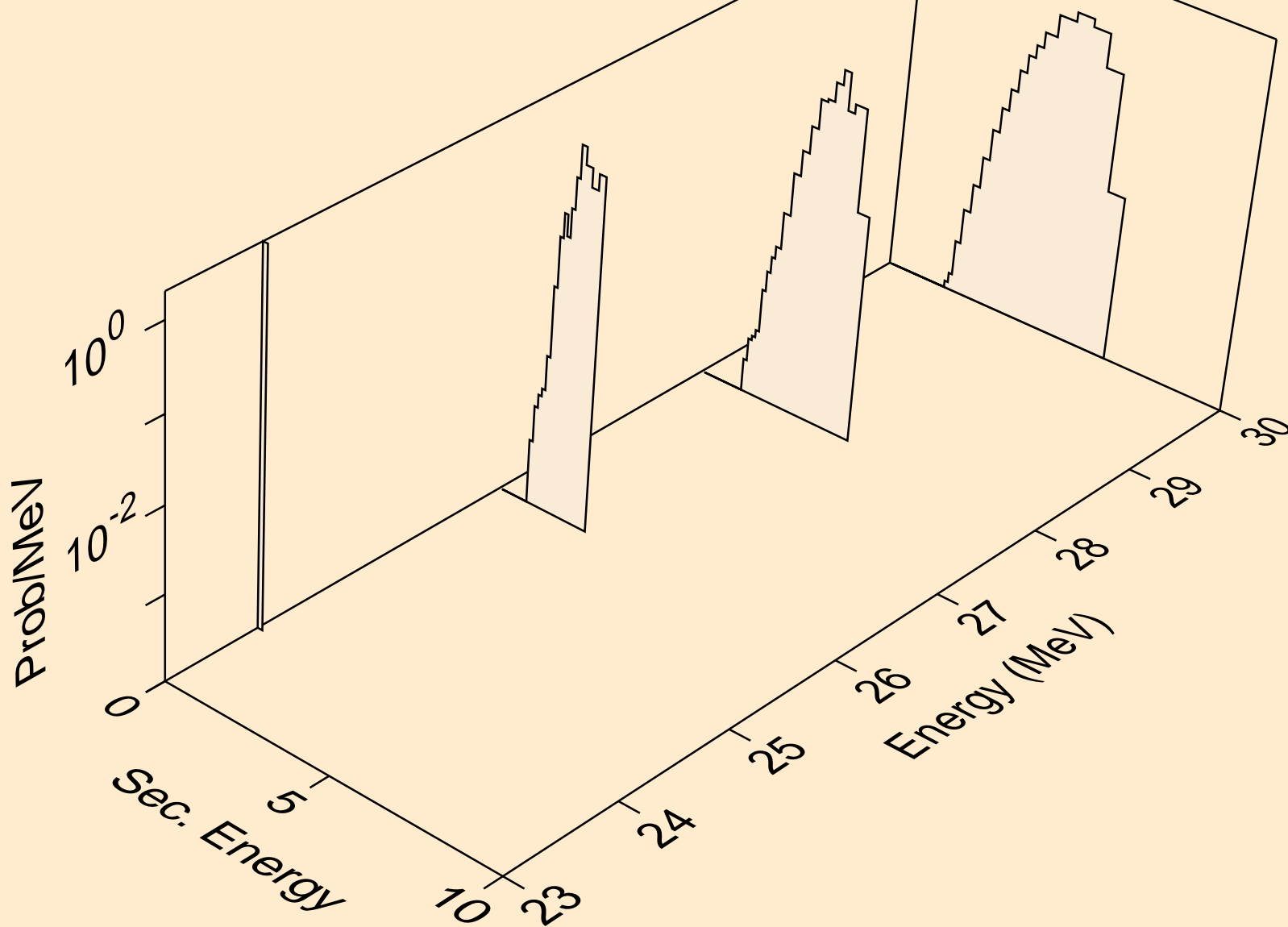

SE085 NEUTRON ACER TENDL-2019 LIBRARY; T=293.16K
deuterons from (n,n*)d

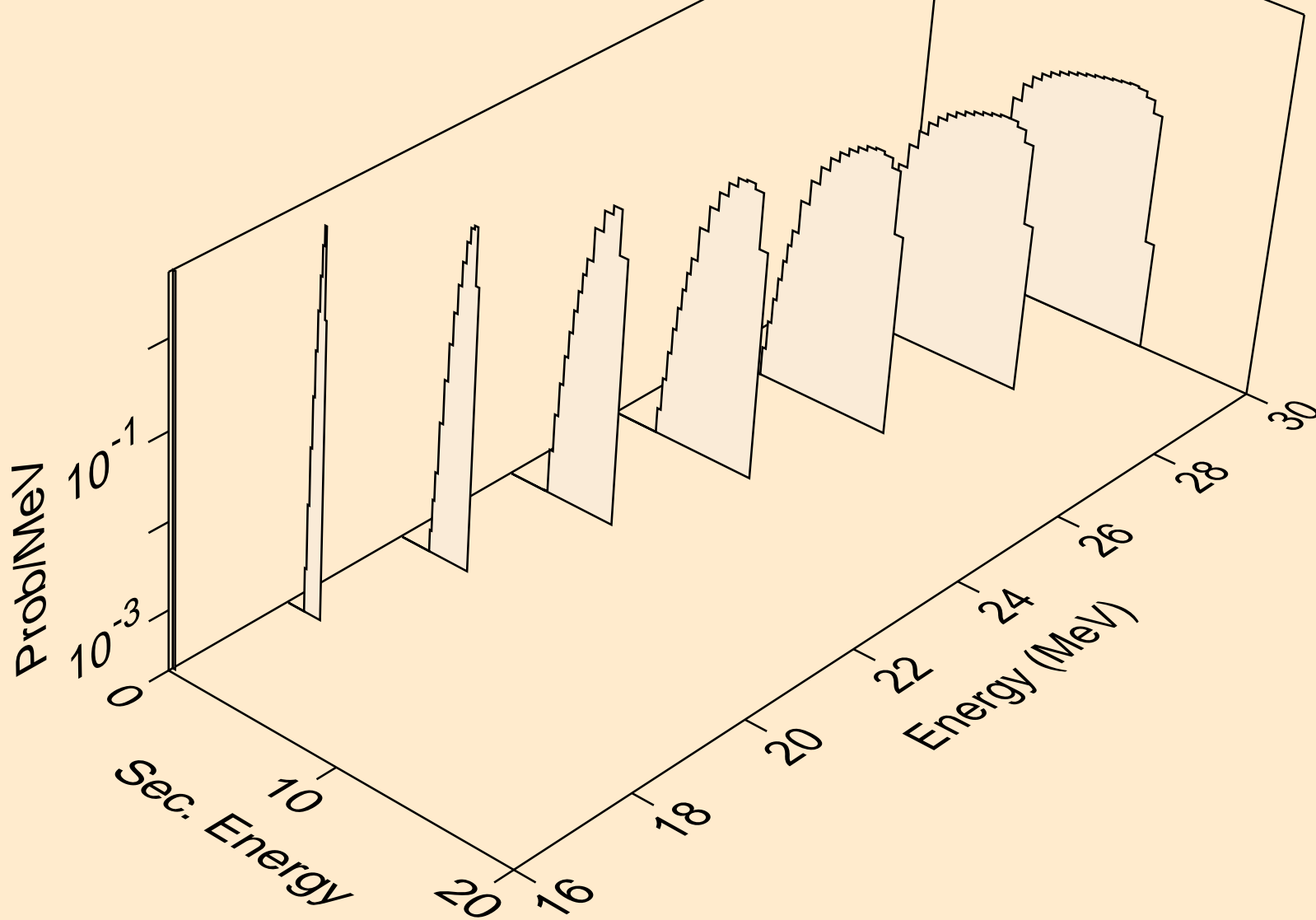

SE085 NEUTRON ACER TENDL-2019 LIBRARY; T=293.16K
deuterons from (n,d)

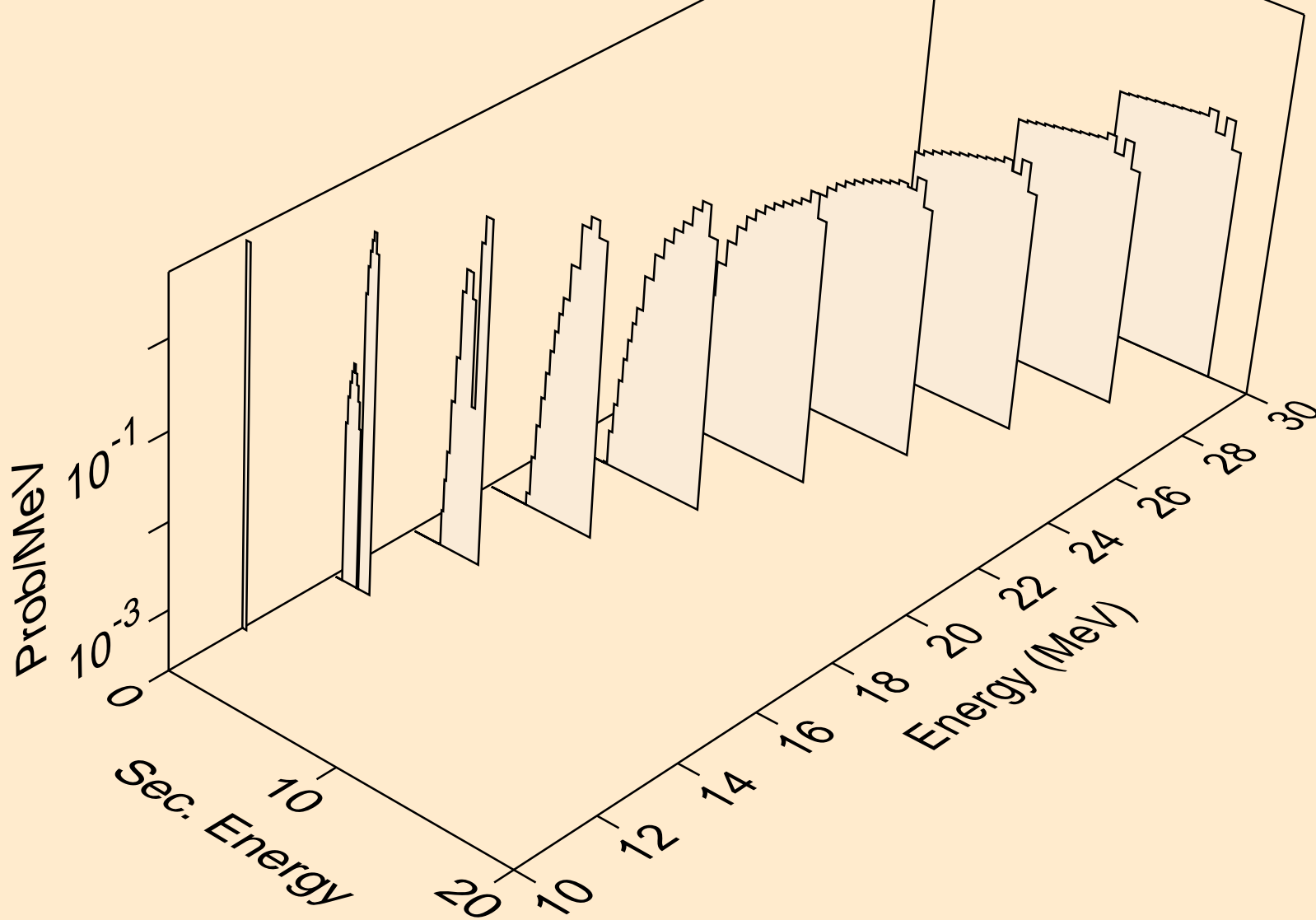

SE085 NEUTRON ACER TENDL-2019 LIBRARY; T=293.16K
tritons from (n,x)

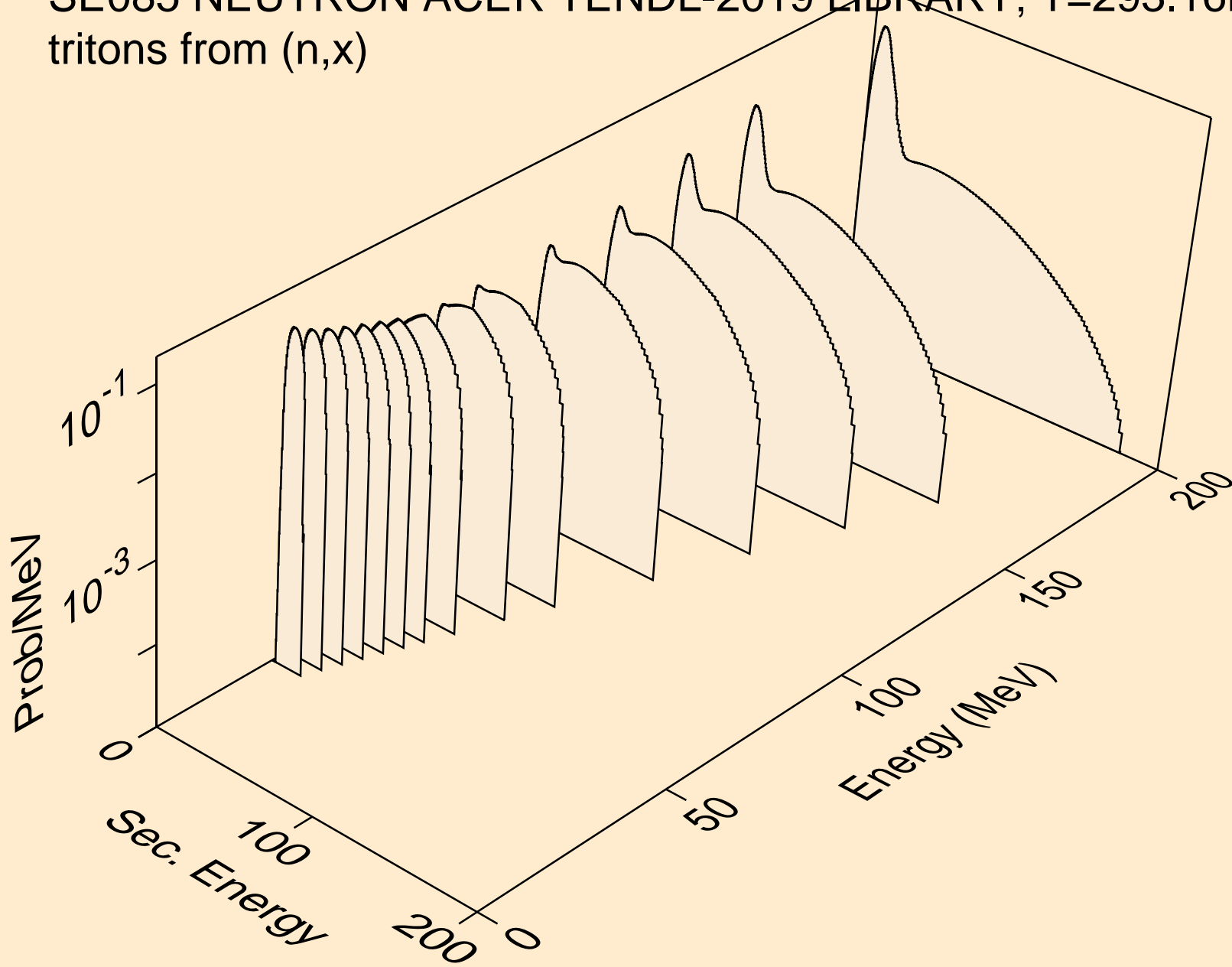

SE085 NEUTRON ACER TENDL-2019 LIBRARY; T=293.16K
tritons from (n,n*)t

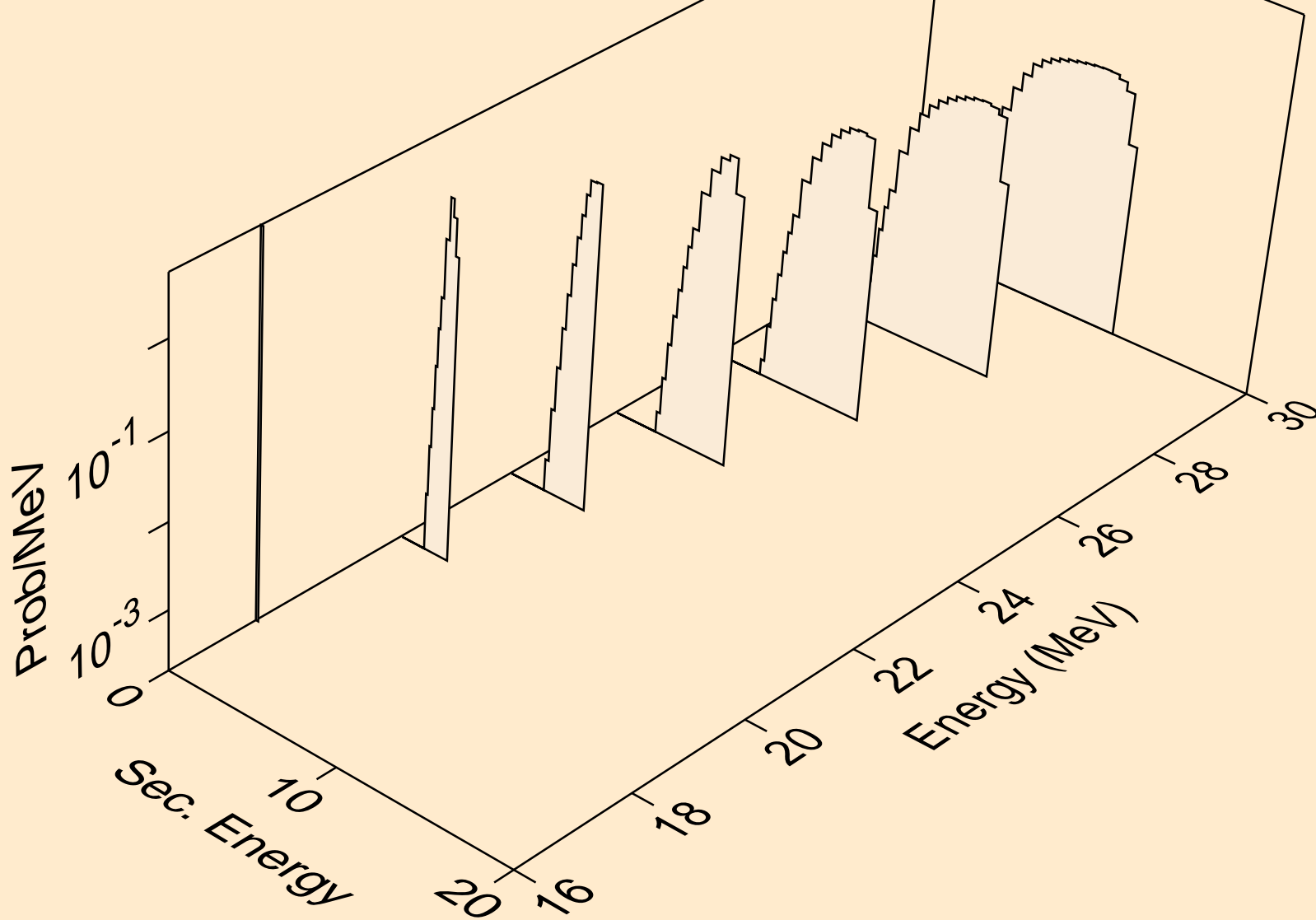

SE085 NEUTRON ACER TENDL-2019 LIBRARY; T=293.16K
tritons from (n,t)

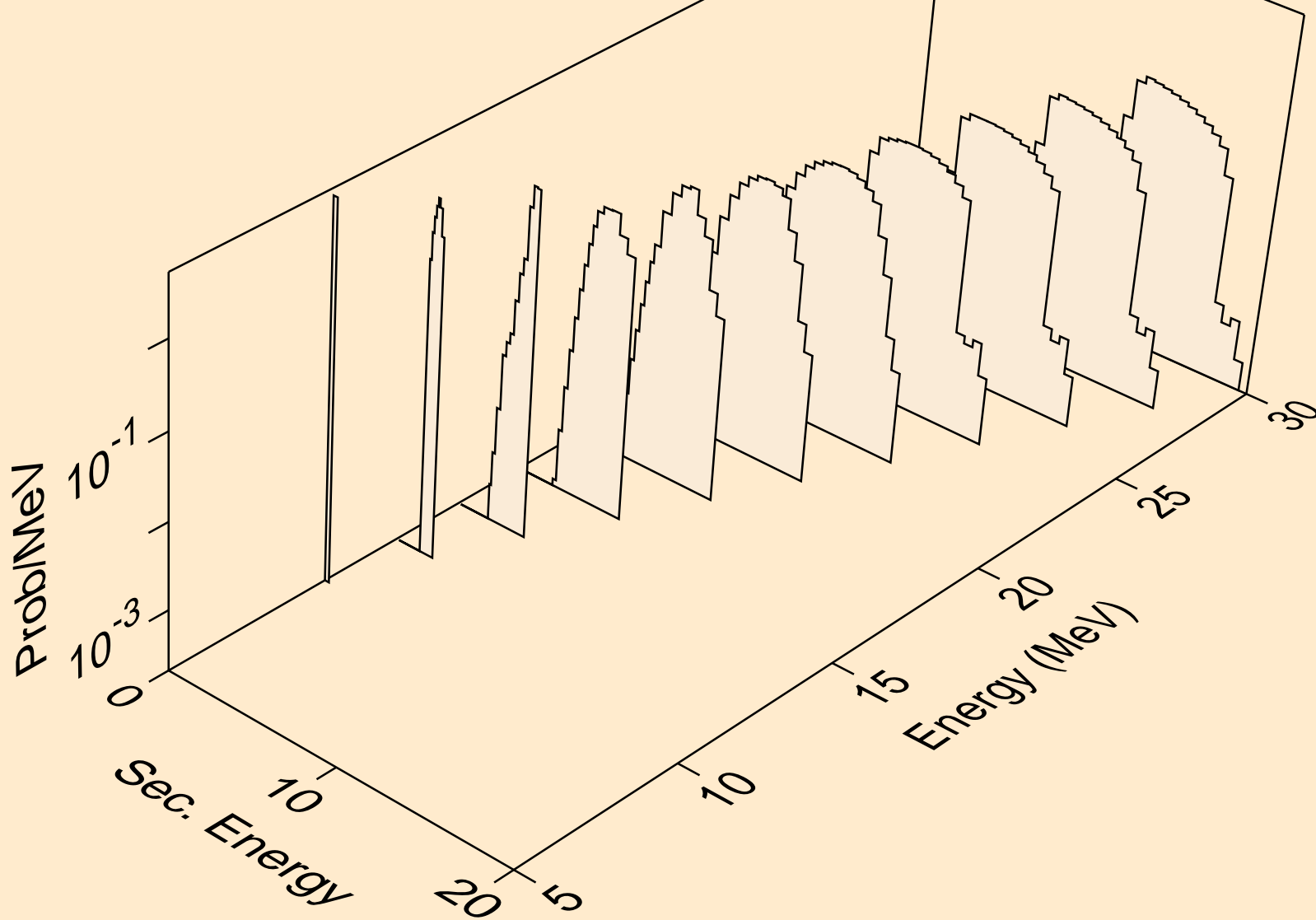

SE085 NEUTRON ACER TENDL-2019 LIBRARY; T=293.16K
he3s from (n,x)

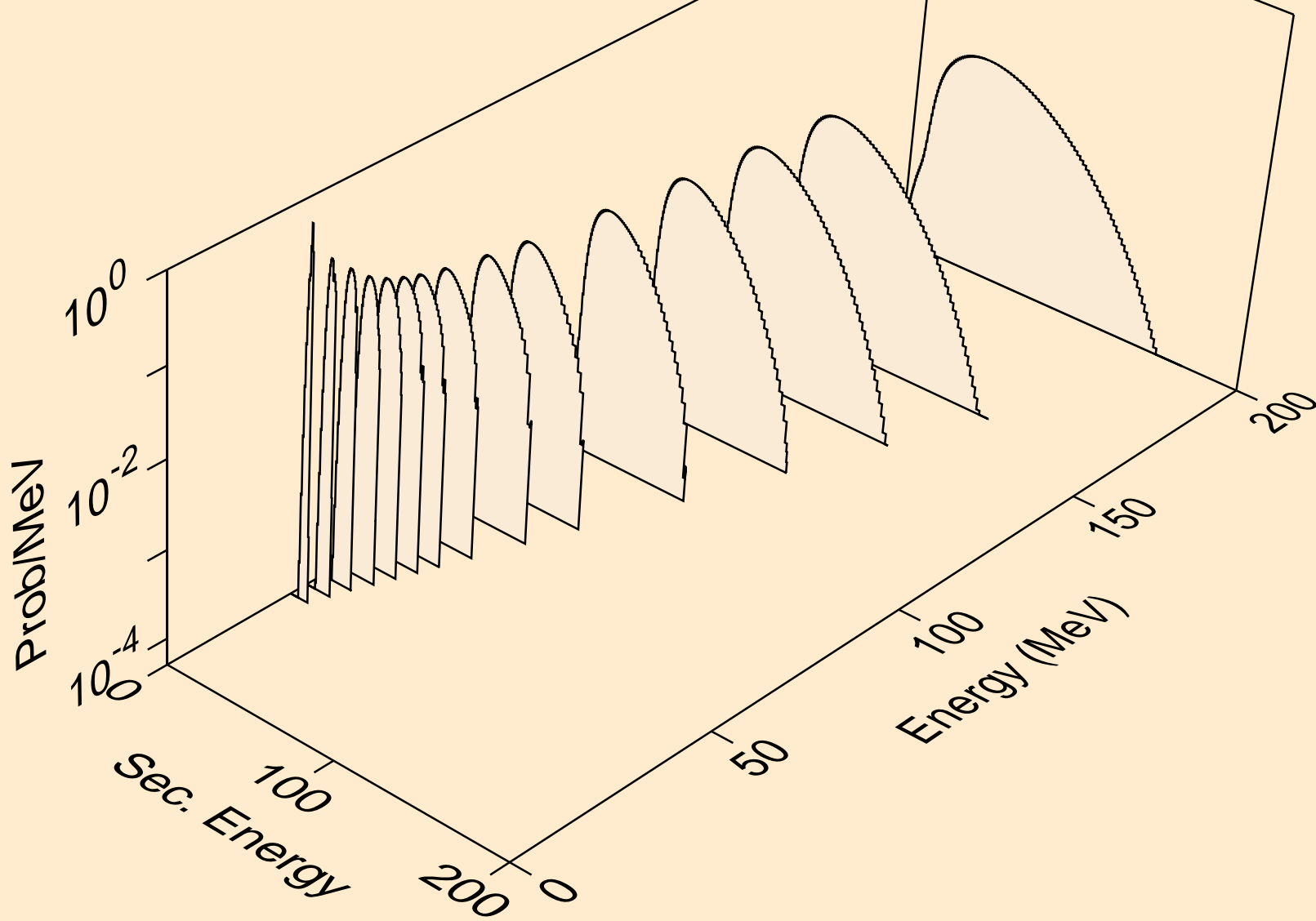

SE085 NEUTRON ACER TENDL-2019 LIBRARY; T=293.16K
he3s from (n,n*)he3

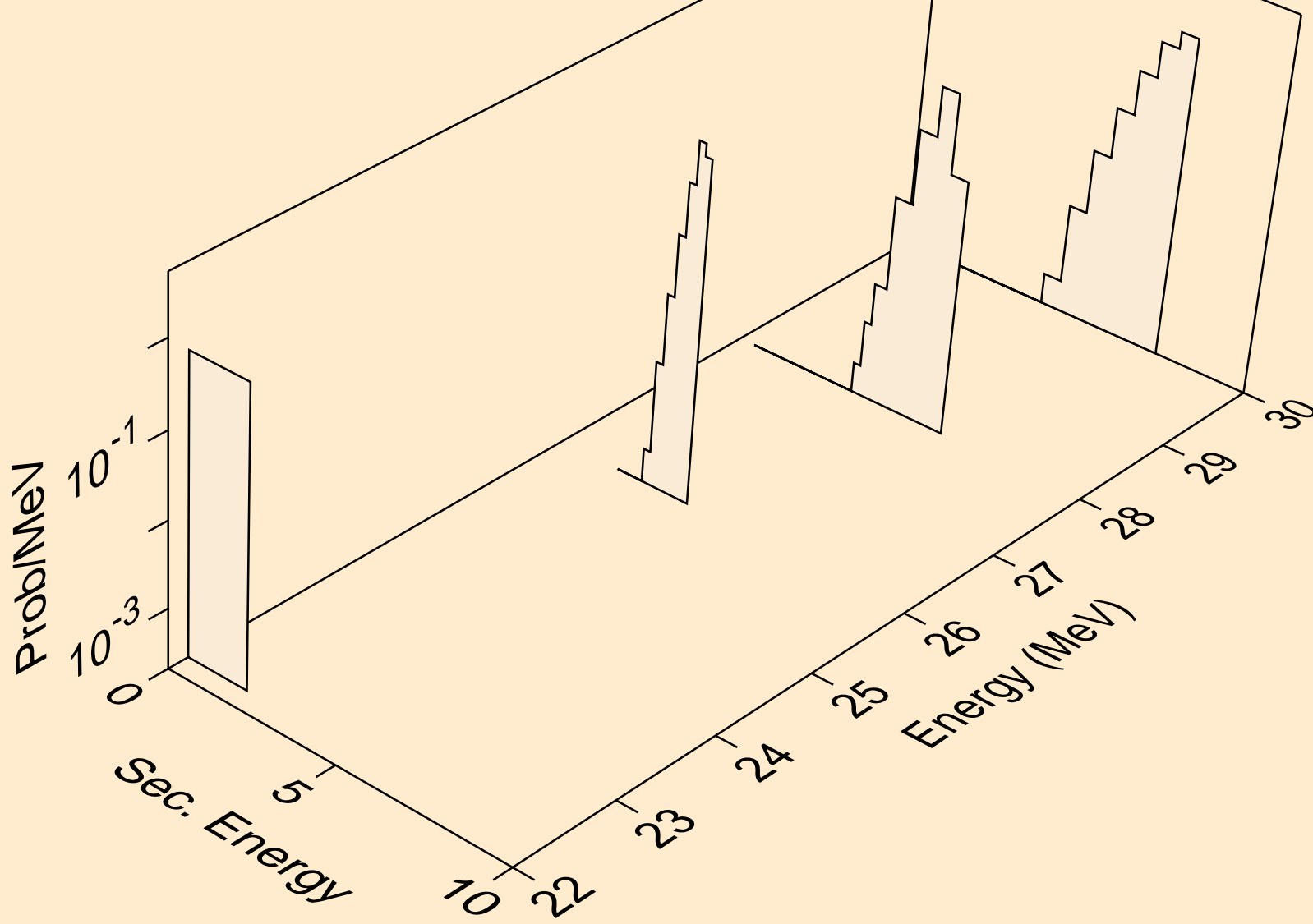

SE085 NEUTRON ACER TENDL-2019 LIBRARY; T=293.16K
he3s from (n,he3)

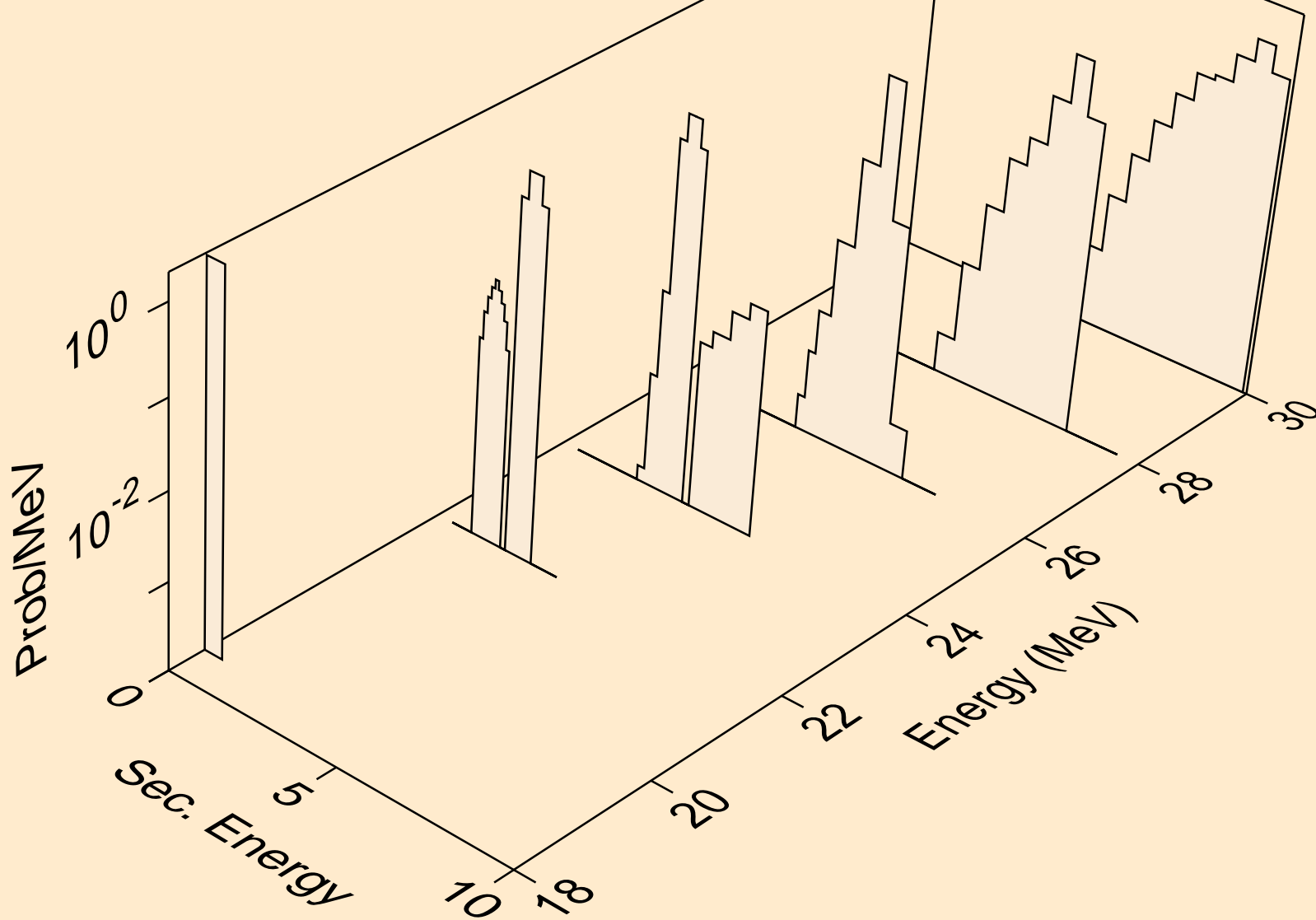

SE085 NEUTRON ACER TENDL-2019 LIBRARY; T=293.16K
alphas from (n,x)

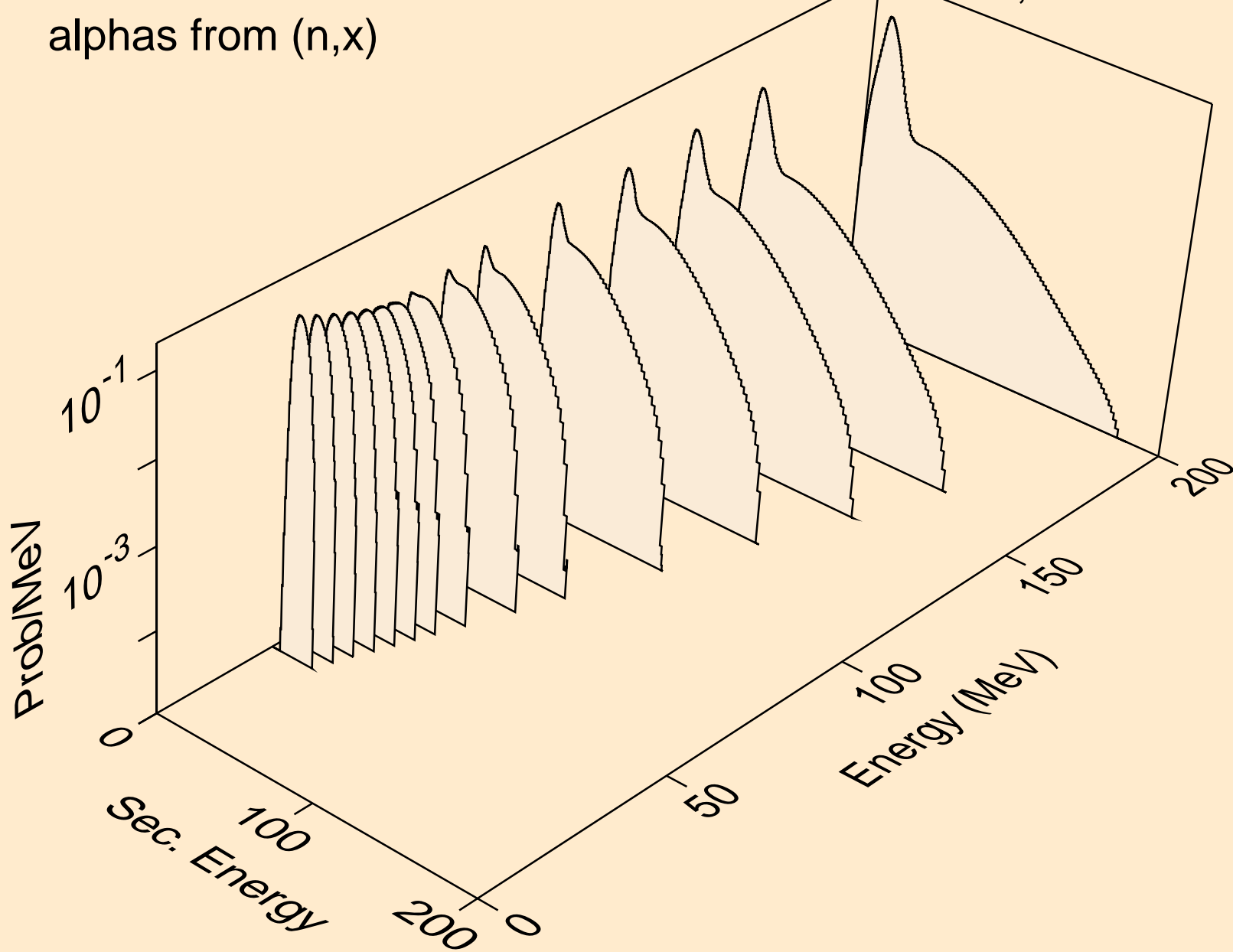

SE085 NEUTRON ACER TENDL-2019 LIBRARY; T=293.16K
alphas from (n,n*)a

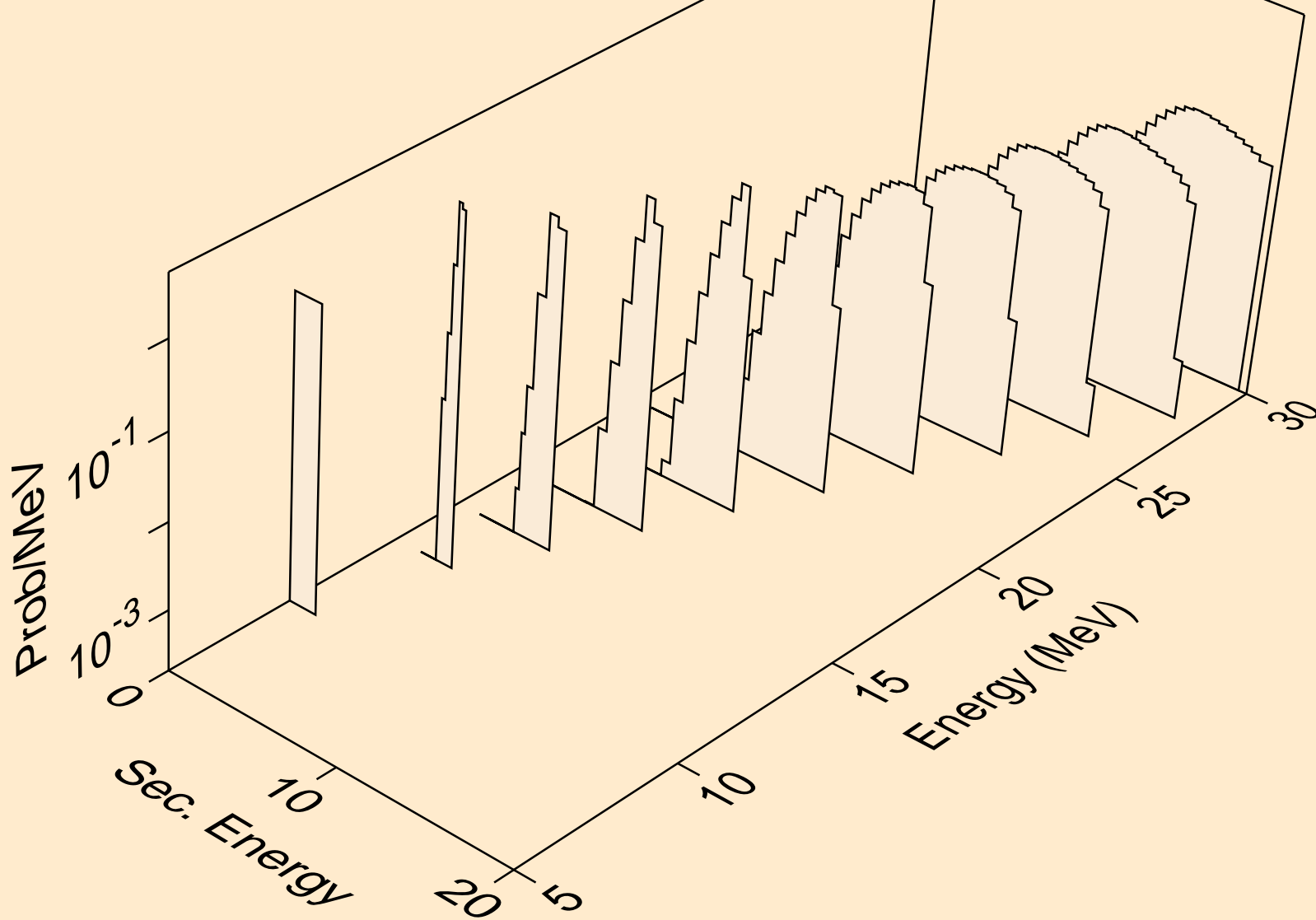

SE085 NEUTRON ACER TENDL-2019 LIBRARY; T=293.16K
alphas from (n,2n)a

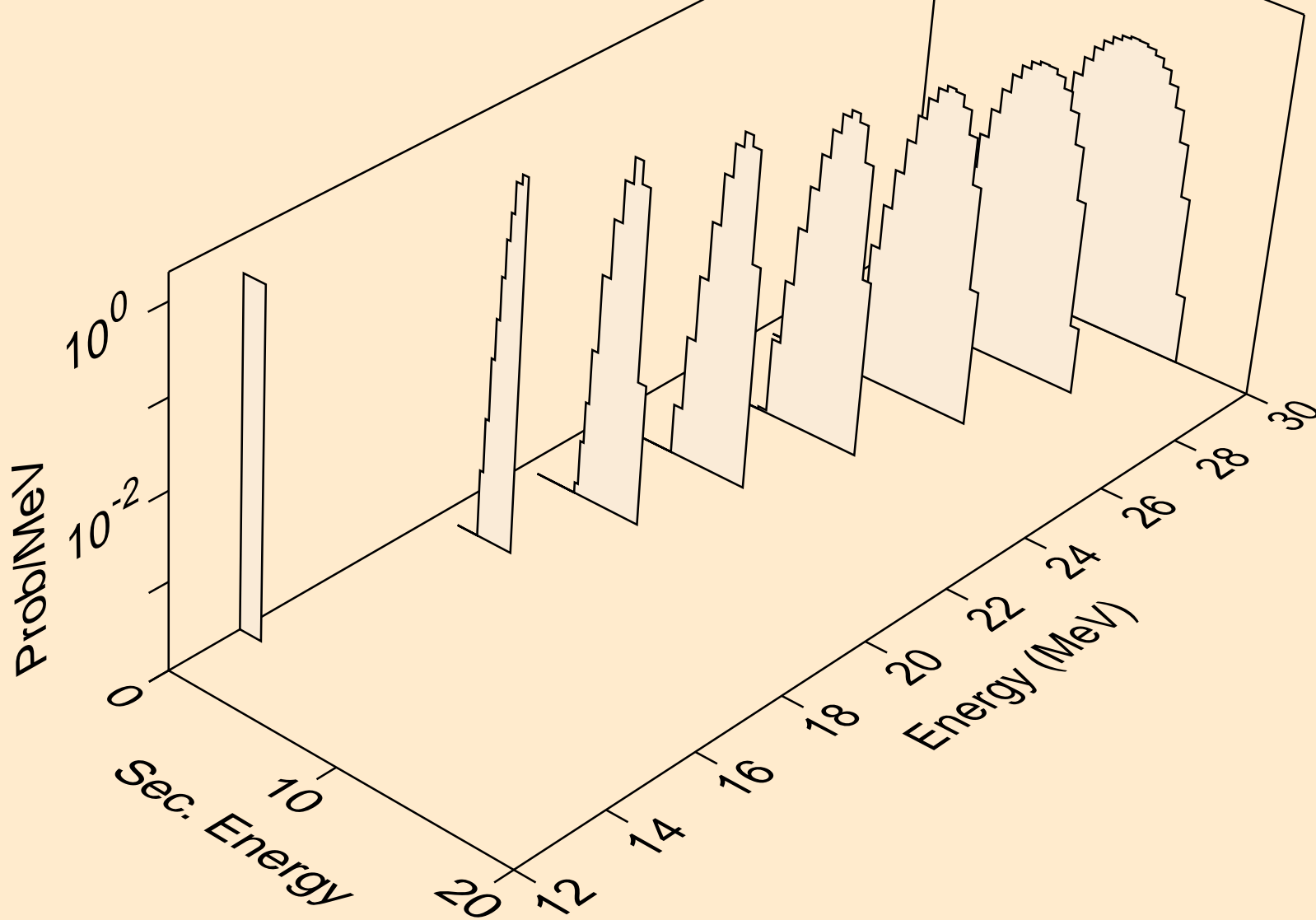

SE085 NEUTRON ACER TENDL-2019 LIBRARY; T=293.16K
alphas from (n,3n)a

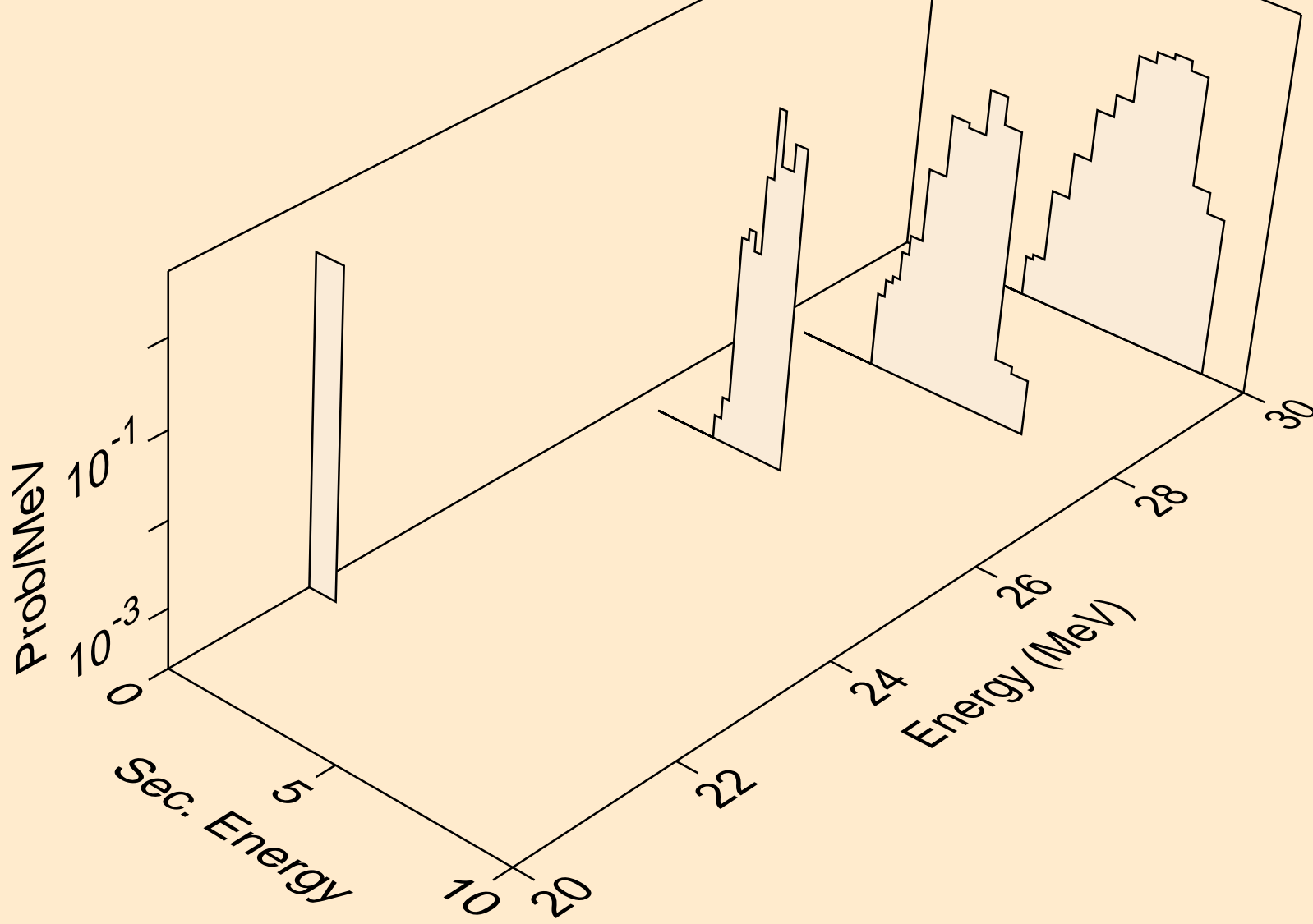

SE085 NEUTRON ACER TENDL-2019 LIBRARY; T=293.16K
alphas from (n,a)

