

SR084 NEUTRON ACER TENDL-2019 LIBRARY; T=293.16K
Principal cross sections

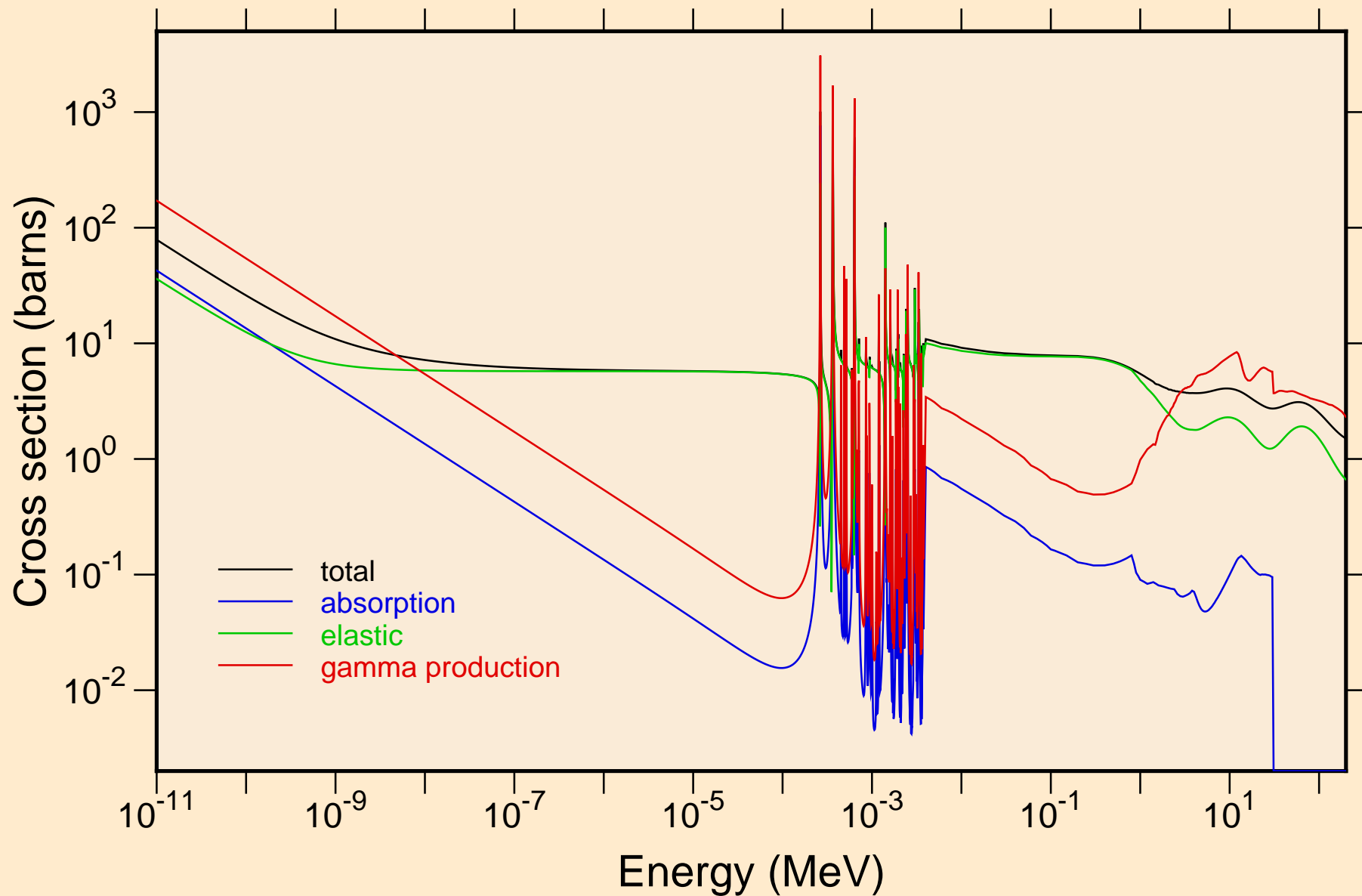

SR084 NEUTRON ACER TENDL-2019 LIBRARY; T=293.16K
resonance total cross section

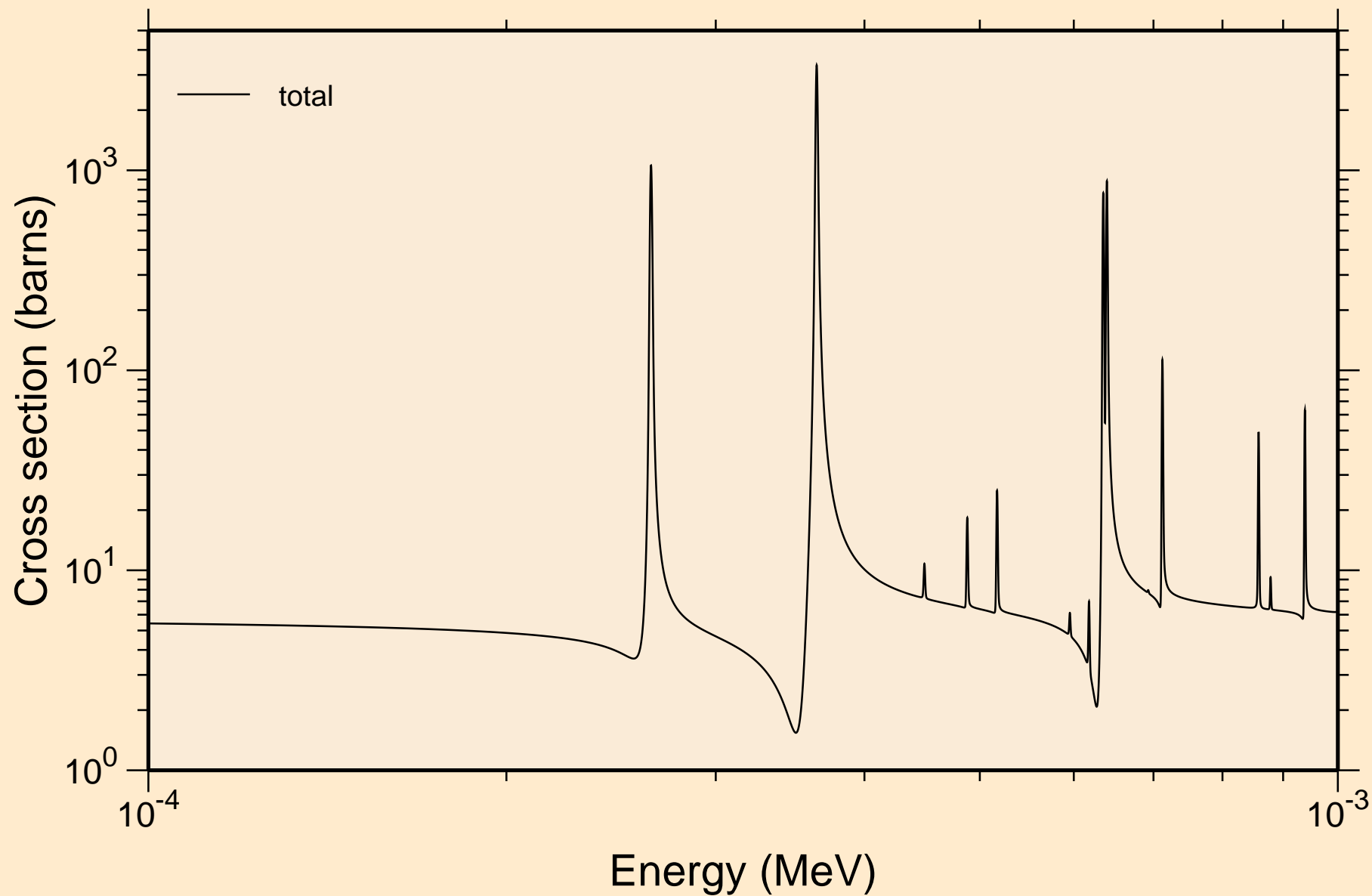

SR084 NEUTRON ACER TENDL-2019 LIBRARY; T=293.16K
resonance total cross section

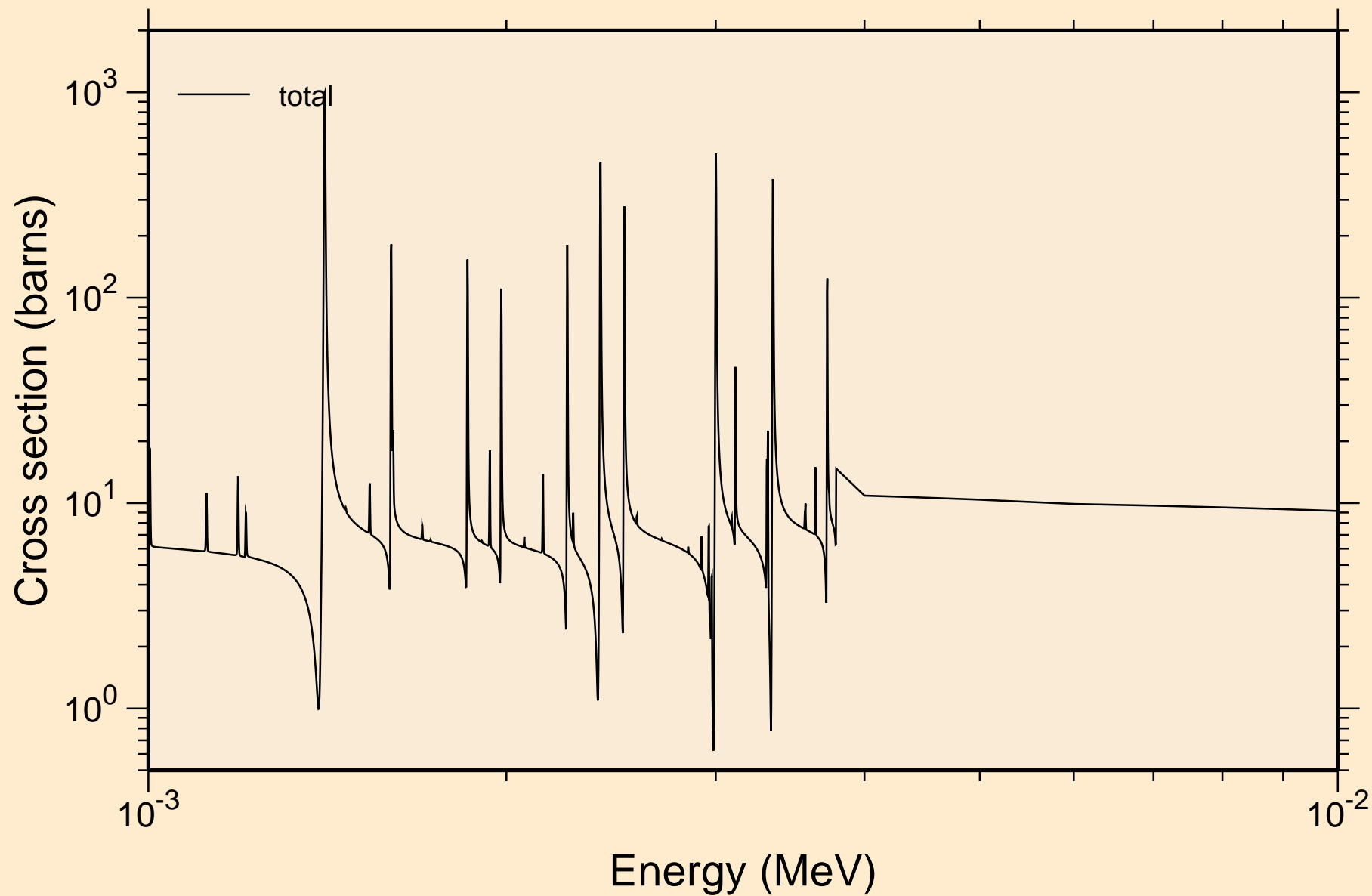

SR084 NEUTRON ACER TENDL-2019 LIBRARY; T=293.16K
resonance total cross section

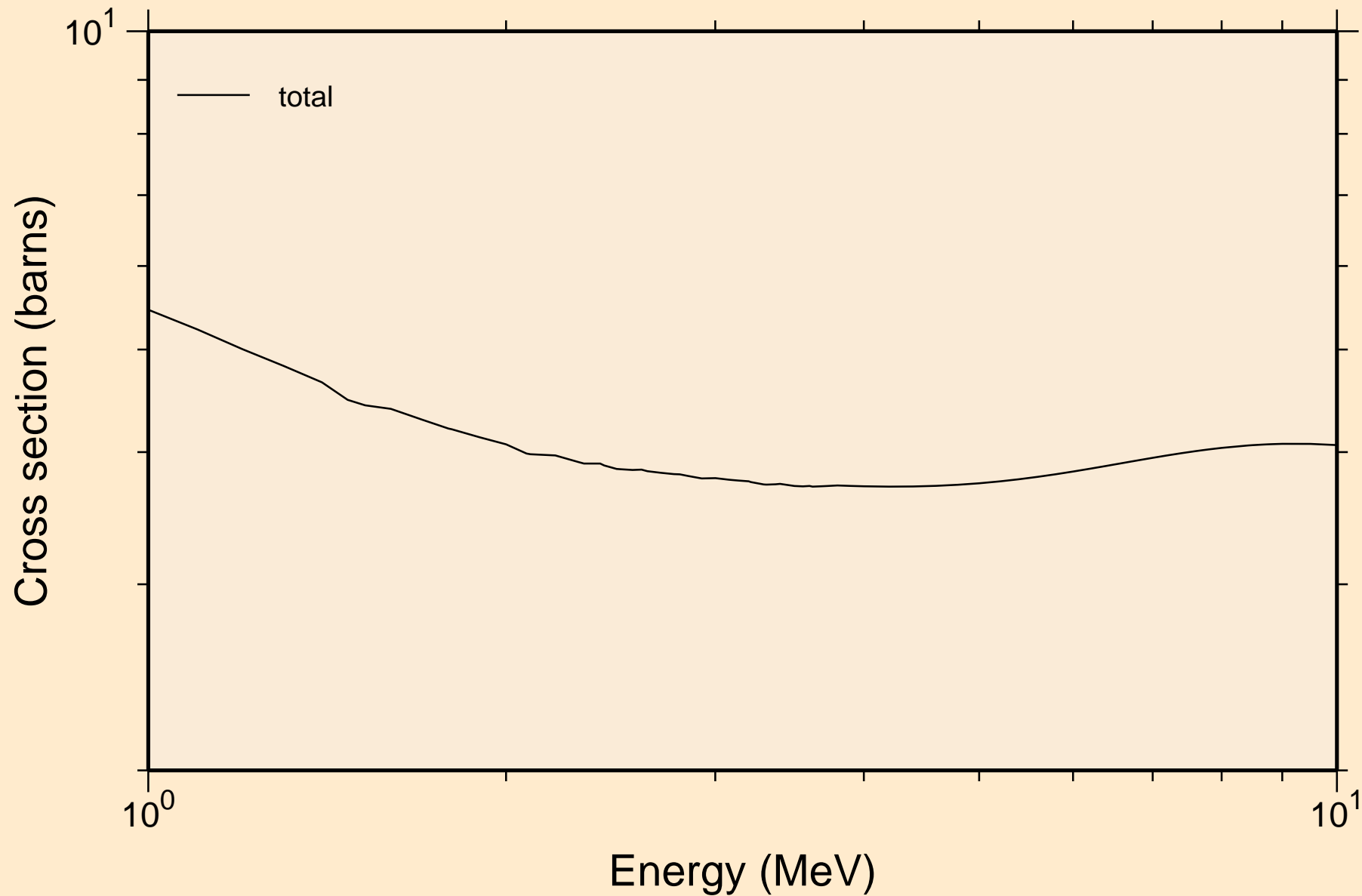

SR084 NEUTRON ACER TENDL-2019 LIBRARY; T=293.16K
resonance absorption cross sections

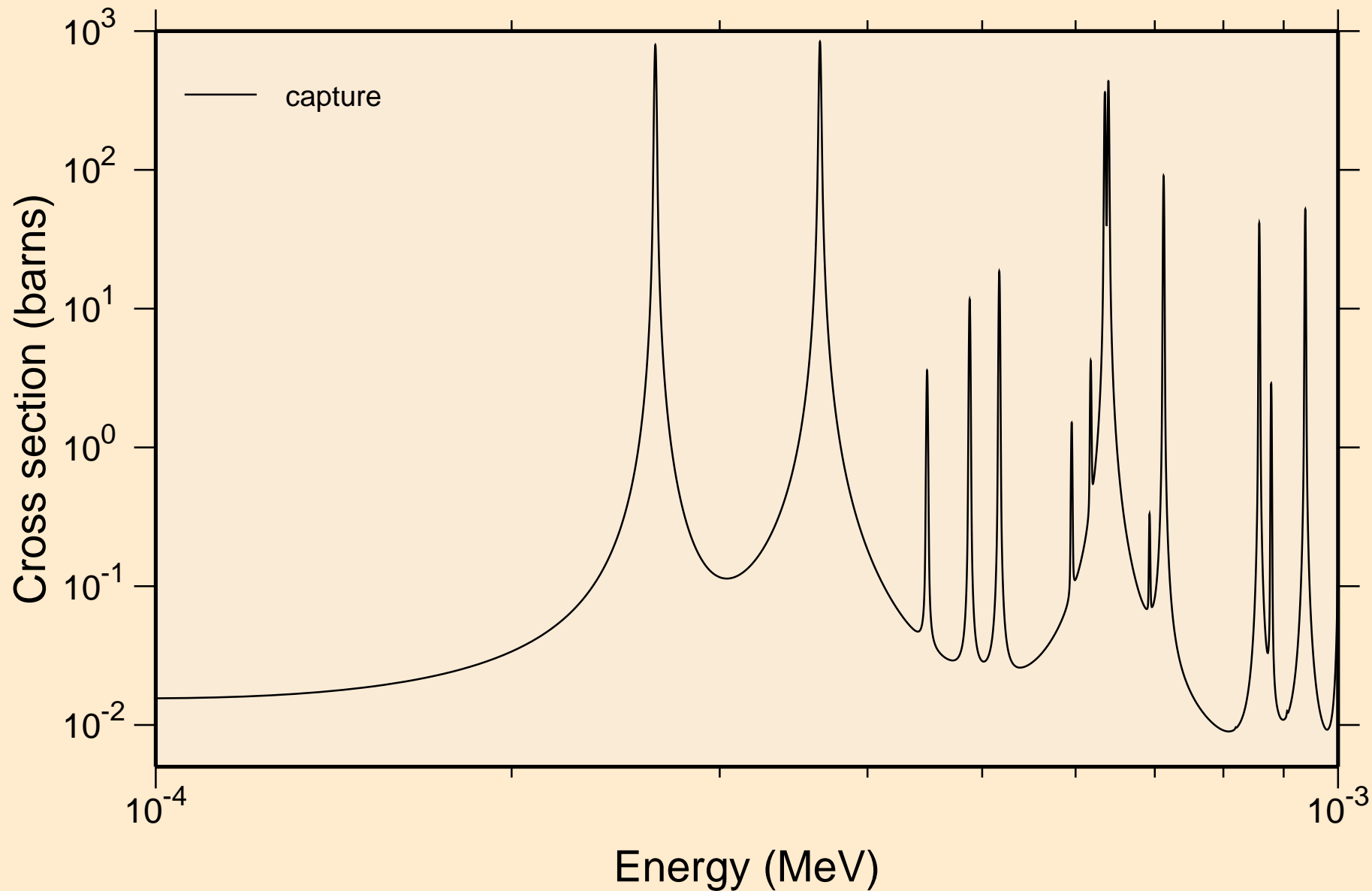

SR084 NEUTRON ACER TENDL-2019 LIBRARY; T=293.16K
resonance absorption cross sections

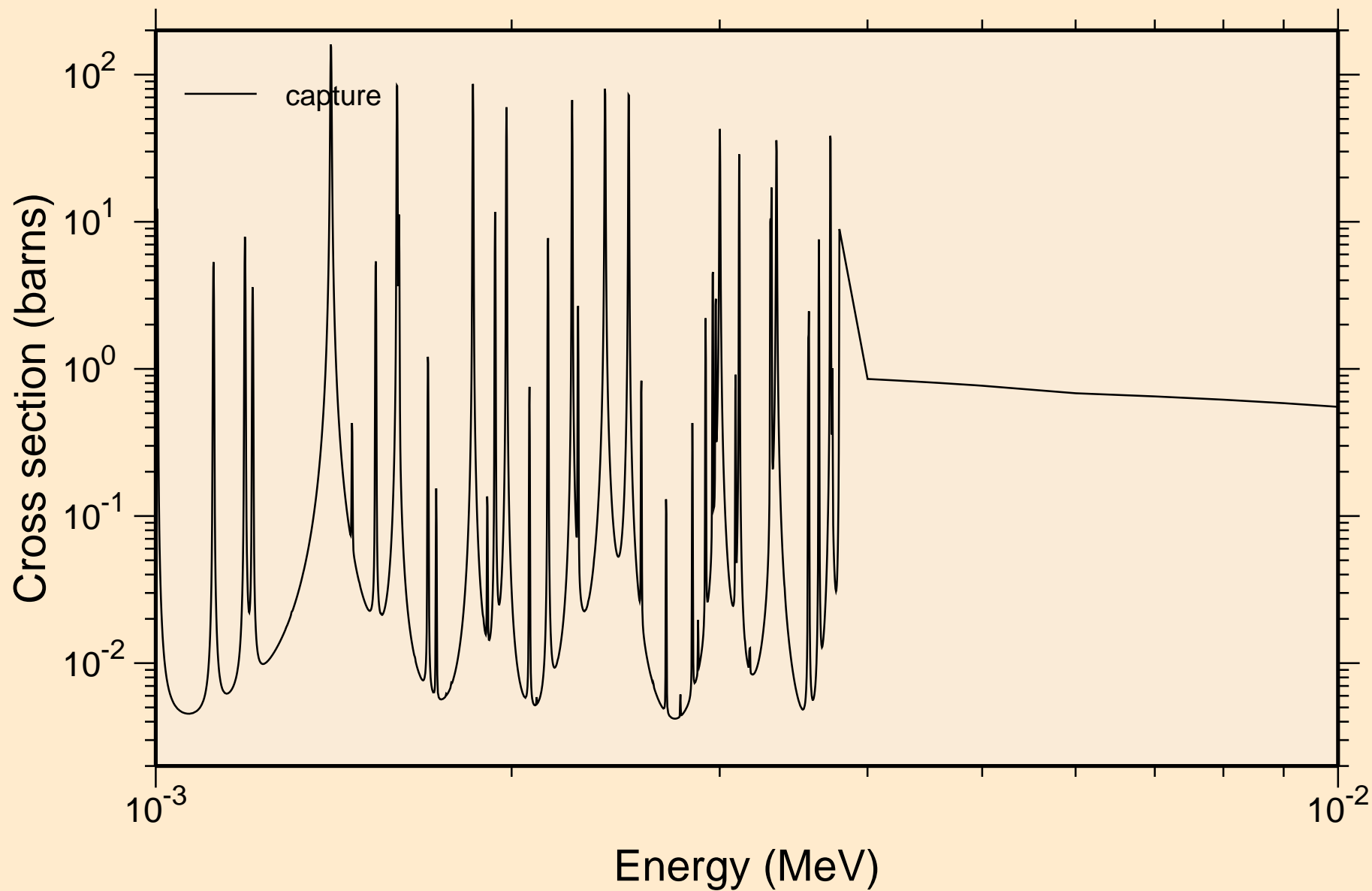

SR084 NEUTRON ACER TENDL-2019 LIBRARY; T=293.16K
resonance absorption cross sections

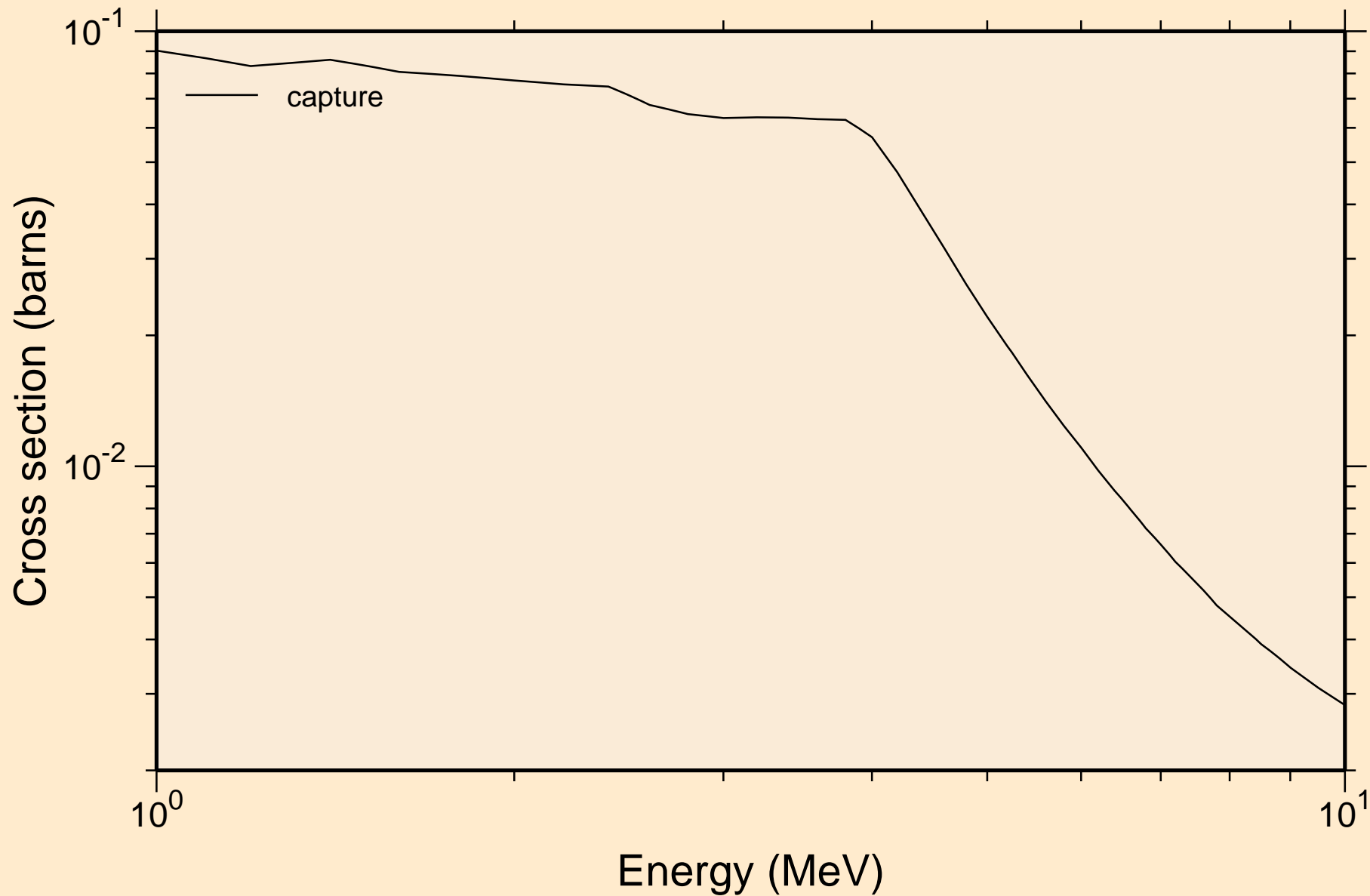

SR084 NEUTRON ACER TENDL-2019 LIBRARY; T=293.16K
Heating

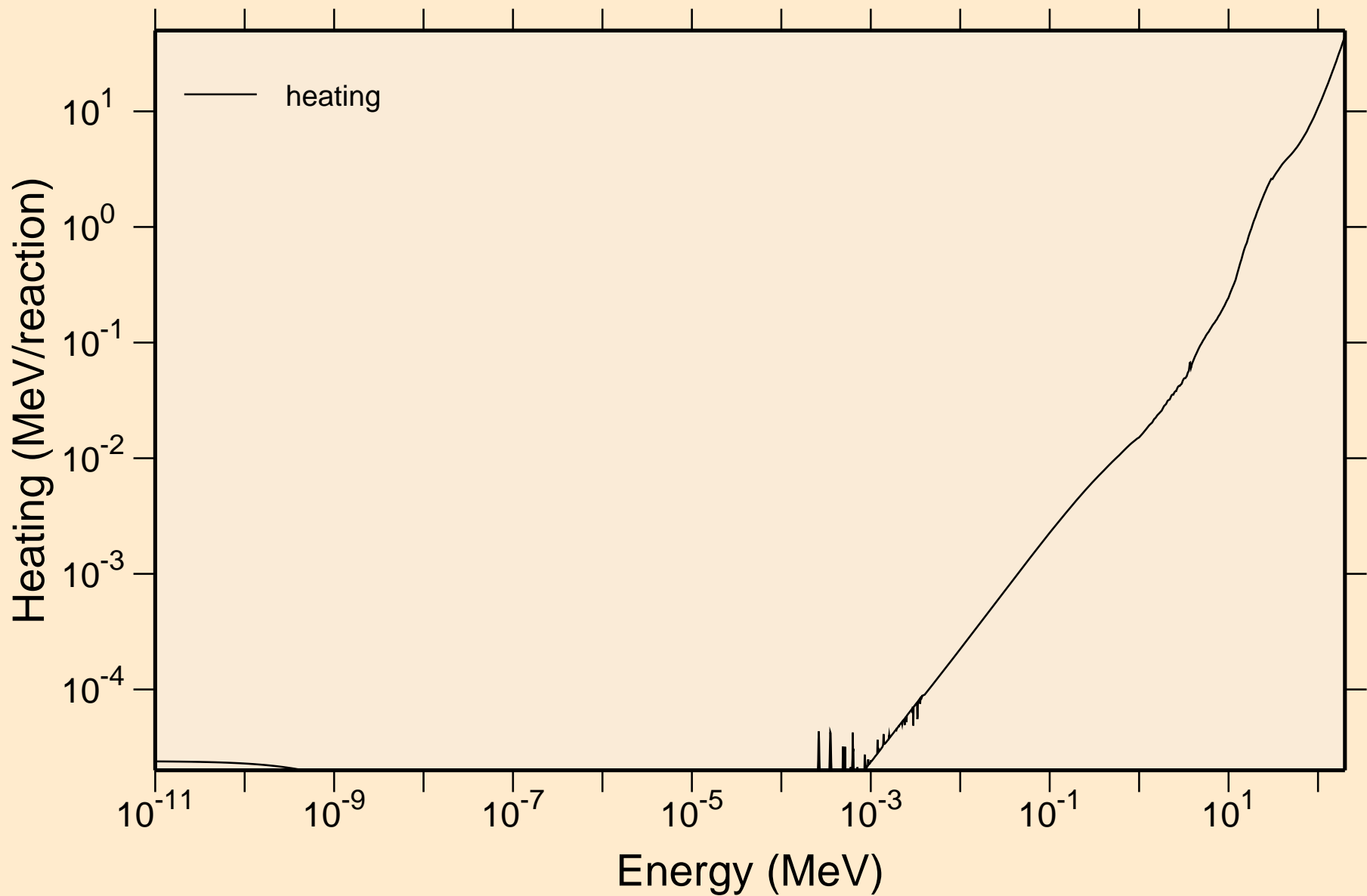

SR084 NEUTRON ACER TENDL-2019 LIBRARY; T=293.16K
Damage

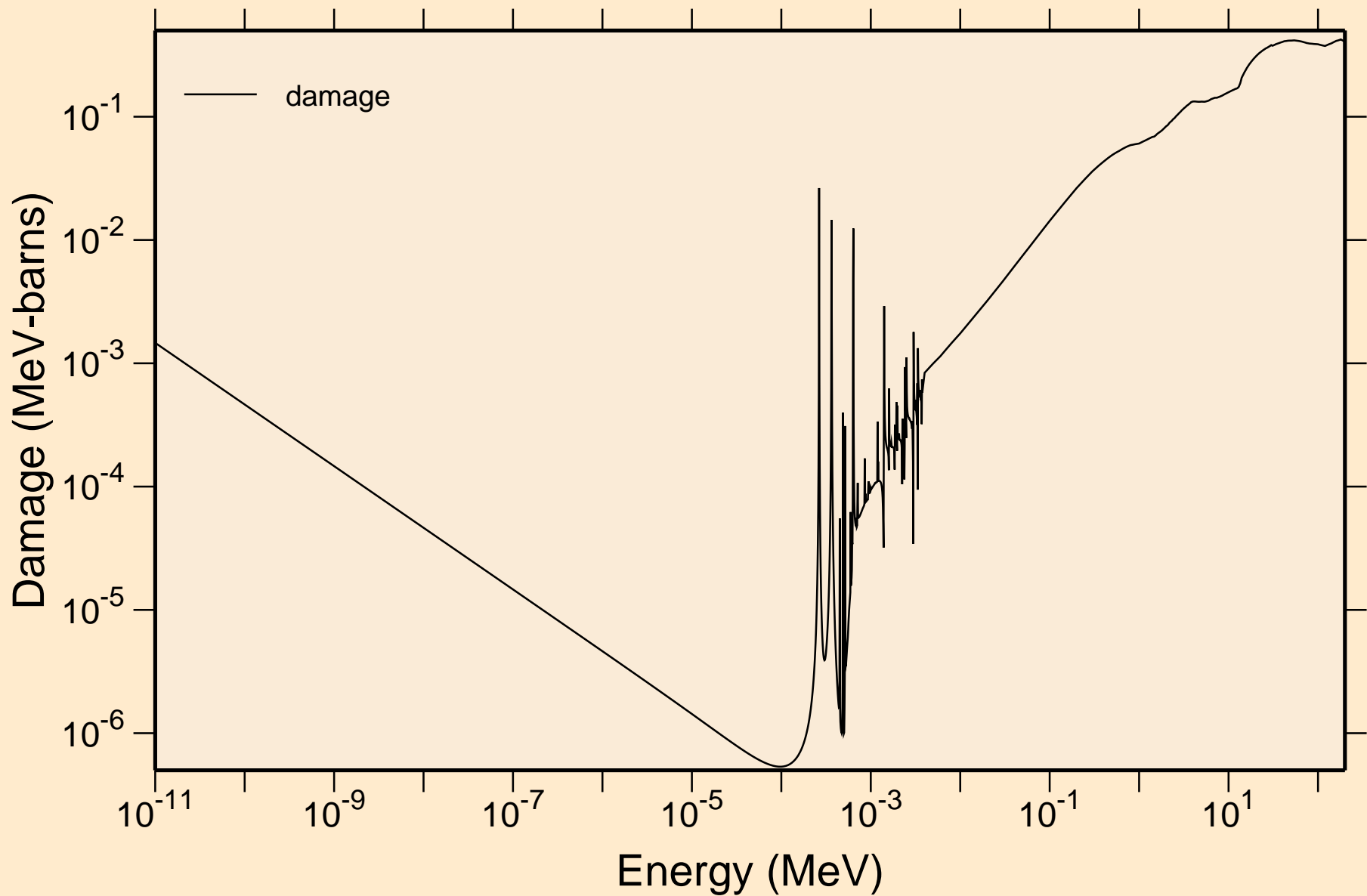

SR084 NEUTRON ACER TENDL-2019 LIBRARY; T=293.16K
Non-threshold reactions

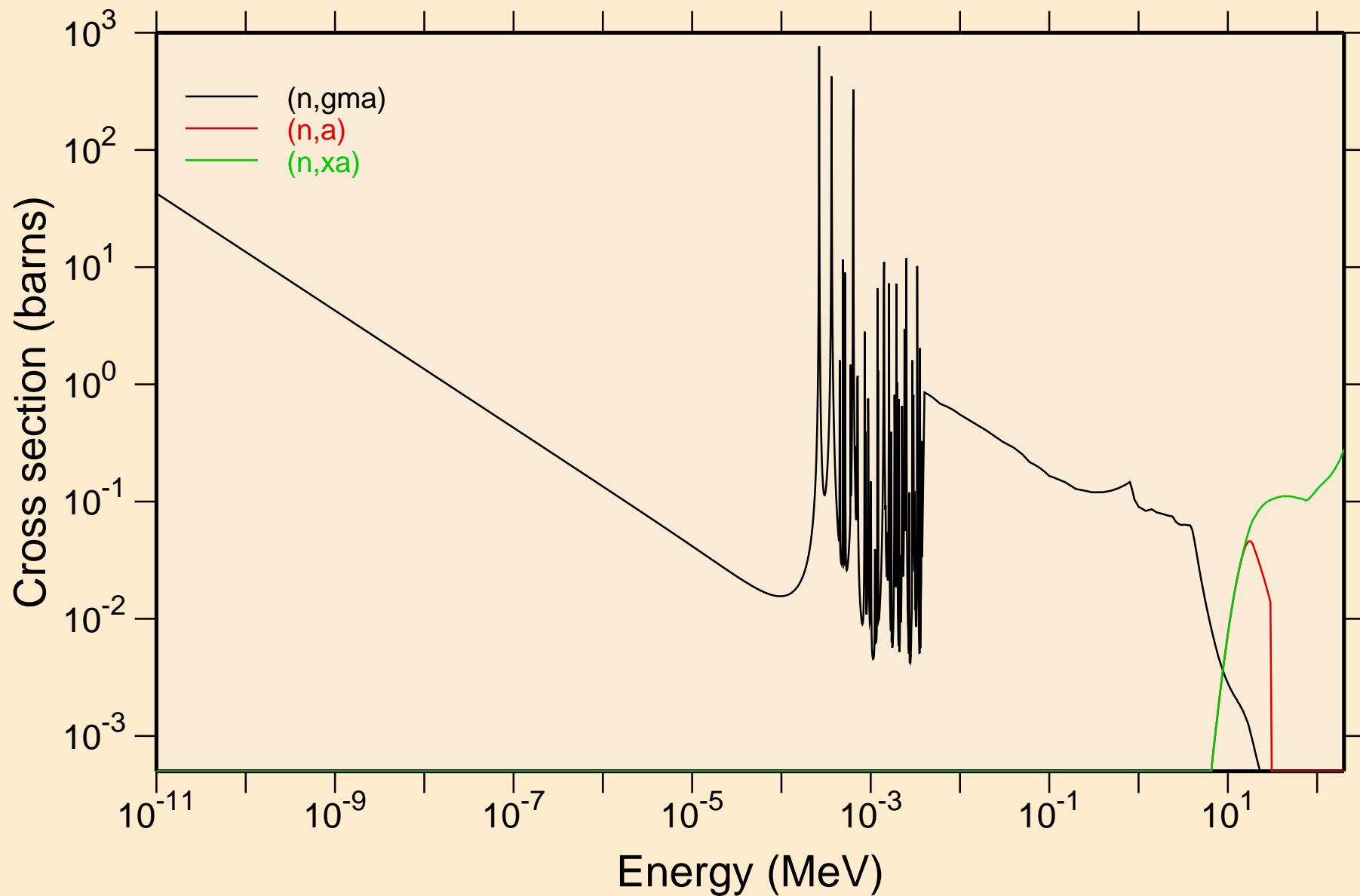

SR084 NEUTRON ACER TENDL-2019 LIBRARY; T=293.16K
Principal cross sections

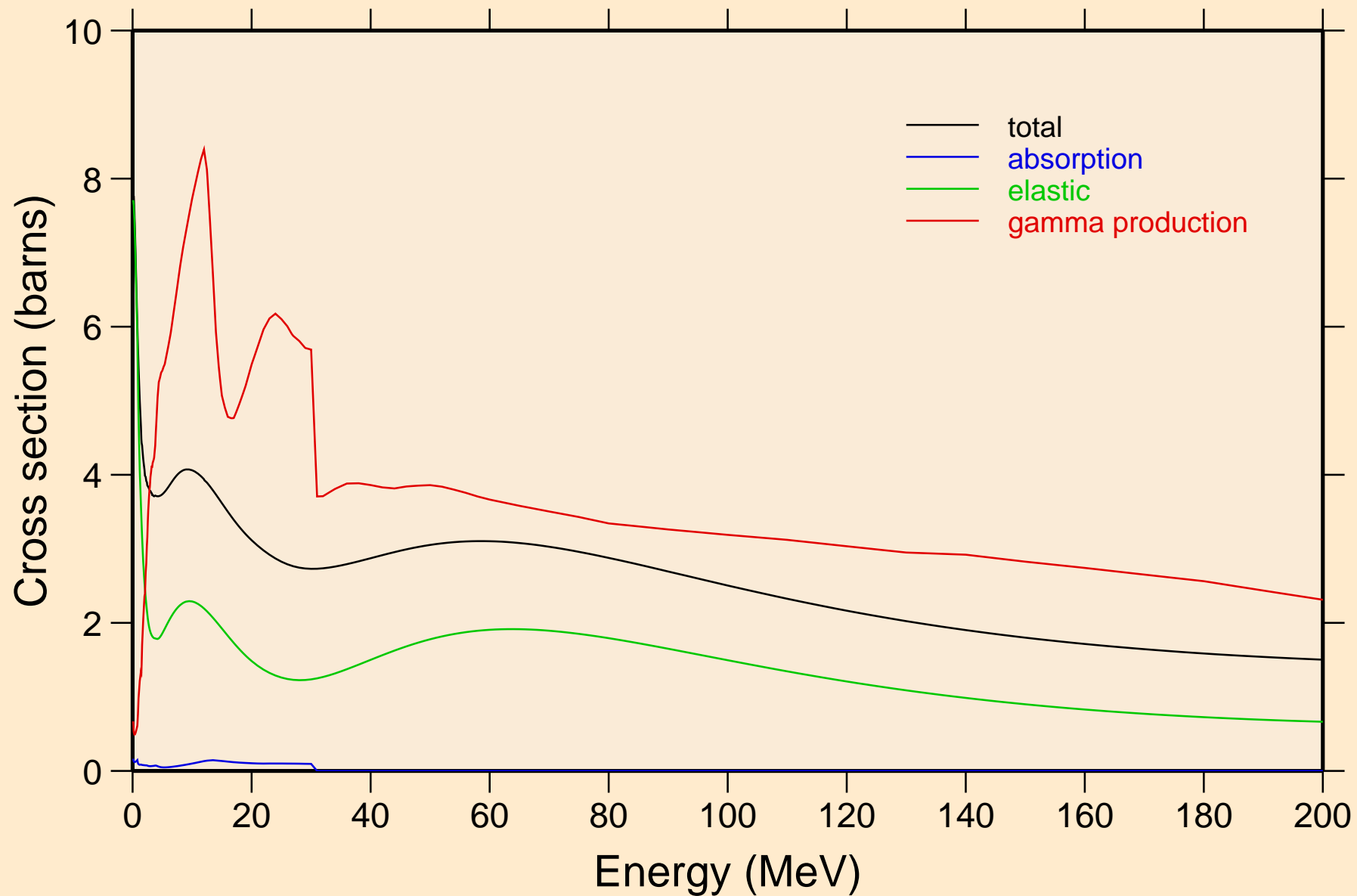

SR084 NEUTRON ACER TENDL-2019 LIBRARY; T=293.16K
Heating

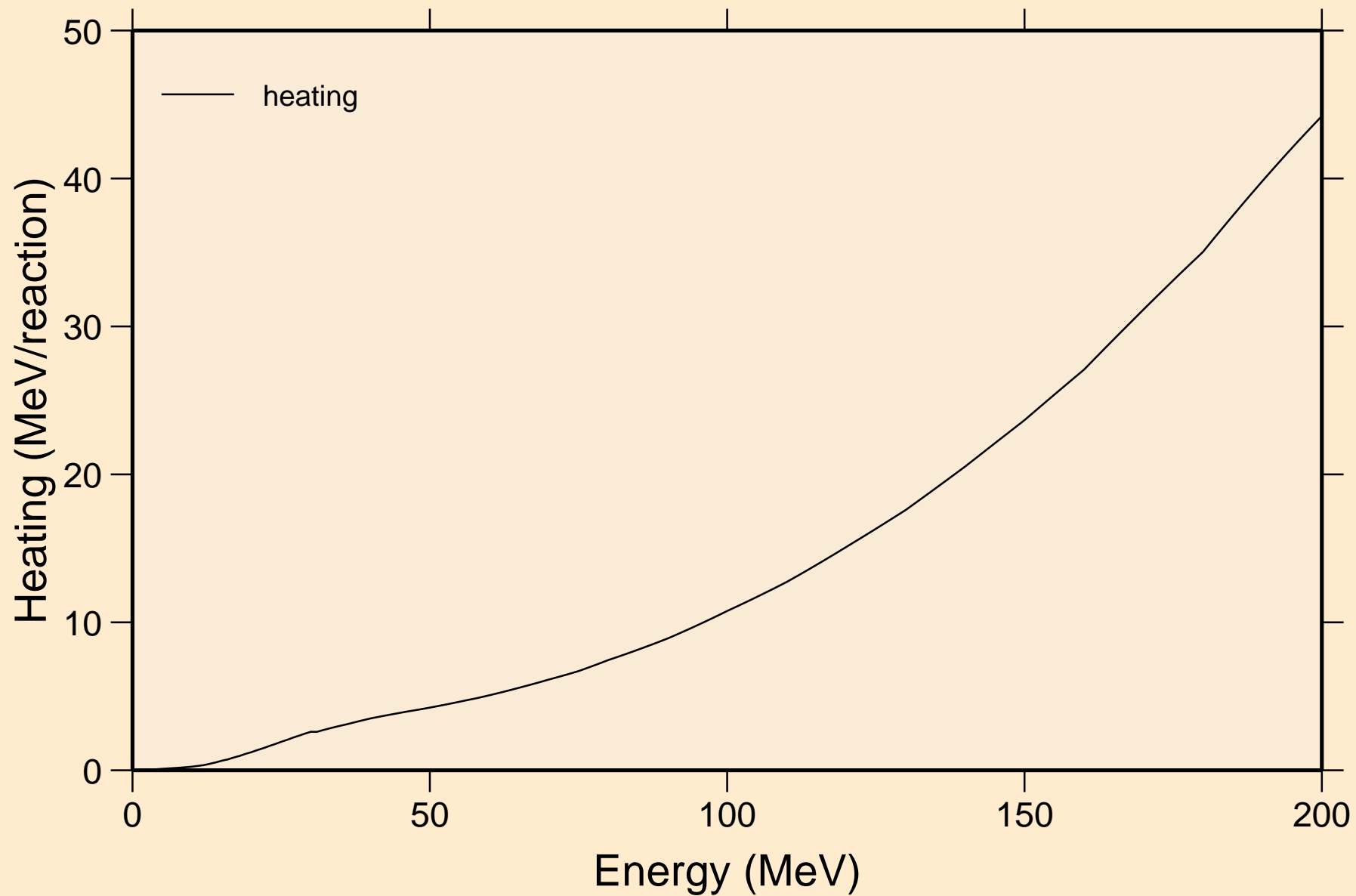

SR084 NEUTRON ACER TENDL-2019 LIBRARY; T=293.16K
Damage

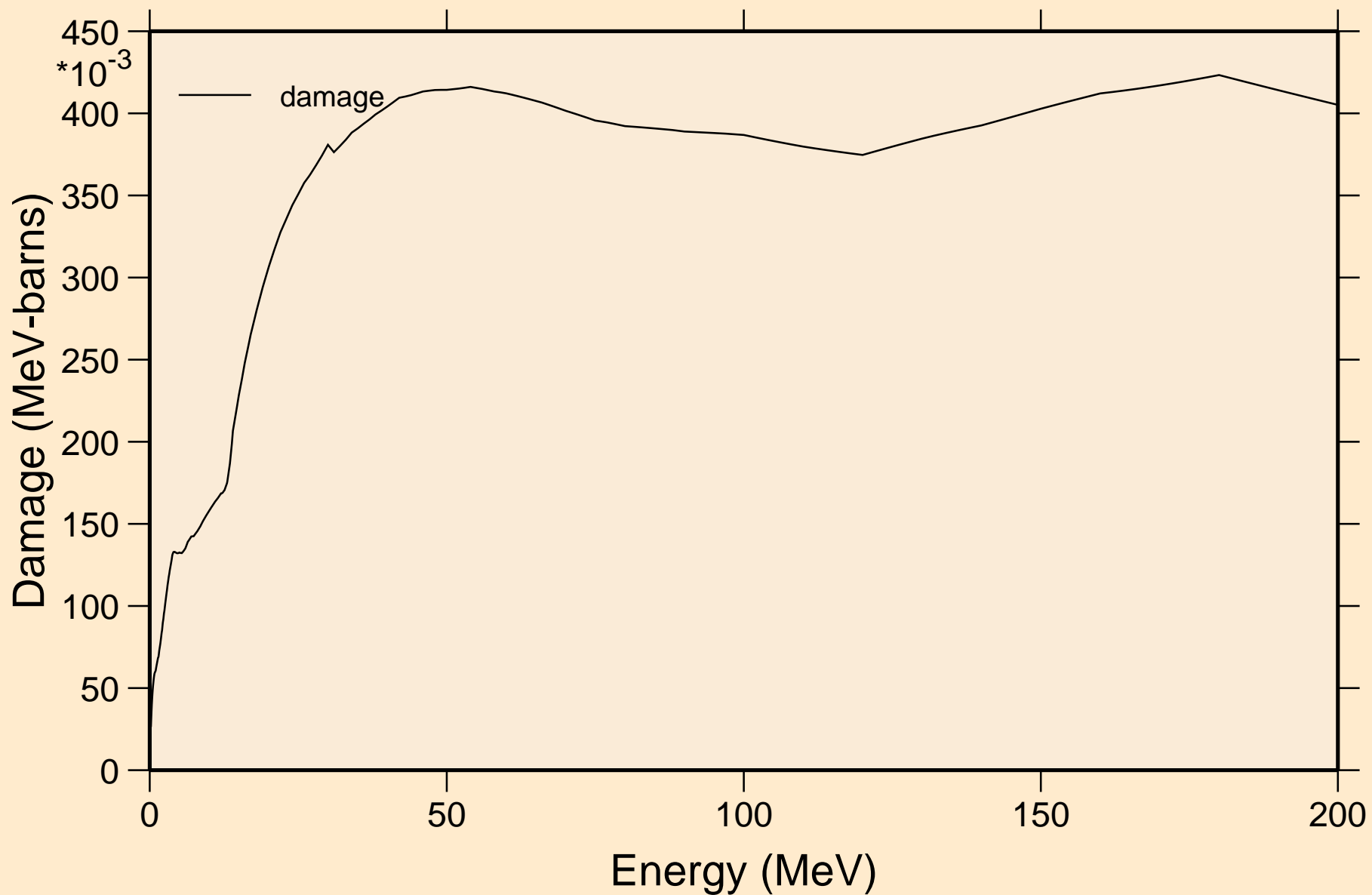

SR084 NEUTRON ACER TENDL-2019 LIBRARY; T=293.16K
Non-threshold reactions

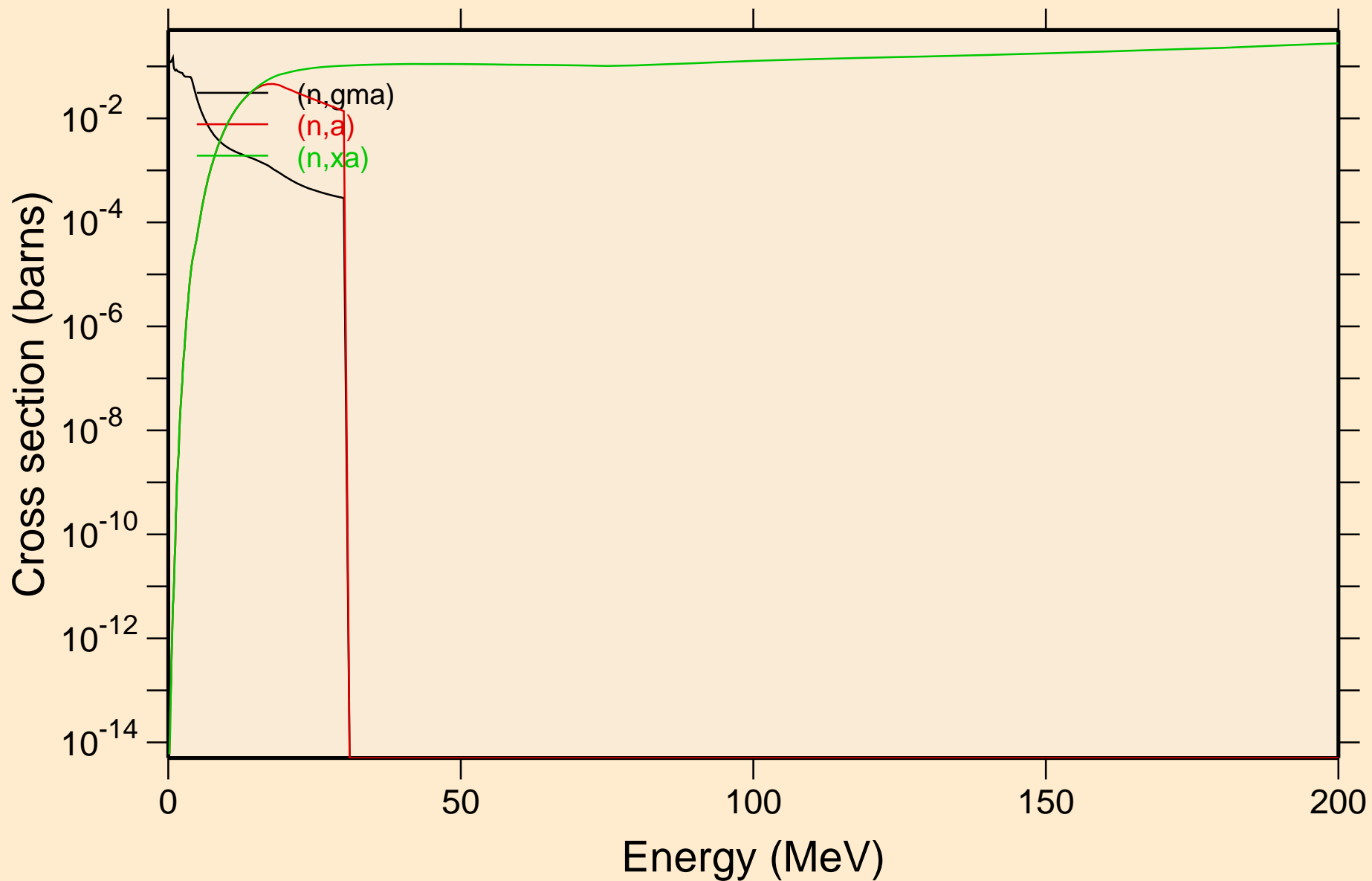

SR084 NEUTRON ACER TENDL-2019 LIBRARY; T=293.16K
Inelastic levels

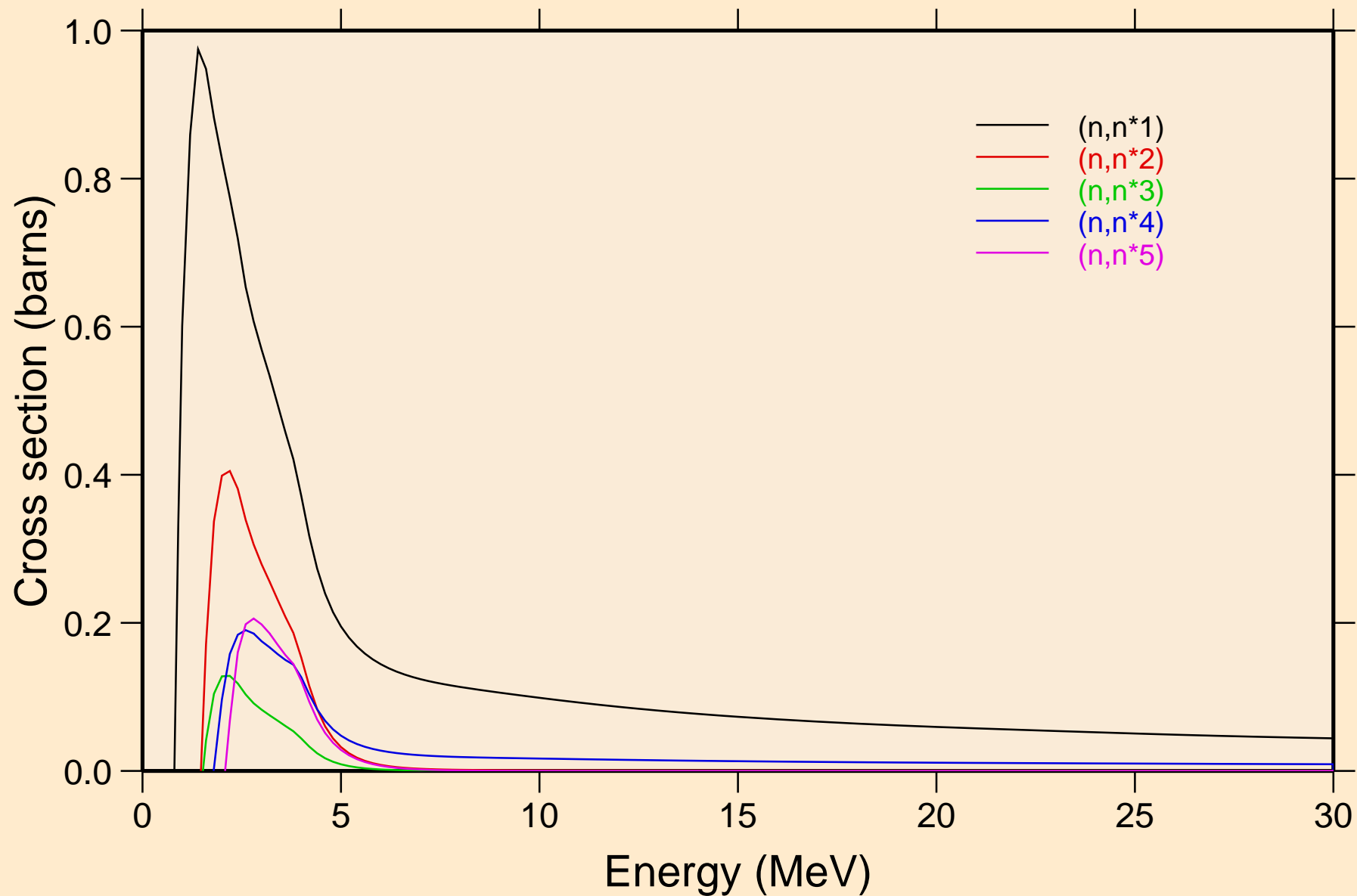

SR084 NEUTRON ACER TENDL-2019 LIBRARY; T=293.16K
Inelastic levels

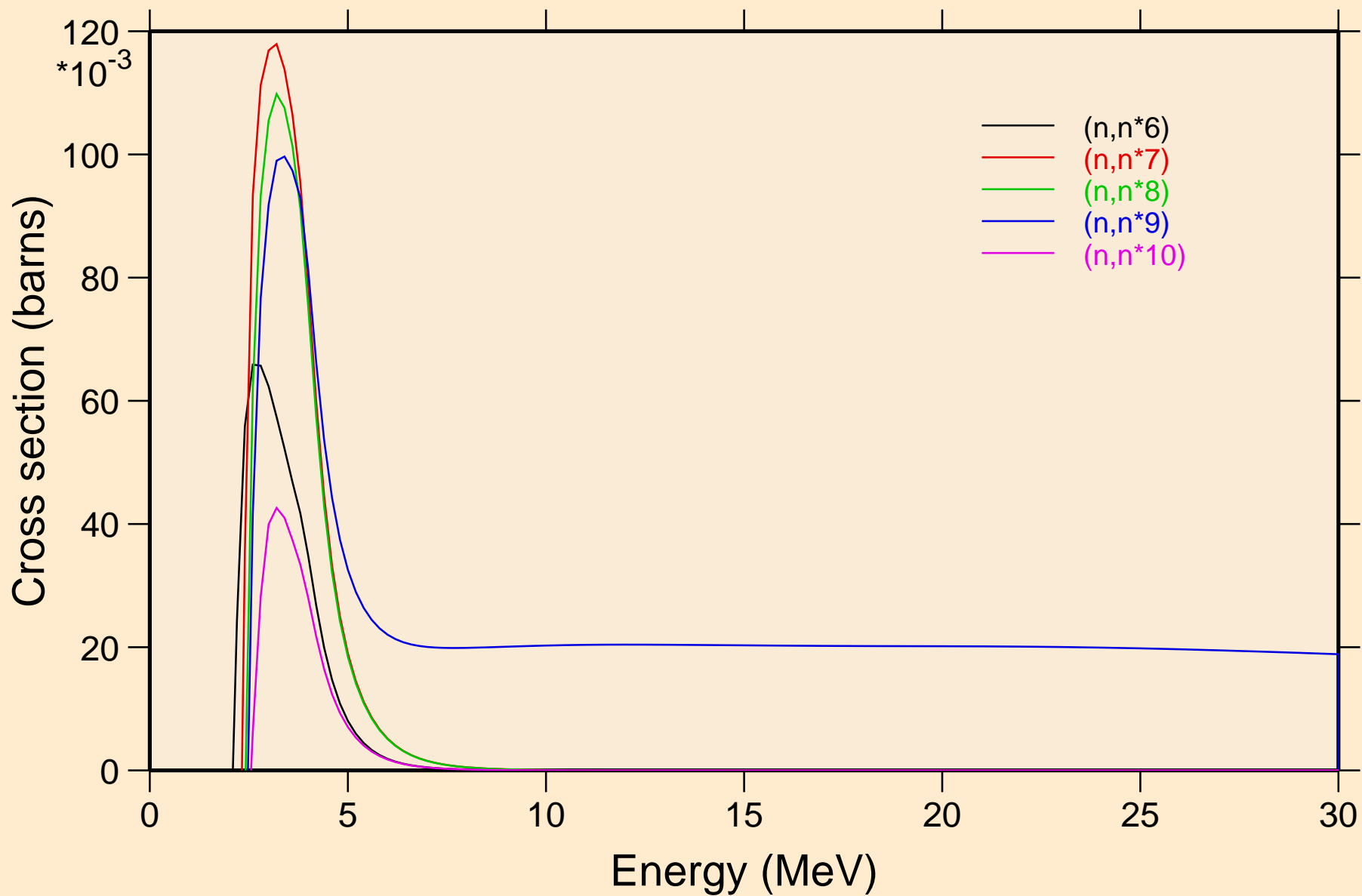

SR084 NEUTRON ACER TENDL-2019 LIBRARY; T=293.16K
Inelastic levels

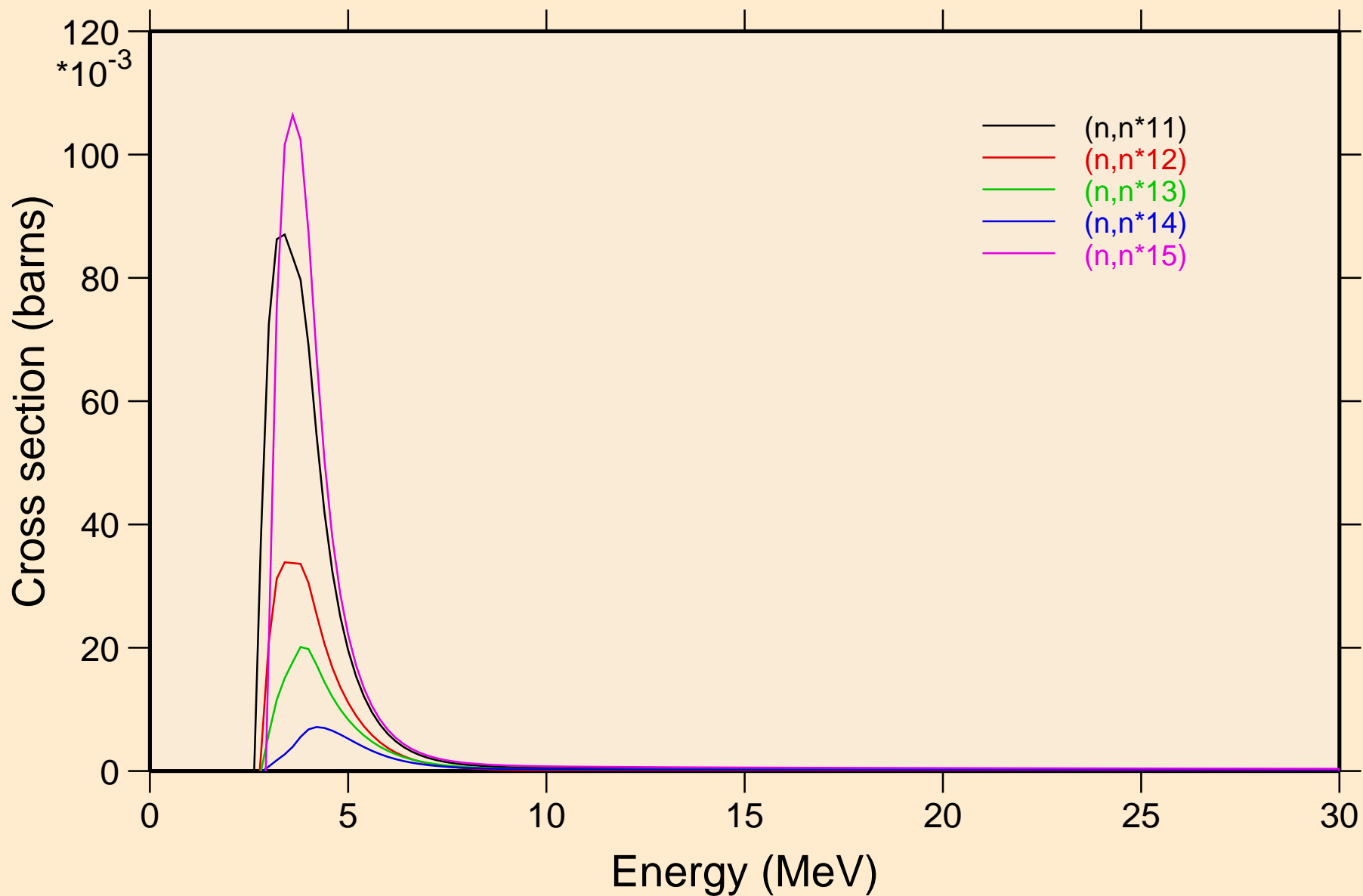

SR084 NEUTRON ACER TENDL-2019 LIBRARY; T=293.16K
Inelastic levels

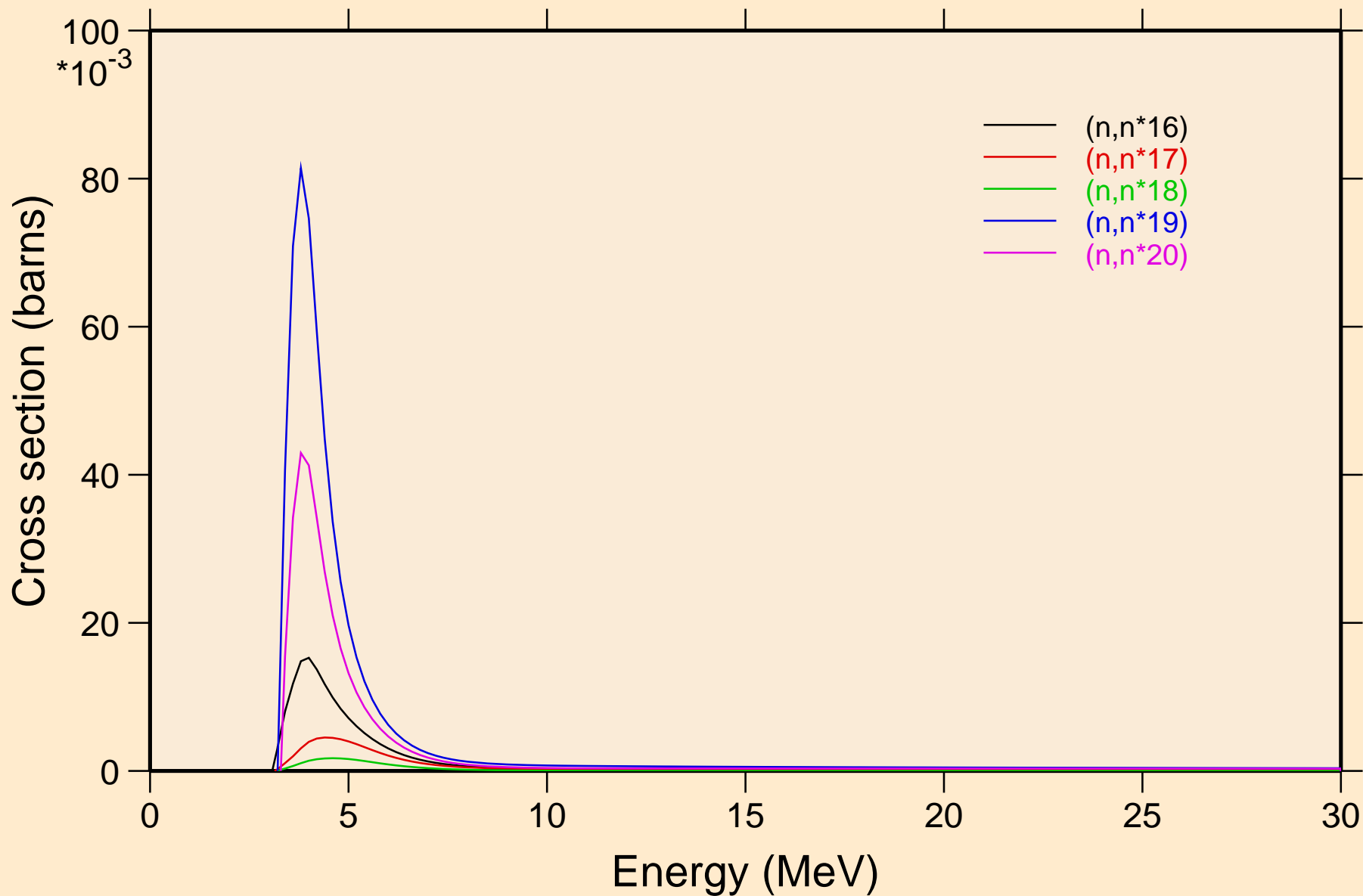

SR084 NEUTRON ACER TENDL-2019 LIBRARY; T=293.16K
Inelastic levels

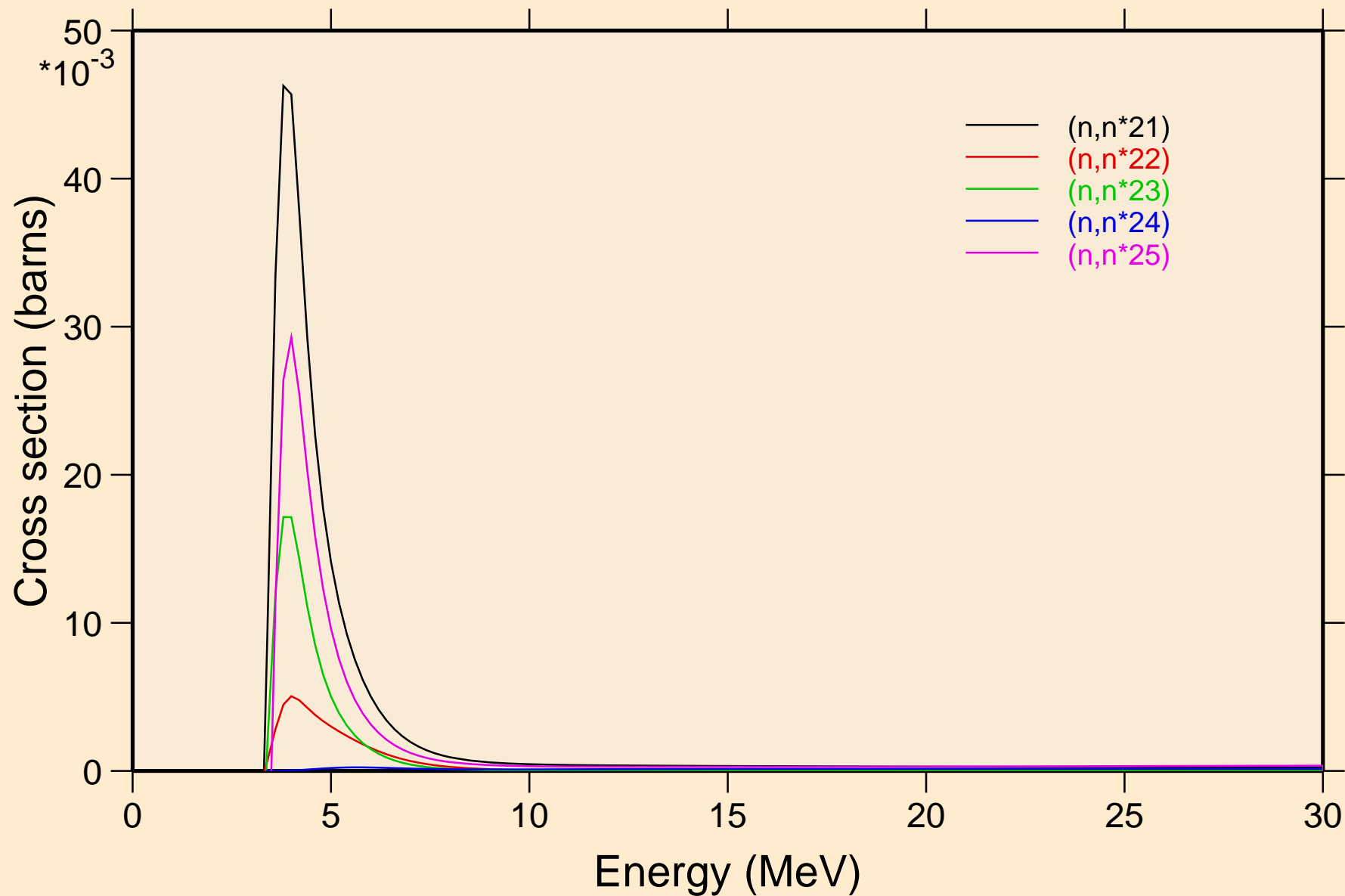

SR084 NEUTRON ACER TENDL-2019 LIBRARY; T=293.16K
Inelastic levels

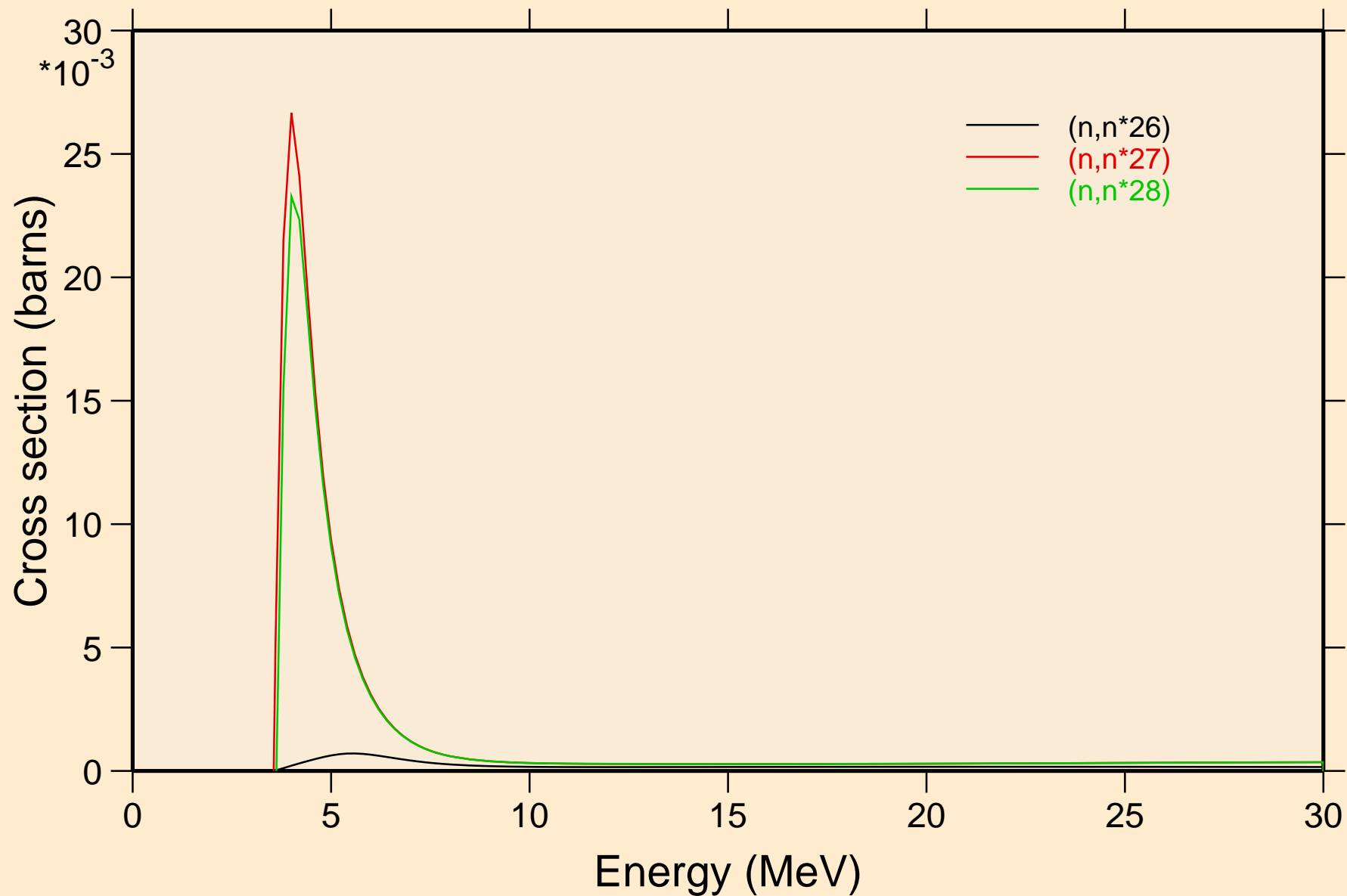

SR084 NEUTRON ACER TENDL-2019 LIBRARY; T=293.16K
Threshold reactions

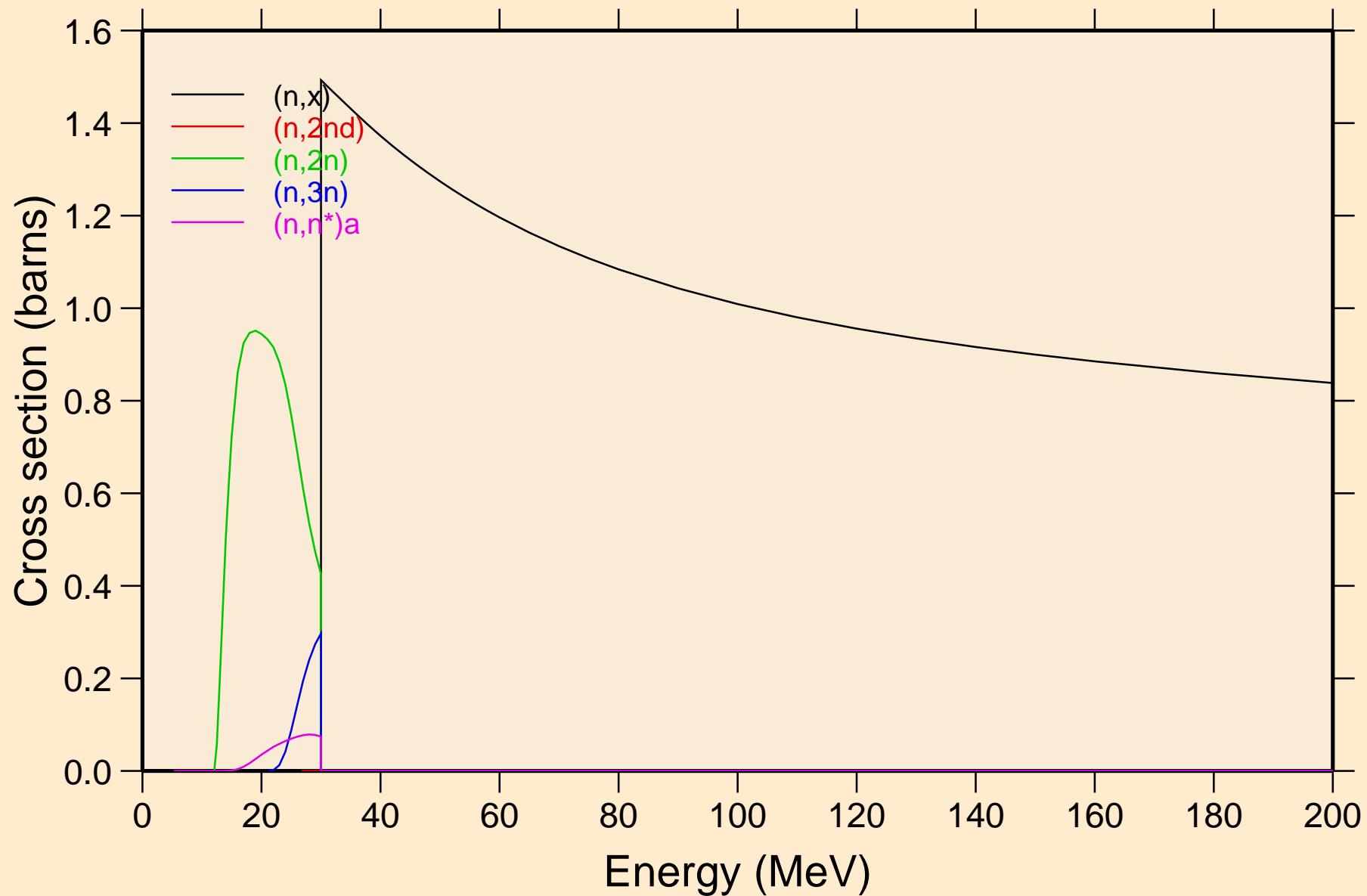

SR084 NEUTRON ACER TENDL-2019 LIBRARY; T=293.16K
Threshold reactions

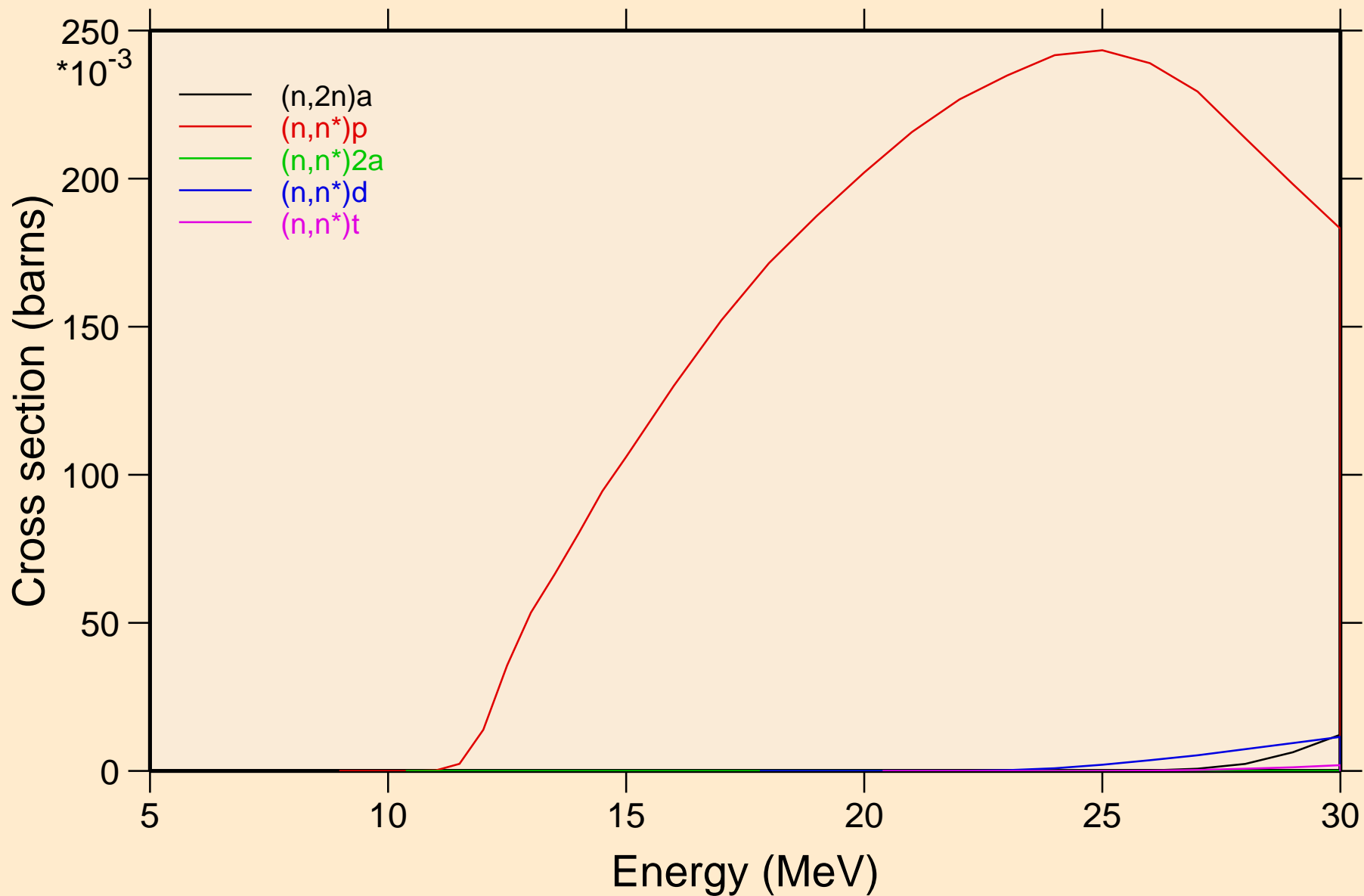

SR084 NEUTRON ACER TENDL-2019 LIBRARY; T=293.16K
Threshold reactions

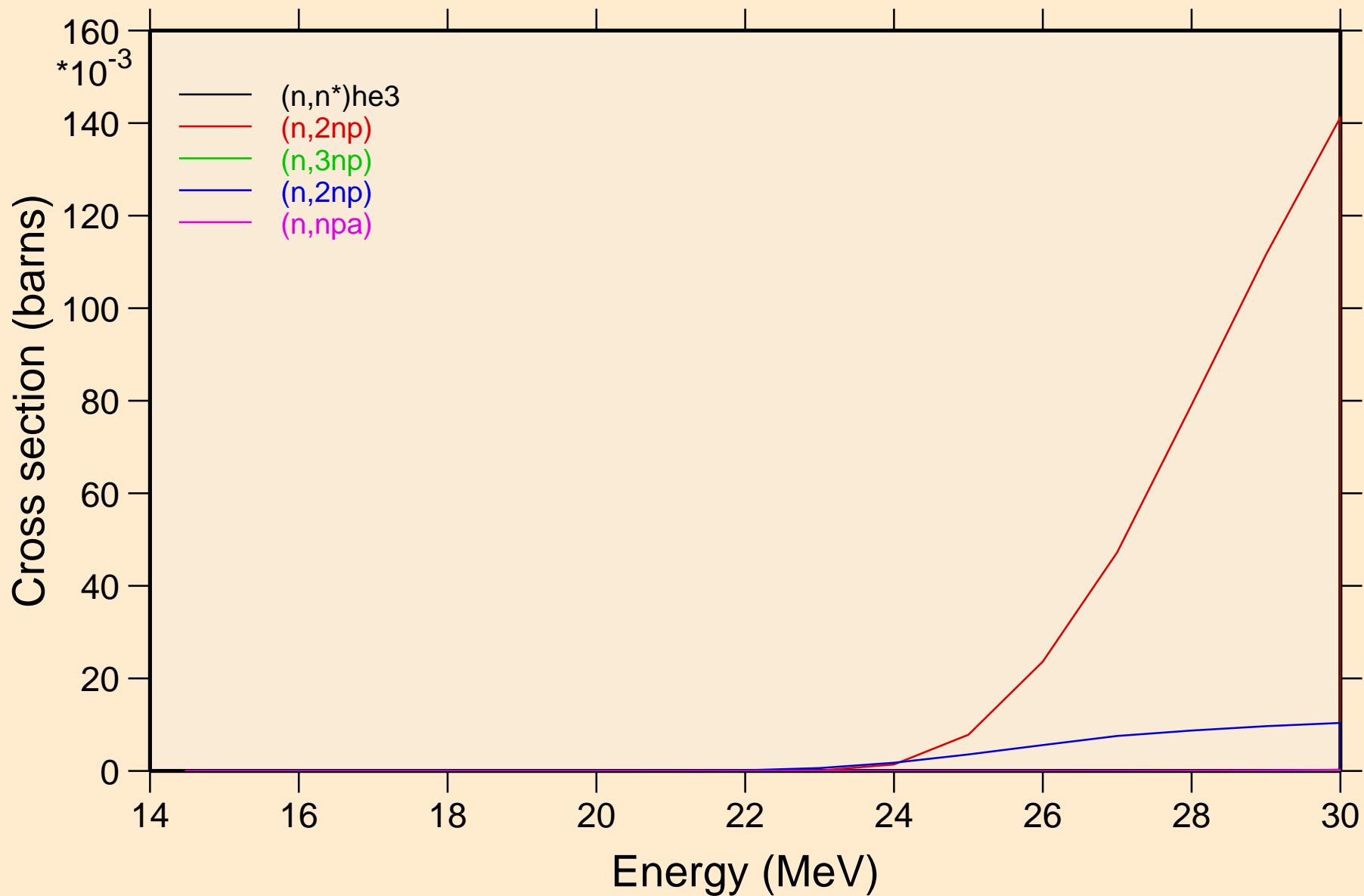

SR084 NEUTRON ACER TENDL-2019 LIBRARY; T=293.16K
Threshold reactions

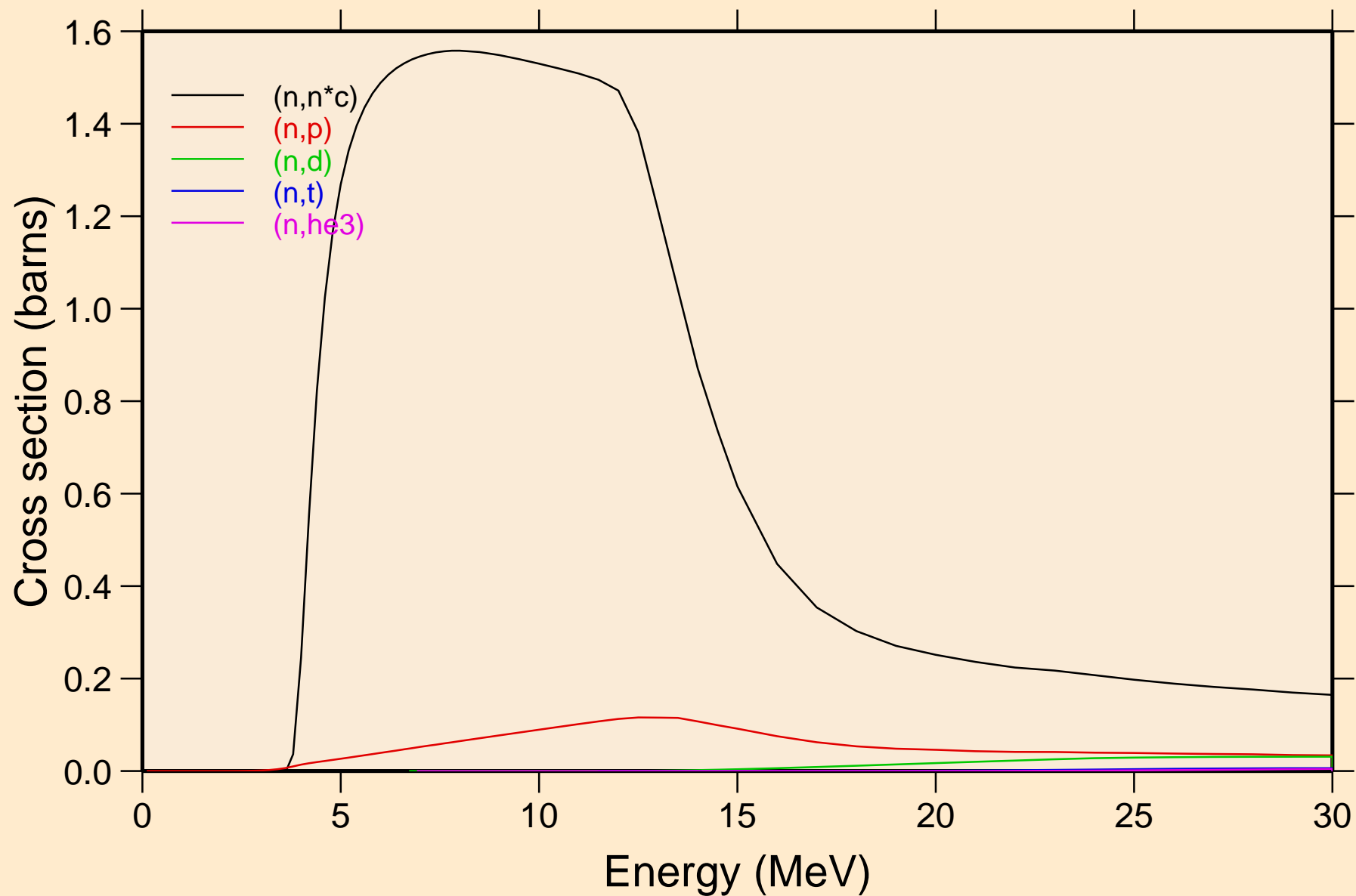

SR084 NEUTRON ACER TENDL-2019 LIBRARY; T=293.16K
Threshold reactions

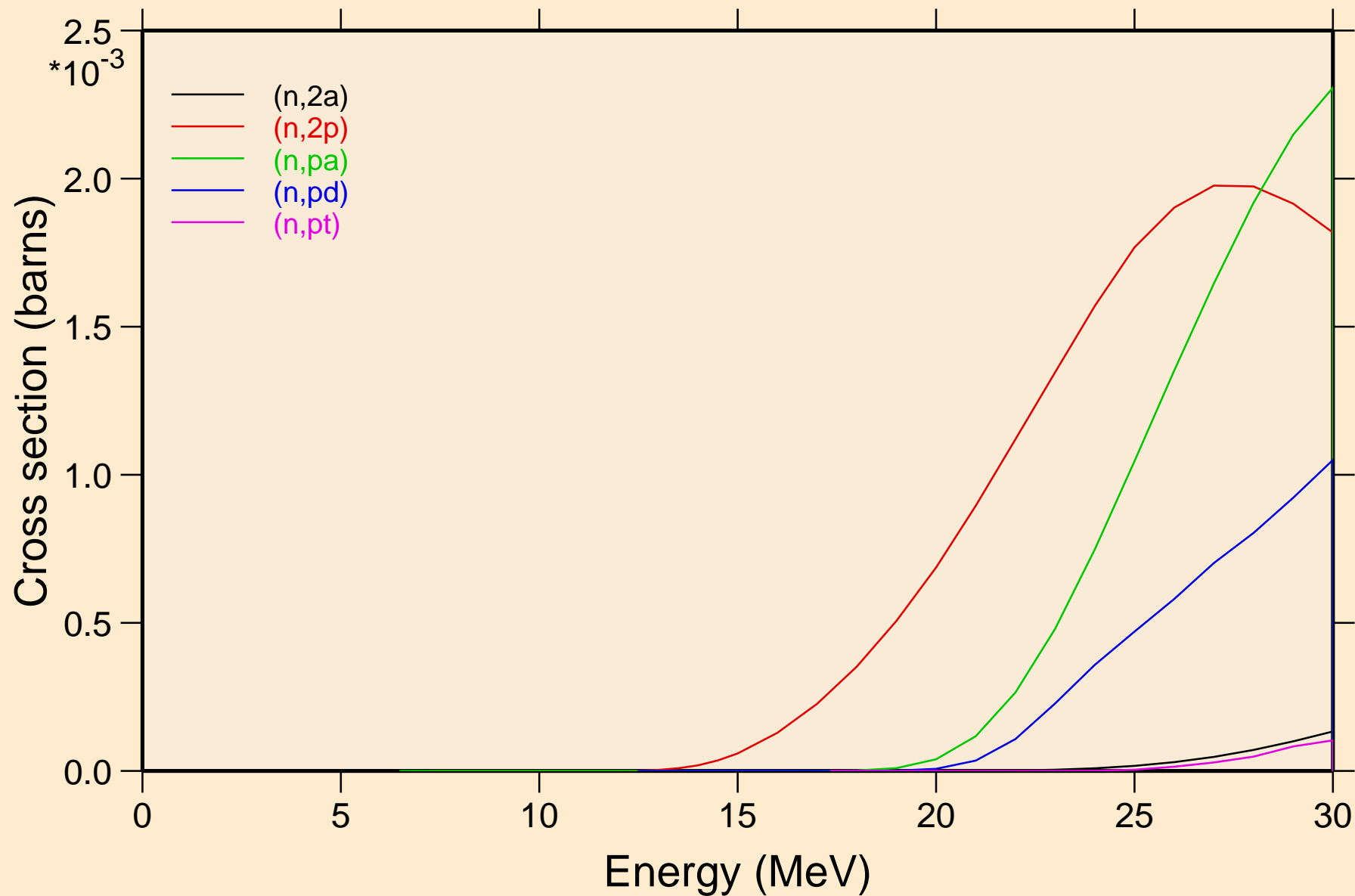

SR084 NEUTRON ACER TENDL-2019 LIBRARY; T=293.16K
Threshold reactions

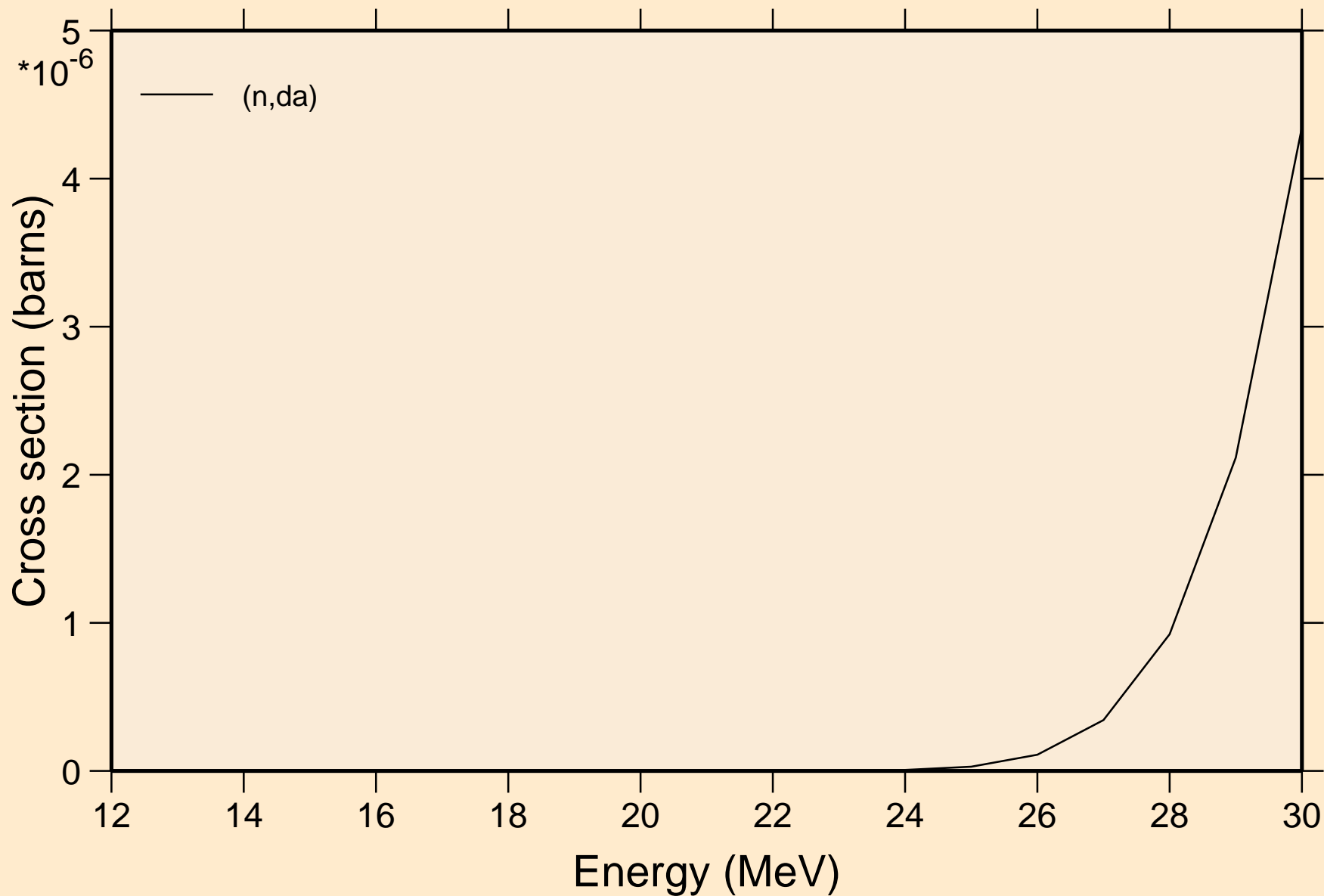

SR084 NEUTRON ACER TENDL-2019 LIBRARY; T=293.16K
Threshold reactions

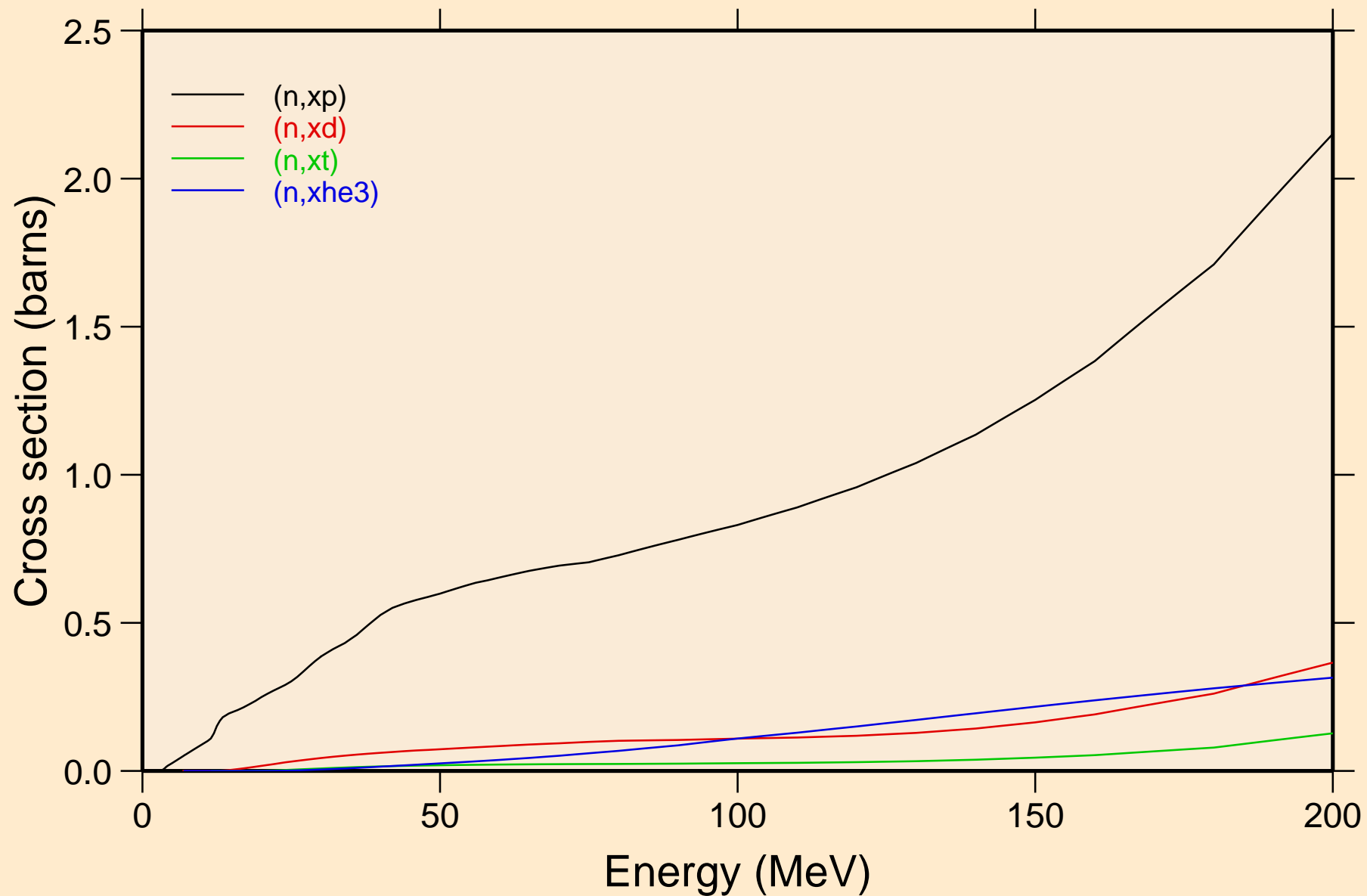

SR084 NEUTRON ACER TENDL-2019 LIBRARY; T=293.16K
angular distribution for elastic

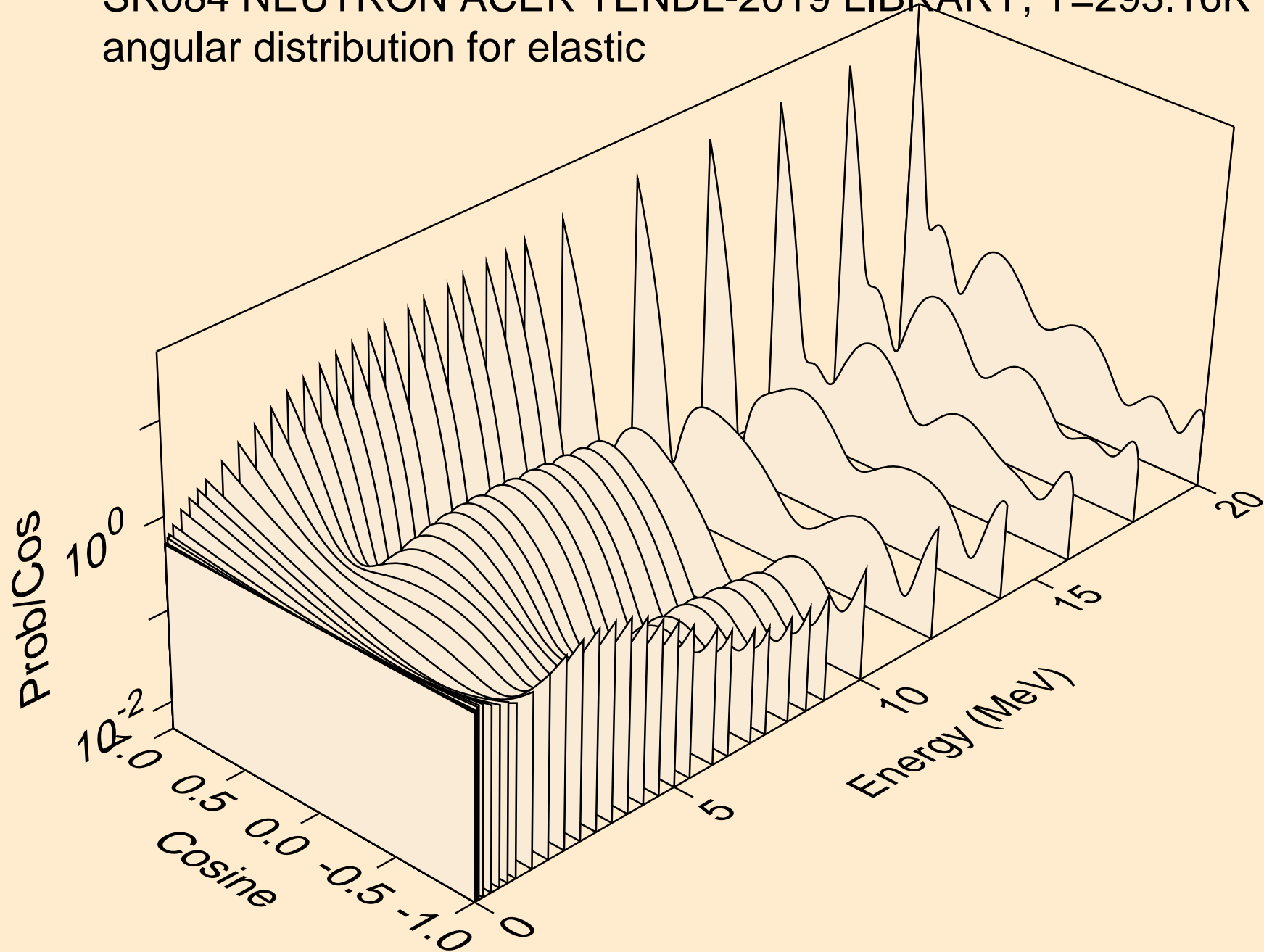

SR084 NEUTRON ACER TENDL-2019 LIBRARY; T=293.16K
angular distribution for elastic

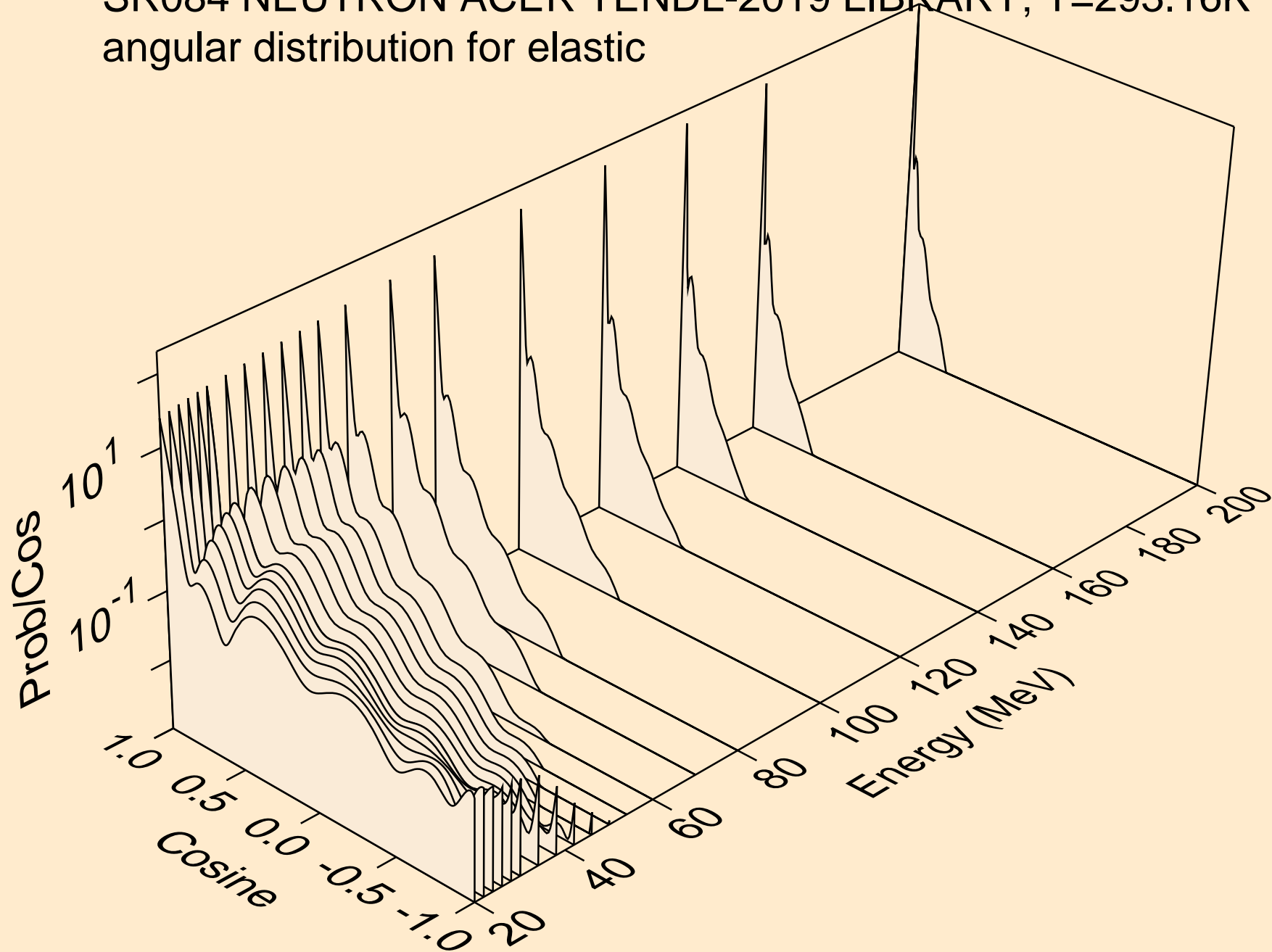

SR084 NEUTRON ACER TENDL-2019 LIBRARY; T=293.16K
angular distribution for (n,n*1)

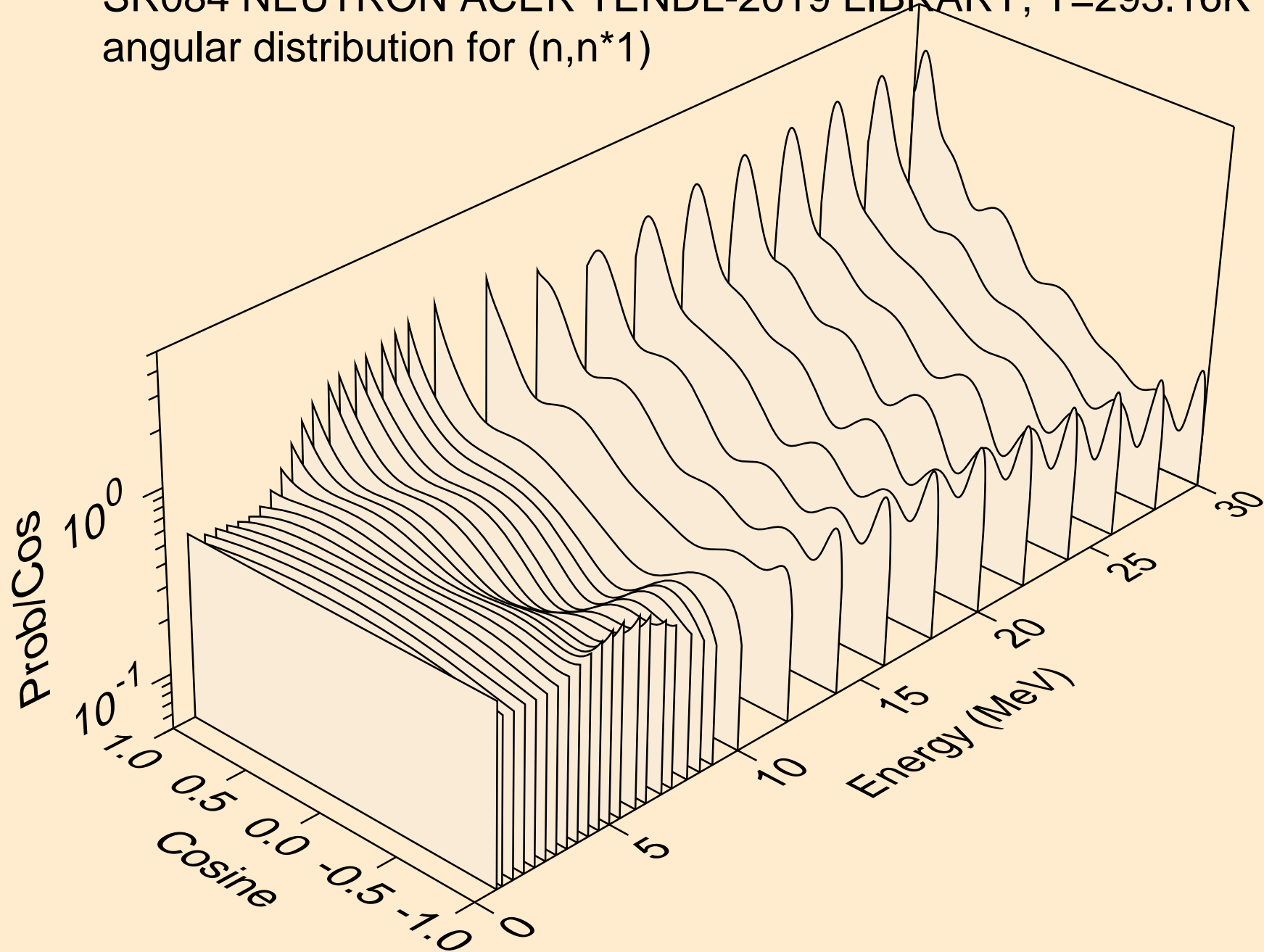

SR084 NEUTRON ACER TENDL-2019 LIBRARY; T=293.16K
angular distribution for (n,n*2)

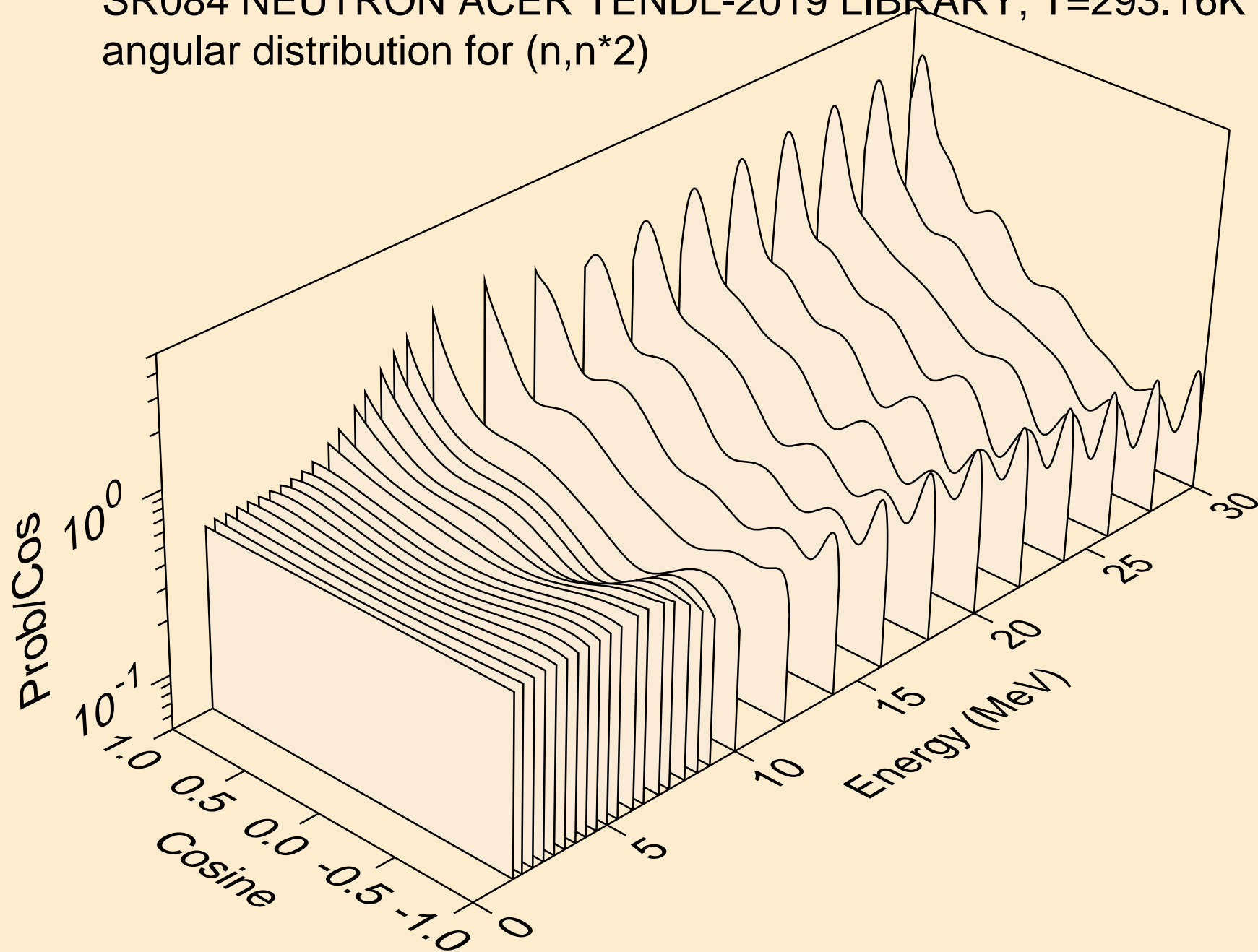

SR084 NEUTRON ACER TENDL-2019 LIBRARY; T=293.16K
angular distribution for (n,n*3)

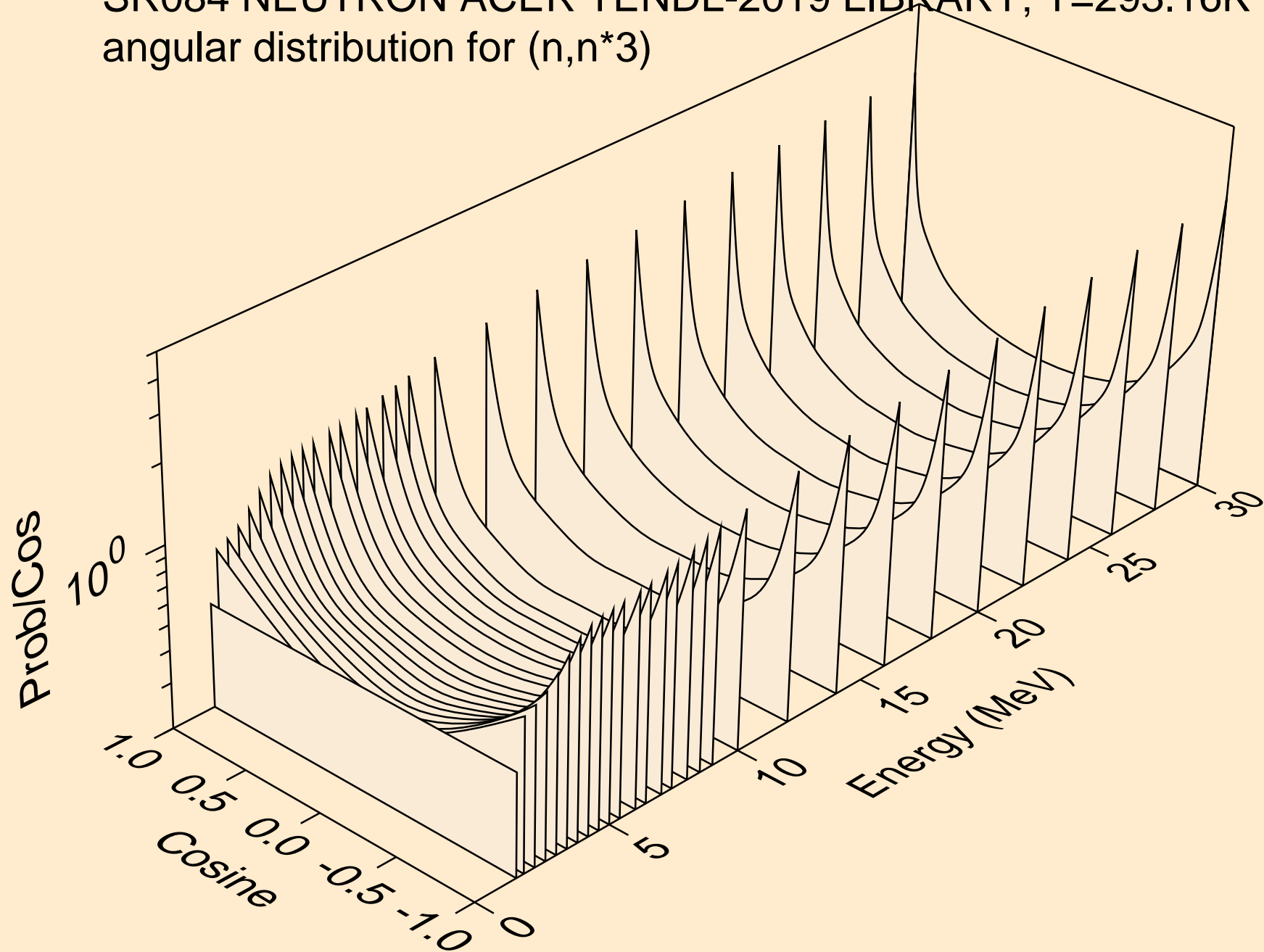

SR084 NEUTRON ACER TENDL-2019 LIBRARY; T=293.16K
angular distribution for (n,n*4)

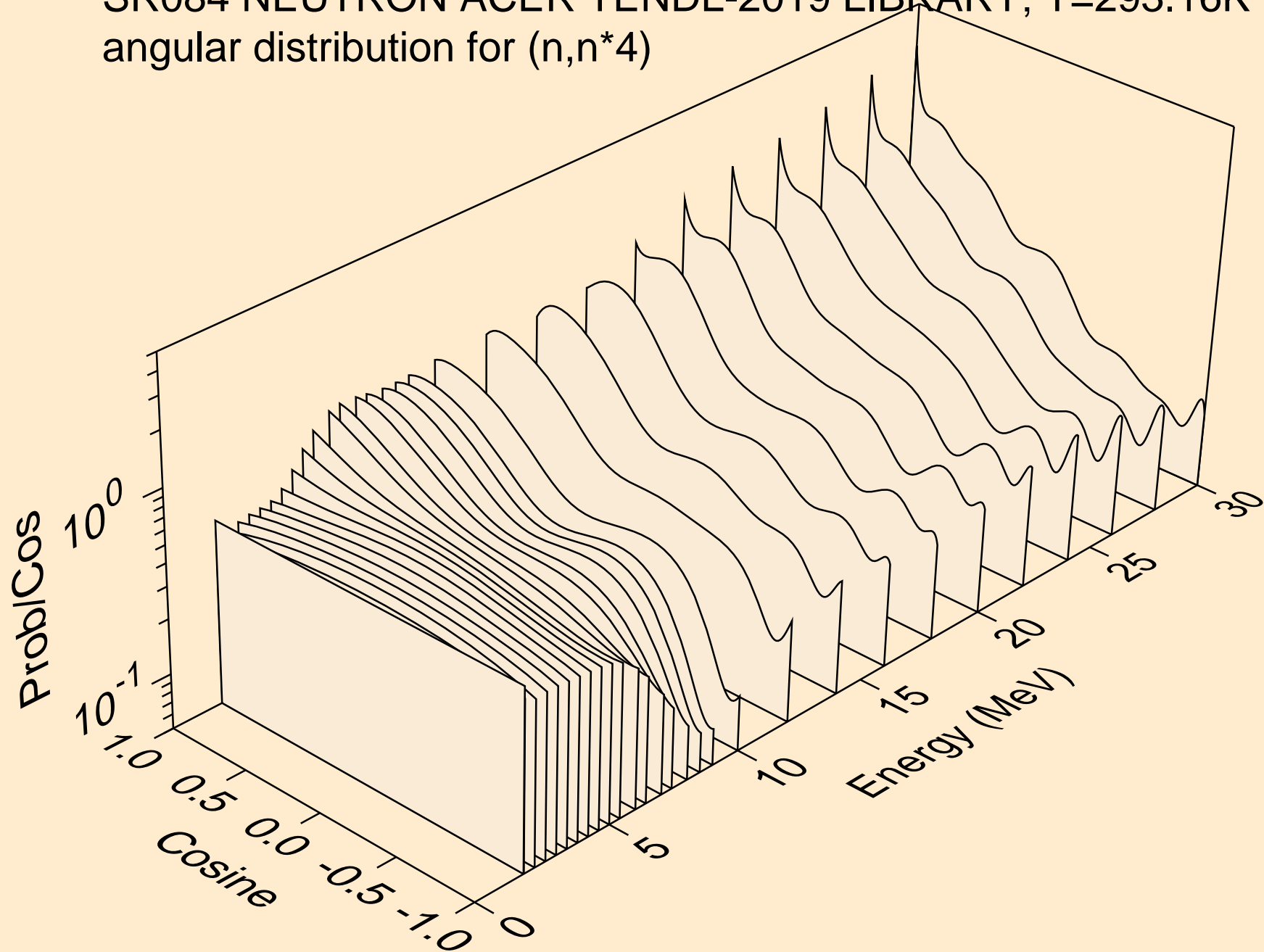

SR084 NEUTRON ACER TENDL-2019 LIBRARY; T=293.16K
angular distribution for (n,n*5)

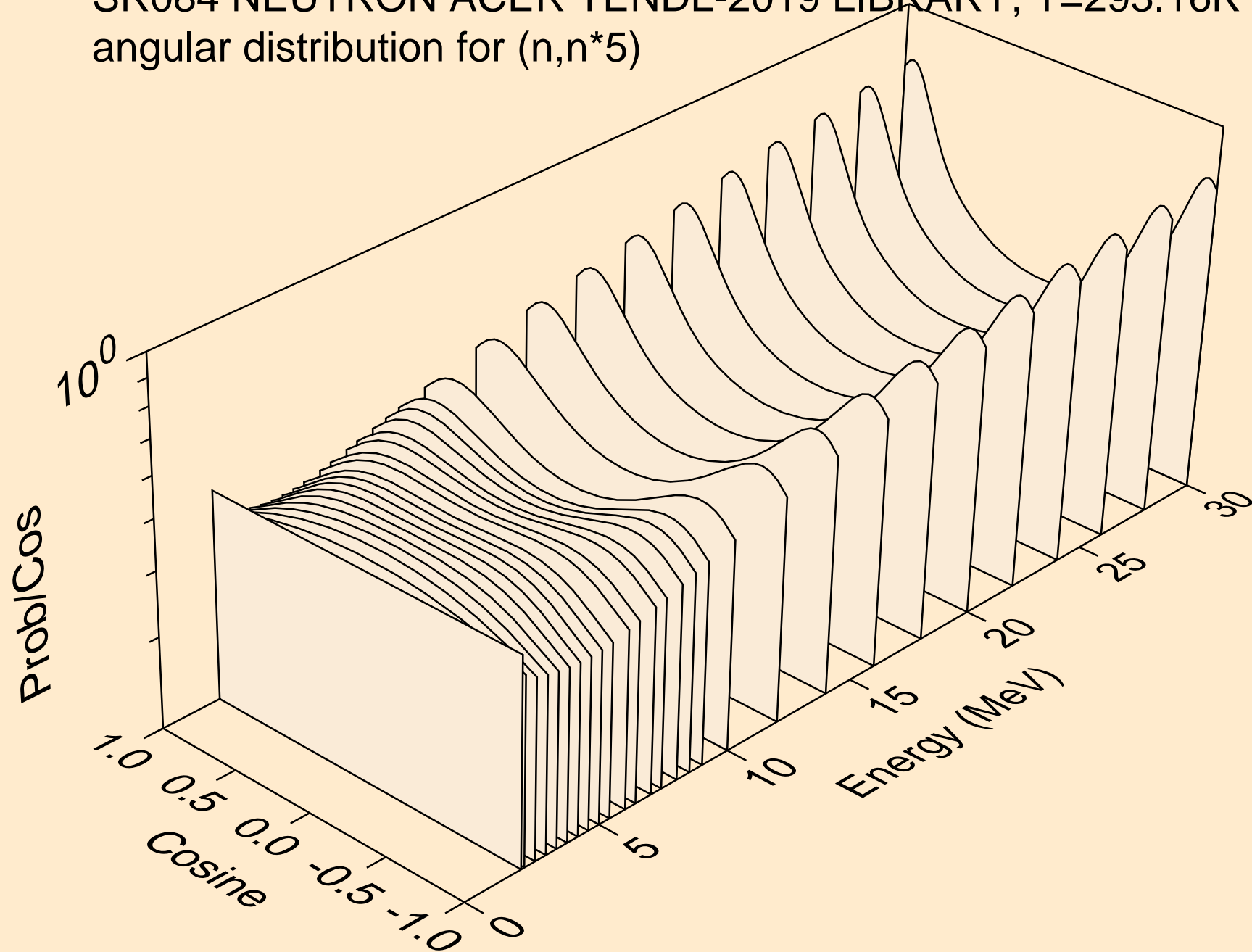

SR084 NEUTRON ACER TENDL-2019 LIBRARY; T=293.16K
angular distribution for (n,n*6)

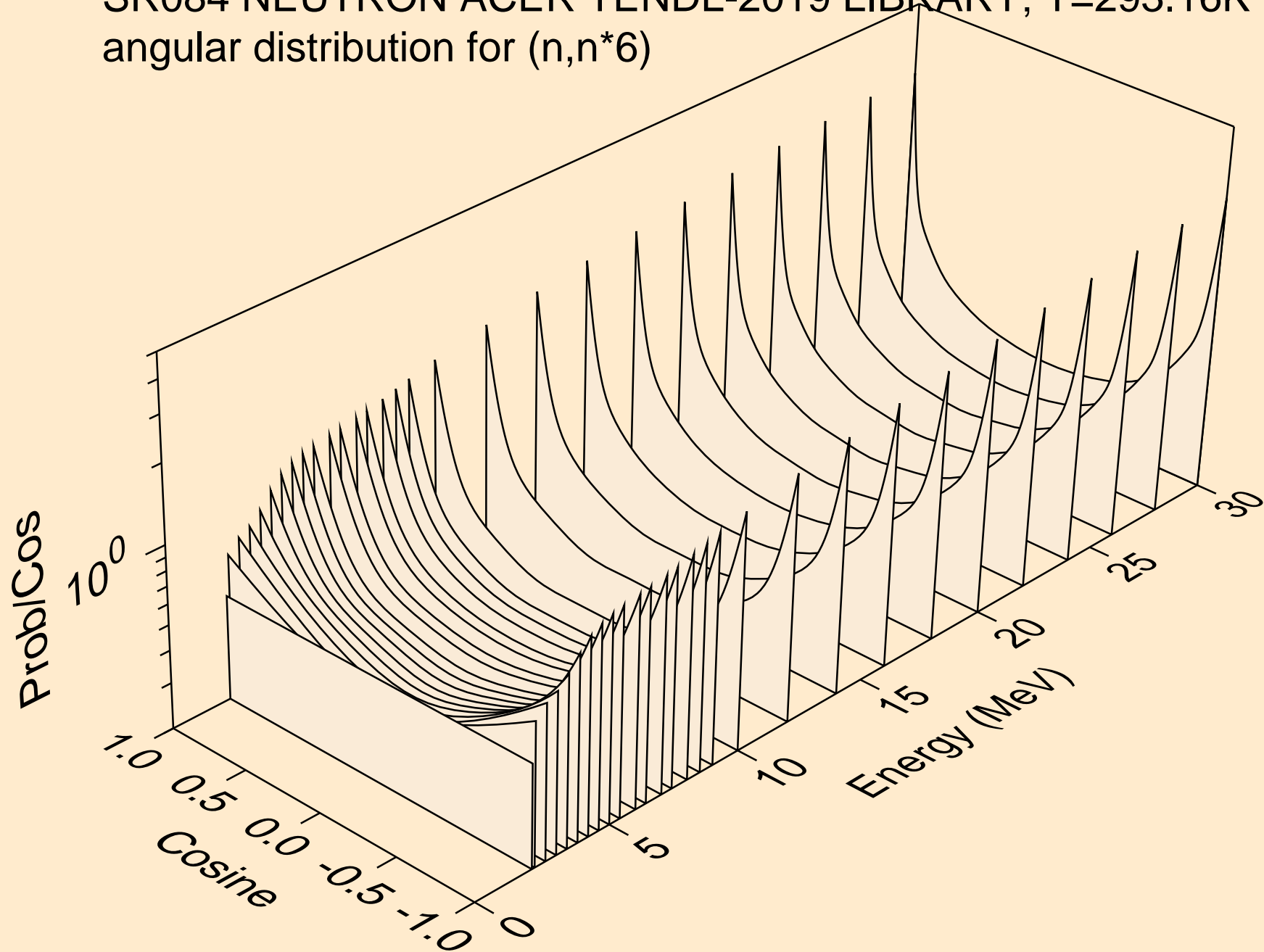

SR084 NEUTRON ACER TENDL-2019 LIBRARY; T=293.16K
angular distribution for (n,n*7)

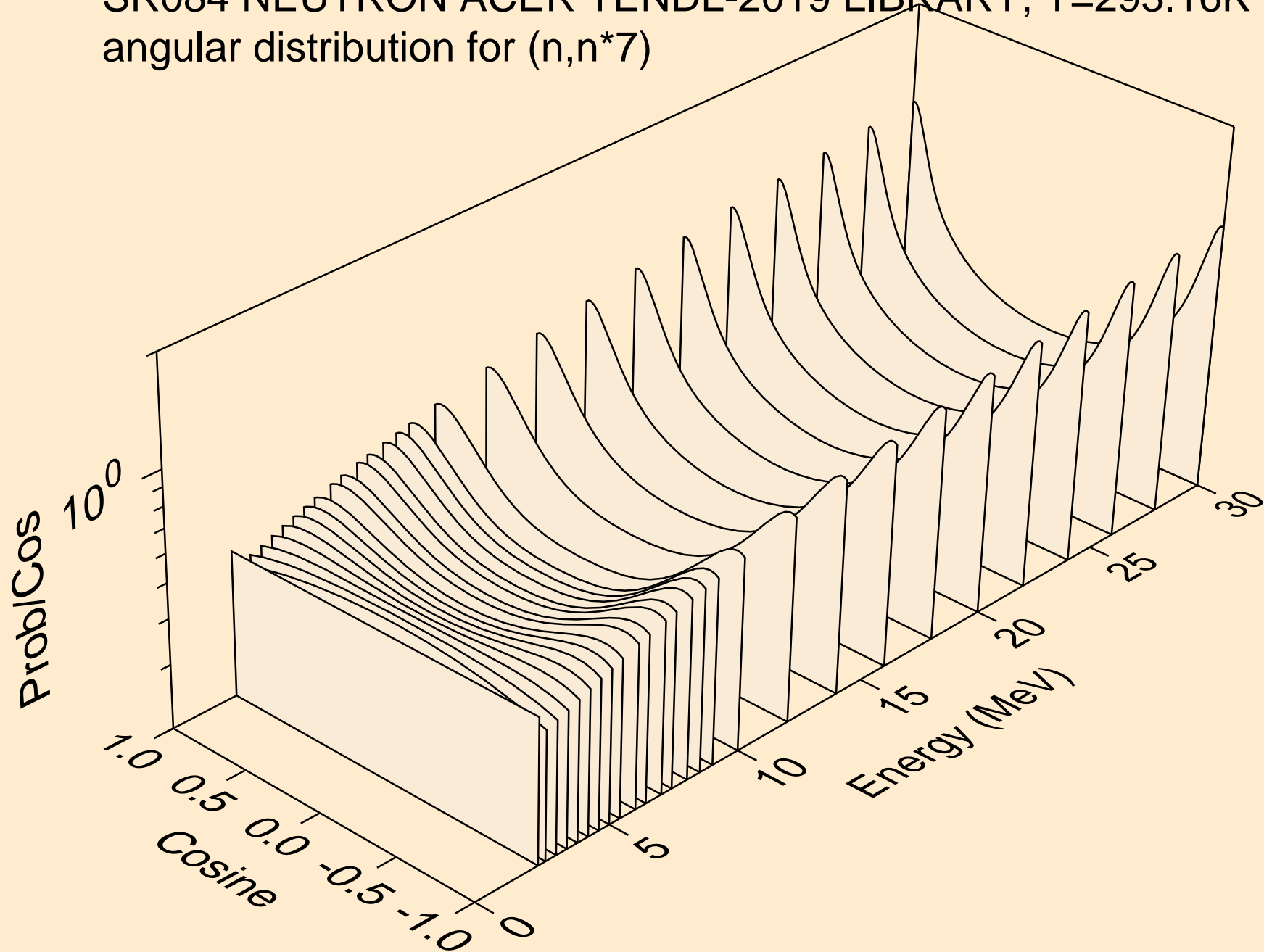

SR084 NEUTRON ACER TENDL-2019 LIBRARY; T=293.16K
angular distribution for (n,n*8)

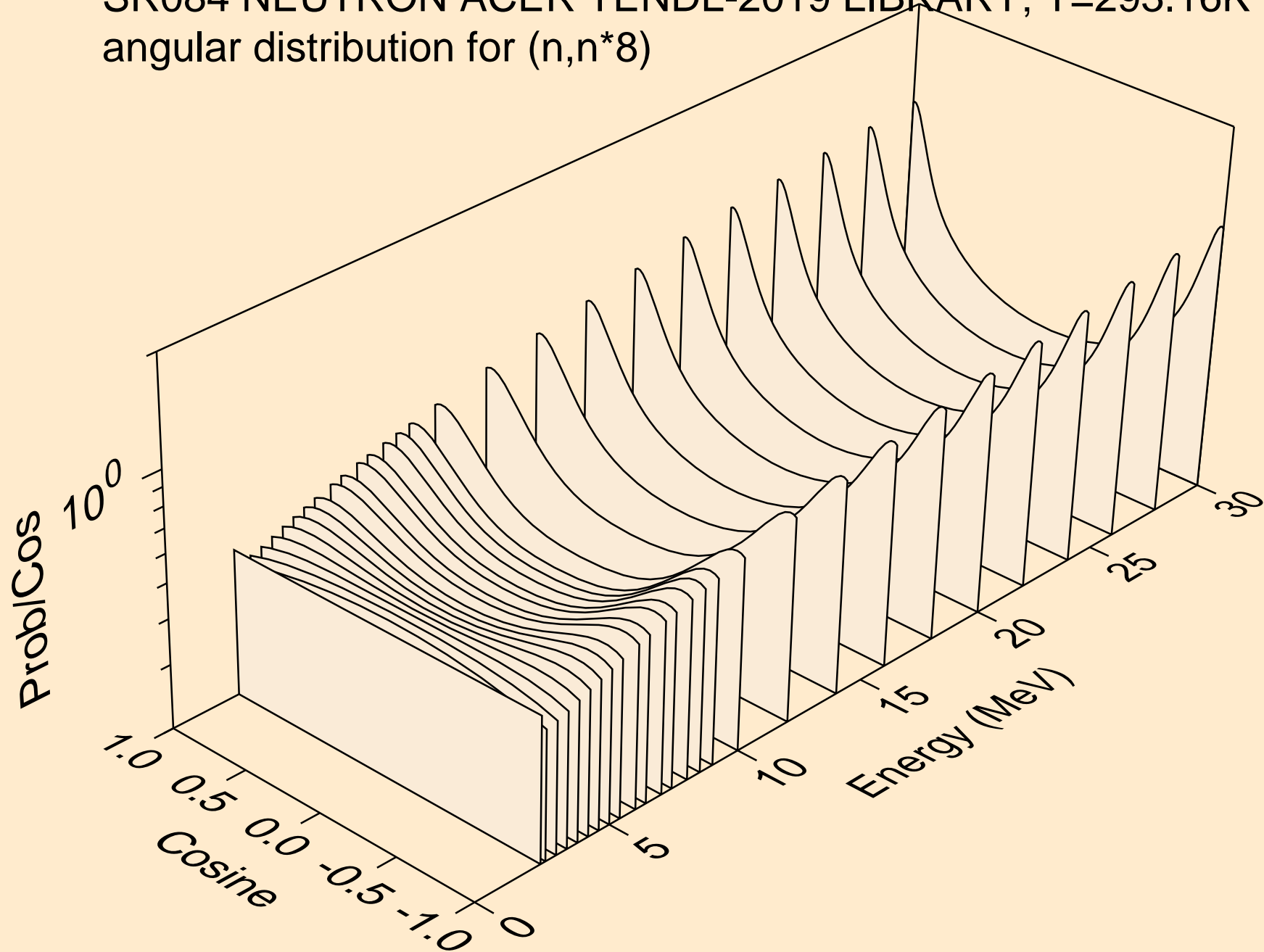

SR084 NEUTRON ACER TENDL-2019 LIBRARY; T=293.16K
angular distribution for (n,n*9)

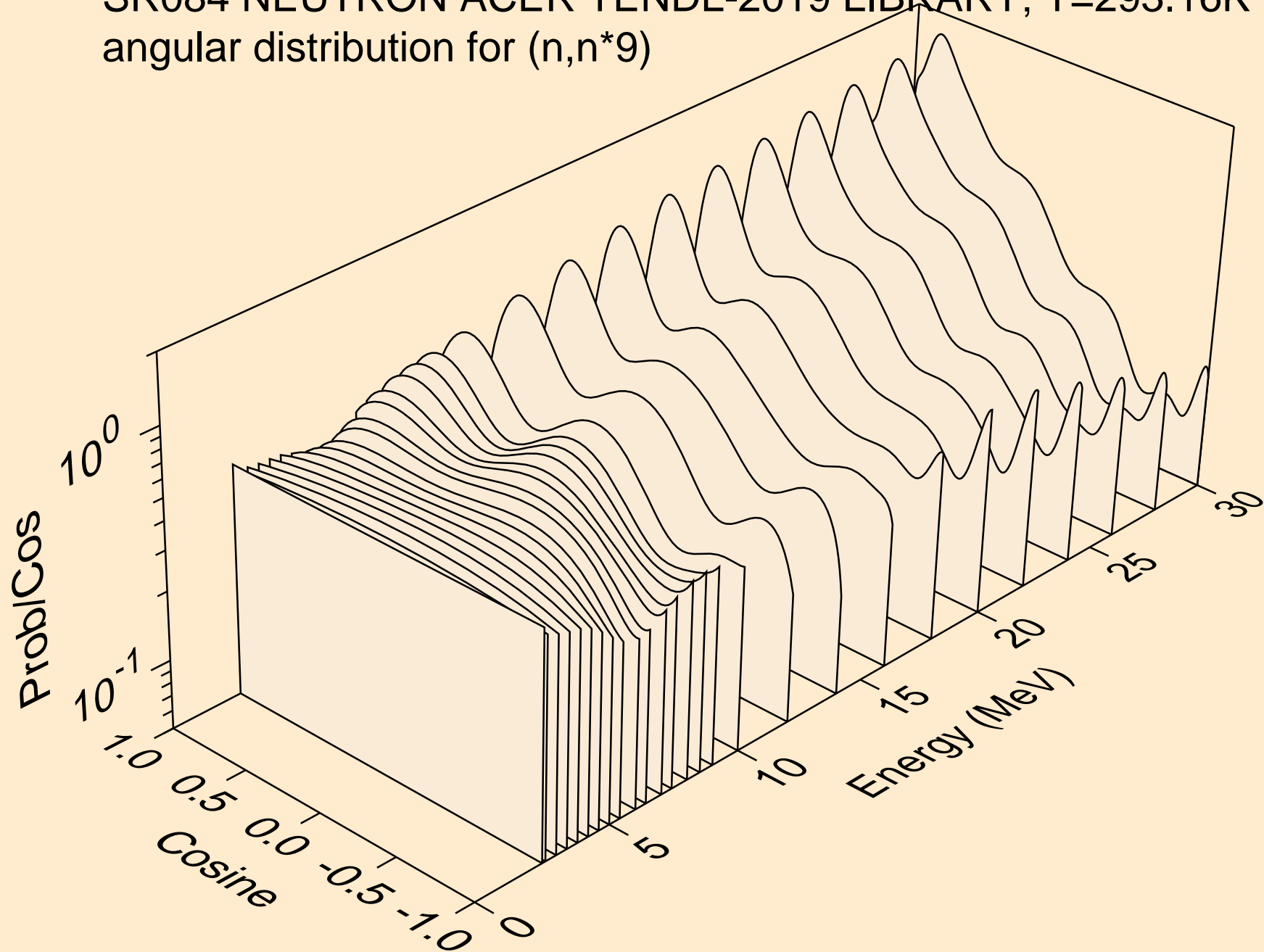

SR084 NEUTRON ACER TENDL-2019 LIBRARY; T=293.16K
angular distribution for (n,n*10)

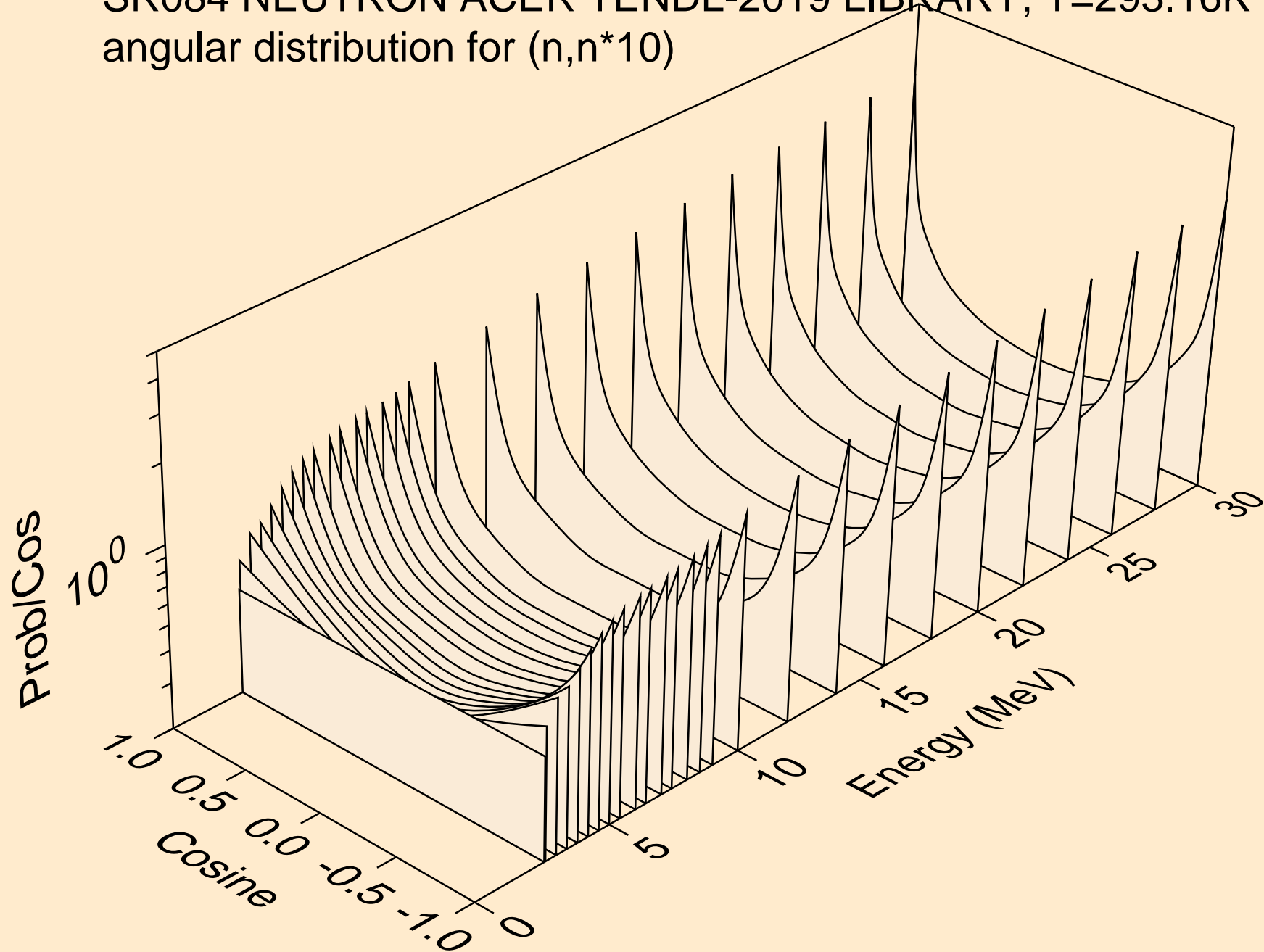

SR084 NEUTRON ACER TENDL-2019 LIBRARY; T=293.16K
angular distribution for (n,n*11)

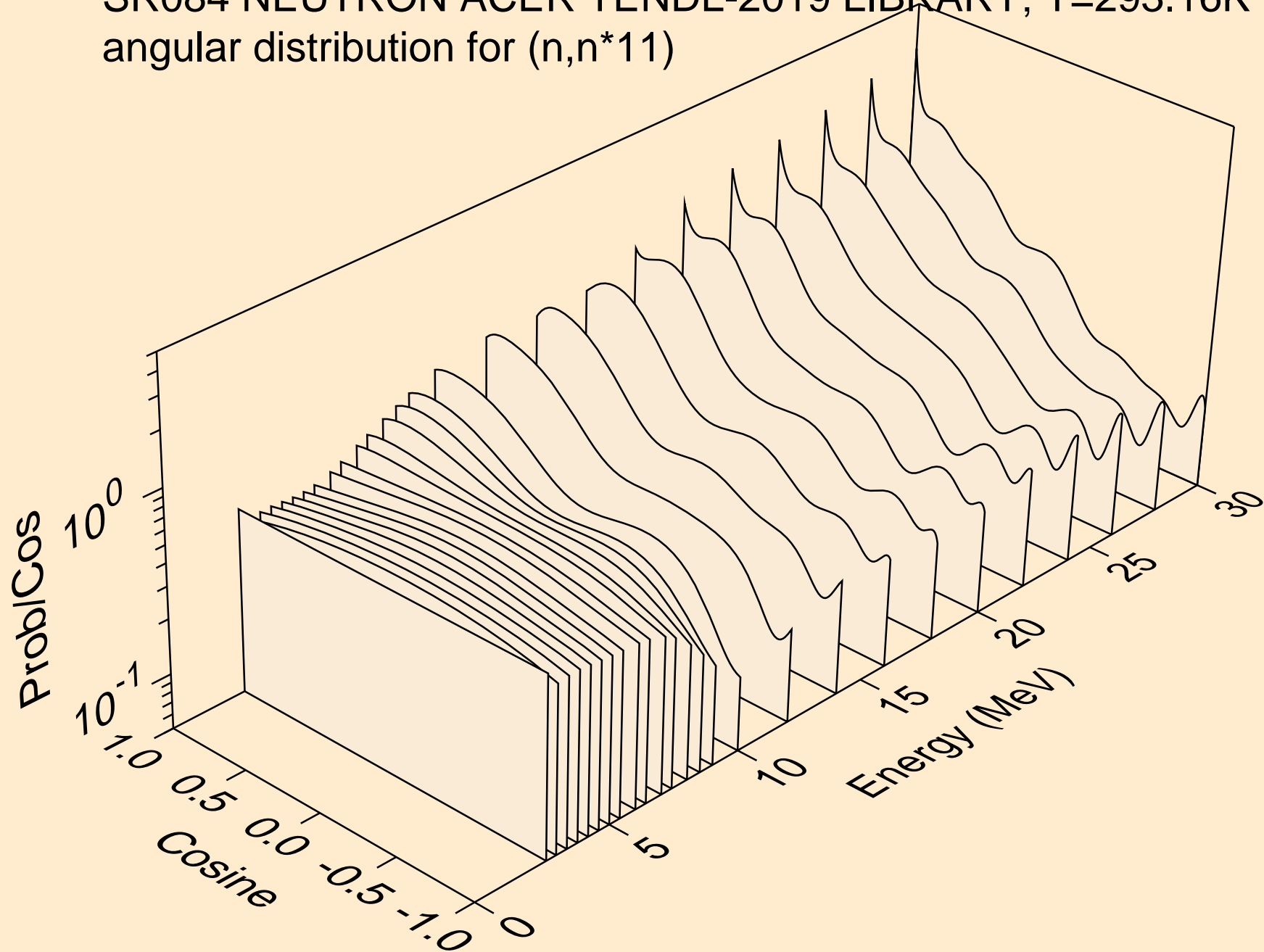

SR084 NEUTRON ACER TENDL-2019 LIBRARY; T=293.16K
angular distribution for (n,n*12)

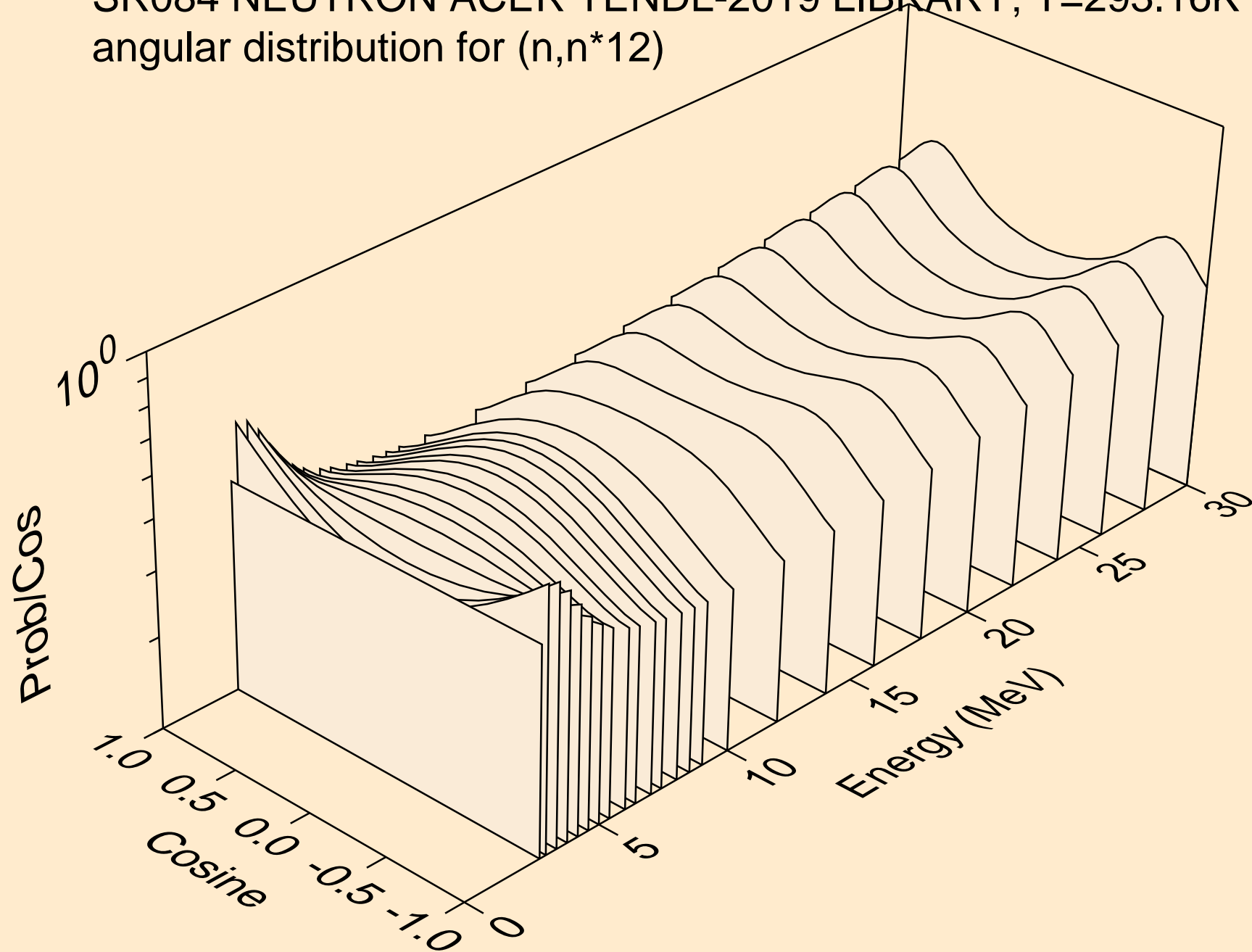

SR084 NEUTRON ACER TENDL-2019 LIBRARY; T=293.16K
angular distribution for (n,n*13)

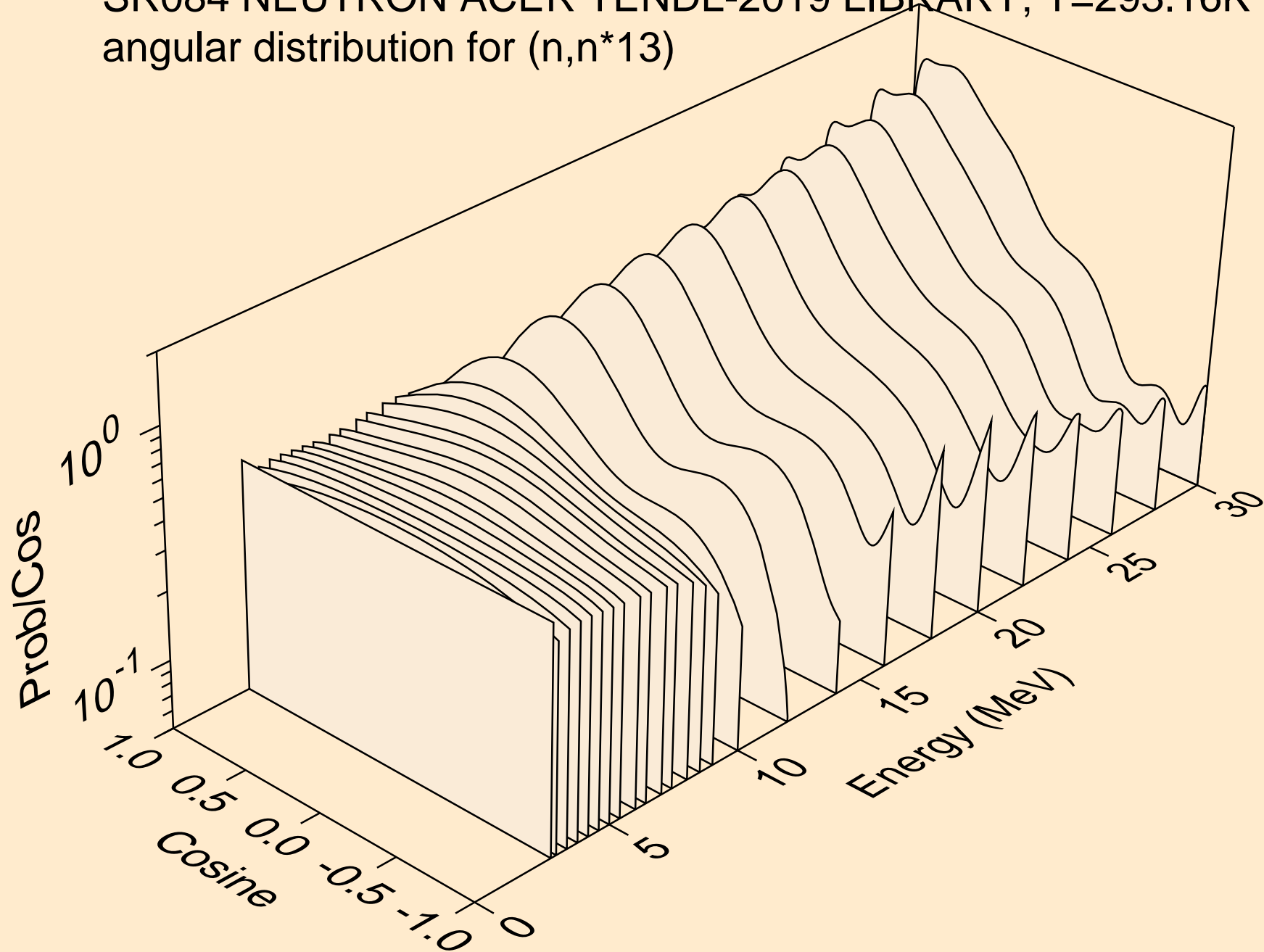

SR084 NEUTRON ACER TENDL-2019 LIBRARY; T=293.16K
angular distribution for (n,n*14)

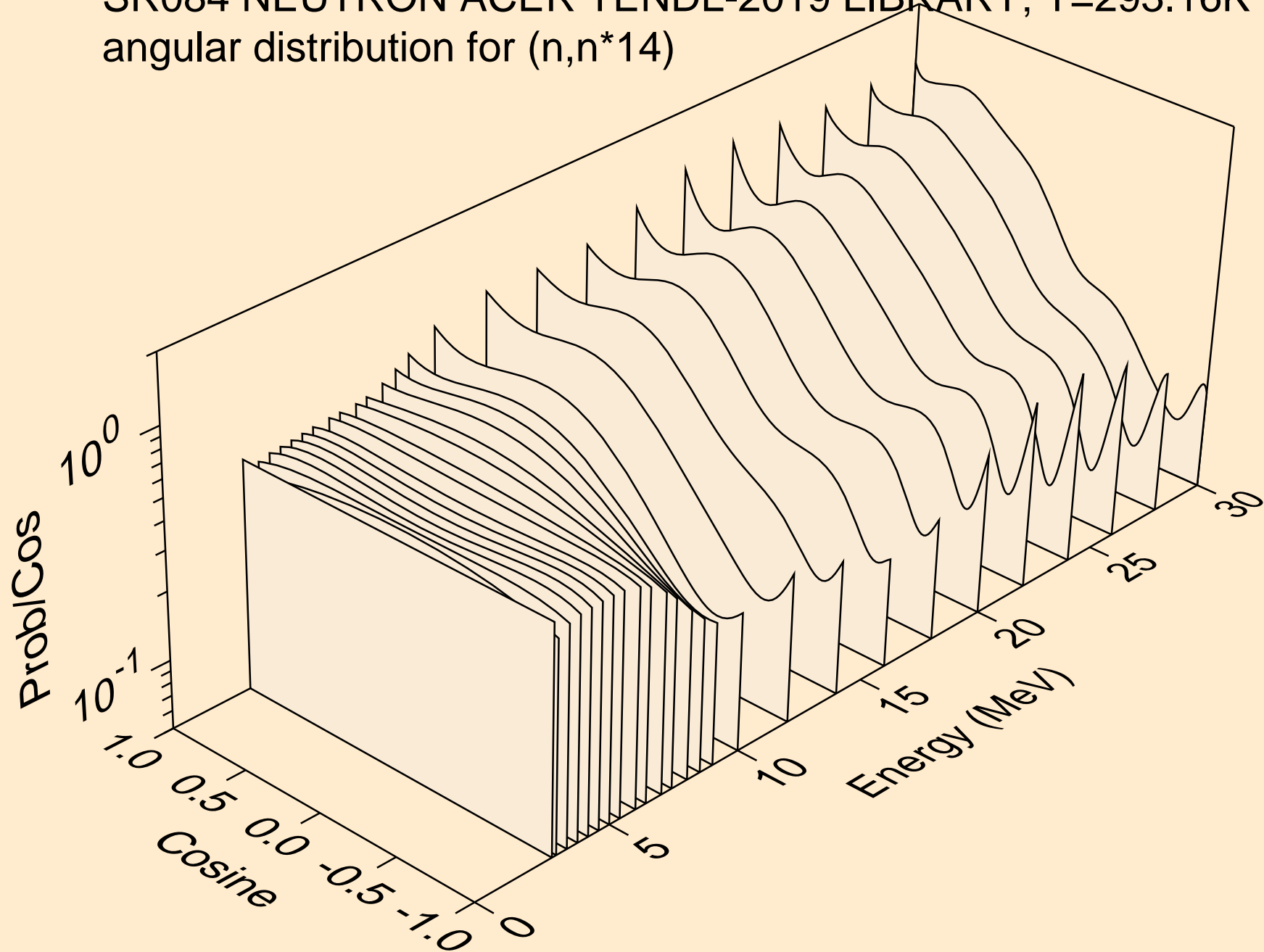

SR084 NEUTRON ACER TENDL-2019 LIBRARY; T=293.16K
angular distribution for (n,n*15)

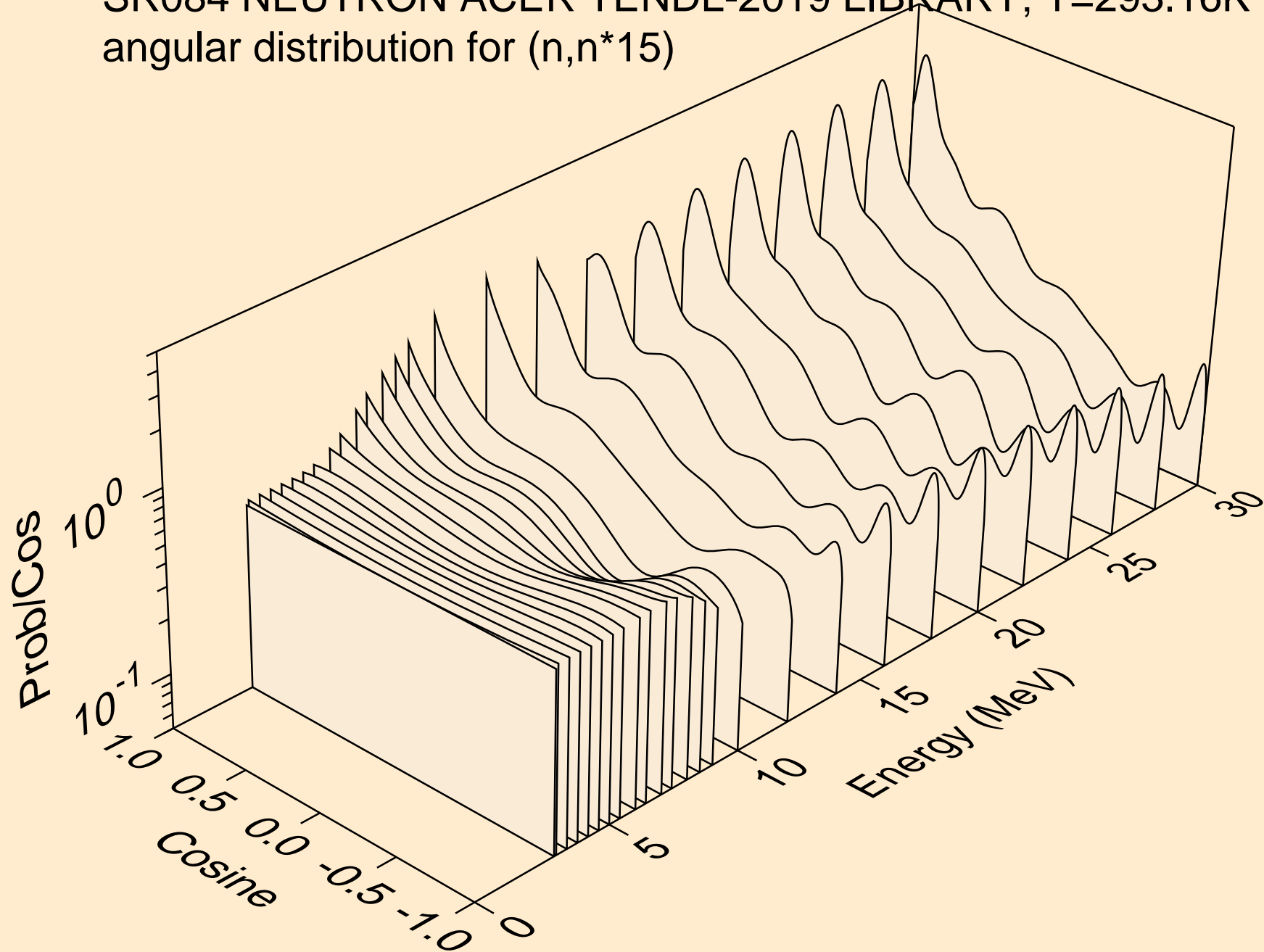

SR084 NEUTRON ACER TENDL-2019 LIBRARY; T=293.16K
angular distribution for (n,n*16)

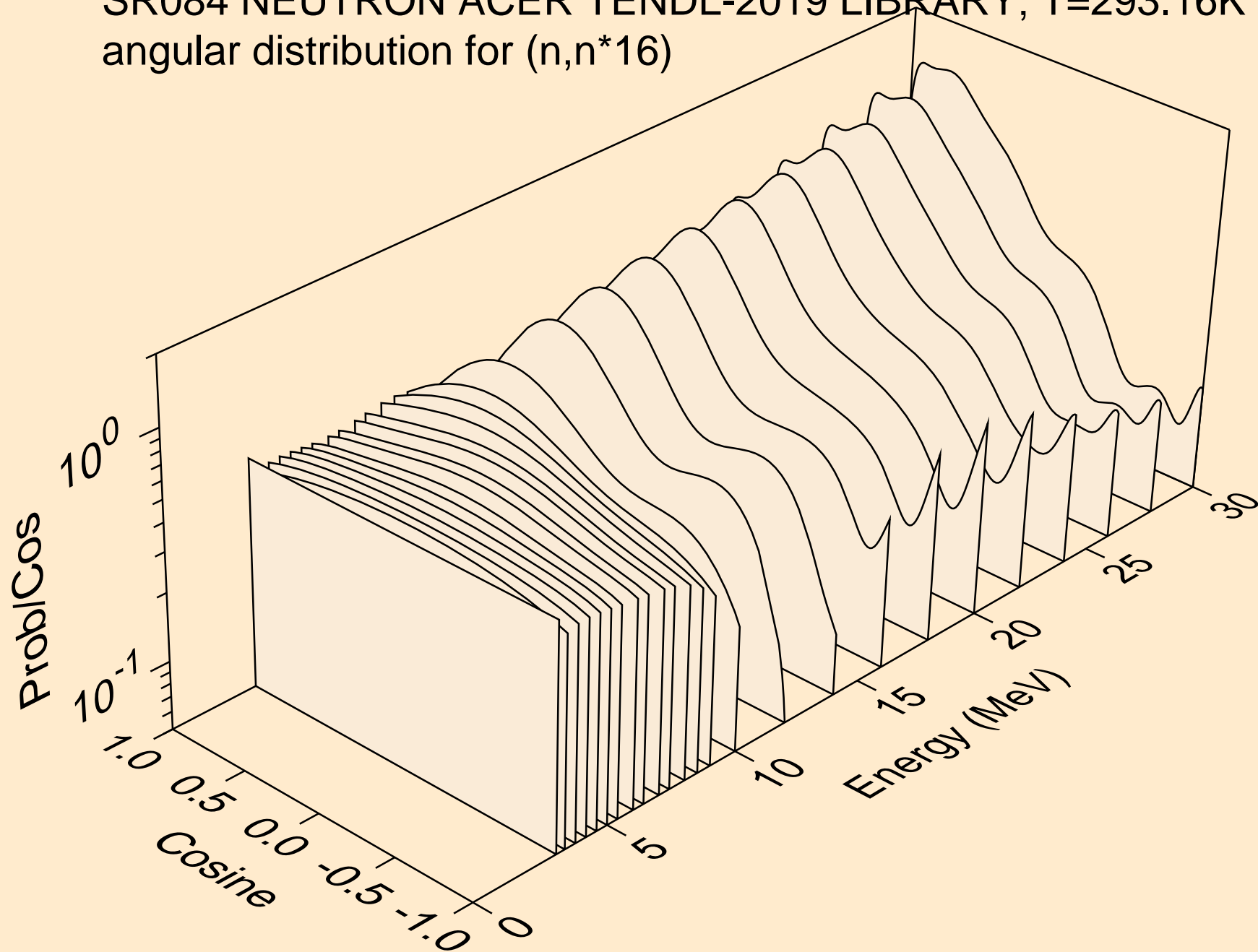

SR084 NEUTRON ACER TENDL-2019 LIBRARY; T=293.16K
angular distribution for (n,n*17)

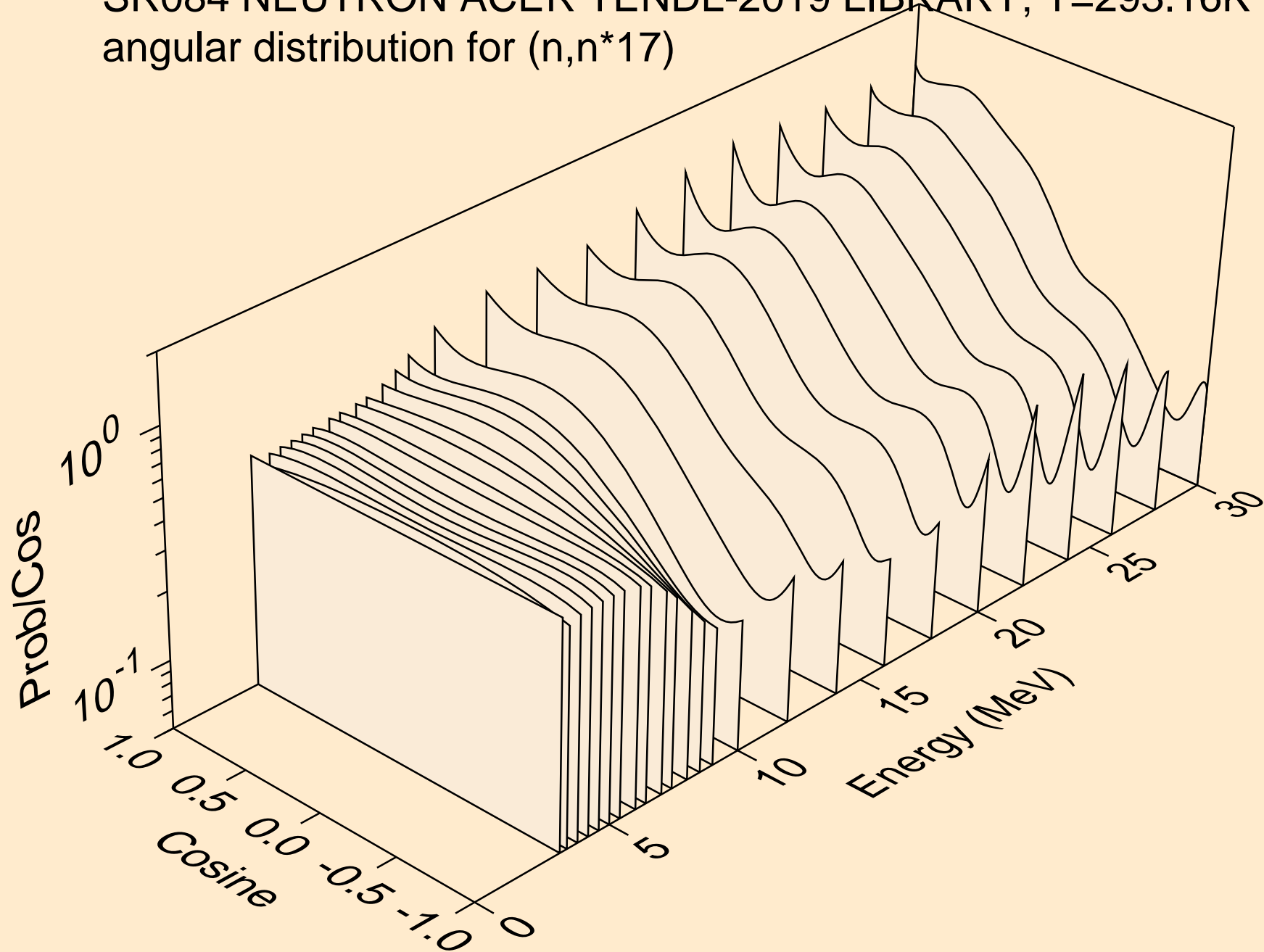

SR084 NEUTRON ACER TENDL-2019 LIBRARY; T=293.16K
angular distribution for (n,n*18)

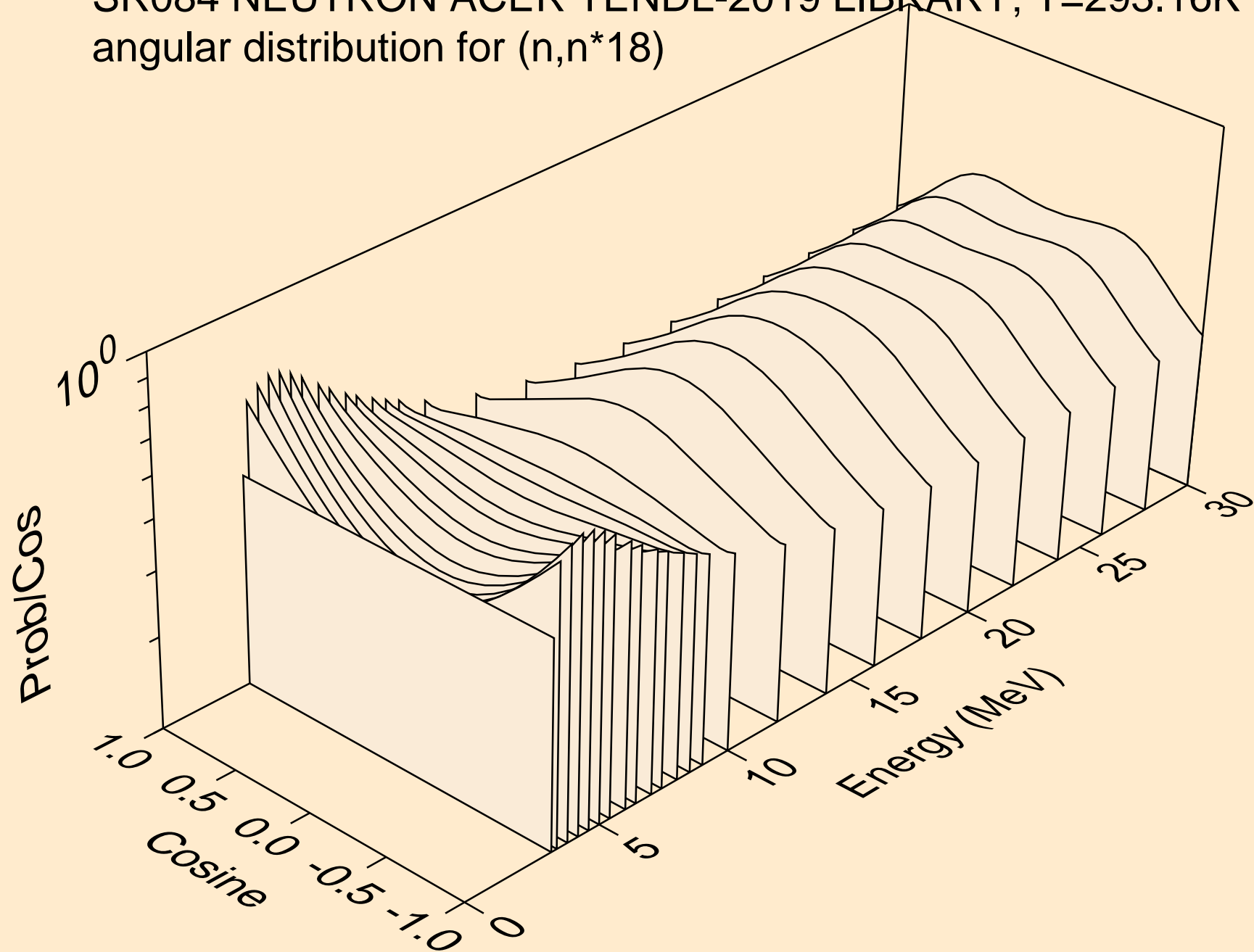

SR084 NEUTRON ACER TENDL-2019 LIBRARY; T=293.16K
angular distribution for (n,n*19)

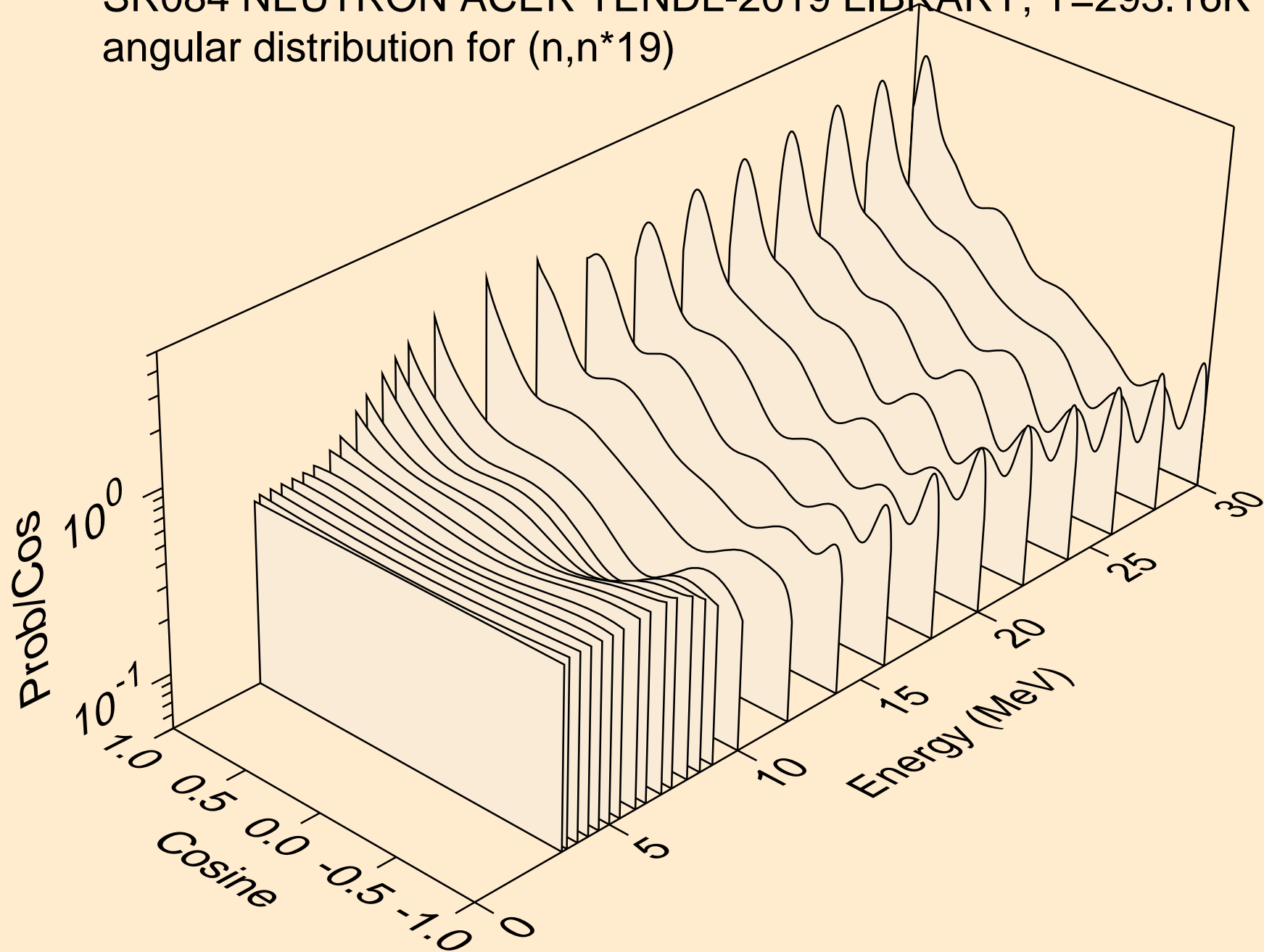

SR084 NEUTRON ACER TENDL-2019 LIBRARY; T=293.16K
angular distribution for (n,n*20)

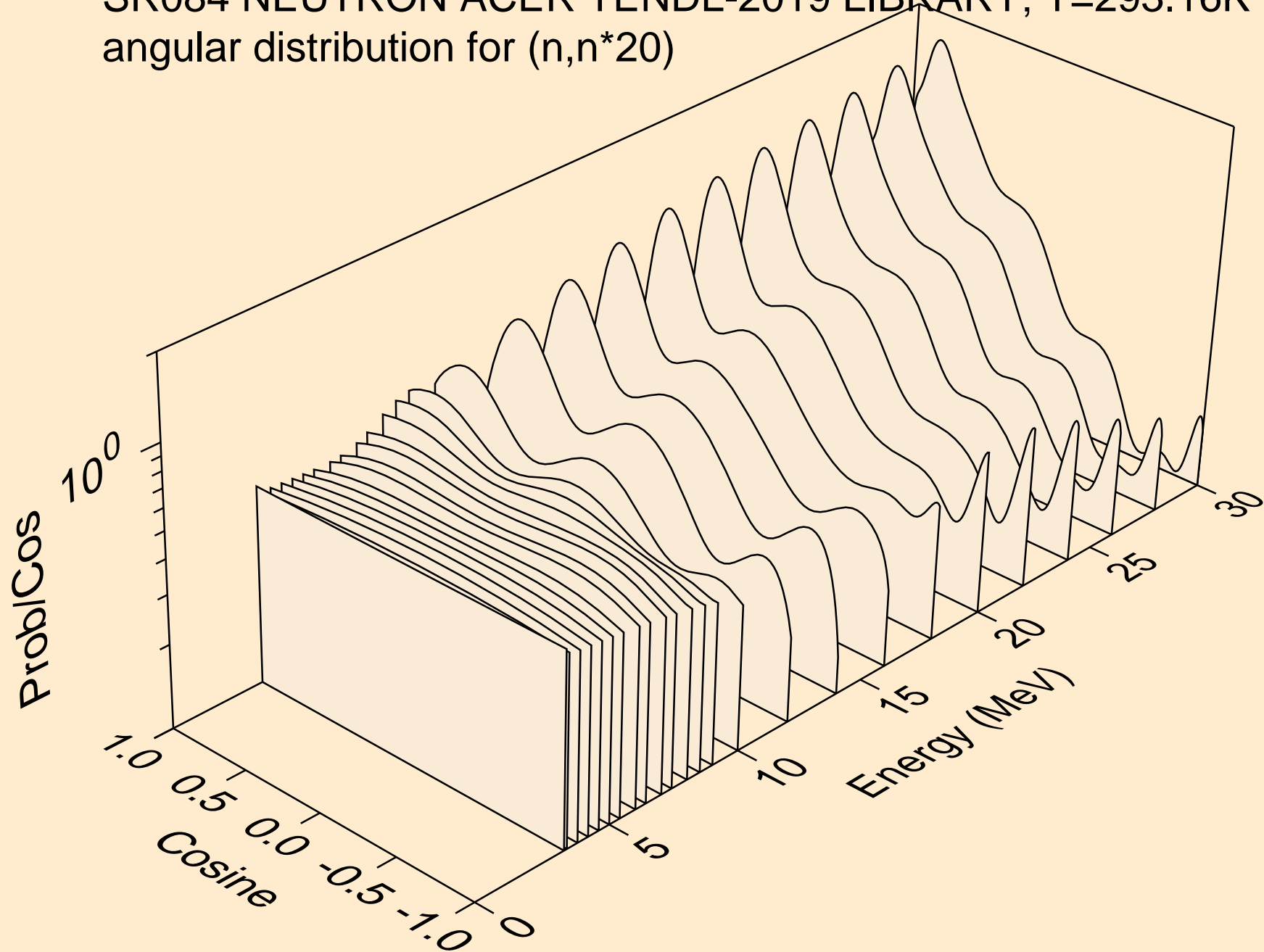

SR084 NEUTRON ACER TENDL-2019 LIBRARY; T=293.16K
angular distribution for (n,n*21)

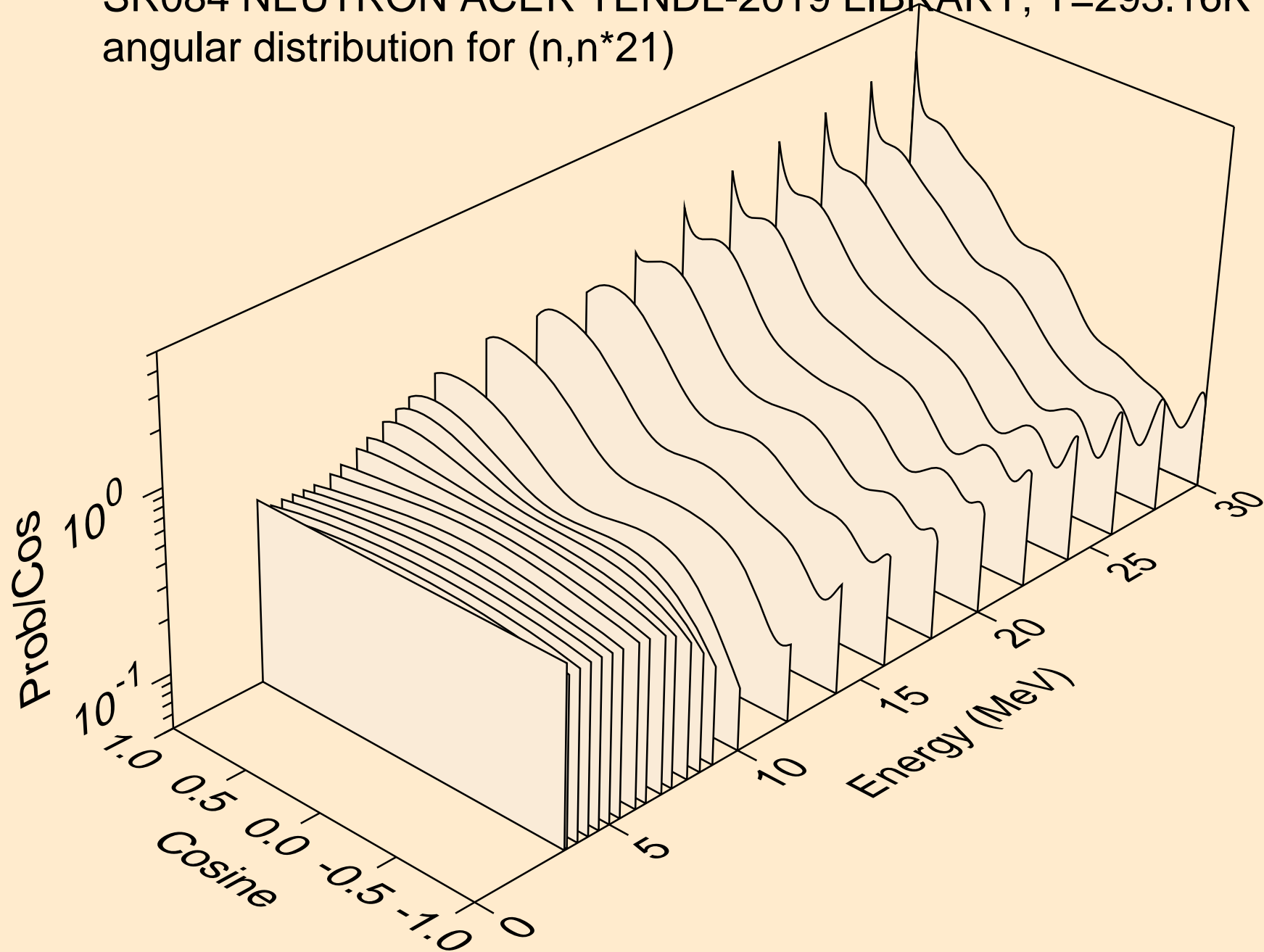

SR084 NEUTRON ACER TENDL-2019 LIBRARY; T=293.16K
angular distribution for (n,n*22)

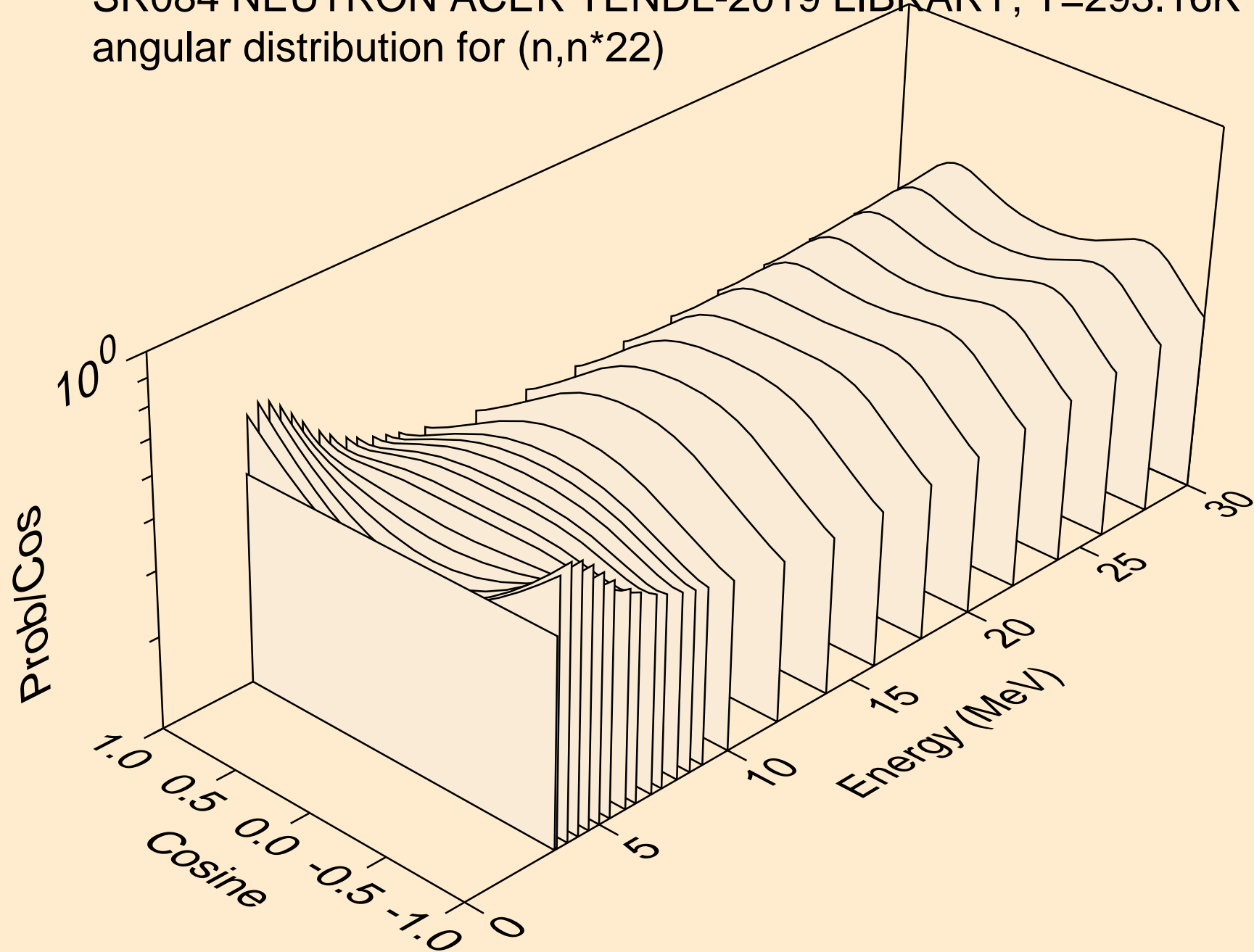

SR084 NEUTRON ACER TENDL-2019 LIBRARY; T=293.16K
angular distribution for (n,n*23)

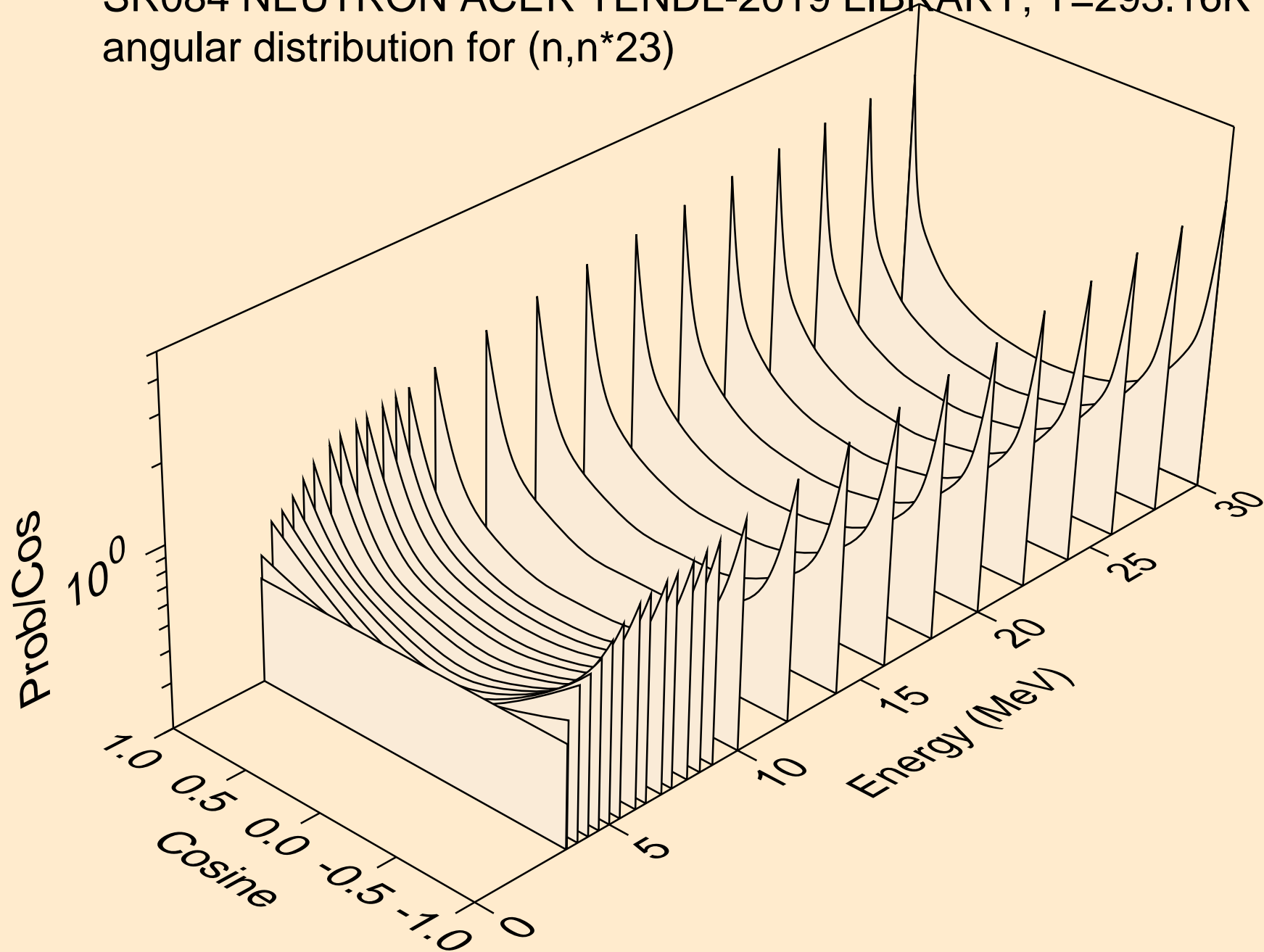

SR084 NEUTRON ACER TENDL-2019 LIBRARY; T=293.16K
angular distribution for (n,n*24)

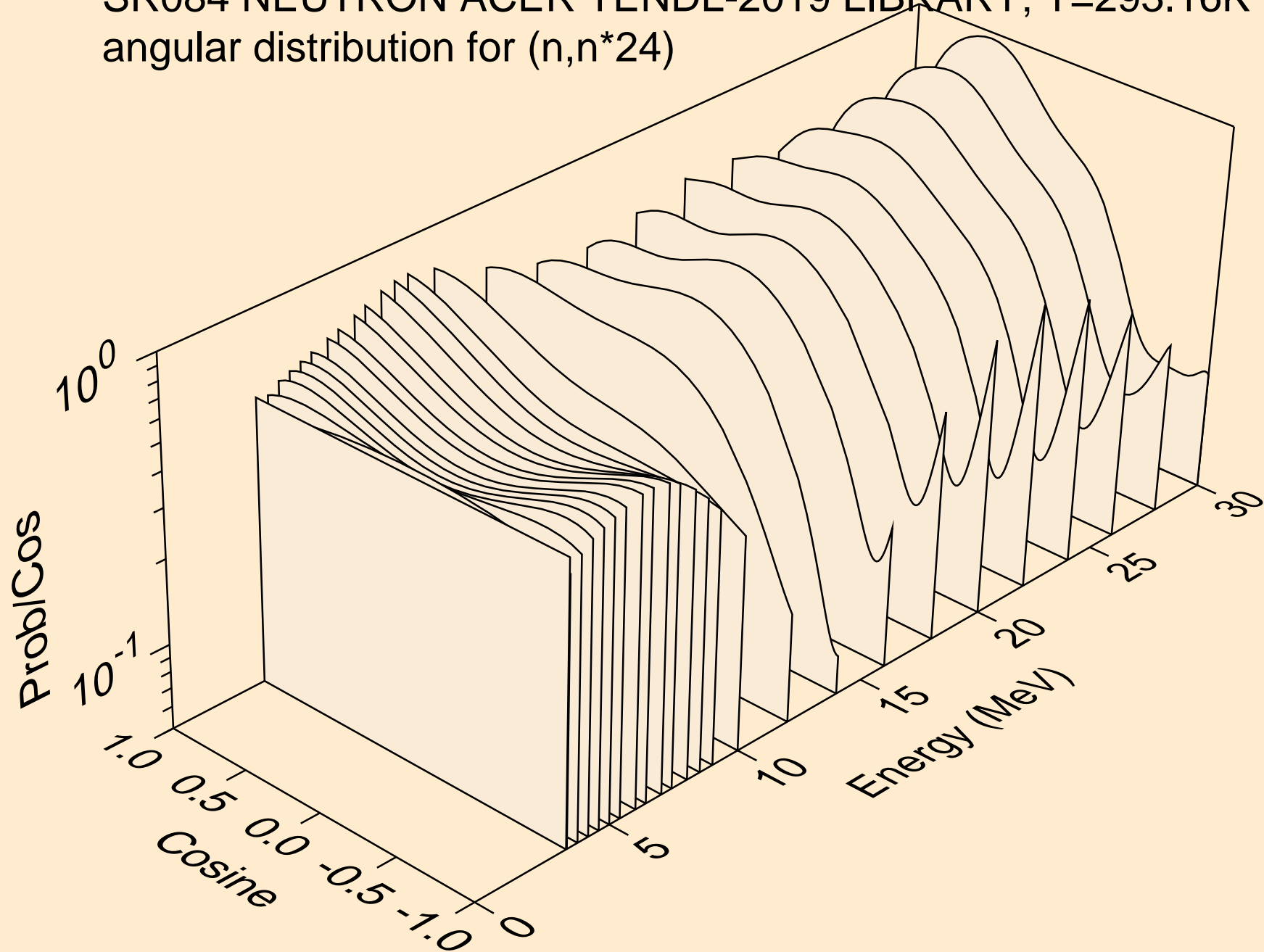

SR084 NEUTRON ACER TENDL-2019 LIBRARY; T=293.16K
angular distribution for (n,n*25)

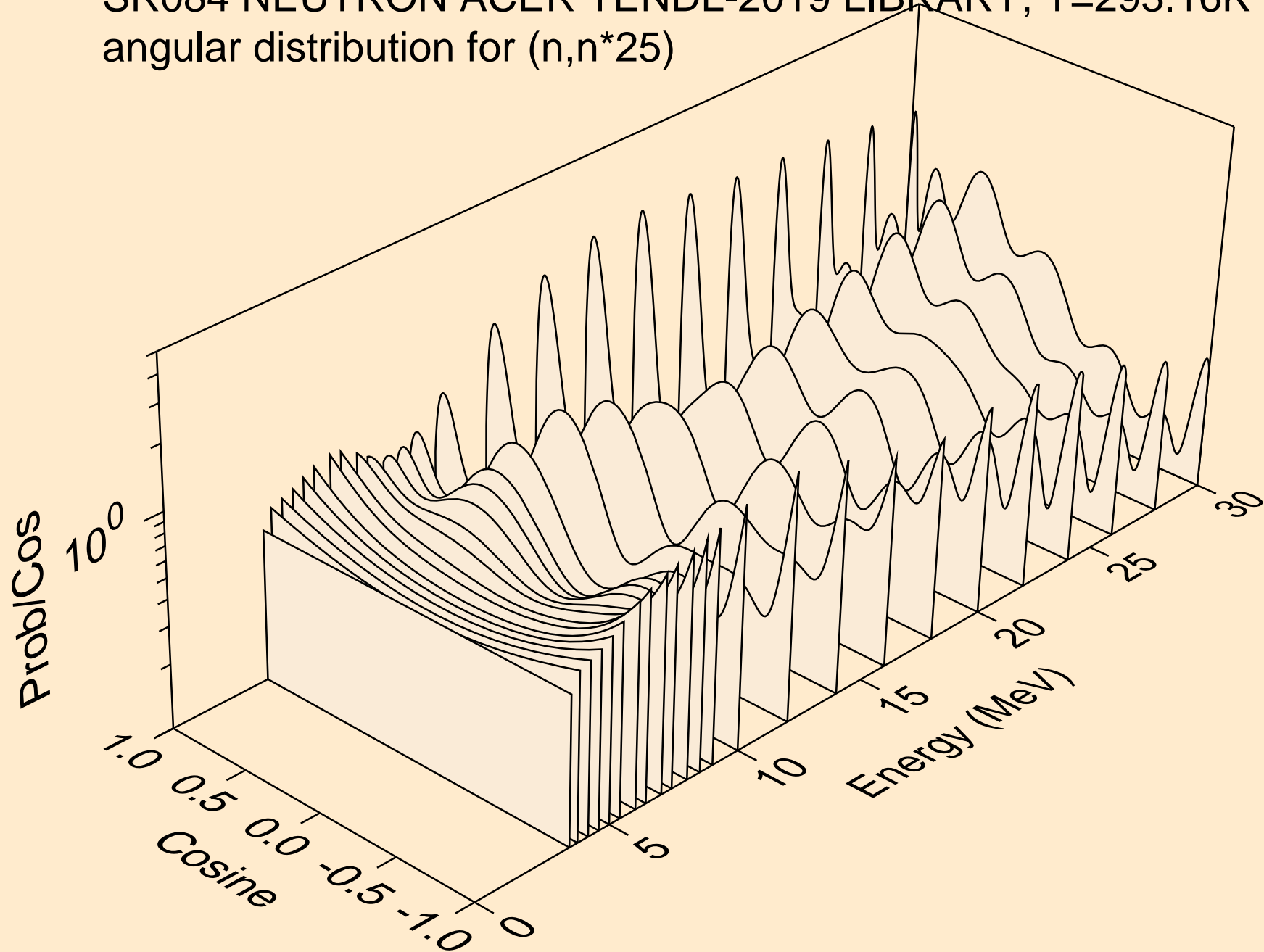

SR084 NEUTRON ACER TENDL-2019 LIBRARY; T=293.16K
angular distribution for (n,n*26)

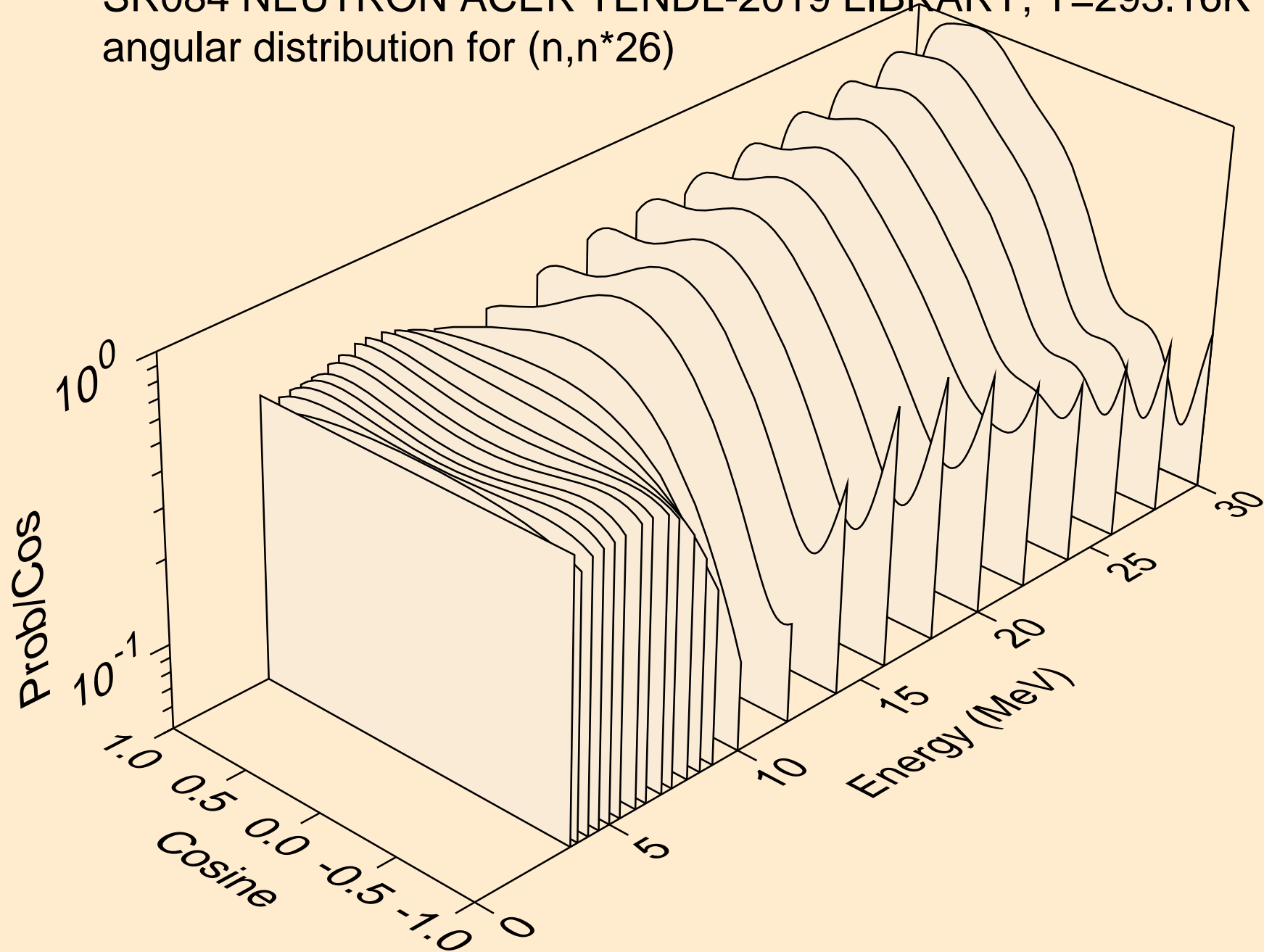

SR084 NEUTRON ACER TENDL-2019 LIBRARY; T=293.16K
angular distribution for (n,n*27)

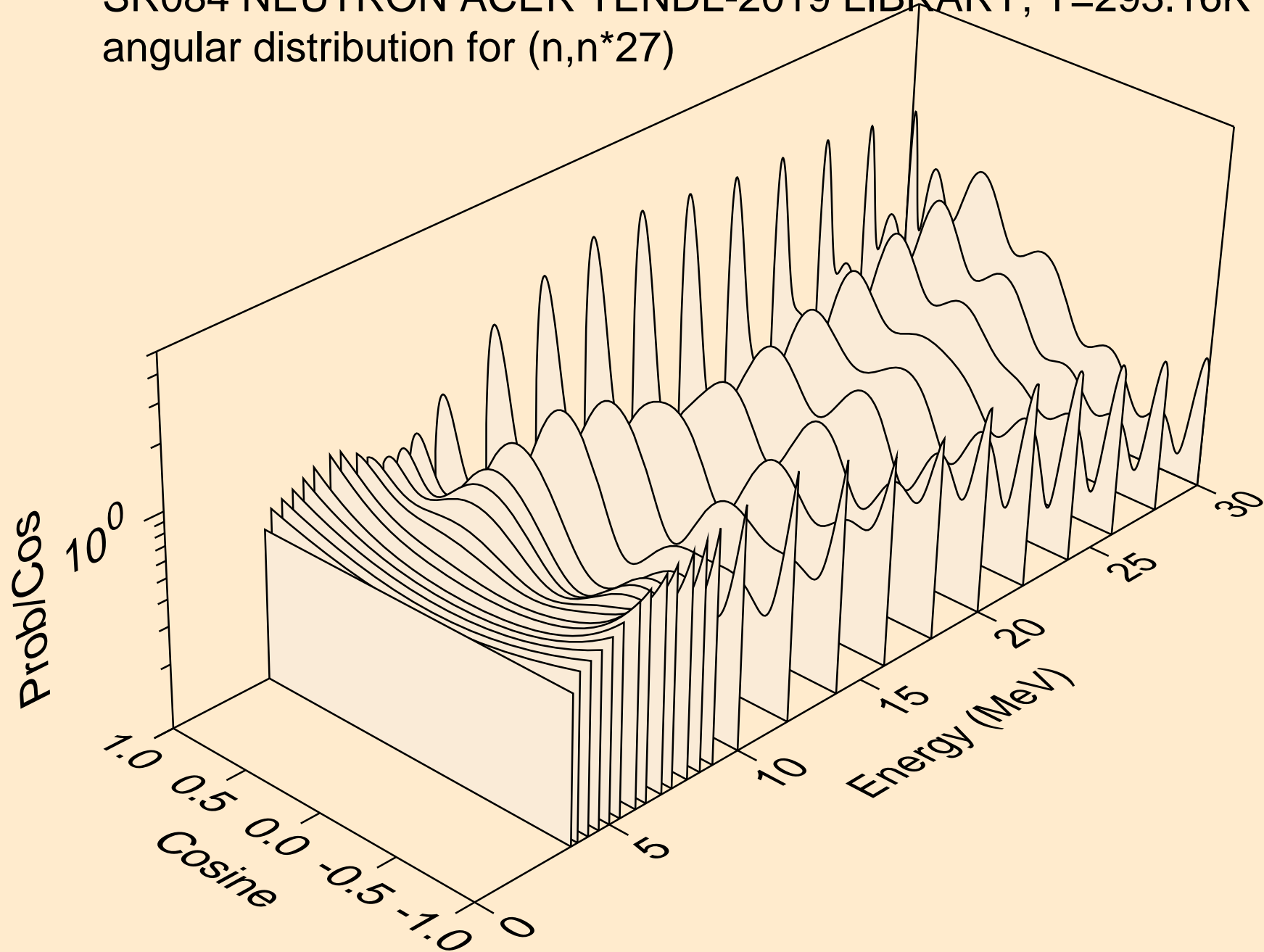

SR084 NEUTRON ACER TENDL-2019 LIBRARY; T=293.16K
angular distribution for (n,n*28)

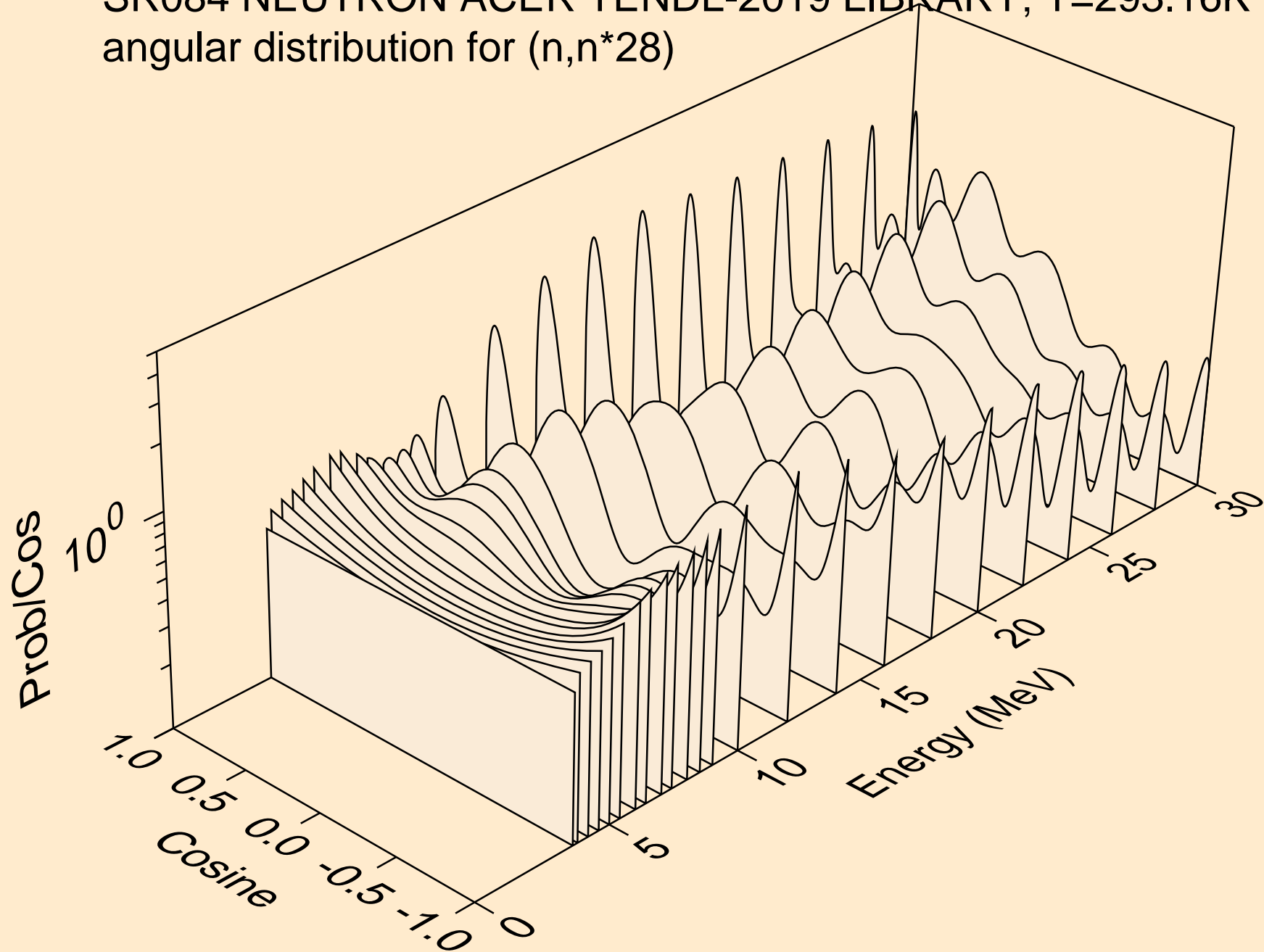

SR084 NEUTRON ACER TENDL-2019 LIBRARY; T=293.16K
Neutron emission for (n,x)

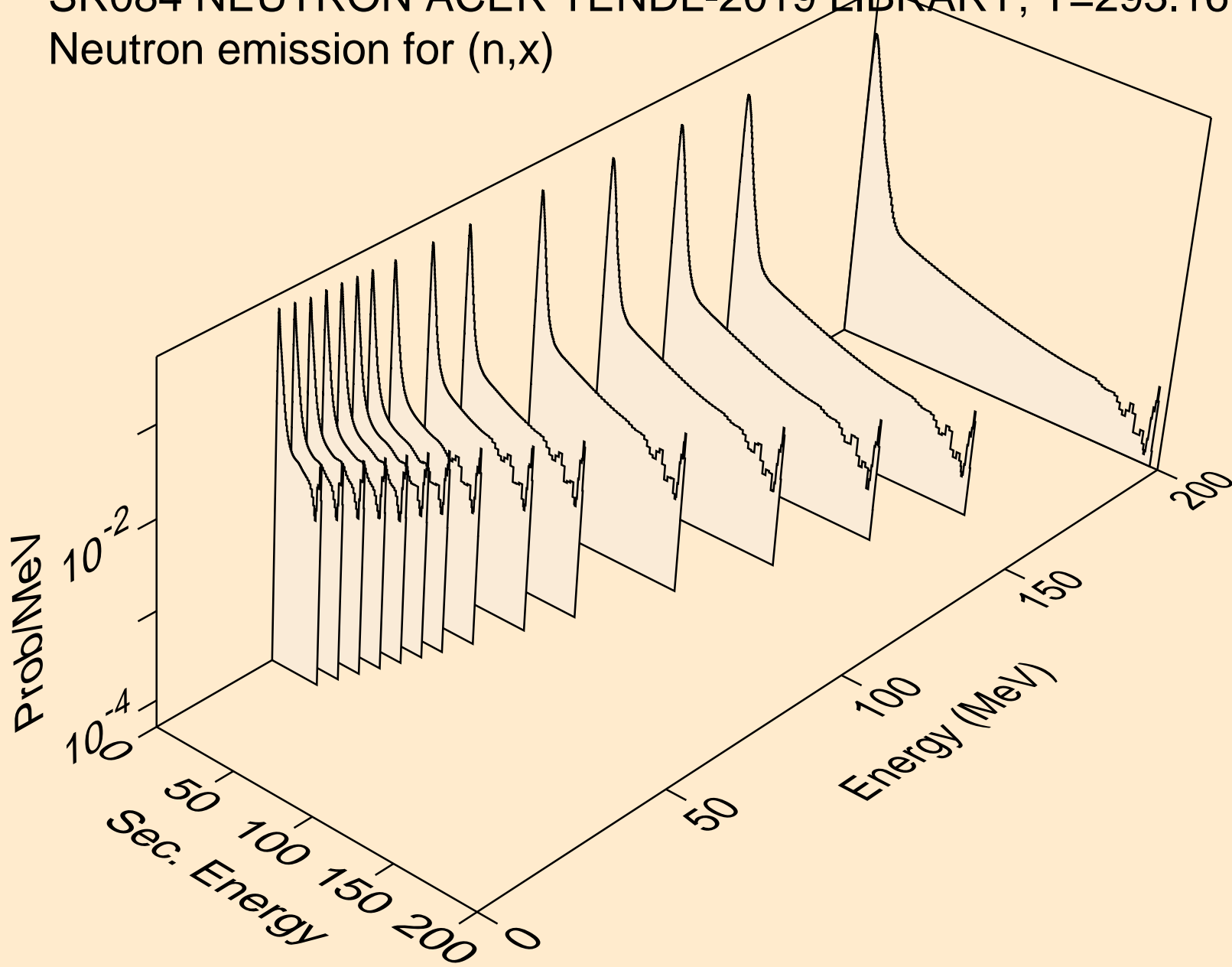

SR084 NEUTRON ACER TENDL-2019 LIBRARY; T=293.16K
Neutron emission for (n,2nd)

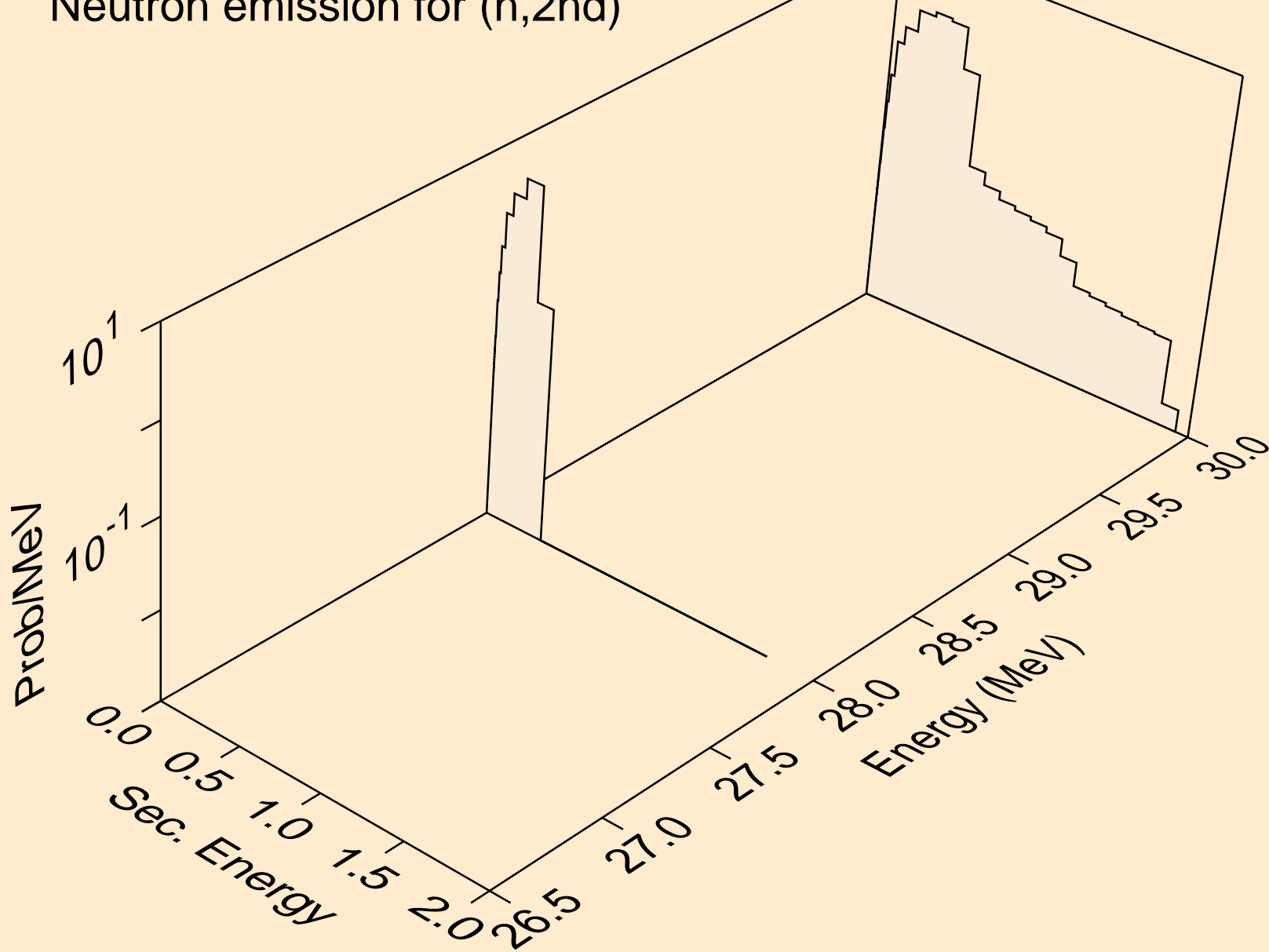

SR084 NEUTRON ACER TENDL-2019 LIBRARY; T=293.16K
Neutron emission for (n,2n)

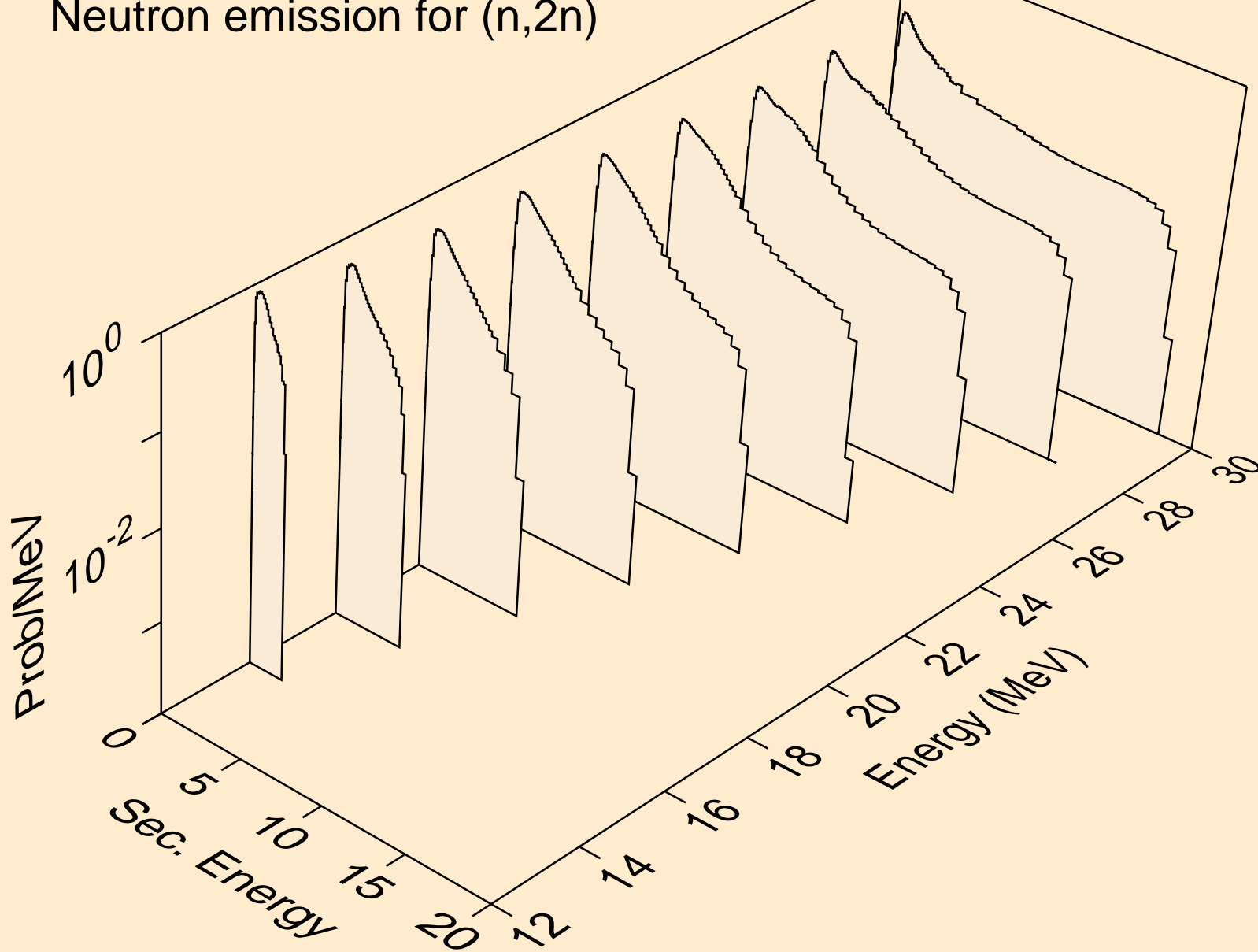

SR084 NEUTRON ACER TENDL-2019 LIBRARY; T=293.16K
Neutron emission for (n,3n)

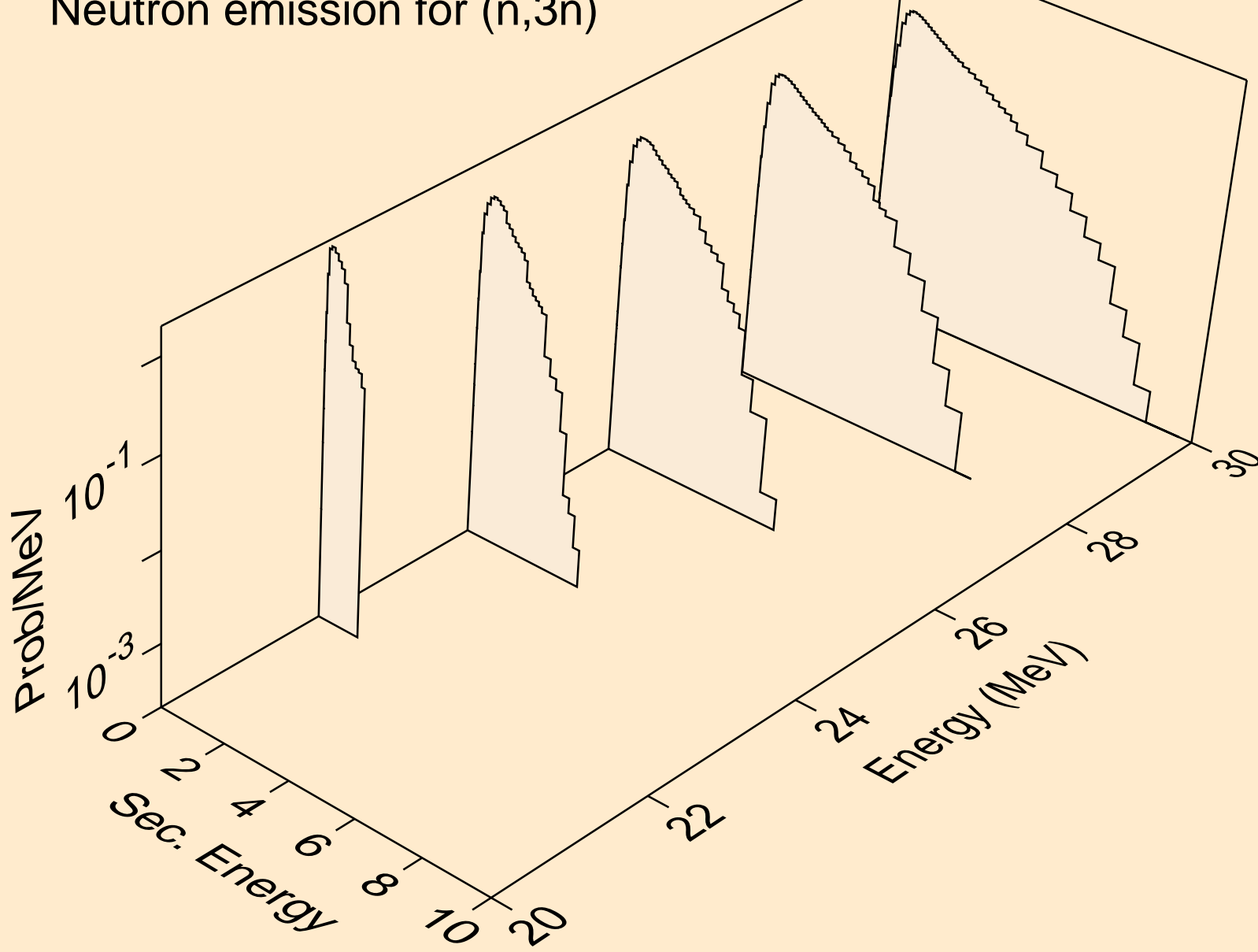

SR084 NEUTRON ACER TENDL-2019 LIBRARY; T=293.16K
Neutron emission for (n,n*)a

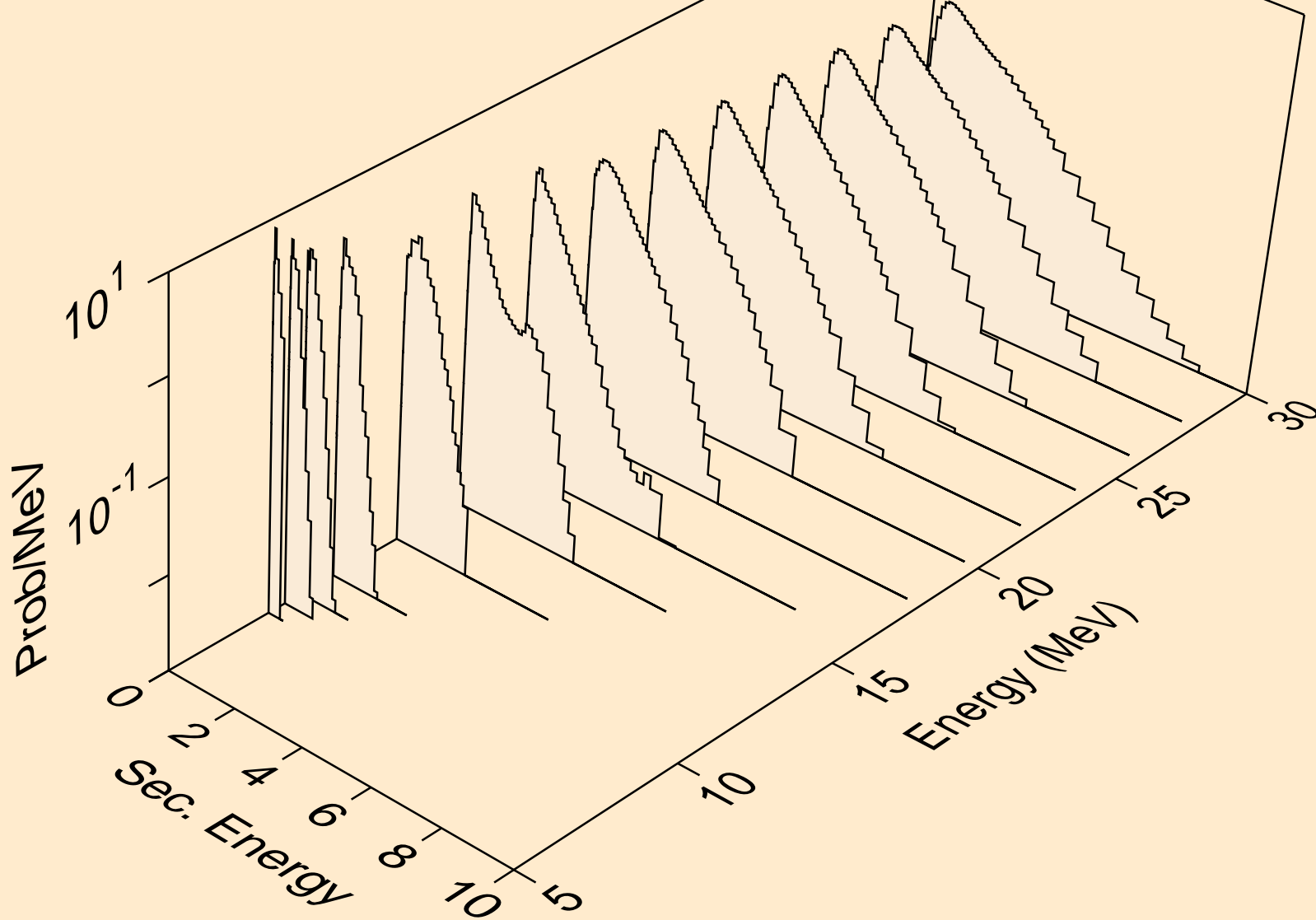

SR084 NEUTRON ACER TENDL-2019 LIBRARY; T=293.16K
Neutron emission for (n,2n)a

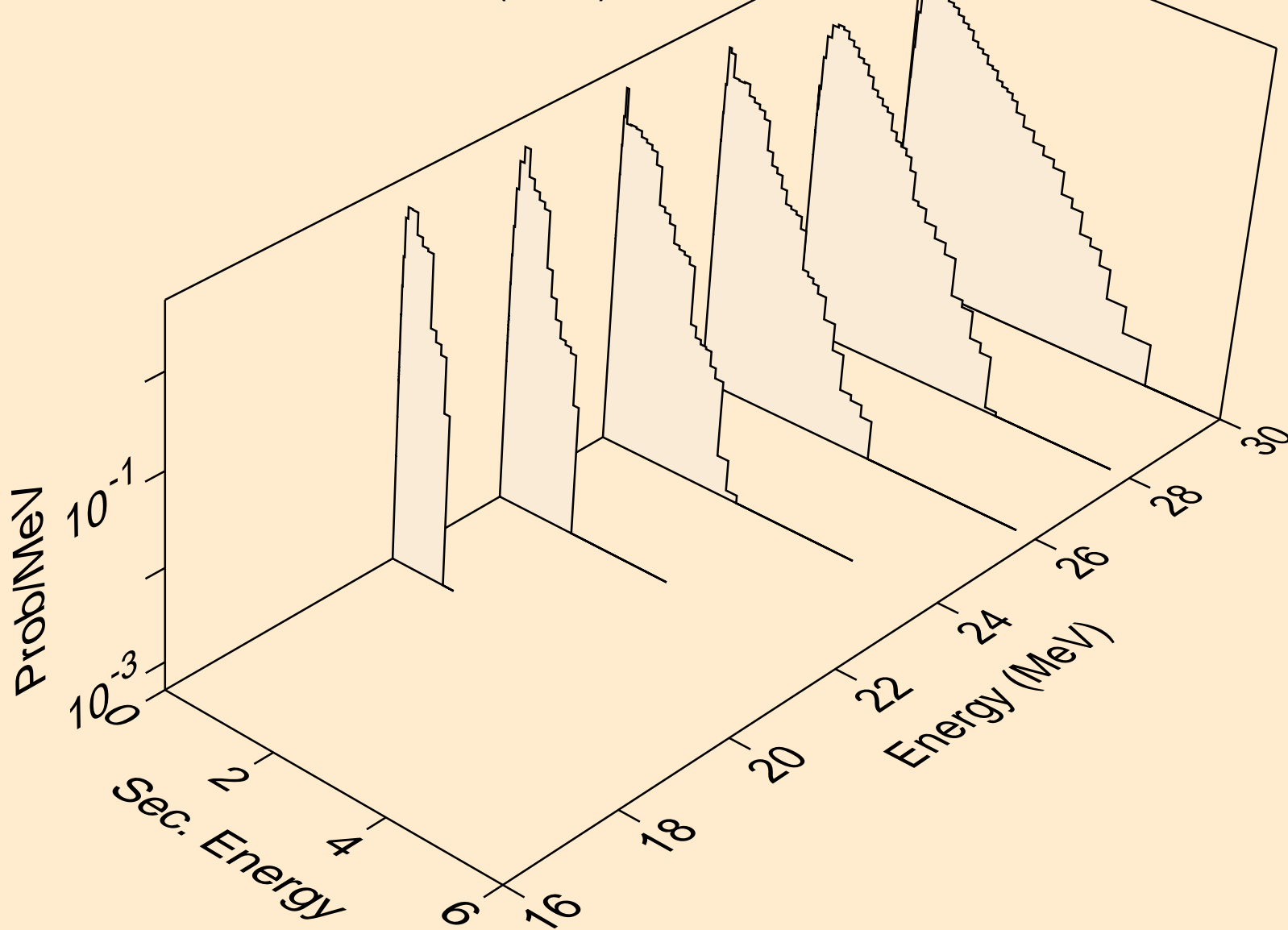

SR084 NEUTRON ACER TENDL-2019 LIBRARY; T=293.16K
Neutron emission for (n,n*)p

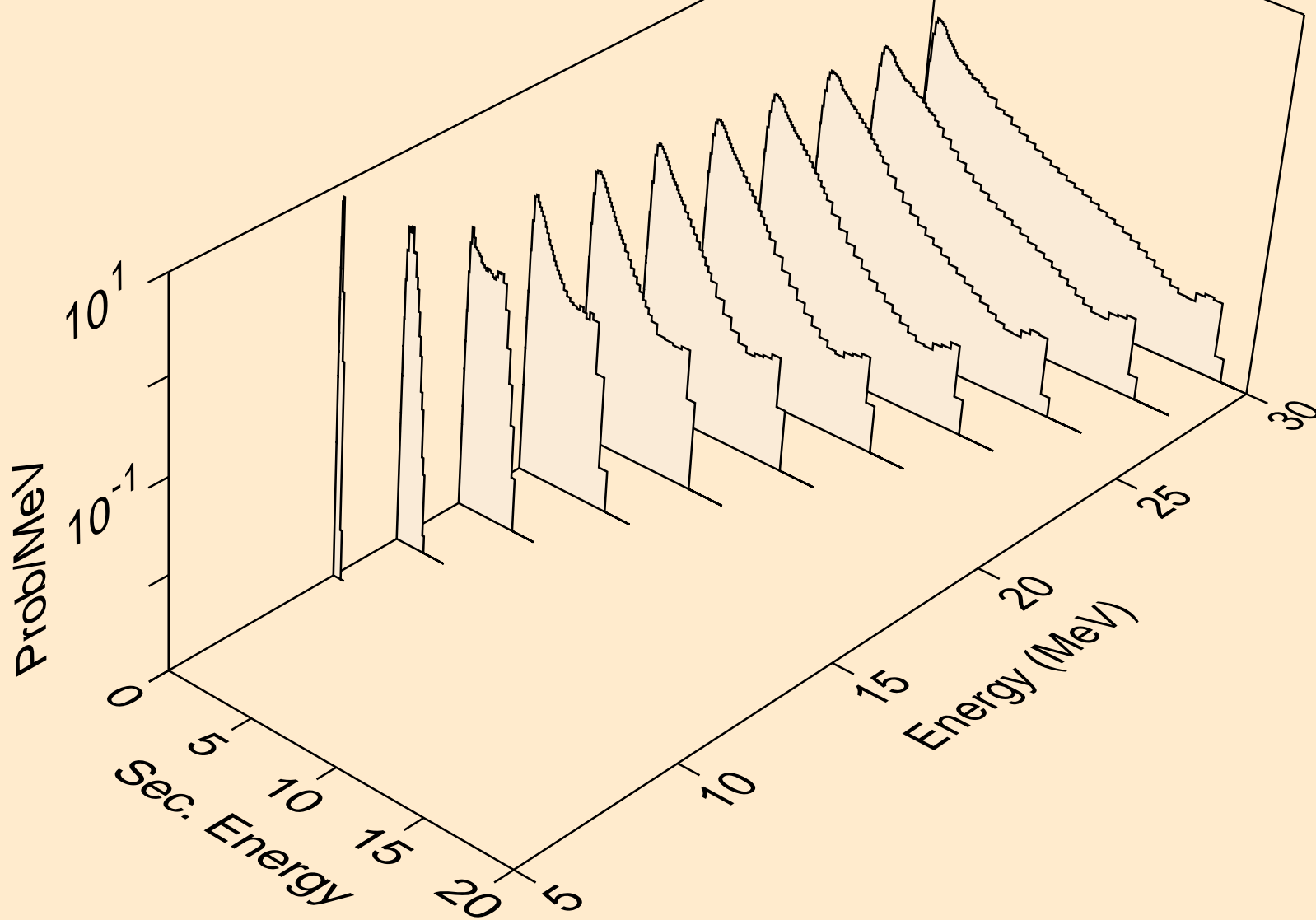

SR084 NEUTRON ACER TENDL-2019 LIBRARY; T=293.16K
Neutron emission for (n,n*)2a

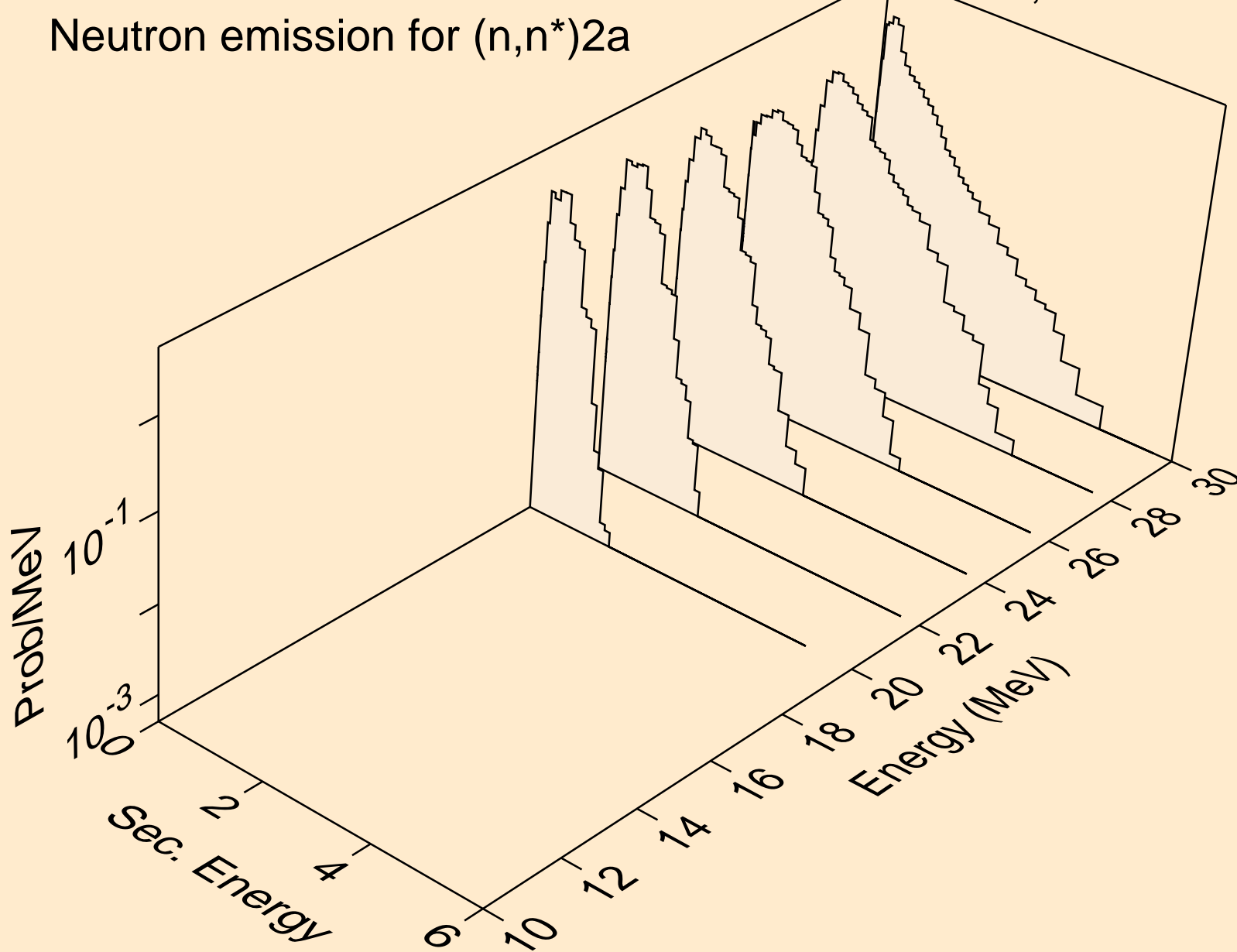

SR084 NEUTRON ACER TENDL-2019 LIBRARY; T=293.16K
Neutron emission for (n,n*)d

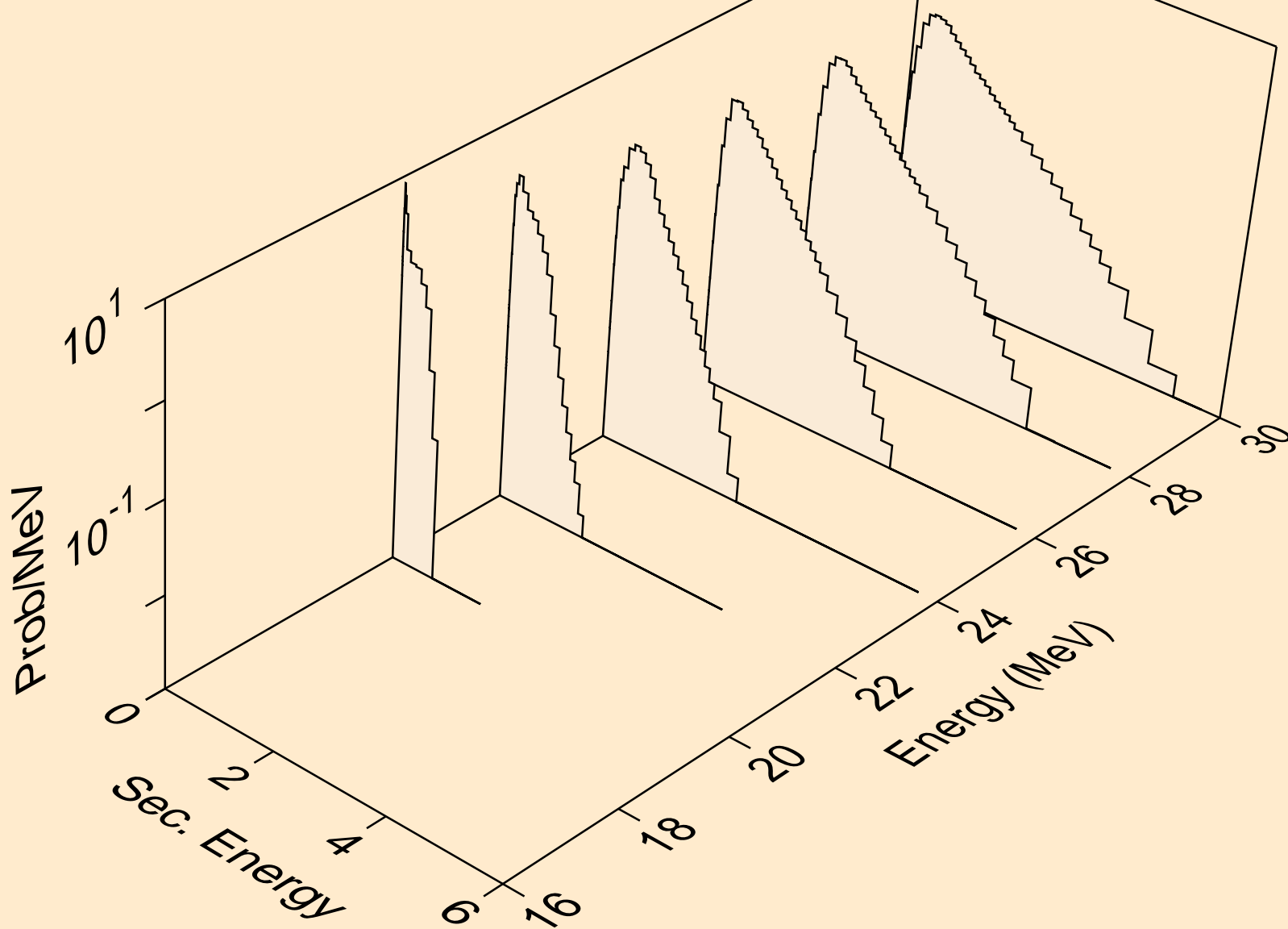

SR084 NEUTRON ACER TENDL-2019 LIBRARY; T=293.16K
Neutron emission for (n,n*)t

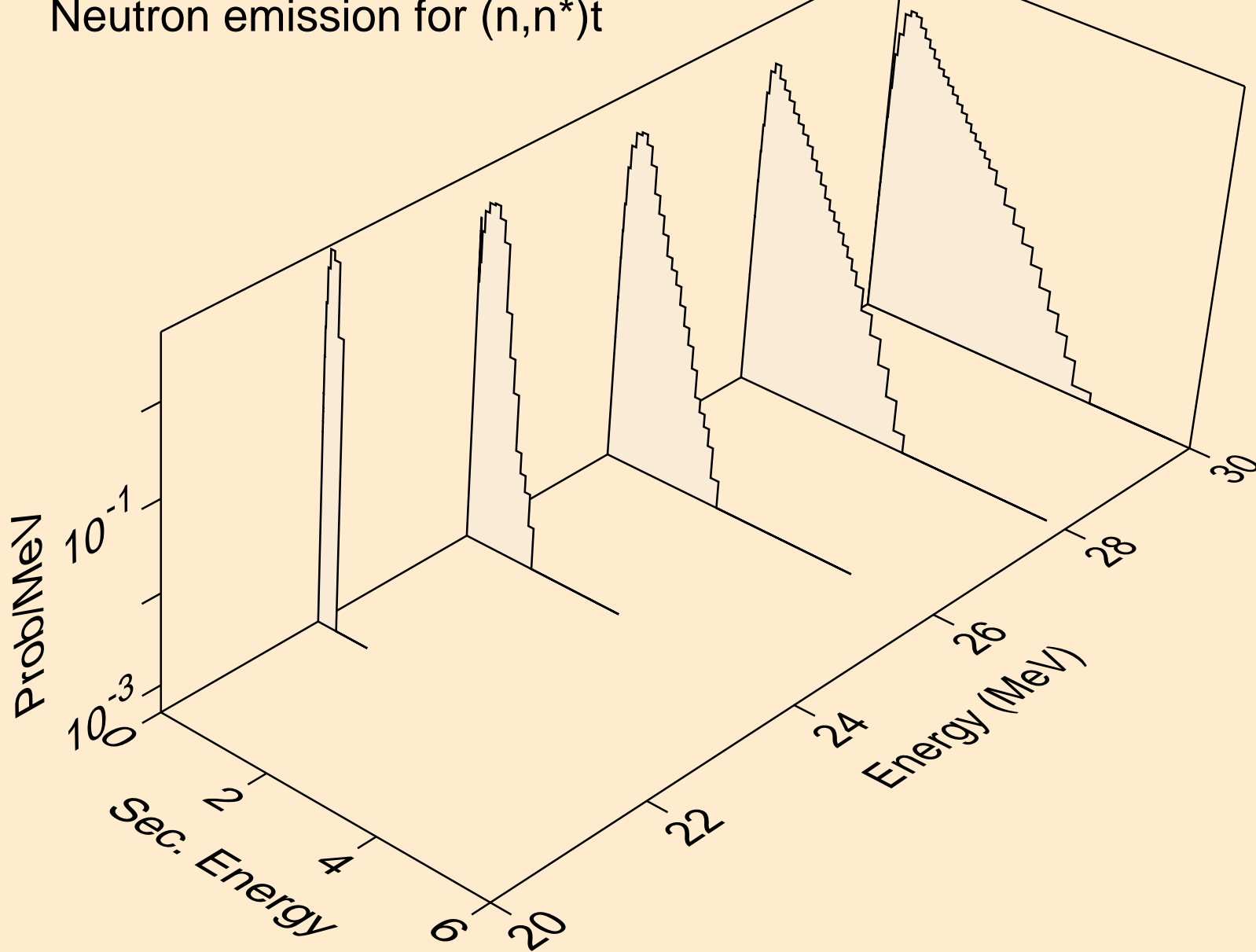

SR084 NEUTRON ACER TENDL-2019 LIBRARY; T=293.16K
Neutron emission for (n,n*)he3

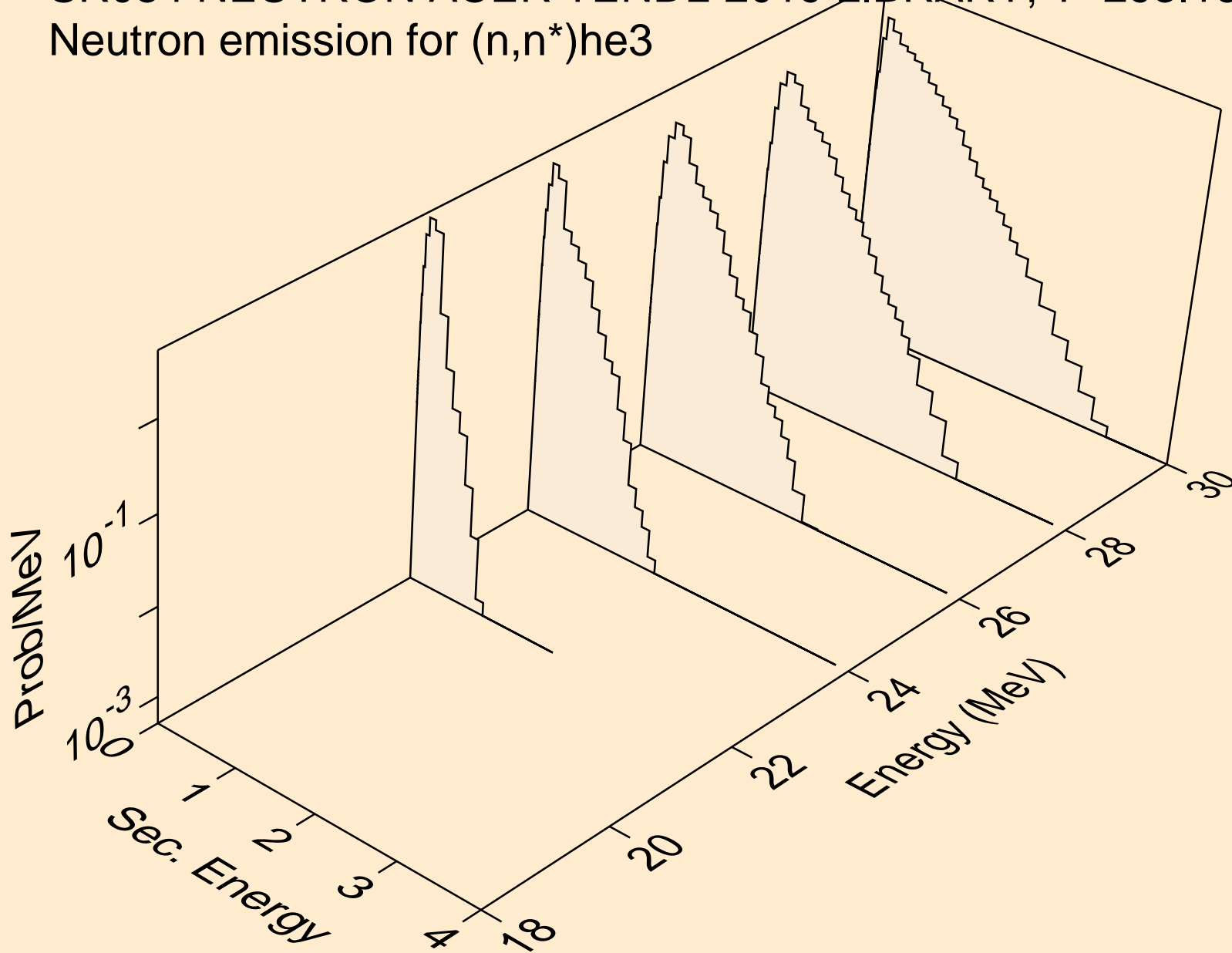

SR084 NEUTRON ACER TENDL-2019 LIBRARY; T=293.16K
Neutron emission for (n,2np)

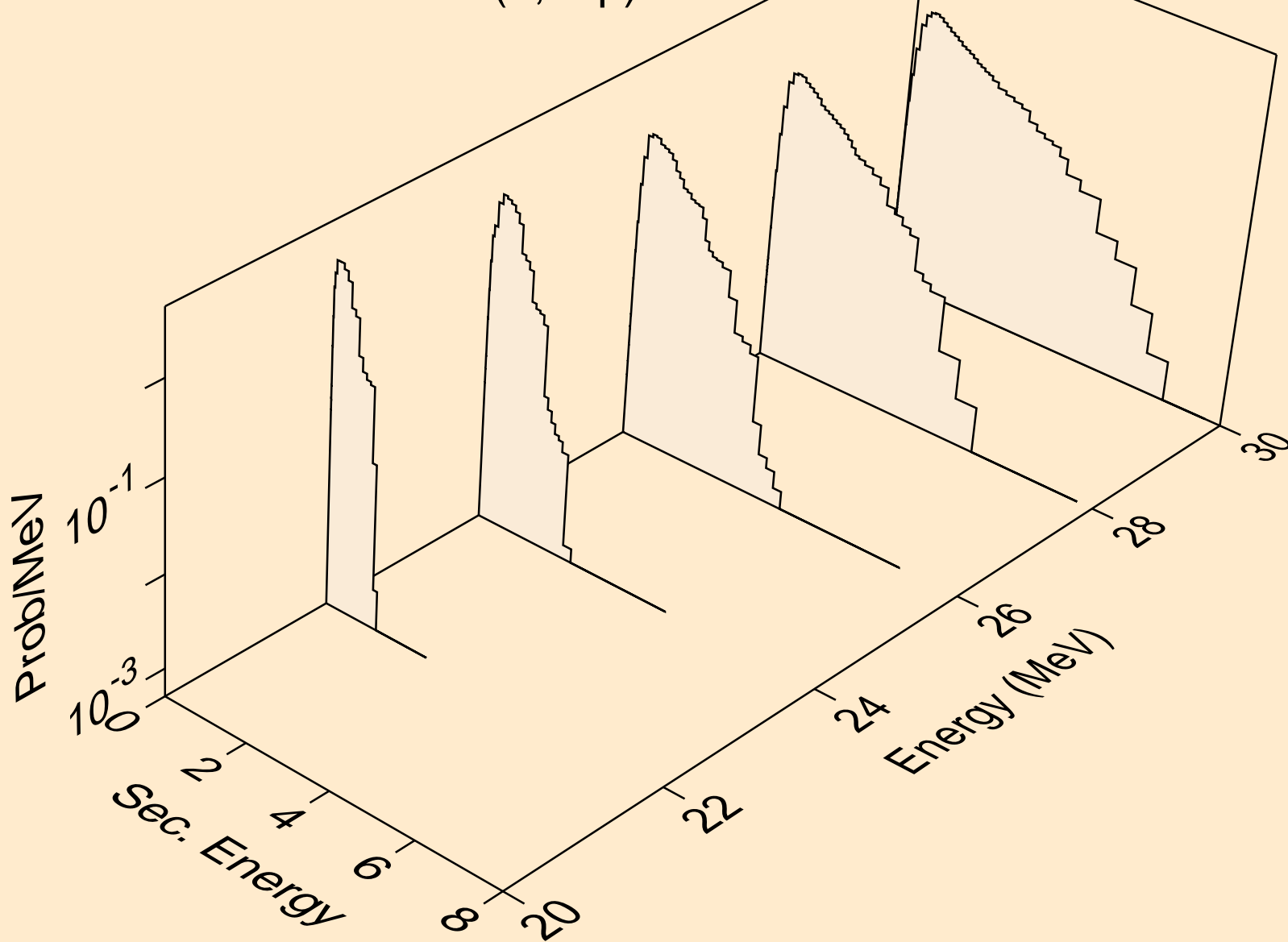

SR084 NEUTRON ACER TENDL-2019 LIBRARY; T=293.16K
Neutron emission for (n,3np)

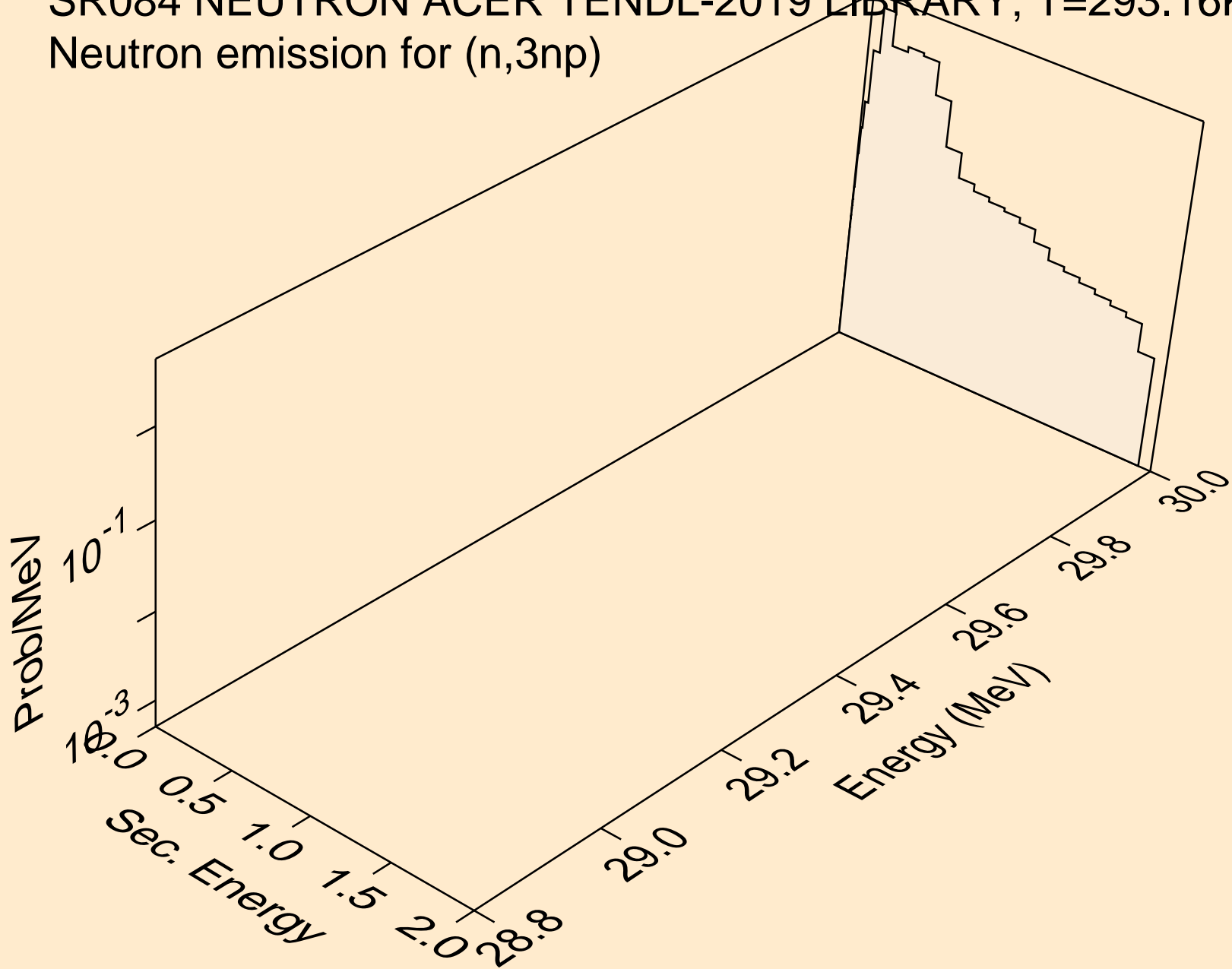

SR084 NEUTRON ACER TENDL-2019 LIBRARY; T=293.16K
Neutron emission for (n,2np)

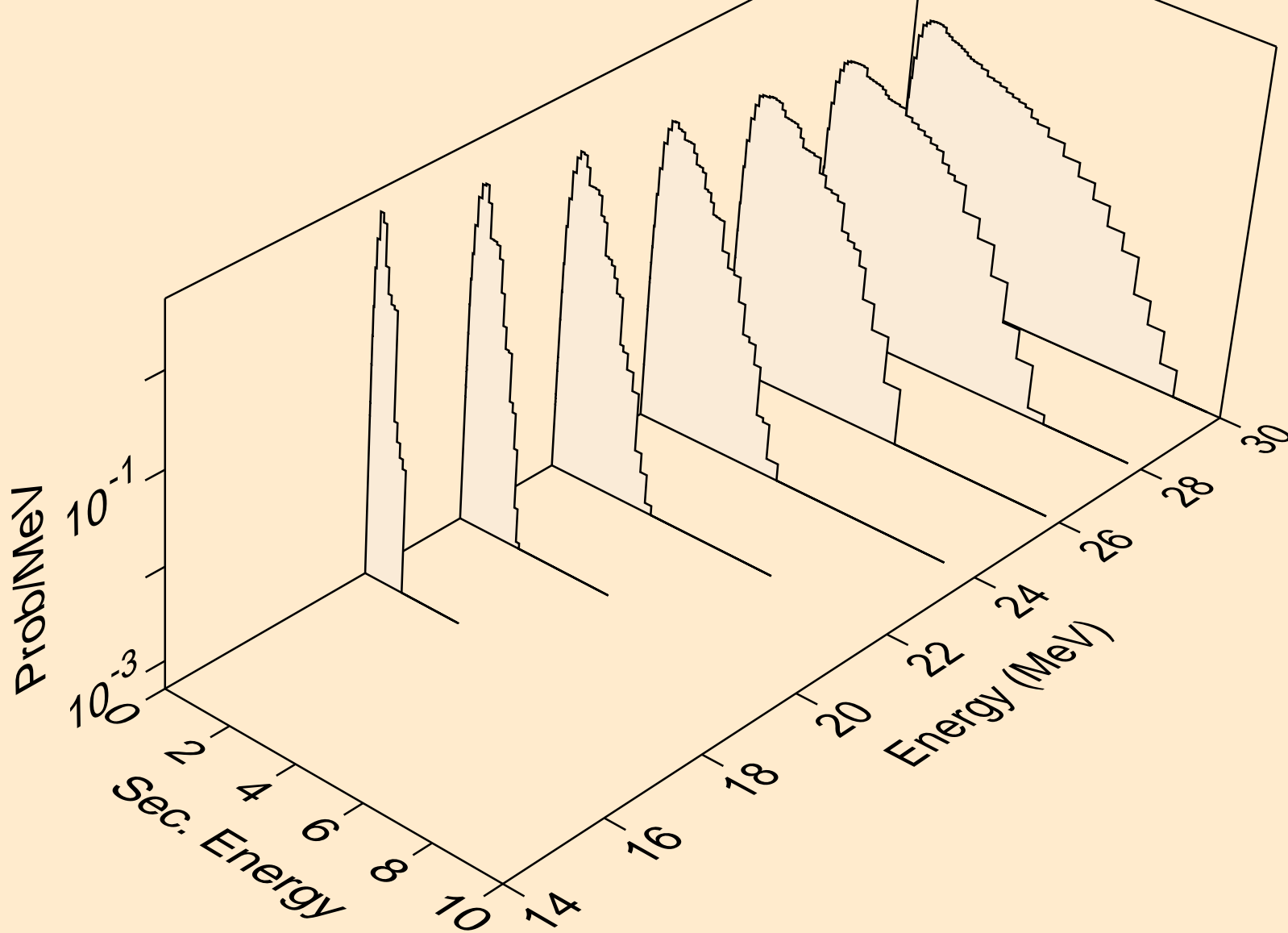

SR084 NEUTRON ACER TENDL-2019 LIBRARY; T=293.16K
Neutron emission for (n,npa)

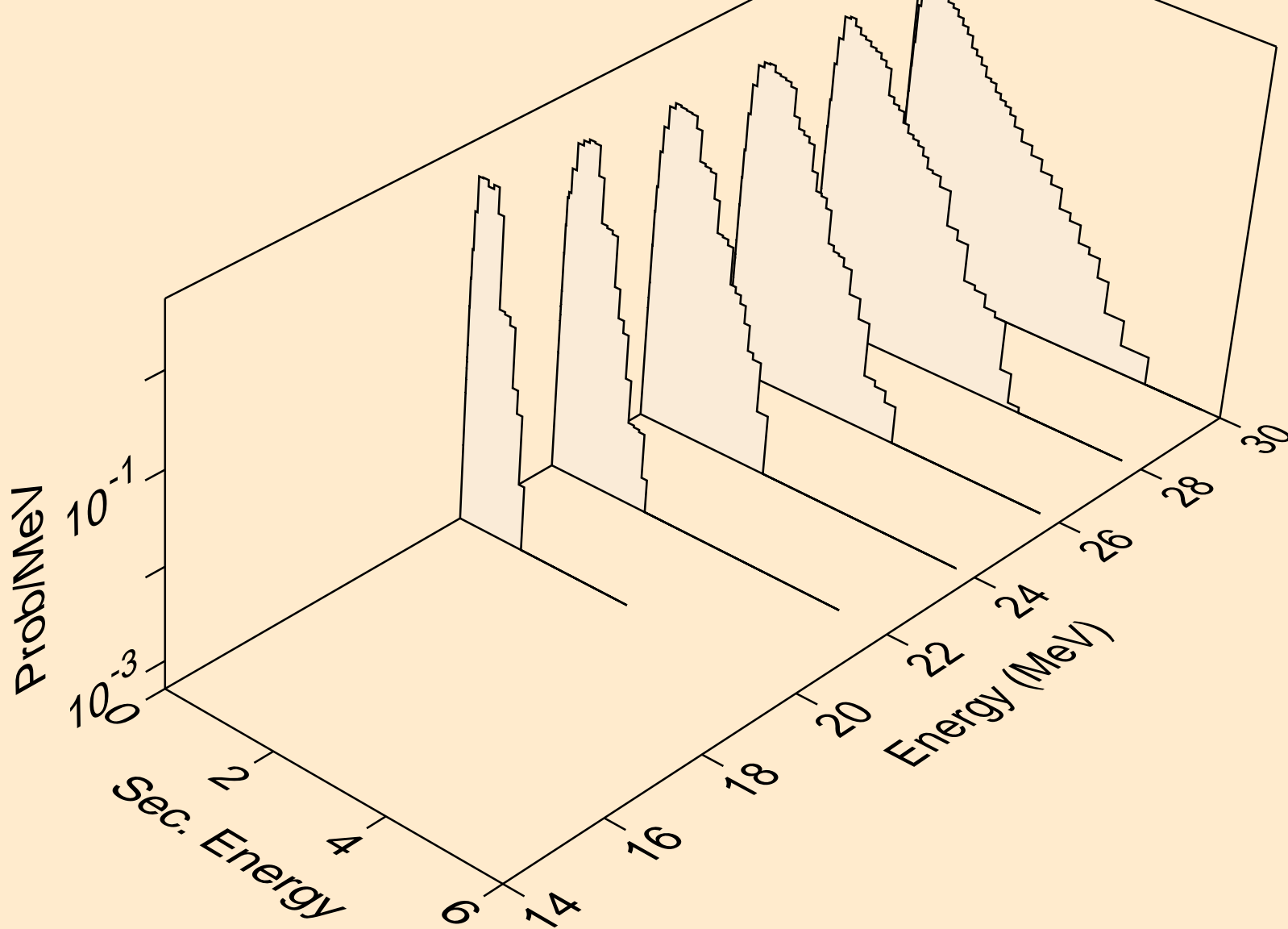

SR084 NEUTRON ACER TENDL-2019 LIBRARY; T=293.16K
Neutron emission for (n,n*c)

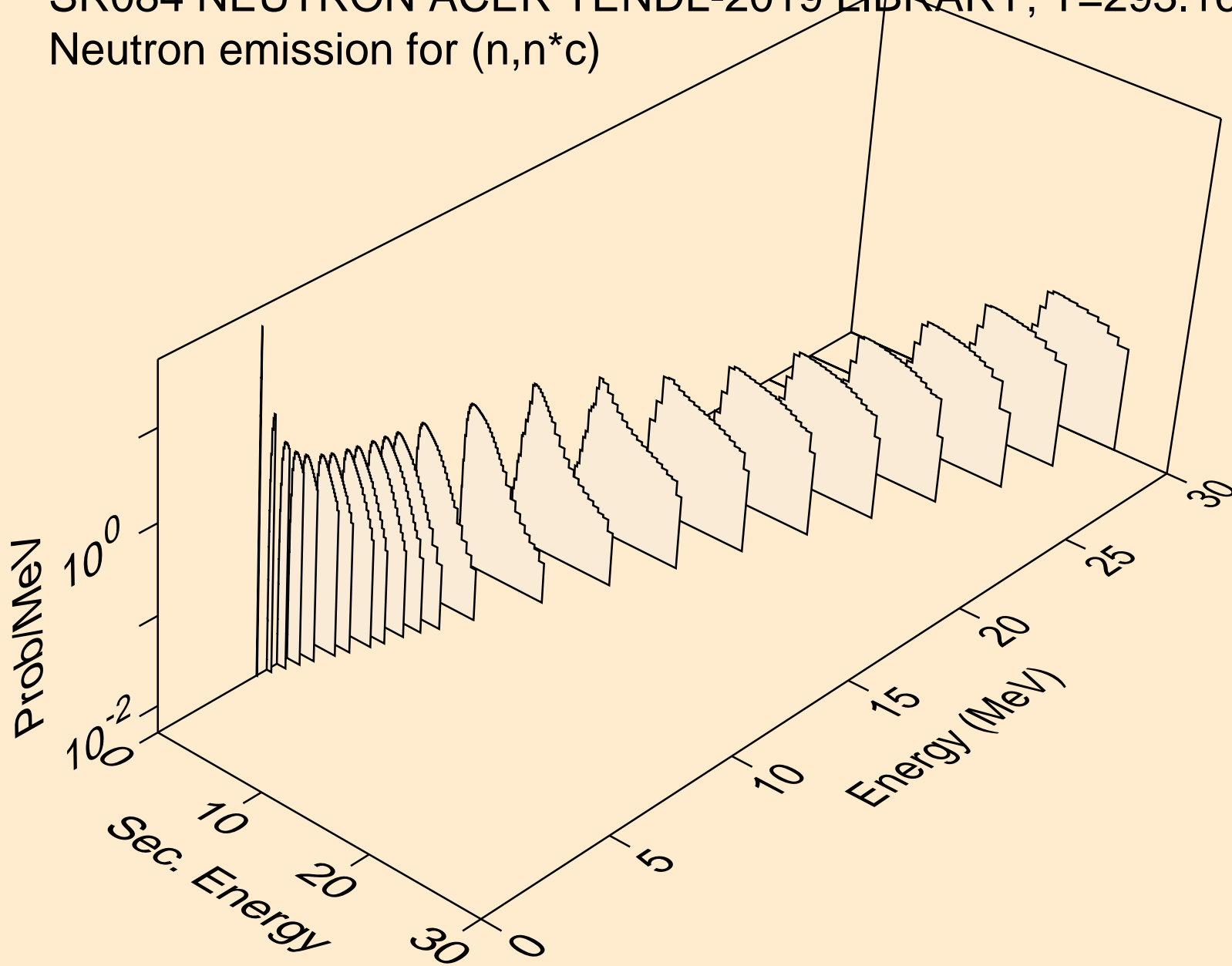

SR084 NEUTRON ACER TENDL-2019 LIBRARY; T=293.16K
Photon emission for (n,x)

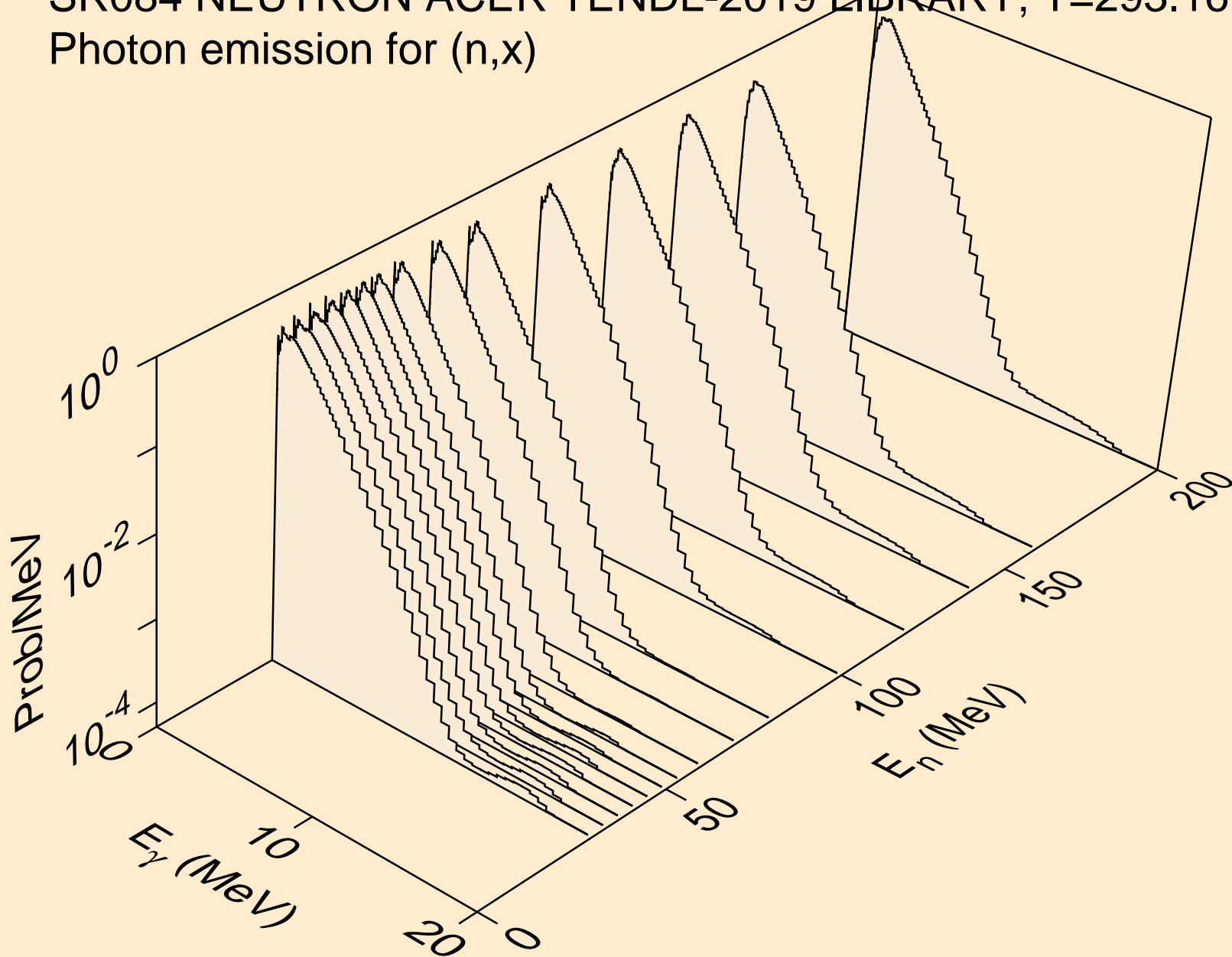

SR084 NEUTRON ACER TENDL-2019 LIBRARY; T=293.16K
Photon emission for (n,2nd)

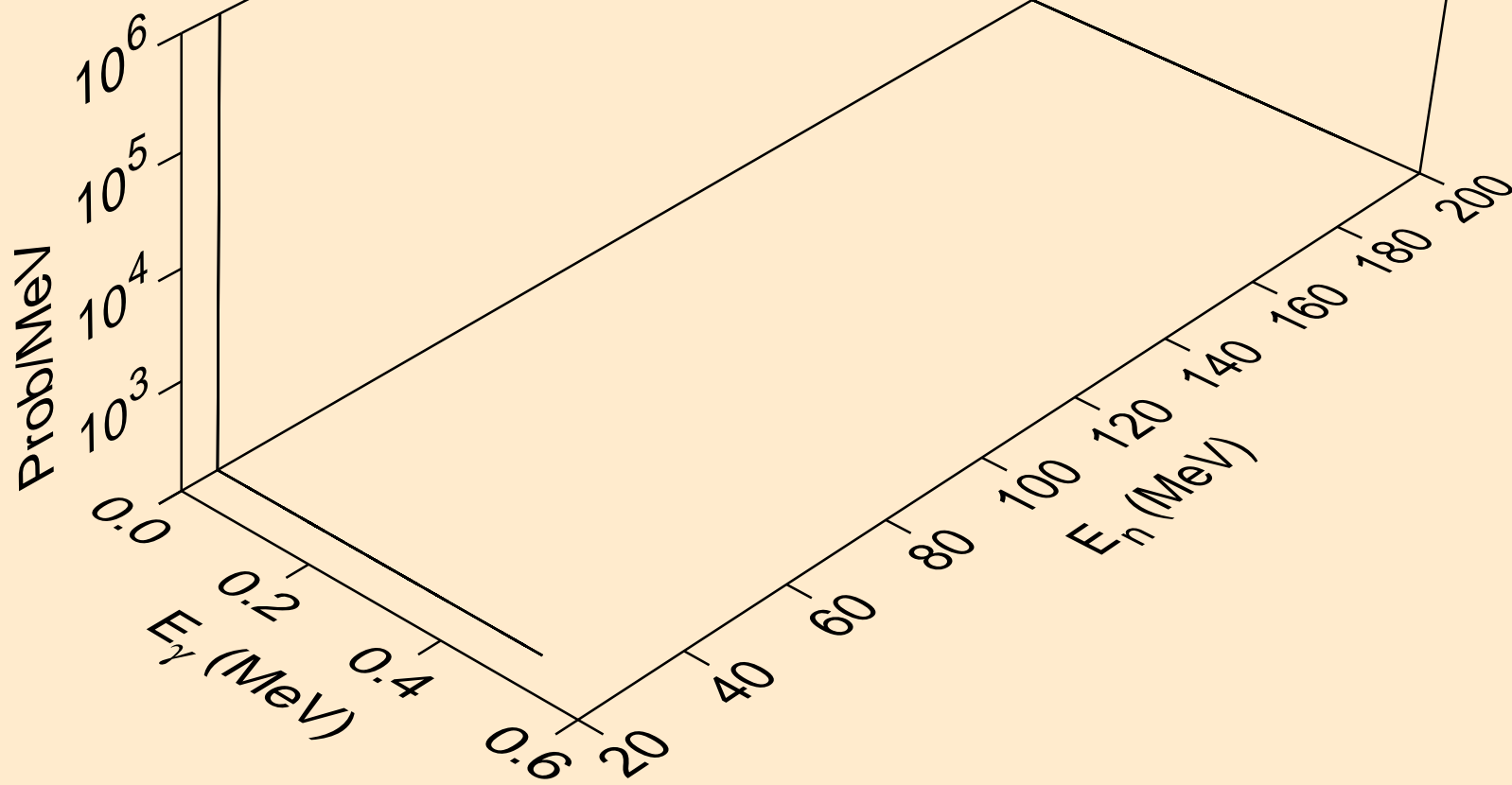

SR084 NEUTRON ACER TENDL-2019 LIBRARY; T=293.16K
Photon emission for (n,2n)

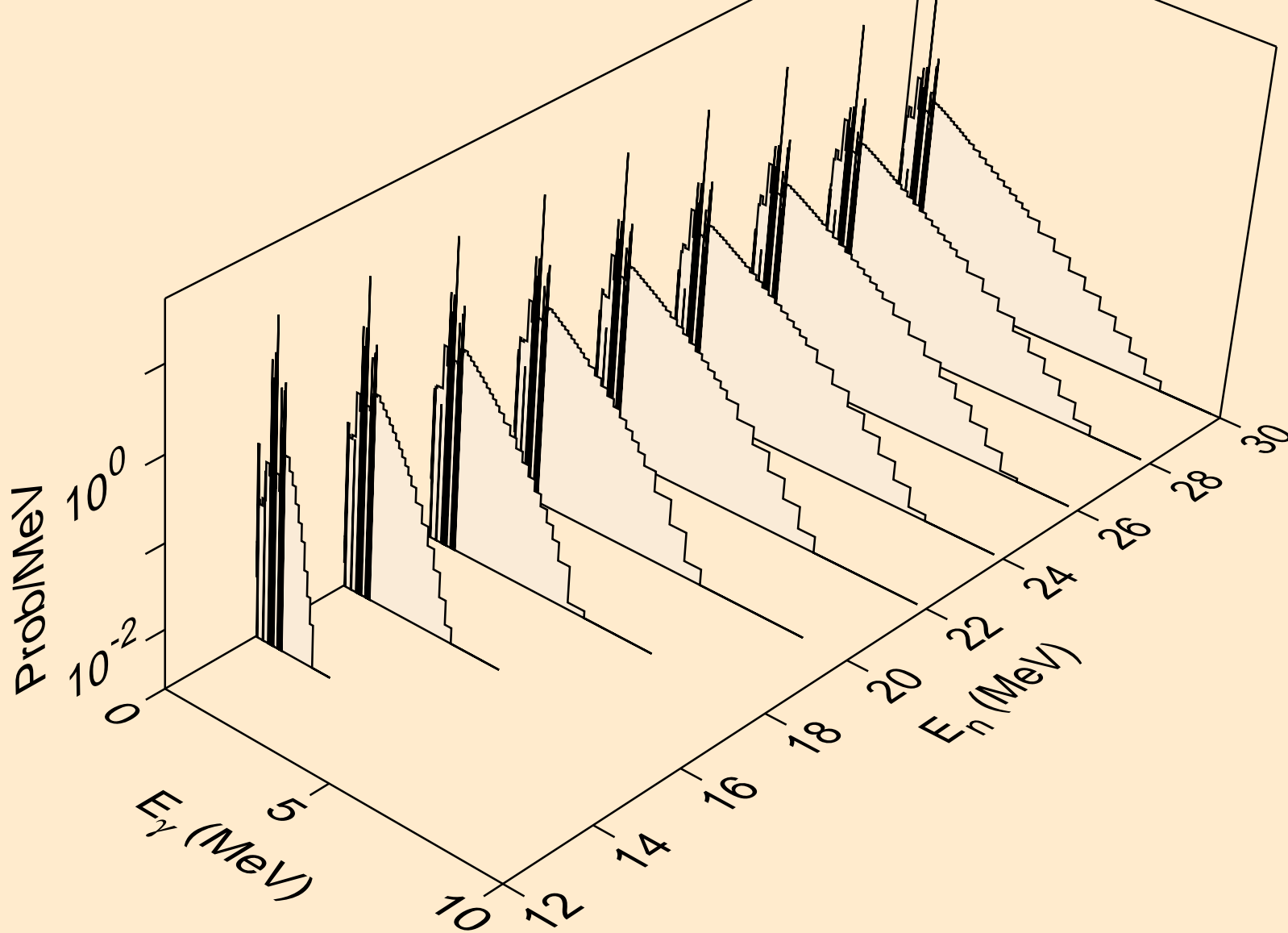

SR084 NEUTRON ACER TENDL-2019 LIBRARY; T=293.16K
Photon emission for (n,3n)

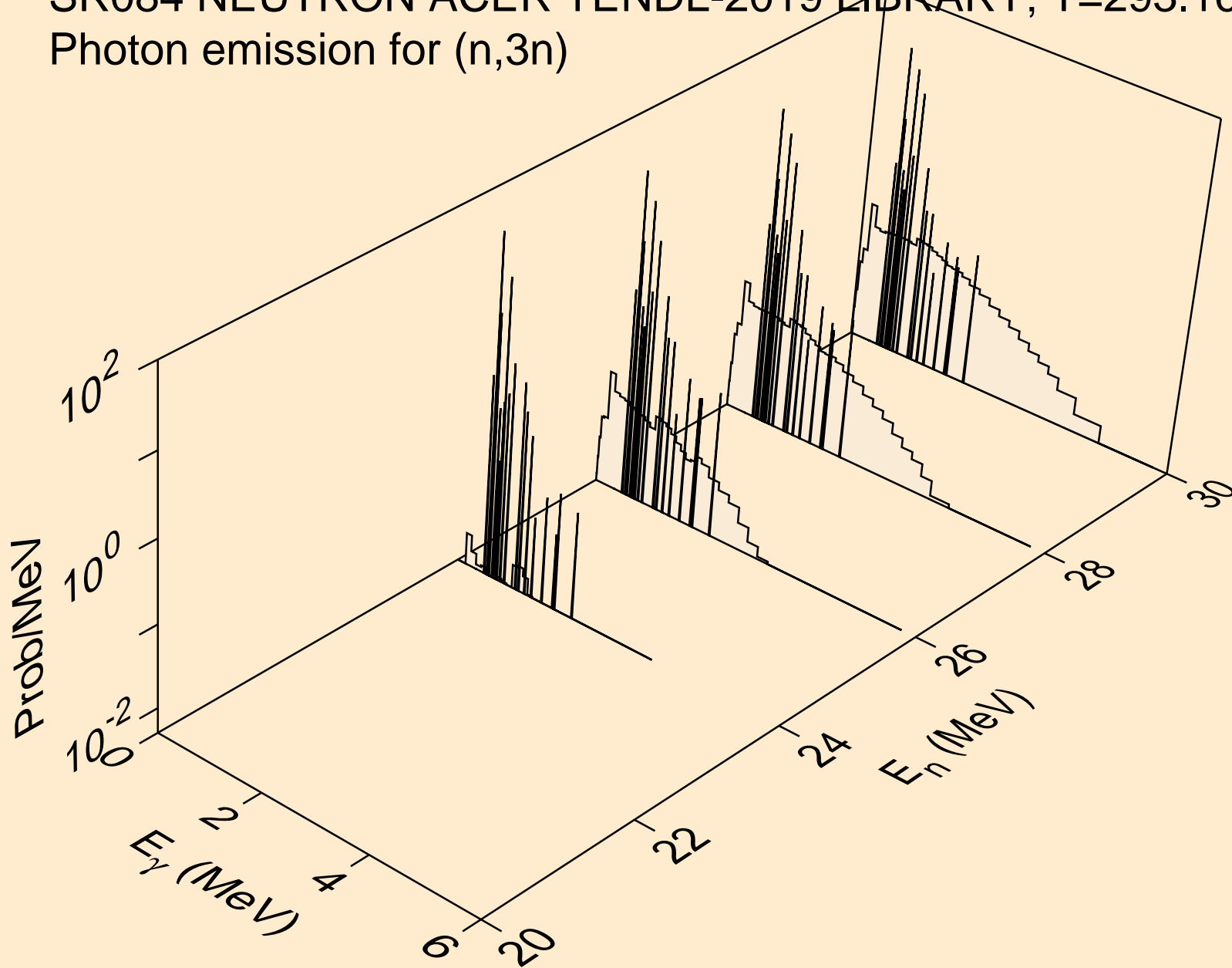

SR084 NEUTRON ACER TENDL-2019 LIBRARY; T=293.16K
Photon emission for (n,n*)a

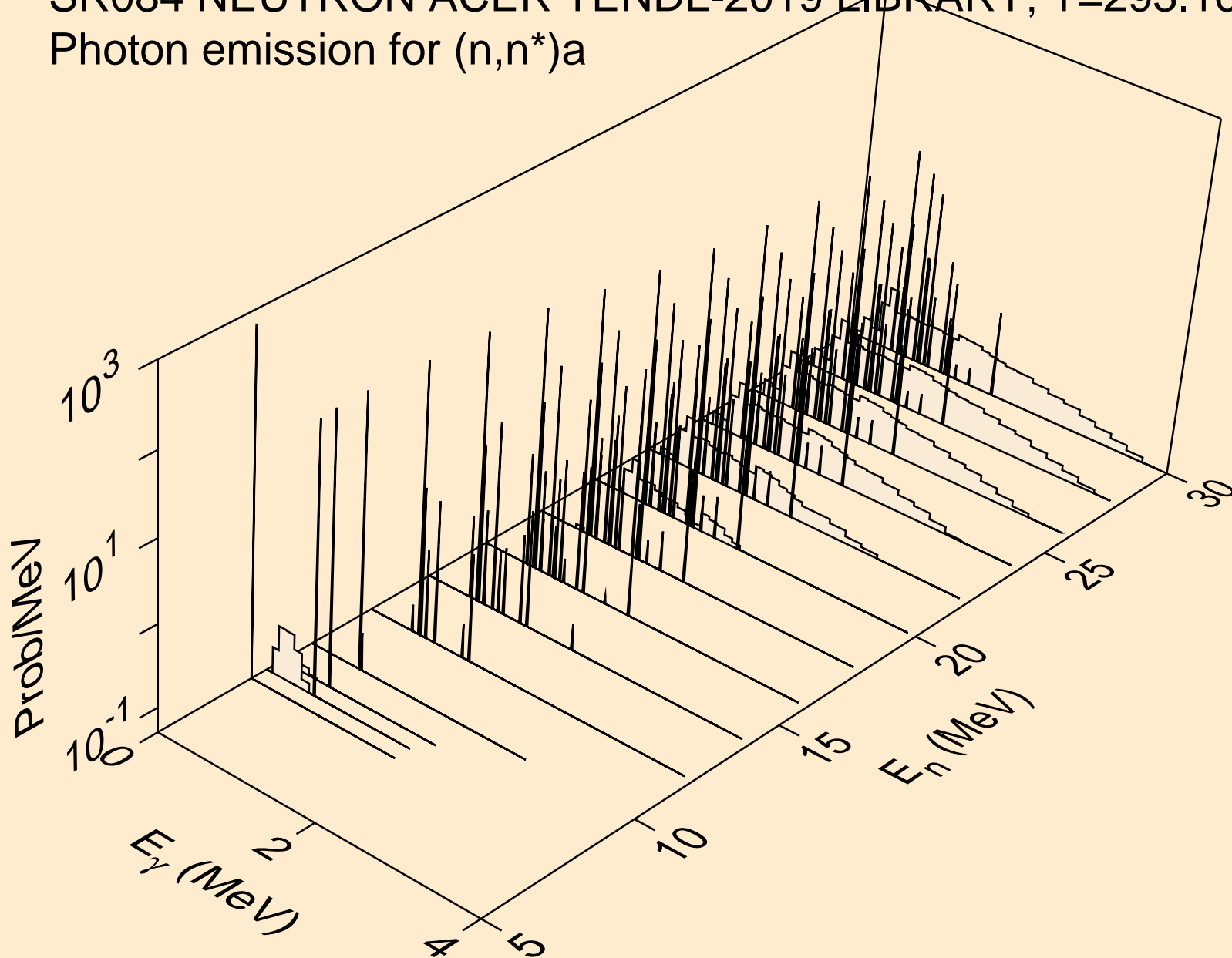

SR084 NEUTRON ACER TENDL-2019 LIBRARY; T=293.16K
Photon emission for (n,2n)a

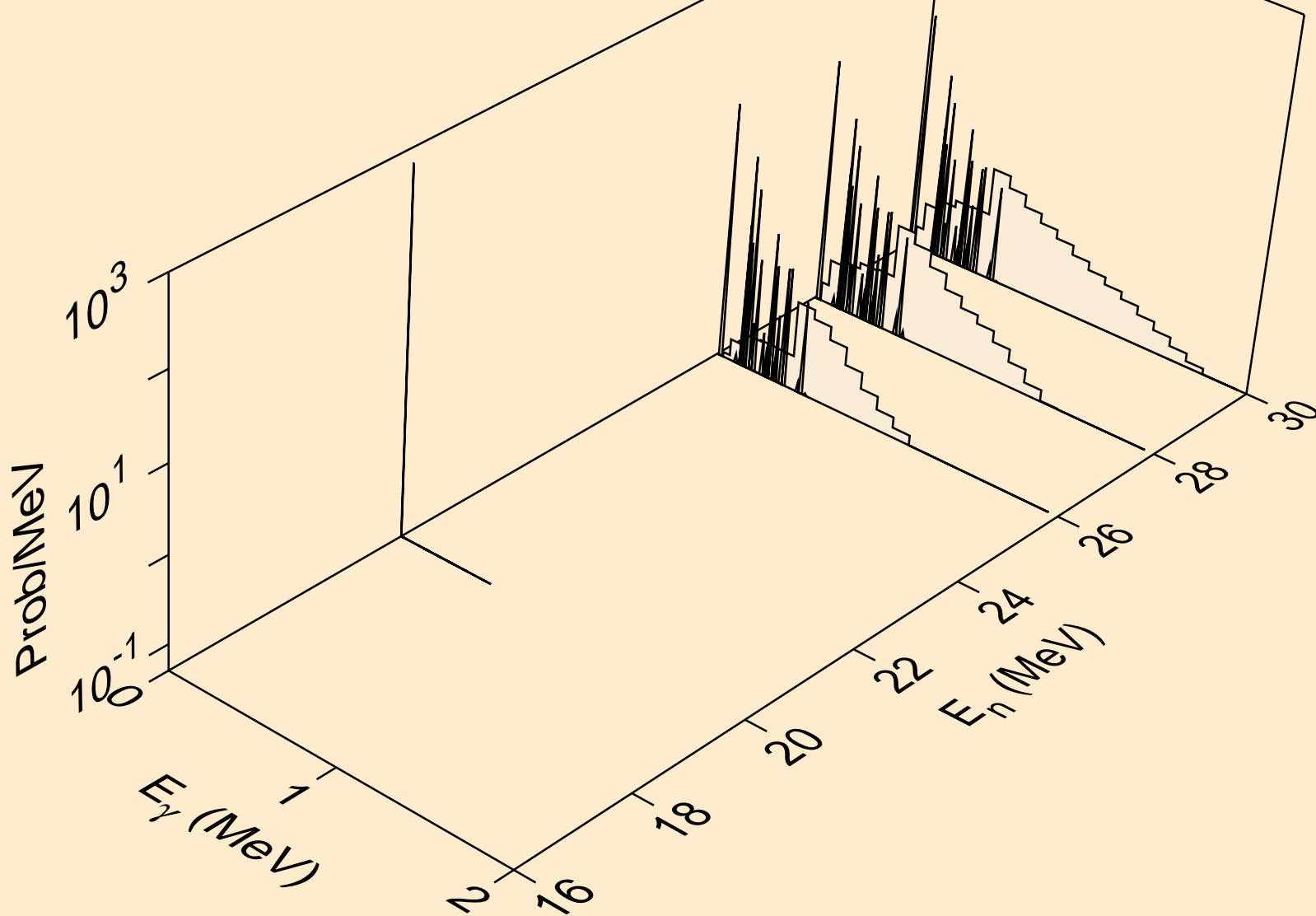

SR084 NEUTRON ACER TENDL-2019 LIBRARY; T=293.16K
Photon emission for (n,n*)p

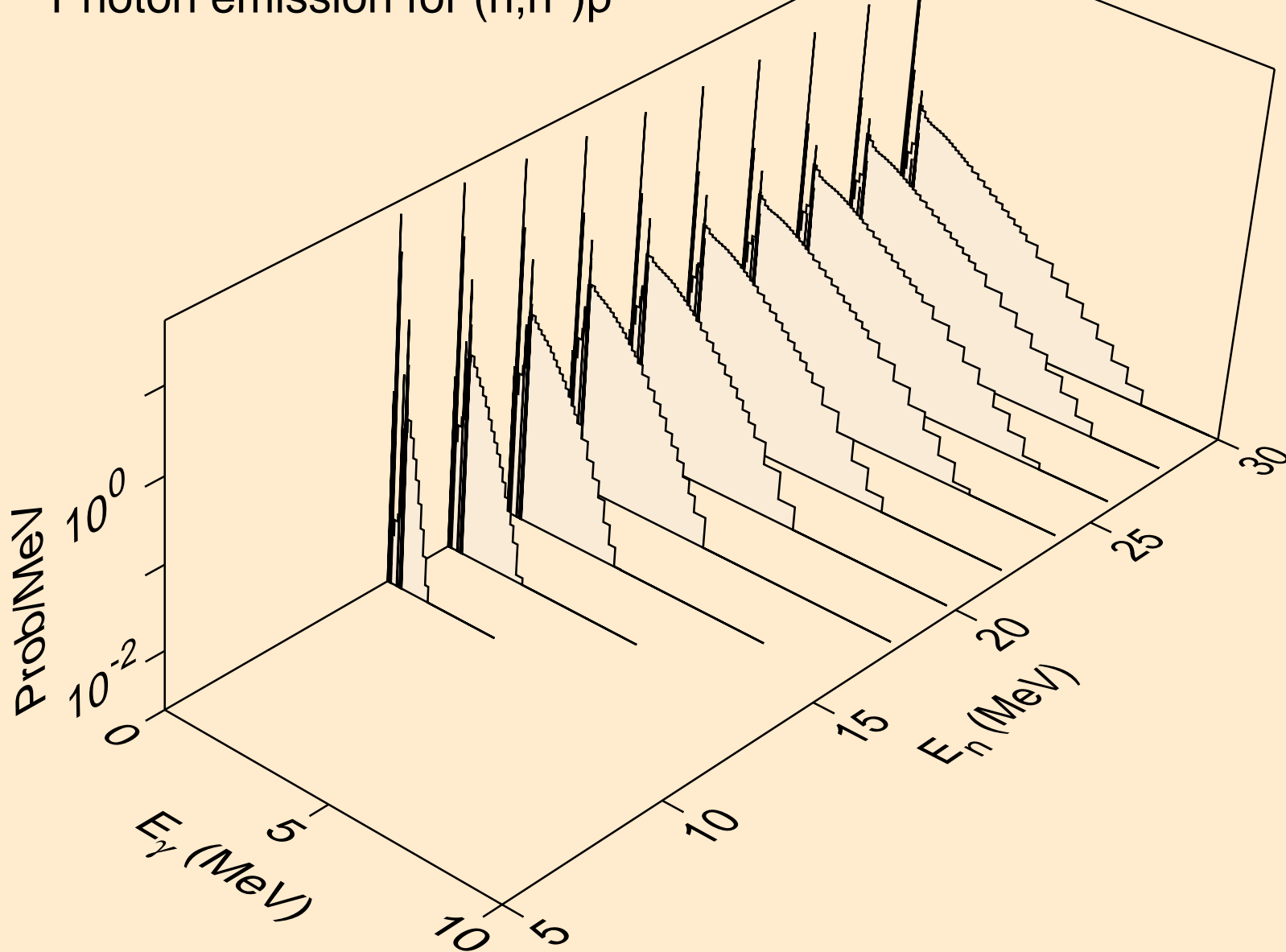

SR084 NEUTRON ACER TENDL-2019 LIBRARY; T=293.16K
Photon emission for (n,n*)2a

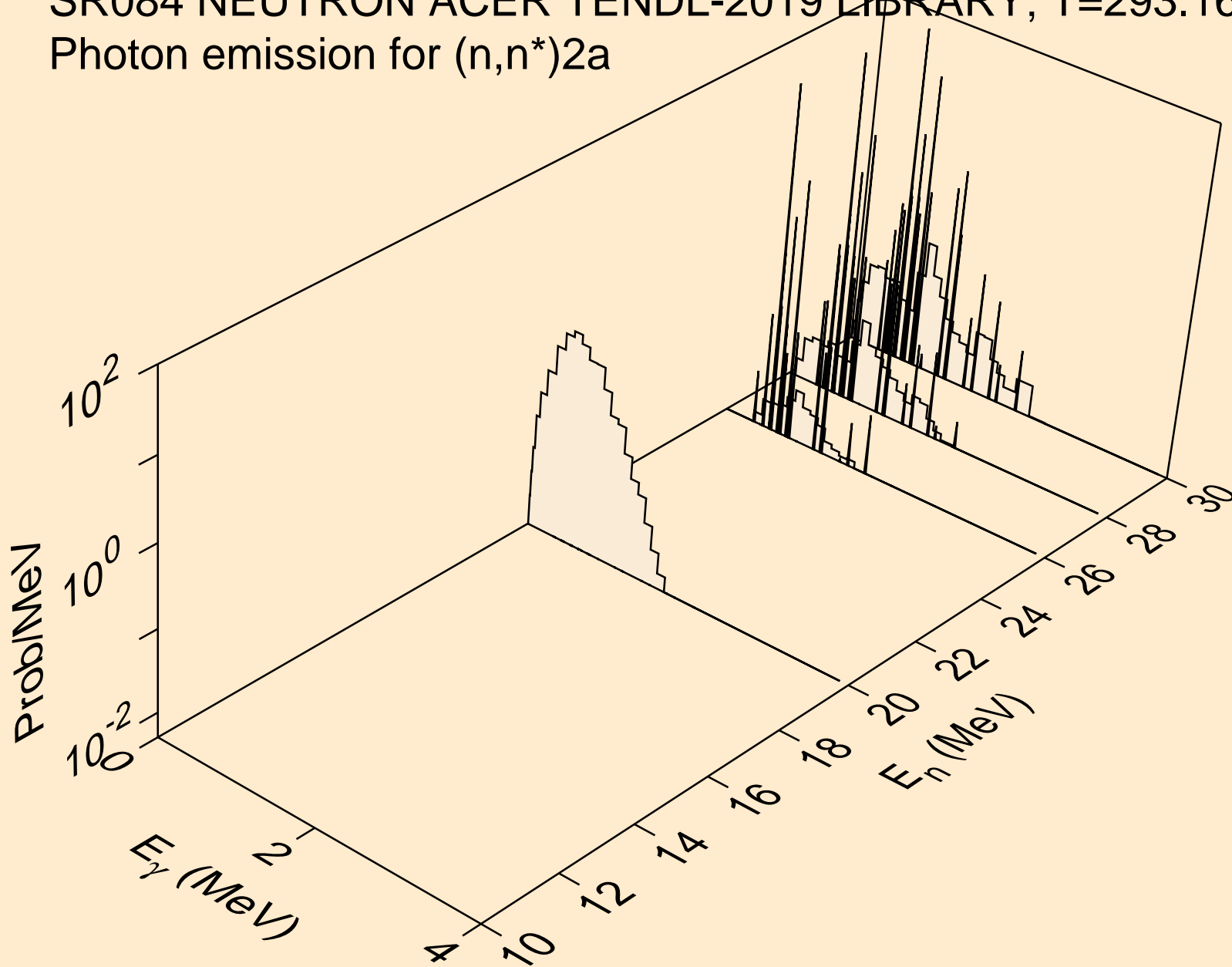

SR084 NEUTRON ACER TENDL-2019 LIBRARY; T=293.16K
Photon emission for (n,n*)d

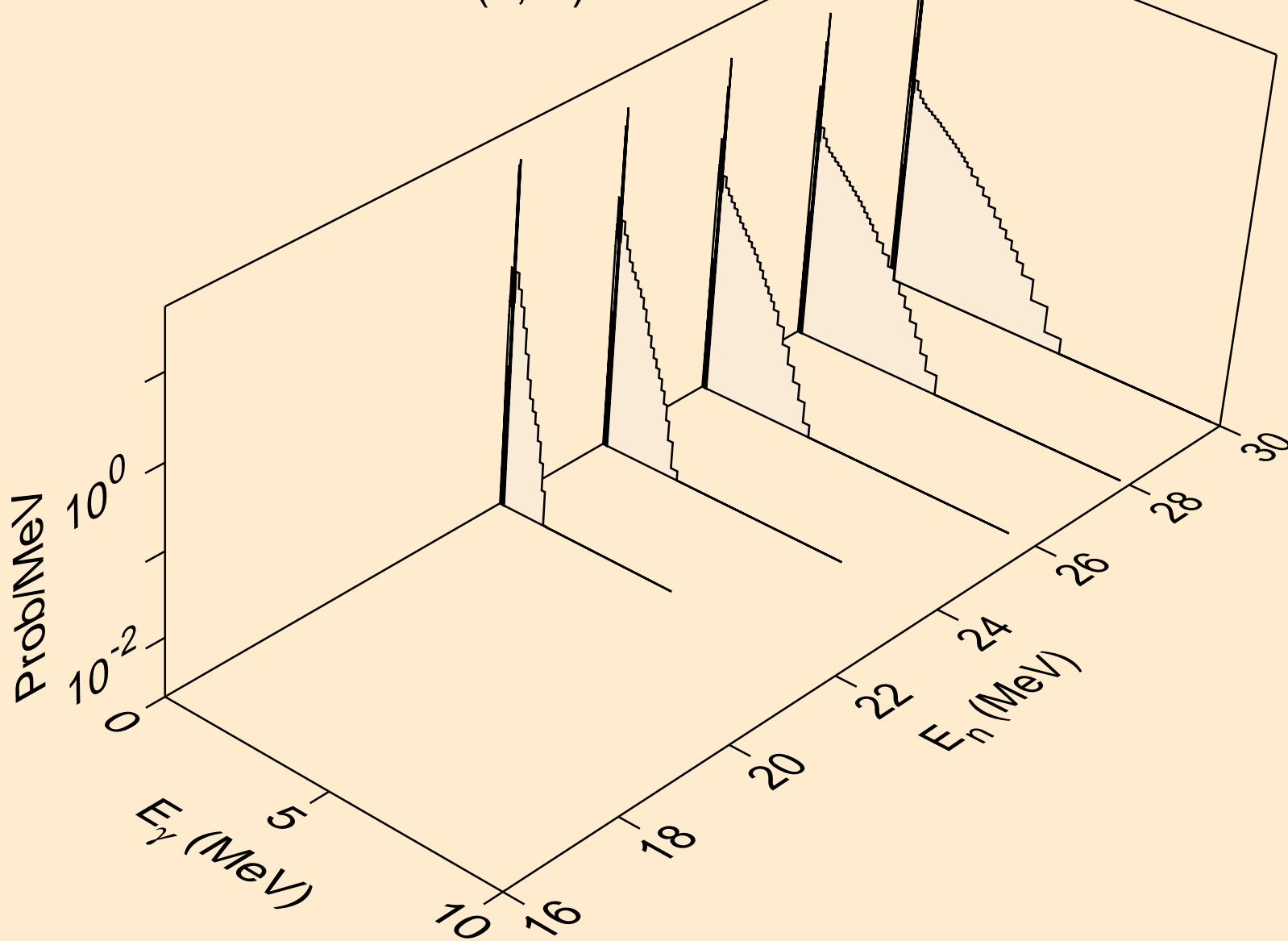

SR084 NEUTRON ACER TENDL-2019 LIBRARY; T=293.16K
Photon emission for (n,n*)t

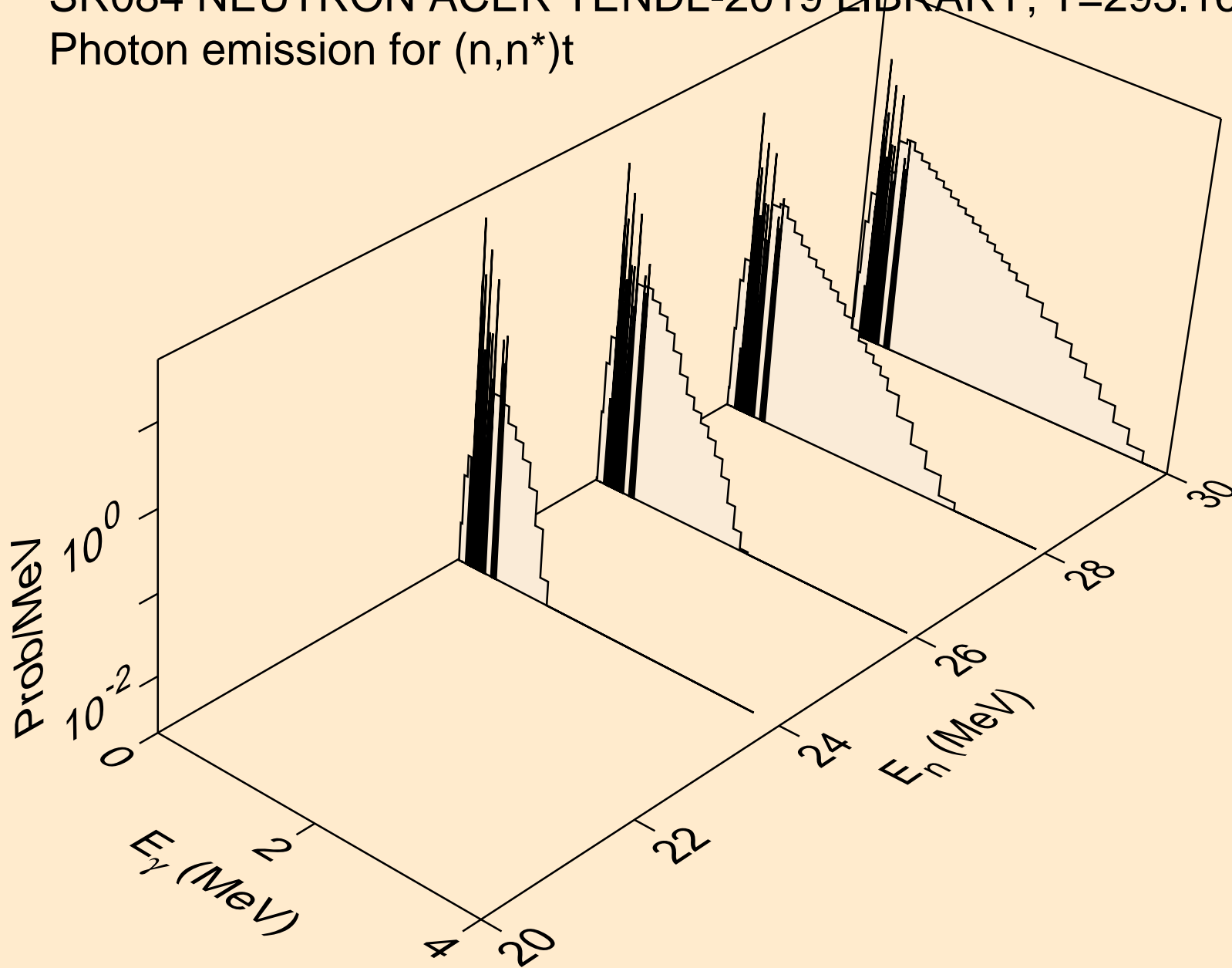

SR084 NEUTRON ACER TENDL-2019 LIBRARY; T=293.16K
Photon emission for (n,n*)he3

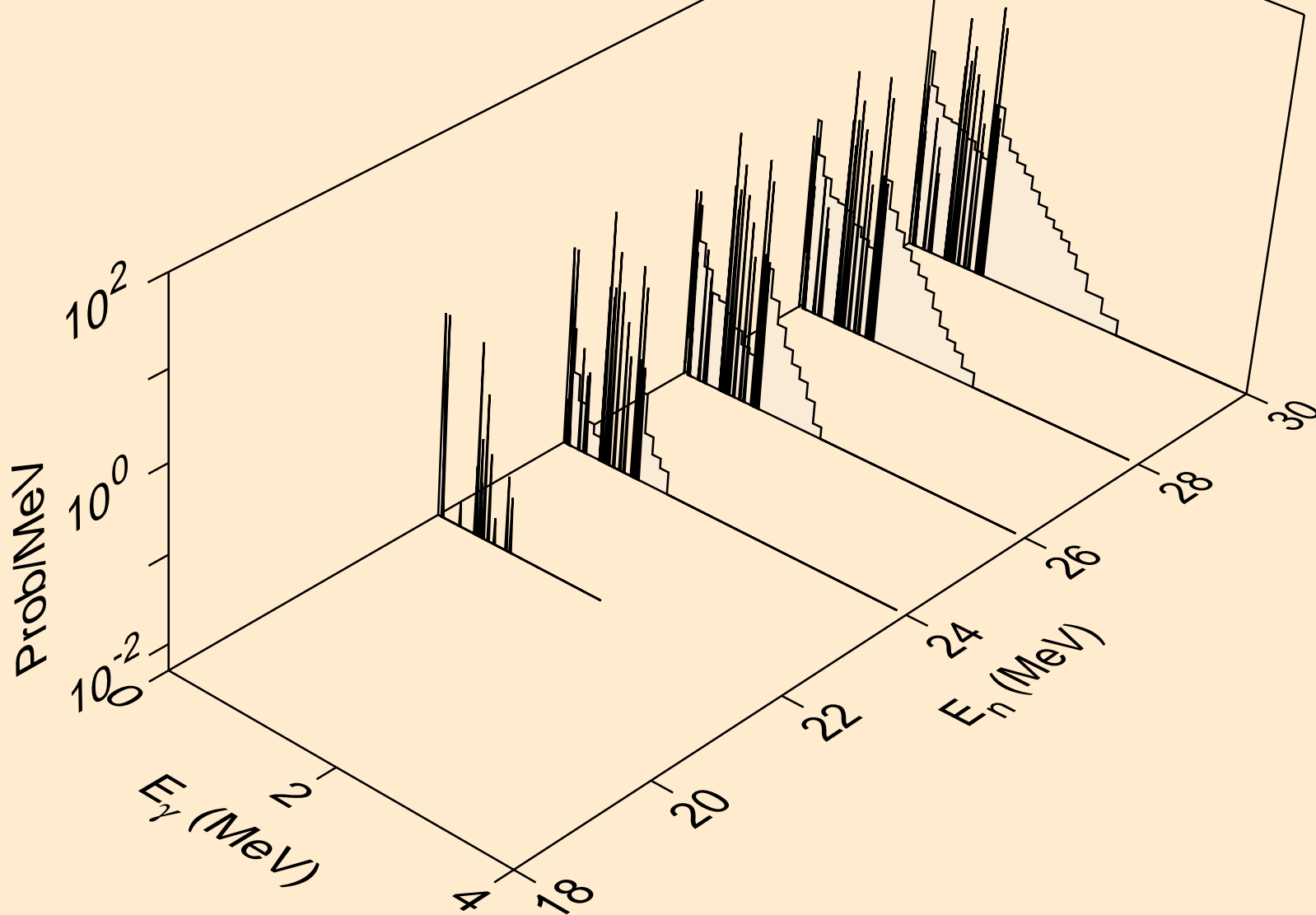

SR084 NEUTRON ACER TENDL-2019 LIBRARY; T=293.16K
Photon emission for (n,2np)

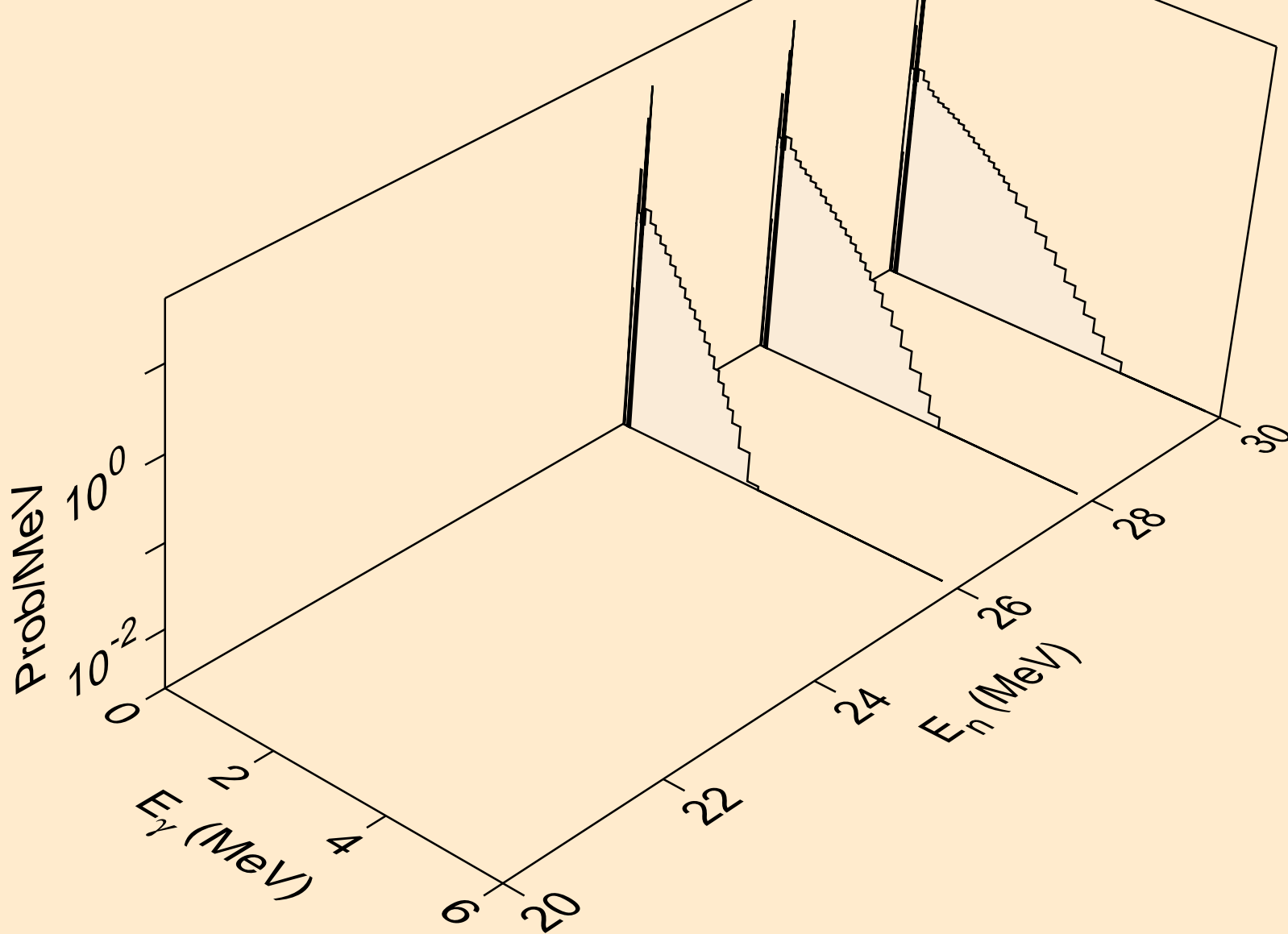

SR084 NEUTRON ACER TENDL-2019 LIBRARY; T=293.16K
Photon emission for (n,3np)

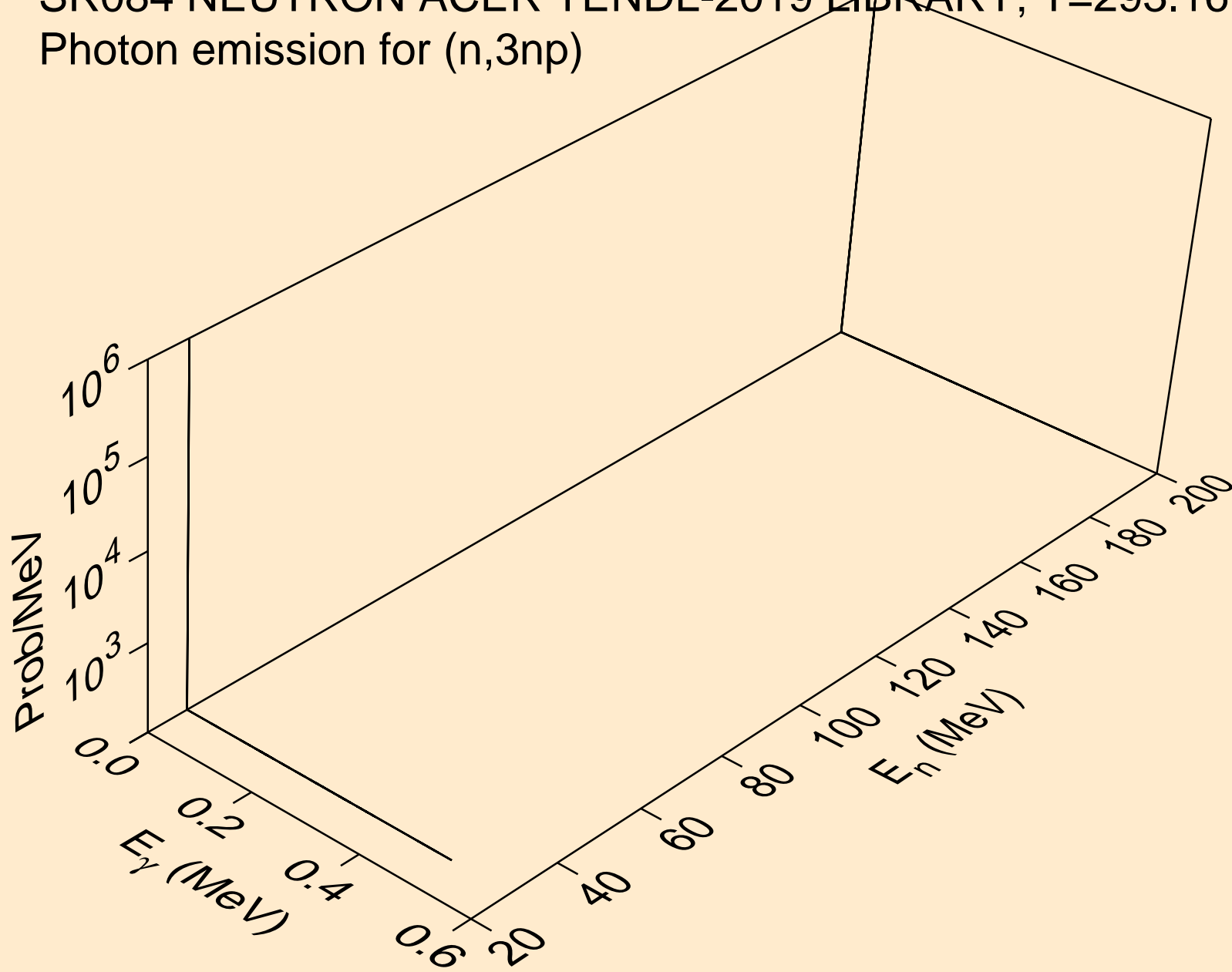

SR084 NEUTRON ACER TENDL-2019 LIBRARY; T=293.16K
Photon emission for (n,2np)

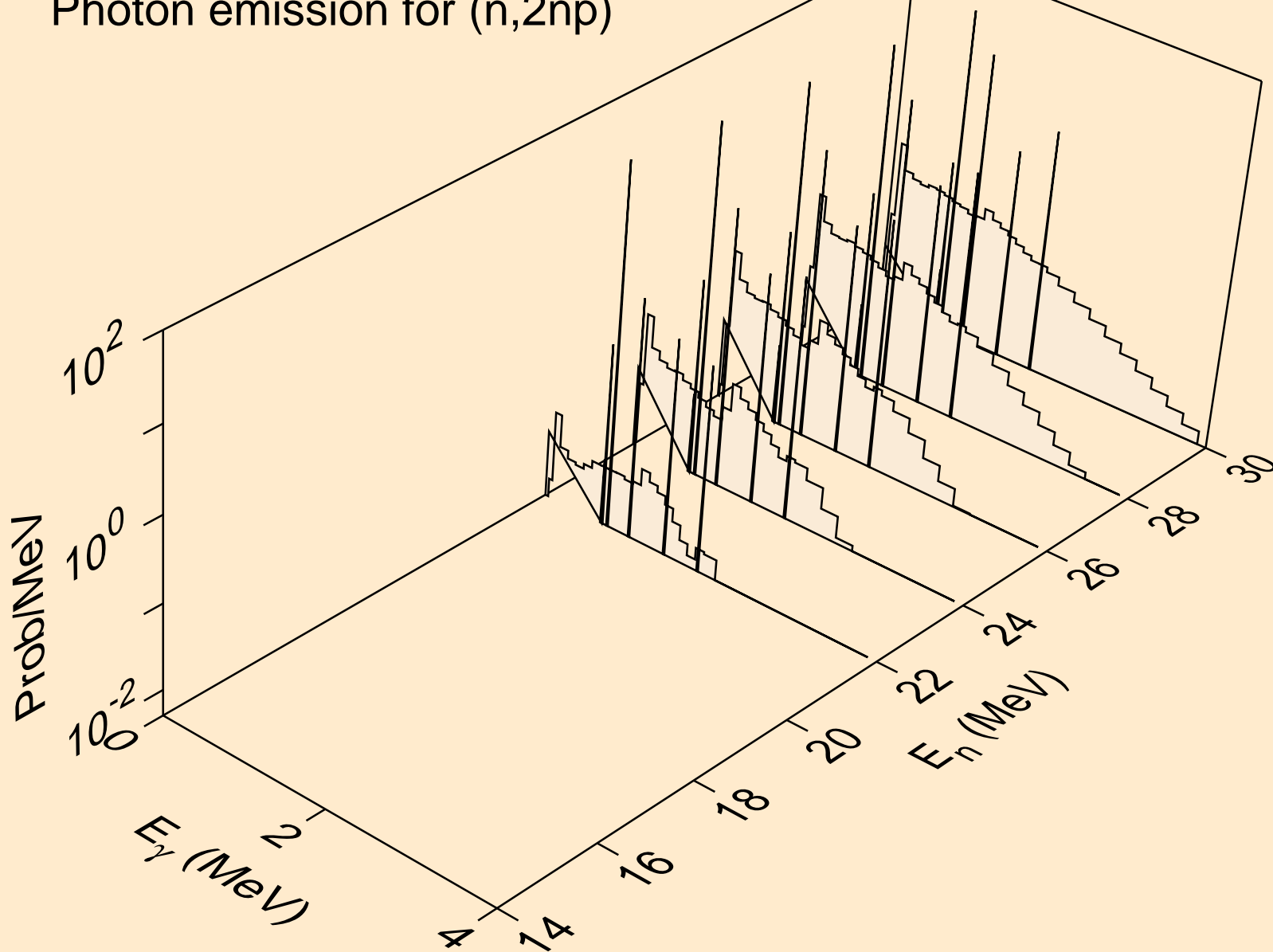

SR084 NEUTRON ACER TENDL-2019 LIBRARY; T=293.16K
Photon emission for (n,npa)

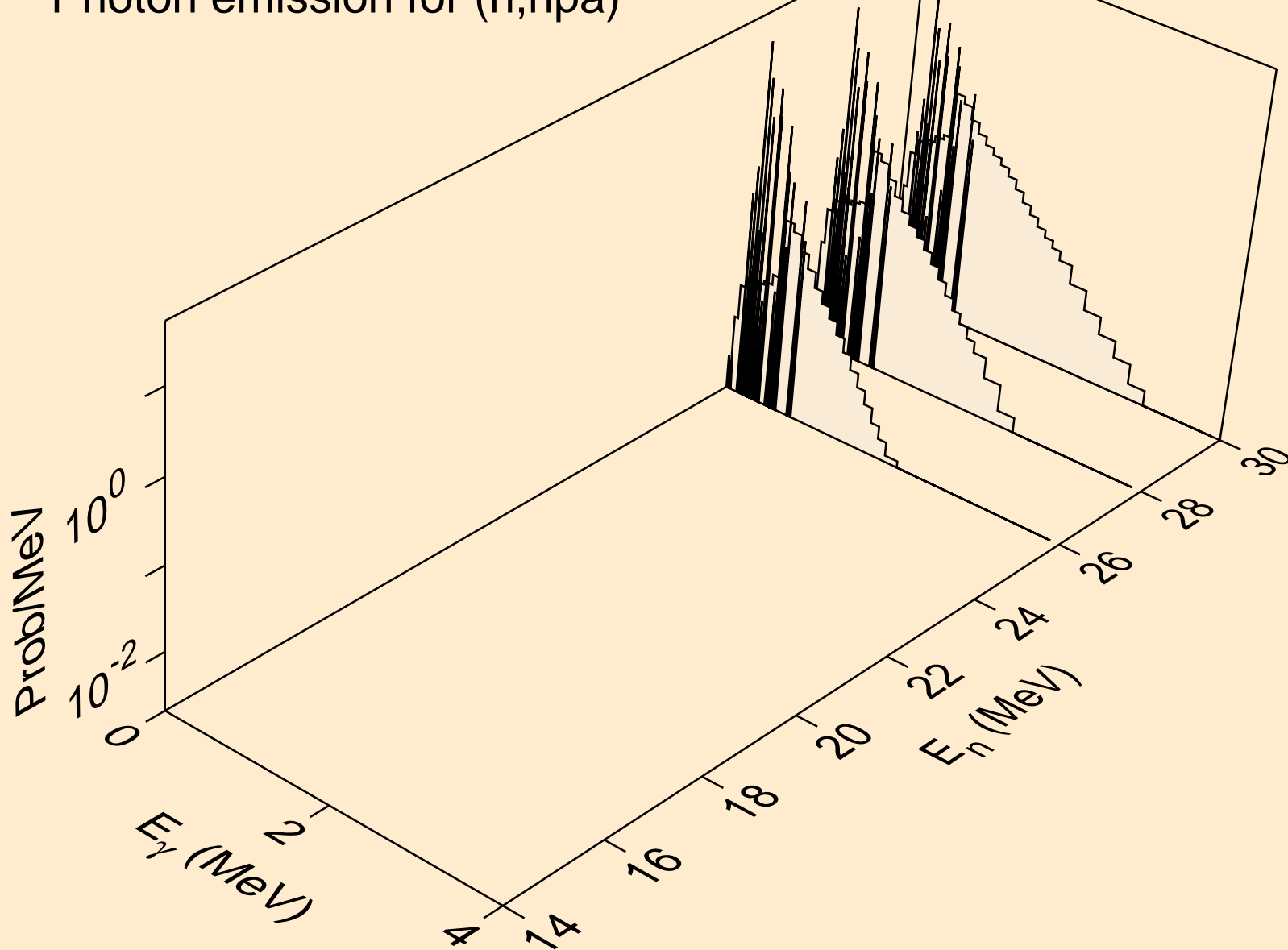

SR084 NEUTRON ACER TENDL-2019 LIBRARY; T=293.16K
Photon emission for (n,n*c)

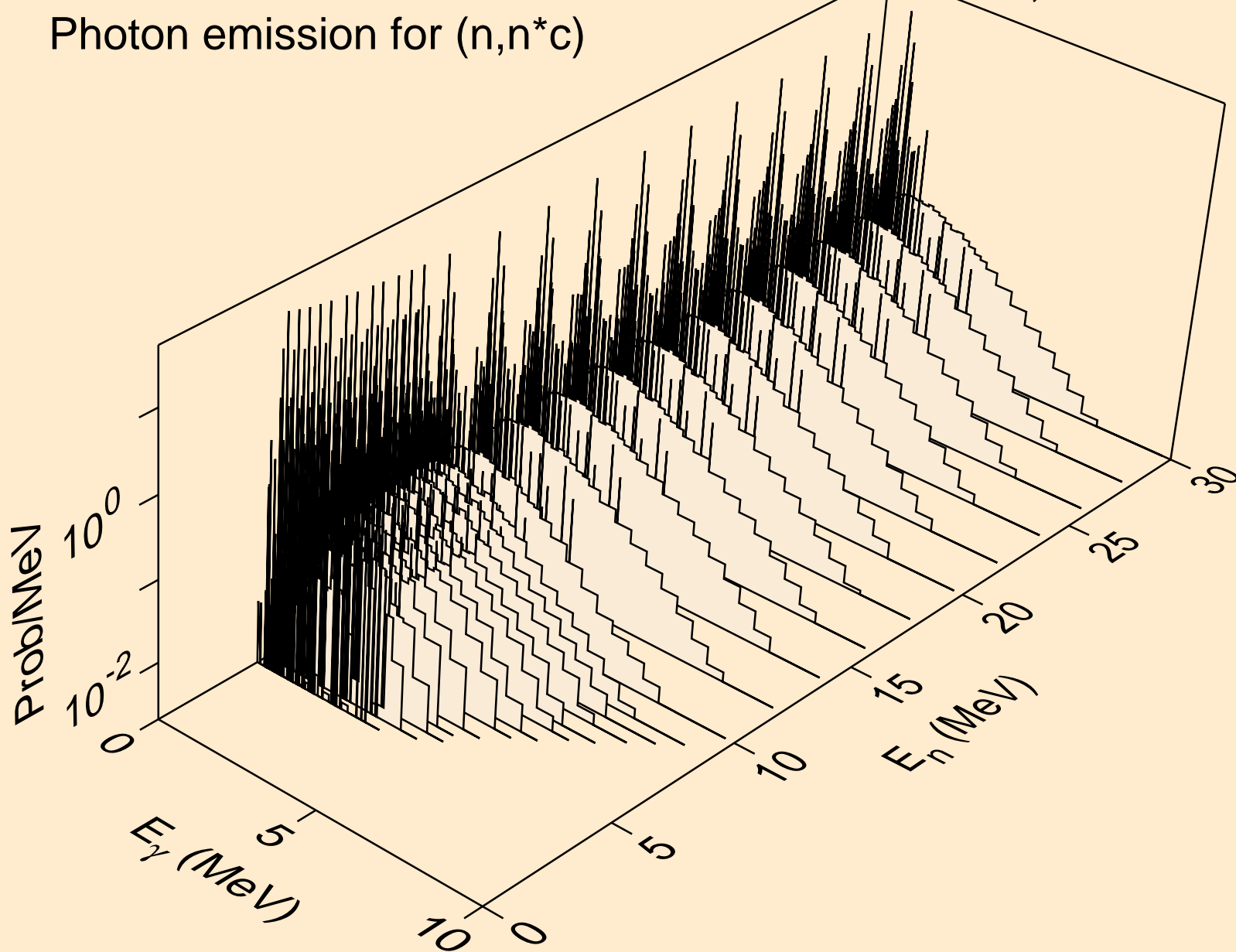

SR084 NEUTRON ACER TENDL-2019 LIBRARY; T=293.16K
Photon emission for (n,gma)

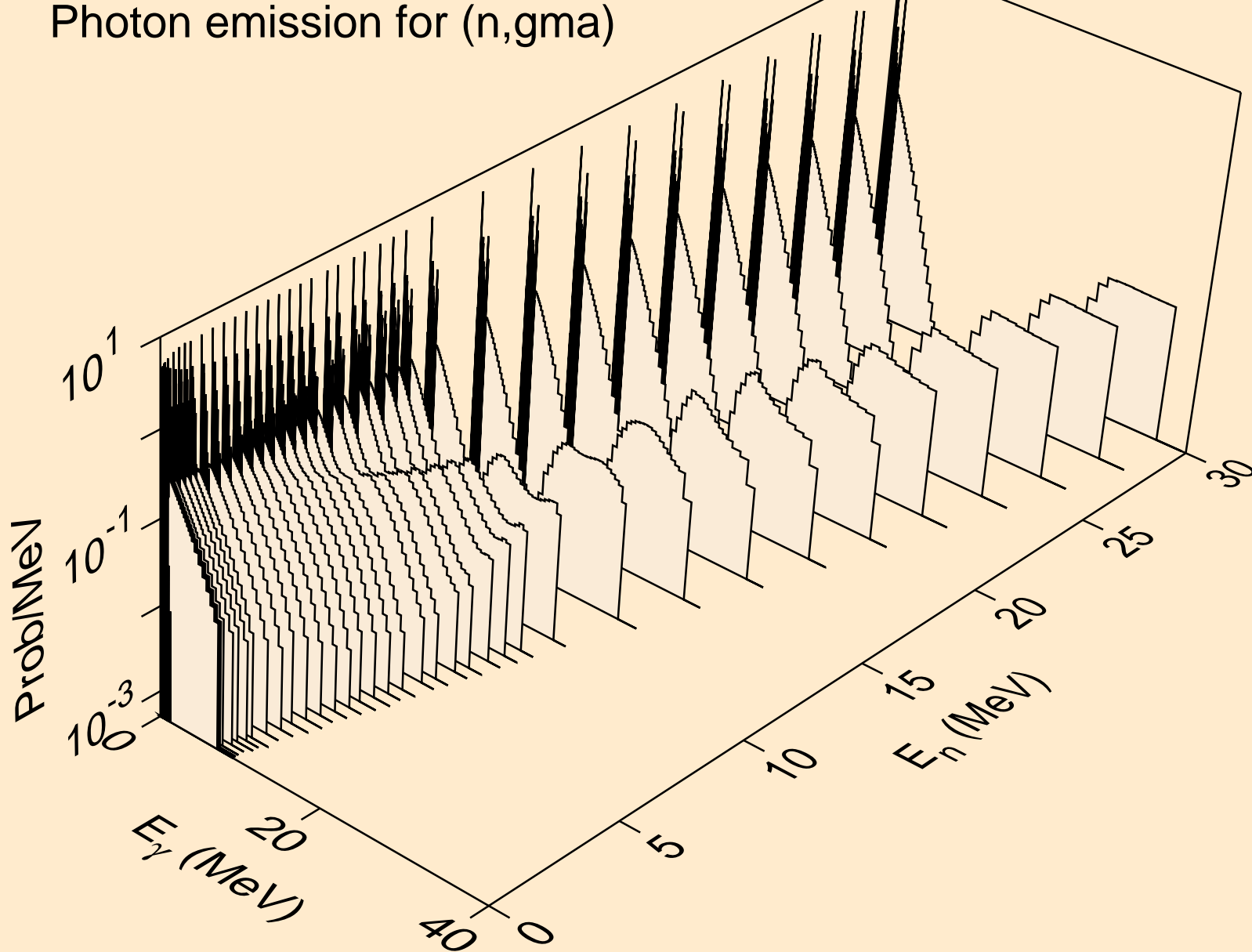

SR084 NEUTRON ACER TENDL-2019 LIBRARY; T=293.16K
Photon emission for (n,p)

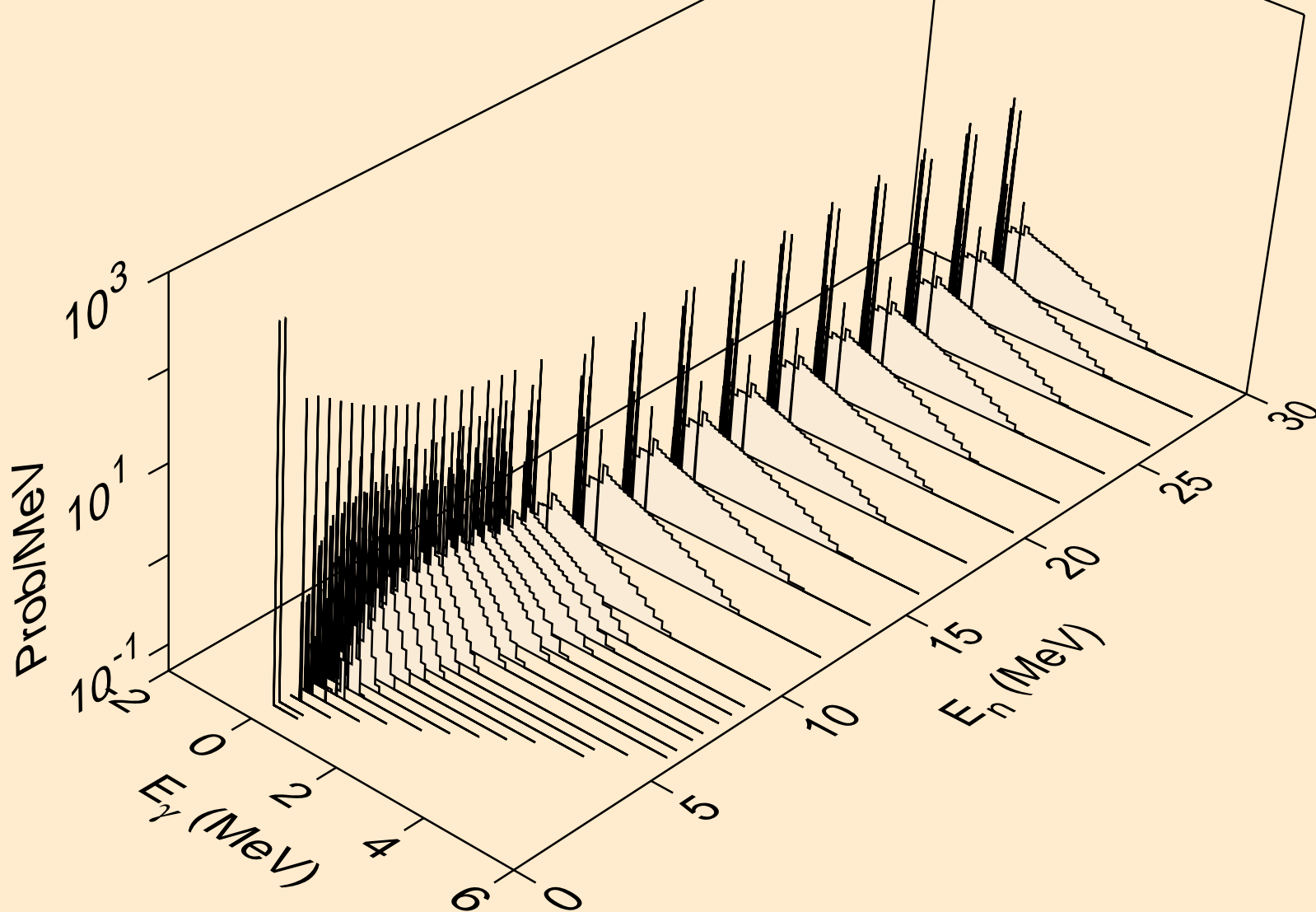

SR084 NEUTRON ACER TENDL-2019 LIBRARY; T=293.16K
Photon emission for (n,d)

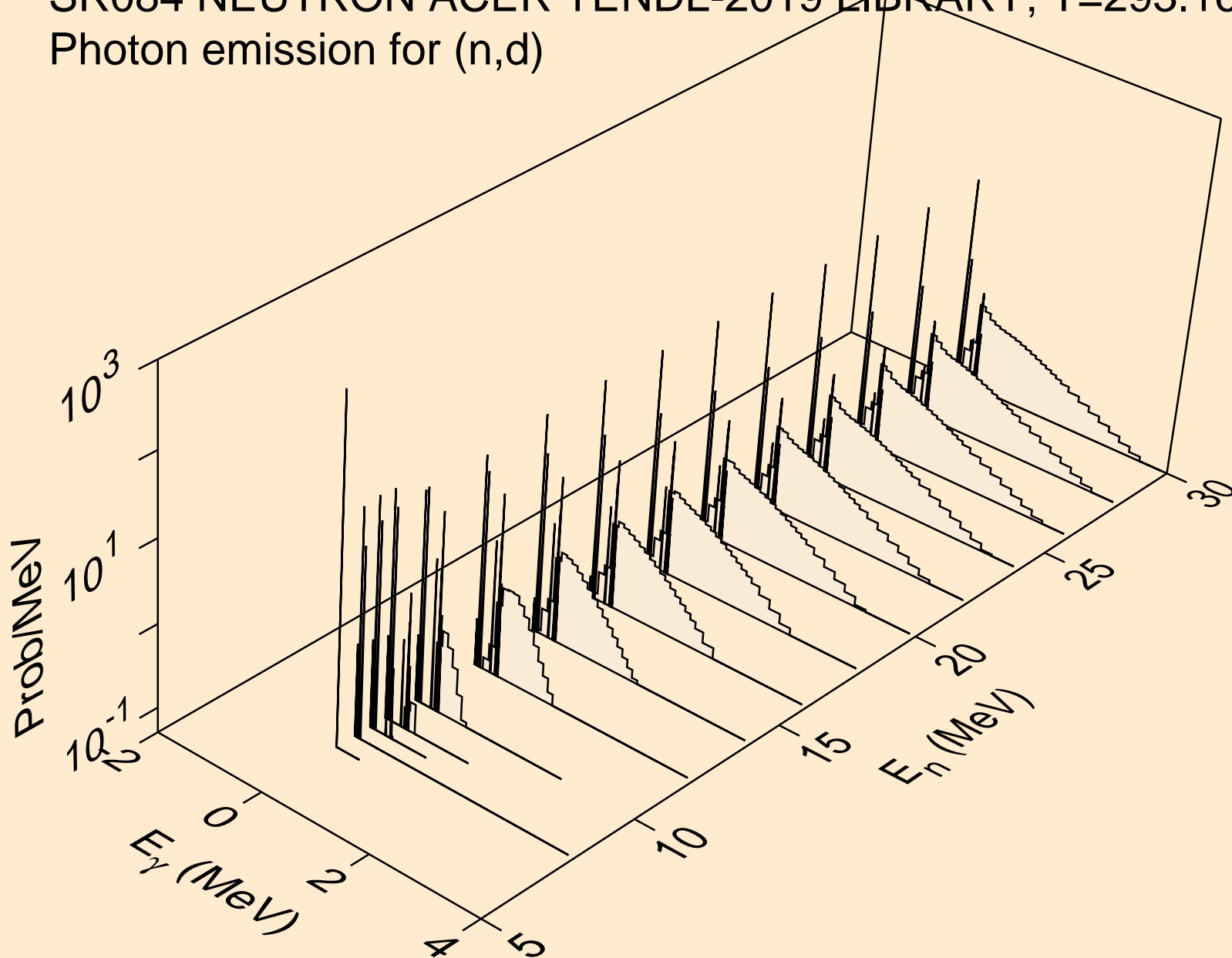

SR084 NEUTRON ACER TENDL-2019 LIBRARY; T=293.16K
Photon emission for (n,t)

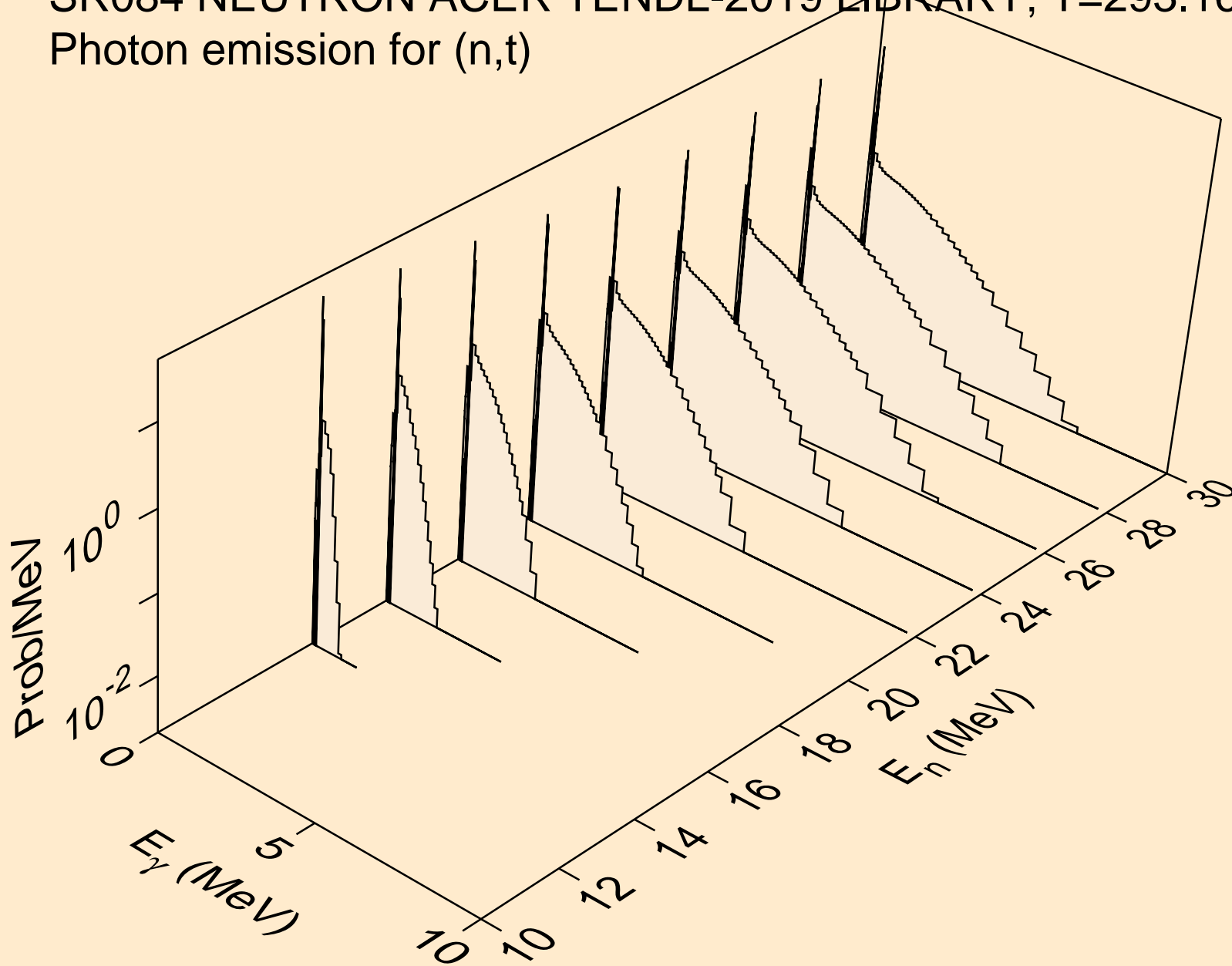

SR084 NEUTRON ACER TENDL-2019 LIBRARY; T=293.16K
Photon emission for (n,he3)

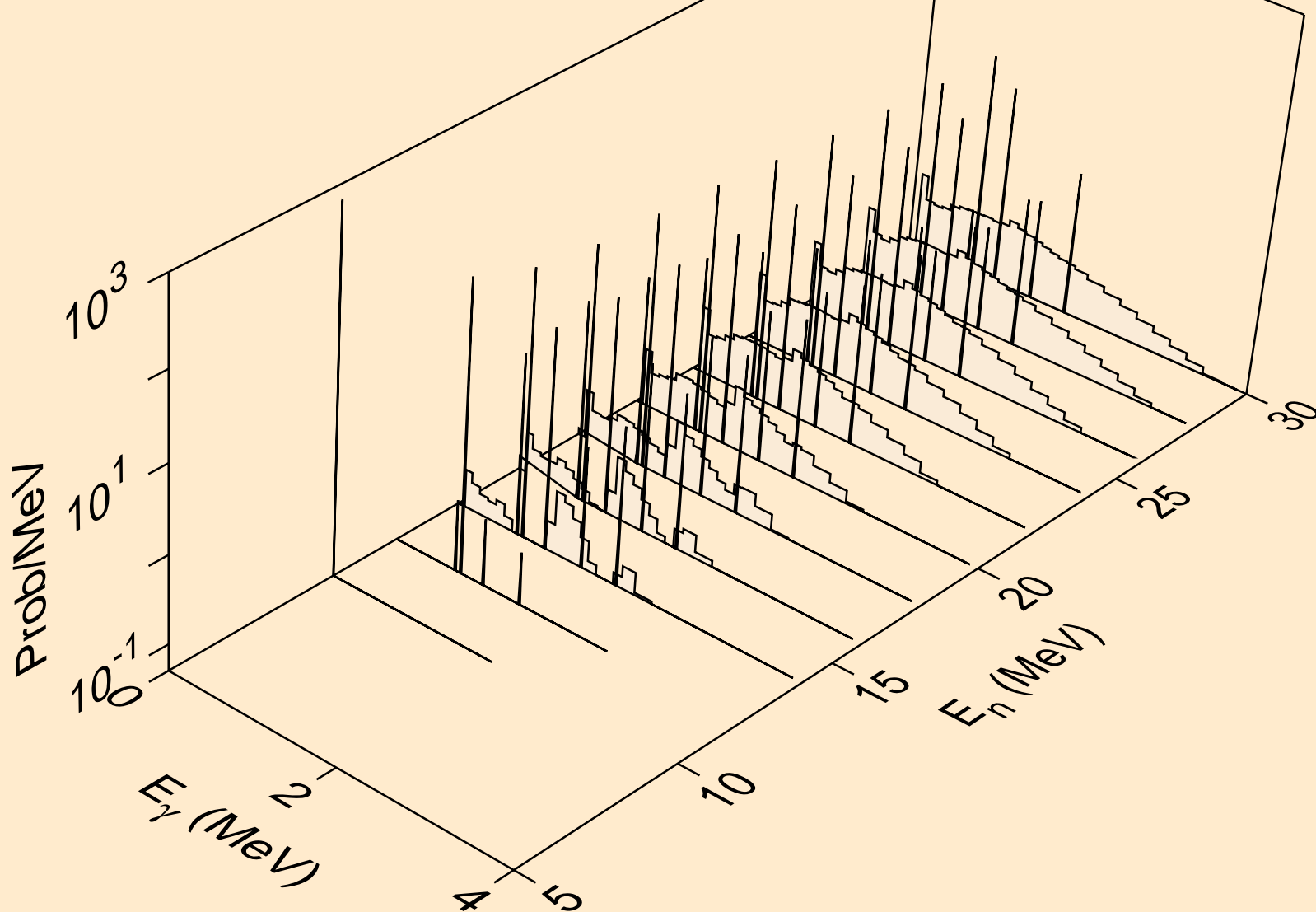

SR084 NEUTRON ACER TENDL-2019 LIBRARY; T=293.16K
Photon emission for (n,a)

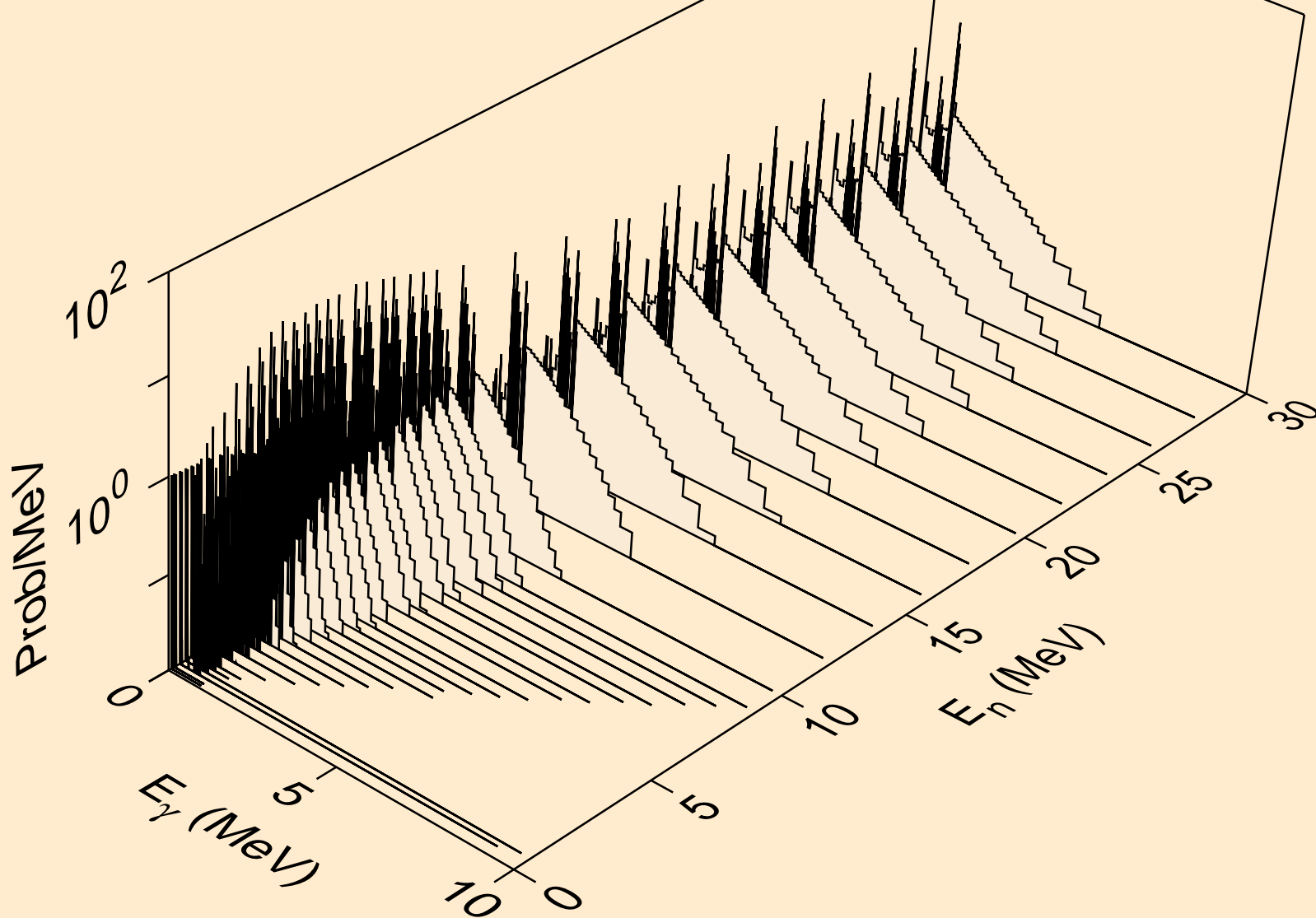

SR084 NEUTRON ACER TENDL-2019 LIBRARY; T=293.16K
Photon emission for (n,2a)

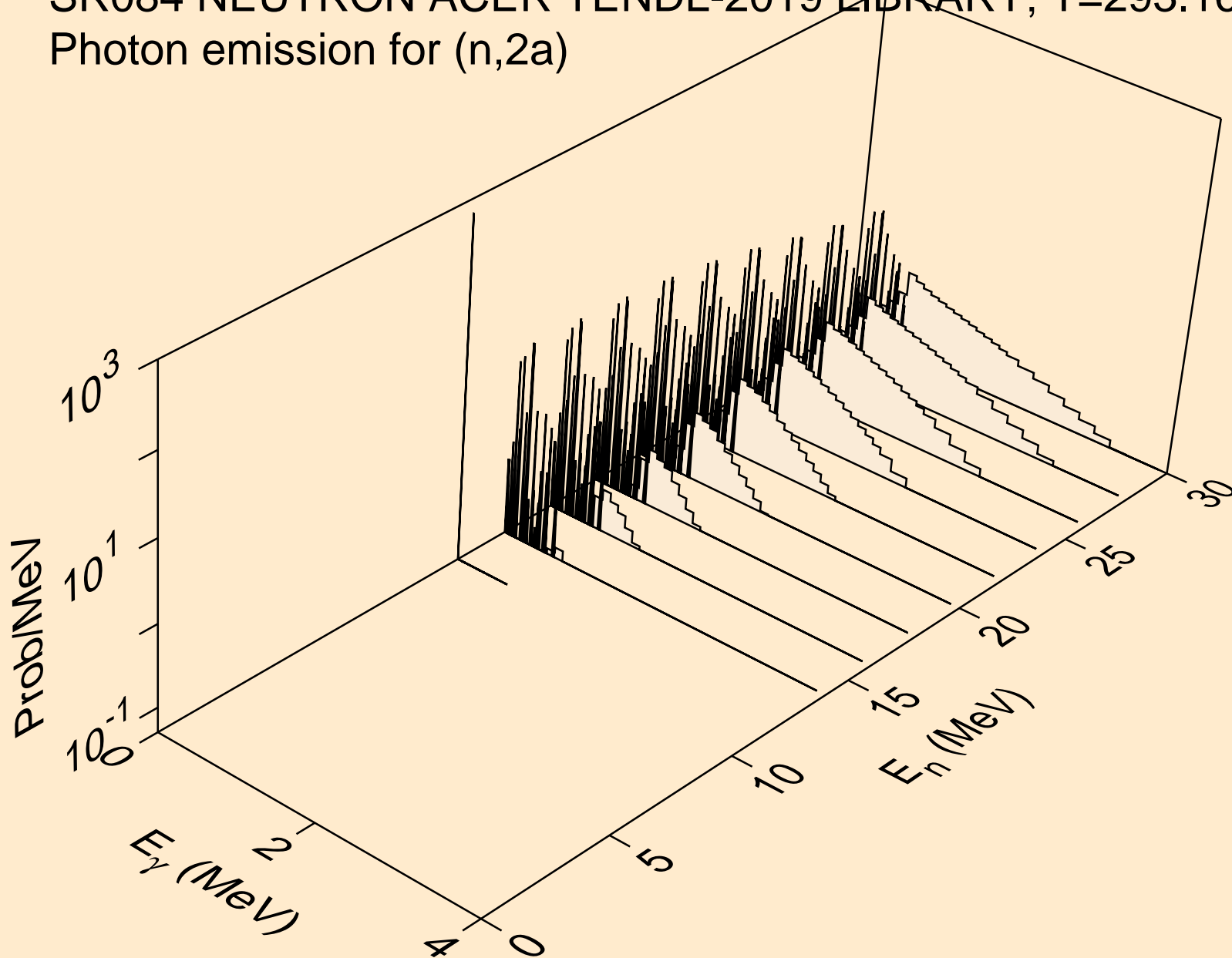

SR084 NEUTRON ACER TENDL-2019 LIBRARY; T=293.16K
Photon emission for (n,2p)

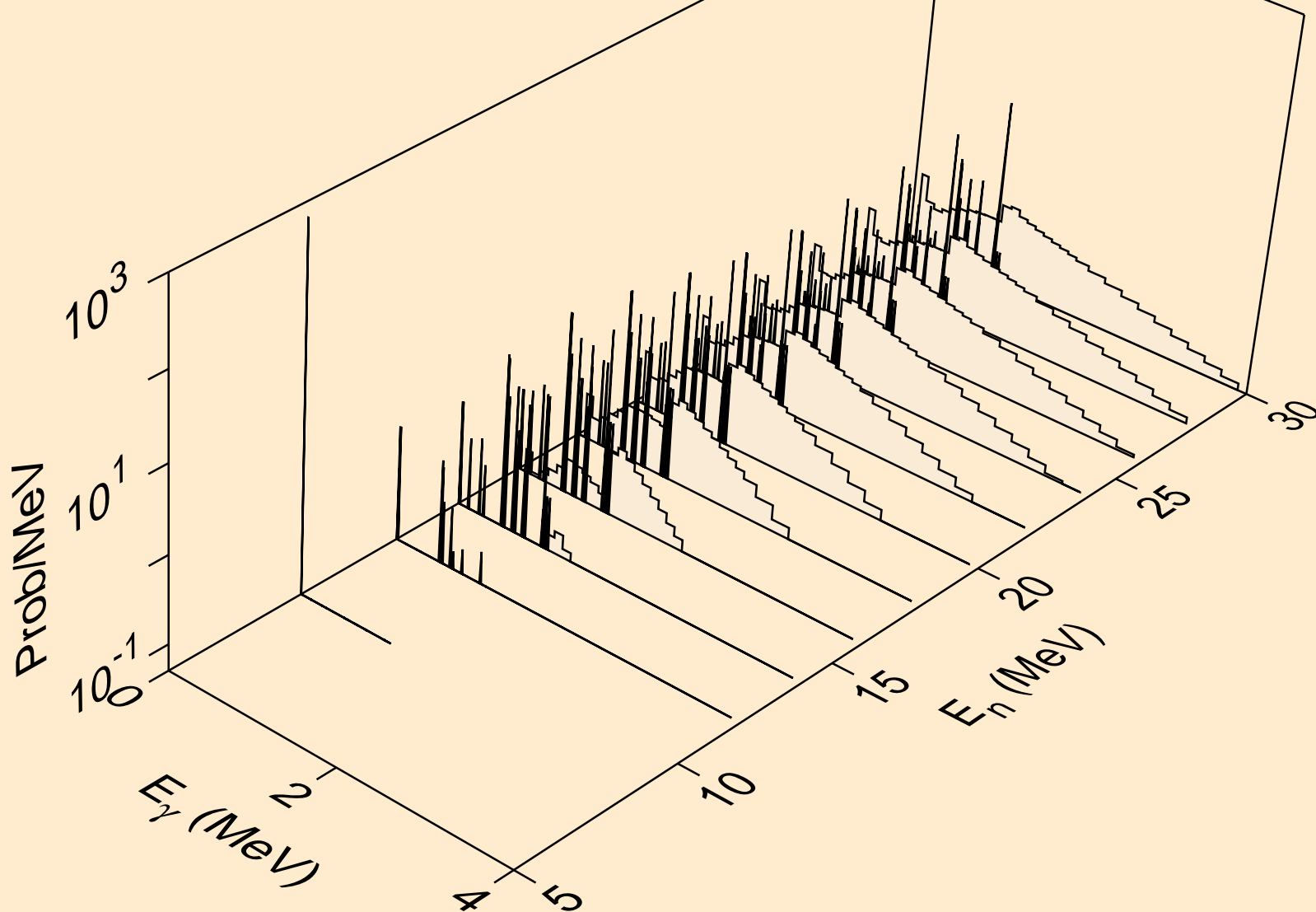

SR084 NEUTRON ACER TENDL-2019 LIBRARY; T=293.16K
Photon emission for (n,p α)

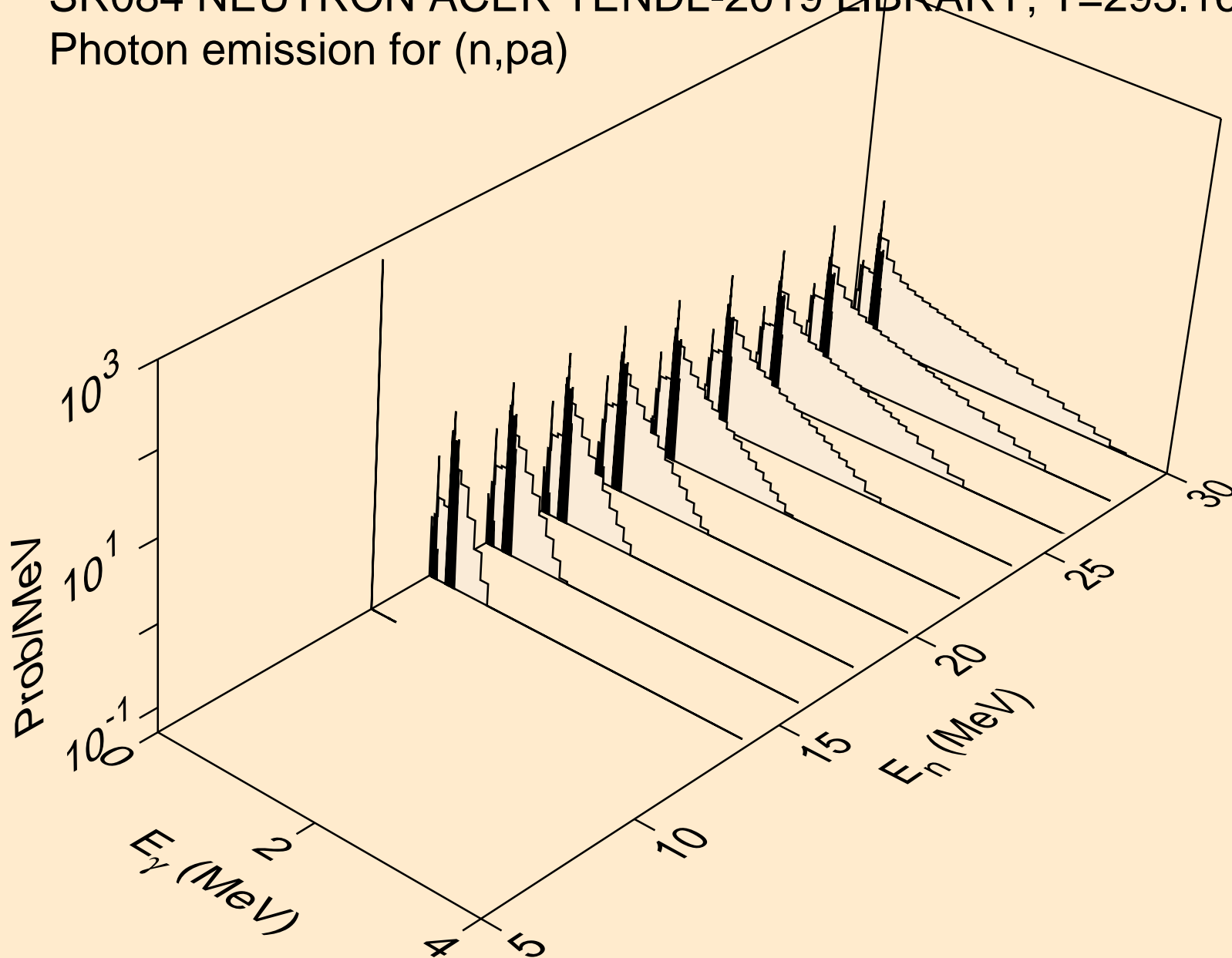

SR084 NEUTRON ACER TENDL-2019 LIBRARY; T=293.16K
Photon emission for (n,pd)

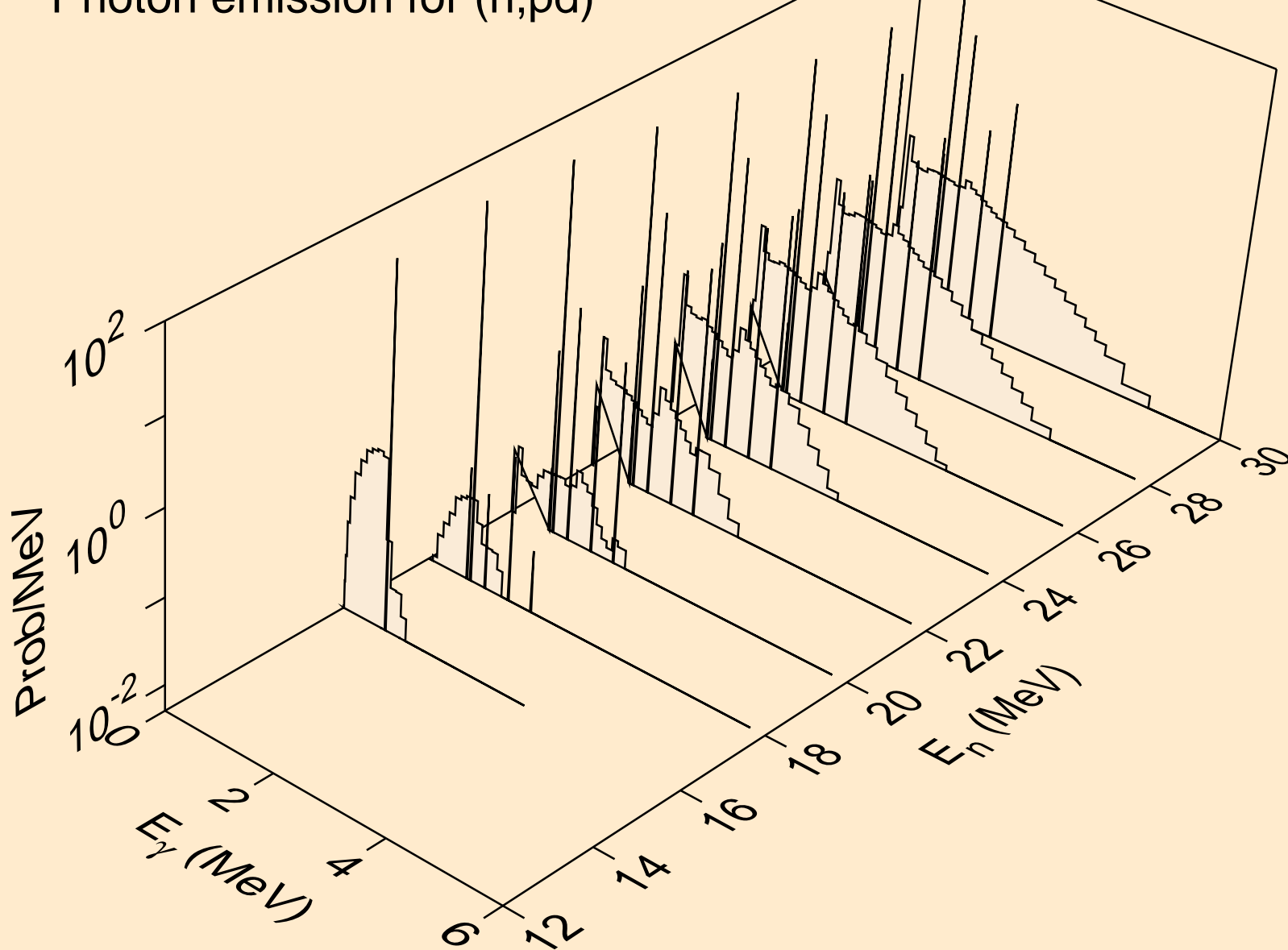

SR084 NEUTRON ACER TENDL-2019 LIBRARY; T=293.16K
Photon emission for (n,pt)

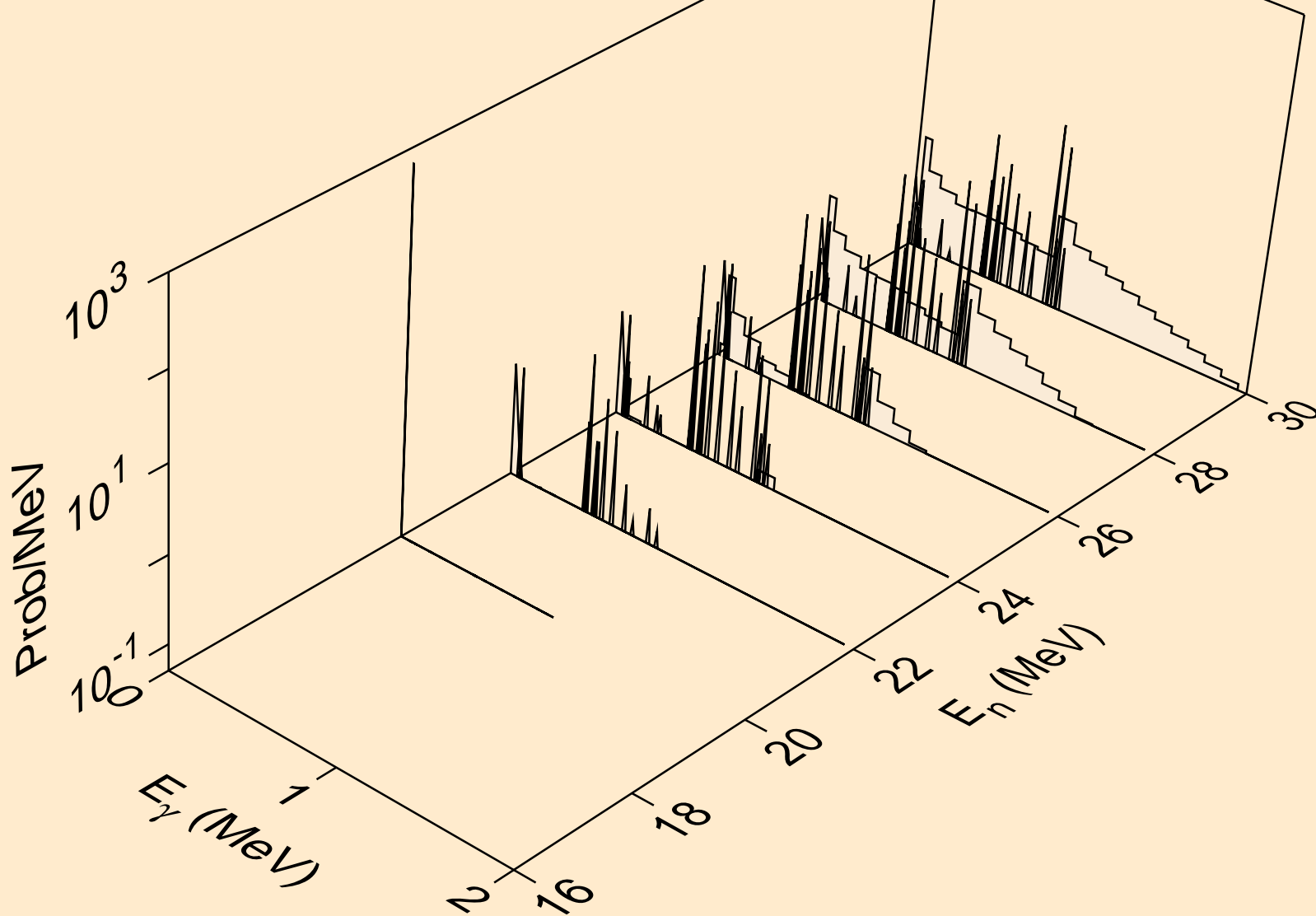

SR084 NEUTRON ACER TENDL-2019 LIBRARY; T=293.16K
Photon emission for (n,da)

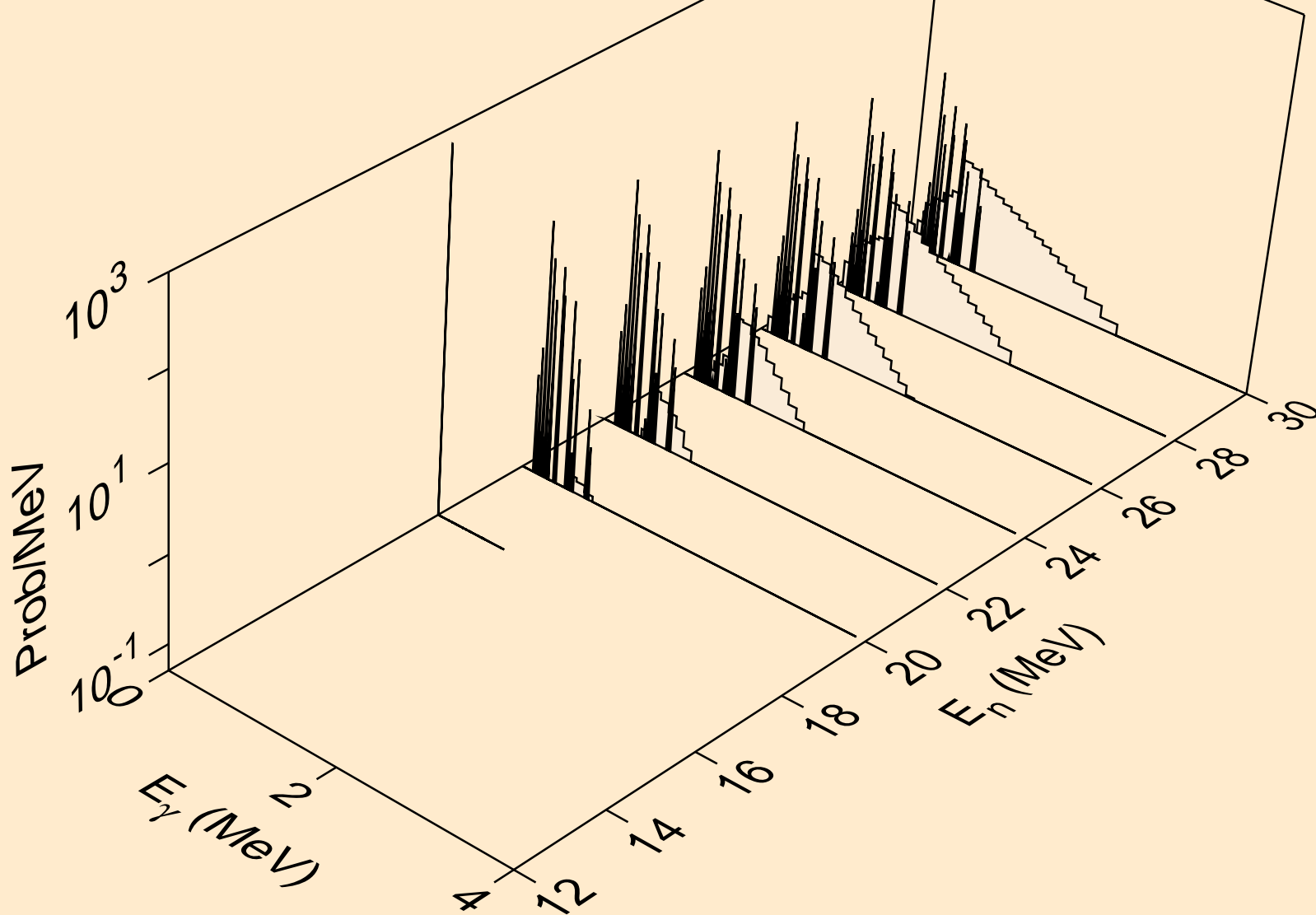

SR084 NEUTRON ACER TENDL-2019 LIBRARY; T=293.16K
thermal capture photon spectrum

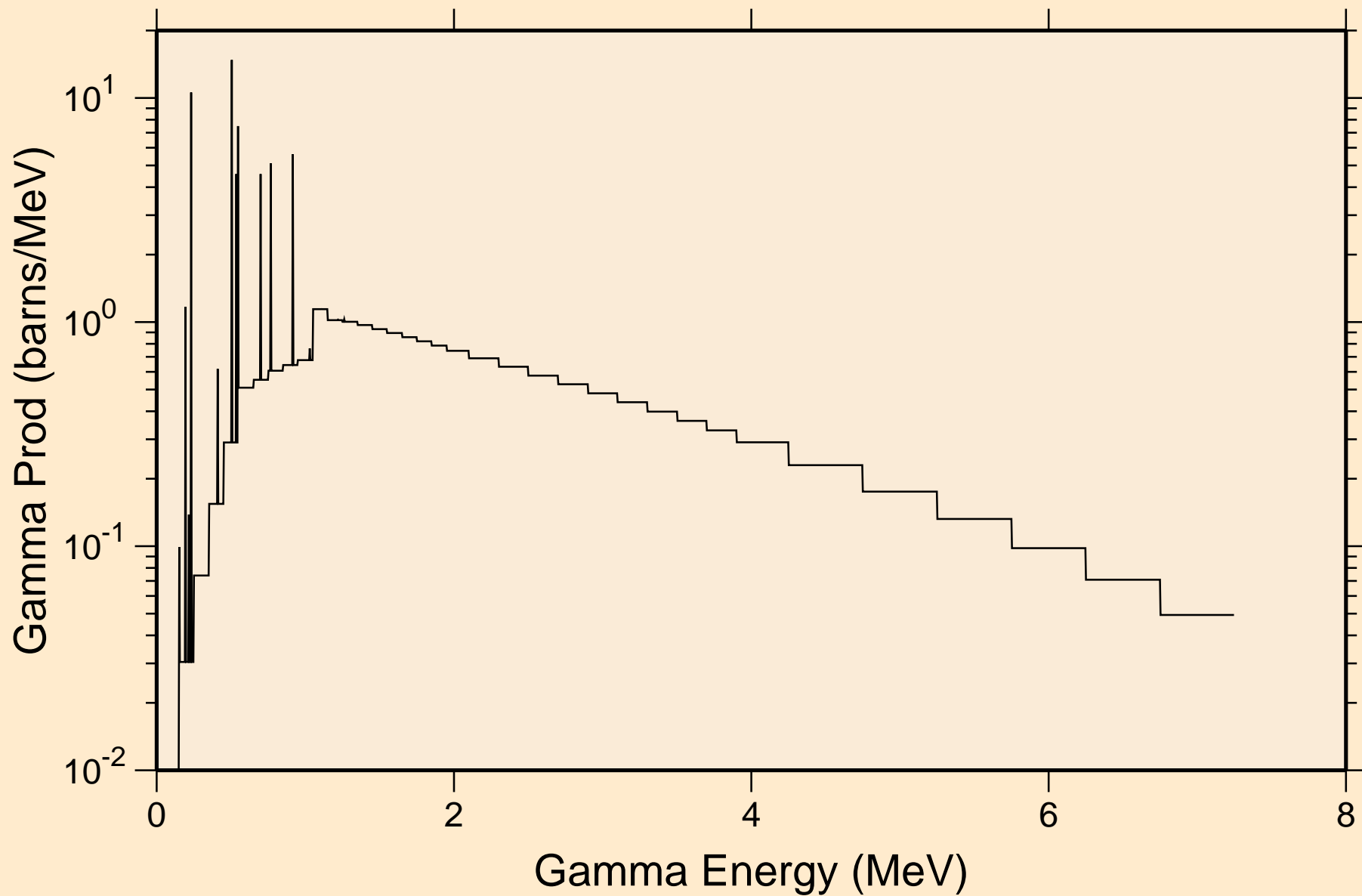

SR084 NEUTRON ACER TENDL-2019 LIBRARY; T=293.16K
14 MeV photon spectrum

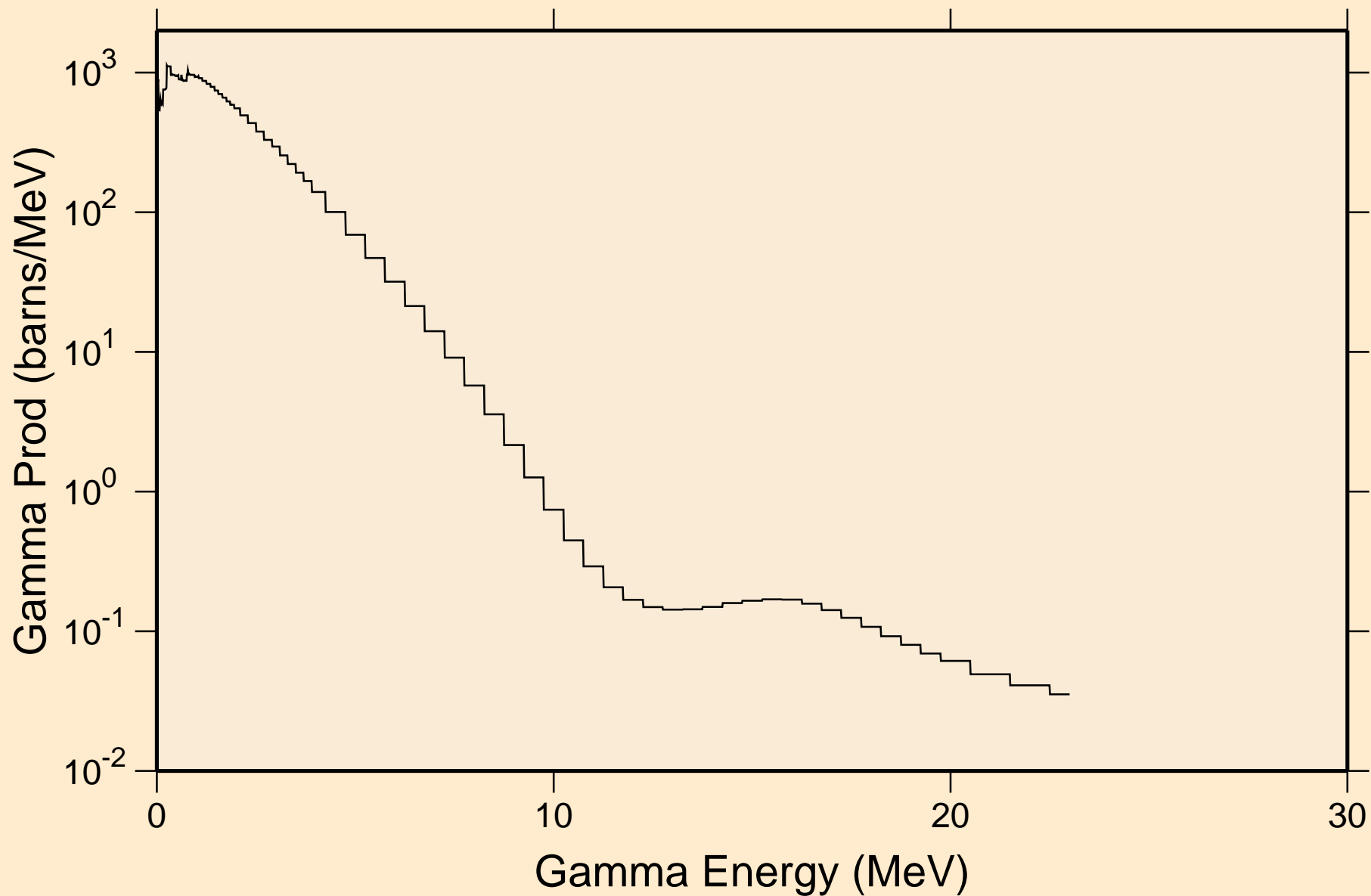

SR084 NEUTRON ACER TENDL-2019 LIBRARY; T=293.16K
Particle heating contributions

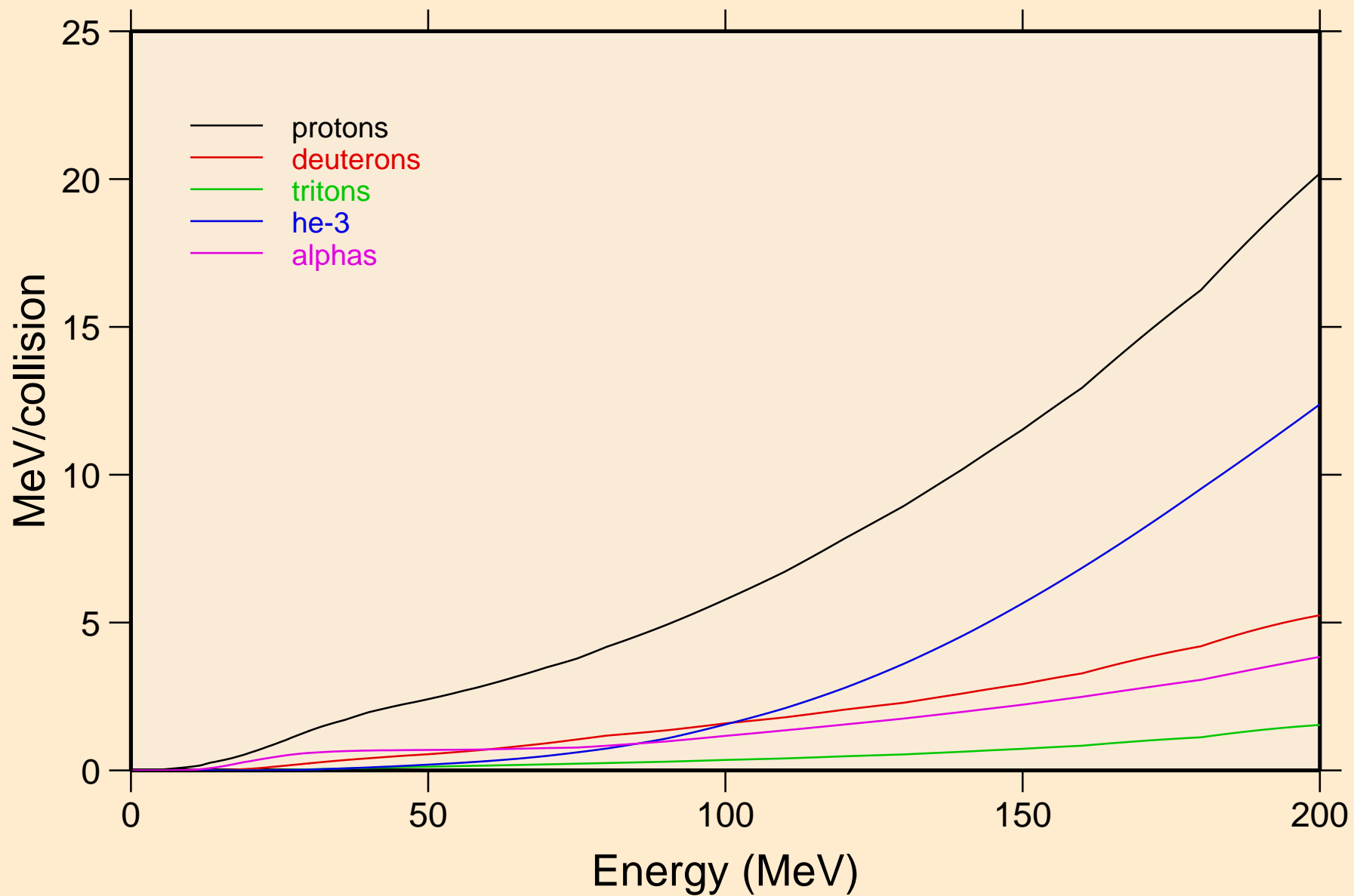

SR084 NEUTRON ACER TENDL-2019 LIBRARY; T=293.16K
Recoil Heating

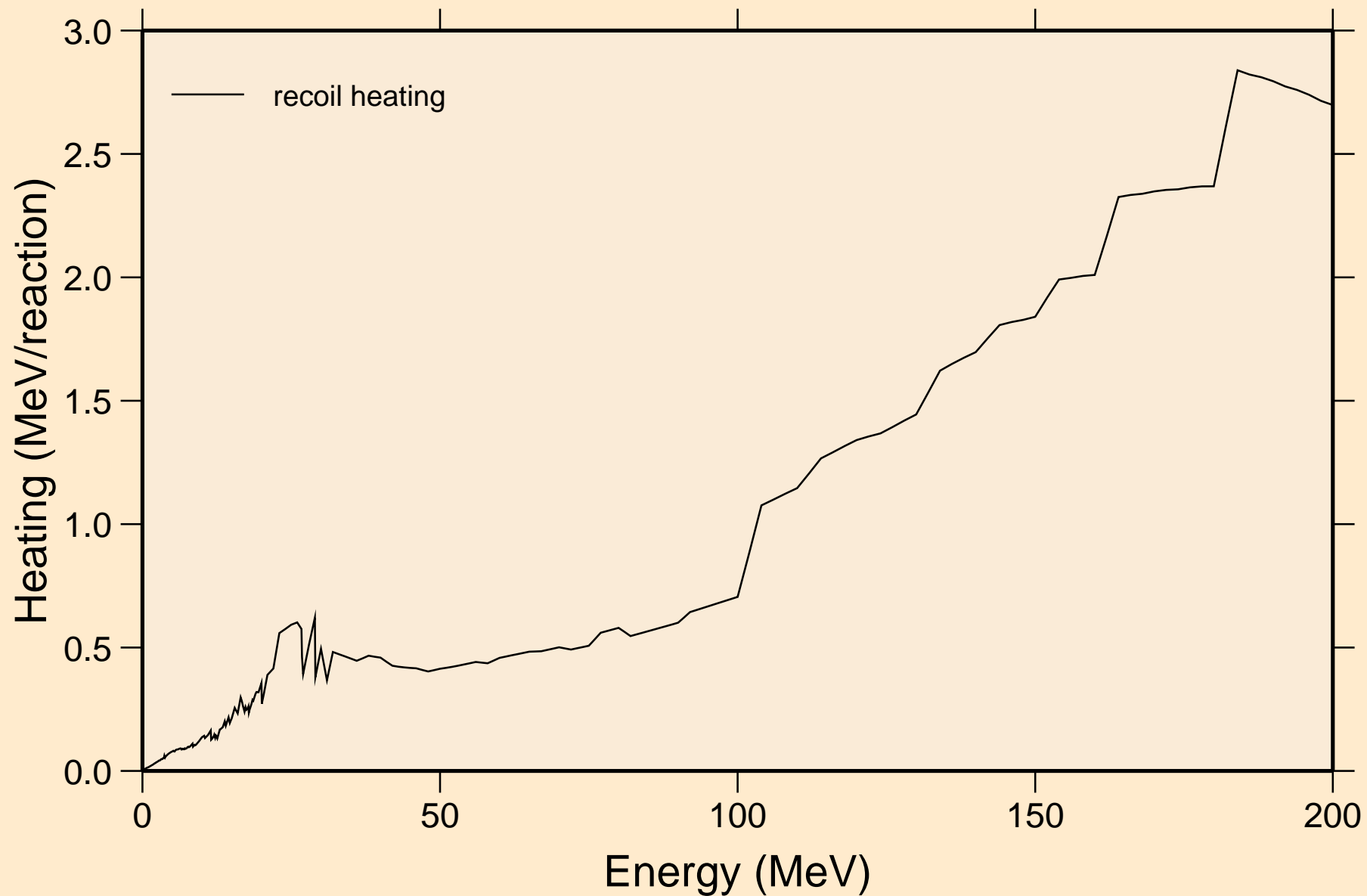

SR084 NEUTRON ACER TENDL-2019 LIBRARY; T=293.16K
Particle production cross sections

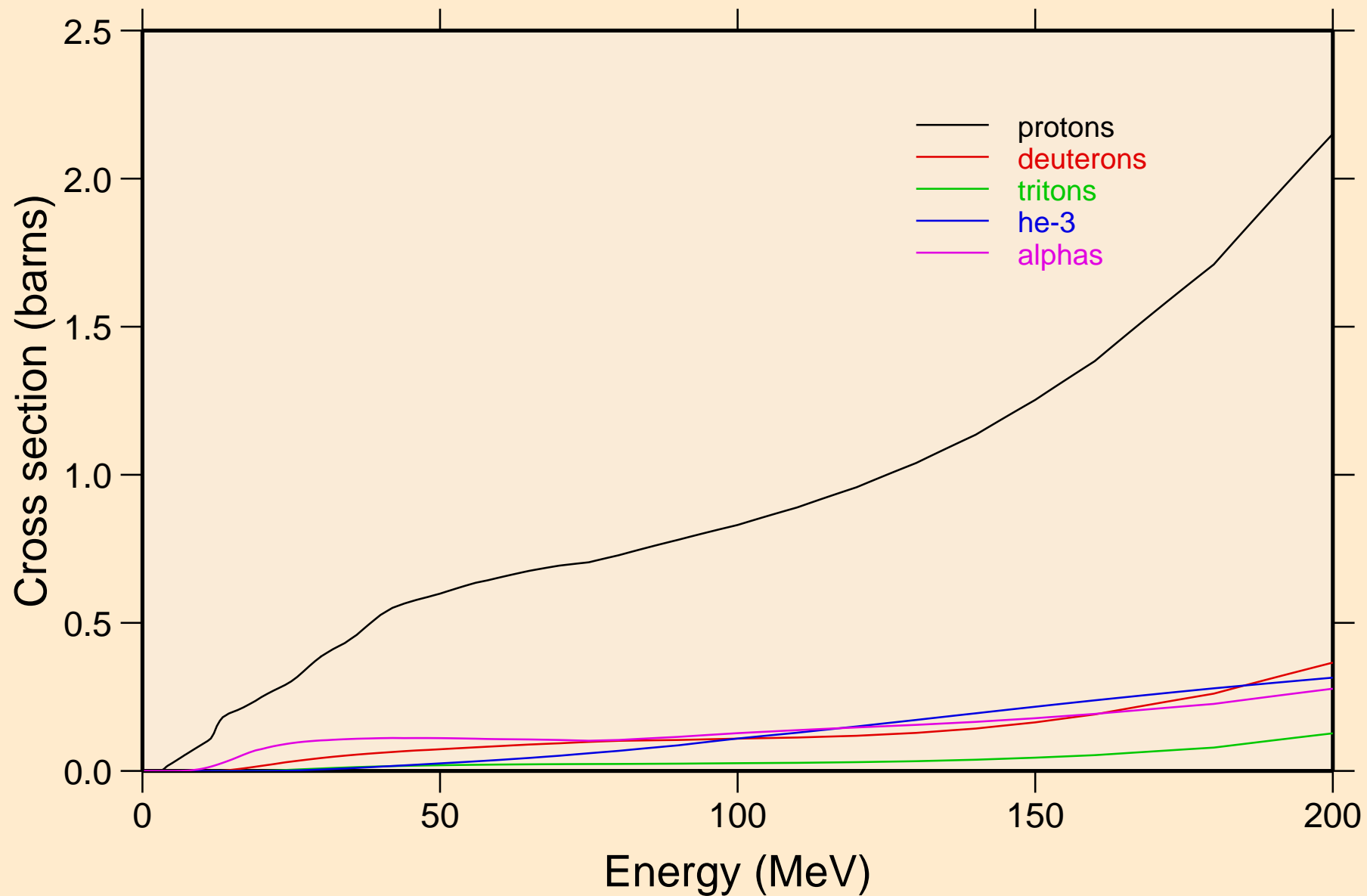

SR084 NEUTRON ACER TENDL-2019 LIBRARY; T=293.16K
protons from (n,x)

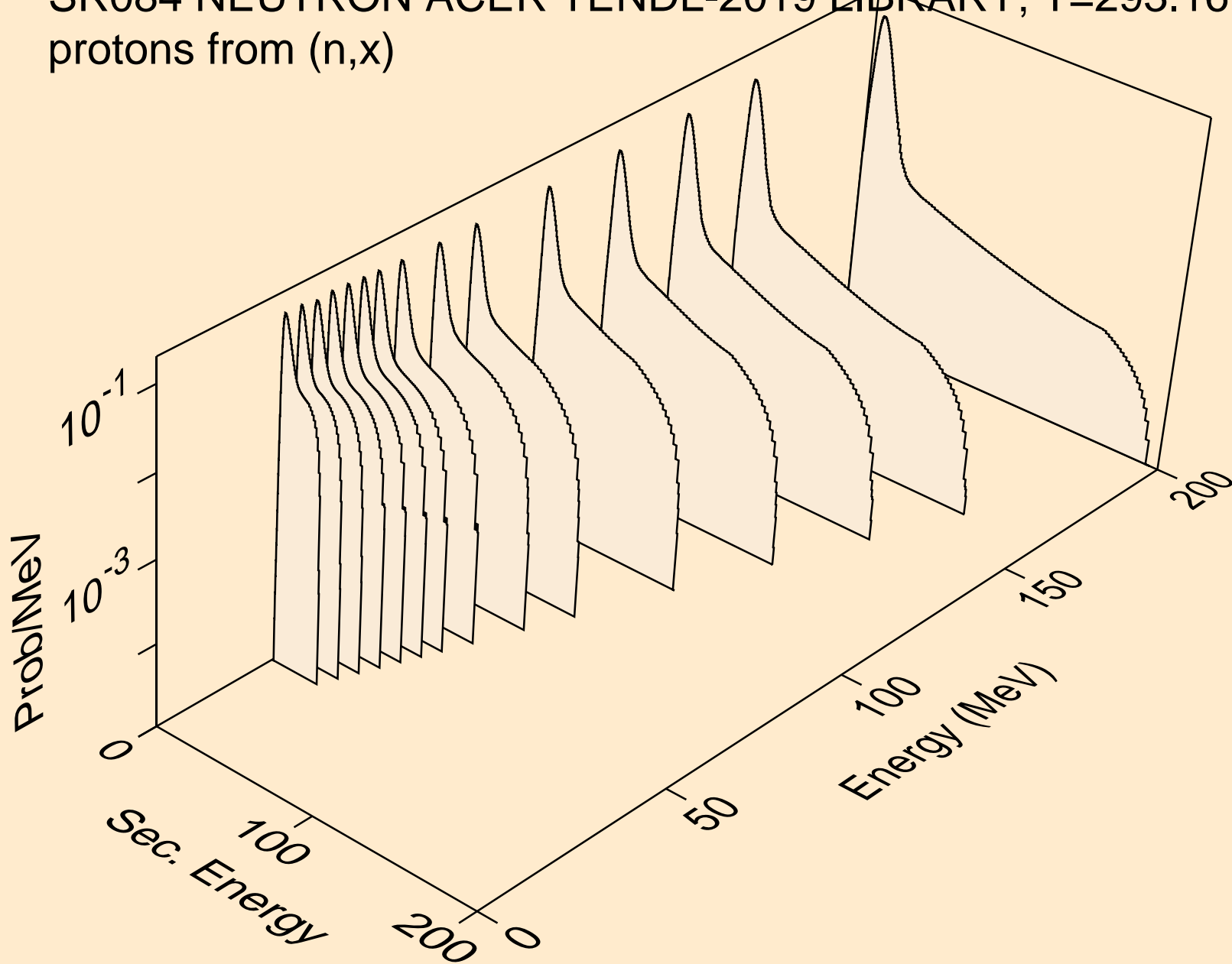

SR084 NEUTRON ACER TENDL-2019 LIBRARY; T=293.16K
protons from (n,n*)p

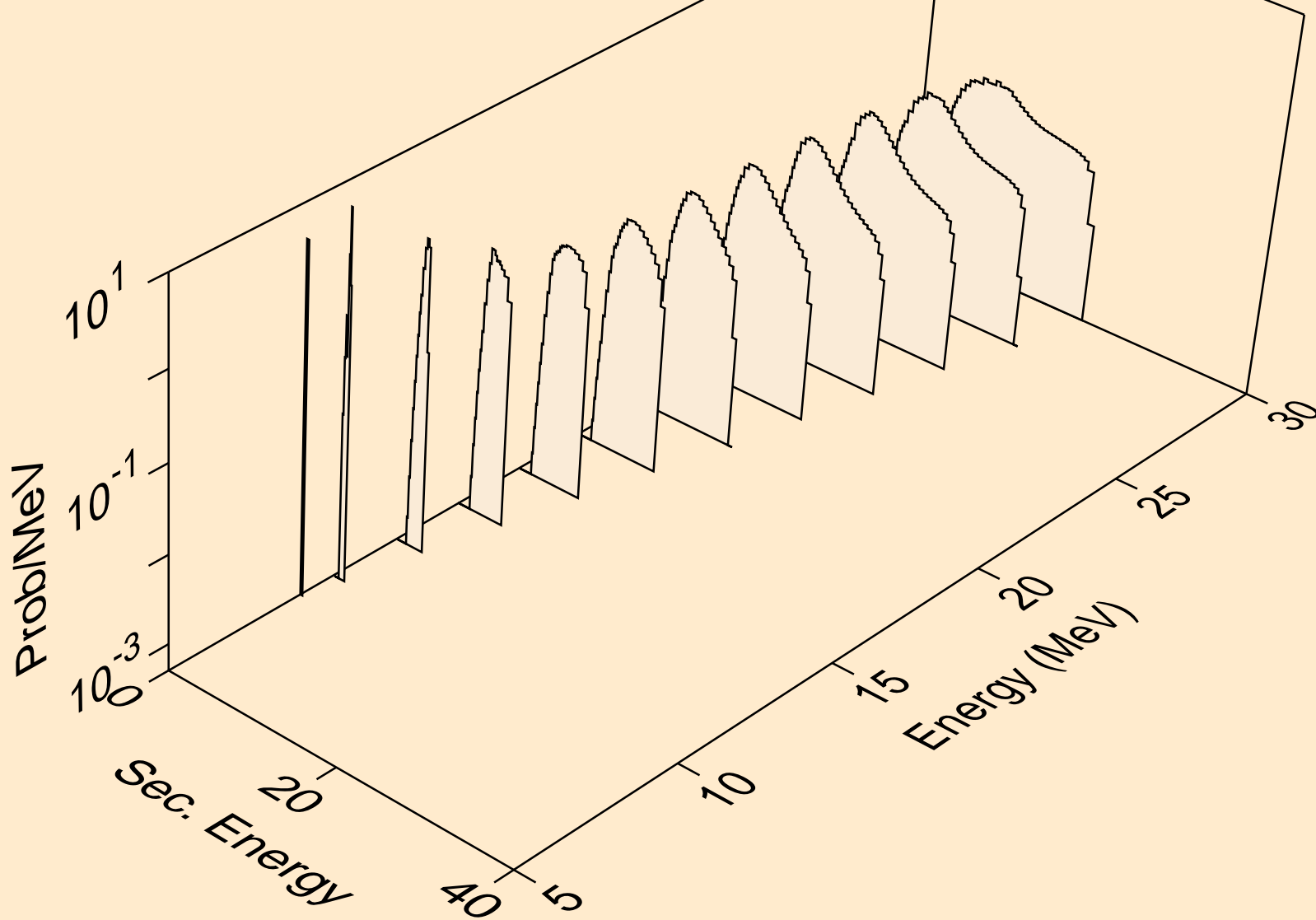

SR084 NEUTRON ACER TENDL-2019 LIBRARY; T=293.16K
protons from (n,2np)

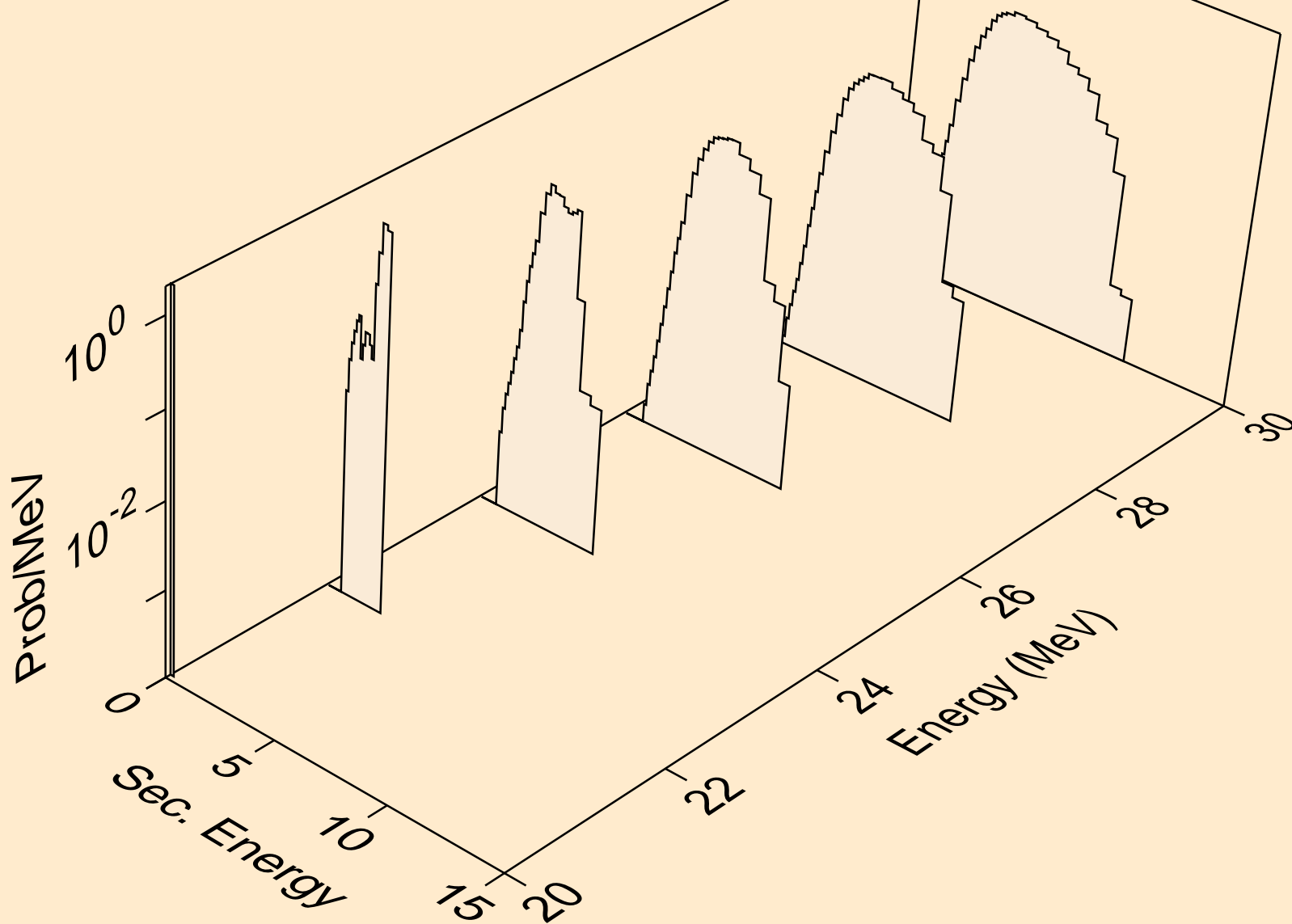

SR084 NEUTRON ACER TENDL-2019 LIBRARY; T=293.16K
protons from (n,3np)

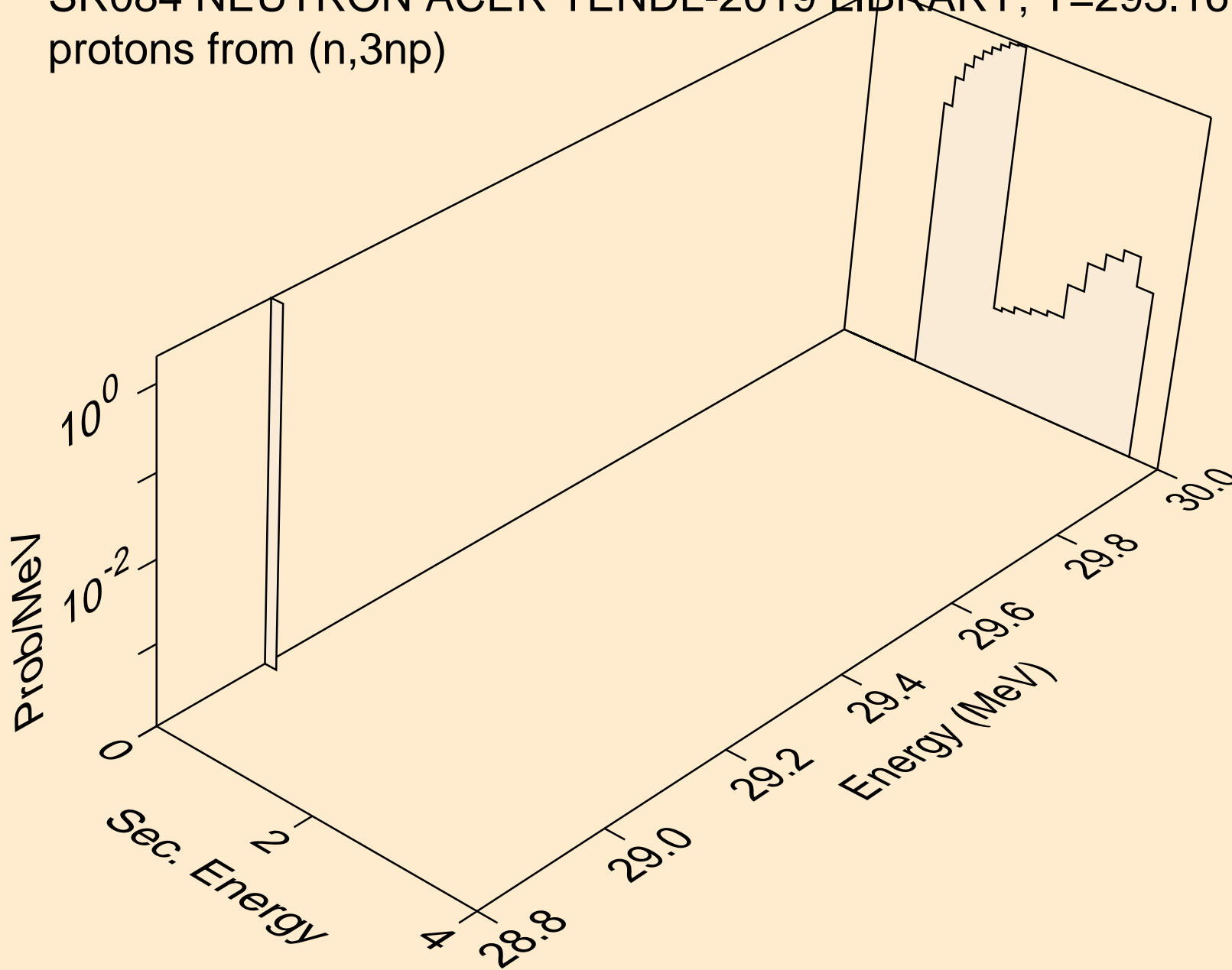

SR084 NEUTRON ACER TENDL-2019 LIBRARY; T=293.16K
protons from (n,2np)

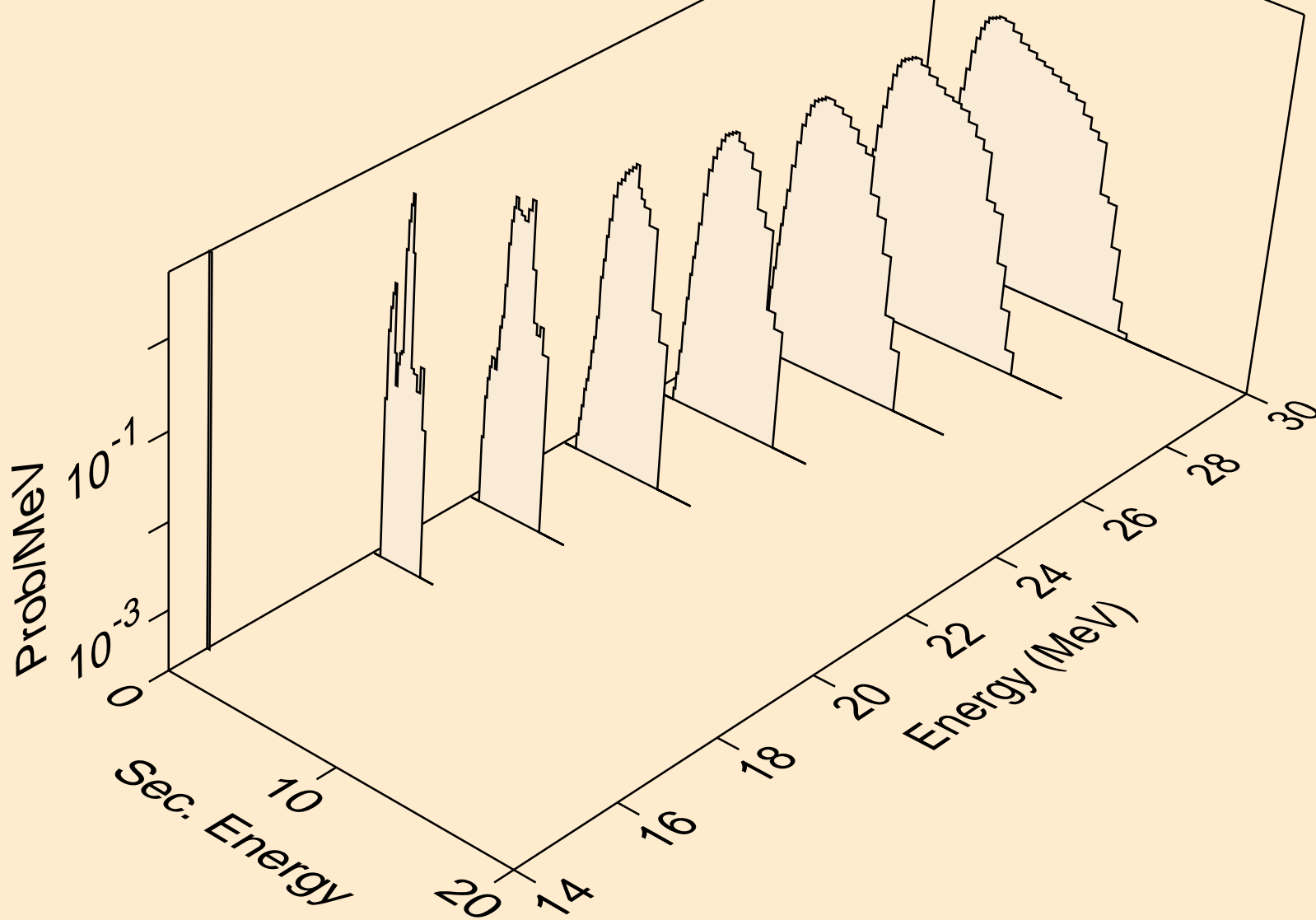

SR084 NEUTRON ACER TENDL-2019 LIBRARY; T=293.16K
protons from (n,npa)

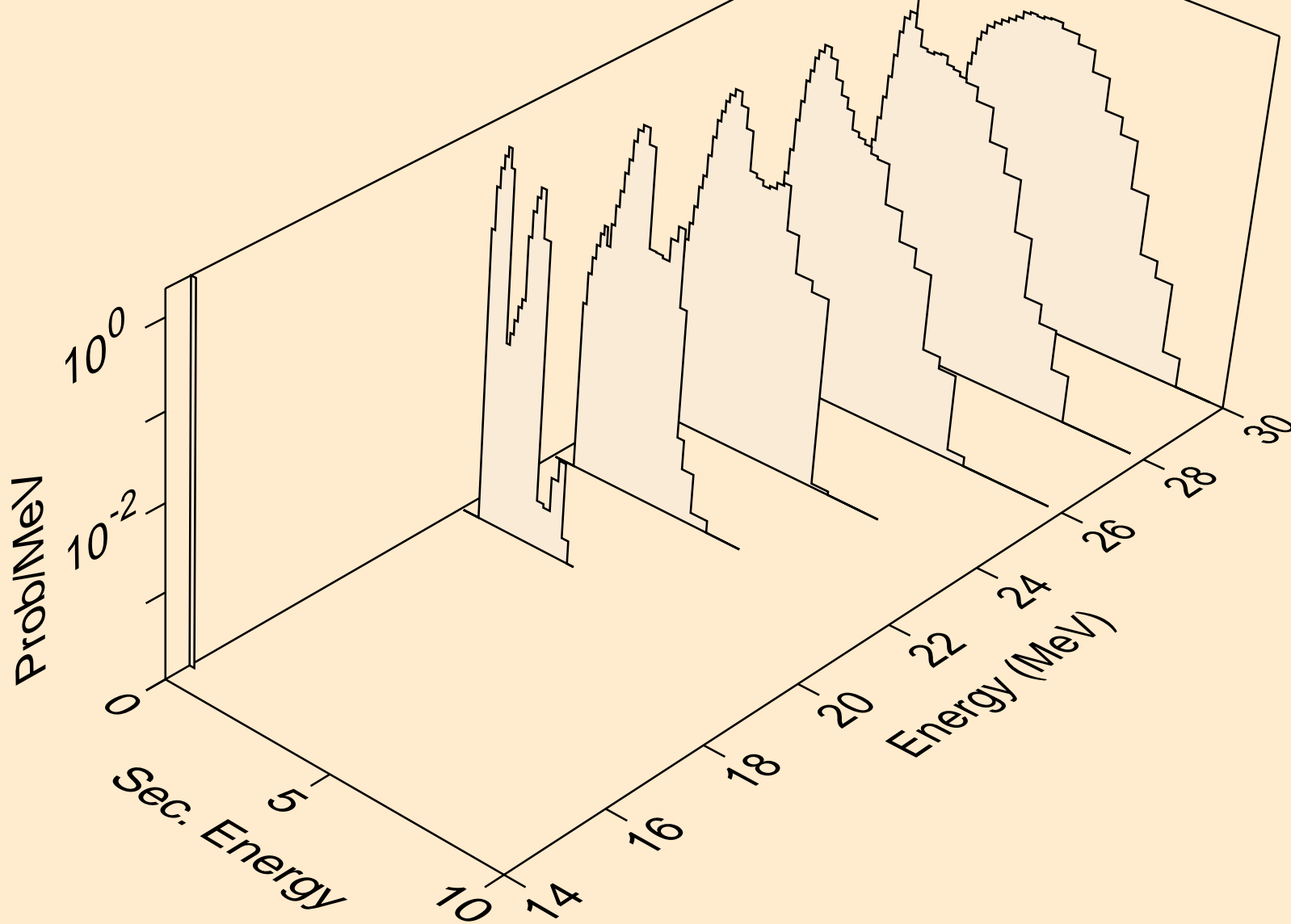

SR084 NEUTRON ACER TENDL-2019 LIBRARY; T=293.16K
protons from (n,p)

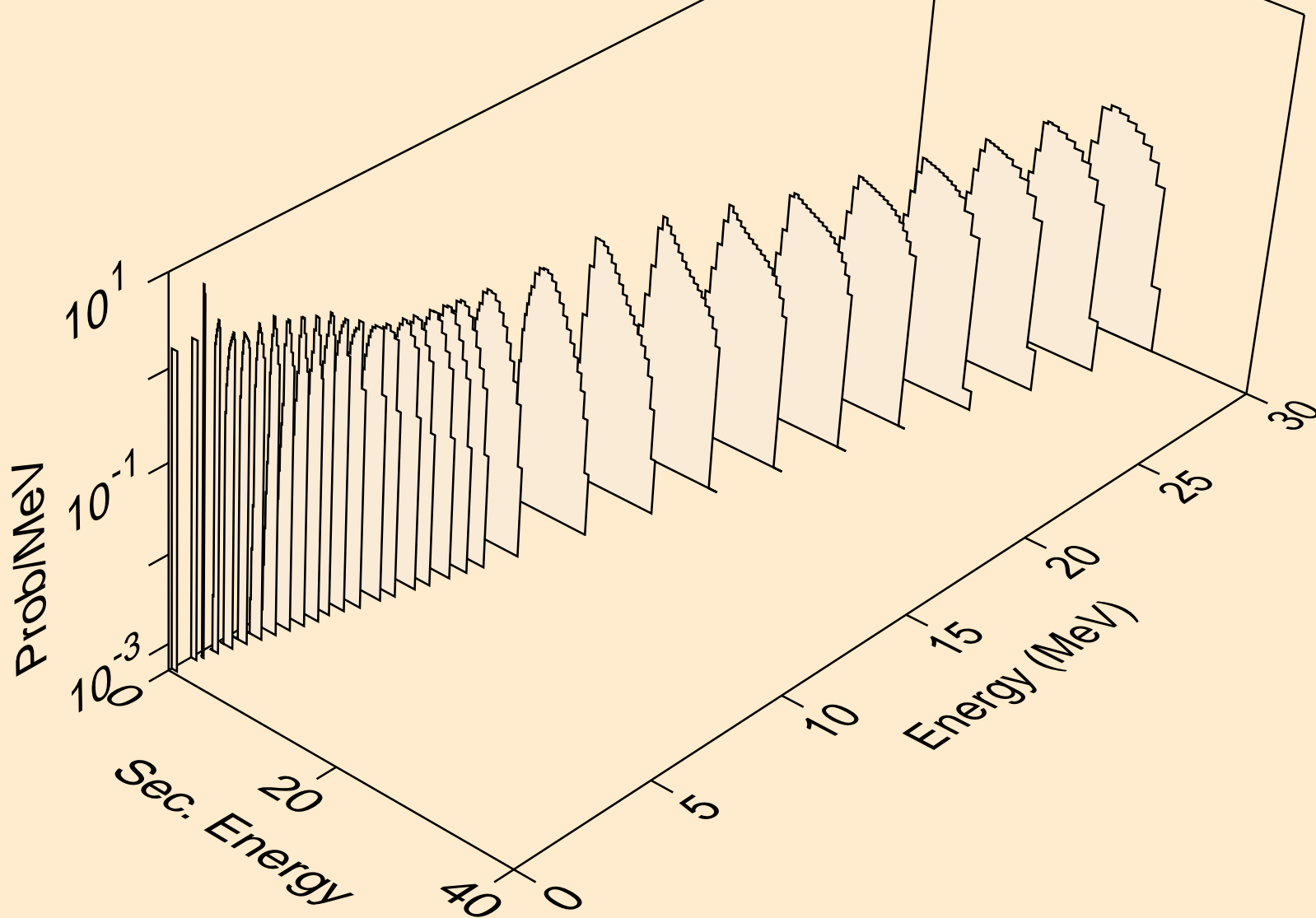

SR084 NEUTRON ACER TENDL-2019 LIBRARY; T=293.16K
protons from (n,2p)

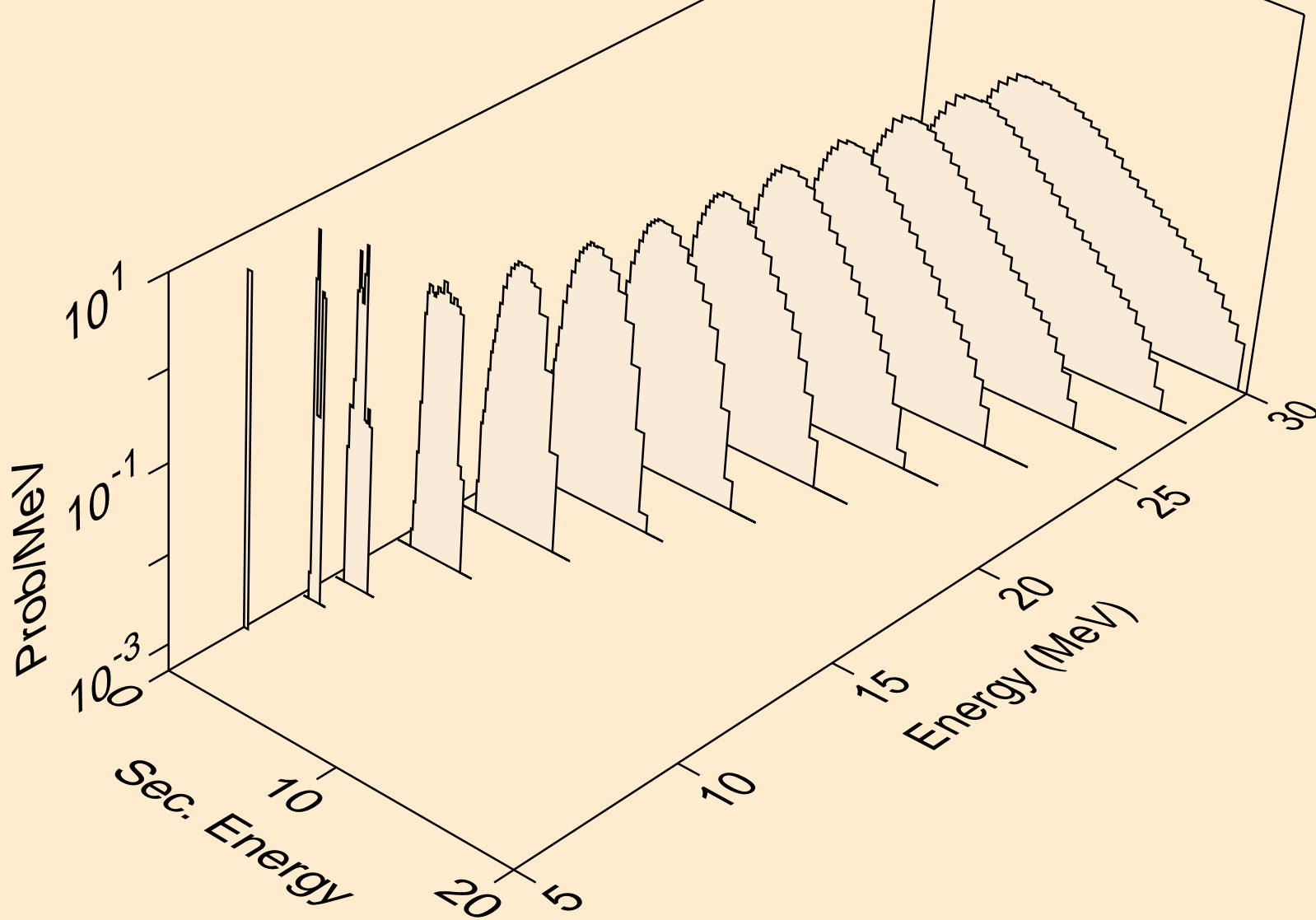

SR084 NEUTRON ACER TENDL-2019 LIBRARY; T=293.16K
protons from (n,p)

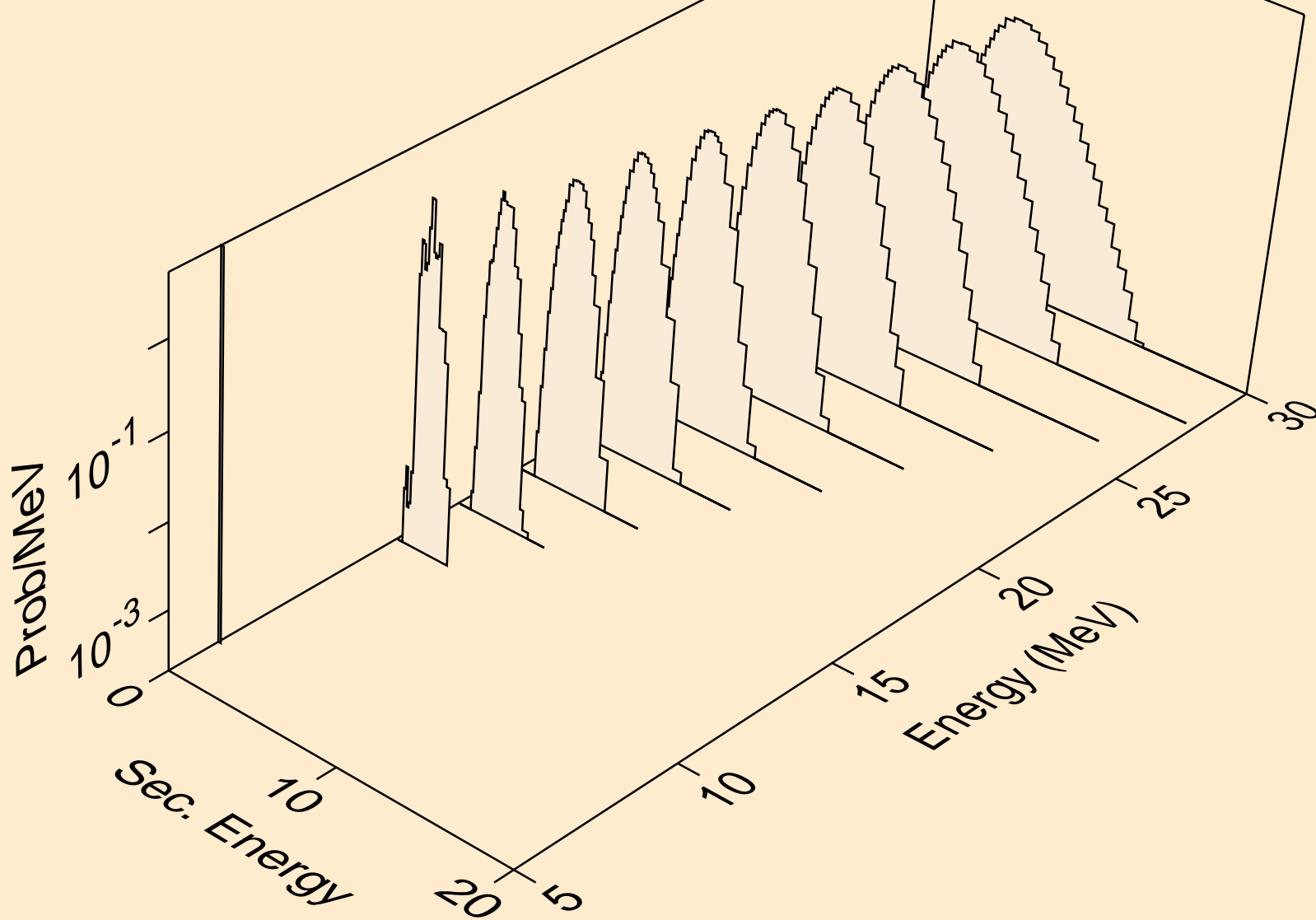

SR084 NEUTRON ACER TENDL-2019 LIBRARY; T=293.16K
protons from (n,pd)

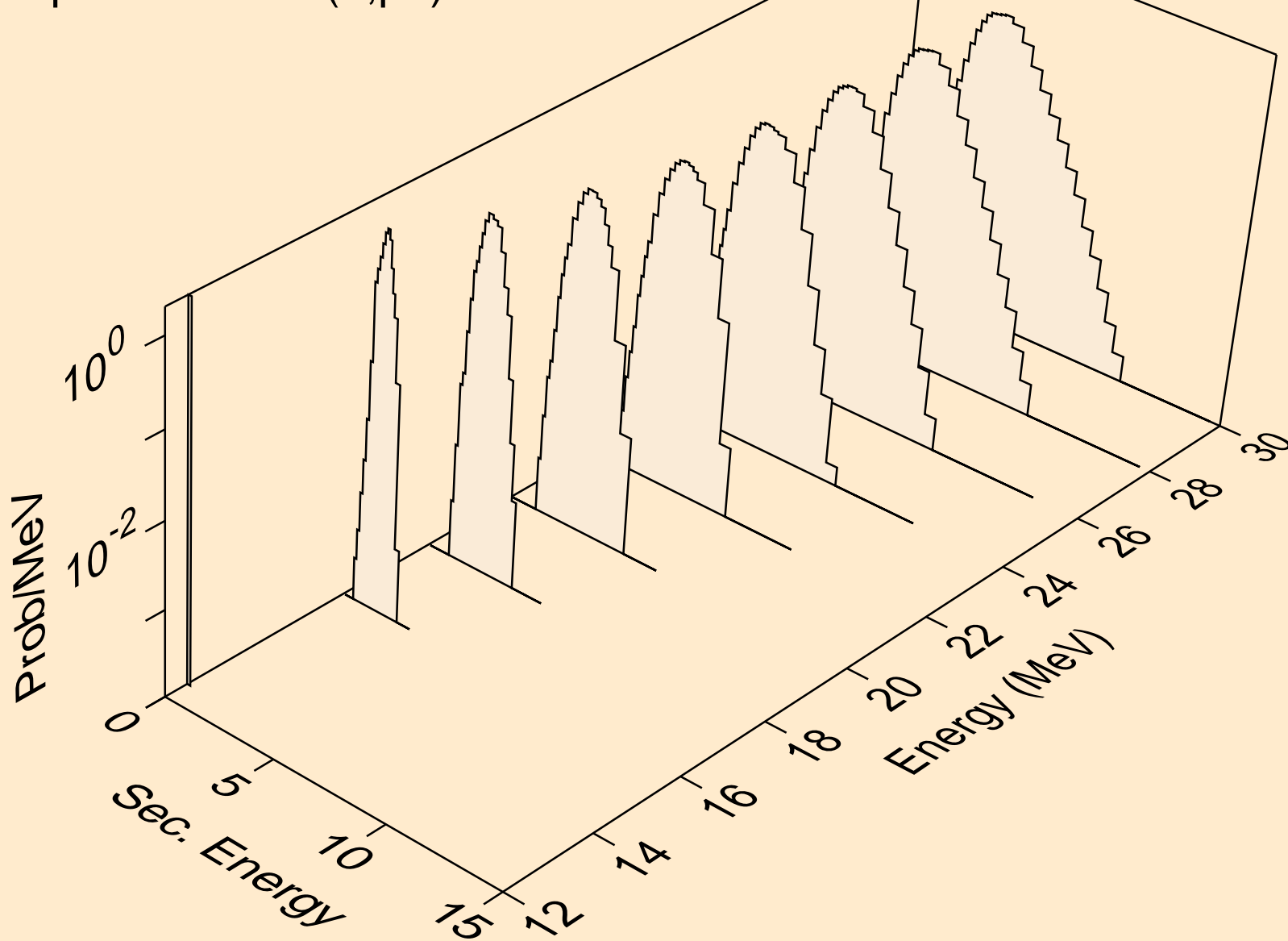

SR084 NEUTRON ACER TENDL-2019 LIBRARY; T=293.16K
protons from (n,pt)

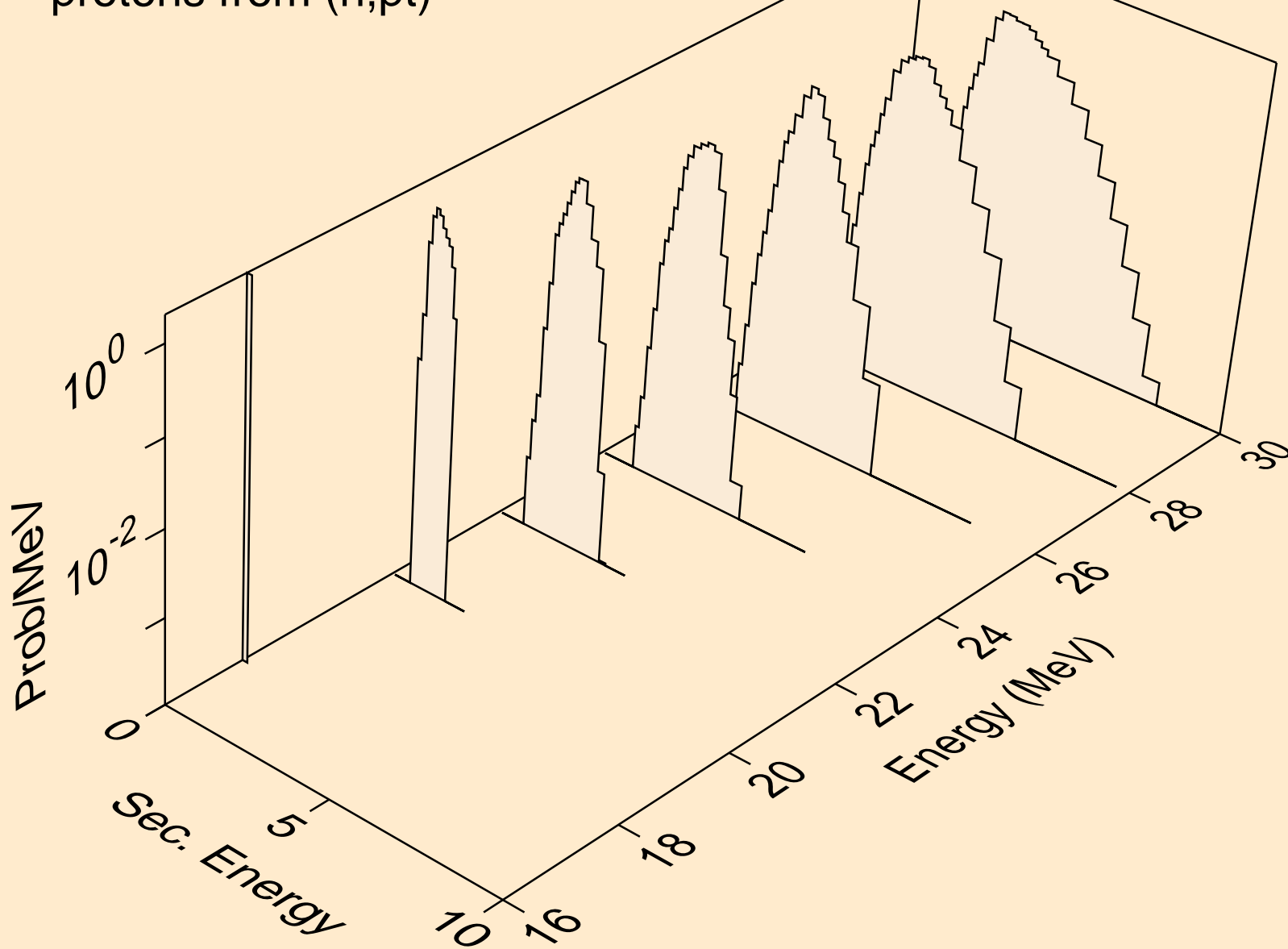

SR084 NEUTRON ACER TENDL-2019 LIBRARY; T=293.16K
deuterons from (n,x)

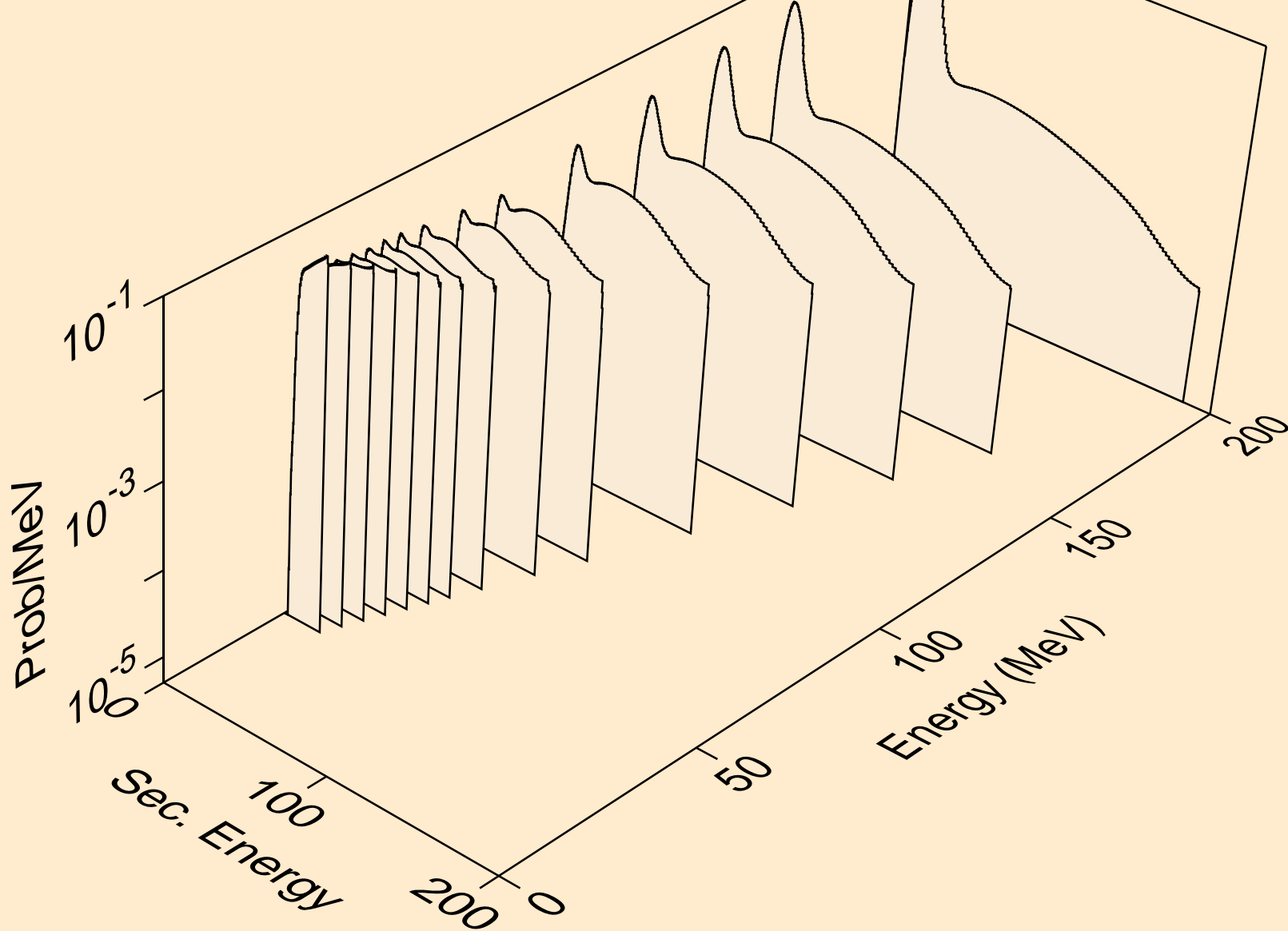

SR084 NEUTRON ACER TENDL-2019 LIBRARY; T=293.16K
deuterons from (n,2nd)

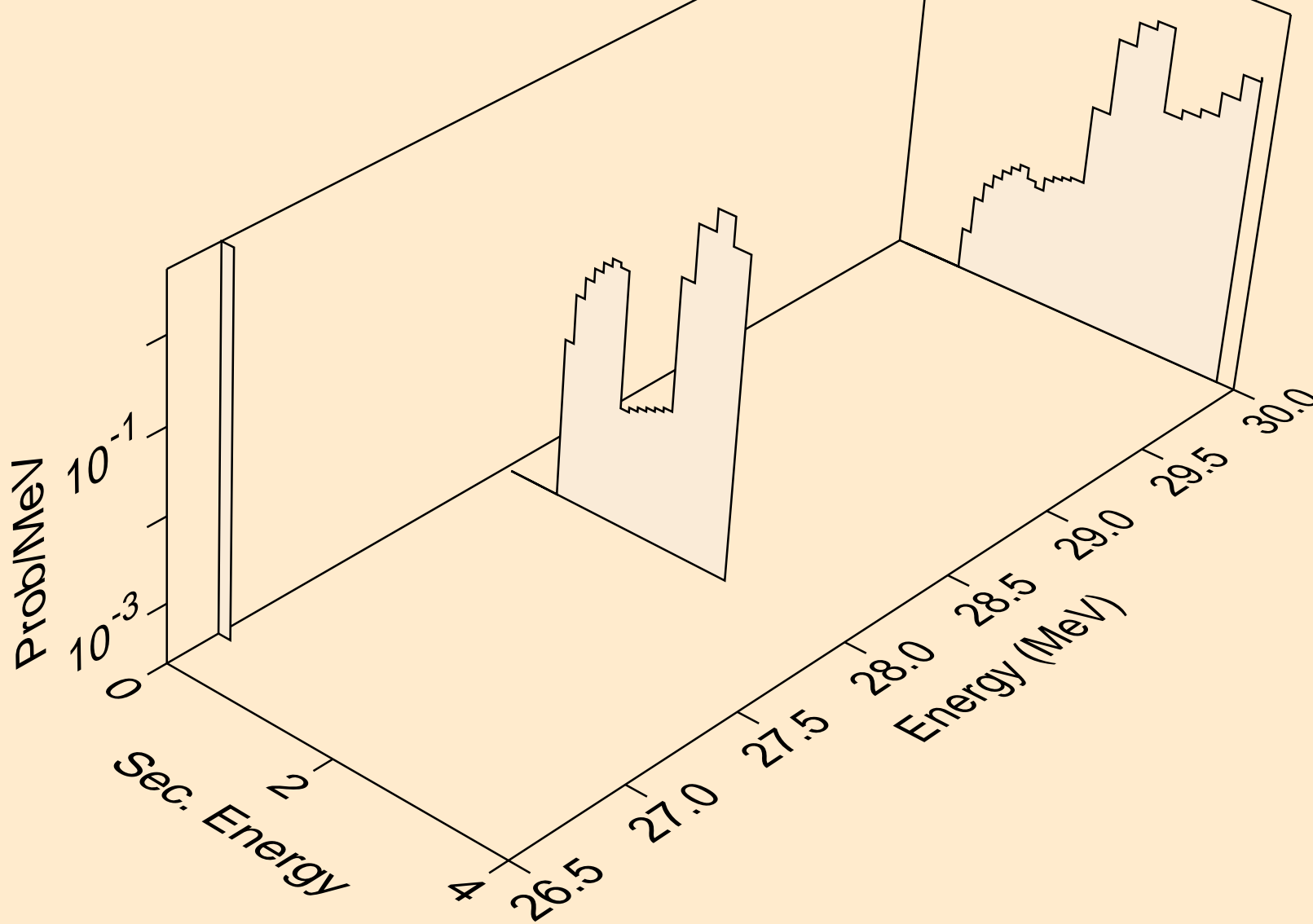

SR084 NEUTRON ACER TENDL-2019 LIBRARY; T=293.16K
deuterons from (n,n*)d

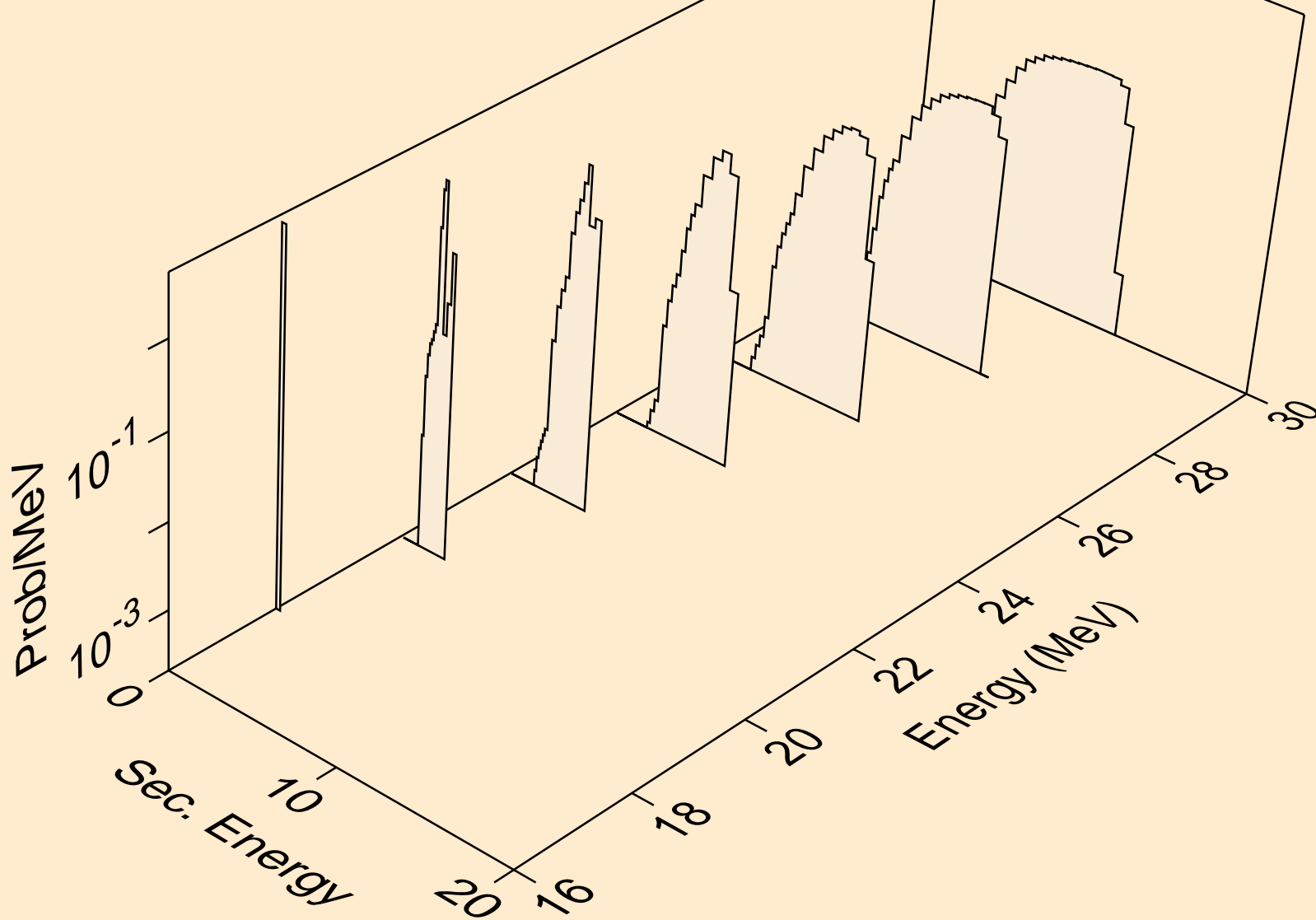

SR084 NEUTRON ACER TENDL-2019 LIBRARY; T=293.16K
deuterons from (n,d)

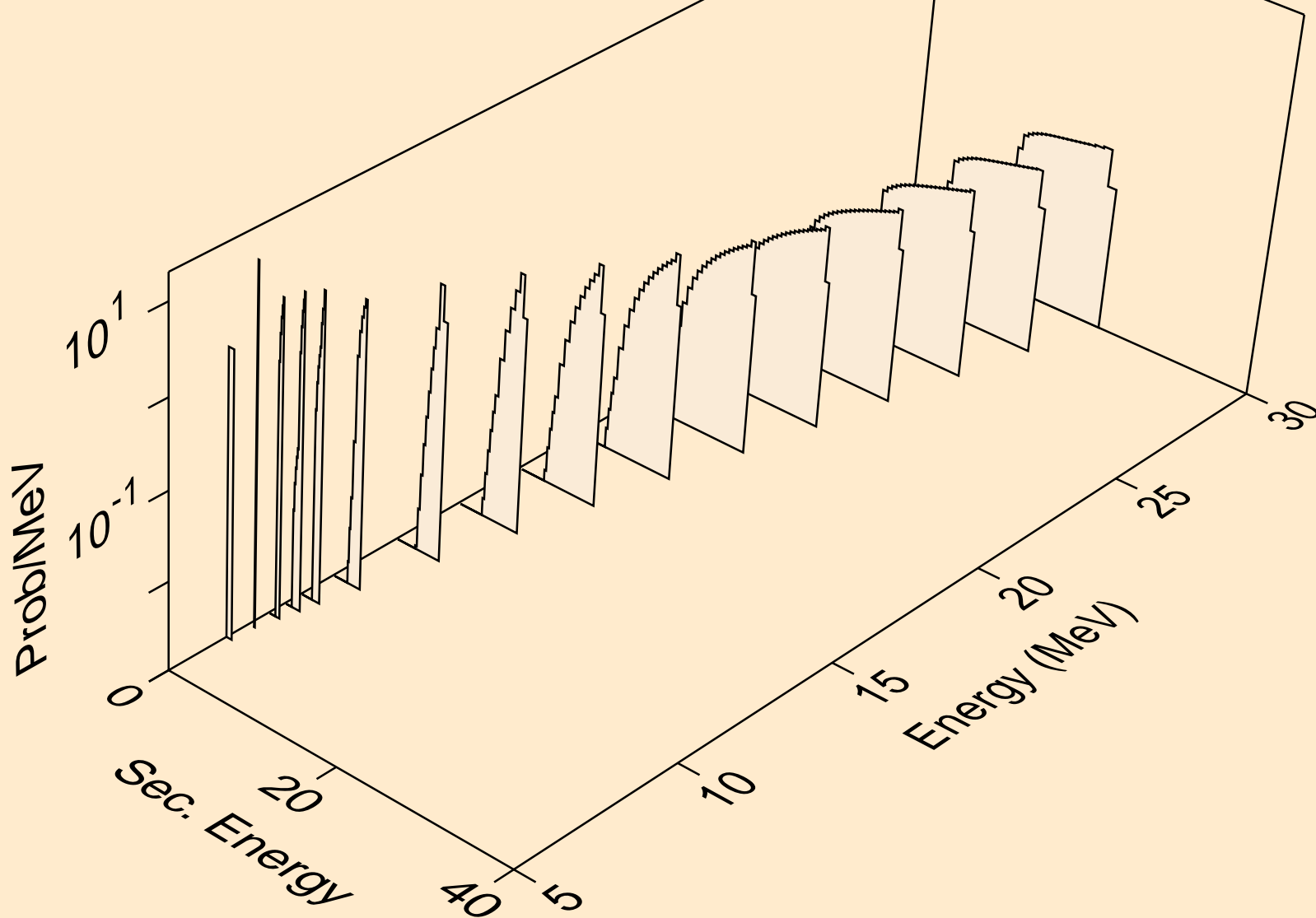

SR084 NEUTRON ACER TENDL-2019 LIBRARY; T=293.16K
deuterons from (n,pd)

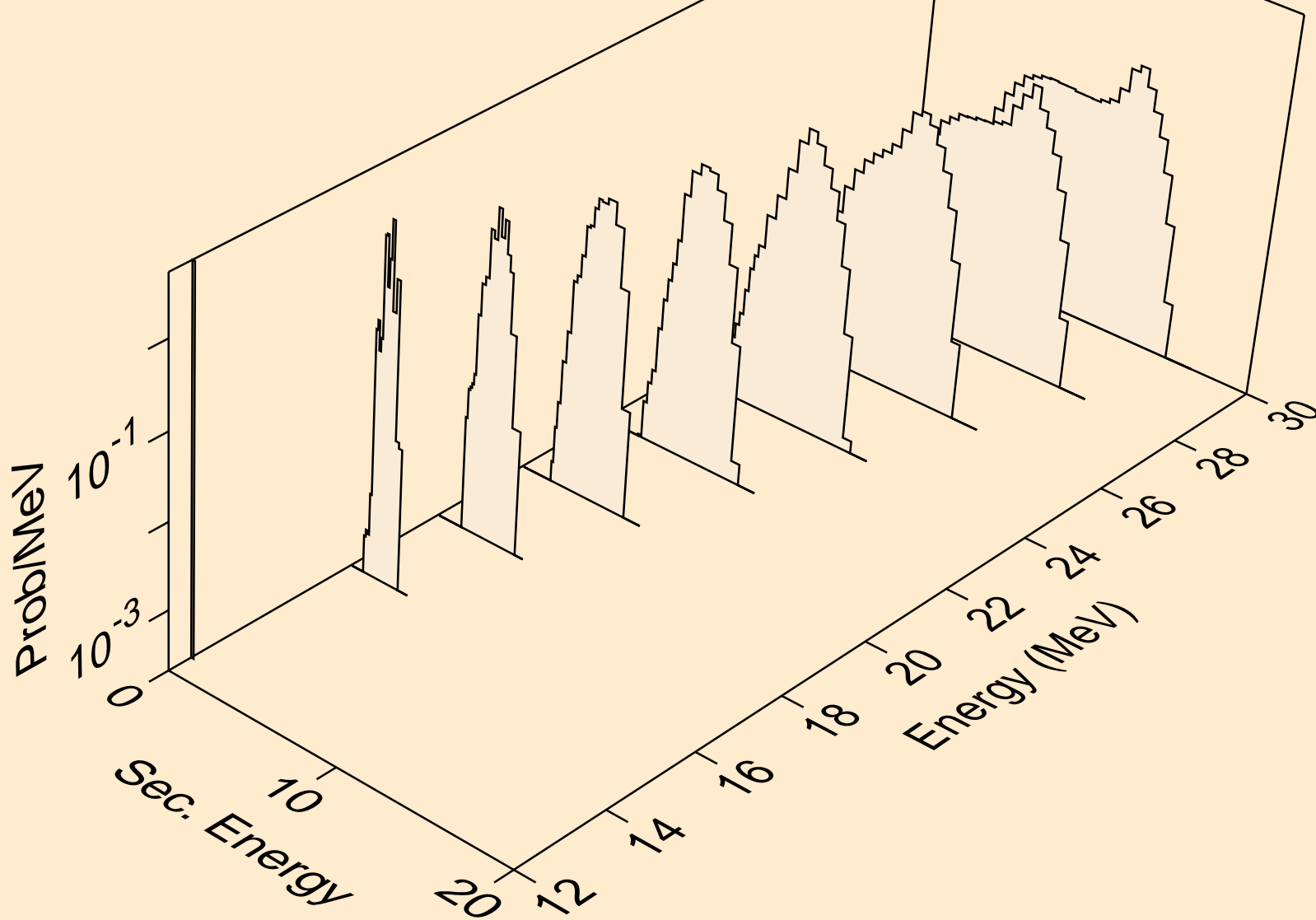

SR084 NEUTRON ACER TENDL-2019 LIBRARY; T=293.16K
deuterons from (n,da)

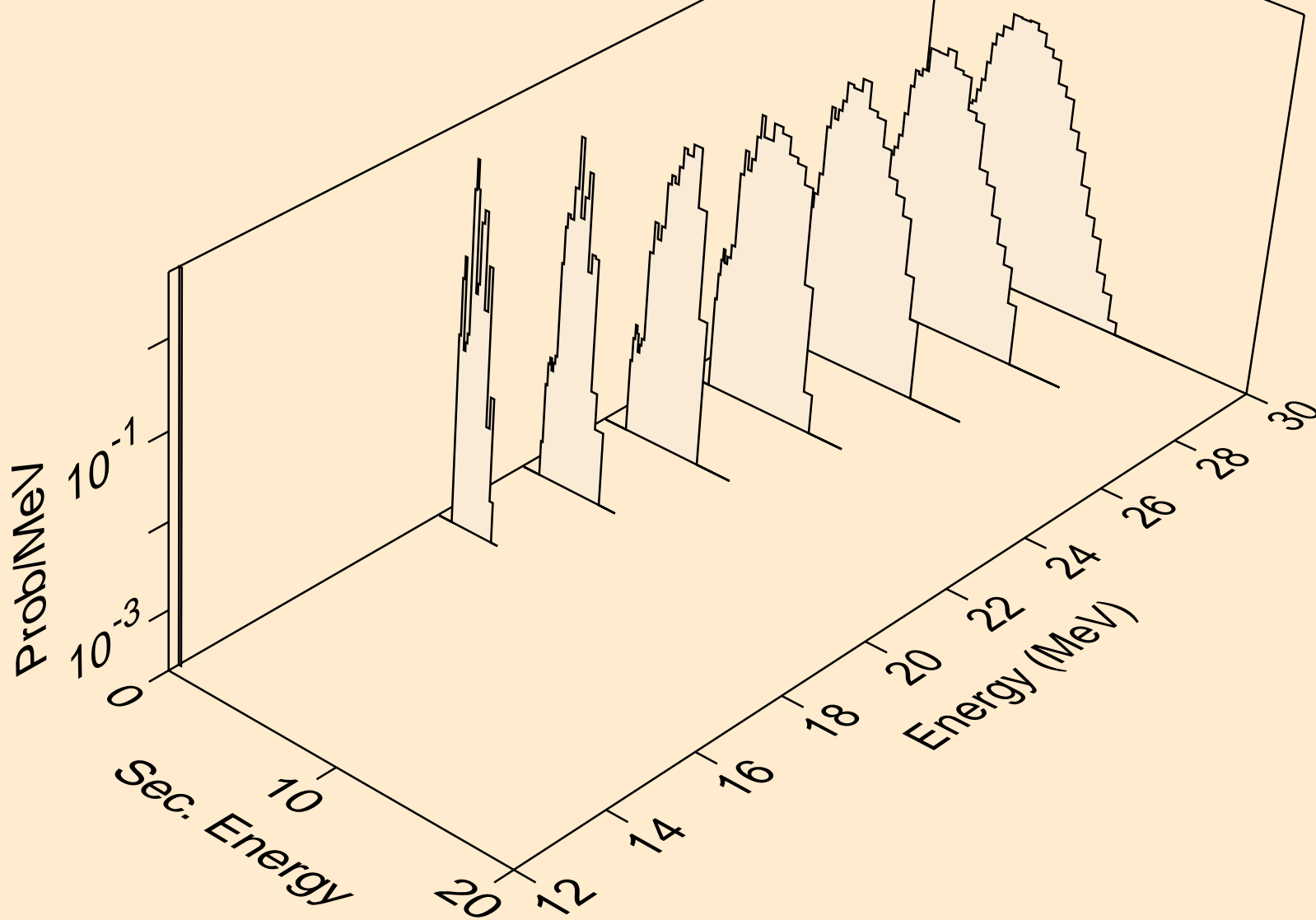

SR084 NEUTRON ACER TENDL-2019 LIBRARY; T=293.16K
tritons from (n,x)

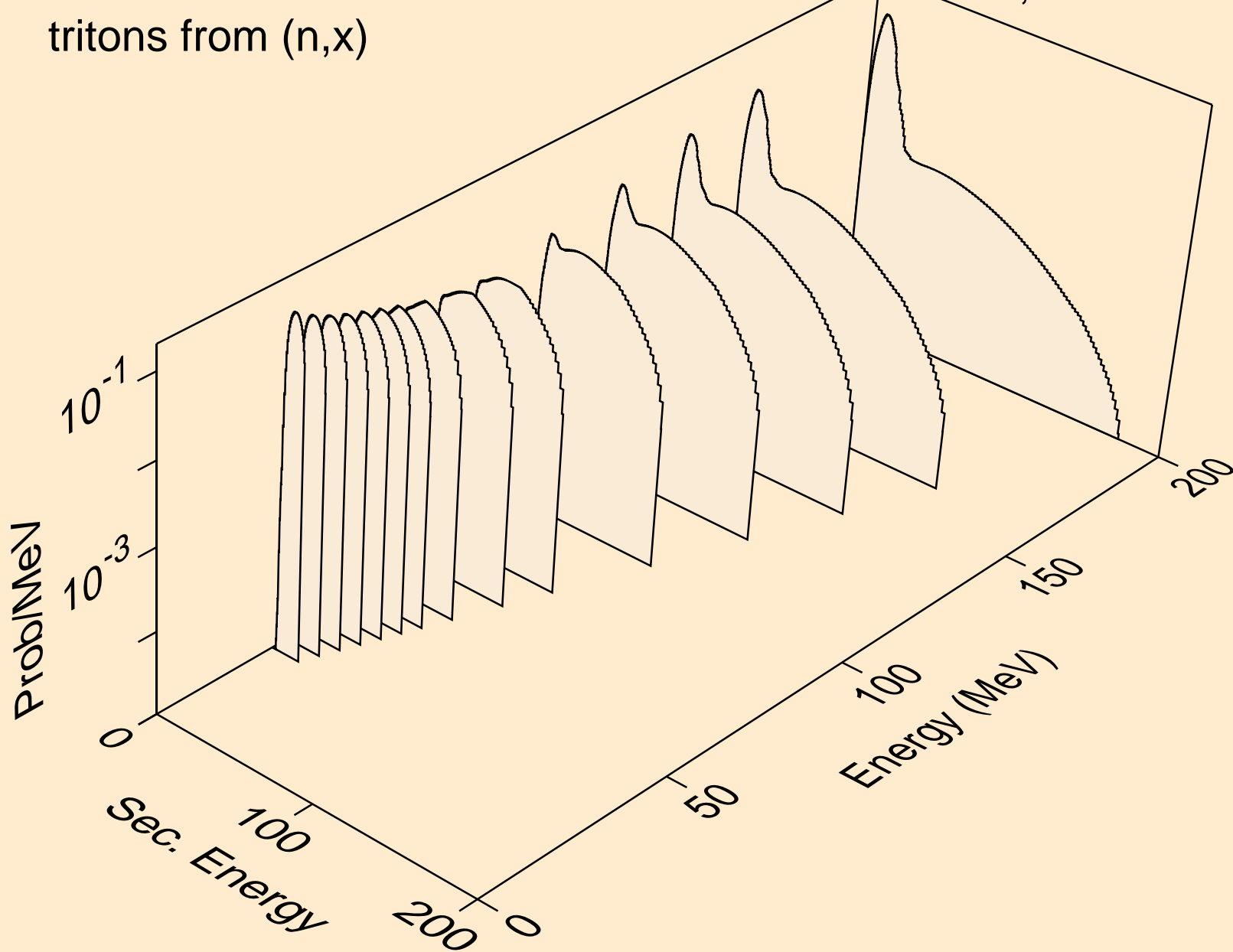

SR084 NEUTRON ACER TENDL-2019 LIBRARY; T=293.16K
tritons from (n,n*)t

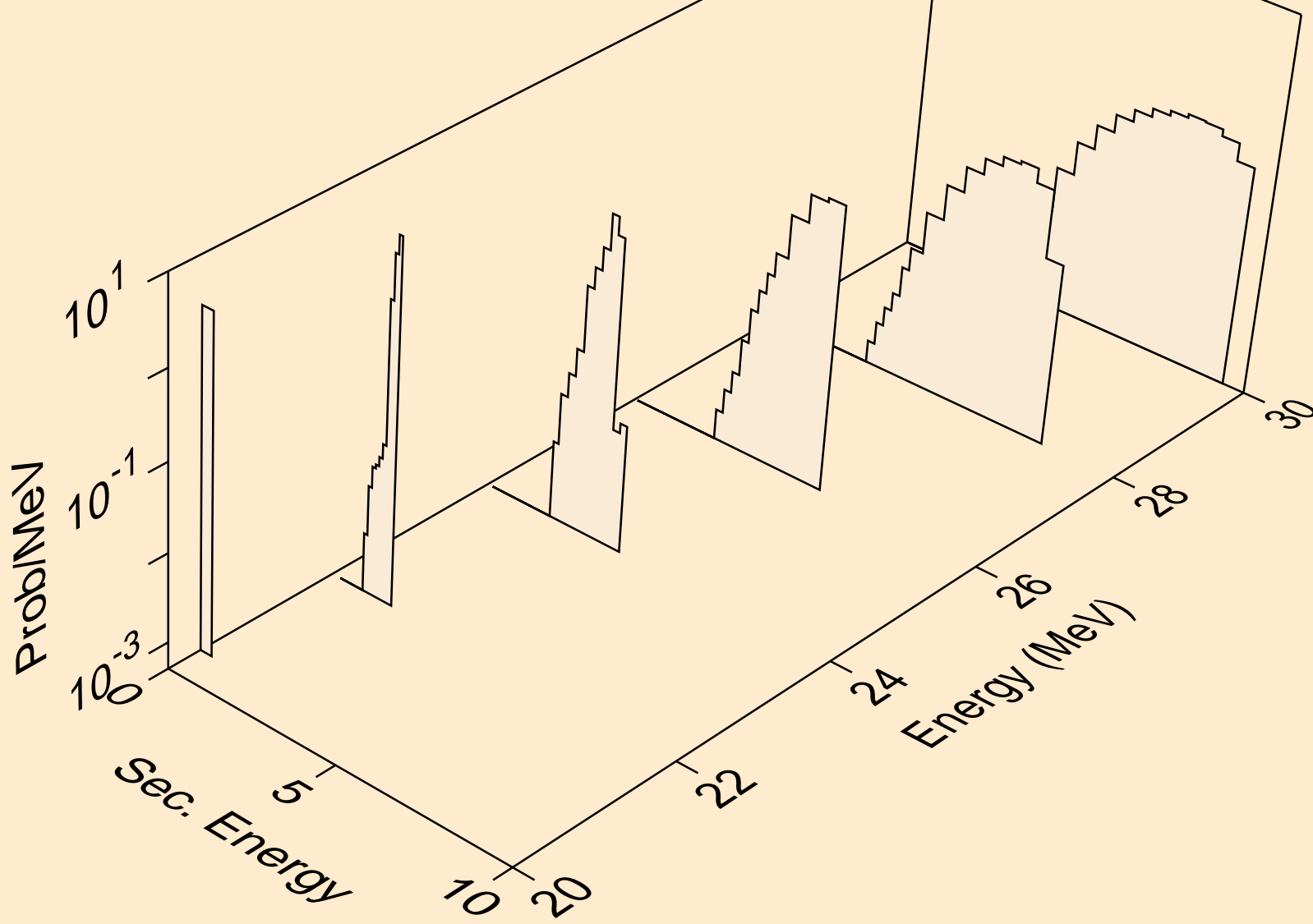

SR084 NEUTRON ACER TENDL-2019 LIBRARY; T=293.16K
tritons from (n,t)

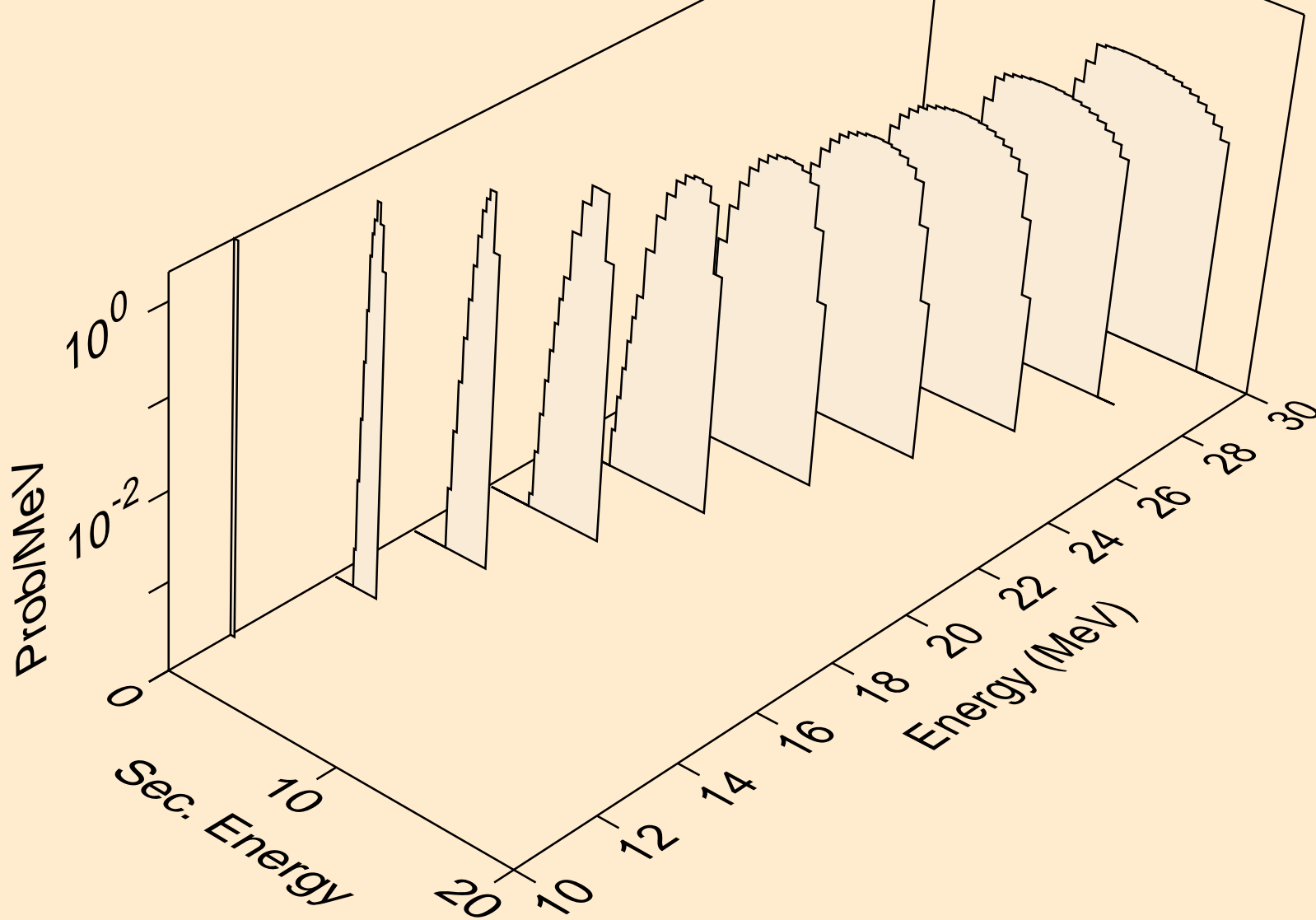

SR084 NEUTRON ACER TENDL-2019 LIBRARY; T=293.16K
tritons from (n,pt)

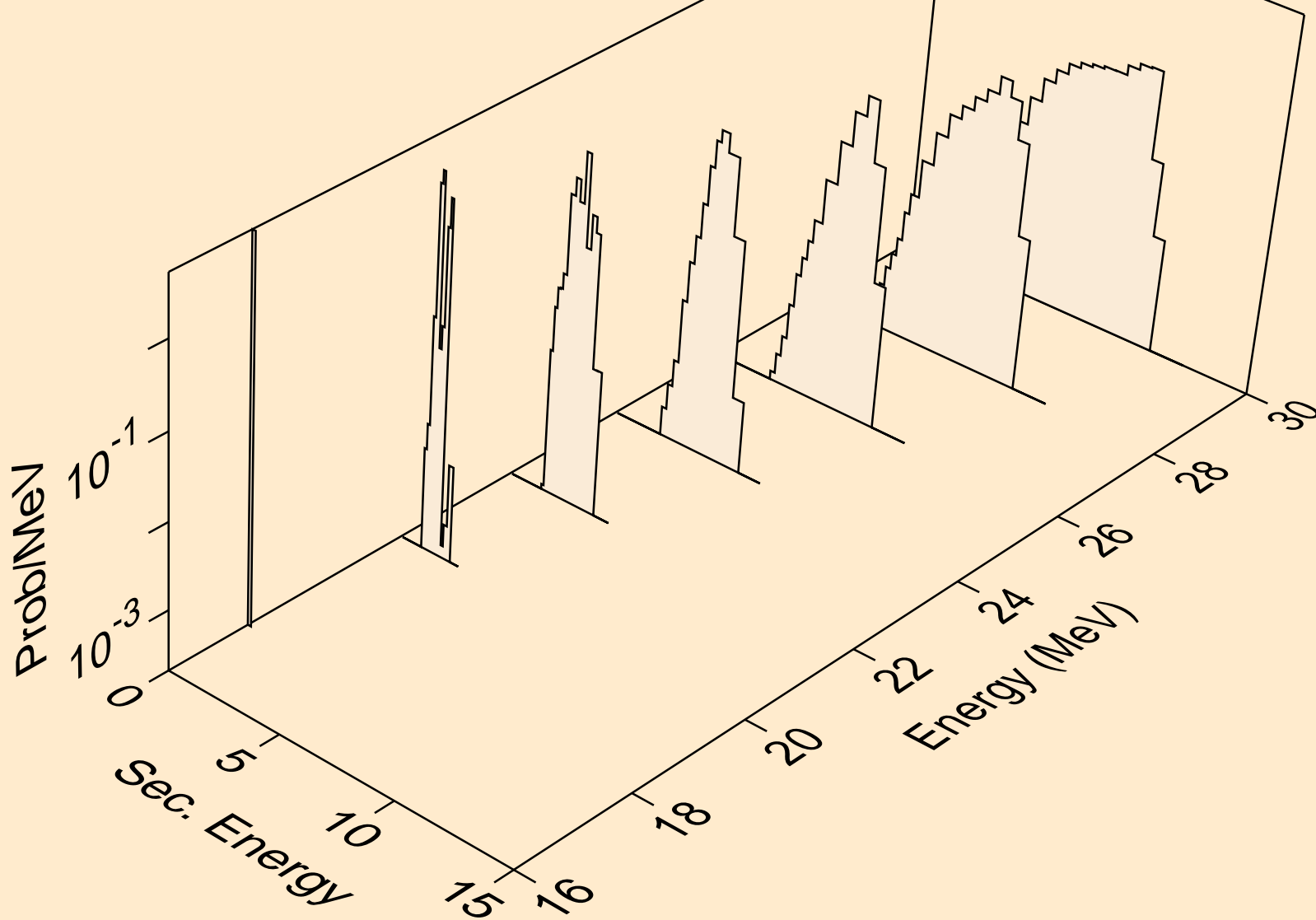

SR084 NEUTRON ACER TENDL-2019 LIBRARY; T=293.16K
he3s from (n,x)

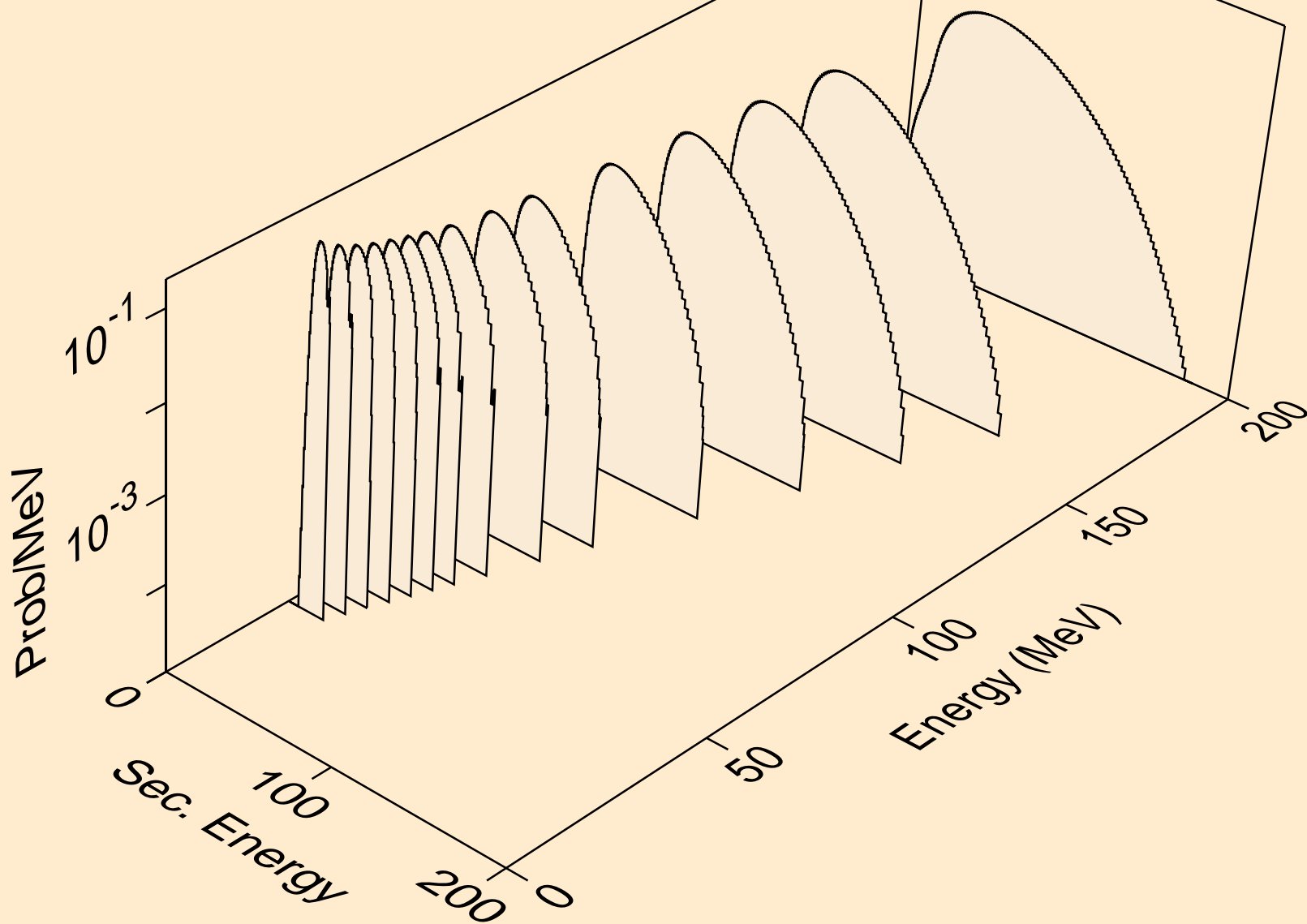

SR084 NEUTRON ACER TENDL-2019 LIBRARY; T=293.16K
he3s from (n,n*)he3

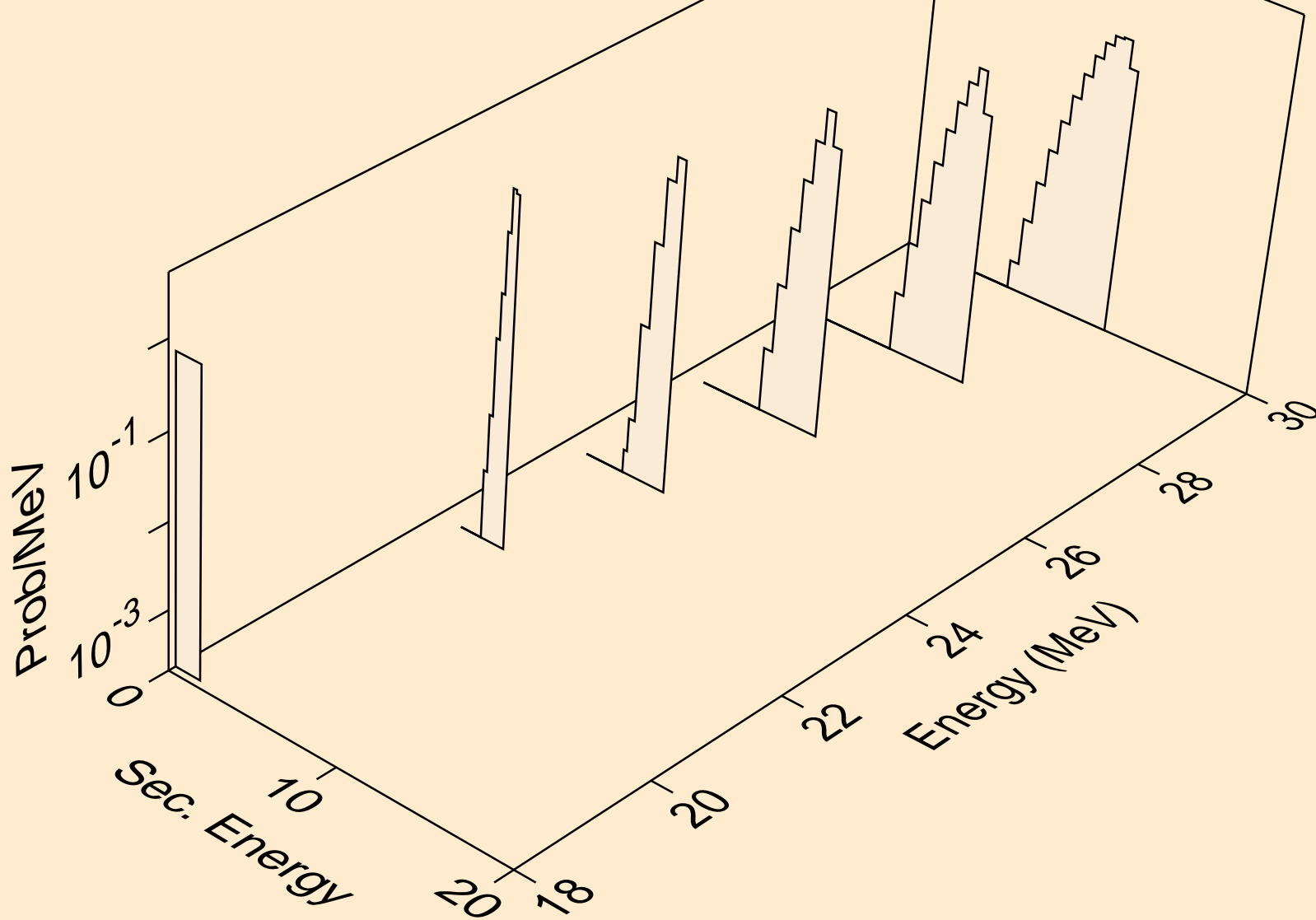

SR084 NEUTRON ACER TENDL-2019 LIBRARY; T=293.16K
he3s from (n,he3)

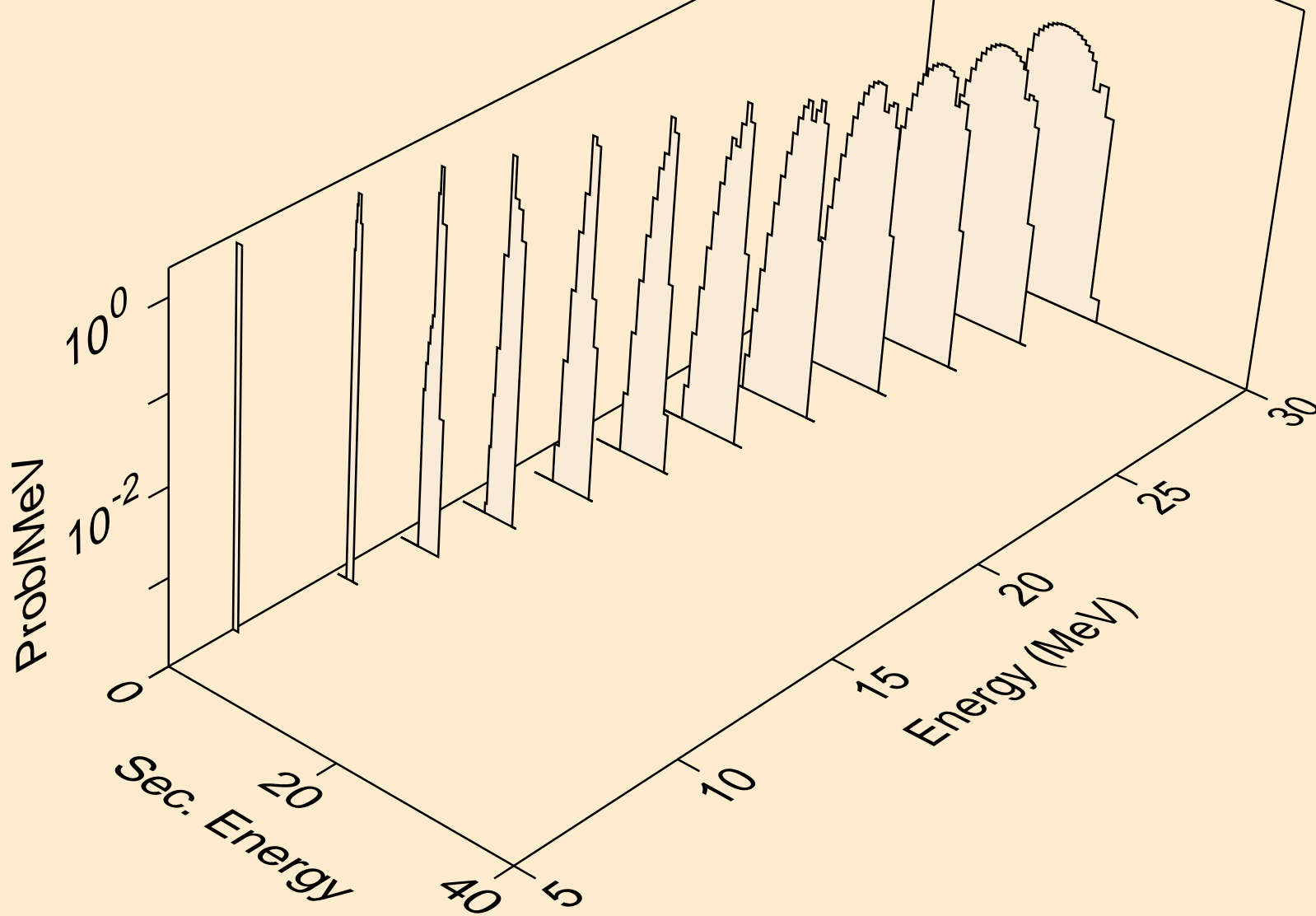

SR084 NEUTRON ACER TENDL-2019 LIBRARY; T=293.16K
alphas from (n,x)

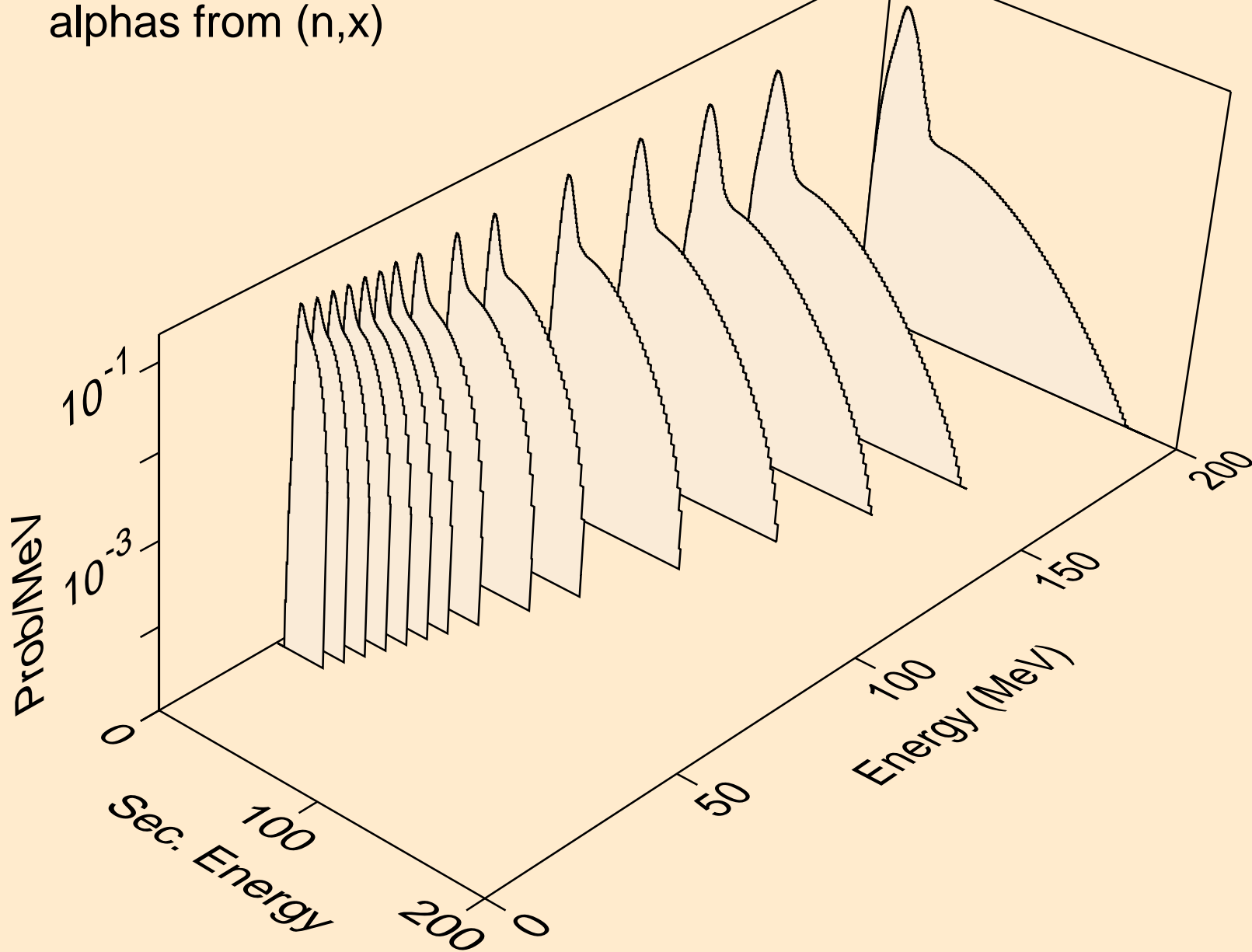

SR084 NEUTRON ACER TENDL-2019 LIBRARY; T=293.16K
alphas from (n,n*)a

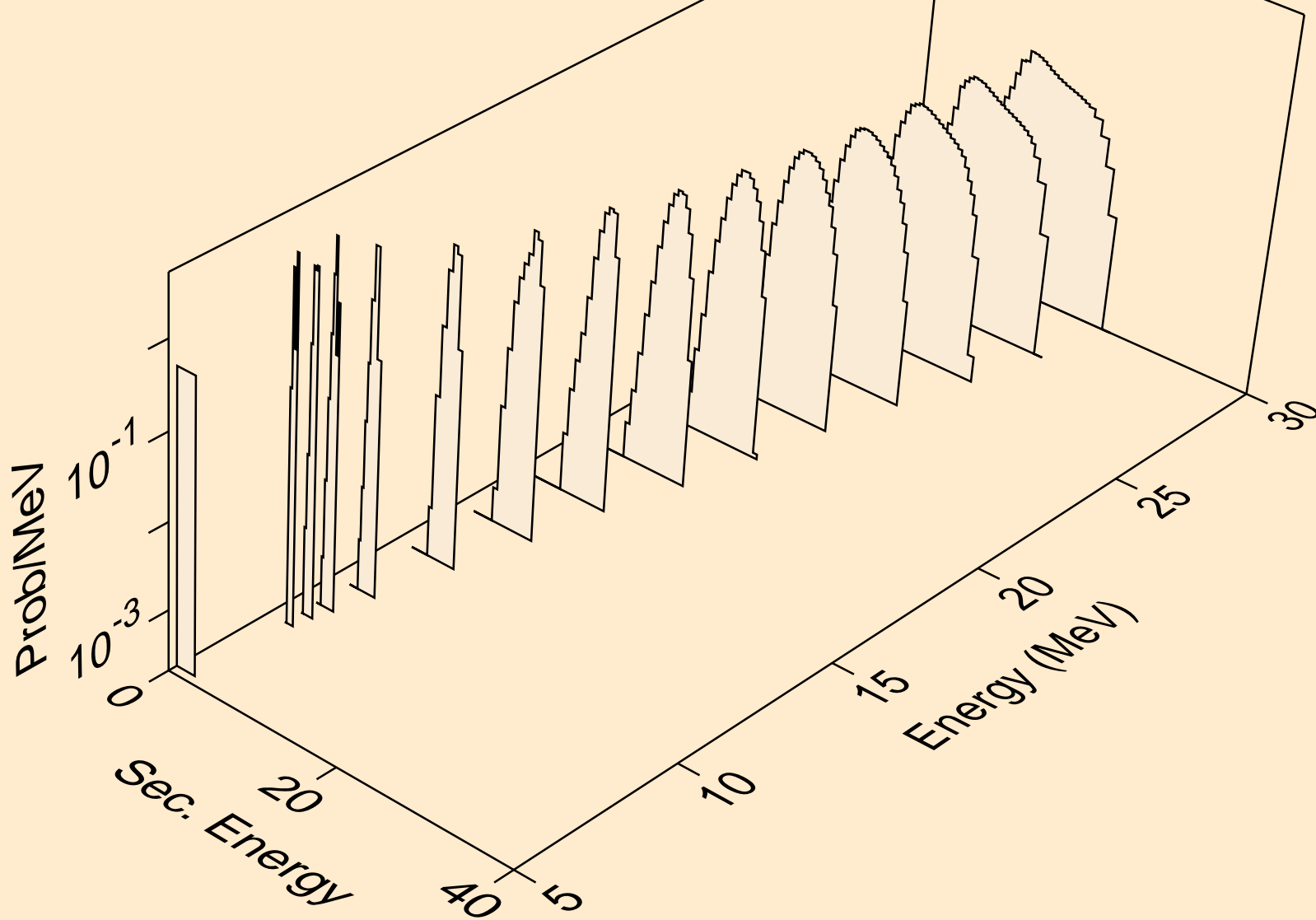

SR084 NEUTRON ACER TENDL-2019 LIBRARY; T=293.16K
alphas from (n,2n)a

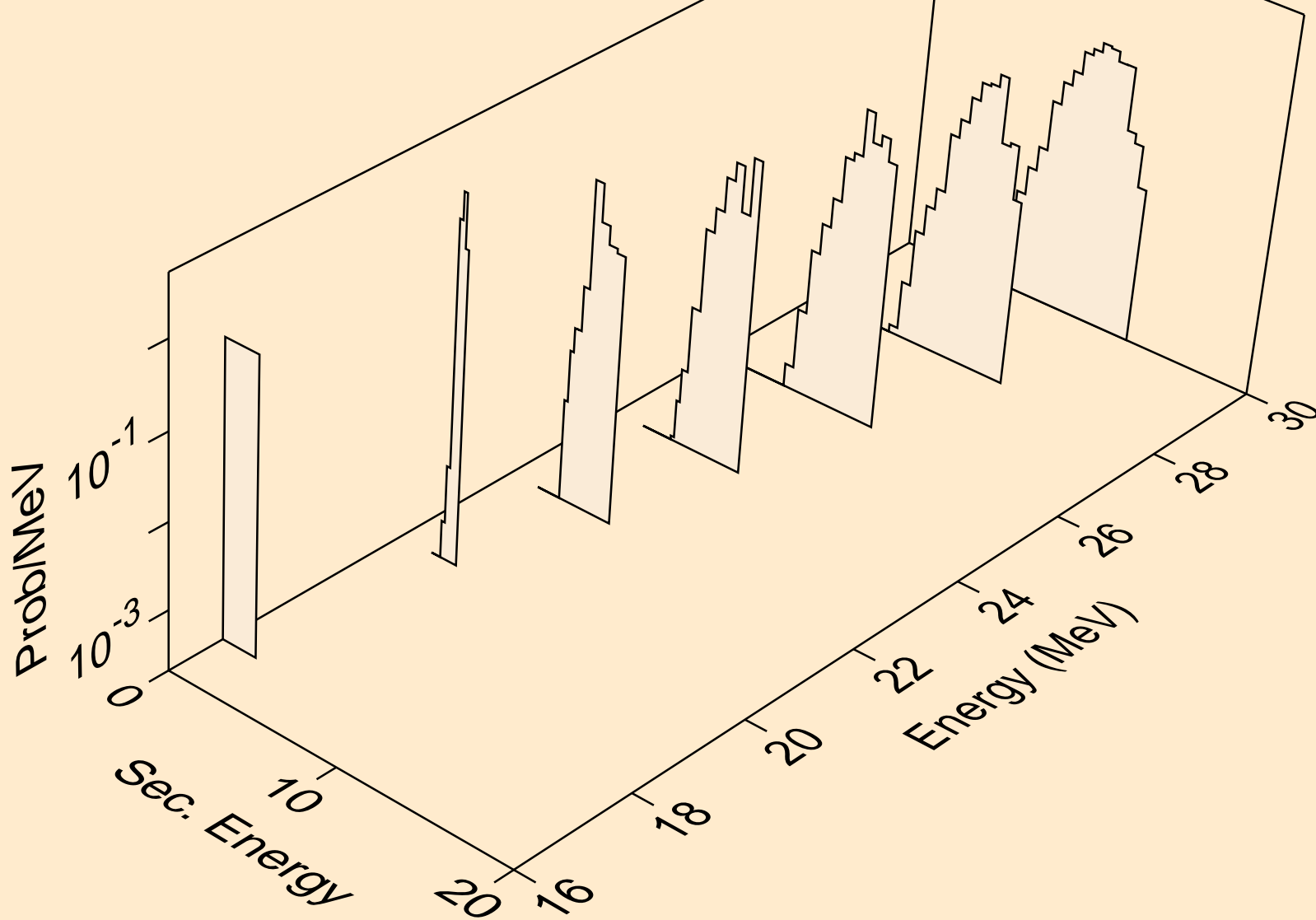

SR084 NEUTRON ACER TENDL-2019 LIBRARY; T=293.16K
alphas from (n,n*)2a

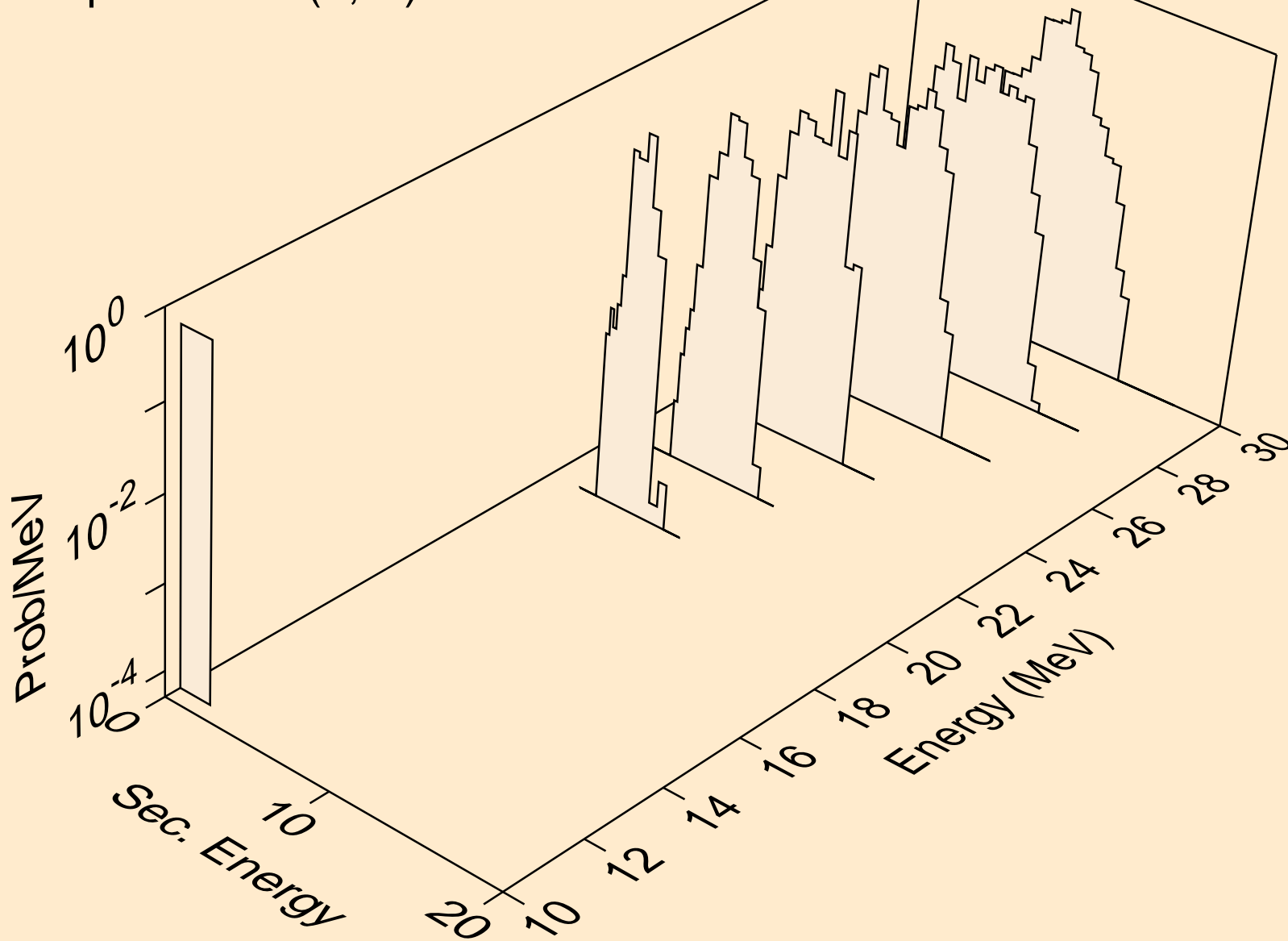

SR084 NEUTRON ACER TENDL-2019 LIBRARY; T=293.16K
alphas from (n,npa)

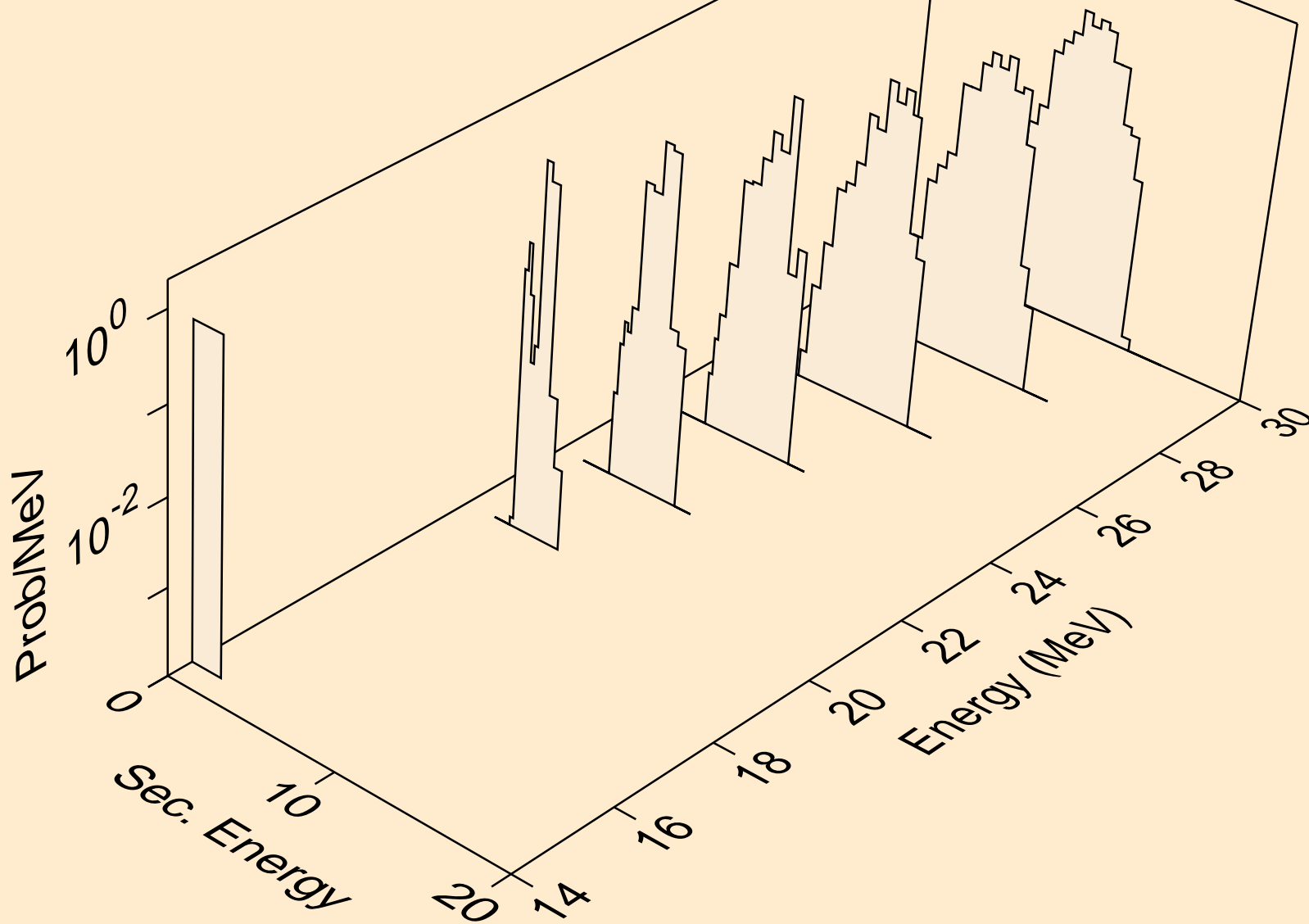

SR084 NEUTRON ACER TENDL-2019 LIBRARY; T=293.16K
alphas from (n,a)

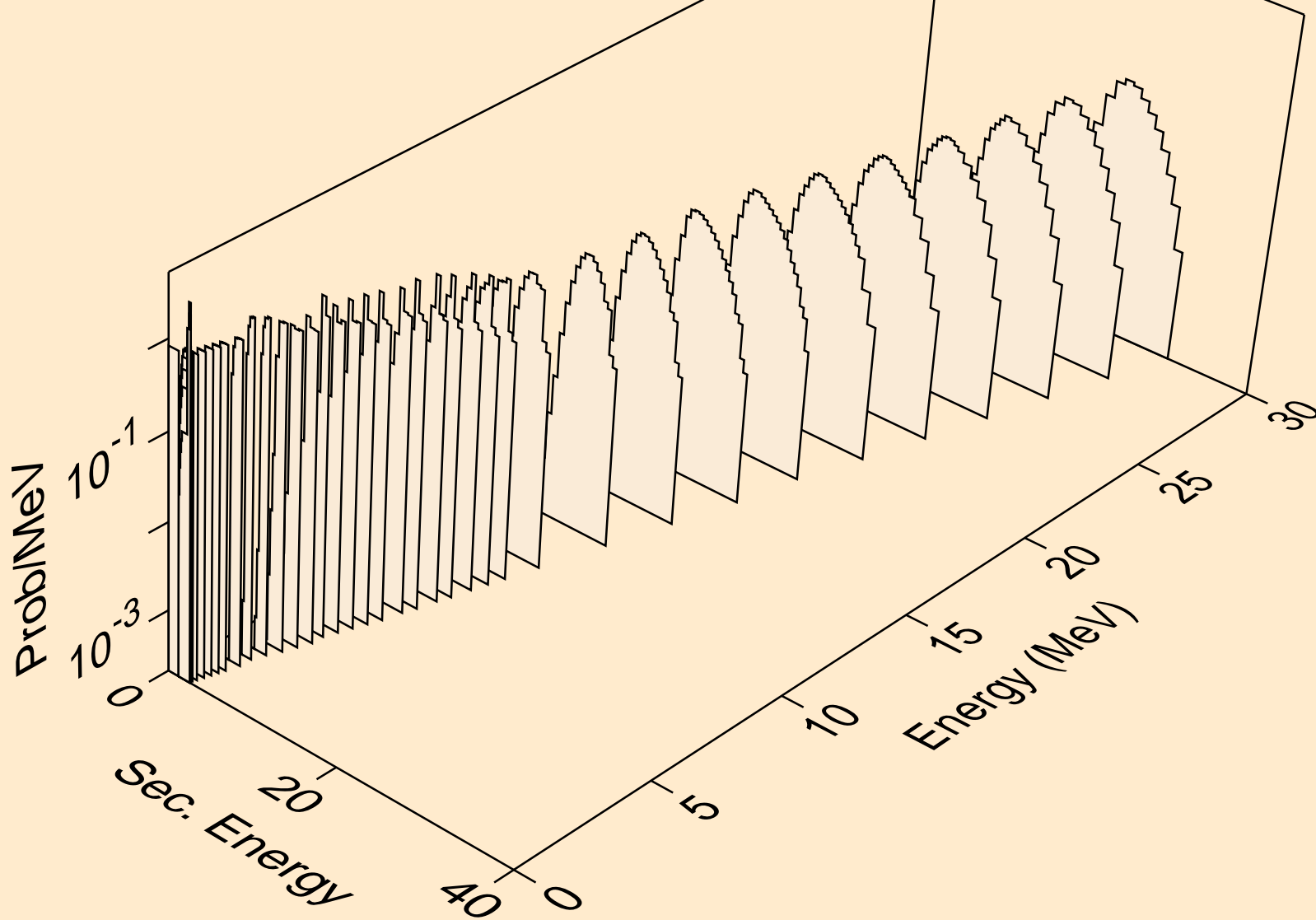

SR084 NEUTRON ACER TENDL-2019 LIBRARY; T=293.16K
alphas from (n,2a)

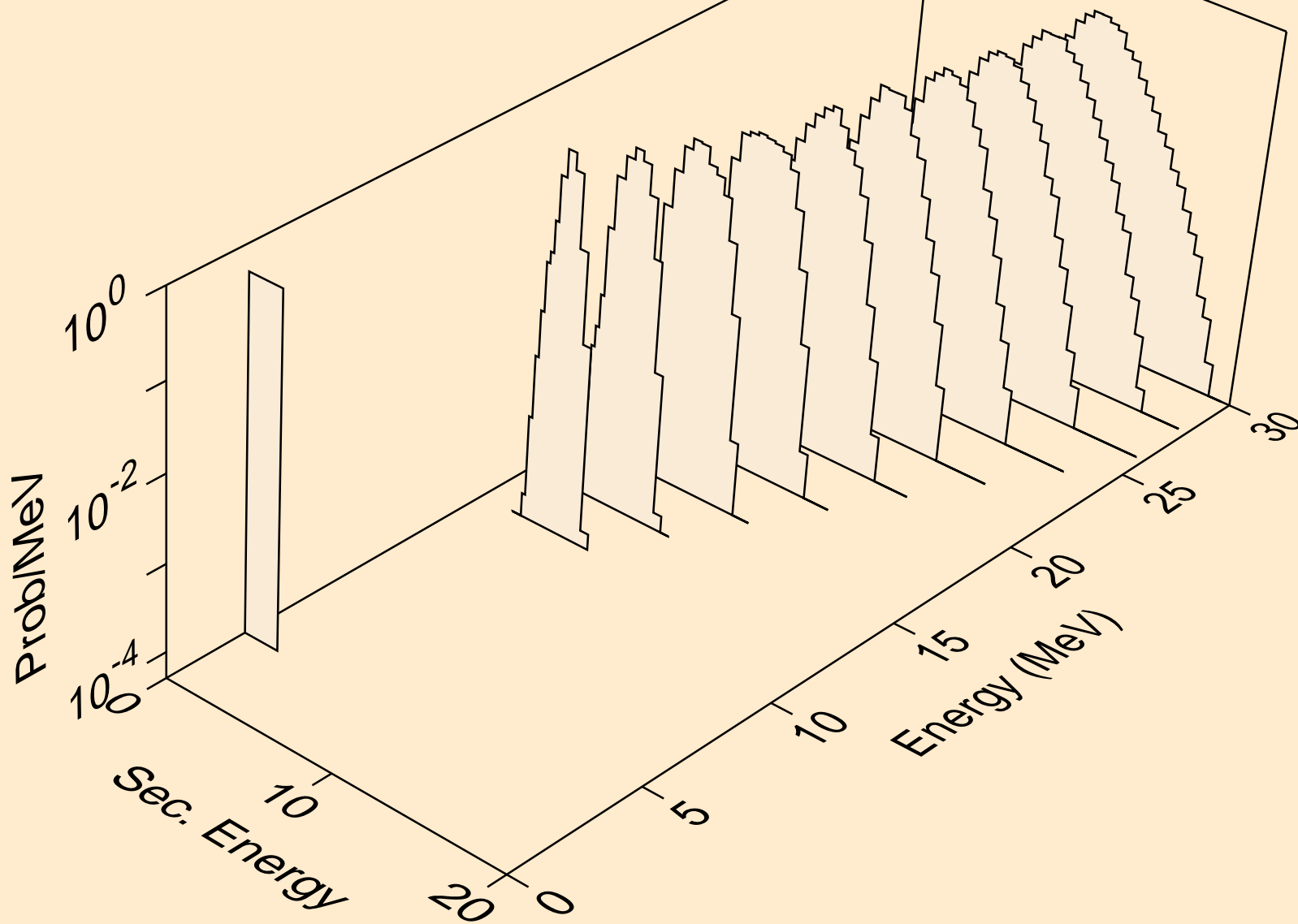

SR084 NEUTRON ACER TENDL-2019 LIBRARY; T=293.16K
alphas from (n,pa)

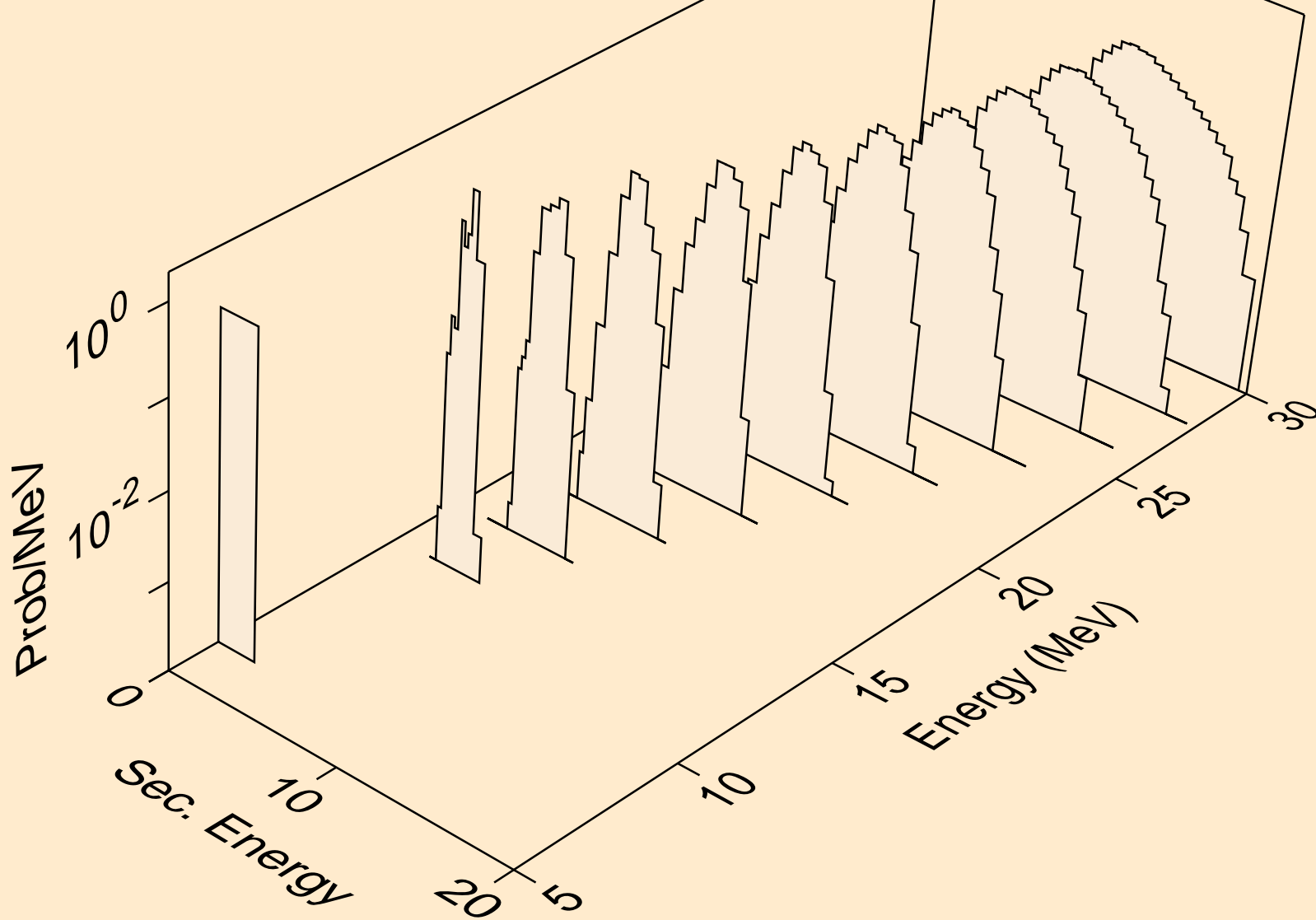

SR084 NEUTRON ACER TENDL-2019 LIBRARY; T=293.16K
alphas from (n,da)

