

TE123 NEUTRON ACER TENDL-2019 LIBRARY; T=293.16K
Principal cross sections

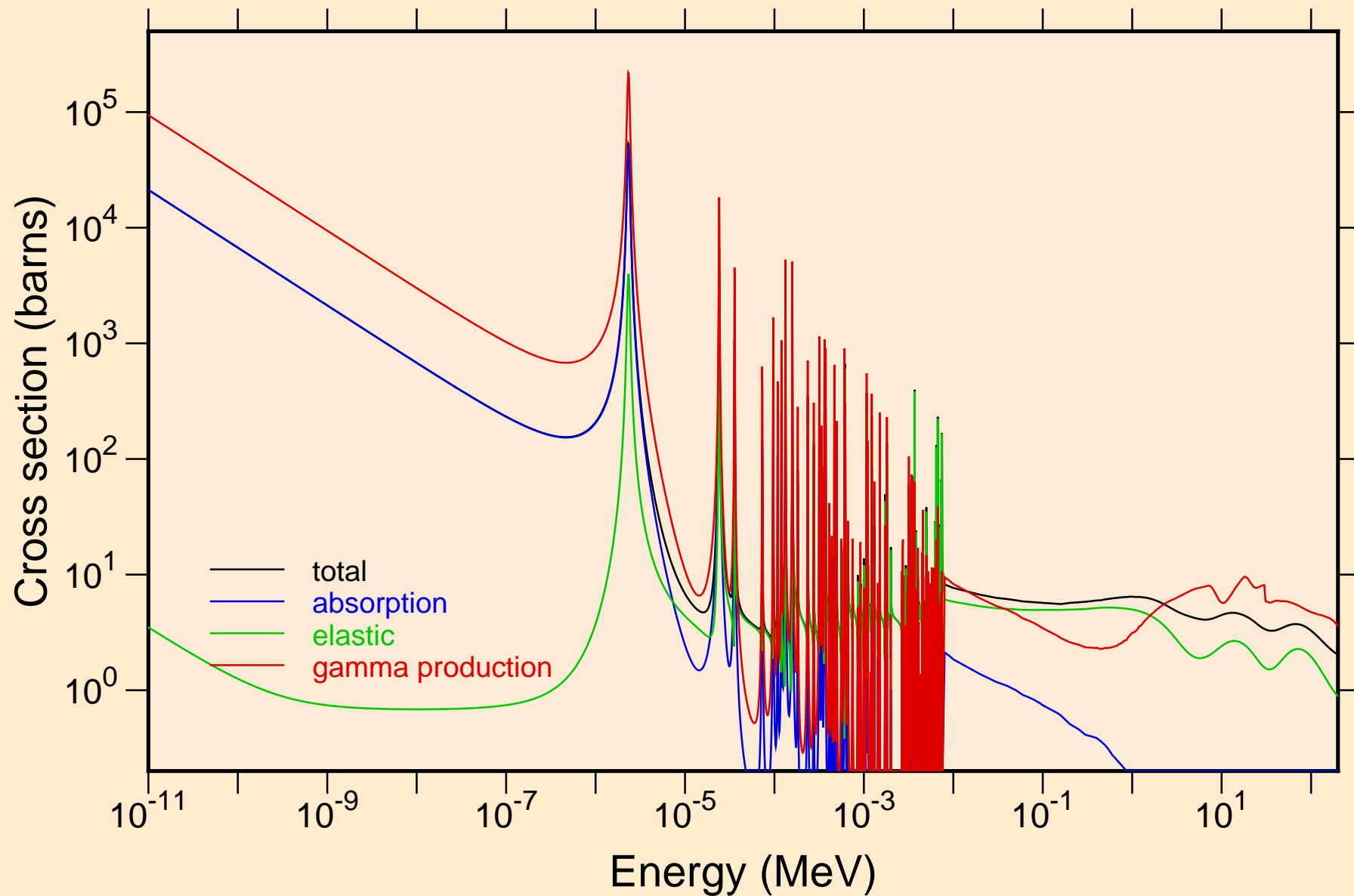

TE123 NEUTRON ACER TENDL-2019 LIBRARY; T=293.16K
resonance total cross section

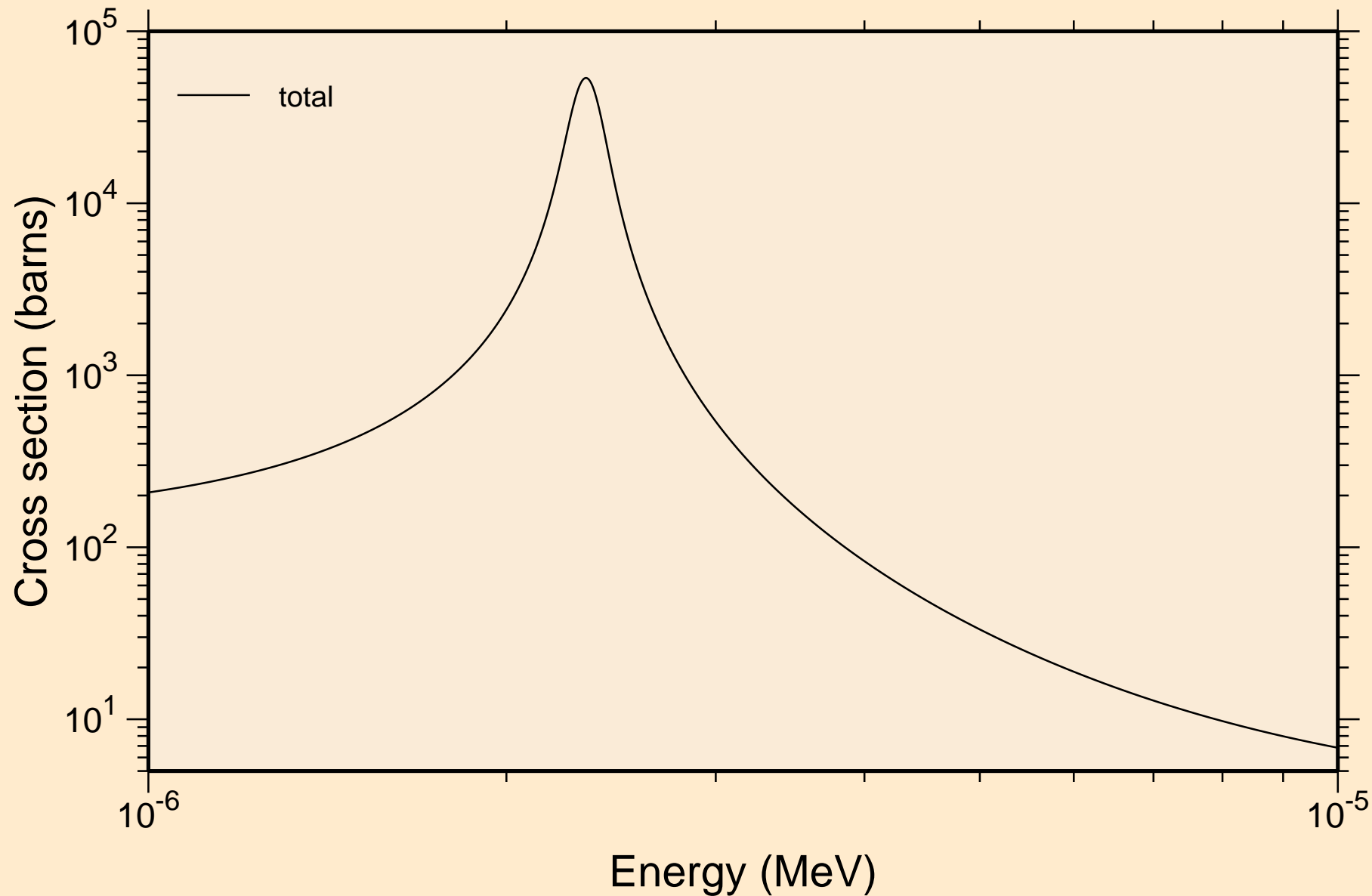

TE123 NEUTRON ACER TENDL-2019 LIBRARY; T=293.16K
resonance total cross section

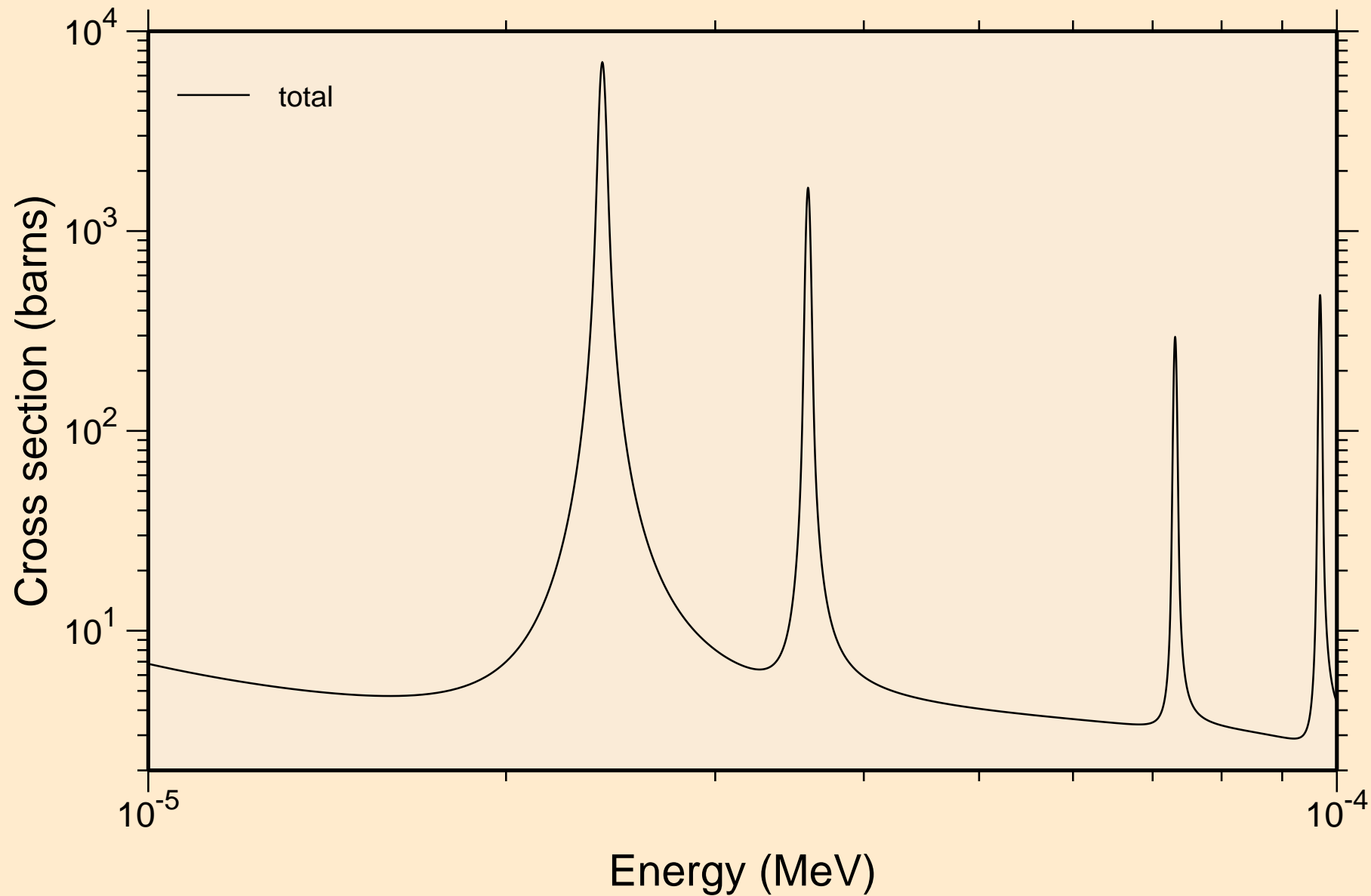

TE123 NEUTRON ACER TENDL-2019 LIBRARY; T=293.16K
resonance total cross section

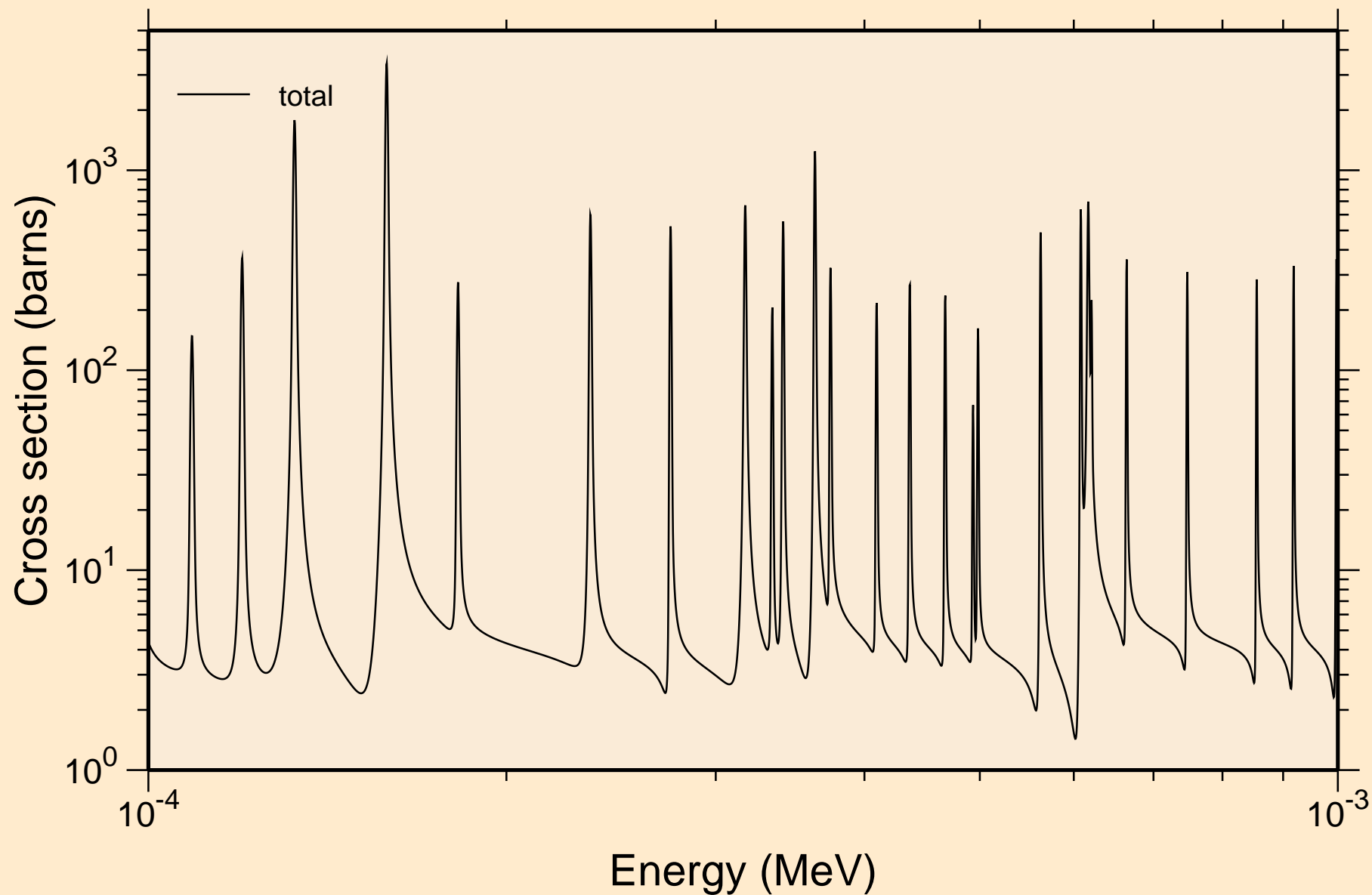

TE123 NEUTRON ACER TENDL-2019 LIBRARY; T=293.16K
resonance total cross section

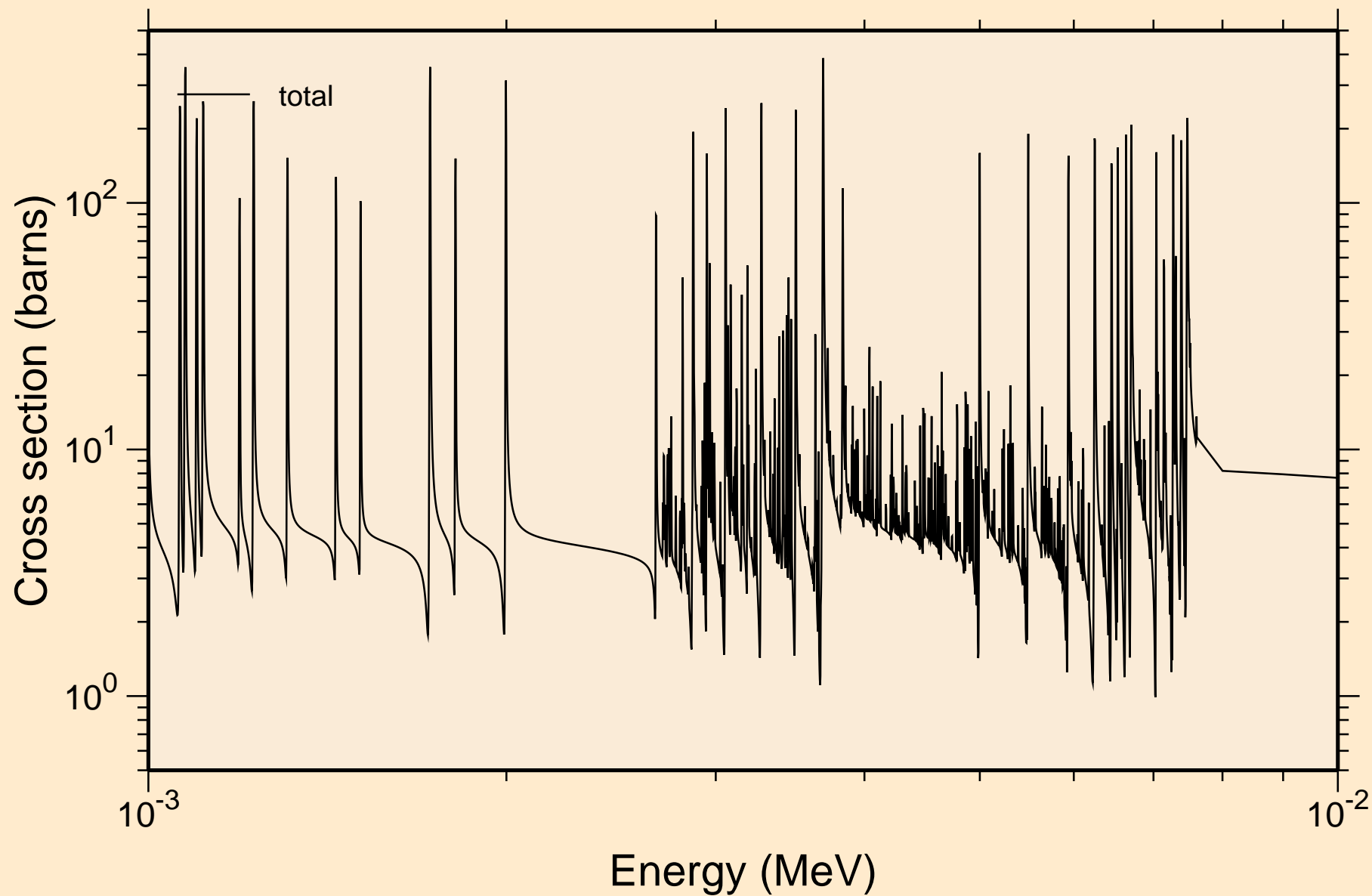

TĒ123 NEUTRON ACER TENDL-2019 LIBRARY; T=293.16K
resonance total cross section

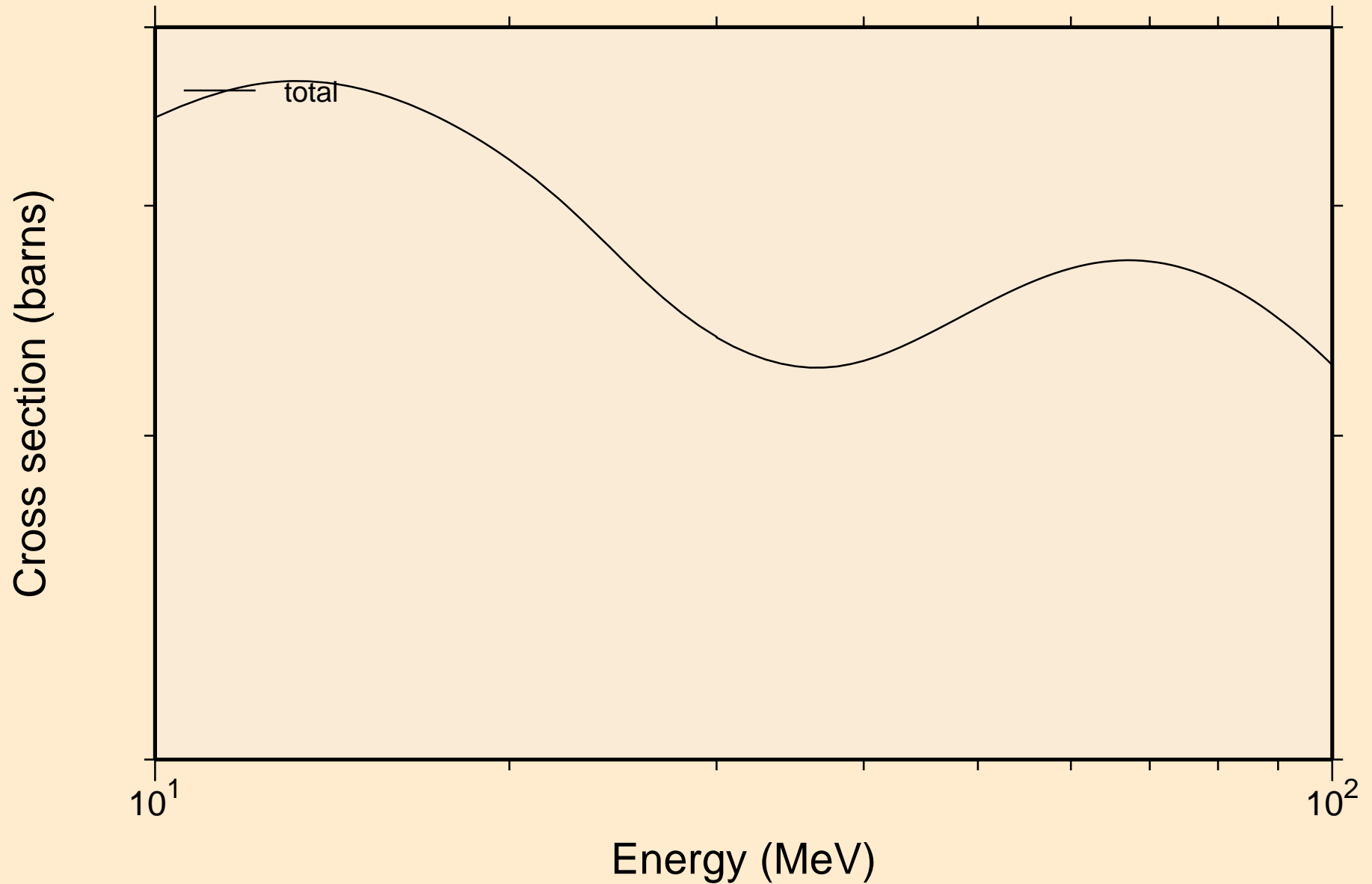

TE123 NEUTRON ACER TENDL-2019 LIBRARY; T=293.16K
resonance absorption cross sections

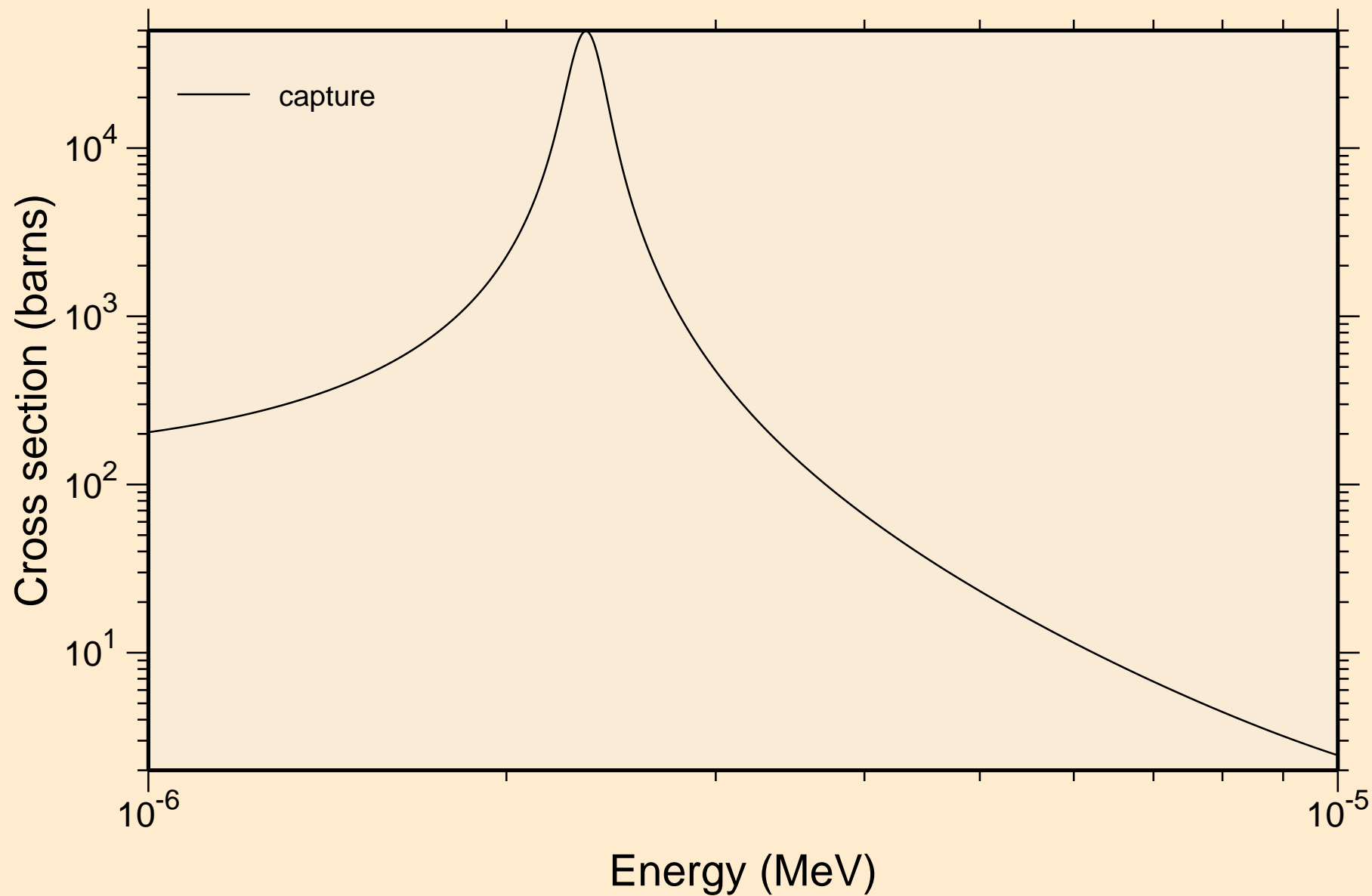

TE123 NEUTRON ACER TENDL-2019 LIBRARY; T=293.16K
resonance absorption cross sections

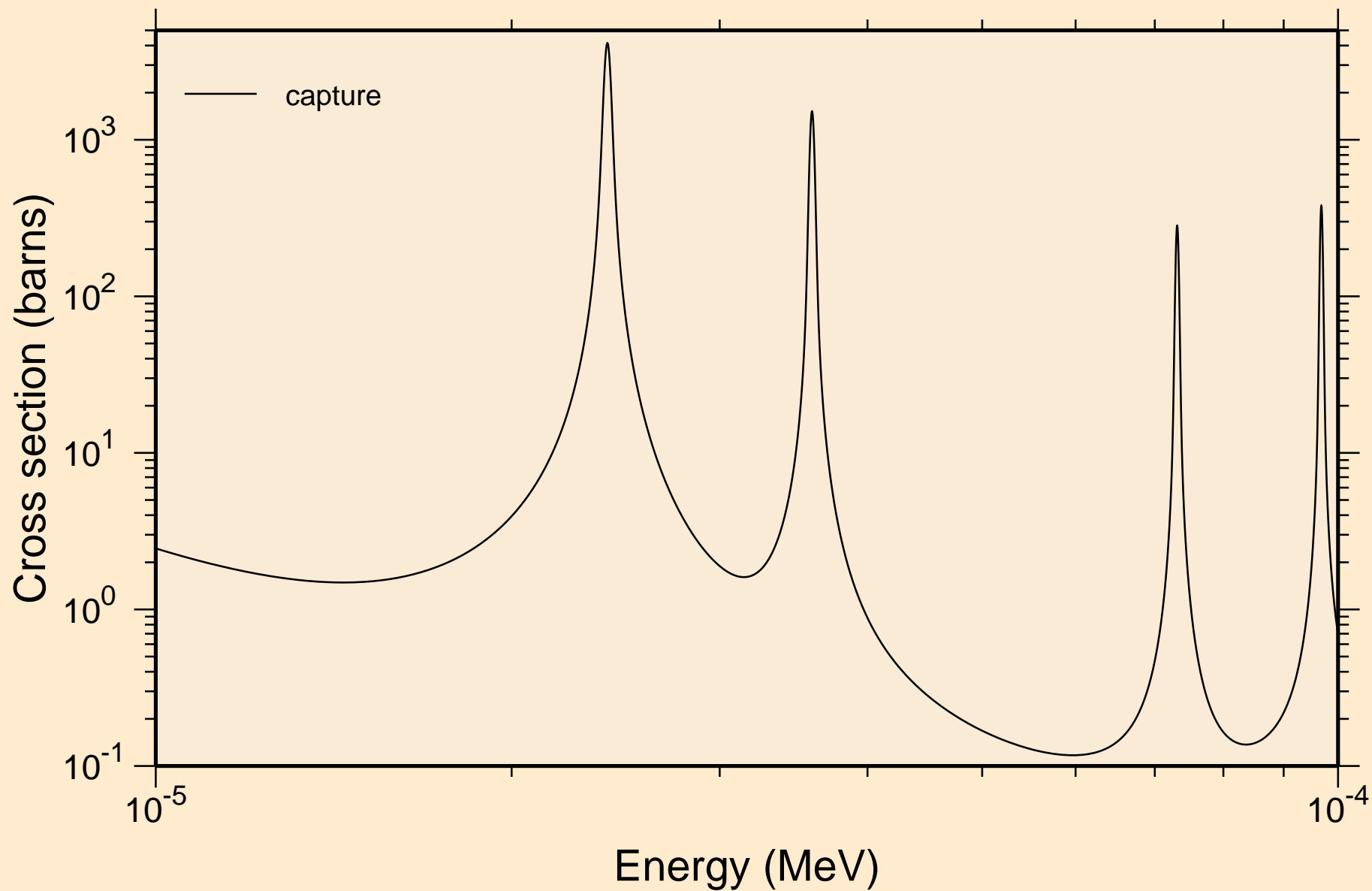

TE123 NEUTRON ACER TENDL-2019 LIBRARY; T=293.16K
resonance absorption cross sections

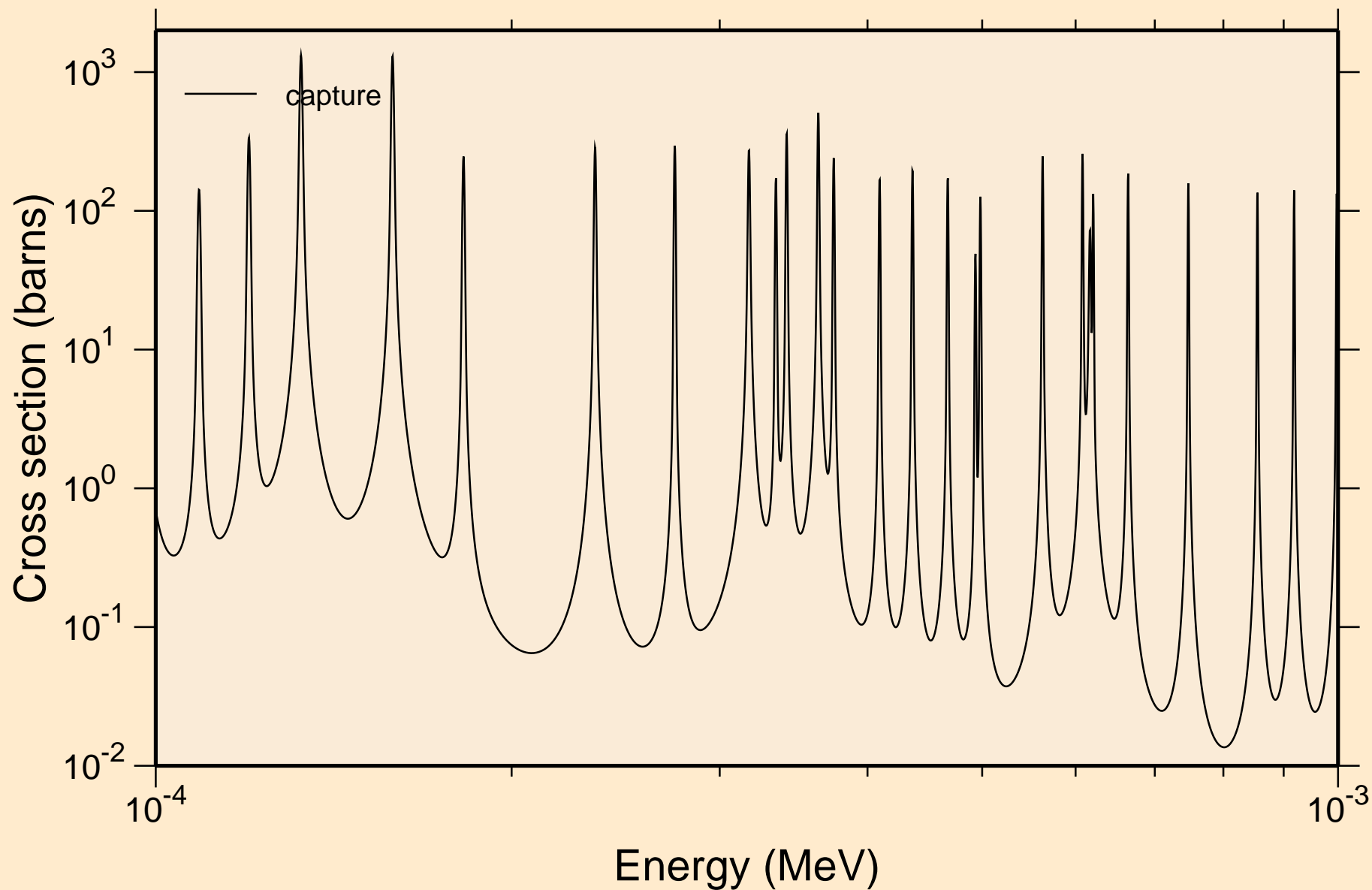

TE123 NEUTRON ACER TENDL-2019 LIBRARY; T=293.16K
resonance absorption cross sections

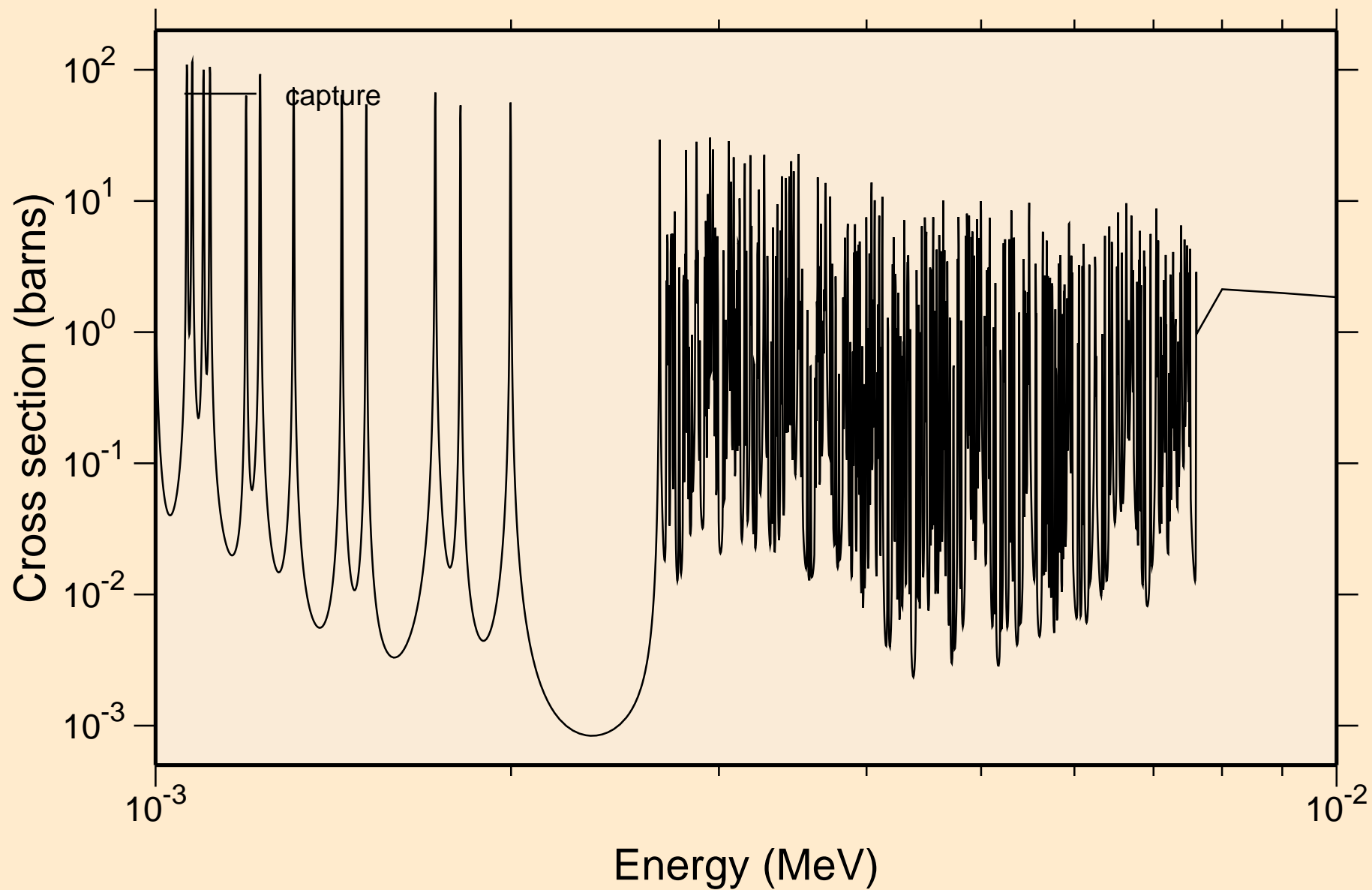

TE123 NEUTRON ACER TENDL-2019 LIBRARY; T=293.16K
resonance absorption cross sections

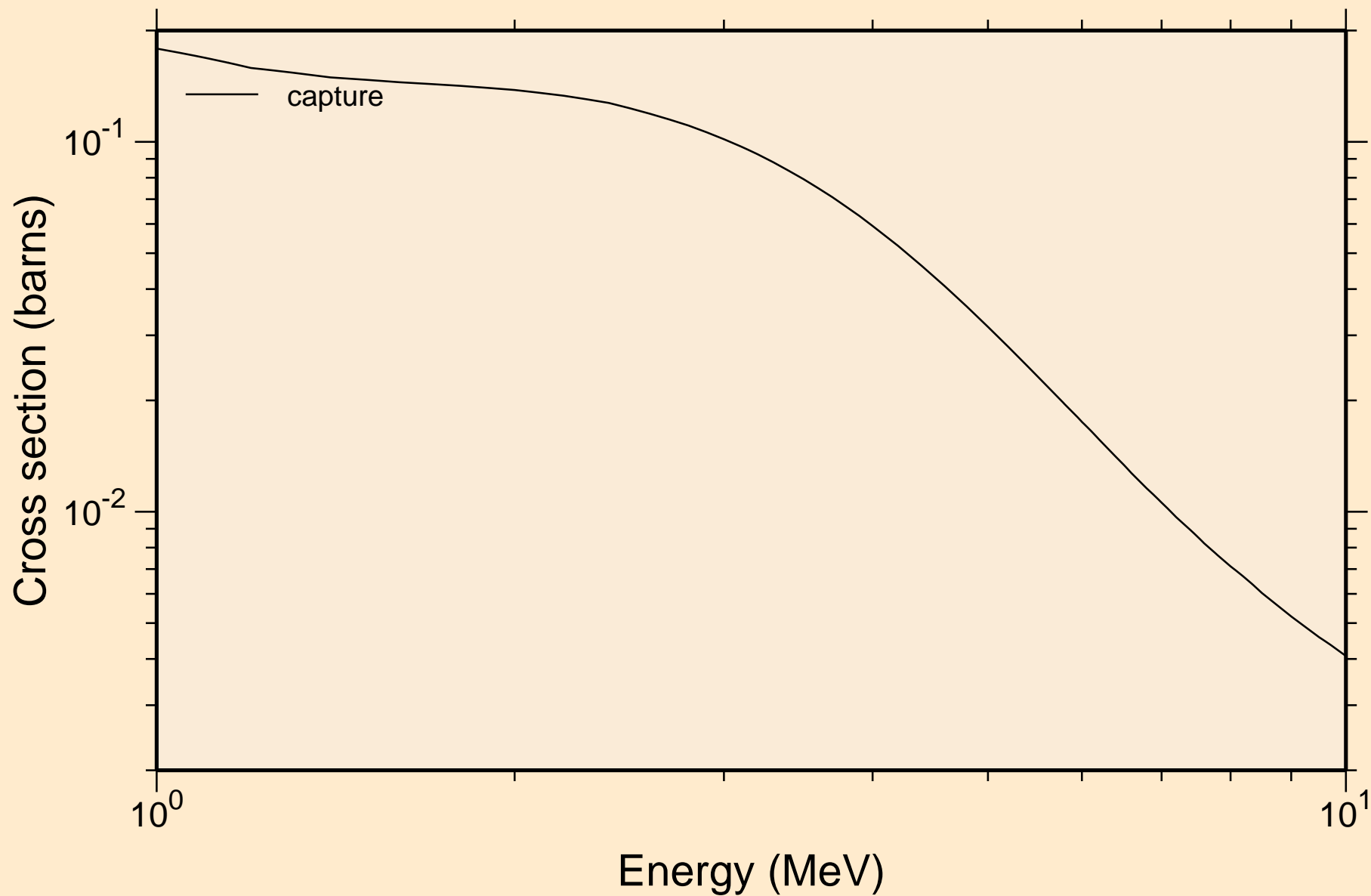

TE123 NEUTRON ACER TENDL-2019 LIBRARY; T=293.16K
Heating

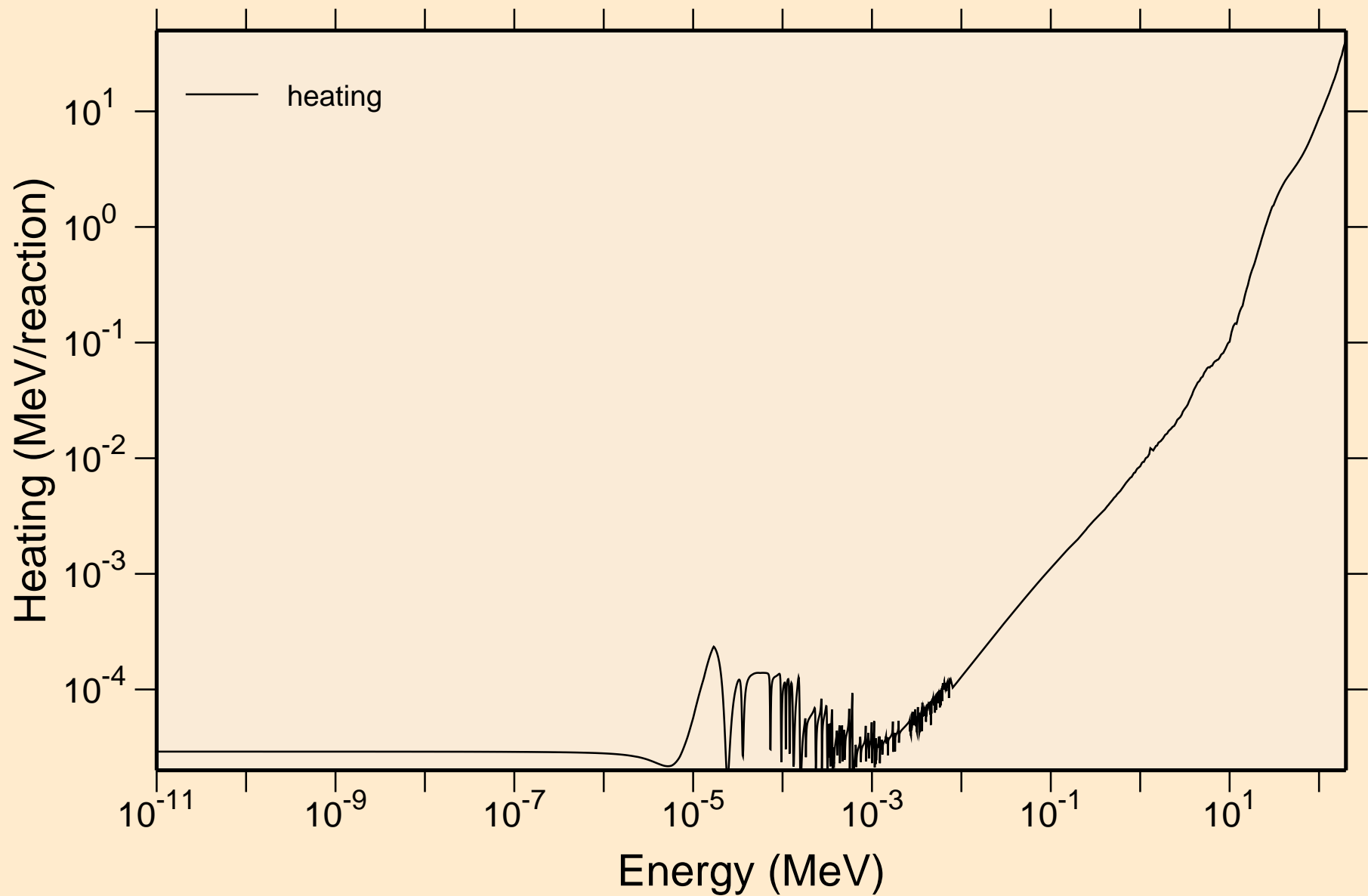

TE123 NEUTRON ACER TENDL-2019 LIBRARY; T=293.16K
Damage

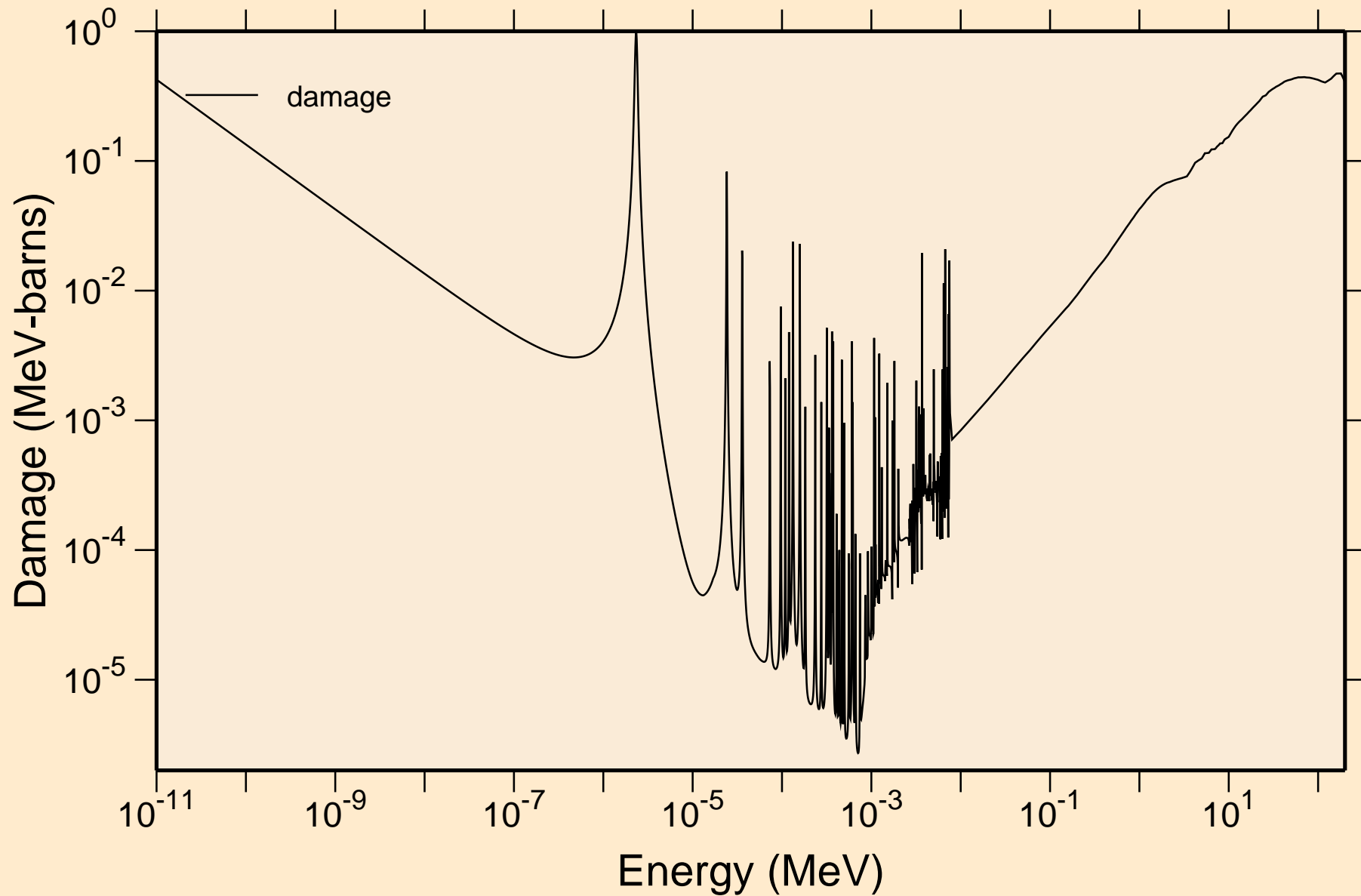

TE123 NEUTRON ACER TENDL-2019 LIBRARY; T=293.16K
Non-threshold reactions

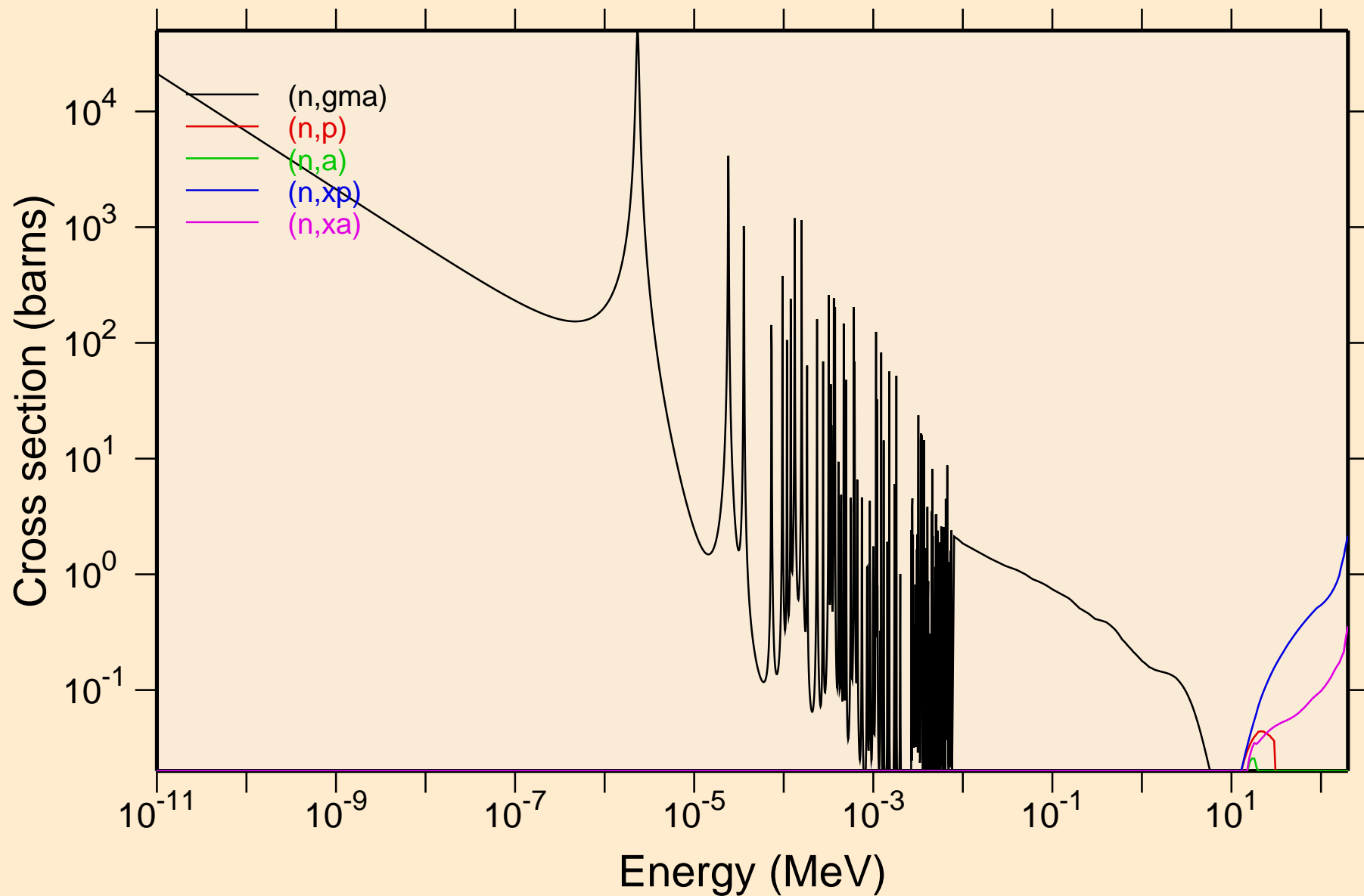

TE123 NEUTRON ACER TENDL-2019 LIBRARY; T=293.16K
Principal cross sections

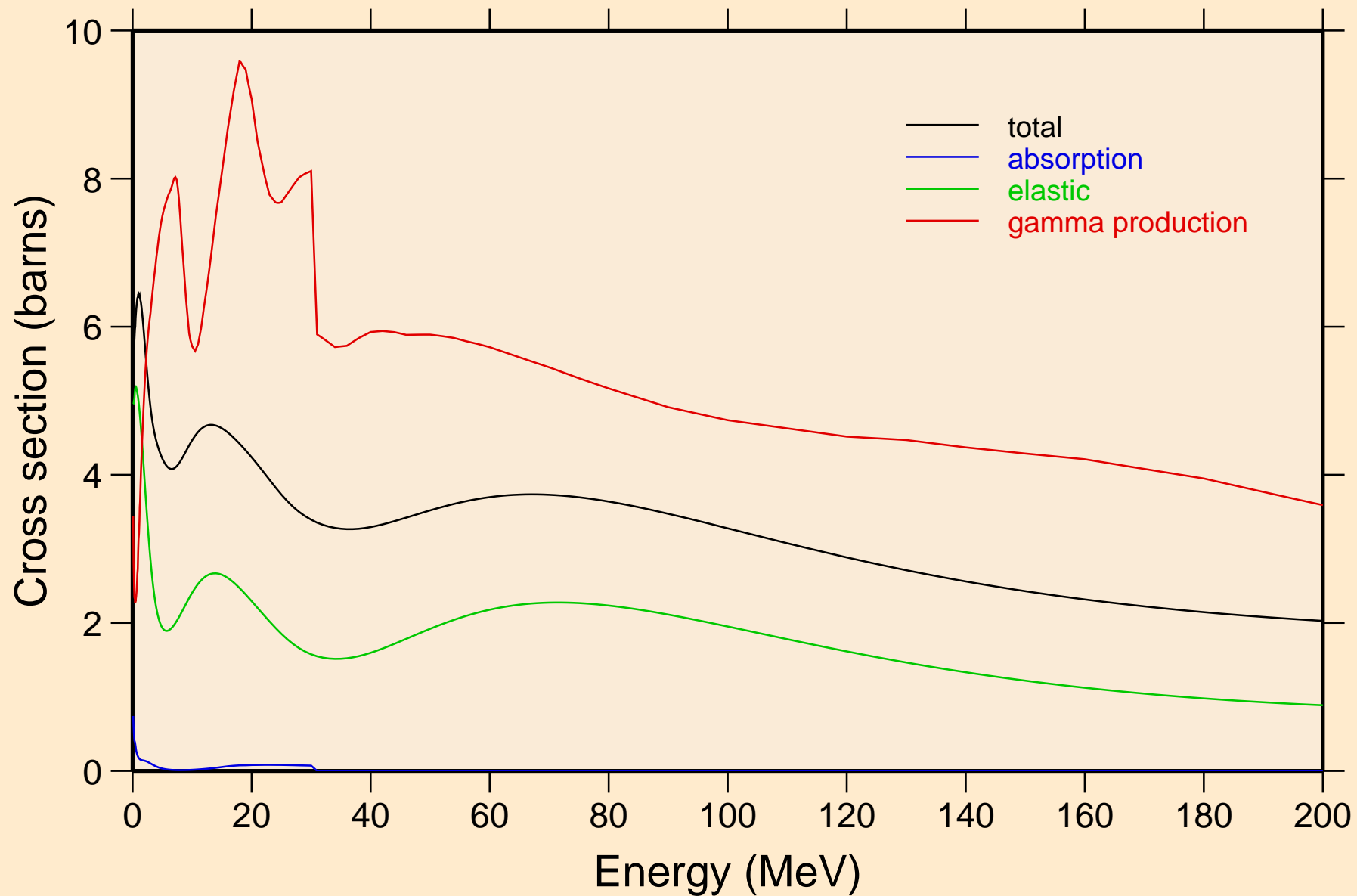

TE123 NEUTRON ACER TENDL-2019 LIBRARY; T=293.16K
Heating

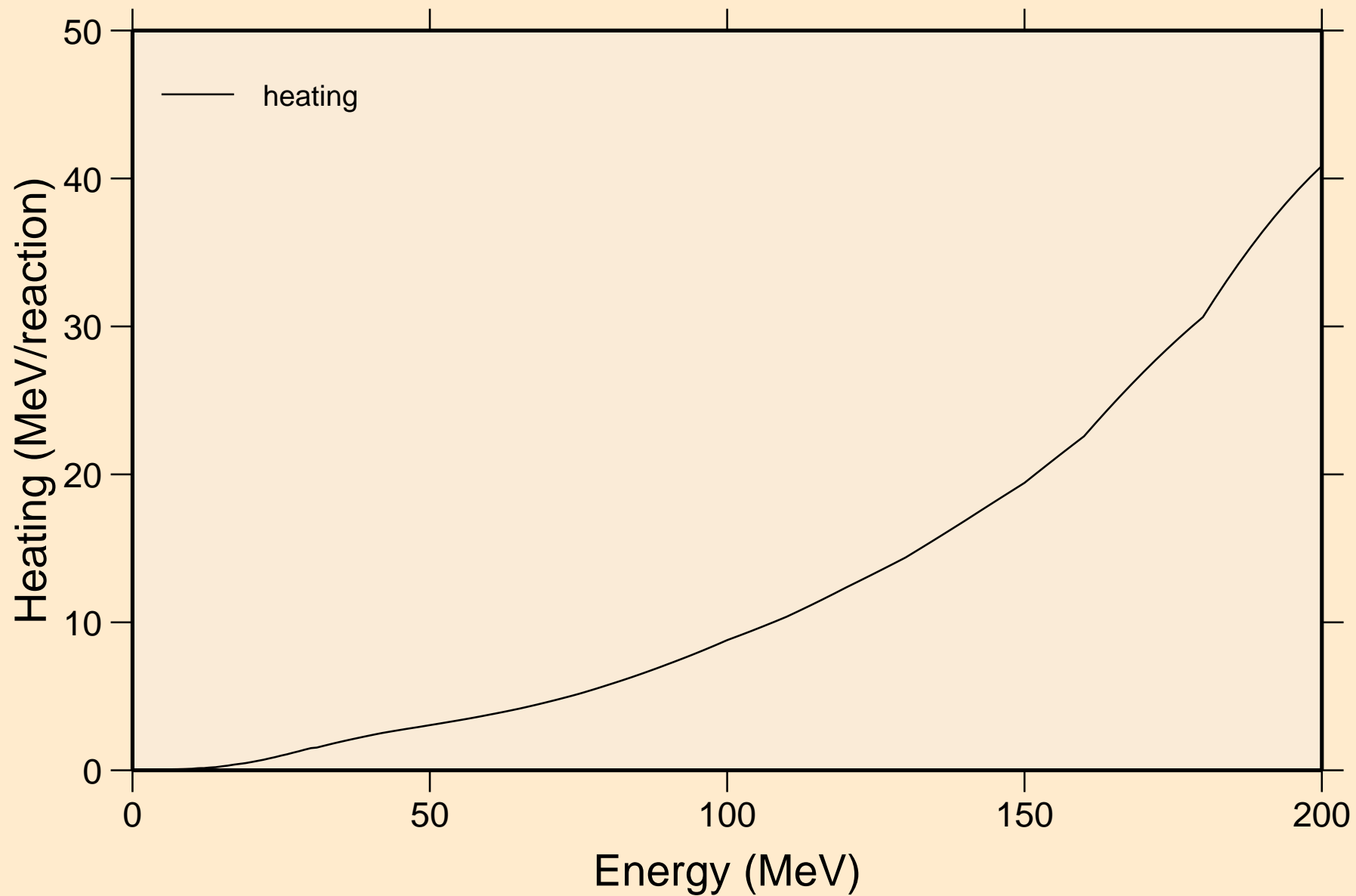

TE123 NEUTRON ACER TENDL-2019 LIBRARY; T=293.16K
Damage

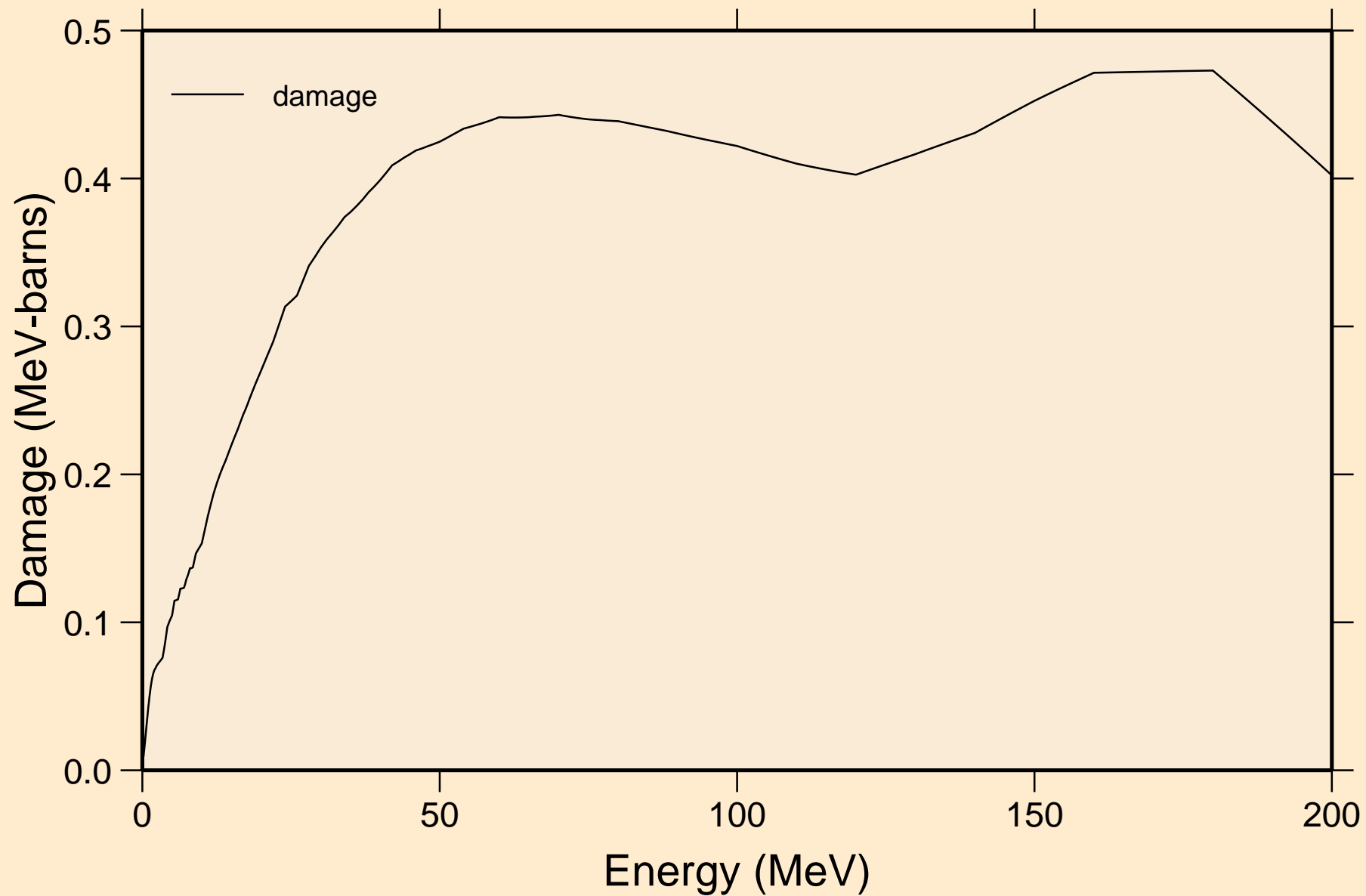

TE123 NEUTRON ACER TENDL-2019 LIBRARY; T=293.16K
Non-threshold reactions

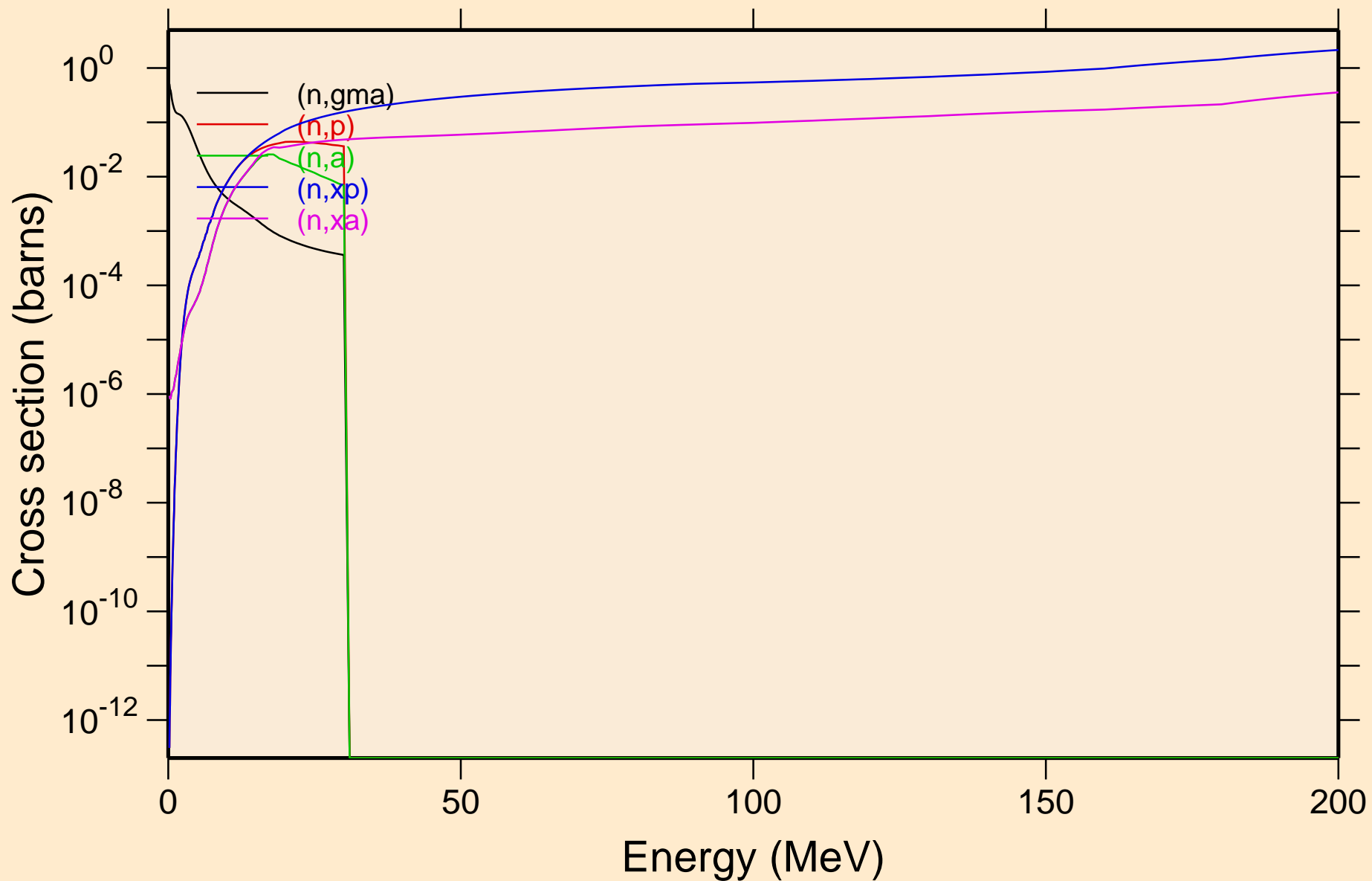

TE123 NEUTRON ACER TENDL-2019 LIBRARY; T=293.16K
Inelastic levels

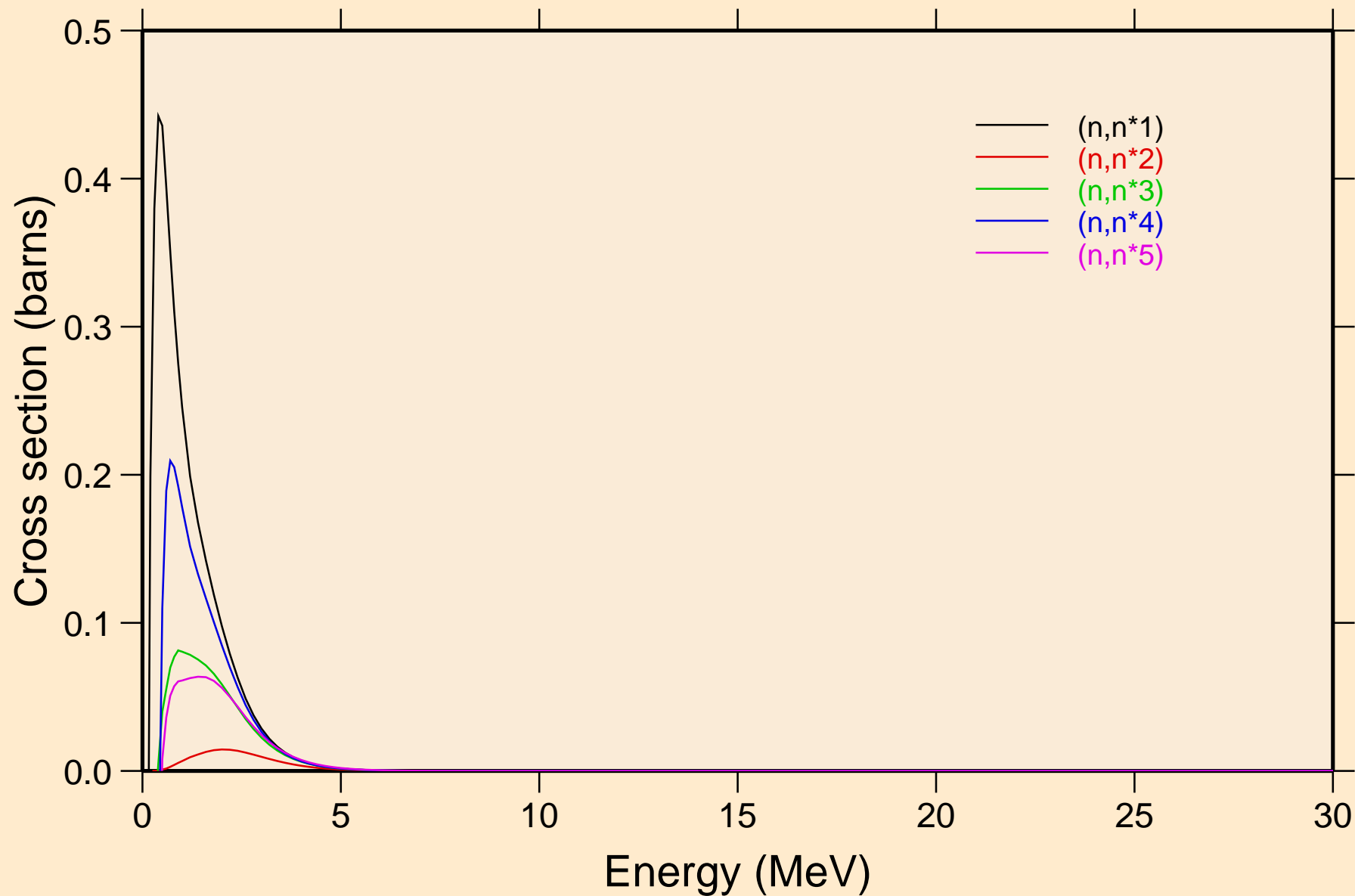

TE123 NEUTRON ACER TENDL-2019 LIBRARY; T=293.16K
Inelastic levels

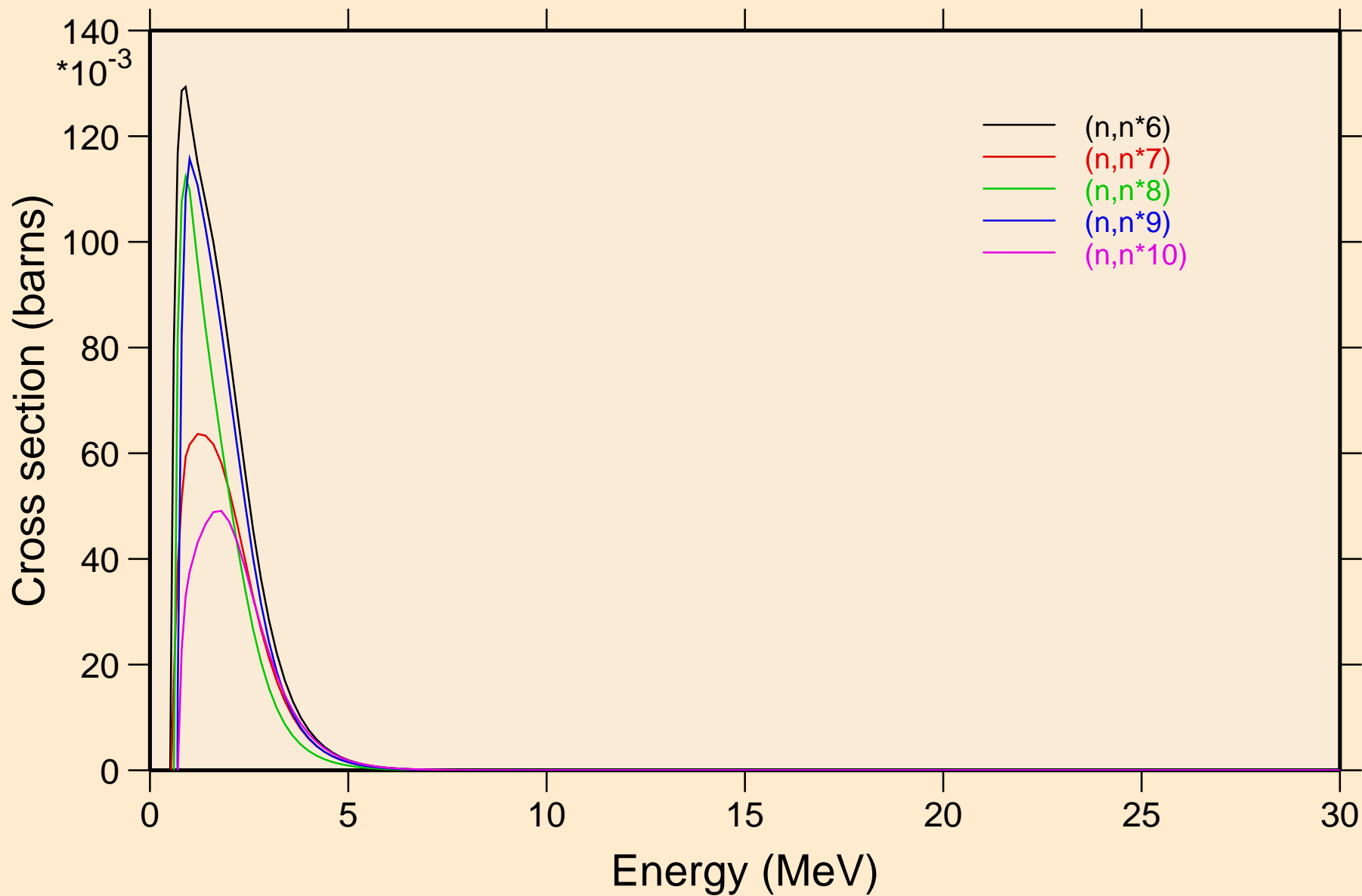

TE123 NEUTRON ACER TENDL-2019 LIBRARY; T=293.16K
Inelastic levels

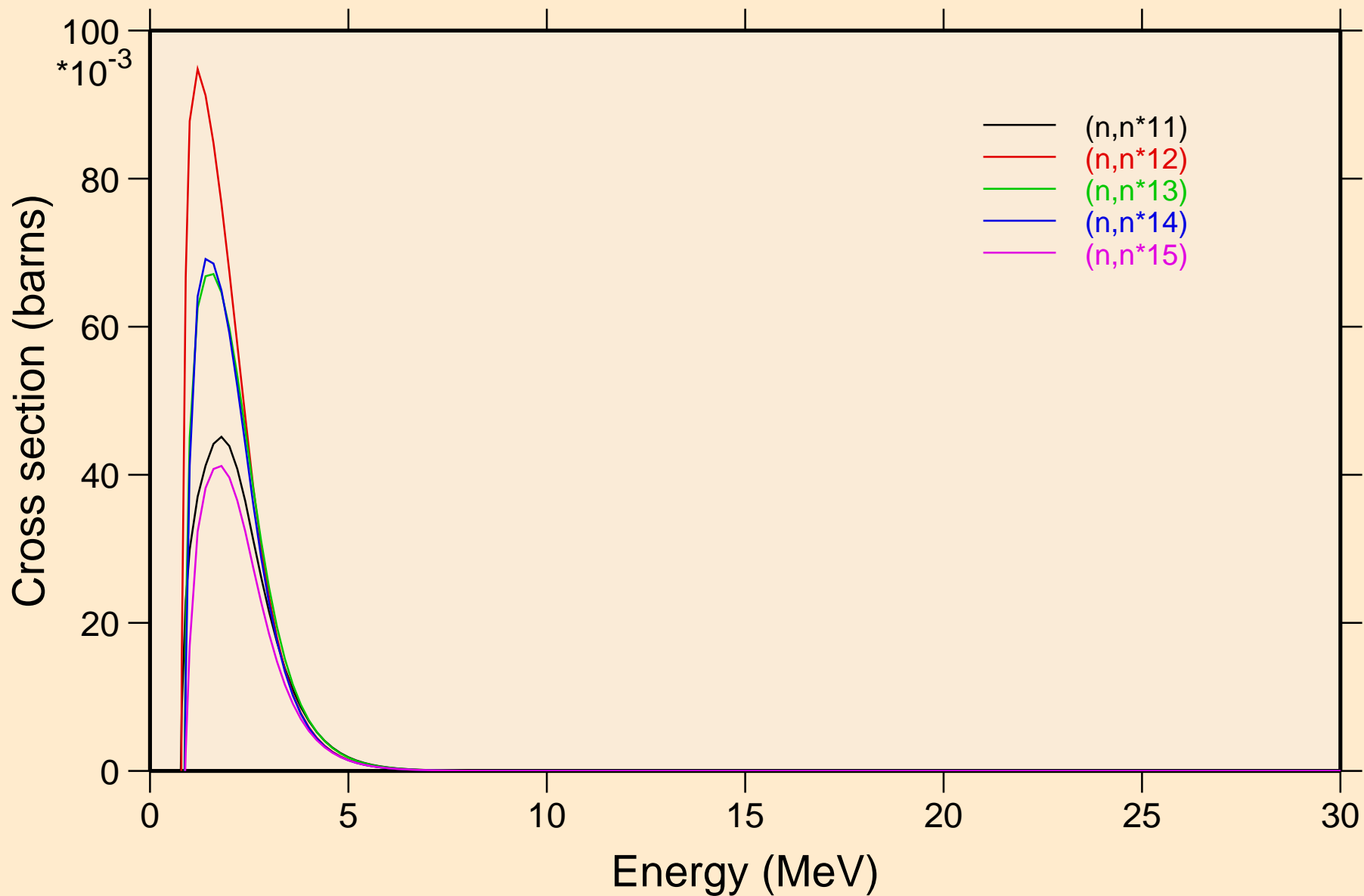

TE123 NEUTRON ACER TENDL-2019 LIBRARY; T=293.16K
Inelastic levels

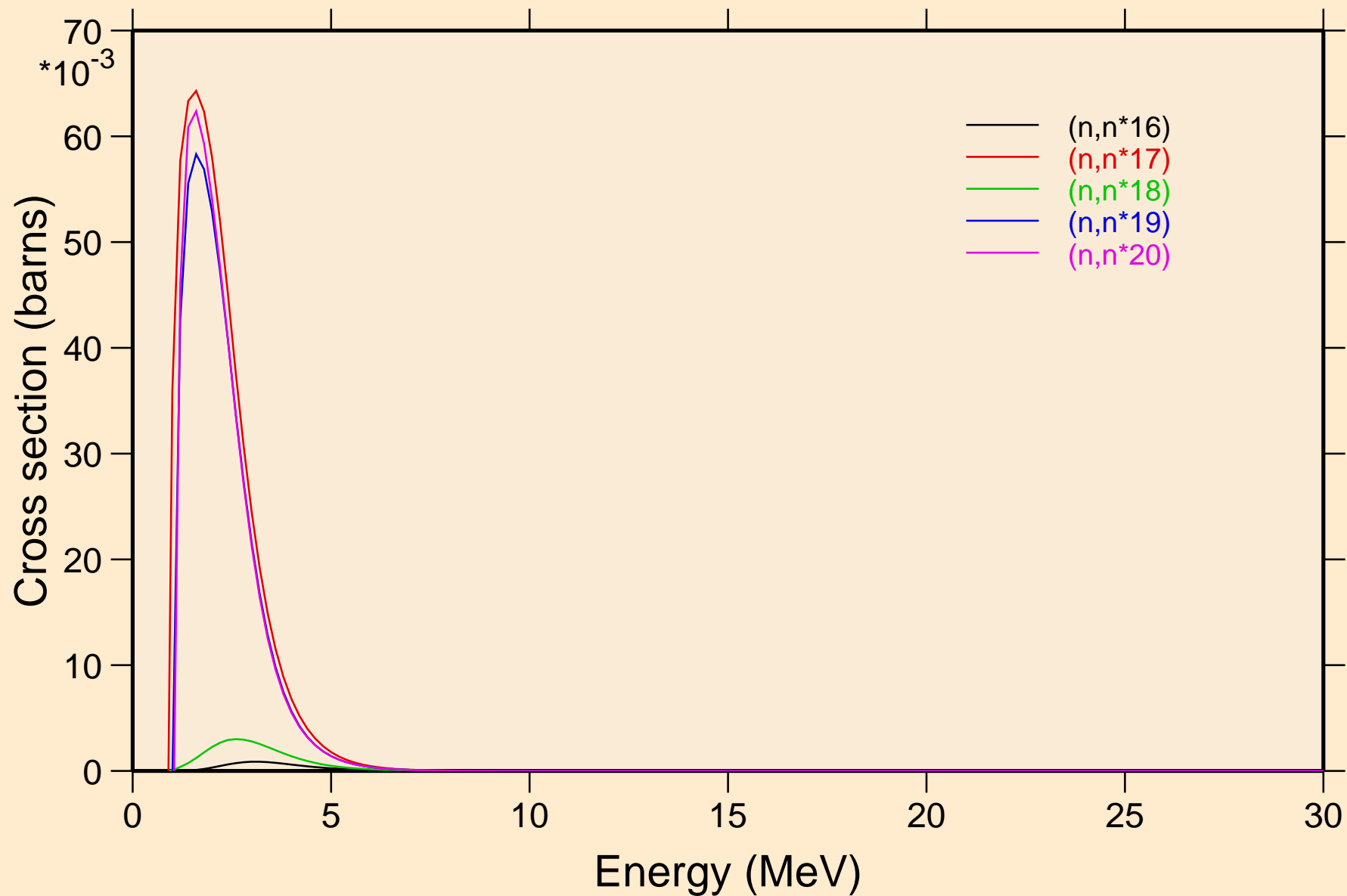

TE123 NEUTRON ACER TENDL-2019 LIBRARY; T=293.16K
Inelastic levels

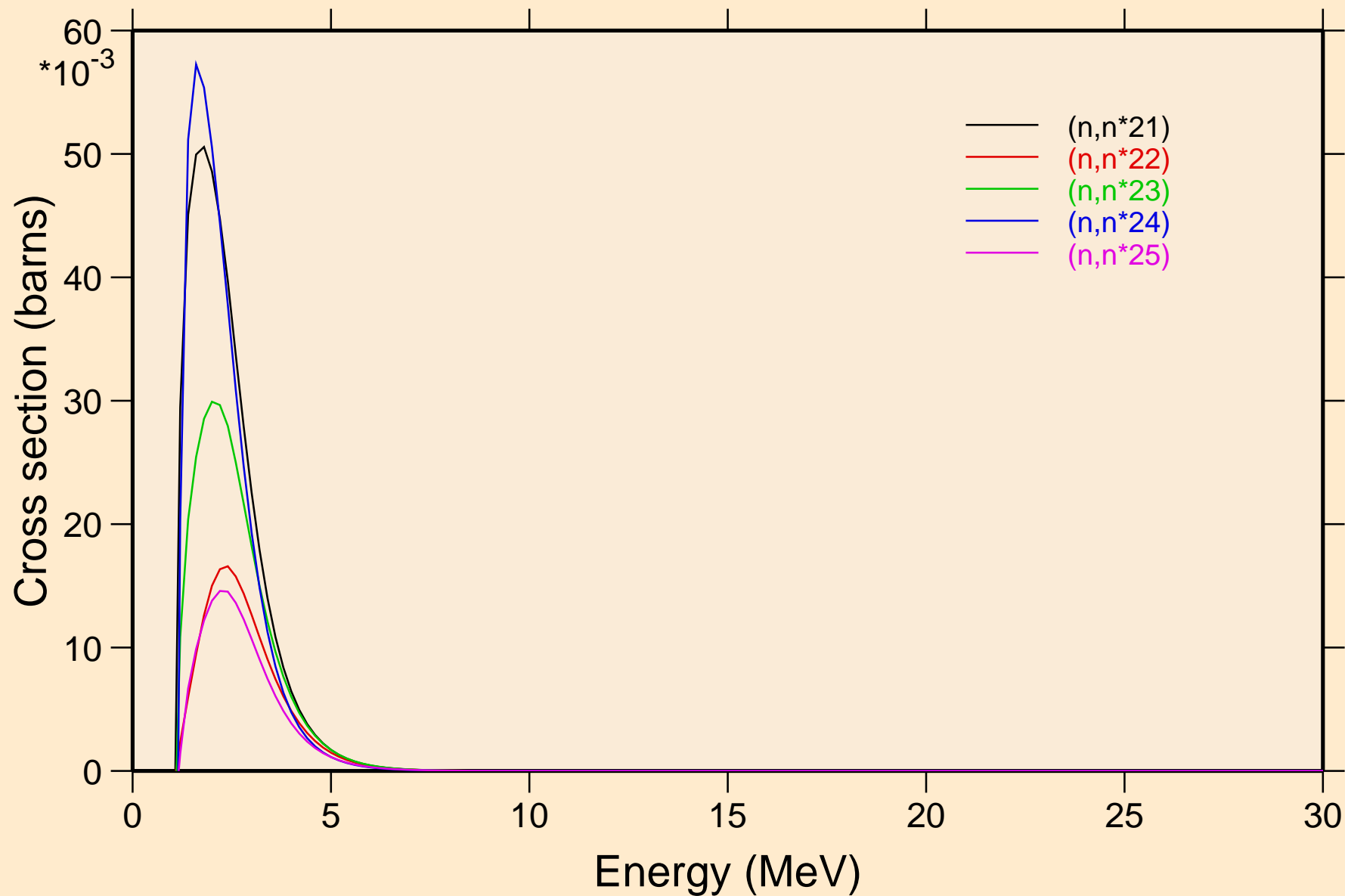

TE123 NEUTRON ACER TENDL-2019 LIBRARY; T=293.16K
Inelastic levels

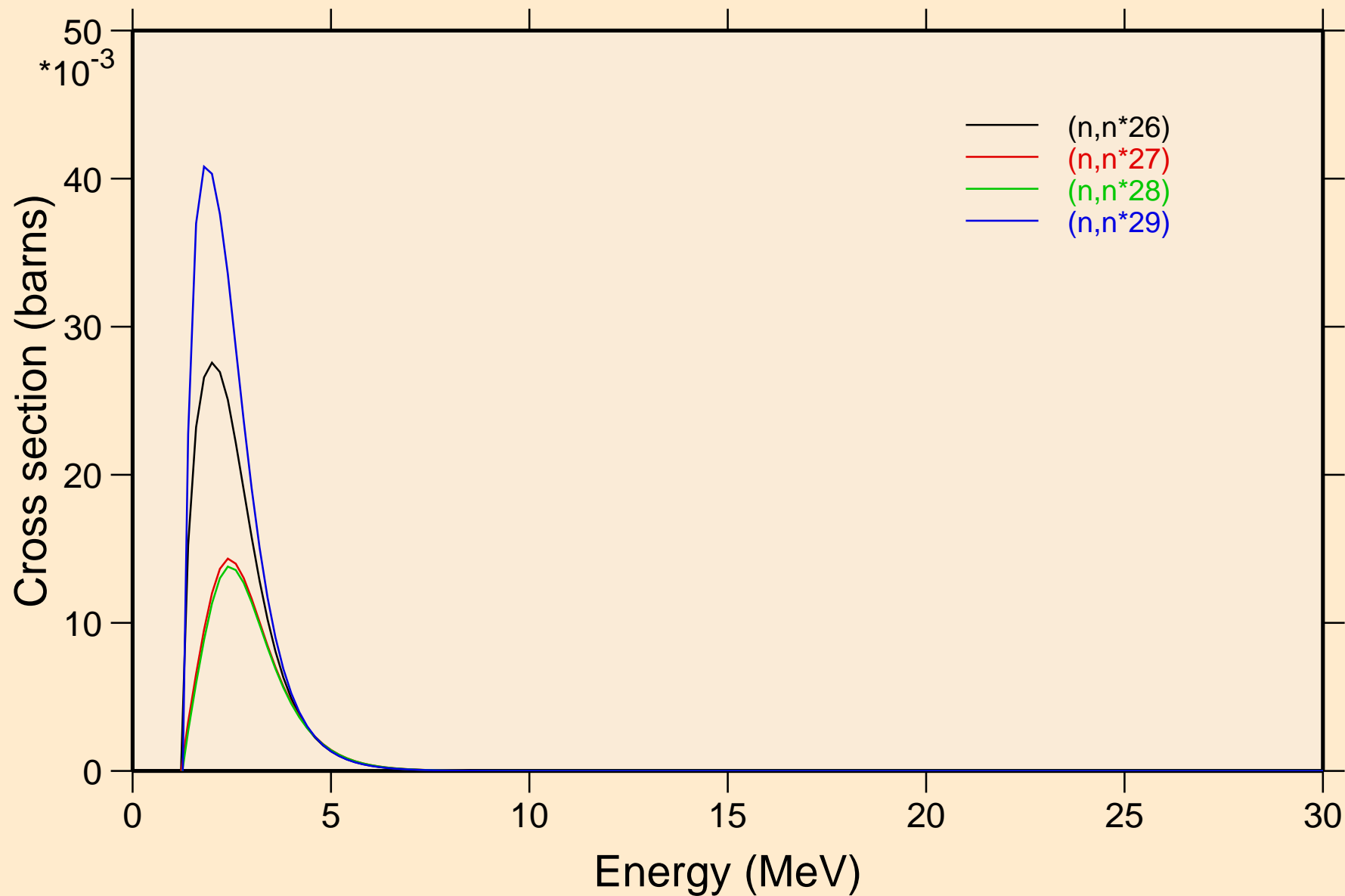

TE123 NEUTRON ACER TENDL-2019 LIBRARY; T=293.16K
Threshold reactions

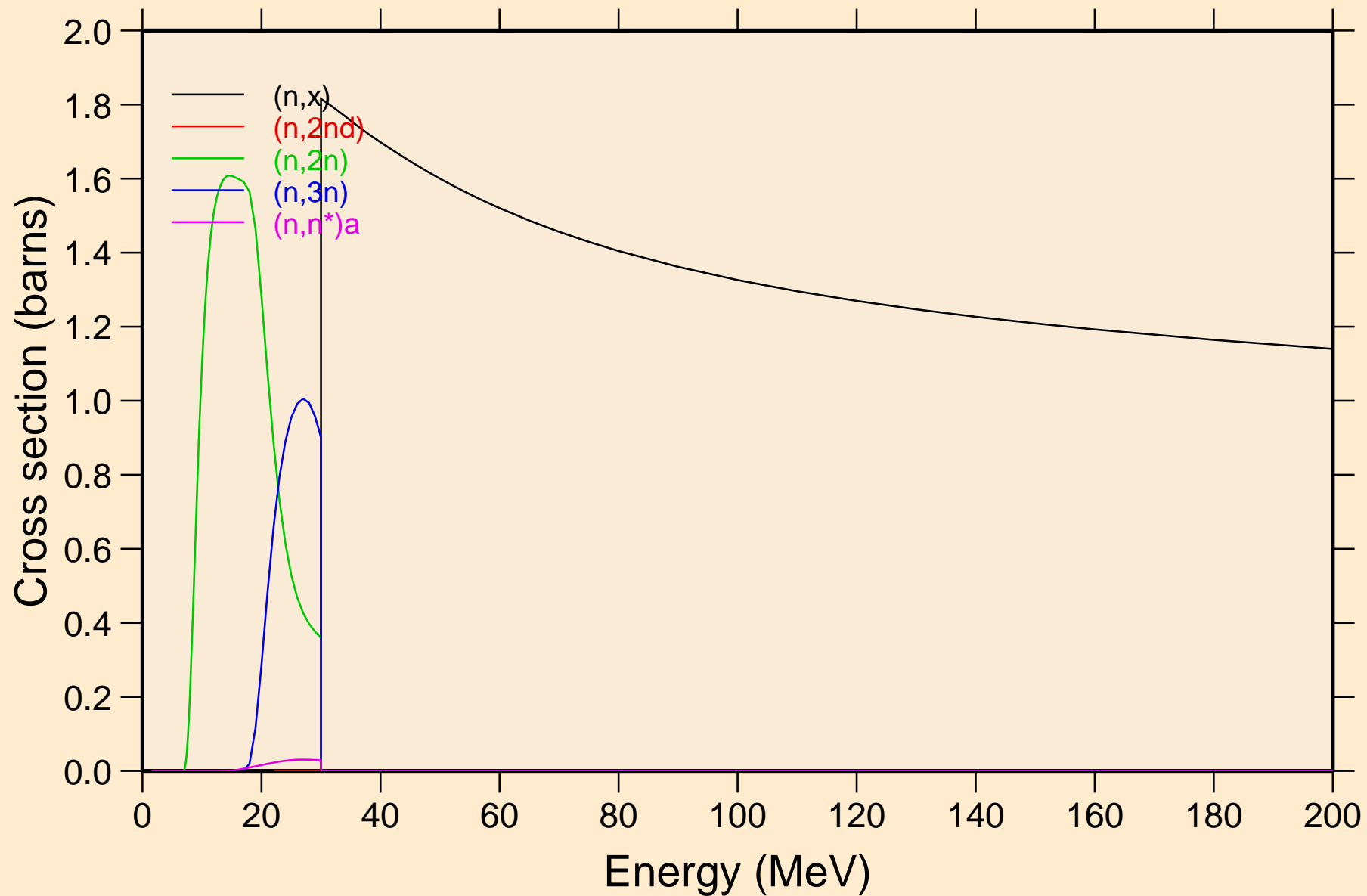

TE123 NEUTRON ACER TENDL-2019 LIBRARY; T=293.16K
Threshold reactions

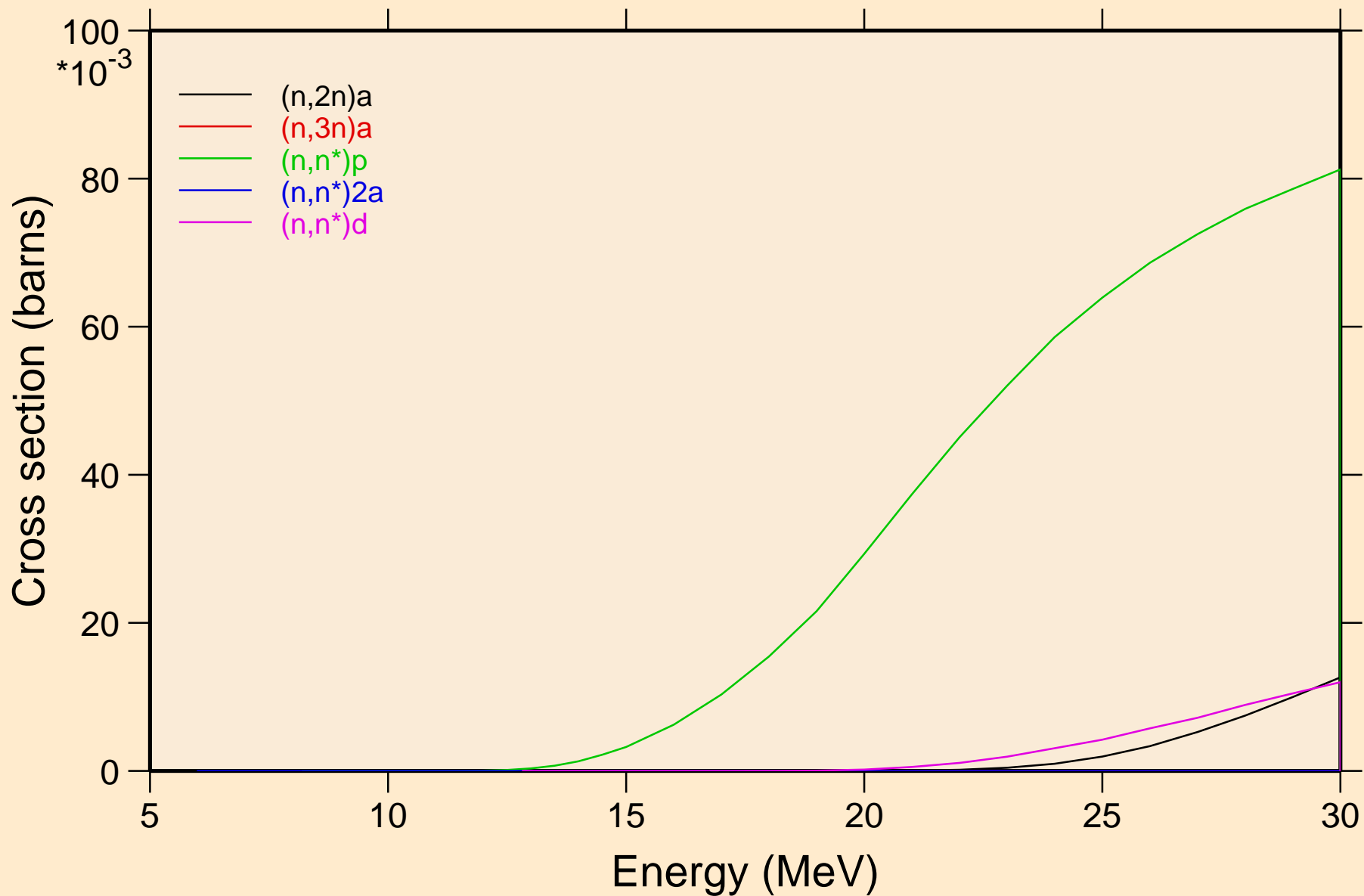

TE123 NEUTRON ACER TENDL-2019 LIBRARY; T=293.16K
Threshold reactions

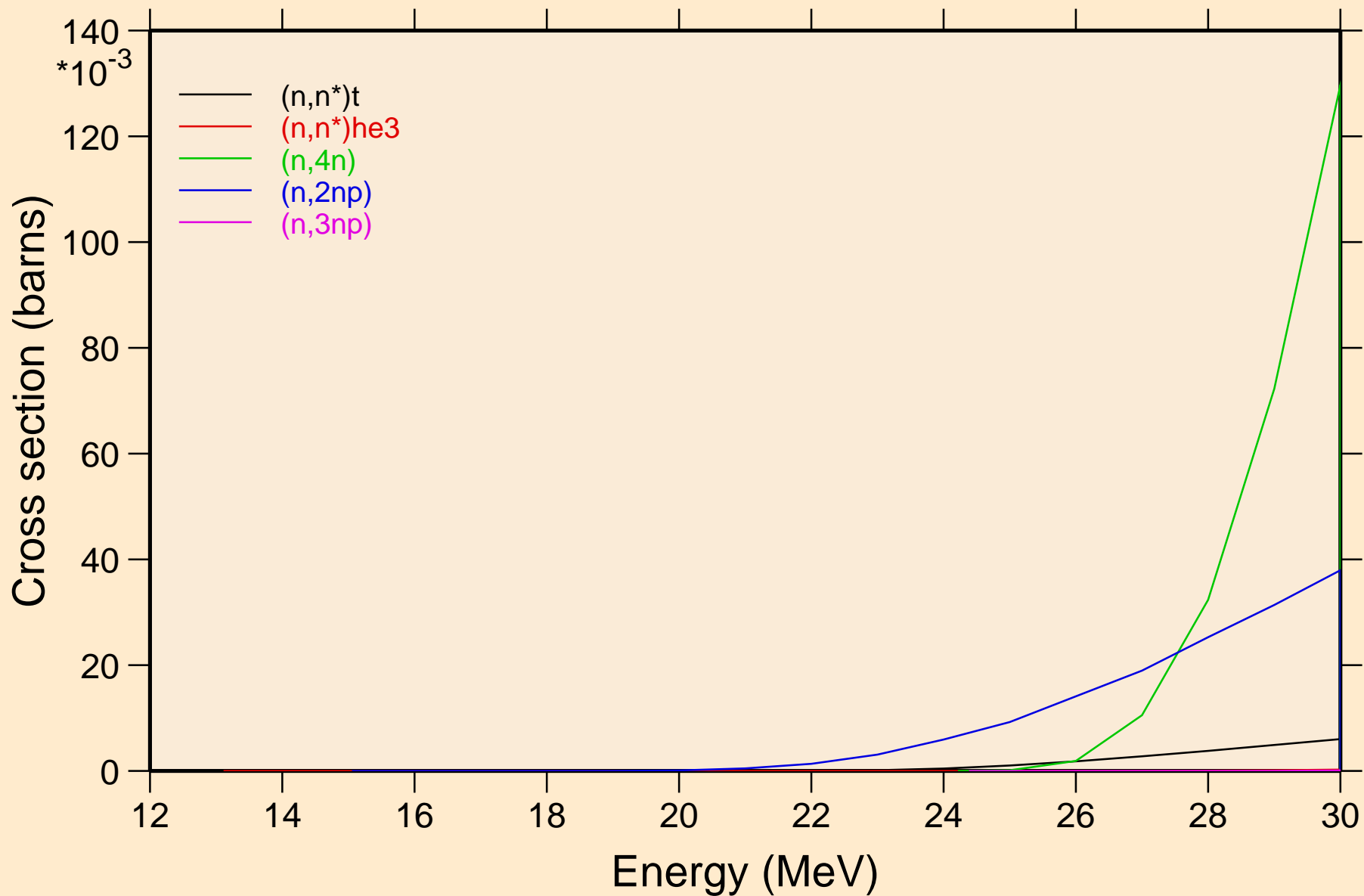

TE123 NEUTRON ACER TENDL-2019 LIBRARY; T=293.16K
Threshold reactions

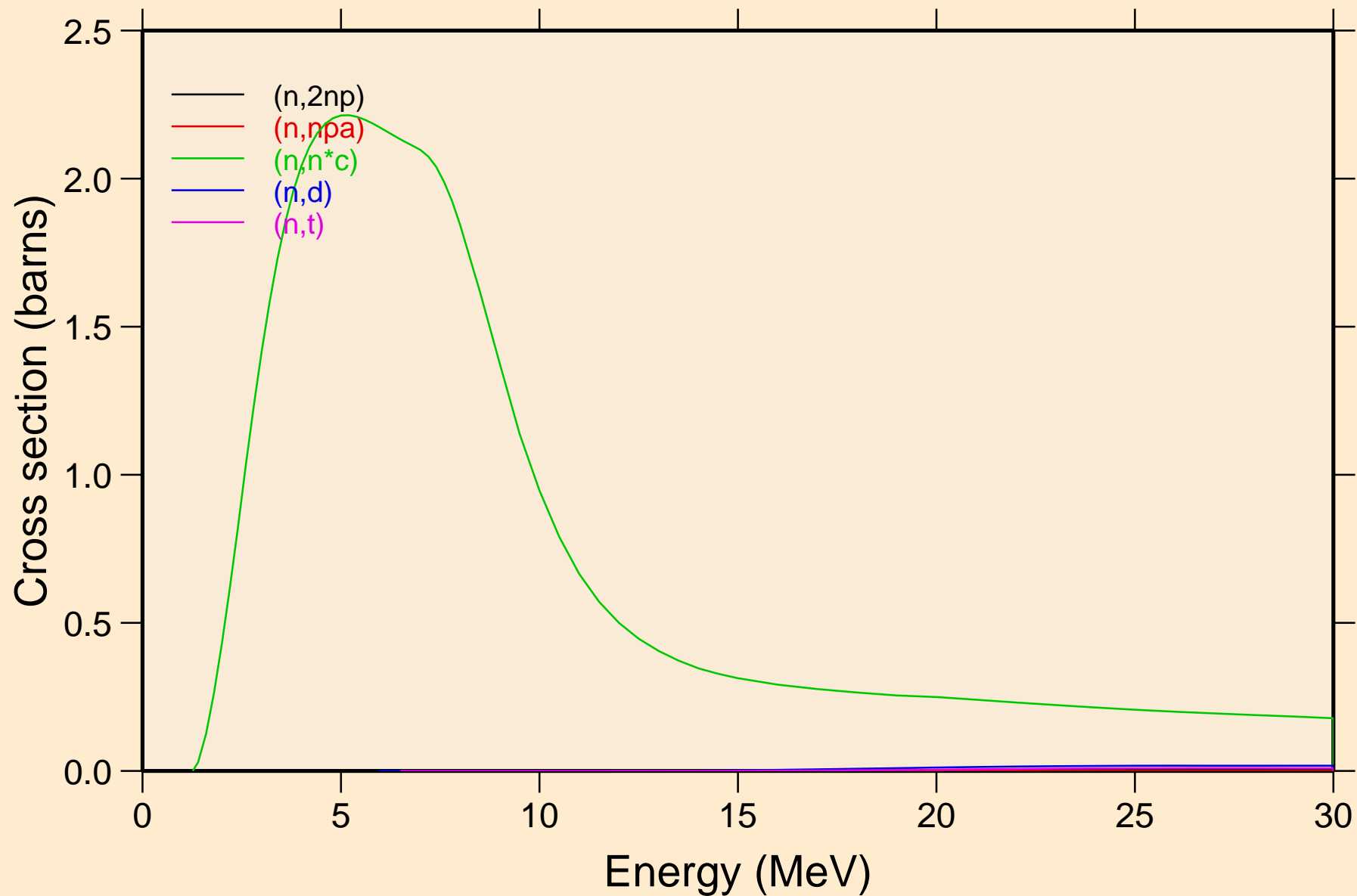

TE123 NEUTRON ACER TENDL-2019 LIBRARY; T=293.16K
Threshold reactions

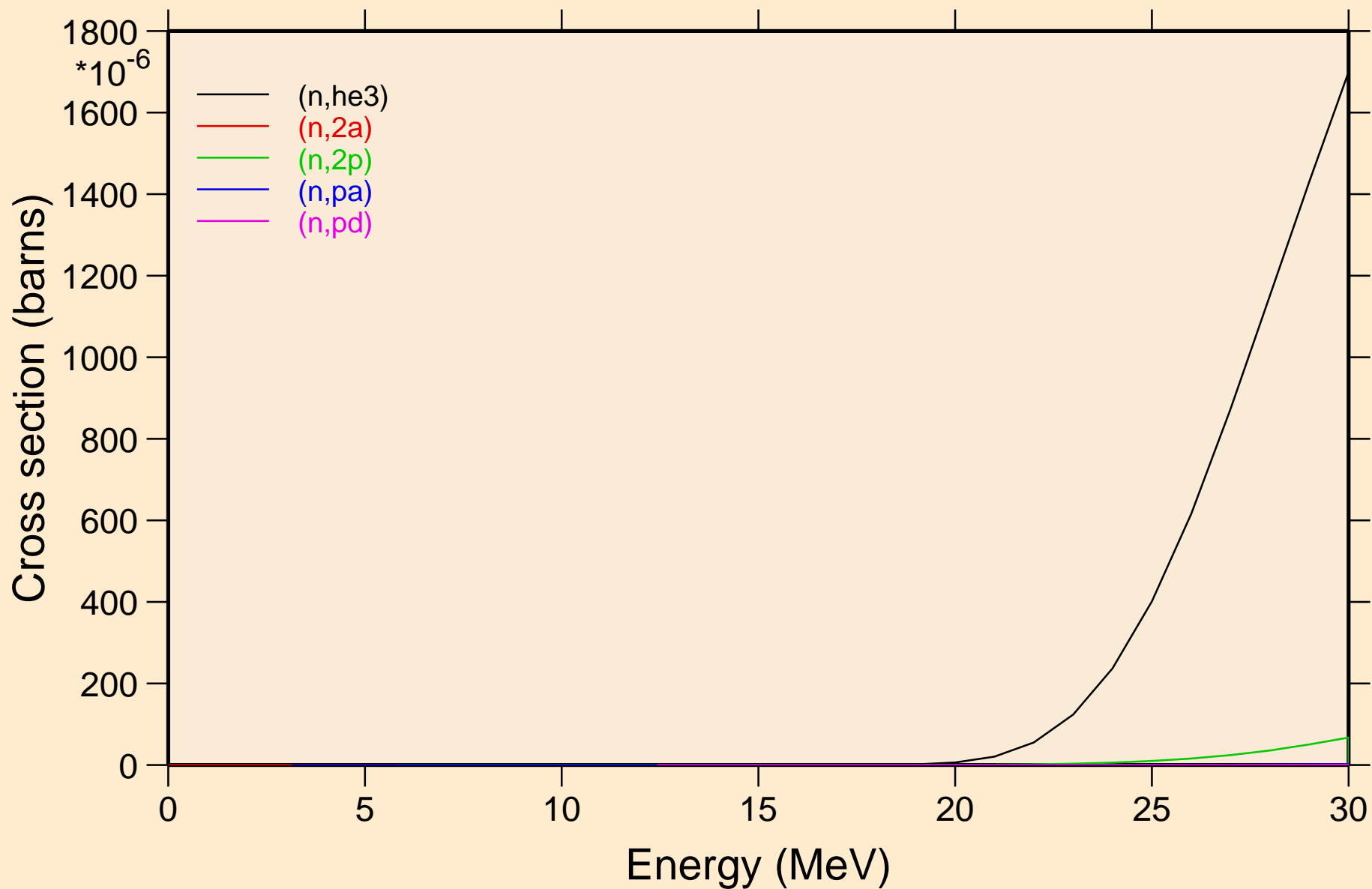

TE123 NEUTRON ACER TENDL-2019 LIBRARY; T=293.16K
Threshold reactions

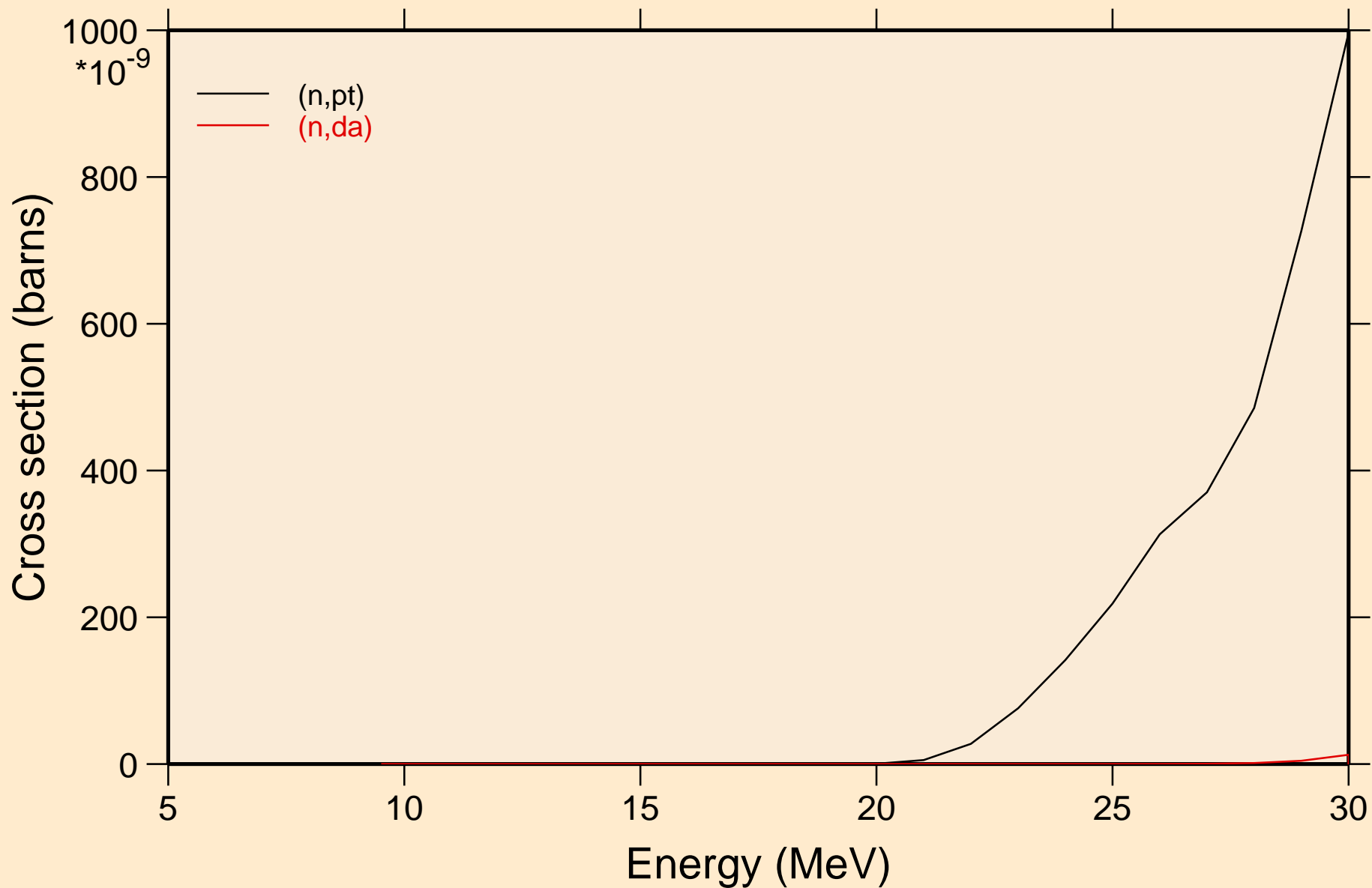

TE123 NEUTRON ACER TENDL-2019 LIBRARY; T=293.16K
Threshold reactions

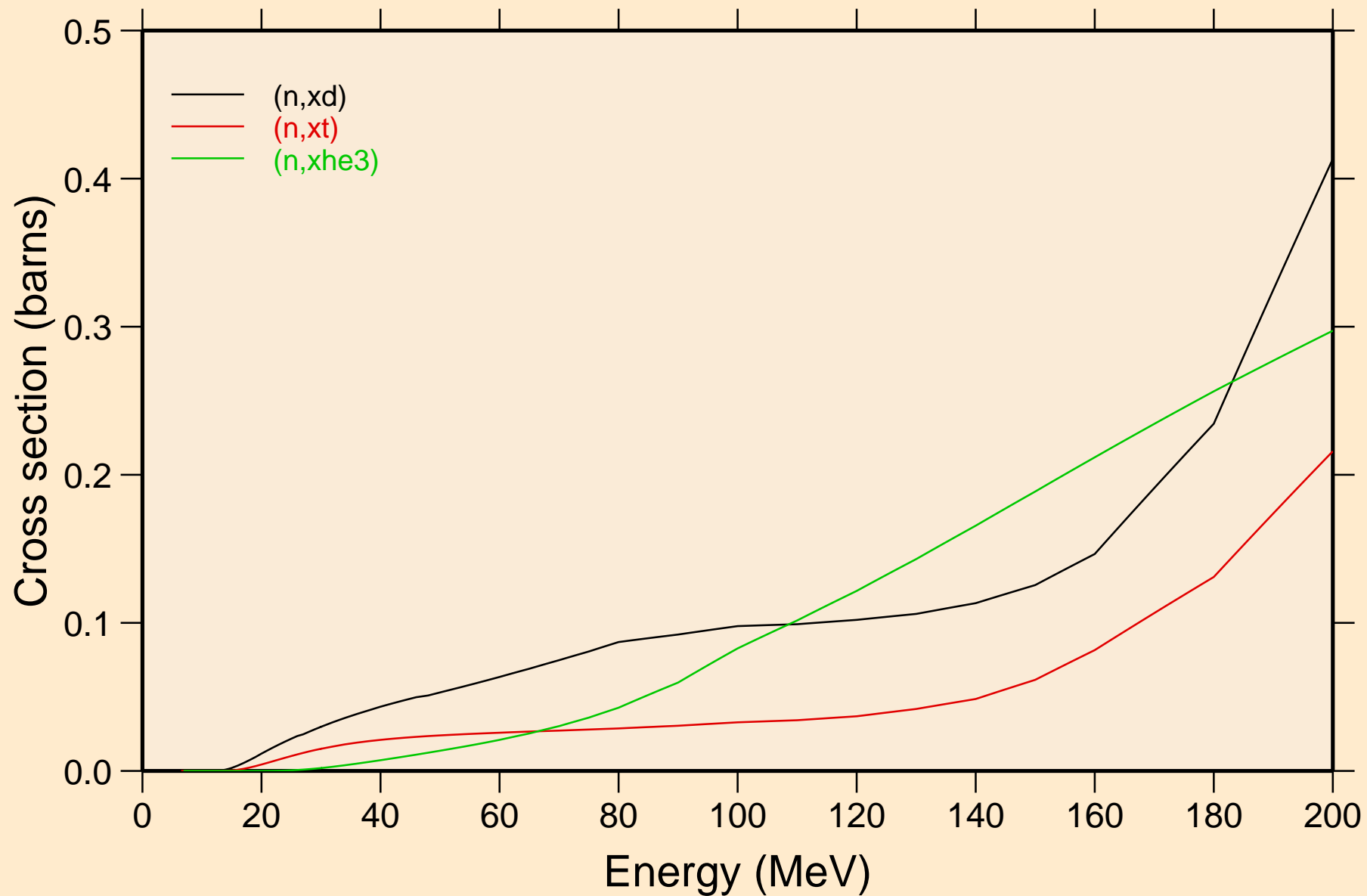

TE123 NEUTRON ACER TENDL-2019 LIBRARY; T=293.16K
angular distribution for elastic

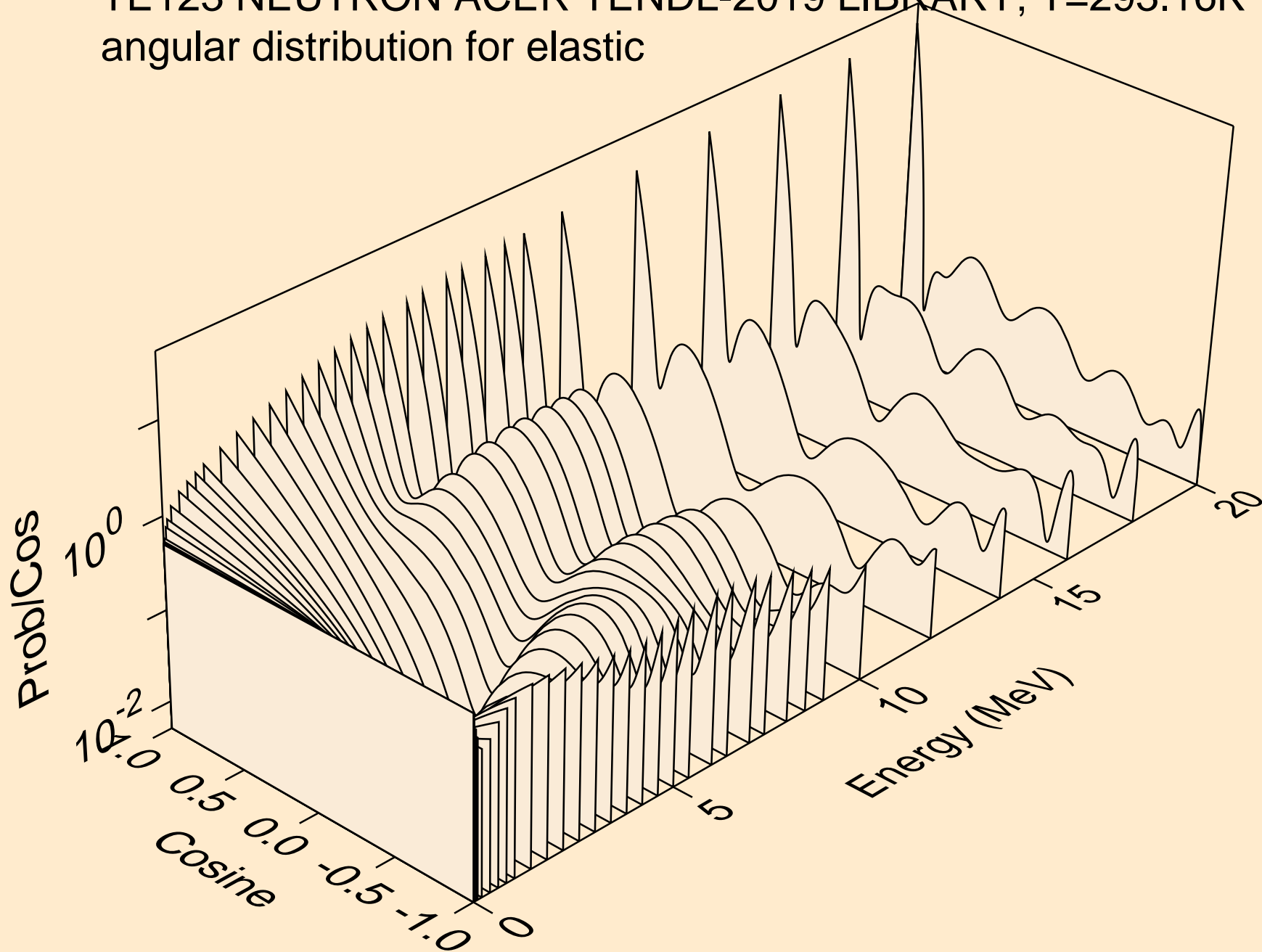

TE123 NEUTRON ACER TENDL-2019 LIBRARY; T=293.16K
angular distribution for elastic

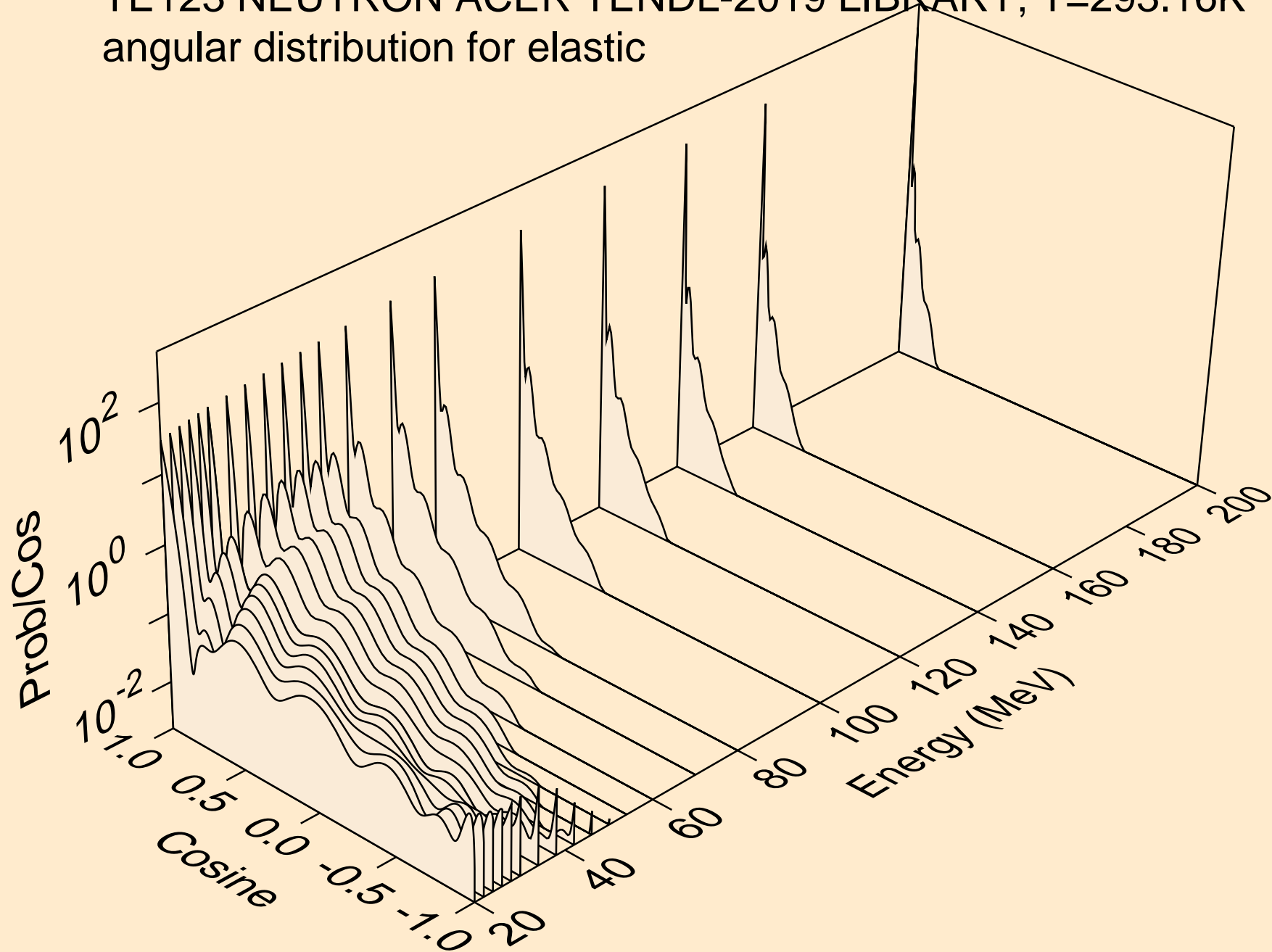

TE123 NEUTRON ACER TENDL-2019 LIBRARY; T=293.16K
angular distribution for (n,n*1)

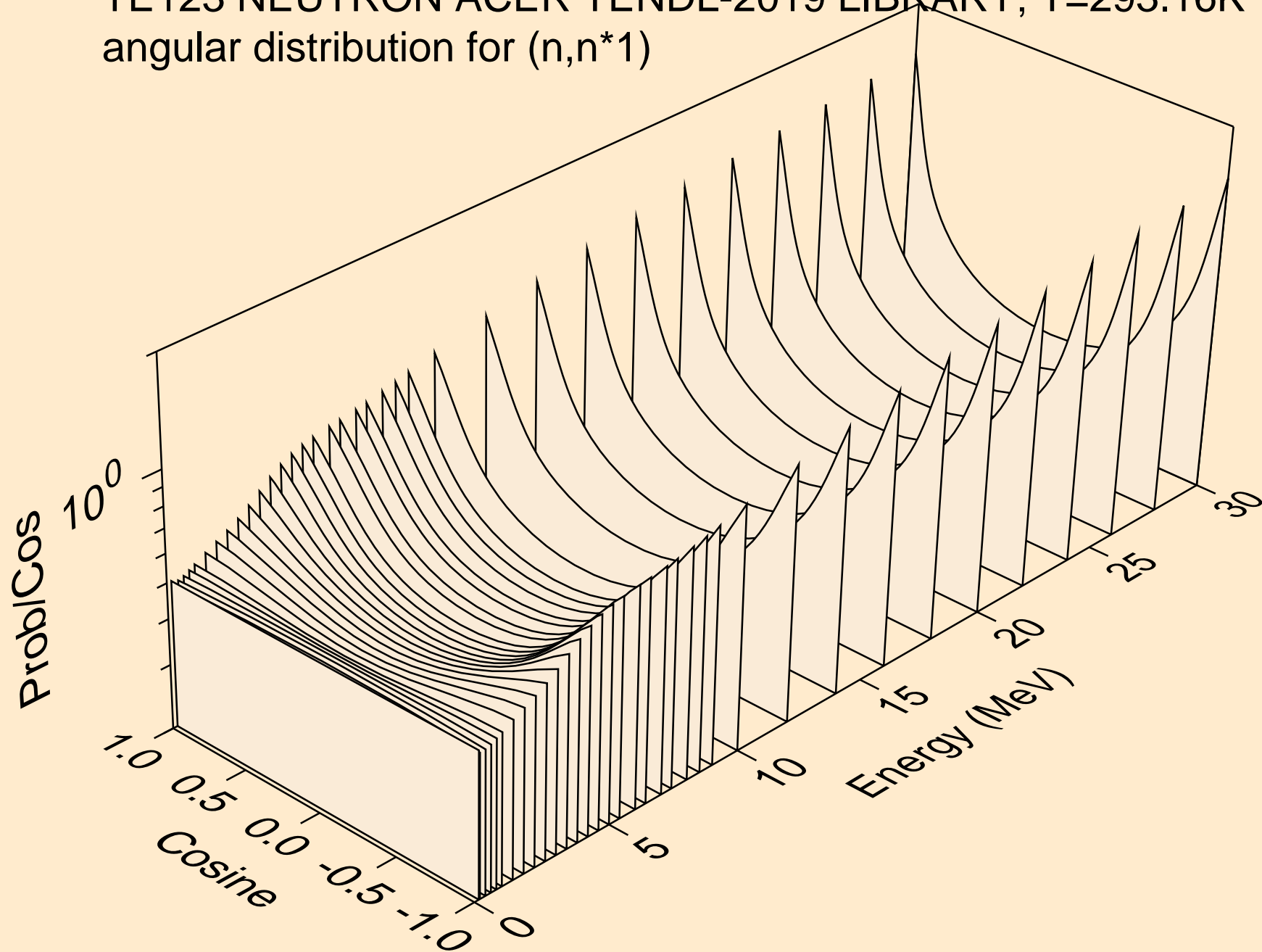

TE123 NEUTRON ACER TENDL-2019 LIBRARY; T=293.16K
angular distribution for (n,n*2)

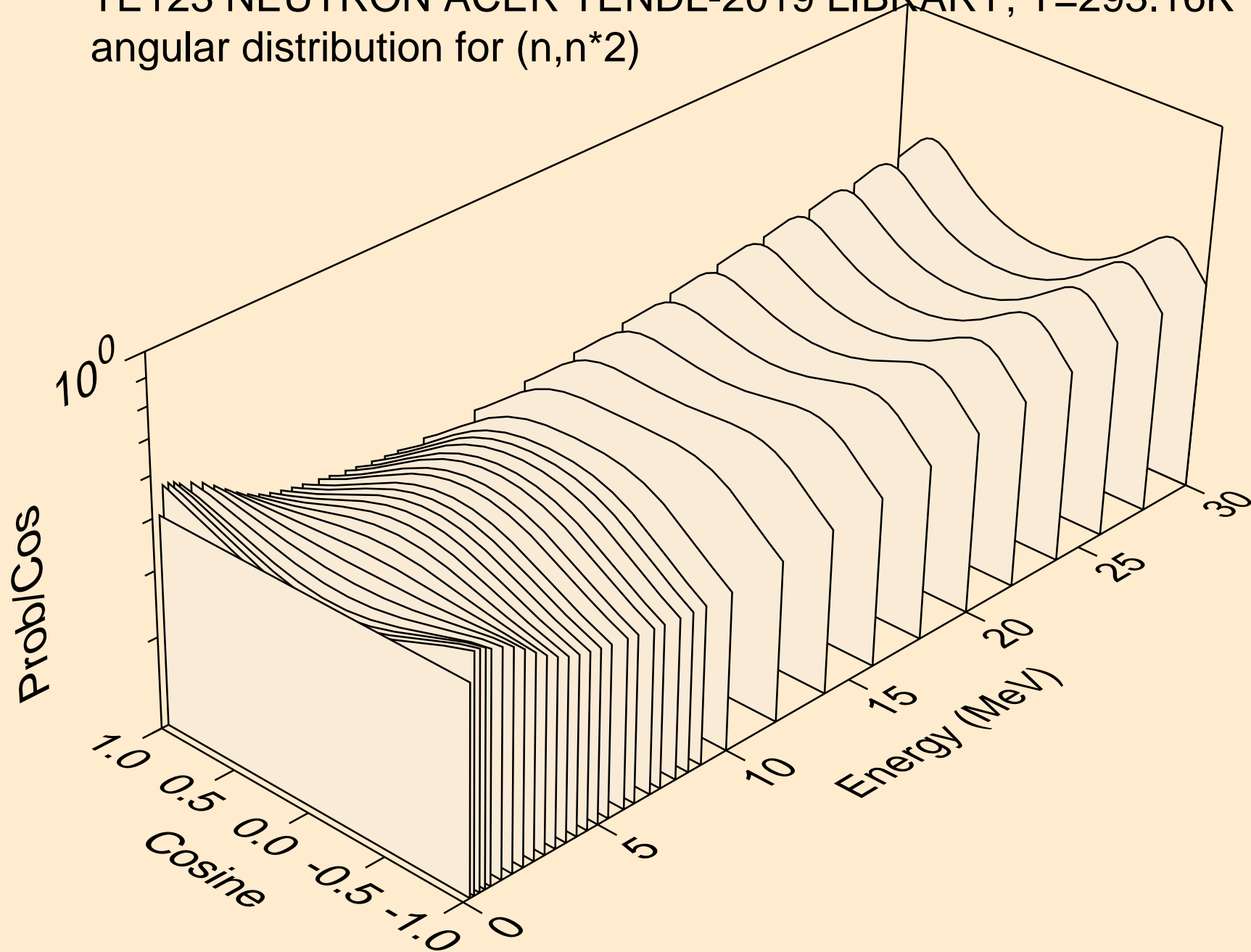

TE123 NEUTRON ACER TENDL-2019 LIBRARY; T=293.16K
angular distribution for (n,n*3)

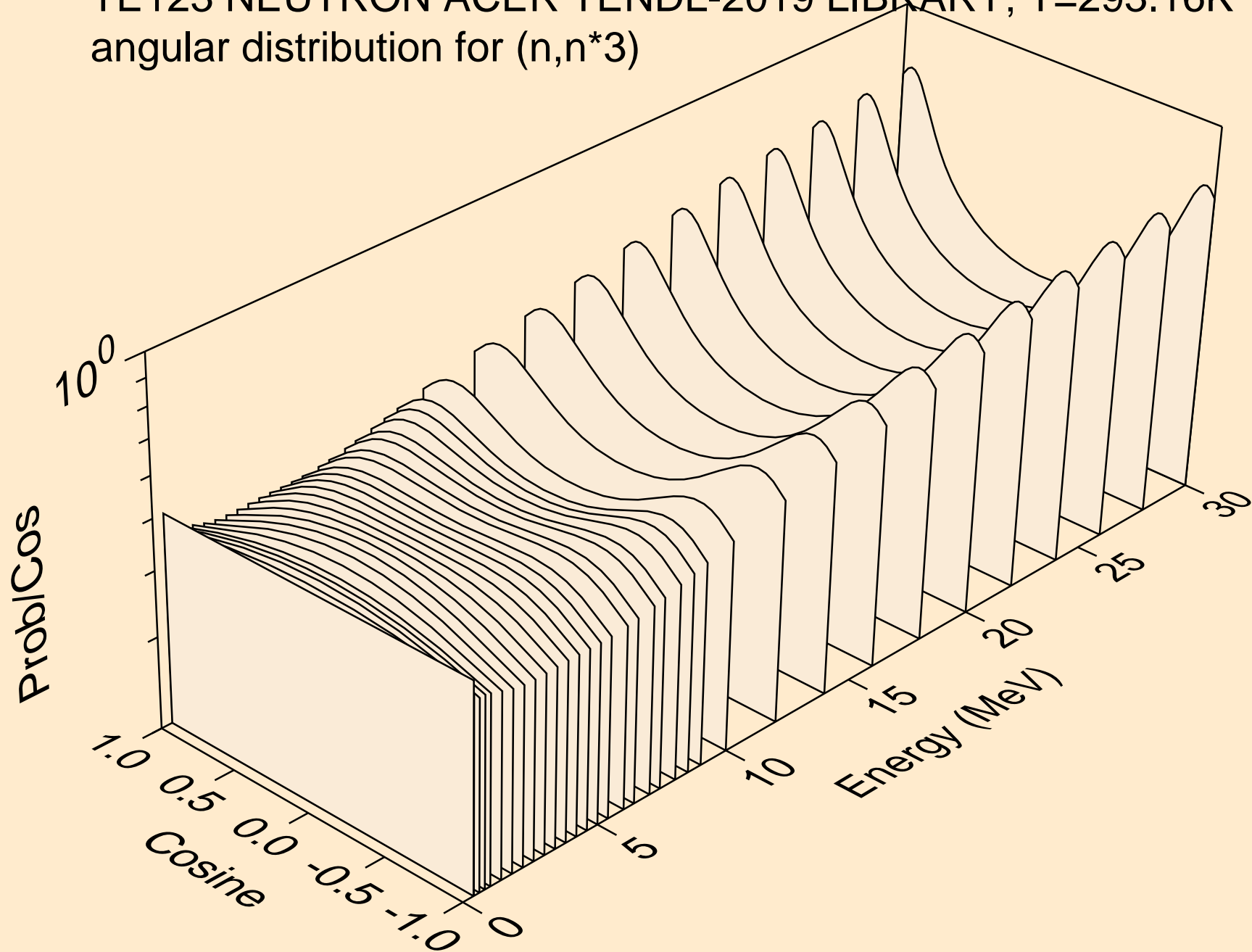

TE123 NEUTRON ACER TENDL-2019 LIBRARY; T=293.16K
angular distribution for (n,n*4)

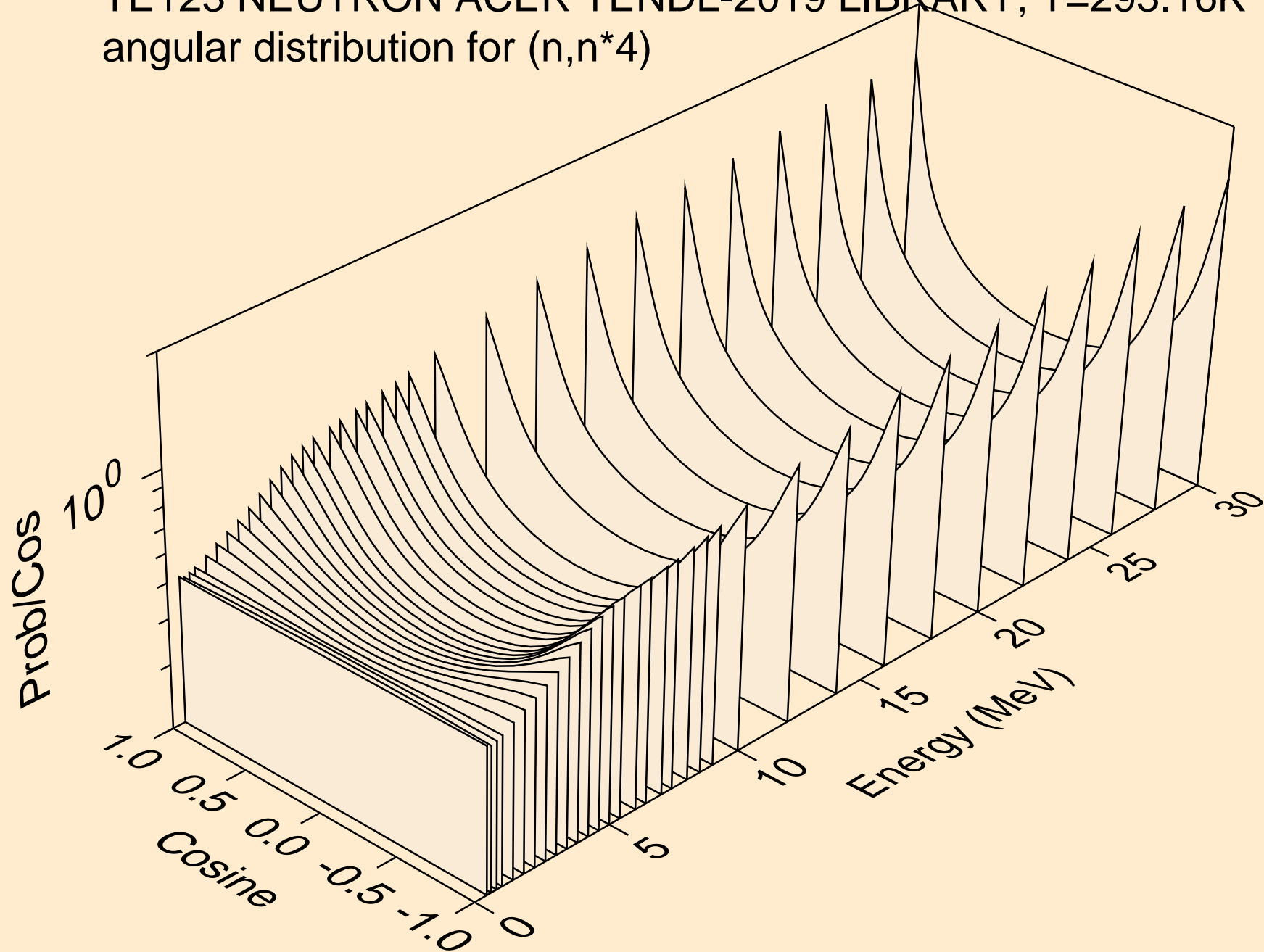

TE123 NEUTRON ACER TENDL-2019 LIBRARY; T=293.16K
angular distribution for (n,n*5)

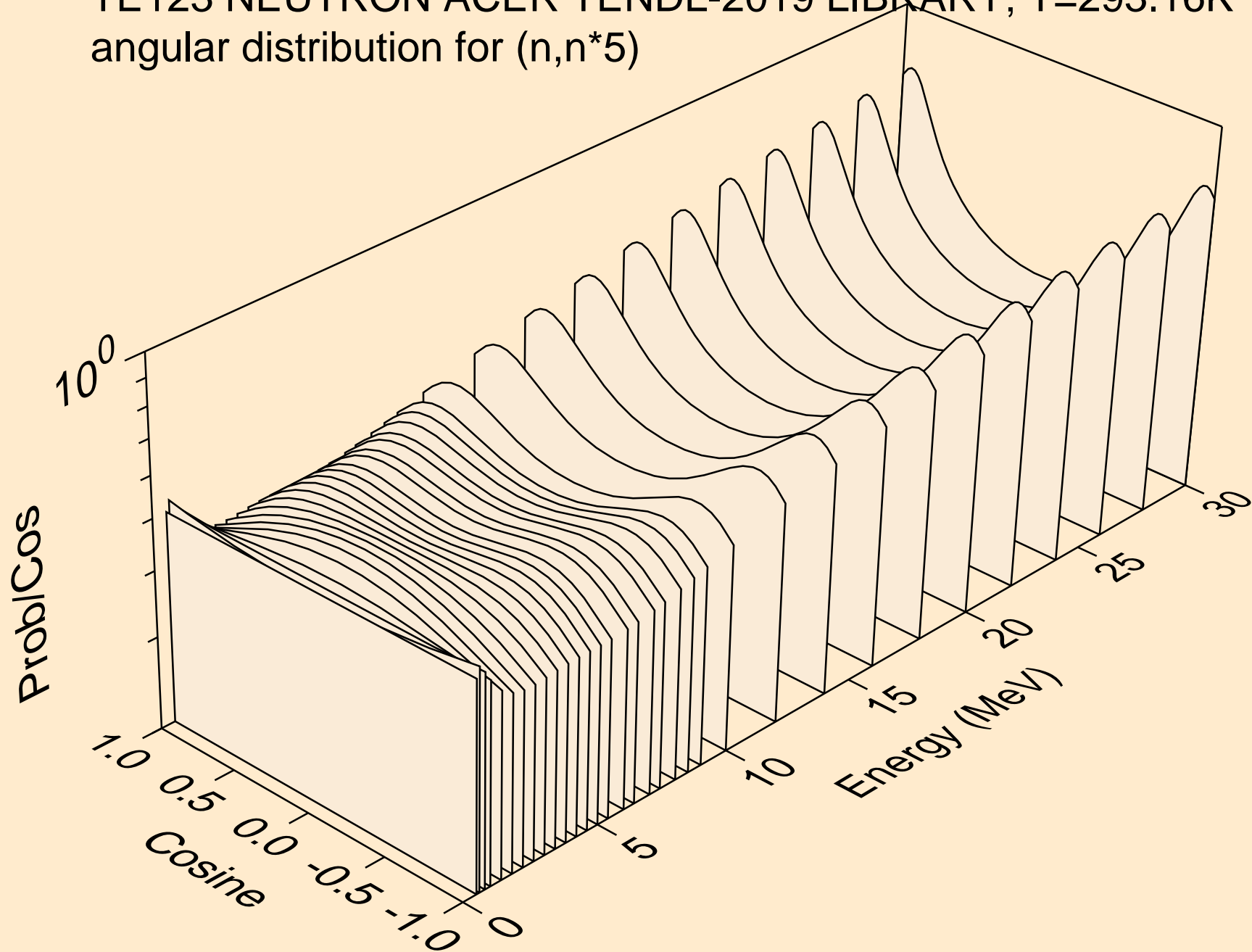

TE123 NEUTRON ACER TENDL-2019 LIBRARY; T=293.16K
angular distribution for (n,n*6)

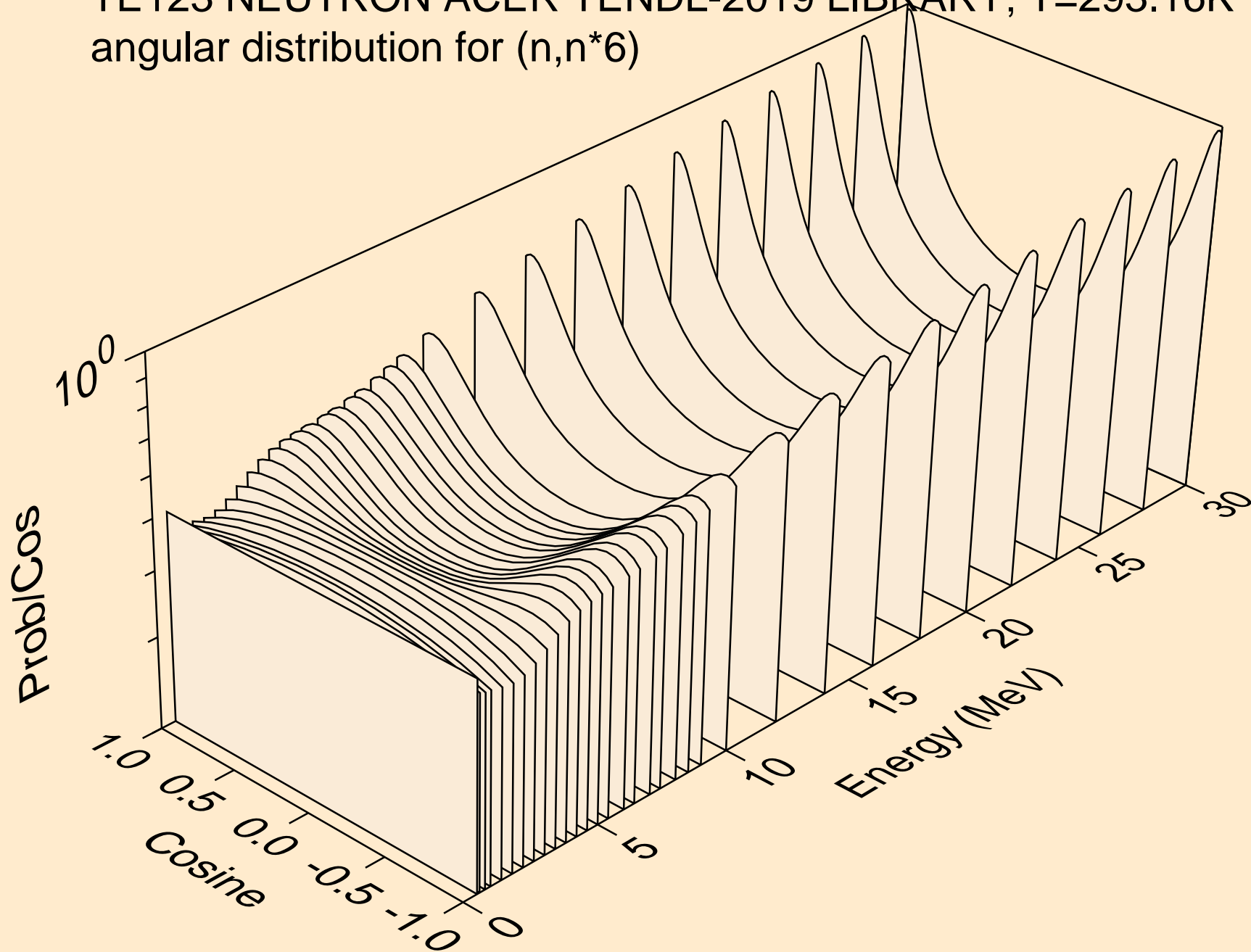

TE123 NEUTRON ACER TENDL-2019 LIBRARY; T=293.16K
angular distribution for (n,n*7)

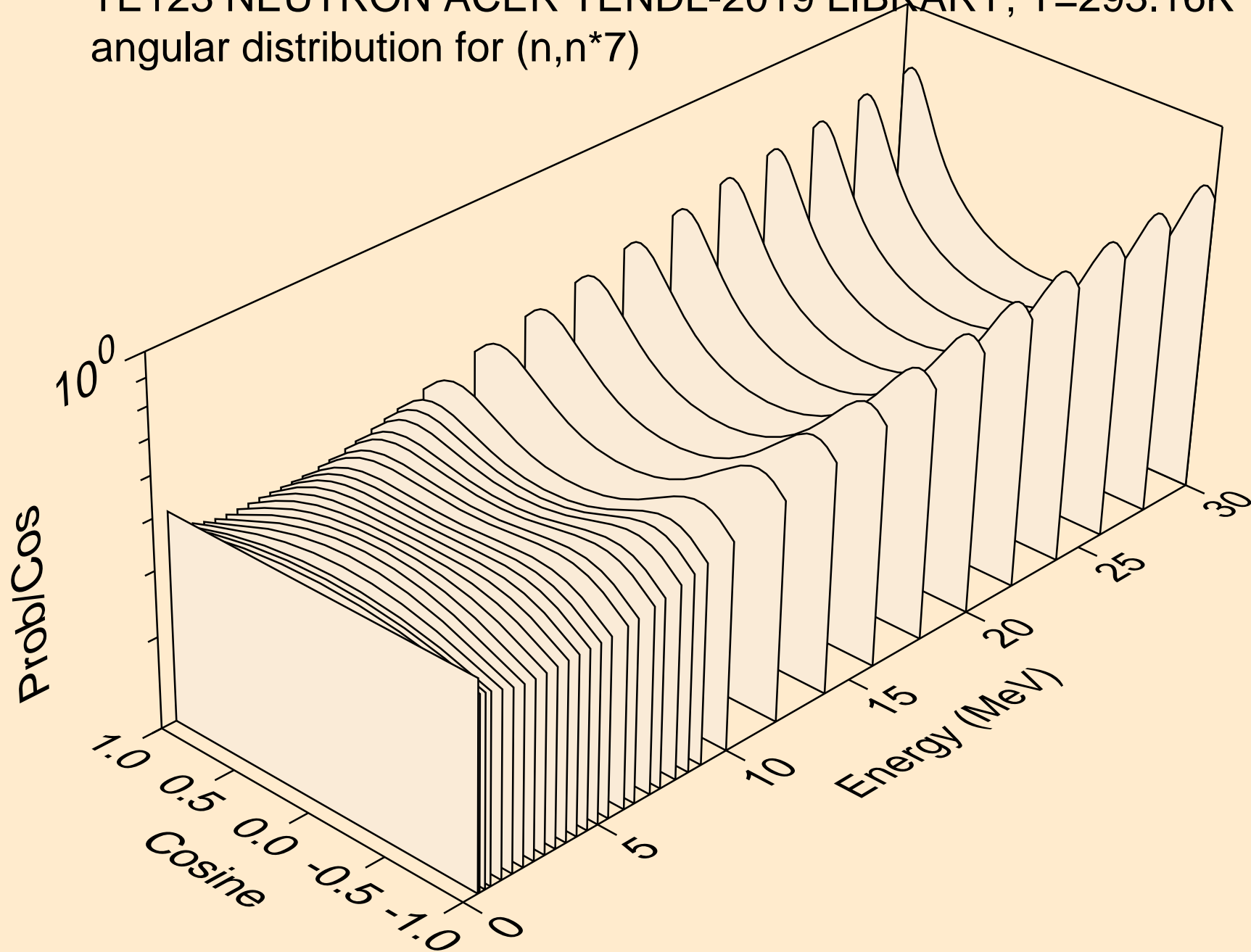

TE123 NEUTRON ACER TENDL-2019 LIBRARY; T=293.16K
angular distribution for (n,n*8)

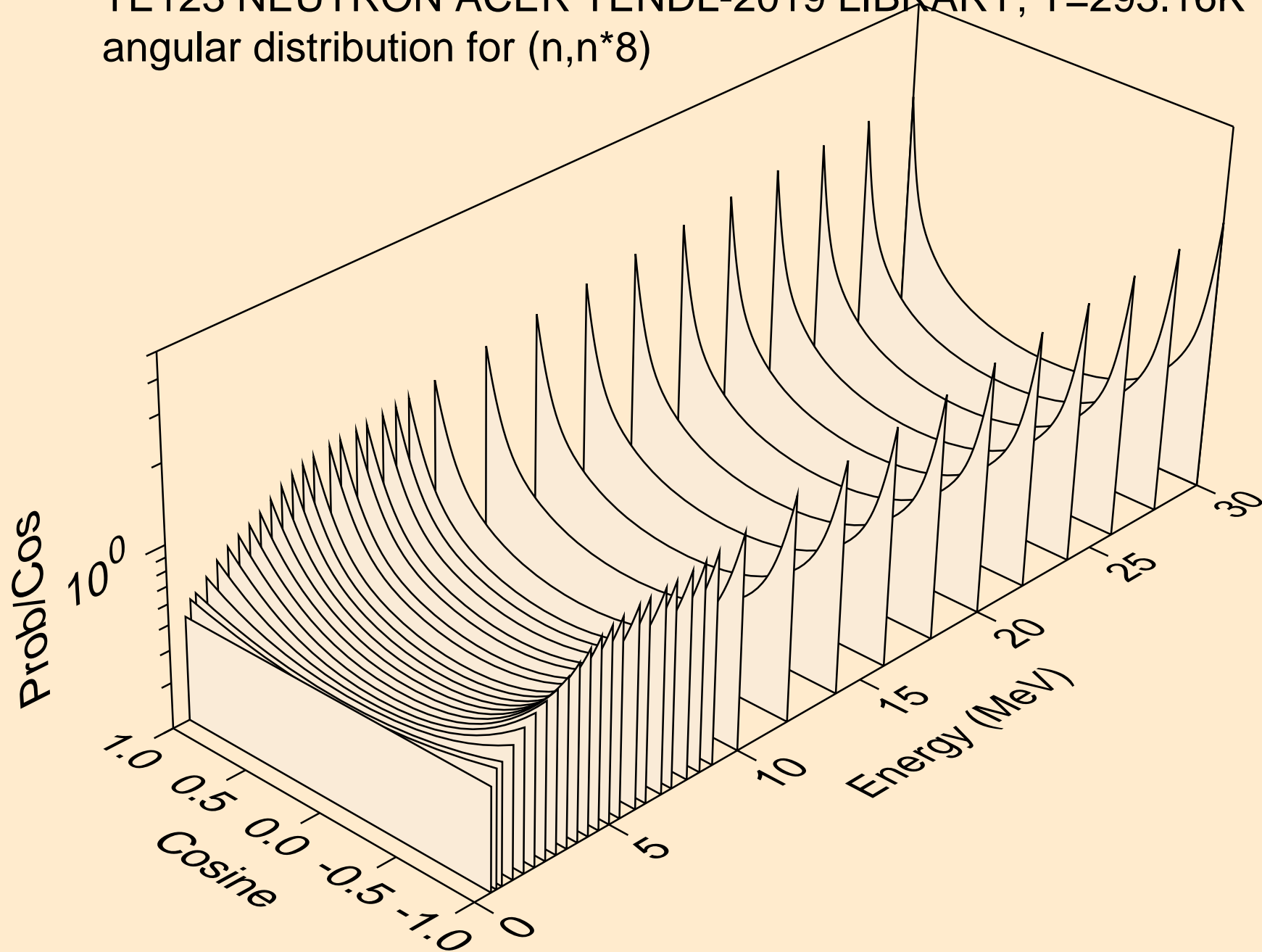

TE123 NEUTRON ACER TENDL-2019 LIBRARY; T=293.16K
angular distribution for (n,n*9)

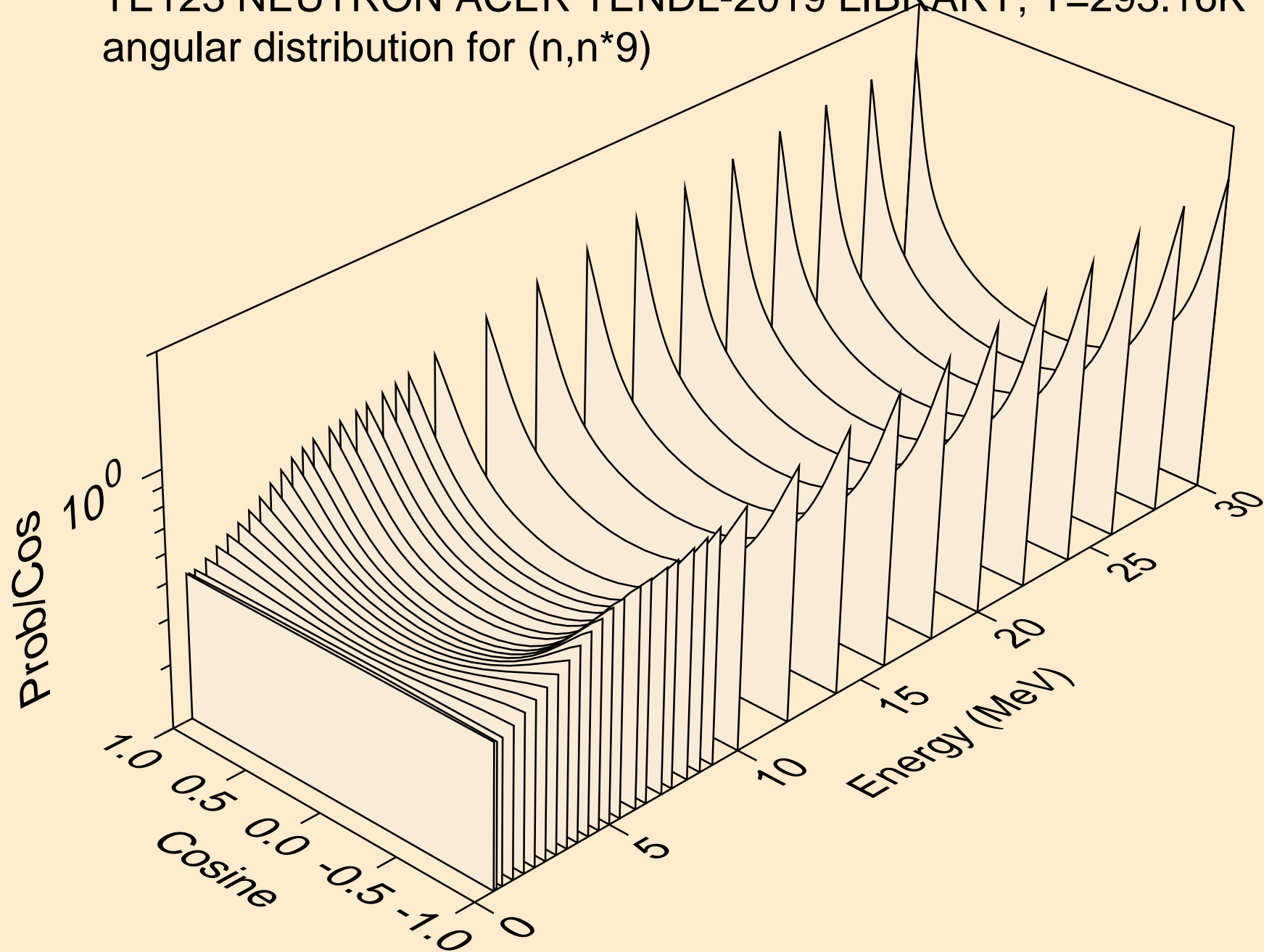

TE123 NEUTRON ACER TENDL-2019 LIBRARY; T=293.16K
angular distribution for (n,n*10)

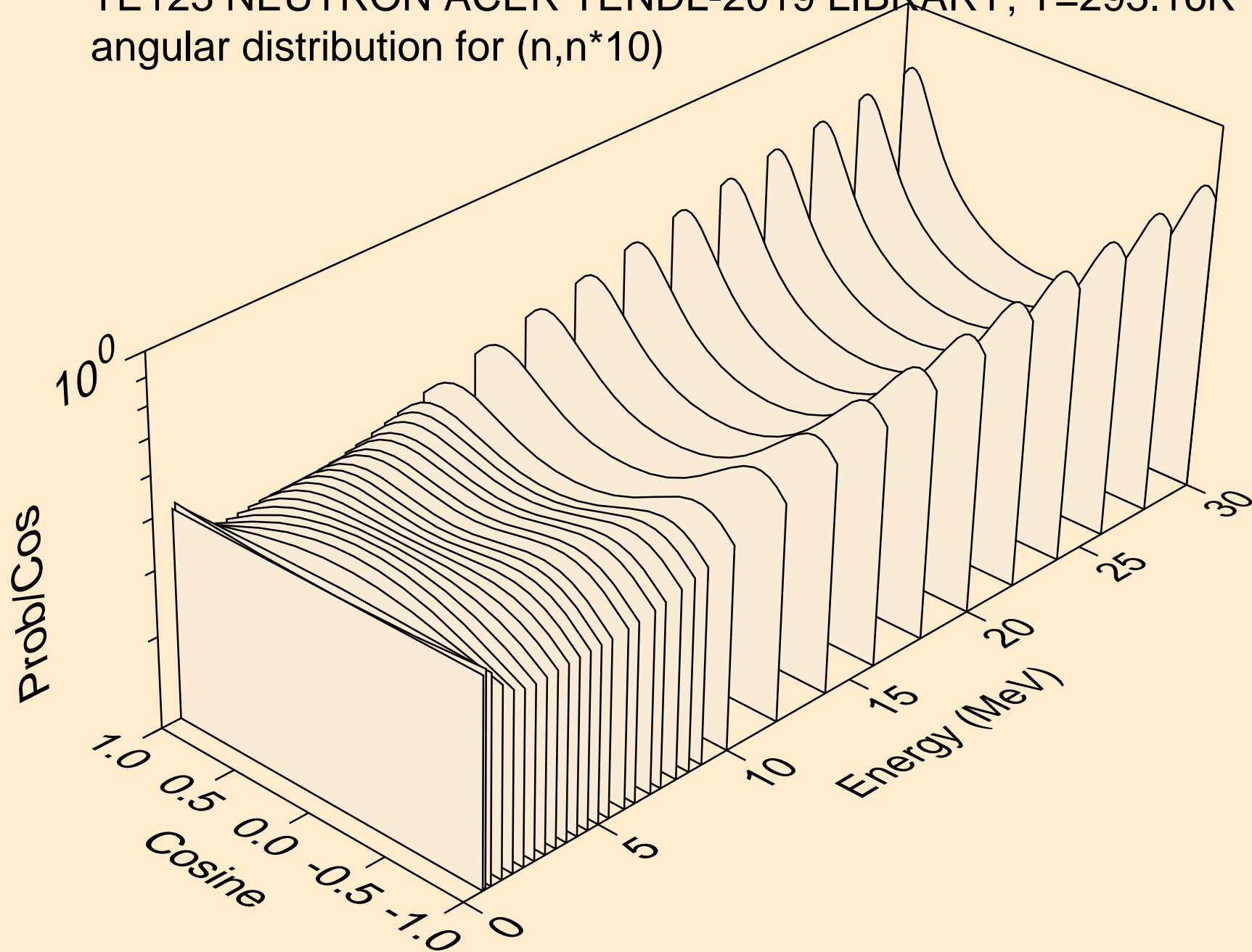

TE123 NEUTRON ACER TENDL-2019 LIBRARY; T=293.16K
angular distribution for (n,n*11)

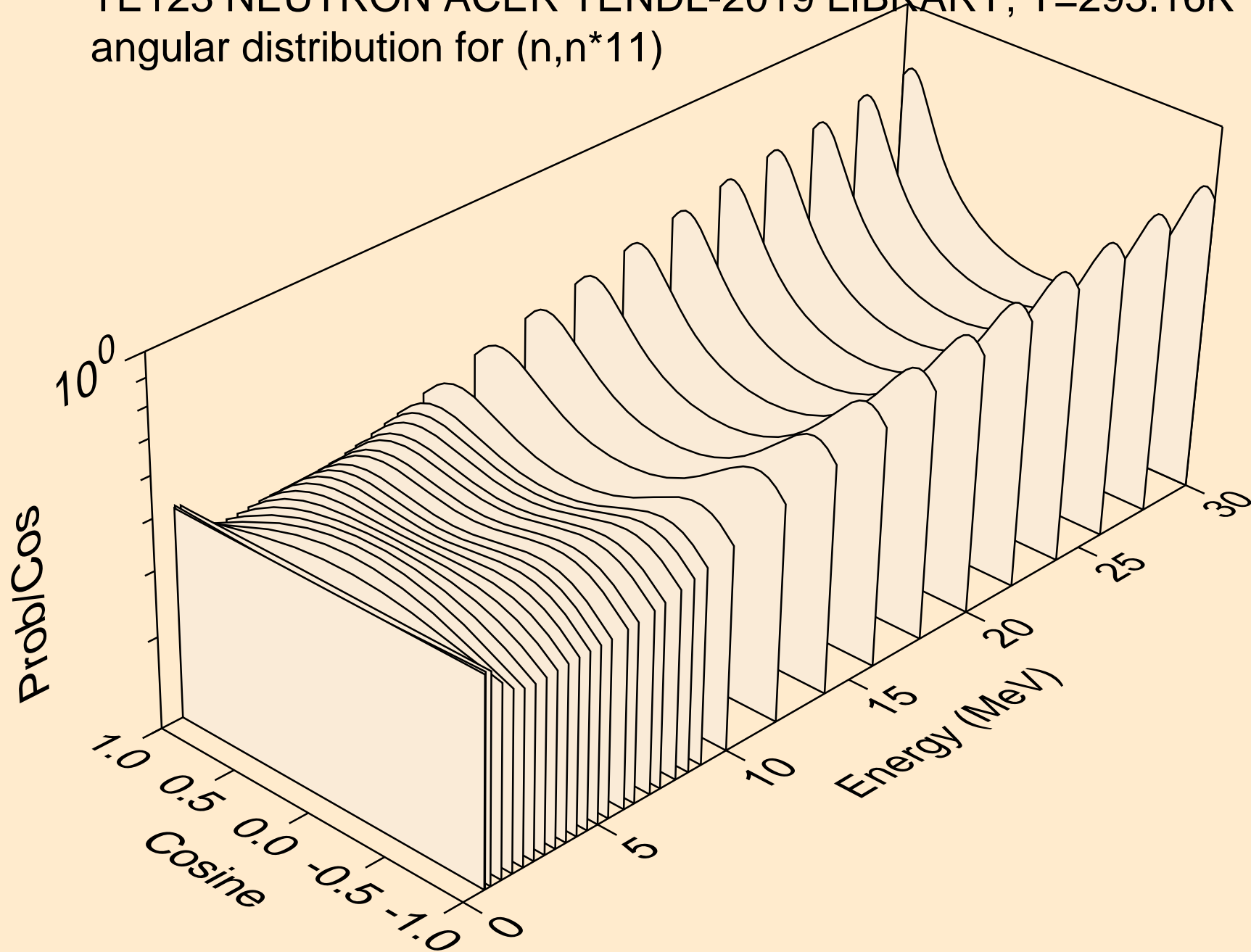

TE123 NEUTRON ACER TENDL-2019 LIBRARY; T=293.16K
angular distribution for (n,n*12)

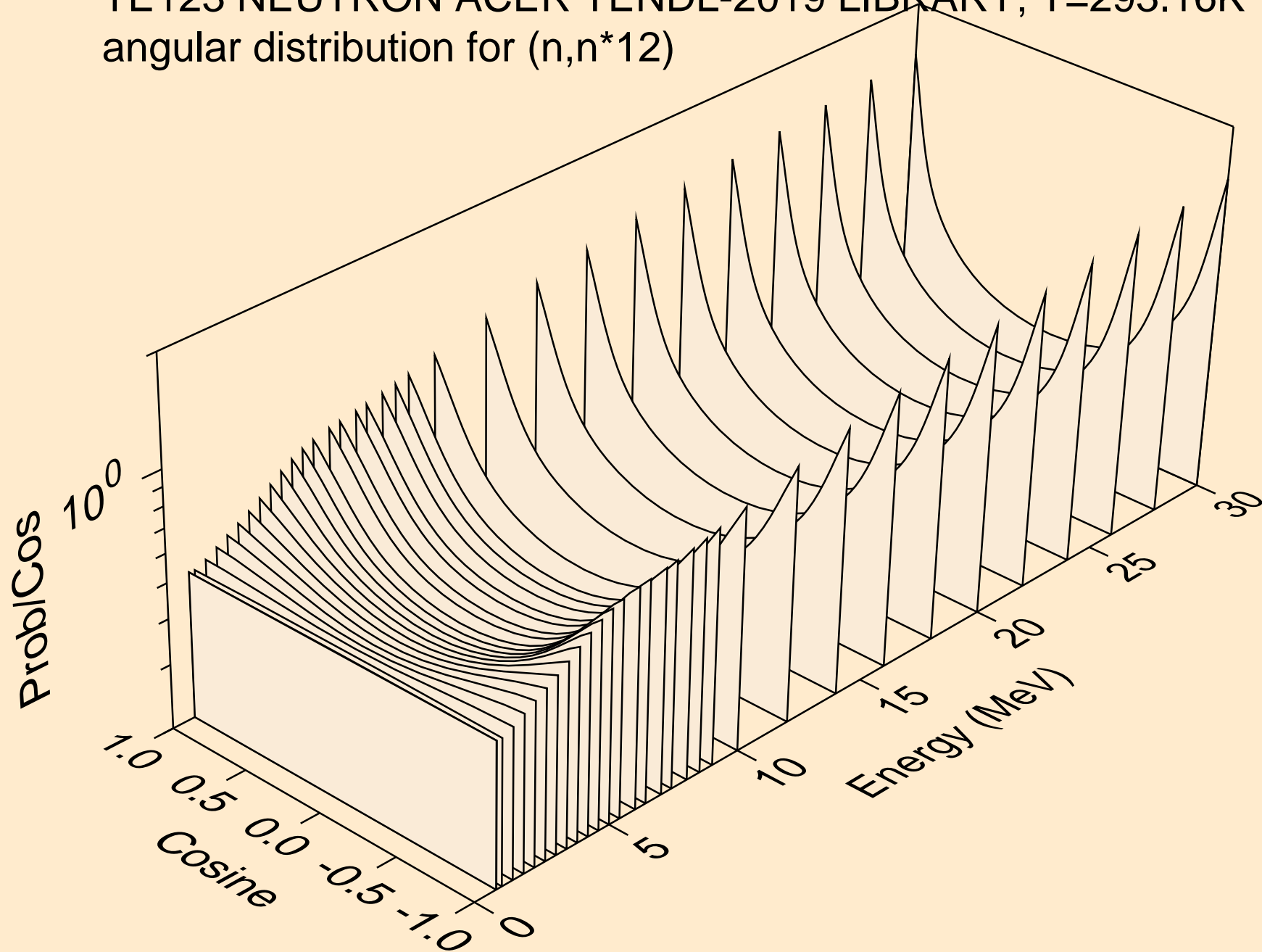

TE123 NEUTRON ACER TENDL-2019 LIBRARY; T=293.16K
angular distribution for (n,n*13)

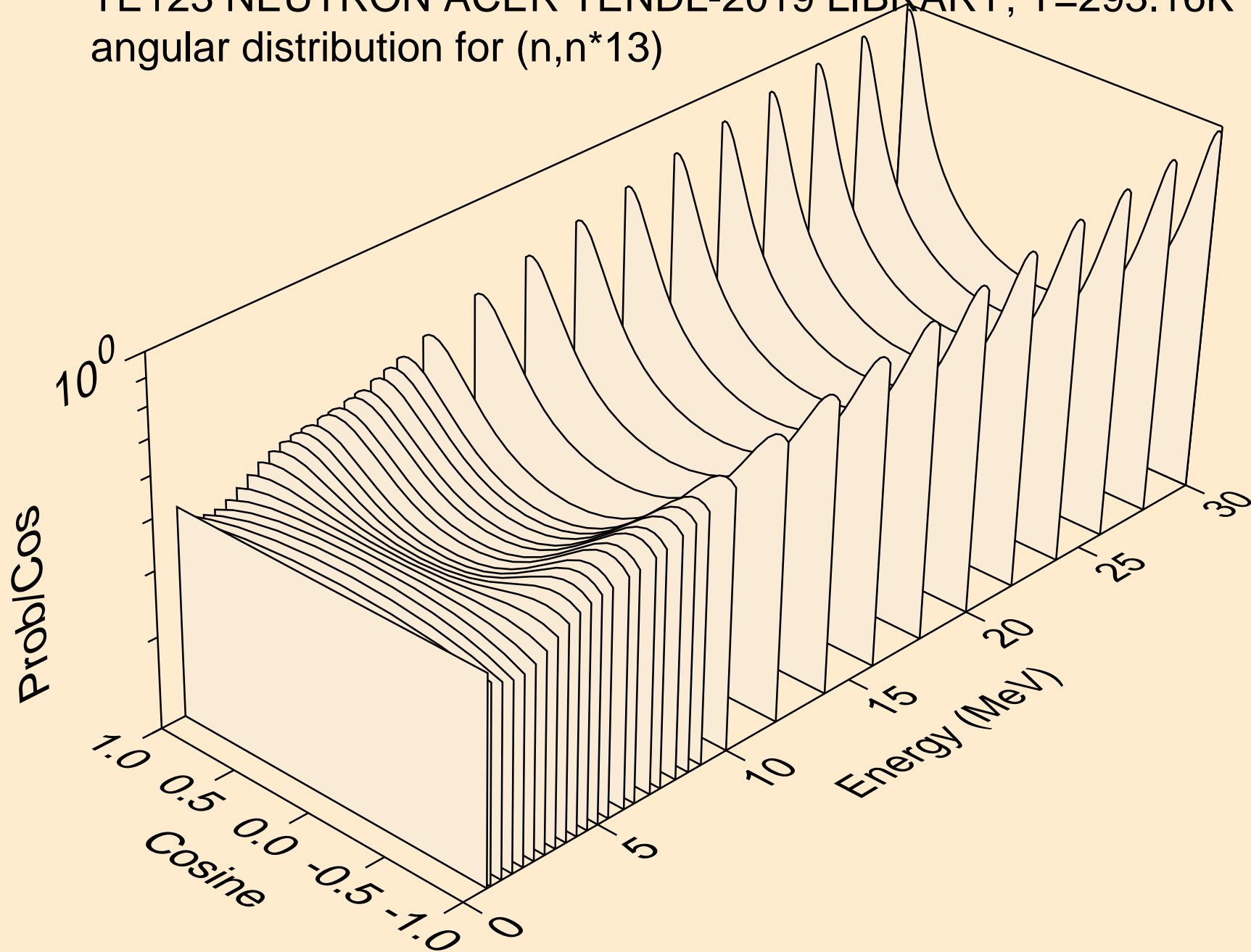

TE123 NEUTRON ACER TENDL-2019 LIBRARY; T=293.16K
angular distribution for (n,n*14)

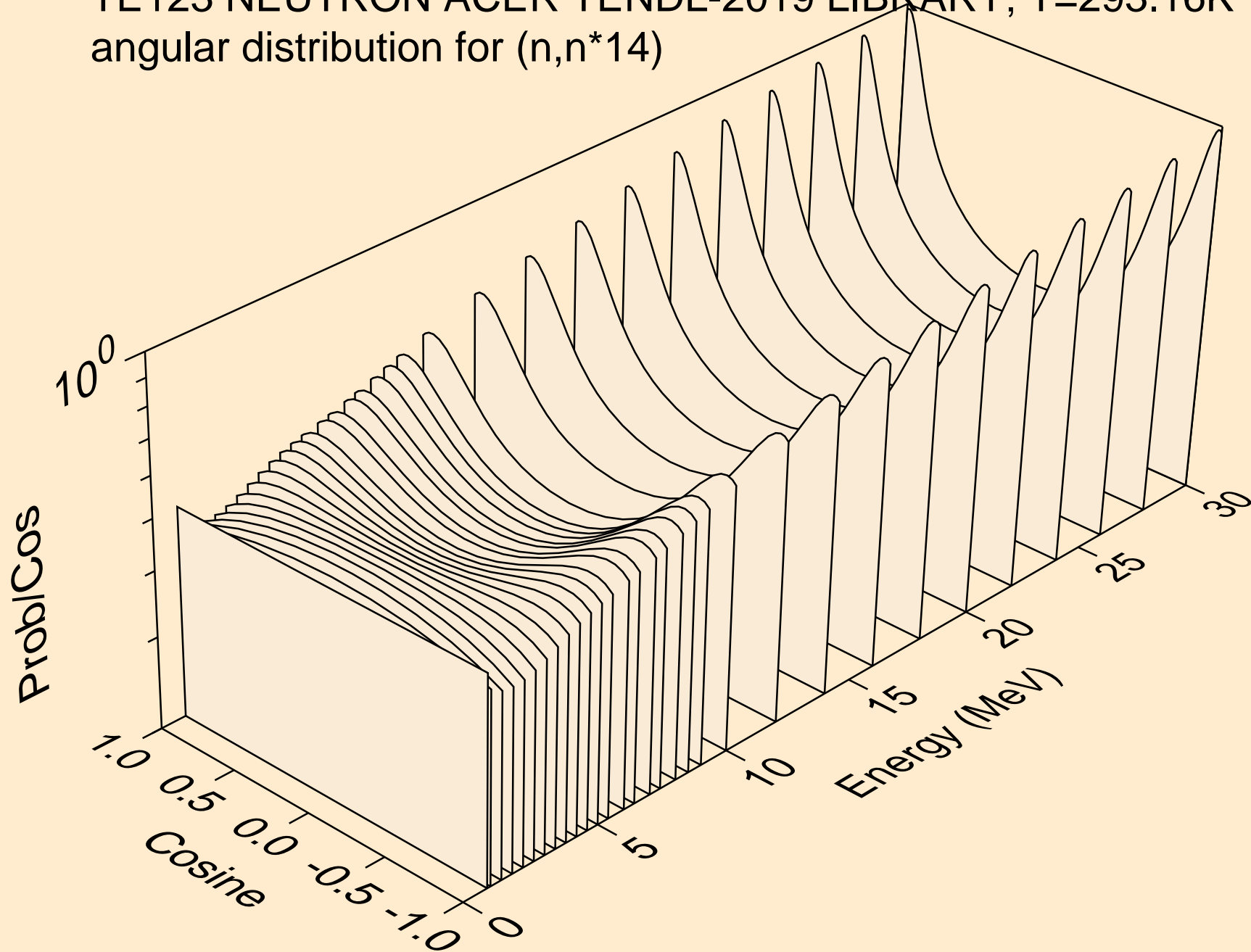

TE123 NEUTRON ACER TENDL-2019 LIBRARY; T=293.16K
angular distribution for (n,n*15)

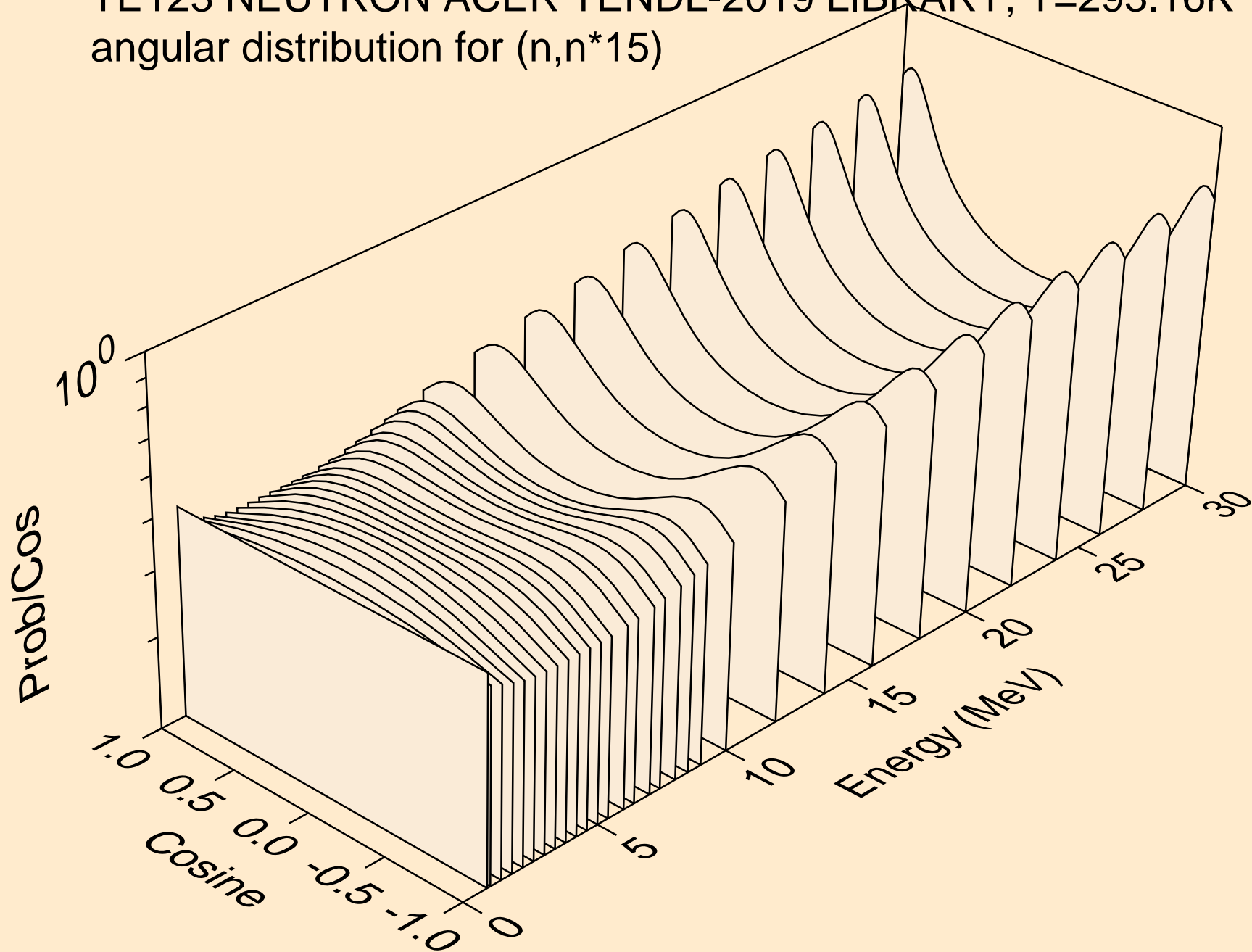

TE123 NEUTRON ACER TENDL-2019 LIBRARY; T=293.16K
angular distribution for (n,n*16)

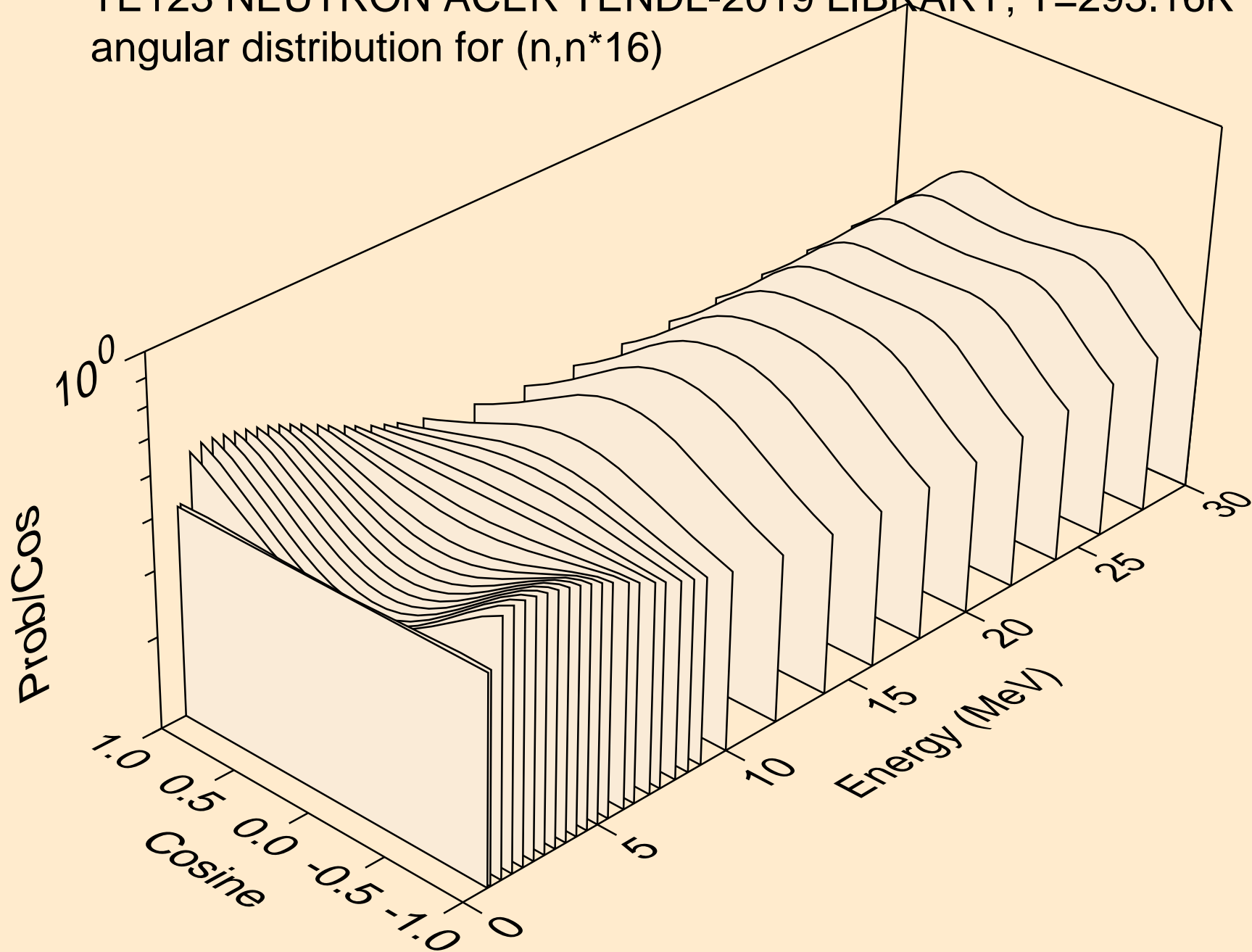

TE123 NEUTRON ACER TENDL-2019 LIBRARY; T=293.16K
angular distribution for (n,n*17)

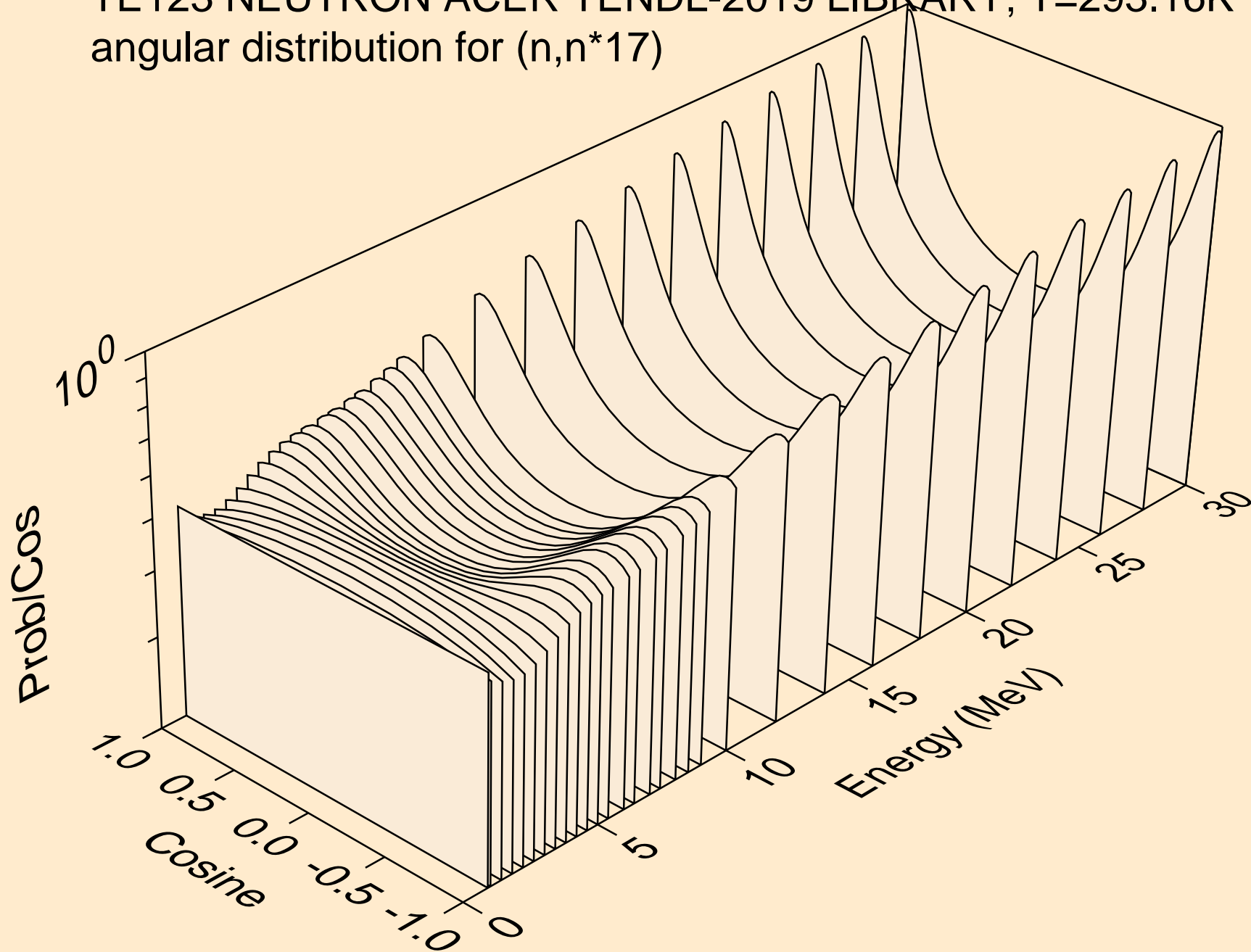

TE123 NEUTRON ACER TENDL-2019 LIBRARY; T=293.16K
angular distribution for (n,n*18)

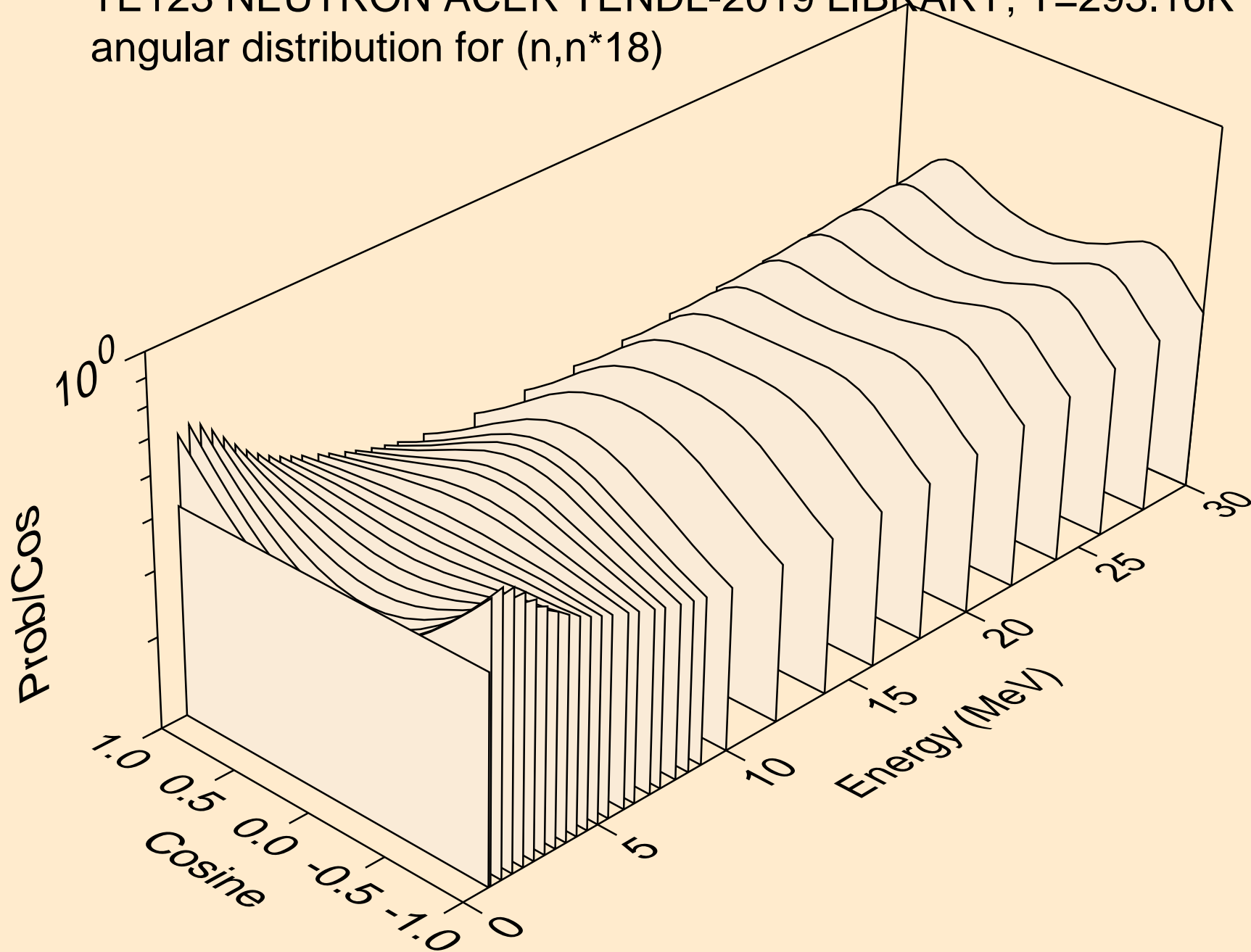

TE123 NEUTRON ACER TENDL-2019 LIBRARY; T=293.16K
angular distribution for (n,n*19)

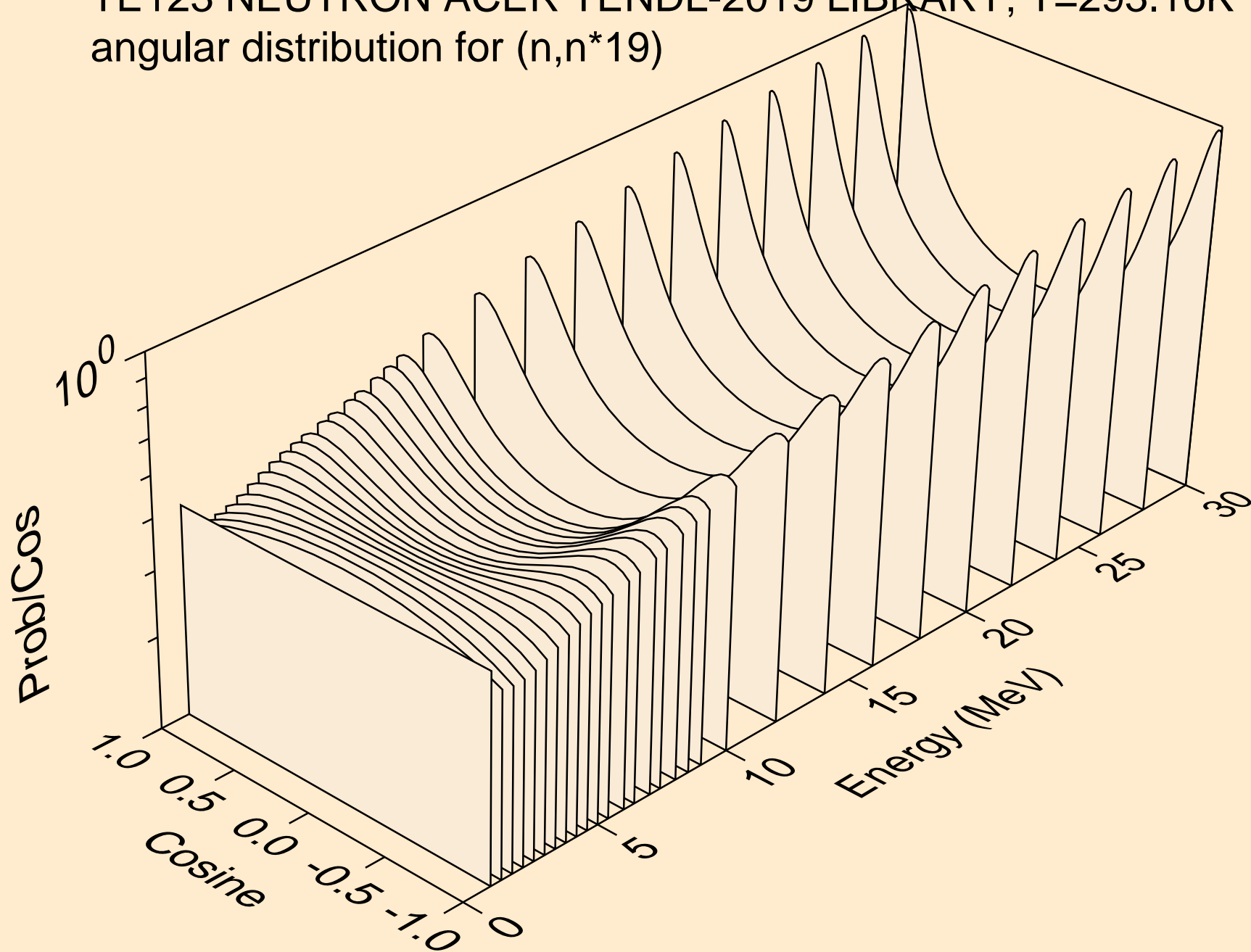

TE123 NEUTRON ACER TENDL-2019 LIBRARY; T=293.16K
angular distribution for (n,n*20)

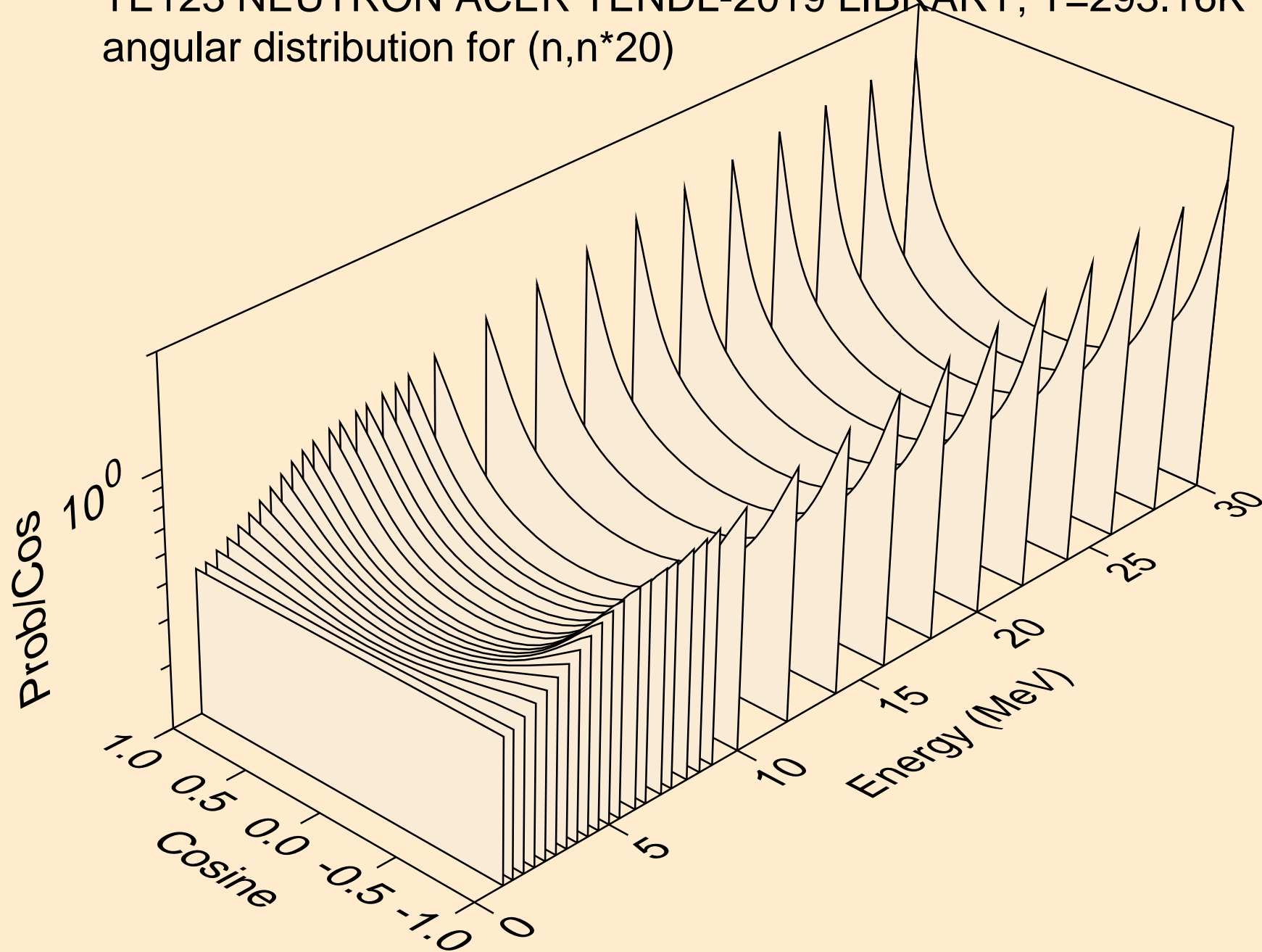

TE123 NEUTRON ACER TENDL-2019 LIBRARY; T=293.16K
angular distribution for (n,n*21)

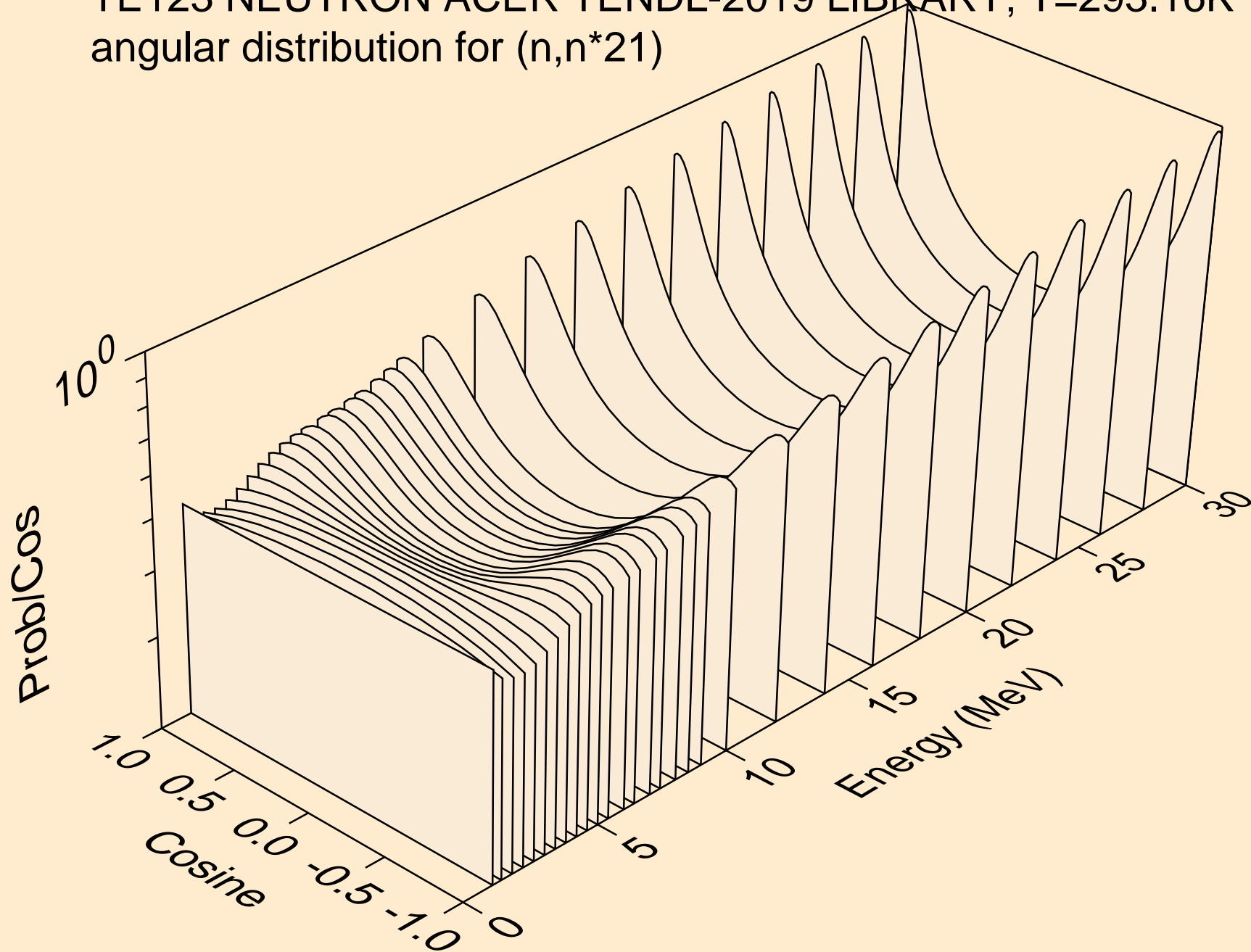

TE123 NEUTRON ACER TENDL-2019 LIBRARY; T=293.16K
angular distribution for (n,n*22)

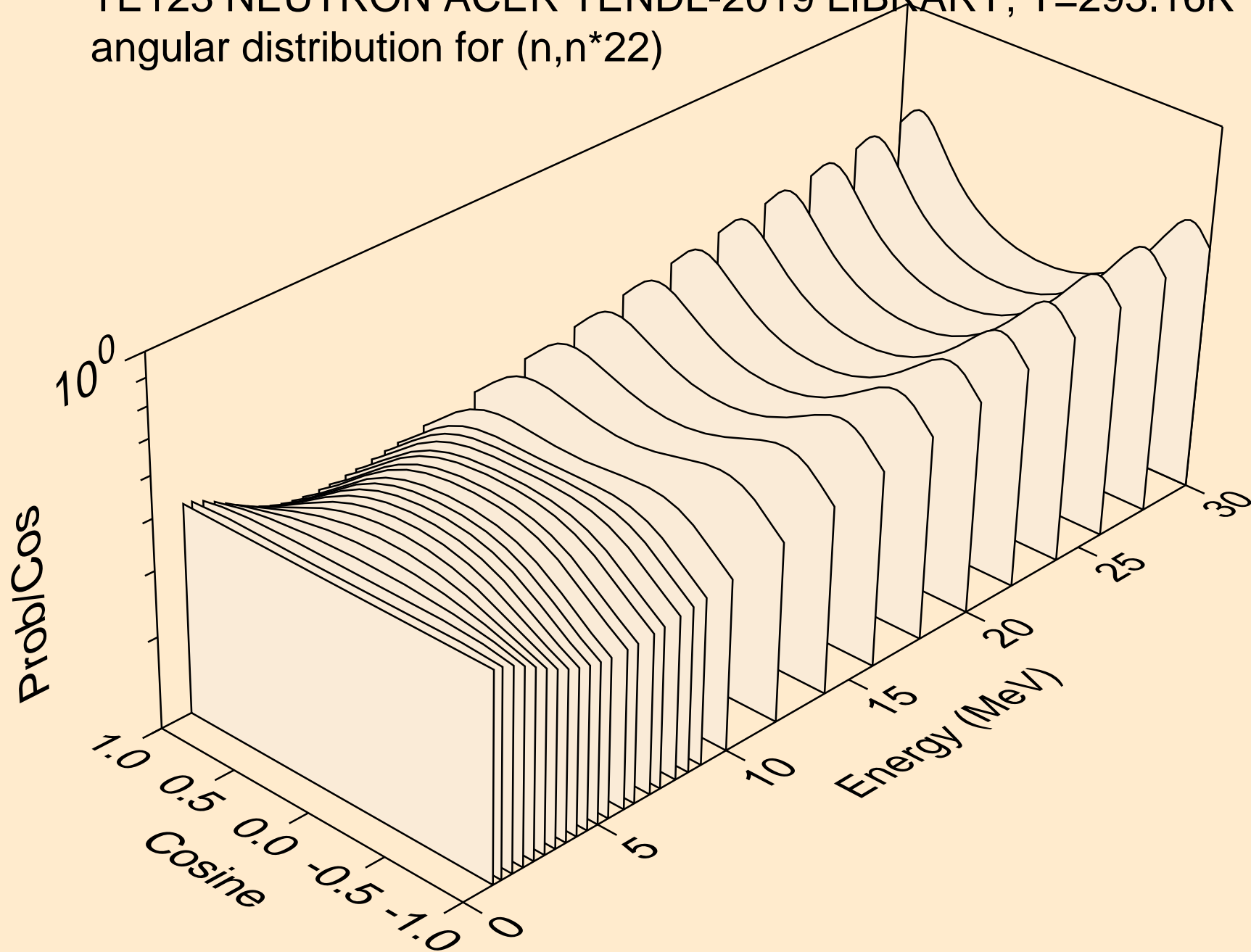

TE123 NEUTRON ACER TENDL-2019 LIBRARY; T=293.16K
angular distribution for (n,n*23)

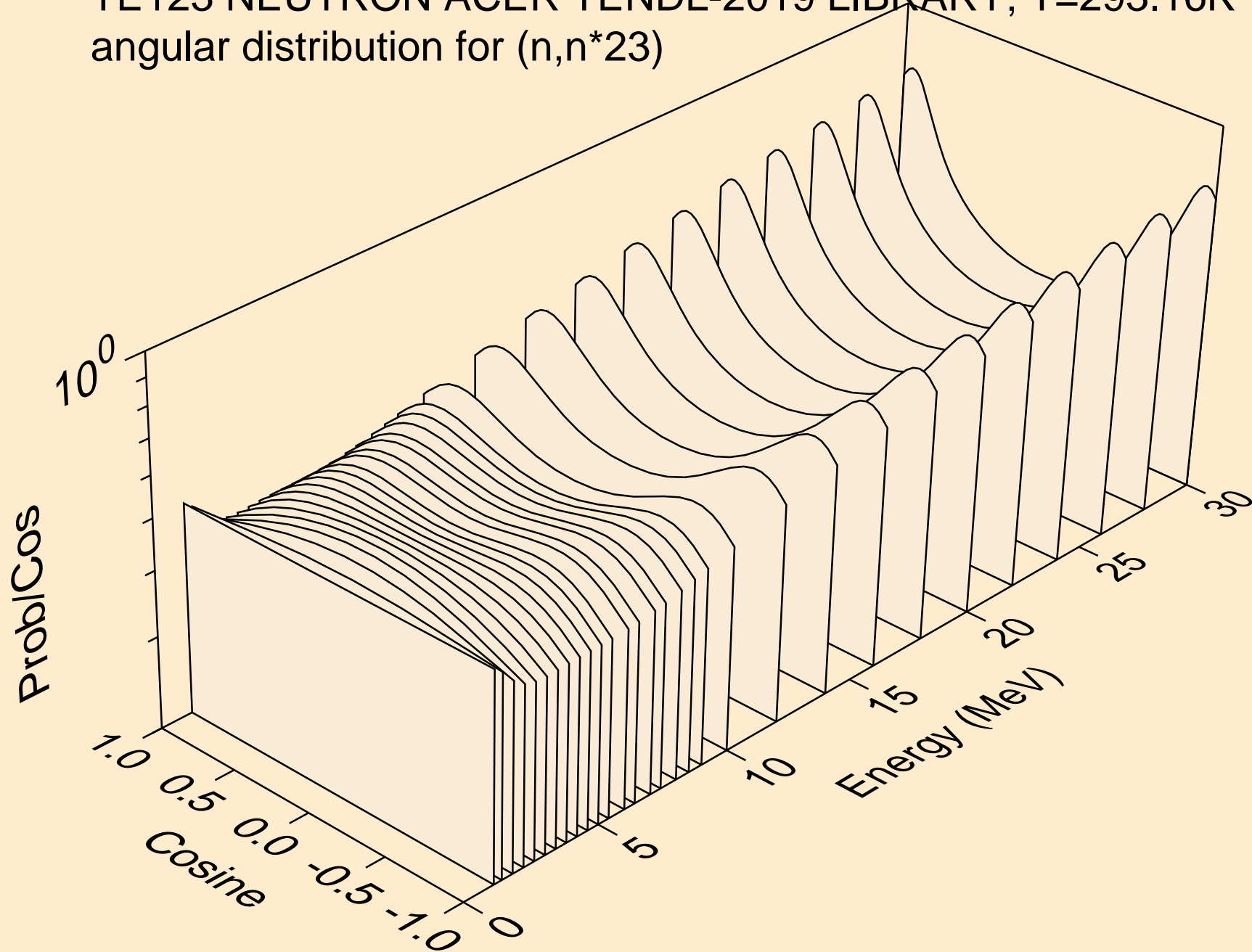

TE123 NEUTRON ACER TENDL-2019 LIBRARY; T=293.16K
angular distribution for (n,n*24)

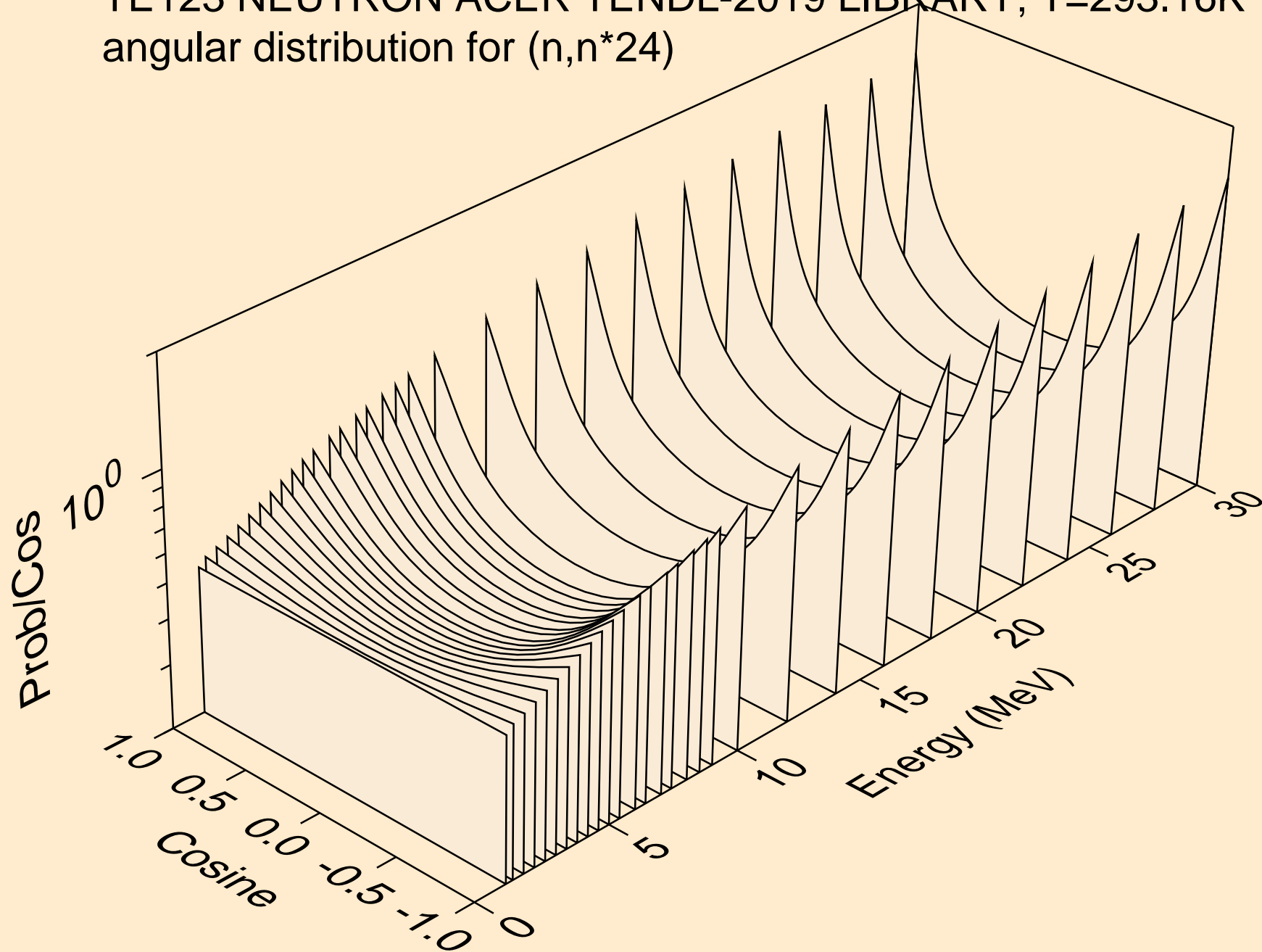

TE123 NEUTRON ACER TENDL-2019 LIBRARY; T=293.16K
angular distribution for (n,n*25)

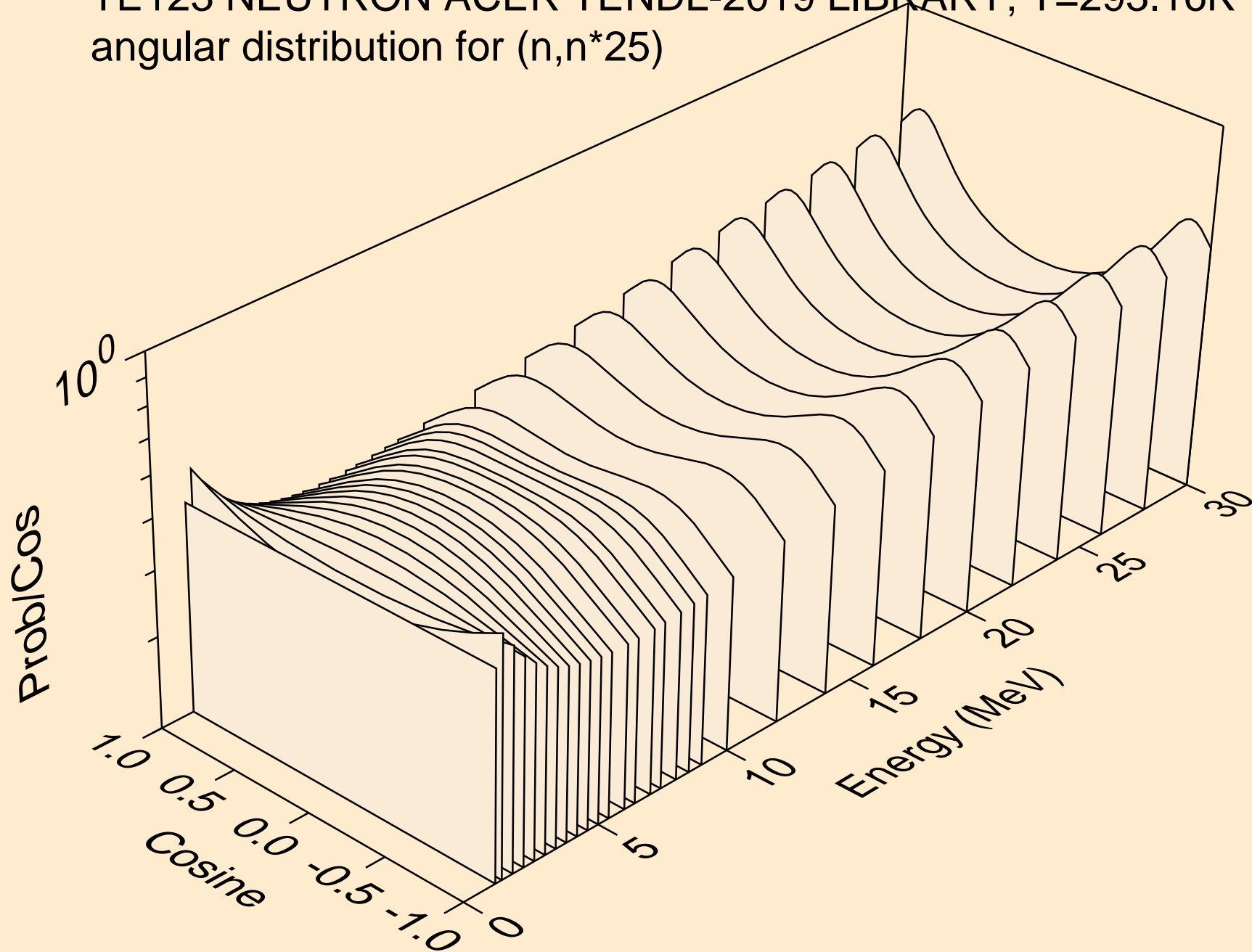

TE123 NEUTRON ACER TENDL-2019 LIBRARY; T=293.16K
angular distribution for (n,n*26)

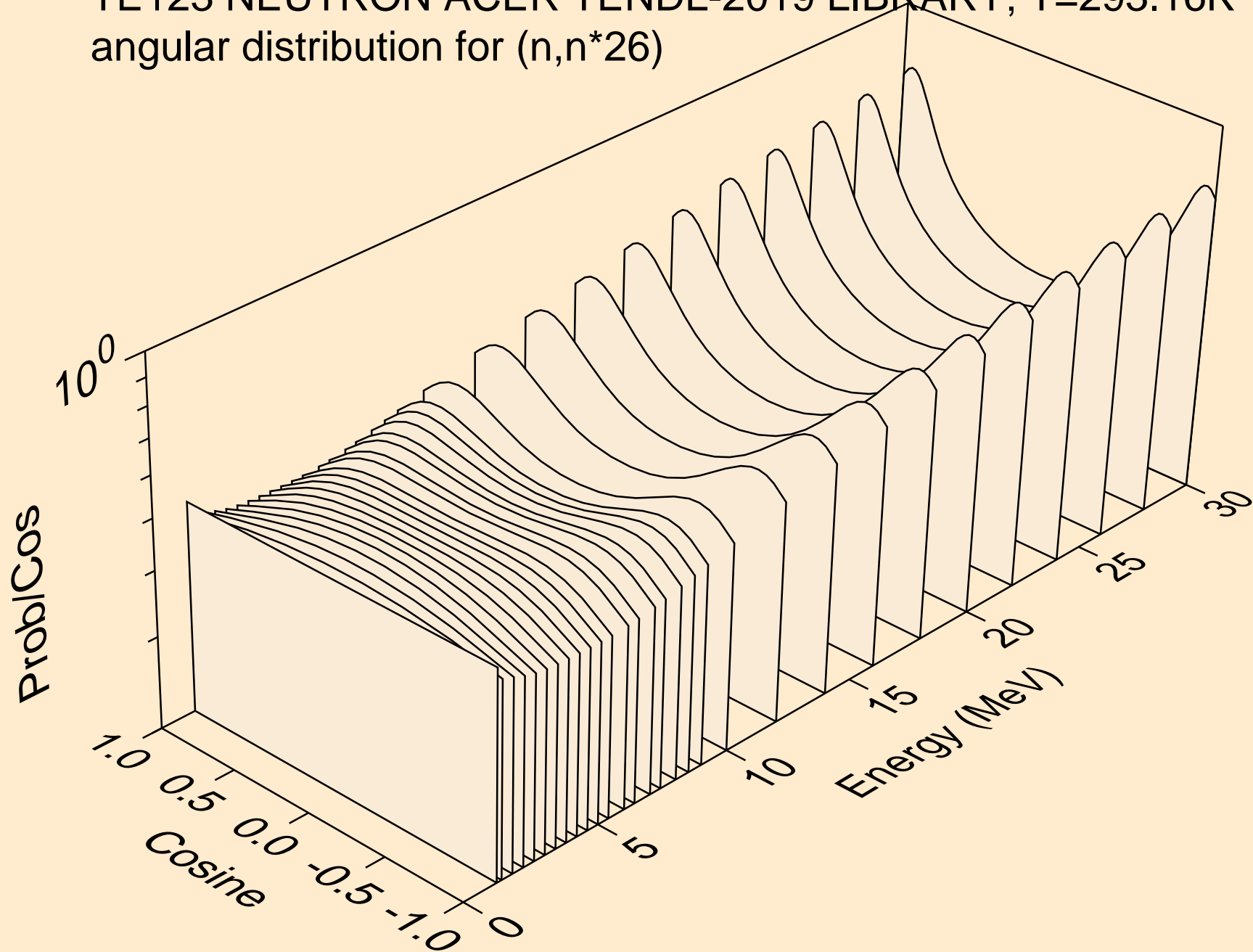

TE123 NEUTRON ACER TENDL-2019 LIBRARY; T=293.16K
angular distribution for (n,n*27)

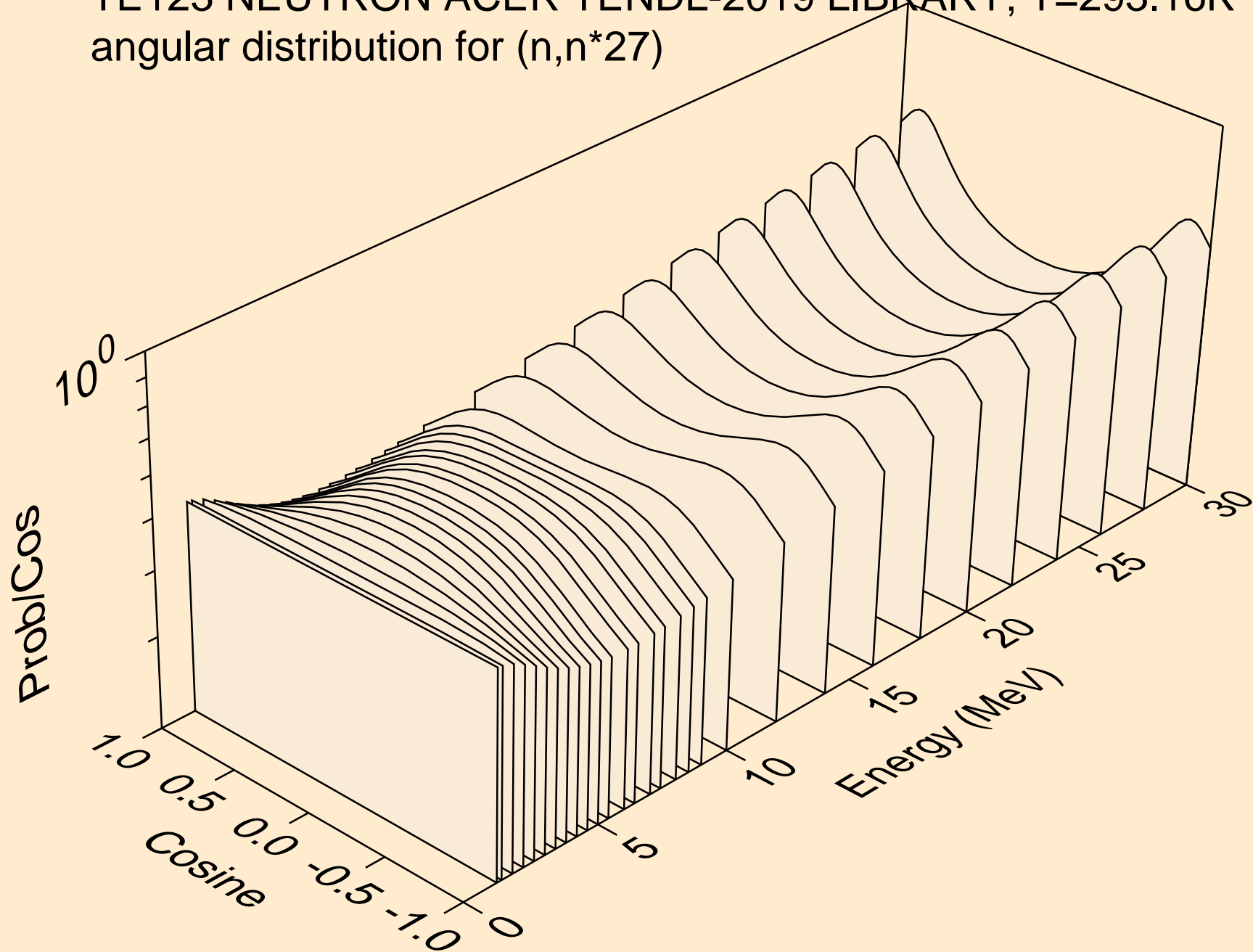

TE123 NEUTRON ACER TENDL-2019 LIBRARY; T=293.16K
angular distribution for (n,n*28)

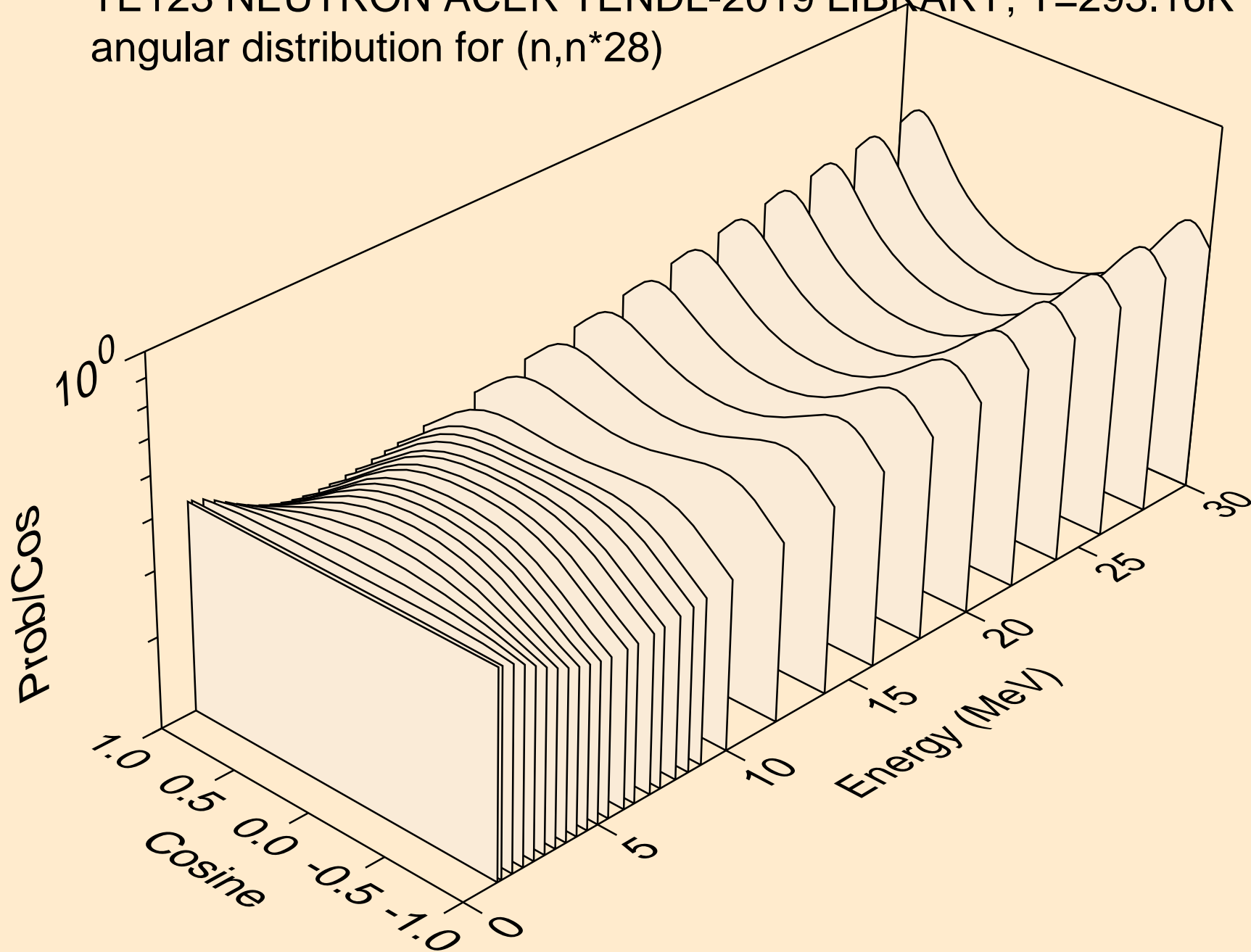

TE123 NEUTRON ACER TENDL-2019 LIBRARY; T=293.16K
angular distribution for (n,n*29)

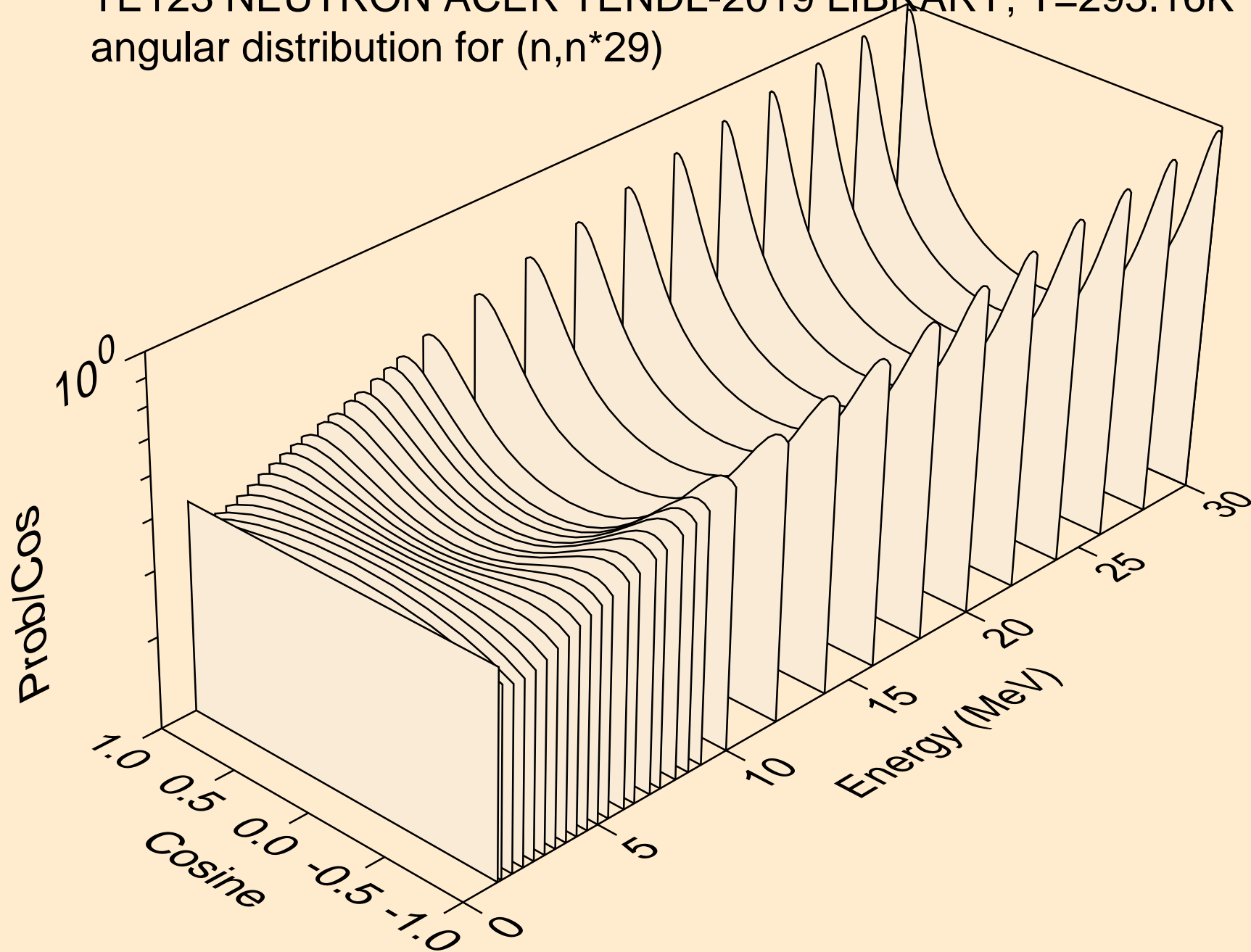

TE123 NEUTRON ACER TENDL-2019 LIBRARY; T=293.16K
Neutron emission for (n,x)

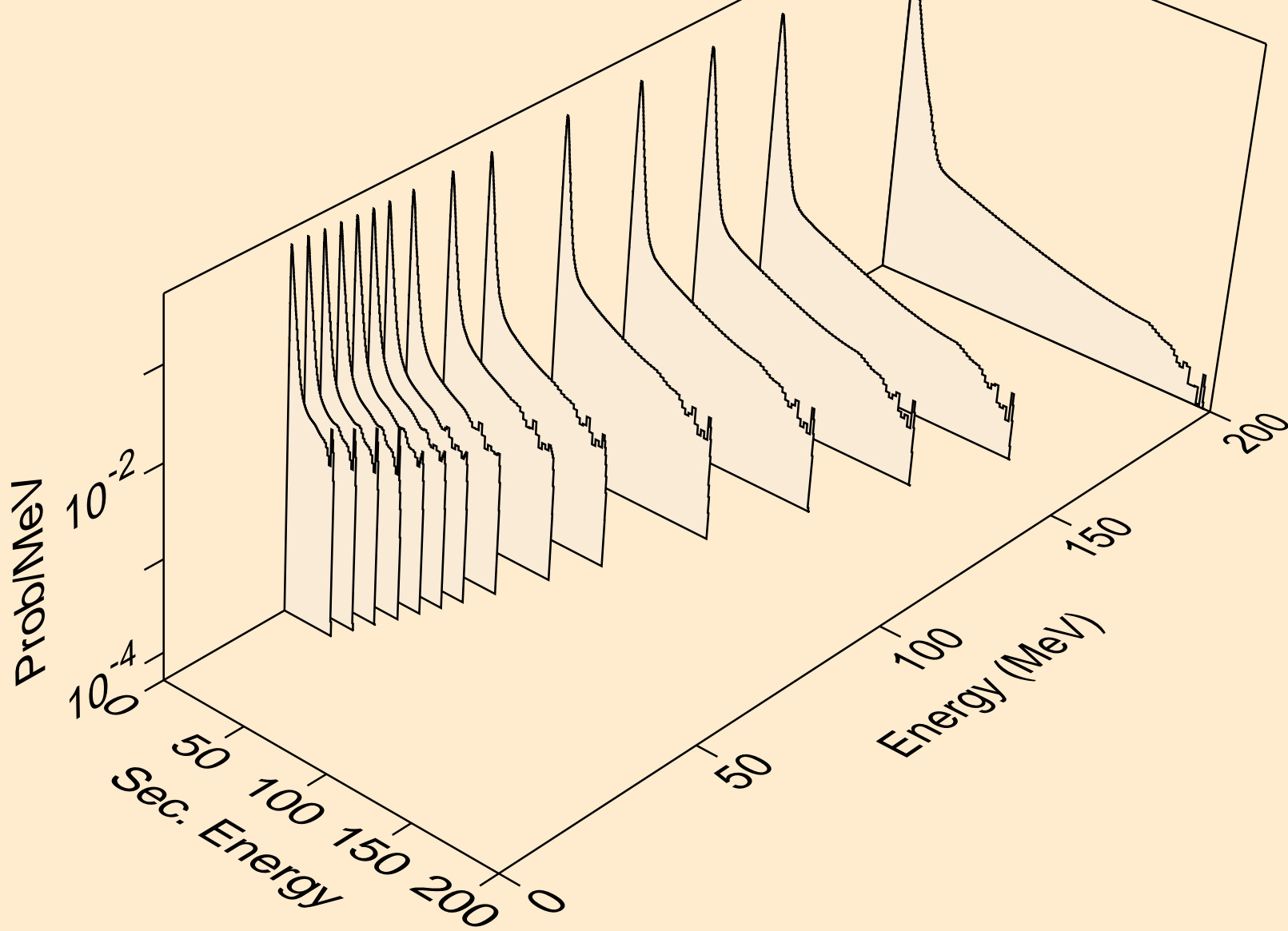

TE123 NEUTRON ACER TENDL-2019 LIBRARY; T=293.16K
Neutron emission for (n,2nd)

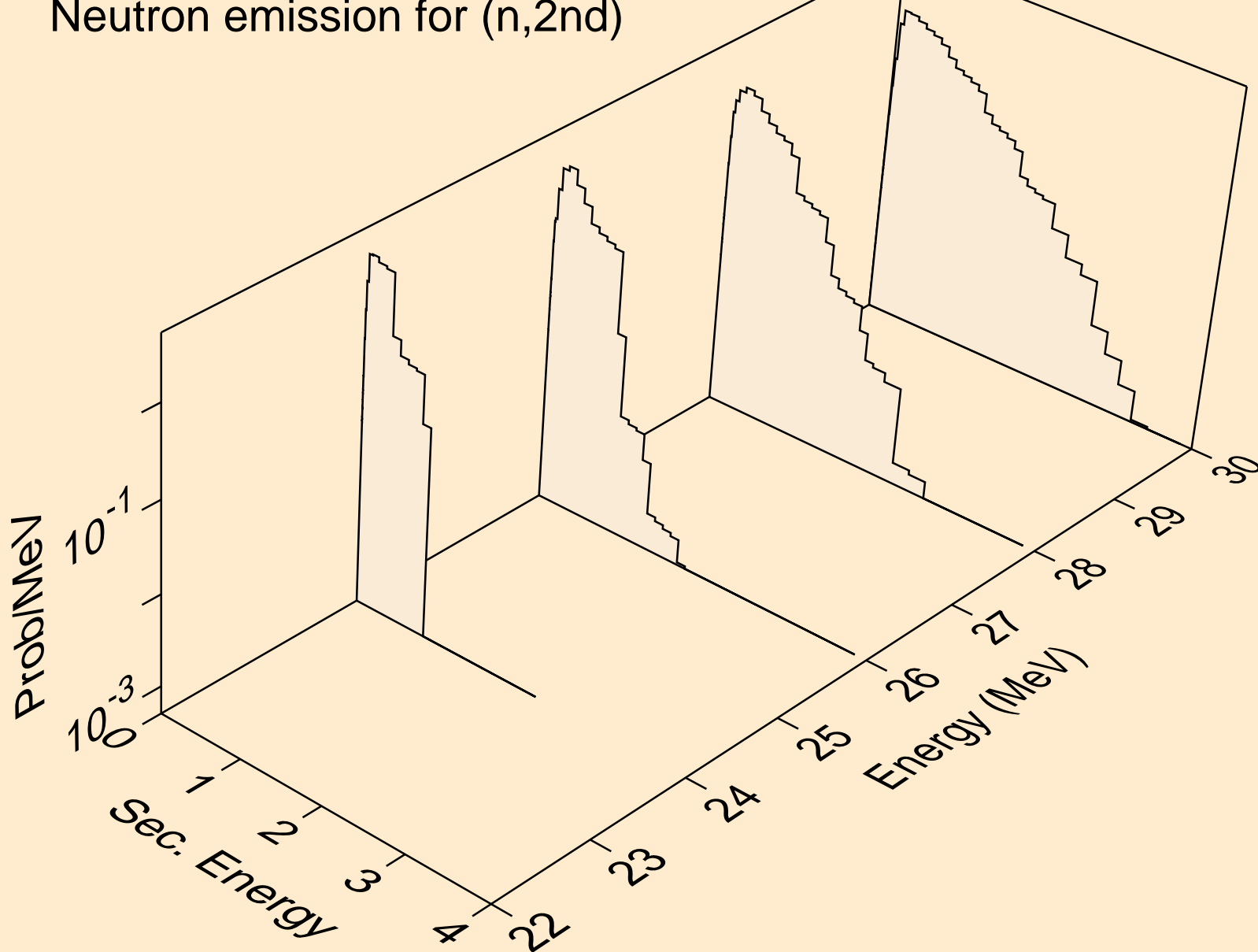

TE123 NEUTRON ACER TENDL-2019 LIBRARY; T=293.16K
Neutron emission for (n,2n)

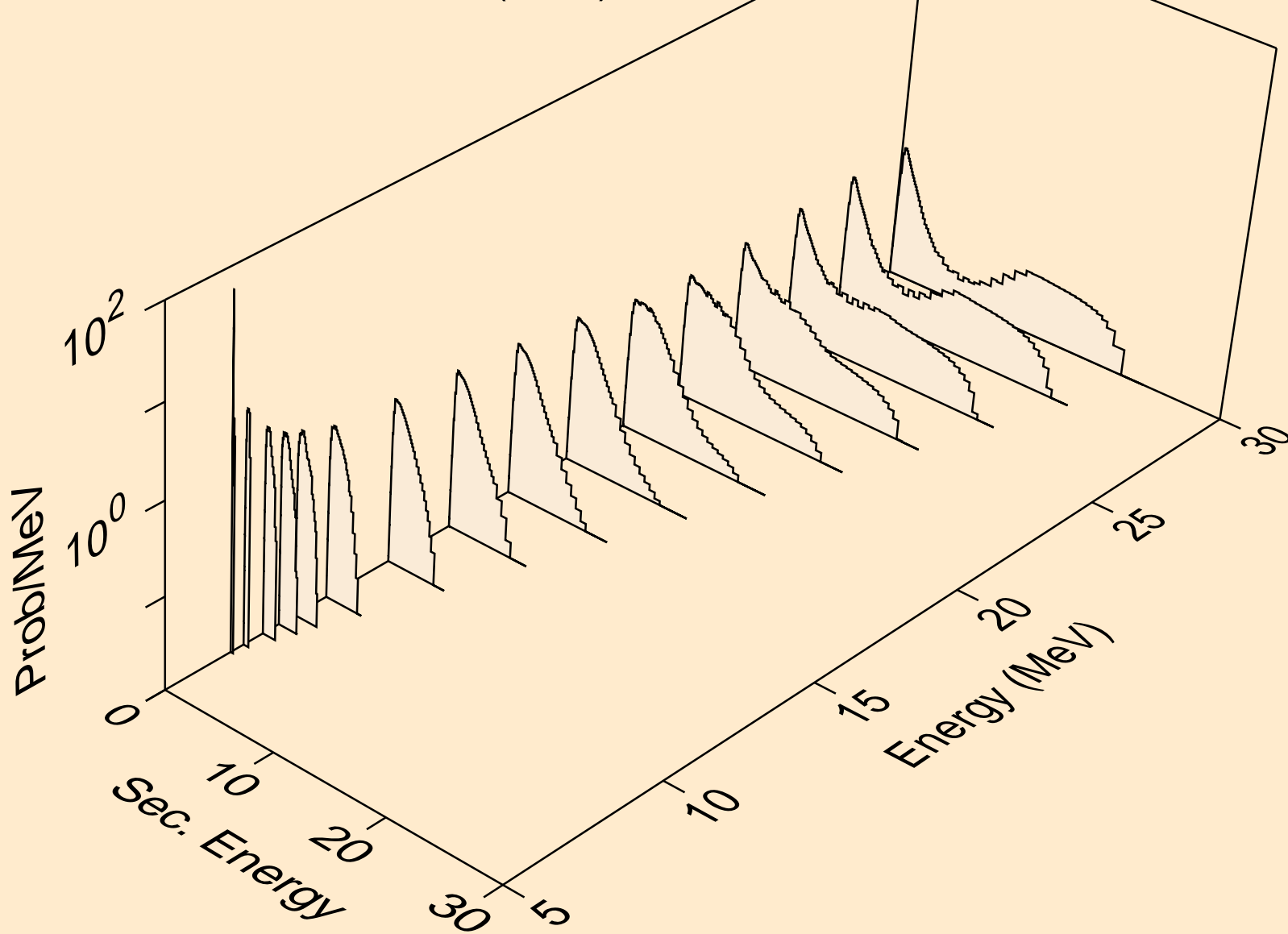

TE123 NEUTRON ACER TENDL-2019 LIBRARY; T=293.16K
Neutron emission for (n,3n)

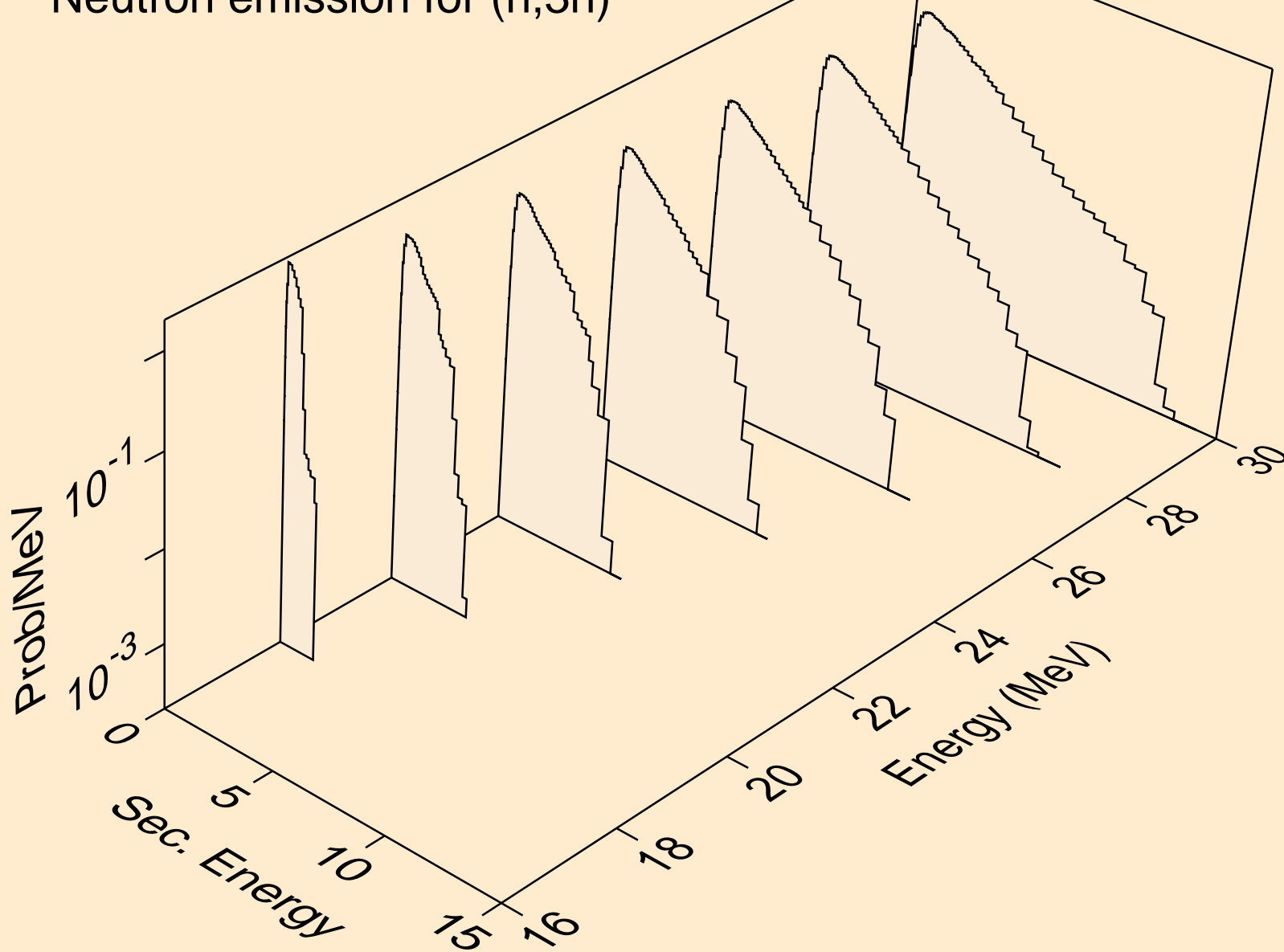

TE123 NEUTRON ACER TENDL-2019 LIBRARY; T=293.16K
Neutron emission for (n,n*)a

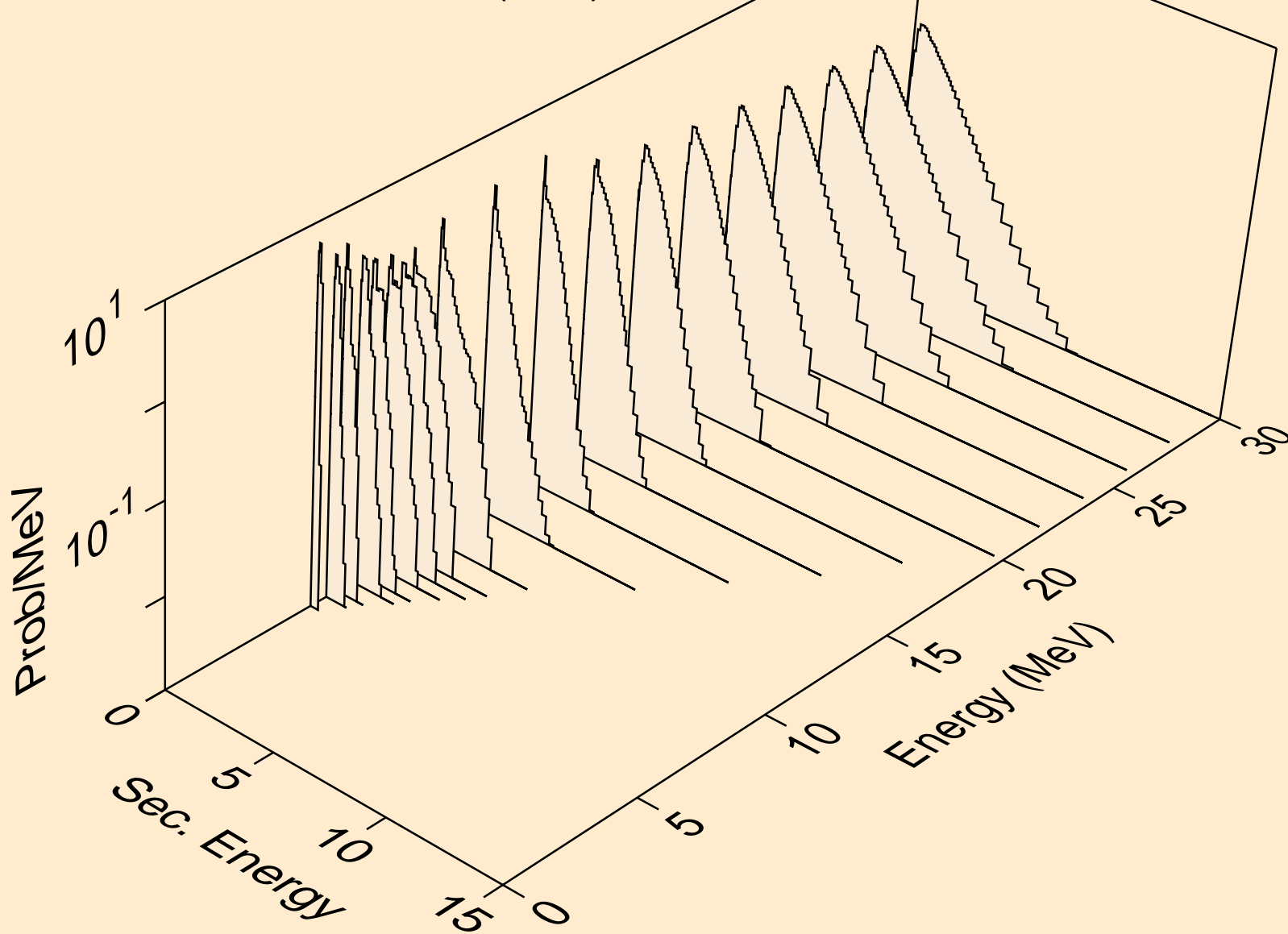

TE123 NEUTRON ACER TENDL-2019 LIBRARY; T=293.16K
Neutron emission for (n,2n)a

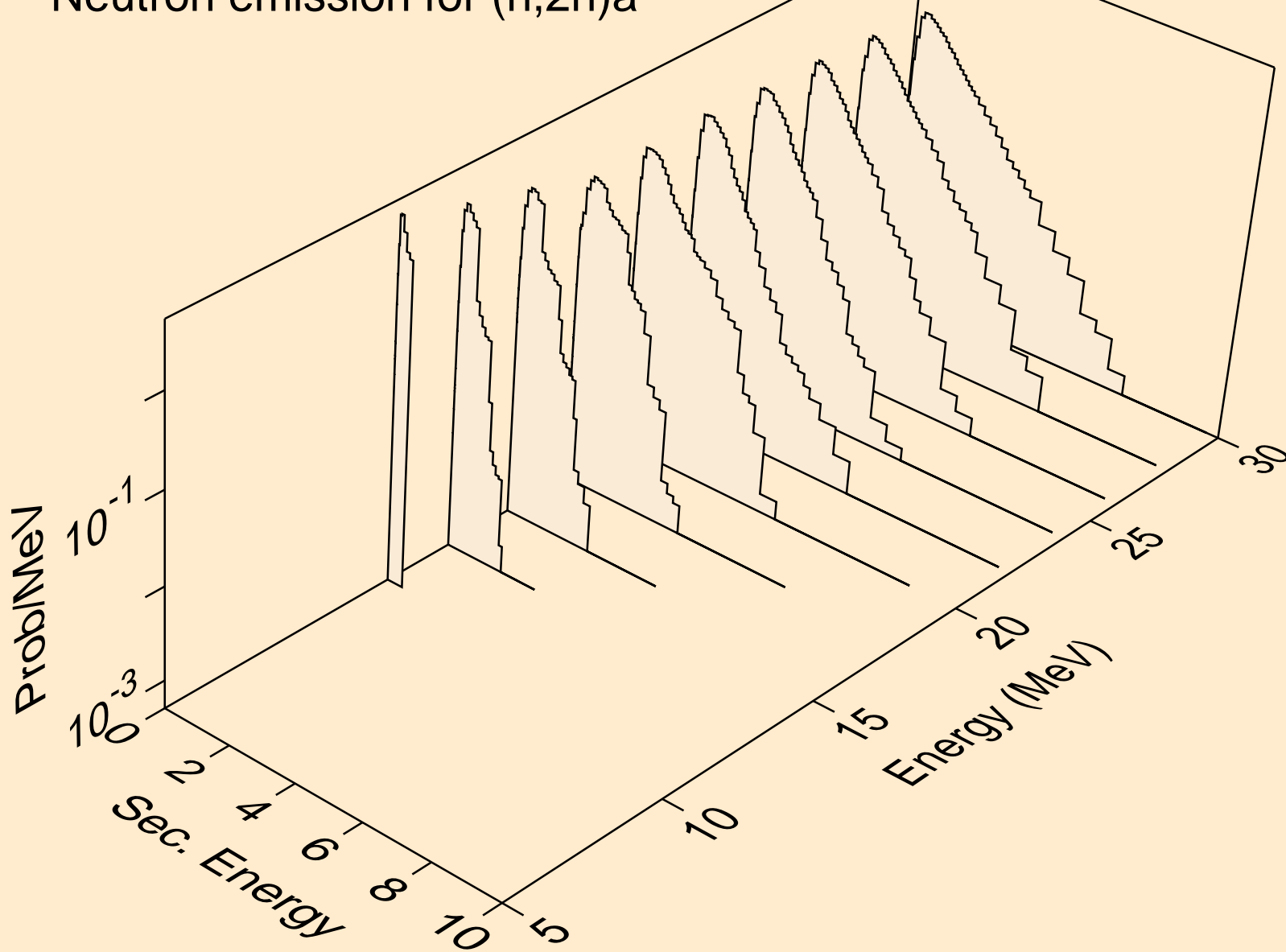

TE123 NEUTRON ACER TENDL-2019 LIBRARY; T=293.16K
Neutron emission for (n,3n)a

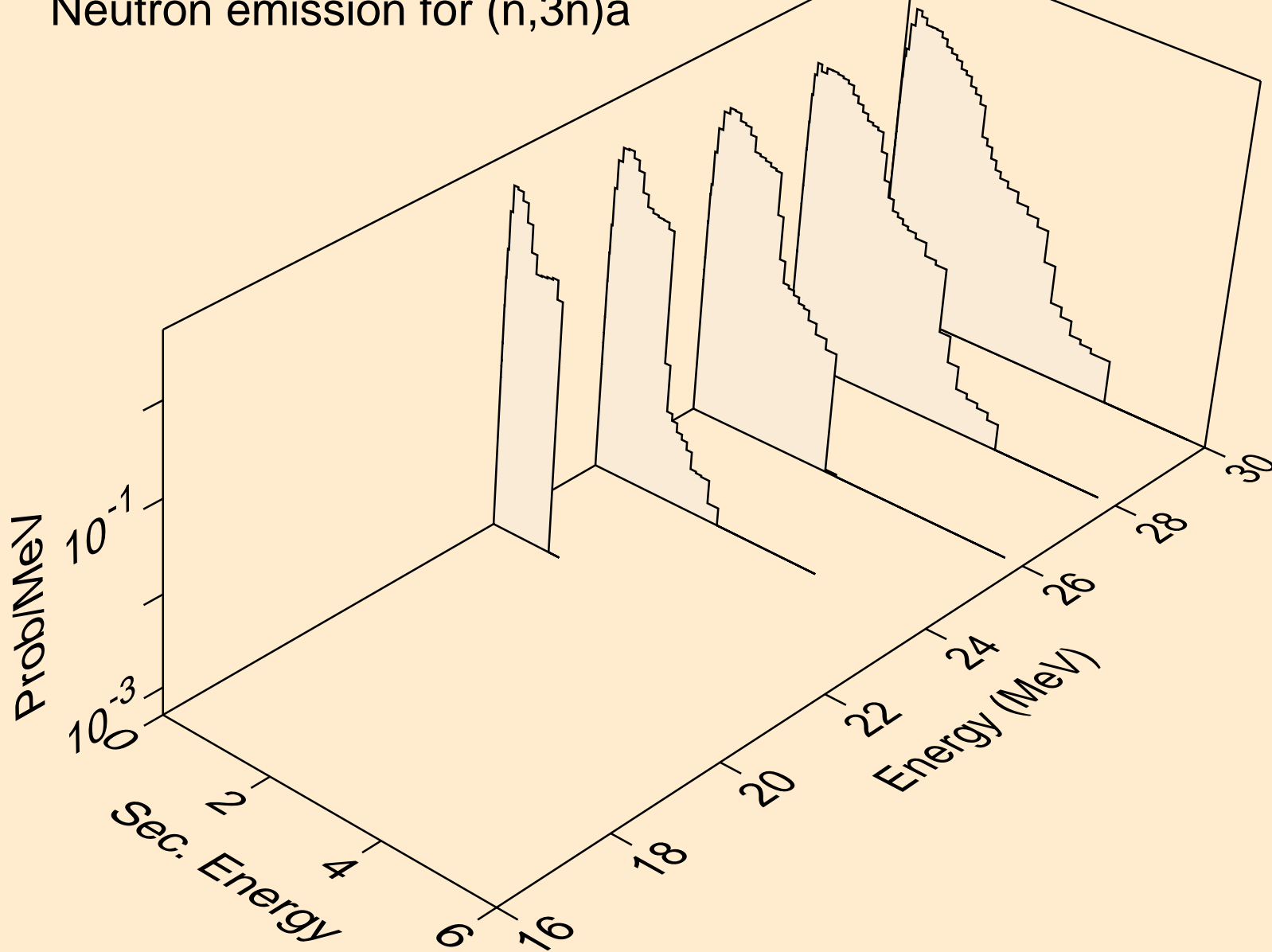

TE123 NEUTRON ACER TENDL-2019 LIBRARY; T=293.16K
Neutron emission for (n,n*)p

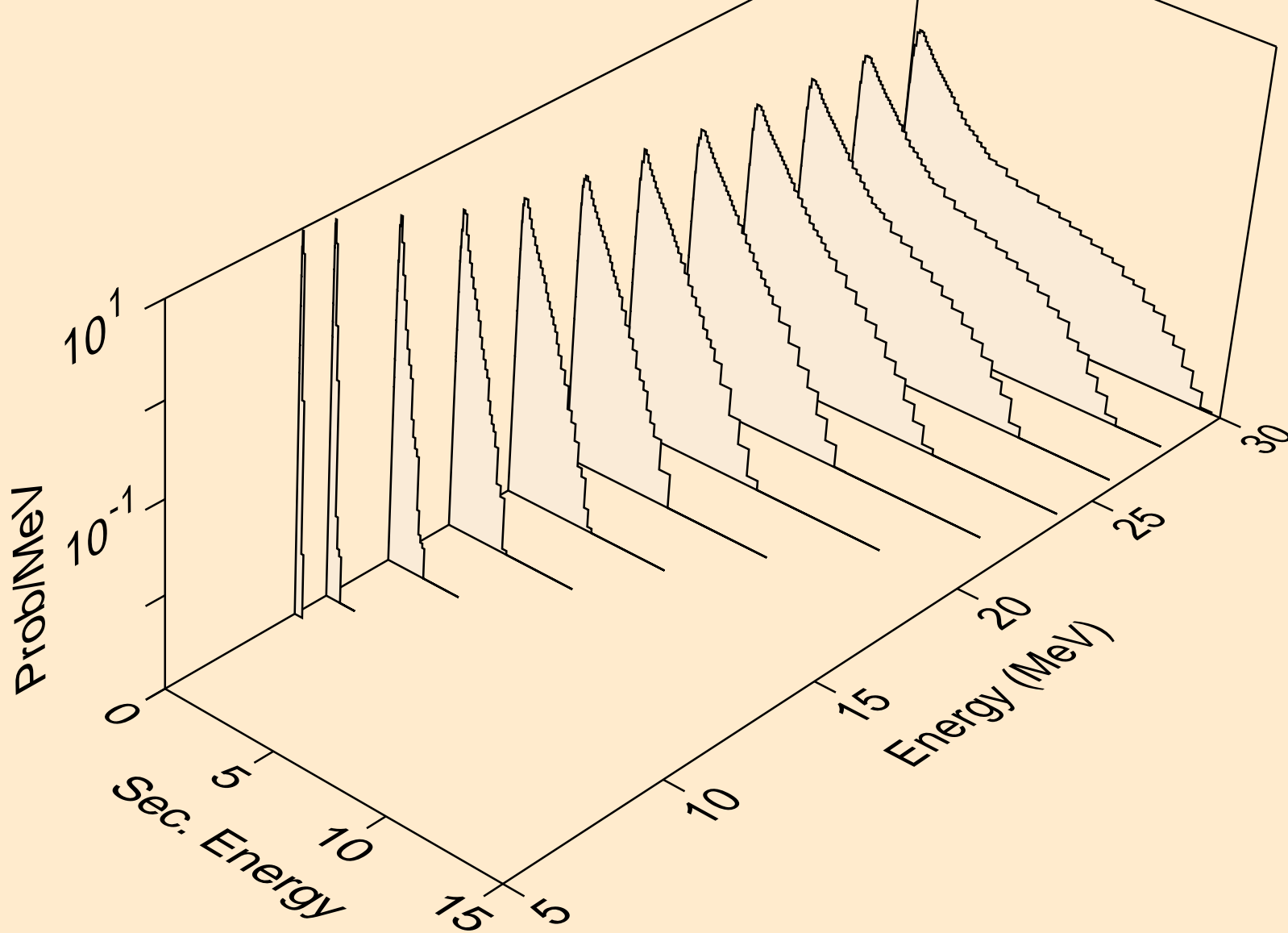

TE123 NEUTRON ACER TENDL-2019 LIBRARY; T=293.16K
Neutron emission for (n,n*)2a

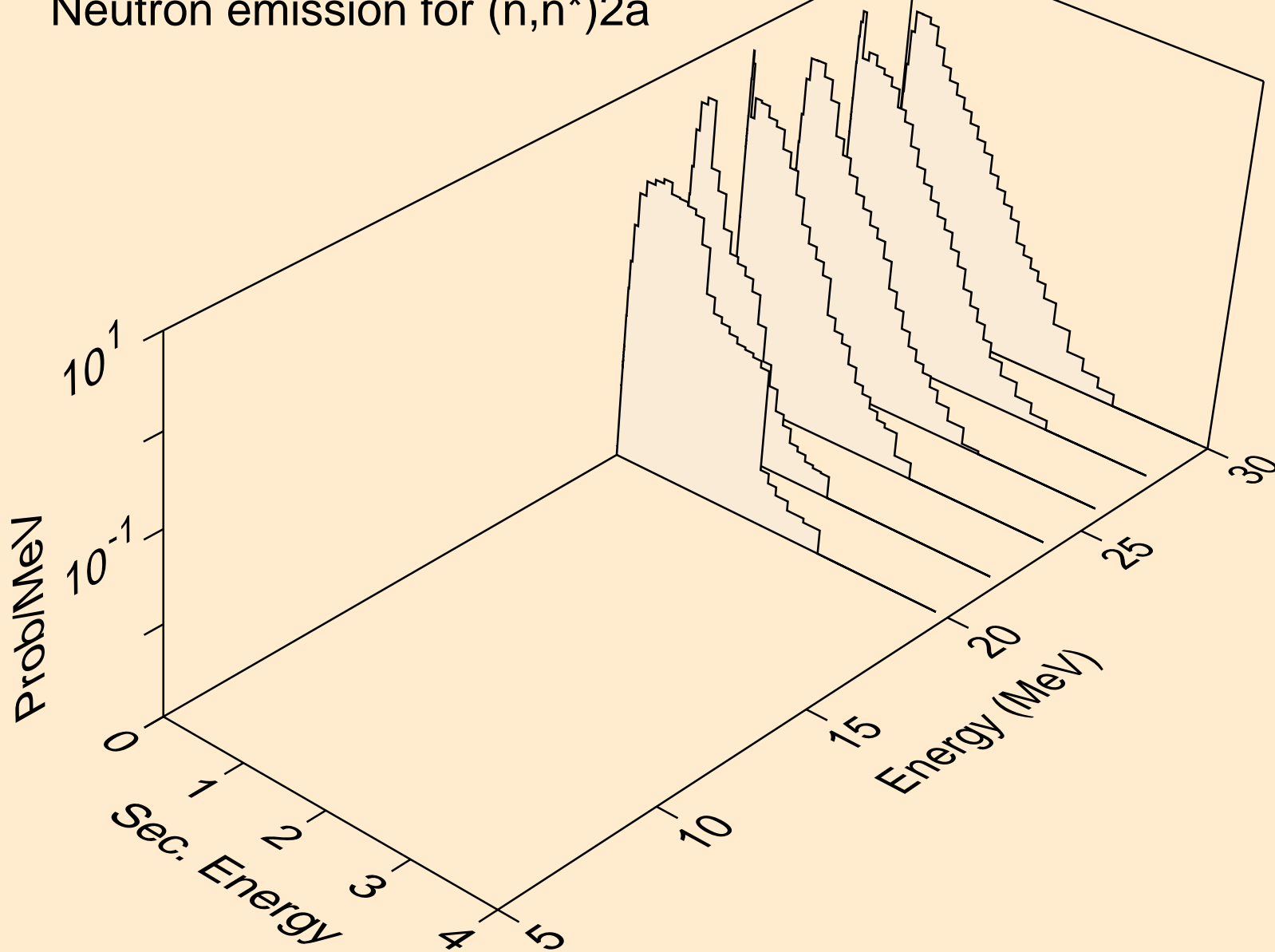

TE123 NEUTRON ACER TENDL-2019 LIBRARY; T=293.16K
Neutron emission for (n,n*)d

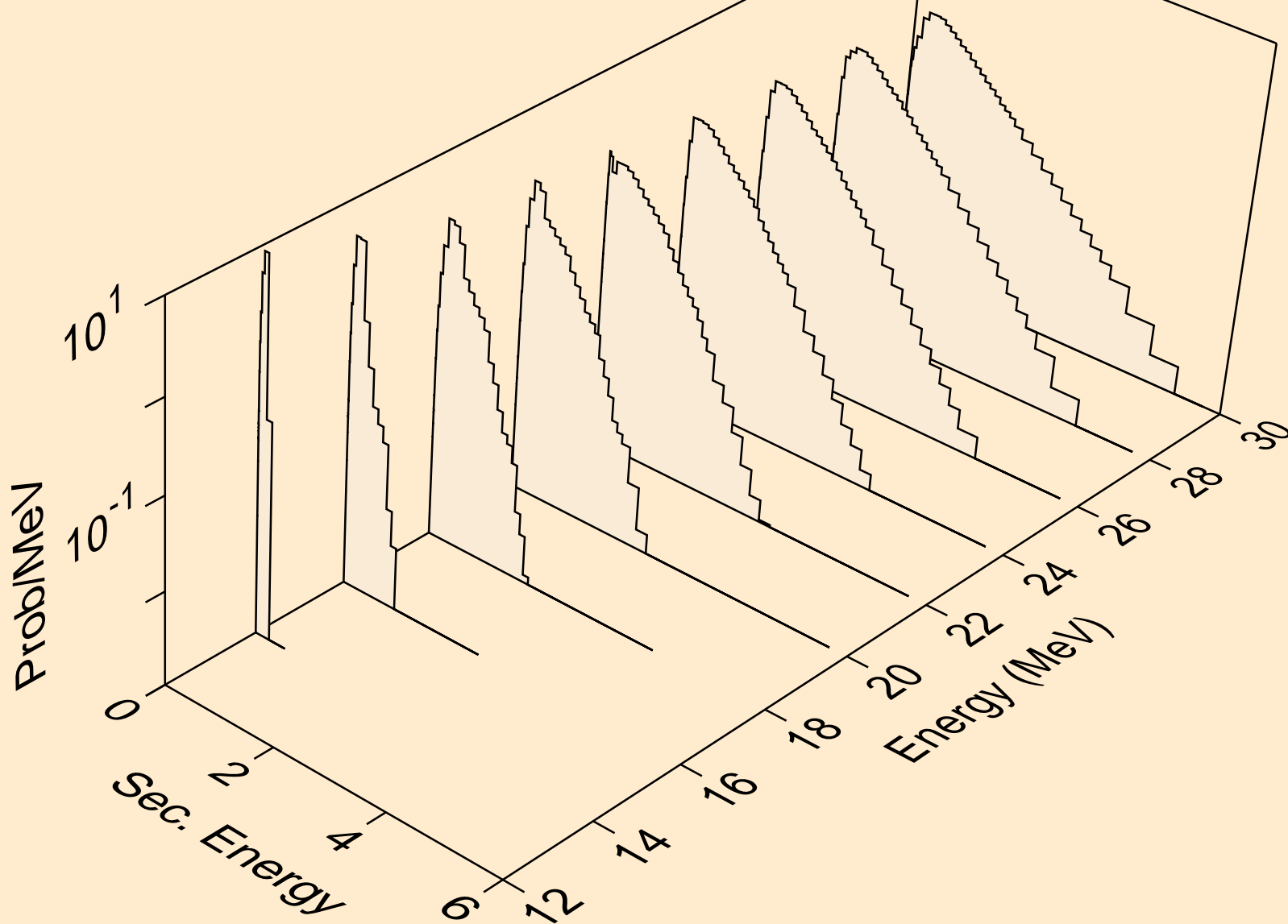

TE123 NEUTRON ACER TENDL-2019 LIBRARY; T=293.16K
Neutron emission for (n,n*)t

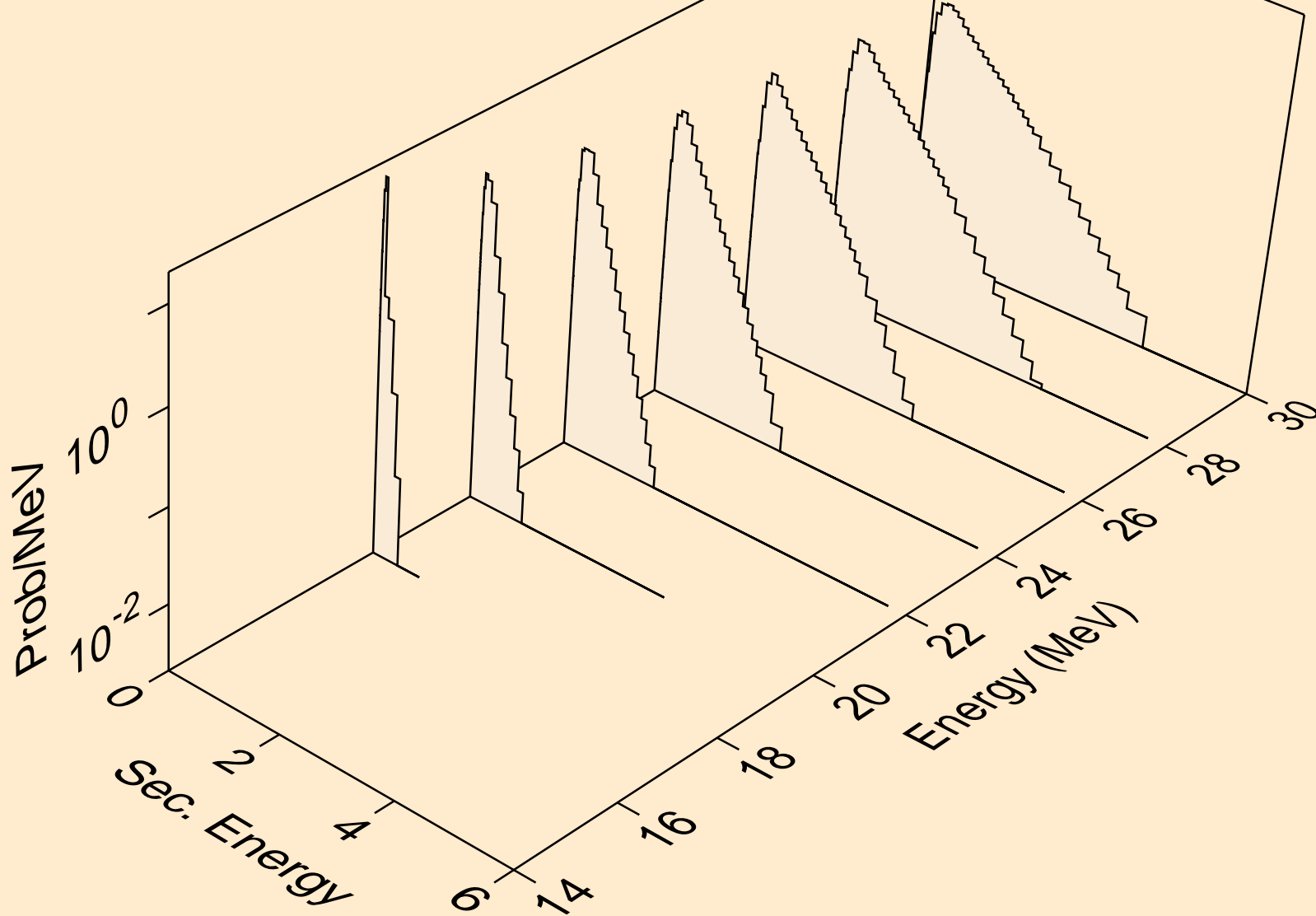

TE123 NEUTRON ACER TENDL-2019 LIBRARY; T=293.16K
Neutron emission for (n,n*)he3

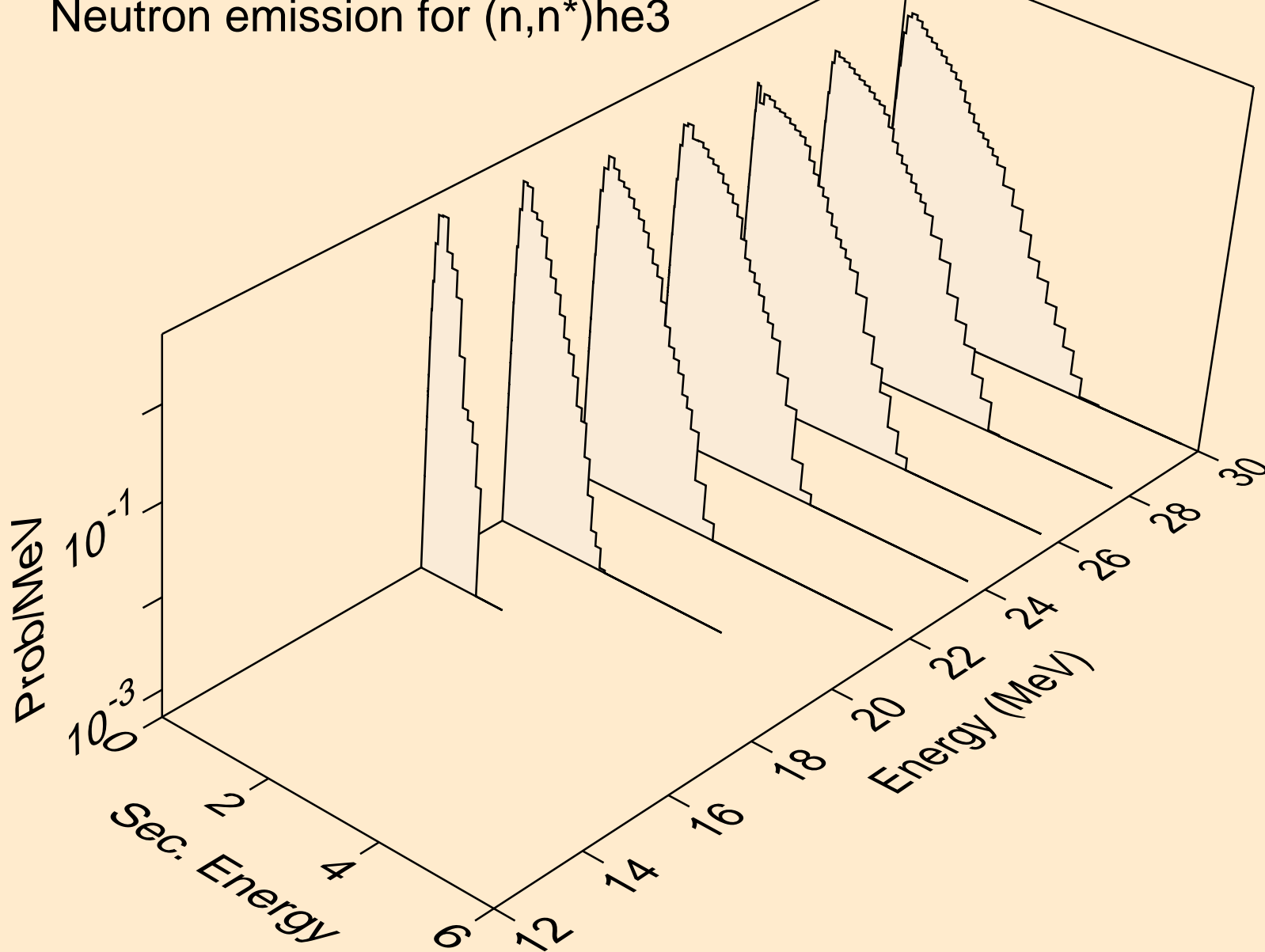

TE123 NEUTRON ACER TENDL-2019 LIBRARY; T=293.16K
Neutron emission for (n,4n)

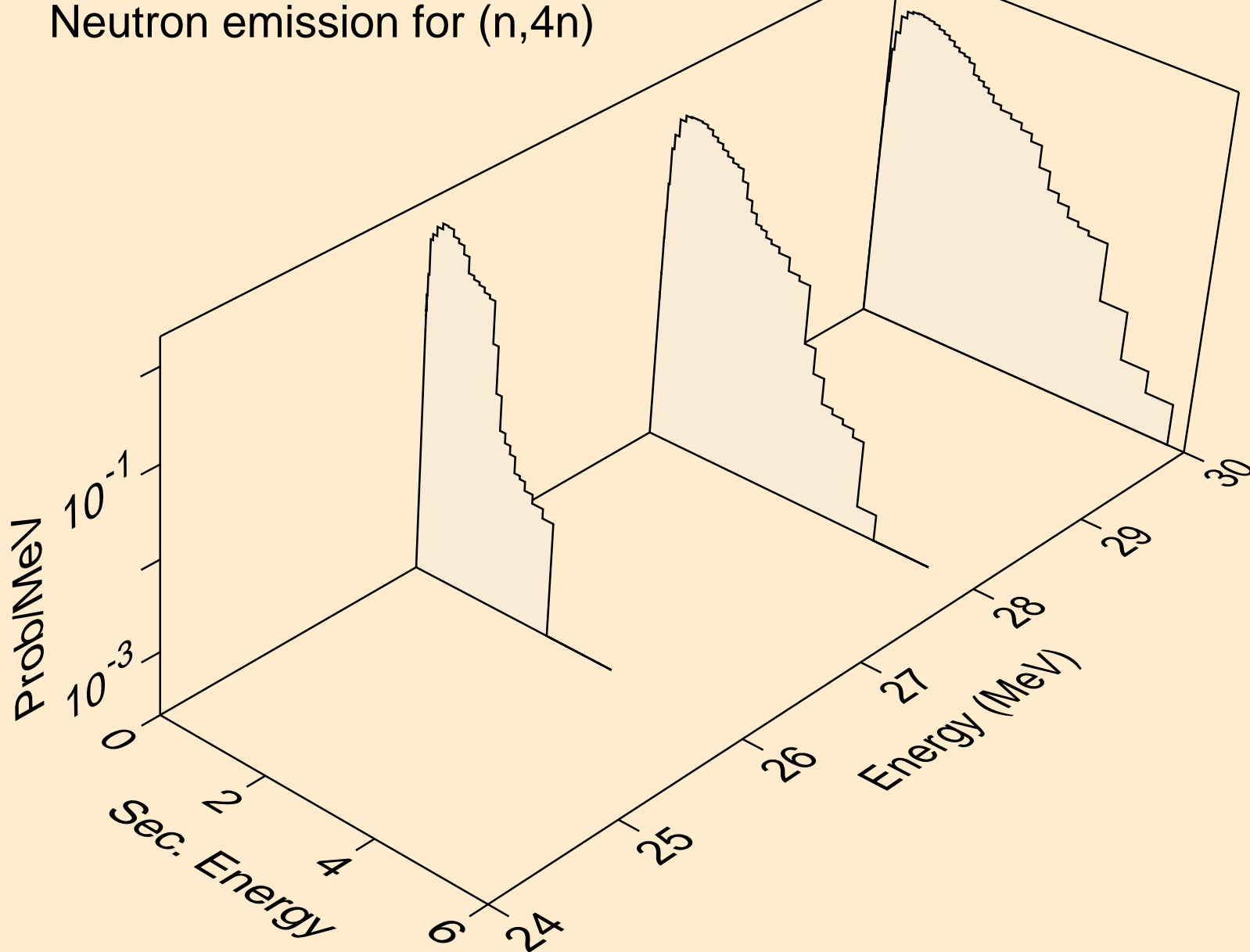

TE123 NEUTRON ACER TENDL-2019 LIBRARY; T=293.16K
Neutron emission for (n,2np)

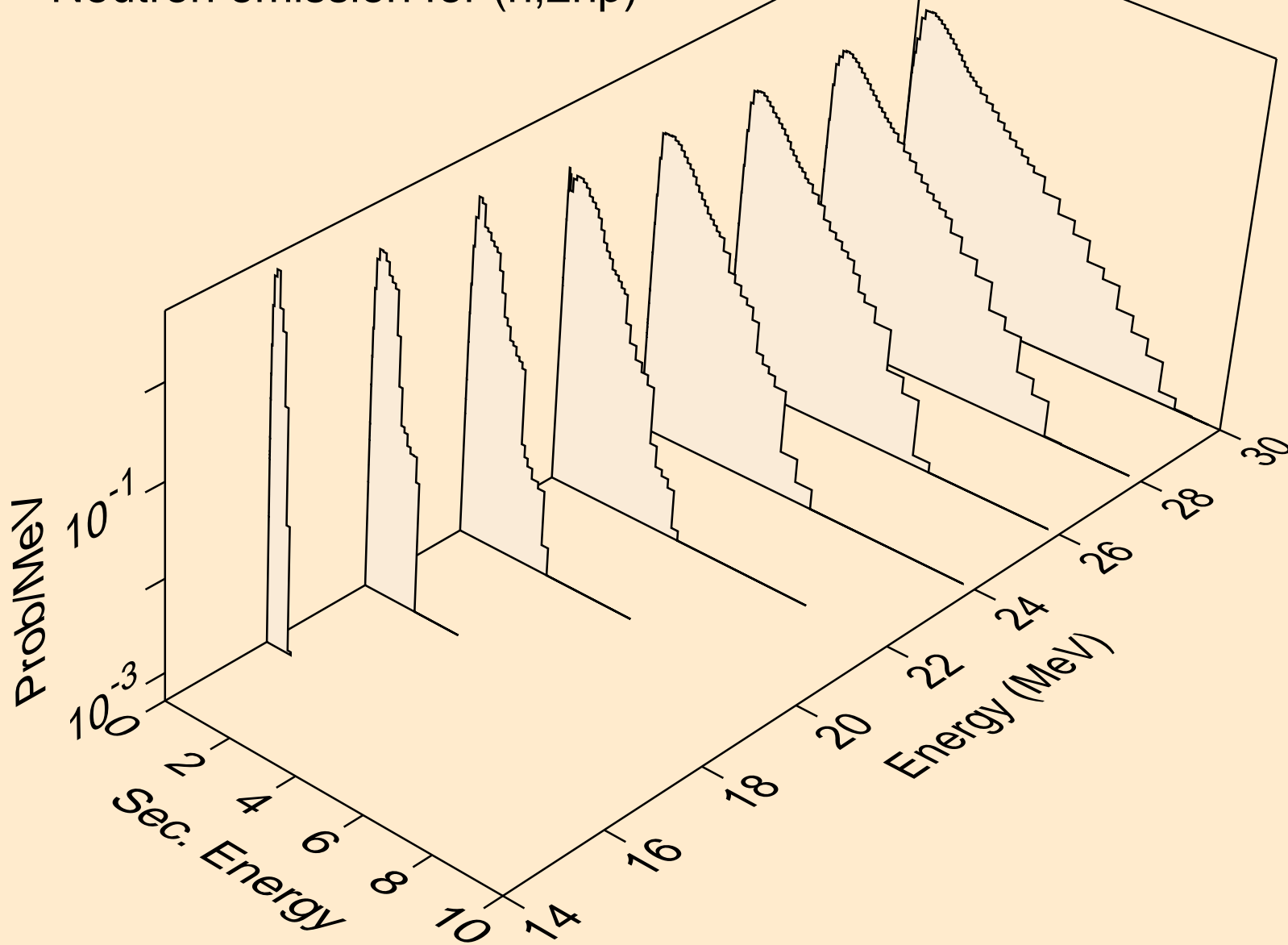

TE123 NEUTRON ACER TENDL-2019 LIBRARY; T=293.16K
Neutron emission for (n,3np)

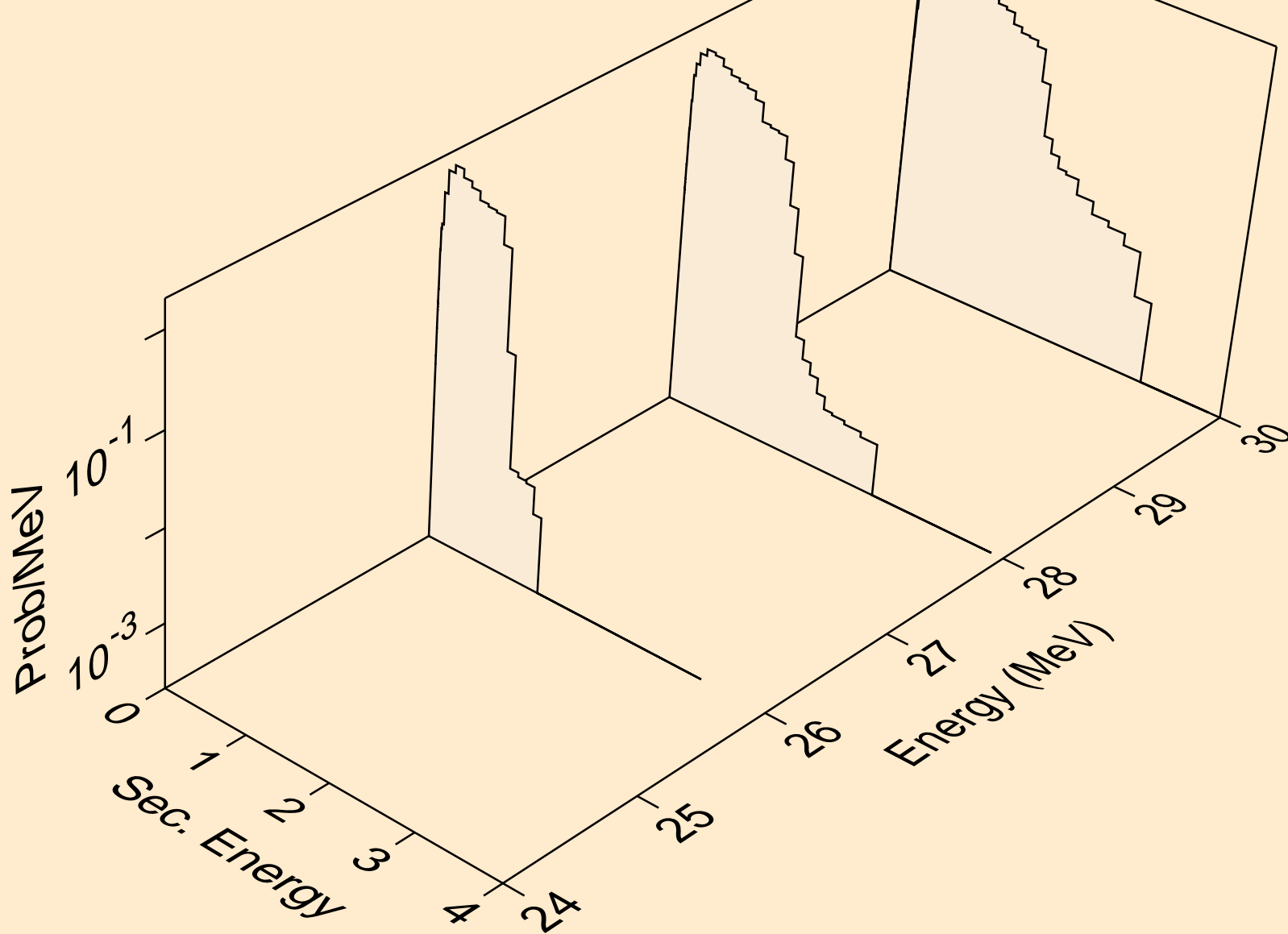

TE123 NEUTRON ACER TENDL-2019 LIBRARY; T=293.16K
Neutron emission for (n,2np)

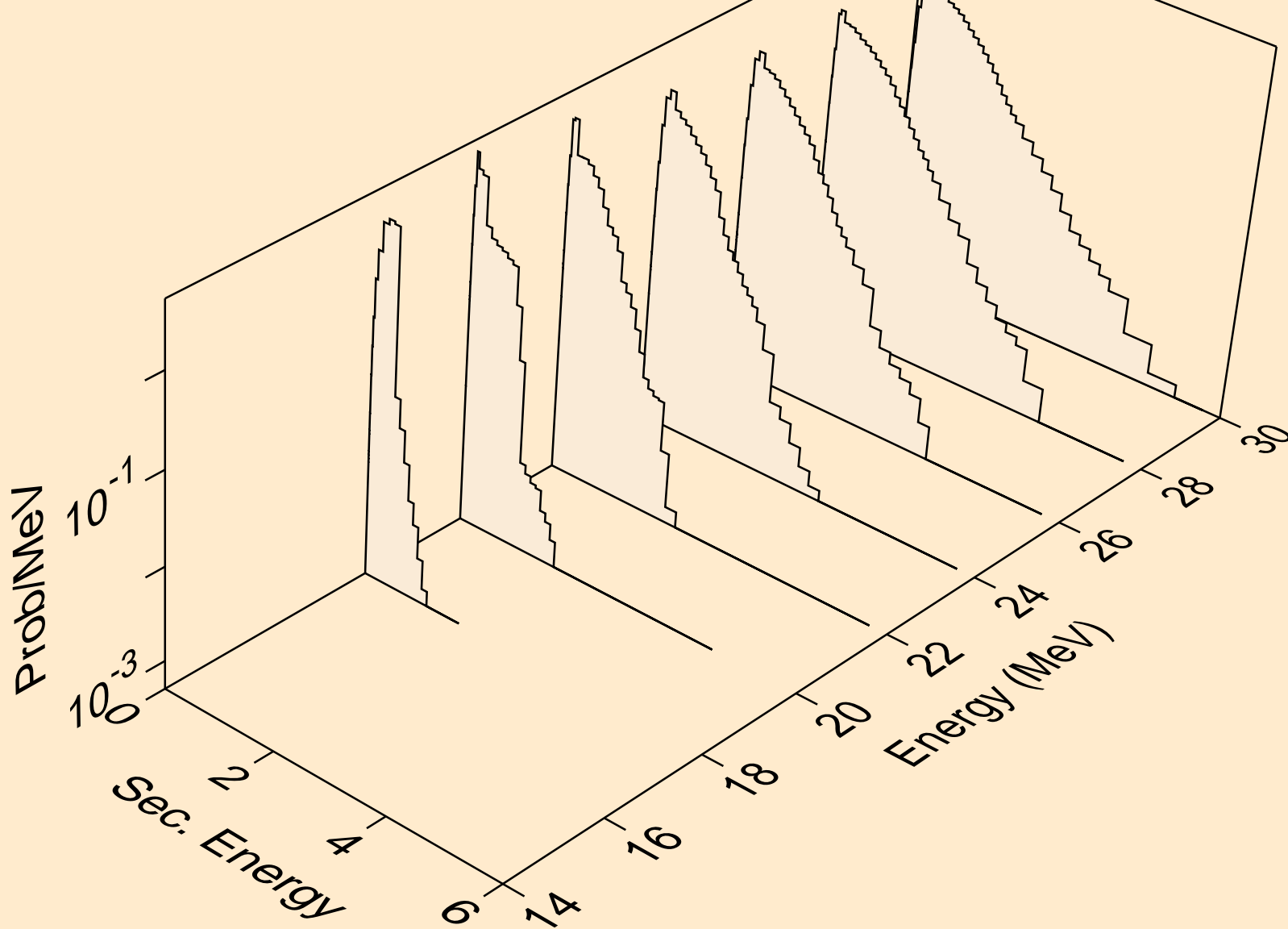

TE123 NEUTRON ACER TENDL-2019 LIBRARY; T=293.16K
Neutron emission for (n,npa)

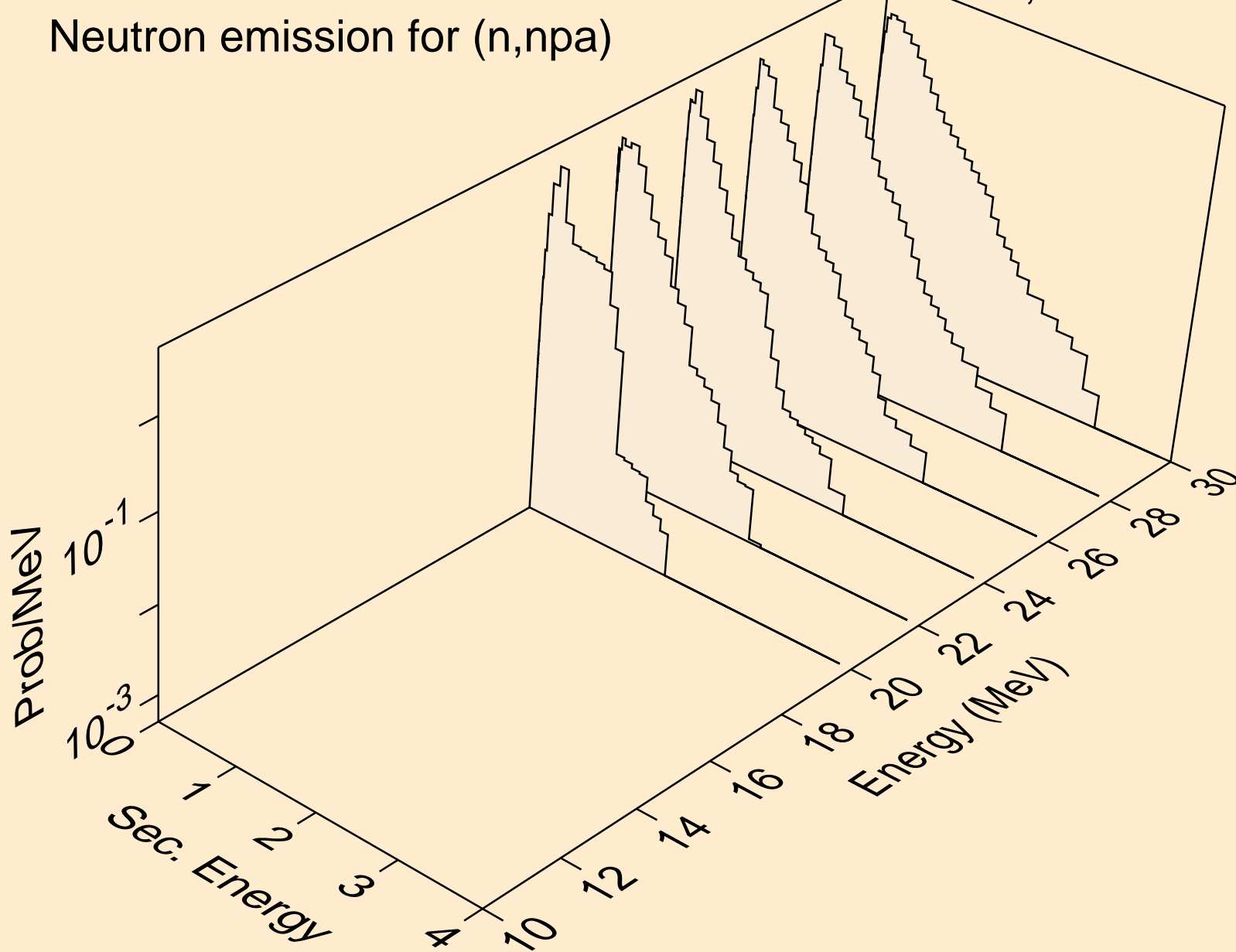

TE123 NEUTRON ACER TENDL-2019 LIBRARY; T=293.16K
Neutron emission for (n,n*c)

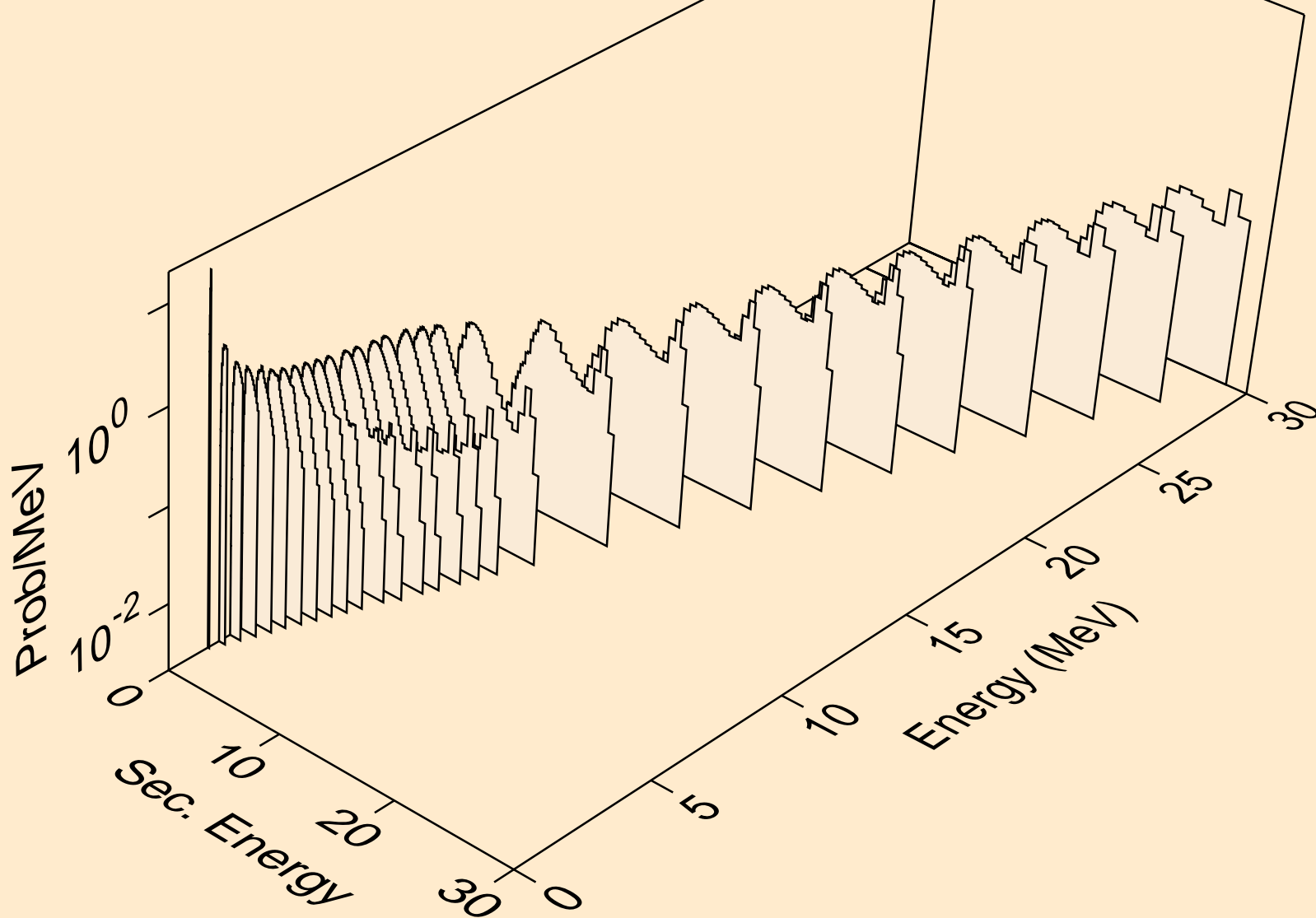

TE123 NEUTRON ACER TENDL-2019 LIBRARY; T=293.16K
Photon emission for (n,x)

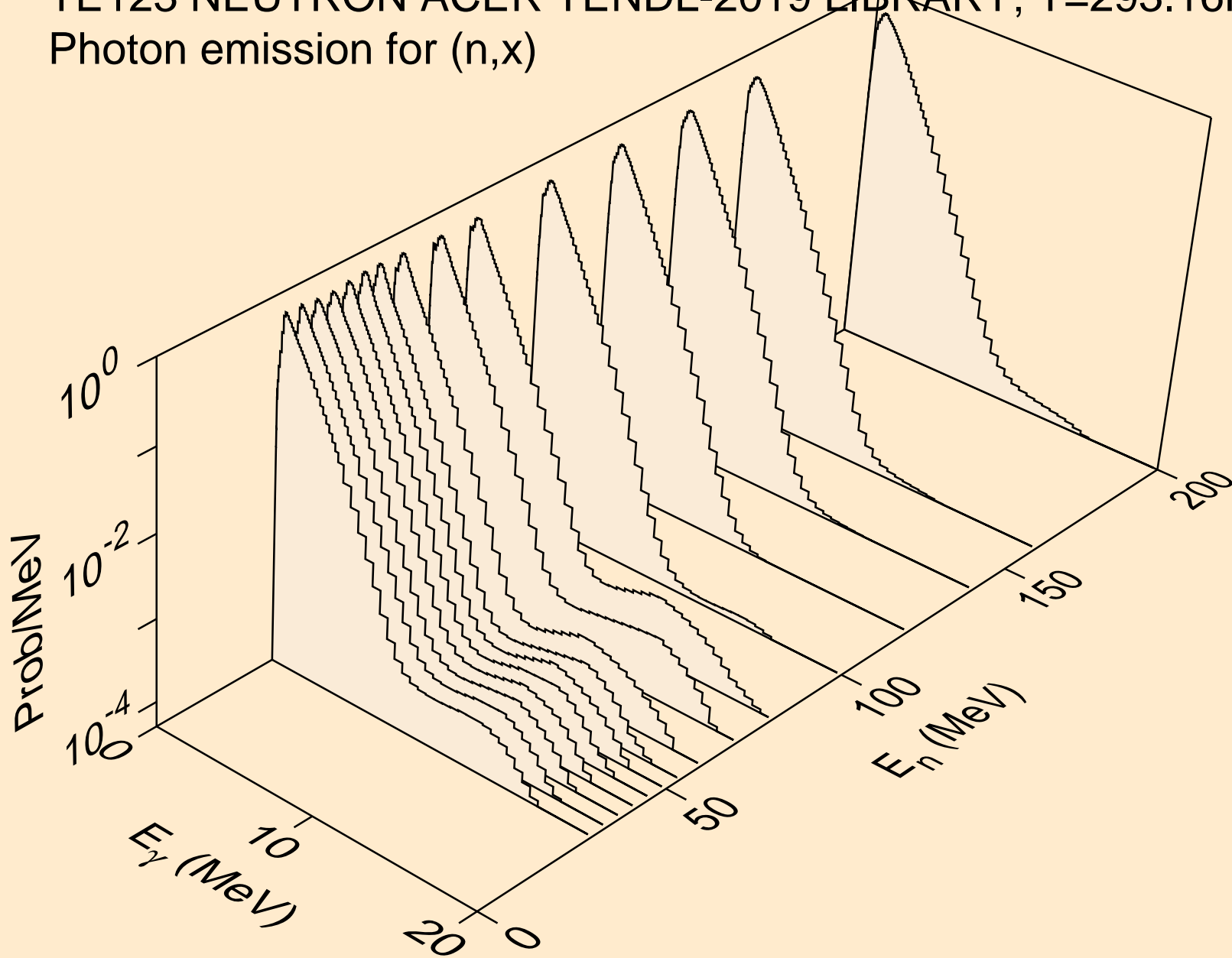

TE123 NEUTRON ACER TENDL-2019 LIBRARY; T=293.16K
Photon emission for (n,2nd)

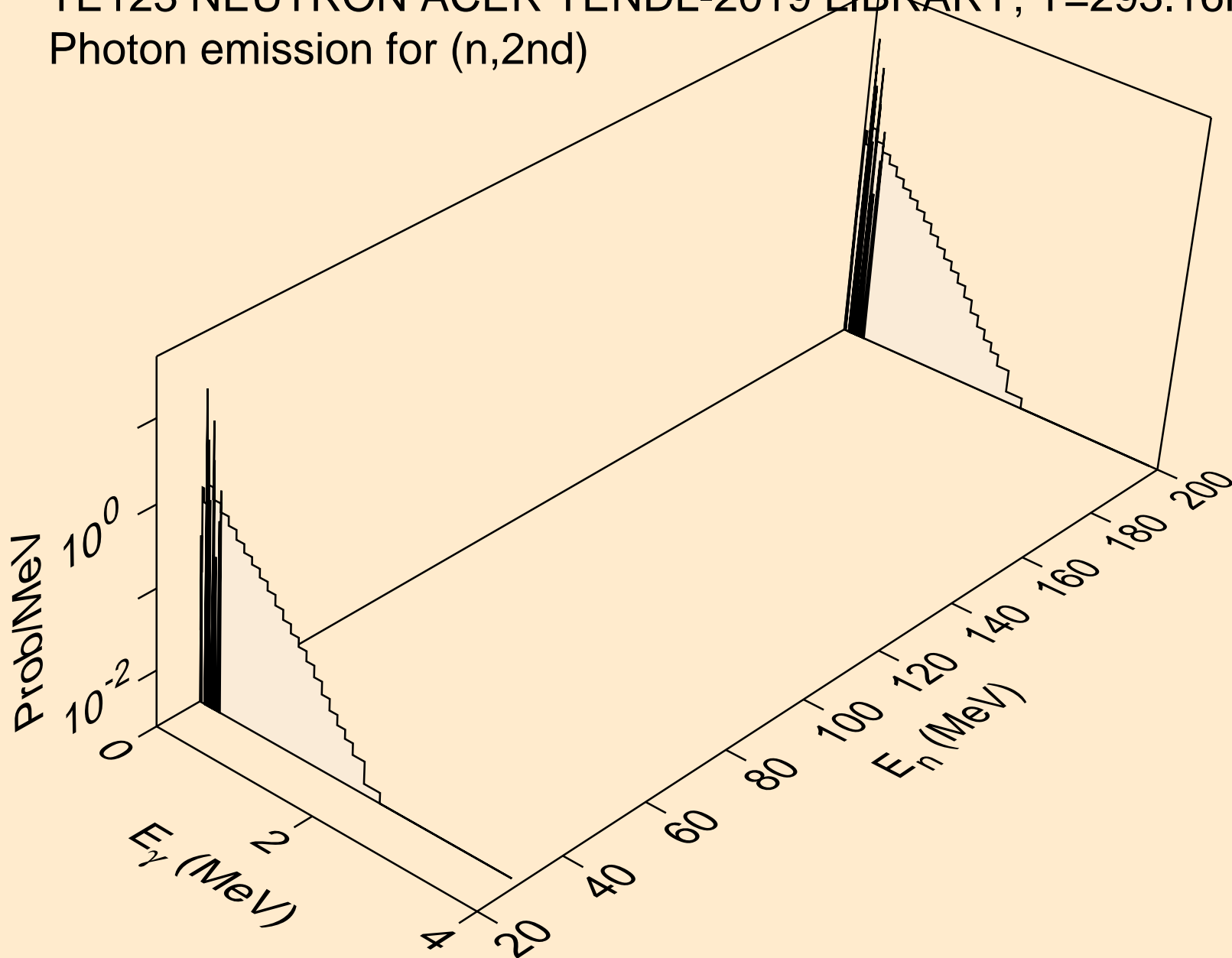

TE123 NEUTRON ACER TENDL-2019 LIBRARY; T=293.16K
Photon emission for (n,2n)

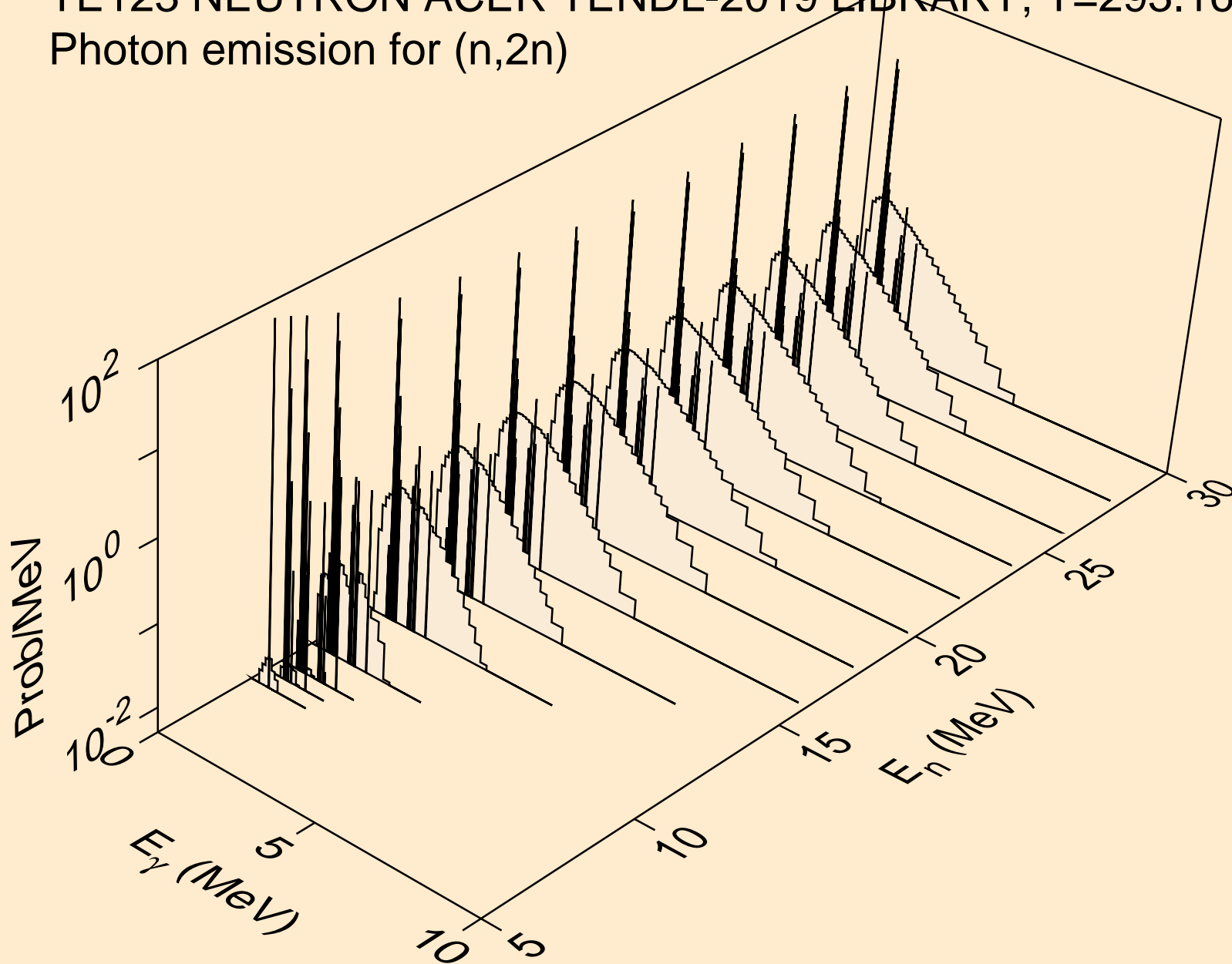

TE123 NEUTRON ACER TENDL-2019 LIBRARY; T=293.16K
Photon emission for (n,3n)

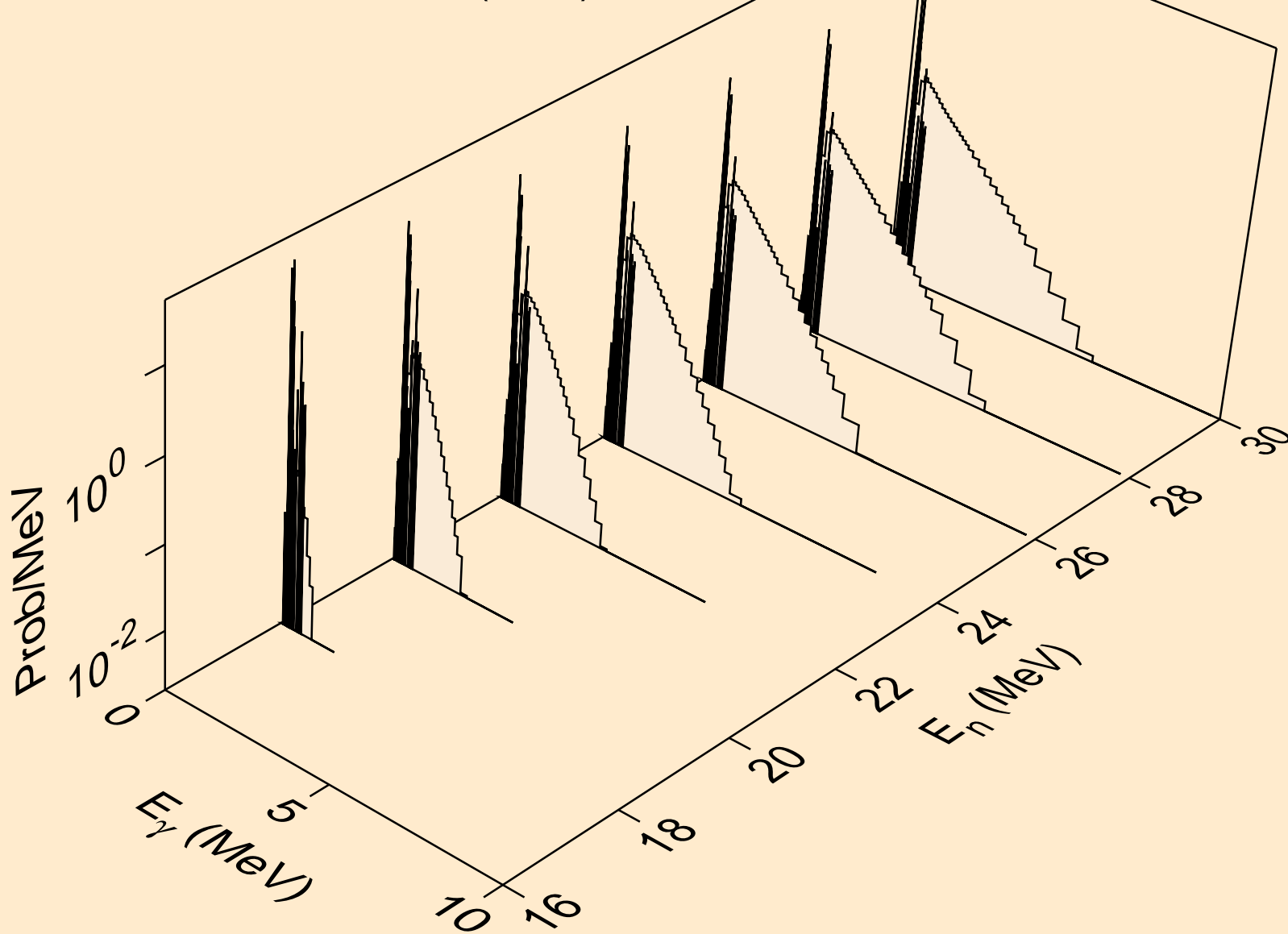

TE123 NEUTRON ACER TENDL-2019 LIBRARY; T=293.16K
Photon emission for (n,n*)a

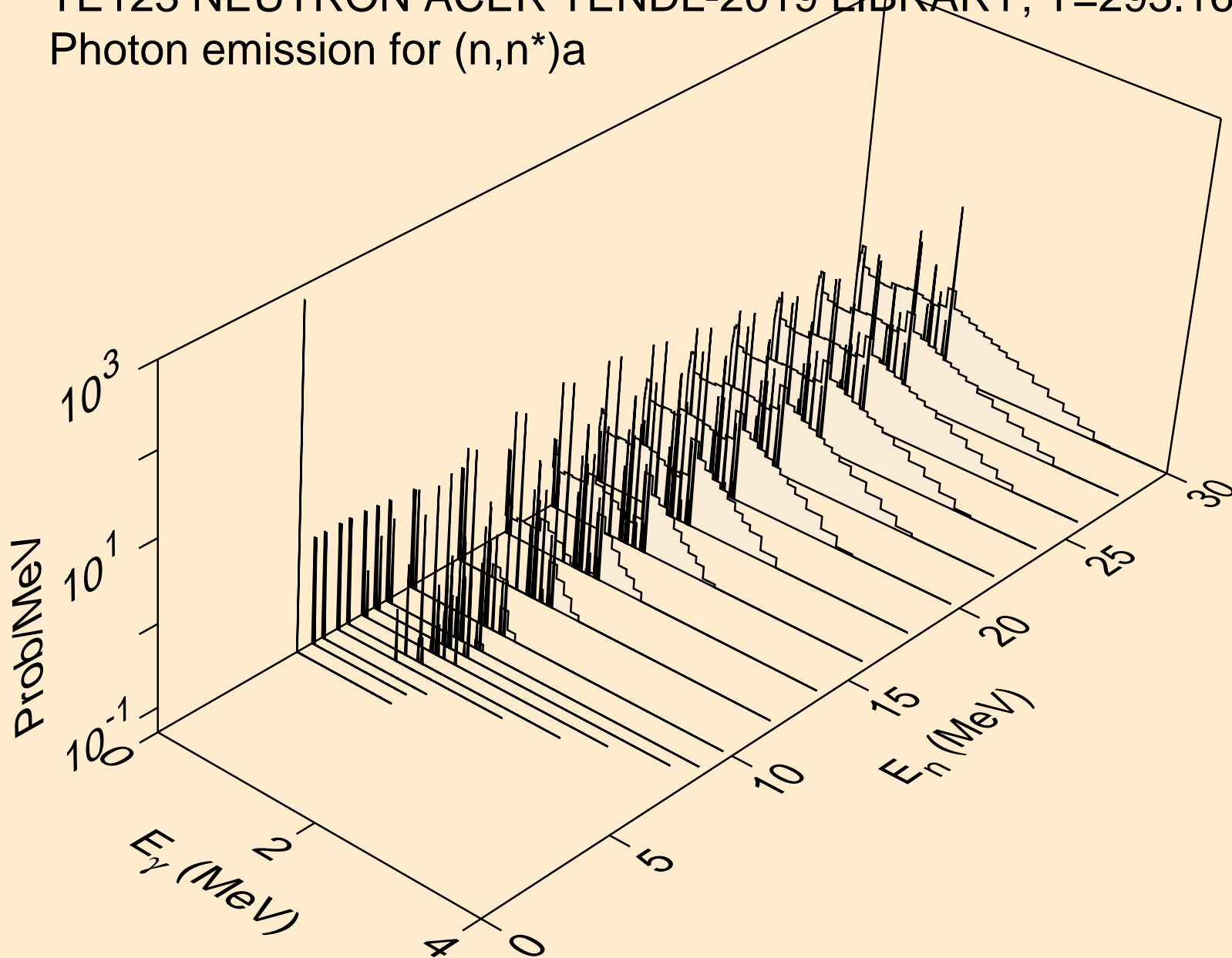

TE123 NEUTRON ACER TENDL-2019 LIBRARY; T=293.16K
Photon emission for (n,2n)a

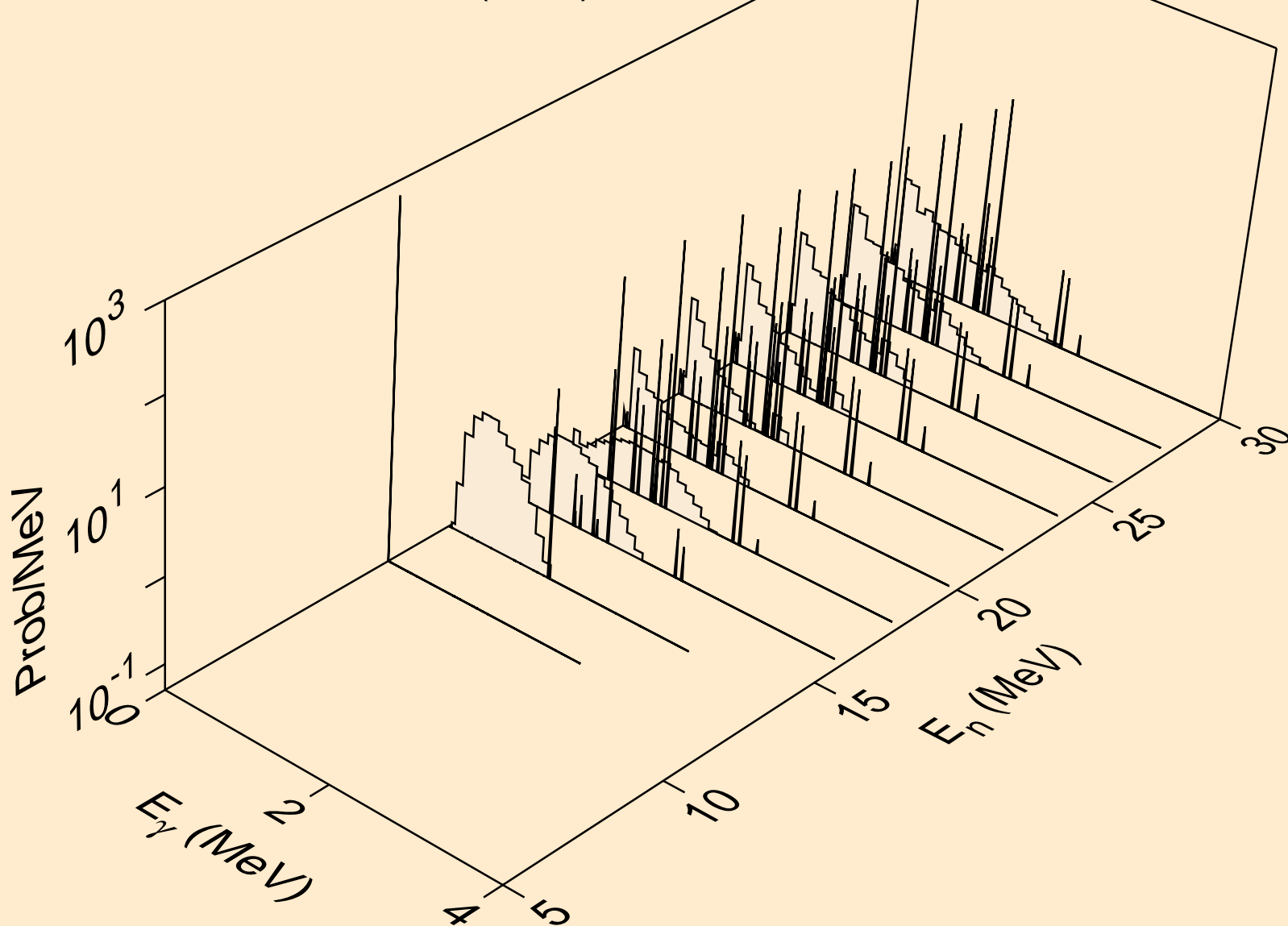

TE123 NEUTRON ACER TENDL-2019 LIBRARY; T=293.16K
Photon emission for (n,3n)a

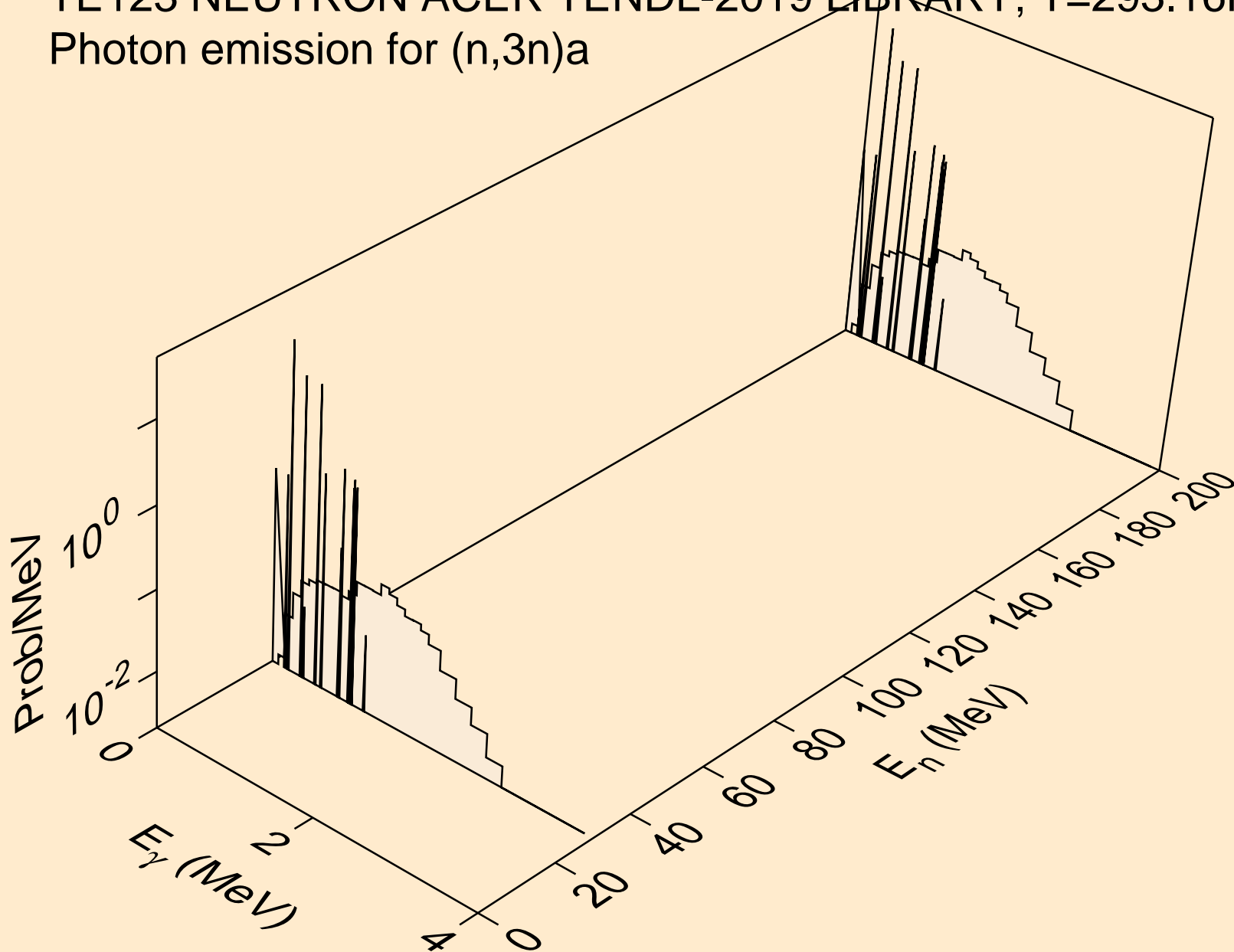

TE123 NEUTRON ACER TENDL-2019 LIBRARY; T=293.16K
Photon emission for (n,n*)p

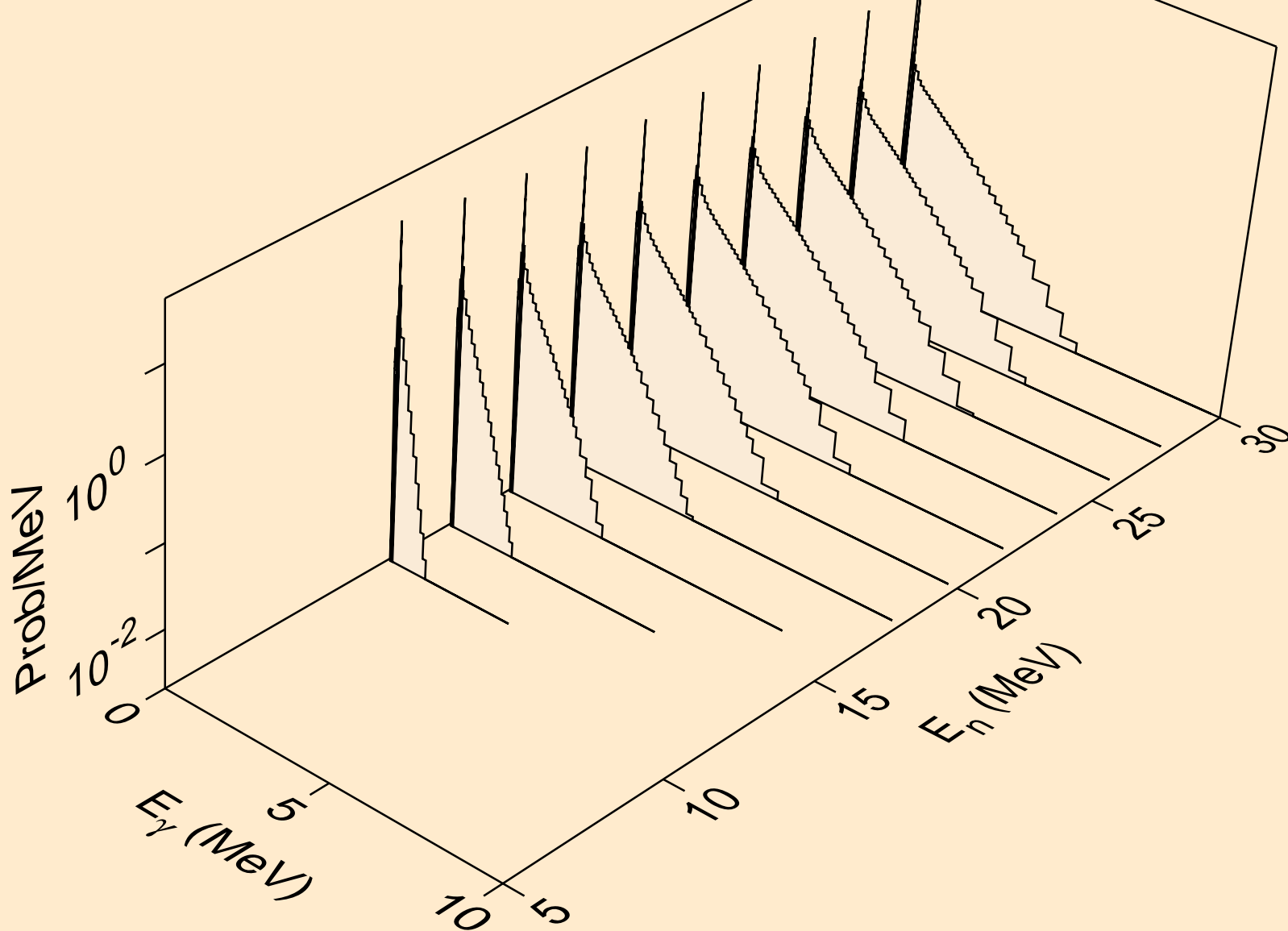

TE123 NEUTRON ACER TENDL-2019 LIBRARY; T=293.16K
Photon emission for (n,n*)2a

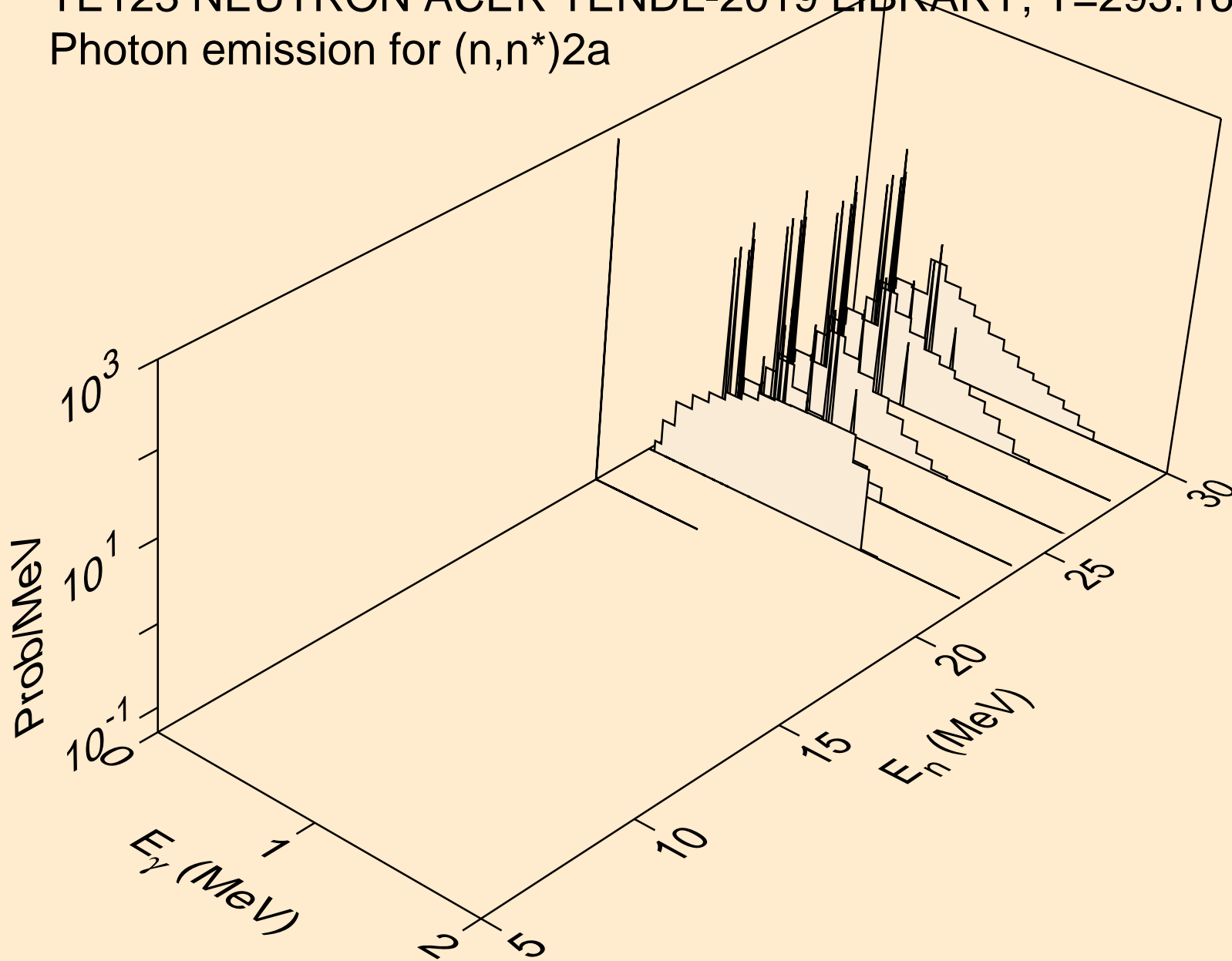

TE123 NEUTRON ACER TENDL-2019 LIBRARY; T=293.16K
Photon emission for (n,n*)d

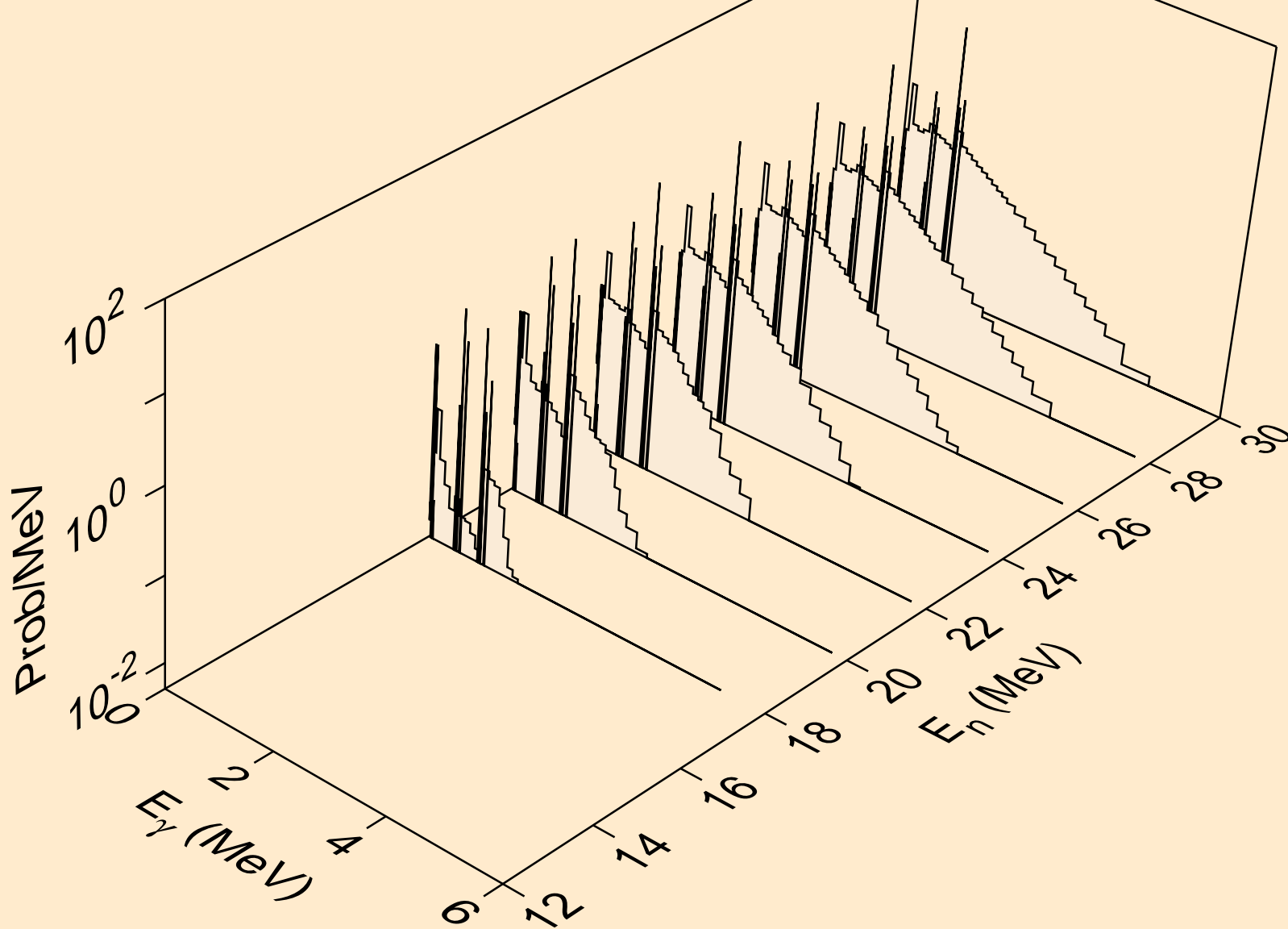

TE123 NEUTRON ACER TENDL-2019 LIBRARY; T=293.16K
Photon emission for (n,n*)t

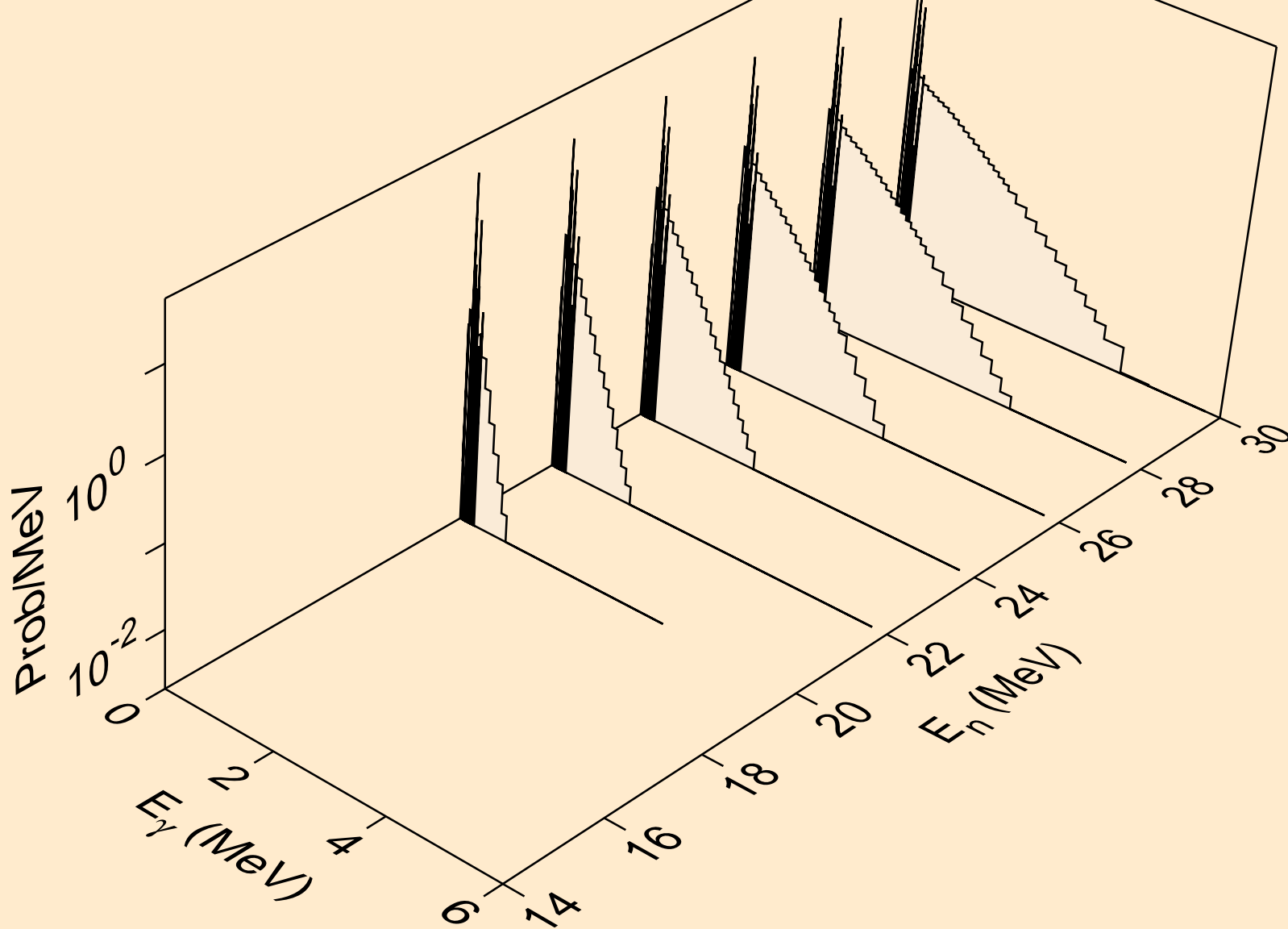

TE123 NEUTRON ACER TENDL-2019 LIBRARY; T=293.16K
Photon emission for (n,n*)he3

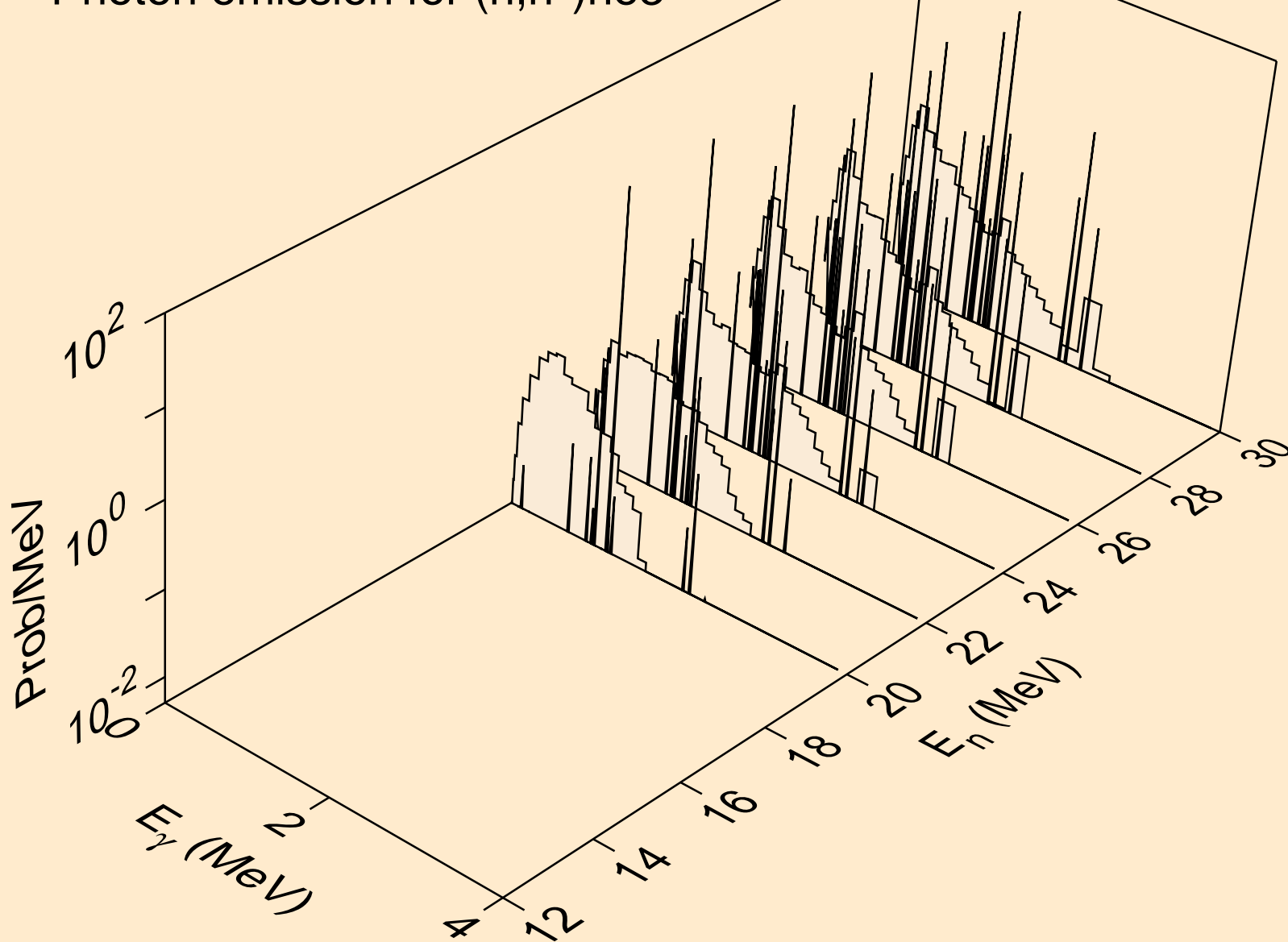

TE123 NEUTRON ACER TENDL-2019 LIBRARY; T=293.16K
Photon emission for (n,4n)

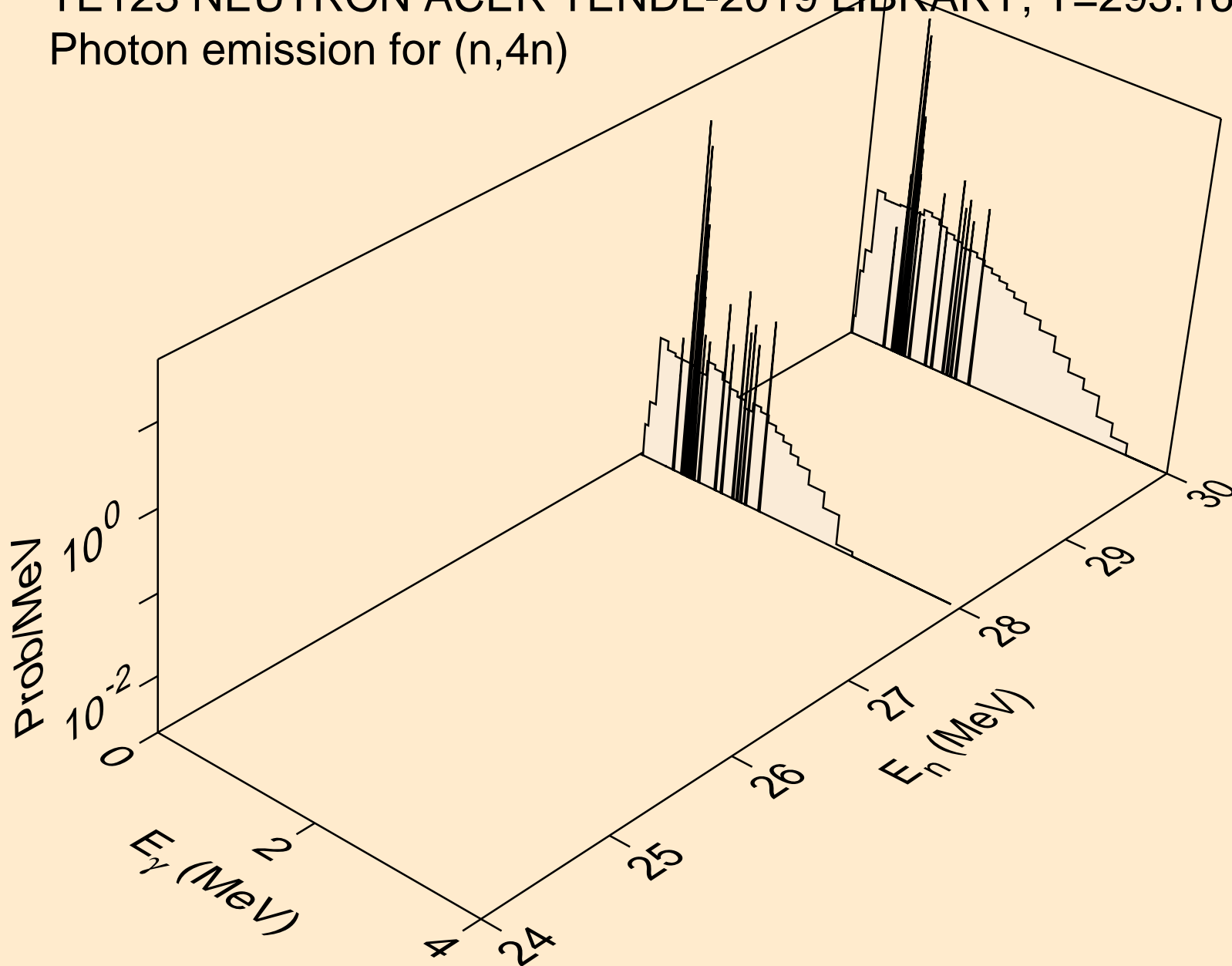

TE123 NEUTRON ACER TENDL-2019 LIBRARY; T=293.16K
Photon emission for (n,2np)

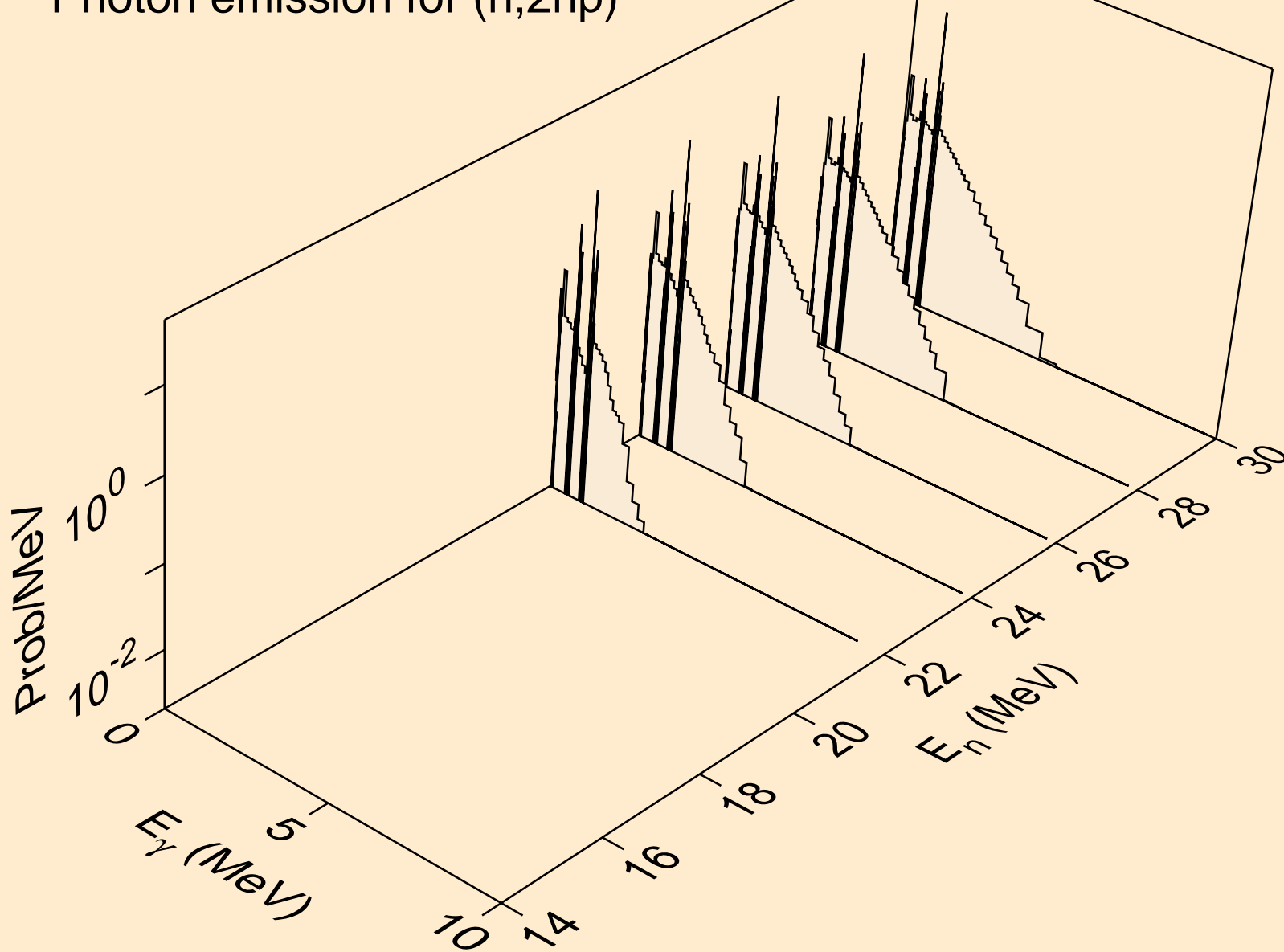

TE123 NEUTRON ACER TENDL-2019 LIBRARY; T=293.16K
Photon emission for (n,3np)

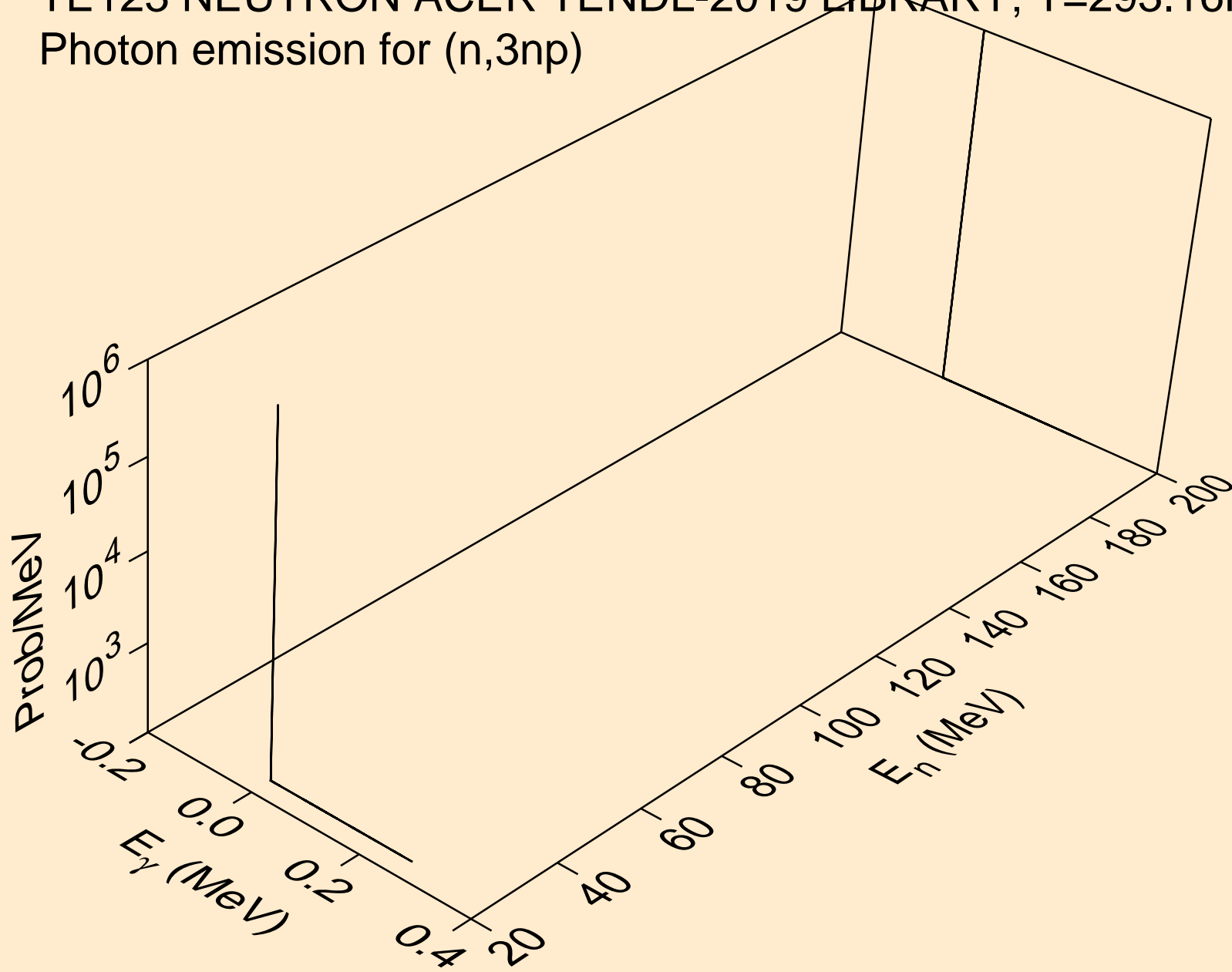

TE123 NEUTRON ACER TENDL-2019 LIBRARY; T=293.16K
Photon emission for (n,2np)

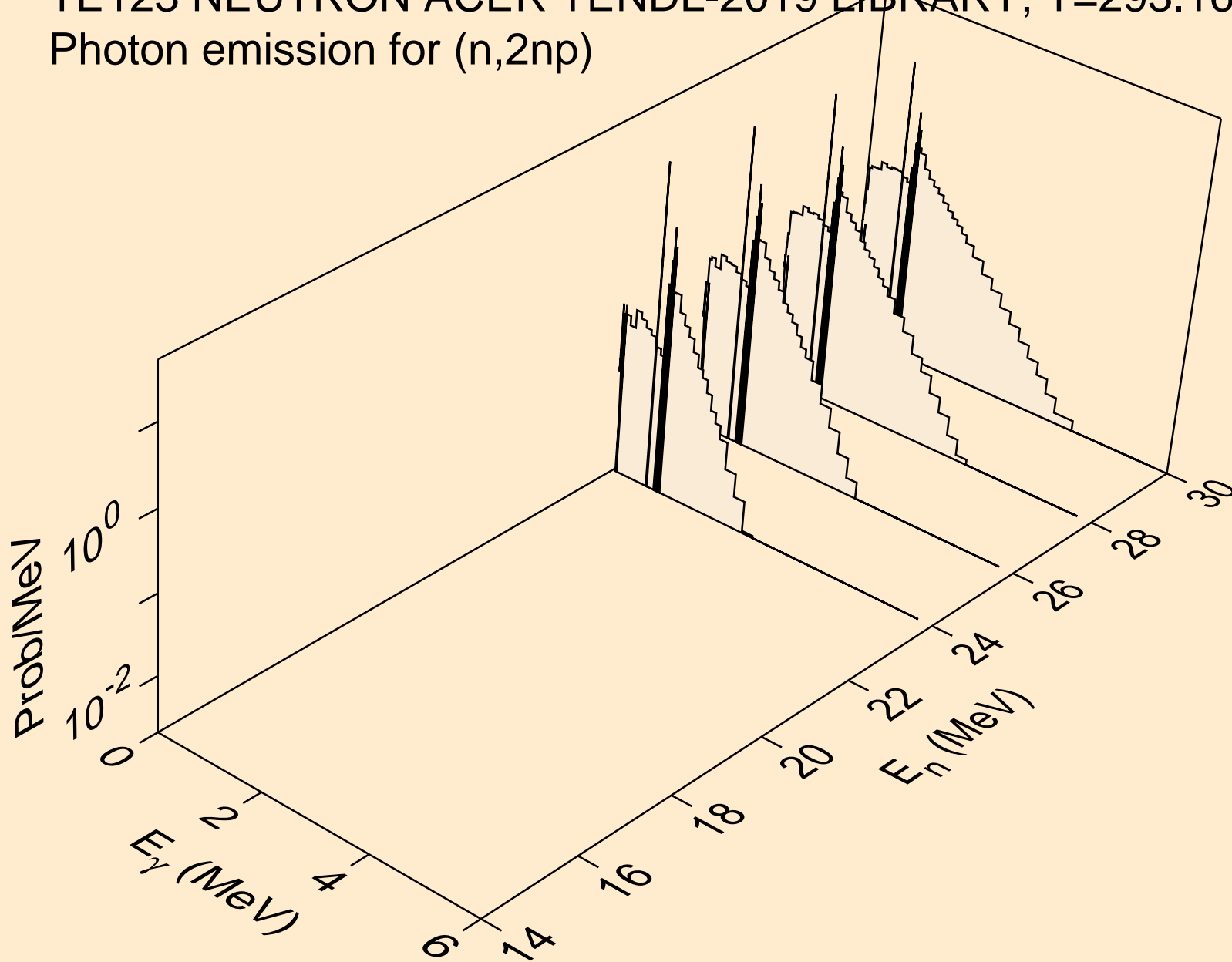

TE123 NEUTRON ACER TENDL-2019 LIBRARY; T=293.16K
Photon emission for (n,npa)

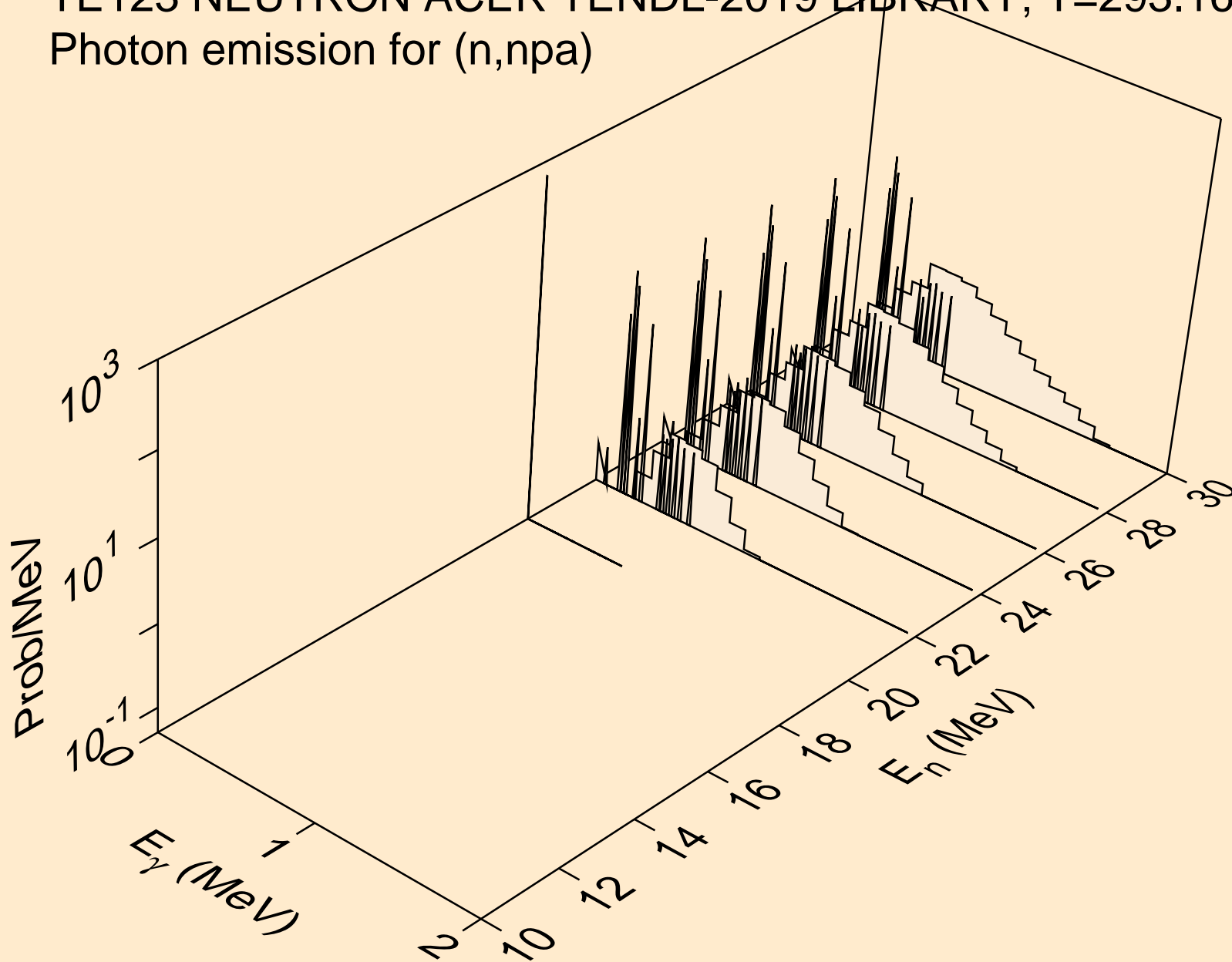

TE123 NEUTRON ACER TENDL-2019 LIBRARY; T=293.16K
Photon emission for (n,n*c)

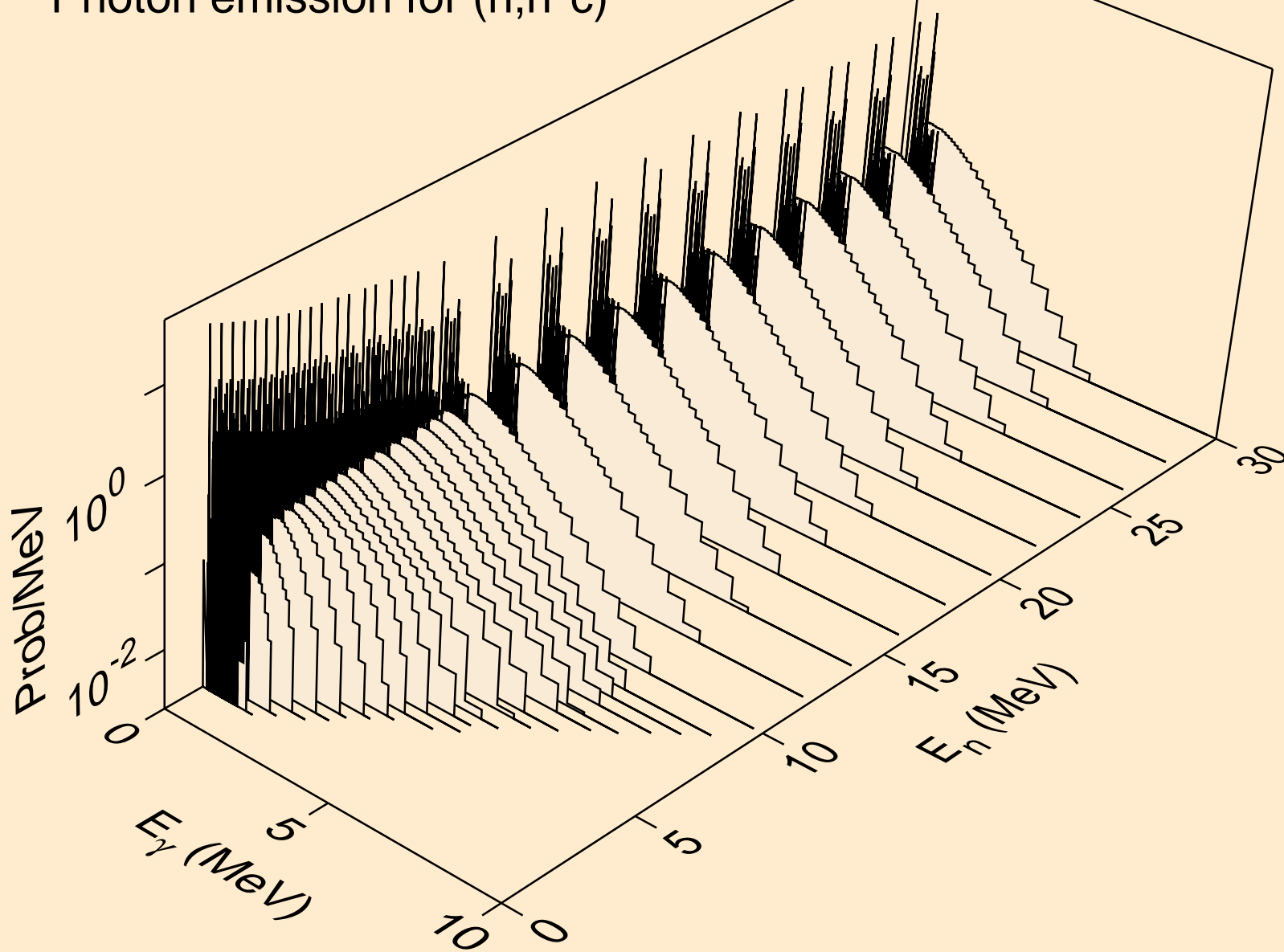

TE123 NEUTRON ACER TENDL-2019 LIBRARY; T=293.16K
Photon emission for (n,gma)

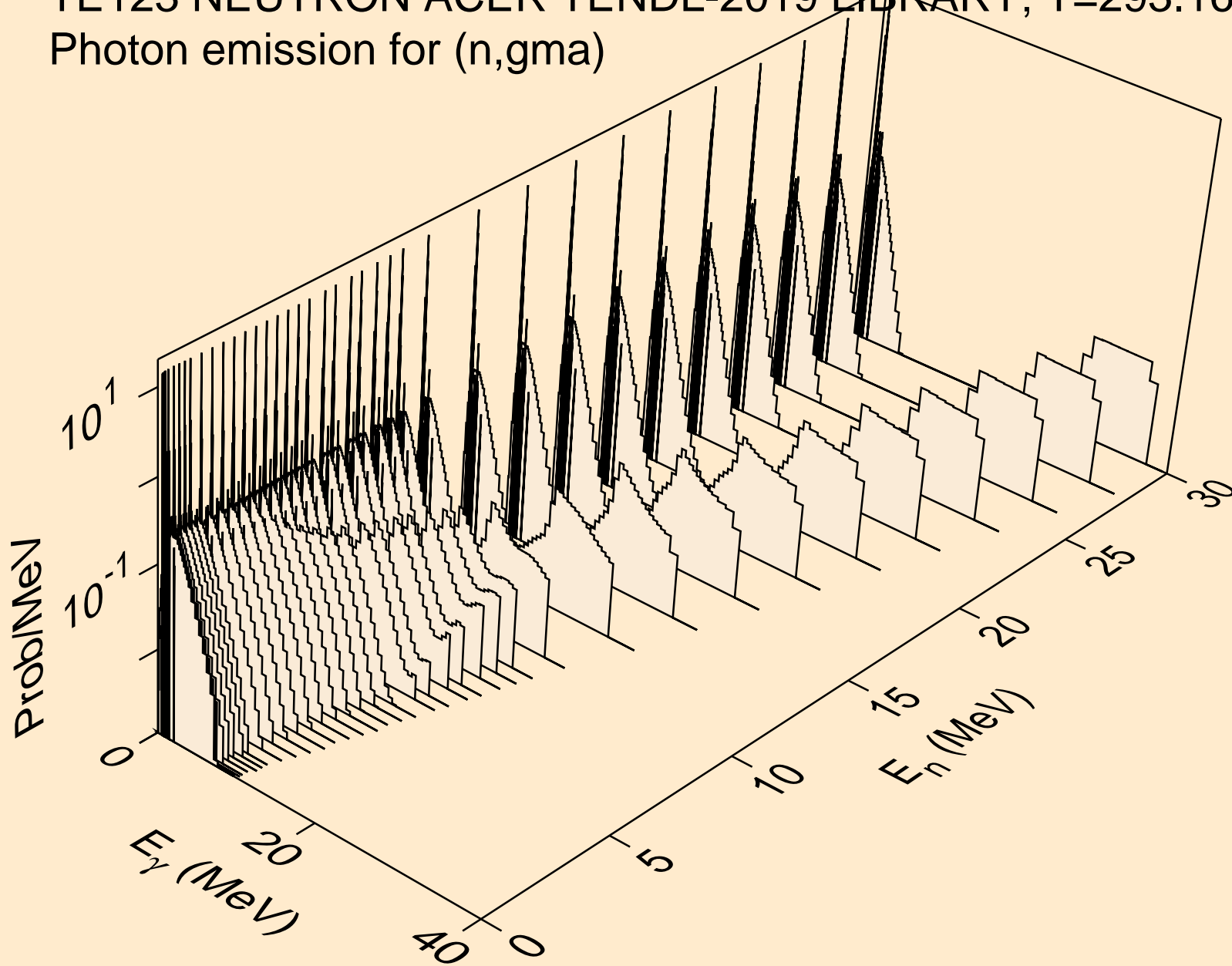

TE123 NEUTRON ACER TENDL-2019 LIBRARY; T=293.16K
Photon emission for (n,p)

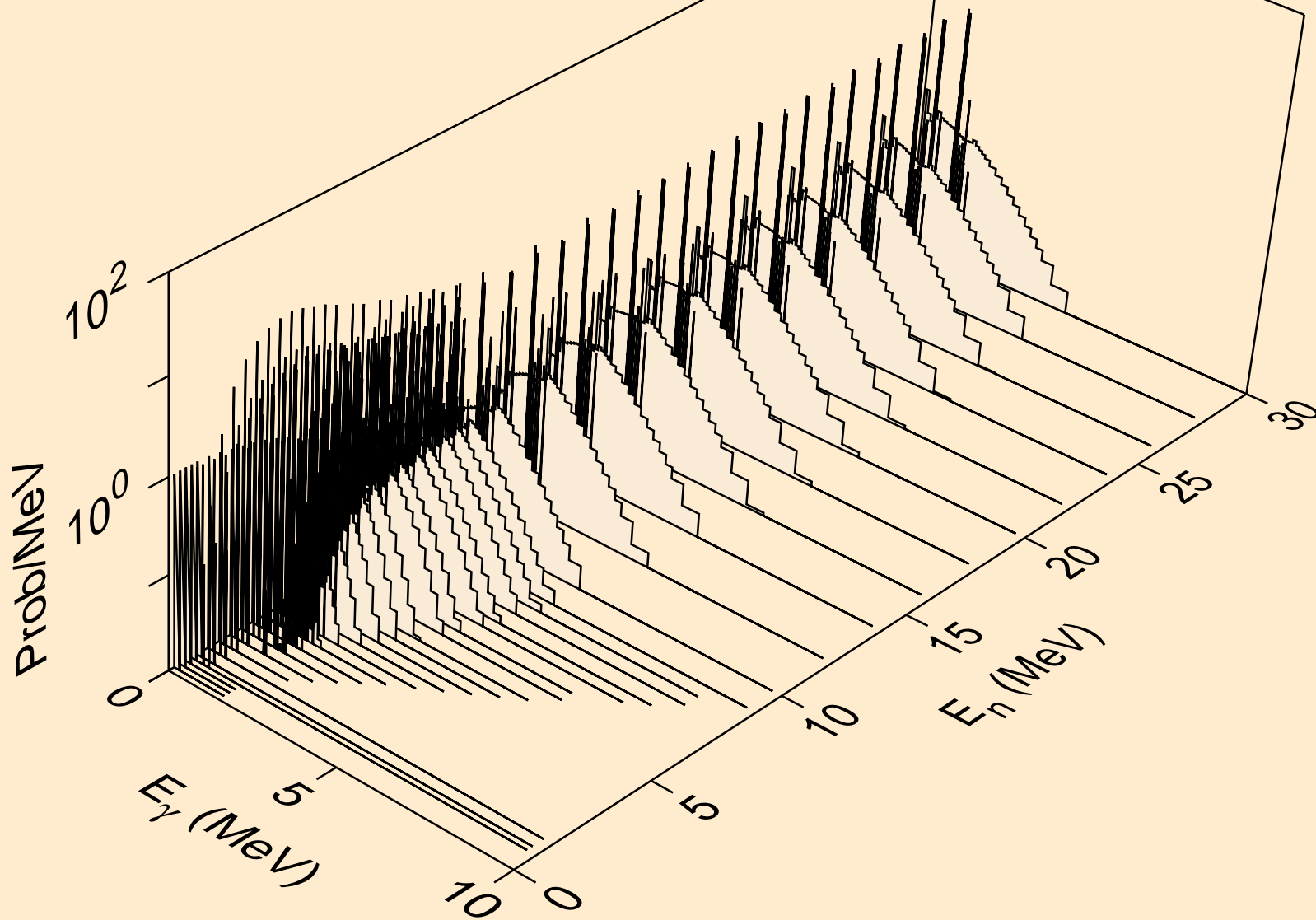

TE123 NEUTRON ACER TENDL-2019 LIBRARY; T=293.16K
Photon emission for (n,d)

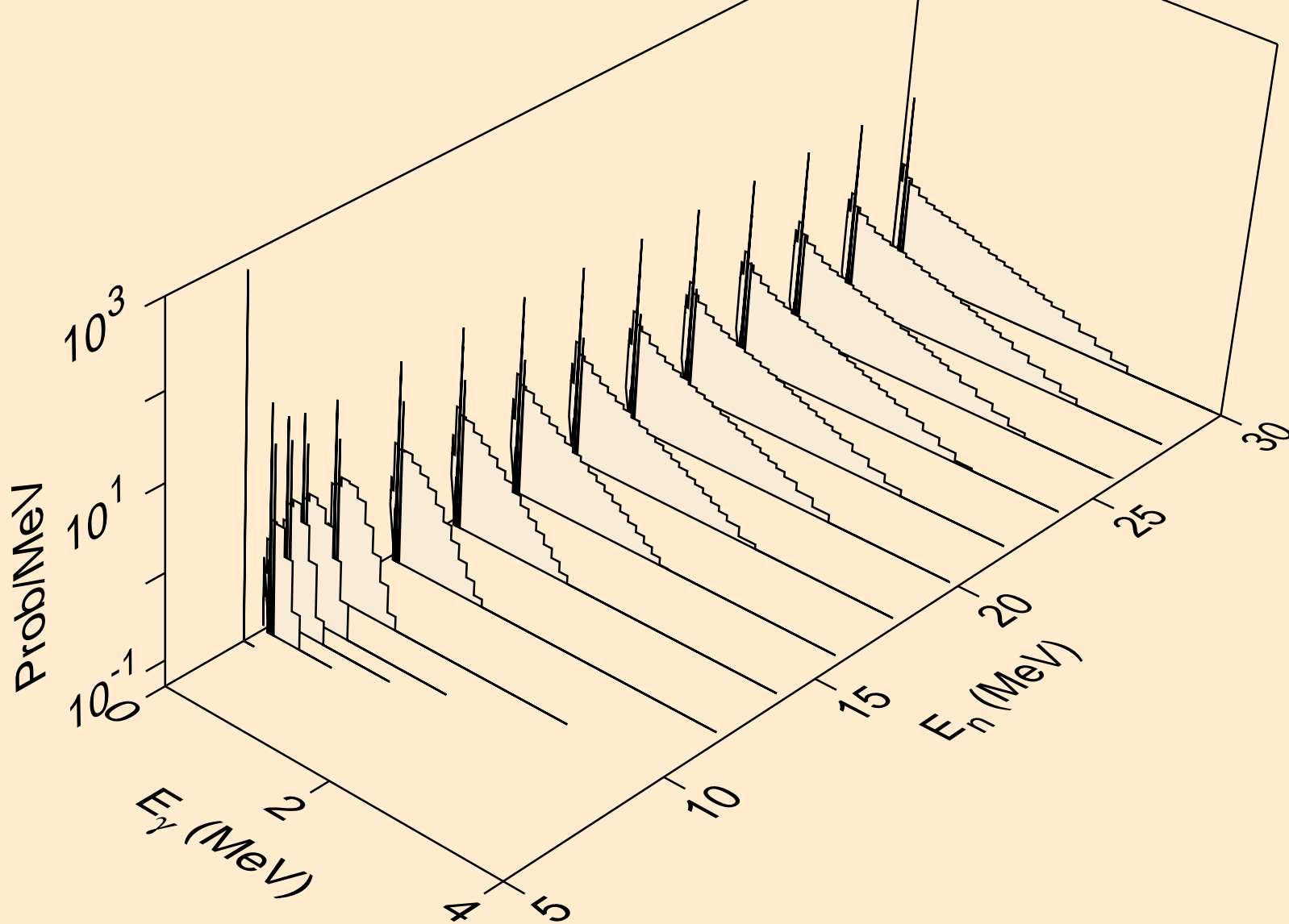

TE123 NEUTRON ACER TENDL-2019 LIBRARY; T=293.16K
Photon emission for (n,t)

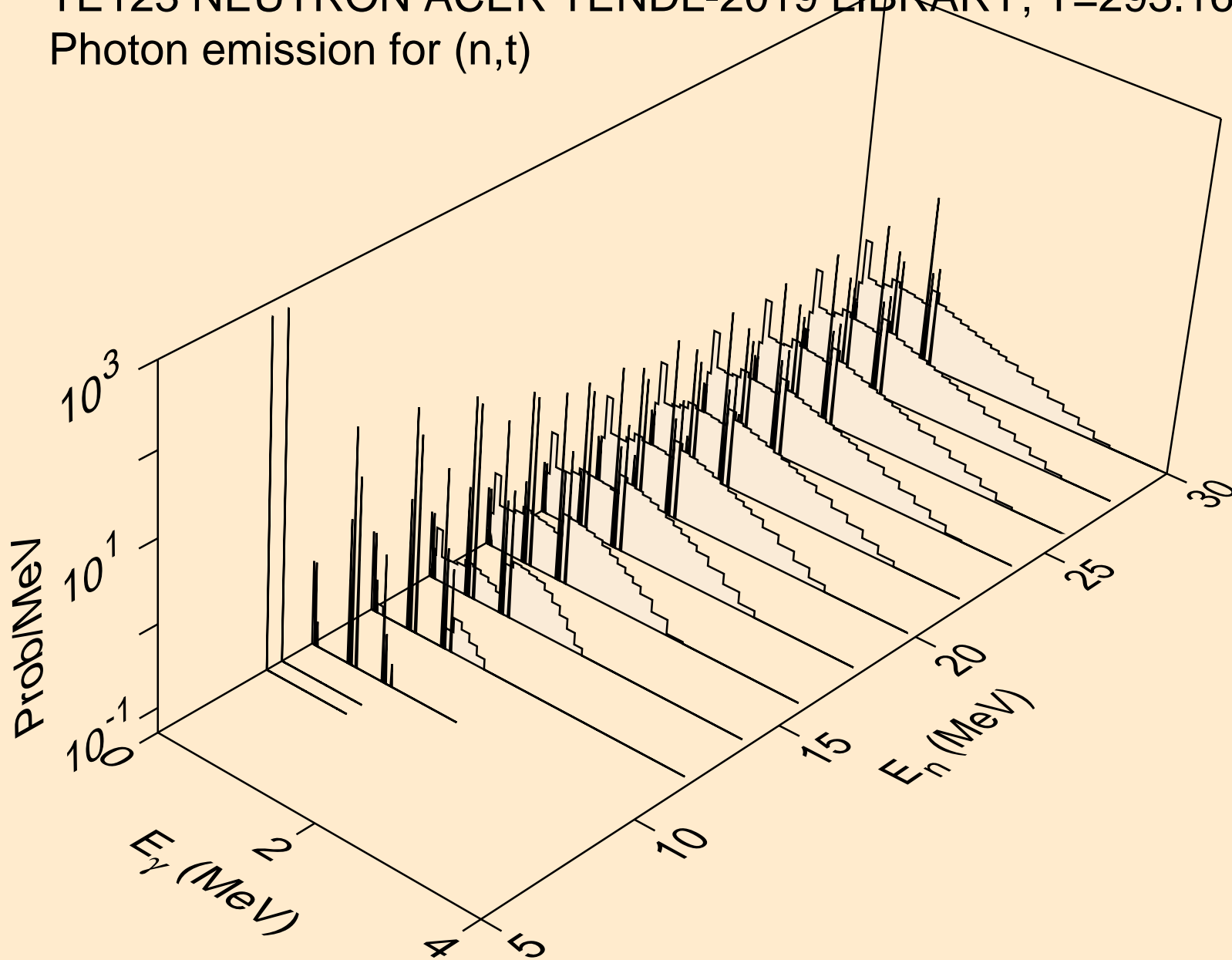

TE123 NEUTRON ACER TENDL-2019 LIBRARY; T=293.16K
Photon emission for (n,he3)

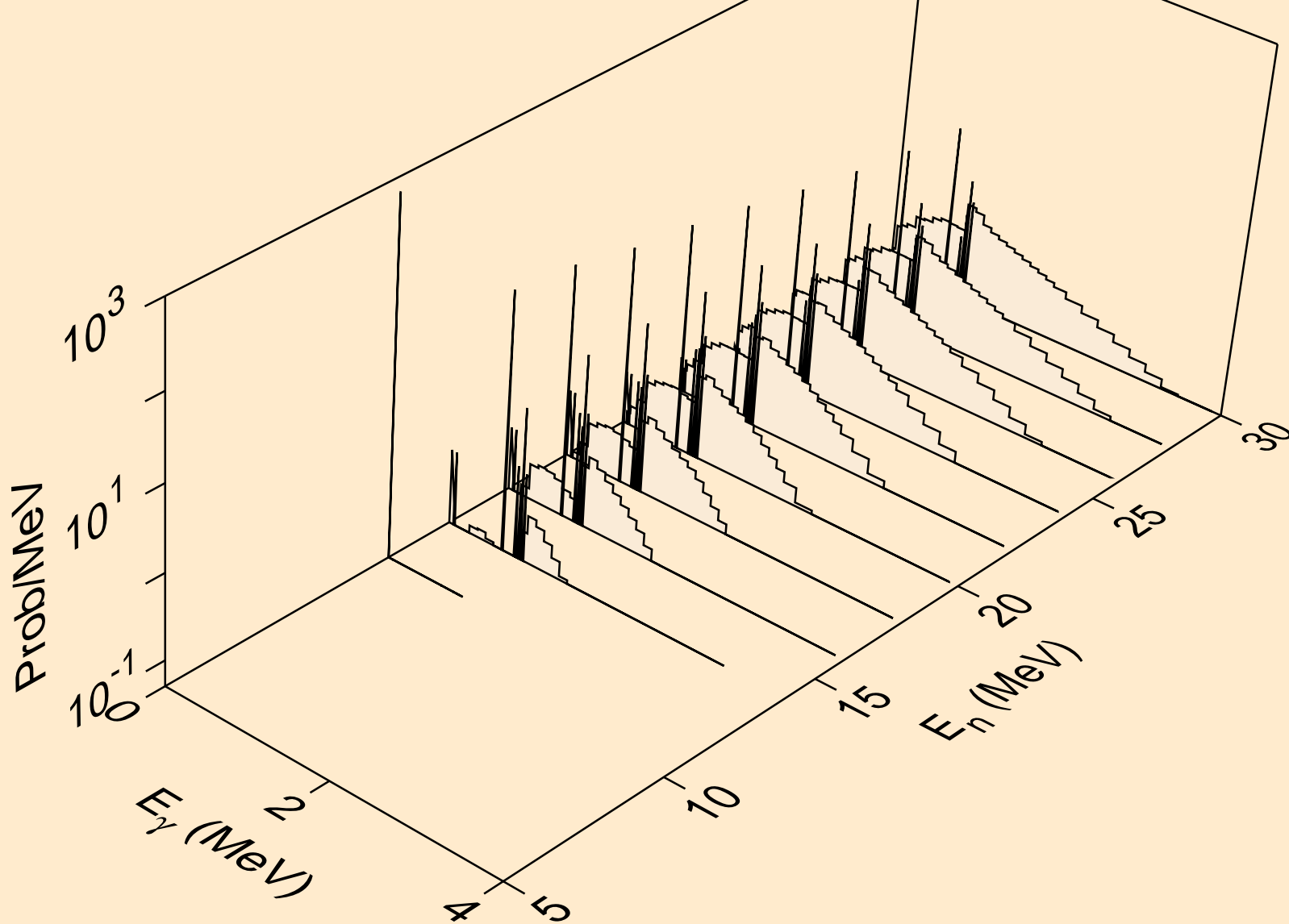

TE123 NEUTRON ACER TENDL-2019 LIBRARY; T=293.16K
Photon emission for (n,a)

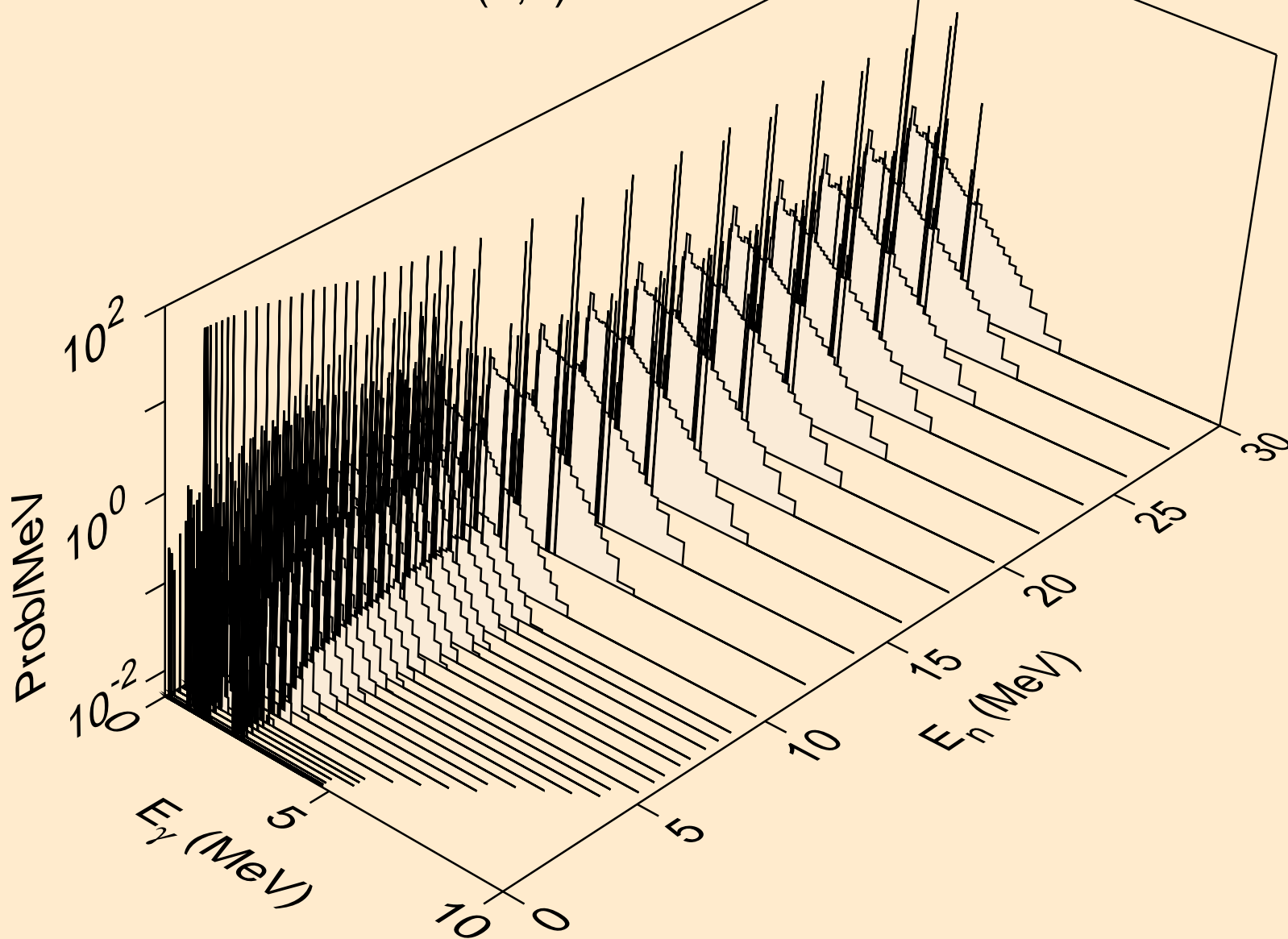

TE123 NEUTRON ACER TENDL-2019 LIBRARY; T=293.16K
Photon emission for (n,2a)

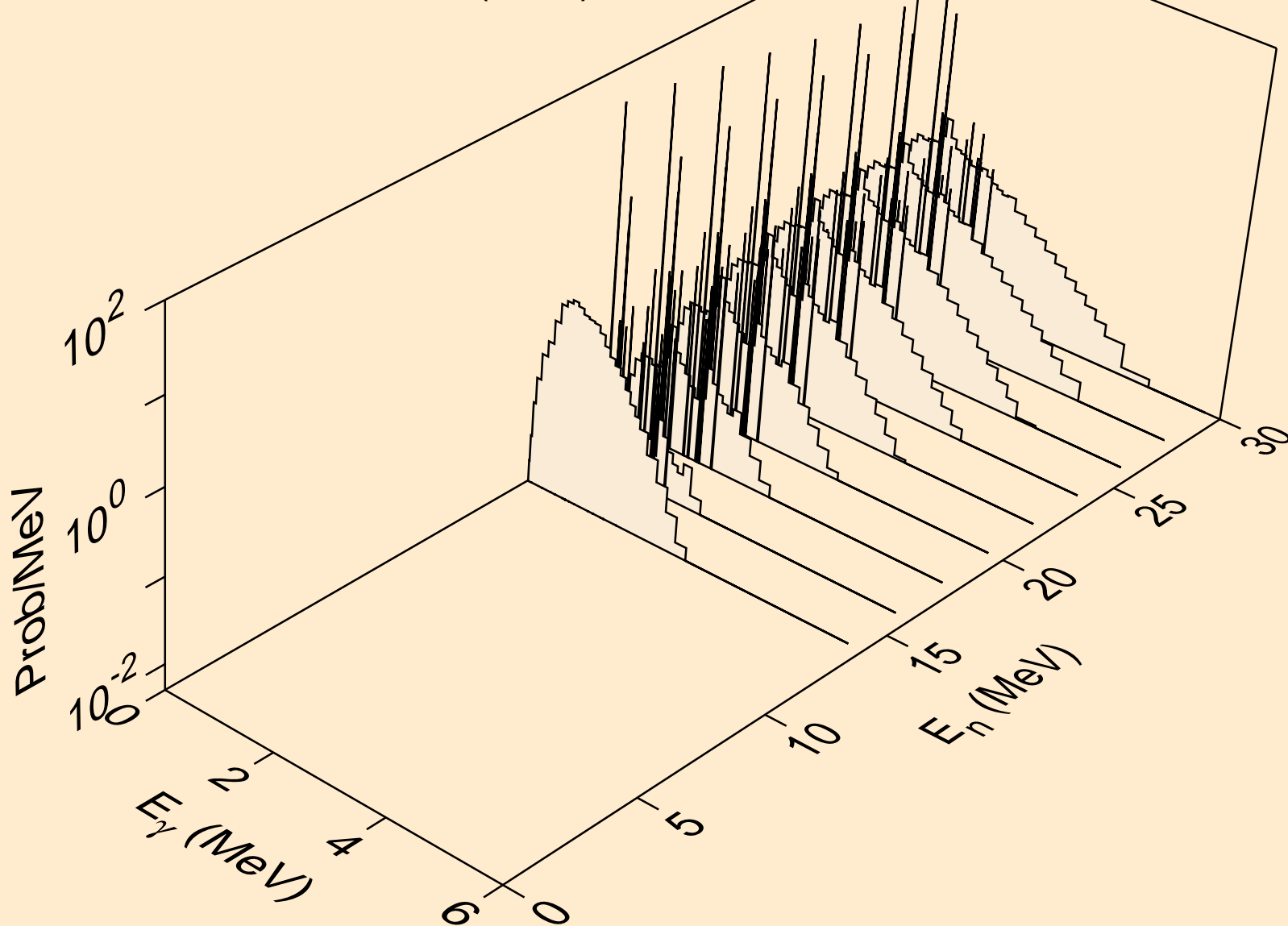

TE123 NEUTRON ACER TENDL-2019 LIBRARY; T=293.16K
Photon emission for (n,2p)

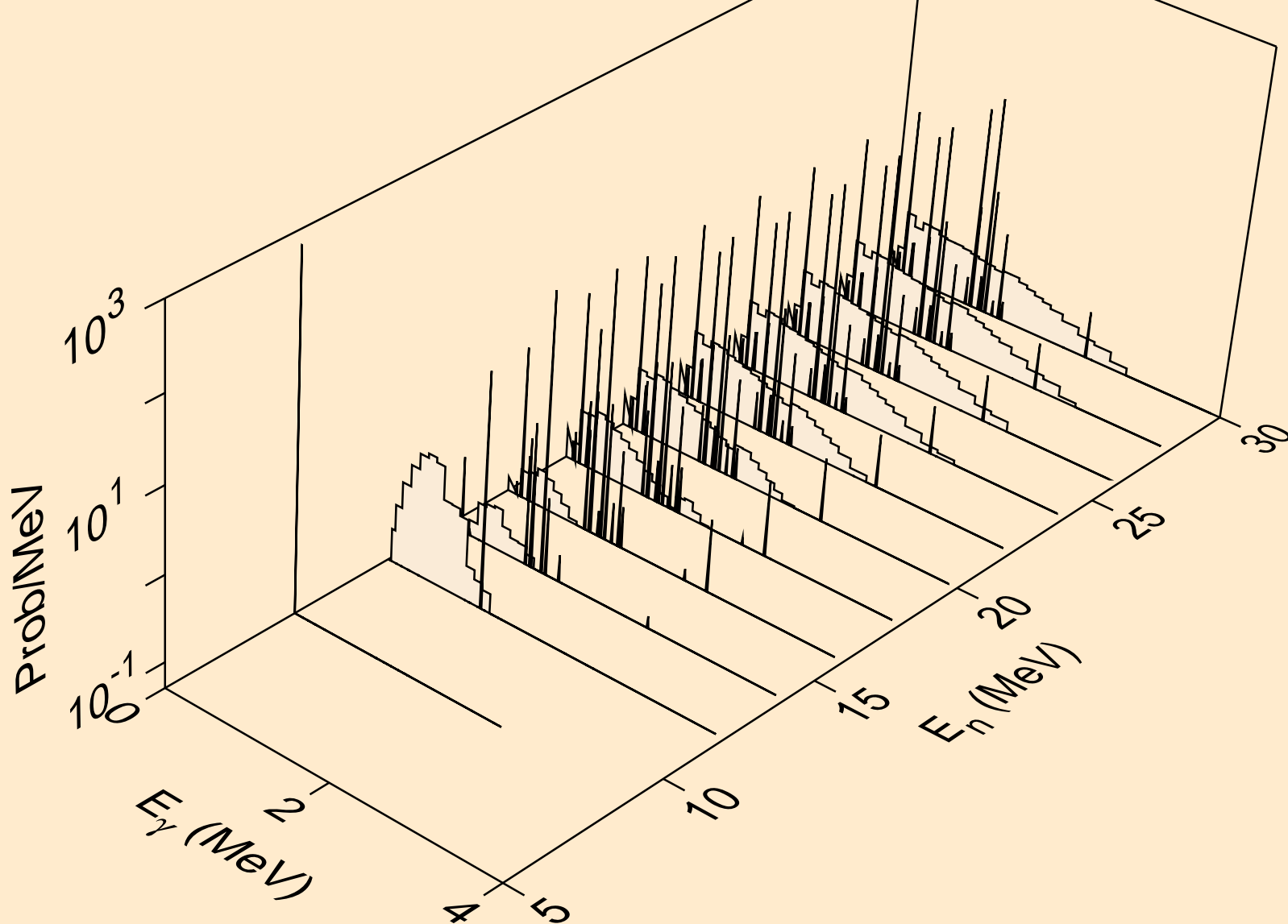

TE123 NEUTRON ACER TENDL-2019 LIBRARY; T=293.16K
Photon emission for (n,p α)

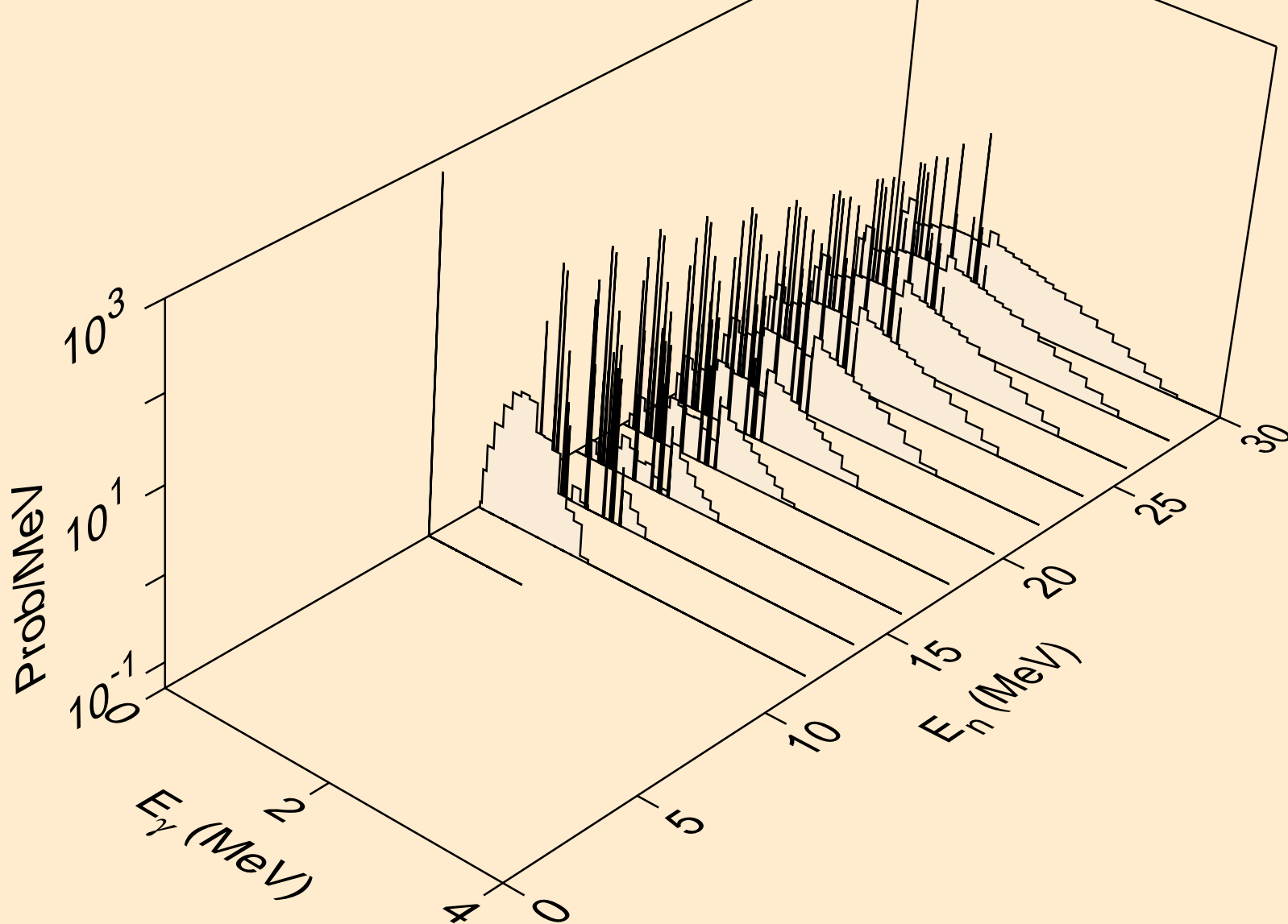

TE123 NEUTRON ACER TENDL-2019 LIBRARY; T=293.16K
Photon emission for (n,pd)

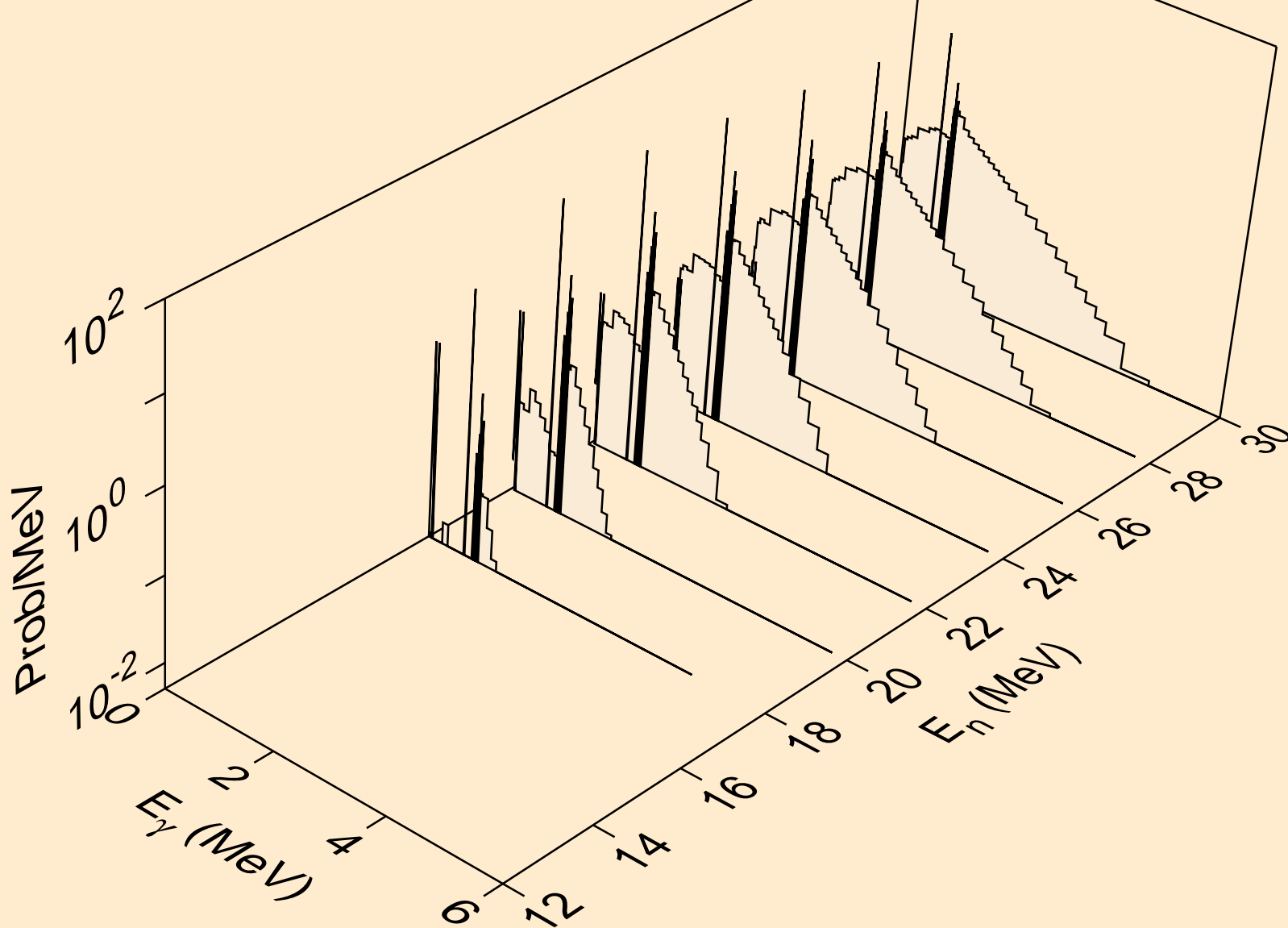

TE123 NEUTRON ACER TENDL-2019 LIBRARY; T=293.16K
Photon emission for (n,pt)

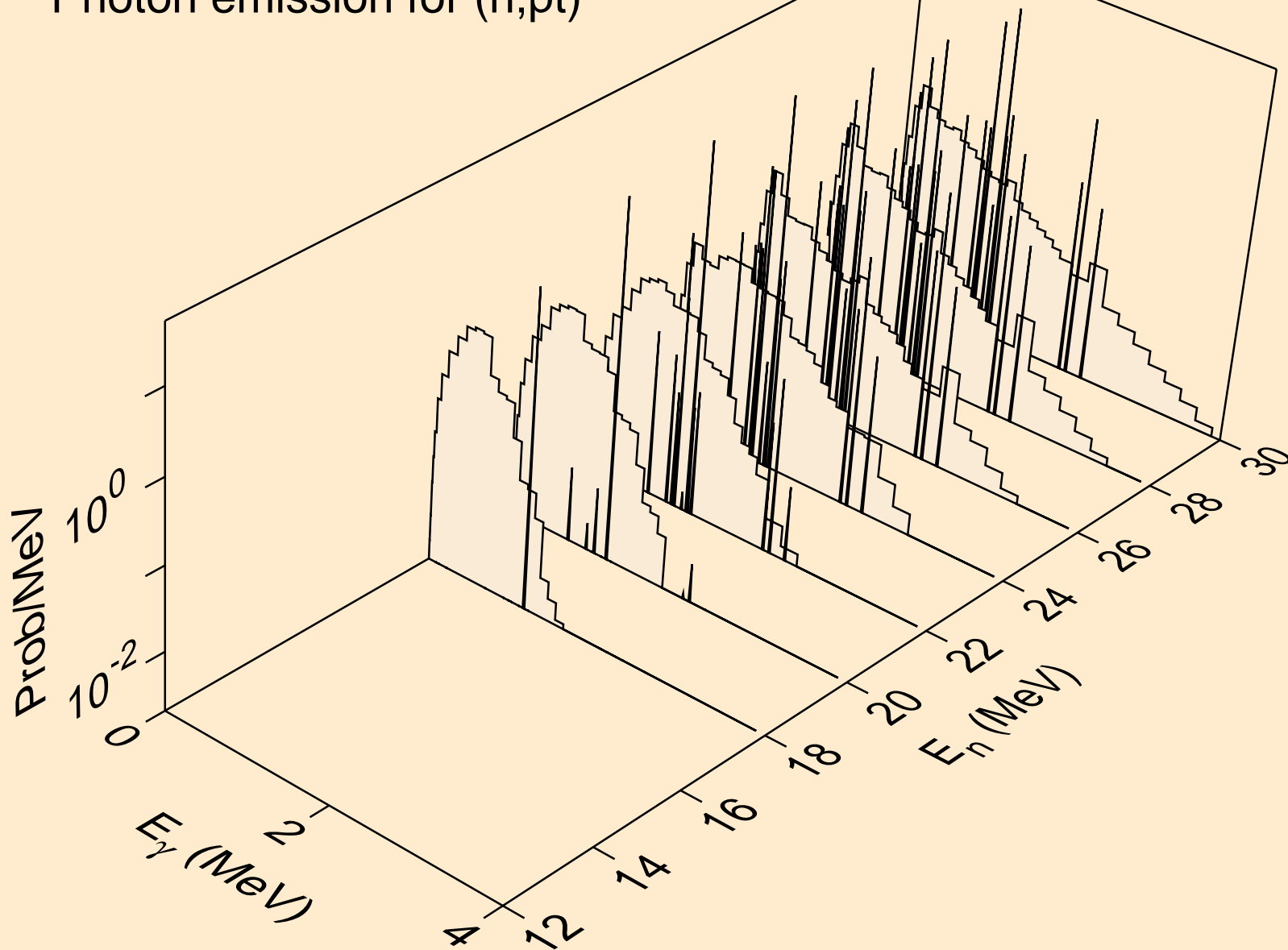

TE123 NEUTRON ACER TENDL-2019 LIBRARY; T=293.16K
Photon emission for (n,da)

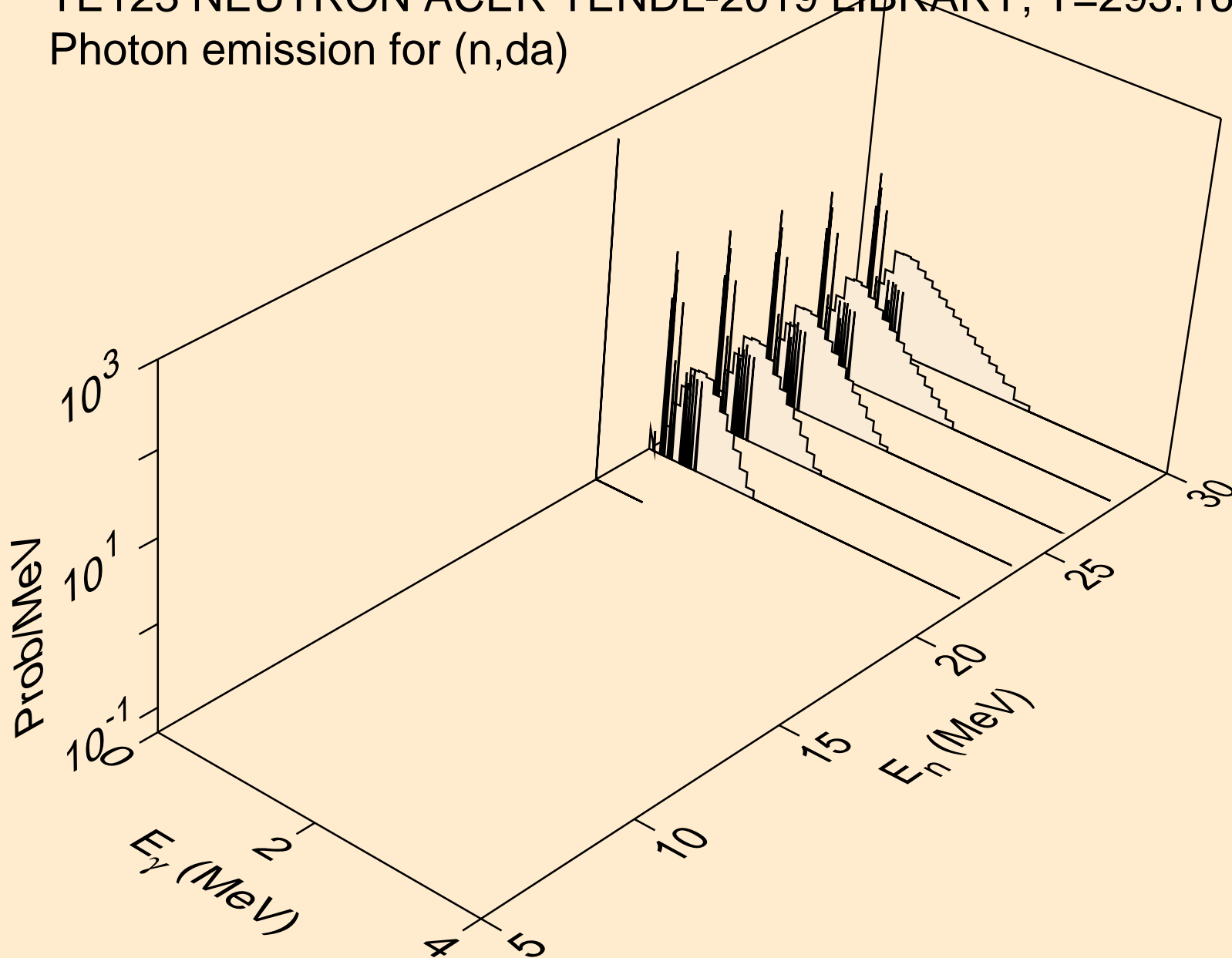

TE123 NEUTRON ACER TENDL-2019 LIBRARY; T=293.16K
thermal capture photon spectrum

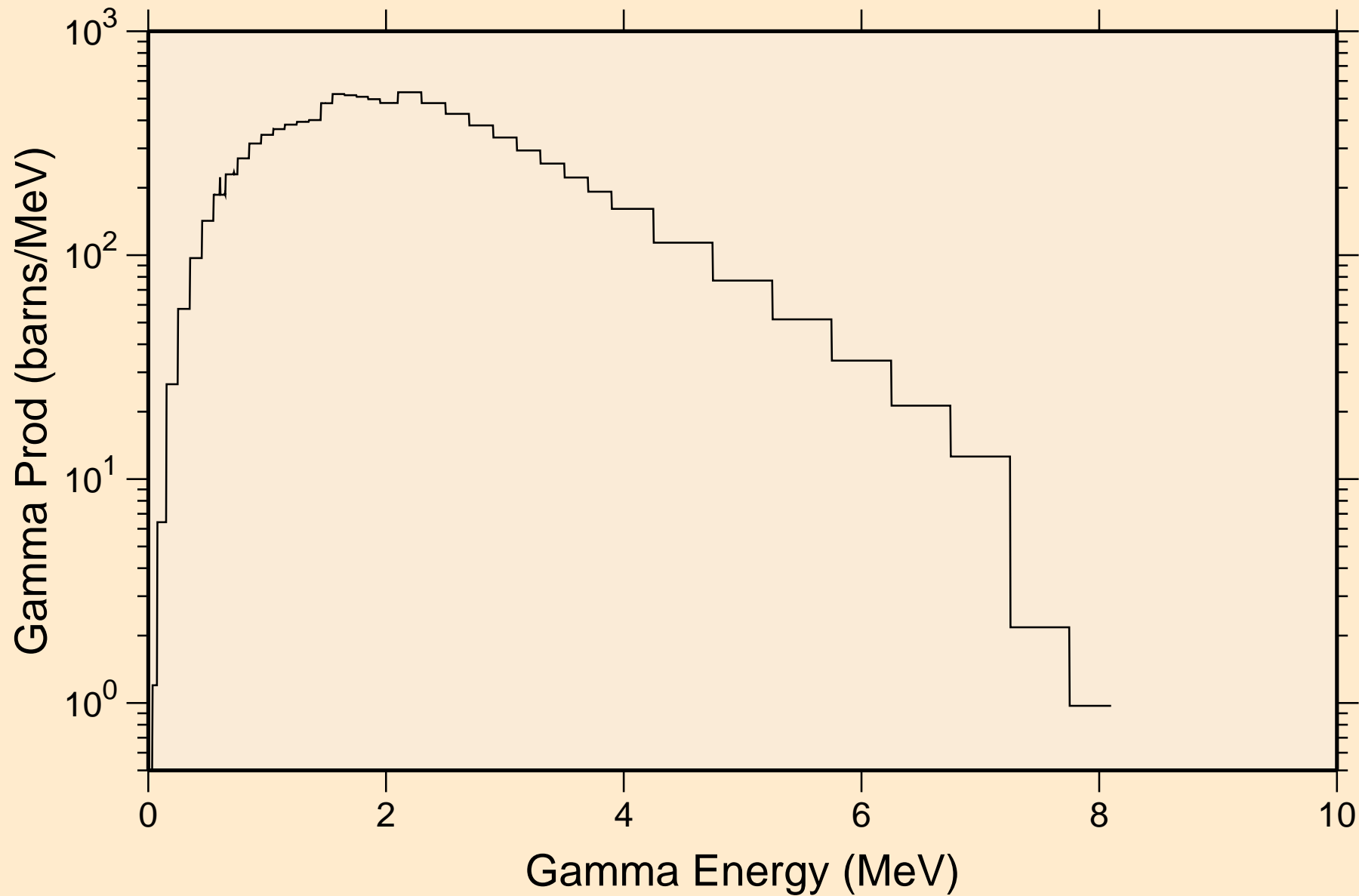

TE123 NEUTRON ACER TENDL-2019 LIBRARY; T=293.16K
14 MeV photon spectrum

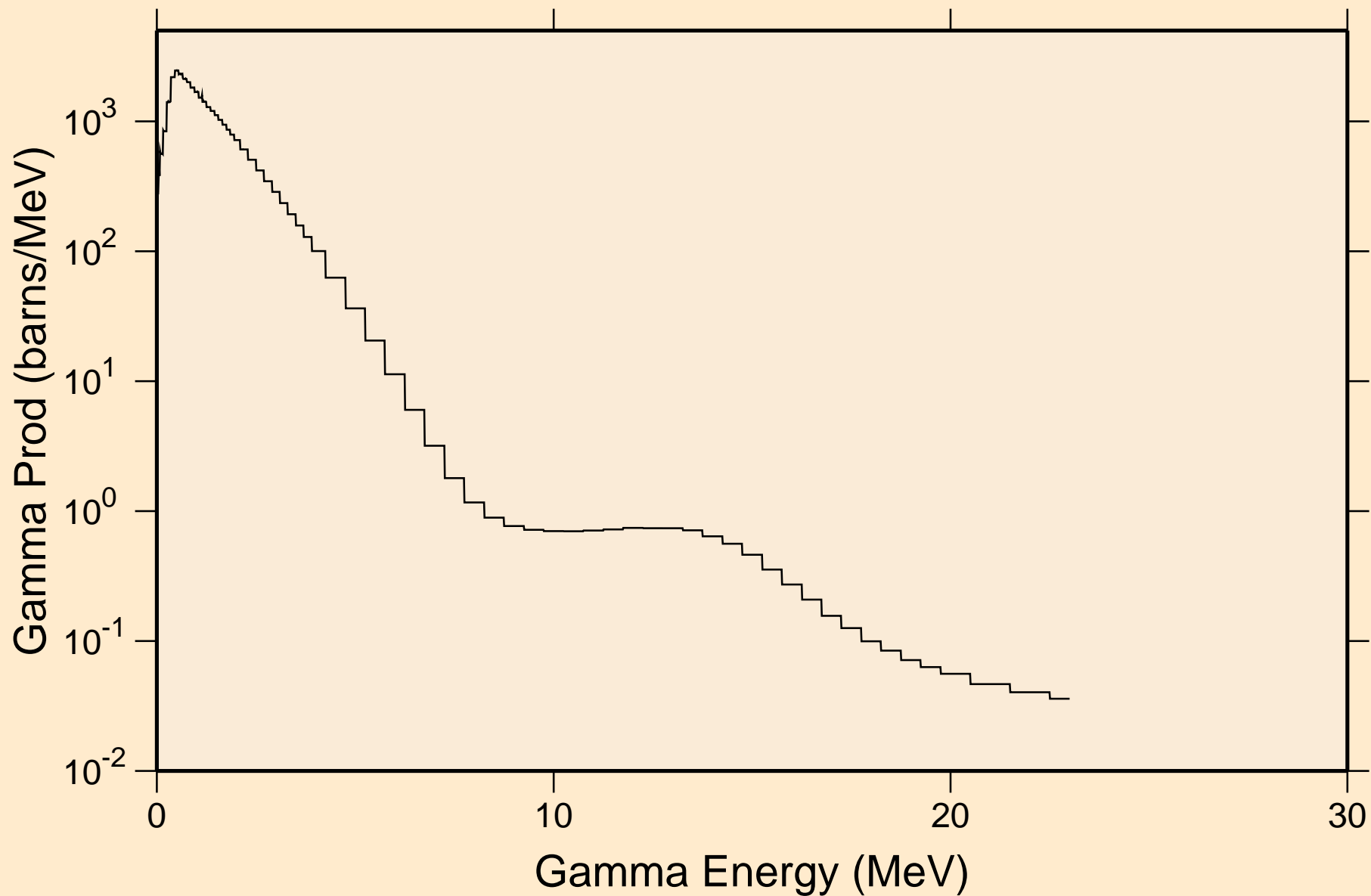

TE123 NEUTRON ACER TENDL-2019 LIBRARY; T=293.16K
Particle heating contributions

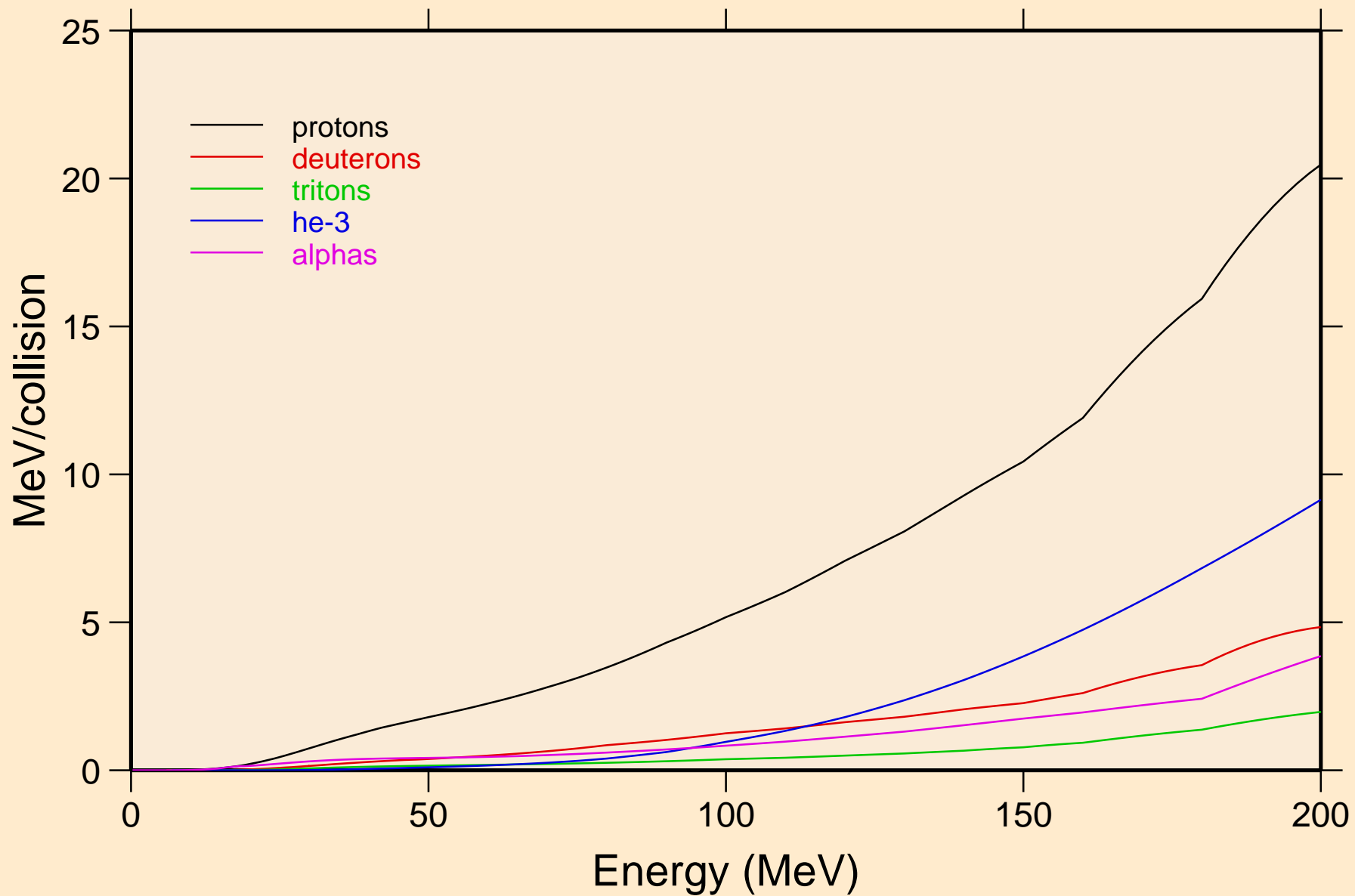

TE123 NEUTRON ACER TENDL-2019 LIBRARY; T=293.16K
Recoil Heating

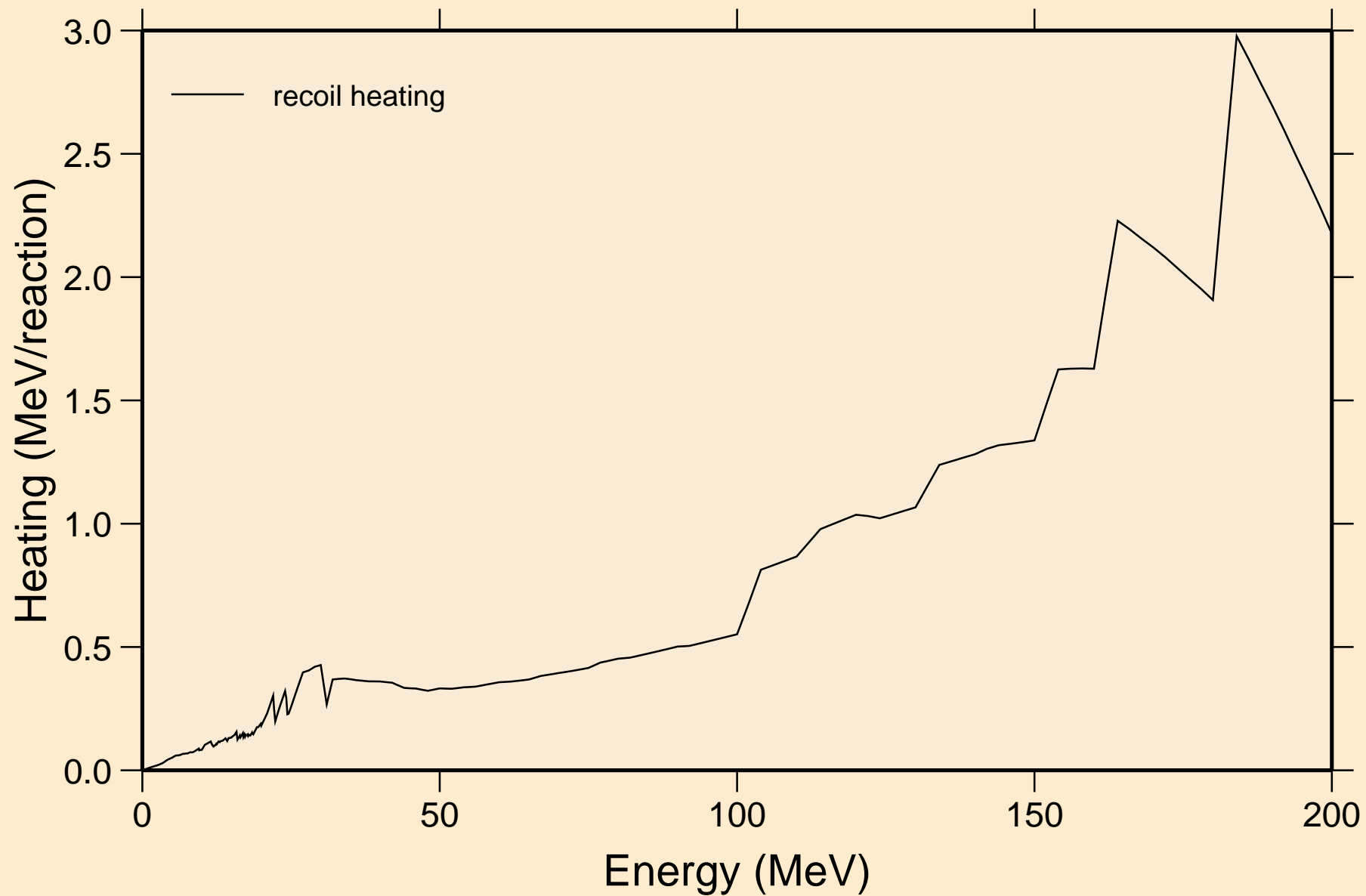

TE123 NEUTRON ACER TENDL-2019 LIBRARY; T=293.16K
Particle production cross sections

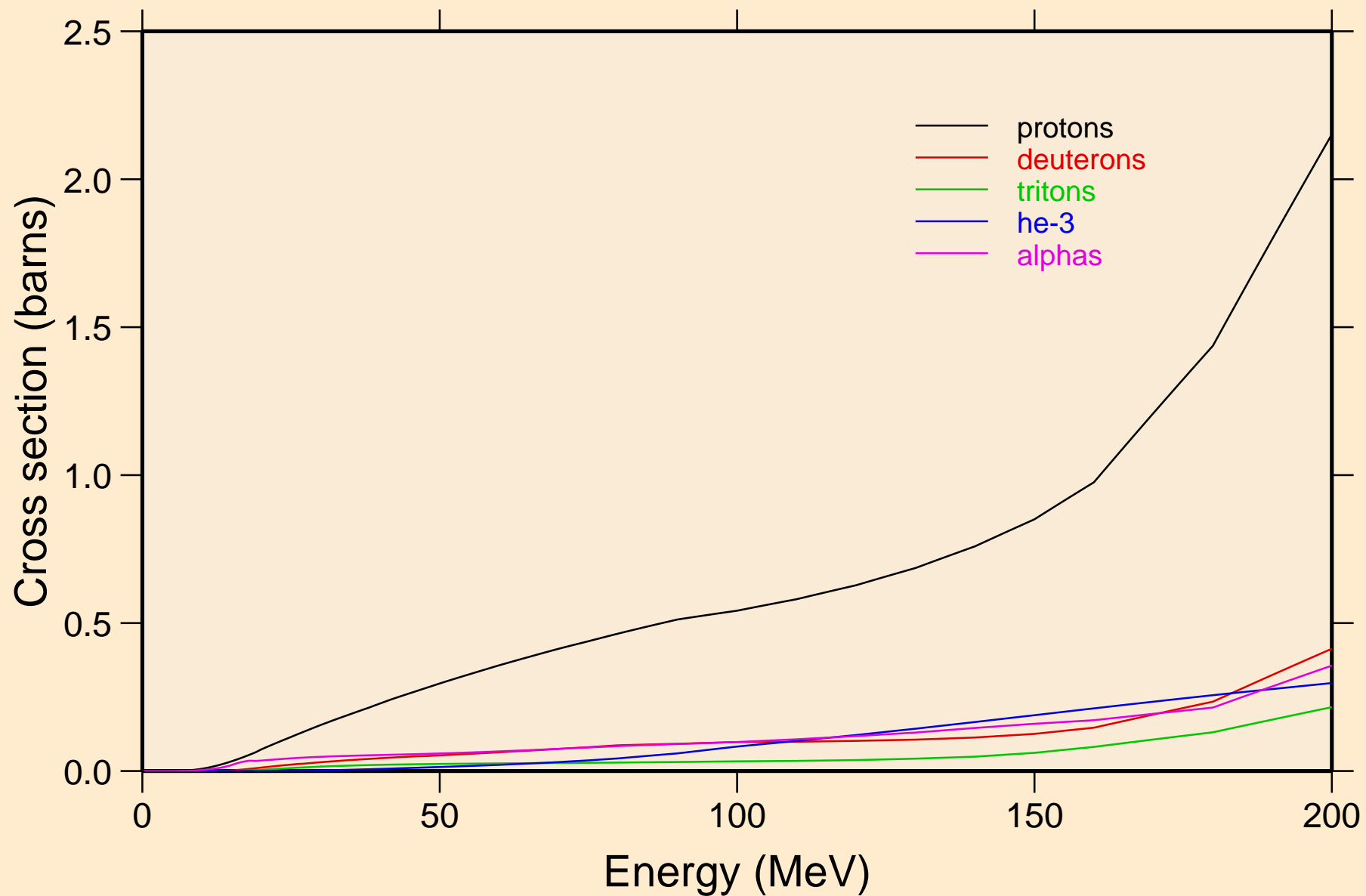

TE123 NEUTRON ACER TENDL-2019 LIBRARY; T=293.16K
protons from (n,x)

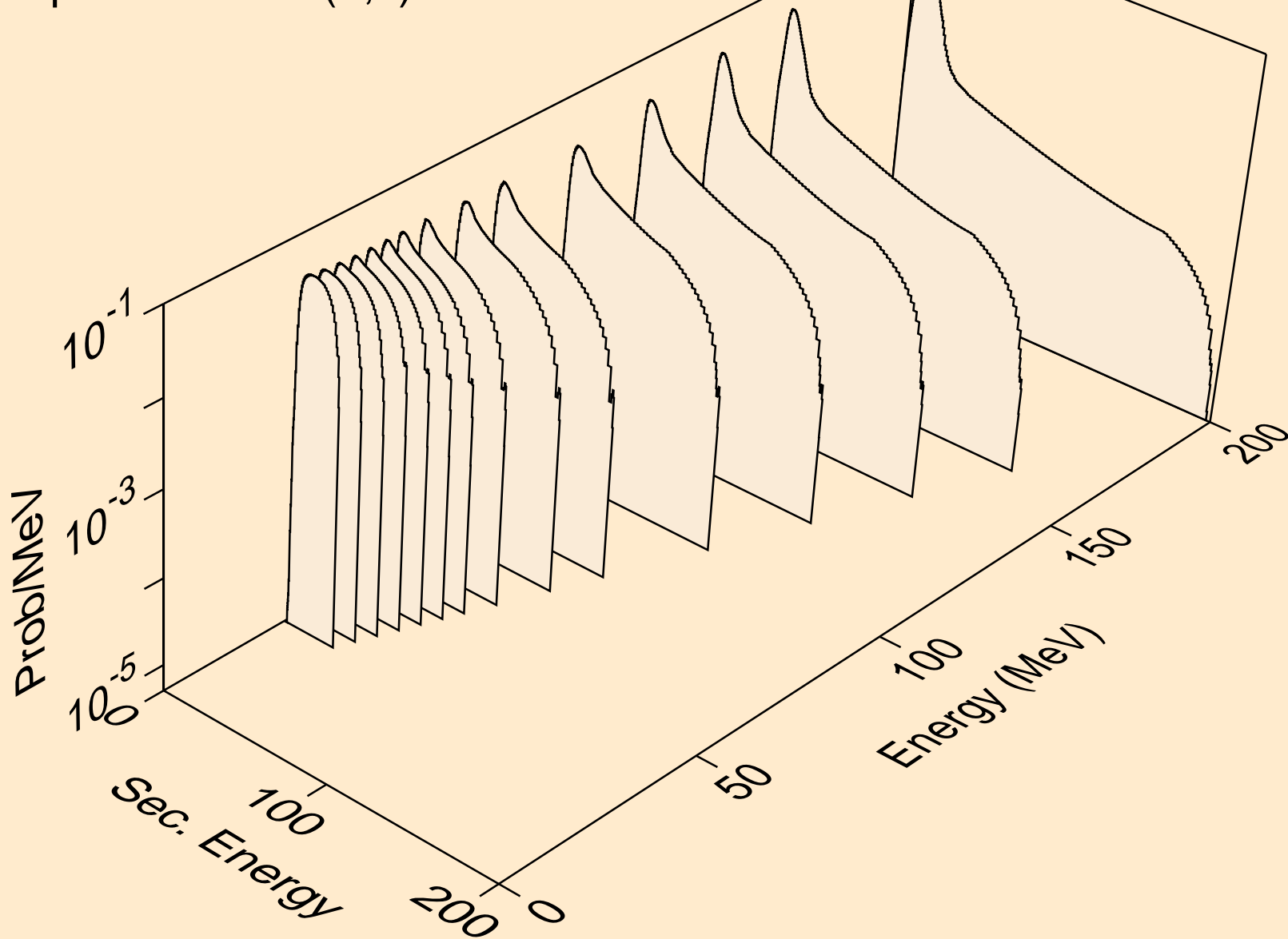

TE123 NEUTRON ACER TENDL-2019 LIBRARY; T=293.16K
protons from (n,n*)p

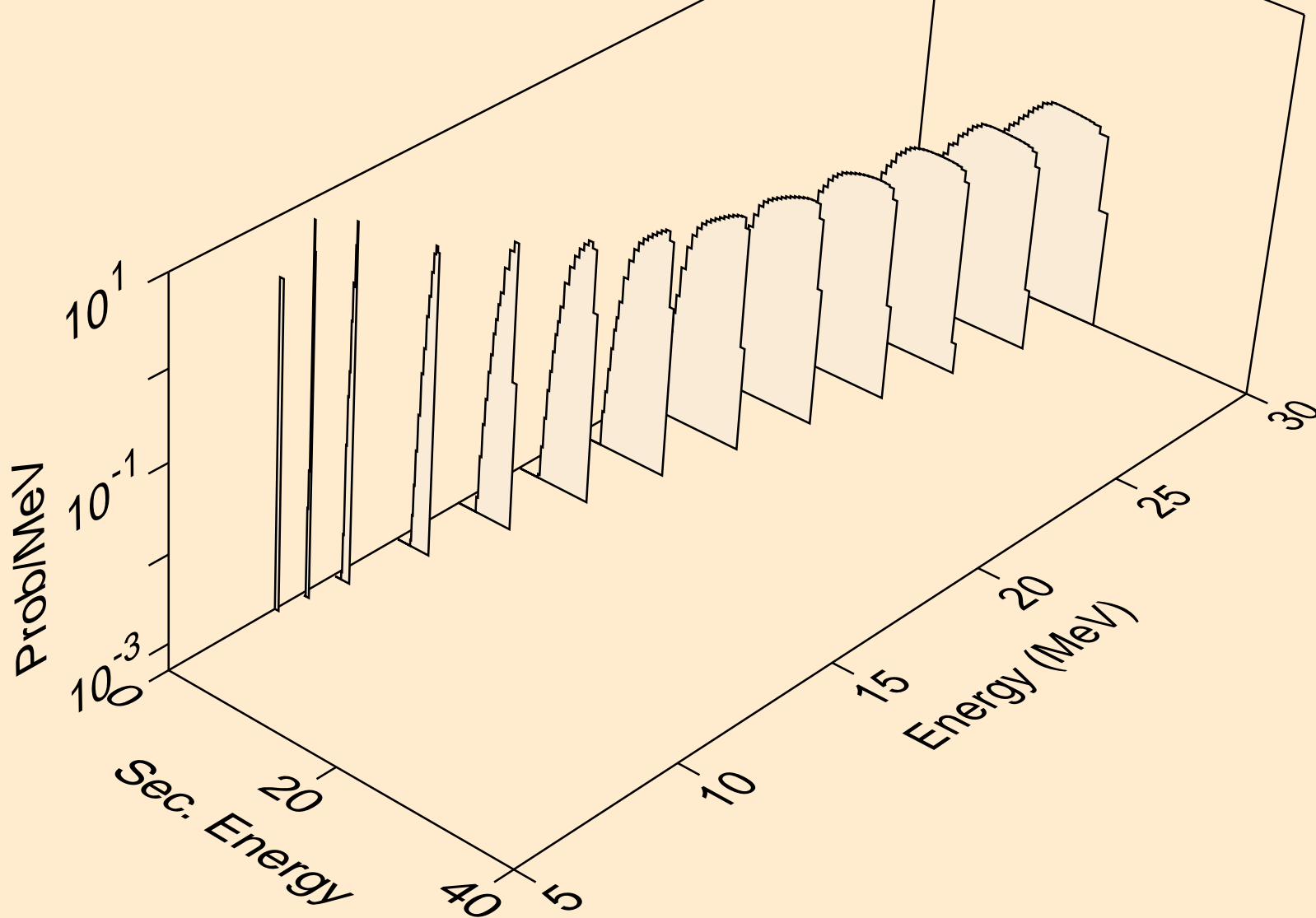

TE123 NEUTRON ACER TENDL-2019 LIBRARY; T=293.16K
protons from (n,2np)

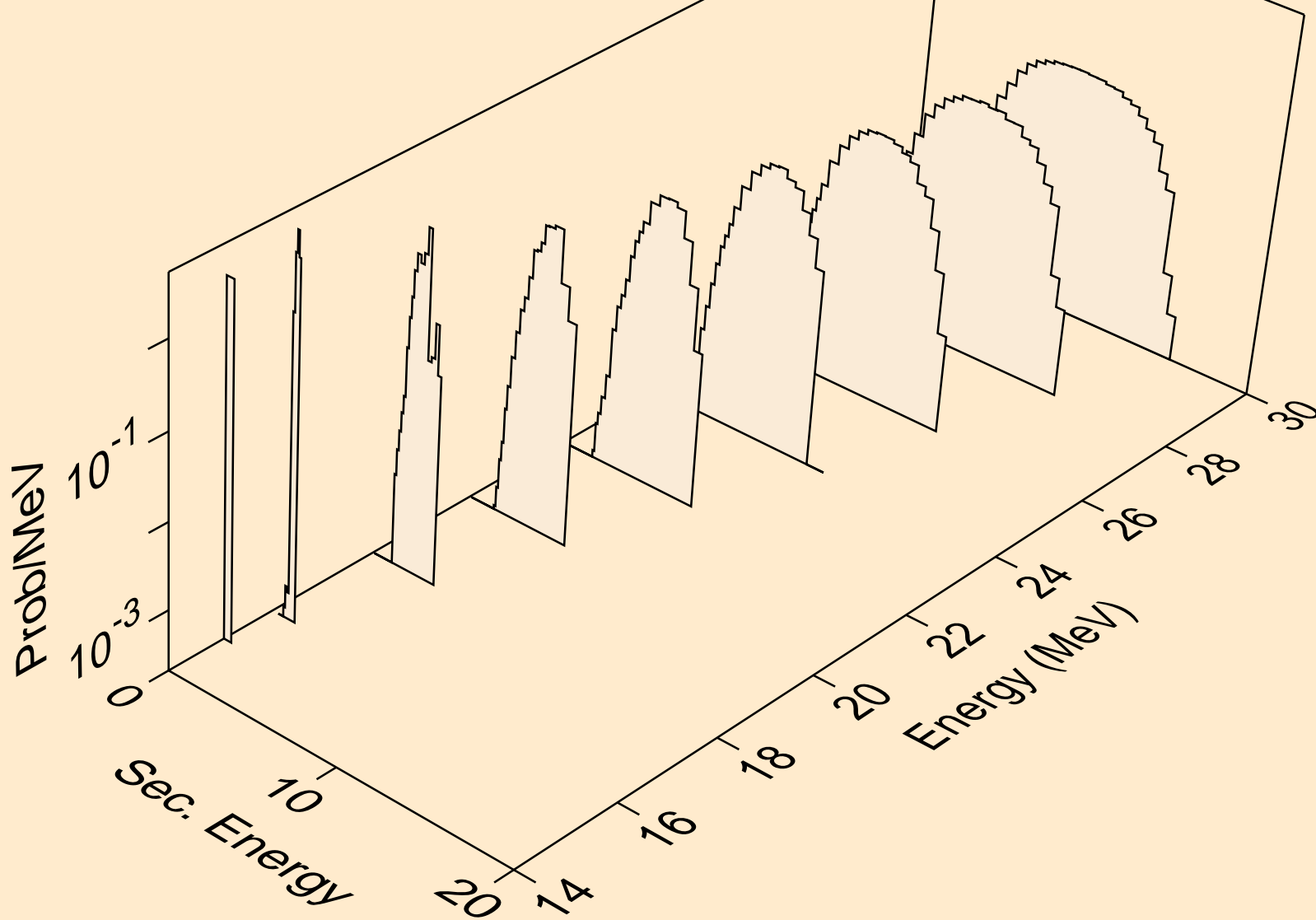

TE123 NEUTRON ACER TENDL-2019 LIBRARY; T=293.16K
protons from (n,3np)

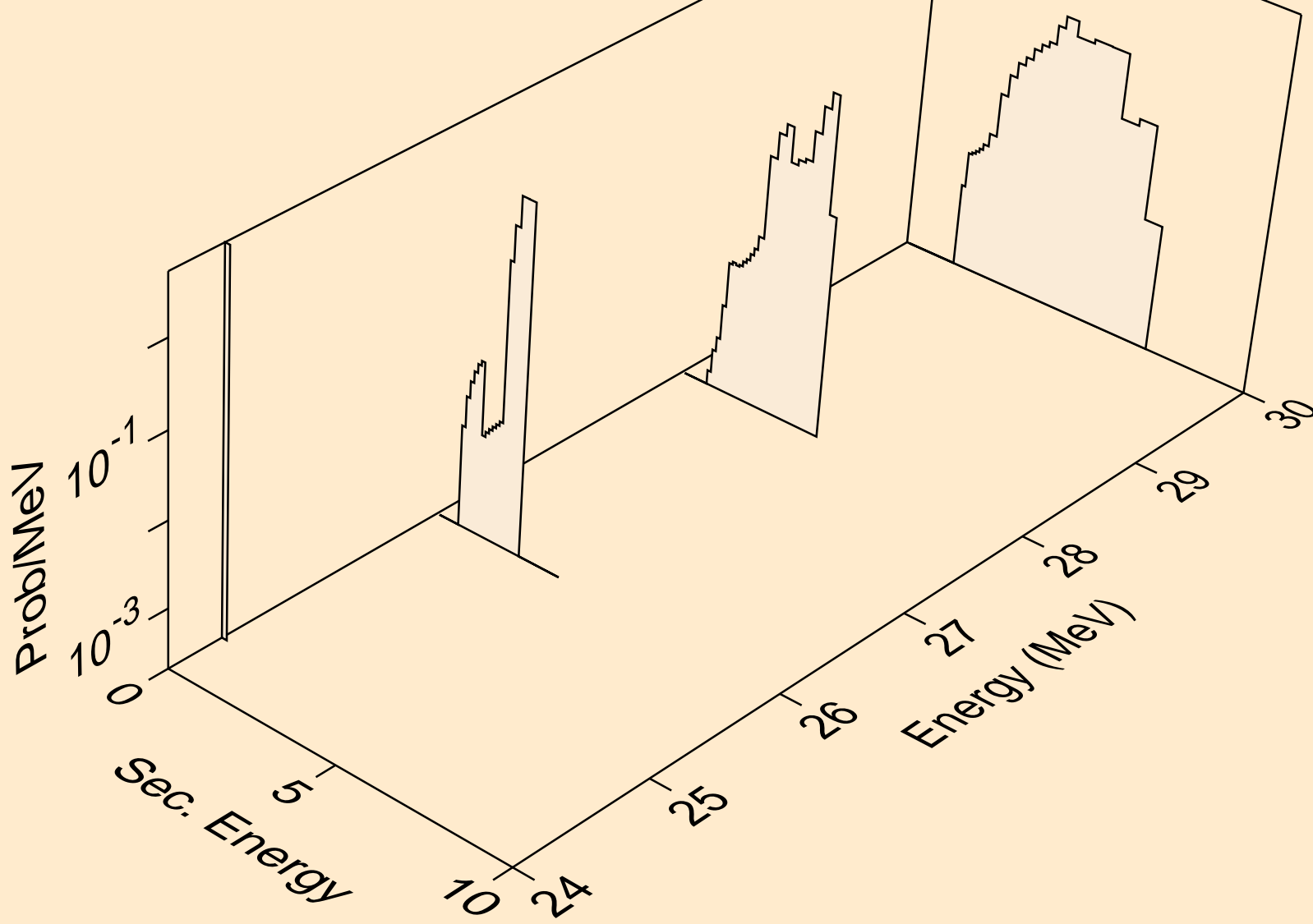

TE123 NEUTRON ACER TENDL-2019 LIBRARY; T=293.16K
protons from (n,2np)

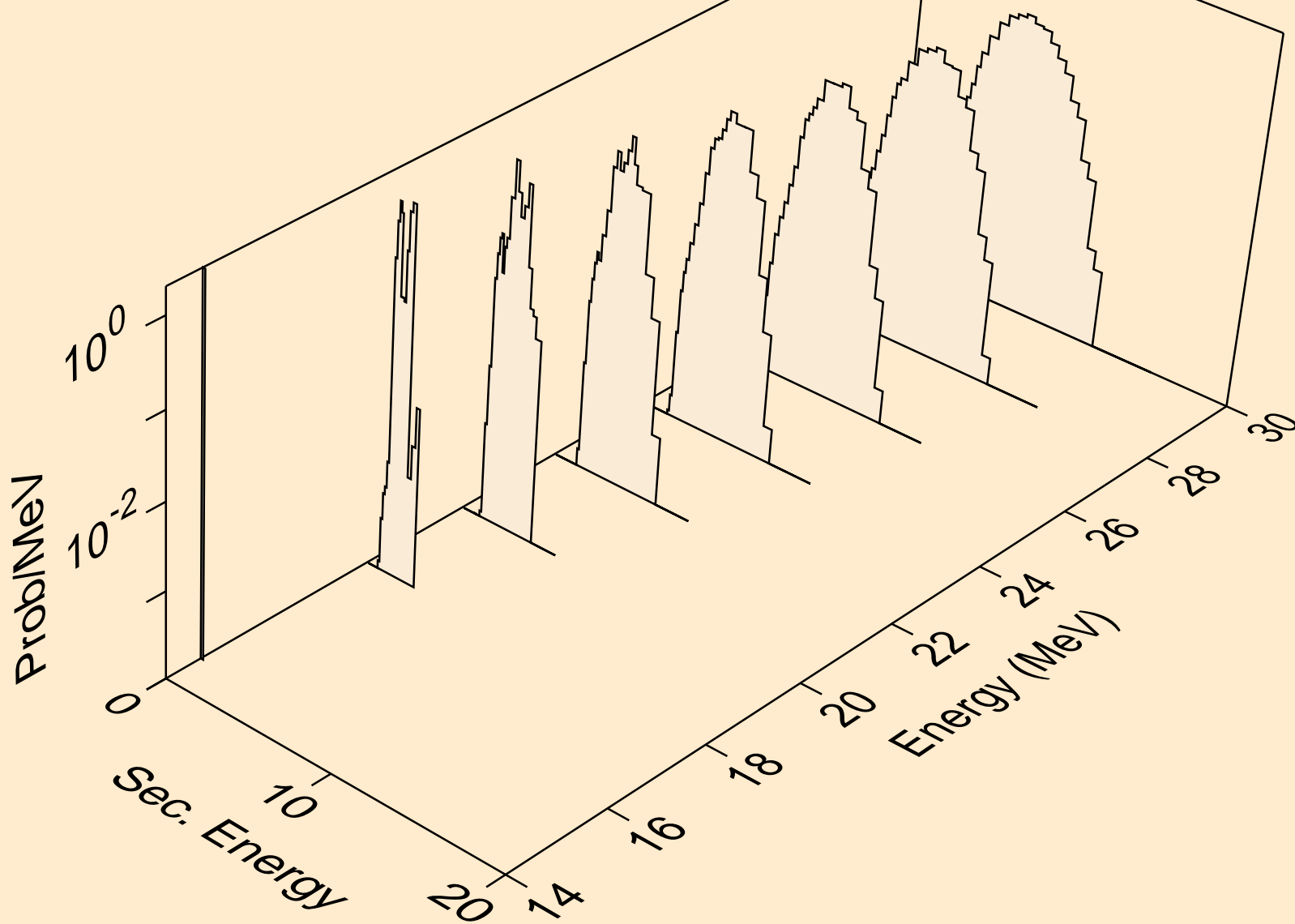

TE123 NEUTRON ACER TENDL-2019 LIBRARY; T=293.16K
protons from (n,npa)

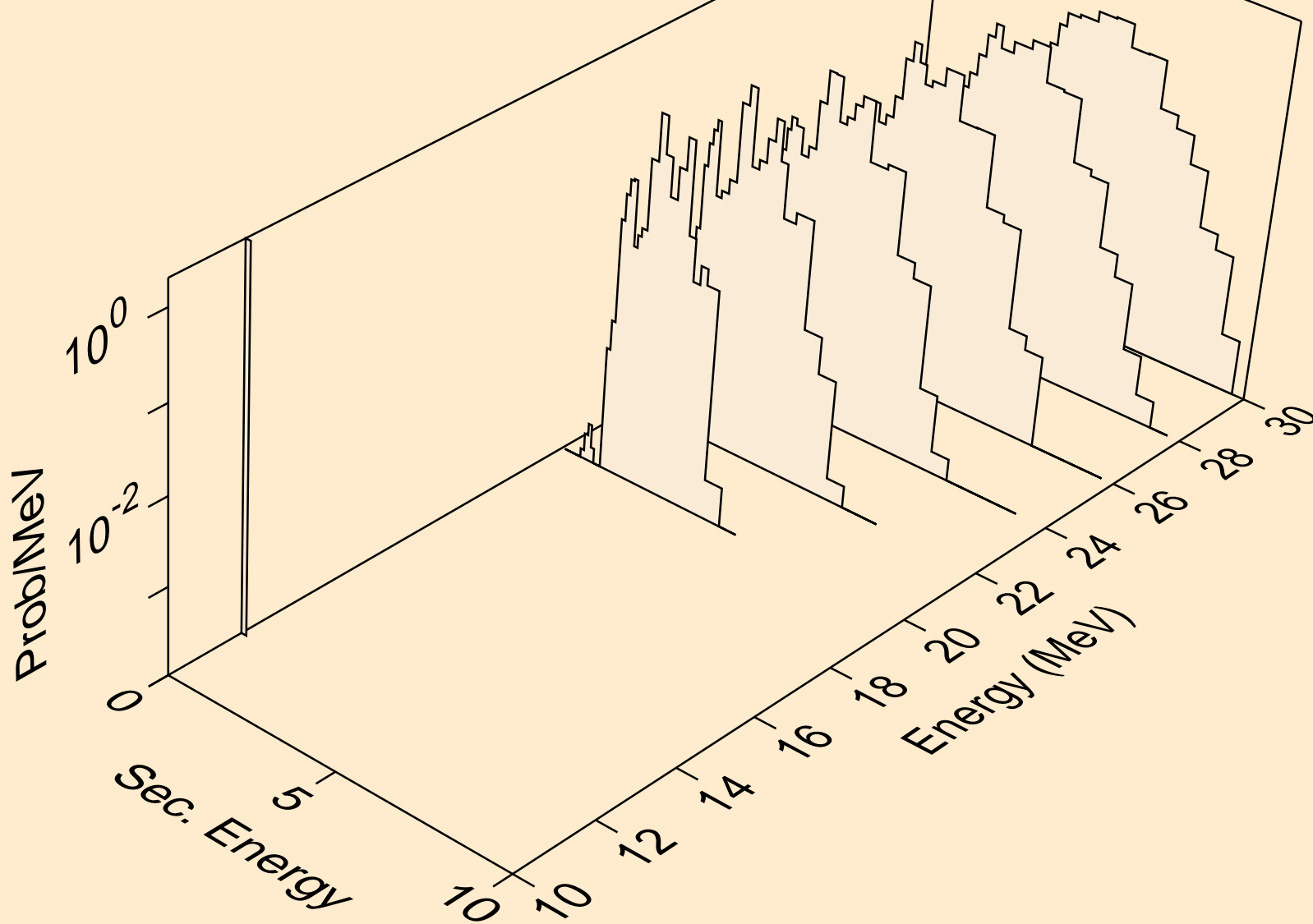

TE123 NEUTRON ACER TENDL-2019 LIBRARY; T=293.16K
protons from (n,p)

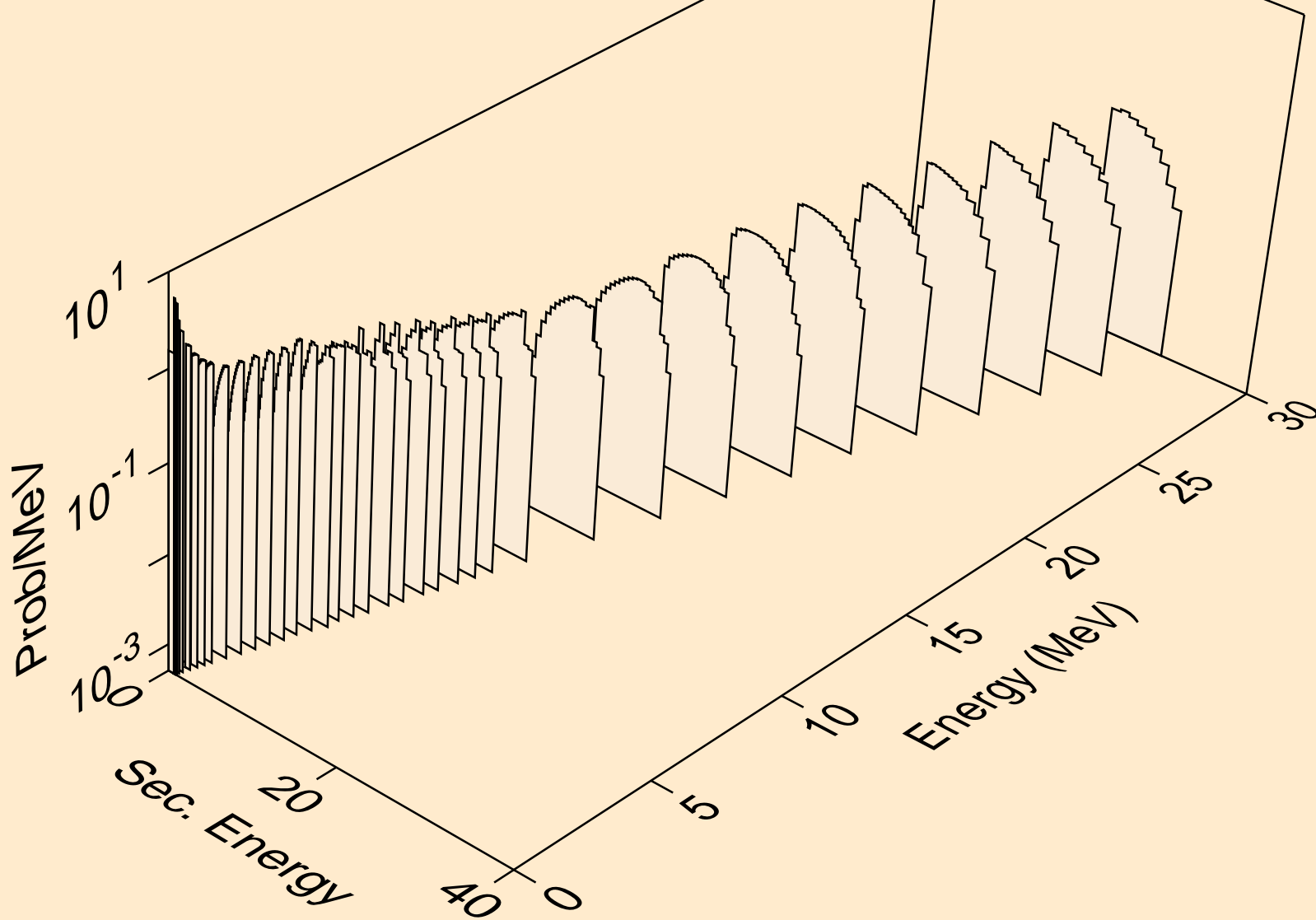

TE123 NEUTRON ACER TENDL-2019 LIBRARY; T=293.16K
protons from (n,2p)

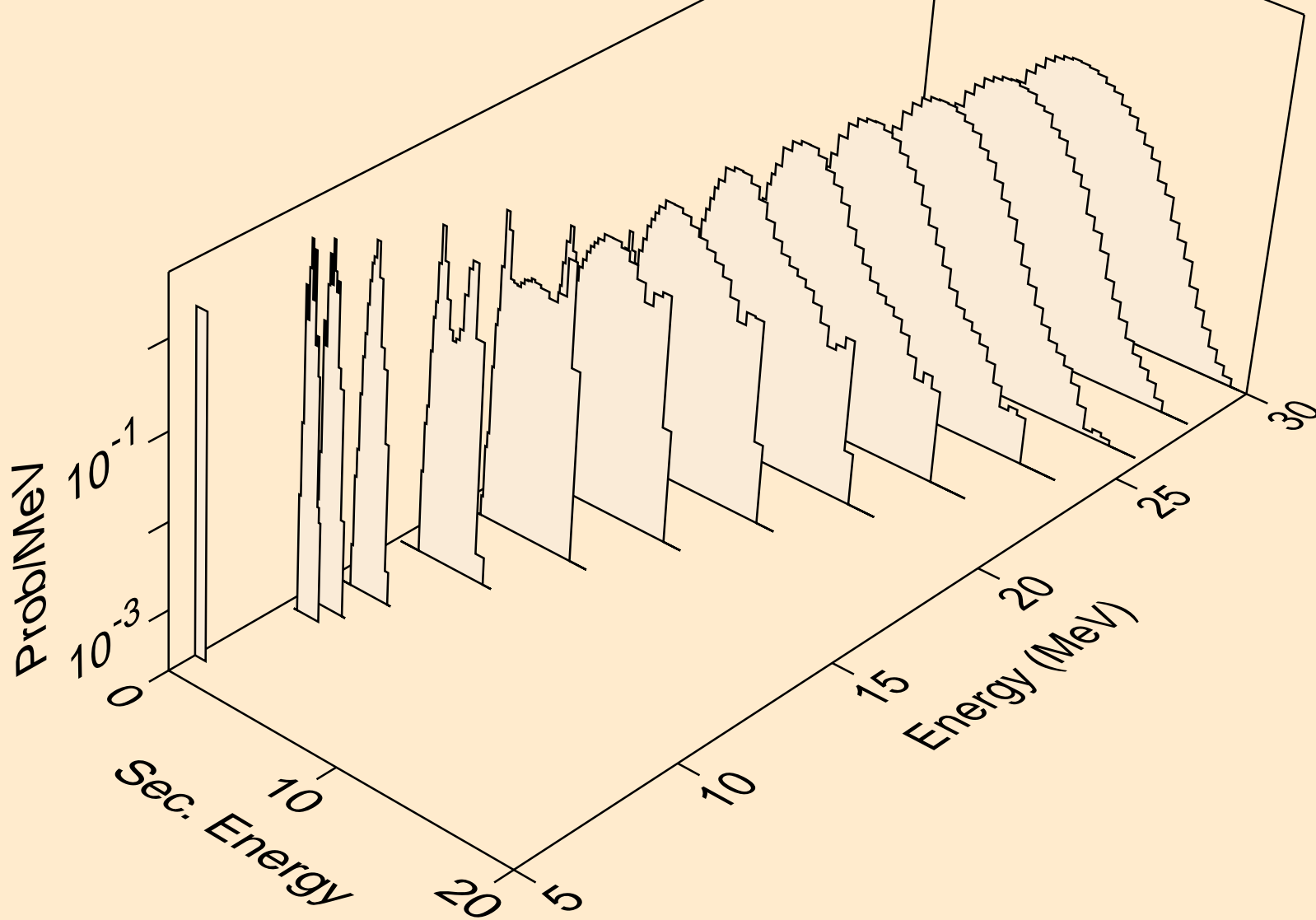

TE123 NEUTRON ACER TENDL-2019 LIBRARY; T=293.16K
protons from (n,p)

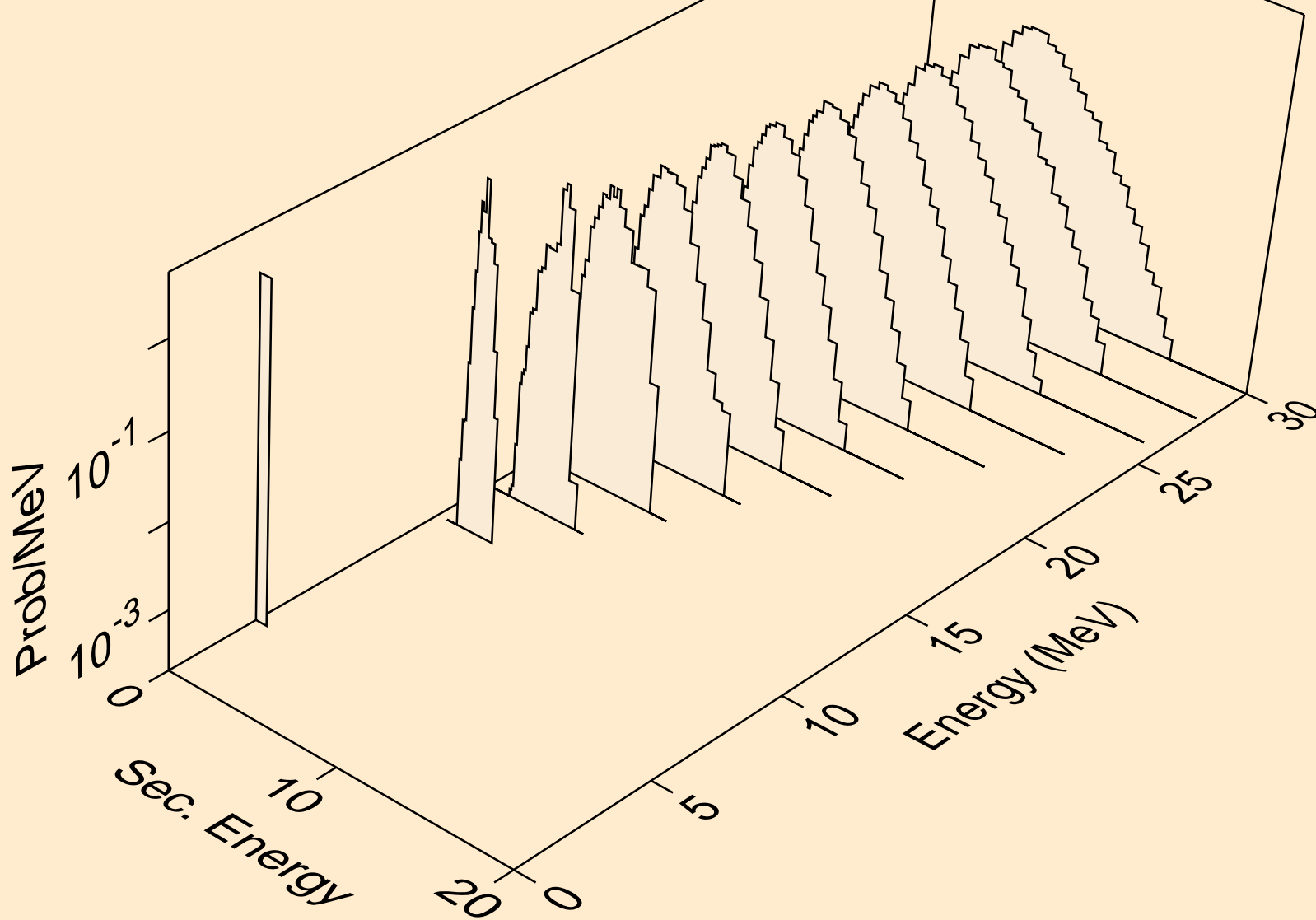

TE123 NEUTRON ACER TENDL-2019 LIBRARY; T=293.16K
protons from (n,pd)

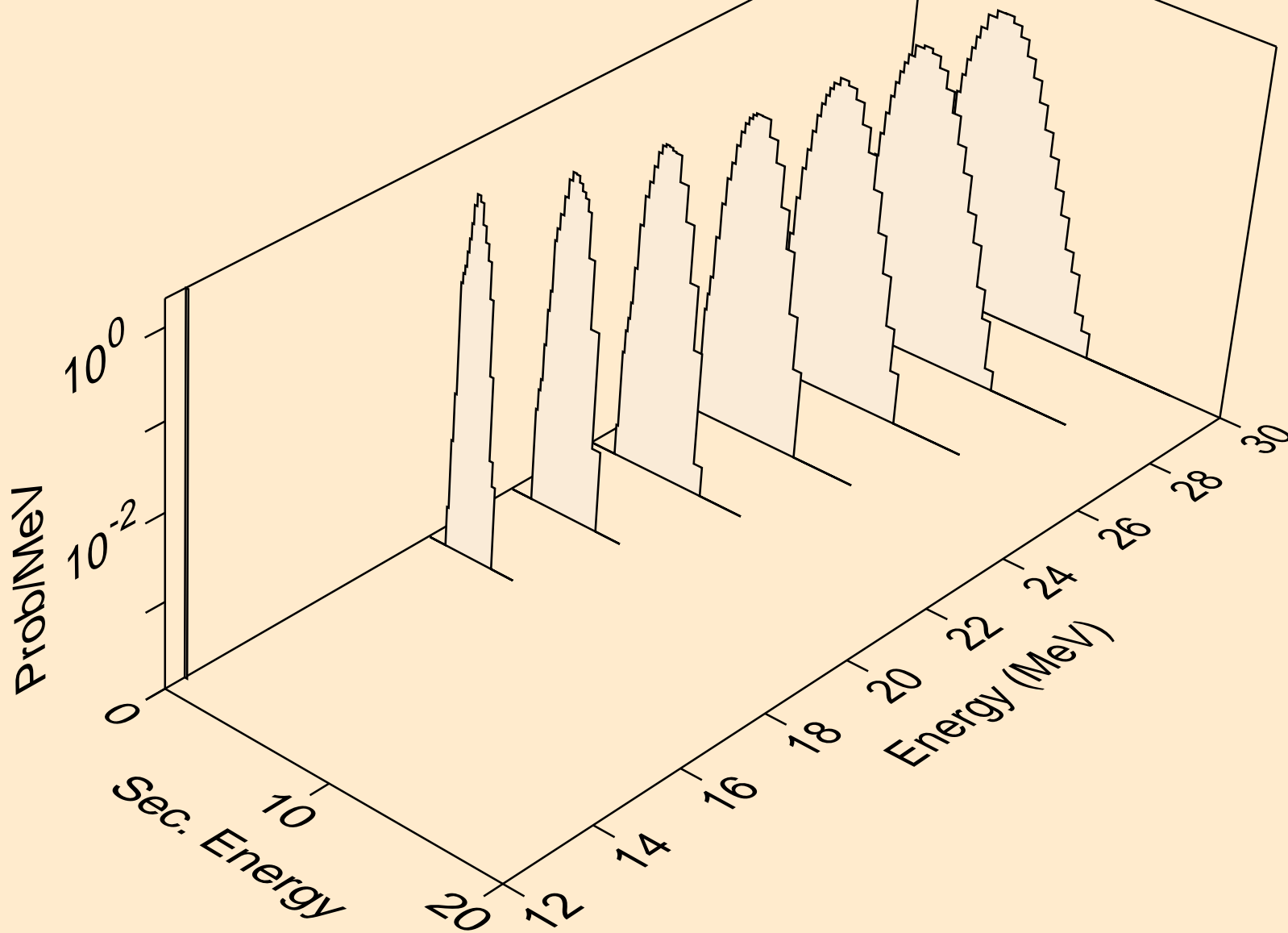

TE123 NEUTRON ACER TENDL-2019 LIBRARY; T=293.16K
protons from (n,pt)

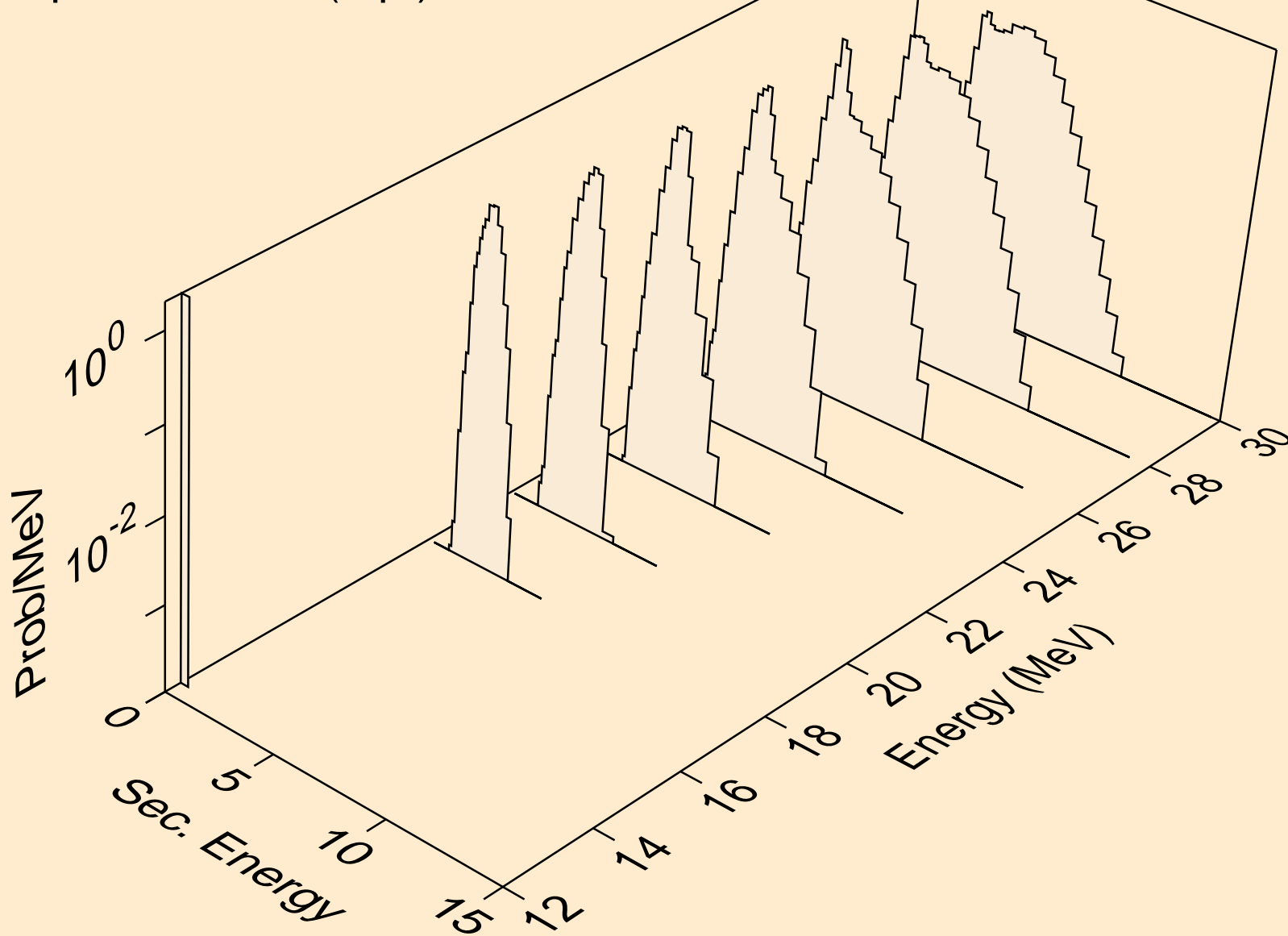

TE123 NEUTRON ACER TENDL-2019 LIBRARY; T=293.16K
deuterons from (n,x)

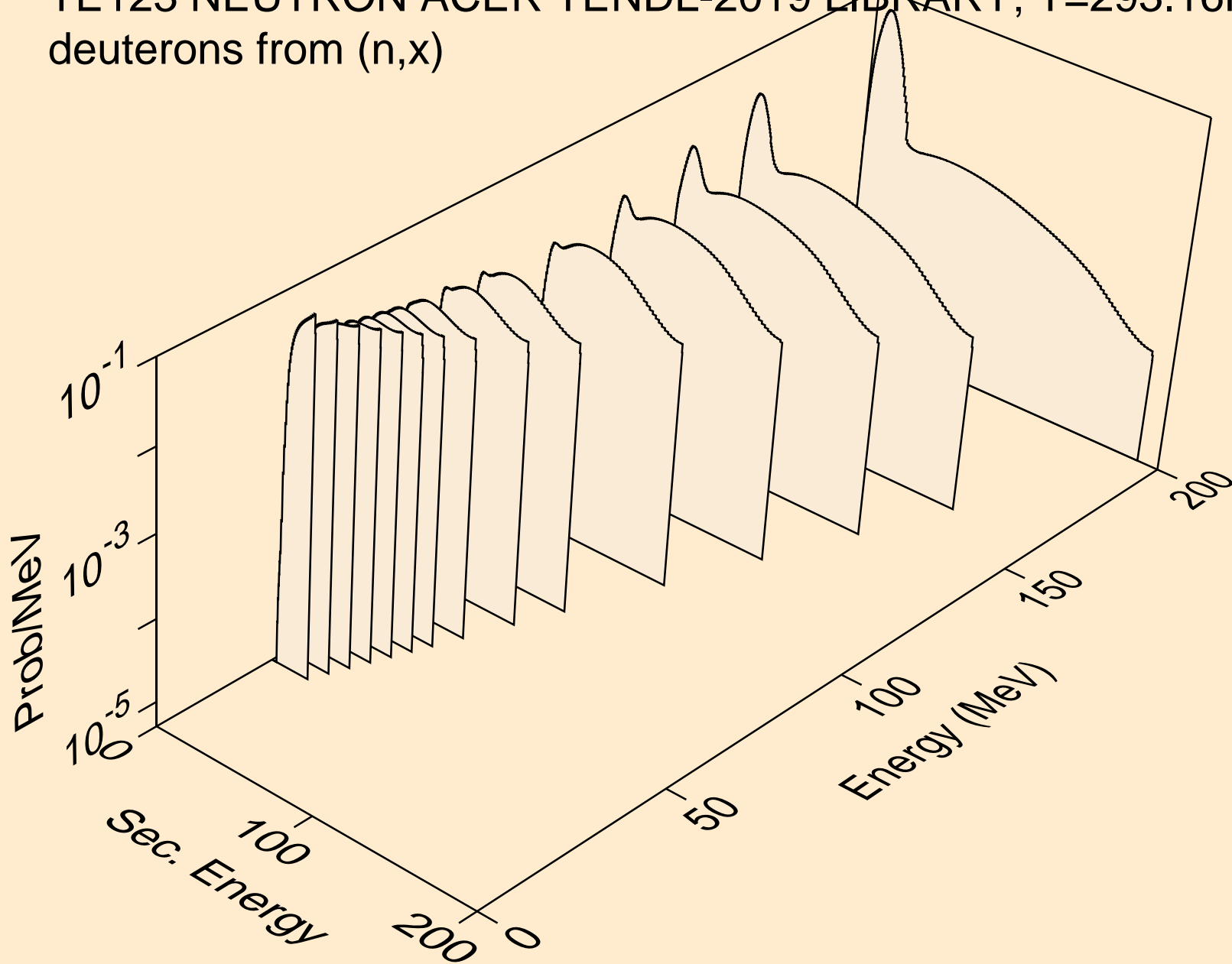

TE123 NEUTRON ACER TENDL-2019 LIBRARY; T=293.16K
deuterons from (n,2nd)

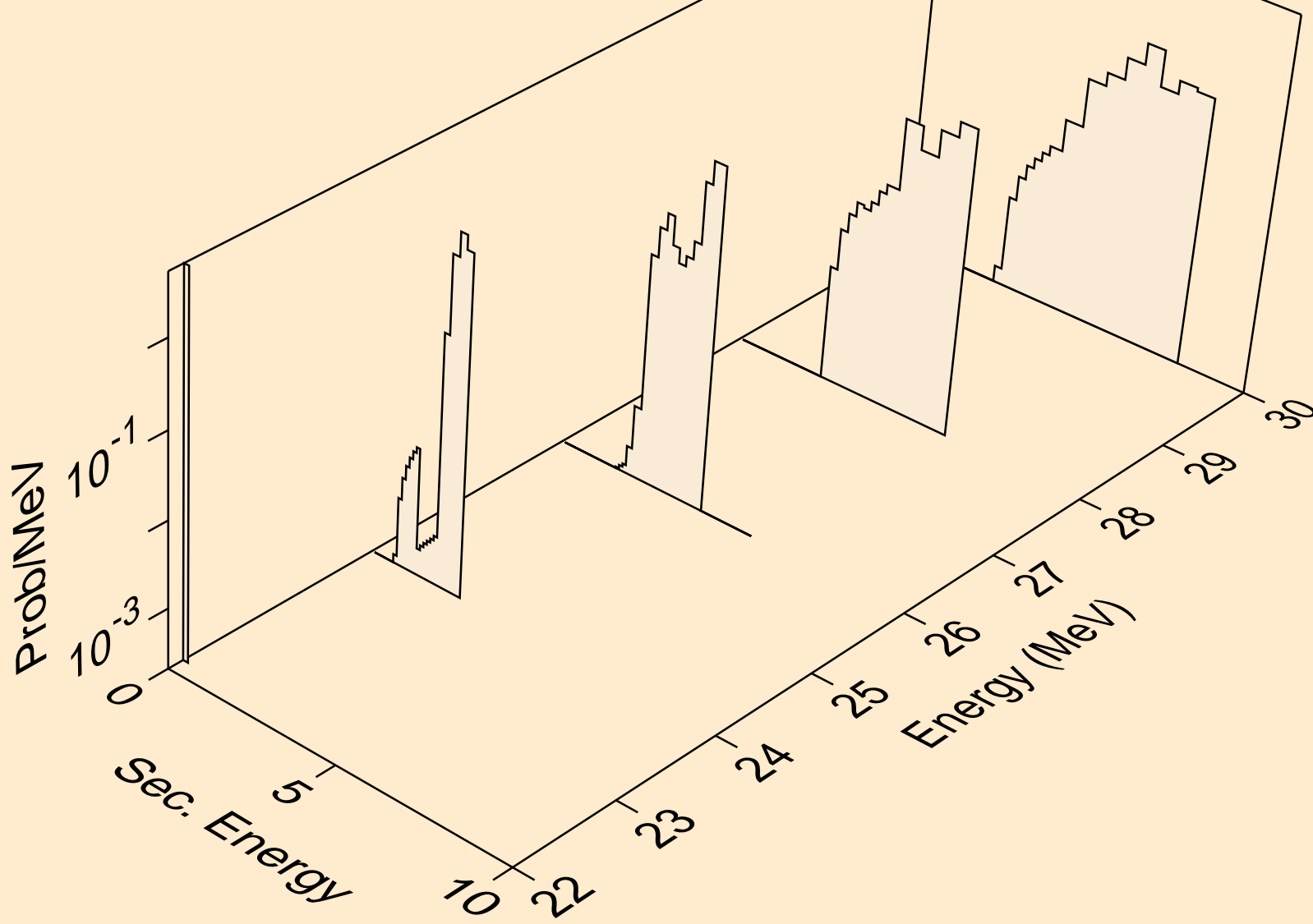

TE123 NEUTRON ACER TENDL-2019 LIBRARY; T=293.16K
deuterons from (n,n*)d

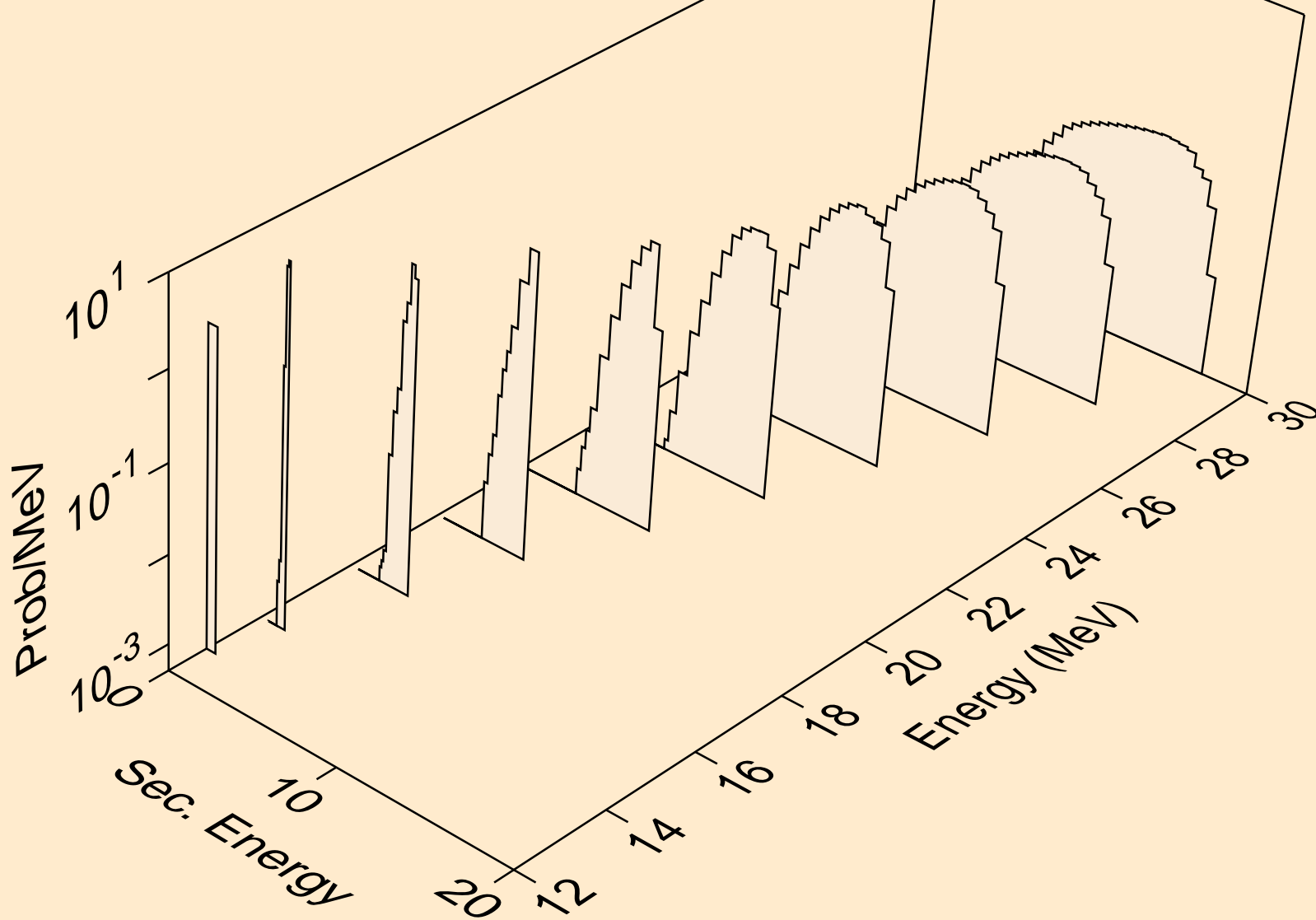

TE123 NEUTRON ACER TENDL-2019 LIBRARY; T=293.16K
deuterons from (n,d)

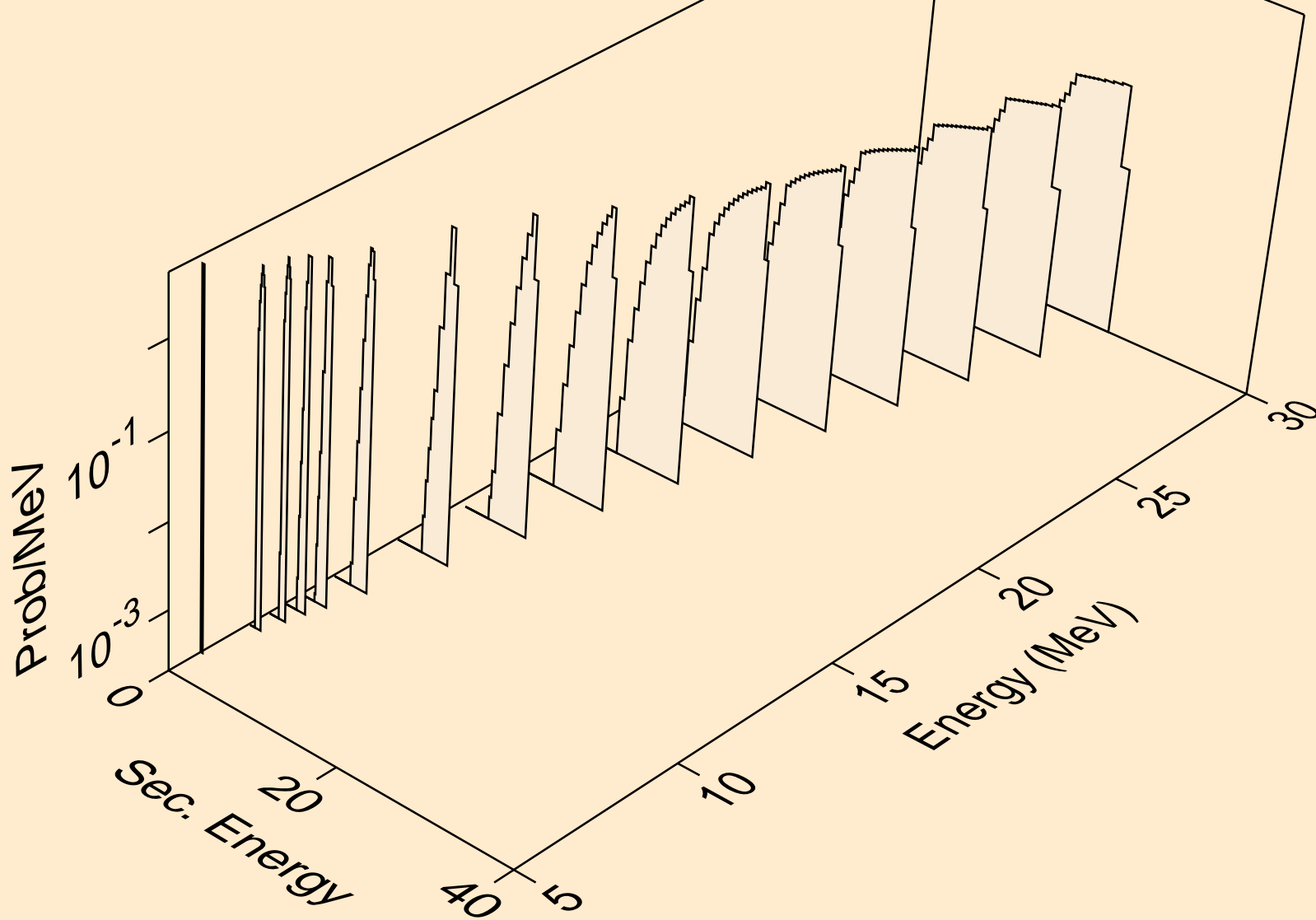

TE123 NEUTRON ACER TENDL-2019 LIBRARY; T=293.16K
deuterons from (n,pd)

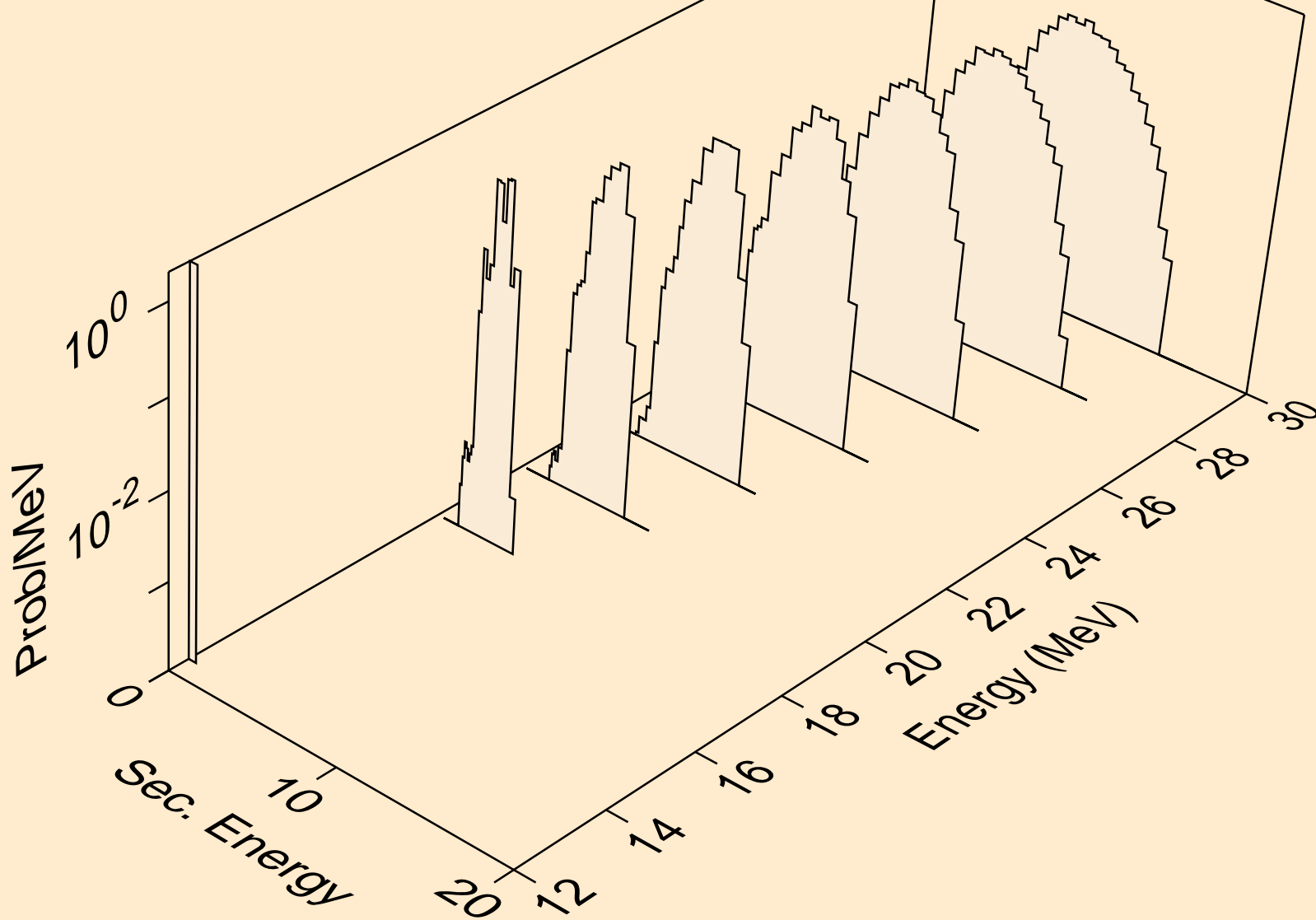

TE123 NEUTRON ACER TENDL-2019 LIBRARY; T=293.16K
deuterons from (n,da)

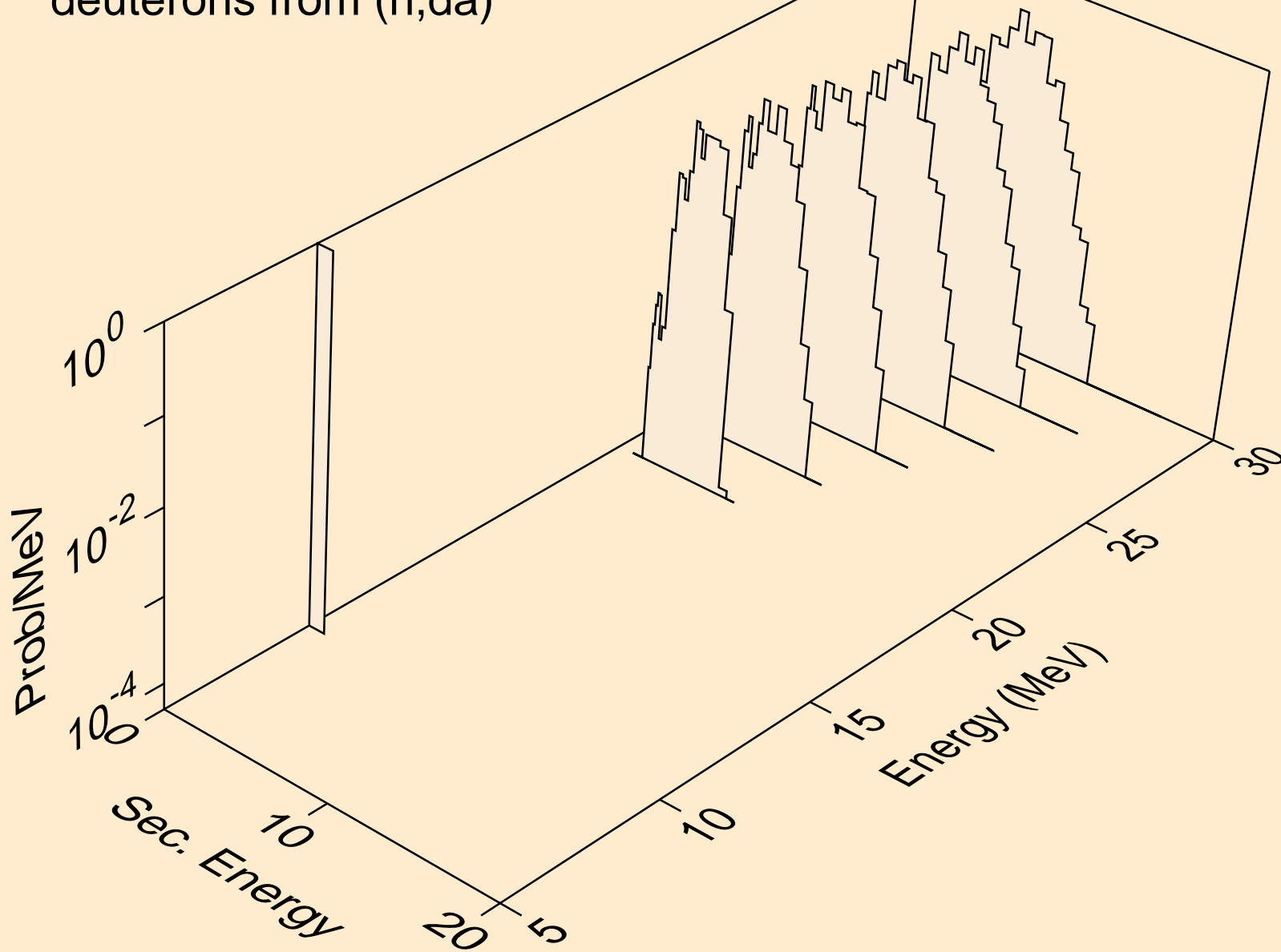

TE123 NEUTRON ACER TENDL-2019 LIBRARY; T=293.16K
tritons from (n,x)

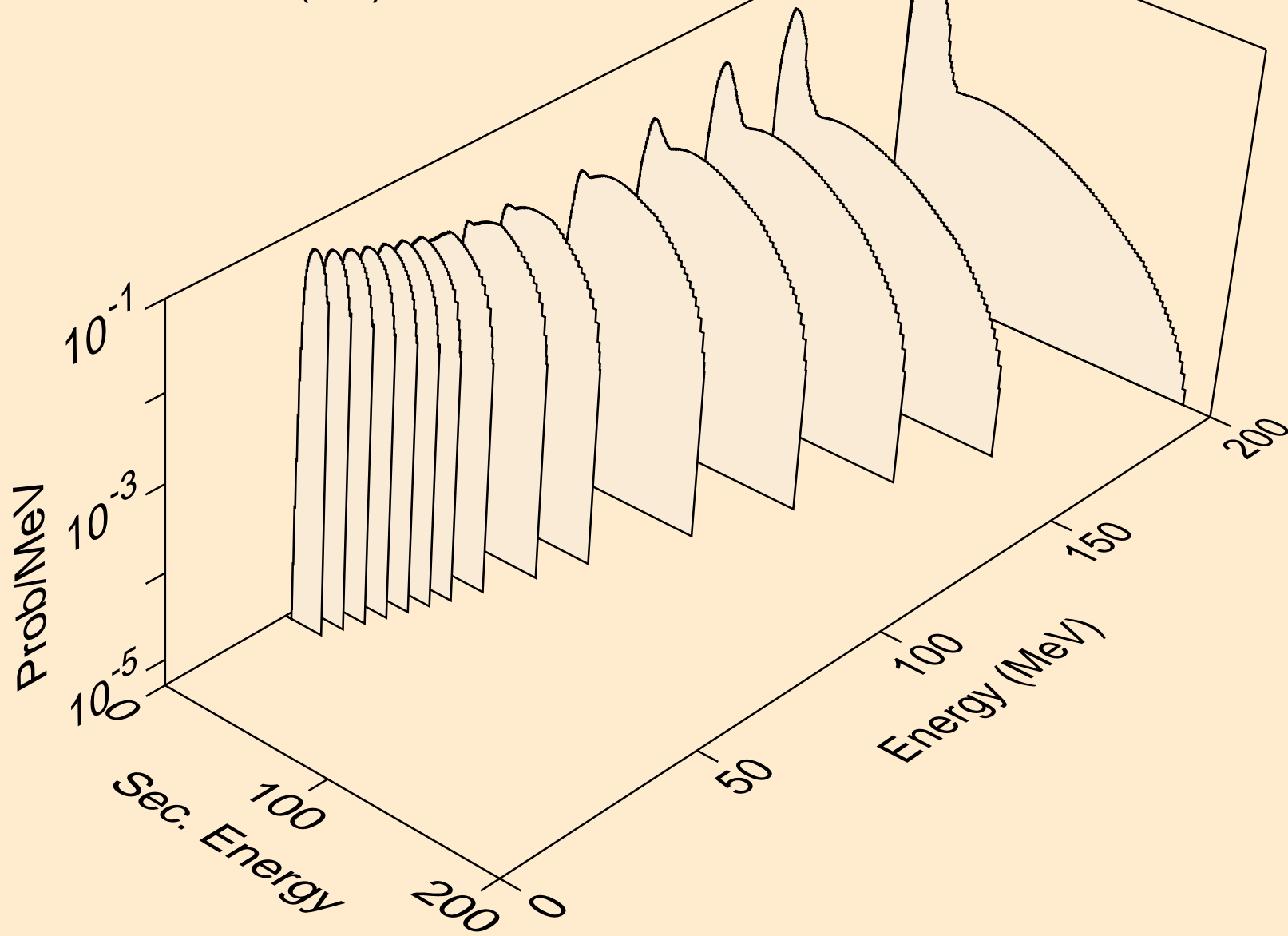

TE123 NEUTRON ACER TENDL-2019 LIBRARY; T=293.16K
tritons from (n,n*)t

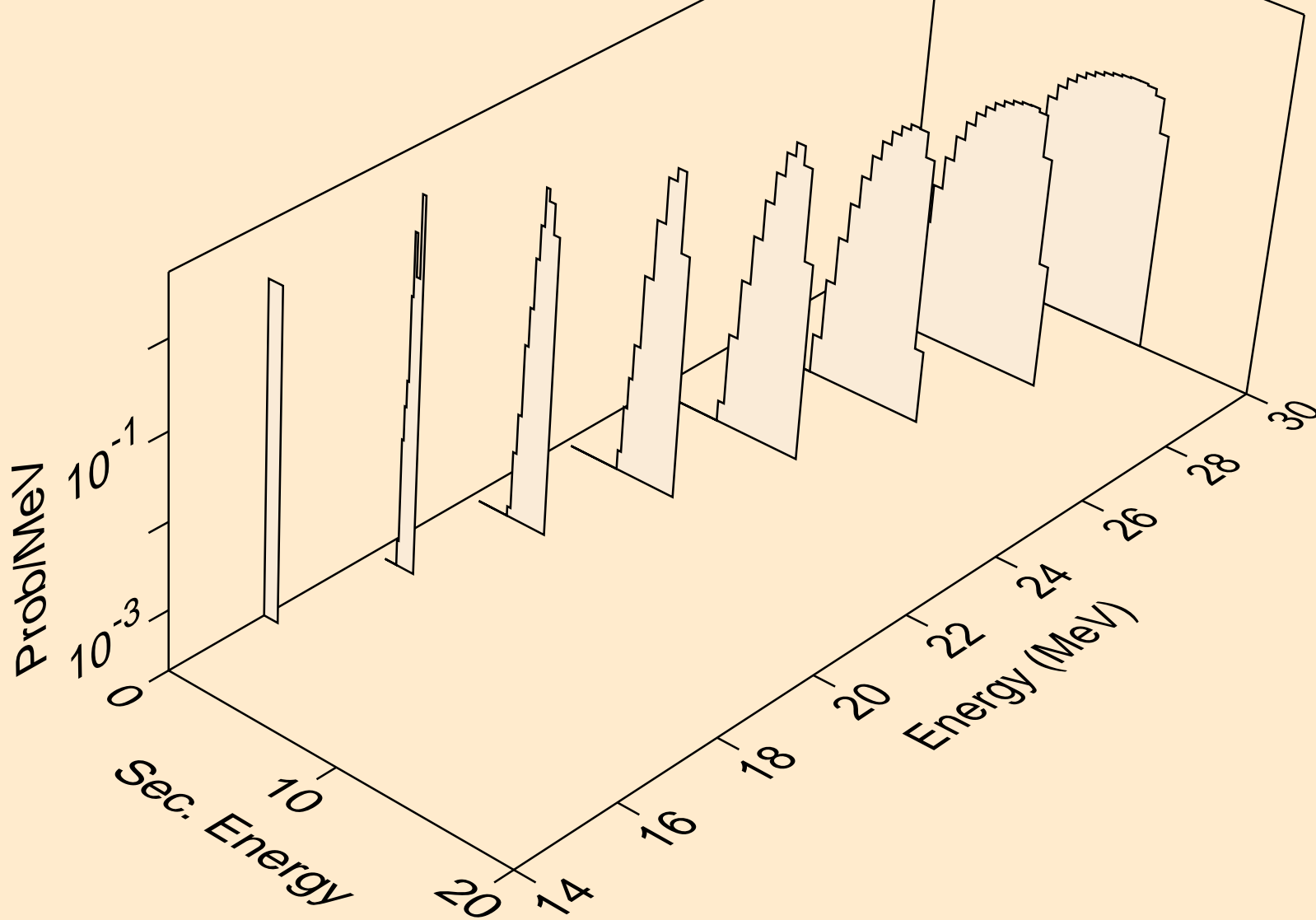

TE123 NEUTRON ACER TENDL-2019 LIBRARY; T=293.16K
tritons from (n,t)

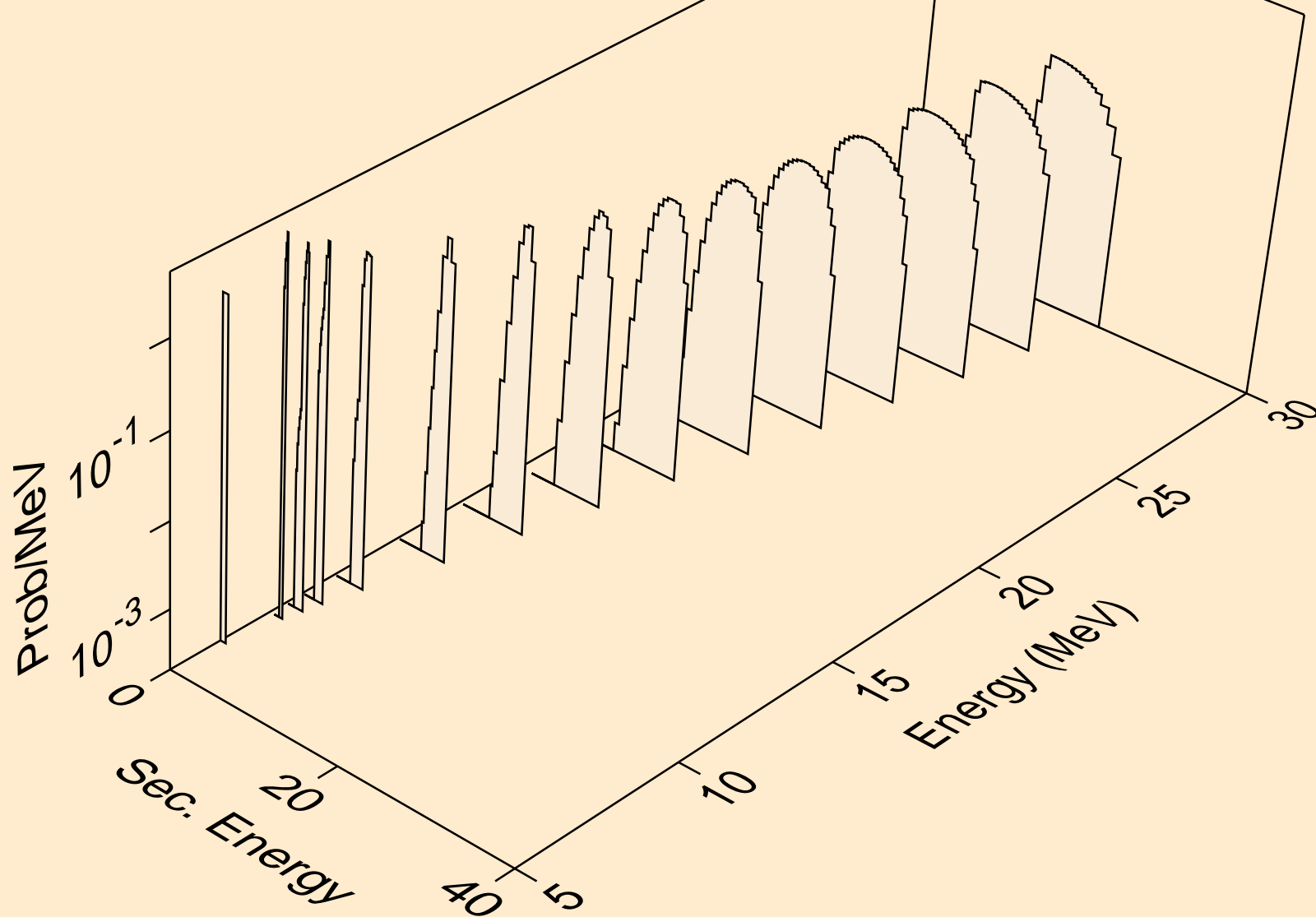

TE123 NEUTRON ACER TENDL-2019 LIBRARY; T=293.16K
tritons from (n,pt)

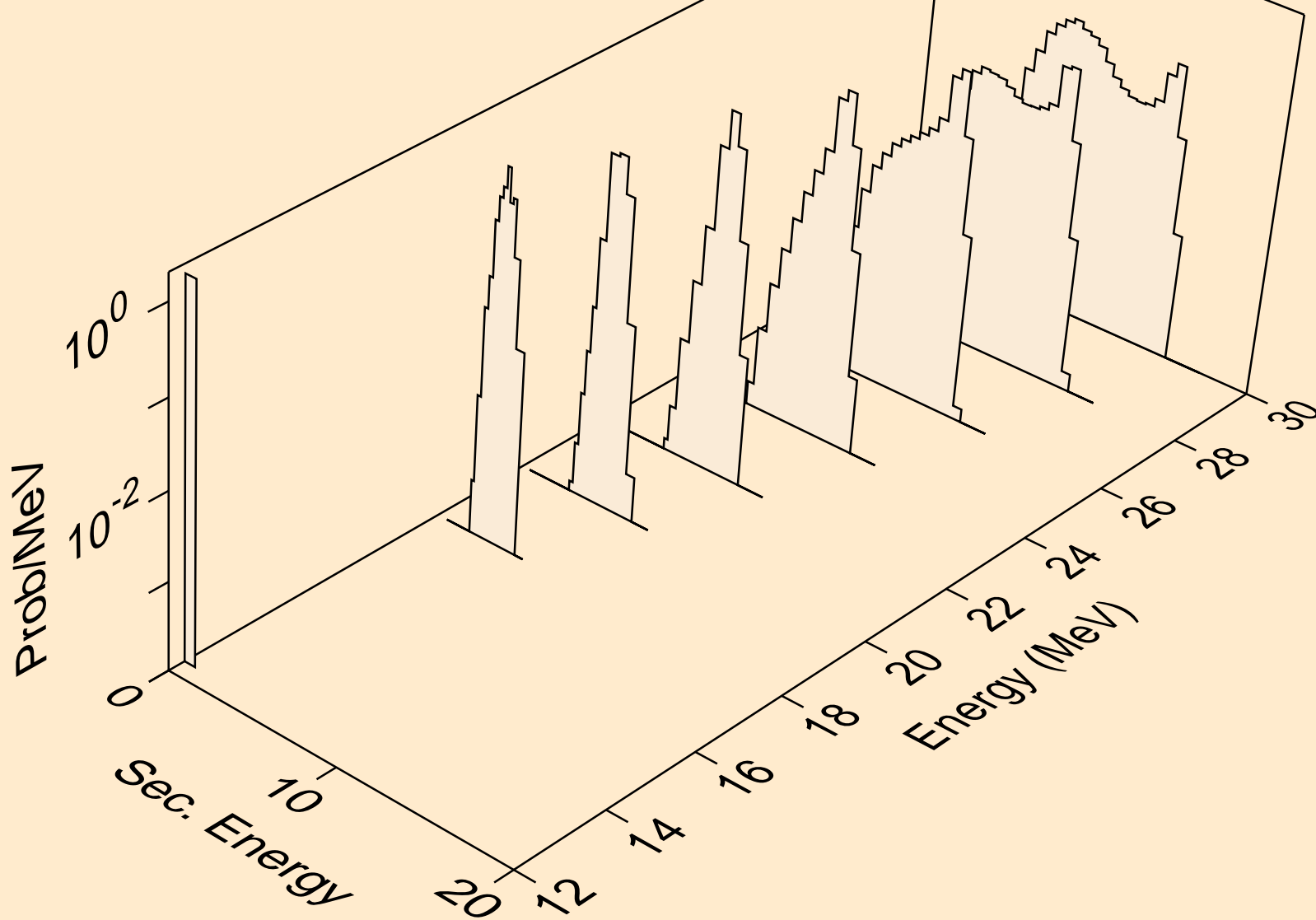

TE123 NEUTRON ACER TENDL-2019 LIBRARY; T=293.16K
he3s from (n,x)

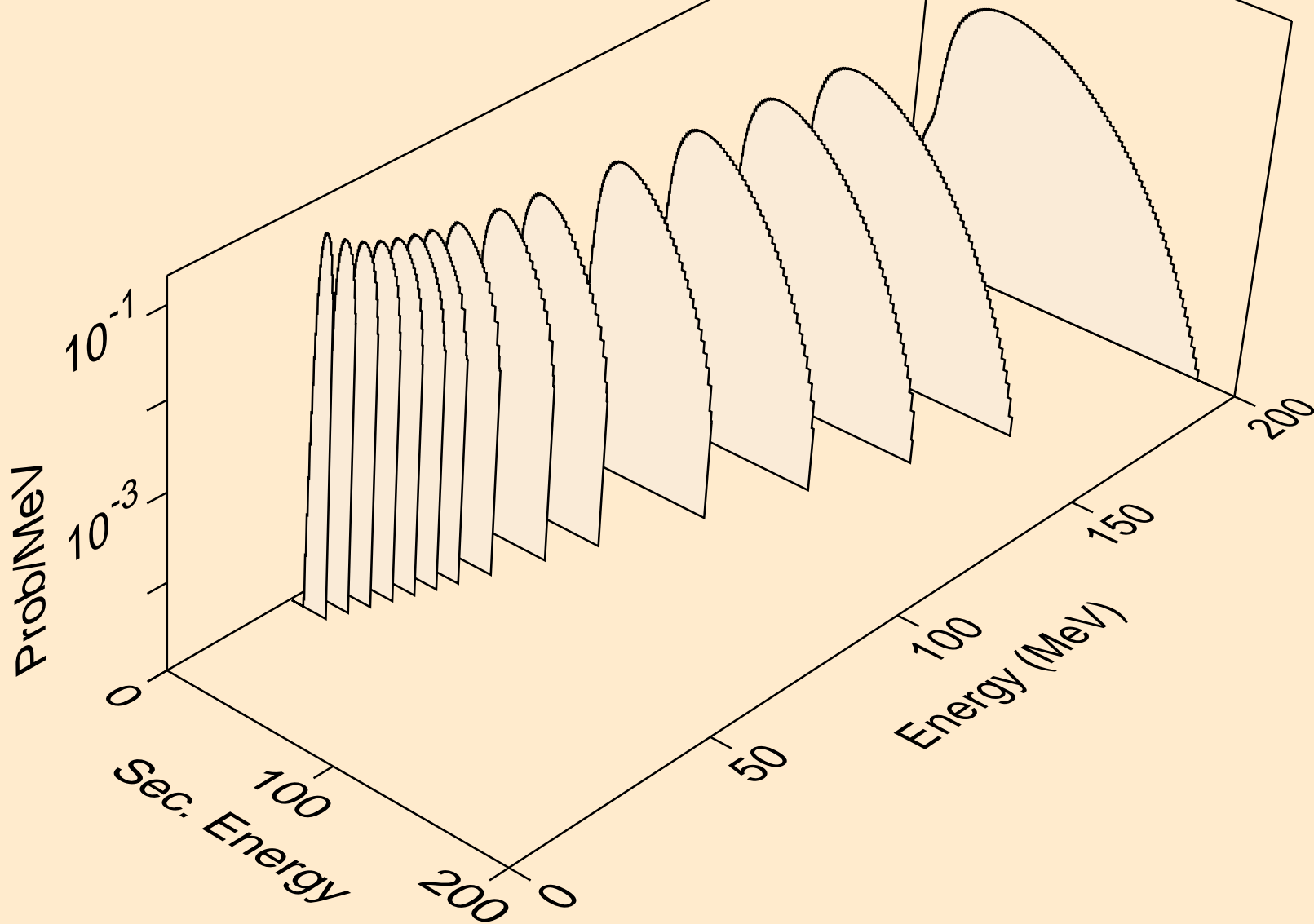

TE123 NEUTRON ACER TENDL-2019 LIBRARY; T=293.16K
he3s from (n,n*)he3

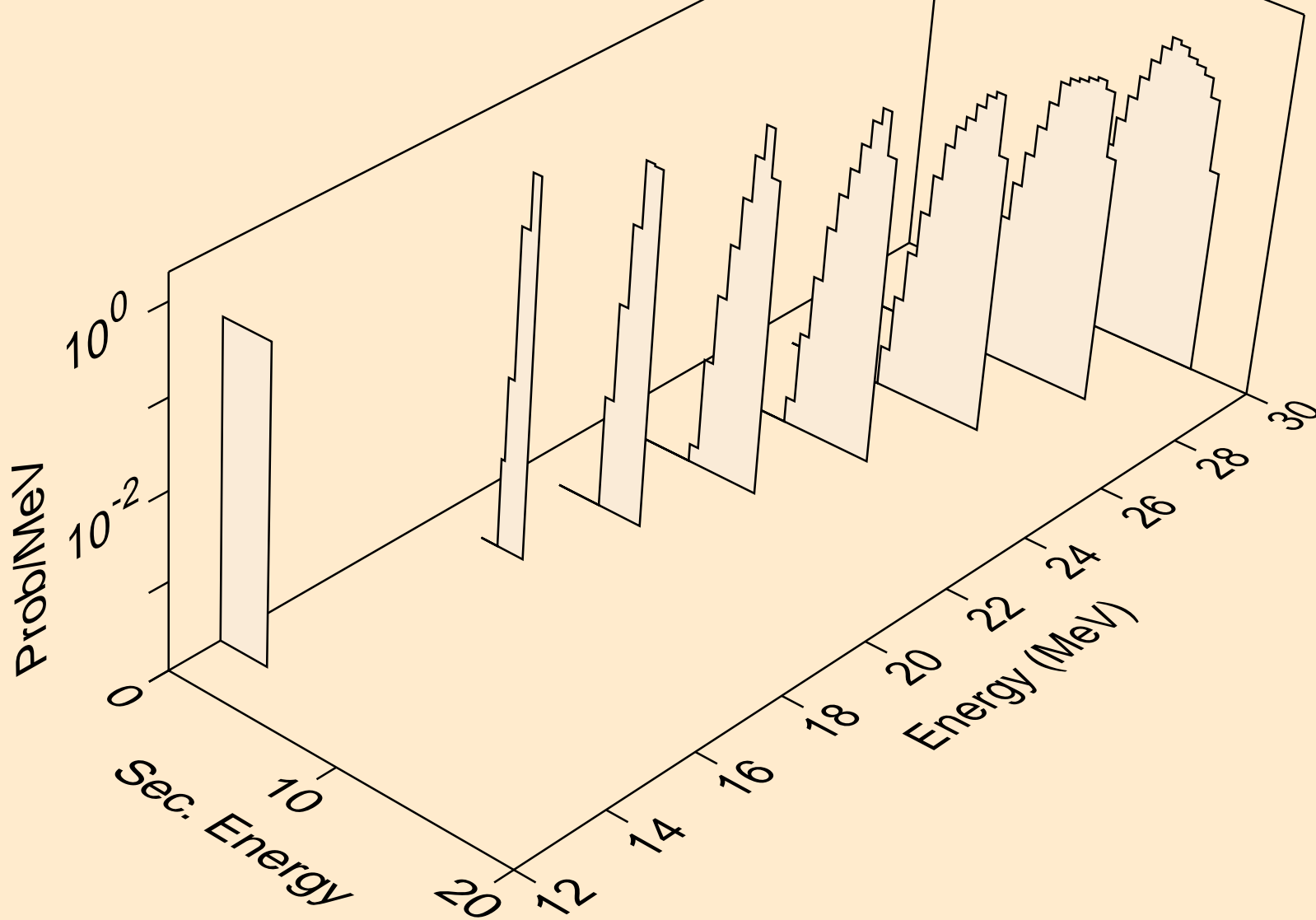

TE123 NEUTRON ACER TENDL-2019 LIBRARY; T=293.16K
he3s from (n,he3)

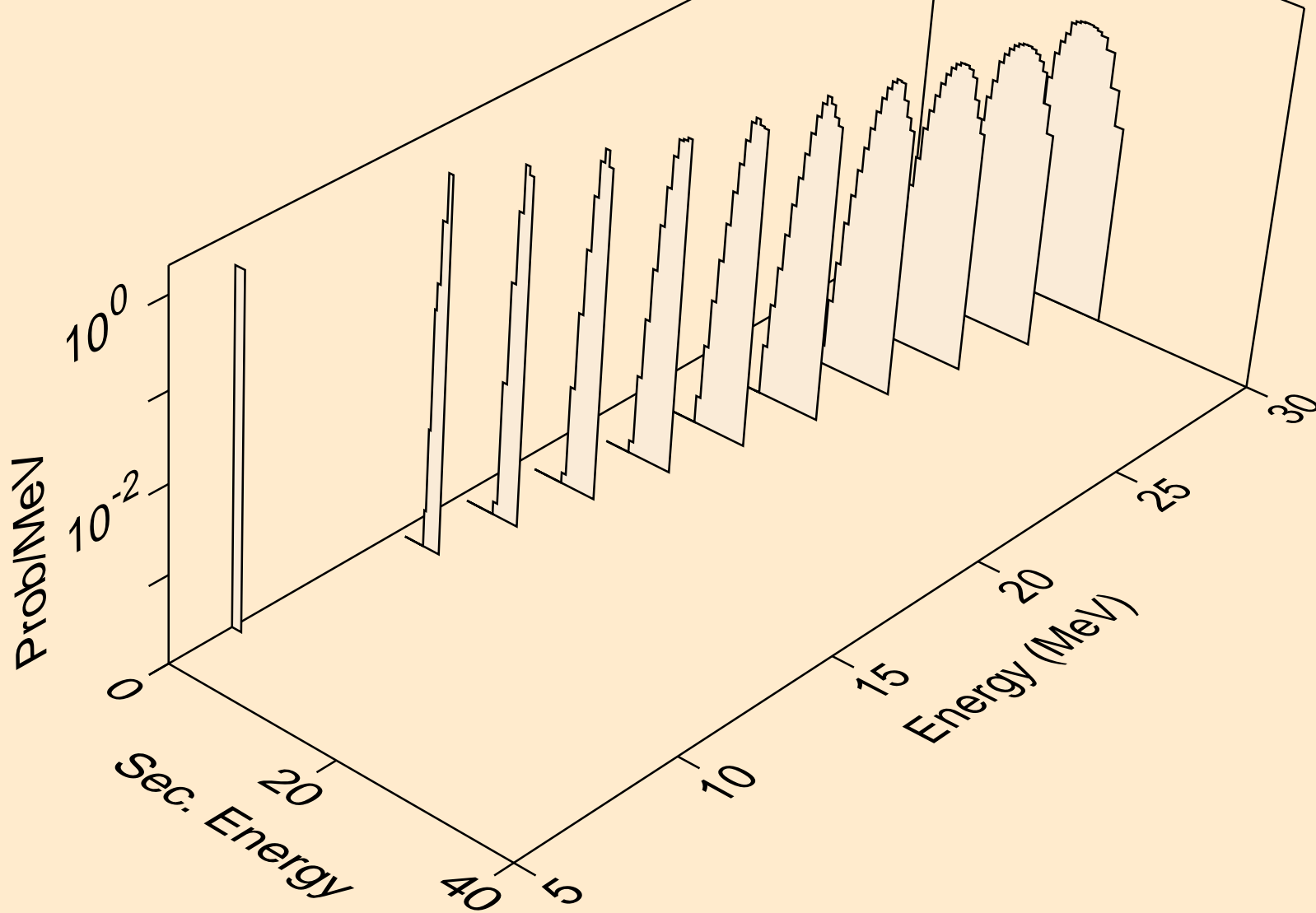

TE123 NEUTRON ACER TENDL-2019 LIBRARY; T=293.16K
alphas from (n,x)

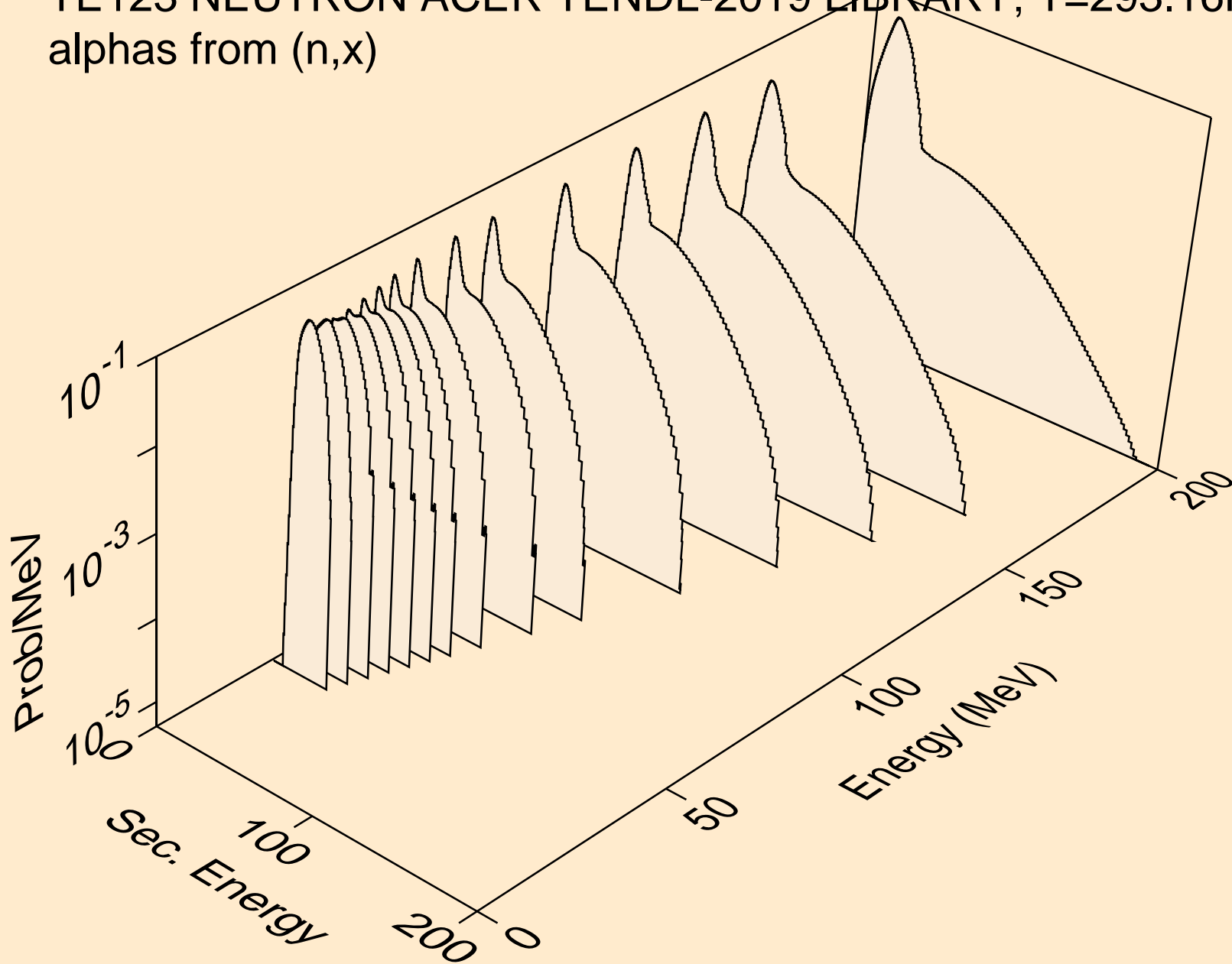

TE123 NEUTRON ACER TENDL-2019 LIBRARY; T=293.16K
alphas from (n,n*)a

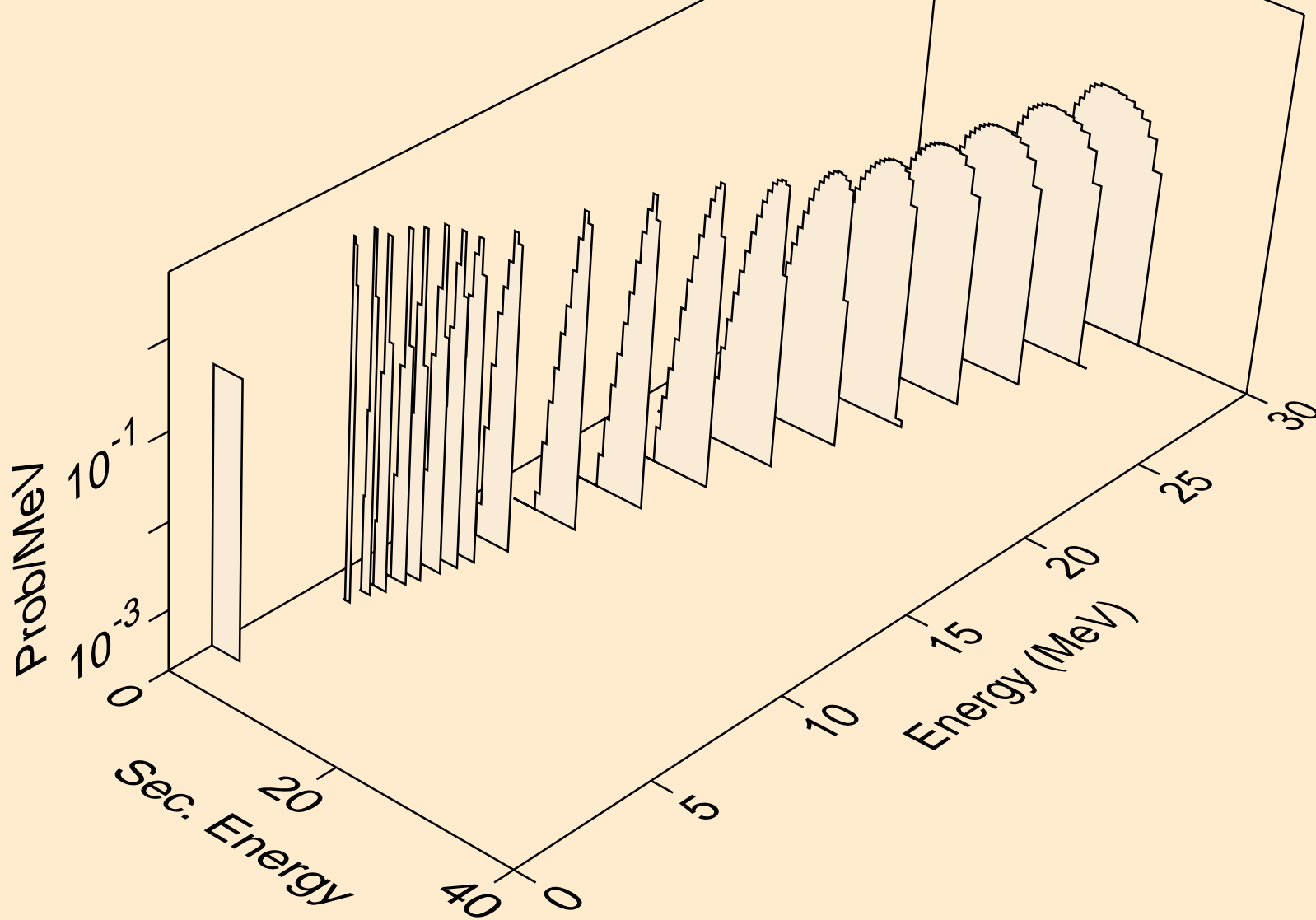

TE123 NEUTRON ACER TENDL-2019 LIBRARY; T=293.16K
alphas from (n,2n)a

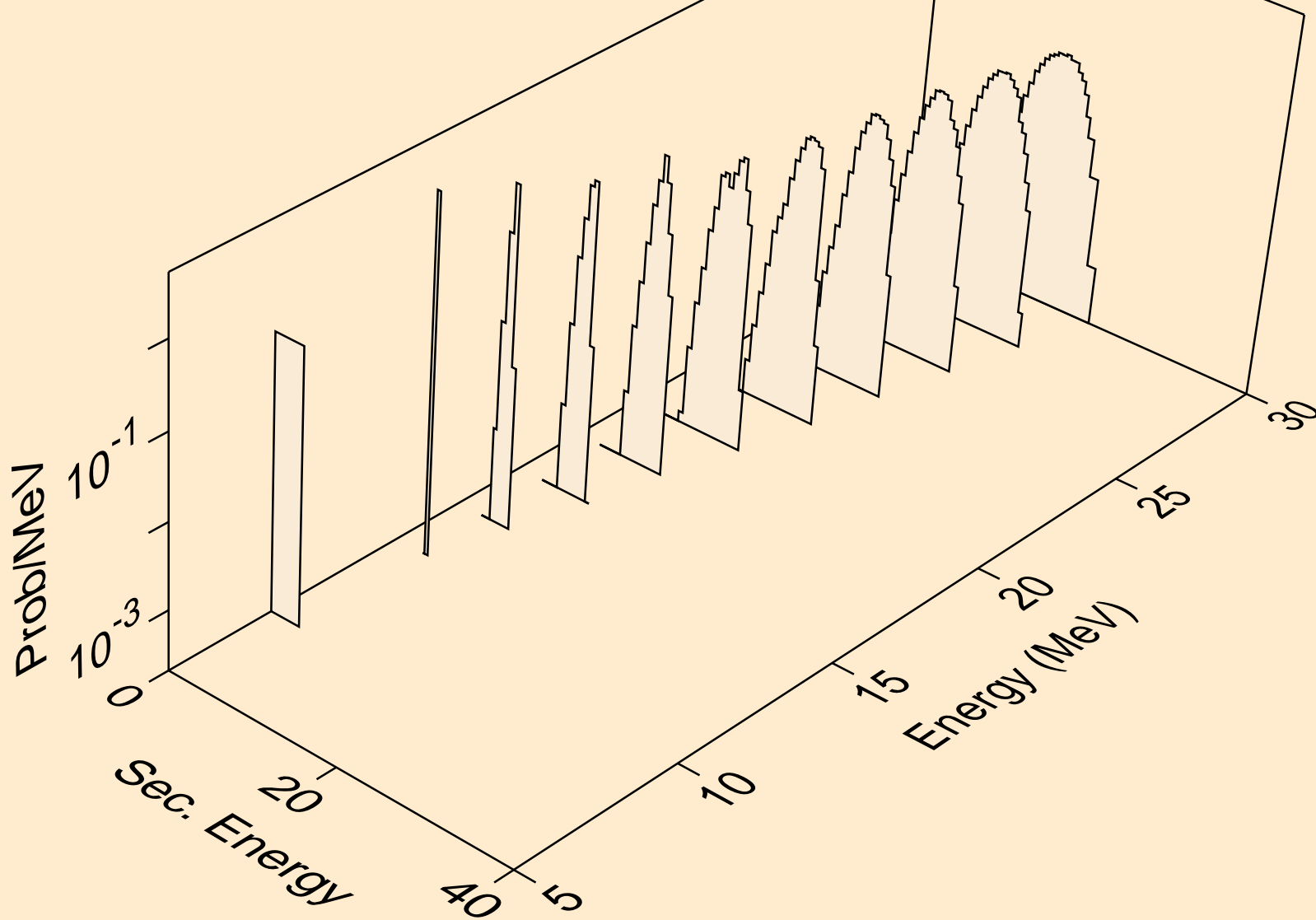

TE123 NEUTRON ACER TENDL-2019 LIBRARY; T=293.16K
alphas from (n,3n)a

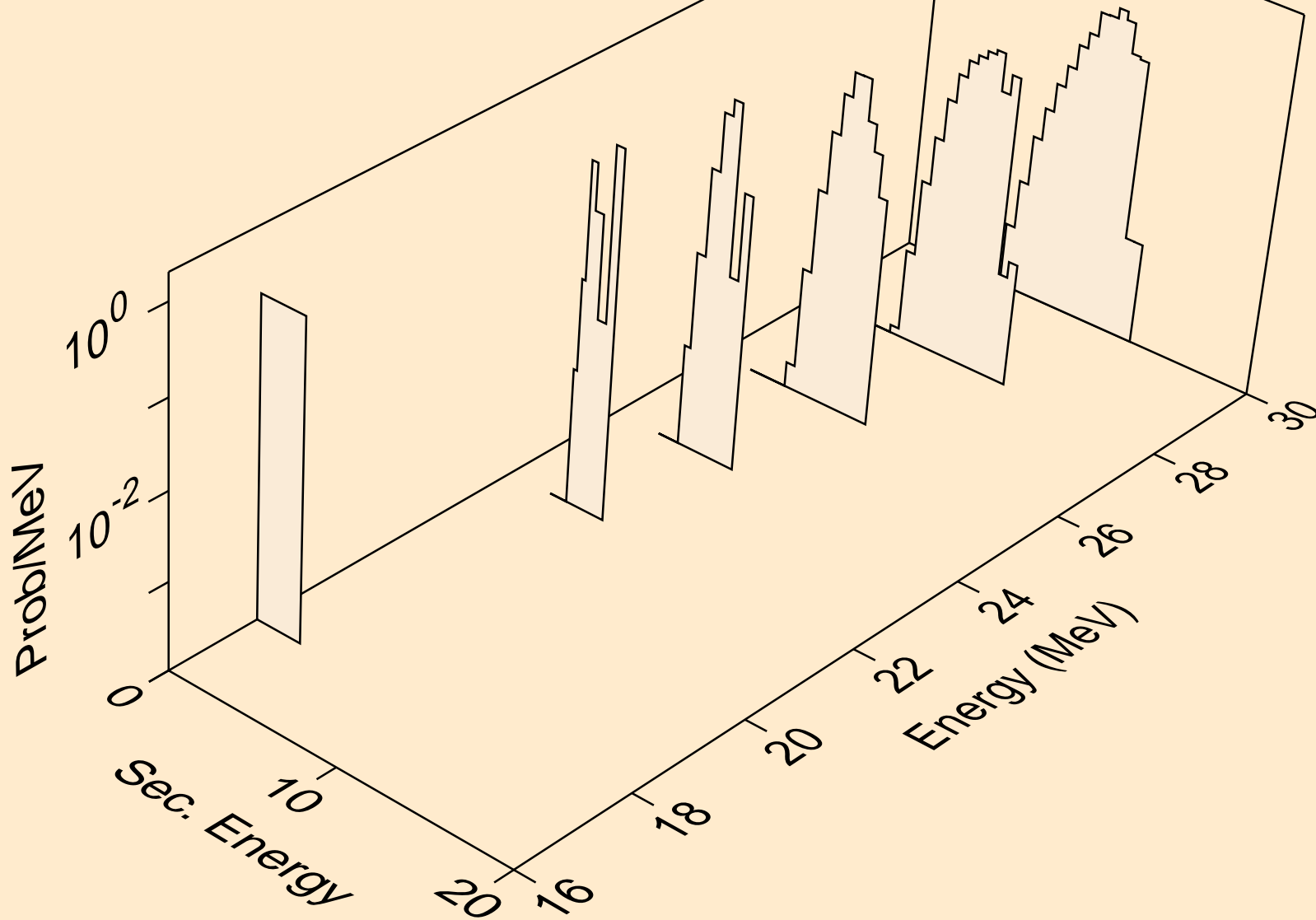

TE123 NEUTRON ACER TENDL-2019 LIBRARY; T=293.16K
alphas from (n,n*)2a

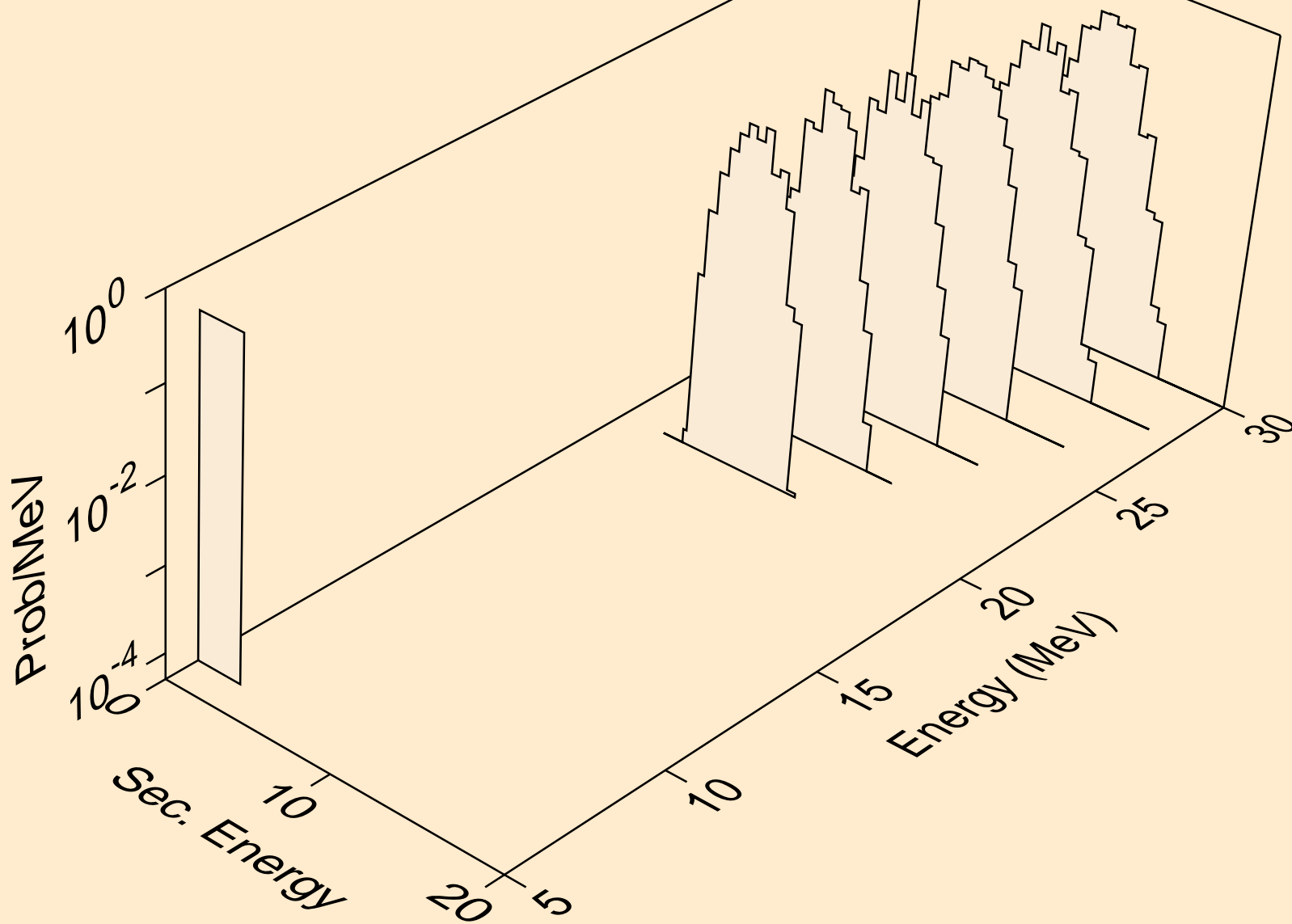

TE123 NEUTRON ACER TENDL-2019 LIBRARY; T=293.16K
alphas from (n,npa)

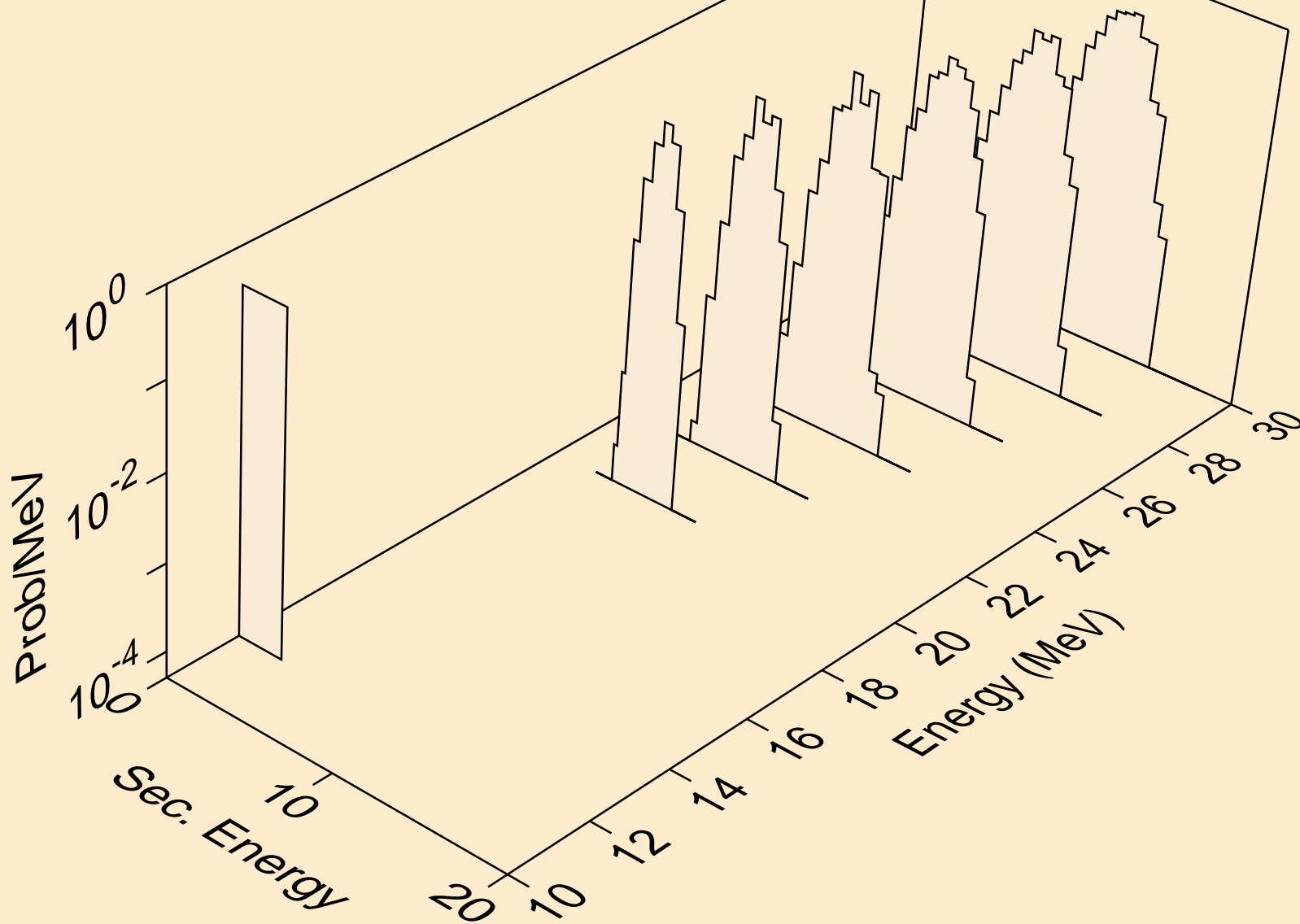

TE123 NEUTRON ACER TENDL-2019 LIBRARY; T=293.16K
alphas from (n,a)

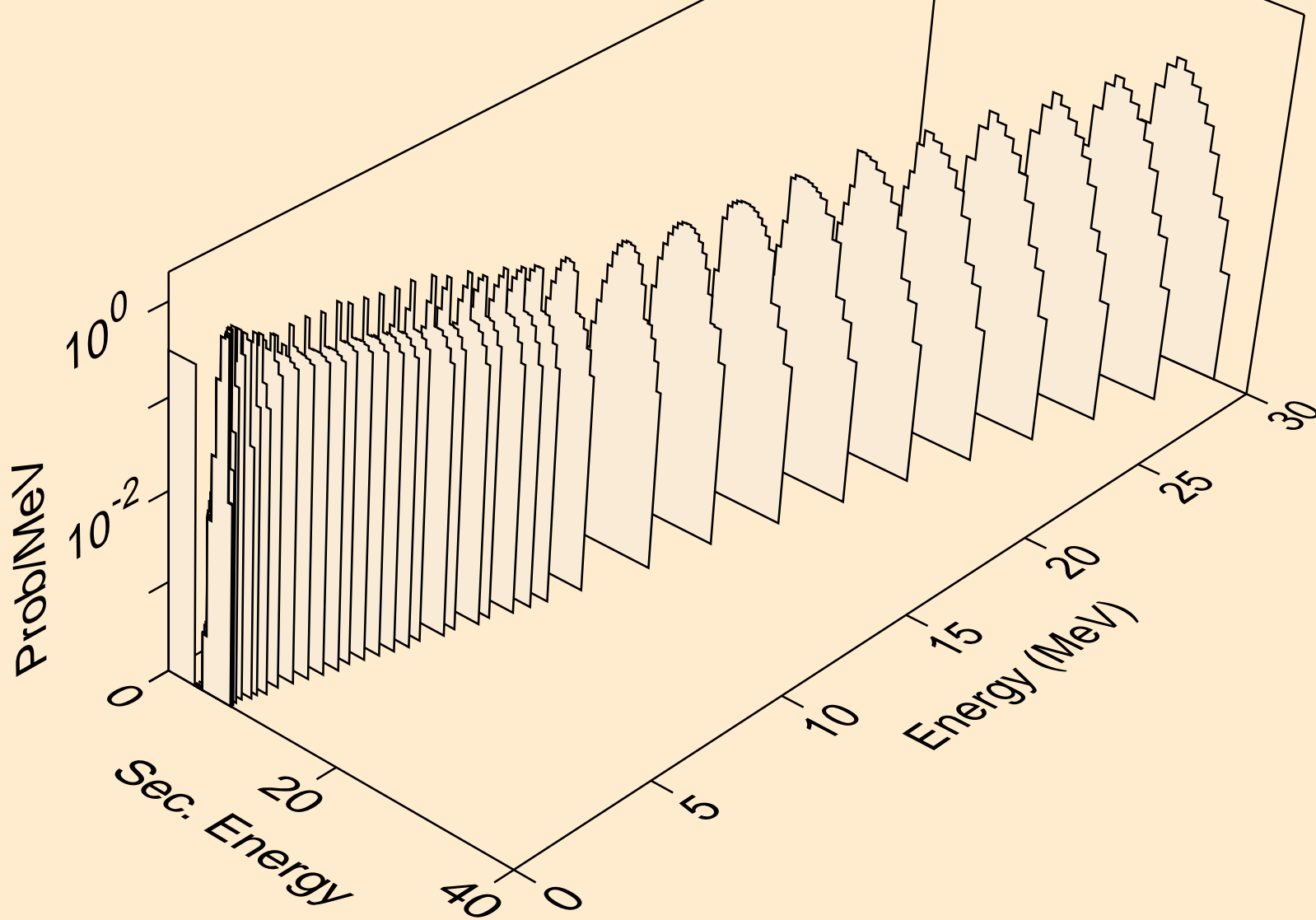

TE123 NEUTRON ACER TENDL-2019 LIBRARY; T=293.16K
alphas from (n,2a)

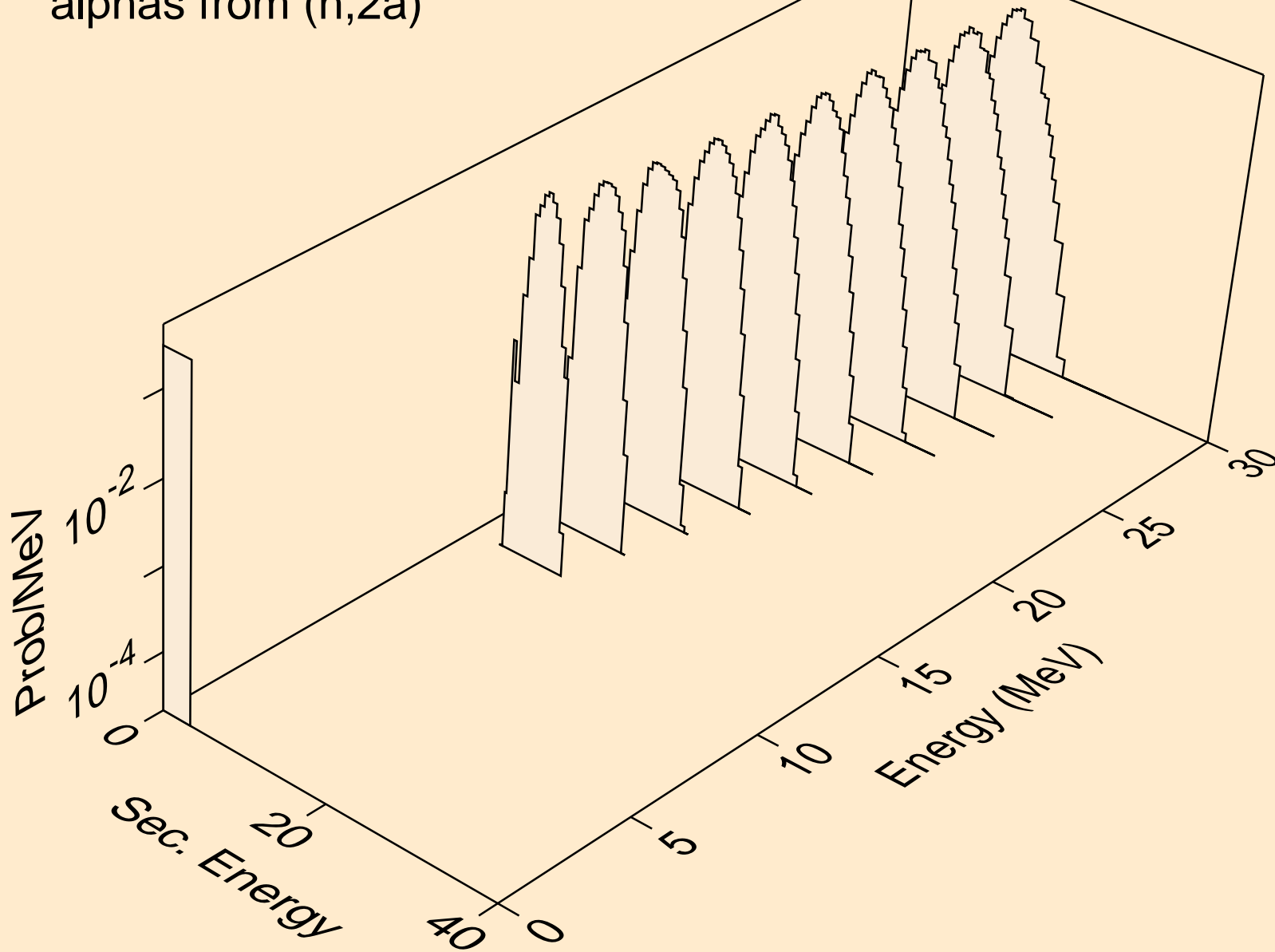

TE123 NEUTRON ACER TENDL-2019 LIBRARY; T=293.16K
alphas from (n,pa)

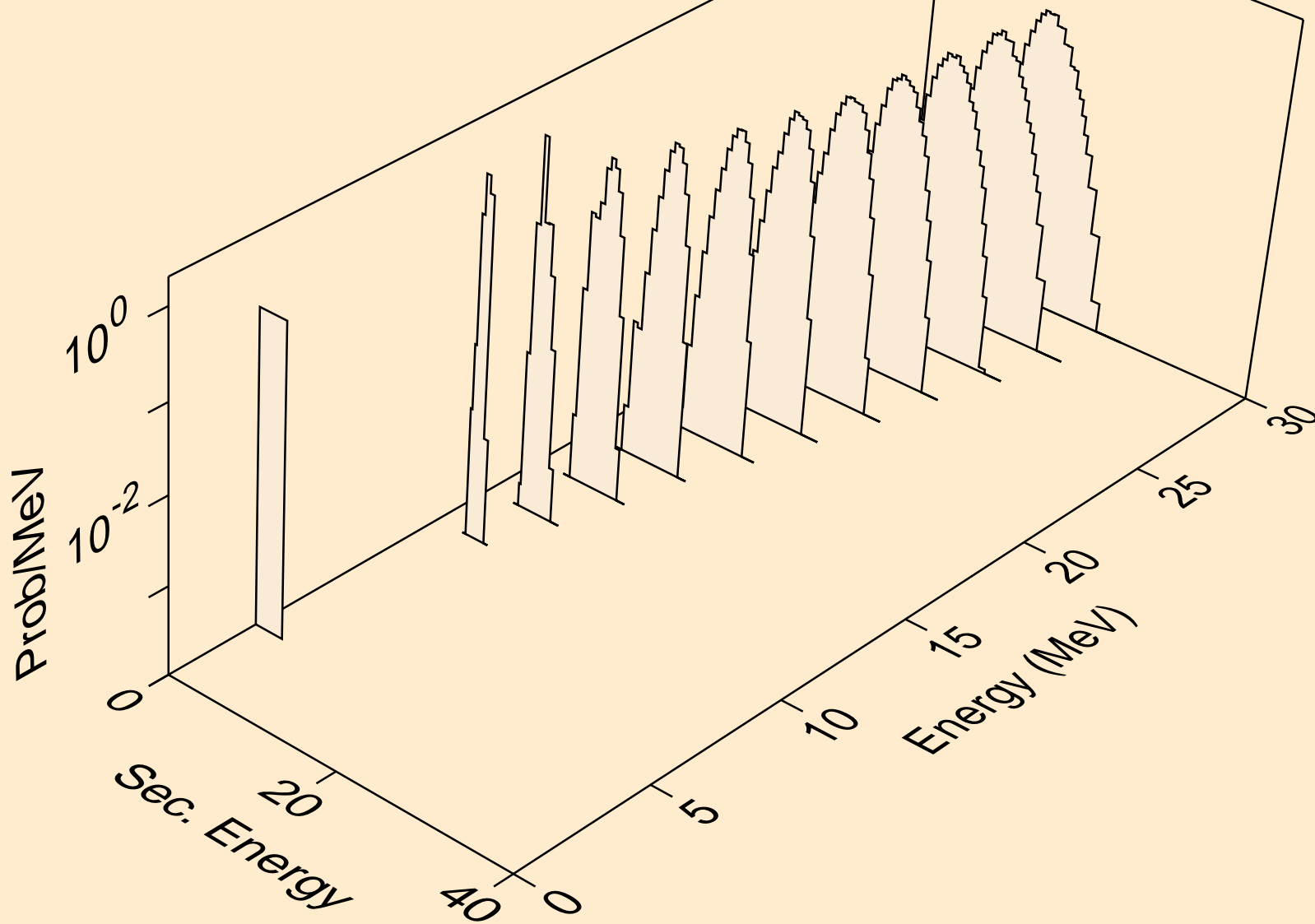

TE123 NEUTRON ACER TENDL-2019 LIBRARY; T=293.16K
alphas from (n,da)

