

TE127 NEUTRON ACER TENDL-2019 LIBRARY; T=293.16K
Principal cross sections

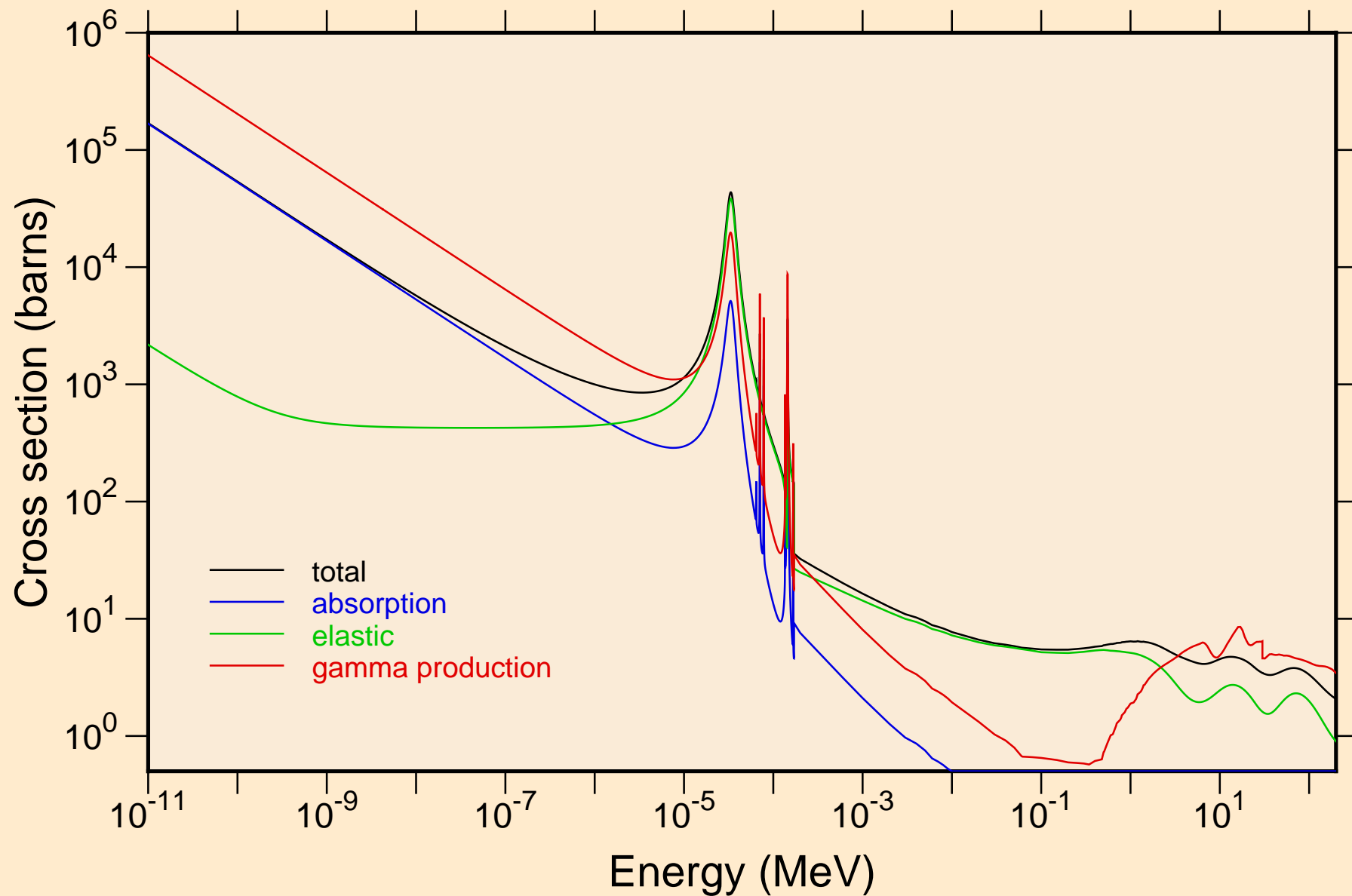

TE127 NEUTRON ACER TENDL-2019 LIBRARY; T=293.16K
resonance total cross section

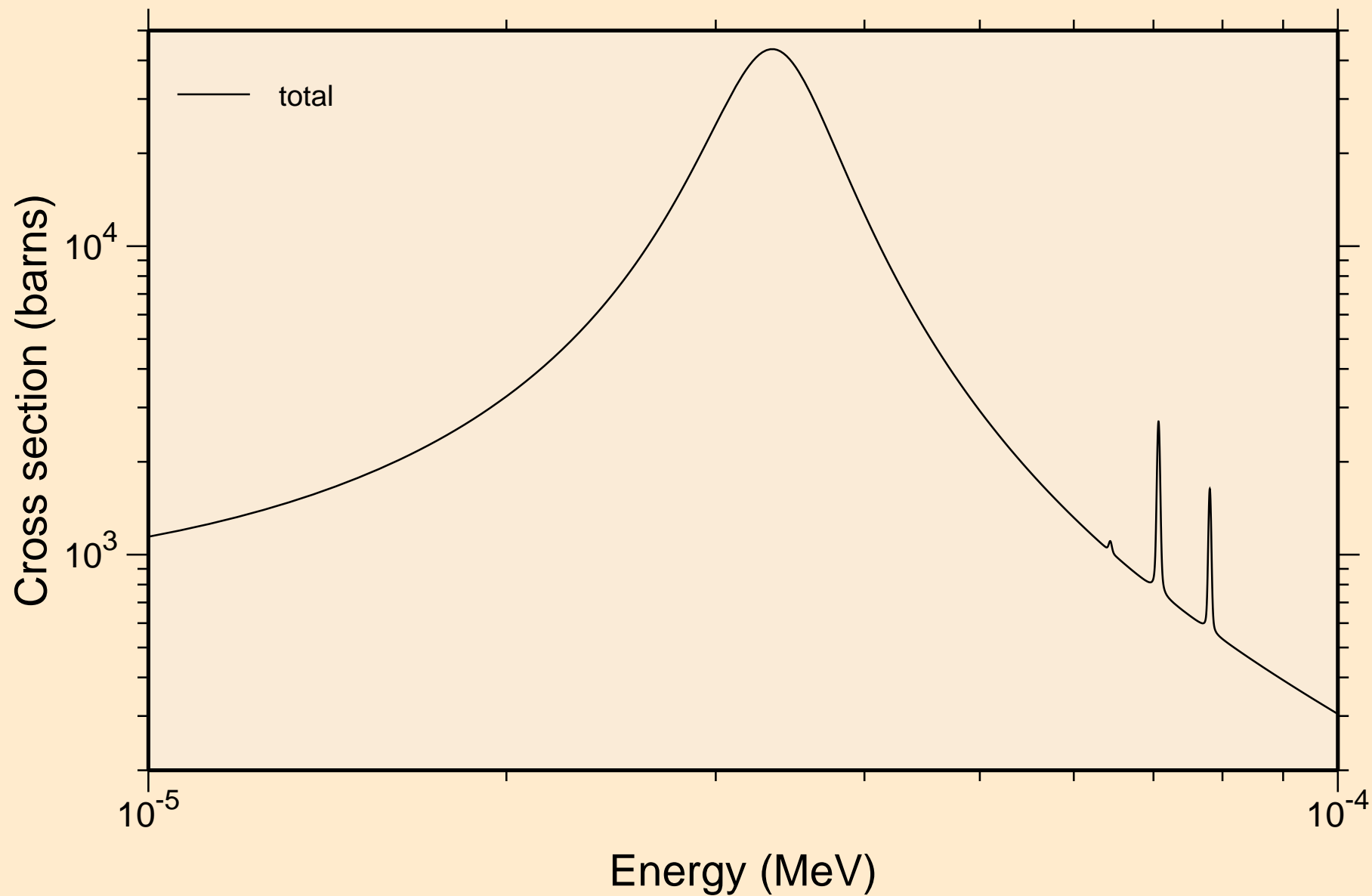

TE127 NEUTRON ACER TENDL-2019 LIBRARY; T=293.16K
resonance total cross section

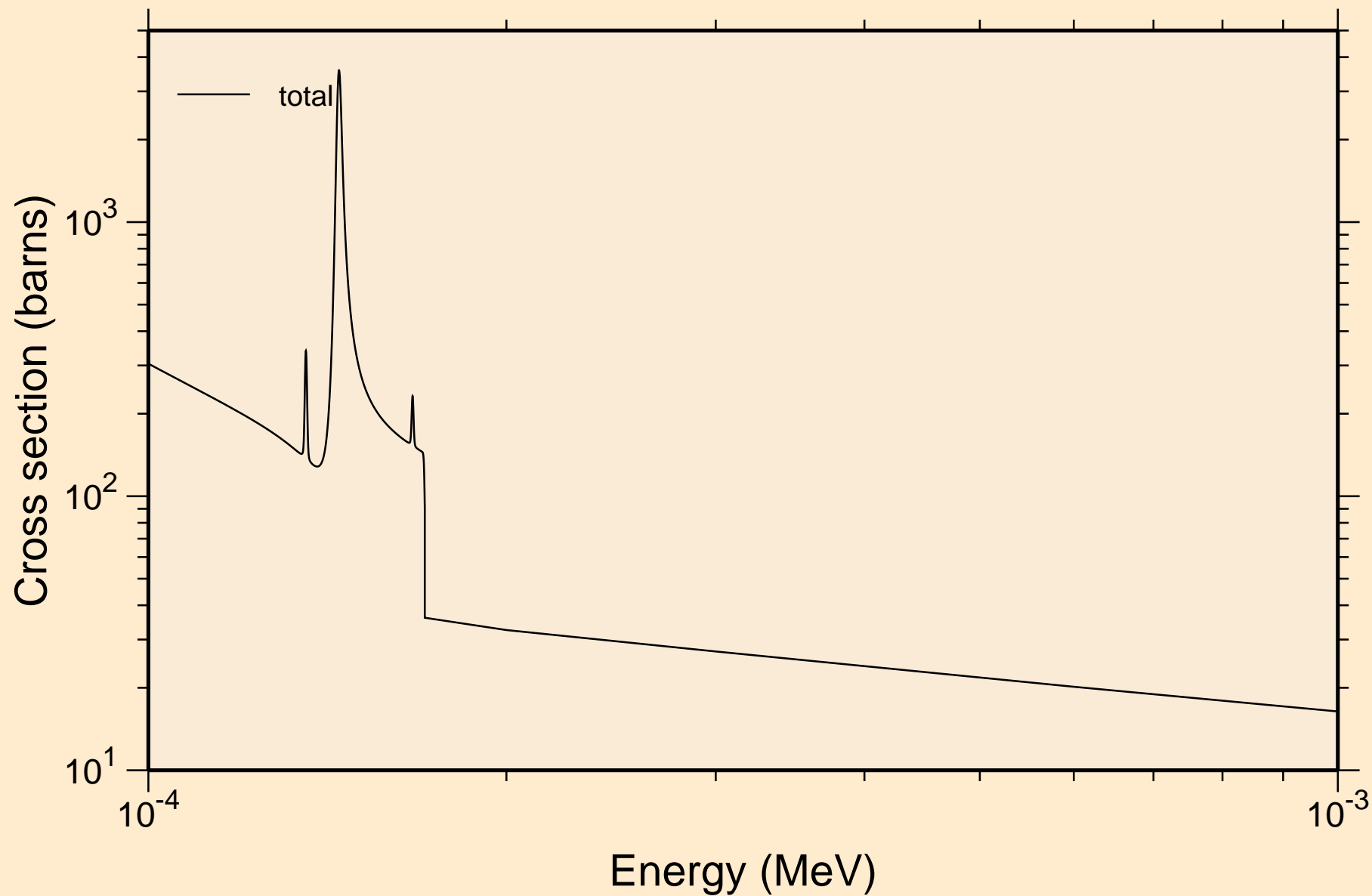

TE127 NEUTRON ACER TENDL-2019 LIBRARY; T=293.16K
resonance total cross section

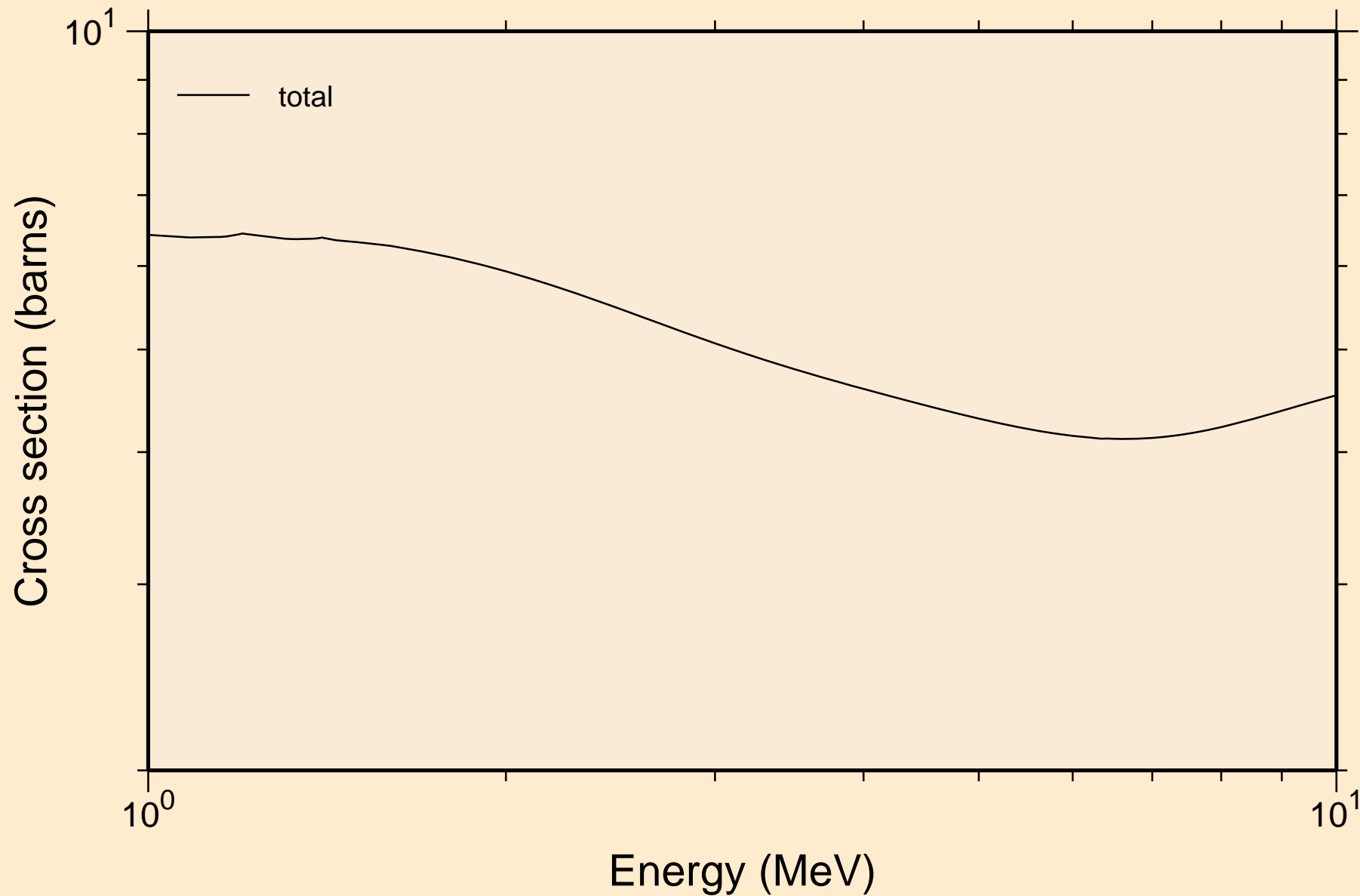

TE127 NEUTRON ACER TENDL-2019 LIBRARY; T=293.16K
resonance absorption cross sections

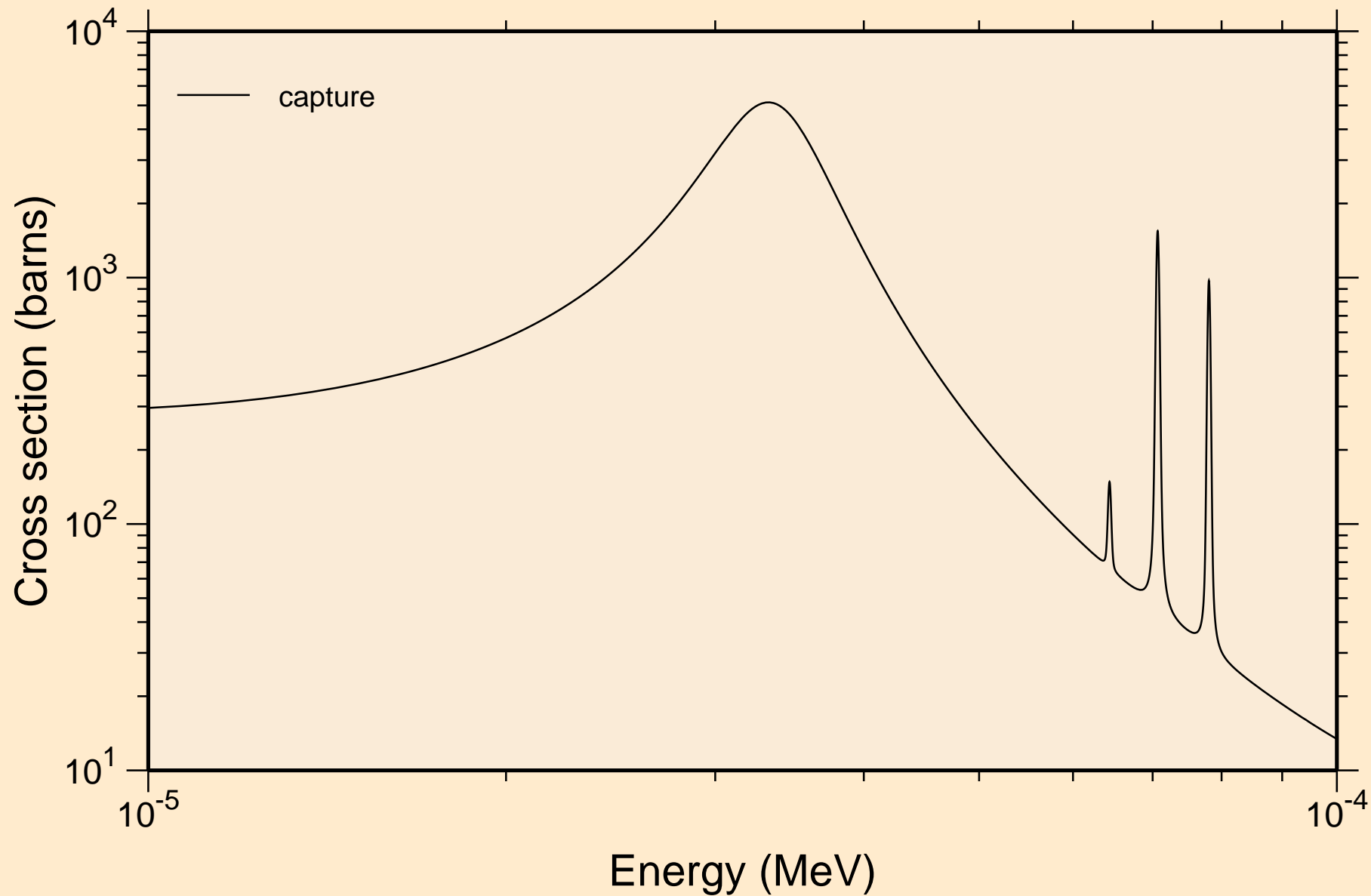

TE127 NEUTRON ACER TENDL-2019 LIBRARY; T=293.16K
resonance absorption cross sections

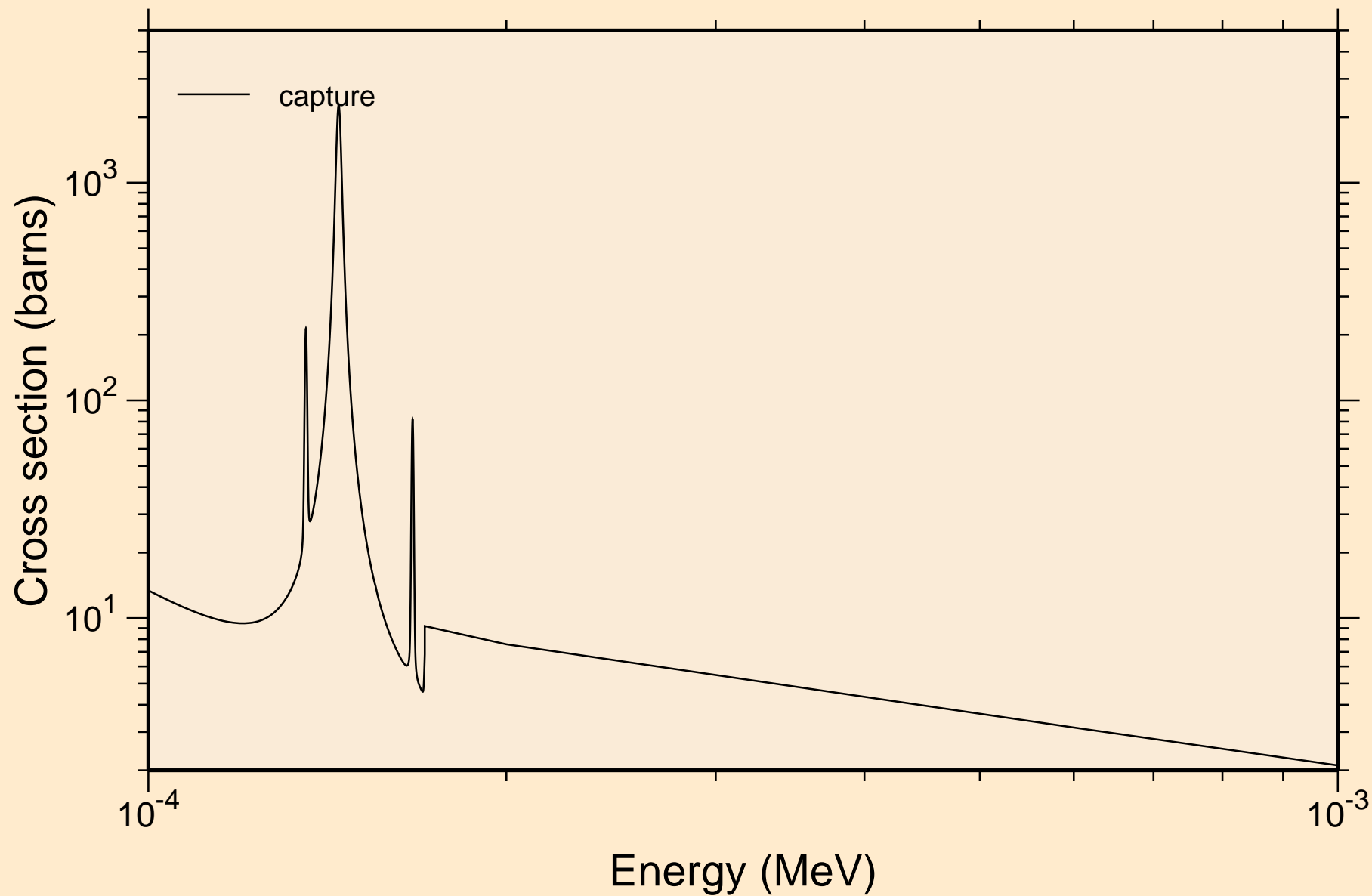

TE127 NEUTRON ACER TENDL-2019 LIBRARY; T=293.16K
resonance absorption cross sections

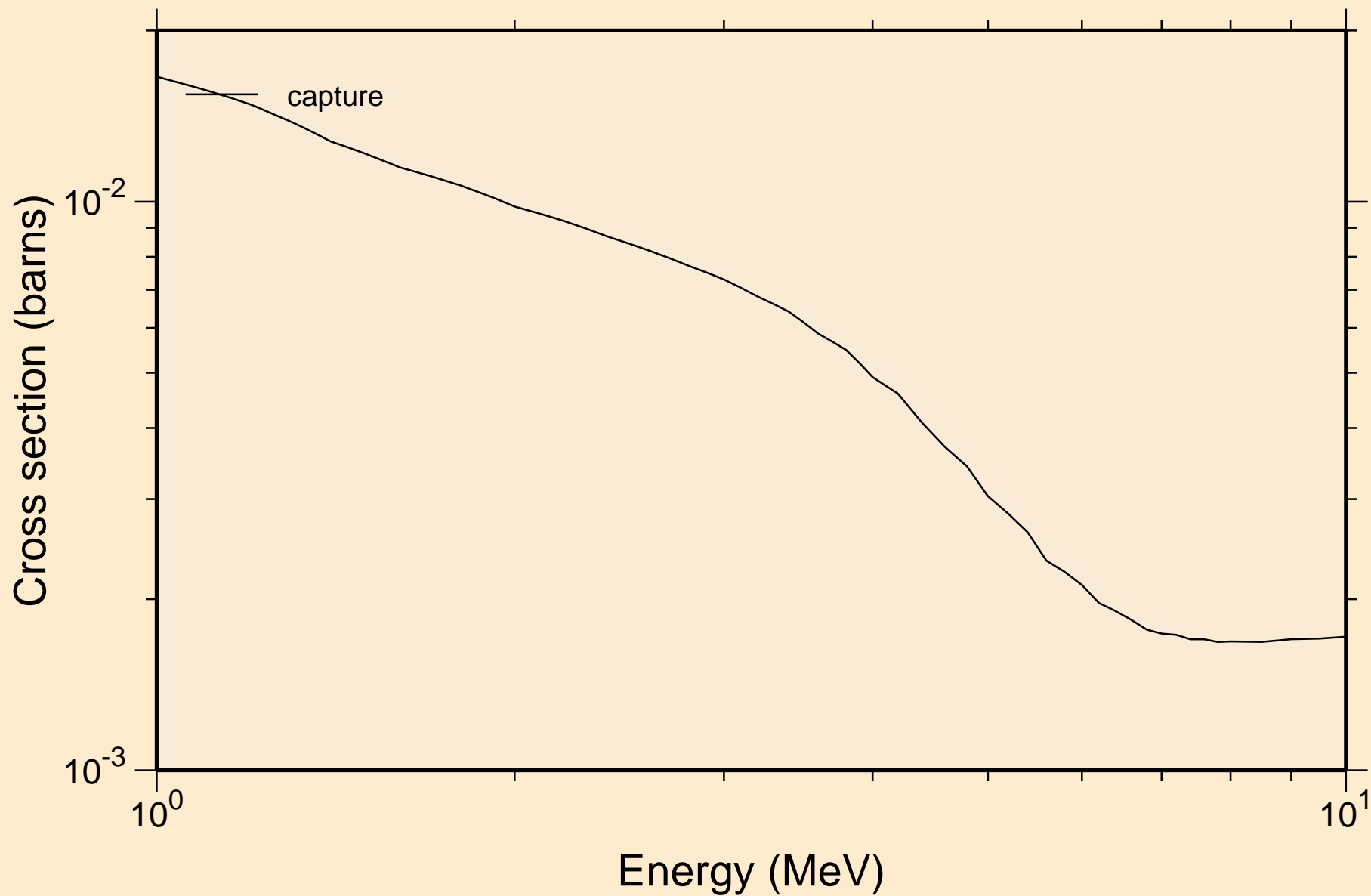

TE127 NEUTRON ACER TENDL-2019 LIBRARY; T=293.16K
Heating

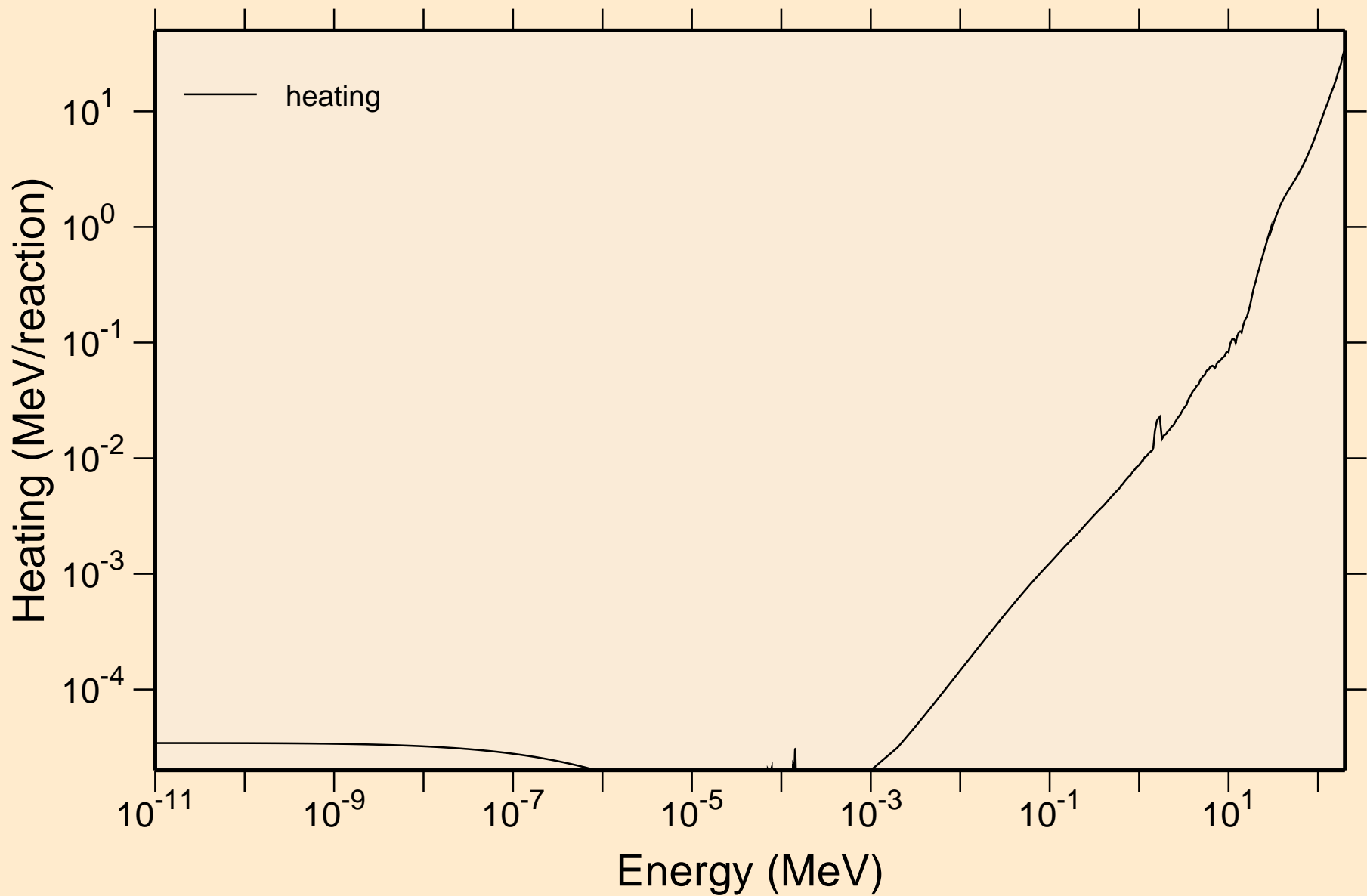

TE127 NEUTRON ACER TENDL-2019 LIBRARY; T=293.16K
Damage

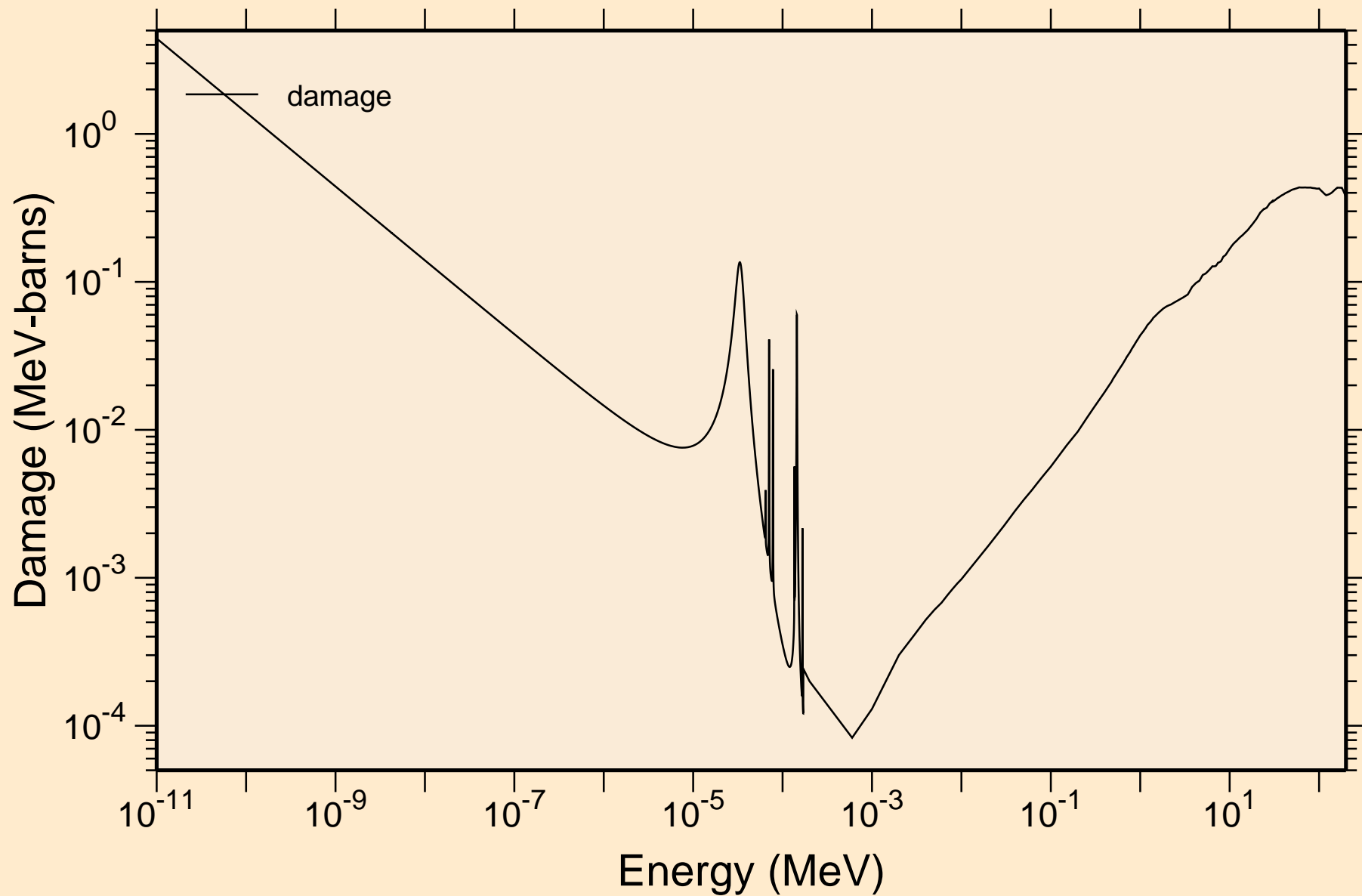

TE127 NEUTRON ACER TENDL-2019 LIBRARY; T=293.16K
Non-threshold reactions

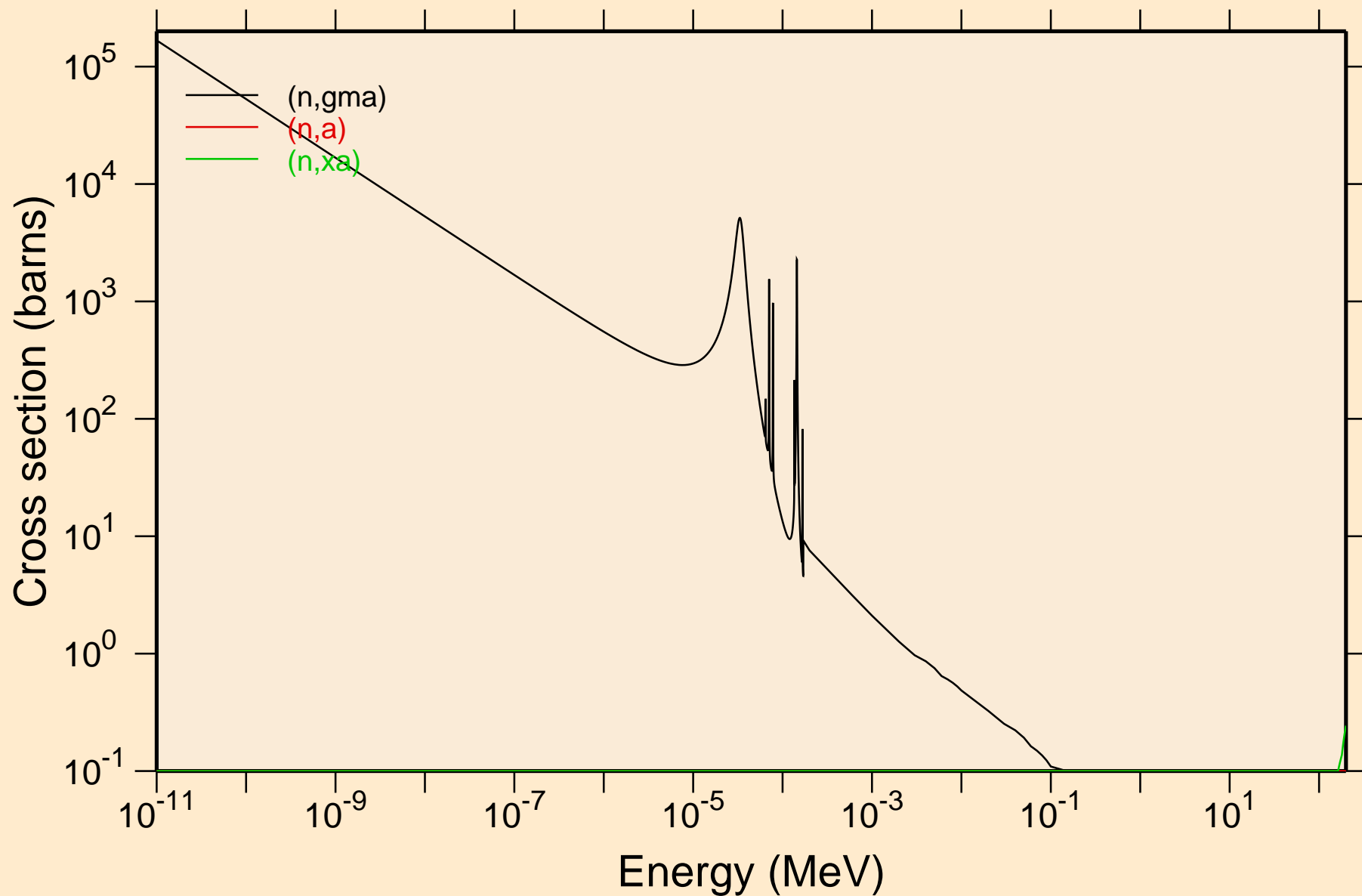

TE127 NEUTRON ACER TENDL-2019 LIBRARY; T=293.16K
Principal cross sections

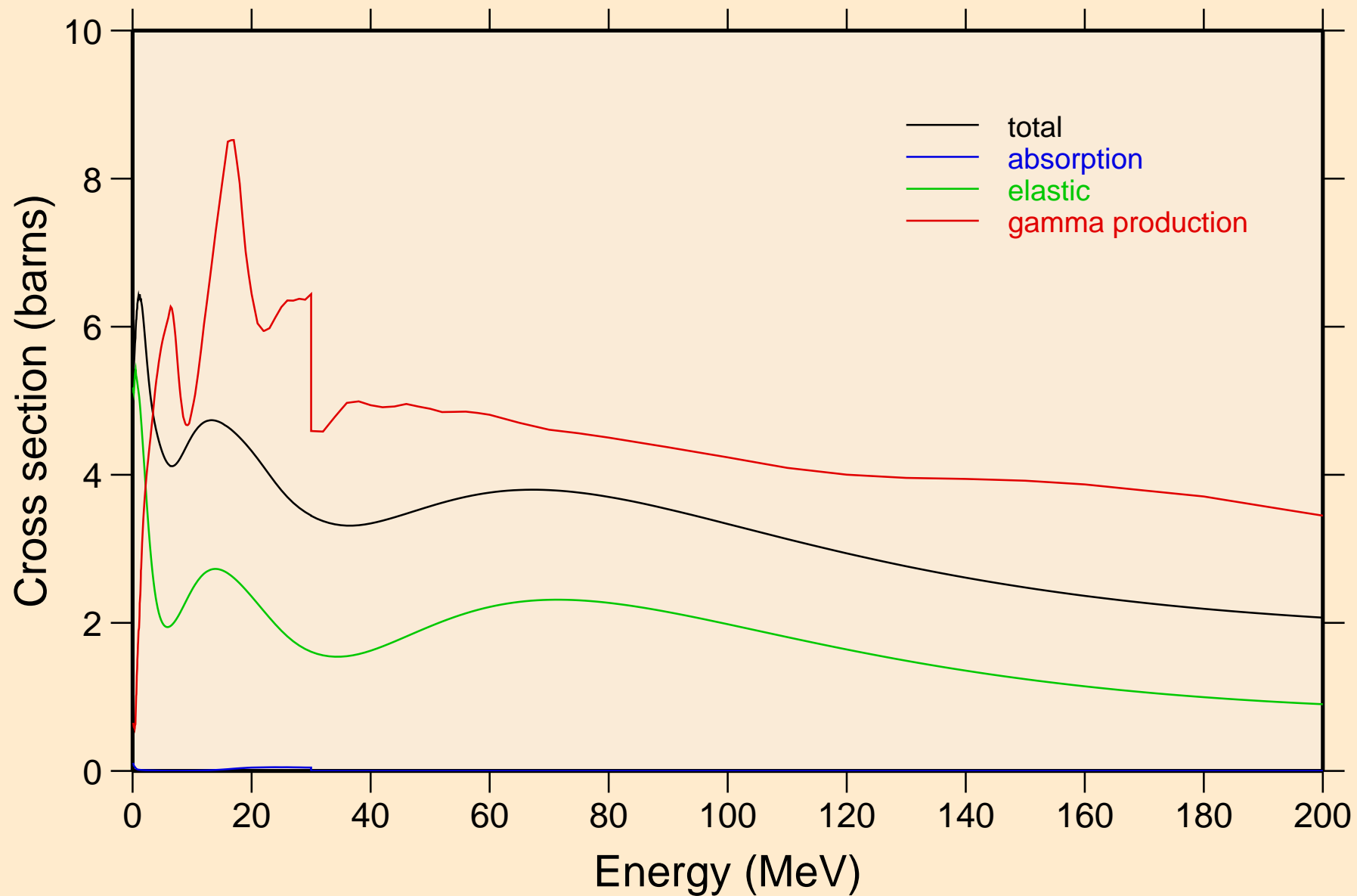

TE127 NEUTRON ACER TENDL-2019 LIBRARY; T=293.16K
Heating

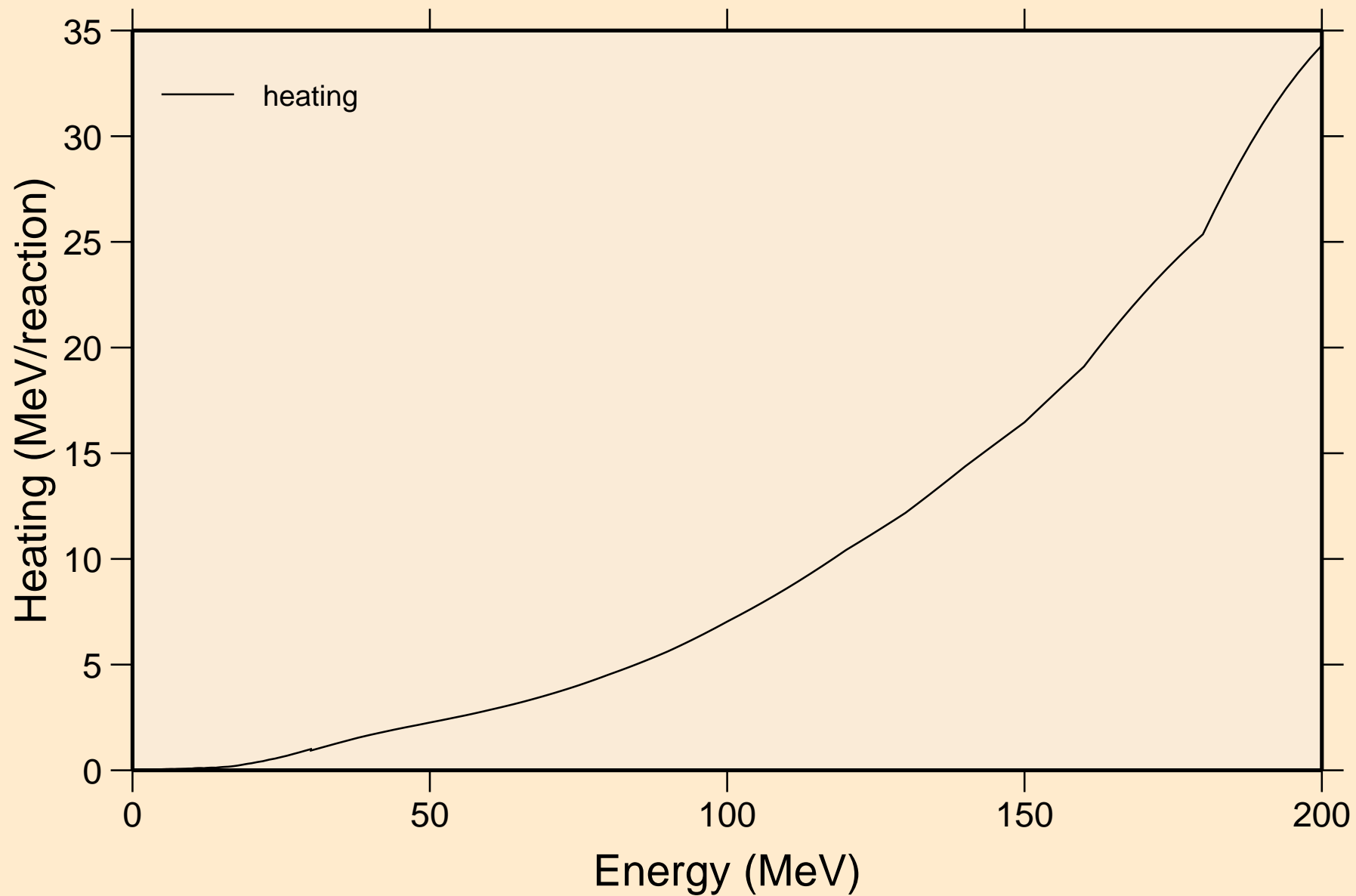

TE127 NEUTRON ACER TENDL-2019 LIBRARY; T=293.16K
Damage

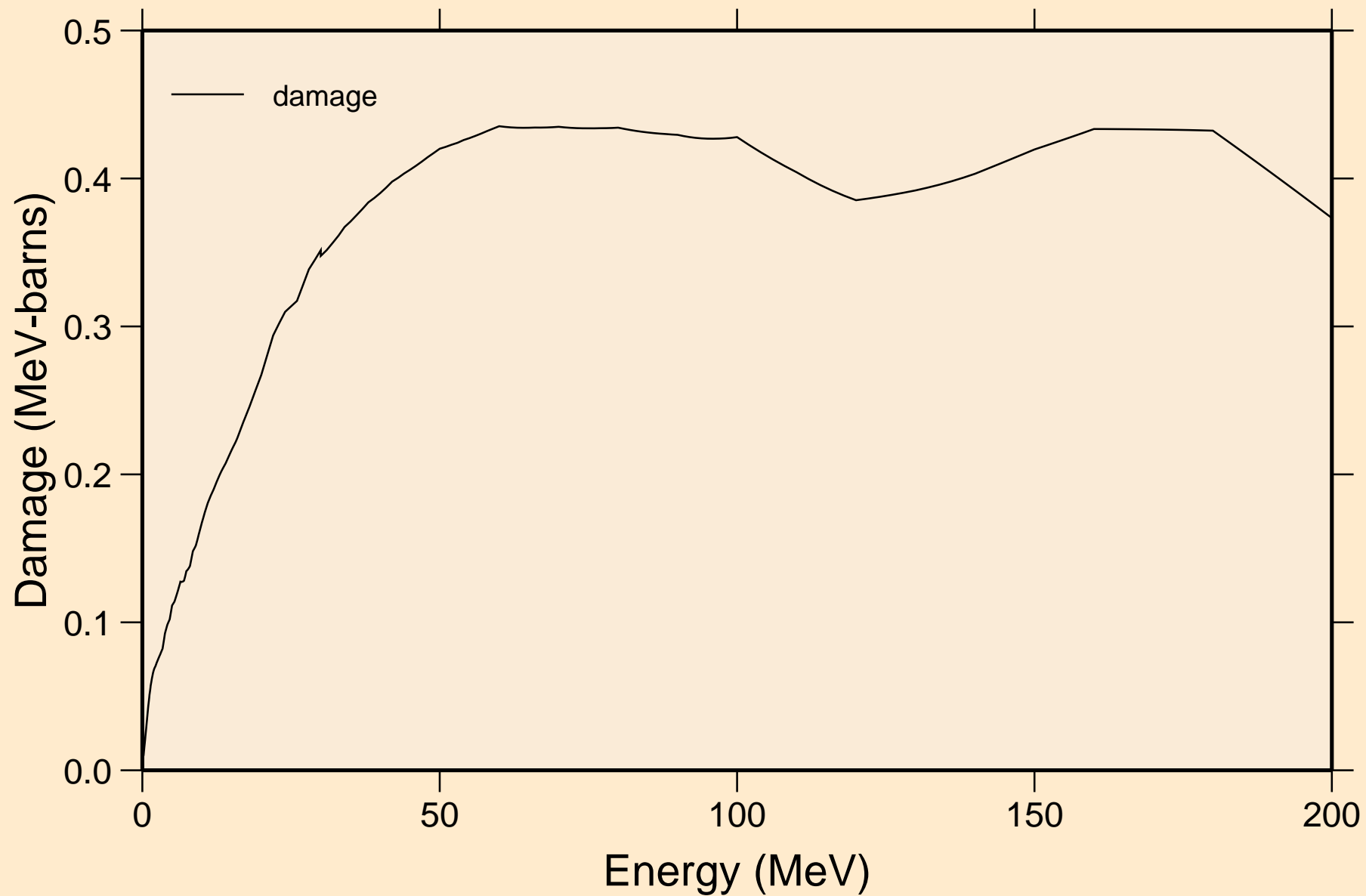

TE127 NEUTRON ACER TENDL-2019 LIBRARY; T=293.16K
Non-threshold reactions

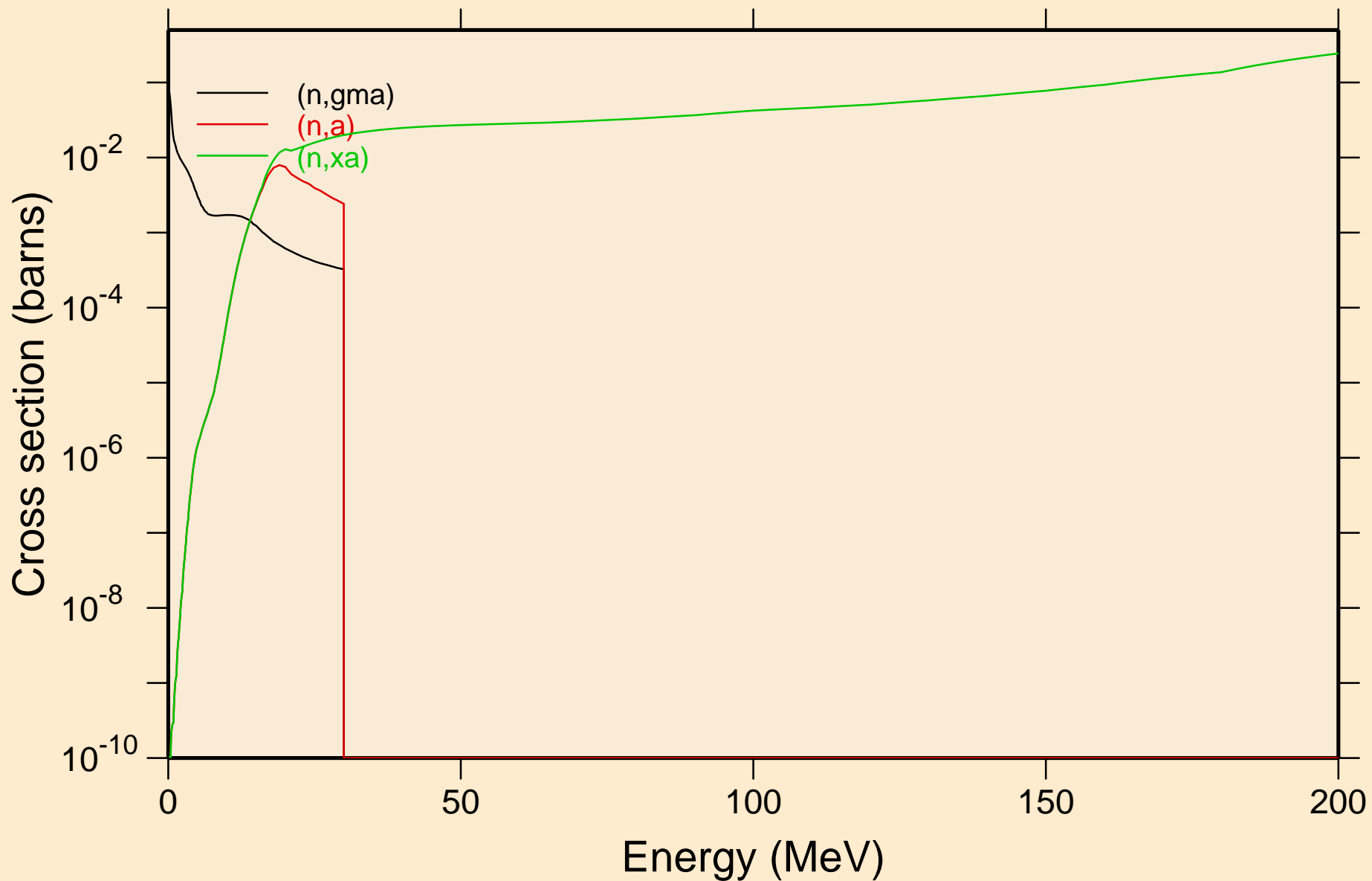

TE127 NEUTRON ACER TENDL-2019 LIBRARY; T=293.16K
Inelastic levels

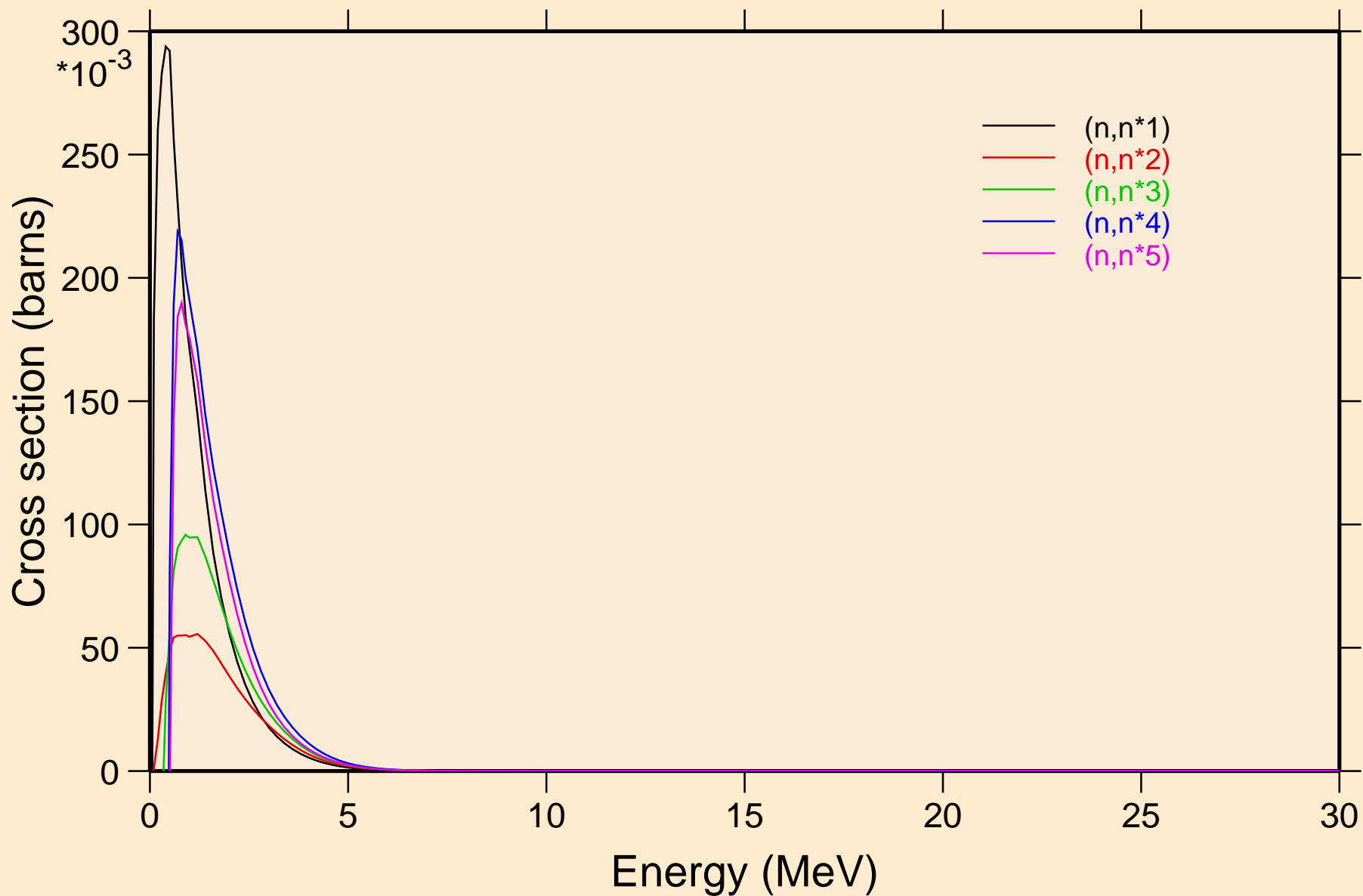

TE127 NEUTRON ACER TENDL-2019 LIBRARY; T=293.16K
Inelastic levels

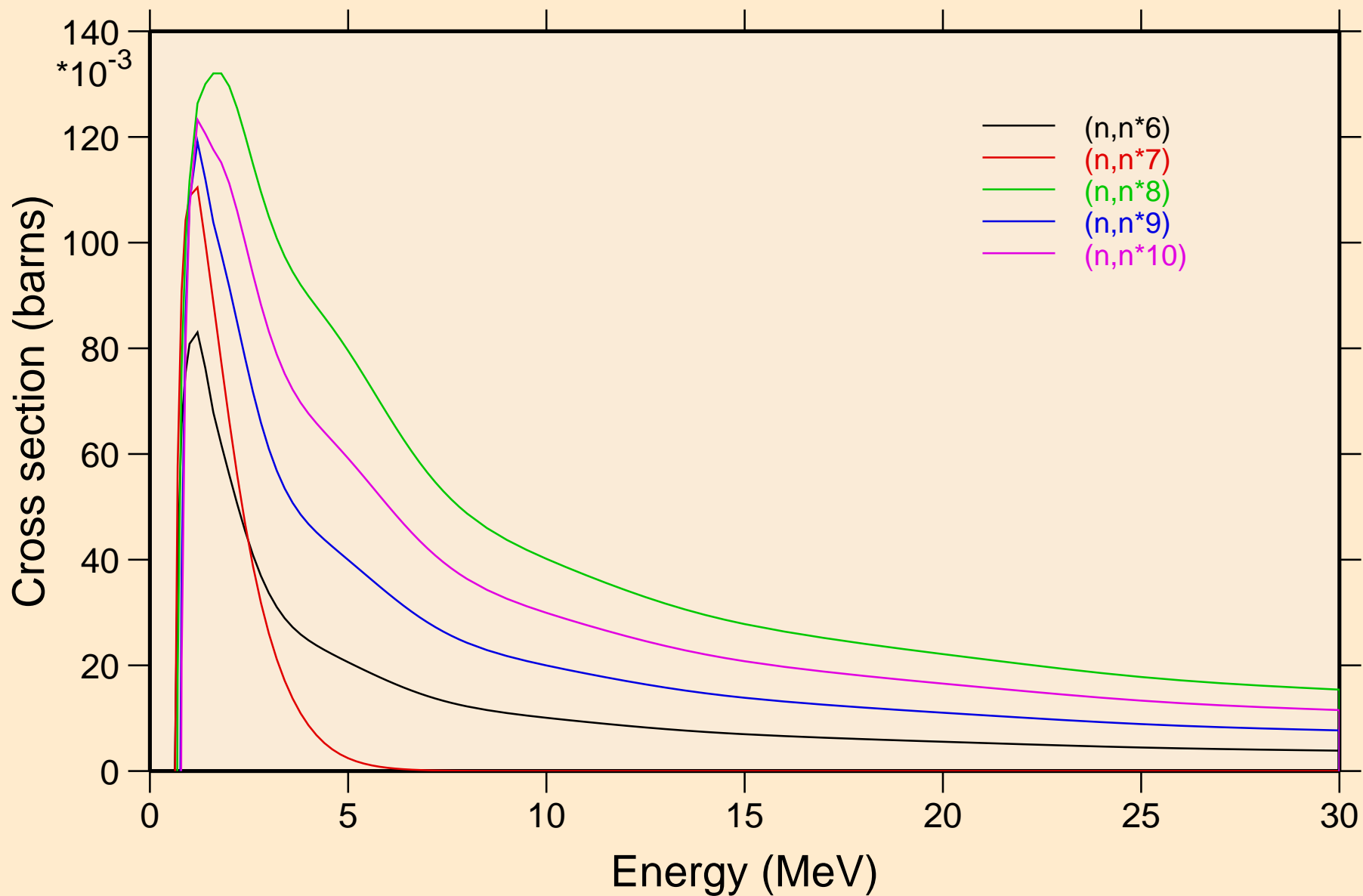

TE127 NEUTRON ACER TENDL-2019 LIBRARY; T=293.16K
Inelastic levels

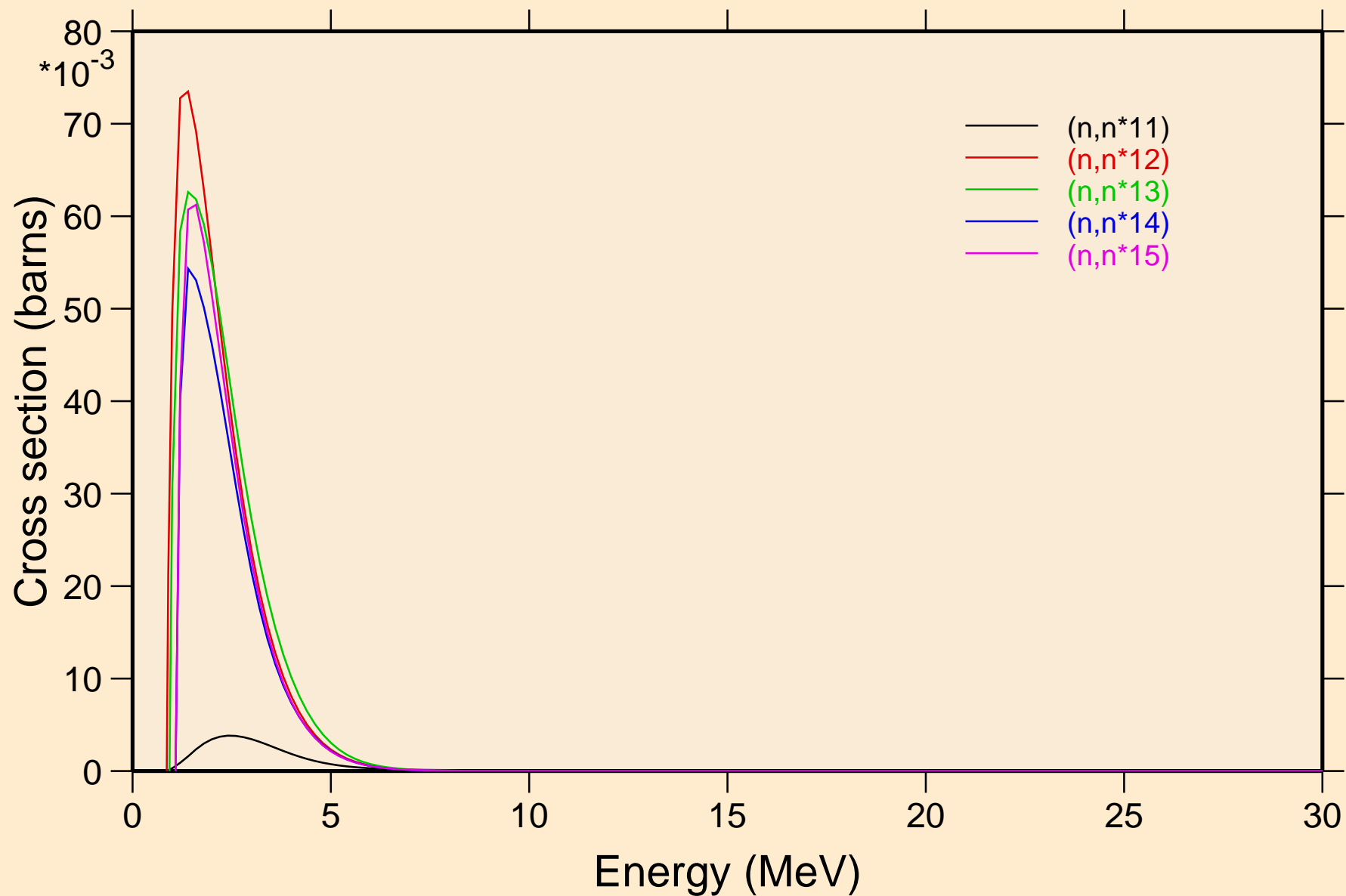

TE127 NEUTRON ACER TENDL-2019 LIBRARY; T=293.16K
Inelastic levels

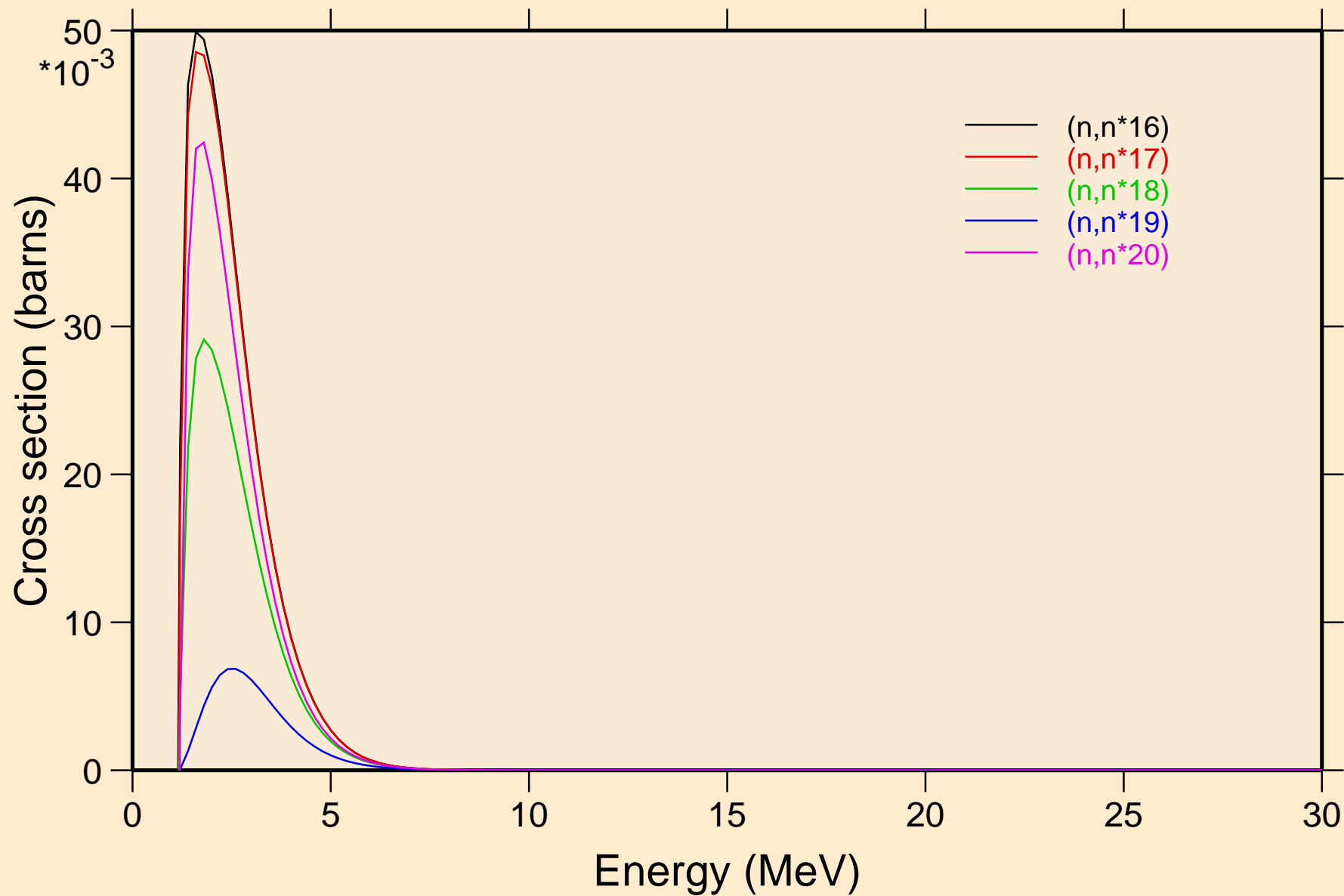

TE127 NEUTRON ACER TENDL-2019 LIBRARY; T=293.16K
Inelastic levels

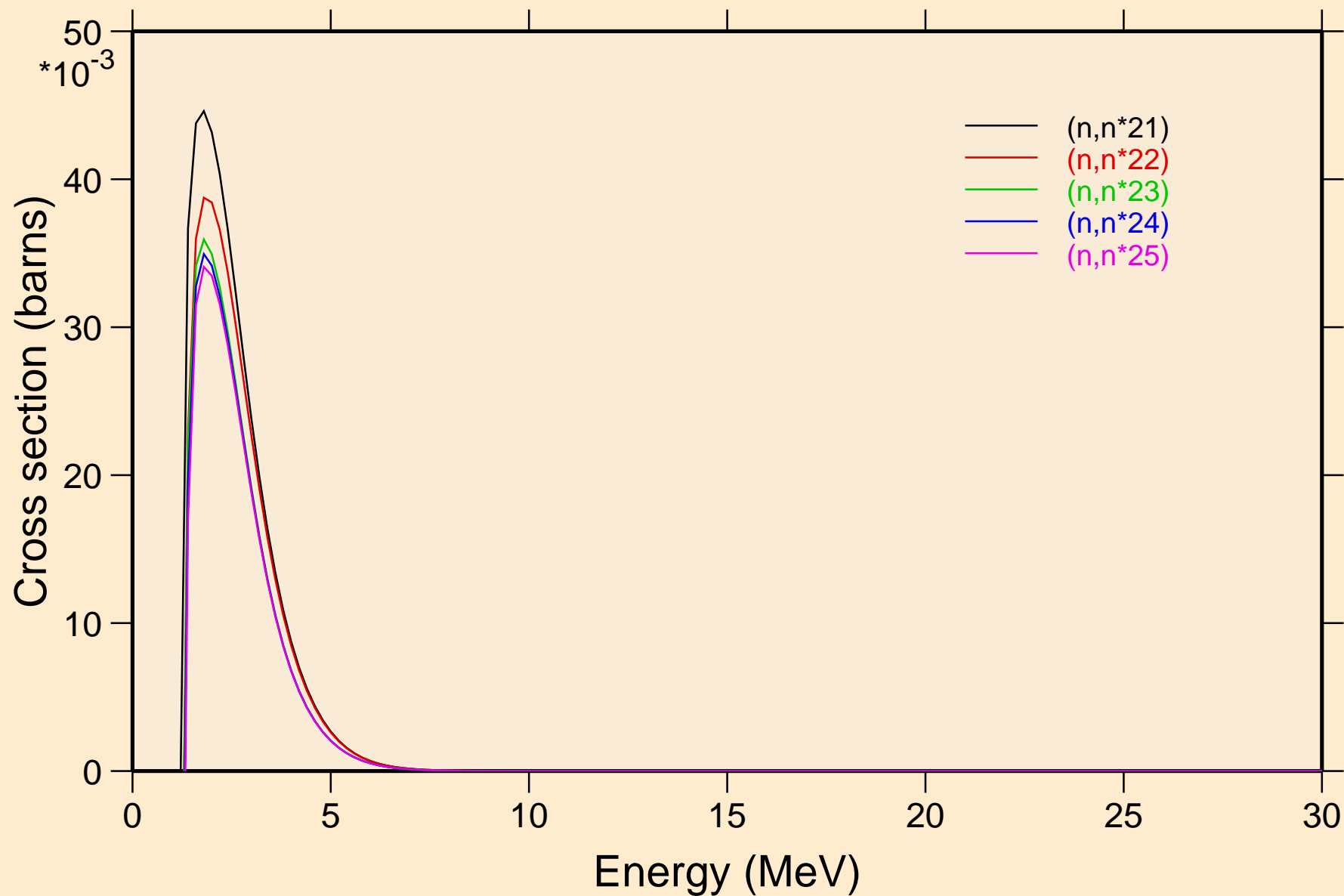

TE127 NEUTRON ACER TENDL-2019 LIBRARY; T=293.16K
Inelastic levels

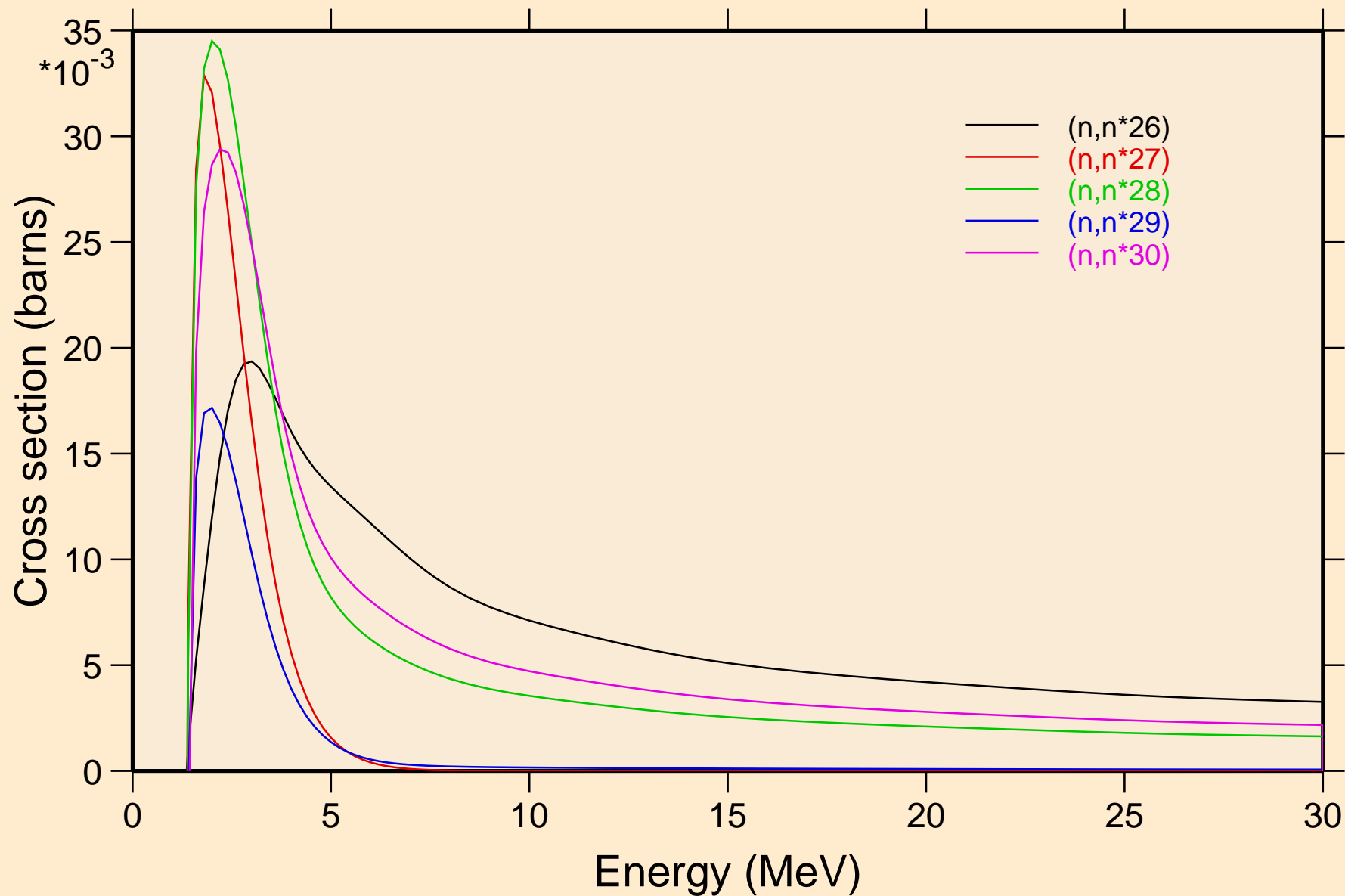

TE127 NEUTRON ACER TENDL-2019 LIBRARY; T=293.16K
Threshold reactions

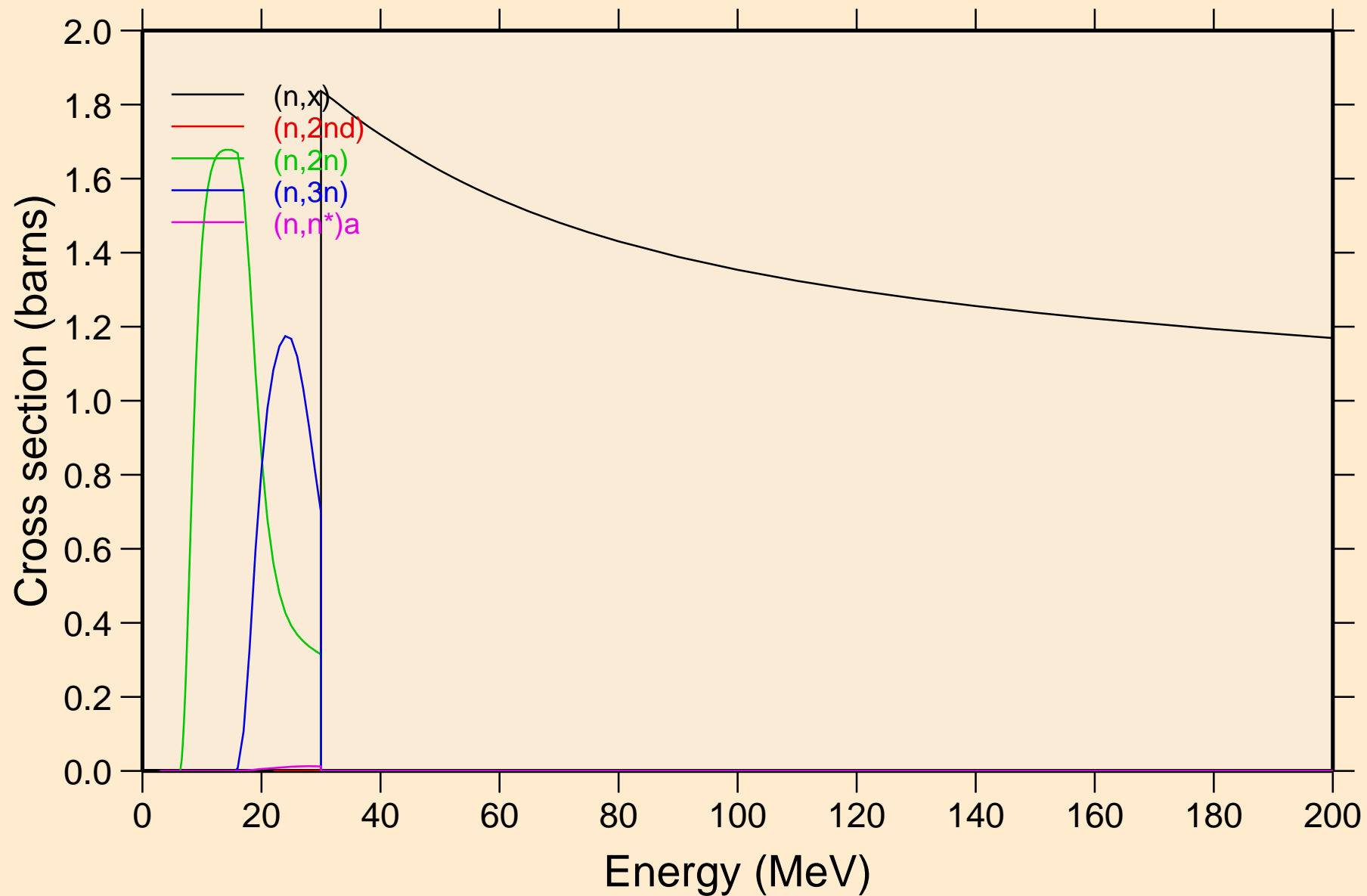

TE127 NEUTRON ACER TENDL-2019 LIBRARY; T=293.16K
Threshold reactions

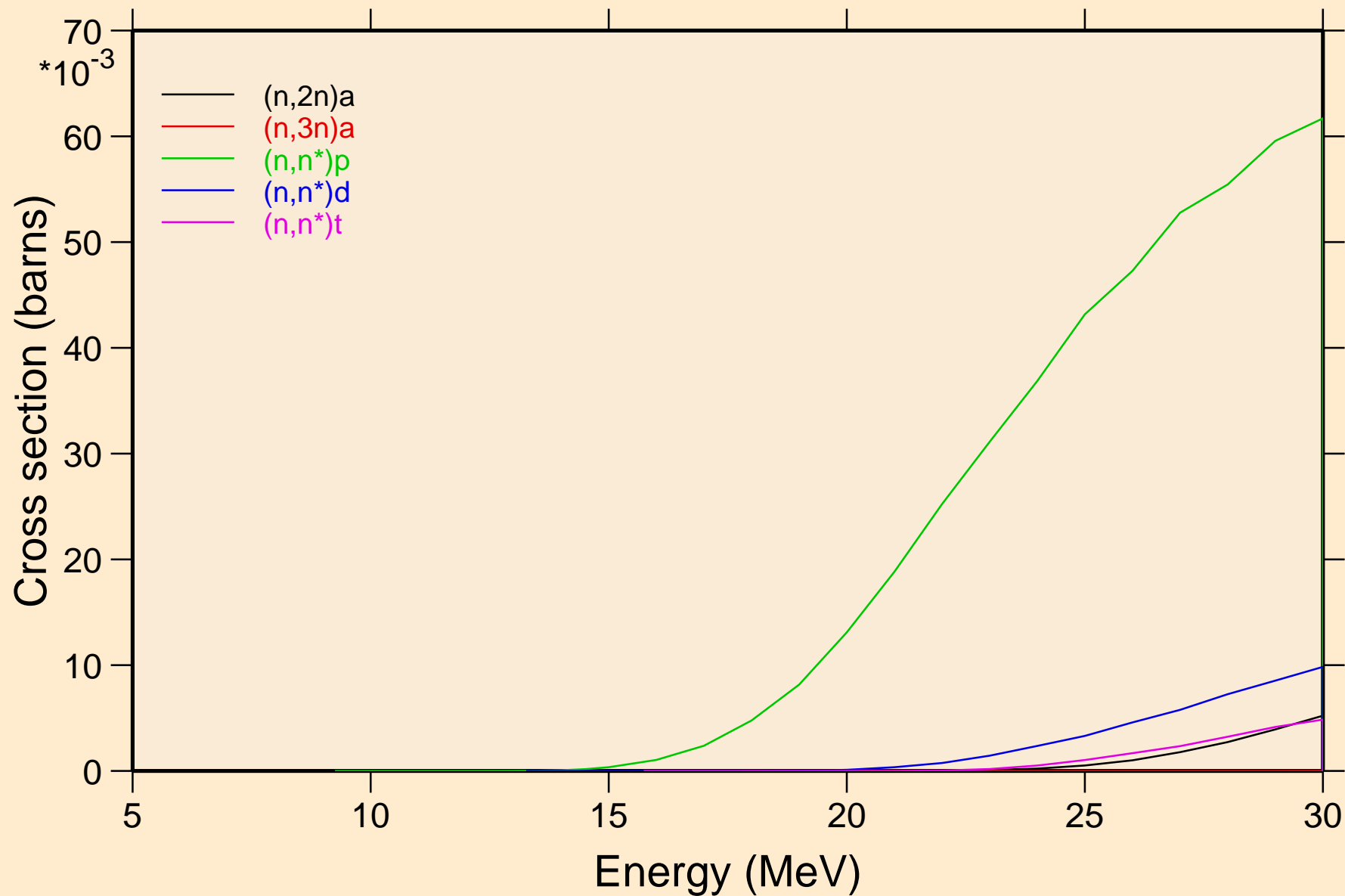

TE127 NEUTRON ACER TENDL-2019 LIBRARY; T=293.16K
Threshold reactions

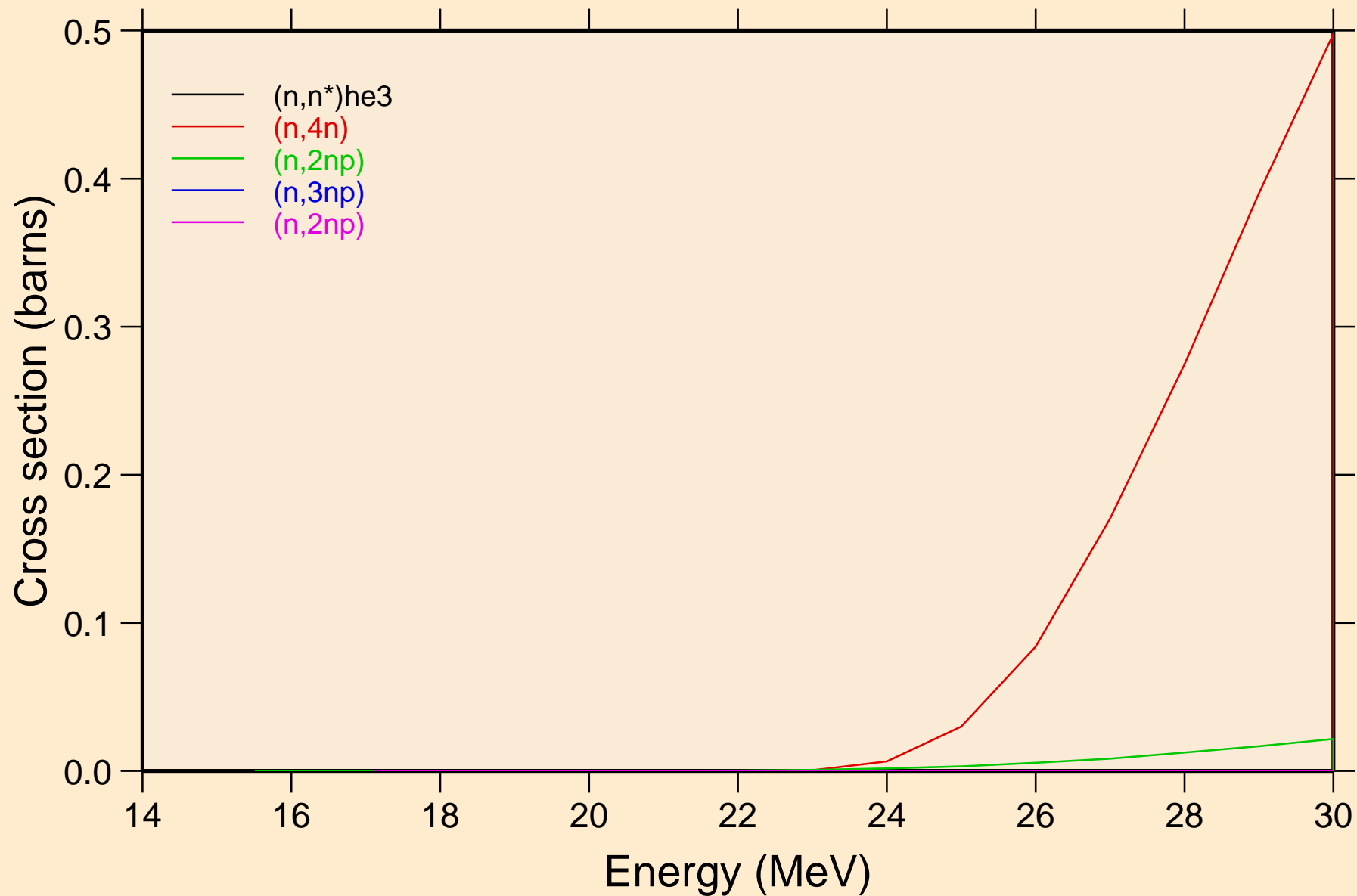

TE127 NEUTRON ACER TENDL-2019 LIBRARY; T=293.16K
Threshold reactions

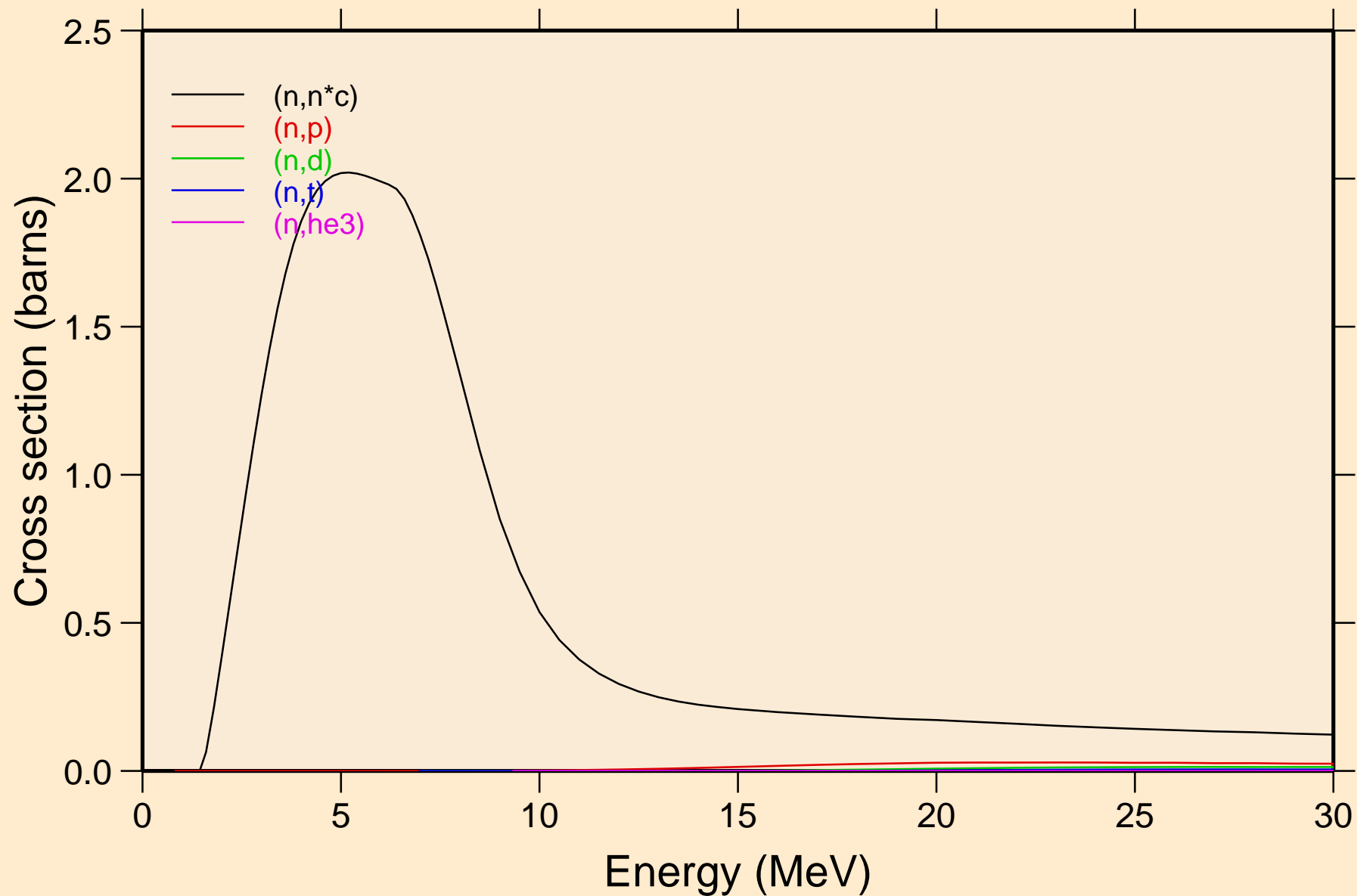

TE127 NEUTRON ACER TENDL-2019 LIBRARY; T=293.16K
Threshold reactions

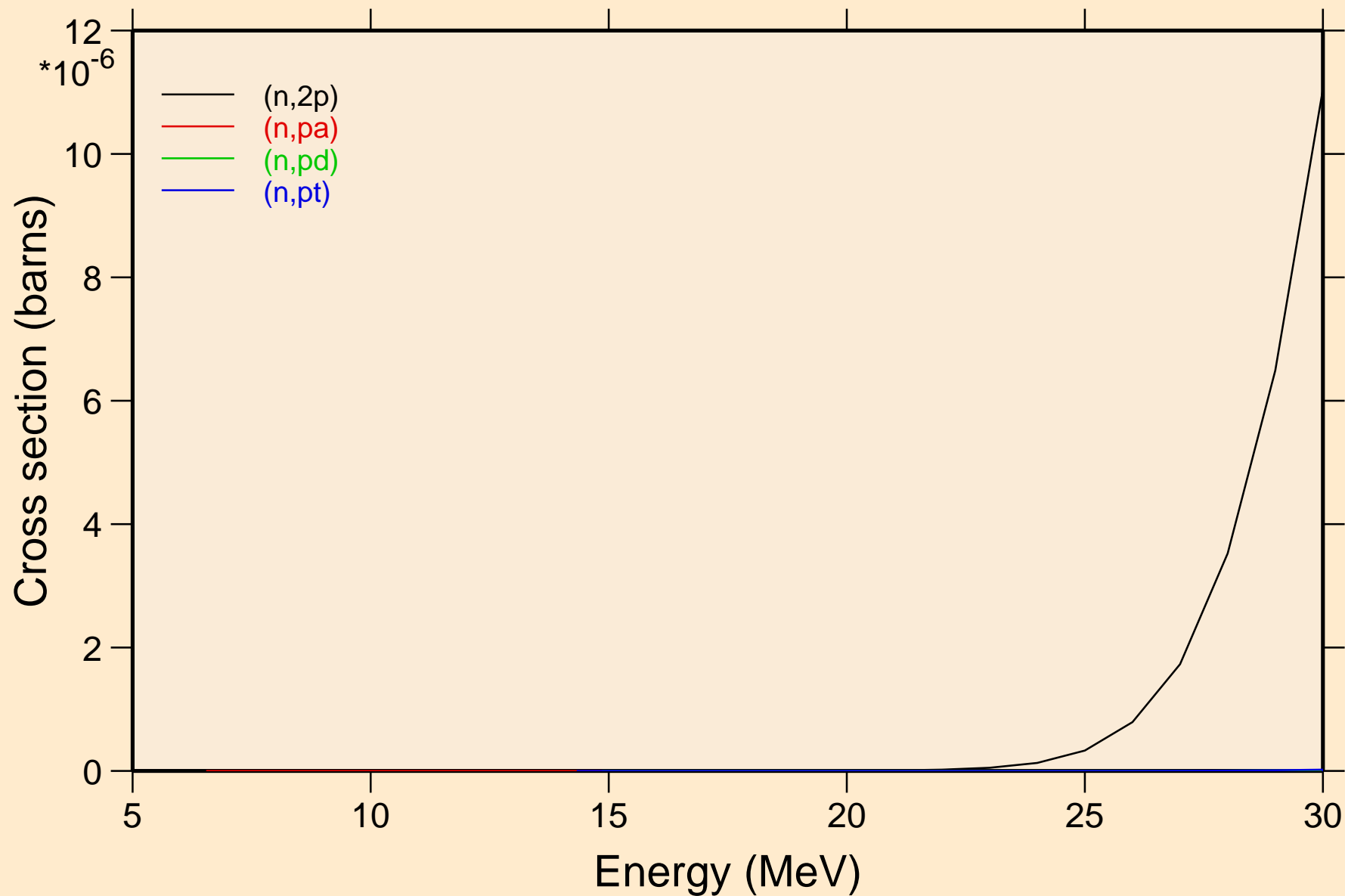

TE127 NEUTRON ACER TENDL-2019 LIBRARY; T=293.16K
Threshold reactions

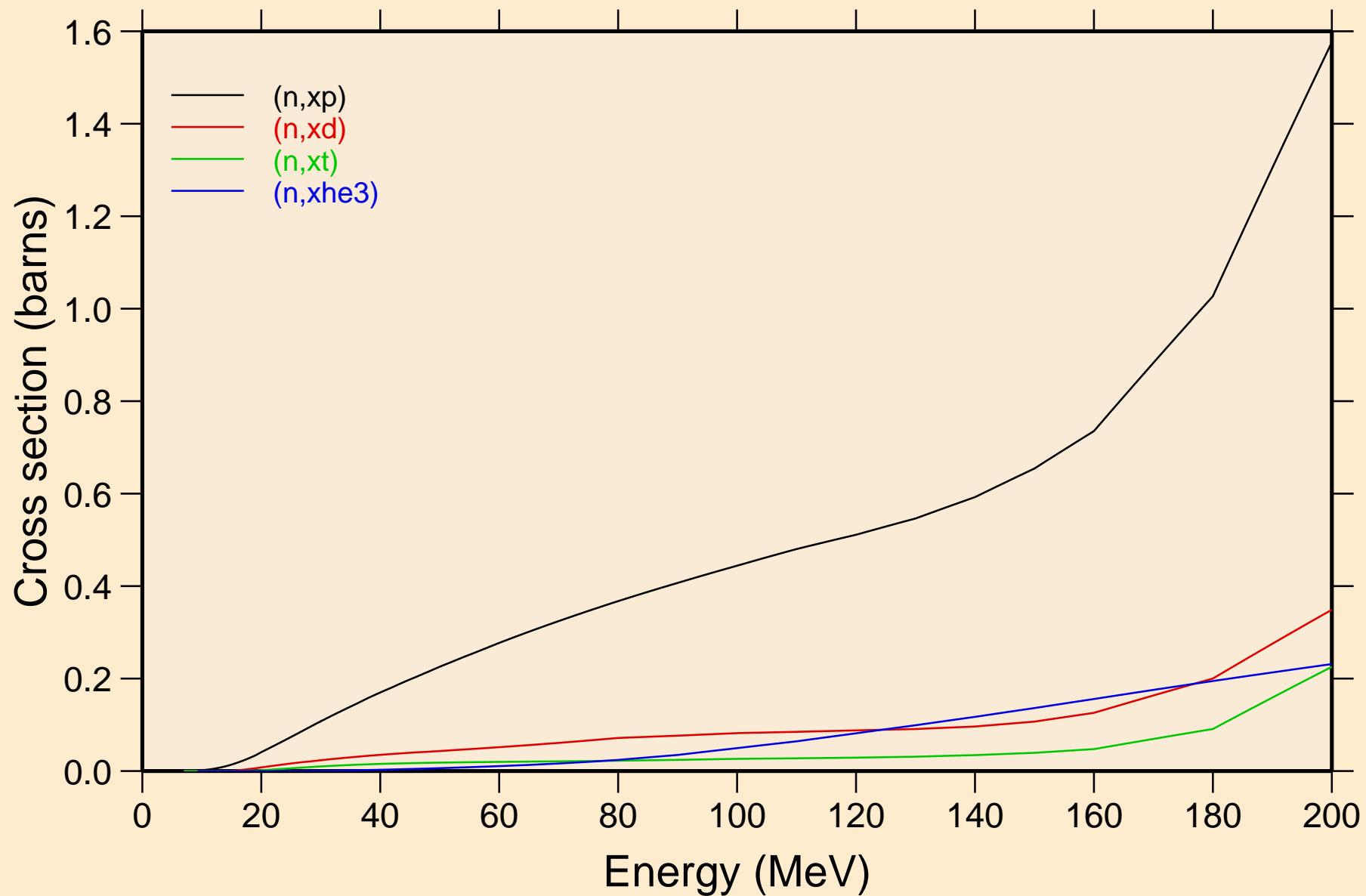

TE127 NEUTRON ACER TENDL-2019 LIBRARY; T=293.16K
angular distribution for elastic

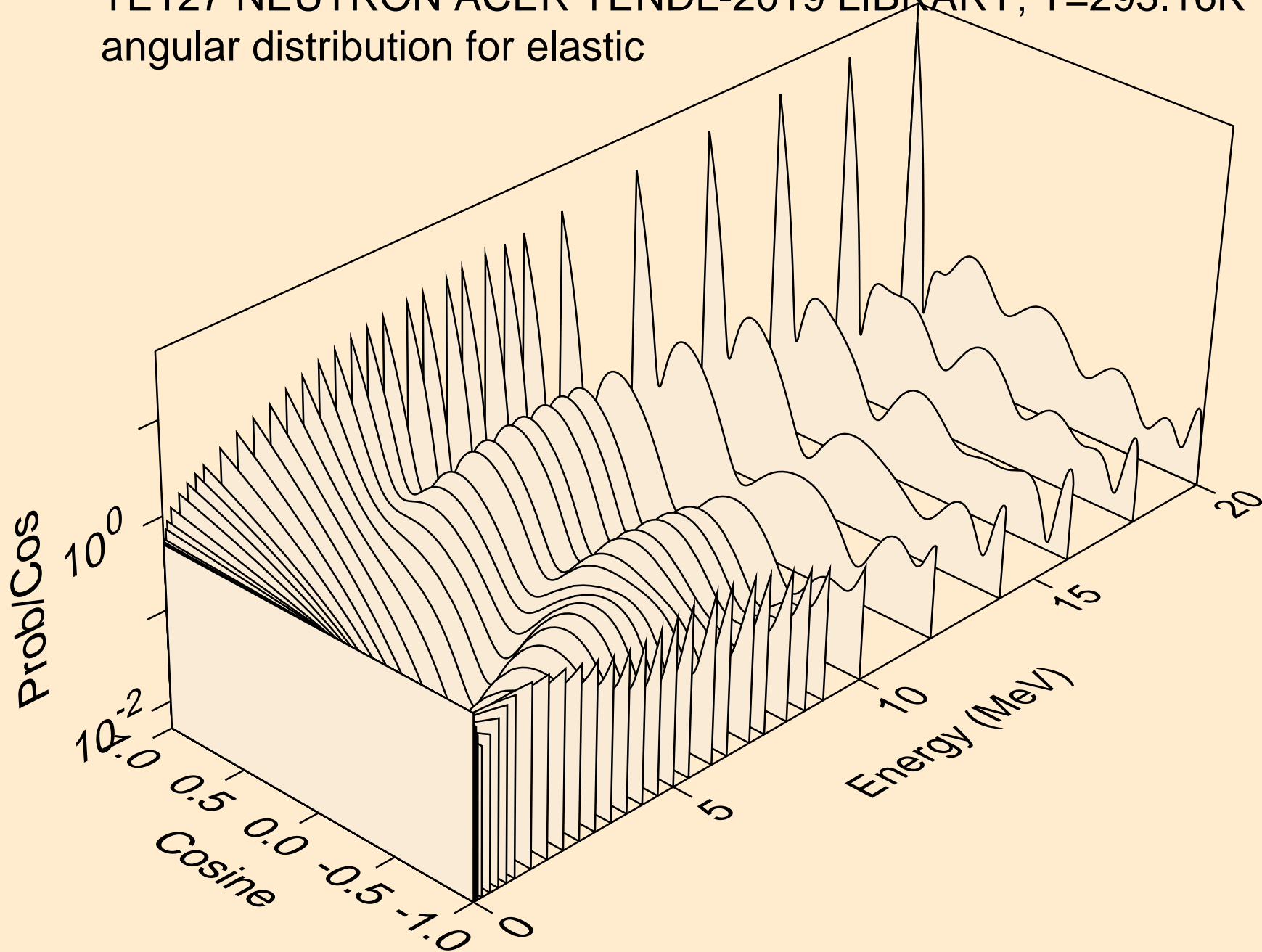

TE127 NEUTRON ACER TENDL-2019 LIBRARY; T=293.16K
angular distribution for elastic

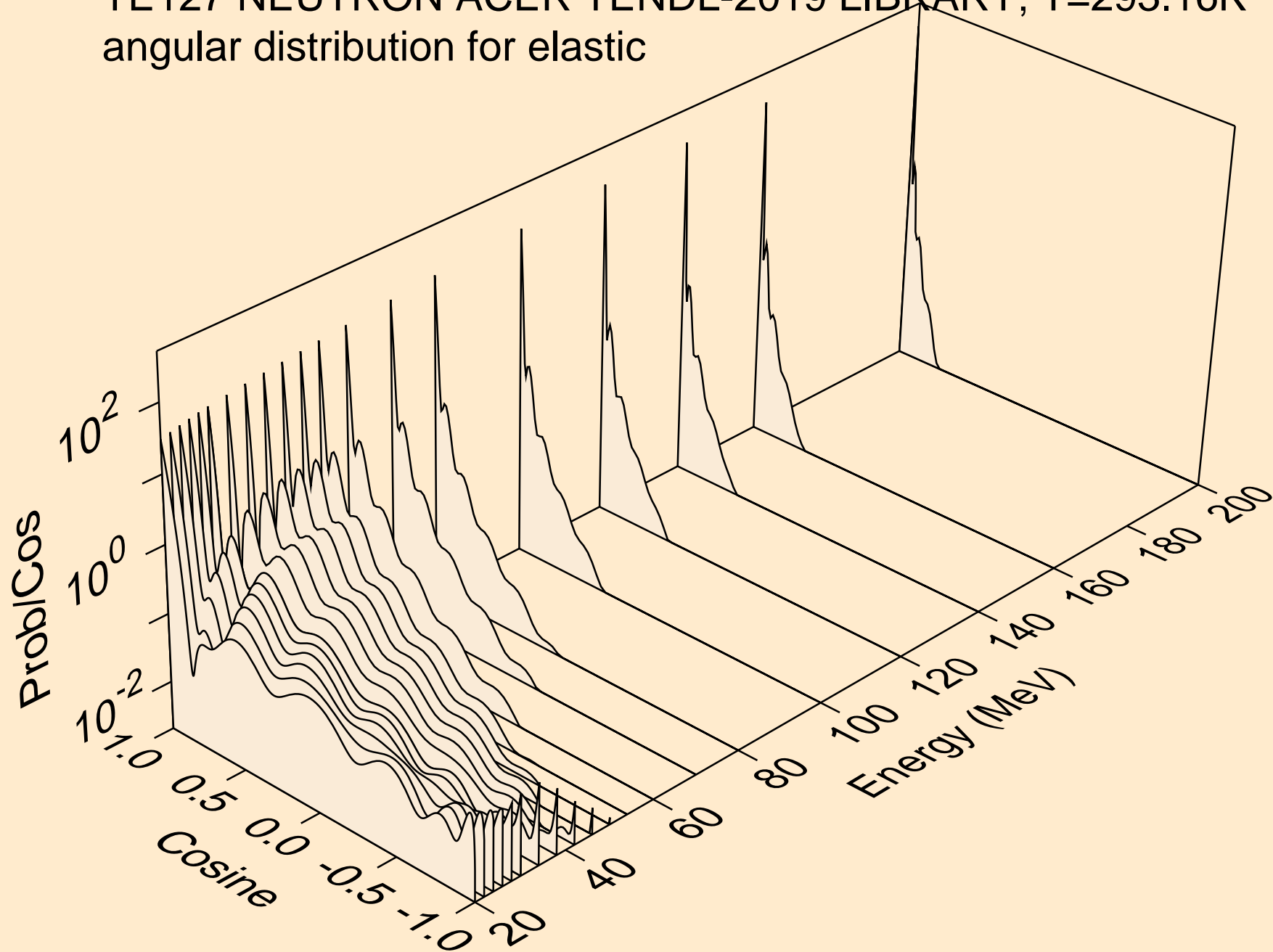

TE127 NEUTRON ACER TENDL-2019 LIBRARY; T=293.16K
angular distribution for (n,n*1)

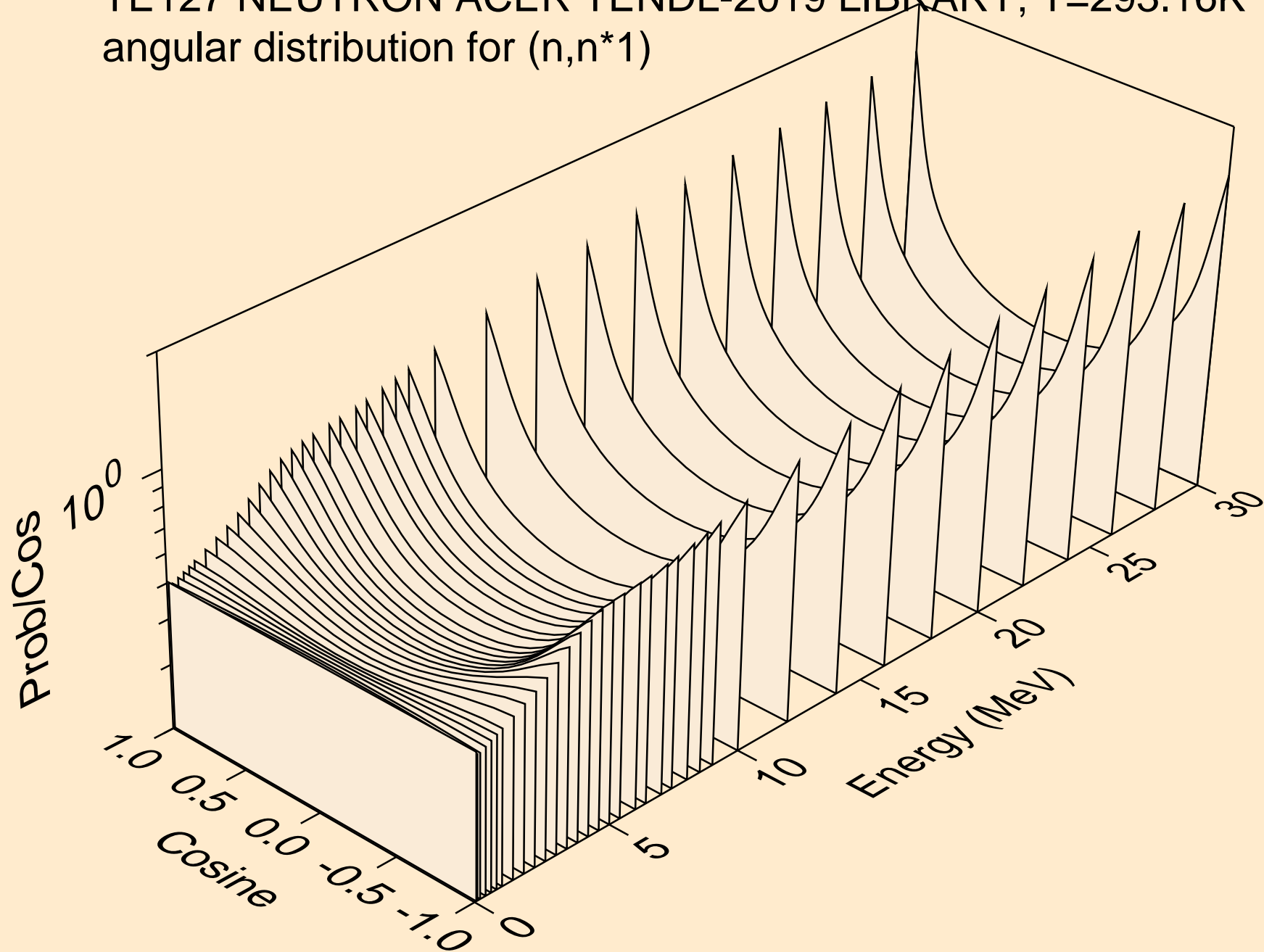

TE127 NEUTRON ACER TENDL-2019 LIBRARY; T=293.16K
angular distribution for (n,n*2)

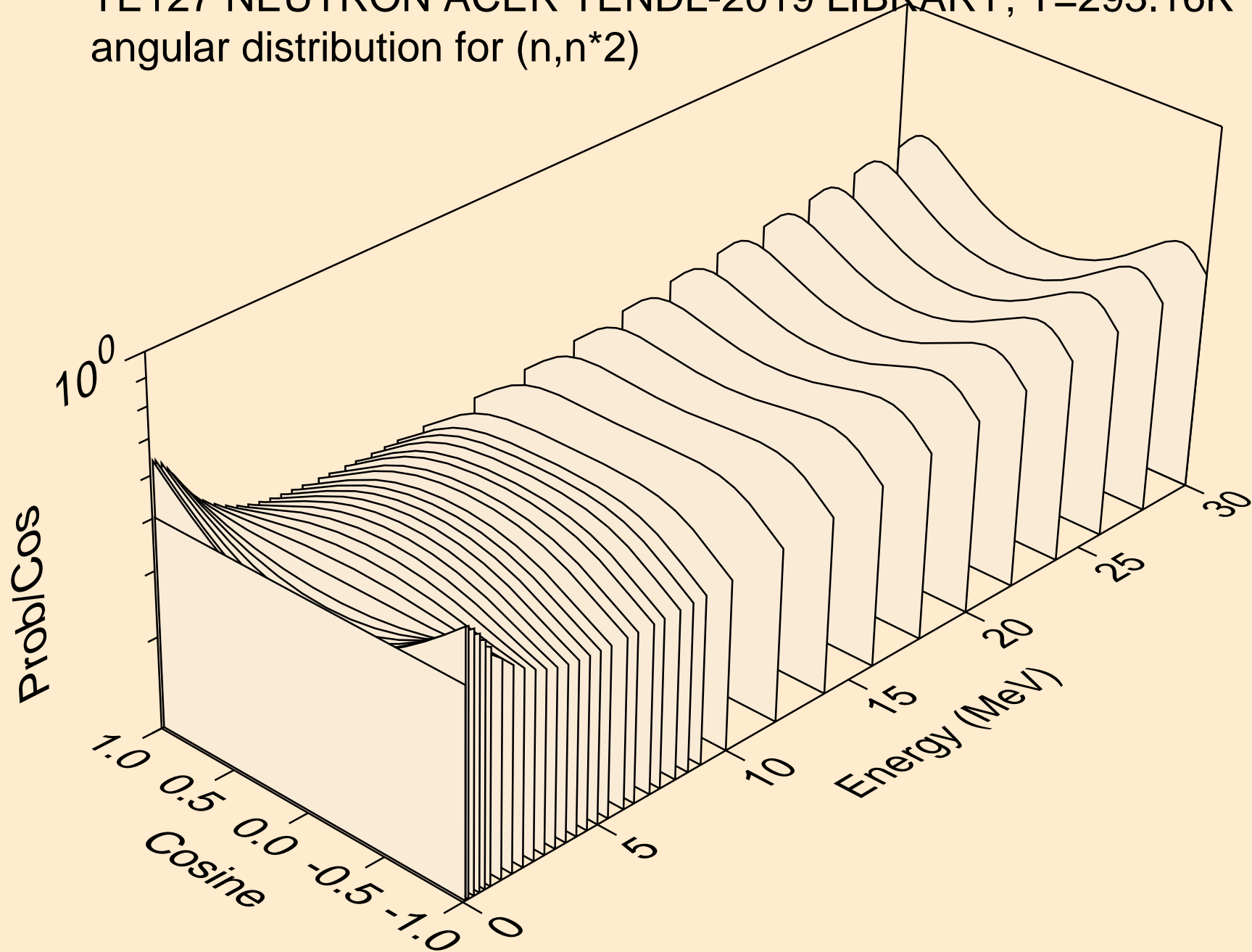

TE127 NEUTRON ACER TENDL-2019 LIBRARY; T=293.16K
angular distribution for (n,n*3)

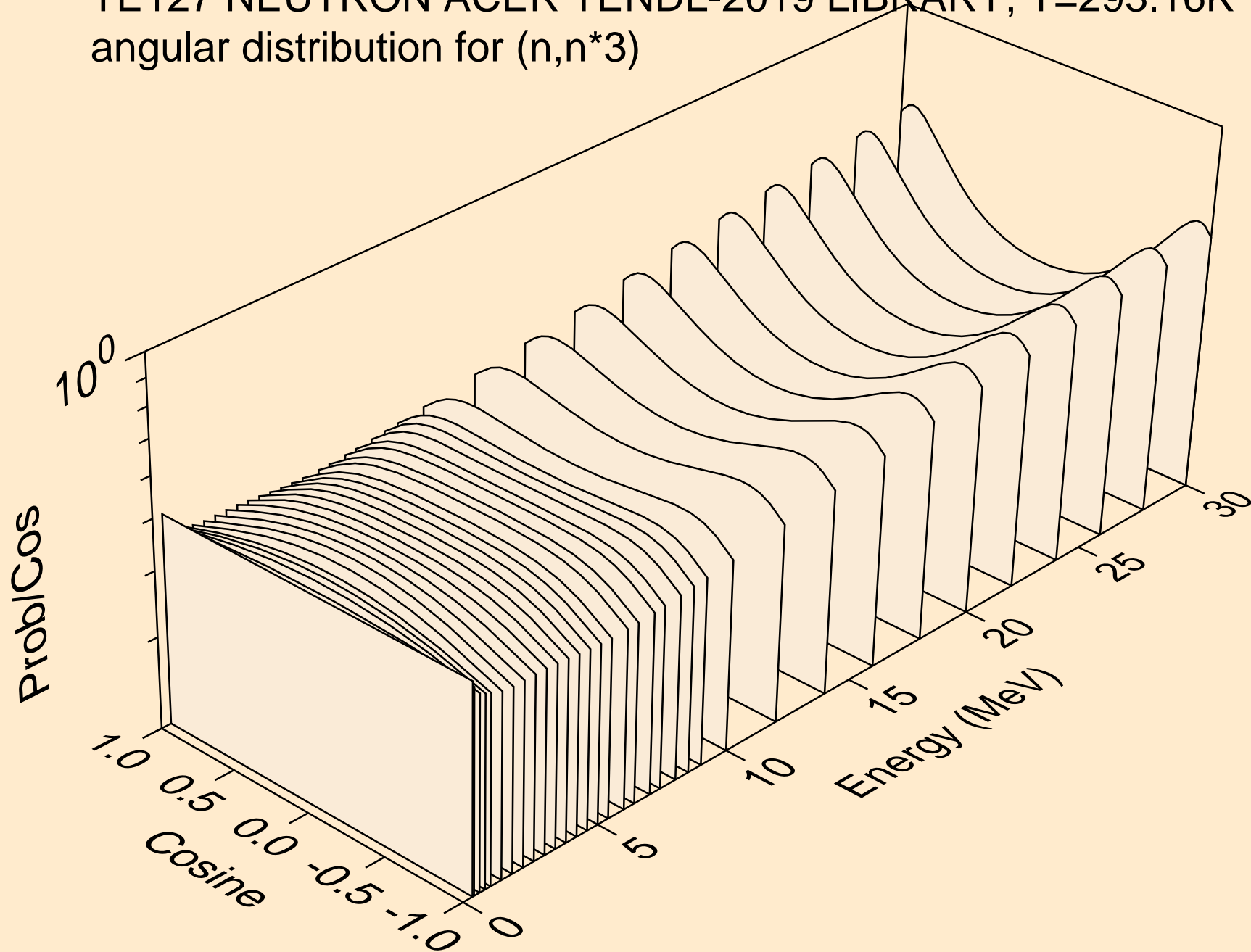

TE127 NEUTRON ACER TENDL-2019 LIBRARY; T=293.16K
angular distribution for (n,n*4)

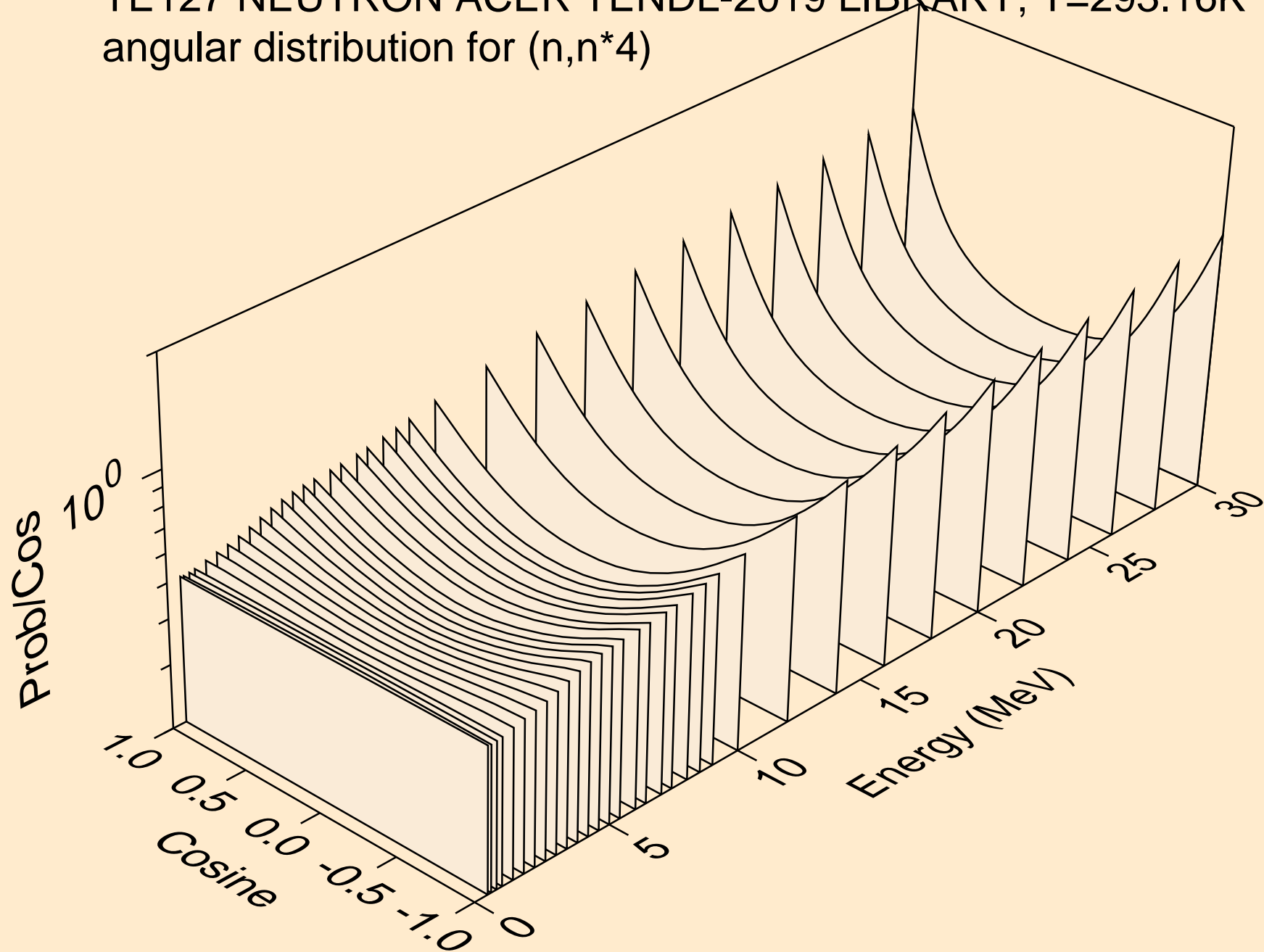

TE127 NEUTRON ACER TENDL-2019 LIBRARY; T=293.16K
angular distribution for (n,n*5)

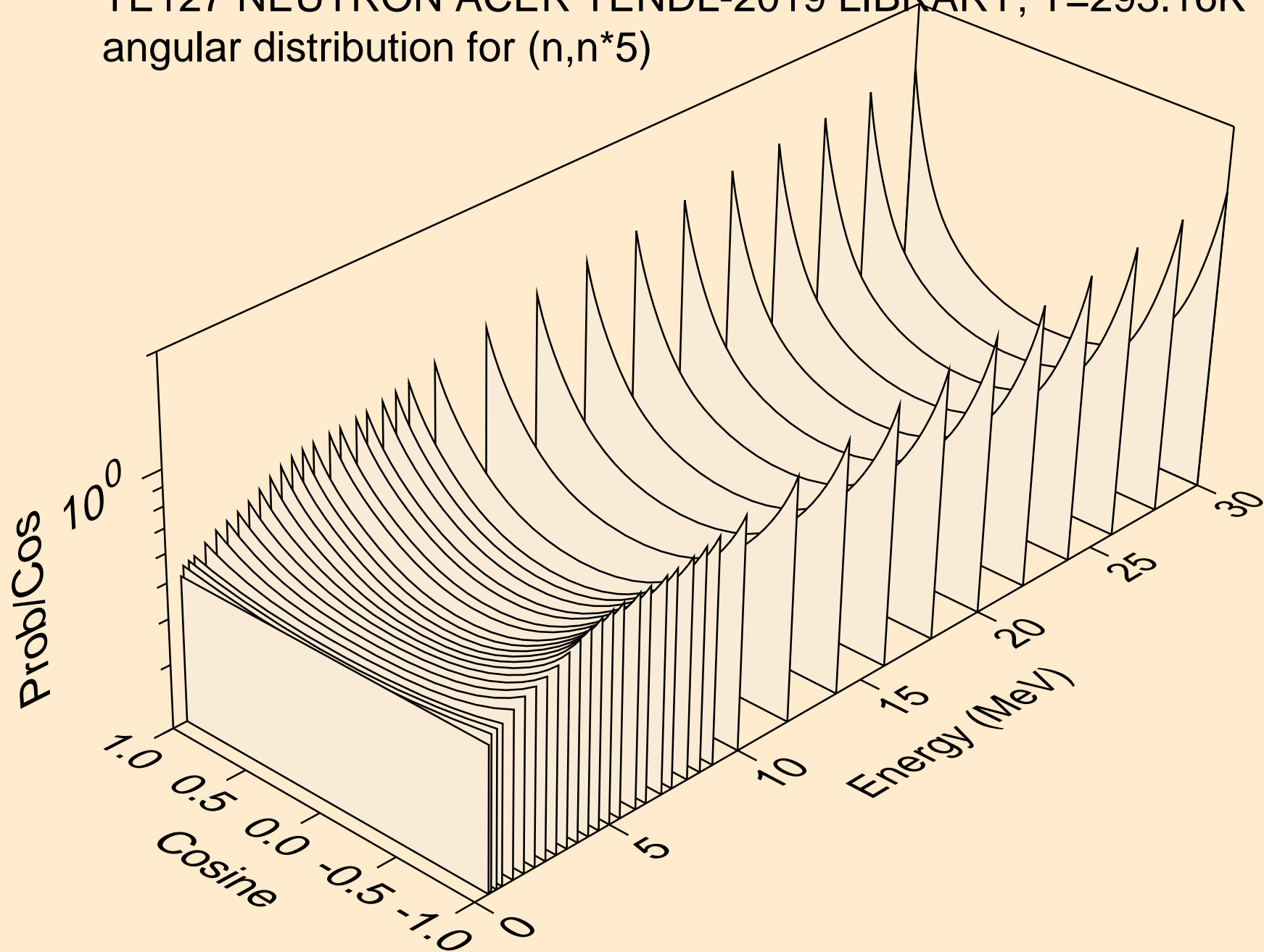

TE127 NEUTRON ACER TENDL-2019 LIBRARY; T=293.16K
angular distribution for (n,n*6)

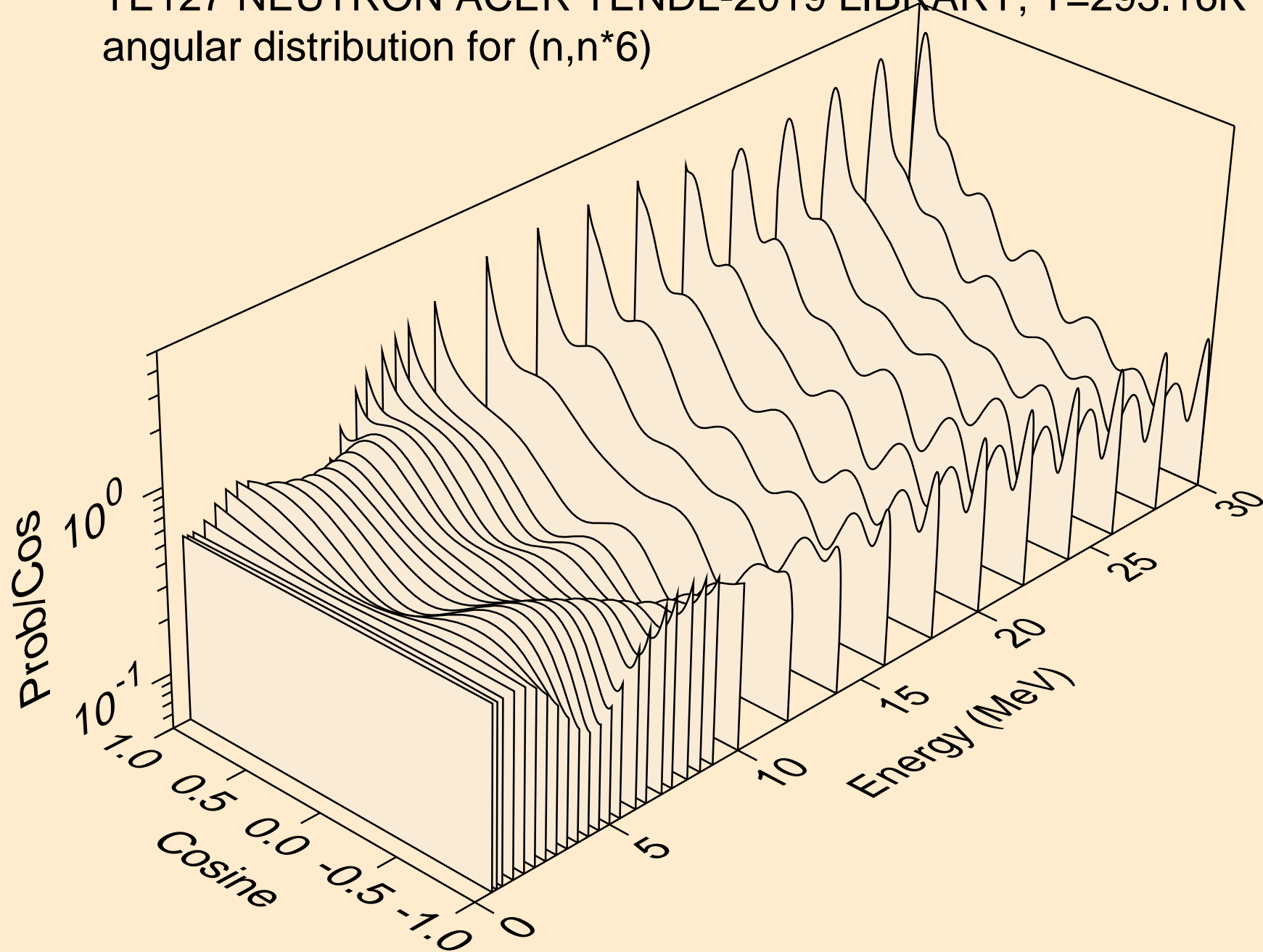

TE127 NEUTRON ACER TENDL-2019 LIBRARY; T=293.16K
angular distribution for (n,n*7)

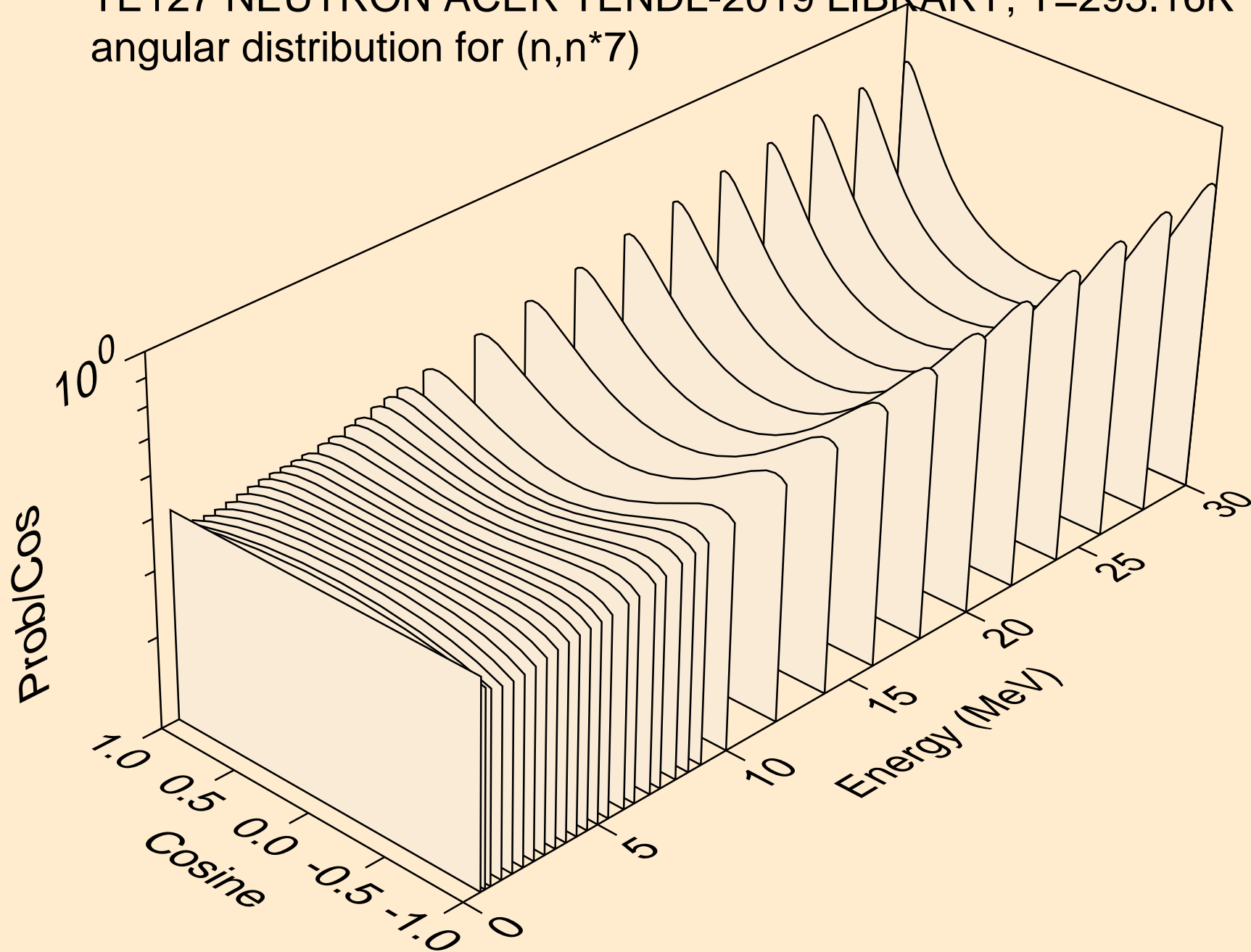

TE127 NEUTRON ACER TENDL-2019 LIBRARY; T=293.16K
angular distribution for (n,n*8)

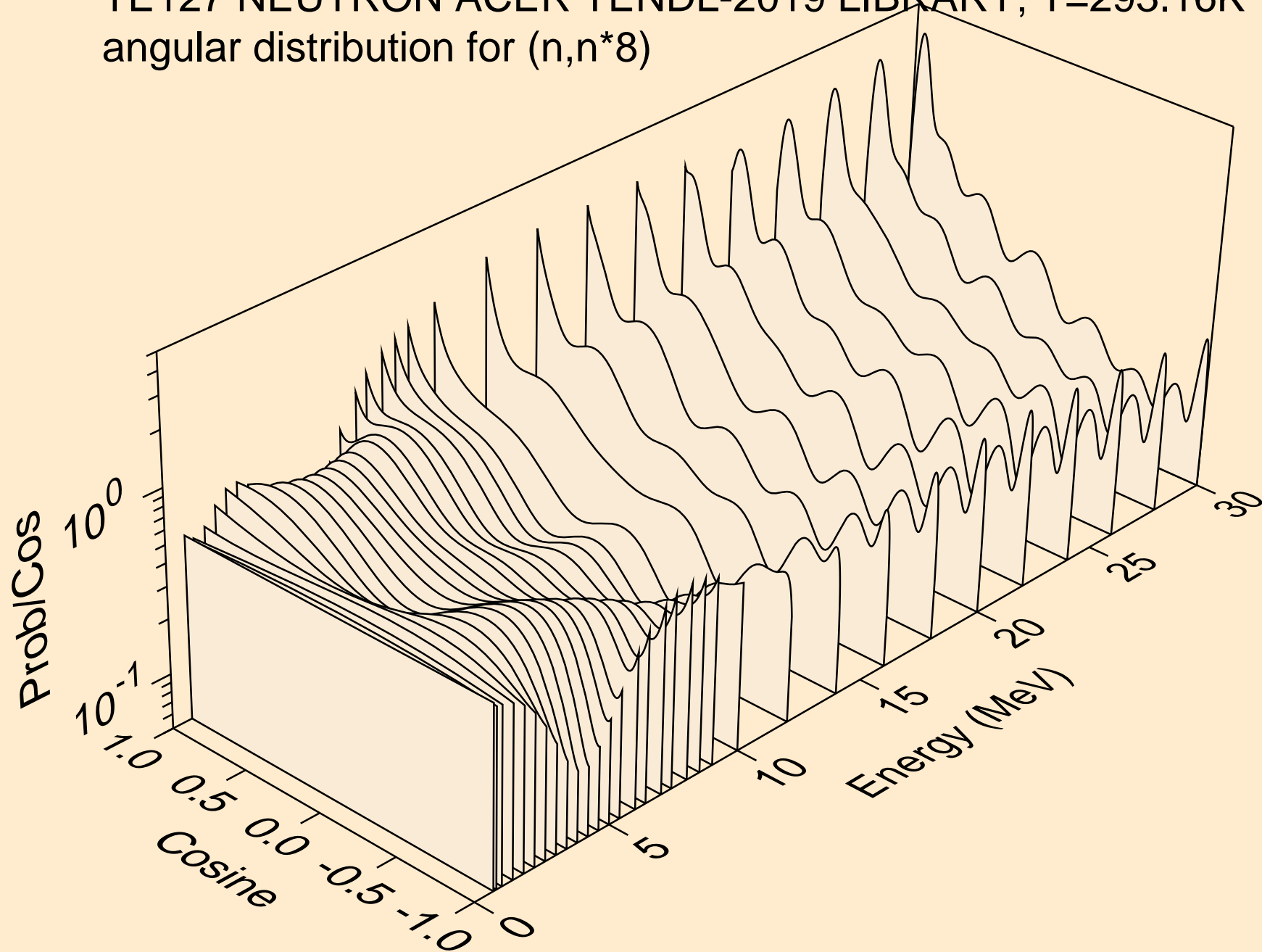

TE127 NEUTRON ACER TENDL-2019 LIBRARY; T=293.16K
angular distribution for (n,n*9)

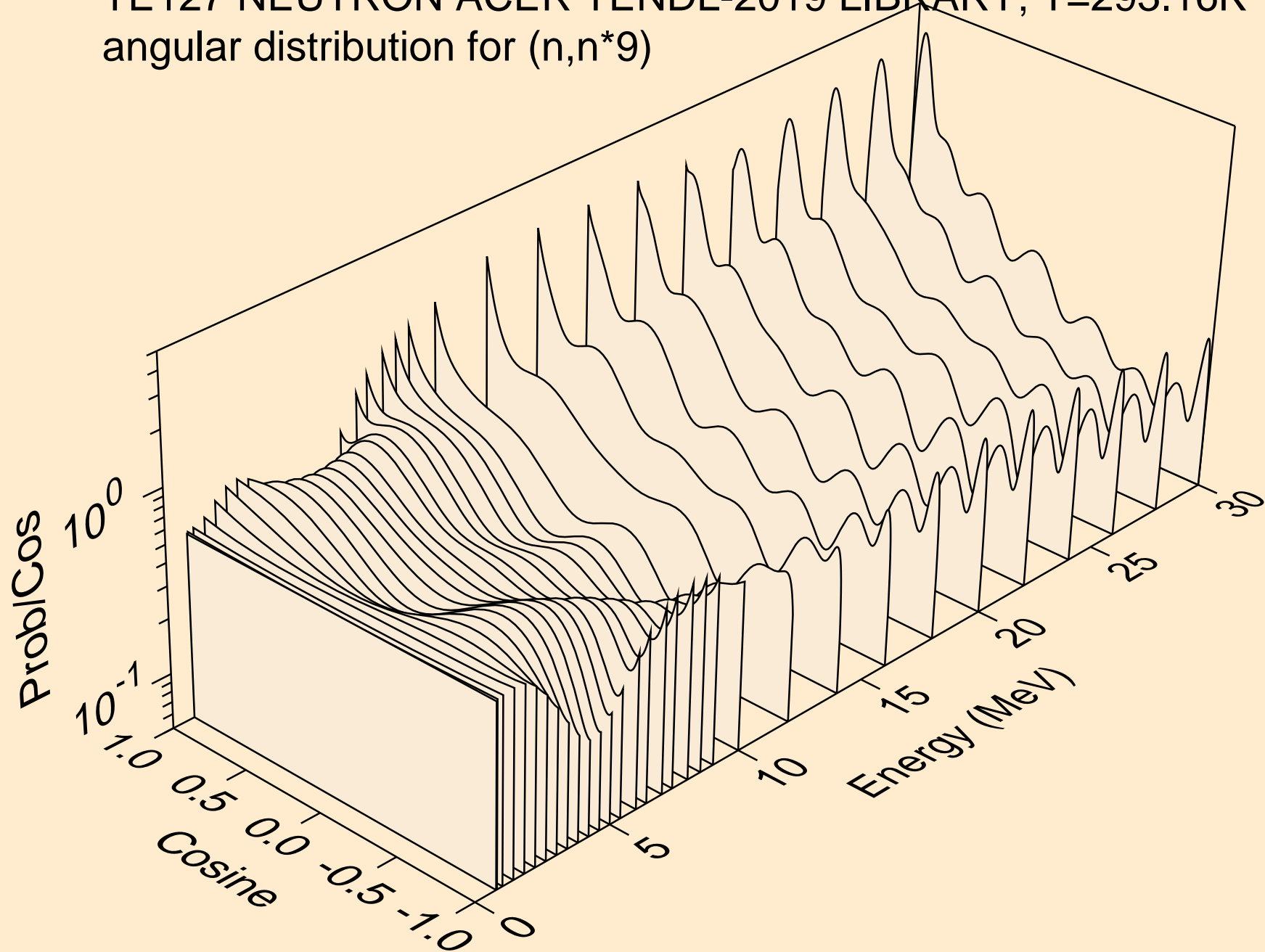

TE127 NEUTRON ACER TENDL-2019 LIBRARY; T=293.16K
angular distribution for (n,n*10)

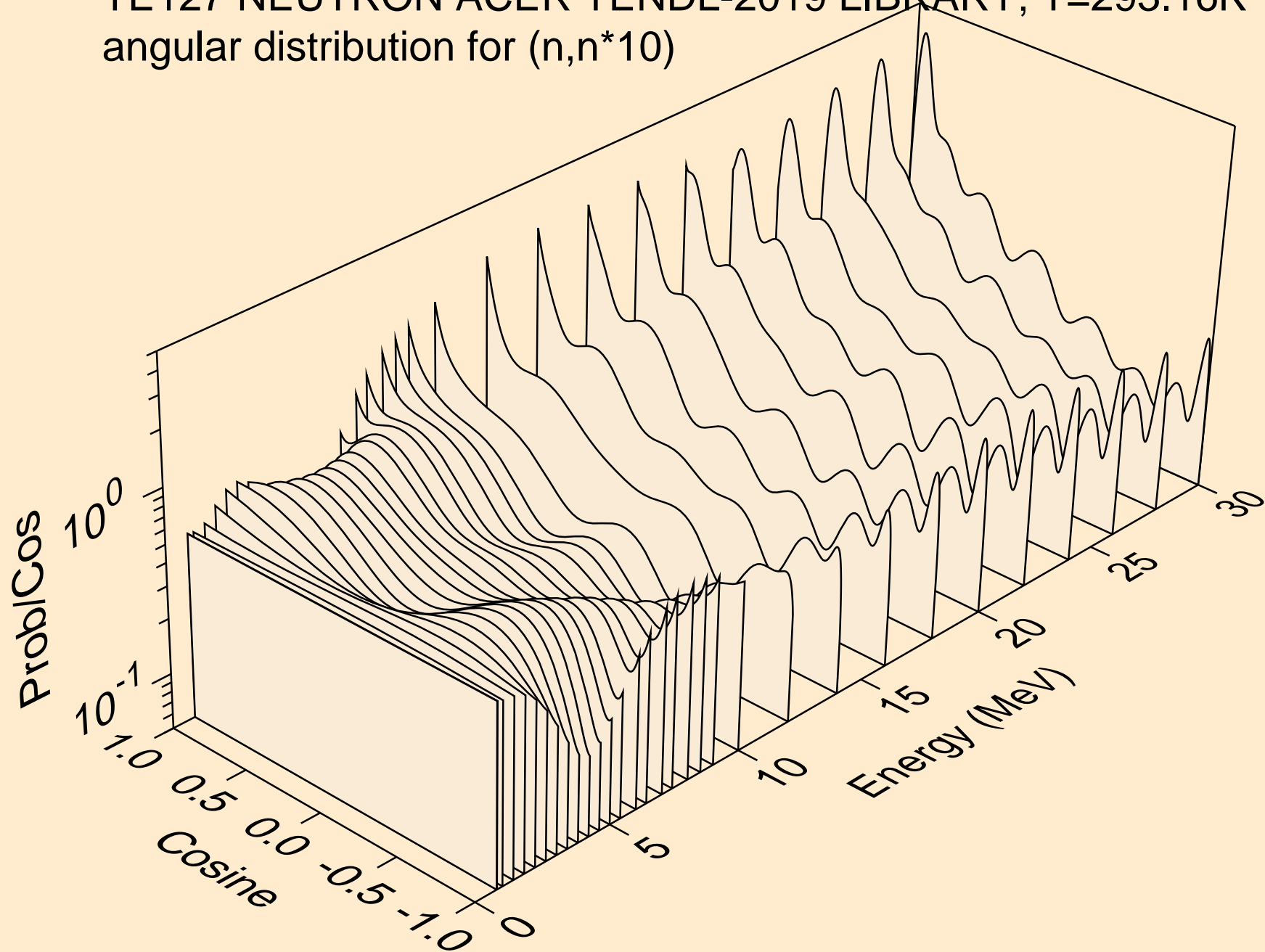

TE127 NEUTRON ACER TENDL-2019 LIBRARY; T=293.16K
angular distribution for (n,n*11)

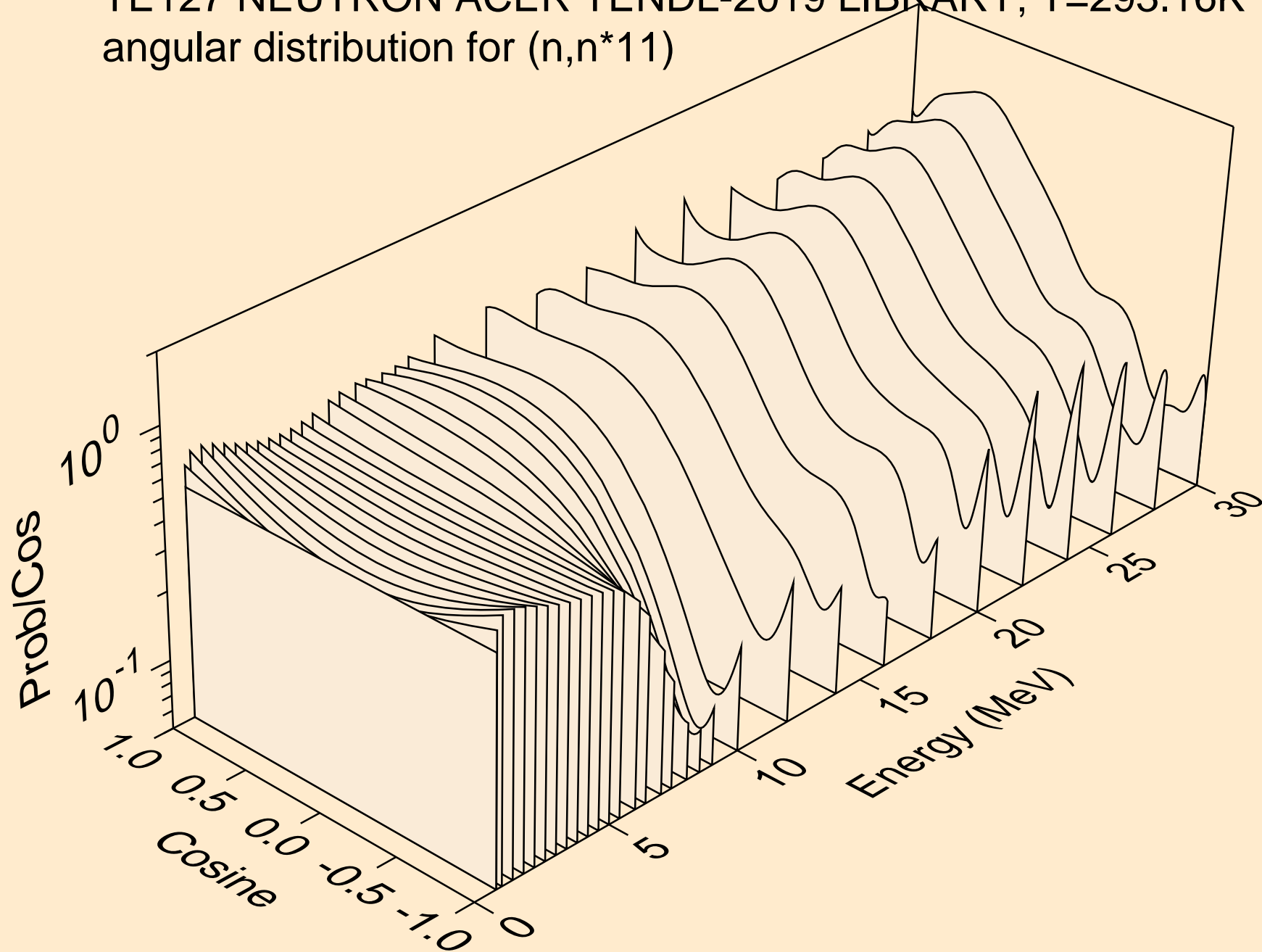

TE127 NEUTRON ACER TENDL-2019 LIBRARY; T=293.16K
angular distribution for (n,n*12)

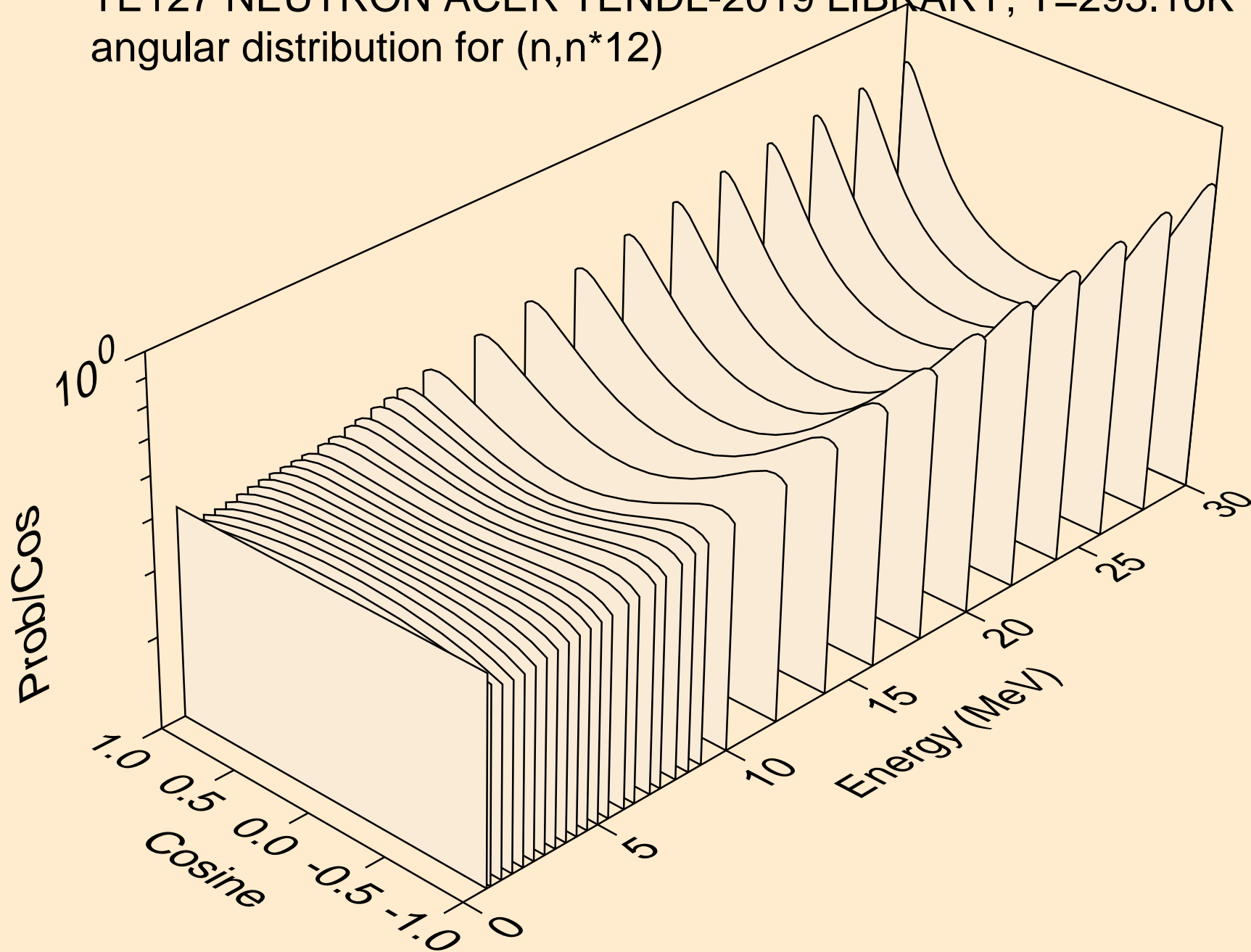

TE127 NEUTRON ACER TENDL-2019 LIBRARY; T=293.16K
angular distribution for (n,n*13)

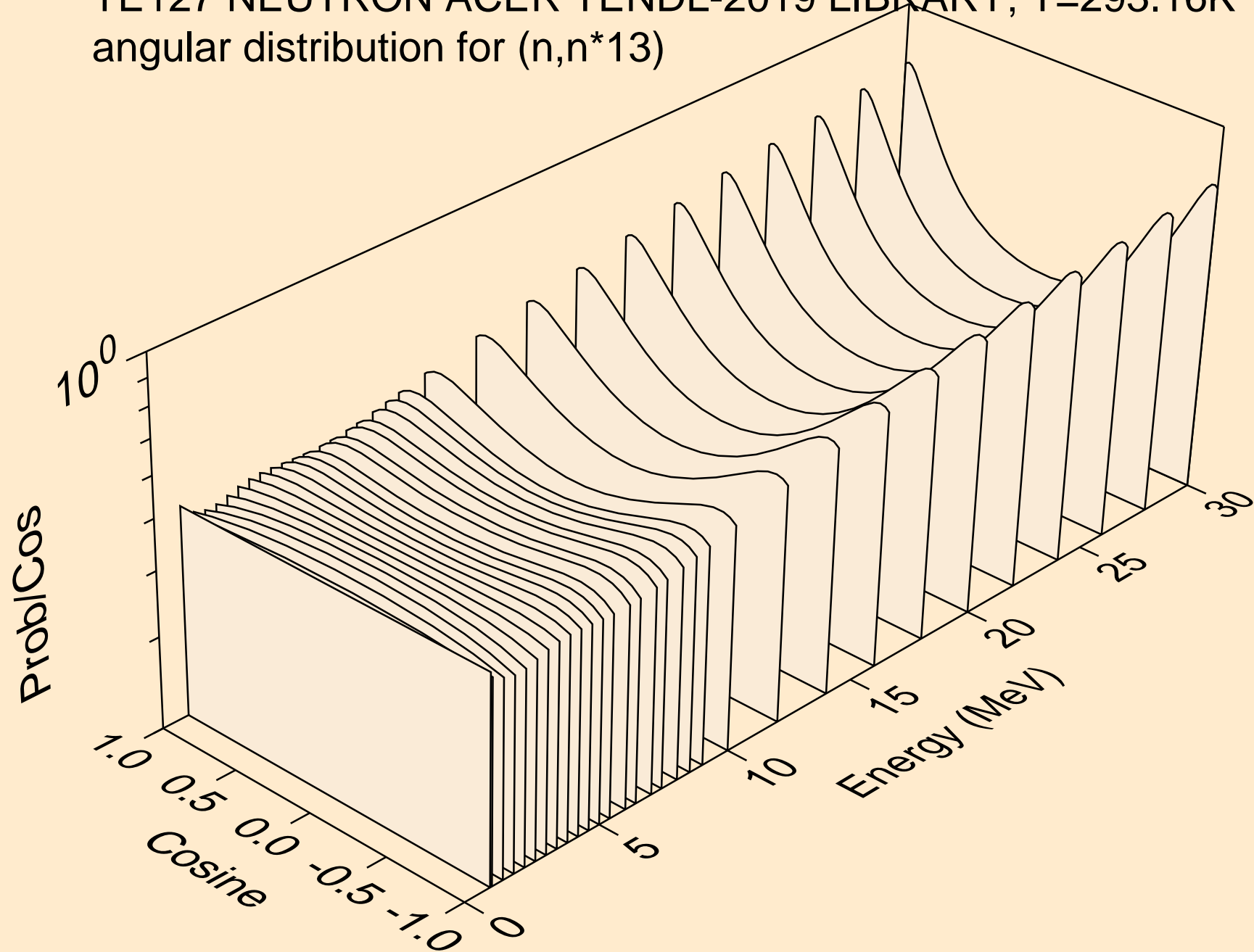

TE127 NEUTRON ACER TENDL-2019 LIBRARY; T=293.16K
angular distribution for (n,n*14)

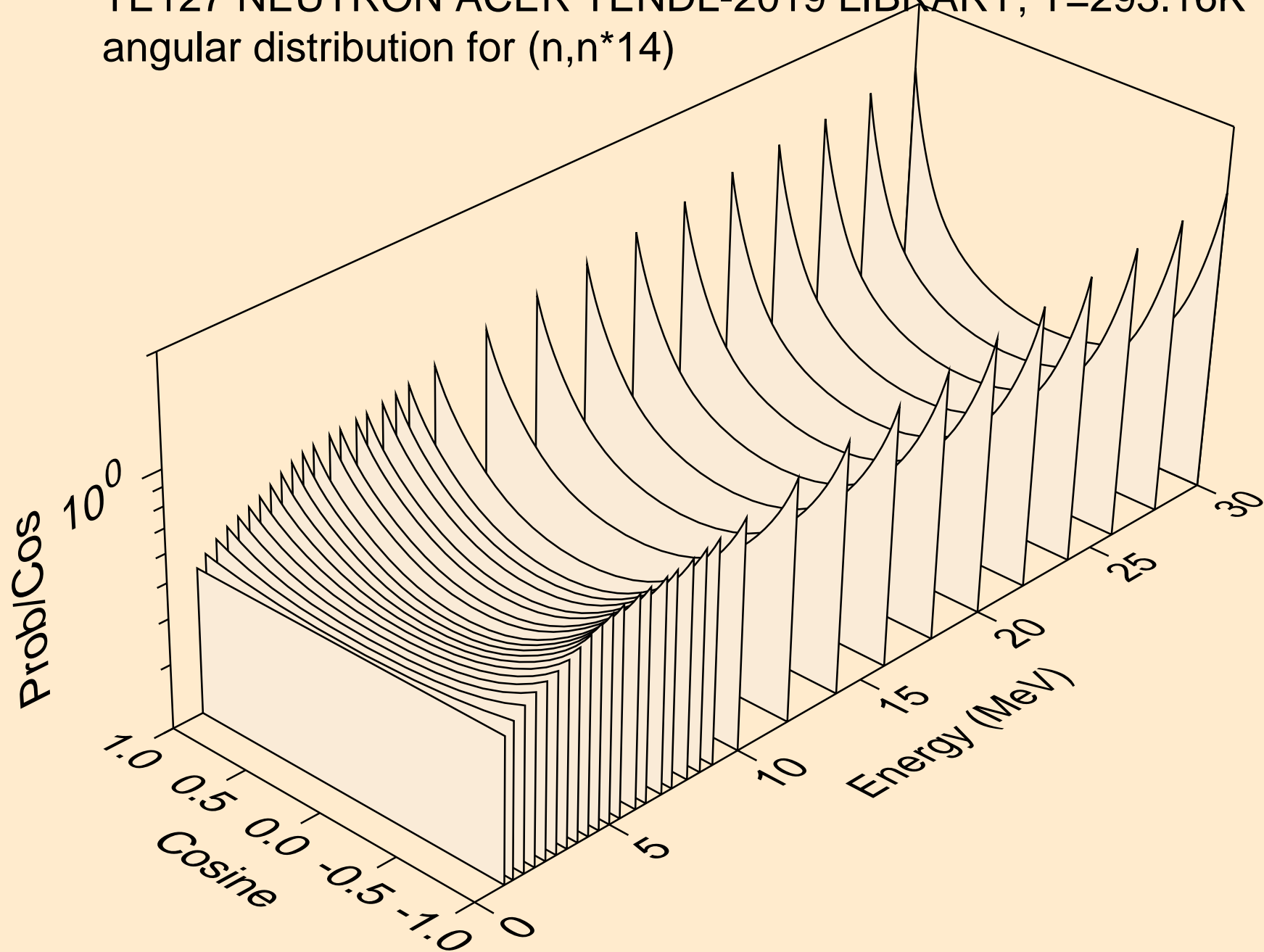

TE127 NEUTRON ACER TENDL-2019 LIBRARY; T=293.16K
angular distribution for (n,n*15)

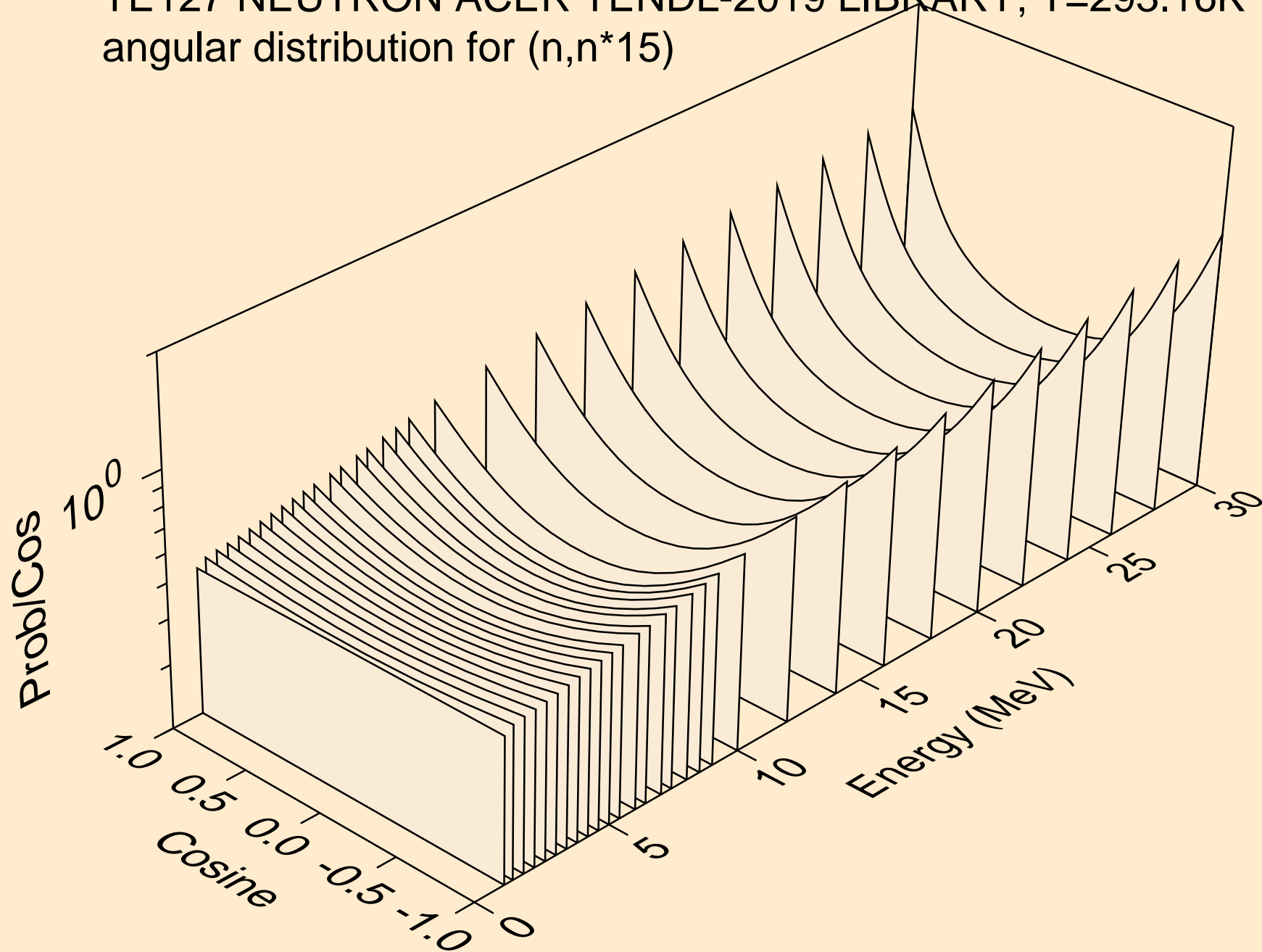

TE127 NEUTRON ACER TENDL-2019 LIBRARY; T=293.16K
angular distribution for (n,n*16)

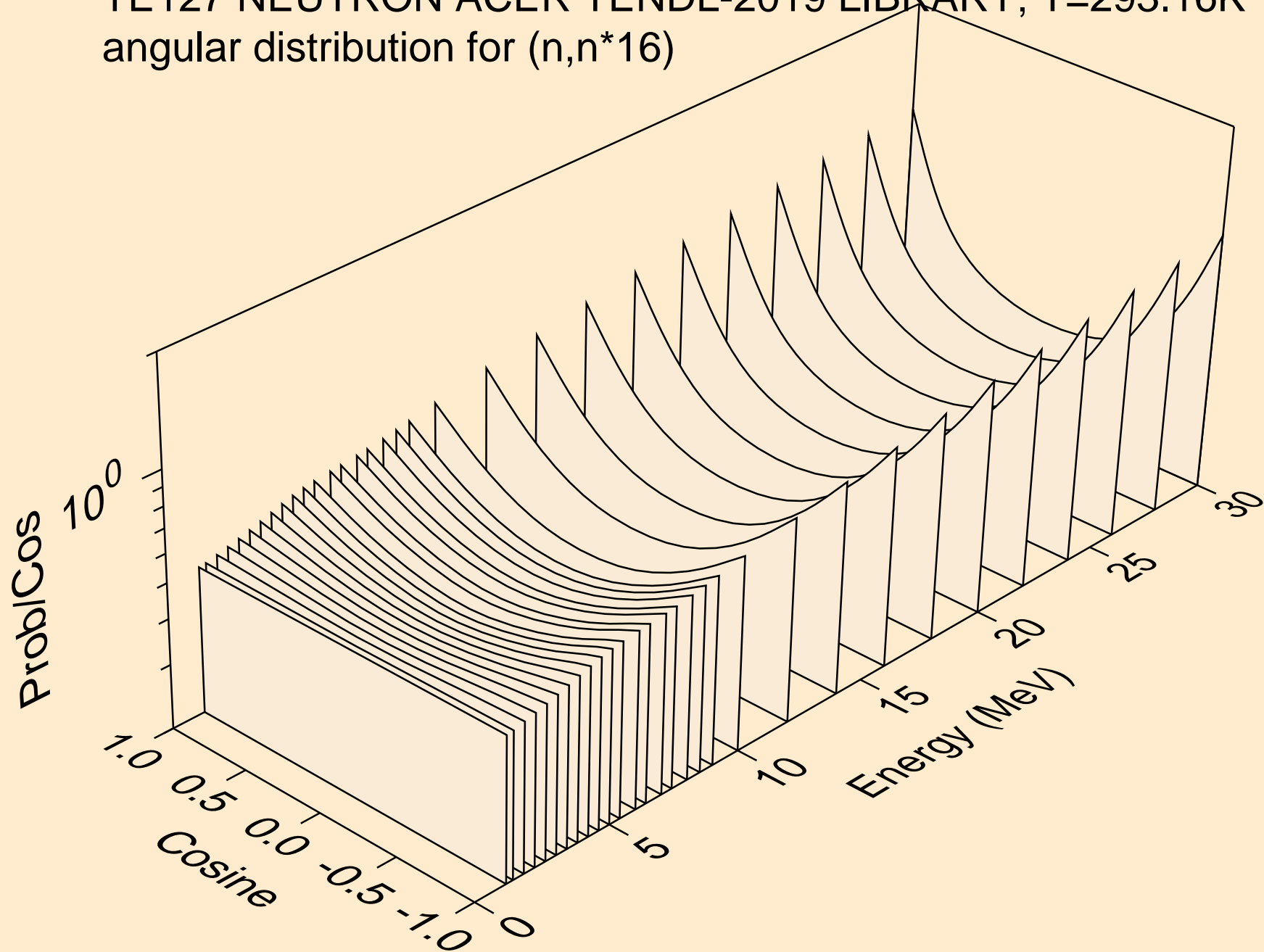

TE127 NEUTRON ACER TENDL-2019 LIBRARY; T=293.16K
angular distribution for (n,n*17)

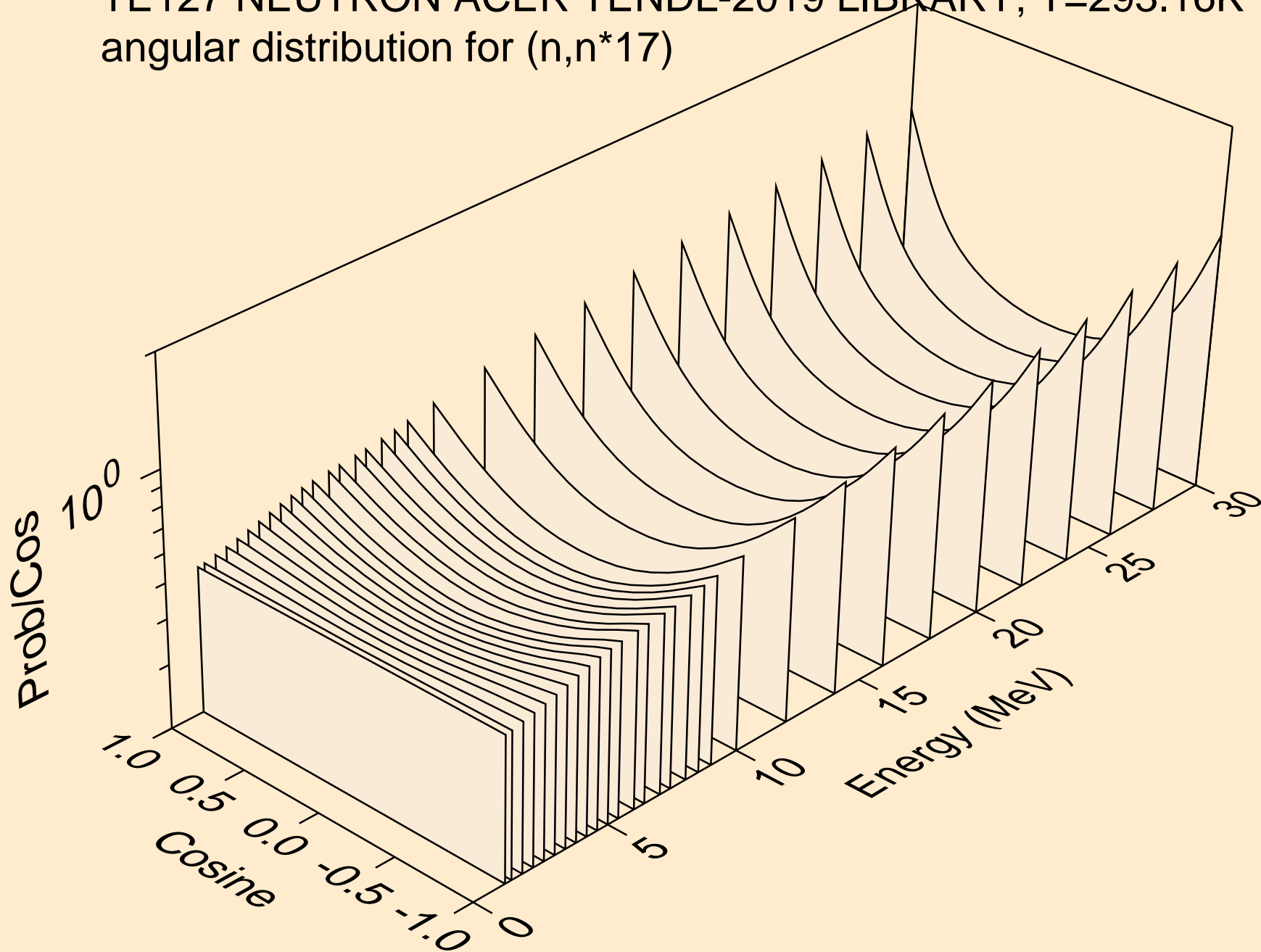

TE127 NEUTRON ACER TENDL-2019 LIBRARY; T=293.16K
angular distribution for (n,n*18)

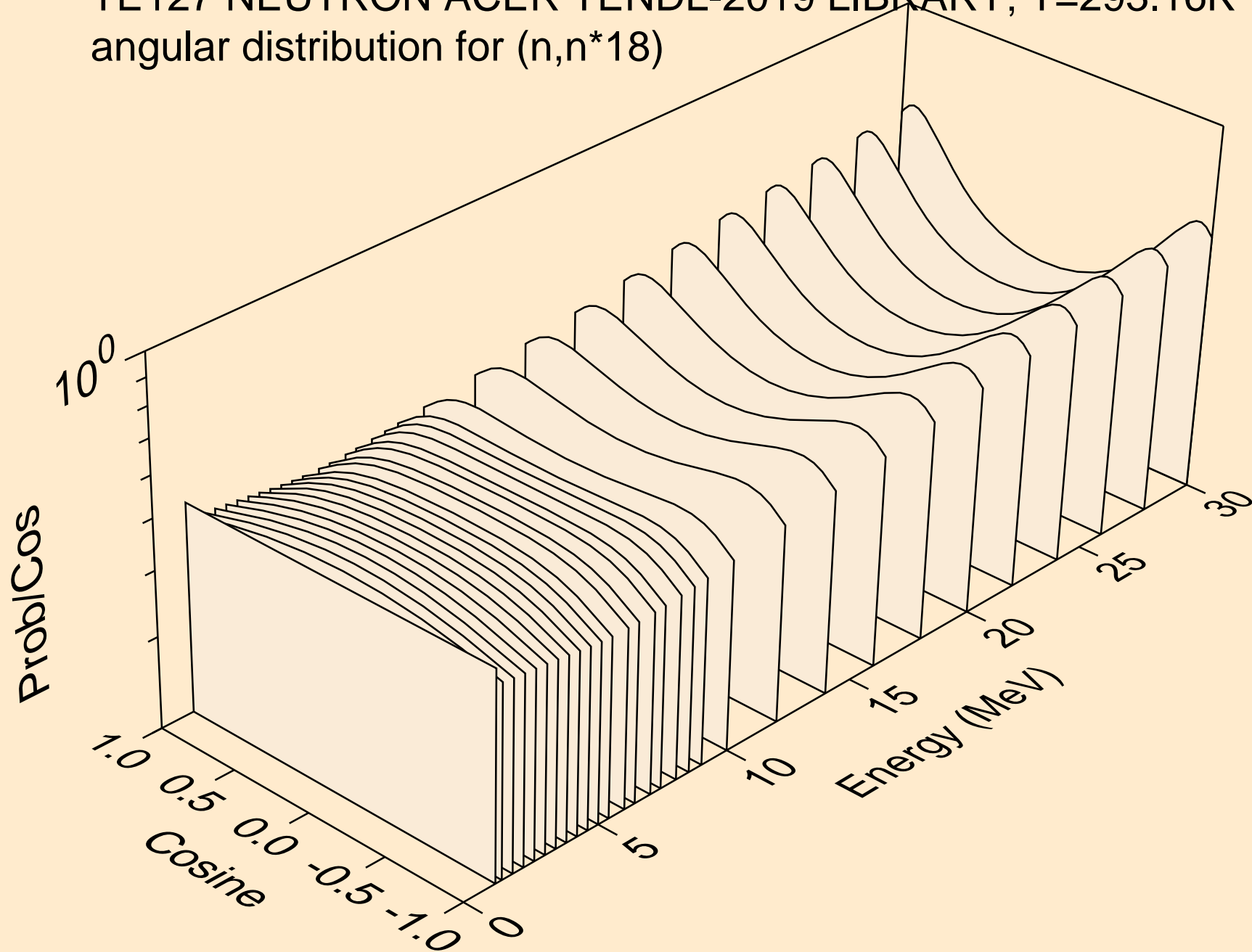

TE127 NEUTRON ACER TENDL-2019 LIBRARY; T=293.16K
angular distribution for (n,n*19)

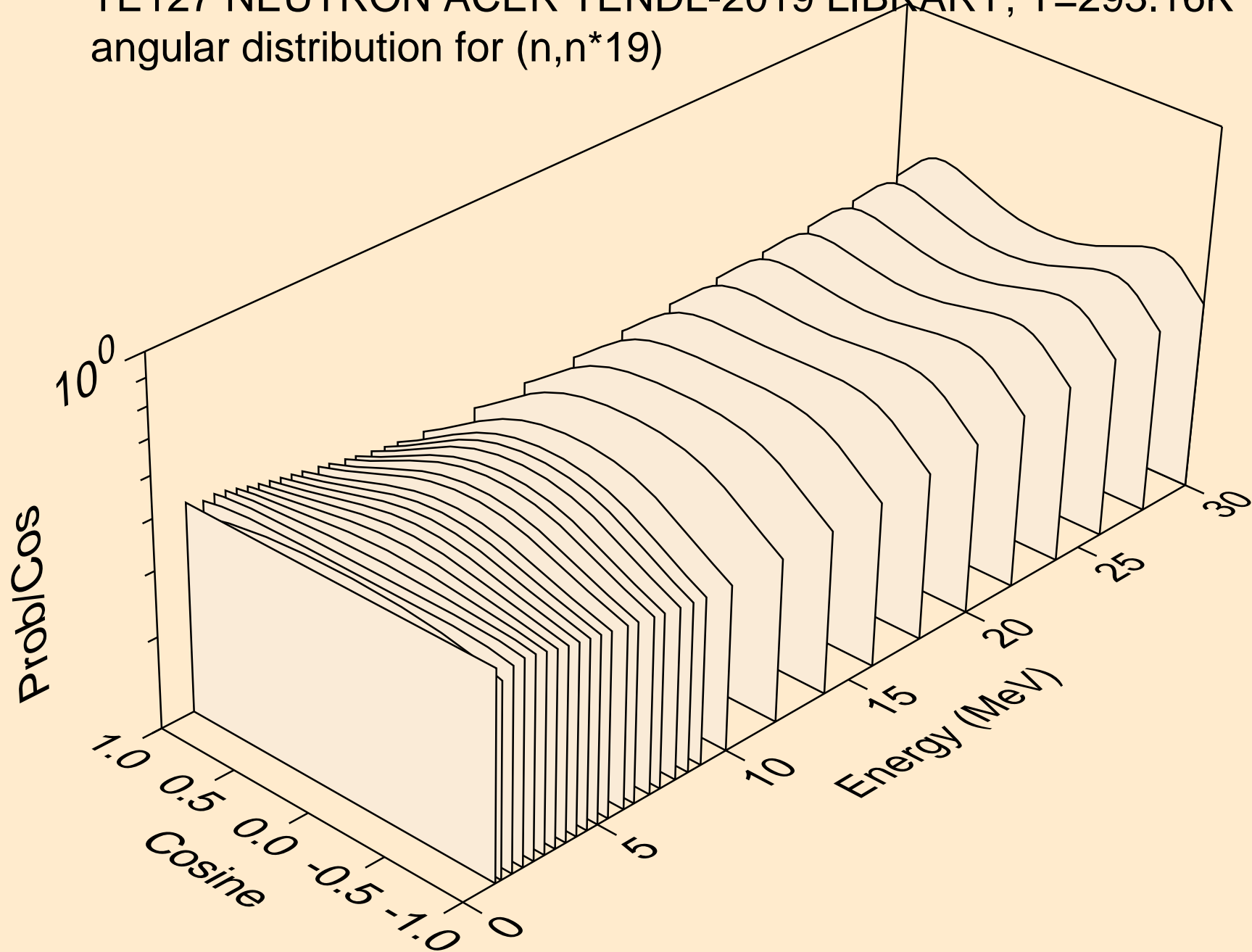

TE127 NEUTRON ACER TENDL-2019 LIBRARY; T=293.16K
angular distribution for (n,n*20)

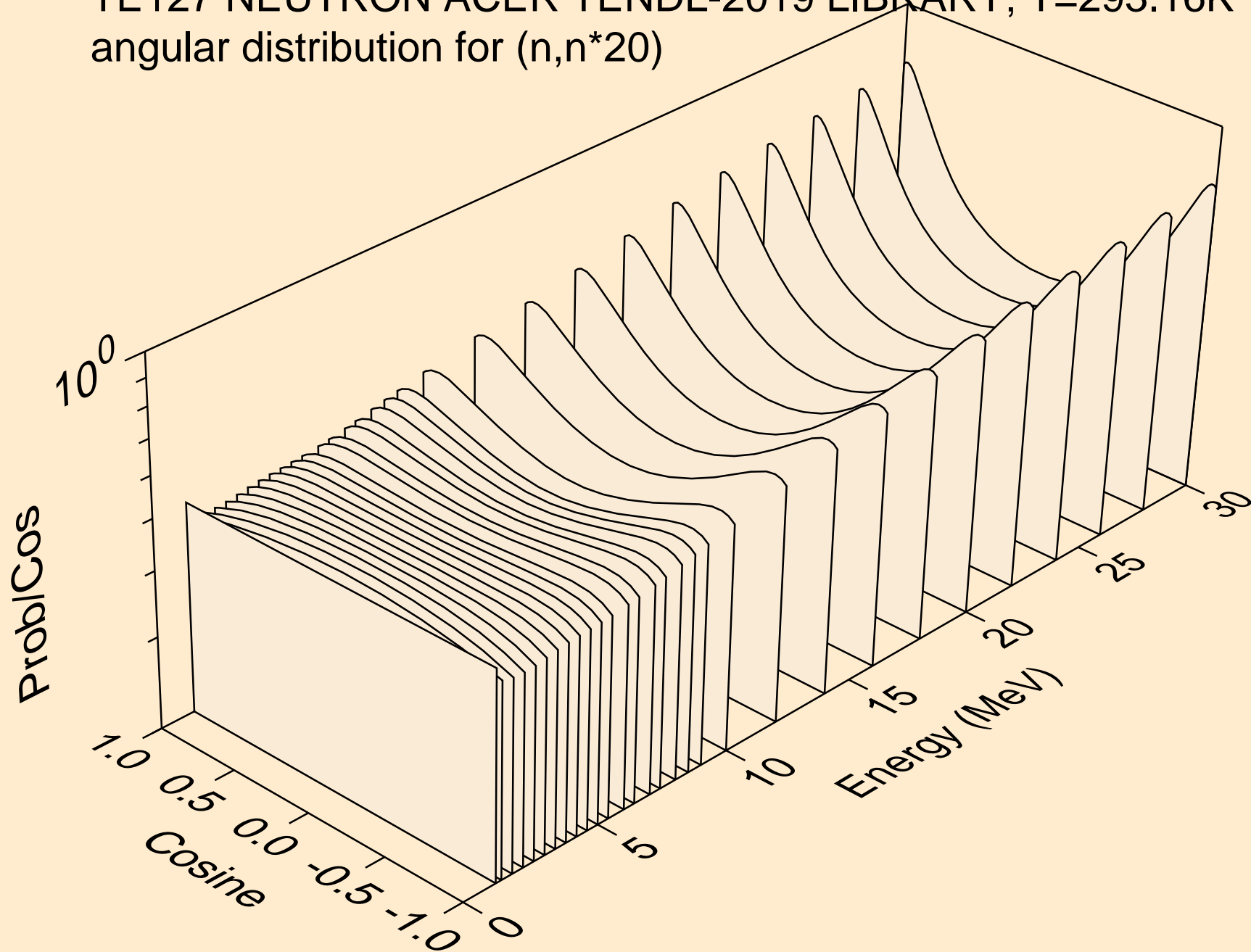

TE127 NEUTRON ACER TENDL-2019 LIBRARY; T=293.16K
angular distribution for (n,n*21)

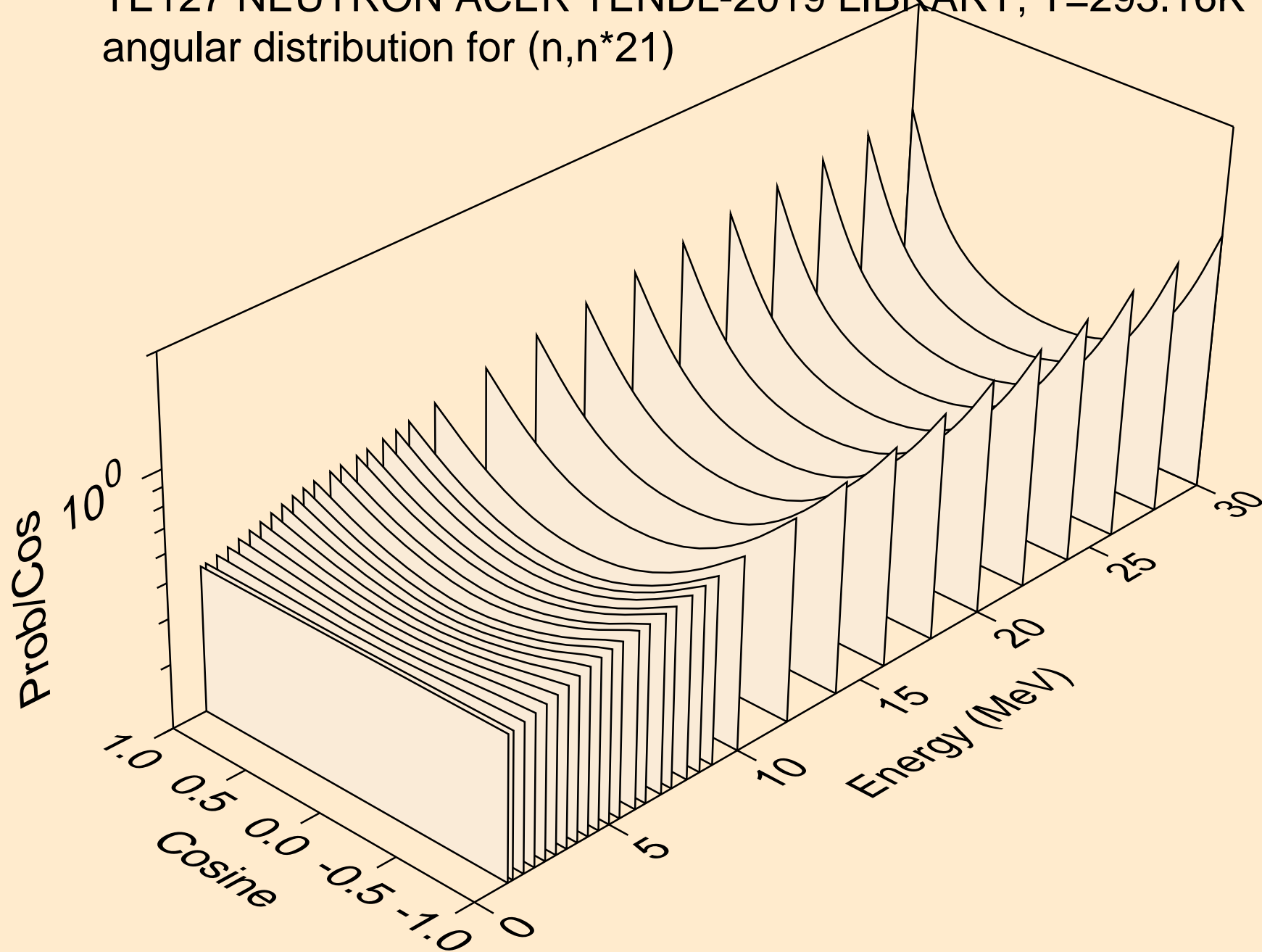

TE127 NEUTRON ACER TENDL-2019 LIBRARY; T=293.16K
angular distribution for (n,n*22)

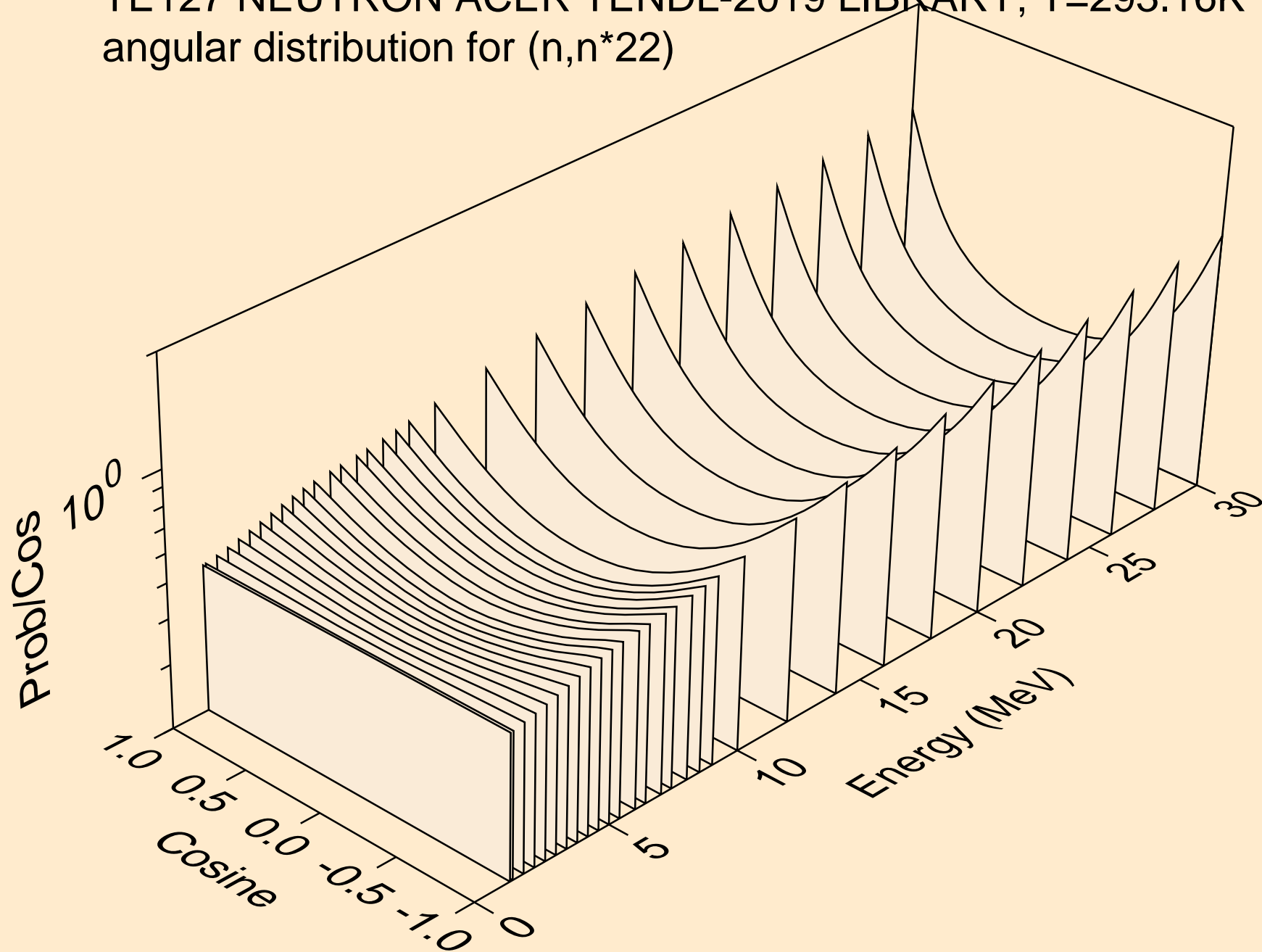

TE127 NEUTRON ACER TENDL-2019 LIBRARY; T=293.16K
angular distribution for (n,n*23)

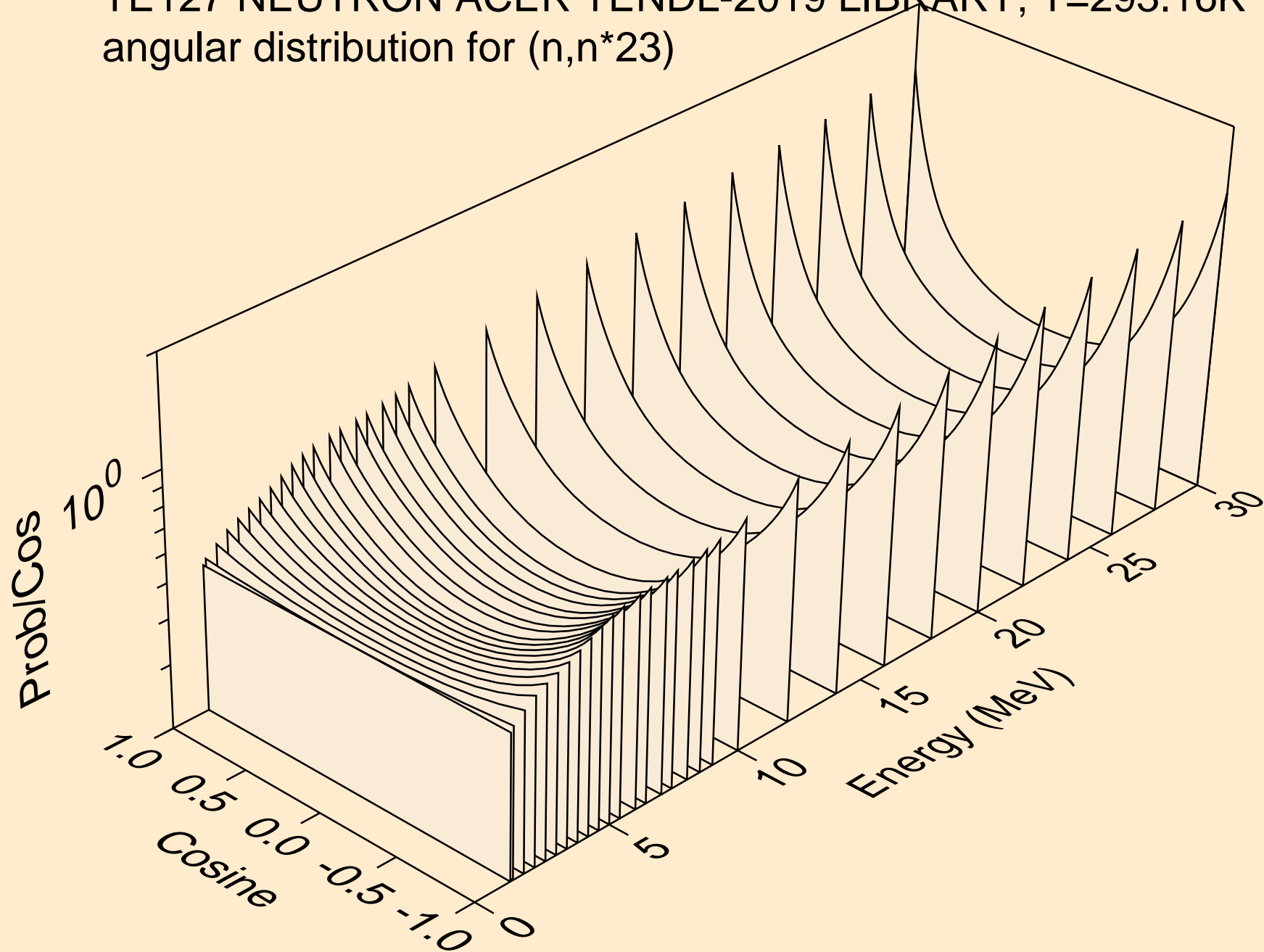

TE127 NEUTRON ACER TENDL-2019 LIBRARY; T=293.16K
angular distribution for (n,n*24)

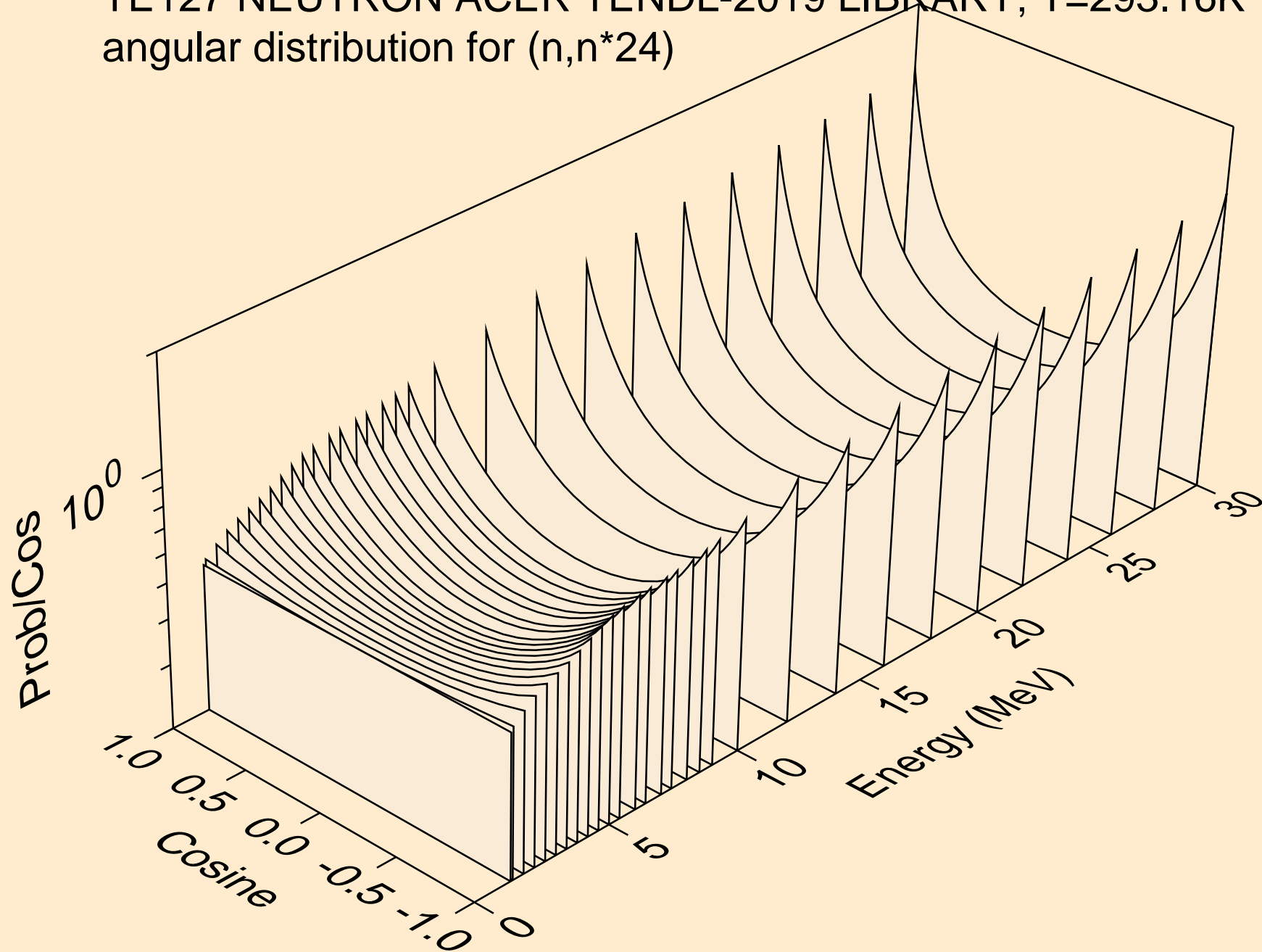

TE127 NEUTRON ACER TENDL-2019 LIBRARY; T=293.16K
angular distribution for (n,n*25)

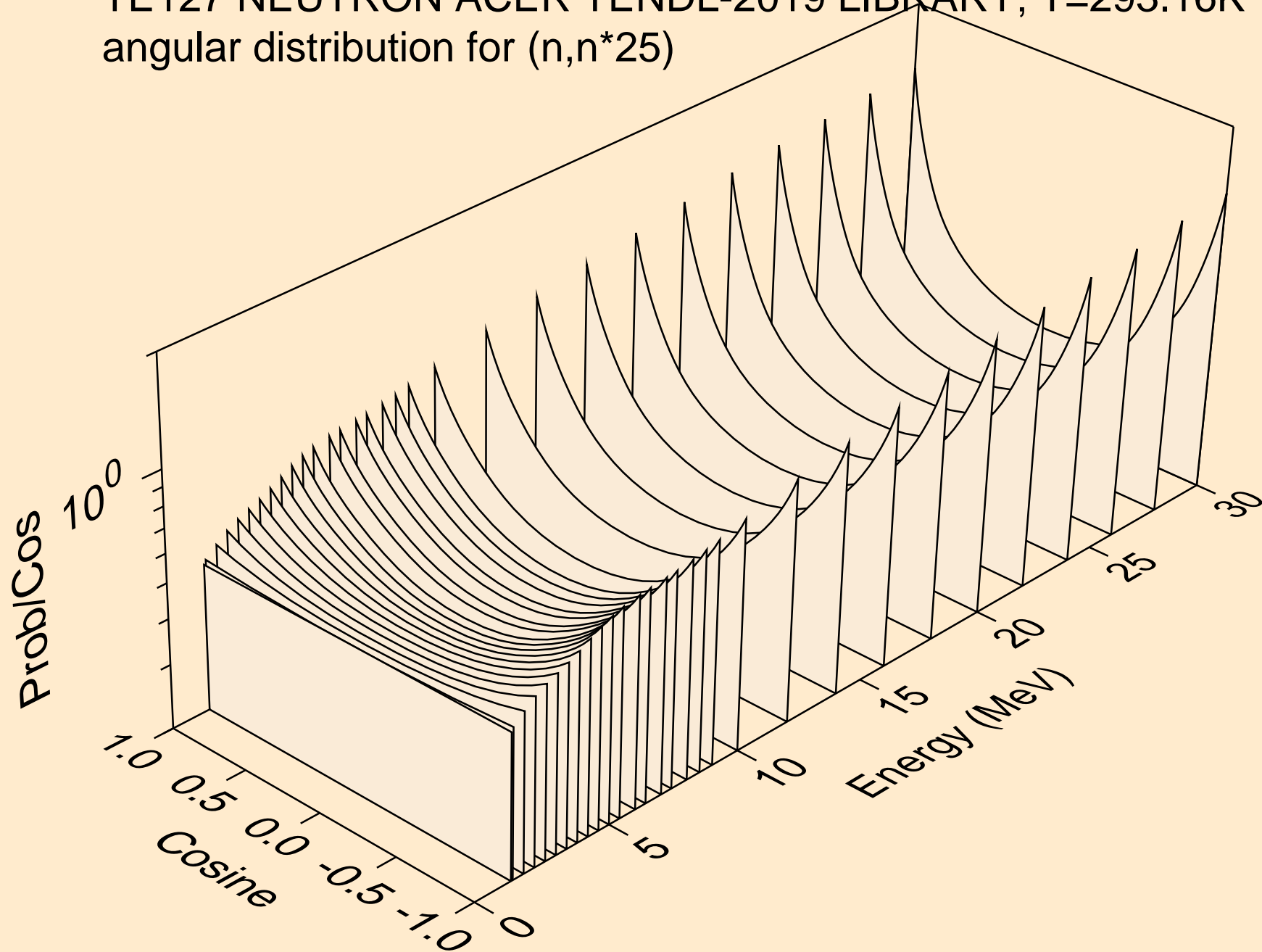

TE127 NEUTRON ACER TENDL-2019 LIBRARY; T=293.16K
angular distribution for (n,n*26)

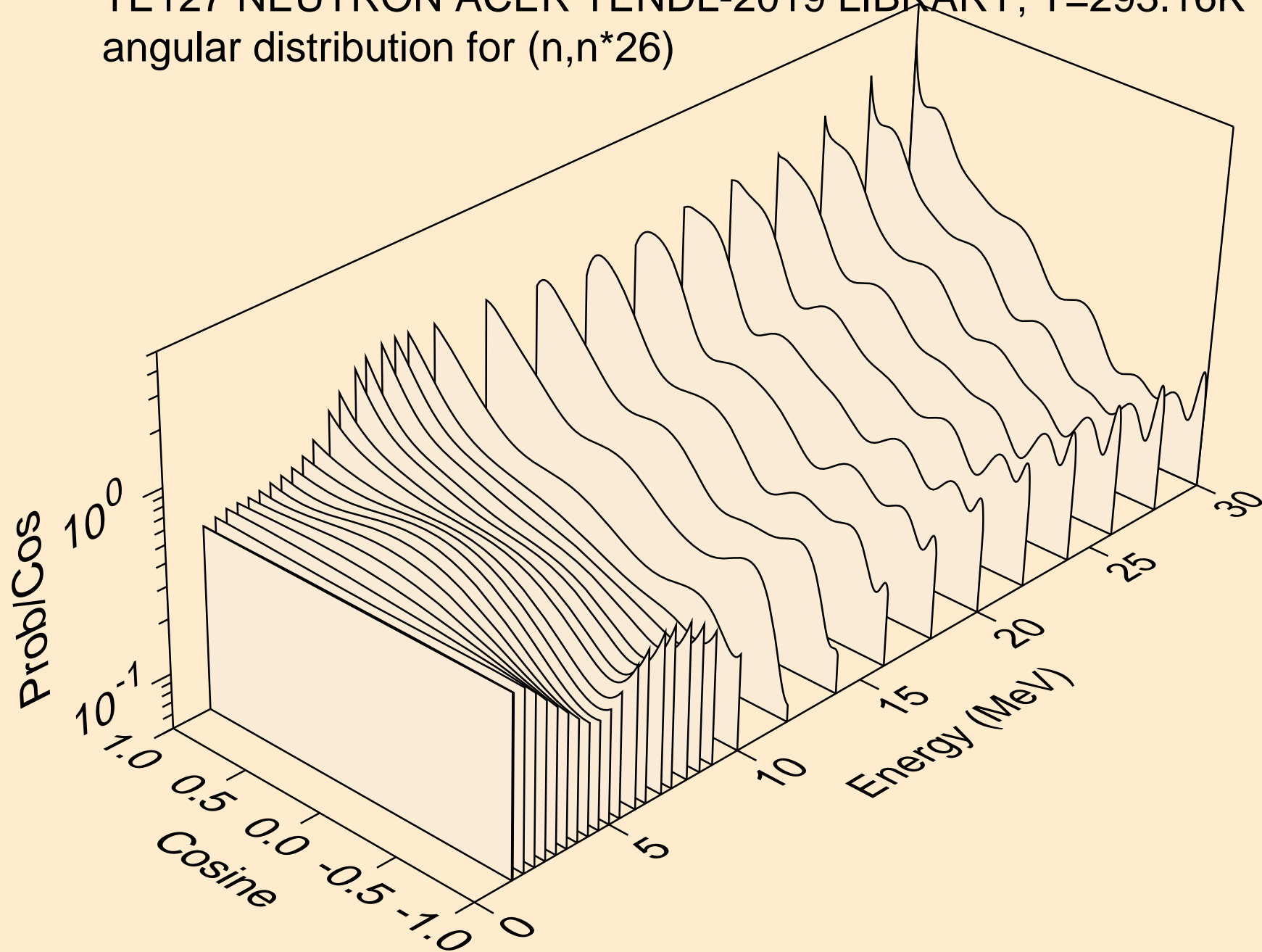

TE127 NEUTRON ACER TENDL-2019 LIBRARY; T=293.16K
angular distribution for (n,n*27)

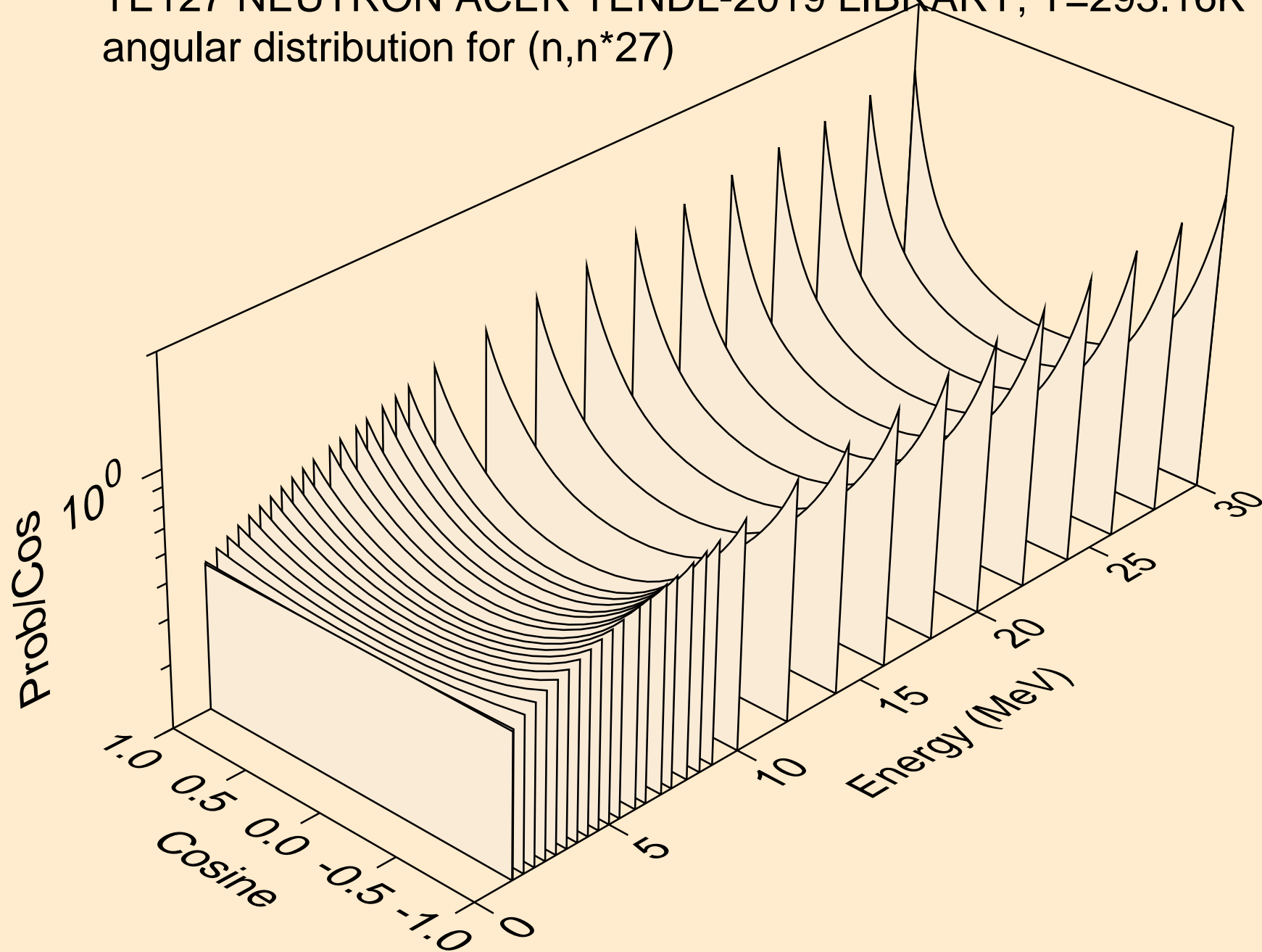

TE127 NEUTRON ACER TENDL-2019 LIBRARY; T=293.16K
angular distribution for (n,n*28)

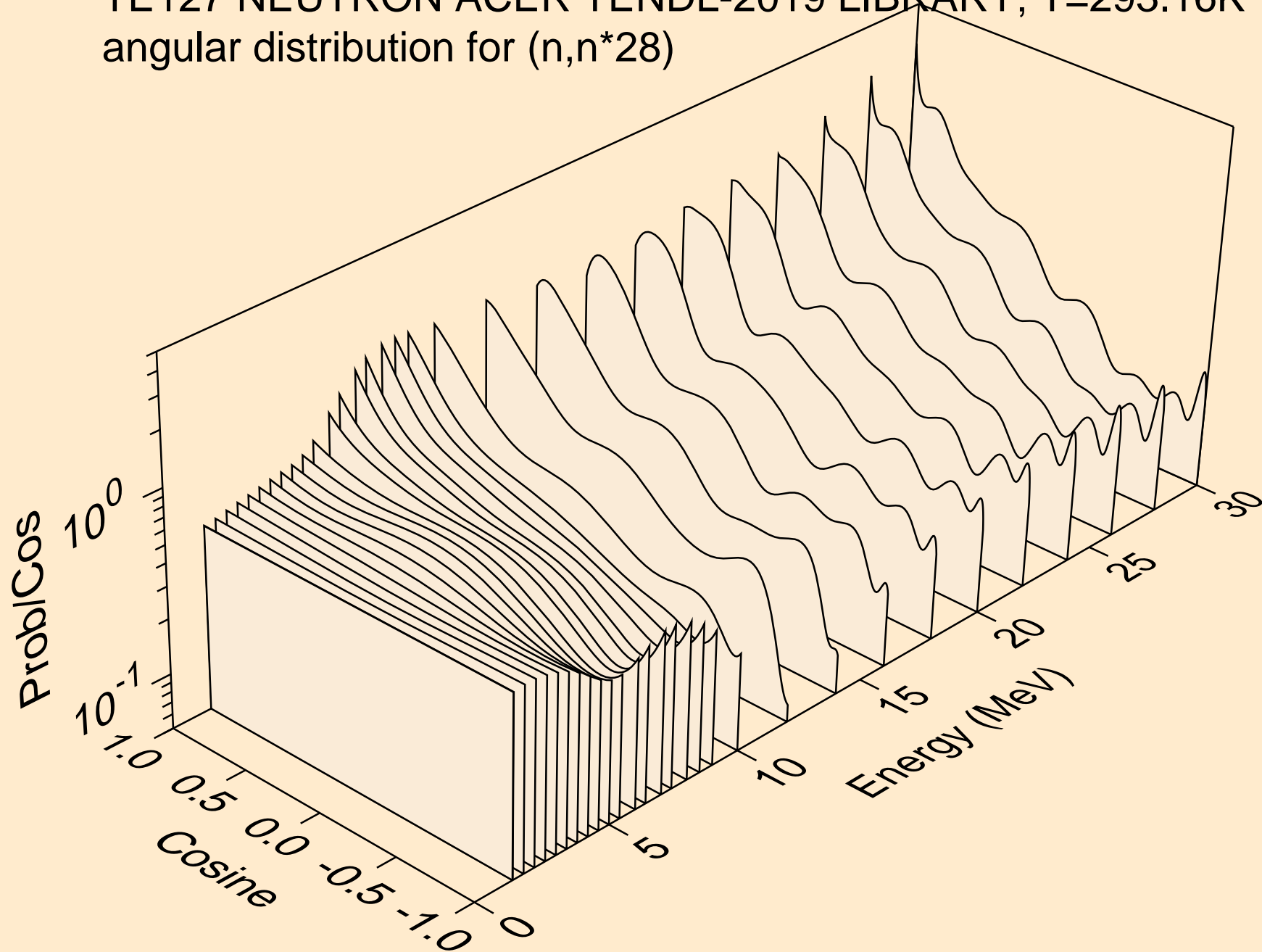

TE127 NEUTRON ACER TENDL-2019 LIBRARY; T=293.16K
angular distribution for (n,n*29)

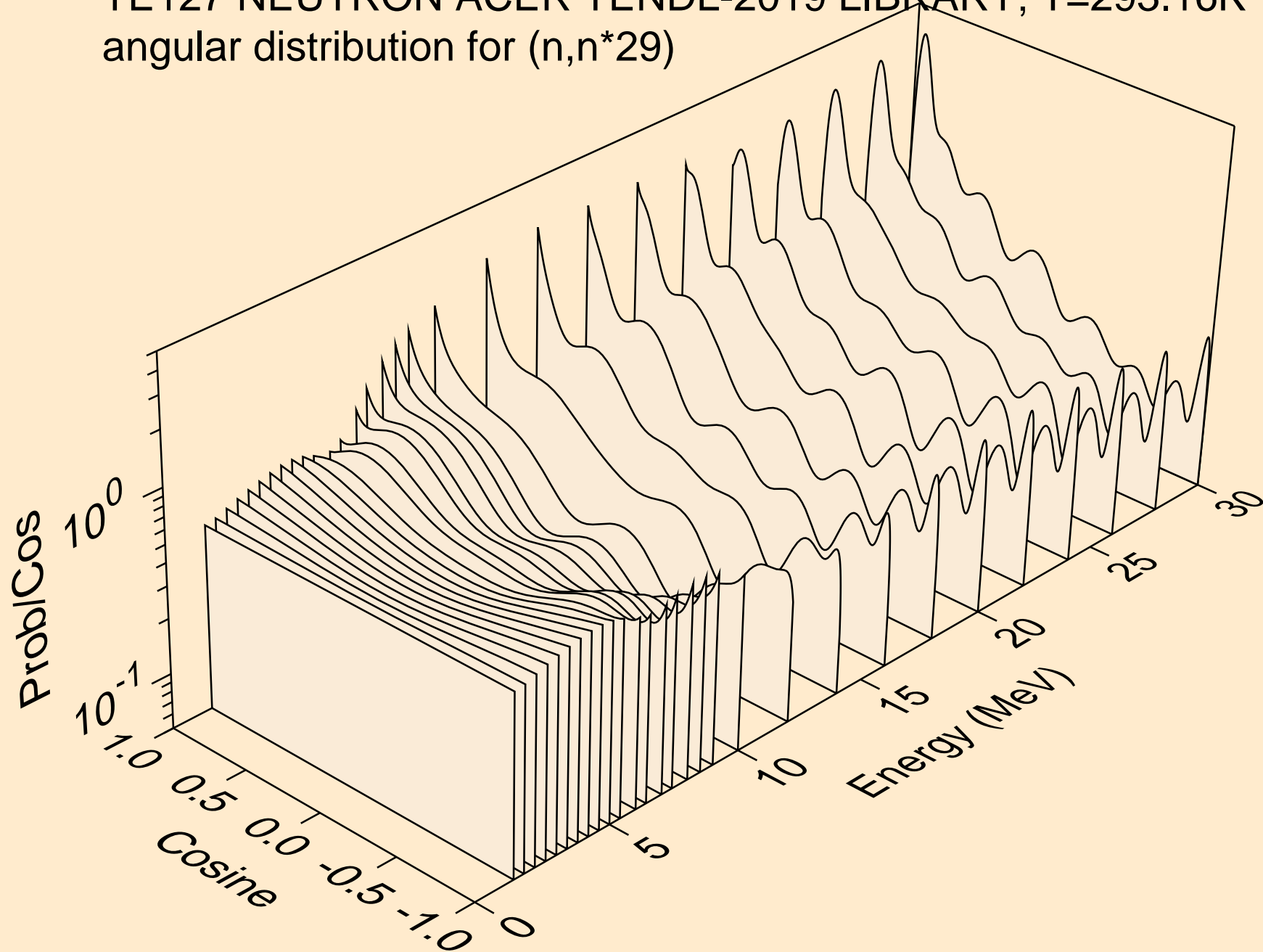

TE127 NEUTRON ACER TENDL-2019 LIBRARY; T=293.16K
angular distribution for (n,n*30)

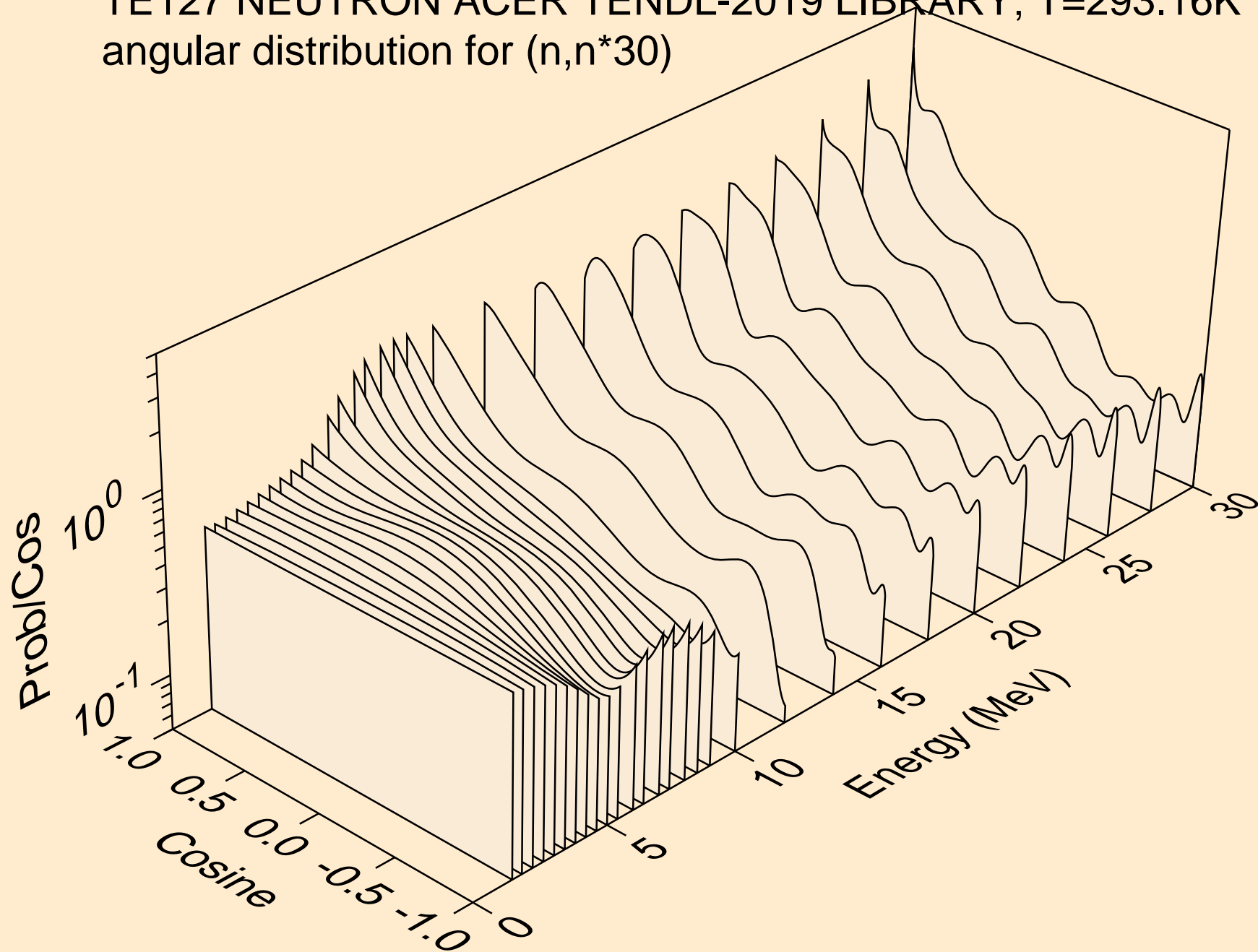

TE127 NEUTRON ACER TENDL-2019 LIBRARY; T=293.16K
Neutron emission for (n,x)

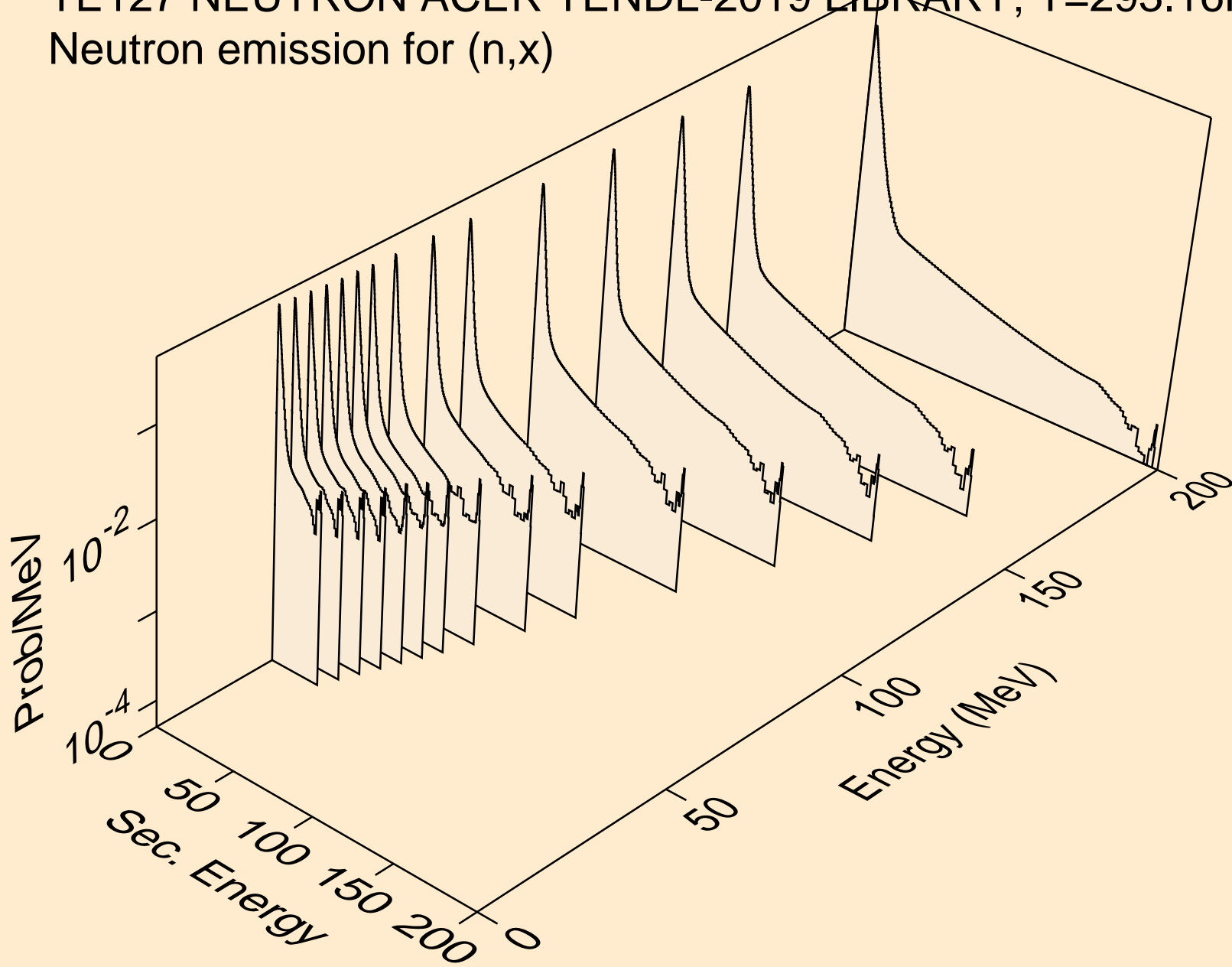

TE127 NEUTRON ACER TENDL-2019 LIBRARY; T=293.16K
Neutron emission for (n,2nd)

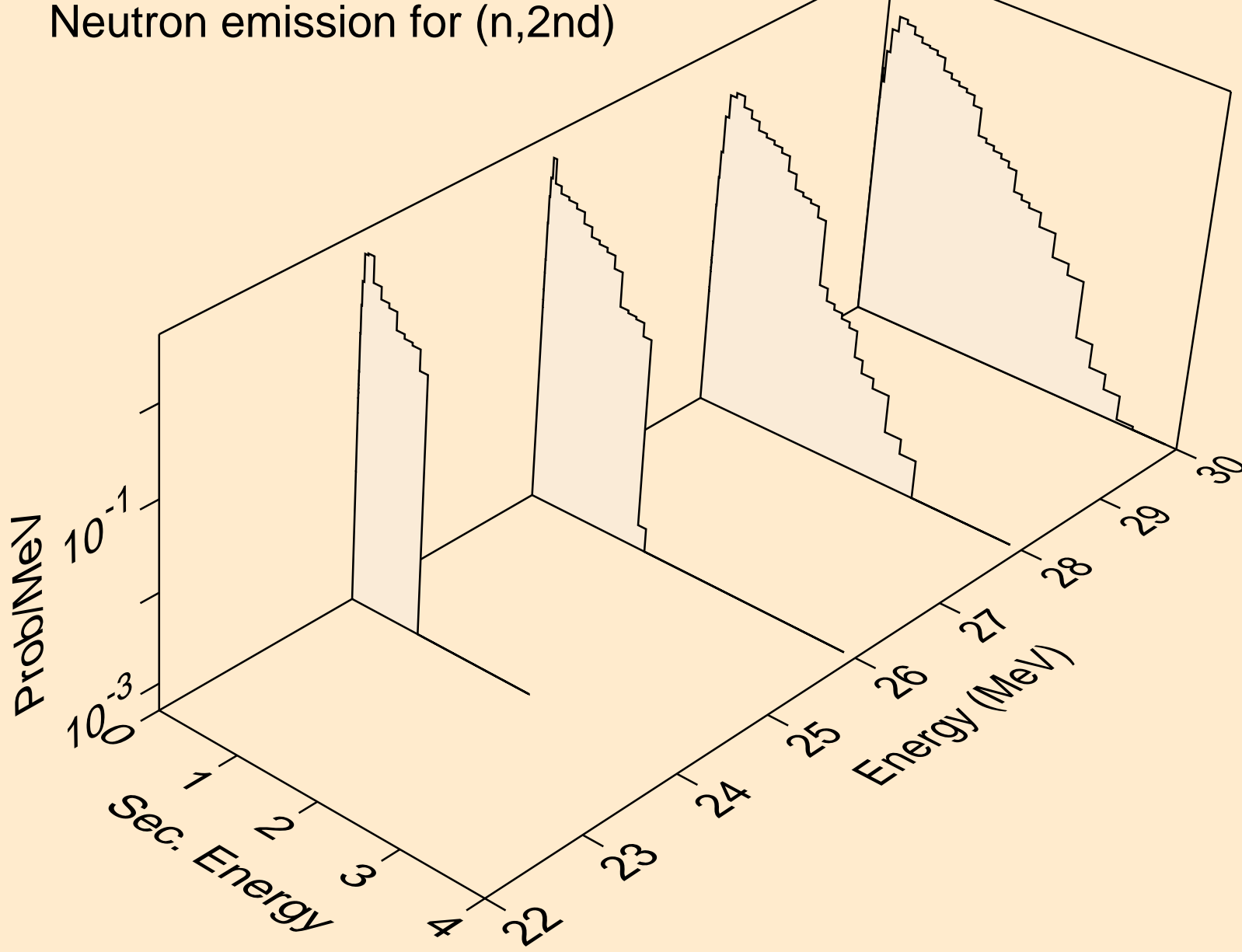

TE127 NEUTRON ACER TENDL-2019 LIBRARY; T=293.16K
Neutron emission for (n,2n)

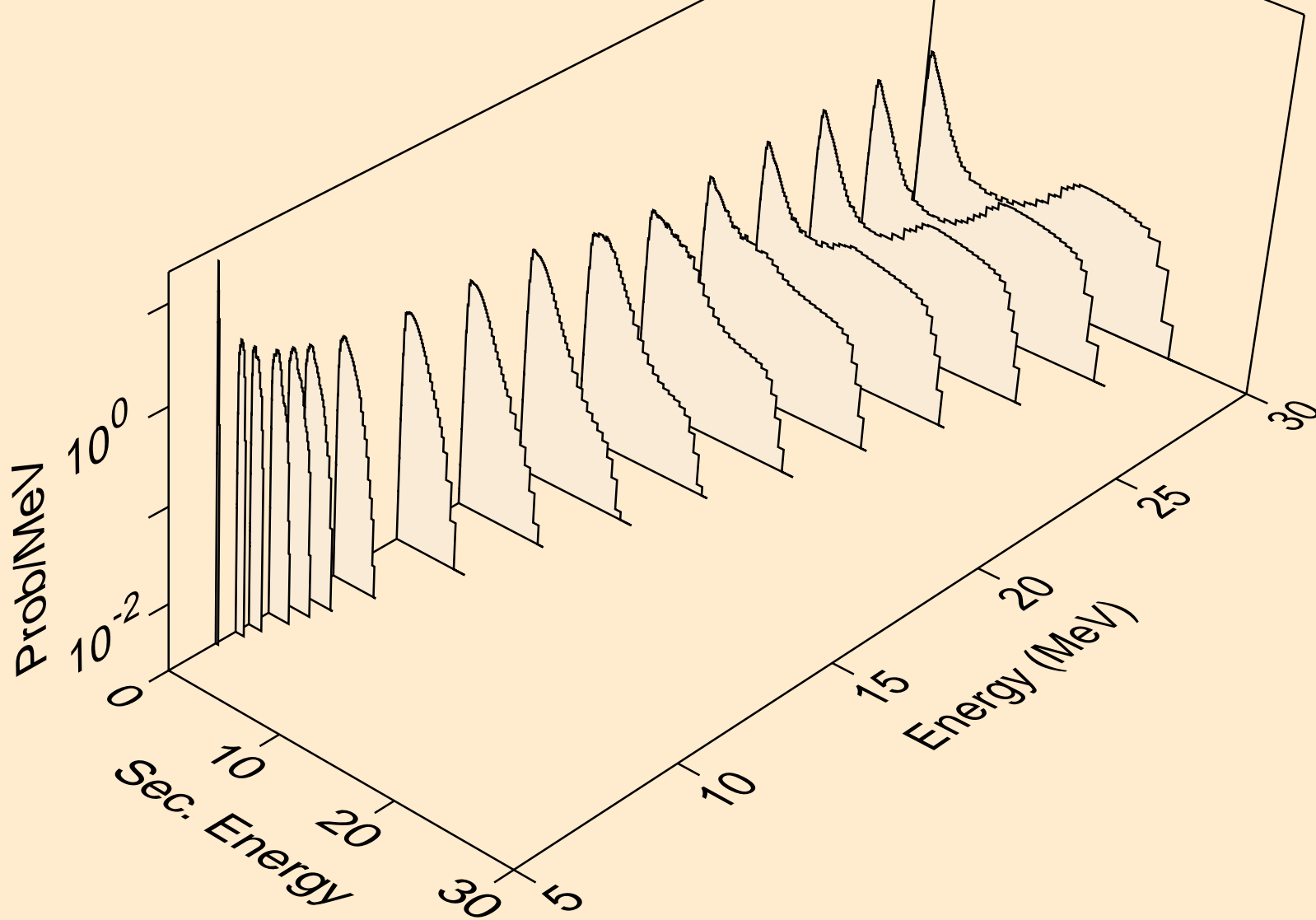

TE127 NEUTRON ACER TENDL-2019 LIBRARY; T=293.16K
Neutron emission for (n,3n)

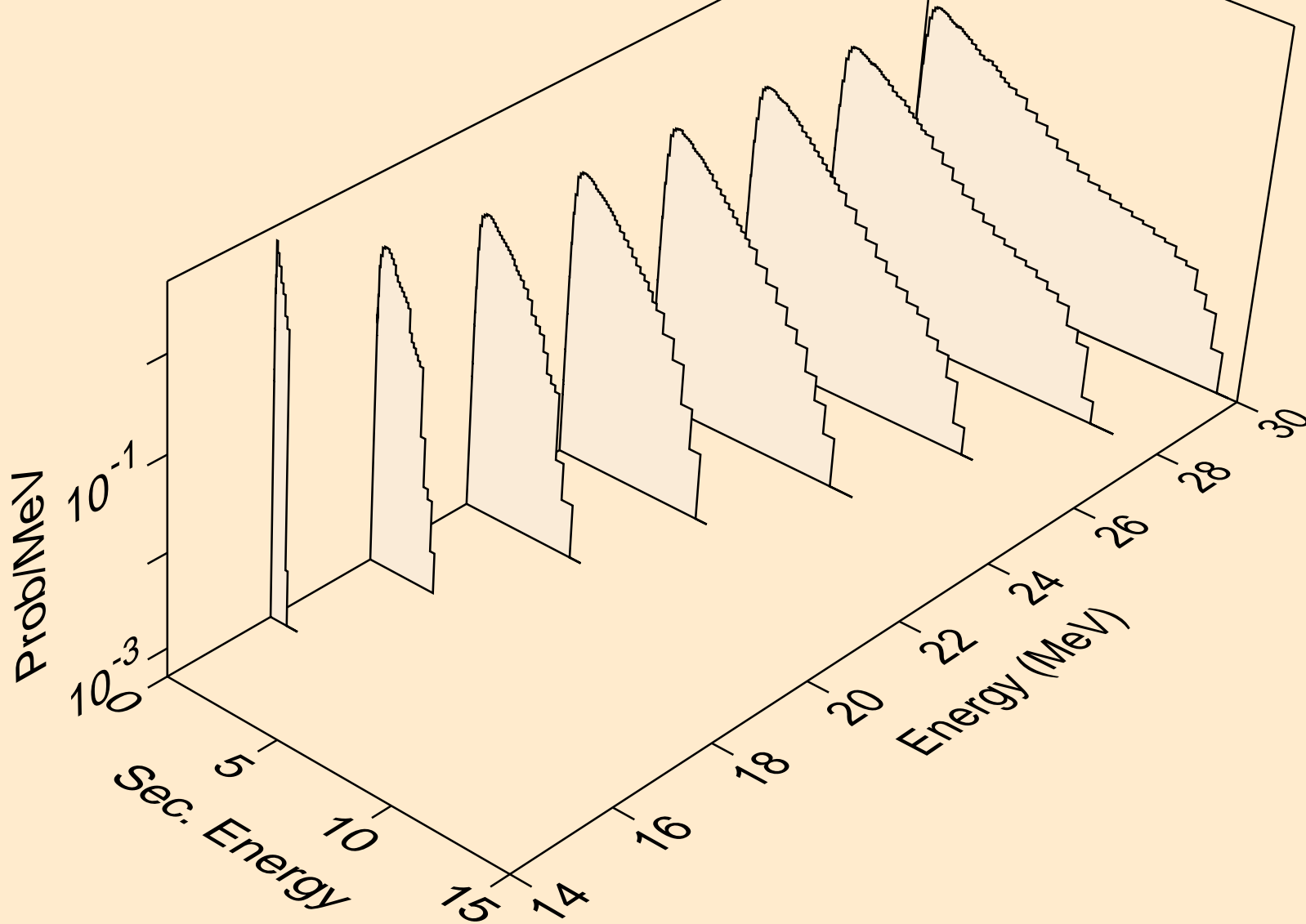

TE127 NEUTRON ACER TENDL-2019 LIBRARY; T=293.16K
Neutron emission for (n,n*)a

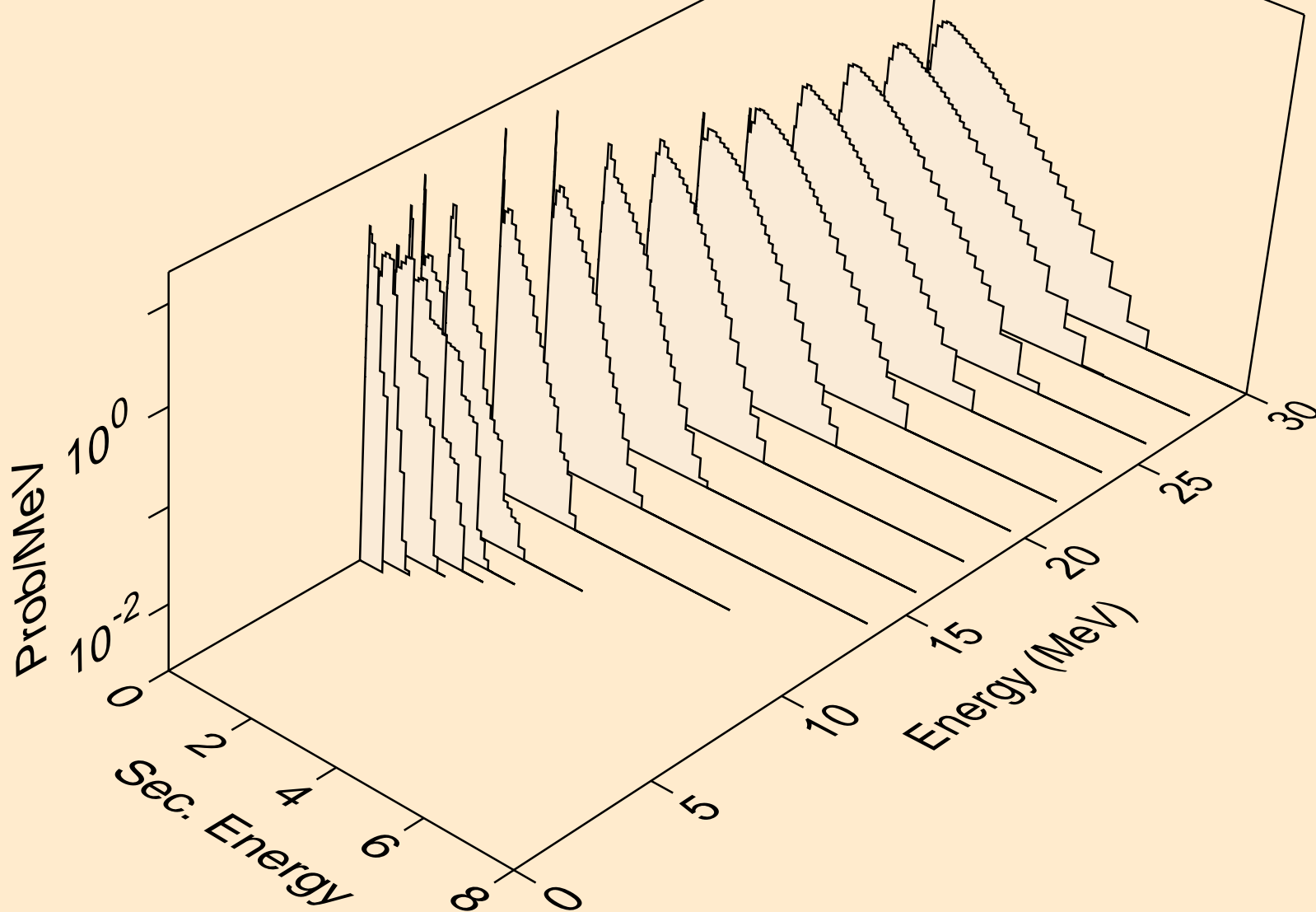

TE127 NEUTRON ACER TENDL-2019 LIBRARY; T=293.16K
Neutron emission for (n,2n)a

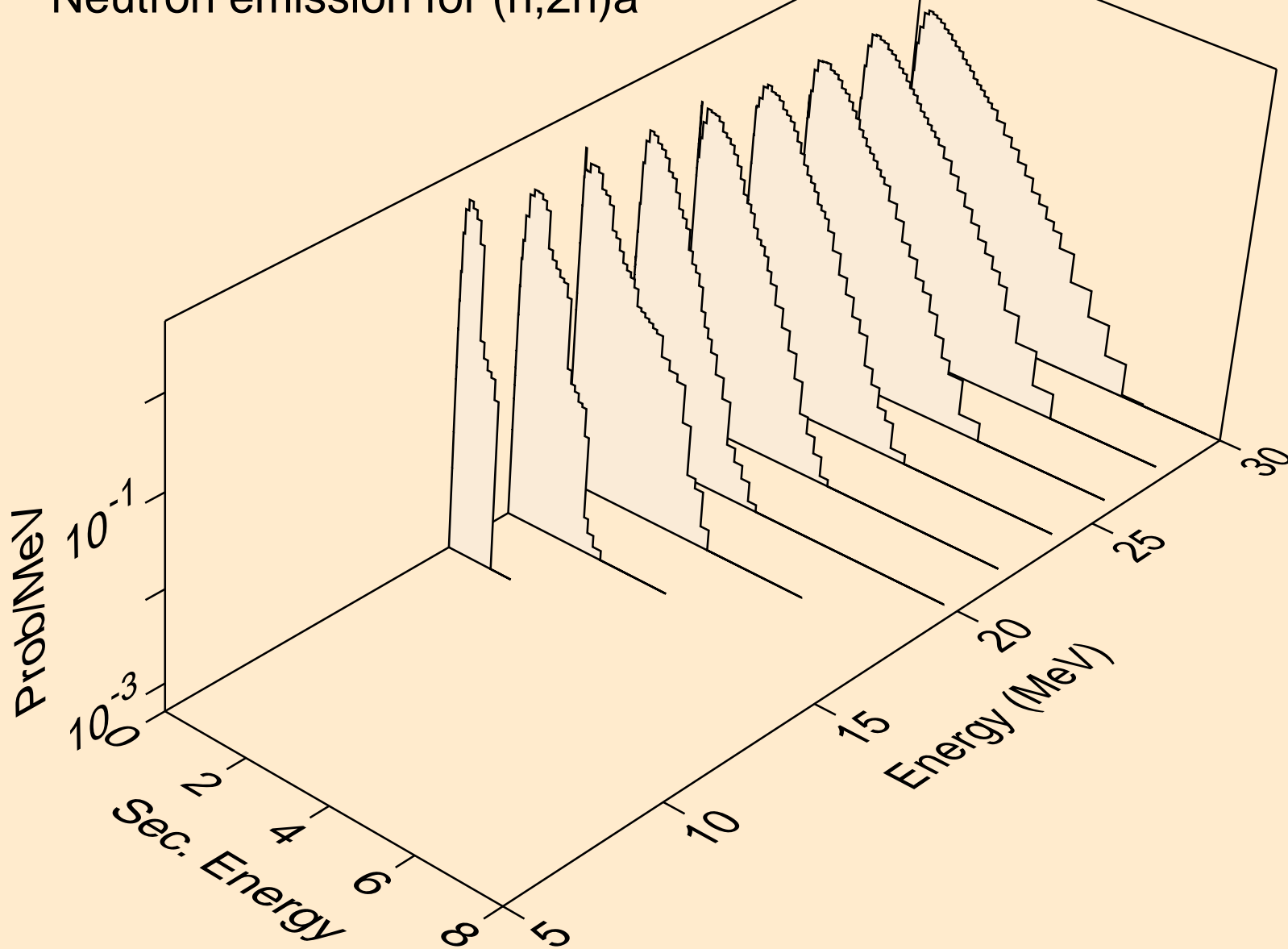

TE127 NEUTRON ACER TENDL-2019 LIBRARY; T=293.16K
Neutron emission for (n,3n)a

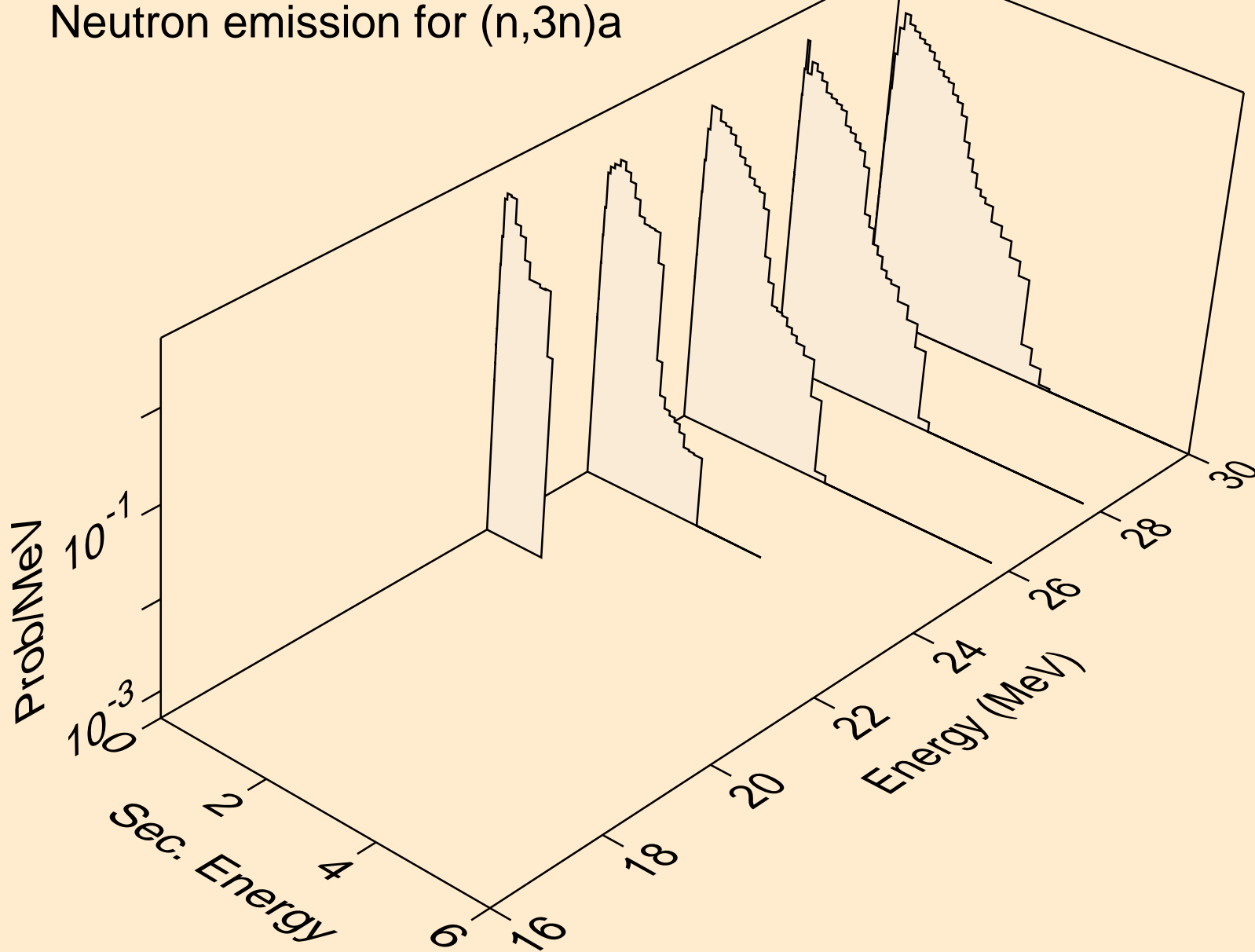

TE127 NEUTRON ACER TENDL-2019 LIBRARY; T=293.16K
Neutron emission for (n,n*)p

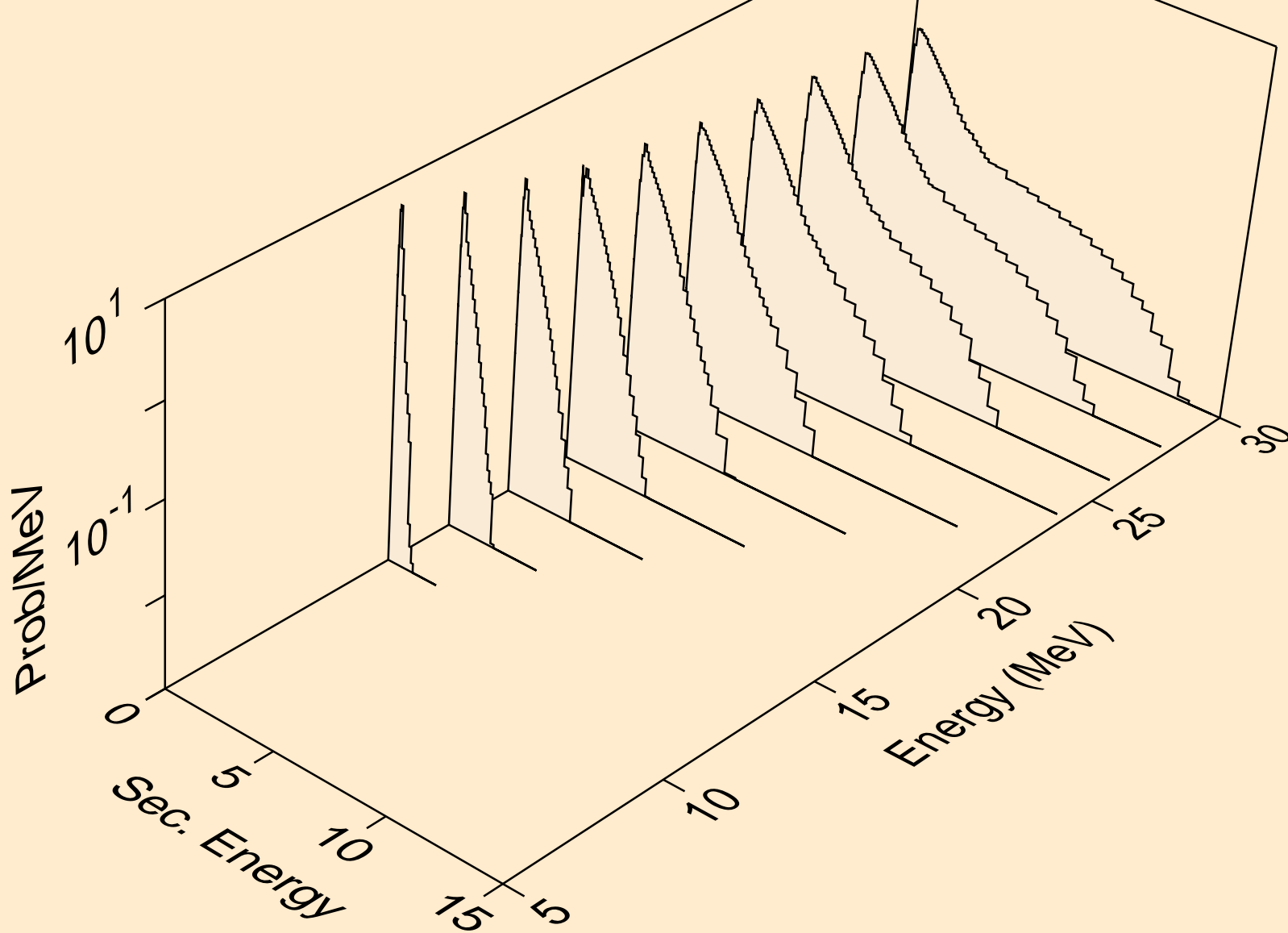

TE127 NEUTRON ACER TENDL-2019 LIBRARY; T=293.16K
Neutron emission for (n,n*)d

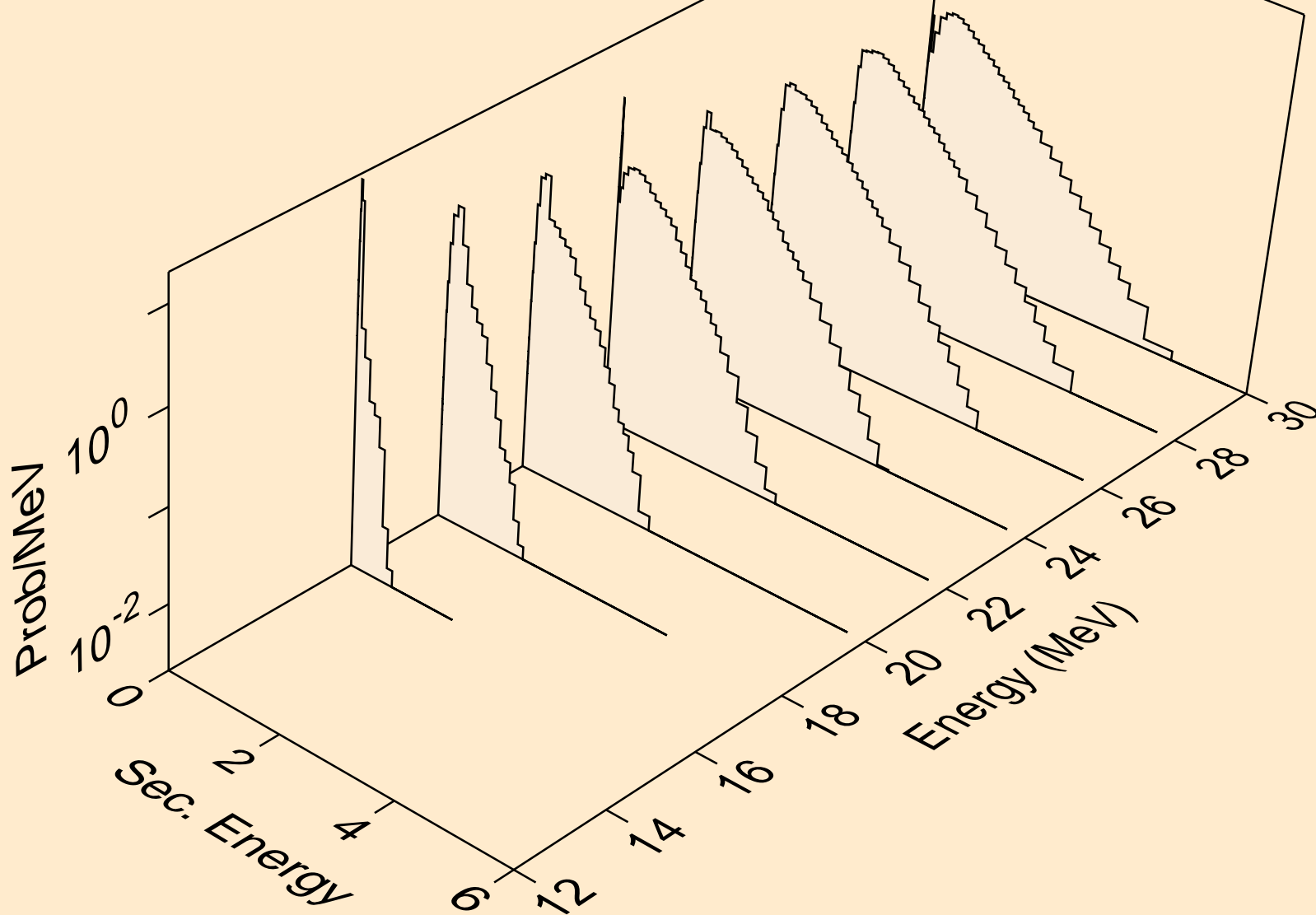

TE127 NEUTRON ACER TENDL-2019 LIBRARY; T=293.16K
Neutron emission for (n,n*)t

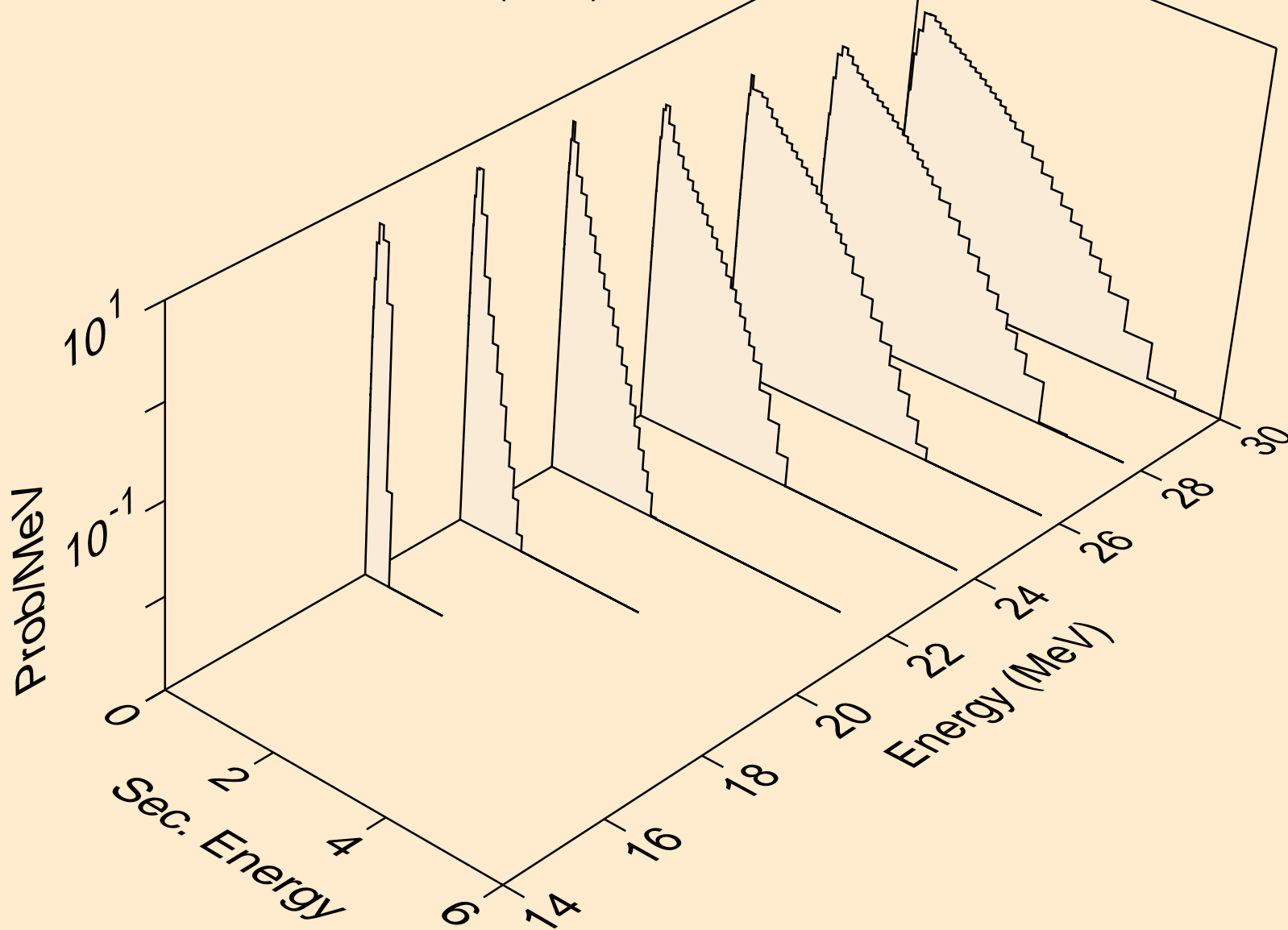

TE127 NEUTRON ACER TENDL-2019 LIBRARY; T=293.16K
Neutron emission for (n,n*)he3

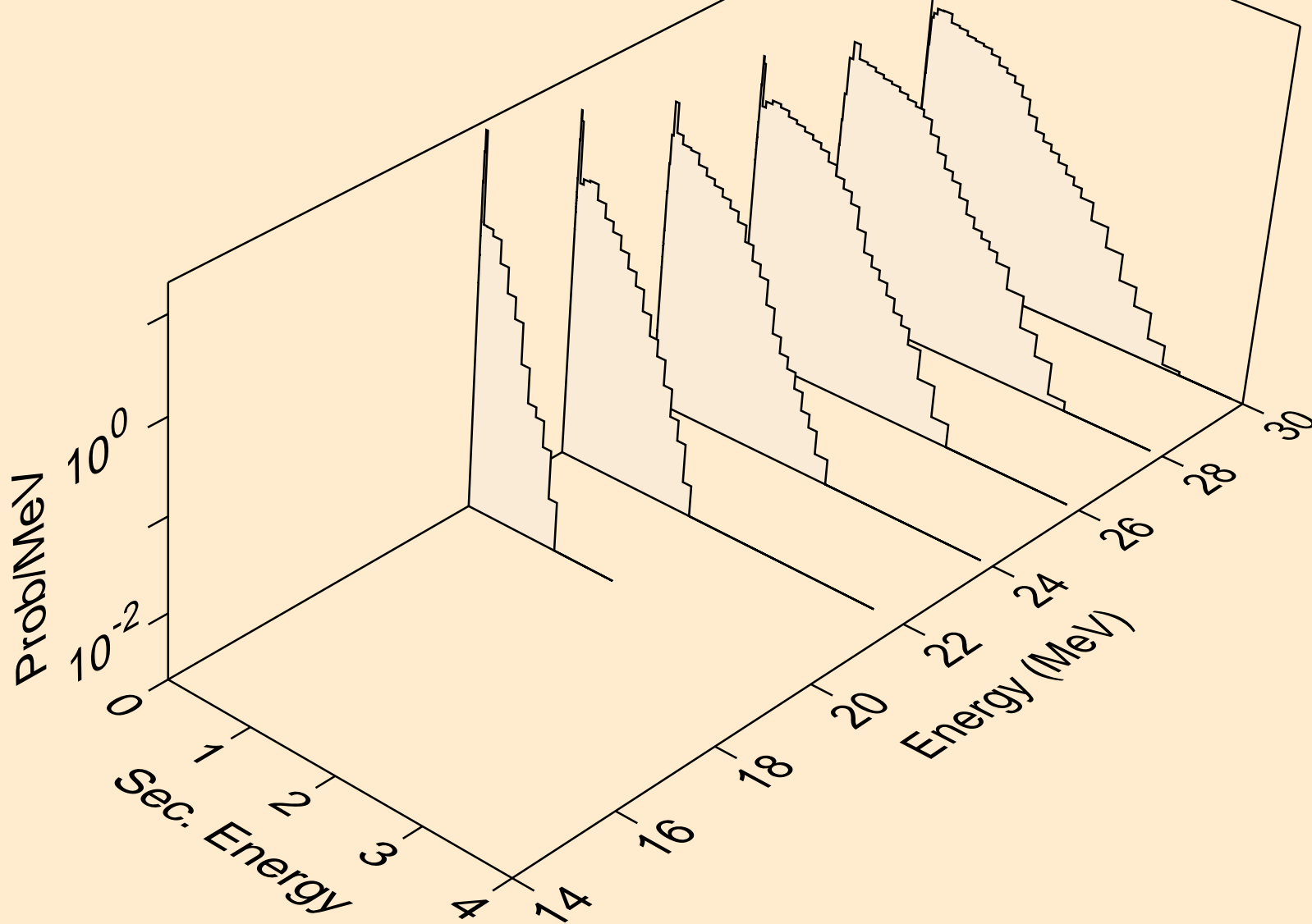

TE127 NEUTRON ACER TENDL-2019 LIBRARY; T=293.16K
Neutron emission for (n,4n)

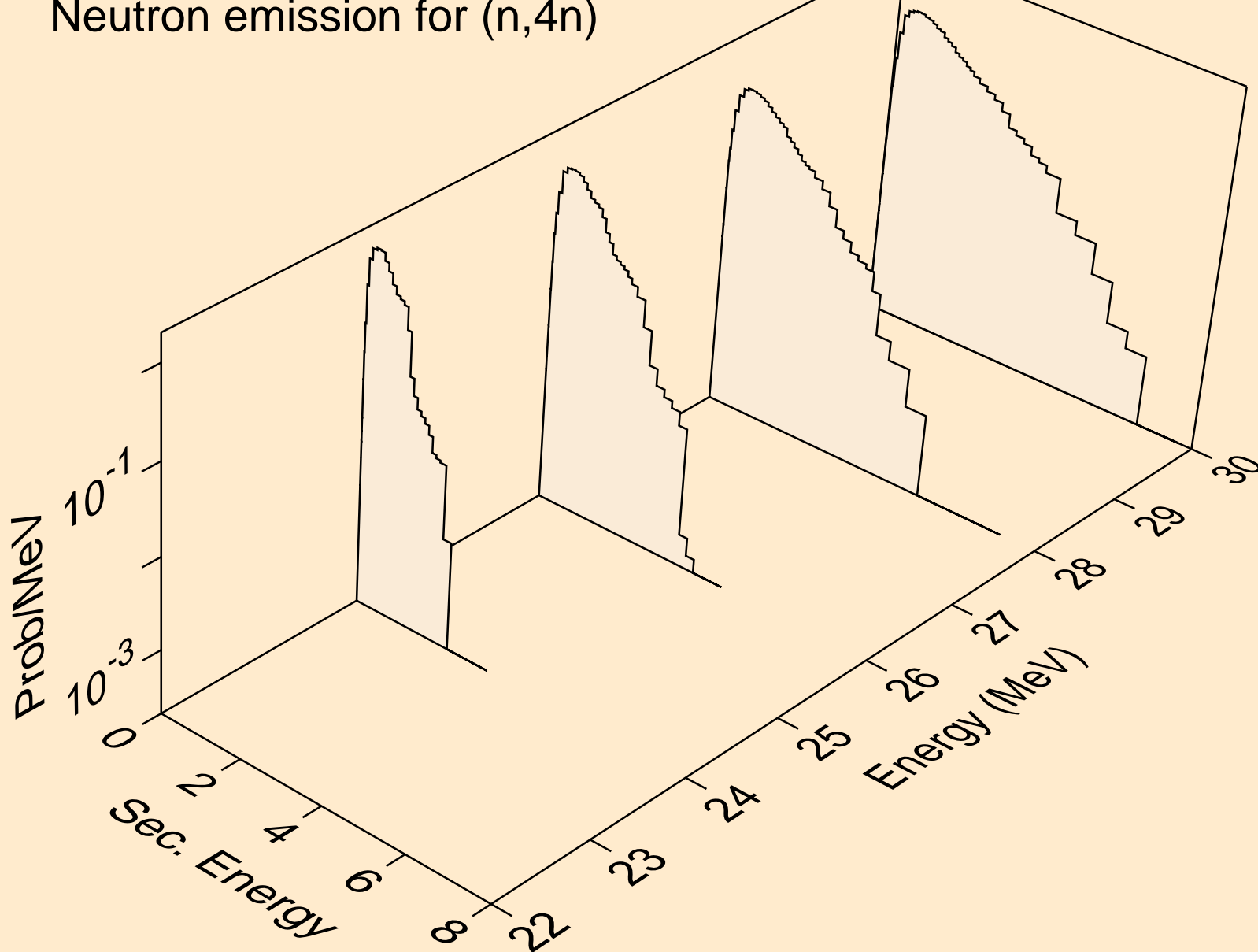

TE127 NEUTRON ACER TENDL-2019 LIBRARY; T=293.16K
Neutron emission for (n,2np)

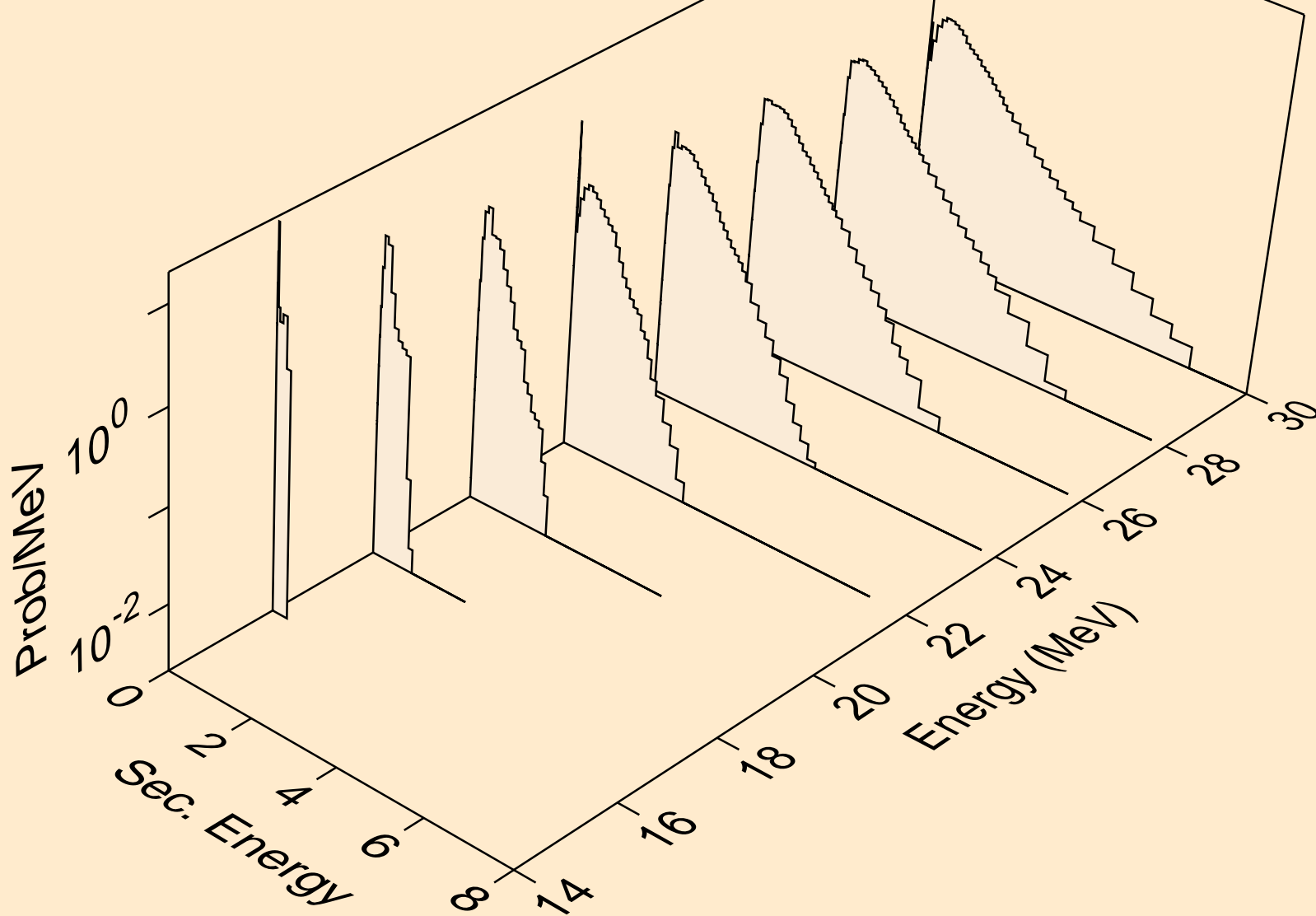

TE127 NEUTRON ACER TENDL-2019 LIBRARY; T=293.16K
Neutron emission for (n,3np)

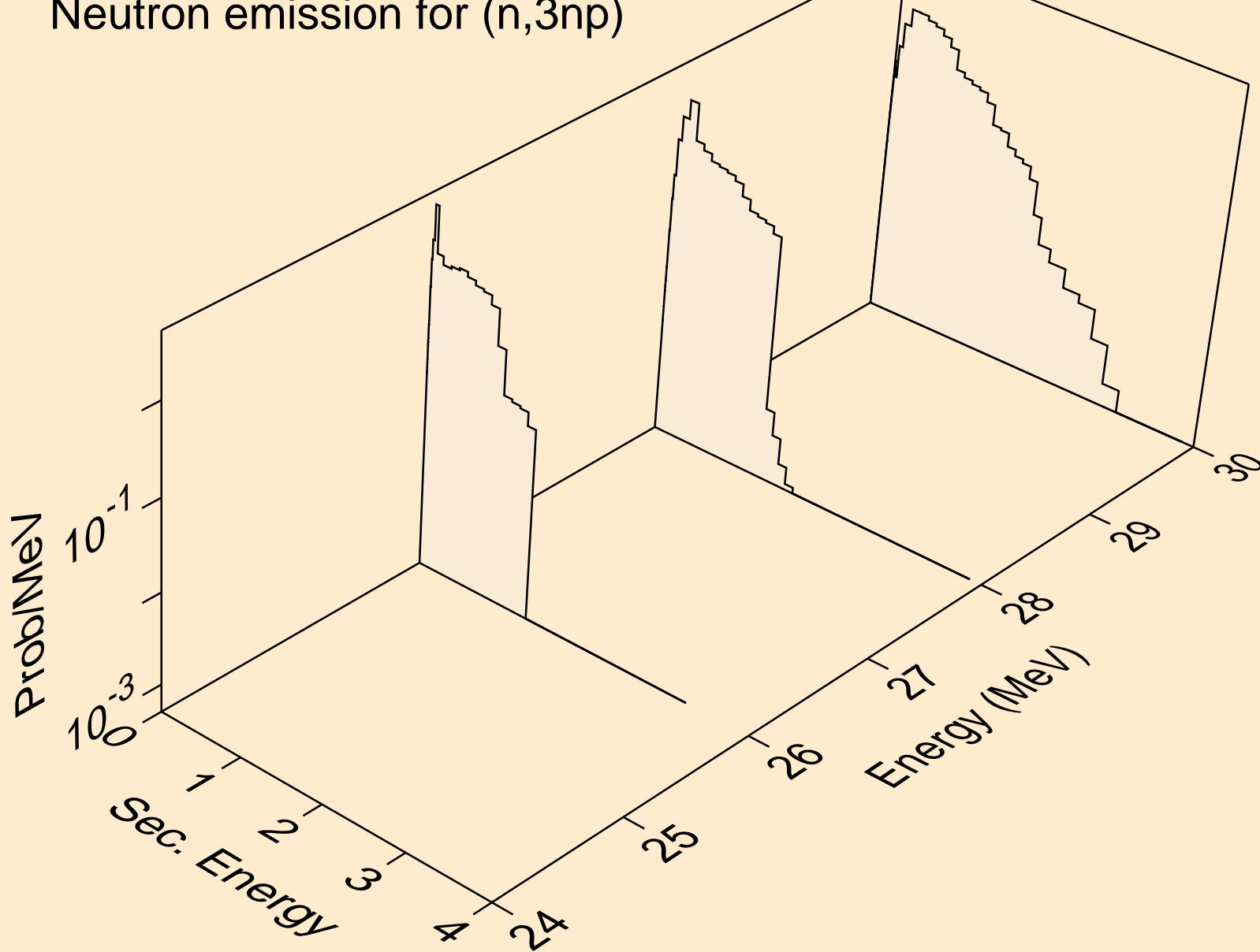

TE127 NEUTRON ACER TENDL-2019 LIBRARY; T=293.16K
Neutron emission for (n,2np)

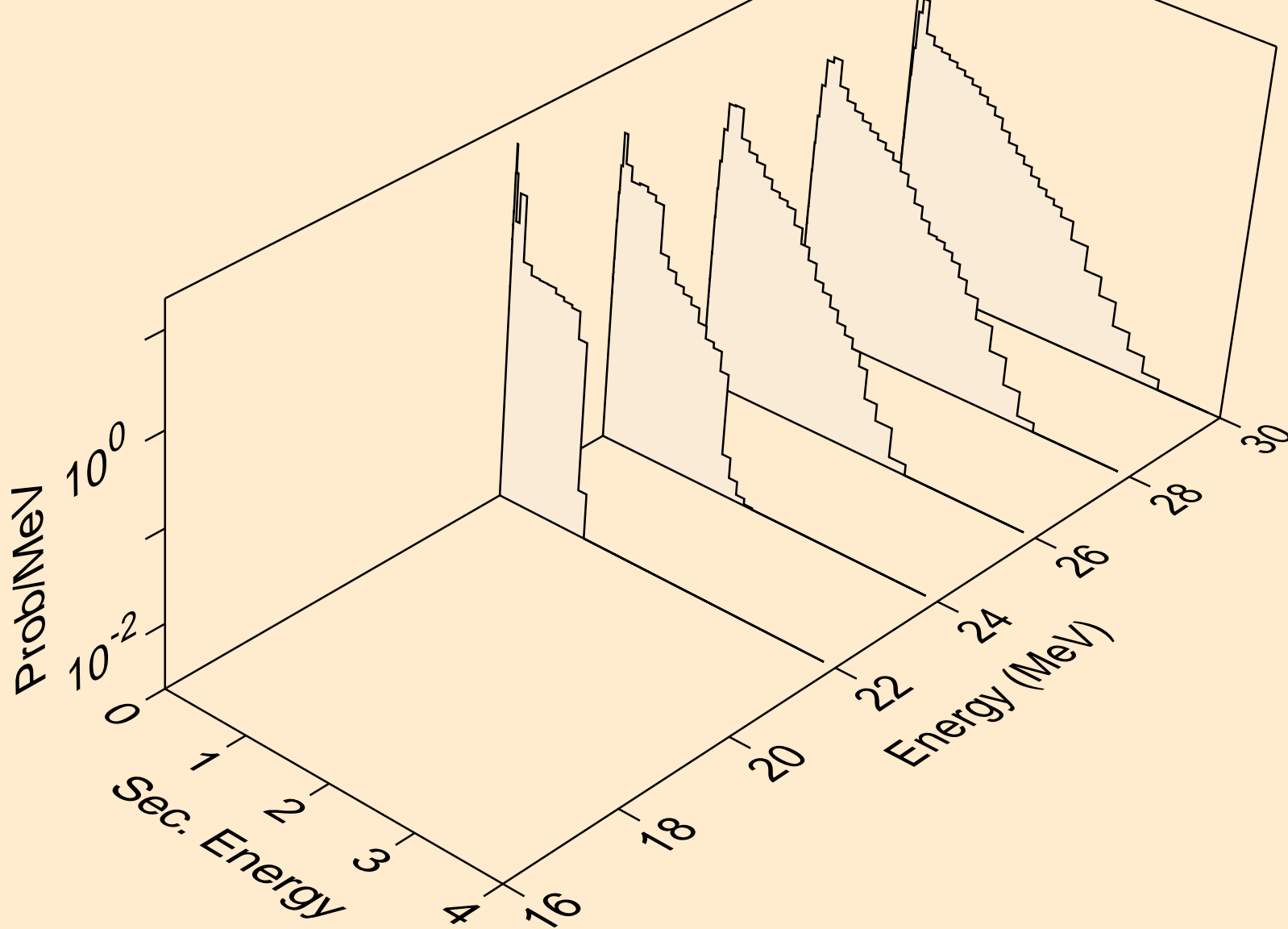

TE127 NEUTRON ACER TENDL-2019 LIBRARY; T=293.16K
Neutron emission for (n,n*c)

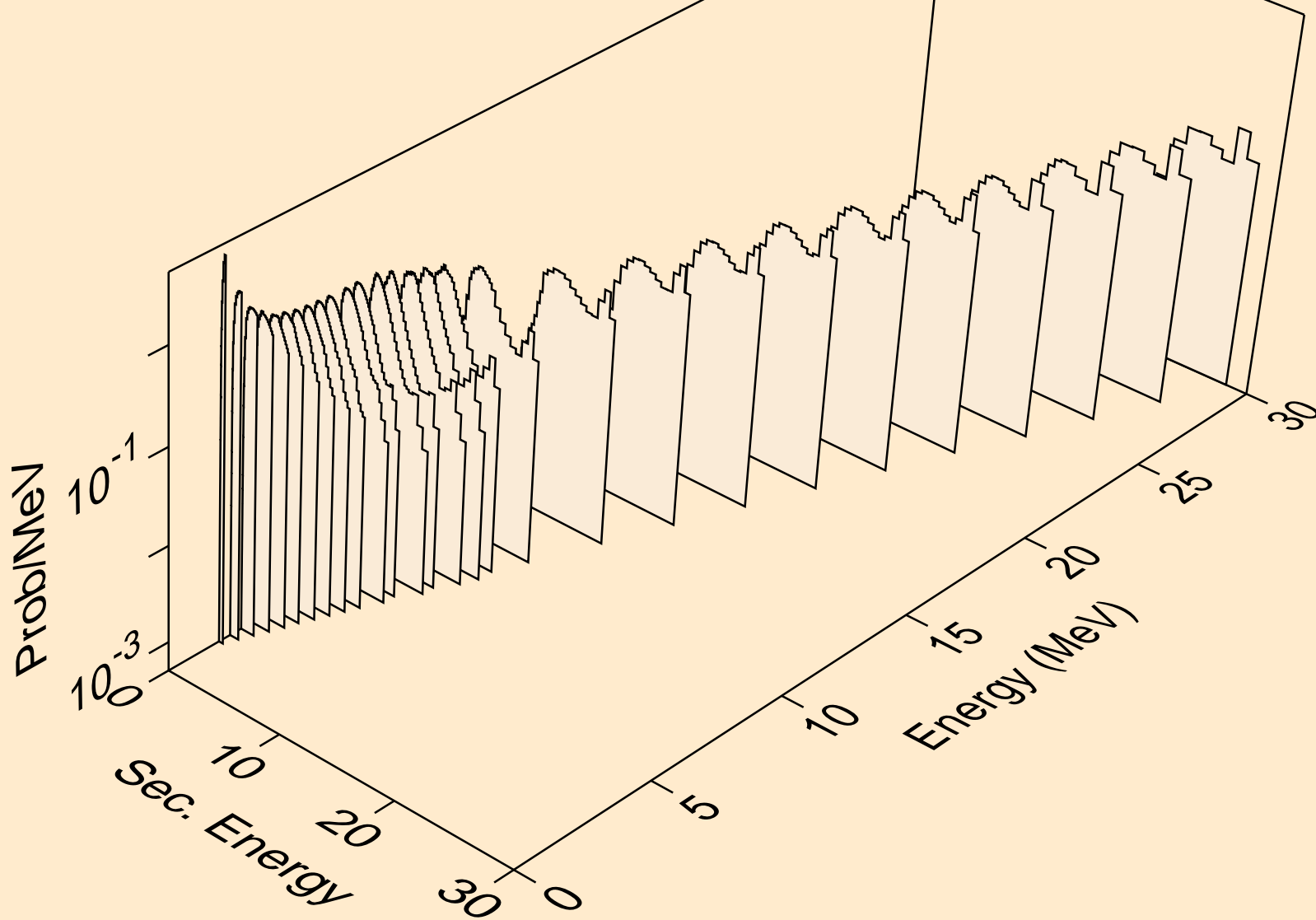

TE127 NEUTRON ACER TENDL-2019 LIBRARY; T=293.16K
Photon emission for (n,x)

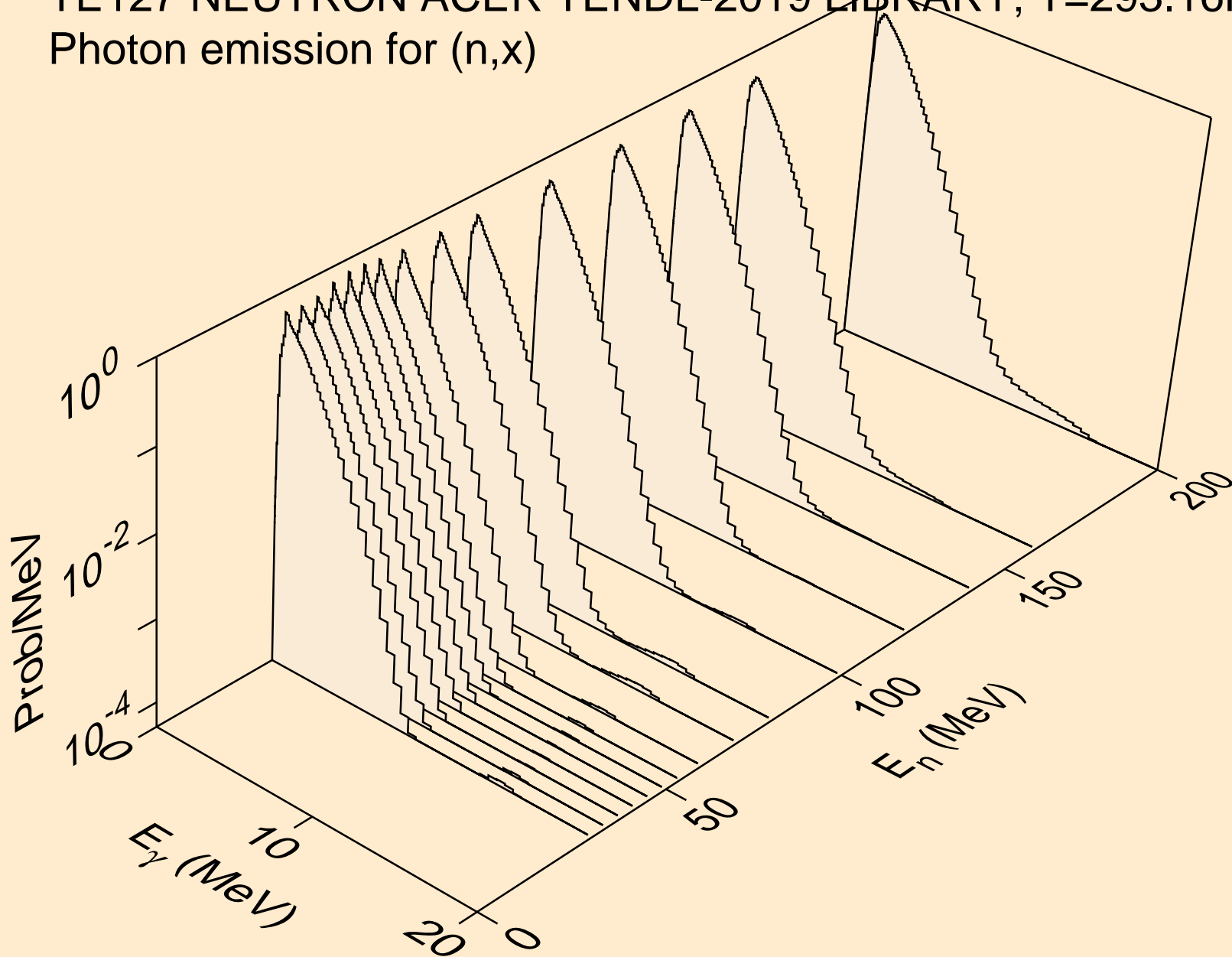

TE127 NEUTRON ACER TENDL-2019 LIBRARY; T=293.16K
Photon emission for (n,2nd)

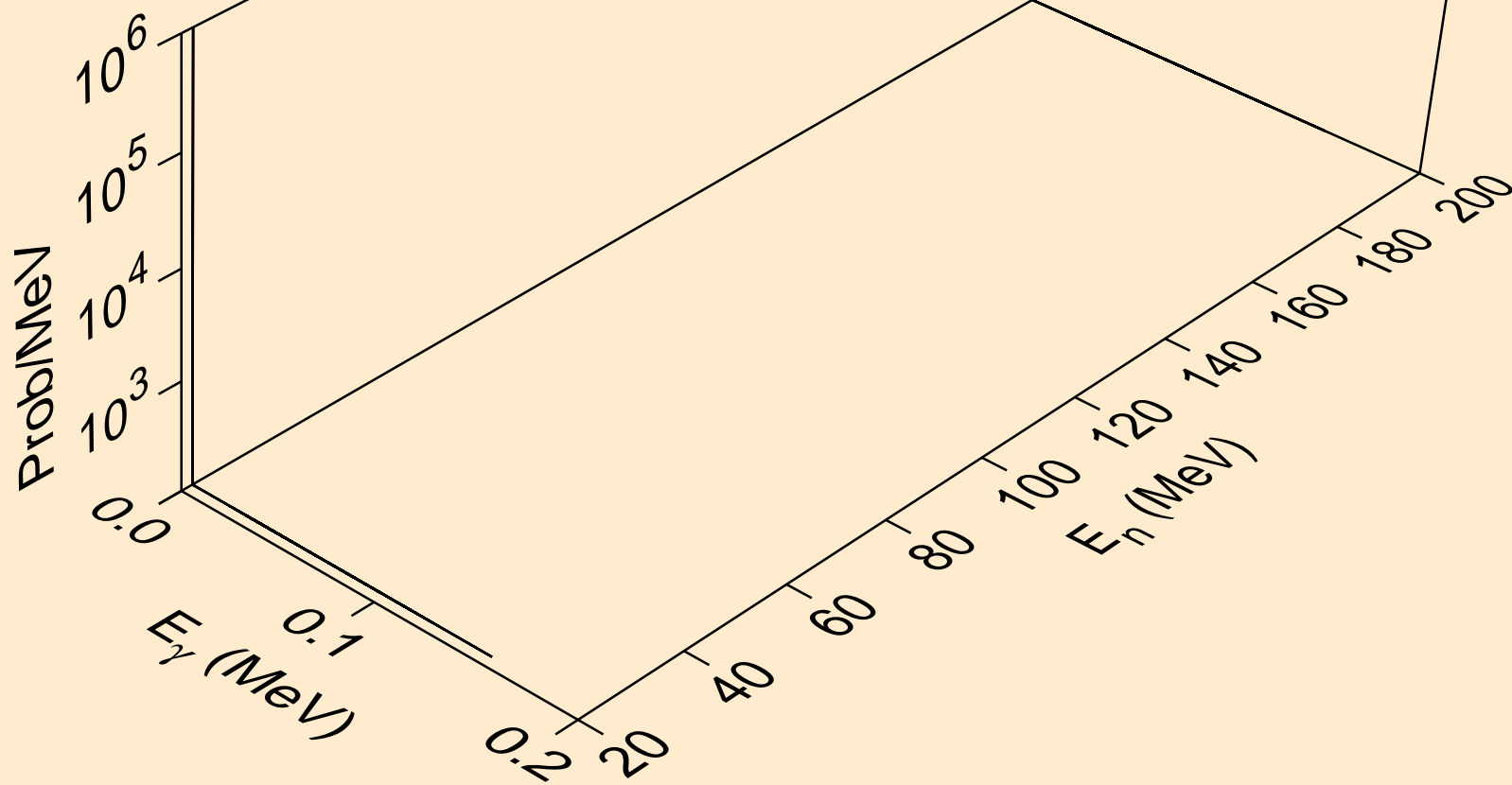

TE127 NEUTRON ACER TENDL-2019 LIBRARY; T=293.16K
Photon emission for (n,2n)

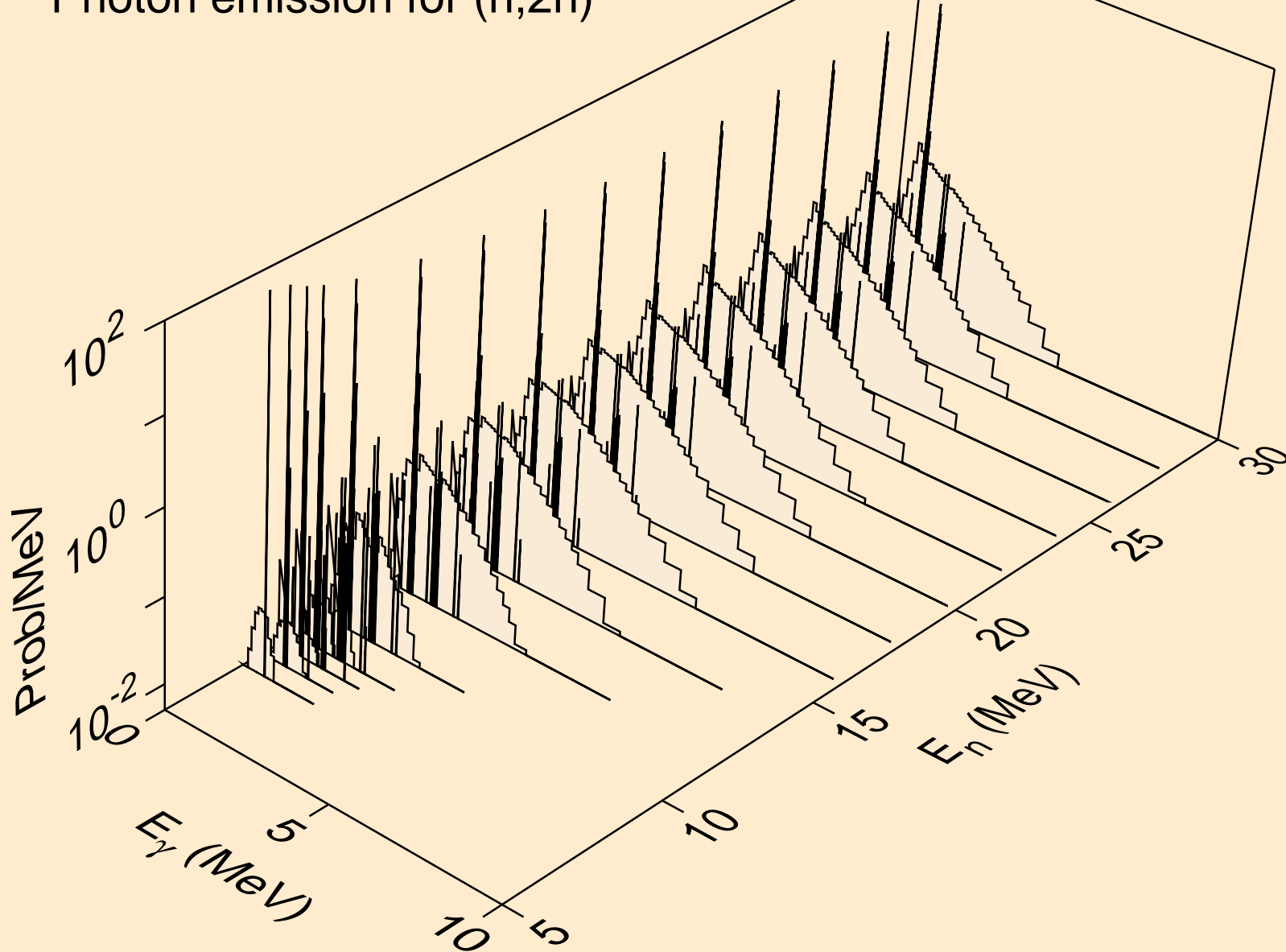

TE127 NEUTRON ACER TENDL-2019 LIBRARY; T=293.16K
Photon emission for (n,3n)

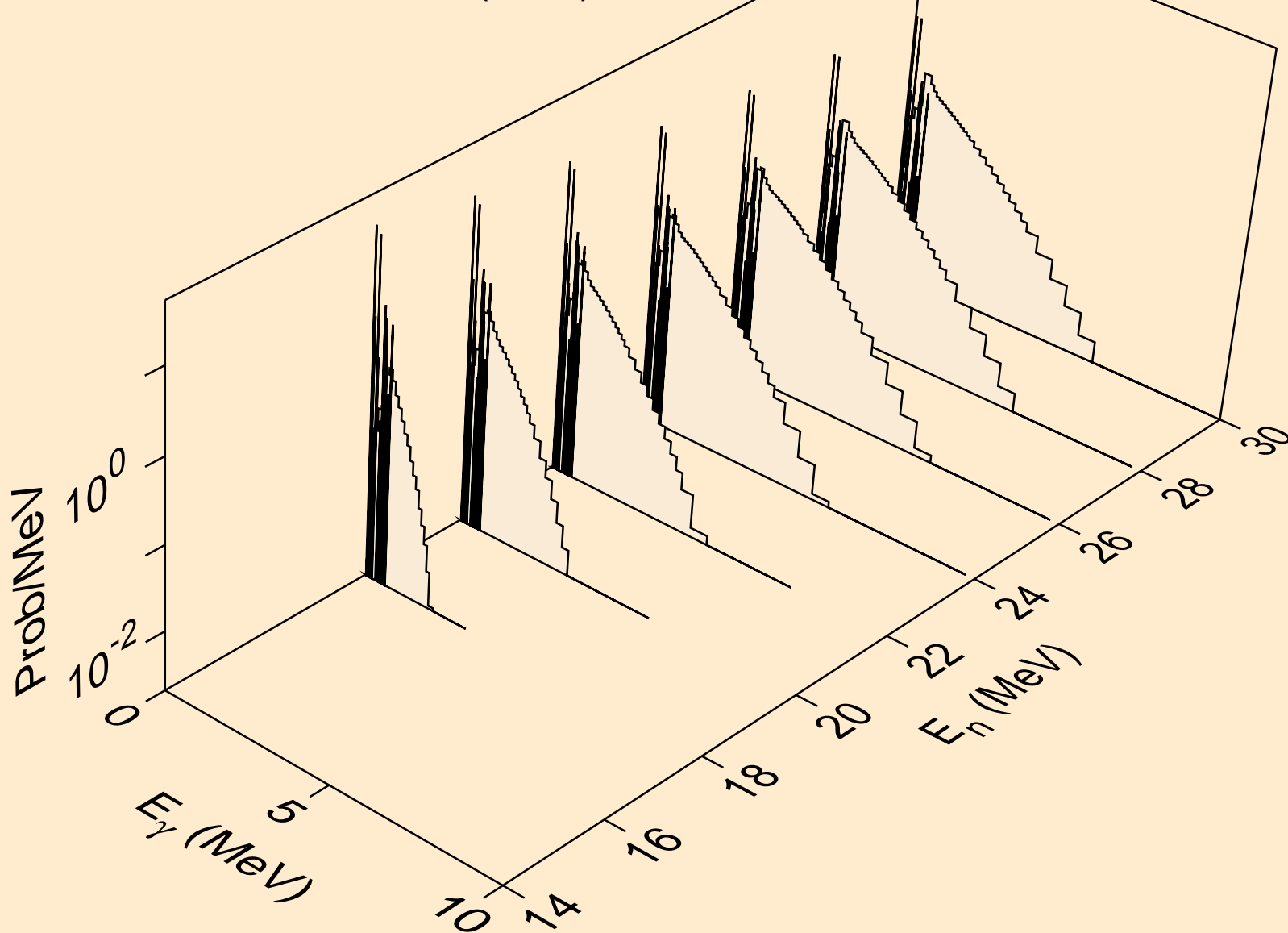

TE127 NEUTRON ACER TENDL-2019 LIBRARY; T=293.16K
Photon emission for (n,n*)a

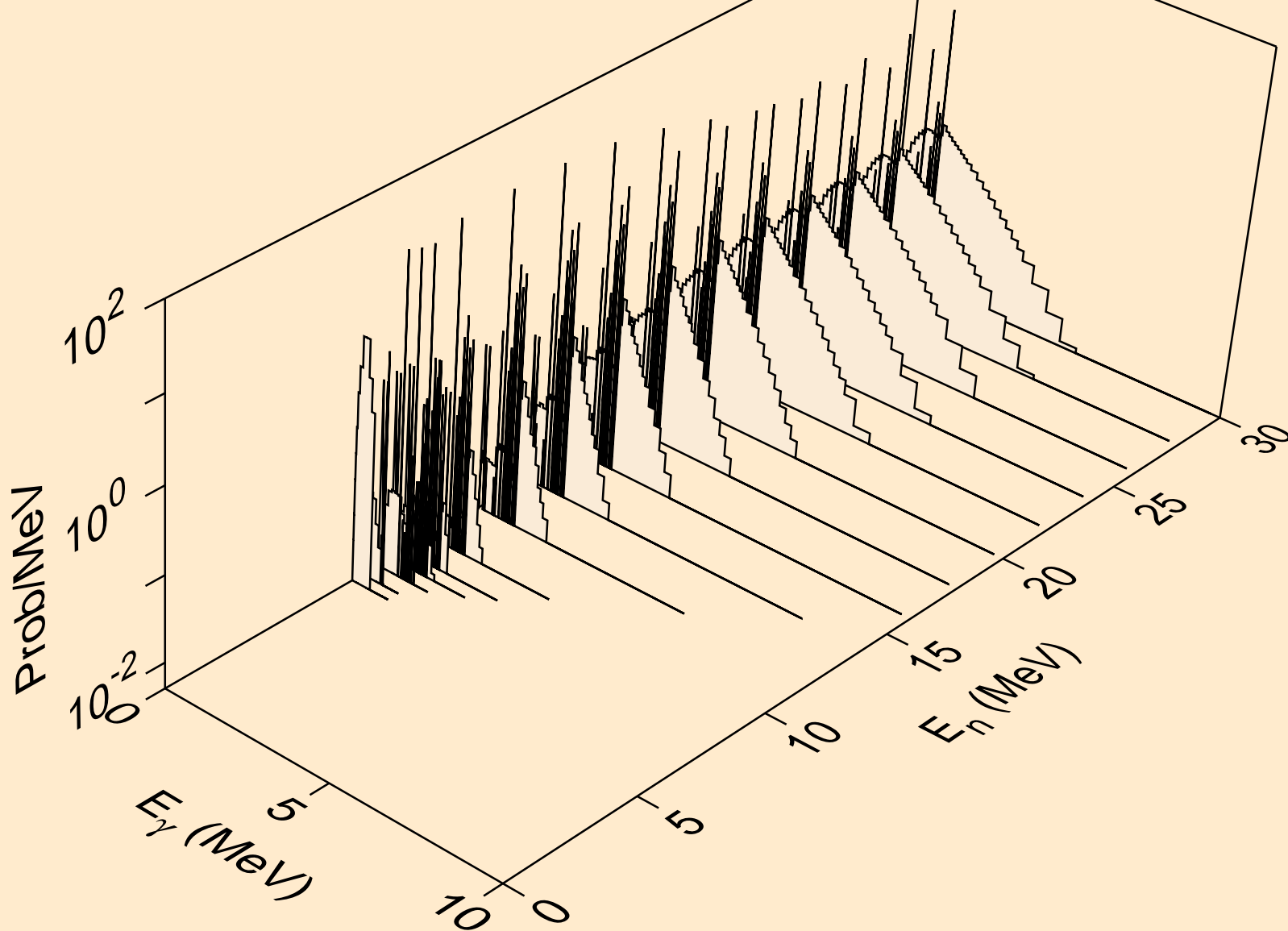

TE127 NEUTRON ACER TENDL-2019 LIBRARY; T=293.16K
Photon emission for (n,2n)a

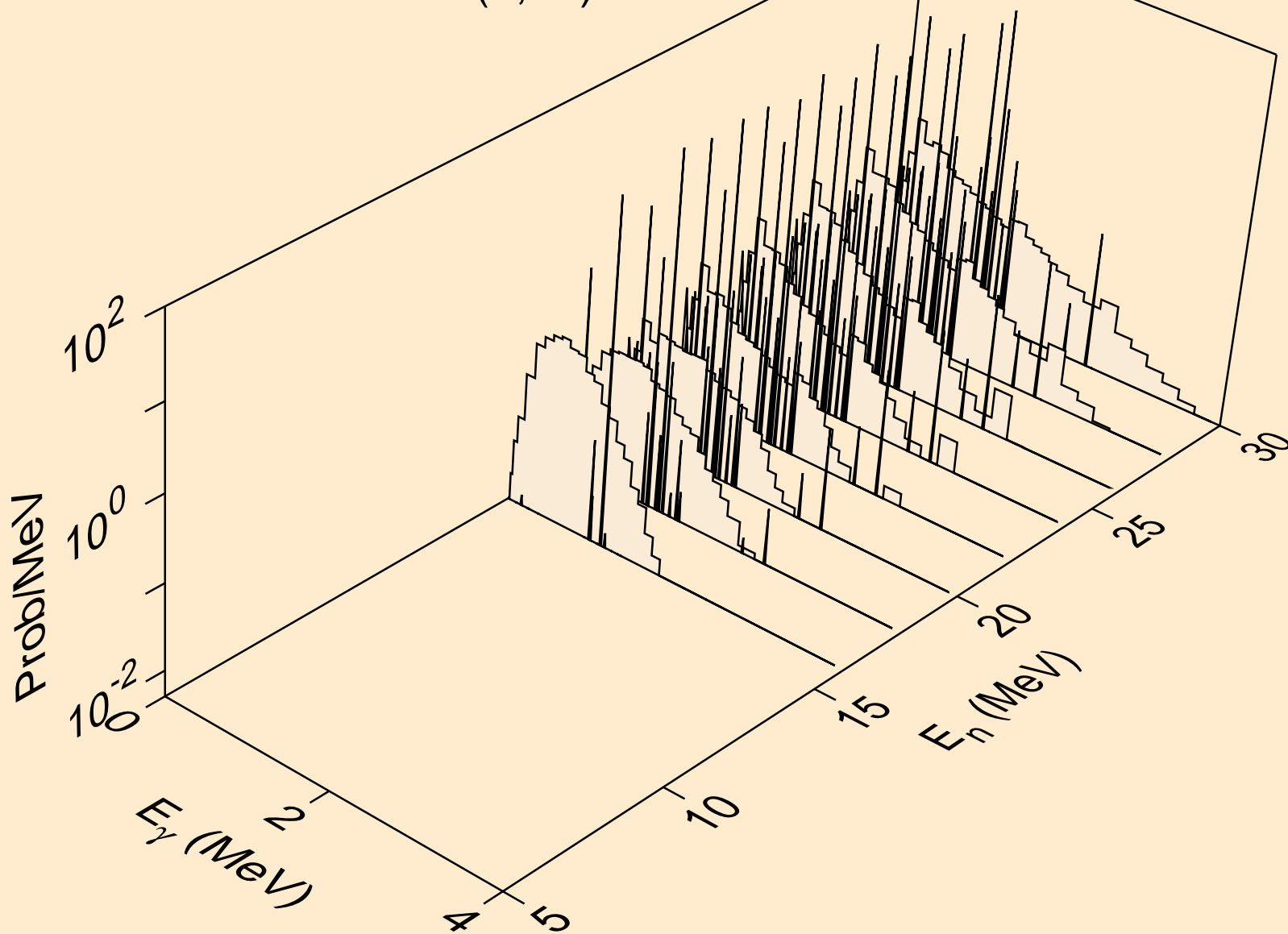

TE127 NEUTRON ACER TENDL-2019 LIBRARY; T=293.16K
Photon emission for (n,3n)a

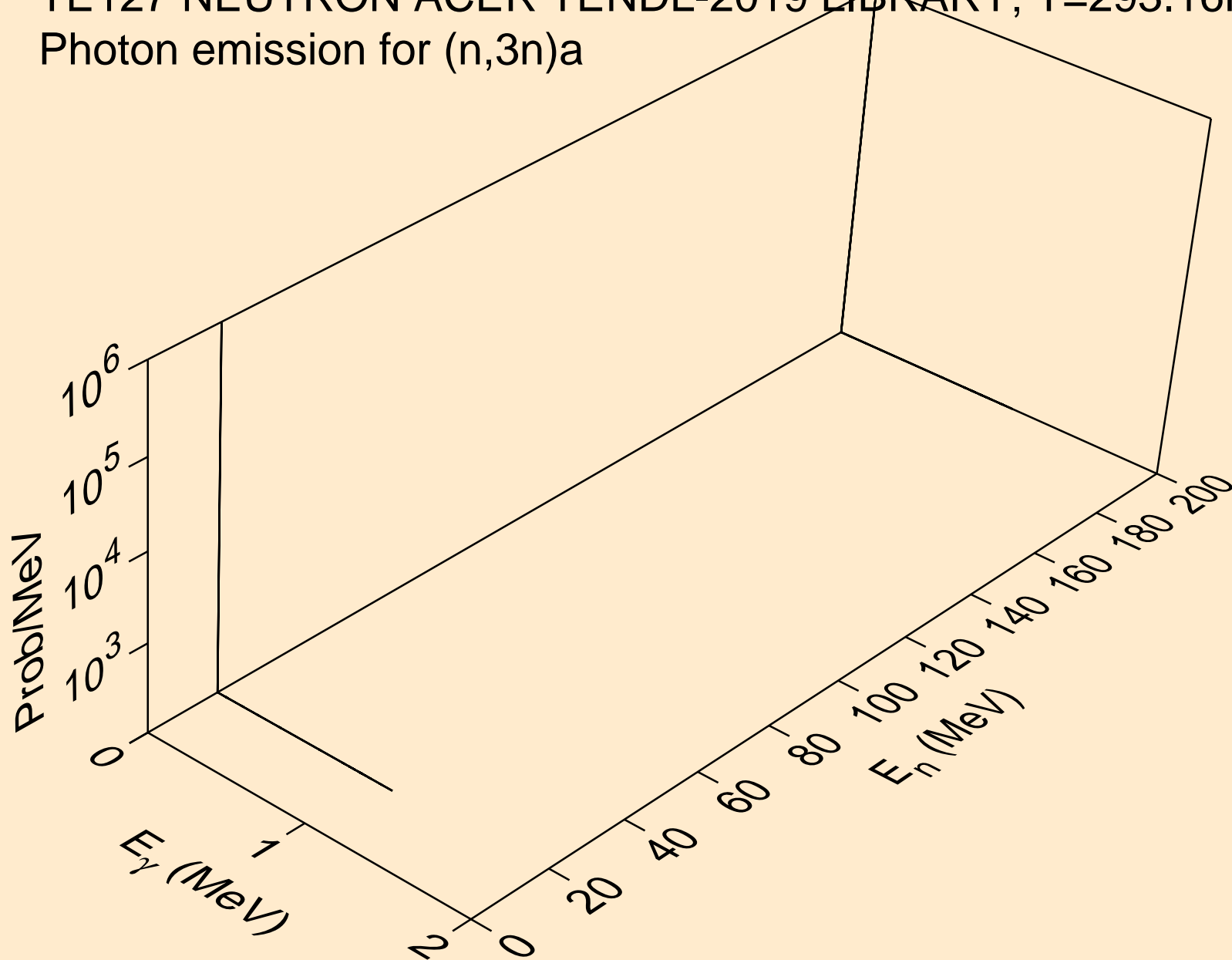

TE127 NEUTRON ACER TENDL-2019 LIBRARY; T=293.16K
Photon emission for (n,n*)p

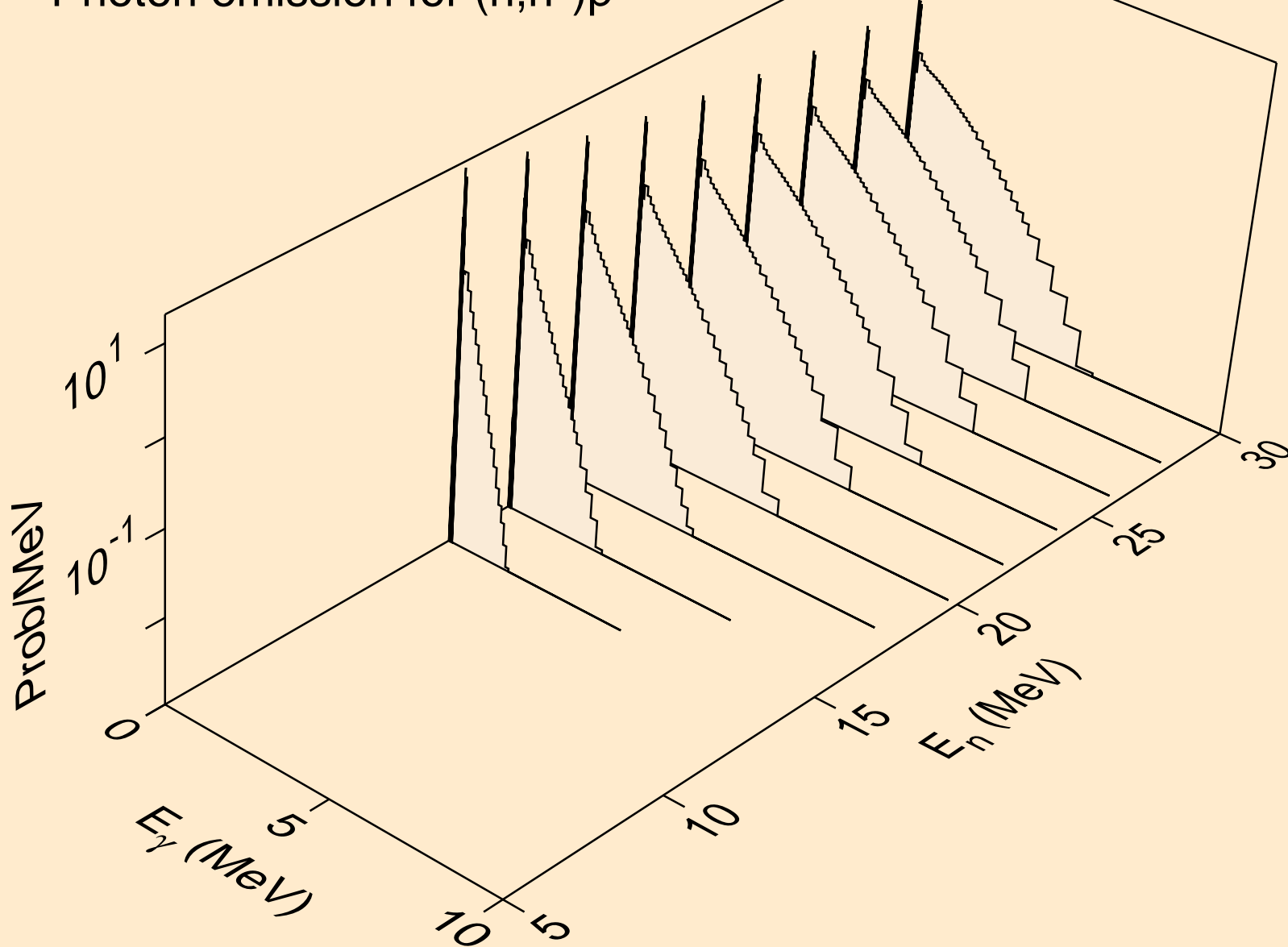

TE127 NEUTRON ACER TENDL-2019 LIBRARY; T=293.16K
Photon emission for (n,n*)d

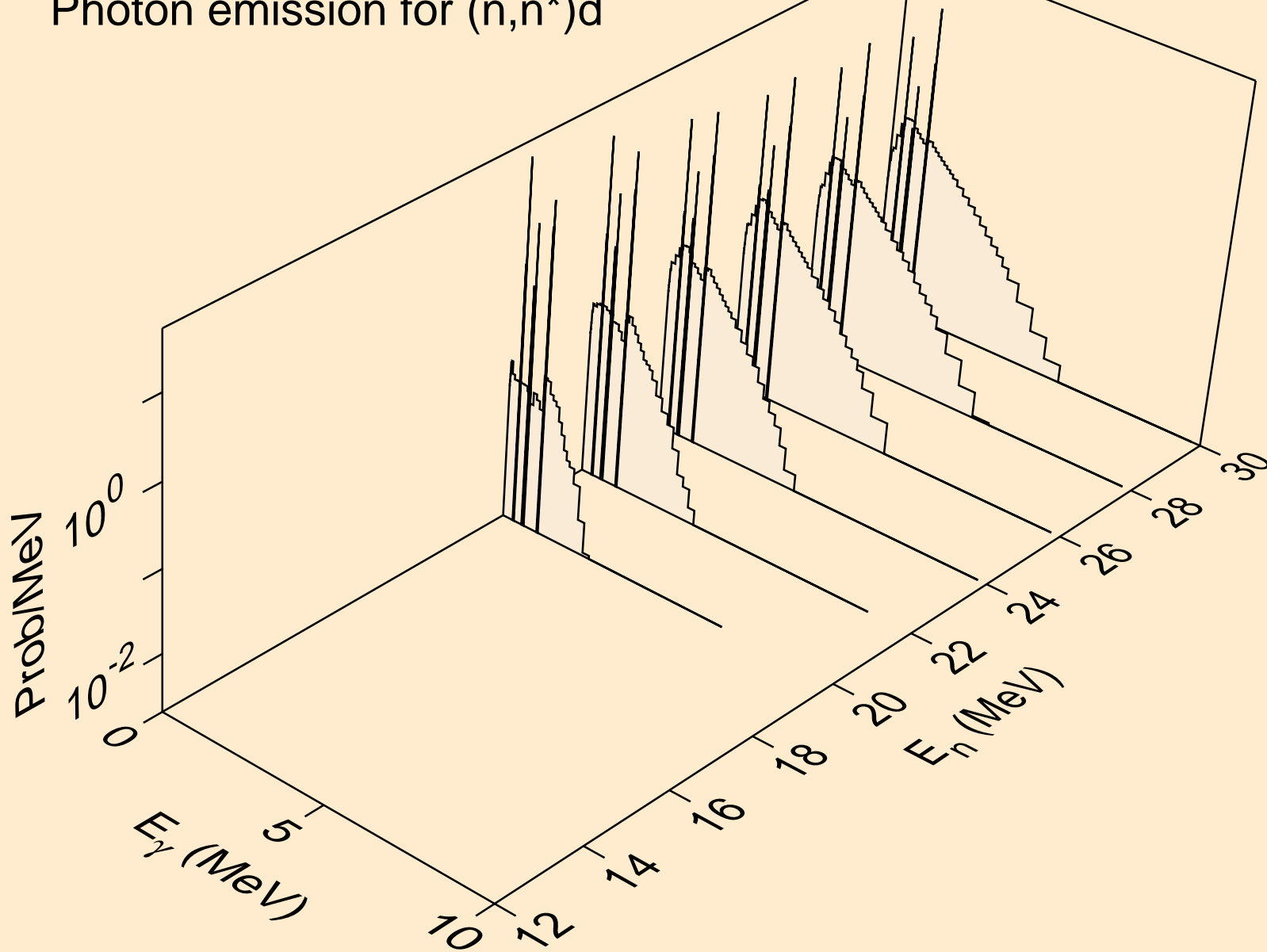

TE127 NEUTRON ACER TENDL-2019 LIBRARY; T=293.16K
Photon emission for (n,n*)t

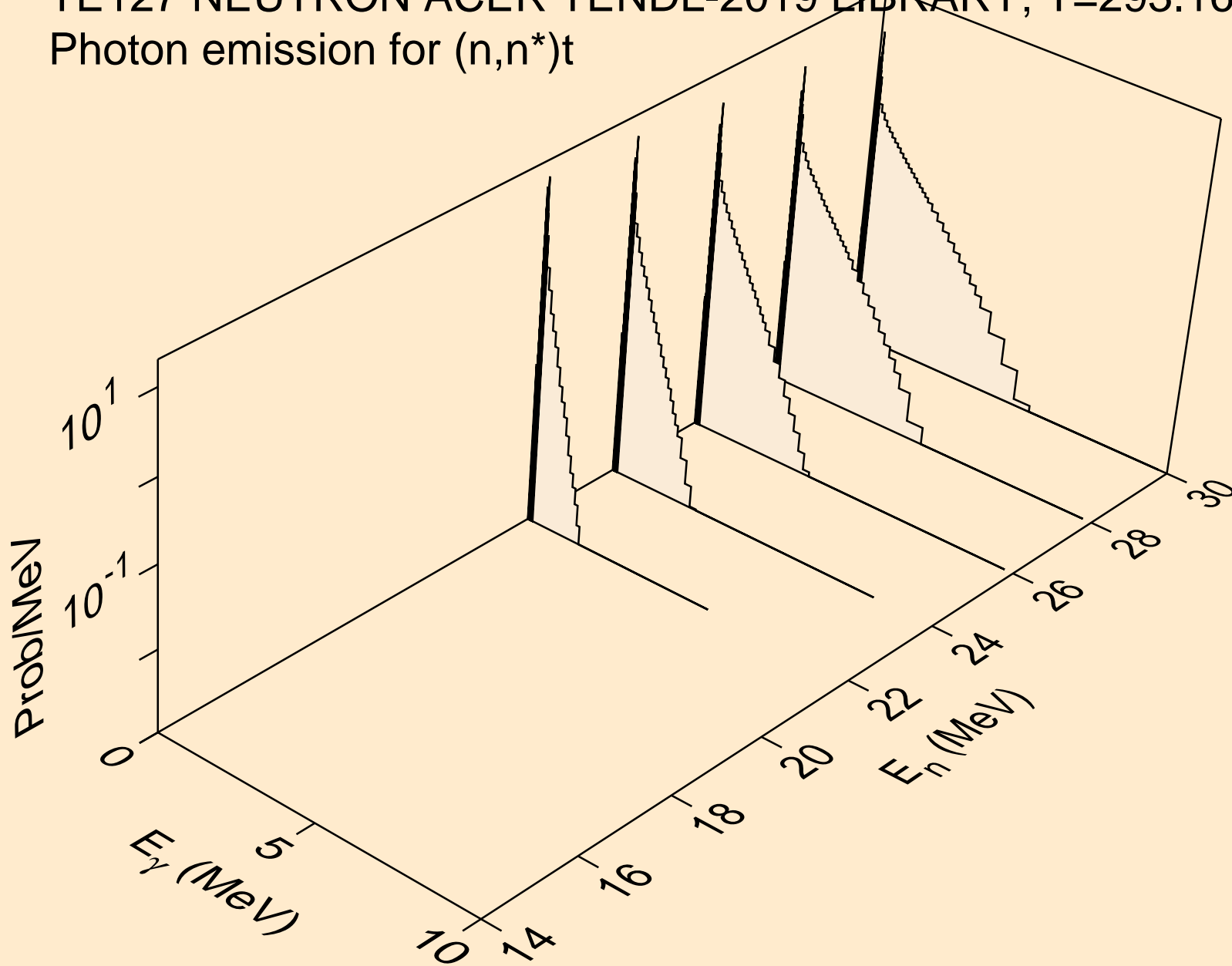

TE127 NEUTRON ACER TENDL-2019 LIBRARY; T=293.16K
Photon emission for (n,n*)he3

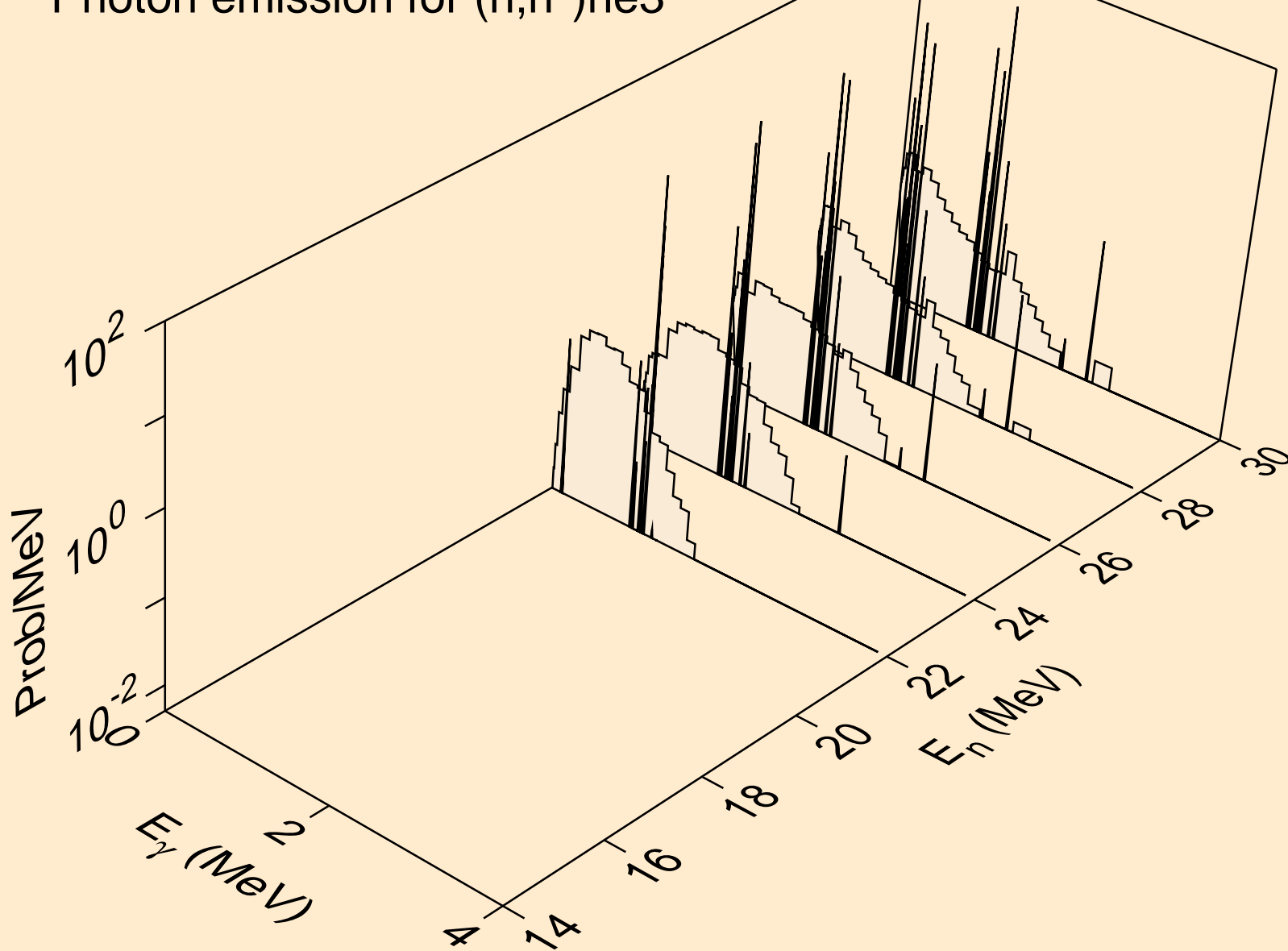

TE127 NEUTRON ACER TENDL-2019 LIBRARY; T=293.16K
Photon emission for (n,4n)

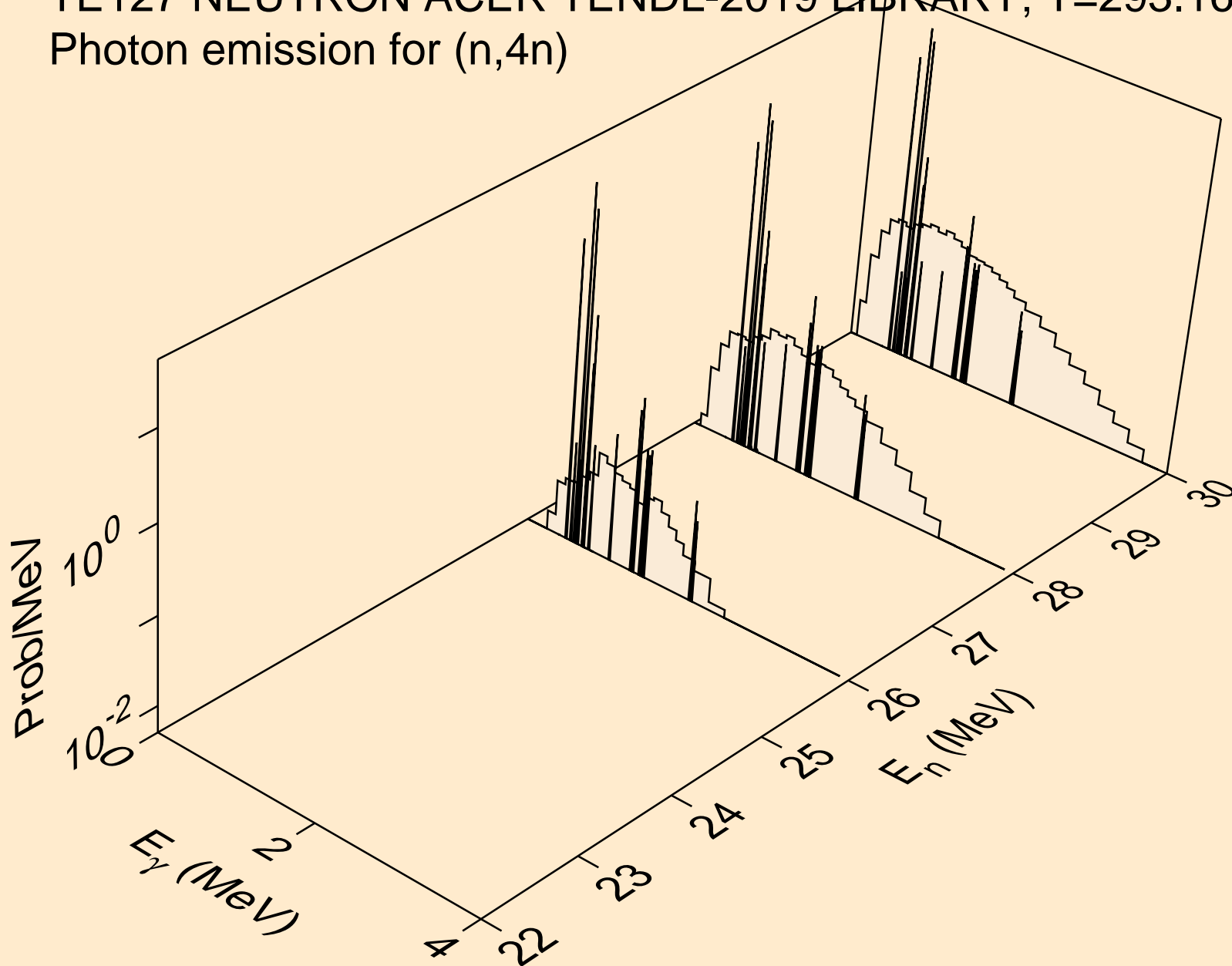

TE127 NEUTRON ACER TENDL-2019 LIBRARY; T=293.16K
Photon emission for (n,2np)

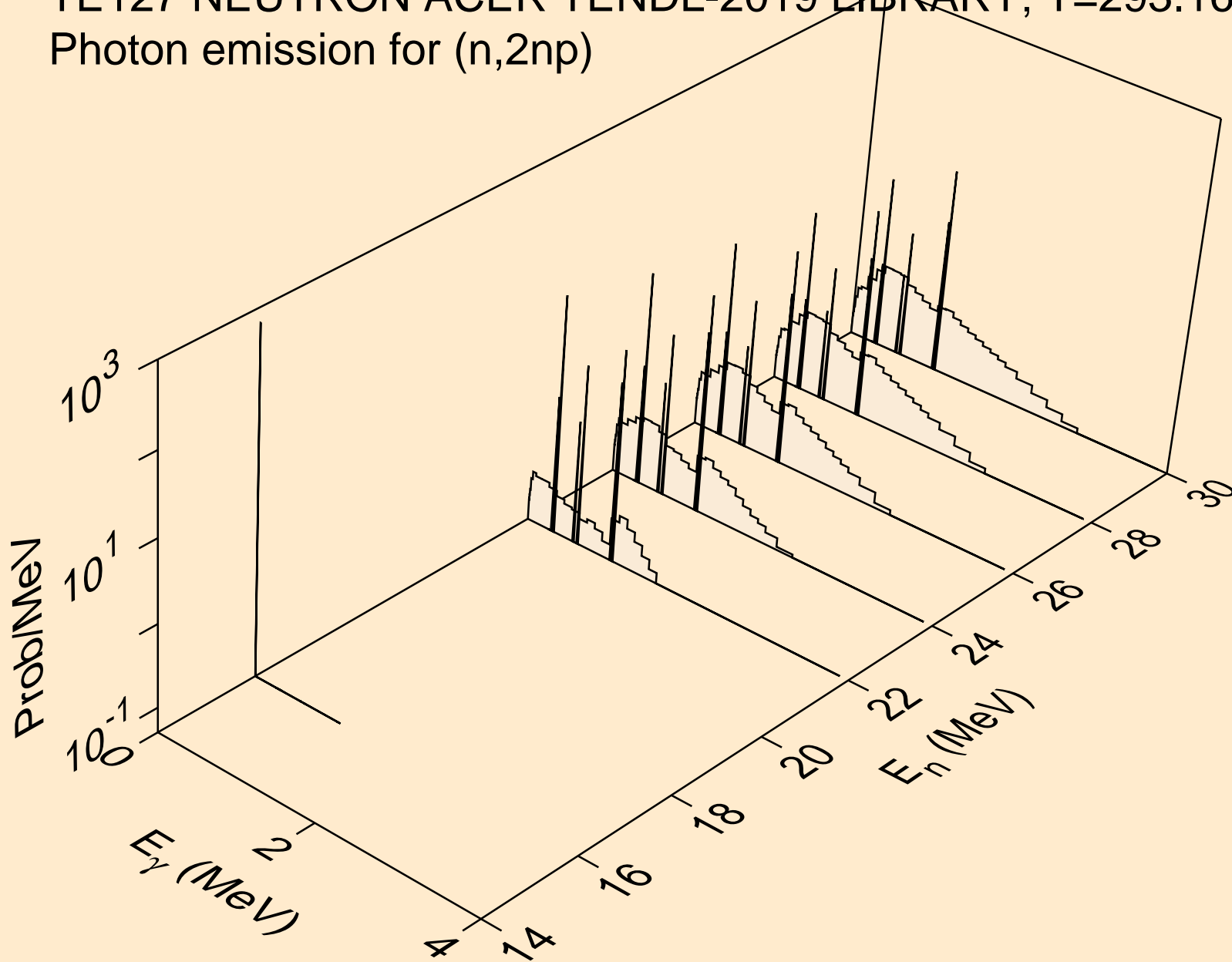

TE127 NEUTRON ACER TENDL-2019 LIBRARY; T=293.16K
Photon emission for (n,3np)

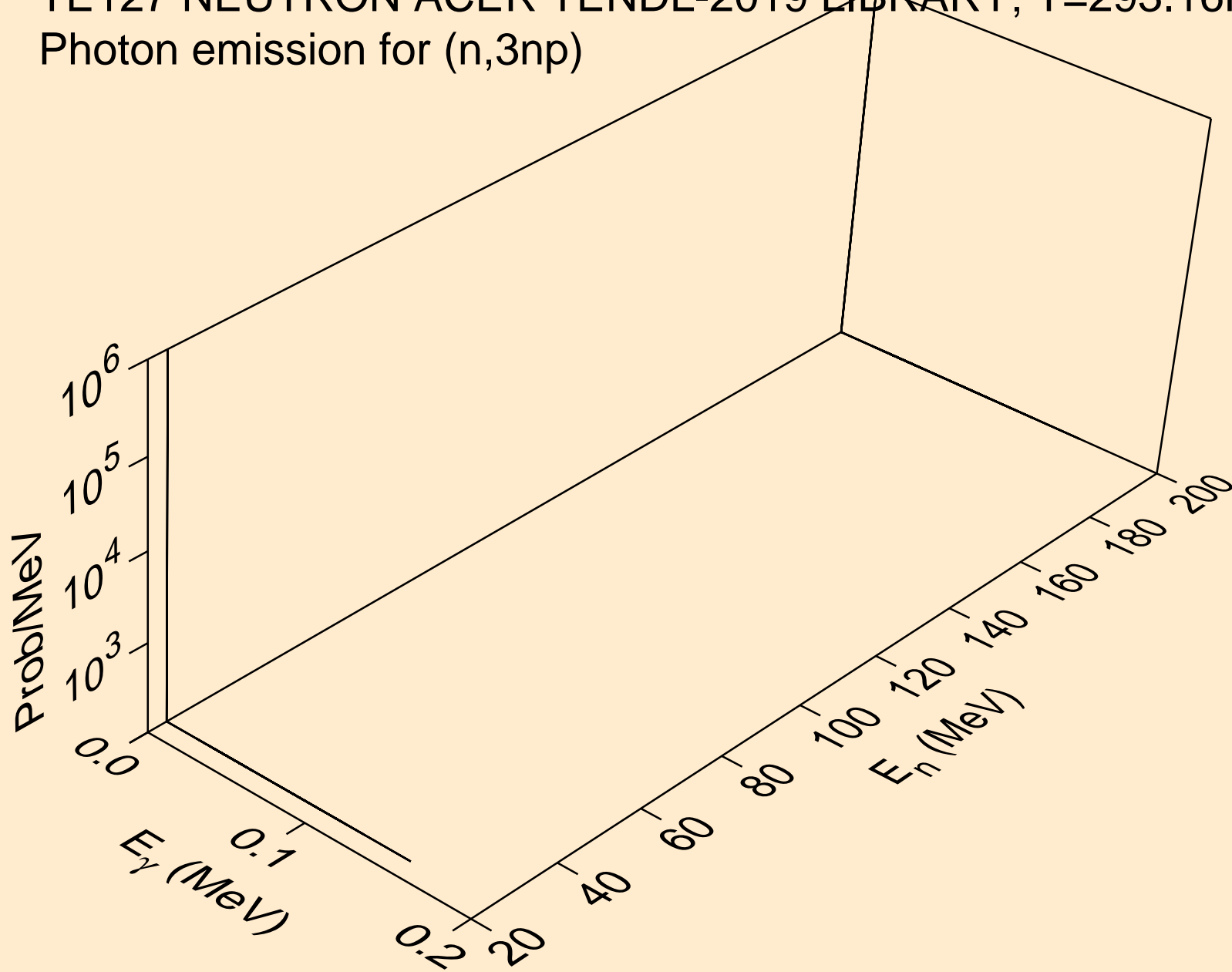

TE127 NEUTRON ACER TENDL-2019 LIBRARY; T=293.16K
Photon emission for (n,2np)

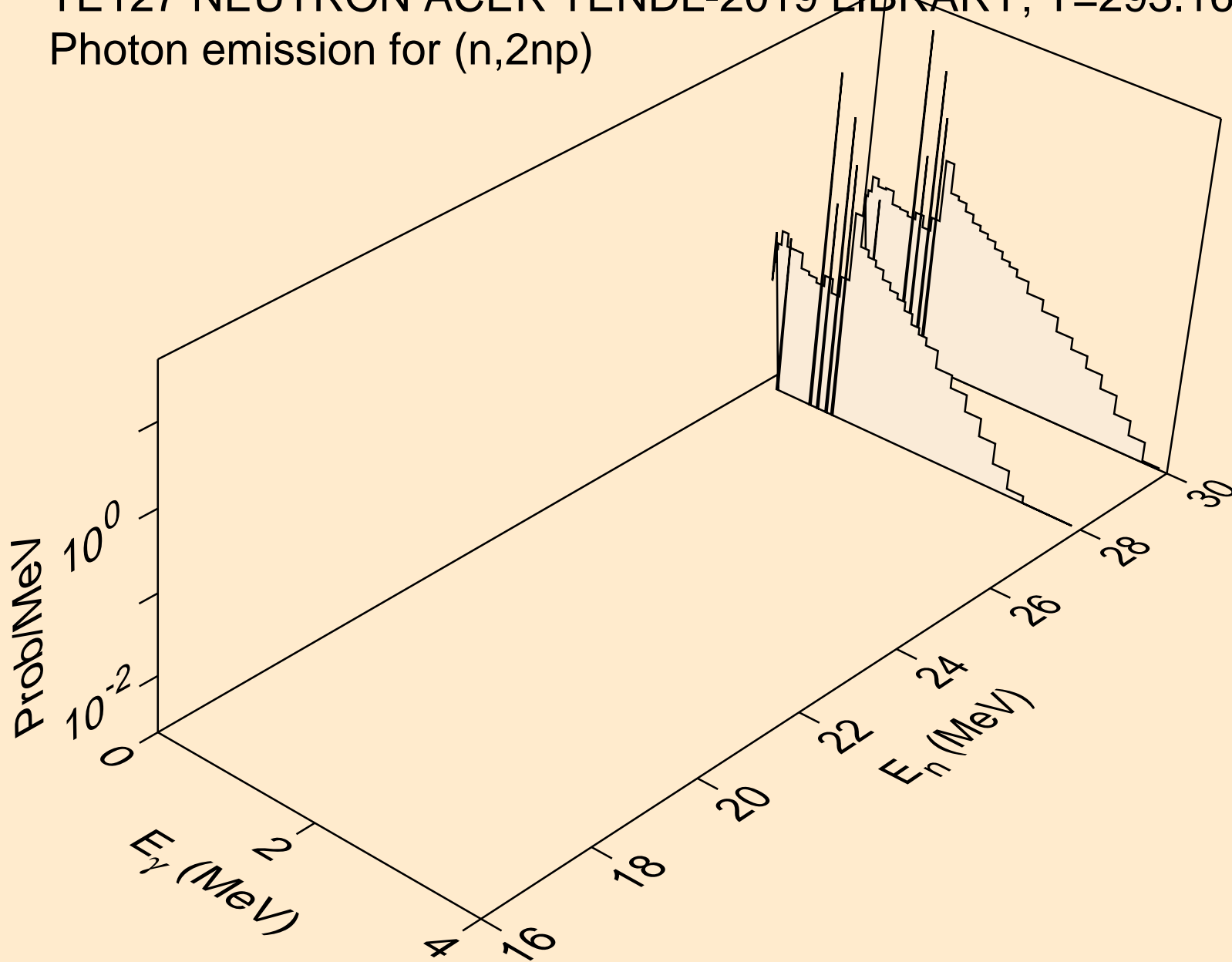

TE127 NEUTRON ACER TENDL-2019 LIBRARY; T=293.16K
Photon emission for (n,n*c)

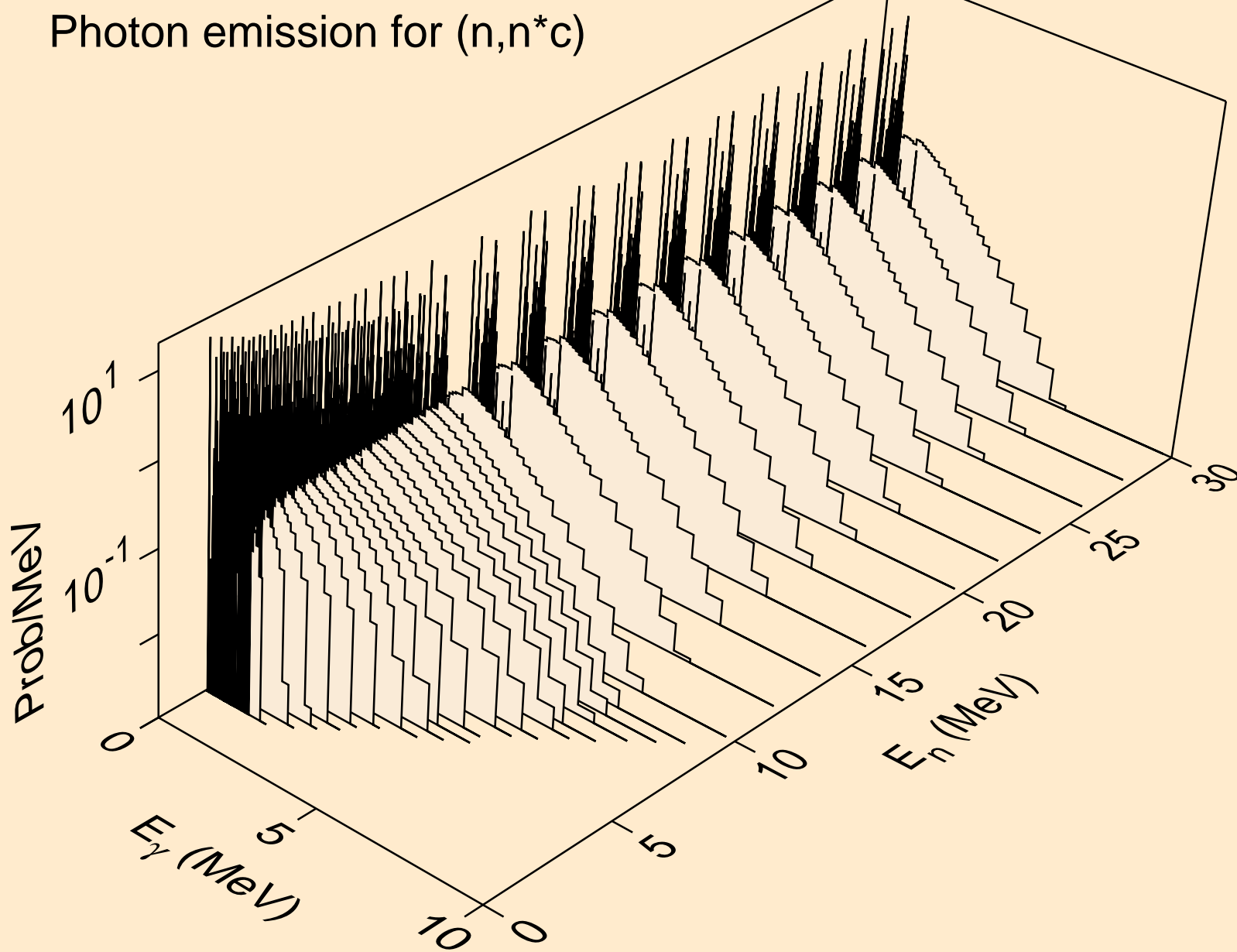

TE127 NEUTRON ACER TENDL-2019 LIBRARY; T=293.16K
Photon emission for (n,gma)

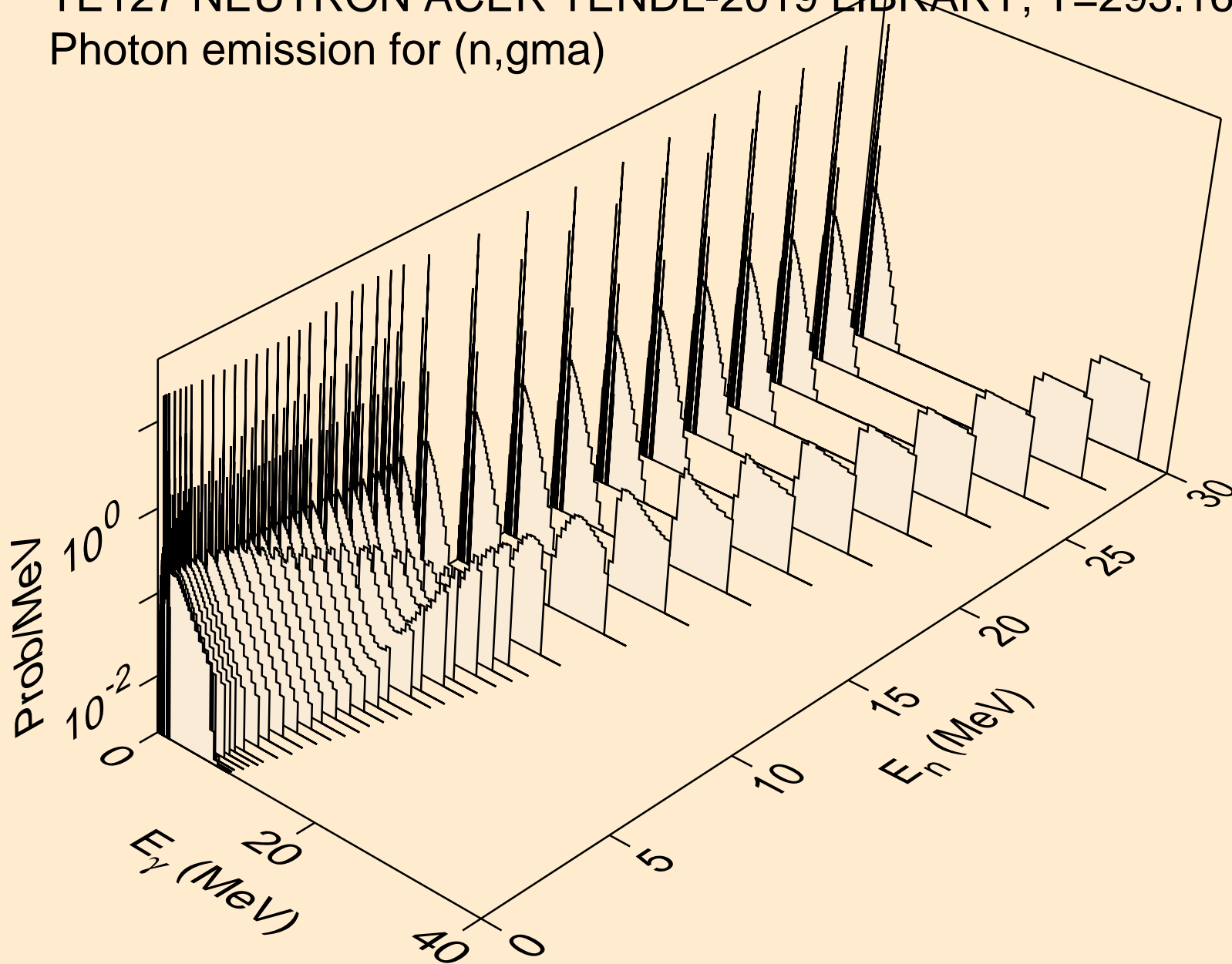

TE127 NEUTRON ACER TENDL-2019 LIBRARY; T=293.16K
Photon emission for (n,p)

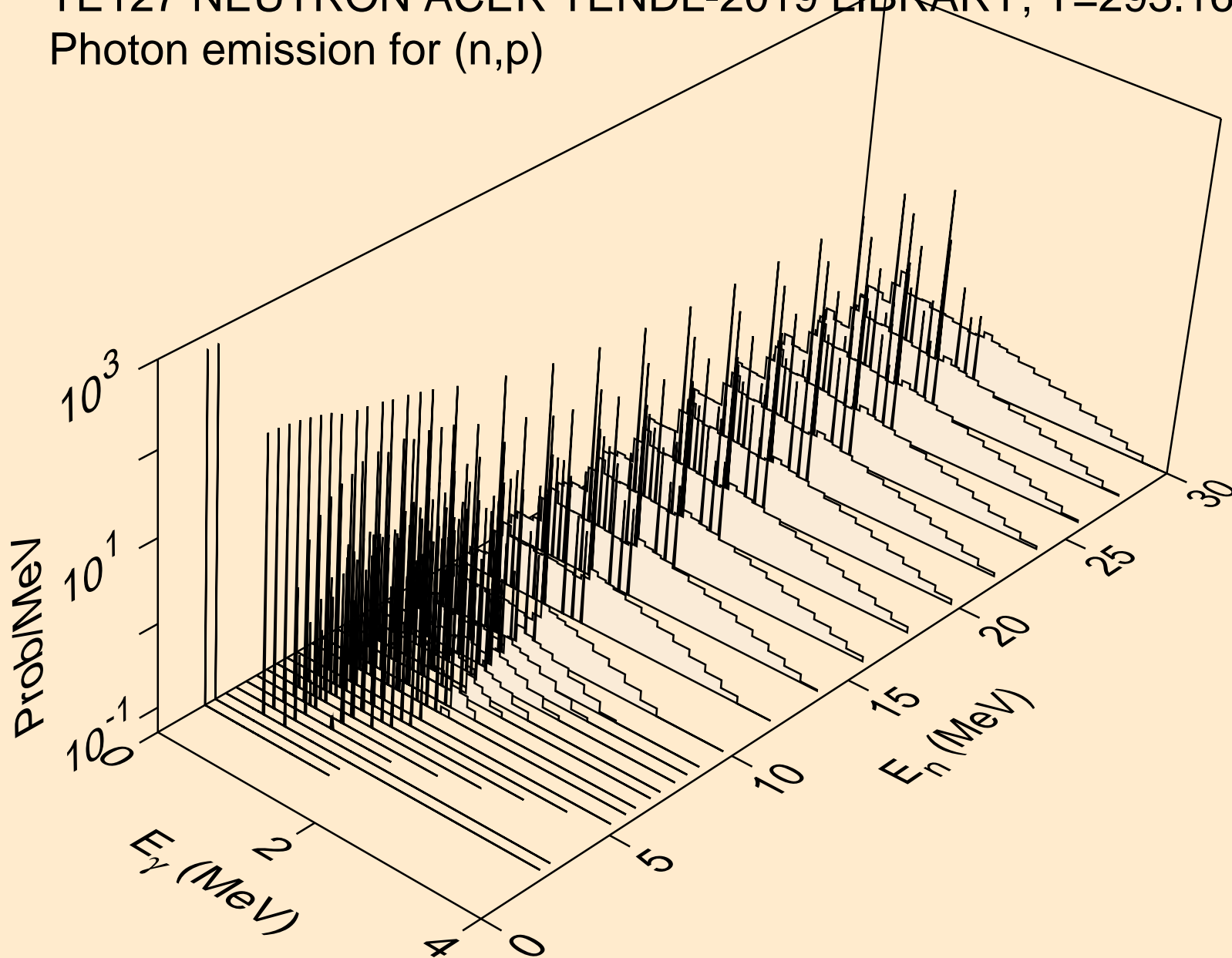

TE127 NEUTRON ACER TENDL-2019 LIBRARY; T=293.16K
Photon emission for (n,d)

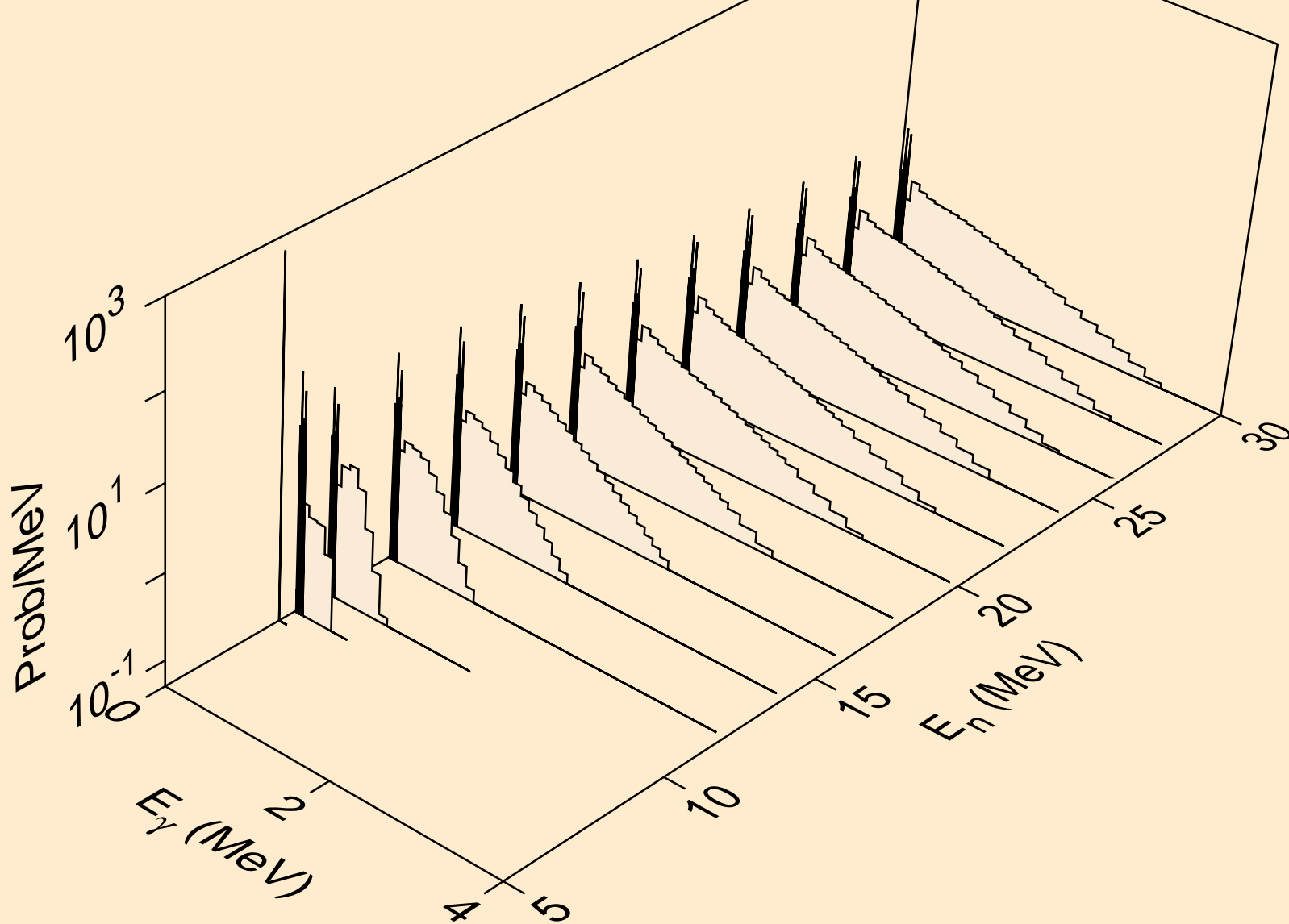

TE127 NEUTRON ACER TENDL-2019 LIBRARY; T=293.16K
Photon emission for (n,t)

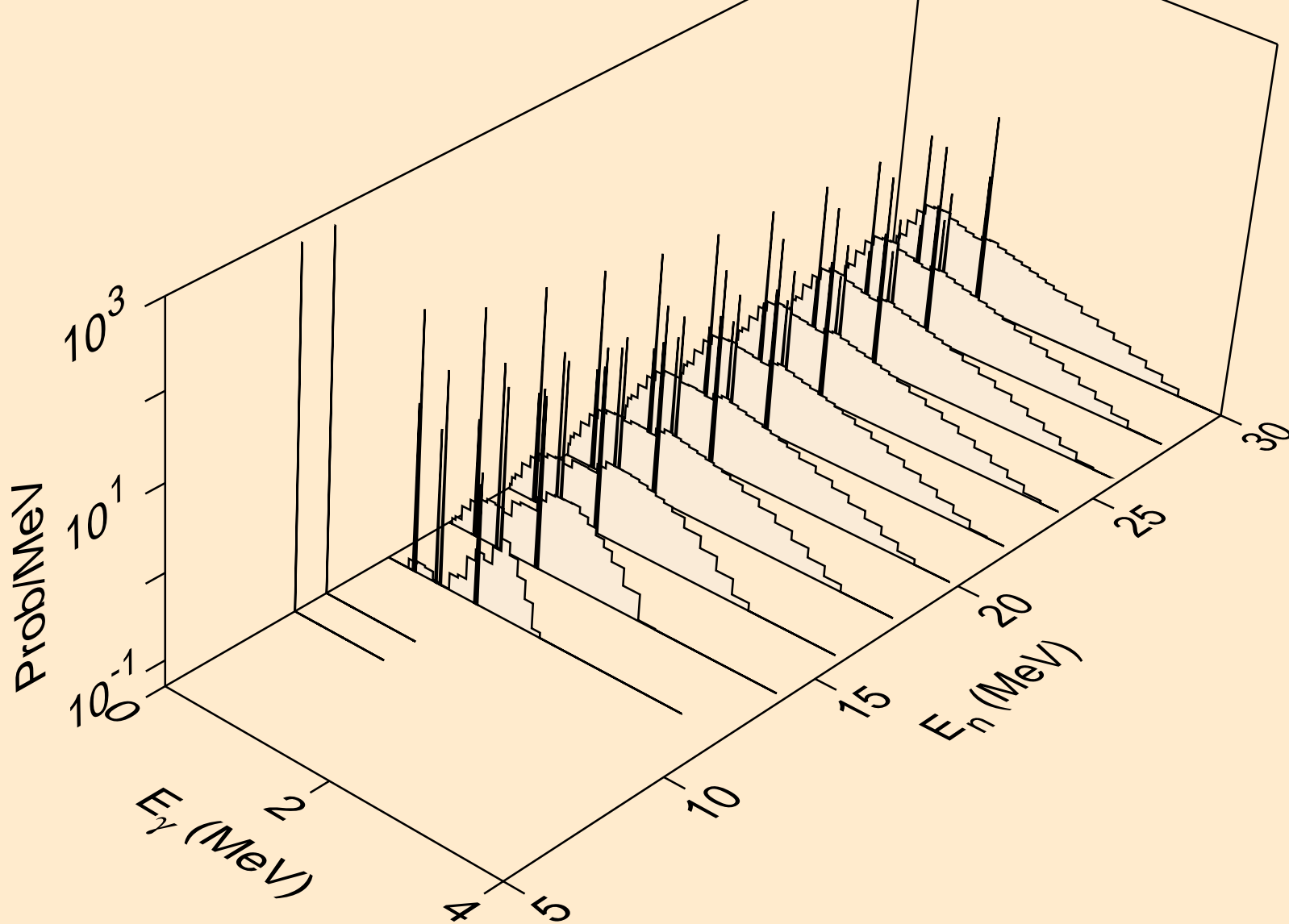

TE127 NEUTRON ACER TENDL-2019 LIBRARY; T=293.16K
Photon emission for (n,he3)

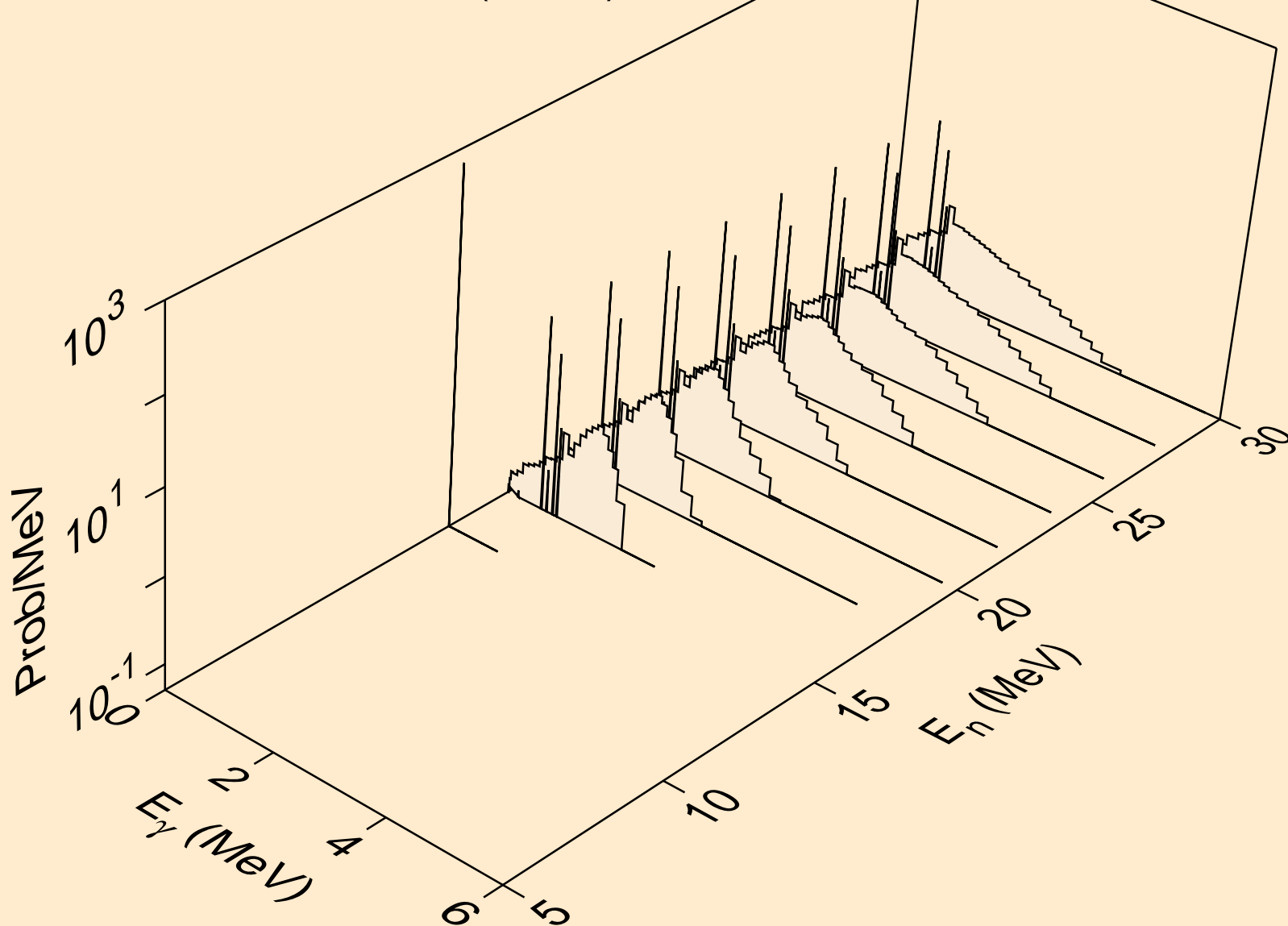

TE127 NEUTRON ACER TENDL-2019 LIBRARY; T=293.16K
Photon emission for (n,a)

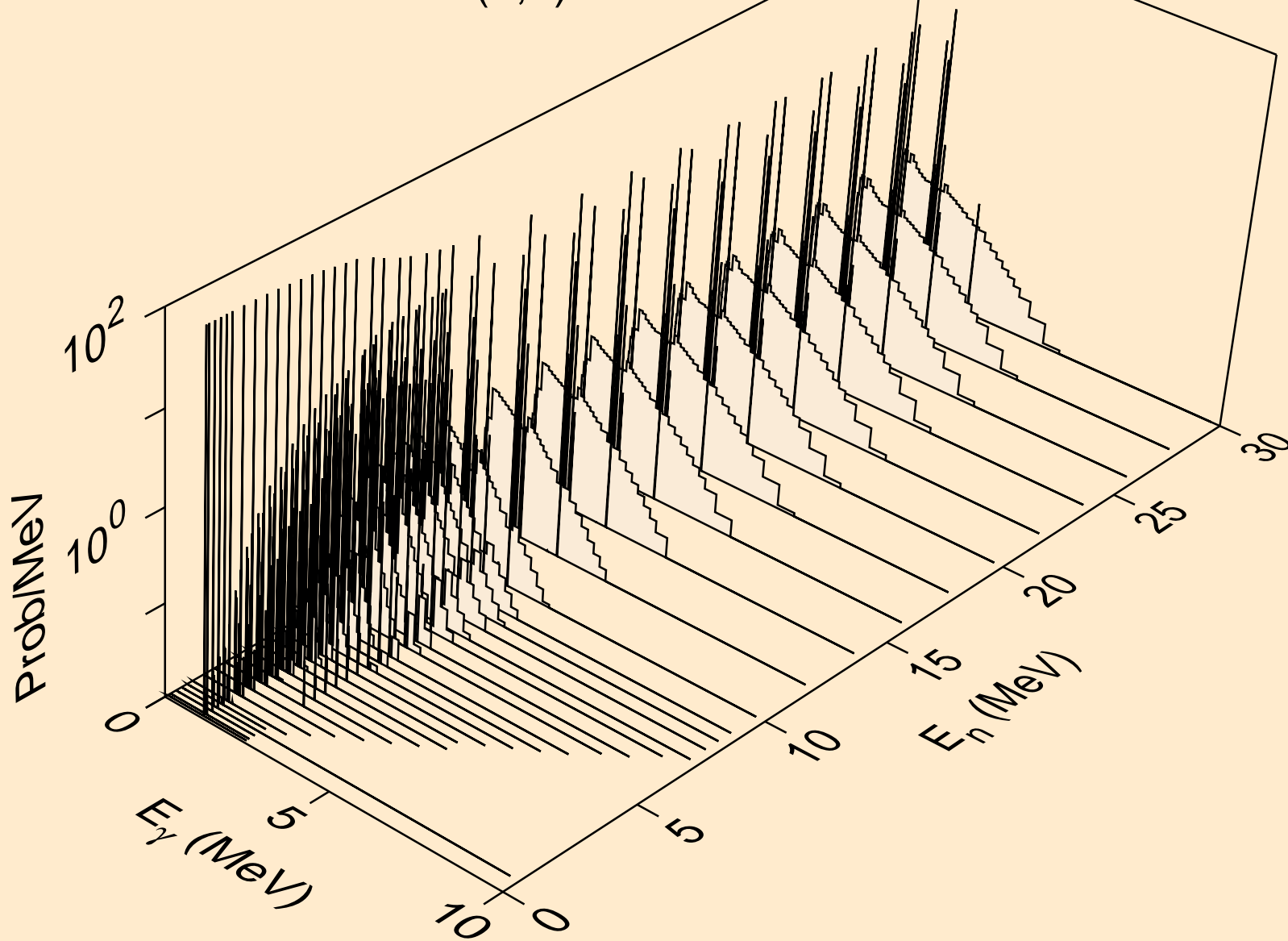

TE127 NEUTRON ACER TENDL-2019 LIBRARY; T=293.16K
Photon emission for (n,2p)

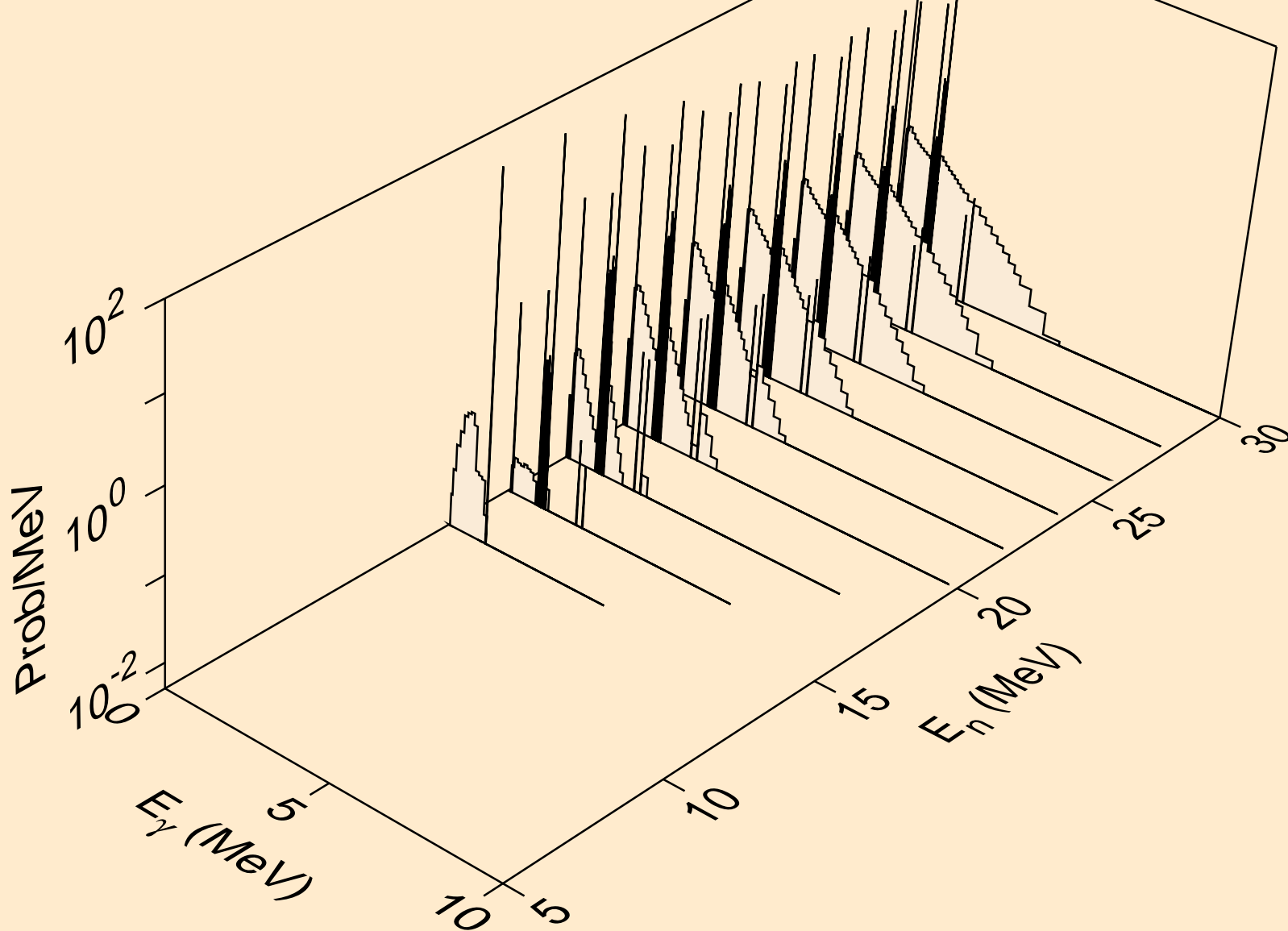

TE127 NEUTRON ACER TENDL-2019 LIBRARY; T=293.16K
Photon emission for (n,p)

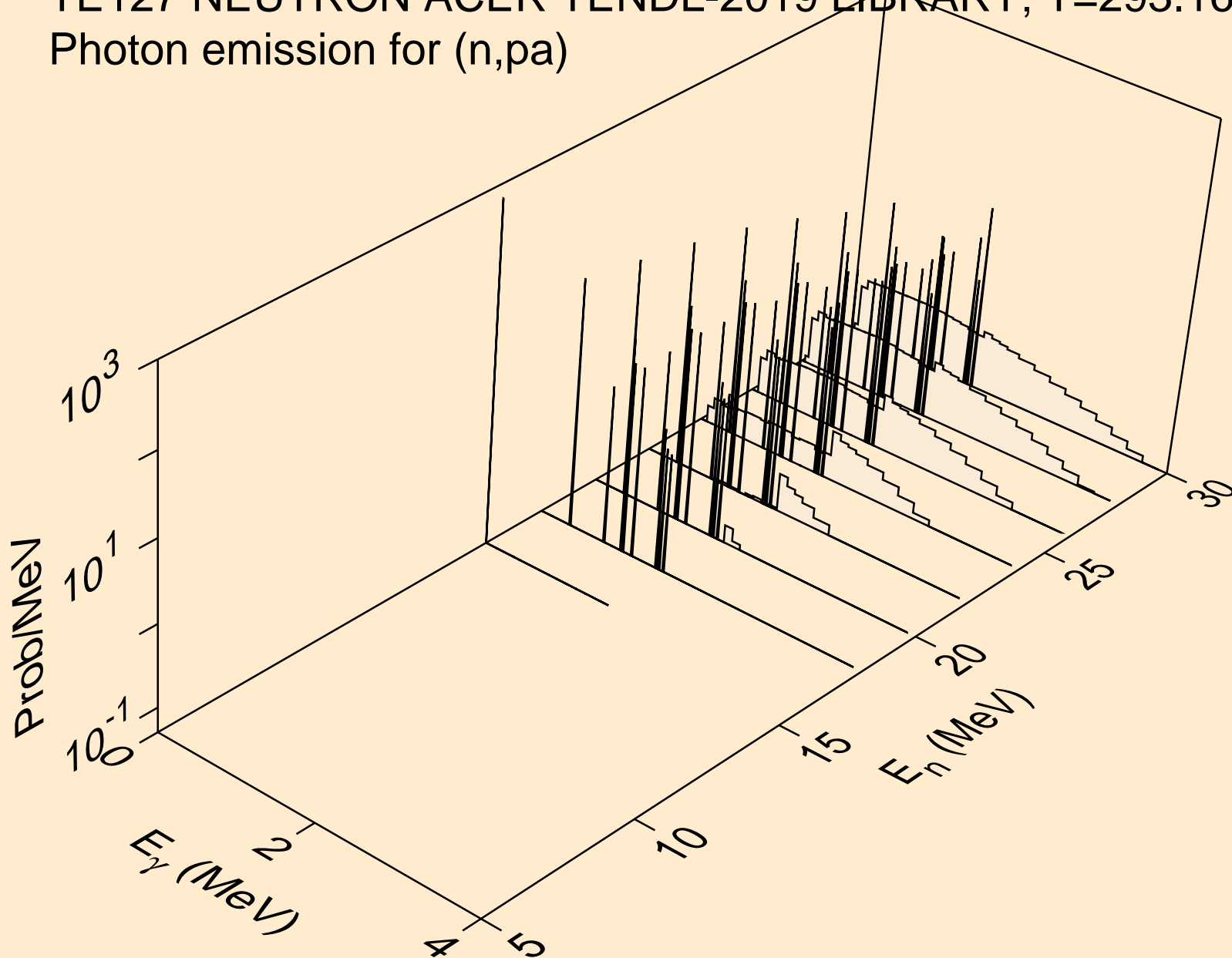

TE127 NEUTRON ACER TENDL-2019 LIBRARY; T=293.16K
Photon emission for (n,pd)

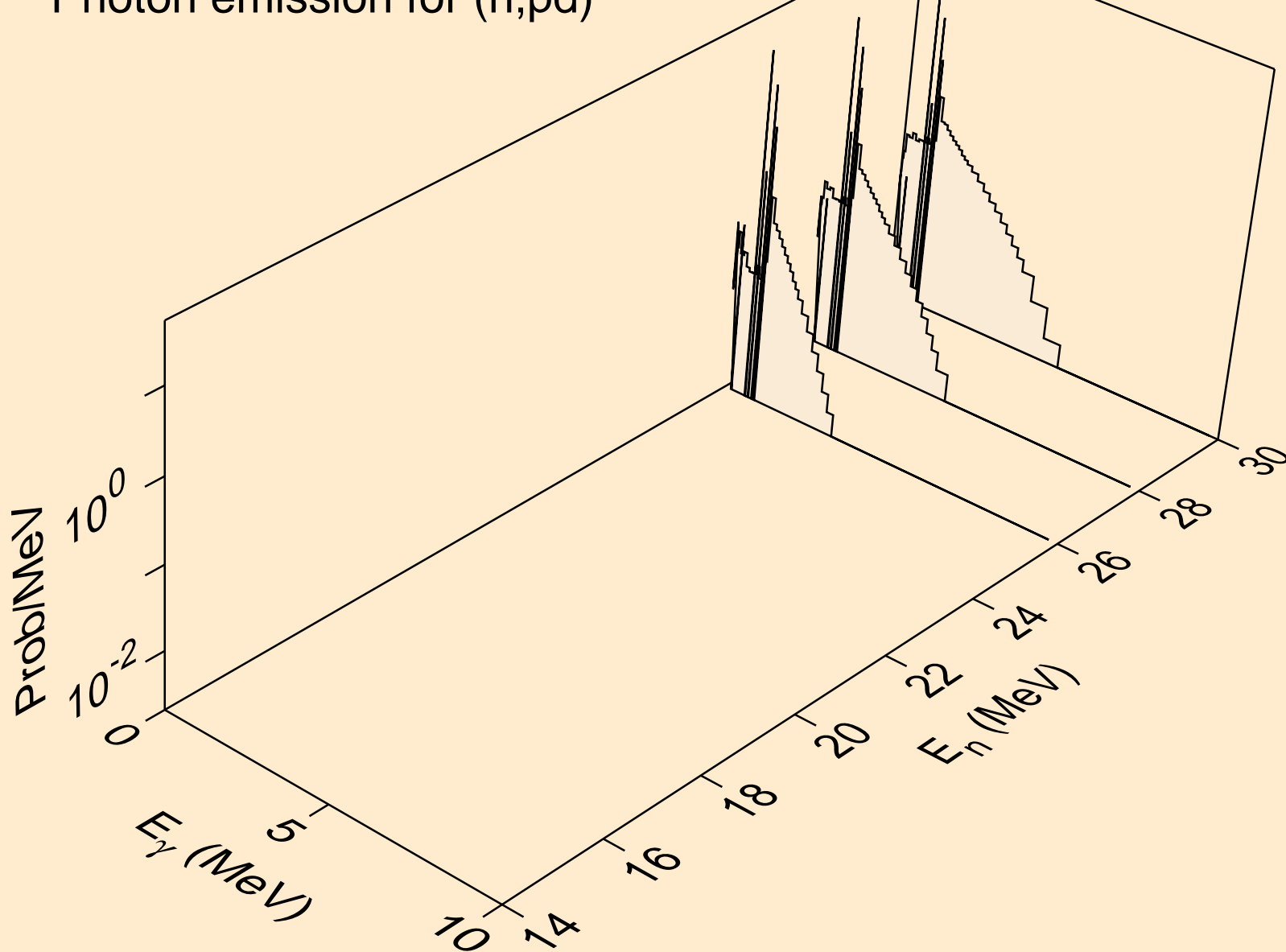

TE127 NEUTRON ACER TENDL-2019 LIBRARY; T=293.16K
Photon emission for (n,pt)

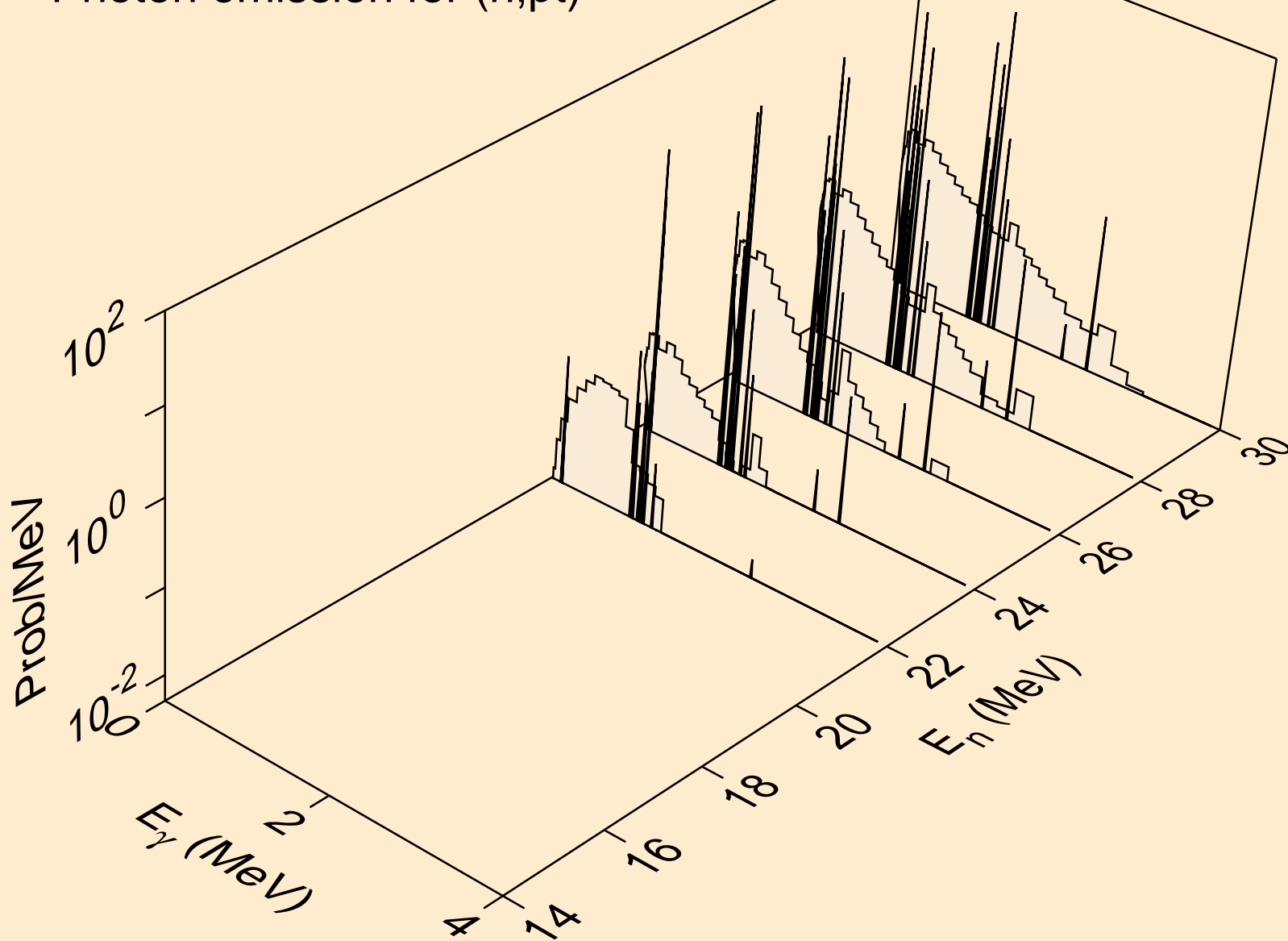

TE127 NEUTRON ACER TENDL-2019 LIBRARY; T=293.16K
thermal capture photon spectrum

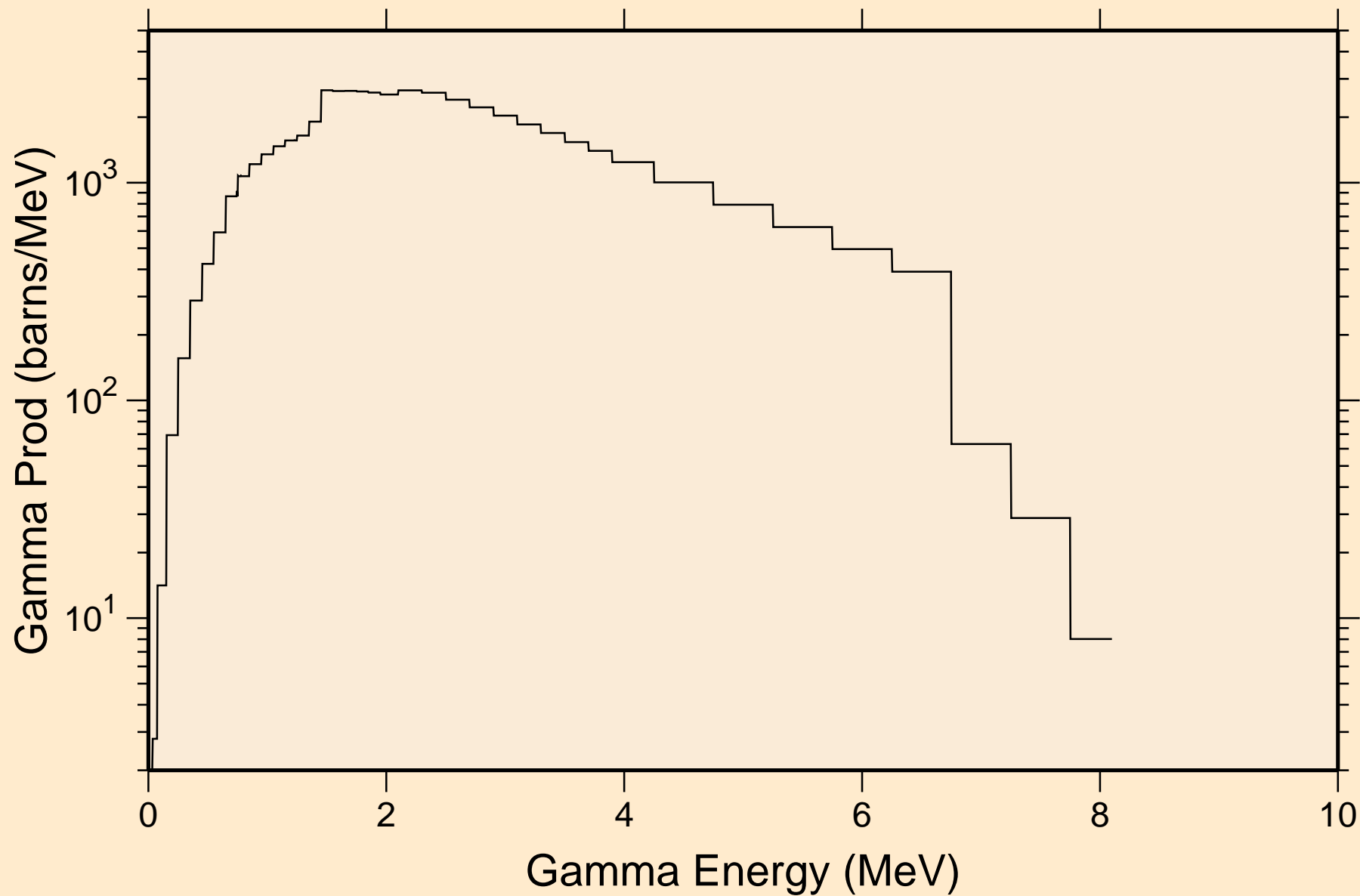

TE127 NEUTRON ACER TENDL-2019 LIBRARY; T=293.16K
14 MeV photon spectrum

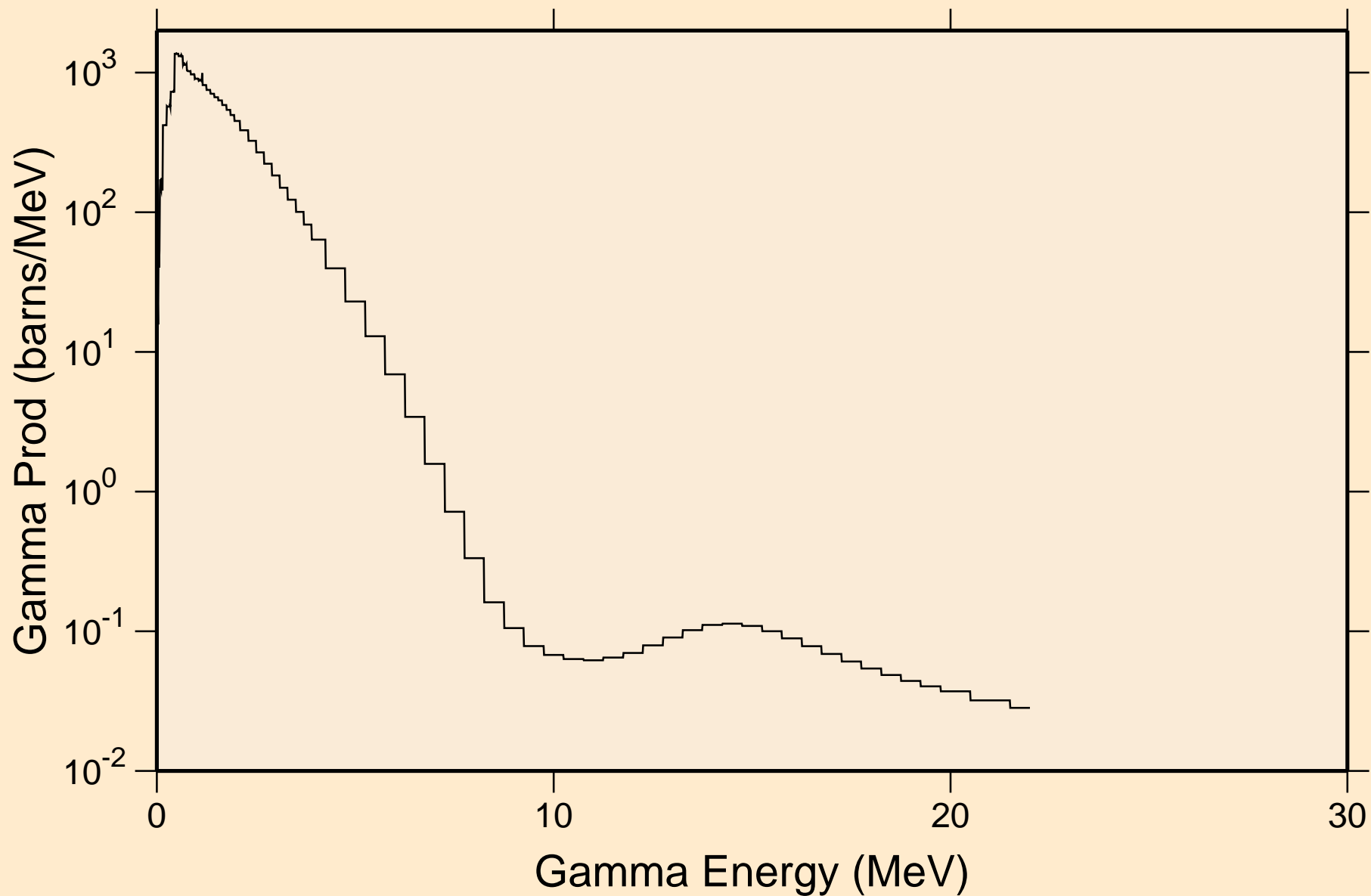

TE127 NEUTRON ACER TENDL-2019 LIBRARY; T=293.16K

Particle heating contributions

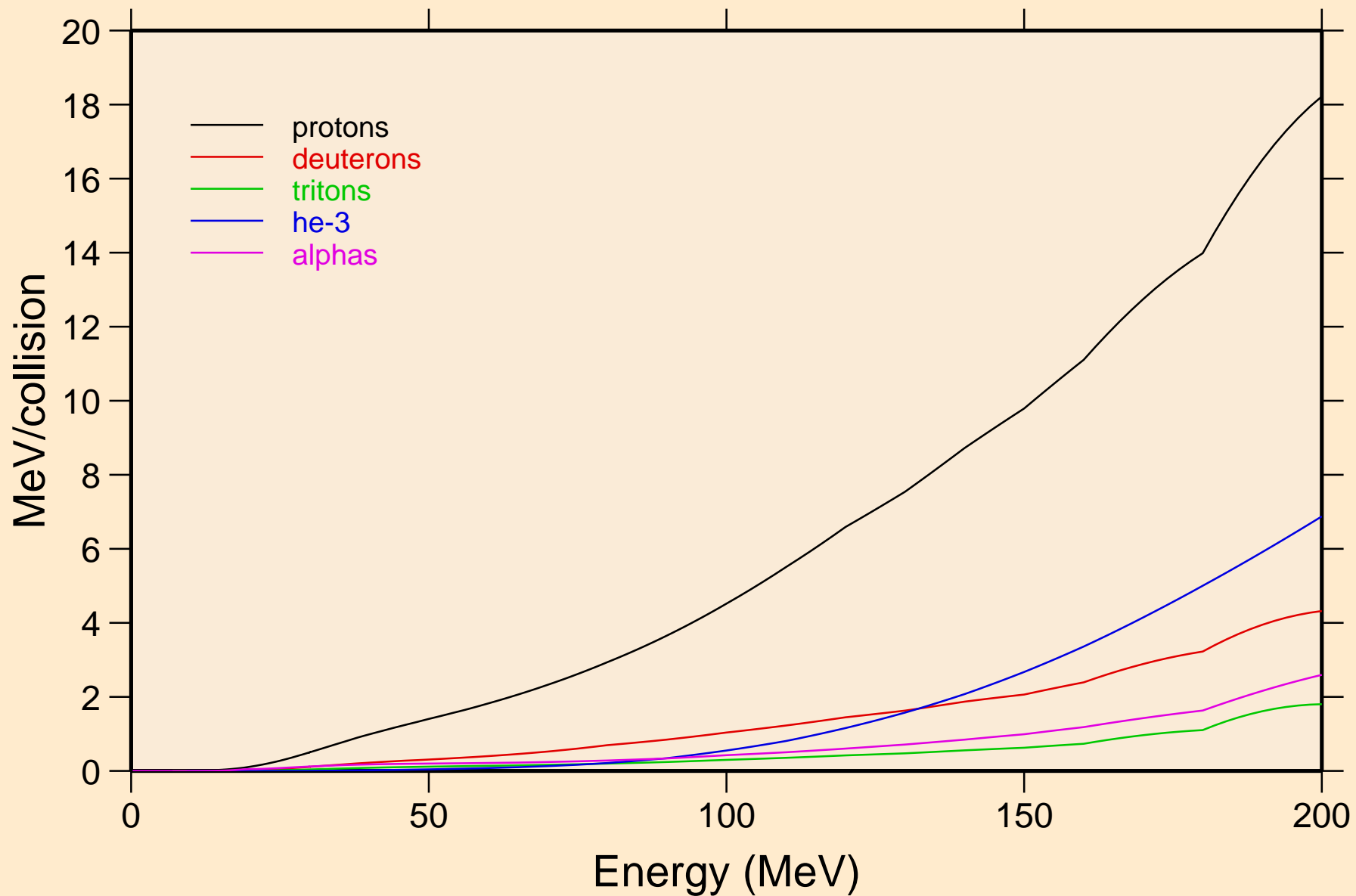

TE127 NEUTRON ACER TENDL-2019 LIBRARY; T=293.16K
Recoil Heating

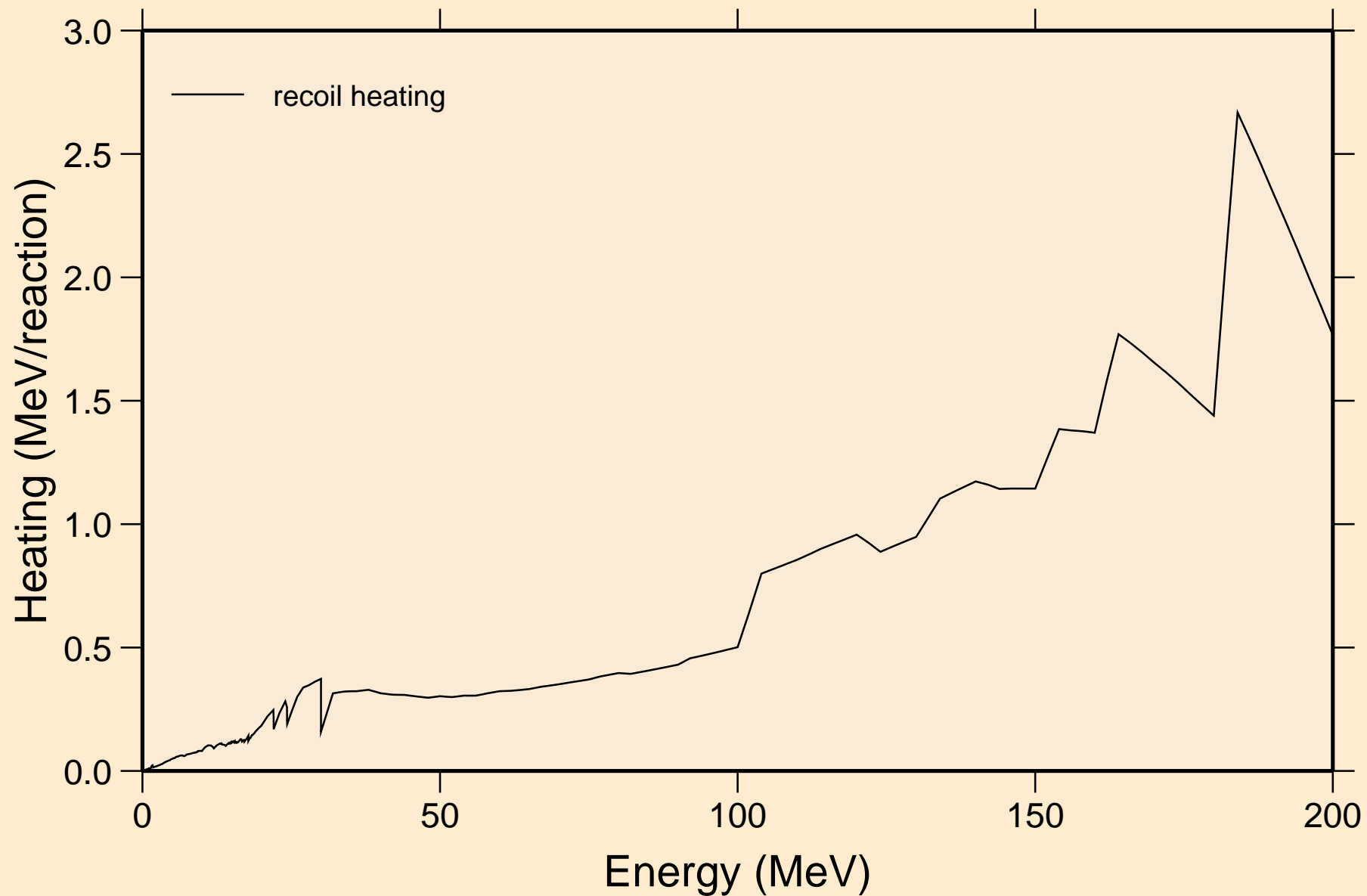

TE127 NEUTRON ACER TENDL-2019 LIBRARY; T=293.16K
Particle production cross sections

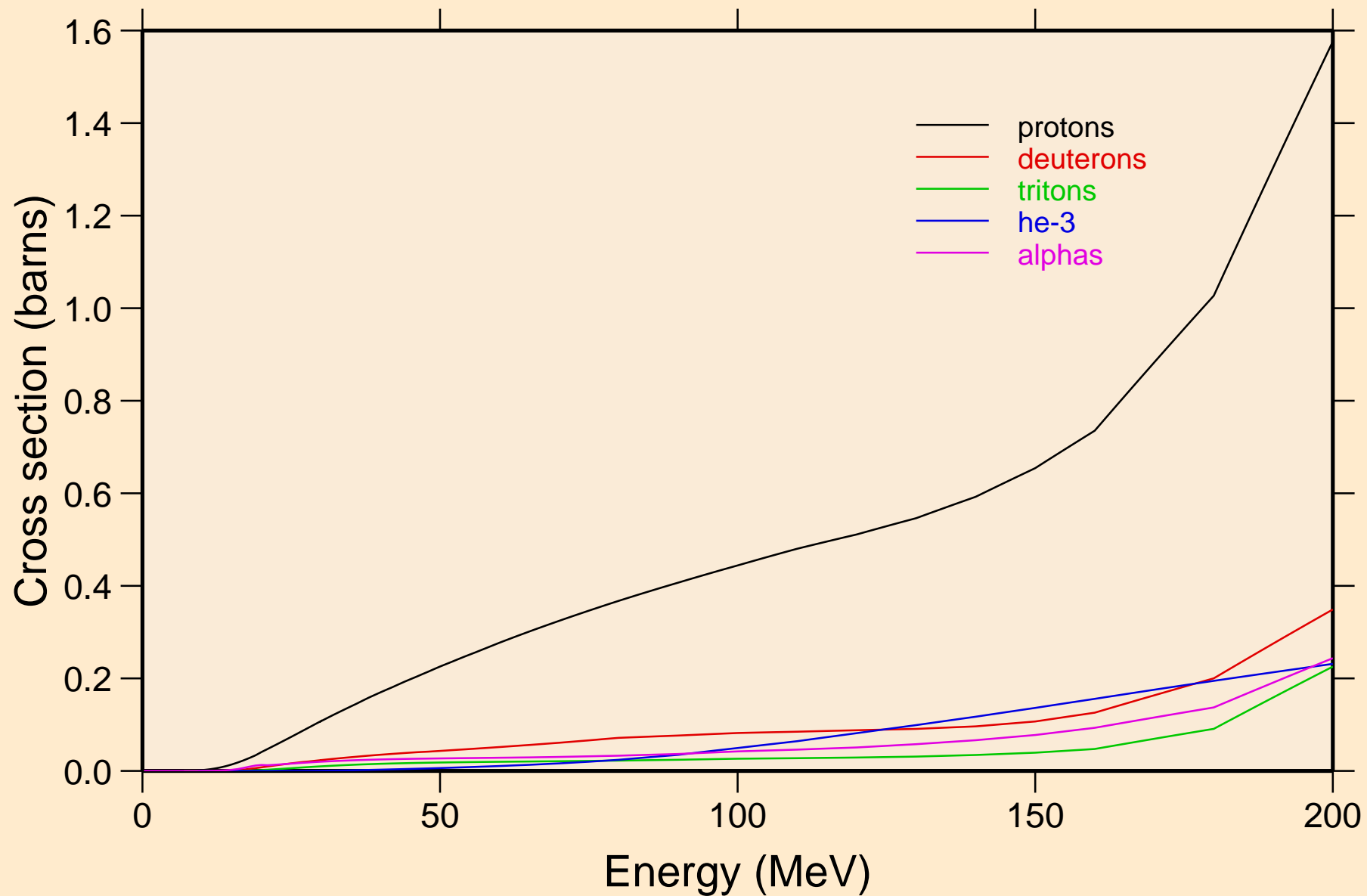

TE127 NEUTRON ACER TENDL-2019 LIBRARY; T=293.16K
protons from (n,x)

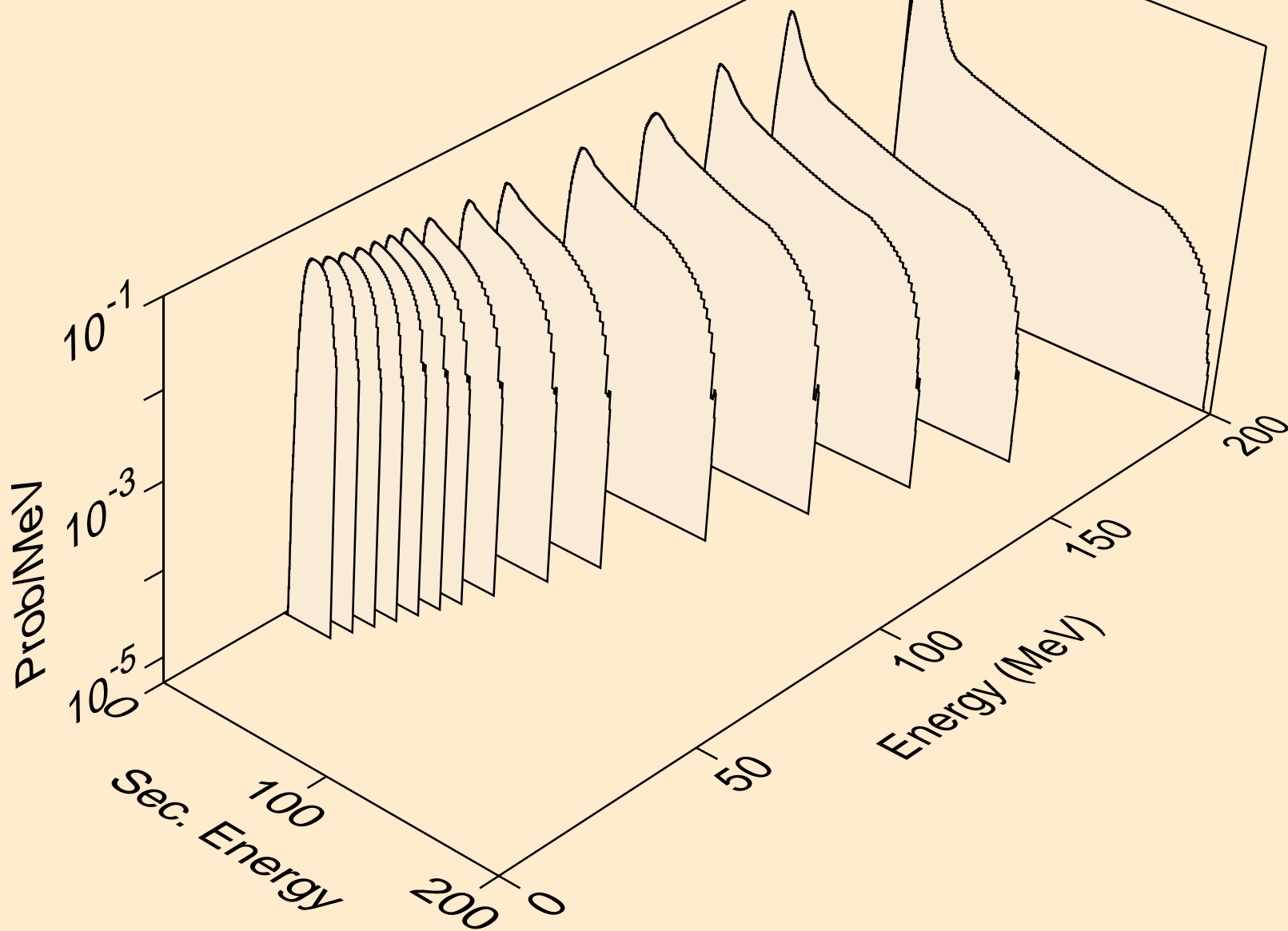

TE127 NEUTRON ACER TENDL-2019 LIBRARY; T=293.16K
protons from (n,n*)p

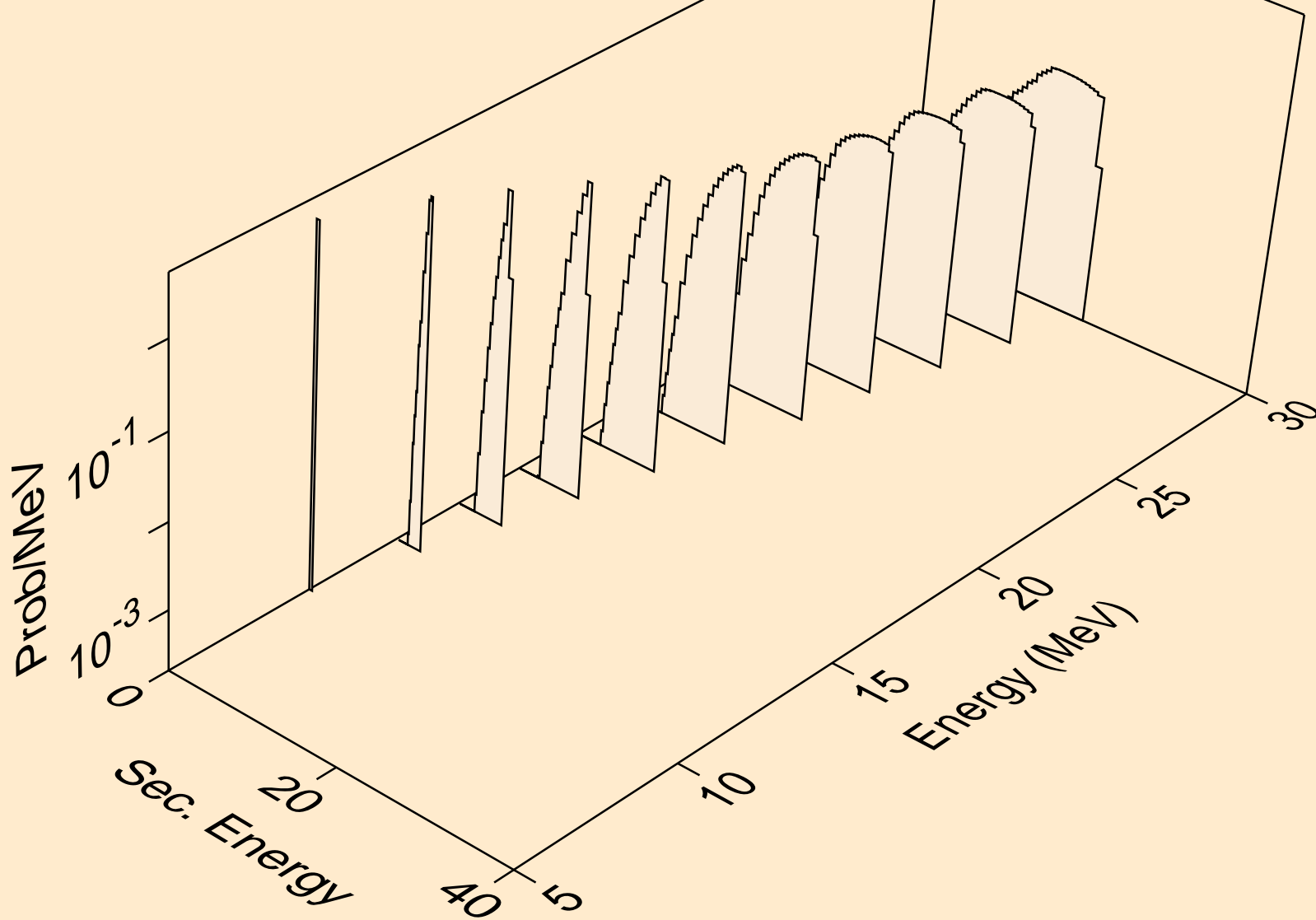

TE127 NEUTRON ACER TENDL-2019 LIBRARY; T=293.16K
protons from (n,2np)

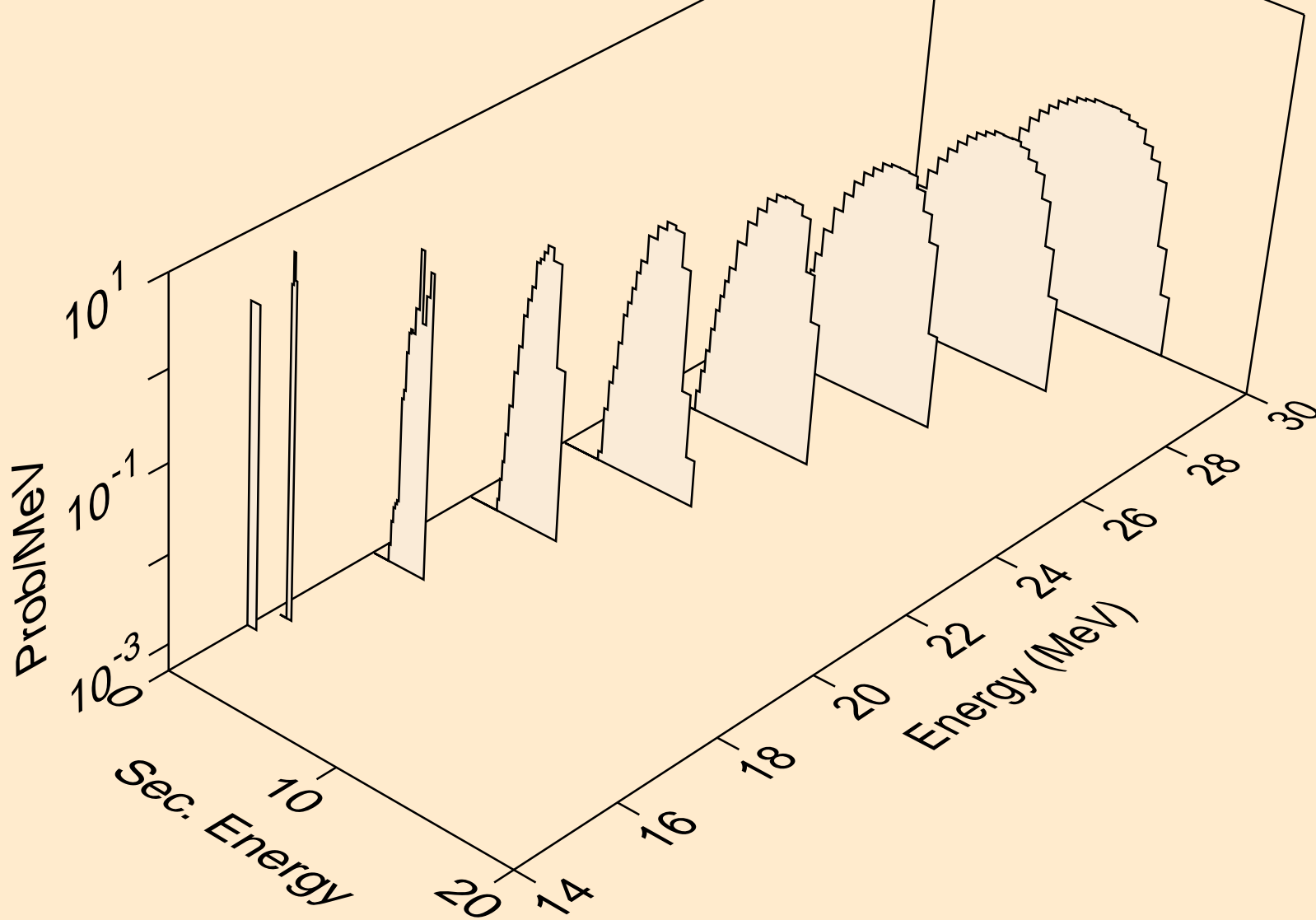

TE127 NEUTRON ACER TENDL-2019 LIBRARY; T=293.16K
protons from (n,3np)

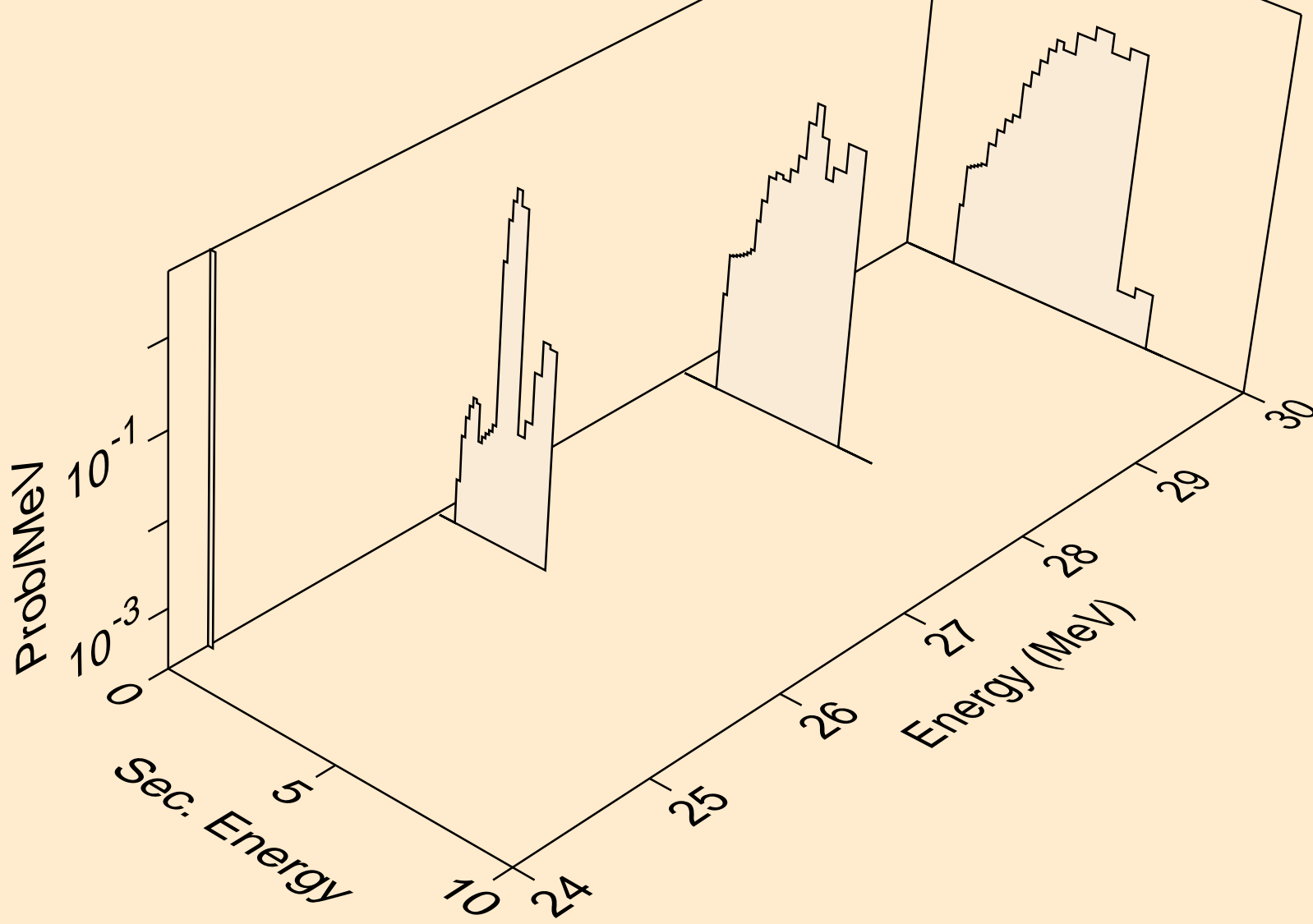

TE127 NEUTRON ACER TENDL-2019 LIBRARY; T=293.16K
protons from (n,2np)

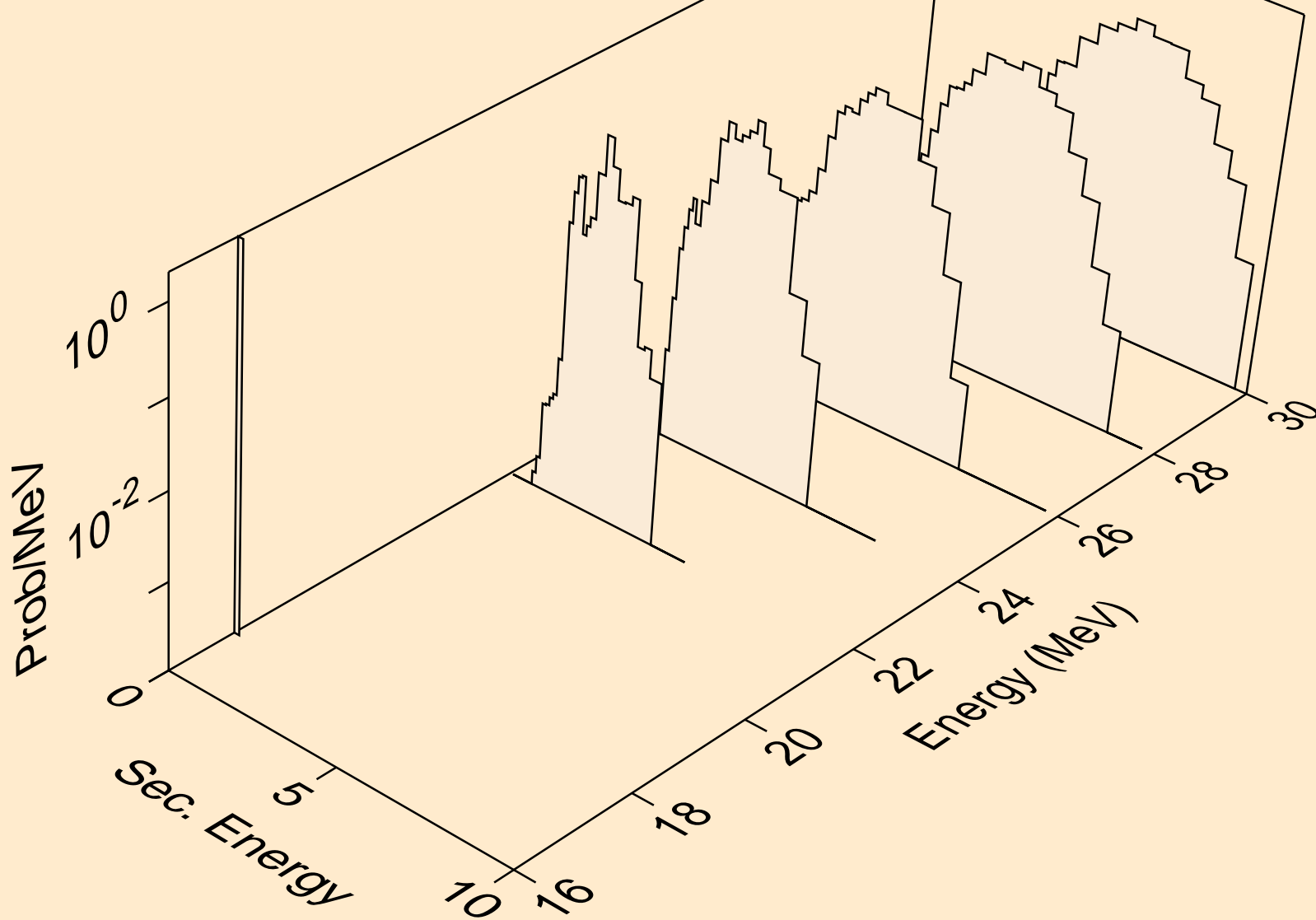

TE127 NEUTRON ACER TENDL-2019 LIBRARY; T=293.16K
protons from (n,p)

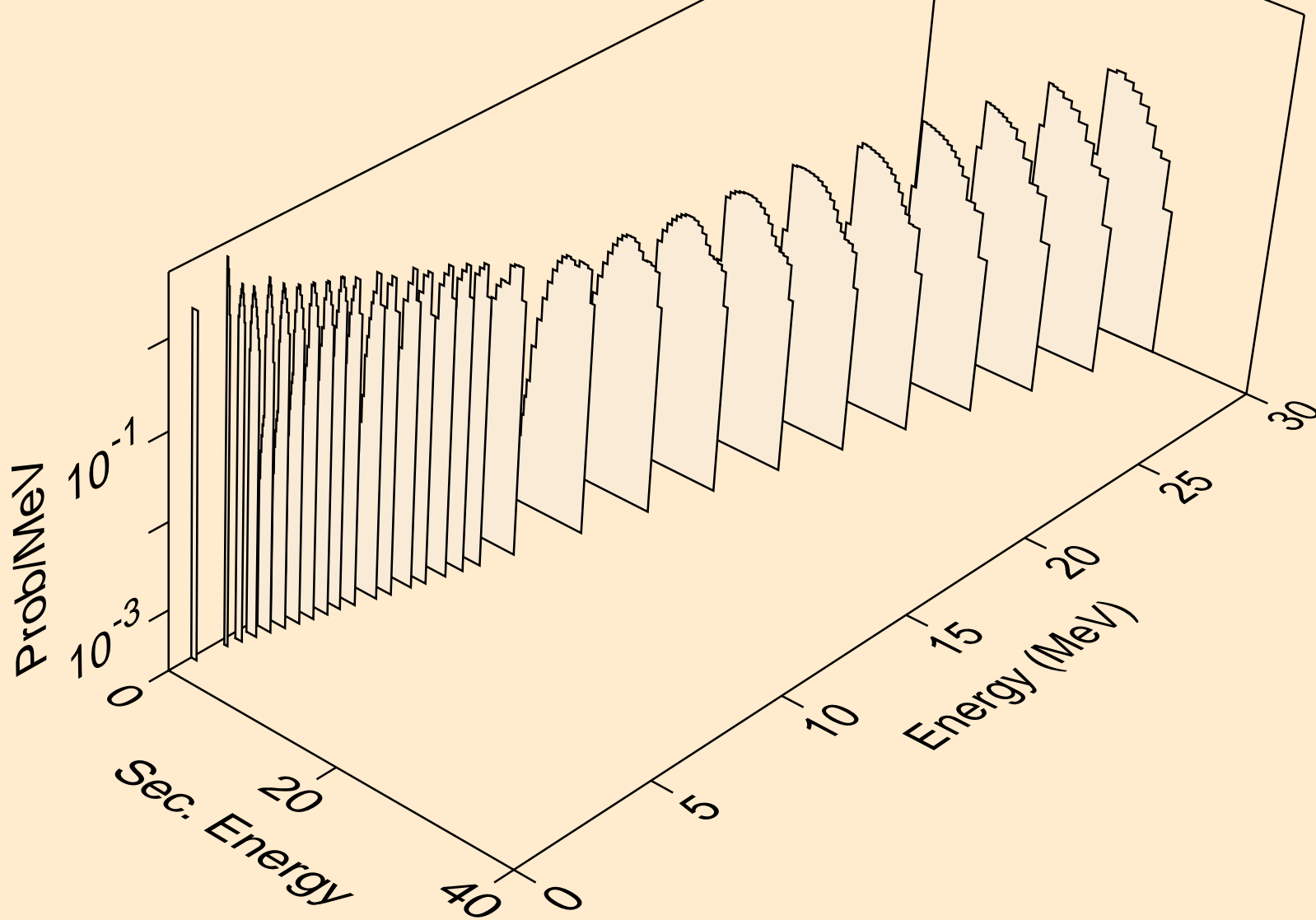

TE127 NEUTRON ACER TENDL-2019 LIBRARY; T=293.16K
protons from (n,2p)

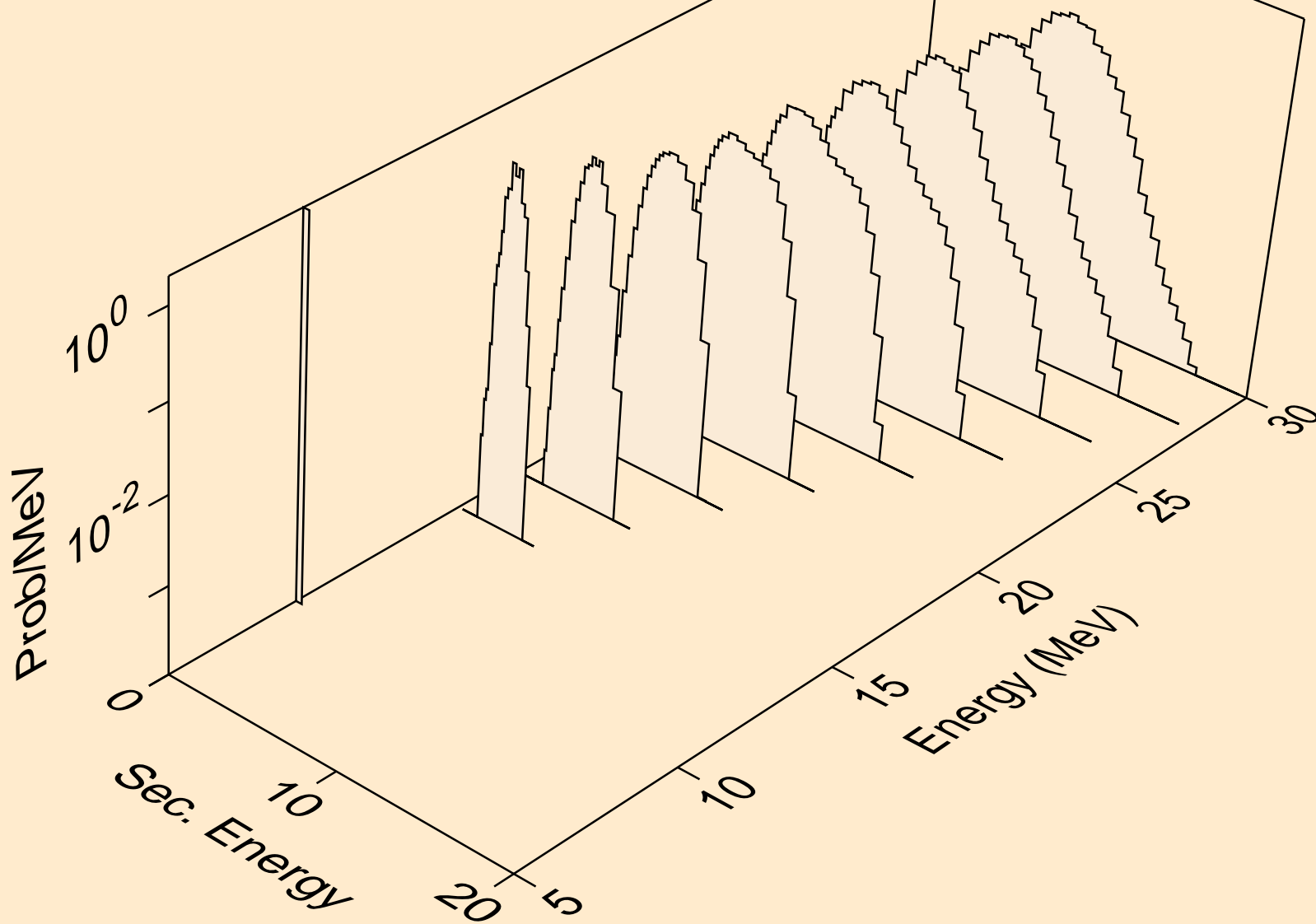

TE127 NEUTRON ACER TENDL-2019 LIBRARY; T=293.16K
protons from (n,p)

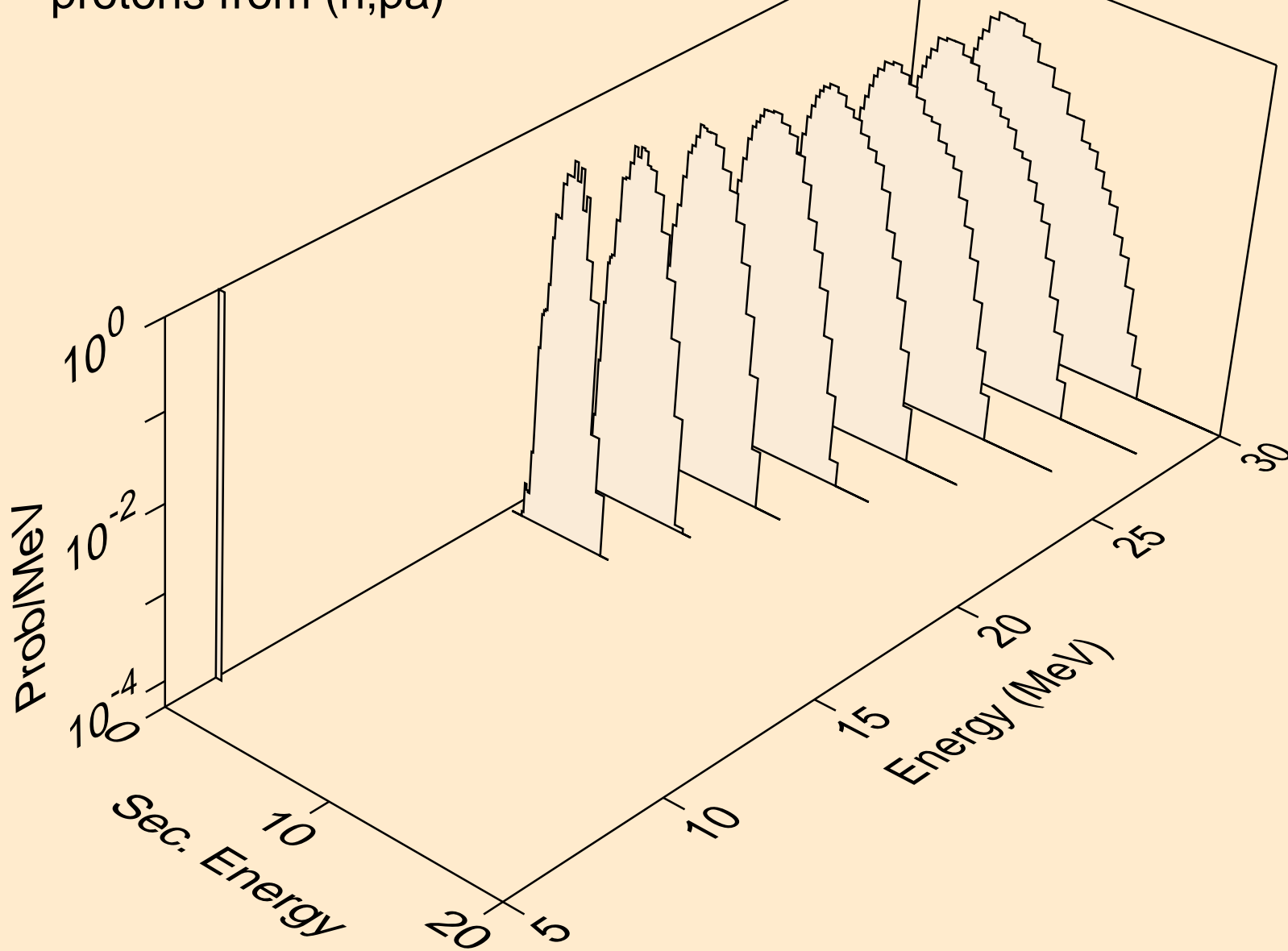

TE127 NEUTRON ACER TENDL-2019 LIBRARY; T=293.16K
protons from (n,pd)

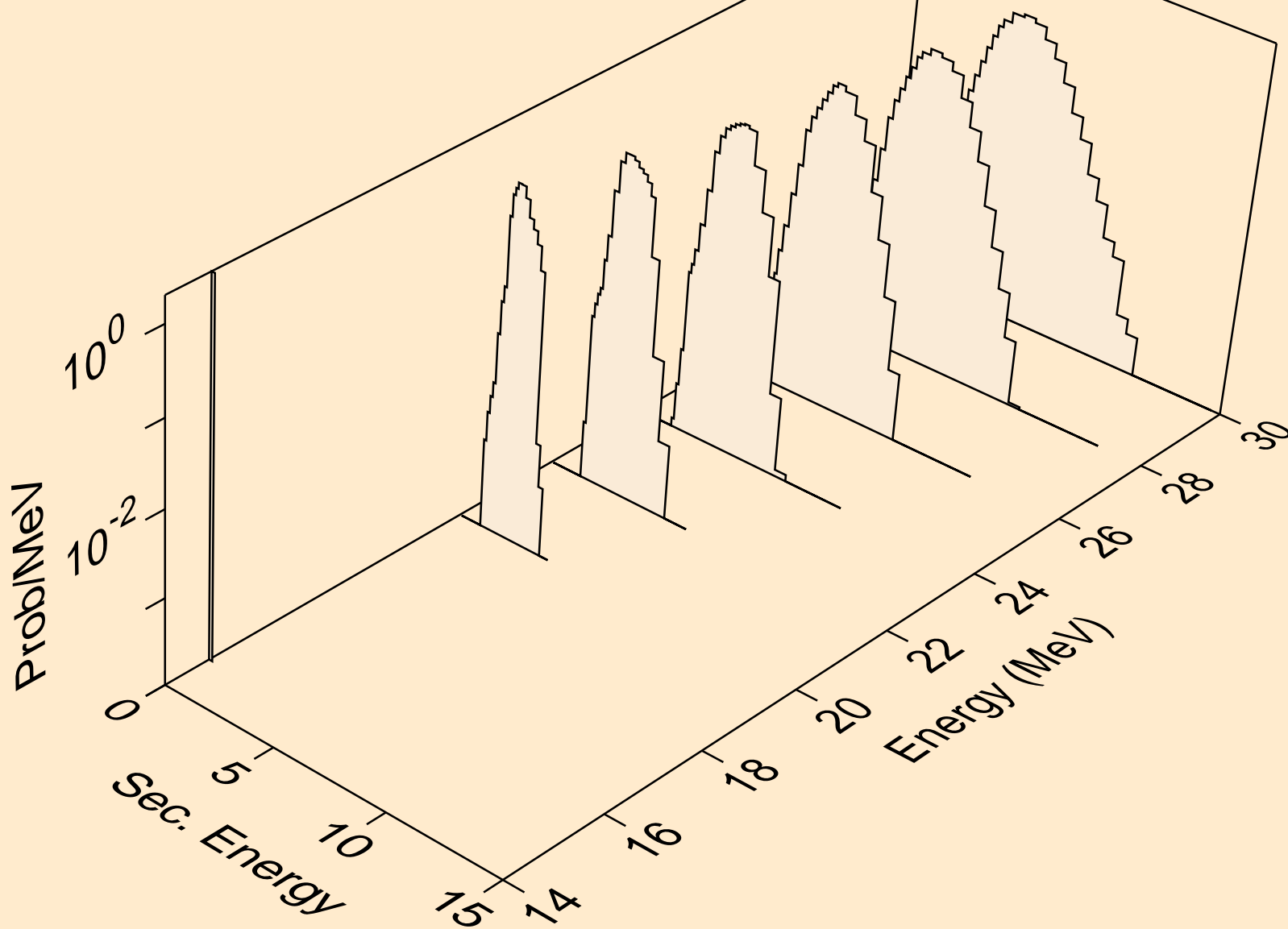

TE127 NEUTRON ACER TENDL-2019 LIBRARY; T=293.16K
protons from (n,pt)

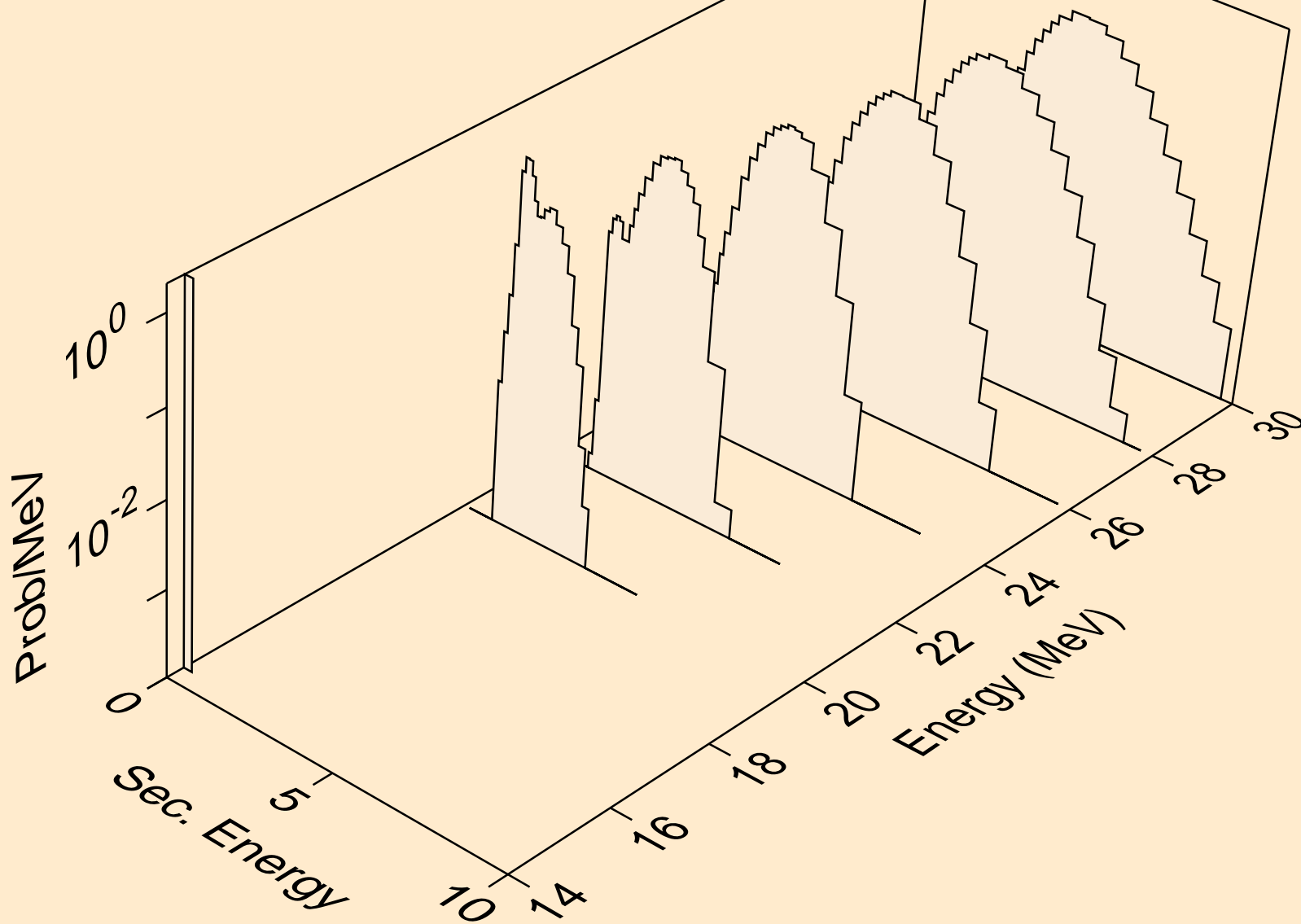

TE127 NEUTRON ACER TENDL-2019 LIBRARY; T=293.16K
deuterons from (n,x)

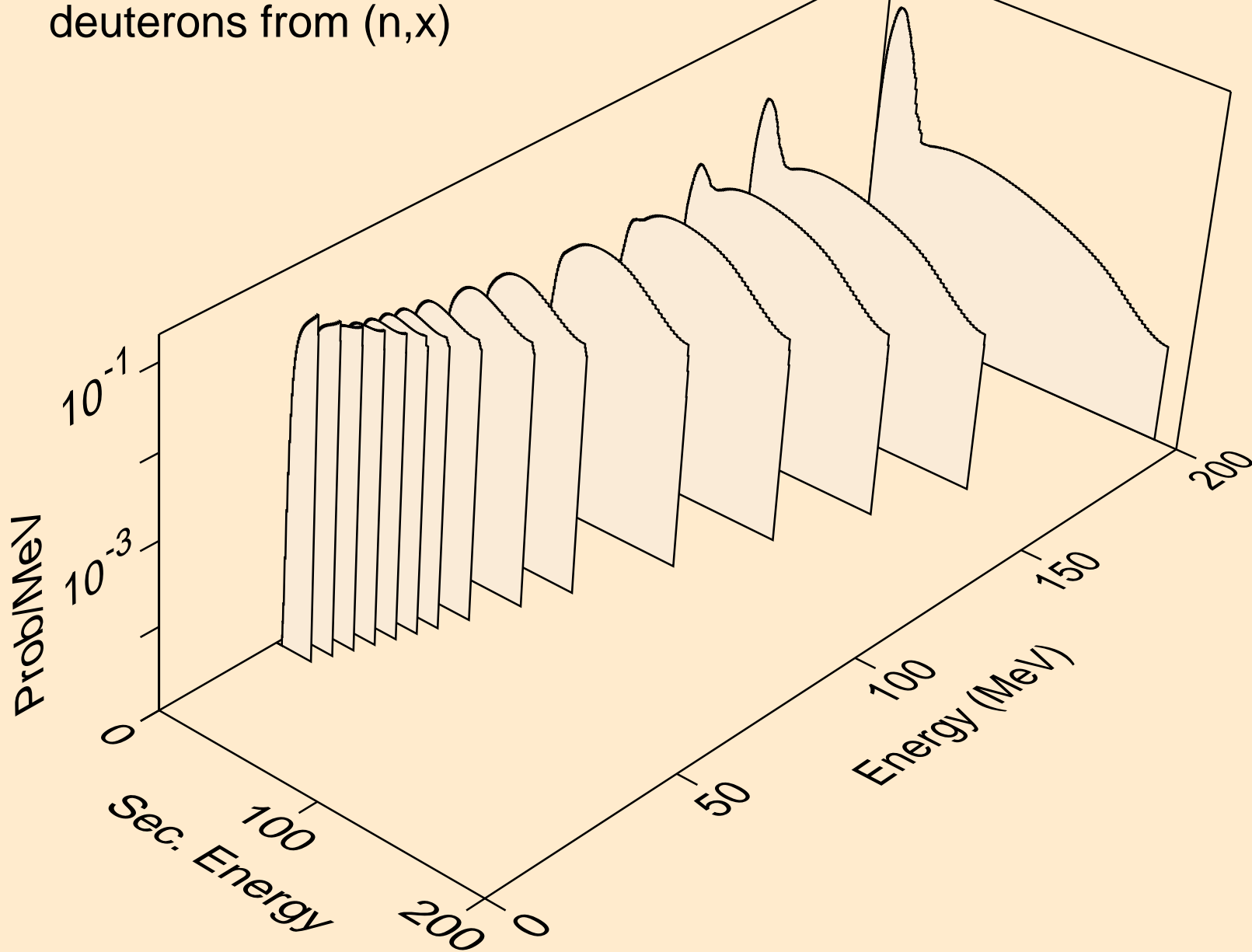

TE127 NEUTRON ACER TENDL-2019 LIBRARY; T=293.16K
deuterons from (n,2nd)

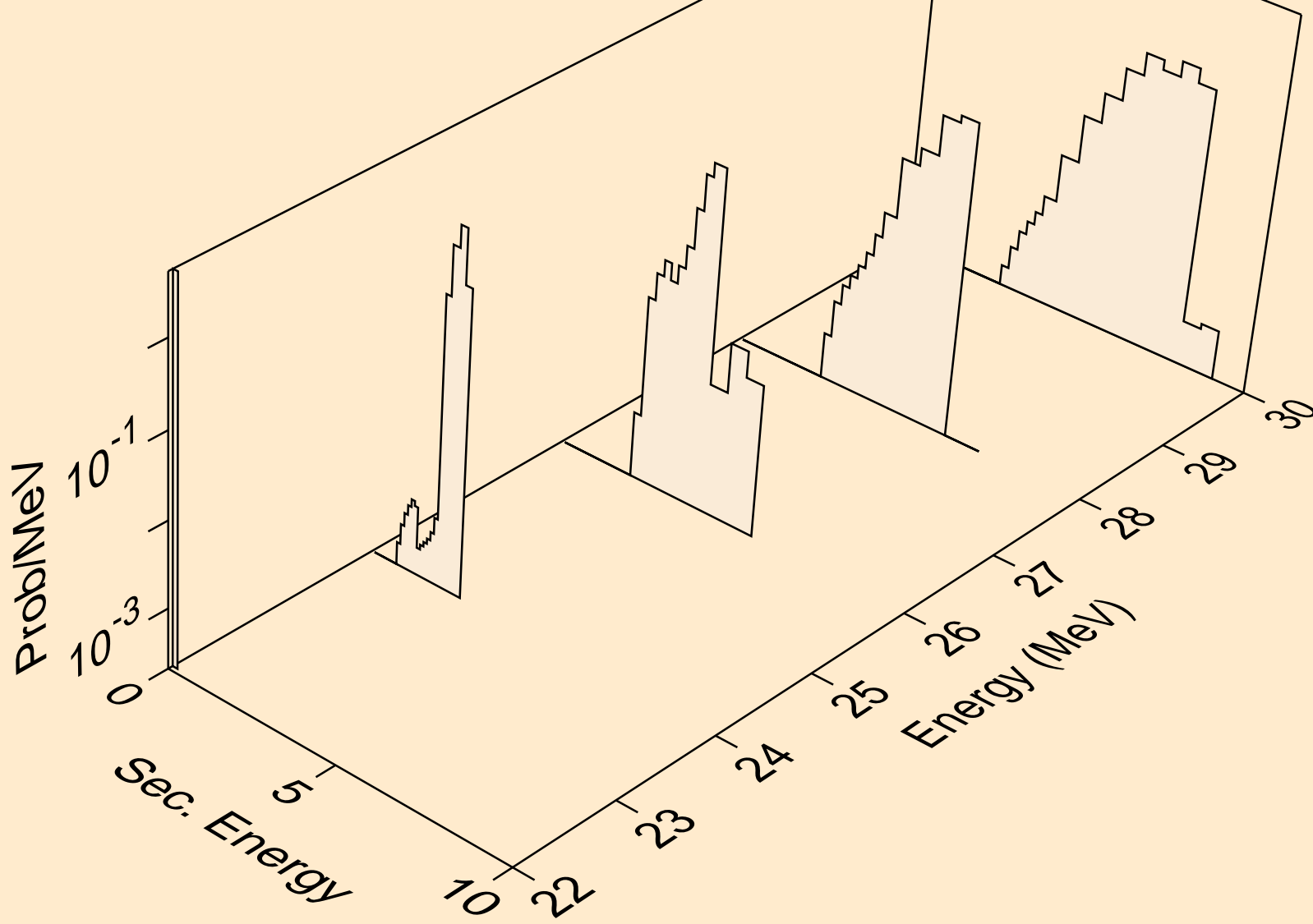

TE127 NEUTRON ACER TENDL-2019 LIBRARY; T=293.16K
deuterons from (n,n*)d

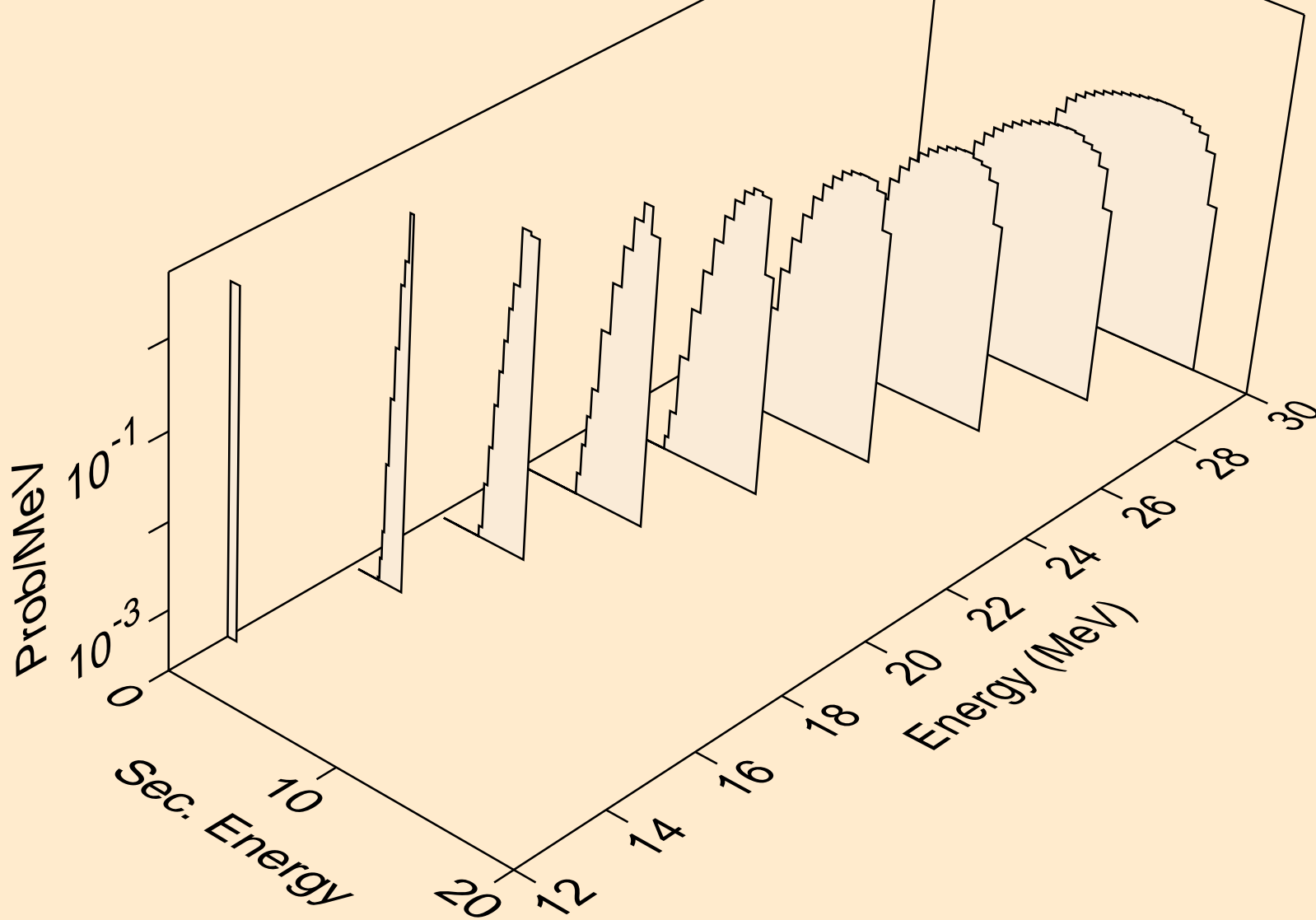

TE127 NEUTRON ACER TENDL-2019 LIBRARY; T=293.16K
deuterons from (n,d)

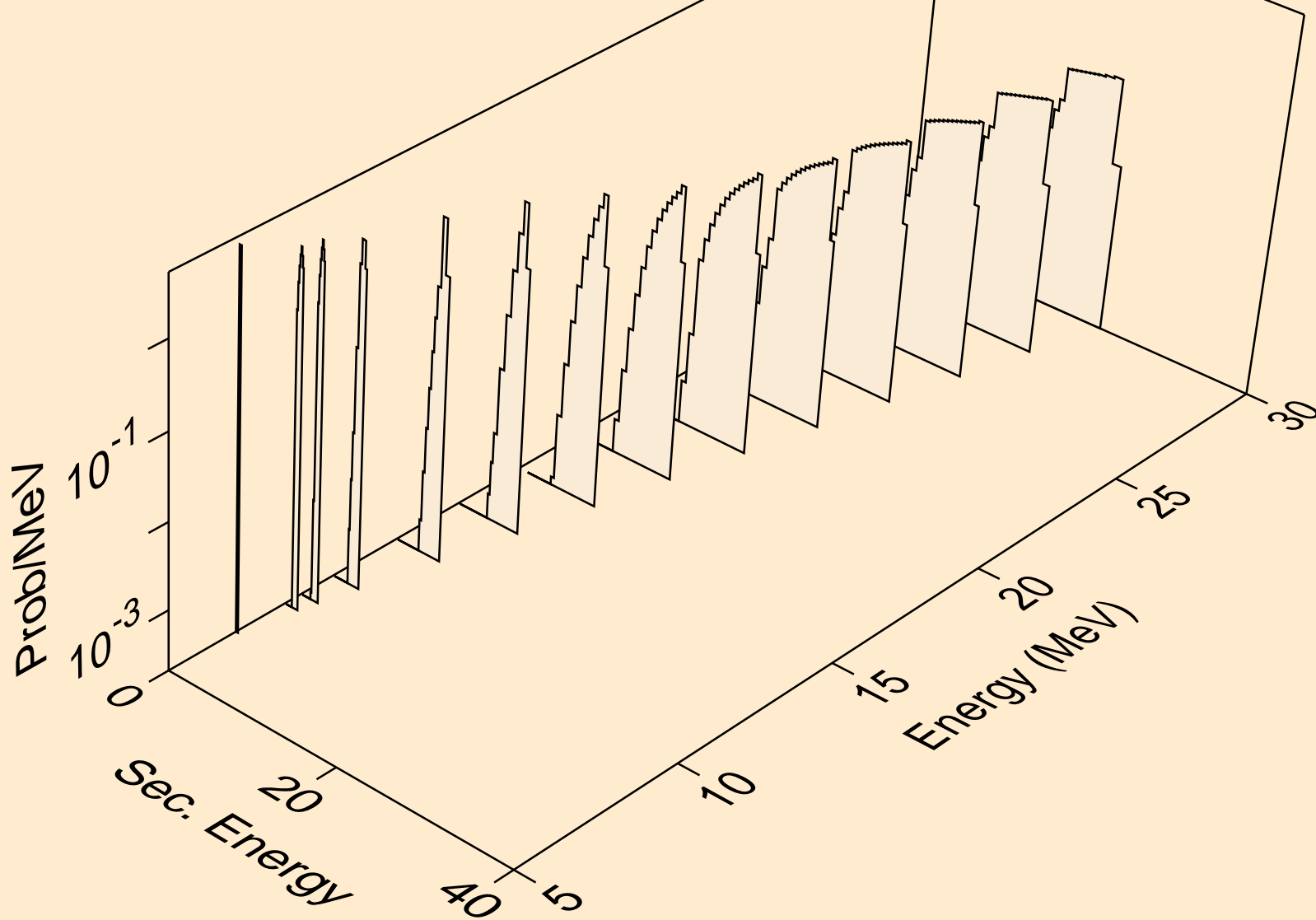

TE127 NEUTRON ACER TENDL-2019 LIBRARY; T=293.16K
deuterons from (n,pd)

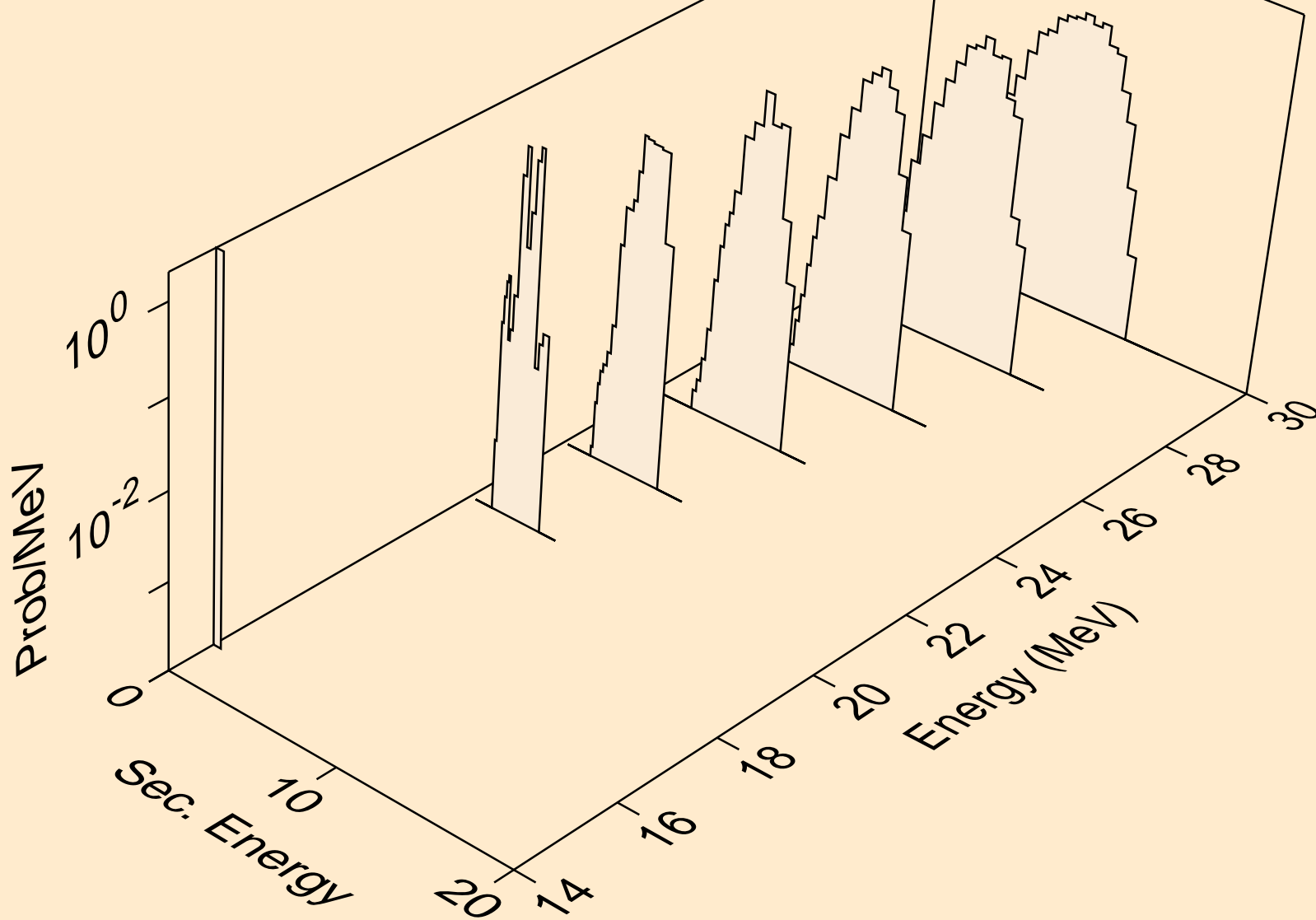

TE127 NEUTRON ACER TENDL-2019 LIBRARY; T=293.16K
tritons from (n,x)

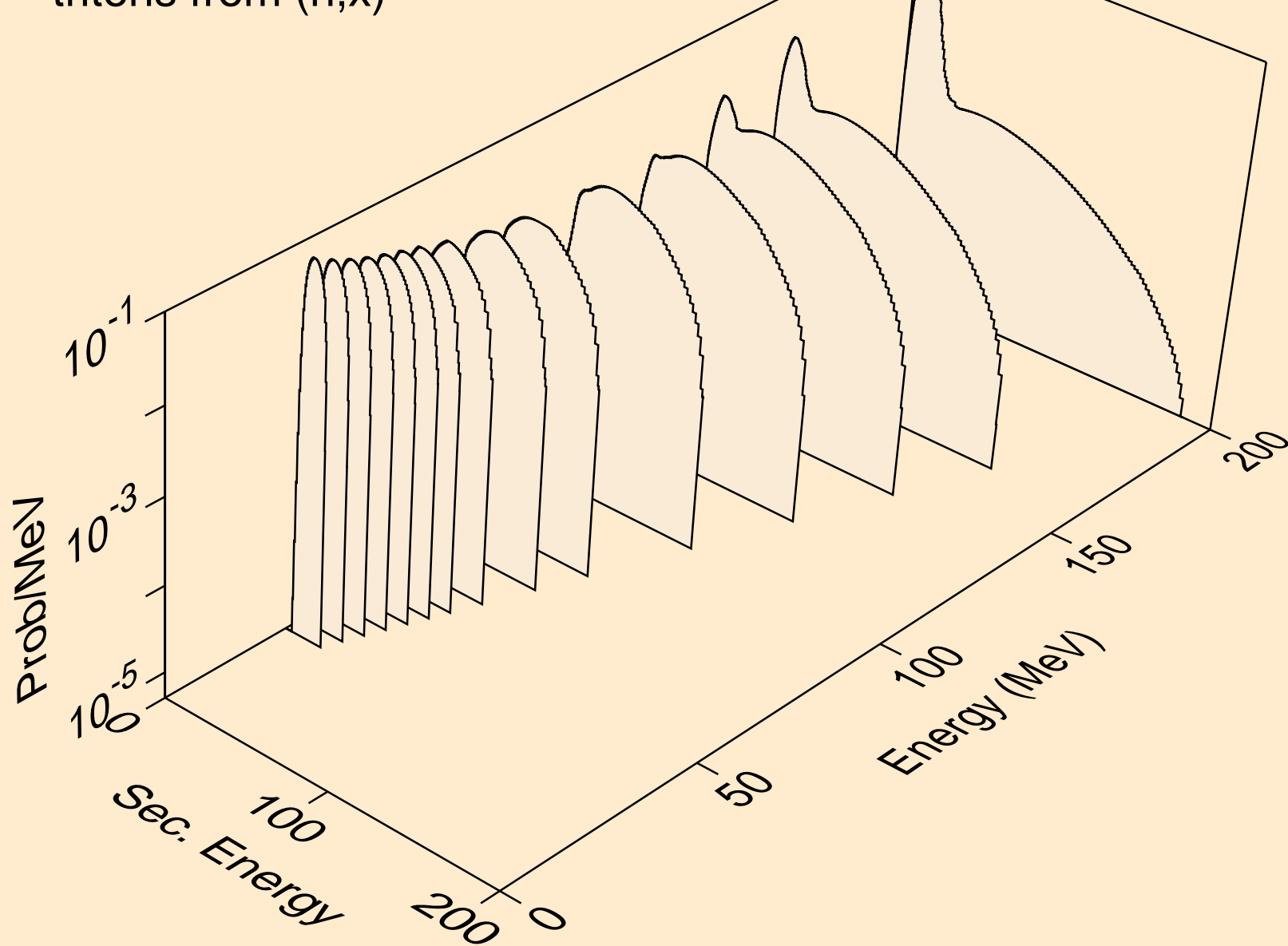

TE127 NEUTRON ACER TENDL-2019 LIBRARY; T=293.16K
tritons from (n,n*)t

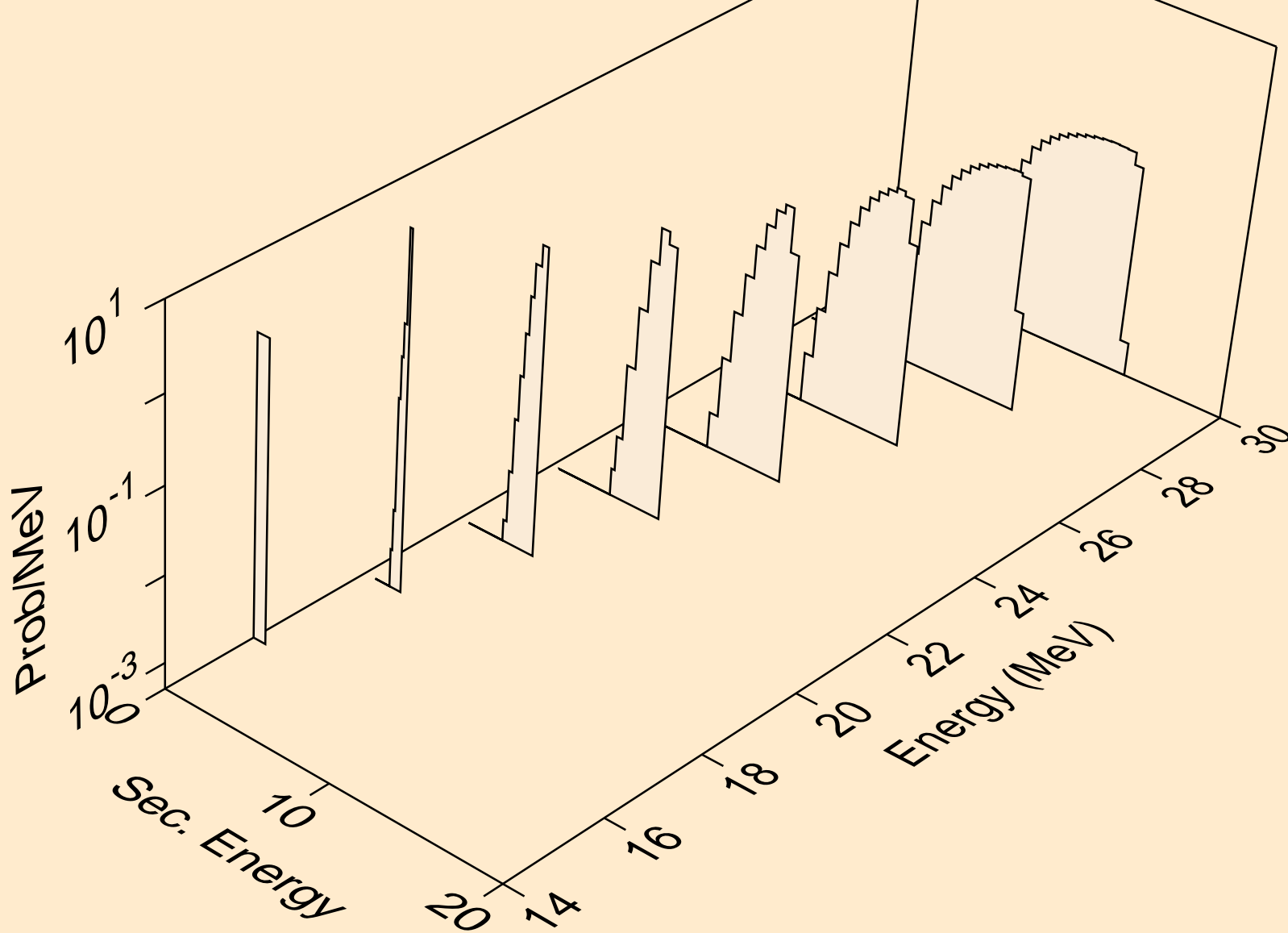

TE127 NEUTRON ACER TENDL-2019 LIBRARY; T=293.16K
tritons from (n,t)

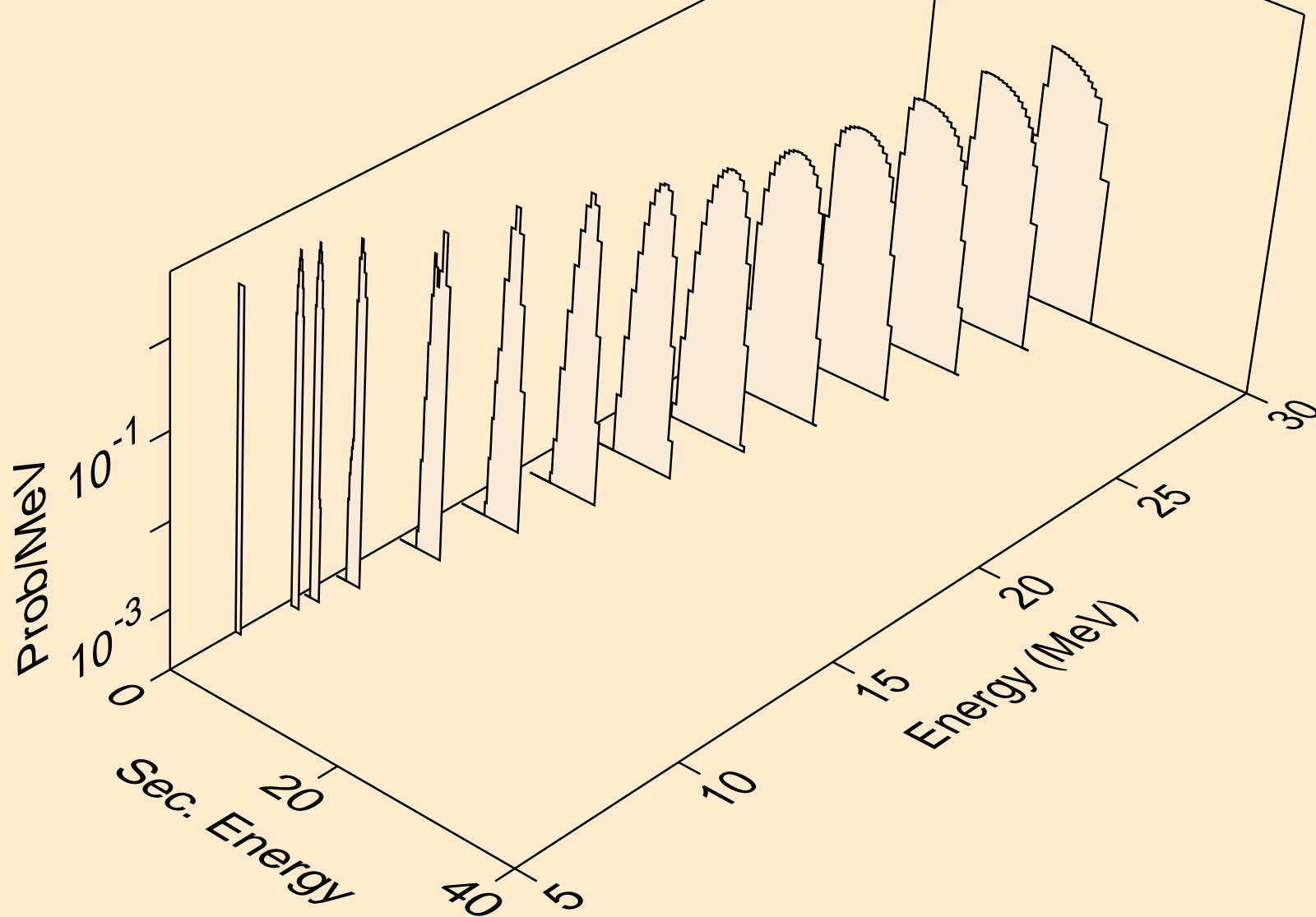

TE127 NEUTRON ACER TENDL-2019 LIBRARY; T=293.16K
tritons from (n,pt)

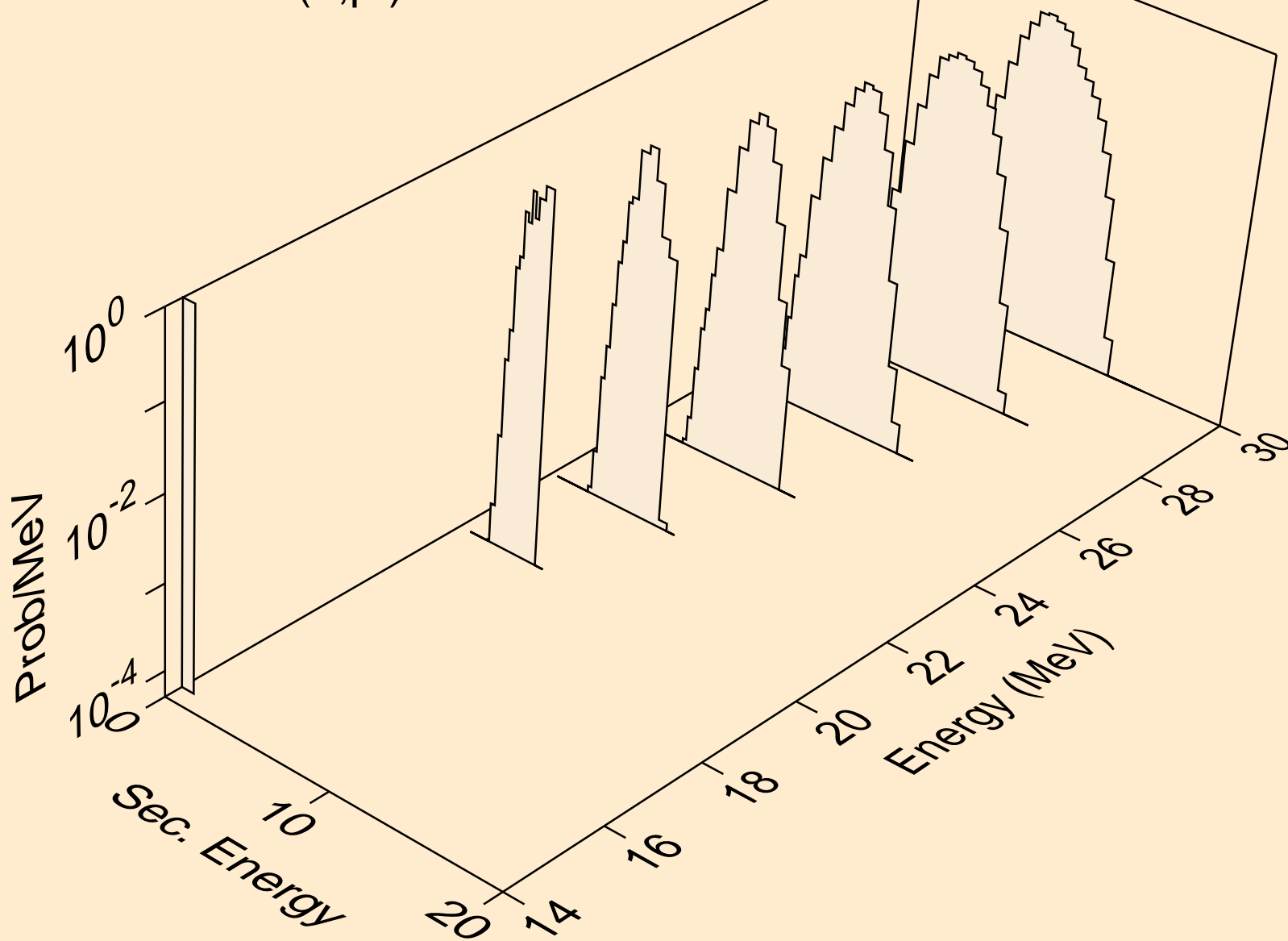

TE127 NEUTRON ACER TENDL-2019 LIBRARY; T=293.16K
he3s from (n,x)

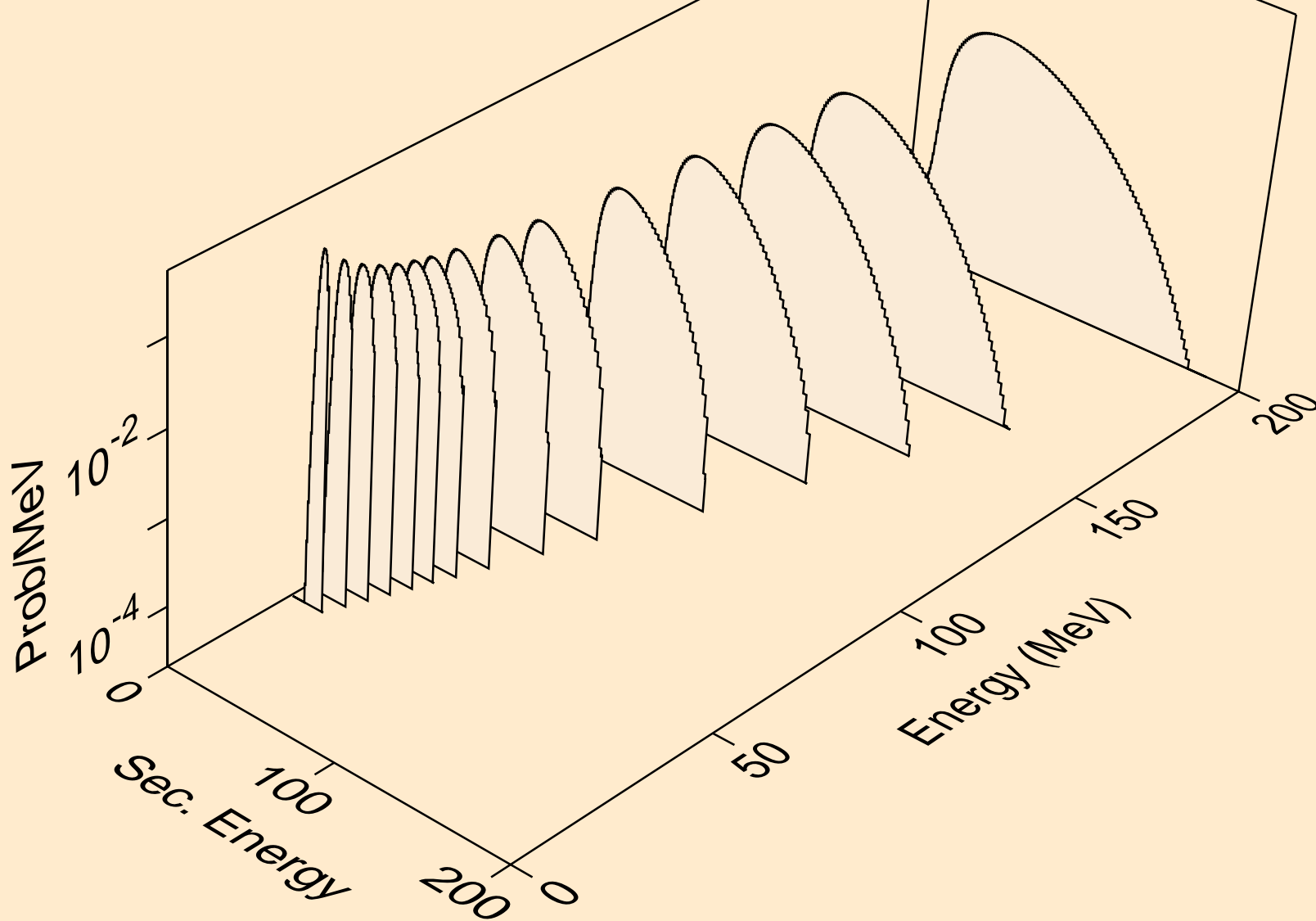

TE127 NEUTRON ACER TENDL-2019 LIBRARY; T=293.16K
he3s from (n,n*)he3

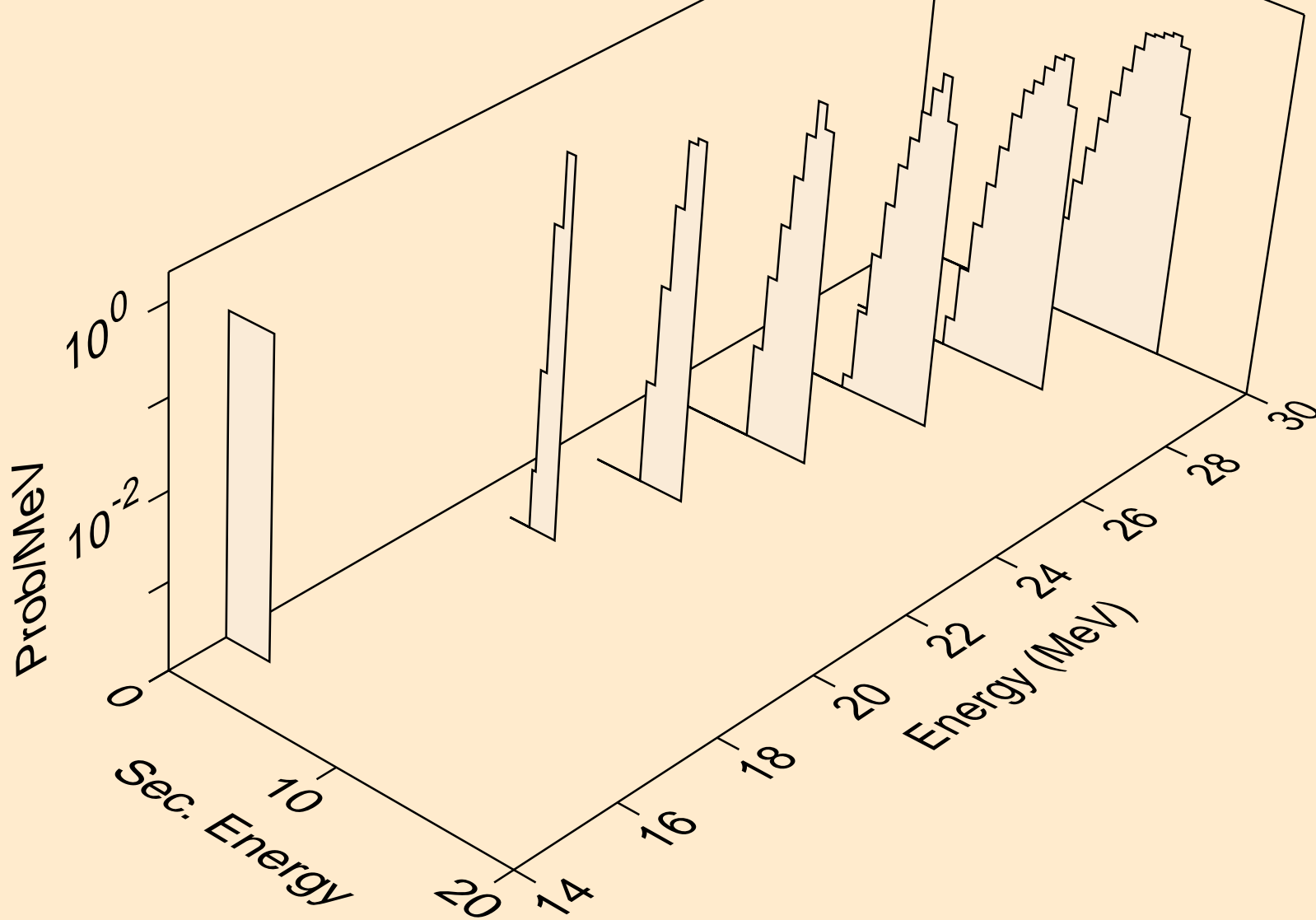

TE127 NEUTRON ACER TENDL-2019 LIBRARY; T=293.16K
he3s from (n,he3)

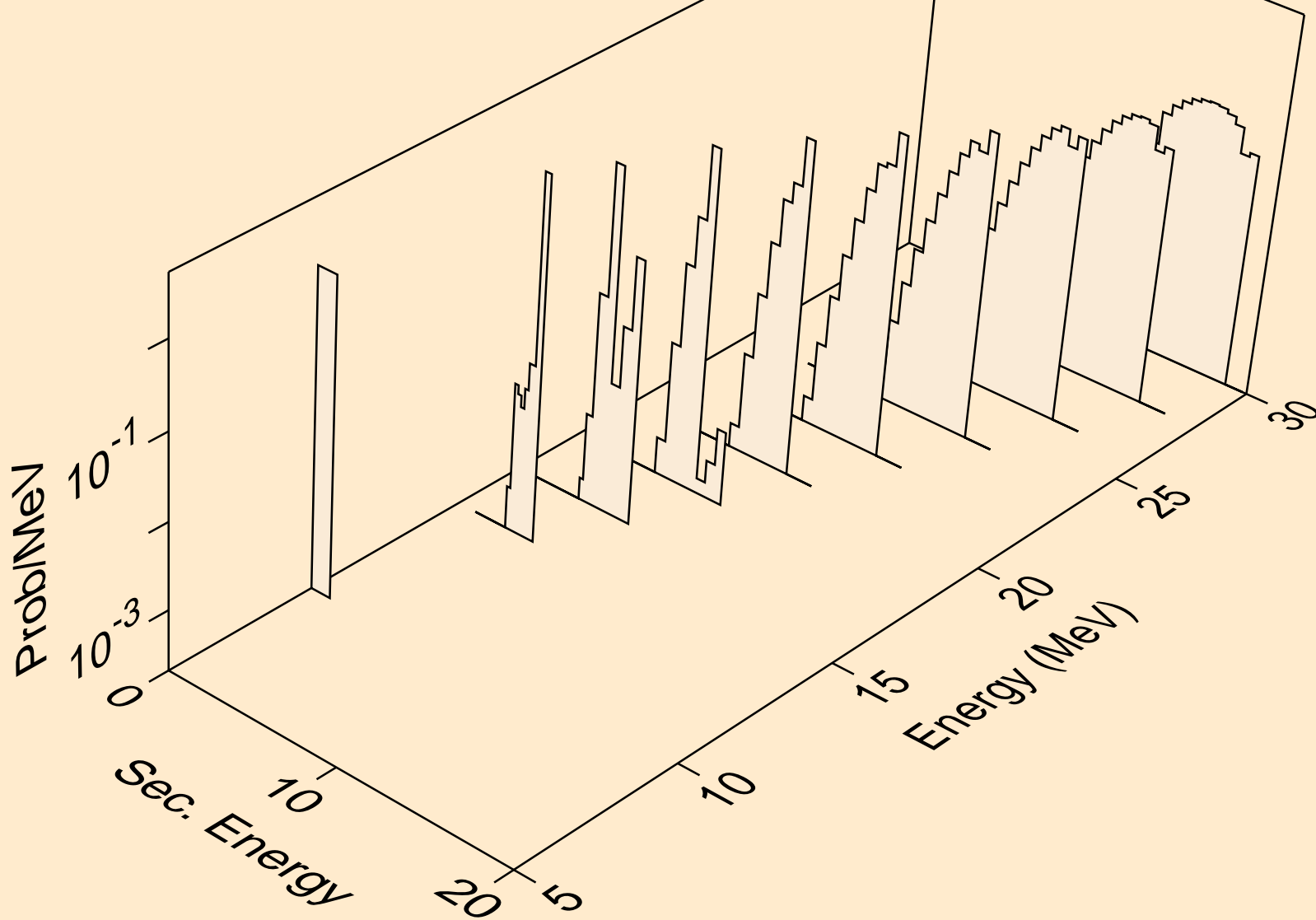

TE127 NEUTRON ACER TENDL-2019 LIBRARY; T=293.16K
alphas from (n,x)

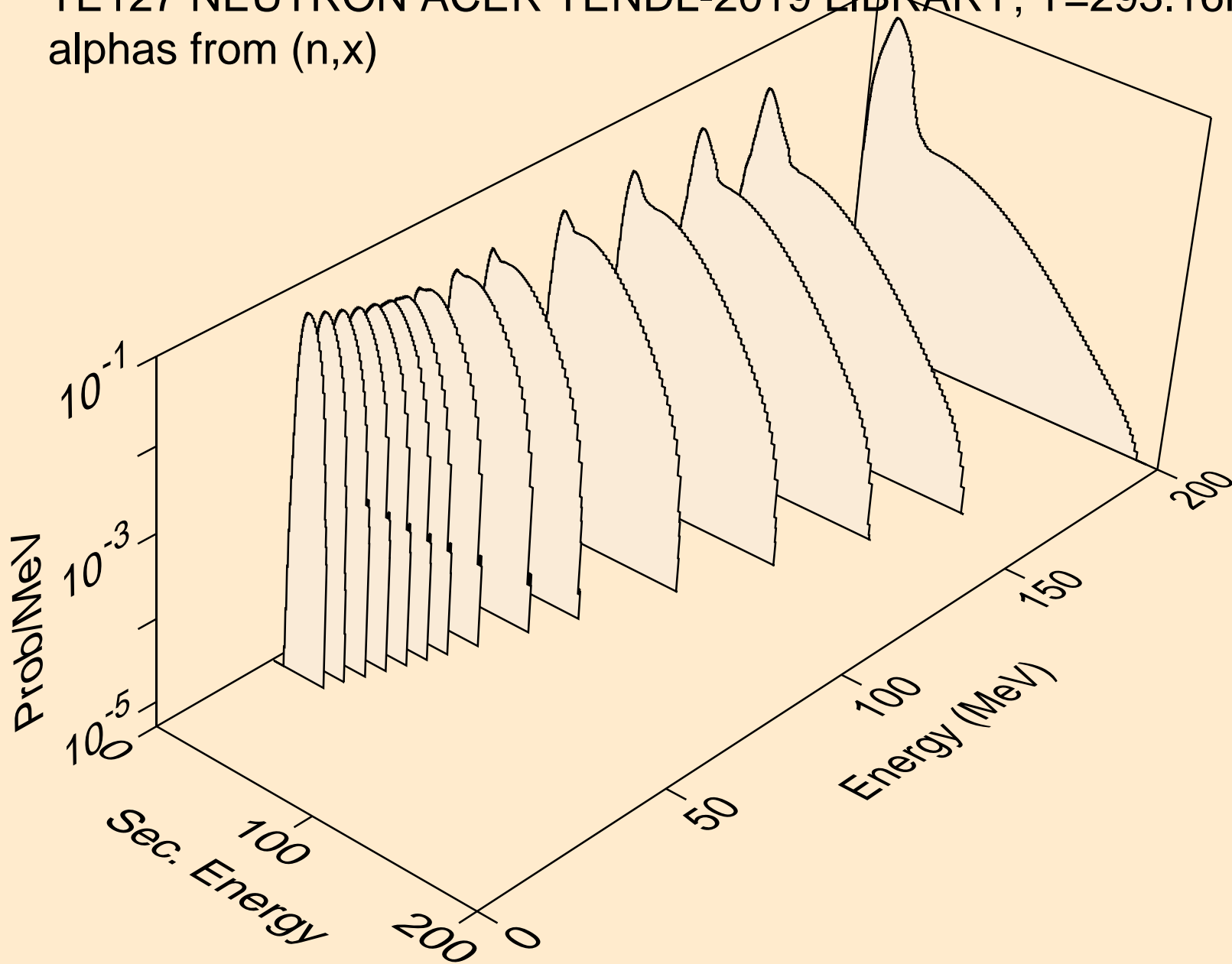

TE127 NEUTRON ACER TENDL-2019 LIBRARY; T=293.16K
alphas from (n,n*)a

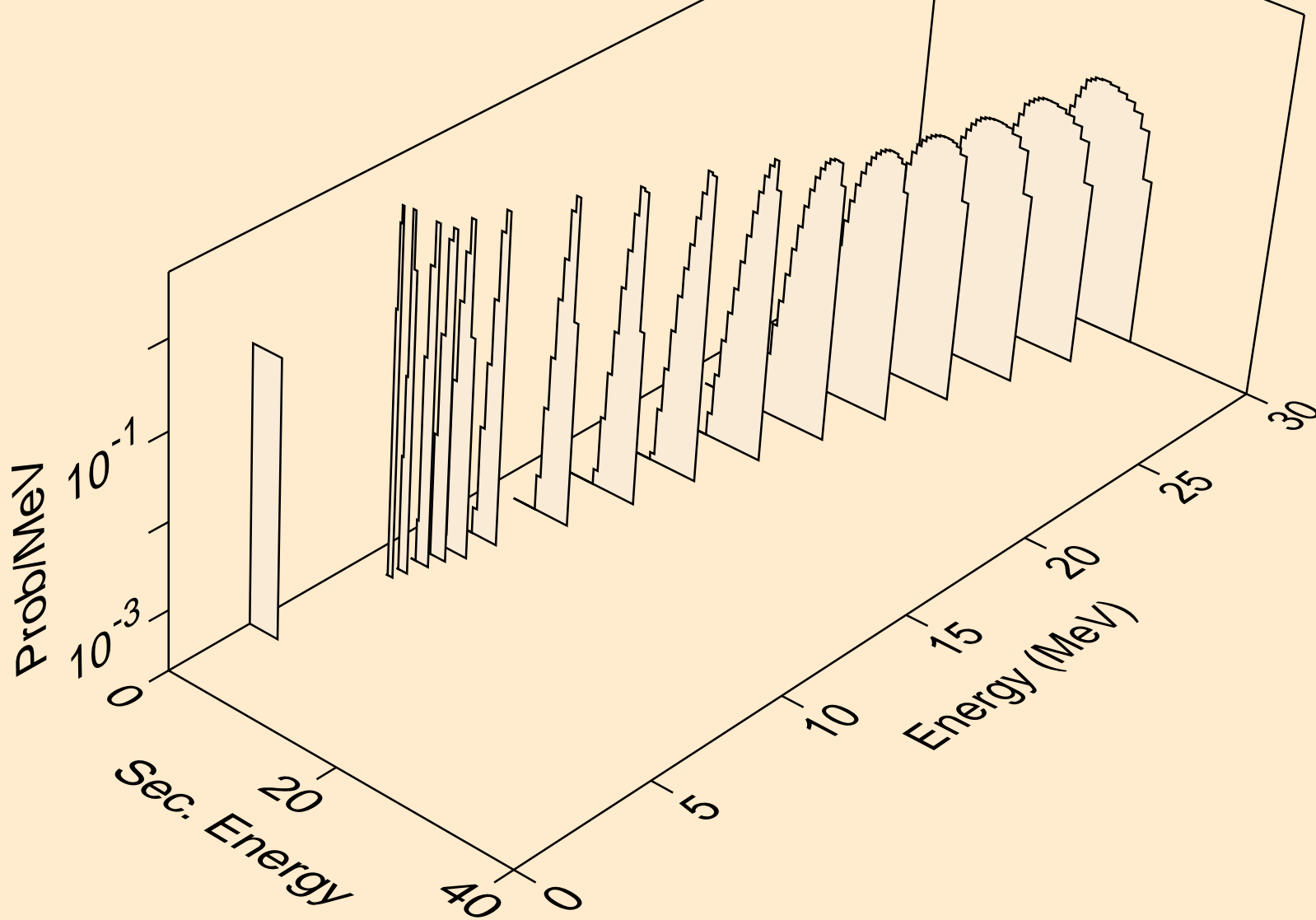

TE127 NEUTRON ACER TENDL-2019 LIBRARY; T=293.16K
alphas from (n,2n)a

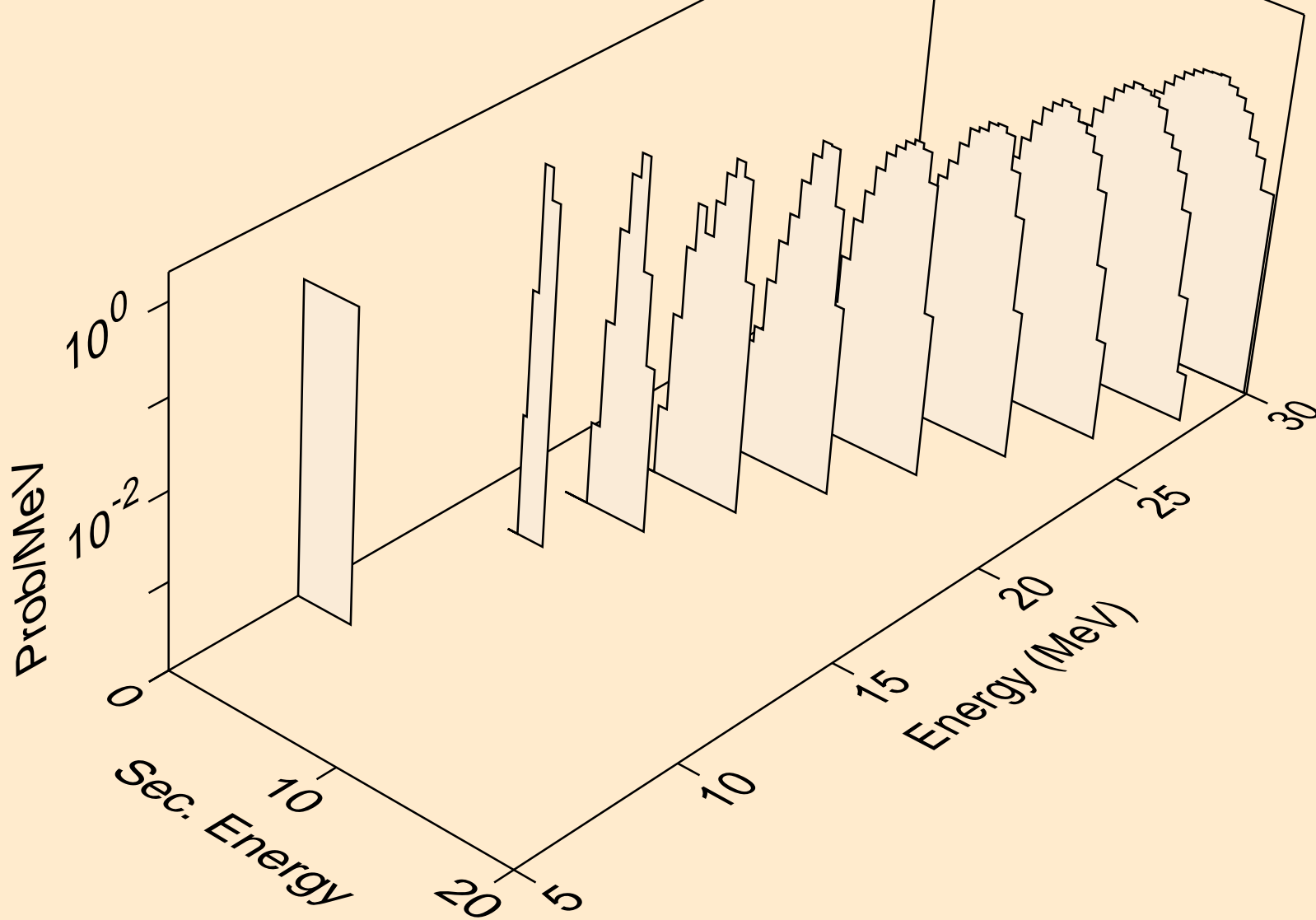

TE127 NEUTRON ACER TENDL-2019 LIBRARY; T=293.16K
alphas from (n,3n)a

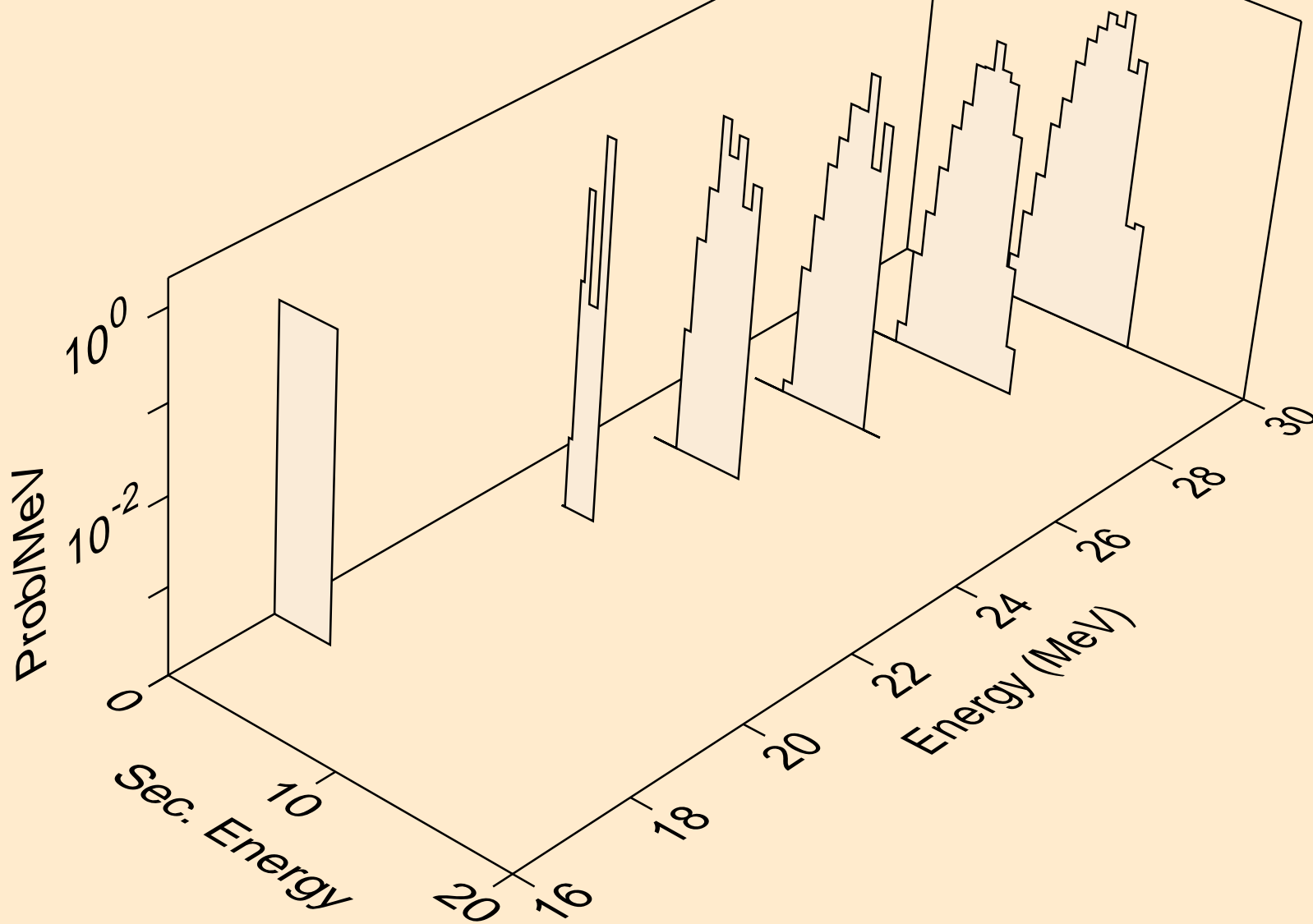

TE127 NEUTRON ACER TENDL-2019 LIBRARY; T=293.16K
alphas from (n,a)

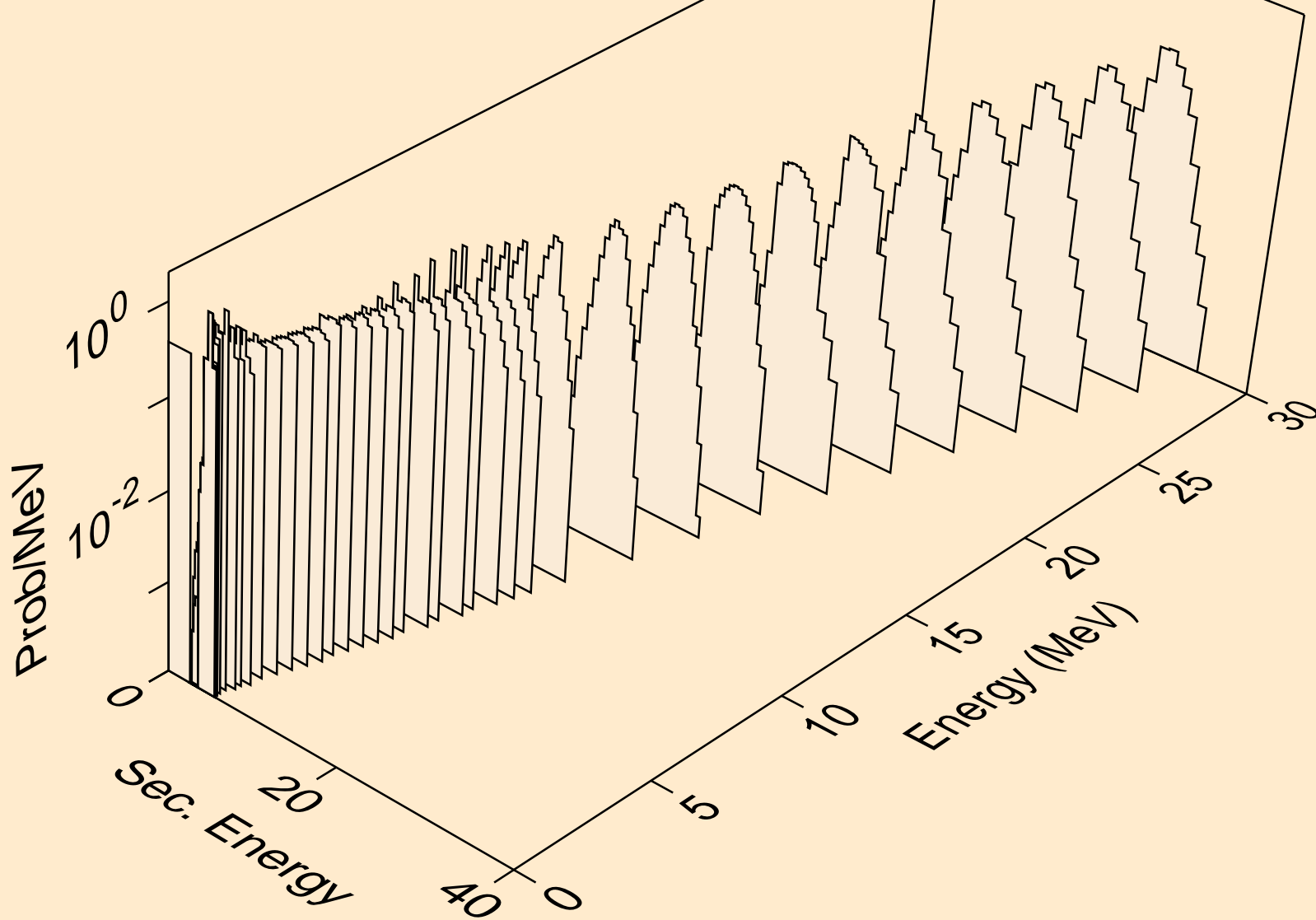

TE127 NEUTRON ACER TENDL-2019 LIBRARY; T=293.16K
alphas from (n,pa)

