

TL189 NEUTRON ACER TENDL-2019 LIBRARY; T=293.16K
Principal cross sections

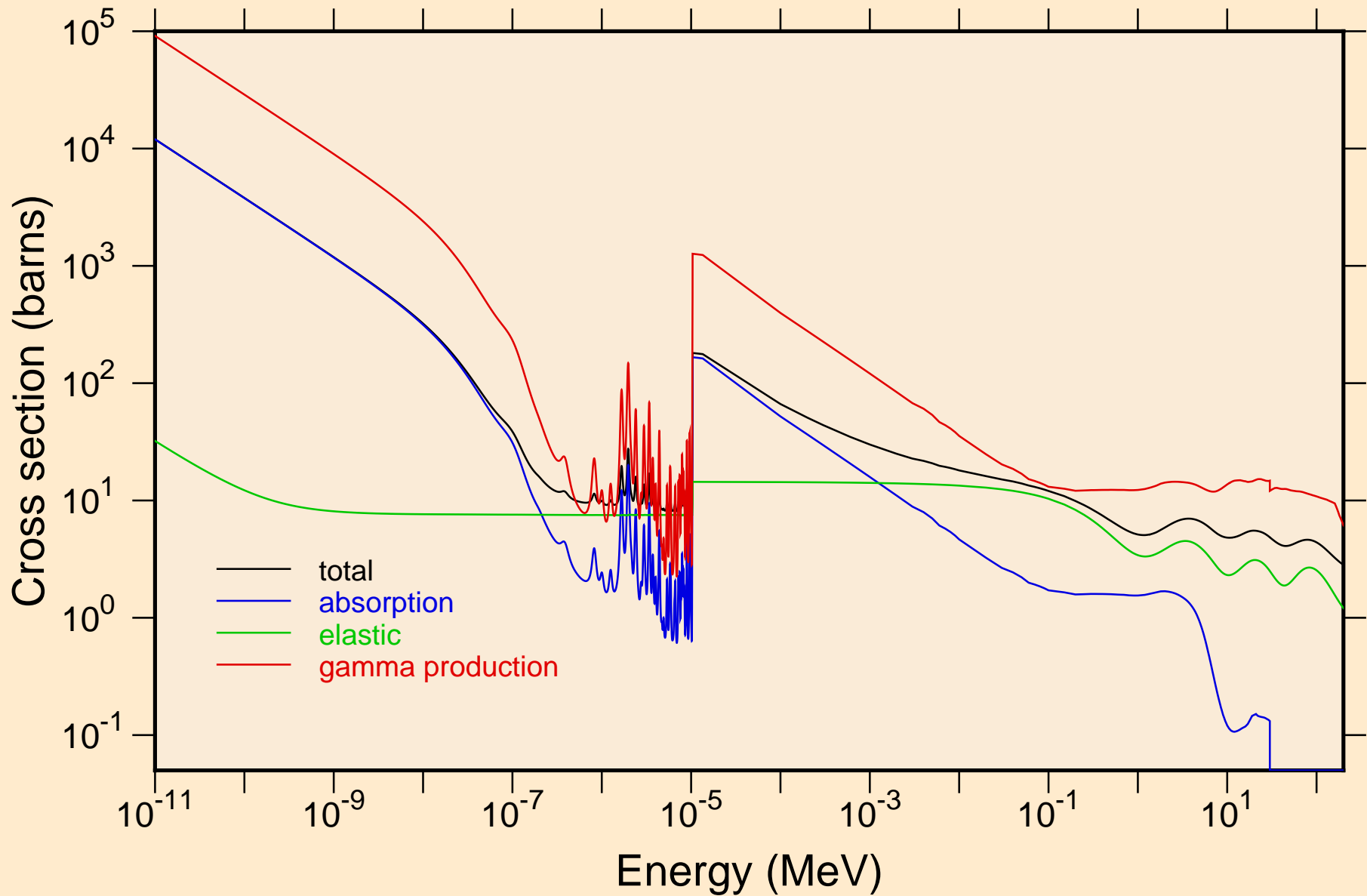

TL189 NEUTRON ACER TENDL-2019 LIBRARY; T=293.16K
resonance total cross section

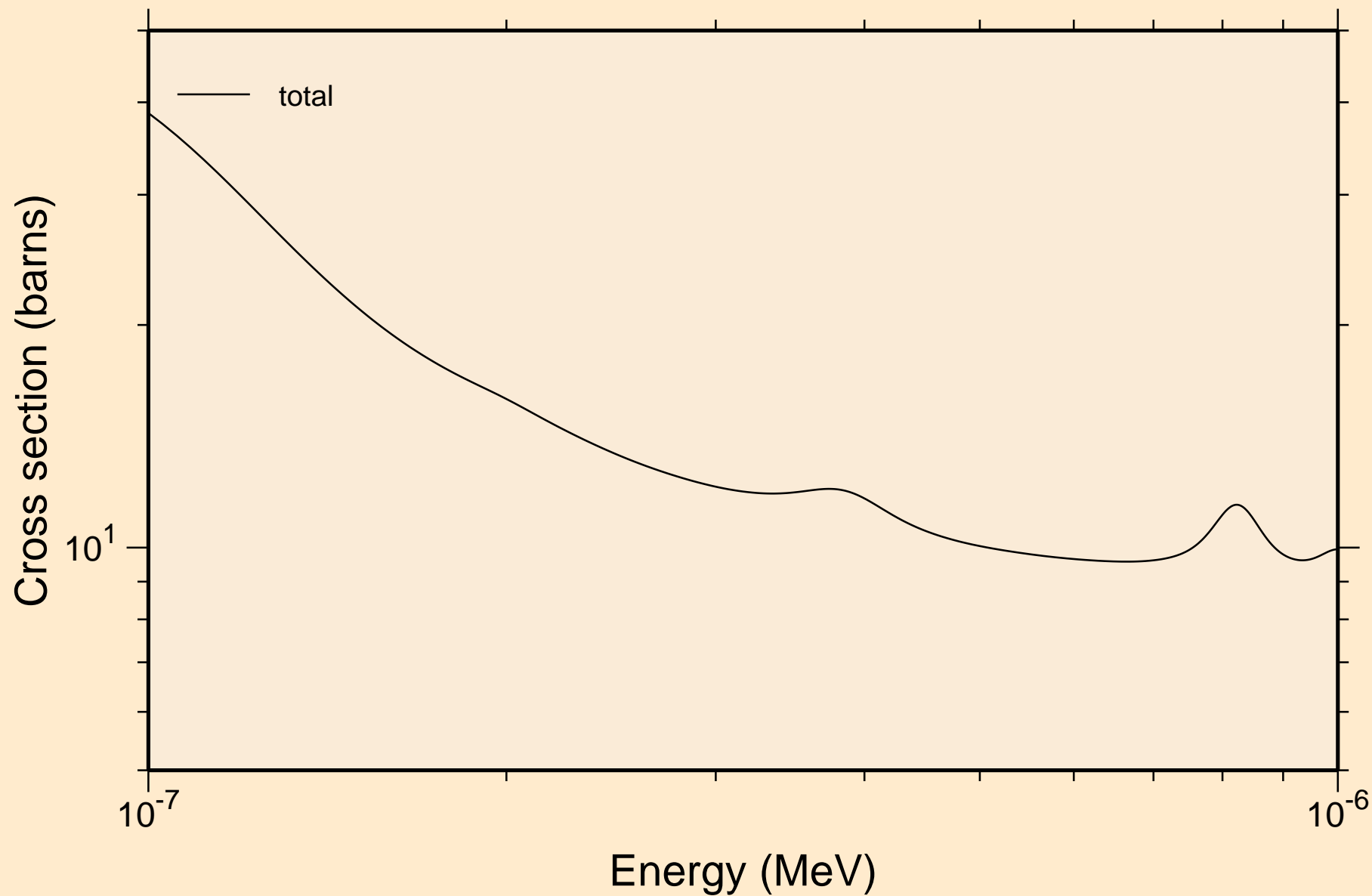

TL189 NEUTRON ACER TENDL-2019 LIBRARY; T=293.16K
resonance total cross section

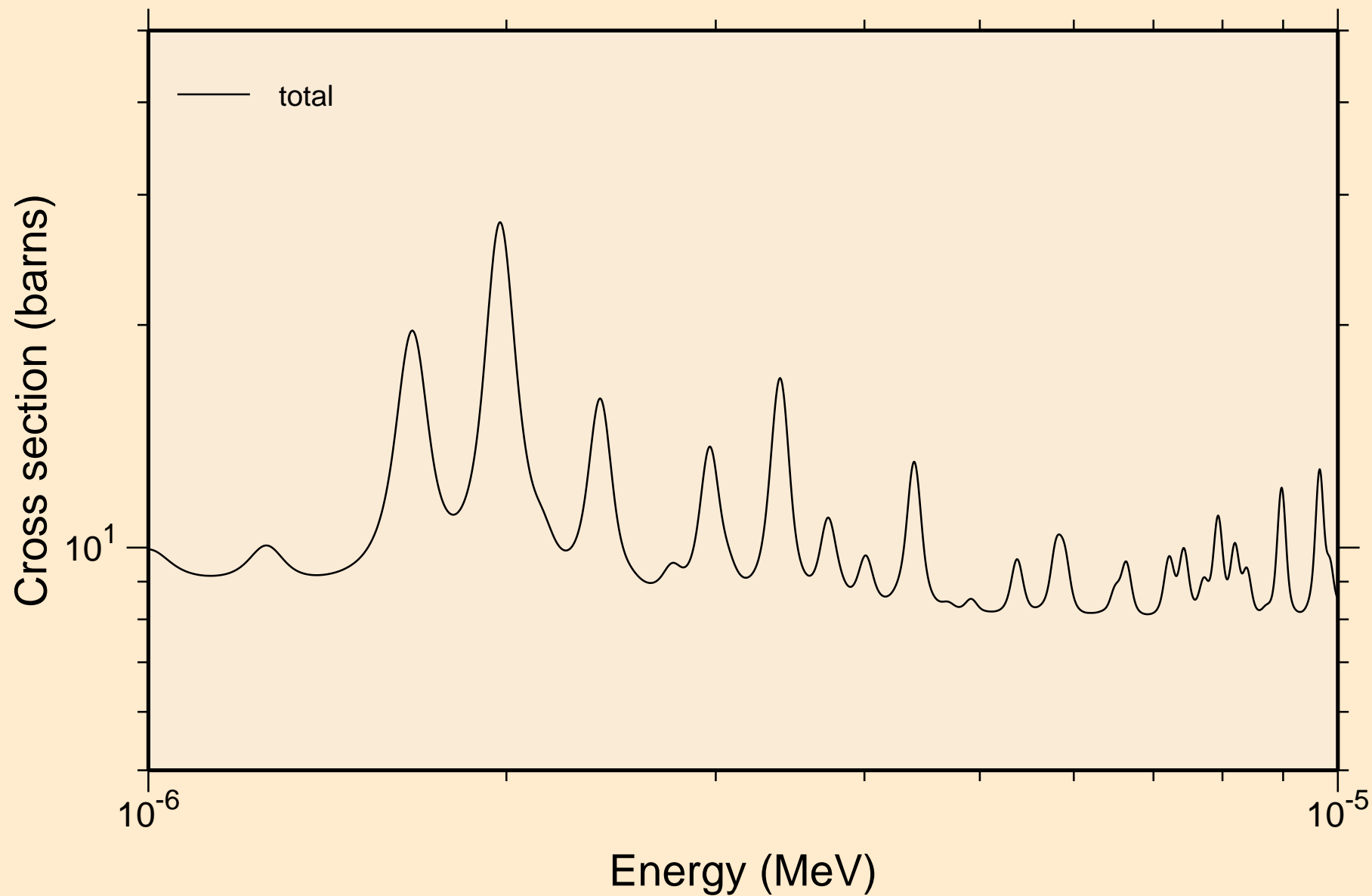

TL189 NEUTRON ACER TENDL-2019 LIBRARY; T=293.16K
resonance total cross section

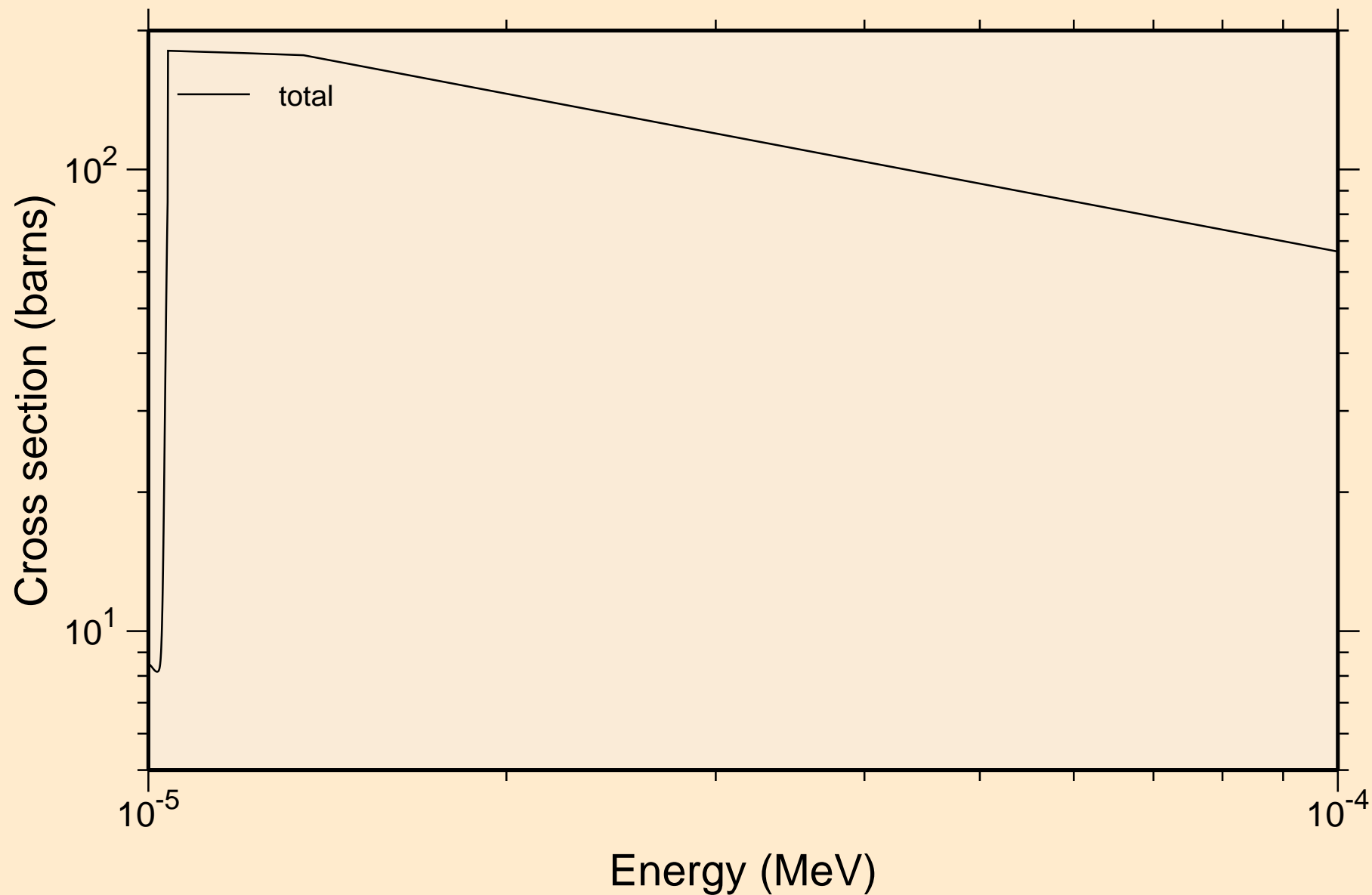

TL189 NEUTRON ACER TENDL-2019 LIBRARY; T=293.16K
resonance total cross section

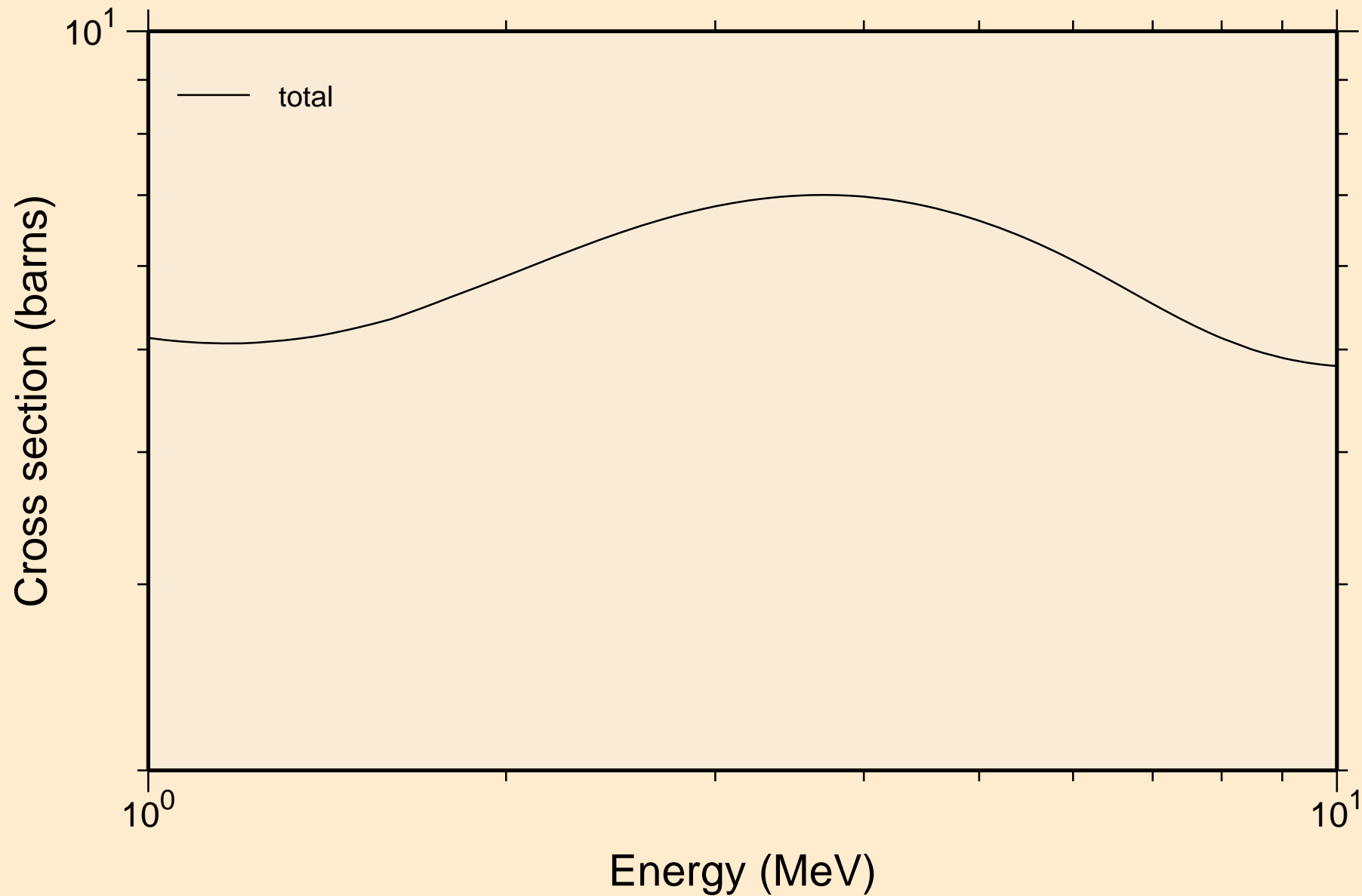

TL189 NEUTRON ACER TENDL-2019 LIBRARY; T=293.16K
resonance absorption cross sections

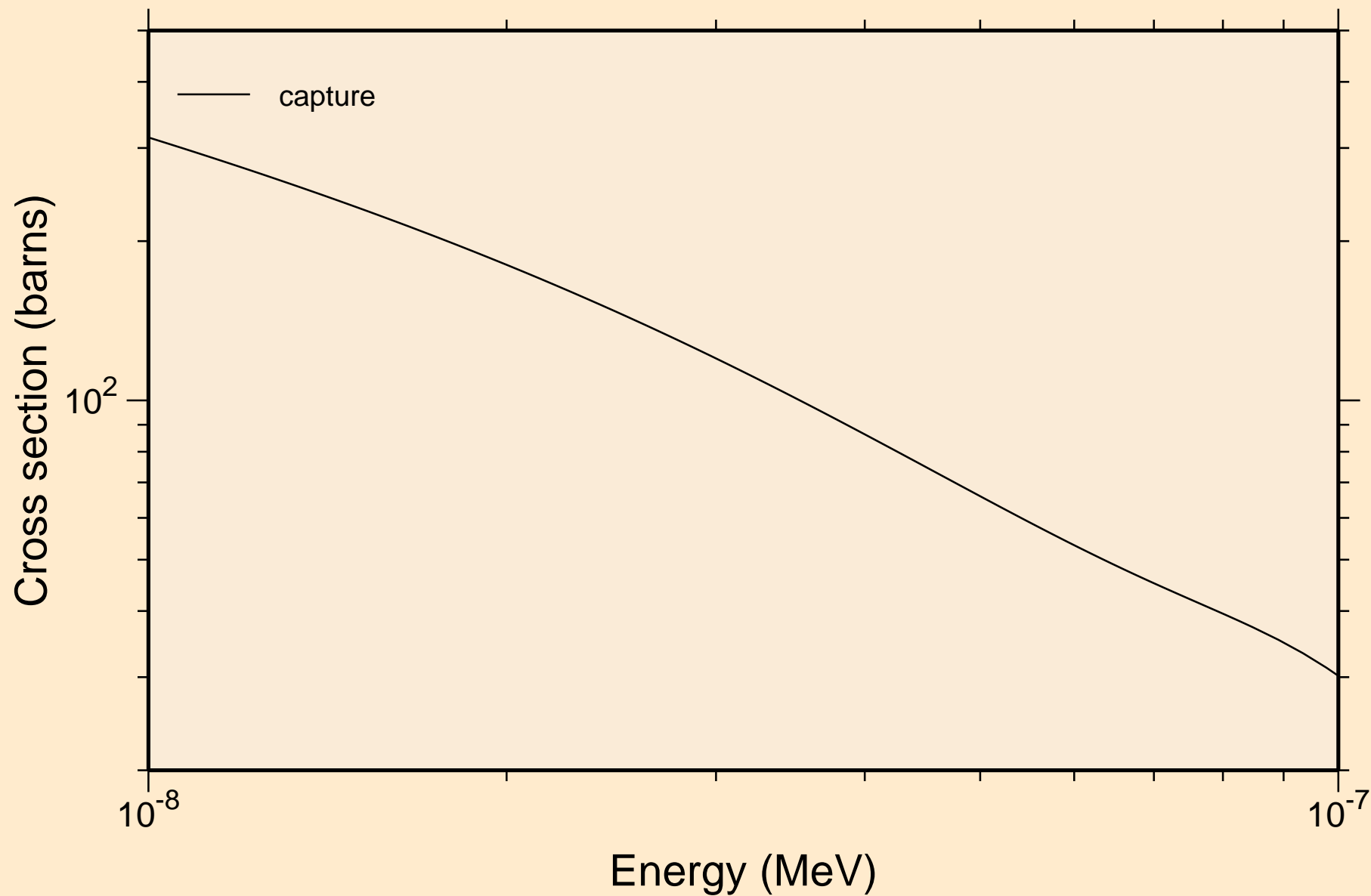

TL189 NEUTRON ACER TENDL-2019 LIBRARY; T=293.16K
resonance absorption cross sections

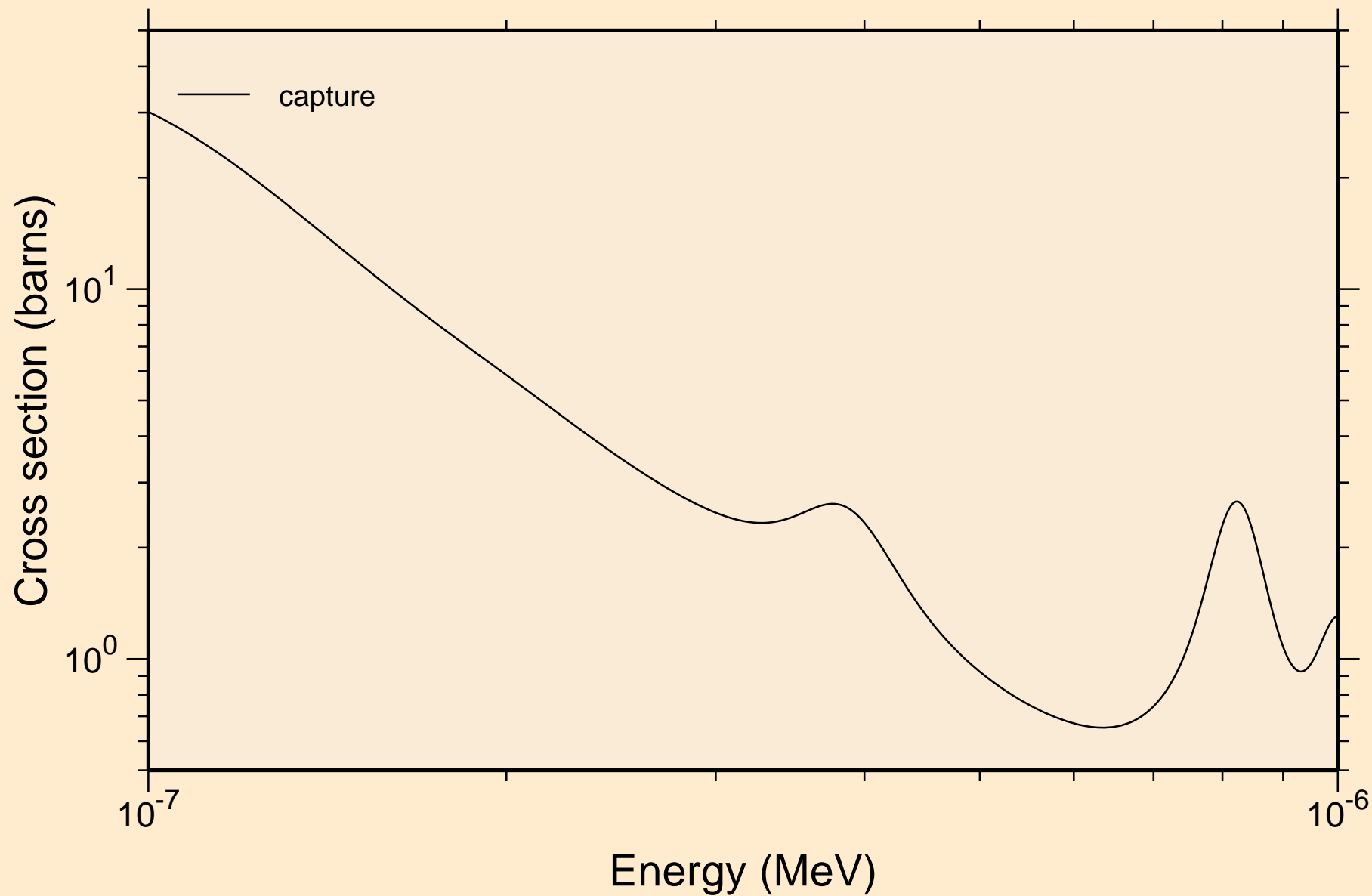

TL189 NEUTRON ACER TENDL-2019 LIBRARY; T=293.16K
resonance absorption cross sections

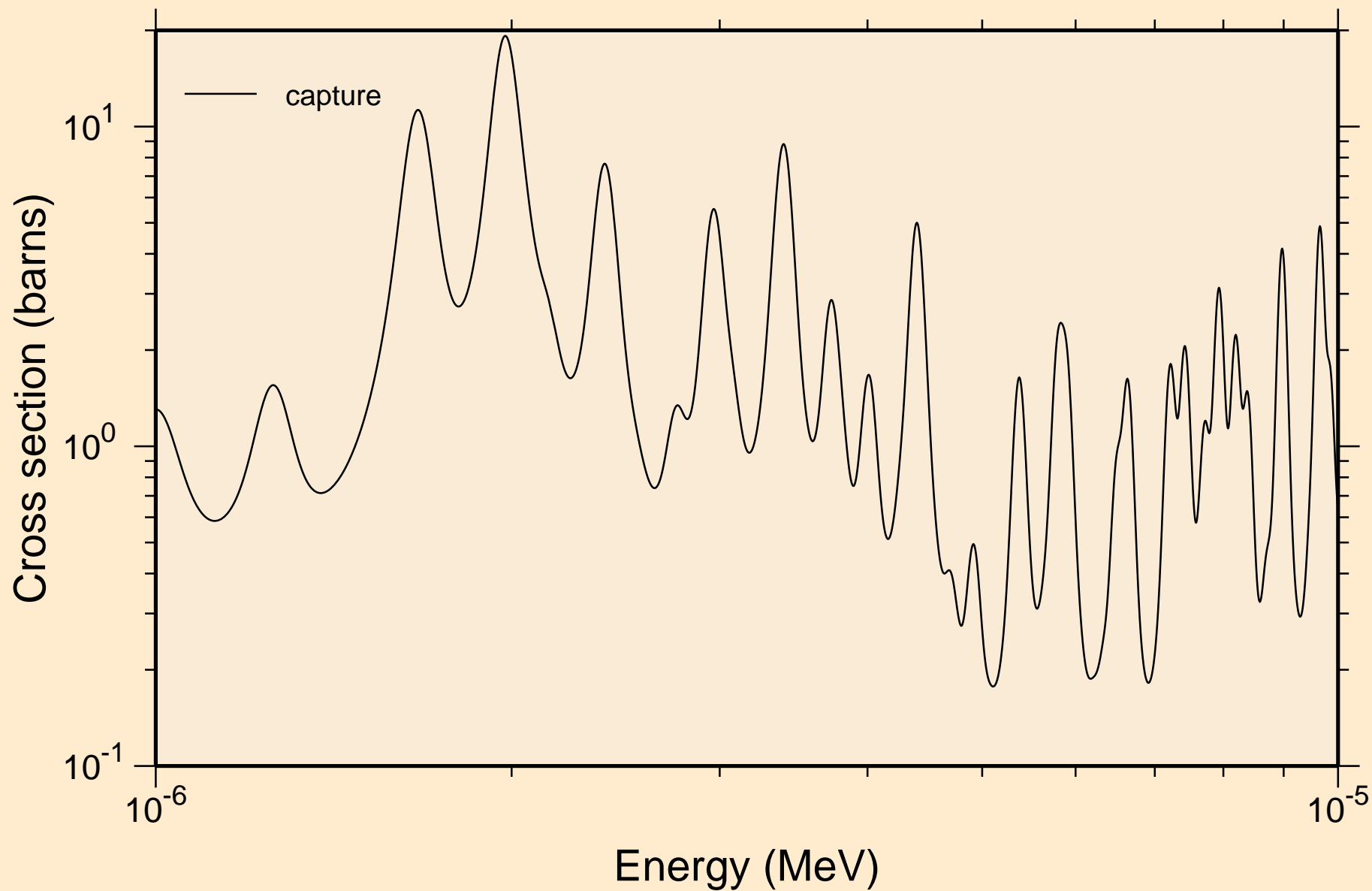

TL189 NEUTRON ACER TENDL-2019 LIBRARY; T=293.16K
resonance absorption cross sections

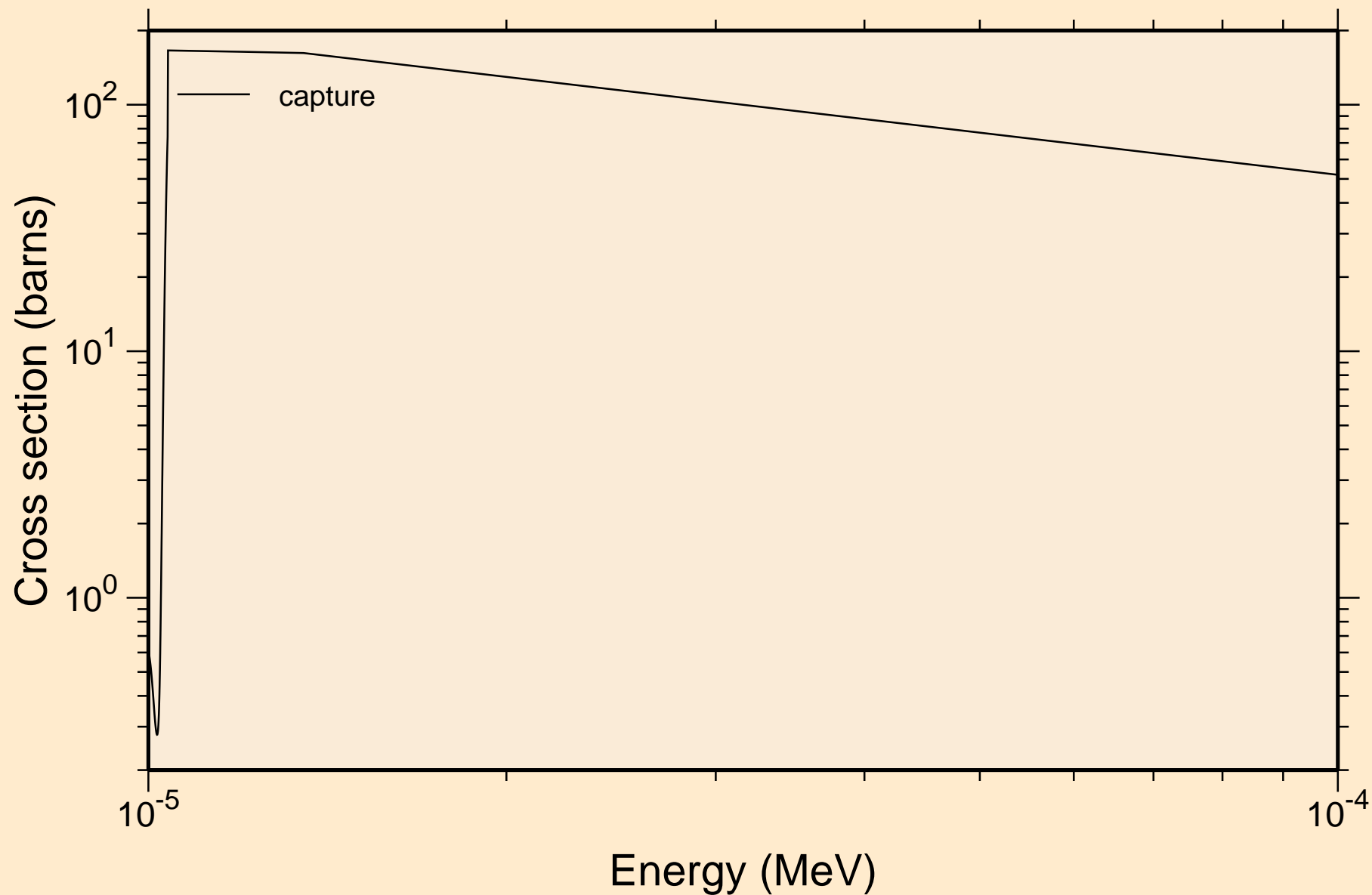

TL189 NEUTRON ACER TENDL-2019 LIBRARY; T=293.16K
resonance absorption cross sections

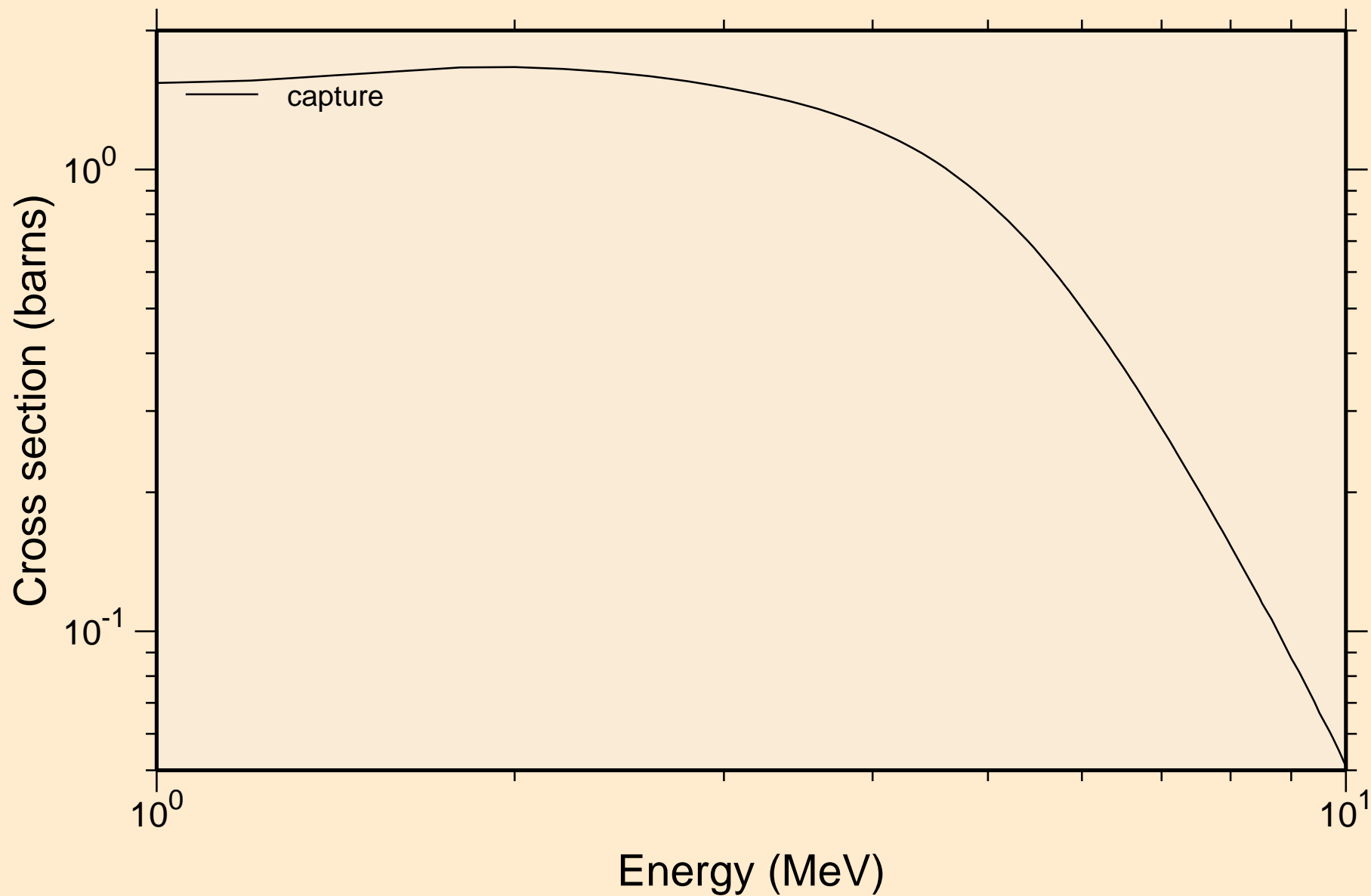

TL189 NEUTRON ACER TENDL-2019 LIBRARY; T=293.16K
Heating

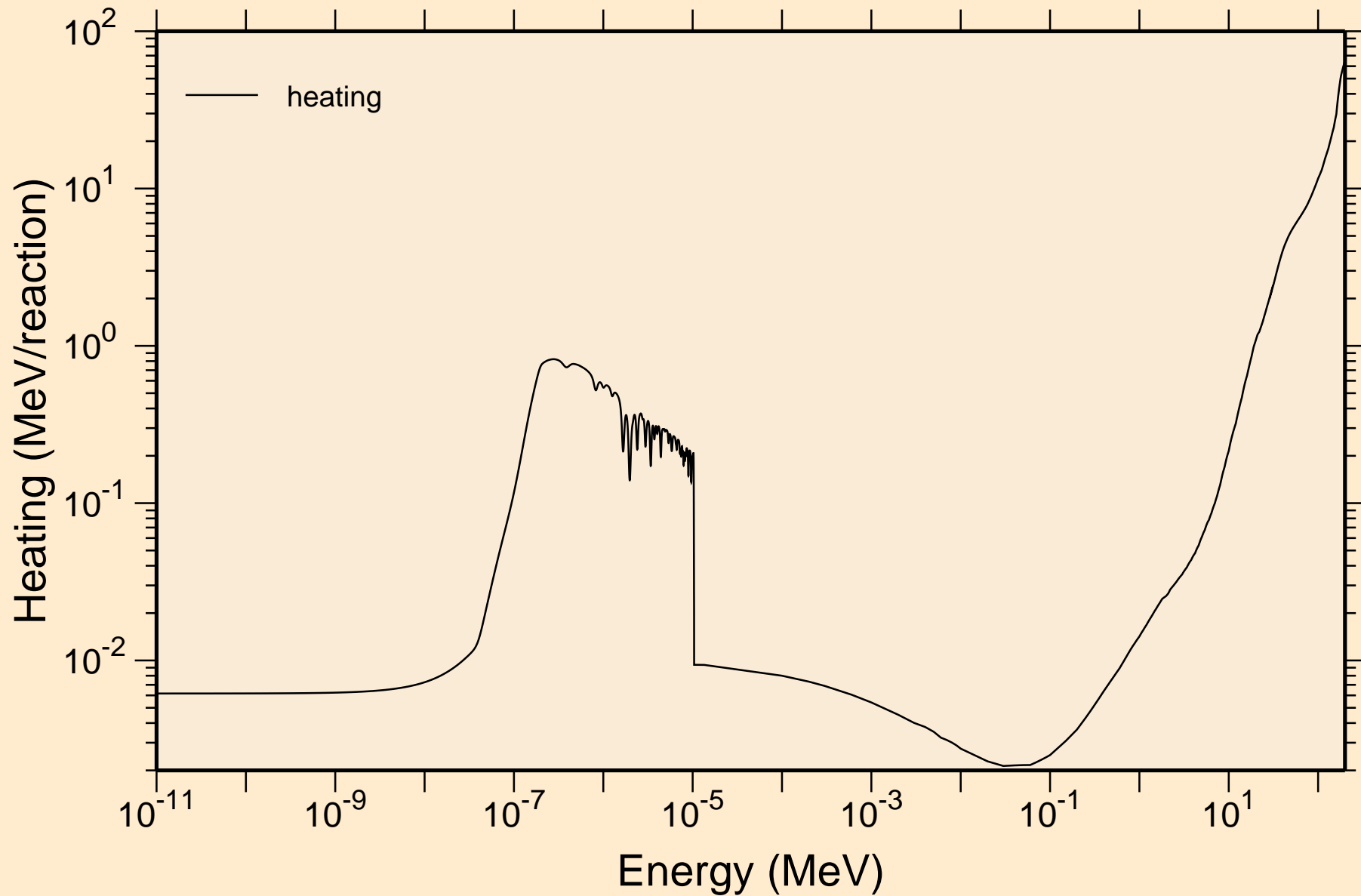

TL189 NEUTRON ACER TENDL-2019 LIBRARY; T=293.16K
Damage

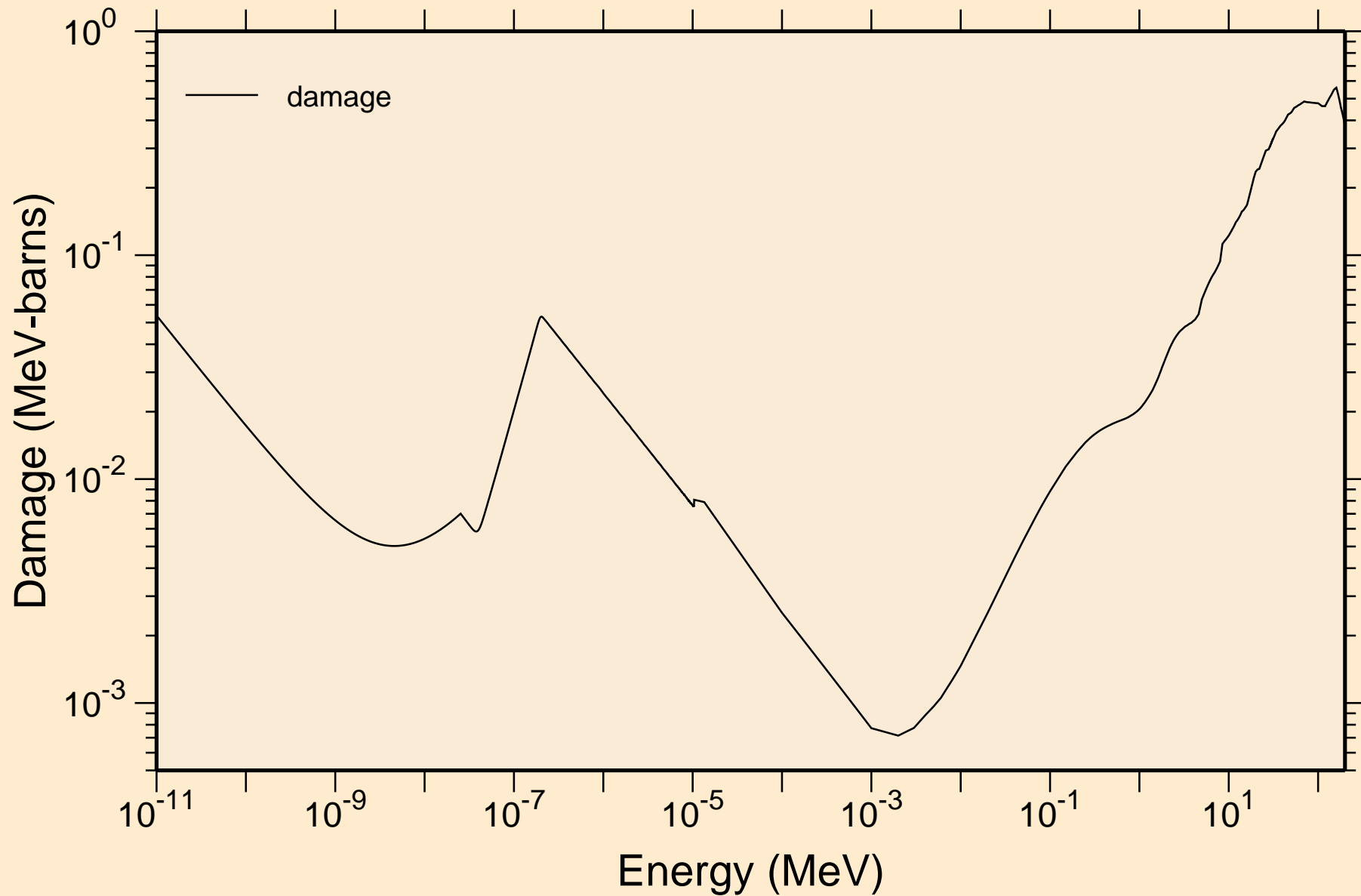

TL189 NEUTRON ACER TENDL-2019 LIBRARY; T=293.16K
Non-threshold reactions

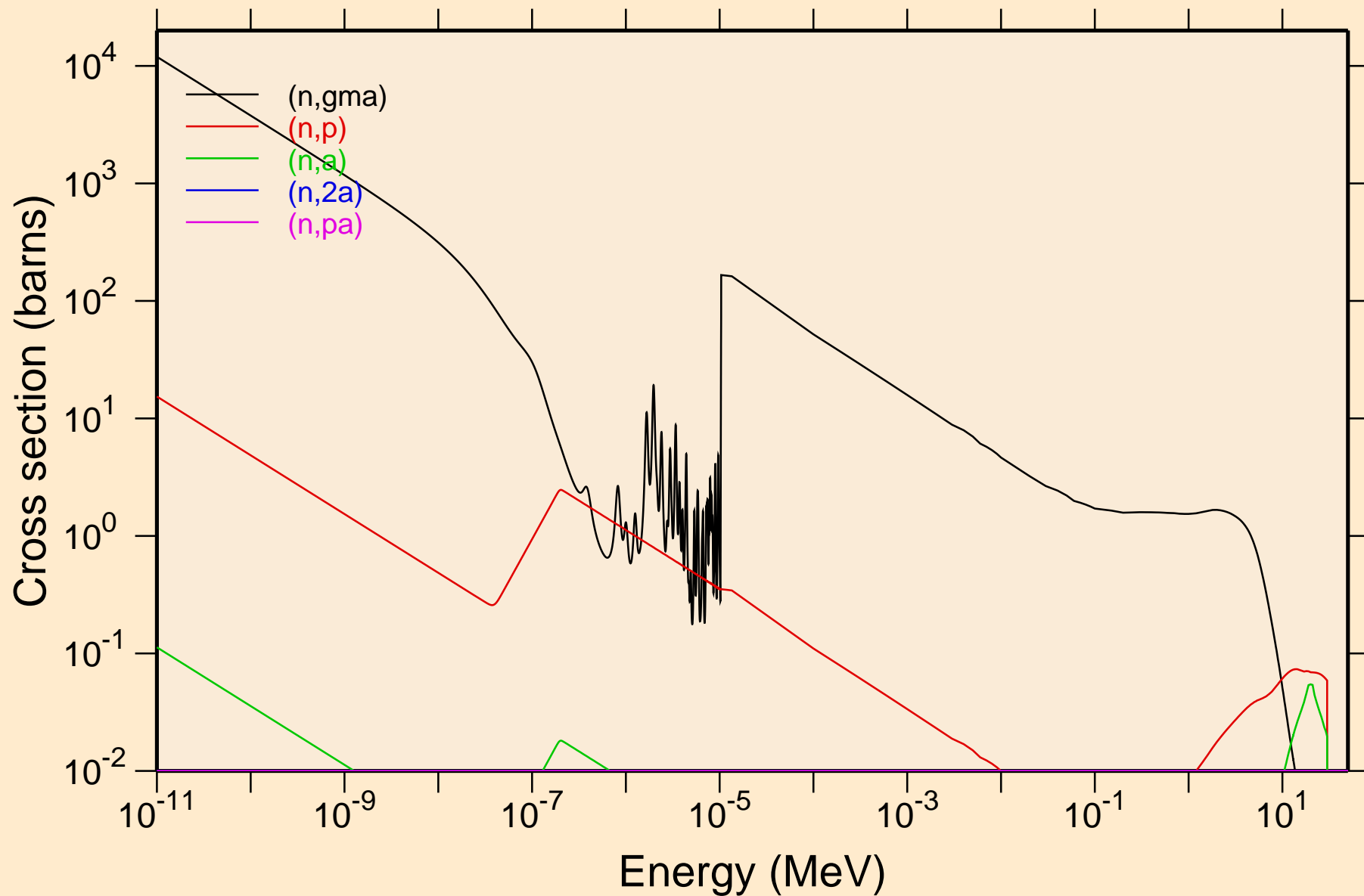

TL189 NEUTRON ACER TENDL-2019 LIBRARY; T=293.16K
Non-threshold reactions

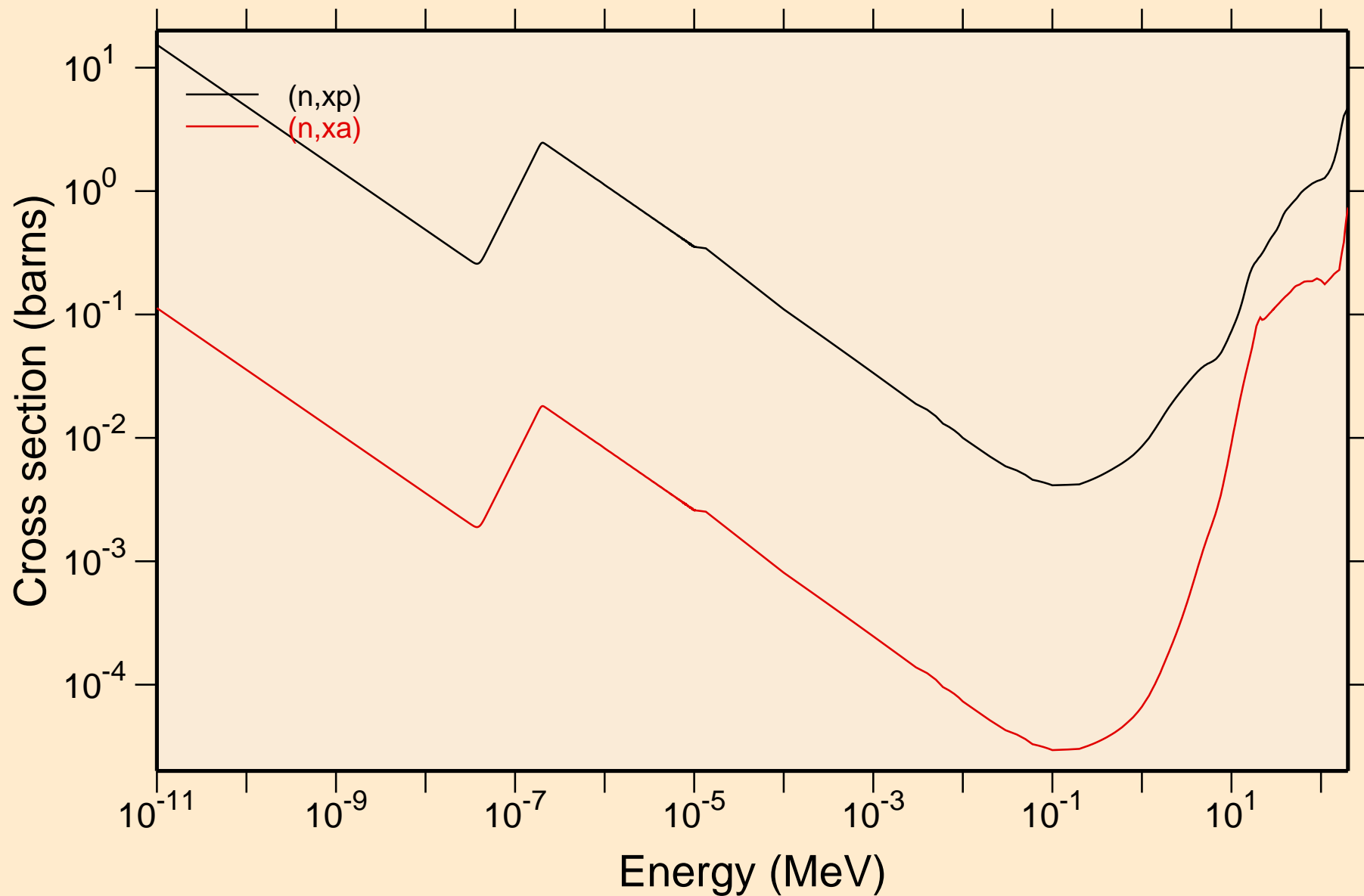

TL189 NEUTRON ACER TENDL-2019 LIBRARY; T=293.16K
Principal cross sections

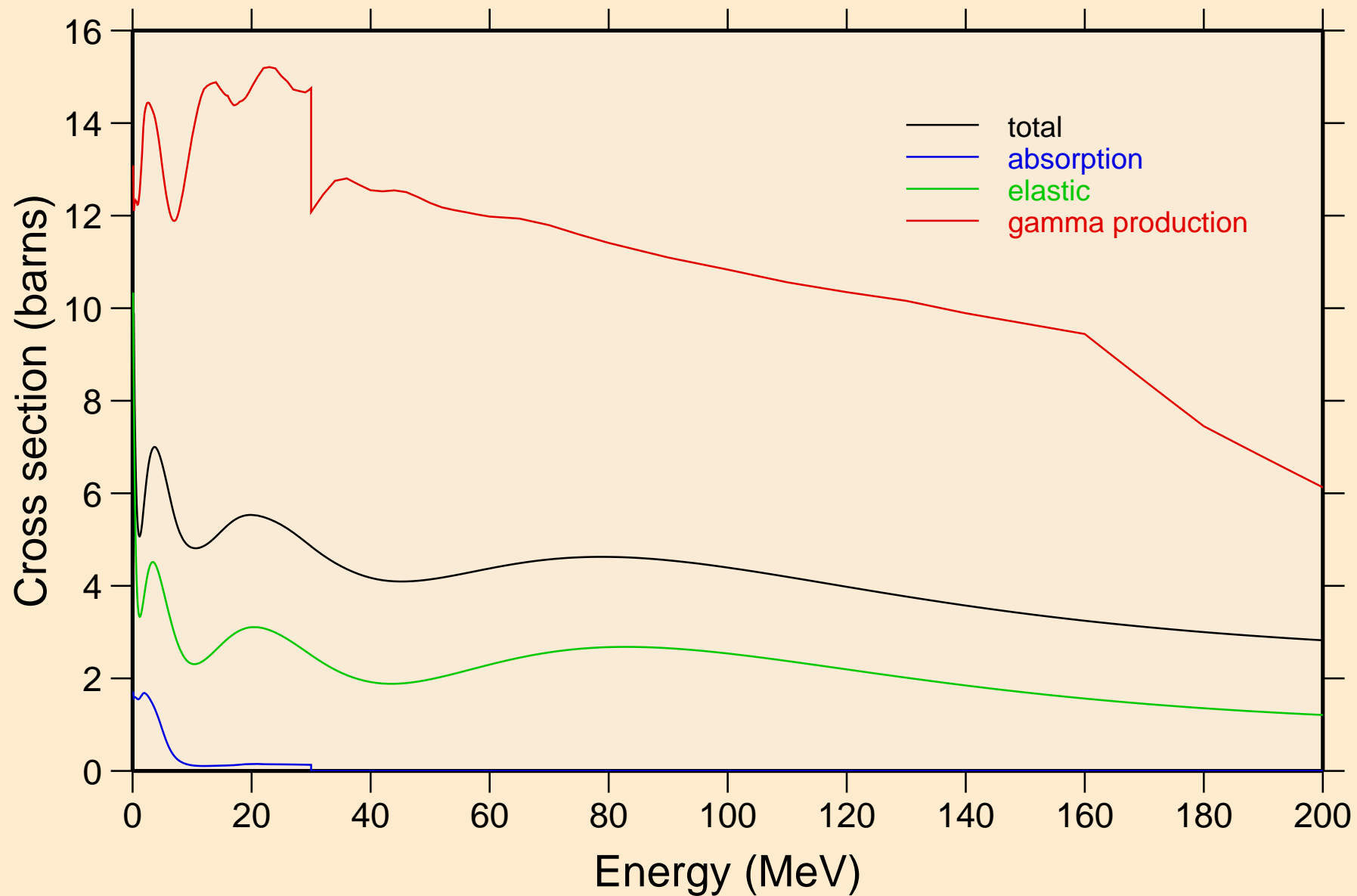

TL189 NEUTRON ACER TENDL-2019 LIBRARY; T=293.16K
Heating

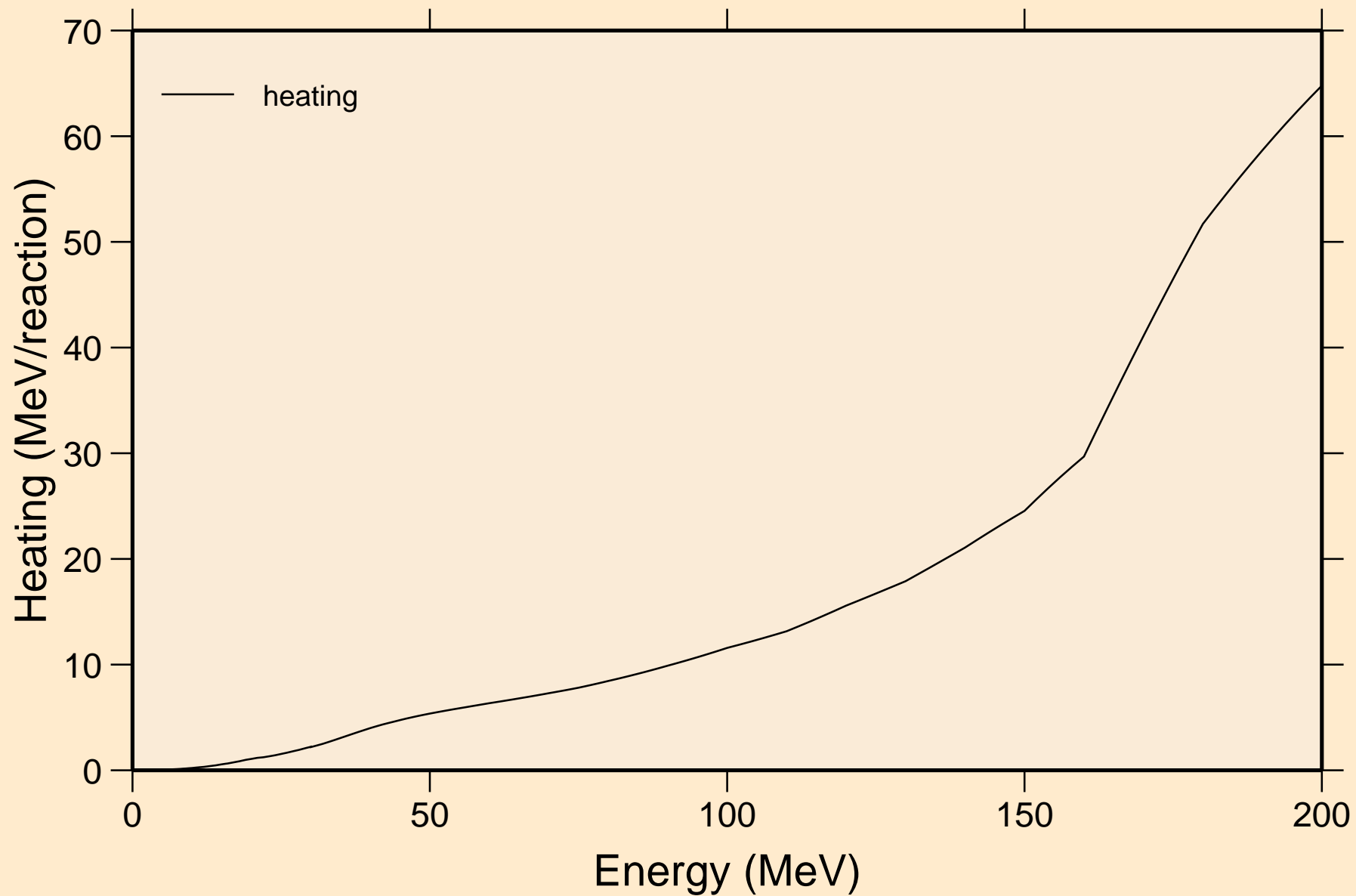

TL189 NEUTRON ACER TENDL-2019 LIBRARY; T=293.16K
Damage

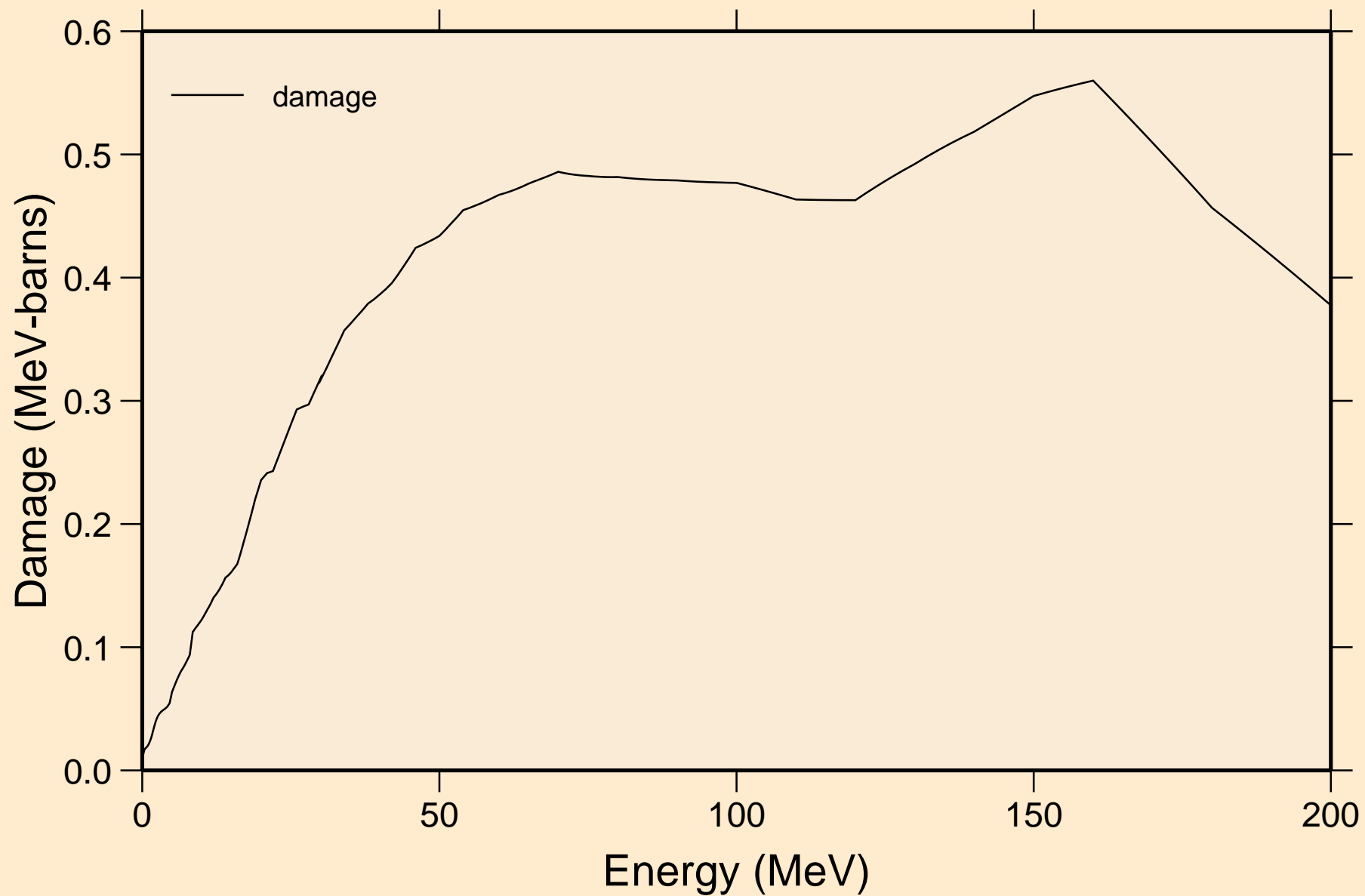

TL189 NEUTRON ACER TENDL-2019 LIBRARY; T=293.16K
Non-threshold reactions

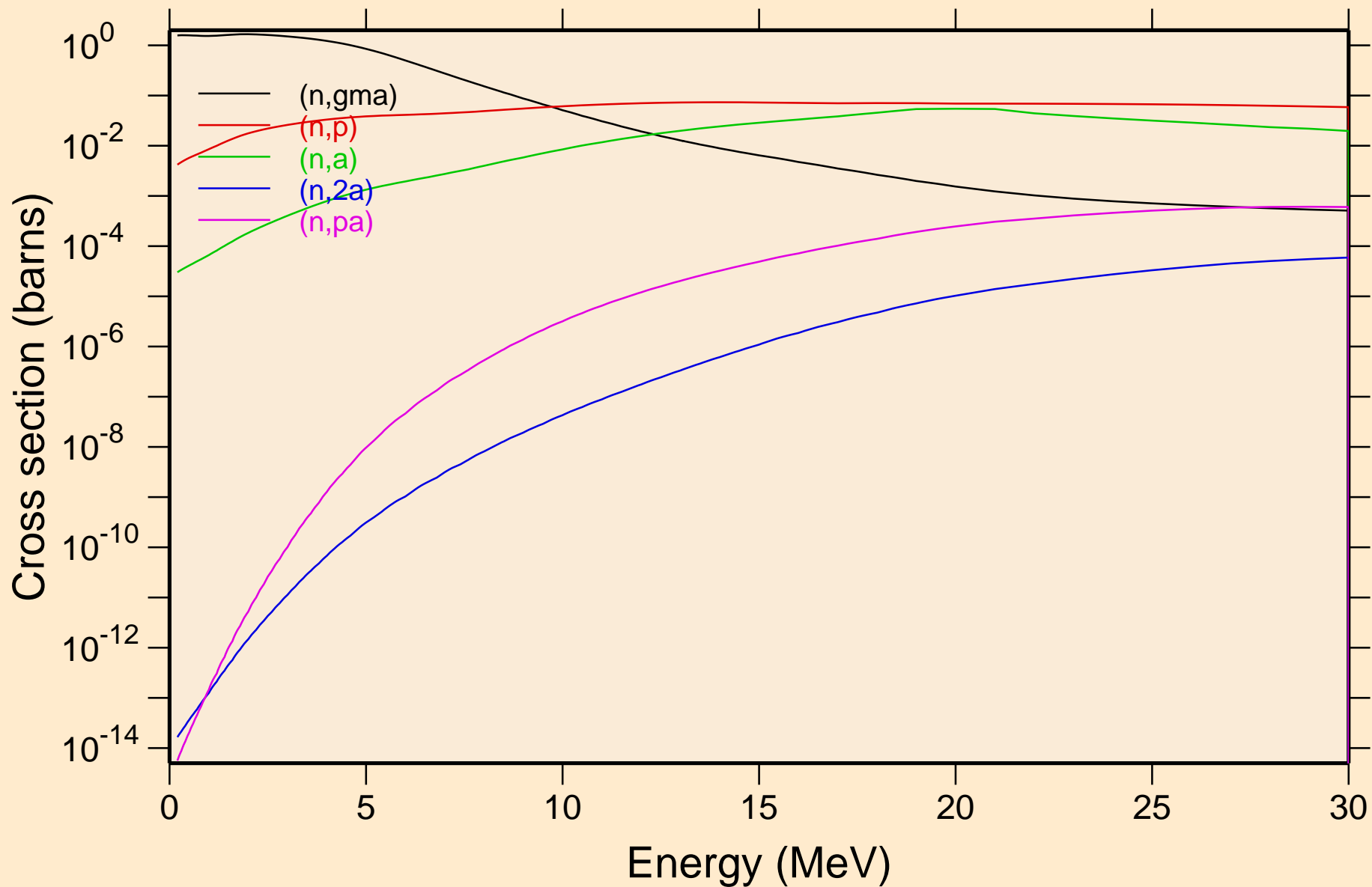

TL189 NEUTRON ACER TENDL-2019 LIBRARY; T=293.16K
Non-threshold reactions

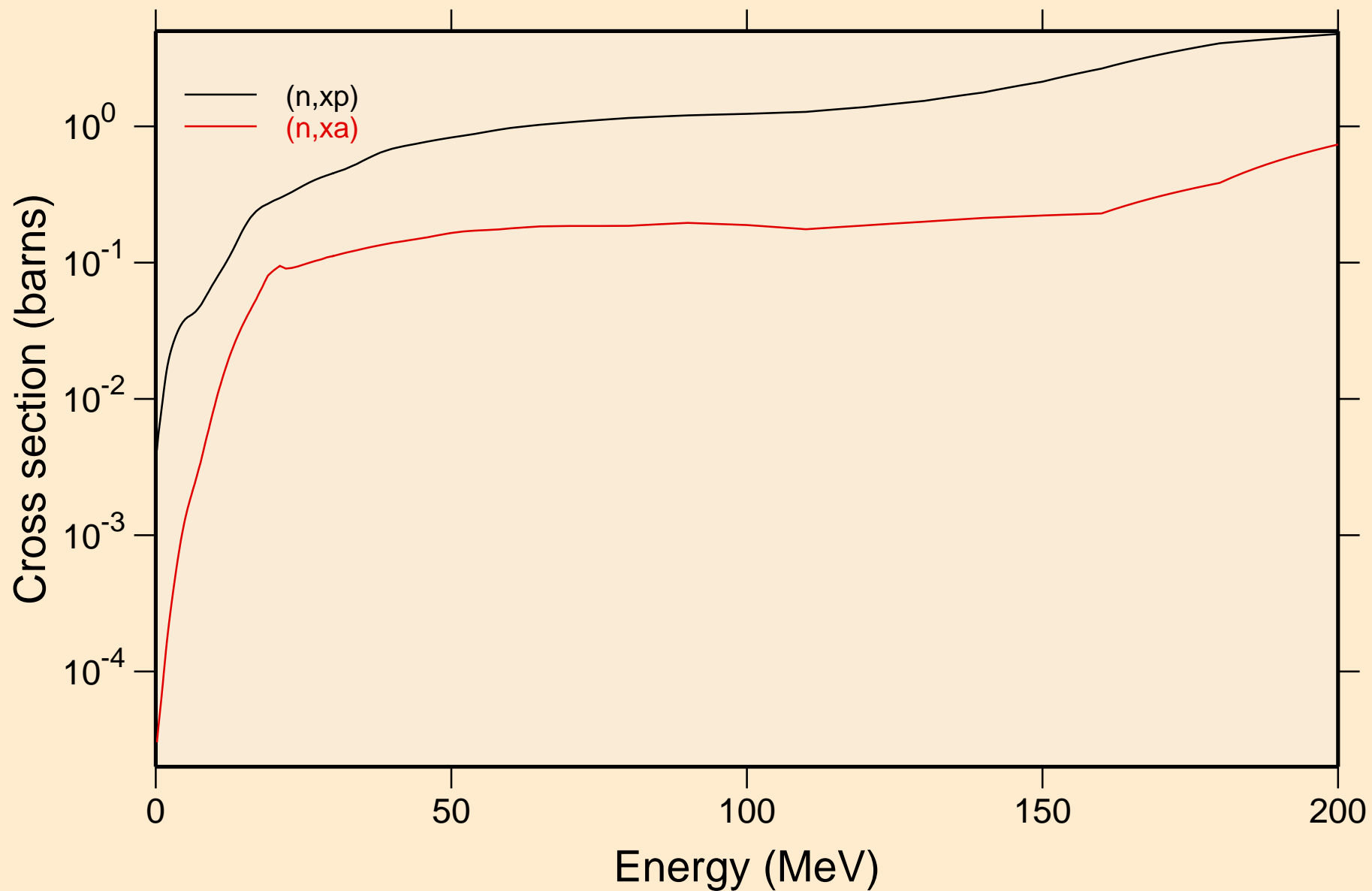

TL189 NEUTRON ACER TENDL-2019 LIBRARY; T=293.16K
Inelastic levels

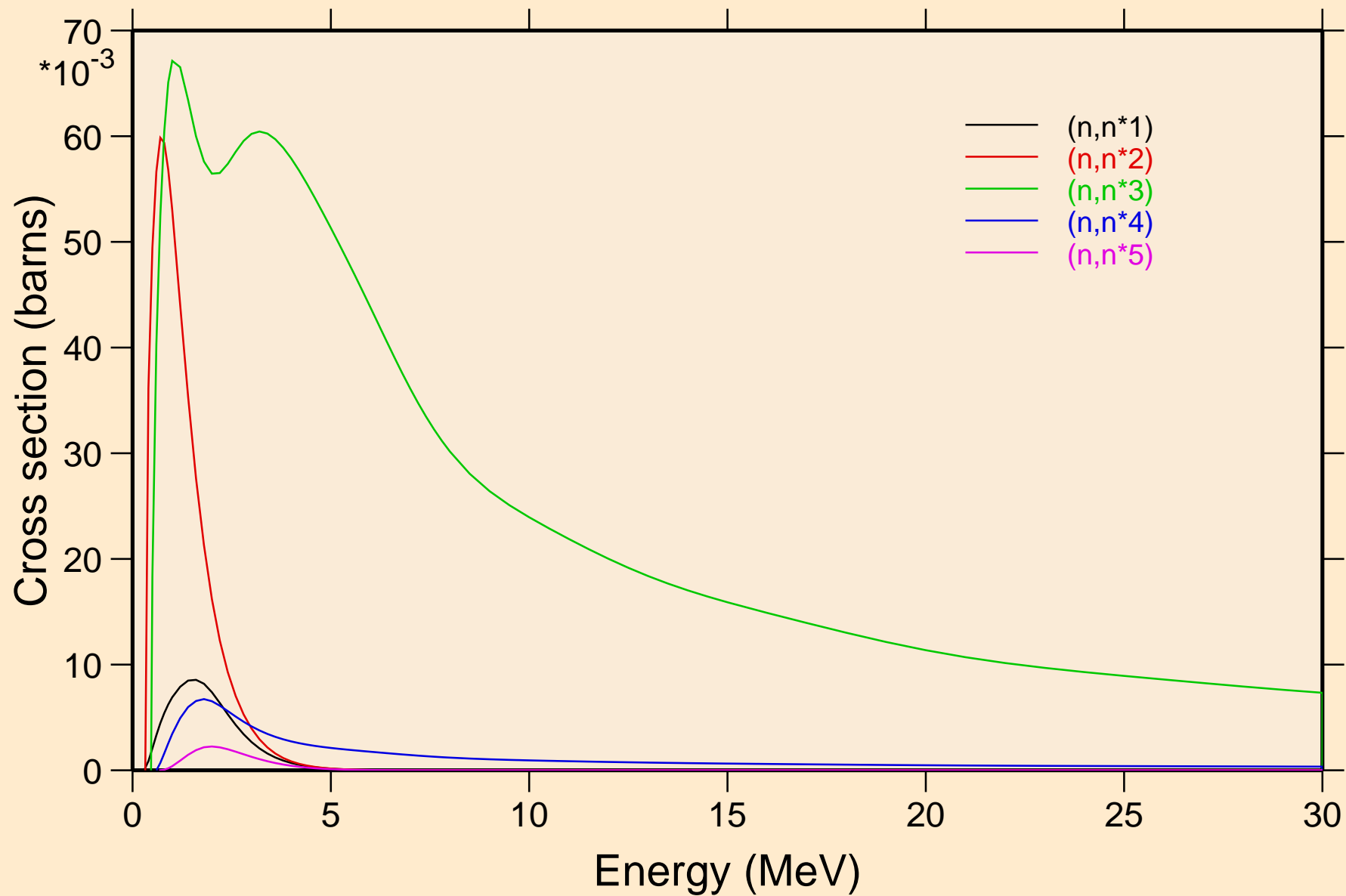

TL189 NEUTRON ACER TENDL-2019 LIBRARY; T=293.16K
Inelastic levels

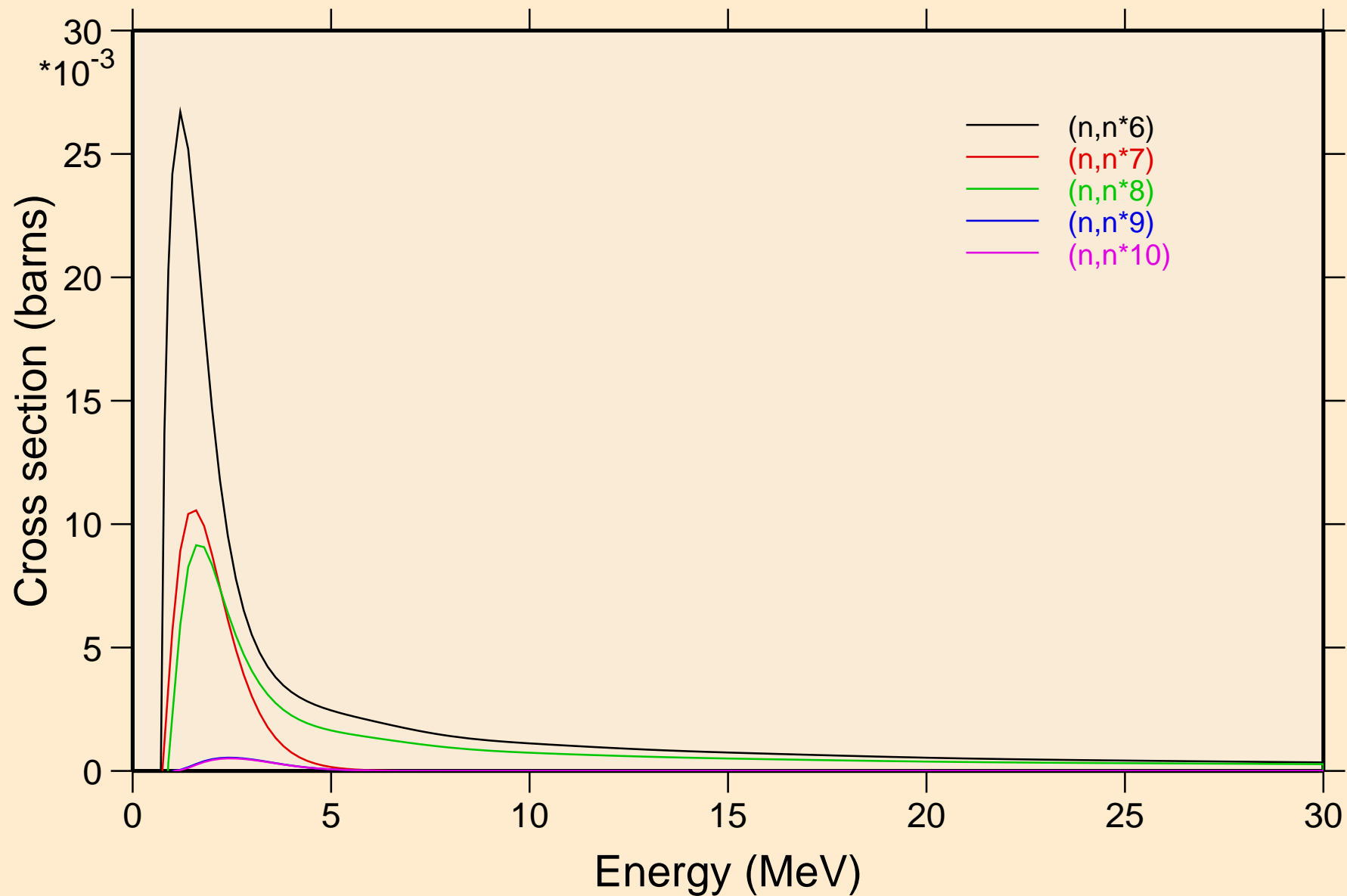

TL189 NEUTRON ACER TENDL-2019 LIBRARY; T=293.16K
Inelastic levels

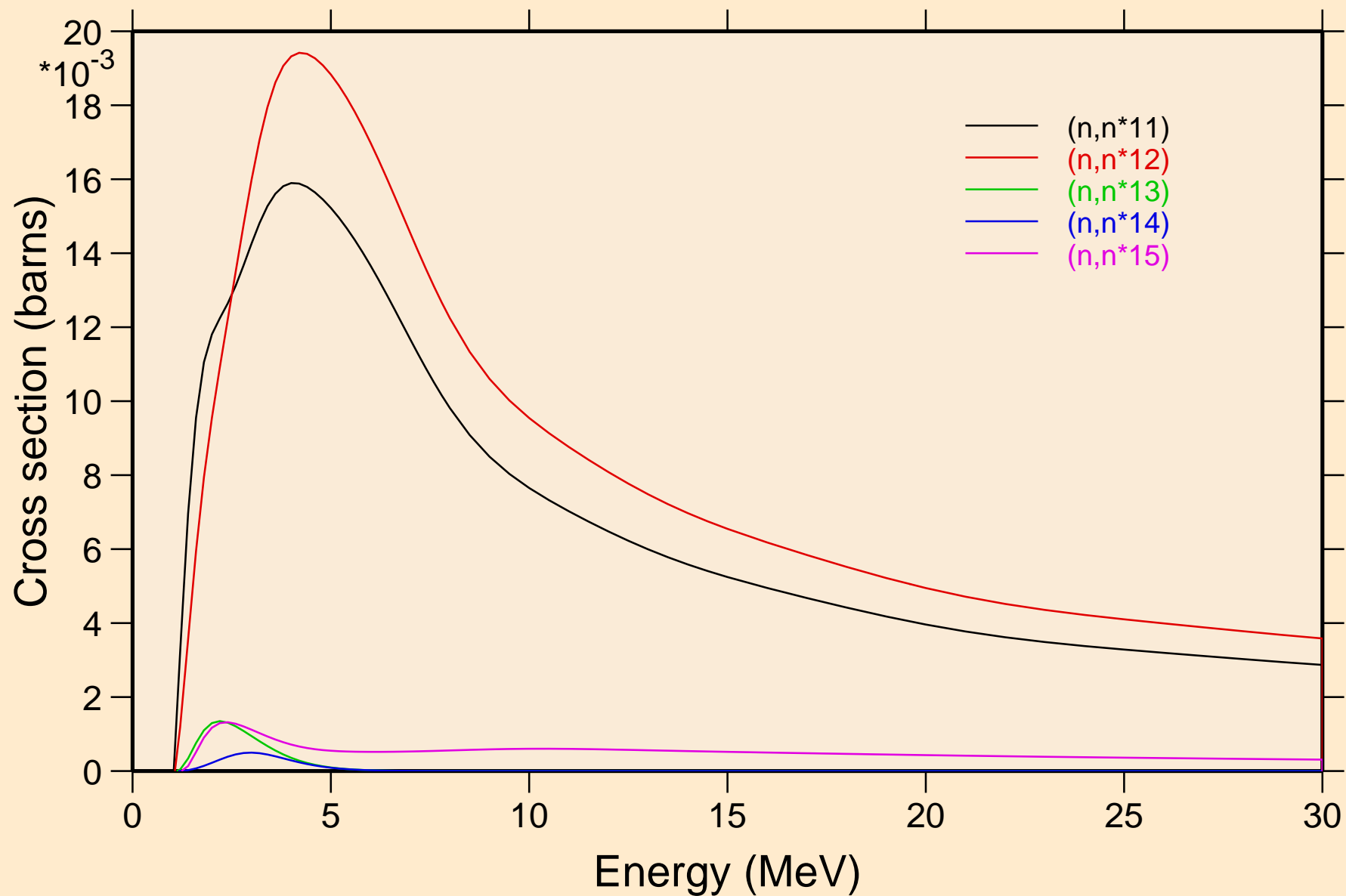

TL189 NEUTRON ACER TENDL-2019 LIBRARY; T=293.16K
Inelastic levels

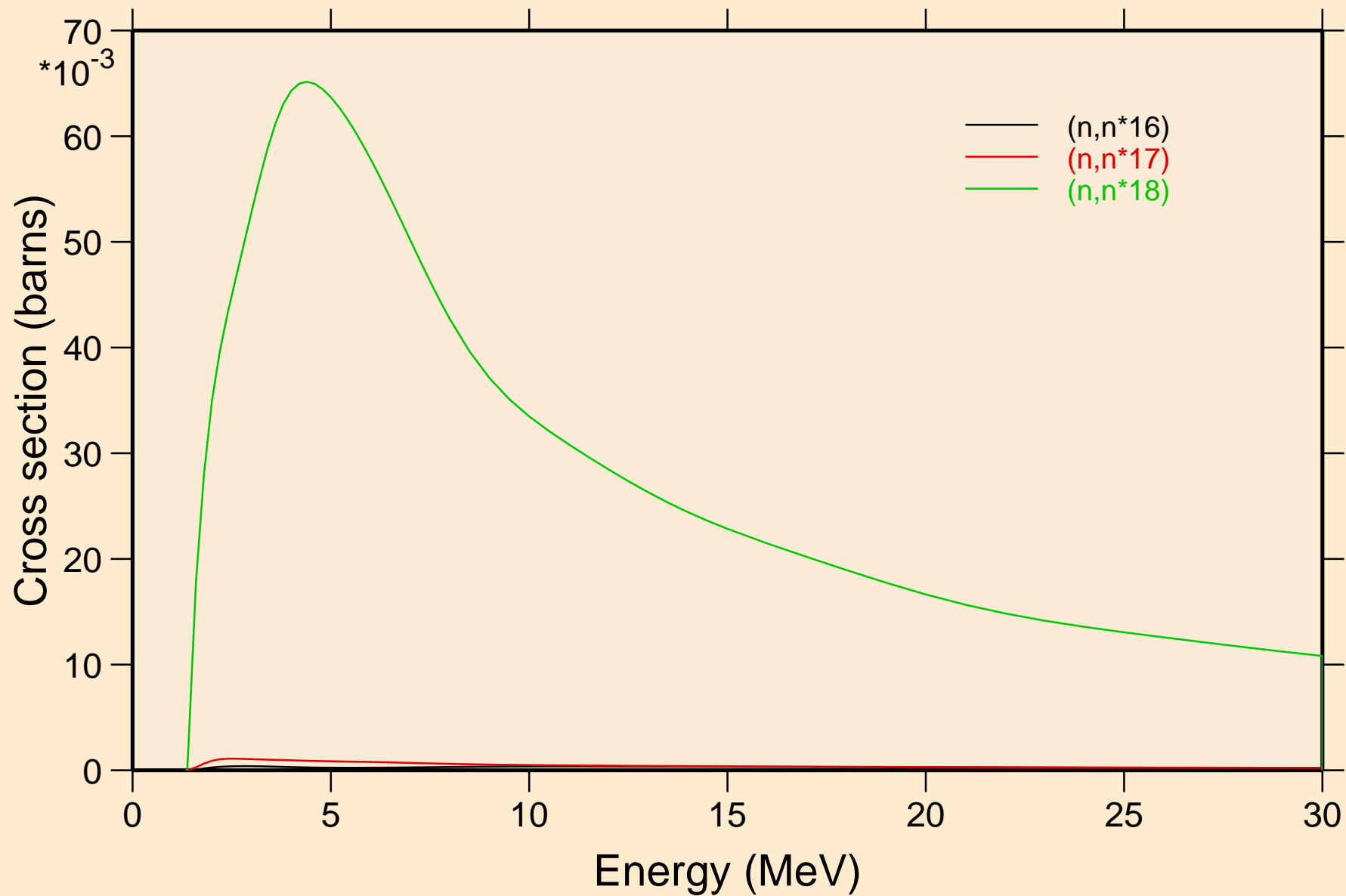

TL189 NEUTRON ACER TENDL-2019 LIBRARY; T=293.16K
Threshold reactions

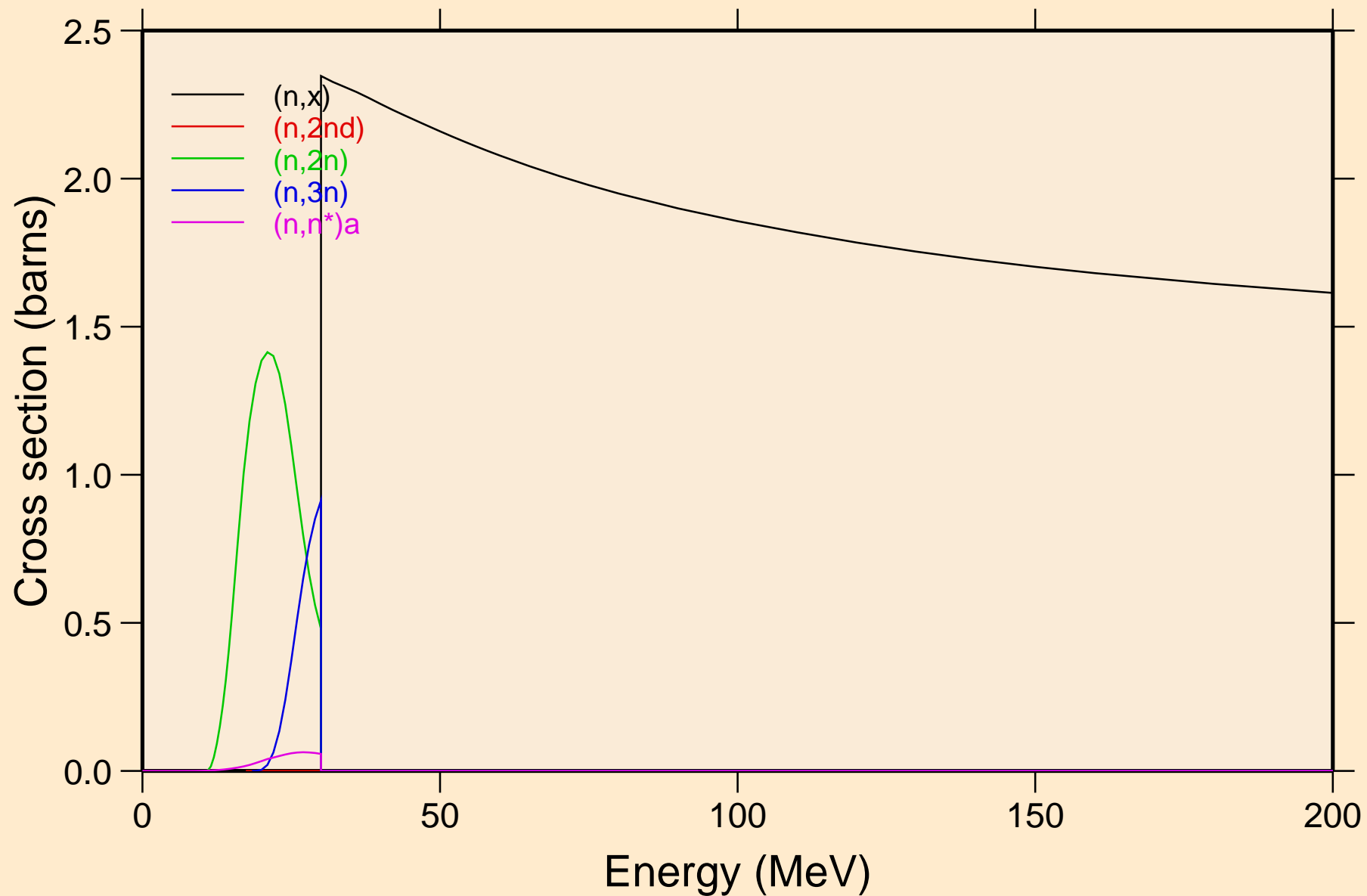

TL189 NEUTRON ACER TENDL-2019 LIBRARY; T=293.16K
Threshold reactions

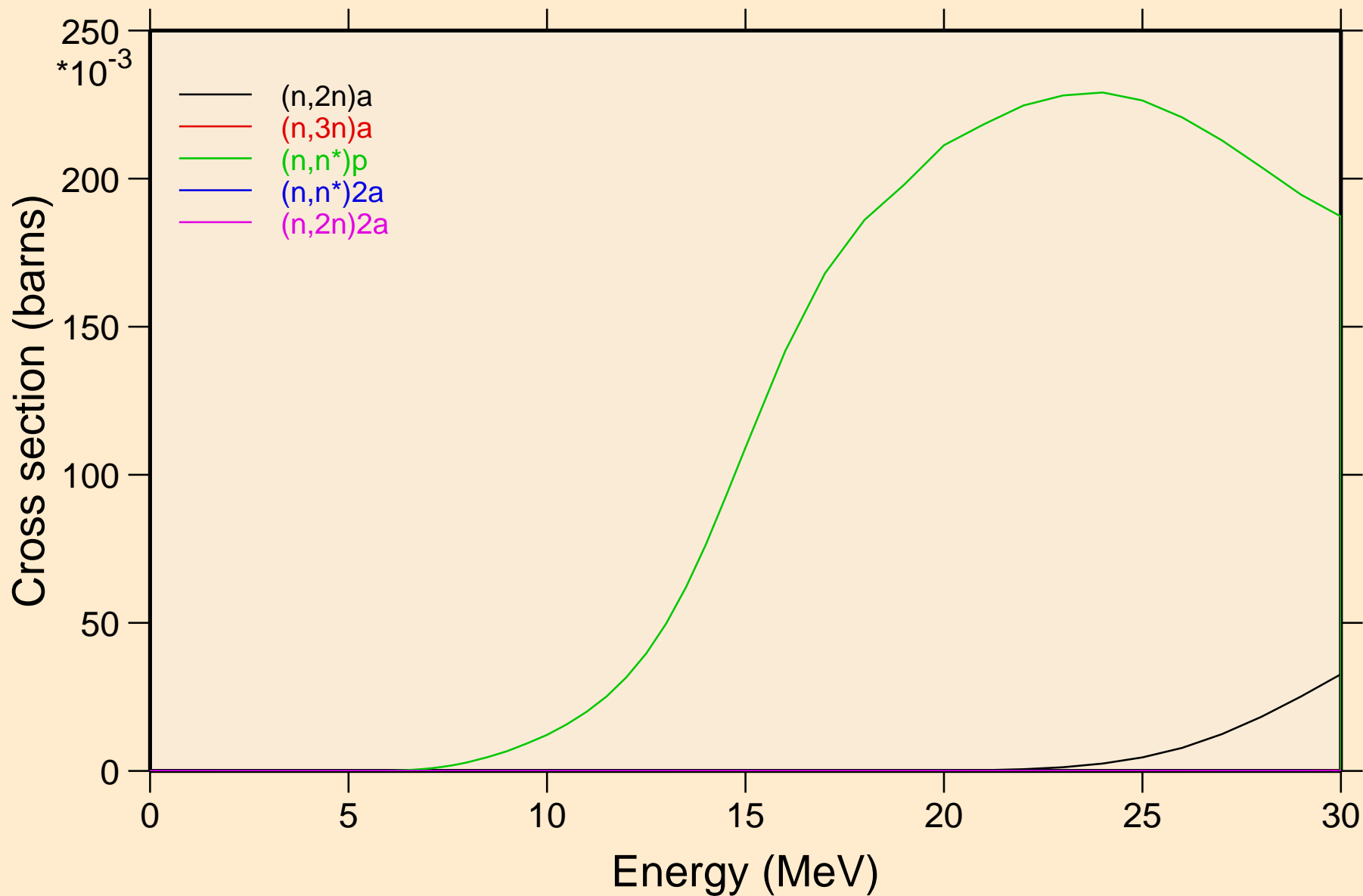

TL189 NEUTRON ACER TENDL-2019 LIBRARY; T=293.16K
Threshold reactions

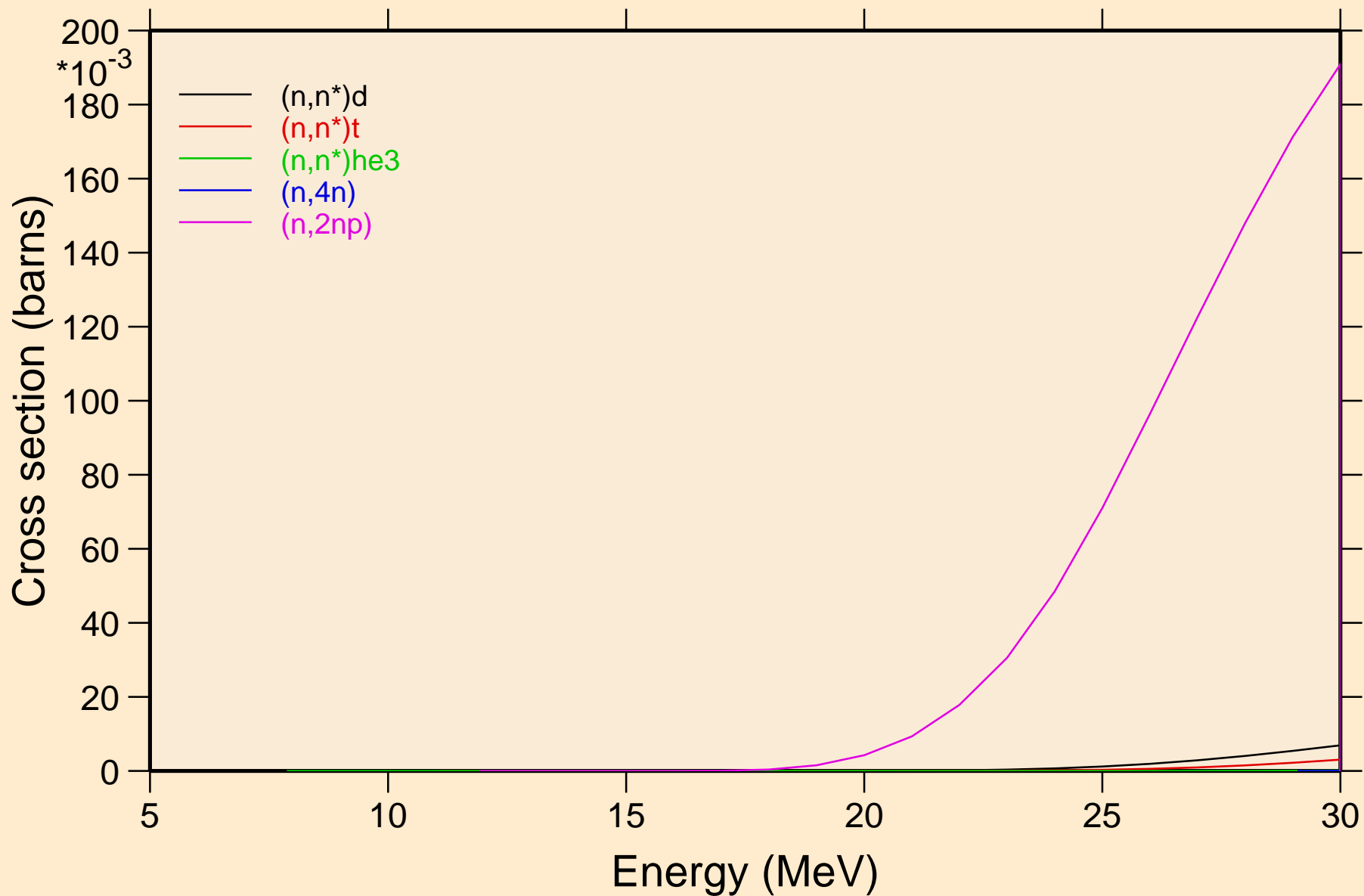

TL189 NEUTRON ACER TENDL-2019 LIBRARY; T=293.16K
Threshold reactions

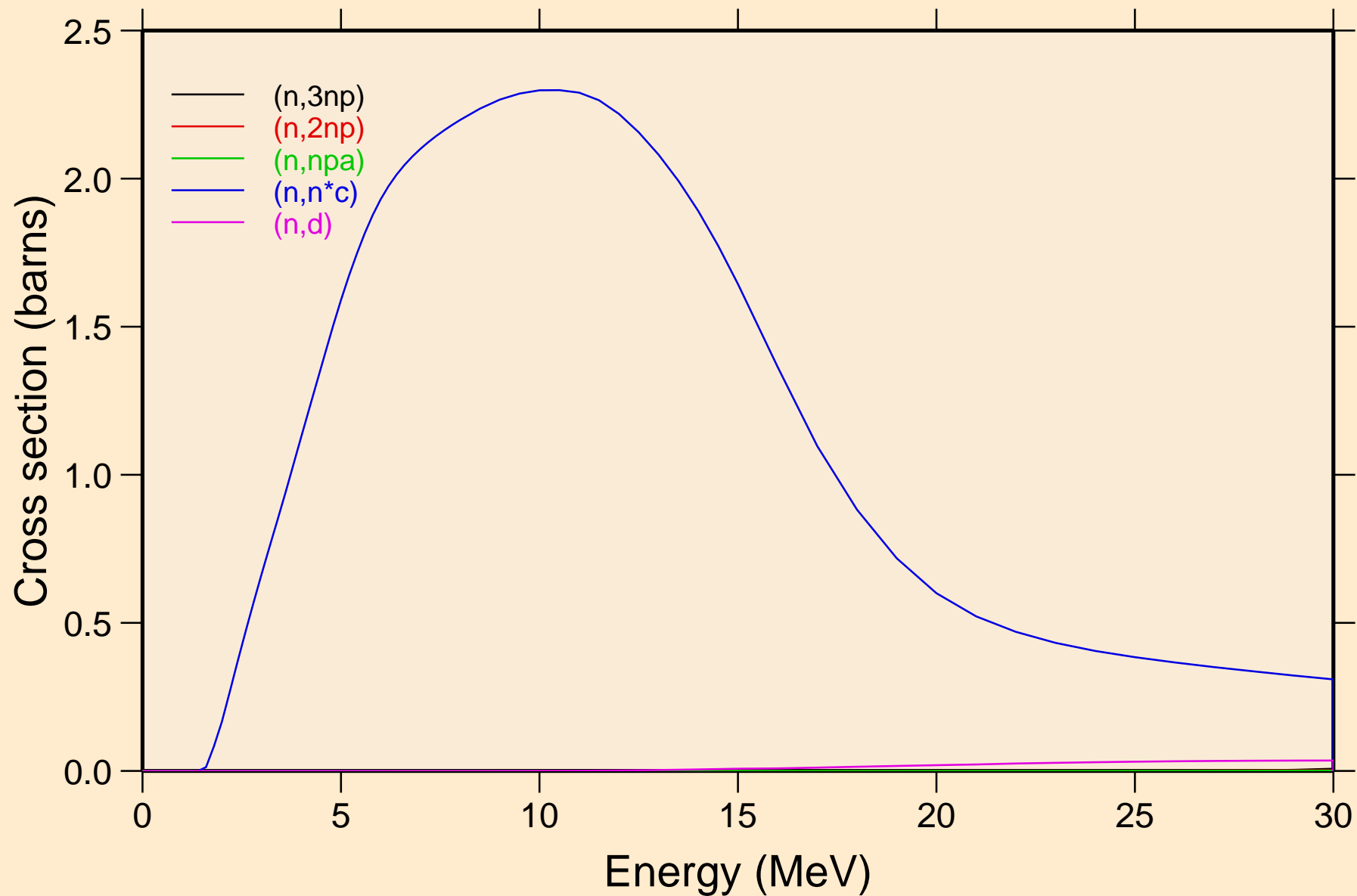

TL189 NEUTRON ACER TENDL-2019 LIBRARY; T=293.16K
Threshold reactions

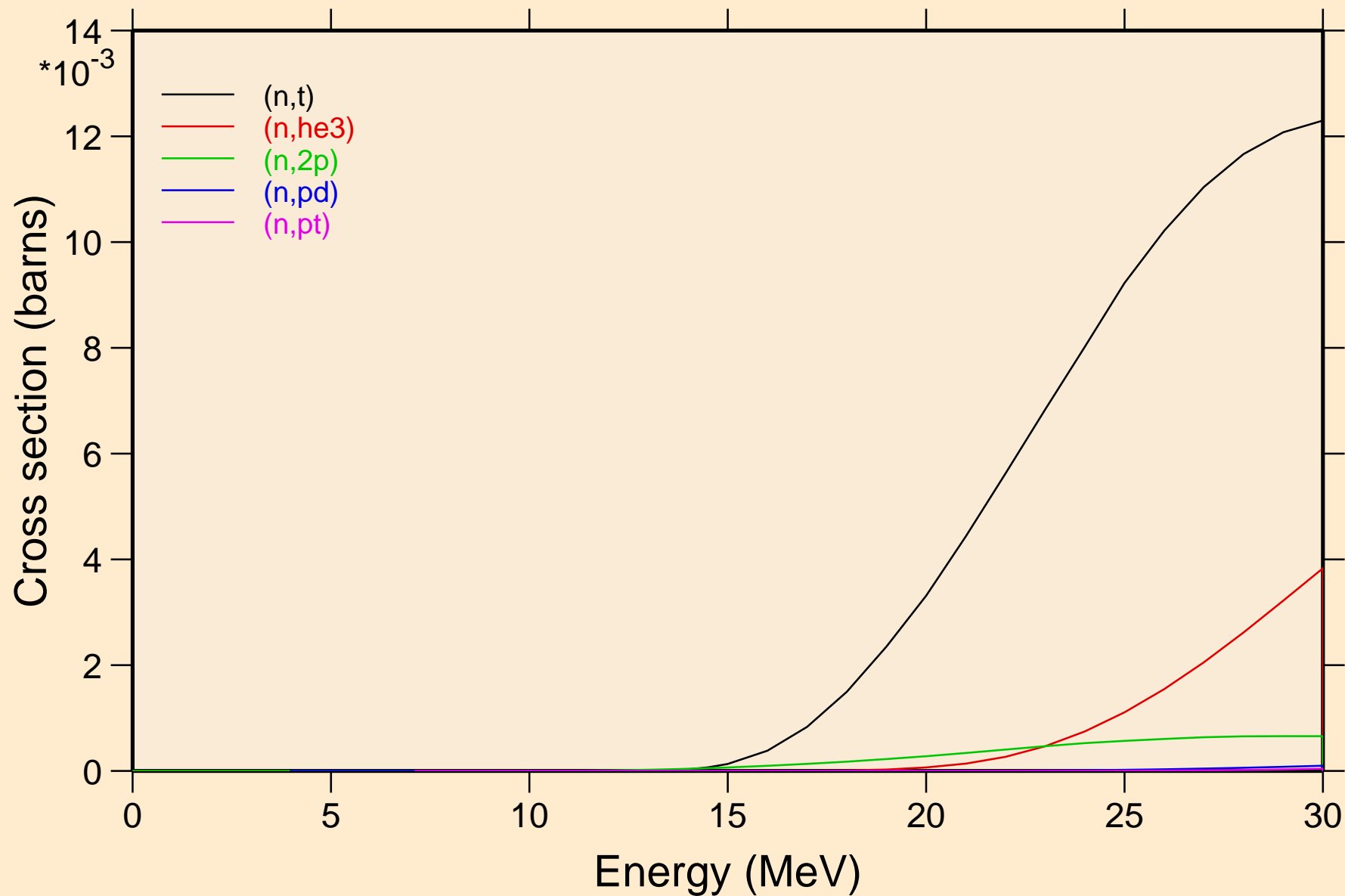

TL189 NEUTRON ACER TENDL-2019 LIBRARY; T=293.16K
Threshold reactions

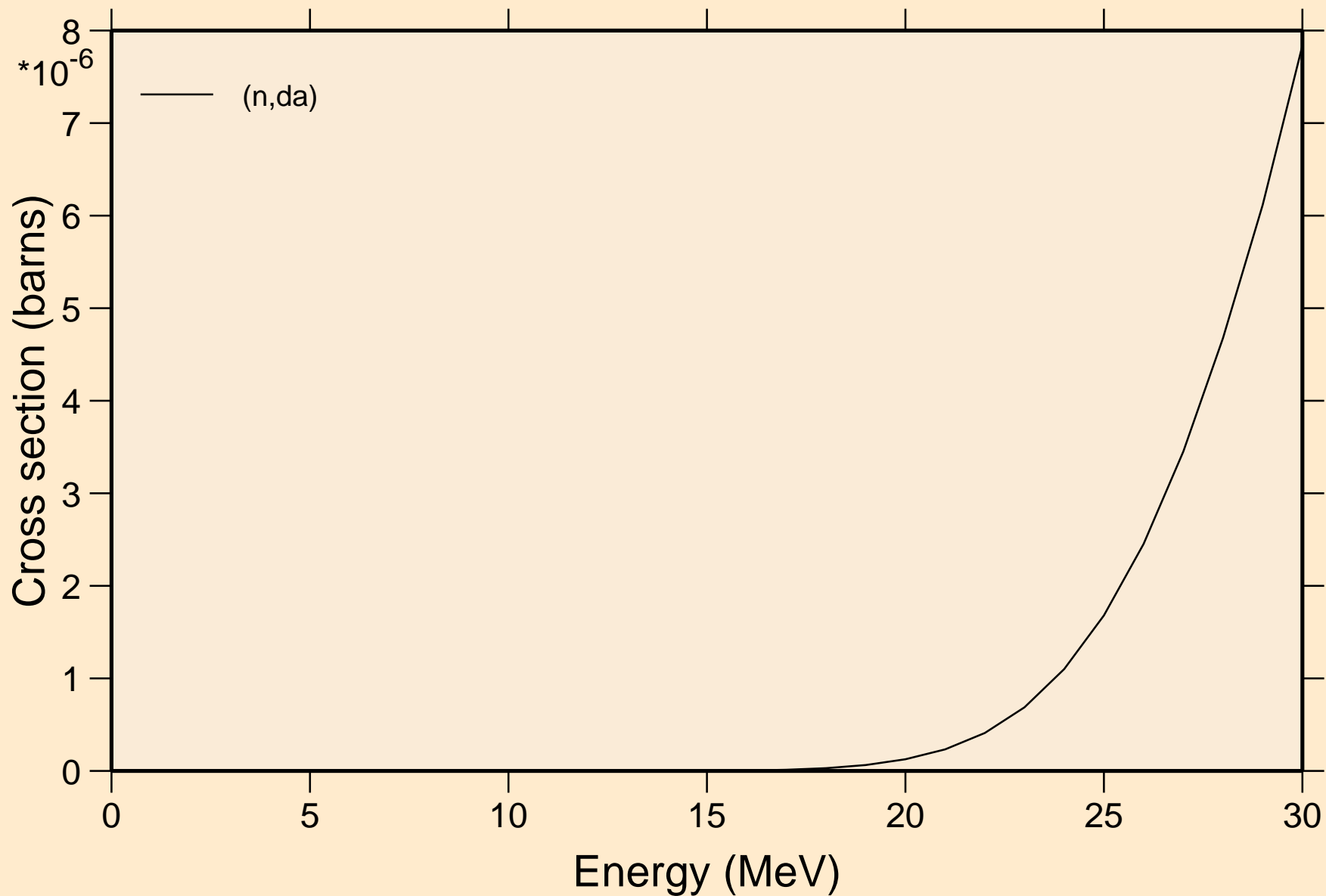

TL189 NEUTRON ACER TENDL-2019 LIBRARY; T=293.16K
Threshold reactions

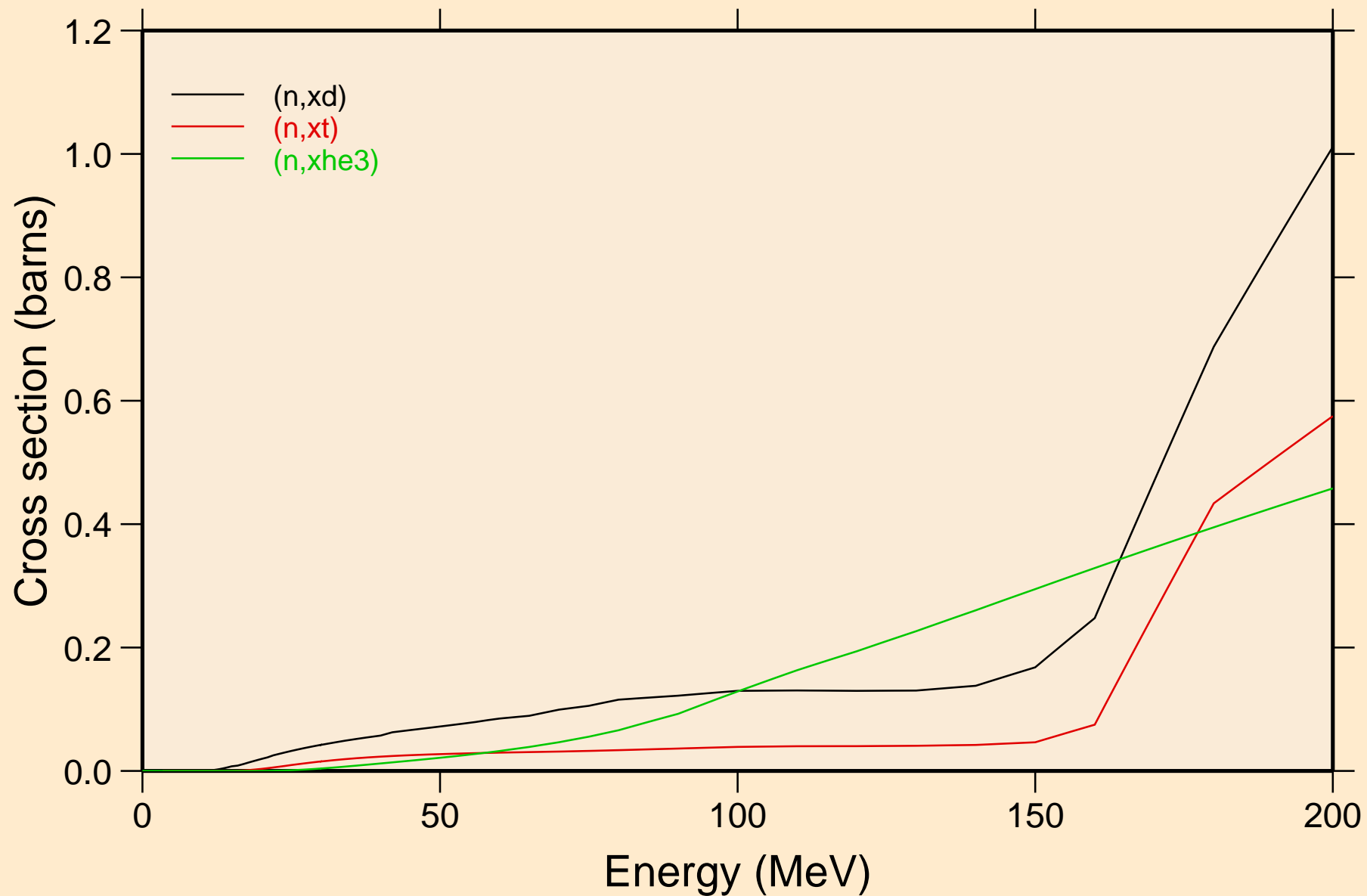

TL189 NEUTRON ACER TENDL-2019 LIBRARY; T=293.16K
angular distribution for elastic

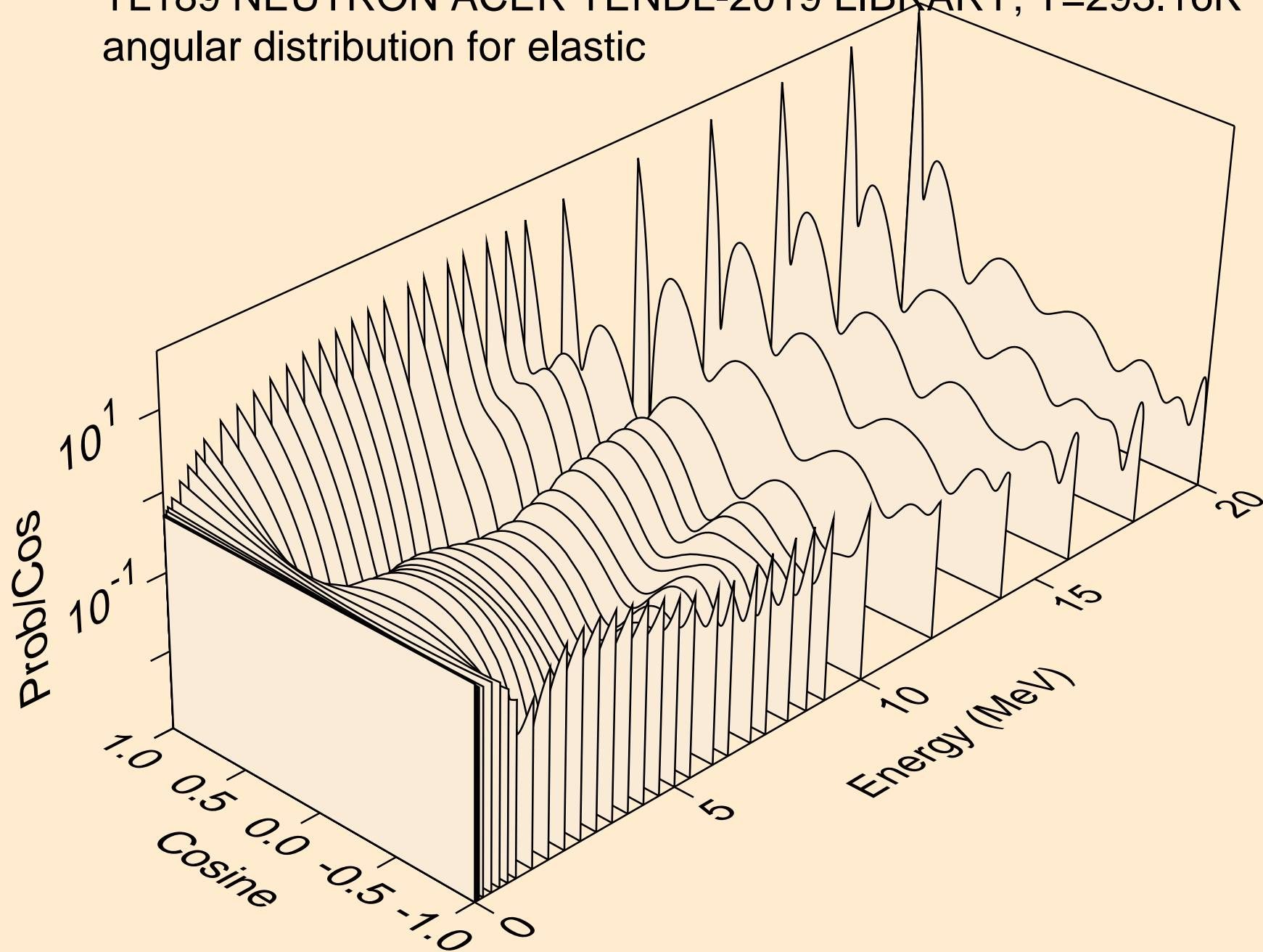

TL189 NEUTRON ACER TENDL-2019 LIBRARY; T=293.16K
angular distribution for elastic

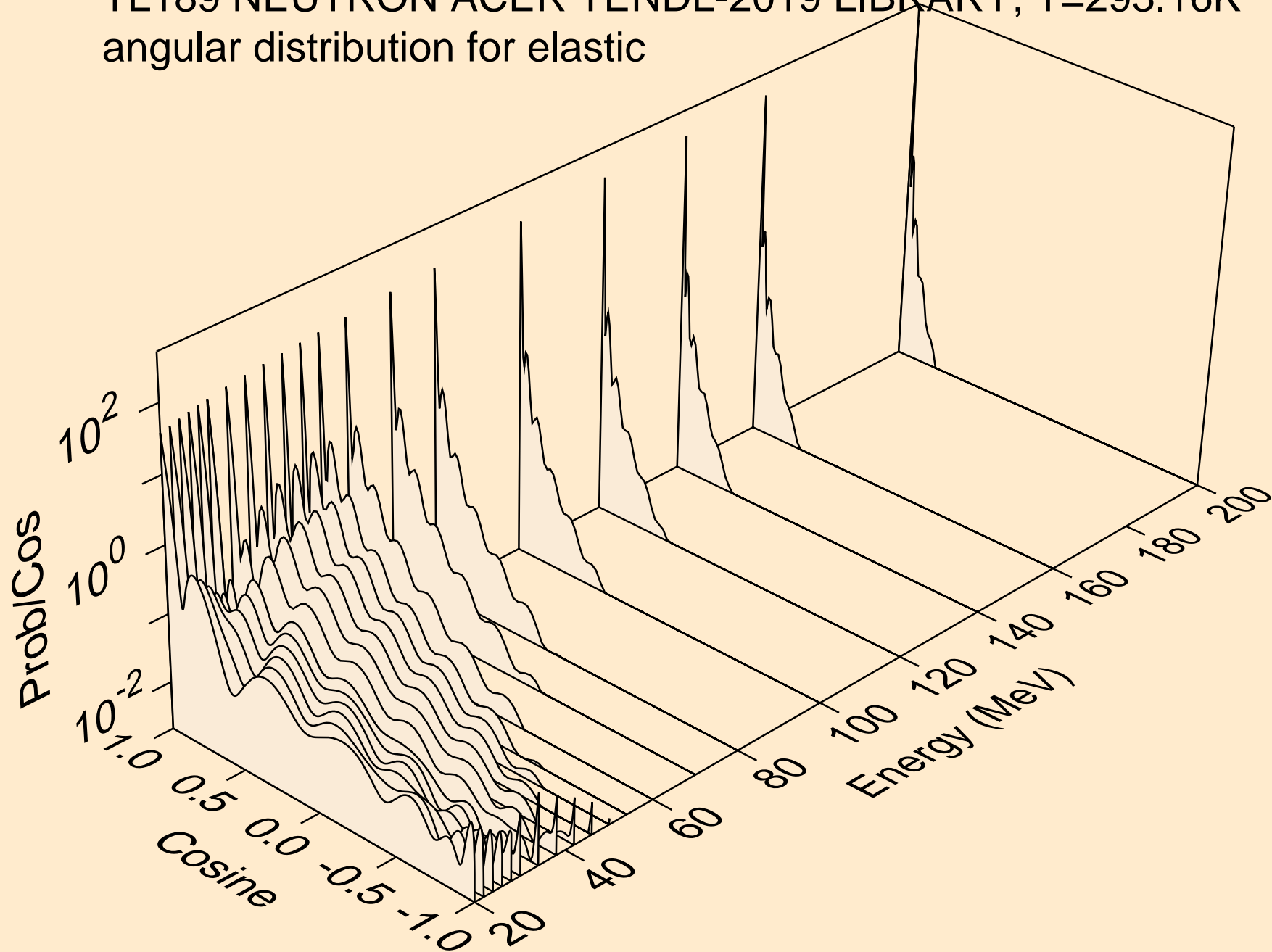

TL189 NEUTRON ACER TENDL-2019 LIBRARY; T=293.16K
angular distribution for (n,n*1)

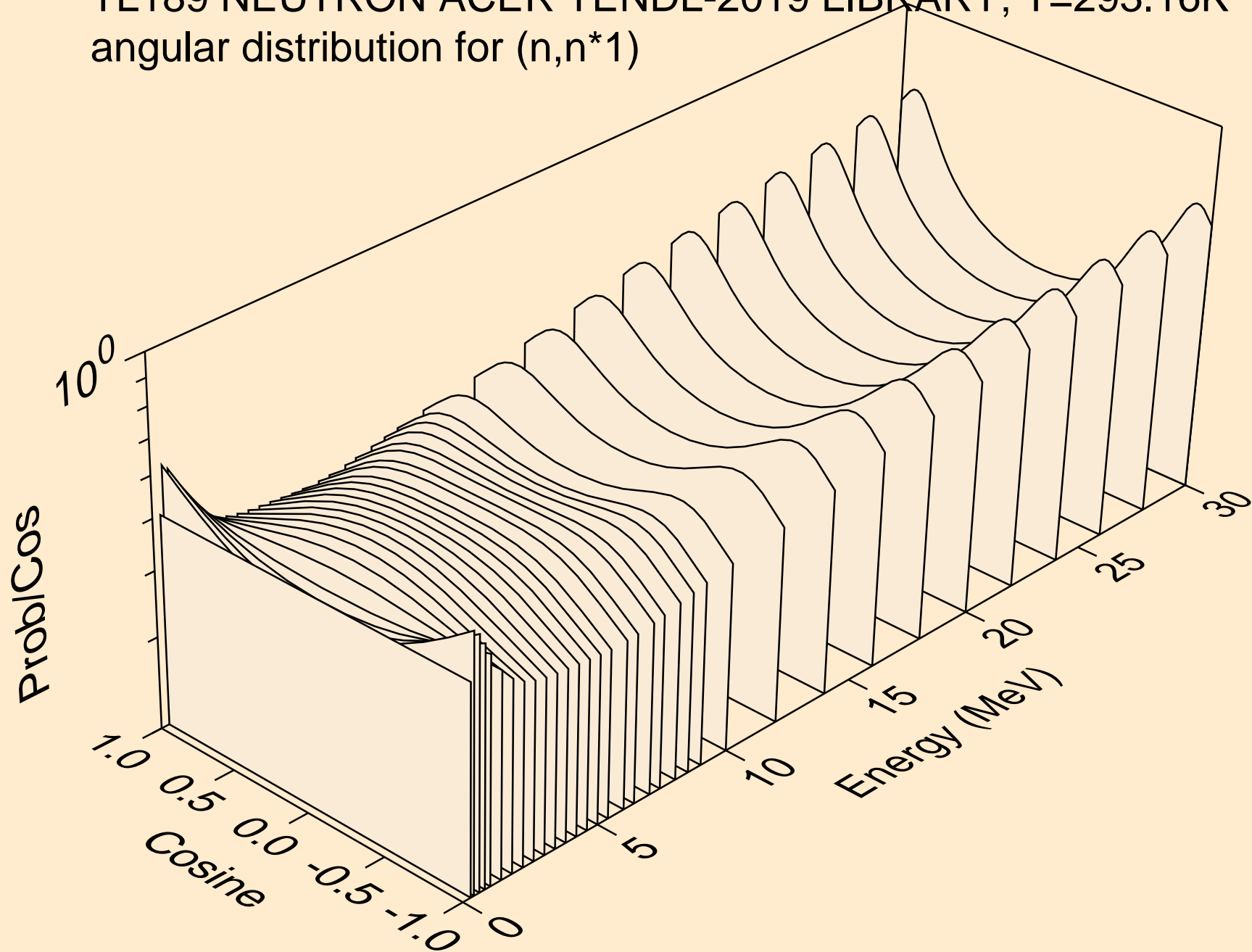

TL189 NEUTRON ACER TENDL-2019 LIBRARY; T=293.16K
angular distribution for (n,n*2)

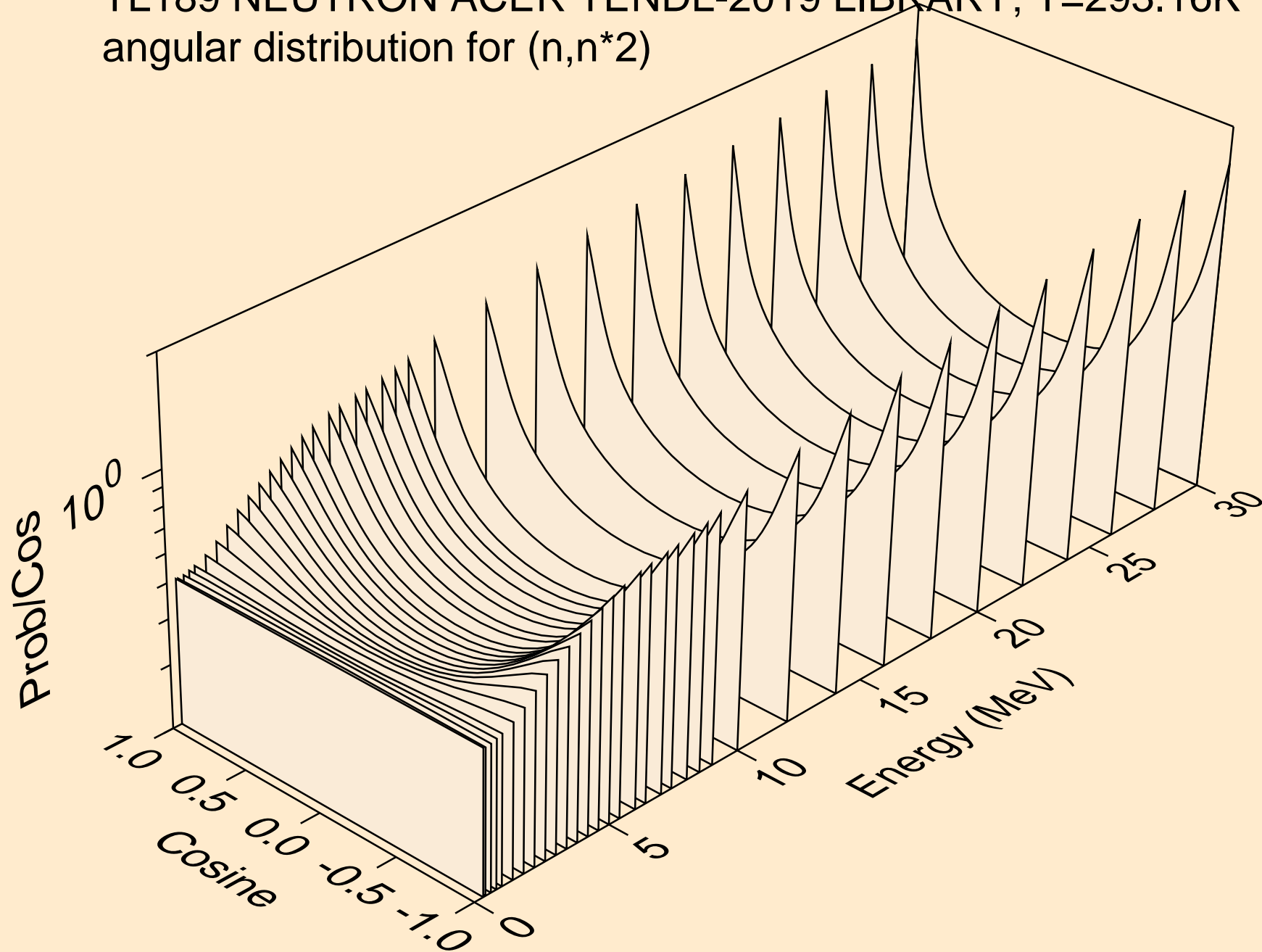

TL189 NEUTRON ACER TENDL-2019 LIBRARY; T=293.16K
angular distribution for (n,n*3)

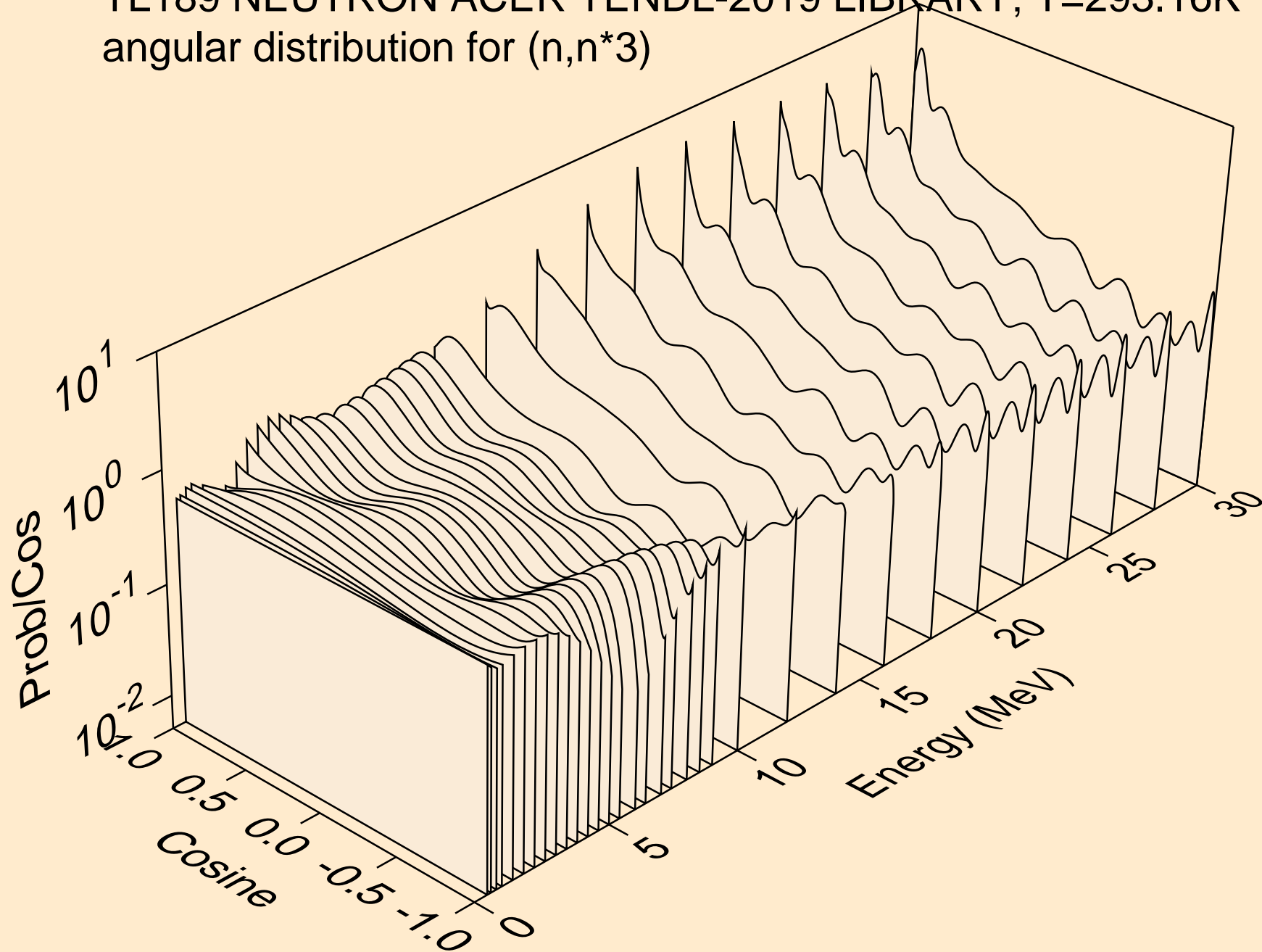

TL189 NEUTRON ACER TENDL-2019 LIBRARY; T=293.16K
angular distribution for (n,n*4)

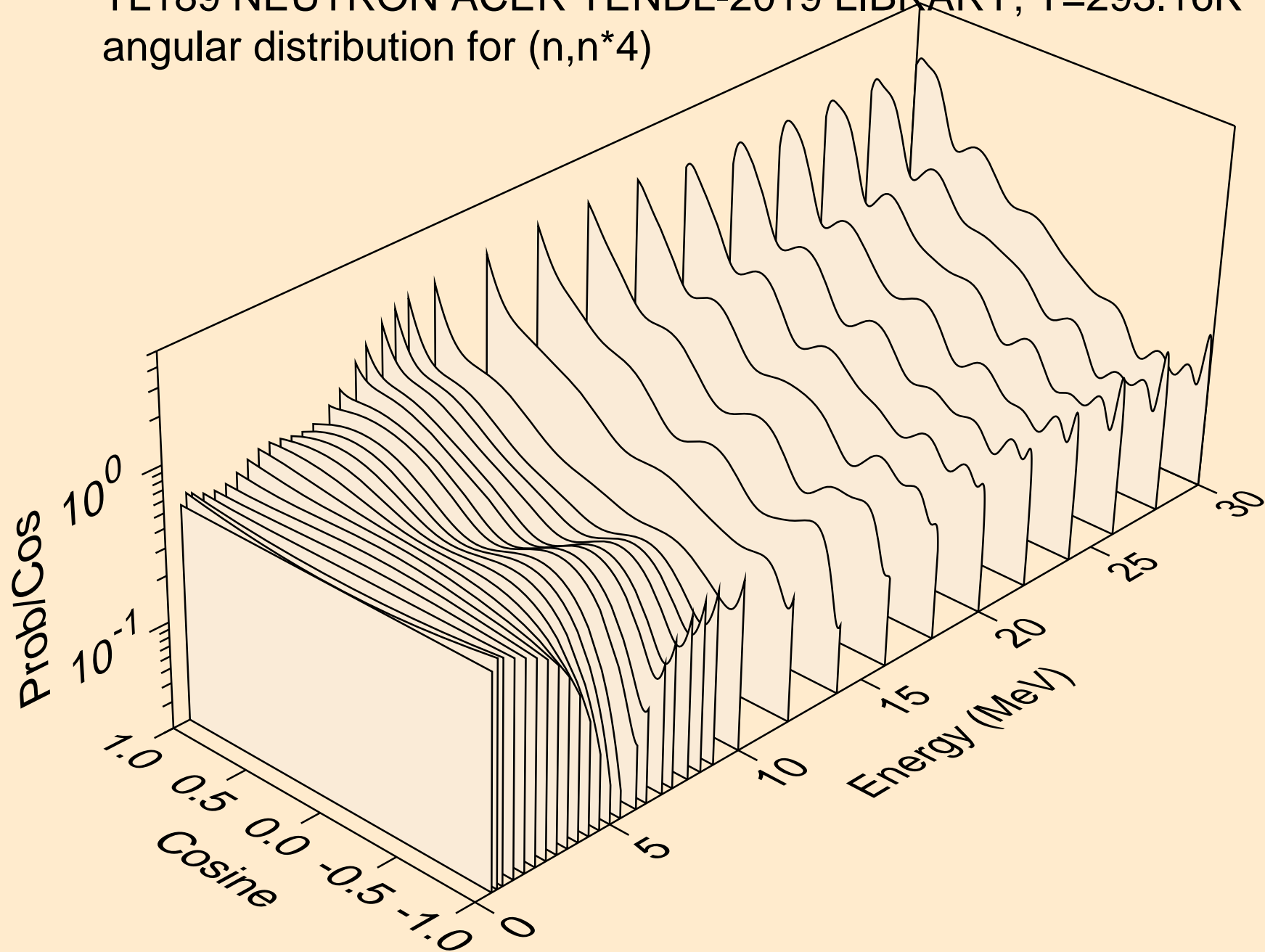

TL189 NEUTRON ACER TENDL-2019 LIBRARY; T=293.16K
angular distribution for (n,n*5)

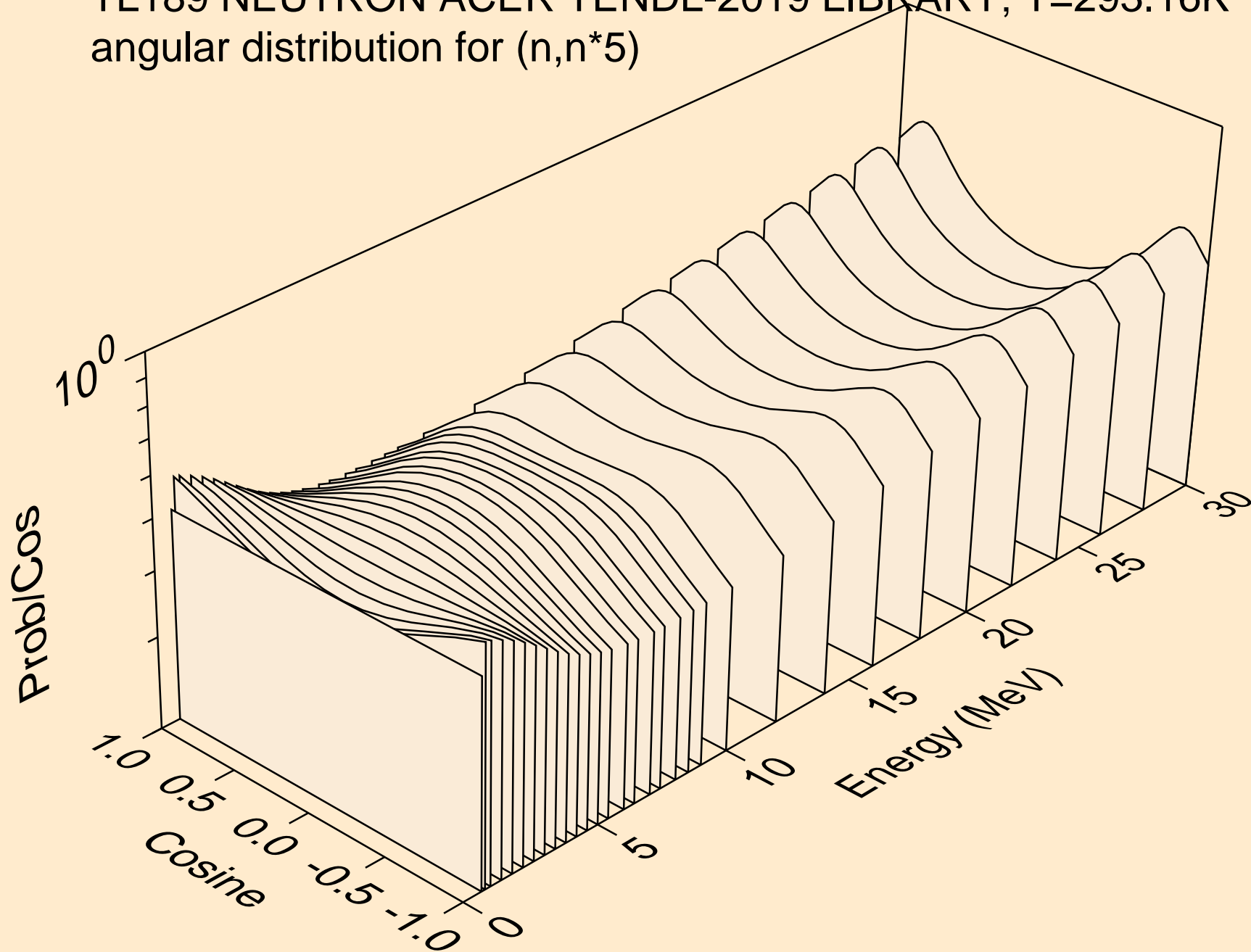

TL189 NEUTRON ACER TENDL-2019 LIBRARY; T=293.16K
angular distribution for (n,n*6)

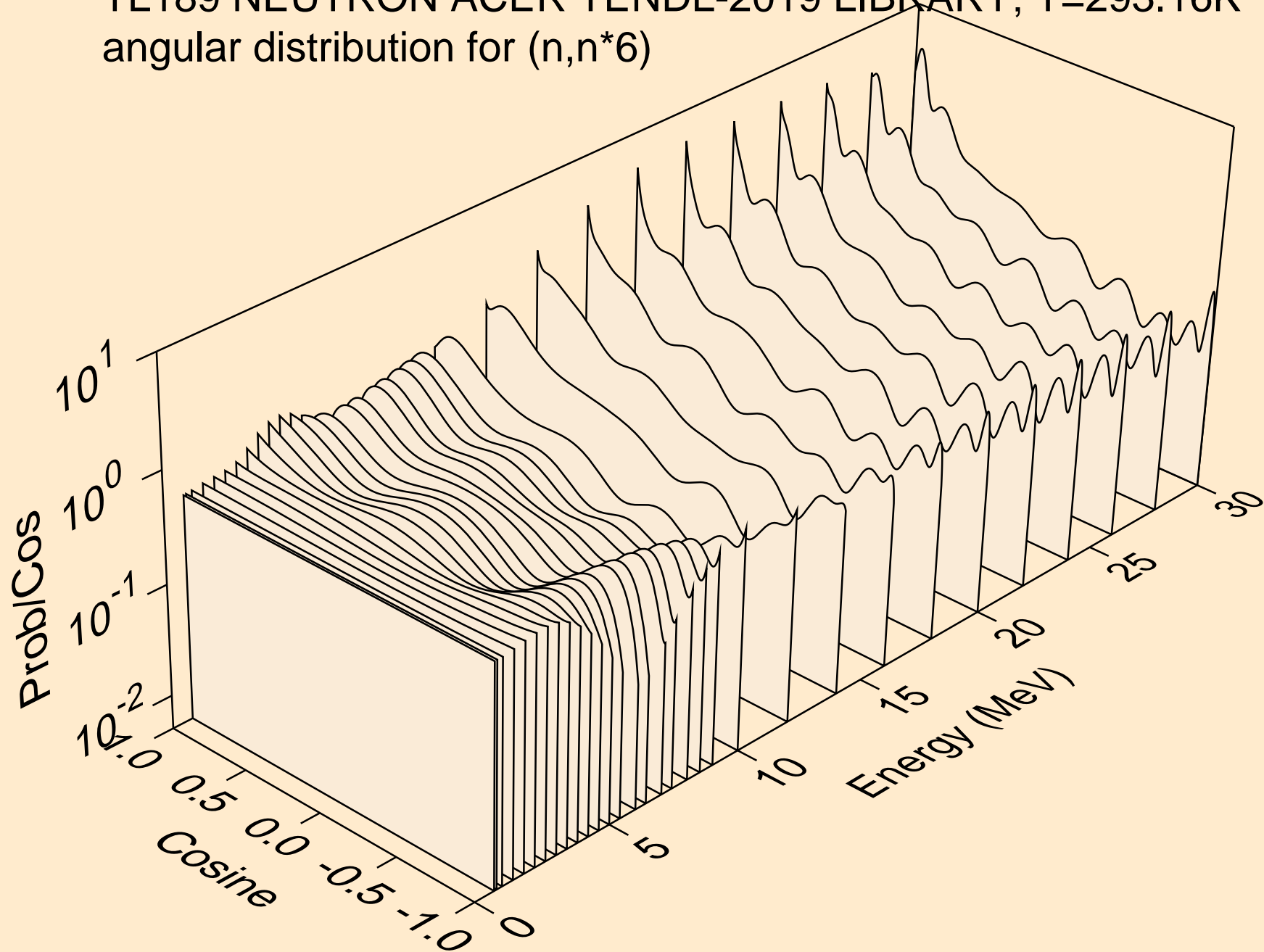

TL189 NEUTRON ACER TENDL-2019 LIBRARY; T=293.16K
angular distribution for (n,n*7)

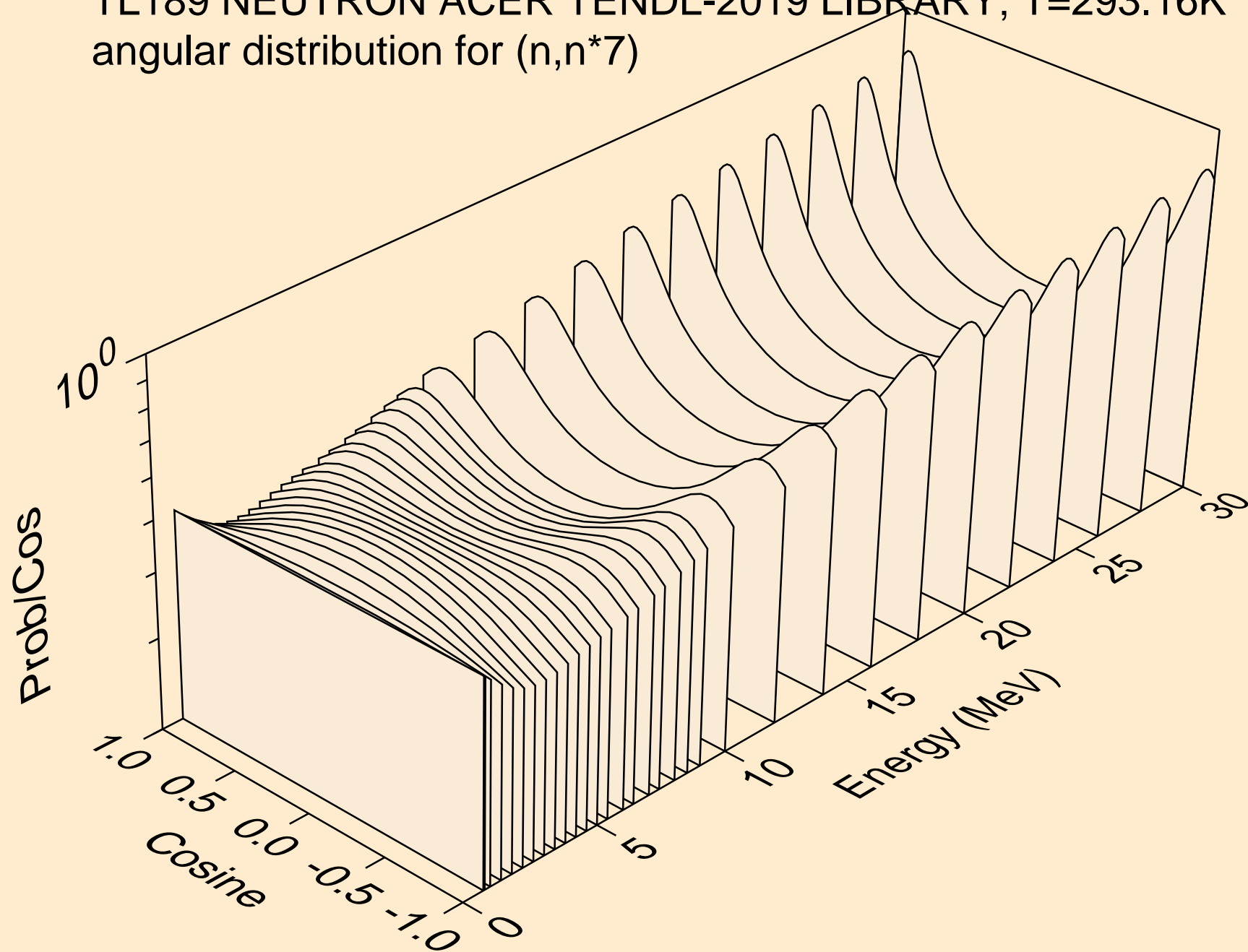

TL189 NEUTRON ACER TENDL-2019 LIBRARY; T=293.16K
angular distribution for (n,n*8)

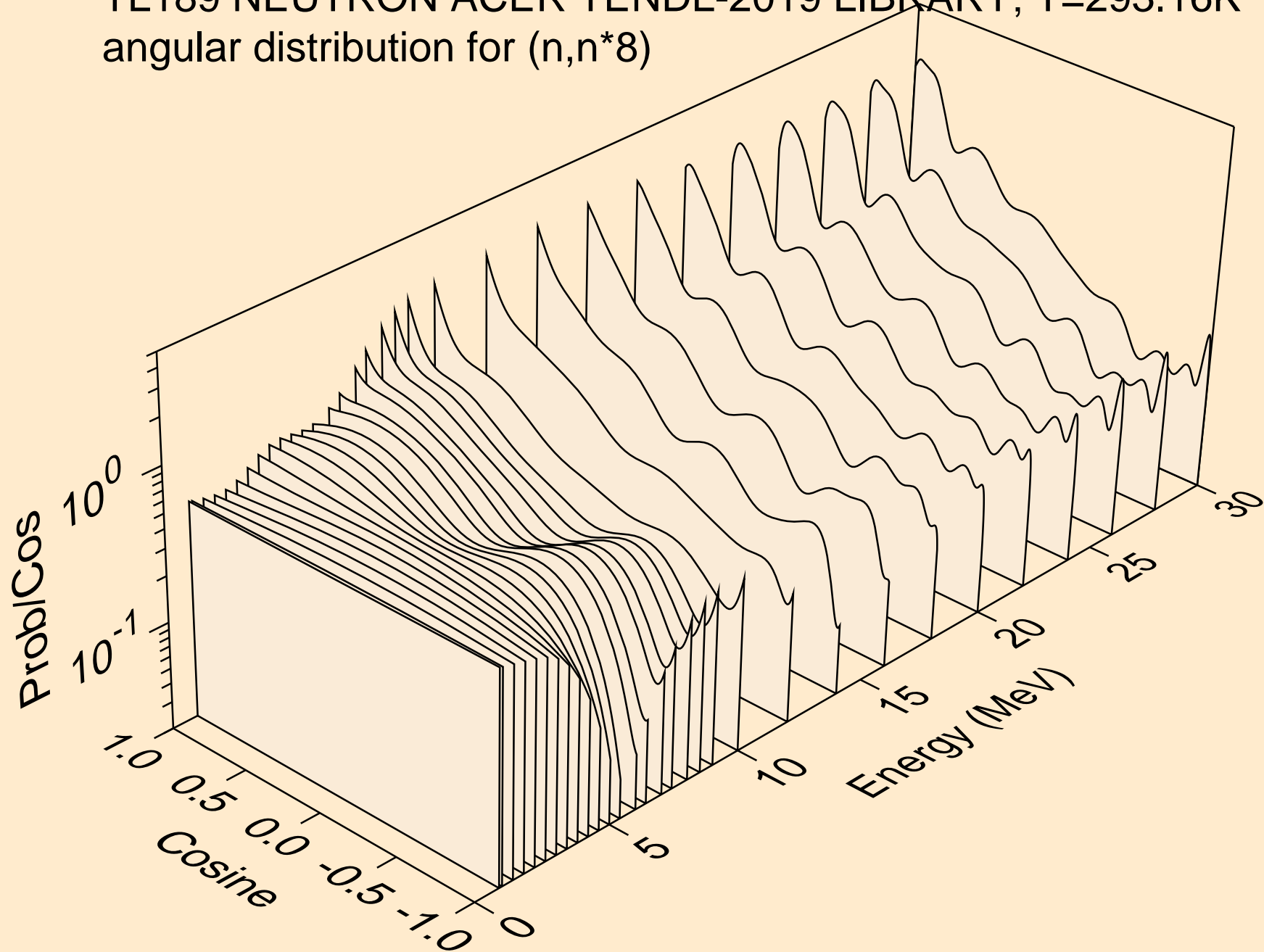

TL189 NEUTRON ACER TENDL-2019 LIBRARY; T=293.16K
angular distribution for (n,n*9)

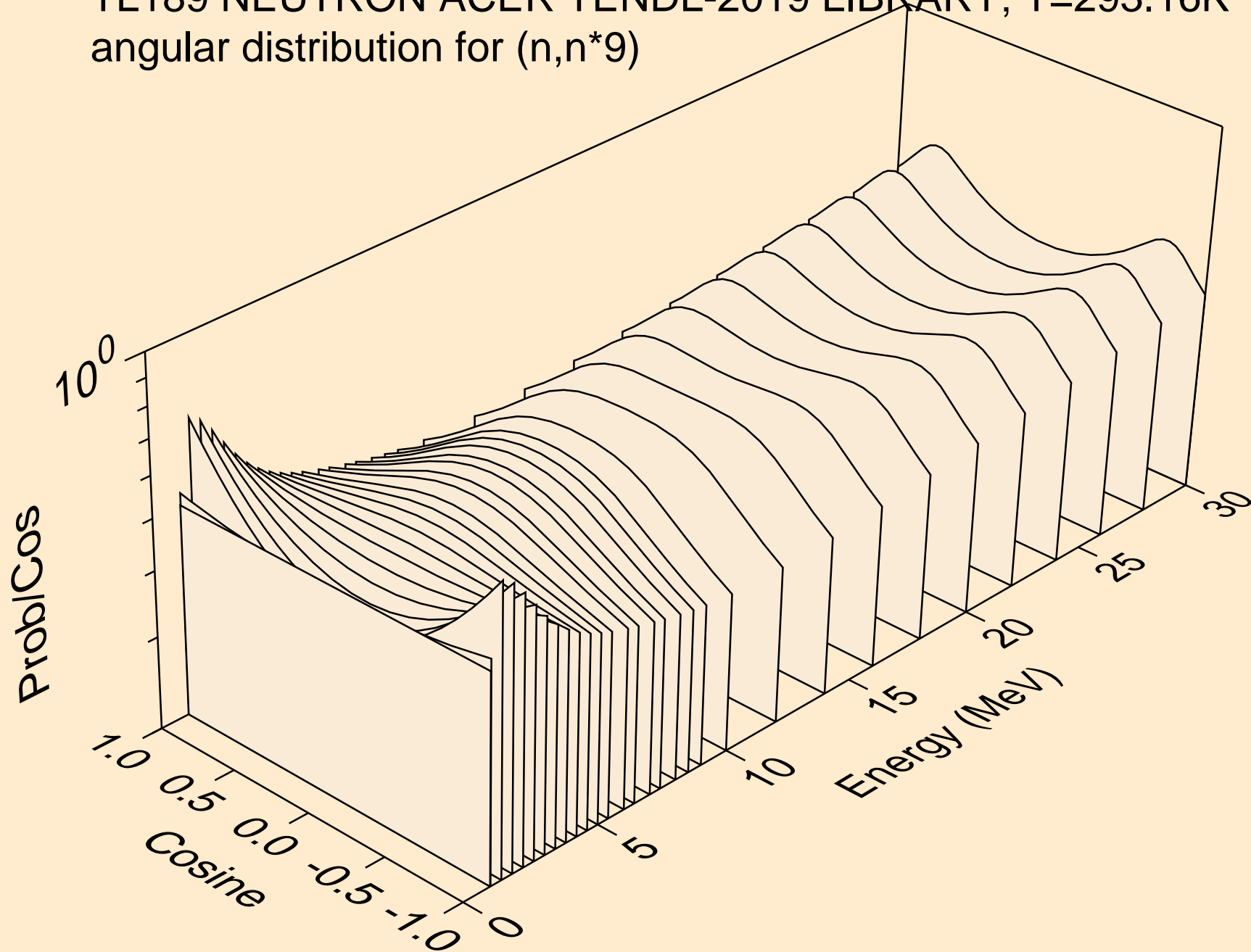

TL189 NEUTRON ACER TENDL-2019 LIBRARY; T=293.16K
angular distribution for (n,n*10)

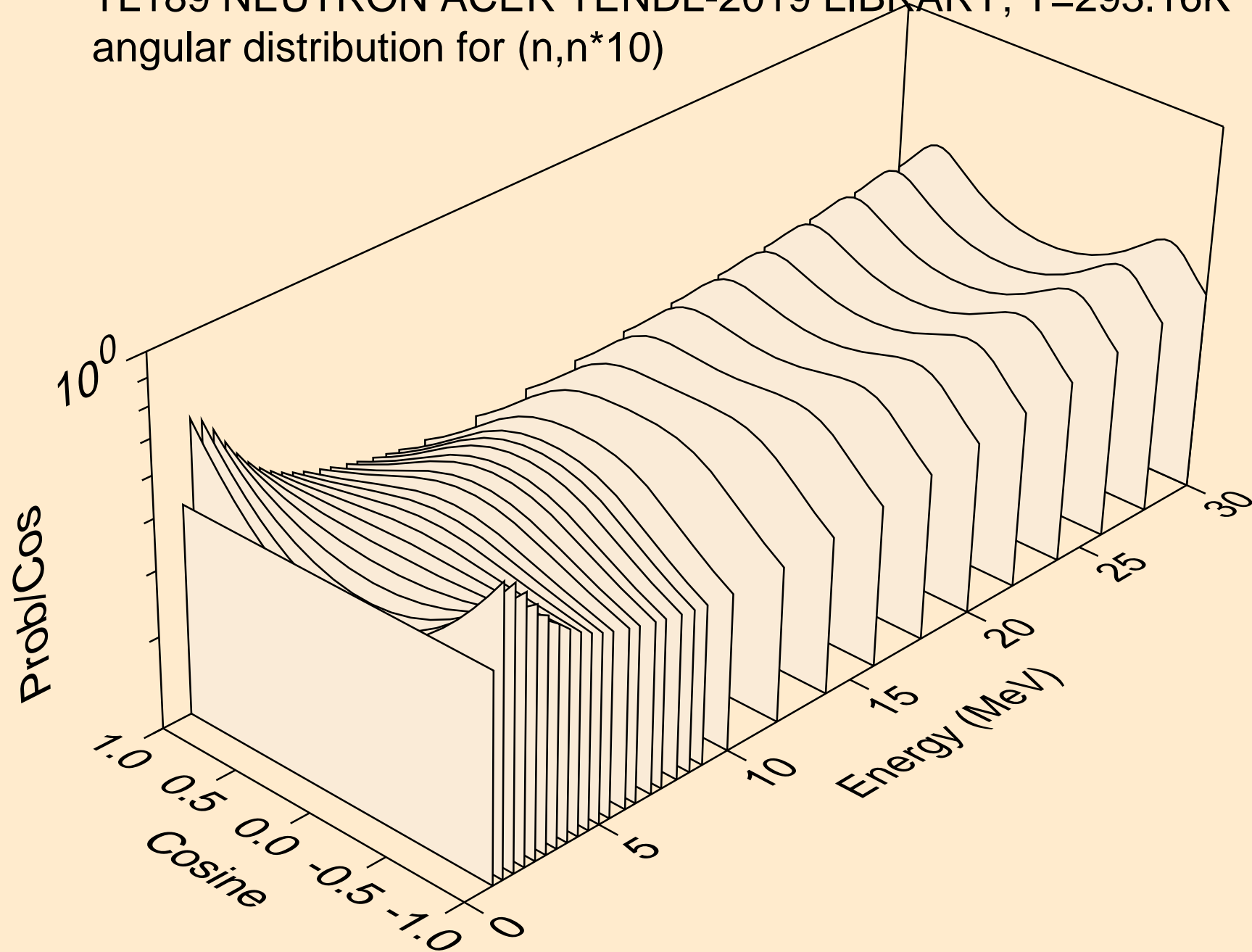

TL189 NEUTRON ACER TENDL-2019 LIBRARY; T=293.16K
angular distribution for (n,n*11)

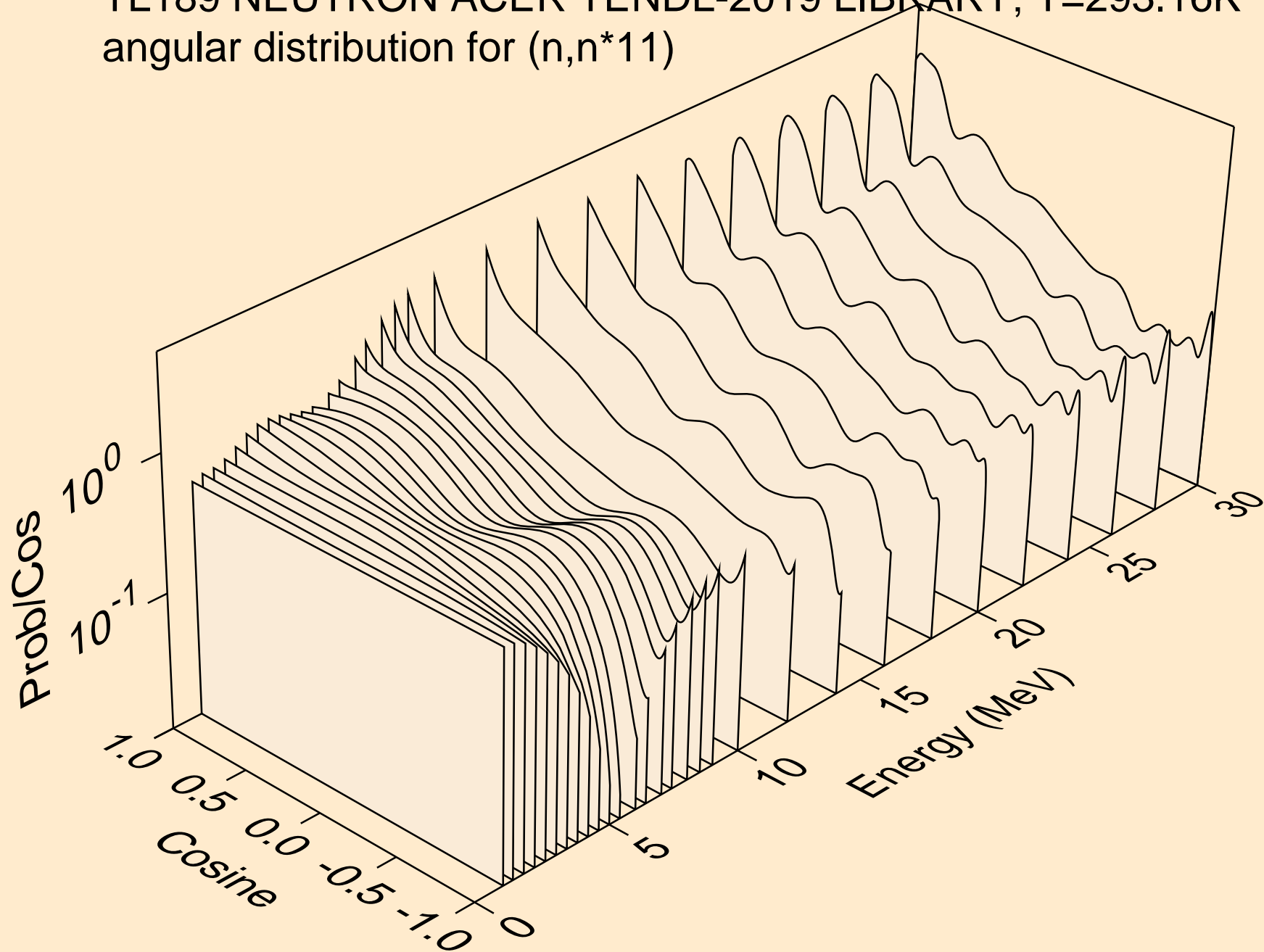

TL189 NEUTRON ACER TENDL-2019 LIBRARY; T=293.16K
angular distribution for (n,n*12)

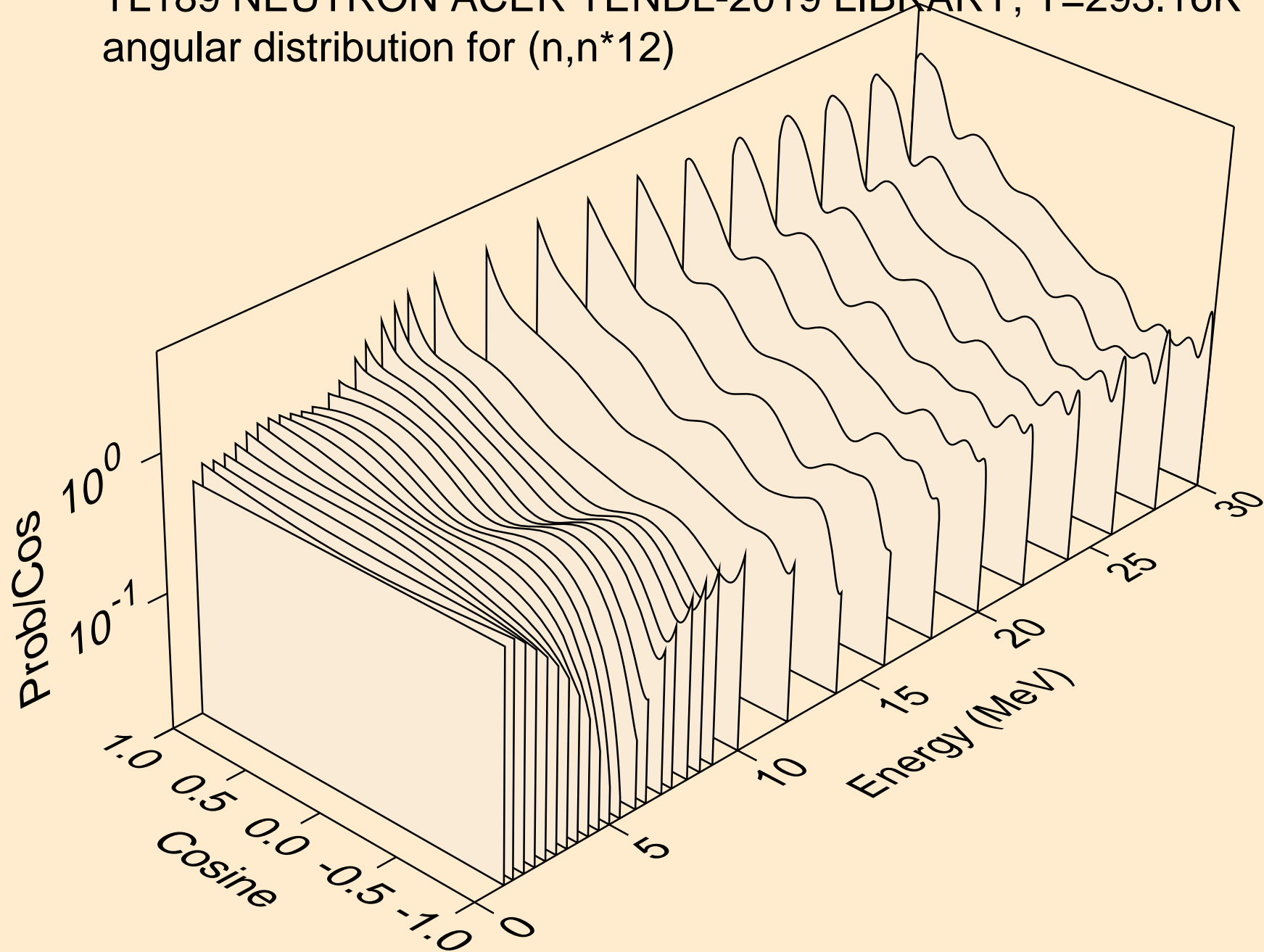

TL189 NEUTRON ACER TENDL-2019 LIBRARY; T=293.16K
angular distribution for (n,n*13)

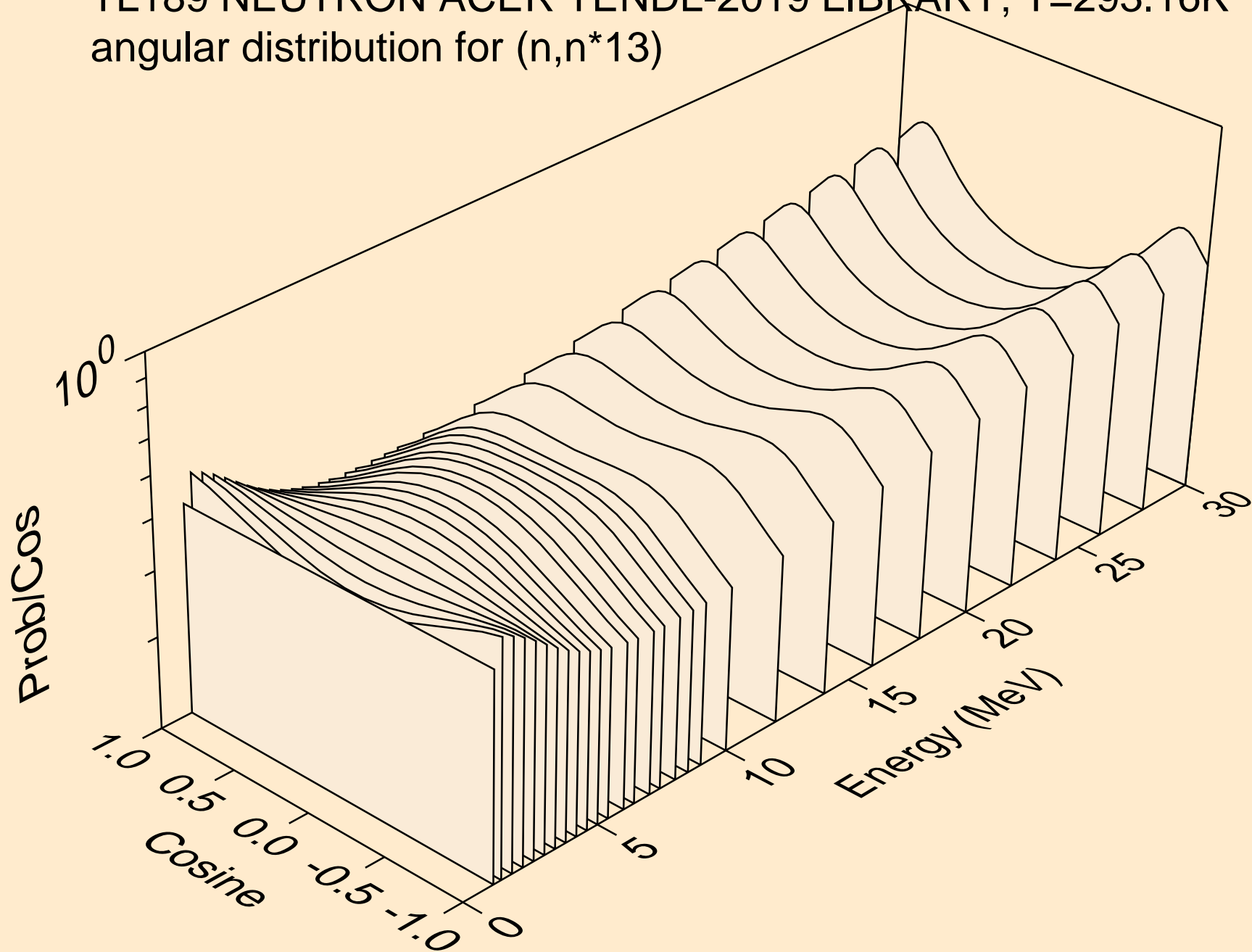

TL189 NEUTRON ACER TENDL-2019 LIBRARY; T=293.16K
angular distribution for (n,n*14)

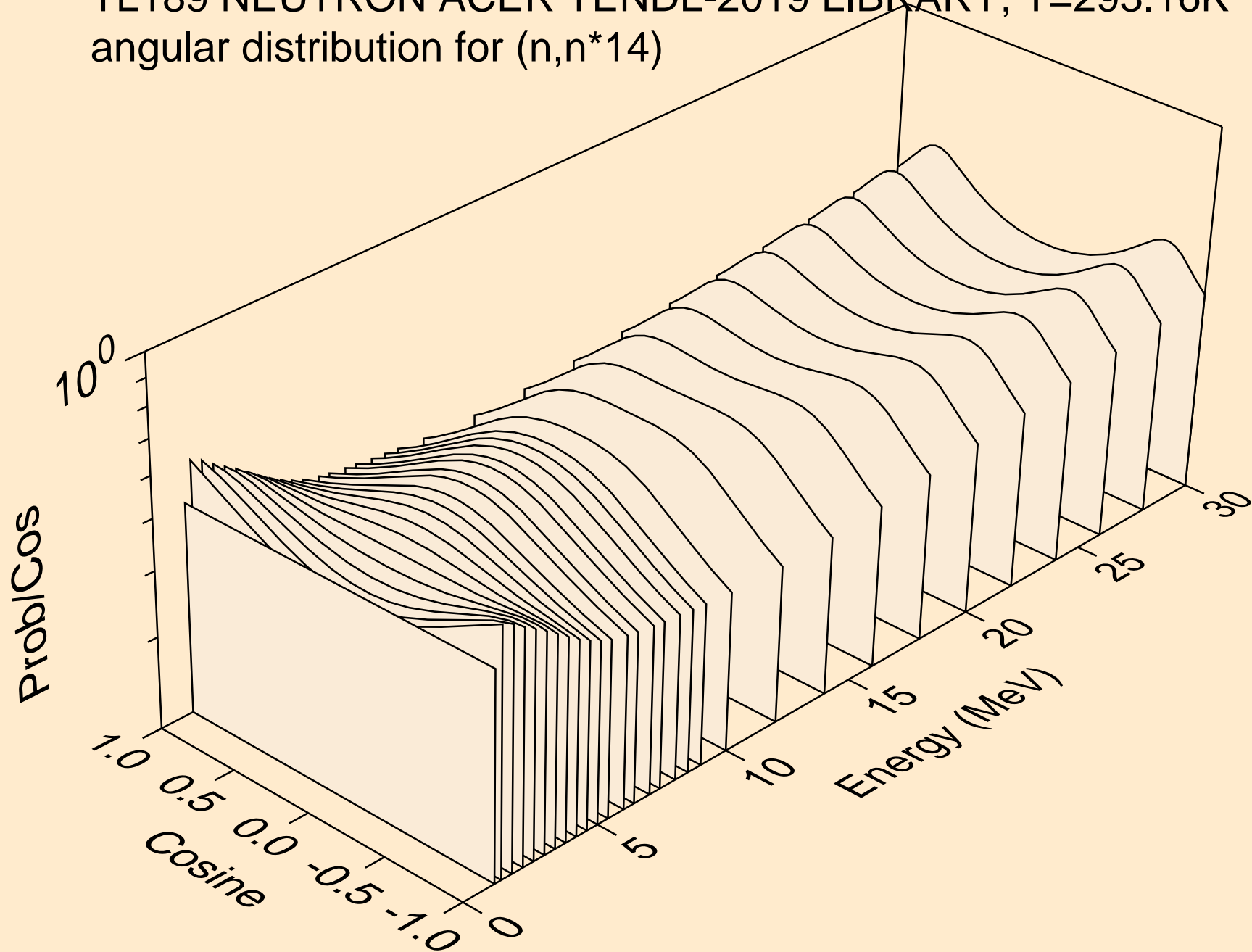

TL189 NEUTRON ACER TENDL-2019 LIBRARY; T=293.16K
angular distribution for (n,n*15)

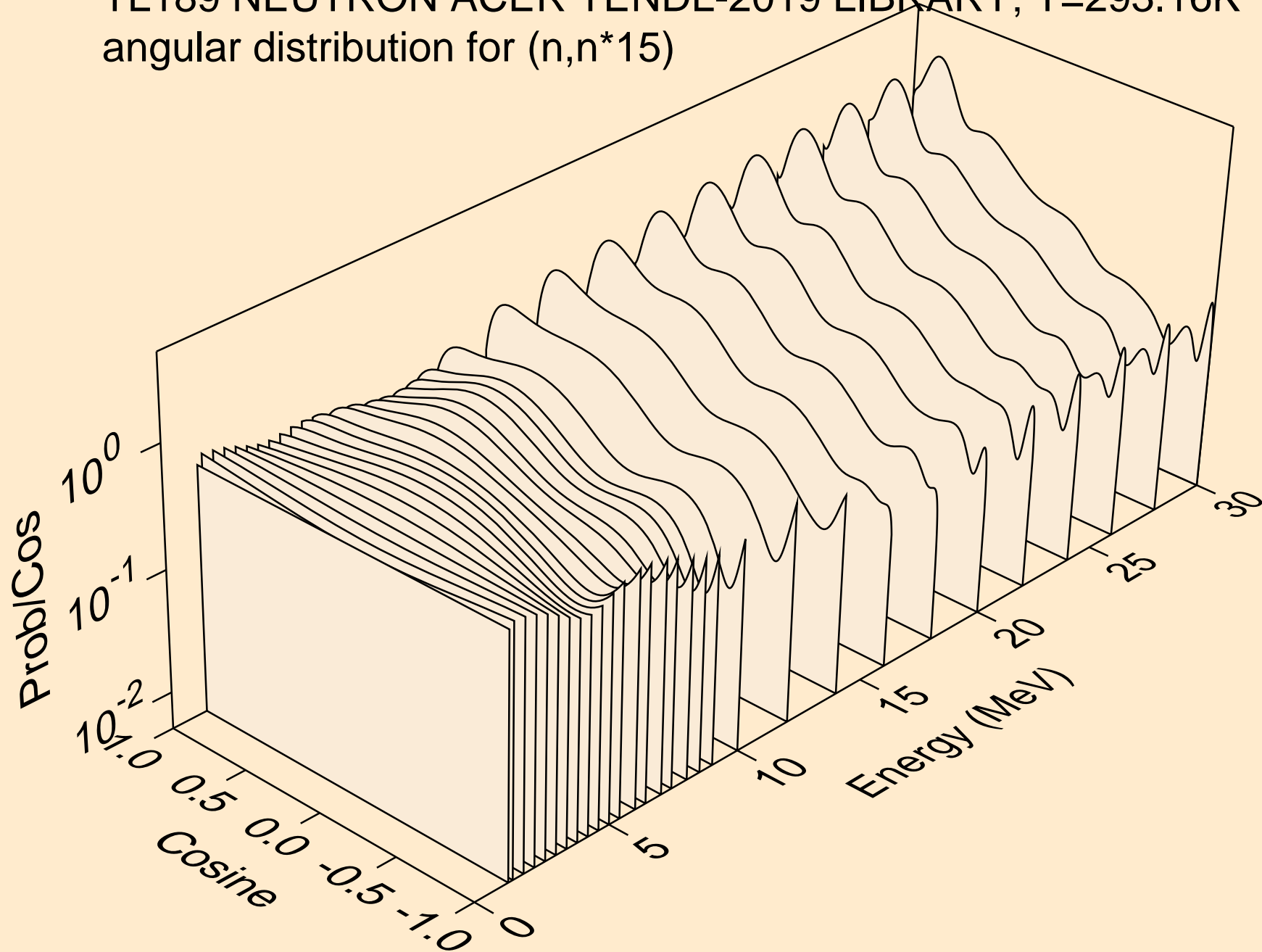

TL189 NEUTRON ACER TENDL-2019 LIBRARY; T=293.16K
angular distribution for (n,n*16)

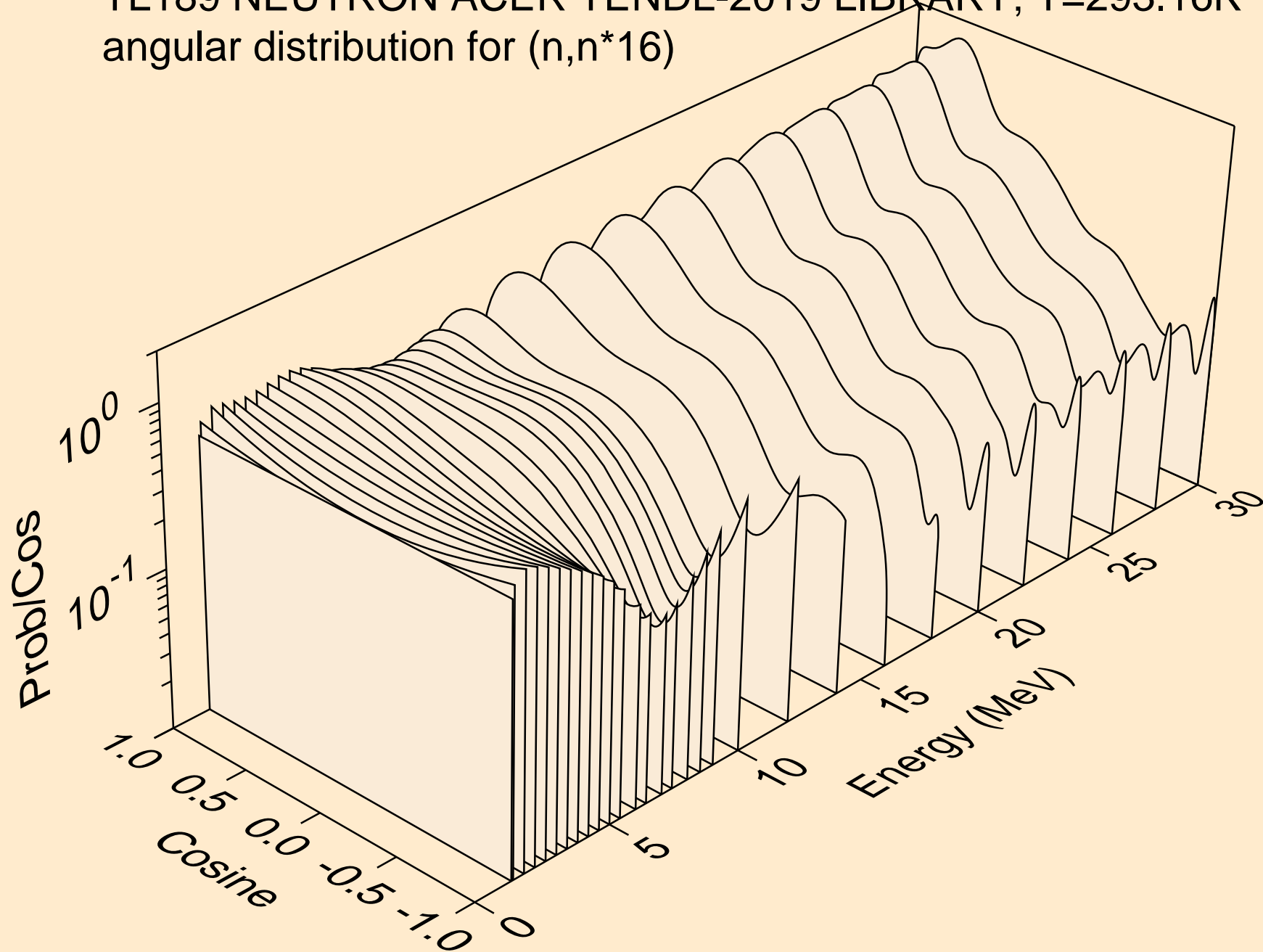

TL189 NEUTRON ACER TENDL-2019 LIBRARY; T=293.16K
angular distribution for (n,n*17)

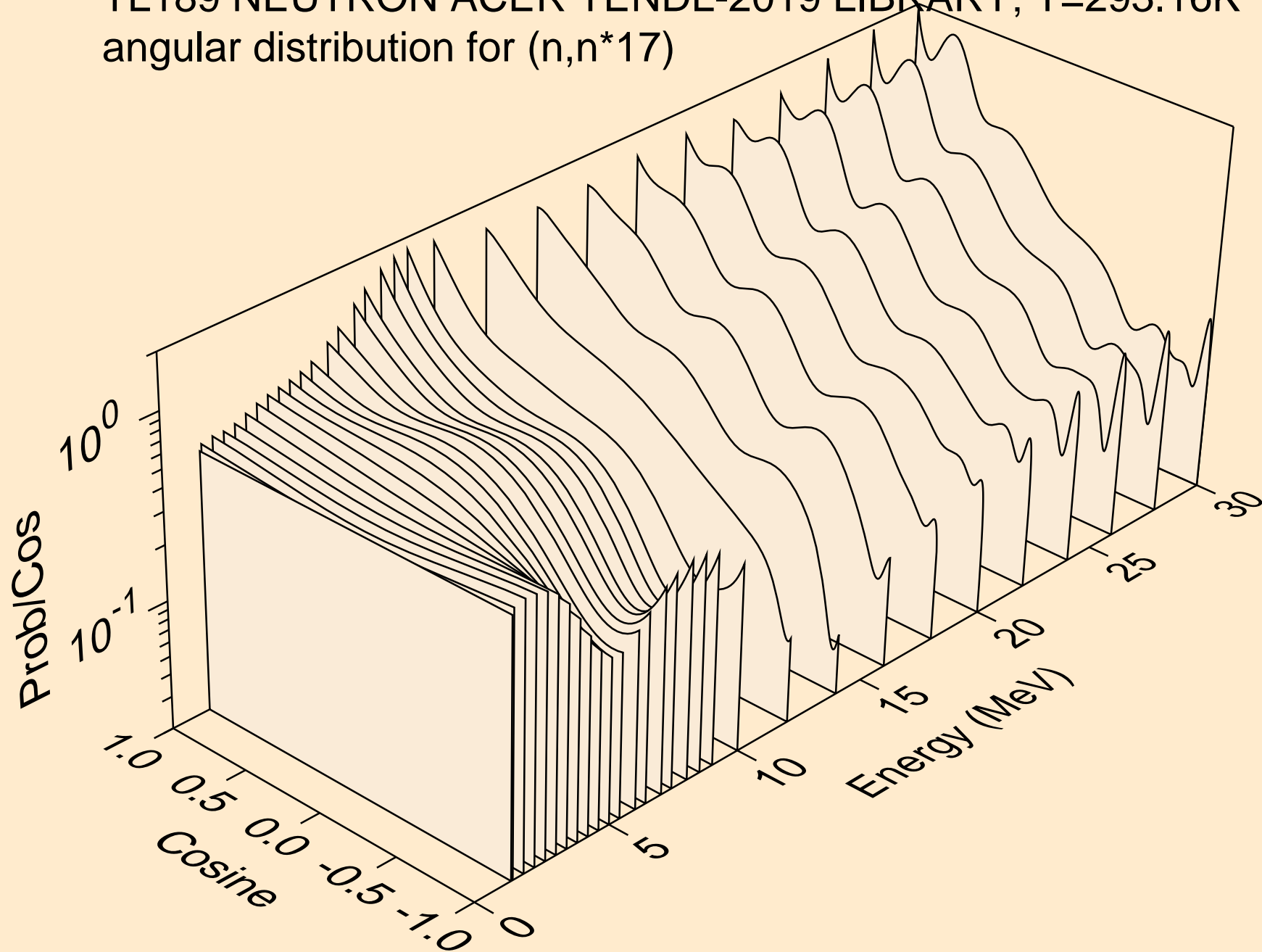

TL189 NEUTRON ACER TENDL-2019 LIBRARY; T=293.16K
angular distribution for (n,n*18)

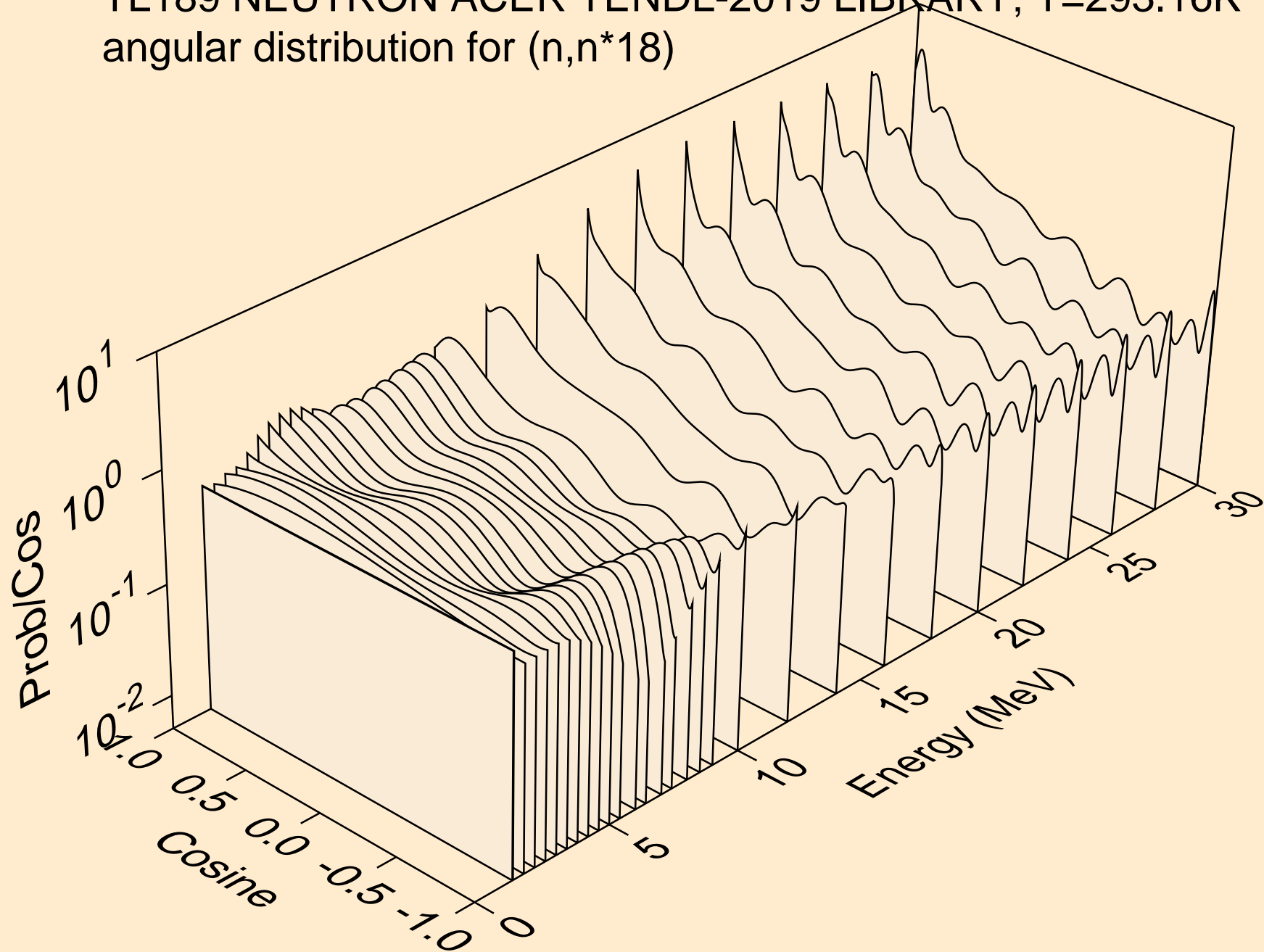

TL189 NEUTRON ACER TENDL-2019 LIBRARY; T=293.16K
Neutron emission for (n,x)

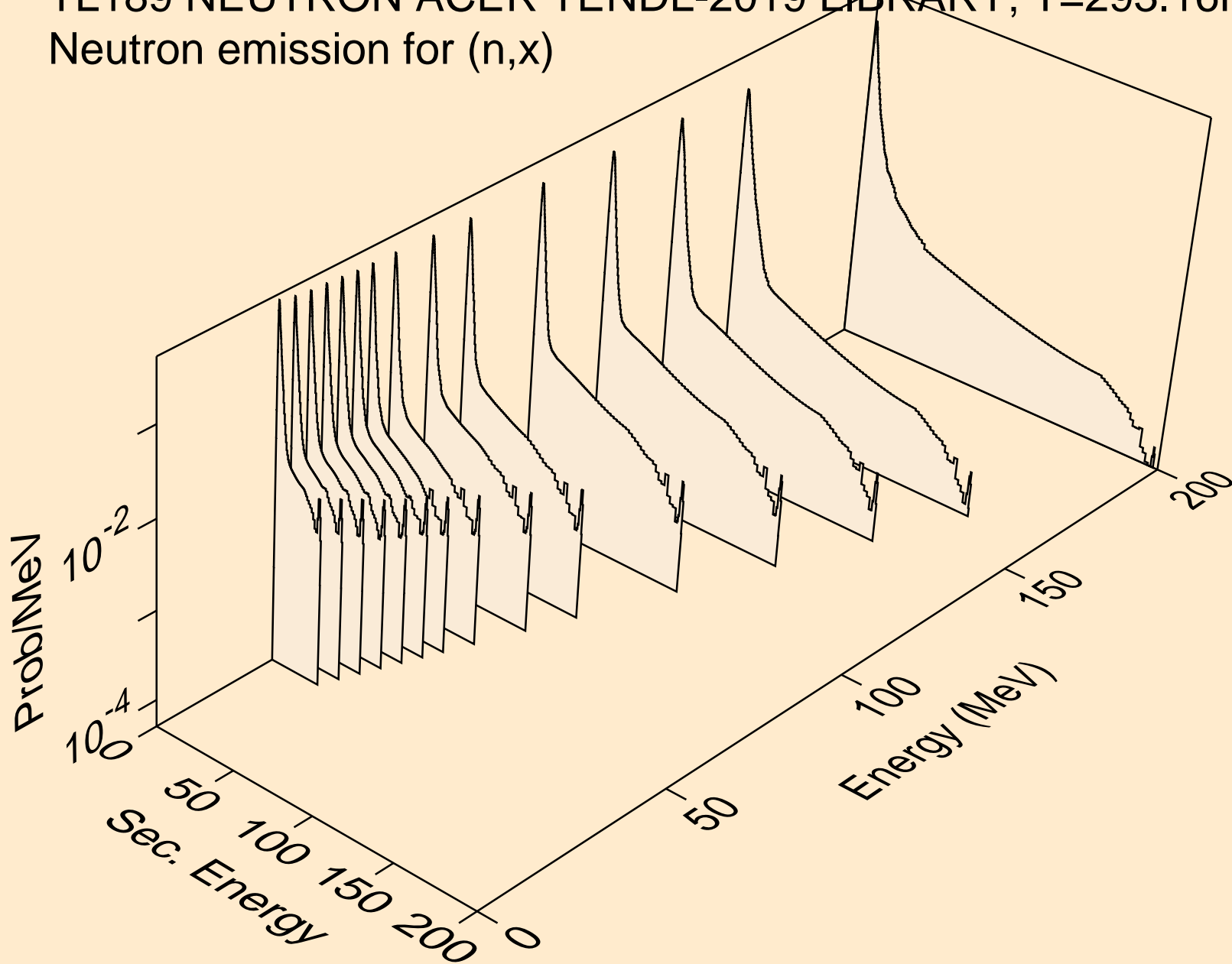

TL189 NEUTRON ACER TENDL-2019 LIBRARY; T=293.16K
Neutron emission for (n,2nd)

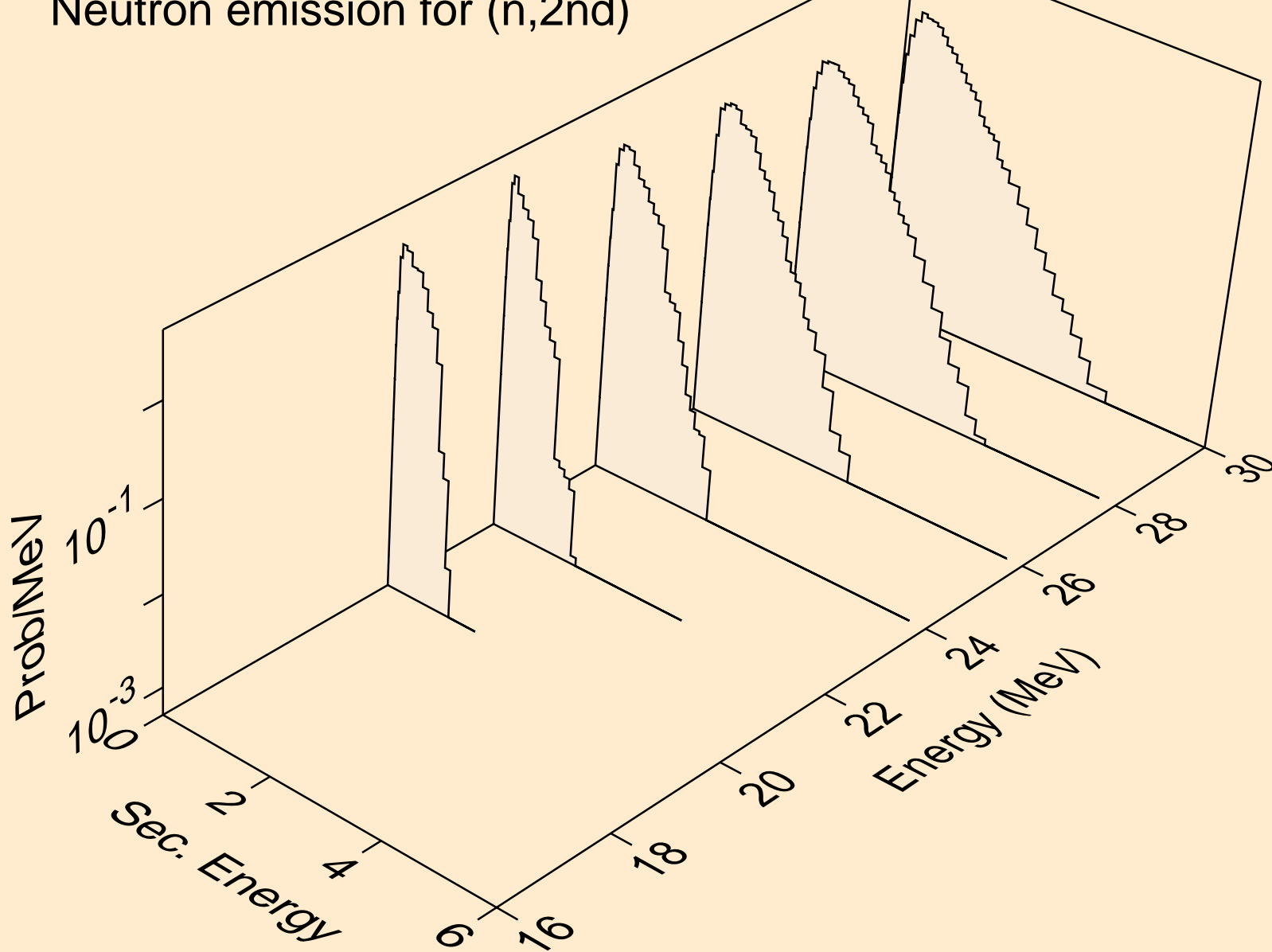

TL189 NEUTRON ACER TENDL-2019 LIBRARY; T=293.16K
Neutron emission for (n,2n)

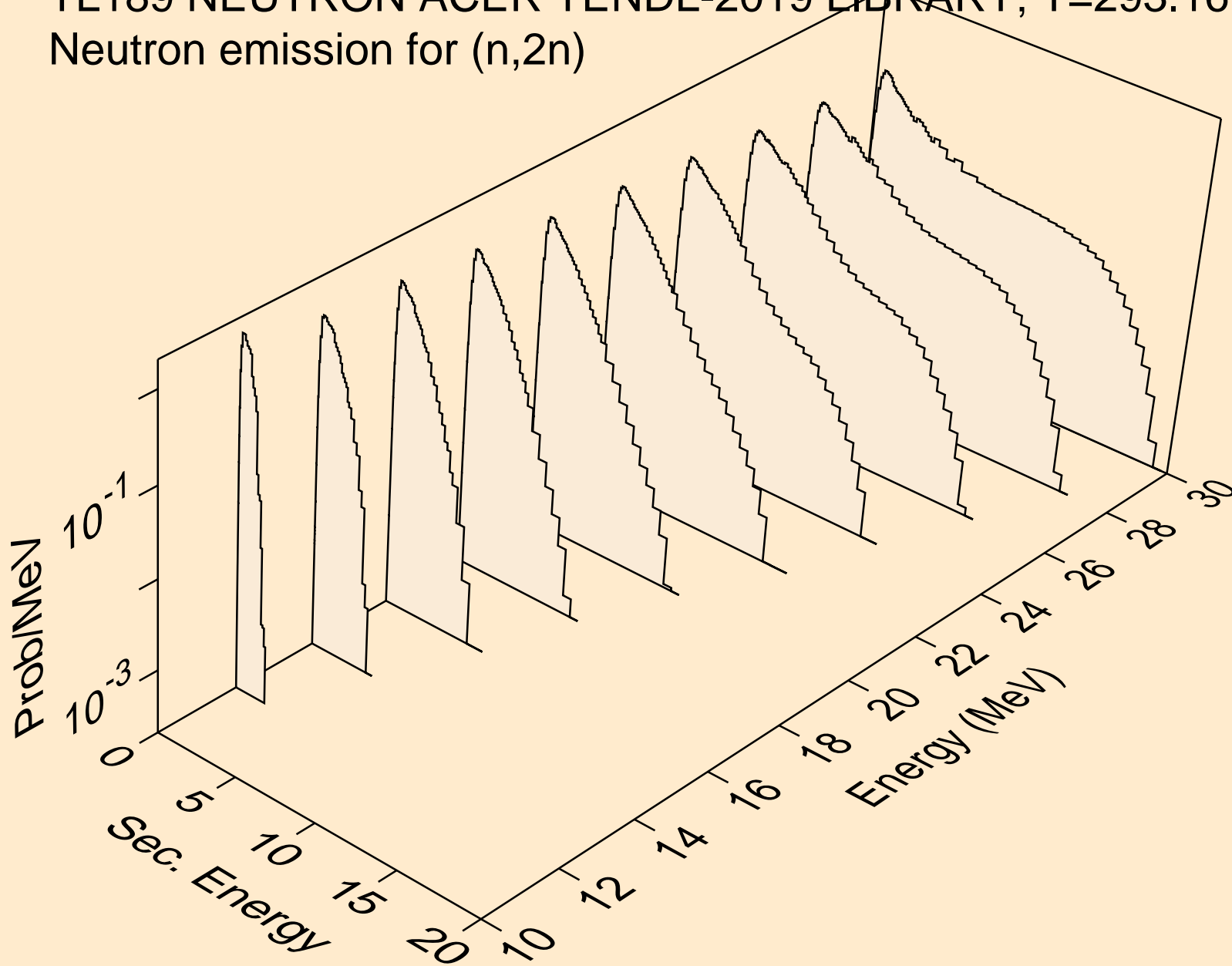

TL189 NEUTRON ACER TENDL-2019 LIBRARY; T=293.16K
Neutron emission for (n,3n)

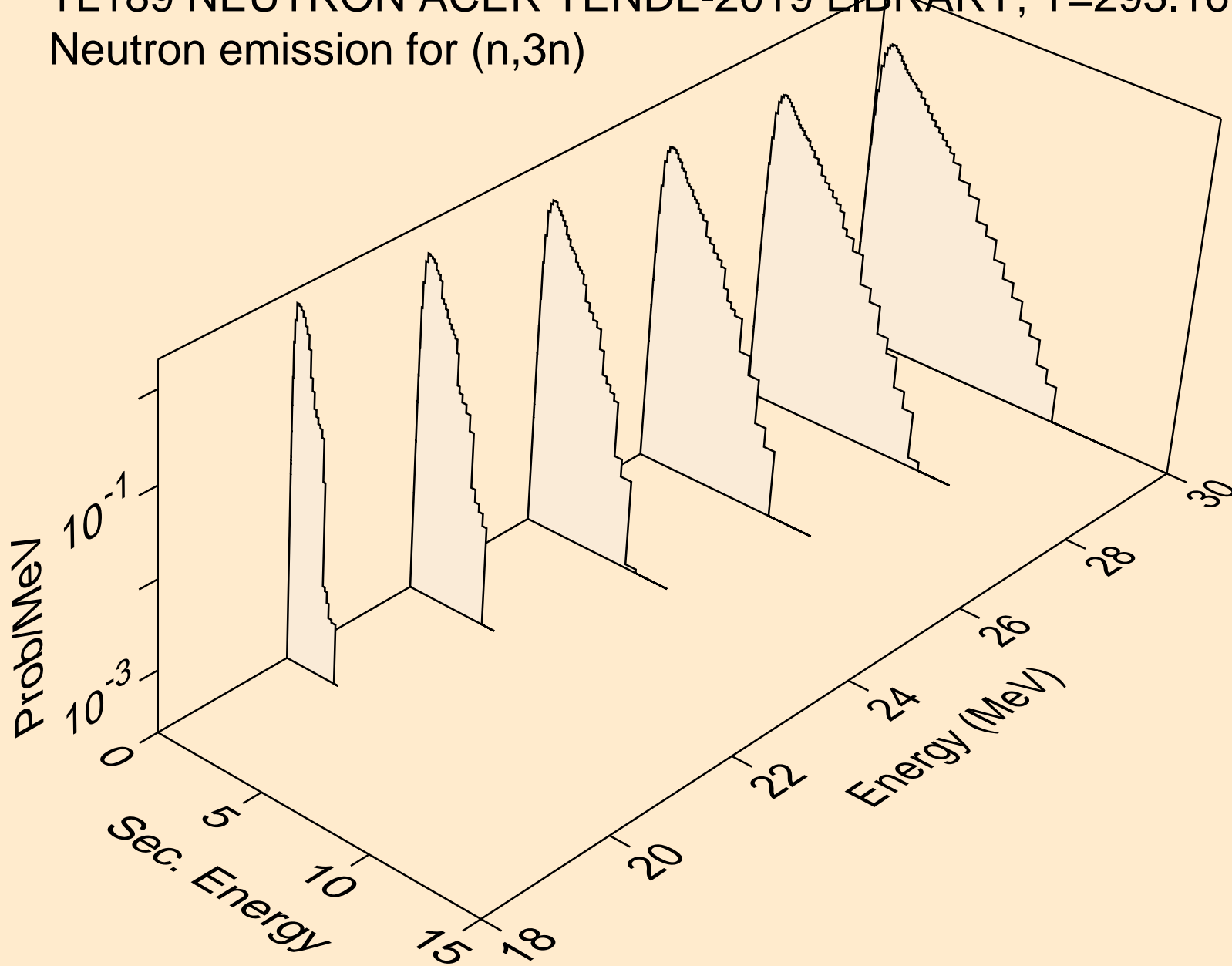

TL189 NEUTRON ACER TENDL-2019 LIBRARY; T=293.16K
Neutron emission for (n,n*)a

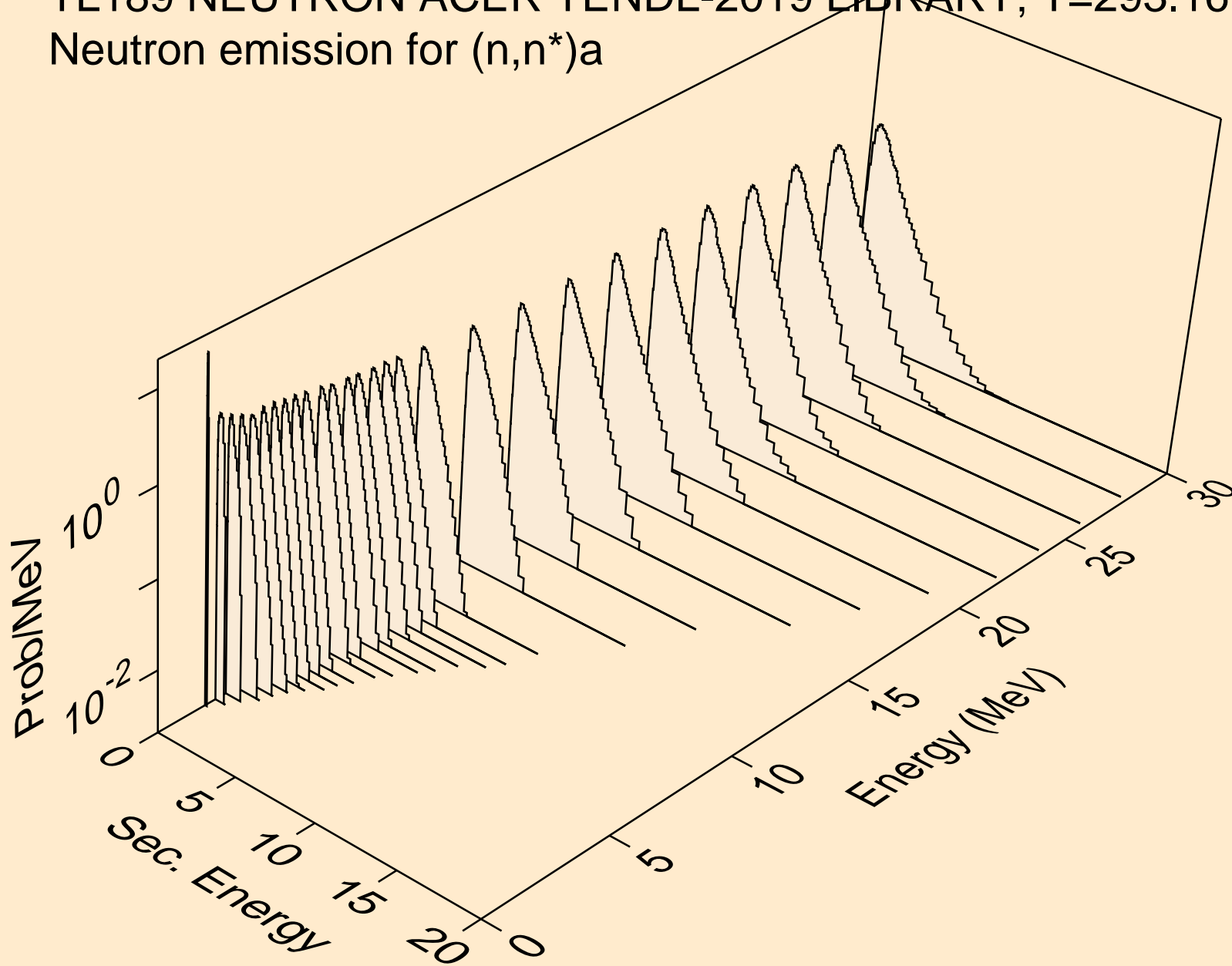

TL189 NEUTRON ACER TENDL-2019 LIBRARY; T=293.16K
Neutron emission for (n,2n)a

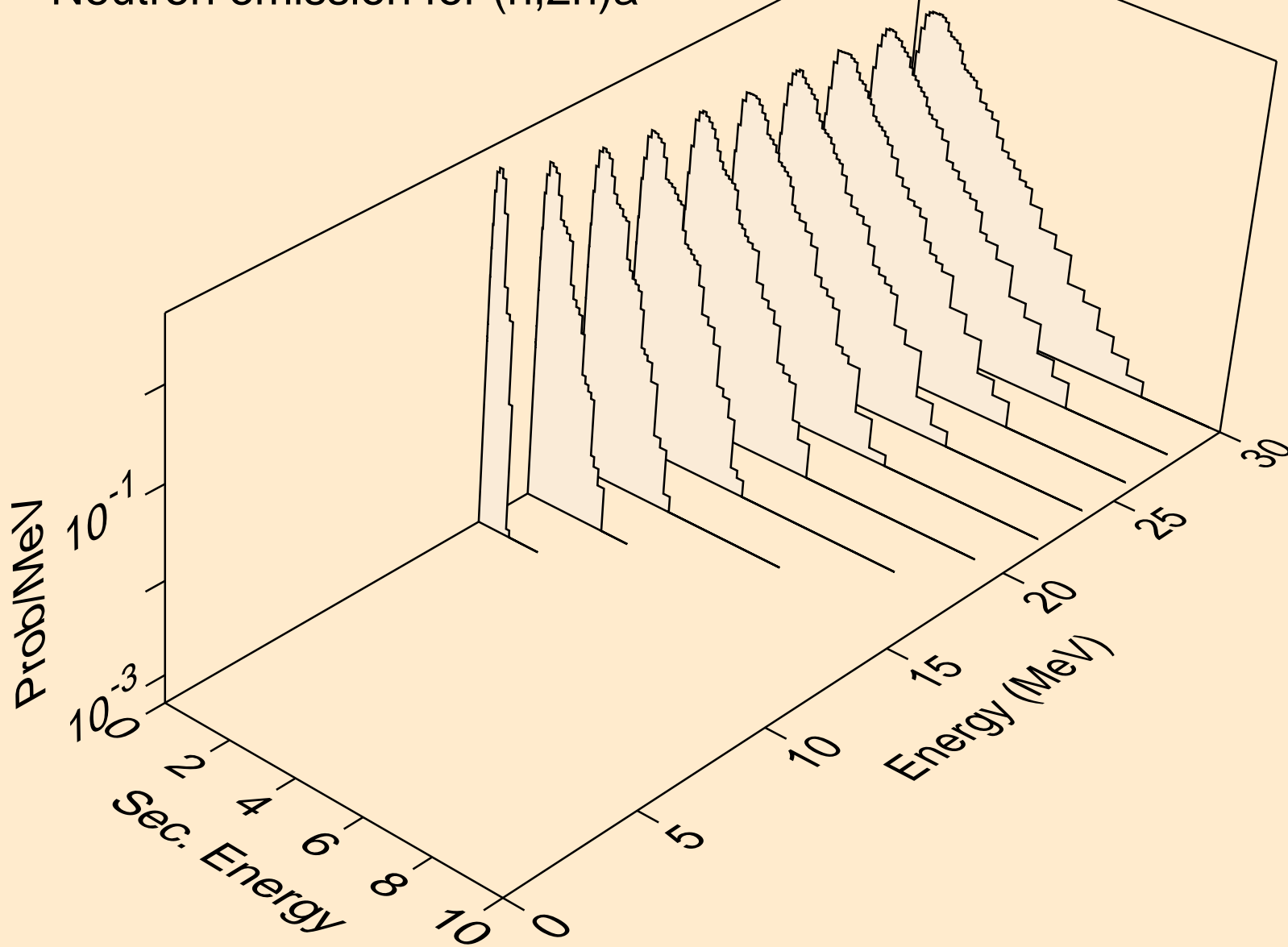

TL189 NEUTRON ACER TENDL-2019 LIBRARY; T=293.16K
Neutron emission for (n,3n)a

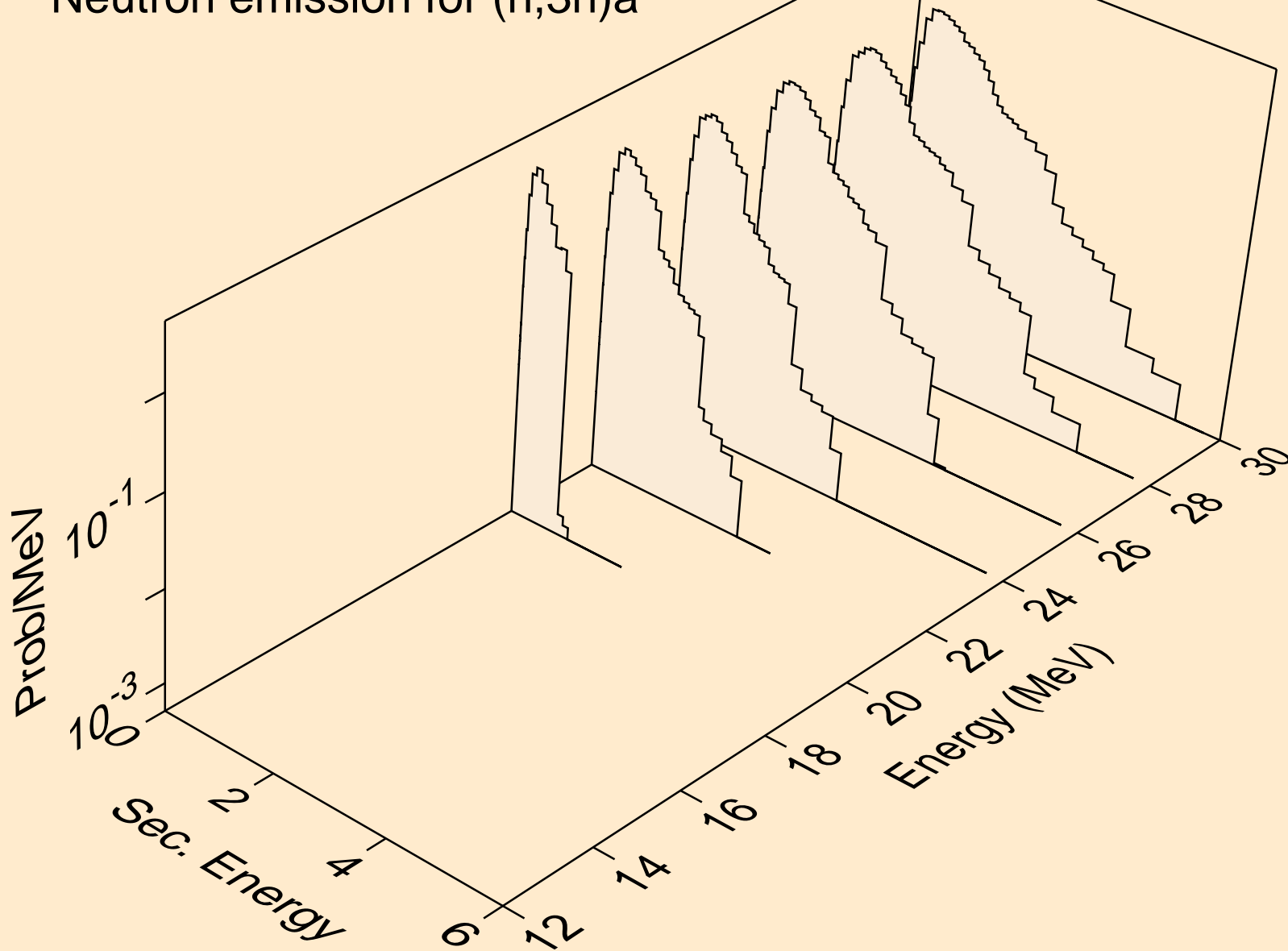

TL189 NEUTRON ACER TENDL-2019 LIBRARY; T=293.16K
Neutron emission for (n,n*)p

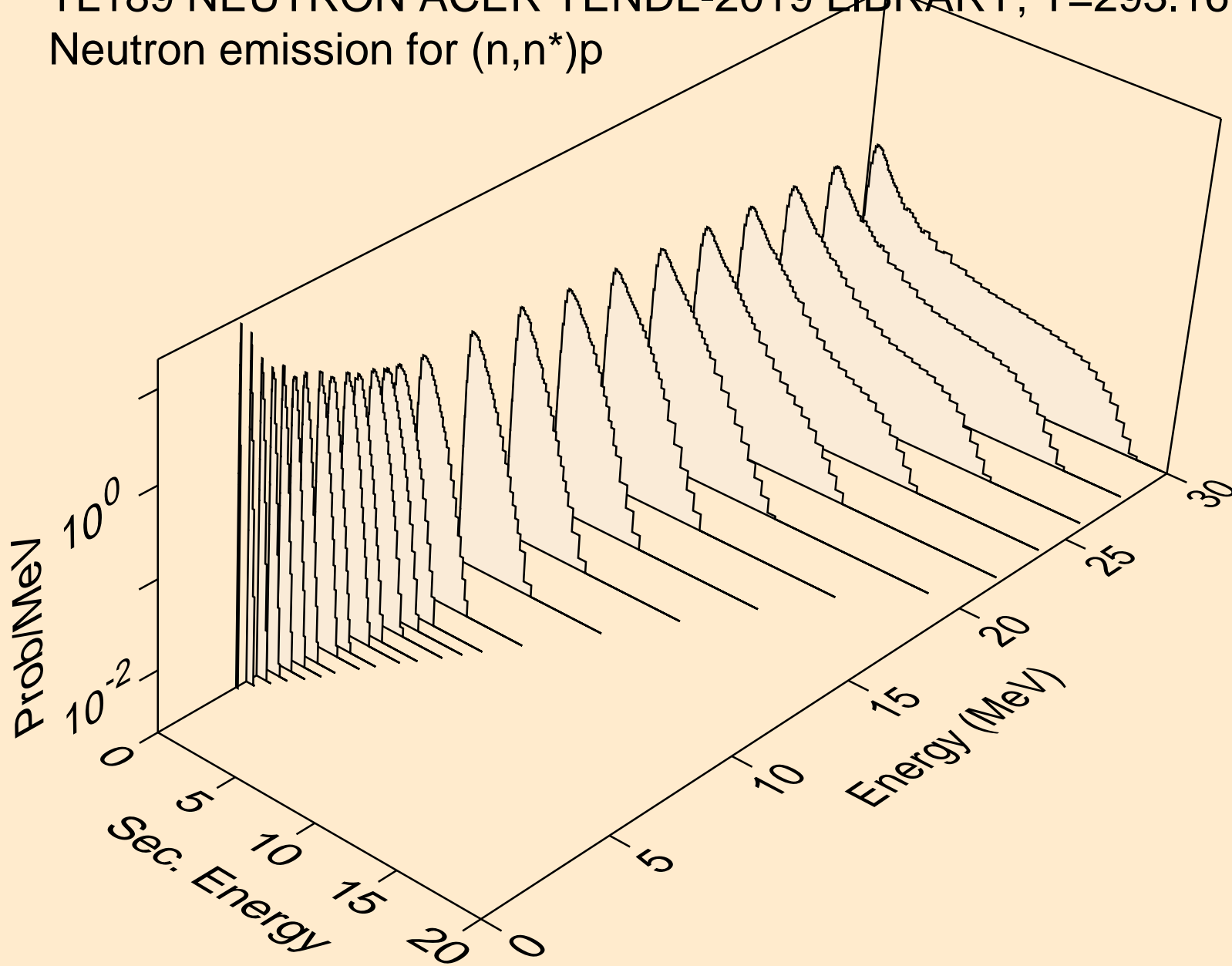

TL189 NEUTRON ACER TENDL-2019 LIBRARY; T=293.16K
Neutron emission for (n,n*)2a

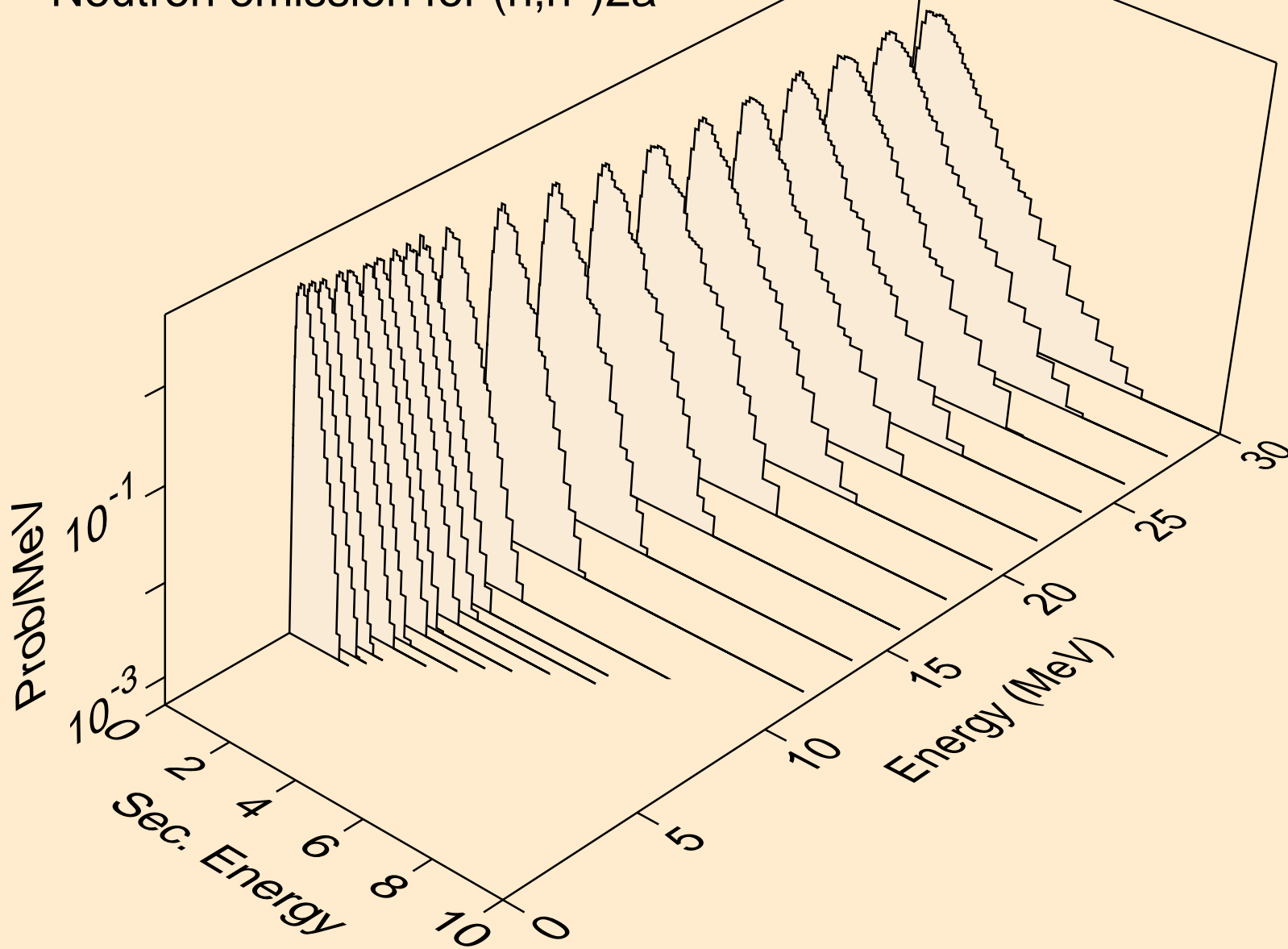

TL189 NEUTRON ACER TENDL-2019 LIBRARY; T=293.16K
Neutron emission for (n,2n)2a

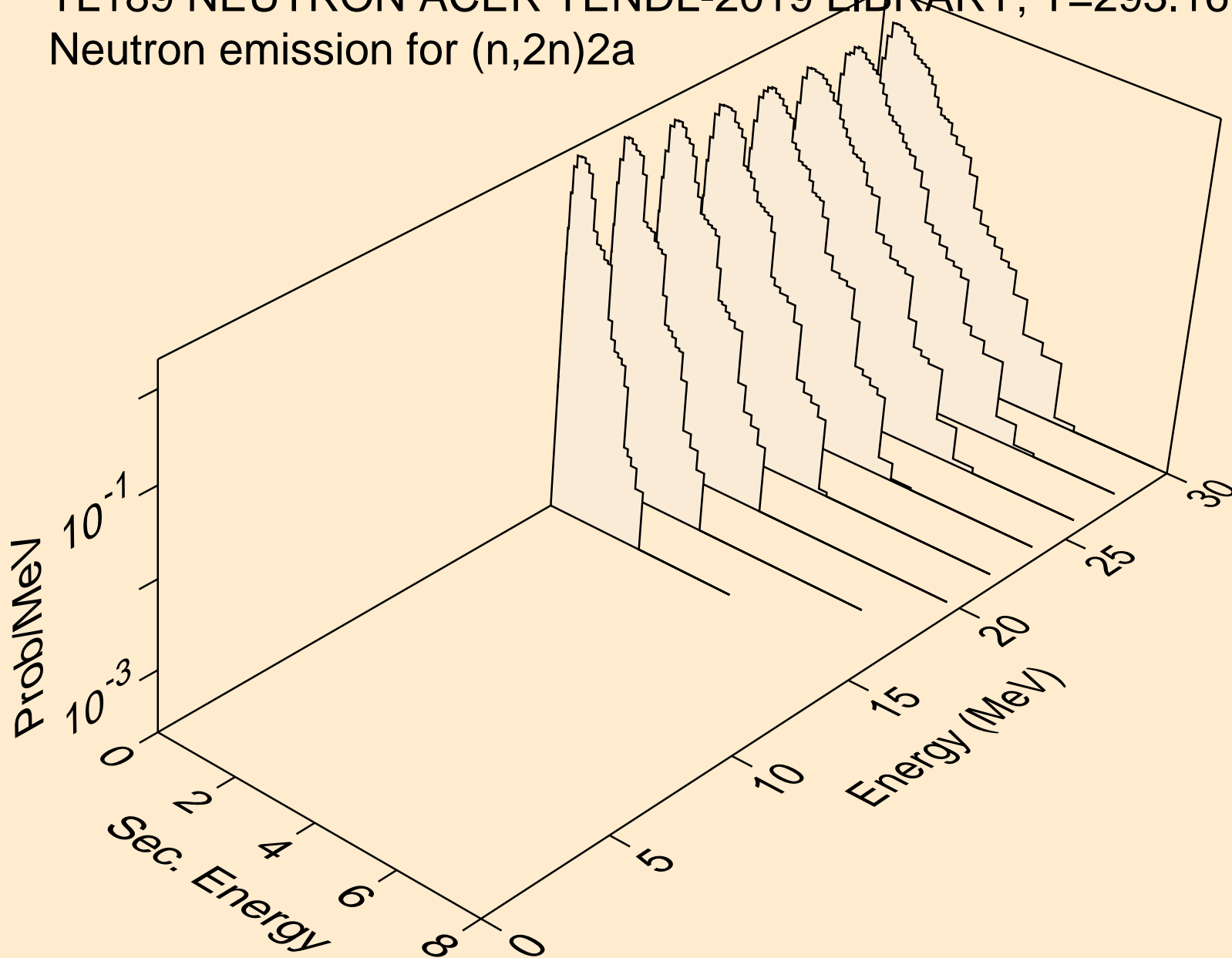

TL189 NEUTRON ACER TENDL-2019 LIBRARY; T=293.16K
Neutron emission for (n,n*)d

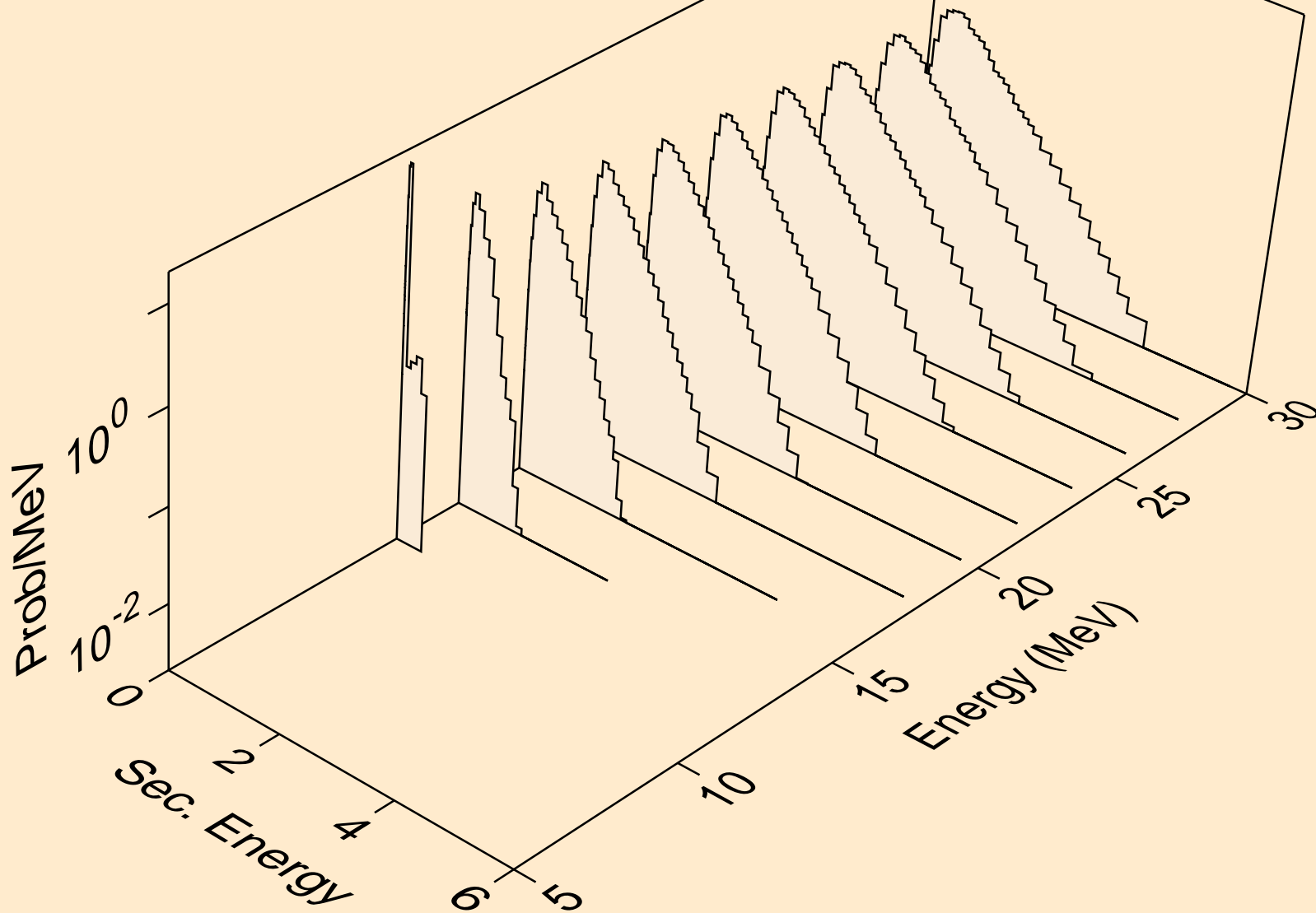

TL189 NEUTRON ACER TENDL-2019 LIBRARY; T=293.16K
Neutron emission for (n,n*)t

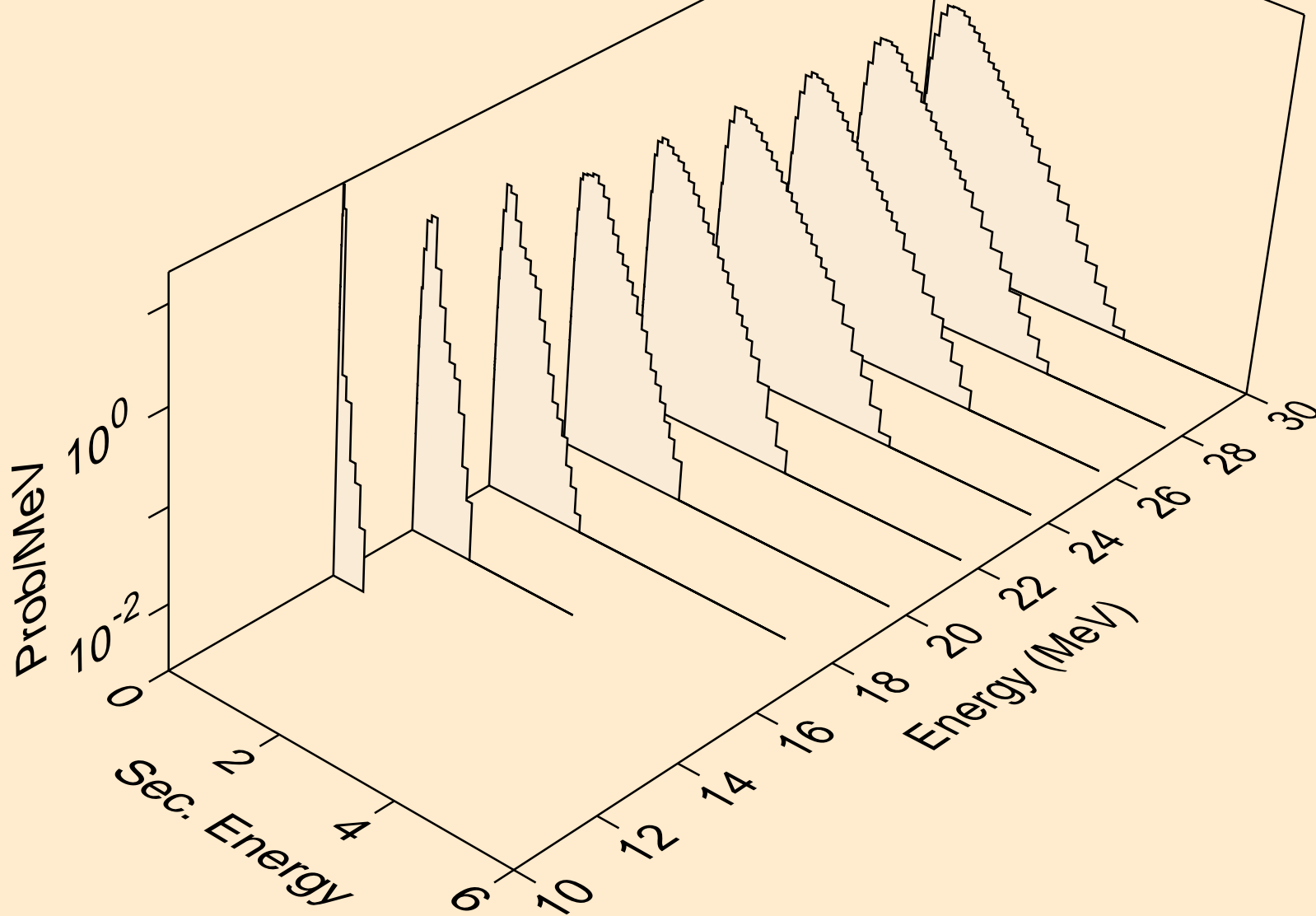

TL189 NEUTRON ACER TENDL-2019 LIBRARY; T=293.16K
Neutron emission for (n,n*)he3

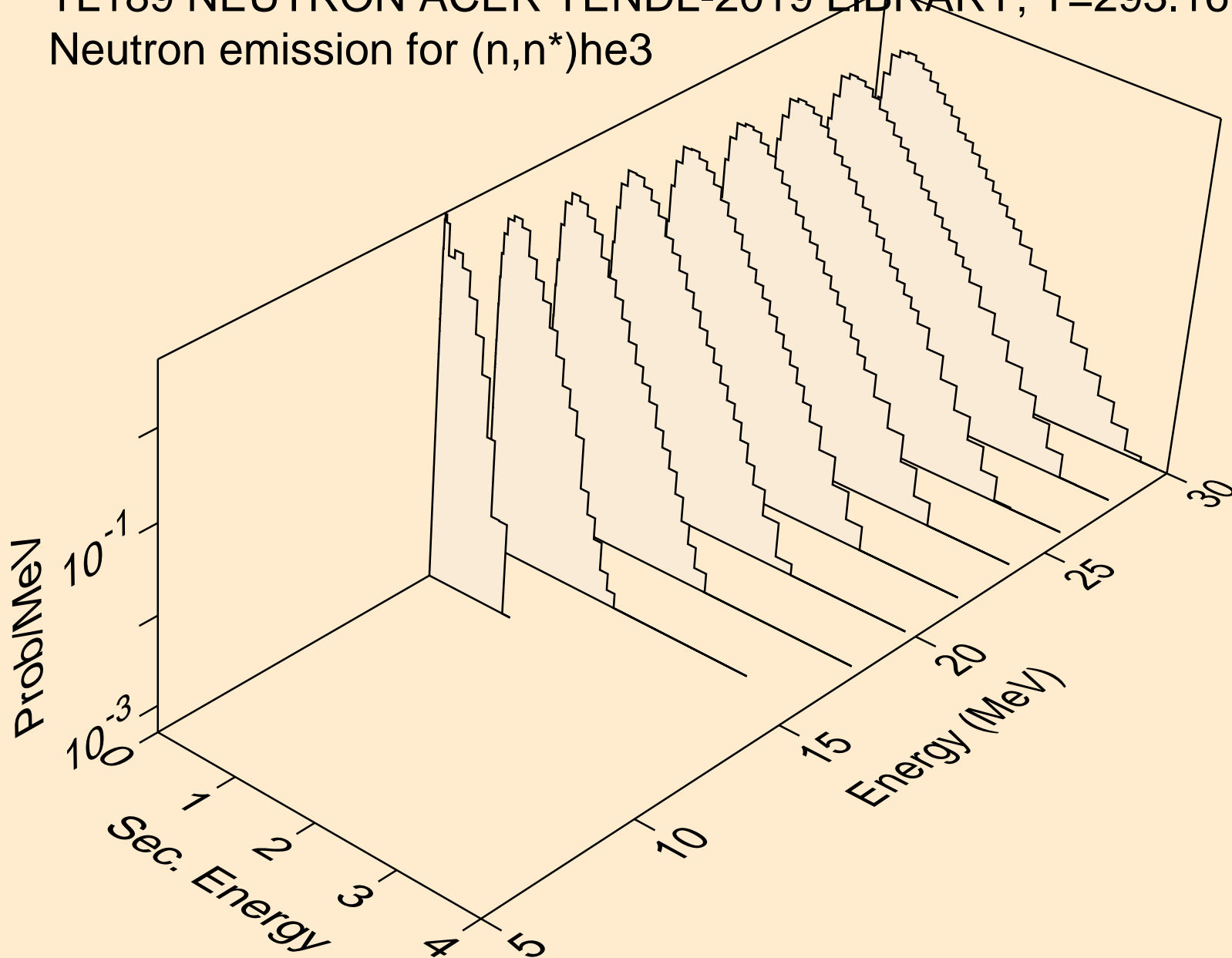

TL189 NEUTRON ACER TENDL-2019 LIBRARY; T=293.16K
Neutron emission for (n,4n)

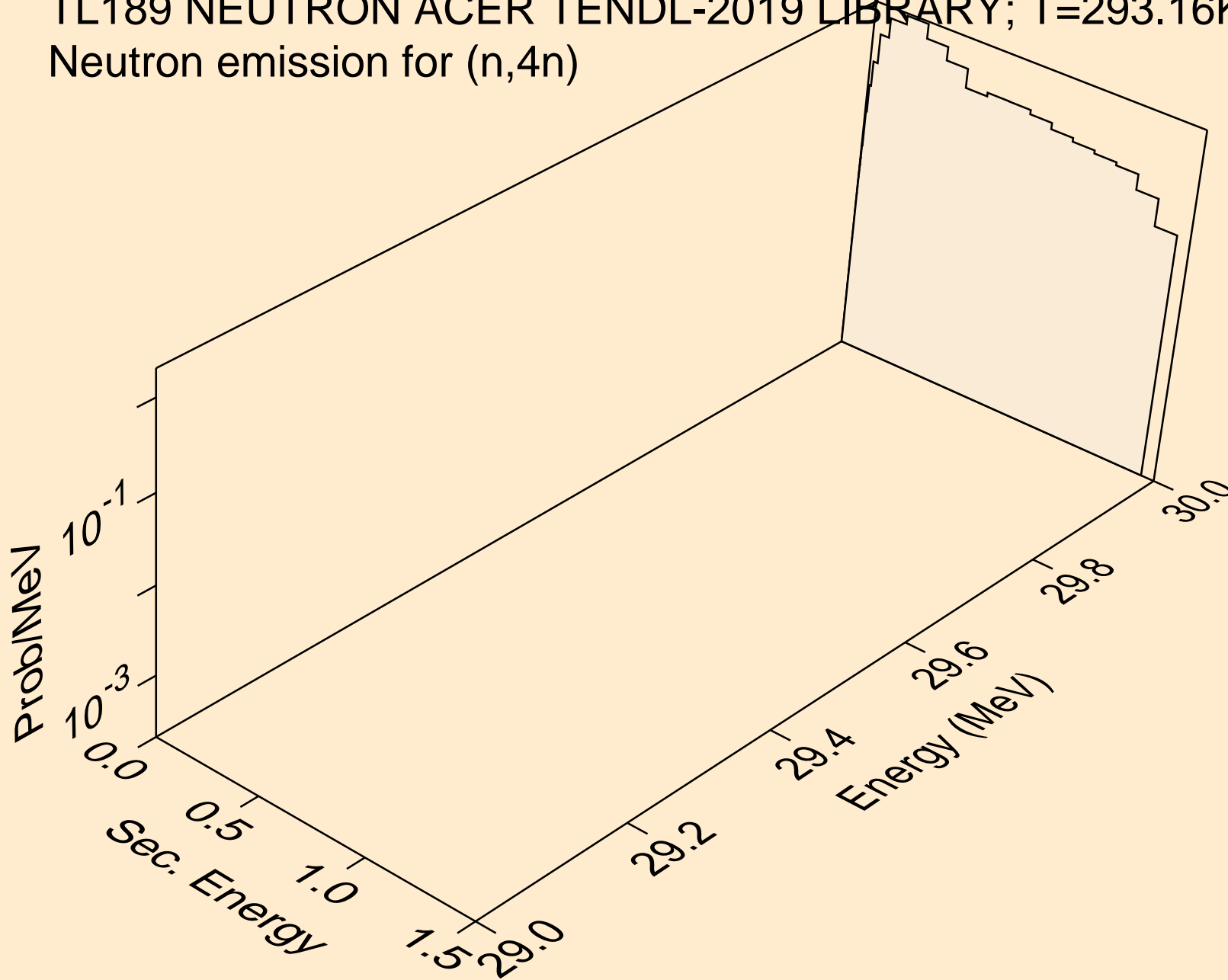

TL189 NEUTRON ACER TENDL-2019 LIBRARY; T=293.16K
Neutron emission for (n,2np)

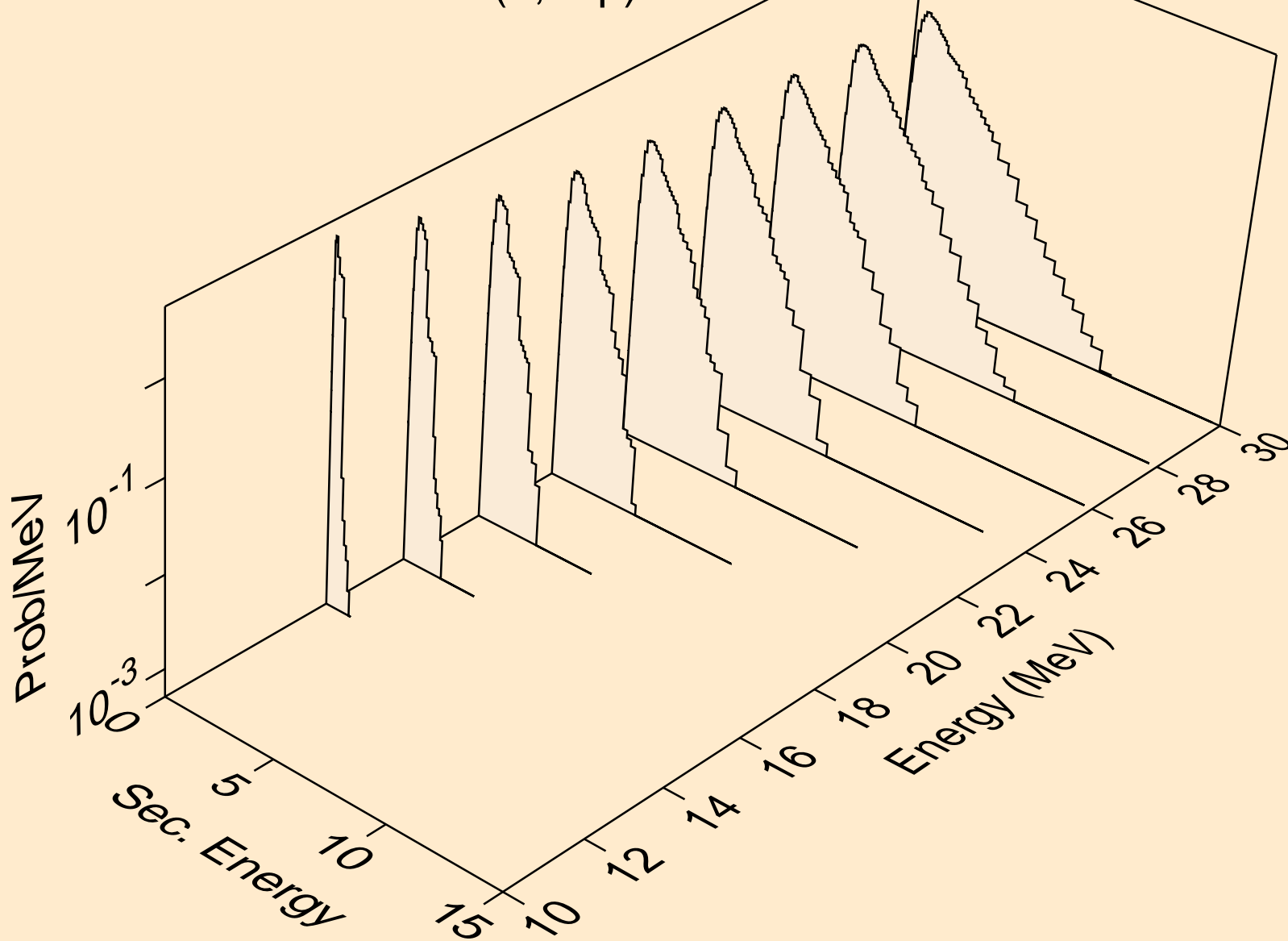

TL189 NEUTRON ACER TENDL-2019 LIBRARY; T=293.16K
Neutron emission for (n,3np)

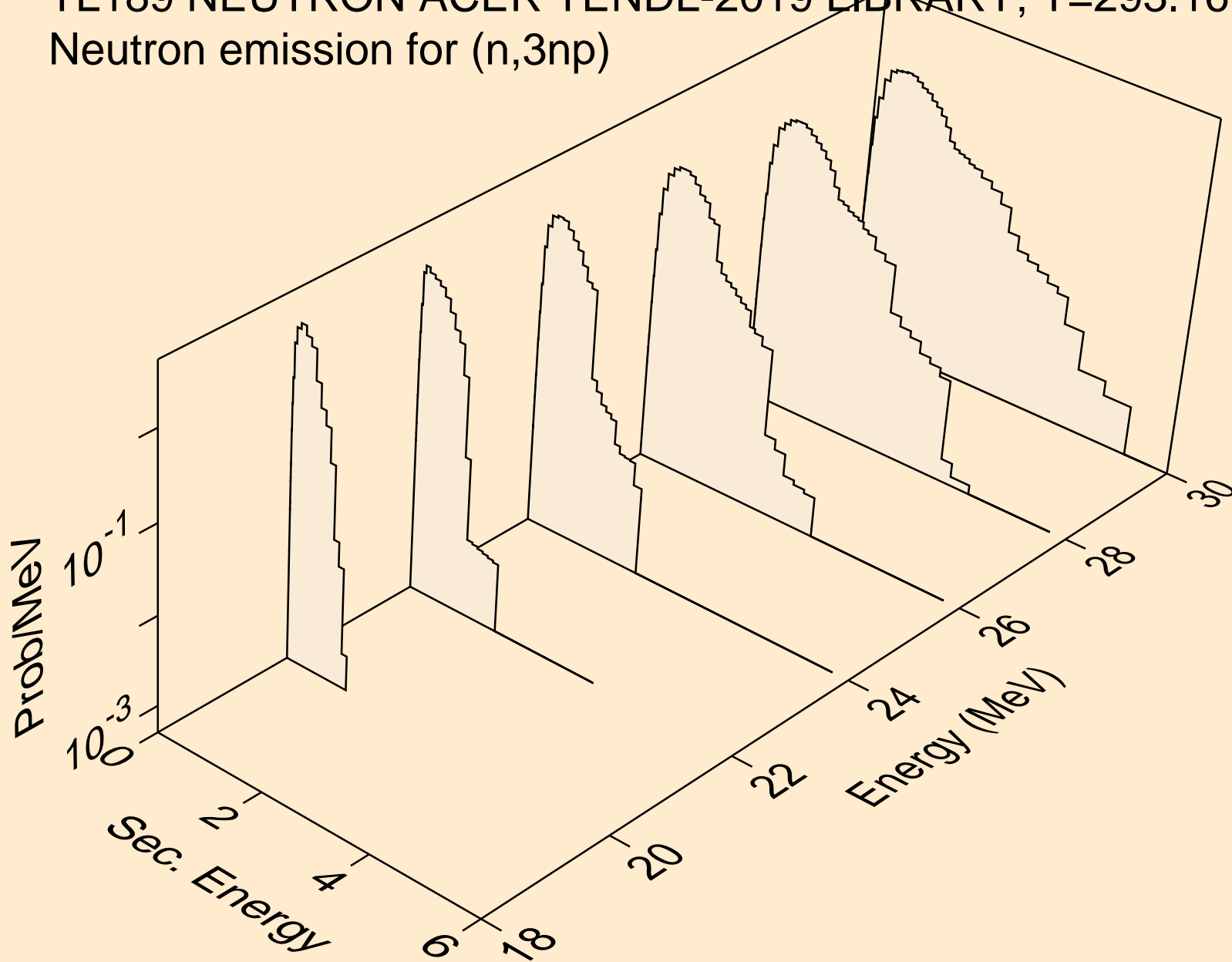

TL189 NEUTRON ACER TENDL-2019 LIBRARY; T=293.16K
Neutron emission for (n,2np)

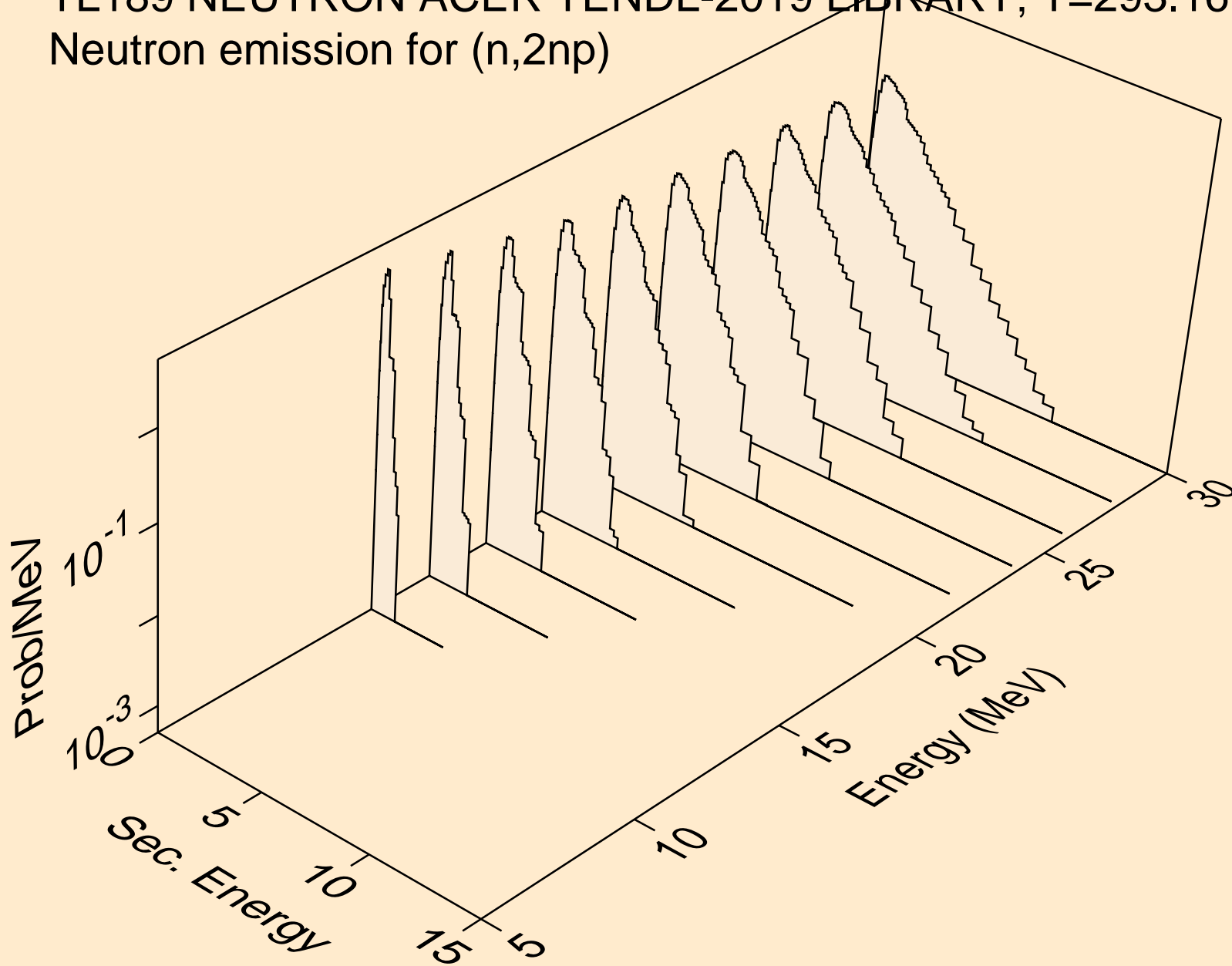

TL189 NEUTRON ACER TENDL-2019 LIBRARY; T=293.16K
Neutron emission for (n,npa)

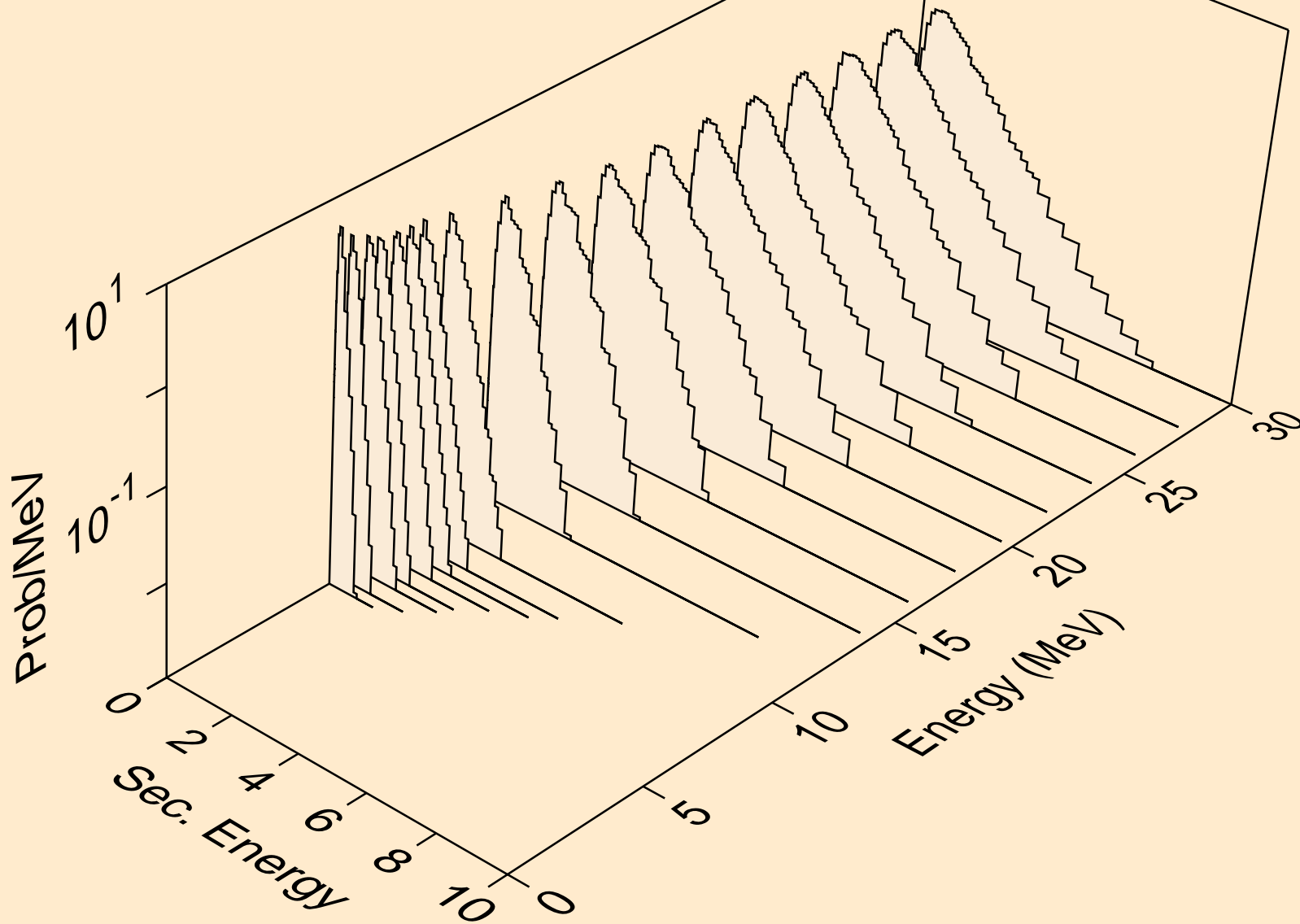

TL189 NEUTRON ACER TENDL-2019 LIBRARY; T=293.16K
Neutron emission for (n,n*c)

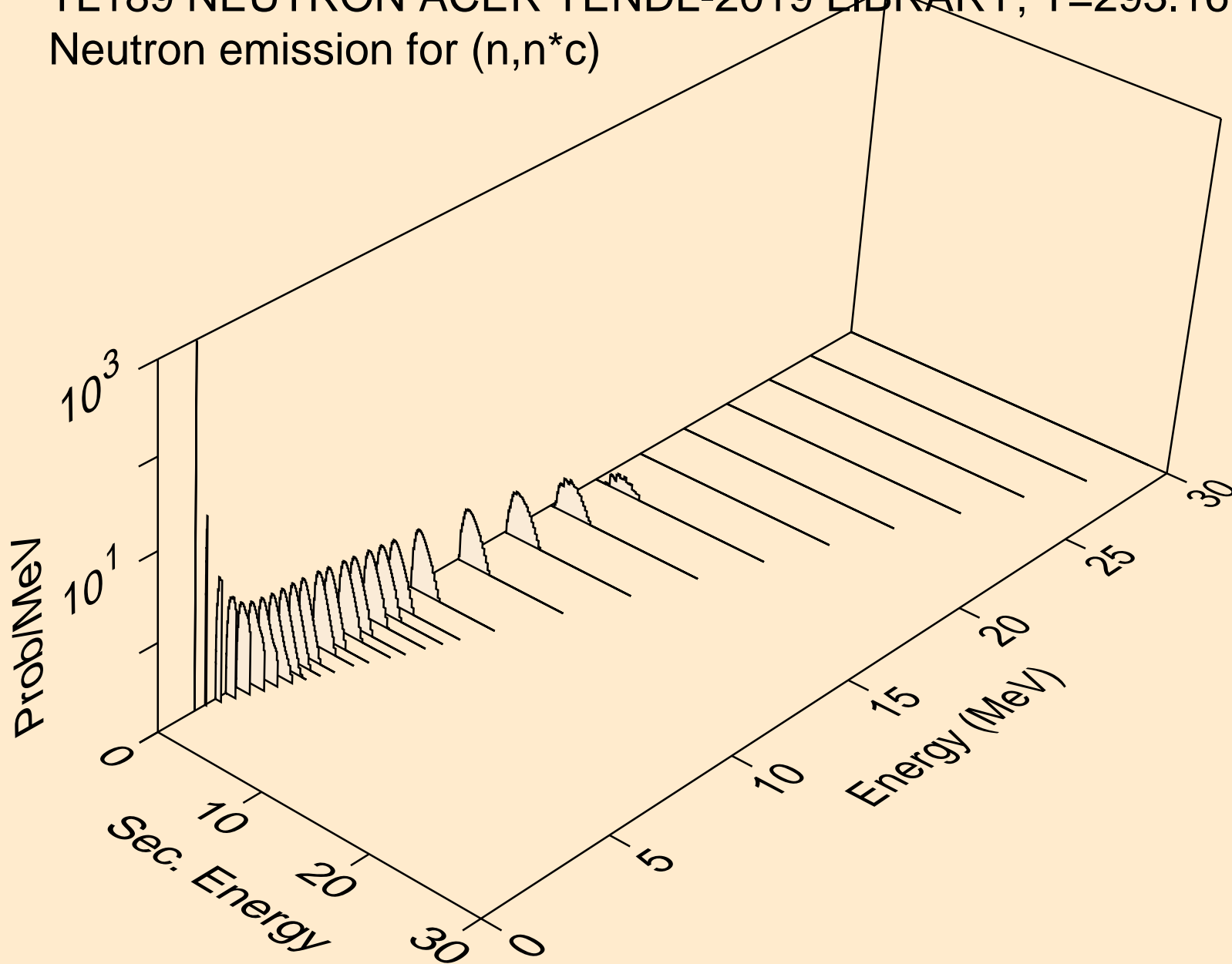

TL189 NEUTRON ACER TENDL-2019 LIBRARY; T=293.16K
Photon emission for (n,x)

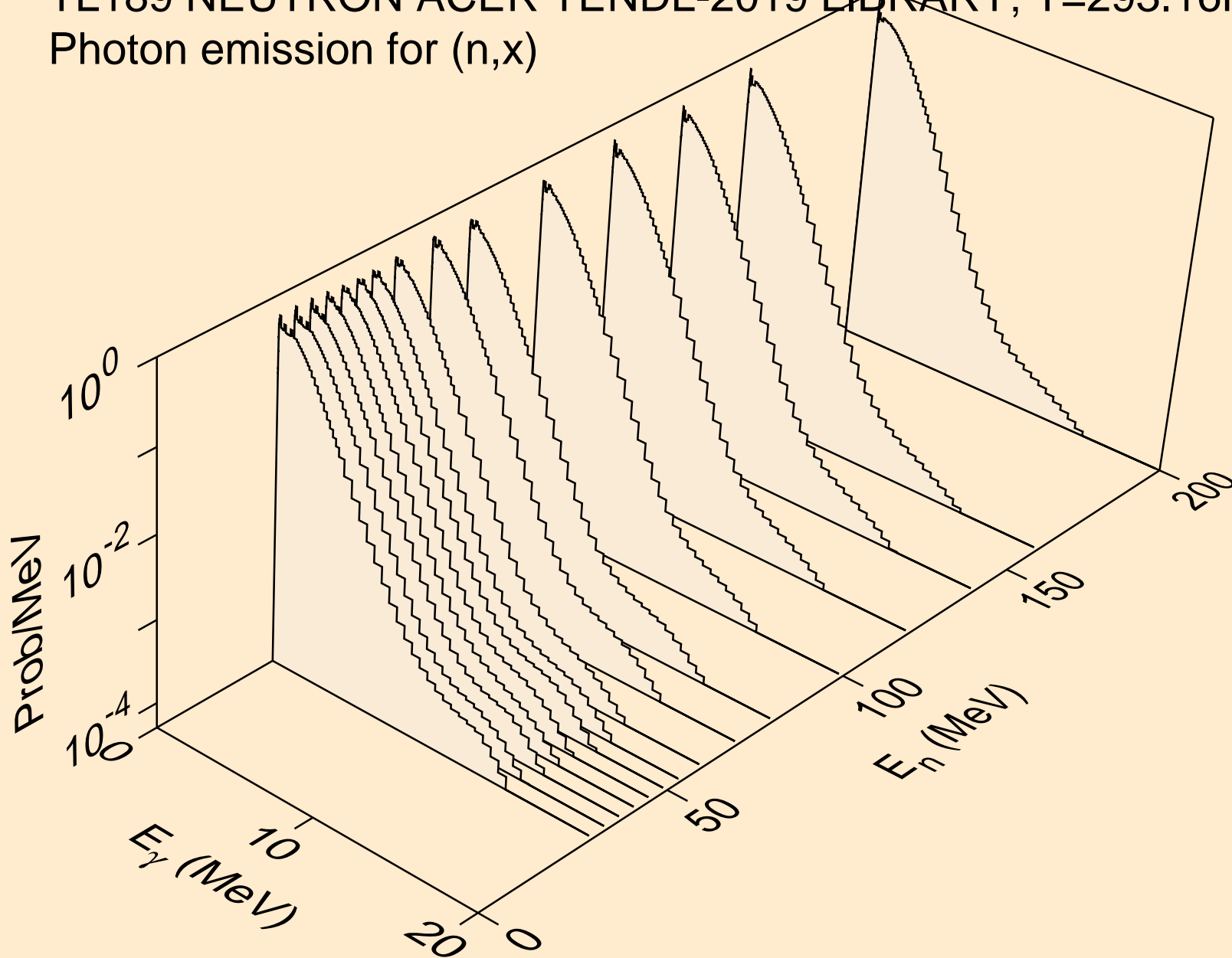

TL189 NEUTRON ACER TENDL-2019 LIBRARY; T=293.16K
Photon emission for (n,2nd)

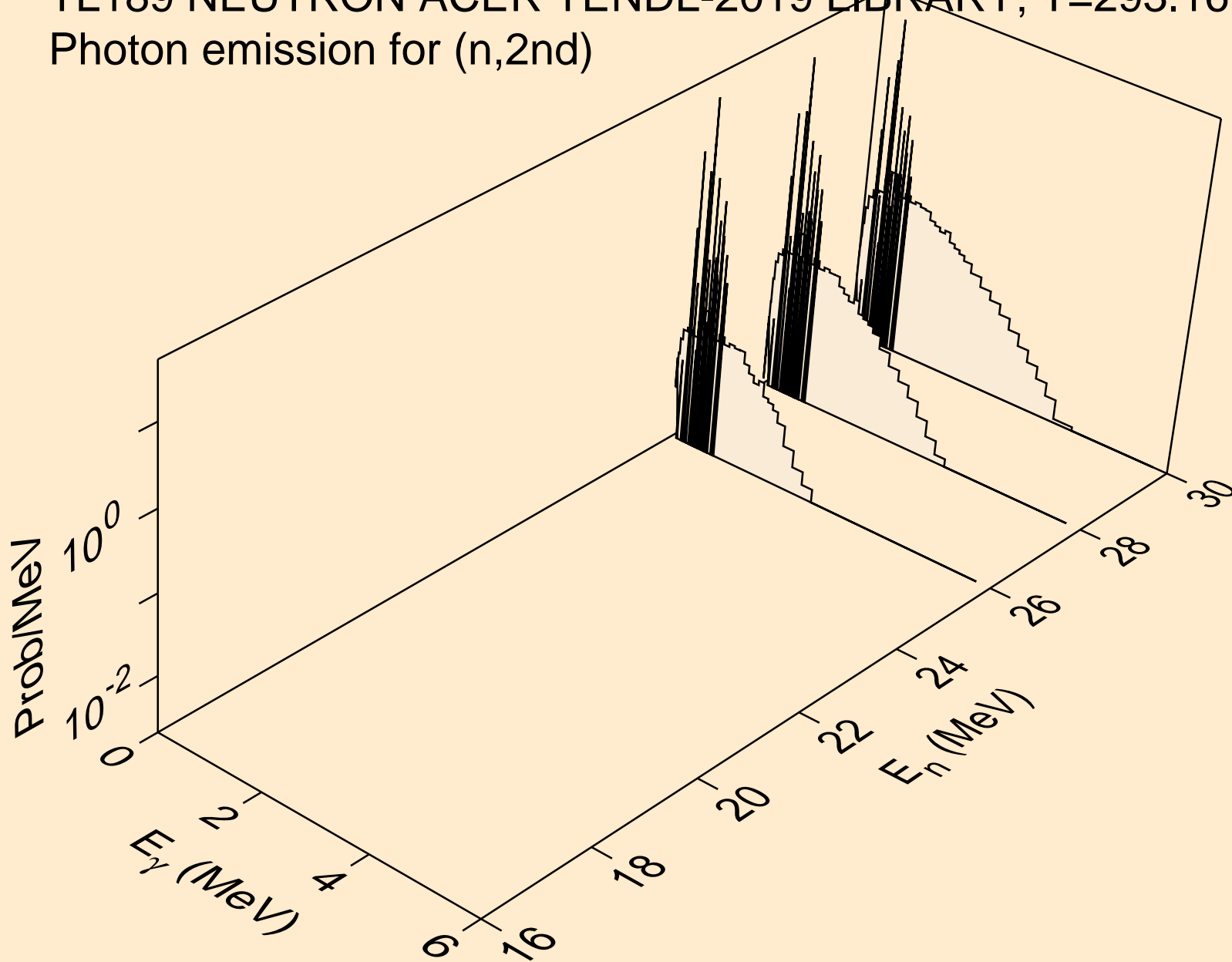

TL189 NEUTRON ACER TENDL-2019 LIBRARY; T=293.16K
Photon emission for (n,2n)

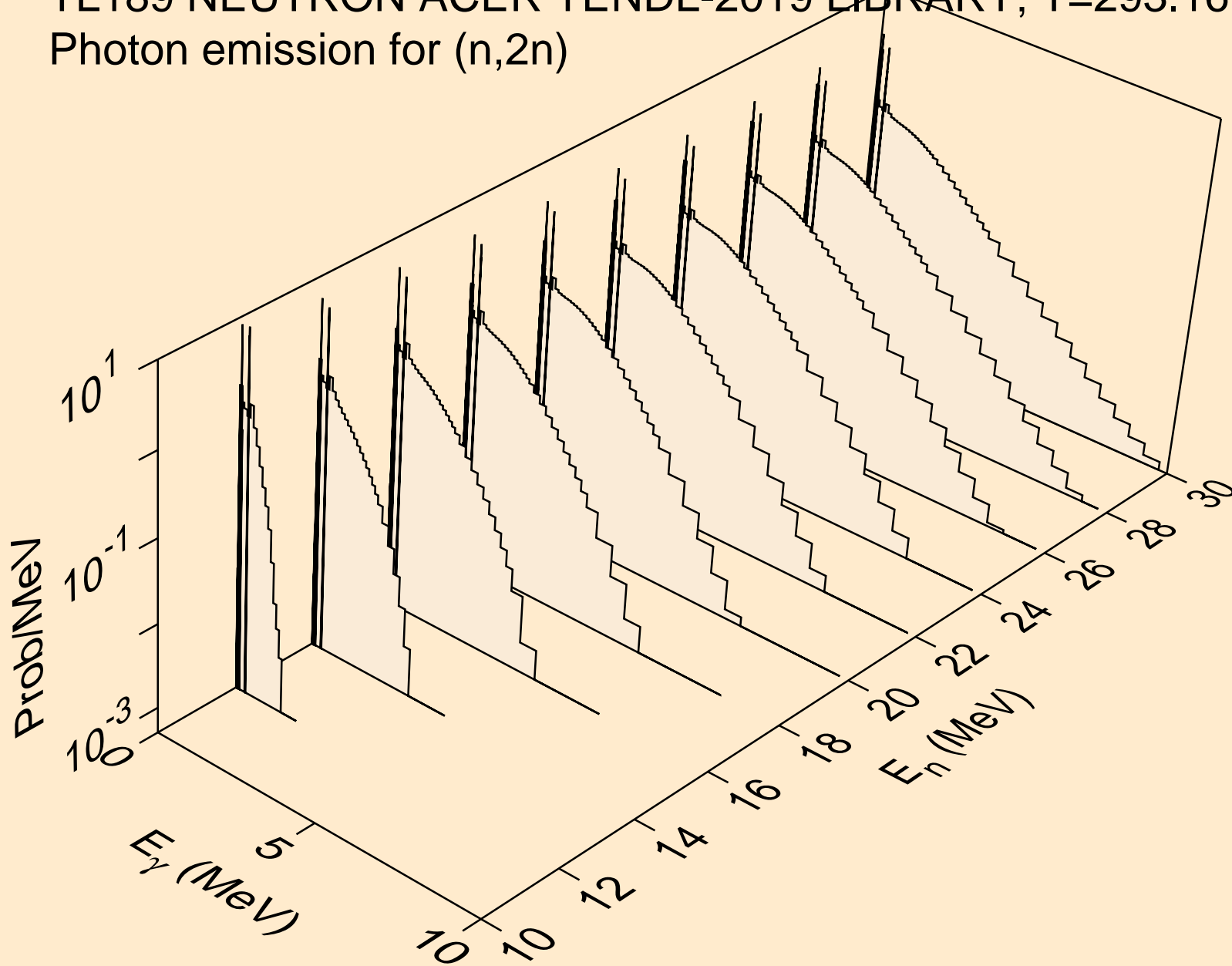

TL189 NEUTRON ACER TENDL-2019 LIBRARY; T=293.16K
Photon emission for (n,3n)

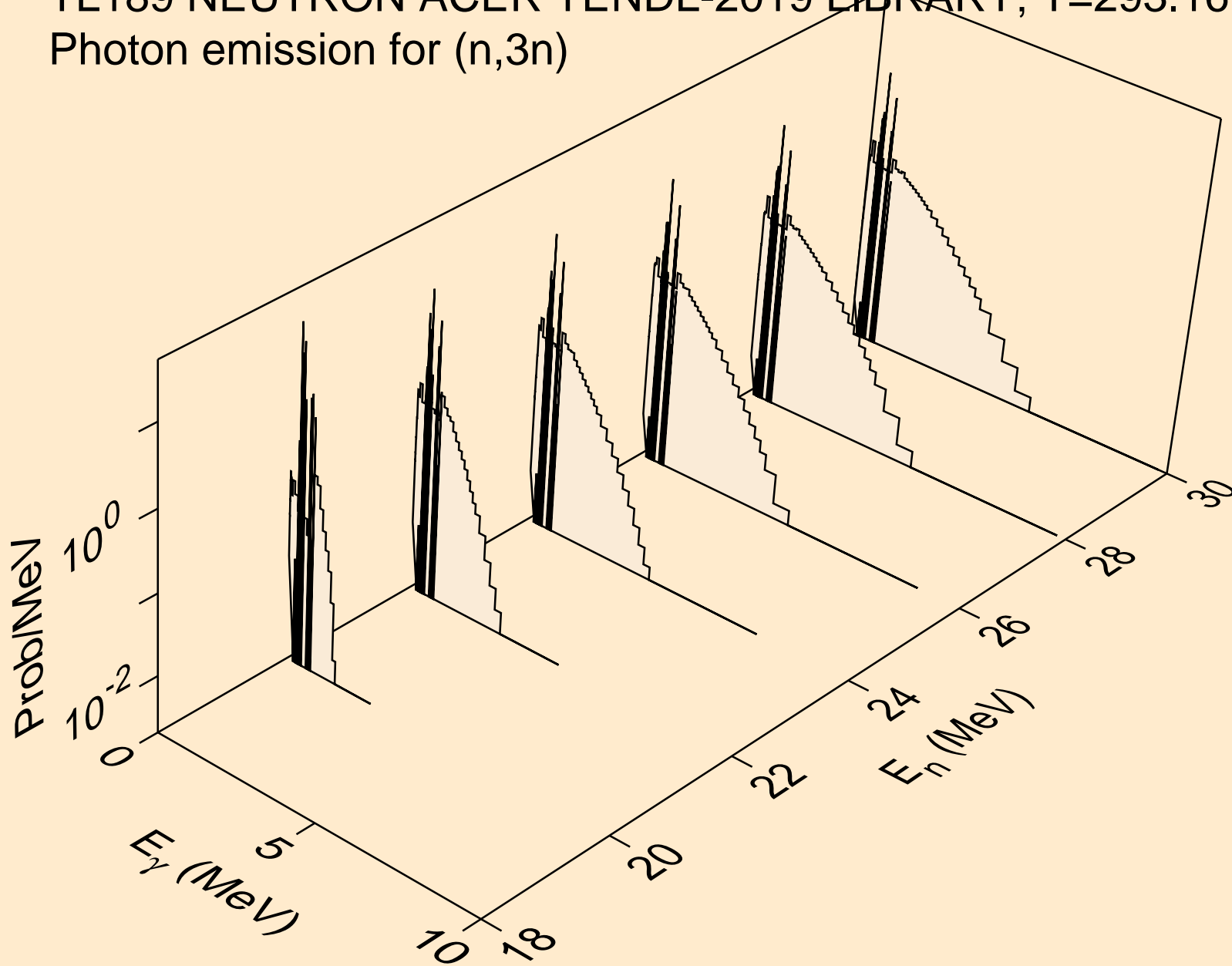

TL189 NEUTRON ACER TENDL-2019 LIBRARY; T=293.16K
Photon emission for (n,n*)a

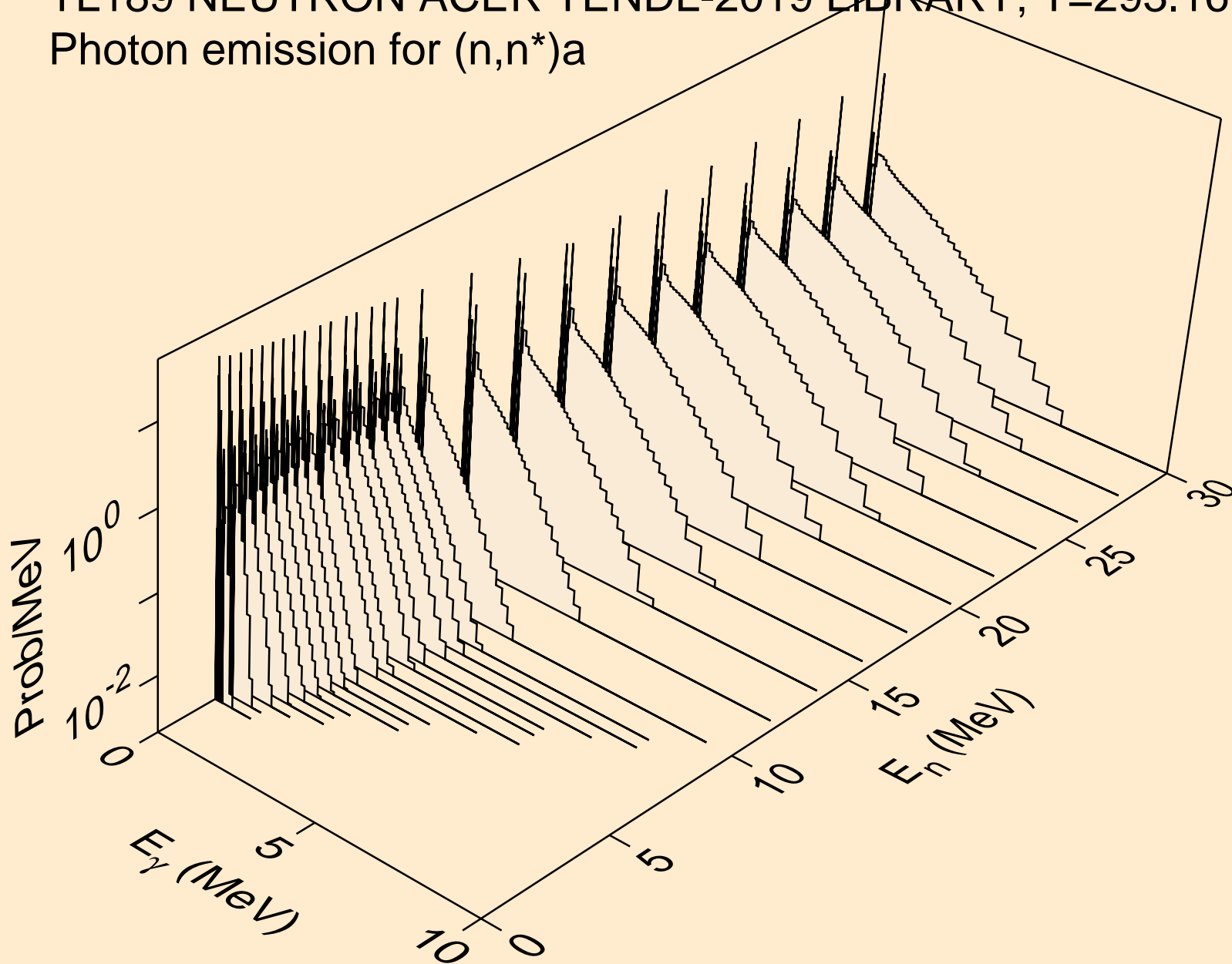

TL189 NEUTRON ACER TENDL-2019 LIBRARY; T=293.16K
Photon emission for (n,2n)a

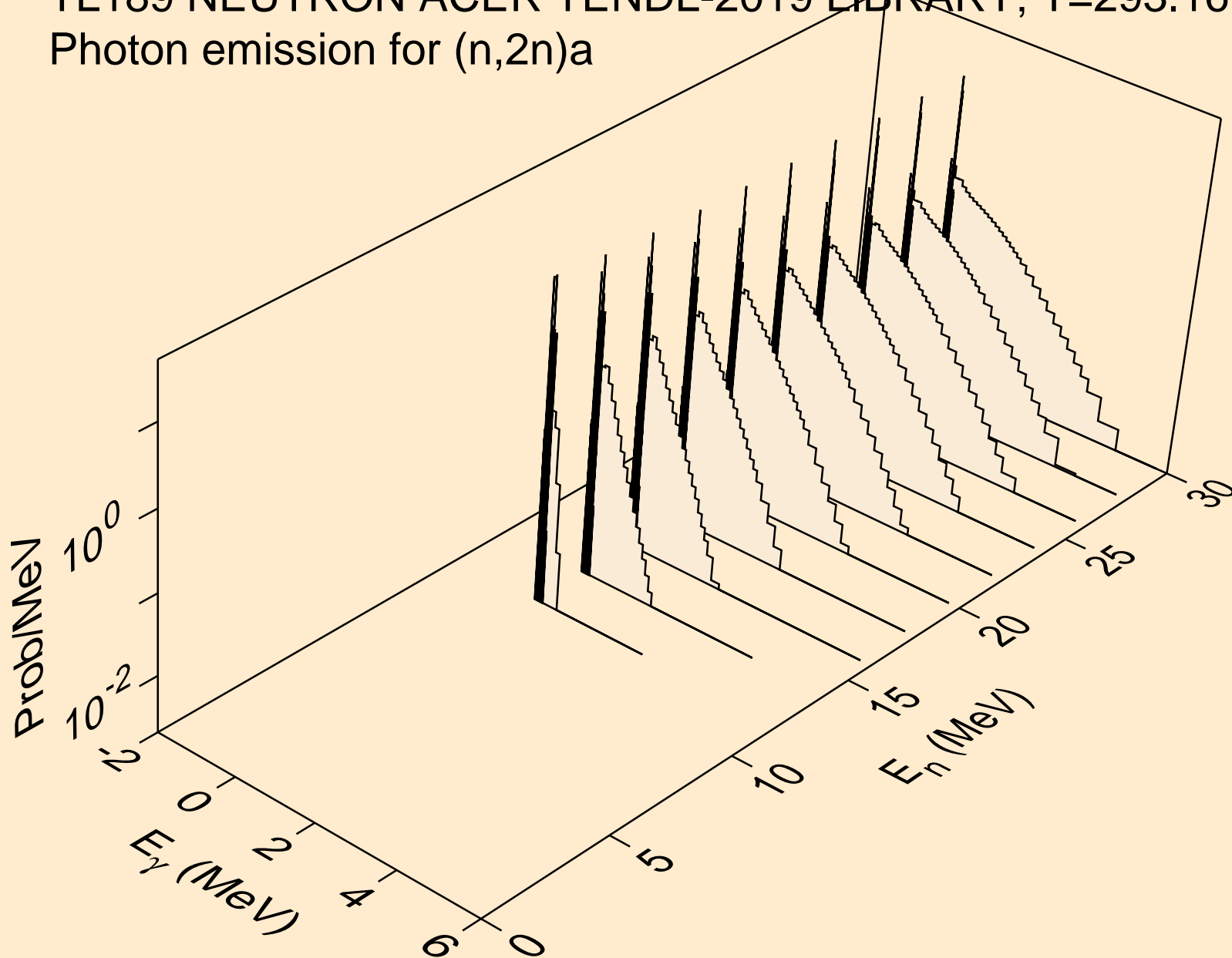

TL189 NEUTRON ACER TENDL-2019 LIBRARY; T=293.16K
Photon emission for (n,3n)a

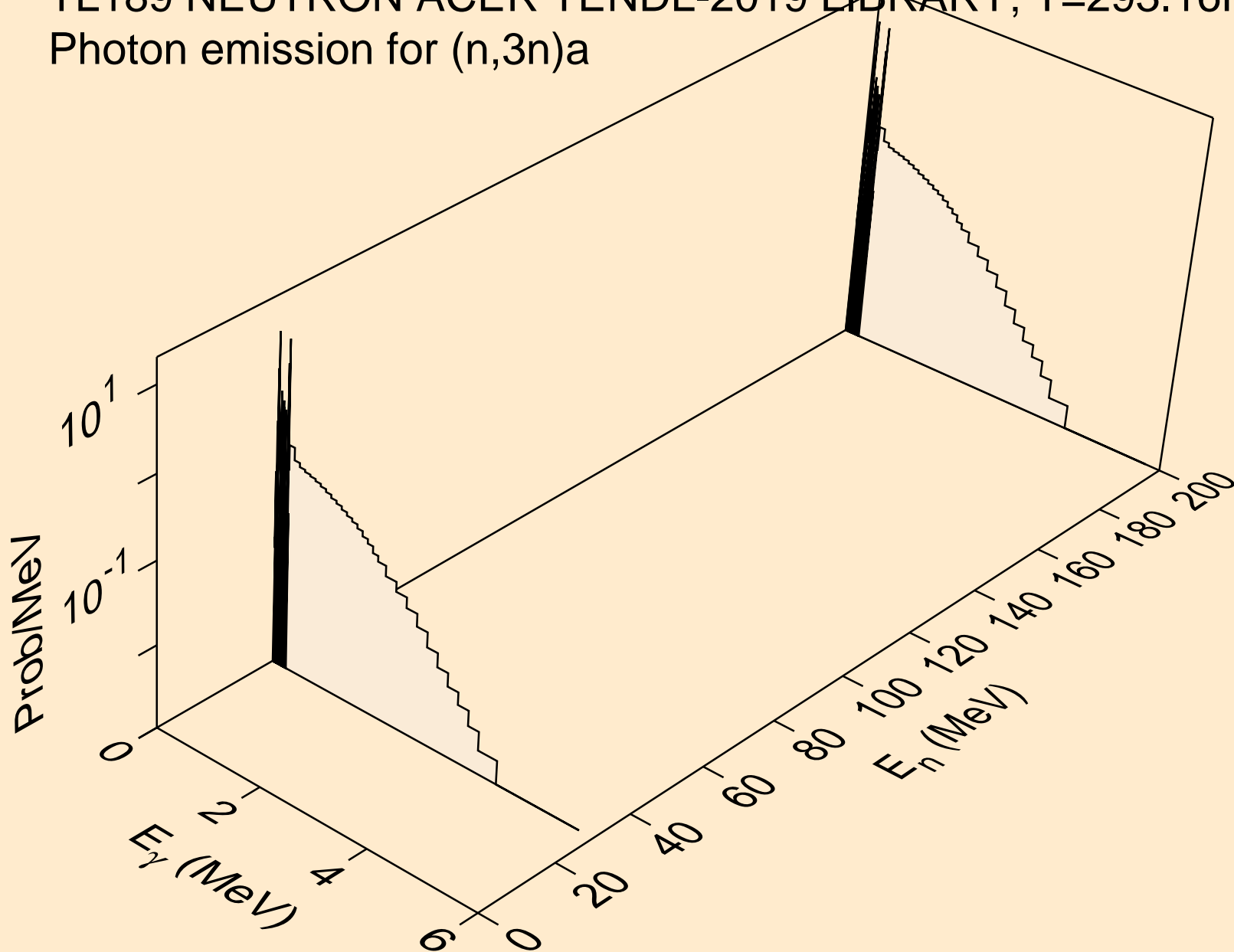

TL189 NEUTRON ACER TENDL-2019 LIBRARY; T=293.16K
Photon emission for (n,n*)p

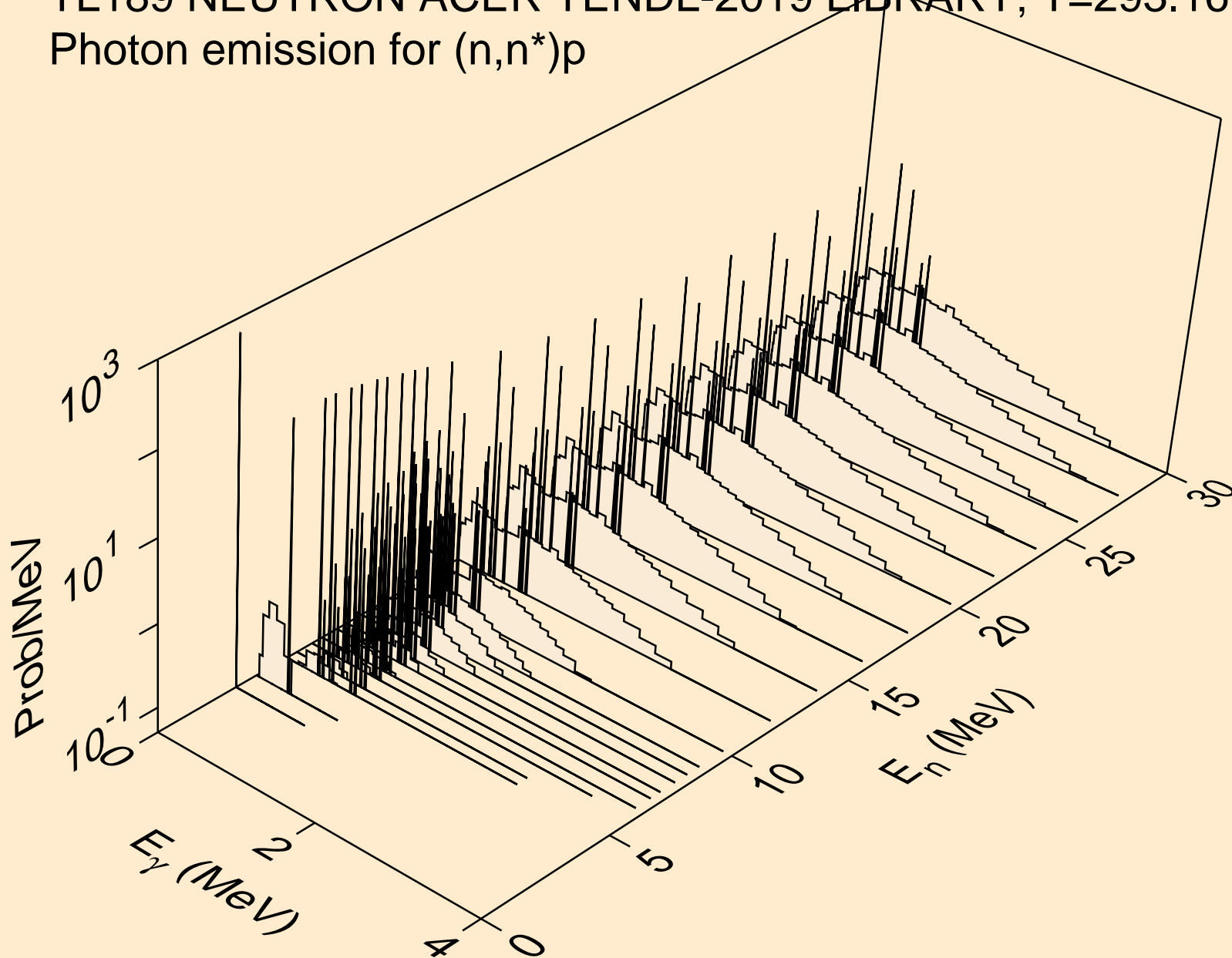

TL189 NEUTRON ACER TENDL-2019 LIBRARY; T=293.16K
Photon emission for (n,n*)2a

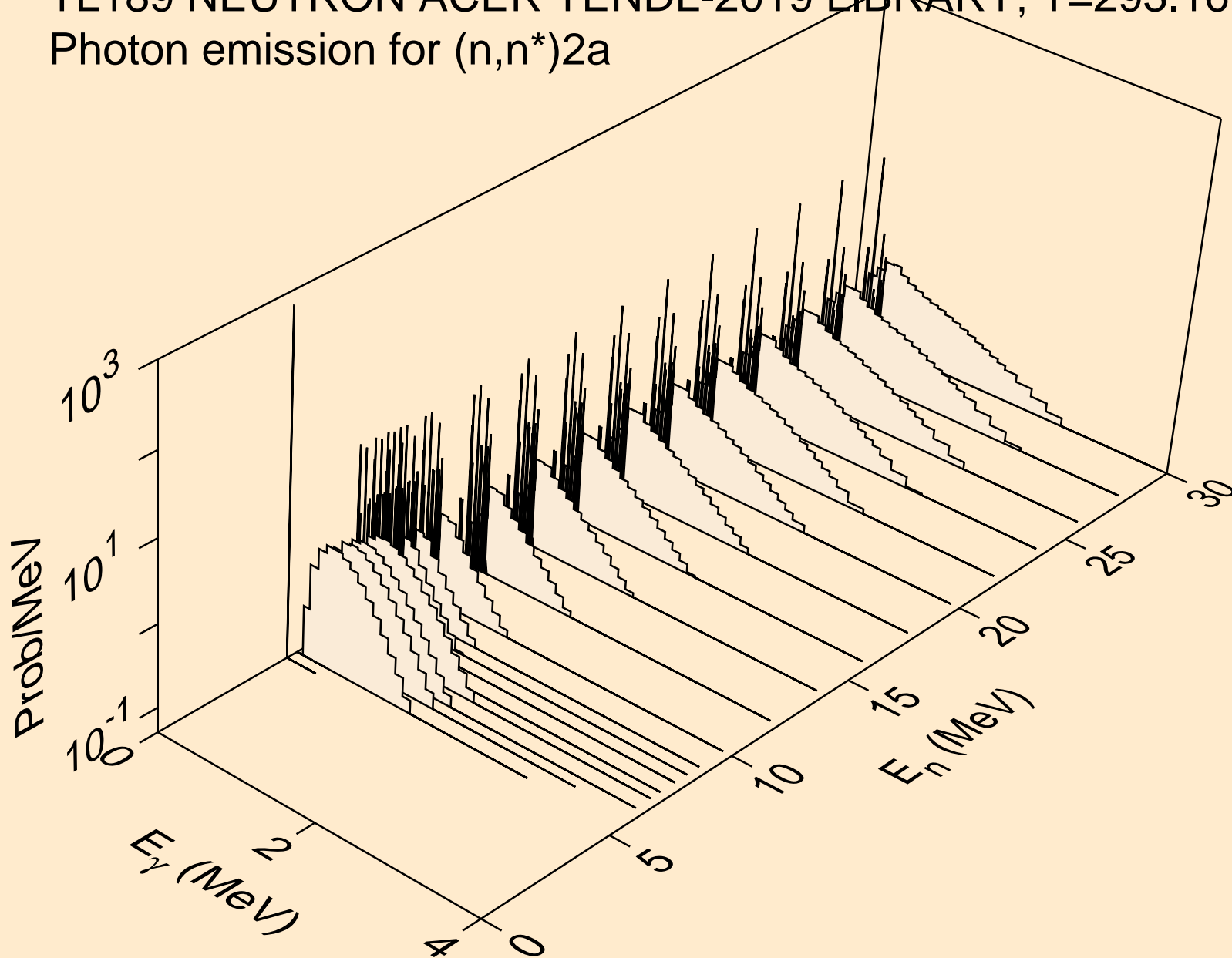

TL189 NEUTRON ACER TENDL-2019 LIBRARY; T=293.16K
Photon emission for (n,2n)2a

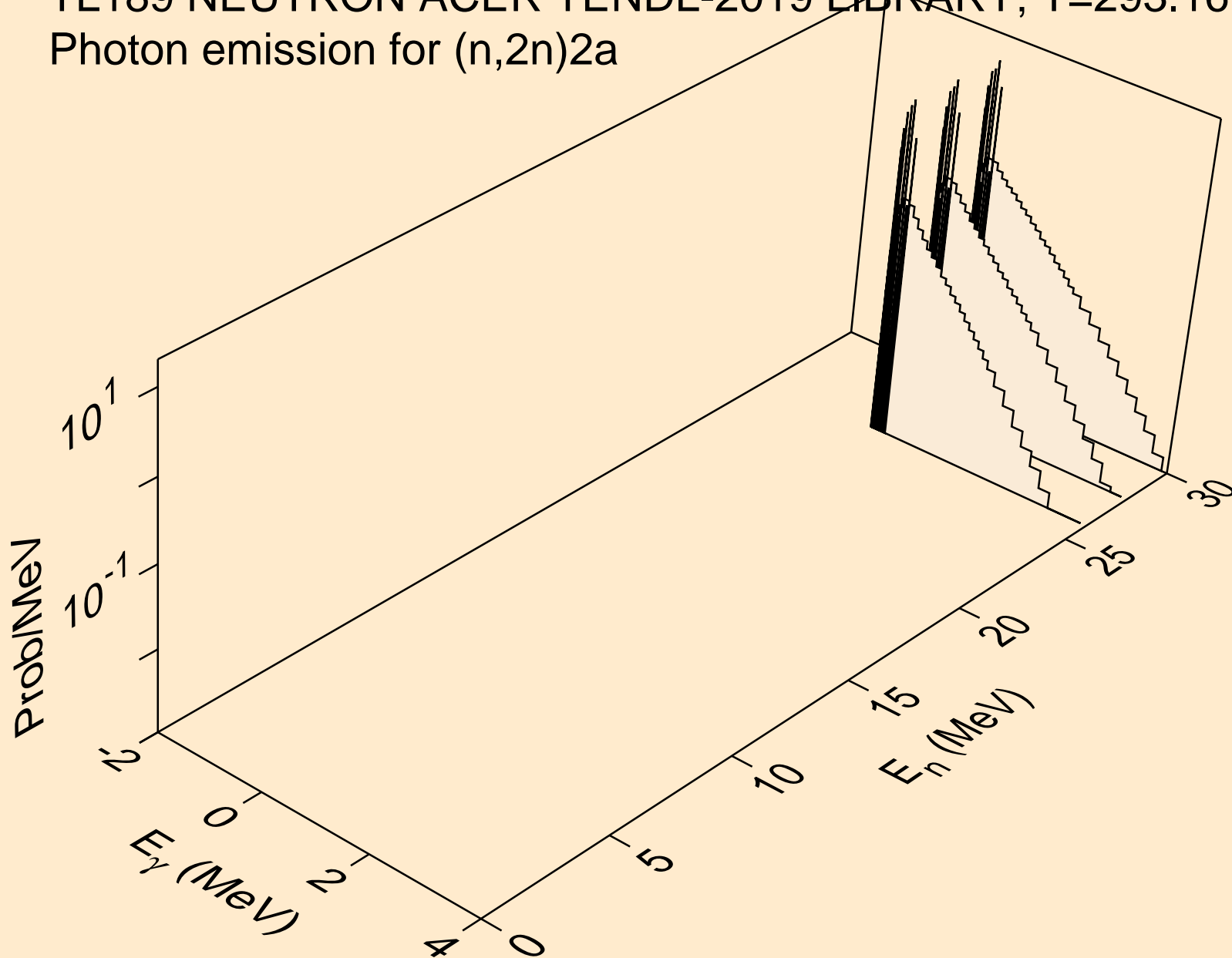

TL189 NEUTRON ACER TENDL-2019 LIBRARY; T=293.16K
Photon emission for (n,n*)d

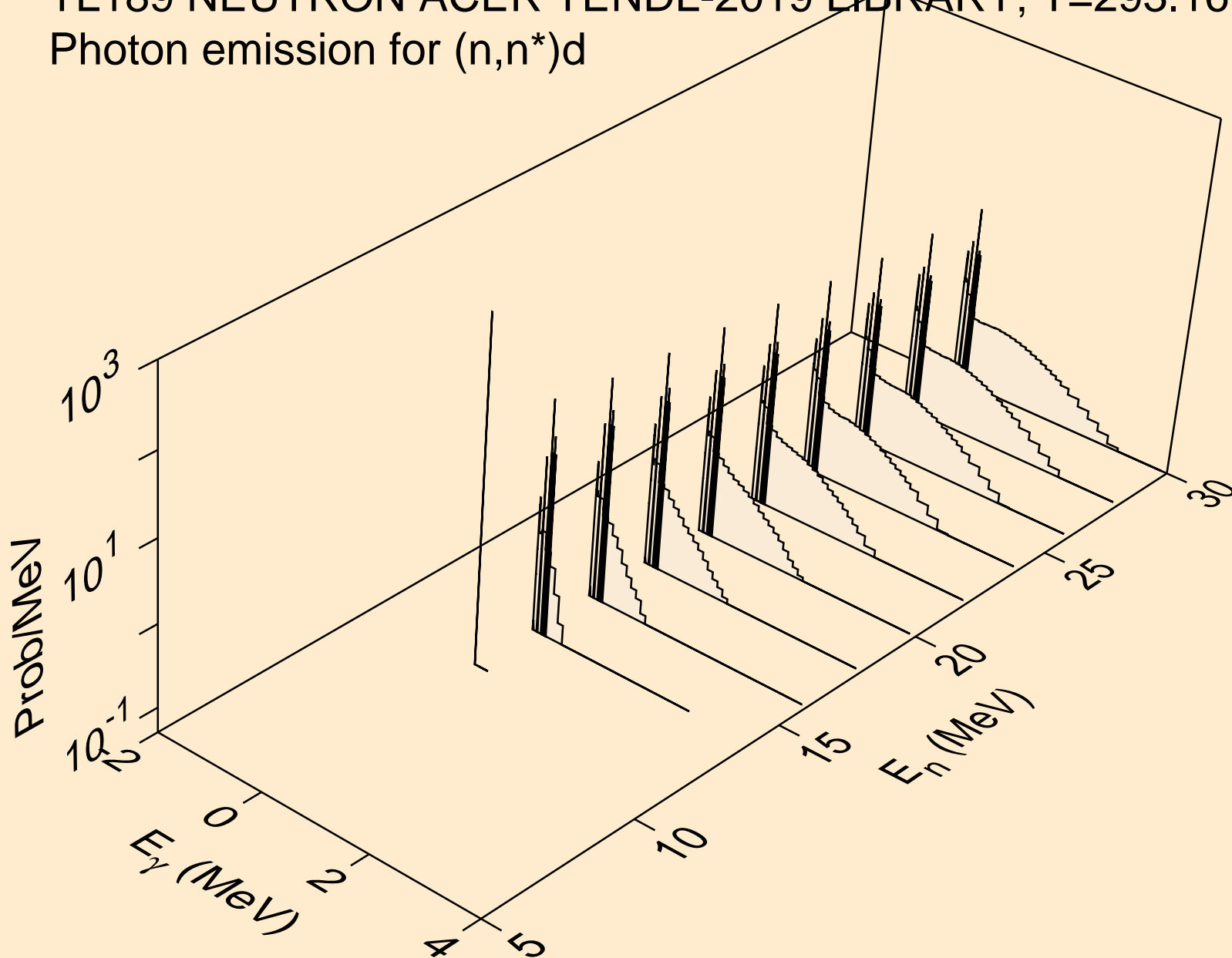

TL189 NEUTRON ACER TENDL-2019 LIBRARY; T=293.16K
Photon emission for (n,n*)t

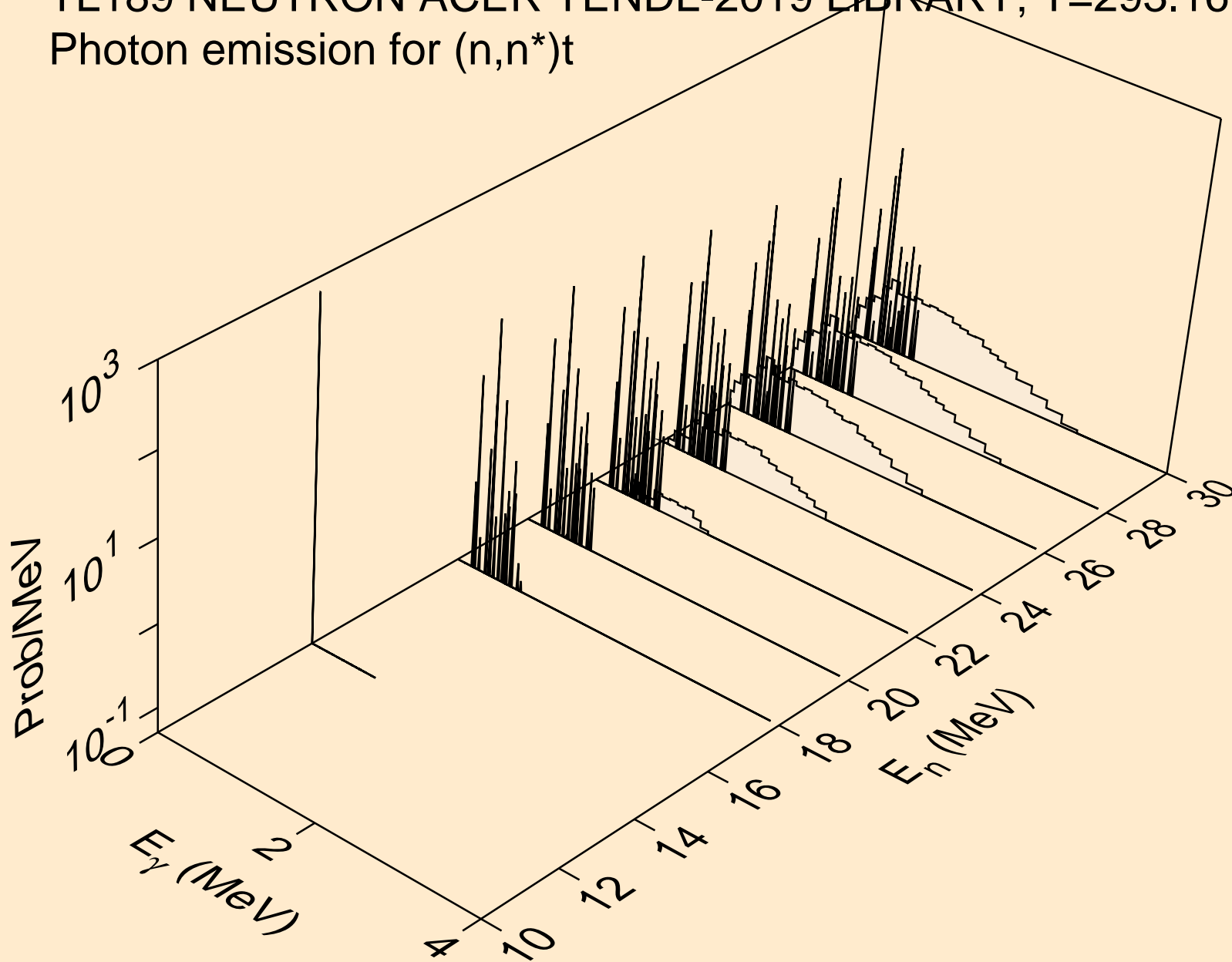

TL189 NEUTRON ACER TENDL-2019 LIBRARY; T=293.16K
Photon emission for (n,n*)he3

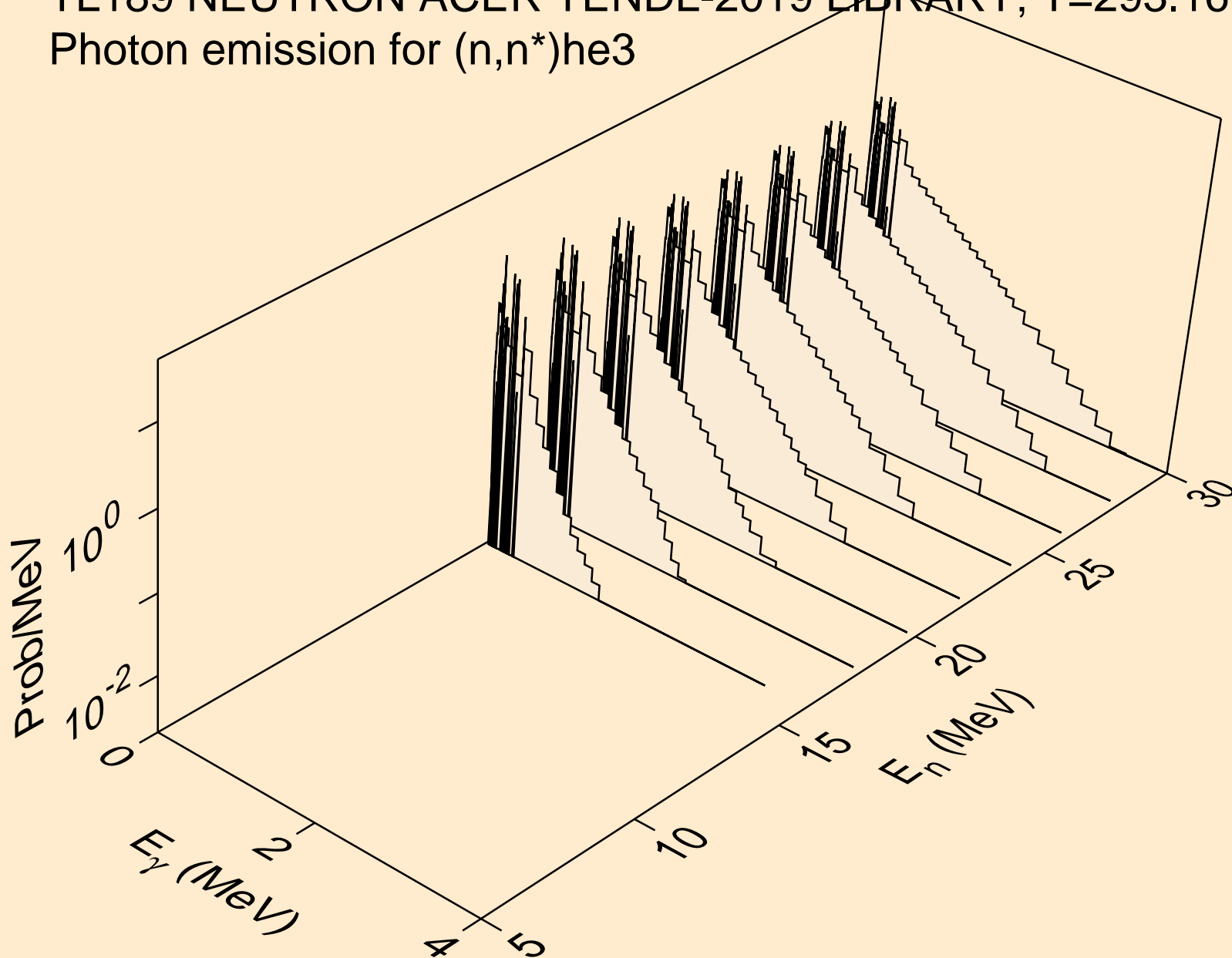

TL189 NEUTRON ACER TENDL-2019 LIBRARY; T=293.16K
Photon emission for (n,4n)

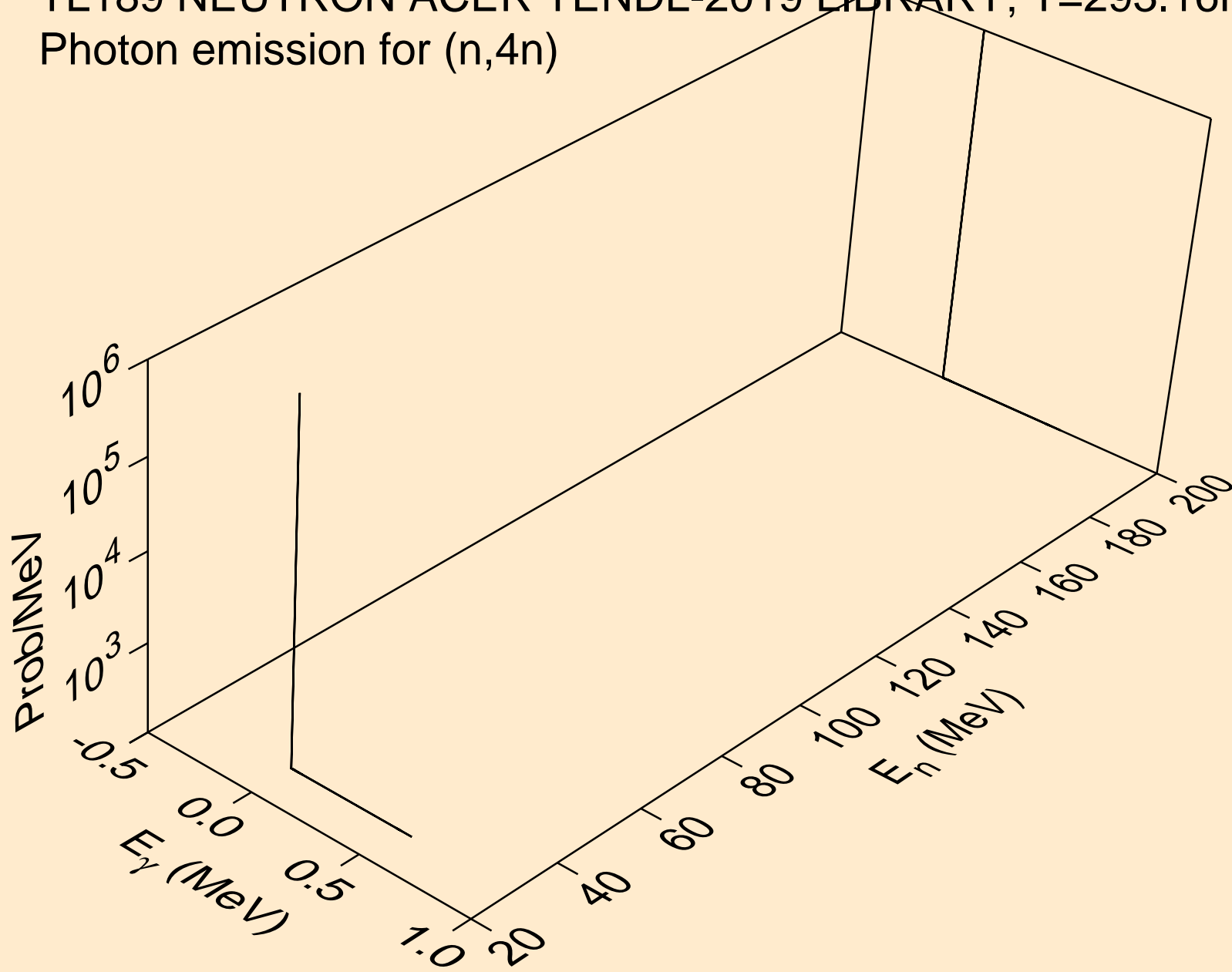

TL189 NEUTRON ACER TENDL-2019 LIBRARY; T=293.16K
Photon emission for (n,2np)

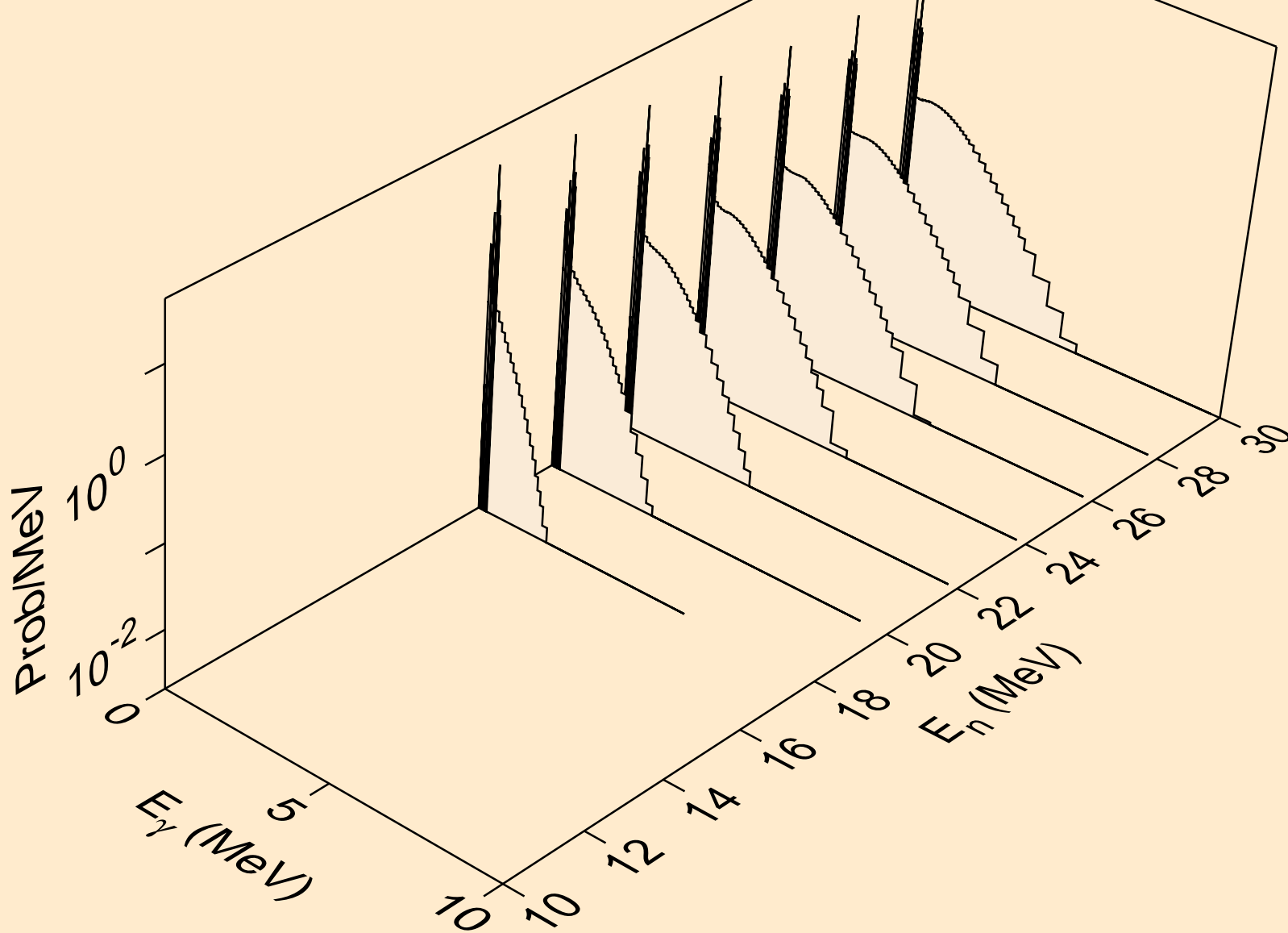

TL189 NEUTRON ACER TENDL-2019 LIBRARY; T=293.16K
Photon emission for (n,3np)

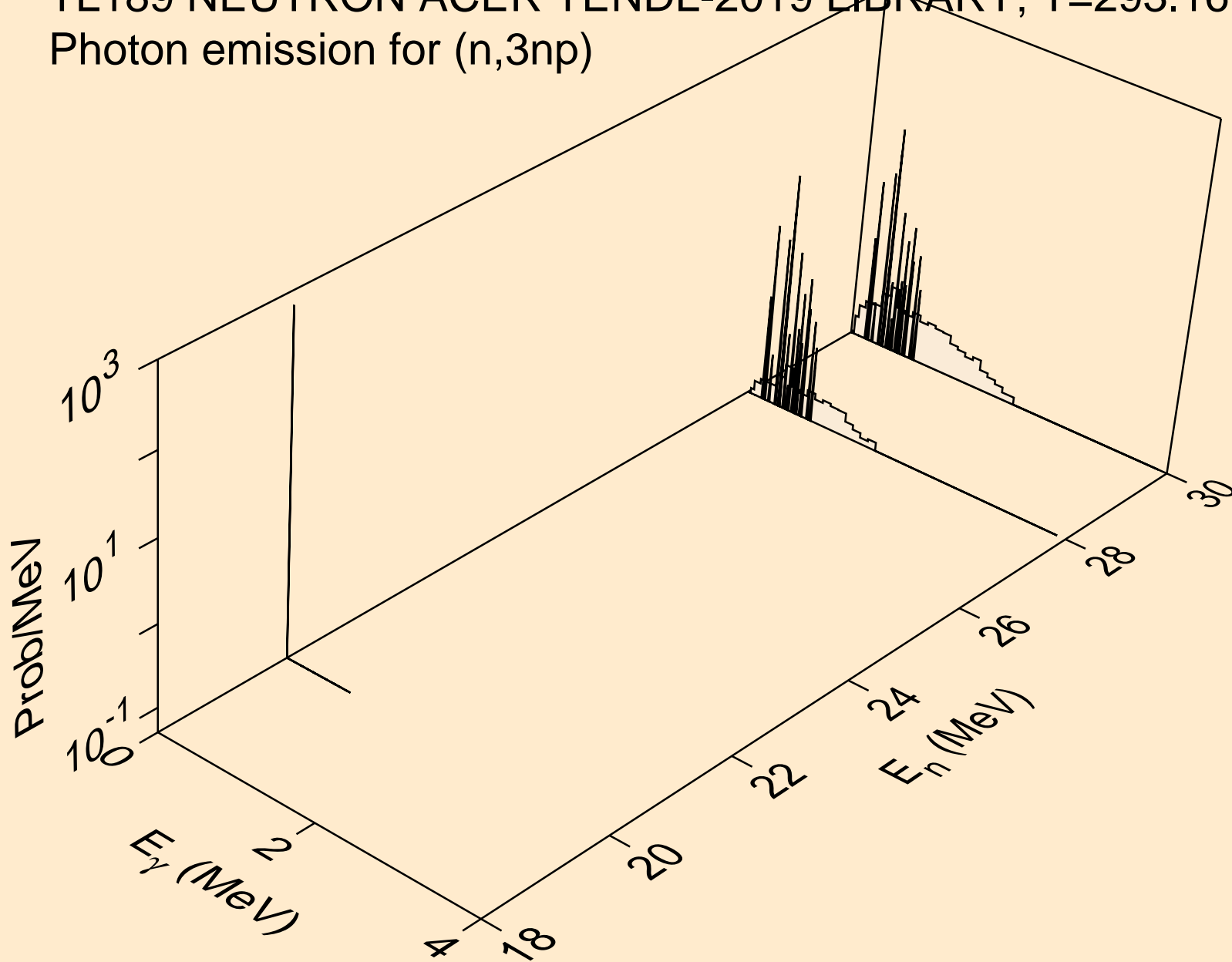

TL189 NEUTRON ACER TENDL-2019 LIBRARY; T=293.16K
Photon emission for (n,2np)

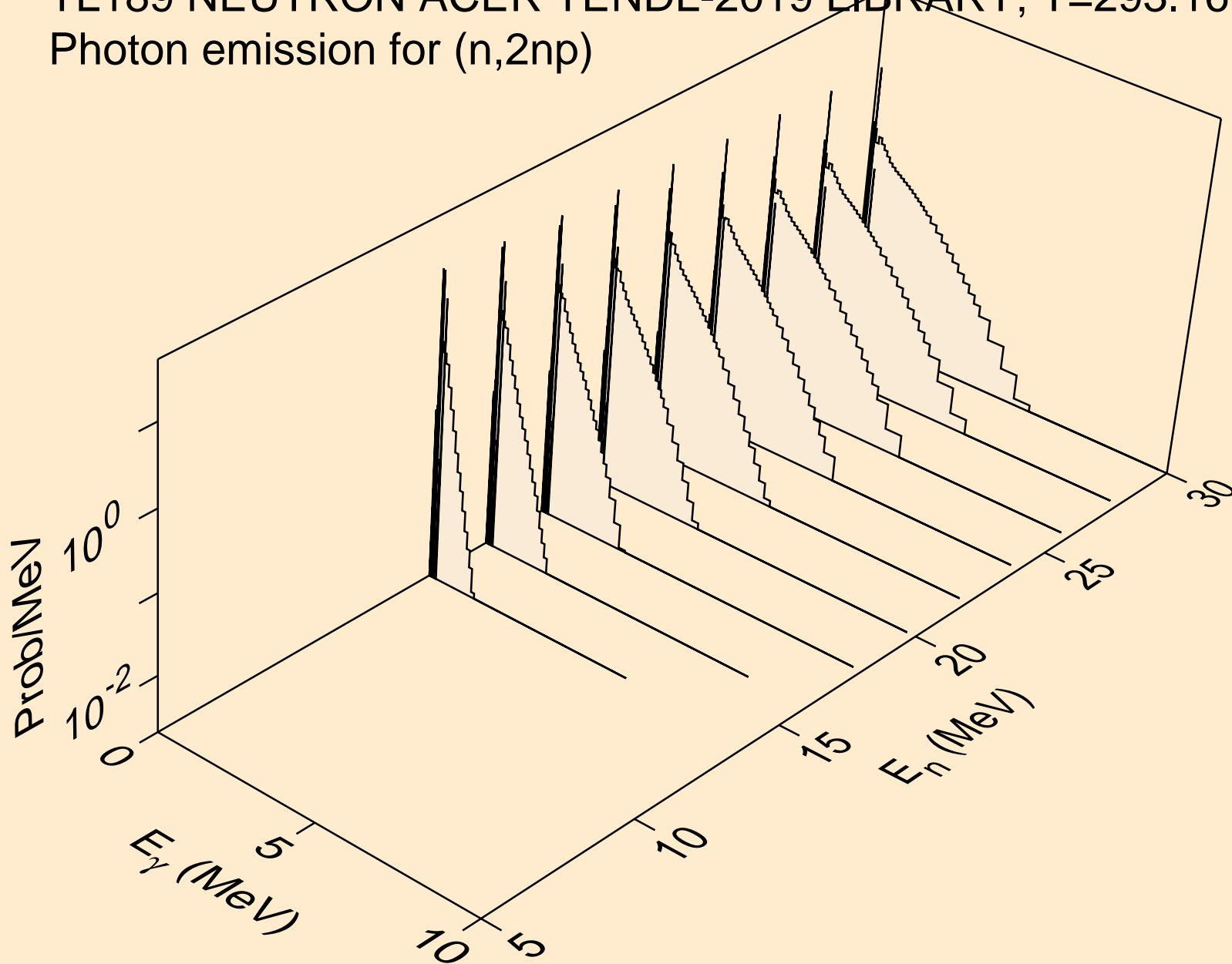

TL189 NEUTRON ACER TENDL-2019 LIBRARY; T=293.16K
Photon emission for (n,npa)

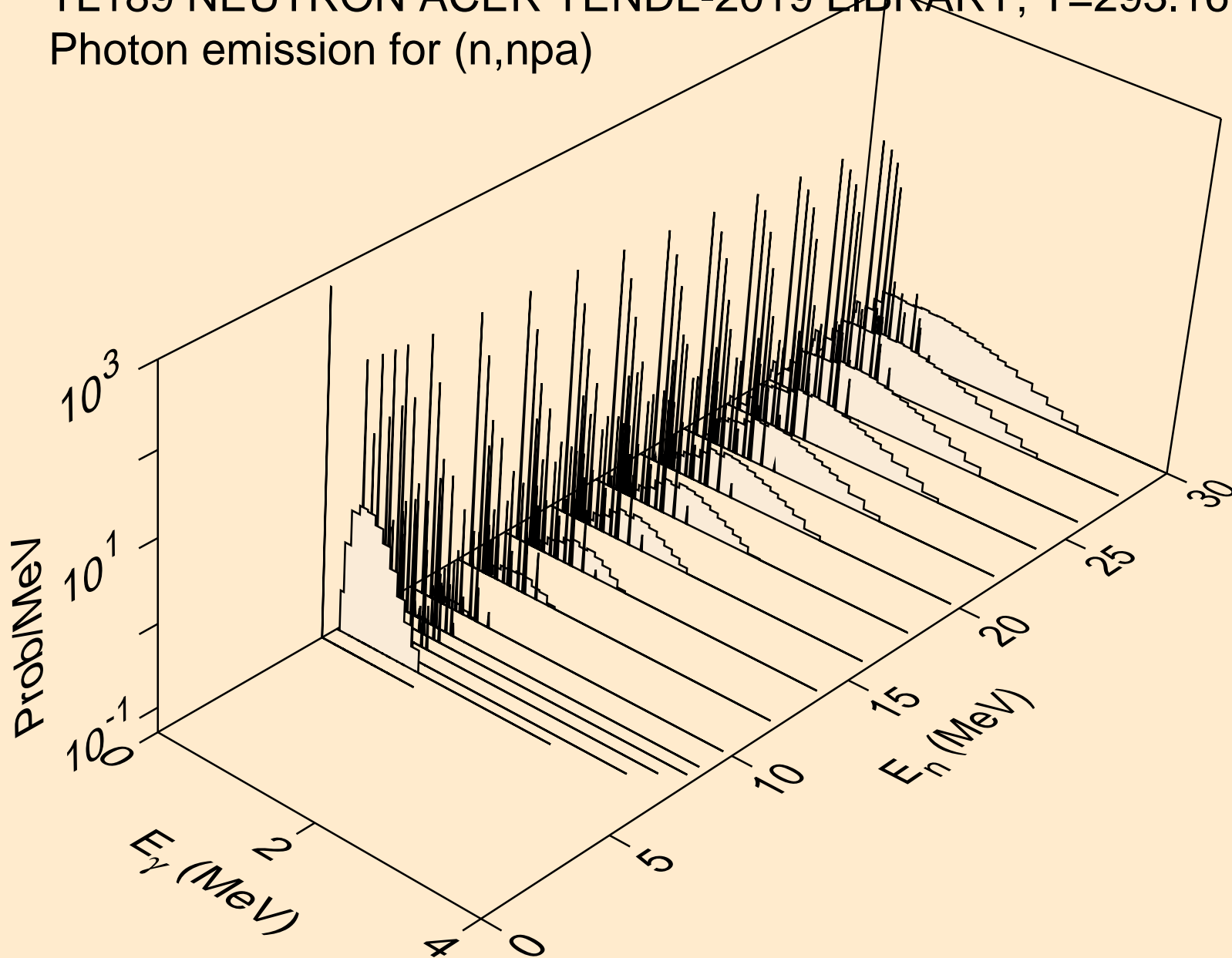

TL189 NEUTRON ACER TENDL-2019 LIBRARY; T=293.16K
Photon emission for (n,n*c)

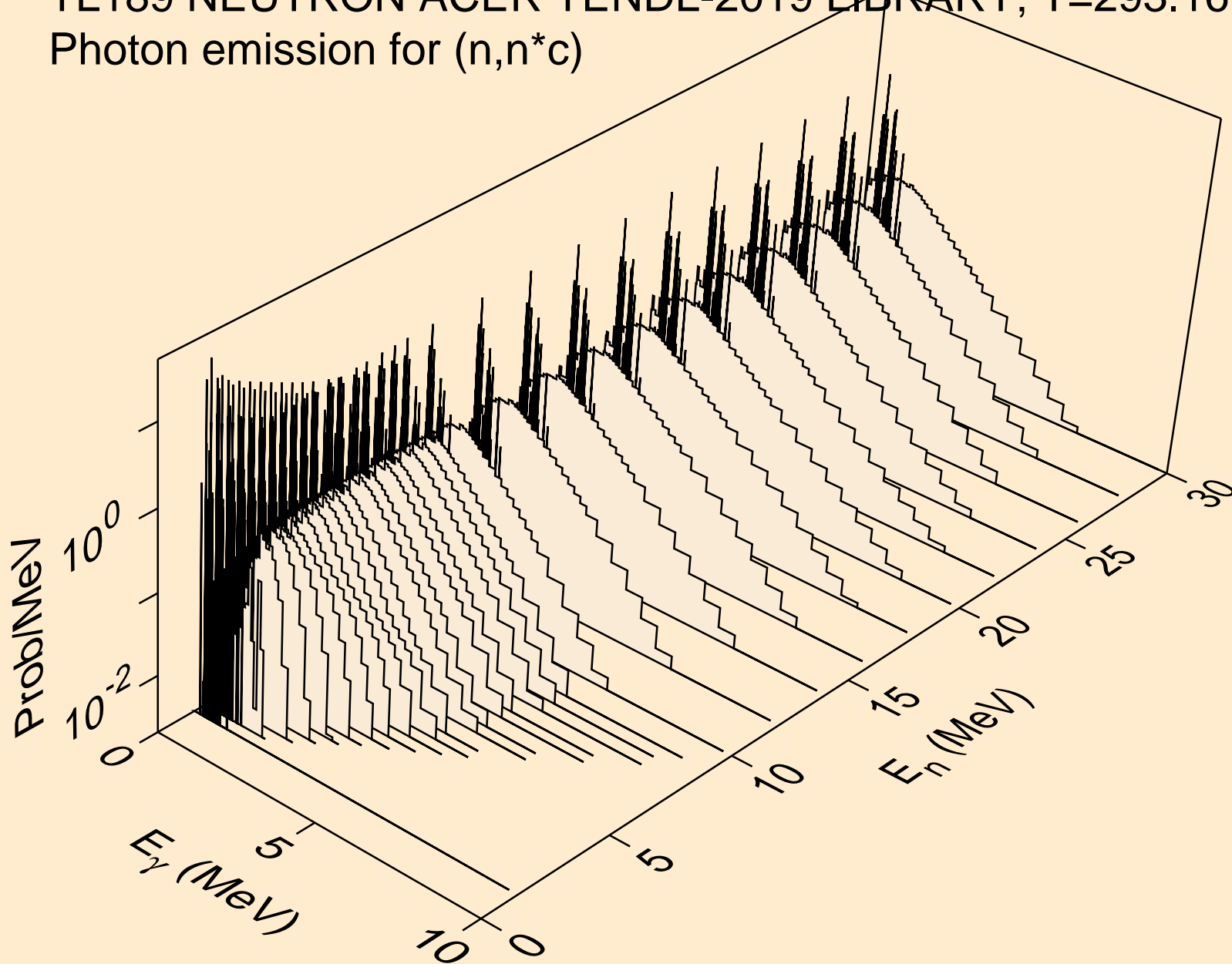

TL189 NEUTRON ACER TENDL-2019 LIBRARY; T=293.16K
Photon emission for (n,gma)

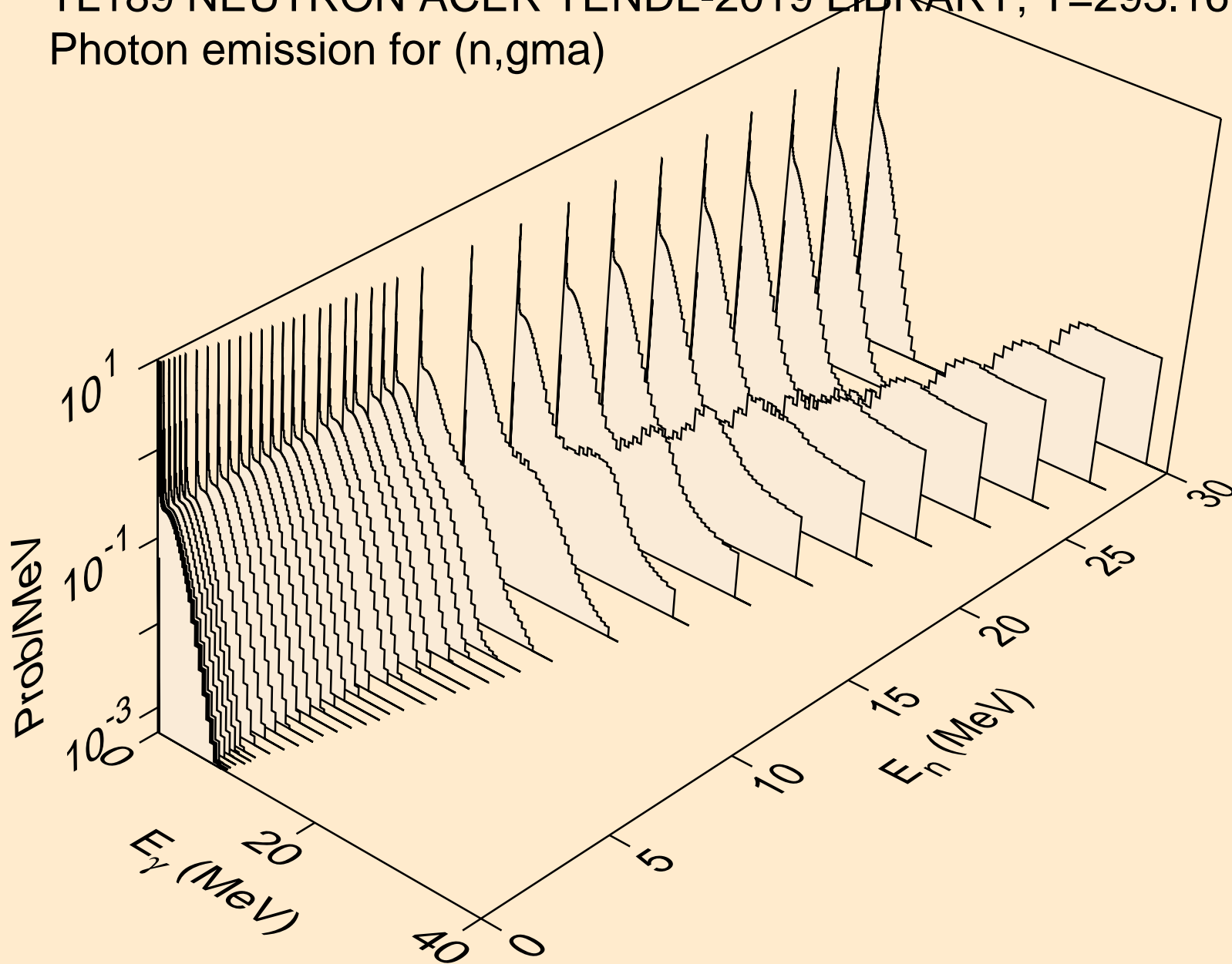

TL189 NEUTRON ACER TENDL-2019 LIBRARY; T=293.16K
Photon emission for (n,p)

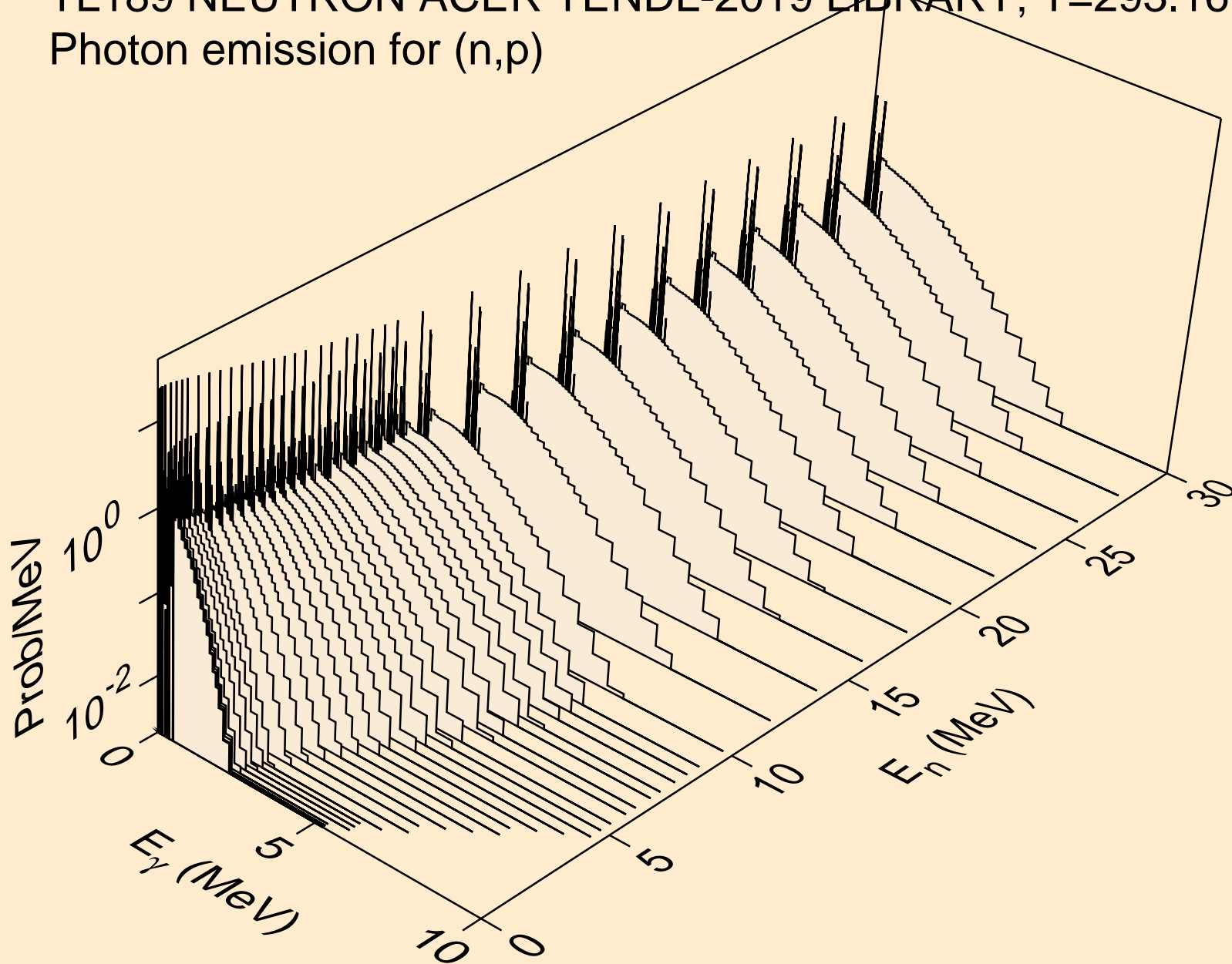

TL189 NEUTRON ACER TENDL-2019 LIBRARY; T=293.16K
Photon emission for (n,d)

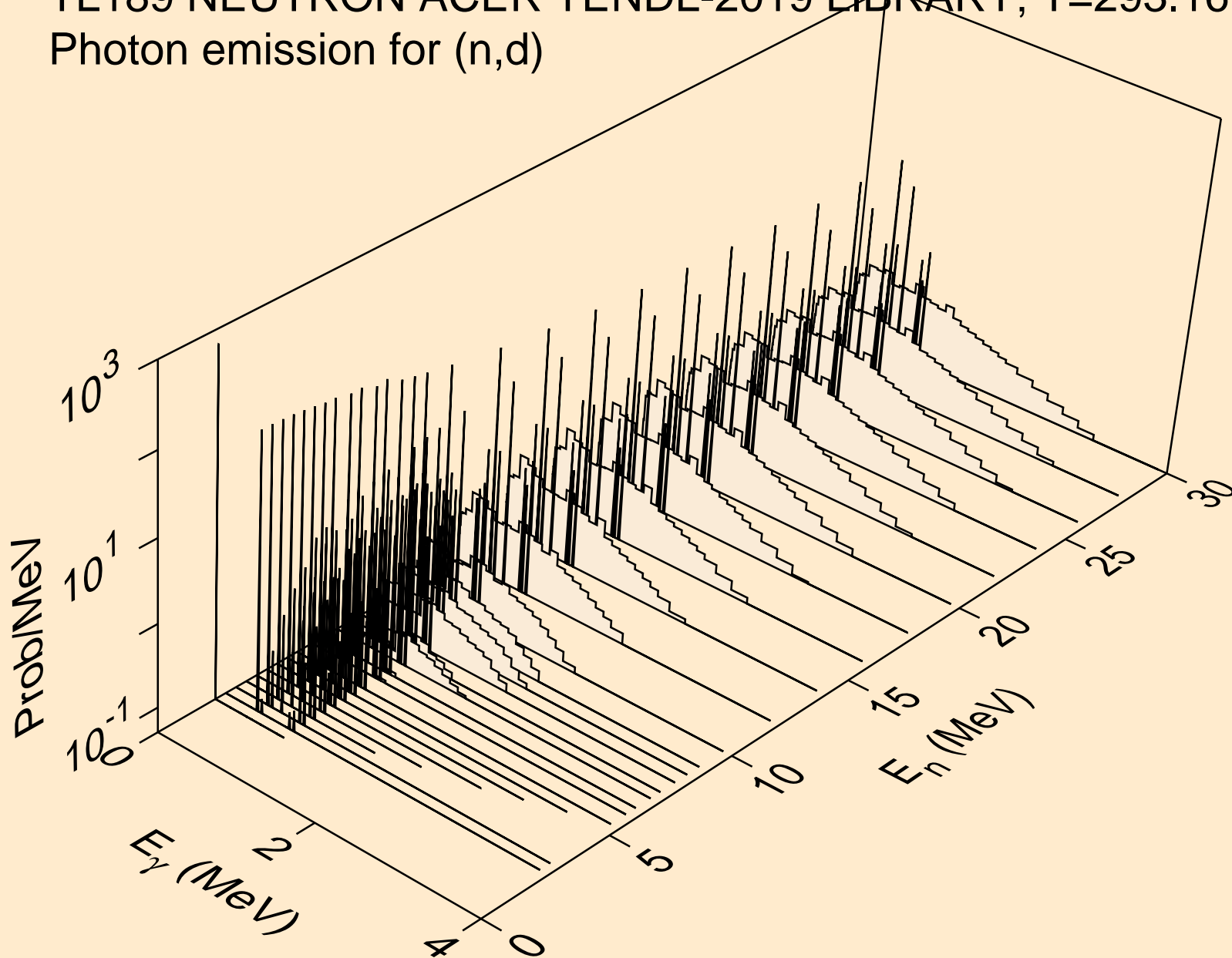

TL189 NEUTRON ACER TENDL-2019 LIBRARY; T=293.16K
Photon emission for (n,t)

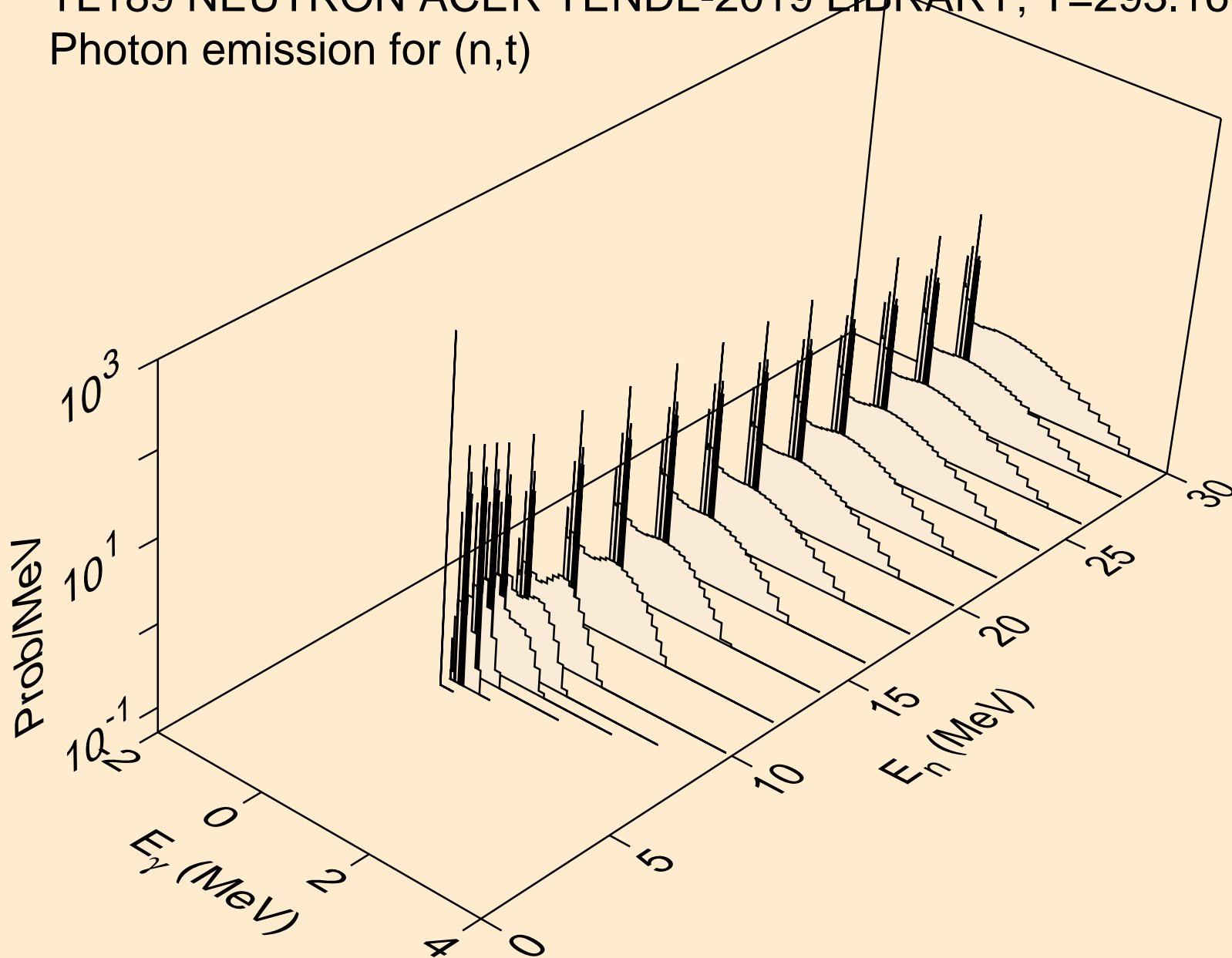

TL189 NEUTRON ACER TENDL-2019 LIBRARY; T=293.16K
Photon emission for (n,he3)

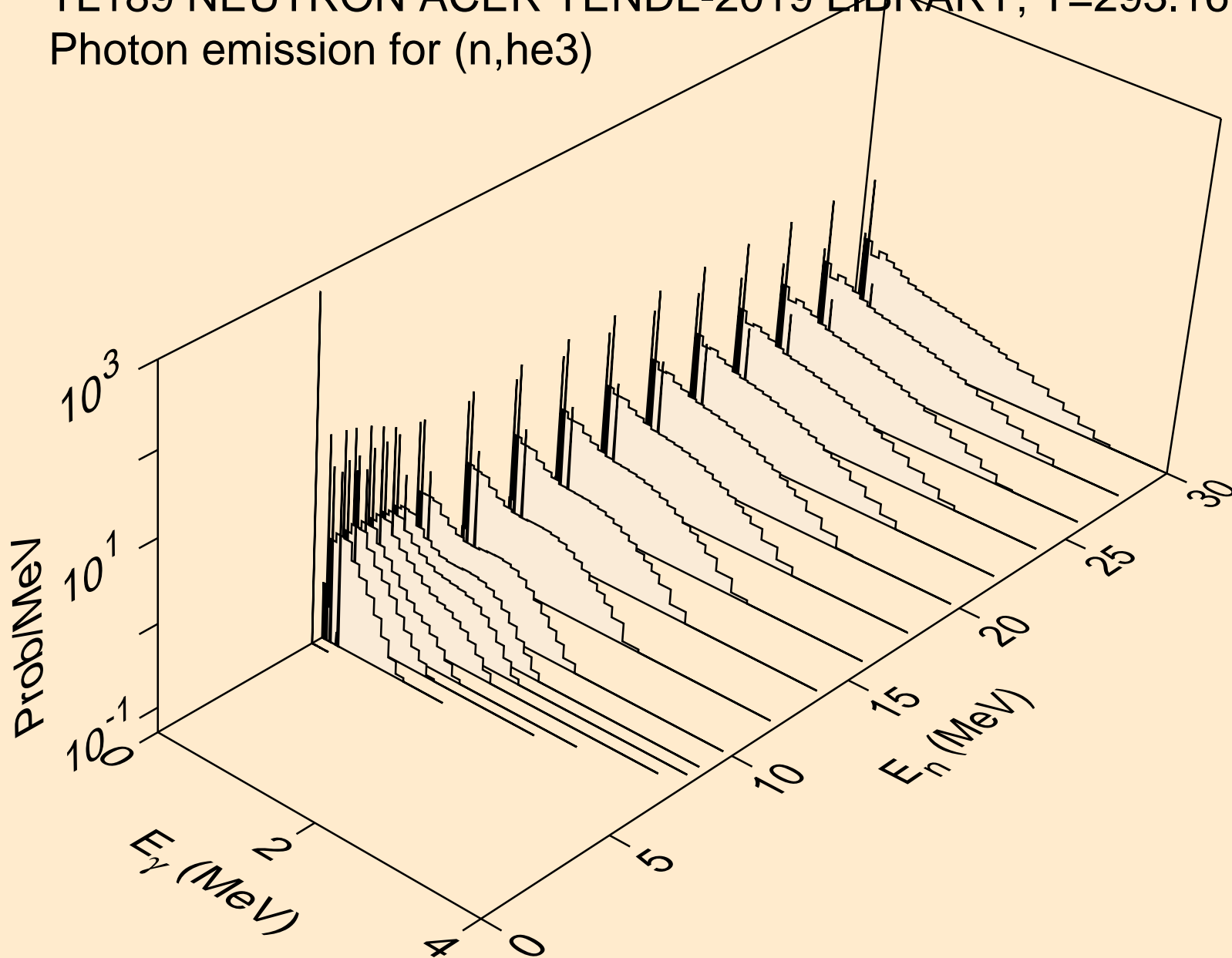

TL189 NEUTRON ACER TENDL-2019 LIBRARY; T=293.16K
Photon emission for (n,a)

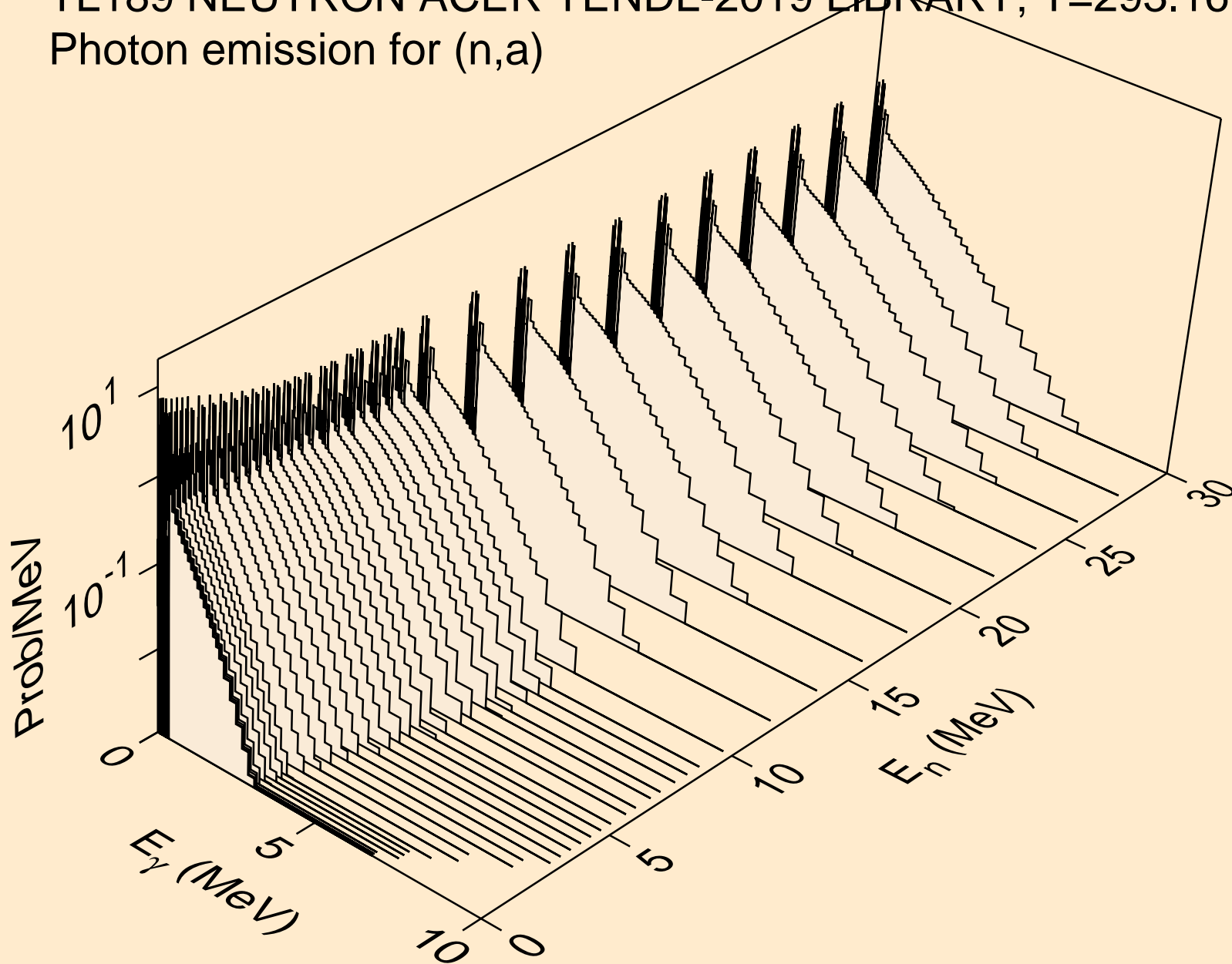

TL189 NEUTRON ACER TENDL-2019 LIBRARY; T=293.16K
Photon emission for (n,2a)

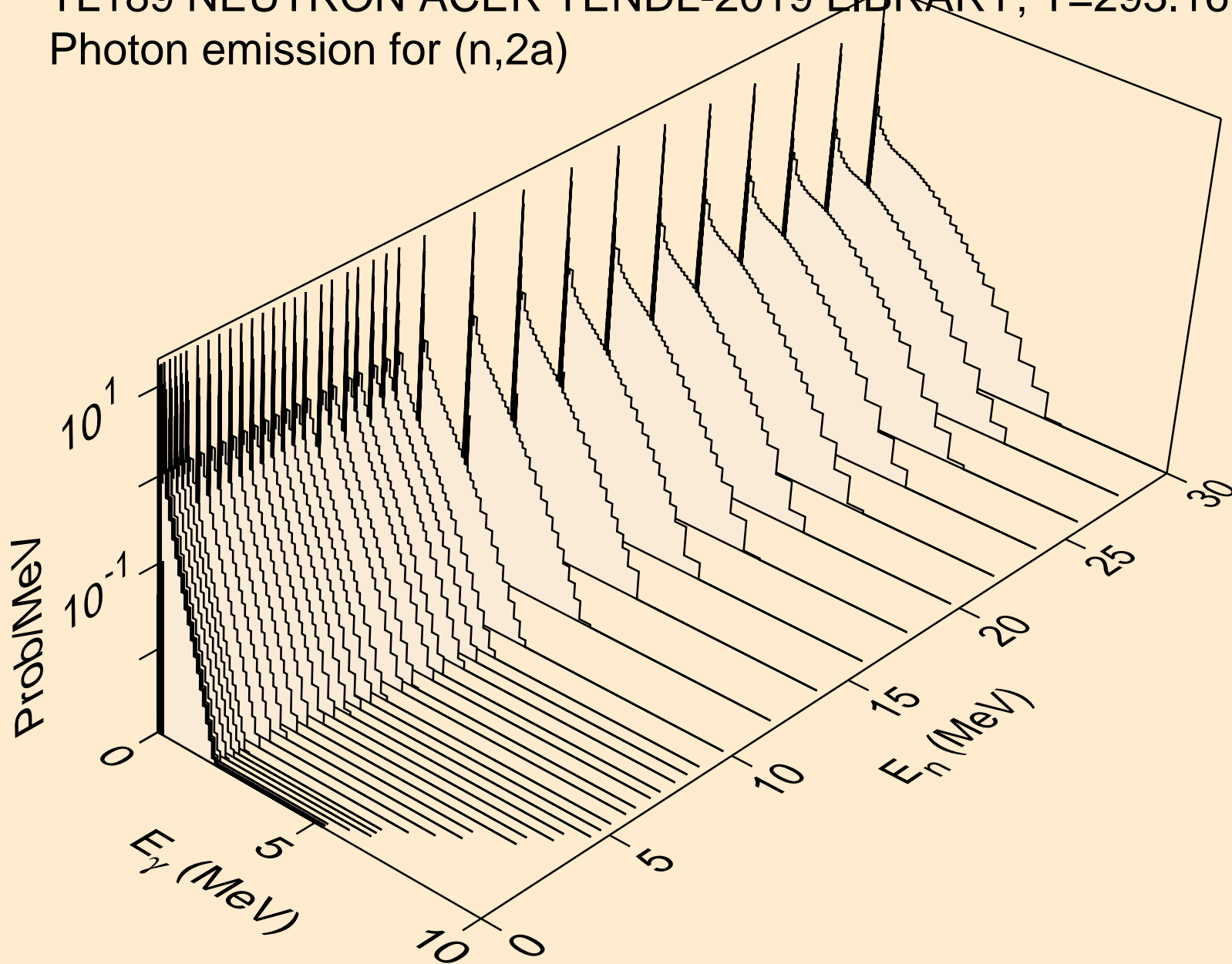

TL189 NEUTRON ACER TENDL-2019 LIBRARY; T=293.16K
Photon emission for (n,2p)

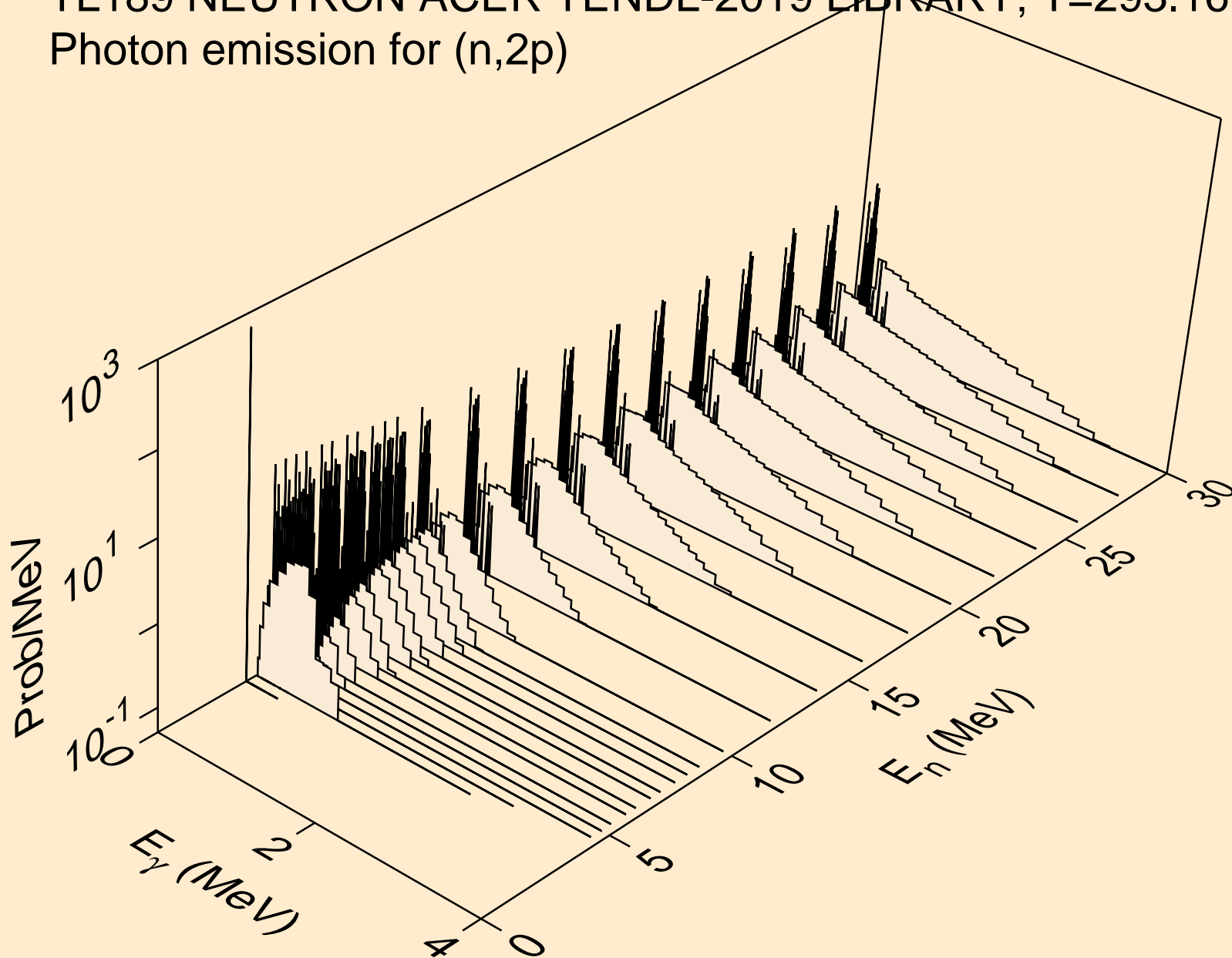

TL189 NEUTRON ACER TENDL-2019 LIBRARY; T=293.16K
Photon emission for (n,p α)

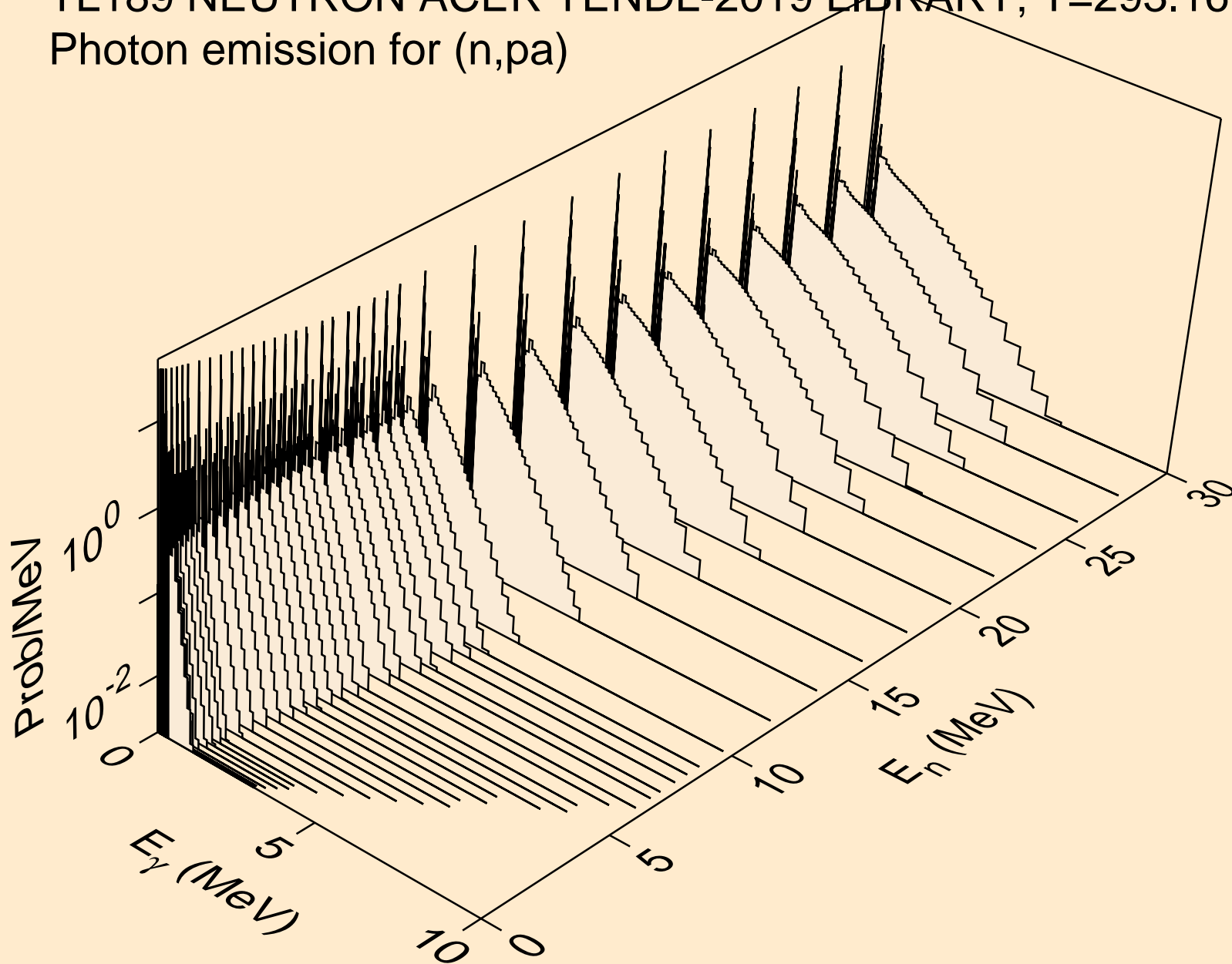

TL189 NEUTRON ACER TENDL-2019 LIBRARY; T=293.16K
Photon emission for (n,pd)

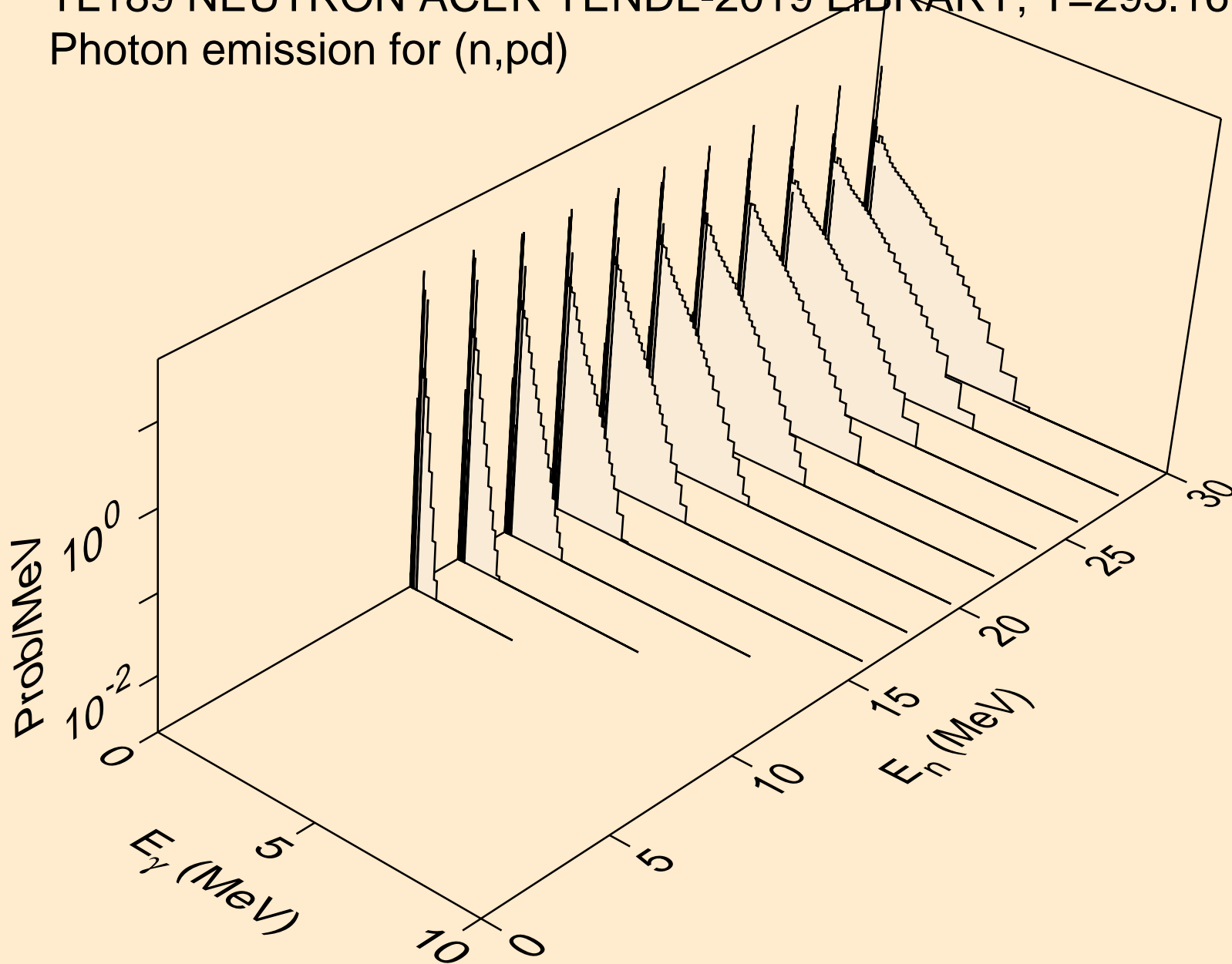

TL189 NEUTRON ACER TENDL-2019 LIBRARY; T=293.16K
Photon emission for (n,pt)

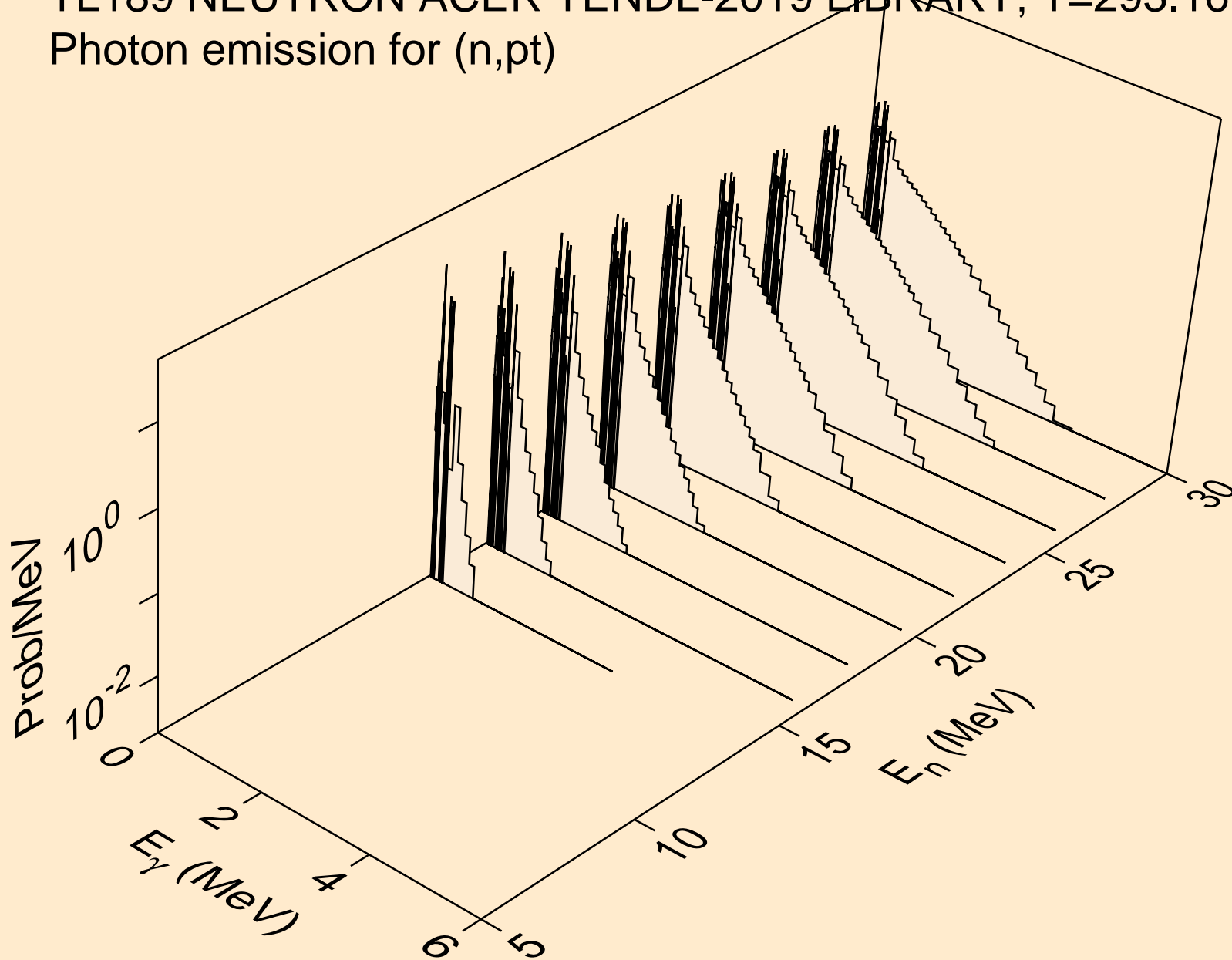

TL189 NEUTRON ACER TENDL-2019 LIBRARY; T=293.16K
Photon emission for (n,da)

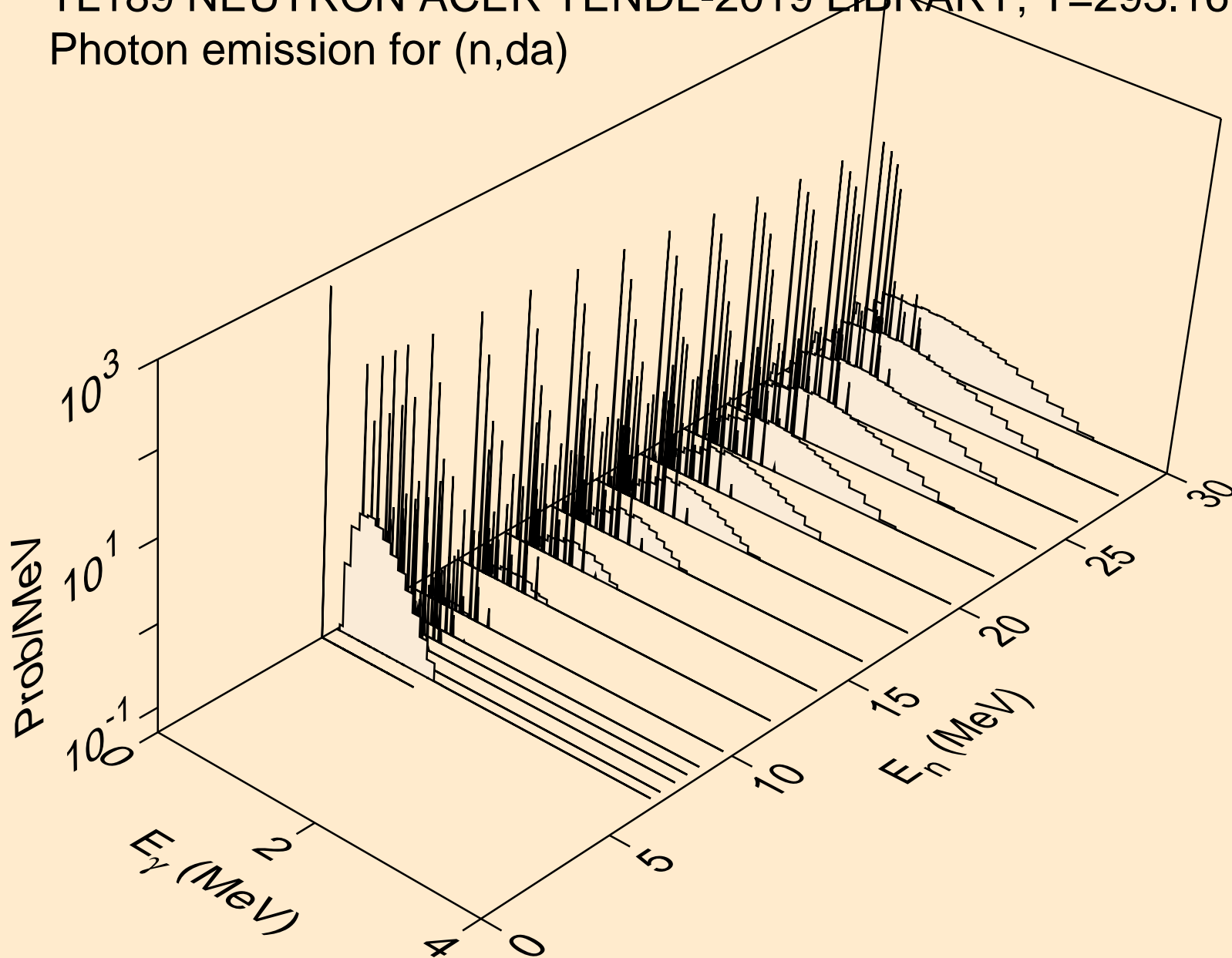

TL189 NEUTRON ACER TENDL-2019 LIBRARY; T=293.16K
thermal capture photon spectrum

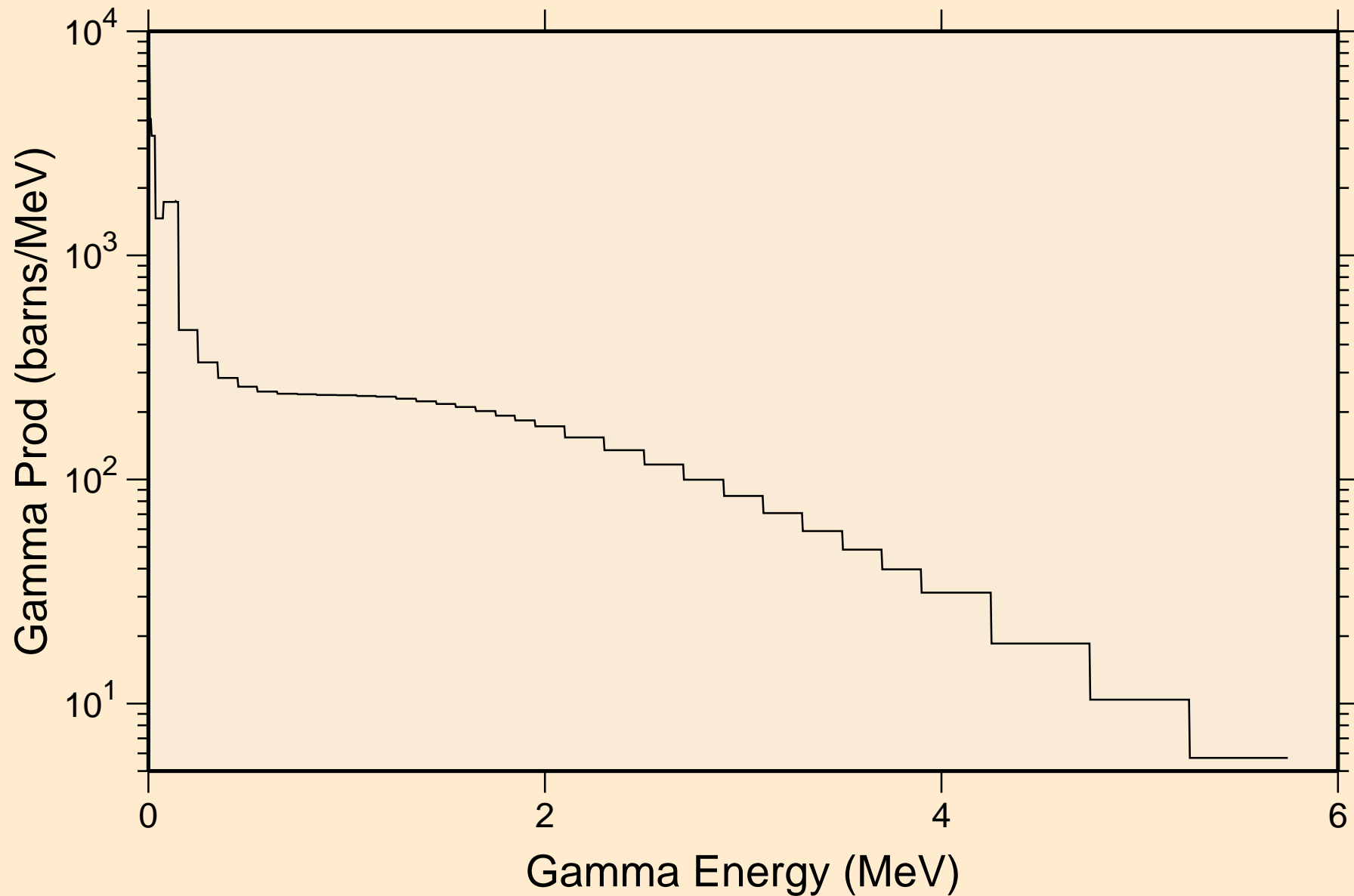

TL189 NEUTRON ACER TENDL-2019 LIBRARY; T=293.16K
14 MeV photon spectrum

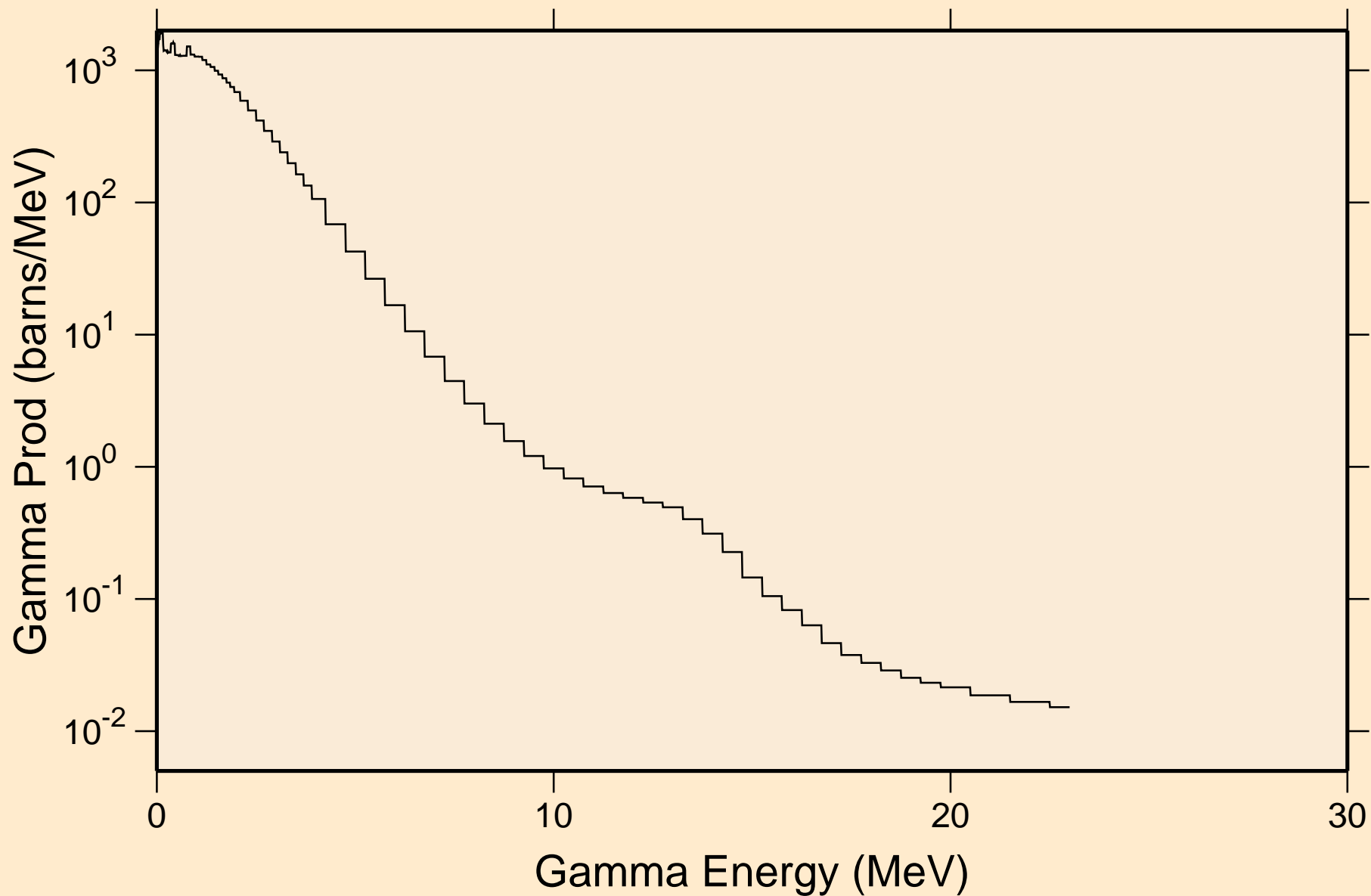

TL189 NEUTRON ACER TENDL-2019 LIBRARY; T=293.16K
Particle heating contributions

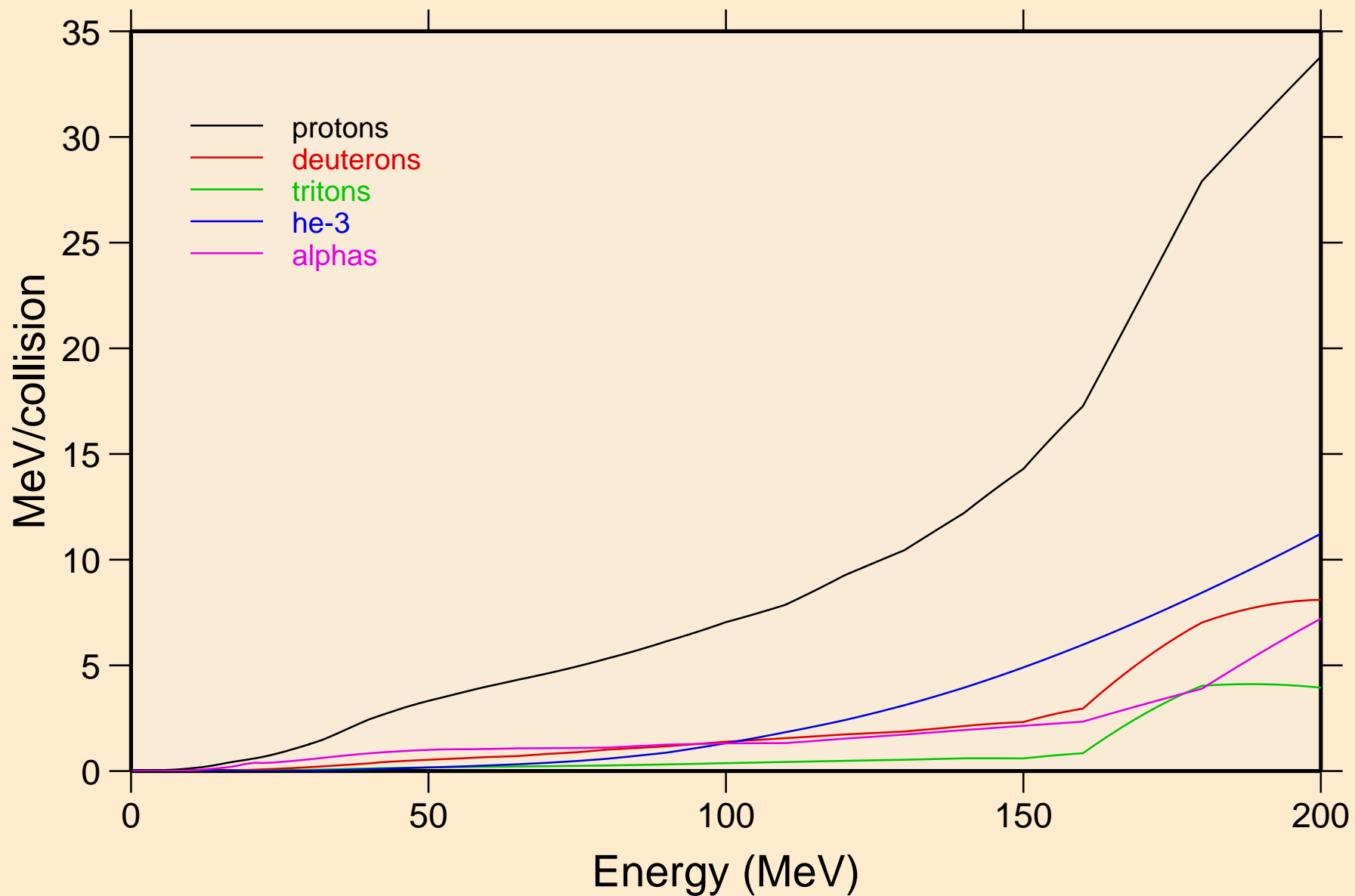

TL189 NEUTRON ACER TENDL-2019 LIBRARY; T=293.16K
Recoil Heating

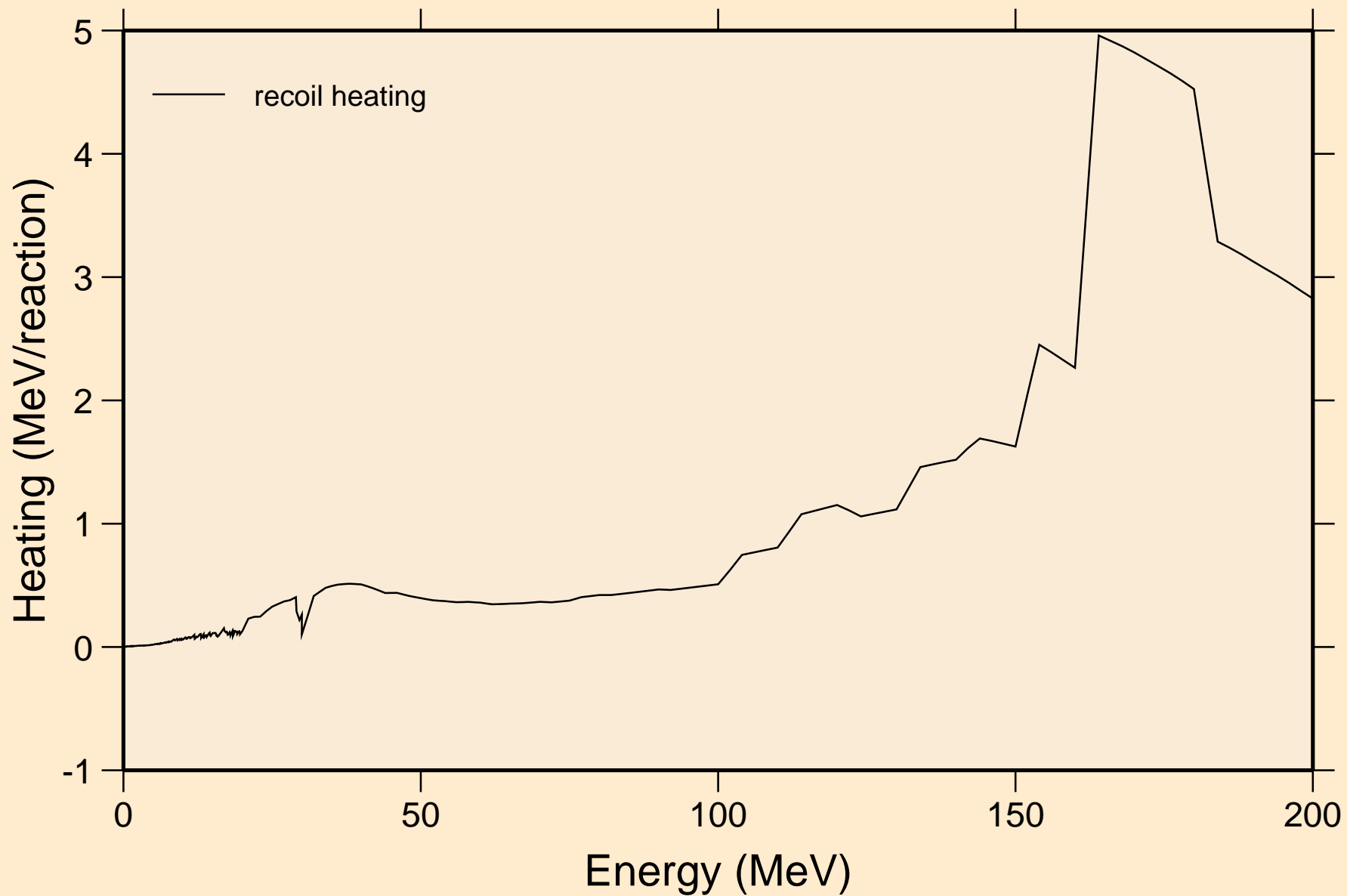

TL189 NEUTRON ACER TENDL-2019 LIBRARY; T=293.16K
Particle production cross sections

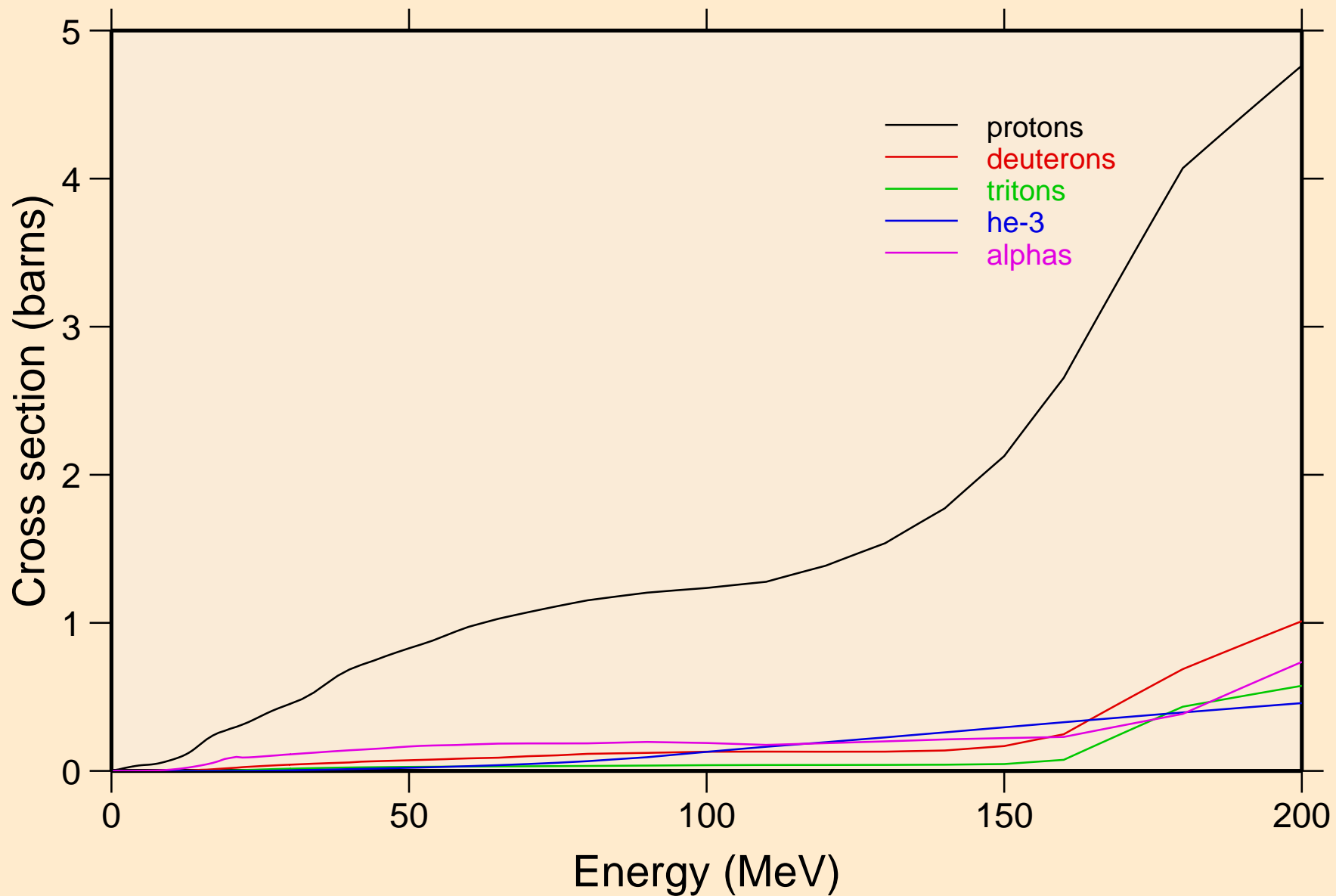

TL189 NEUTRON ACER TENDL-2019 LIBRARY; T=293.16K
protons from (n,x)

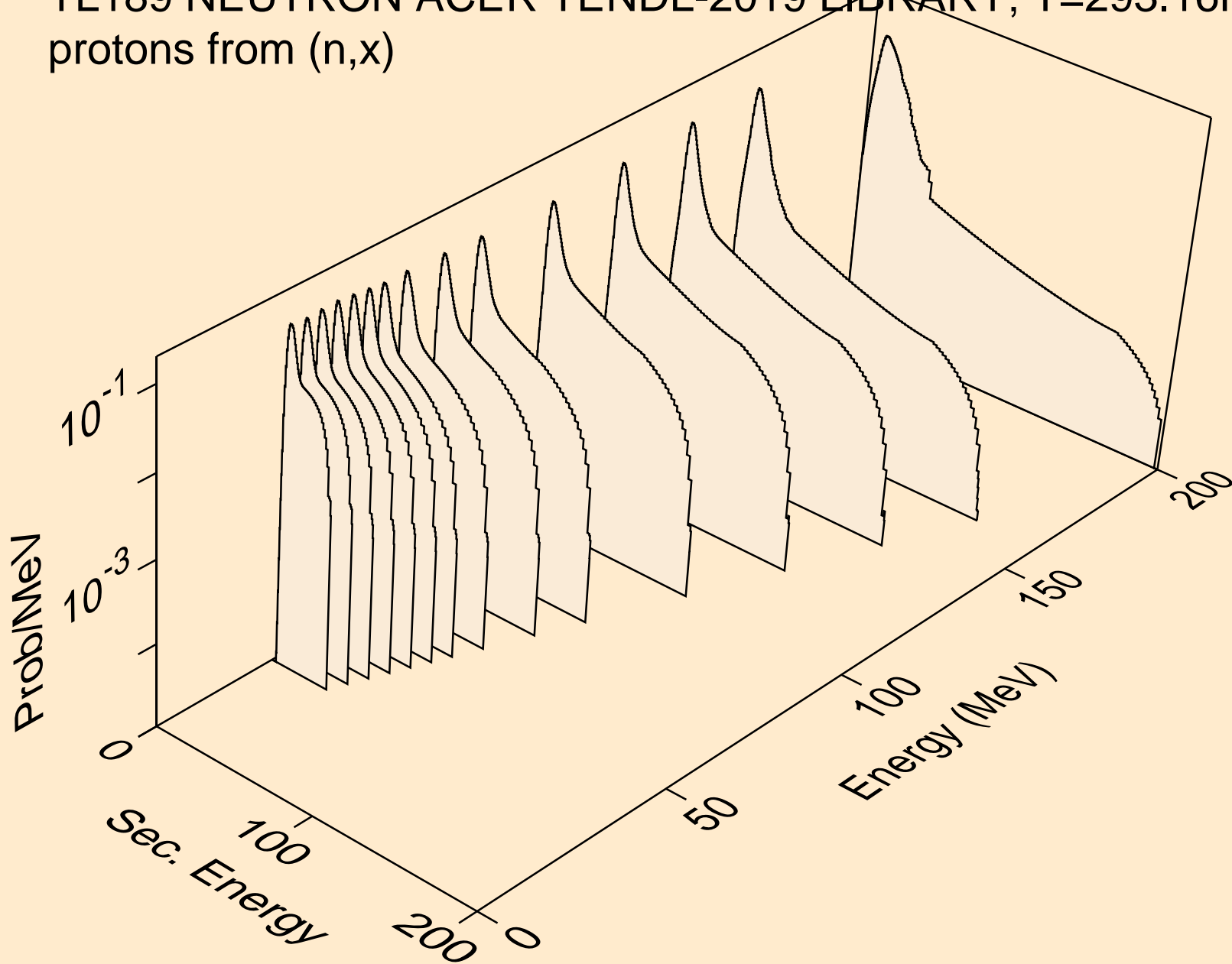

TL189 NEUTRON ACER TENDL-2019 LIBRARY; T=293.16K
protons from (n,n*)p

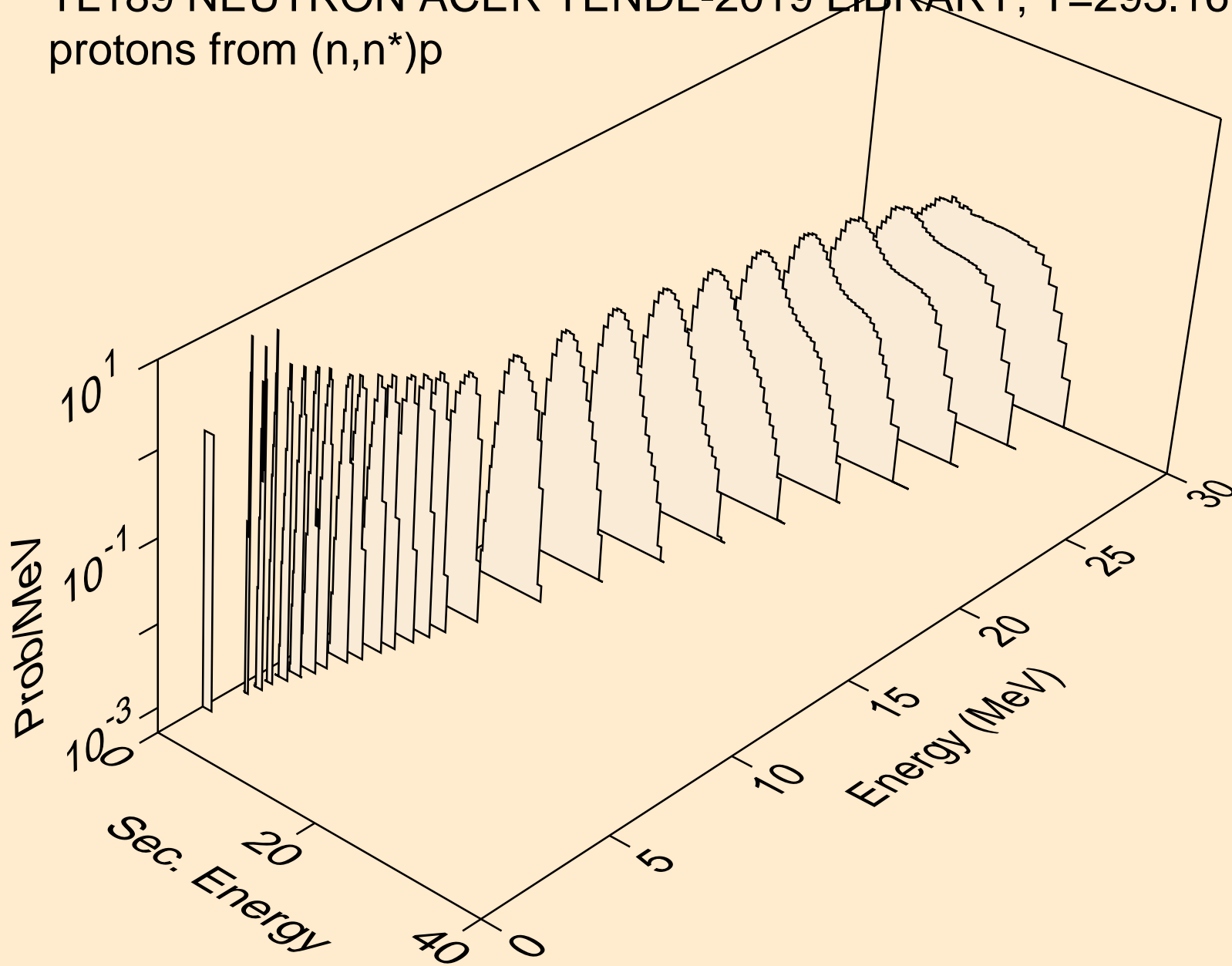

TL189 NEUTRON ACER TENDL-2019 LIBRARY; T=293.16K
protons from (n,2np)

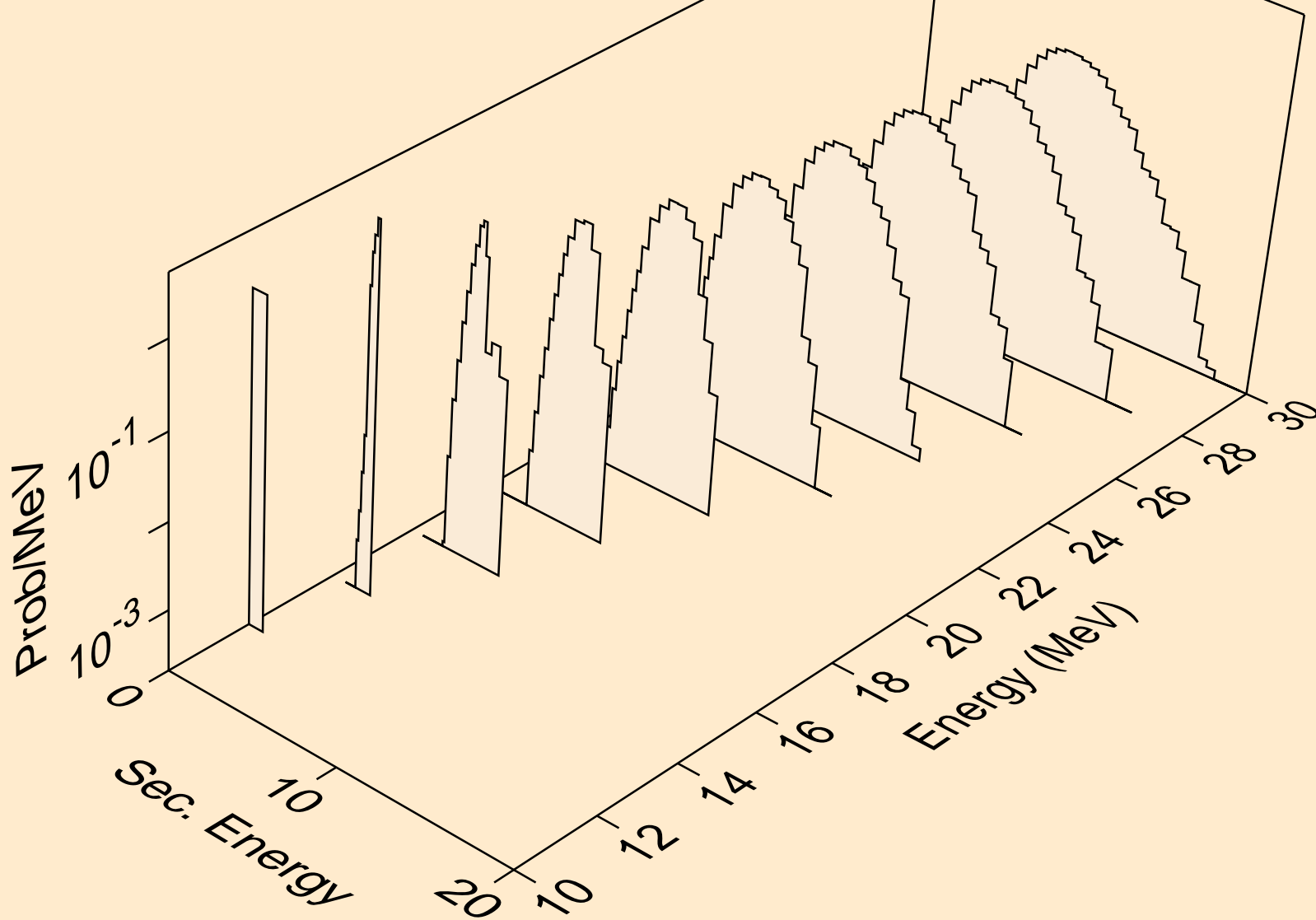

TL189 NEUTRON ACER TENDL-2019 LIBRARY; T=293.16K
protons from (n,3np)

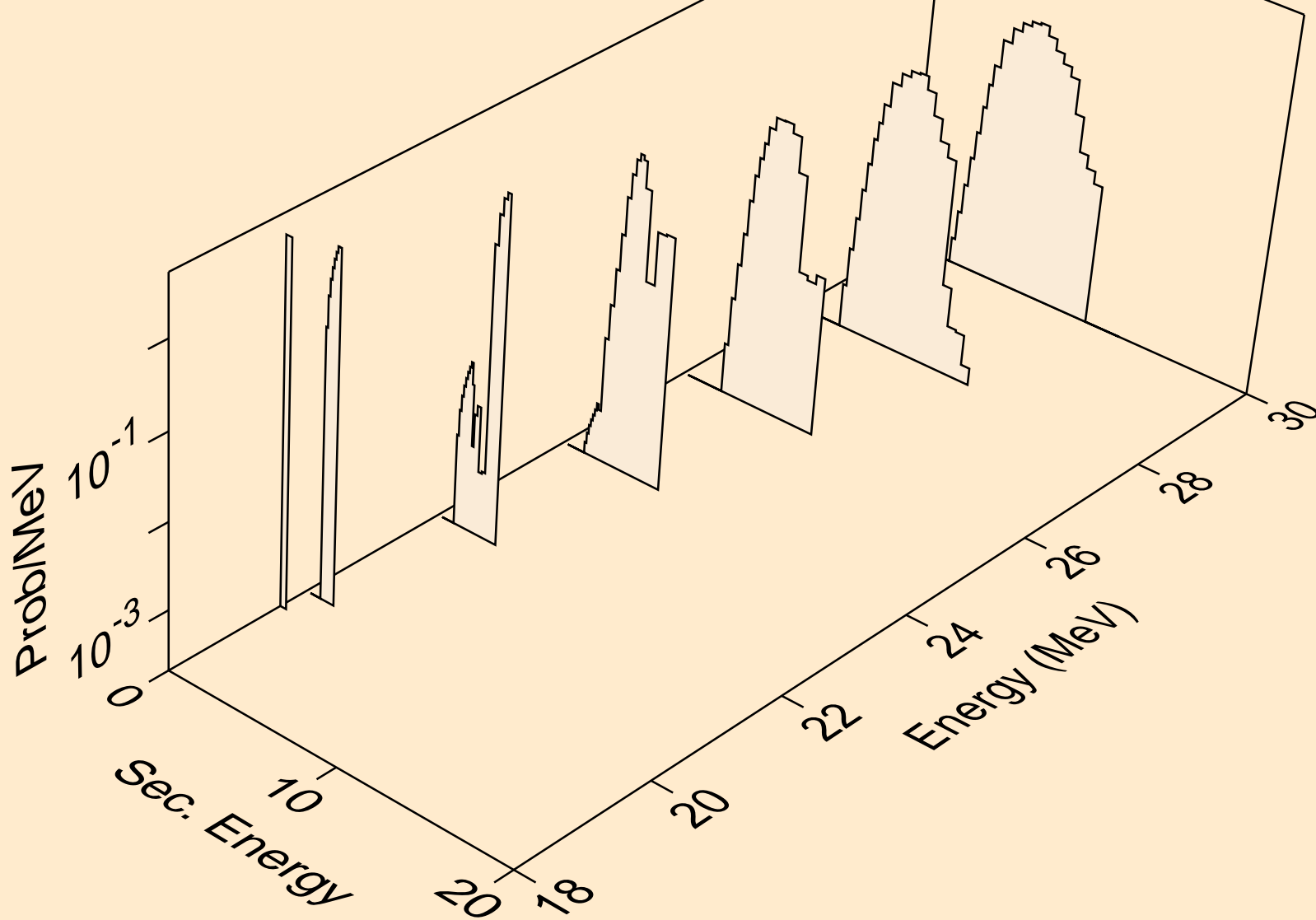

TL189 NEUTRON ACER TENDL-2019 LIBRARY; T=293.16K
protons from (n,2np)

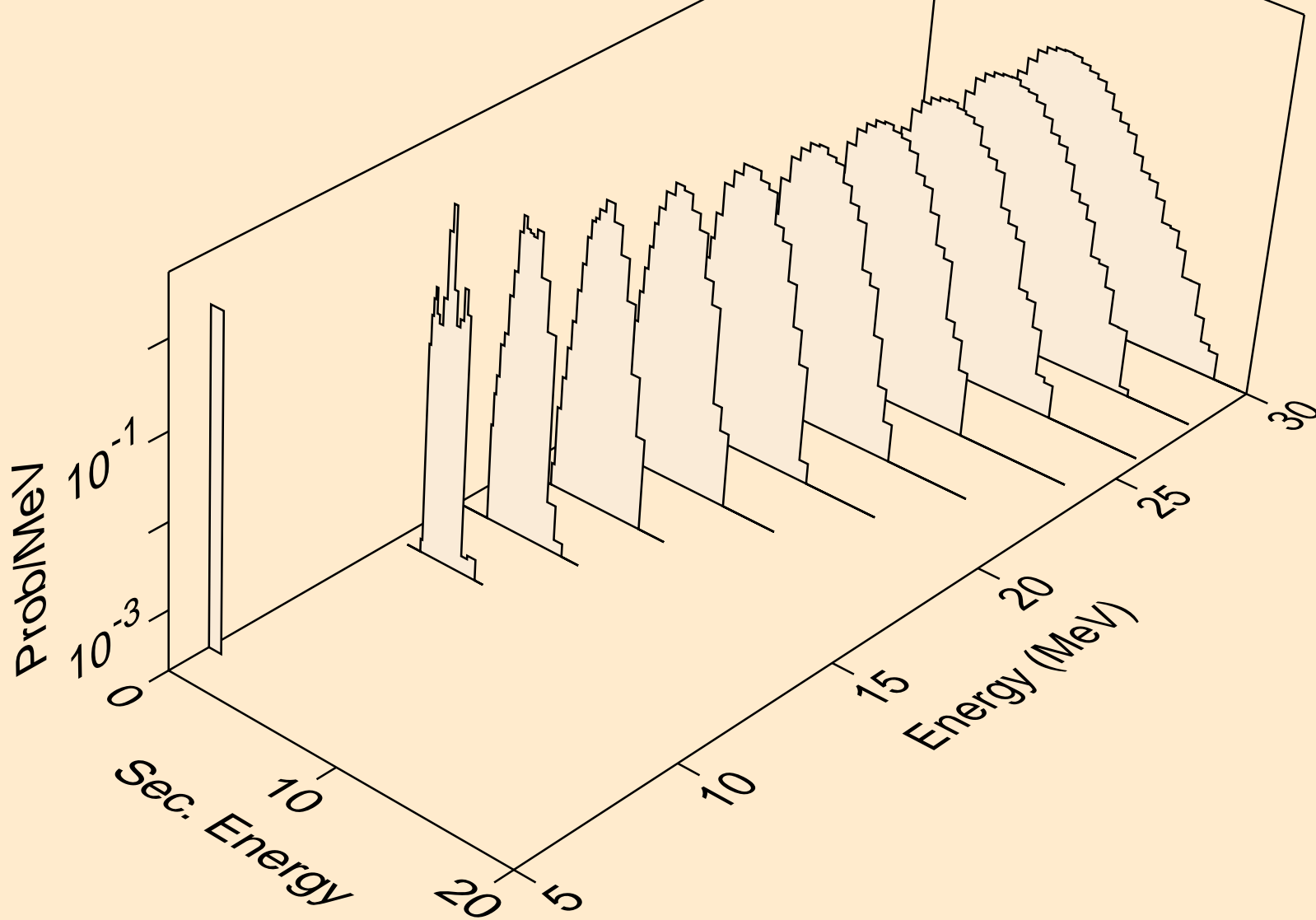

TL189 NEUTRON ACER TENDL-2019 LIBRARY; T=293.16K
protons from (n,npa)

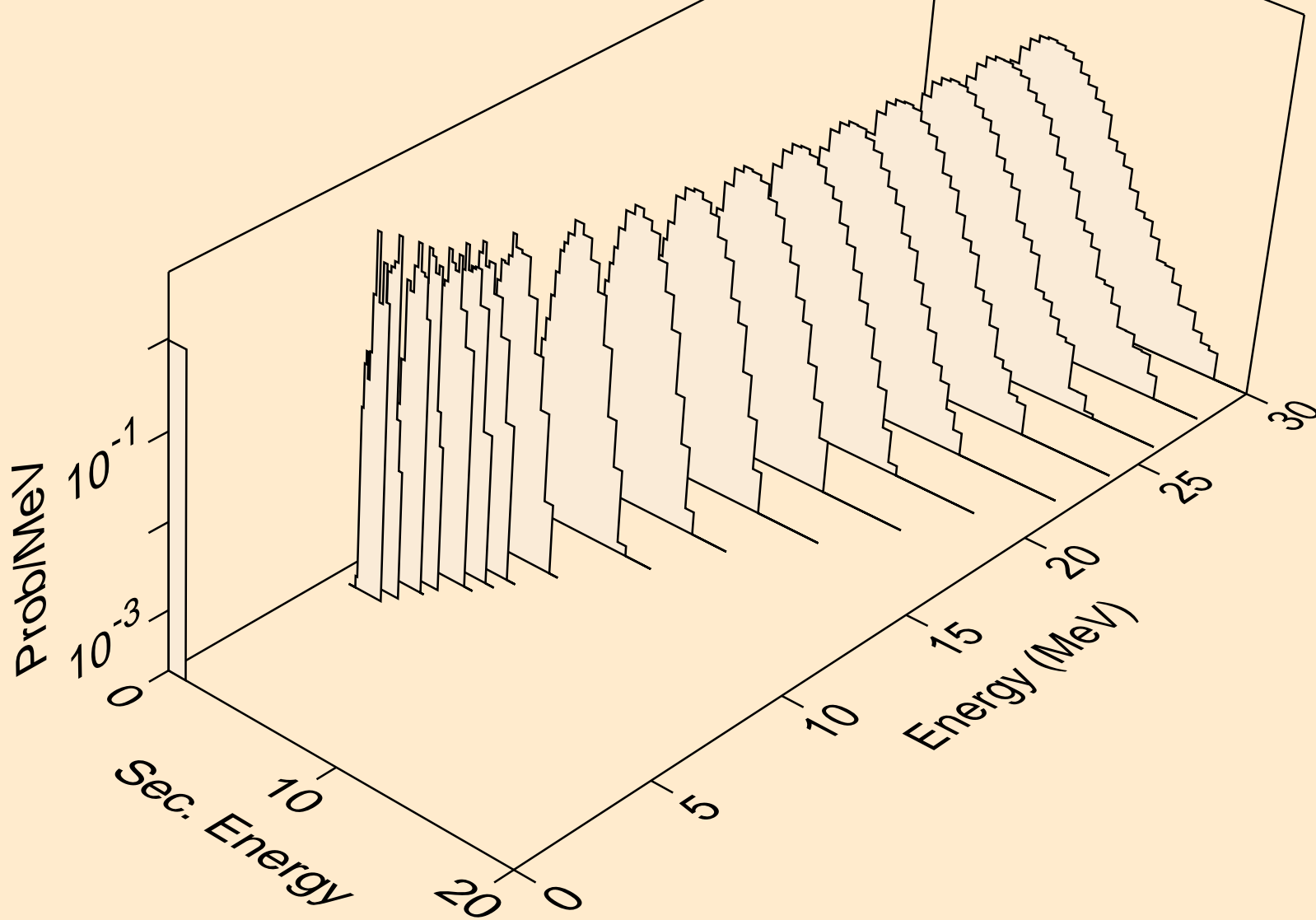

TL189 NEUTRON ACER TENDL-2019 LIBRARY; T=293.16K
protons from (n,p)

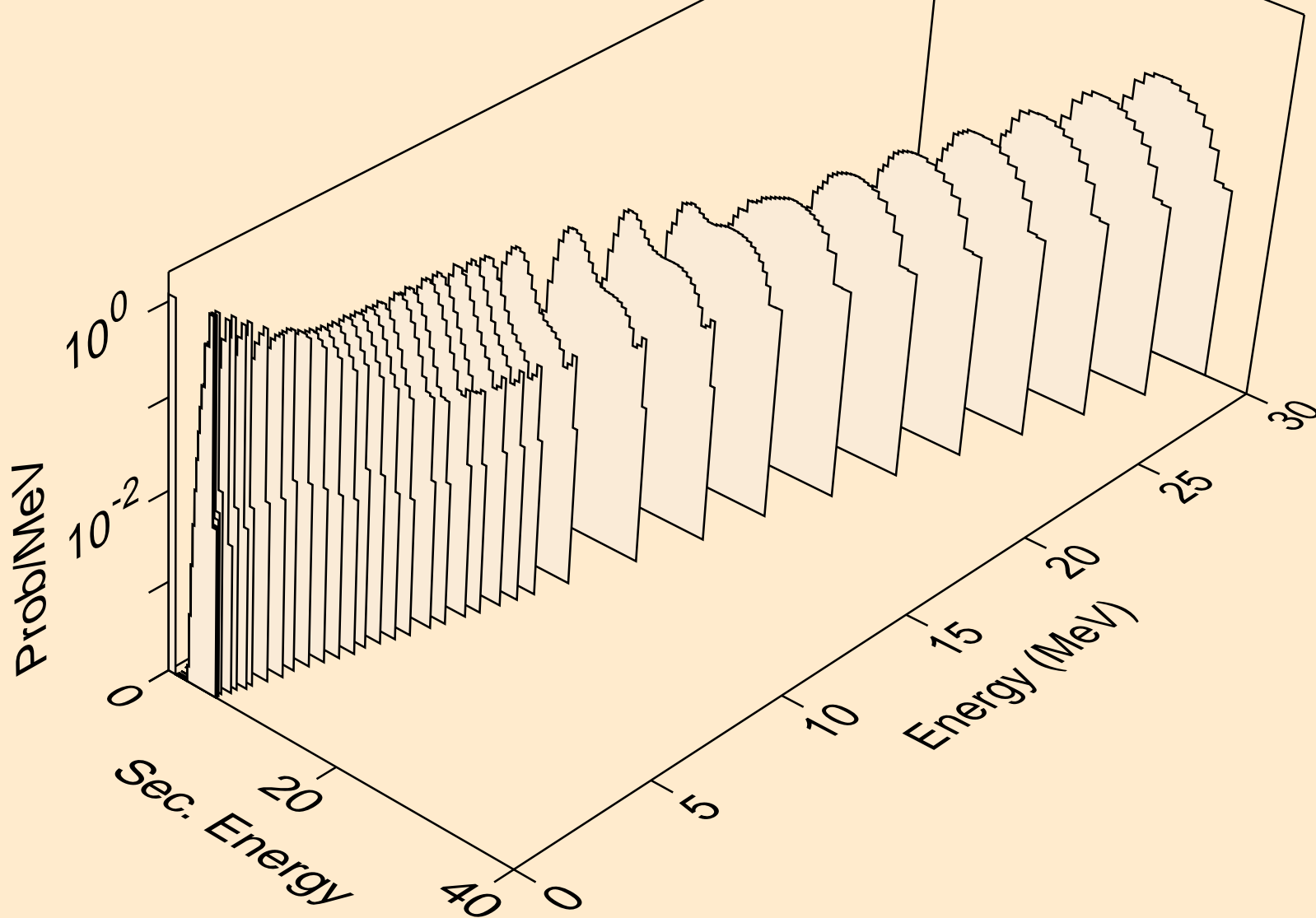

TL189 NEUTRON ACER TENDL-2019 LIBRARY; T=293.16K
protons from (n,2p)

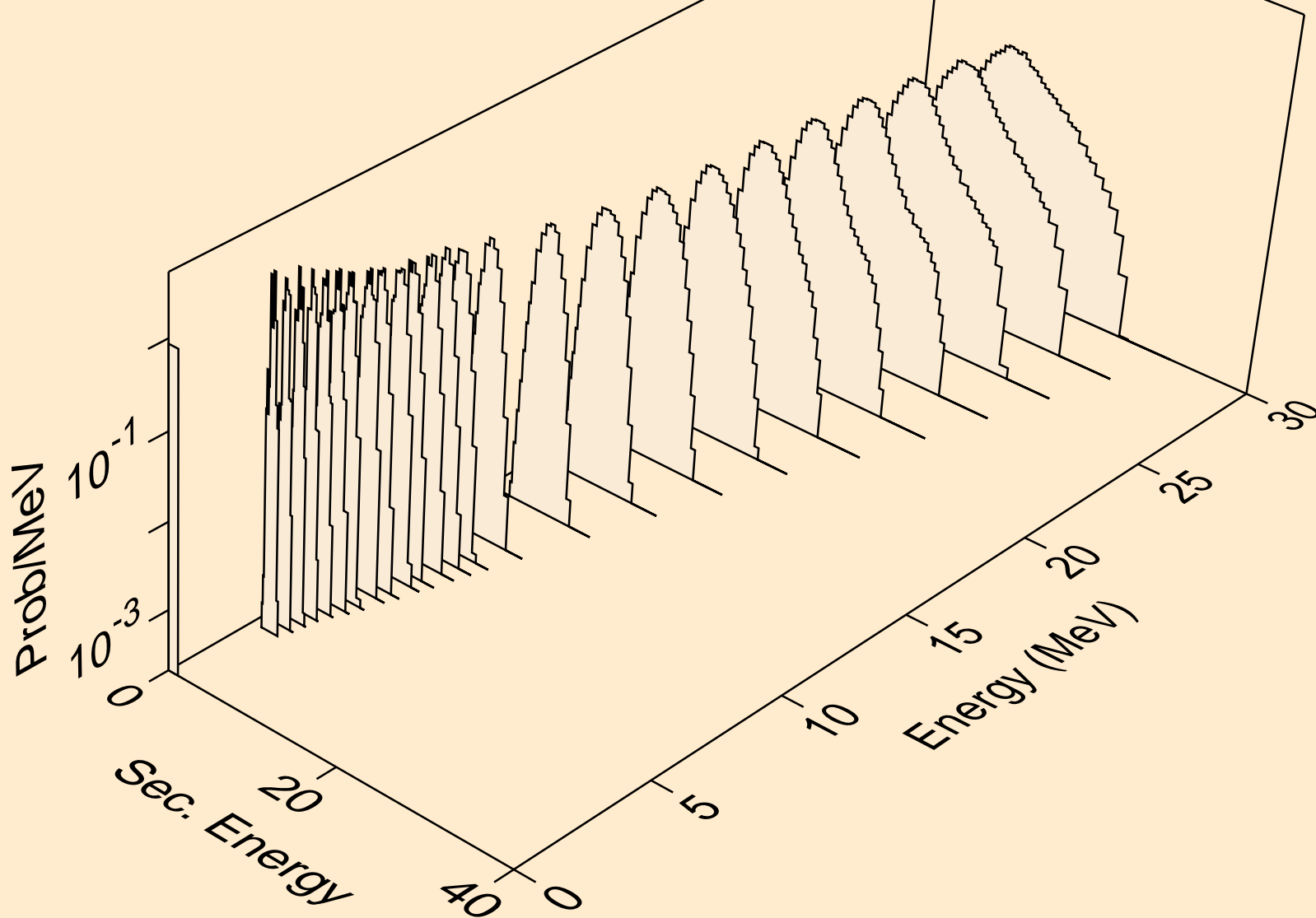

TL189 NEUTRON ACER TENDL-2019 LIBRARY; T=293.16K
protons from (n,p)

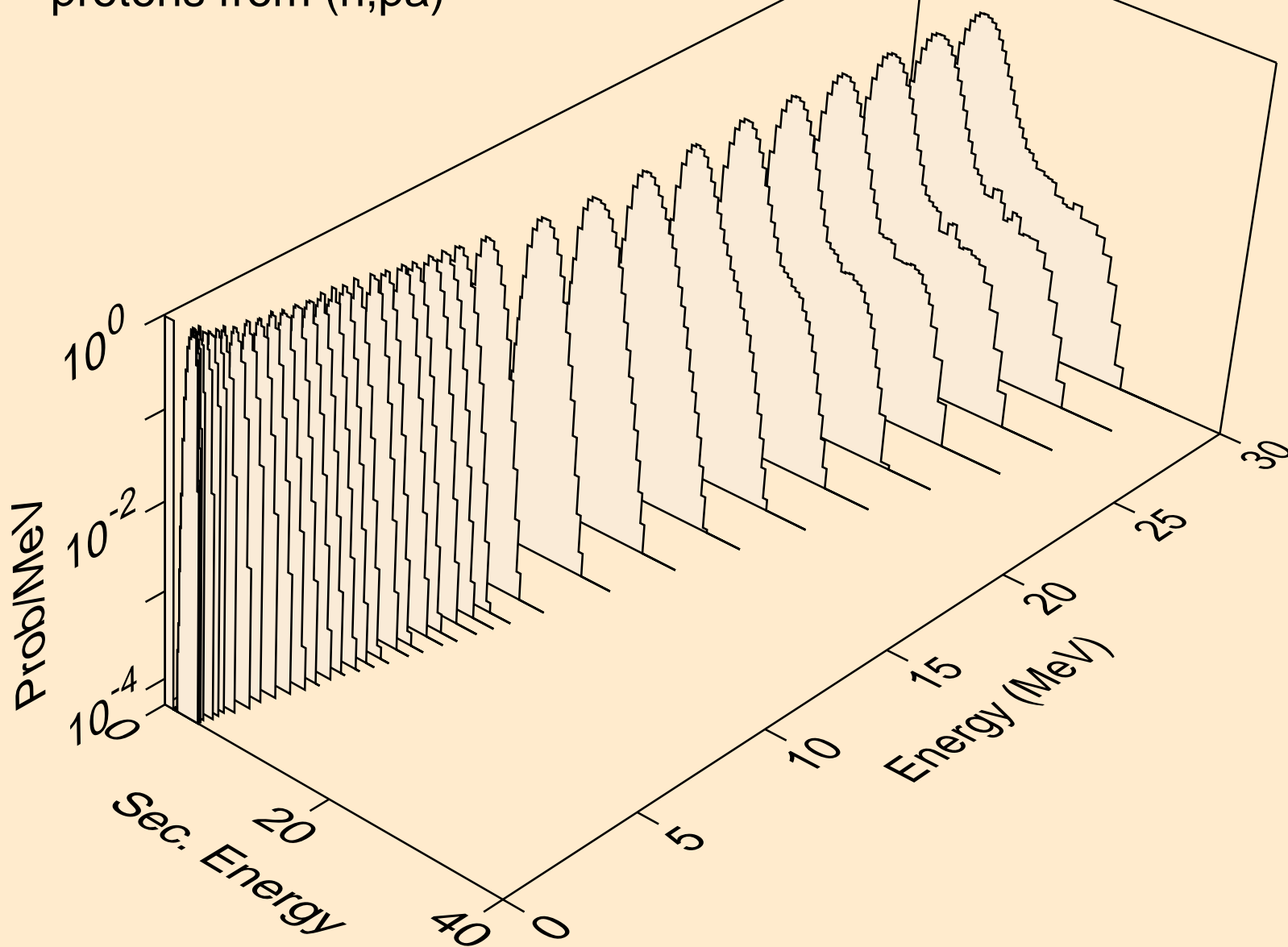

TL189 NEUTRON ACER TENDL-2019 LIBRARY; T=293.16K
protons from (n,pd)

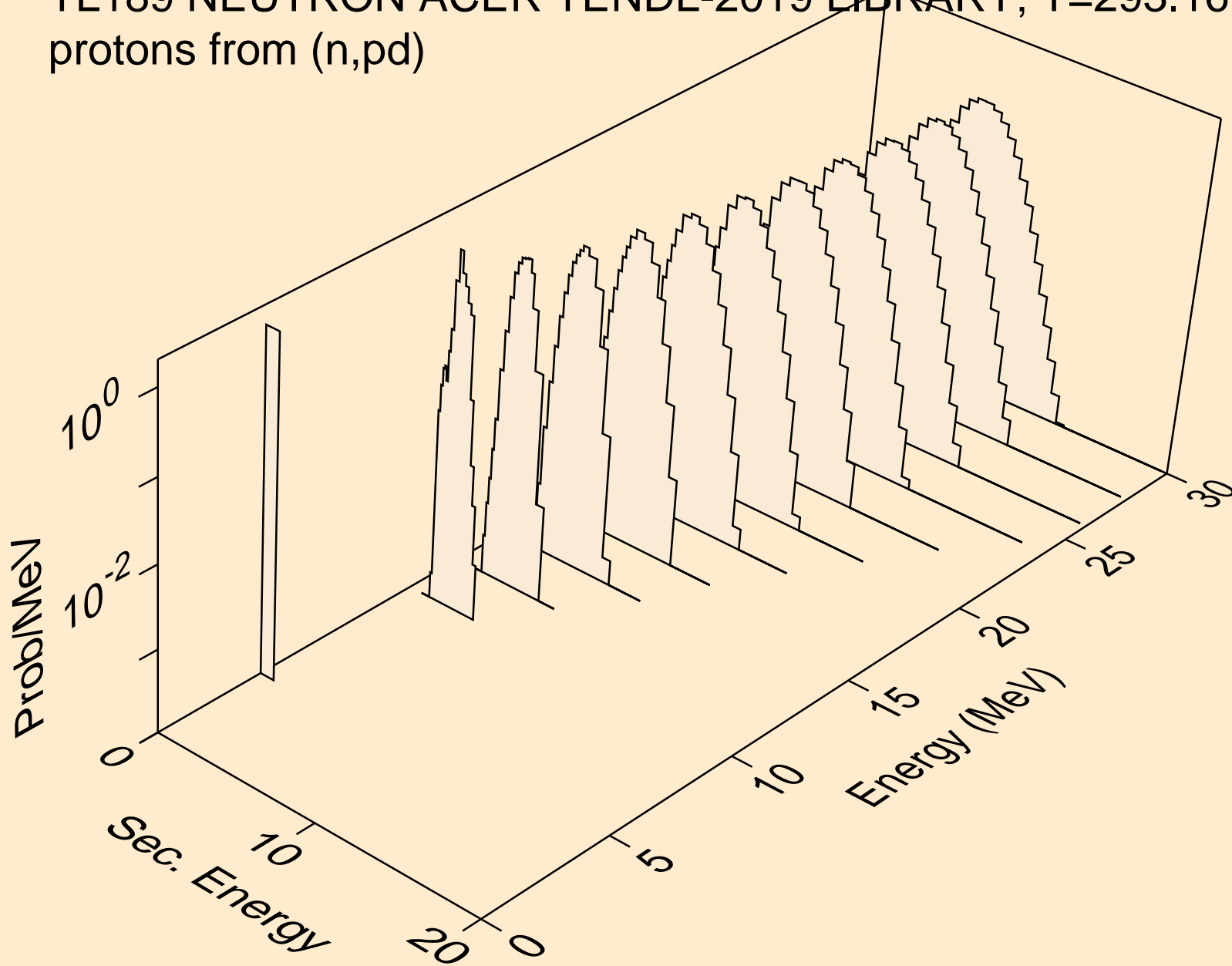

TL189 NEUTRON ACER TENDL-2019 LIBRARY; T=293.16K
protons from (n,pt)

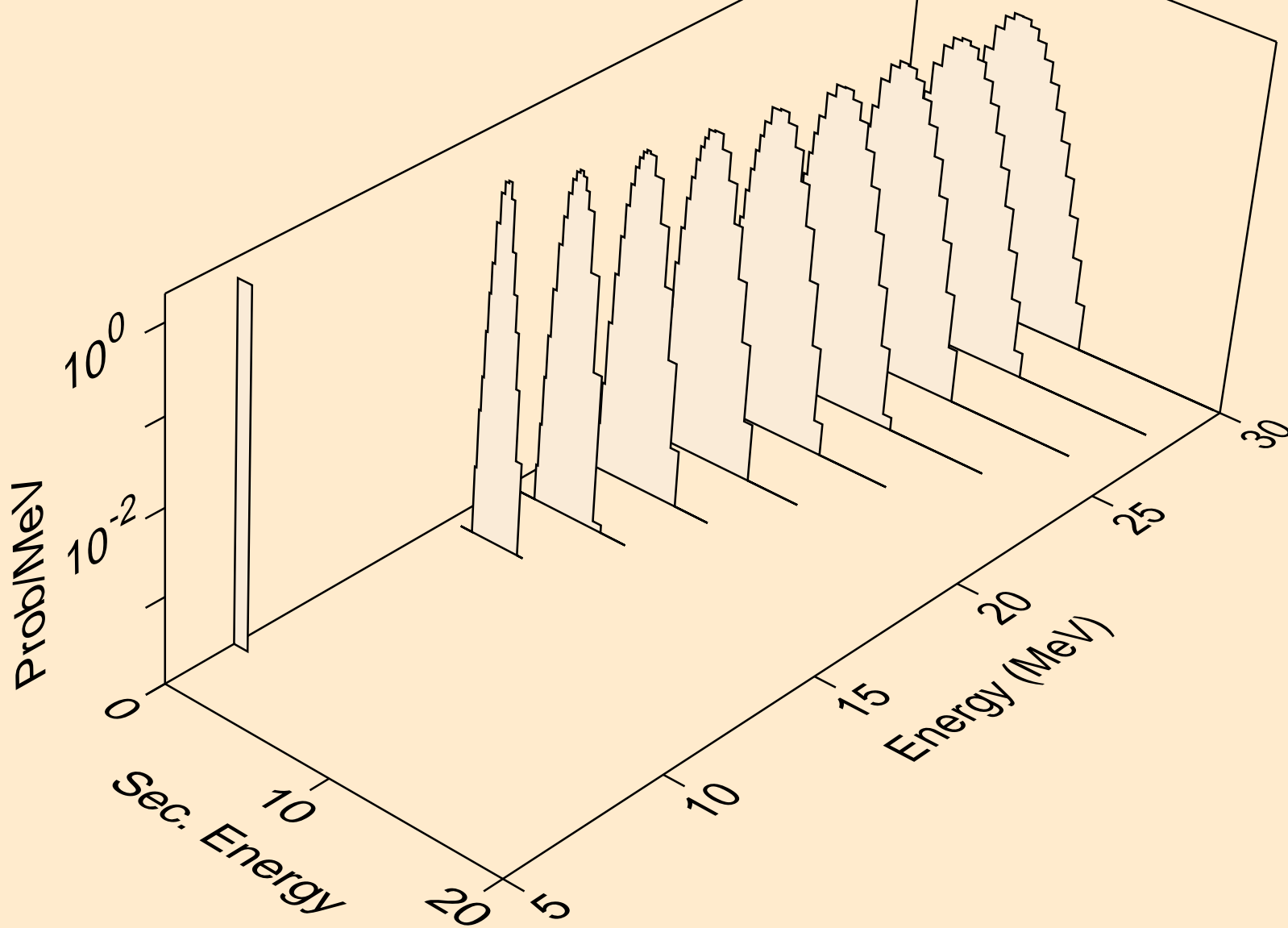

TL189 NEUTRON ACER TENDL-2019 LIBRARY; T=293.16K
deuterons from (n,x)

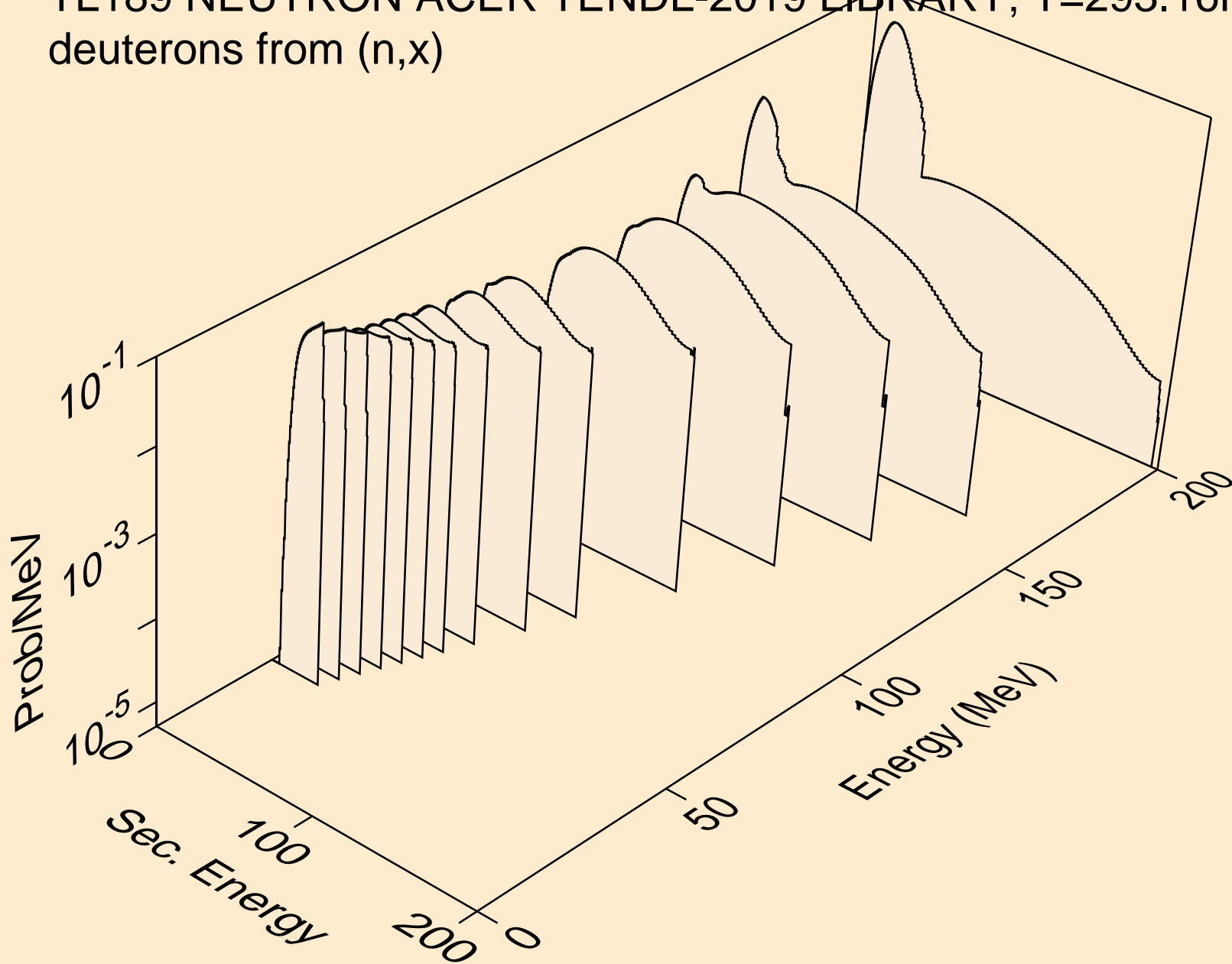

TL189 NEUTRON ACER TENDL-2019 LIBRARY; T=293.16K
deuterons from (n,2nd)

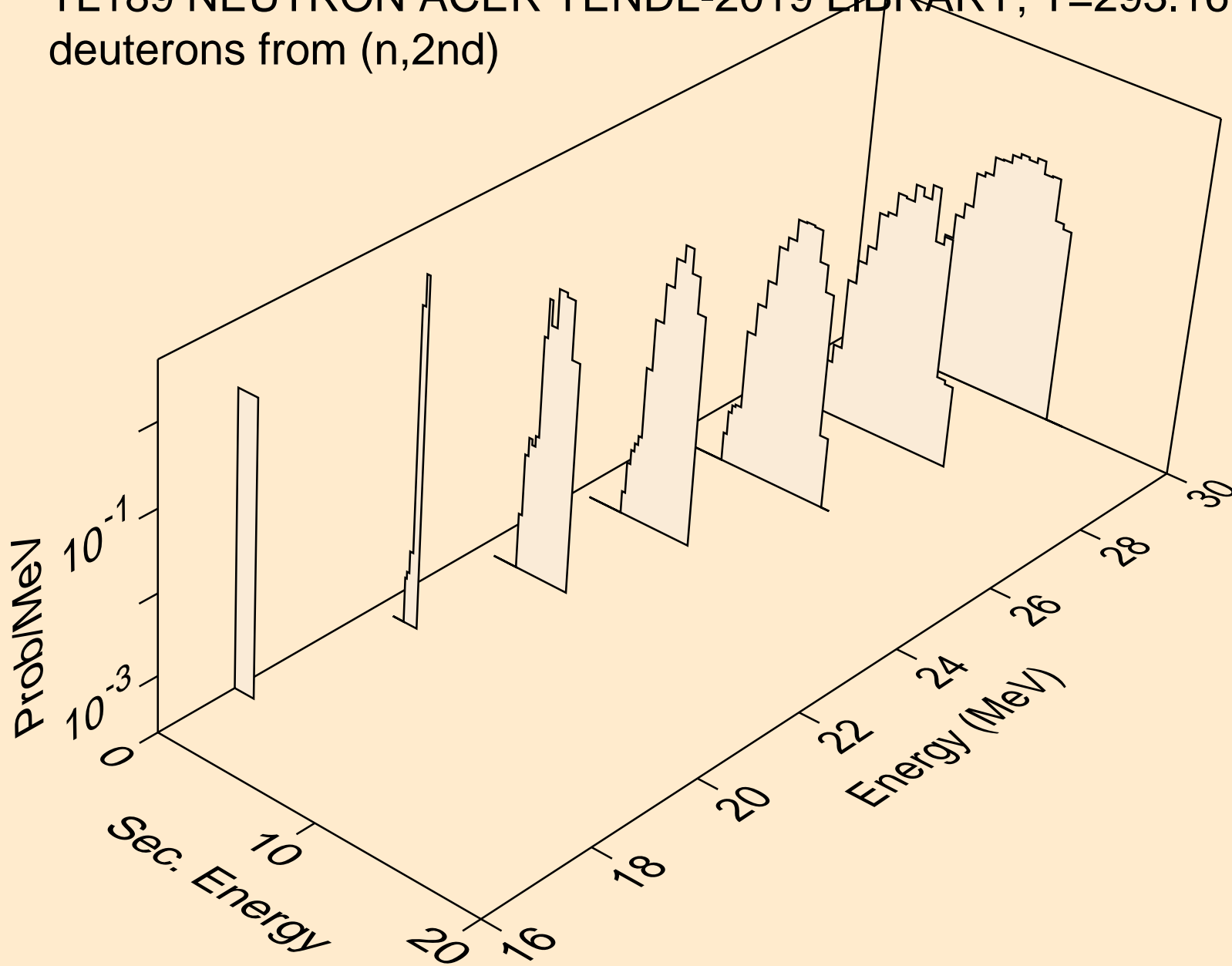

TL189 NEUTRON ACER TENDL-2019 LIBRARY; T=293.16K
deuterons from (n,n*)d

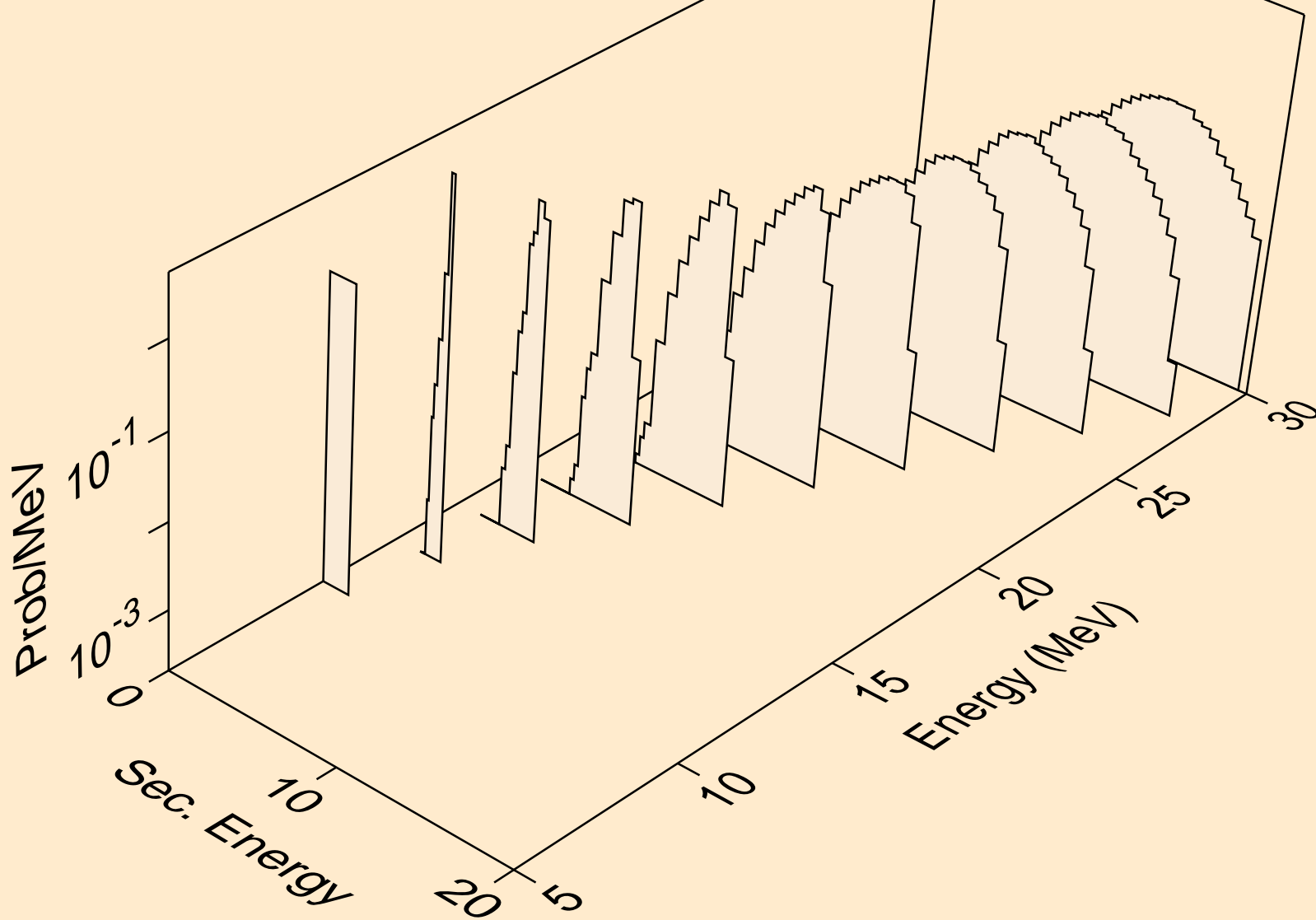

TL189 NEUTRON ACER TENDL-2019 LIBRARY; T=293.16K
deuterons from (n,d)

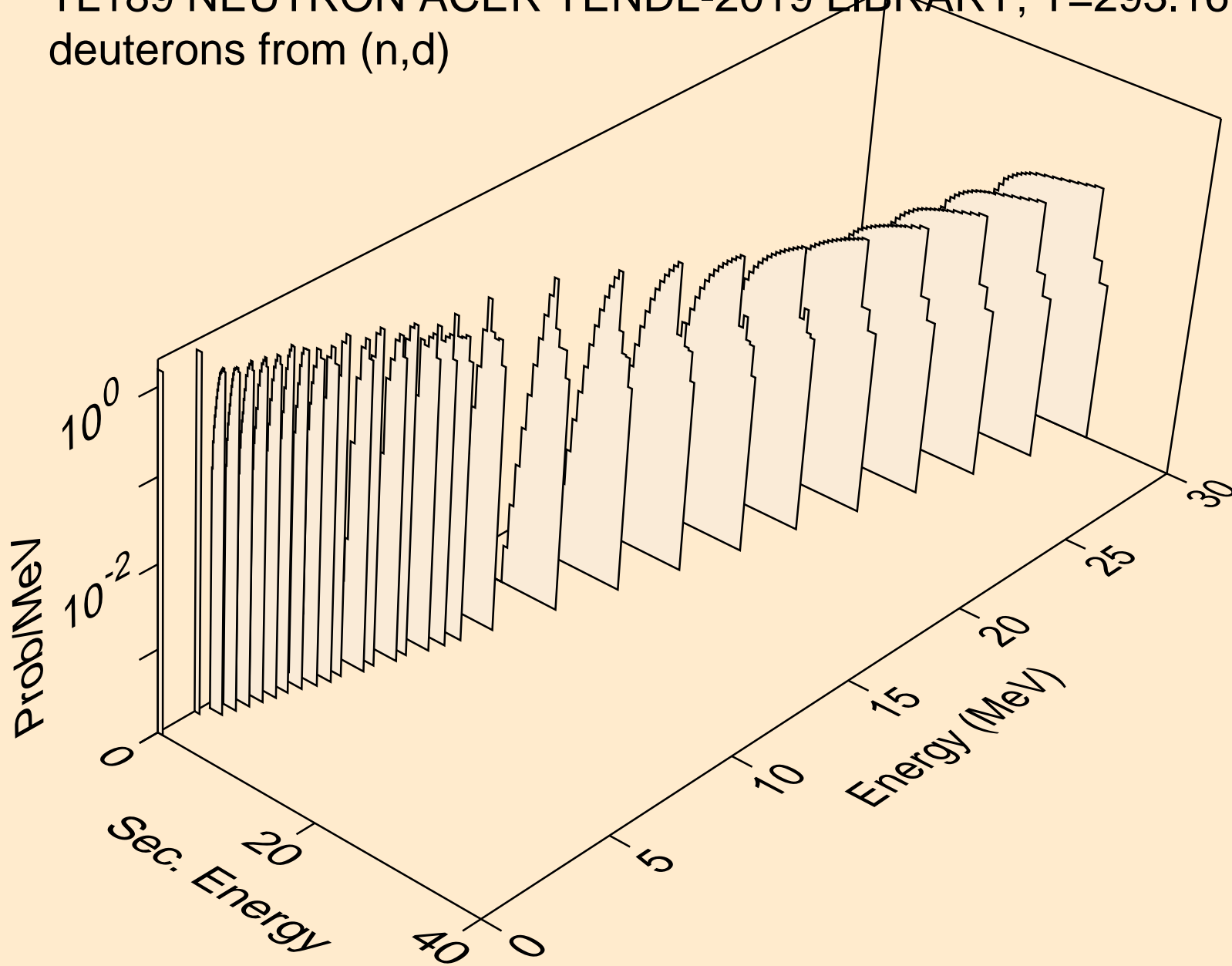

TL189 NEUTRON ACER TENDL-2019 LIBRARY; T=293.16K
deuterons from (n,pd)

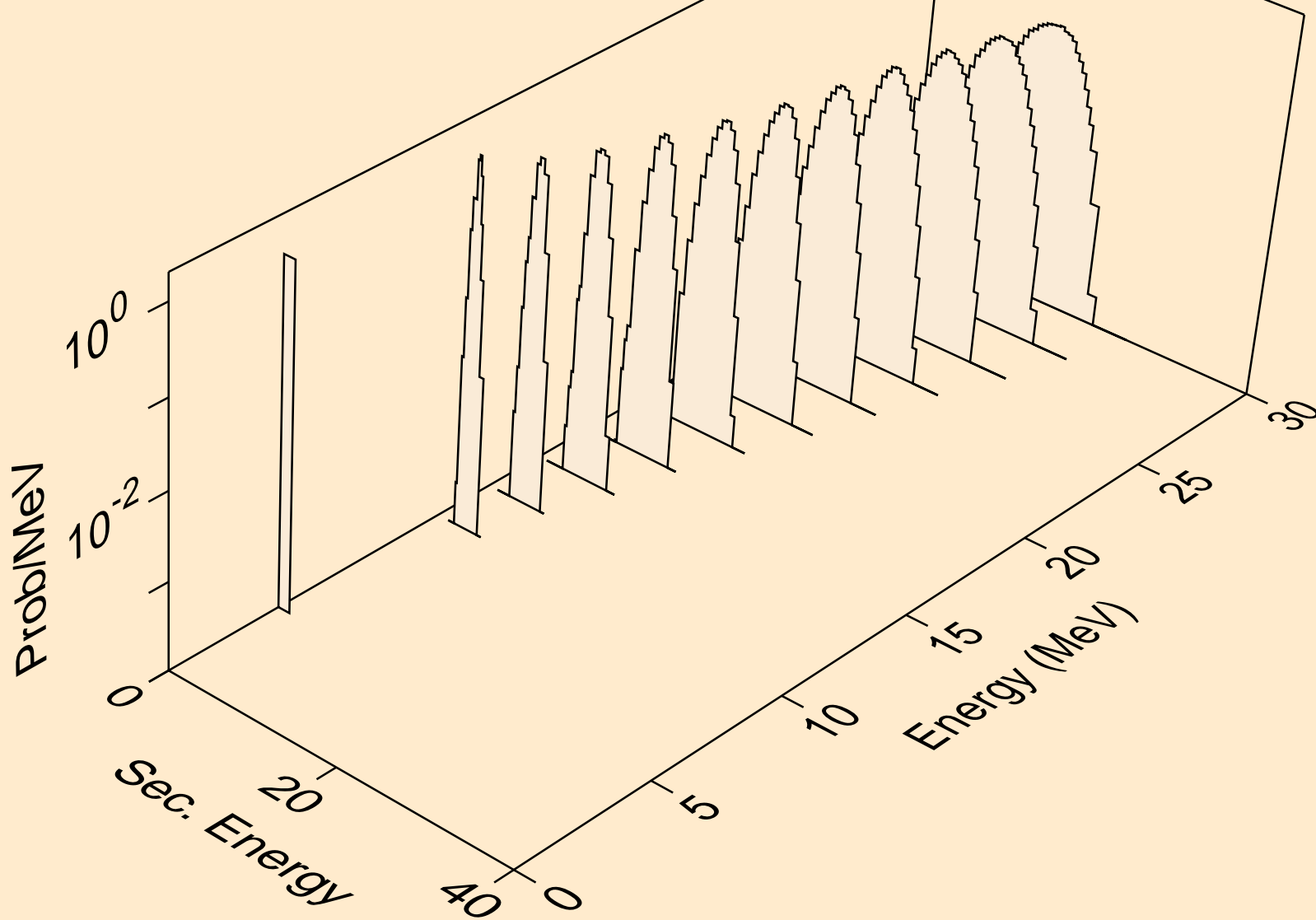

TL189 NEUTRON ACER TENDL-2019 LIBRARY; T=293.16K
deuterons from (n,da)

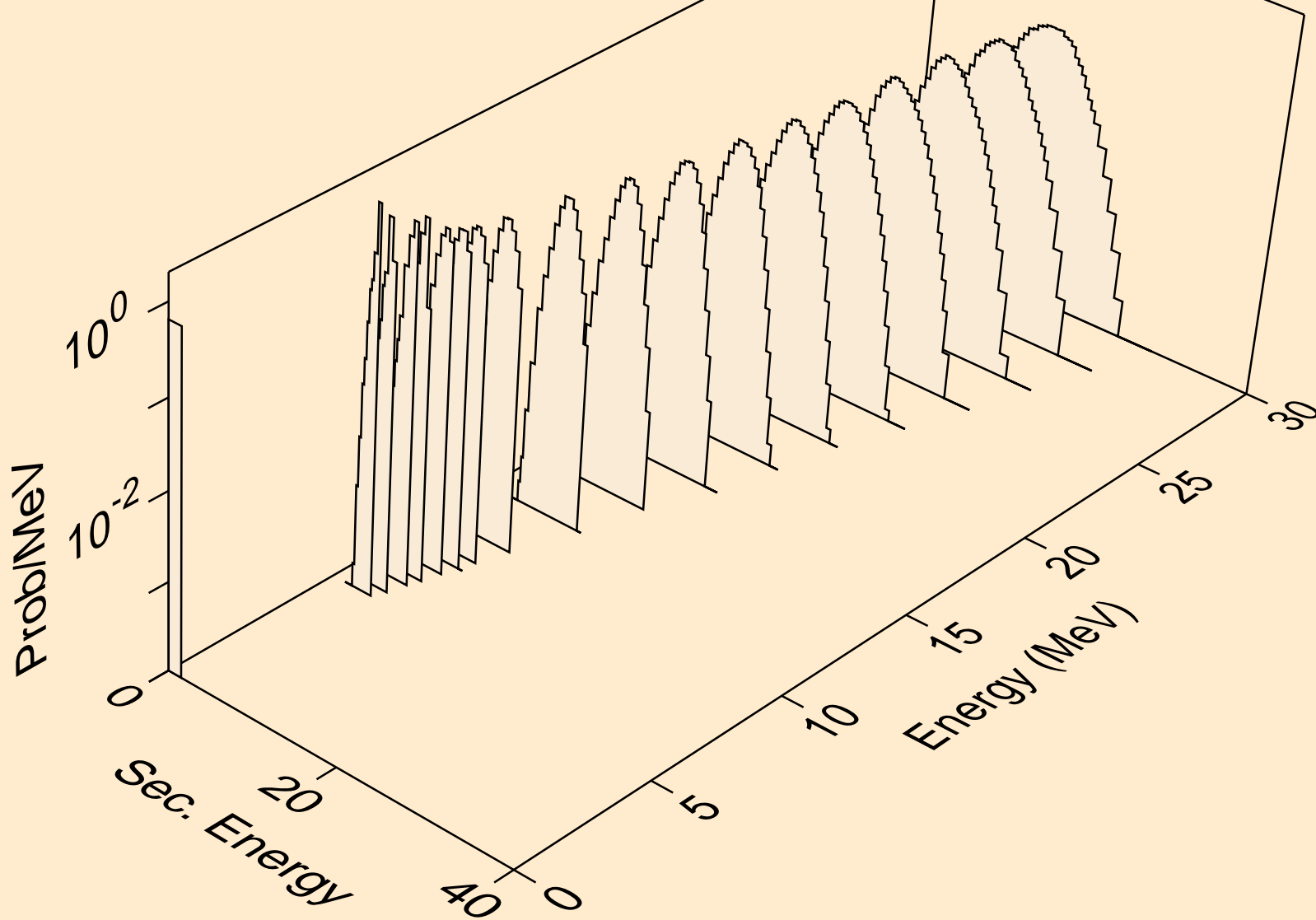

TL189 NEUTRON ACER TENDL-2019 LIBRARY; T=293.16K
tritons from (n,x)

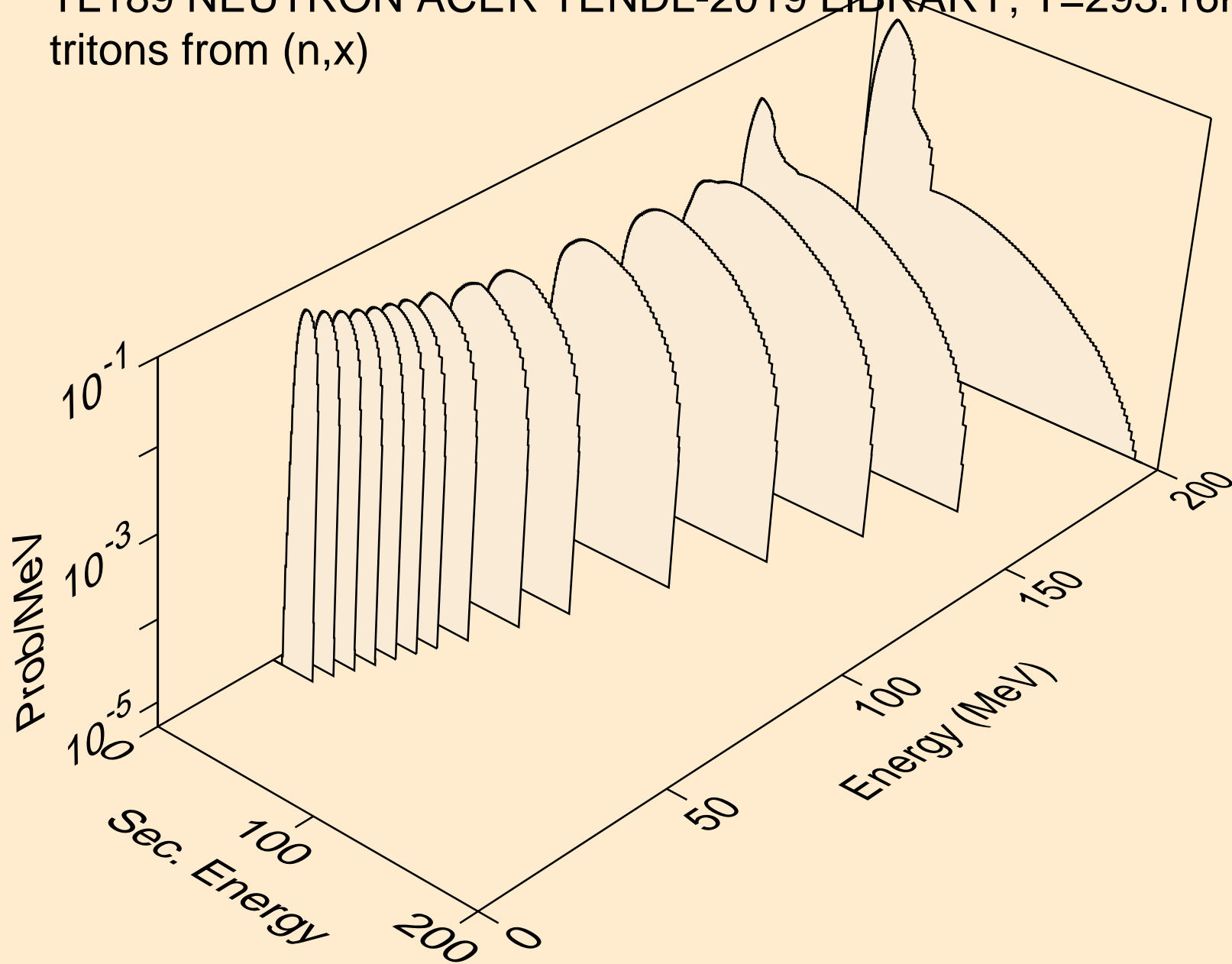

TL189 NEUTRON ACER TENDL-2019 LIBRARY; T=293.16K
tritons from (n,n*)t

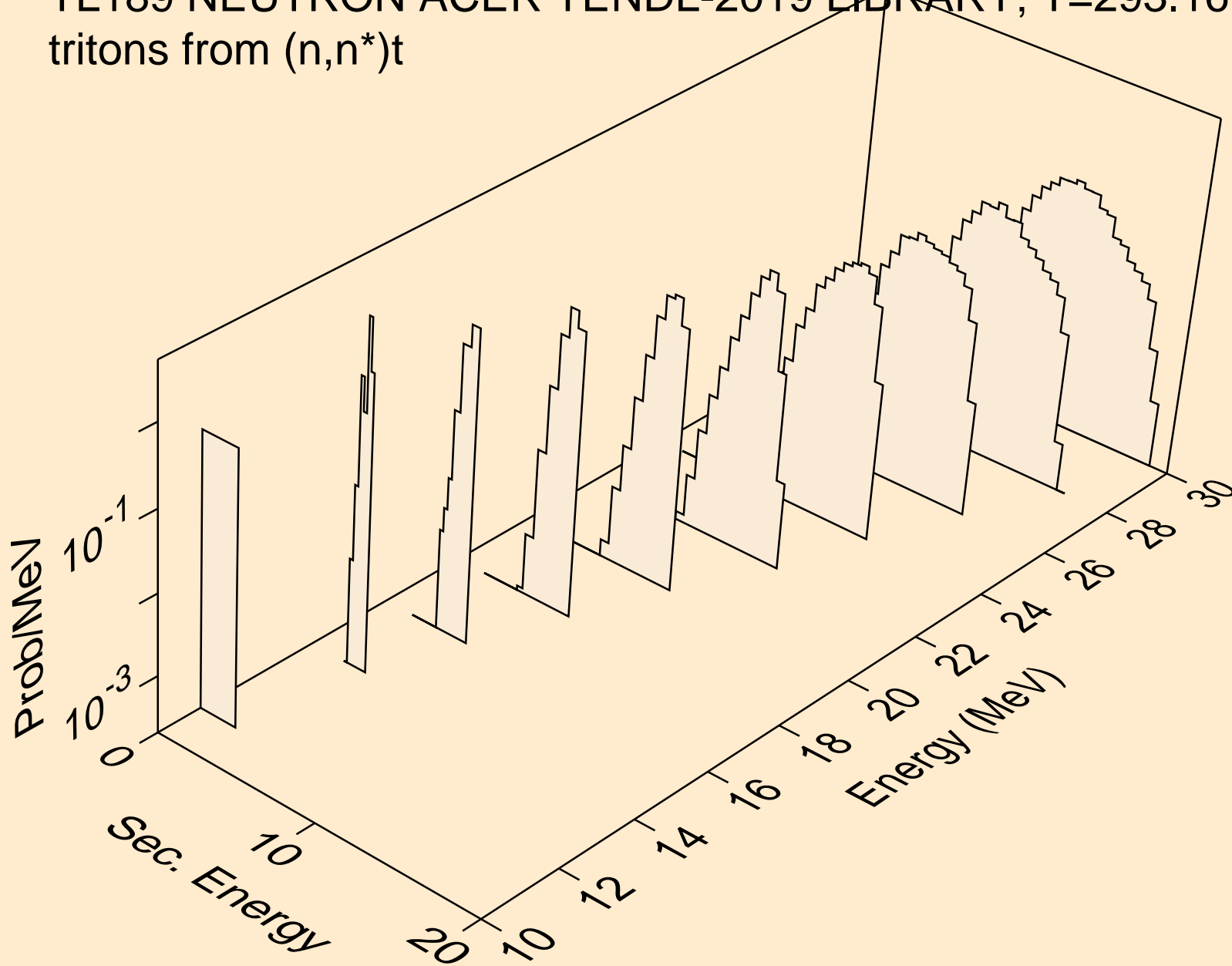

TL189 NEUTRON ACER TENDL-2019 LIBRARY; T=293.16K
tritons from (n,t)

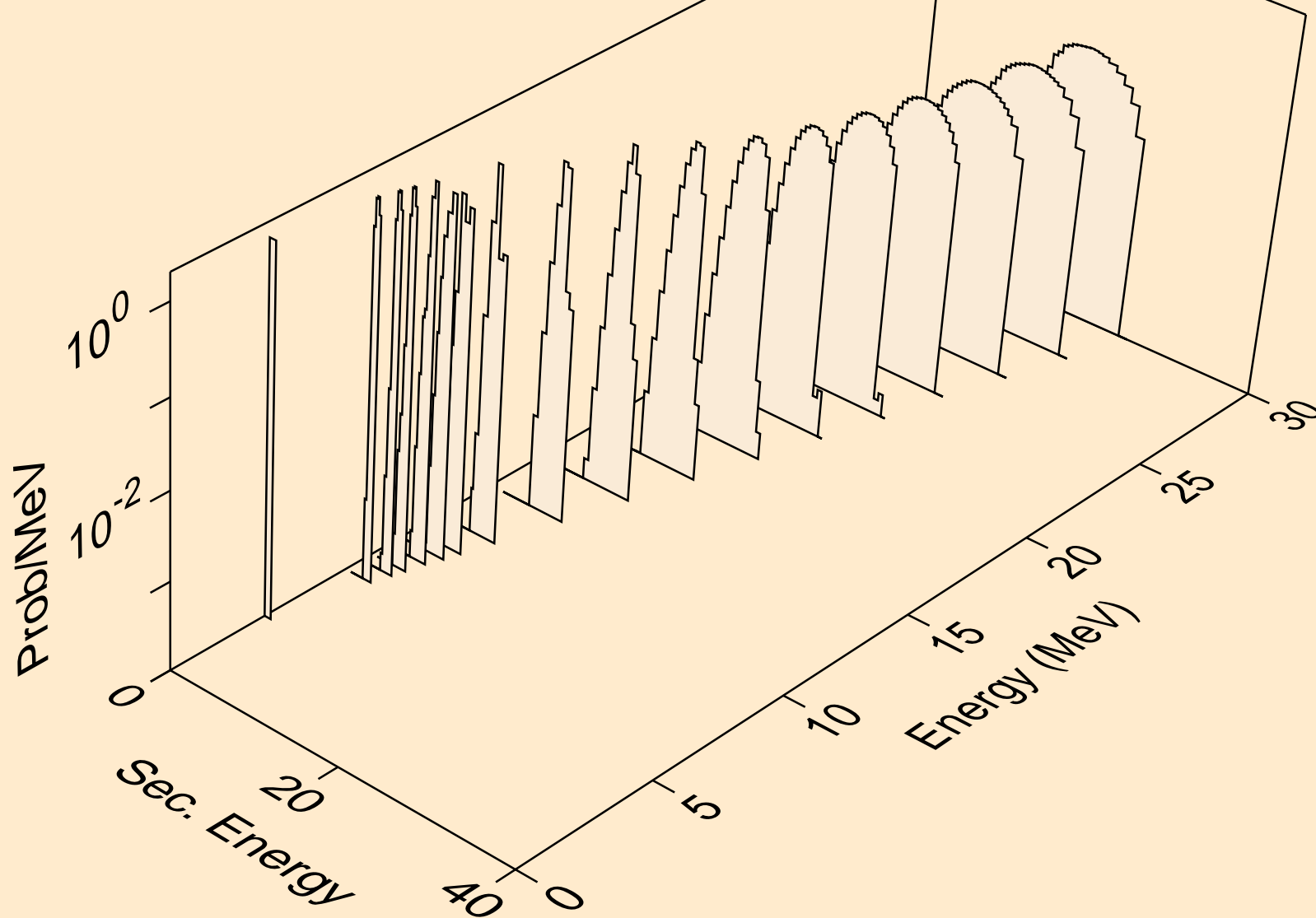

TL189 NEUTRON ACER TENDL-2019 LIBRARY; T=293.16K
tritons from (n,pt)

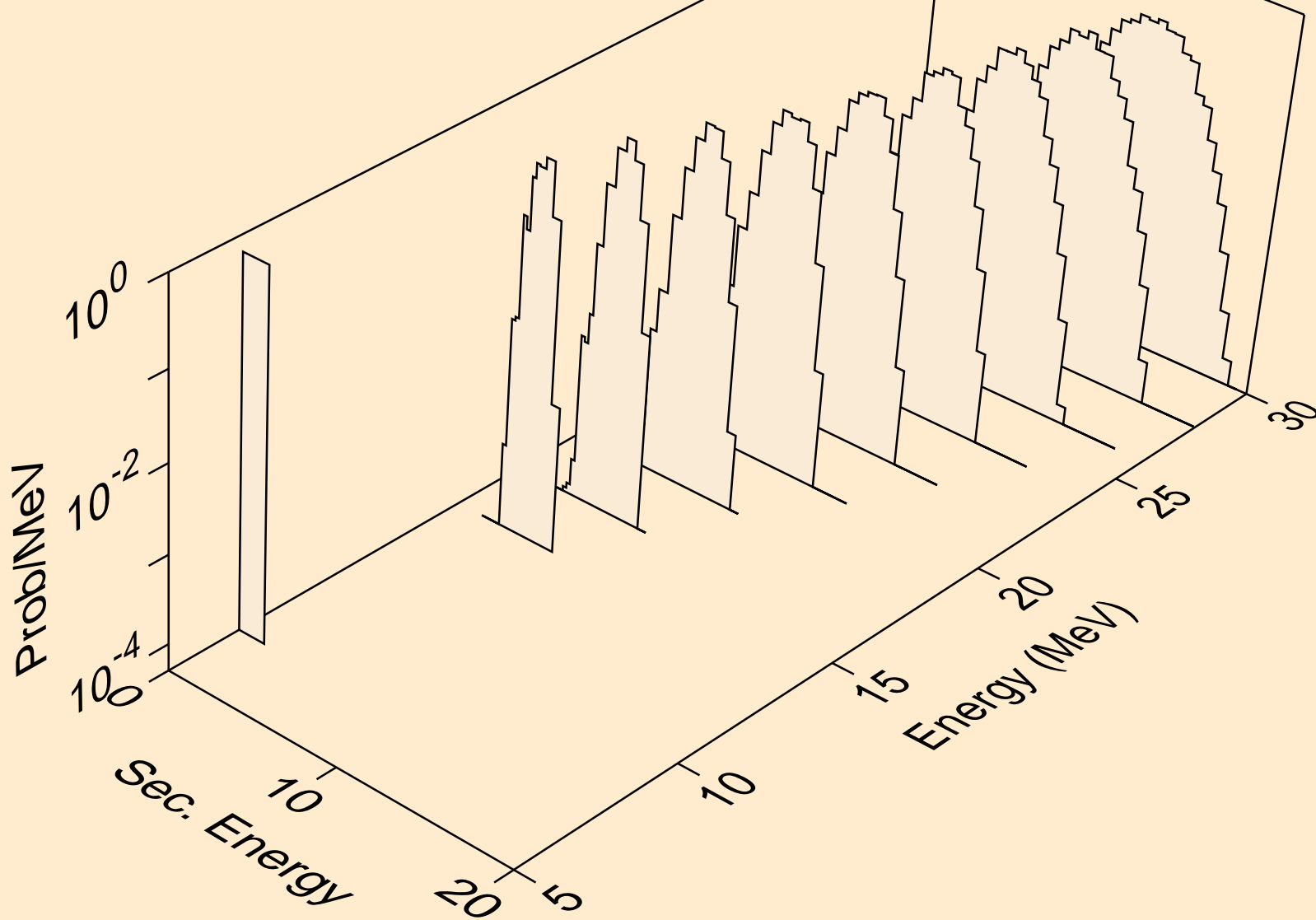

TL189 NEUTRON ACER TENDL-2019 LIBRARY; T=293.16K
he3s from (n,x)

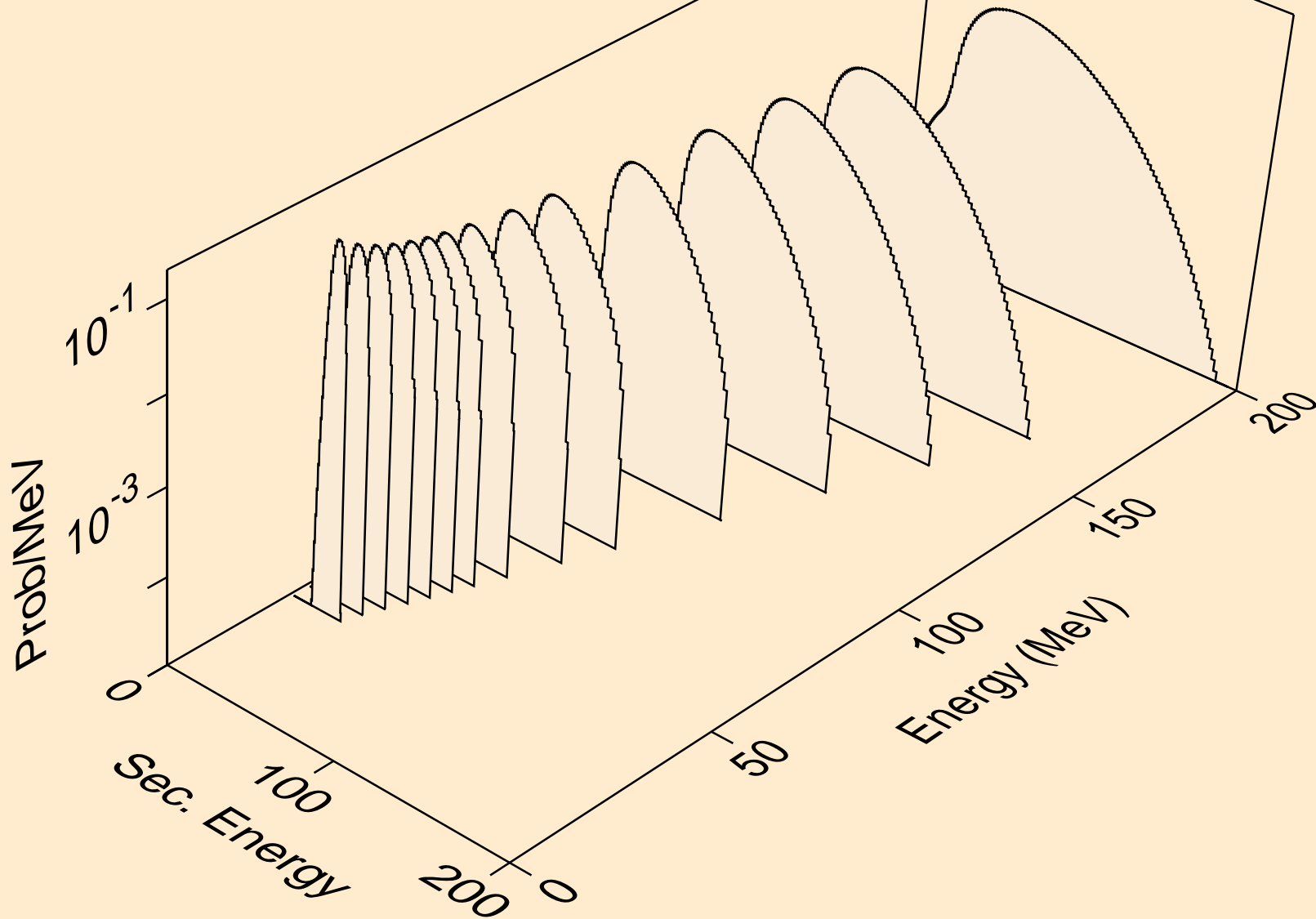

TL189 NEUTRON ACER TENDL-2019 LIBRARY; T=293.16K
he3s from (n,n*)he3

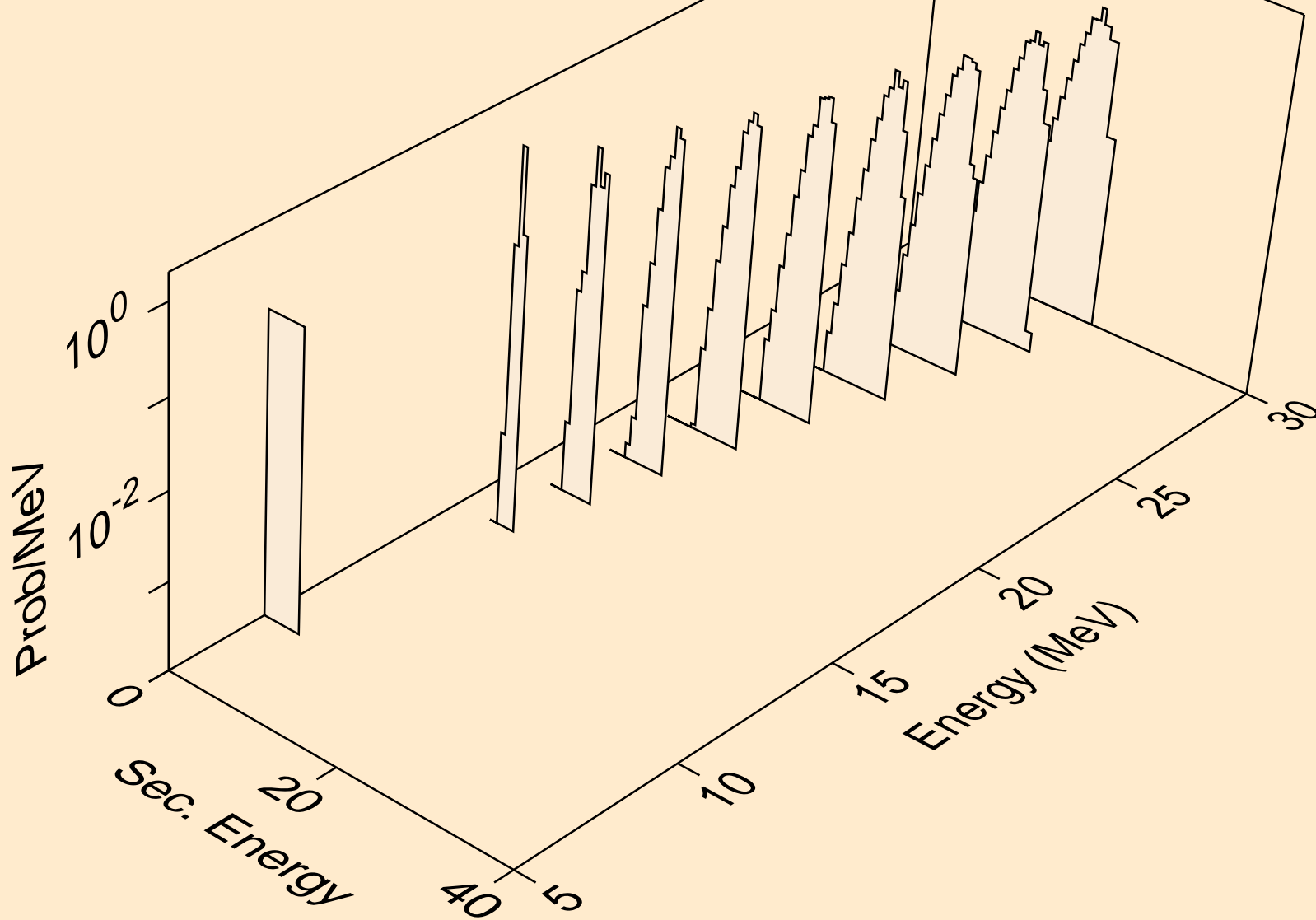

TL189 NEUTRON ACER TENDL-2019 LIBRARY; T=293.16K
he3s from (n,he3)

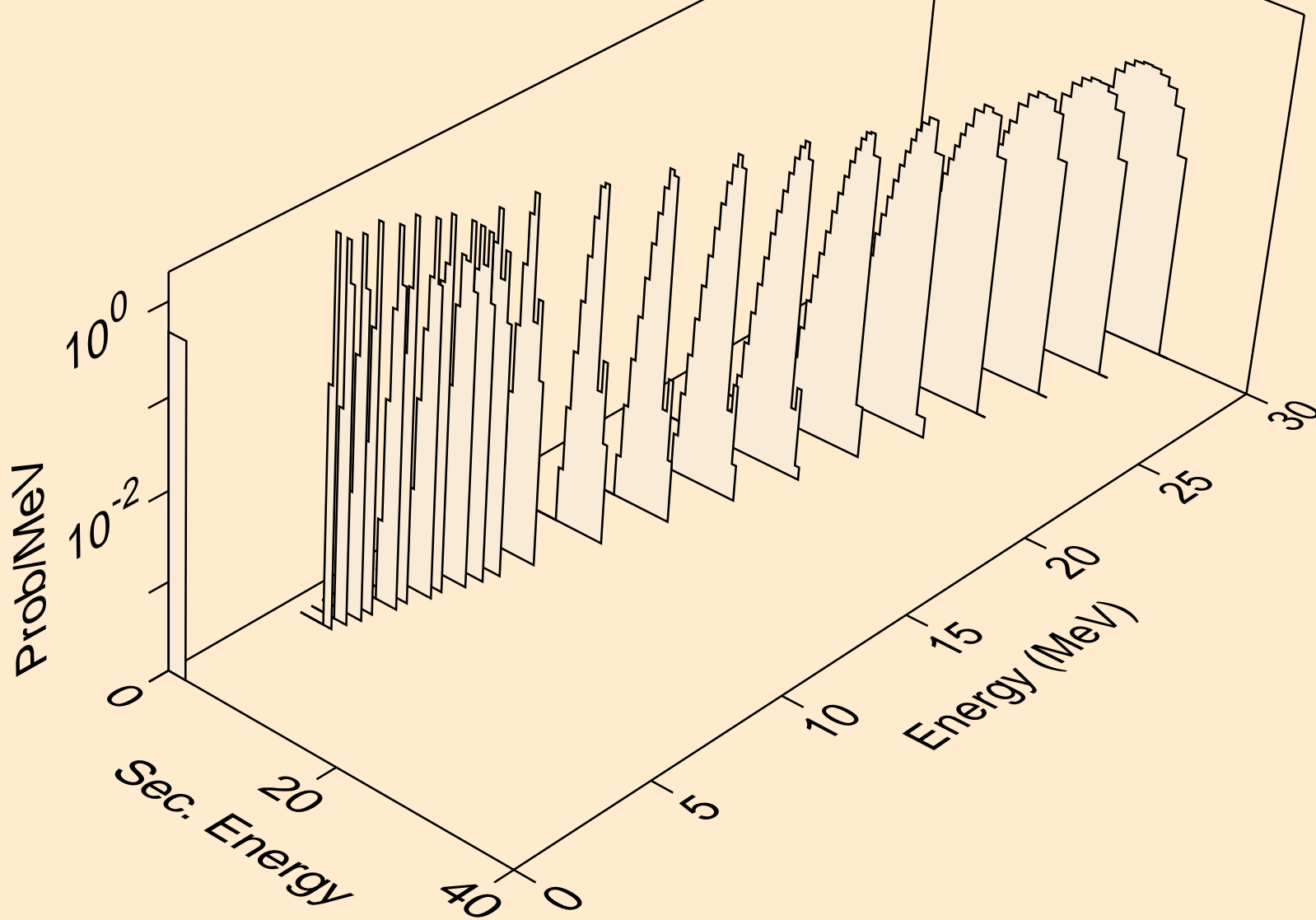

TL189 NEUTRON ACER TENDL-2019 LIBRARY; T=293.16K
alphas from (n,x)

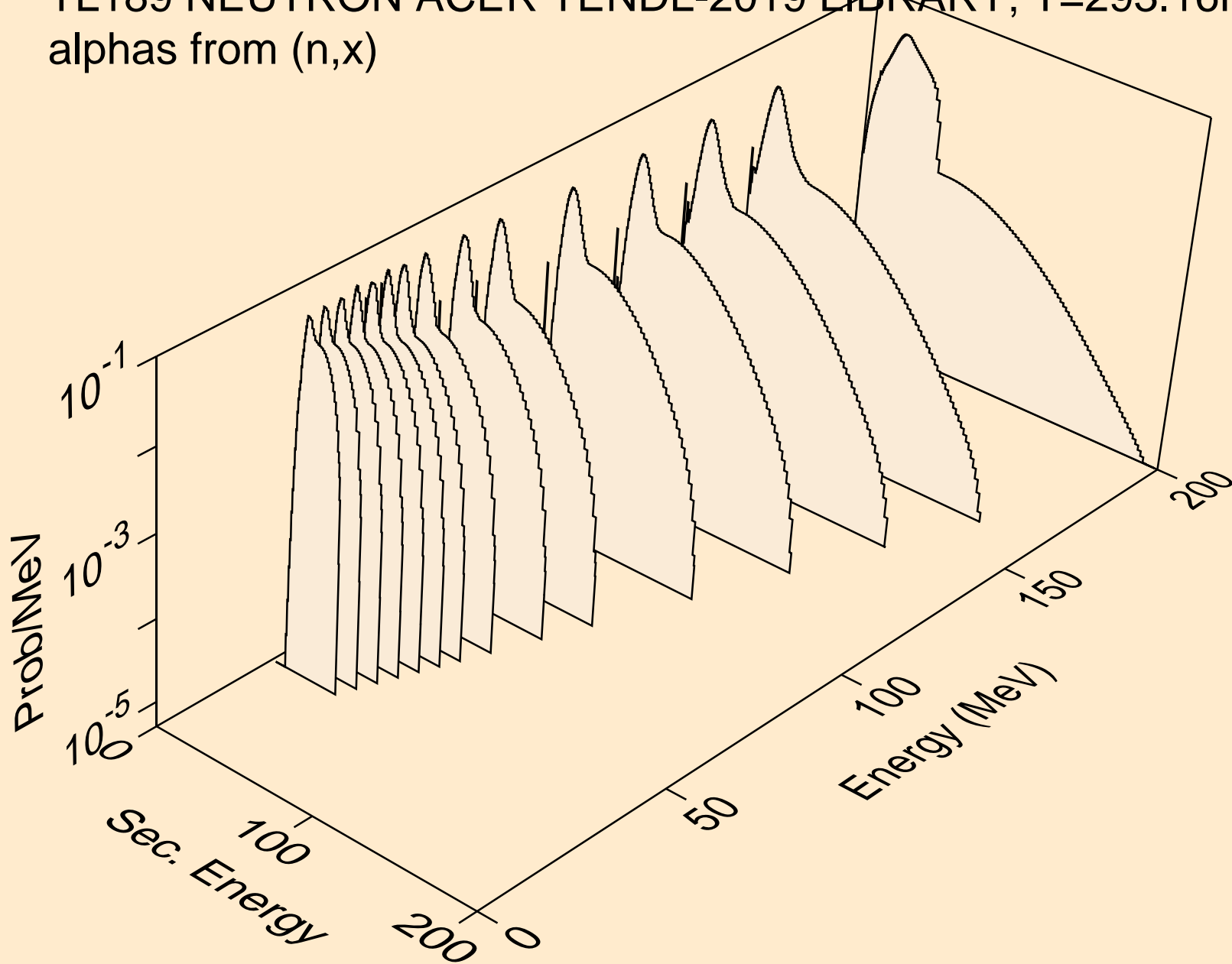

TL189 NEUTRON ACER TENDL-2019 LIBRARY; T=293.16K
alphas from (n,n*)a

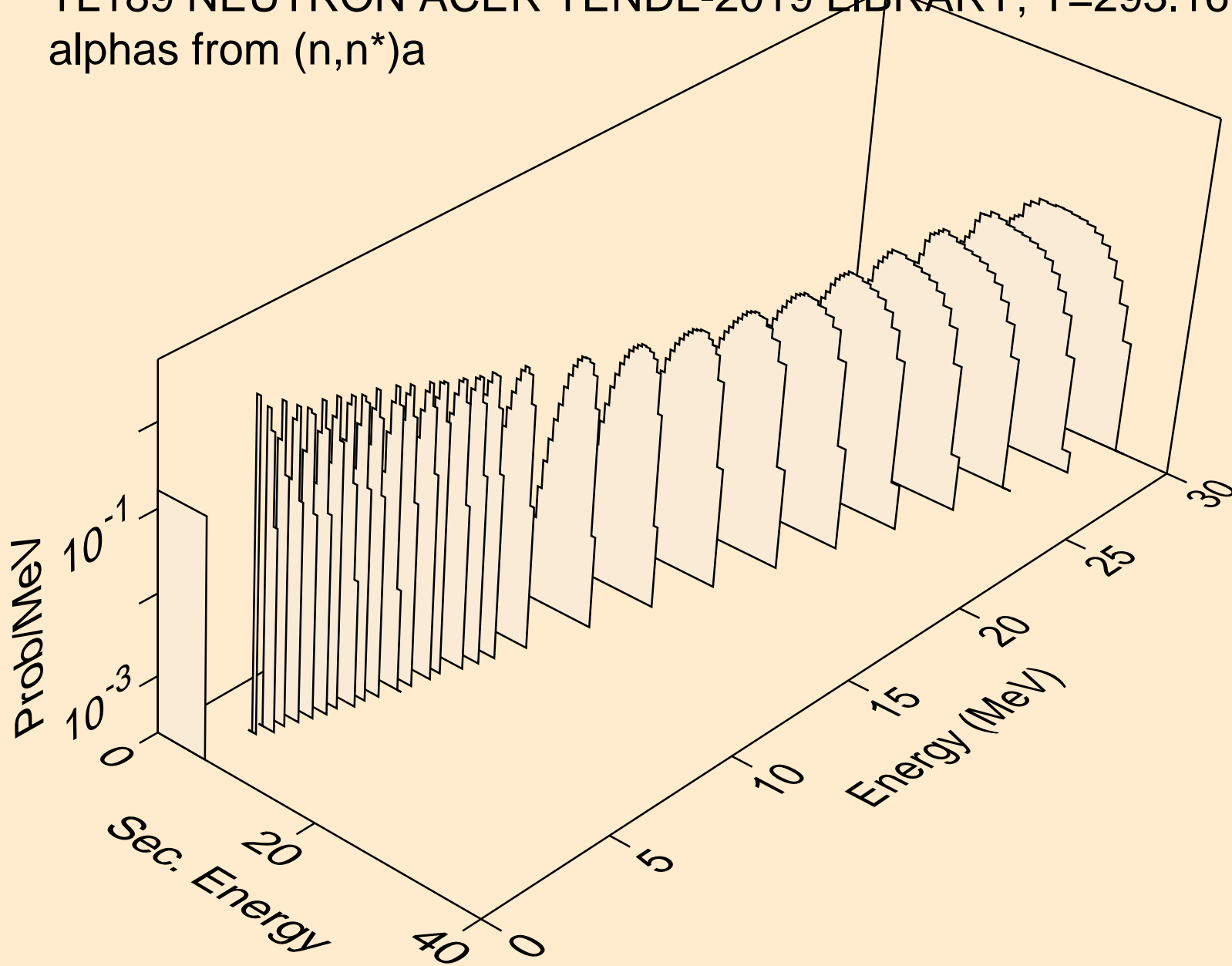

TL189 NEUTRON ACER TENDL-2019 LIBRARY; T=293.16K
alphas from (n,2n)a

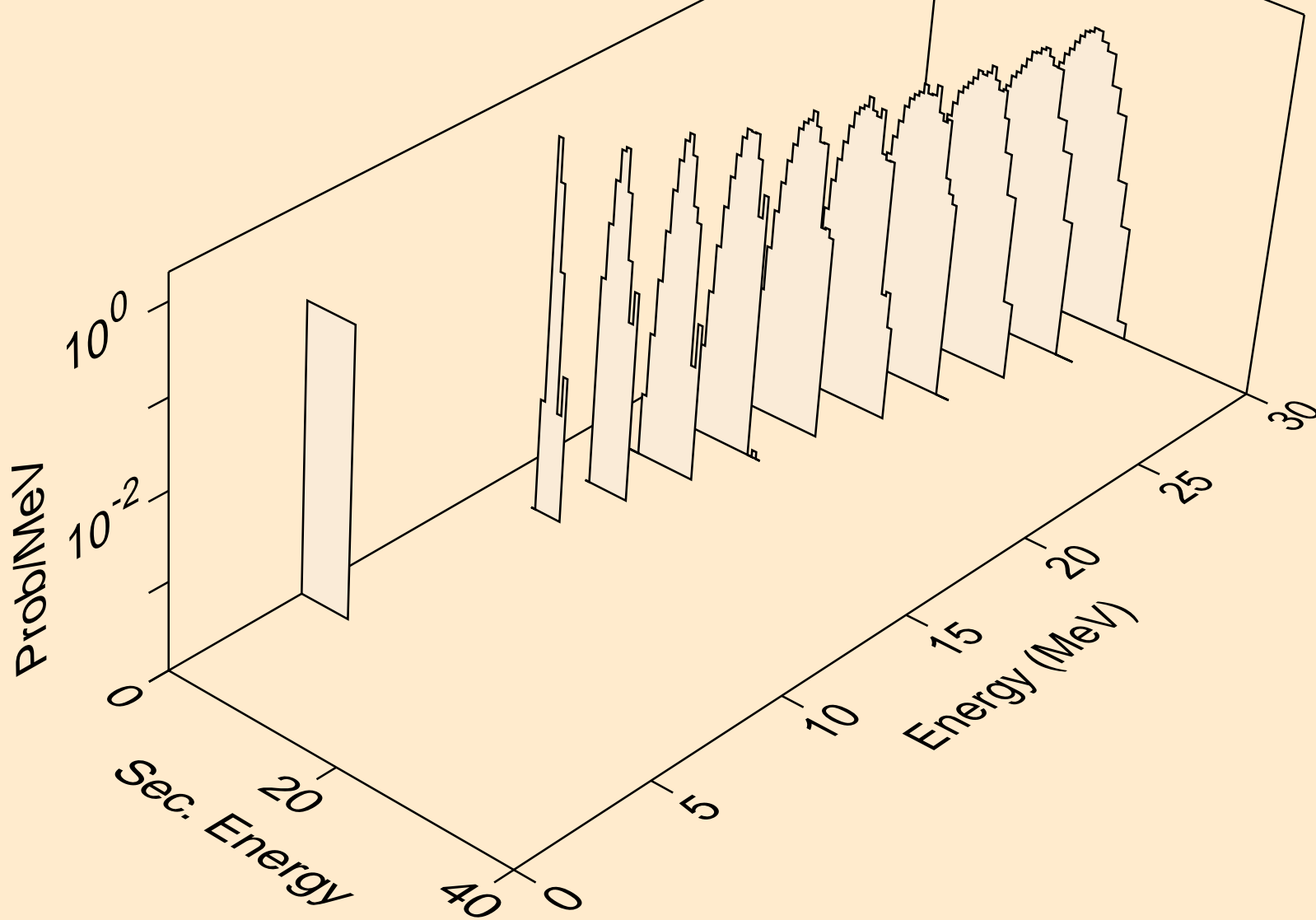

TL189 NEUTRON ACER TENDL-2019 LIBRARY; T=293.16K
alphas from (n,3n)a

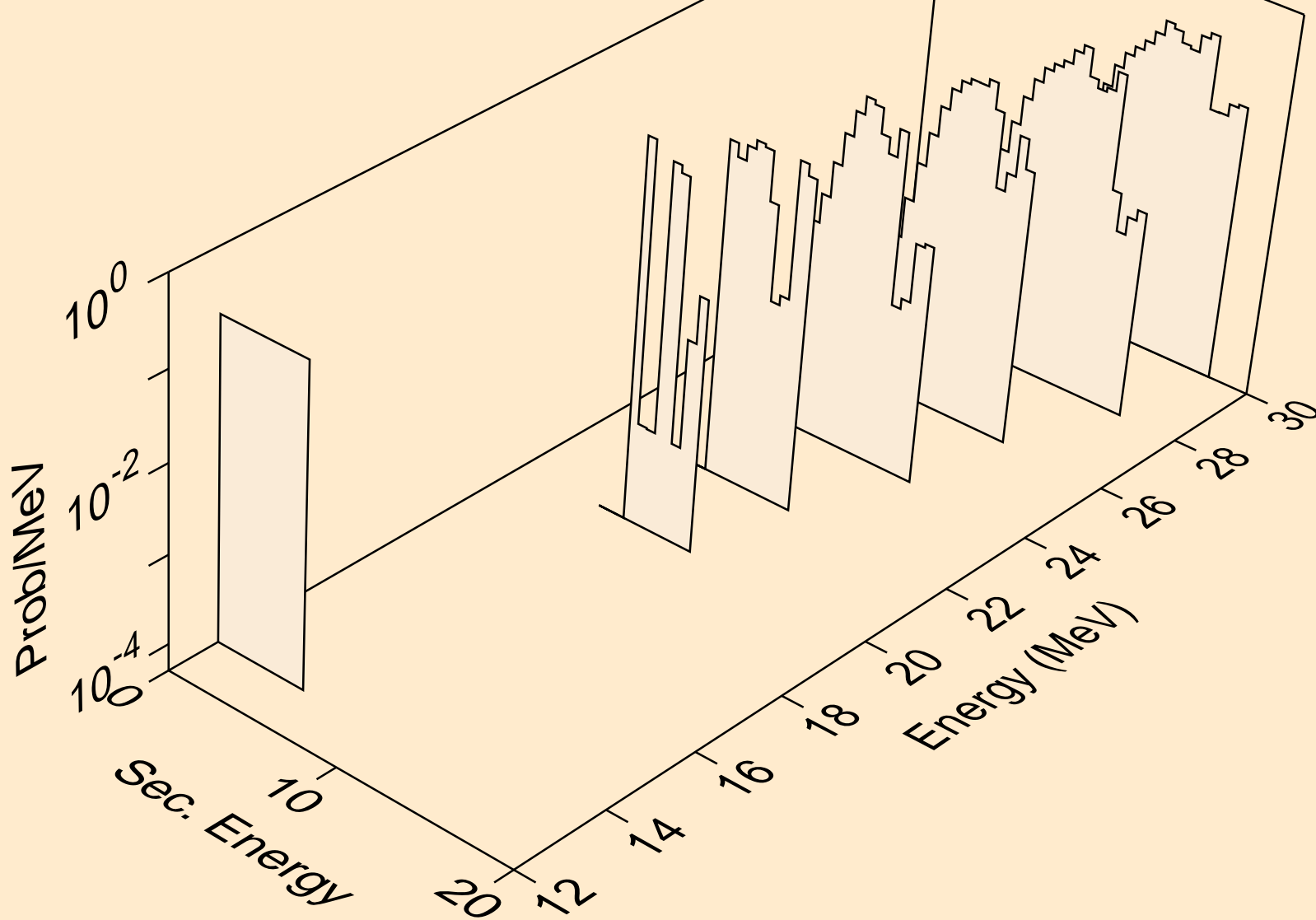

TL189 NEUTRON ACER TENDL-2019 LIBRARY; T=293.16K
alphas from (n,n*)2a

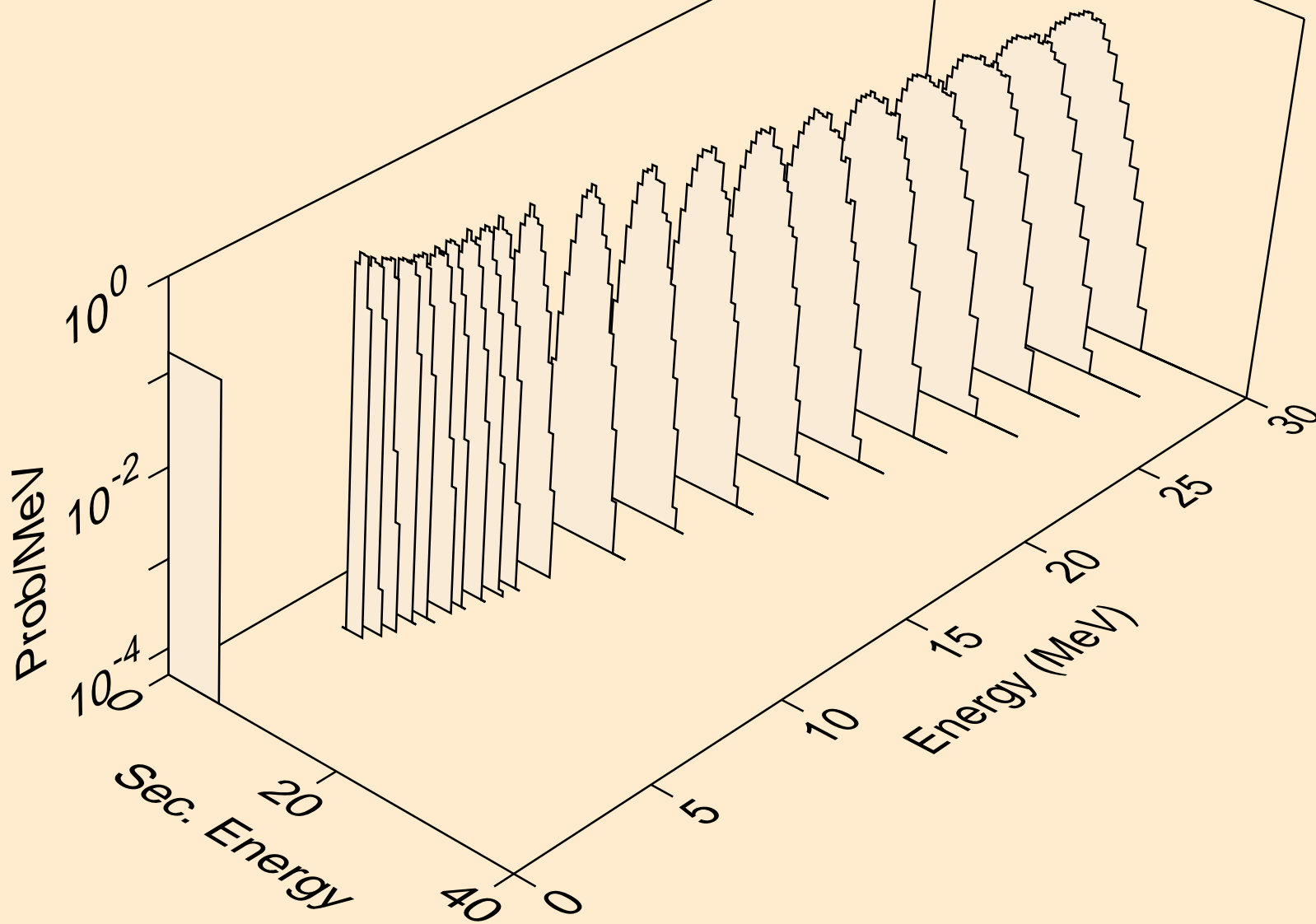

TL189 NEUTRON ACER TENDL-2019 LIBRARY; T=293.16K
alphas from (n,2n)2a

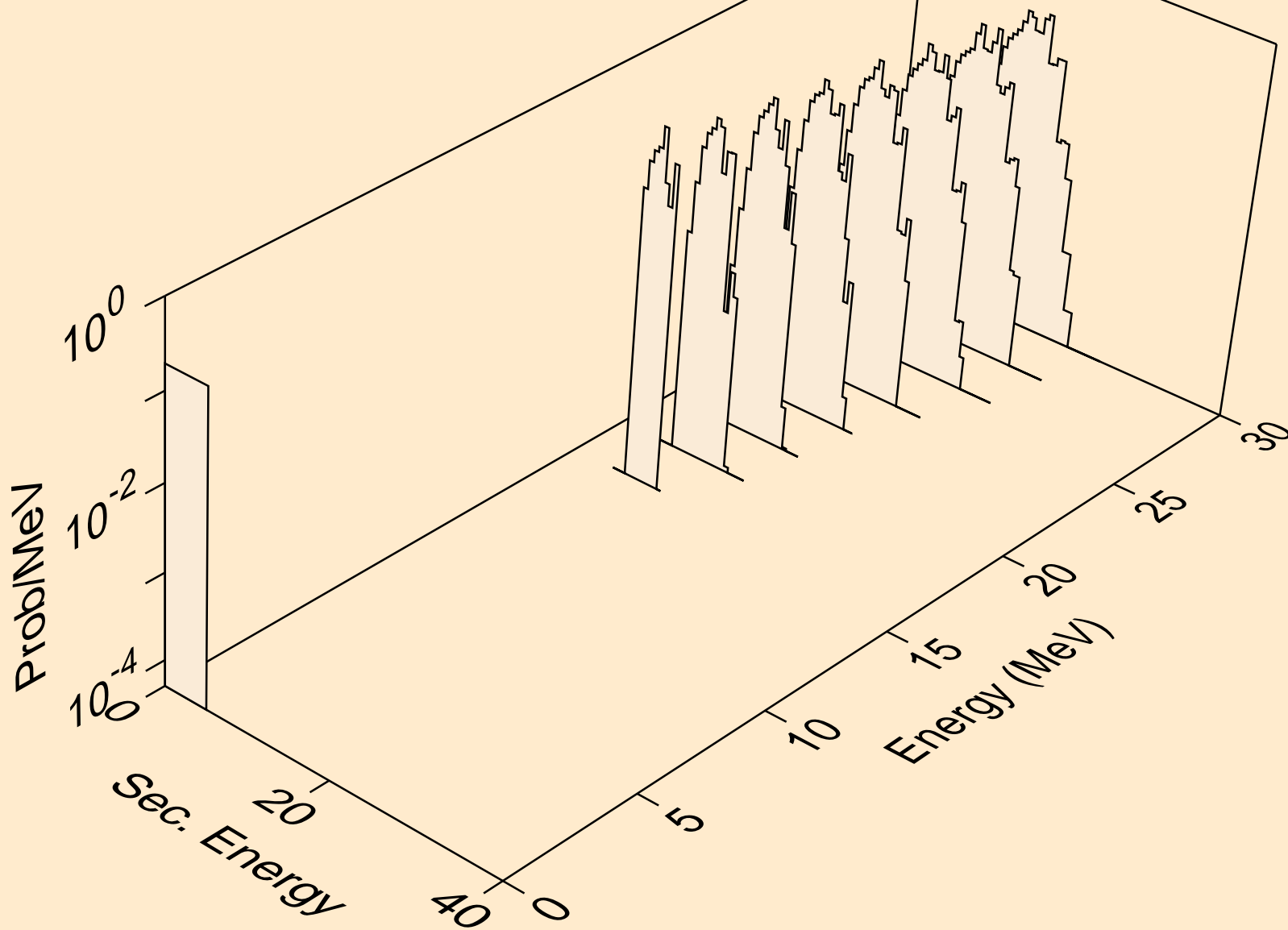

TL189 NEUTRON ACER TENDL-2019 LIBRARY; T=293.16K
alphas from (n,npa)

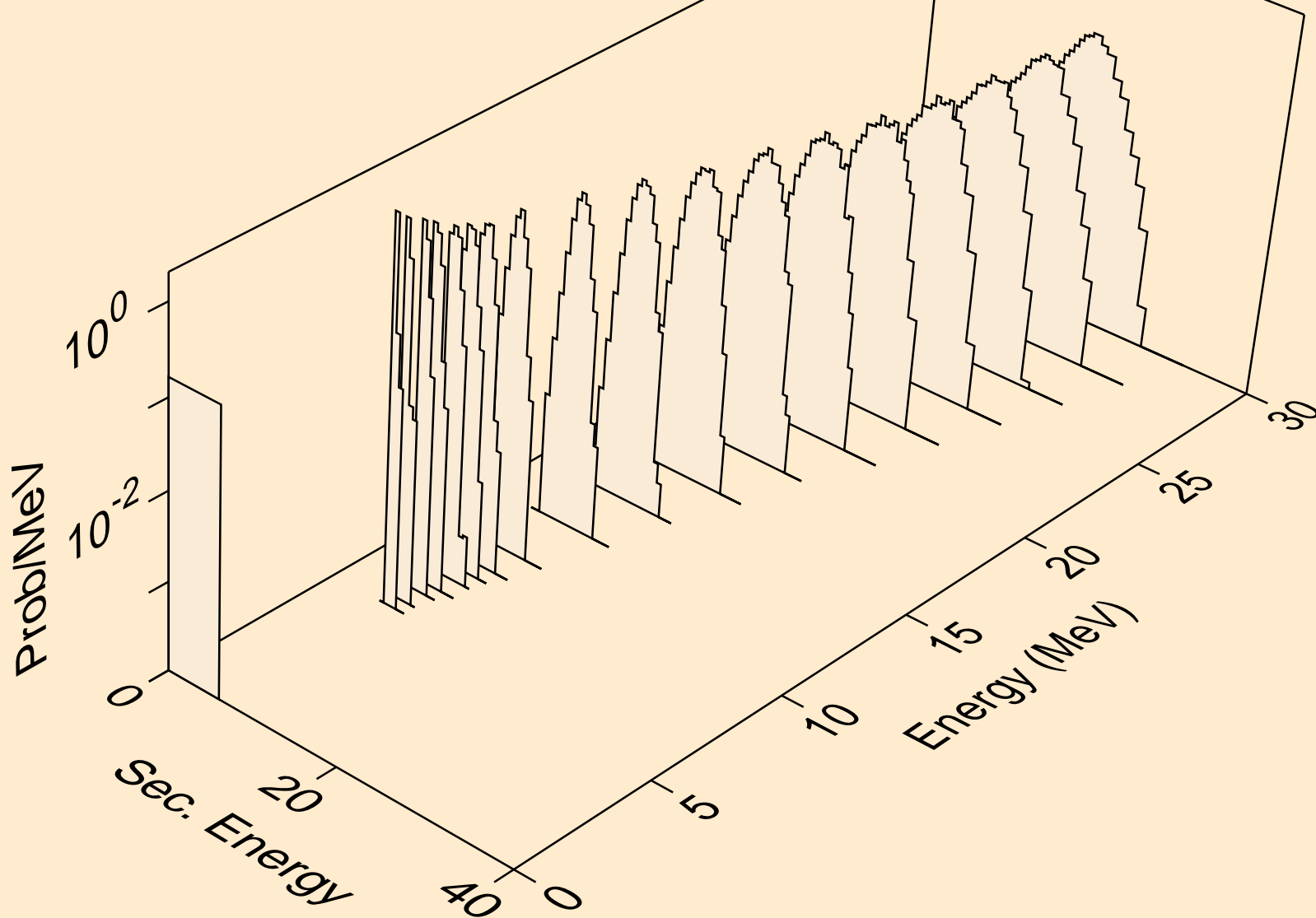

TL189 NEUTRON ACER TENDL-2019 LIBRARY; T=293.16K
alphas from (n,a)

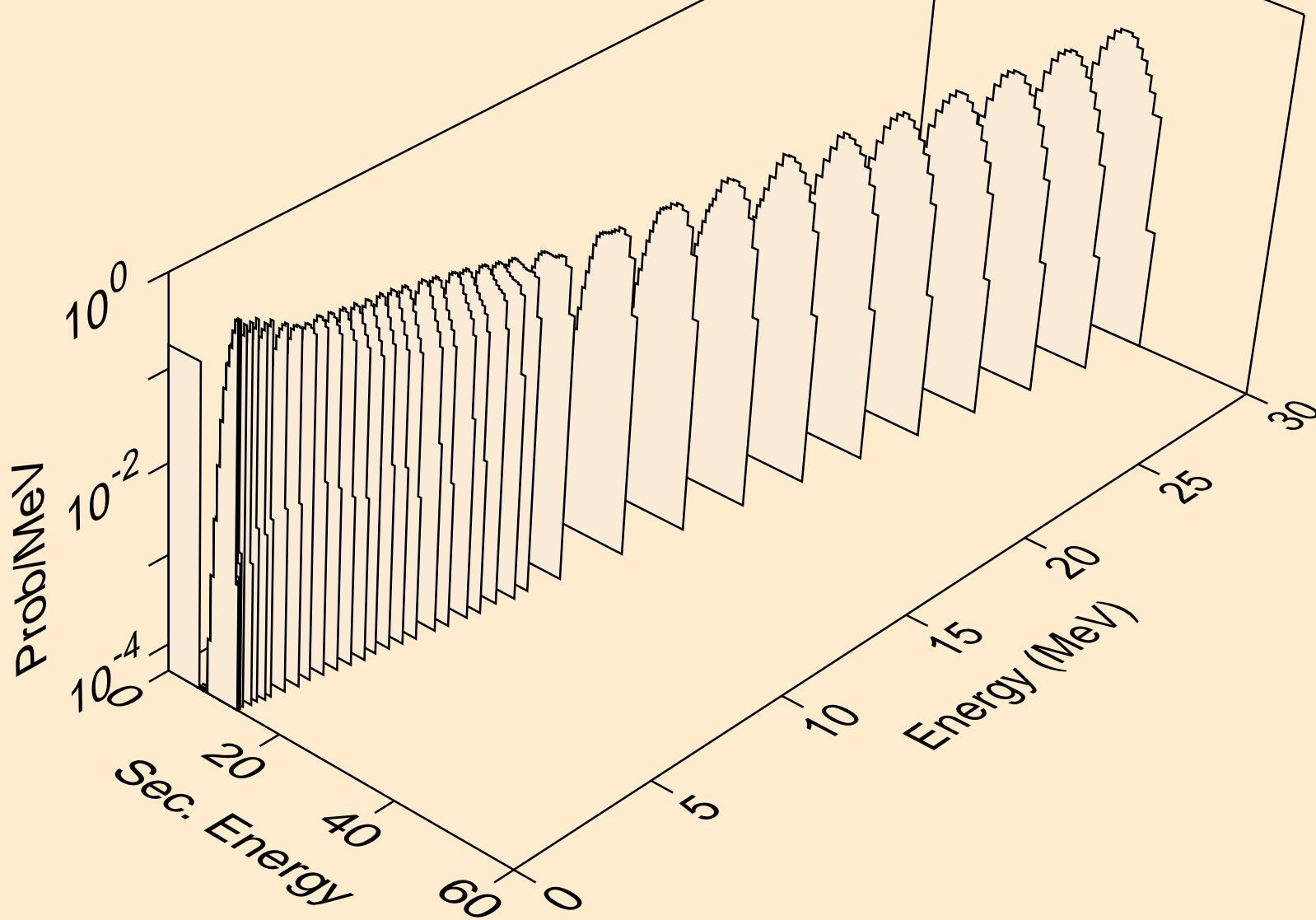

TL189 NEUTRON ACER TENDL-2019 LIBRARY; T=293.16K
alphas from (n,2a)

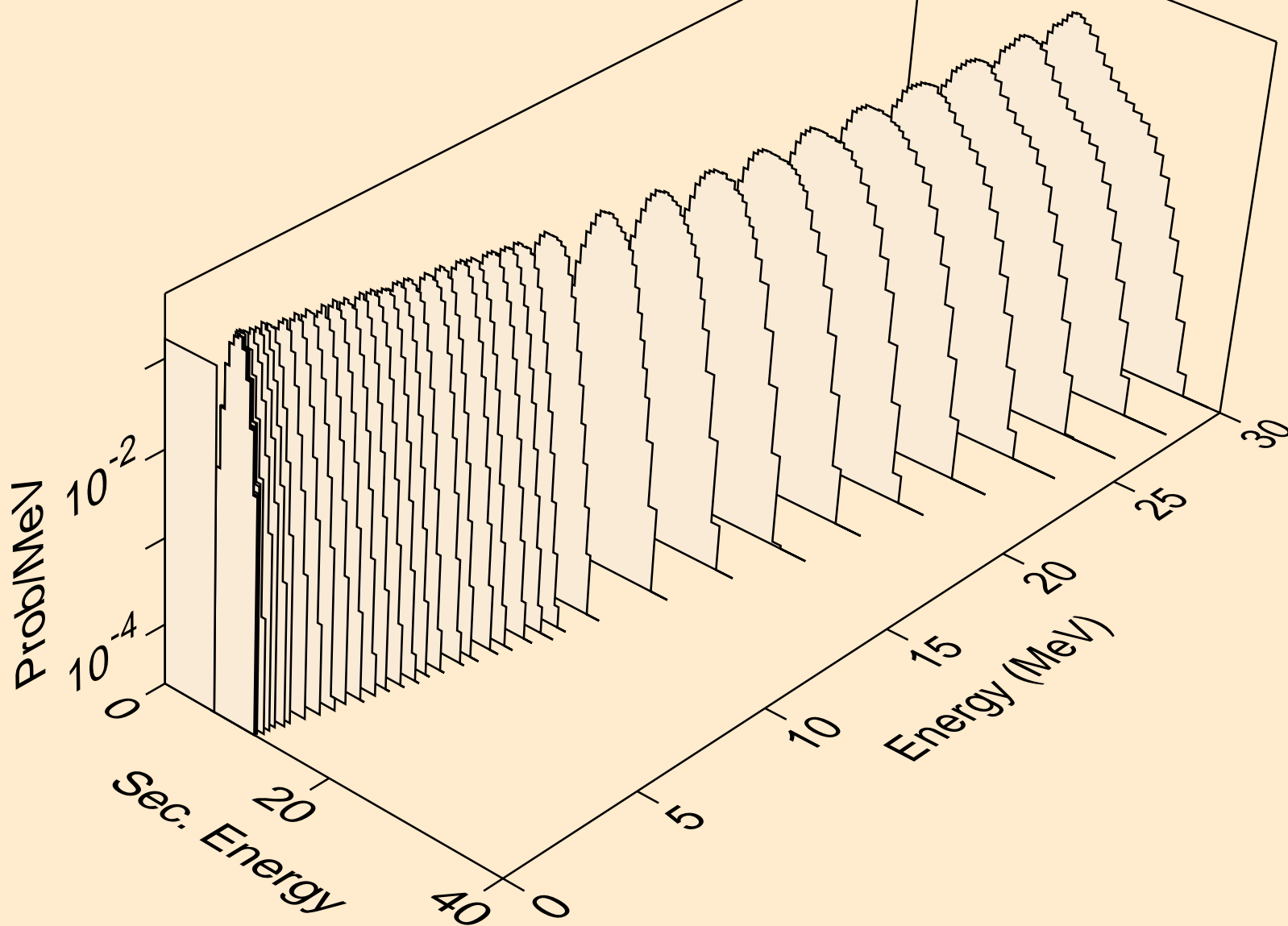

TL189 NEUTRON ACER TENDL-2019 LIBRARY; T=293.16K
alphas from (n,pa)

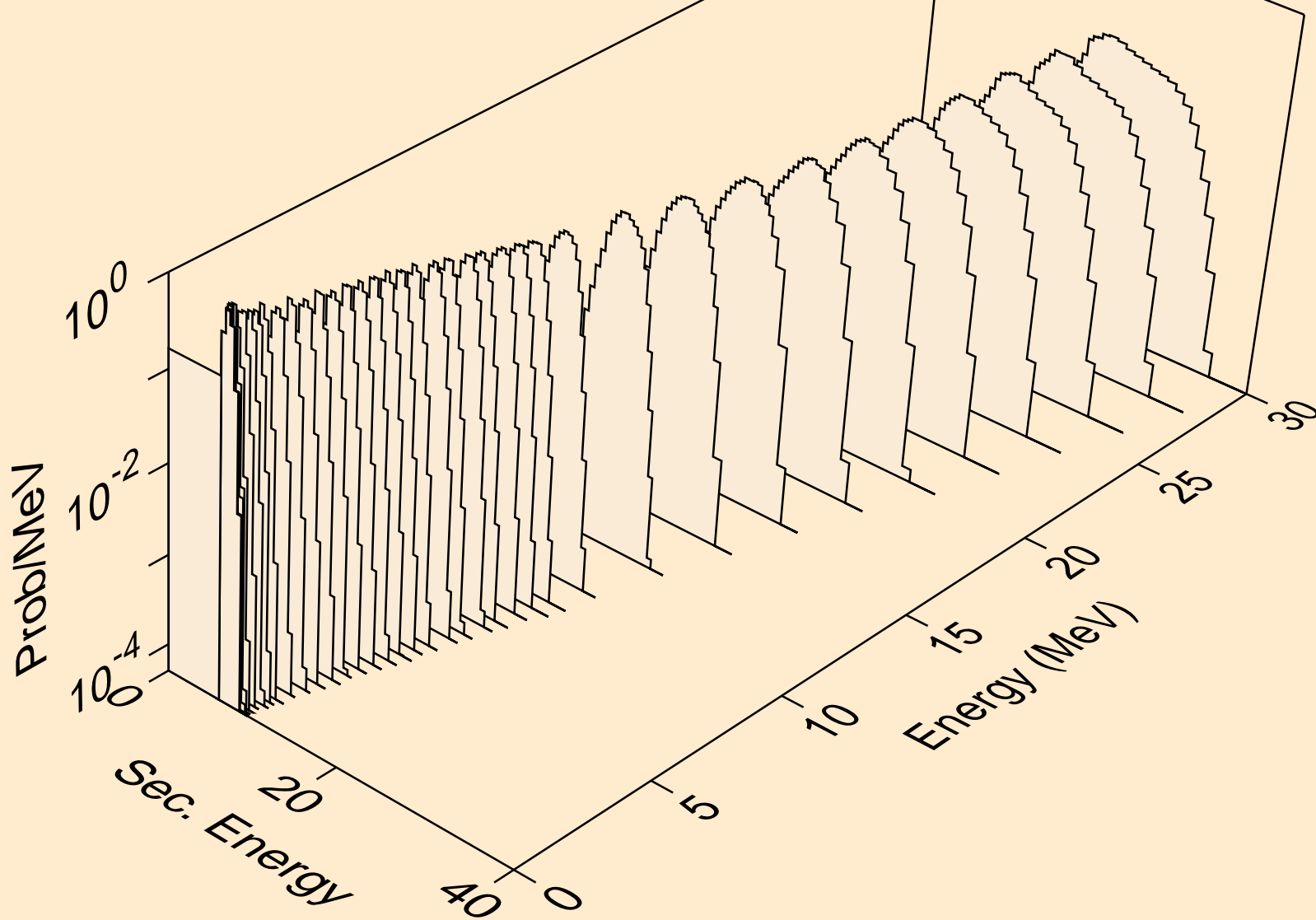

TL189 NEUTRON ACER TENDL-2019 LIBRARY; T=293.16K
alphas from (n,da)

