

Program EVALPLOT
(Version 2018-1)

by

Dermott E. Cullen
(Present Contact Information)

Dermott E. Cullen
1466 Hudson Way
Livermore, CA 94550
U.S.A.

Tele: 925-443-1911

E.Mail:redcullen1@comcast.net
Web:redcullen1.net/HOMEPAGE.NEW

Press Mouse Button to Start

MAT 5410

Major
293 Kelvin Cross Sections

54-Xe-119

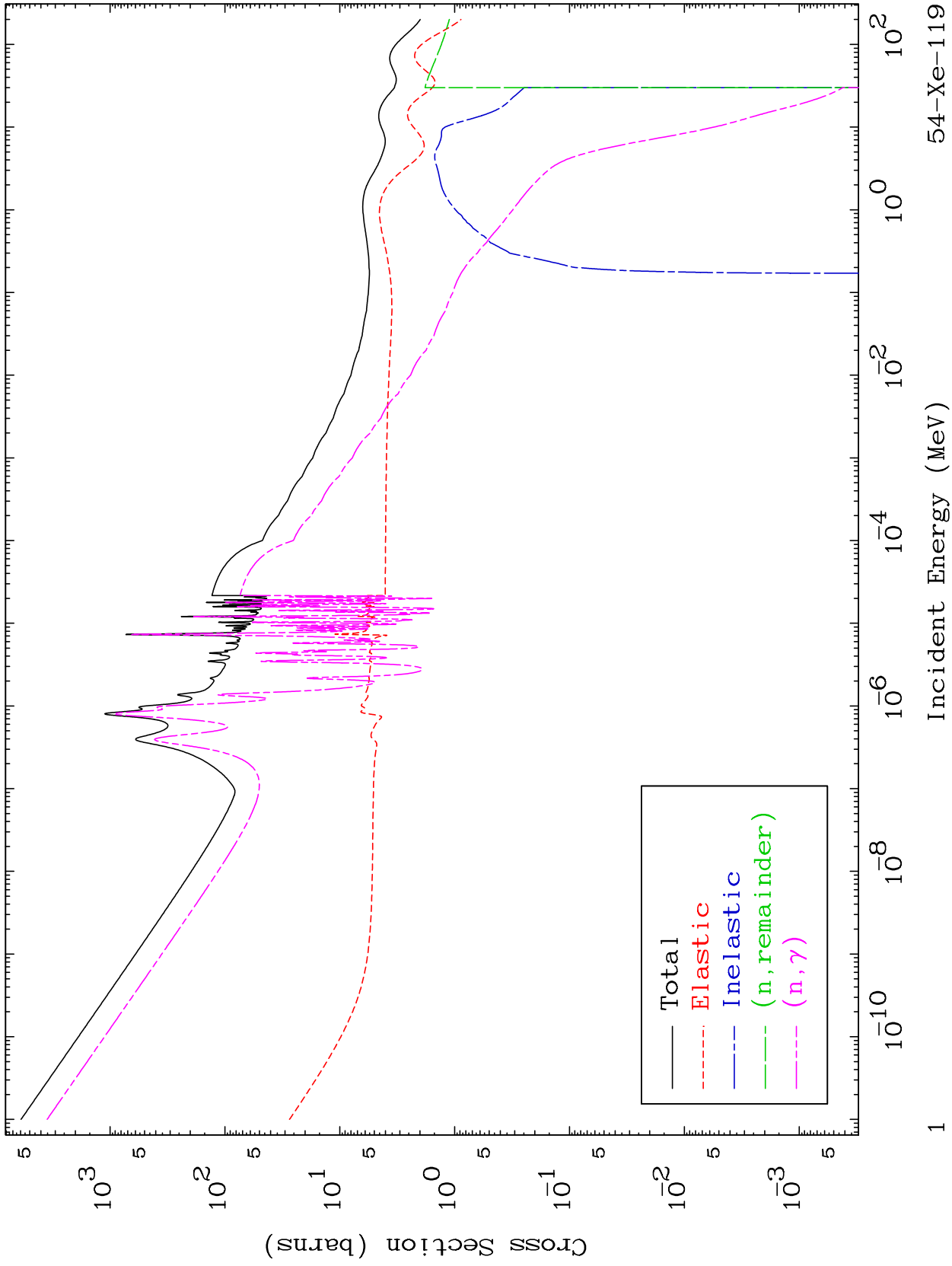

MAT 5410

Neutron Production
293 Kelvin Cross Sections

54-Xe-119

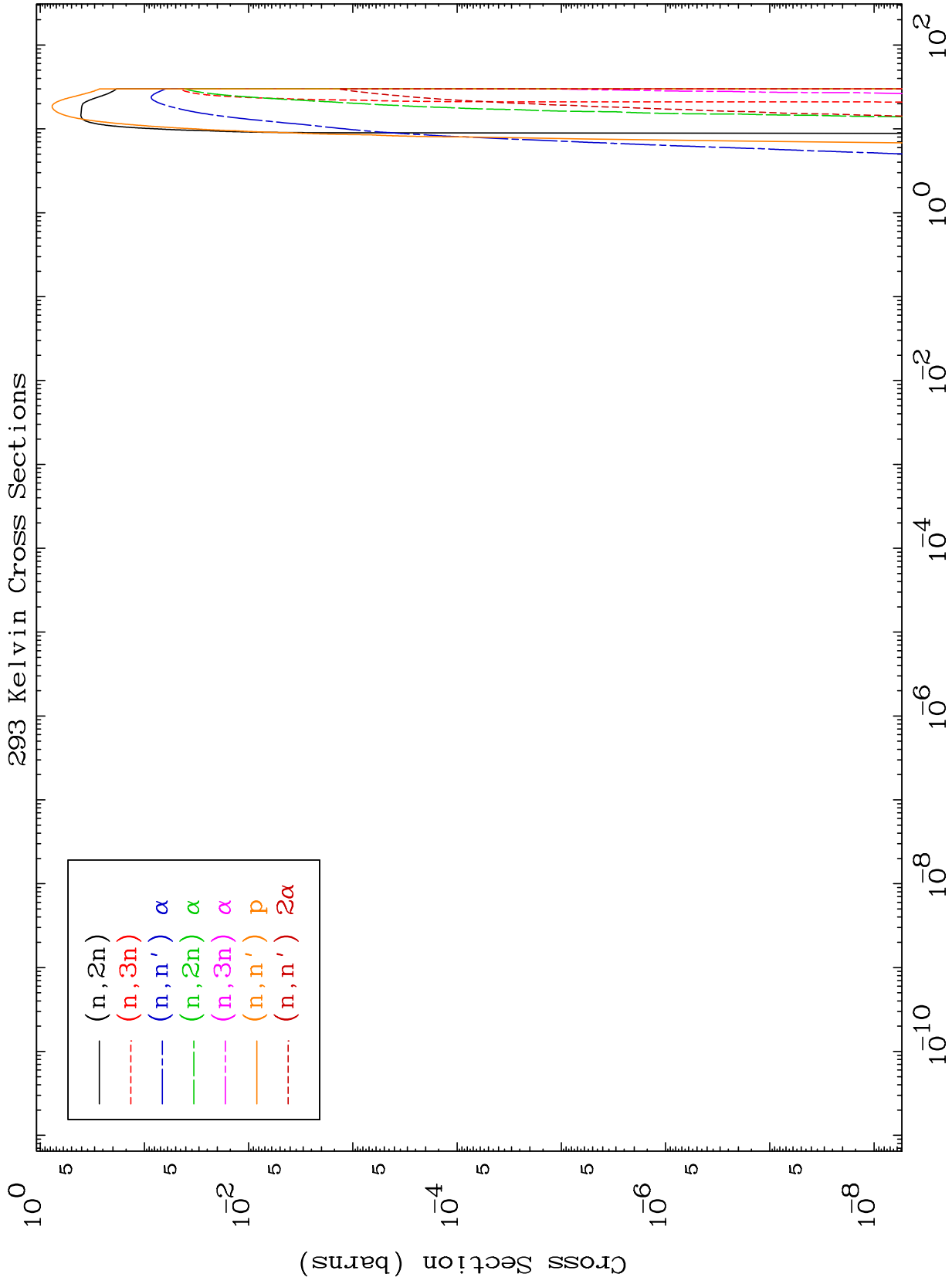

2

54-Xe-119

MAT 5410

Neutron Production
293 Kelvin Cross Sections

54-Xe-119

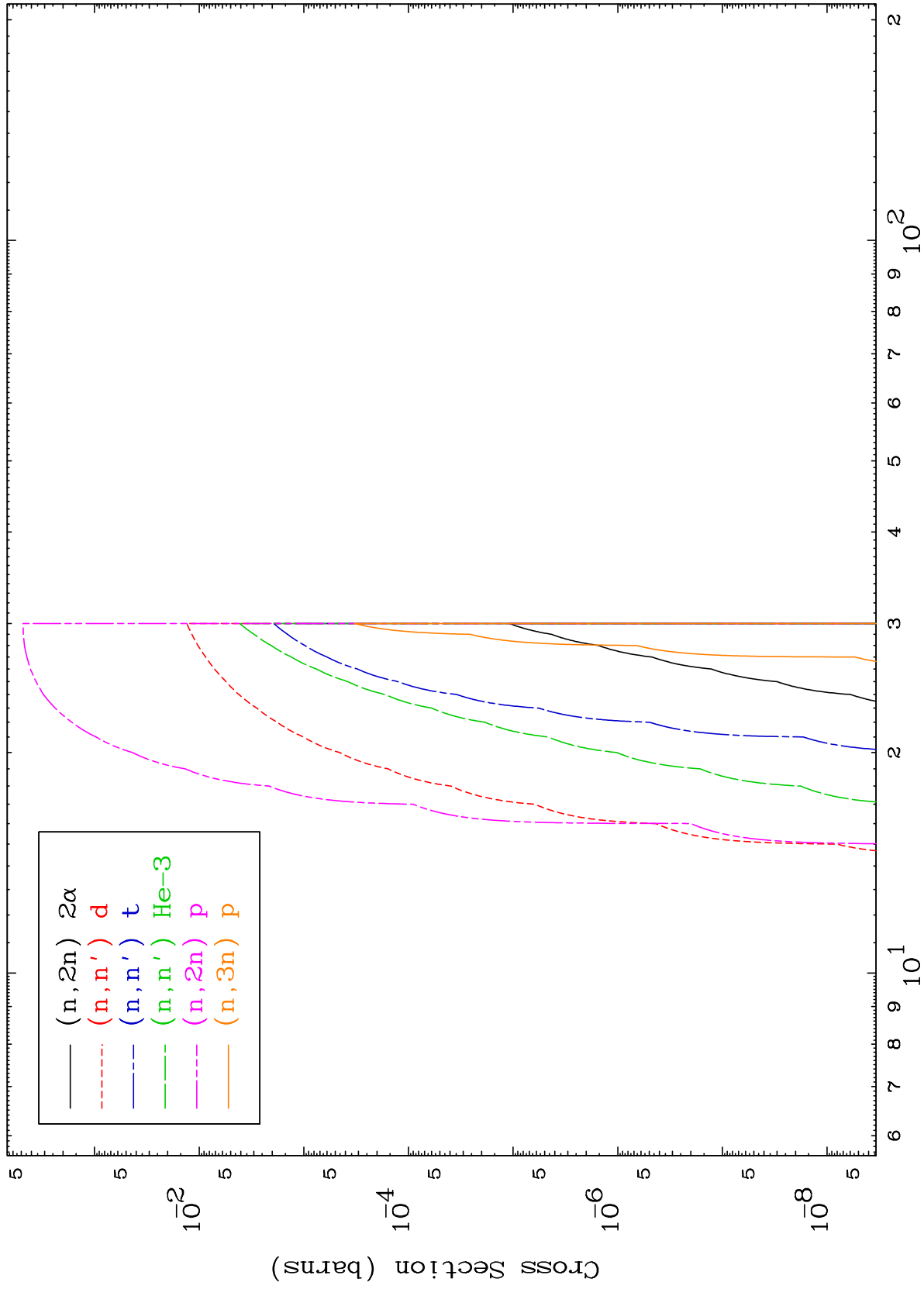

3

Incident Energy (MeV)

54-Xe-119

MAT 5410

293 Kelvin Cross Sections

54-Xe-119

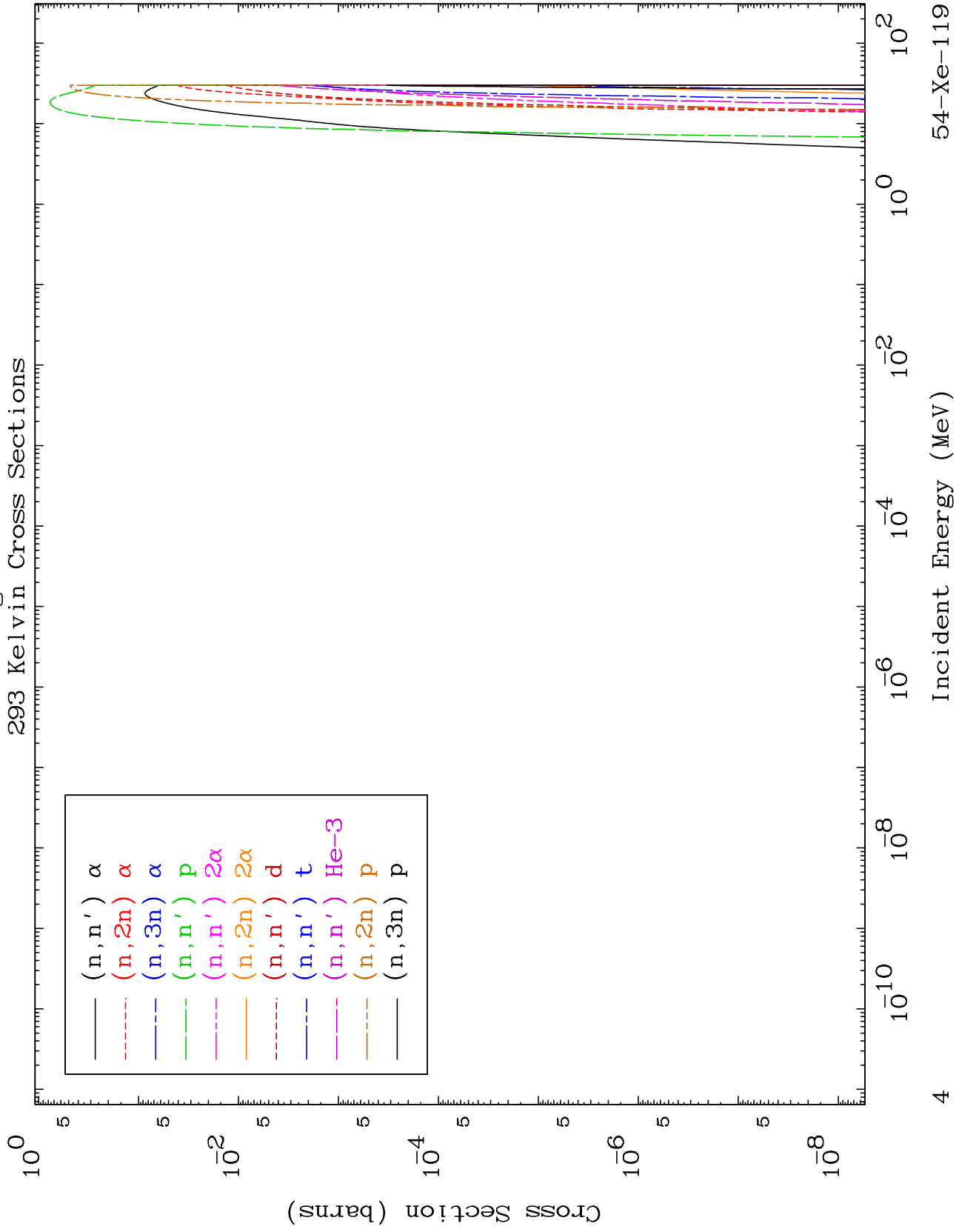

MAT 5410

293 Kelvin Cross Sections

54-Xe-119

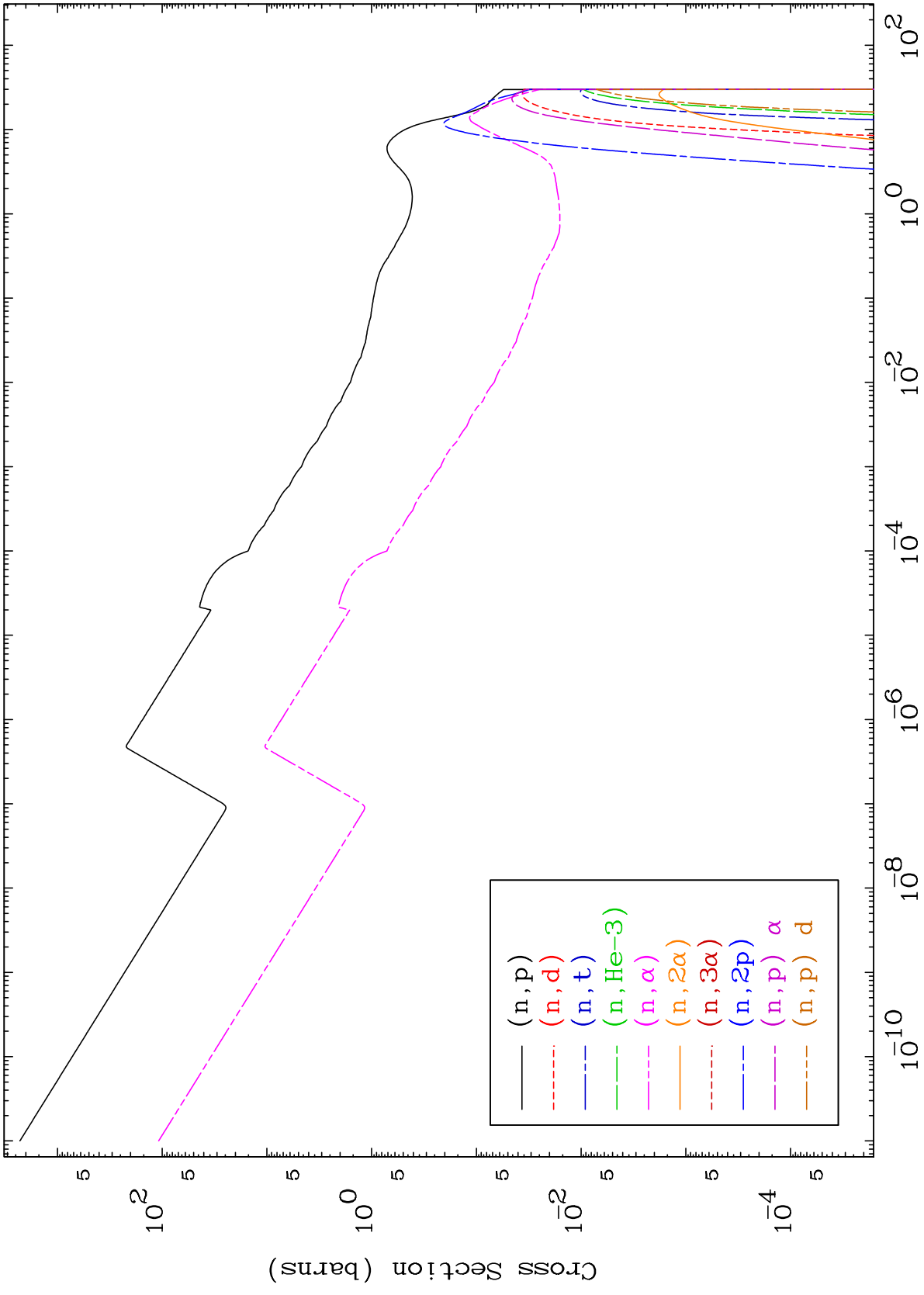

54-Xe-119

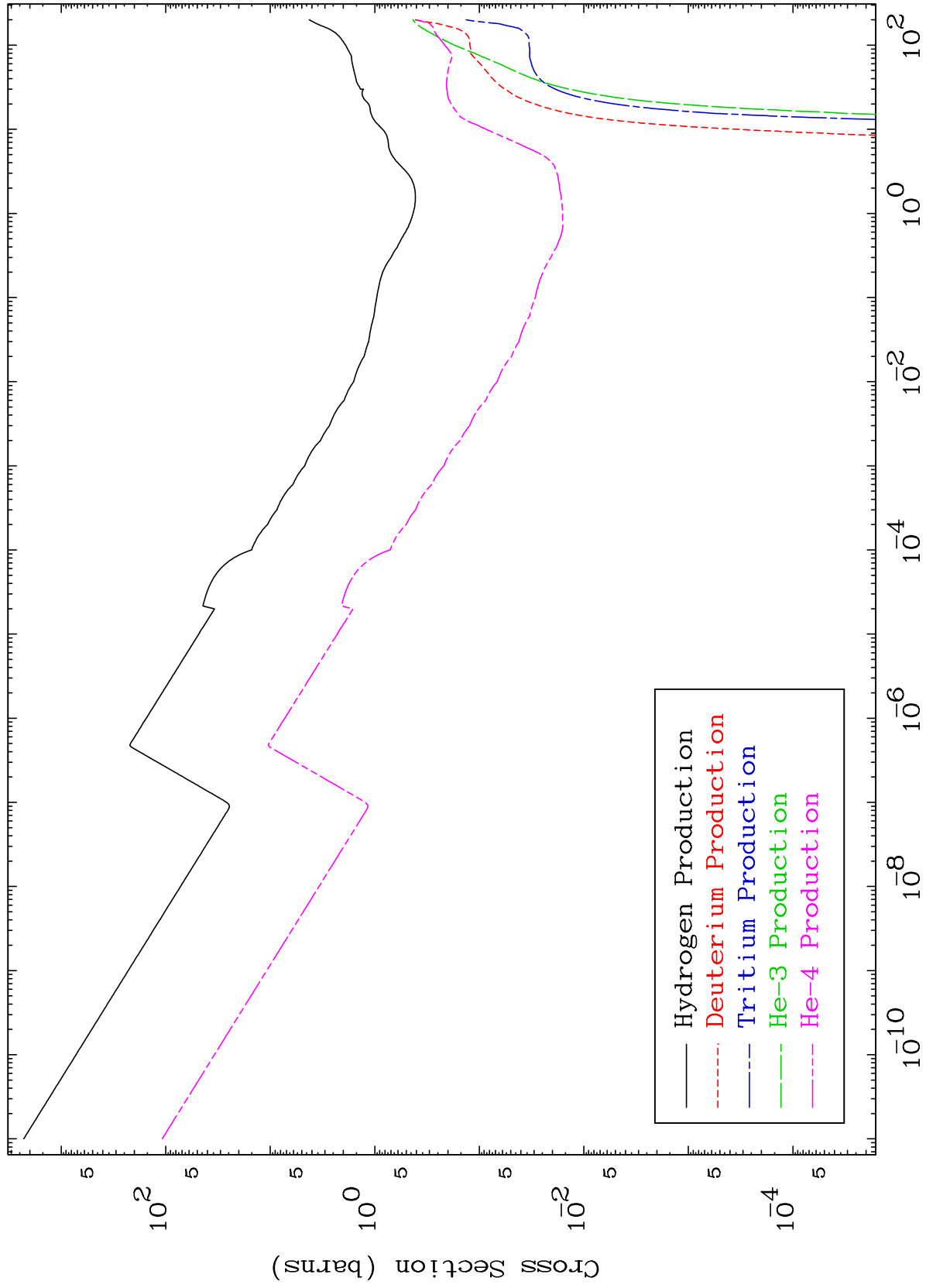

MAT 5410

(n,n') Level

54-Xe-119

293 Kelvin Cross Sections

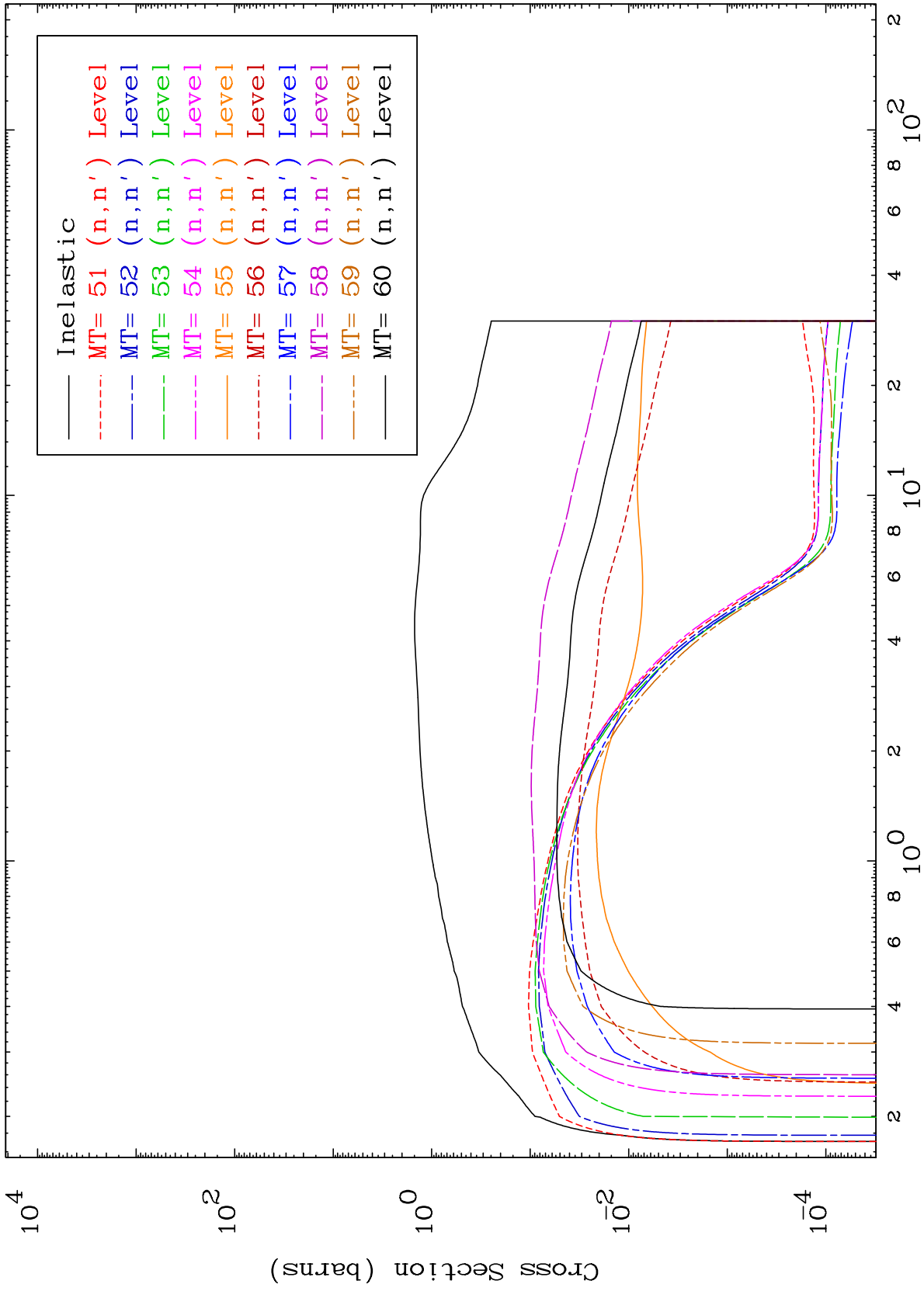

7

Incident Energy (MeV)

54-Xe-119

MAT 5410

(n,n') Level
293 Kelvin Cross Sections

54-Xe-119

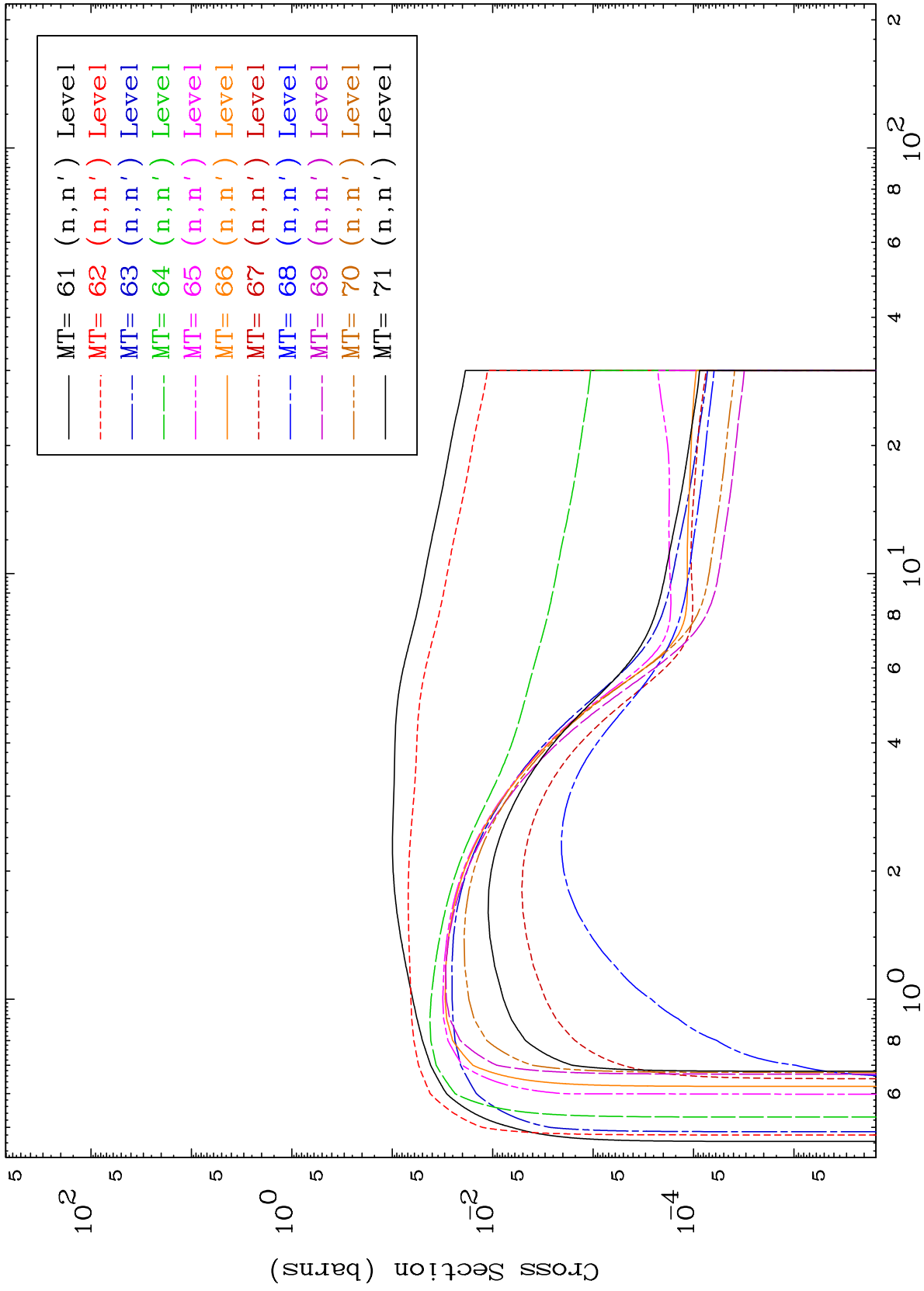

8

Incident Energy (MeV)

54-Xe-119

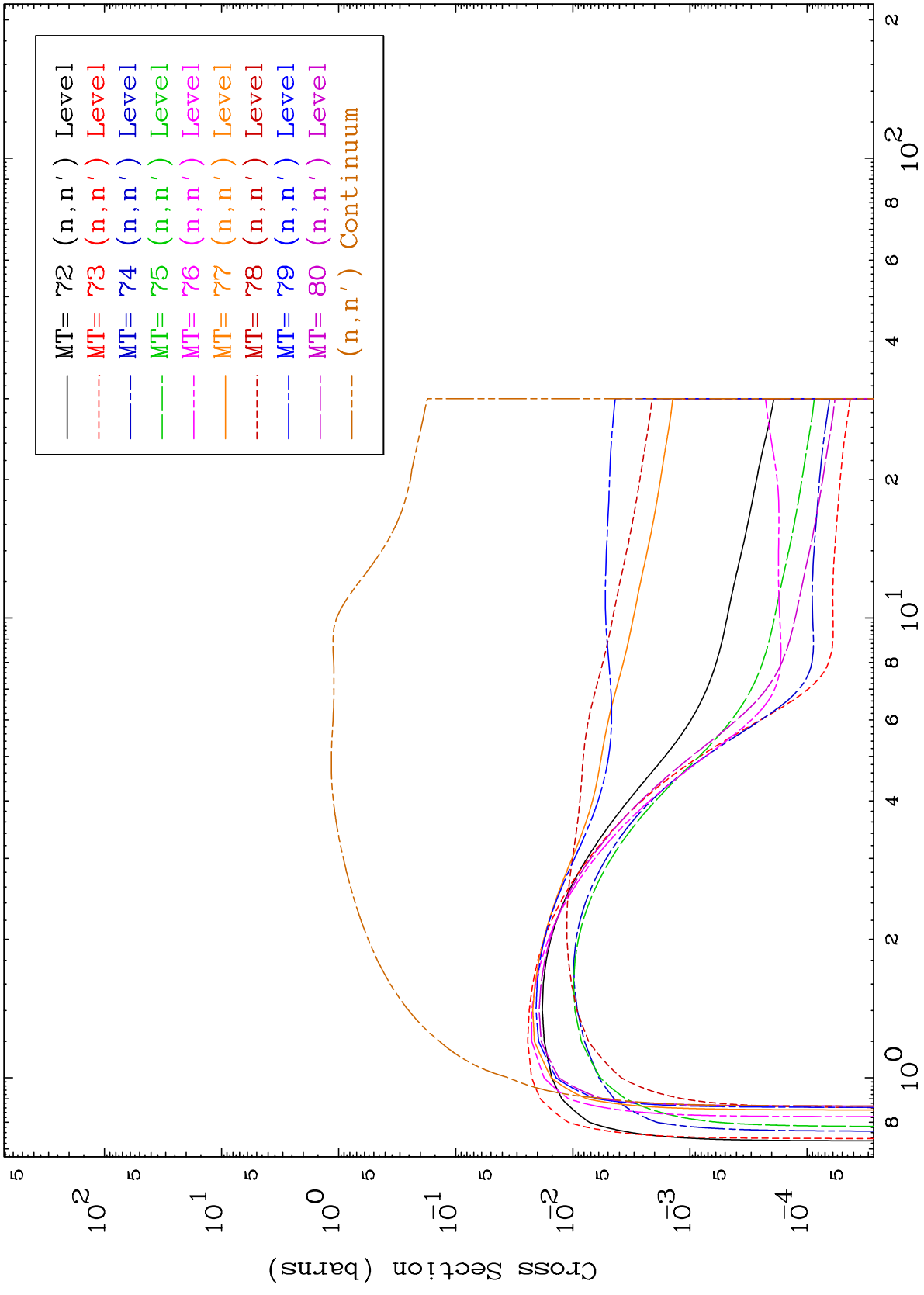

MAT 5410

(n,p) Levels
293 Kelvin Cross Sections

54-Xe-119

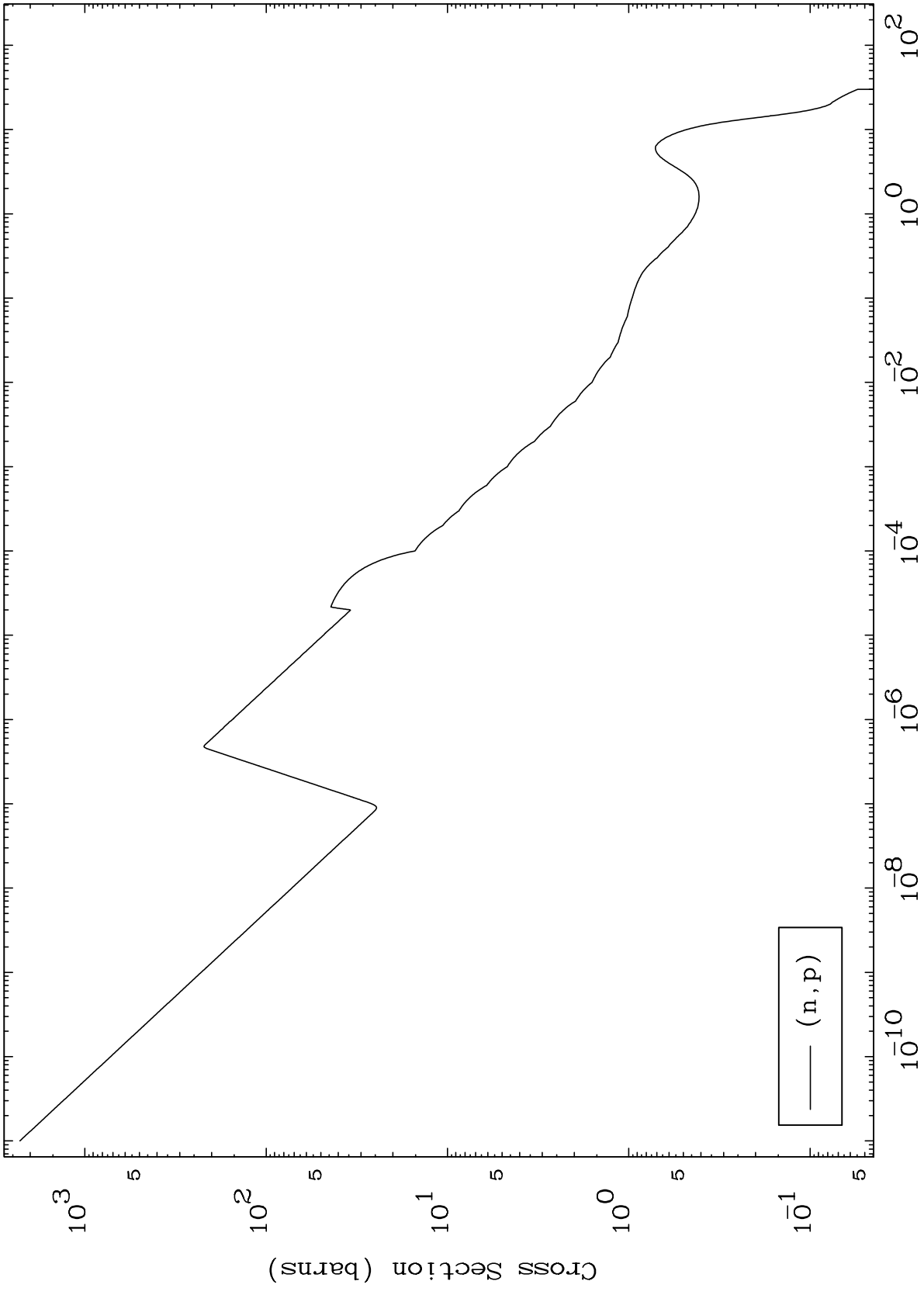

10

Incident Energy (MeV)

54-Xe-119

(n,p)

MAT 5410

(n,d) Levels
293 Kelvin Cross Sections

54-Xe-119

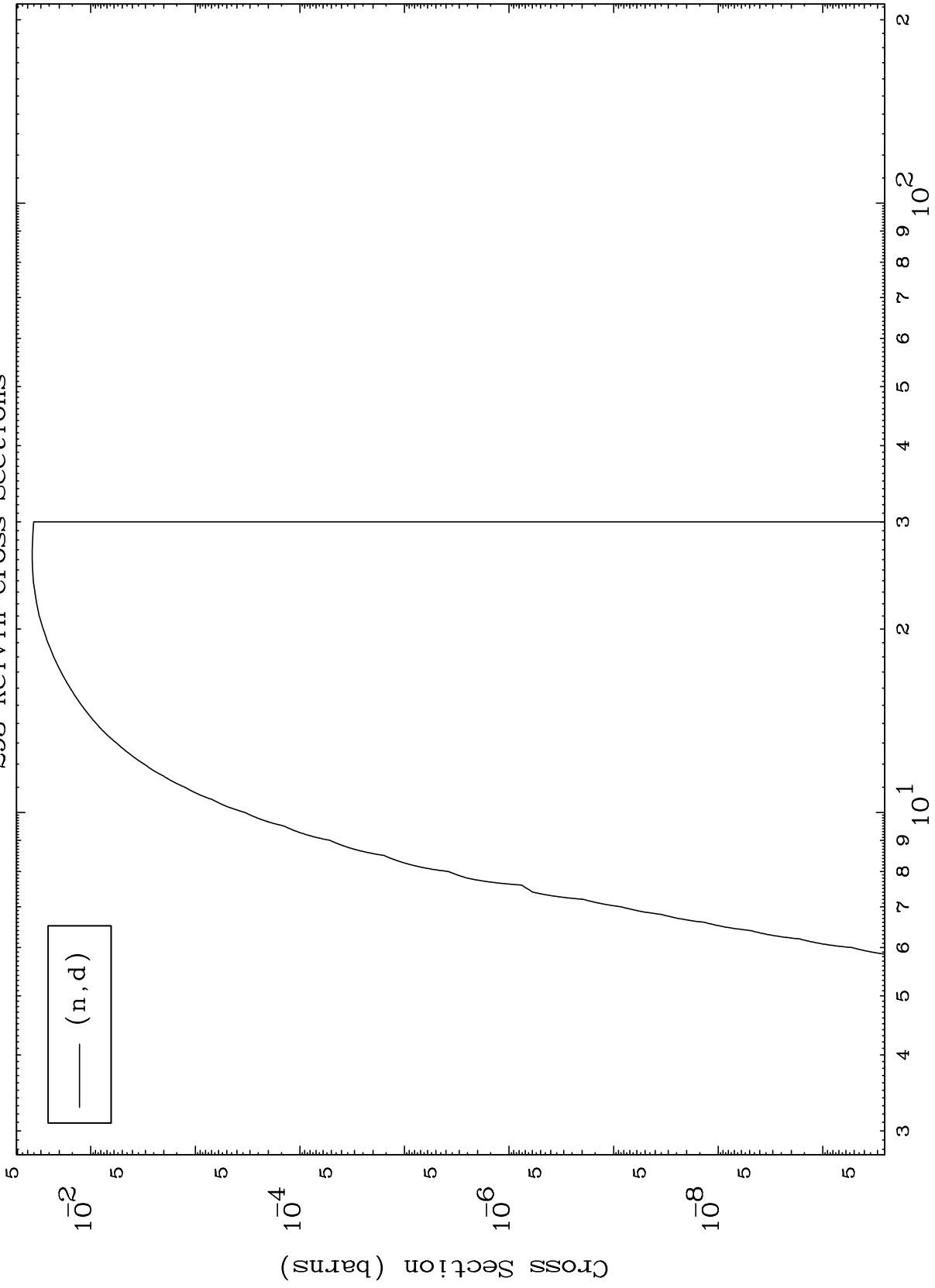

11

Incident Energy (MeV)

54-Xe-119

MAT 5410

(n,t) Levels
293 Kelvin Cross Sections

54-Xe-119

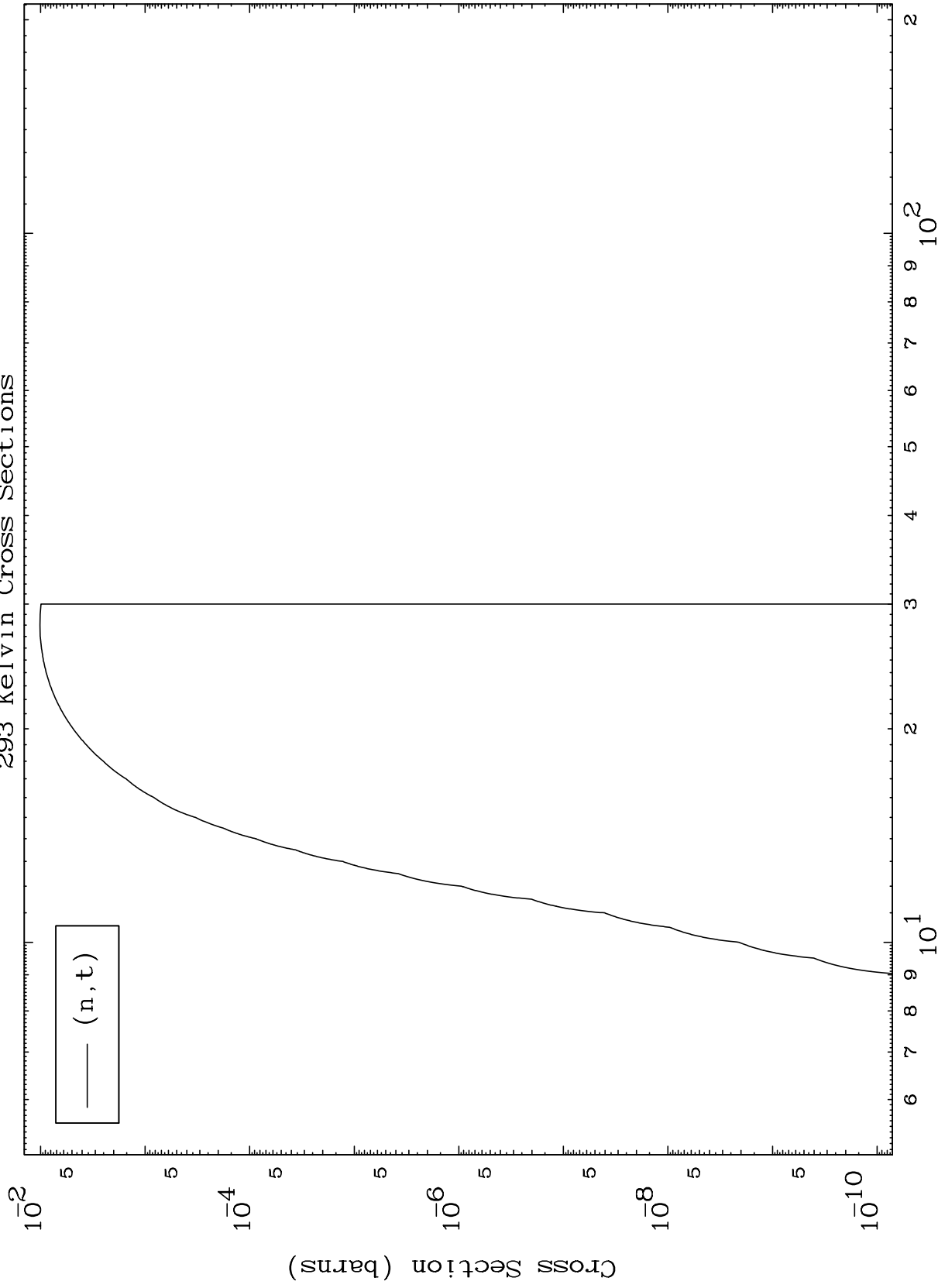

12

Incident Energy (MeV)

54-Xe-119

MAT 5410

(n,He3) Levels

54-Xe-119

293 Kelvin Cross Sections

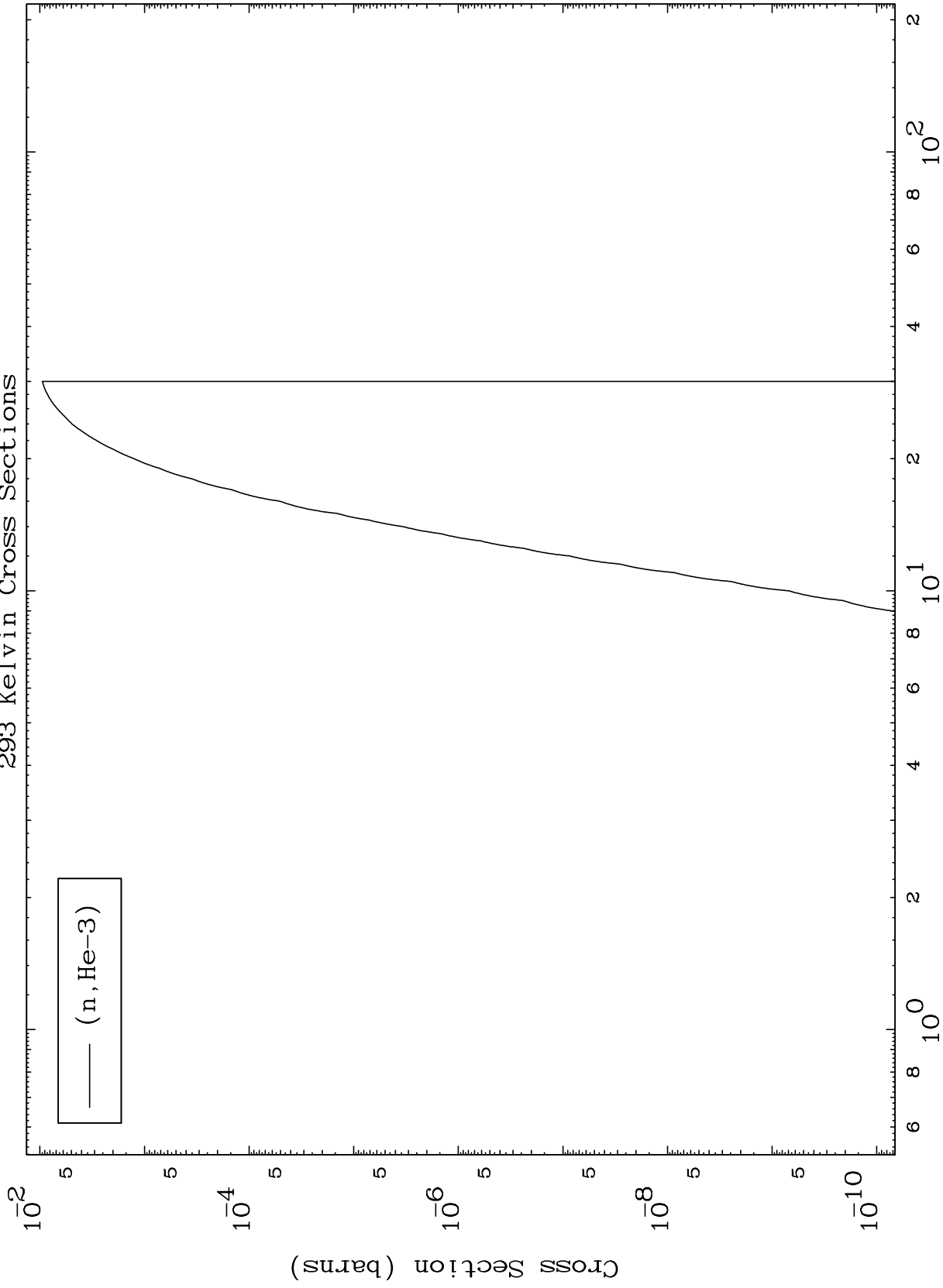

13

Incident Energy (MeV)

54-Xe-119

MAT 5410

(n, α) Levels
293 Kelvin Cross Sections

54-Xe-119

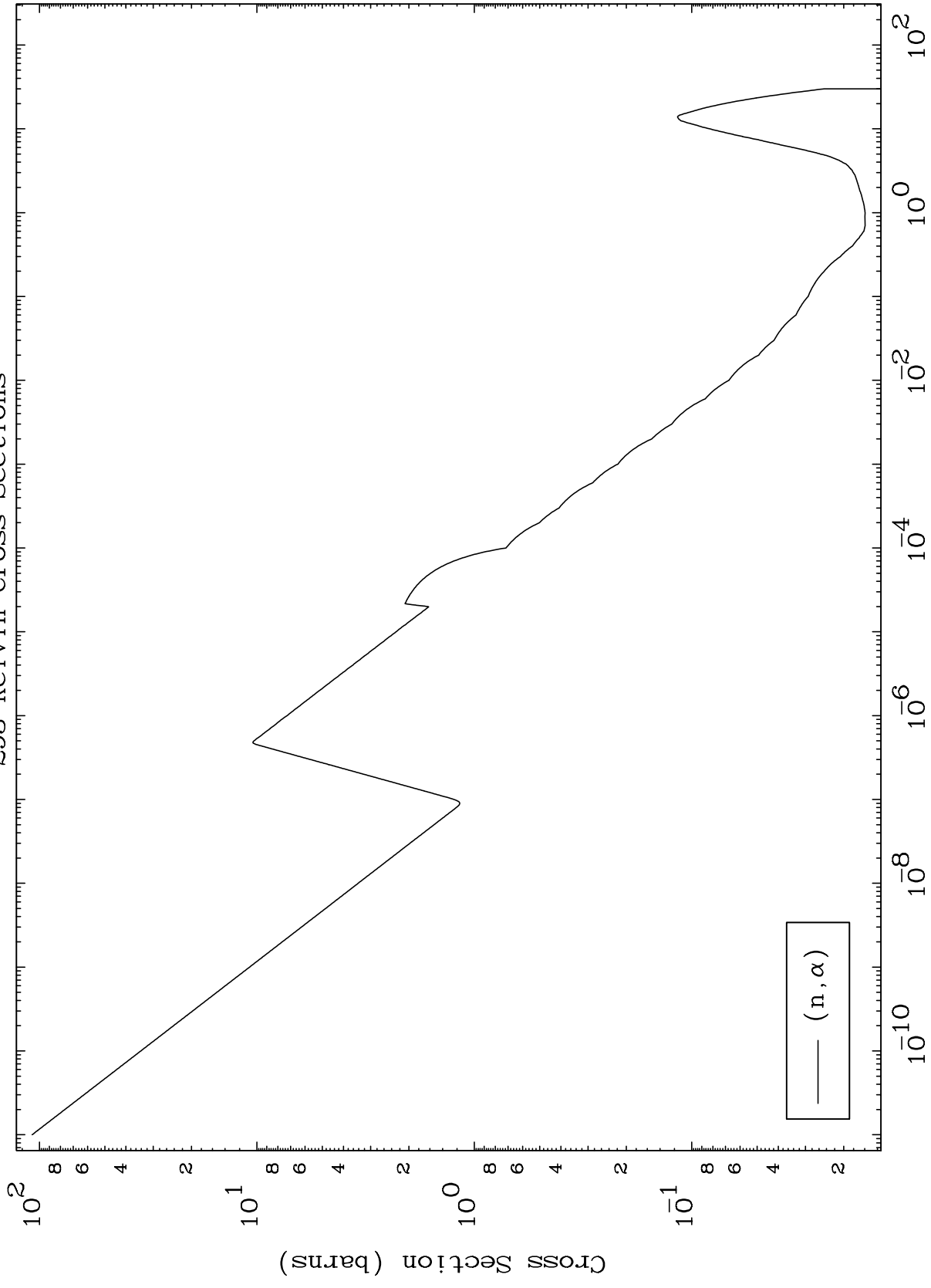

54-Xe-119

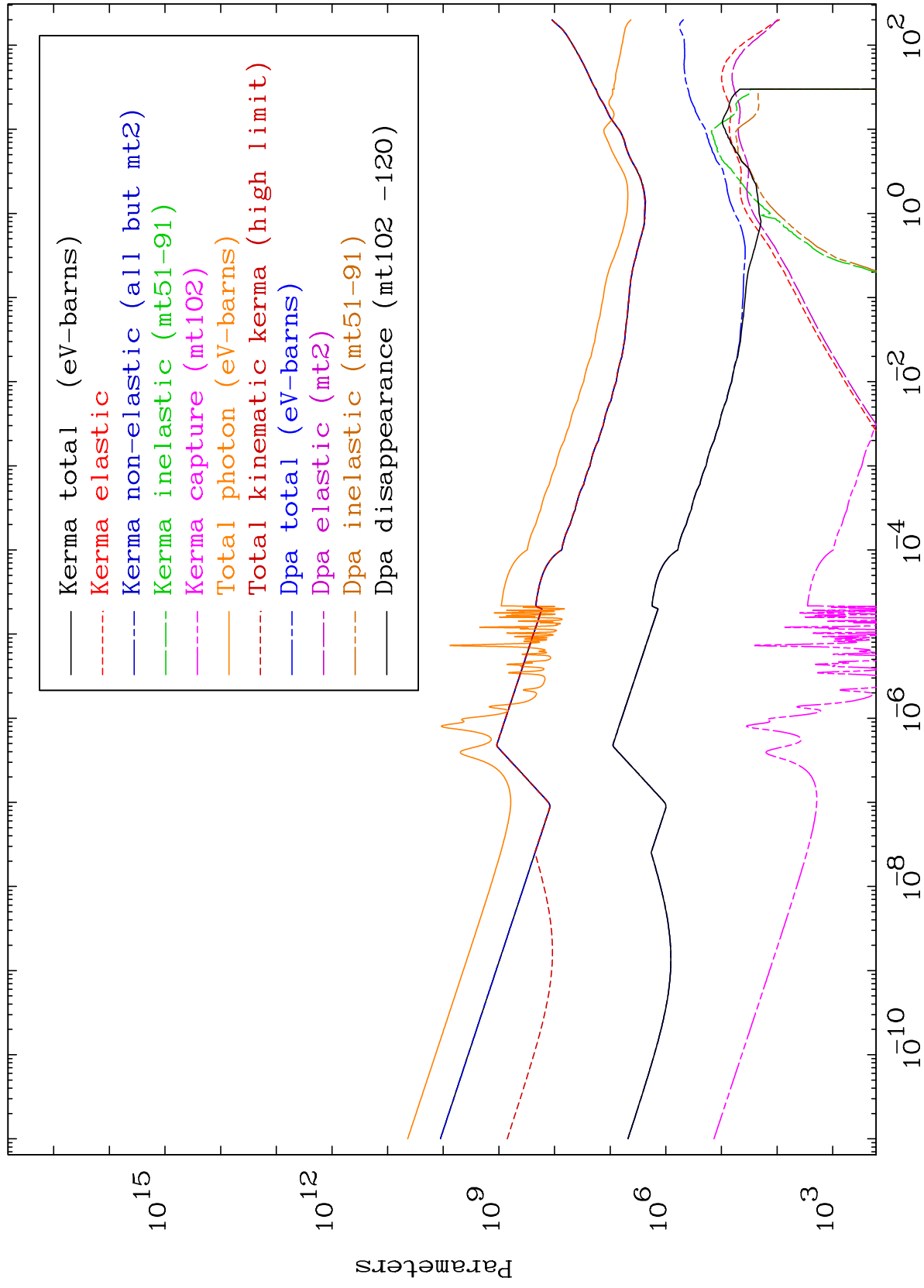

MAT 5410

Elastic Legendre Coefficients

54-Xe-119

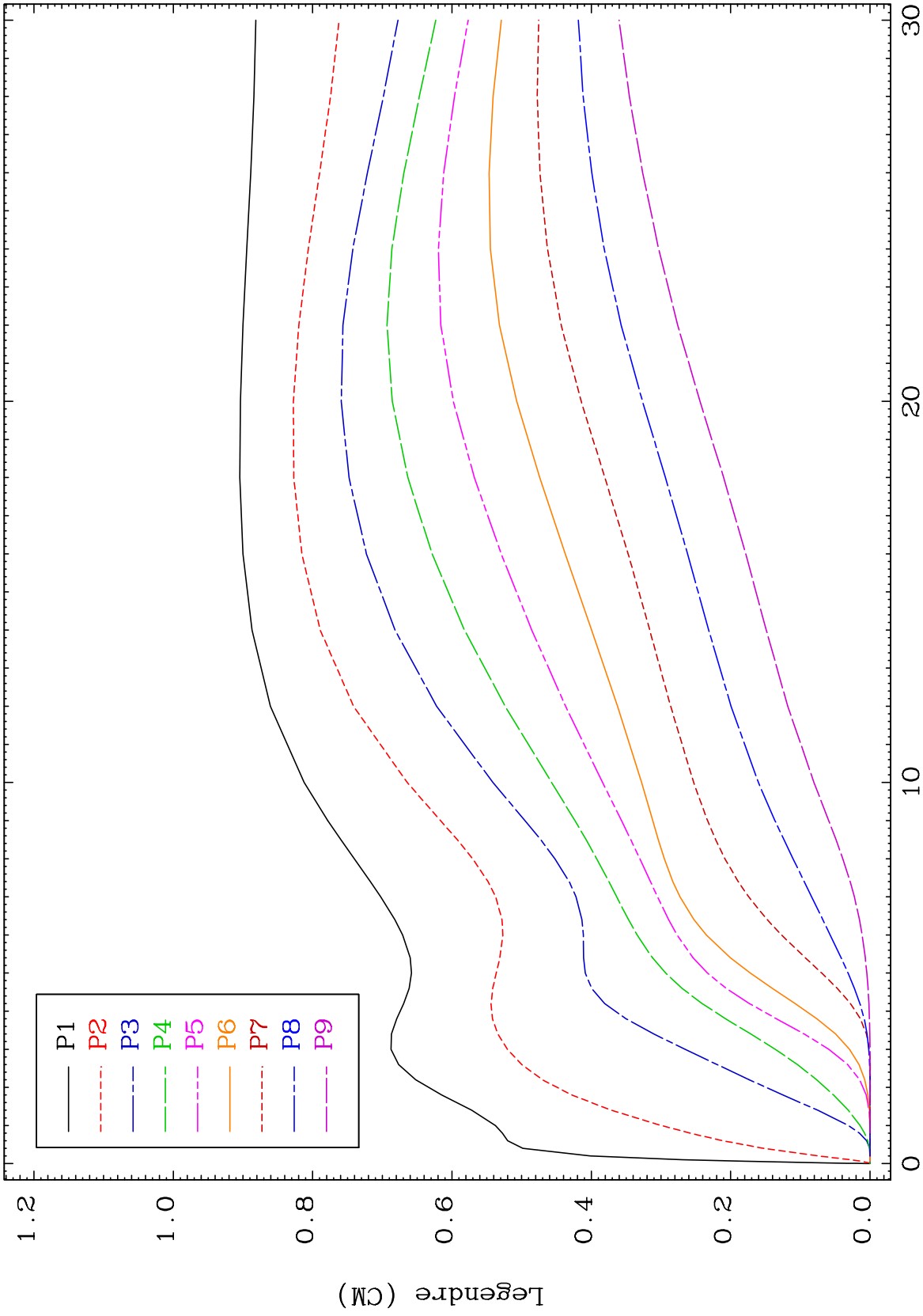

16

Incident Energy (MeV)

54-Xe-119

MAT 5410

Elastic Legendre Coefficients

54-Xe-119

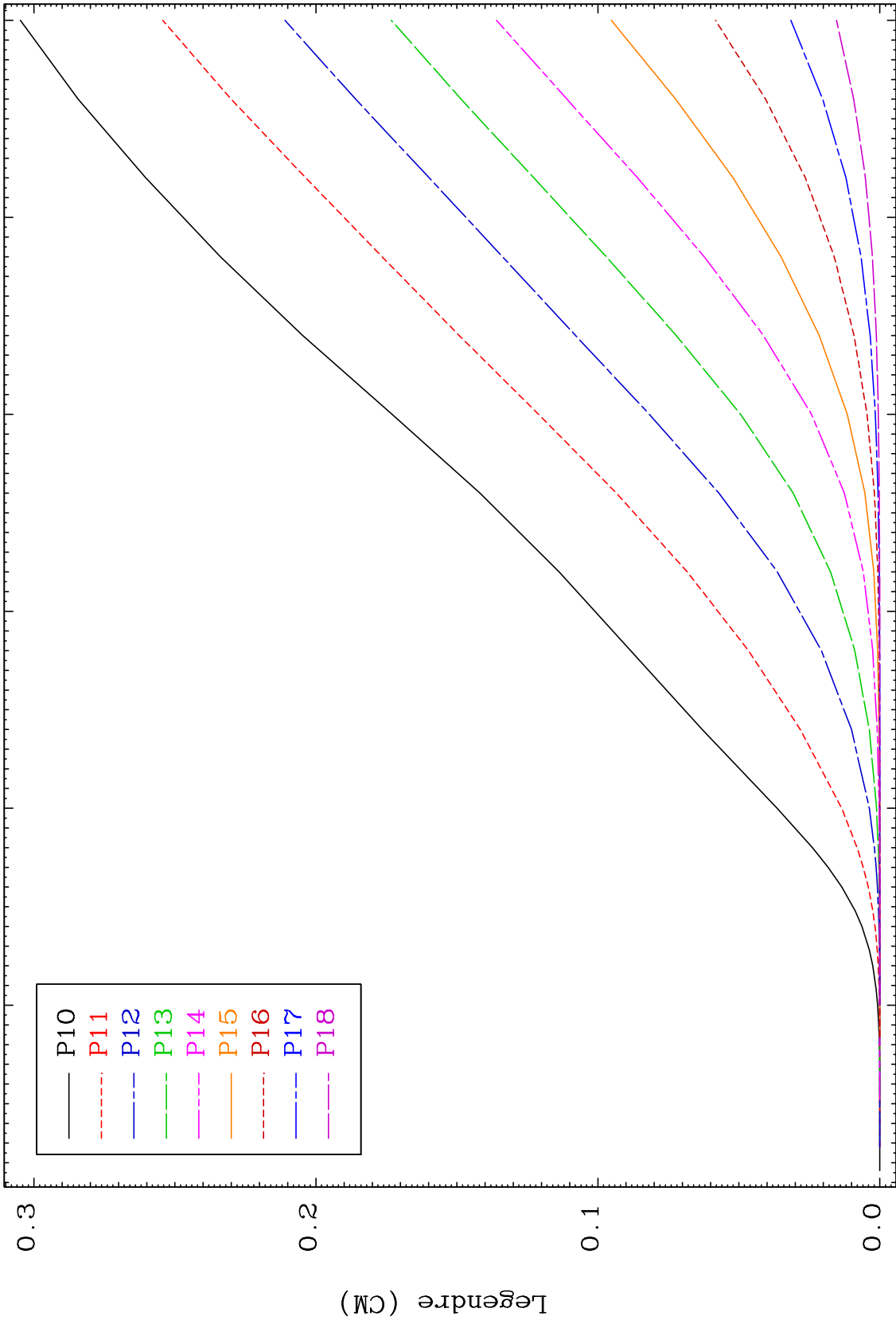

17

Incident Energy (MeV)

54-Xe-119

MAT 5410

Elastic Legendre Coefficients

54-Xe-119

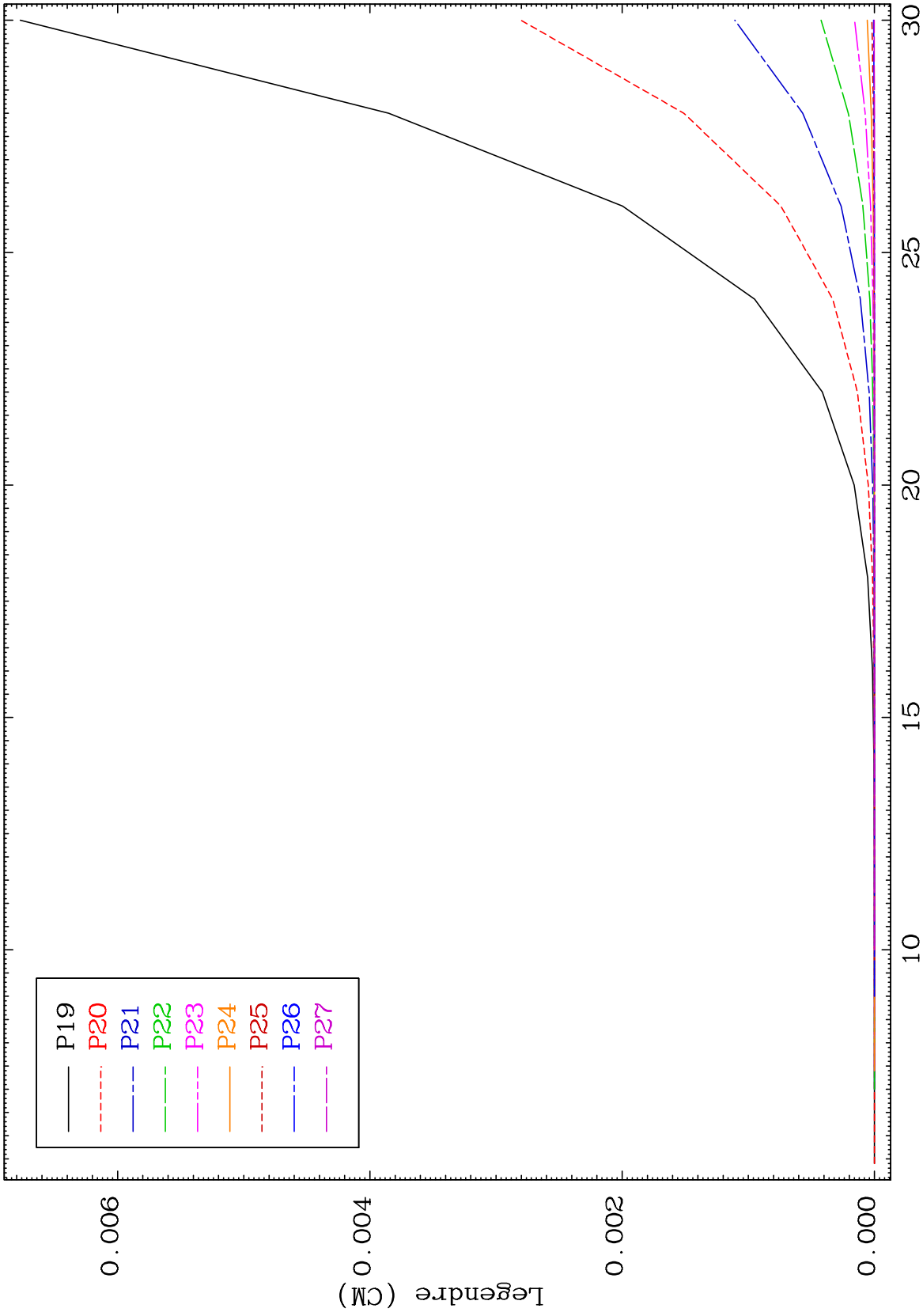

18

Incident Energy (MeV)

54-Xe-119

MAT 5410

Elastic Legendre Coefficients

54-Xe-119

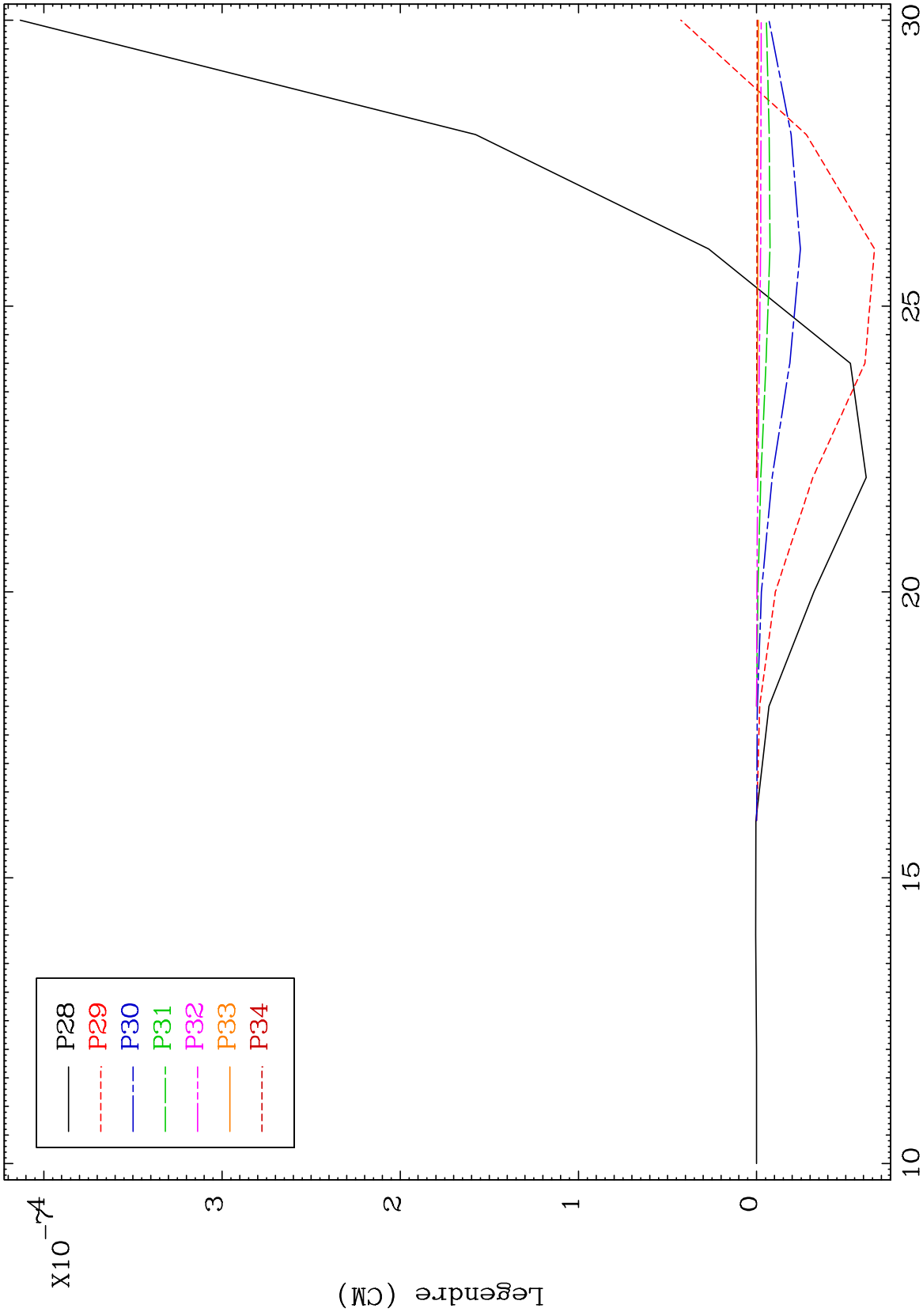

19

Incident Energy (MeV)

54-Xe-119

MAT 5410

MT= 51 (n,n') Level
Legendre Coefficients

54-Xe-119

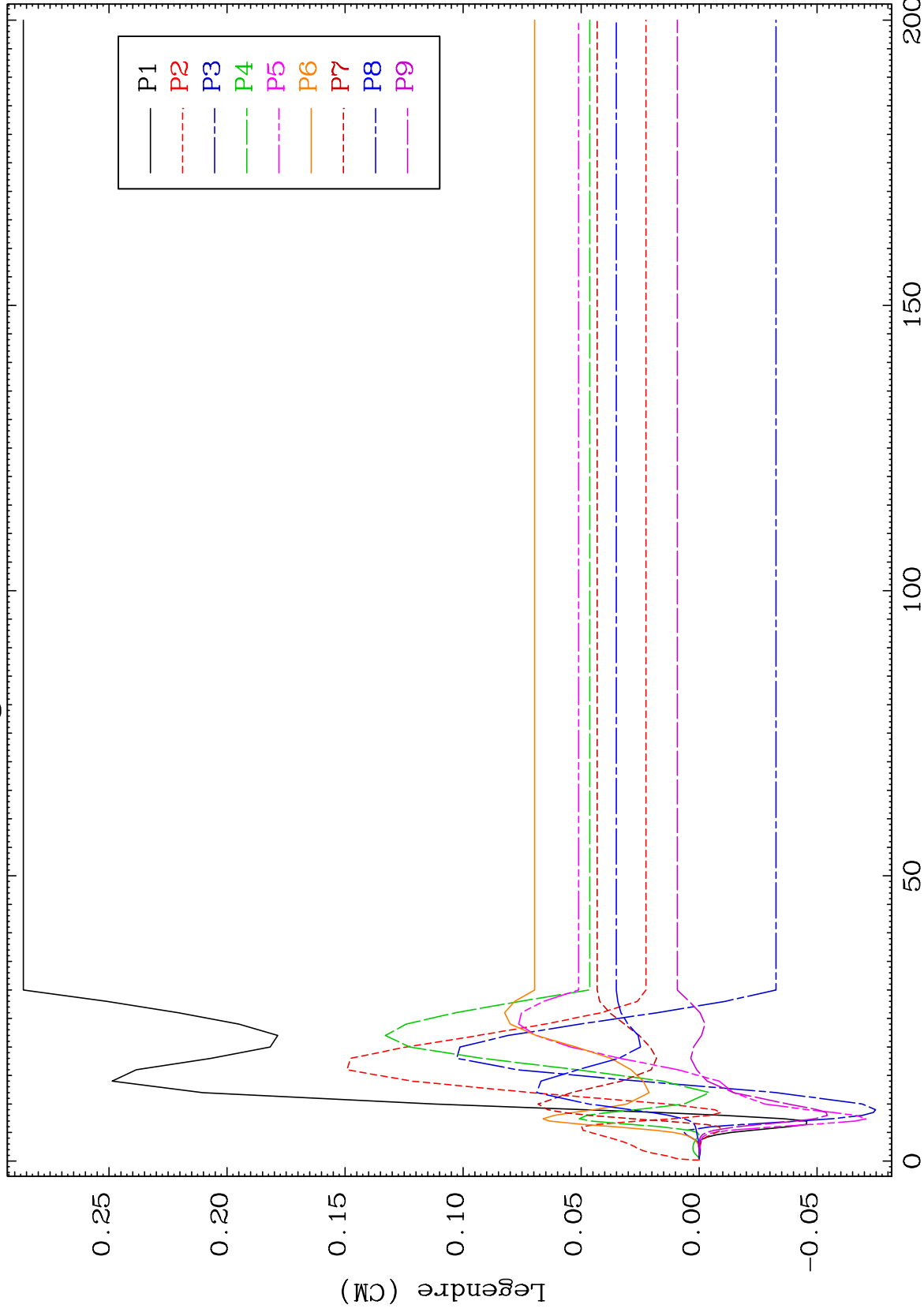

54-Xe-119

Incident Energy (MeV)

MAT 5410

MT= 51 (n,n') Level
Legendre Coefficients

54-Xe-119

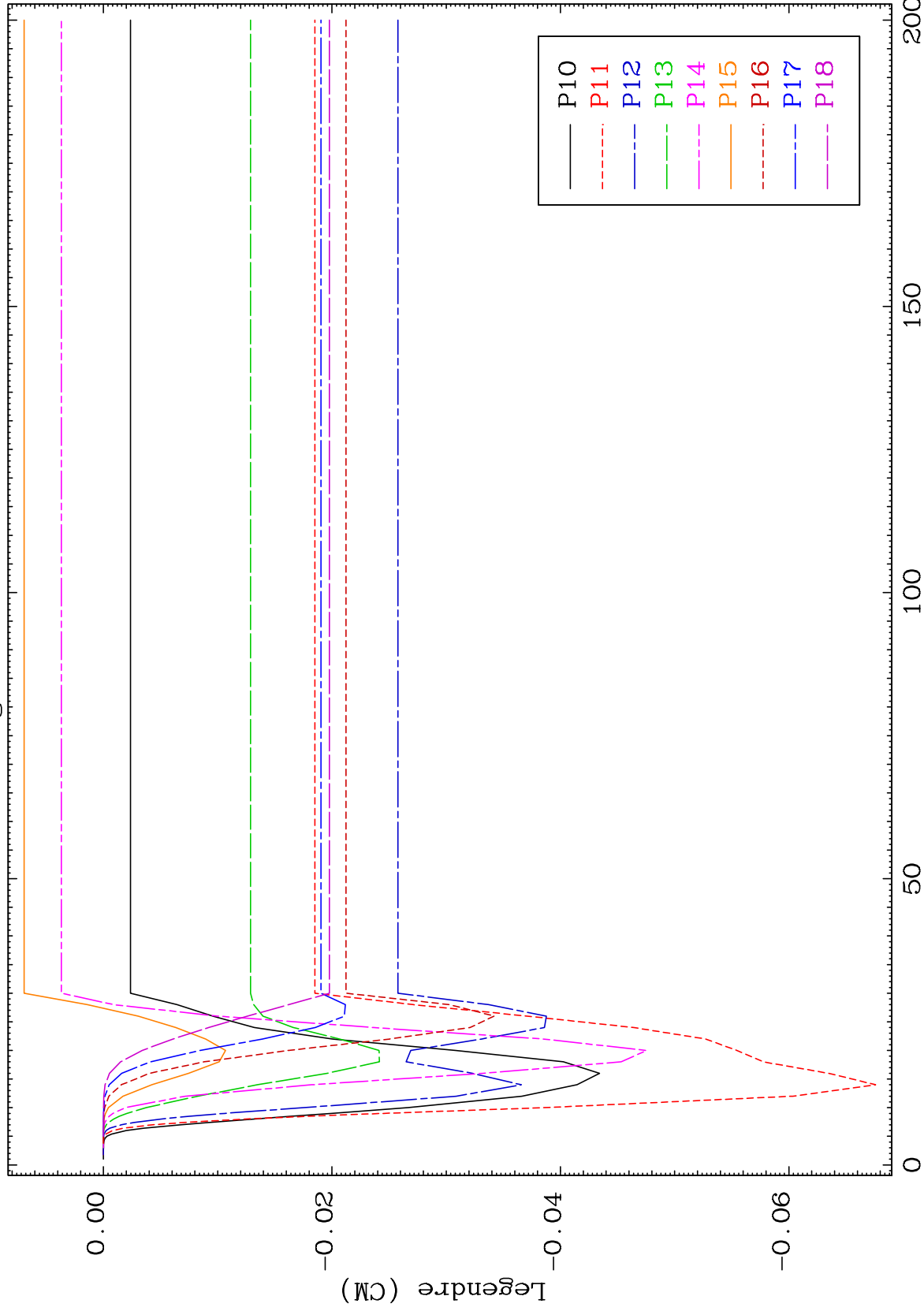

21

Incident Energy (MeV)

54-Xe-119

MAT 5410 MT= 51 (n,n') Level Legendre Coefficients 54-Xe-119

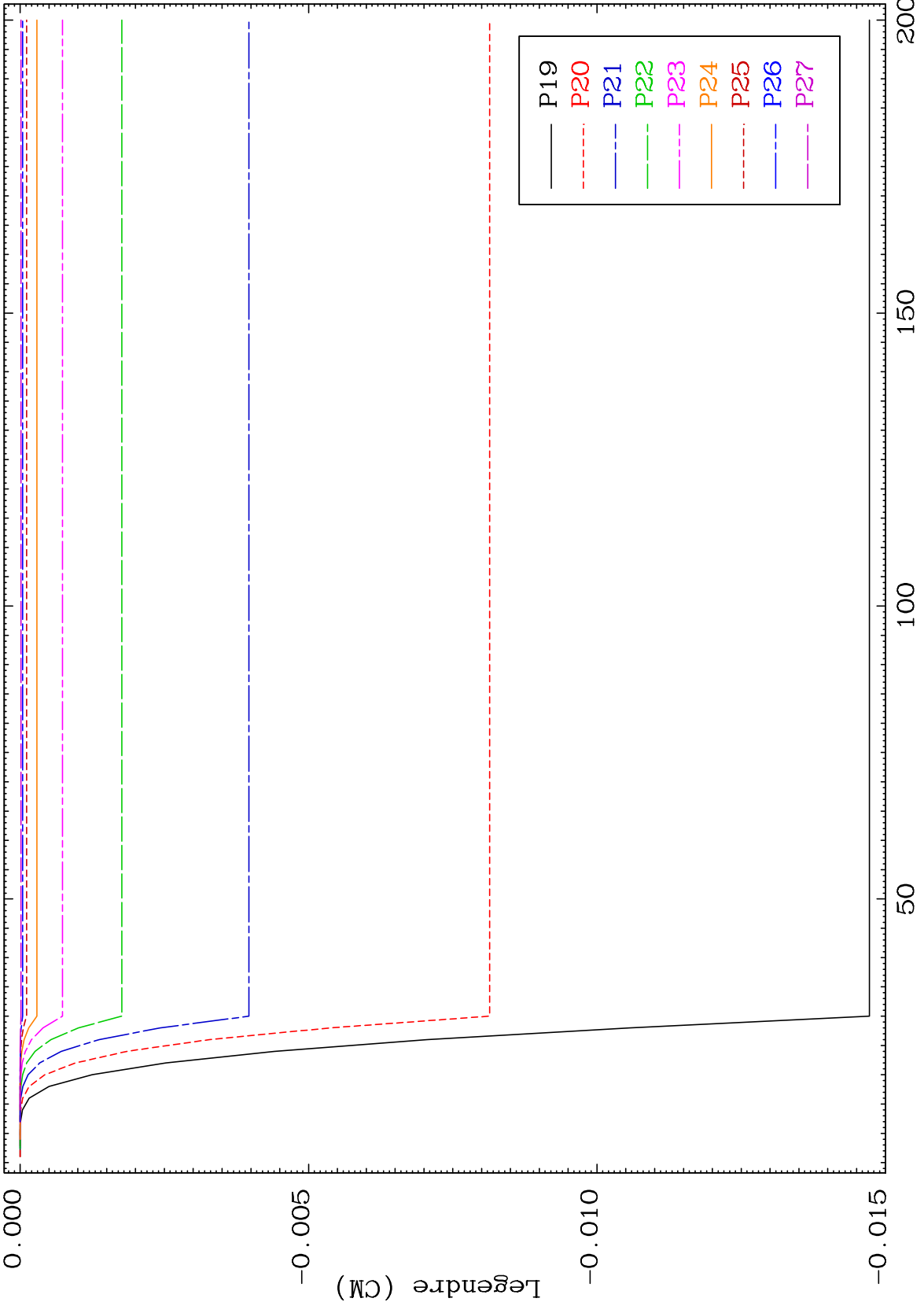

22 Incident Energy (MeV) 54-Xe-119

MAT 5410

MT= 51 (n,n') Level
Legendre Coefficients

54-Xe-119

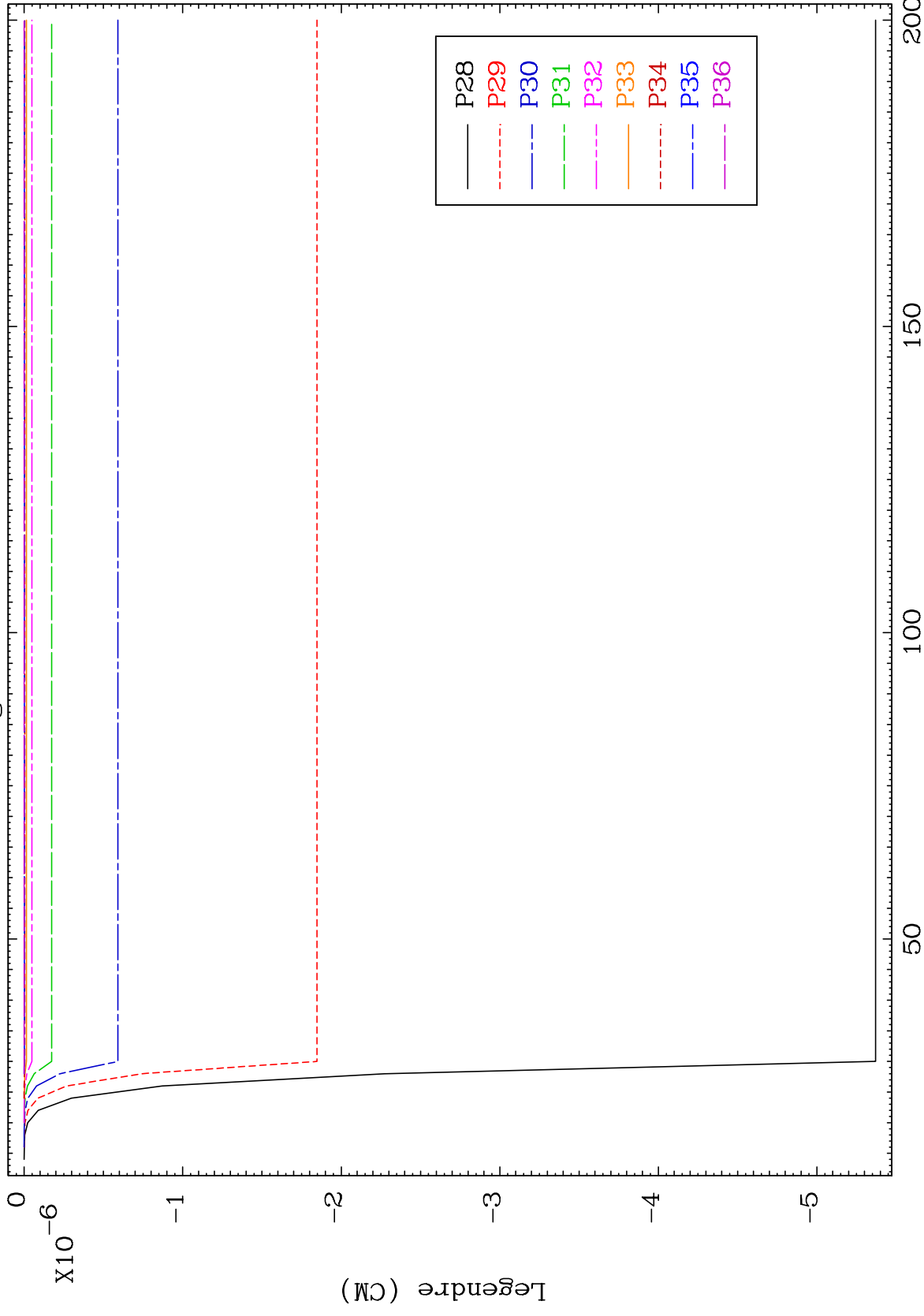

54-Xe-119

Incident Energy (MeV)

23

MAT 5410

MT= 52 (n,n') Level
Legendre Coefficients

54-Xe-119

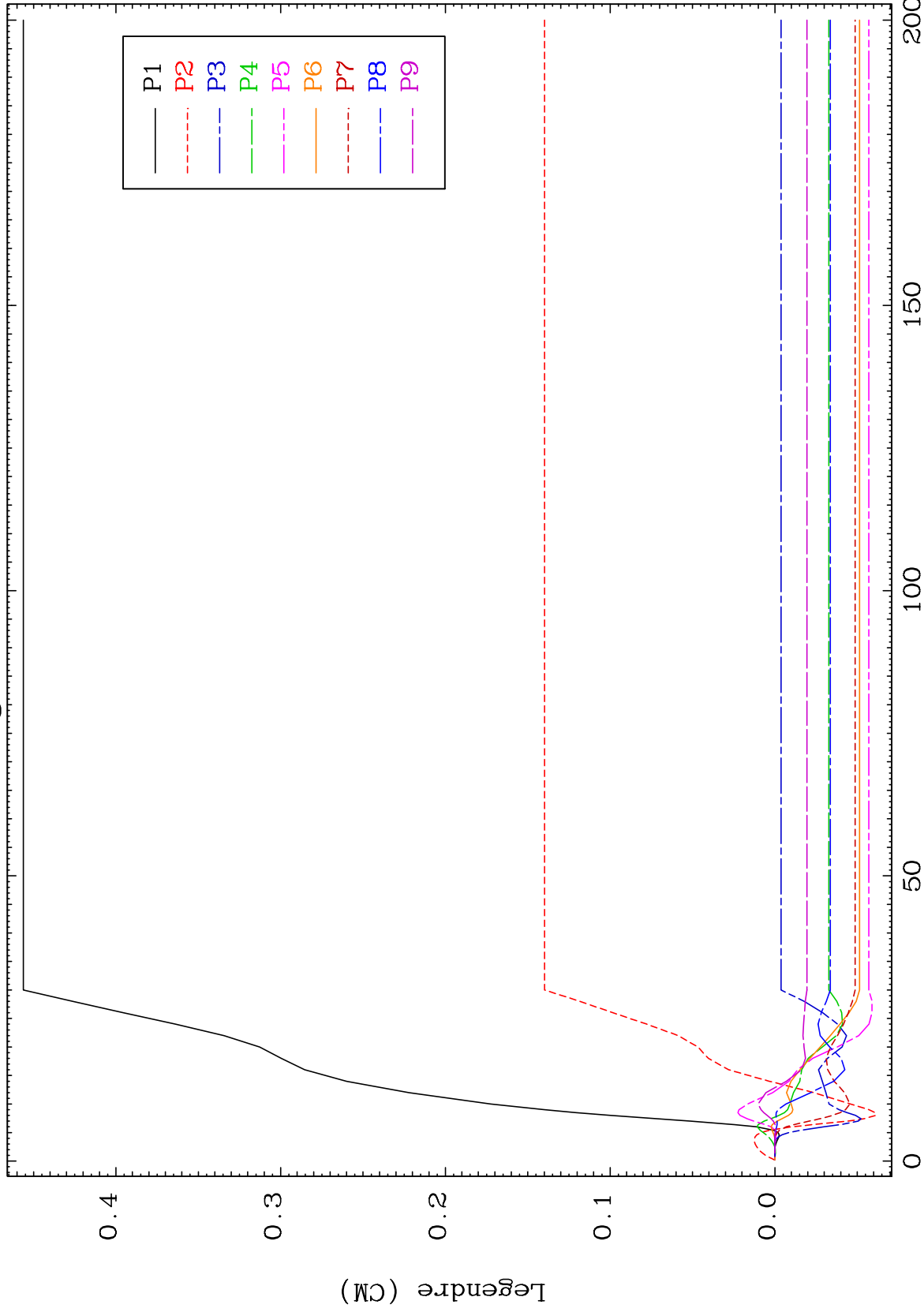

24

Incident Energy (MeV)

54-Xe-119

MAT 5410 MT= 52 (n,n') Level Legendre Coefficients 54-Xe-119

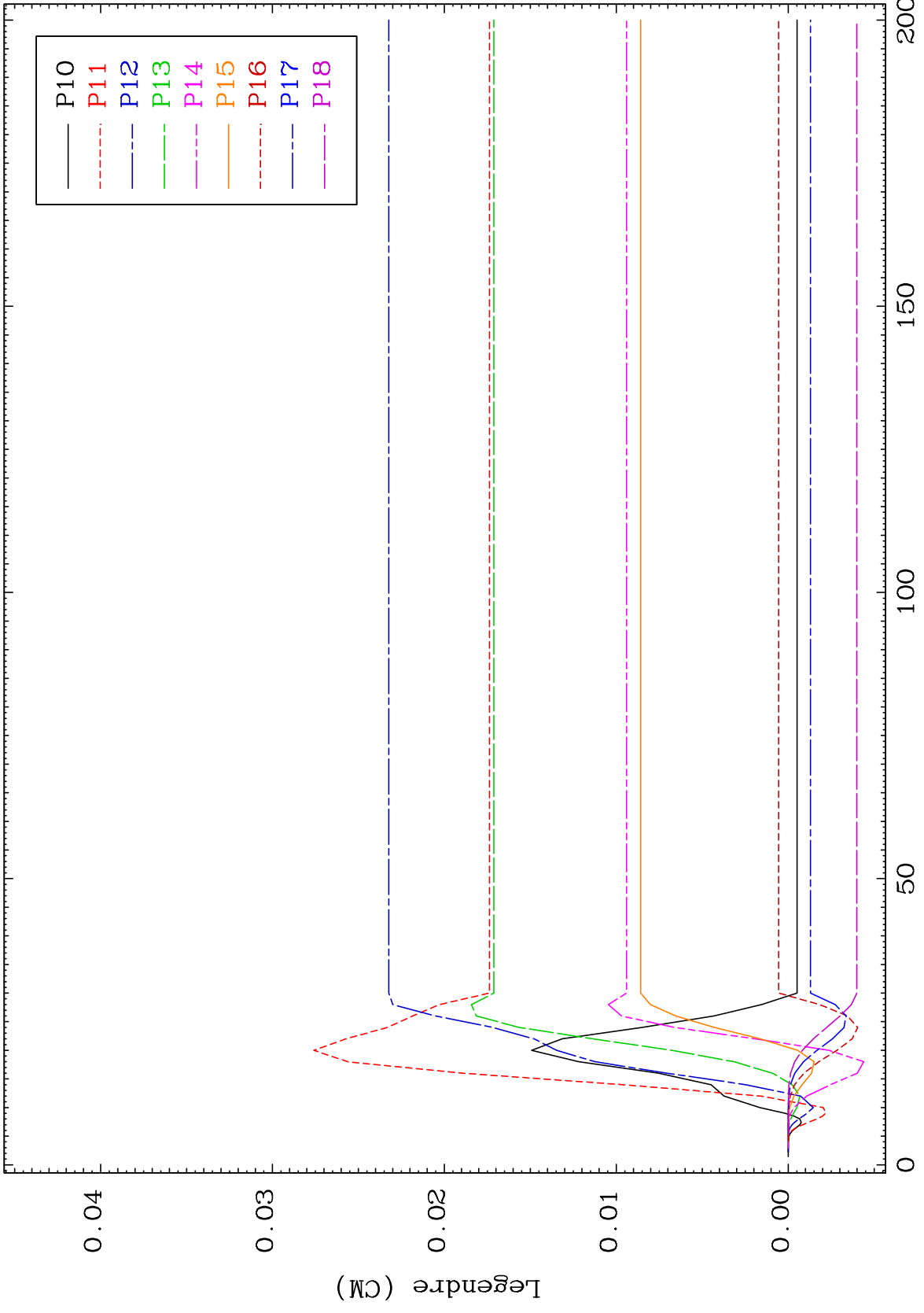

54-Xe-119

MAT 5410

MT= 52 (n,n') Level
Legendre Coefficients

54-Xe-119

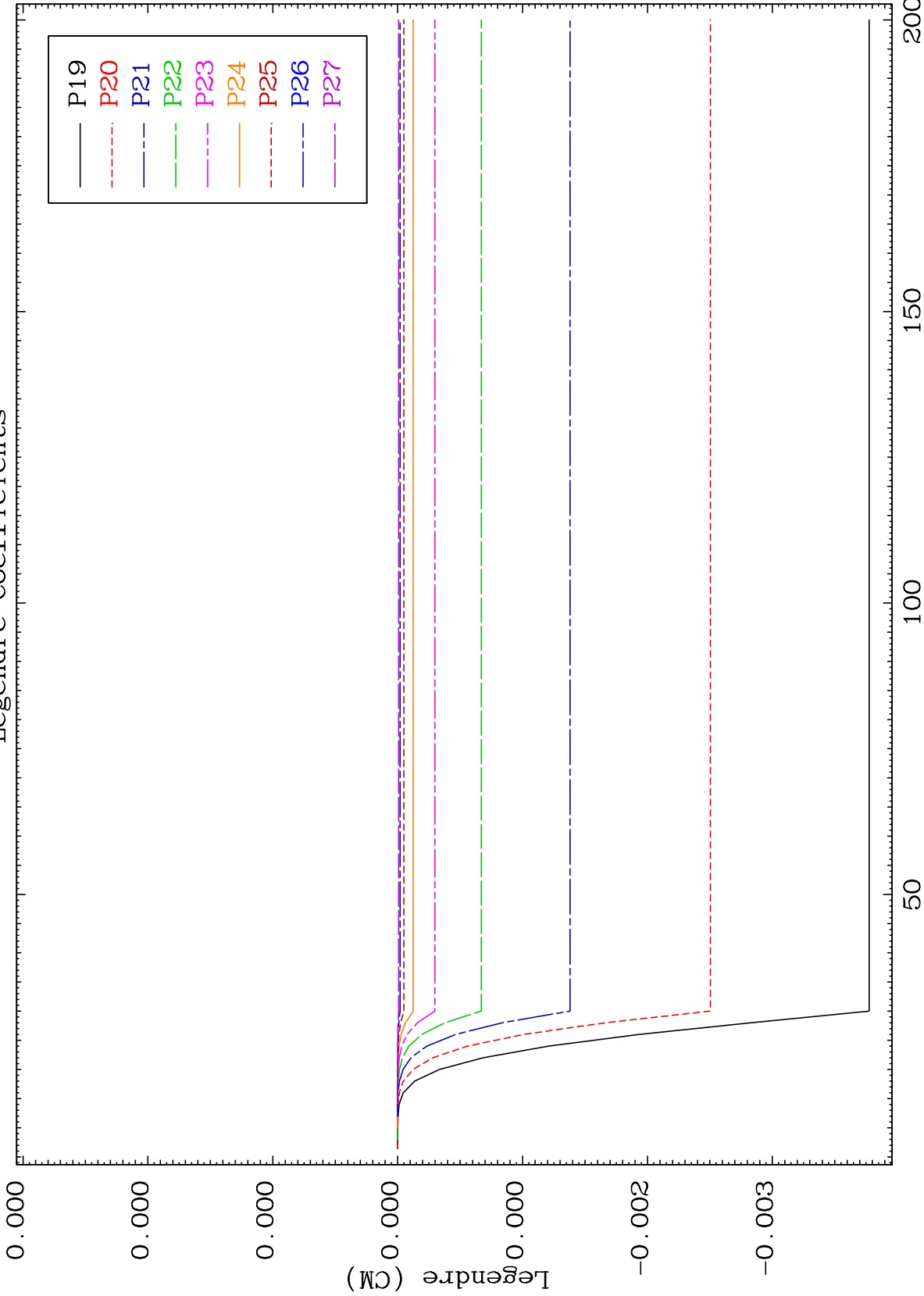

26

Incident Energy (MeV)

54-Xe-119

MAT 5410

MT= 52 (n,n') Level
Legendre Coefficients

54-Xe-119

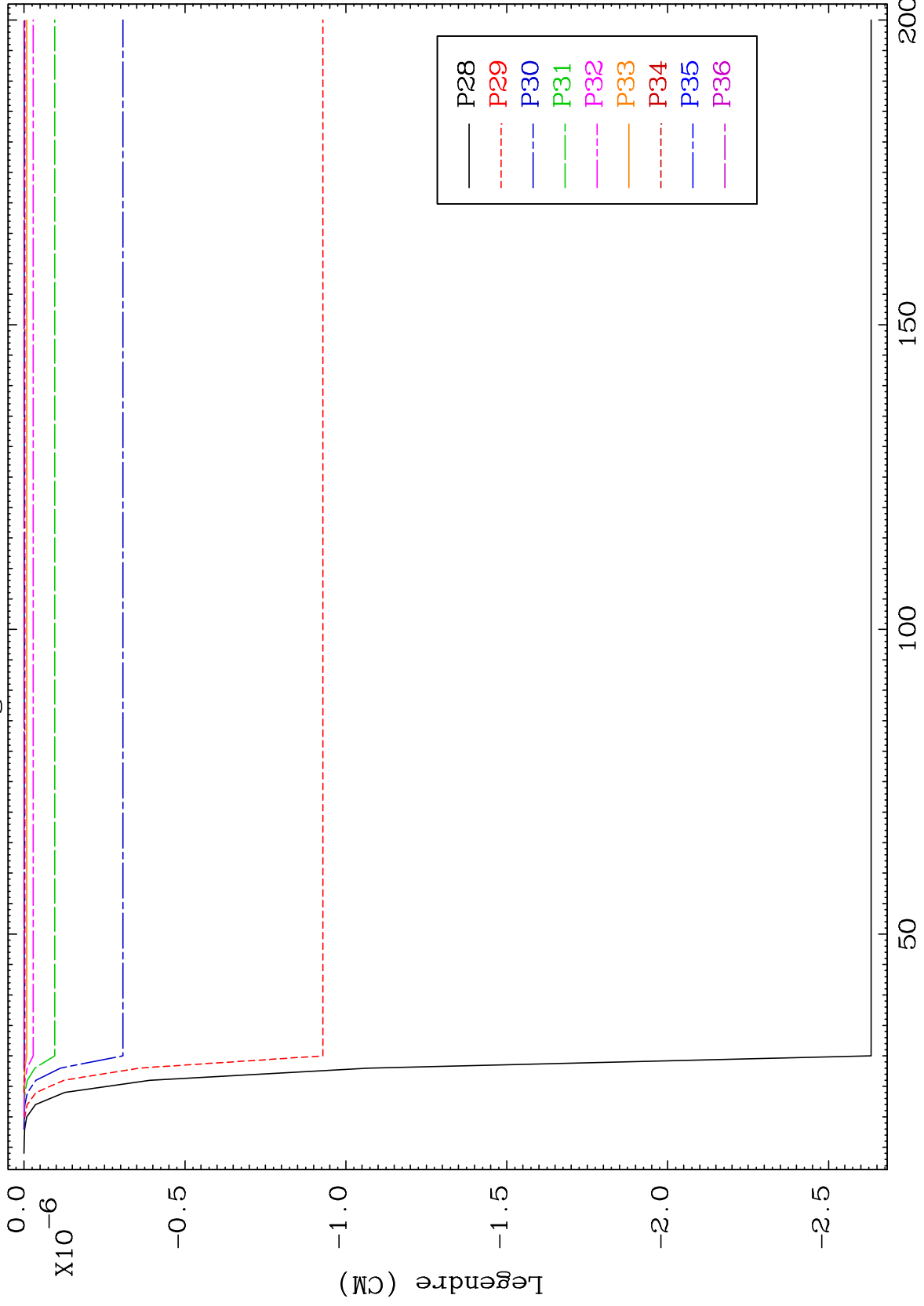

27

54-Xe-119

200

MAT 5410

MT= 53 (n,n') Level
Legendre Coefficients

54-Xe-119

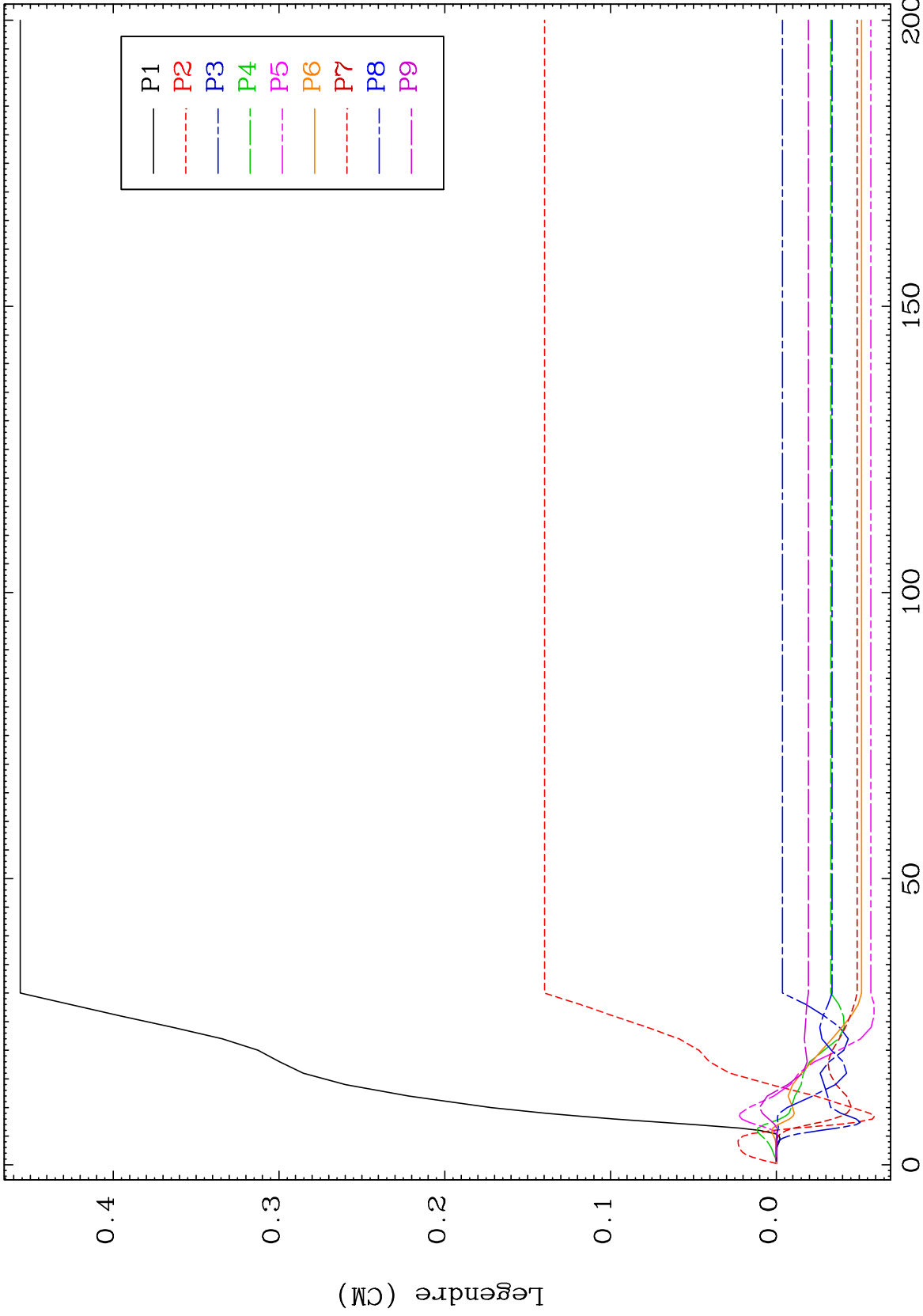

28

Incident Energy (MeV)

54-Xe-119

MAT 5410

MT= 53 (n,n') Level
Legendre Coefficients

54-Xe-119

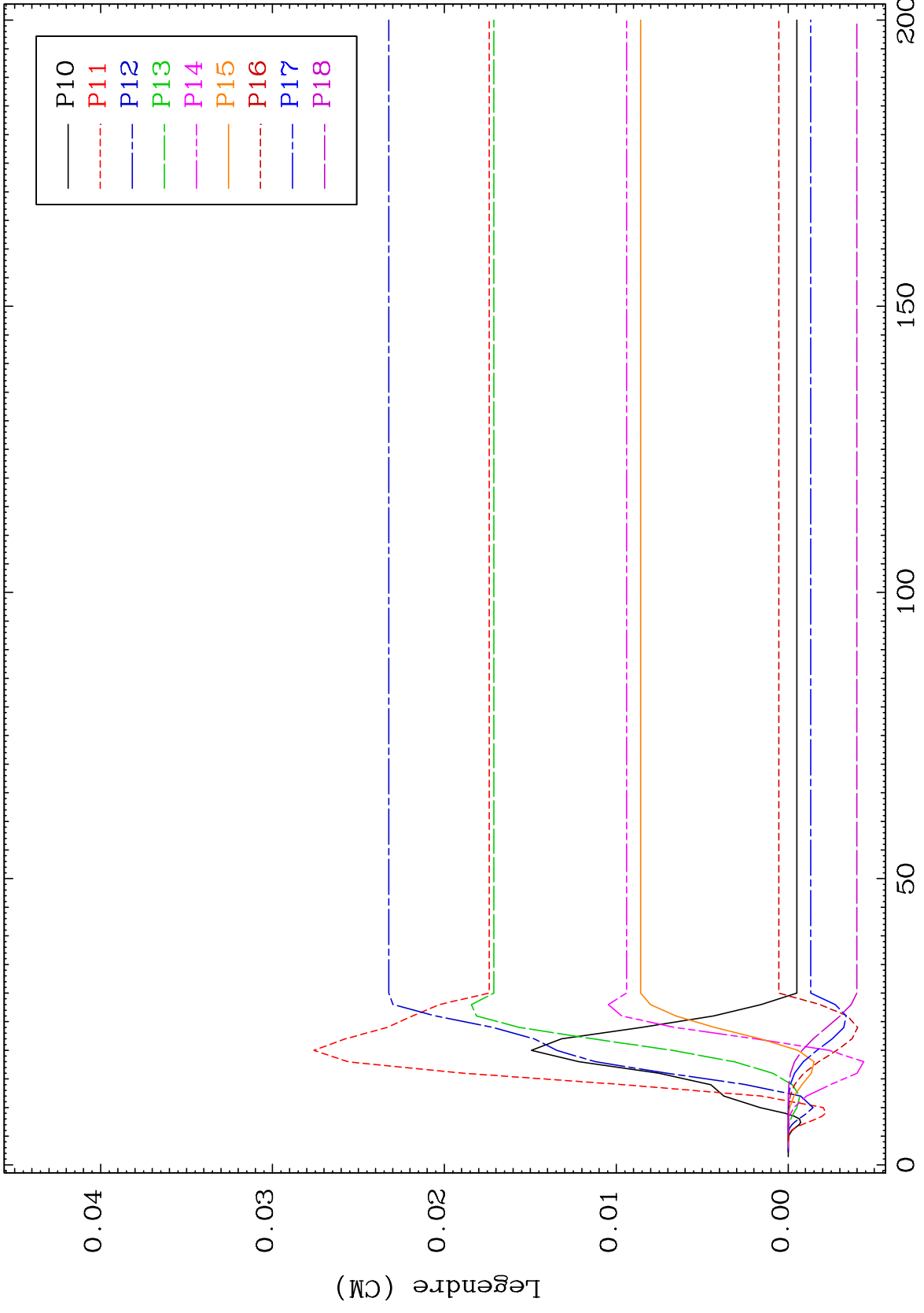

29

Incident Energy (MeV)

54-Xe-119

MAT 5410 MT= 53 (n,n') Level Legendre Coefficients 54-Xe-119

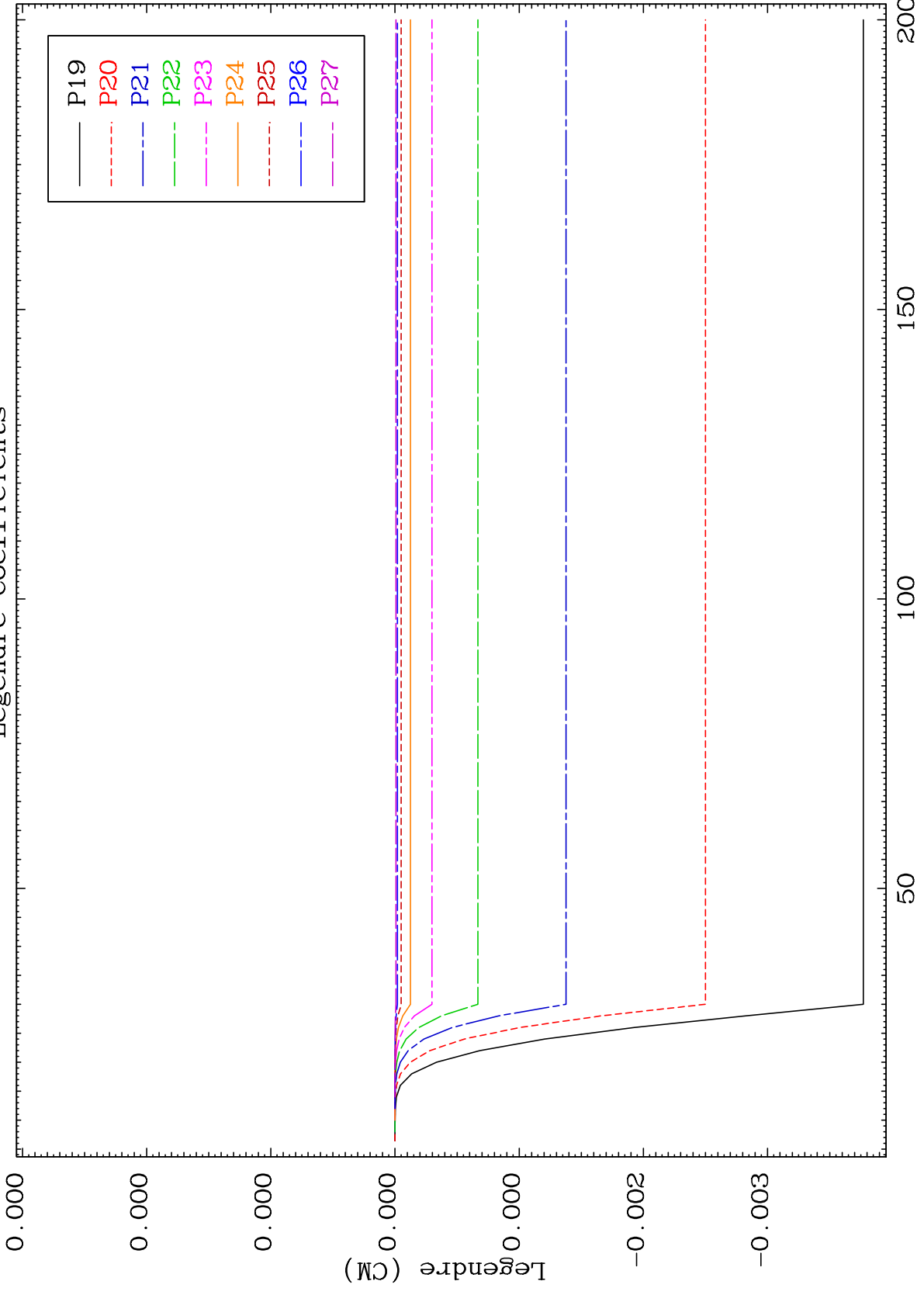

30 50 100 150 200 Incident Energy (MeV) 54-Xe-119

MAT 5410

MT= 53 (n,n') Level
Legendre Coefficients

54-Xe-119

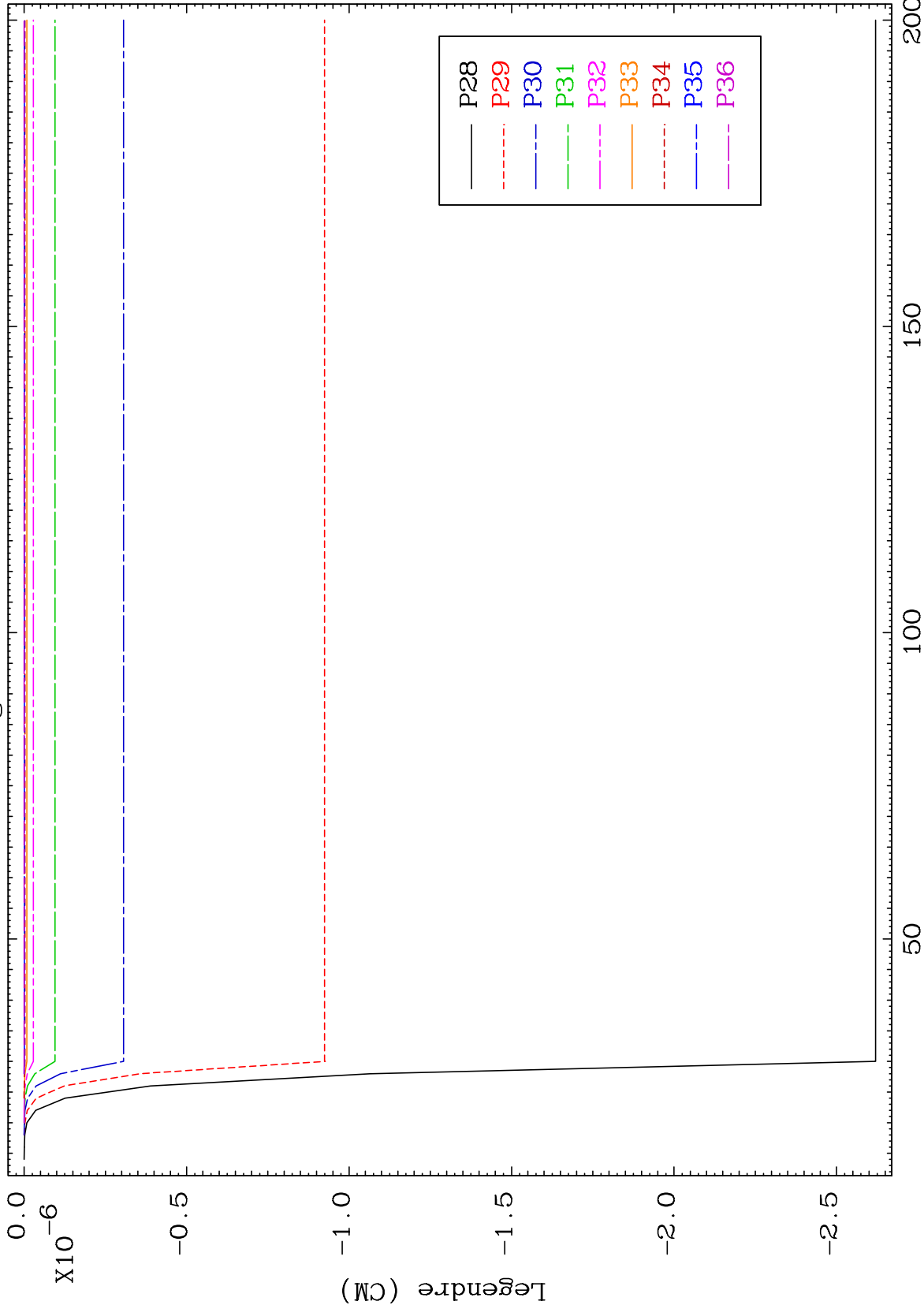

54-Xe-119

Incident Energy (MeV)

31

MAT 5410

MT= 54 (n,n') Level
Legendre Coefficients

54-Xe-119

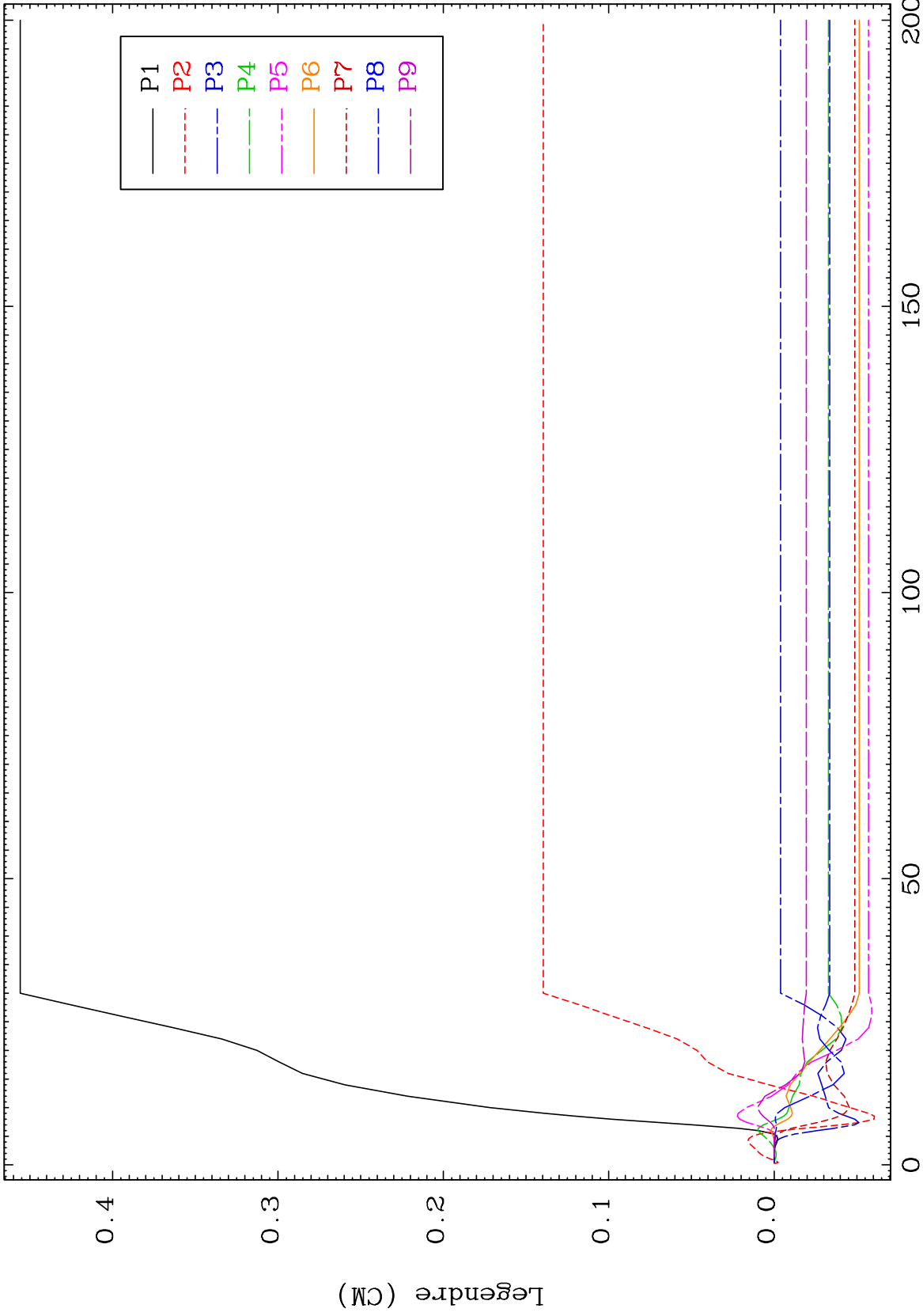

32

Incident Energy (MeV)

54-Xe-119

MAT 5410

MT= 54 (n,n') Level
Legendre Coefficients

54-Xe-119

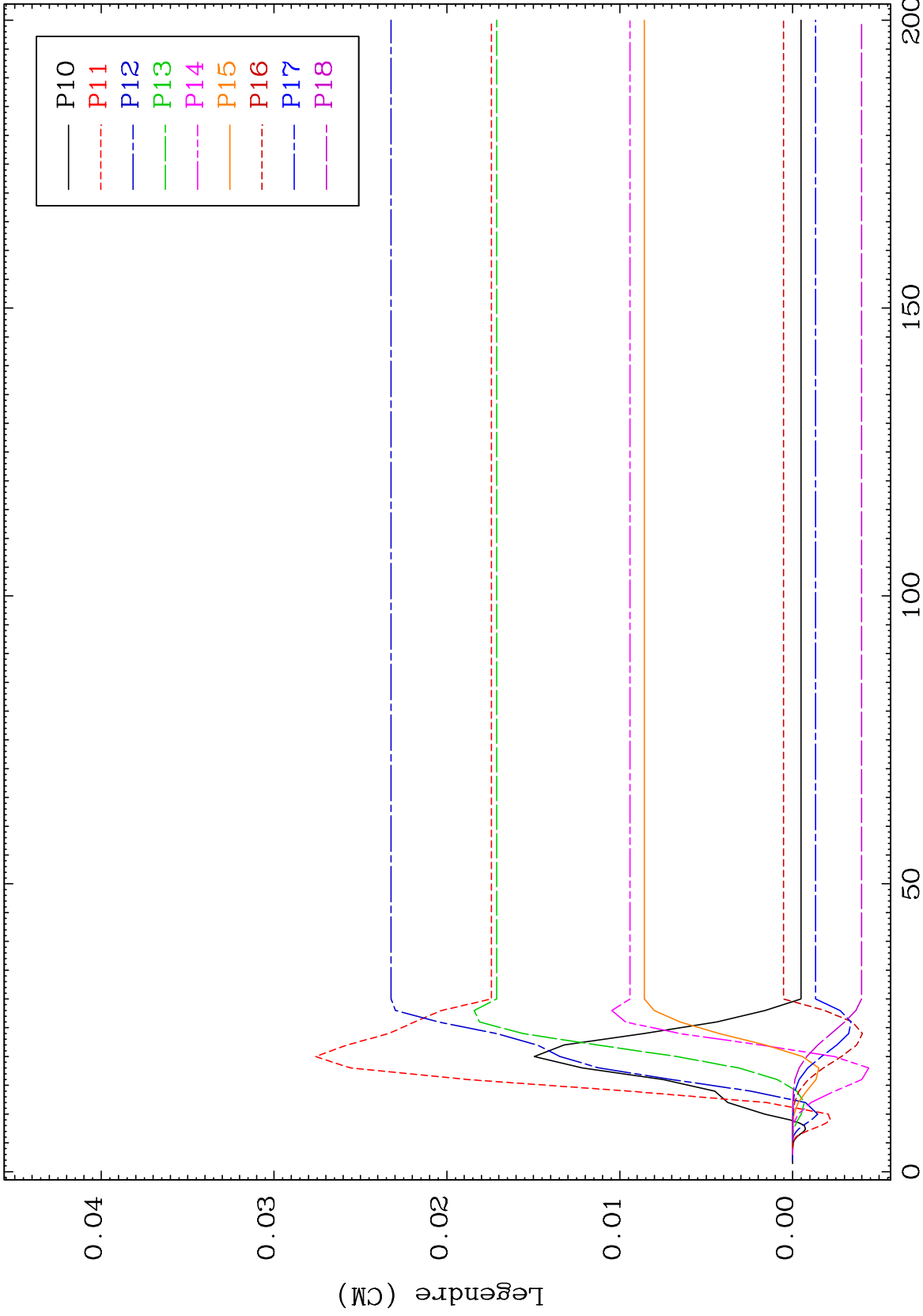

33

Incident Energy (MeV)

54-Xe-119

MAT 5410 MT= 54 (n,n') Level Legendre Coefficients 54-Xe-119

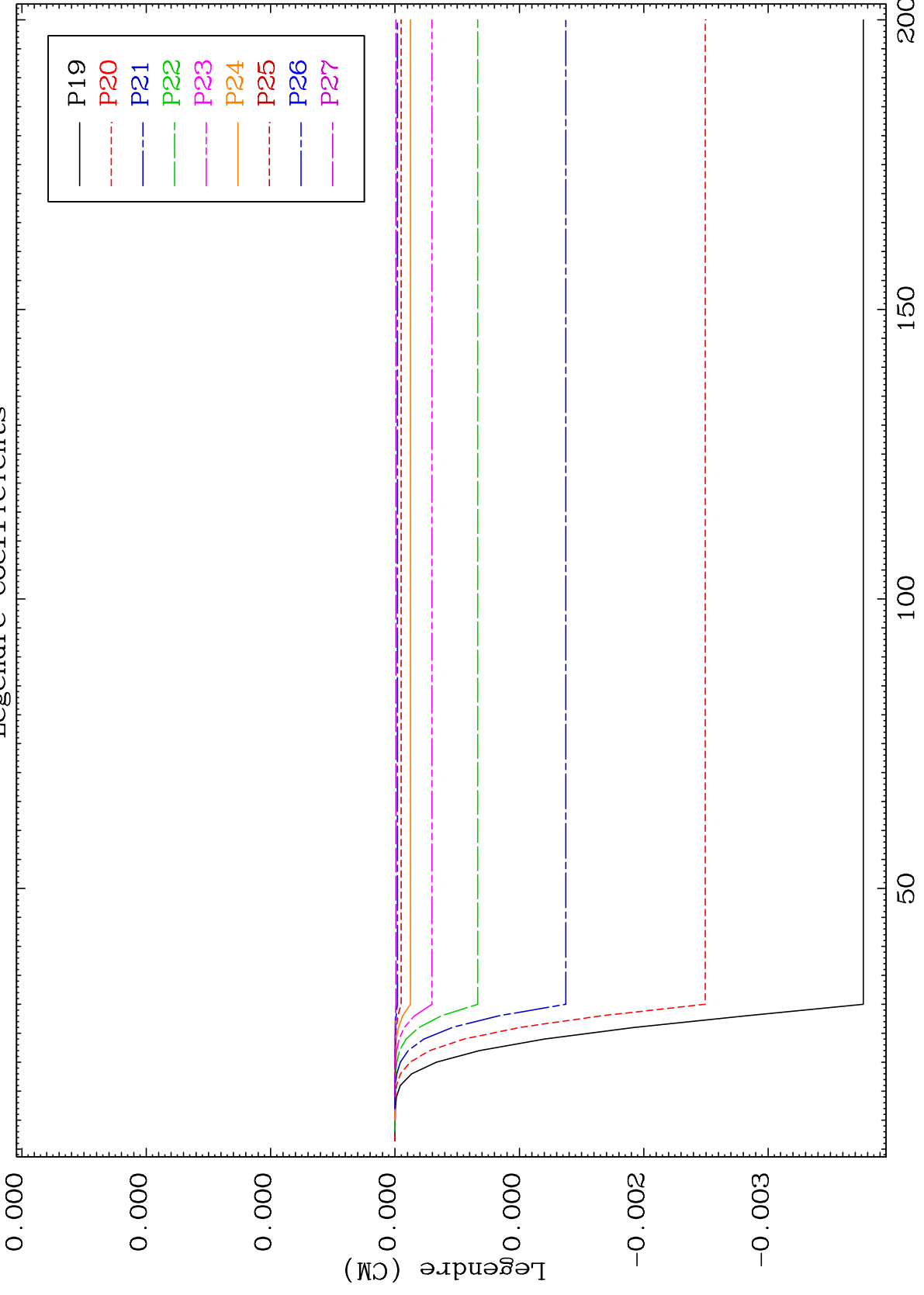

34 54-Xe-119

MAT 5410

MT= 54 (n,n') Level
Legendre Coefficients

54-Xe-119

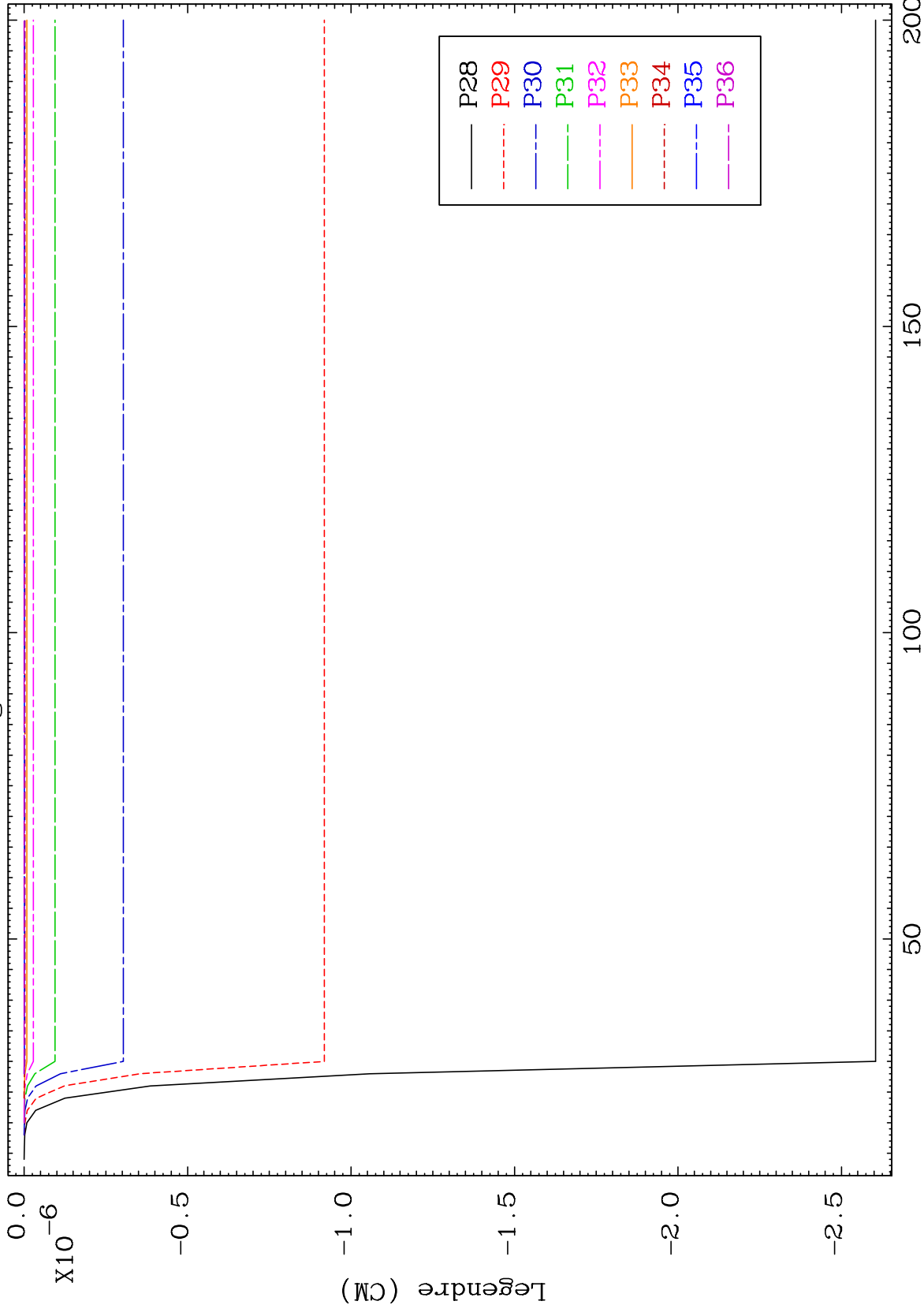

54-Xe-119

Incident Energy (MeV)

35

MAT 5410

MT= 55 (n,n') Level
Legendre Coefficients

54-Xe-119

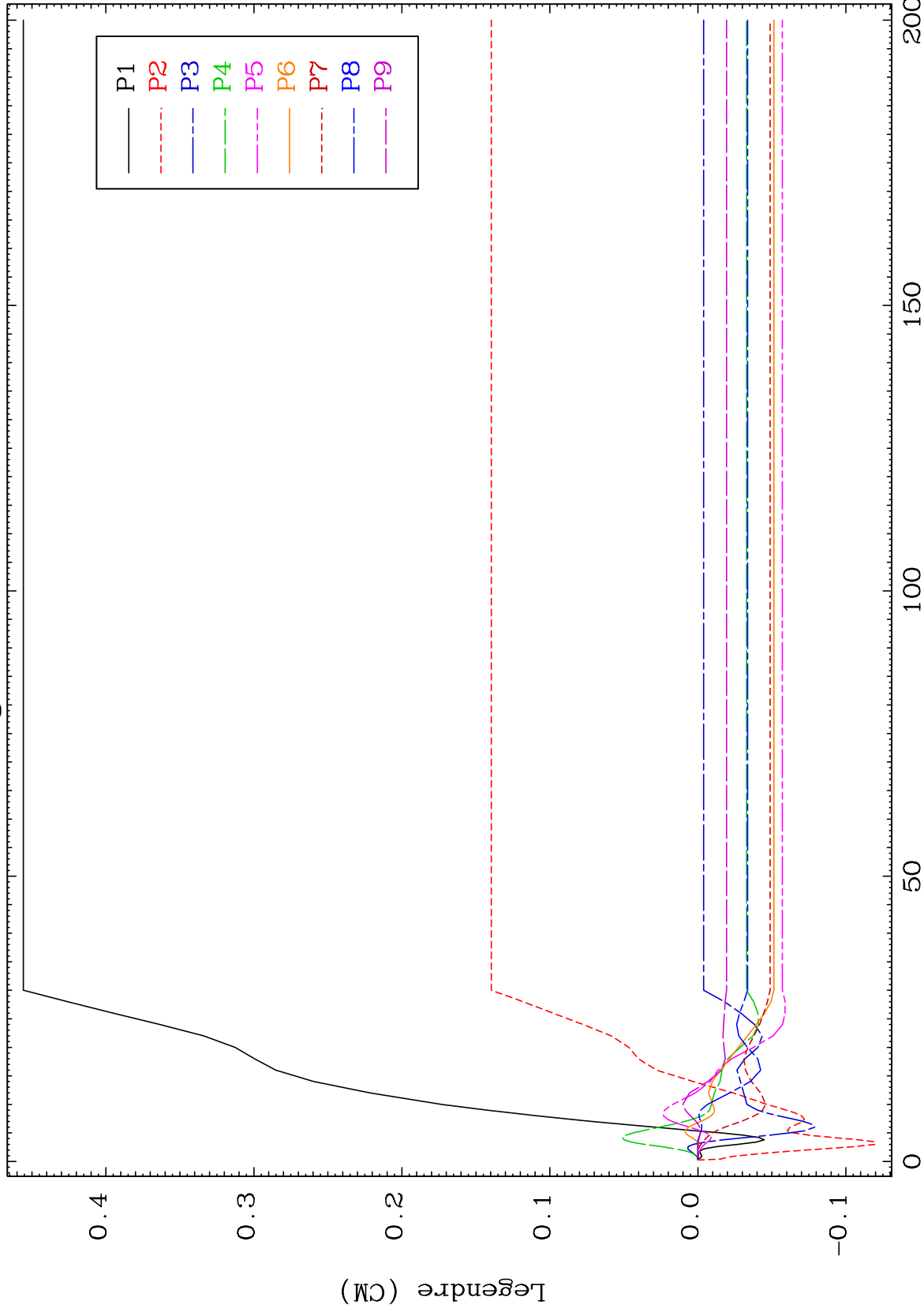

36

Incident Energy (MeV)

54-Xe-119

MAT 5410

MT= 55 (n,n') Level
Legendre Coefficients

54-Xe-119

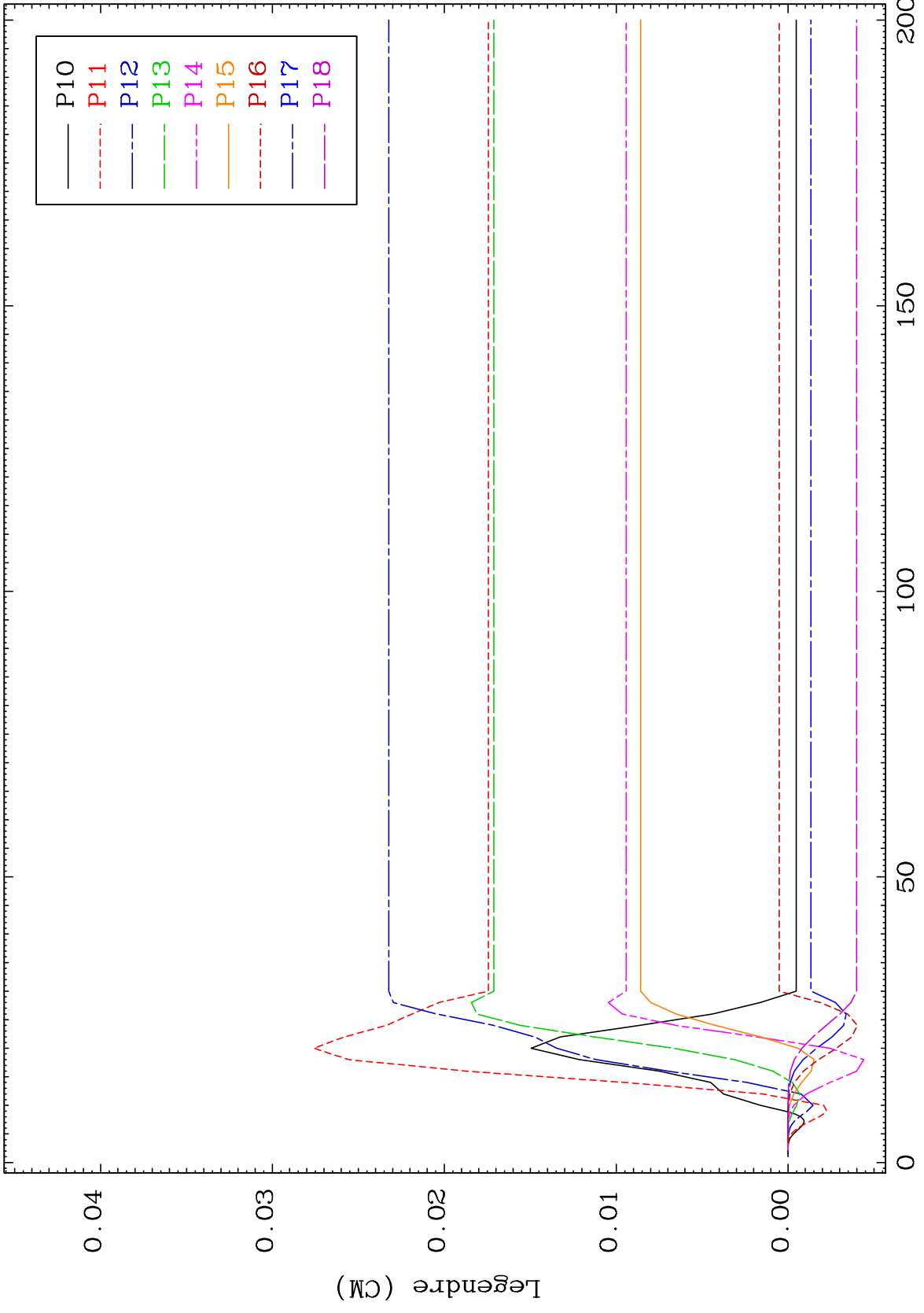

37

Incident Energy (MeV)

54-Xe-119

MAT 5410 MT= 55 (n,n') Level Legendre Coefficients 54-Xe-119

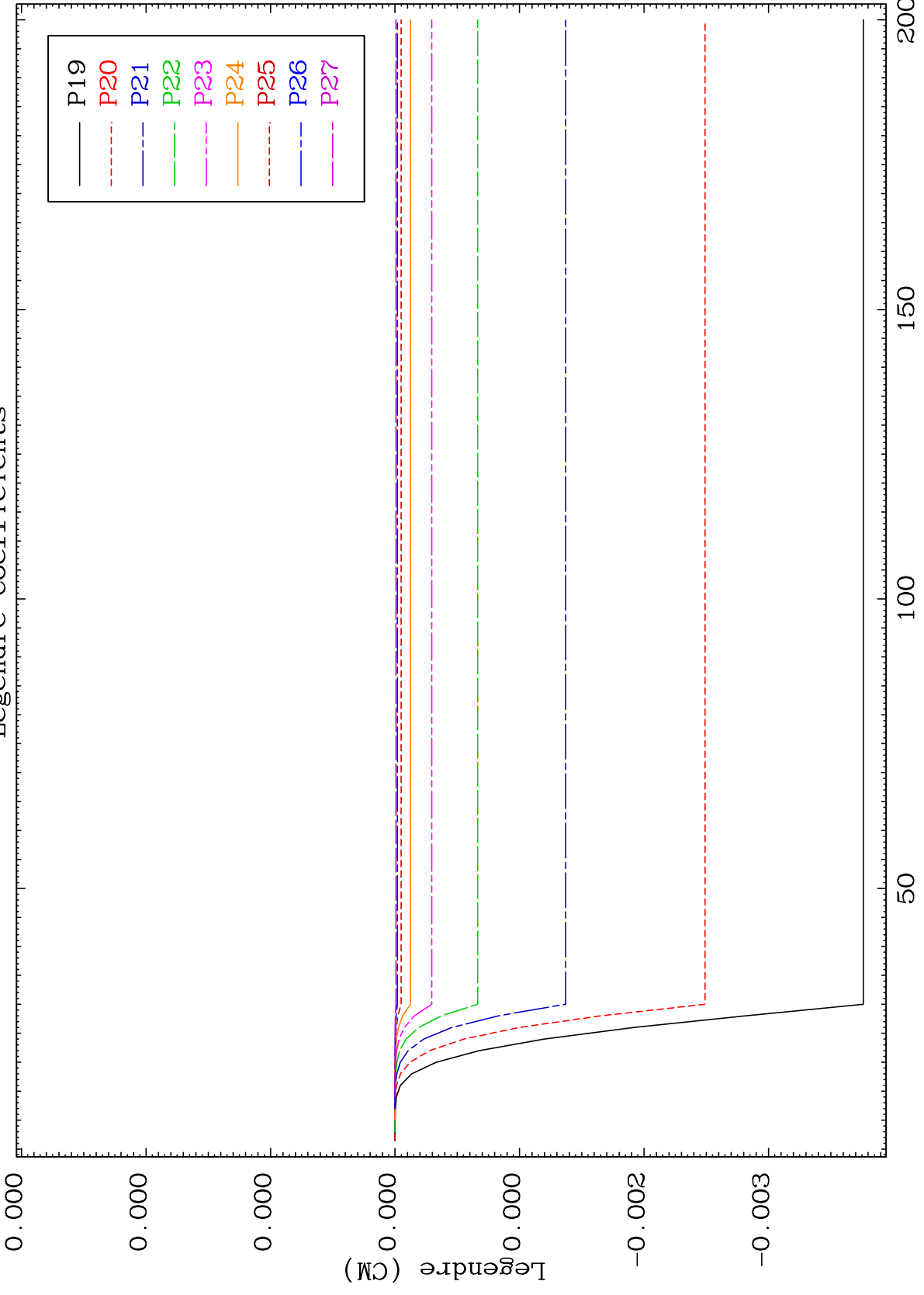

38 54-Xe-119

MAT 5410

MT= 55 (n,n') Level
Legendre Coefficients

54-Xe-119

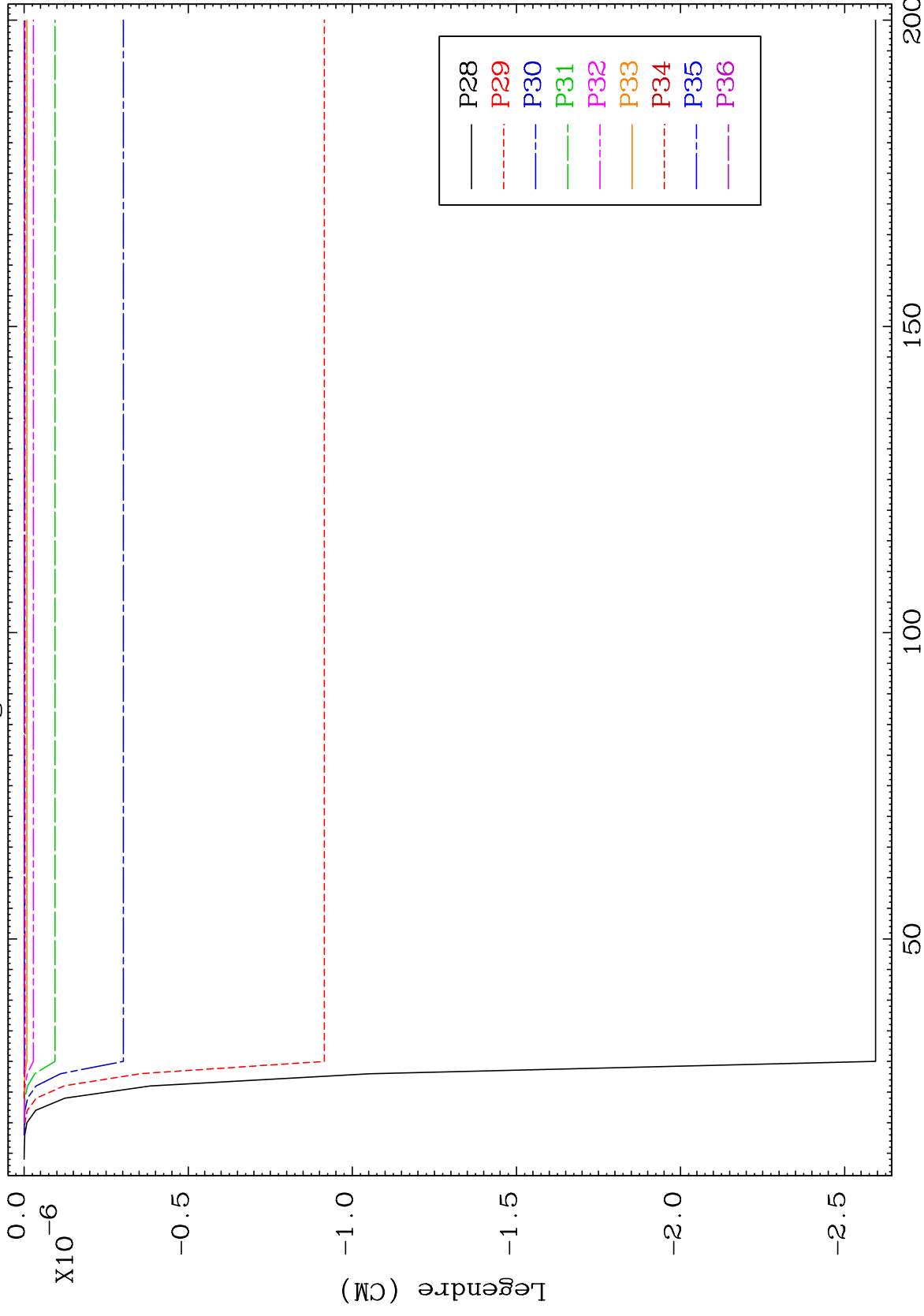

54-Xe-119

Incident Energy (MeV)

39

MAT 5410

MT= 56 (n,n') Level
Legendre Coefficients

54-Xe-119

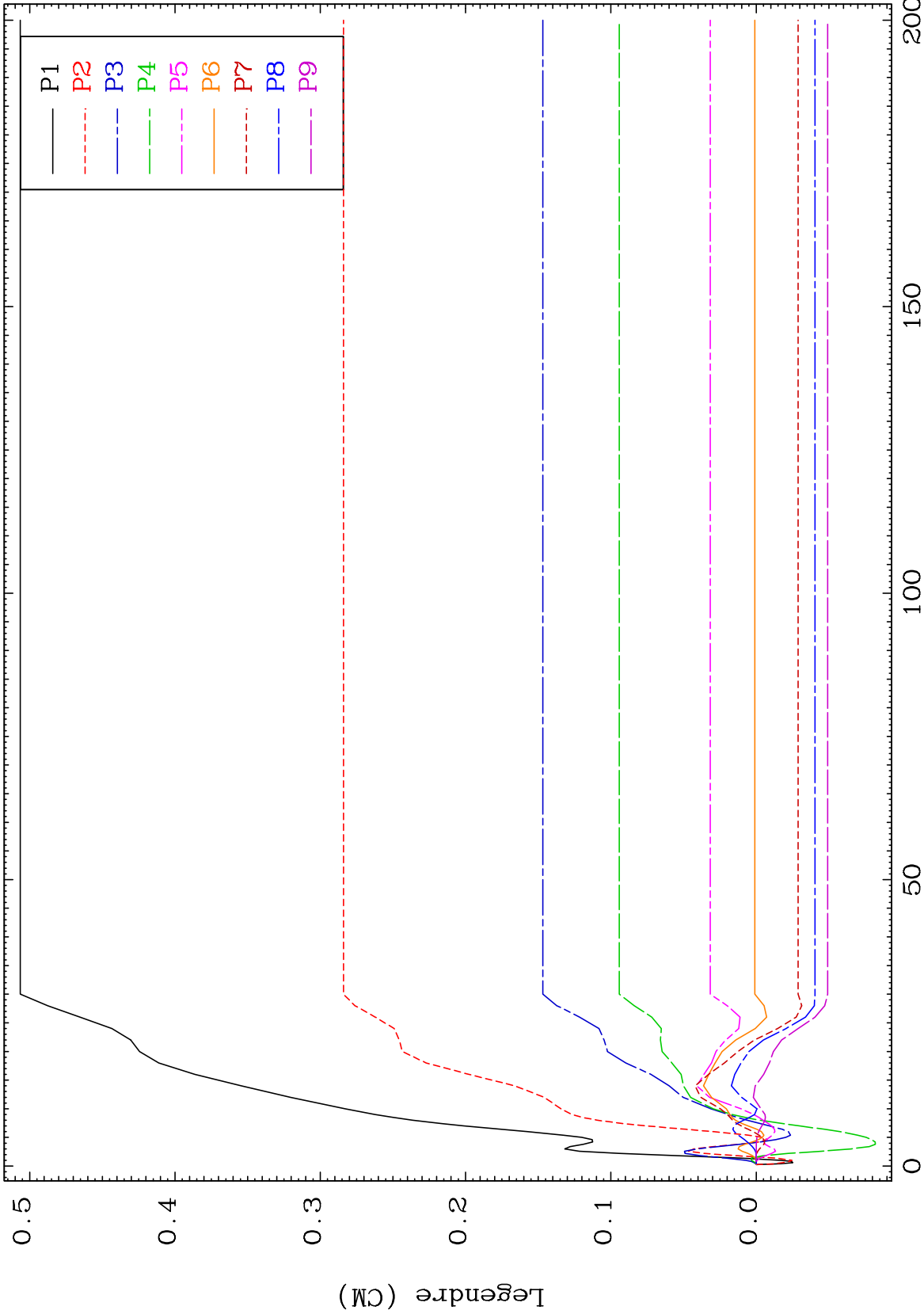

40

0

50

100

150

200

54-Xe-119

MAT 5410 MT= 56 (n,n') Level Legendre Coefficients 54-Xe-119

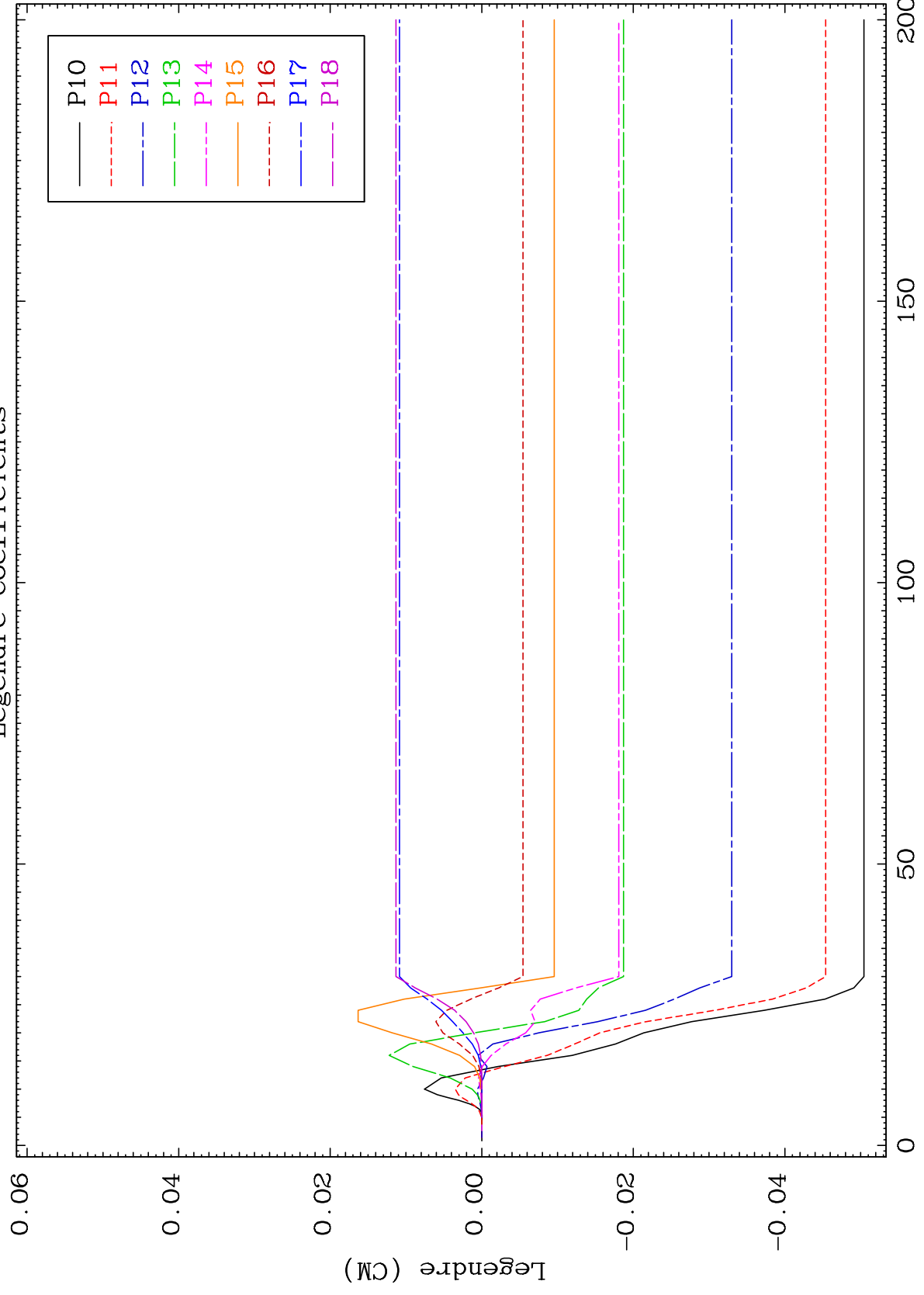

41 54-Xe-119

MAT 5410

MT= 56 (n,n') Level
Legendre Coefficients

54-Xe-119

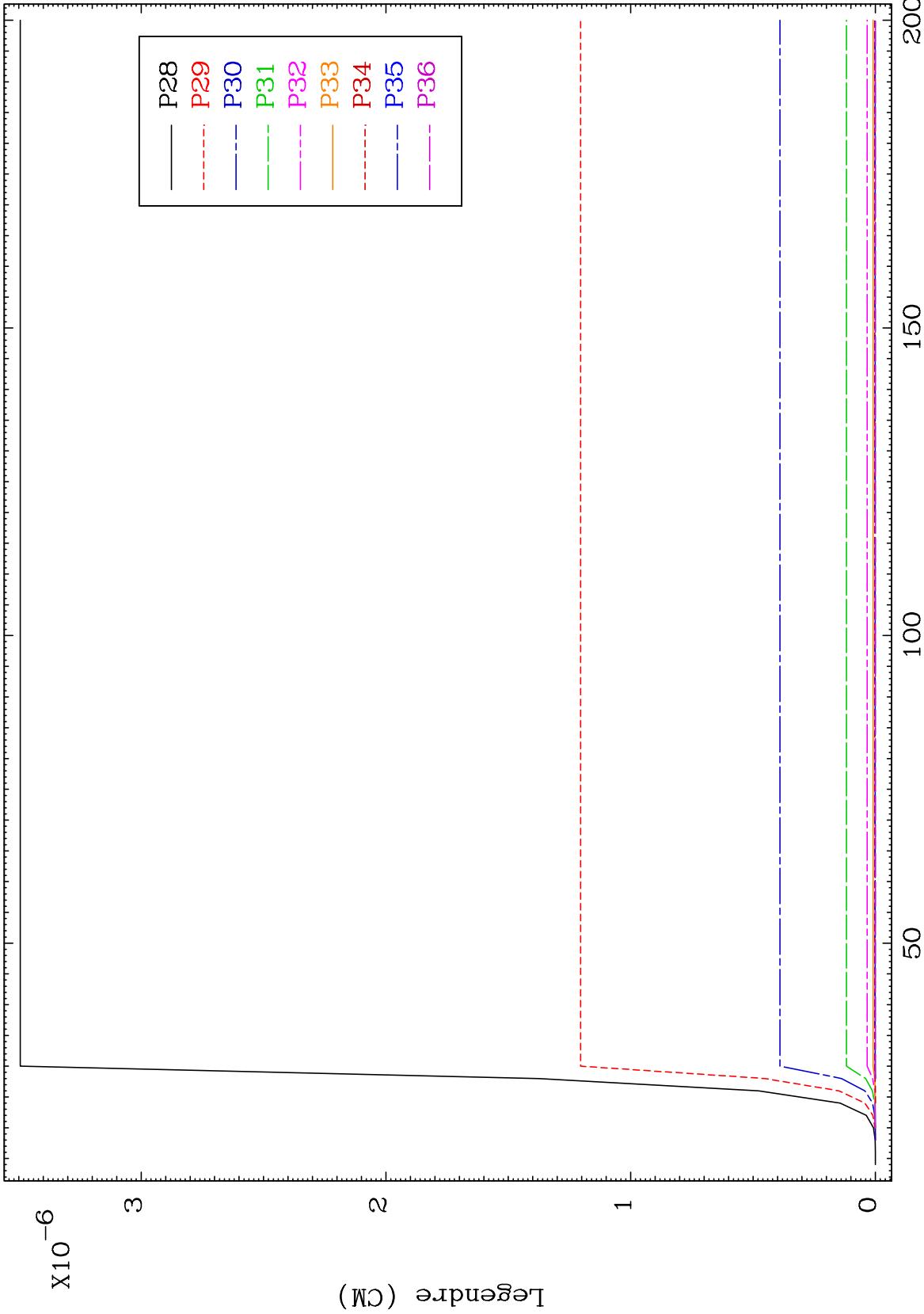

43

Incident Energy (MeV)

54-Xe-119

MAT 5410

MT= 57 (n,n') Level
Legendre Coefficients

54-Xe-119

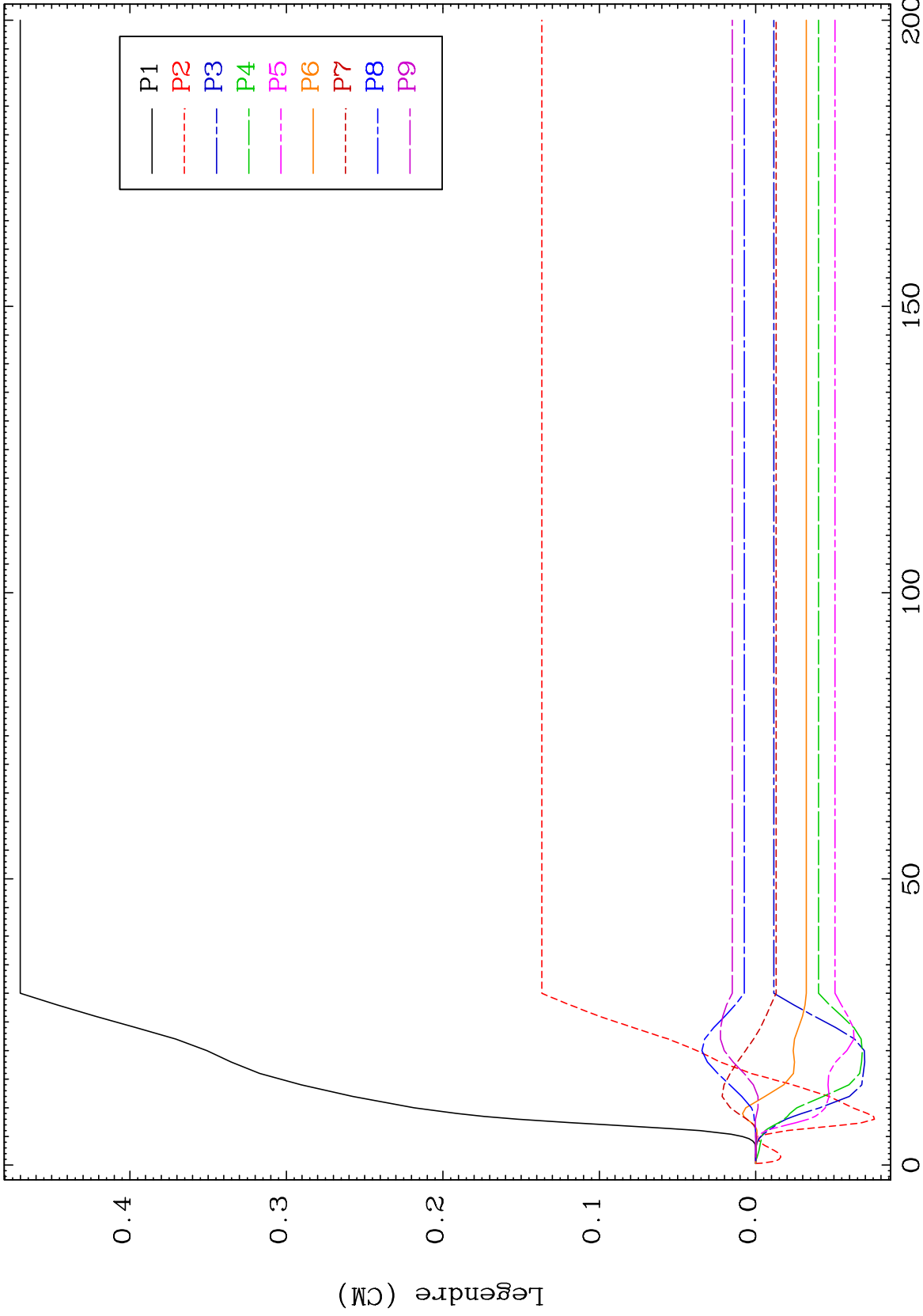

44

Incident Energy (MeV)

54-Xe-119

MAT 5410

MT= 57 (n,n') Level
Legendre Coefficients

54-Xe-119

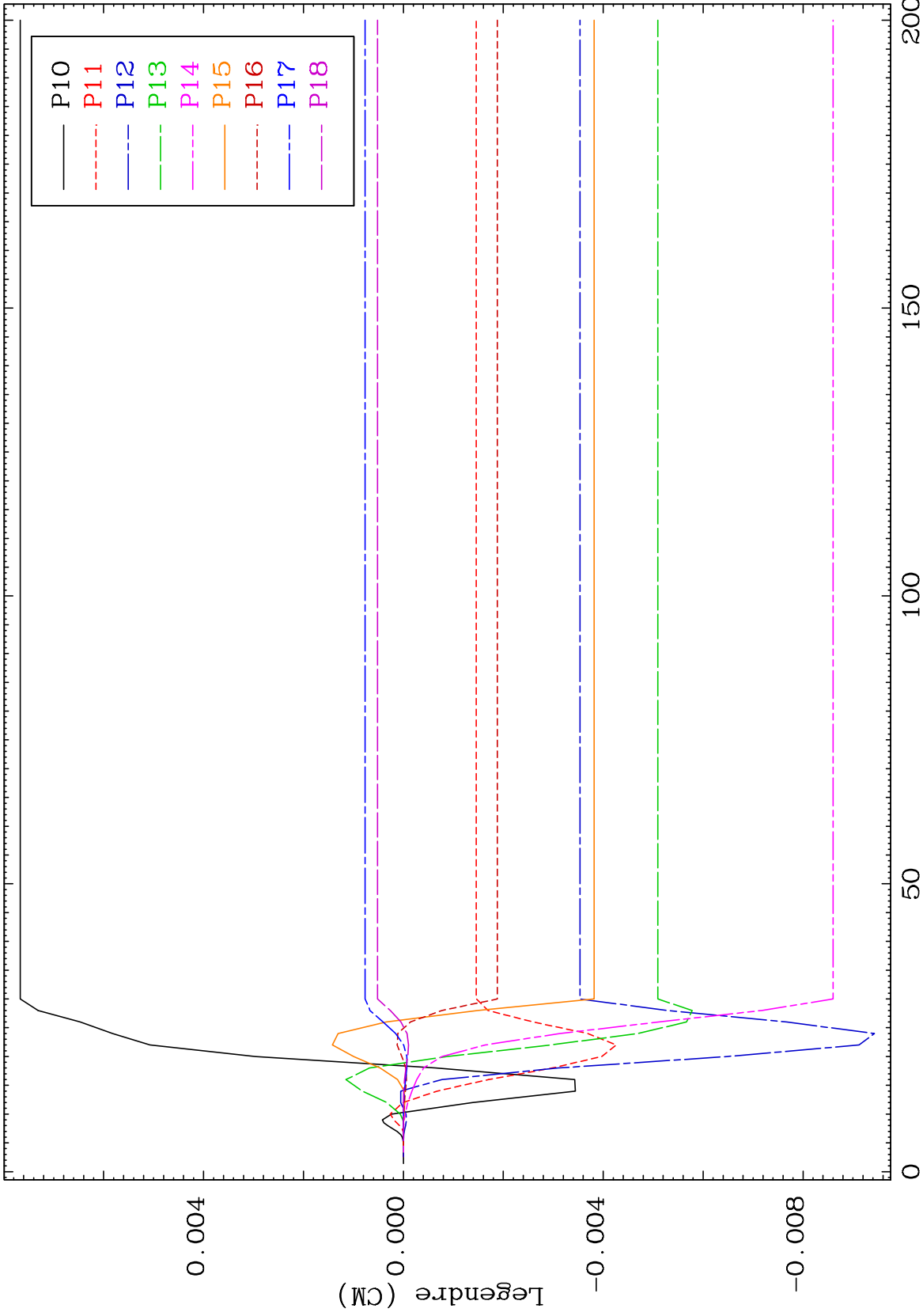

45

Incident Energy (MeV)

54-Xe-119

MAT 5410

MT= 57 (n,n') Level
Legendre Coefficients

54-Xe-119

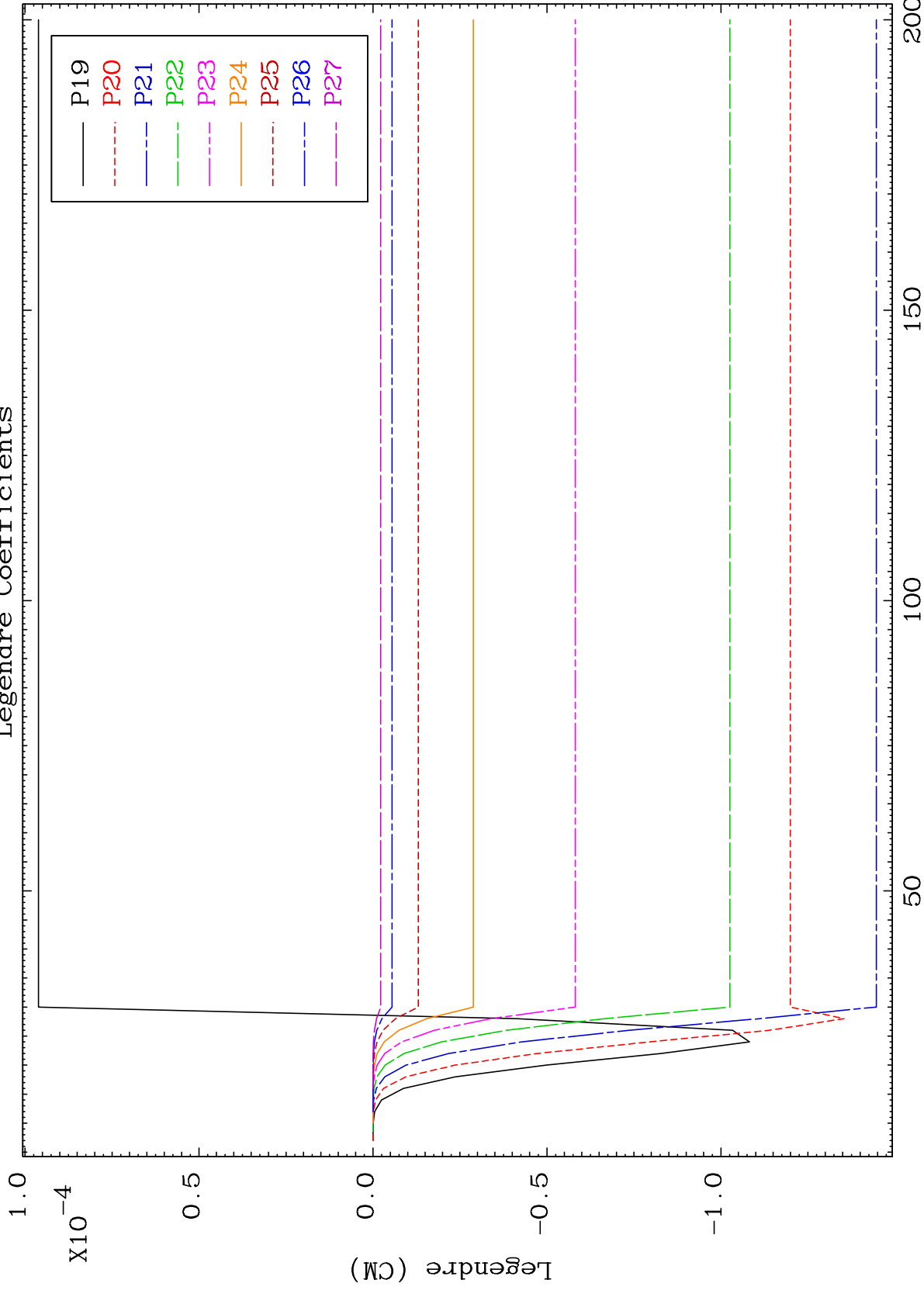

46

Incident Energy (MeV)

54-Xe-119

MAT 5410

MT= 57 (n,n') Level
Legendre Coefficients

54-Xe-119

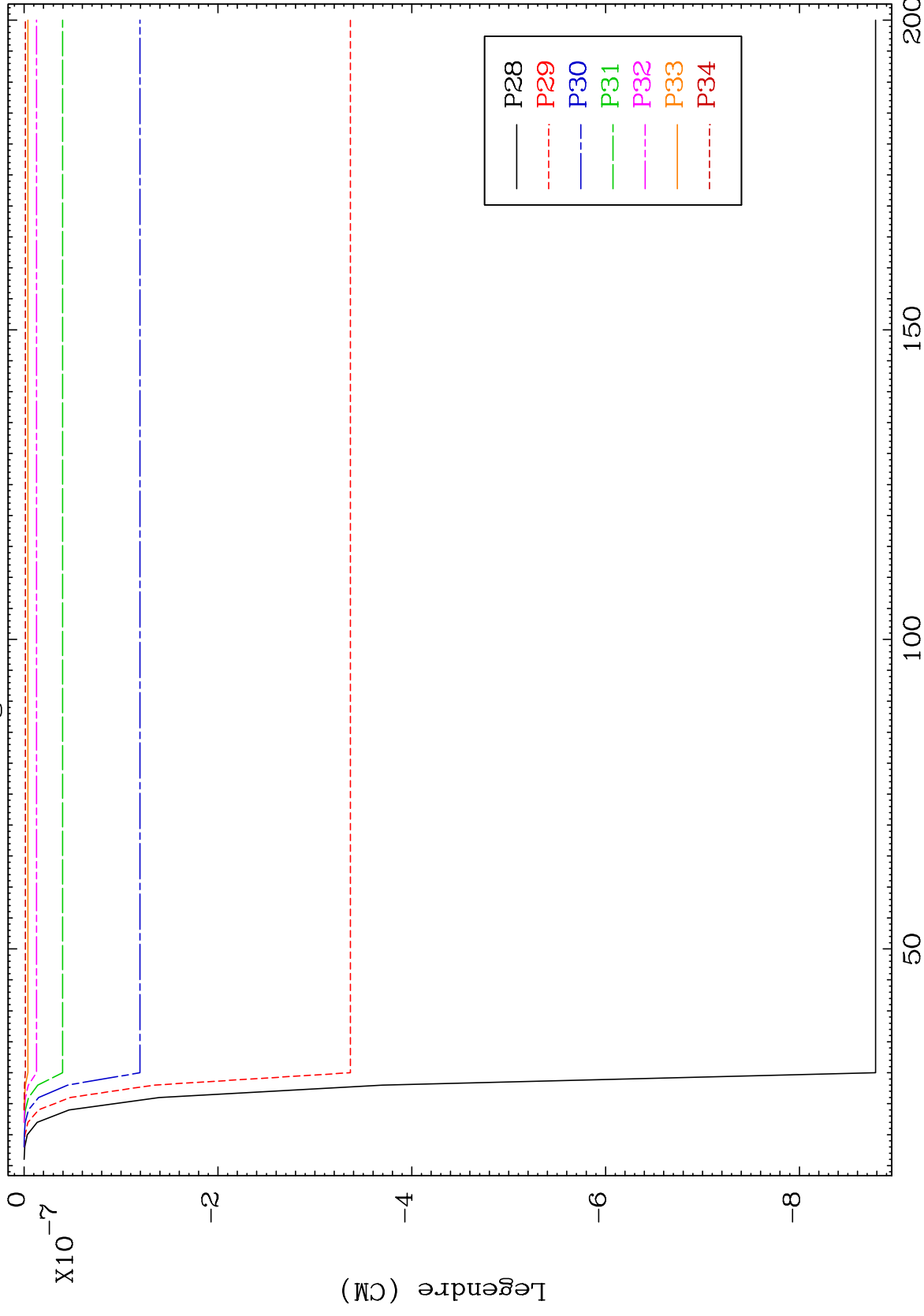

47

54-Xe-119

MAT 5410

MT= 58 (n,n') Level
Legendre Coefficients

54-Xe-119

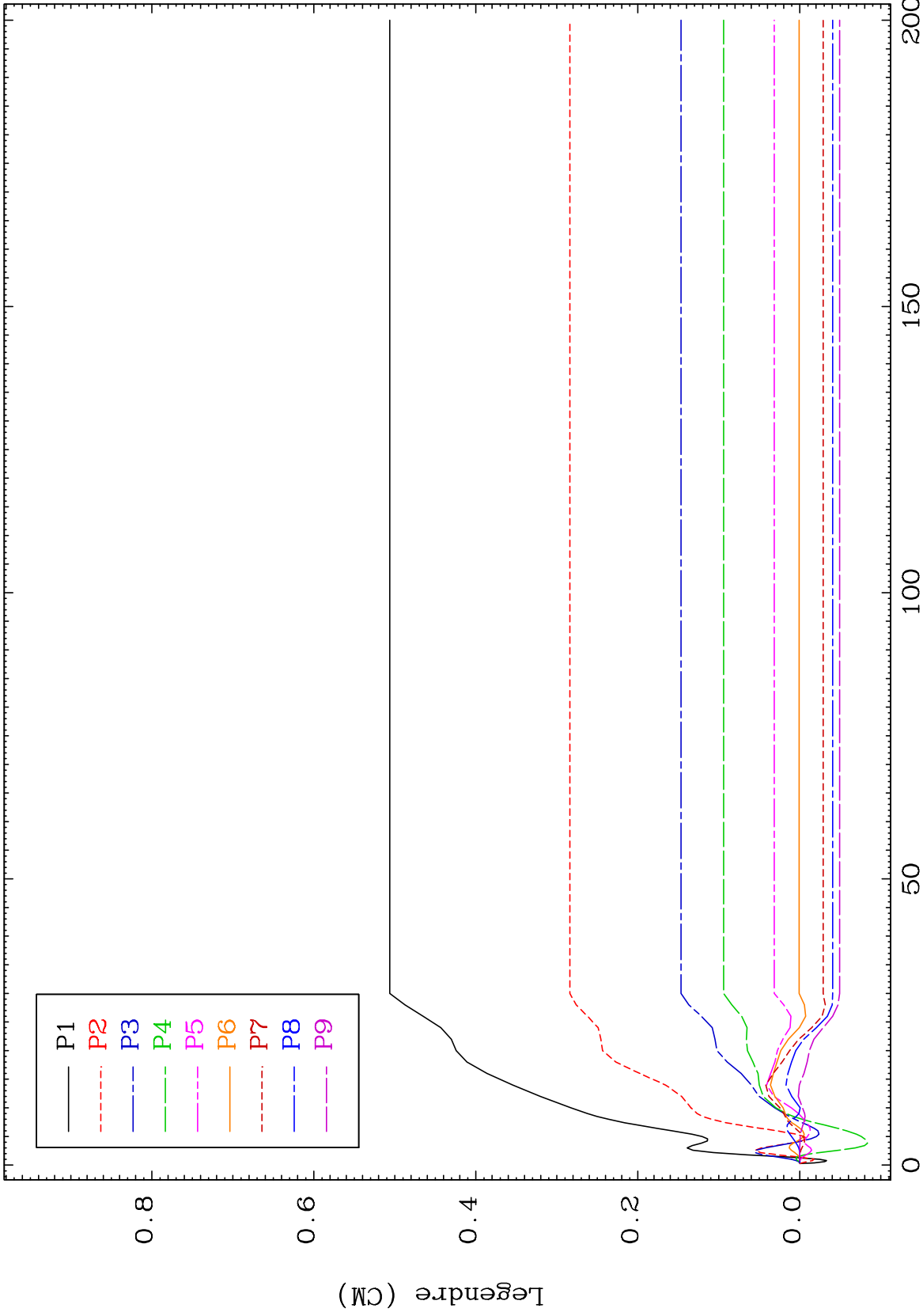

48

Incident Energy (MeV)

54-Xe-119

MAT 5410 MT= 58 (n,n') Level Legendre Coefficients 54-Xe-119

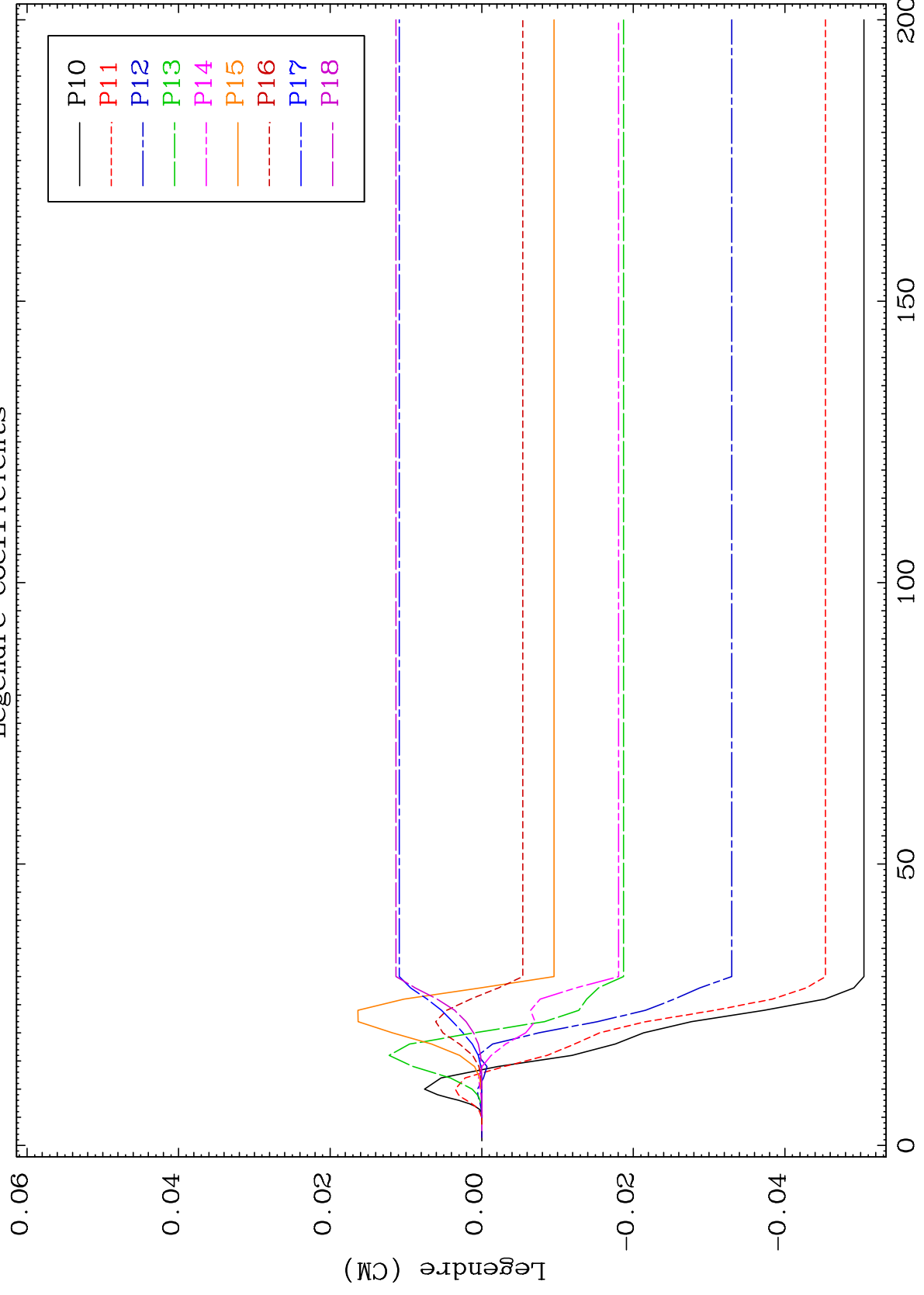

49 54-Xe-119

MAT 5410

MT= 58 (n,n') Level
Legendre Coefficients

54-Xe-119

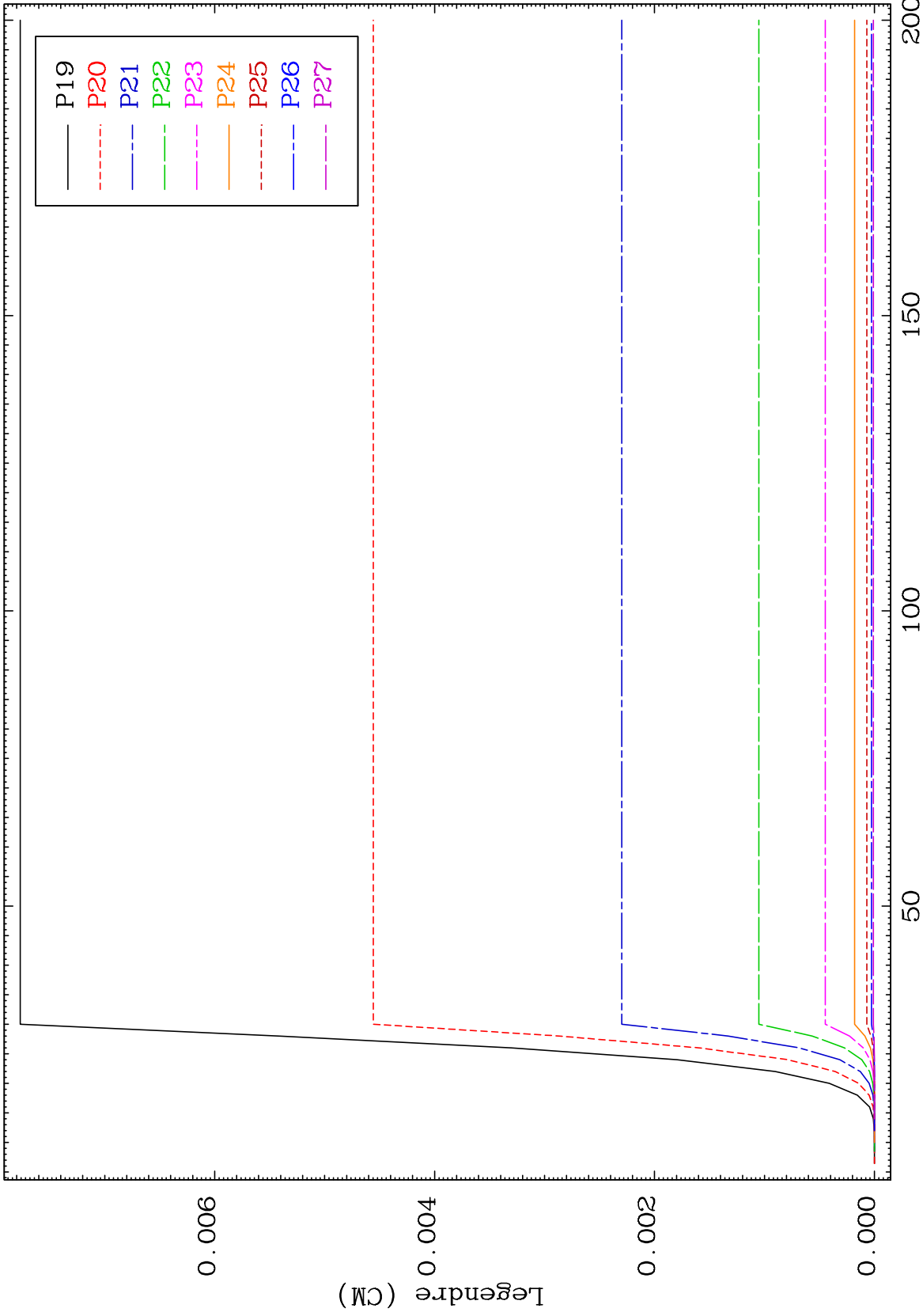

50

Incident Energy (MeV)

150

54-Xe-119

200

MAT 5410

MT= 58 (n,n') Level
Legendre Coefficients

54-Xe-119

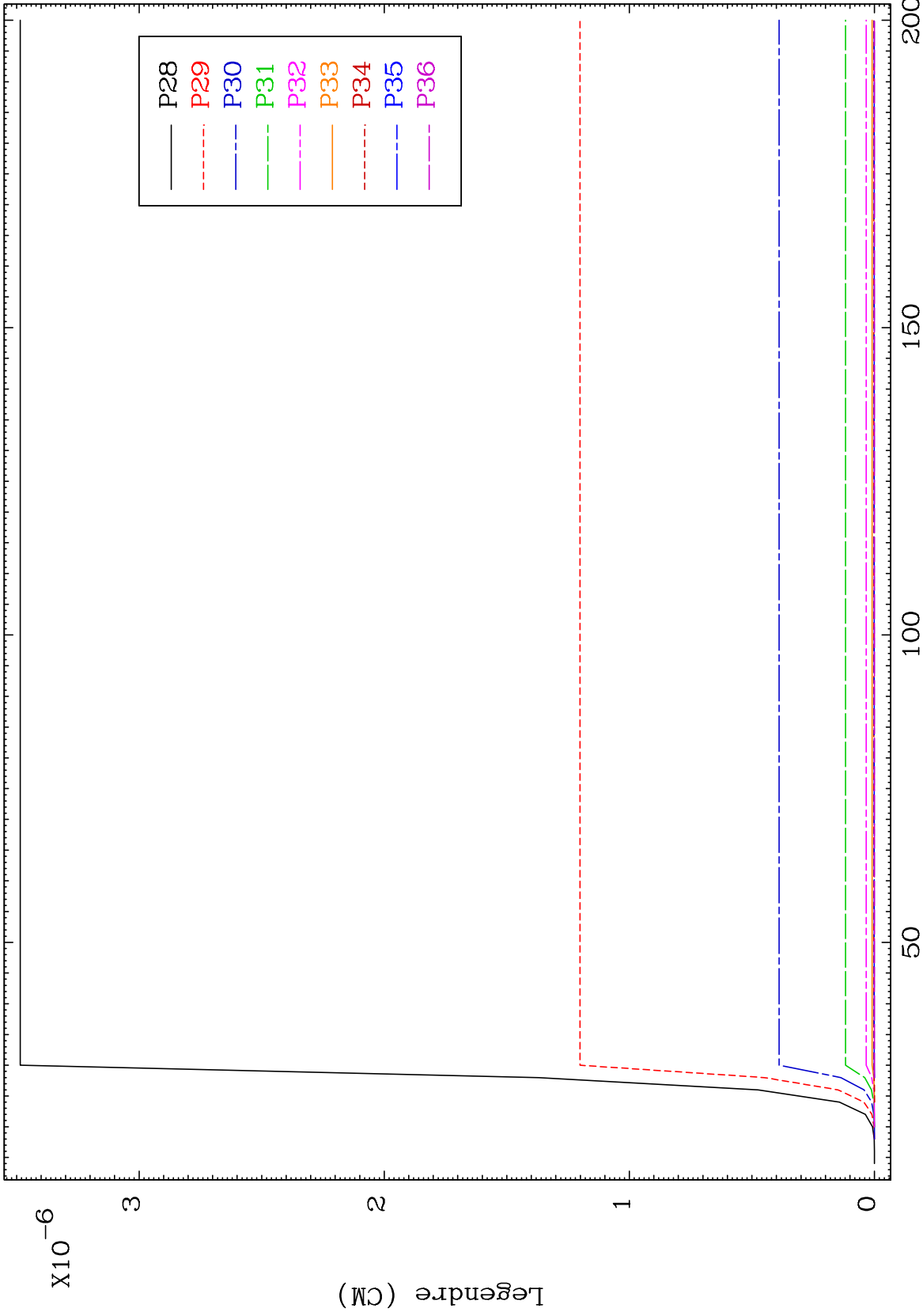

51

54-Xe-119

MAT 5410

MT= 59 (n,n') Level
Legendre Coefficients

54-Xe-119

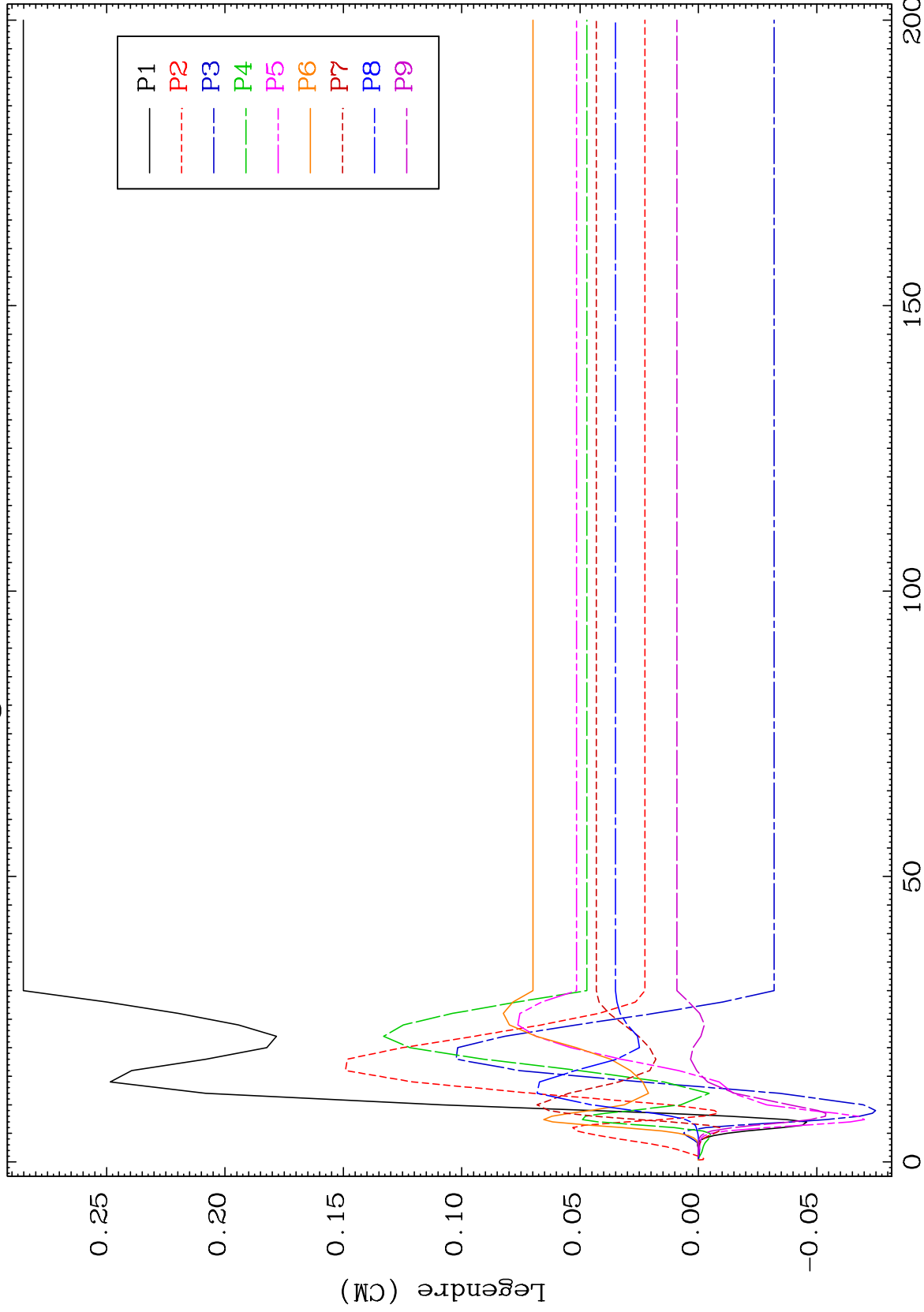

52

Incident Energy (MeV)

54-Xe-119

MAT 5410

MT= 59 (n,n') Level
Legendre Coefficients

54-Xe-119

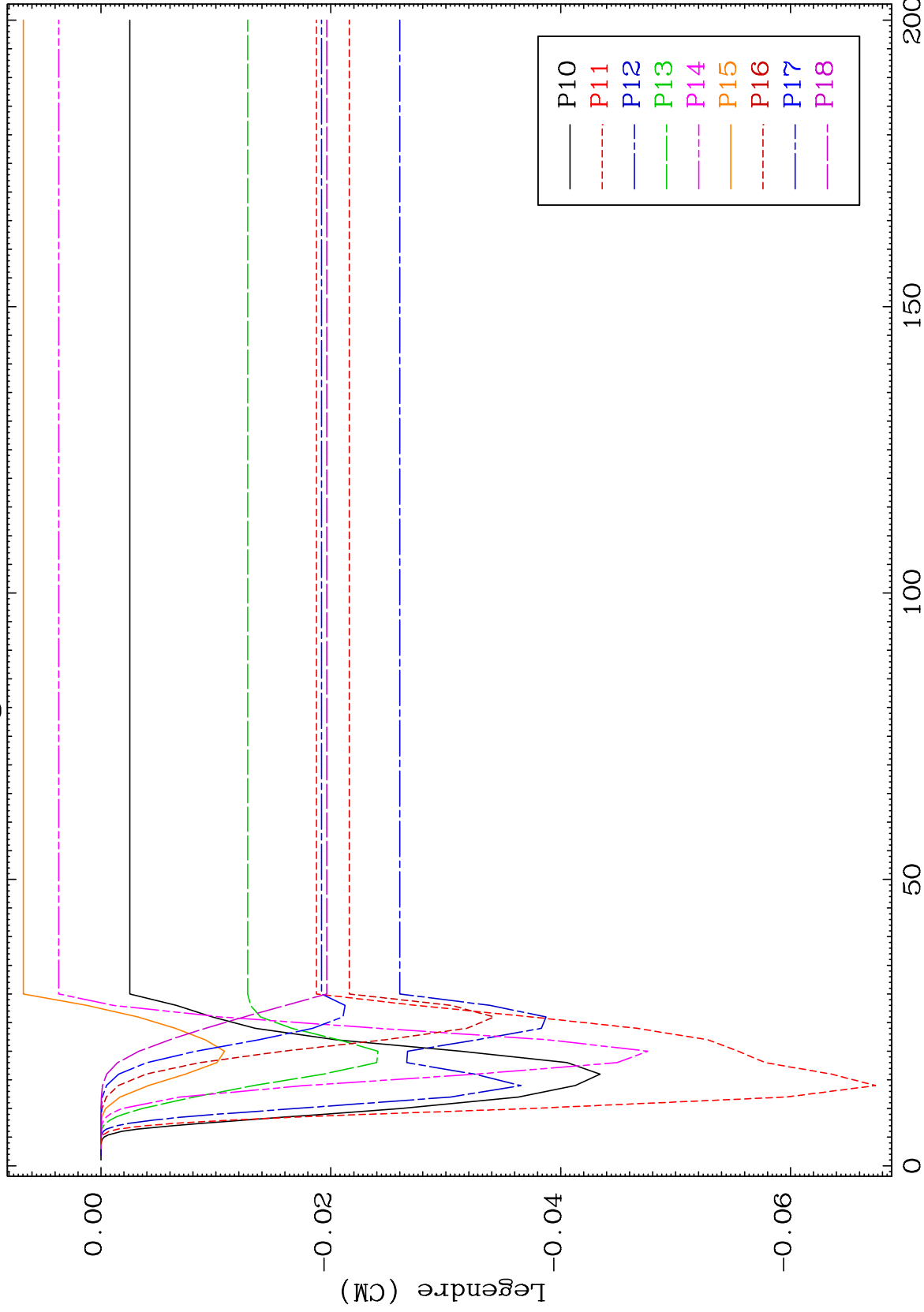

53

Incident Energy (MeV)

54-Xe-119

MAT 5410 MT= 59 (n,n') Level Legendre Coefficients 54-Xe-119

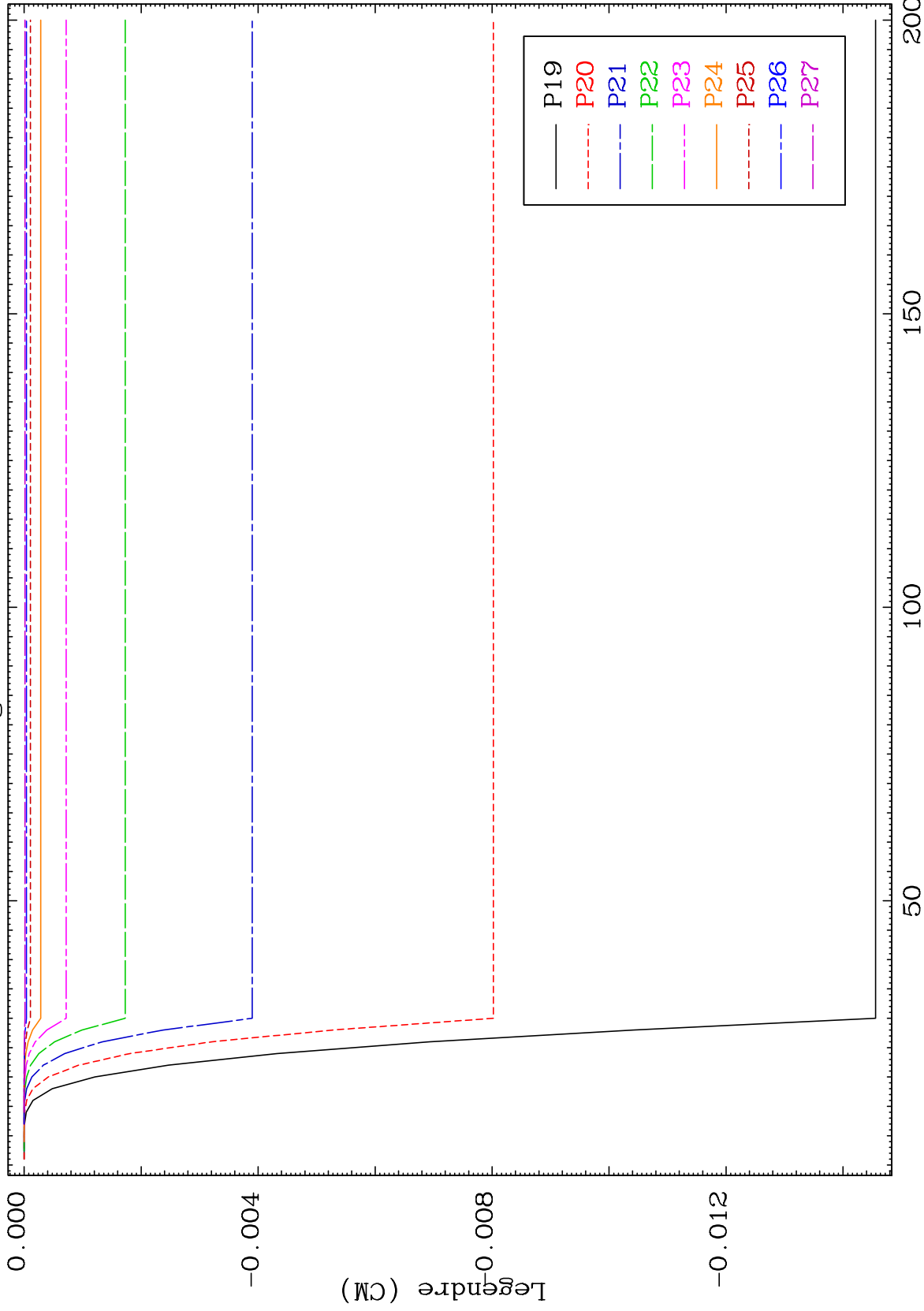

54 54-Xe-119

MAT 5410

MT= 59 (n,n') Level
Legendre Coefficients

54-Xe-119

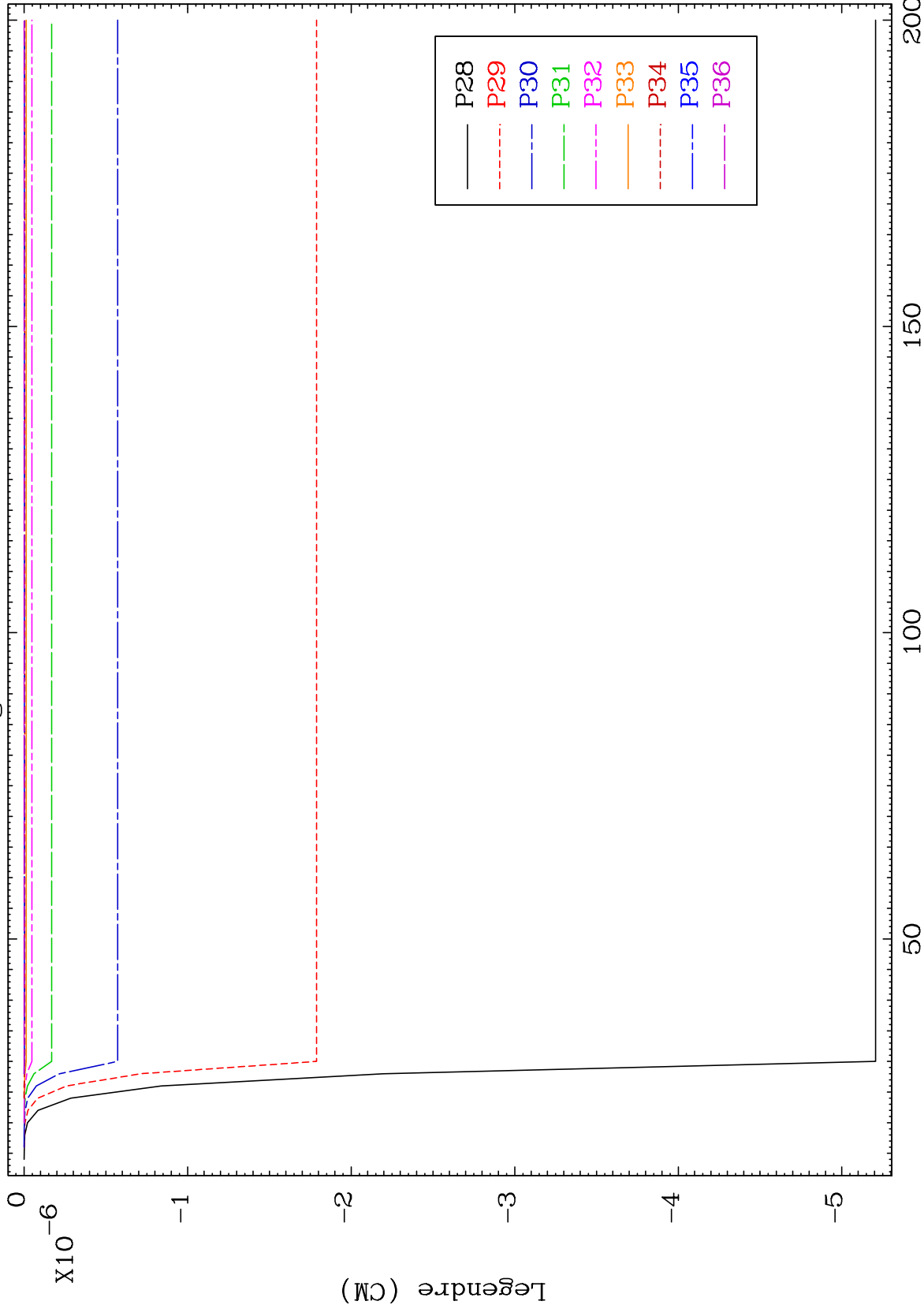

54-Xe-119

Incident Energy (MeV)

55

MAT 5410

MT= 60 (n,n') Level
Legendre Coefficients

54-Xe-119

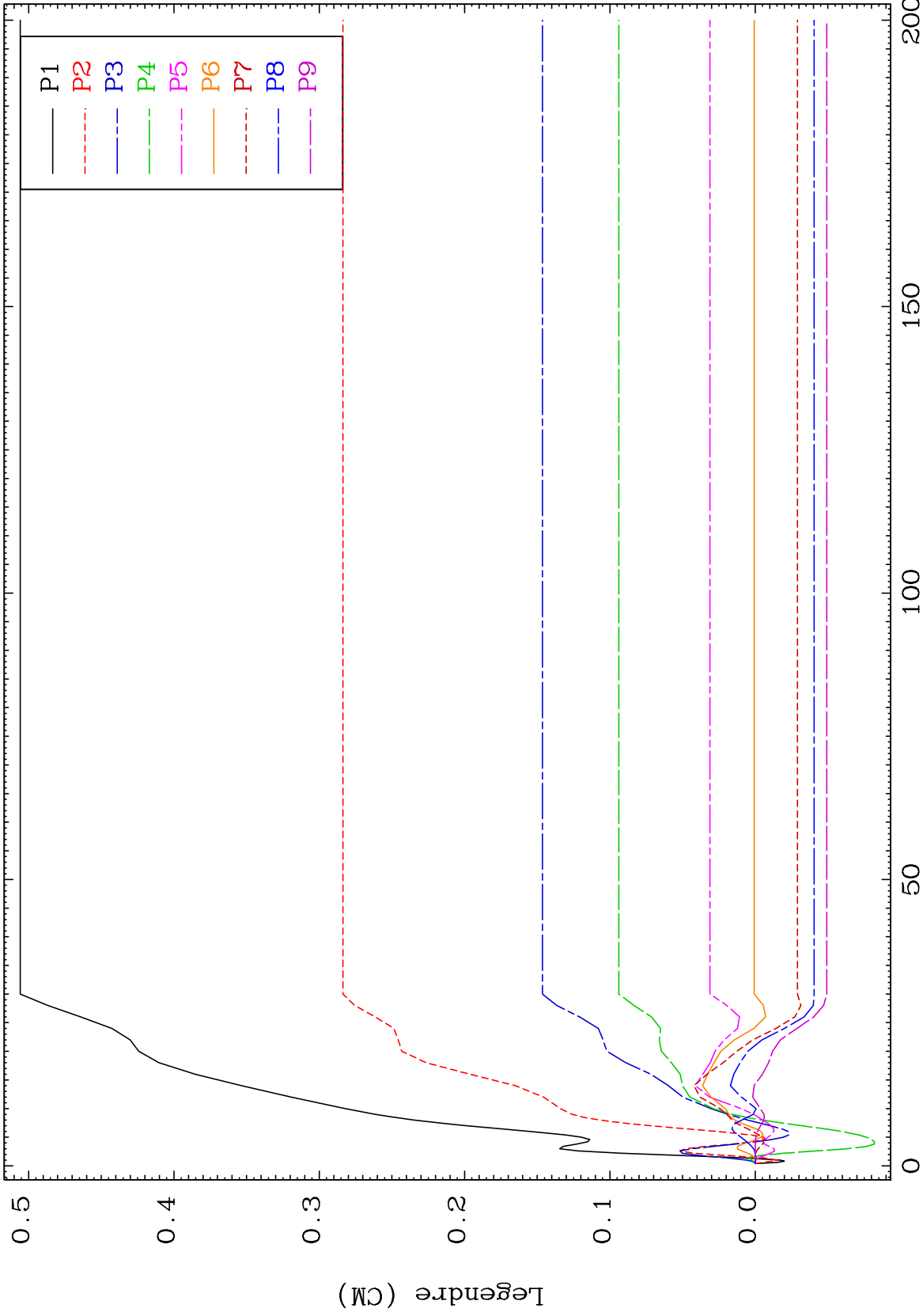

56

Incident Energy (MeV)

54-Xe-119

MAT 5410 MT= 60 (n,n') Level Legendre Coefficients 54-Xe-119

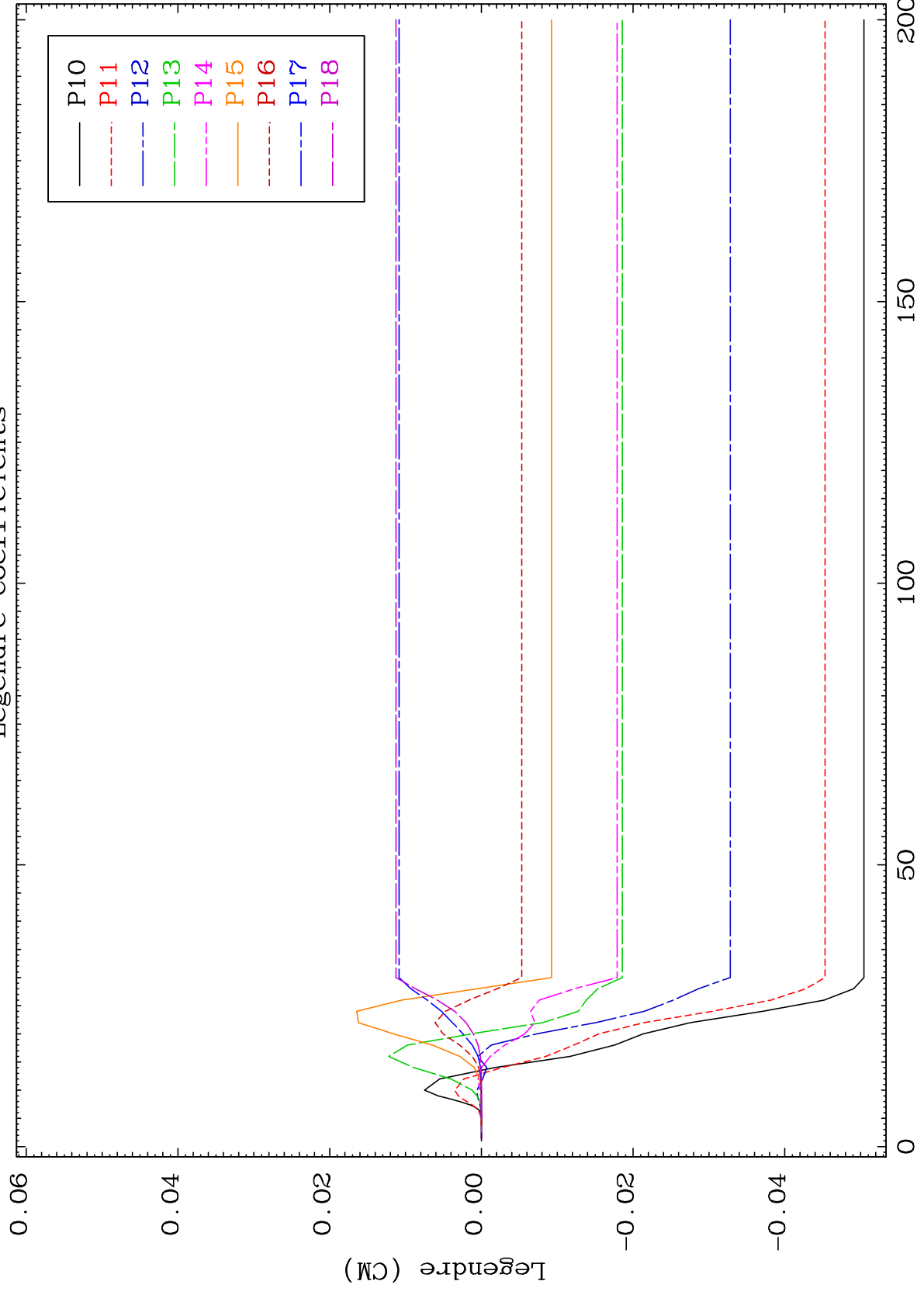

57 54-Xe-119

MAT 5410

MT= 60 (n,n') Level
Legendre Coefficients

54-Xe-119

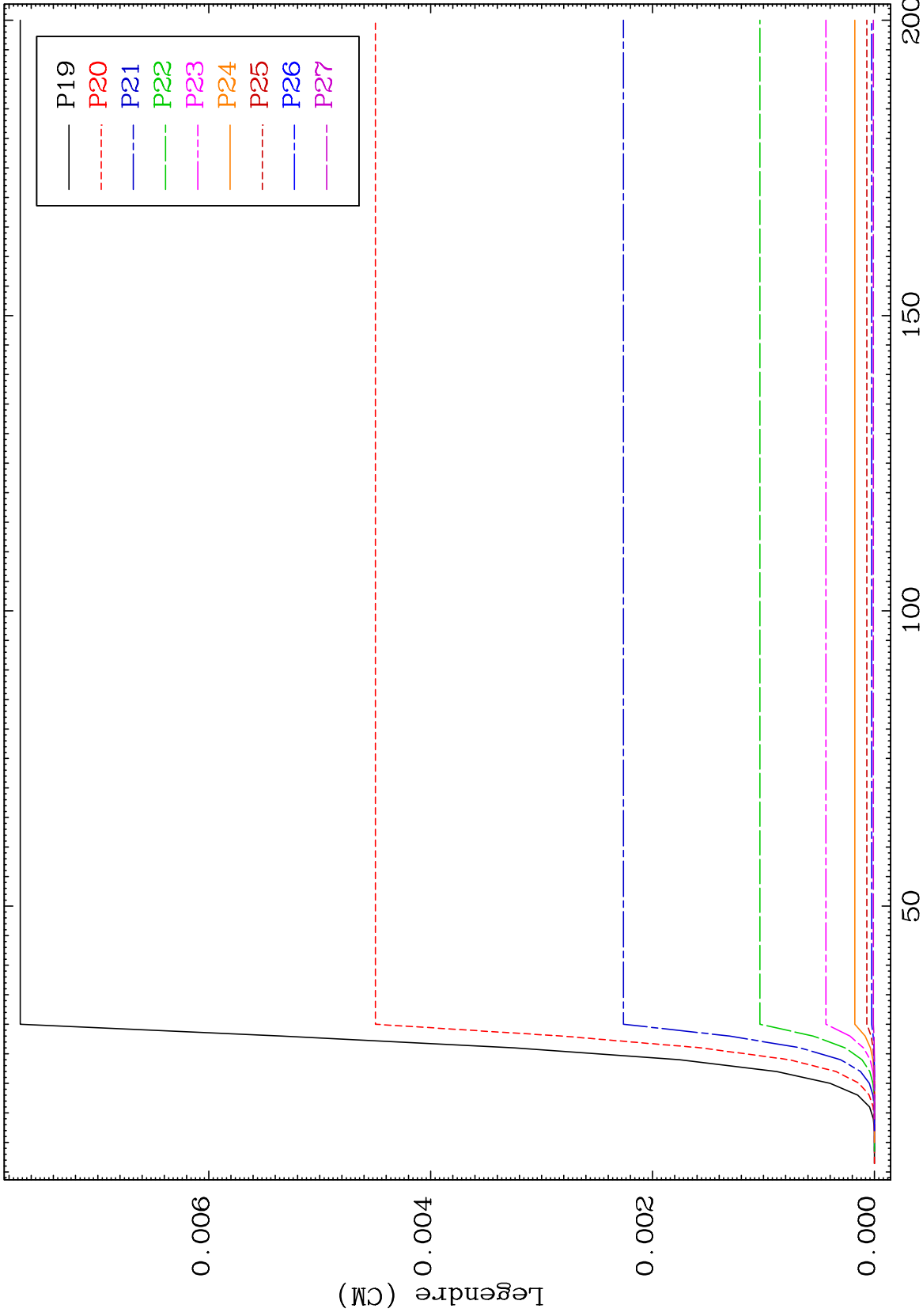

58

Incident Energy (MeV)

54-Xe-119

MAT 5410

MT= 60 (n,n') Level
Legendre Coefficients

54-Xe-119

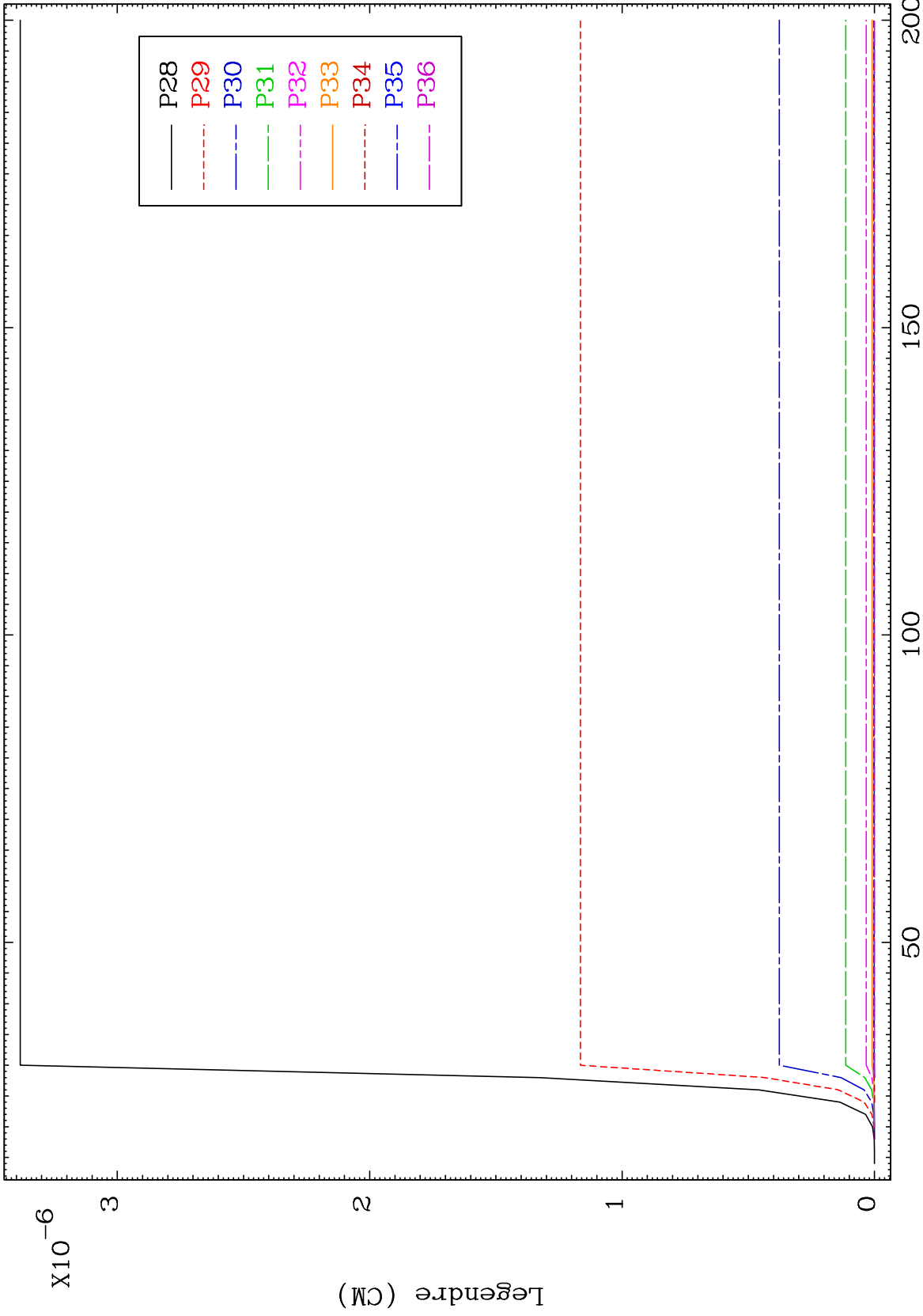

59

54-Xe-119

MAT 5410

MT= 61 (n,n') Level
Legendre Coefficients

54-Xe-119

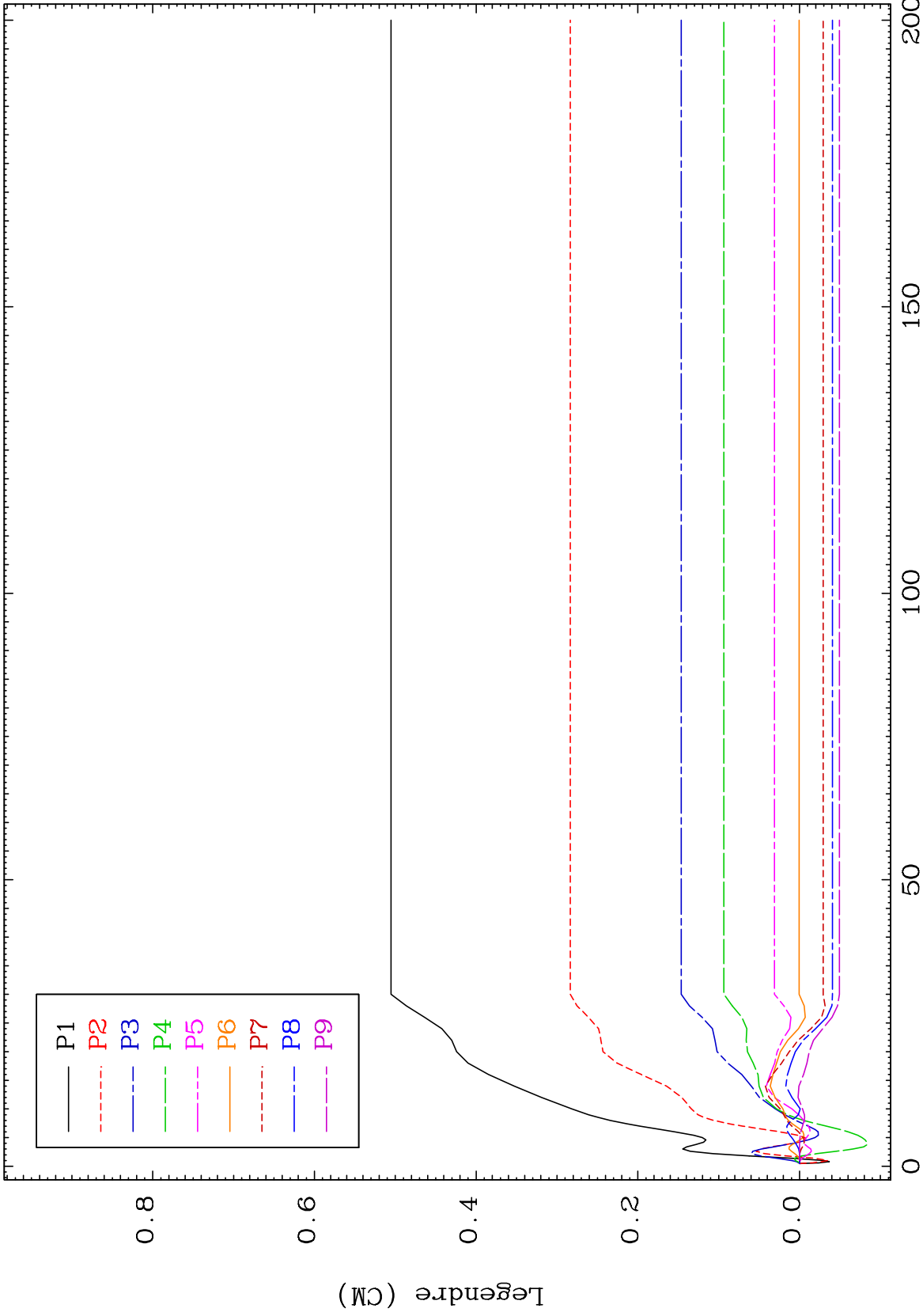

60

Incident Energy (MeV)

54-Xe-119

MAT 5410 MT= 61 (n,n') Level Legendre Coefficients 54-Xe-119

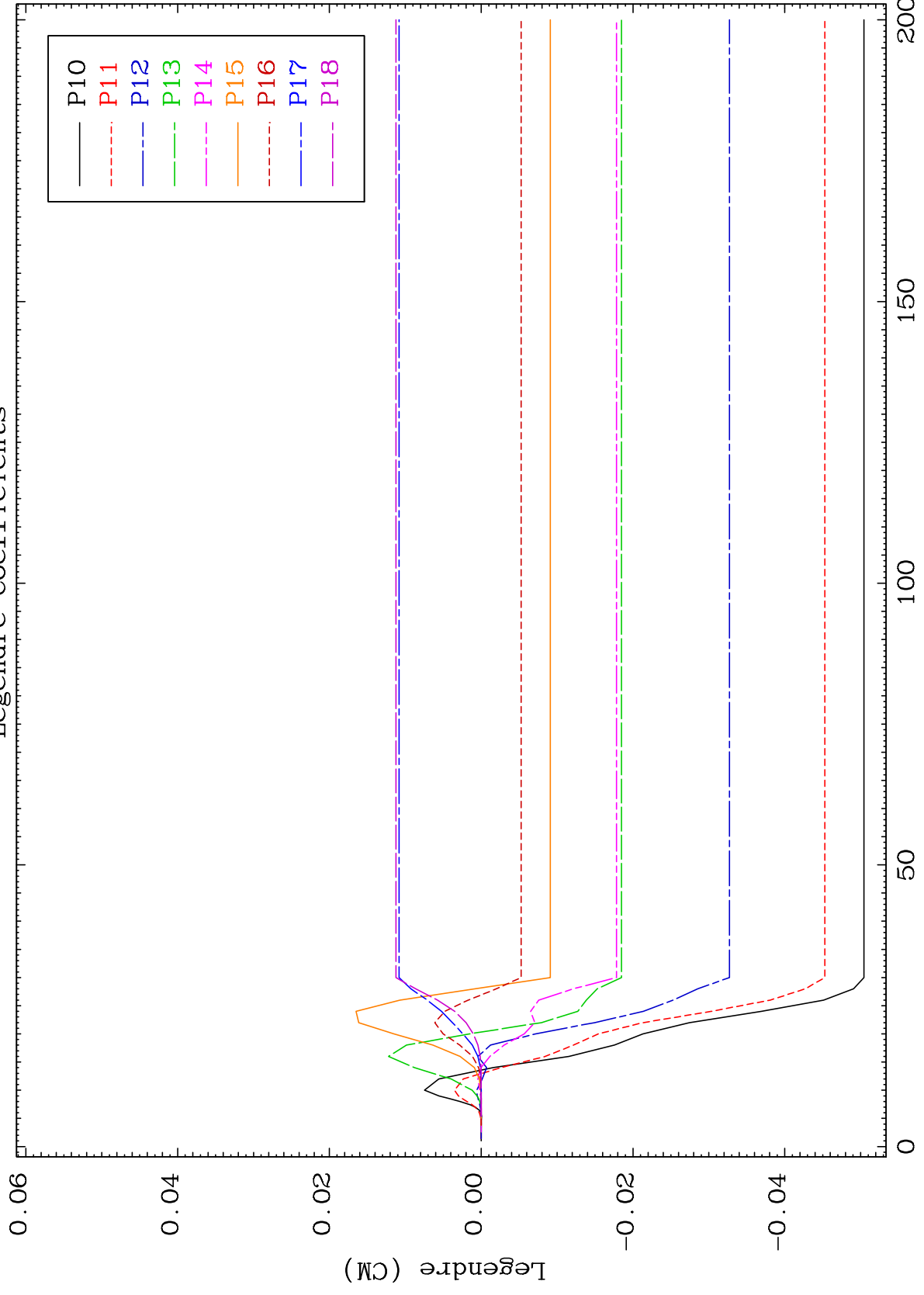

61 54-Xe-119

MAT 5410

MT= 61 (n,n') Level
Legendre Coefficients

54-Xe-119

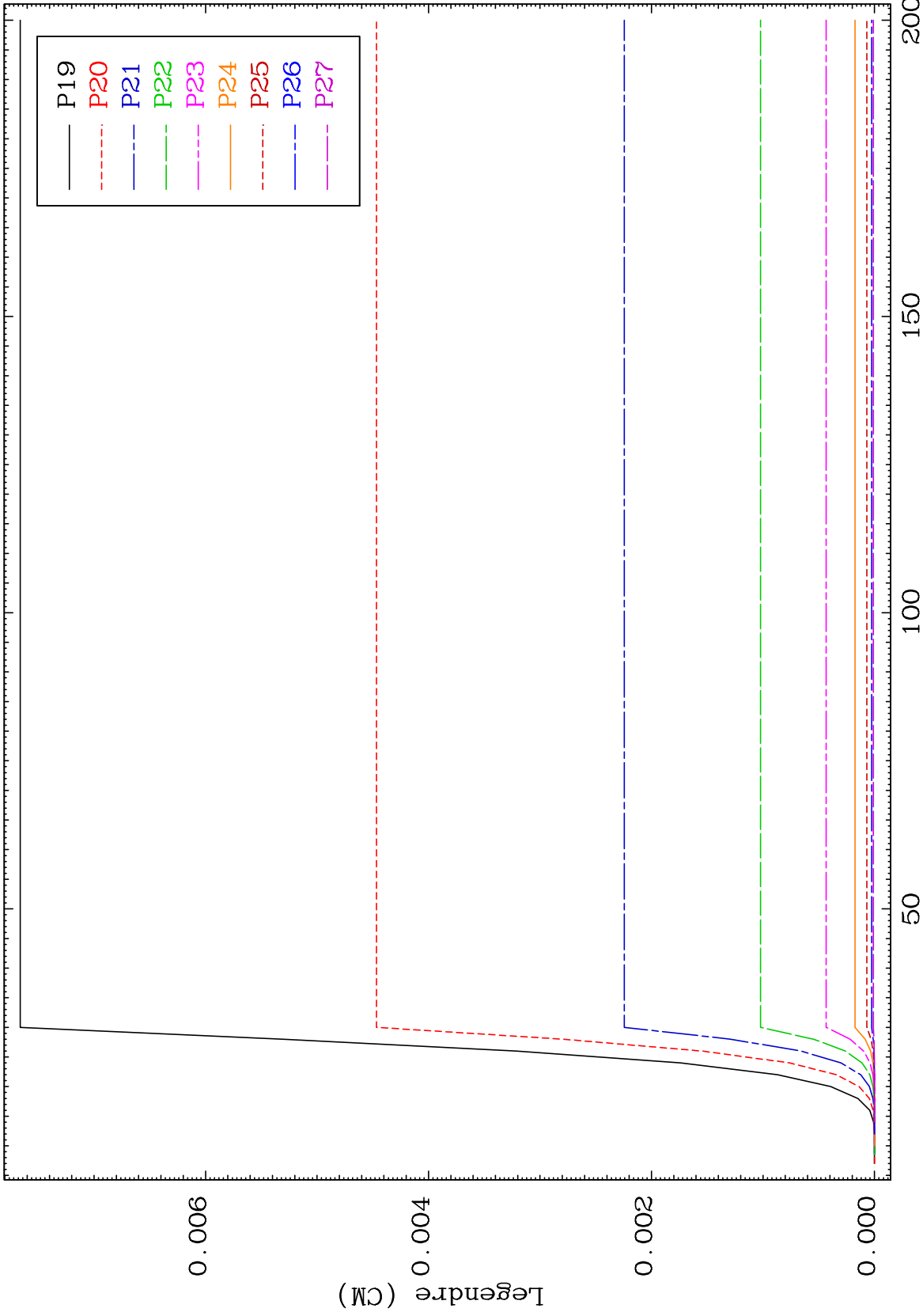

62

Incident Energy (MeV)

54-Xe-119

MAT 5410

MT= 61 (n,n') Level
Legendre Coefficients

54-Xe-119

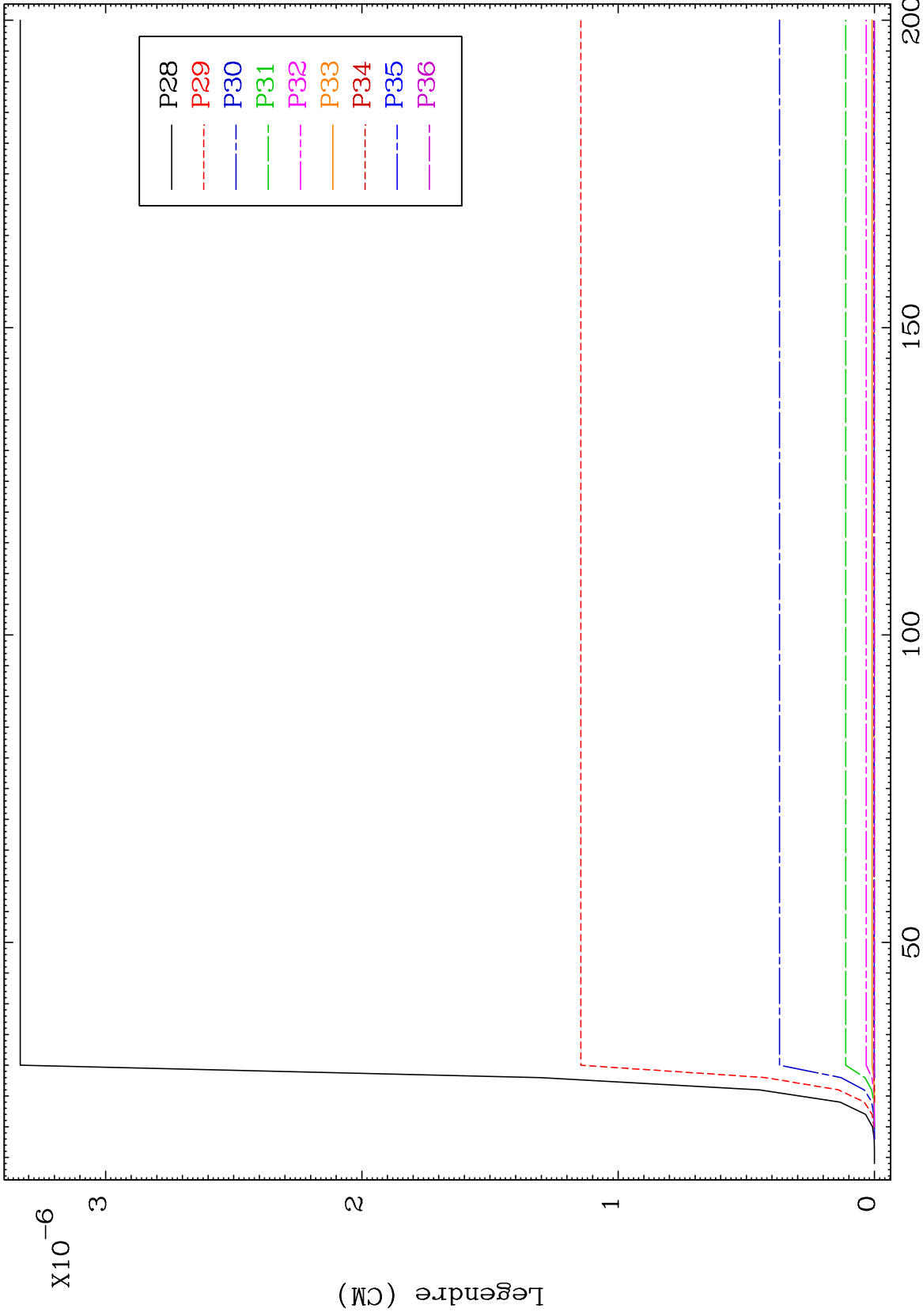

63

54-Xe-119

MAT 5410

MT= 62 (n,n') Level
Legendre Coefficients

54-Xe-119

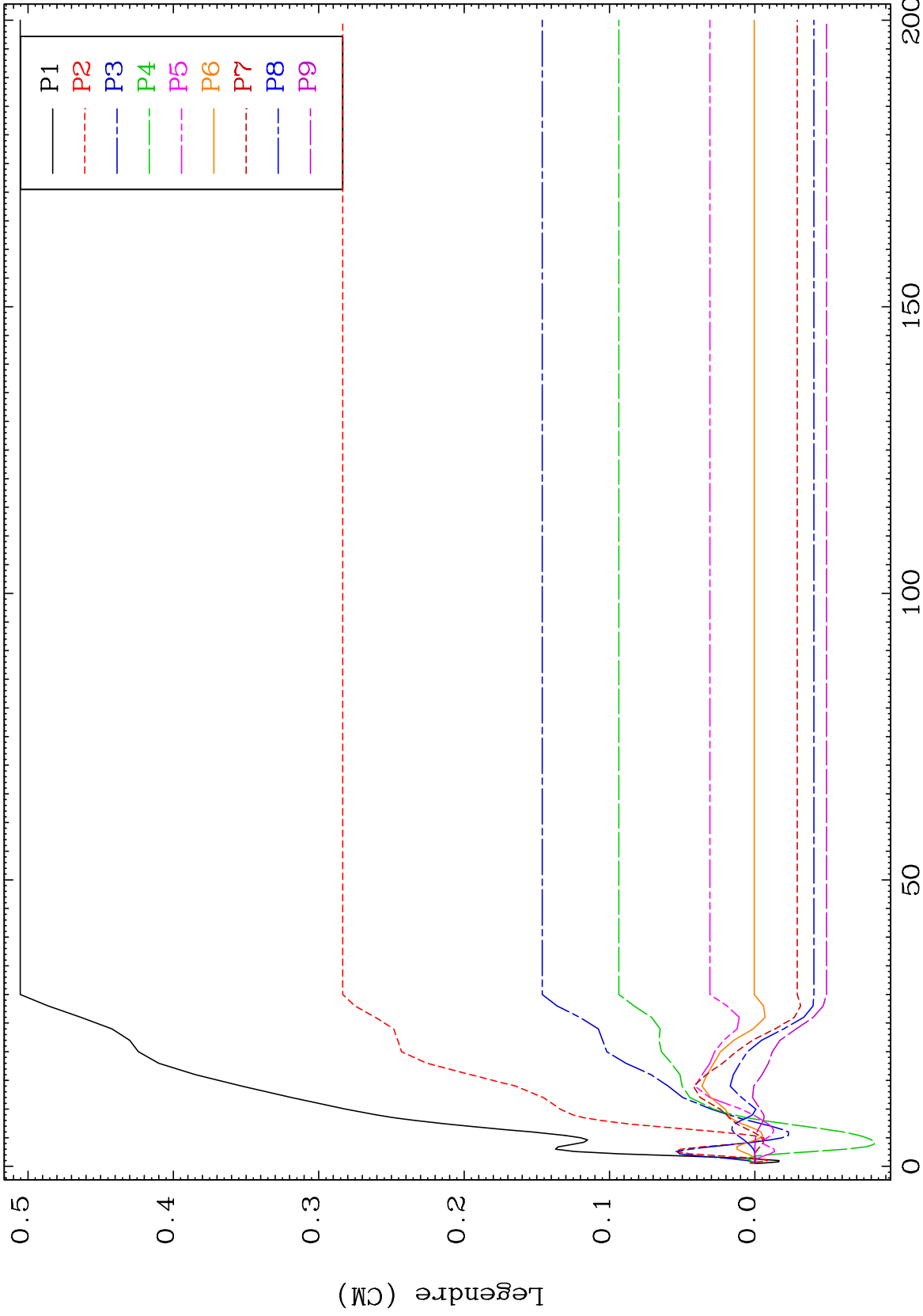

64

Incident Energy (MeV)

54-Xe-119

MAT 5410 MT= 62 (n,n') Level Legendre Coefficients 54-Xe-119

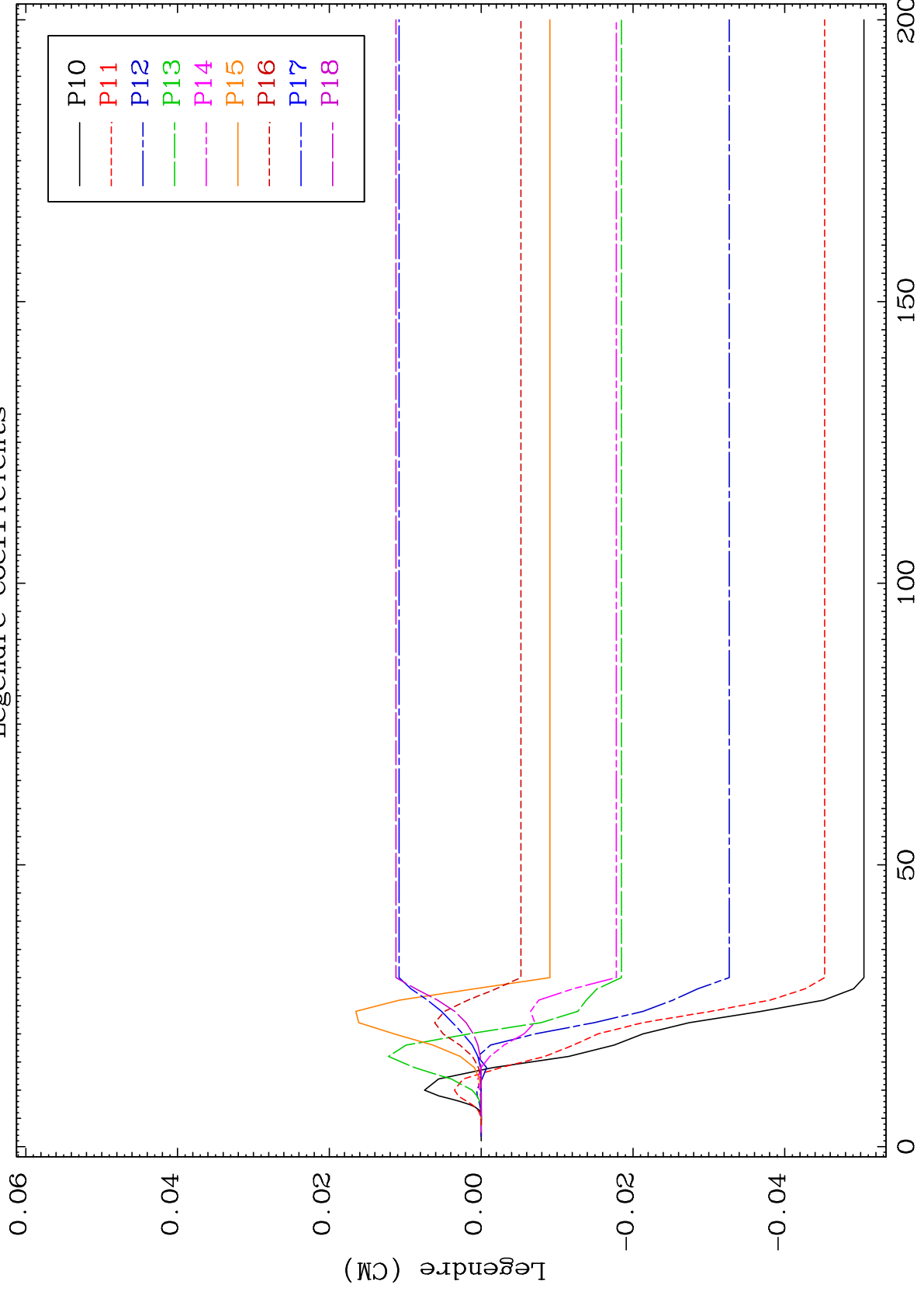

65 54-Xe-119

MAT 5410

MT= 62 (n,n') Level
Legendre Coefficients

54-Xe-119

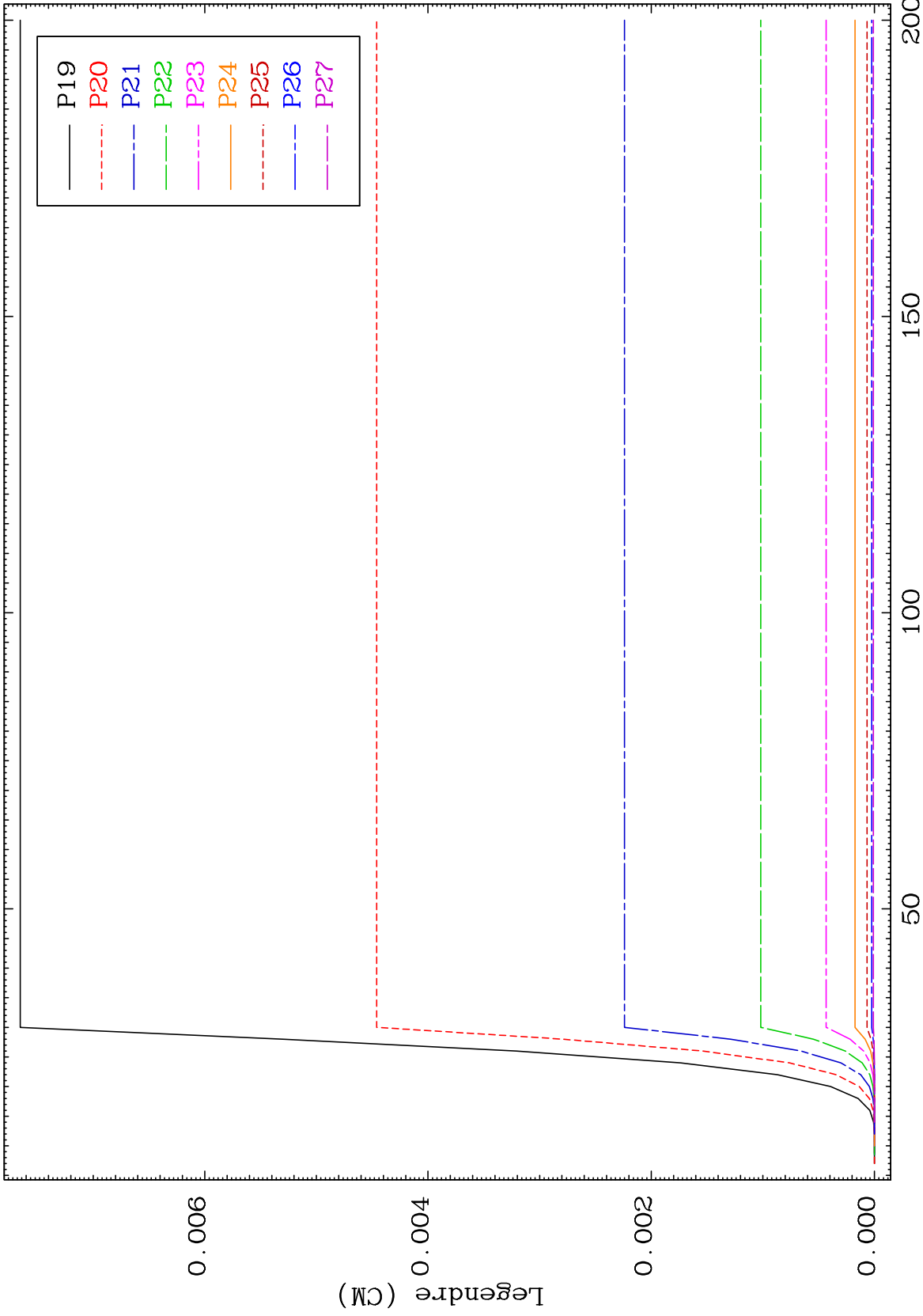

66

Incident Energy (MeV)

54-Xe-119

MAT 5410

MT= 62 (n,n') Level
Legendre Coefficients

54-Xe-119

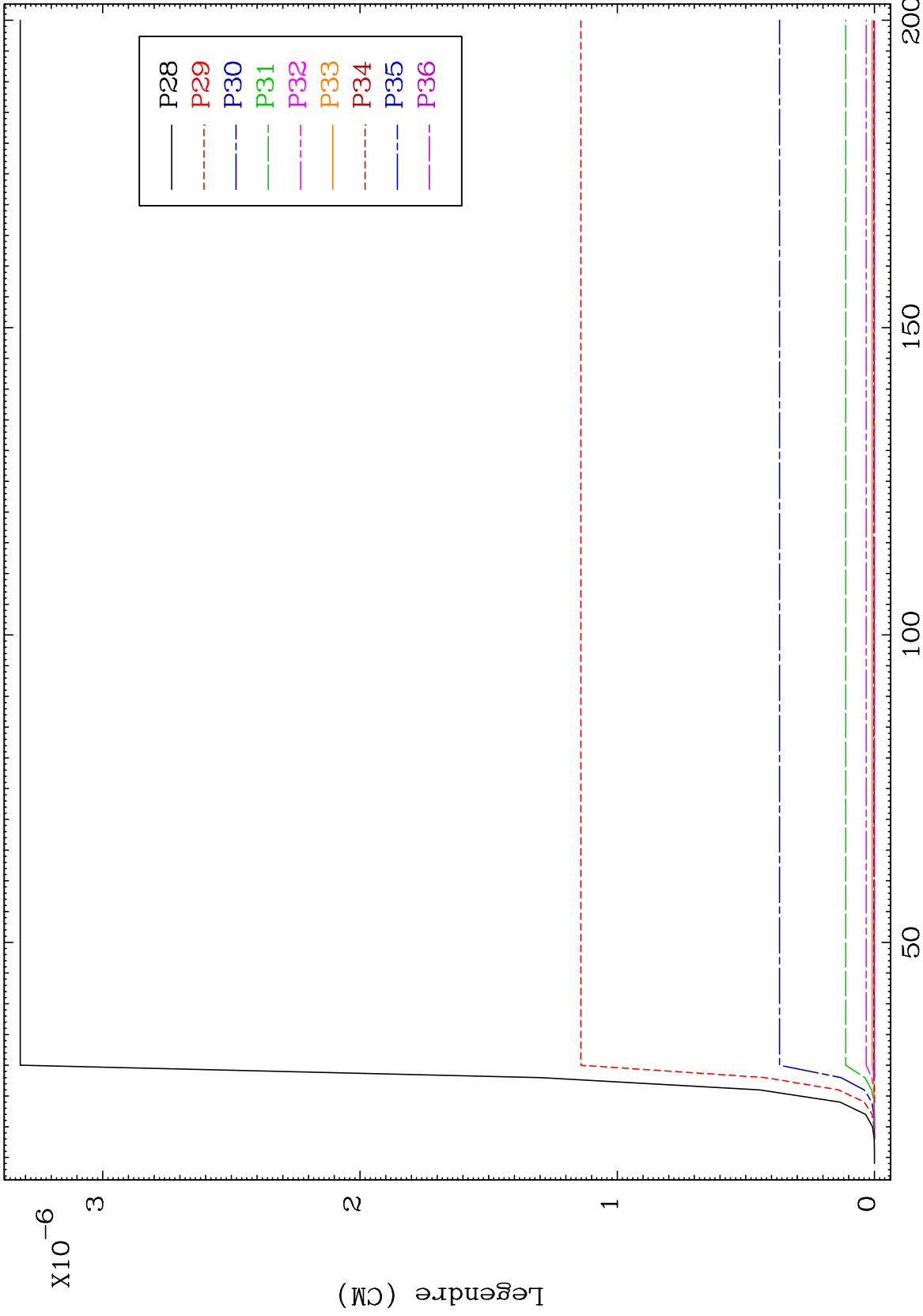

67

54-Xe-119

MAT 5410

MT= 63 (n,n') Level
Legendre Coefficients

54-Xe-119

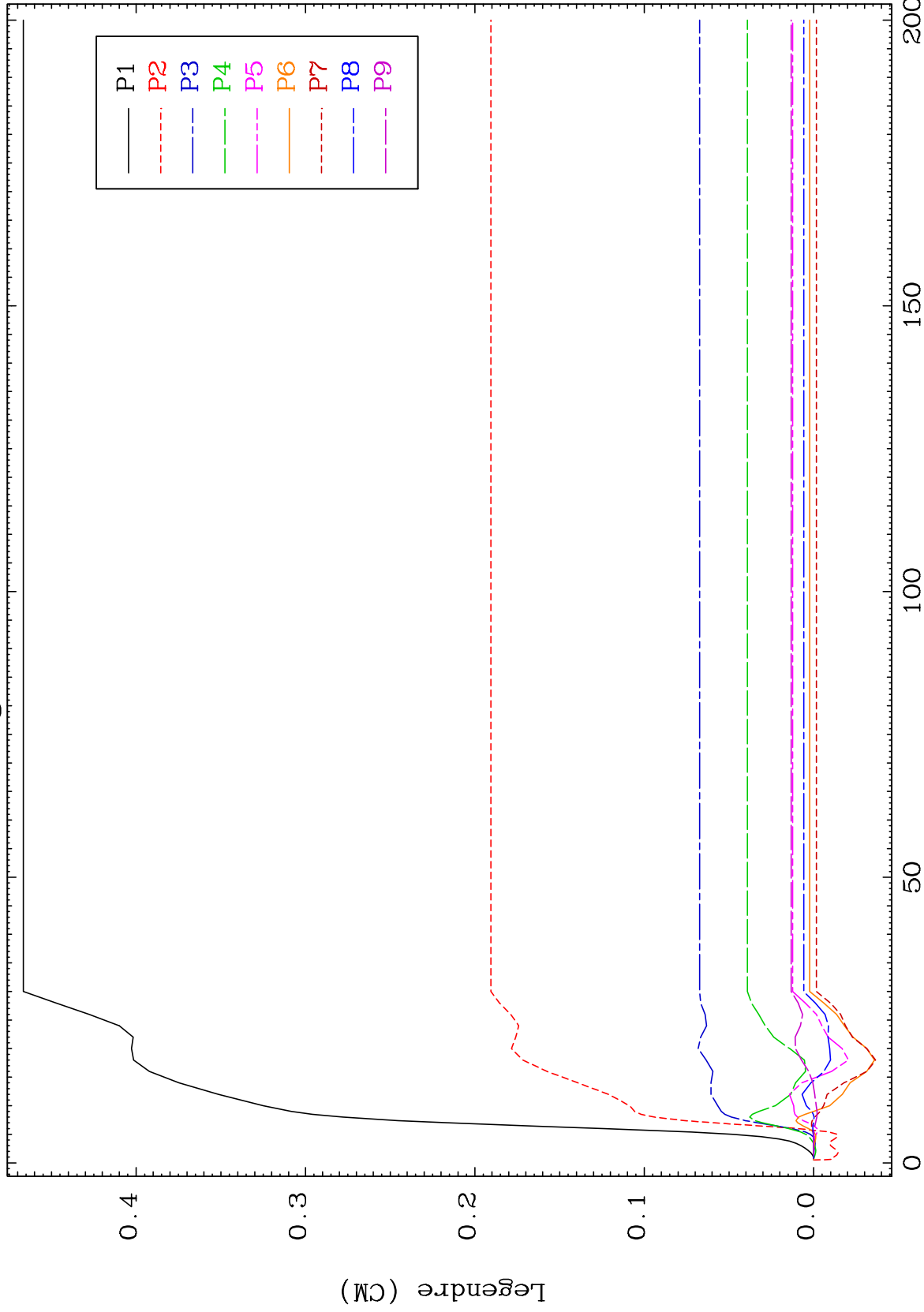

68

Incident Energy (MeV)

54-Xe-119

MAT 5410

MT= 63 (n,n') Level
Legendre Coefficients

54-Xe-119

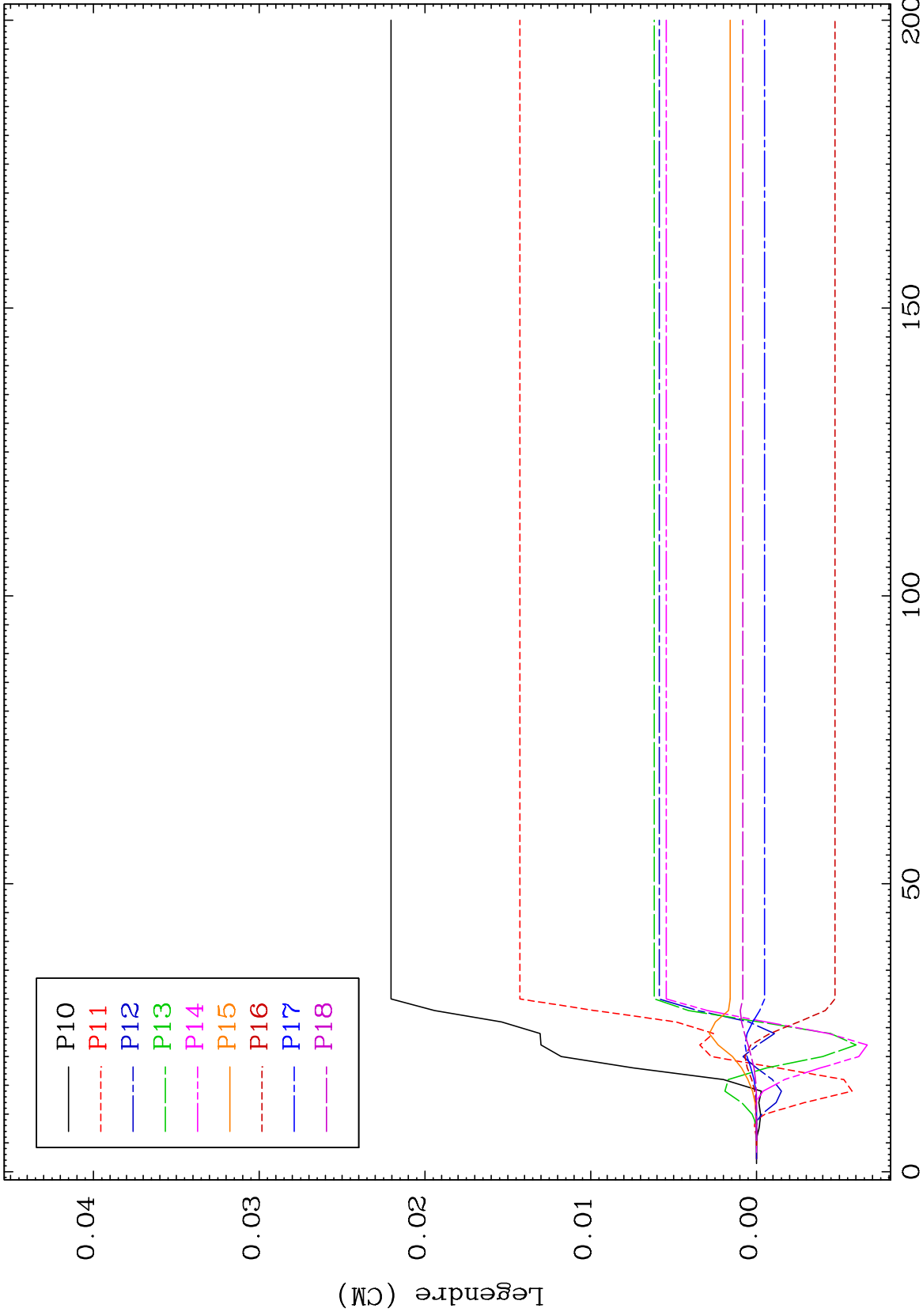

69

Incident Energy (MeV)

54-Xe-119

MAT 5410

MT= 63 (n,n') Level
Legendre Coefficients

54-Xe-119

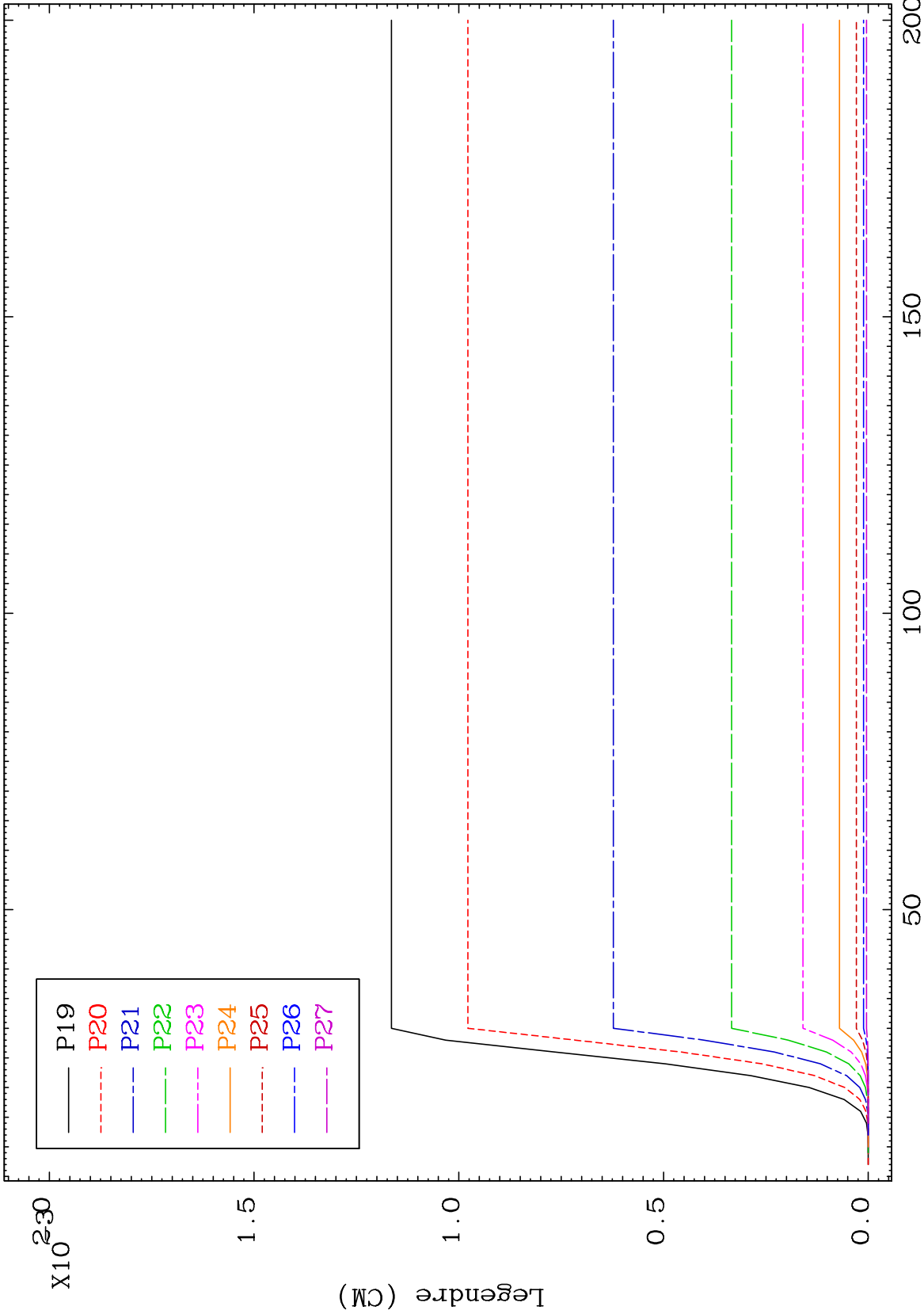

70

Incident Energy (MeV)

54-Xe-119

MAT 5410

MT= 63 (n,n') Level
Legendre Coefficients

54-Xe-119

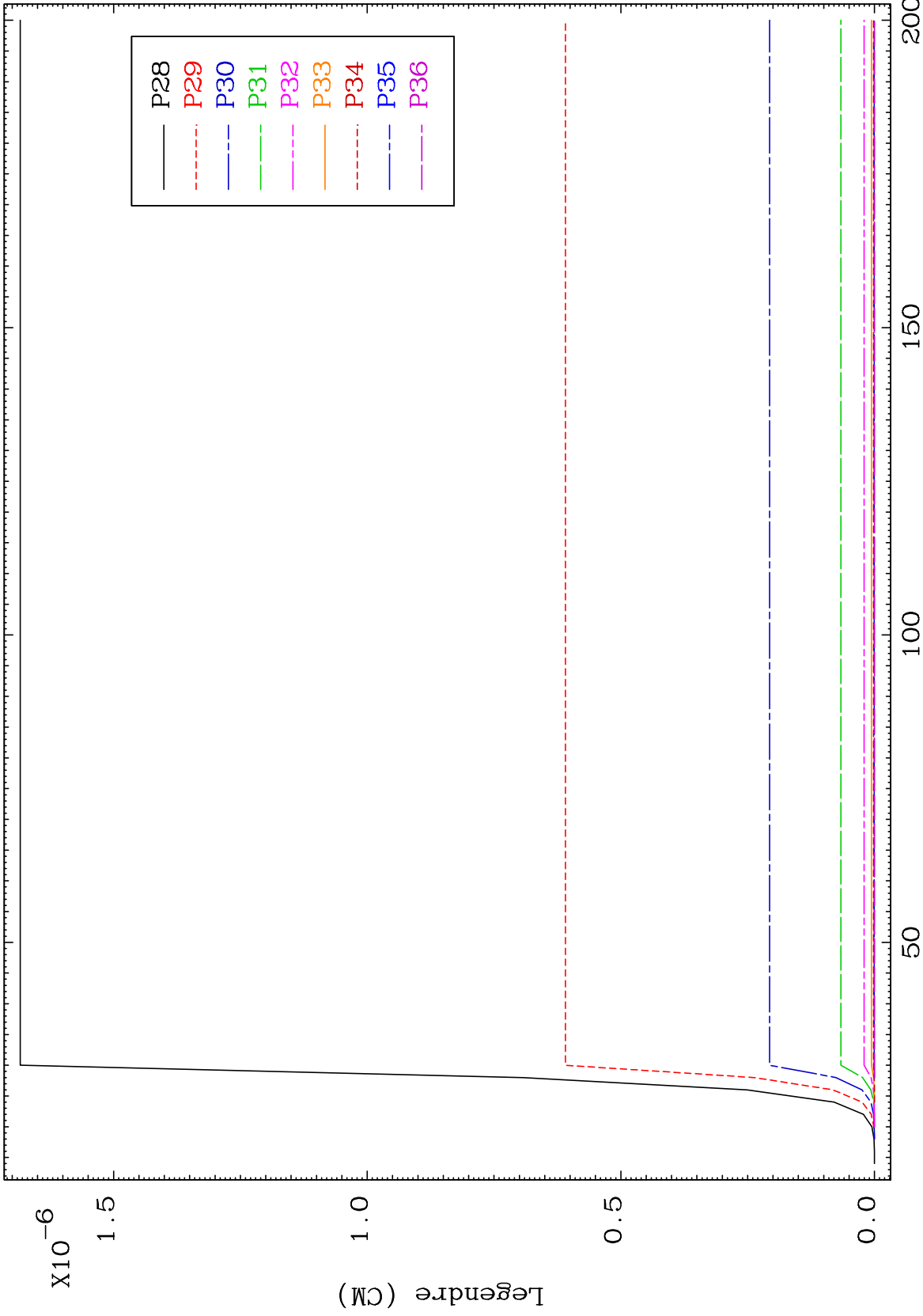

71

54-Xe-119

MAT 5410

MT= 64 (n,n') Level
Legendre Coefficients

54-Xe-119

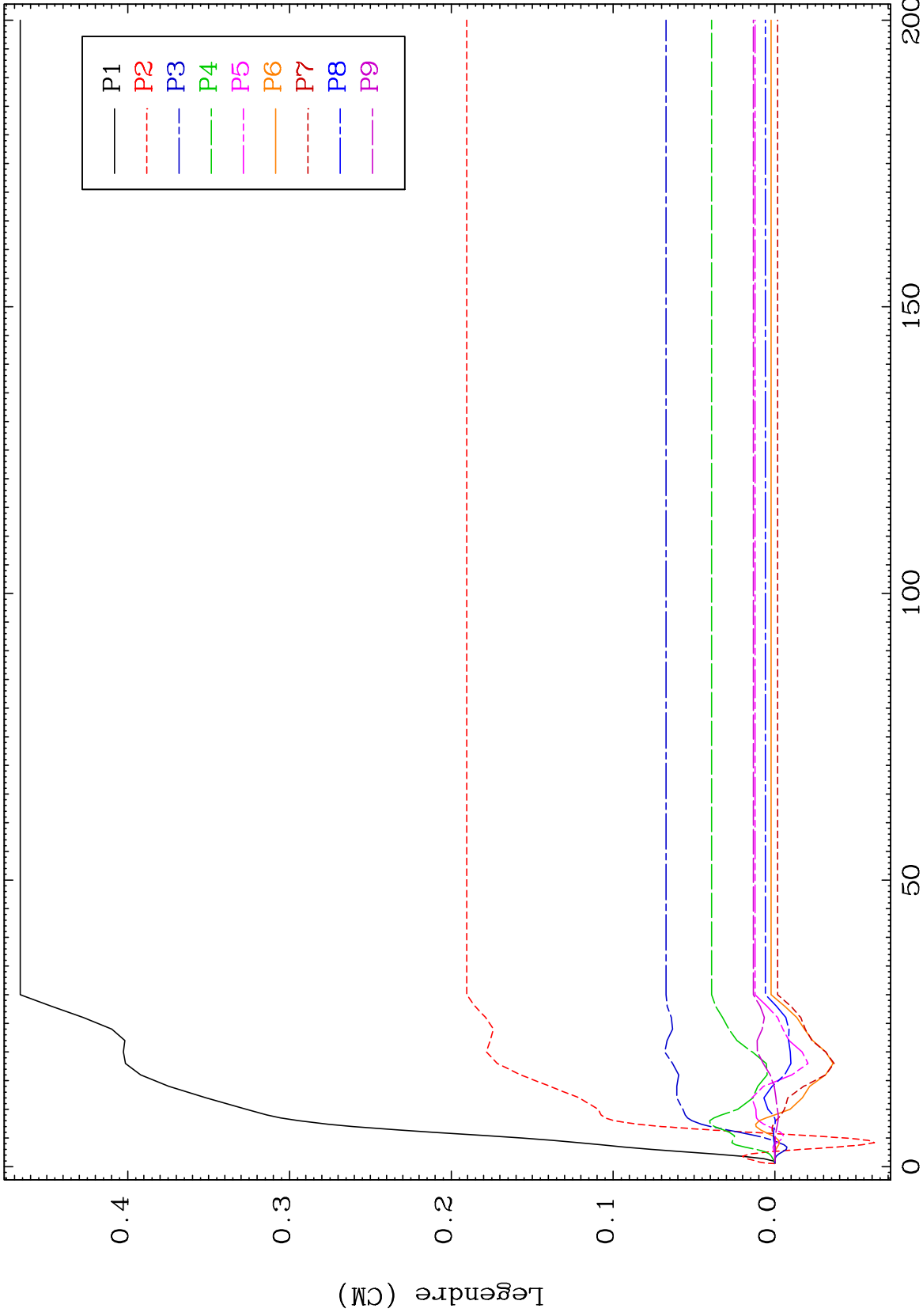

72

Incident Energy (MeV)

54-Xe-119

MAT 5410

MT= 64 (n,n') Level
Legendre Coefficients

54-Xe-119

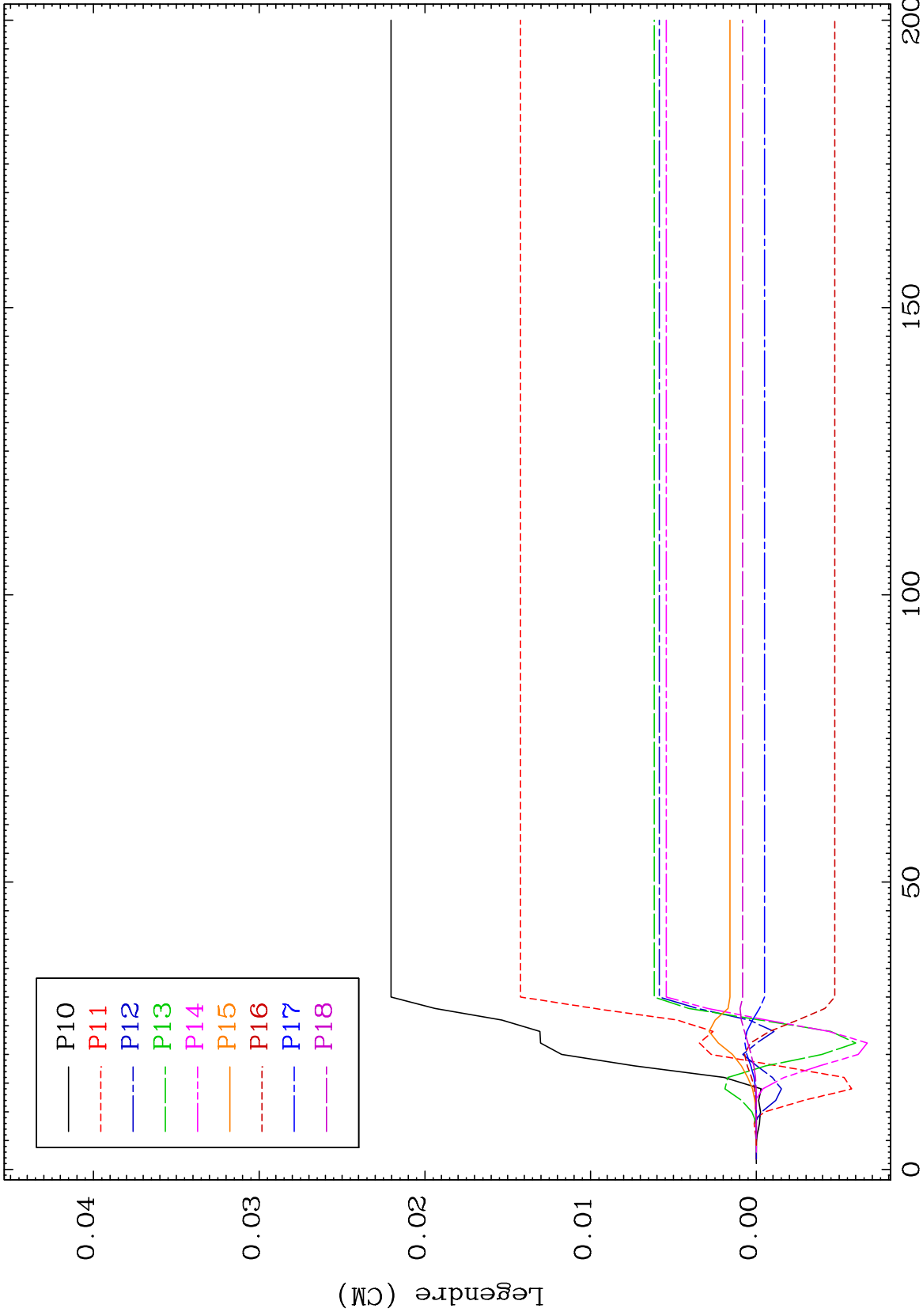

73

Incident Energy (MeV)

54-Xe-119

MAT 5410

MT= 64 (n,n') Level
Legendre Coefficients

54-Xe-119

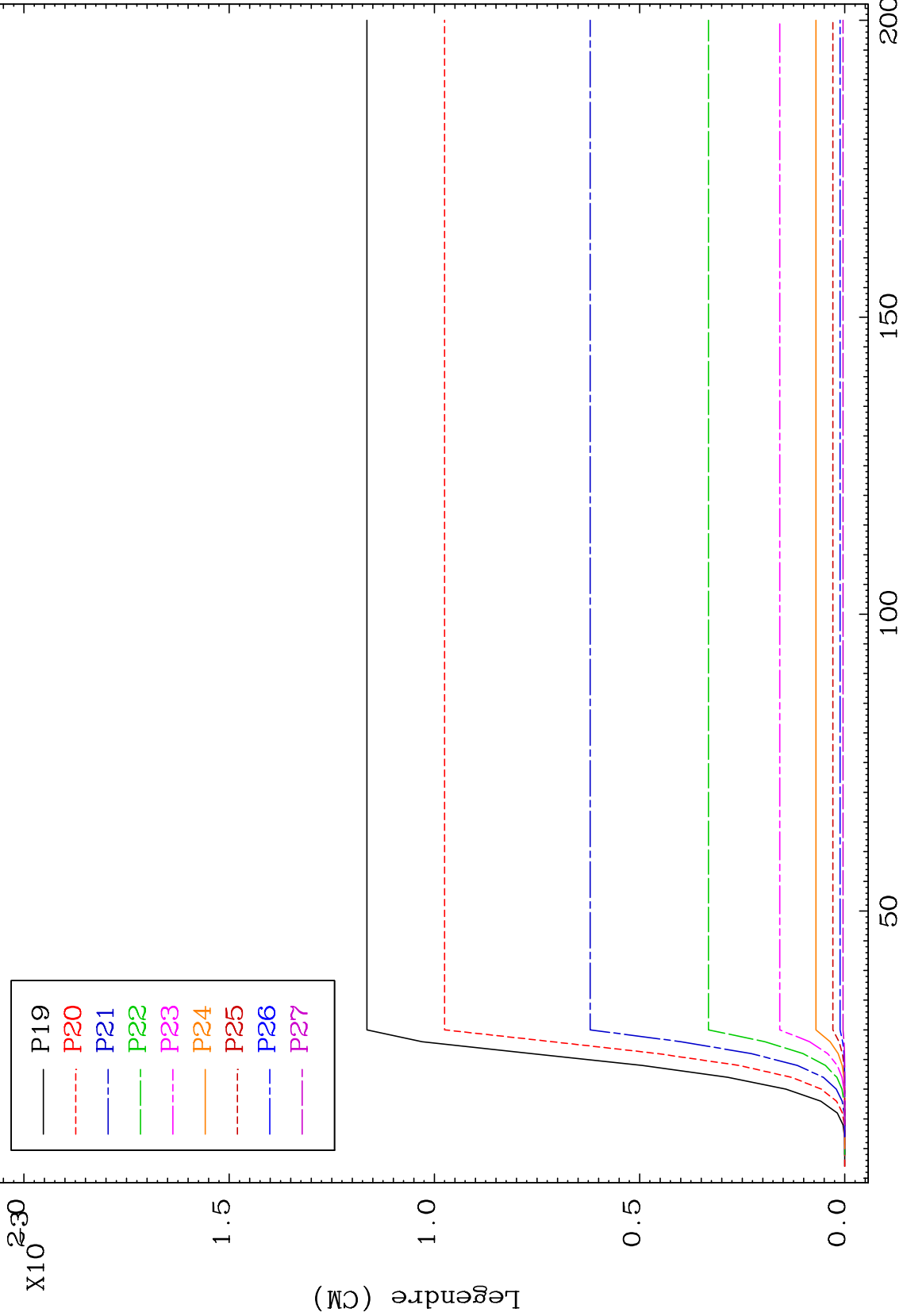
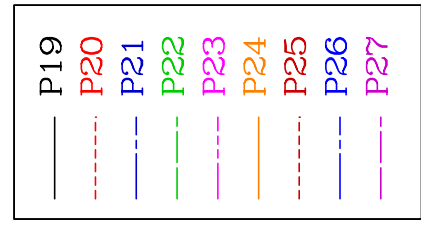

74

Incident Energy (MeV)

54-Xe-119

MAT 5410

MT= 64 (n,n') Level
Legendre Coefficients

54-Xe-119

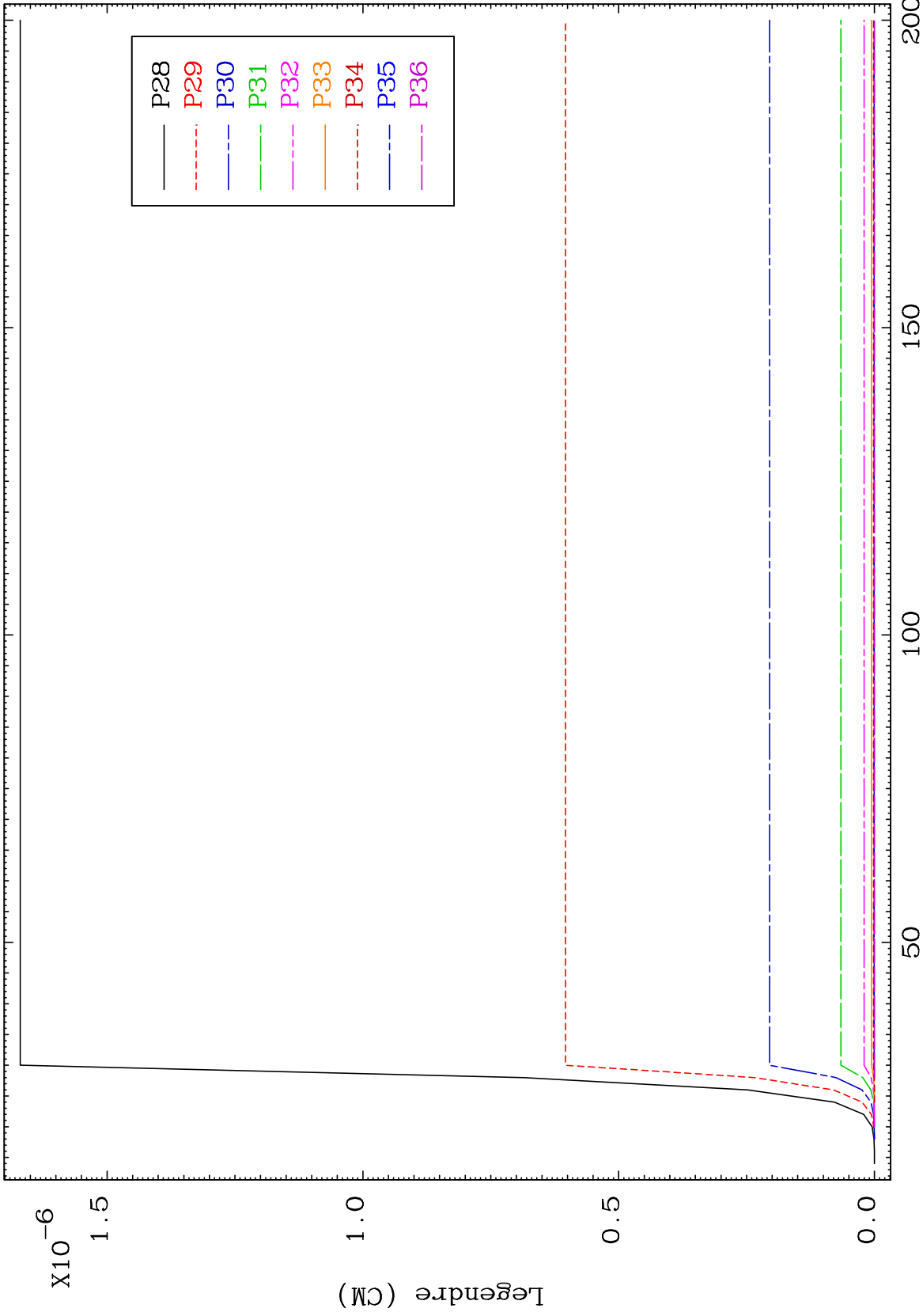

75

Incident Energy (MeV)

54-Xe-119

MAT 5410

MT= 65 (n,n') Level
Legendre Coefficients

54-Xe-119

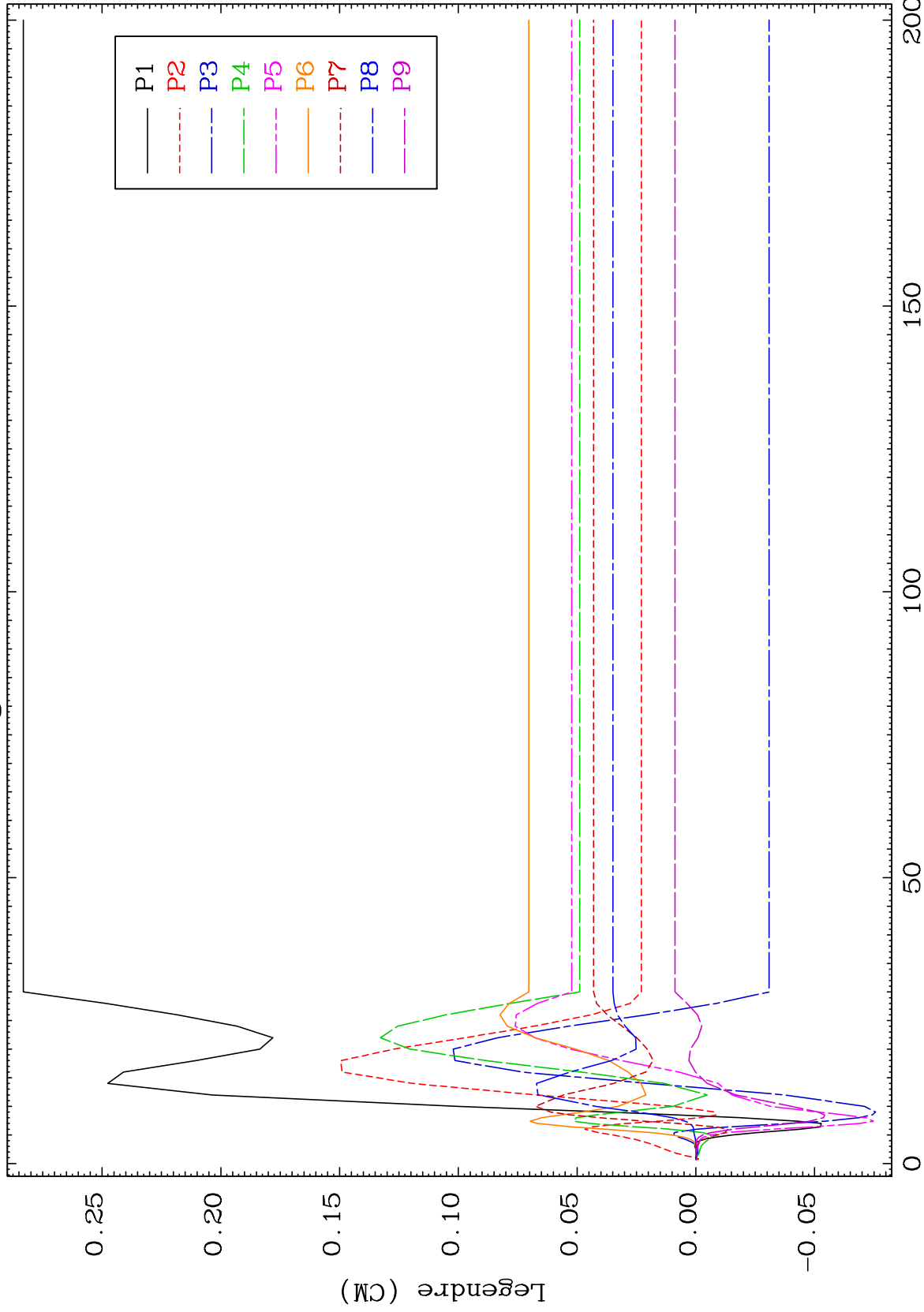

76

Incident Energy (MeV)

54-Xe-119

MAT 5410

MT= 65 (n,n') Level
Legendre Coefficients

54-Xe-119

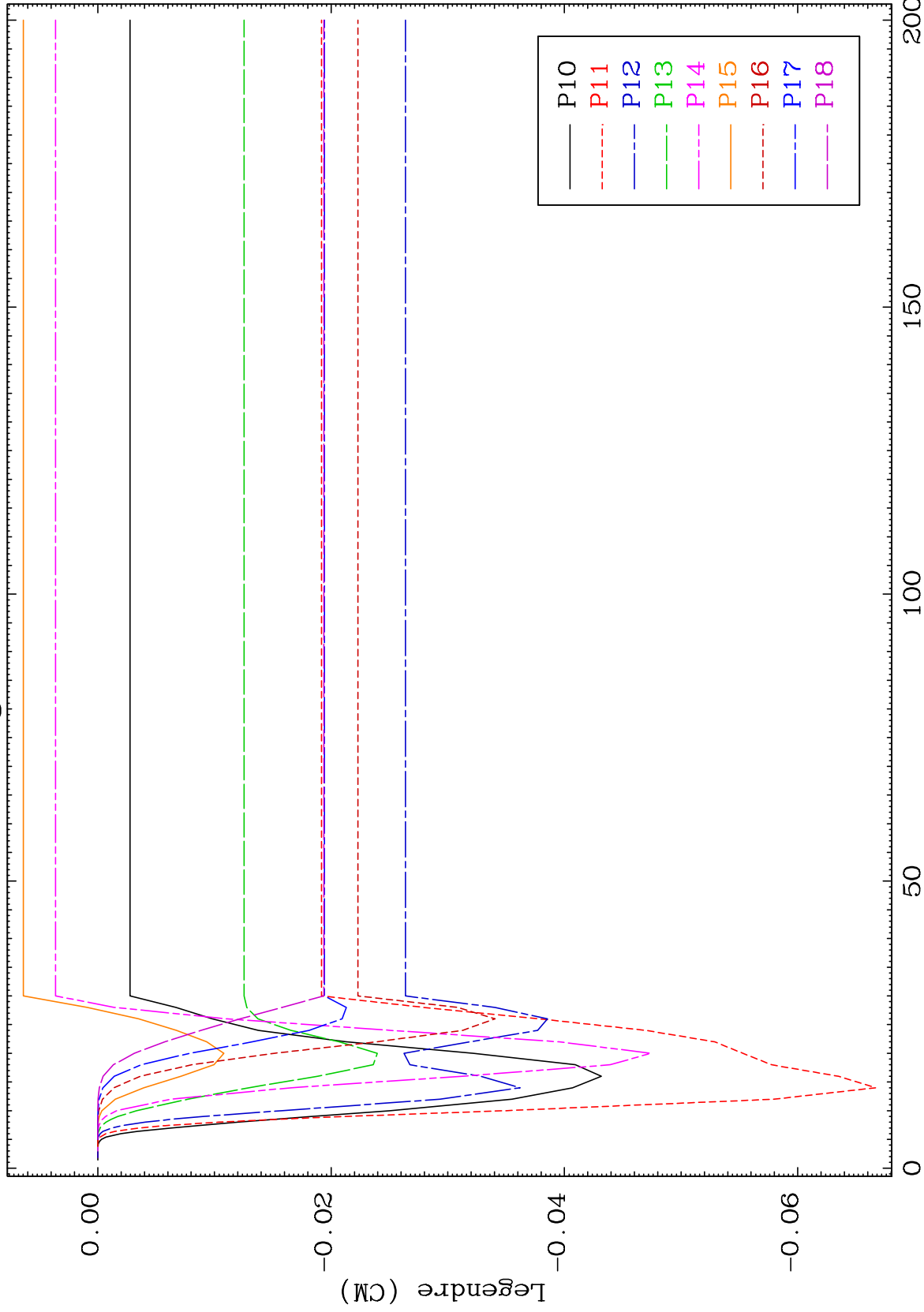

77

Incident Energy (MeV)

54-Xe-119

MAT 5410

MT= 65 (n,n') Level
Legendre Coefficients

54-Xe-119

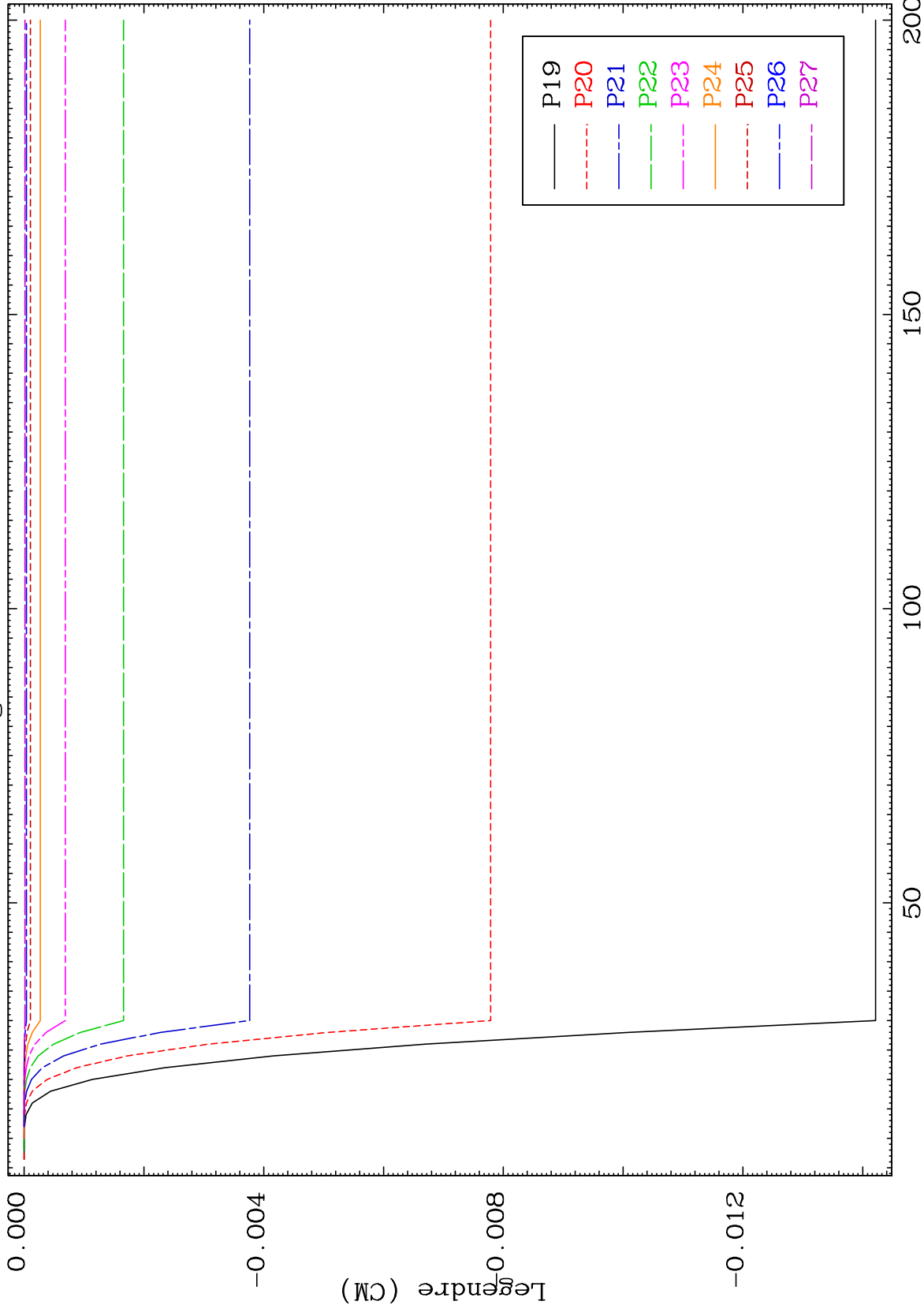

54-Xe-119

Incident Energy (MeV)

78

MAT 5410

MT= 65 (n,n') Level
Legendre Coefficients

54-Xe-119

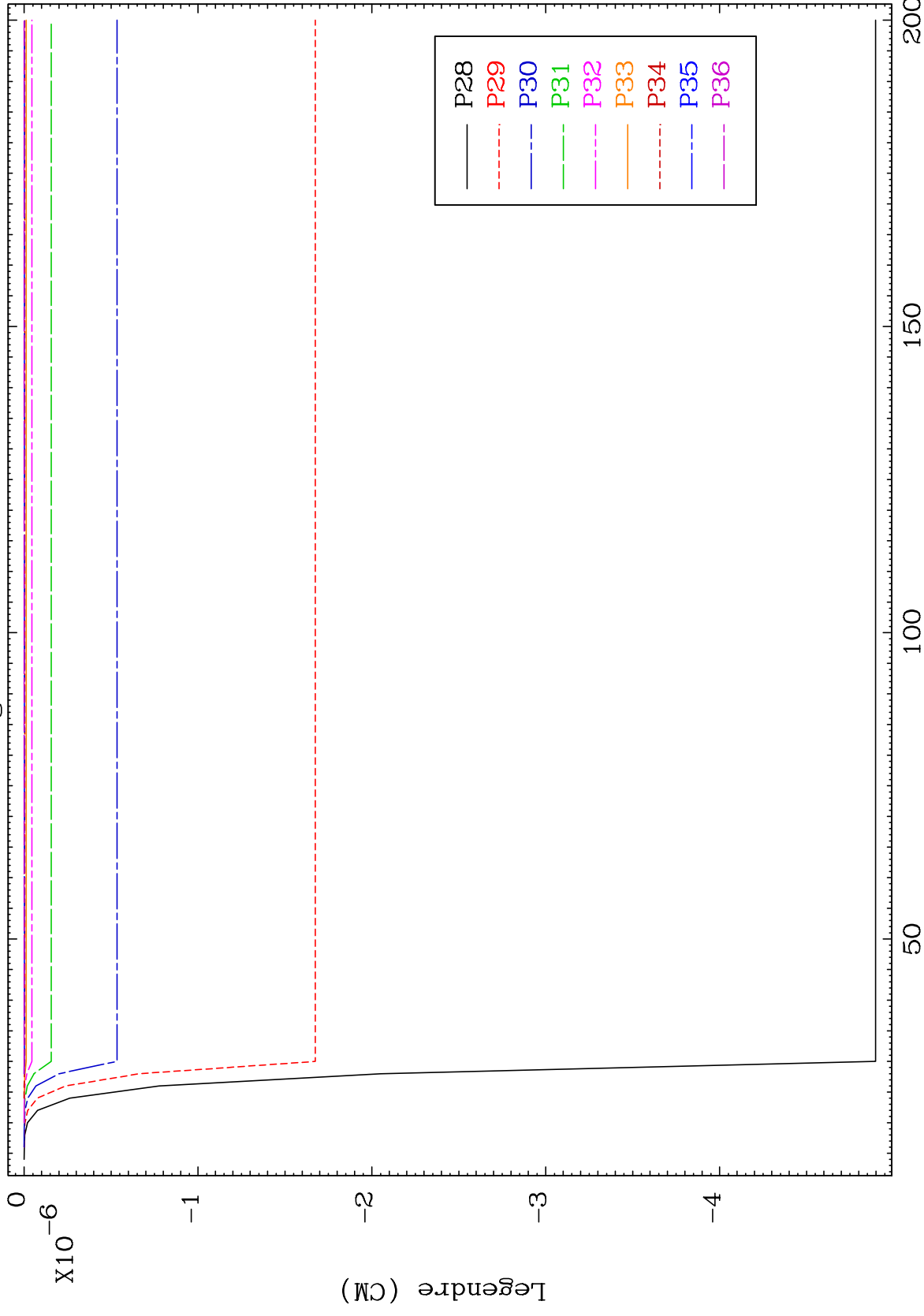

54-Xe-119

Incident Energy (MeV)

79

MAT 5410

MT= 66 (n,n') Level
Legendre Coefficients

54-Xe-119

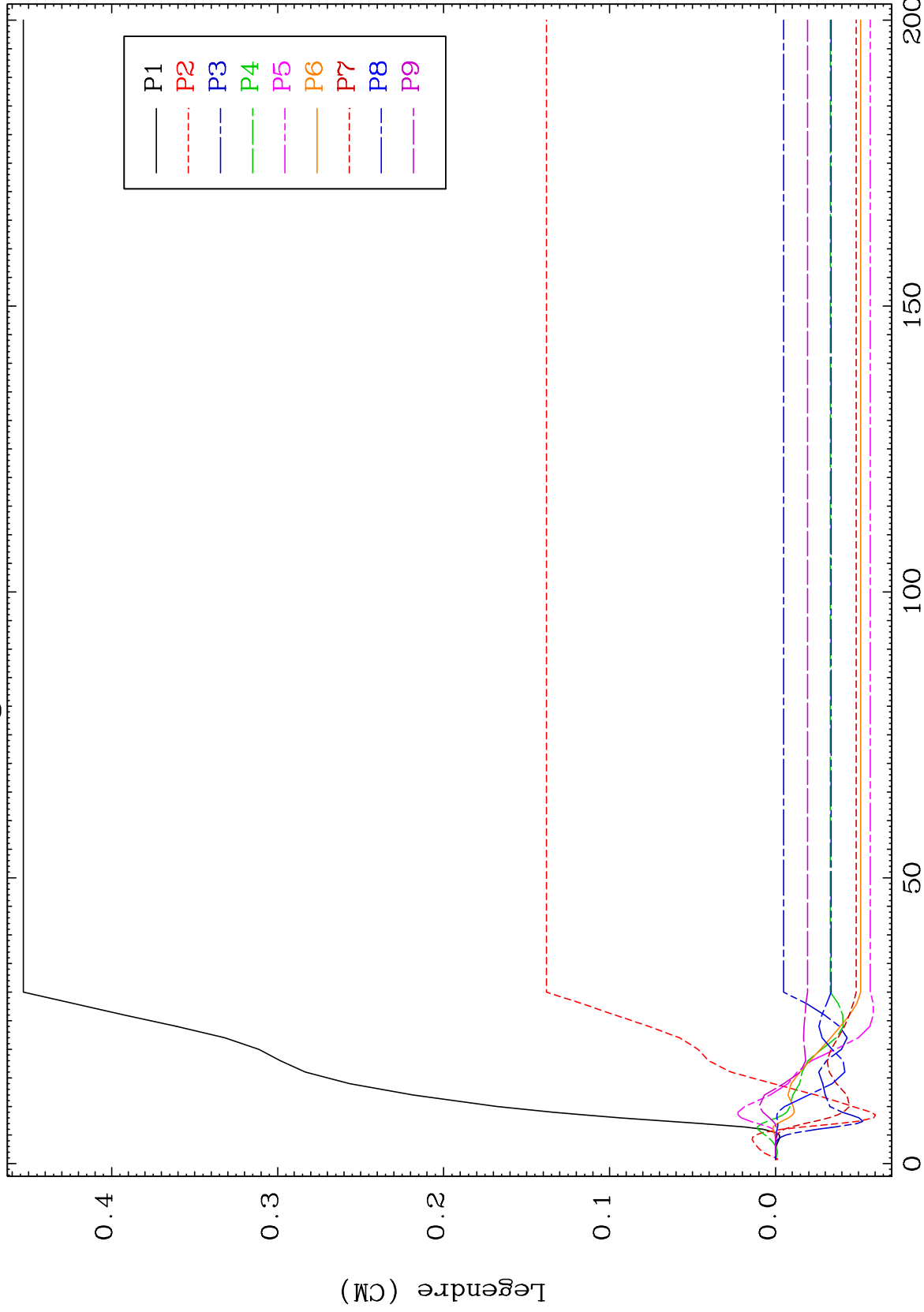

54-Xe-119

Incident Energy (MeV)

MAT 5410

MT= 66 (n,n') Level
Legendre Coefficients

54-Xe-119

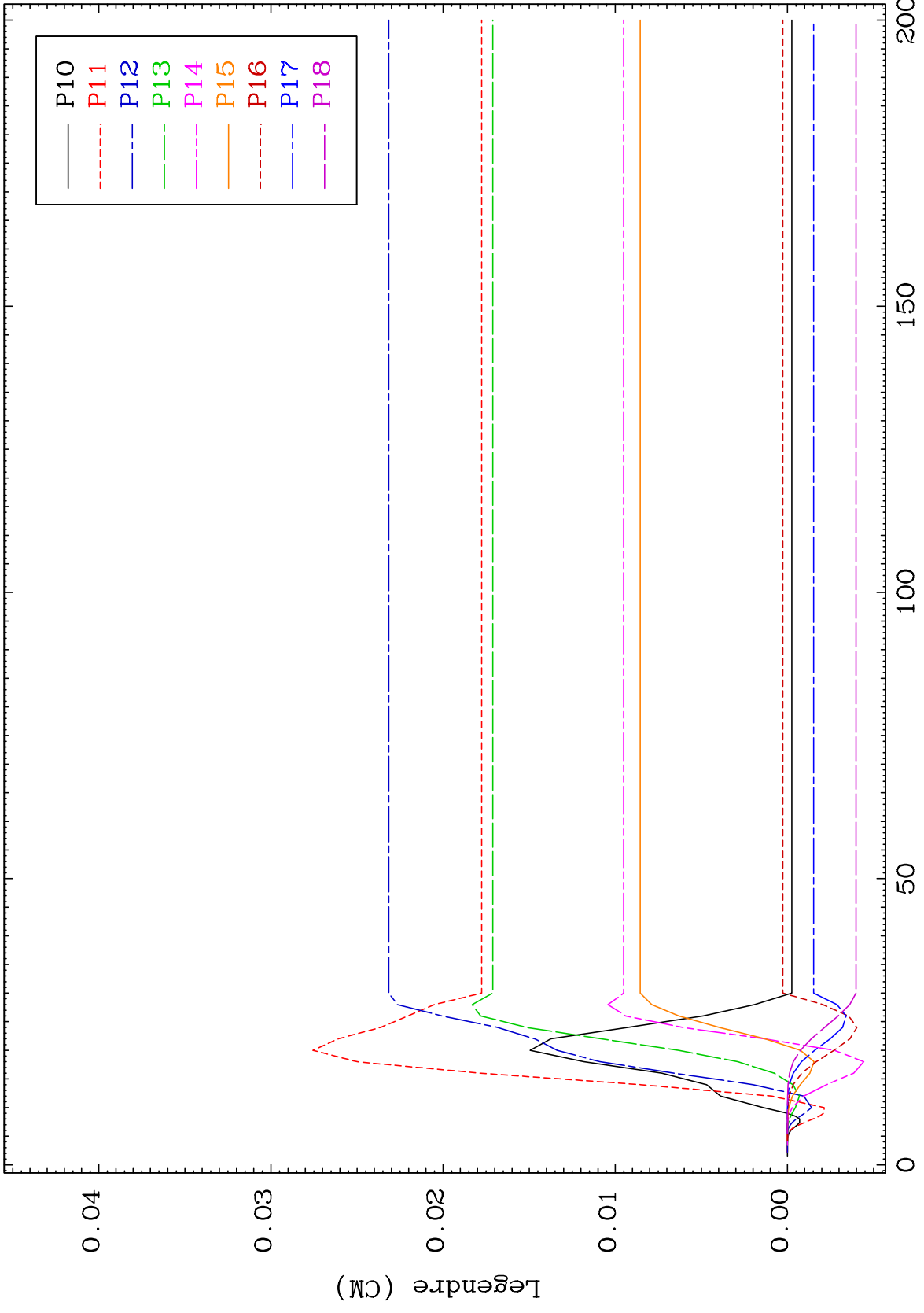

81

Incident Energy (MeV)

54-Xe-119

MAT 5410

MT= 66 (n,n') Level
Legendre Coefficients

54-Xe-119

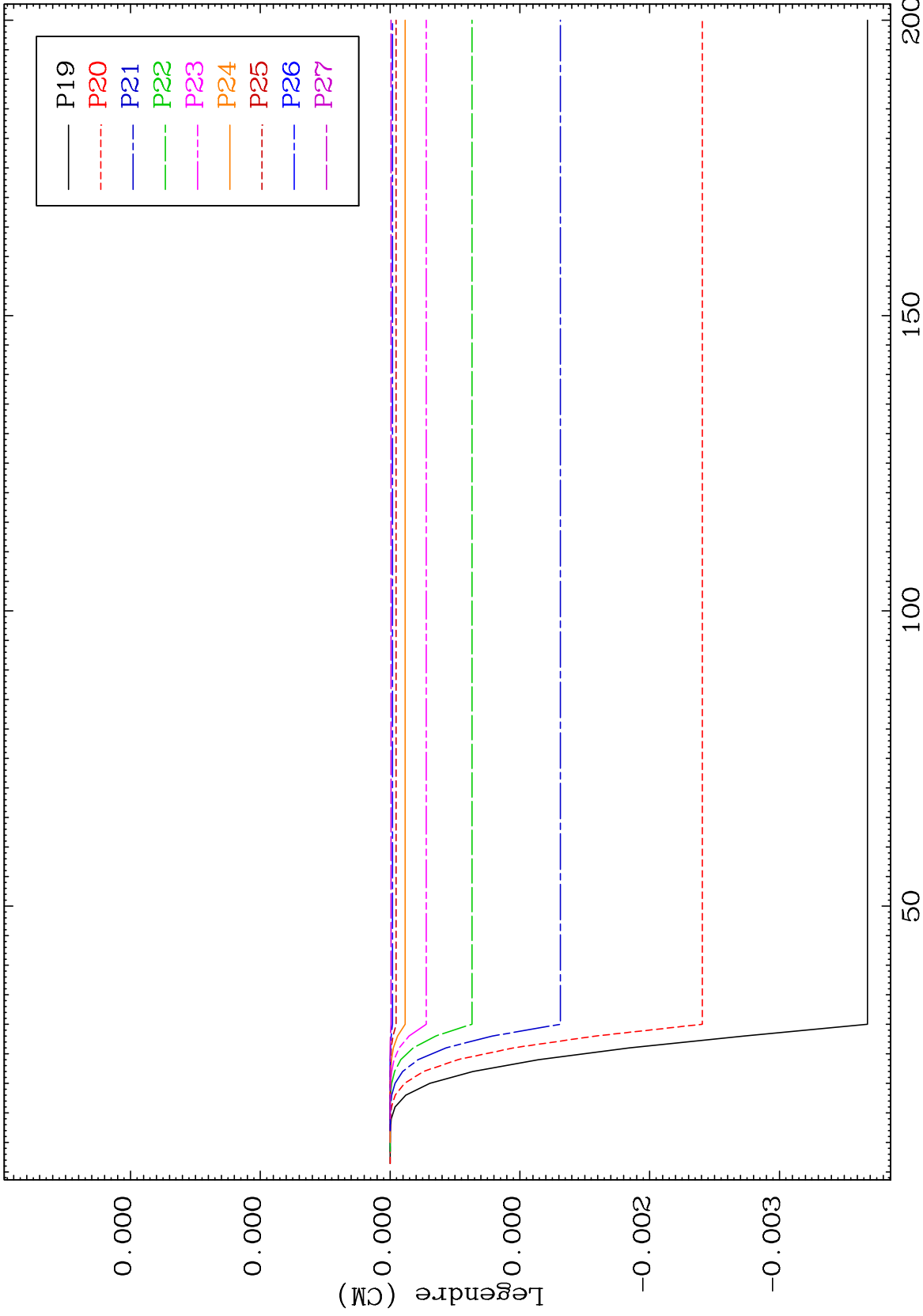

82

Incident Energy (MeV)

54-Xe-119

MAT 5410

MT= 66 (n,n') Level
Legendre Coefficients

54-Xe-119

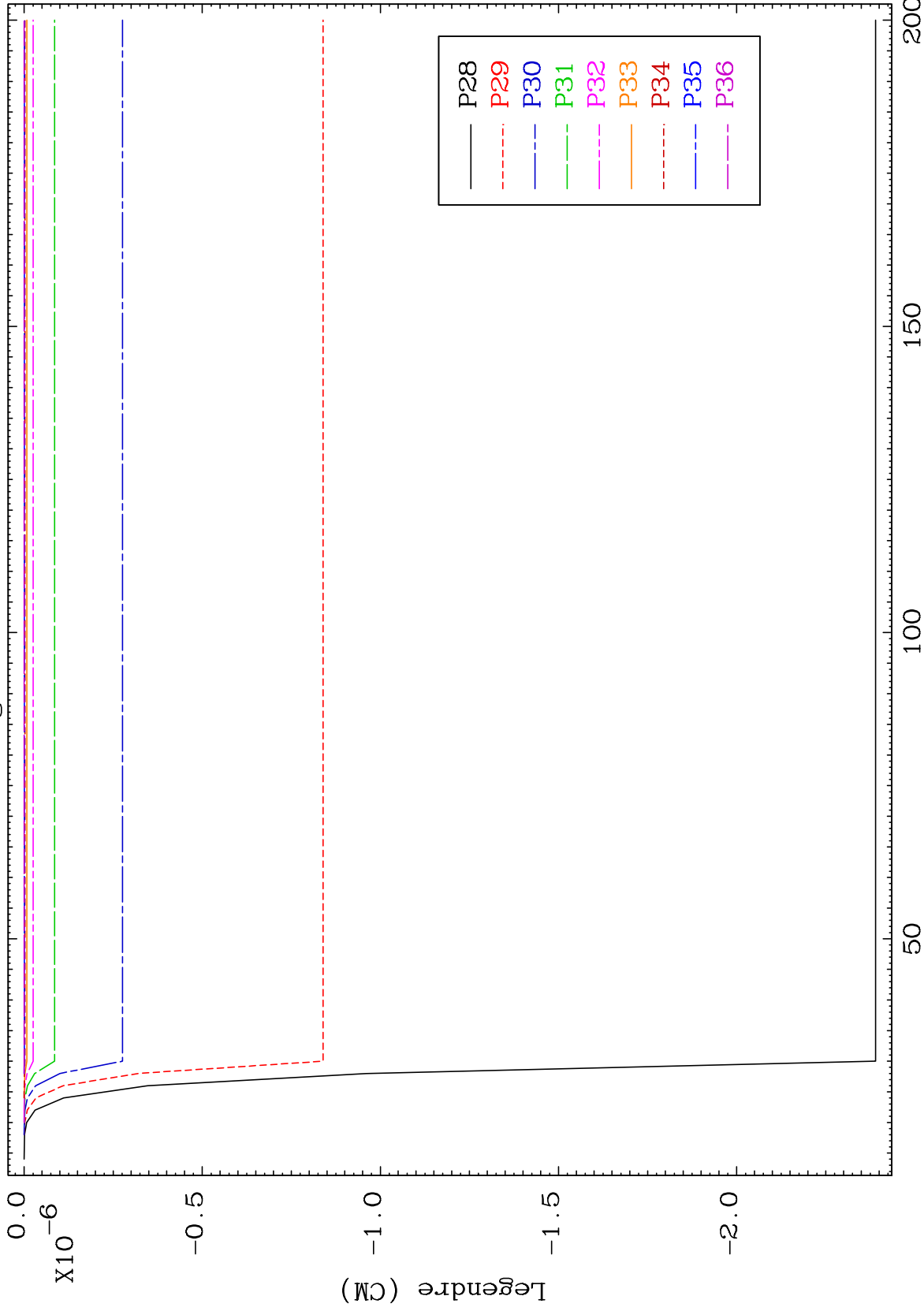

83

Incident Energy (MeV)

54-Xe-119

MAT 5410

MT= 67 (n,n') Level
Legendre Coefficients

54-Xe-119

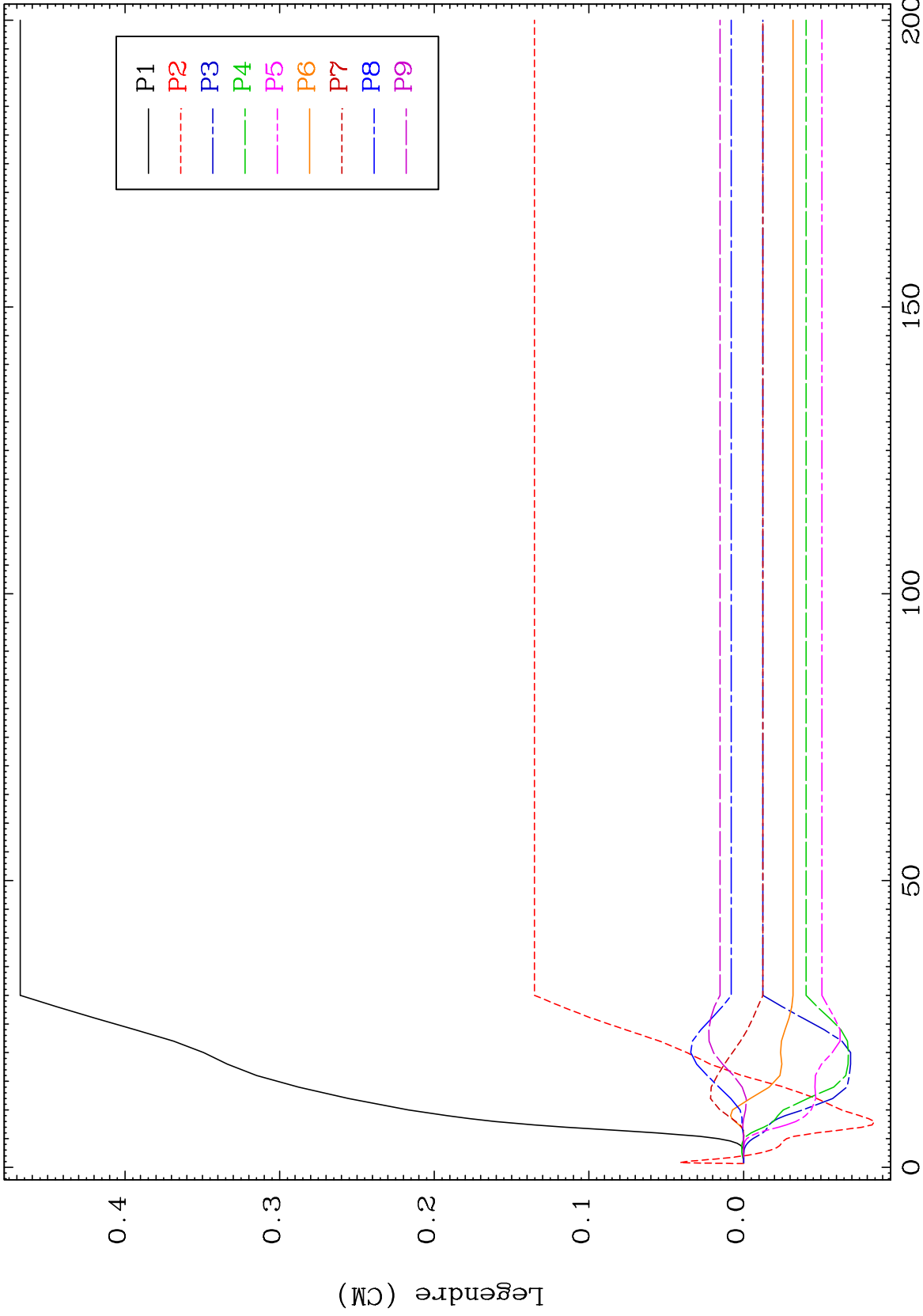

84

Incident Energy (MeV)

54-Xe-119

MAT 5410

MT= 67 (n,n') Level
Legendre Coefficients

54-Xe-119

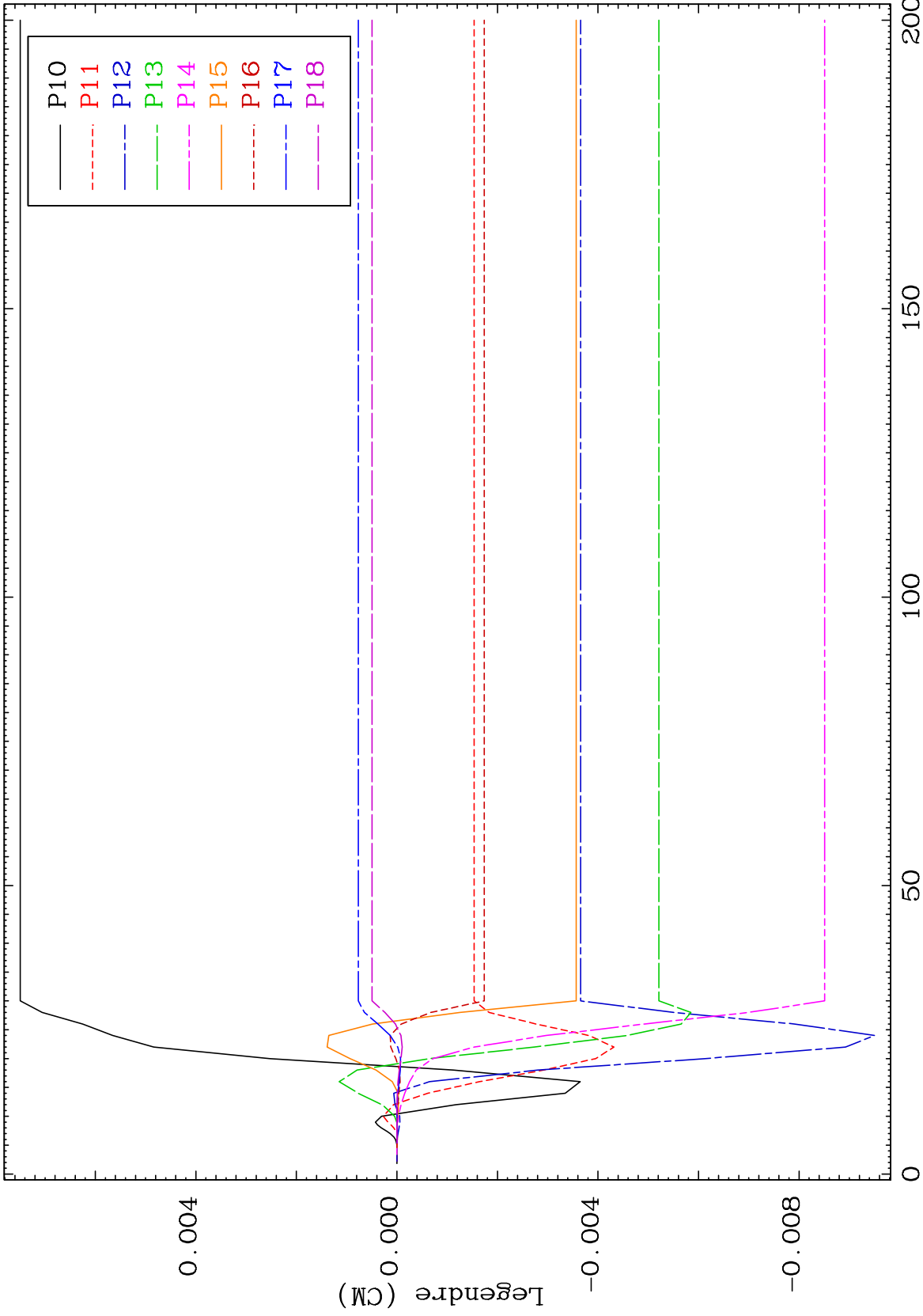

85

Incident Energy (MeV)

54-Xe-119

MAT 5410

MT= 67 (n,n') Level
Legendre Coefficients

54-Xe-119

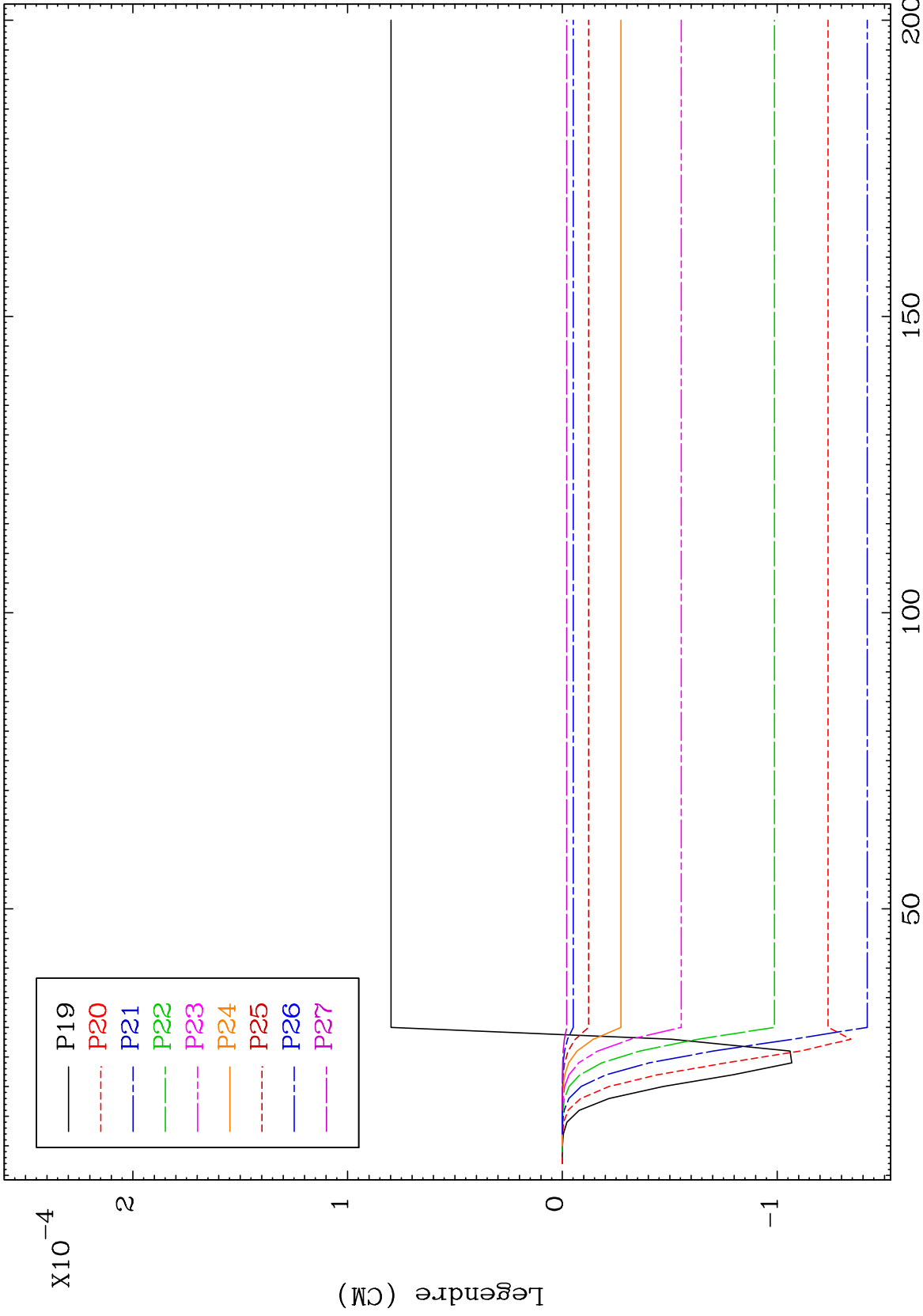

MAT 5410

MT= 67 (n,n') Level
Legendre Coefficients

54-Xe-119

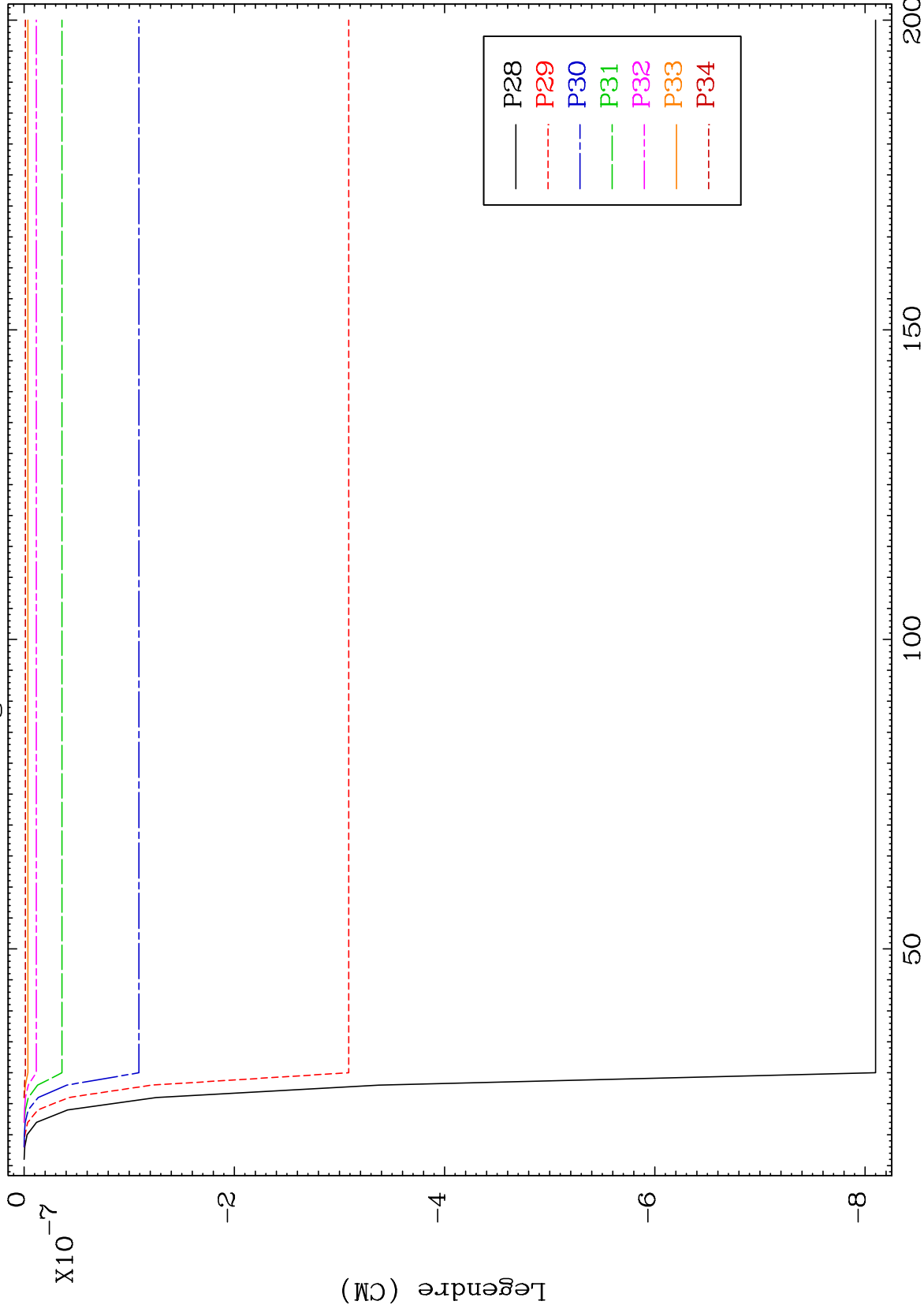

54-Xe-119

87

MAT 5410

MT= 68 (n,n') Level
Legendre Coefficients

54-Xe-119

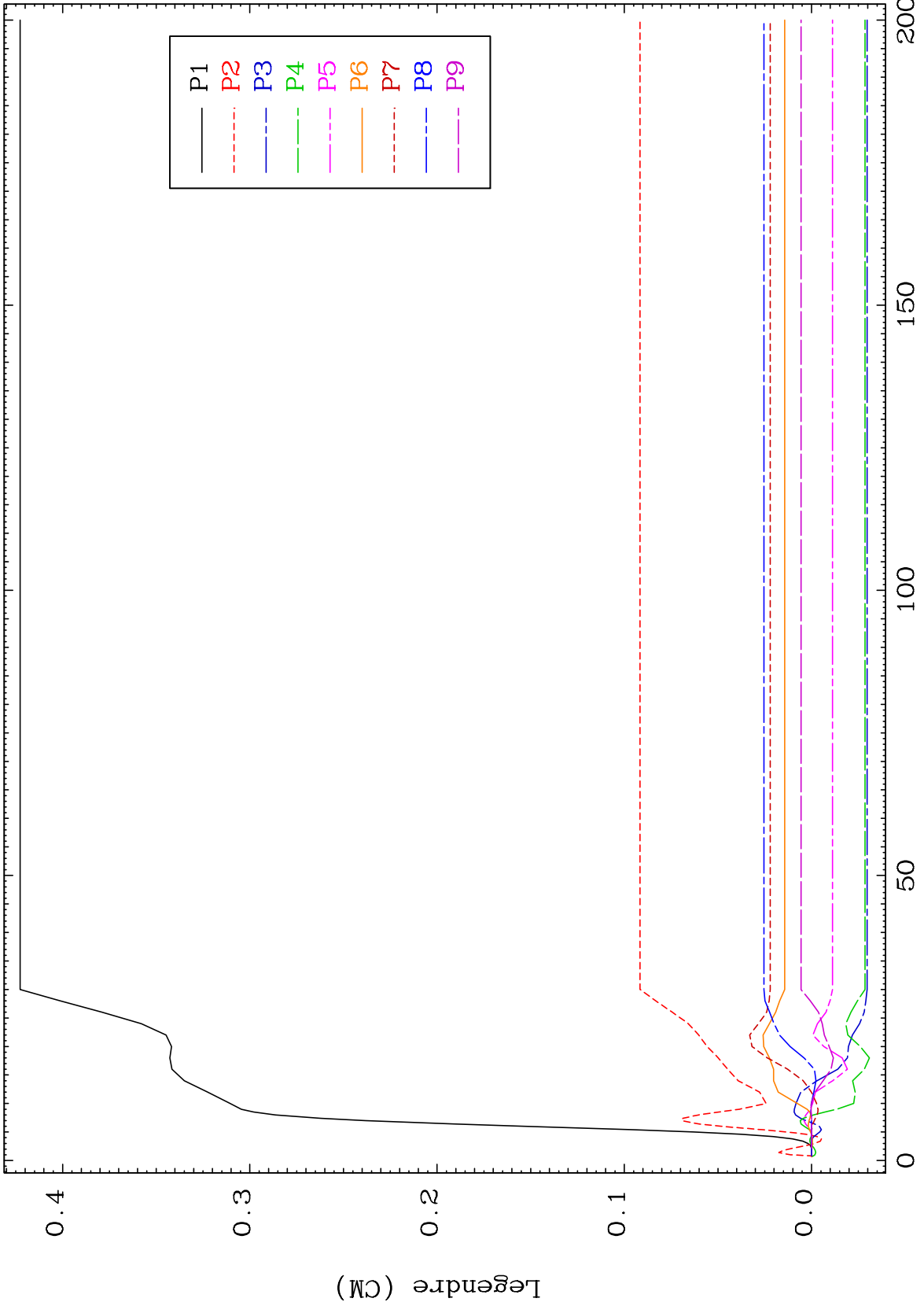

88

Incident Energy (MeV)

54-Xe-119

MAT 5410 MT= 68 (n,n') Level Legendre Coefficients 54-Xe-119

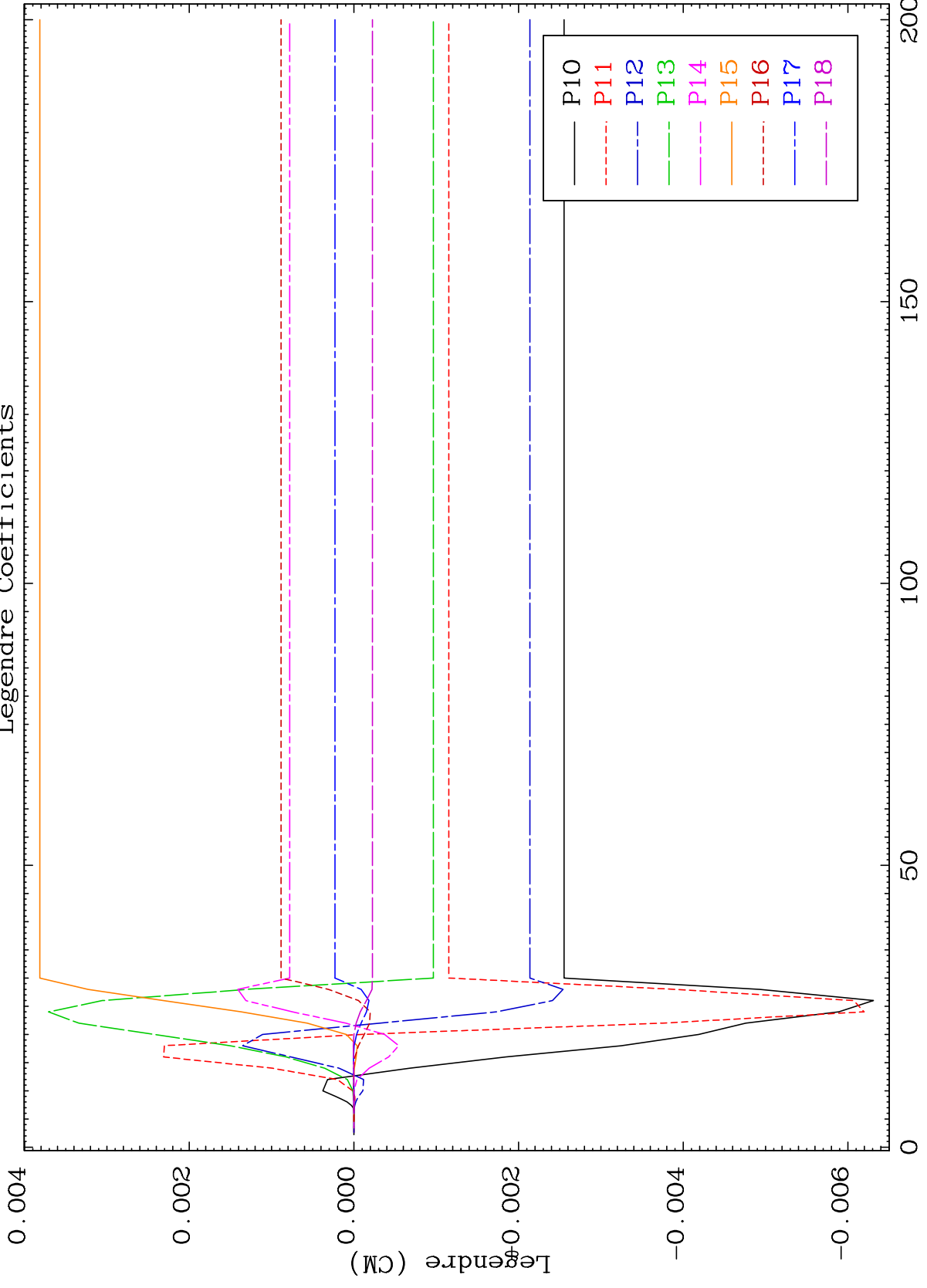

89 54-Xe-119

MAT 5410

MT= 68 (n,n') Level
Legendre Coefficients

54-Xe-119

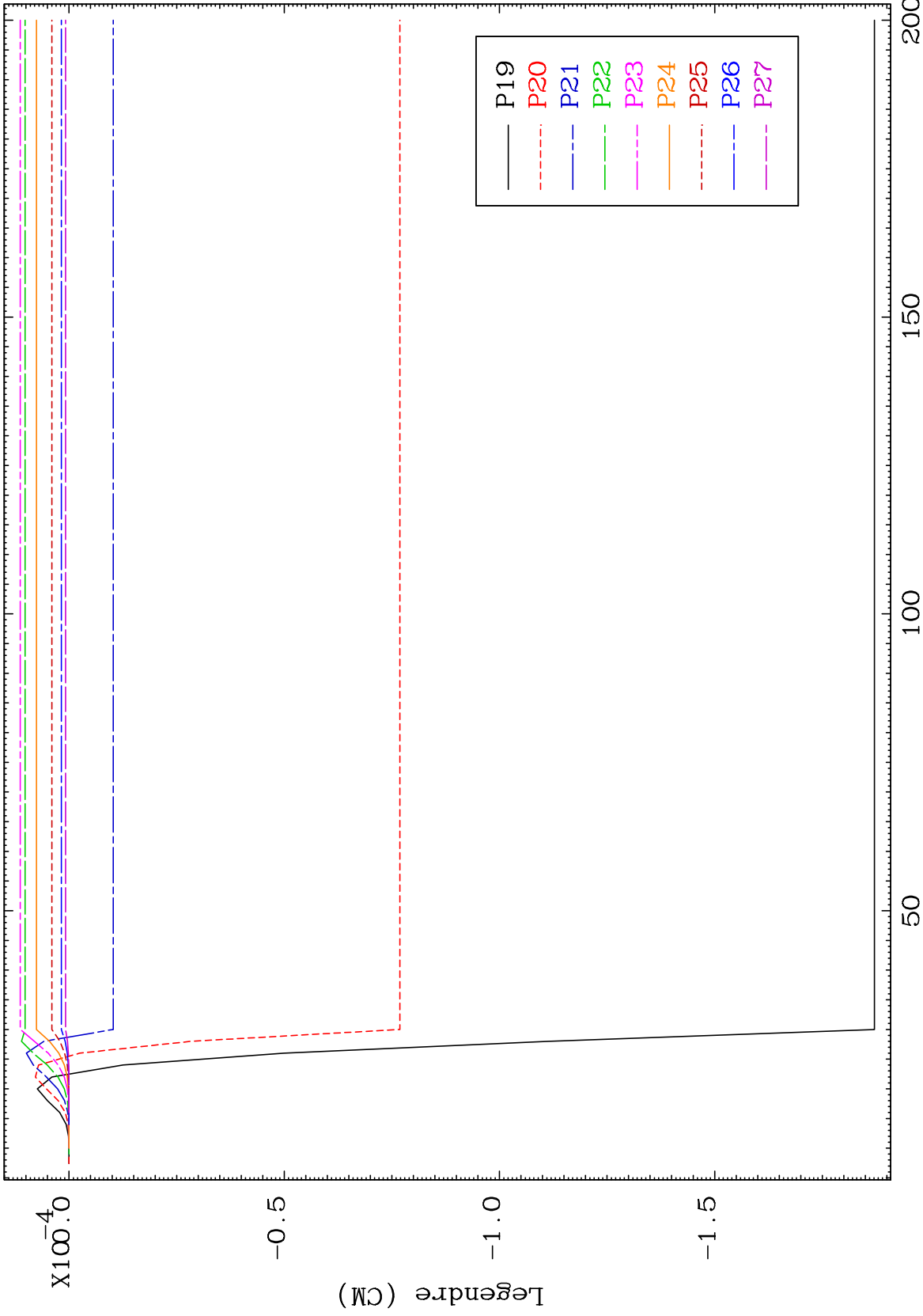

54-Xe-119

Incident Energy (MeV)

90

MAT 5410

MT= 68 (n,n') Level
Legendre Coefficients

54-Xe-119

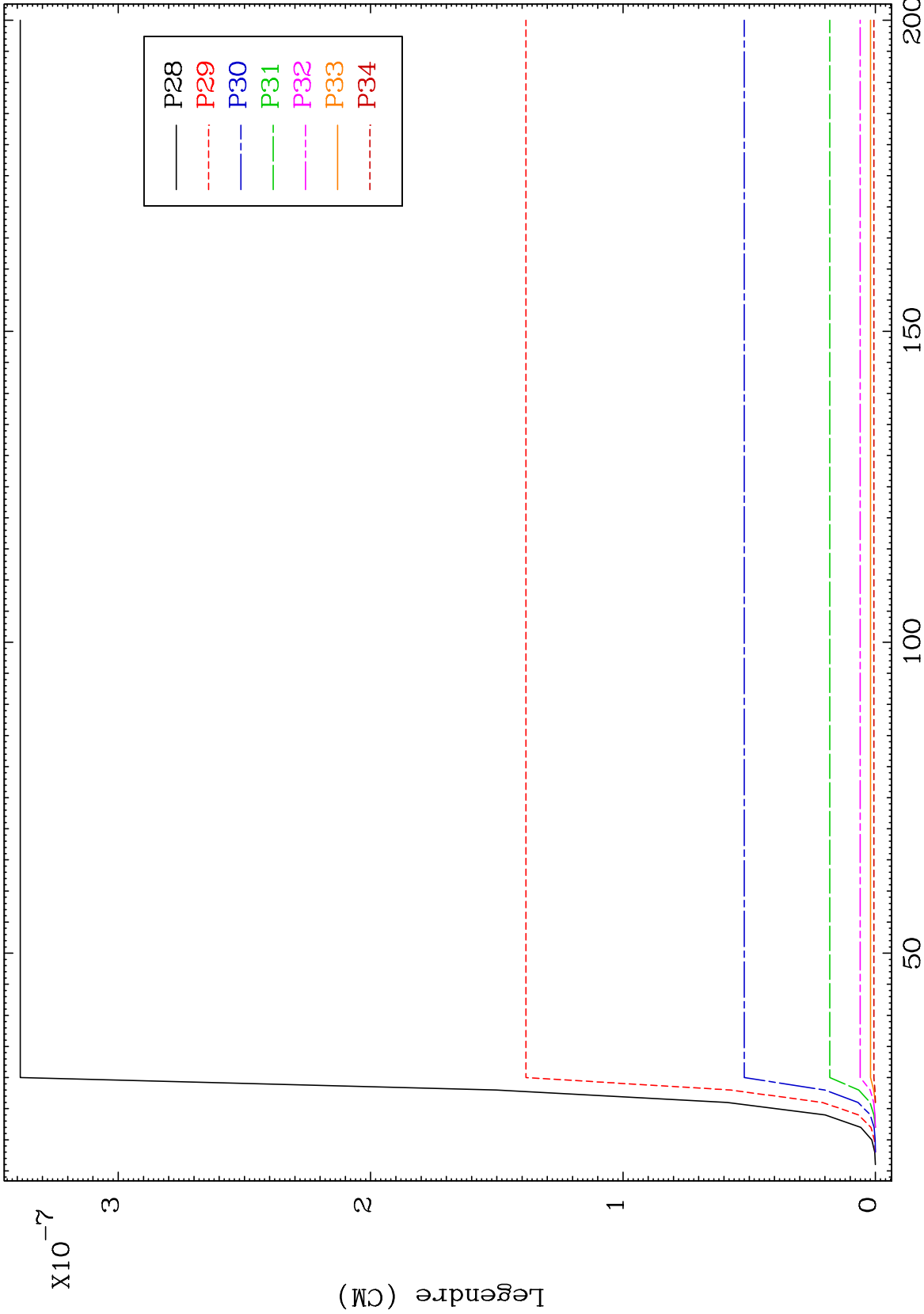

91

54-Xe-119

MAT 5410

MT= 69 (n,n') Level
Legendre Coefficients

54-Xe-119

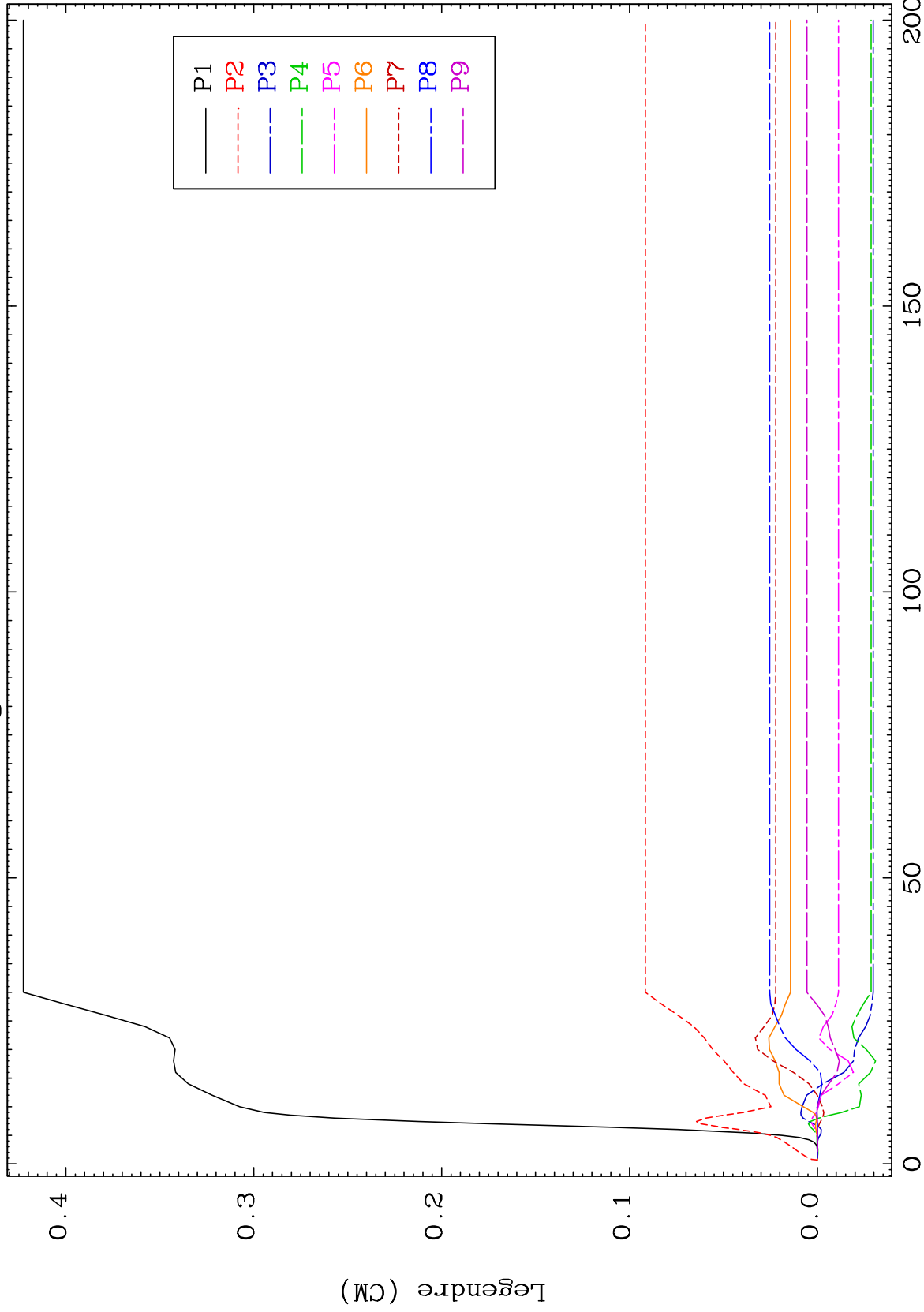

92

Incident Energy (MeV)

54-Xe-119

MAT 5410 MT= 69 (n,n') Level Legendre Coefficients 54-Xe-119

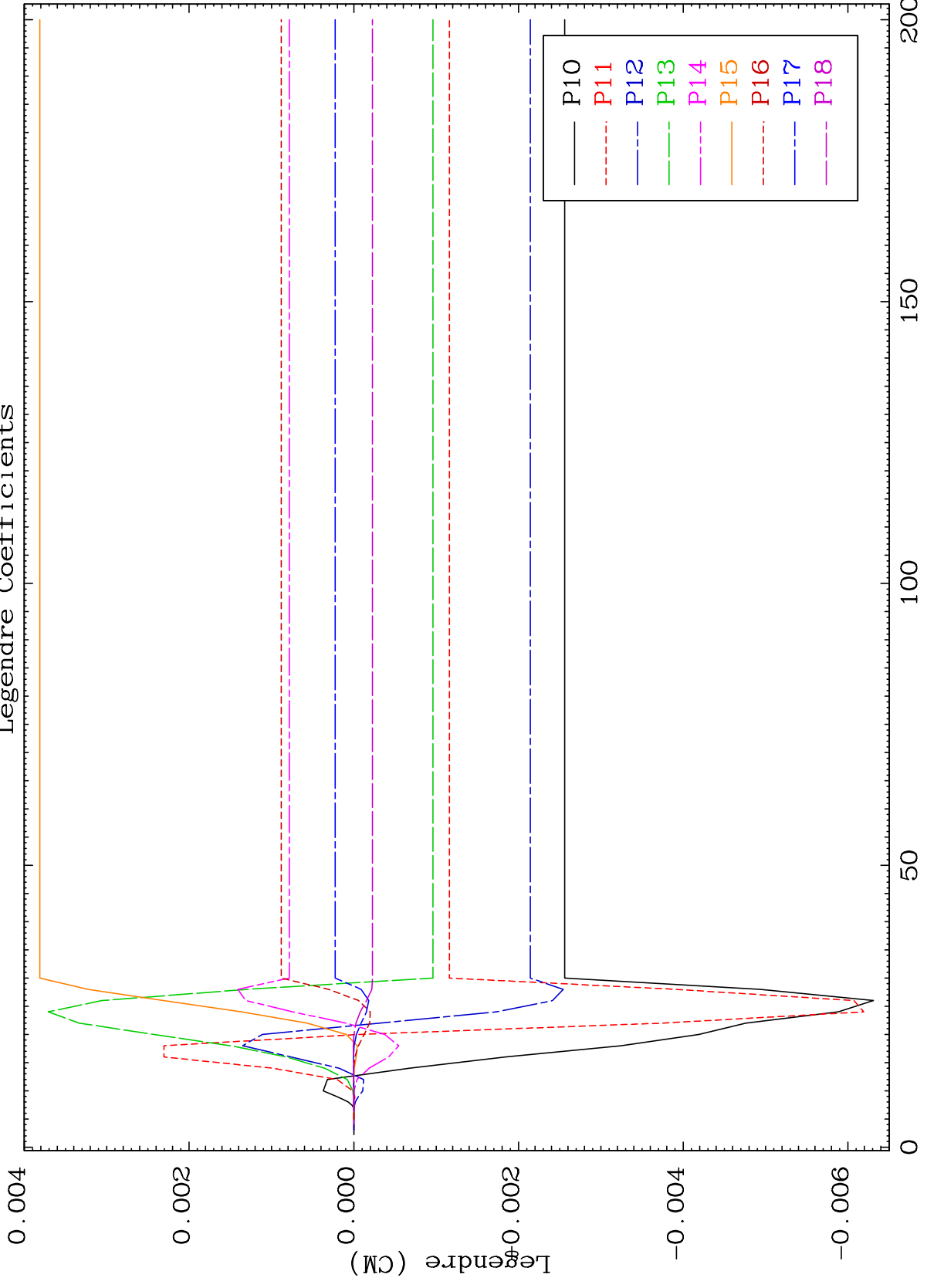

93 54-Xe-119

MAT 5410

MT= 69 (n,n') Level
Legendre Coefficients

54-Xe-119

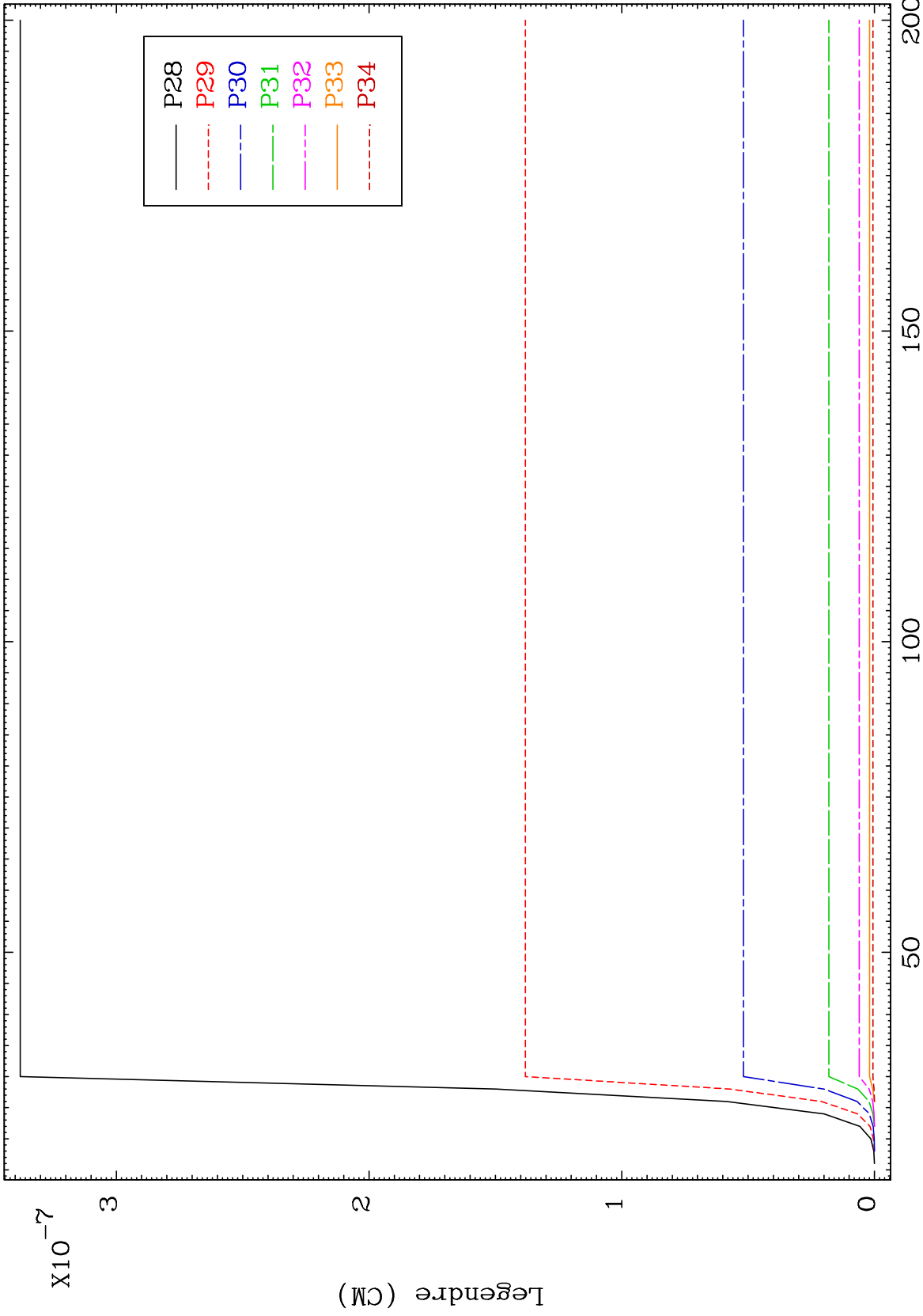

MAT 5410

MT= 70 (n,n') Level
Legendre Coefficients

54-Xe-119

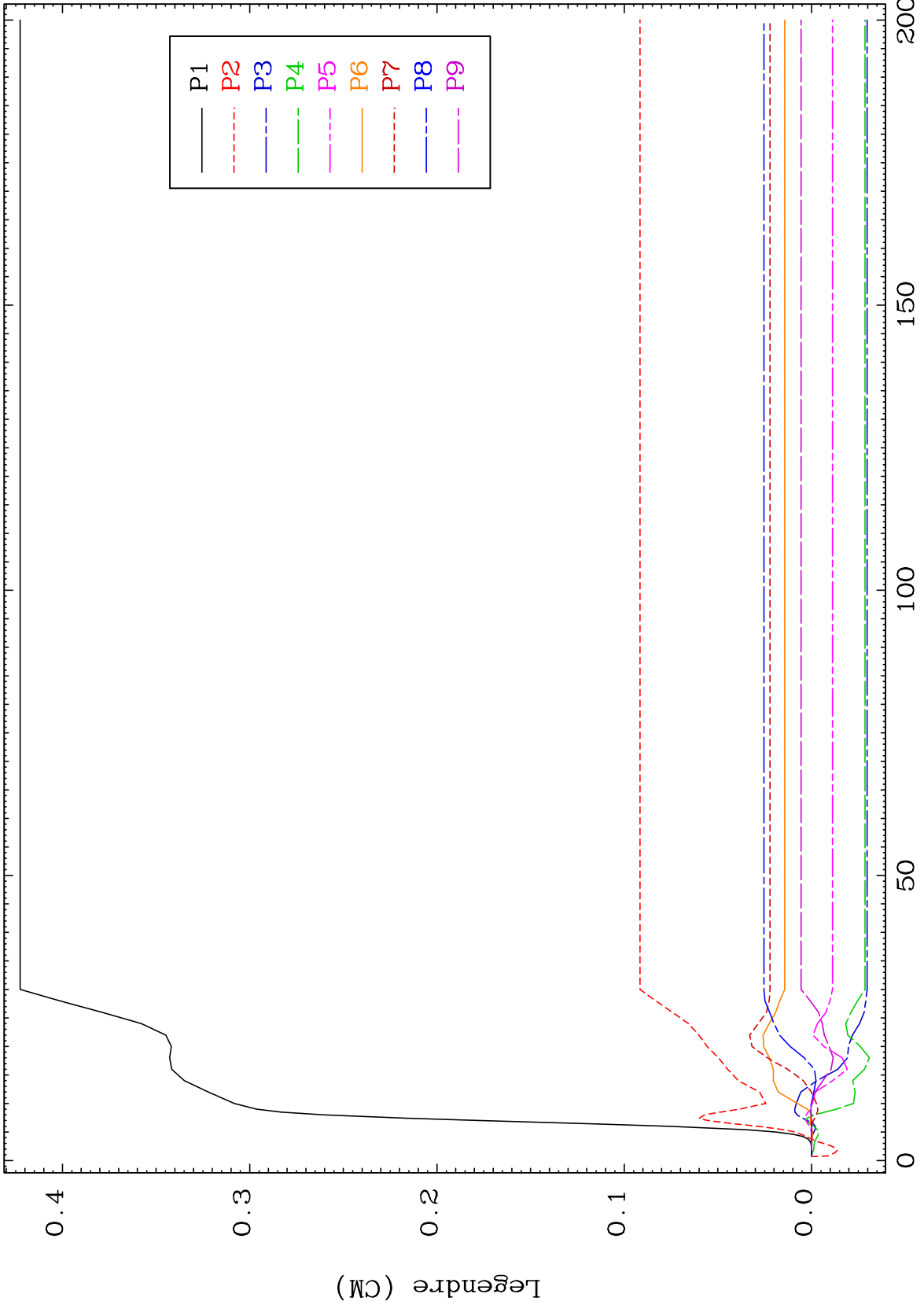

96

Incident Energy (MeV)

54-Xe-119

MAT 5410 MT= 70 (n,n') Level Legendre Coefficients 54-Xe-119

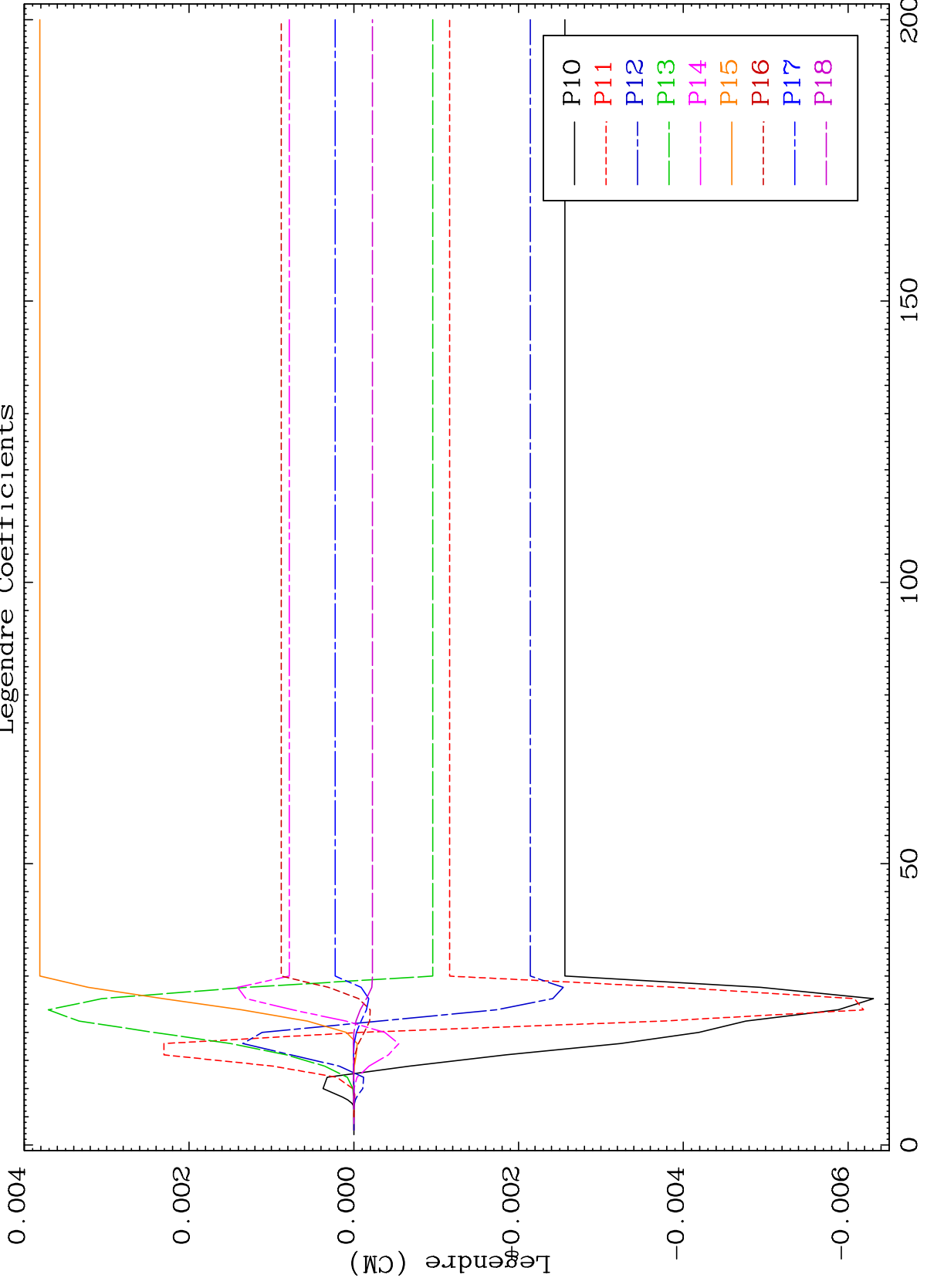

97 54-Xe-119

MAT 5410

MT= 70 (n,n') Level
Legendre Coefficients

54-Xe-119

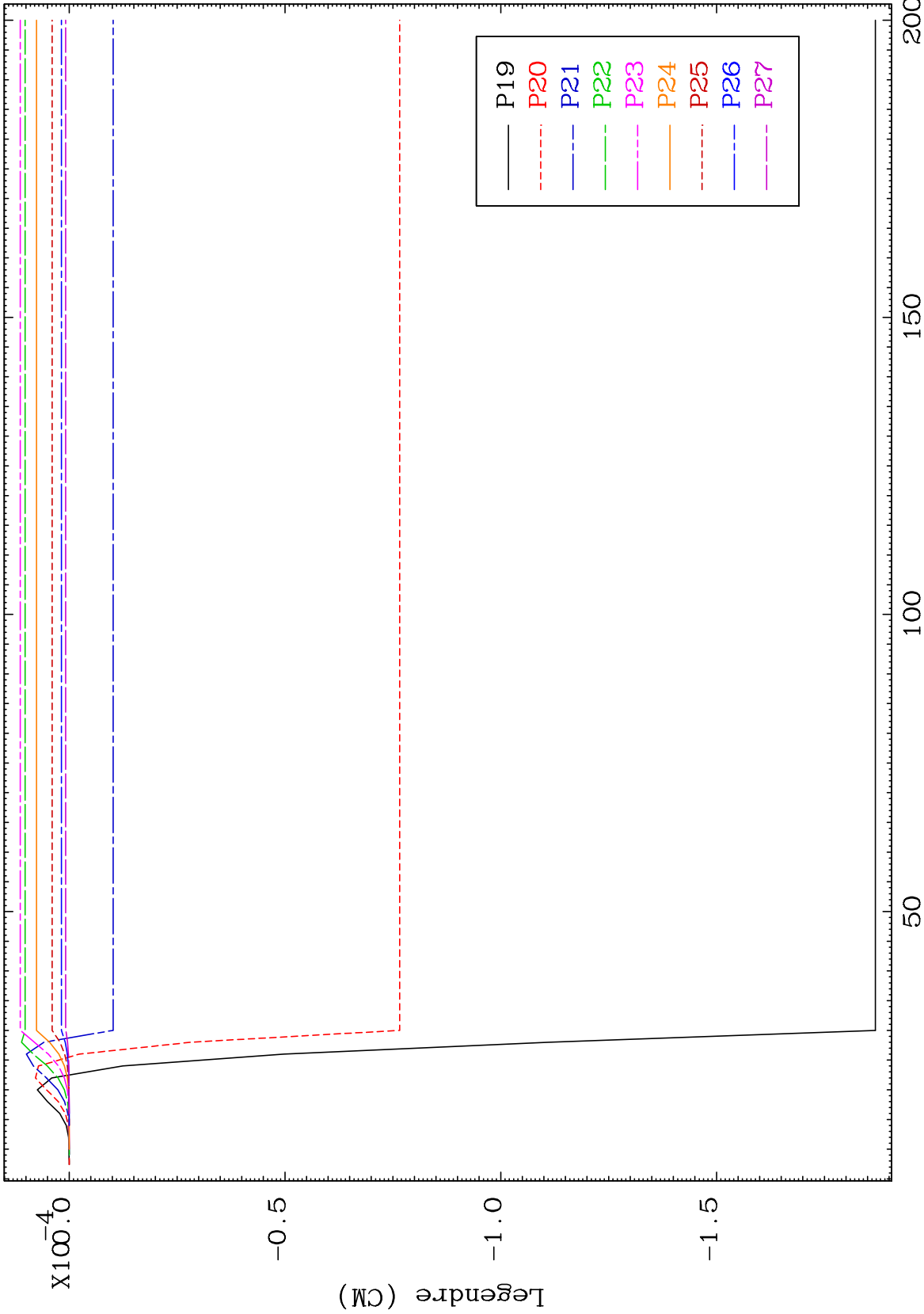

54-Xe-119

Incident Energy (MeV)

98

MAT 5410

MT= 70 (n,n') Level
Legendre Coefficients

54-Xe-119

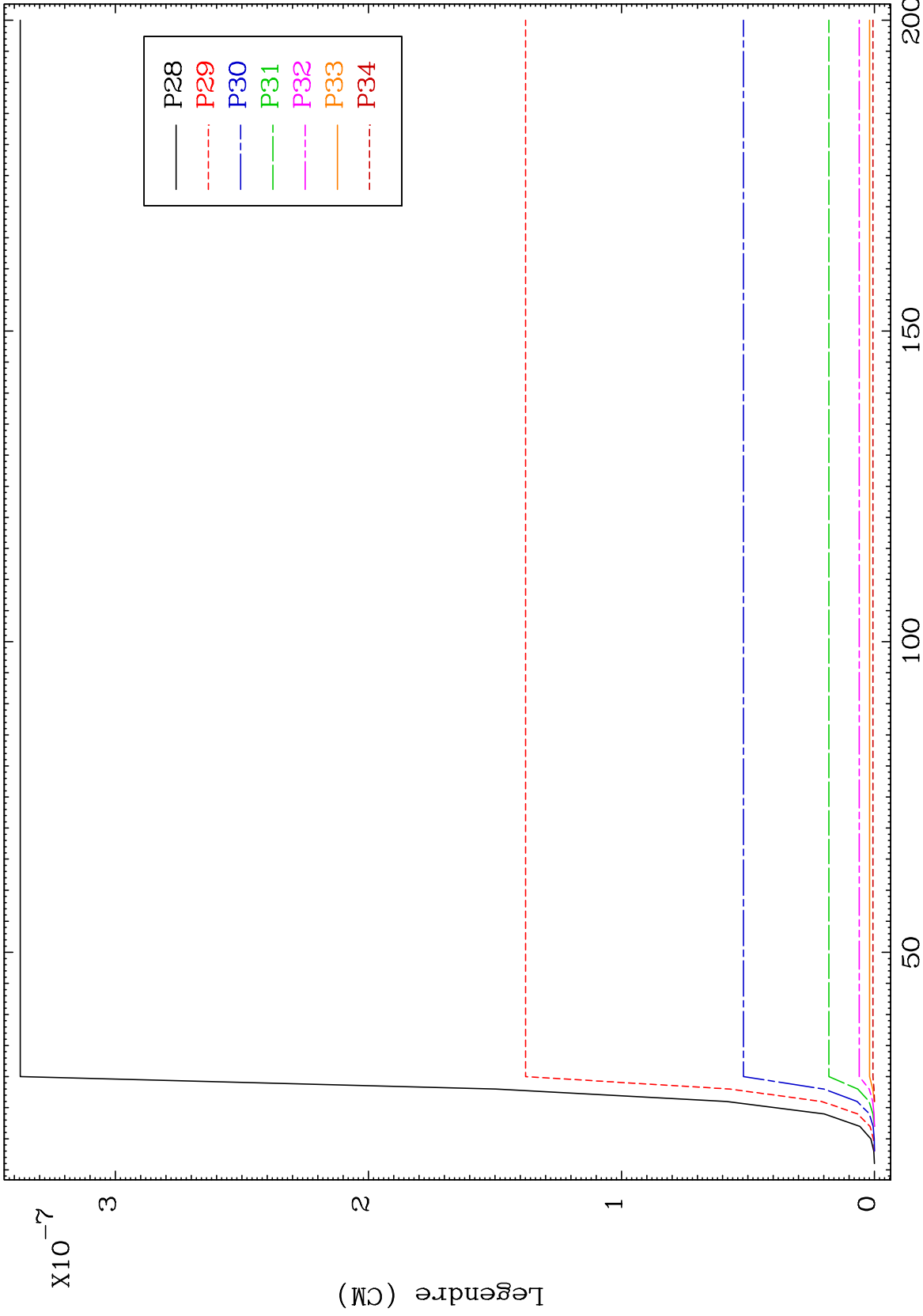

99

54-Xe-119

MAT 5410

MT= 71 (n,n') Level
Legendre Coefficients

54-Xe-119

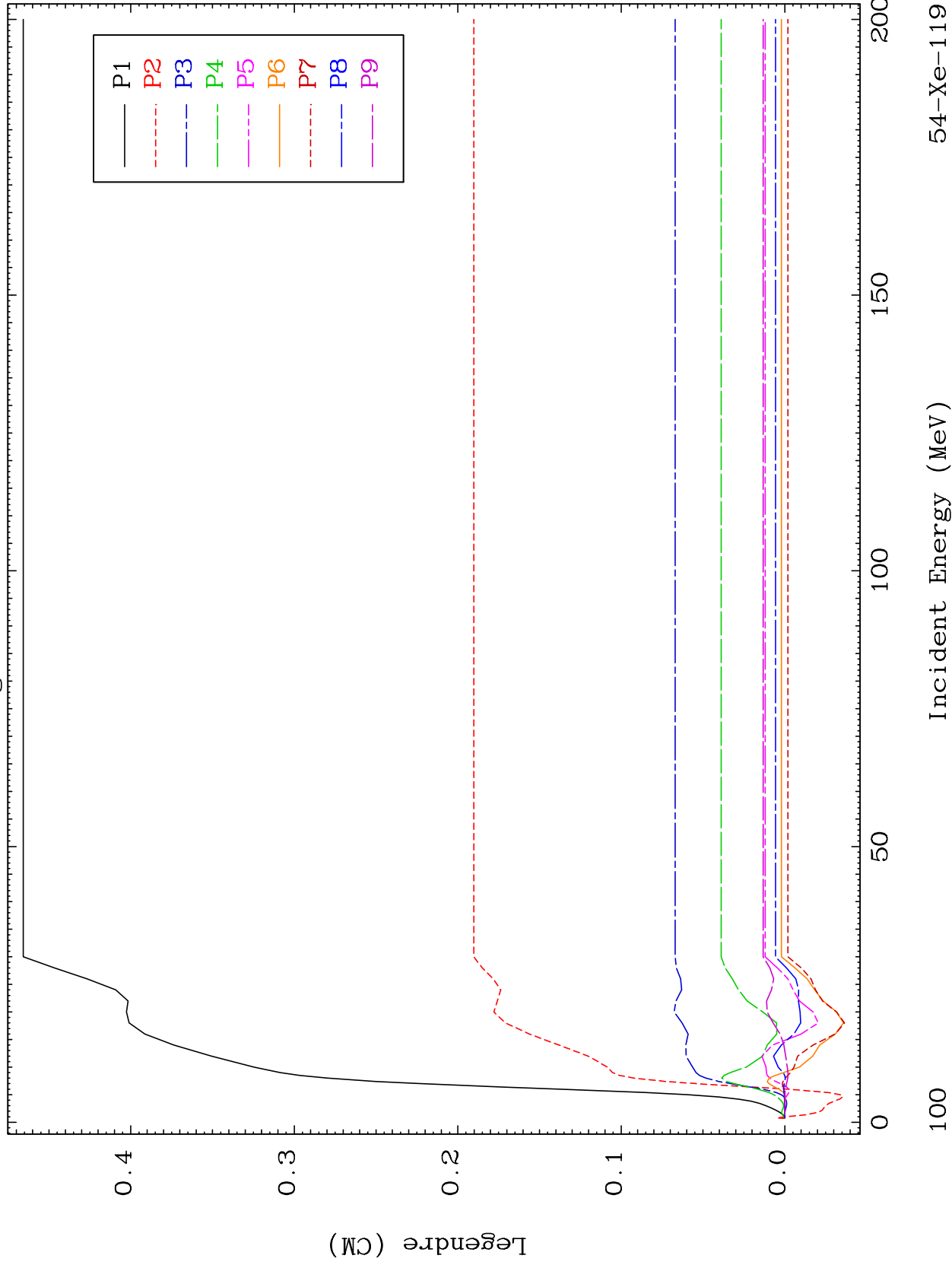

54-Xe-119

MAT 5410

MT= 71 (n,n') Level
Legendre Coefficients

54-Xe-119

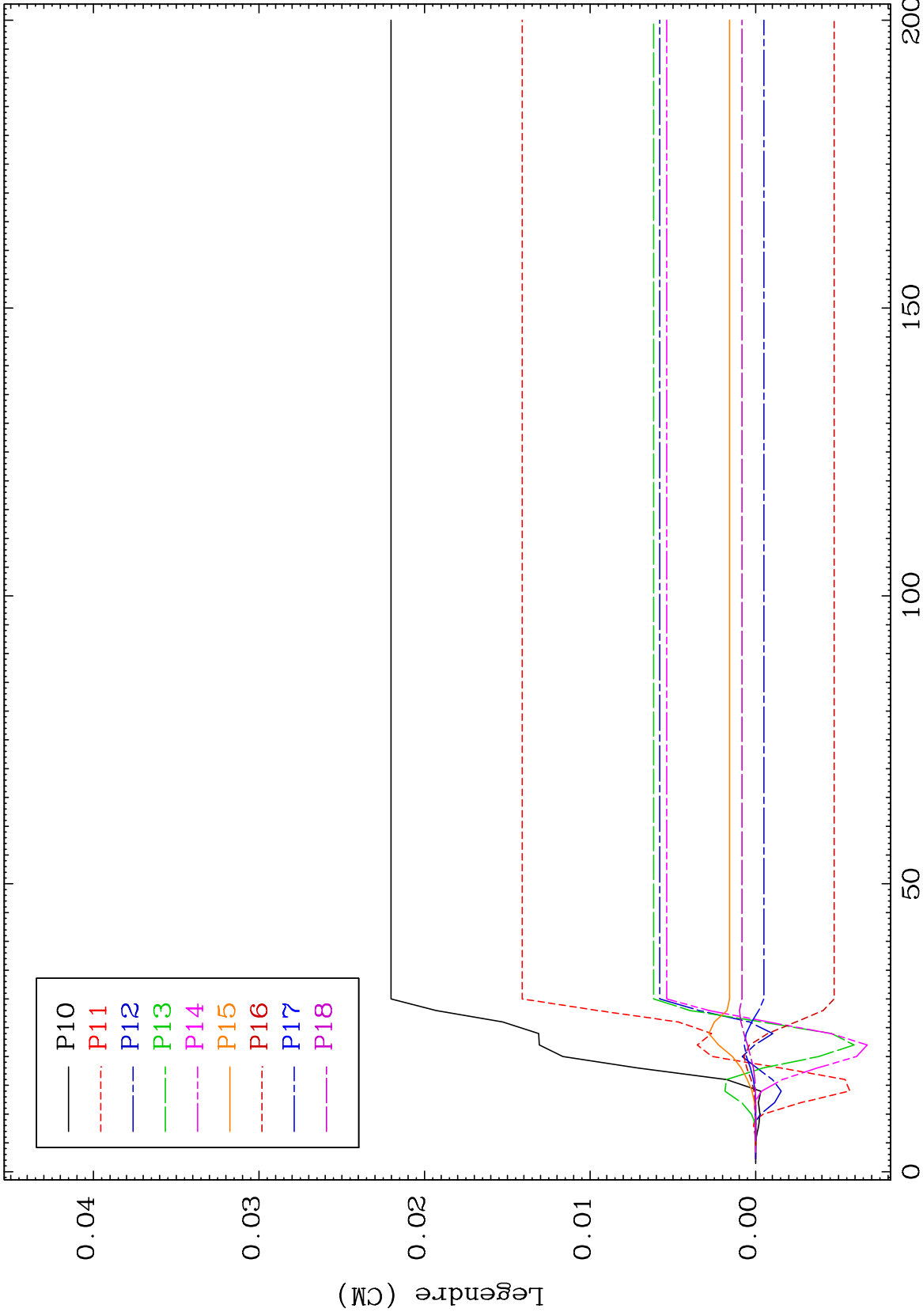

101

Incident Energy (MeV)

54-Xe-119

MAT 5410

MT= 71 (n,n') Level
Legendre Coefficients

54-Xe-119

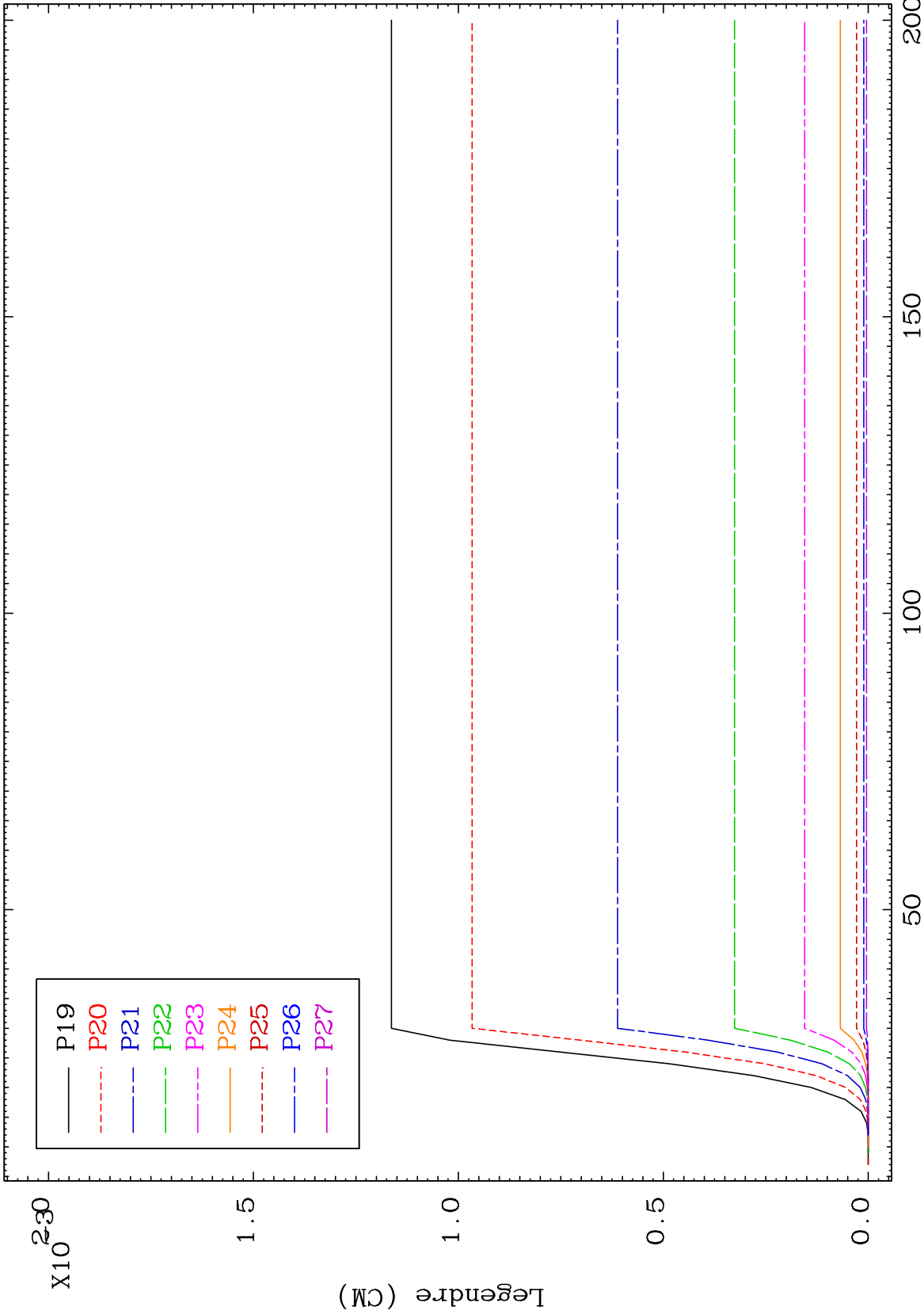

102

Incident Energy (MeV)

54-Xe-119

MAT 5410

MT= 71 (n,n') Level
Legendre Coefficients

54-Xe-119

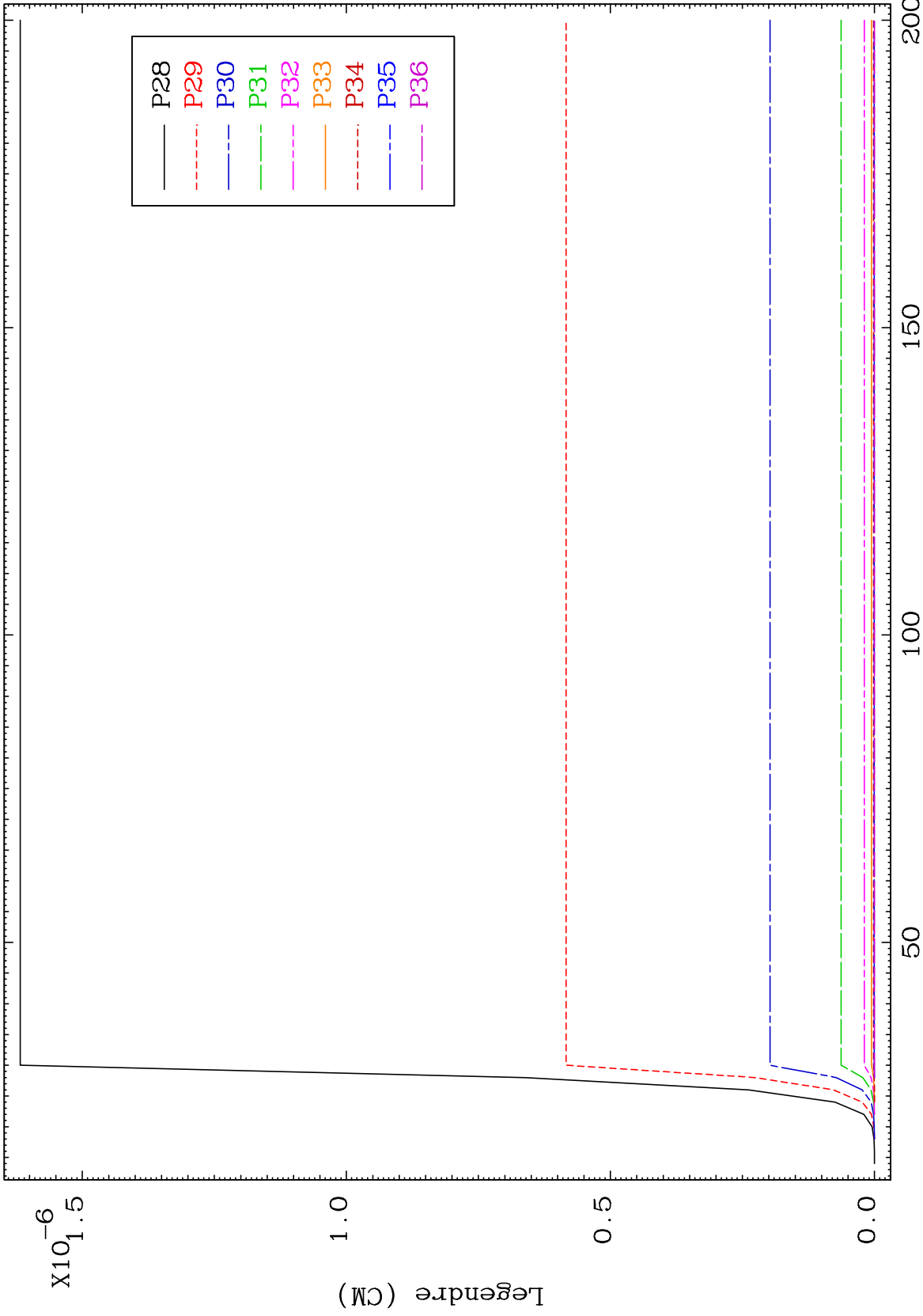

103

Incident Energy (MeV)

54-Xe-119

MAT 5410

MT= 72 (n,n') Level
Legendre Coefficients

54-Xe-119

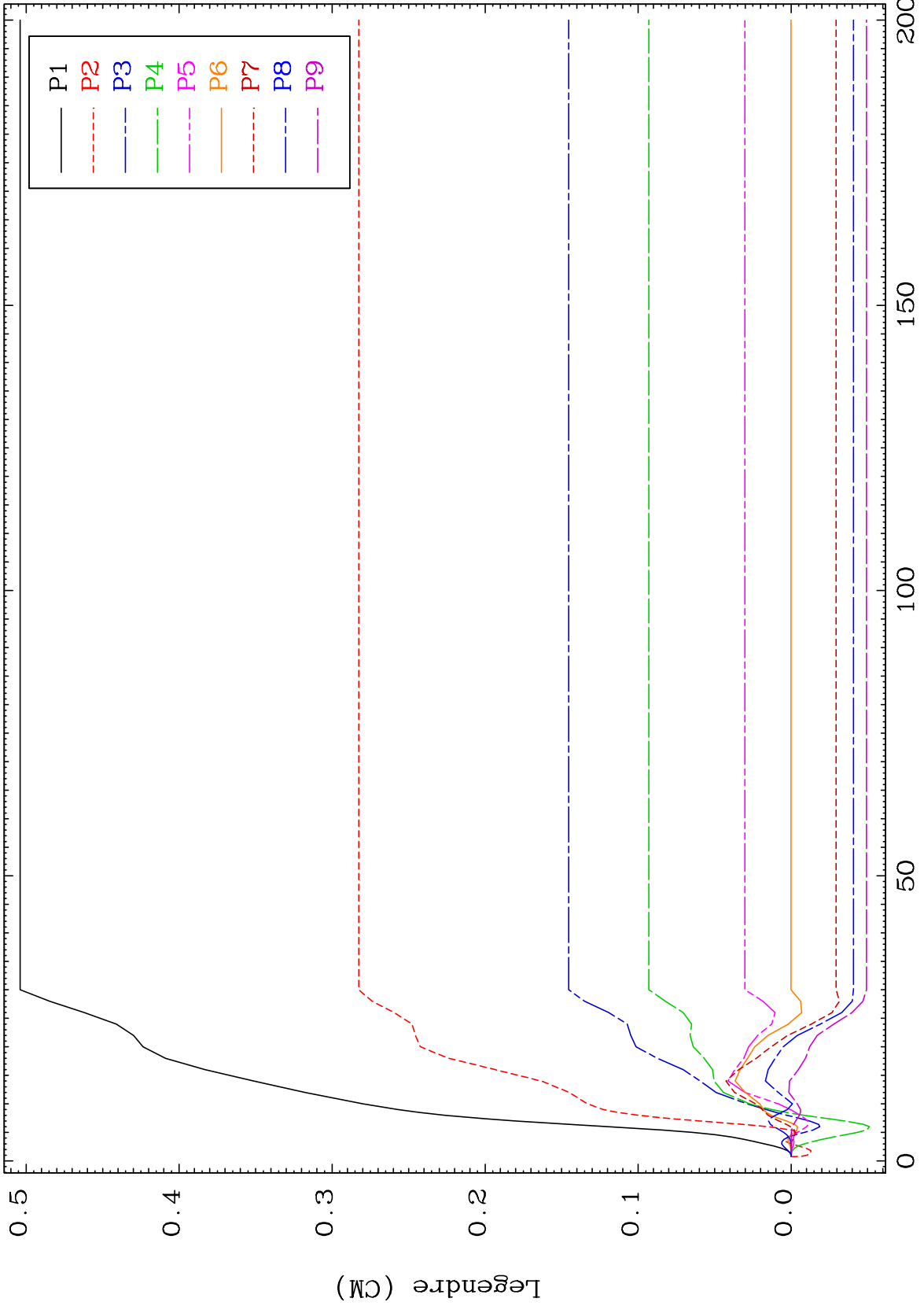

104

Incident Energy (MeV)

54-Xe-119

MAT 5410 MT= 72 (n,n') Level Legendre Coefficients 54-Xe-119

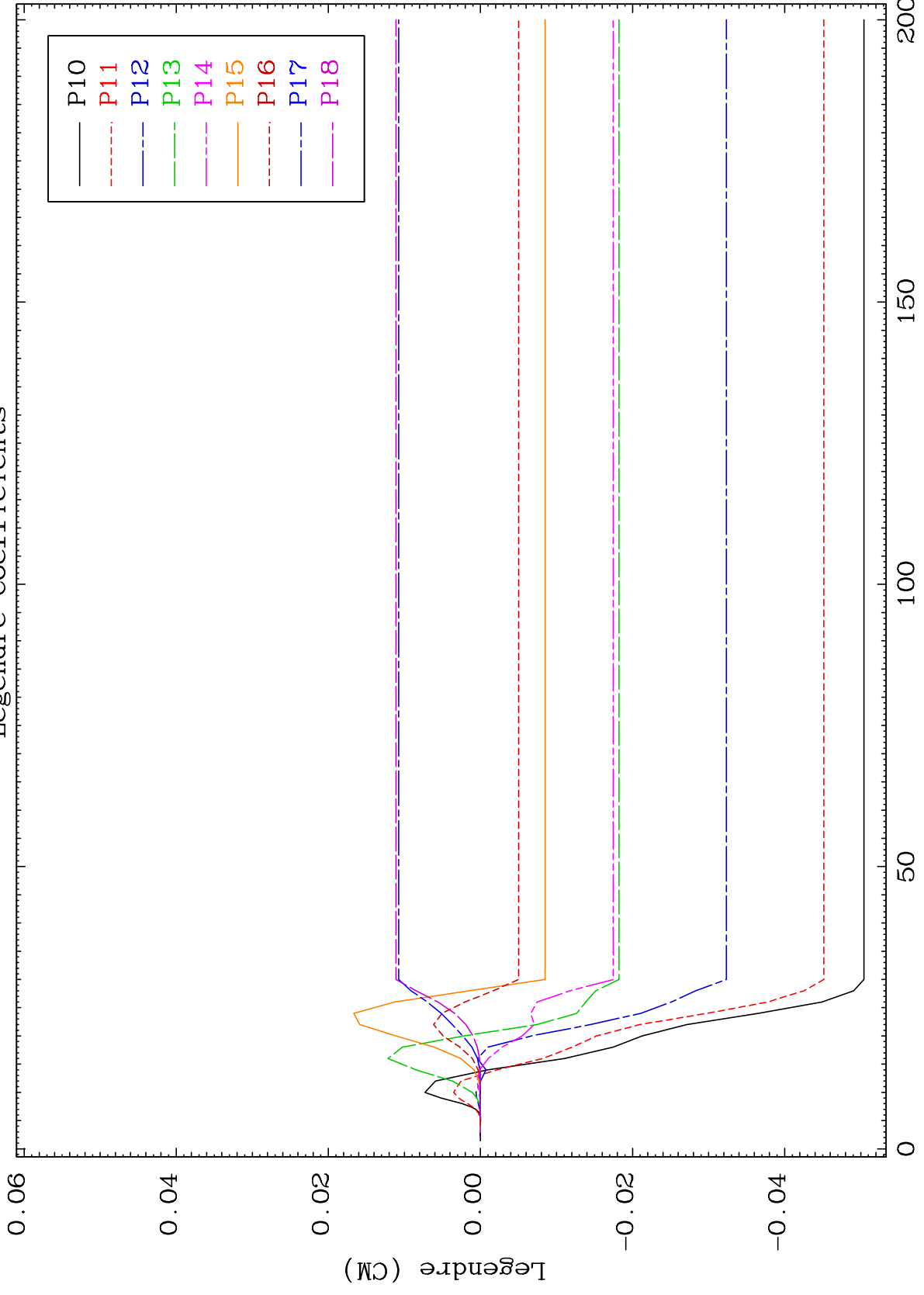

105 54-Xe-119

MAT 5410

MT= 72 (n,n') Level
Legendre Coefficients

54-Xe-119

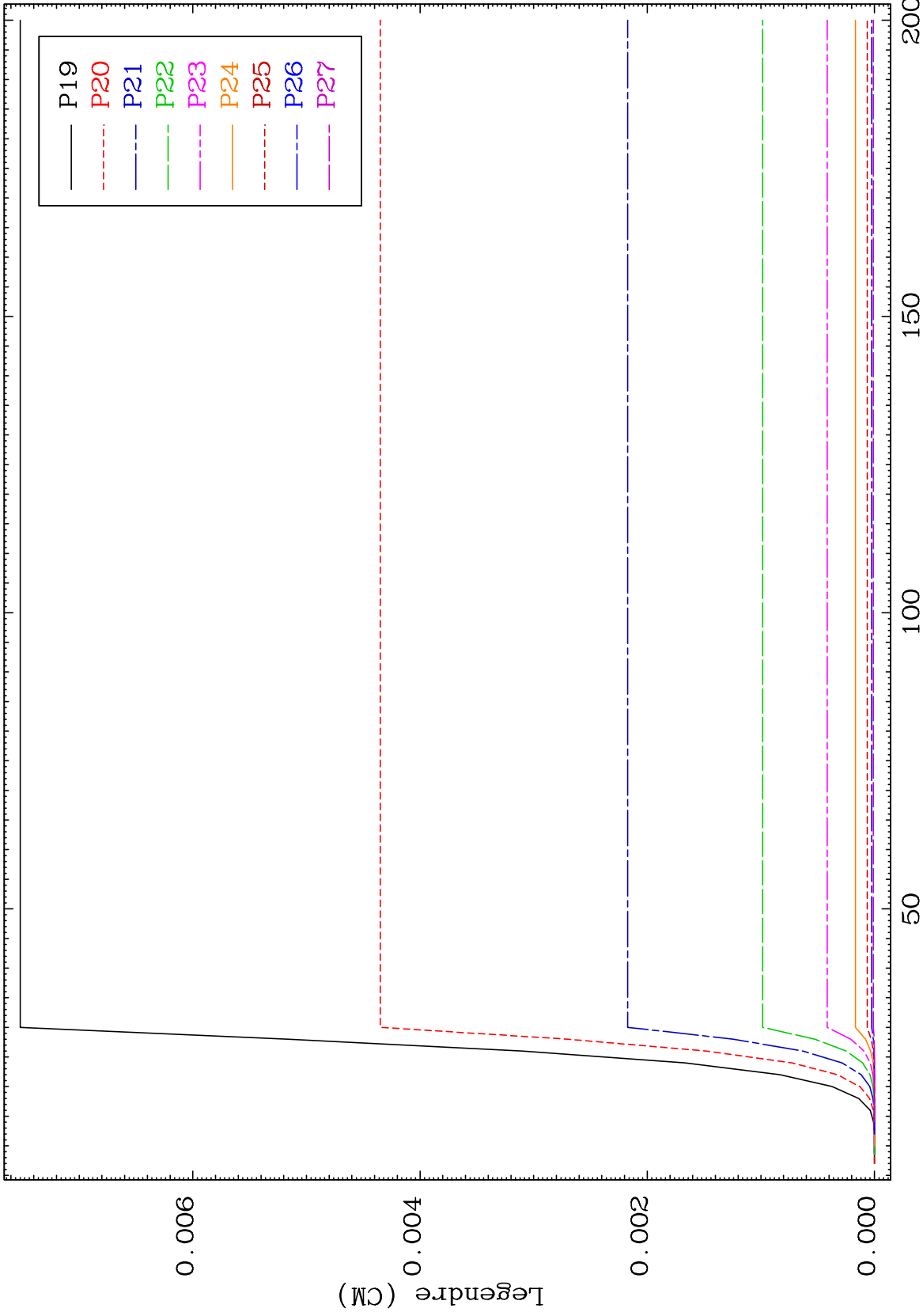

106

Incident Energy (MeV)

54-Xe-119

MAT 5410

MT= 72 (n,n') Level
Legendre Coefficients

54-Xe-119

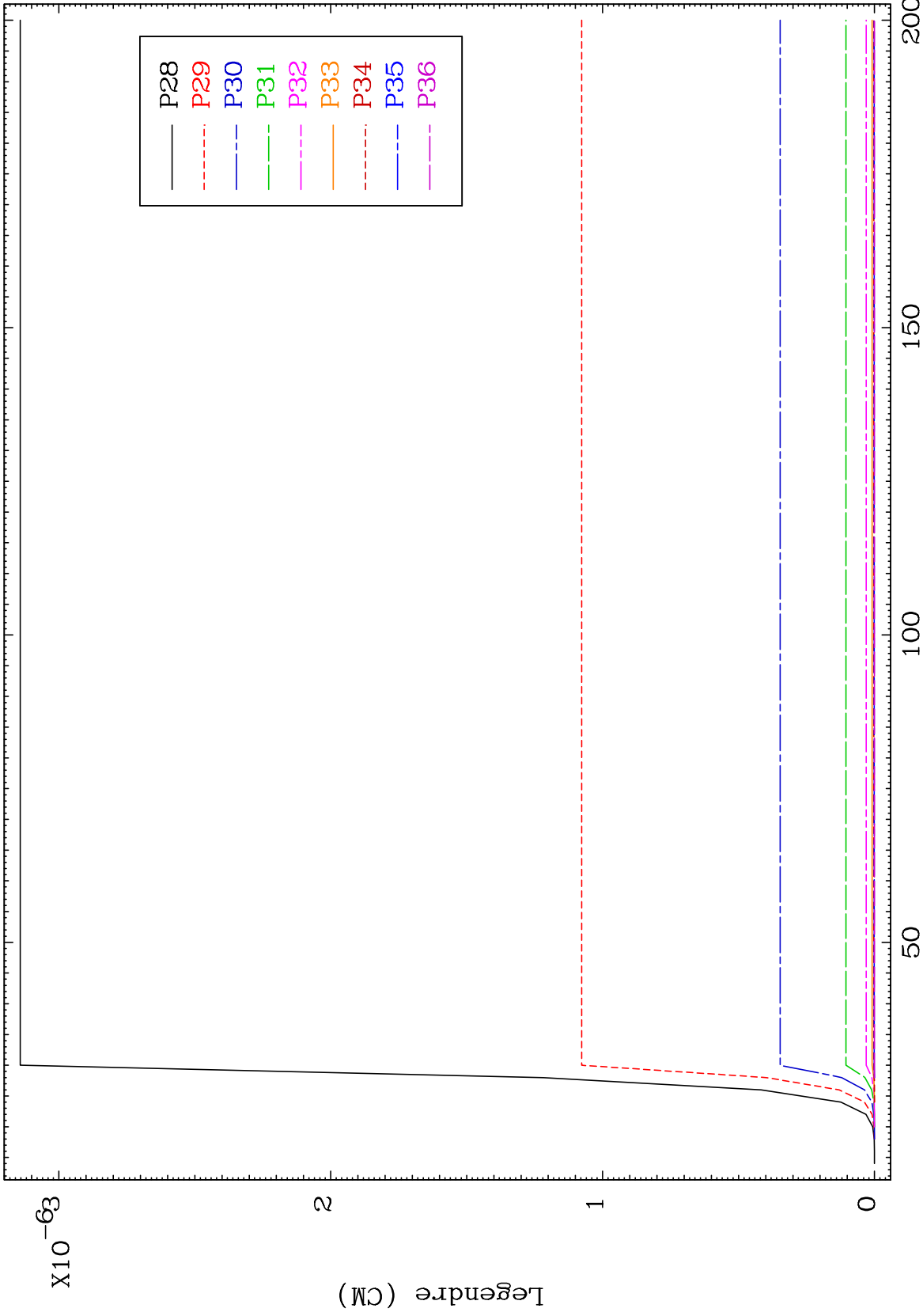

107

Incident Energy (MeV)

54-Xe-119

MAT 5410

MT= 73 (n,n') Level
Legendre Coefficients

54-Xe-119

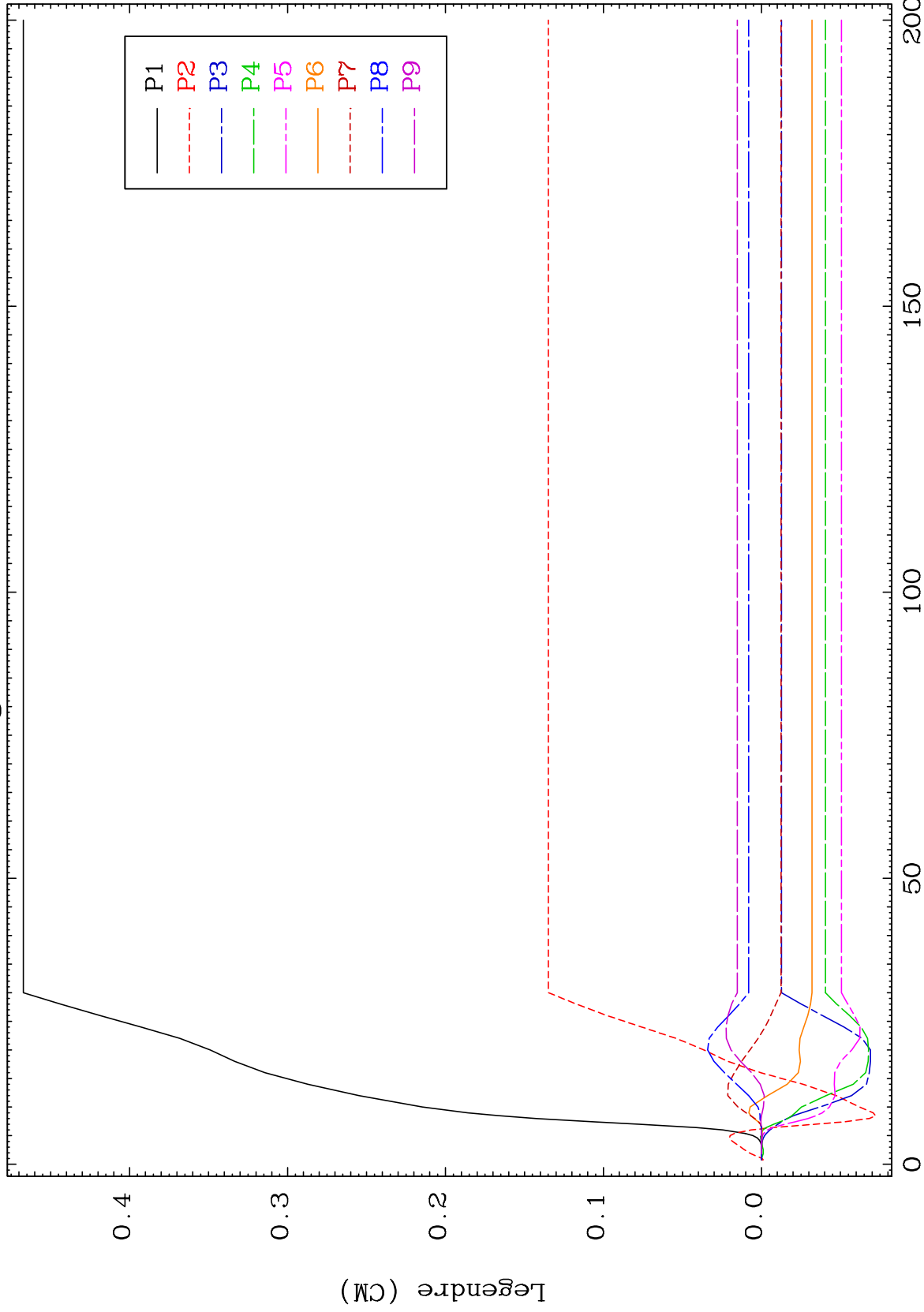

108

Incident Energy (MeV)

54-Xe-119

MAT 5410

MT= 73 (n,n') Level
Legendre Coefficients

54-Xe-119

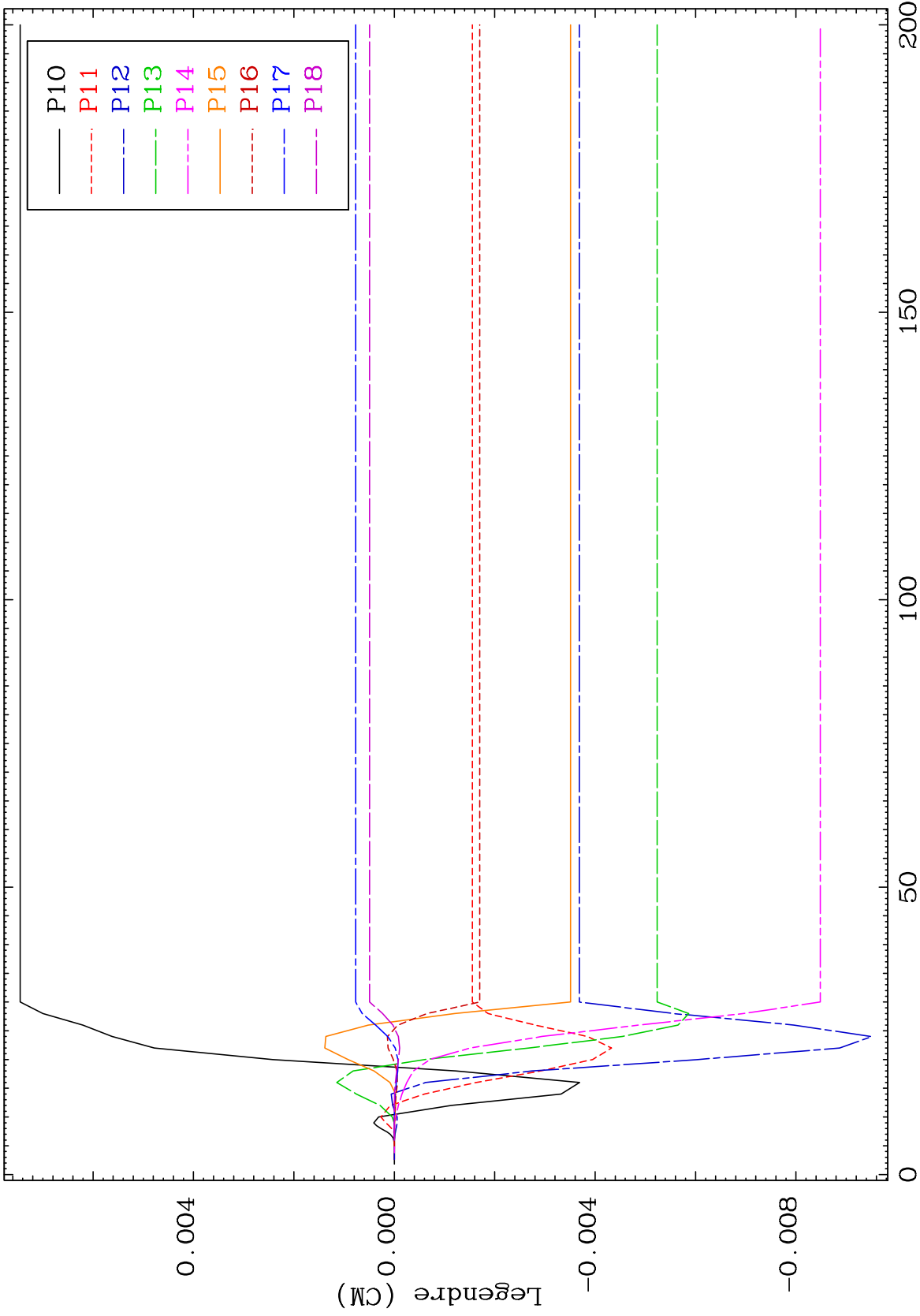

109

Incident Energy (MeV)

54-Xe-119

MAT 5410

MT= 73 (n,n') Level
Legendre Coefficients

54-Xe-119

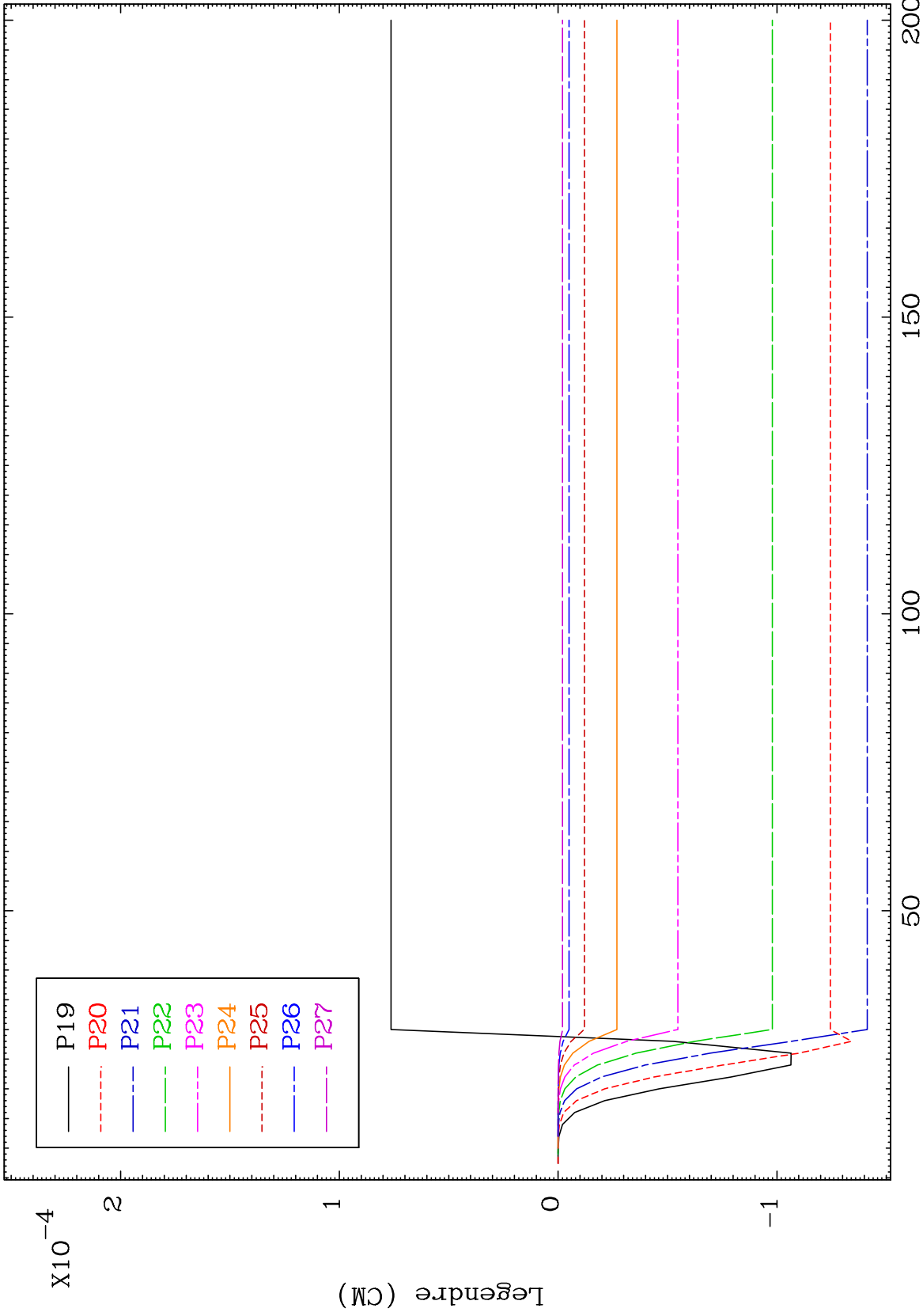

110

54-Xe-119

MAT 5410

MT= 73 (n,n') Level
Legendre Coefficients

54-Xe-119

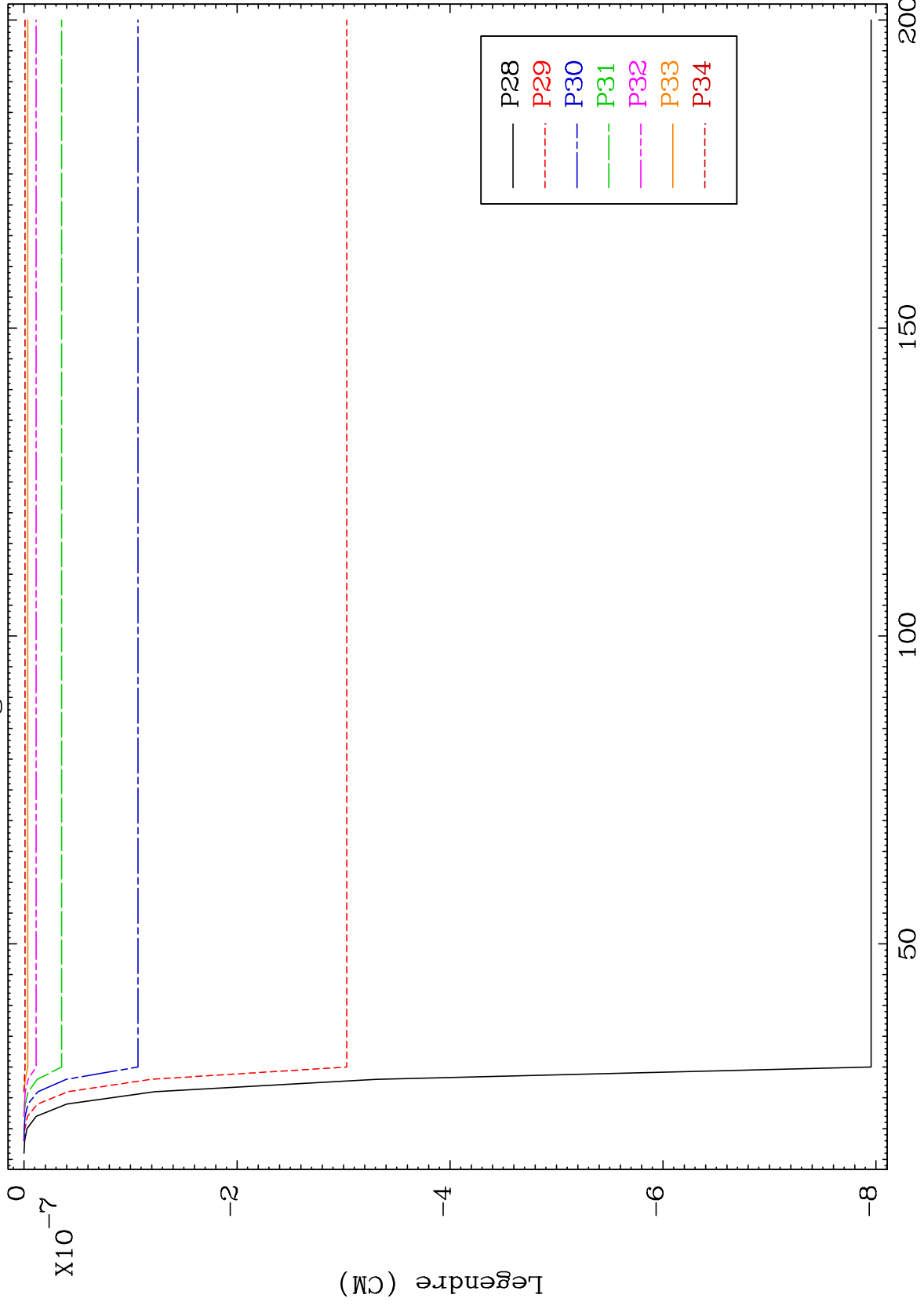

54-Xe-119

111

MAT 5410

MT= 74 (n,n') Level
Legendre Coefficients

54-Xe-119

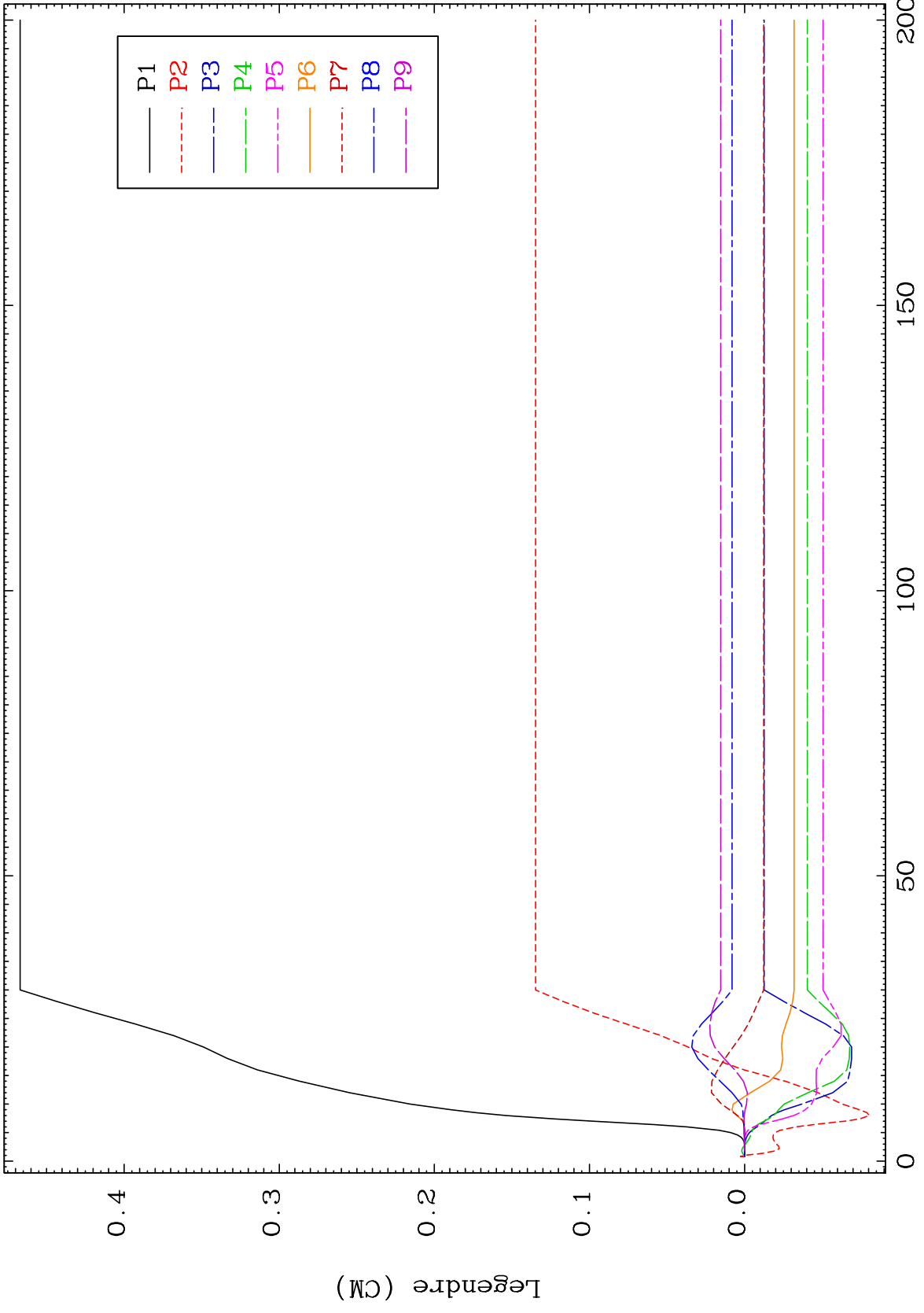

112

Incident Energy (MeV)

54-Xe-119

MAT 5410

MT= 74 (n,n') Level
Legendre Coefficients

54-Xe-119

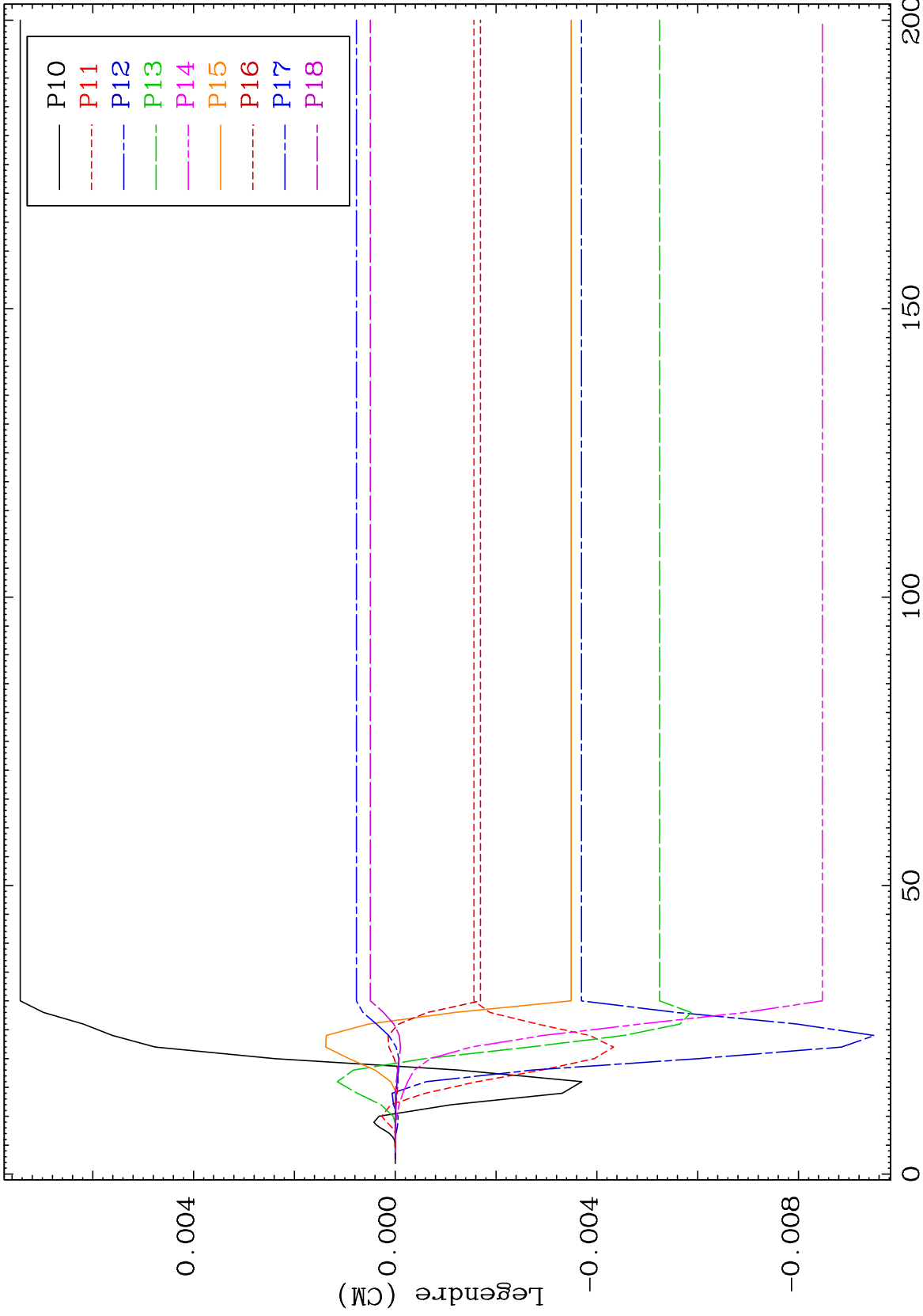

113

Incident Energy (MeV)

54-Xe-119

MAT 5410

MT= 74 (n,n') Level
Legendre Coefficients

54-Xe-119

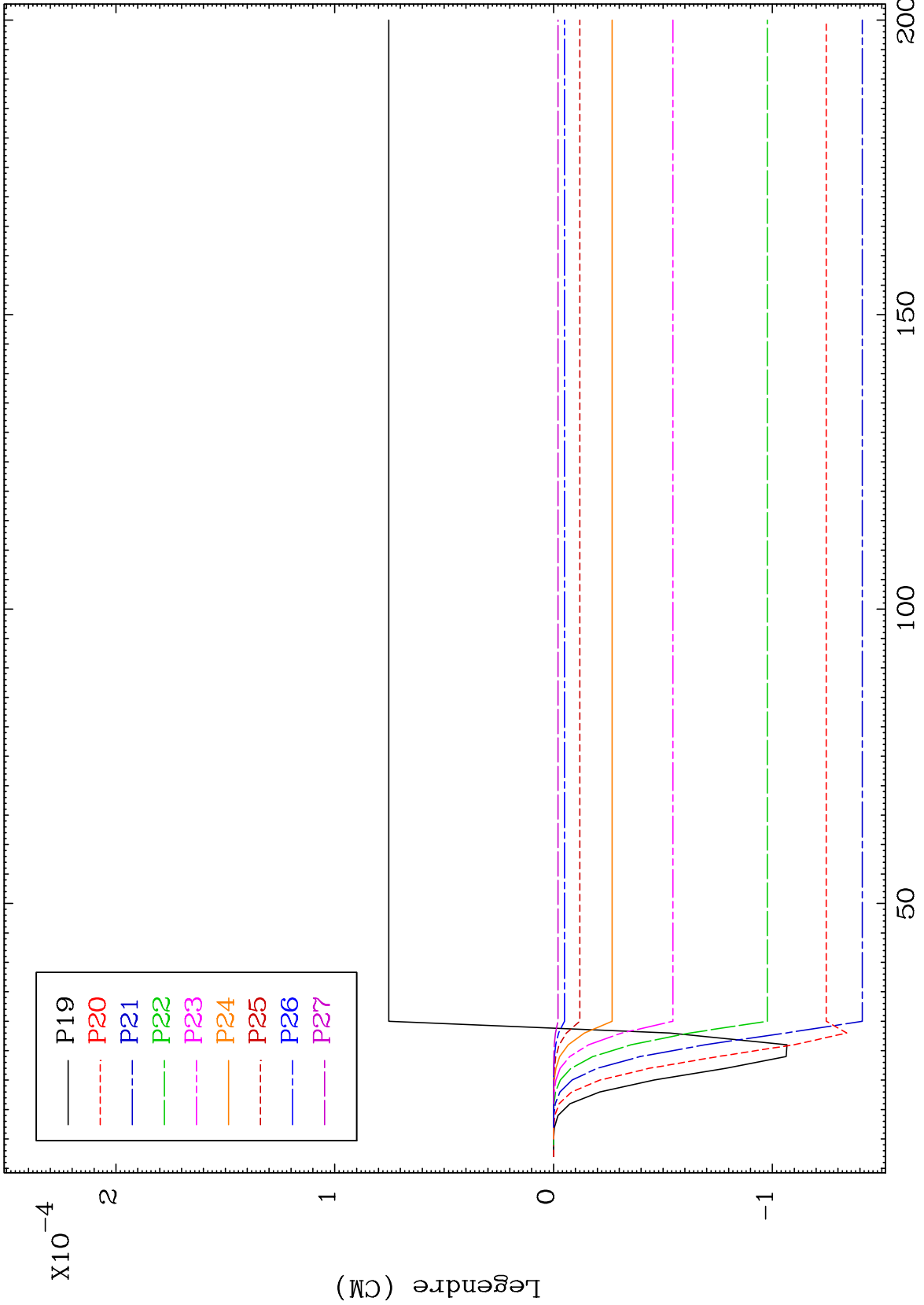

114

54-Xe-119

MAT 5410

MT= 74 (n,n') Level
Legendre Coefficients

54-Xe-119

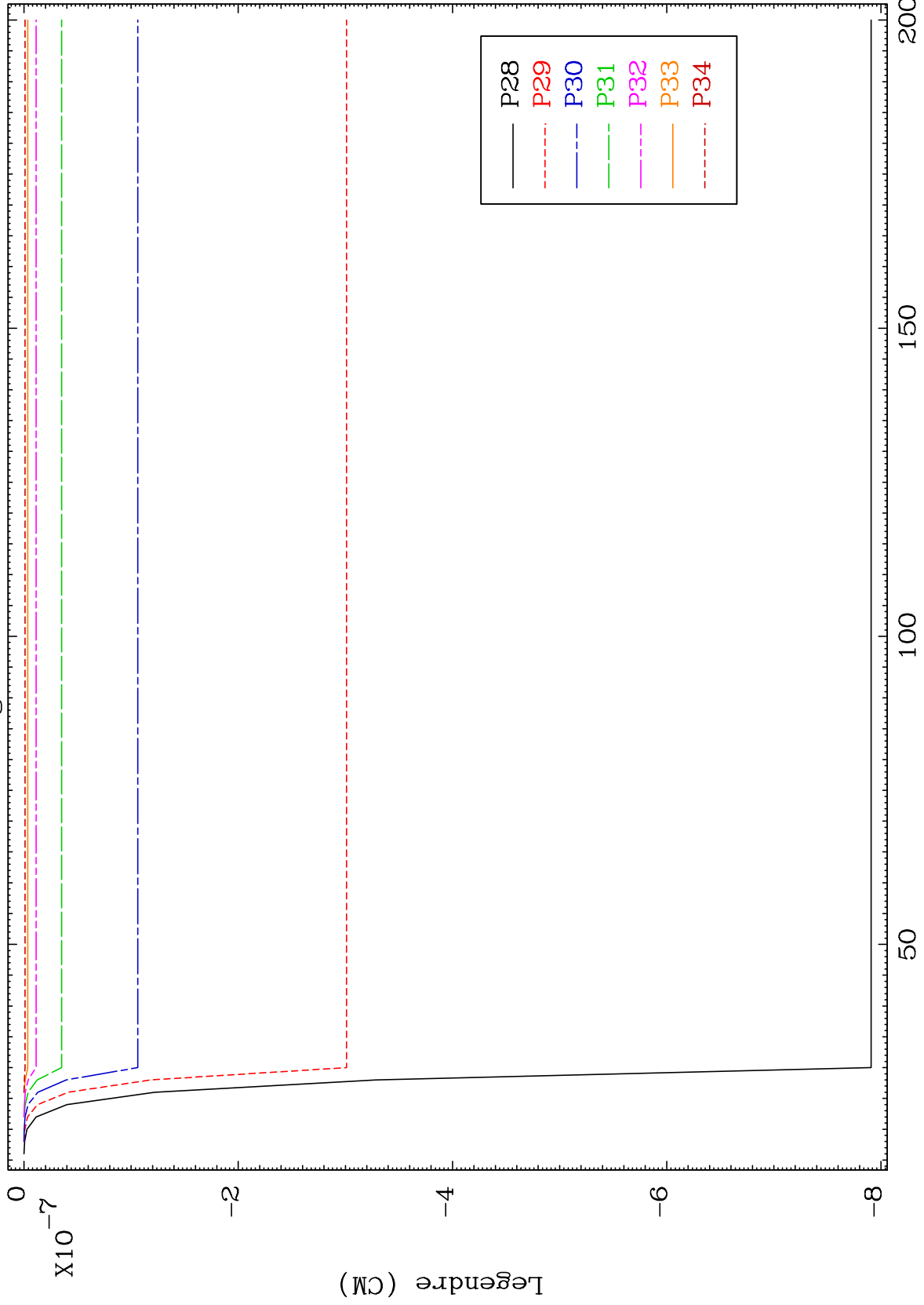

54-Xe-119

Incident Energy (MeV)

115

MAT 5410

MT= 75 (n,n') Level
Legendre Coefficients

54-Xe-119

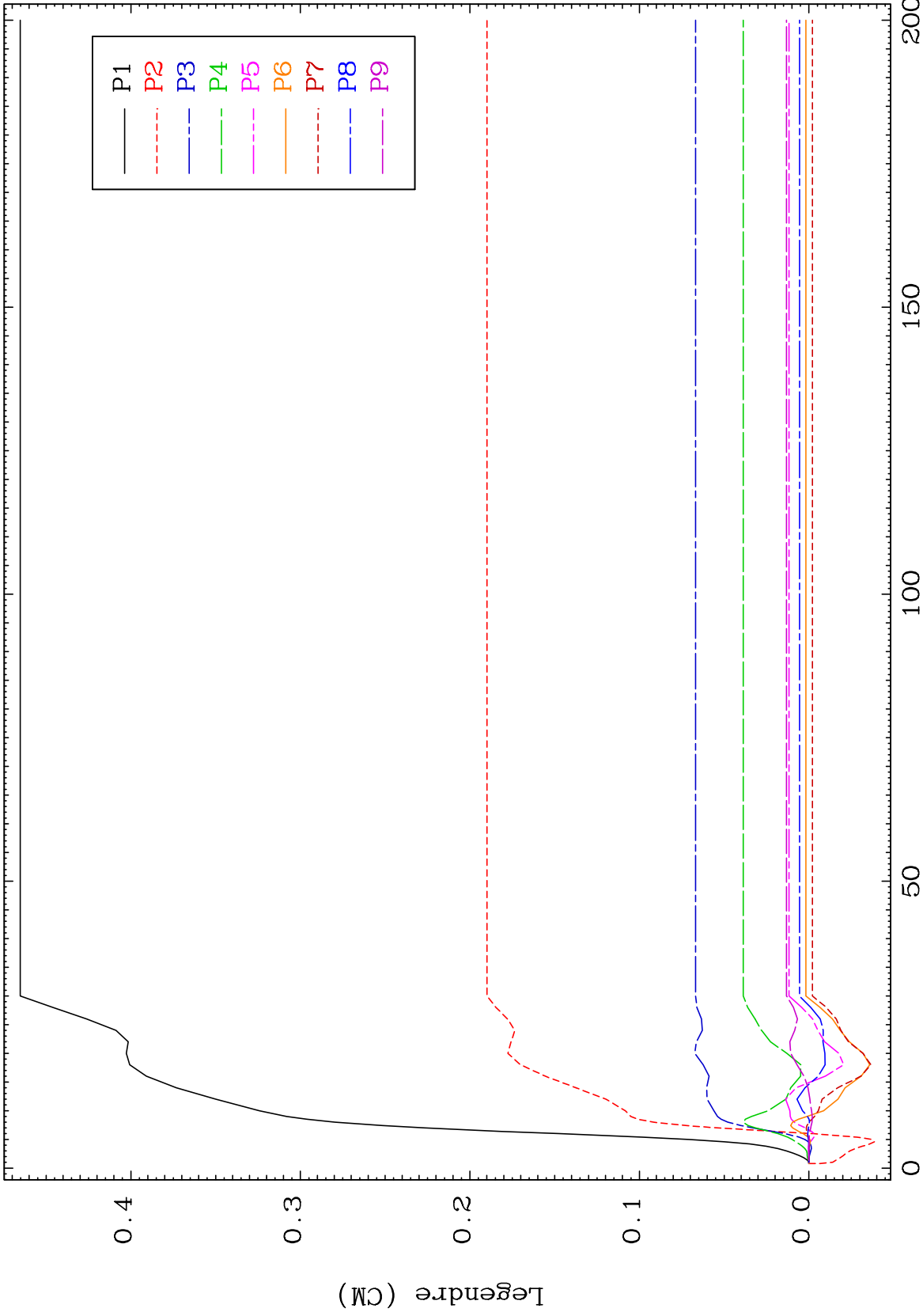

116

Incident Energy (MeV)

54-Xe-119

MAT 5410

MT= 75 (n,n') Level
Legendre Coefficients

54-Xe-119

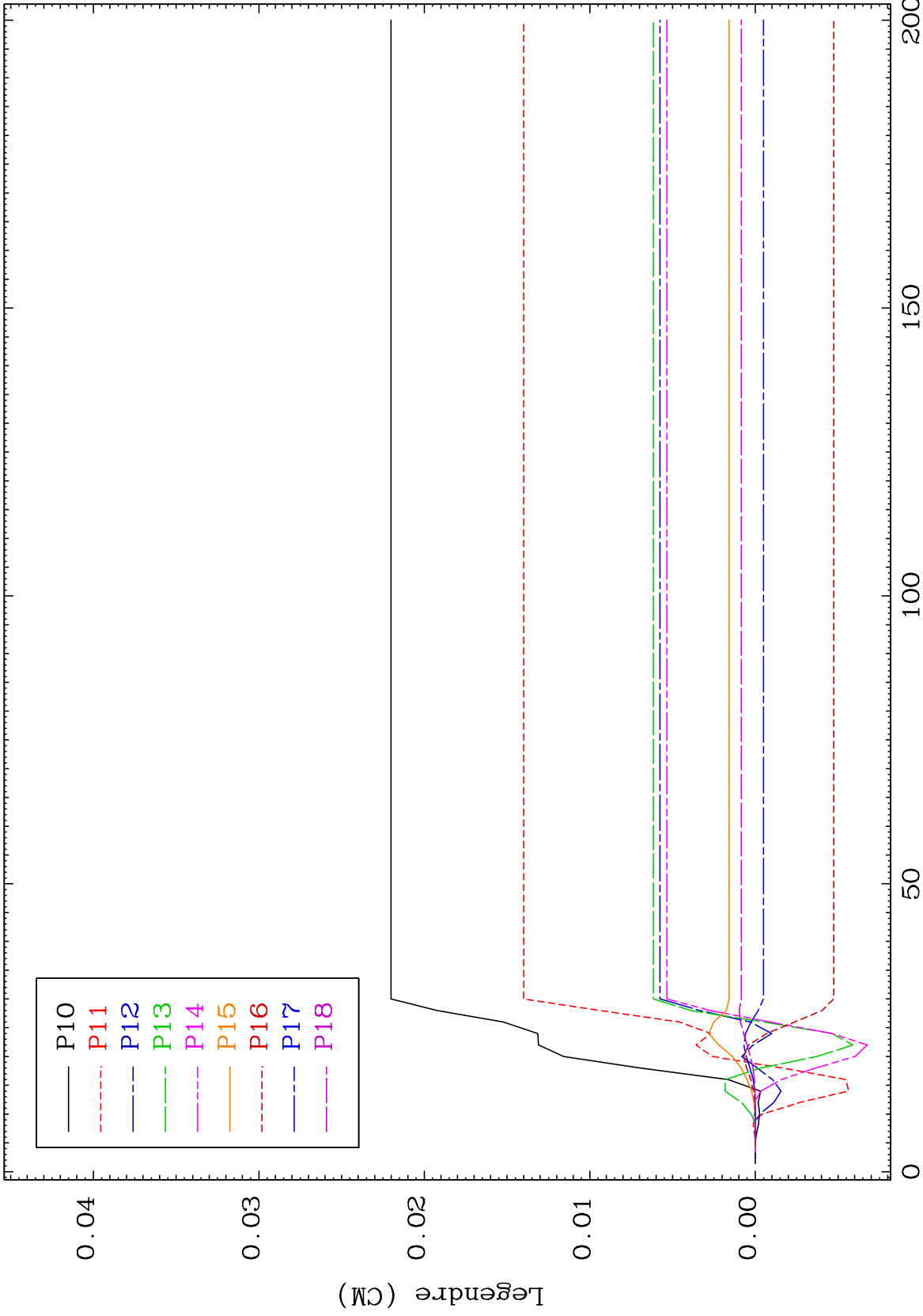

117

Incident Energy (MeV)

54-Xe-119

MAT 5410

MT= 75 (n,n') Level
Legendre Coefficients

54-Xe-119

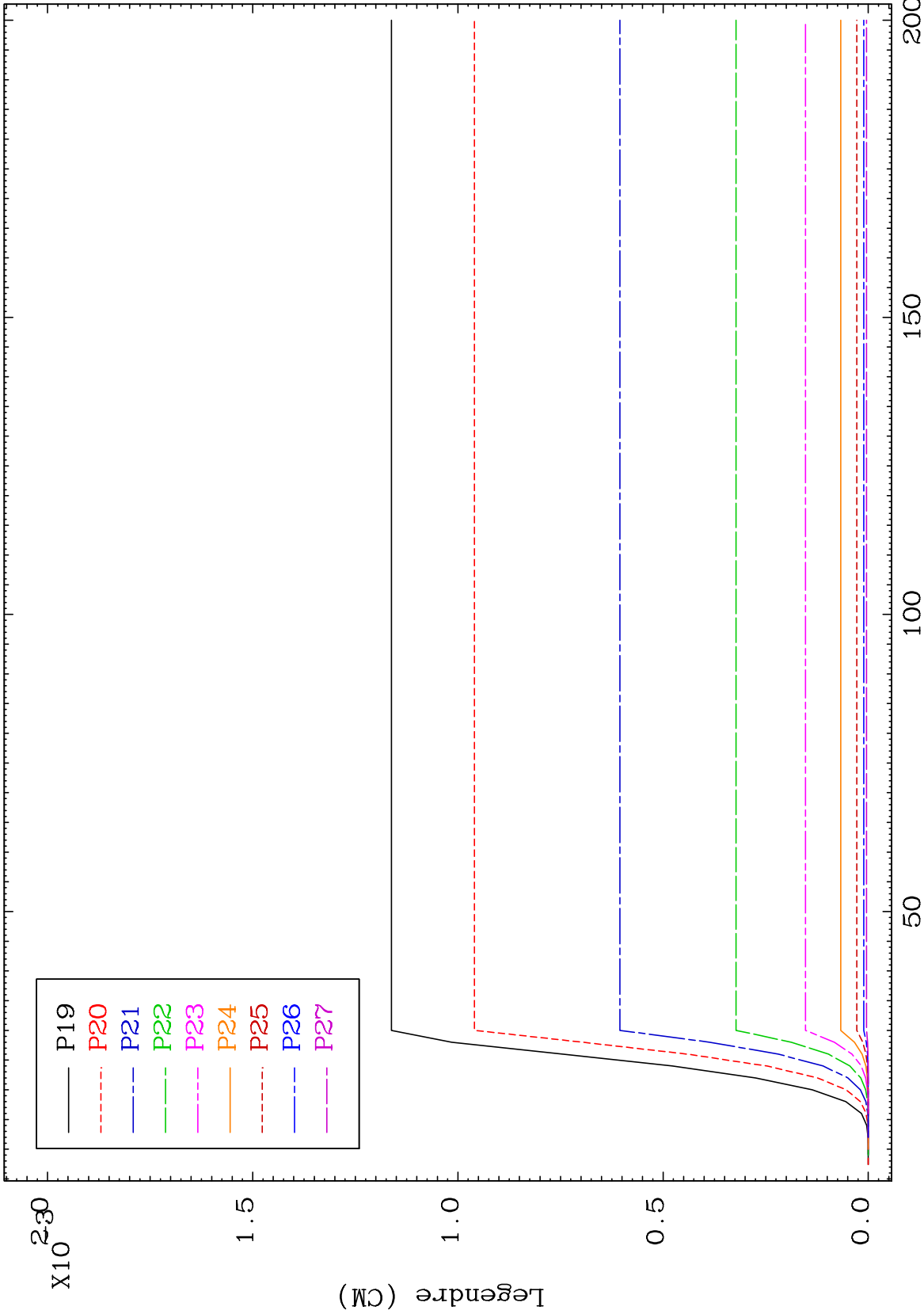

118

54-Xe-119

MAT 5410

MT= 75 (n,n') Level
Legendre Coefficients

54-Xe-119

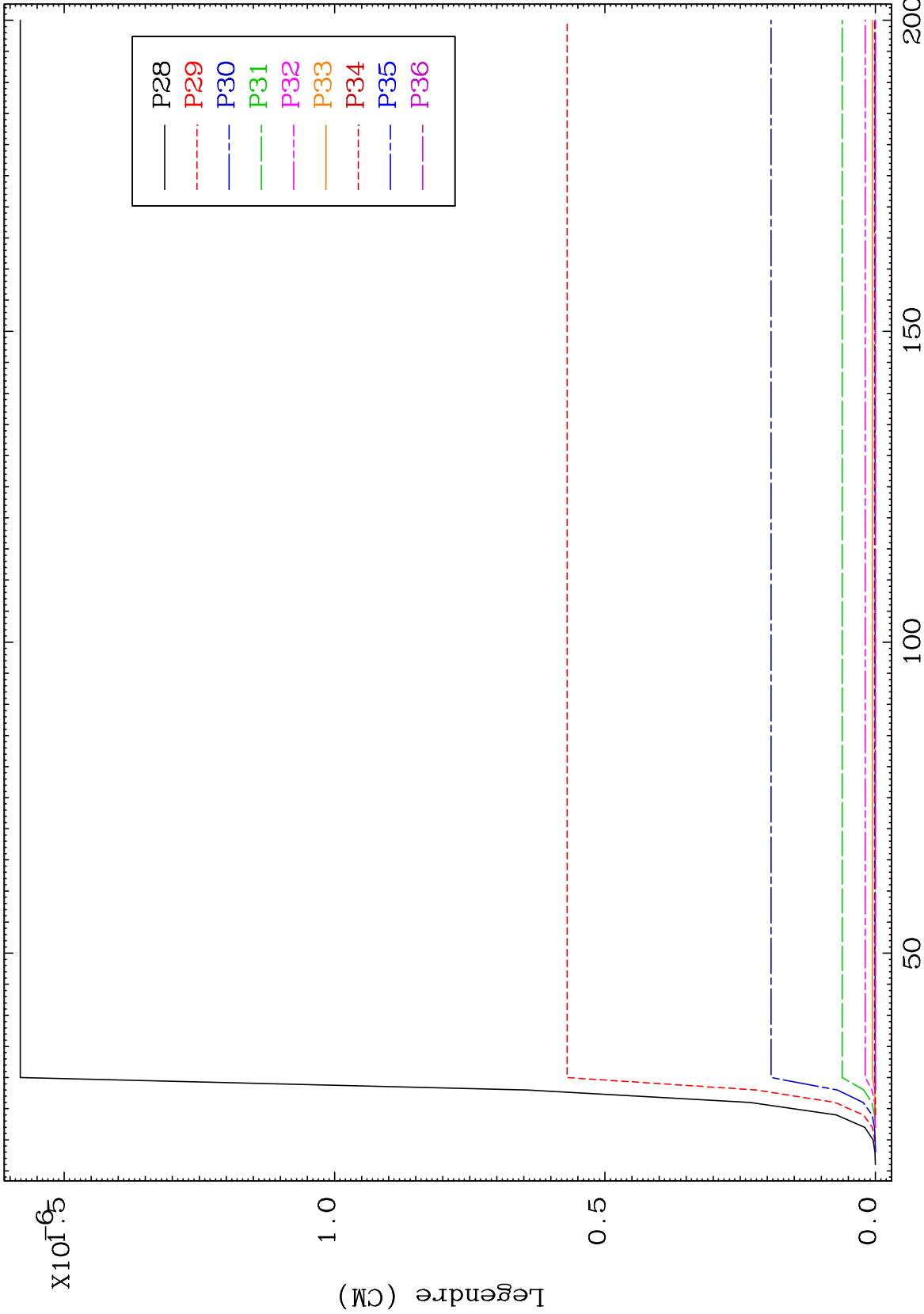

119

Incident Energy (MeV)

54-Xe-119

MAT 5410

MT= 76 (n,n') Level
Legendre Coefficients

54-Xe-119

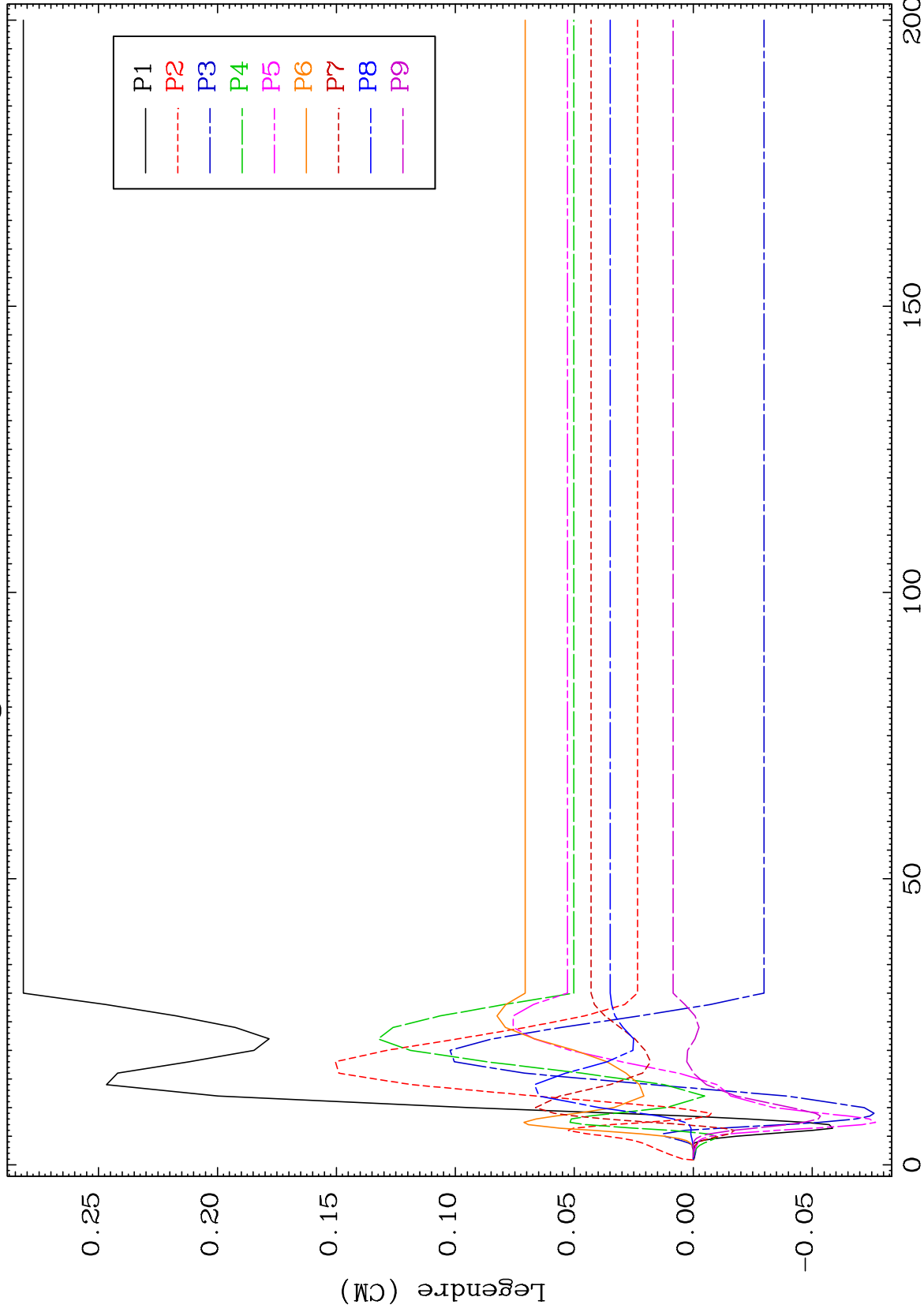

54-Xe-119

Incident Energy (MeV)

120

MAT 5410

MT= 76 (n,n') Level
Legendre Coefficients

54-Xe-119

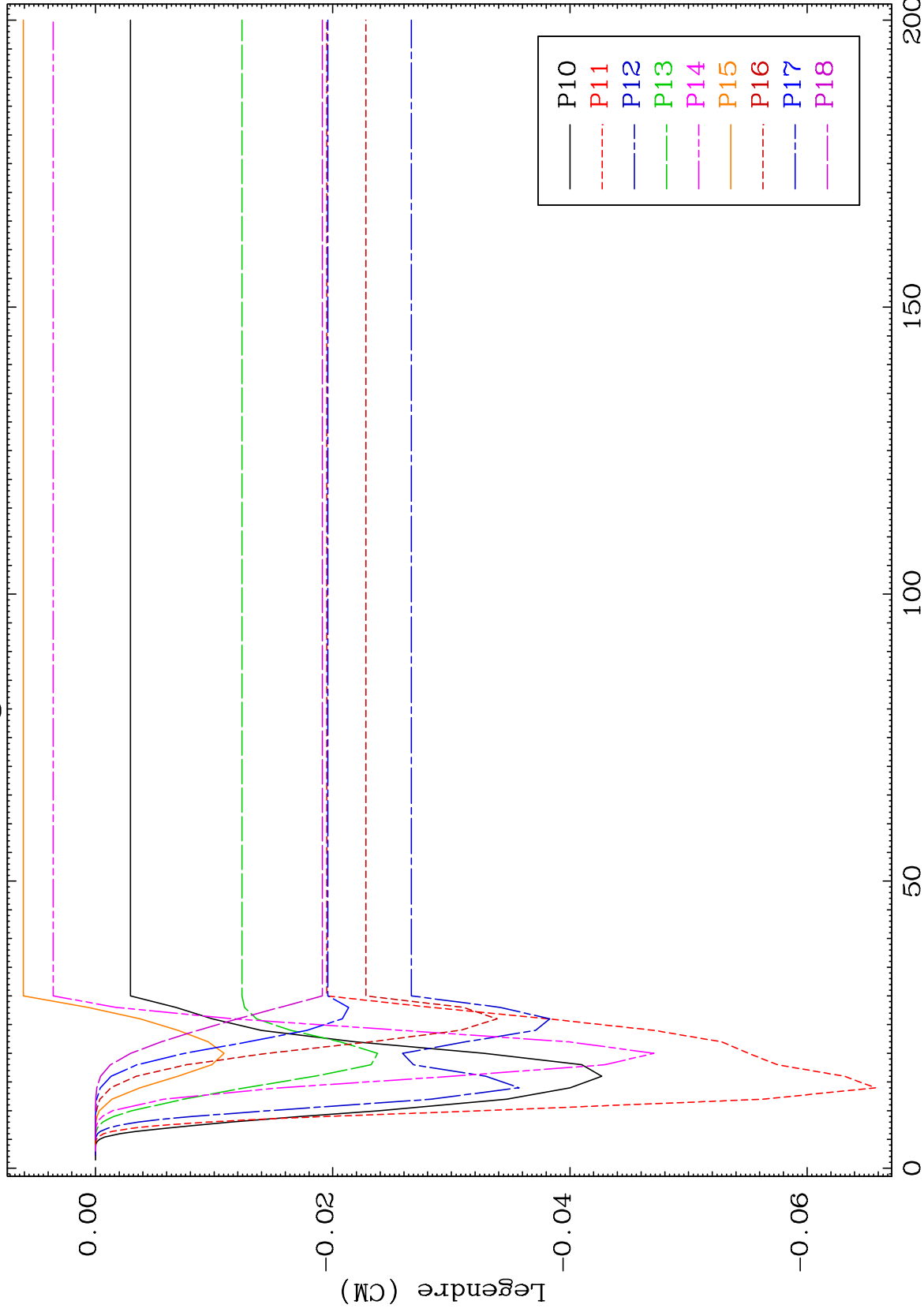

121

Incident Energy (MeV)

54-Xe-119

MAT 5410 MT= 76 (n,n') Level Legendre Coefficients 54-Xe-119

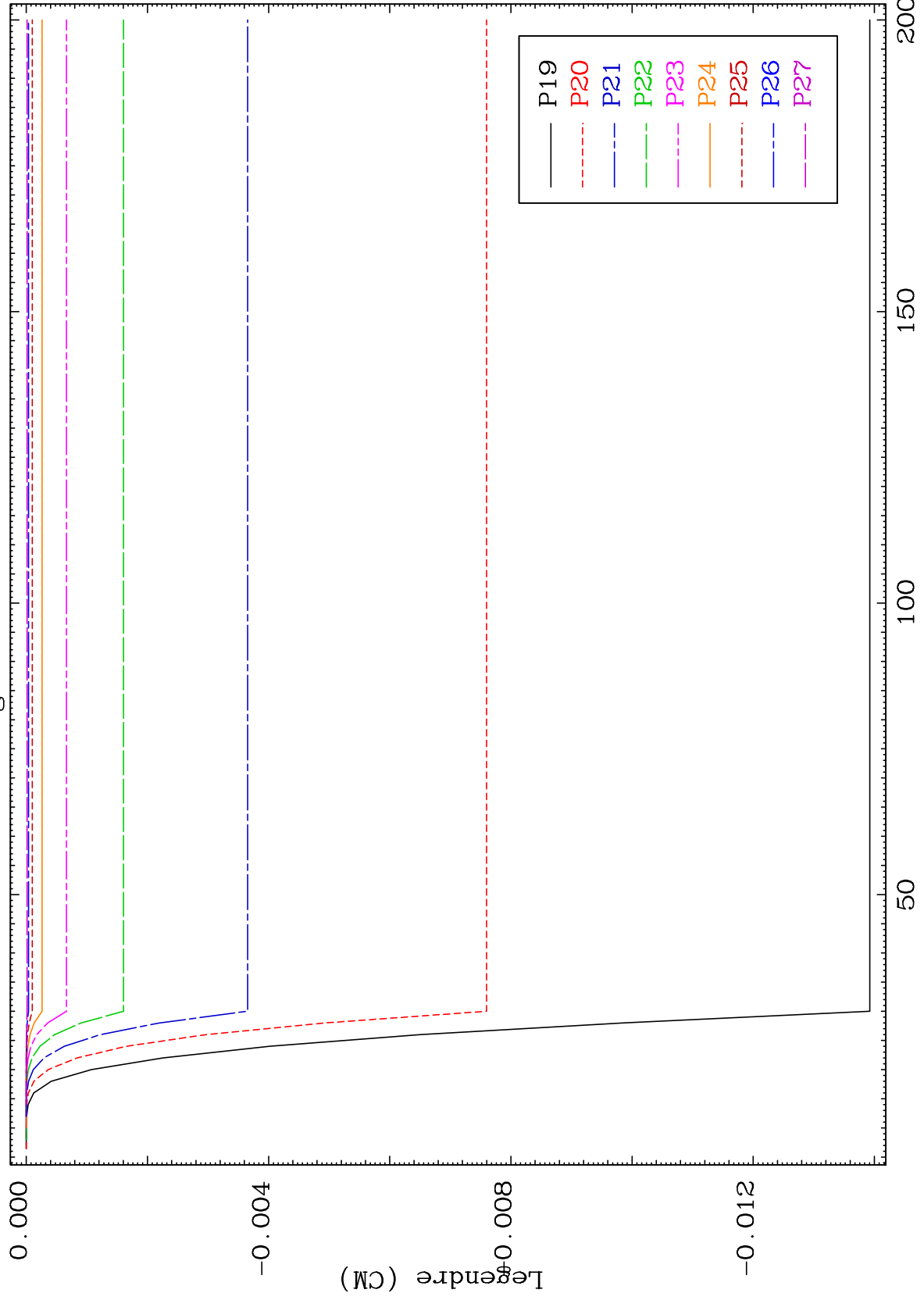

MAT 5410

MT= 76 (n,n') Level
Legendre Coefficients

54-Xe-119

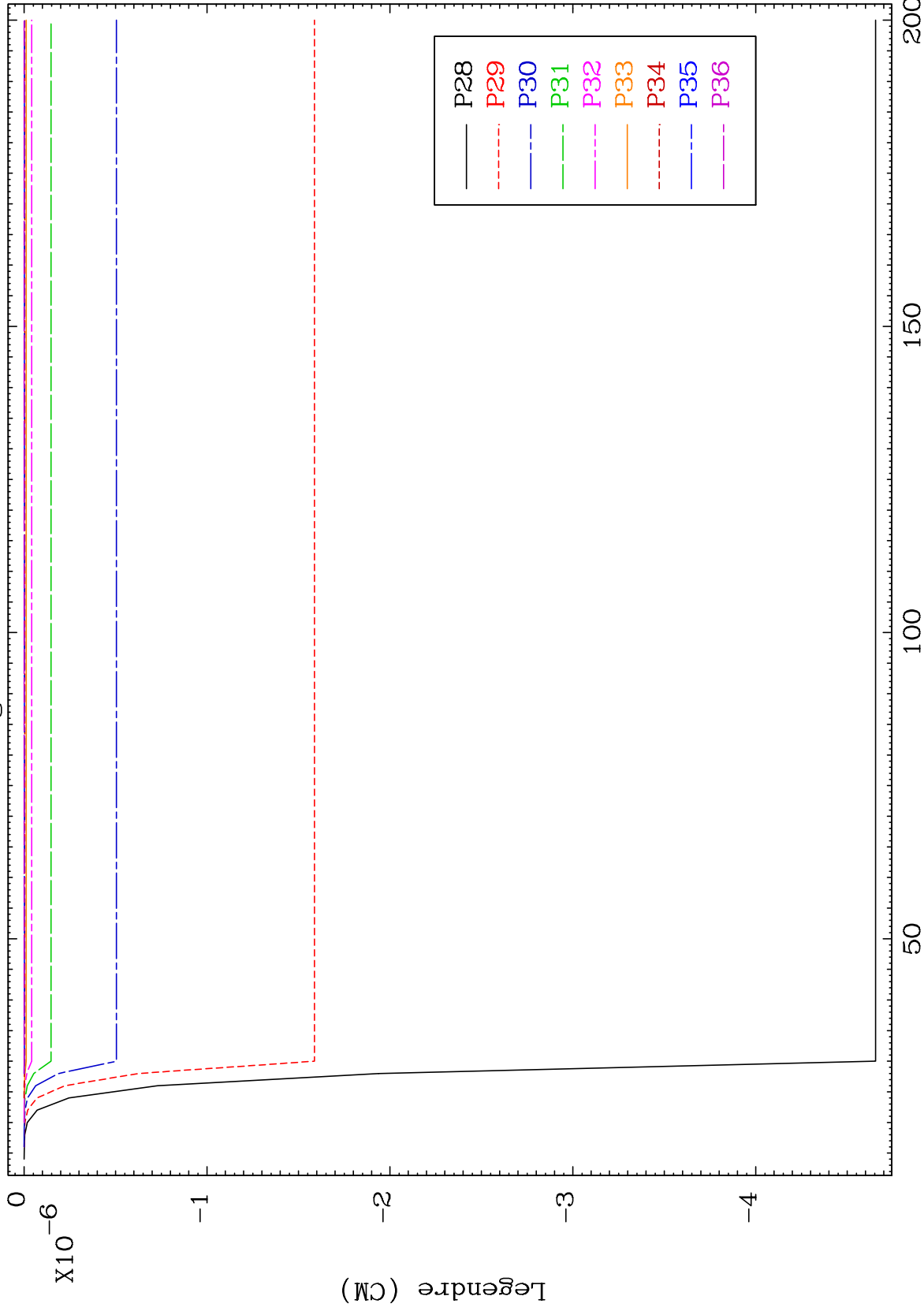

123

54-Xe-119

MAT 5410

MT= 77 (n,n') Level
Legendre Coefficients

54-Xe-119

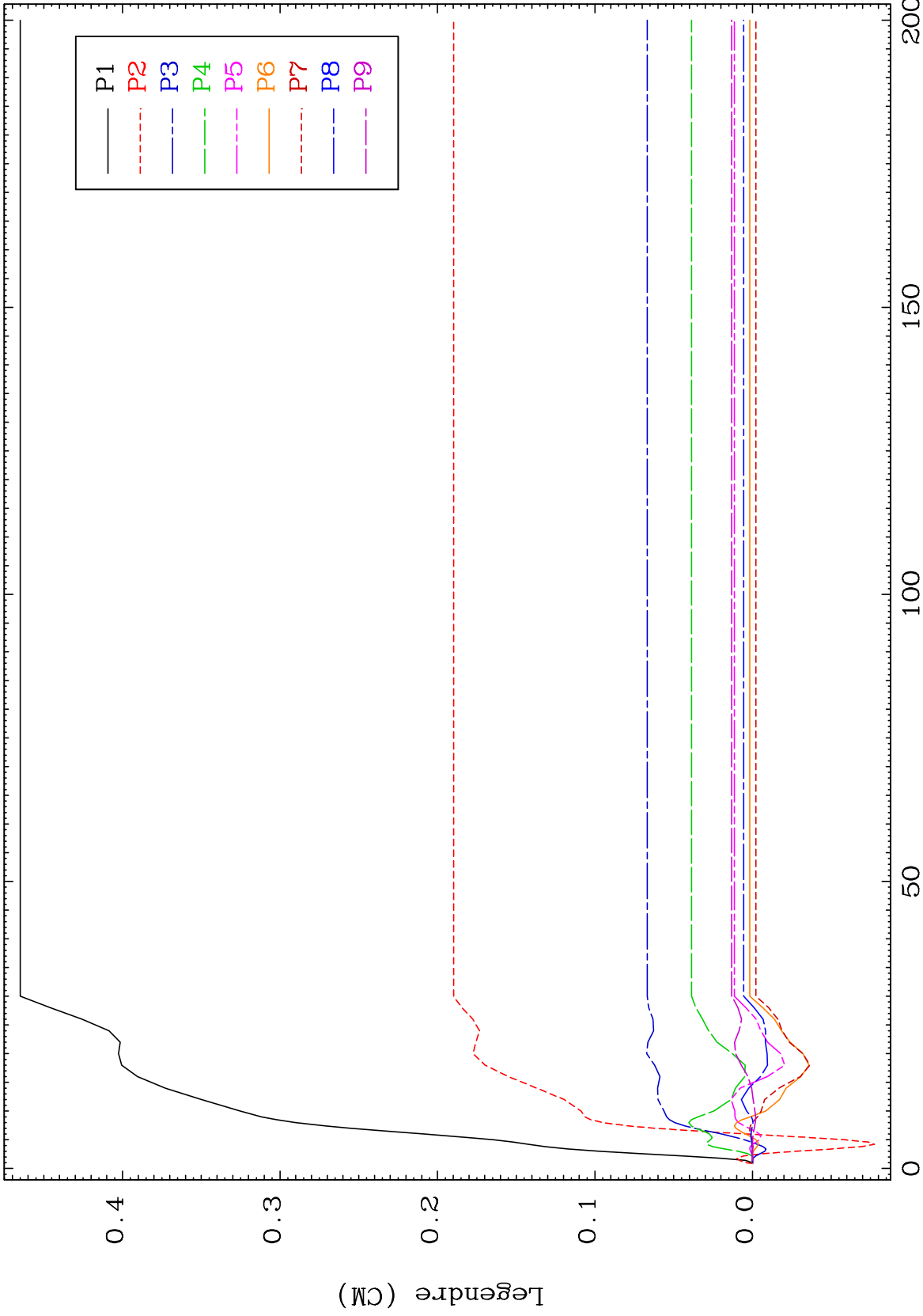

54-Xe-119

124

MAT 5410

MT= 77 (n,n') Level
Legendre Coefficients

54-Xe-119

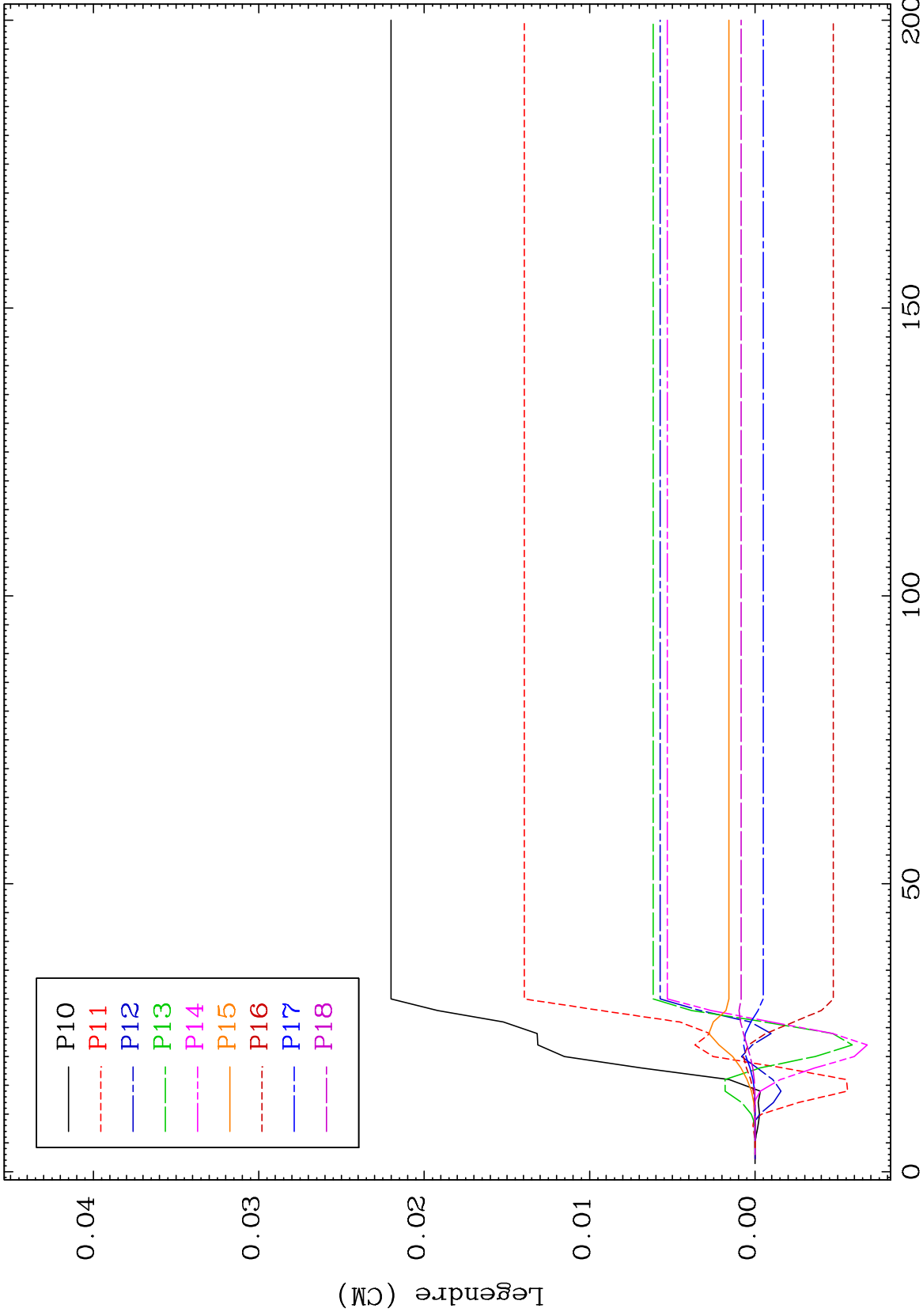

125

Incident Energy (MeV)

54-Xe-119

MAT 5410

MT= 77 (n,n') Level
Legendre Coefficients

54-Xe-119

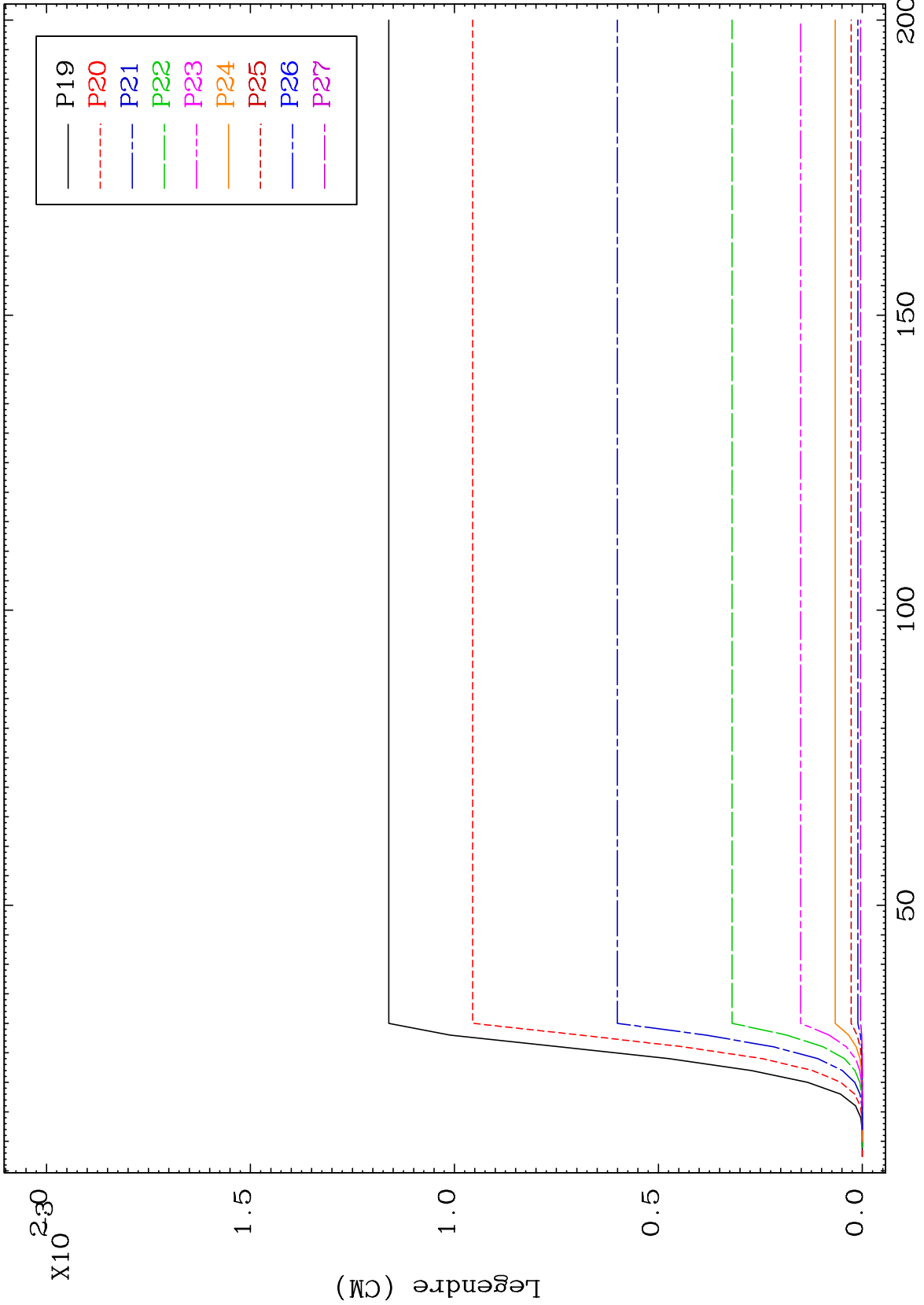

126

Incident Energy (MeV)

54-Xe-119

MAT 5410

MT= 77 (n,n') Level
Legendre Coefficients

54-Xe-119

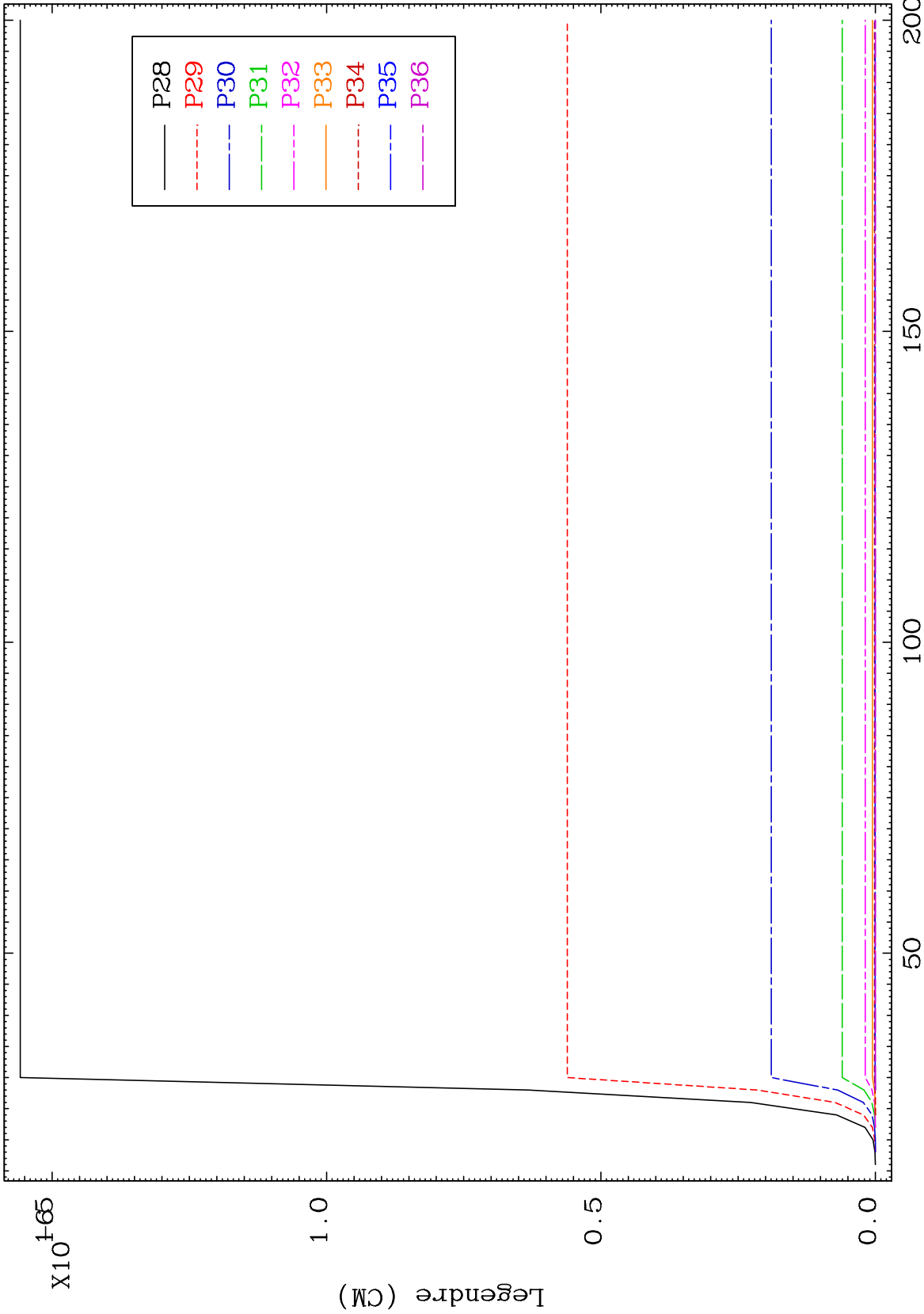

127

54-Xe-119

MAT 5410

MT= 78 (n,n') Level
Legendre Coefficients

54-Xe-119

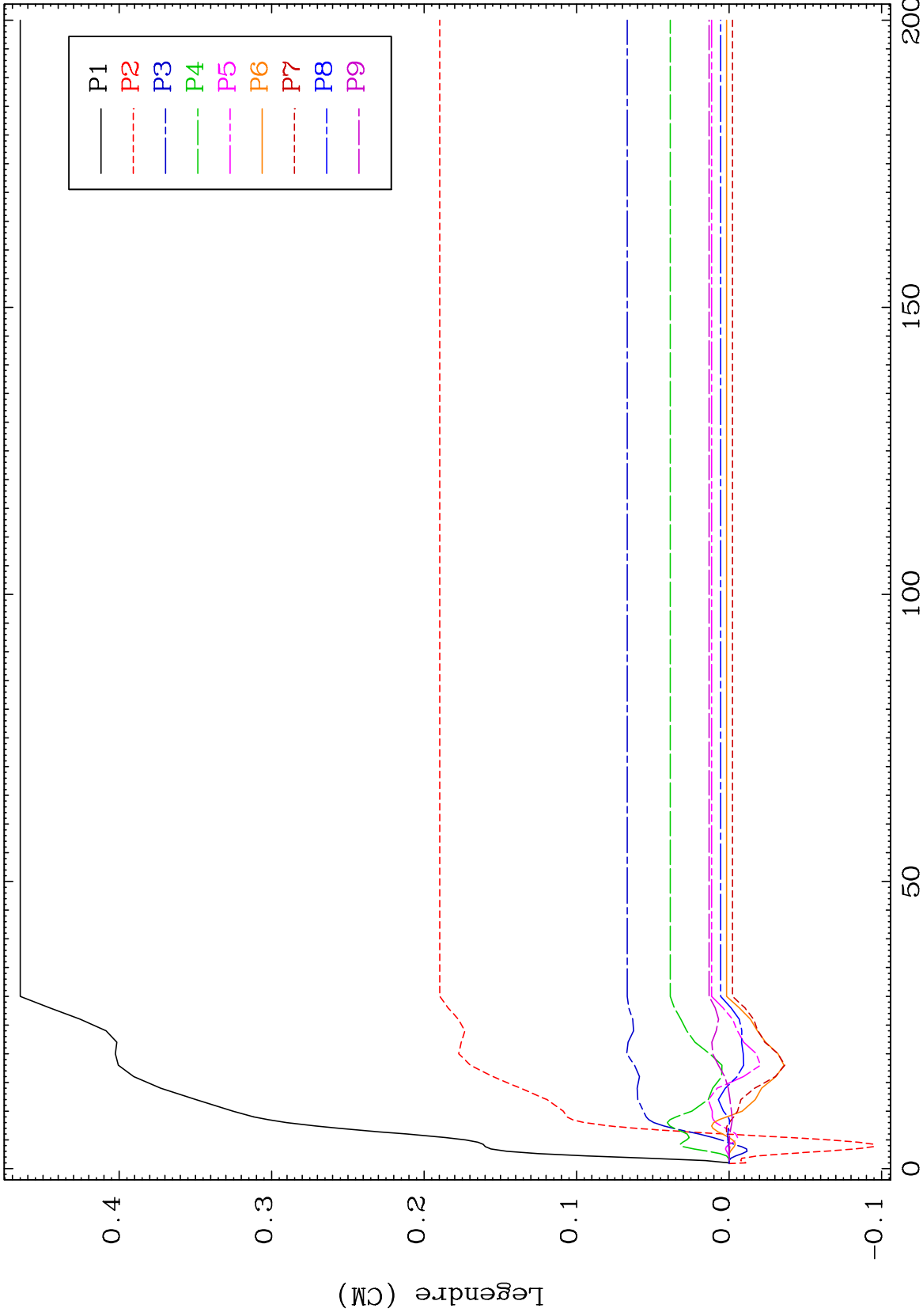

54-Xe-119

Incident Energy (MeV)

128

MAT 5410

MT= 78 (n,n') Level
Legendre Coefficients

54-Xe-119

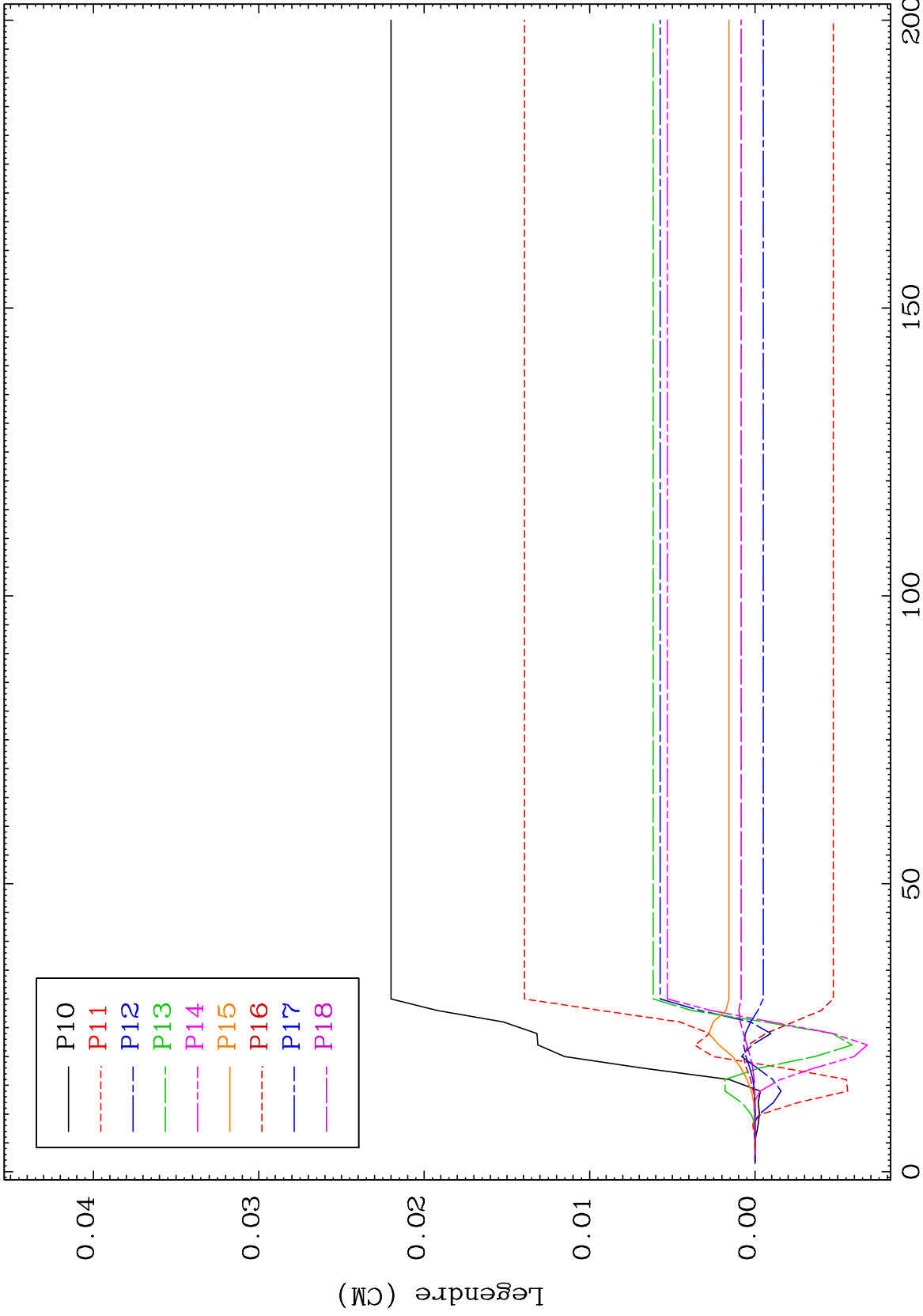

129

54-Xe-119

MAT 5410

MT= 78 (n,n') Level
Legendre Coefficients

54-Xe-119

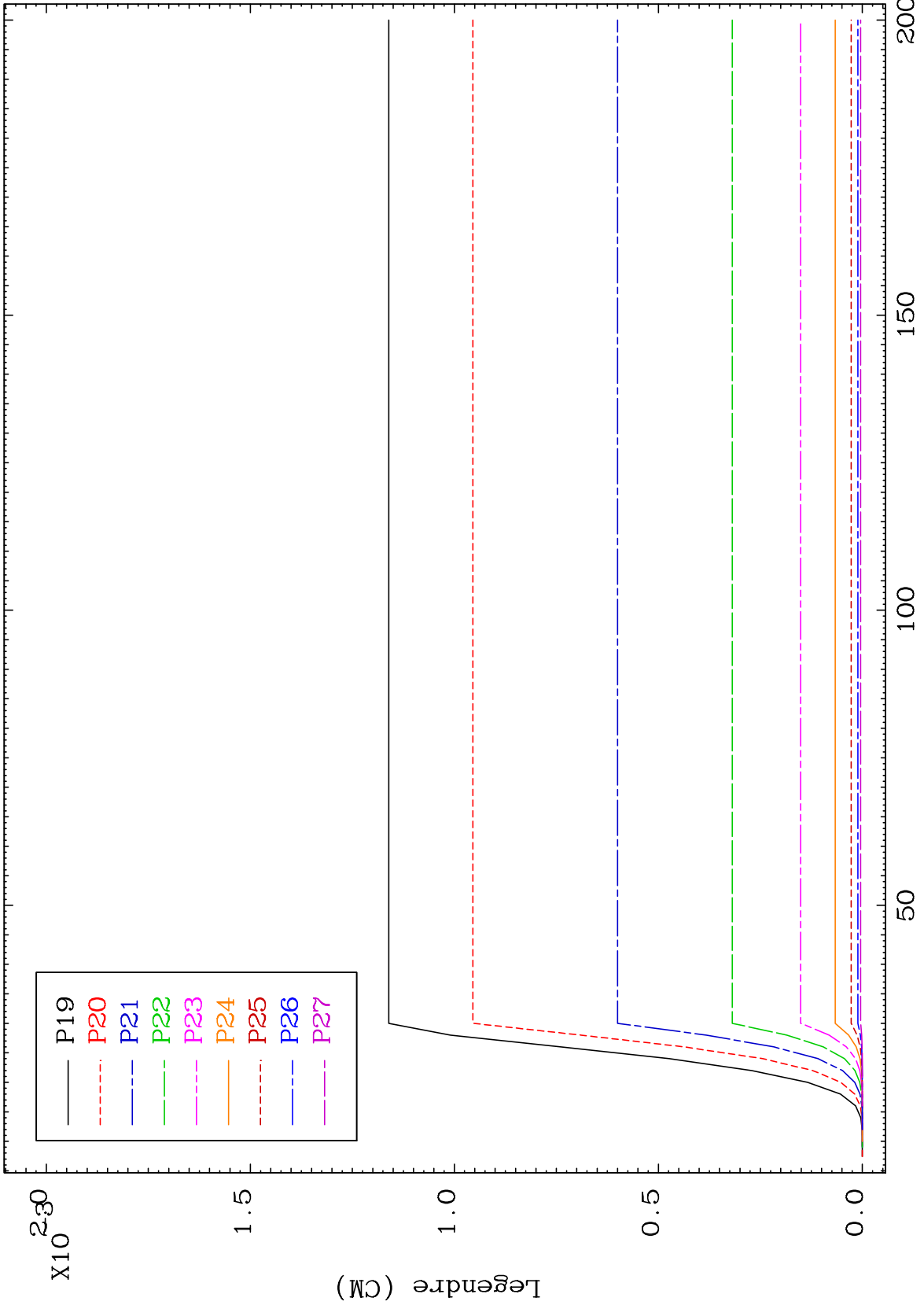

130

Incident Energy (MeV)

54-Xe-119

MAT 5410

MT= 78 (n,n') Level
Legendre Coefficients

54-Xe-119

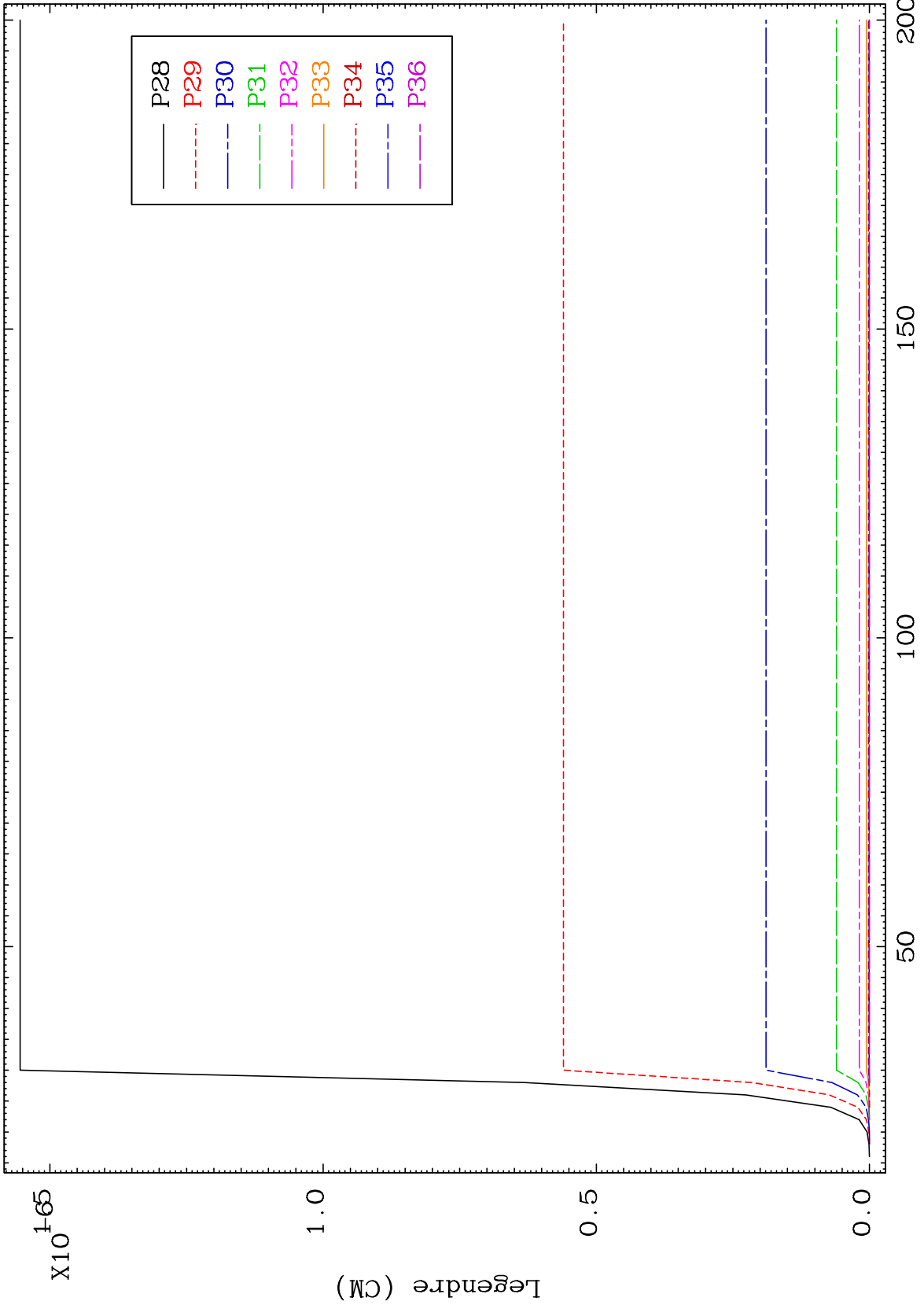

131

54-Xe-119

MAT 5410

MT= 79 (n,n') Level
Legendre Coefficients

54-Xe-119

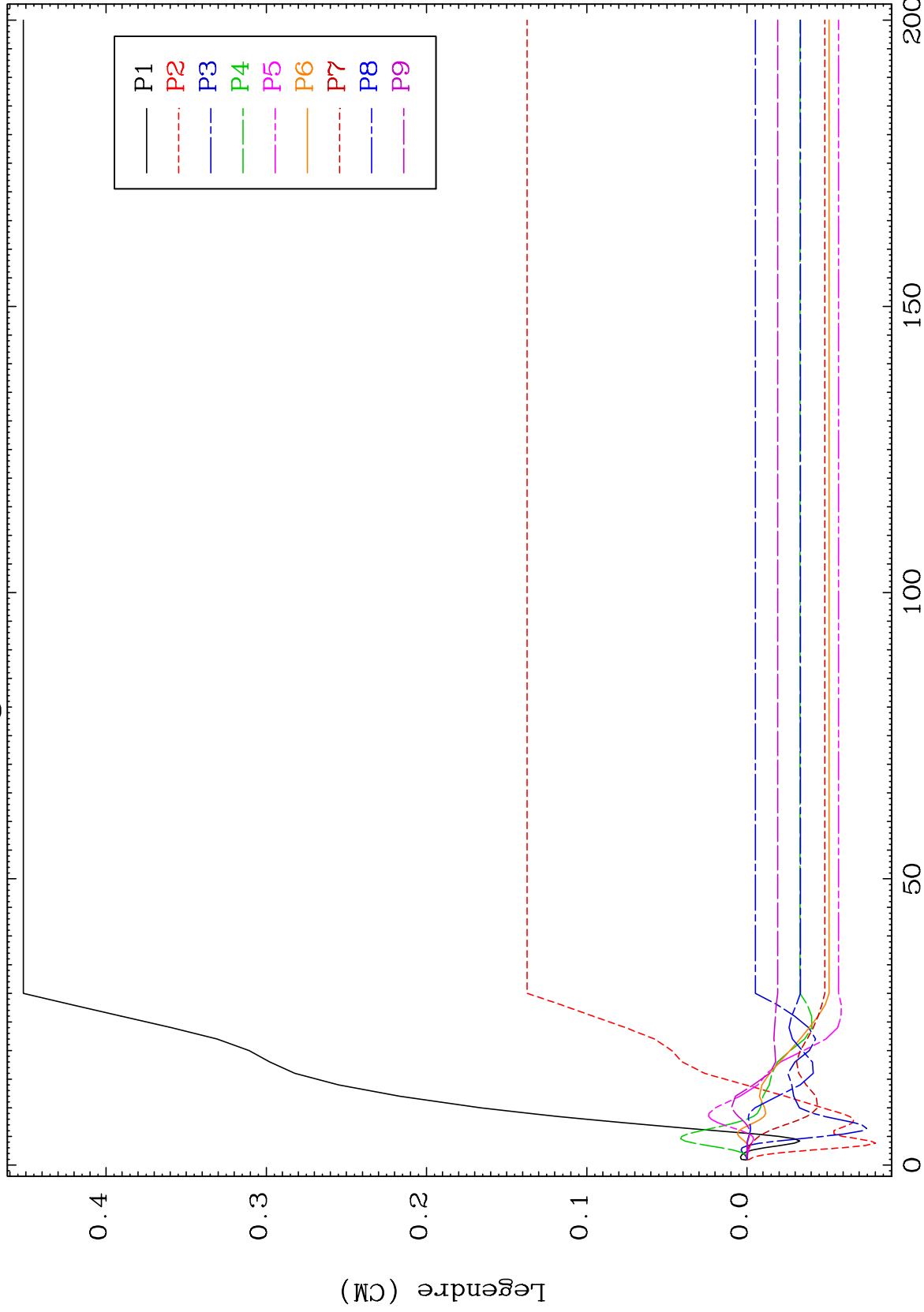

132

Incident Energy (MeV)

54-Xe-119

MAT 5410

MT= 79 (n,n') Level
Legendre Coefficients

54-Xe-119

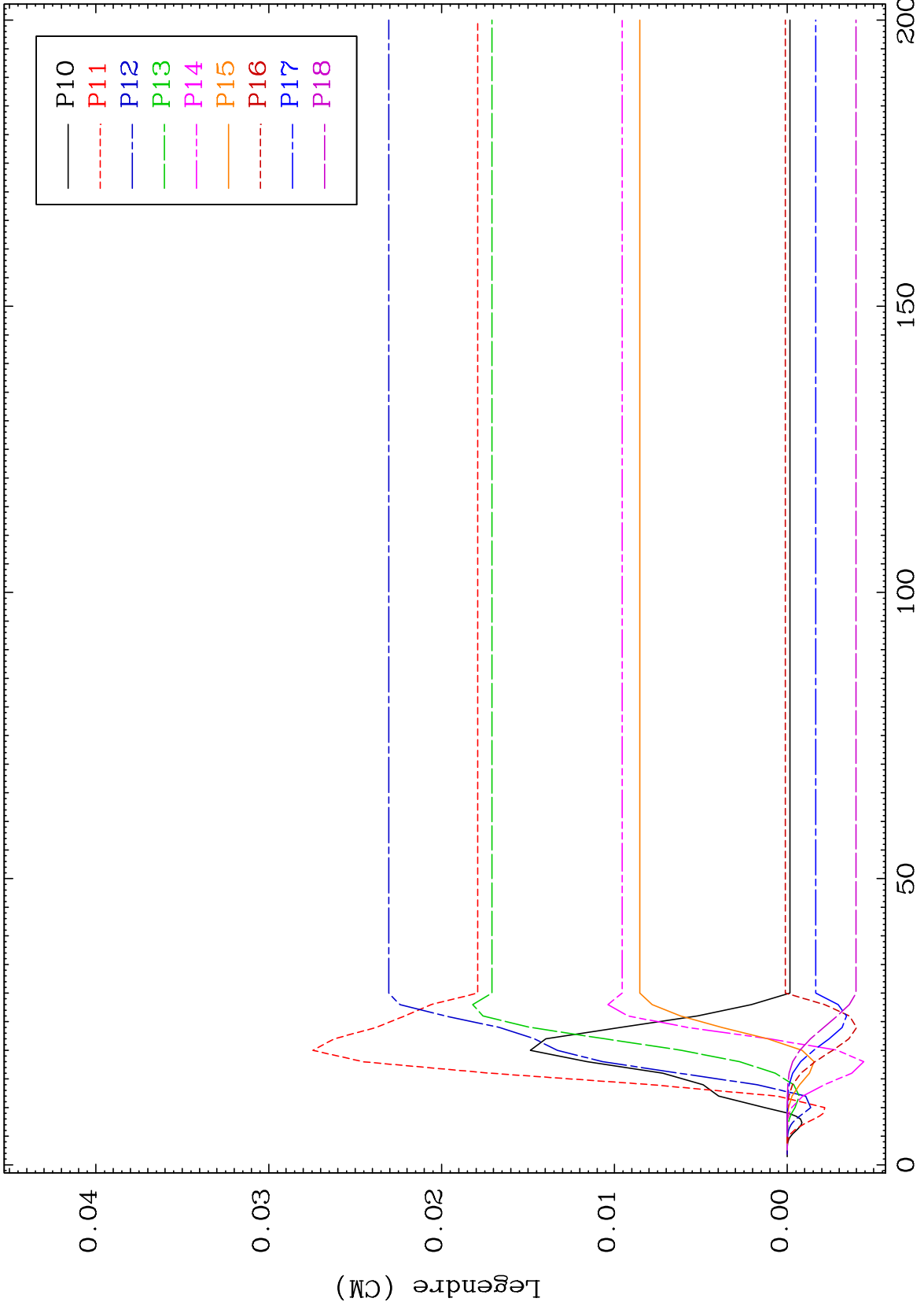

133

Incident Energy (MeV)

54-Xe-119

MAT 5410

MT= 79 (n,n') Level
Legendre Coefficients

54-Xe-119

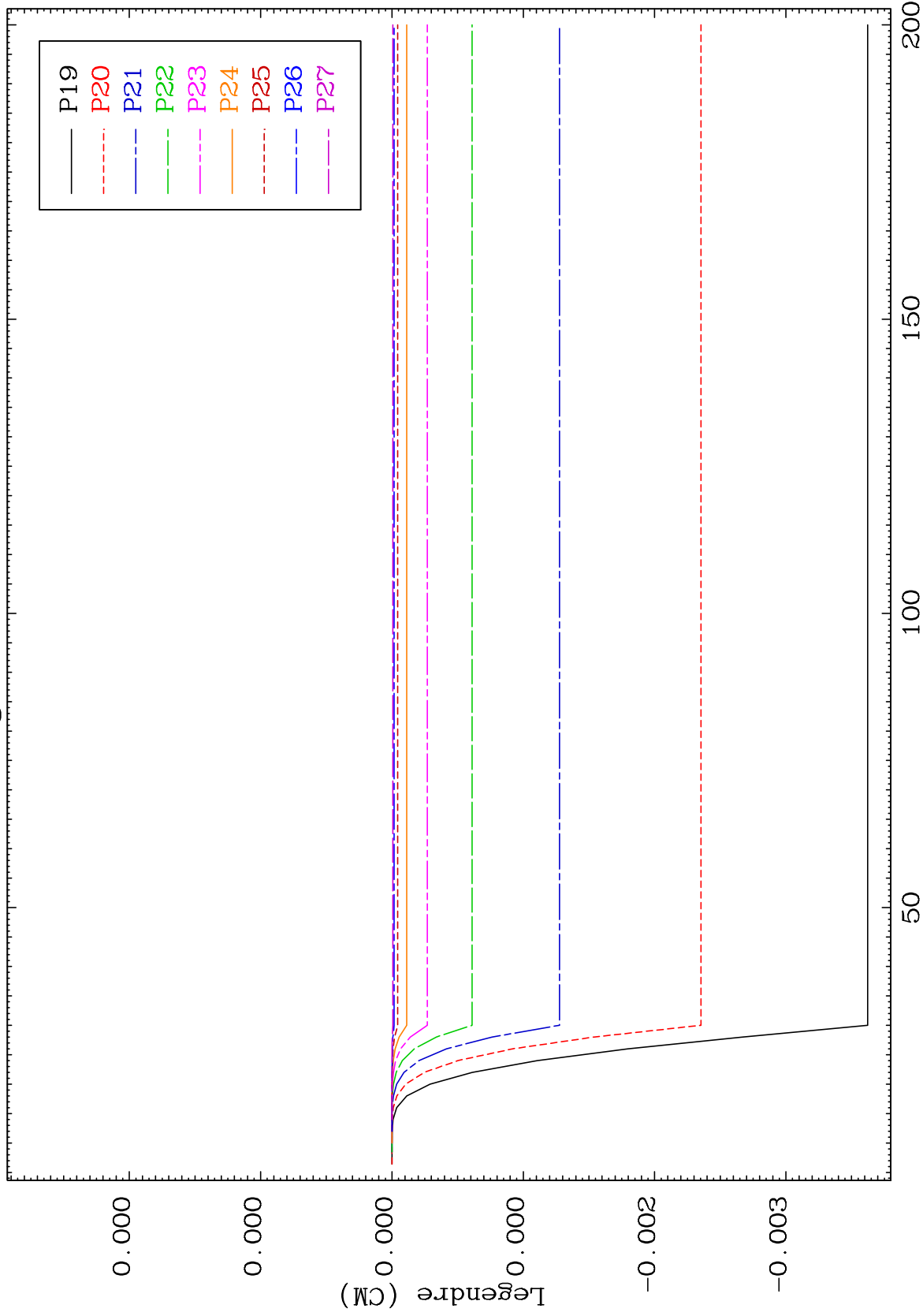

134

Incident Energy (MeV)

54-Xe-119

MAT 5410

MT= 79 (n,n') Level
Legendre Coefficients

54-Xe-119

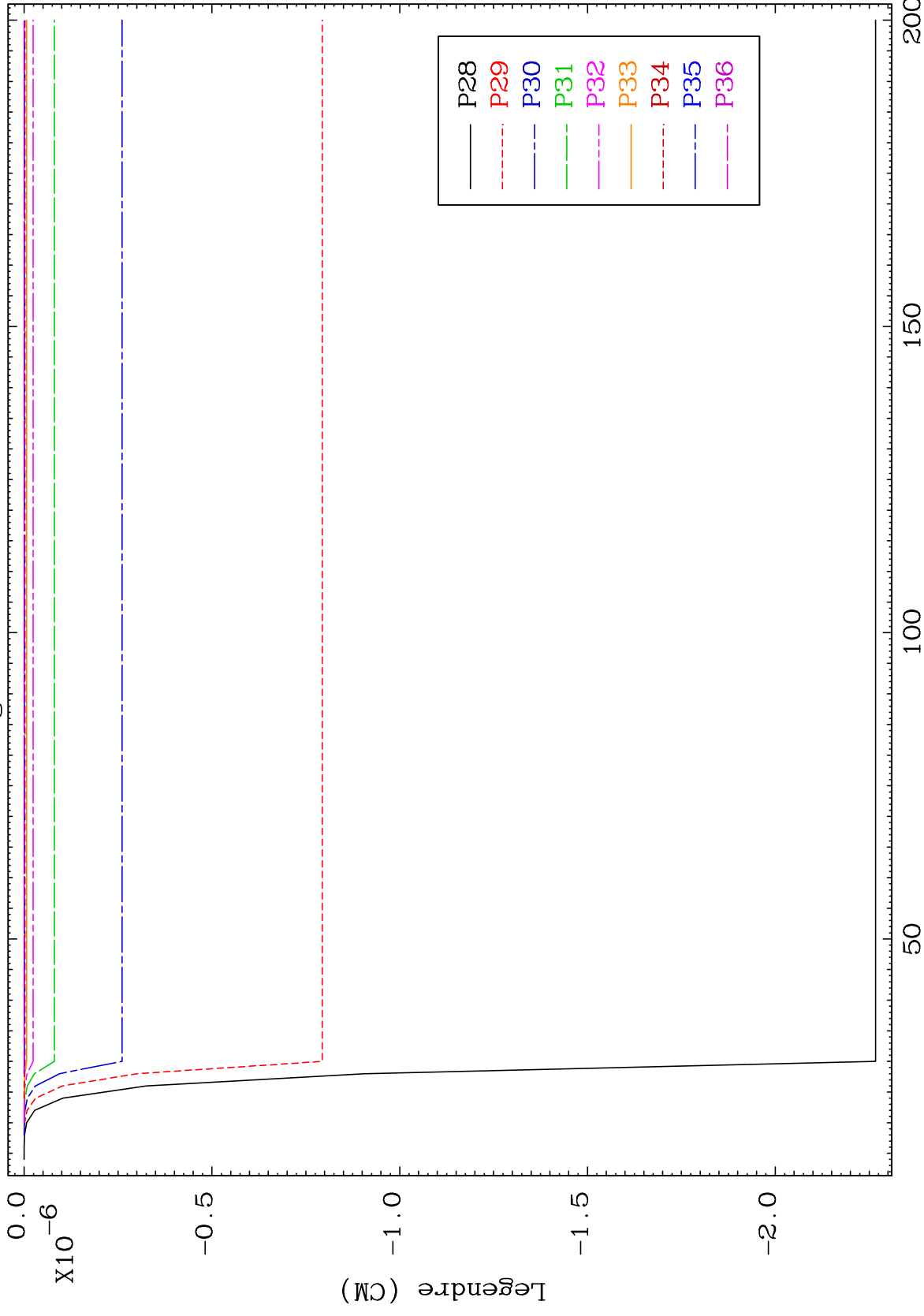

135

54-Xe-119

MAT 5410

MT= 80 (n,n') Level
Legendre Coefficients

54-Xe-119

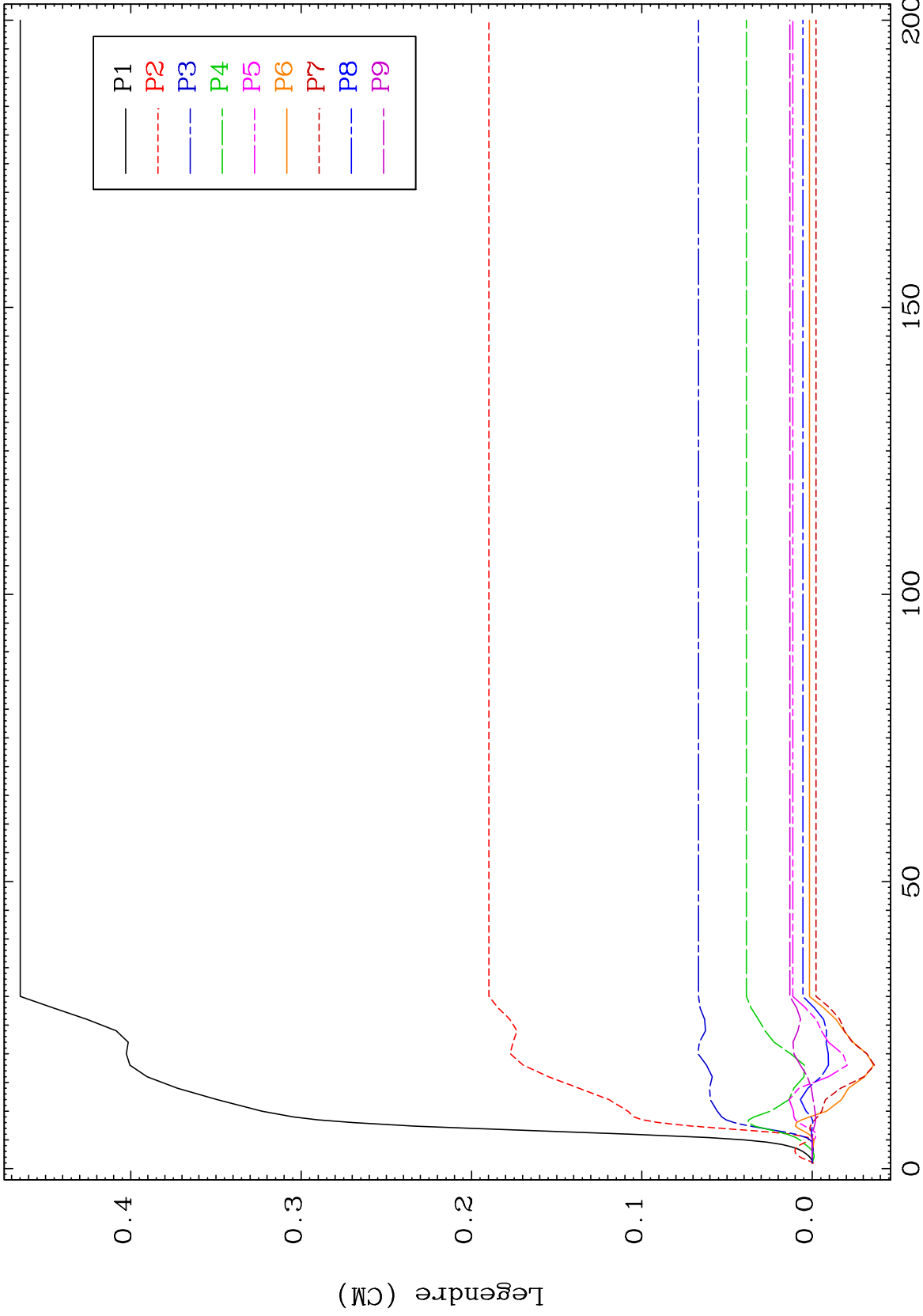

136

54-Xe-119

MAT 5410

MT= 80 (n,n') Level
Legendre Coefficients

54-Xe-119

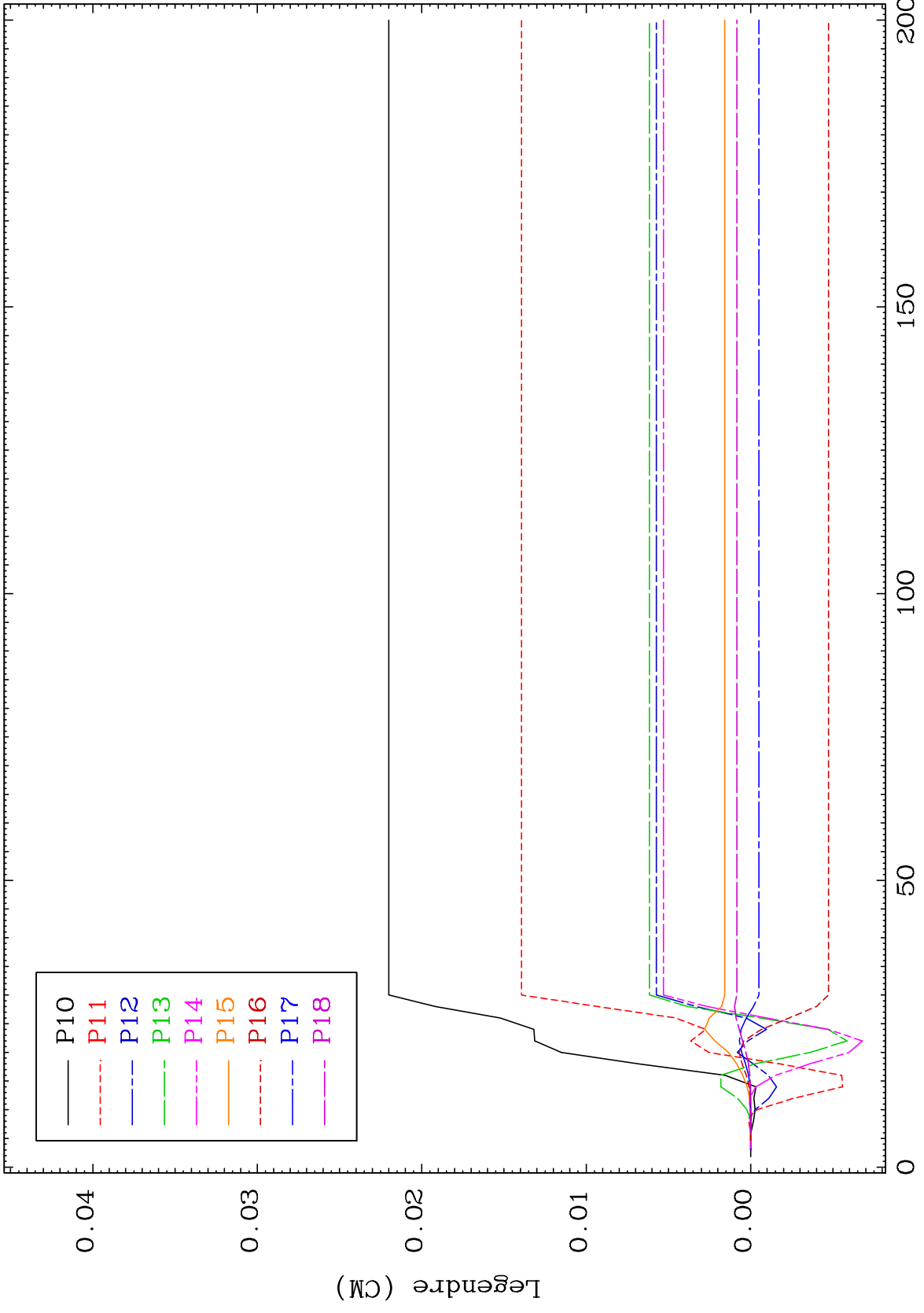

137

Incident Energy (MeV)

54-Xe-119

MAT 5410

MT= 80 (n,n') Level
Legendre Coefficients

54-Xe-119

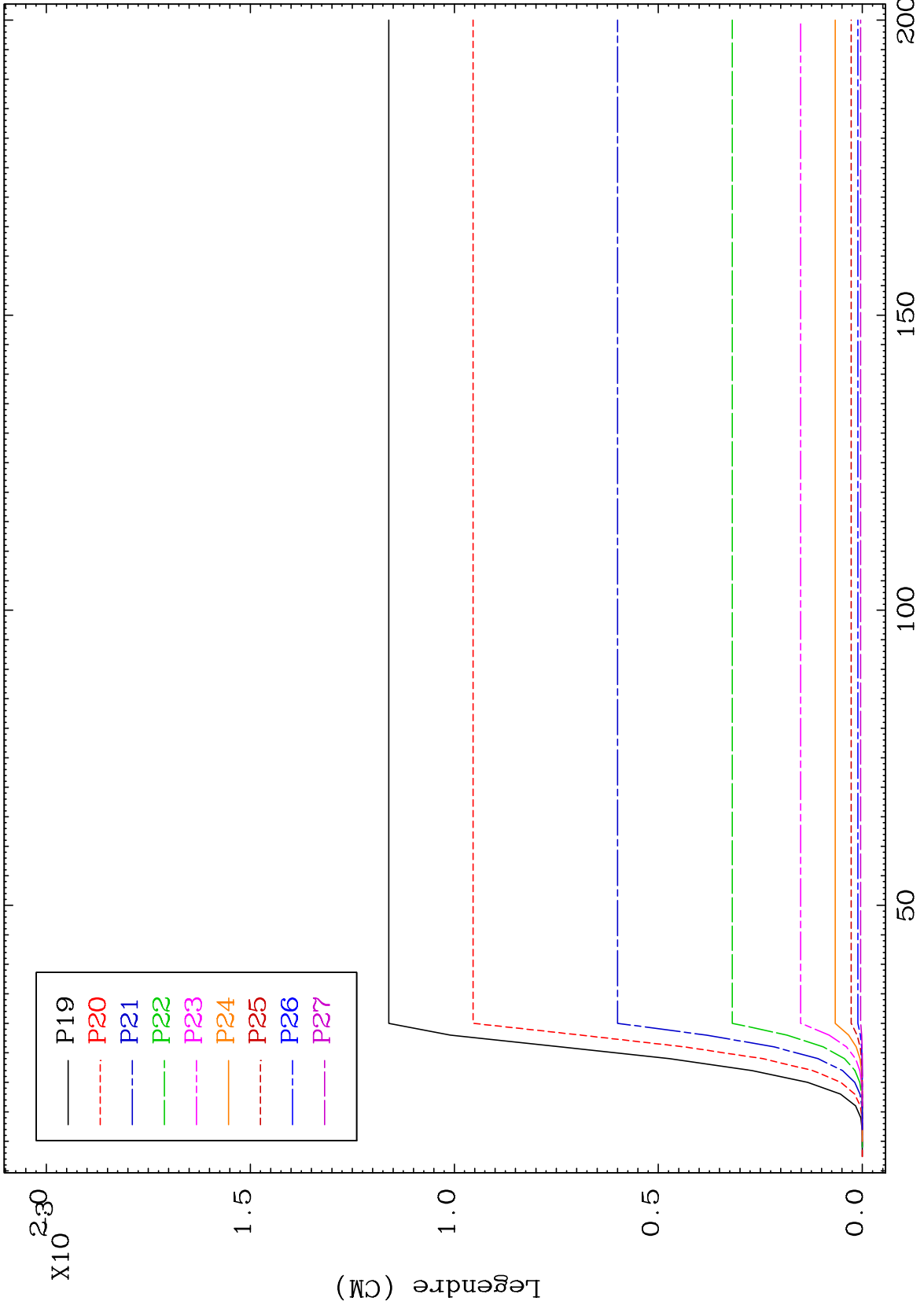

138

54-Xe-119

MAT 5410

MT= 80 (n,n') Level
Legendre Coefficients

54-Xe-119

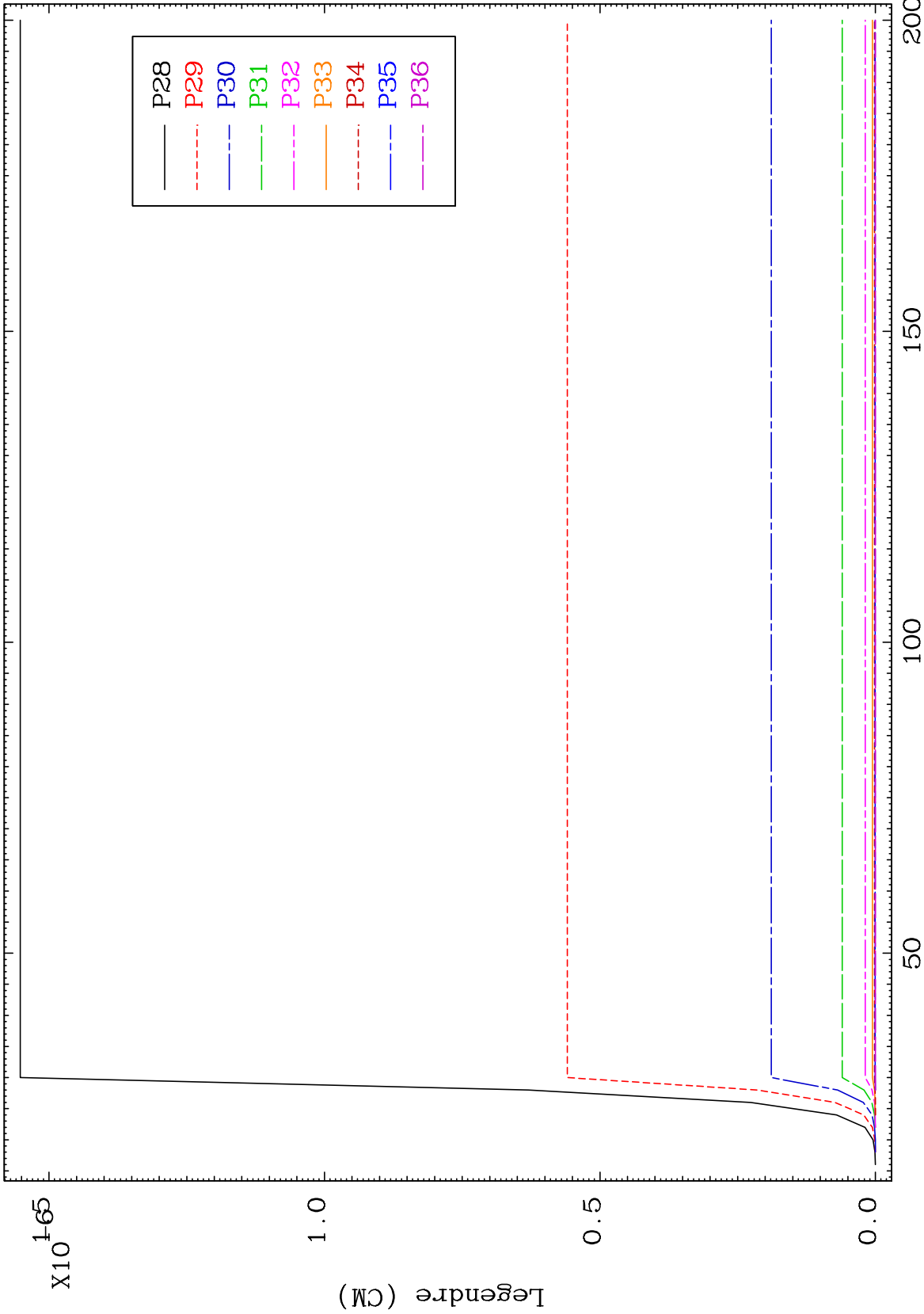

139

54-Xe-119

MAT 5410

(n,n') α

54-Xe-119

Radionuclide Production Cross Section

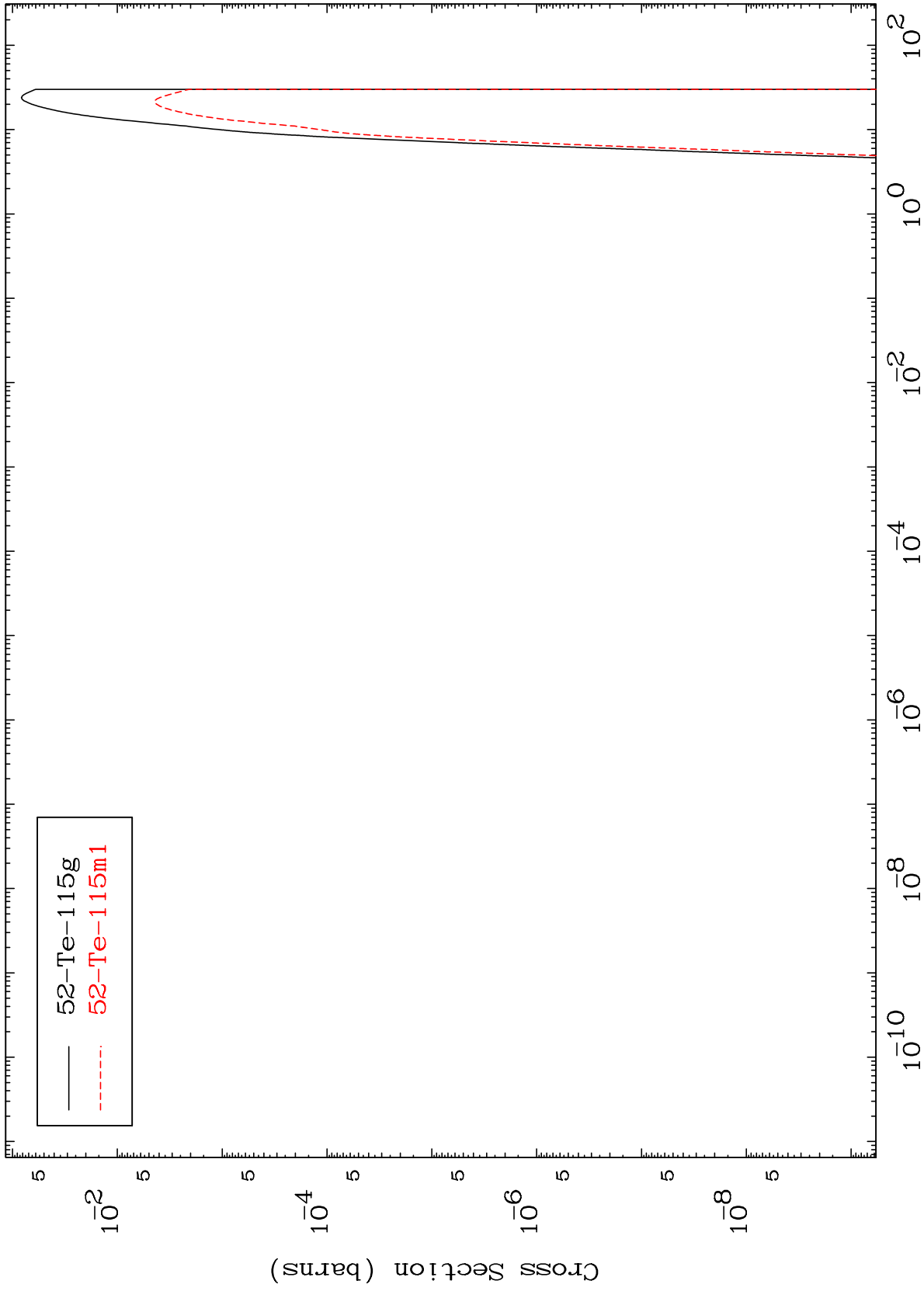

140

Incident Energy (MeV)

54-Xe-119

MAT 5410

(n,n') p

54-Xe-119

Radionuclide Production Cross Section

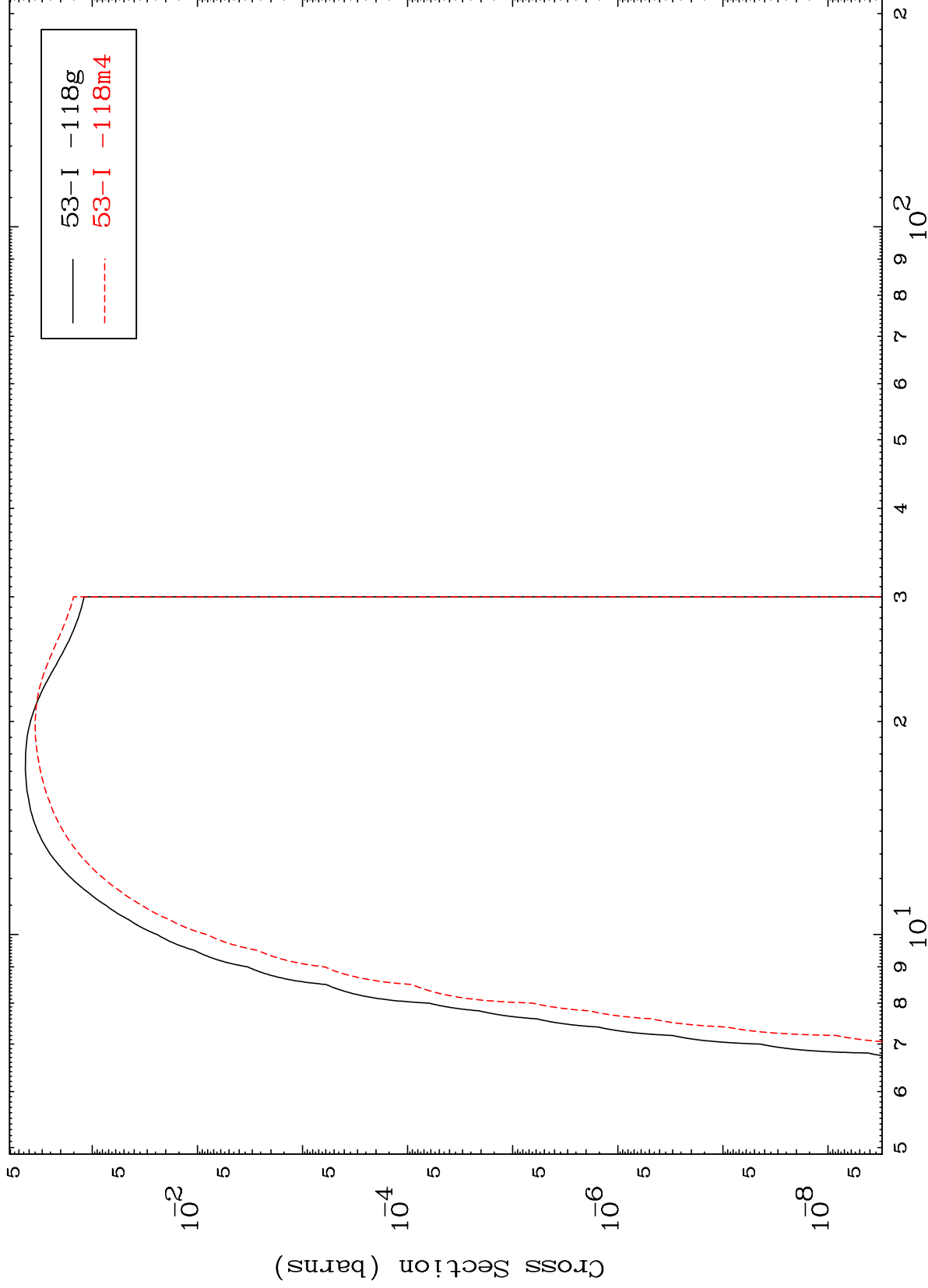

141

Incident Energy (MeV)

54-Xe-119

MAT 5410

(n,2n) p

54-Xe-119

Radionuclide Production Cross Section

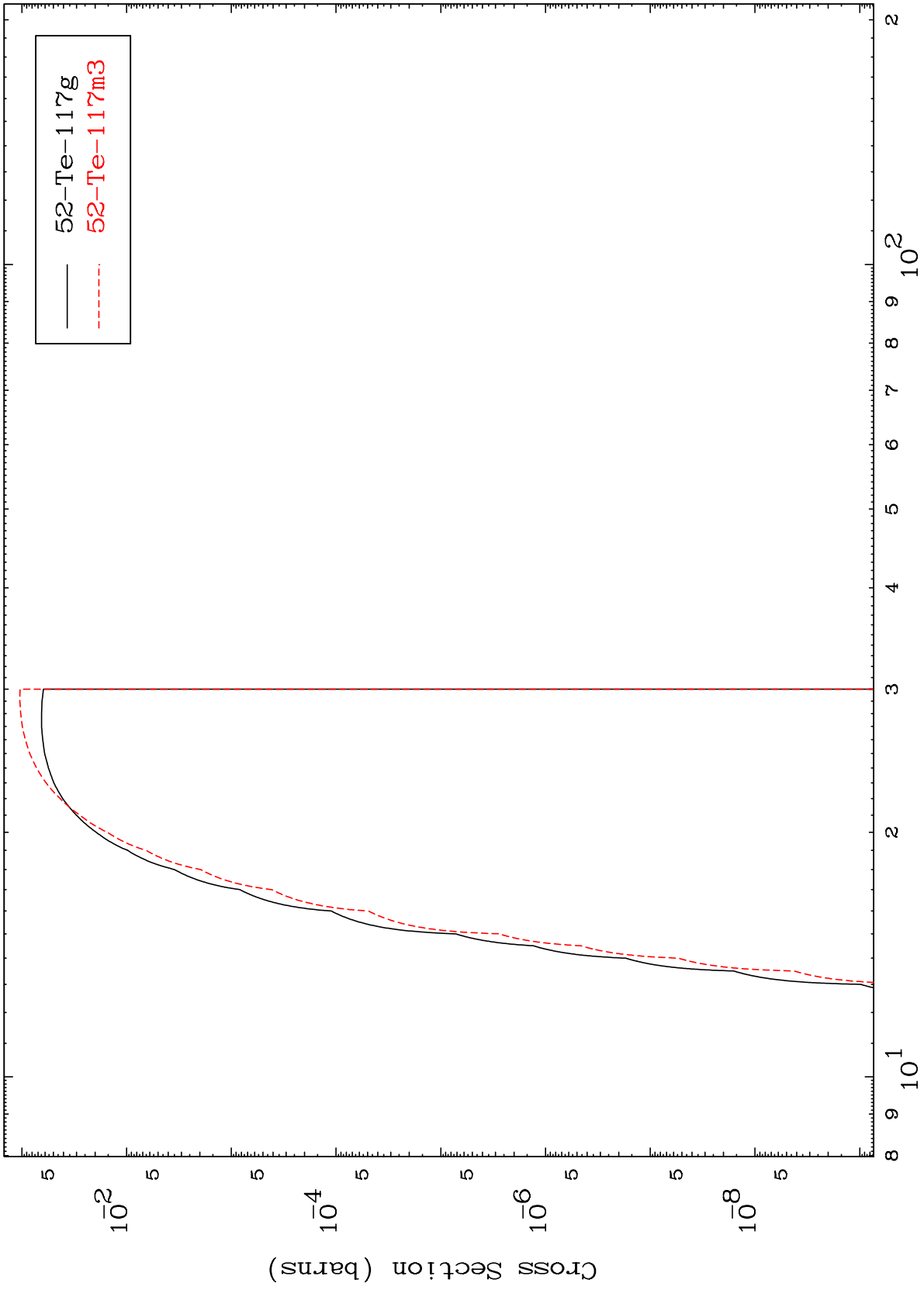

142

Incident Energy (MeV)

54-Xe-119

MAT 5410

Radionuclide Production Cross Section
(n,d)

54-Xe-119

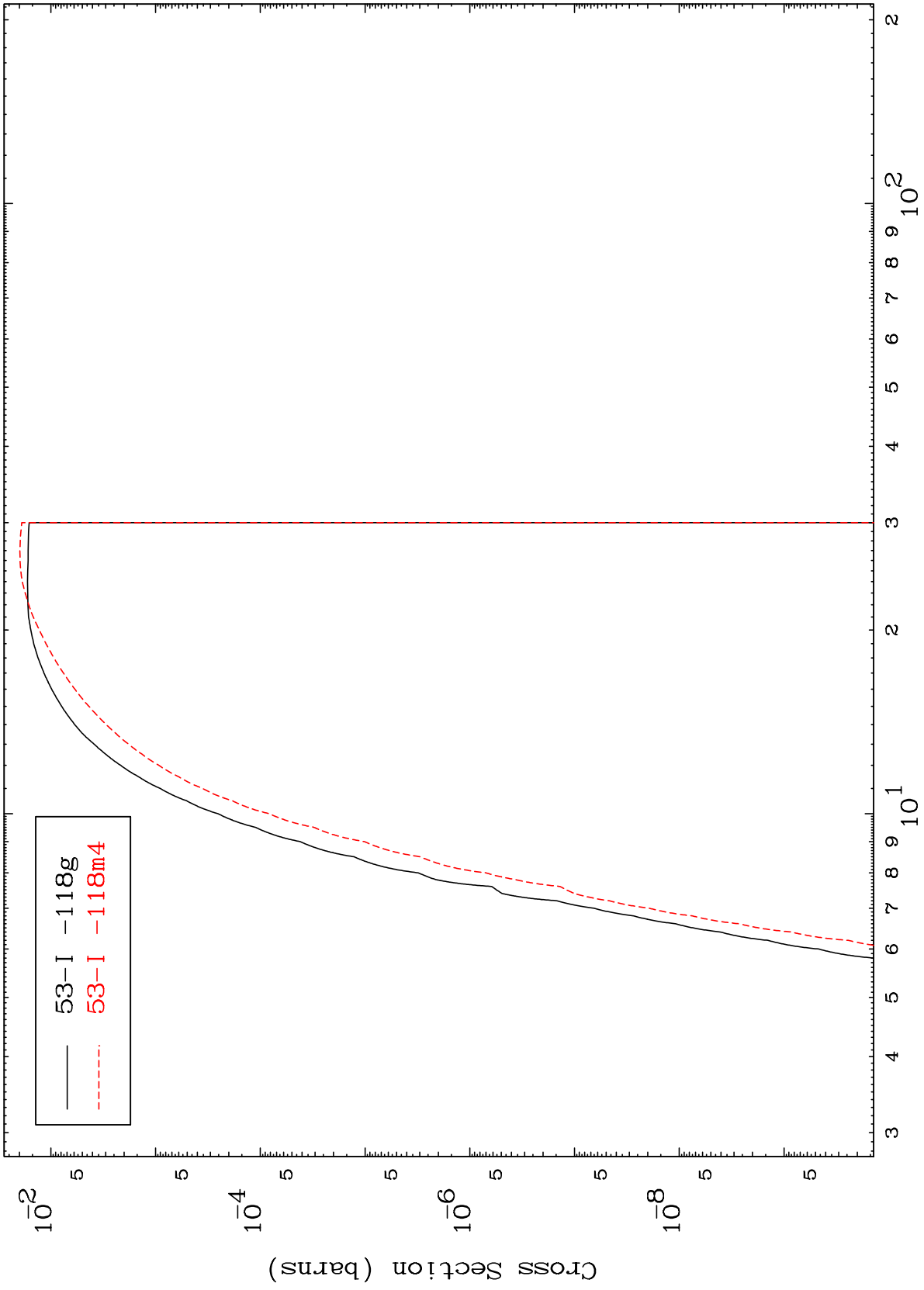

53-I -118g
53-I -118m4

143

Incident Energy (MeV)

54-Xe-119

MAT 5410

(n, He-3)

54-Xe-119

Radionuclide Production Cross Section

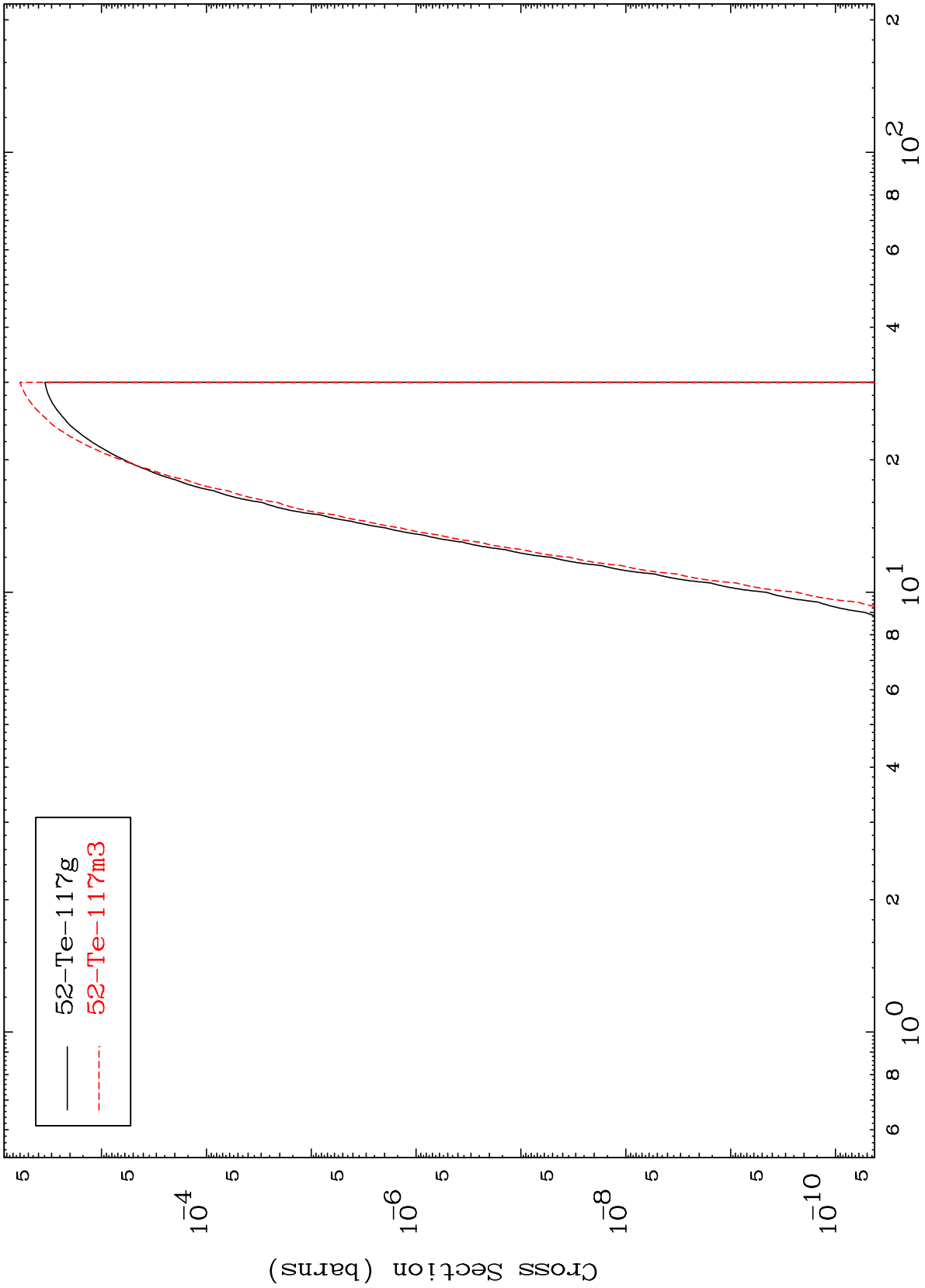

52-Te-117g
52-Te-117m3

144

Incident Energy (MeV)

54-Xe-119

MAT 5410

(n,p) d

54-Xe-119

Radionuclide Production Cross Section

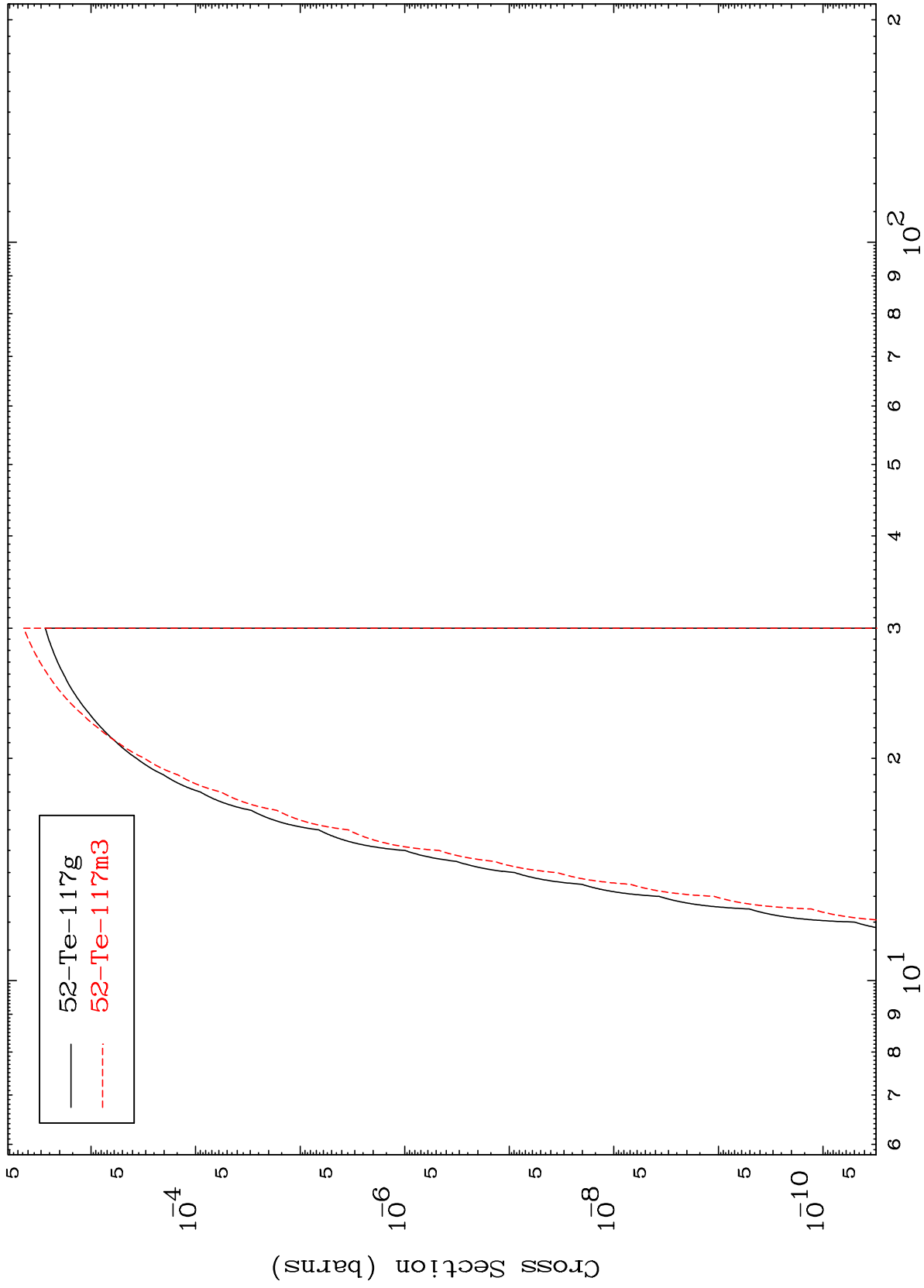

145

Incident Energy (MeV)

54-Xe-119