

CM237 NEUTRON ACER TENDL-2019 LIBRARY; T=293.16K

Principal cross sections

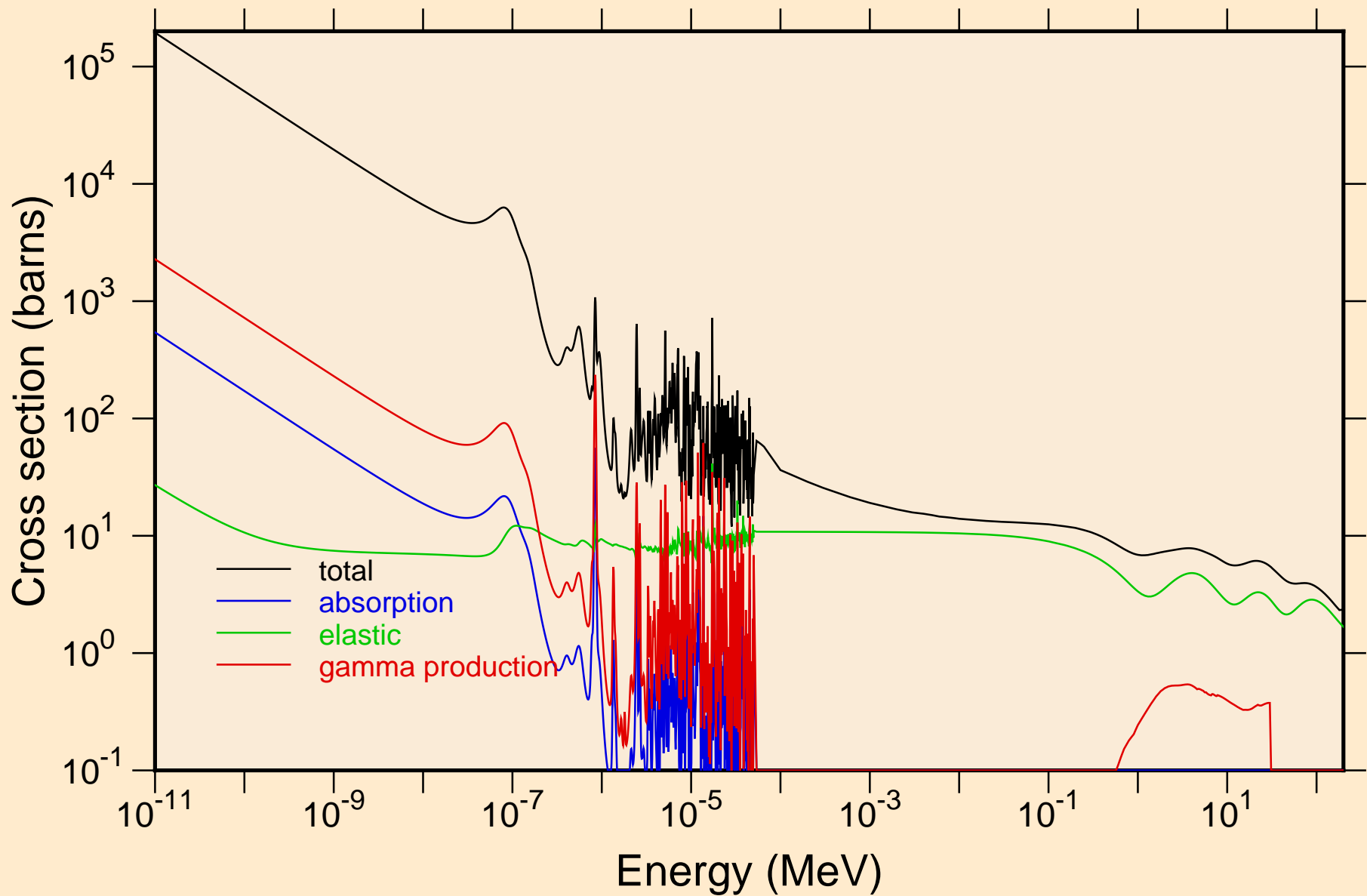

CM237 NEUTRON ACER TENDL-2019 LIBRARY; T=293.16K
resonance total cross section

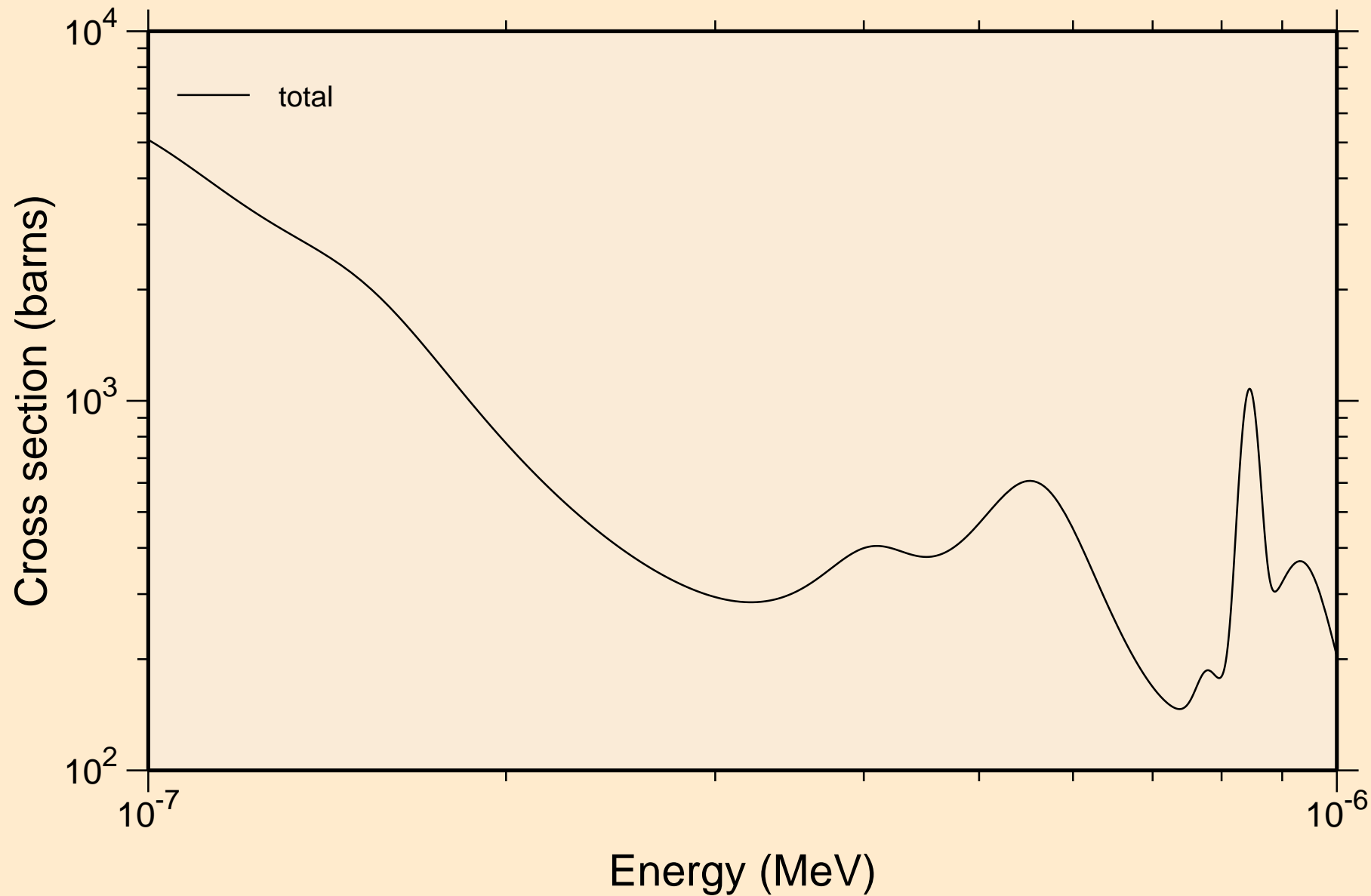

CM237 NEUTRON ACER TENDL-2019 LIBRARY; T=293.16K
resonance total cross section

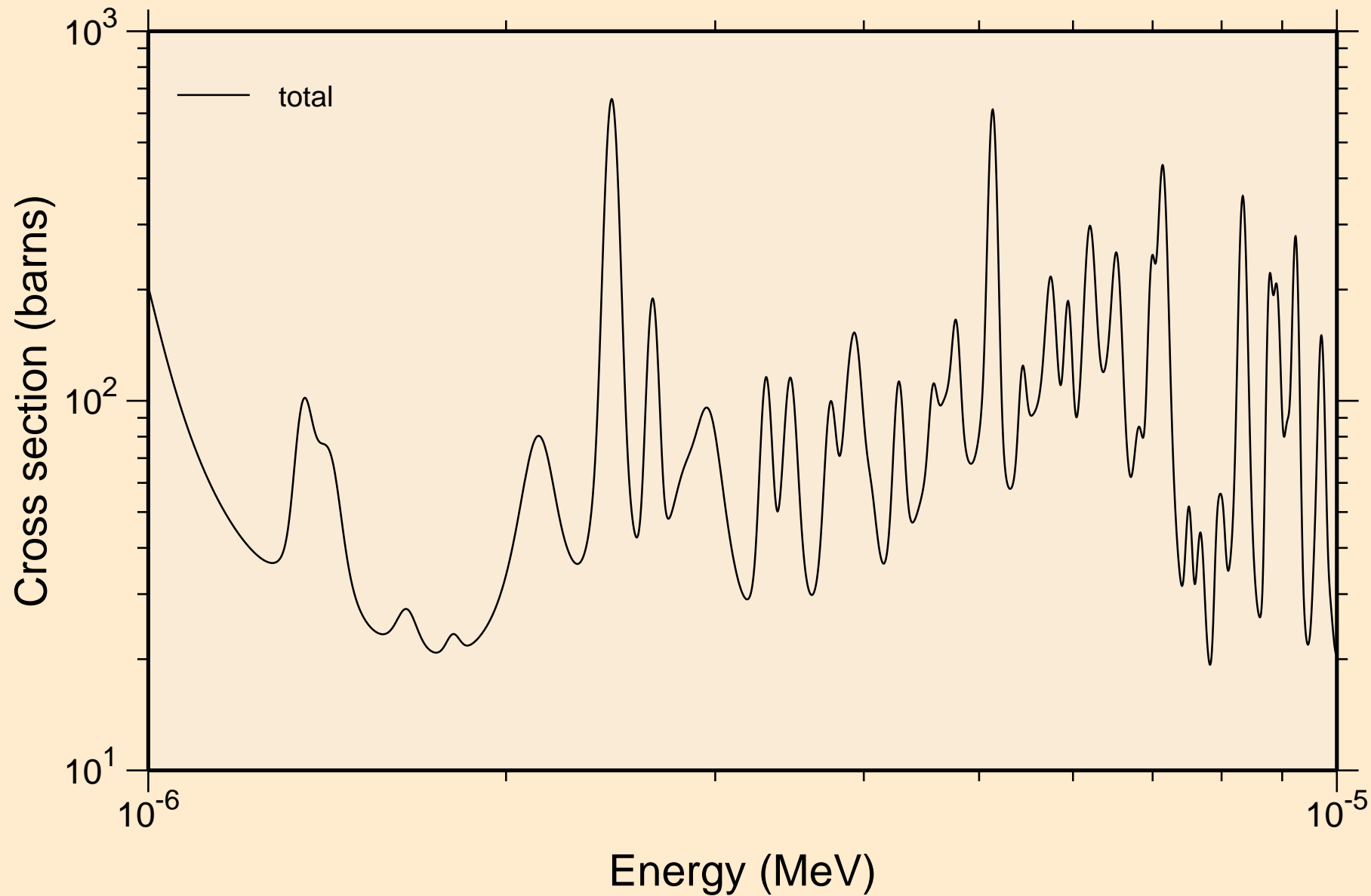

CM237 NEUTRON ACER TENDL-2019 LIBRARY; T=293.16K
resonance total cross section

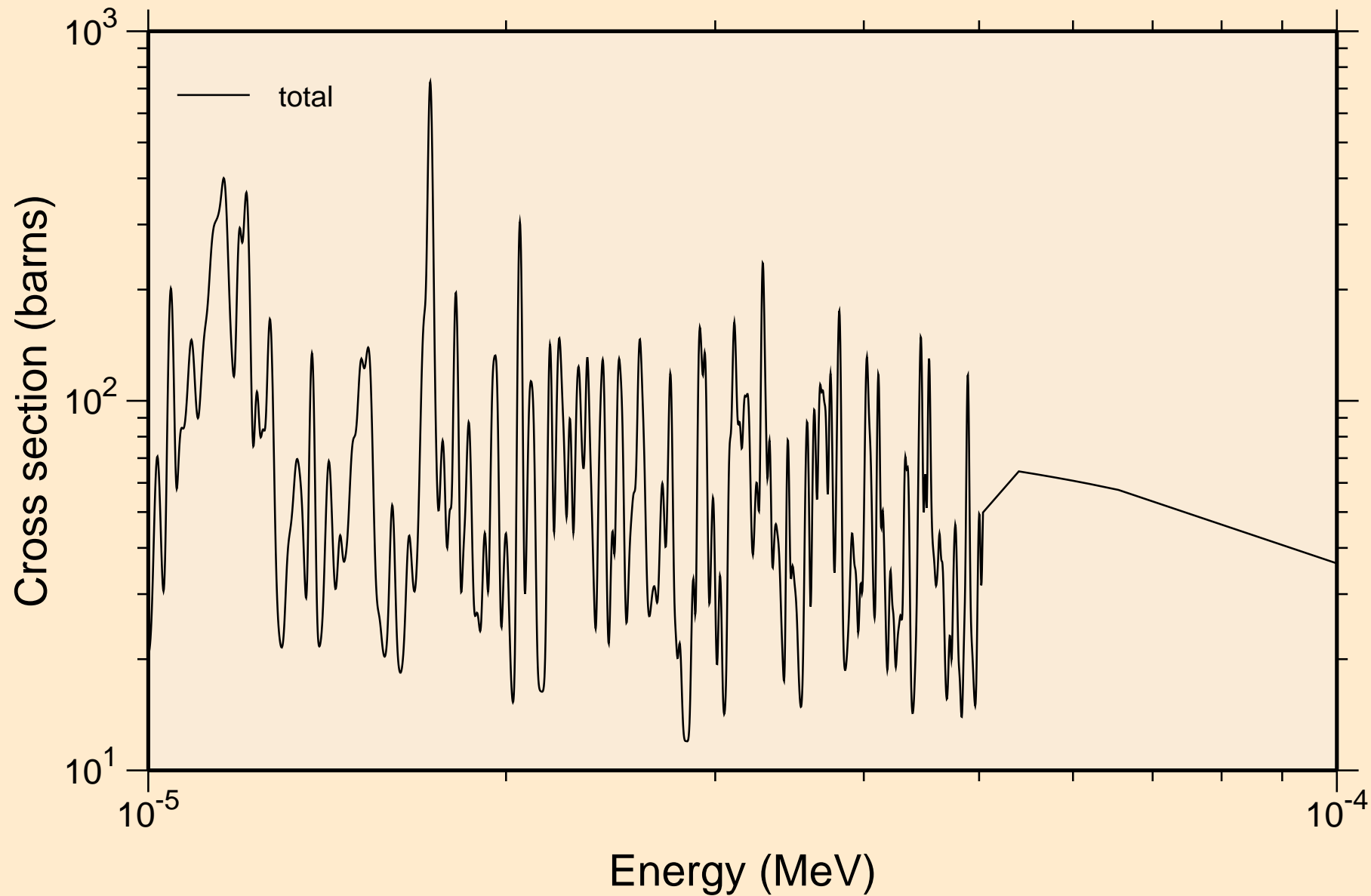

CM237 NEUTRON ACER TENDL-2019 LIBRARY; T=293.16K
resonance total cross section

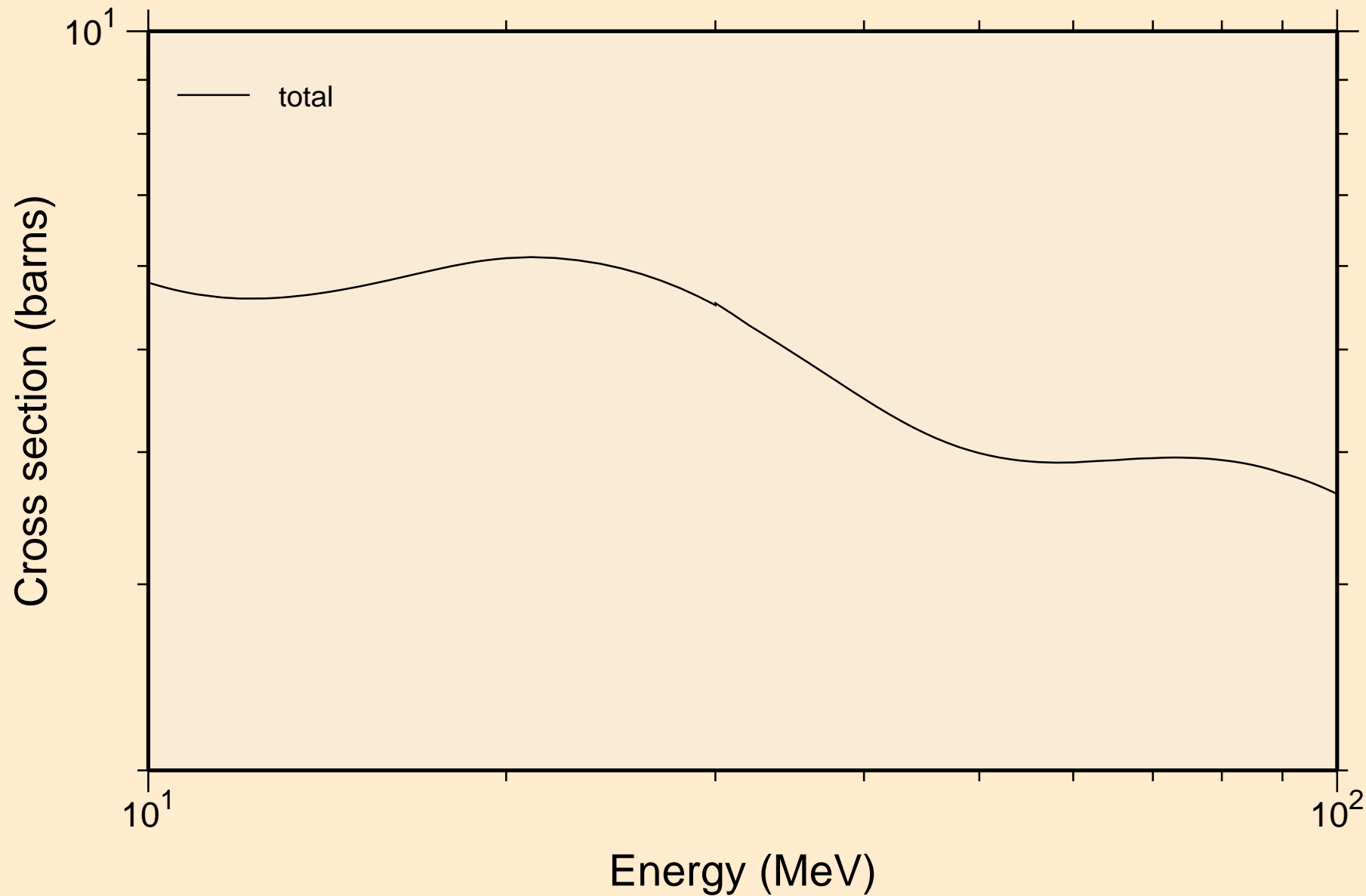

CM237 NEUTRON ACER TENDL-2019 LIBRARY; T=293.16K
resonance absorption cross sections

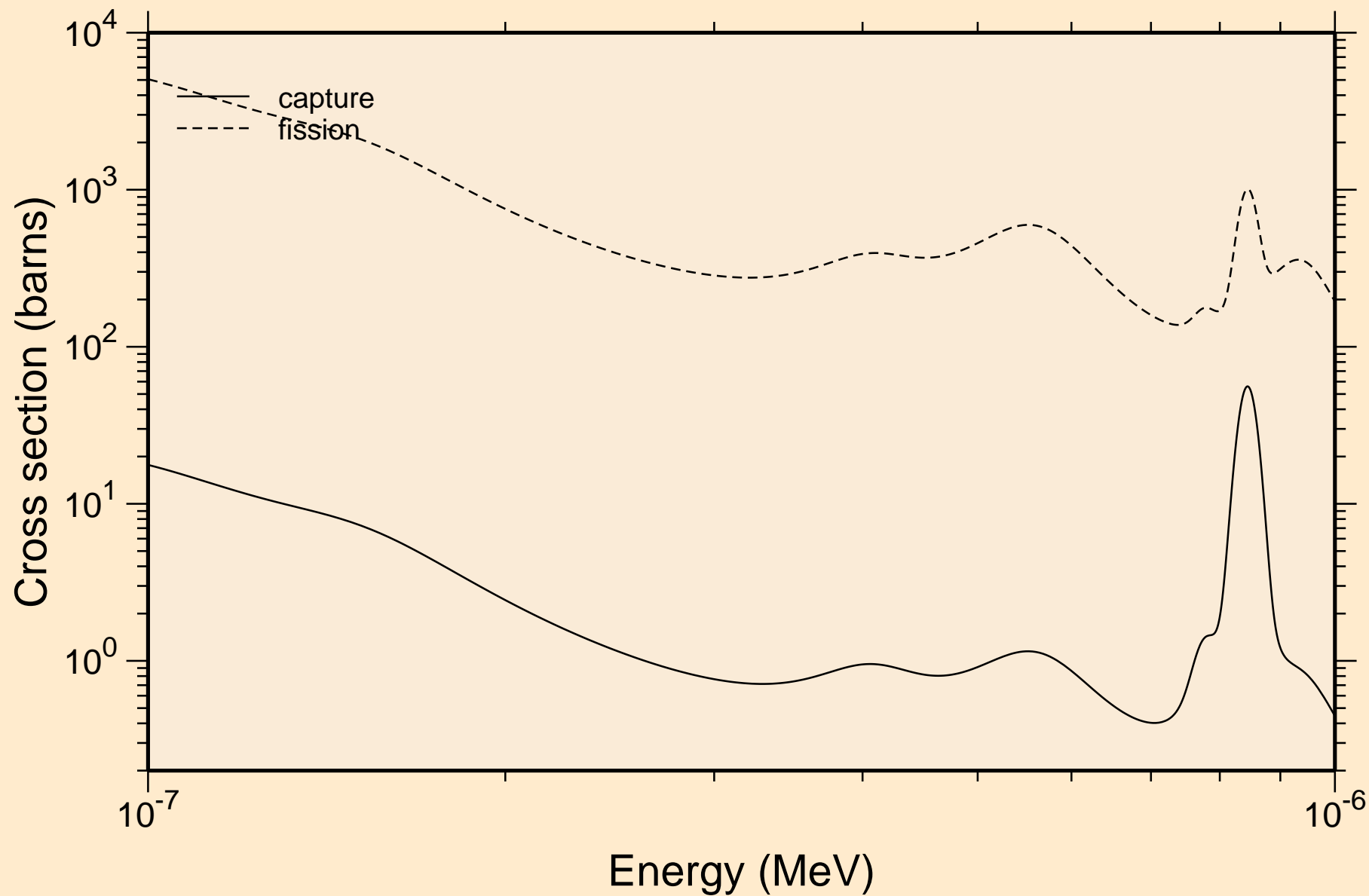

CM237 NEUTRON ACER TENDL-2019 LIBRARY; T=293.16K
resonance absorption cross sections

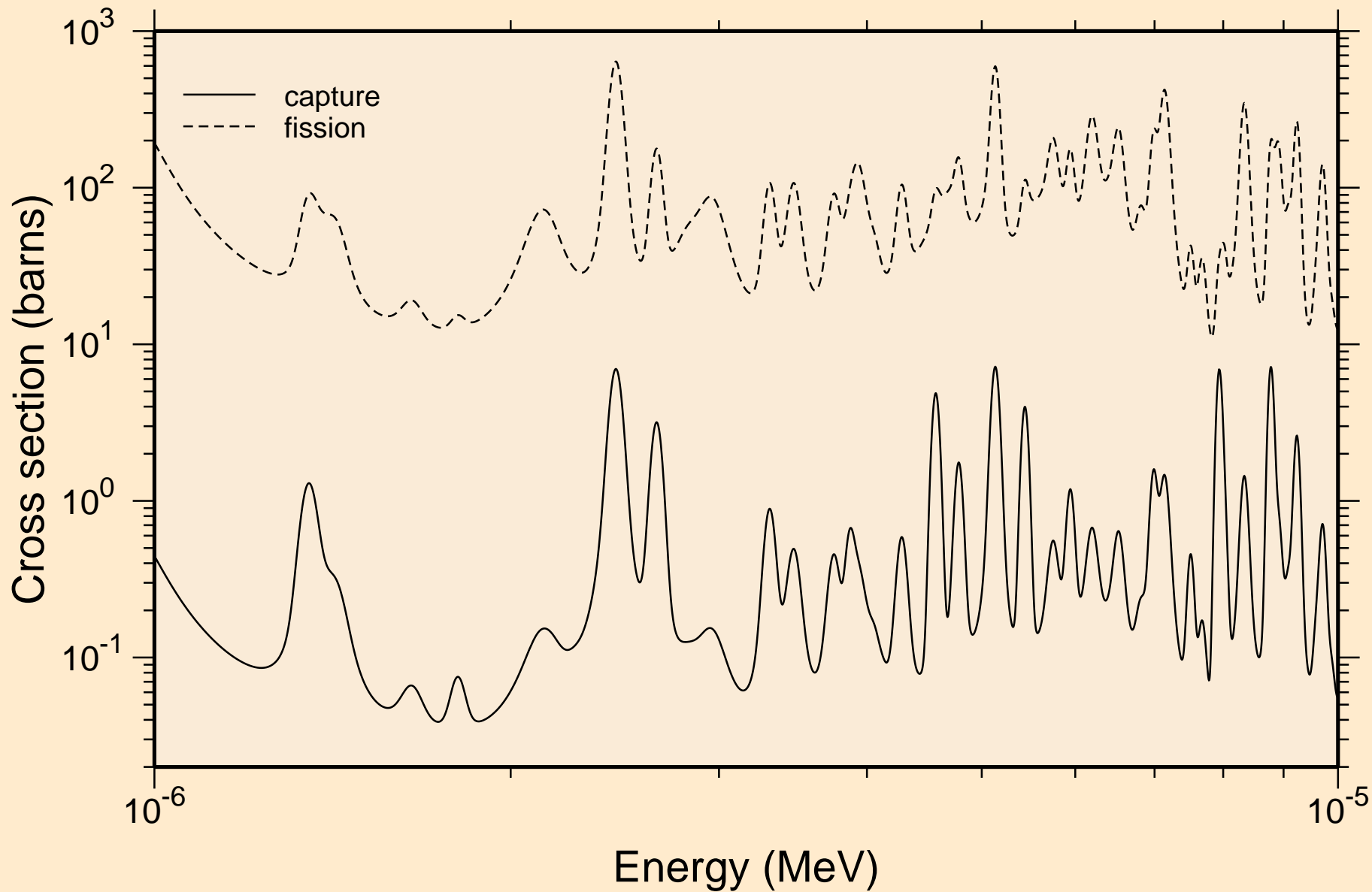

CM237 NEUTRON ACER TENDL-2019 LIBRARY; T=293.16K
resonance absorption cross sections

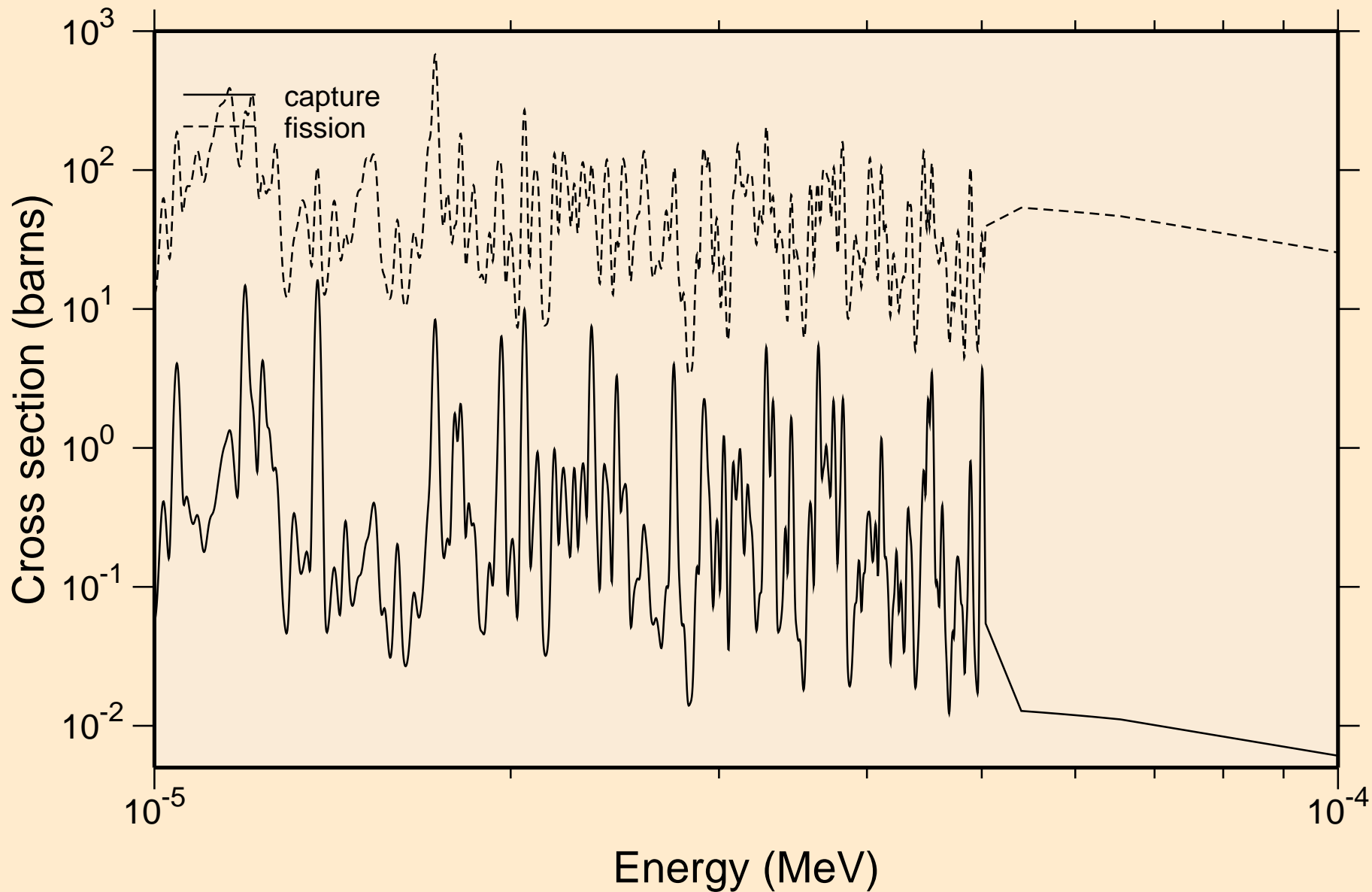

CM237 NEUTRON ACER TENDL-2019 LIBRARY; T=293.16K
resonance absorption cross sections

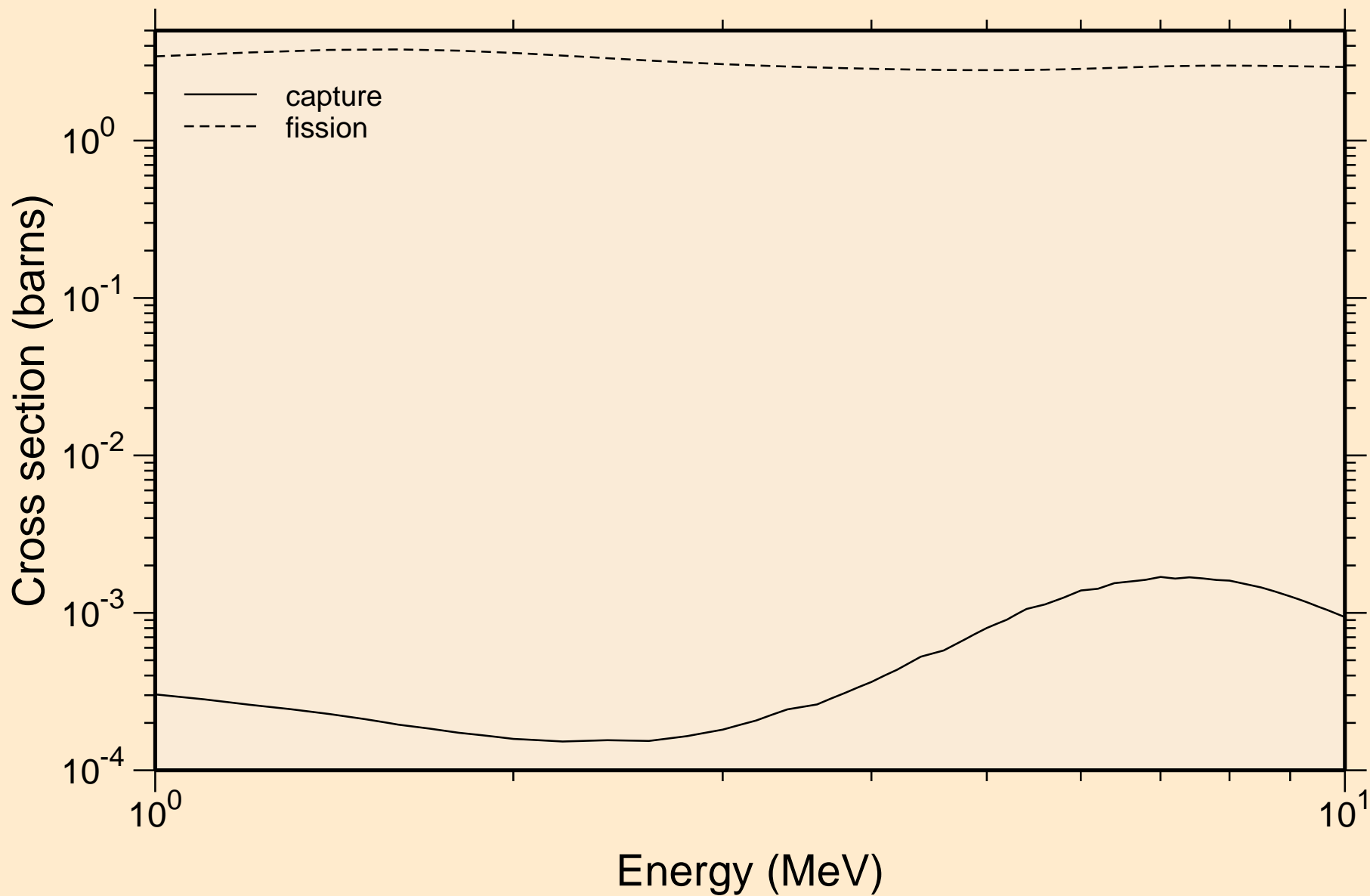

CM237 NEUTRON ACER TENDL-2019 LIBRARY; T=293.16K
Heating

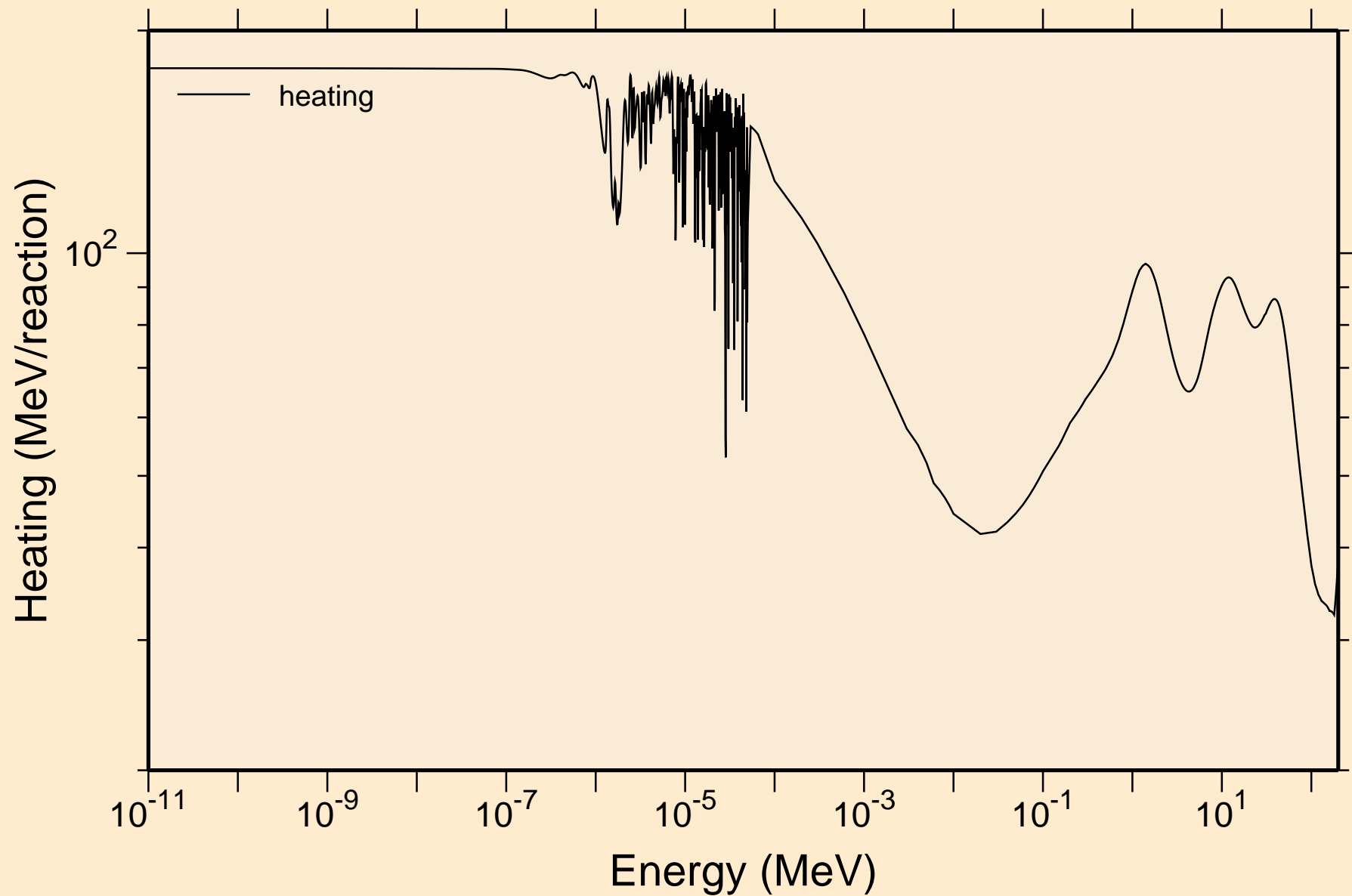

CM237 NEUTRON ACER TENDL-2019 LIBRARY; T=293.16K Damage

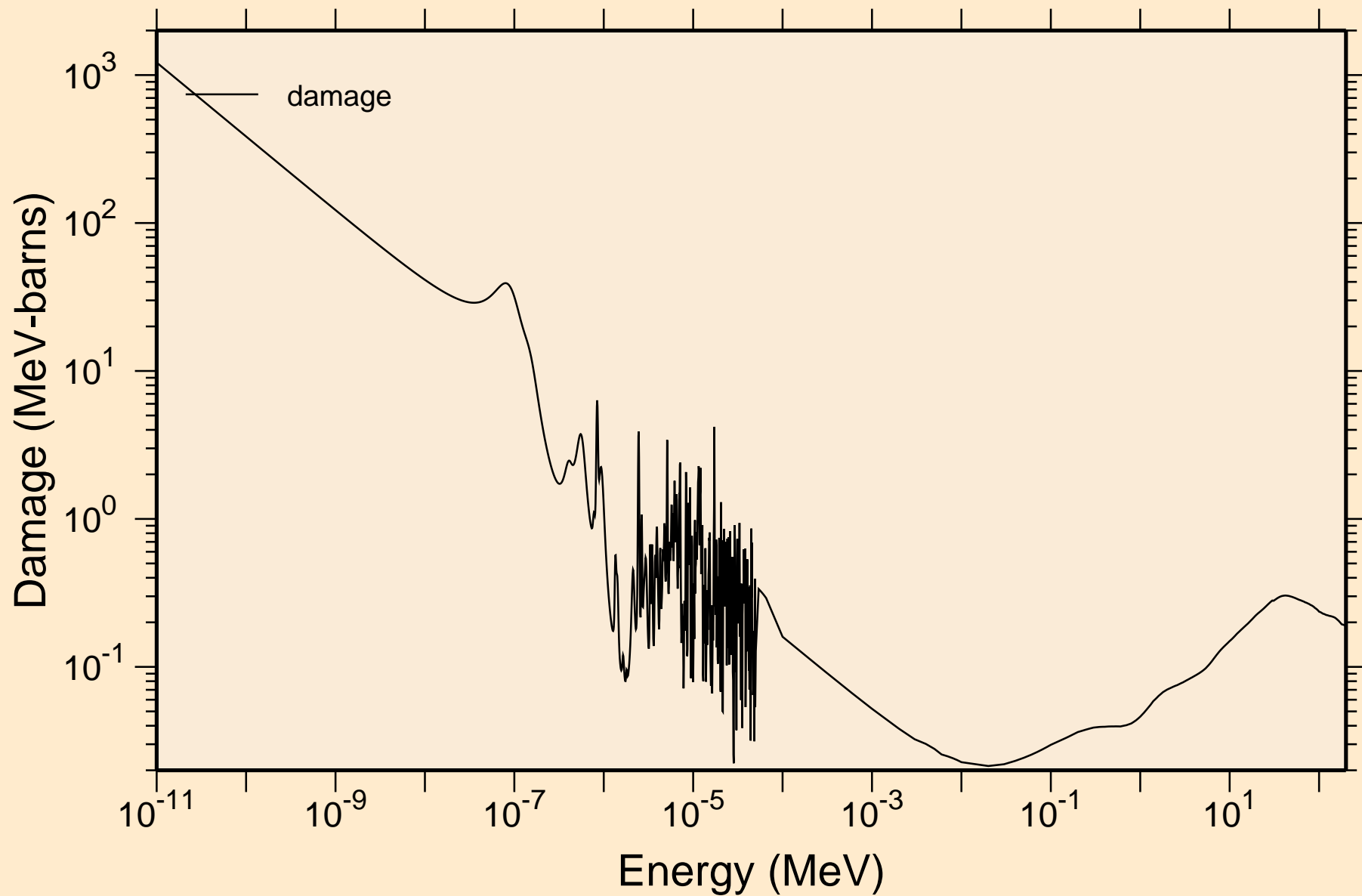

CM237 NEUTRON ACER TENDL-2019 LIBRARY; T=293.16K
Non-threshold reactions

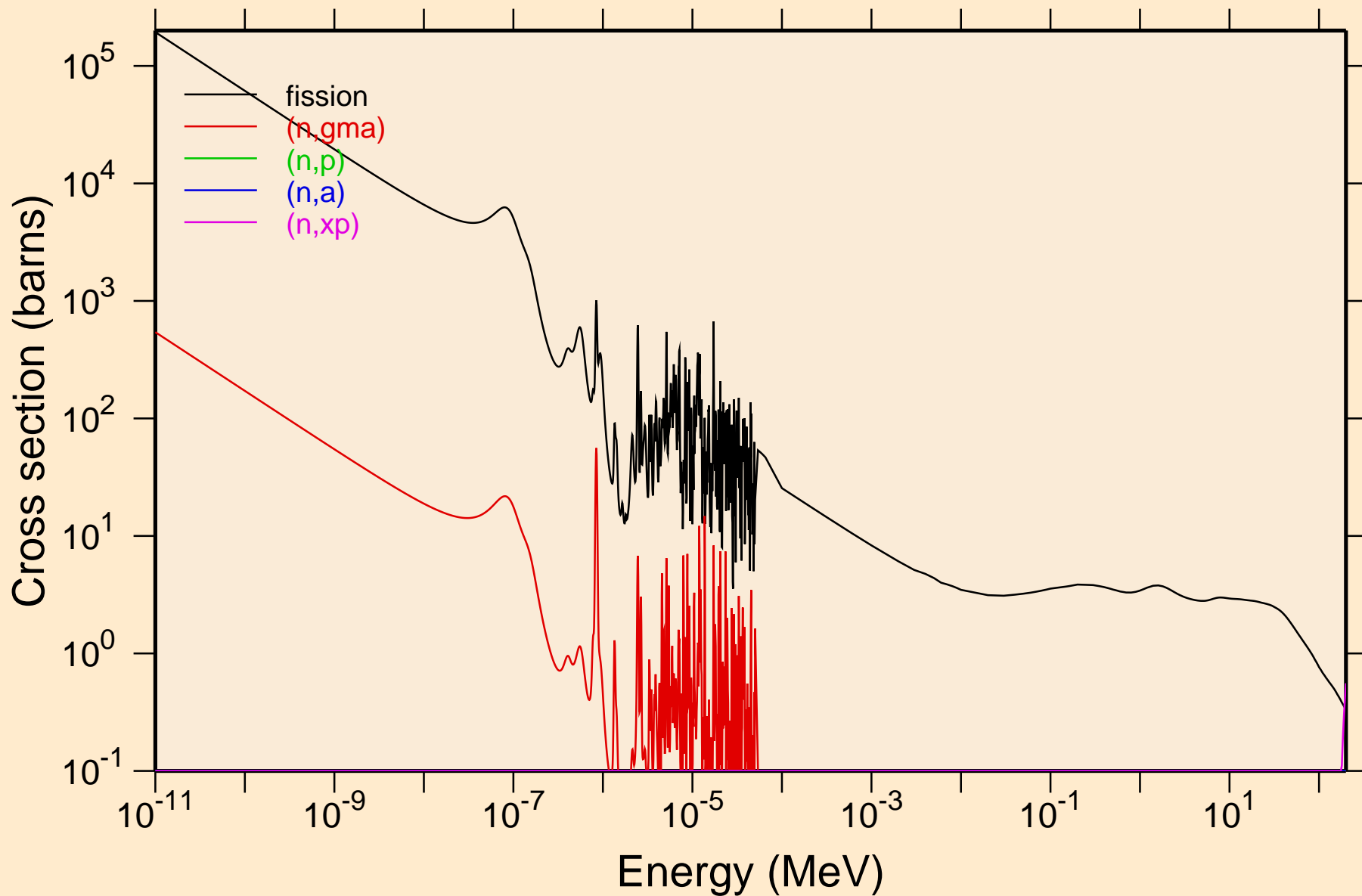

CM237 NEUTRON ACER TENDL-2019 LIBRARY; T=293.16K
Non-threshold reactions

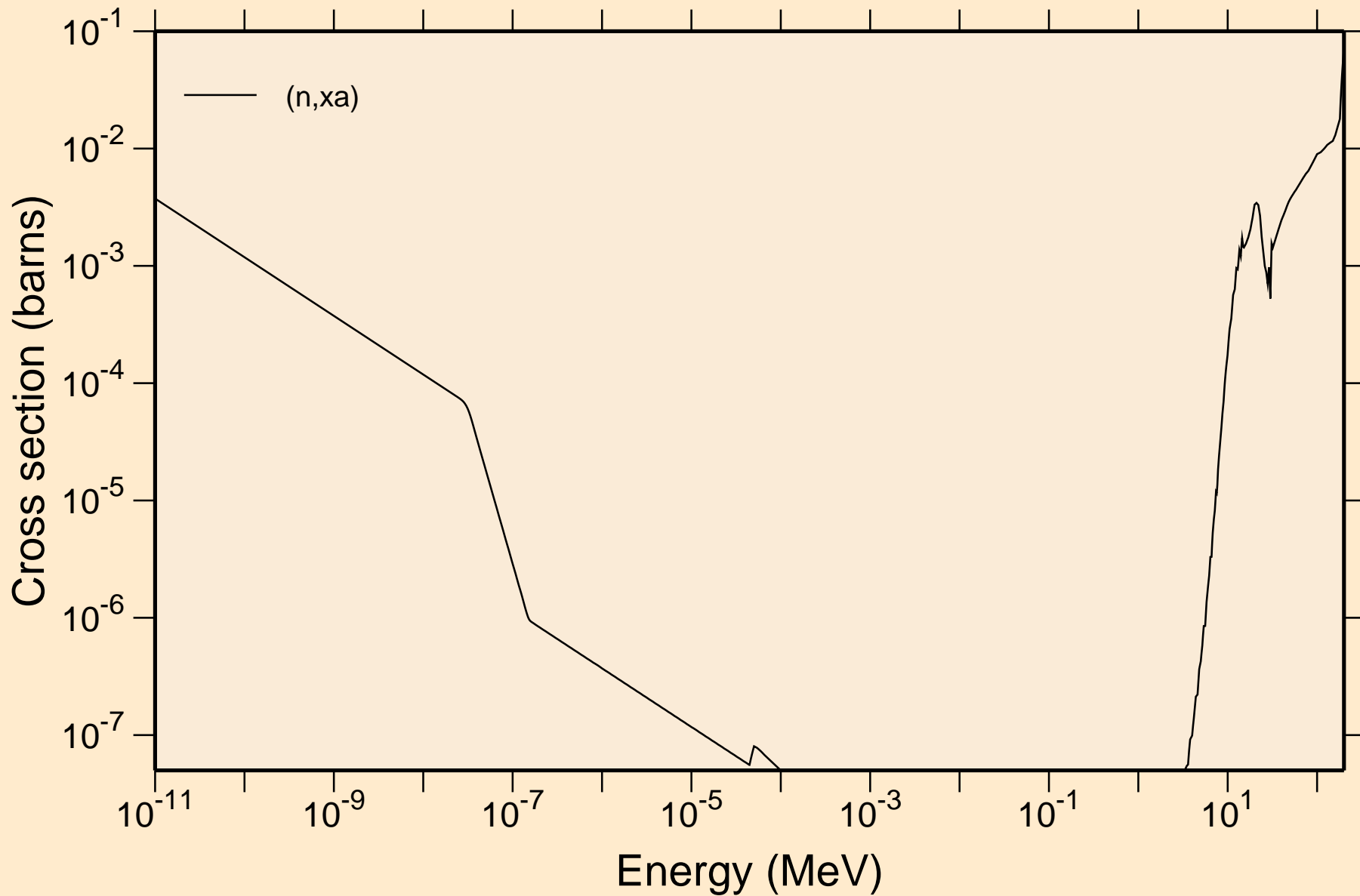

CM237 NEUTRON ACER TENDL-2019 LIBRARY; T=293.16K

Principal cross sections

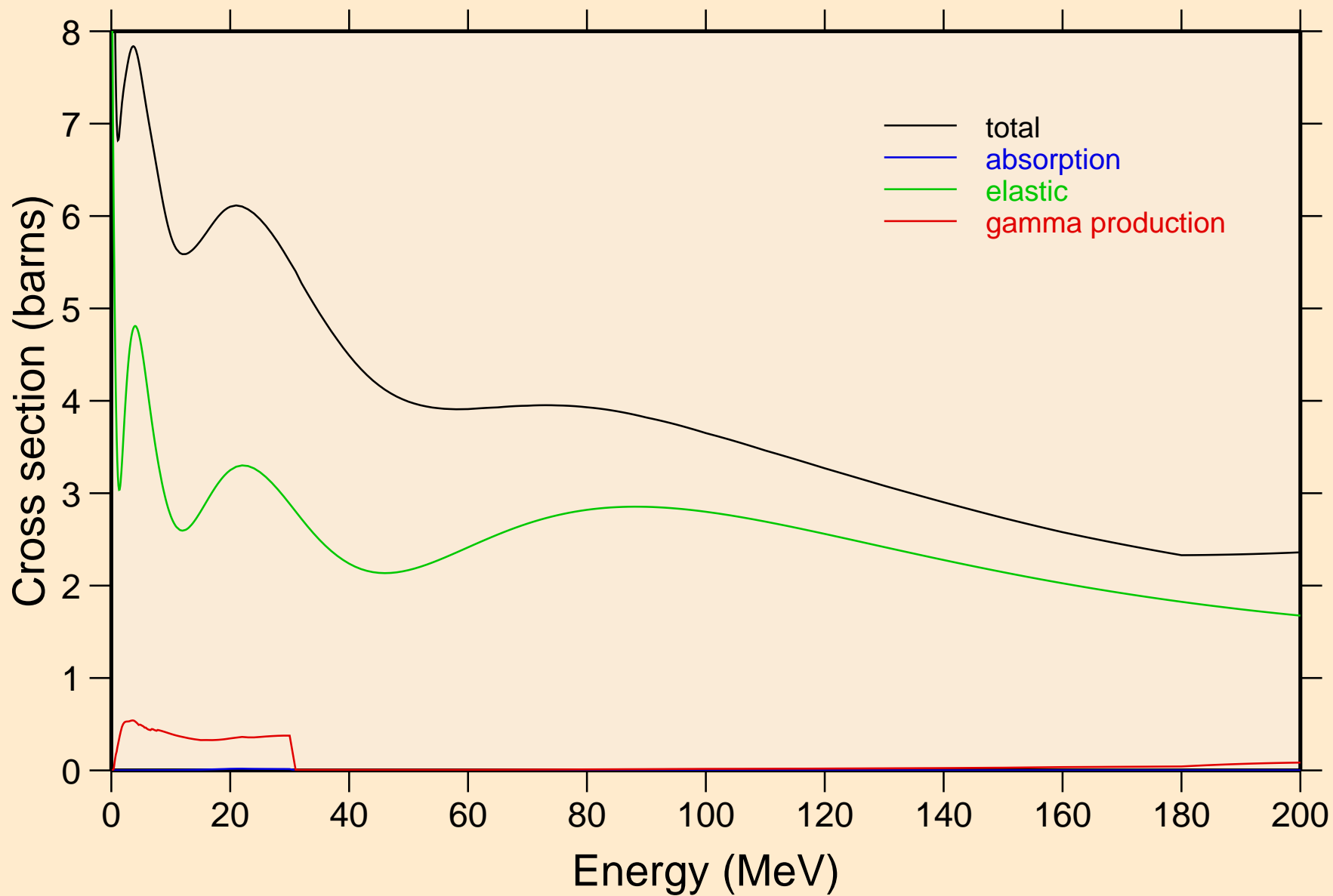

CM237 NEUTRON ACER TENDL-2019 LIBRARY; T=293.16K
Heating

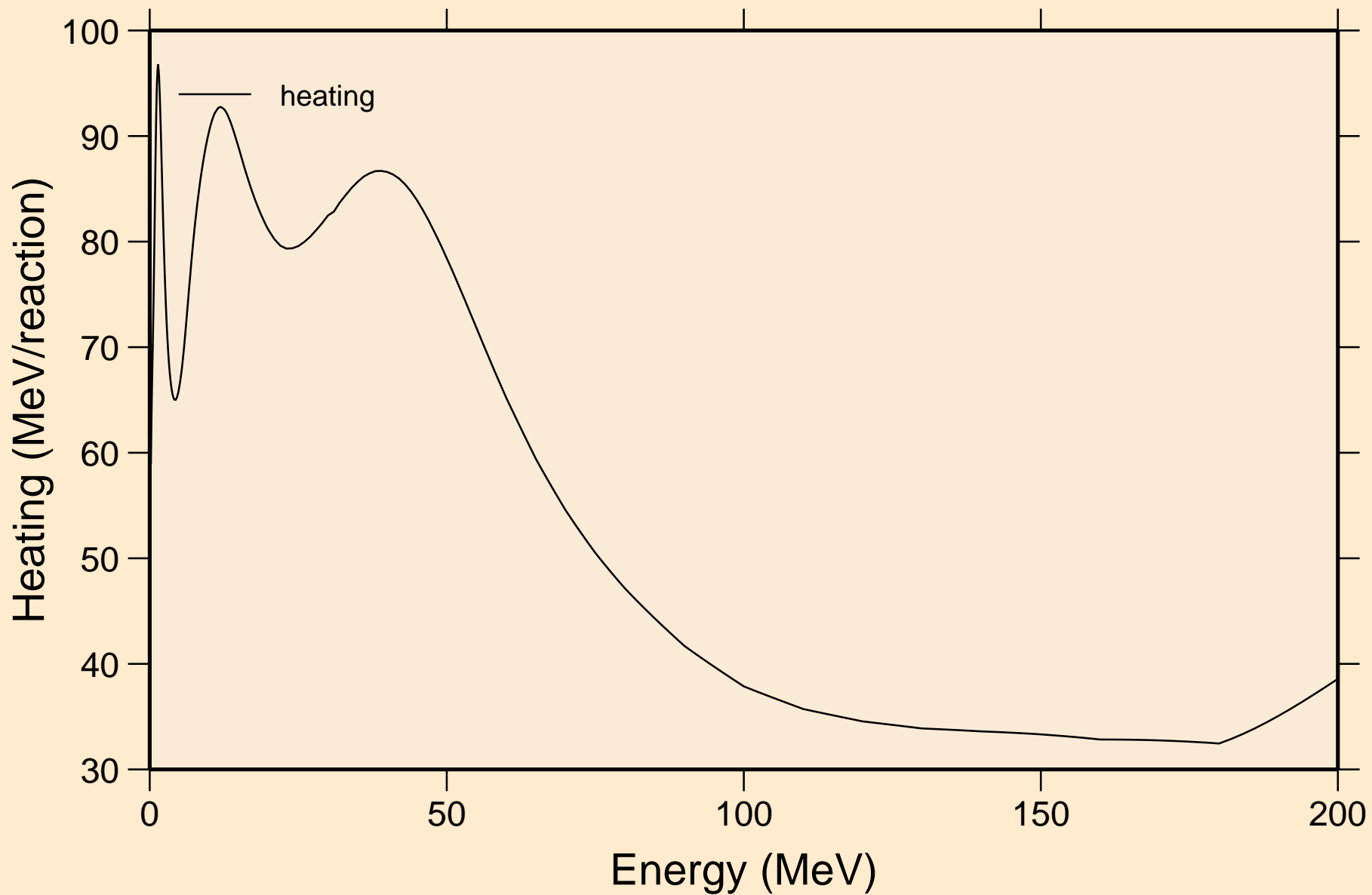

CM237 NEUTRON ACER TENDL-2019 LIBRARY; T=293.16K
Damage

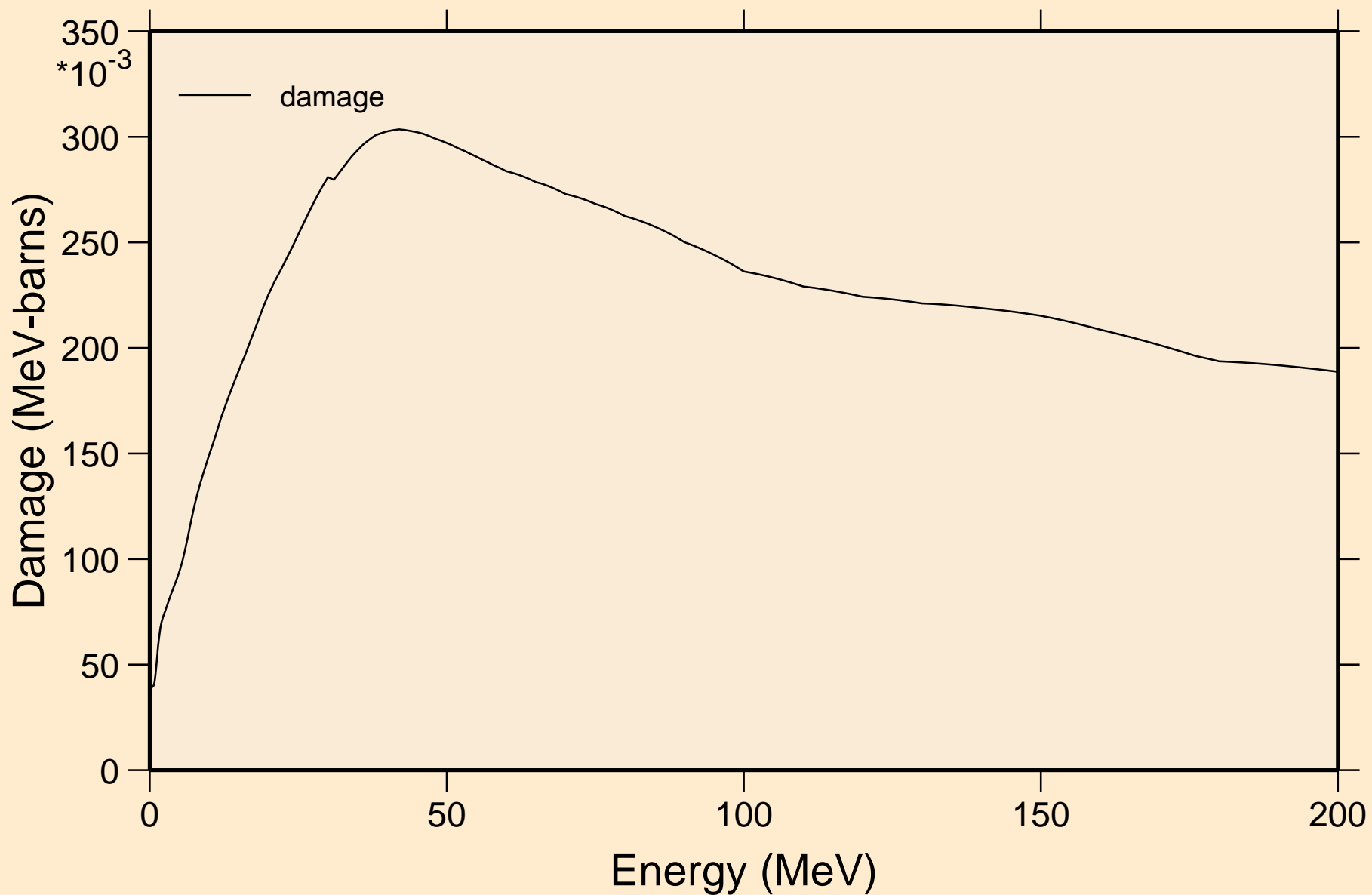

CM237 NEUTRON ACER TENDL-2019 LIBRARY; T=293.16K

Non-threshold reactions

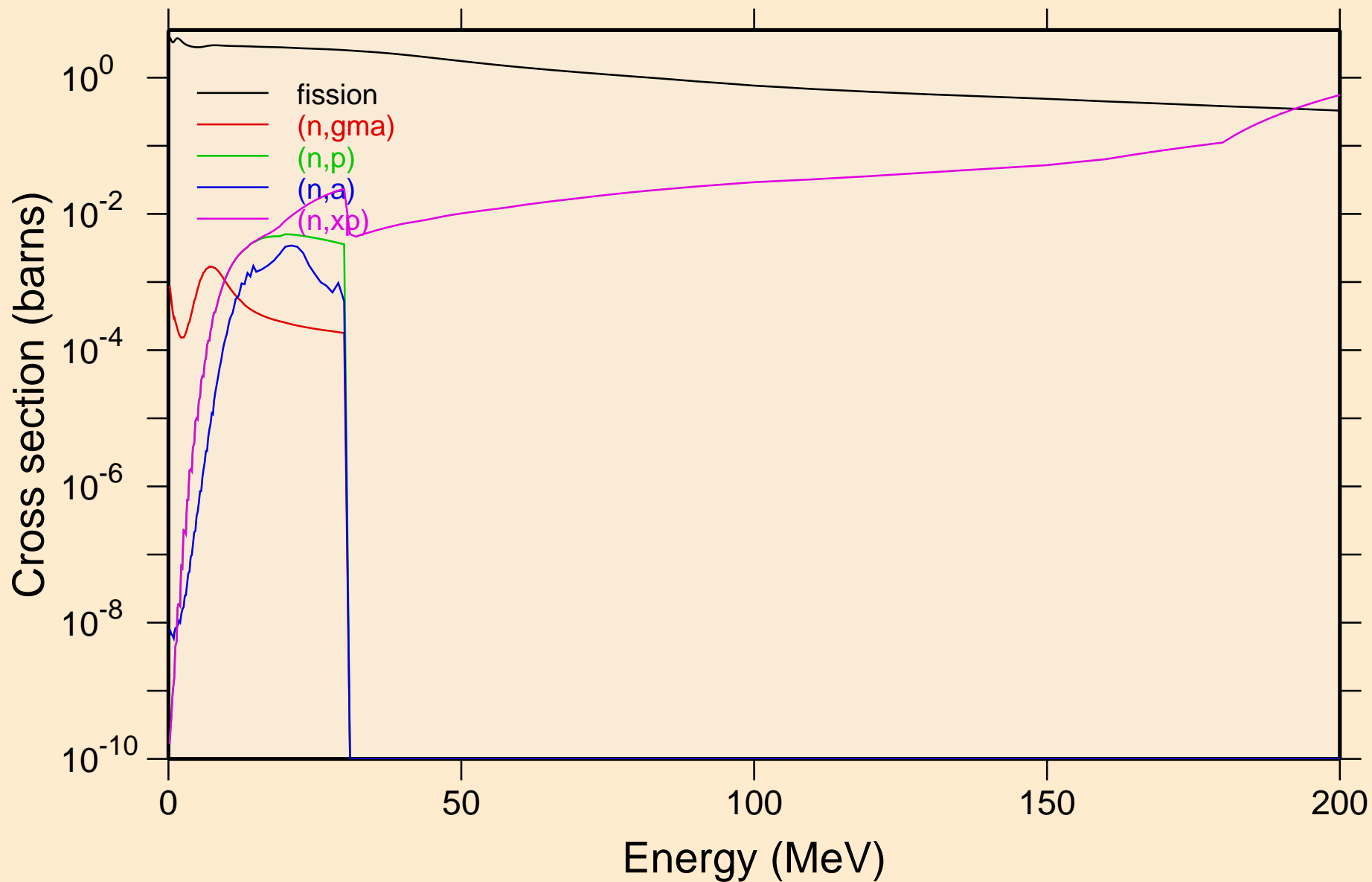

CM237 NEUTRON ACER TENDL-2019 LIBRARY; T=293.16K
Non-threshold reactions

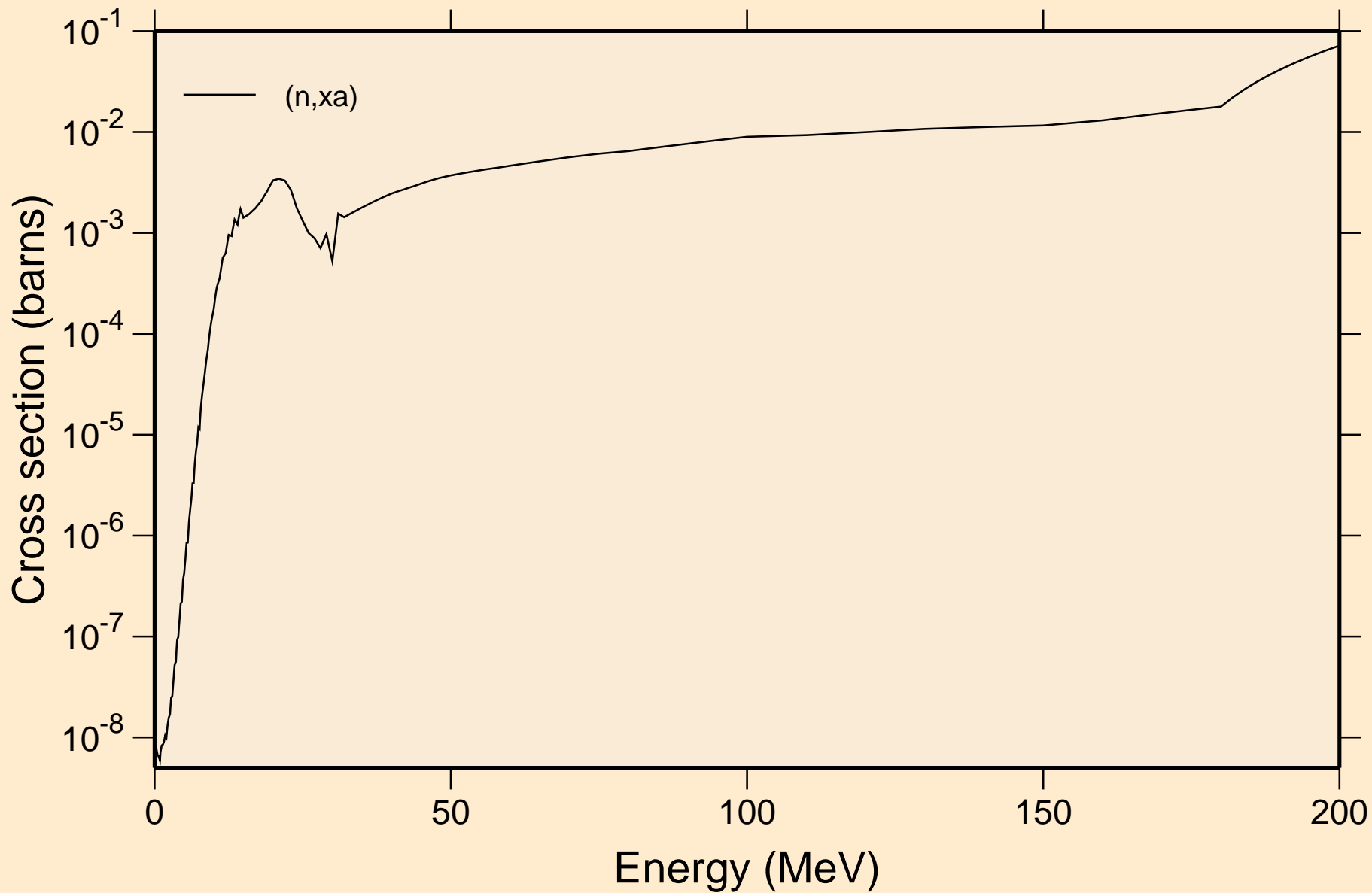

CM237 NEUTRON ACER TENDL-2019 LIBRARY; T=293.16K
Inelastic levels

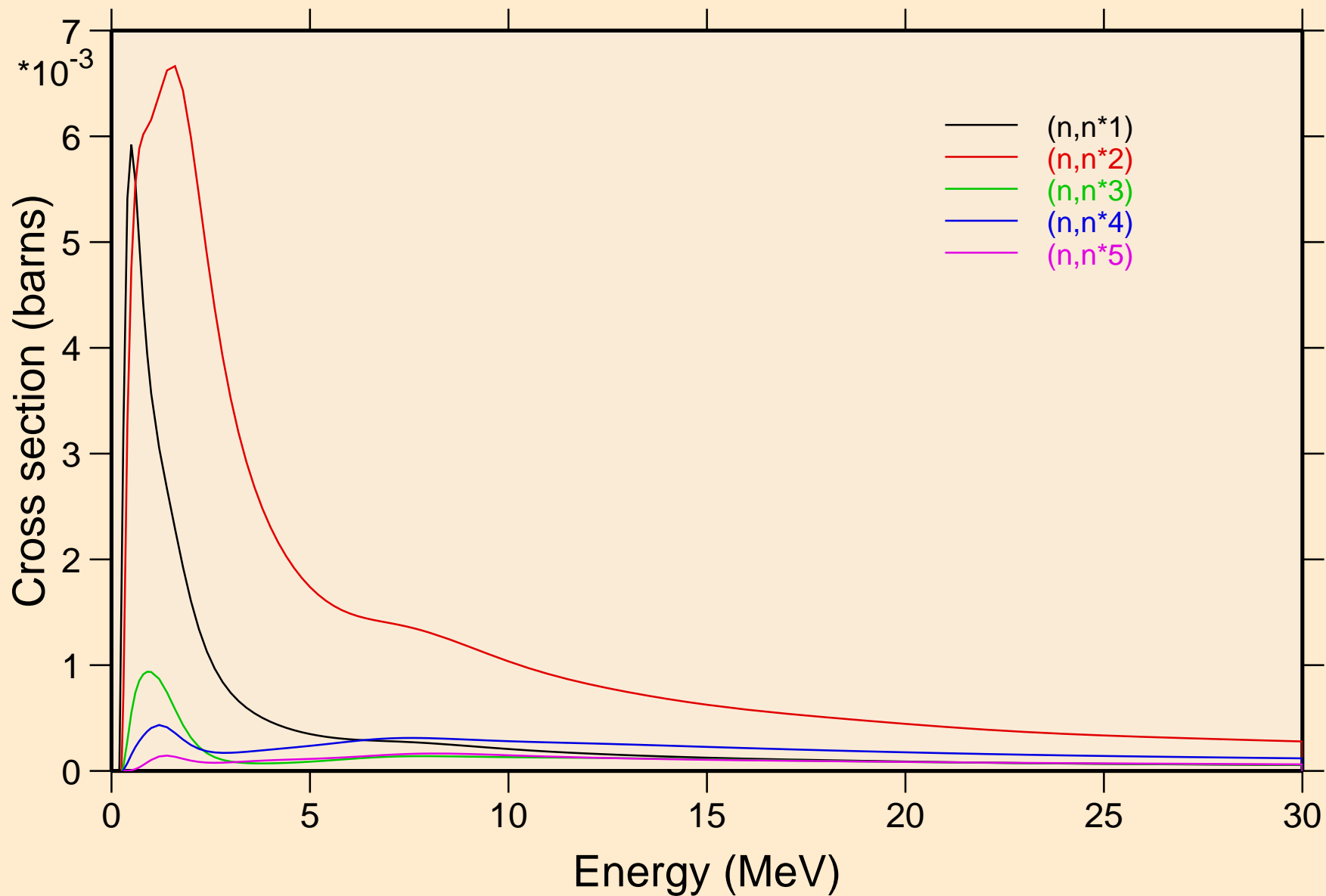

CM237 NEUTRON ACER TENDL-2019 LIBRARY; T=293.16K
Inelastic levels

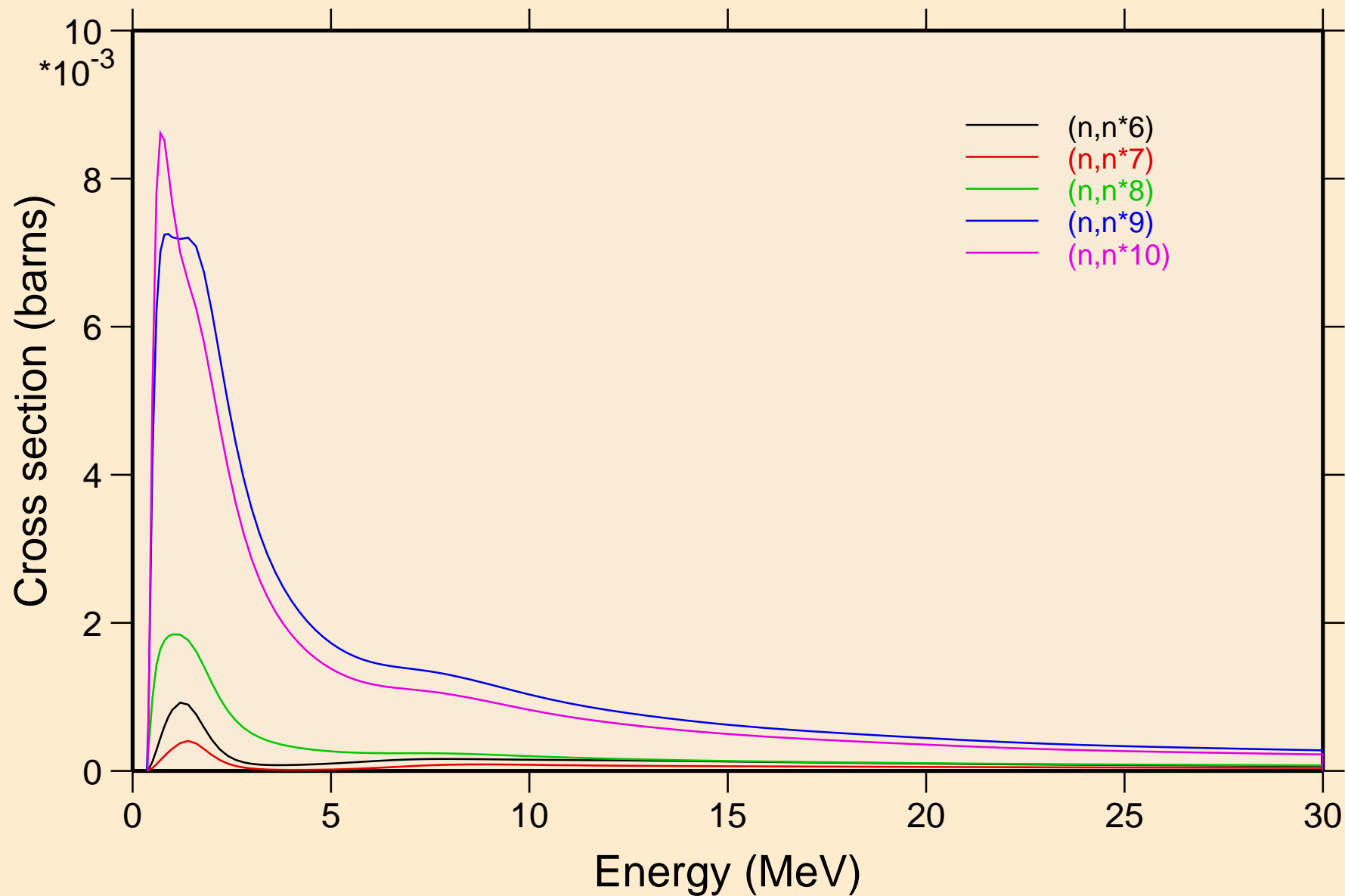

CM237 NEUTRON ACER TENDL-2019 LIBRARY; T=293.16K
Inelastic levels

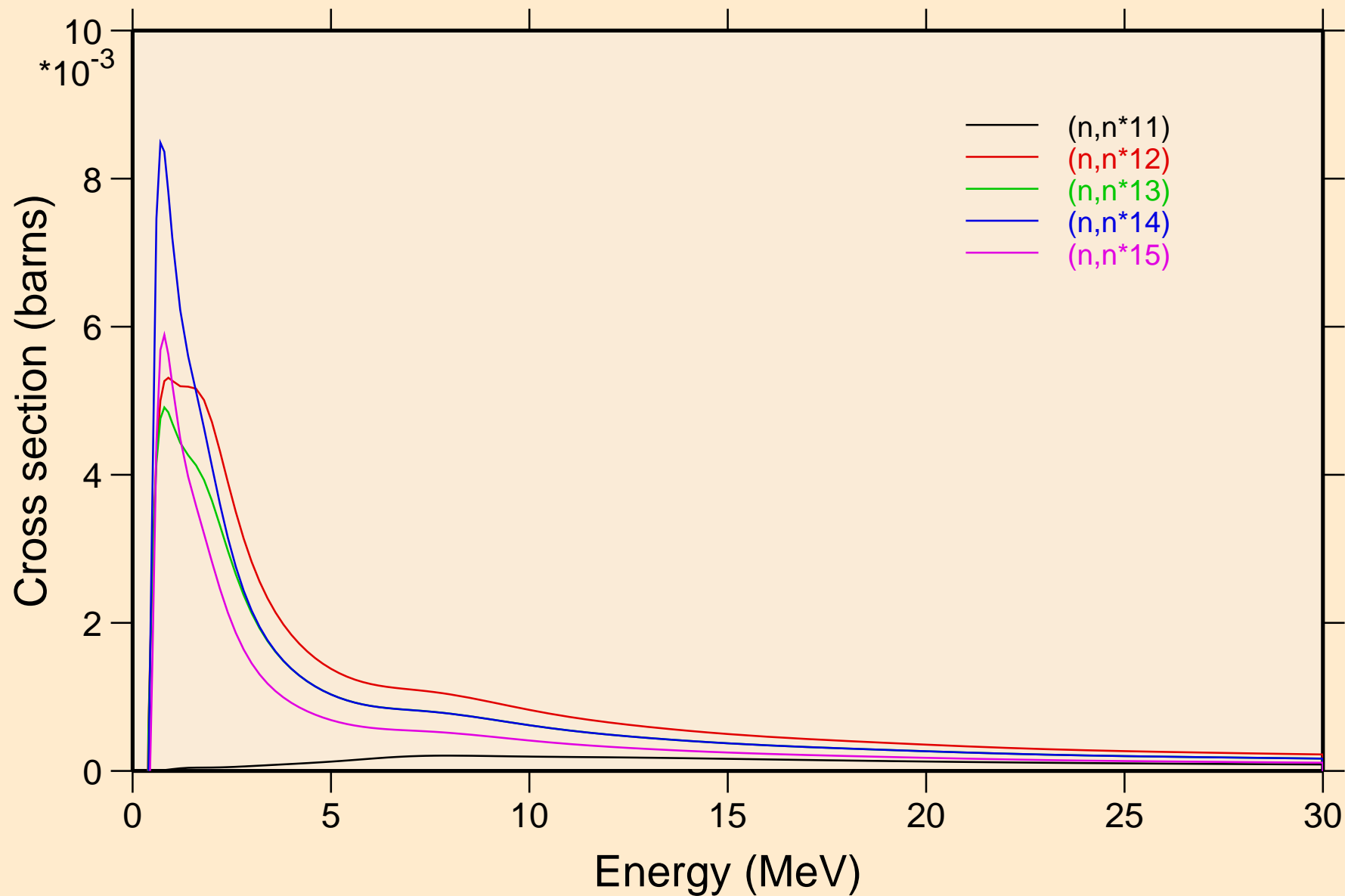

CM237 NEUTRON ACER TENDL-2019 LIBRARY; T=293.16K
Inelastic levels

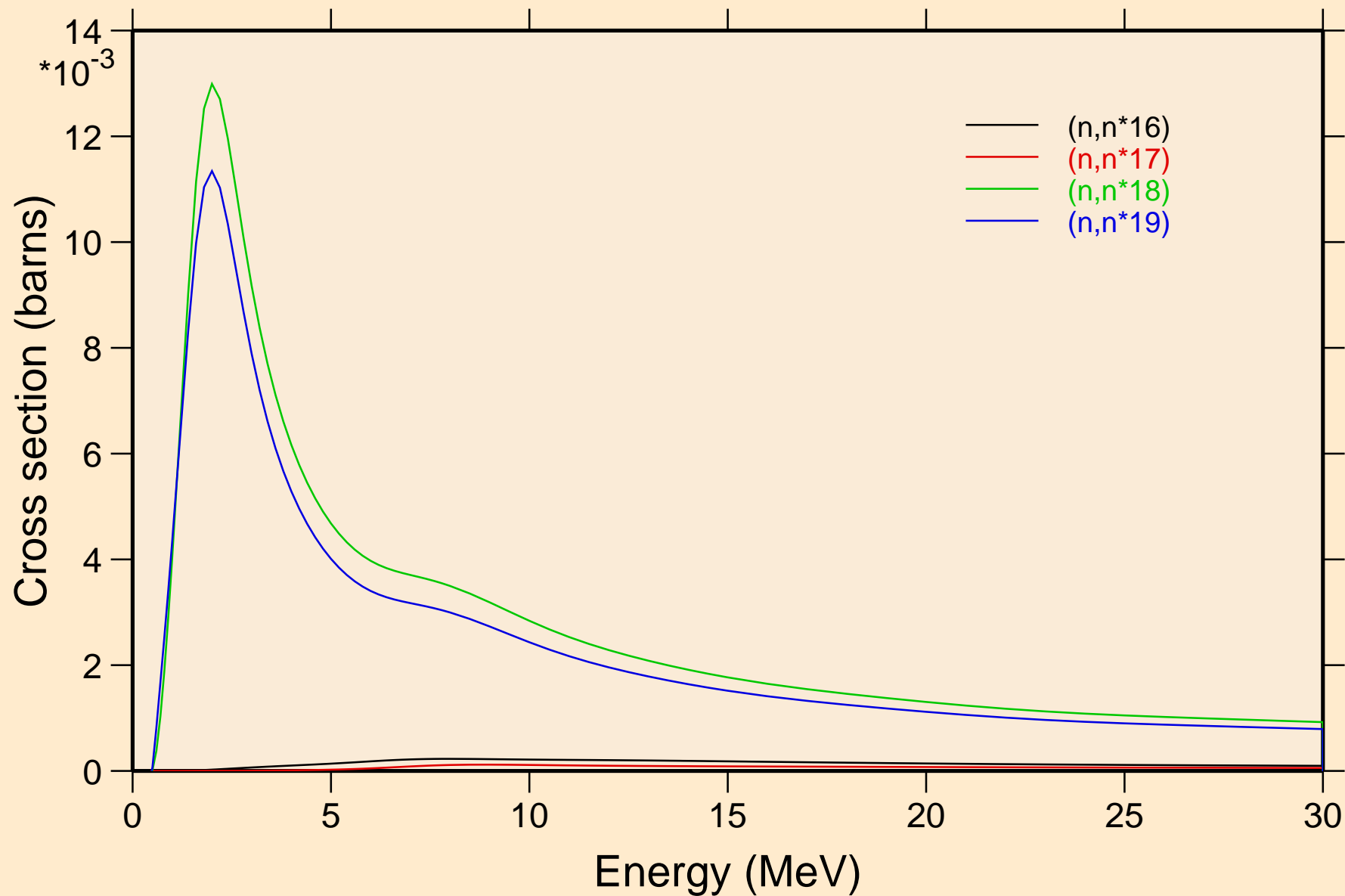

CM237 NEUTRON ACER TENDL-2019 LIBRARY; T=293.16K

Threshold reactions

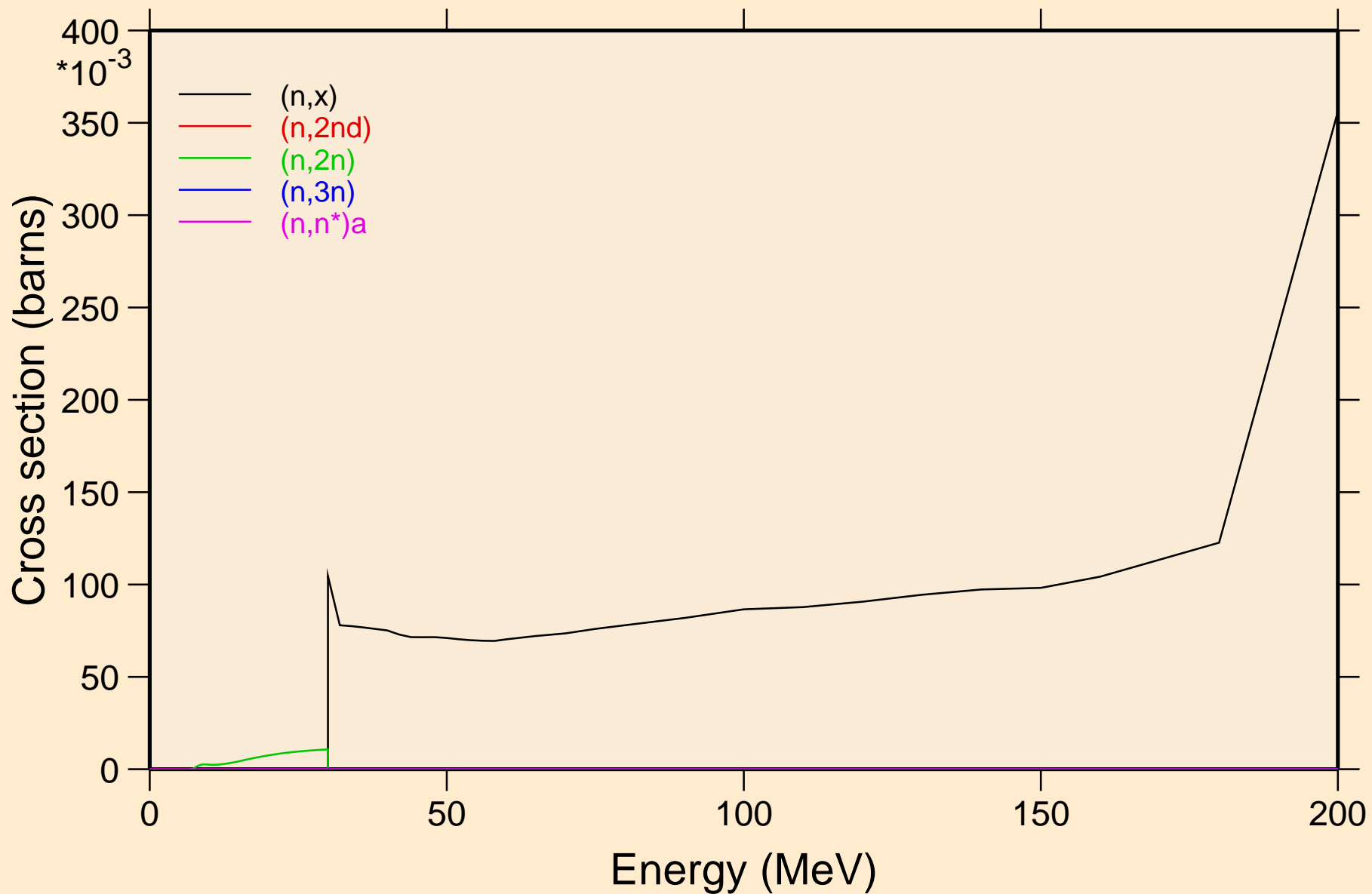

CM237 NEUTRON ACER TENDL-2019 LIBRARY; T=293.16K
Threshold reactions

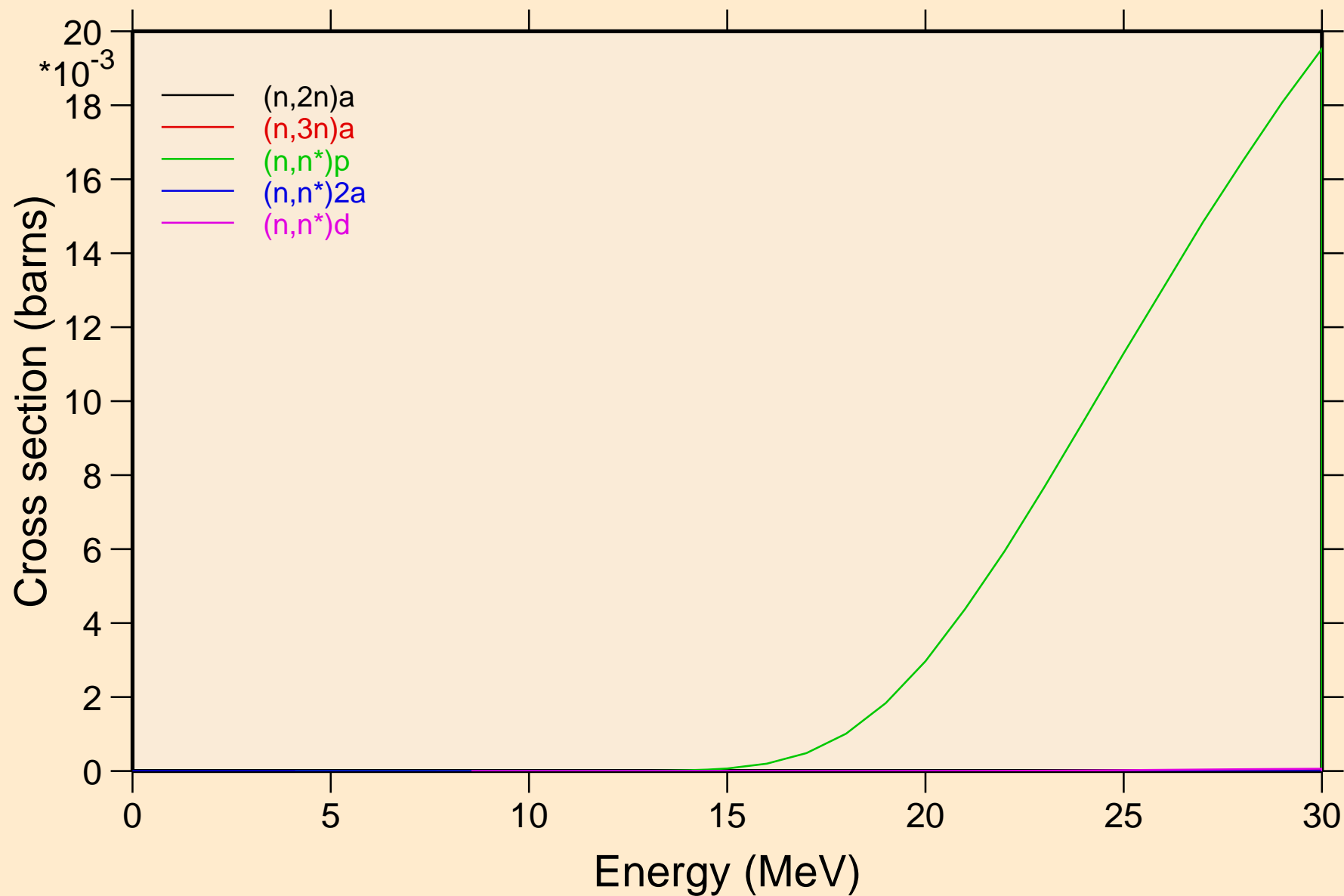

CM237 NEUTRON ACER TENDL-2019 LIBRARY; T=293.16K

Threshold reactions

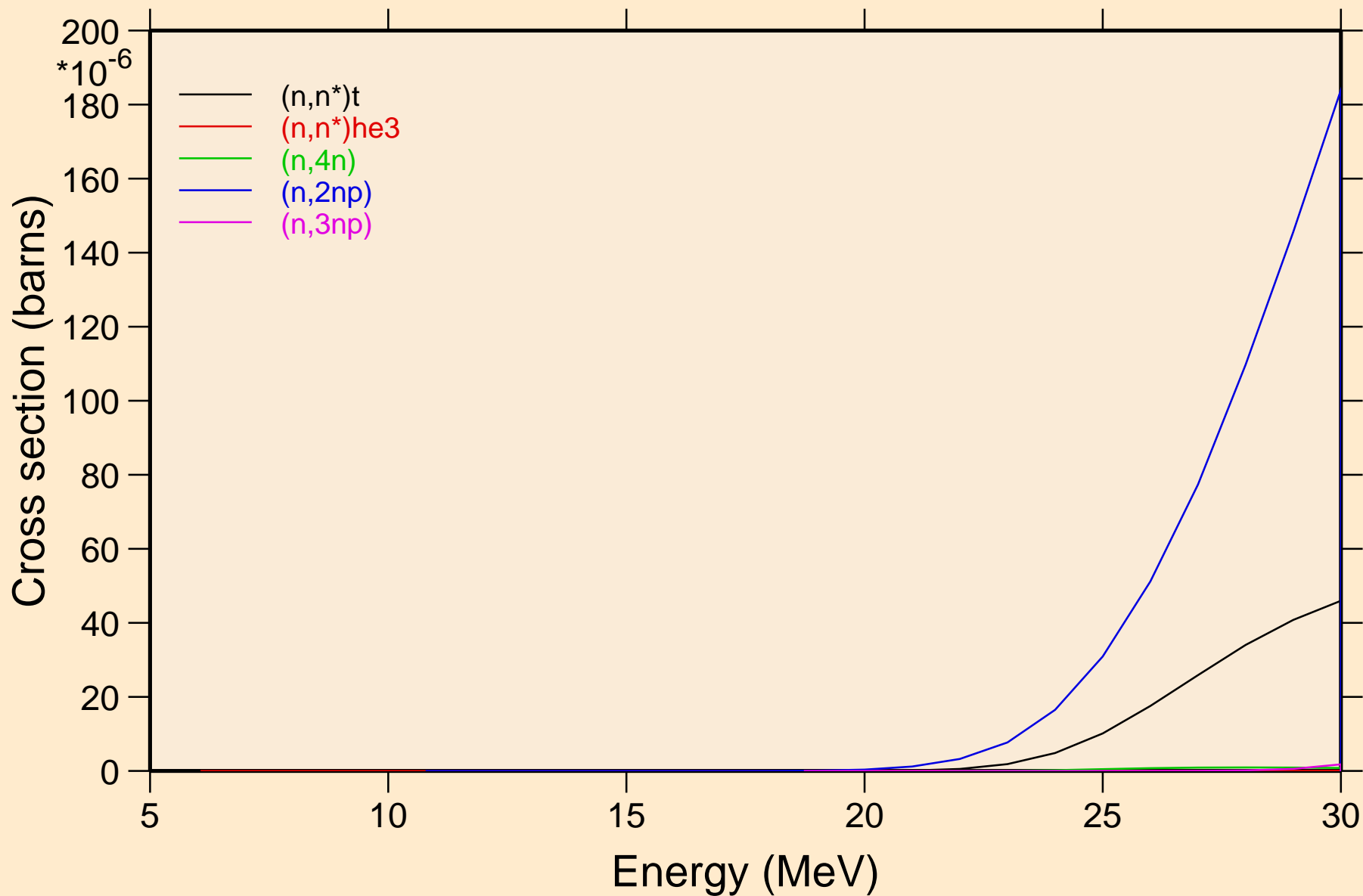

CM237 NEUTRON ACER TENDL-2019 LIBRARY; T=293.16K
Threshold reactions

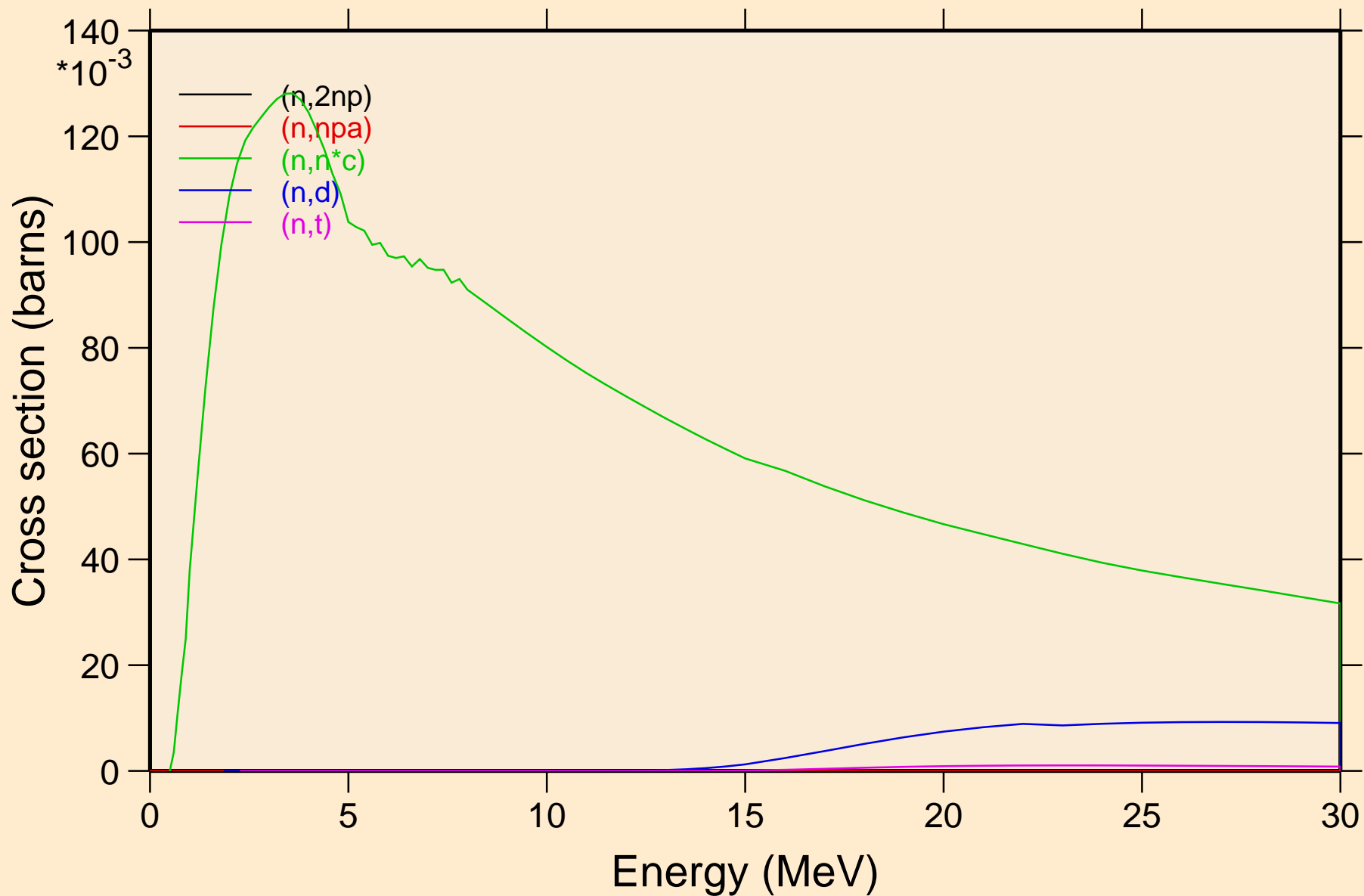

CM237 NEUTRON ACER TENDL-2019 LIBRARY; T=293.16K
Threshold reactions

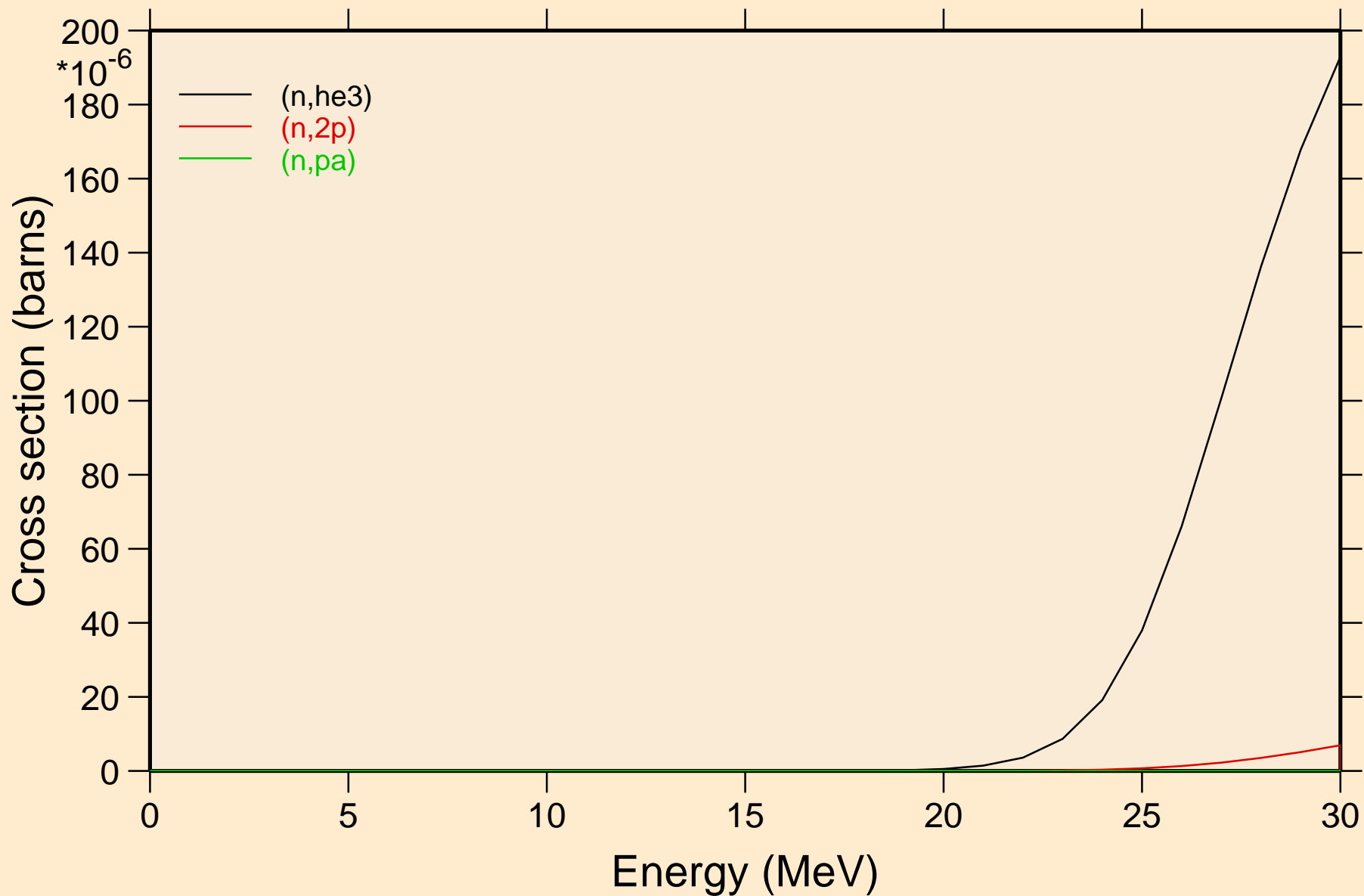

CM237 NEUTRON ACER TENDL-2019 LIBRARY; T=293.16K
Threshold reactions

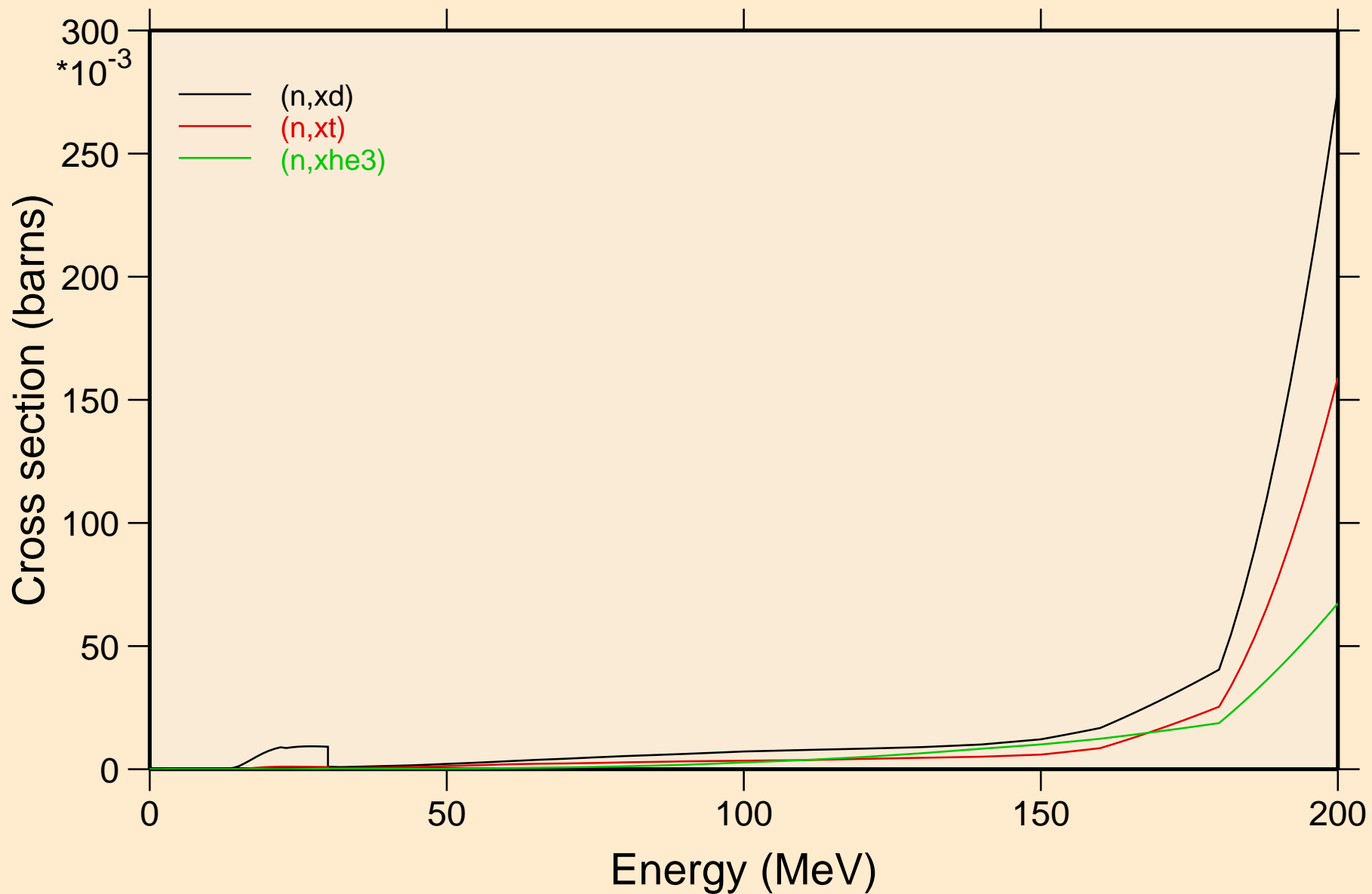

CM237 NEUTRON ACER TENDL-2019 LIBRARY; T=293.16K
angular distribution for elastic

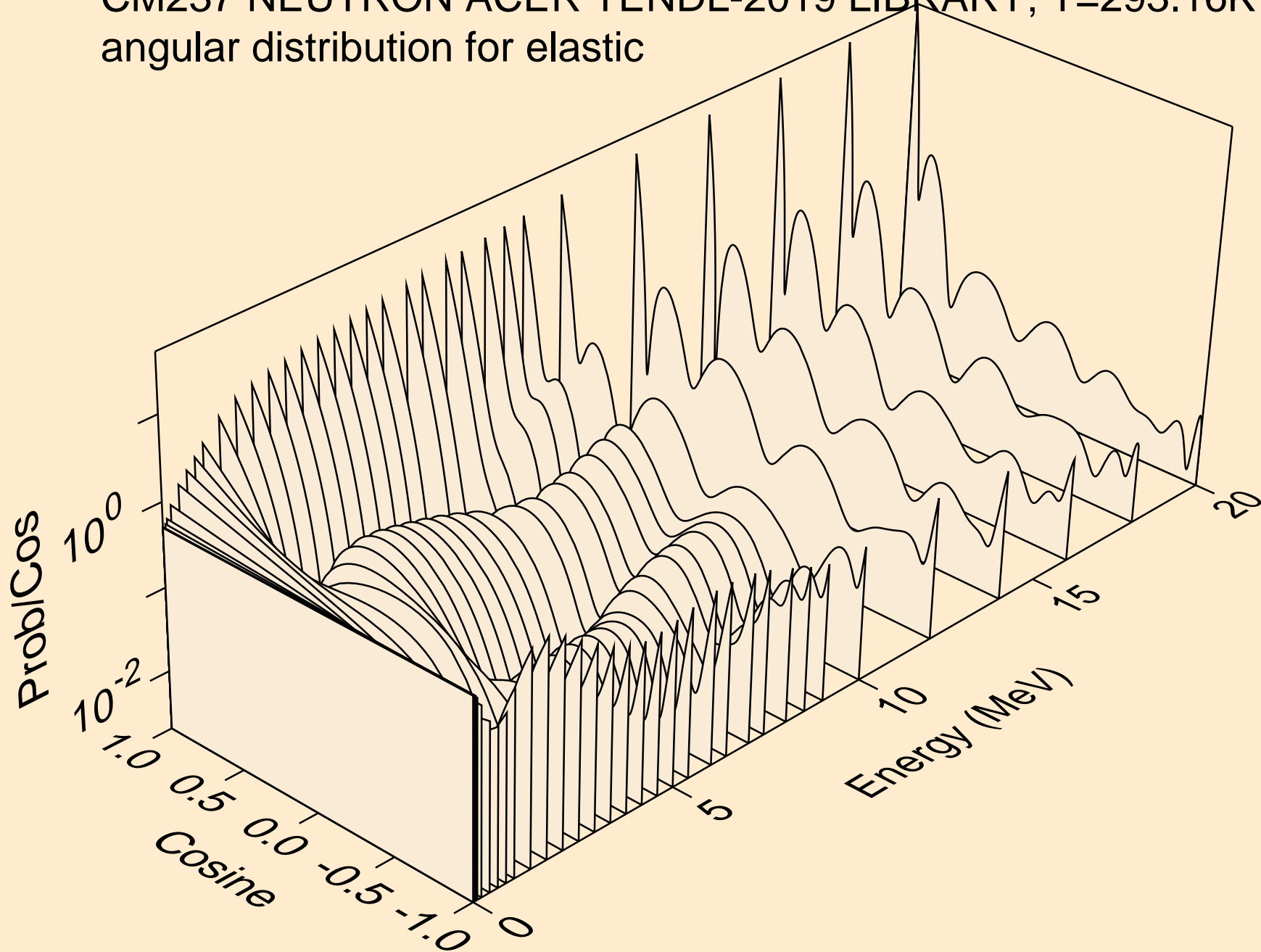

CM237 NEUTRON ACER TENDL-2019 LIBRARY; T=293.16K
angular distribution for elastic

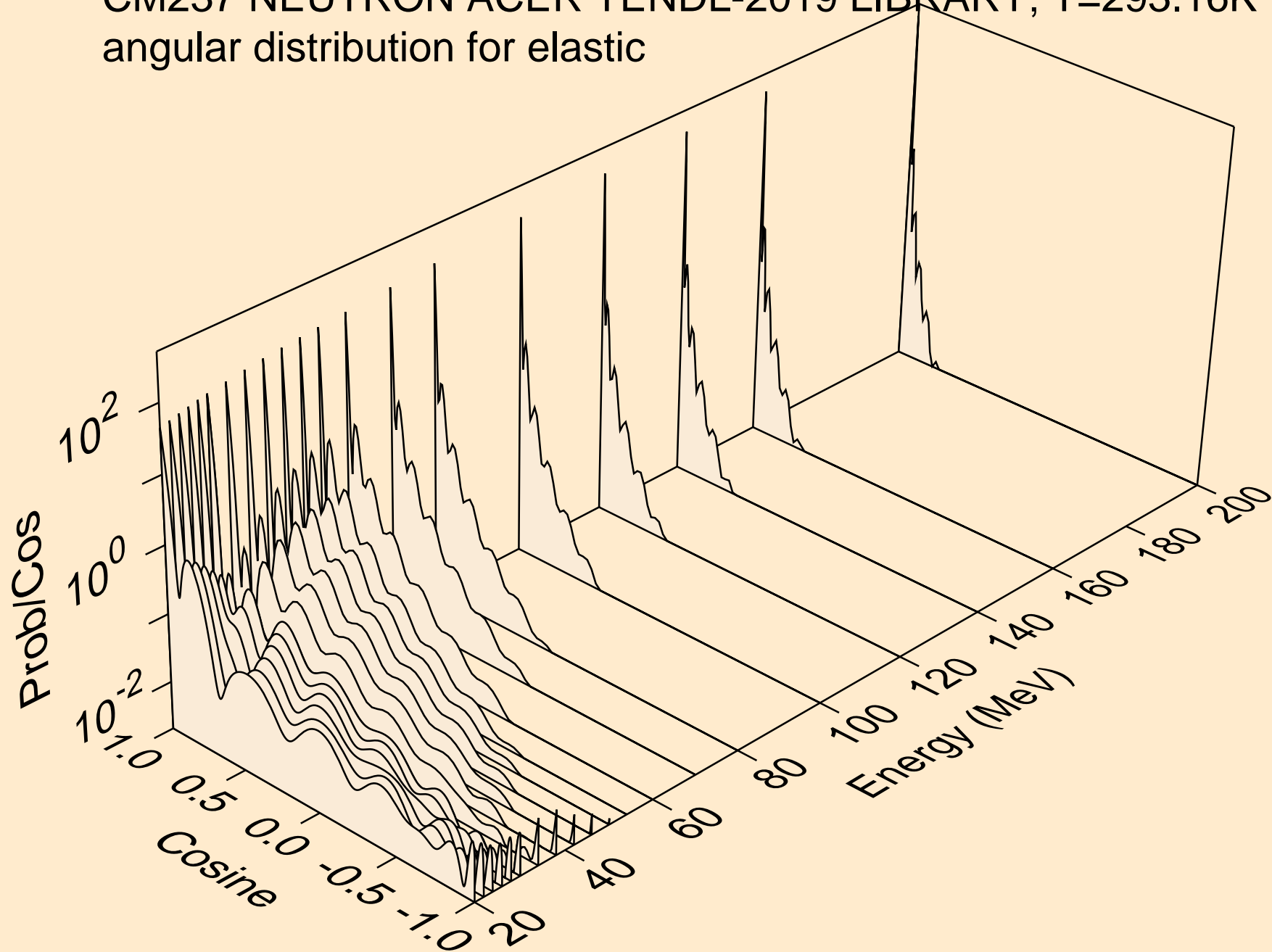

CM237 NEUTRON ACER TENDL-2019 LIBRARY; T=293.16K
angular distribution for (n,n*1)

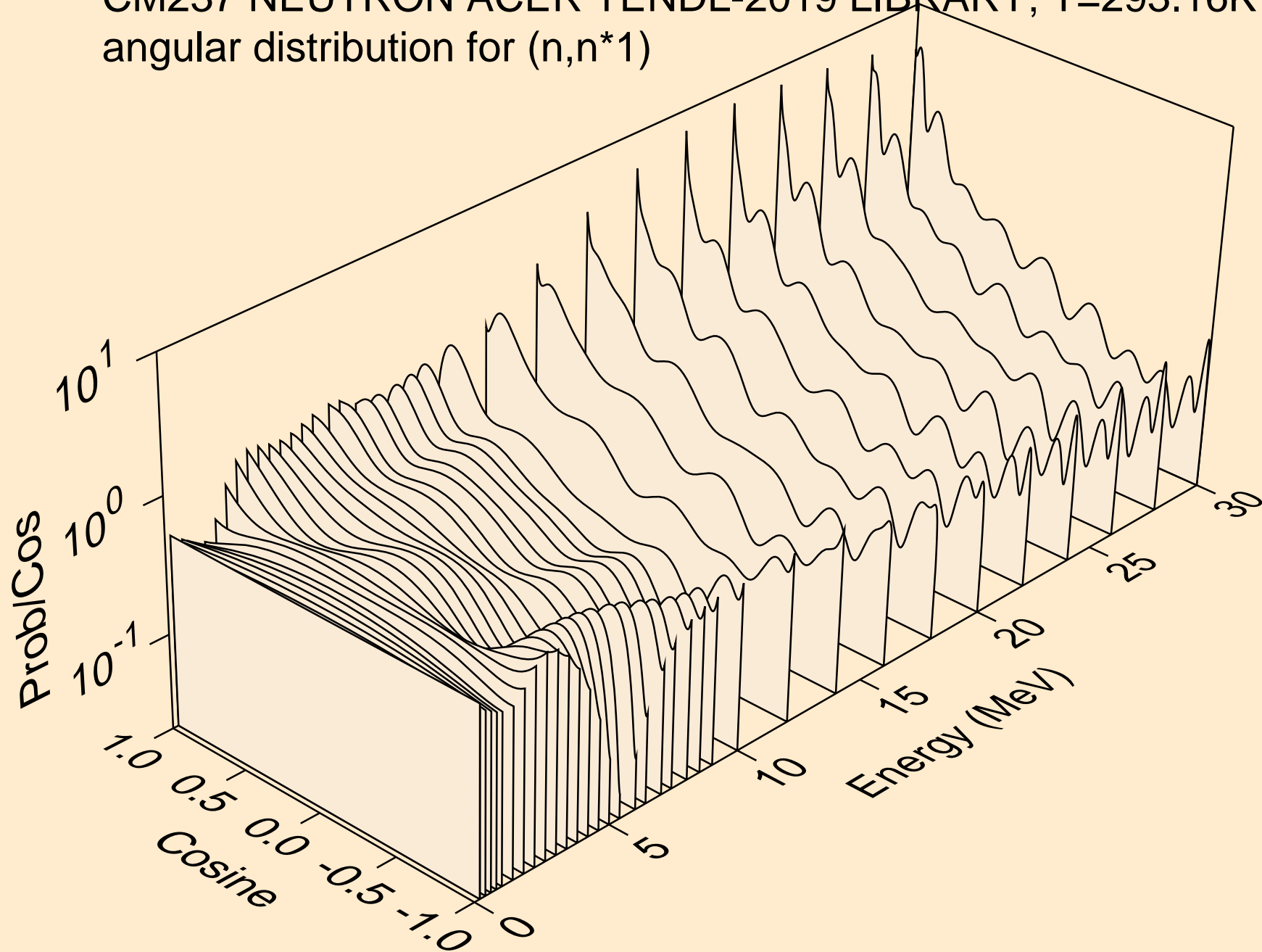

CM237 NEUTRON ACER TENDL-2019 LIBRARY; T=293.16K
angular distribution for (n,n*2)

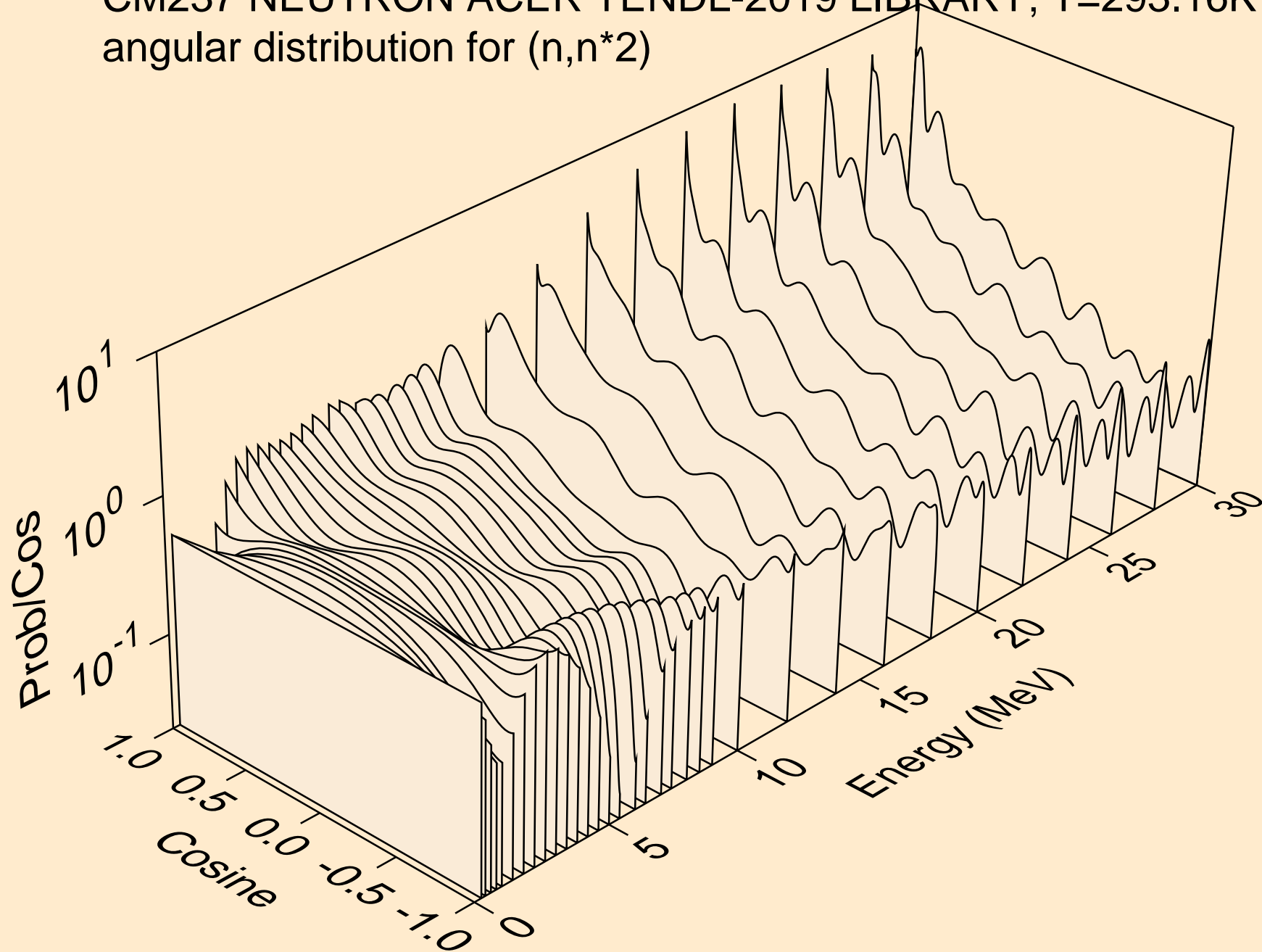

CM237 NEUTRON ACER TENDL-2019 LIBRARY; T=293.16K
angular distribution for (n,n*3)

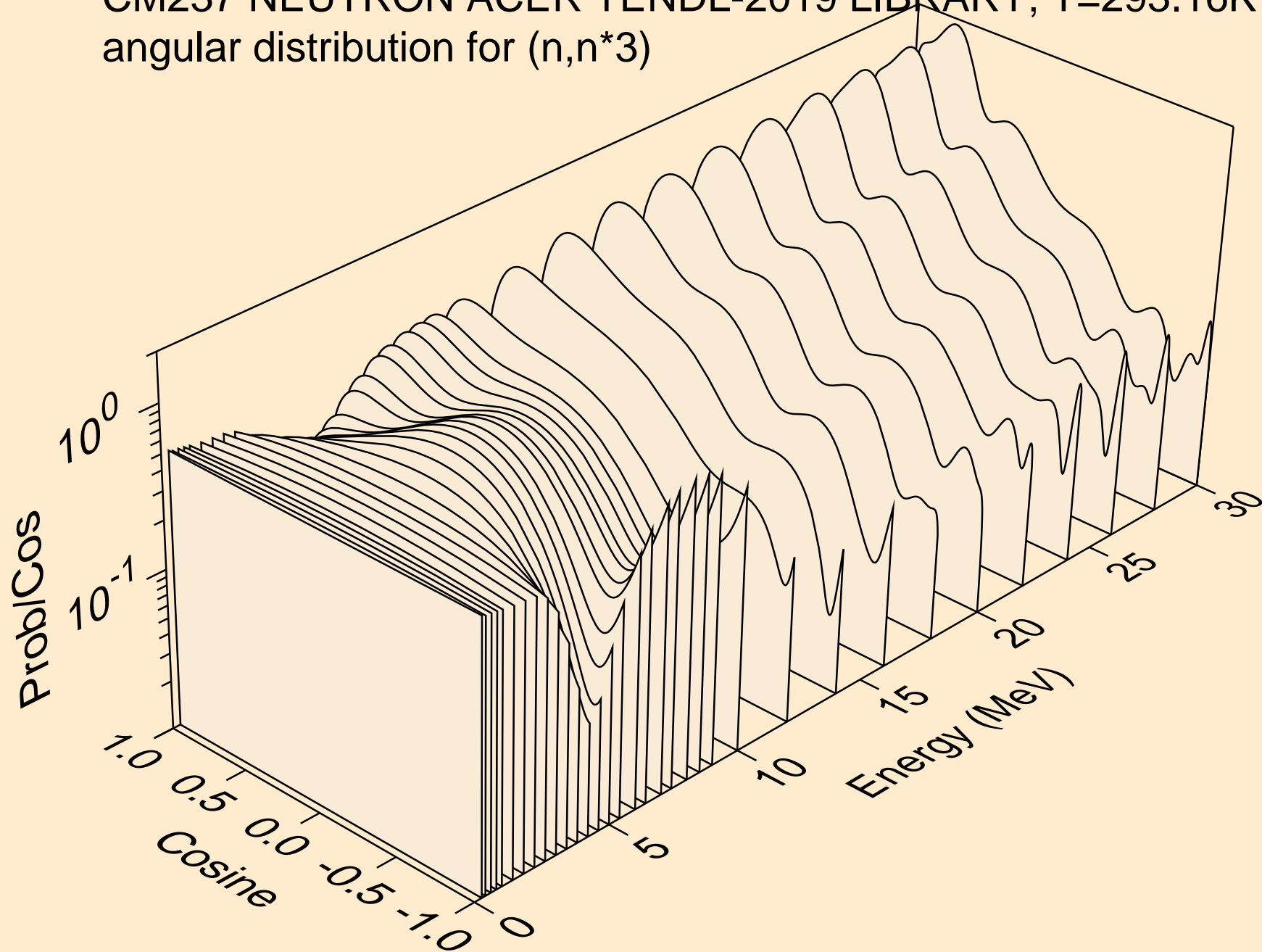

CM237 NEUTRON ACER TENDL-2019 LIBRARY; T=293.16K
angular distribution for (n,n*4)

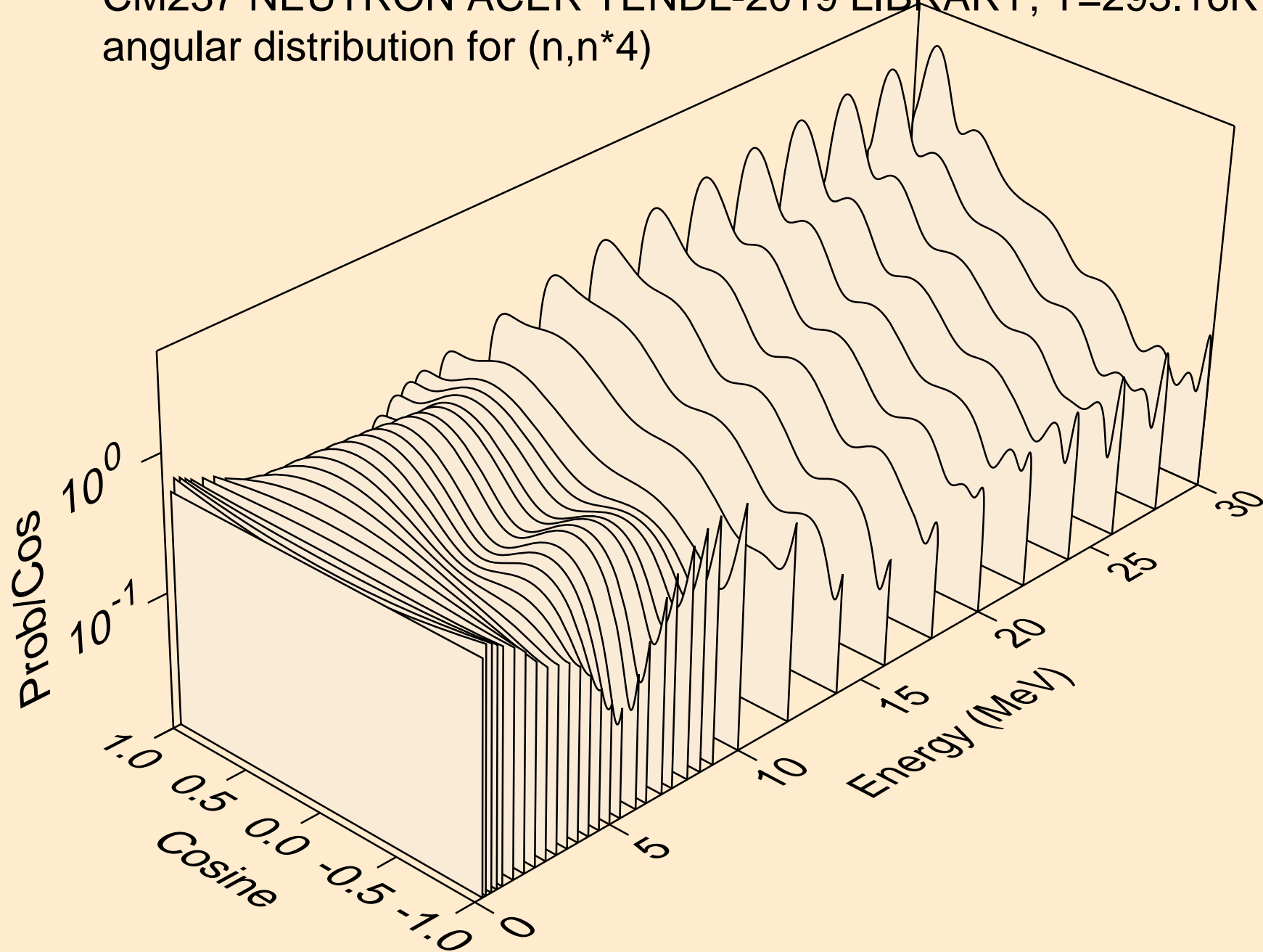

CM237 NEUTRON ACER TENDL-2019 LIBRARY; T=293.16K
angular distribution for (n,n*5)

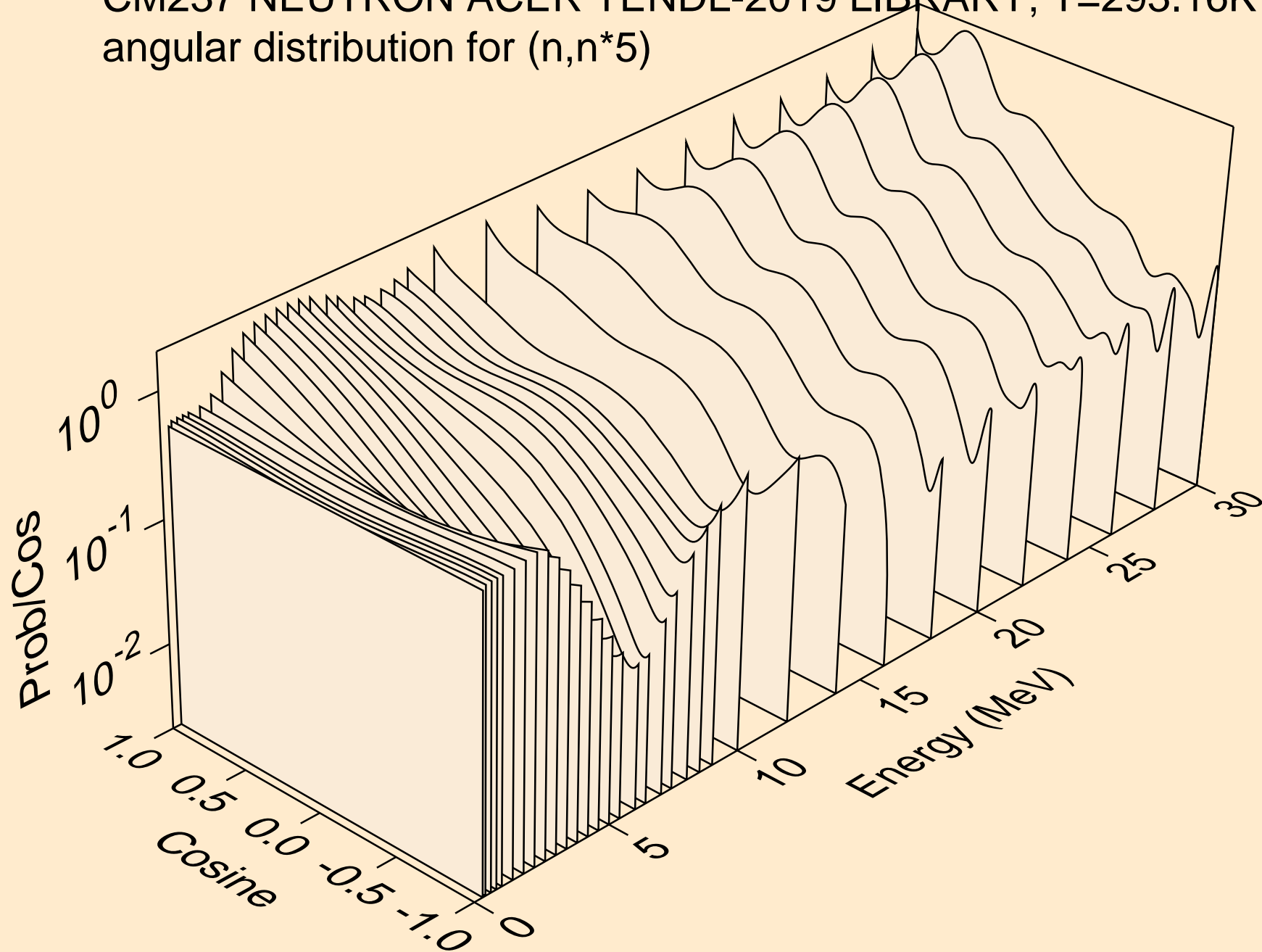

CM237 NEUTRON ACER TENDL-2019 LIBRARY; T=293.16K
angular distribution for (n,n*6)

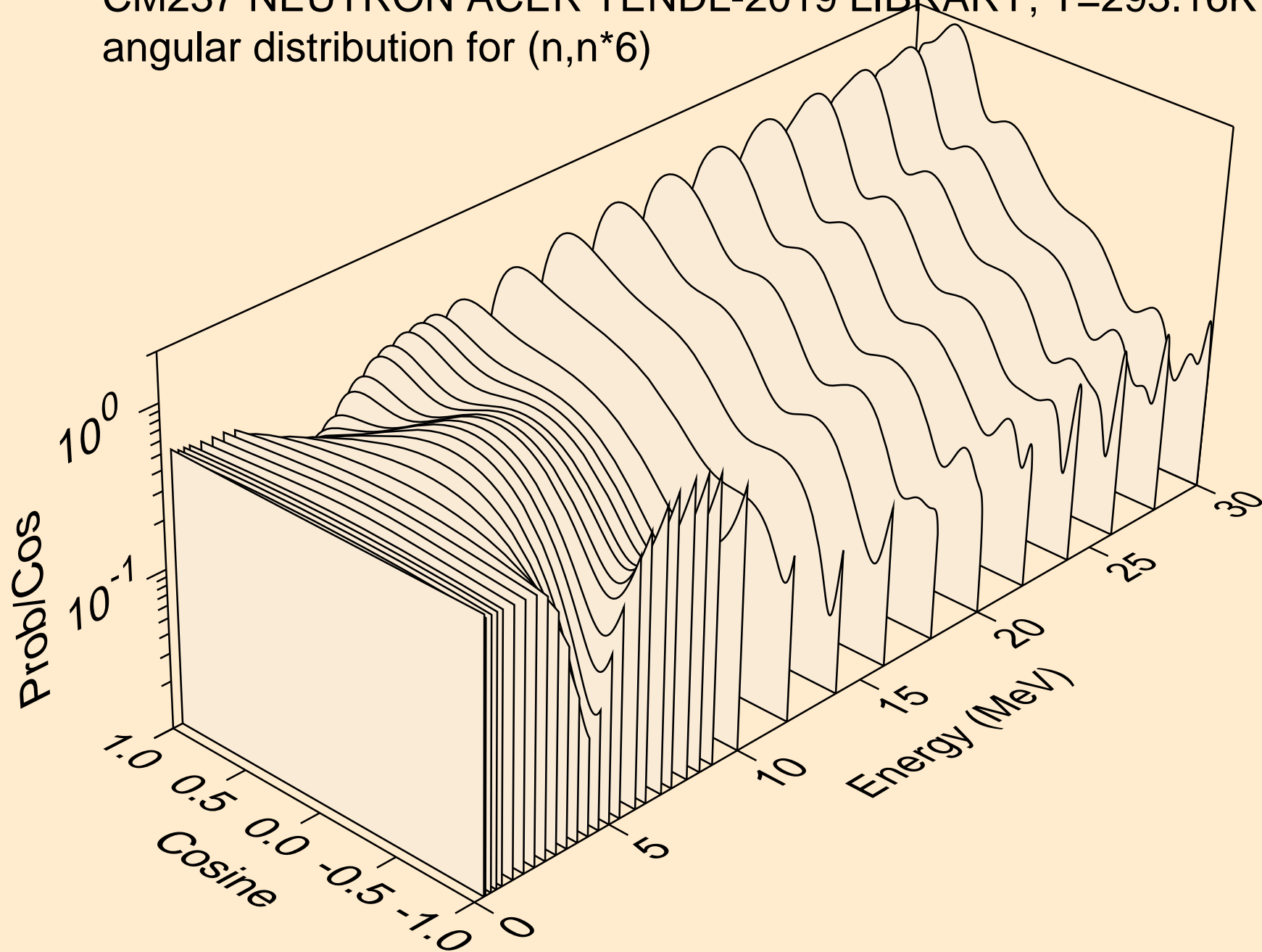

CM237 NEUTRON ACER TENDL-2019 LIBRARY; T=293.16K
angular distribution for (n,n*7)

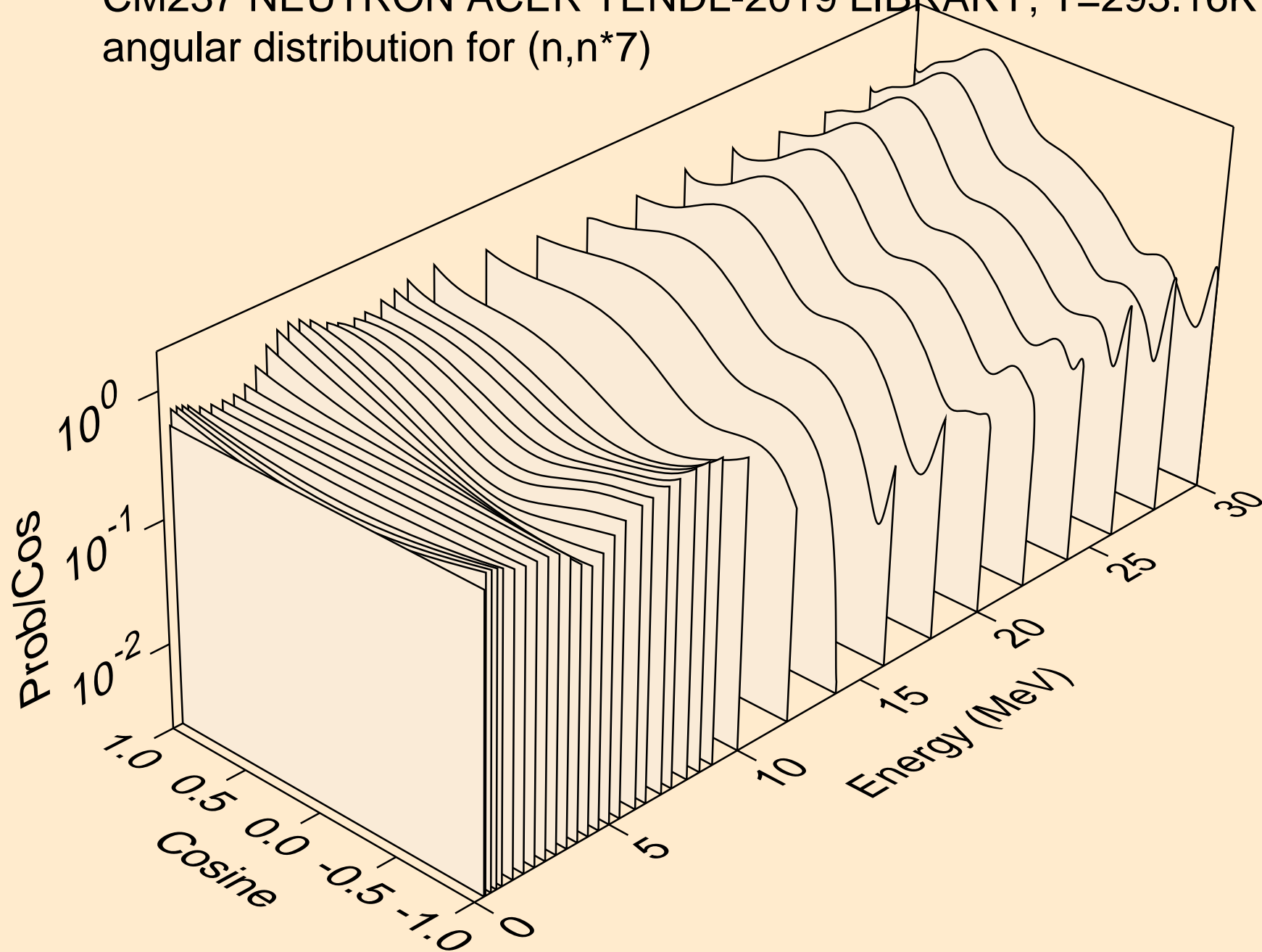

CM237 NEUTRON ACER TENDL-2019 LIBRARY; T=293.16K
angular distribution for (n,n*8)

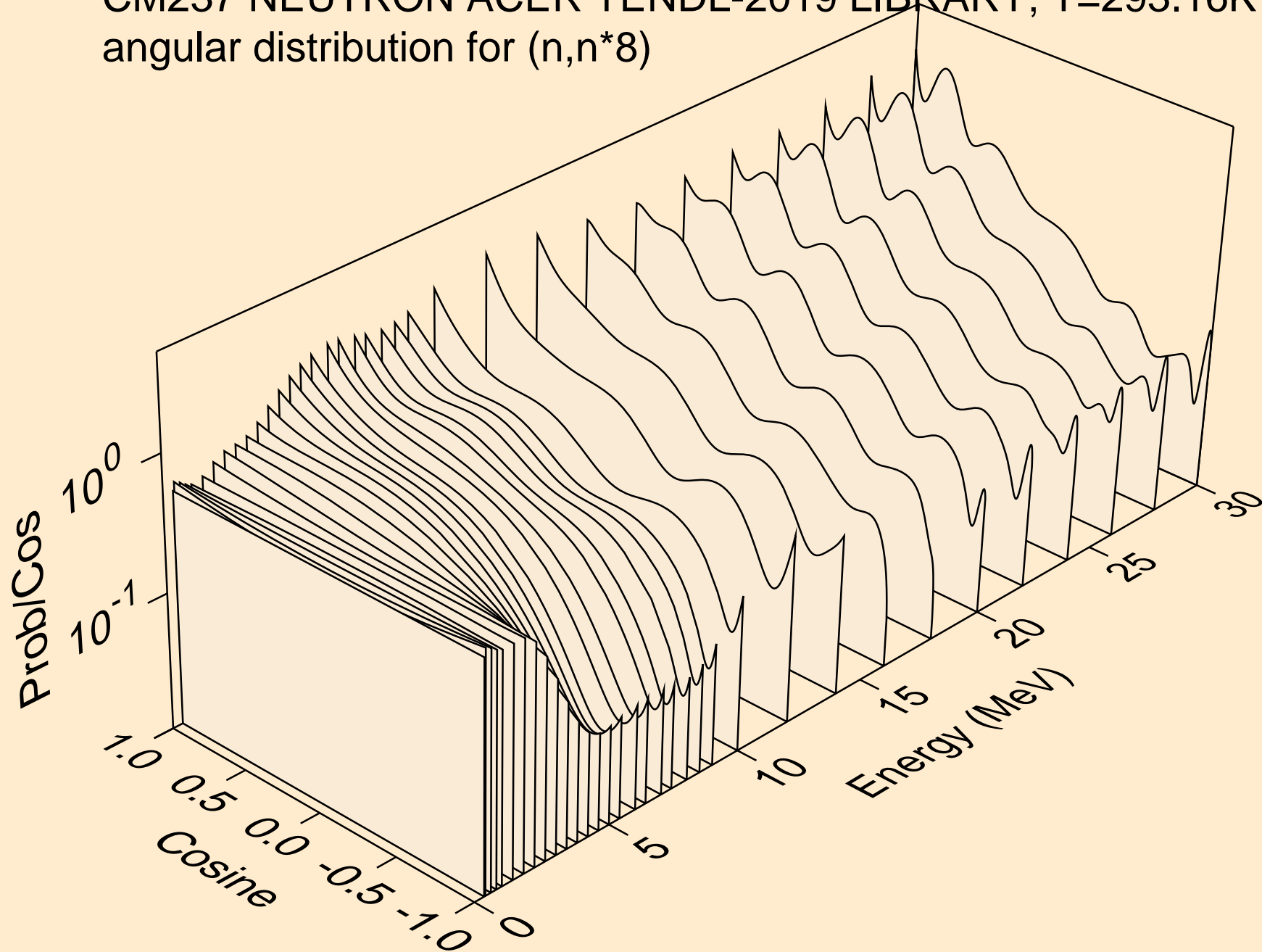

CM237 NEUTRON ACER TENDL-2019 LIBRARY; T=293.16K
angular distribution for (n,n*9)

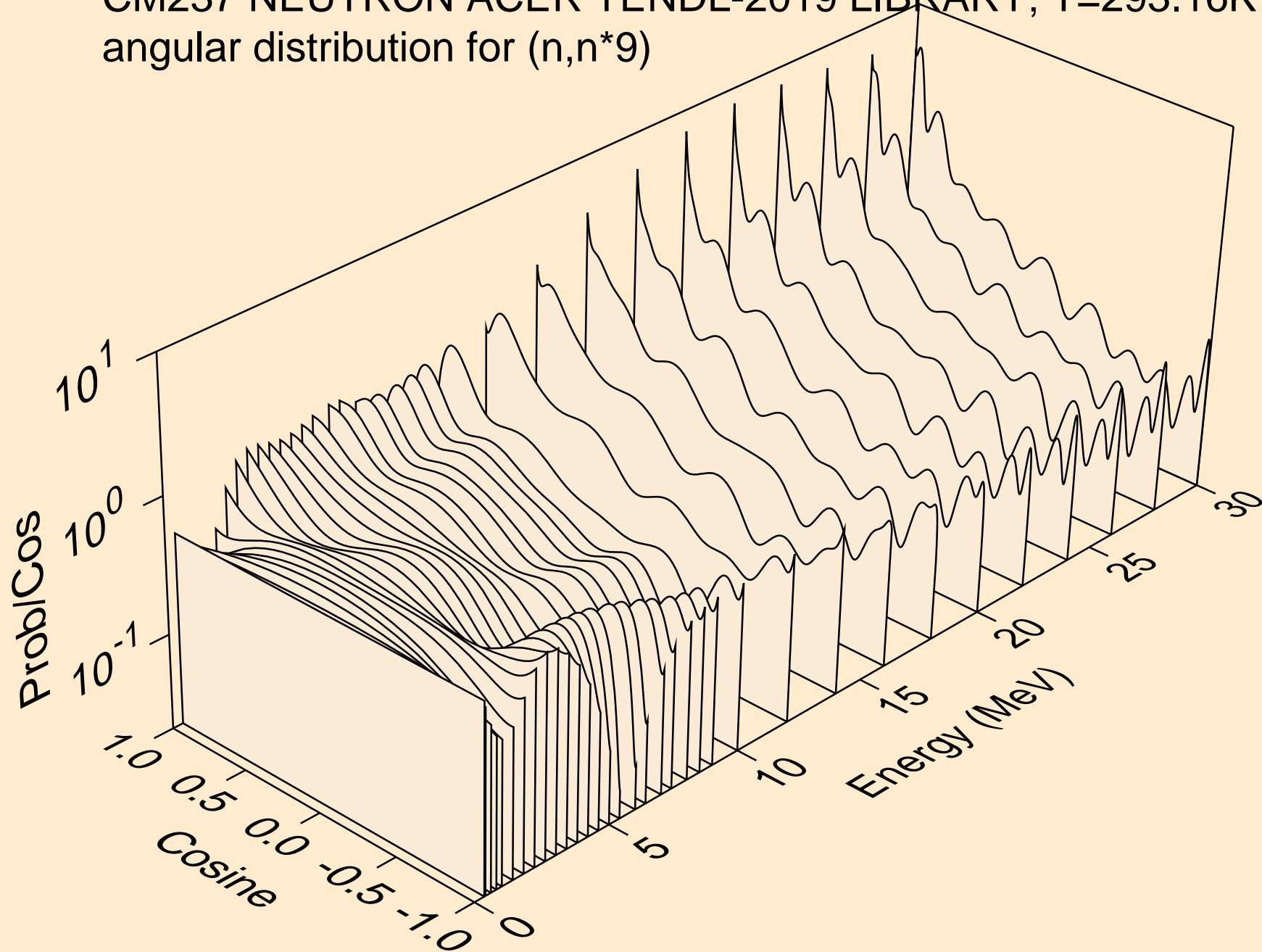

CM237 NEUTRON ACER TENDL-2019 LIBRARY; T=293.16K
angular distribution for (n,n*10)

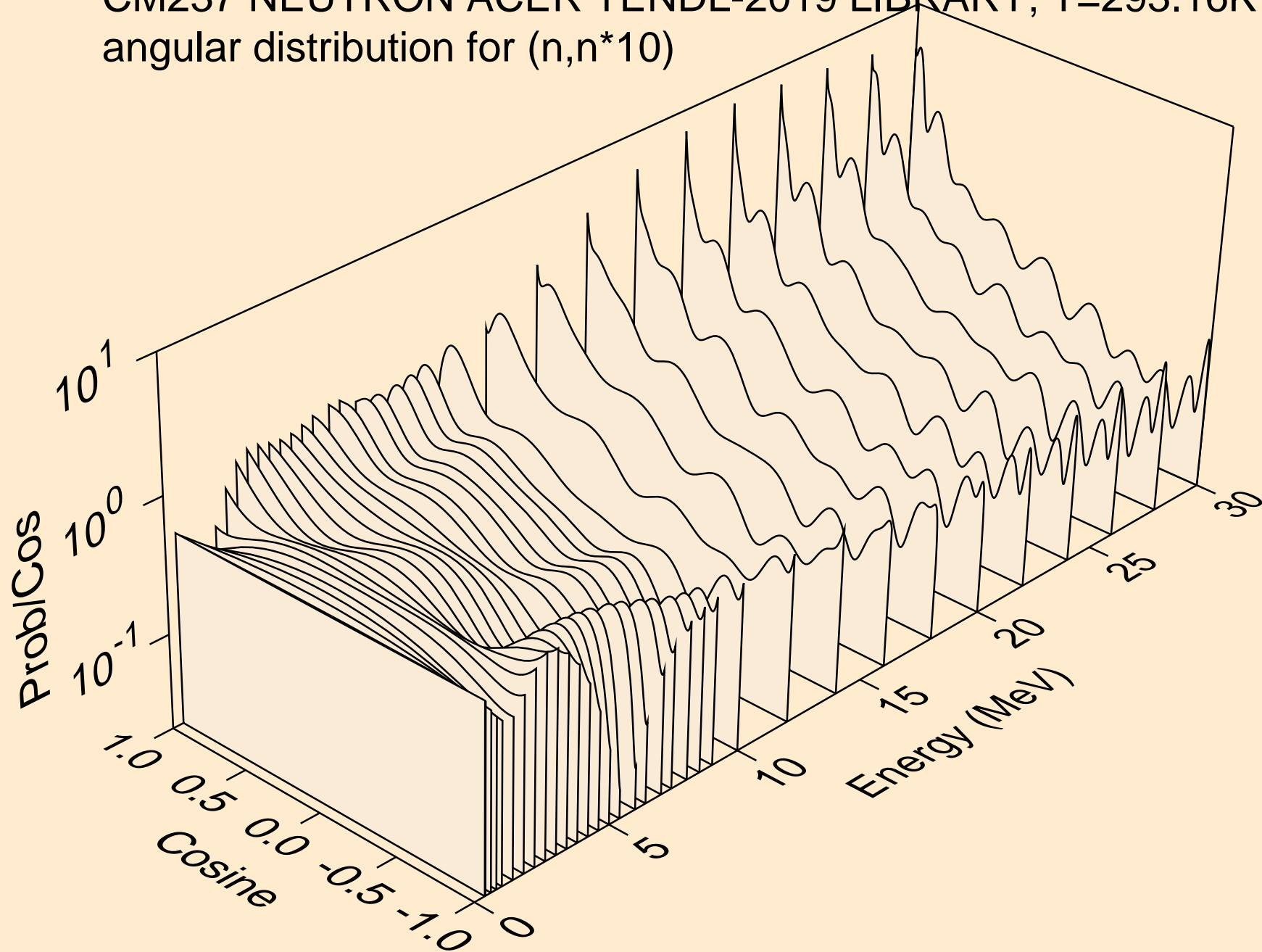

CM237 NEUTRON ACER TENDL-2019 LIBRARY; T=293.16K
angular distribution for (n,n*11)

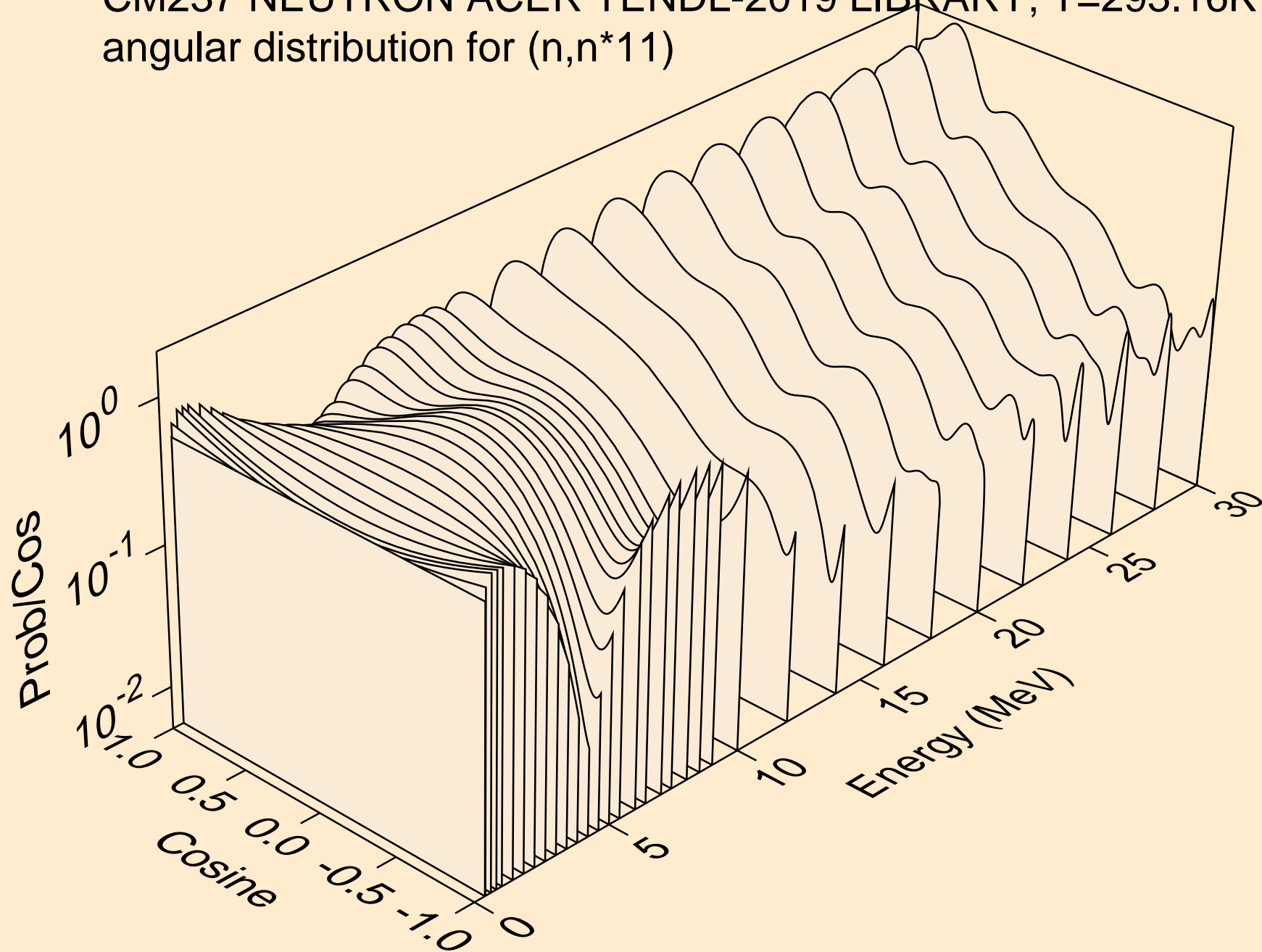

CM237 NEUTRON ACER TENDL-2019 LIBRARY; T=293.16K
angular distribution for (n,n*12)

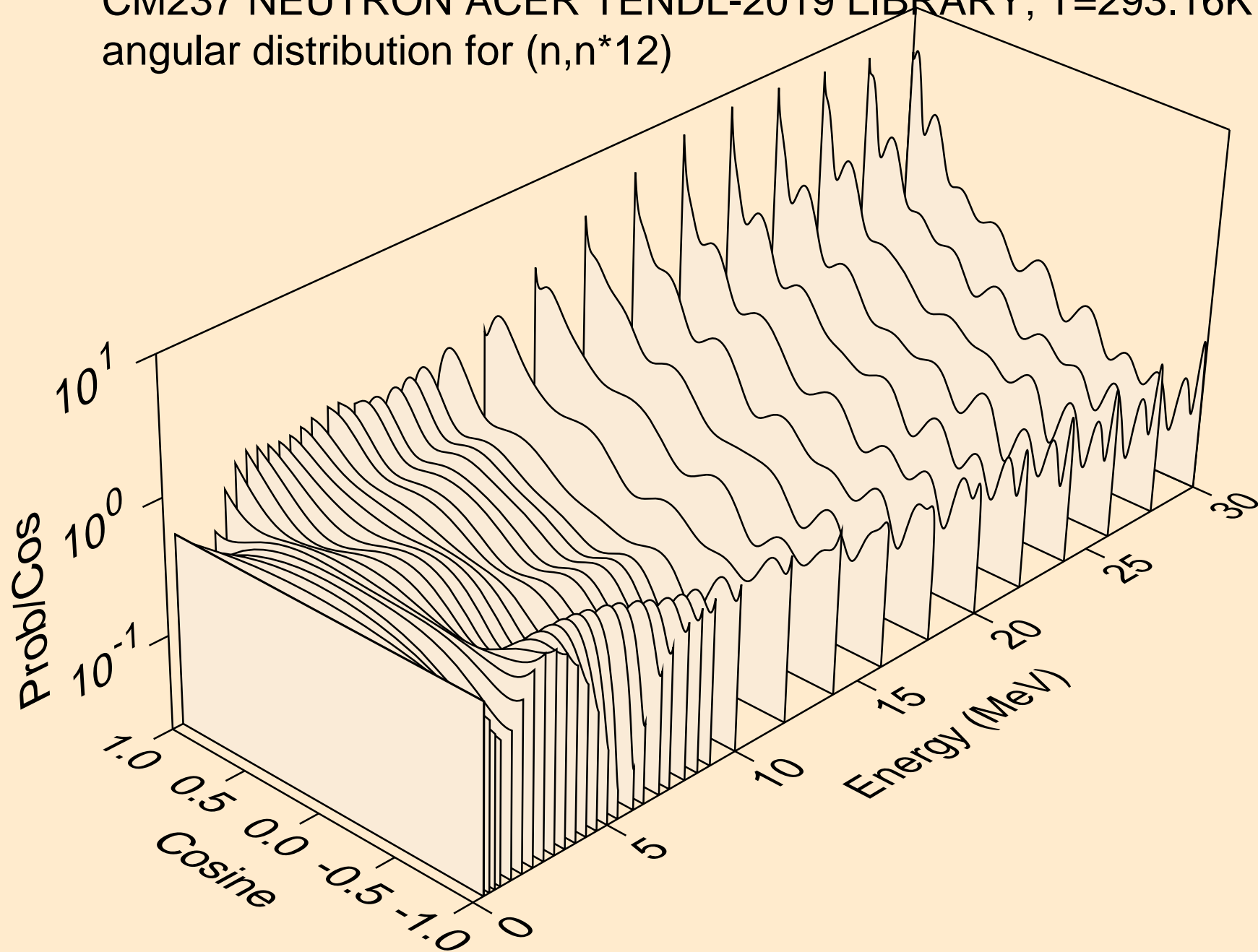

CM237 NEUTRON ACER TENDL-2019 LIBRARY; T=293.16K
angular distribution for (n,n*13)

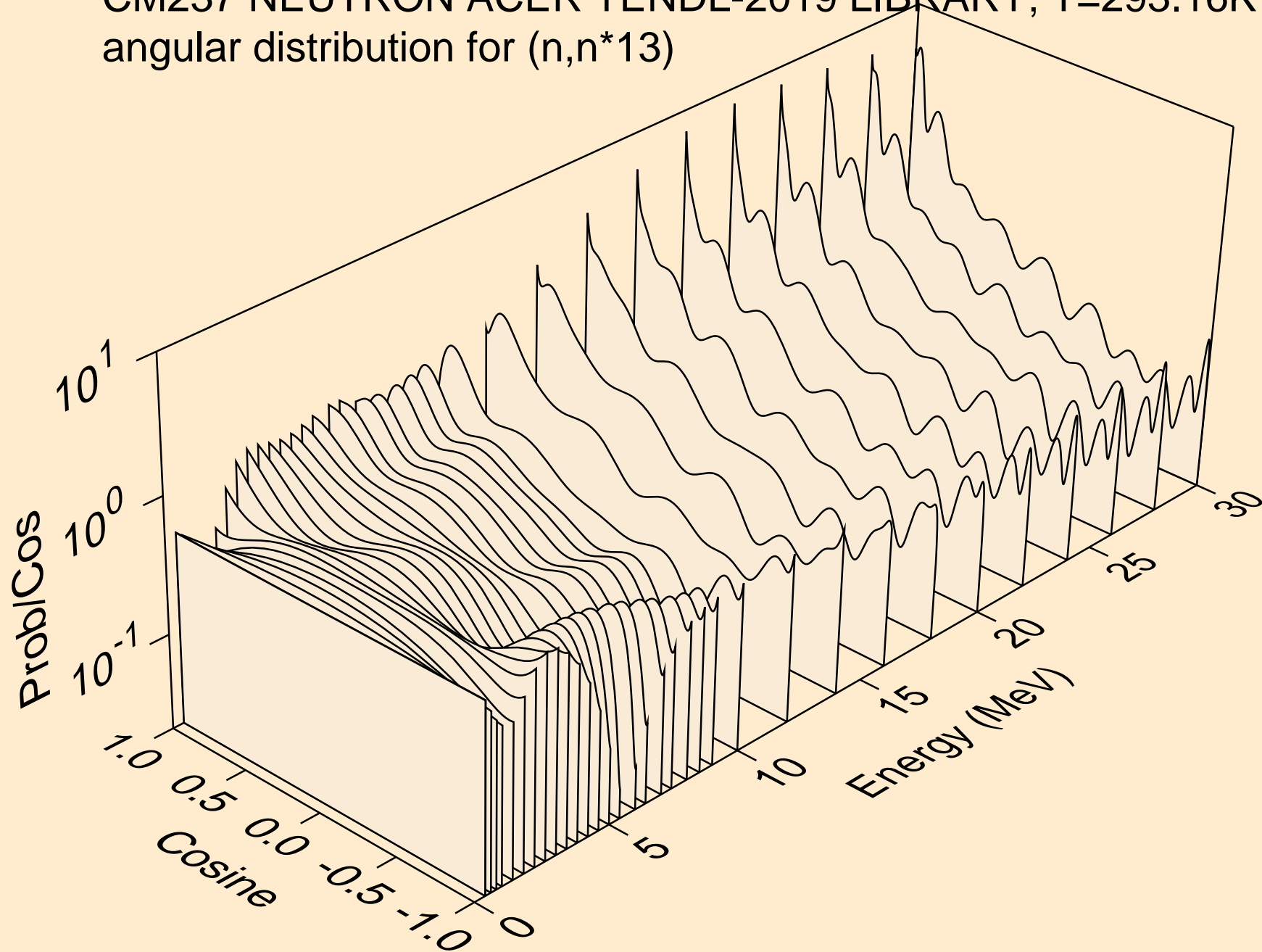

CM237 NEUTRON ACER TENDL-2019 LIBRARY; T=293.16K
angular distribution for (n,n*14)

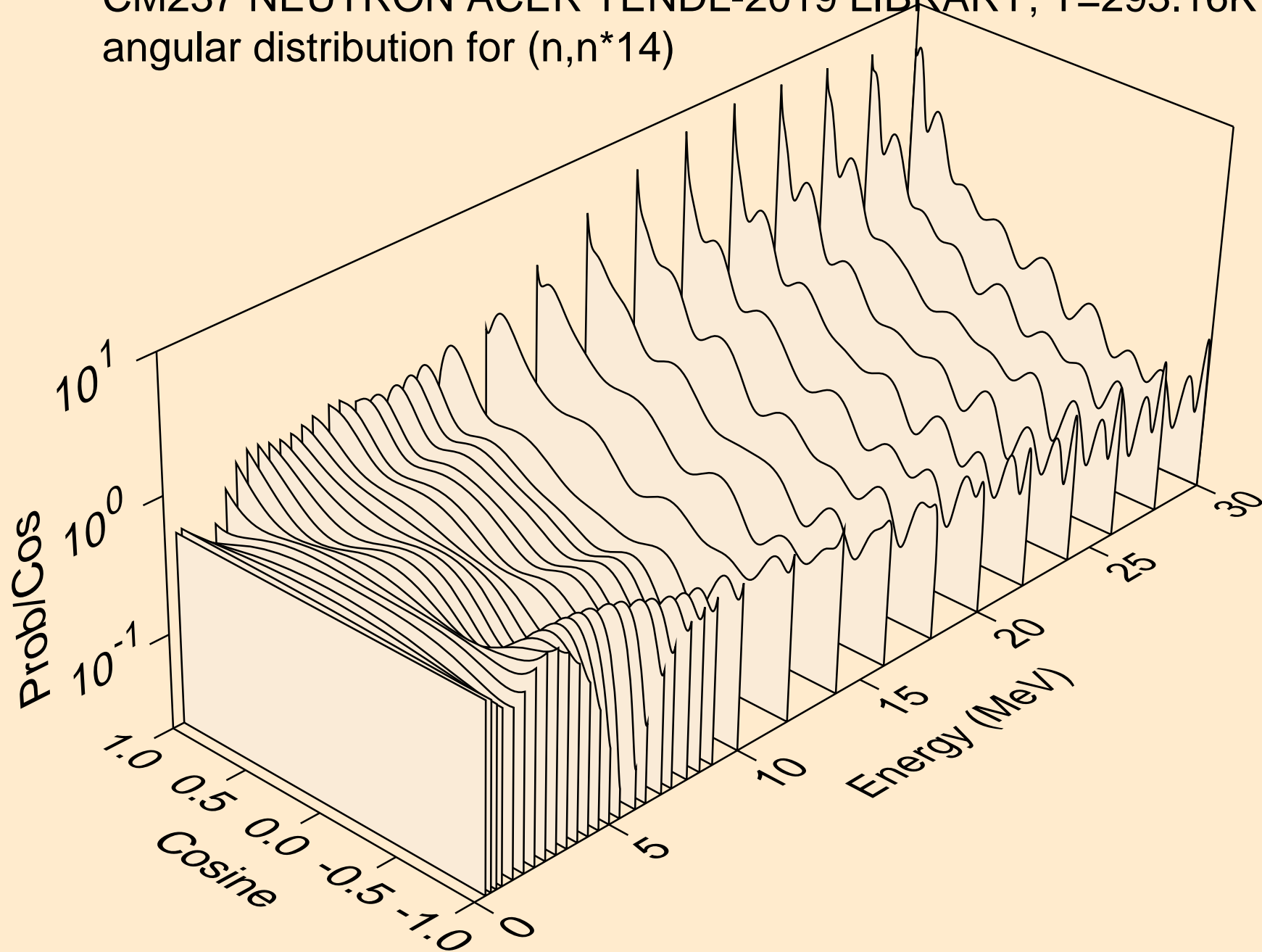

CM237 NEUTRON ACER TENDL-2019 LIBRARY; T=293.16K
angular distribution for (n,n*15)

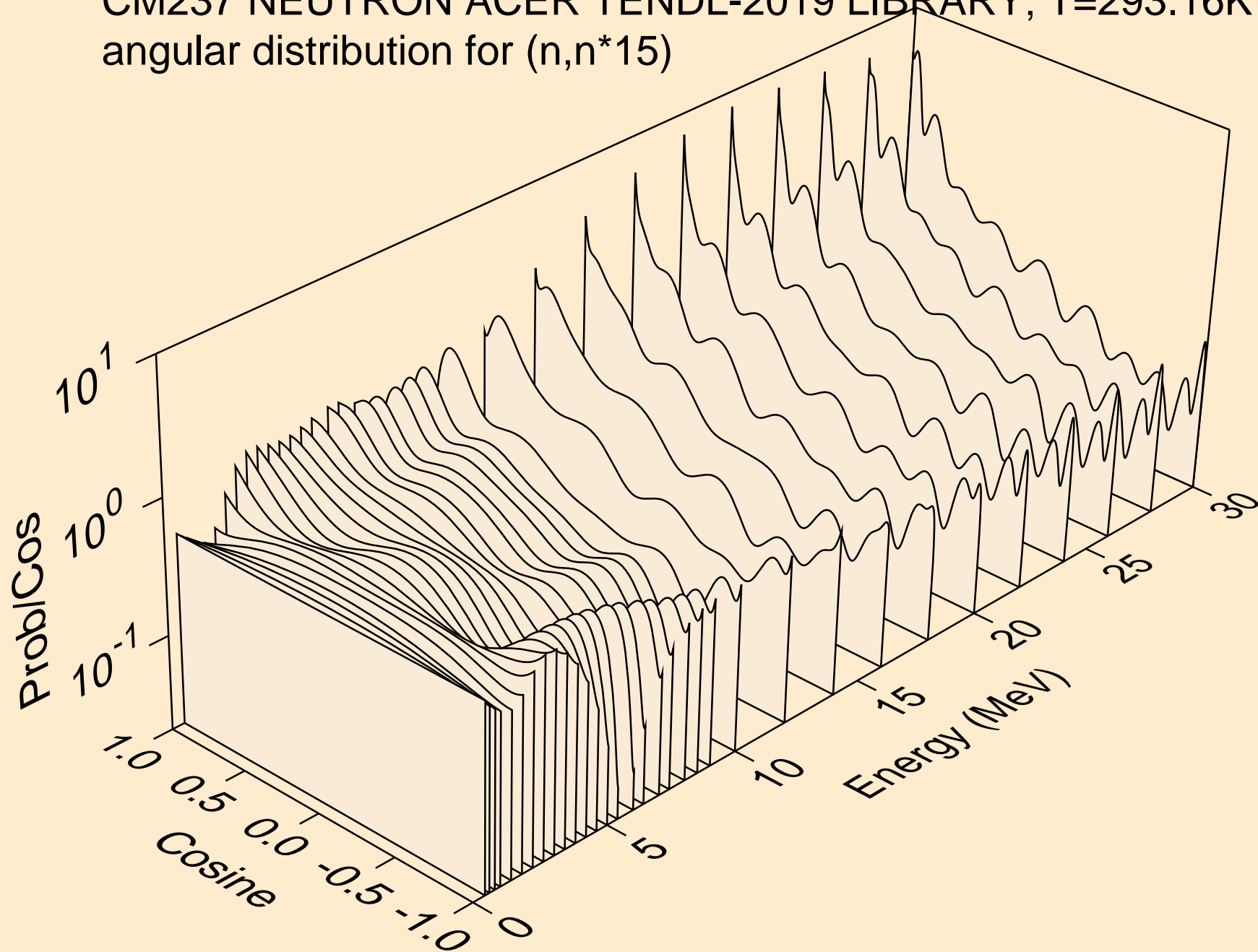

CM237 NEUTRON ACER TENDL-2019 LIBRARY; T=293.16K
angular distribution for (n,n*16)

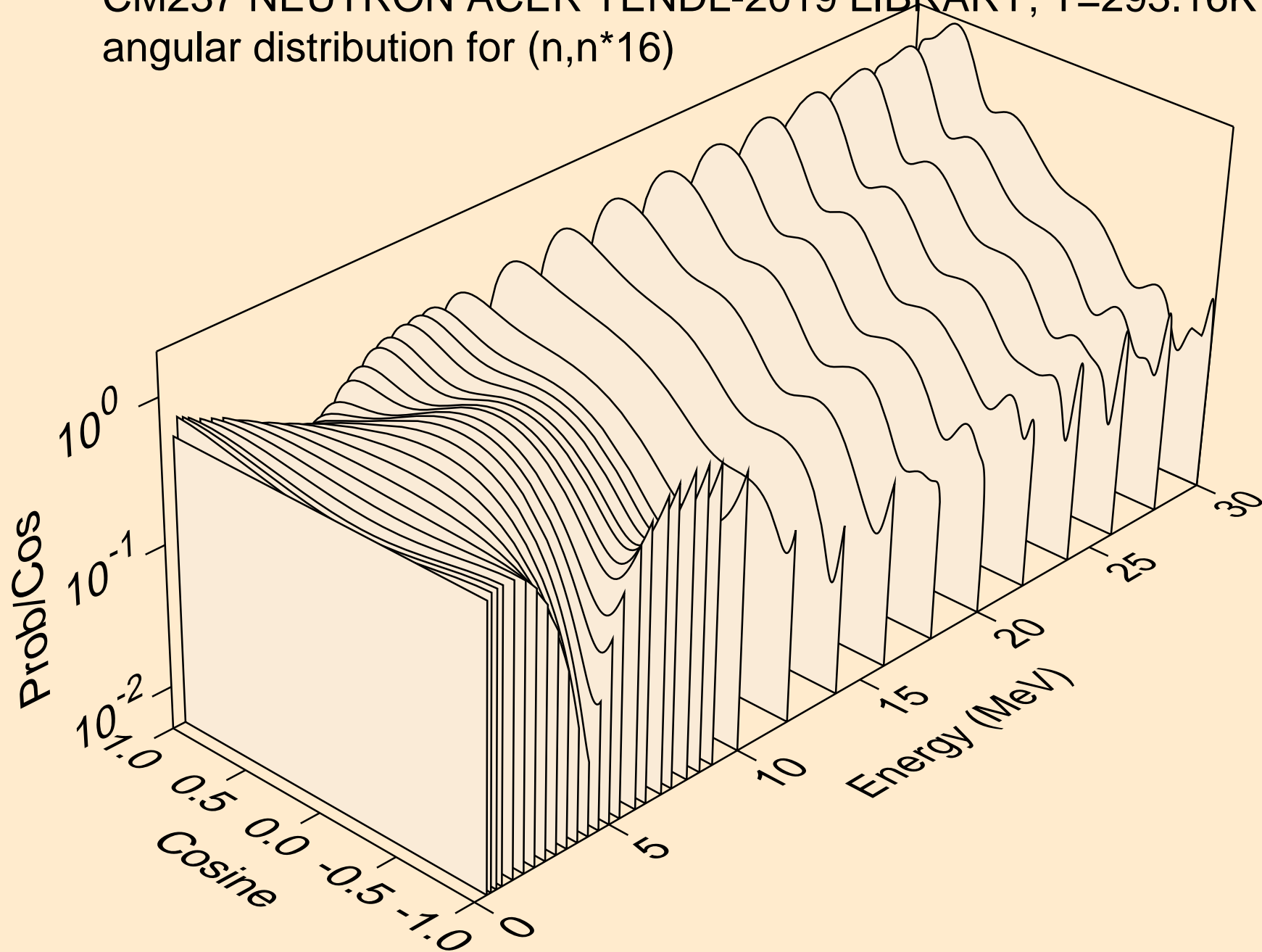

CM237 NEUTRON ACER TENDL-2019 LIBRARY; T=293.16K
angular distribution for (n,n*17)

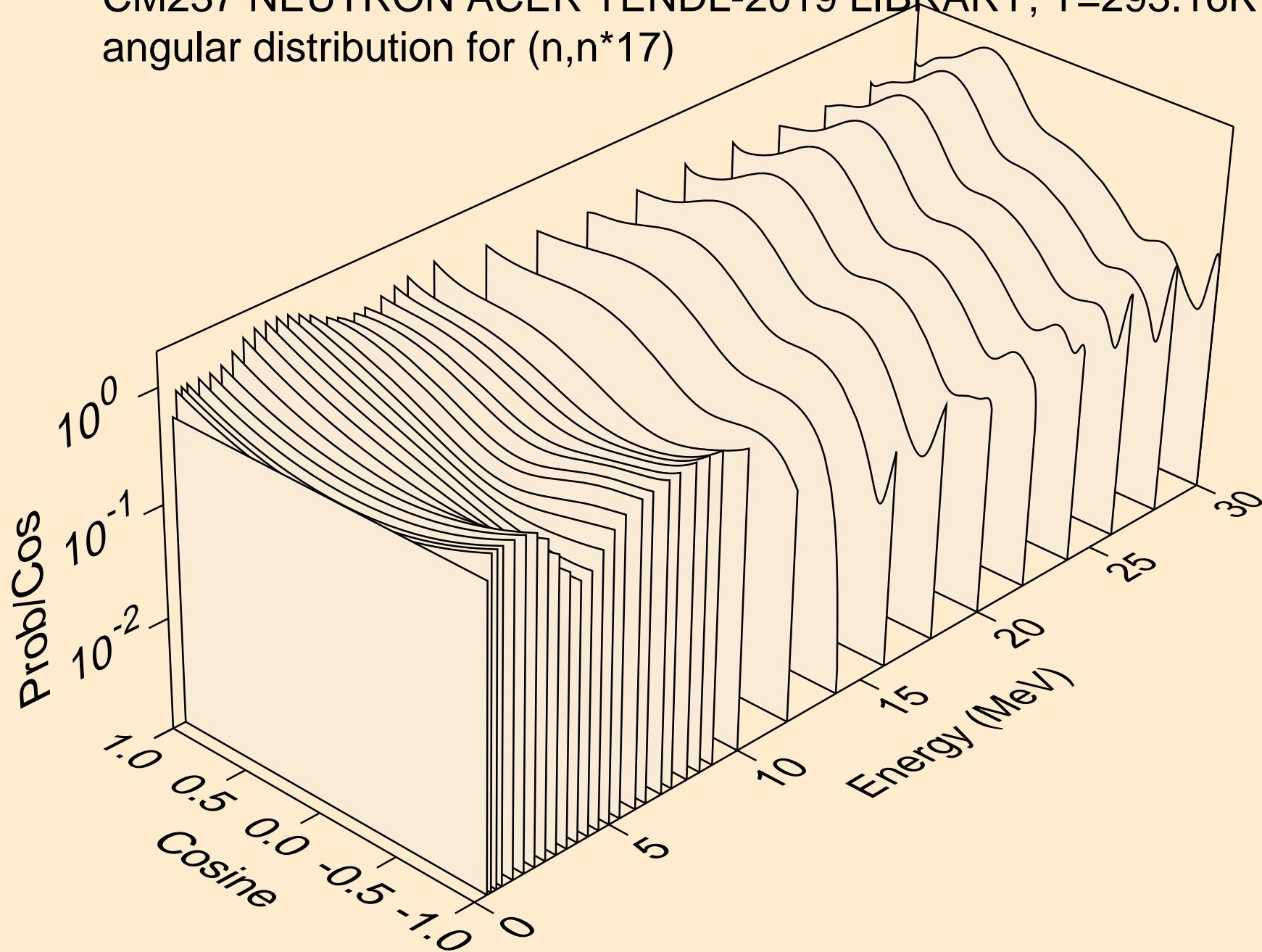

CM237 NEUTRON ACER TENDL-2019 LIBRARY; T=293.16K
angular distribution for (n,n*18)

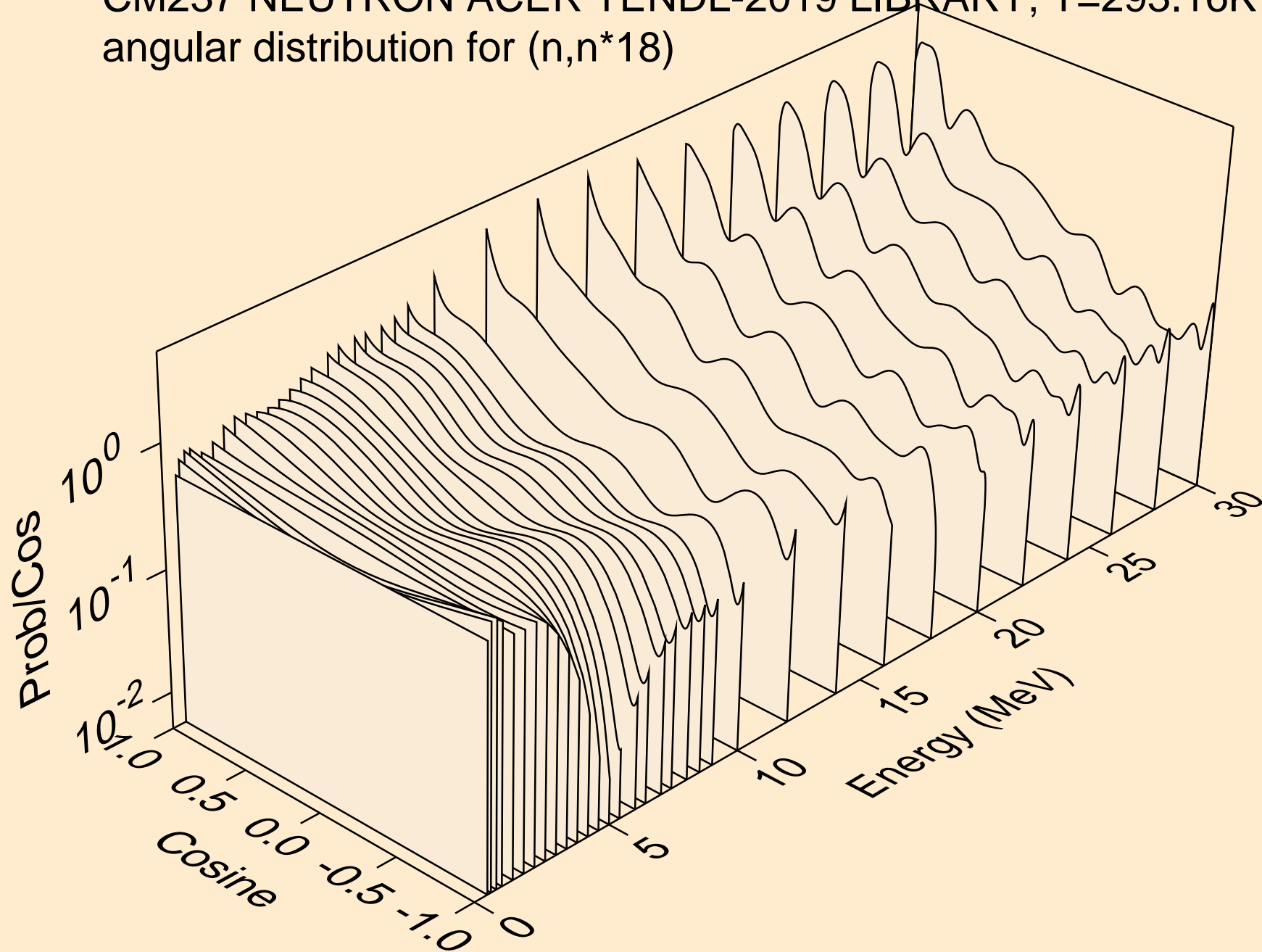

CM237 NEUTRON ACER TENDL-2019 LIBRARY; T=293.16K
angular distribution for (n,n*19)

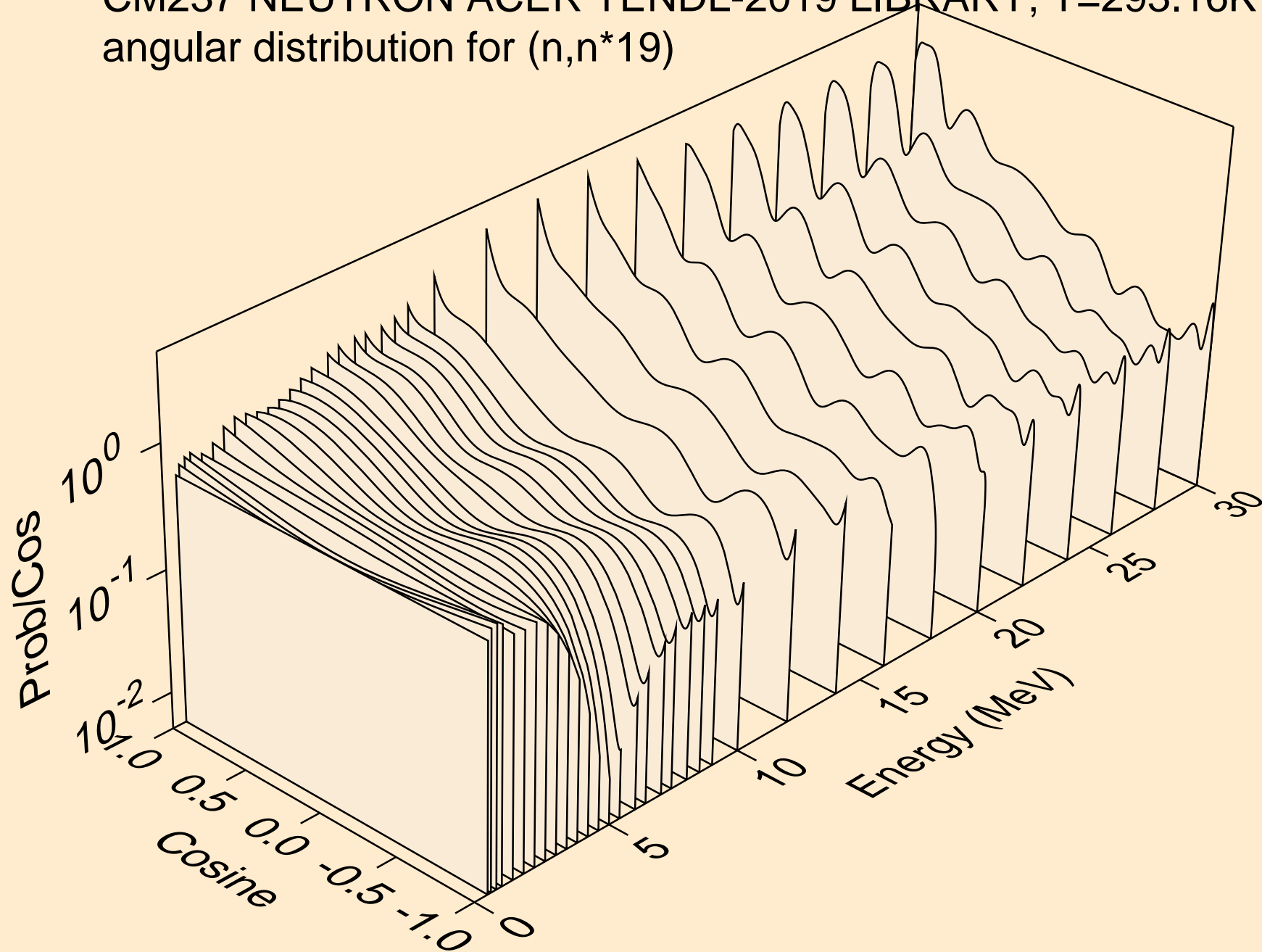

CM237 NEUTRON ACER TENDL-2019 LIBRARY; T=293.16K
Total fission nuabar

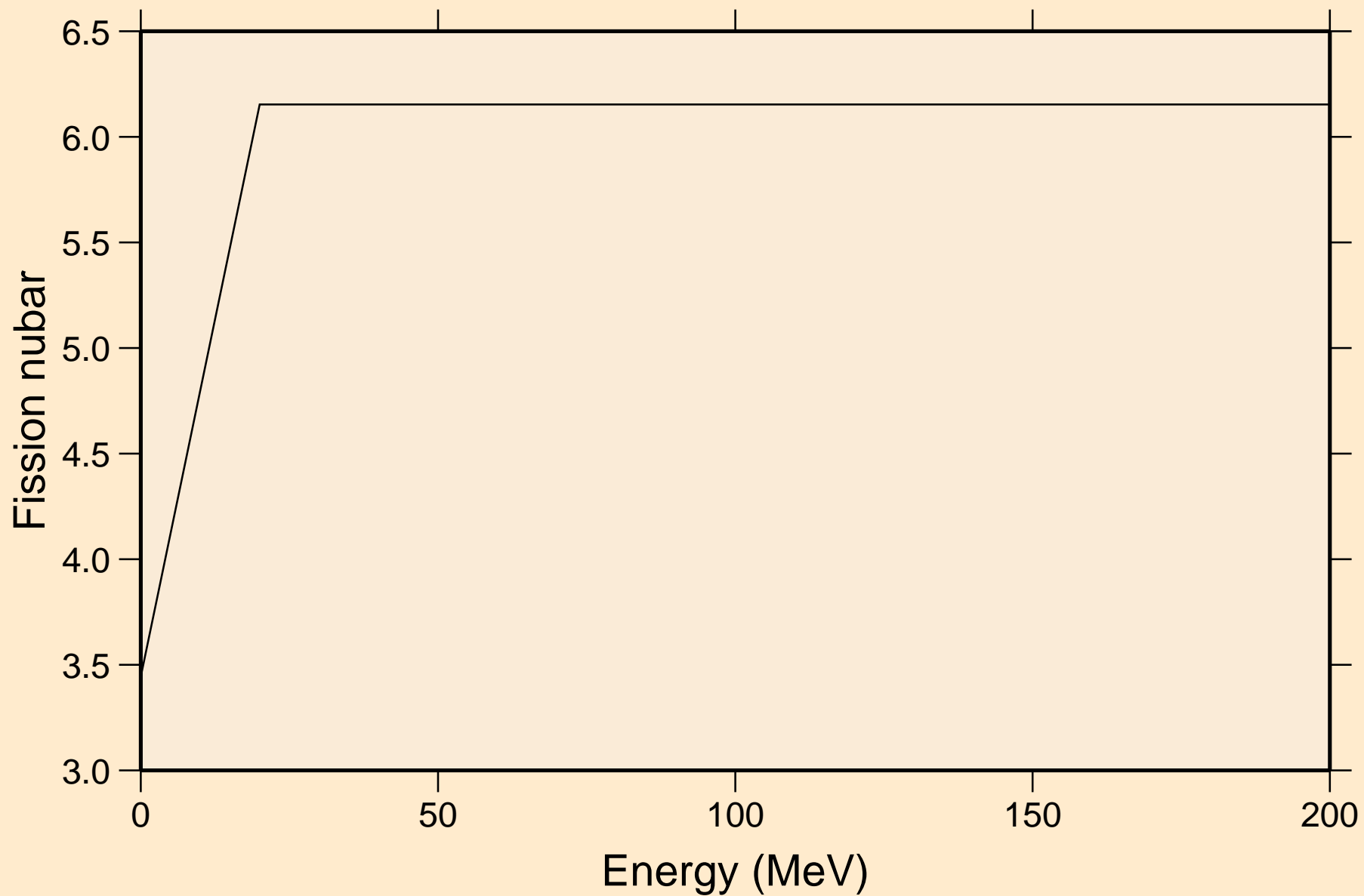

CM237 NEUTRON ACER TENDL-2019 LIBRARY; T=293.16K
Neutron emission for (n,x)

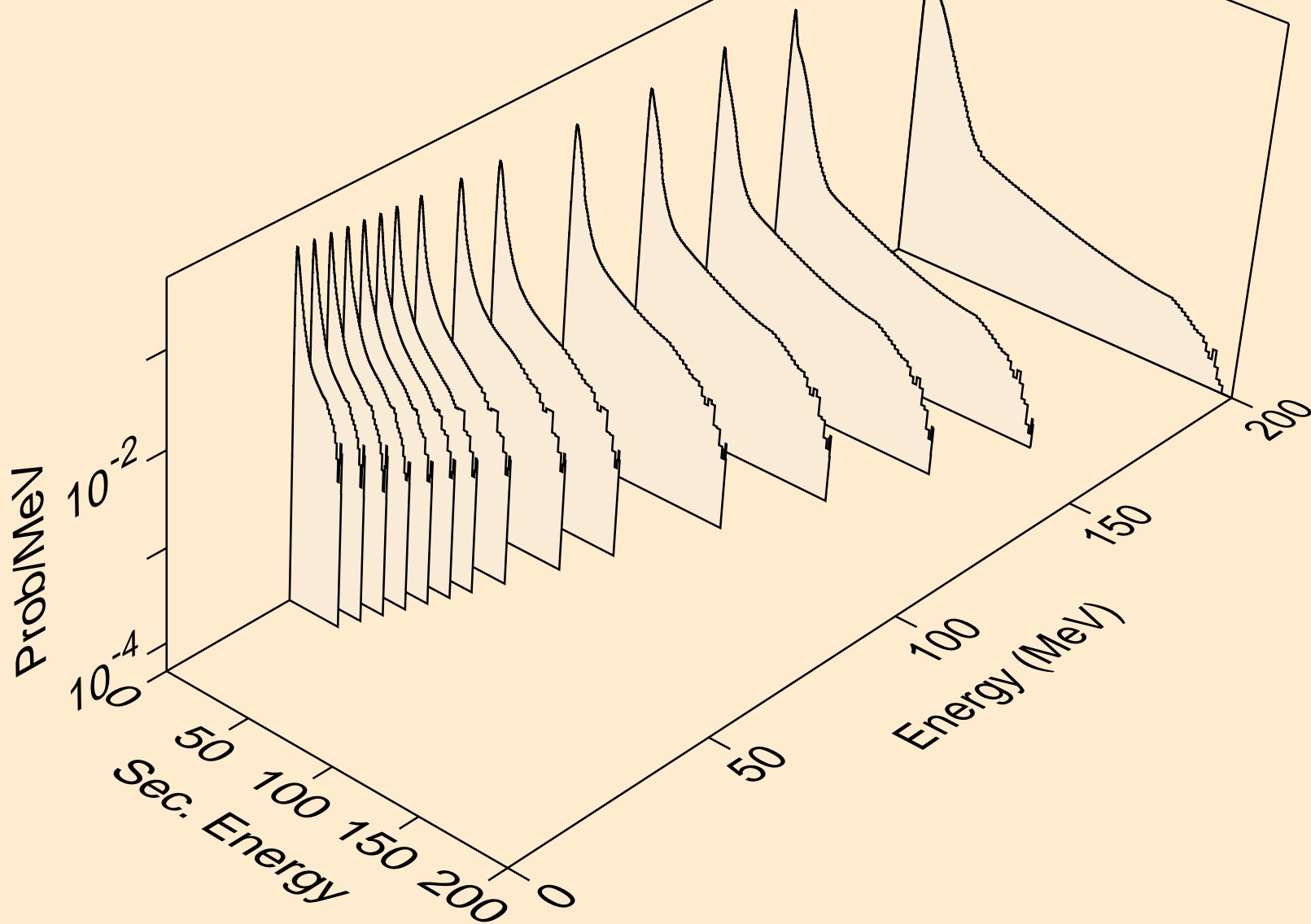

CM237 NEUTRON ACER TENDL-2019 LIBRARY; T=293.16K
Neutron emission for (n,2nd)

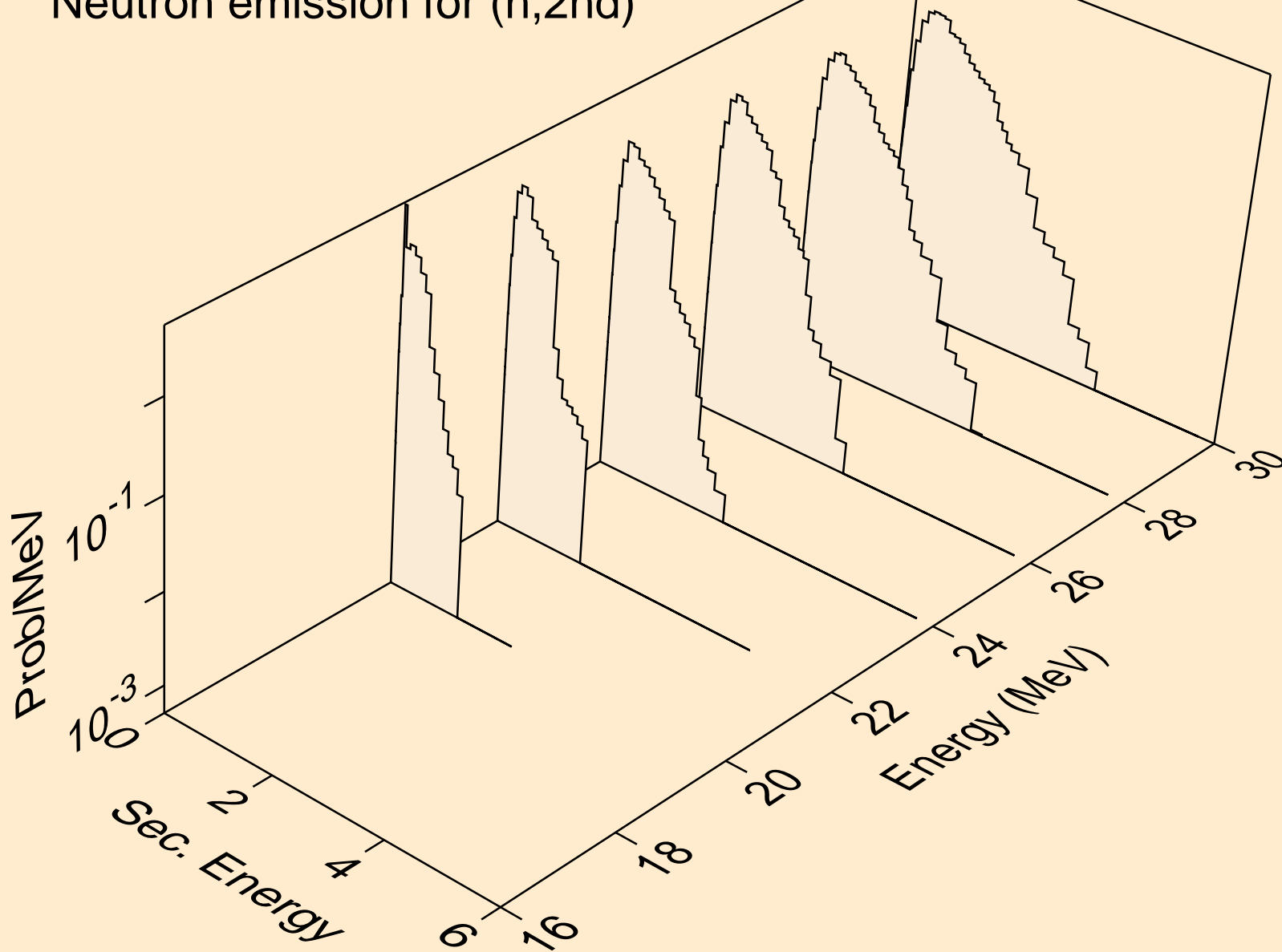

CM237 NEUTRON ACER TENDL-2019 LIBRARY; T=293.16K
Neutron emission for (n,2n)

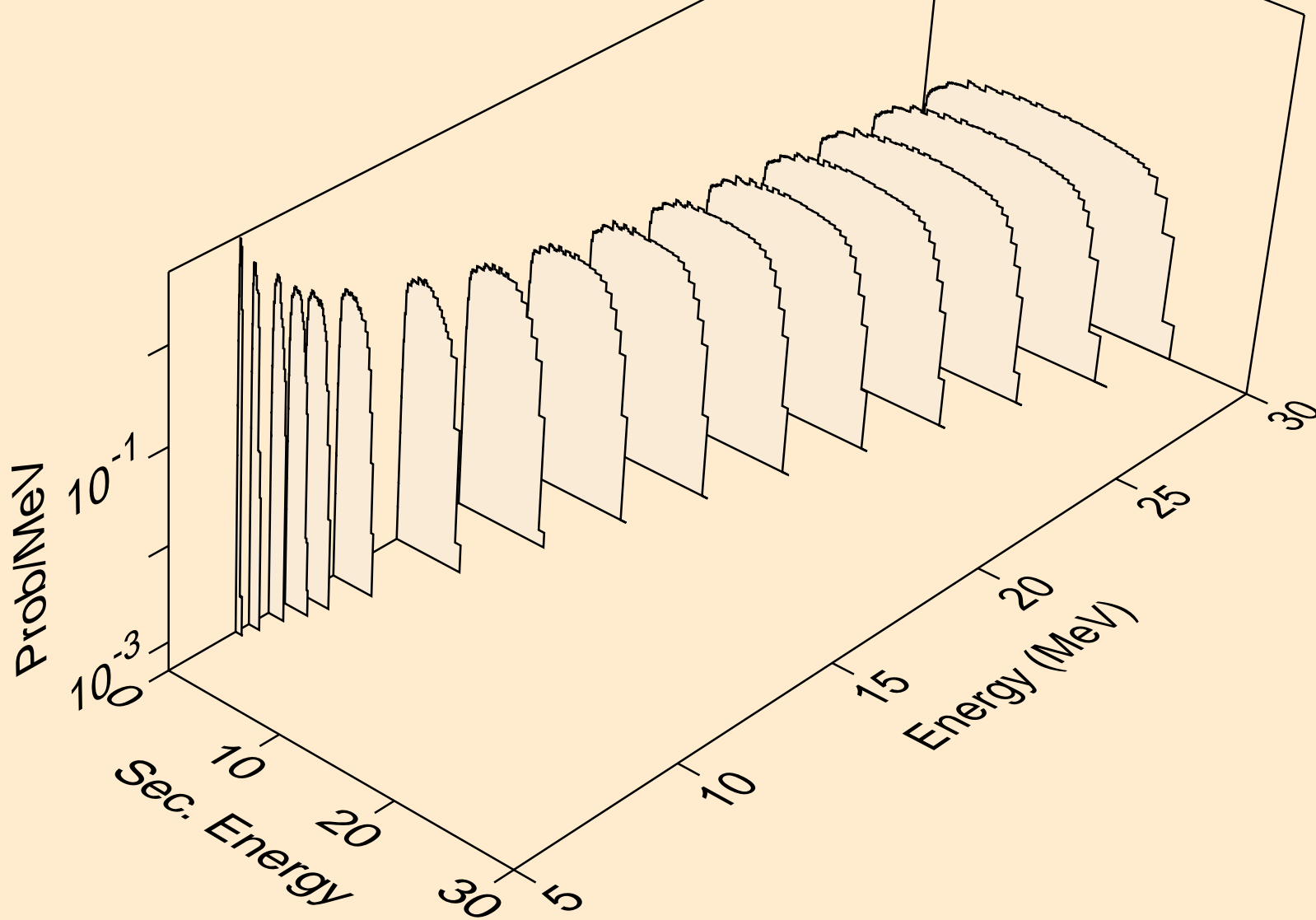

CM237 NEUTRON ACER TENDL-2019 LIBRARY; T=293.16K
Neutron emission for (n,3n)

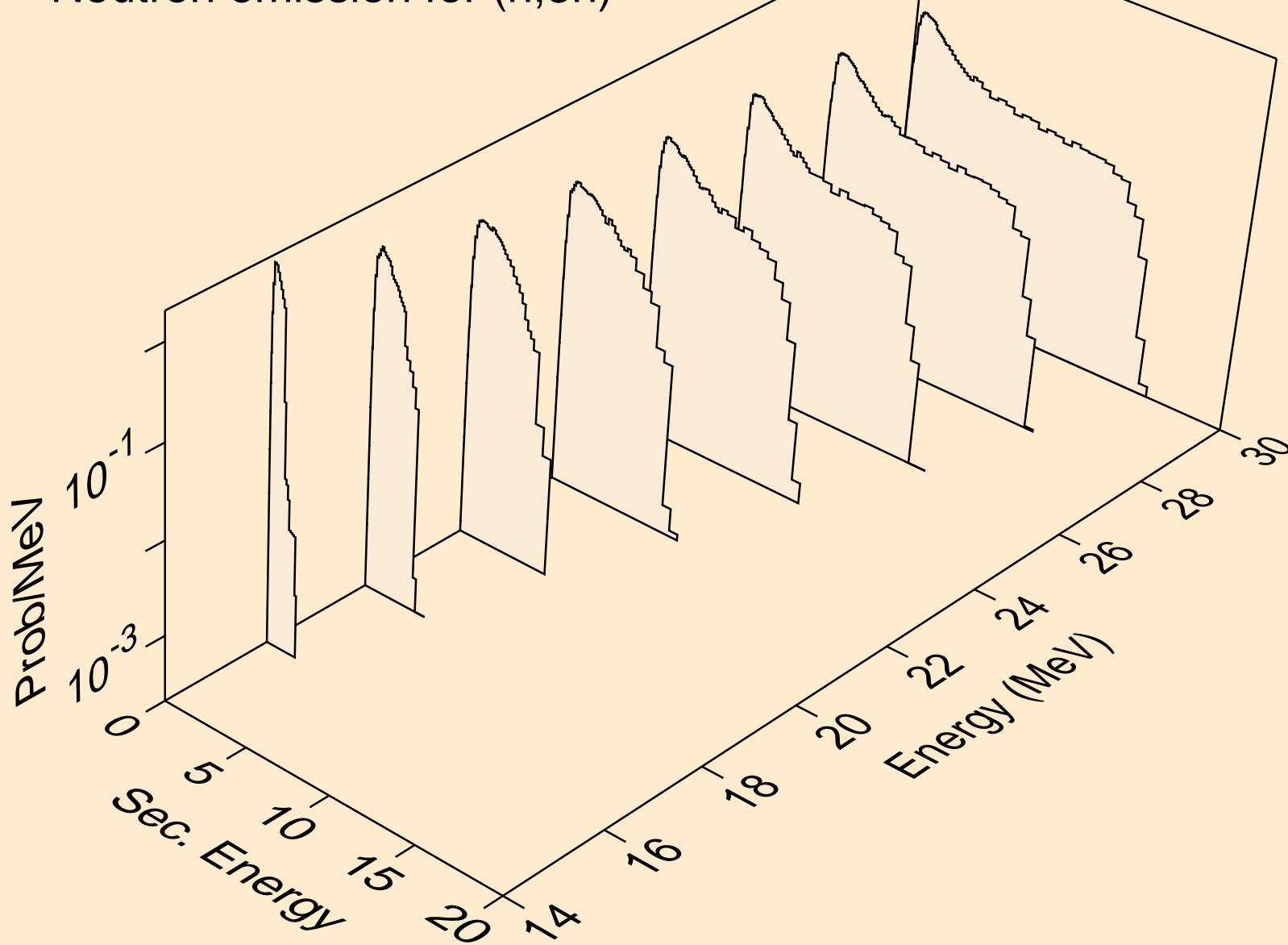

CM237 NEUTRON ACER TENDL-2019 LIBRARY; T=293.16K
Neutron emission for fission

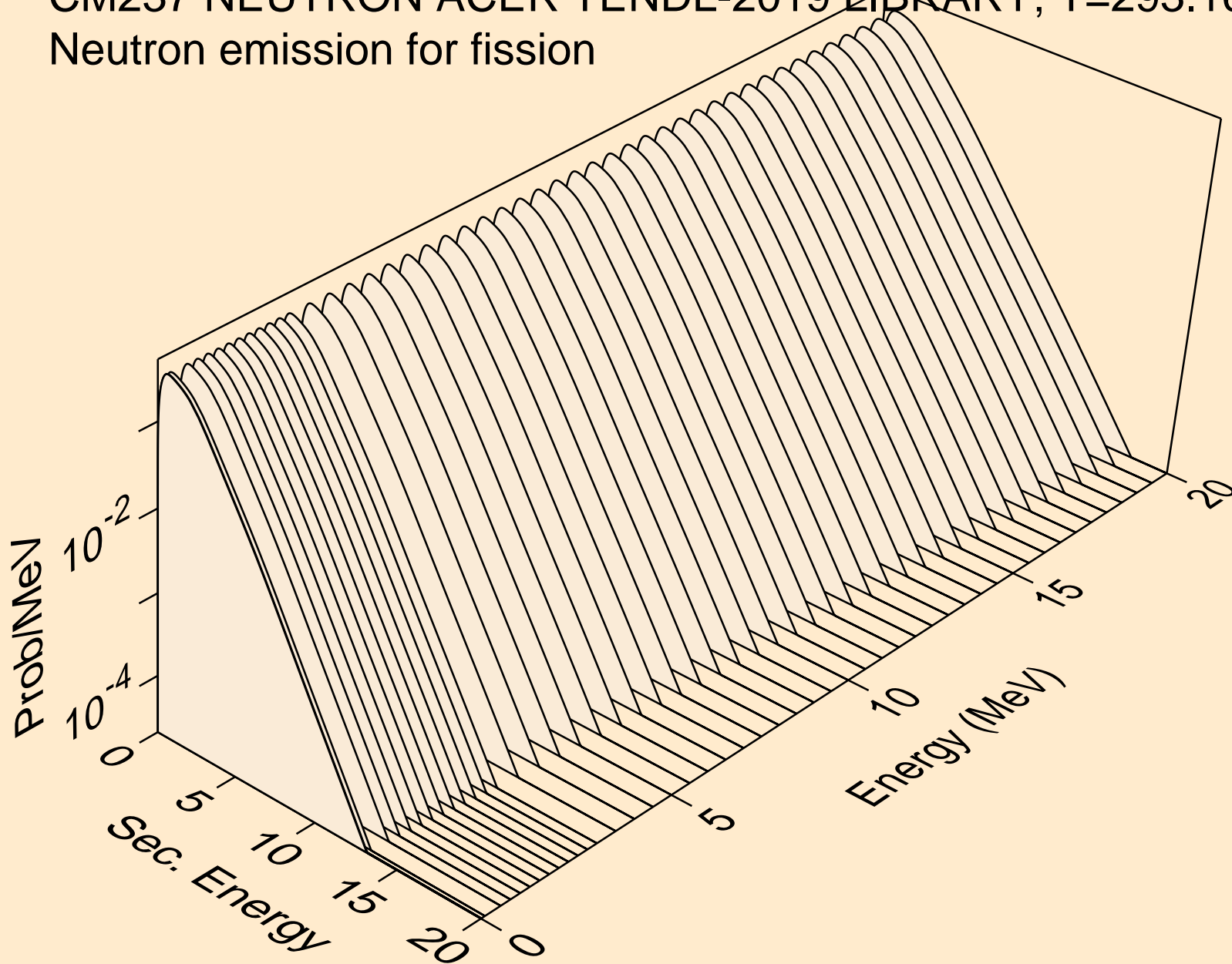

CM237 NEUTRON ACER TENDL-2019 LIBRARY; T=293.16K
Neutron emission for (n,n*)a

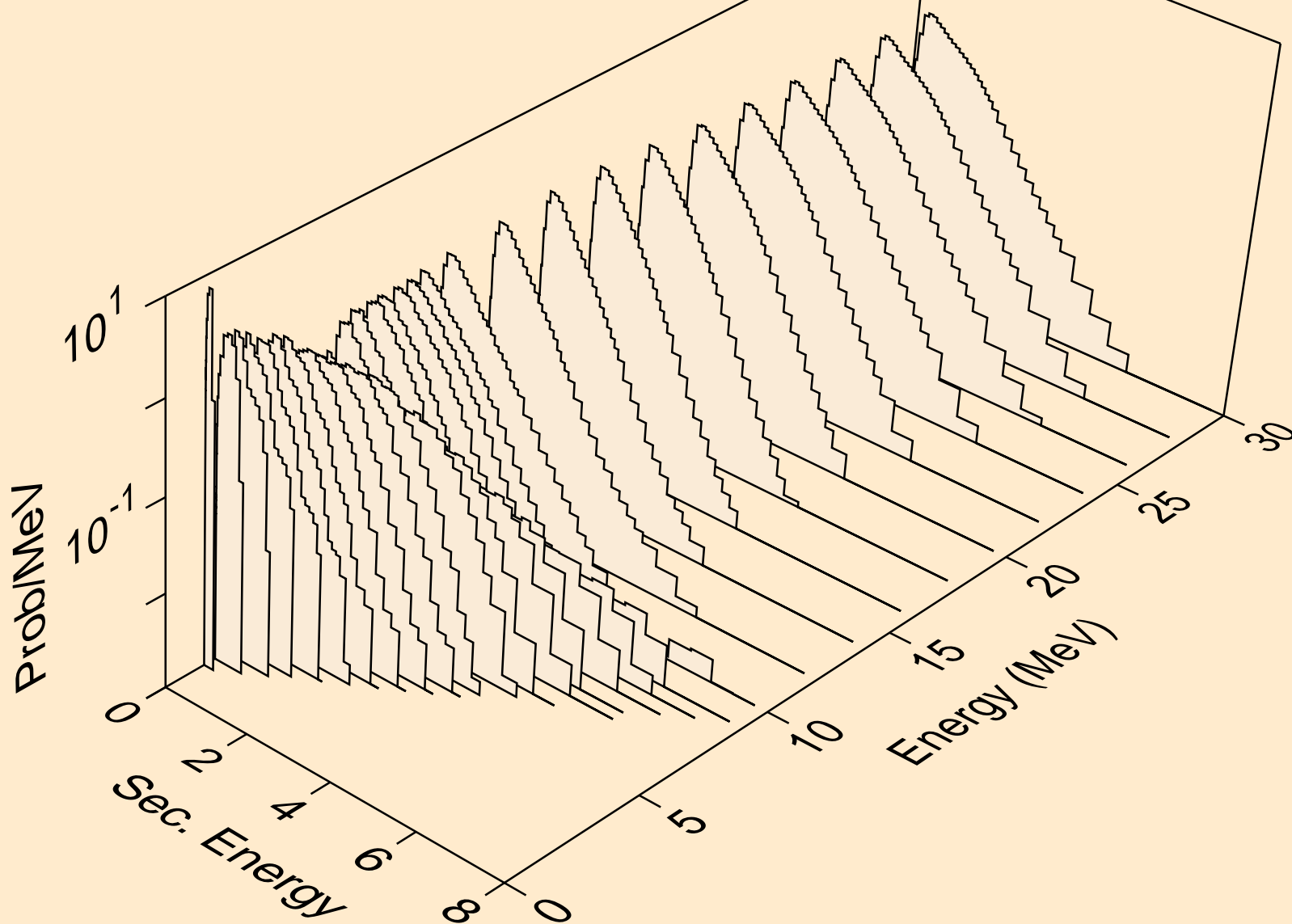

CM237 NEUTRON ACER TENDL-2019 LIBRARY; T=293.16K
Neutron emission for (n,2n)a

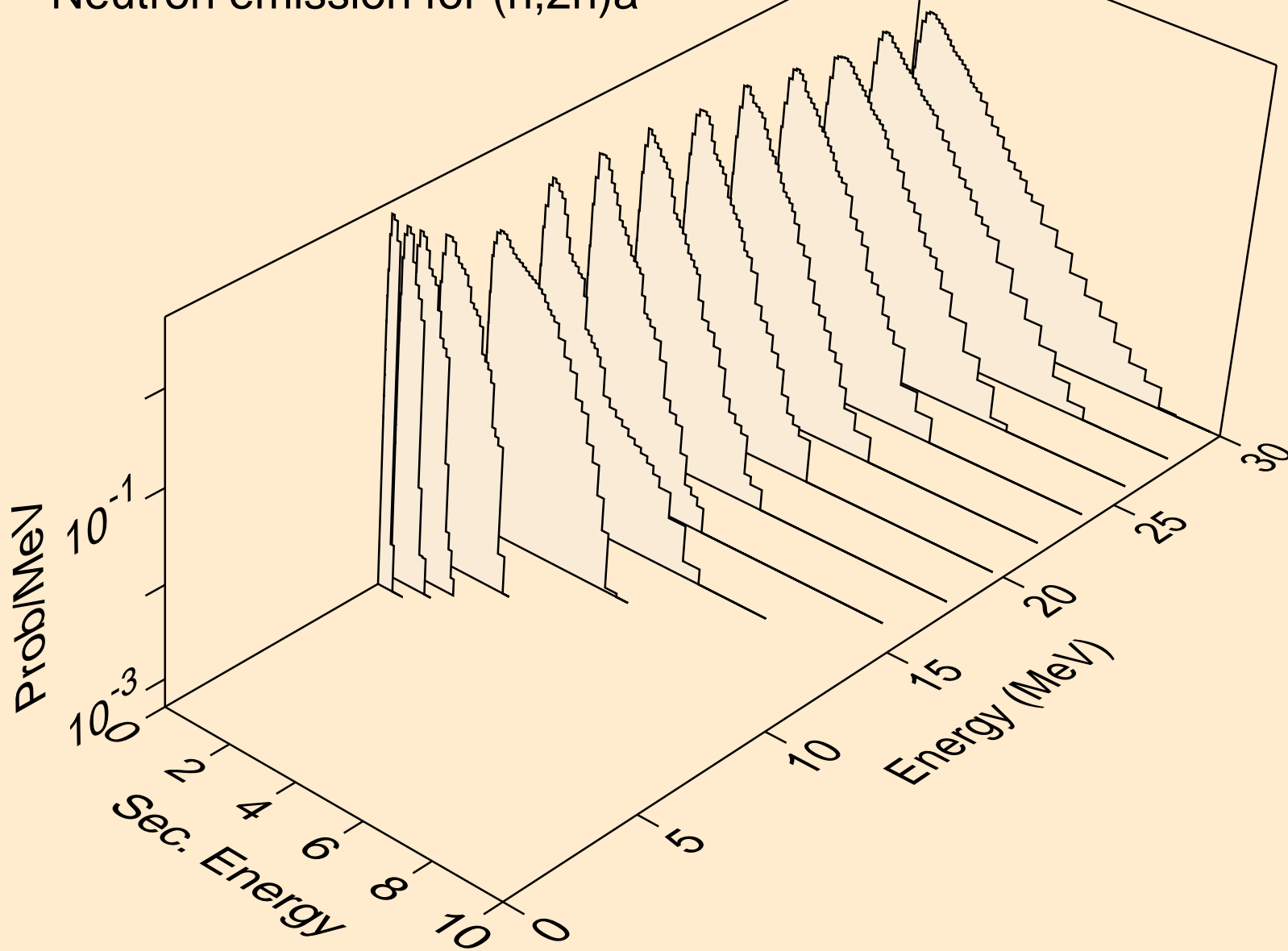

CM237 NEUTRON ACER TENDL-2019 LIBRARY; T=293.16K
Neutron emission for (n,3n)a

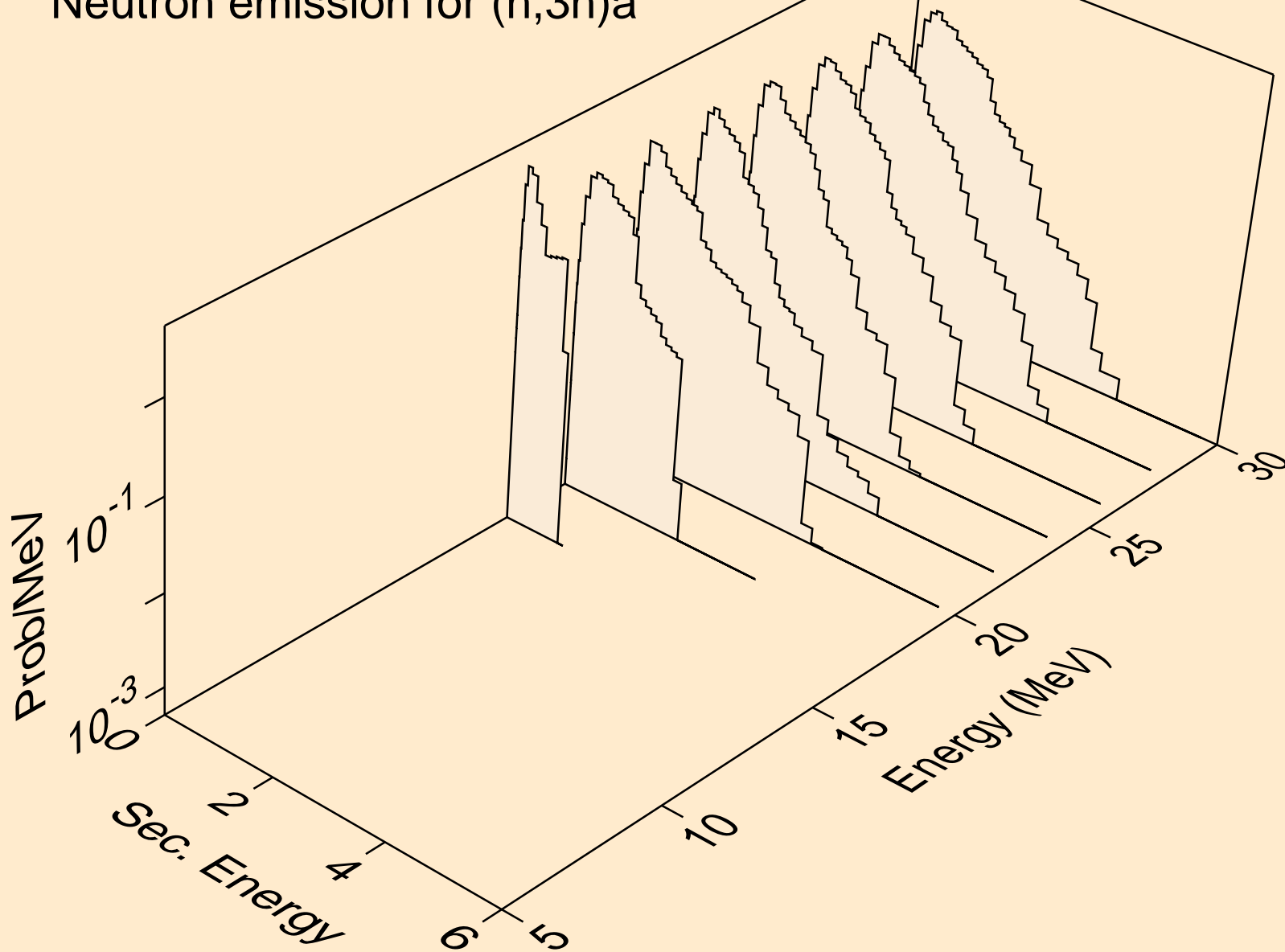

CM237 NEUTRON ACER TENDL-2019 LIBRARY; T=293.16K
Neutron emission for (n,n*)p

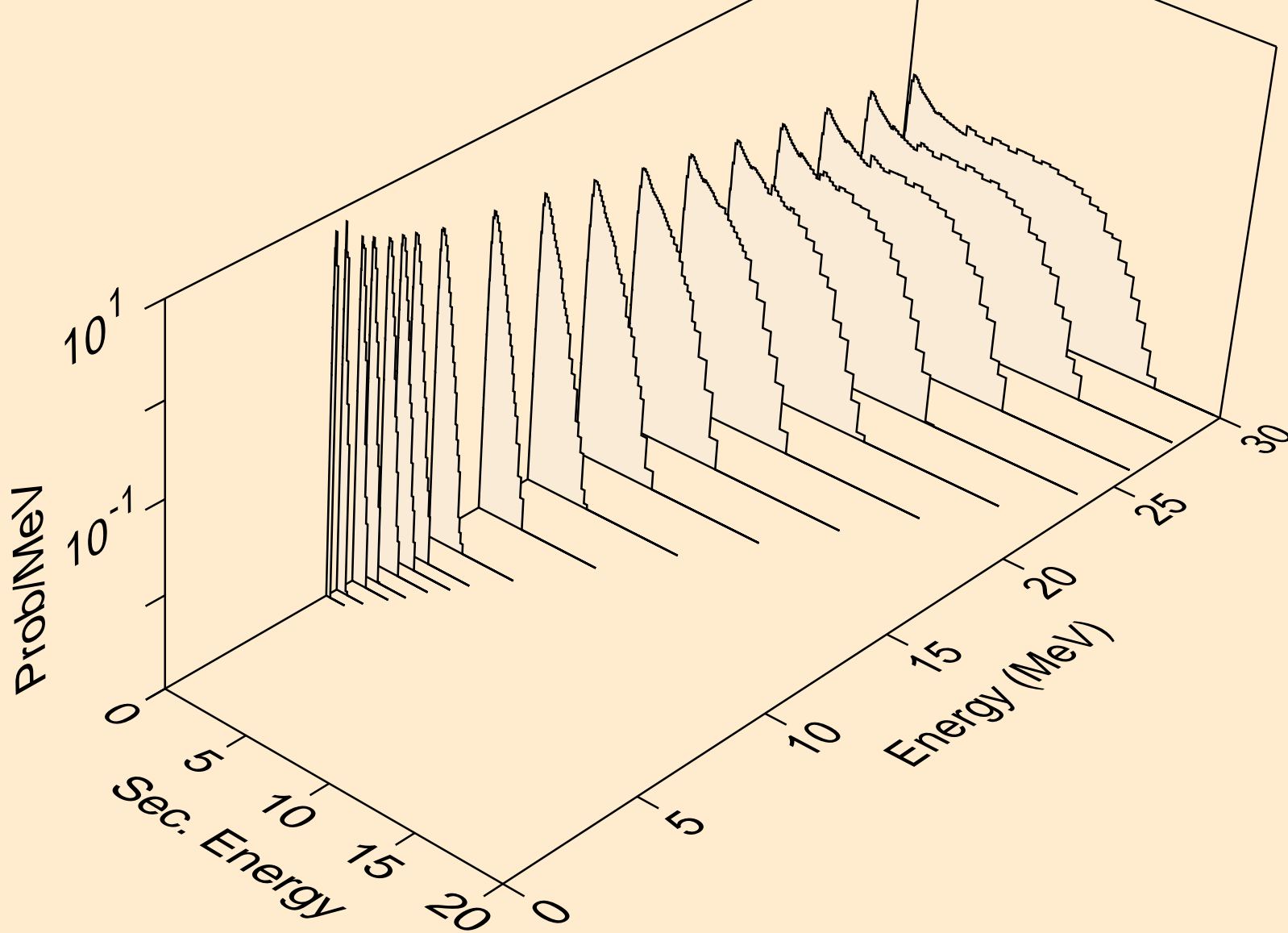

CM237 NEUTRON ACER TENDL-2019 LIBRARY; T=293.16K
Neutron emission for (n,n*)2a

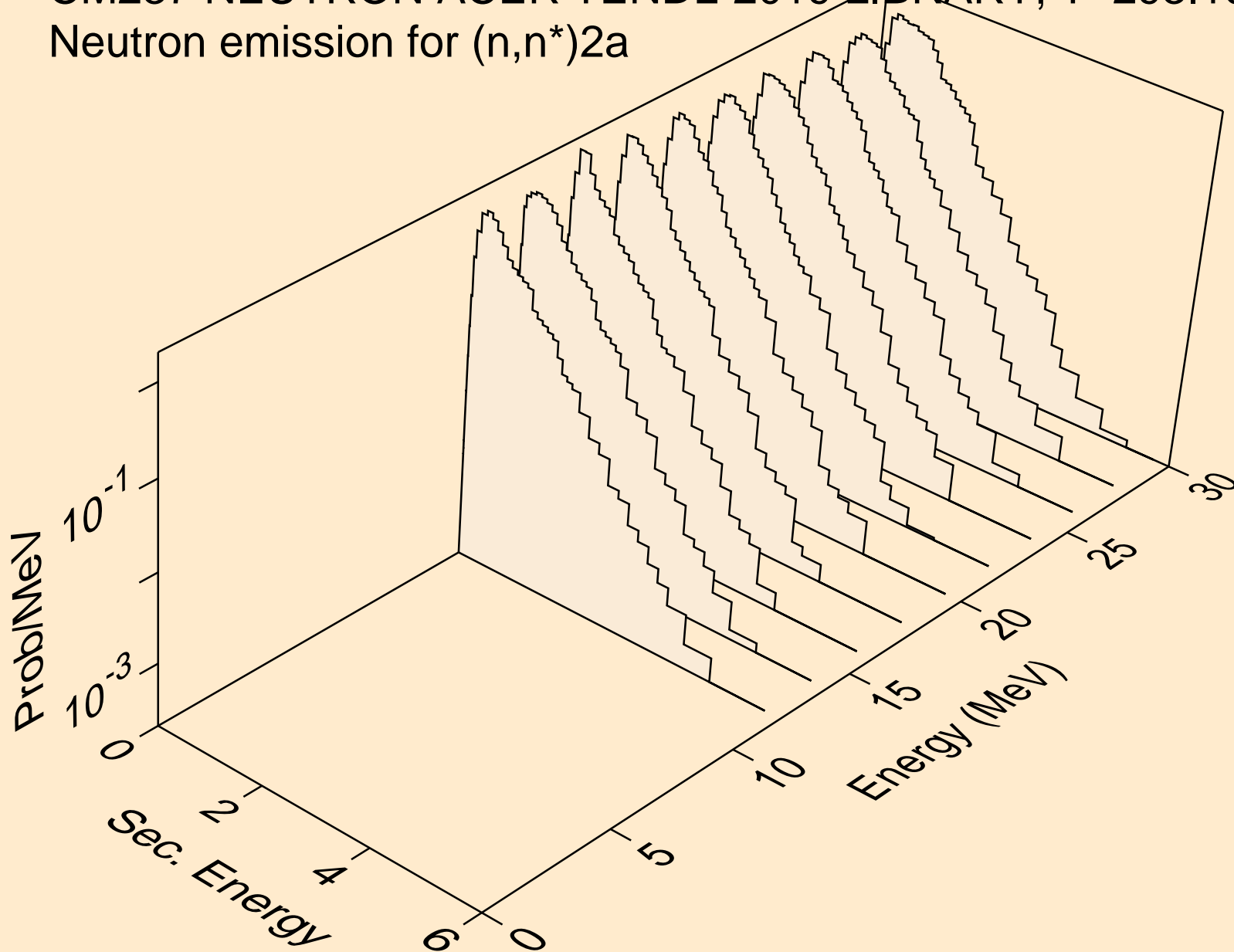

CM237 NEUTRON ACER TENDL-2019 LIBRARY; T=293.16K
Neutron emission for (n,n*)d

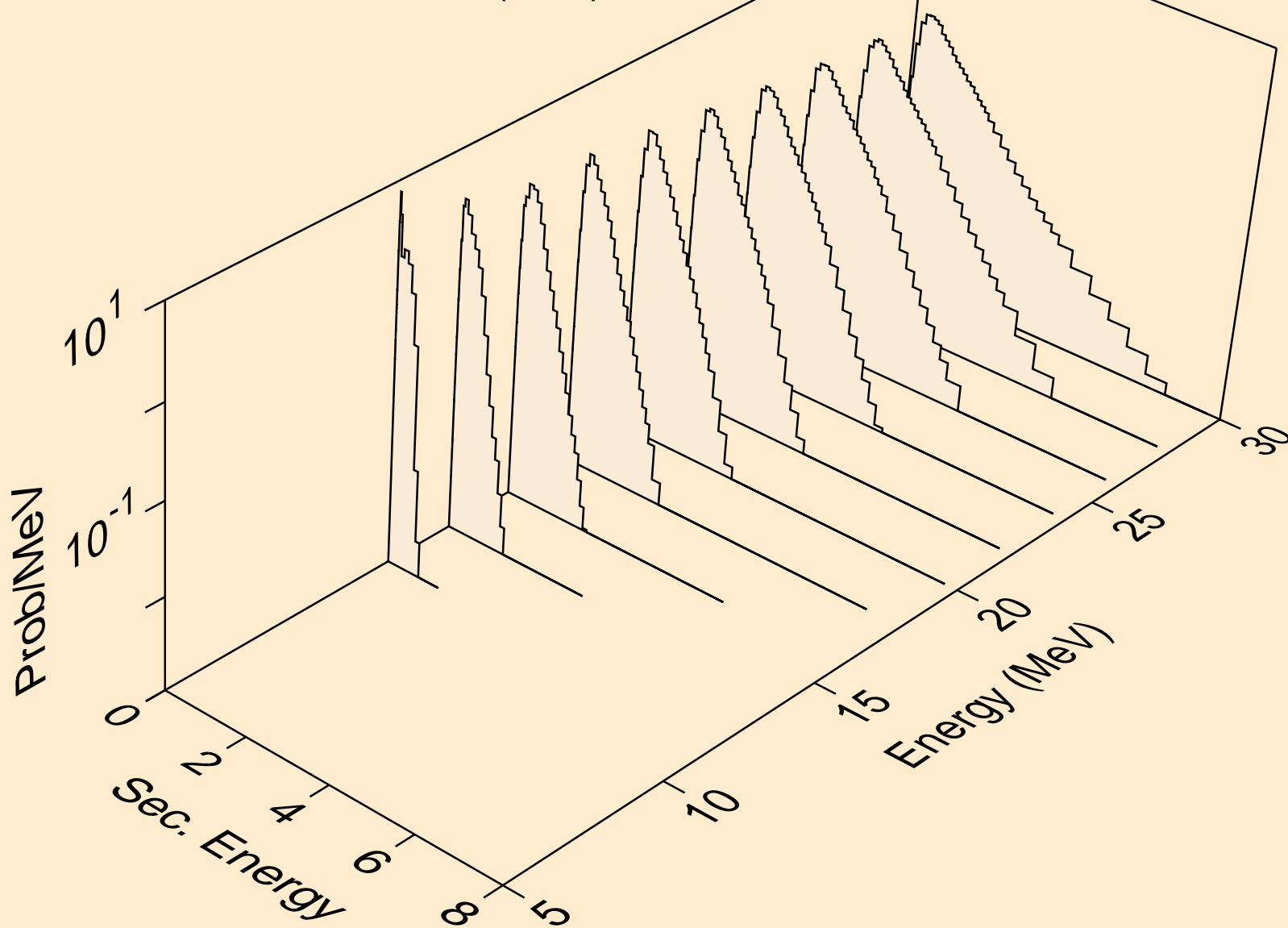

CM237 NEUTRON ACER TENDL-2019 LIBRARY; T=293.16K
Neutron emission for (n,n*)t

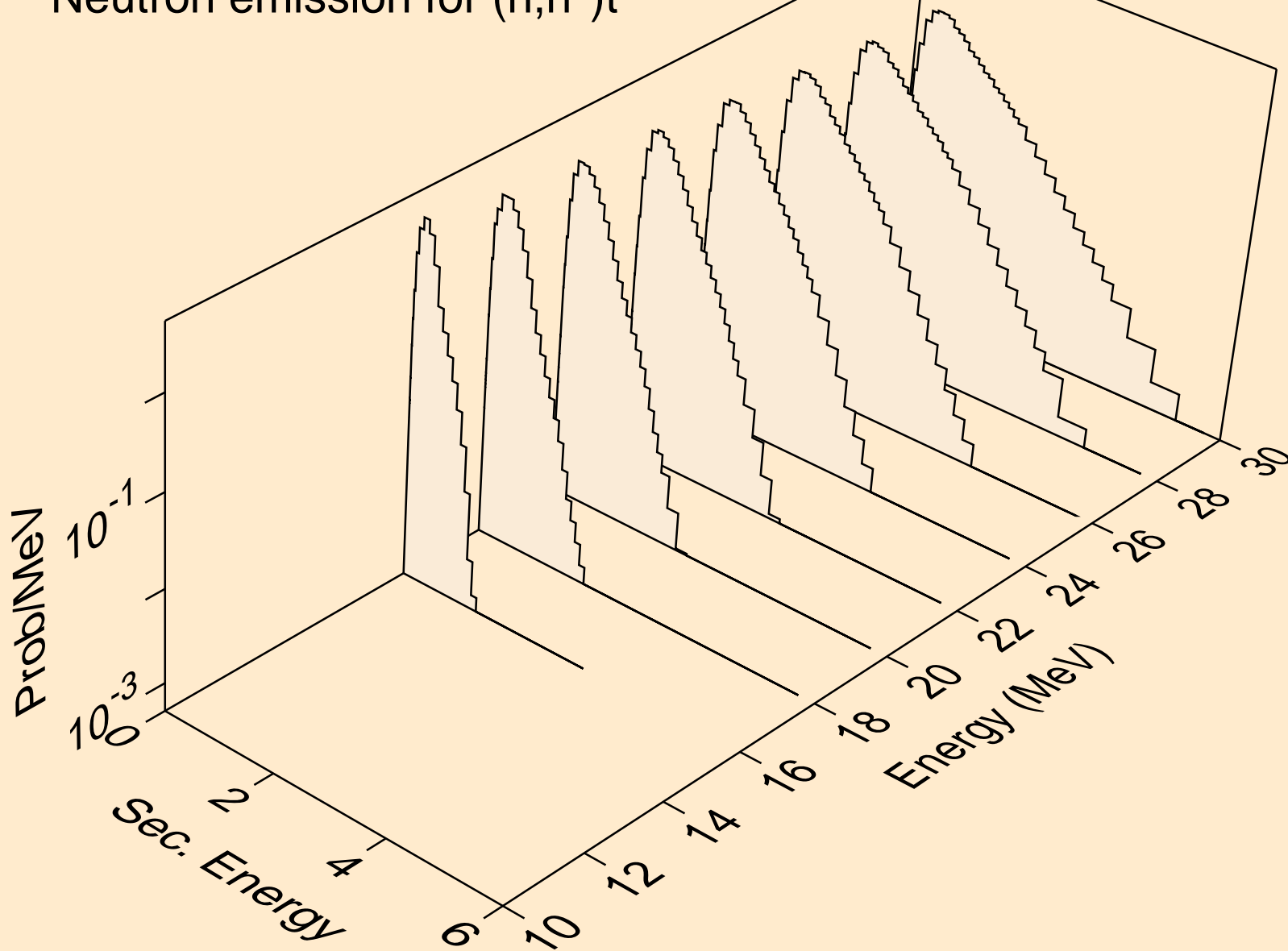

CM237 NEUTRON ACER TENDL-2019 LIBRARY; T=293.16K
Neutron emission for (n,n*)he3

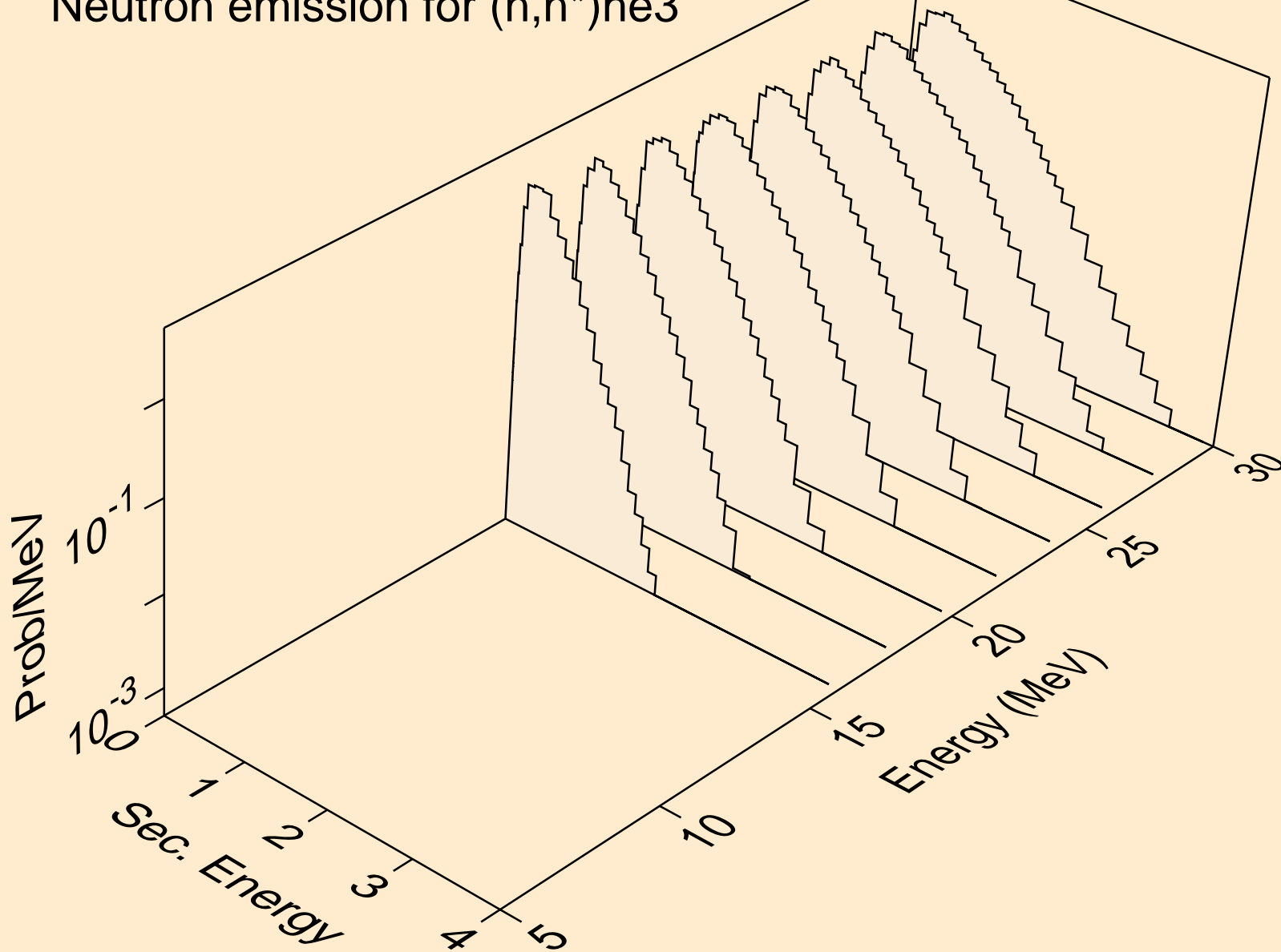

CM237 NEUTRON ACER TENDL-2019 LIBRARY; T=293.16K
Neutron emission for (n,4n)

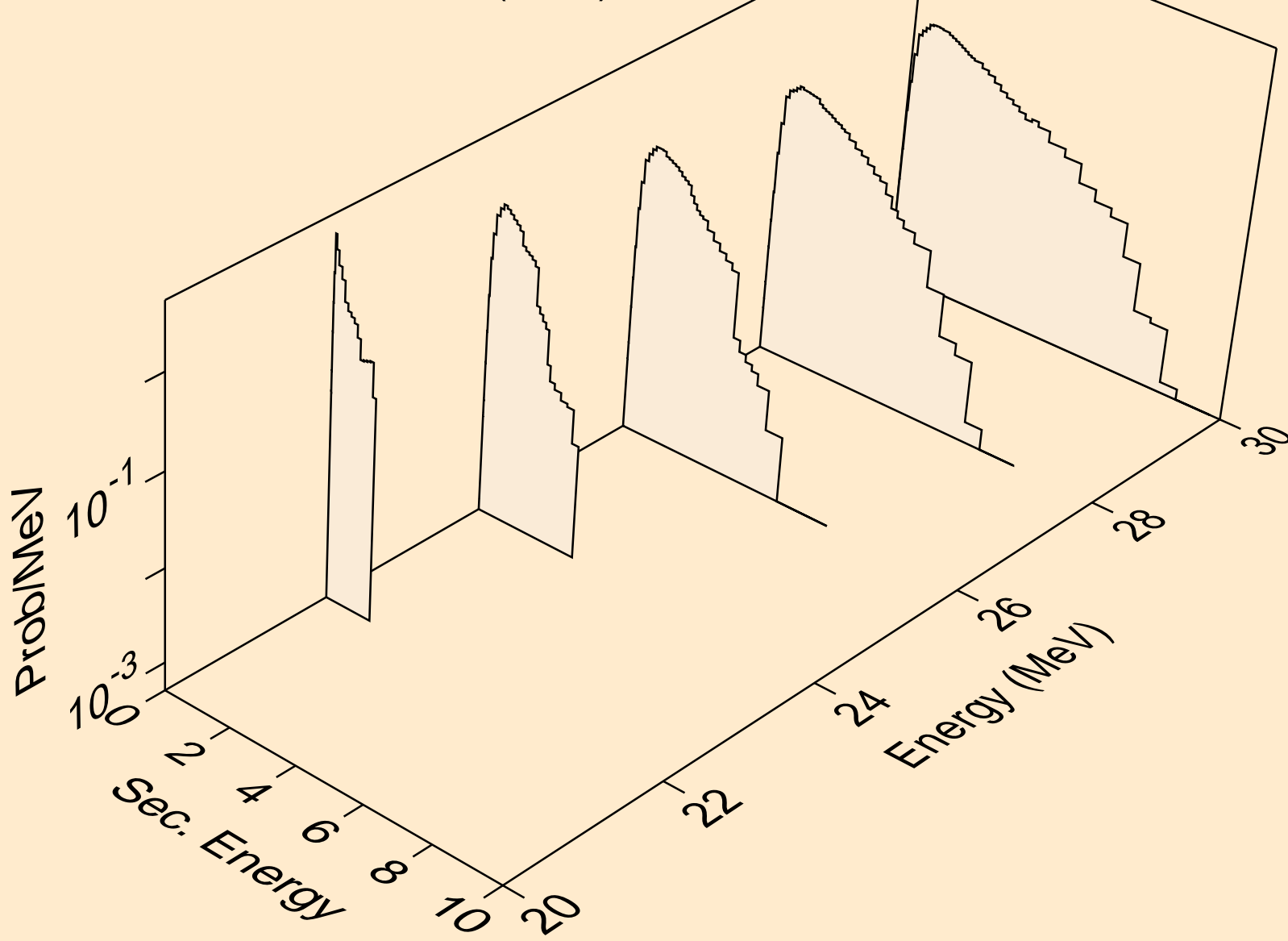

CM237 NEUTRON ACER TENDL-2019 LIBRARY; T=293.16K
Neutron emission for (n,2np)

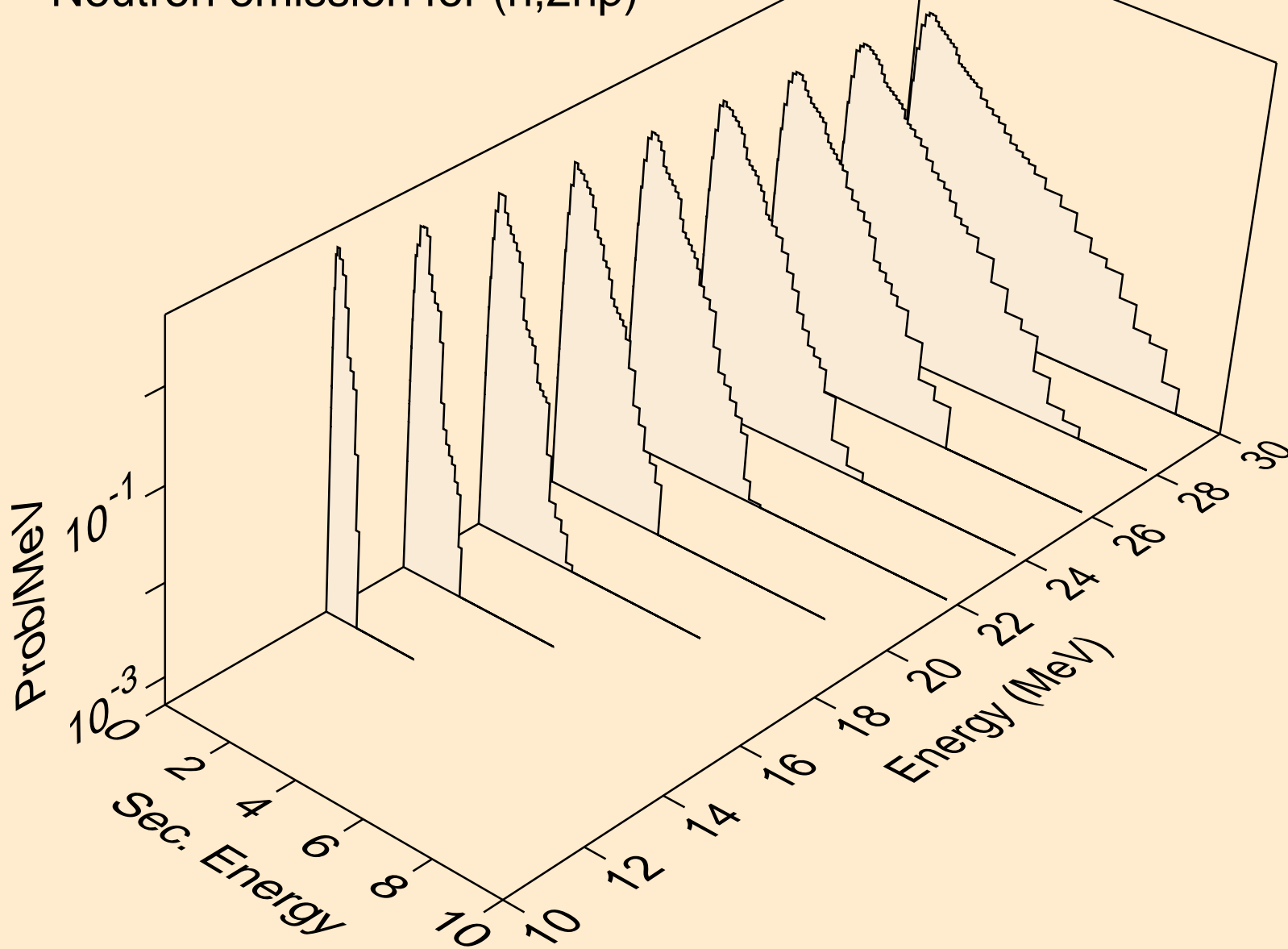

CM237 NEUTRON ACER TENDL-2019 LIBRARY; T=293.16K
Neutron emission for (n,3np)

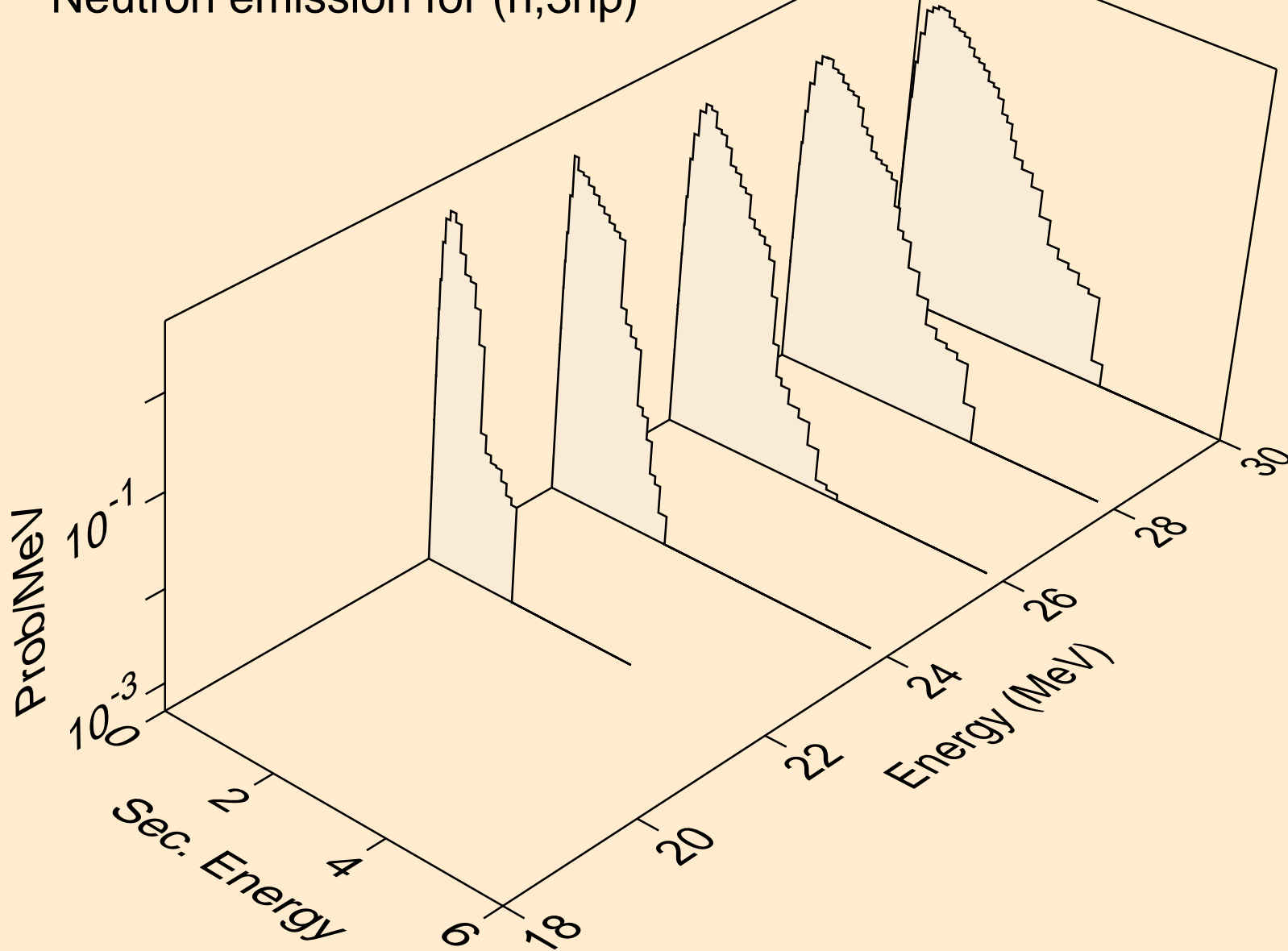

CM237 NEUTRON ACER TENDL-2019 LIBRARY; T=293.16K
Neutron emission for (n,2np)

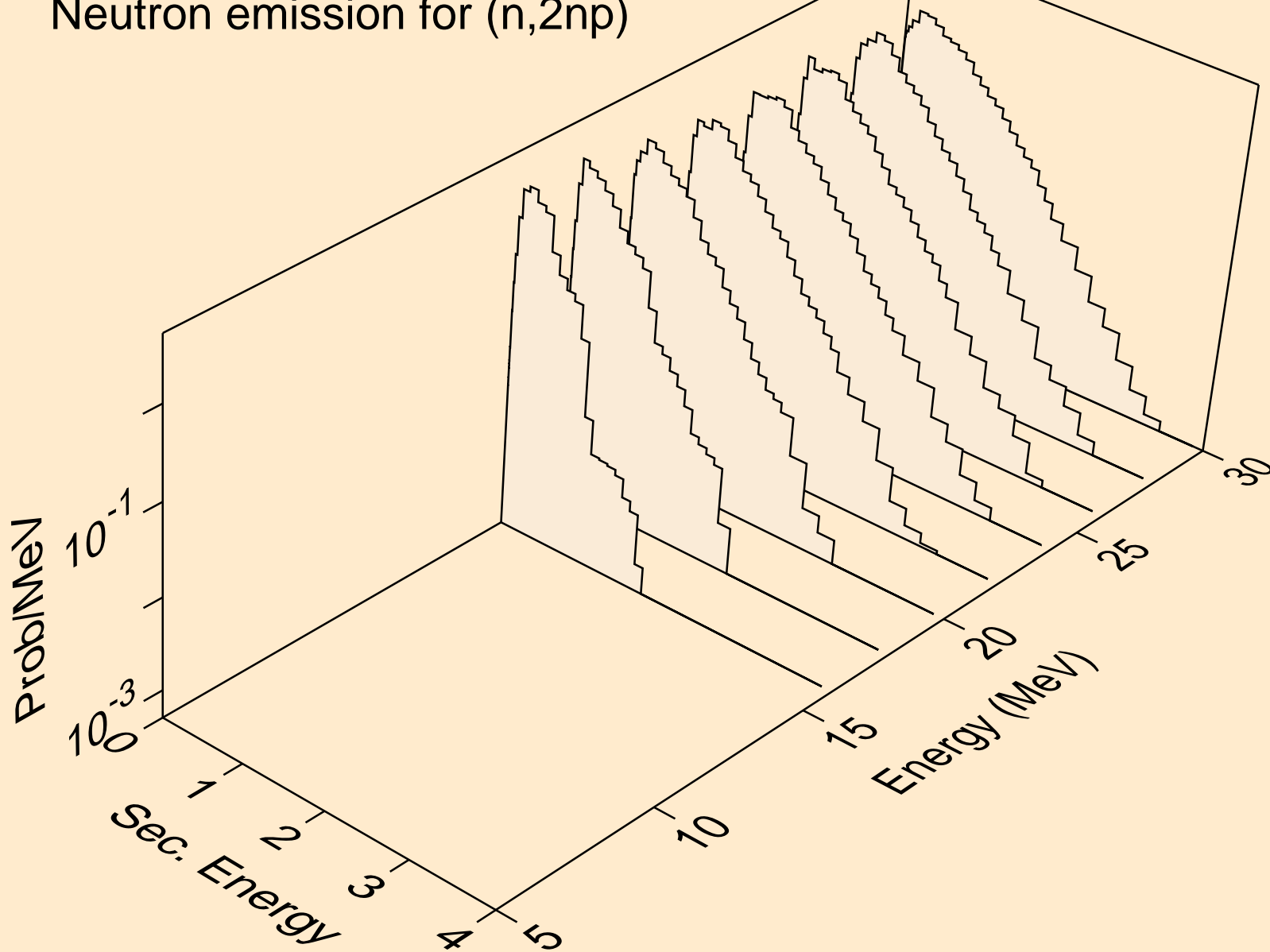

CM237 NEUTRON ACER TENDL-2019 LIBRARY; T=293.16K
Neutron emission for (n,npa)

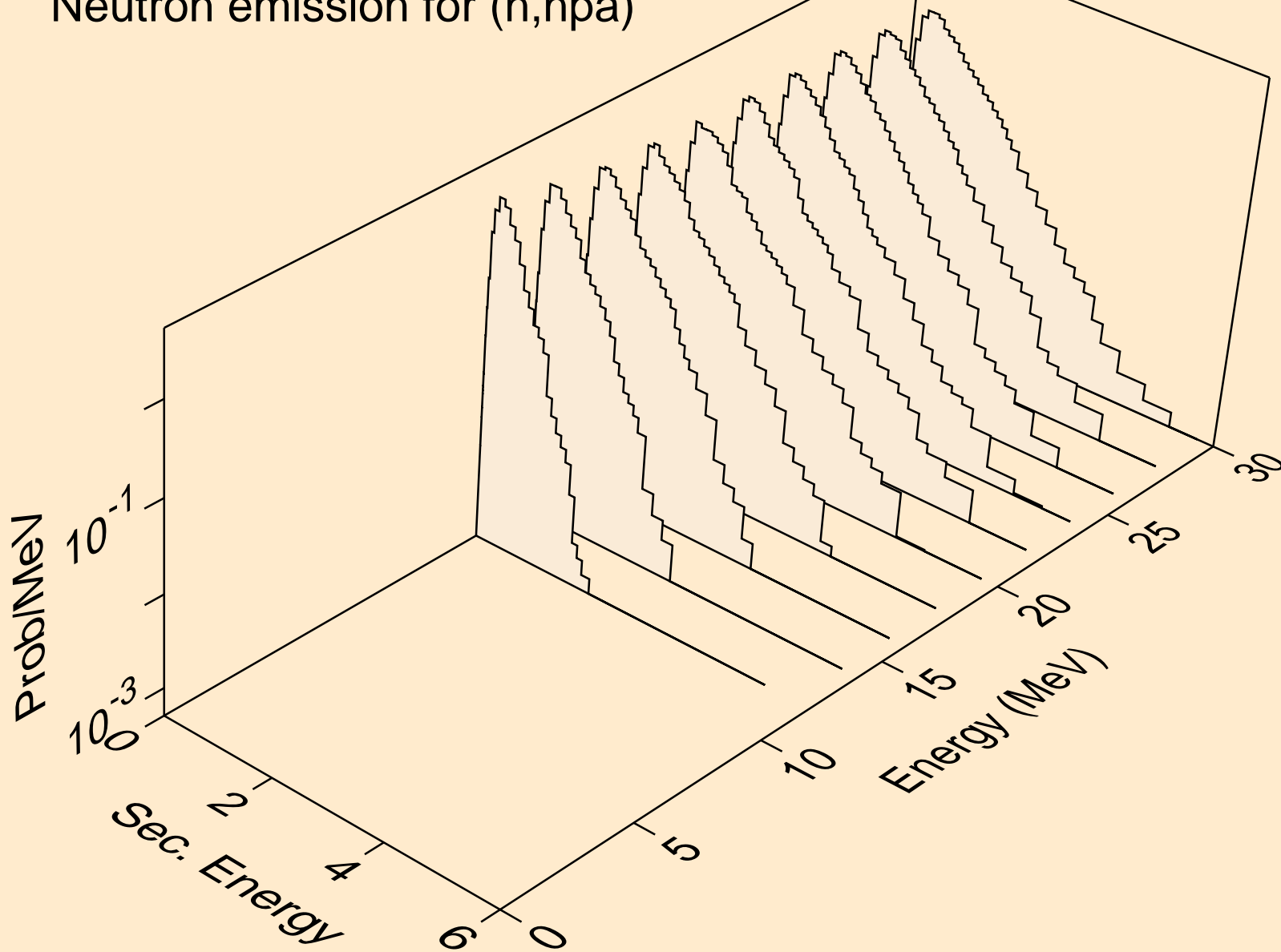

CM237 NEUTRON ACER TENDL-2019 LIBRARY; T=293.16K
Neutron emission for (n,n*c)

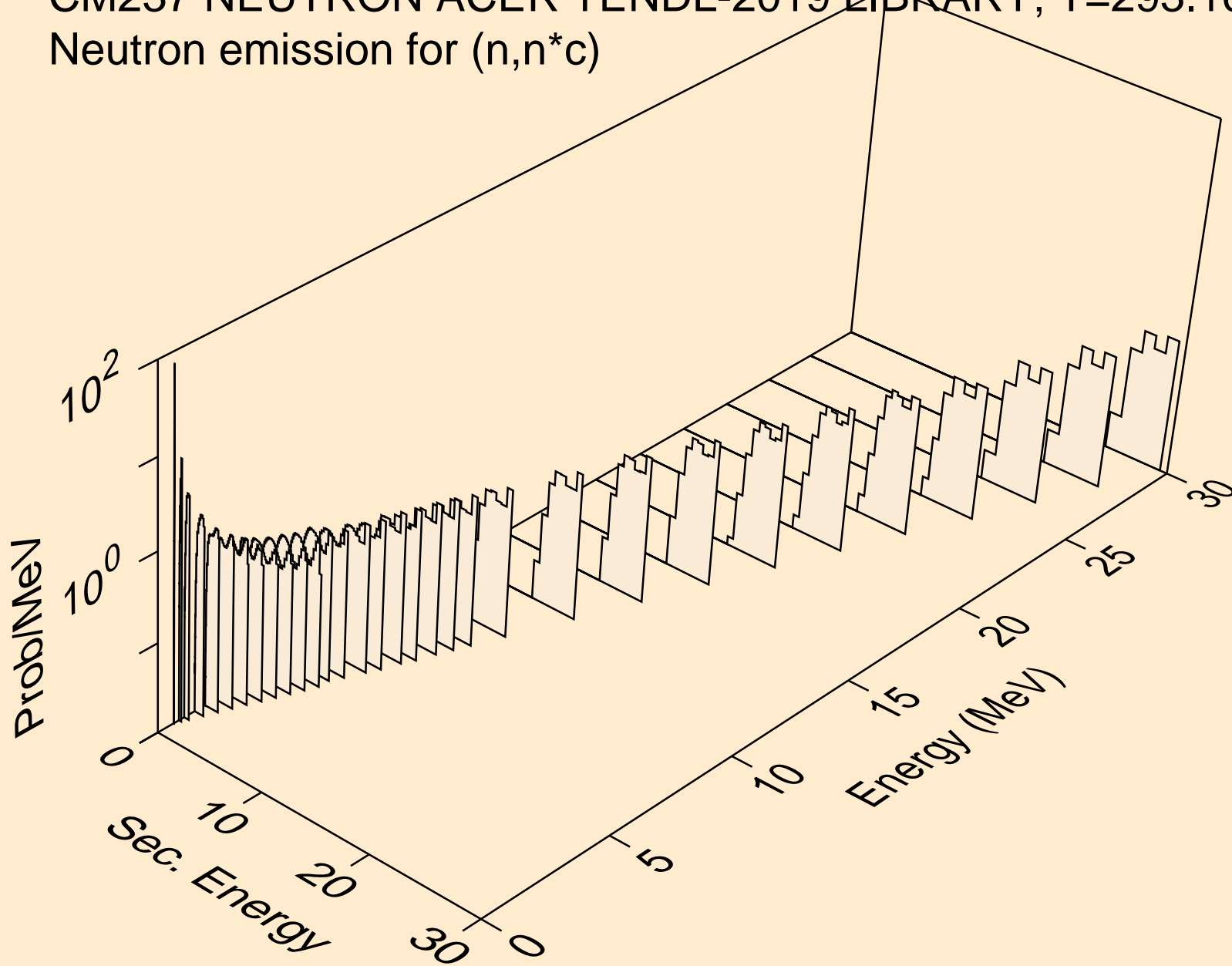

CM237 NEUTRON ACER TENDL-2019 LIBRARY; T=293.16K

Delayed nubar

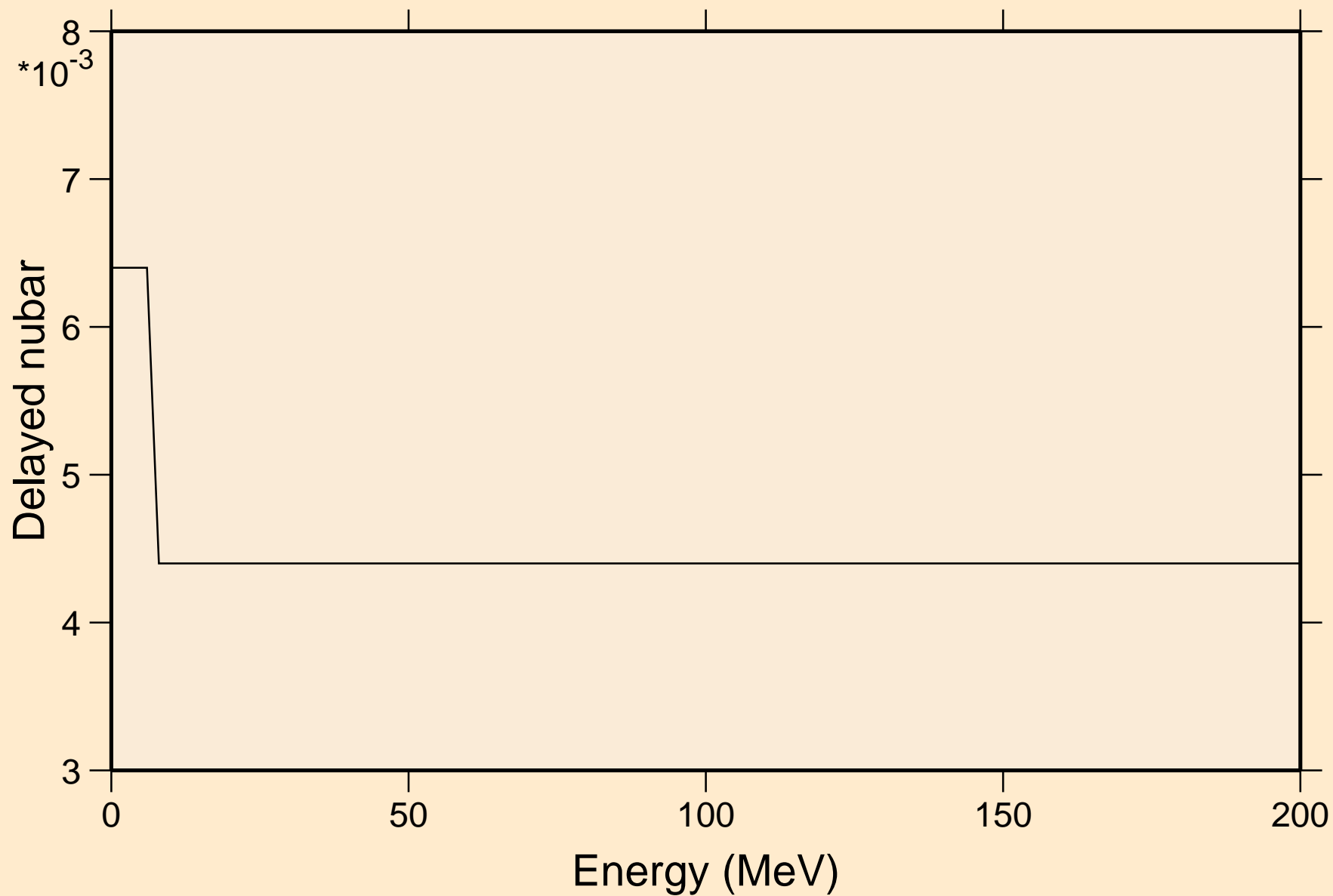

CM237 NEUTRON ACER TENDL-2019 LIBRARY; T=293.16K

Delayed neutron spectra

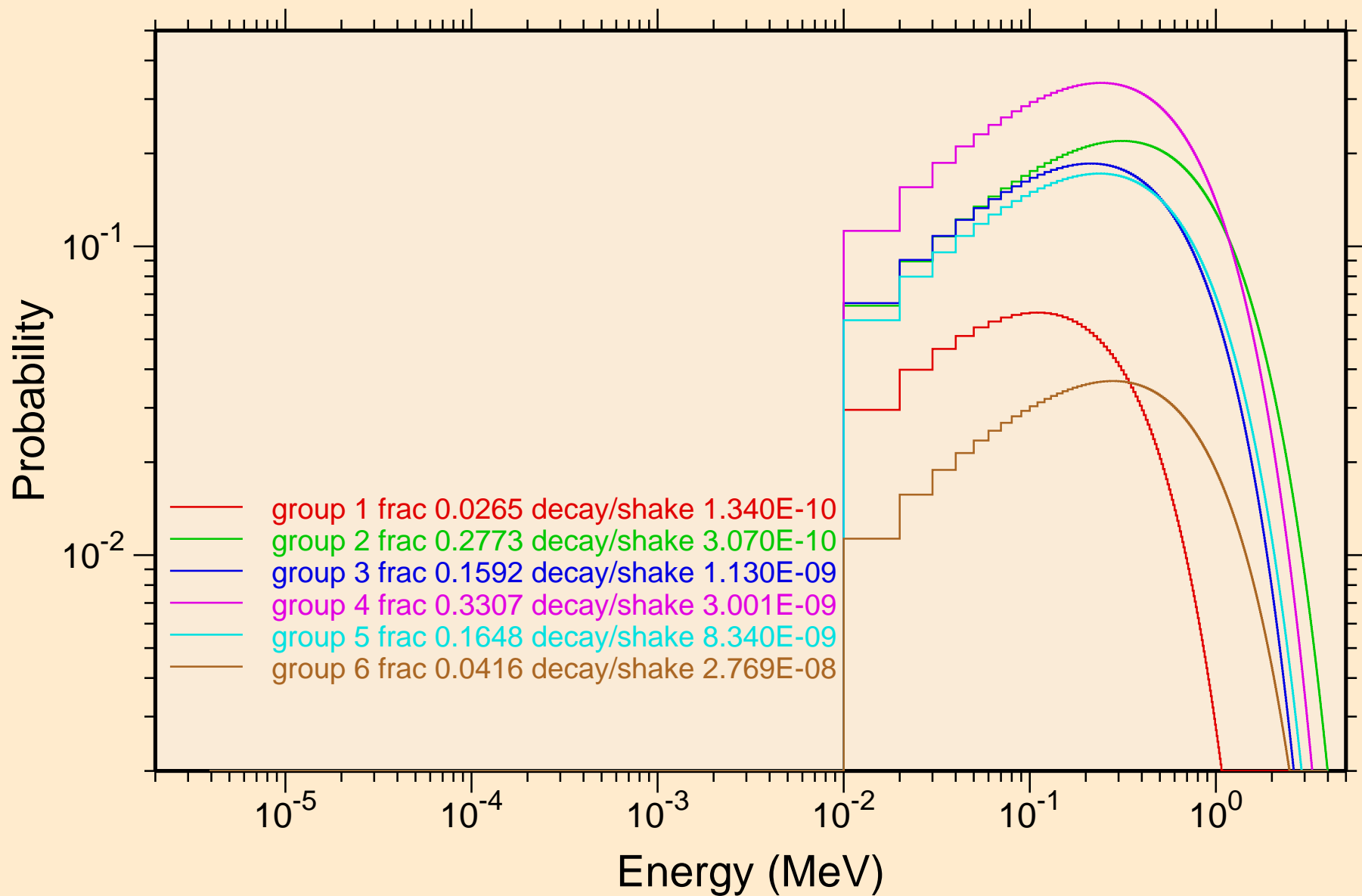

CM237 NEUTRON ACER TENDL-2019 LIBRARY; T=293.16K
Photon emission for (n,x)

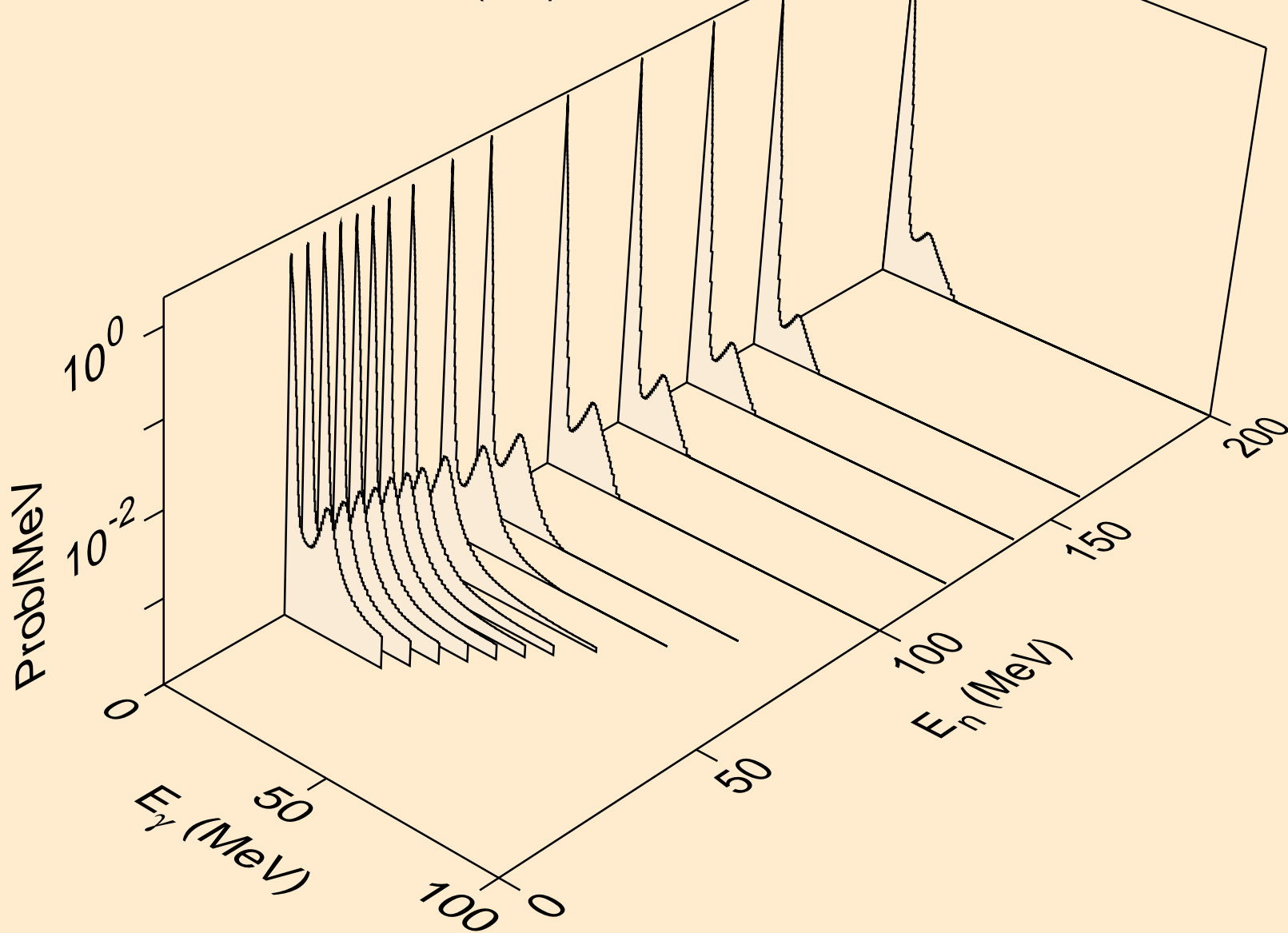

CM237 NEUTRON ACER TENDL-2019 LIBRARY; T=293.16K
Photon emission for (n,2nd)

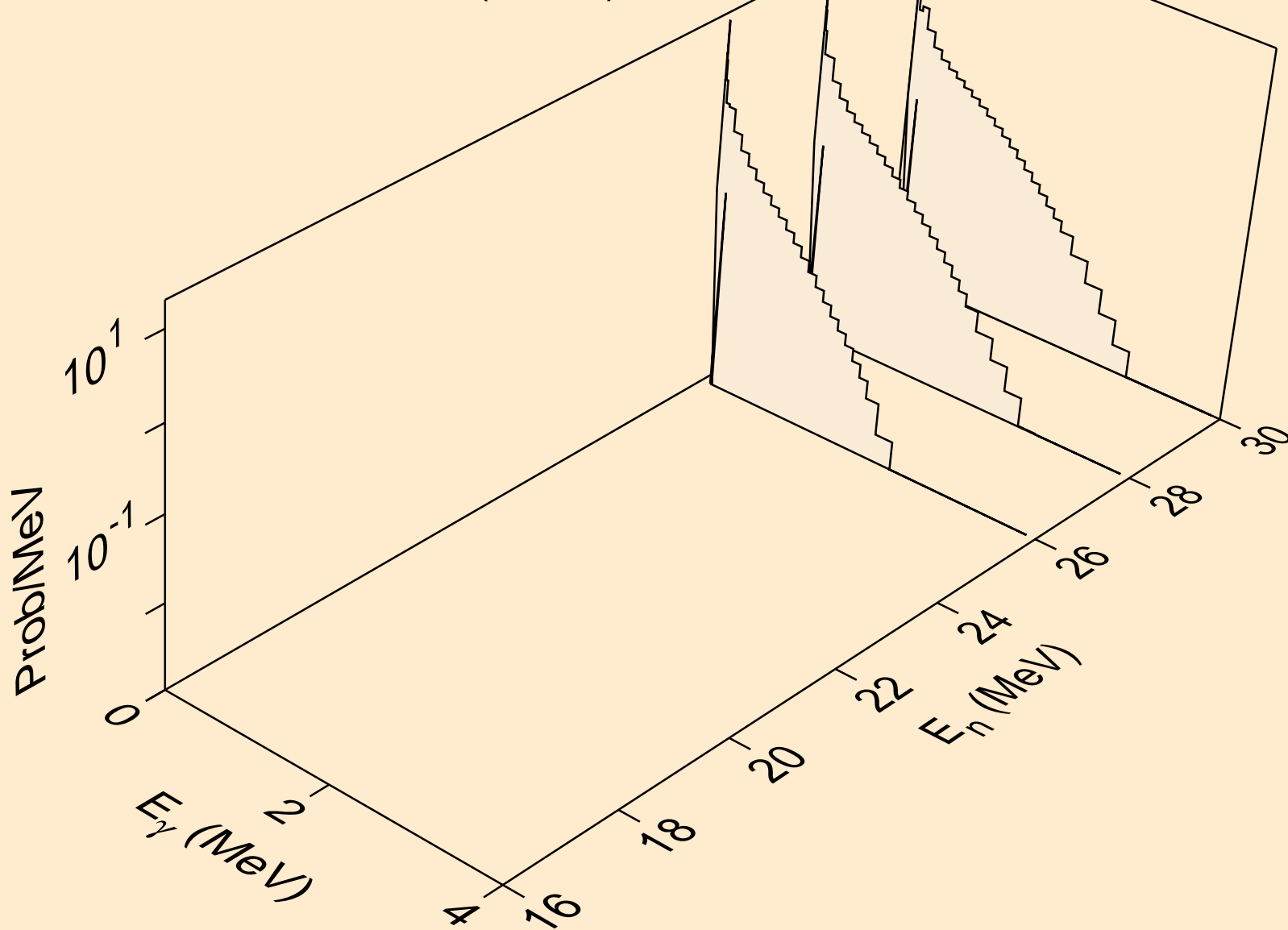

CM237 NEUTRON ACER TENDL-2019 LIBRARY; T=293.16K
Photon emission for (n,2n)

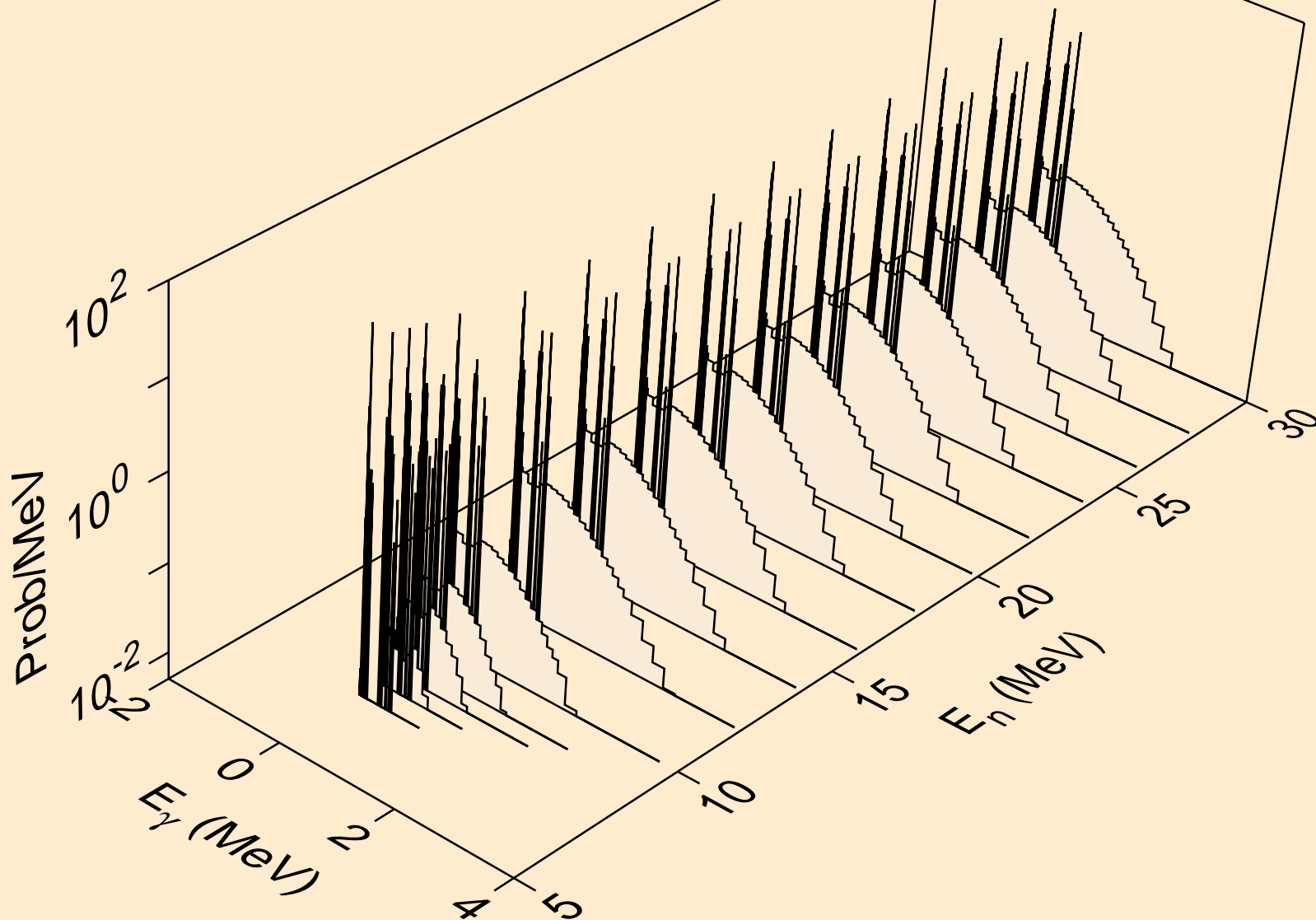

CM237 NEUTRON ACER TENDL-2019 LIBRARY; T=293.16K
Photon emission for (n,3n)

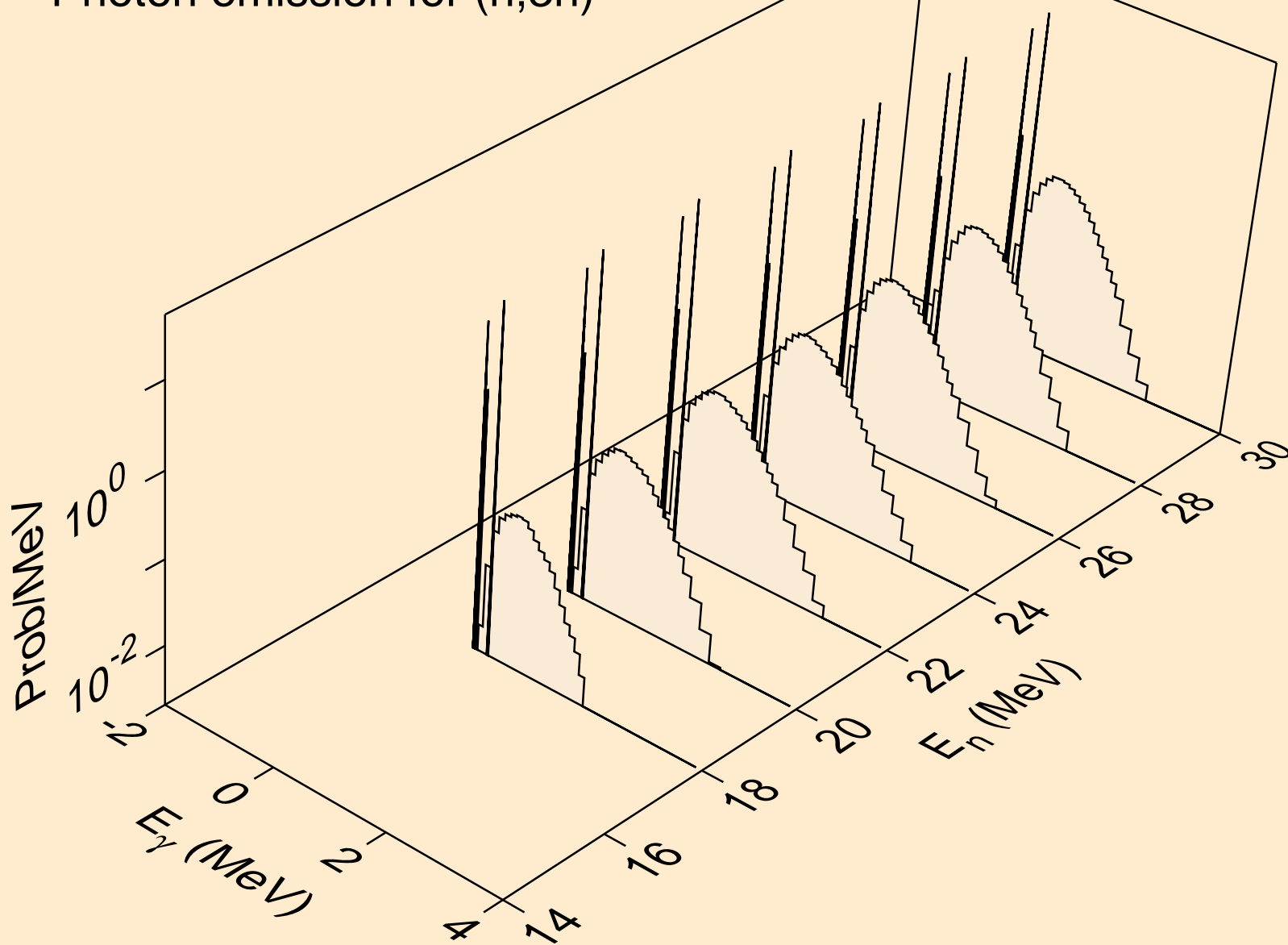

CM237 NEUTRON ACER TENDL-2019 LIBRARY; T=293.16K
Photon emission for (n,n*)a

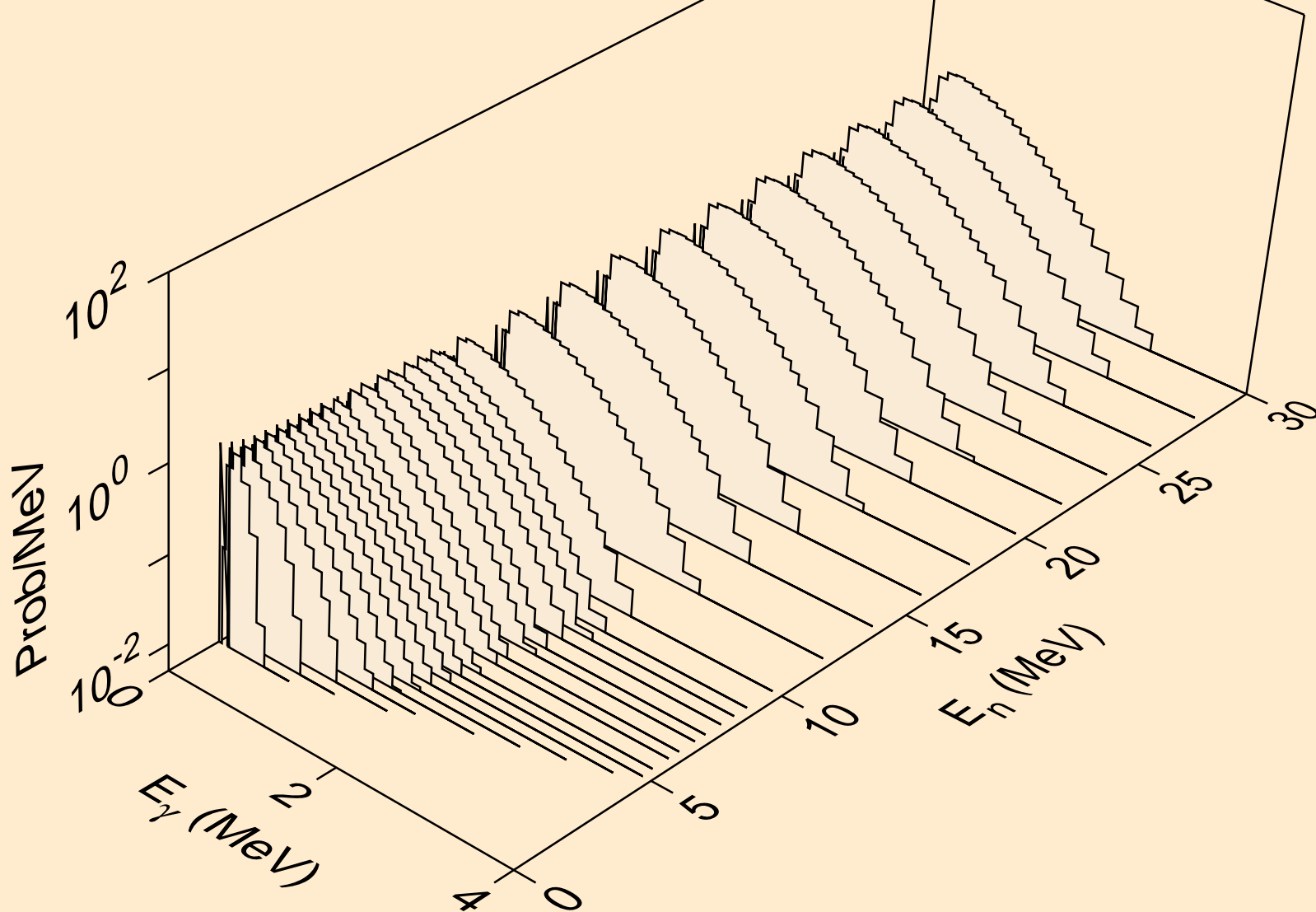

CM237 NEUTRON ACER TENDL-2019 LIBRARY; T=293.16K
Photon emission for (n,2n)_a

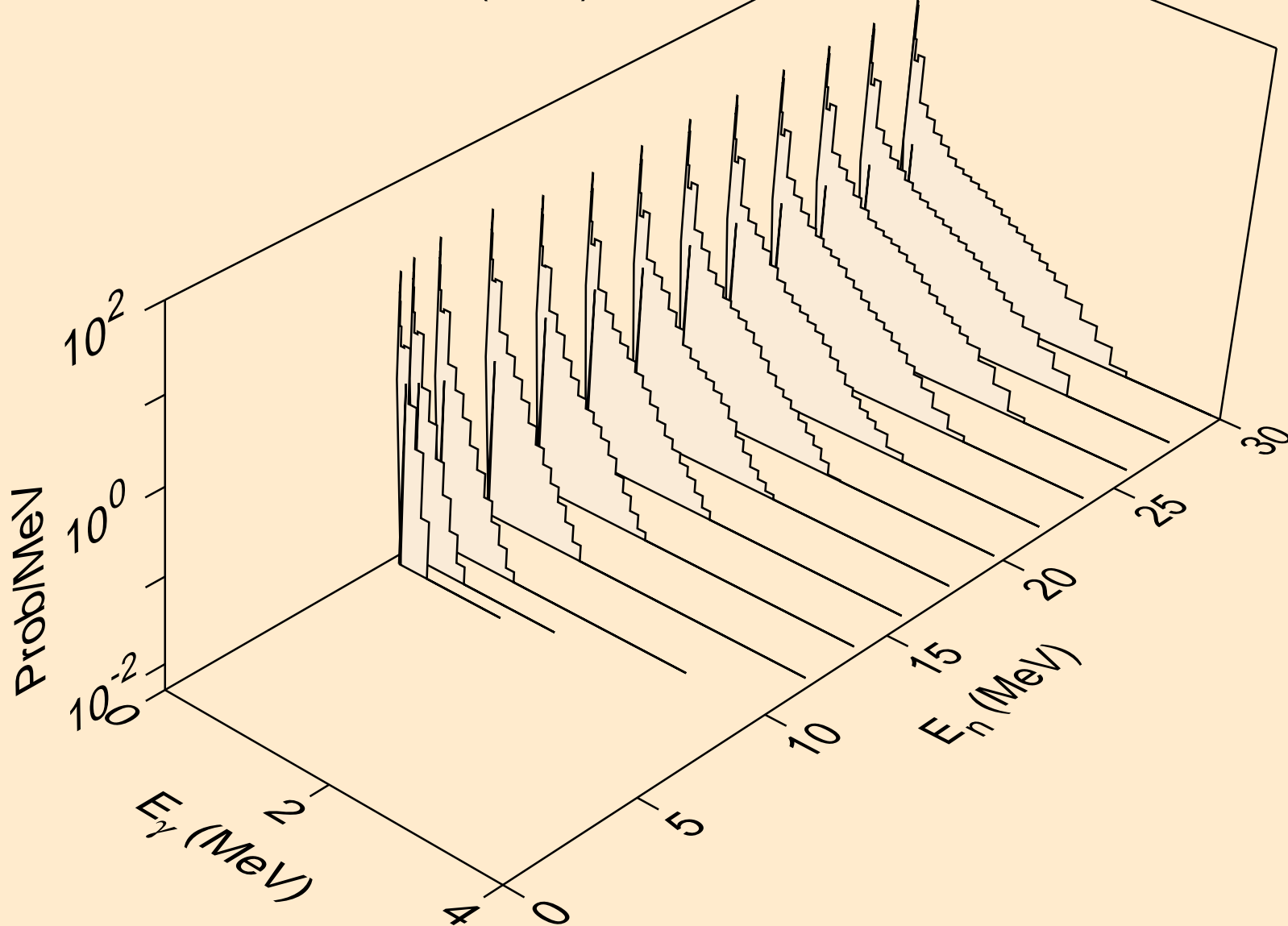

CM237 NEUTRON ACER TENDL-2019 LIBRARY; T=293.16K
Photon emission for (n,3n)a

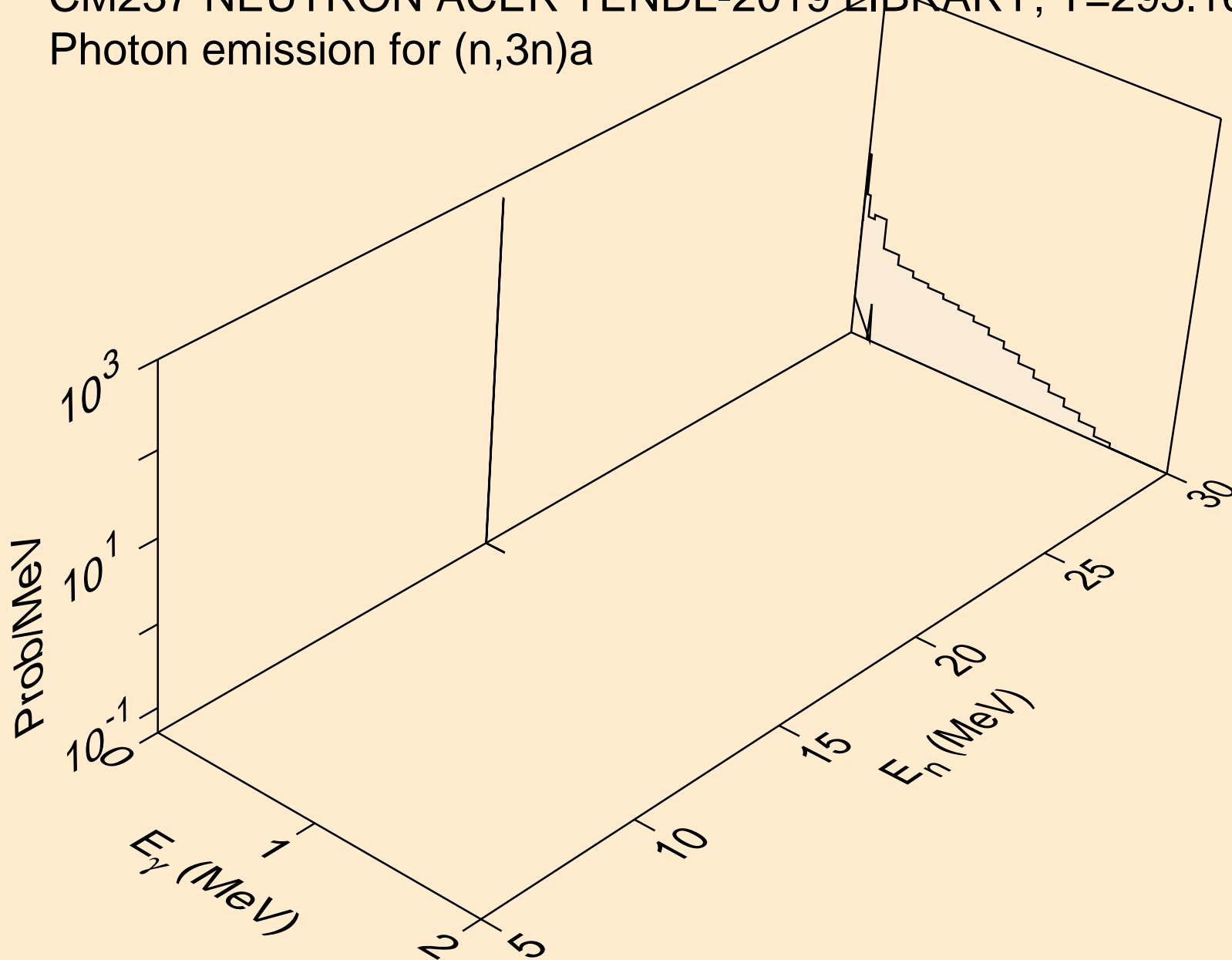

CM237 NEUTRON ACER TENDL-2019 LIBRARY; T=293.16K
Photon emission for (n,n*)p

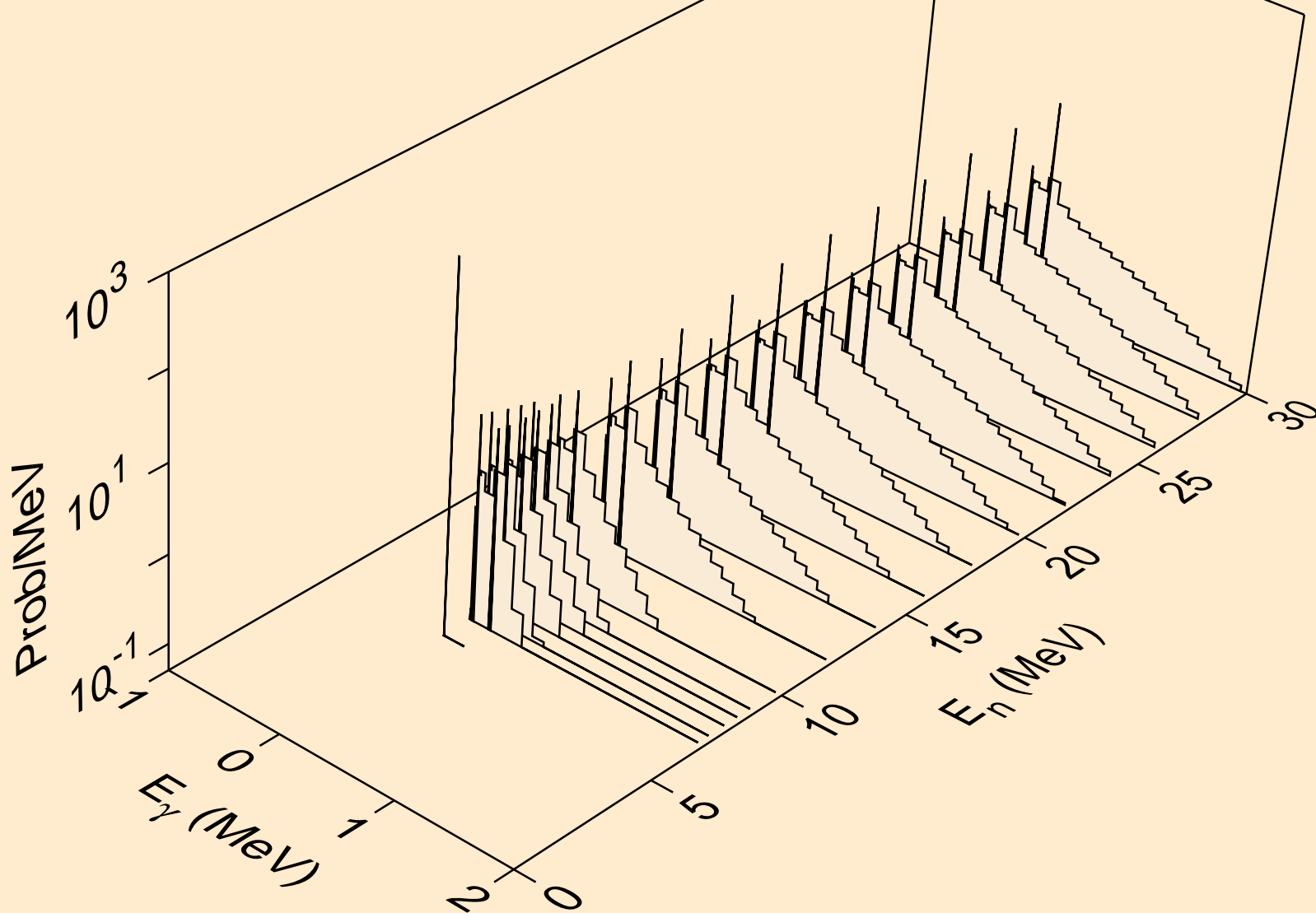

CM237 NEUTRON ACER TENDL-2019 LIBRARY; T=293.16K
Photon emission for (n,n*)2a

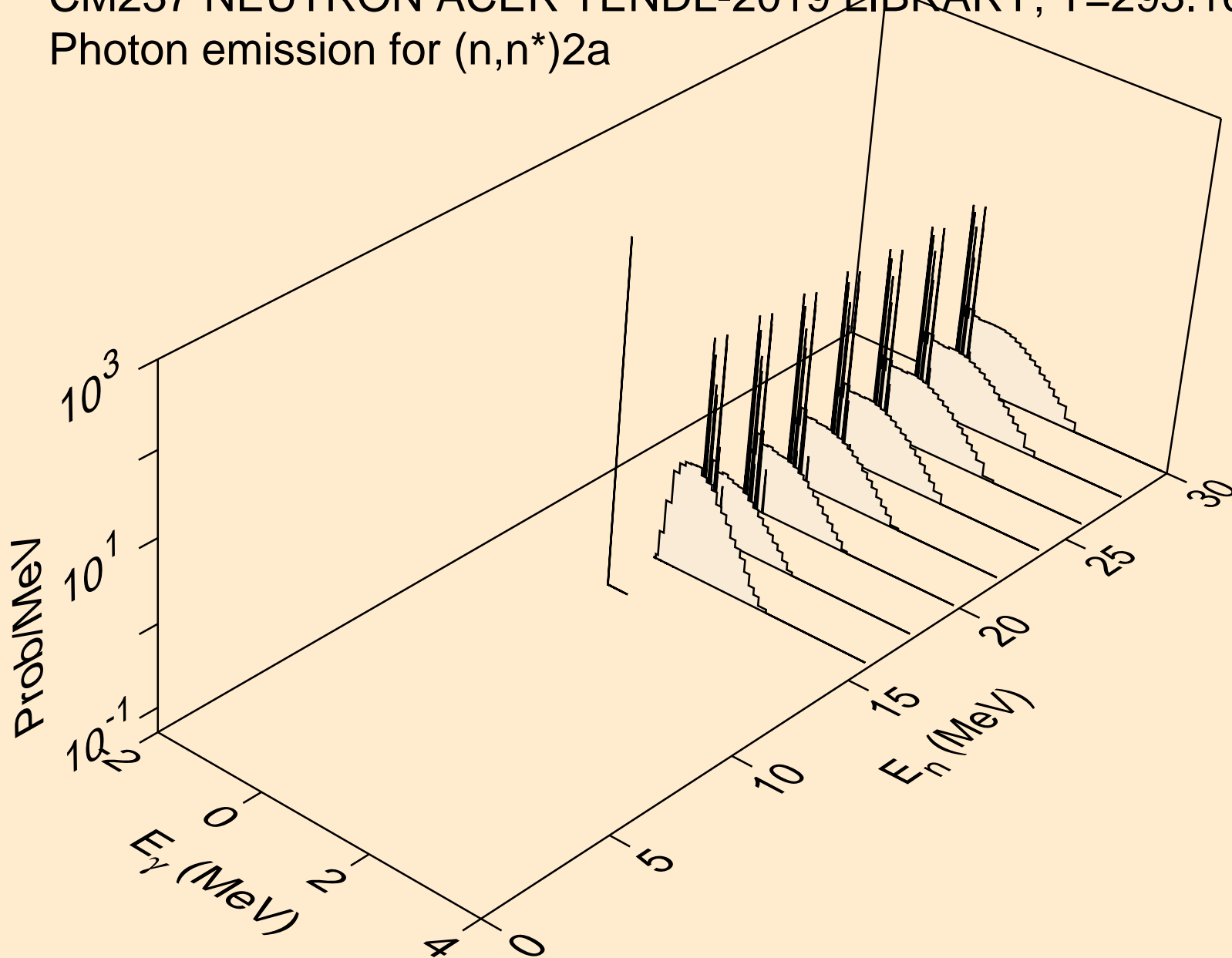

CM237 NEUTRON ACER TENDL-2019 LIBRARY; T=293.16K
Photon emission for (n,n*)d

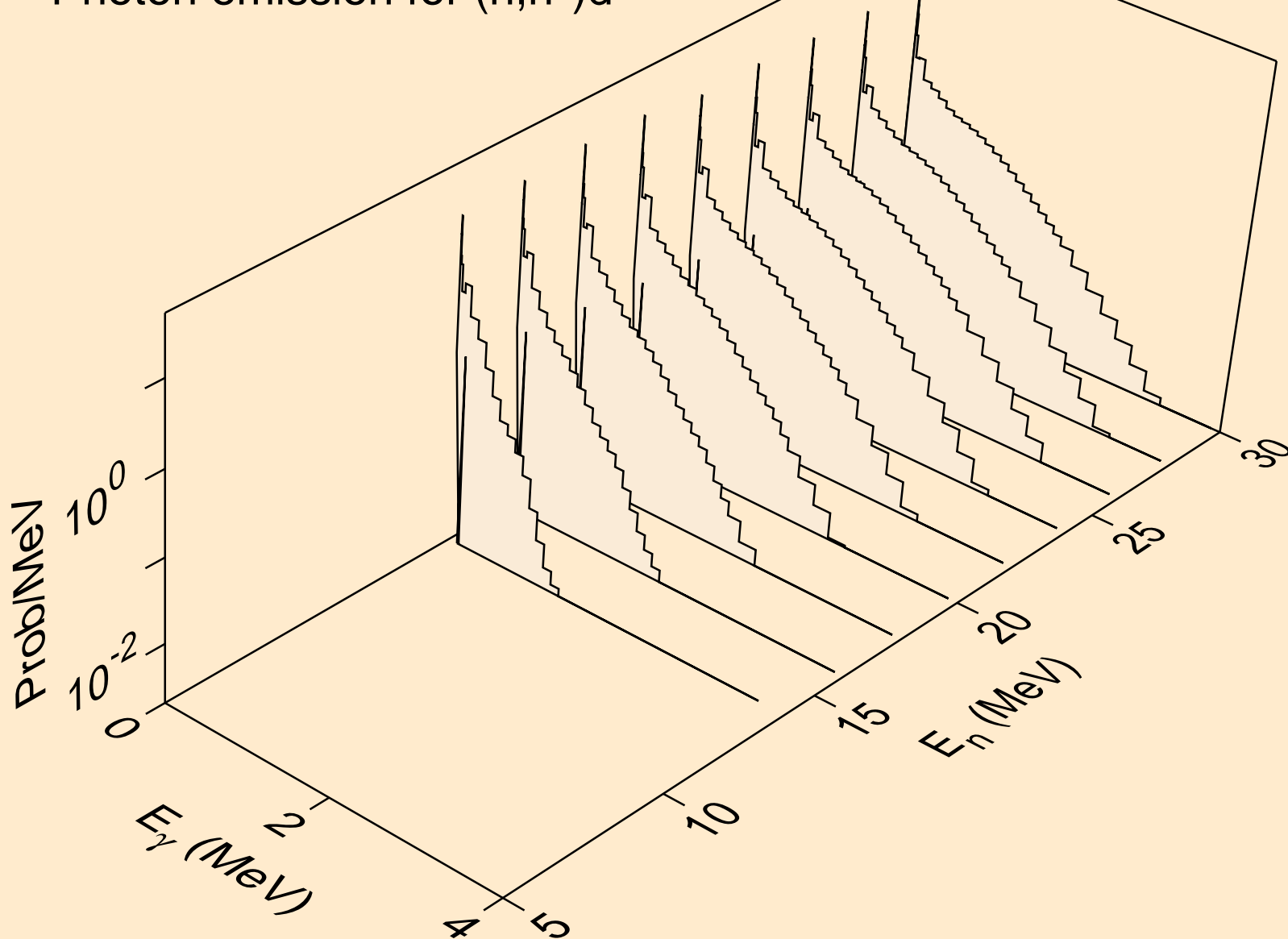

CM237 NEUTRON ACER TENDL-2019 LIBRARY; T=293.16K
Photon emission for (n,n*)t

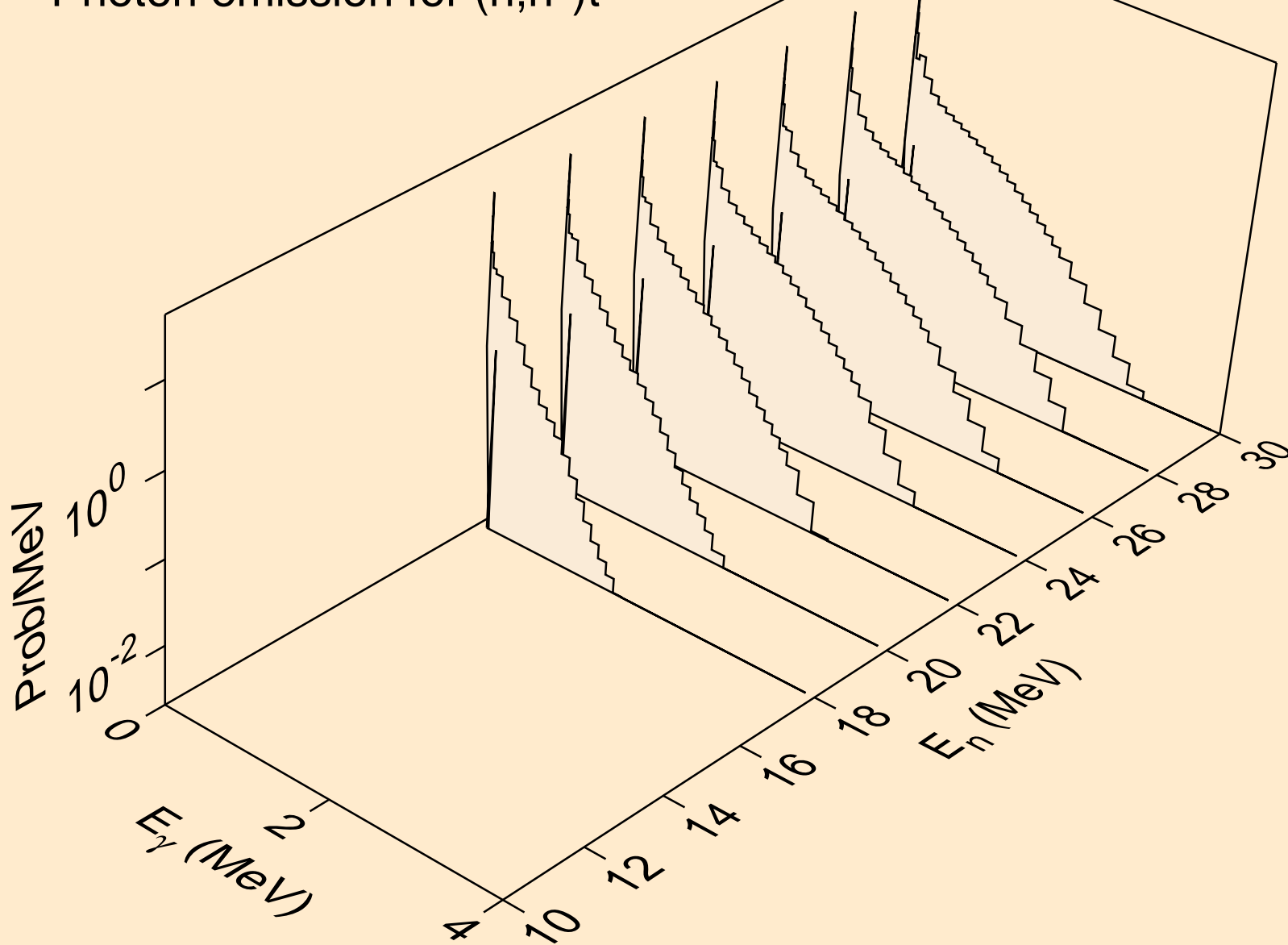

CM237 NEUTRON ACER TENDL-2019 LIBRARY; T=293.16K
Photon emission for (n,n*)he3

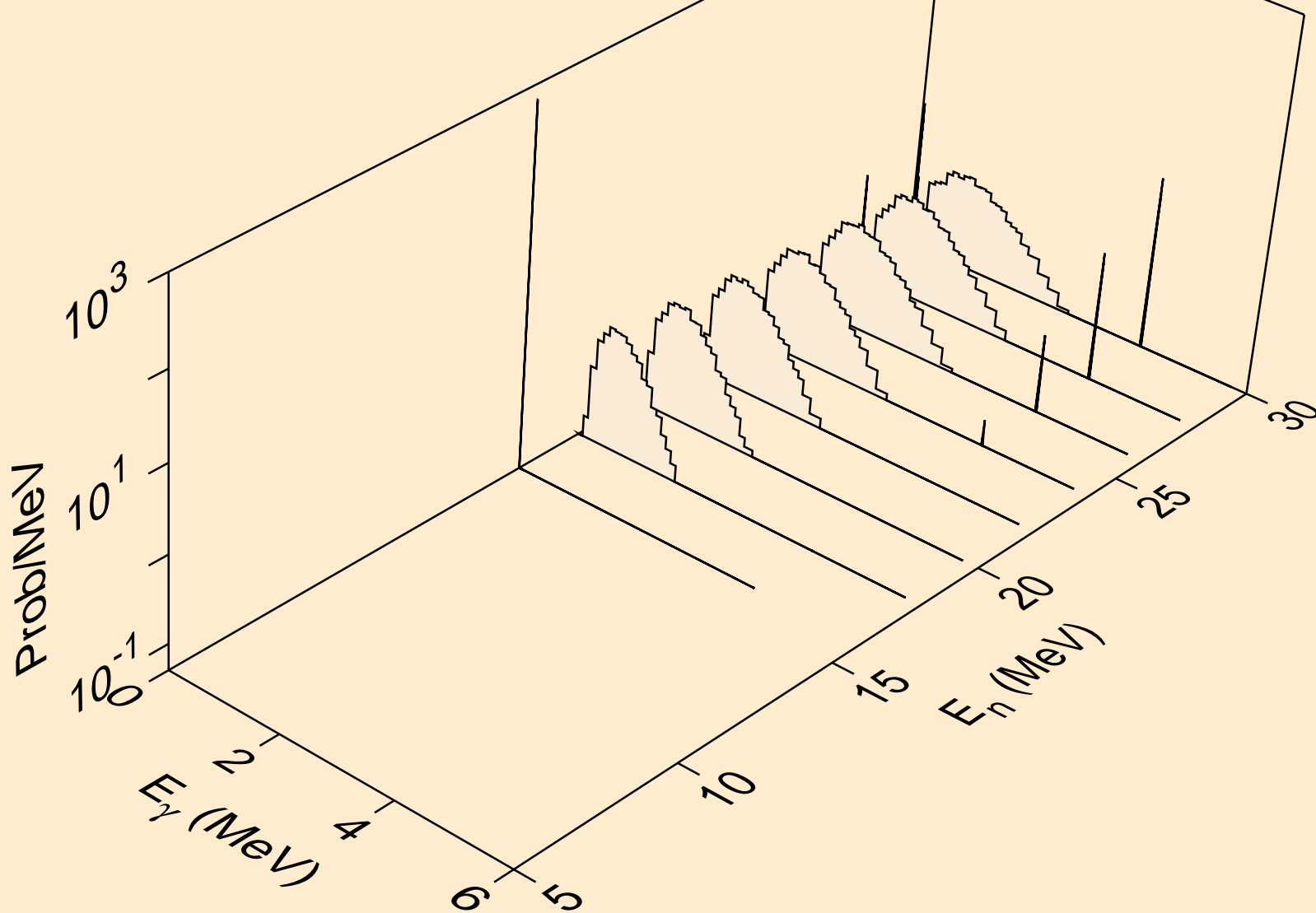

CM237 NEUTRON ACER TENDL-2019 LIBRARY; T=293.16K
Photon emission for (n,4n)

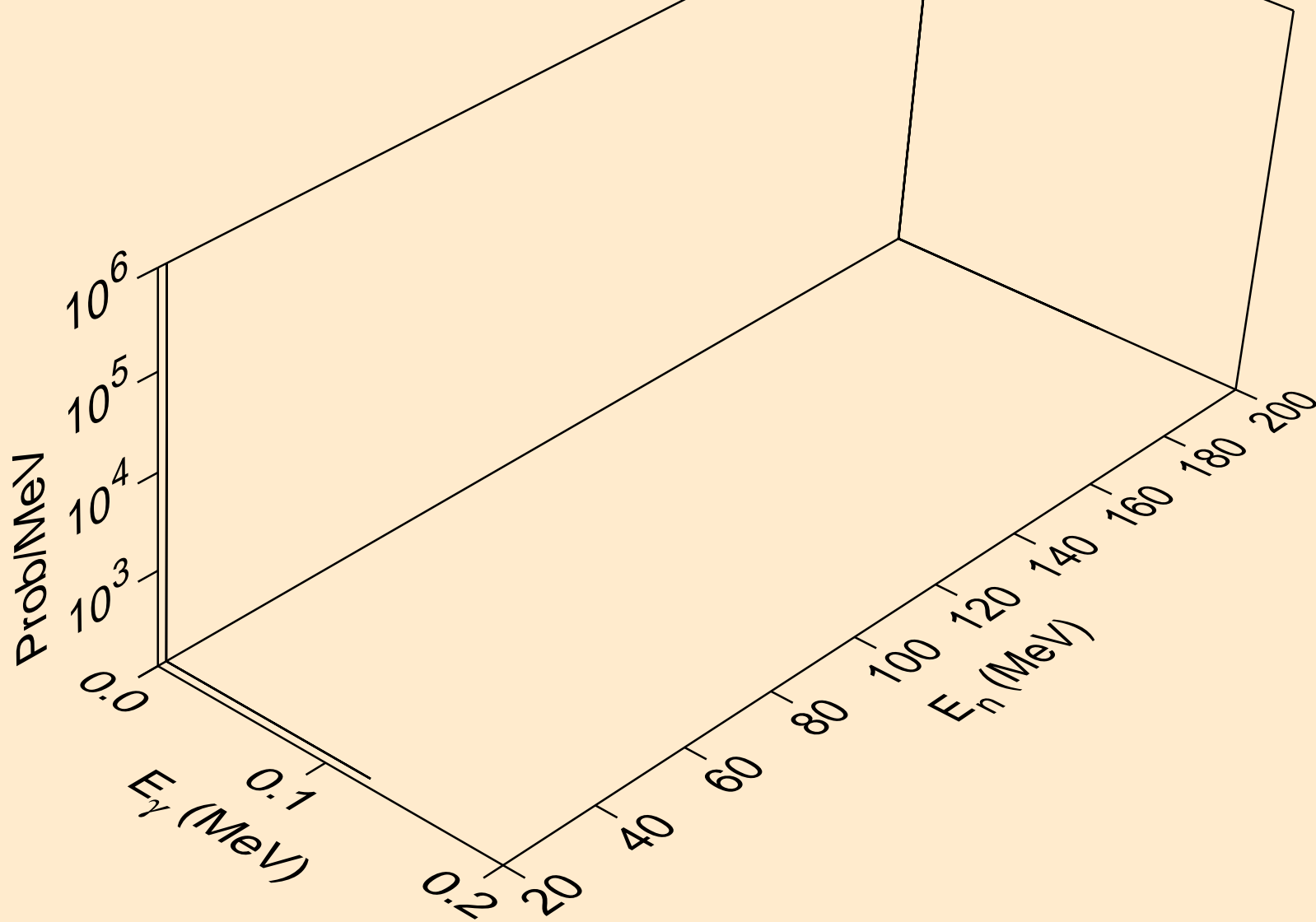

CM237 NEUTRON ACER TENDL-2019 LIBRARY; T=293.16K
Photon emission for (n,2np)

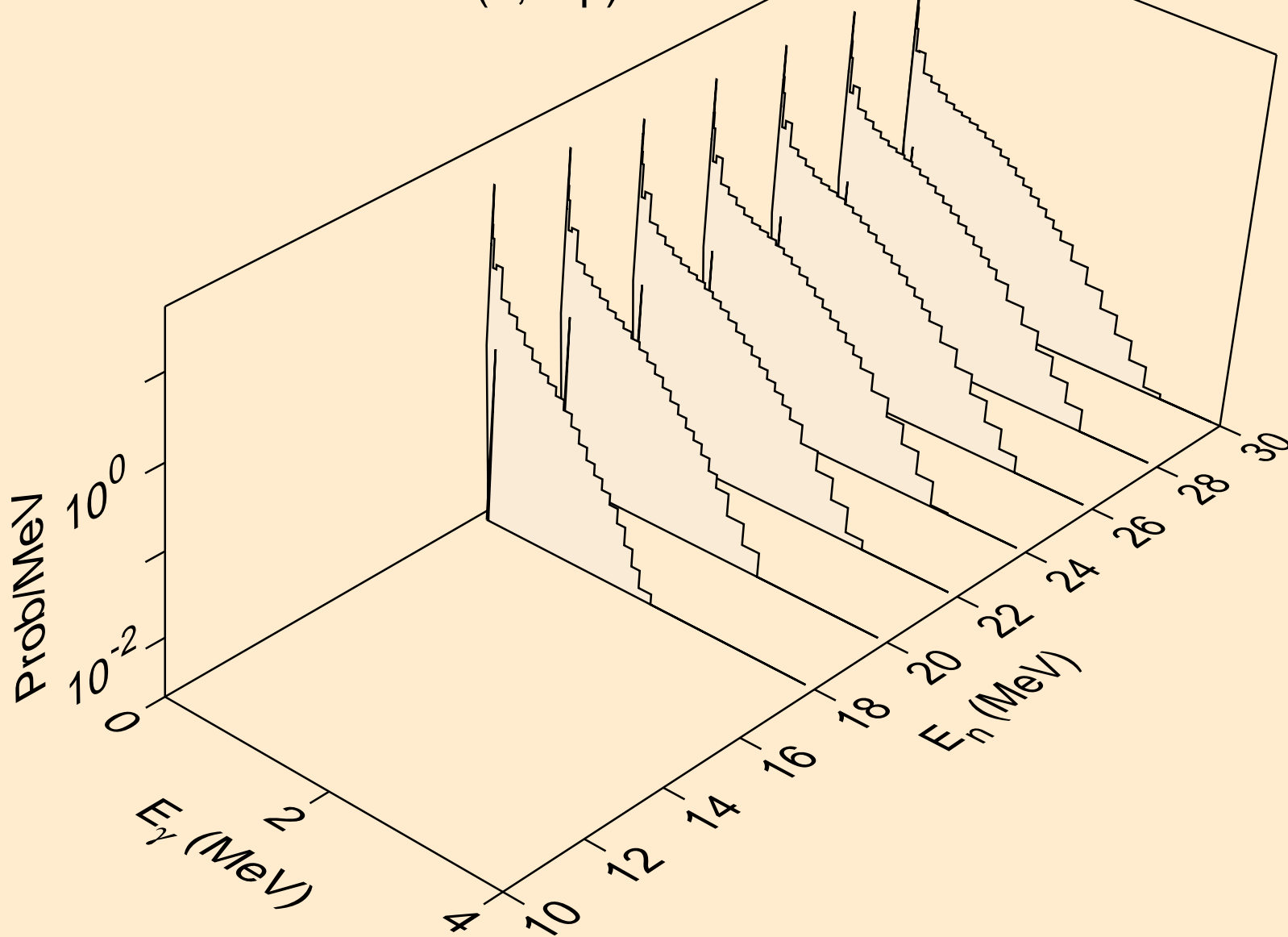

CM237 NEUTRON ACER TENDL-2019 LIBRARY; T=293.16K
Photon emission for (n,3np)

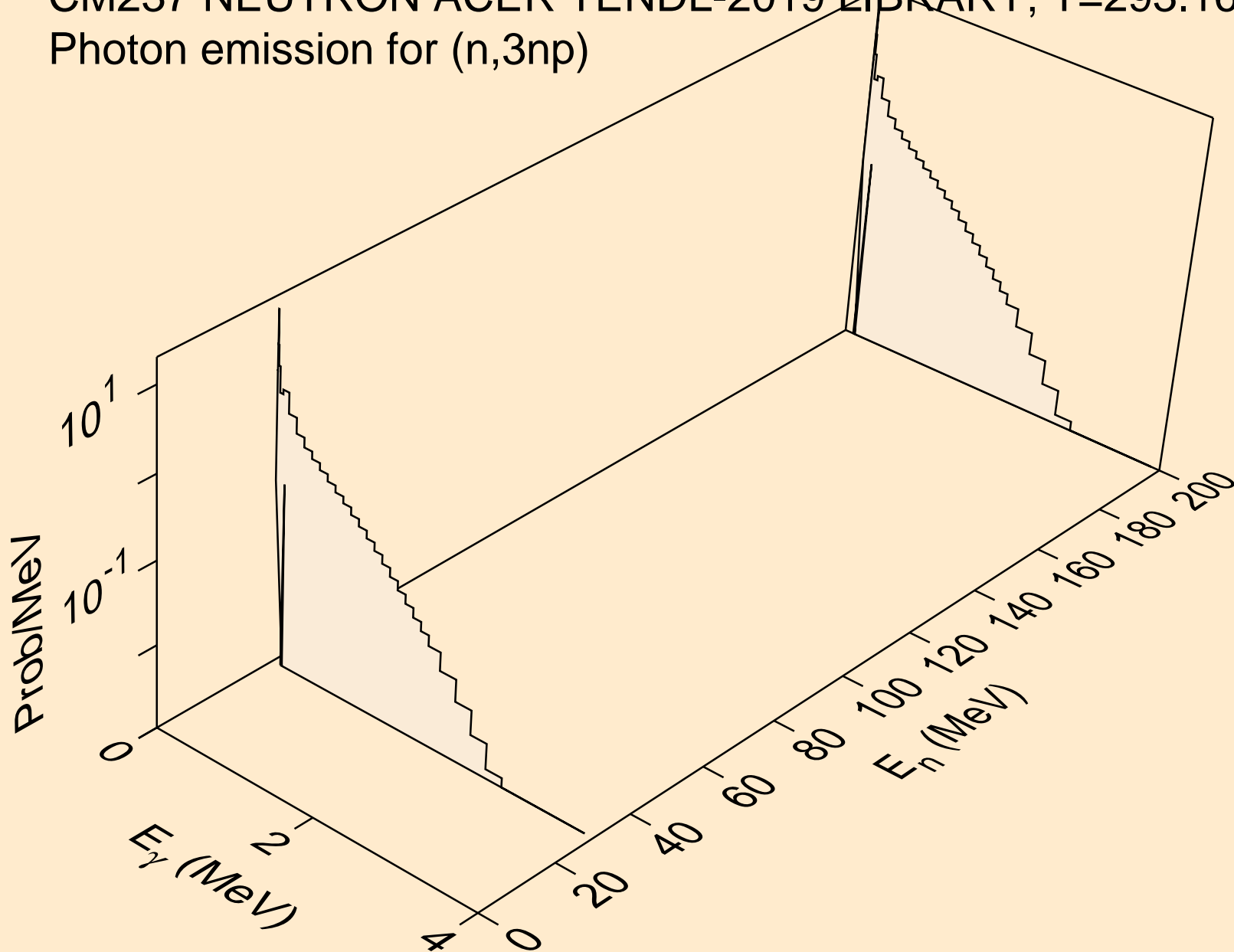

CM237 NEUTRON ACER TENDL-2019 LIBRARY; T=293.16K
Photon emission for (n,2np)

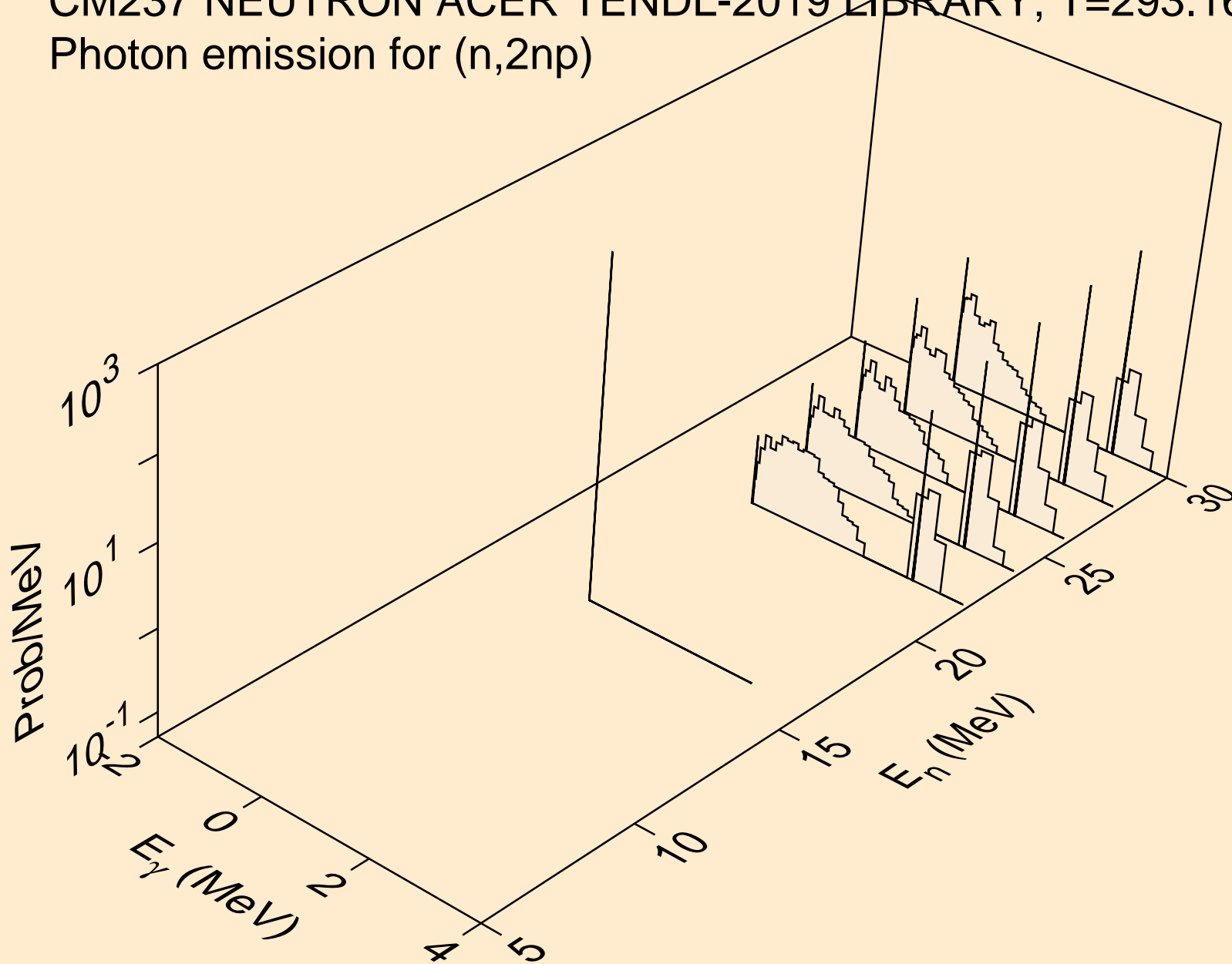

CM237 NEUTRON ACER TENDL-2019 LIBRARY; T=293.16K
Photon emission for (n,npa)

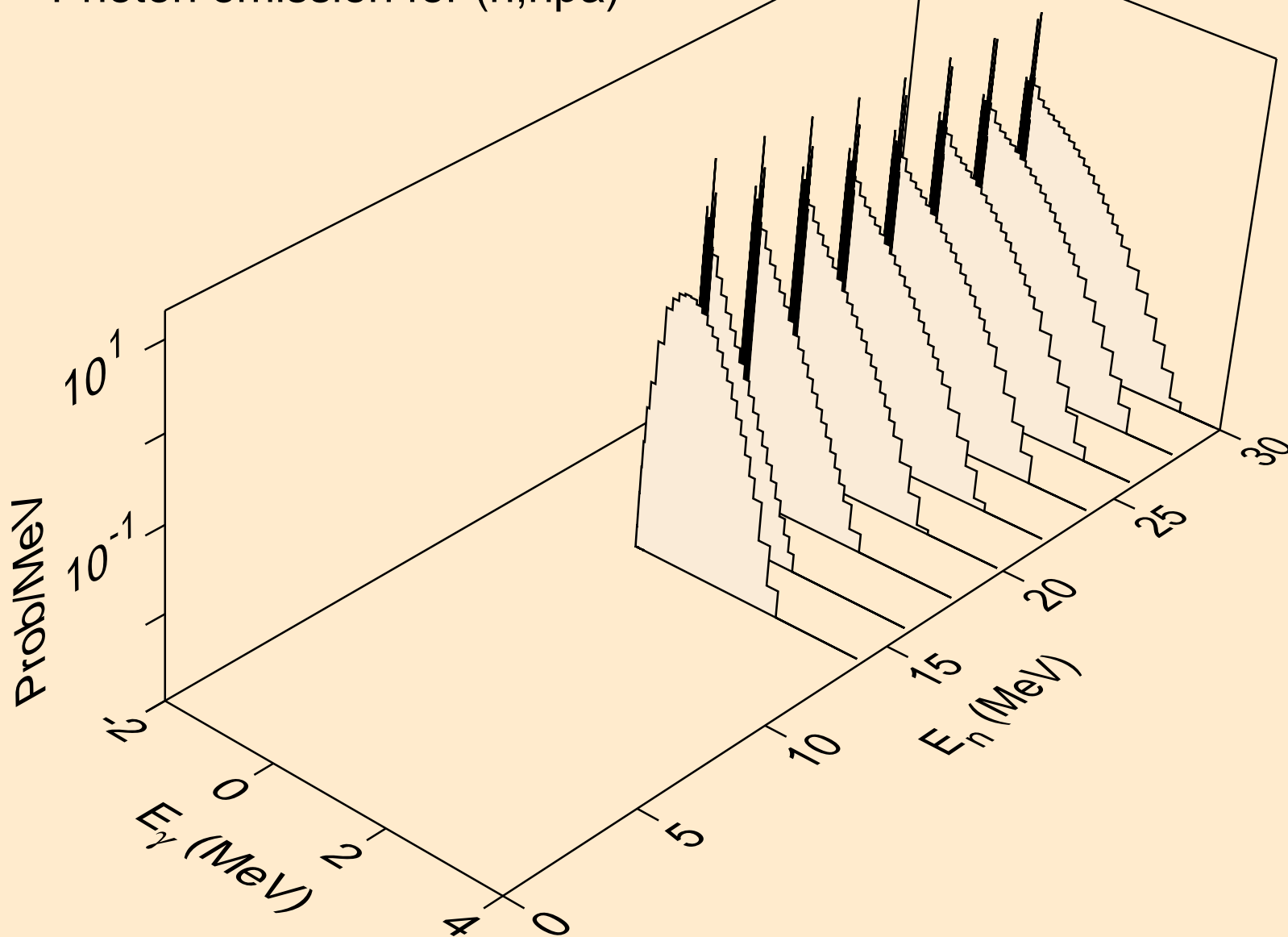

CM237 NEUTRON ACER TENDL-2019 LIBRARY; T=293.16K
Photon emission for (n,n*c)

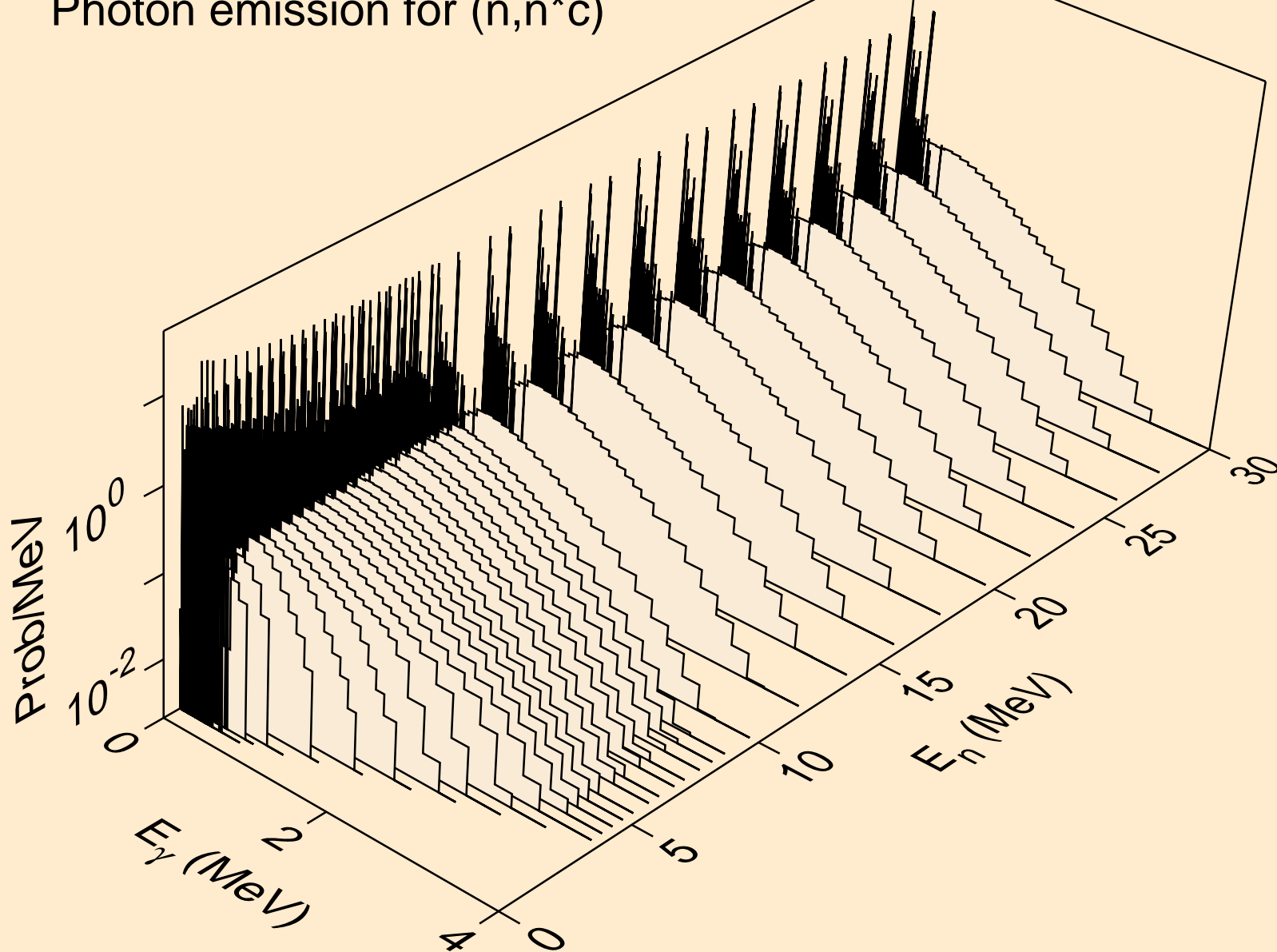

CM237 NEUTRON ACER TENDL-2019 LIBRARY; T=293.16K
Photon emission for (n,gma)

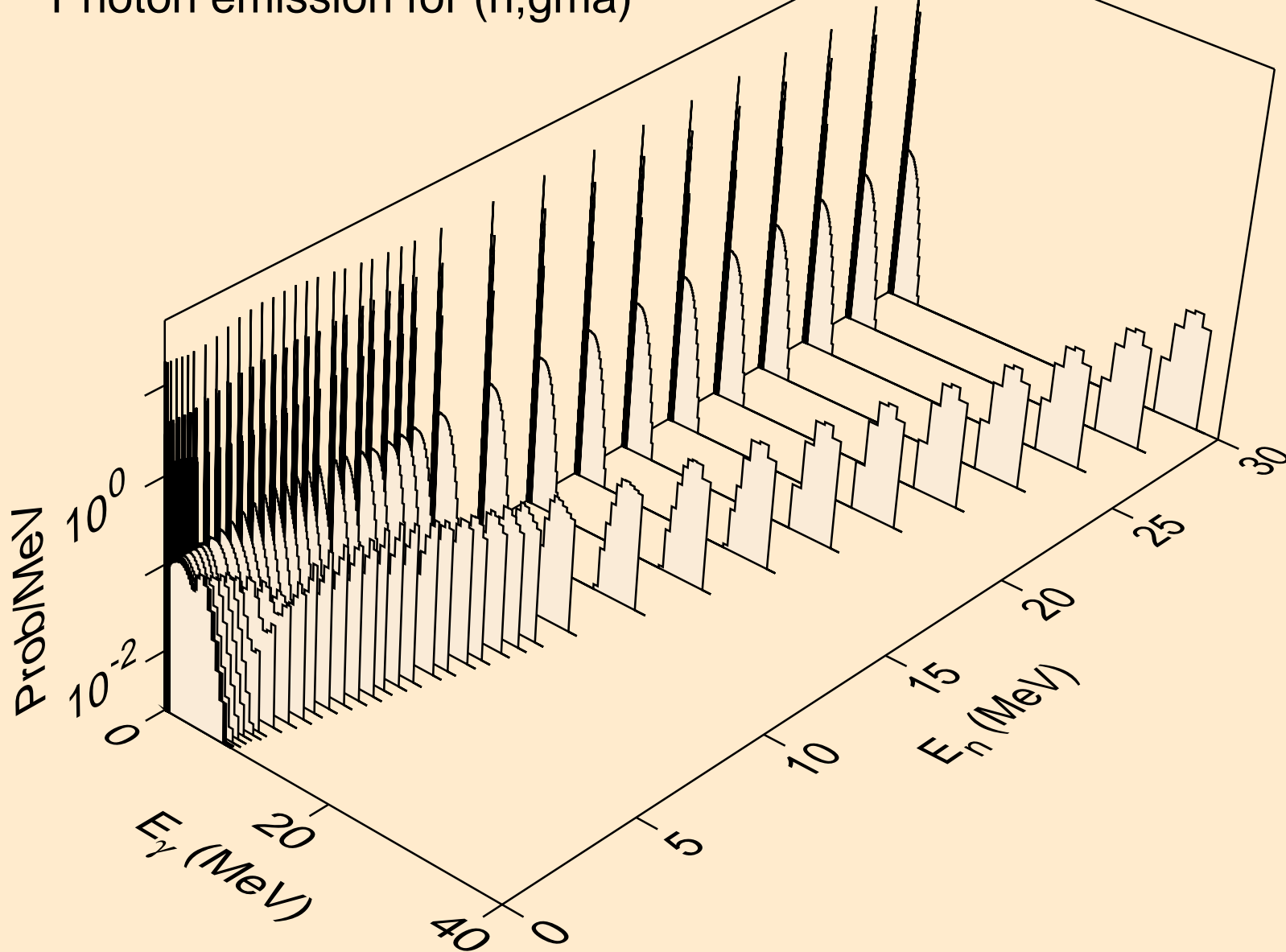

CM237 NEUTRON ACER TENDL-2019 LIBRARY; T=293.16K
Photon emission for (n,p)

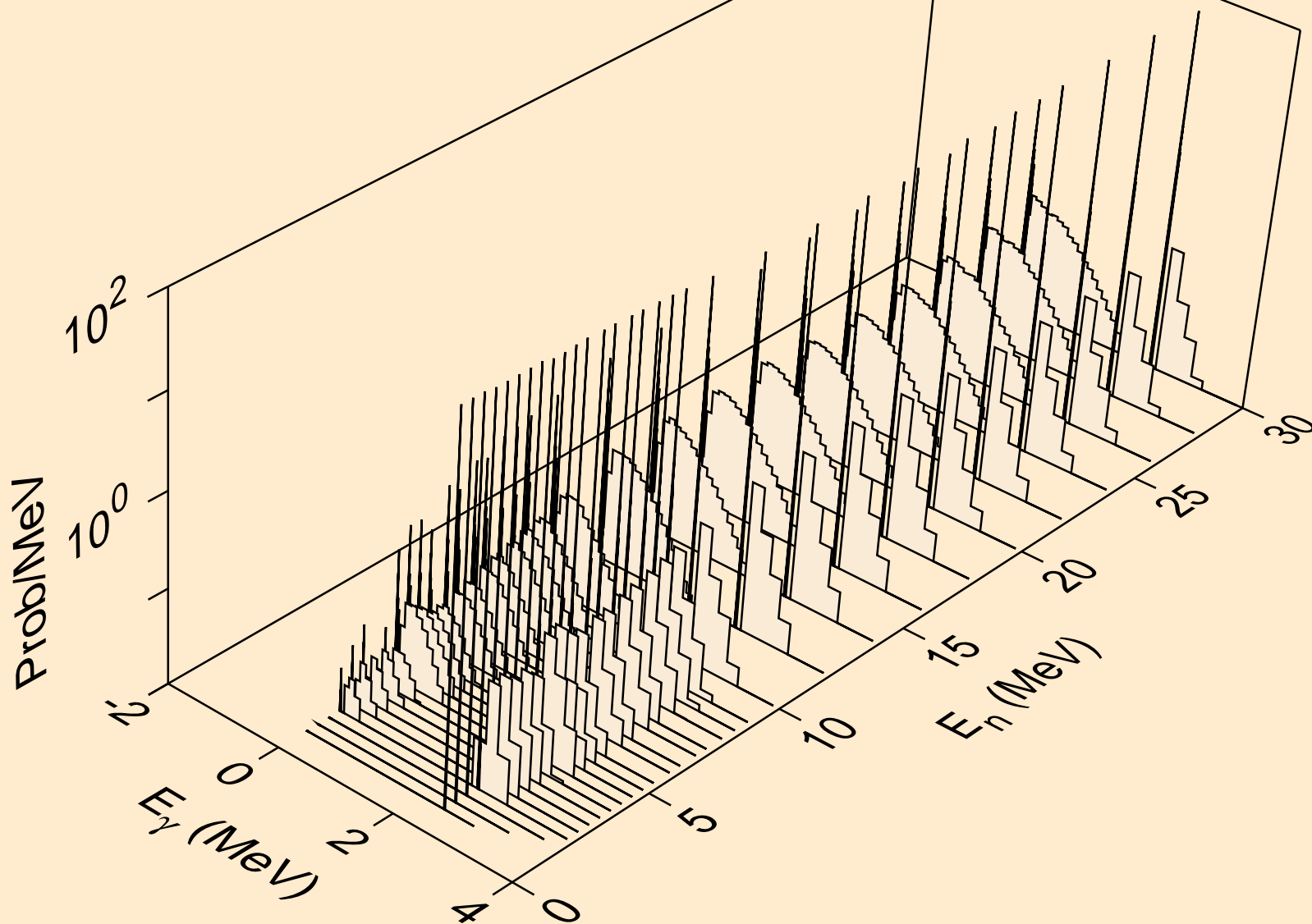

CM237 NEUTRON ACER TENDL-2019 LIBRARY; T=293.16K
Photon emission for (n,d)

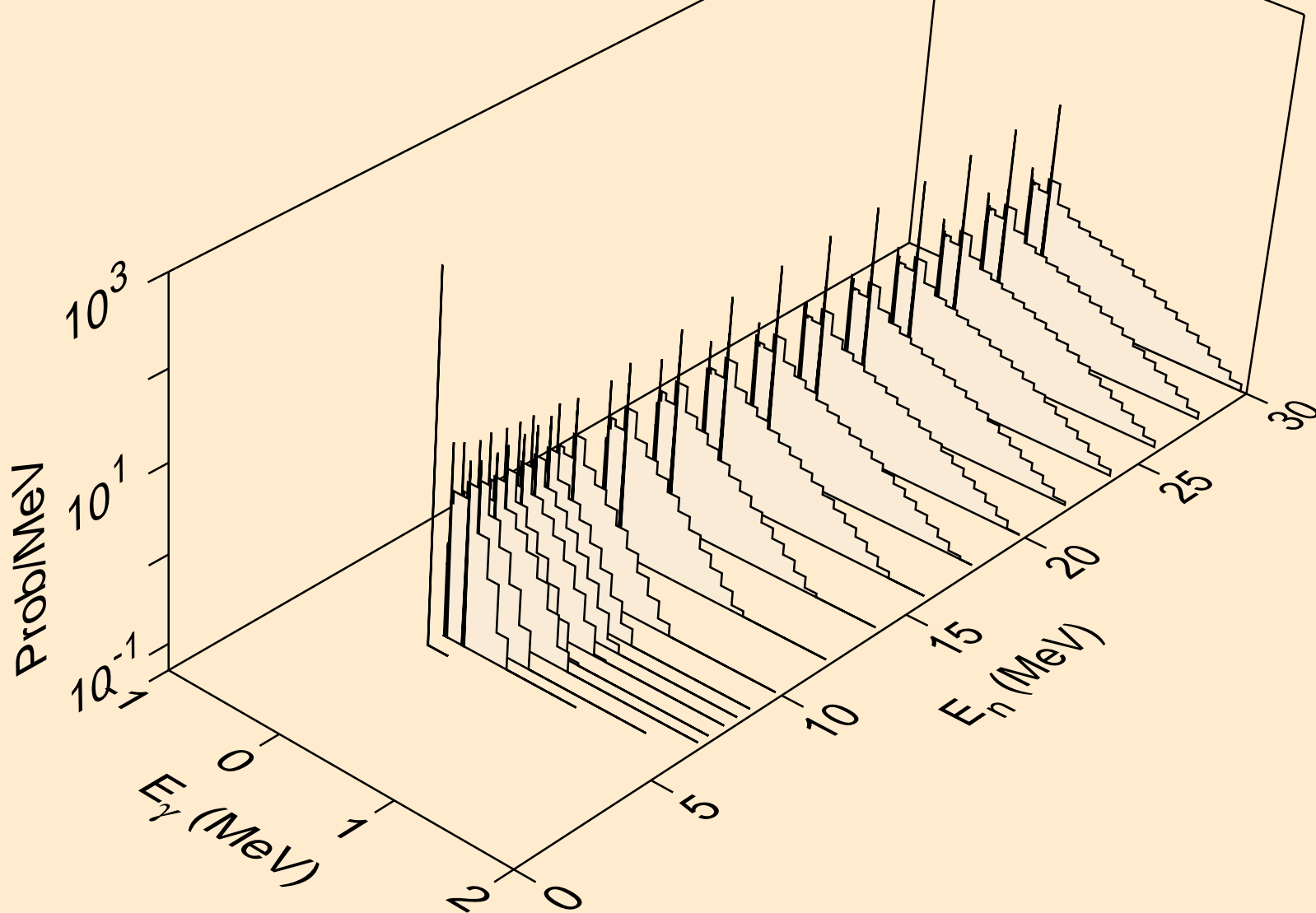

CM237 NEUTRON ACER TENDL-2019 LIBRARY; T=293.16K
Photon emission for (n,t)

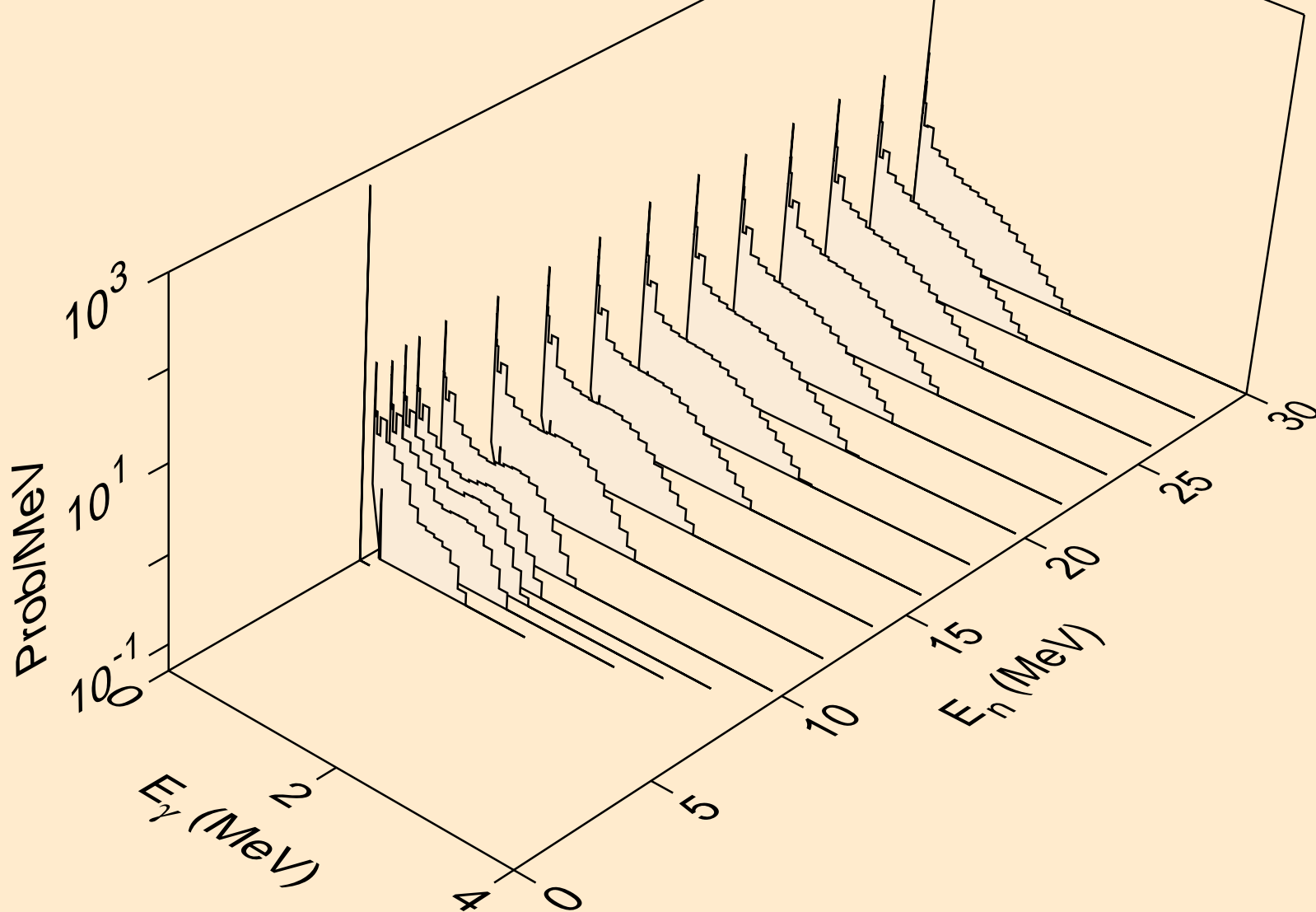

CM237 NEUTRON ACER TENDL-2019 LIBRARY; T=293.16K
Photon emission for (n,he3)

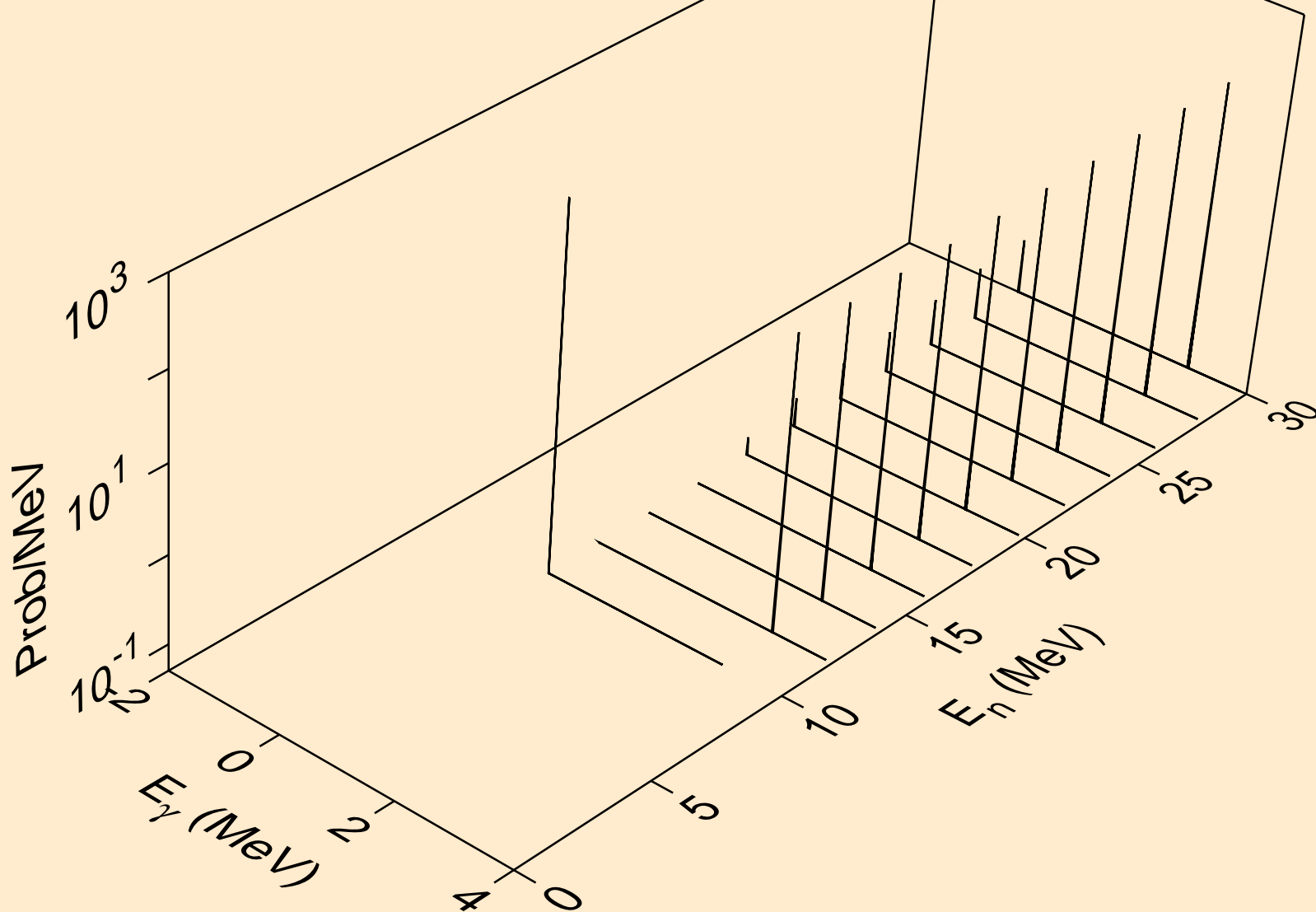

CM237 NEUTRON ACER TENDL-2019 LIBRARY; T=293.16K
Photon emission for (n,a)

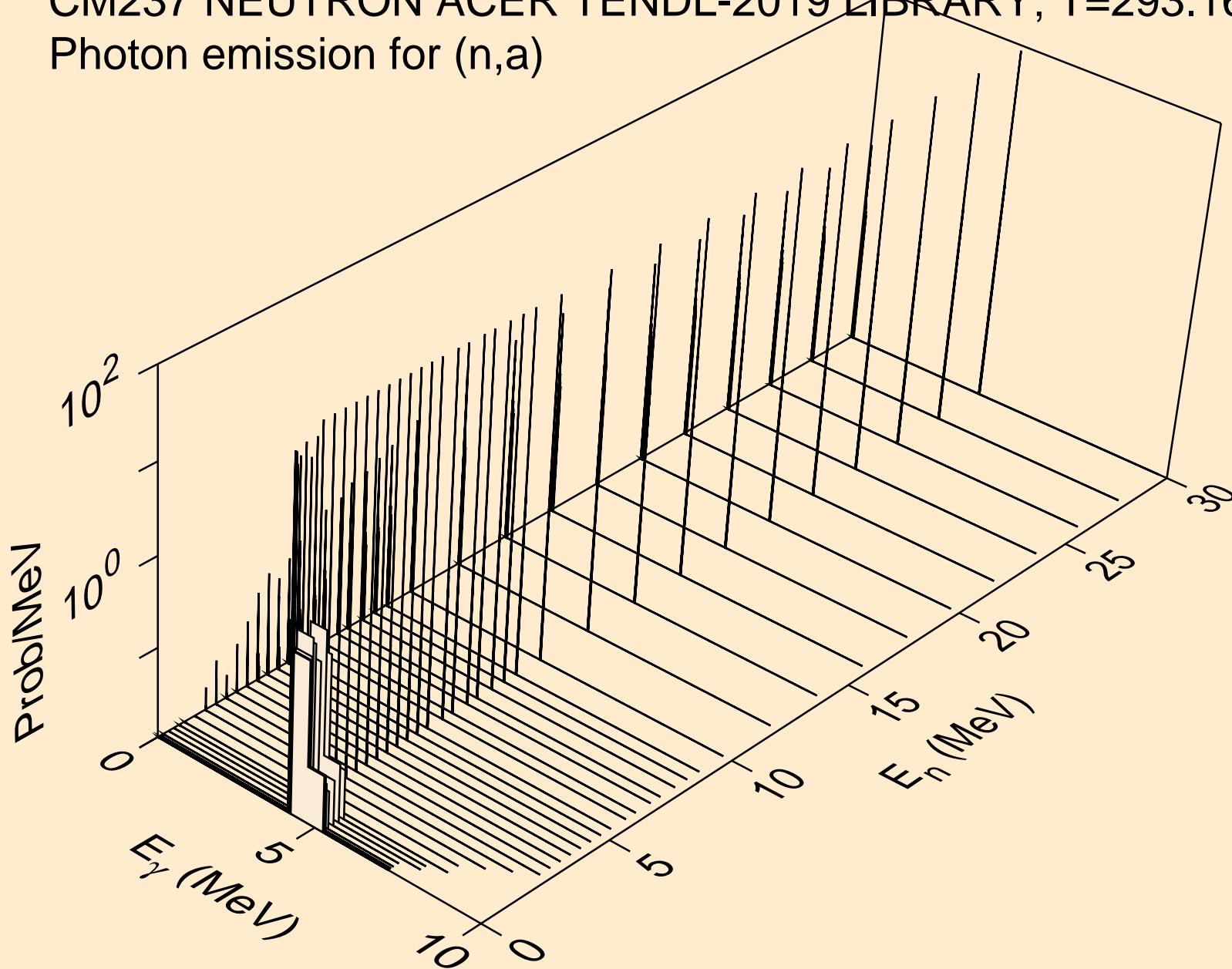

CM237 NEUTRON ACER TENDL-2019 LIBRARY; T=293.16K
Photon emission for (n,2p)

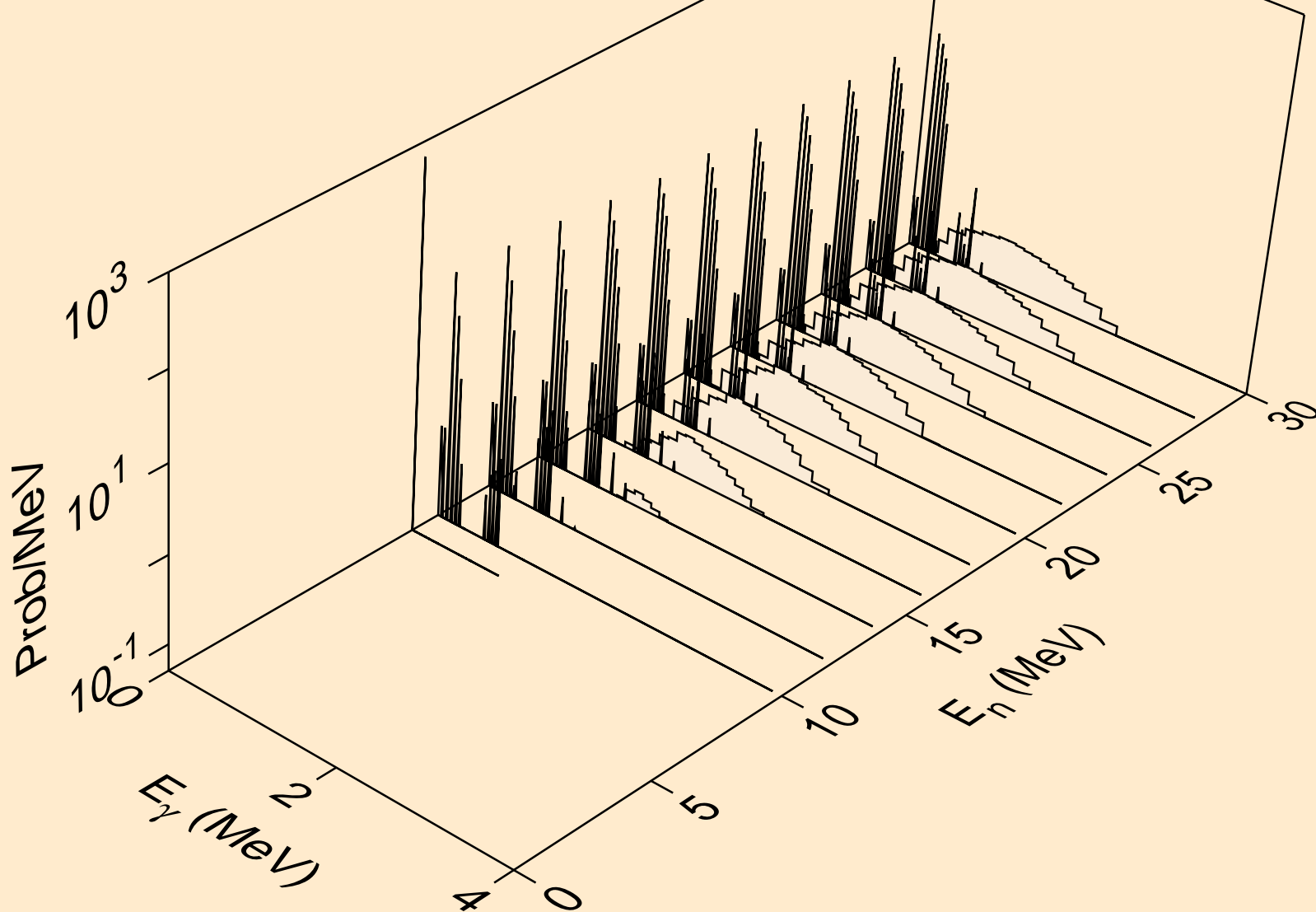

CM237 NEUTRON ACER TENDL-2019 LIBRARY; T=293.16K
Photon emission for (n,p α)

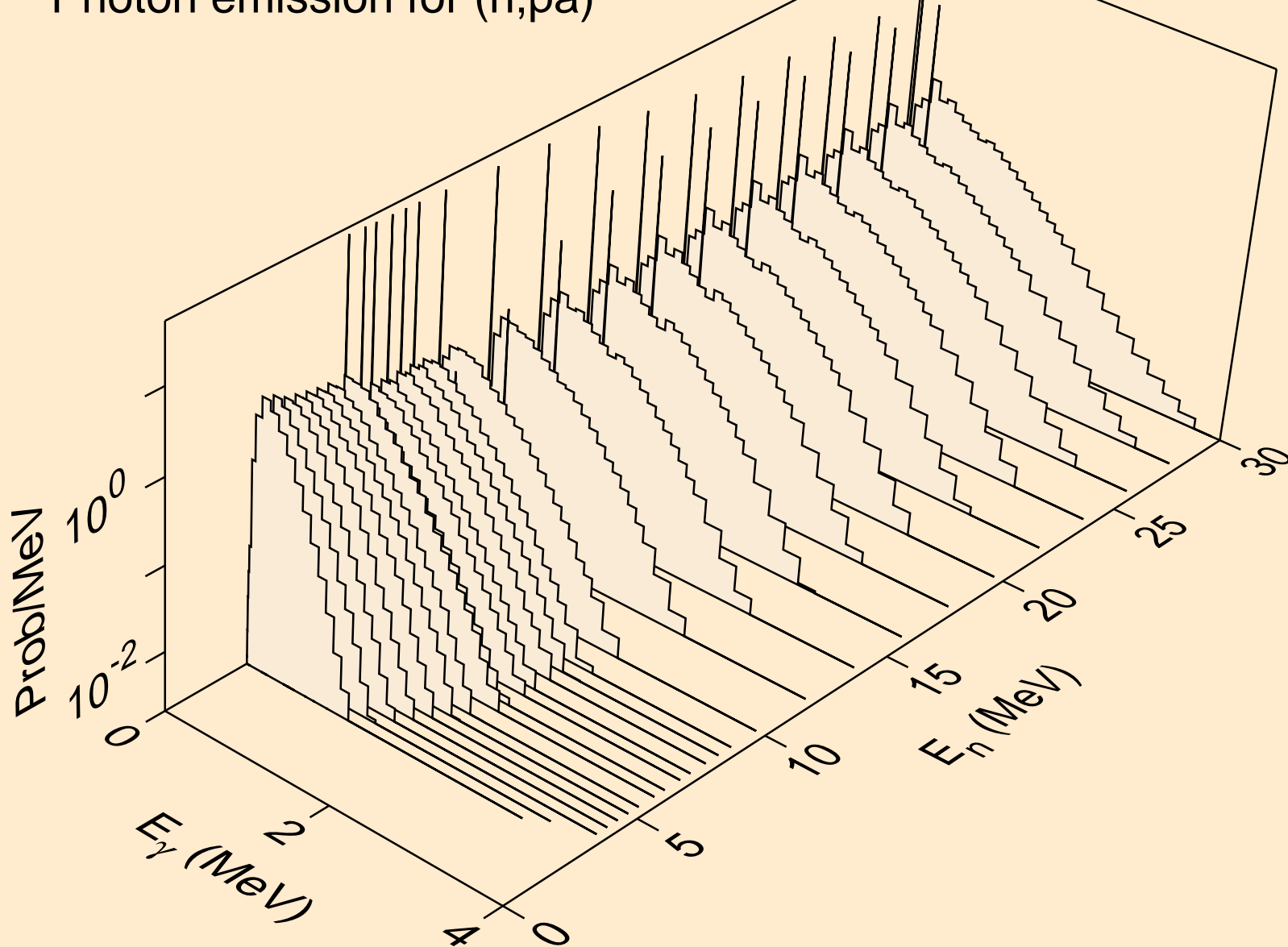

CM237 NEUTRON ACER TENDL-2019 LIBRARY; T=293.16K
thermal capture photon spectrum

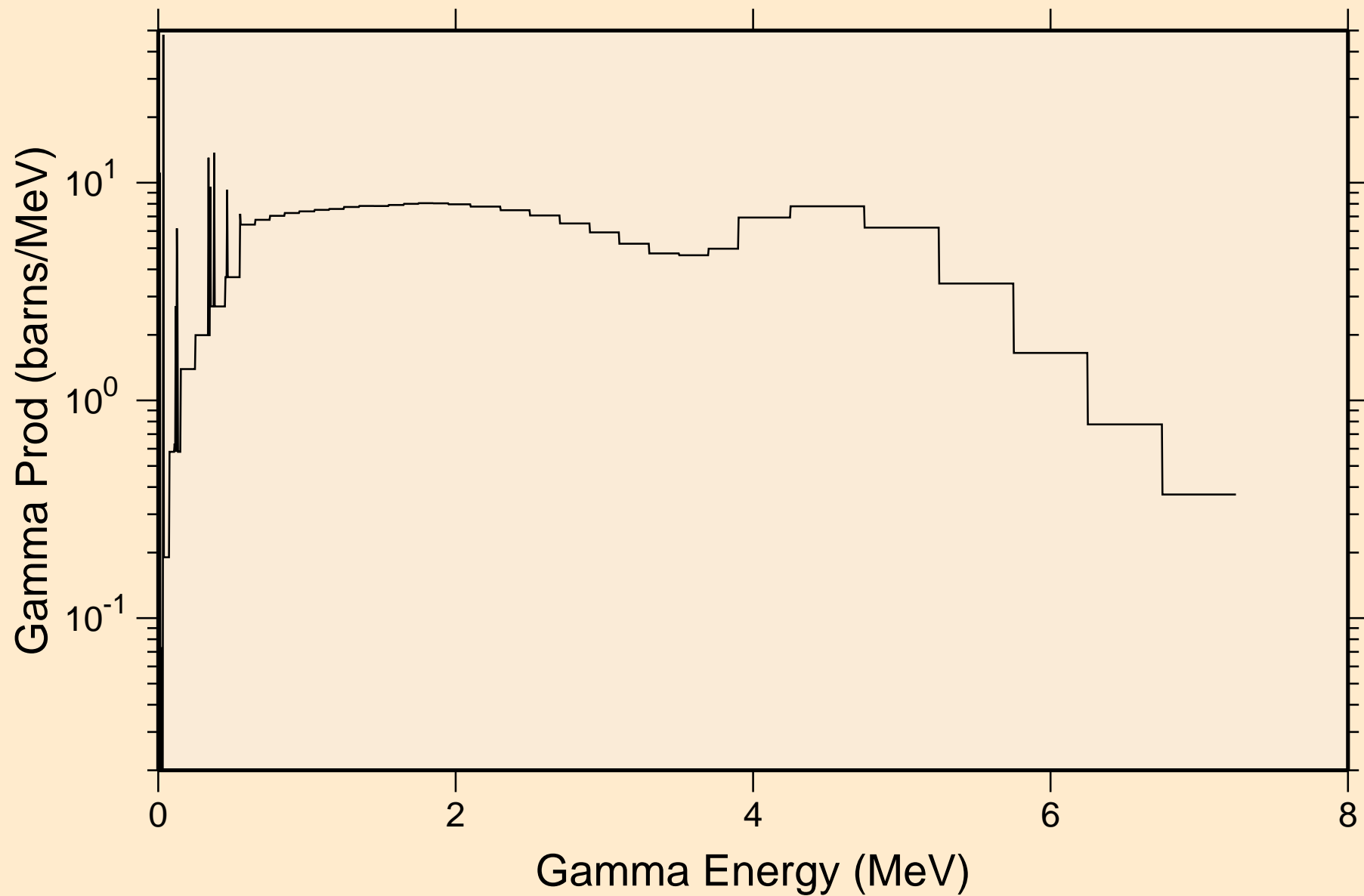

CM237 NEUTRON ACER TENDL-2019 LIBRARY; T=293.16K
14 MeV photon spectrum

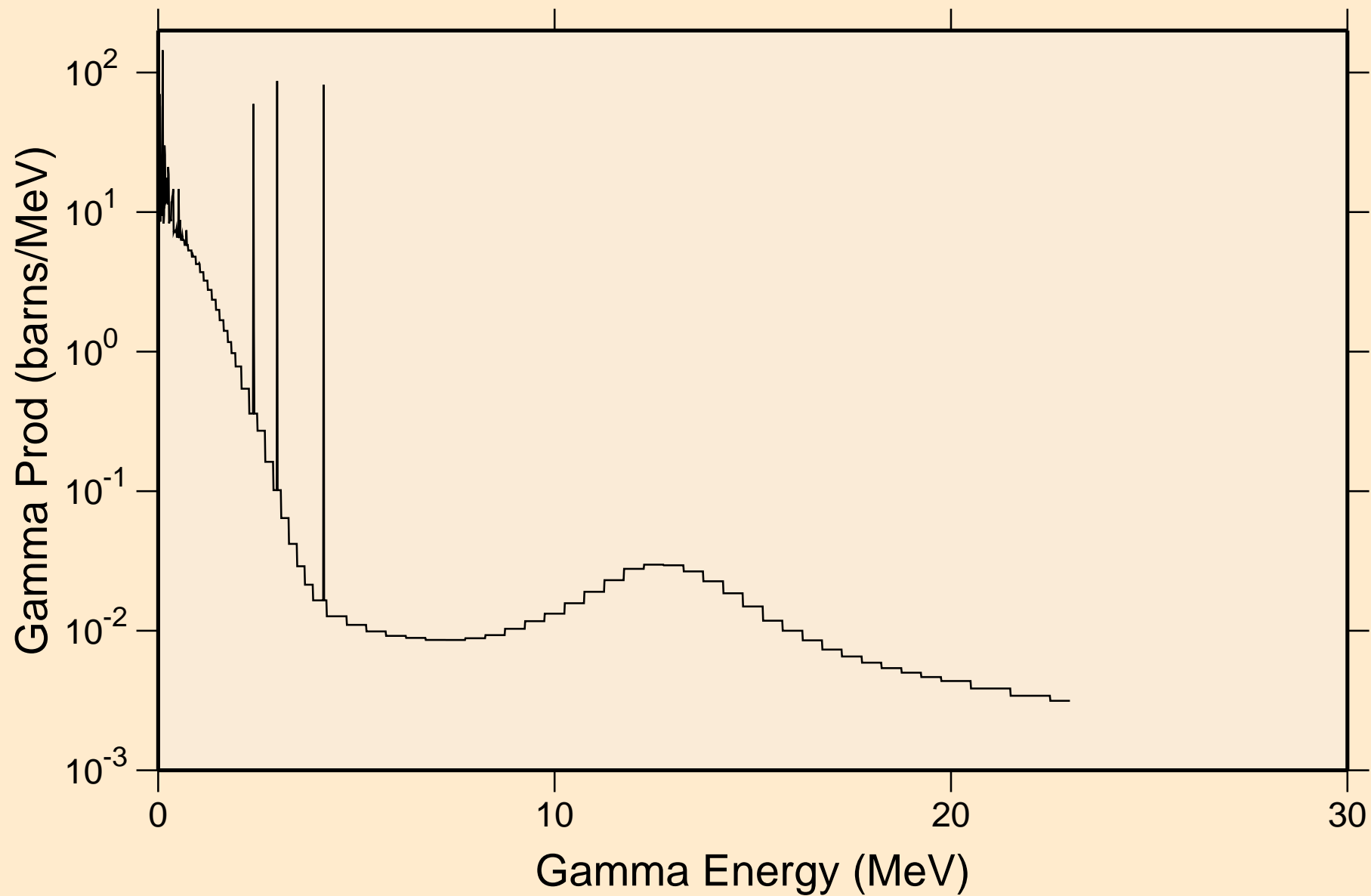

CM237 NEUTRON ACER TENDL-2019 LIBRARY; T=293.16K
Particle heating contributions

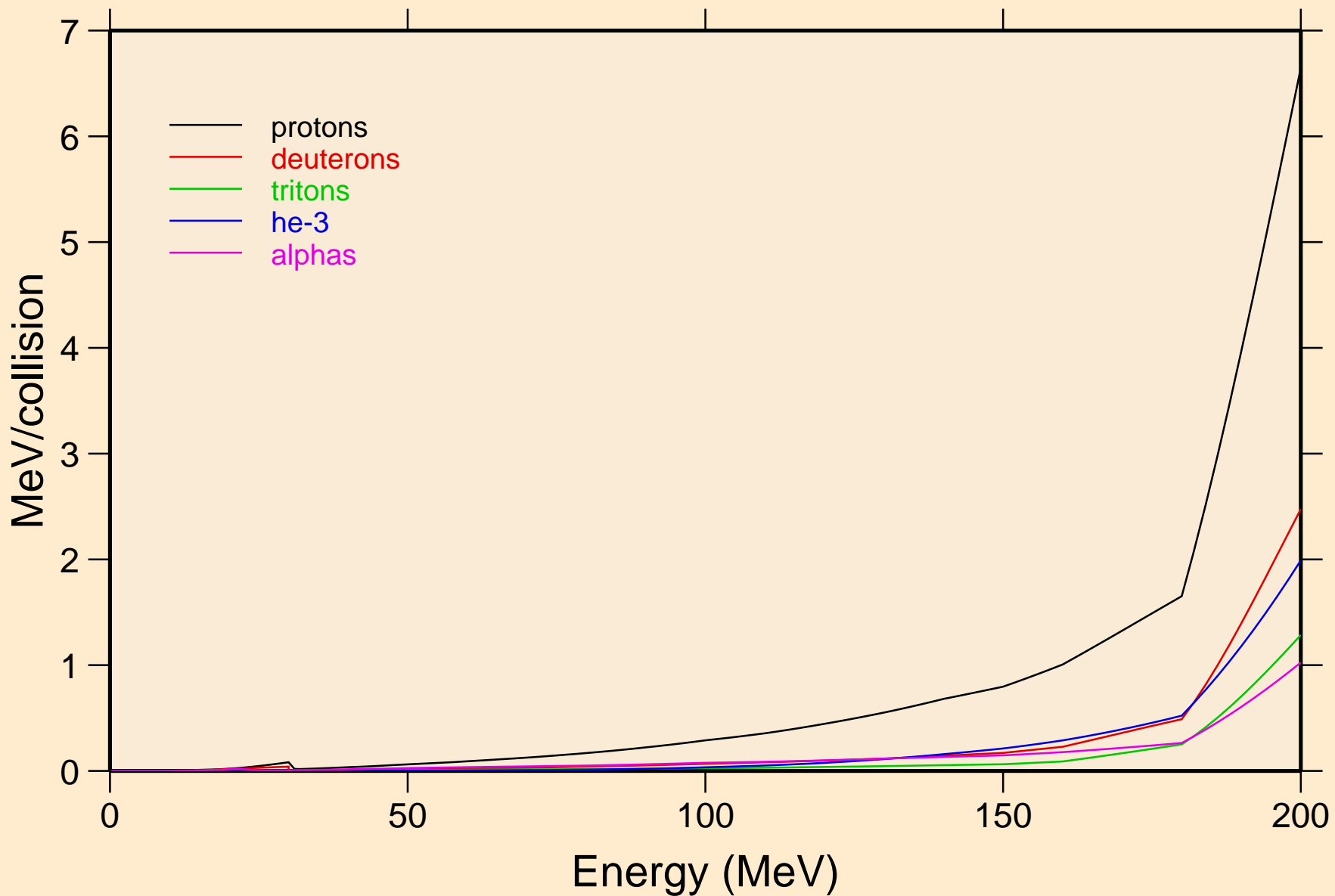

CM237 NEUTRON ACER TENDL-2019 LIBRARY; T=293.16K
Recoil Heating

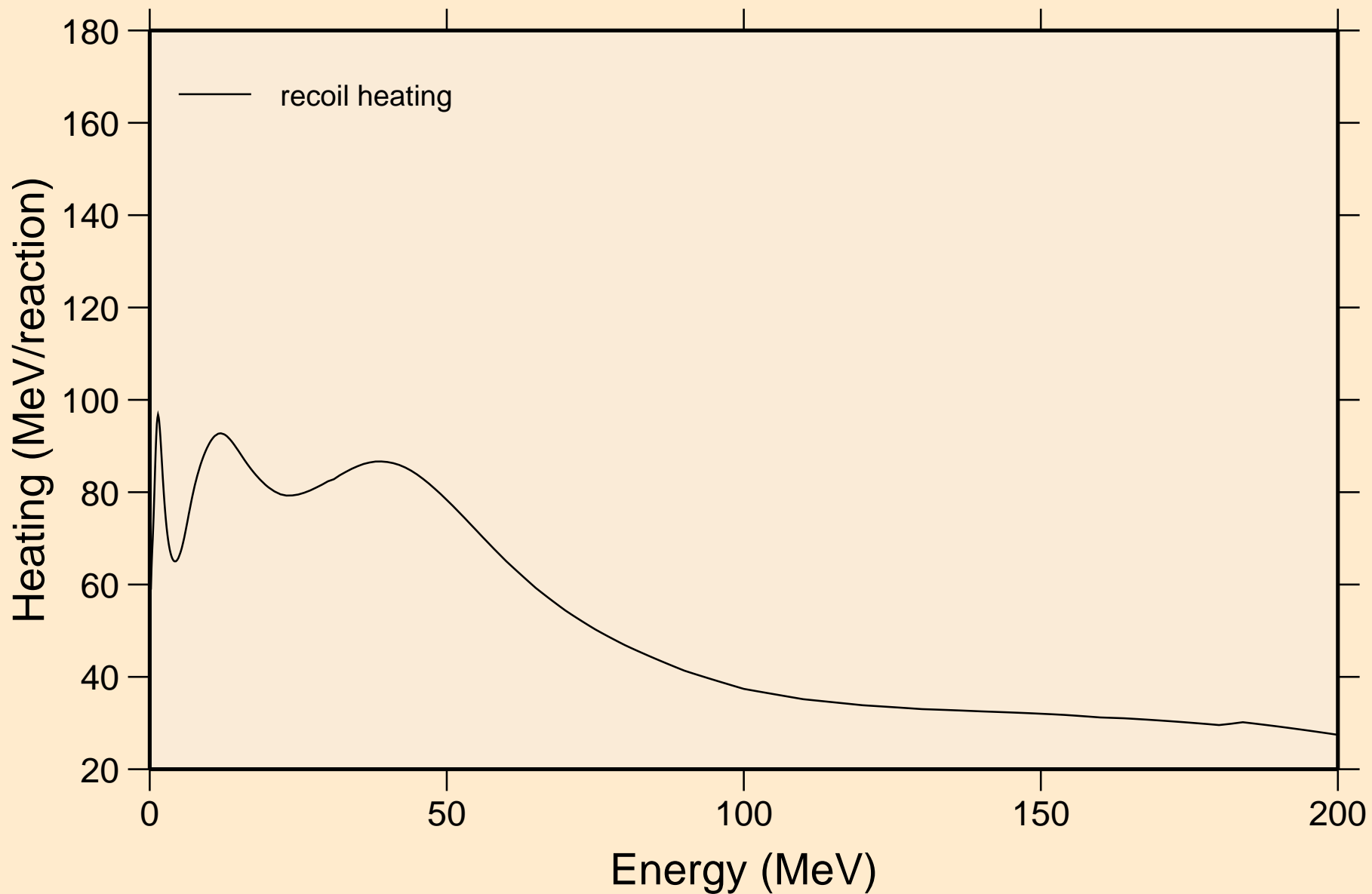

CM237 NEUTRON ACER TENDL-2019 LIBRARY; T=293.16K

Particle production cross sections

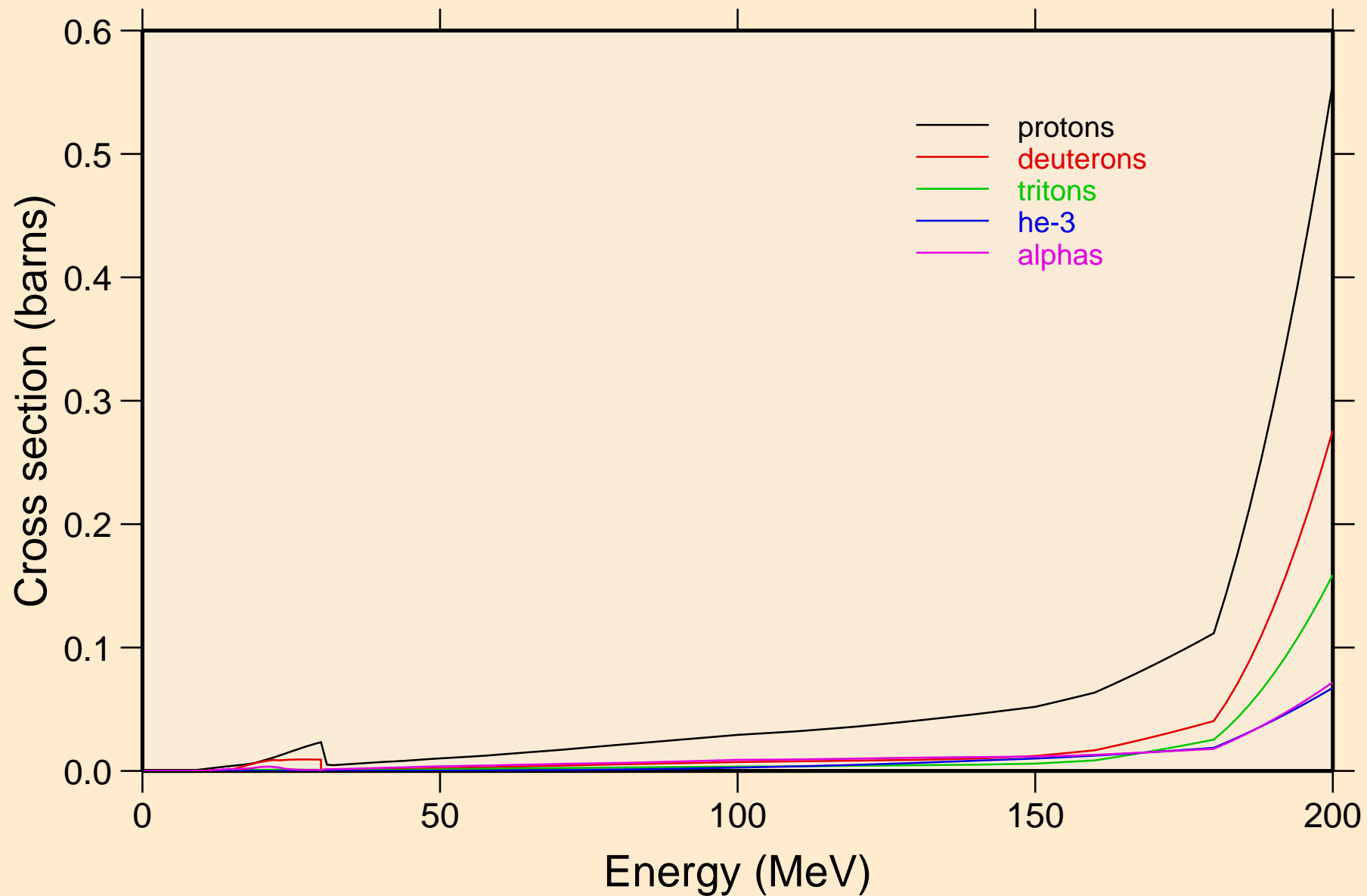

CM237 NEUTRON ACER TENDL-2019 LIBRARY; T=293.16K
protons from (n,x)

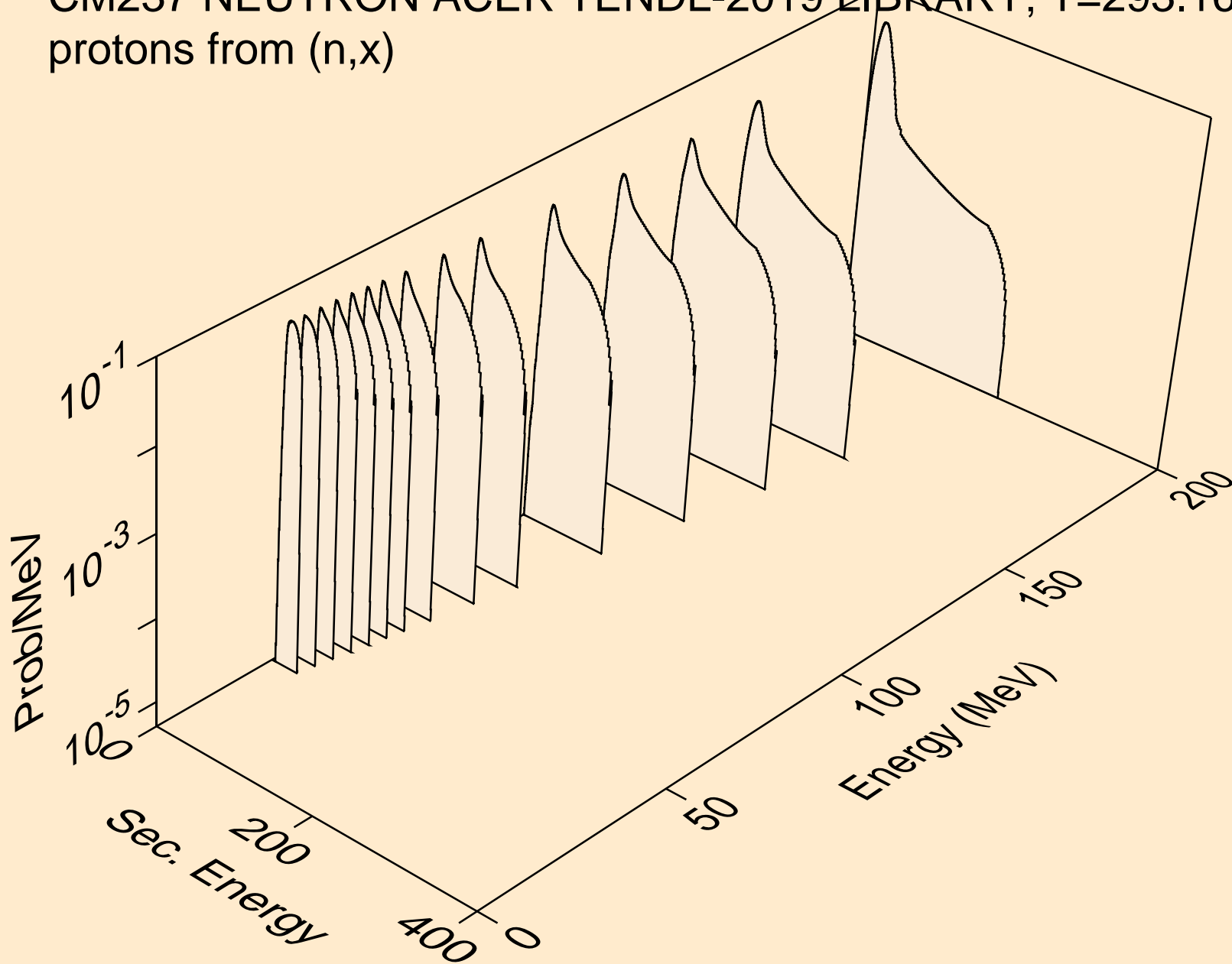

CM237 NEUTRON ACER TENDL-2019 LIBRARY; T=293.16K
protons from (n,n*)p

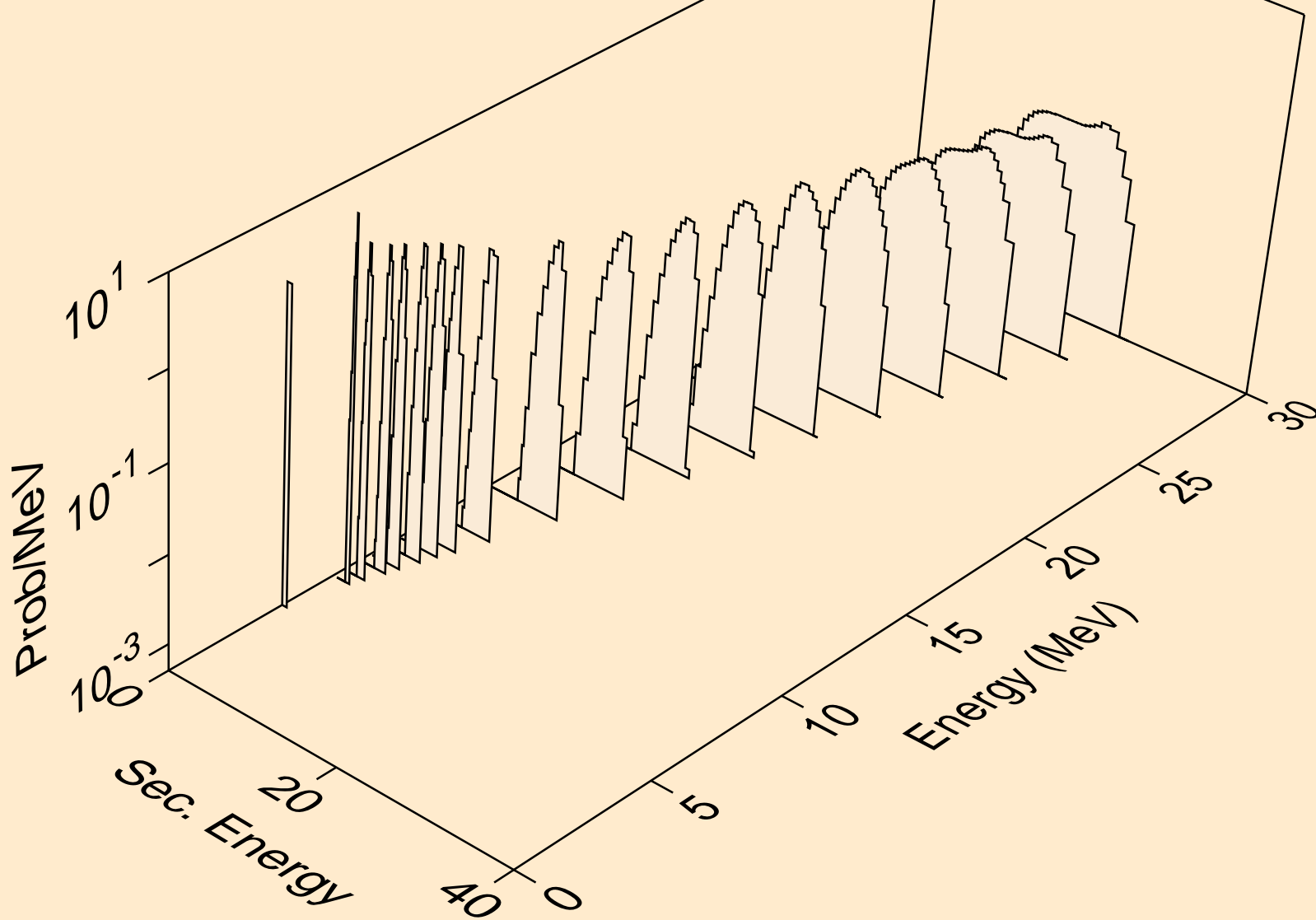

CM237 NEUTRON ACER TENDL-2019 LIBRARY; T=293.16K
protons from (n,2np)

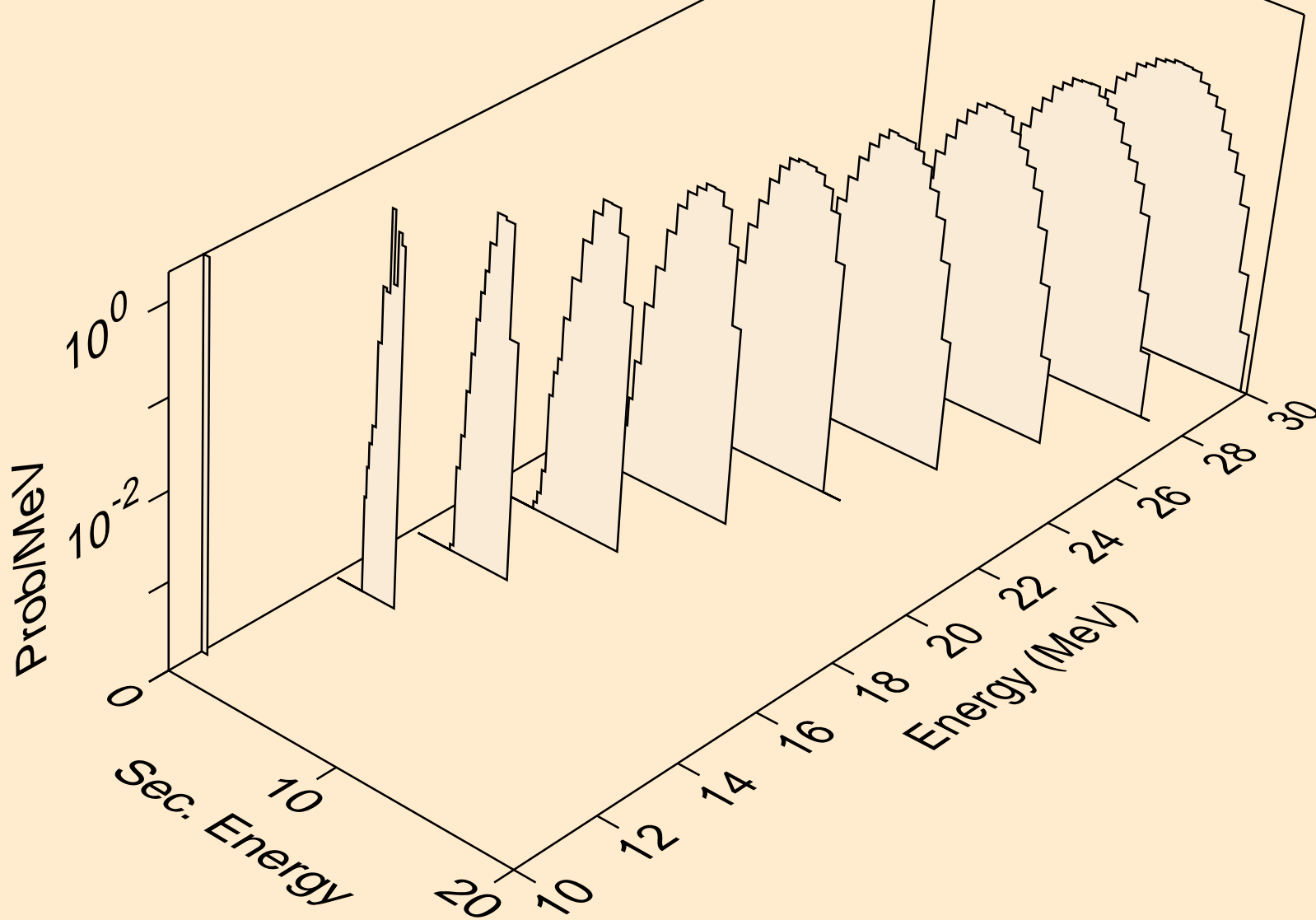

CM237 NEUTRON ACER TENDL-2019 LIBRARY; T=293.16K
protons from (n,3np)

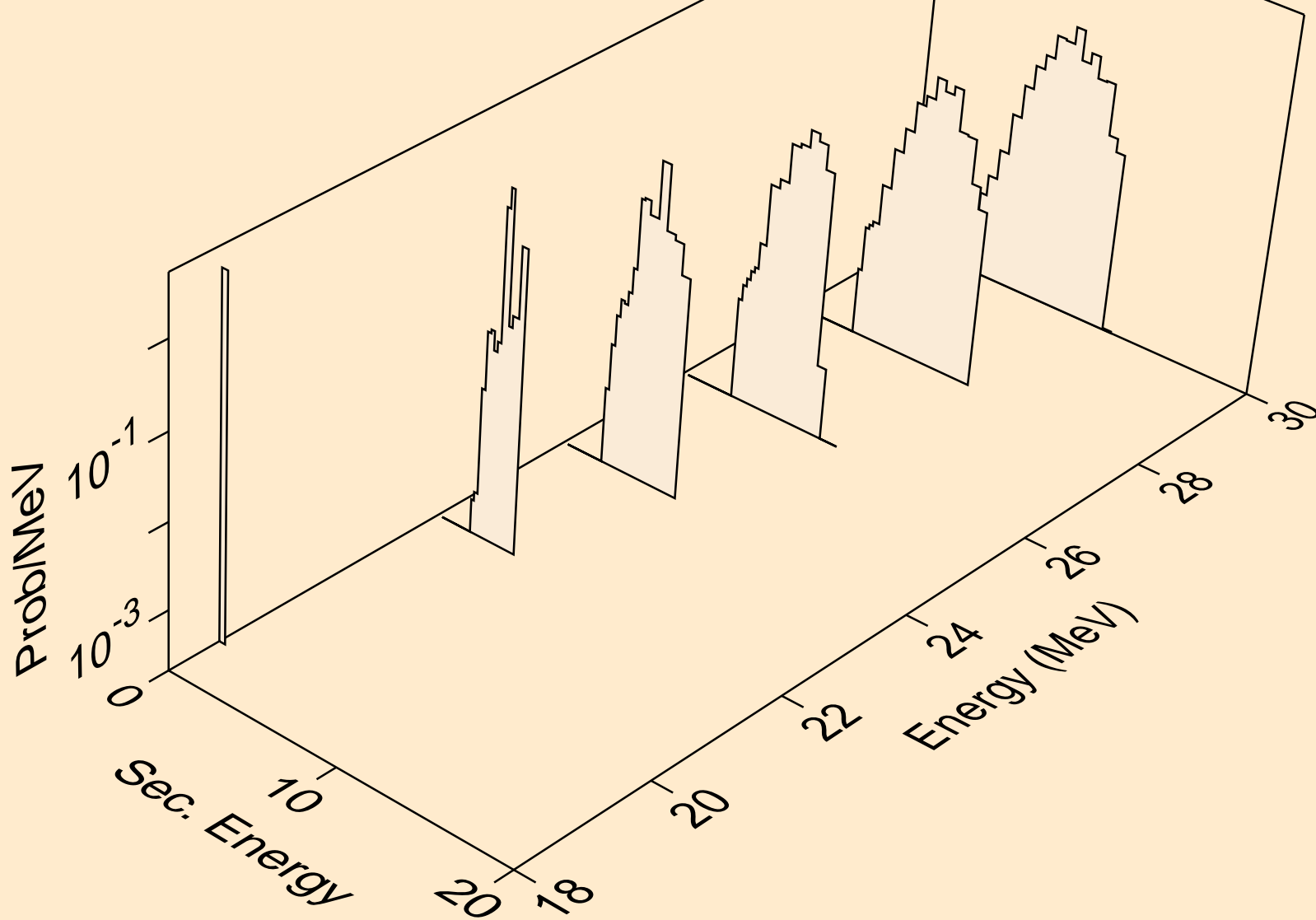

CM237 NEUTRON ACER TENDL-2019 LIBRARY; T=293.16K
protons from (n,2np)

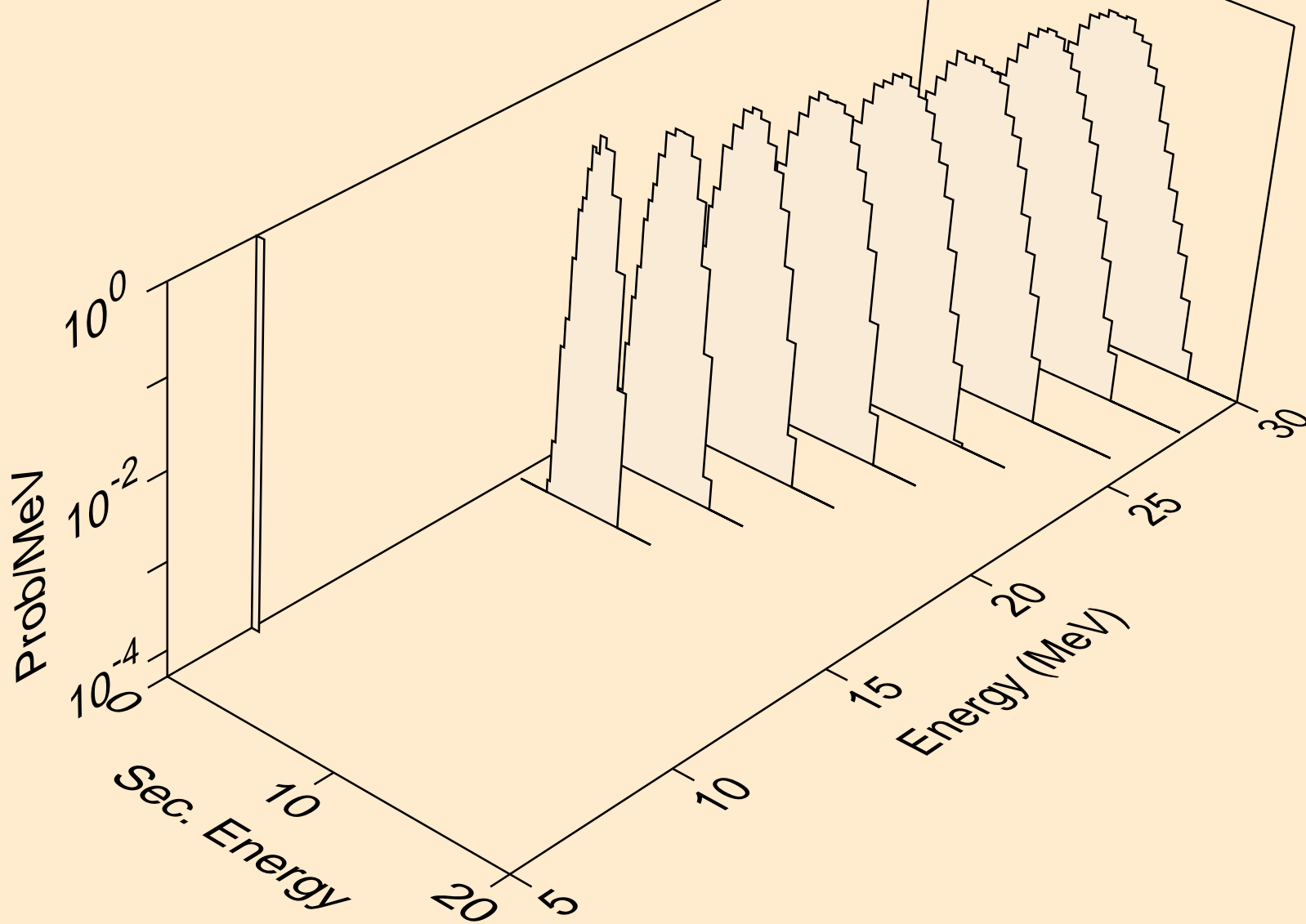

CM237 NEUTRON ACER TENDL-2019 LIBRARY; T=293.16K
protons from (n,npa)

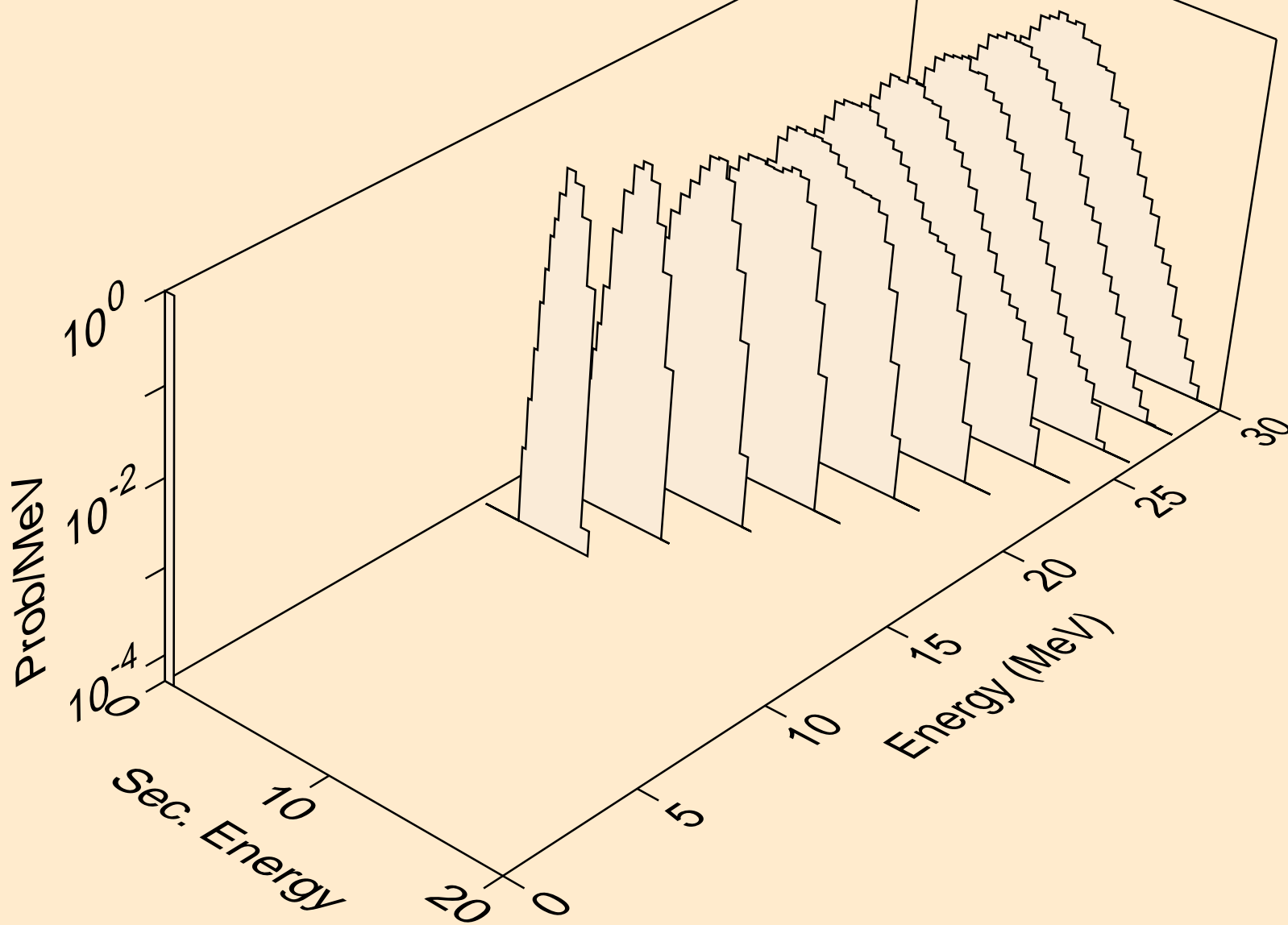

CM237 NEUTRON ACER TENDL-2019 LIBRARY; T=293.16K
protons from (n,p)

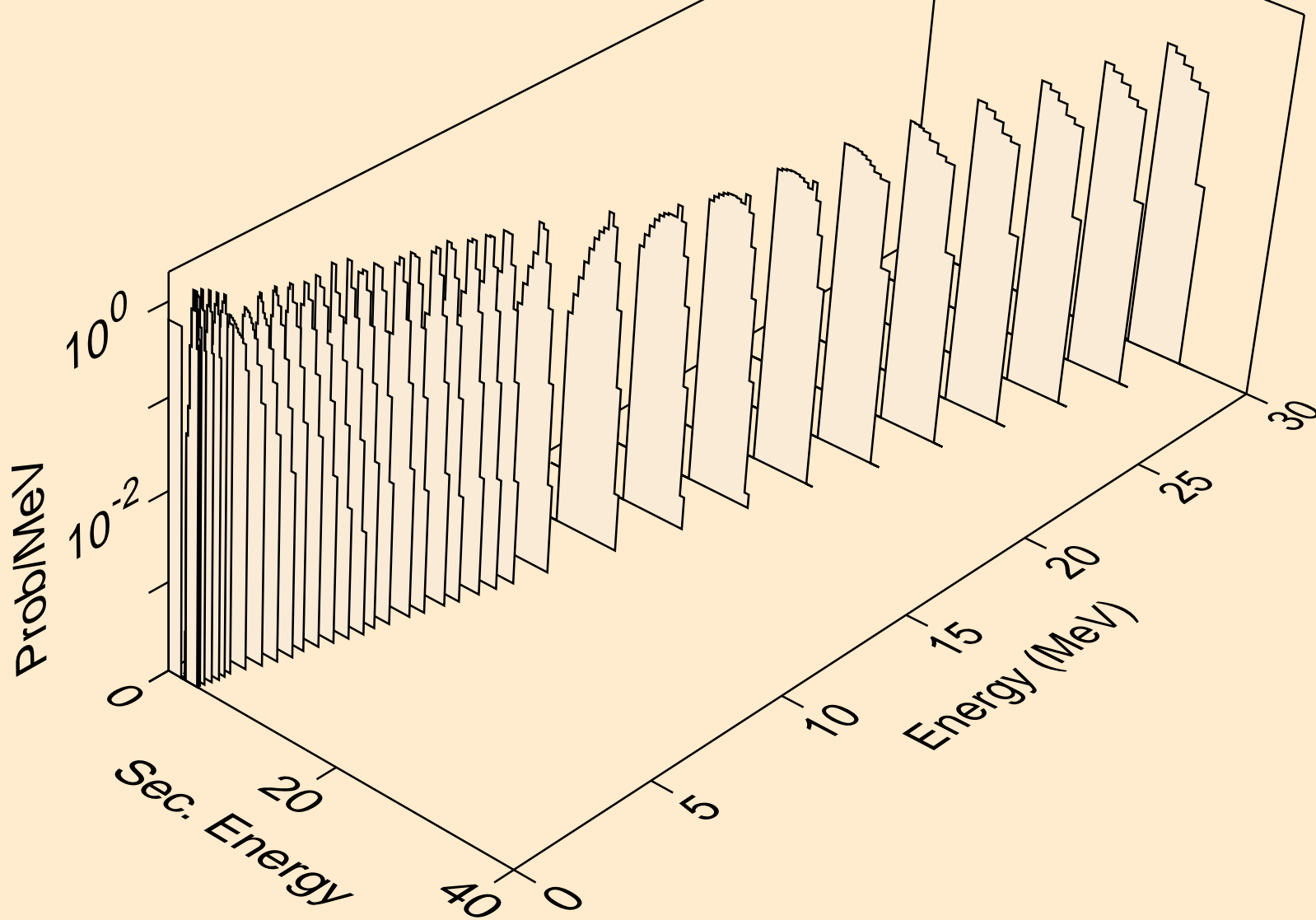

CM237 NEUTRON ACER TENDL-2019 LIBRARY; T=293.16K
protons from (n,2p)

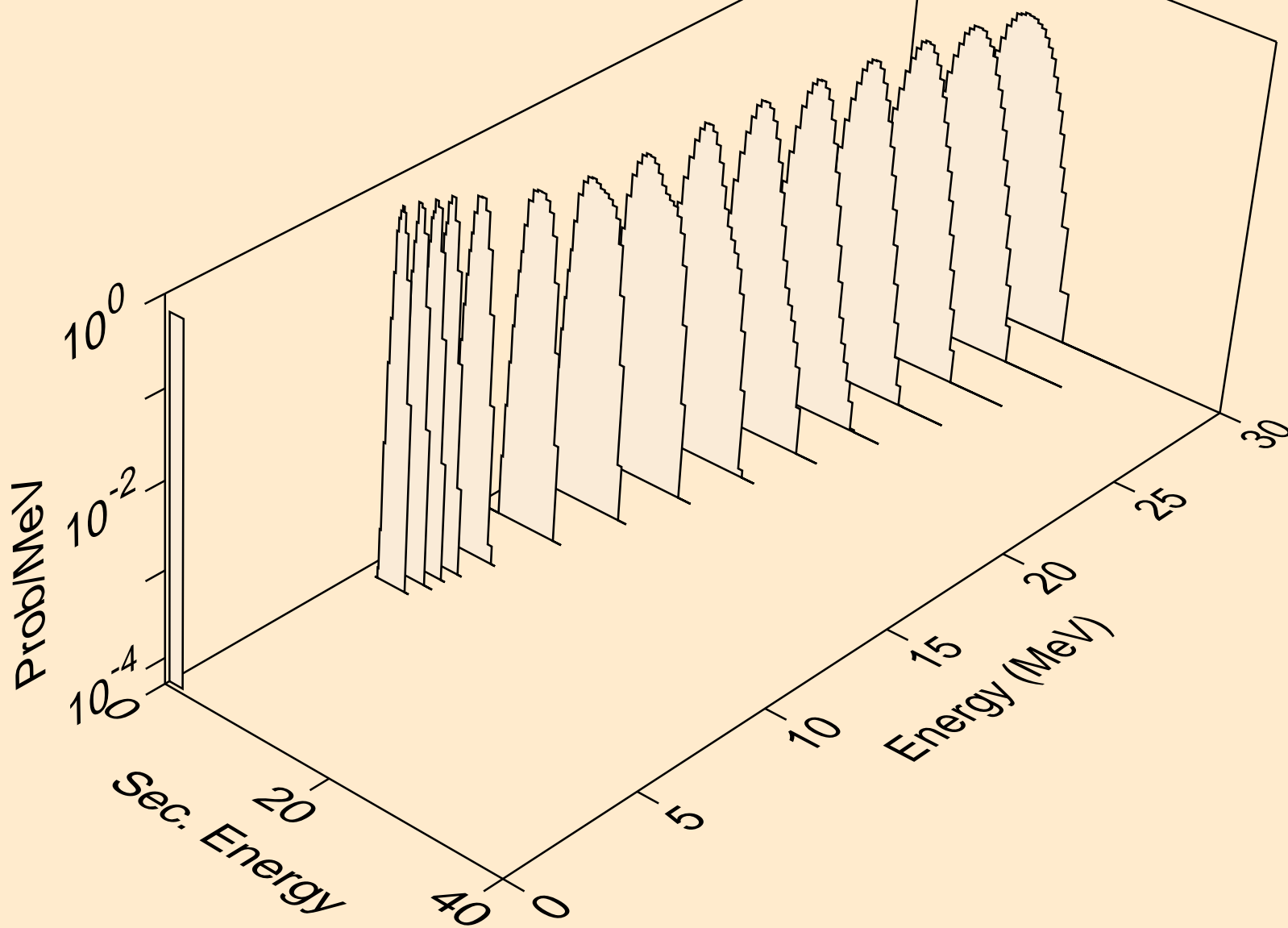

CM237 NEUTRON ACER TENDL-2019 LIBRARY; T=293.16K
protons from (n,p)

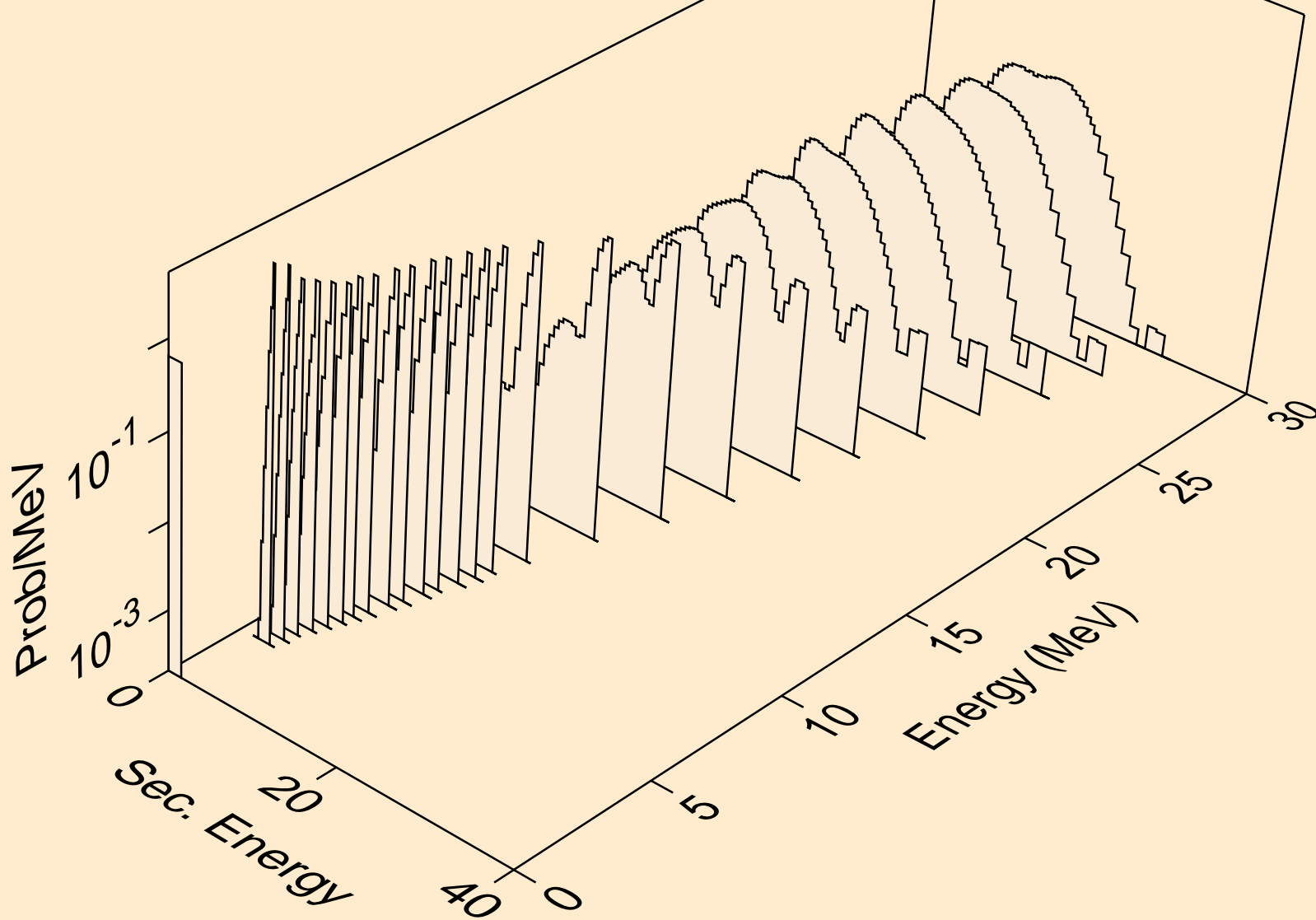

CM237 NEUTRON ACER TENDL-2019 LIBRARY; T=293.16K
deuterons from (n,x)

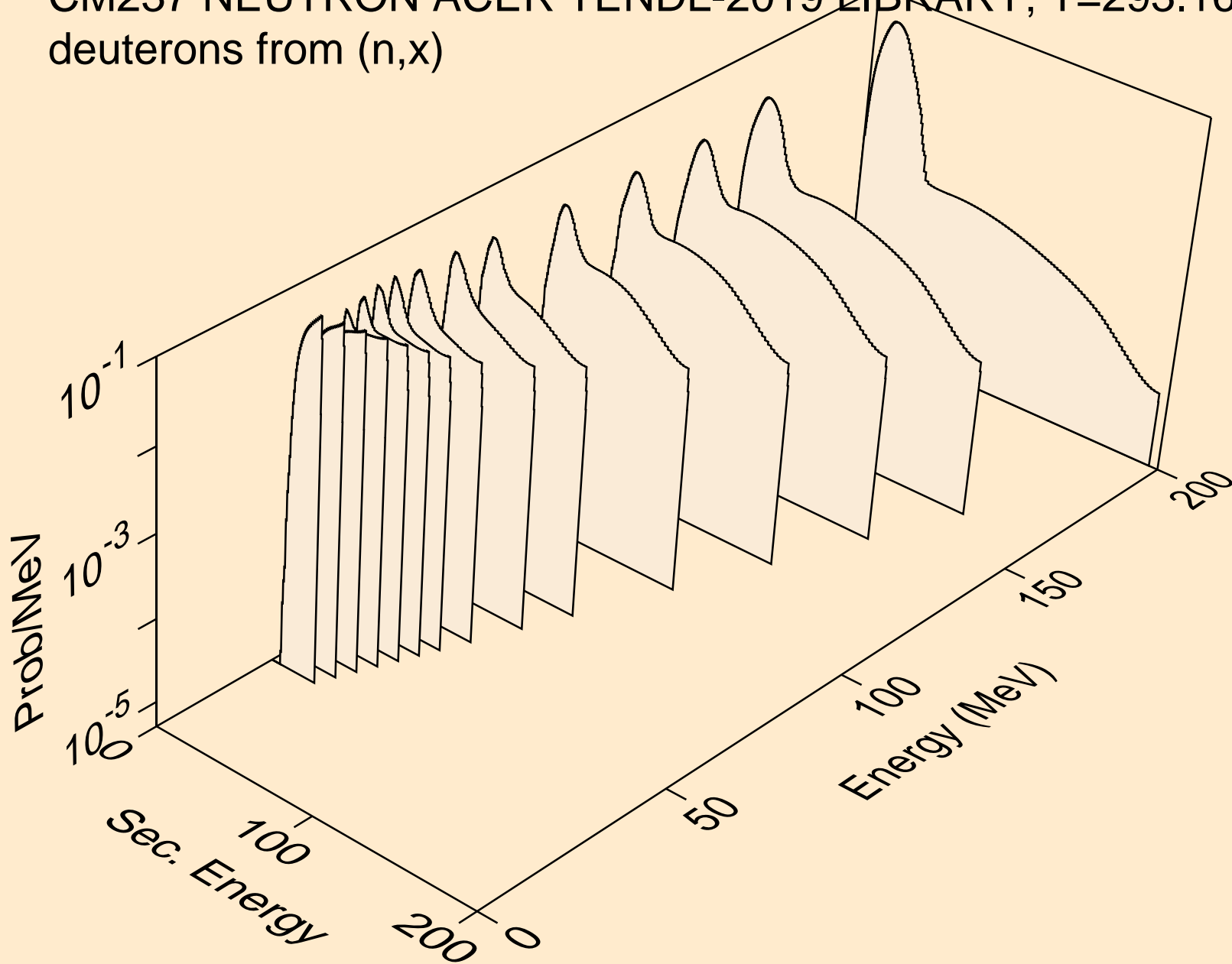

CM237 NEUTRON ACER TENDL-2019 LIBRARY; T=293.16K
deuterons from (n,2nd)

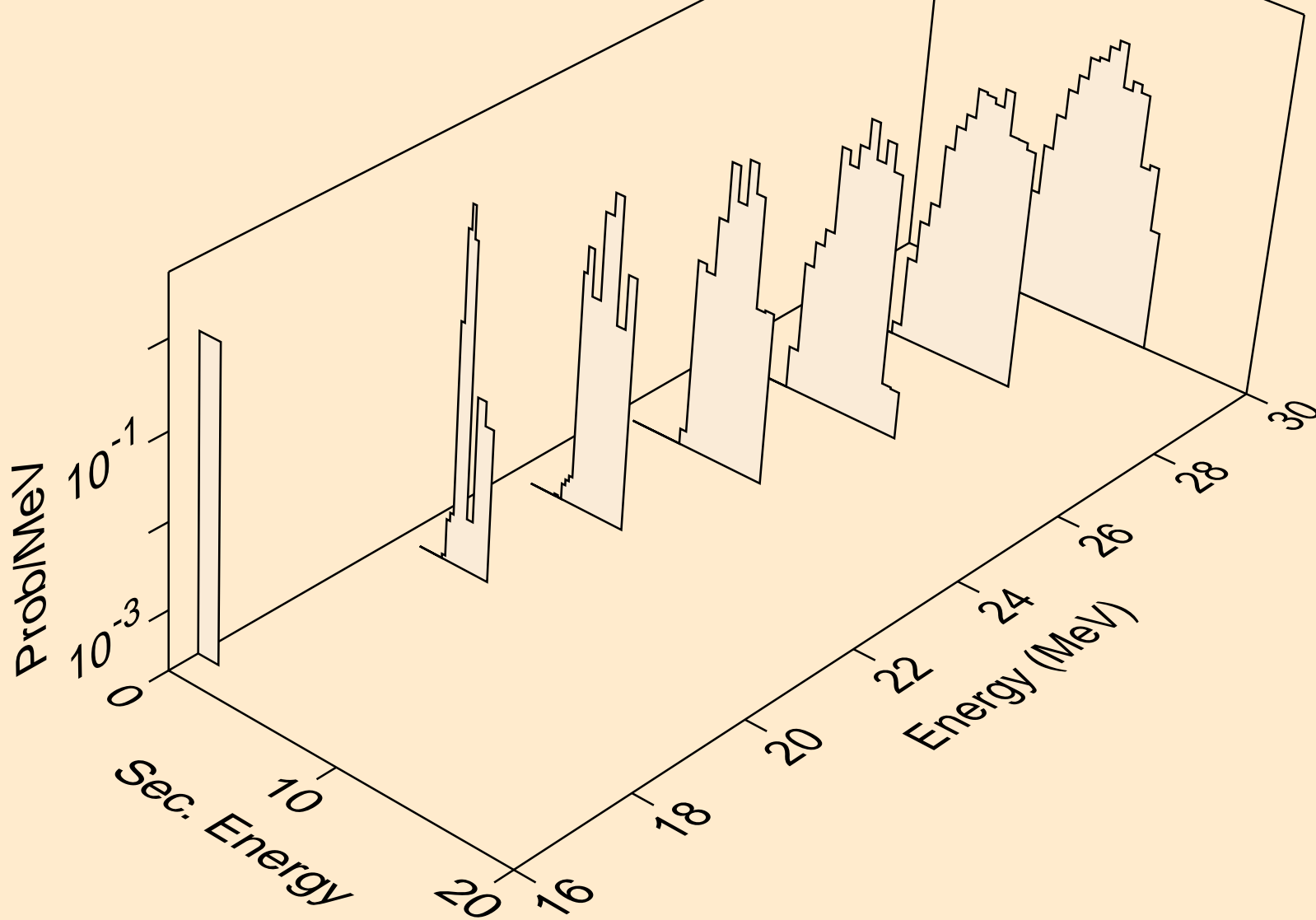

CM237 NEUTRON ACER TENDL-2019 LIBRARY; T=293.16K
deuterons from (n,n*)d

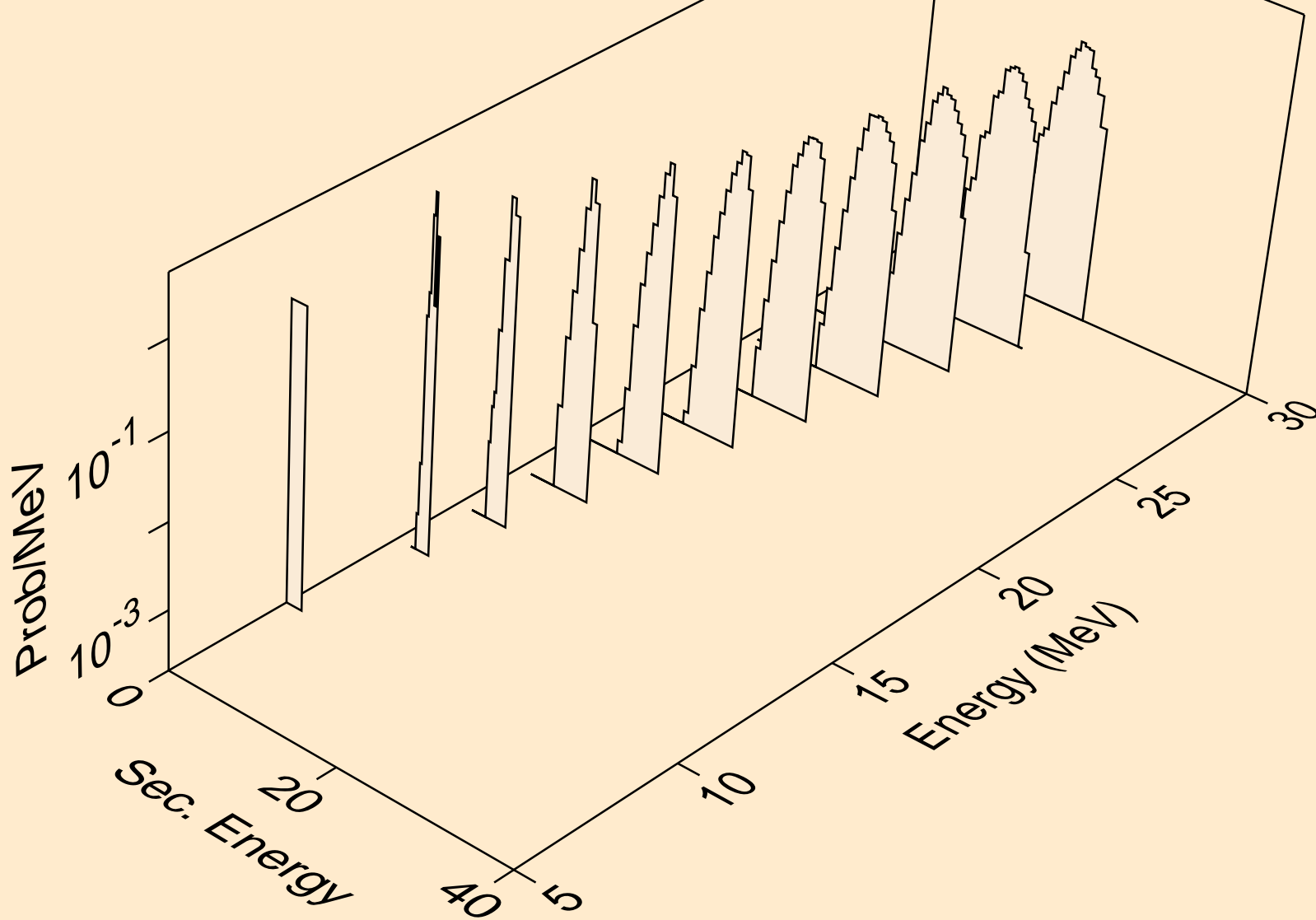

CM237 NEUTRON ACER TENDL-2019 LIBRARY; T=293.16K
deuterons from (n,d)

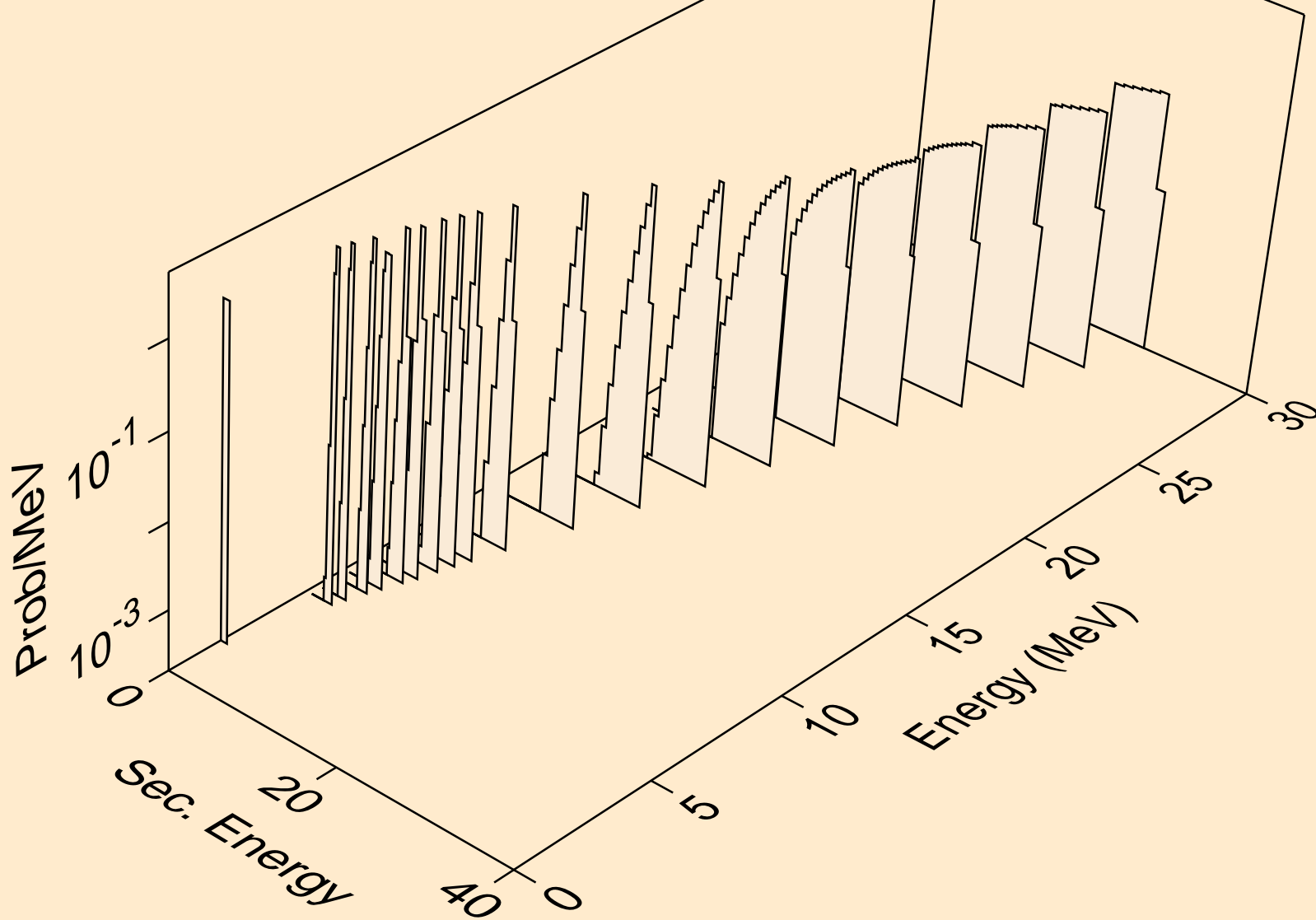

CM237 NEUTRON ACER TENDL-2019 LIBRARY; T=293.16K
tritons from (n,x)

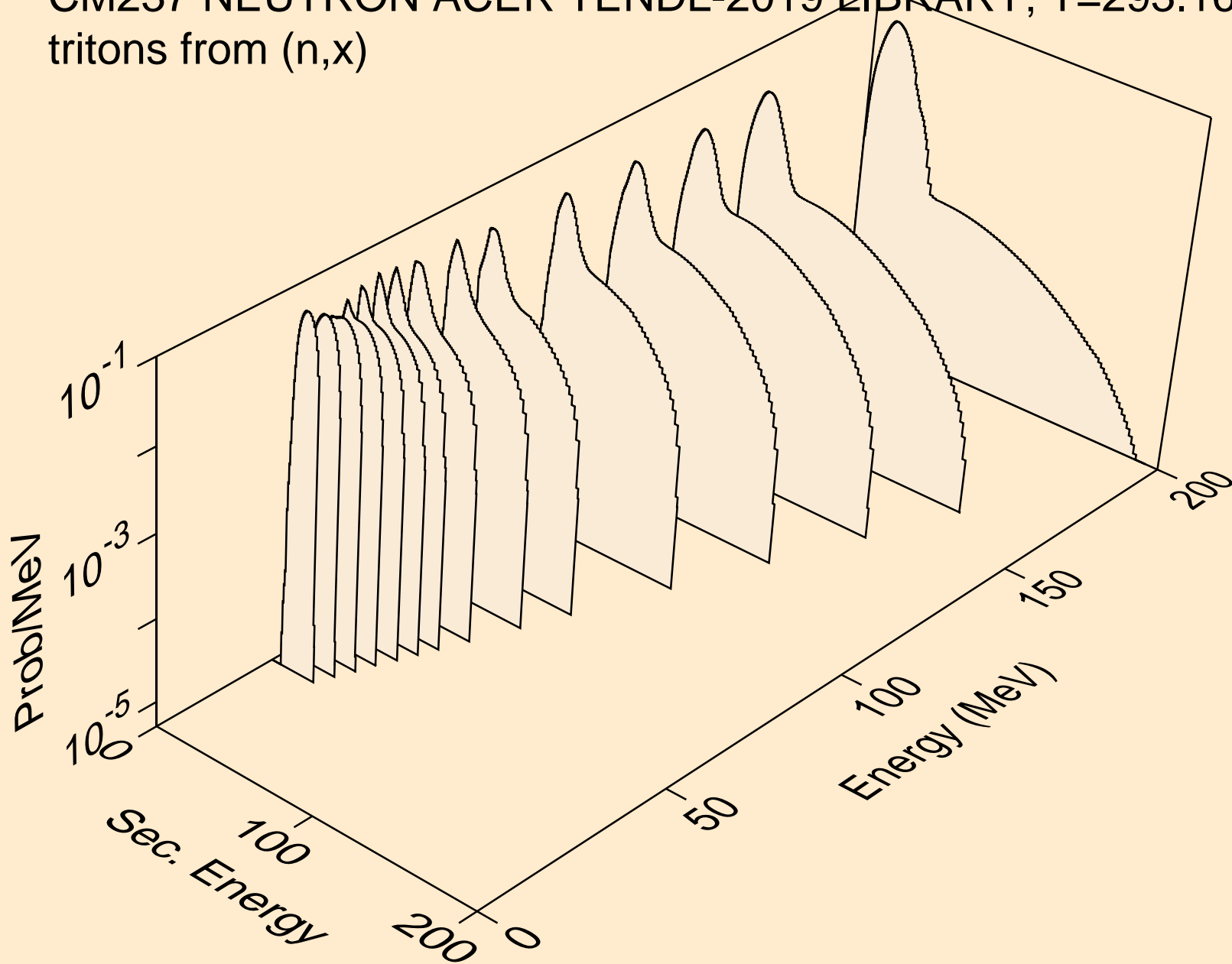

CM237 NEUTRON ACER TENDL-2019 LIBRARY; T=293.16K
tritons from (n,n*)t

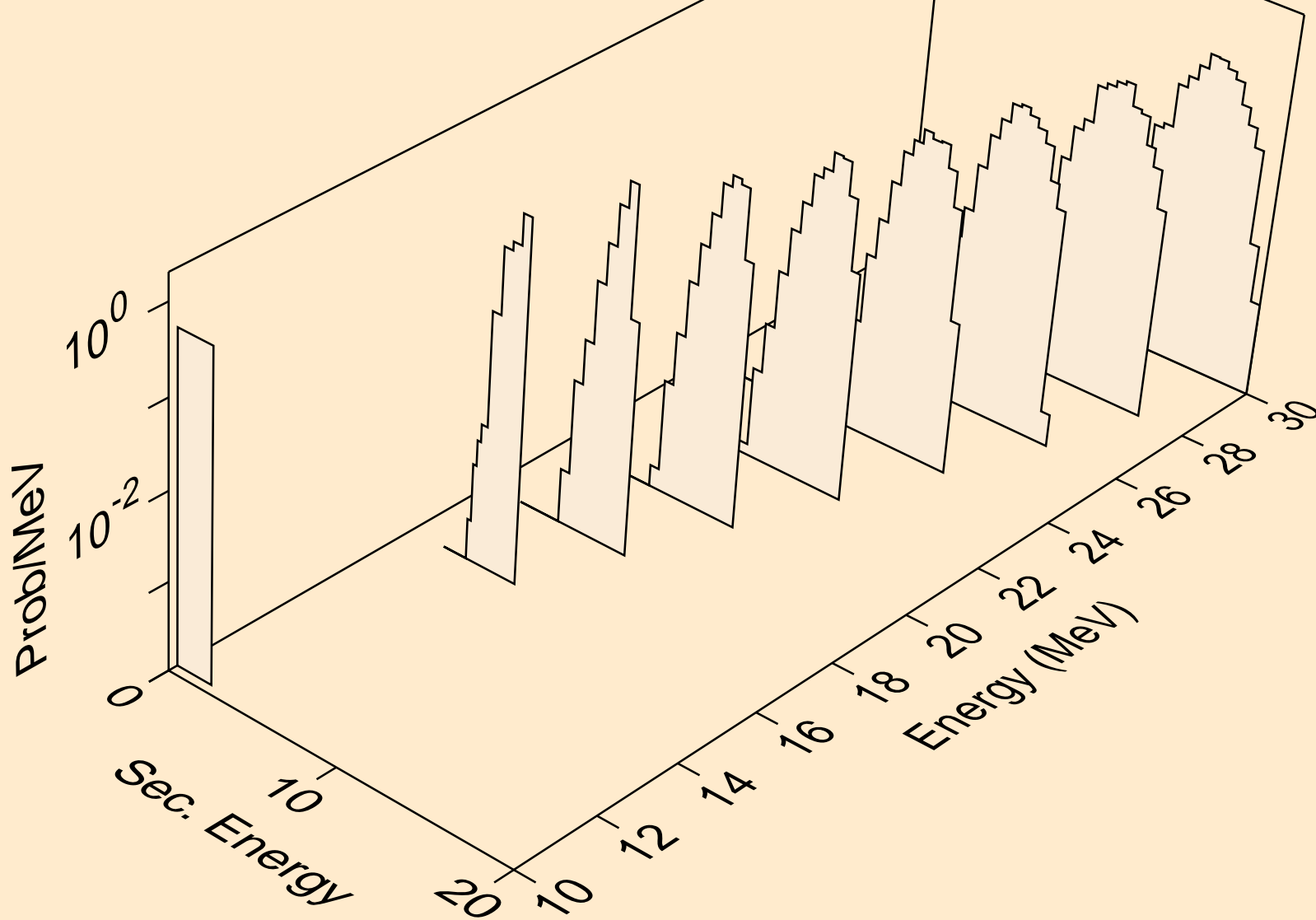

CM237 NEUTRON ACER TENDL-2019 LIBRARY; T=293.16K
tritons from (n,t)

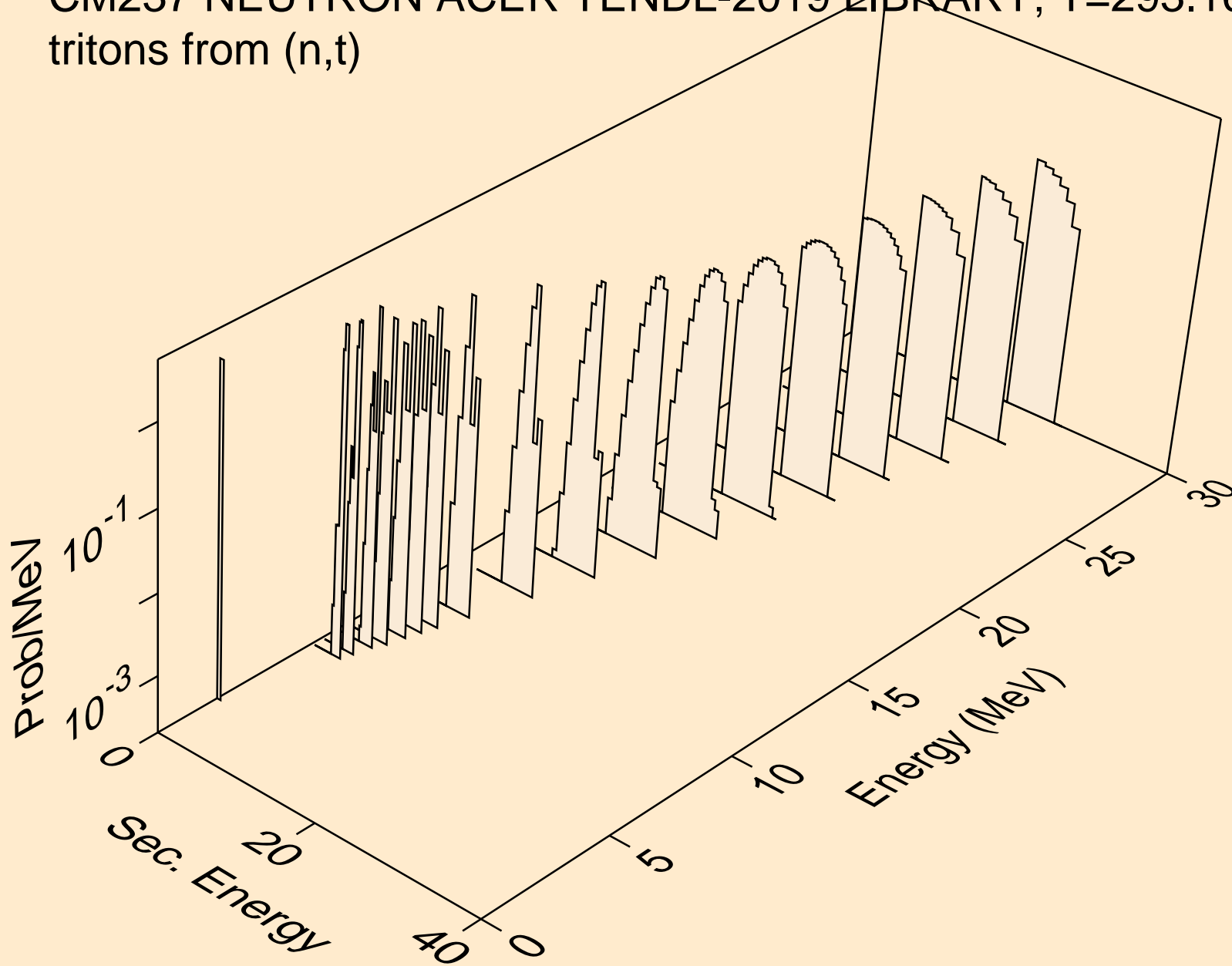

CM237 NEUTRON ACER TENDL-2019 LIBRARY; T=293.16K
he3s from (n,x)

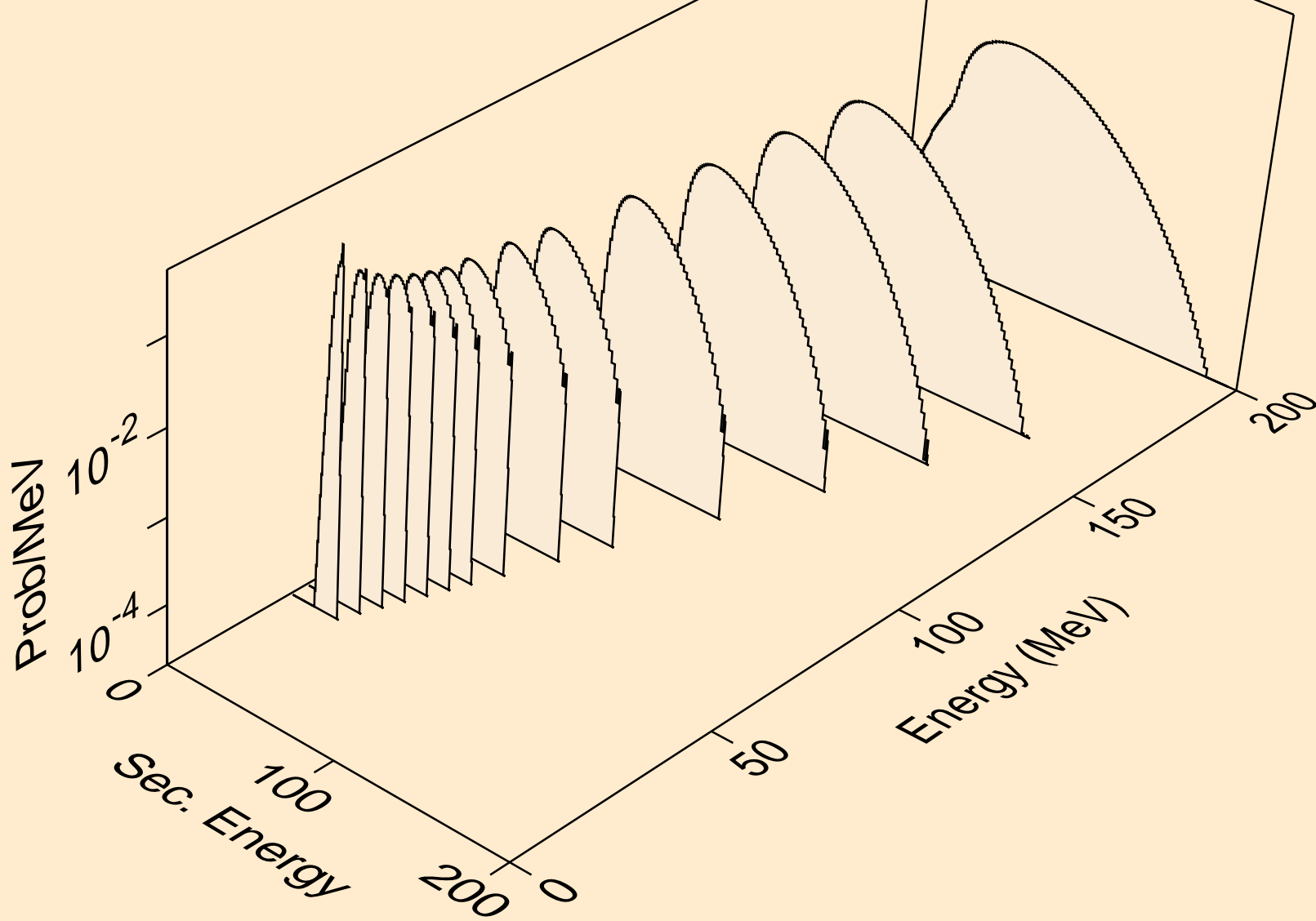

CM237 NEUTRON ACER TENDL-2019 LIBRARY; T=293.16K
he3s from (n,n*)he3

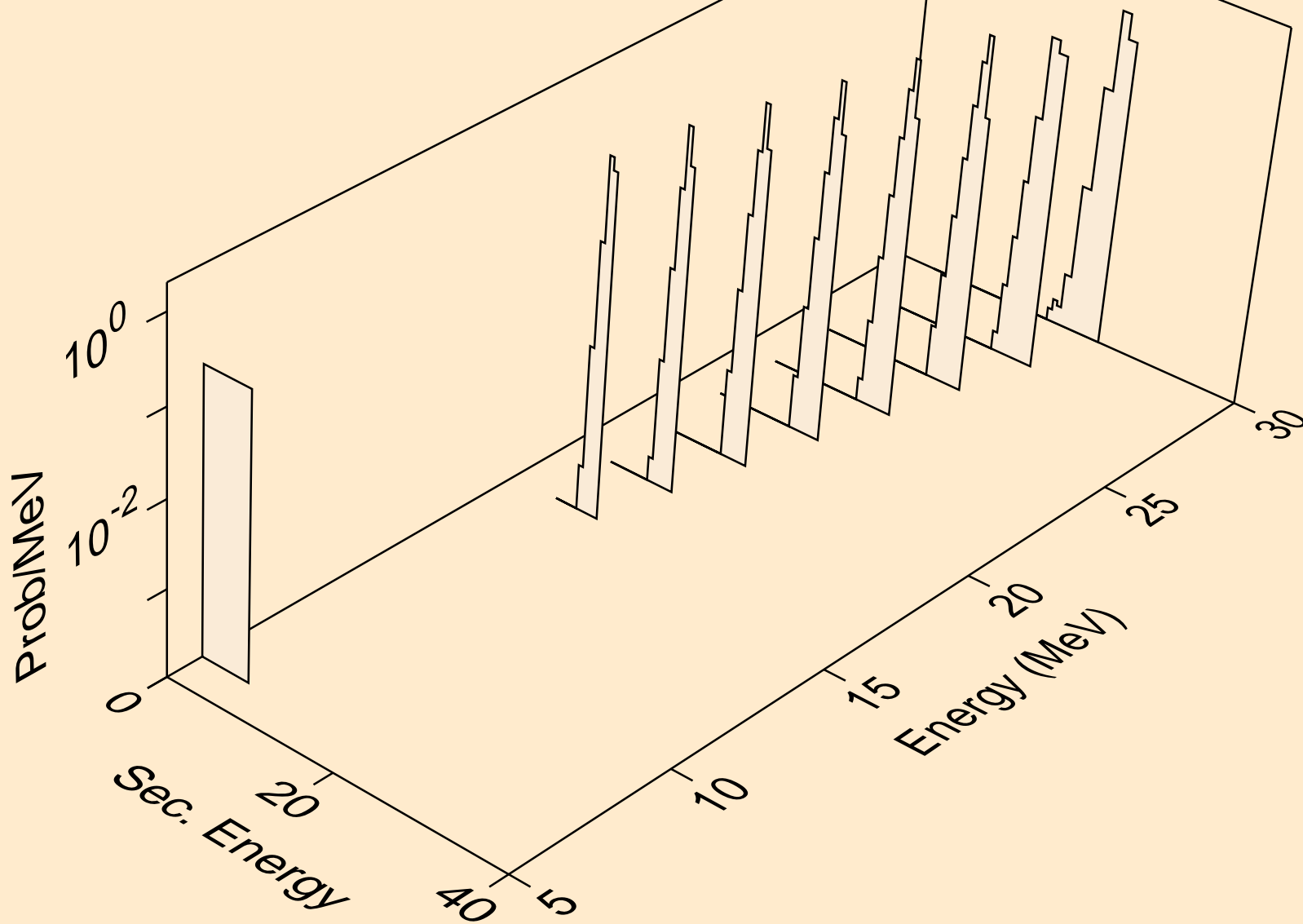

CM237 NEUTRON ACER TENDL-2019 LIBRARY; T=293.16K
he3s from (n,he3)

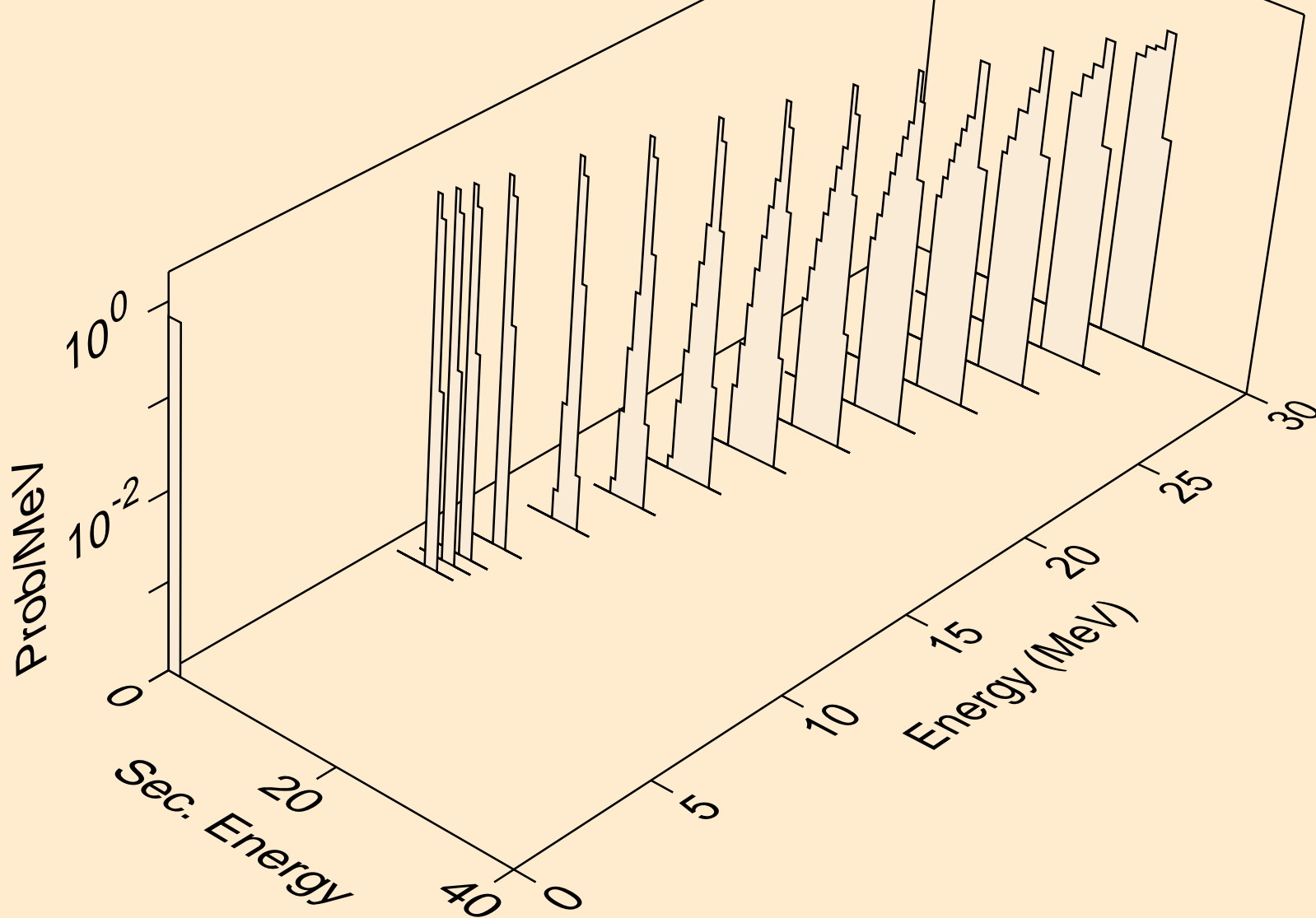

CM237 NEUTRON ACER TENDL-2019 LIBRARY; T=293.16K
alphas from (n,x)

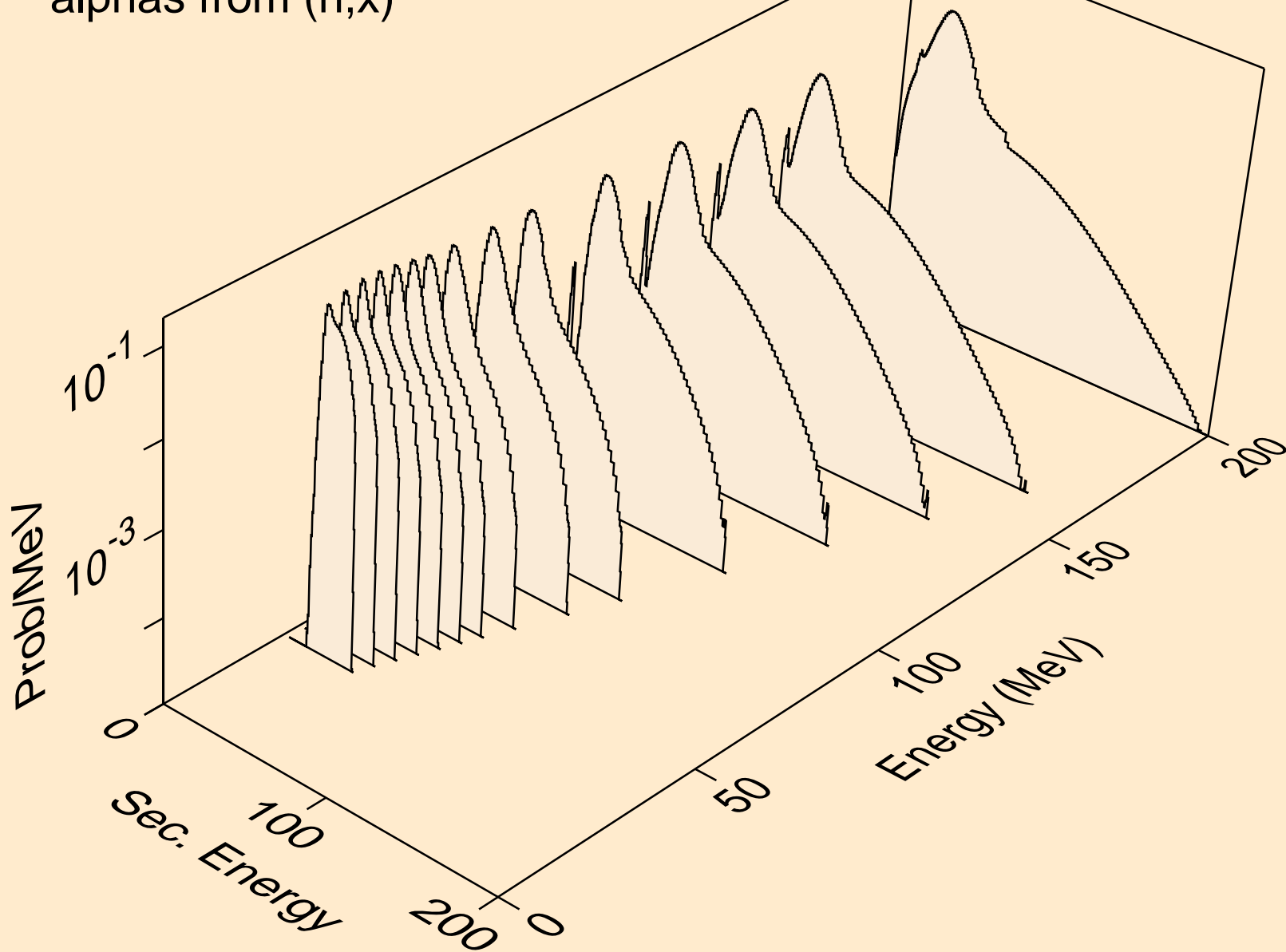

CM237 NEUTRON ACER TENDL-2019 LIBRARY; T=293.16K
alphas from (n,n*)a

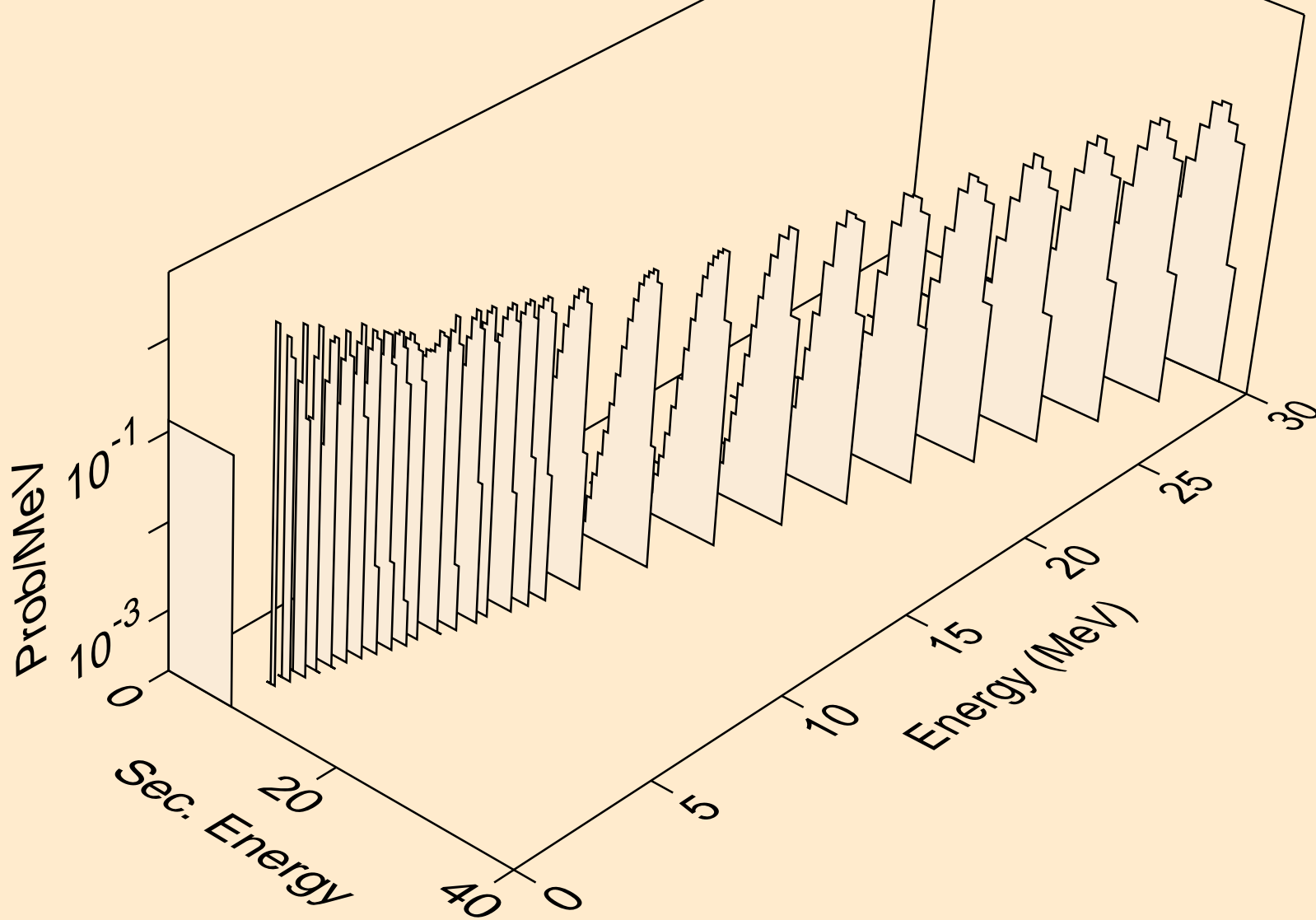

CM237 NEUTRON ACER TENDL-2019 LIBRARY; T=293.16K
alphas from (n,2n)a

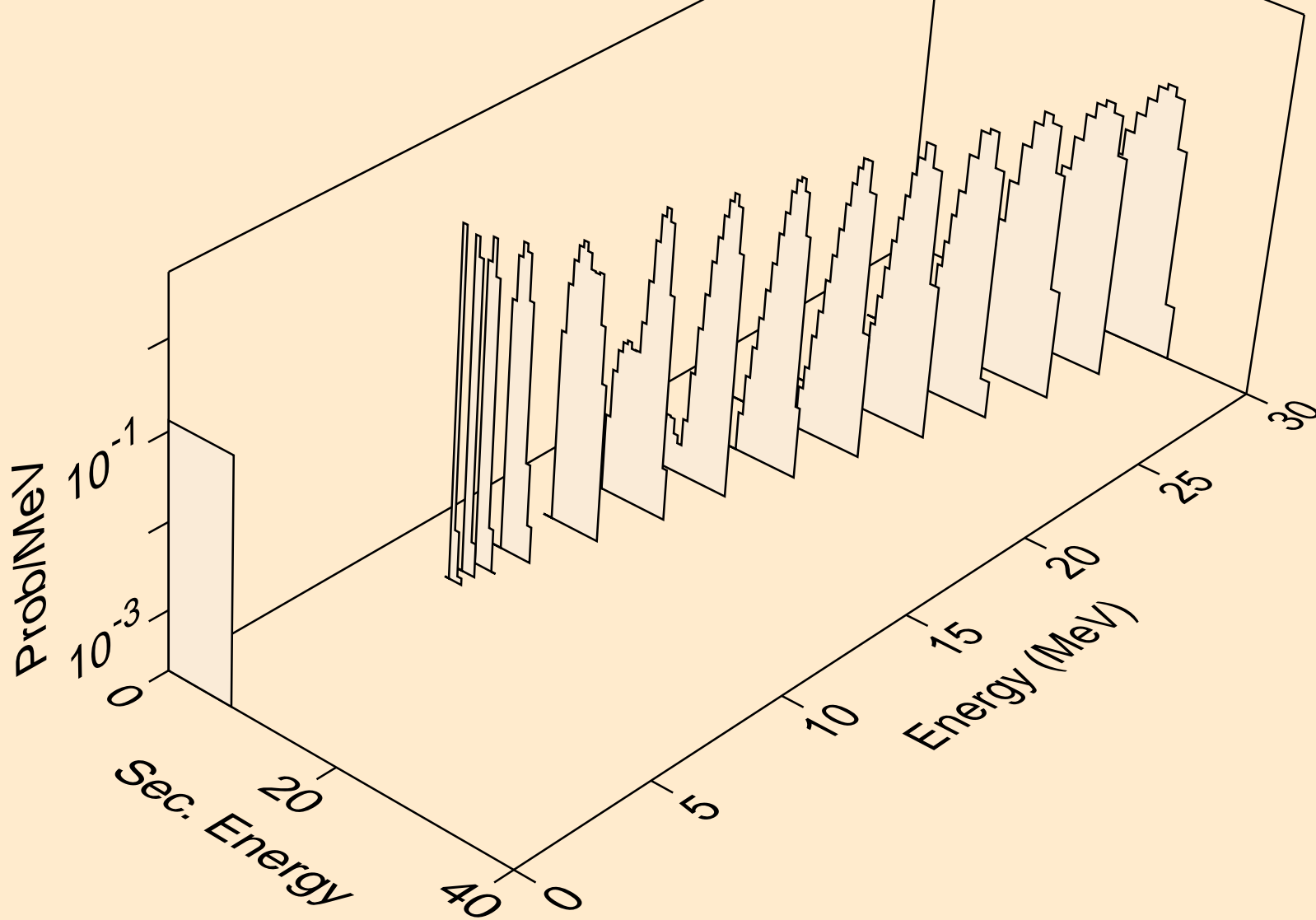

CM237 NEUTRON ACER TENDL-2019 LIBRARY; T=293.16K
alphas from (n,3n)a

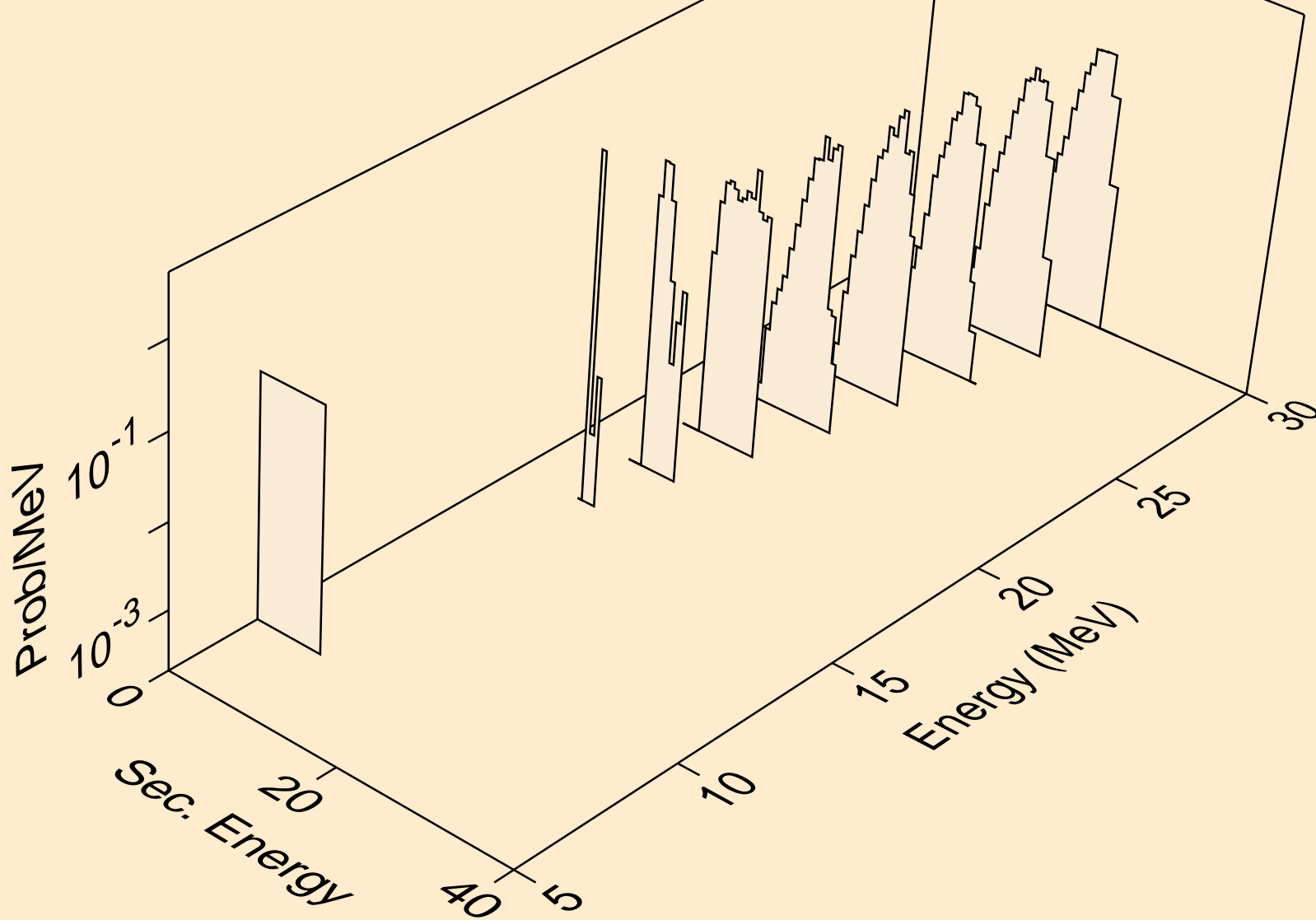

CM237 NEUTRON ACER TENDL-2019 LIBRARY; T=293.16K
alphas from (n,n*)2a

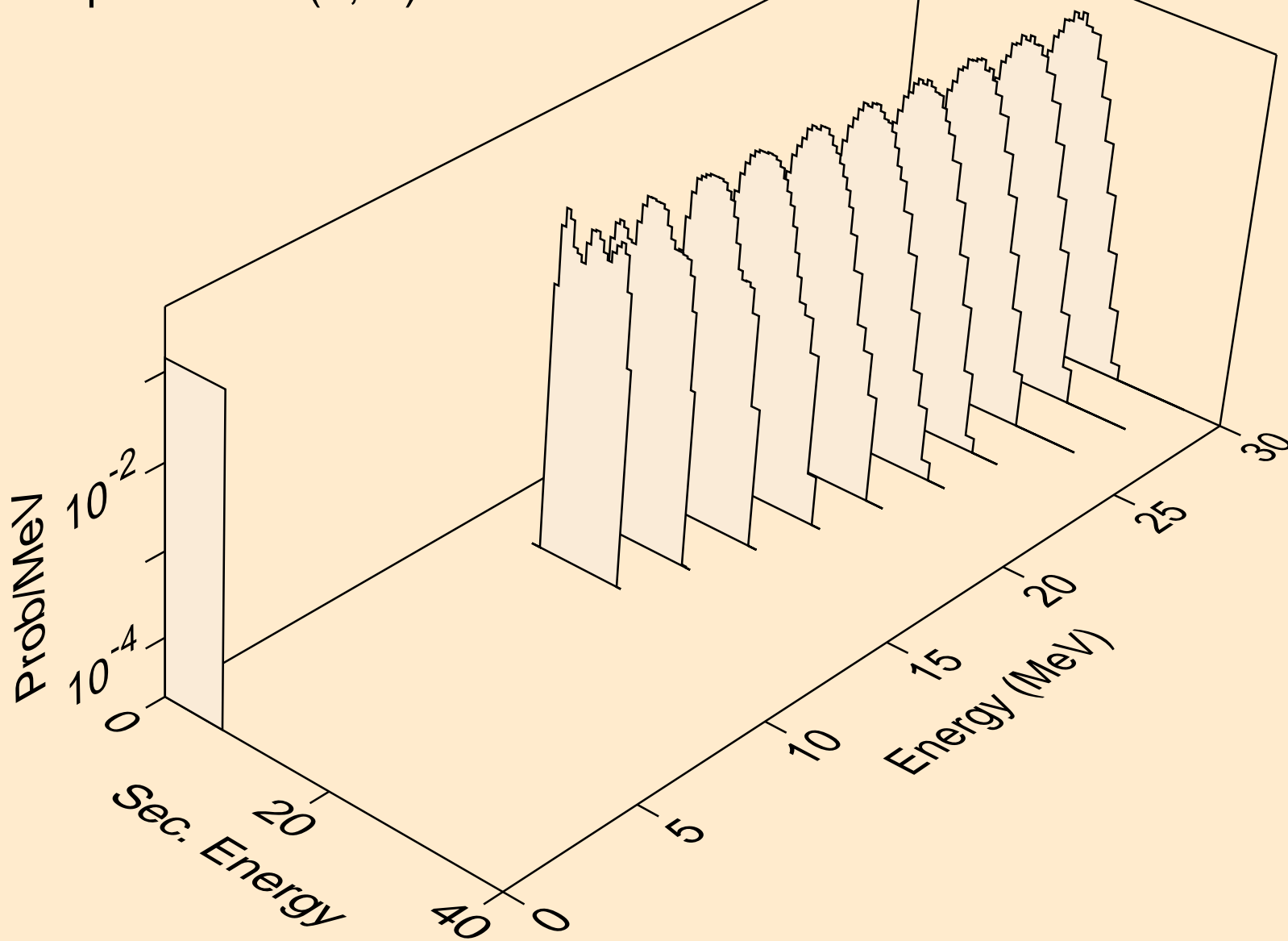

CM237 NEUTRON ACER TENDL-2019 LIBRARY; T=293.16K
alphas from (n,npa)

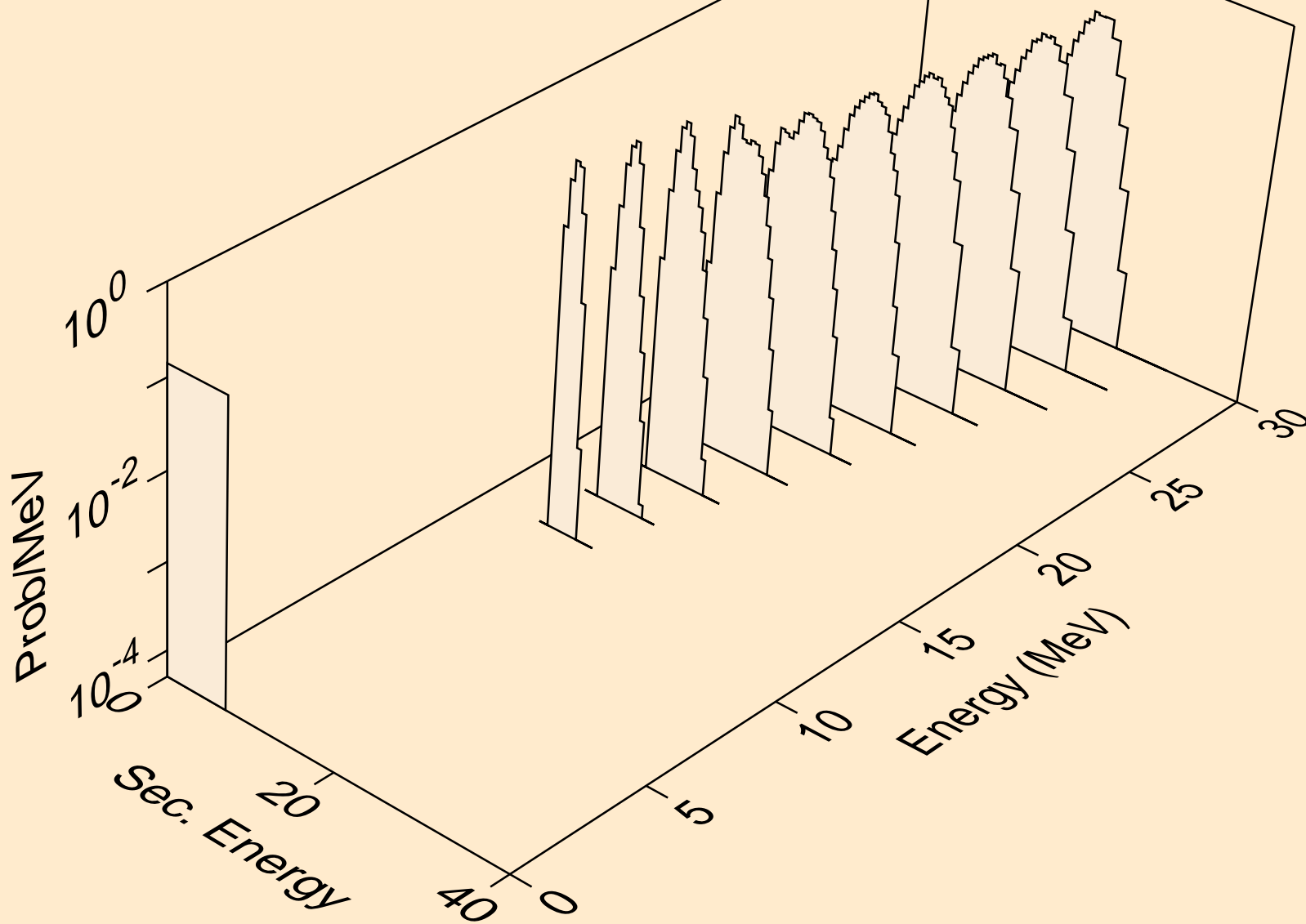

CM237 NEUTRON ACER TENDL-2019 LIBRARY; T=293.16K
alphas from (n,a)

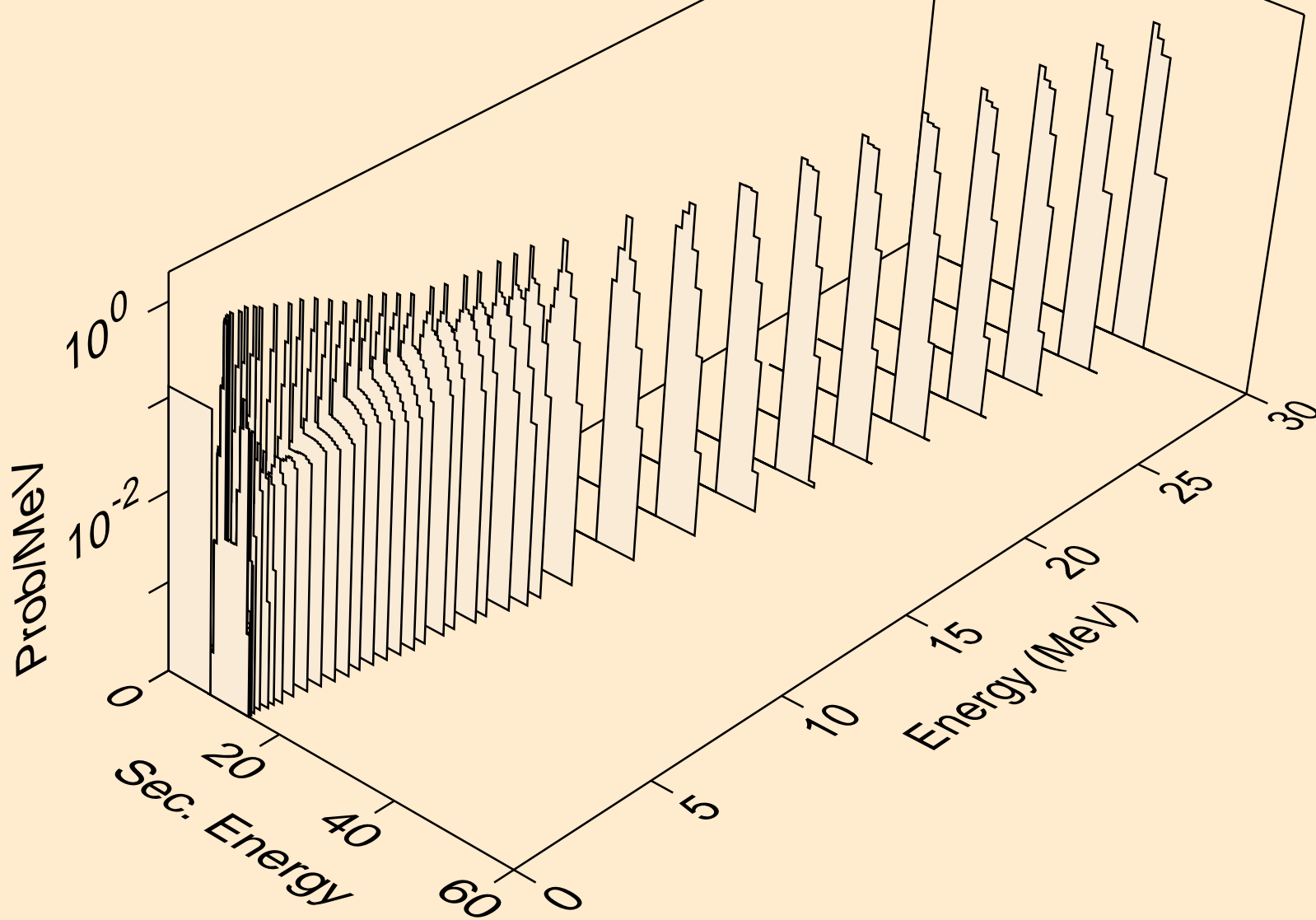

CM237 NEUTRON ACER TENDL-2019 LIBRARY; T=293.16K
alphas from (n,p)

