

CM249 NEUTRON ACER TENDL-2019 LIBRARY; T=293.16K  
Principal cross sections

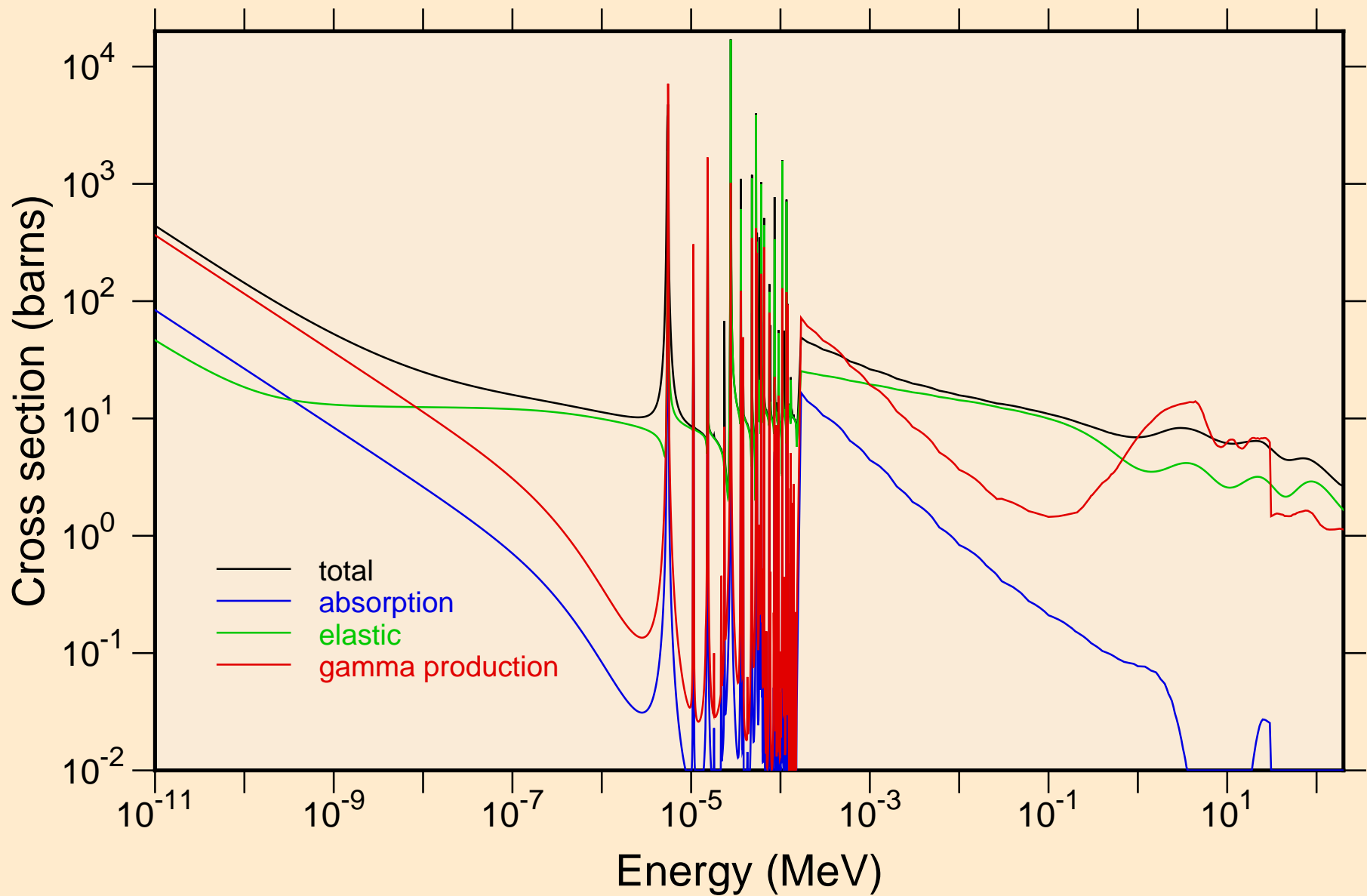

CM249 NEUTRON ACER TENDL-2019 LIBRARY; T=293.16K  
resonance total cross section

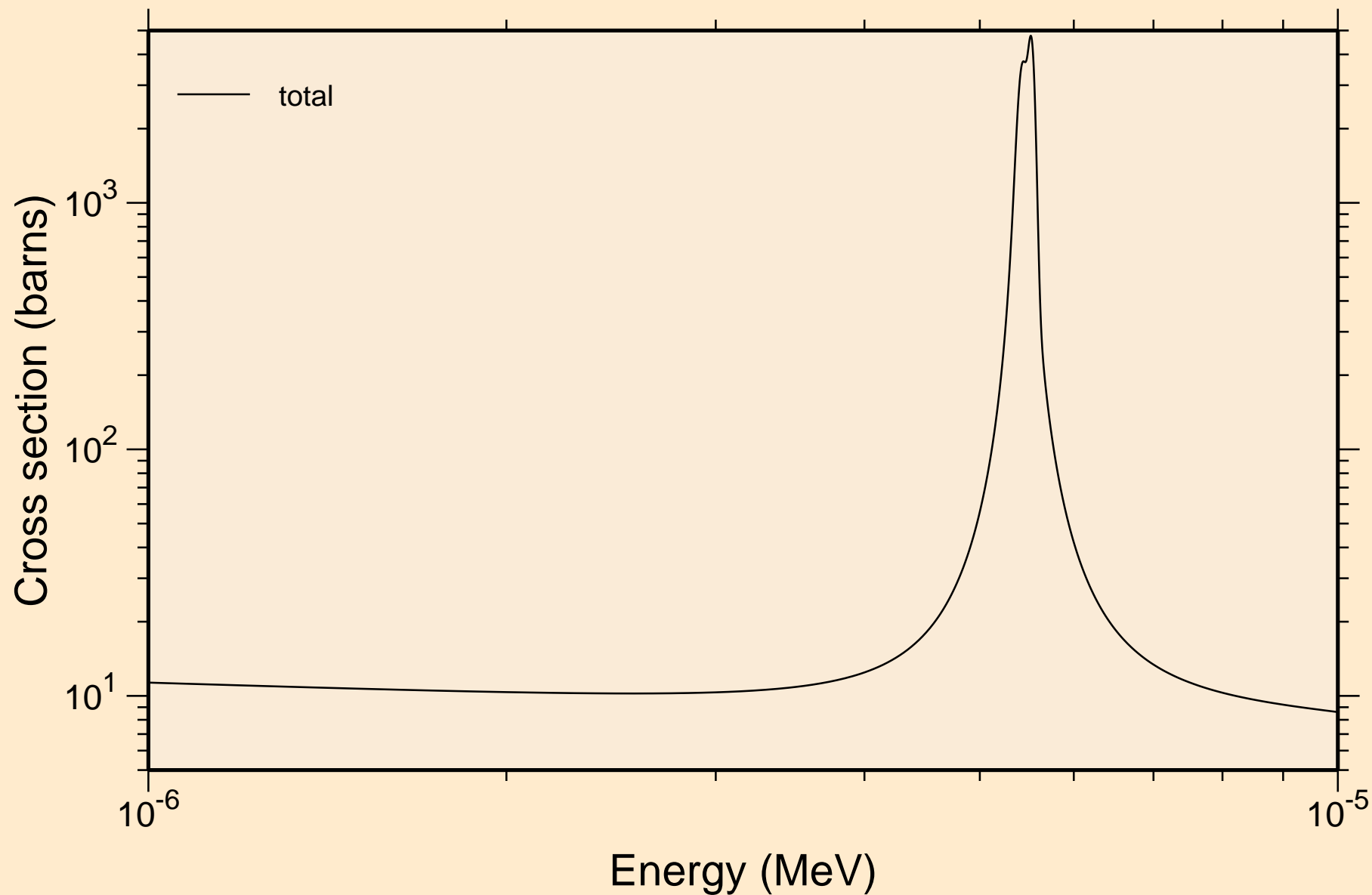

CM249 NEUTRON ACER TENDL-2019 LIBRARY; T=293.16K  
resonance total cross section

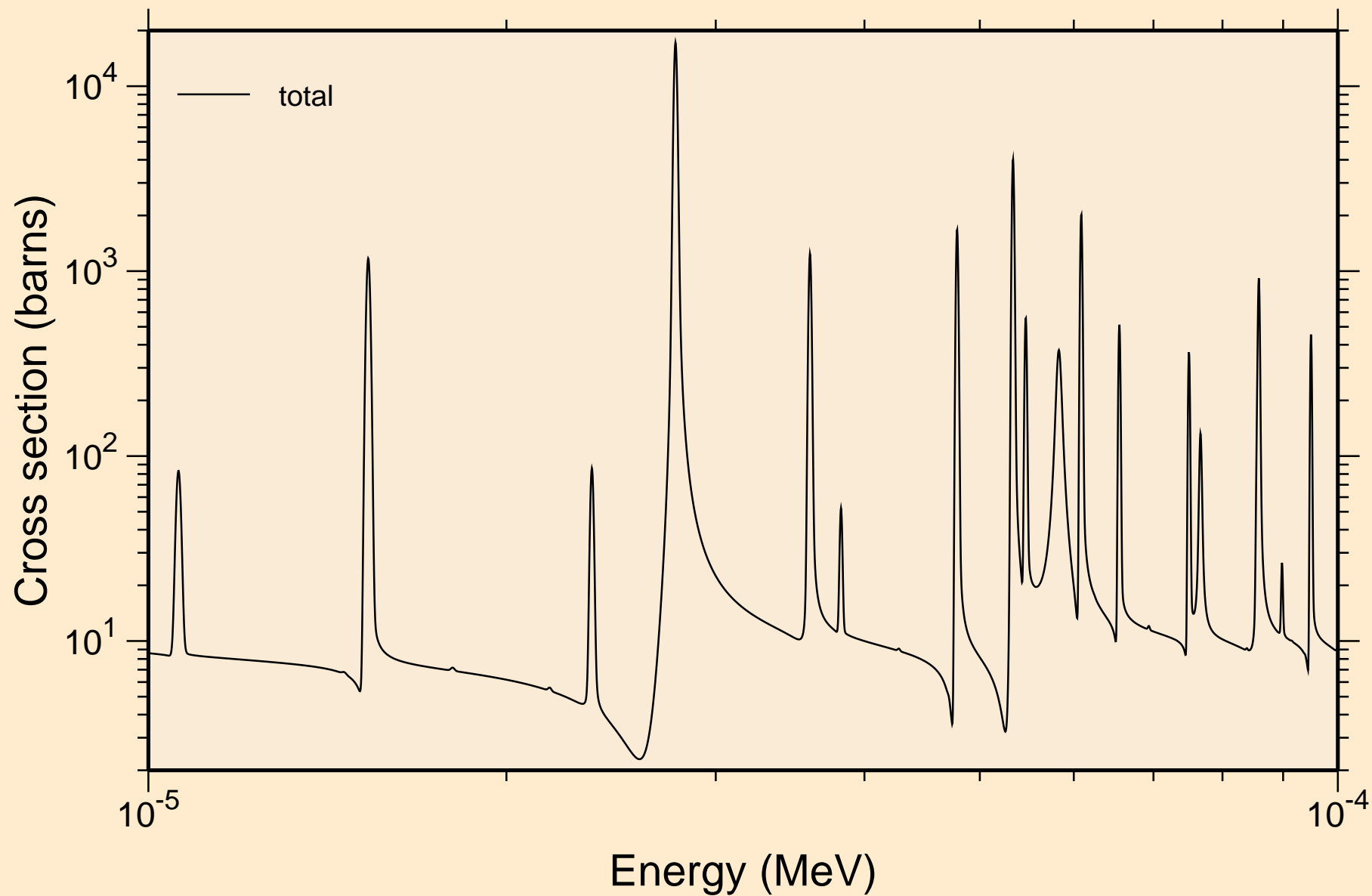

CM249 NEUTRON ACER TENDL-2019 LIBRARY; T=293.16K  
resonance total cross section

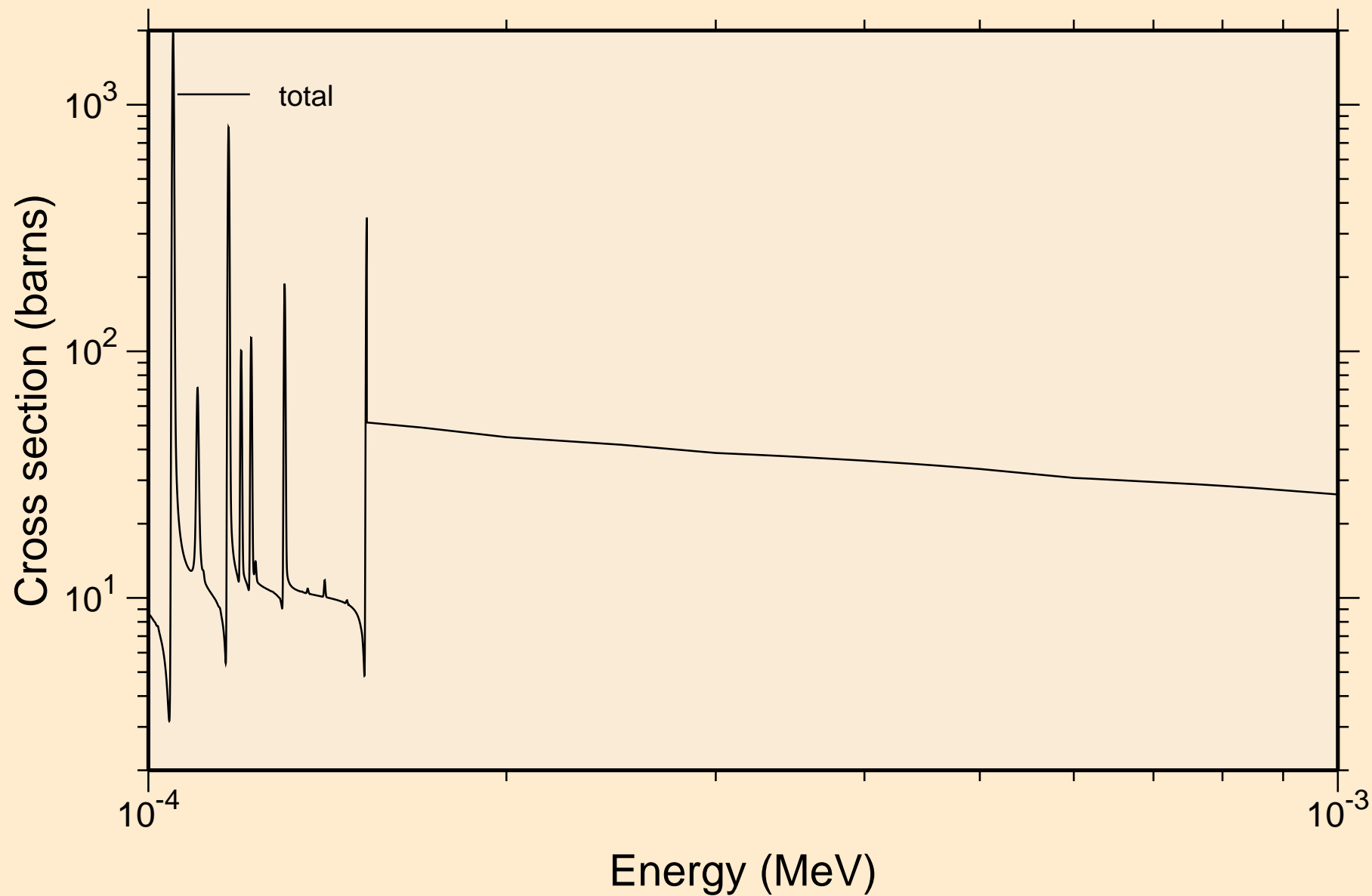

CM249 NEUTRON ACER TENDL-2019 LIBRARY; T=293.16K  
resonance total cross section

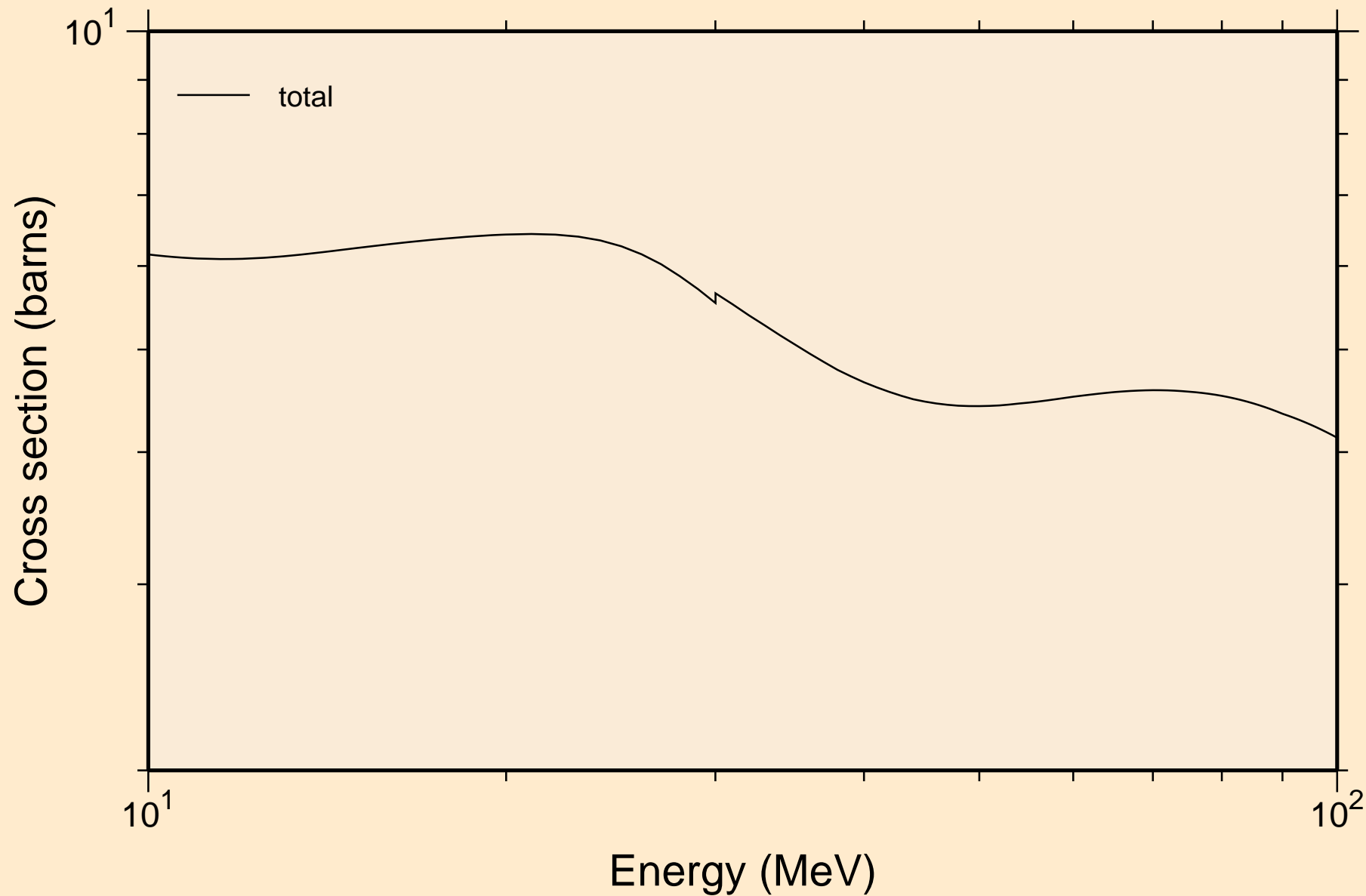

CM249 NEUTRON ACER TENDL-2019 LIBRARY; T=293.16K  
resonance absorption cross sections

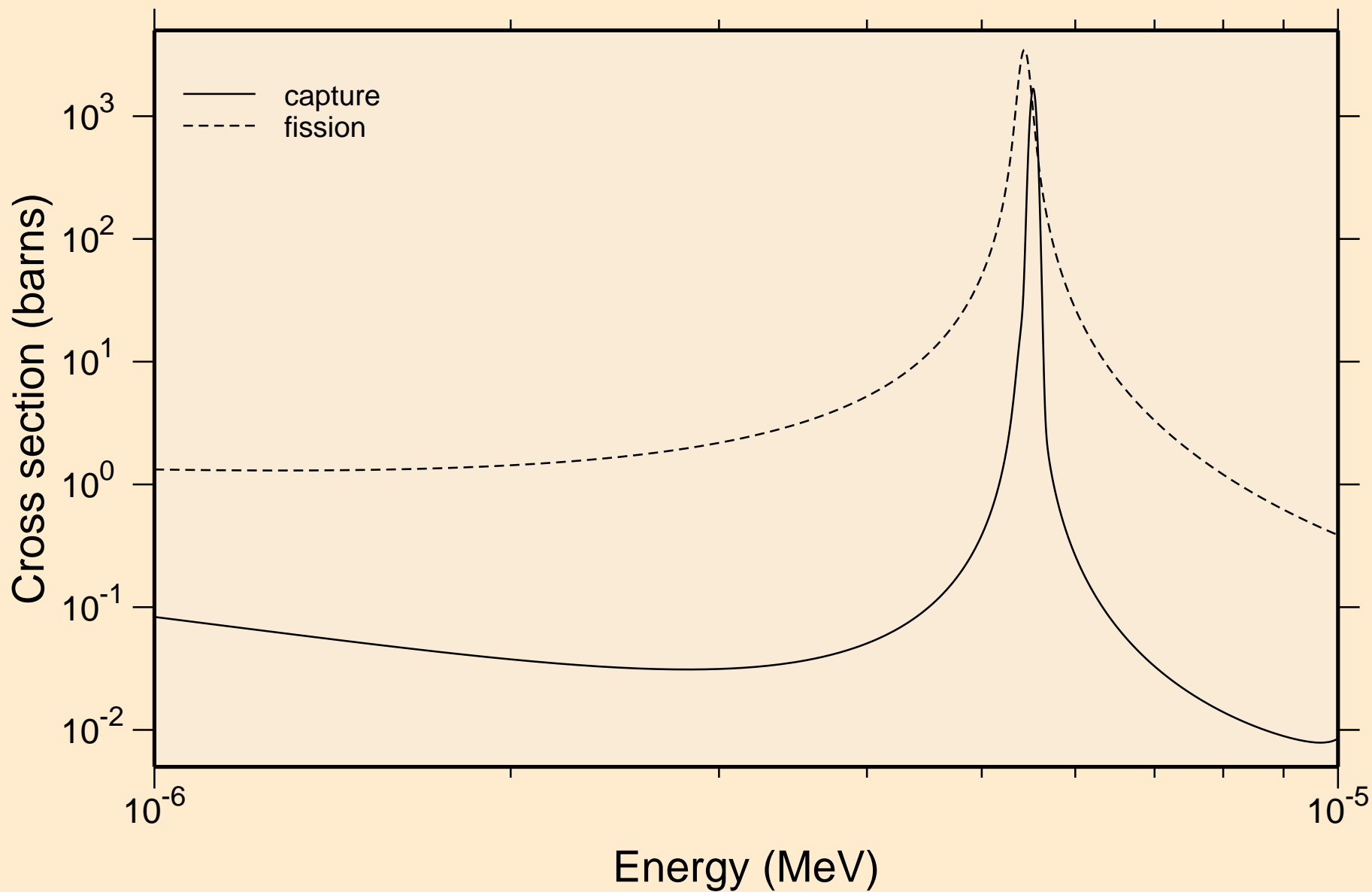

CM249 NEUTRON ACER TENDL-2019 LIBRARY; T=293.16K  
resonance absorption cross sections

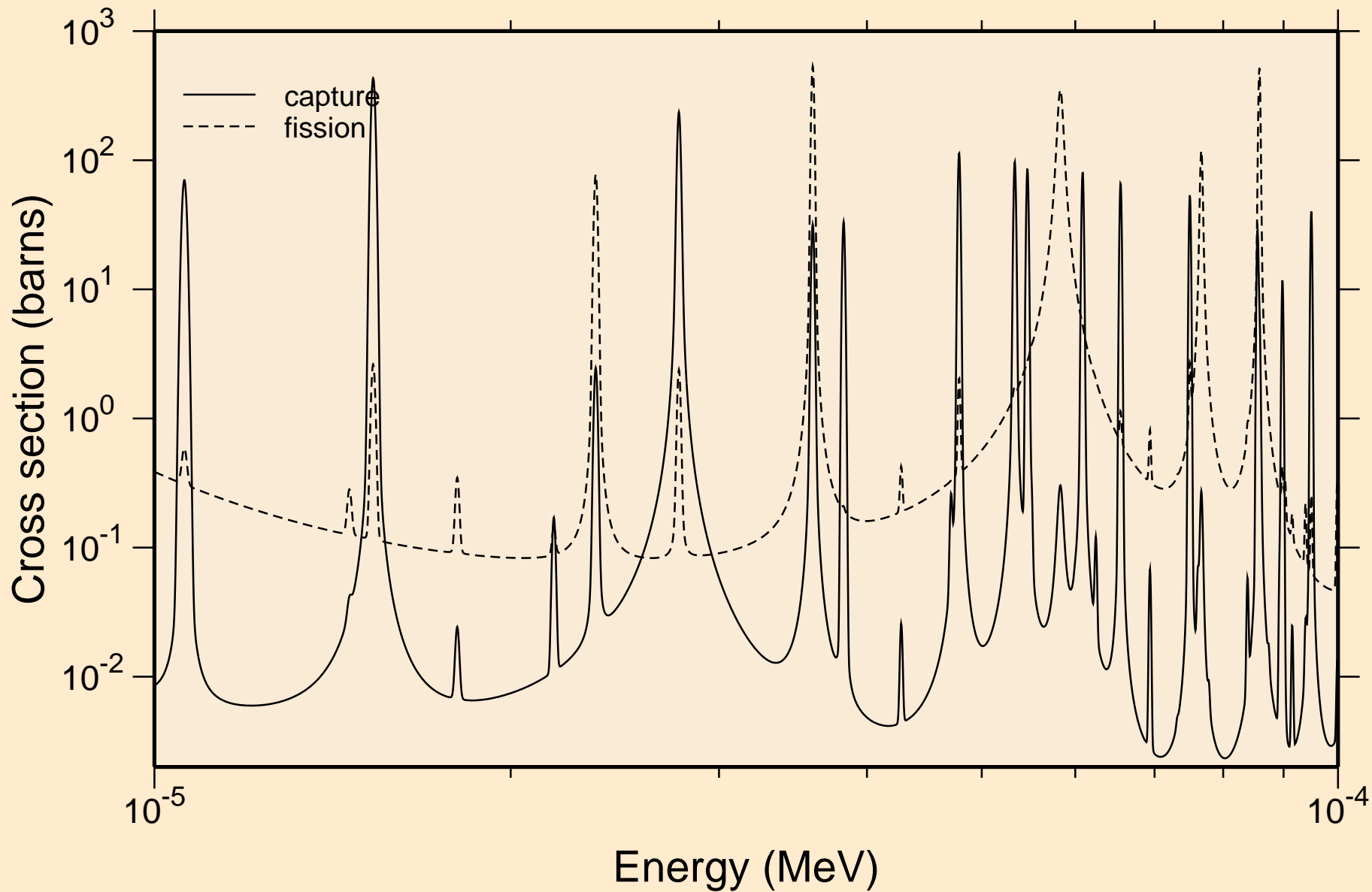

CM249 NEUTRON ACER TENDL-2019 LIBRARY; T=293.16K  
resonance absorption cross sections

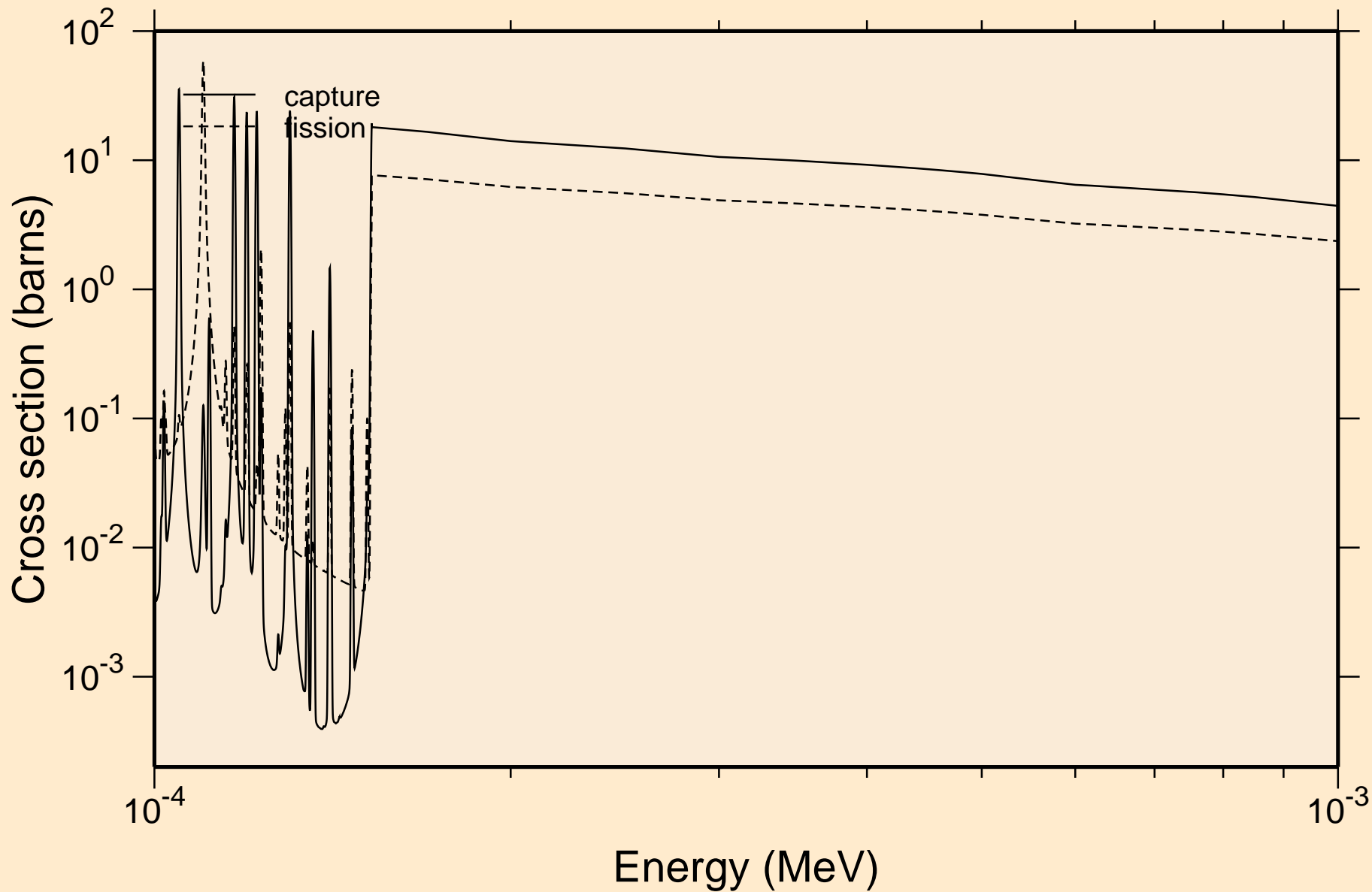

CM249 NEUTRON ACER TENDL-2019 LIBRARY; T=293.16K  
resonance absorption cross sections

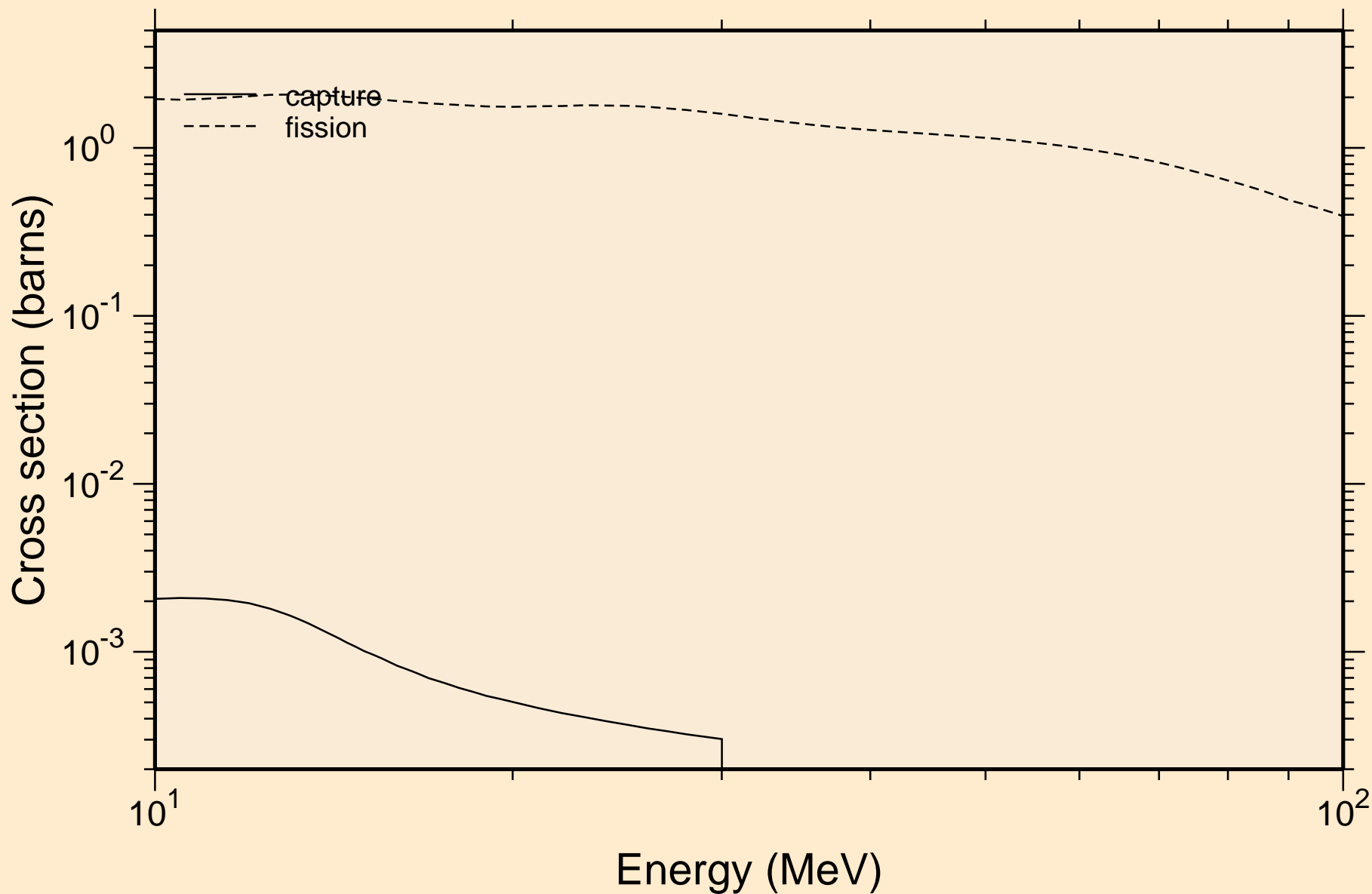

CM249 NEUTRON ACER TENDL-2019 LIBRARY; T=293.16K  
Heating

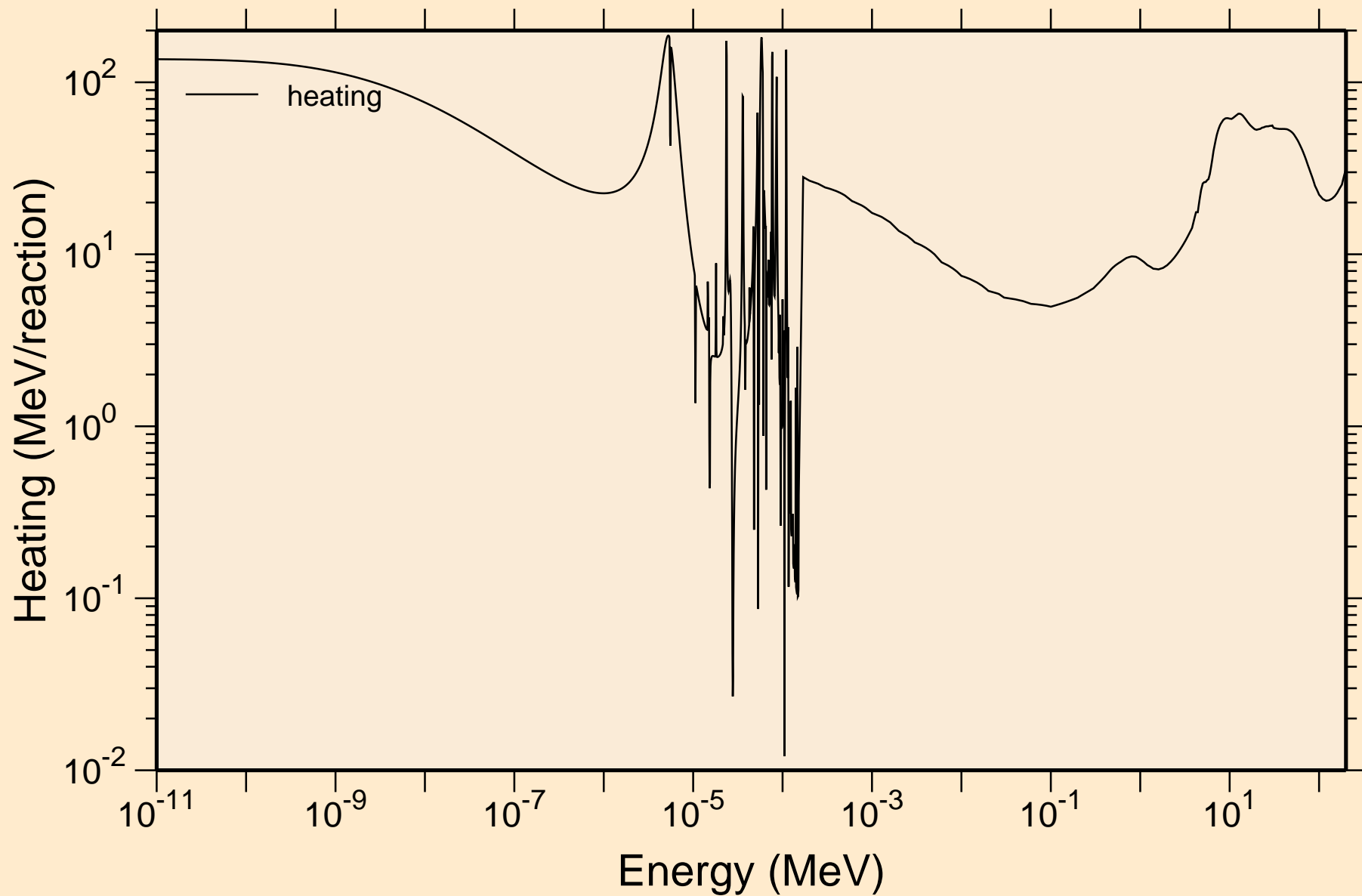

CM249 NEUTRON ACER TENDL-2019 LIBRARY; T=293.16K  
Damage

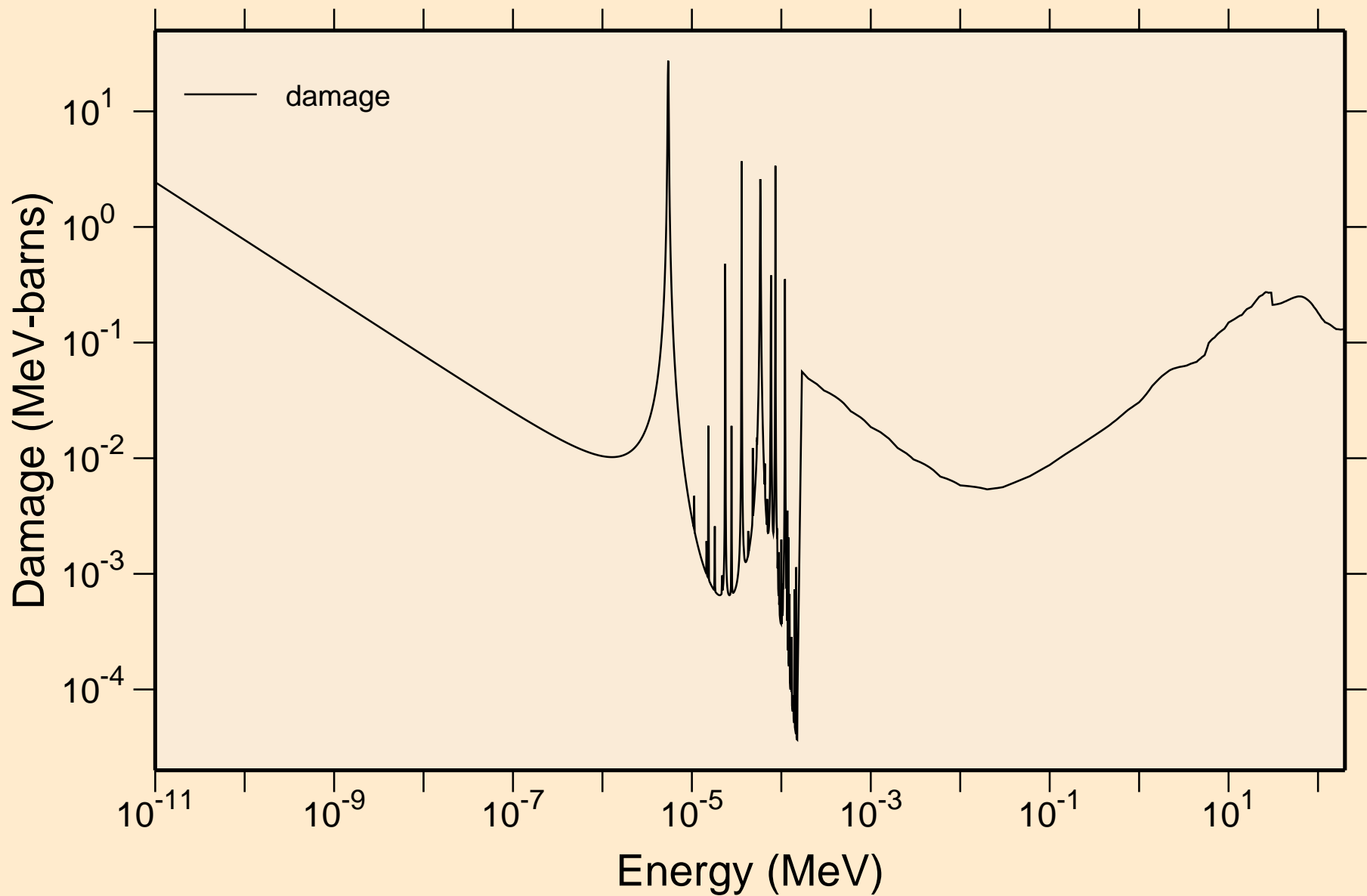

CM249 NEUTRON ACER TENDL-2019 LIBRARY; T=293.16K  
Non-threshold reactions

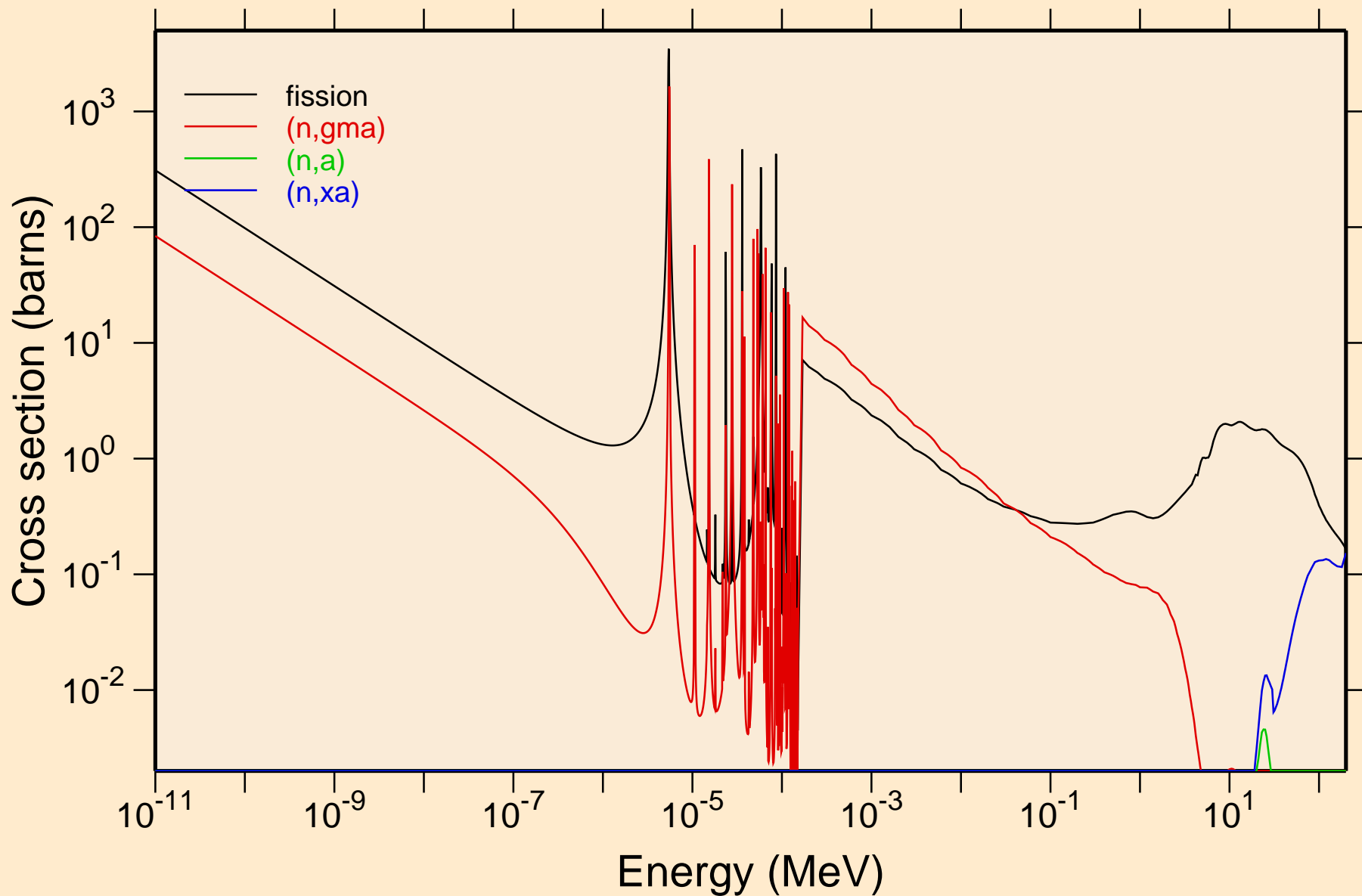

CM249 NEUTRON ACER TENDL-2019 LIBRARY; T=293.16K  
Principal cross sections

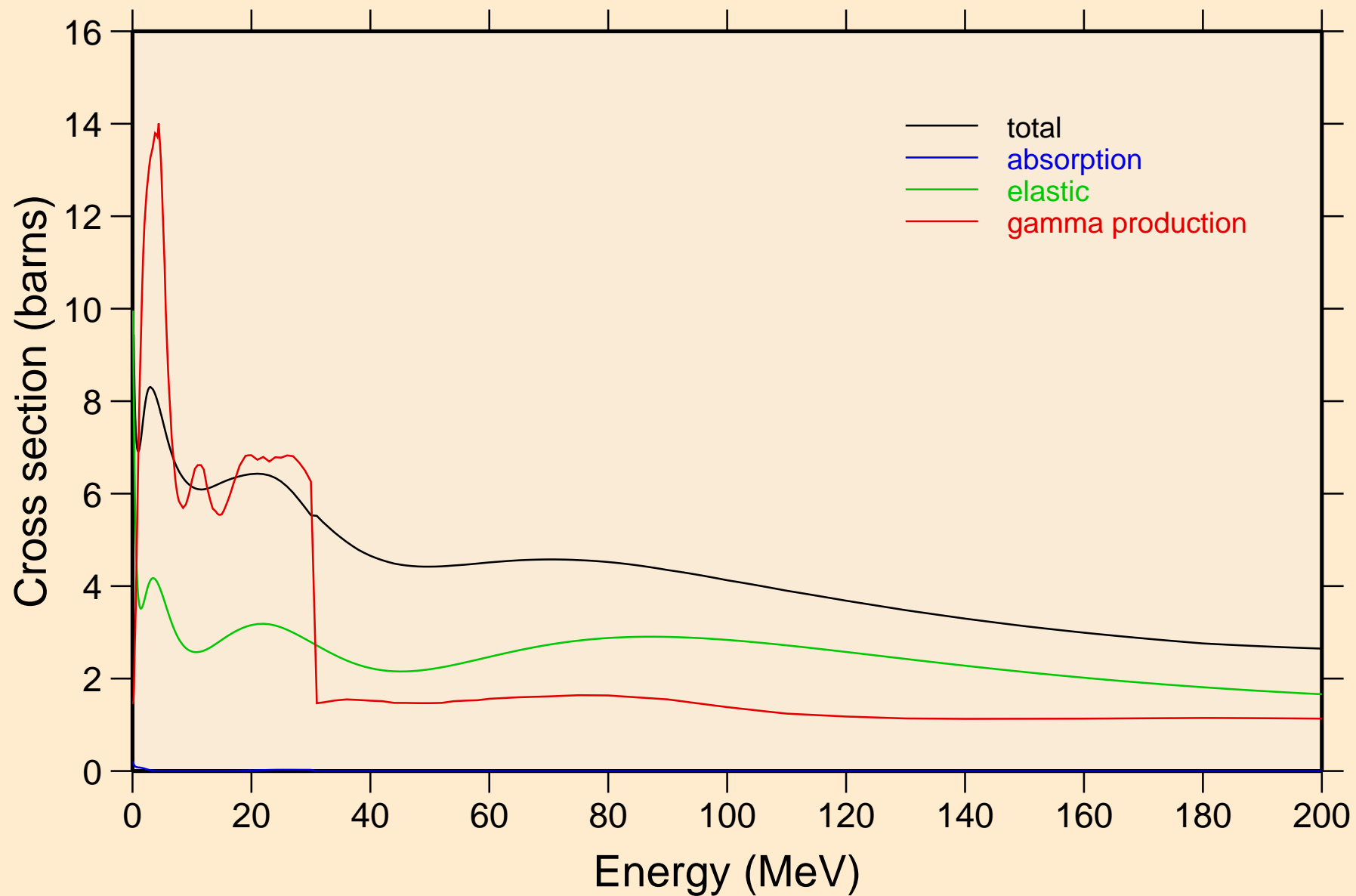

CM249 NEUTRON ACER TENDL-2019 LIBRARY; T=293.16K  
Heating

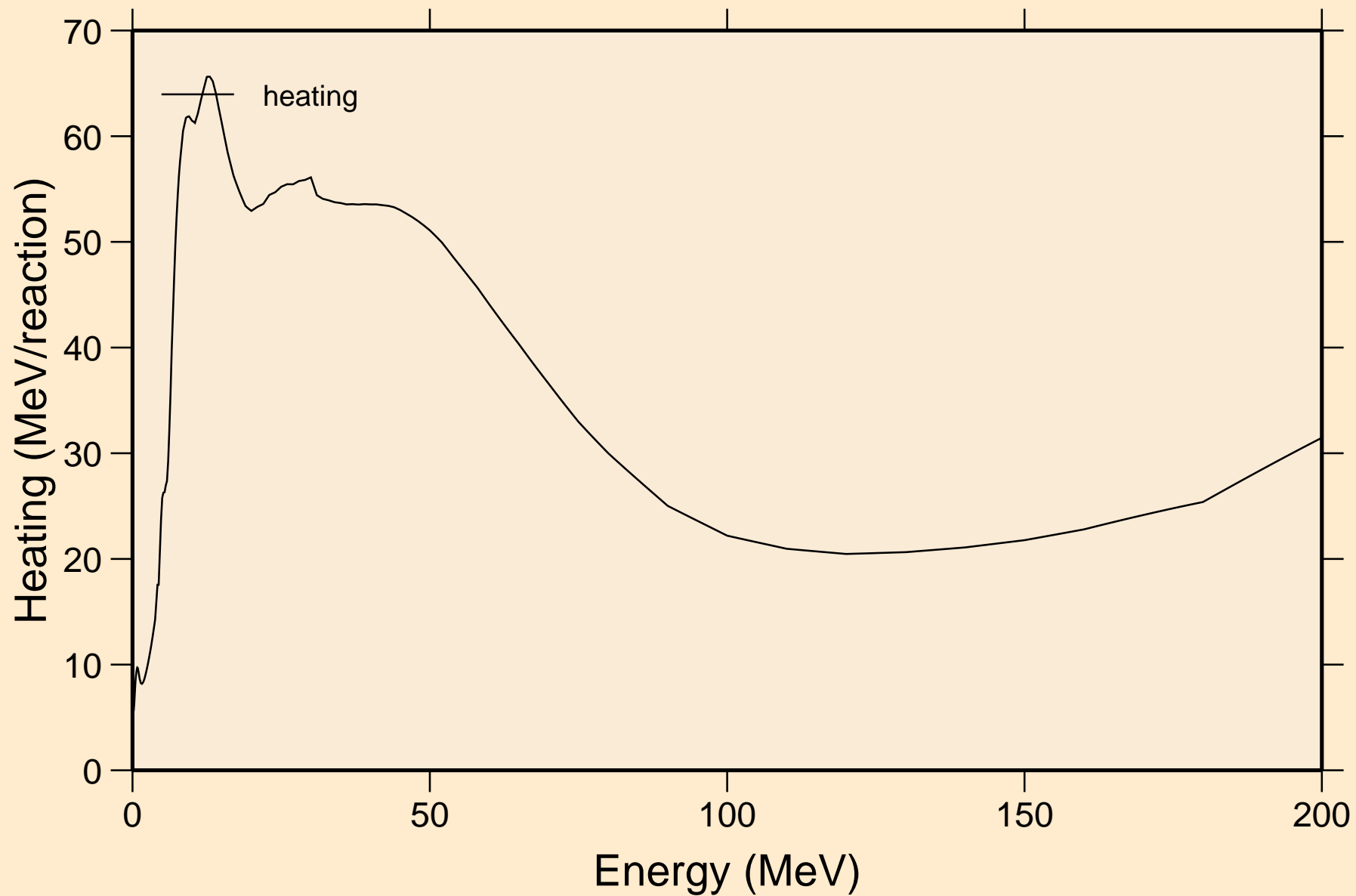

CM249 NEUTRON ACER TENDL-2019 LIBRARY; T=293.16K  
Damage

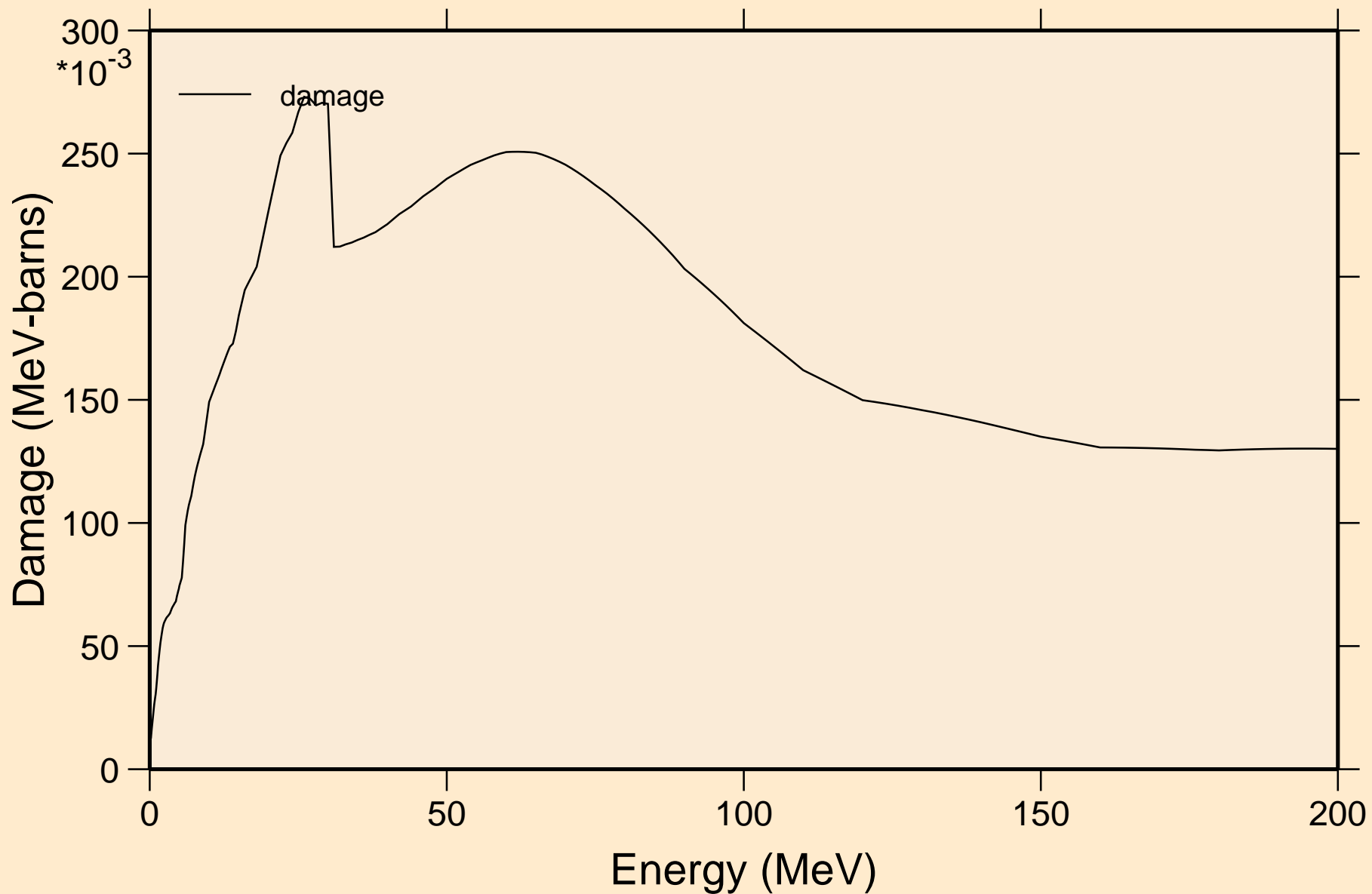

CM249 NEUTRON ACER TENDL-2019 LIBRARY; T=293.16K  
Non-threshold reactions

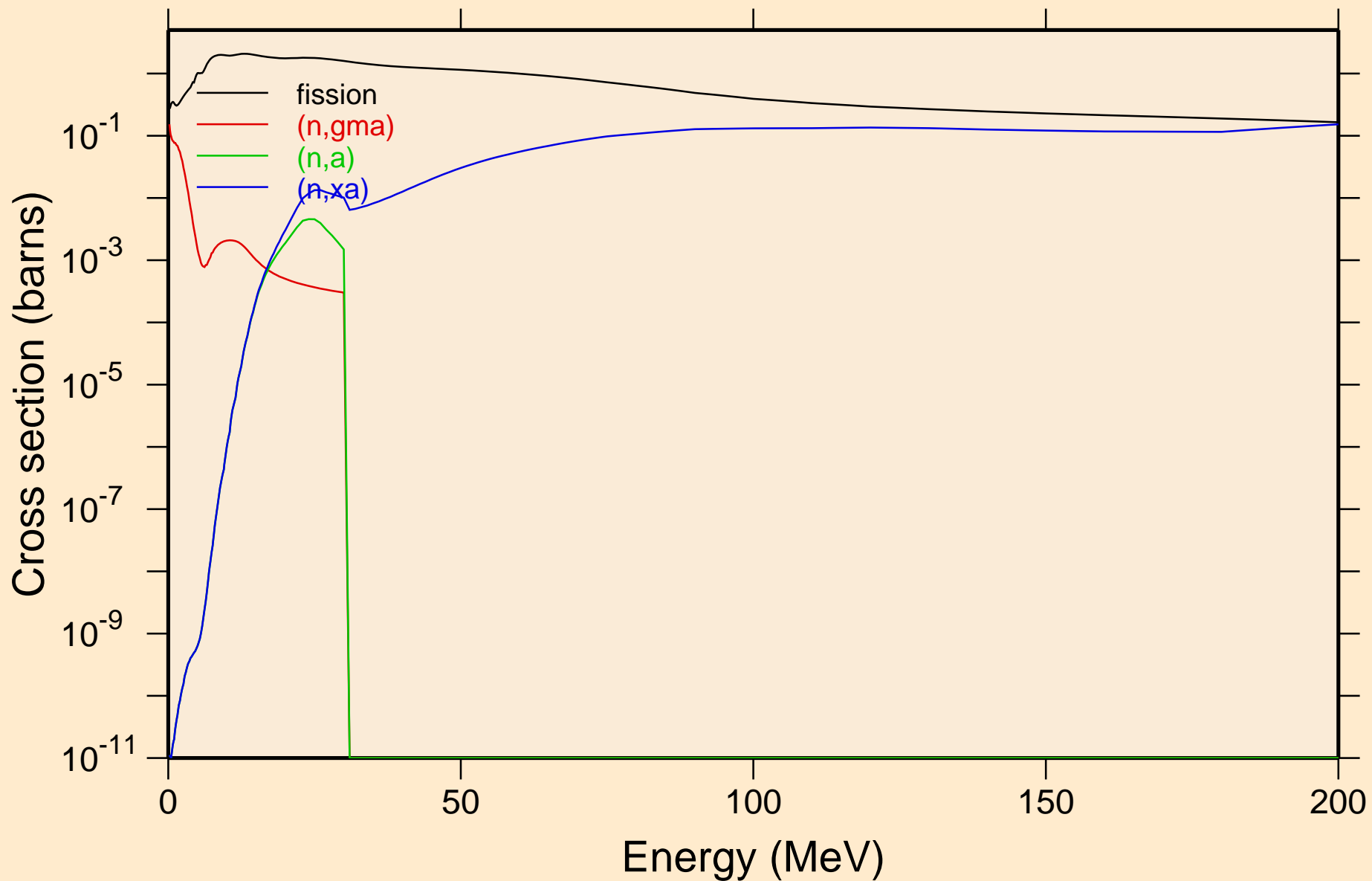

CM249 NEUTRON ACER TENDL-2019 LIBRARY; T=293.16K  
Inelastic levels

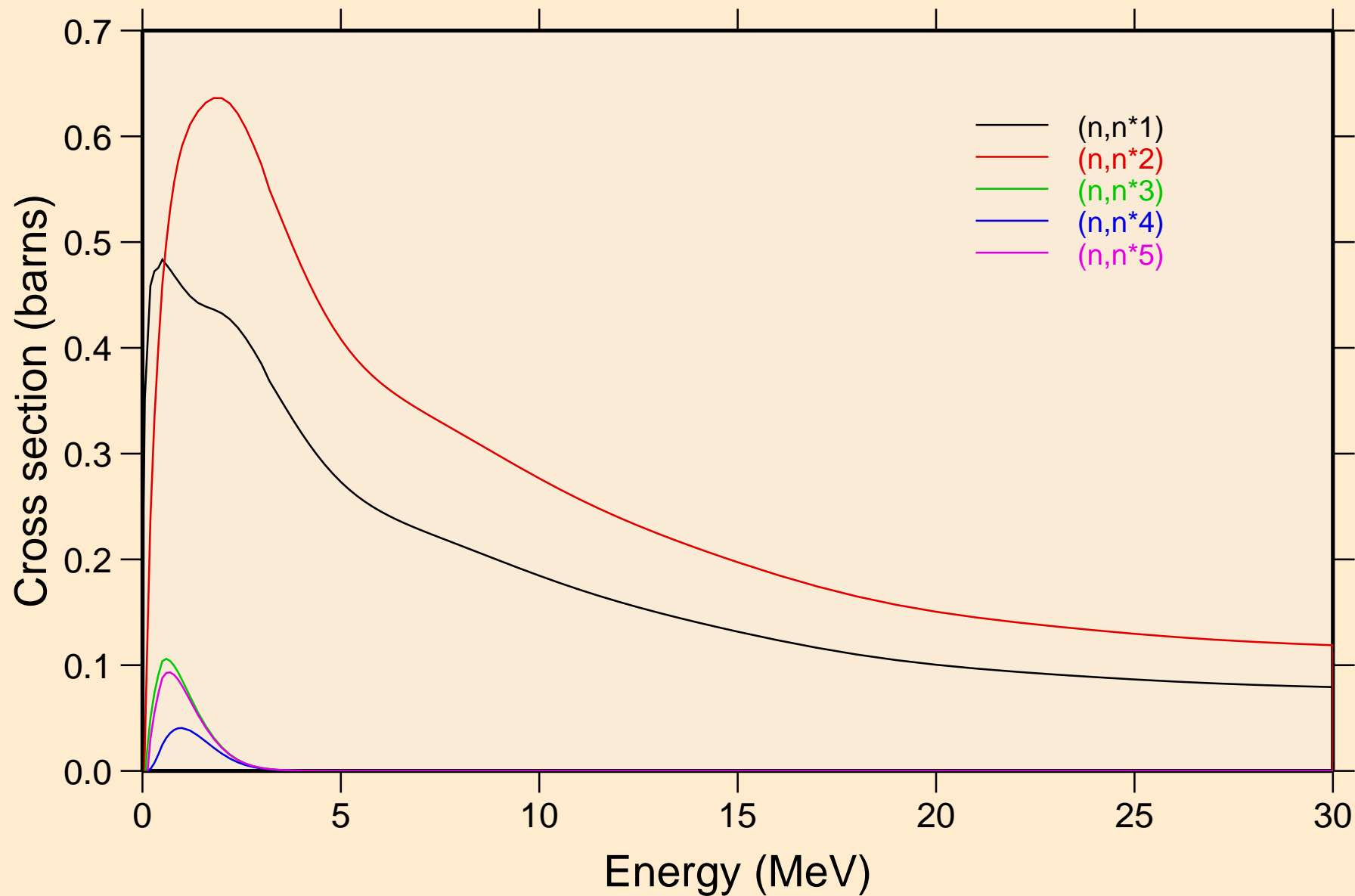

CM249 NEUTRON ACER TENDL-2019 LIBRARY; T=293.16K  
Inelastic levels

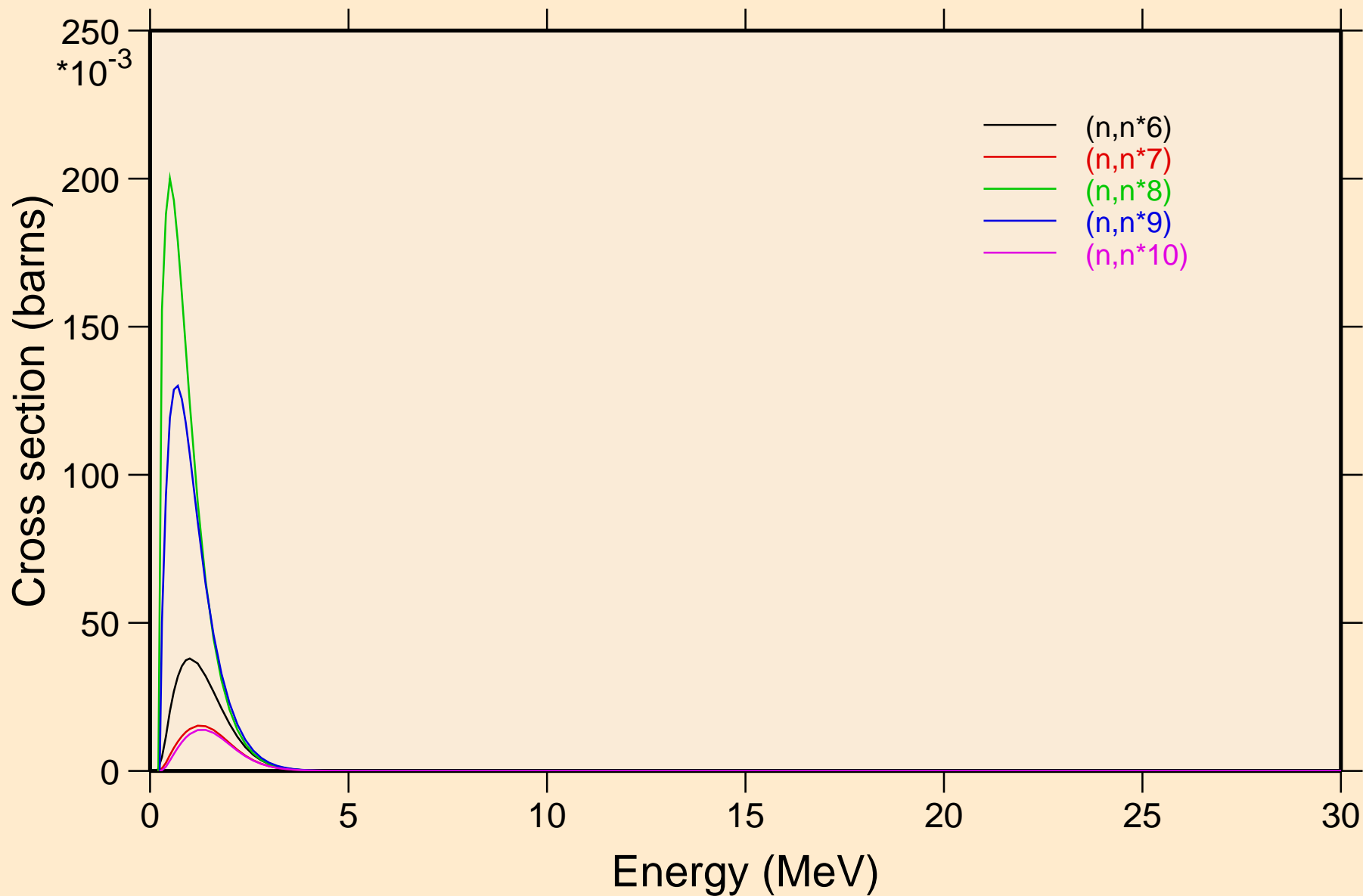

CM249 NEUTRON ACER TENDL-2019 LIBRARY; T=293.16K  
Inelastic levels

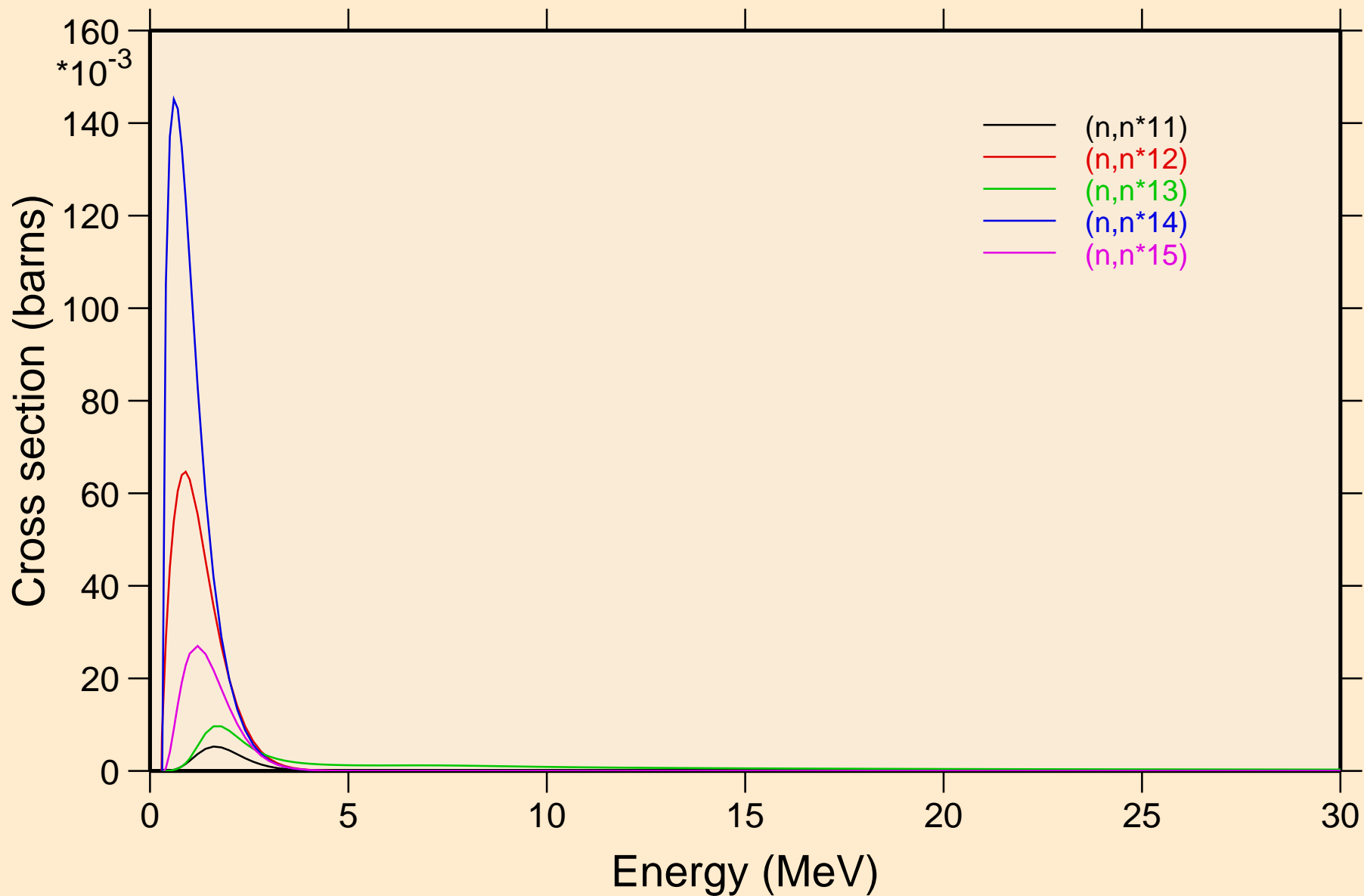

CM249 NEUTRON ACER TENDL-2019 LIBRARY; T=293.16K  
Inelastic levels

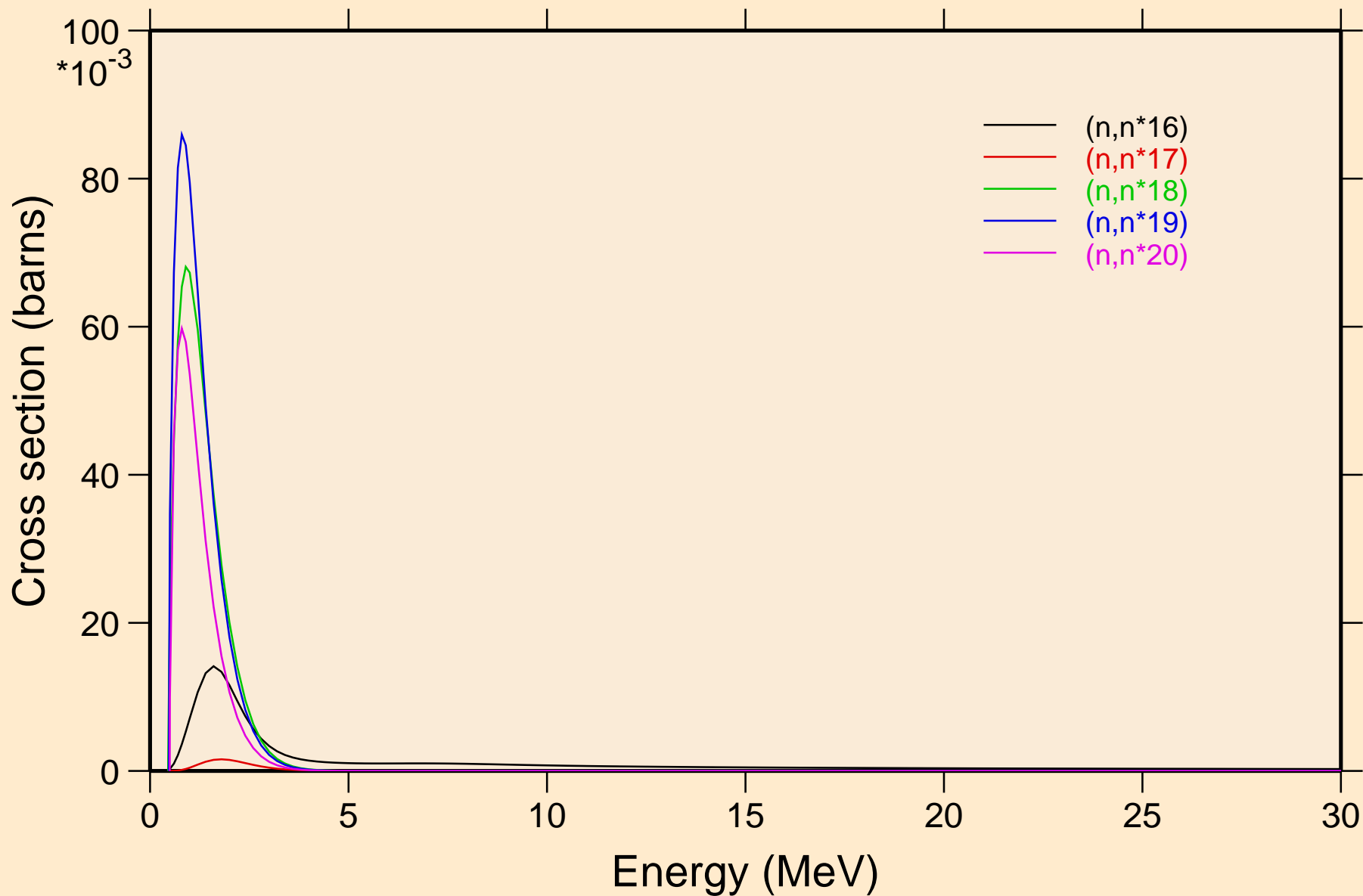

CM249 NEUTRON ACER TENDL-2019 LIBRARY; T=293.16K  
Inelastic levels

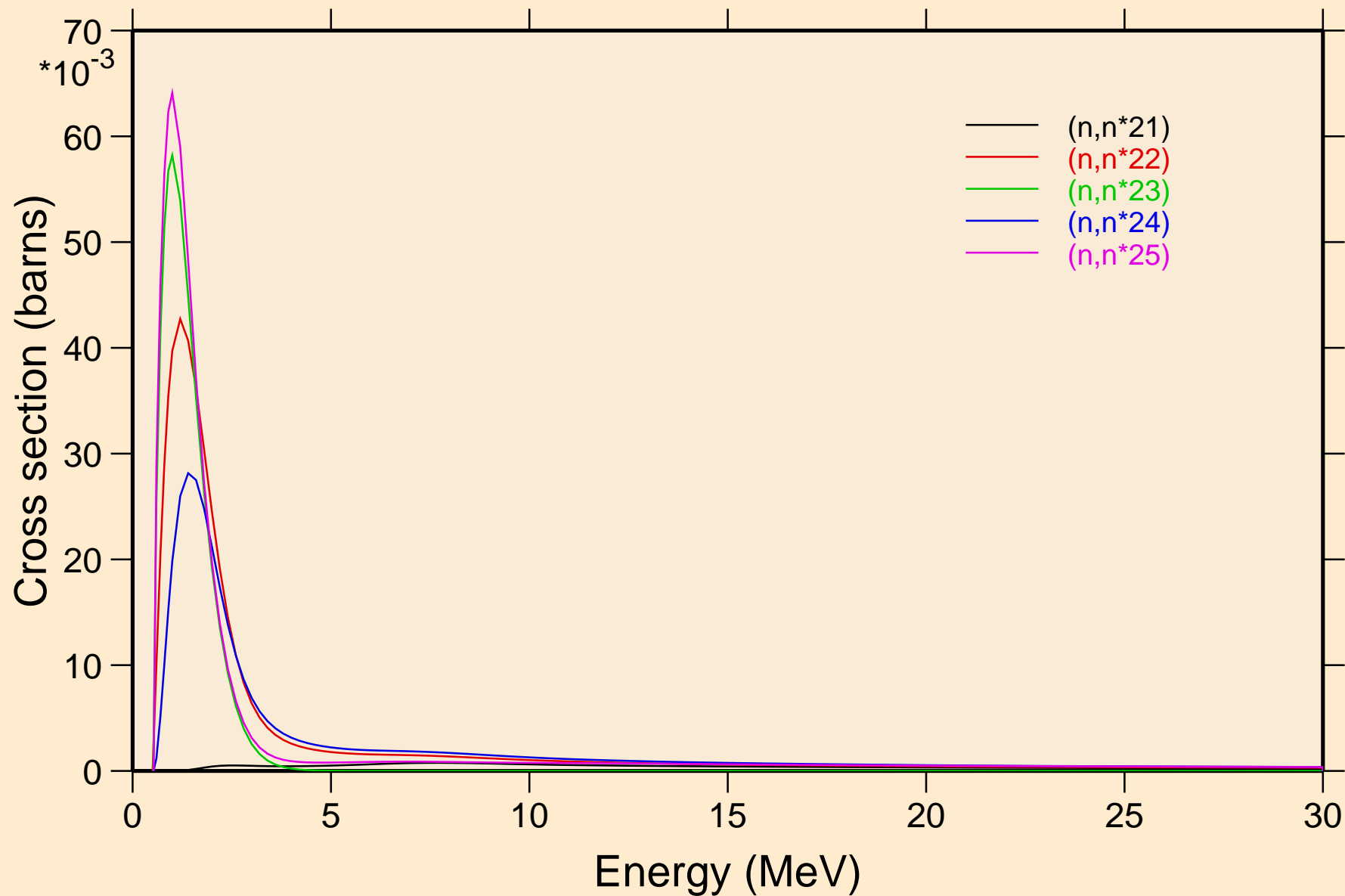

CM249 NEUTRON ACER TENDL-2019 LIBRARY; T=293.16K  
Inelastic levels

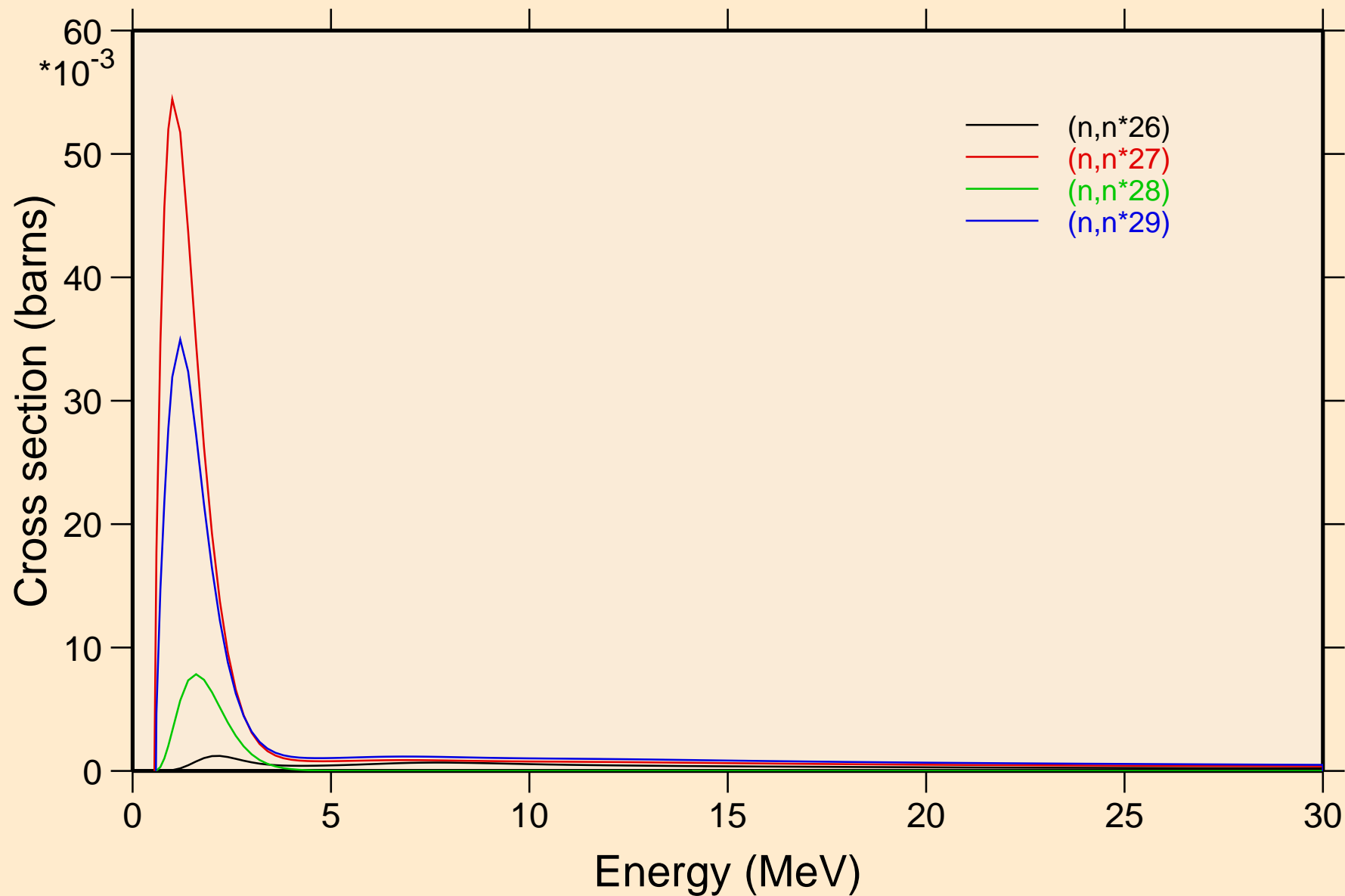

# CM249 NEUTRON ACER TENDL-2019 LIBRARY; T=293.16K

## Threshold reactions

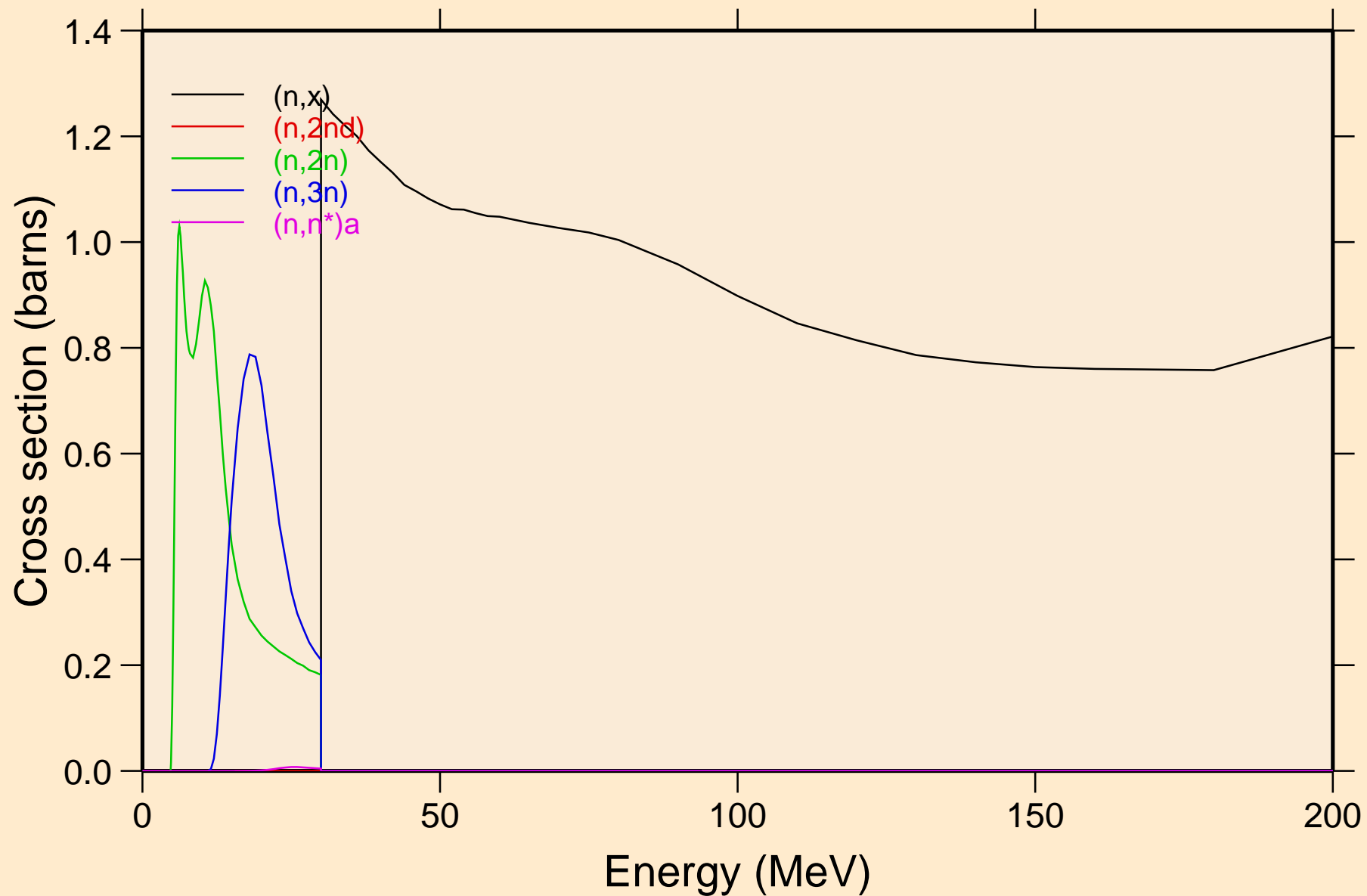

CM249 NEUTRON ACER TENDL-2019 LIBRARY; T=293.16K  
Threshold reactions

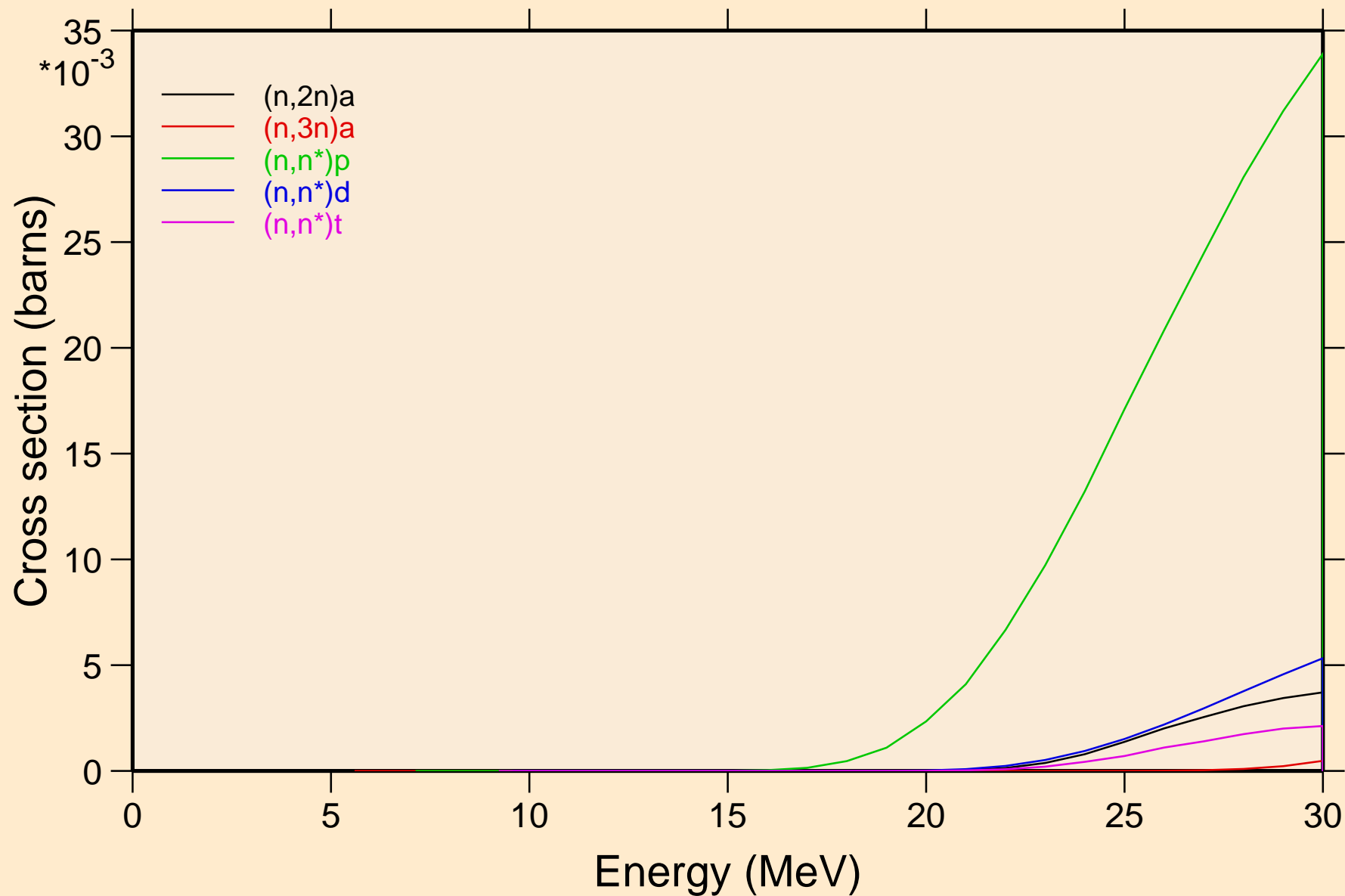

CM249 NEUTRON ACER TENDL-2019 LIBRARY; T=293.16K  
Threshold reactions

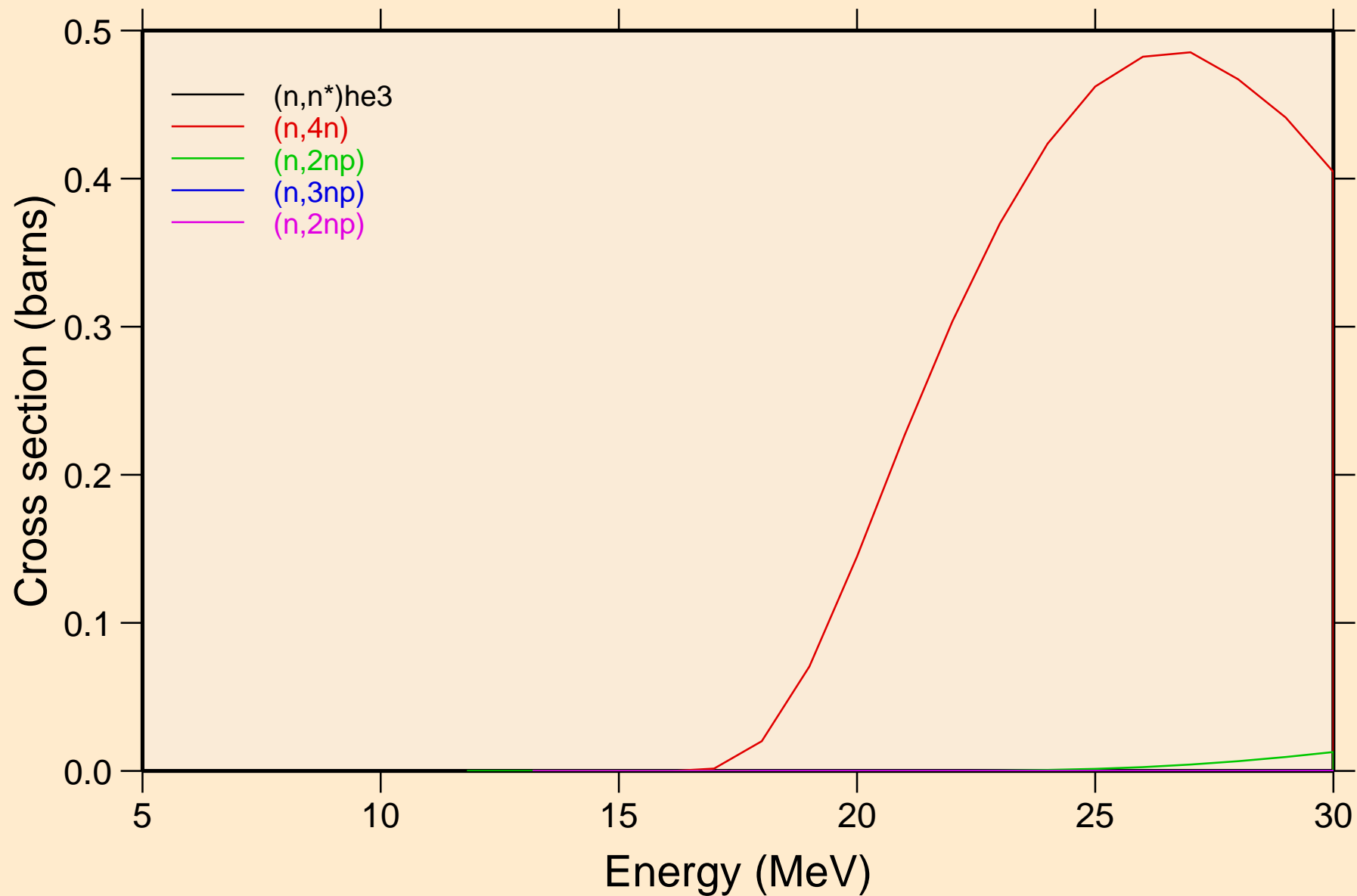

CM249 NEUTRON ACER TENDL-2019 LIBRARY; T=293.16K  
Threshold reactions

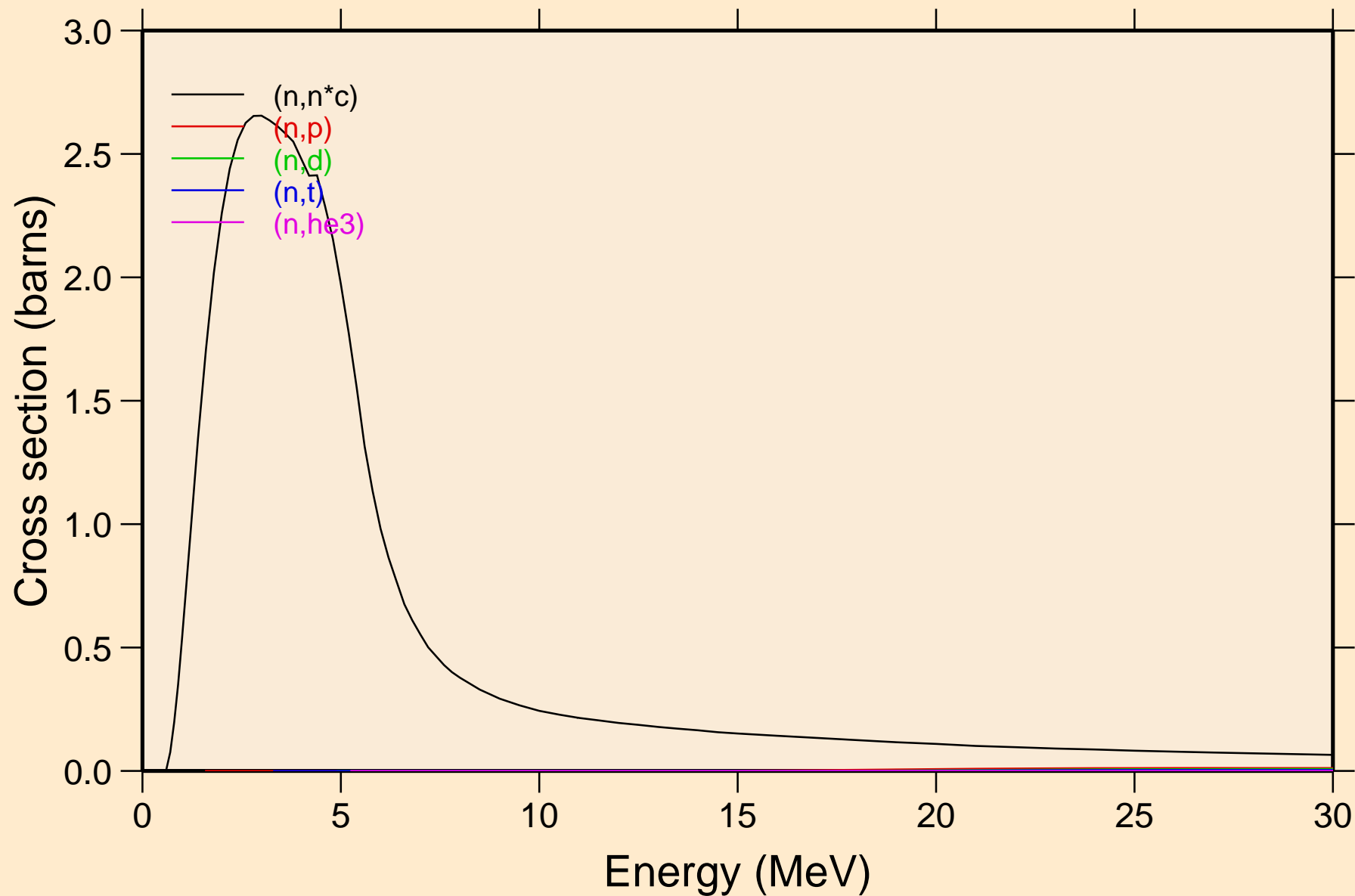

CM249 NEUTRON ACER TENDL-2019 LIBRARY; T=293.16K  
Threshold reactions

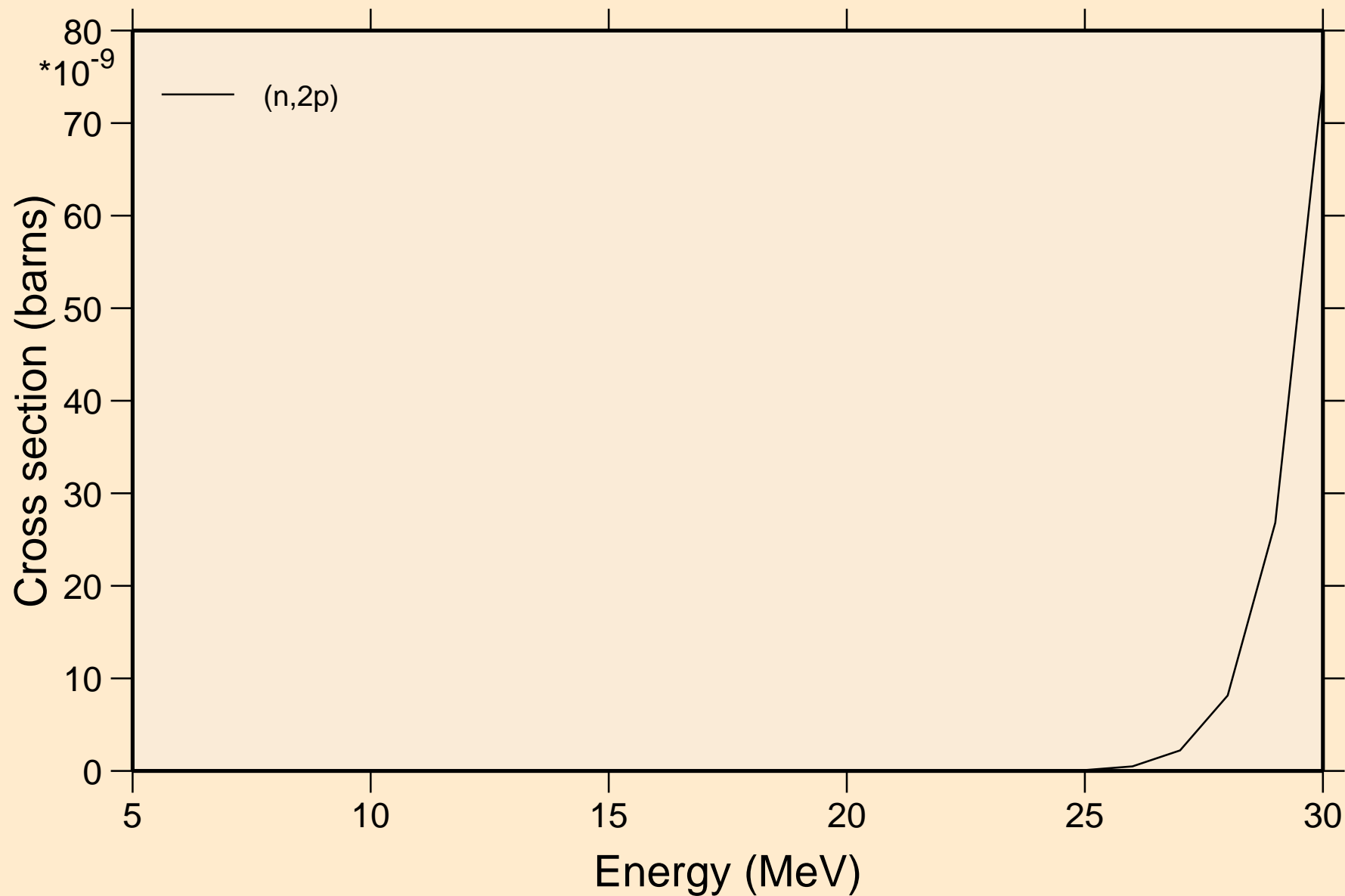

CM249 NEUTRON ACER TENDL-2019 LIBRARY; T=293.16K  
Threshold reactions

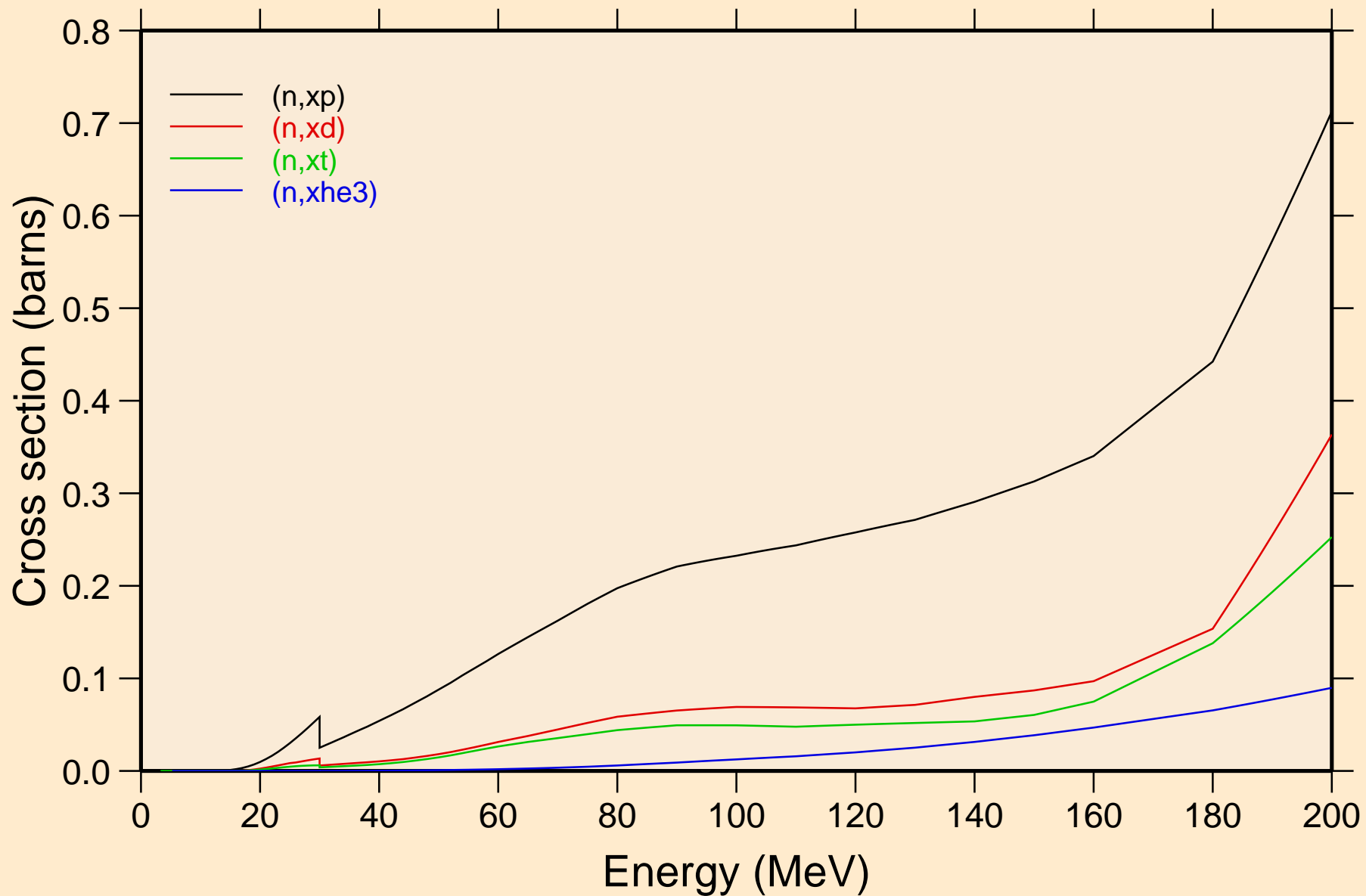

CM249 NEUTRON ACER TENDL-2019 LIBRARY; T=293.16K  
angular distribution for elastic

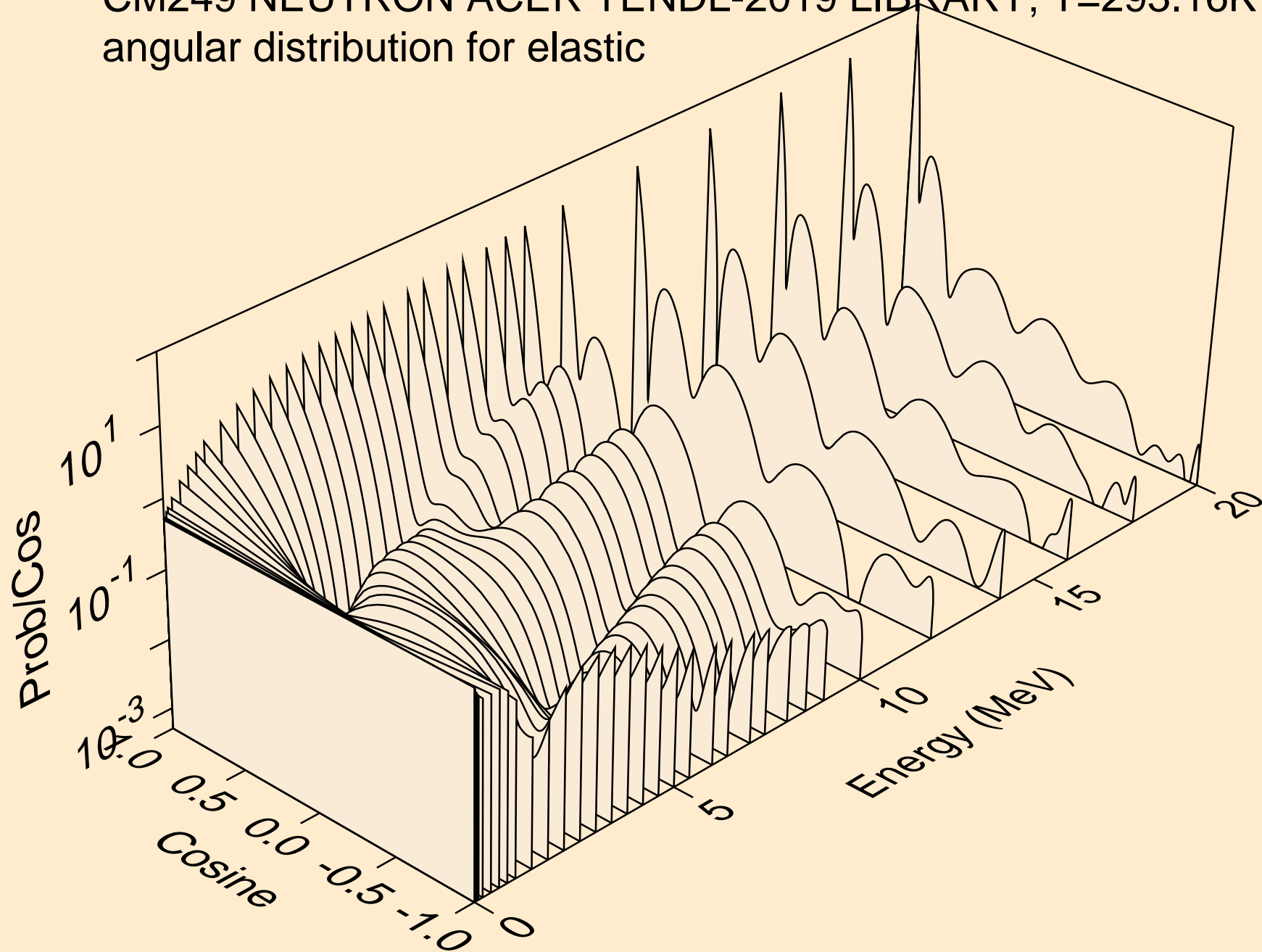

CM249 NEUTRON ACER TENDL-2019 LIBRARY; T=293.16K  
angular distribution for elastic

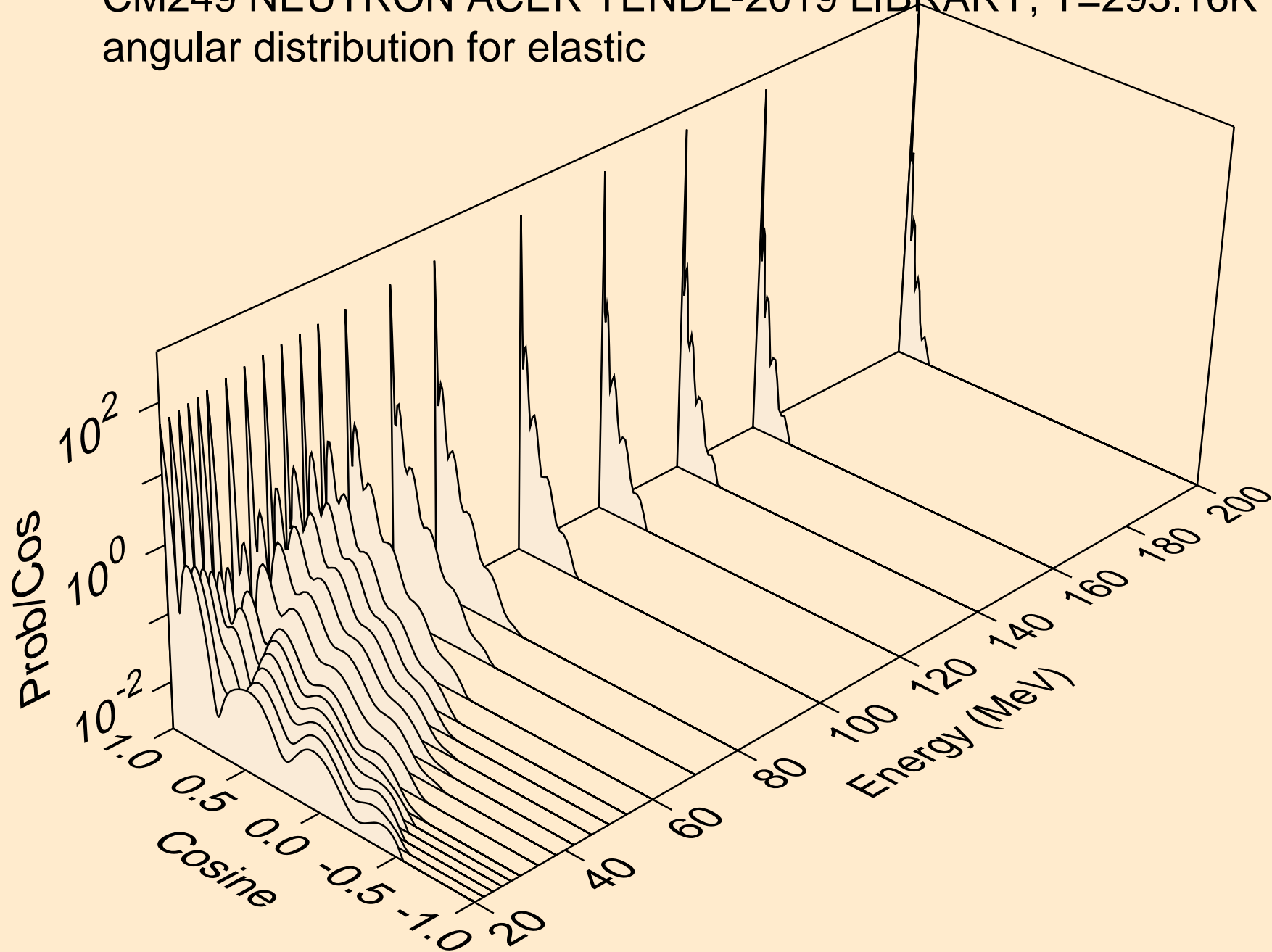

CM249 NEUTRON ACER TENDL-2019 LIBRARY; T=293.16K  
angular distribution for (n,n\*1)

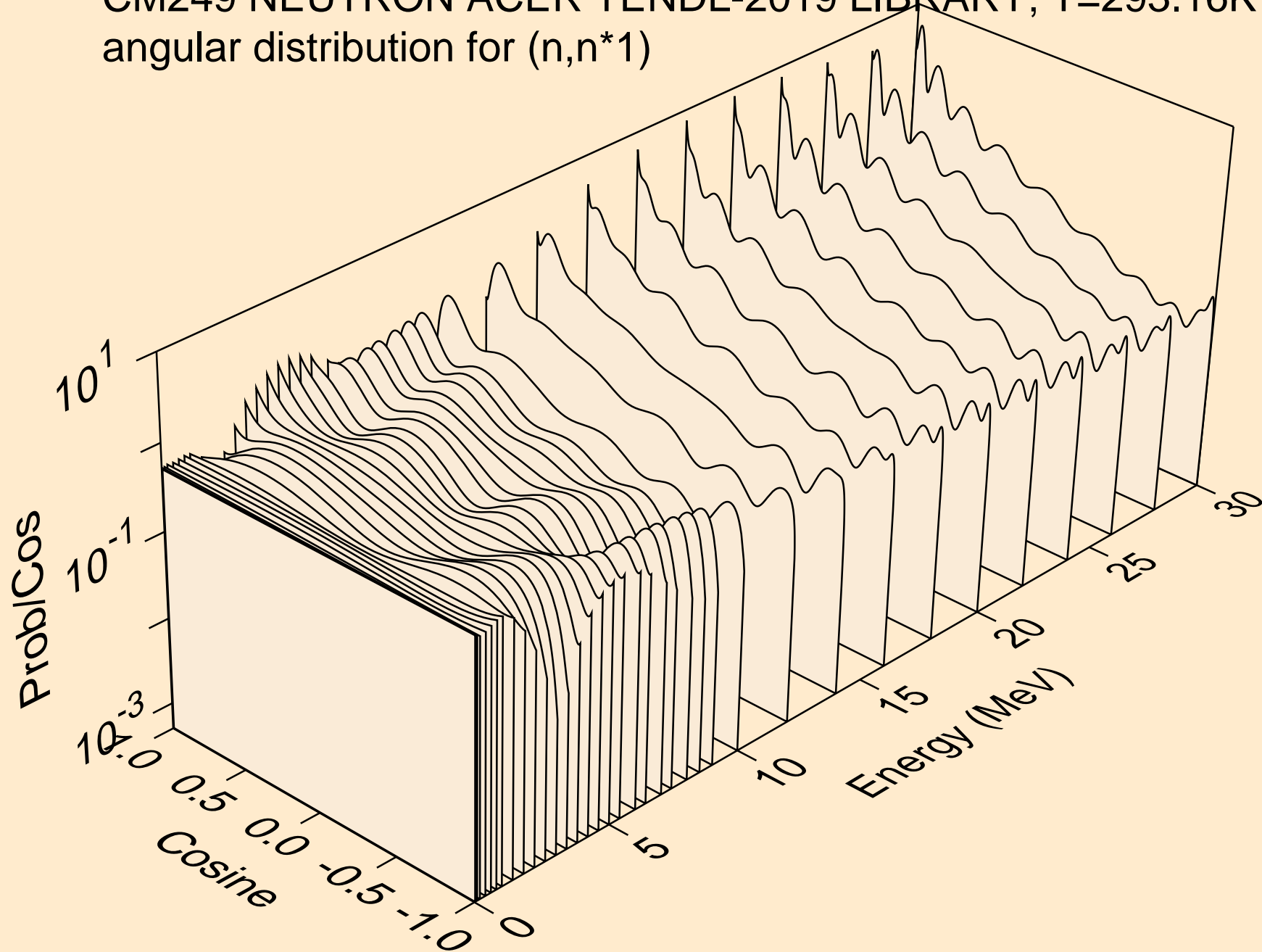

CM249 NEUTRON ACER TENDL-2019 LIBRARY; T=293.16K  
angular distribution for (n,n\*2)

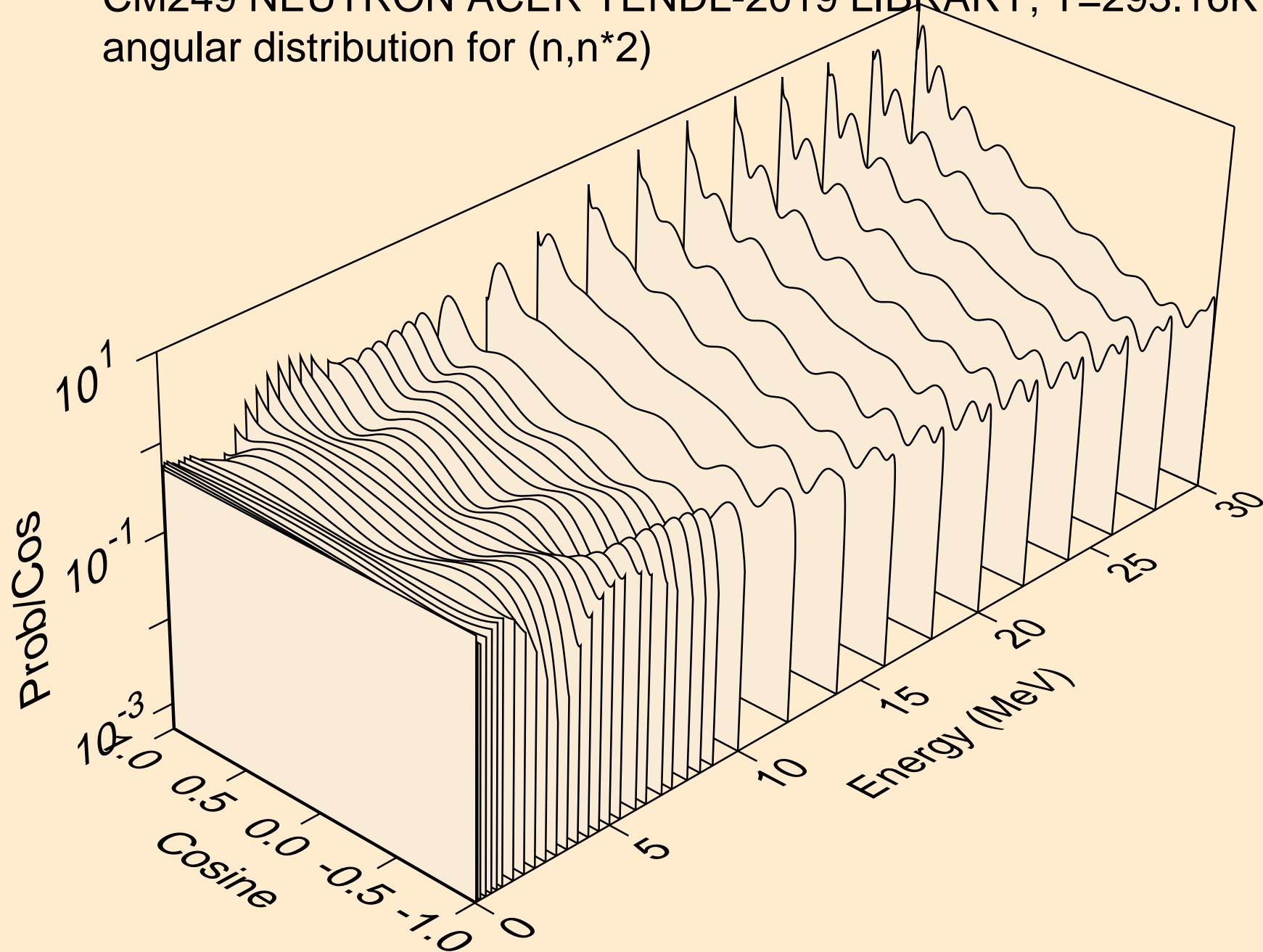

CM249 NEUTRON ACER TENDL-2019 LIBRARY; T=293.16K  
angular distribution for (n,n\*3)

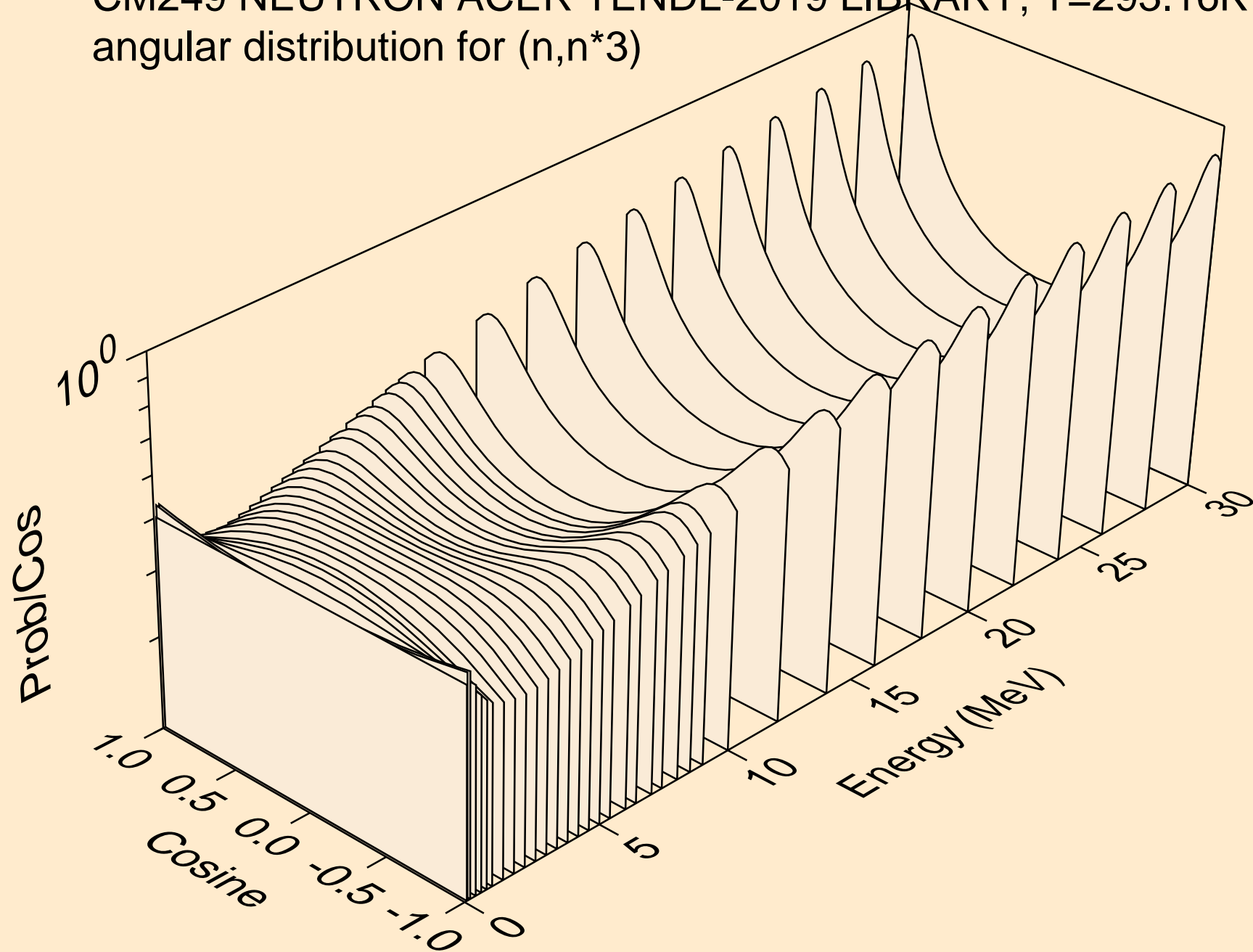

CM249 NEUTRON ACER TENDL-2019 LIBRARY; T=293.16K  
angular distribution for (n,n\*4)

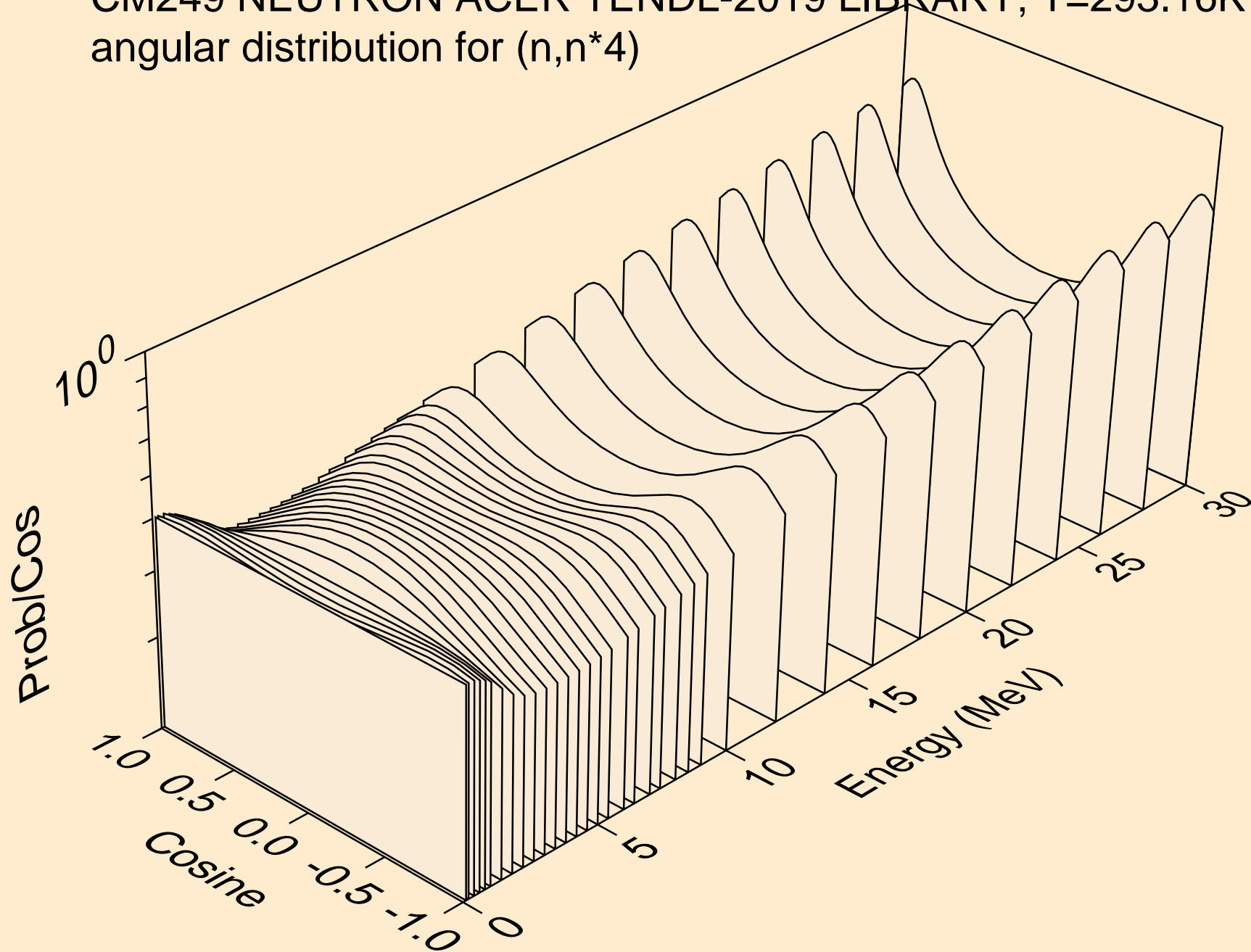

CM249 NEUTRON ACER TENDL-2019 LIBRARY; T=293.16K  
angular distribution for (n,n\*5)

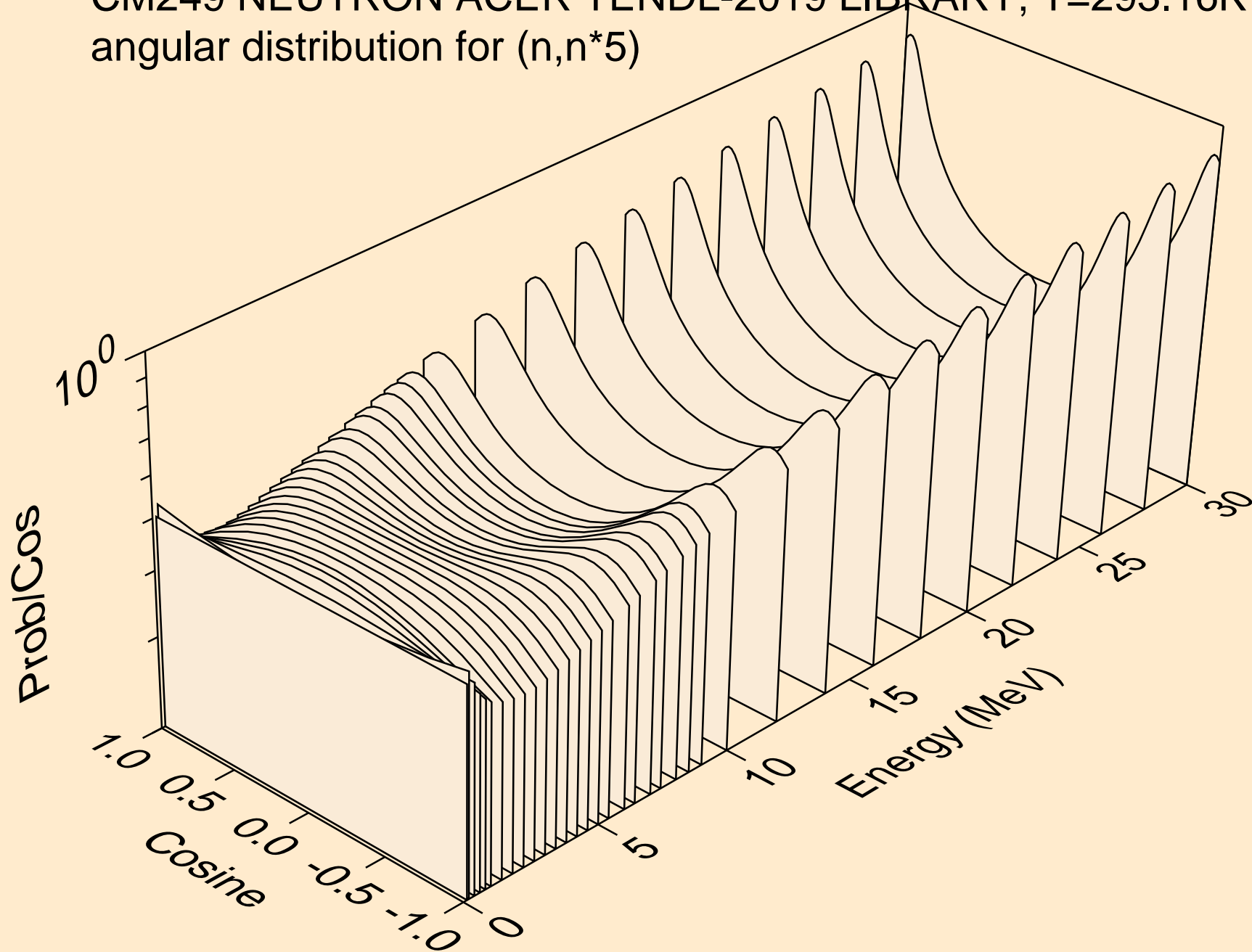

CM249 NEUTRON ACER TENDL-2019 LIBRARY; T=293.16K  
angular distribution for (n,n\*6)

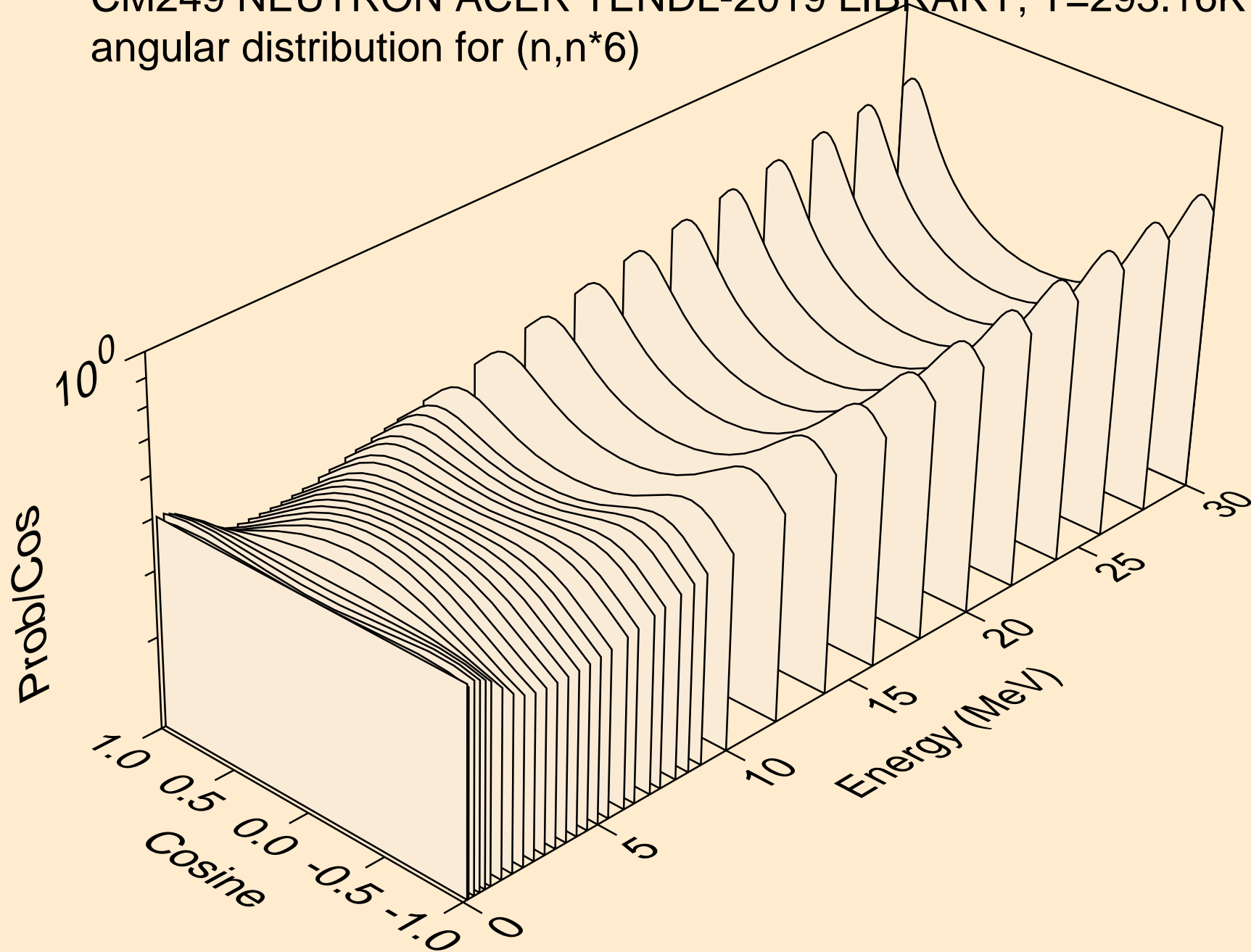

CM249 NEUTRON ACER TENDL-2019 LIBRARY; T=293.16K  
angular distribution for (n,n\*7)

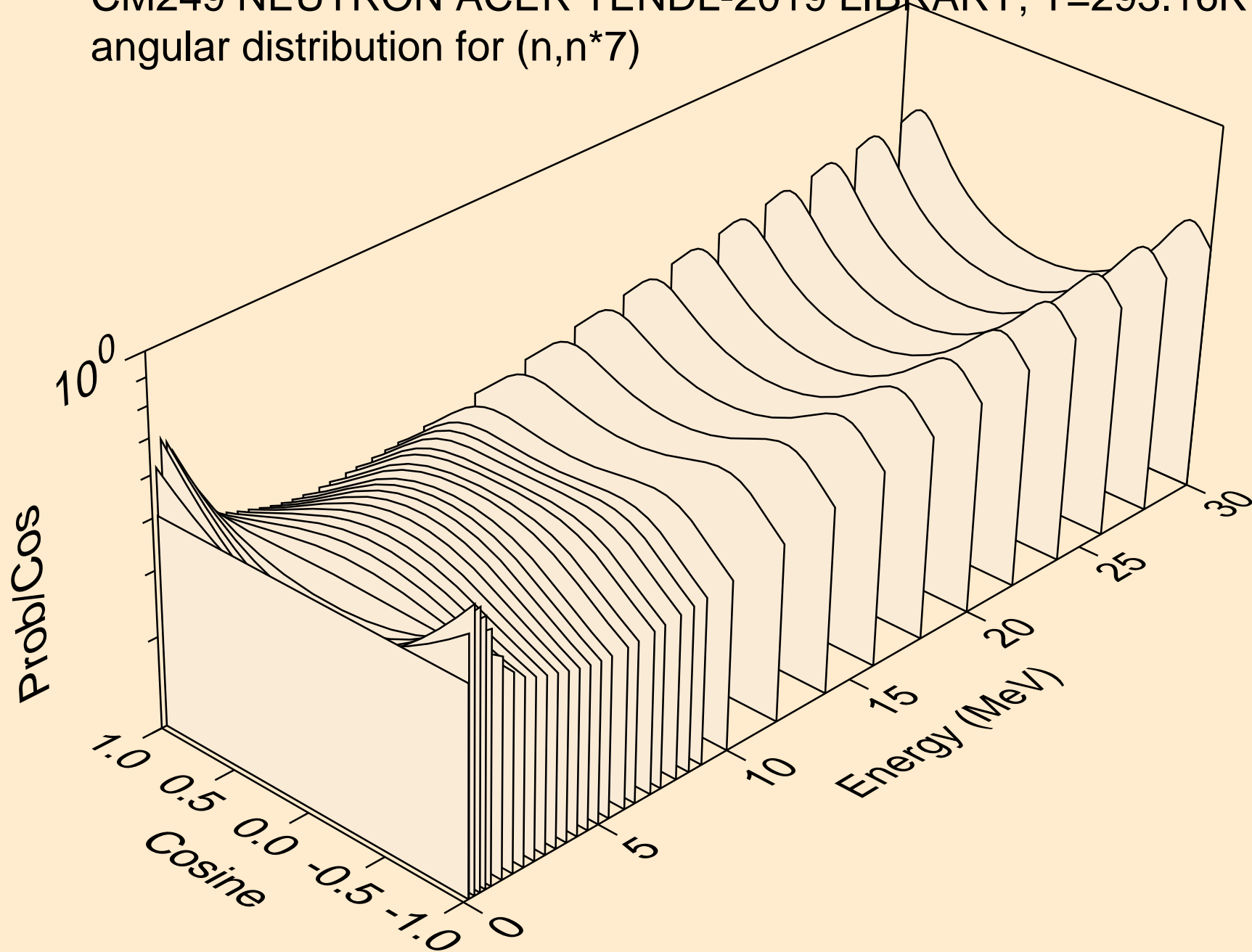

CM249 NEUTRON ACER TENDL-2019 LIBRARY; T=293.16K  
angular distribution for (n,n\*8)

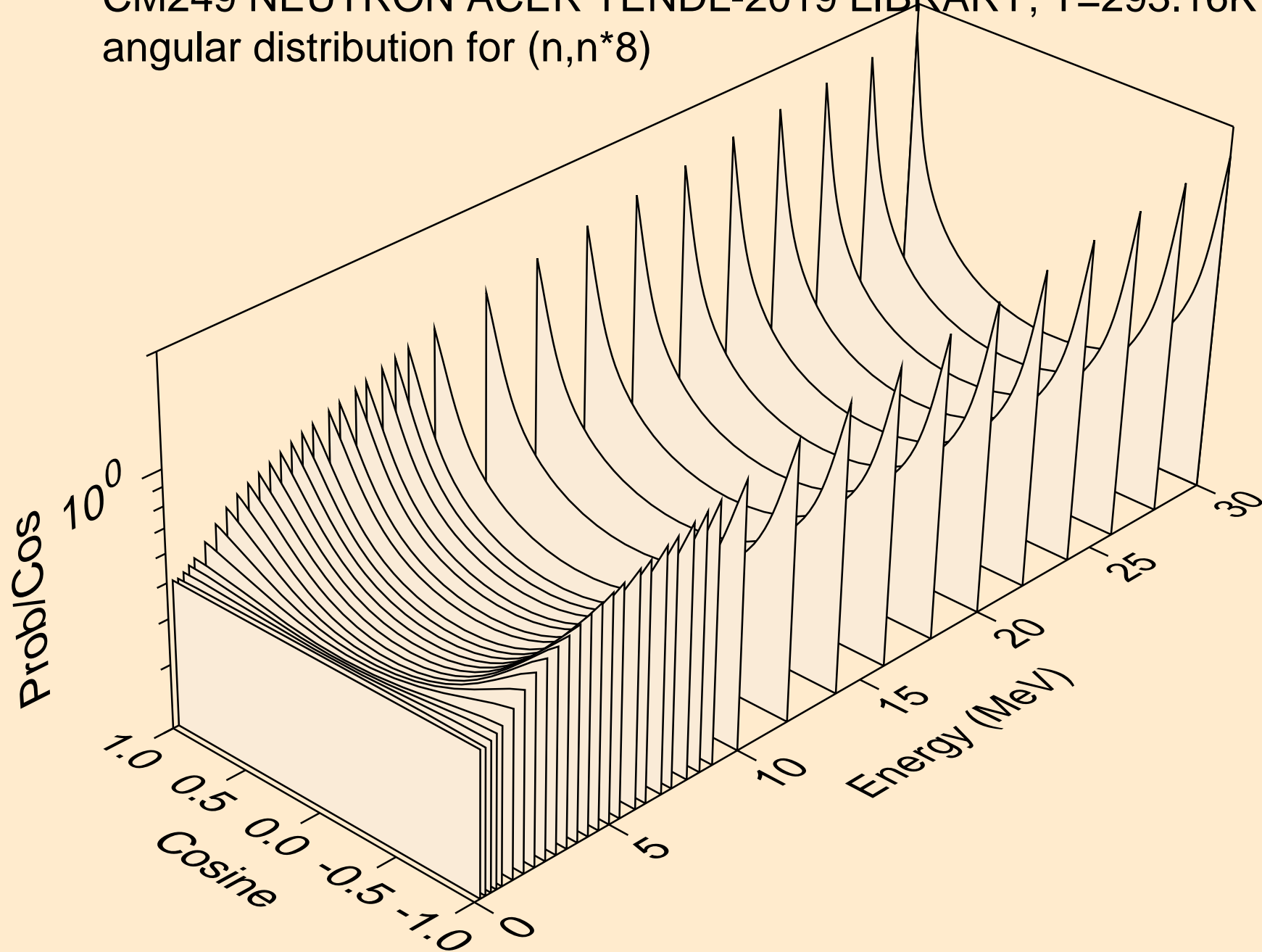

CM249 NEUTRON ACER TENDL-2019 LIBRARY; T=293.16K  
angular distribution for (n,n\*9)

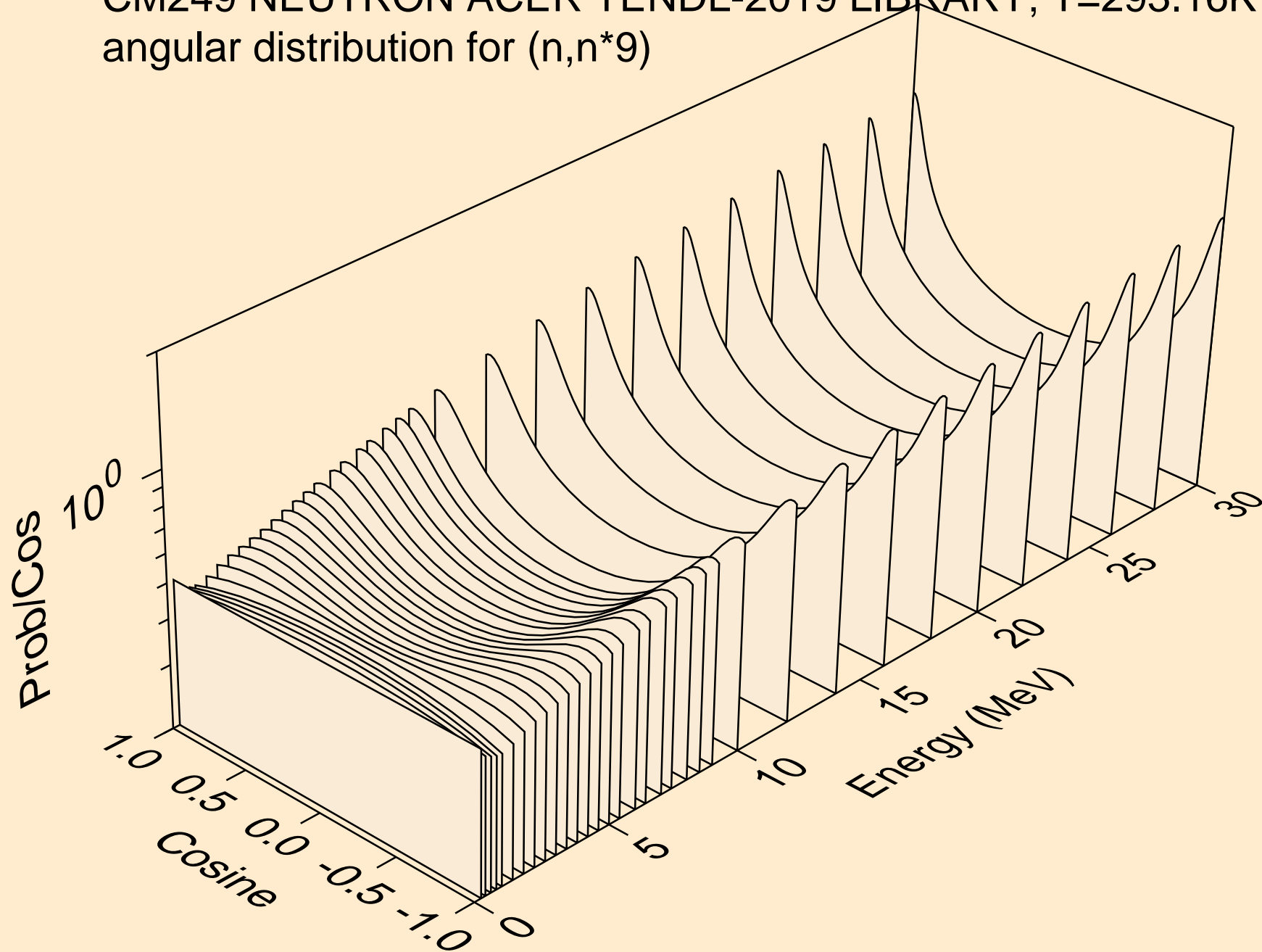

CM249 NEUTRON ACER TENDL-2019 LIBRARY; T=293.16K  
angular distribution for (n,n\*10)

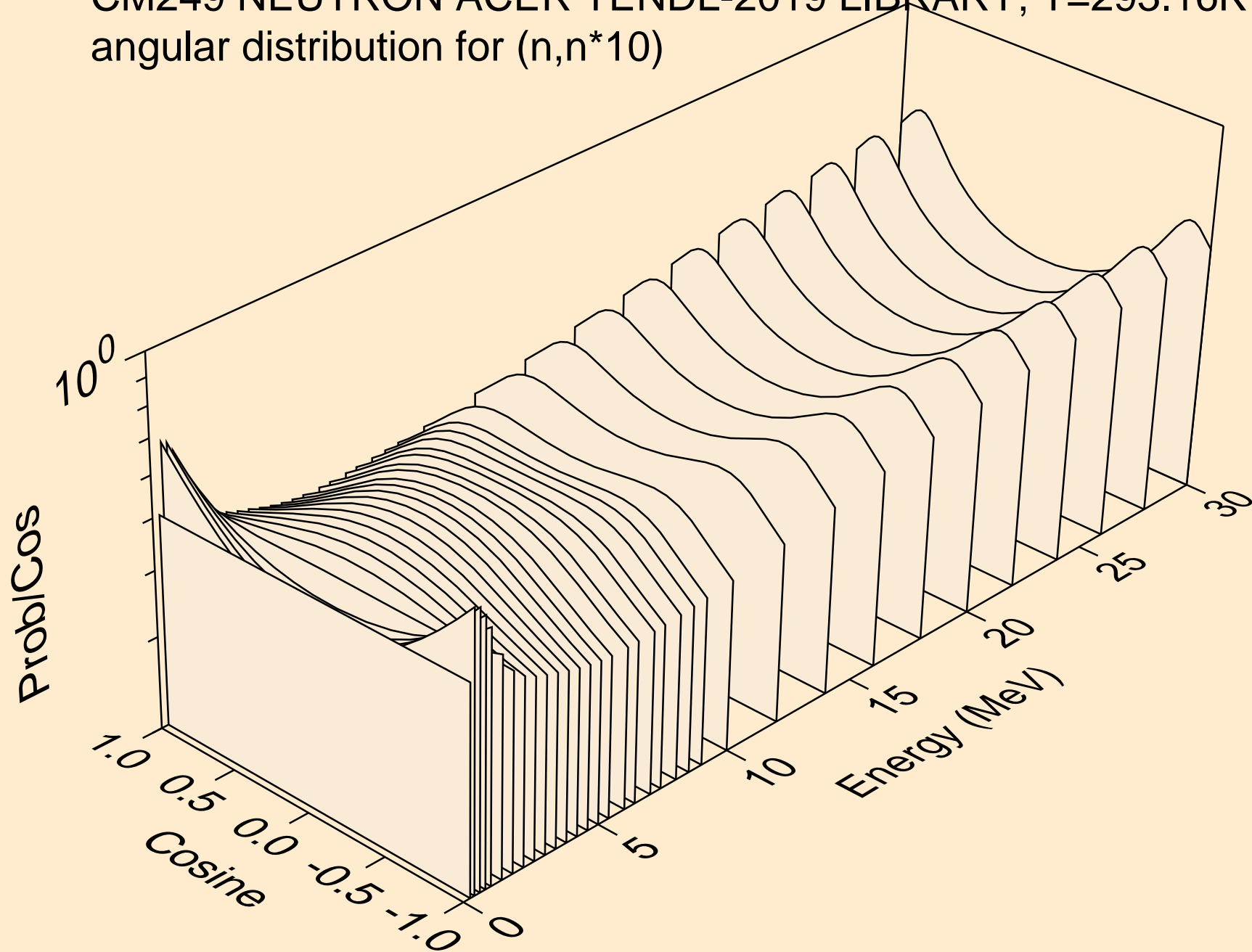

CM249 NEUTRON ACER TENDL-2019 LIBRARY; T=293.16K  
angular distribution for (n,n\*11)

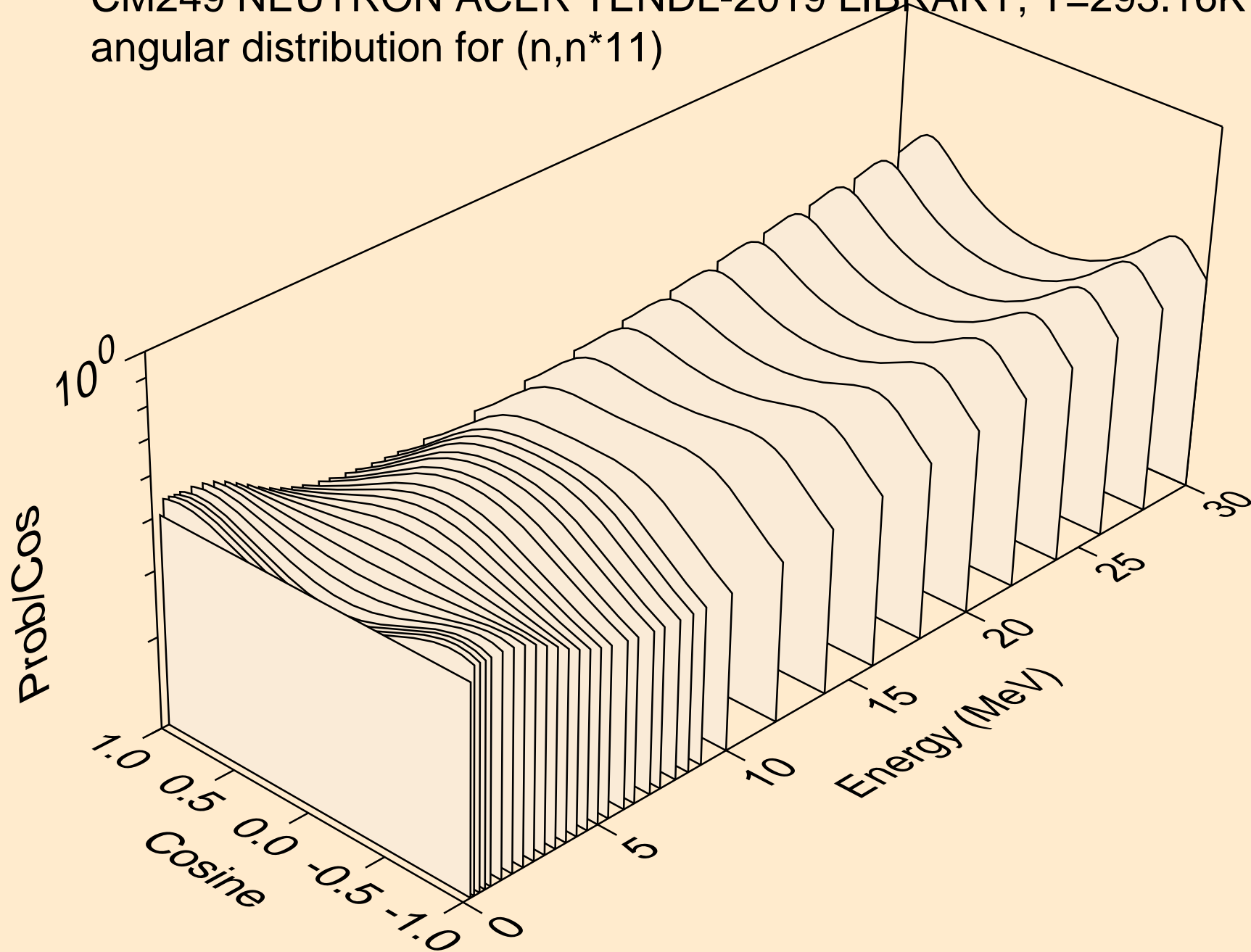

CM249 NEUTRON ACER TENDL-2019 LIBRARY; T=293.16K  
angular distribution for (n,n\*12)

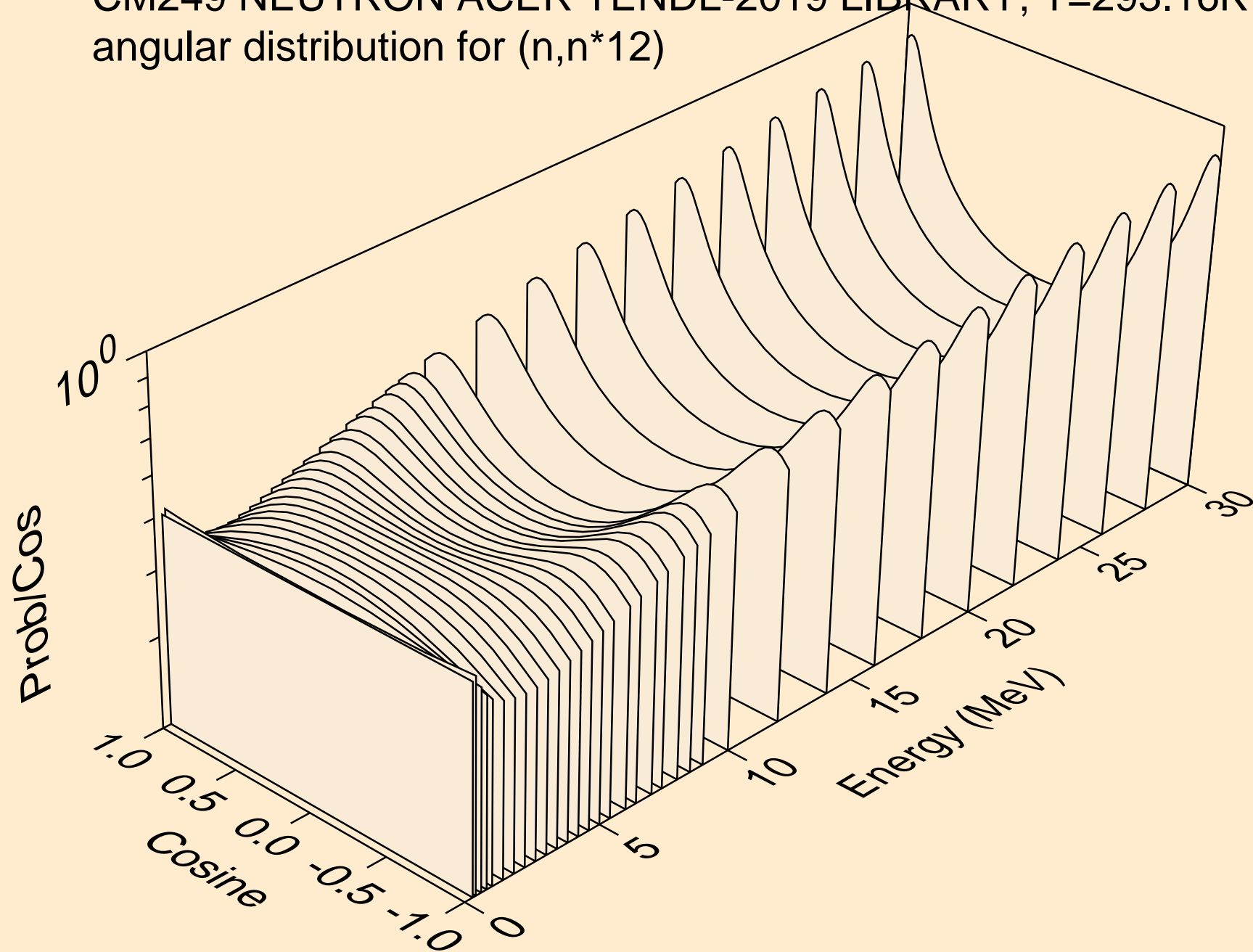

CM249 NEUTRON ACER TENDL-2019 LIBRARY; T=293.16K  
angular distribution for (n,n\*13)

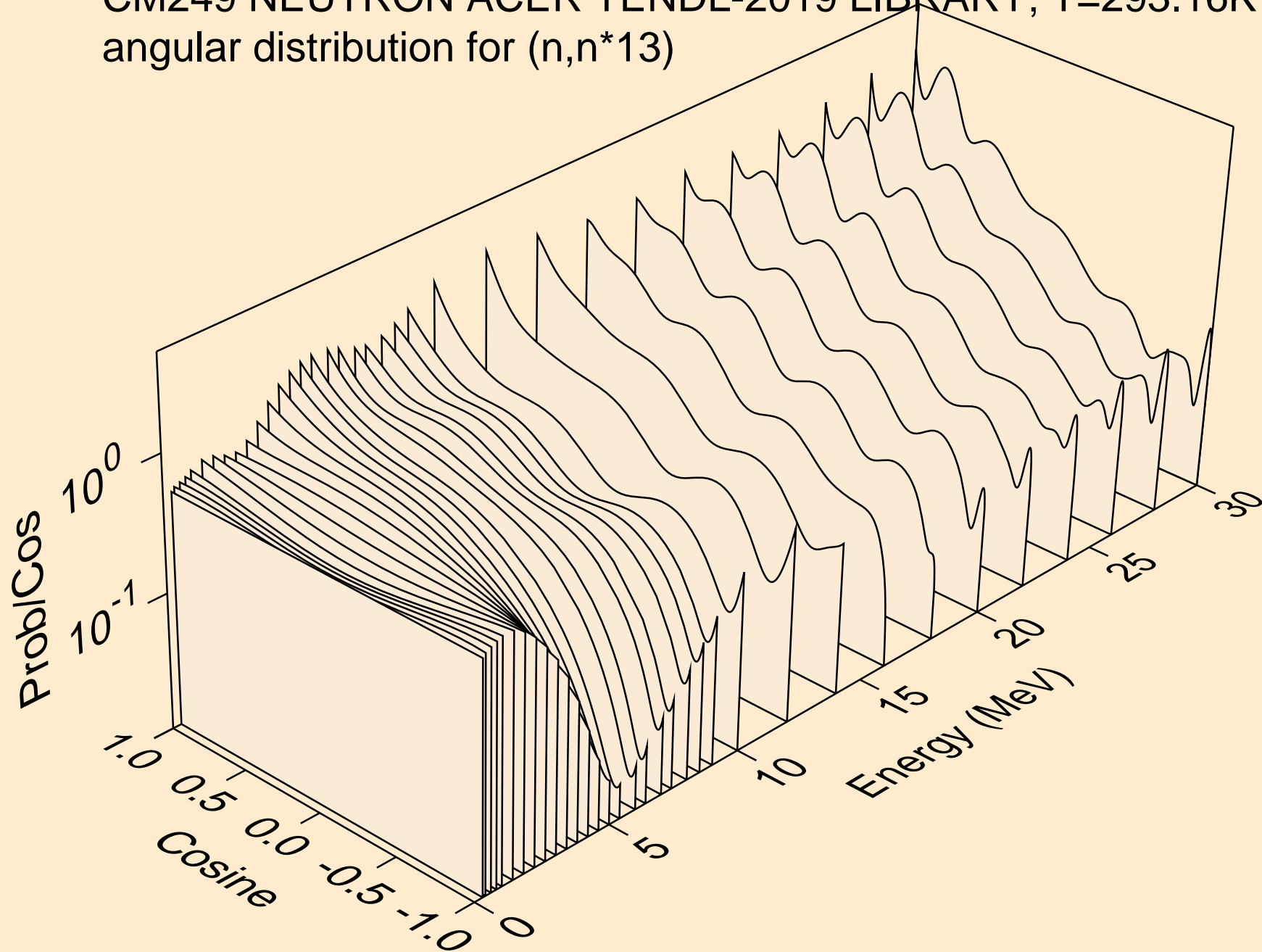

CM249 NEUTRON ACER TENDL-2019 LIBRARY; T=293.16K  
angular distribution for (n,n\*14)

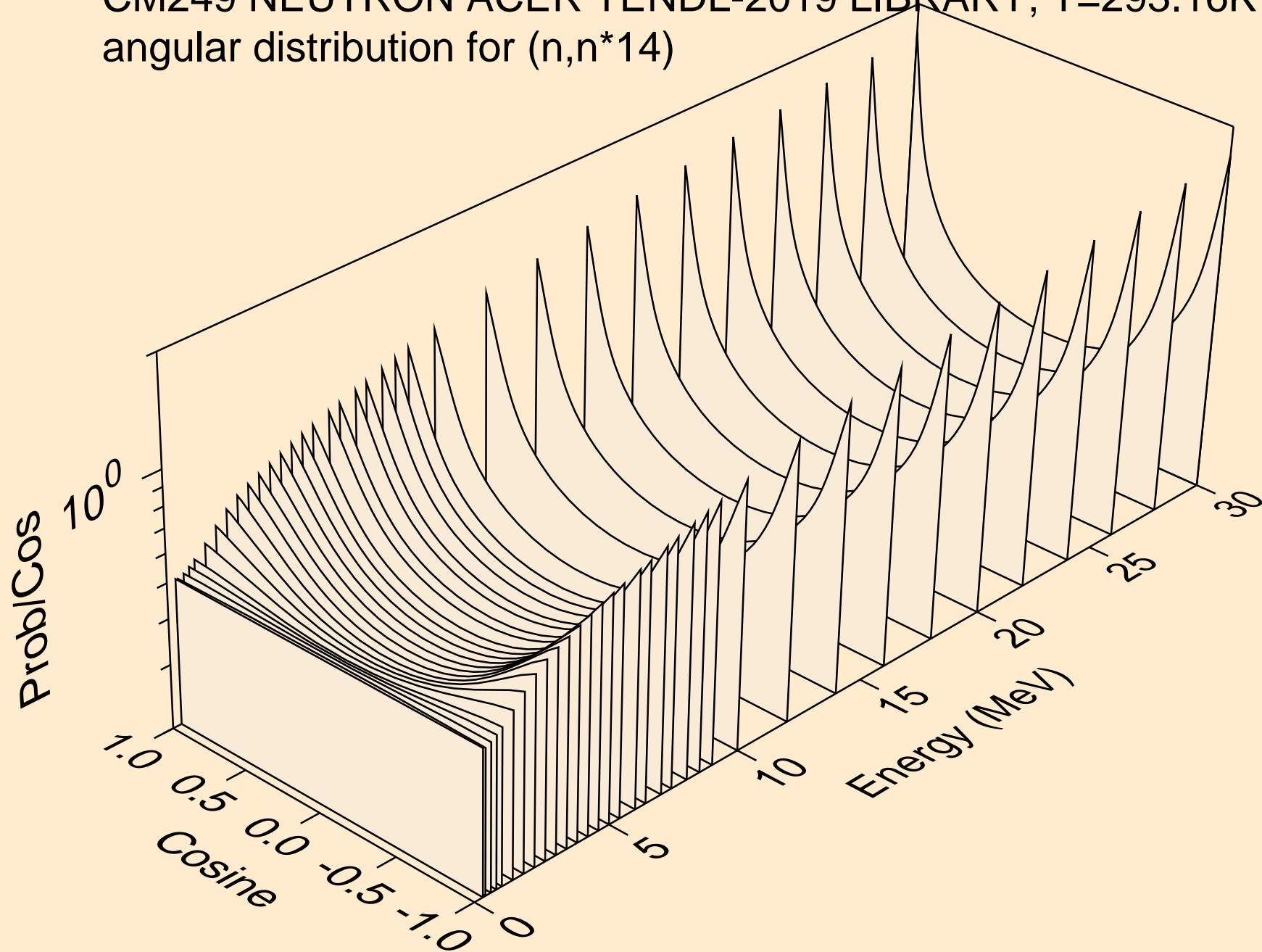

CM249 NEUTRON ACER TENDL-2019 LIBRARY; T=293.16K  
angular distribution for (n,n\*15)

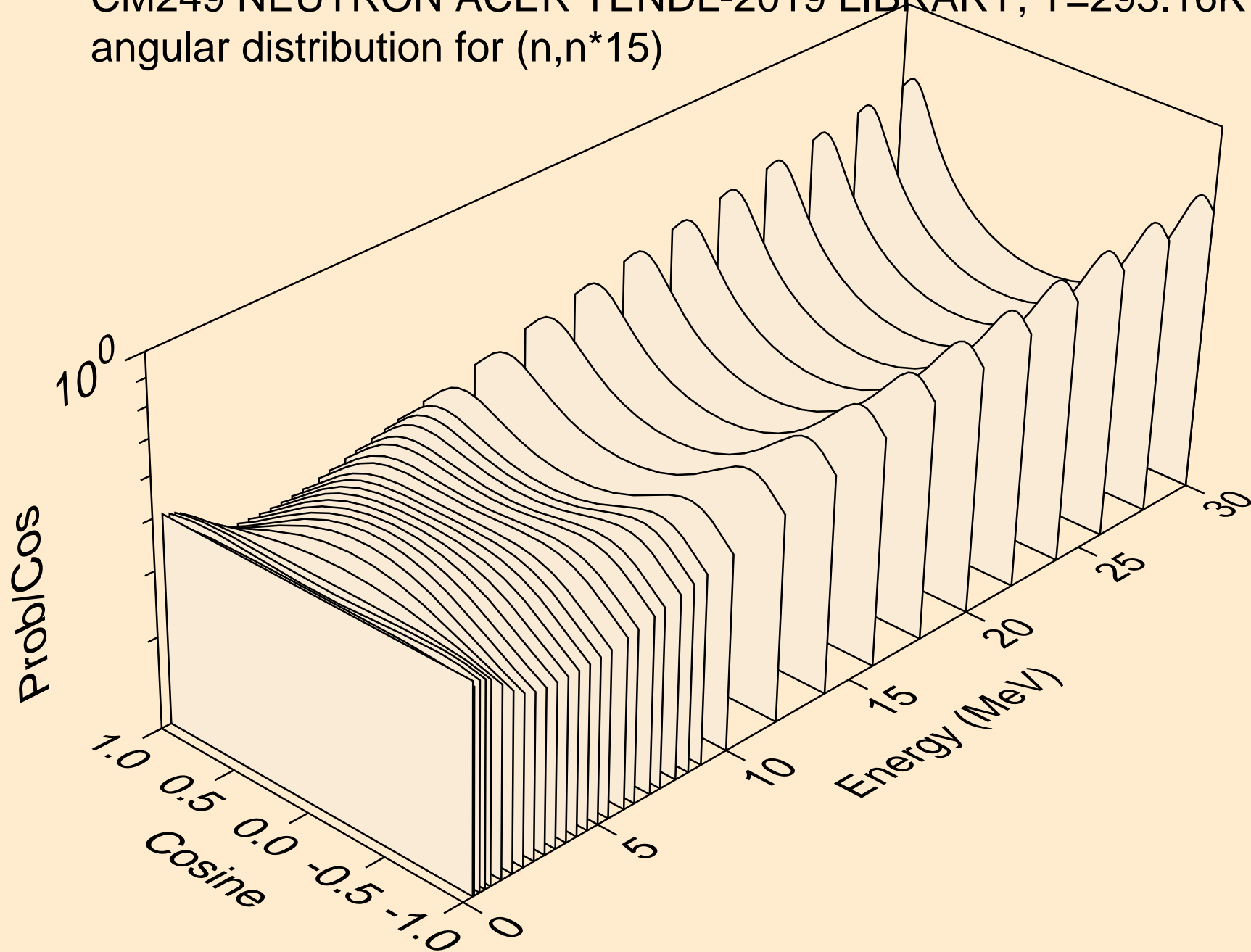

CM249 NEUTRON ACER TENDL-2019 LIBRARY; T=293.16K  
angular distribution for (n,n\*16)

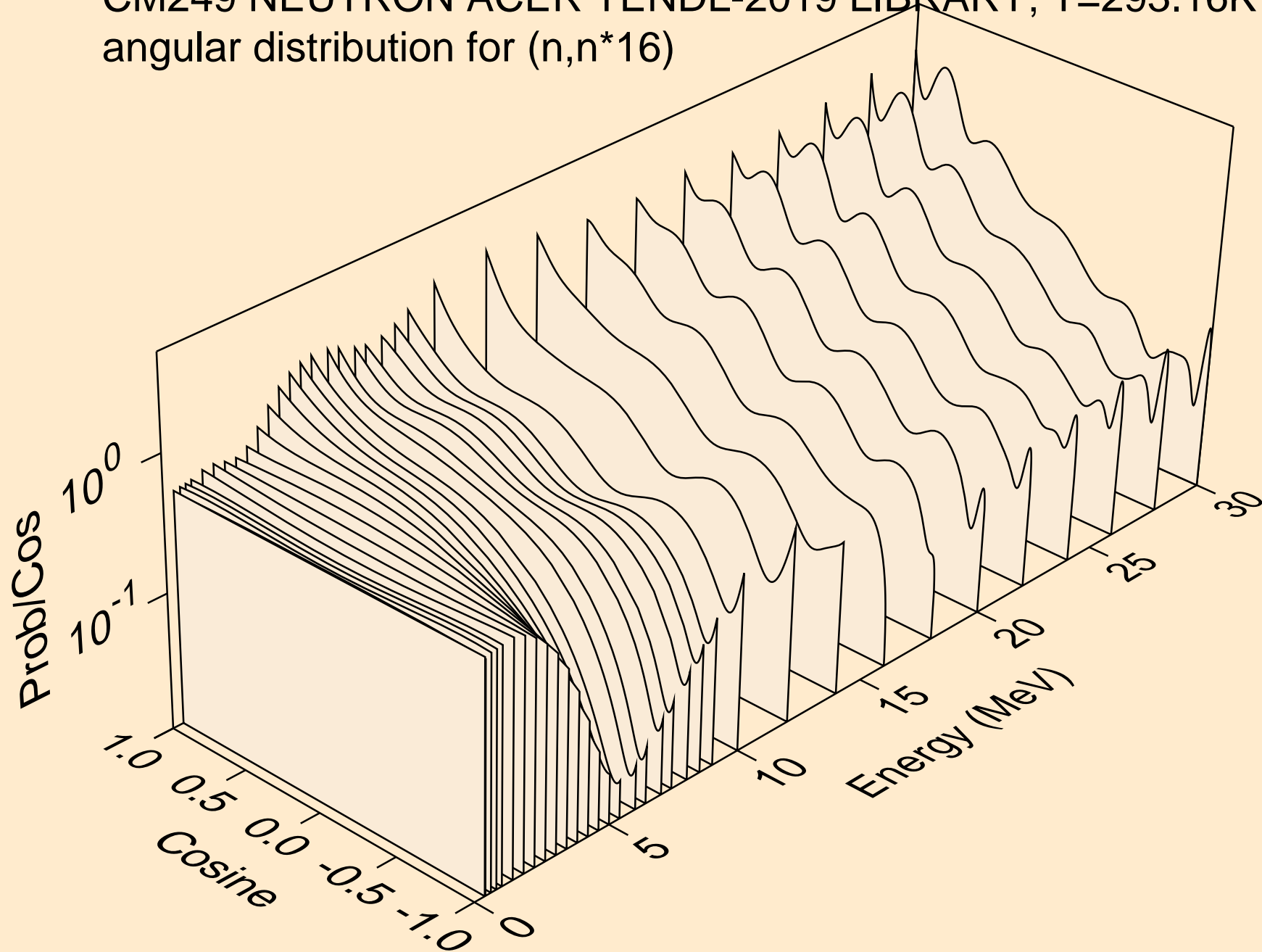

CM249 NEUTRON ACER TENDL-2019 LIBRARY; T=293.16K  
angular distribution for (n,n\*17)

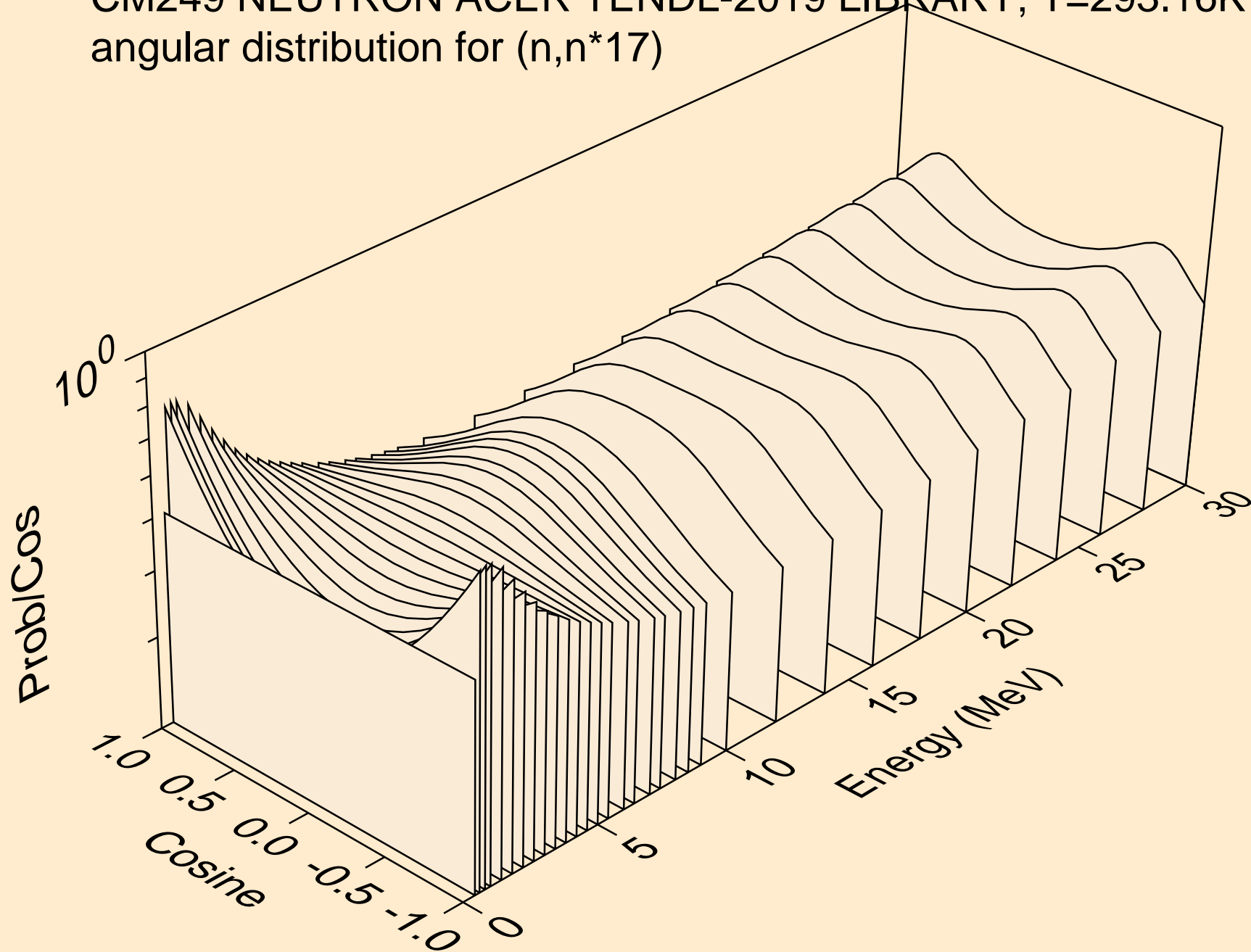

CM249 NEUTRON ACER TENDL-2019 LIBRARY; T=293.16K  
angular distribution for (n,n\*18)

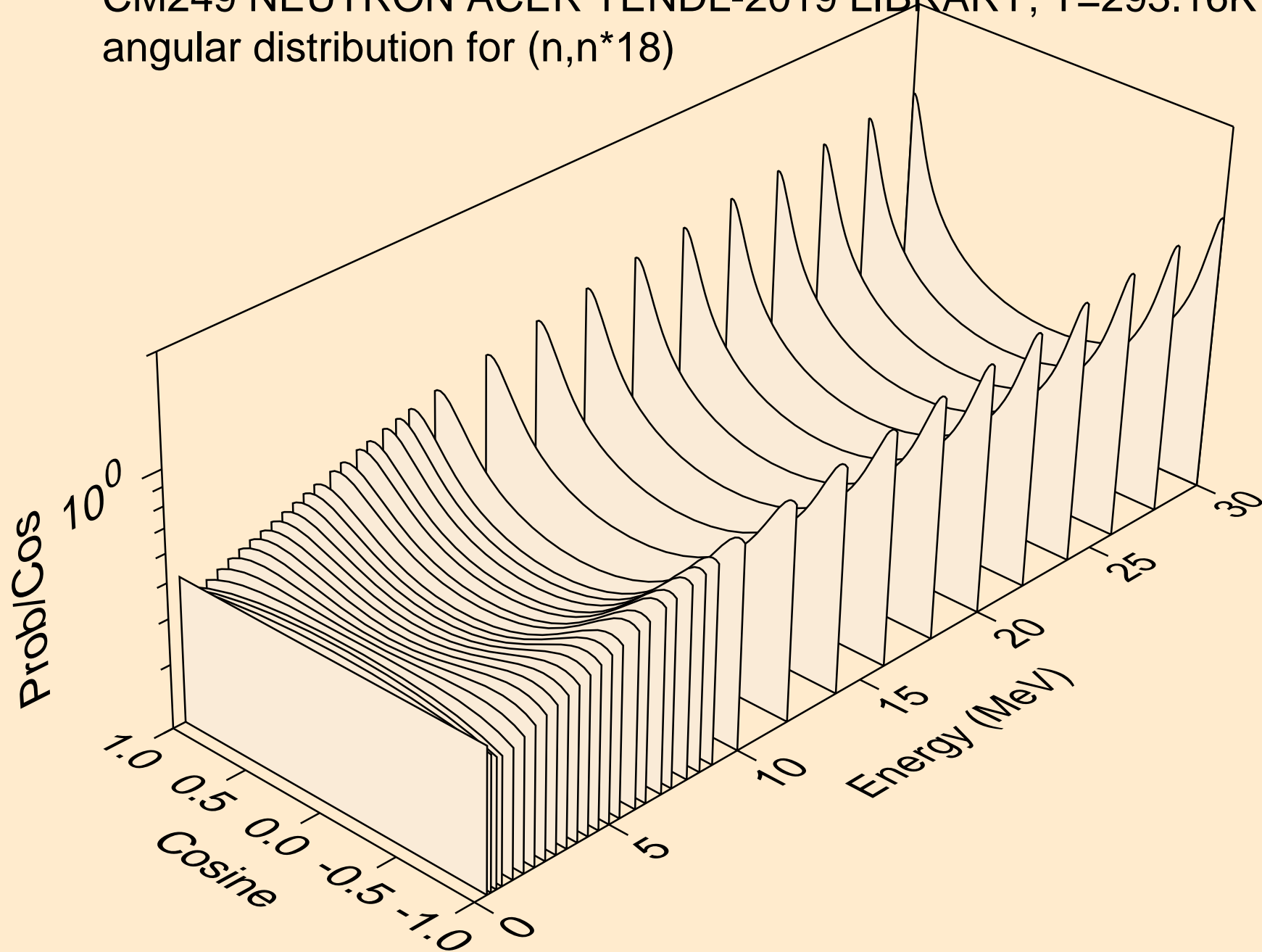

CM249 NEUTRON ACER TENDL-2019 LIBRARY; T=293.16K  
angular distribution for (n,n\*19)

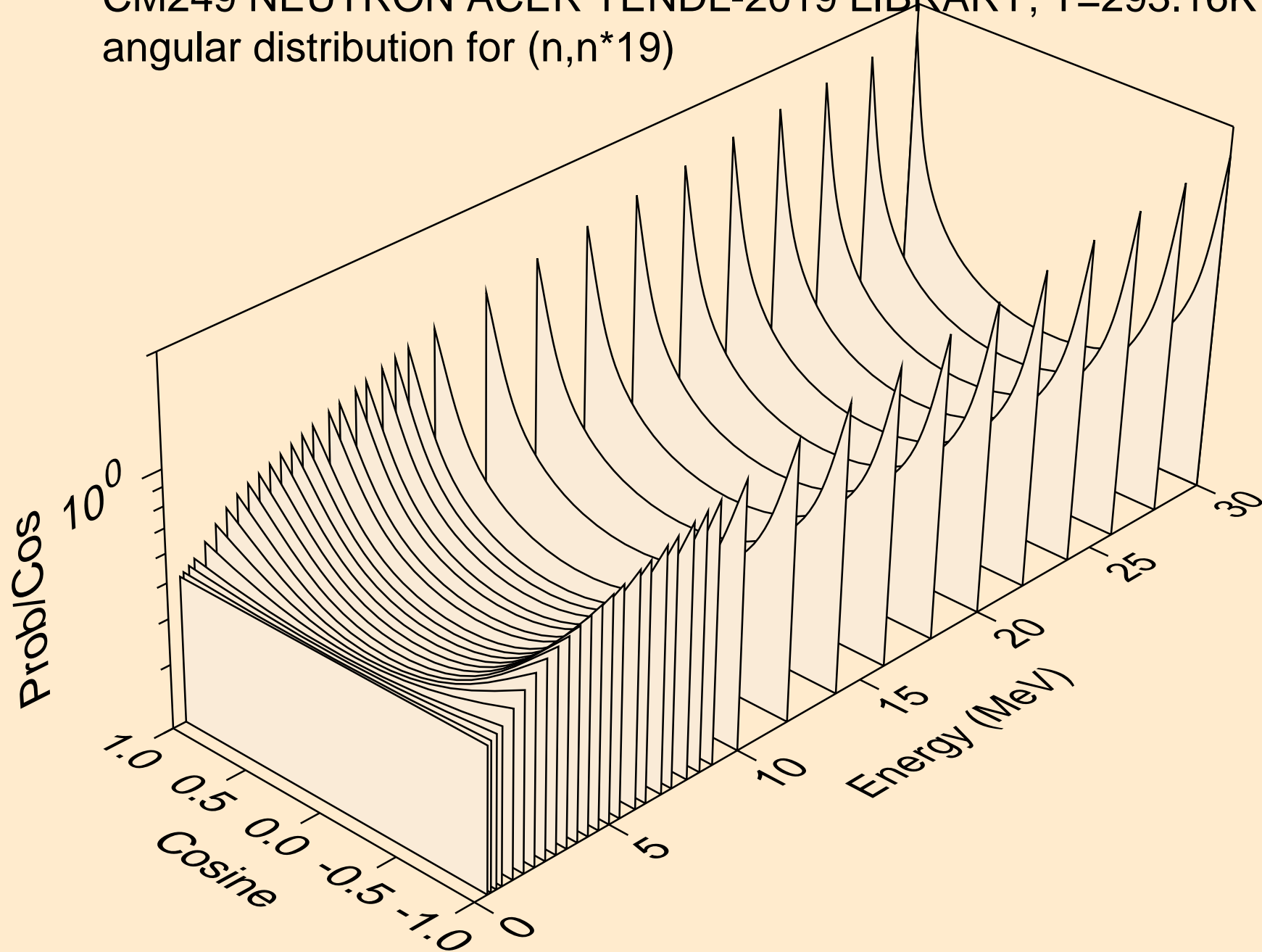

CM249 NEUTRON ACER TENDL-2019 LIBRARY; T=293.16K  
angular distribution for (n,n\*20)

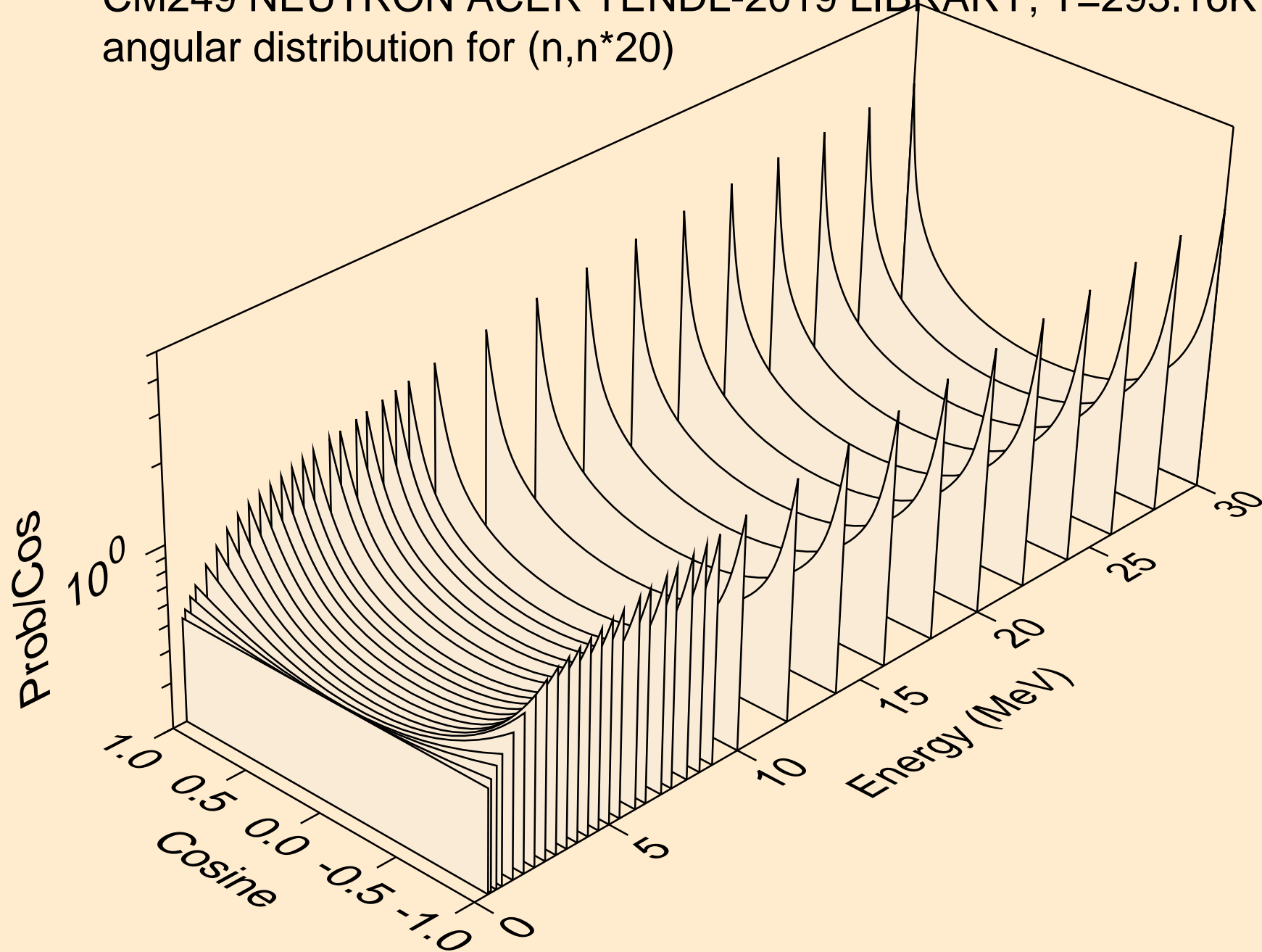

CM249 NEUTRON ACER TENDL-2019 LIBRARY; T=293.16K  
angular distribution for (n,n\*21)

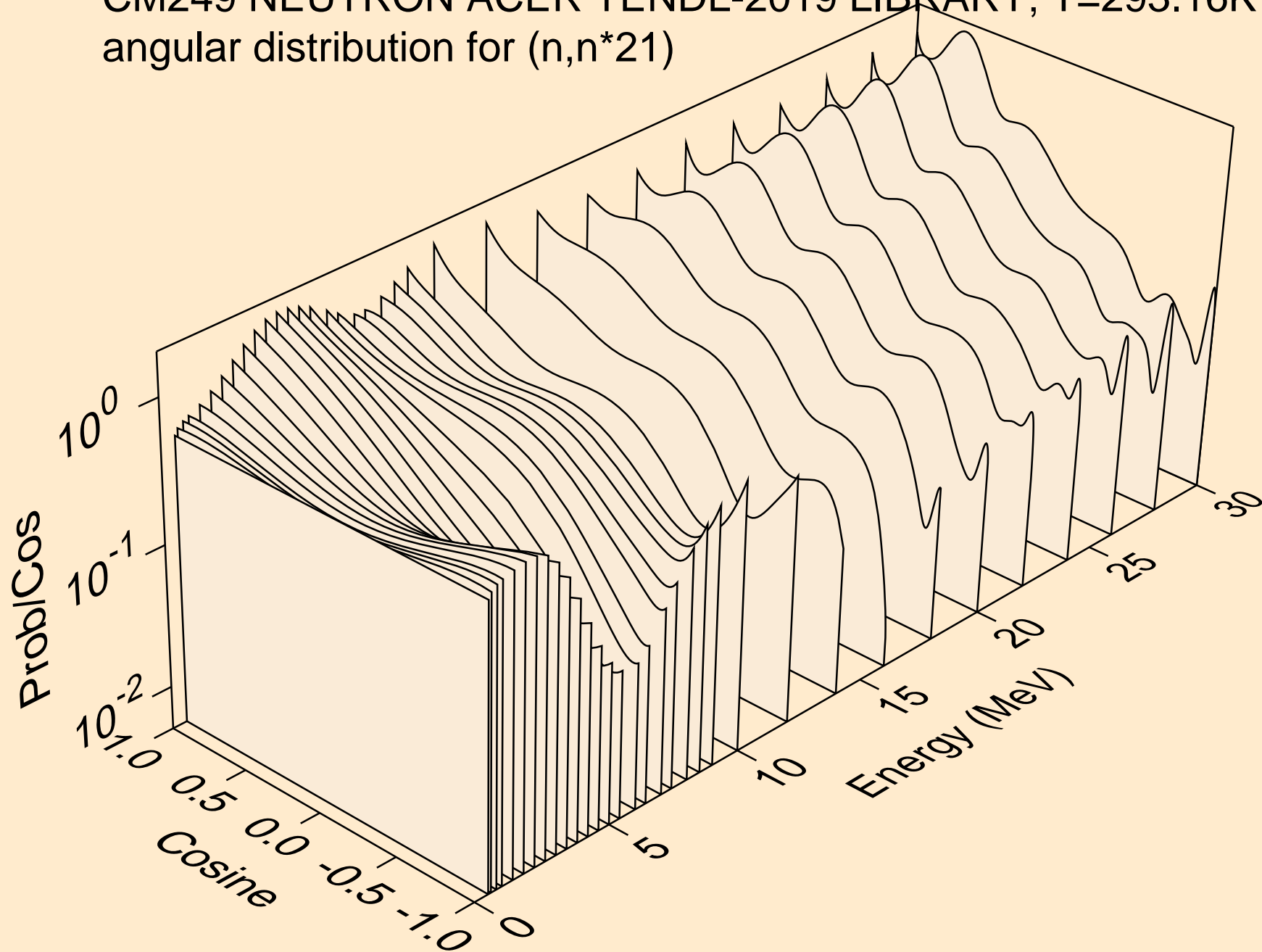

CM249 NEUTRON ACER TENDL-2019 LIBRARY; T=293.16K  
angular distribution for (n,n\*22)

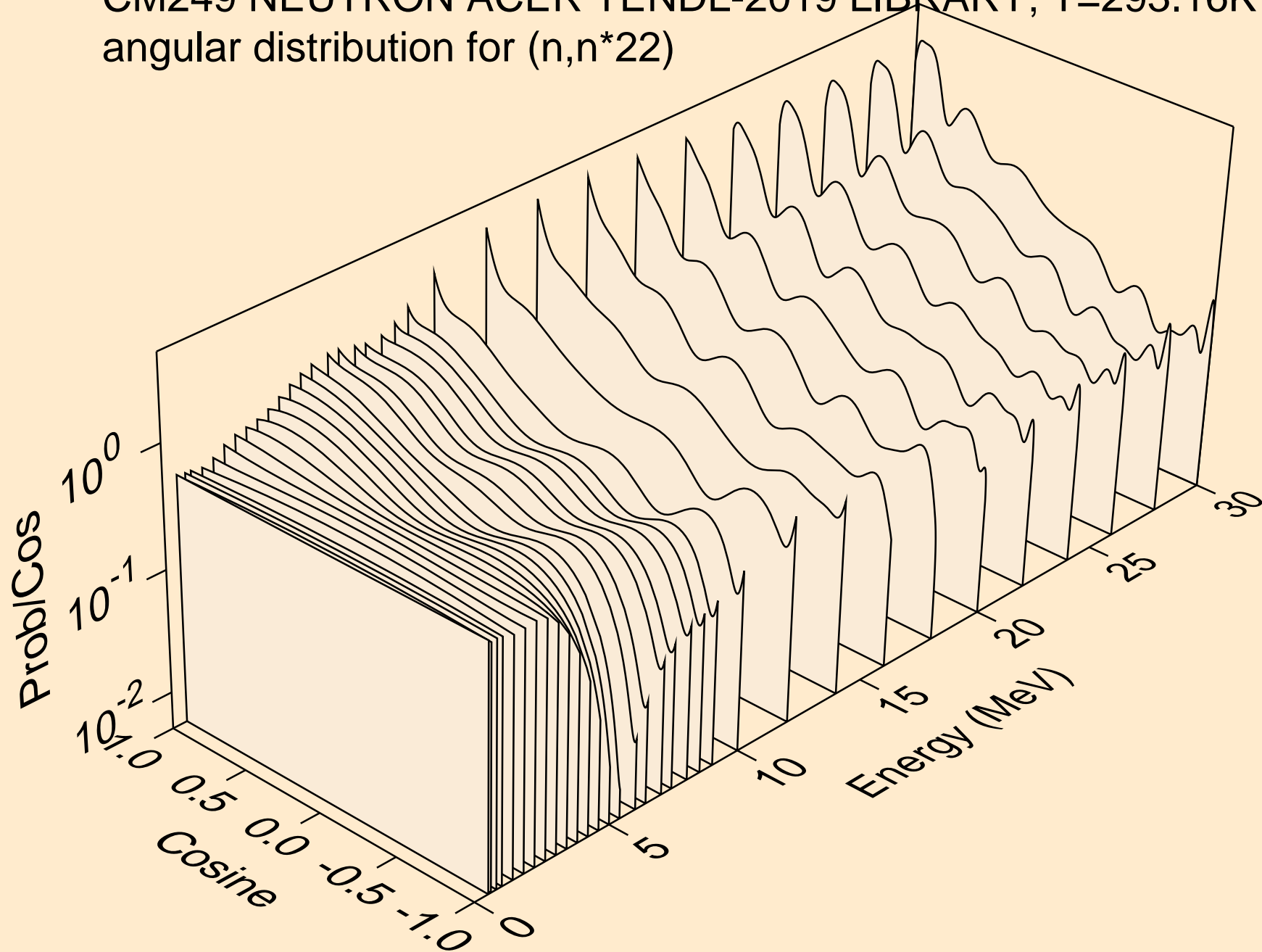

CM249 NEUTRON ACER TENDL-2019 LIBRARY; T=293.16K  
angular distribution for (n,n\*23)

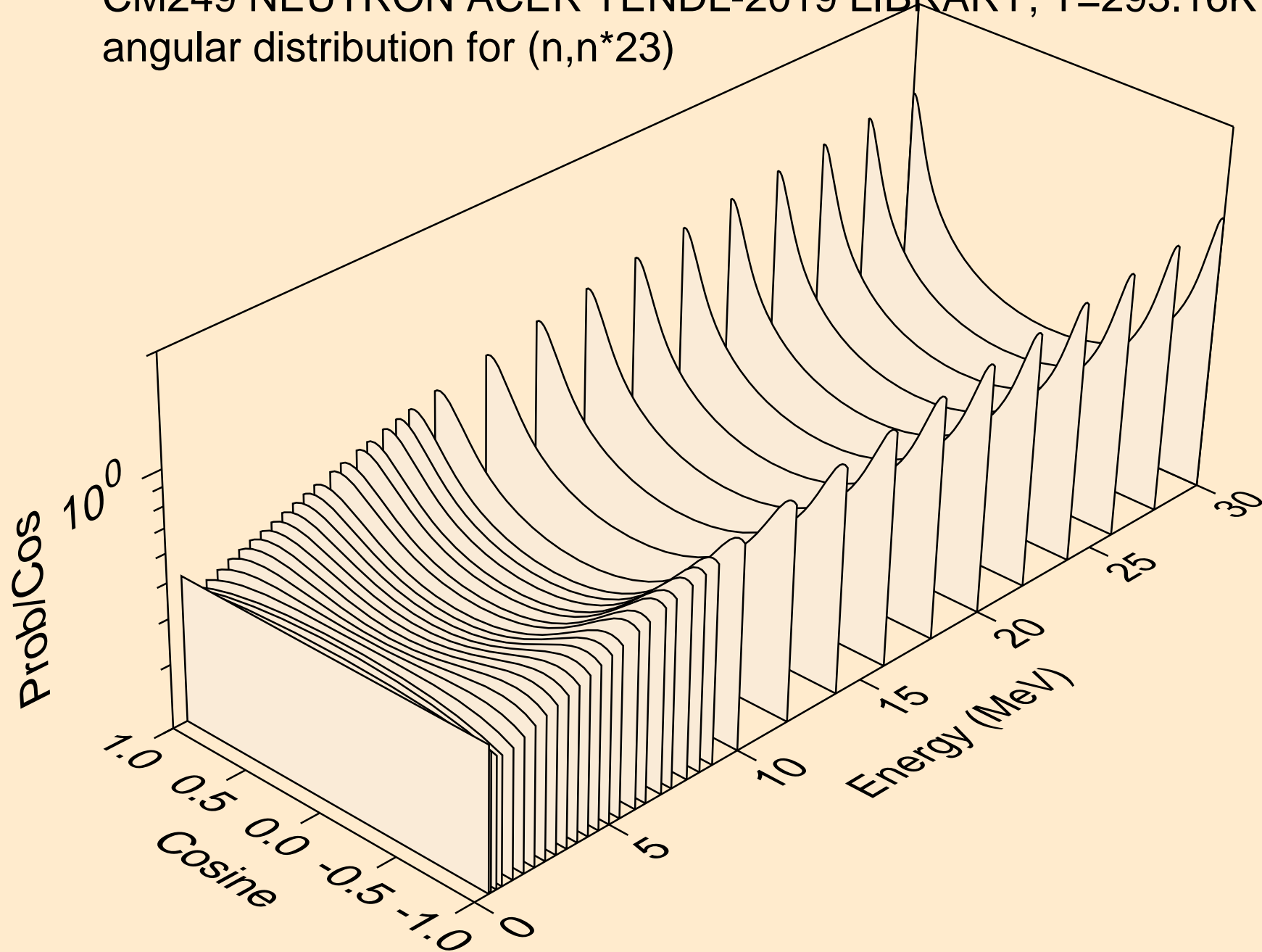

CM249 NEUTRON ACER TENDL-2019 LIBRARY; T=293.16K  
angular distribution for (n,n\*24)

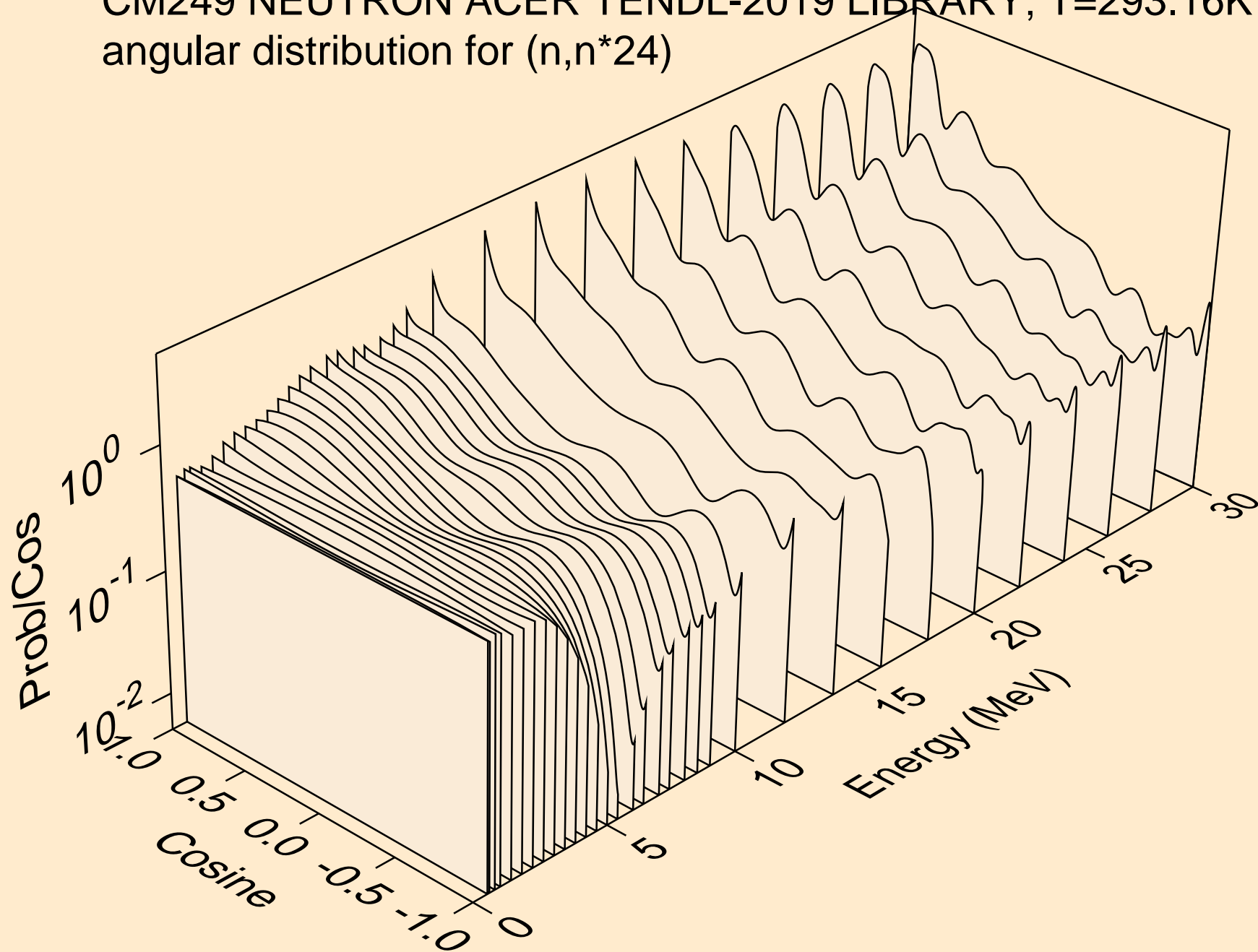

CM249 NEUTRON ACER TENDL-2019 LIBRARY; T=293.16K  
angular distribution for (n,n\*25)

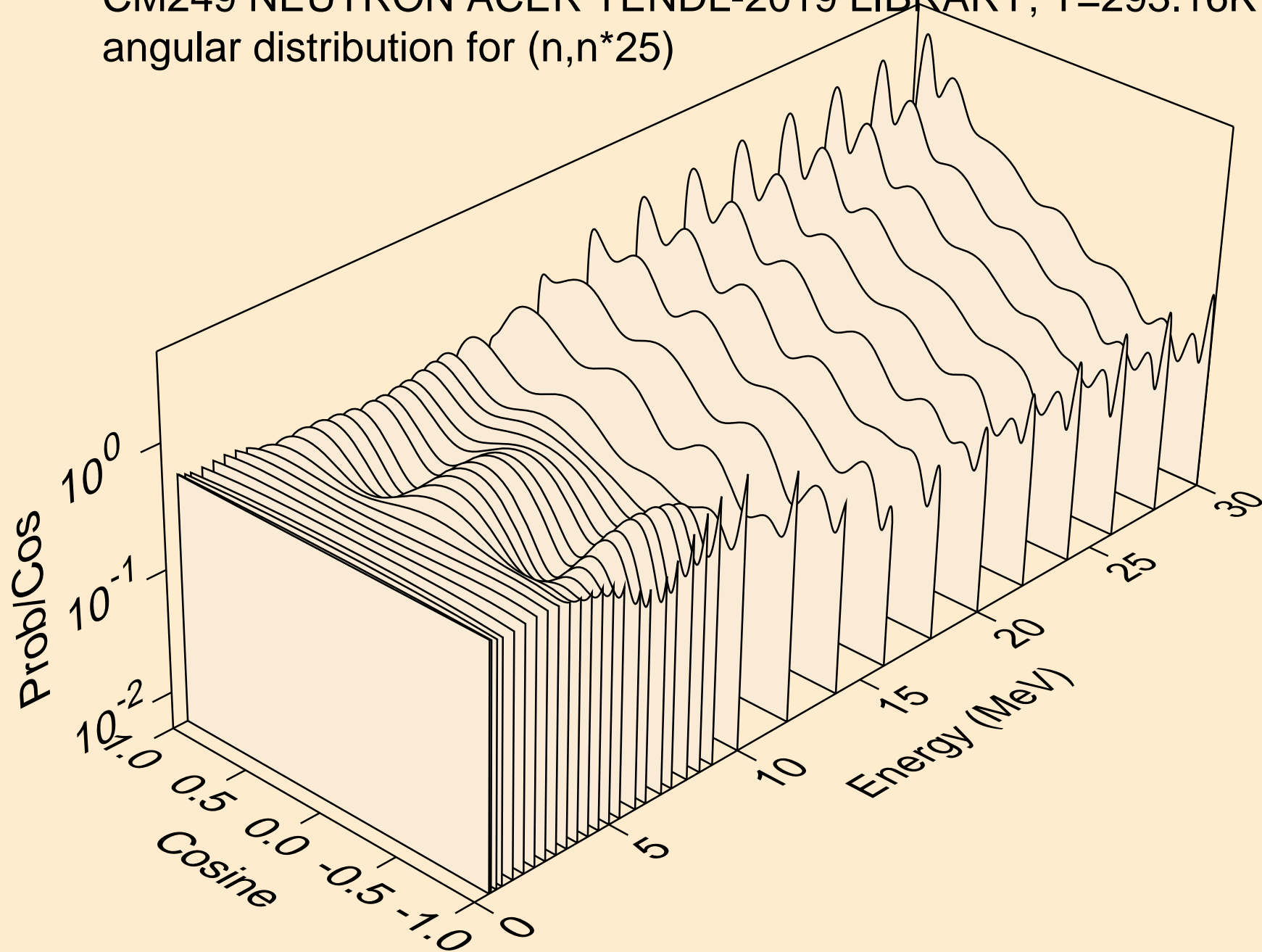

CM249 NEUTRON ACER TENDL-2019 LIBRARY; T=293.16K  
angular distribution for (n,n\*26)

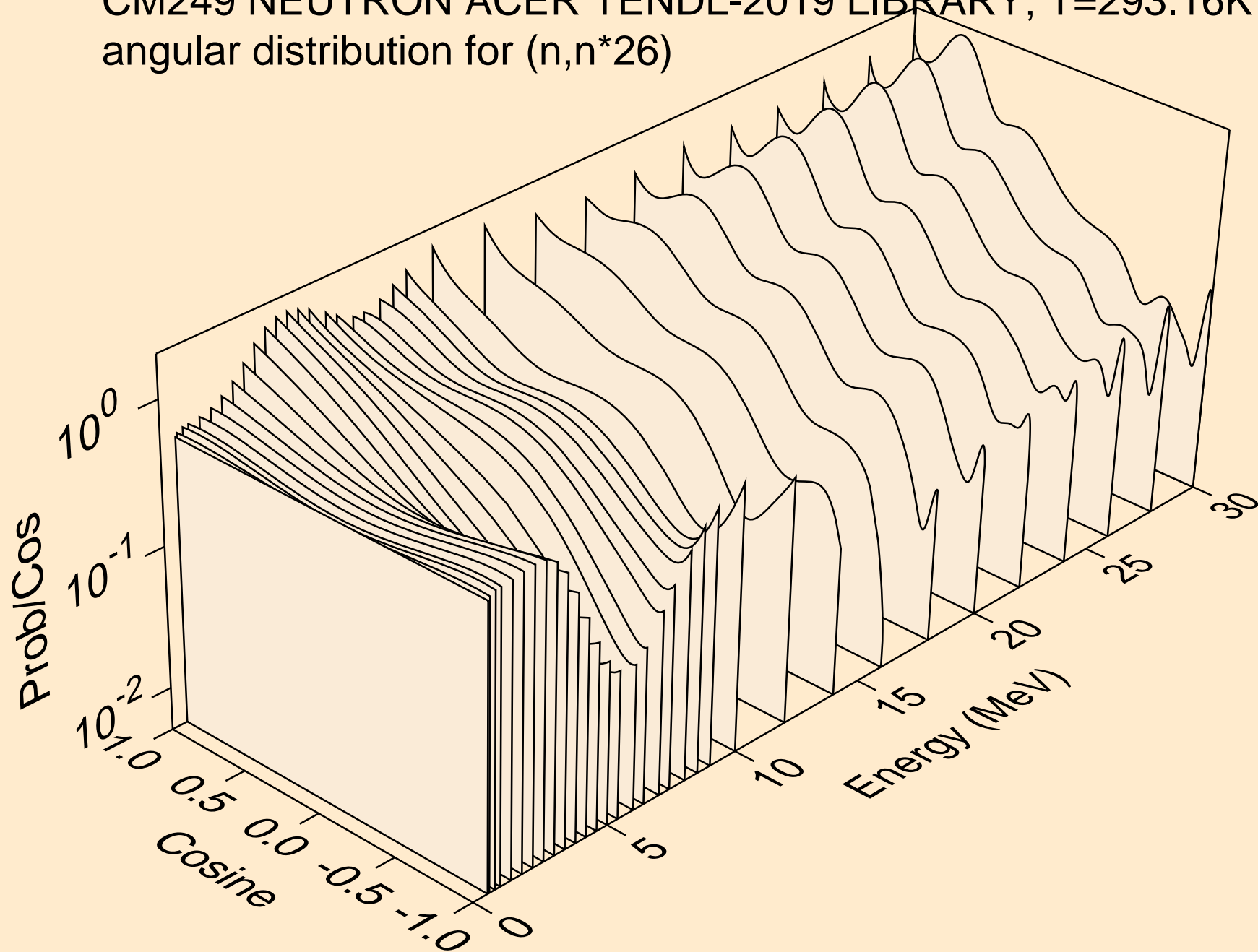

CM249 NEUTRON ACER TENDL-2019 LIBRARY; T=293.16K  
angular distribution for (n,n\*27)

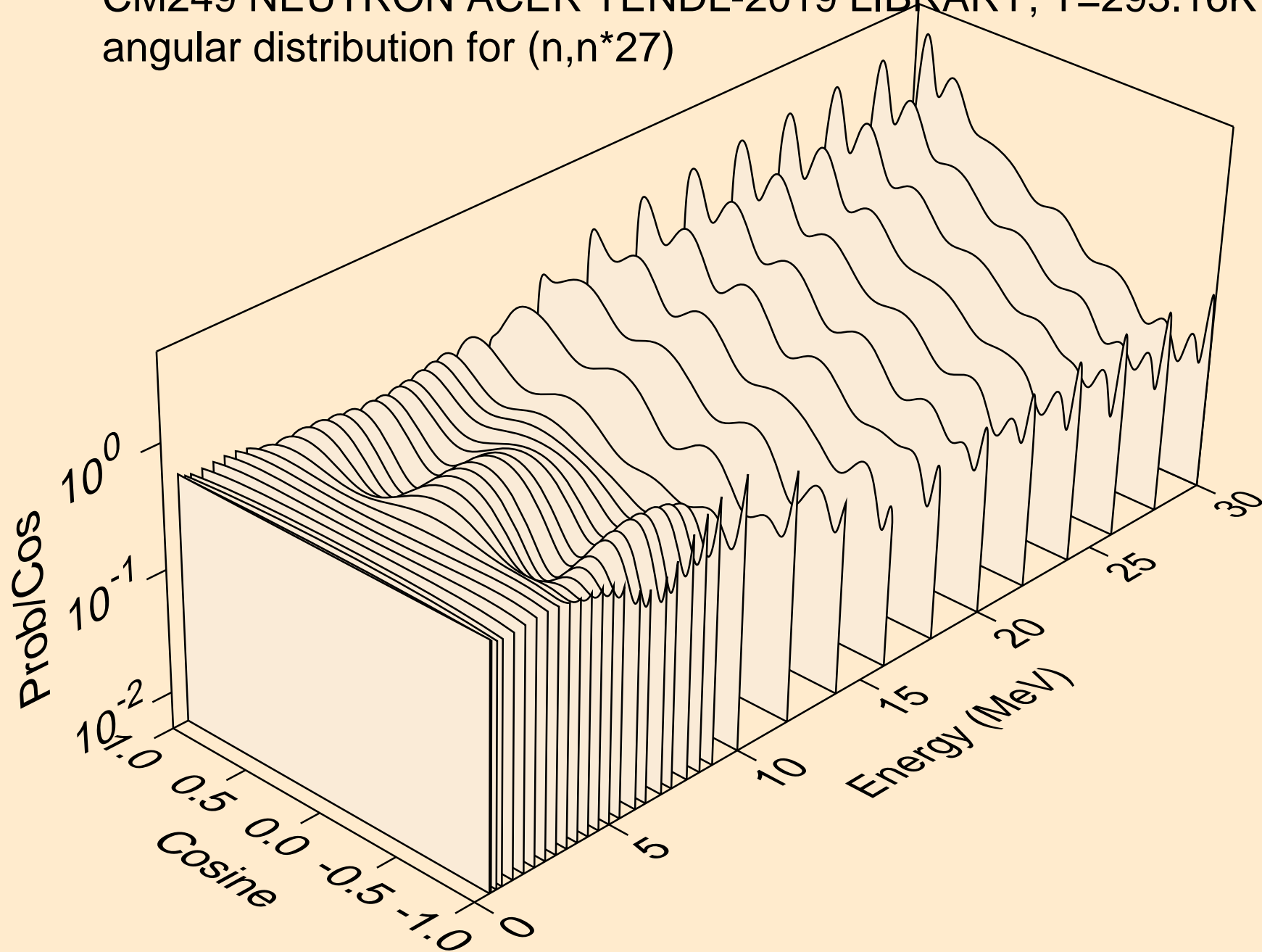

CM249 NEUTRON ACER TENDL-2019 LIBRARY; T=293.16K  
angular distribution for (n,n\*28)

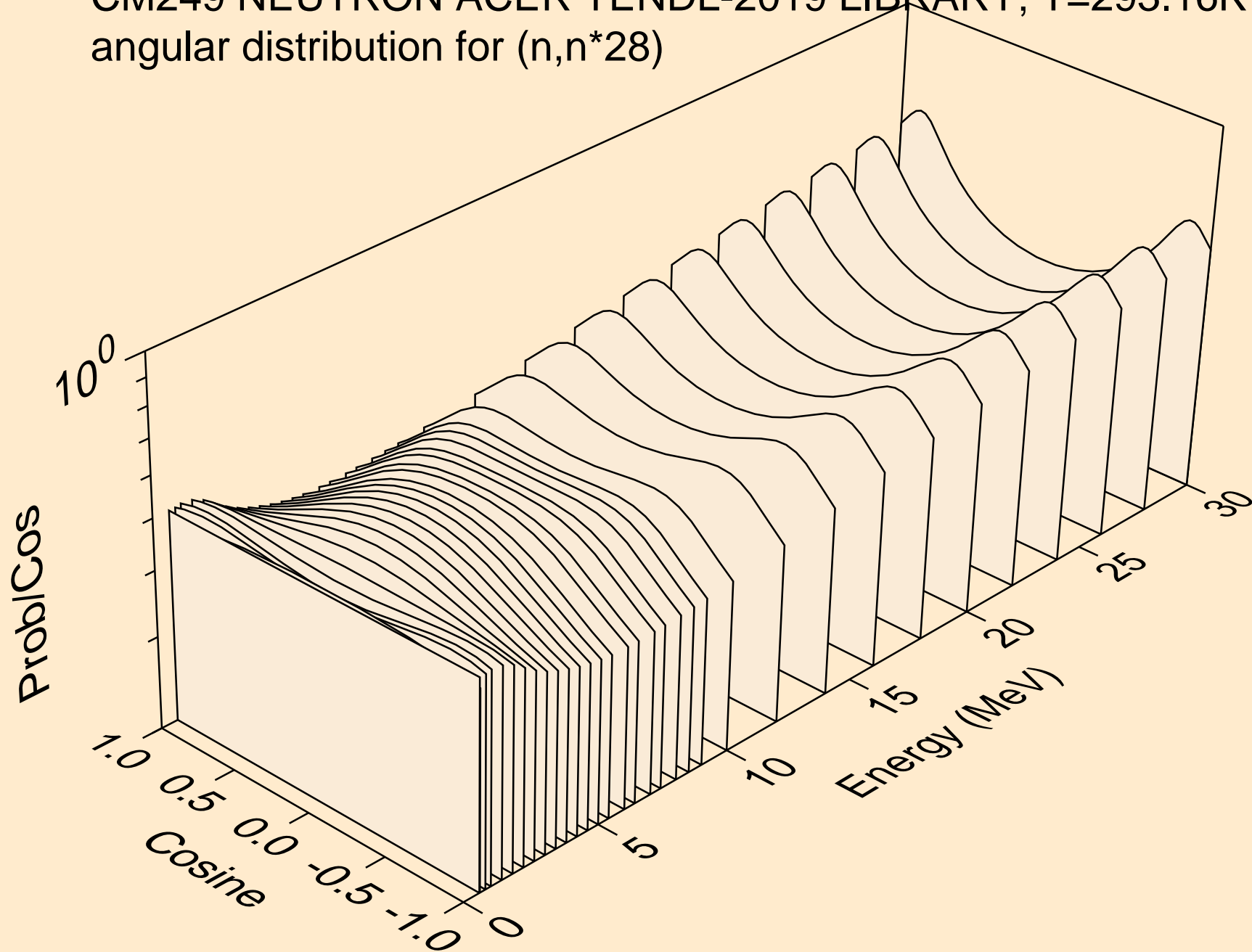

CM249 NEUTRON ACER TENDL-2019 LIBRARY; T=293.16K  
angular distribution for (n,n\*29)

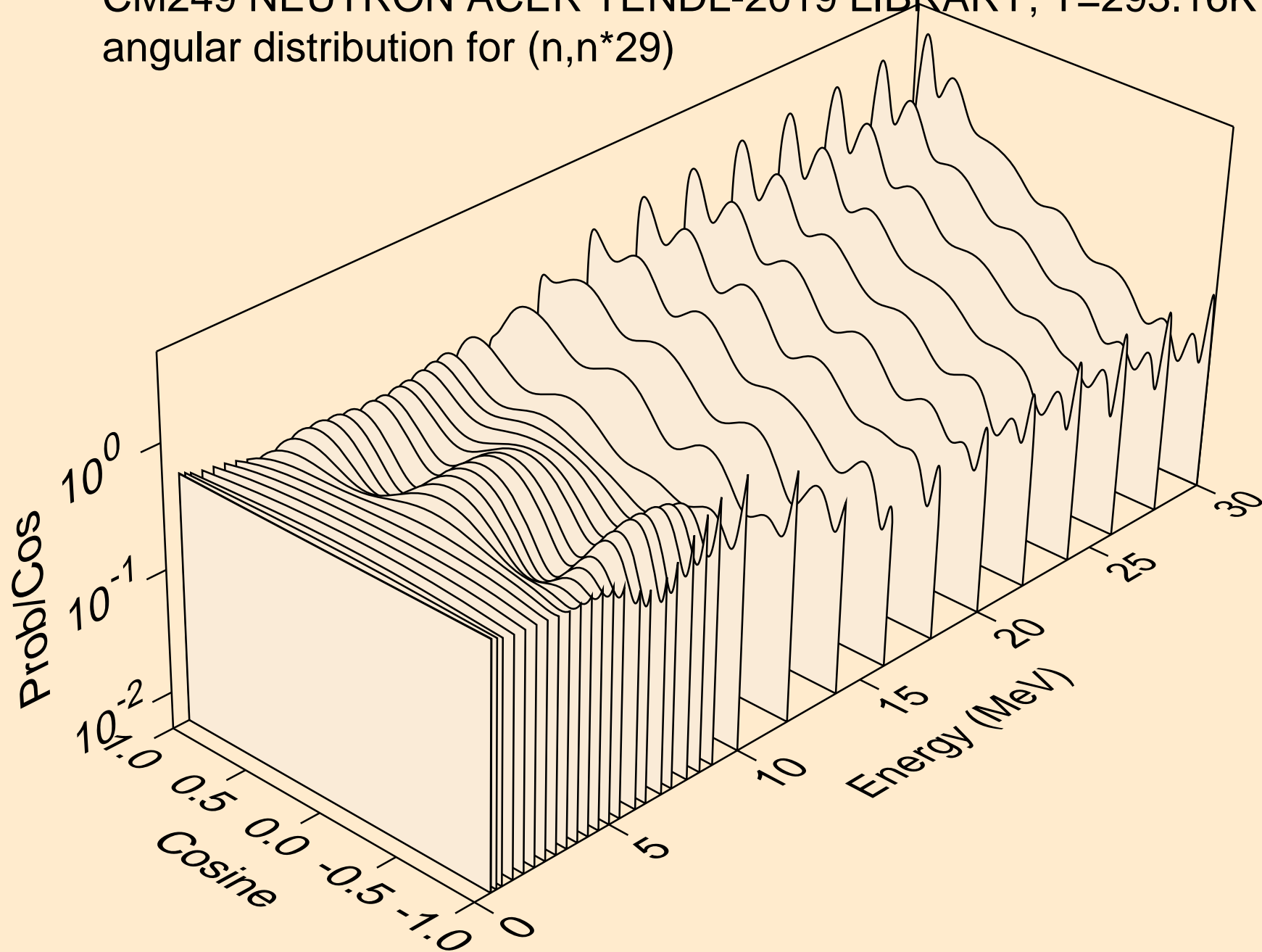

CM249 NEUTRON ACER TENDL-2019 LIBRARY; T=293.16K  
Total fission nubar

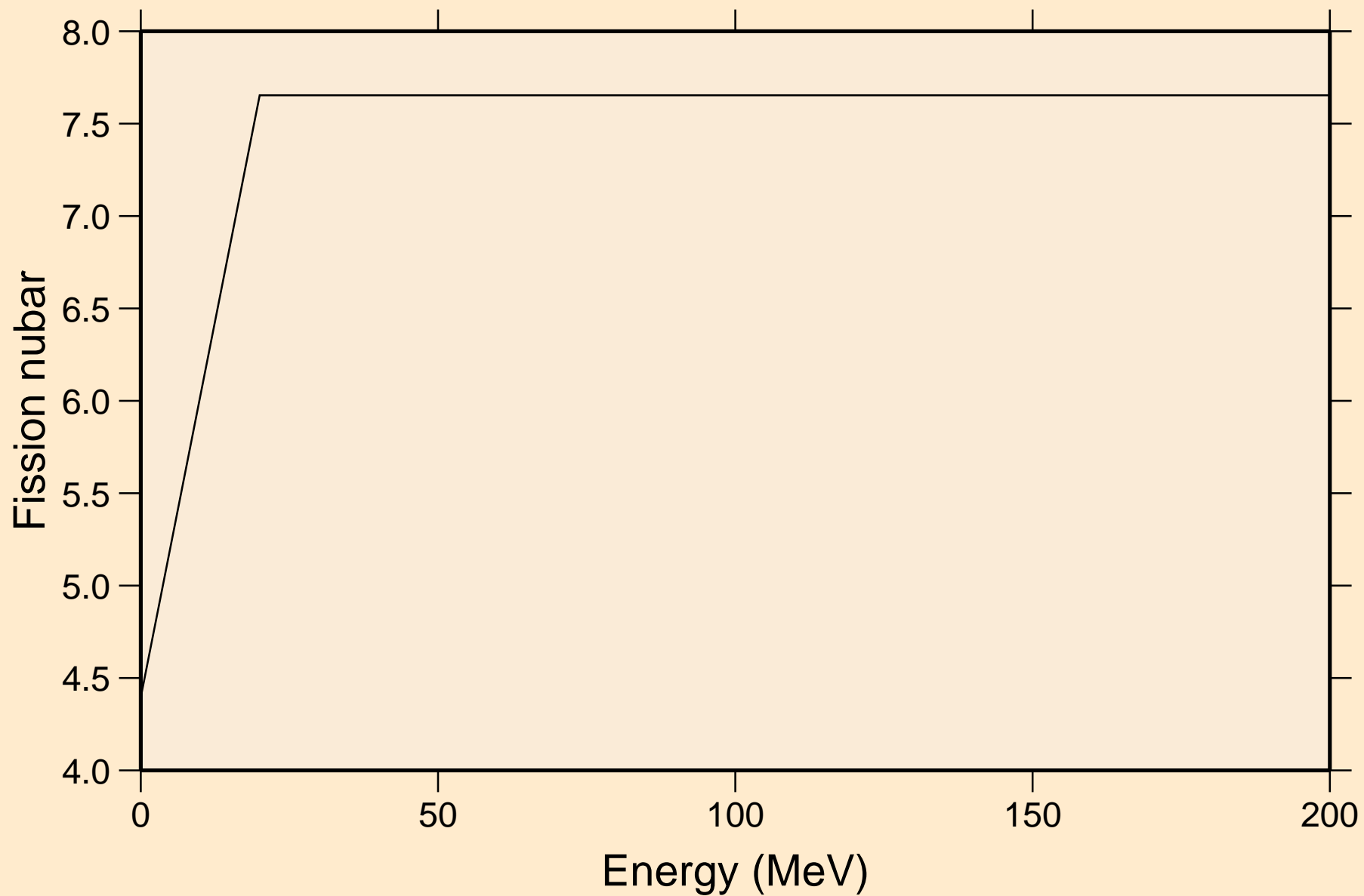

CM249 NEUTRON ACER TENDL-2019 LIBRARY; T=293.16K  
Neutron emission for (n,x)

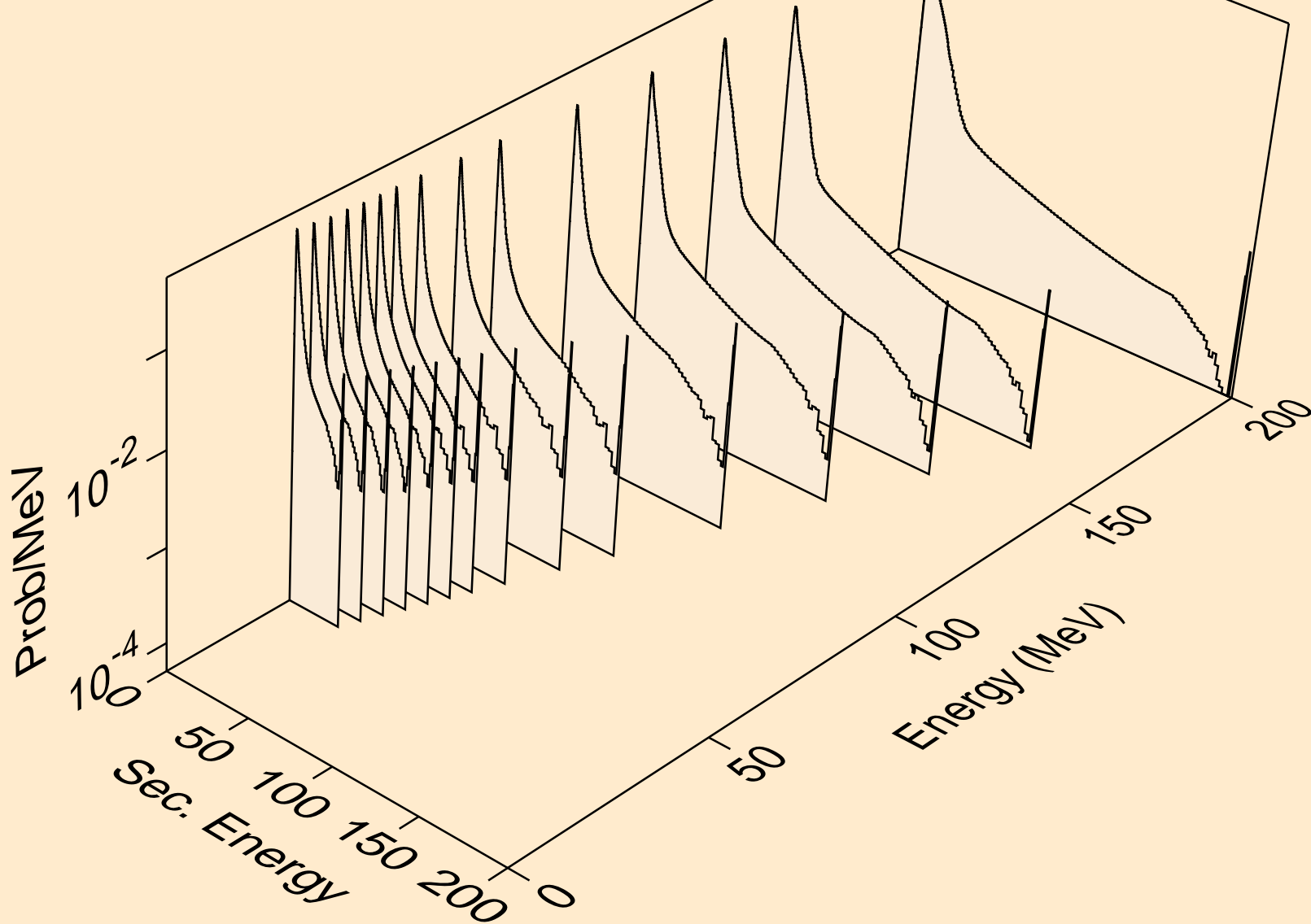

CM249 NEUTRON ACER TENDL-2019 LIBRARY; T=293.16K  
Neutron emission for (n,2nd)

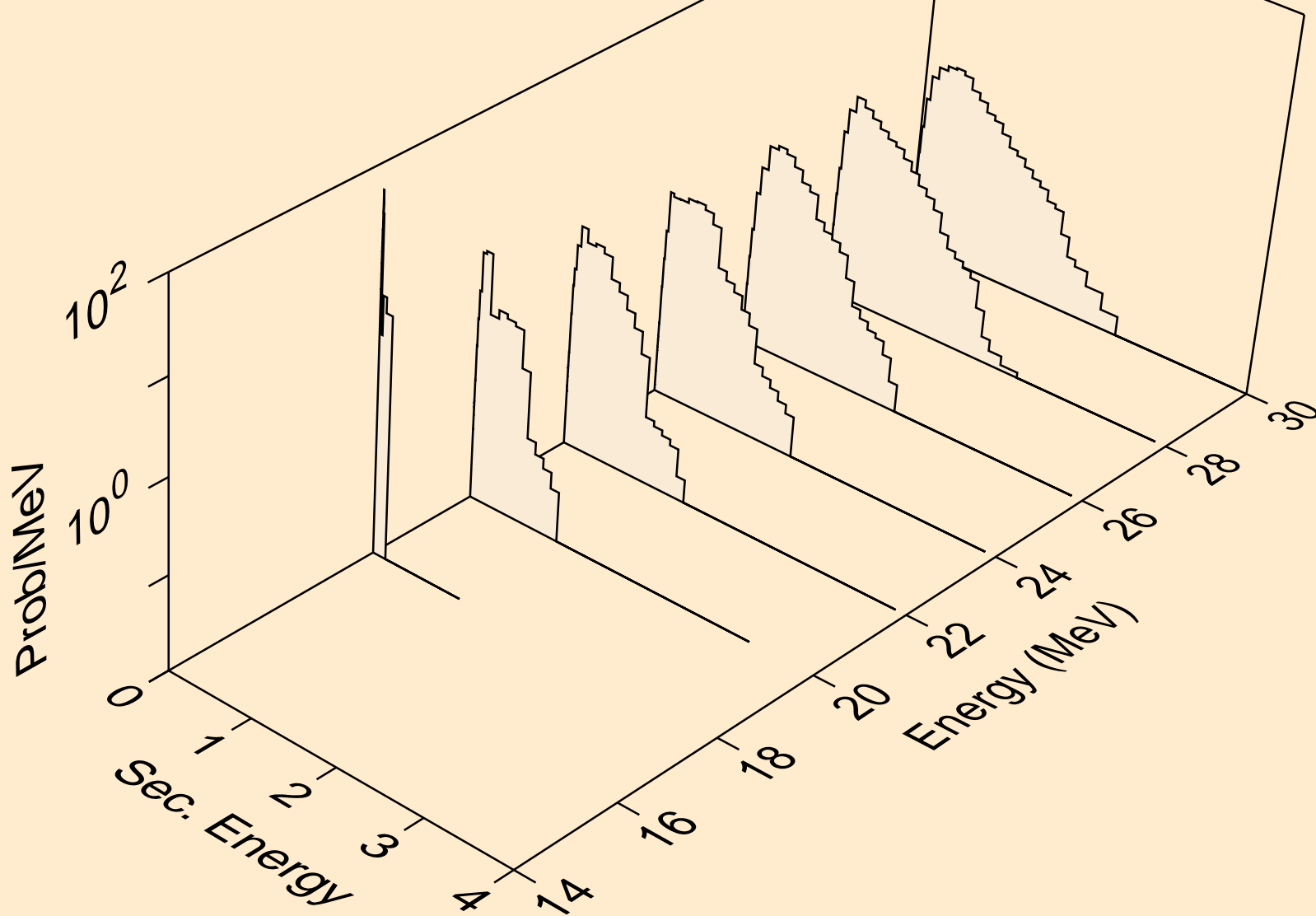

CM249 NEUTRON ACER TENDL-2019 LIBRARY; T=293.16K  
Neutron emission for (n,2n)

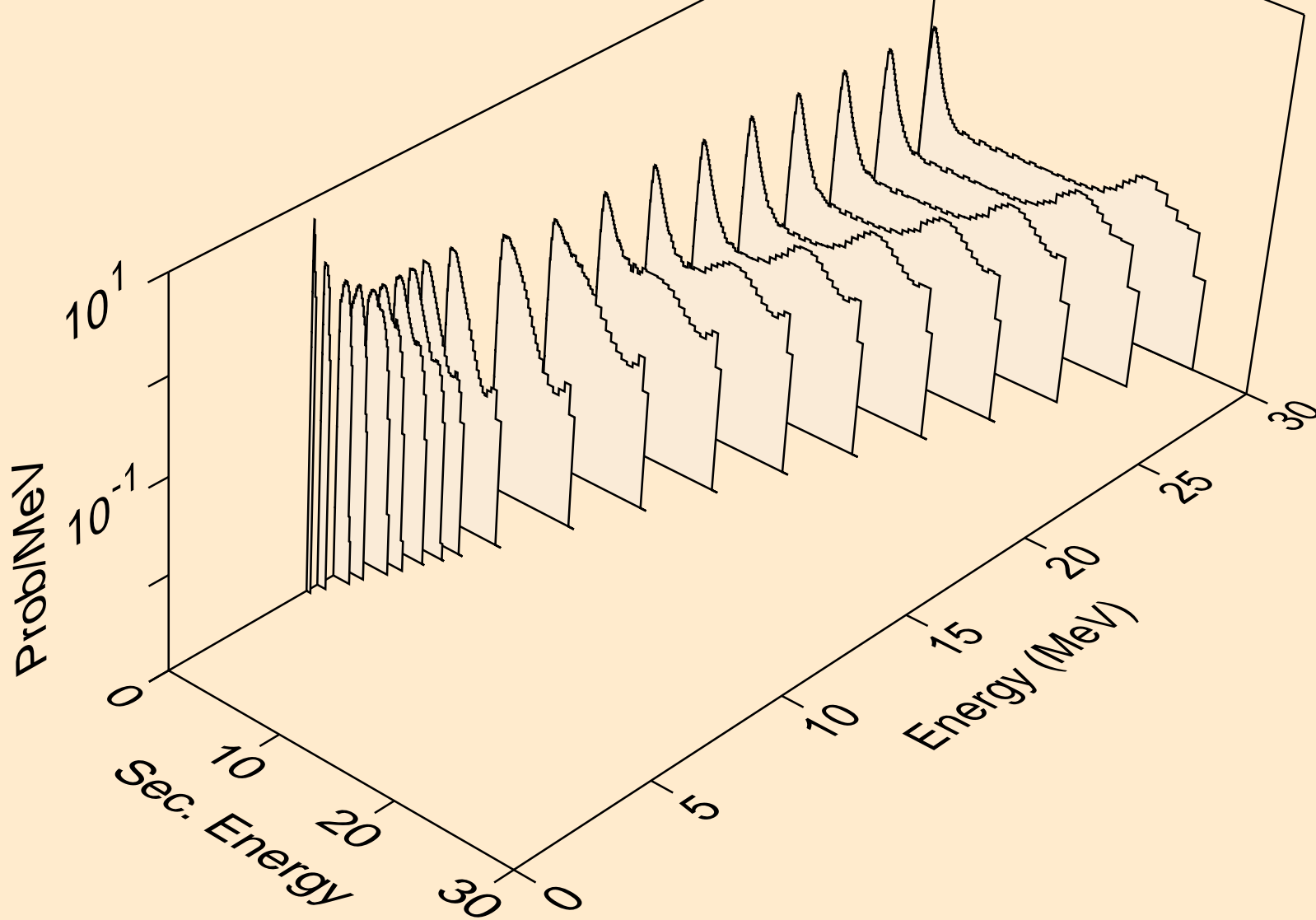

CM249 NEUTRON ACER TENDL-2019 LIBRARY; T=293.16K  
Neutron emission for (n,3n)

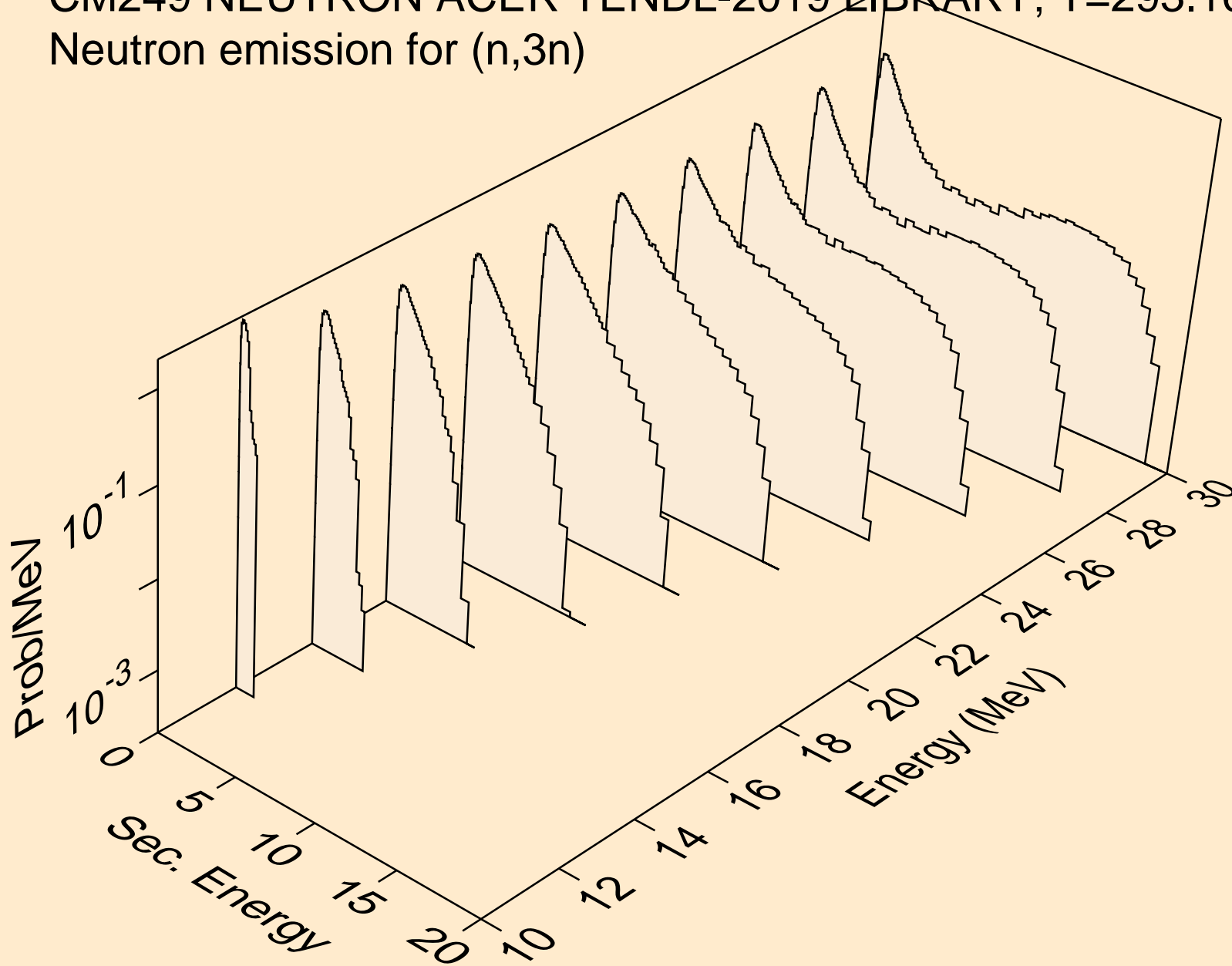

CM249 NEUTRON ACER TENDL-2019 LIBRARY; T=293.16K  
Neutron emission for fission

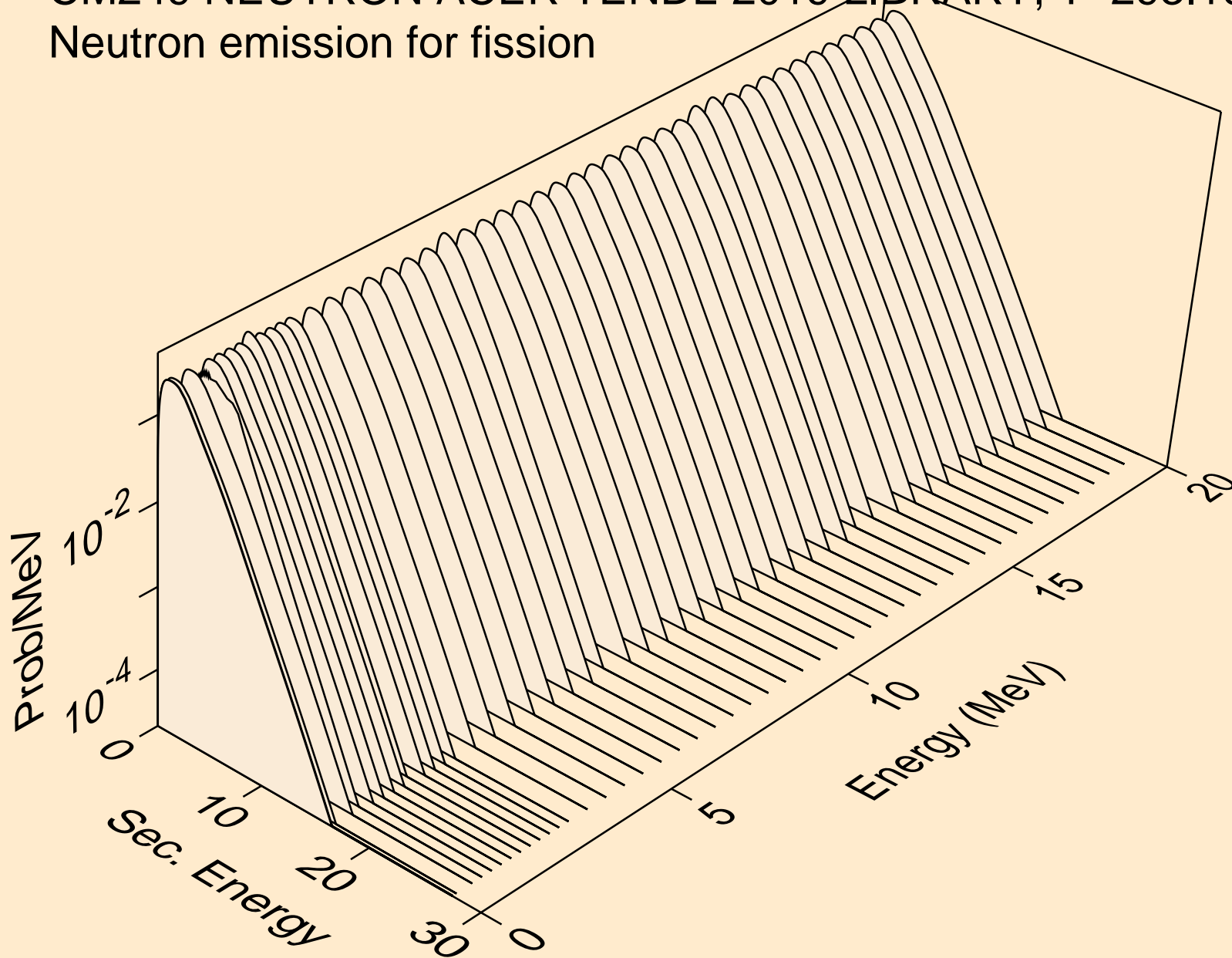

CM249 NEUTRON ACER TENDL-2019 LIBRARY; T=293.16K  
Neutron emission for (n,n\*)a

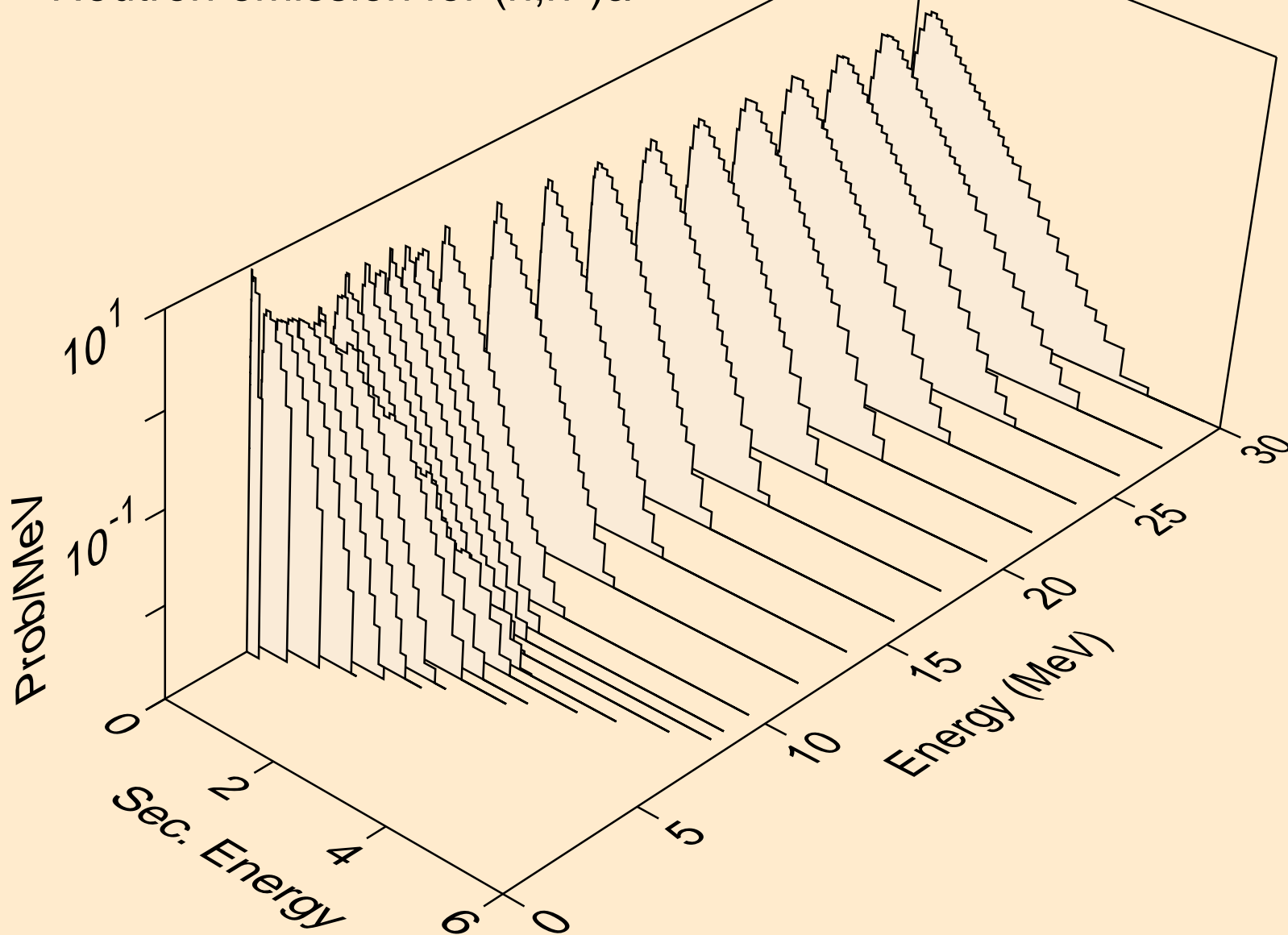

CM249 NEUTRON ACER TENDL-2019 LIBRARY; T=293.16K  
Neutron emission for (n,2n)a

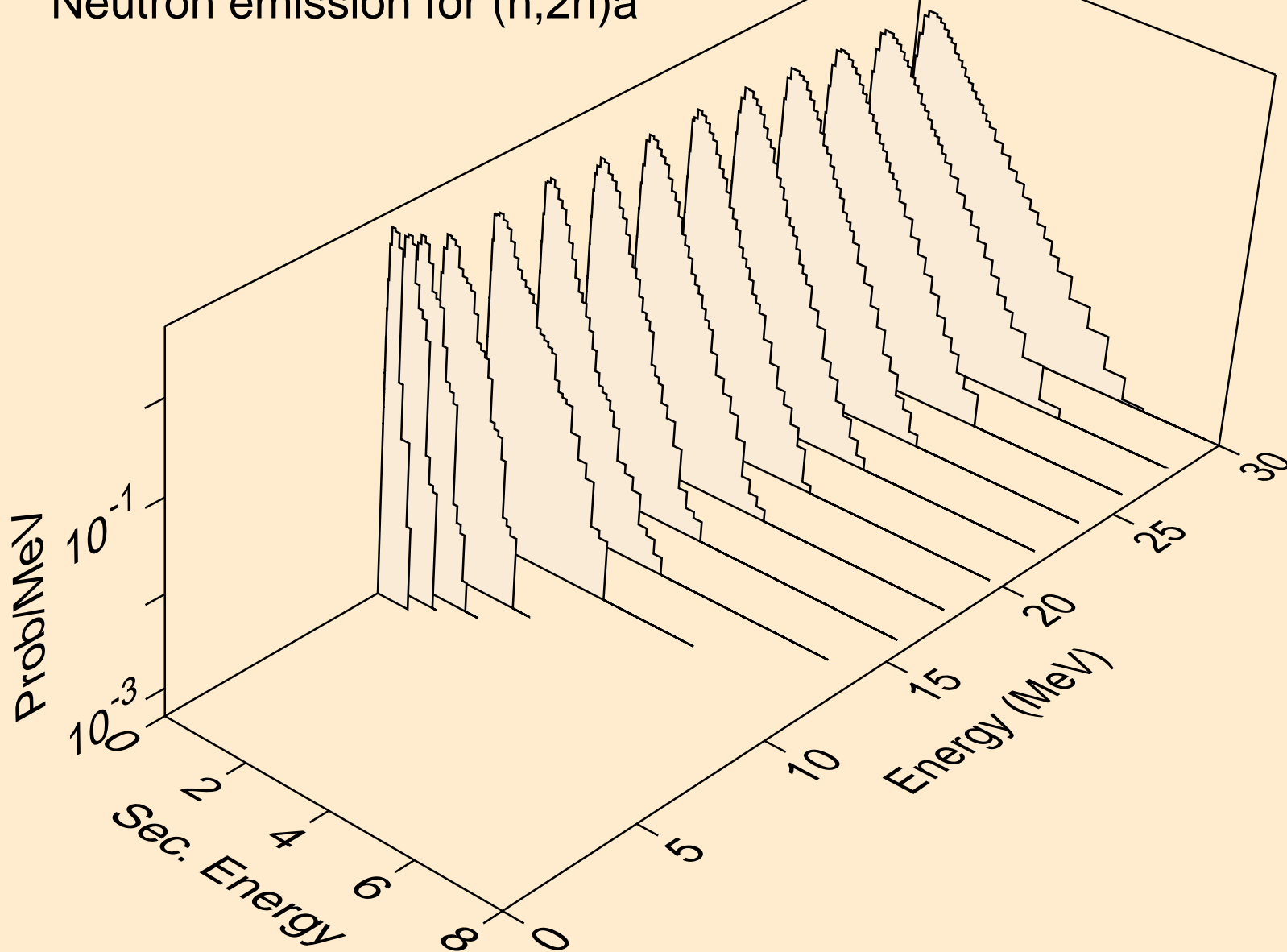

CM249 NEUTRON ACER TENDL-2019 LIBRARY; T=293.16K  
Neutron emission for (n,3n)a

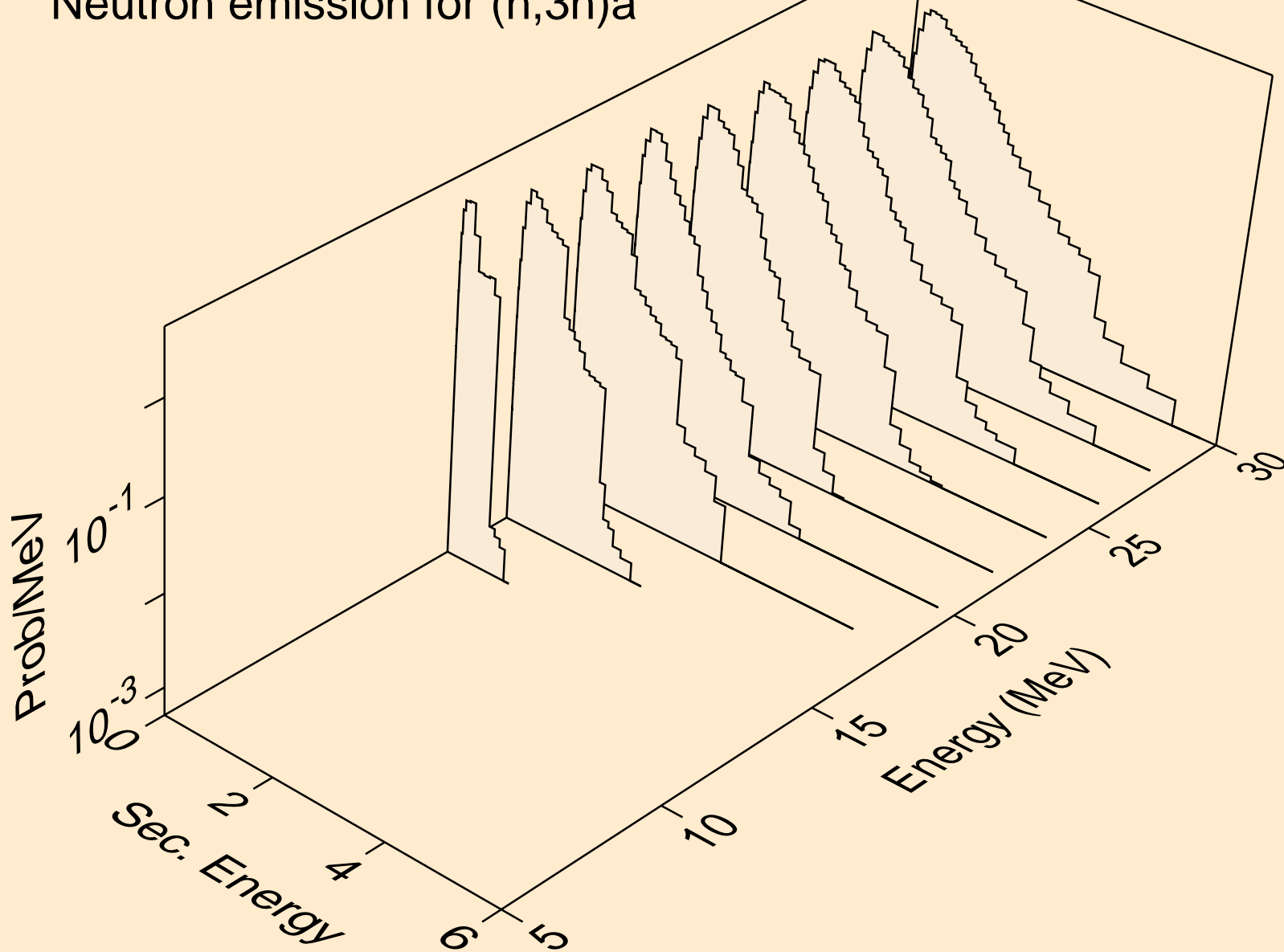

CM249 NEUTRON ACER TENDL-2019 LIBRARY; T=293.16K  
Neutron emission for (n,n\*)p

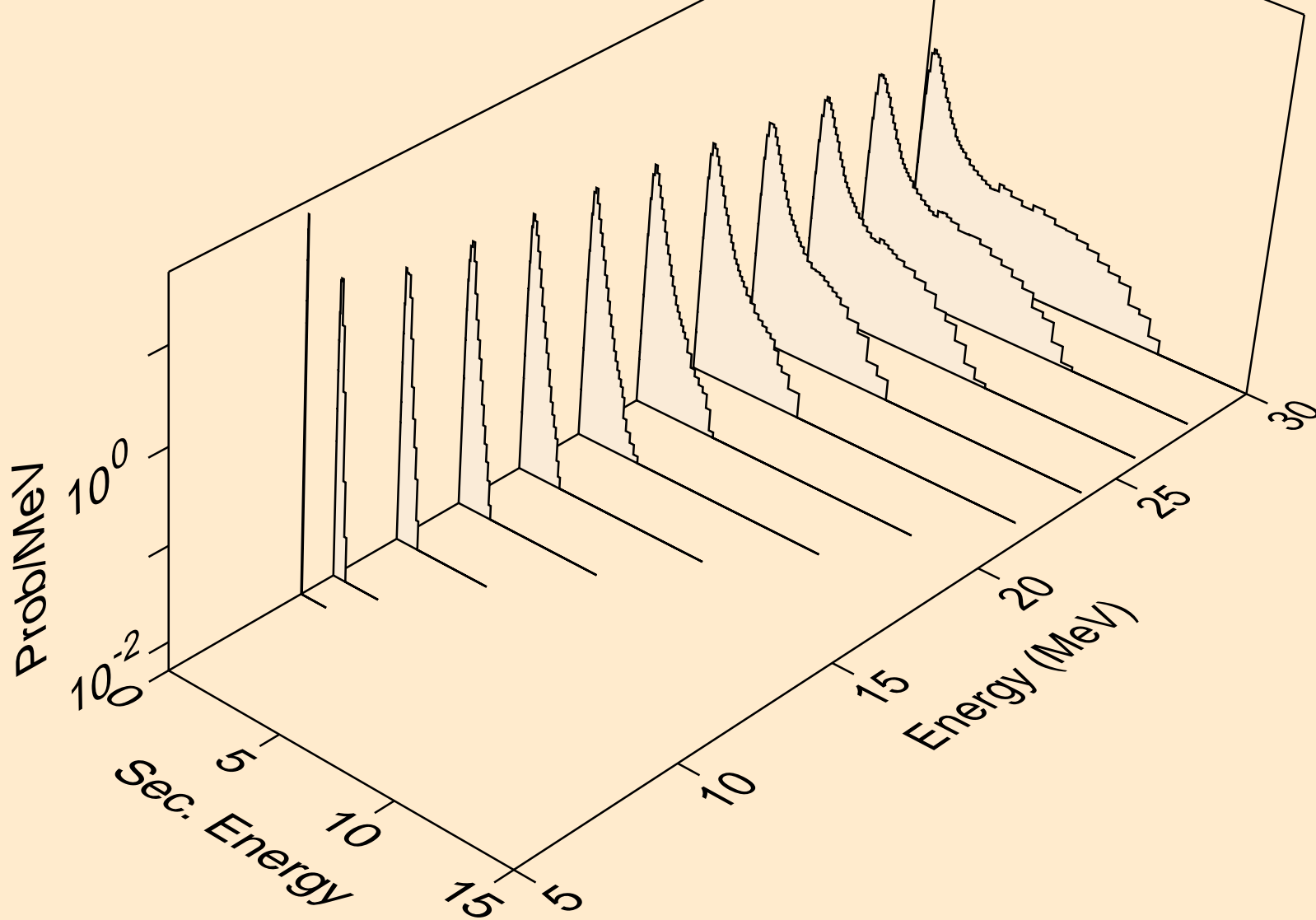

CM249 NEUTRON ACER TENDL-2019 LIBRARY; T=293.16K  
Neutron emission for (n,n\*)d

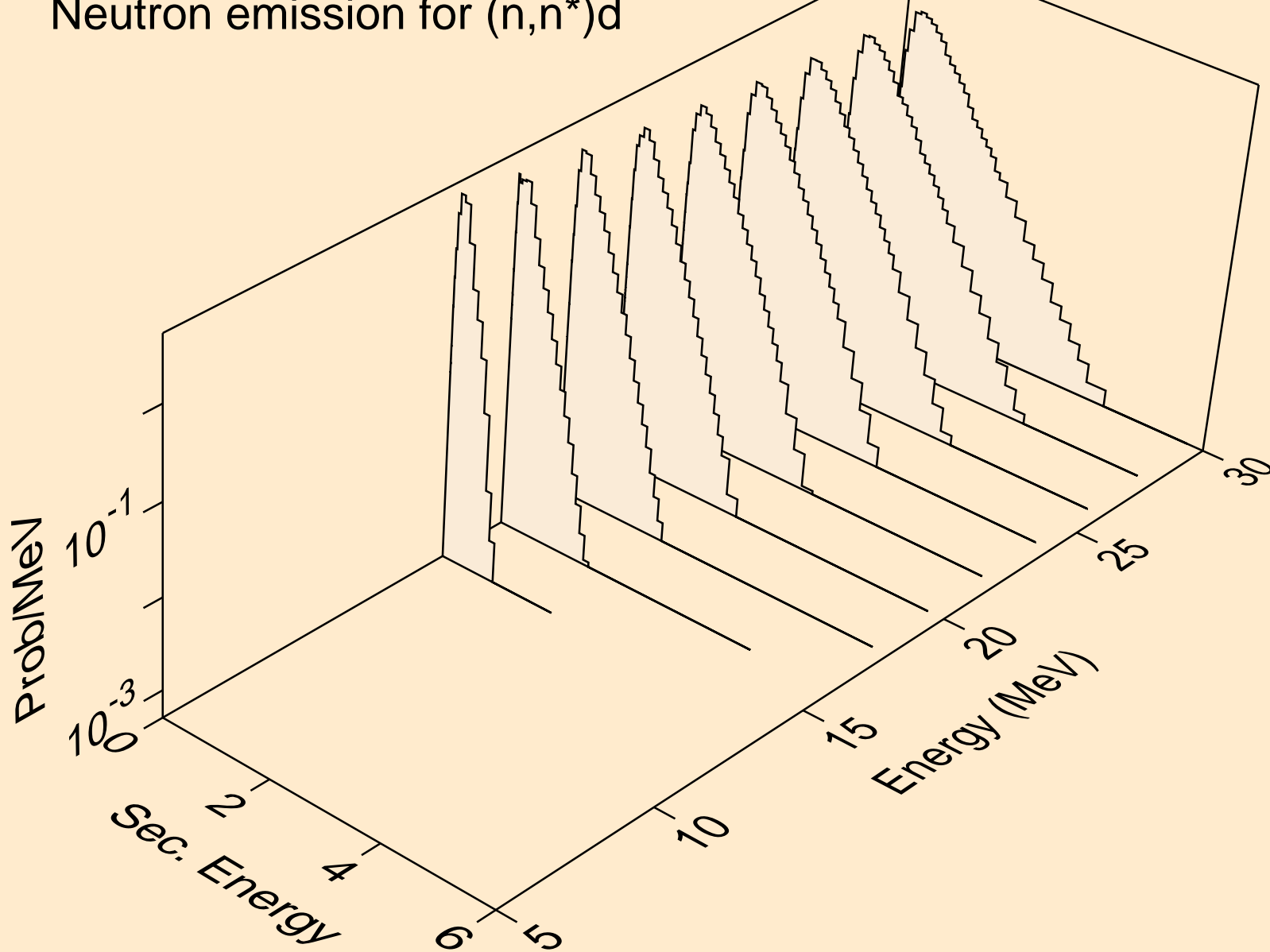

CM249 NEUTRON ACER TENDL-2019 LIBRARY; T=293.16K  
Neutron emission for (n,n\*)t

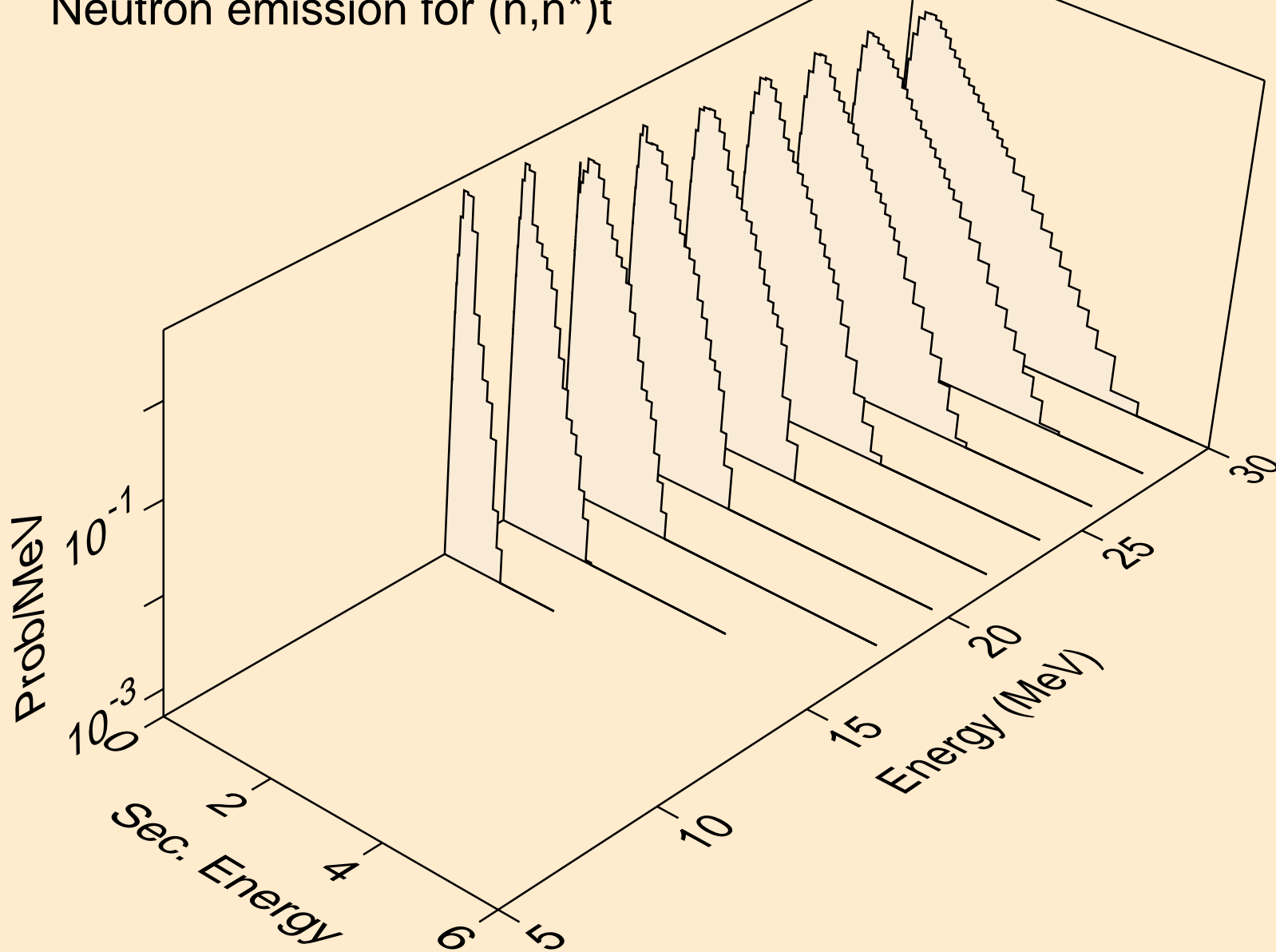

CM249 NEUTRON ACER TENDL-2019 LIBRARY; T=293.16K  
Neutron emission for (n,n\*)he3

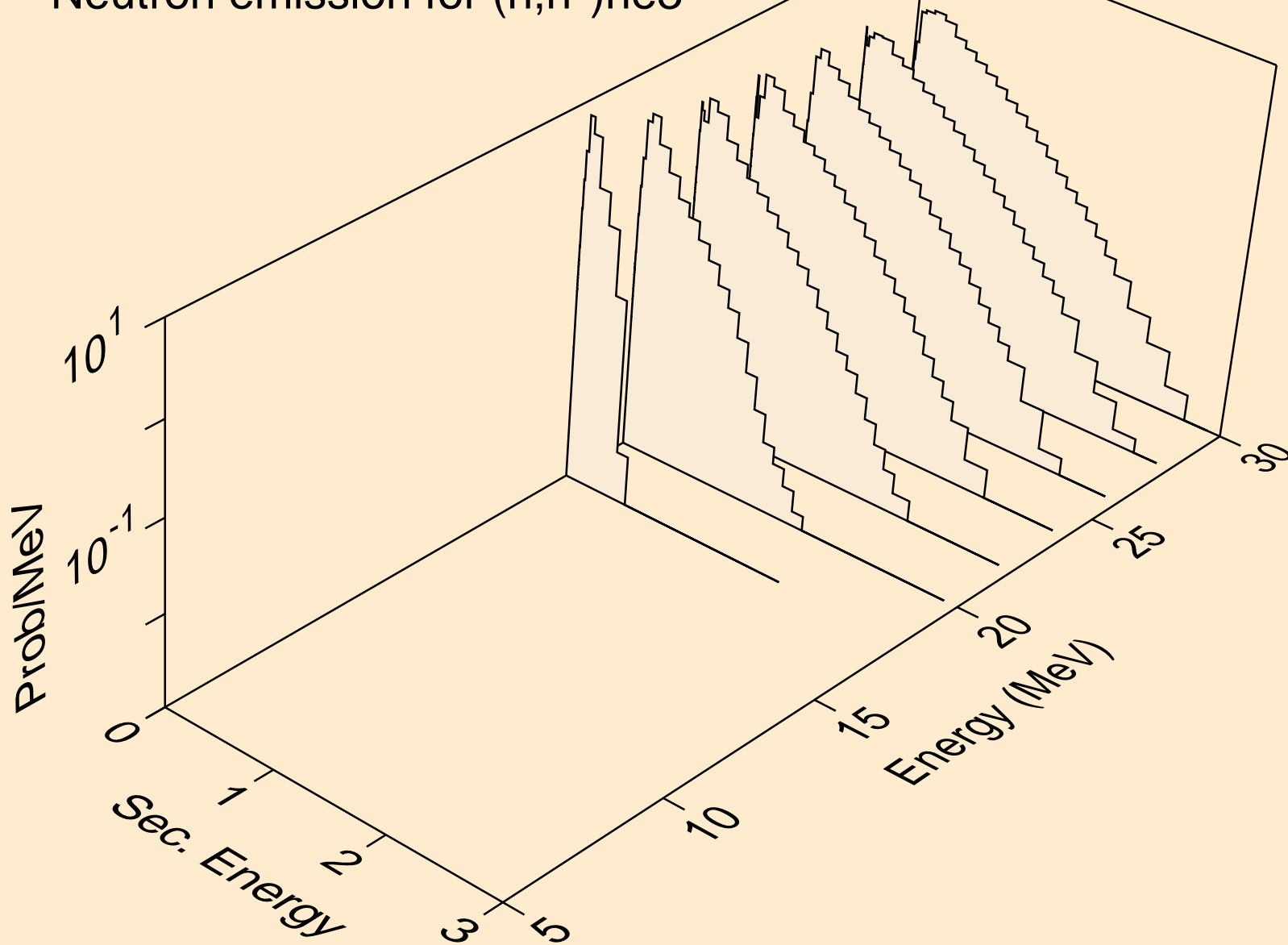

CM249 NEUTRON ACER TENDL-2019 LIBRARY; T=293.16K  
Neutron emission for (n,4n)

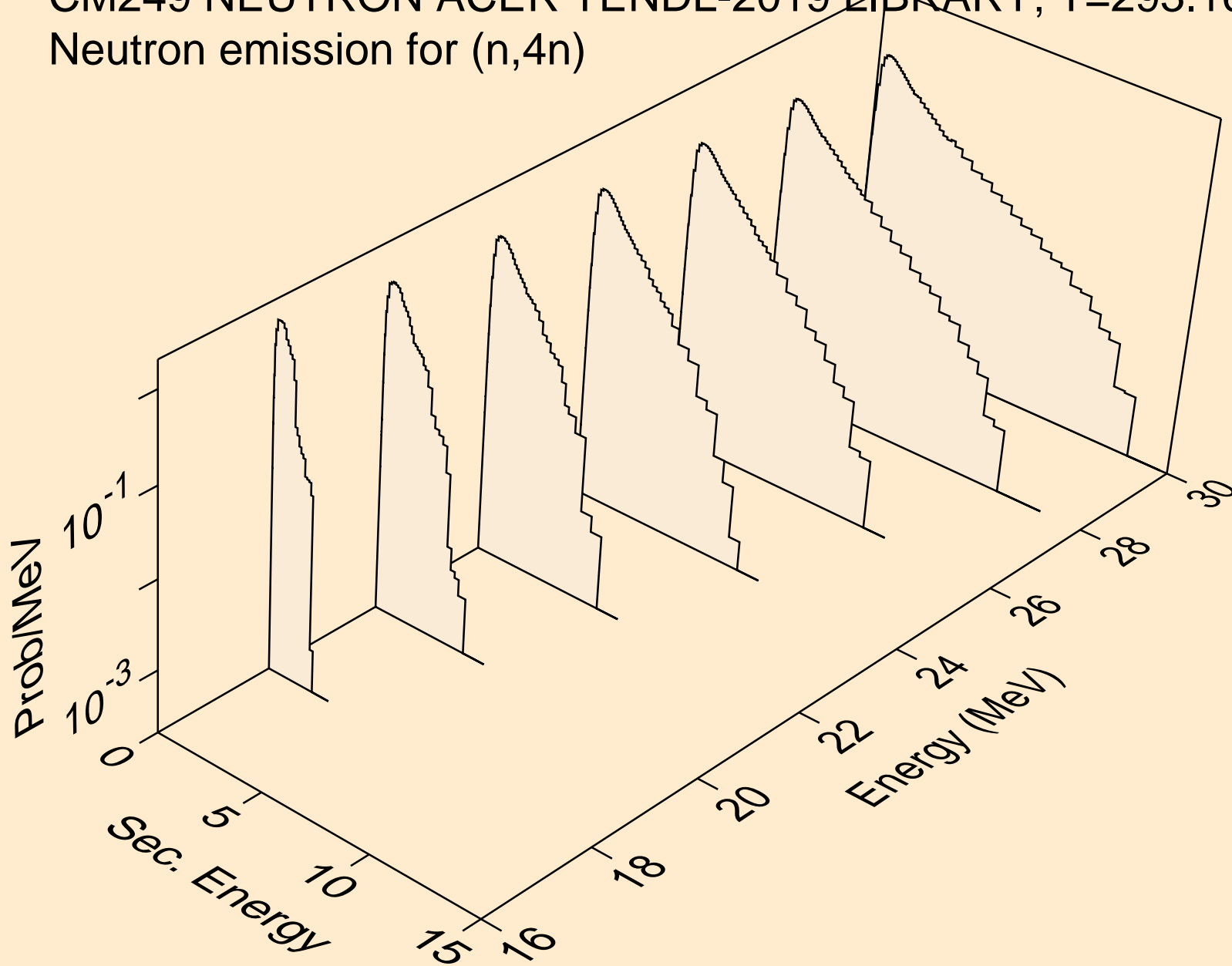

CM249 NEUTRON ACER TENDL-2019 LIBRARY; T=293.16K  
Neutron emission for (n,2np)

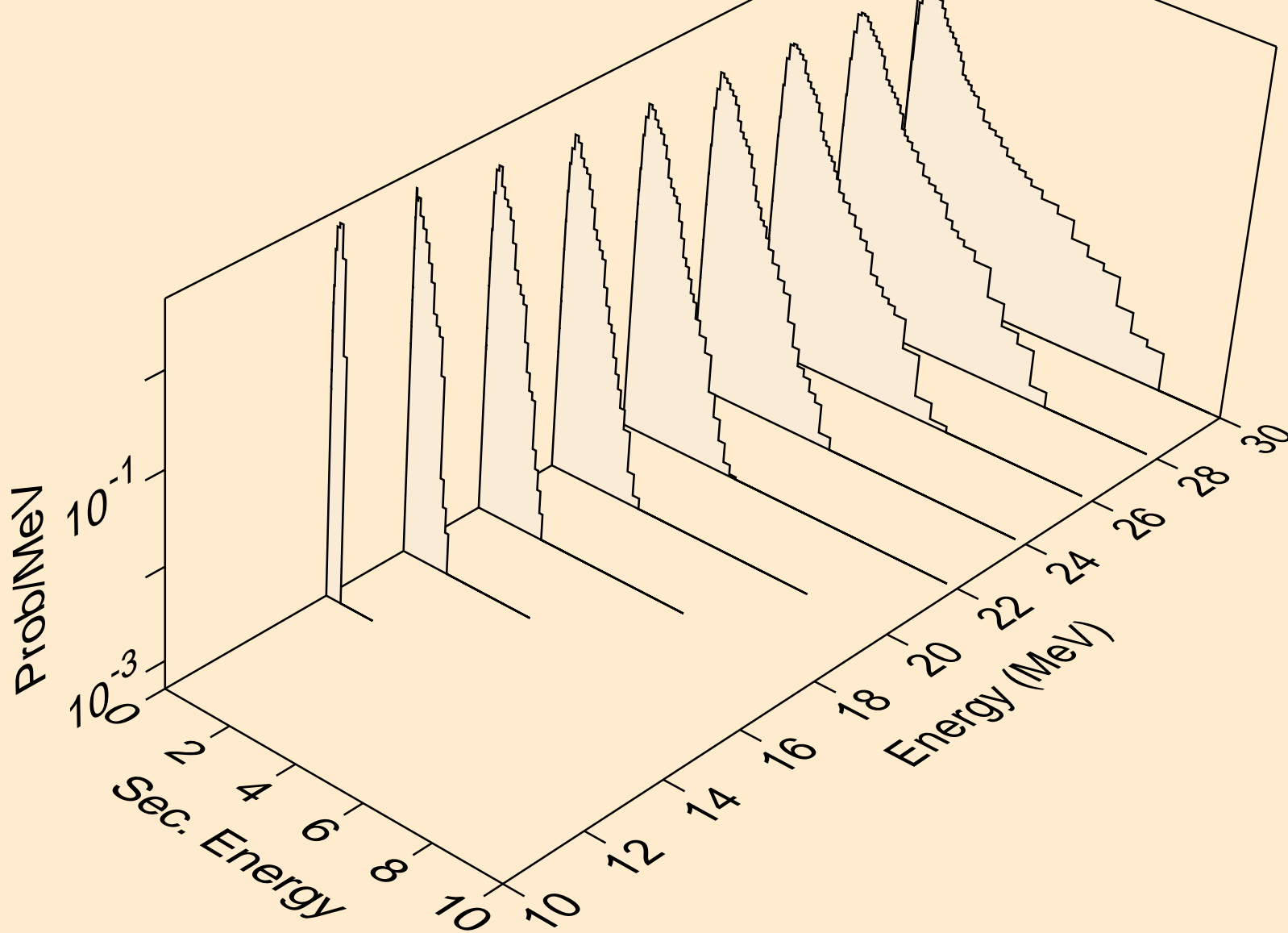

CM249 NEUTRON ACER TENDL-2019 LIBRARY; T=293.16K  
Neutron emission for (n,3np)

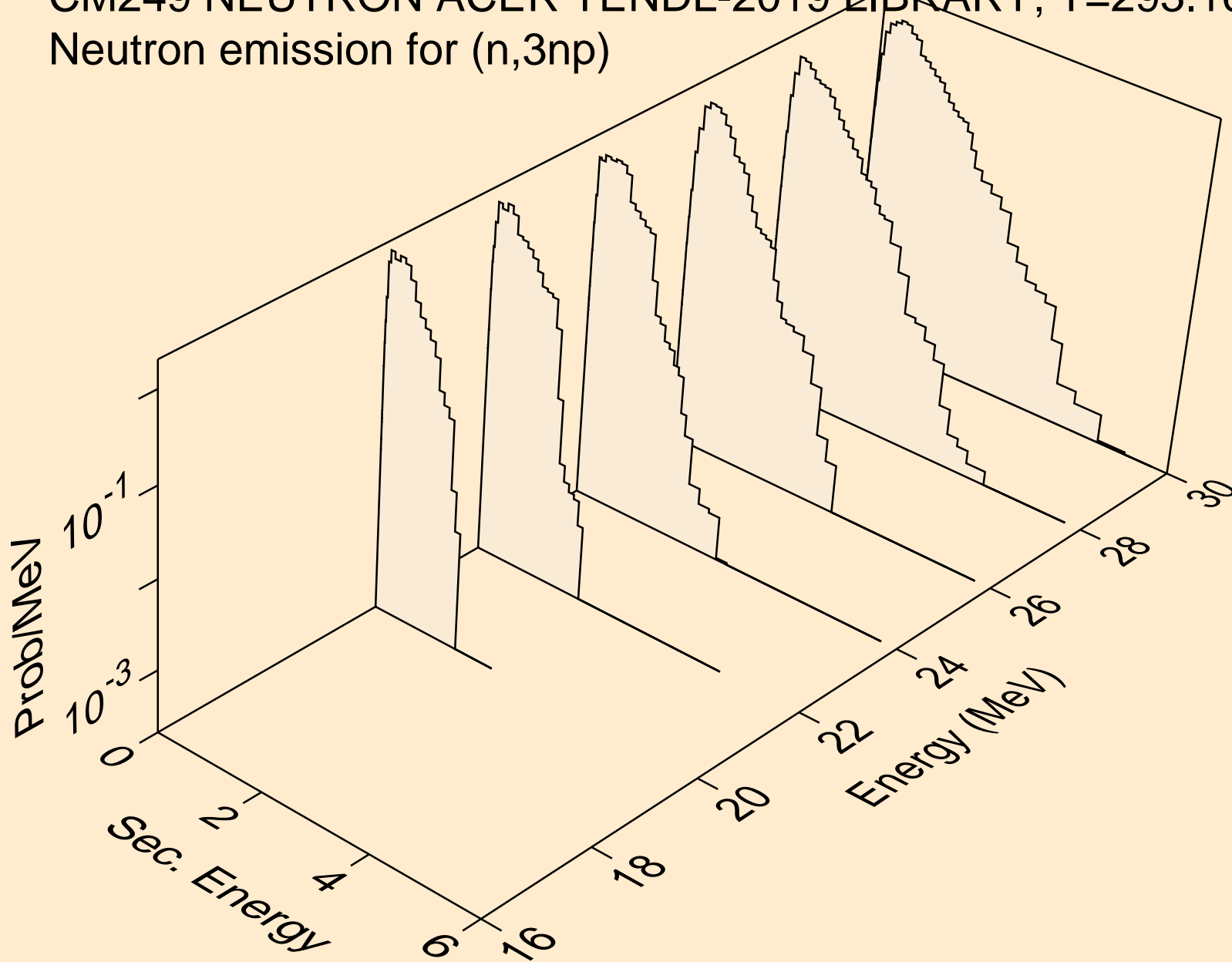

CM249 NEUTRON ACER TENDL-2019 LIBRARY; T=293.16K  
Neutron emission for (n,2np)

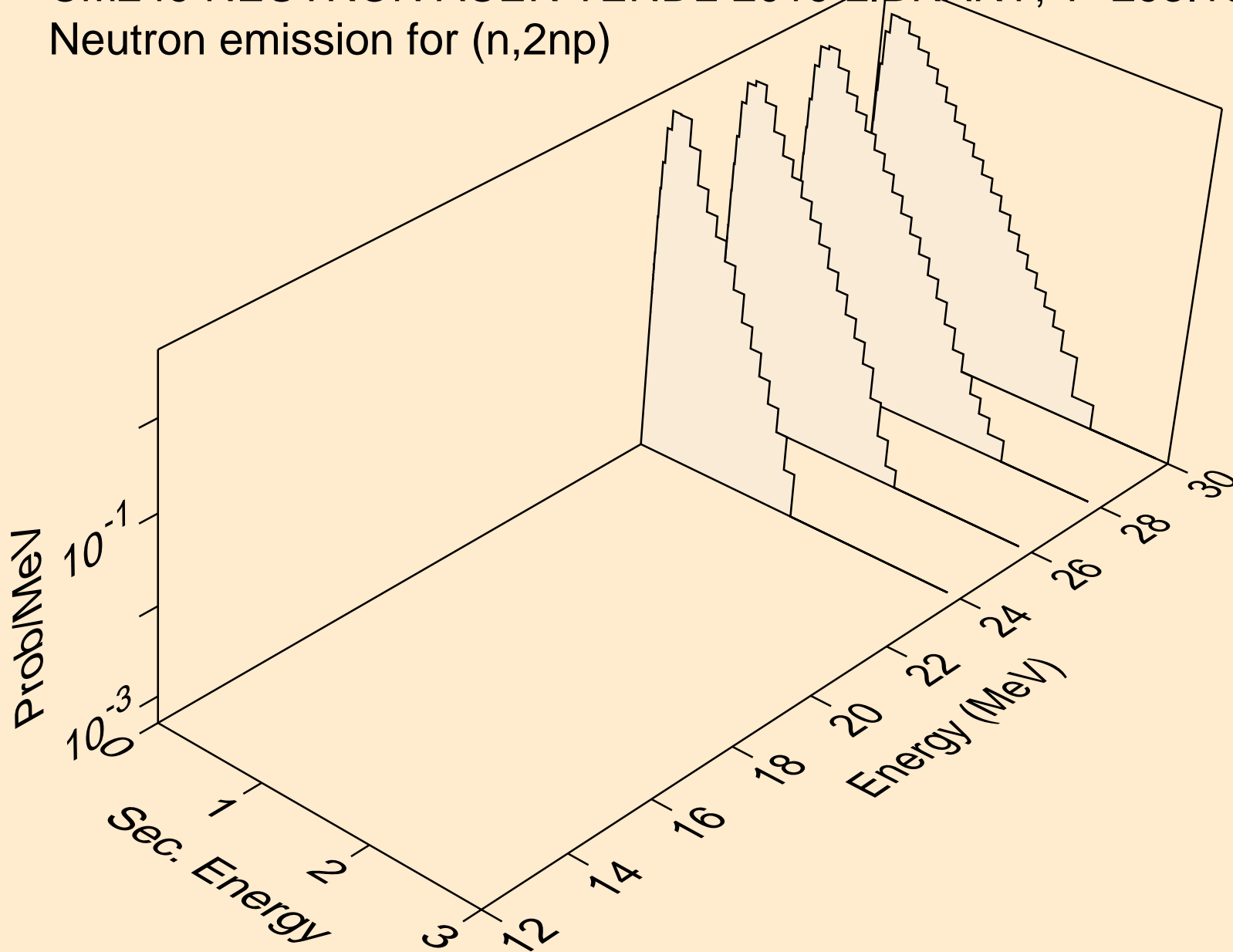

CM249 NEUTRON ACER TENDL-2019 LIBRARY; T=293.16K  
Neutron emission for (n,n\*c)

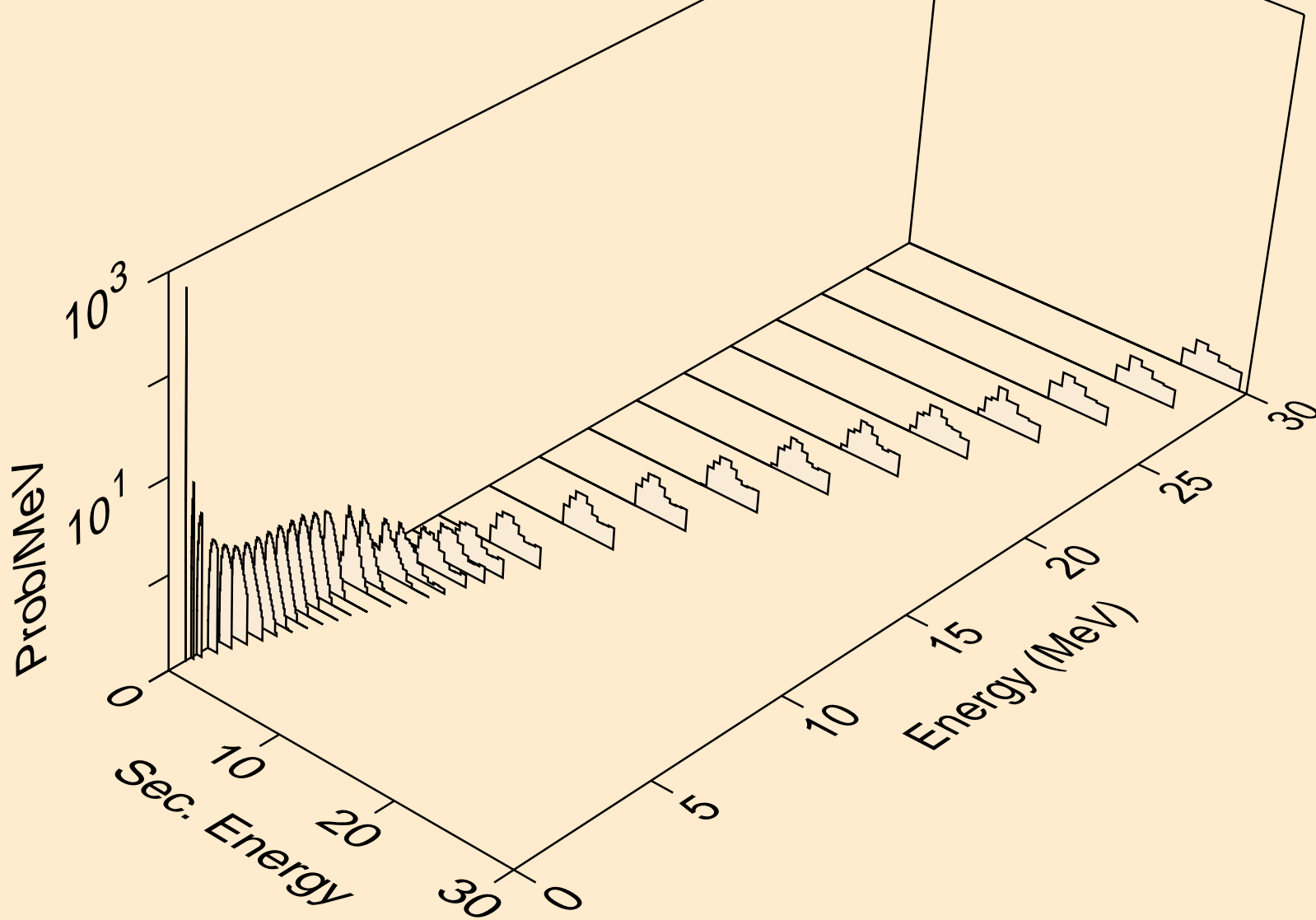

# CM249 NEUTRON ACER TENDL-2019 LIBRARY; T=293.16K

## Delayed nubar

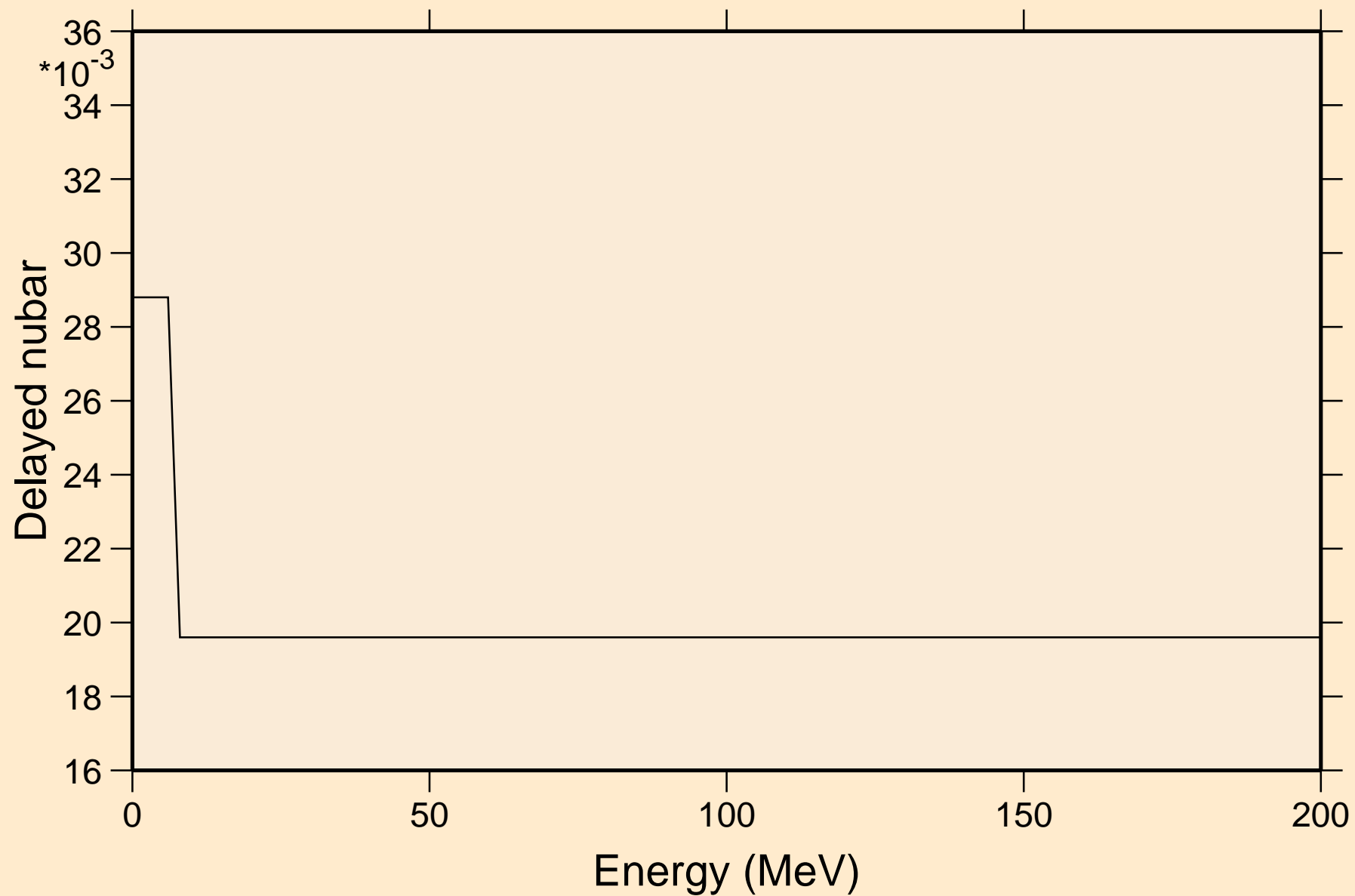

# CM249 NEUTRON ACER TENDL-2019 LIBRARY; T=293.16K

## Delayed neutron spectra

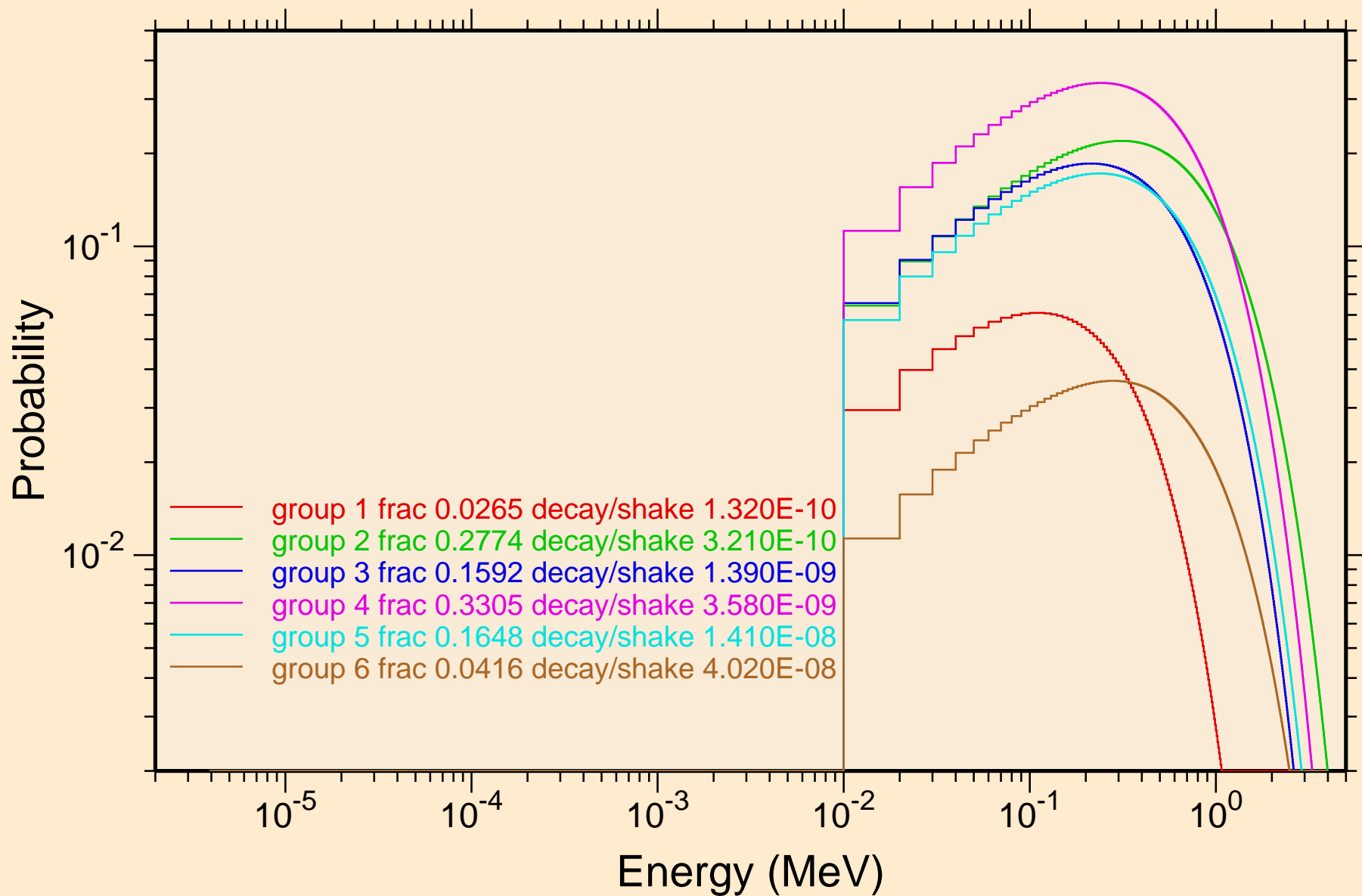

CM249 NEUTRON ACER TENDL-2019 LIBRARY; T=293.16K  
Photon emission for (n,x)

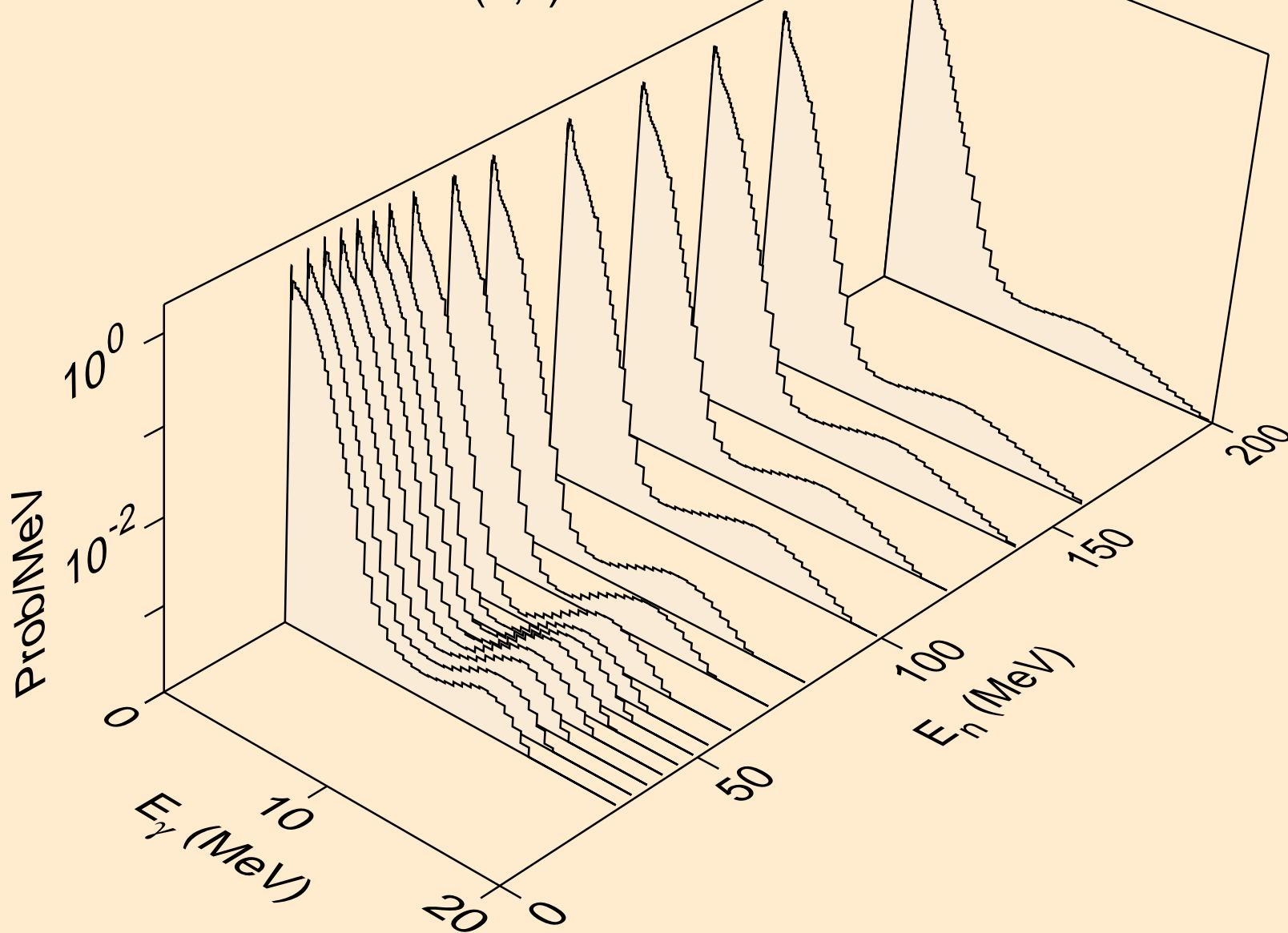

CM249 NEUTRON ACER TENDL-2019 LIBRARY; T=293.16K  
Photon emission for (n,2nd)

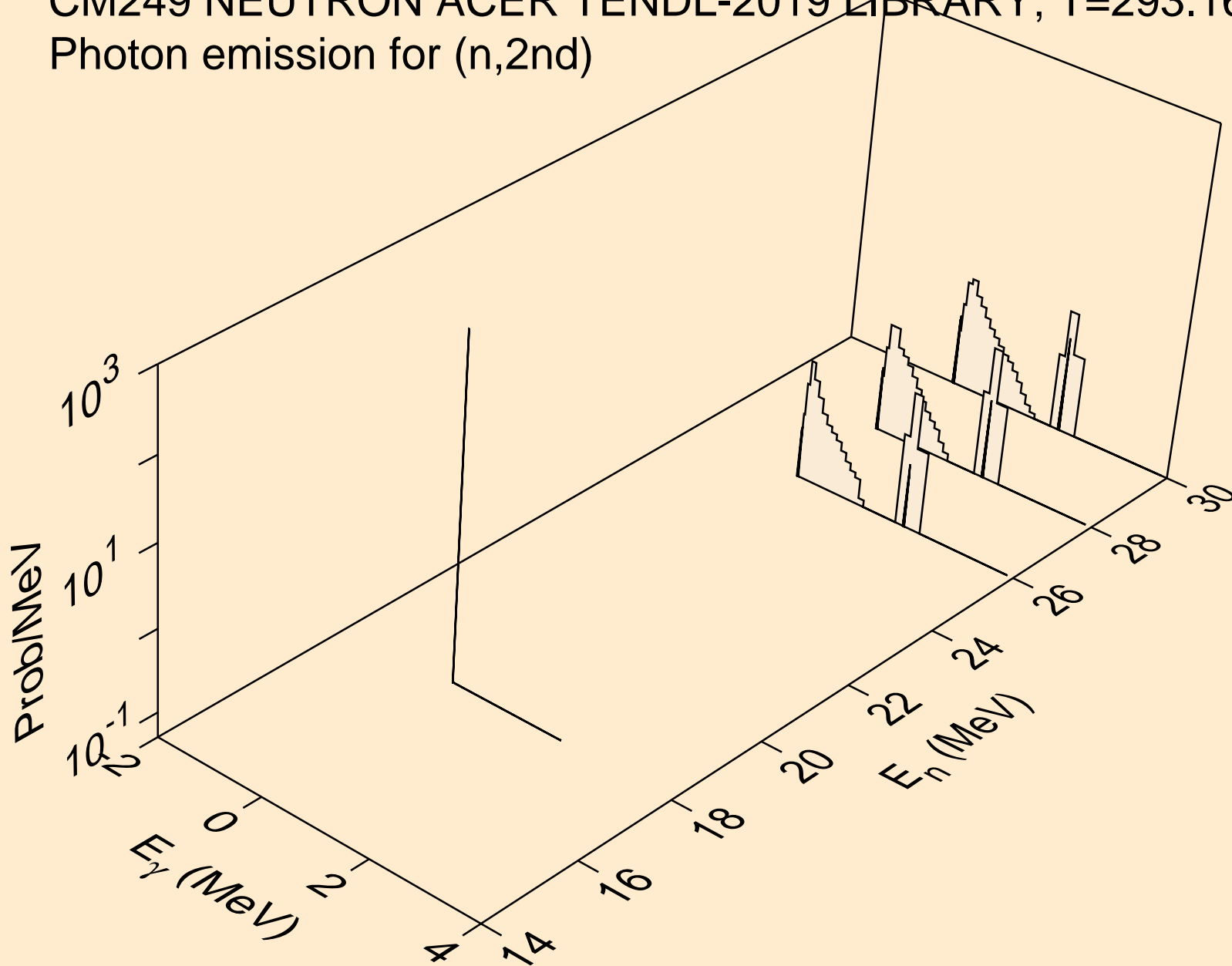

CM249 NEUTRON ACER TENDL-2019 LIBRARY; T=293.16K  
Photon emission for (n,2n)

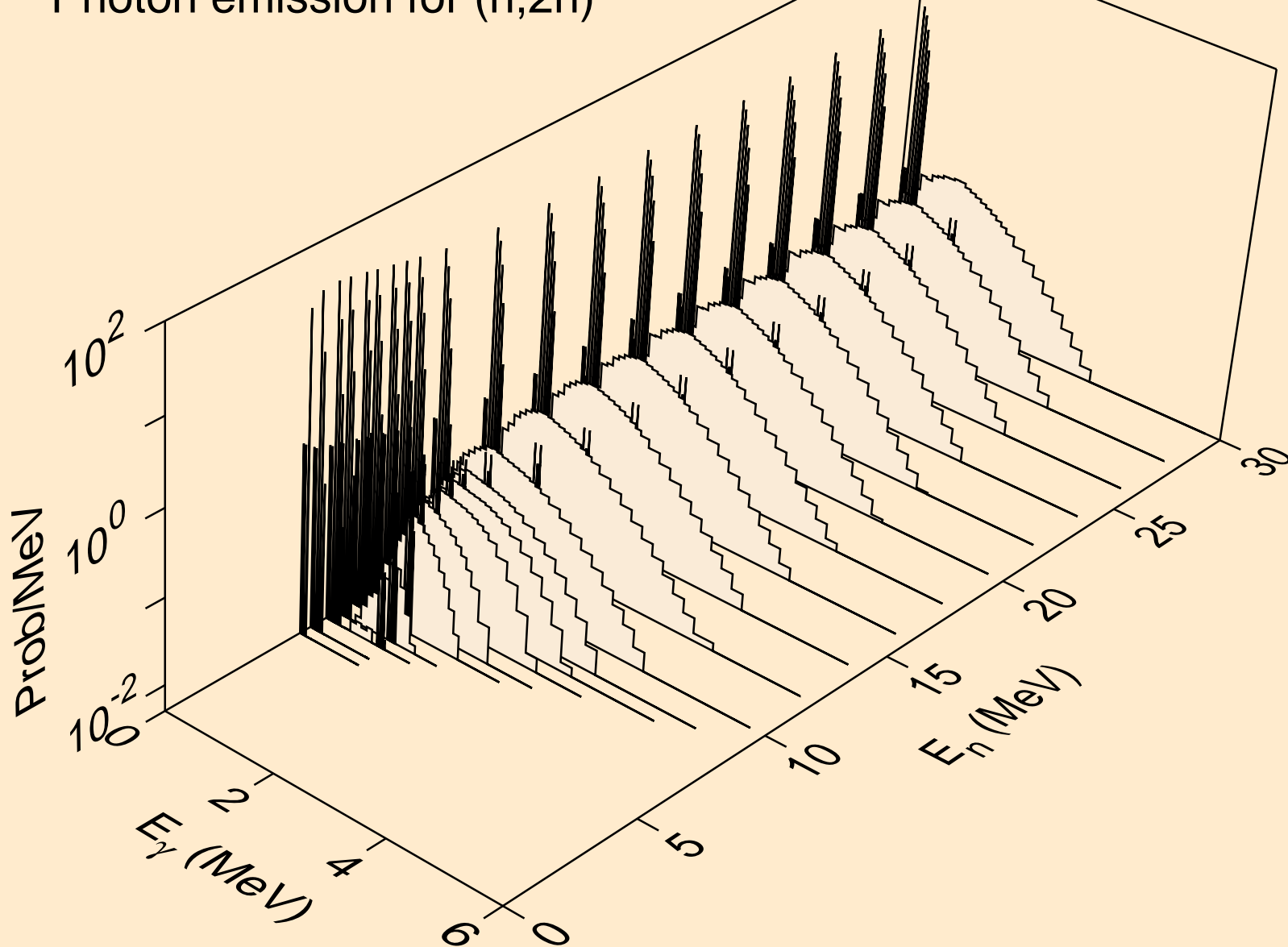

CM249 NEUTRON ACER TENDL-2019 LIBRARY; T=293.16K  
Photon emission for (n,3n)

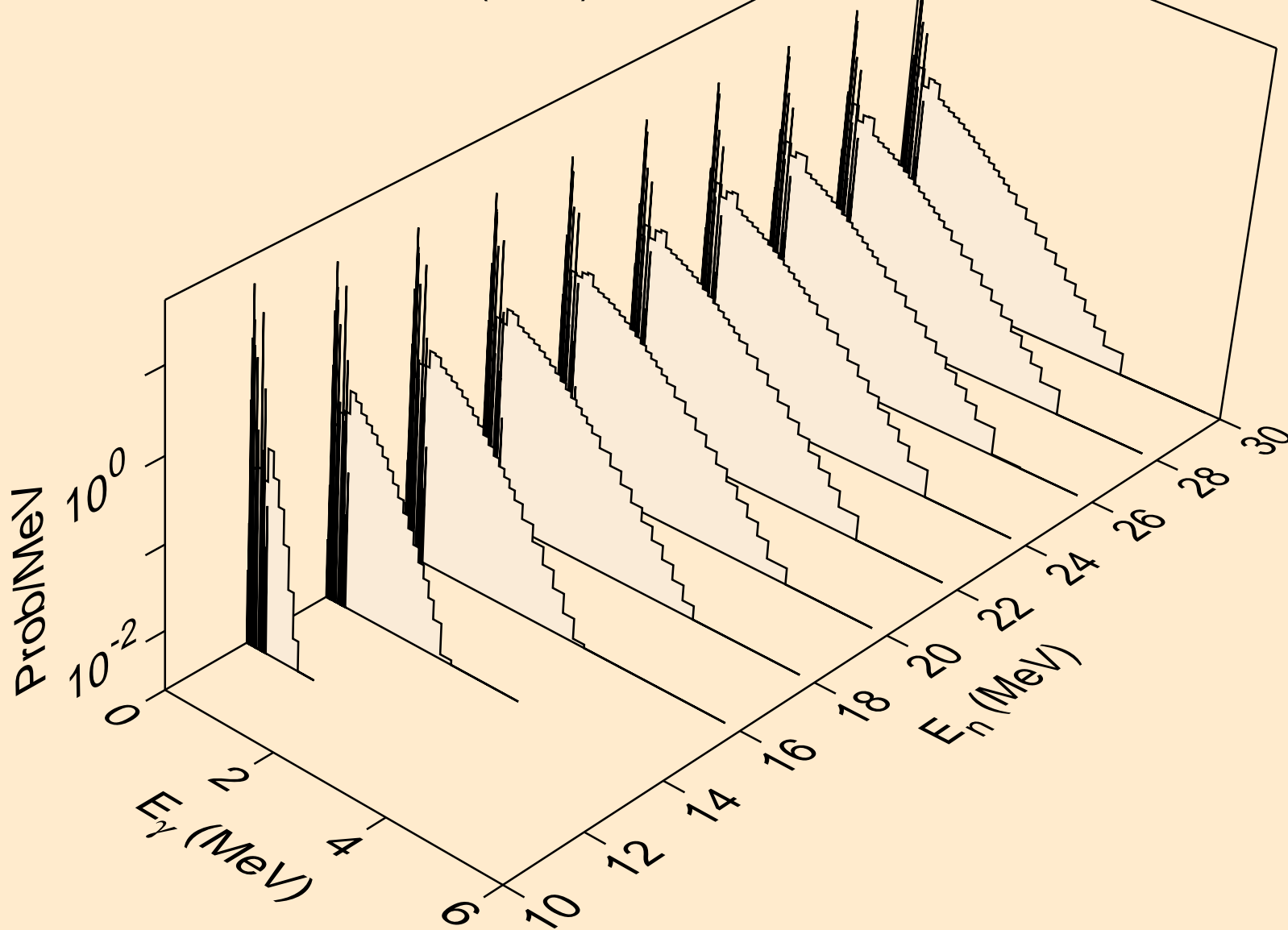

CM249 NEUTRON ACER TENDL-2019 LIBRARY; T=293.16K  
Photon emission for (n,n\*)a

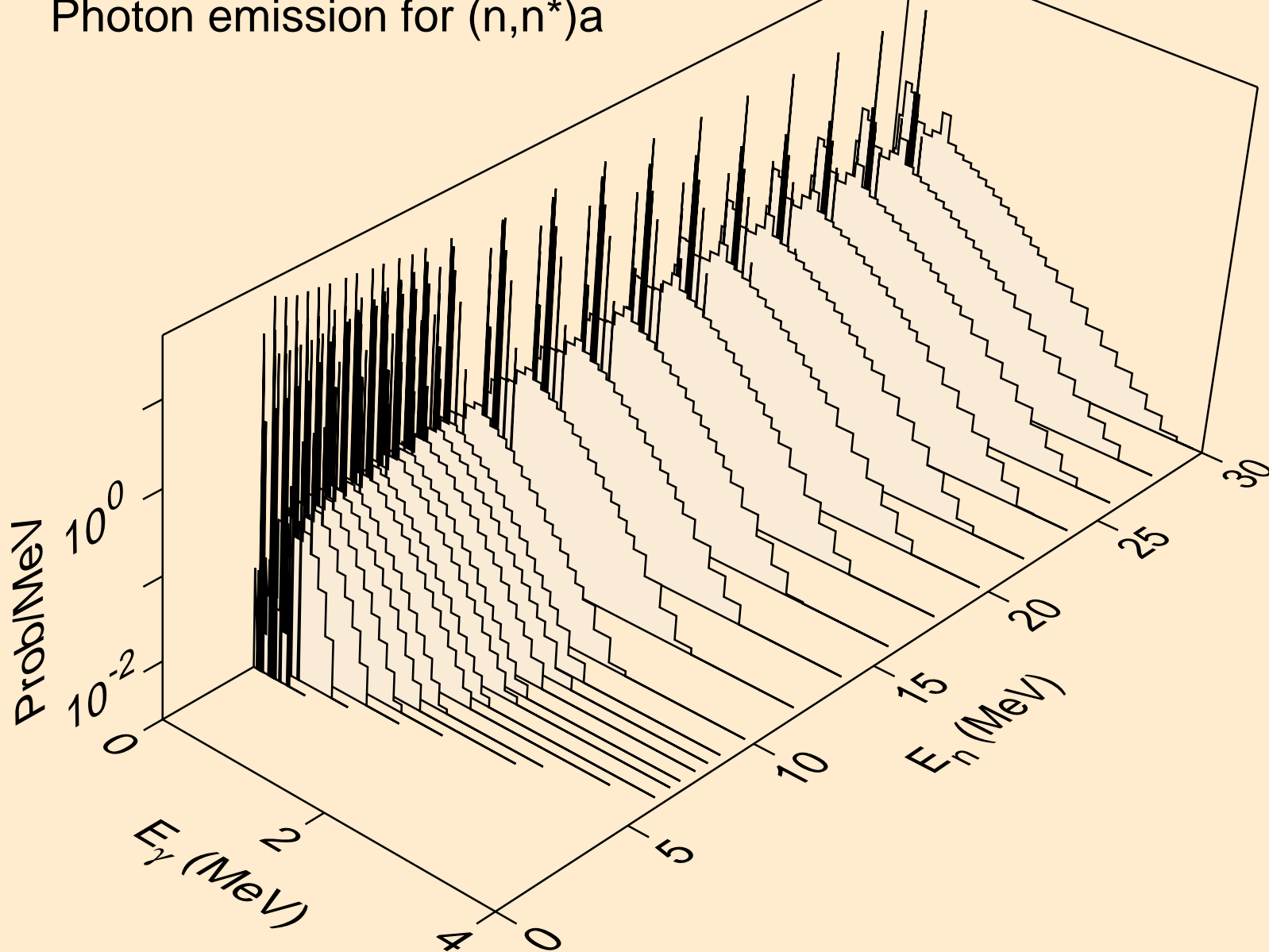

CM249 NEUTRON ACER TENDL-2019 LIBRARY; T=293.16K  
Photon emission for (n,2n)a

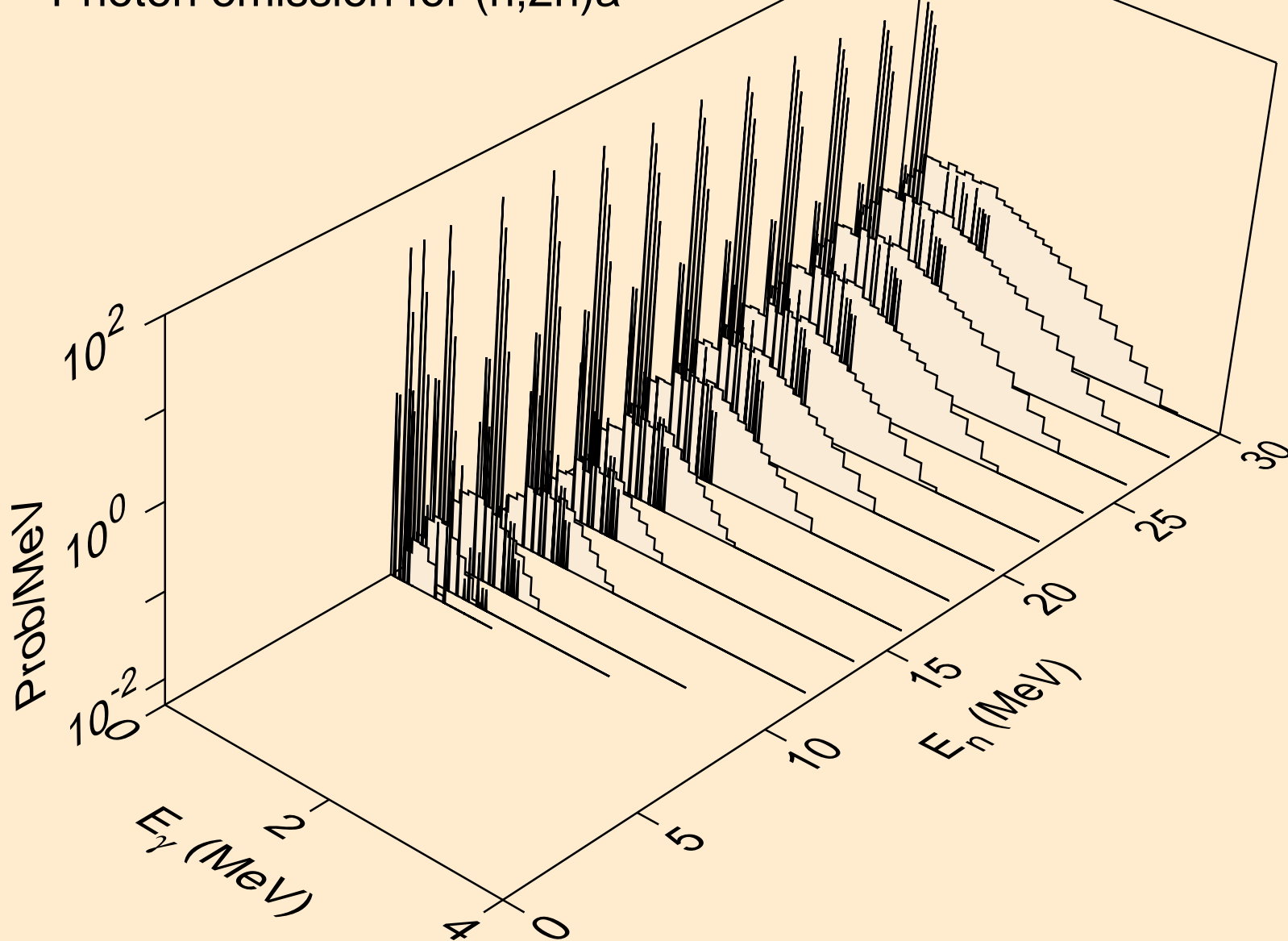

CM249 NEUTRON ACER TENDL-2019 LIBRARY; T=293.16K  
Photon emission for (n,3n)a

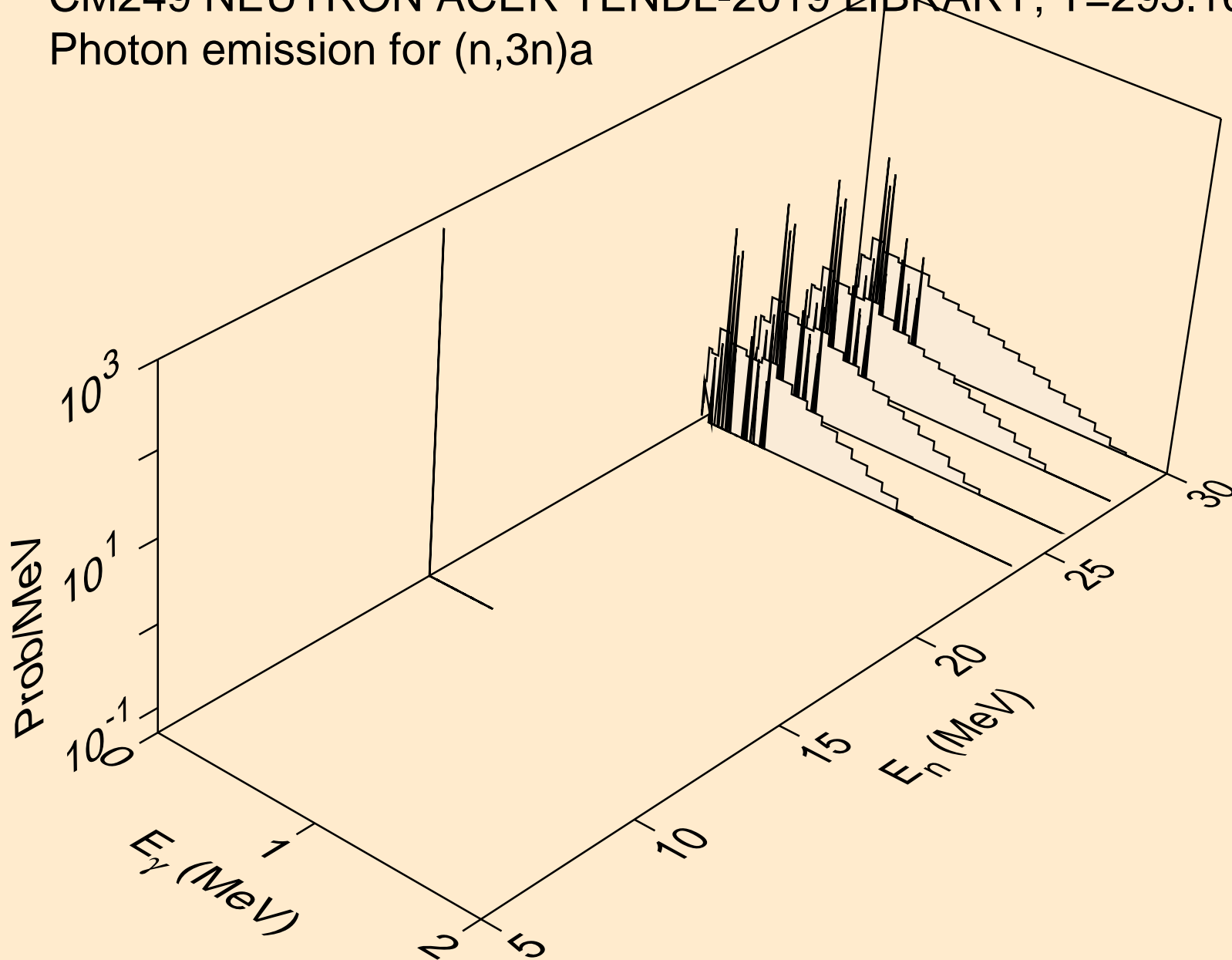

CM249 NEUTRON ACER TENDL-2019 LIBRARY; T=293.16K  
Photon emission for (n,n\*)p

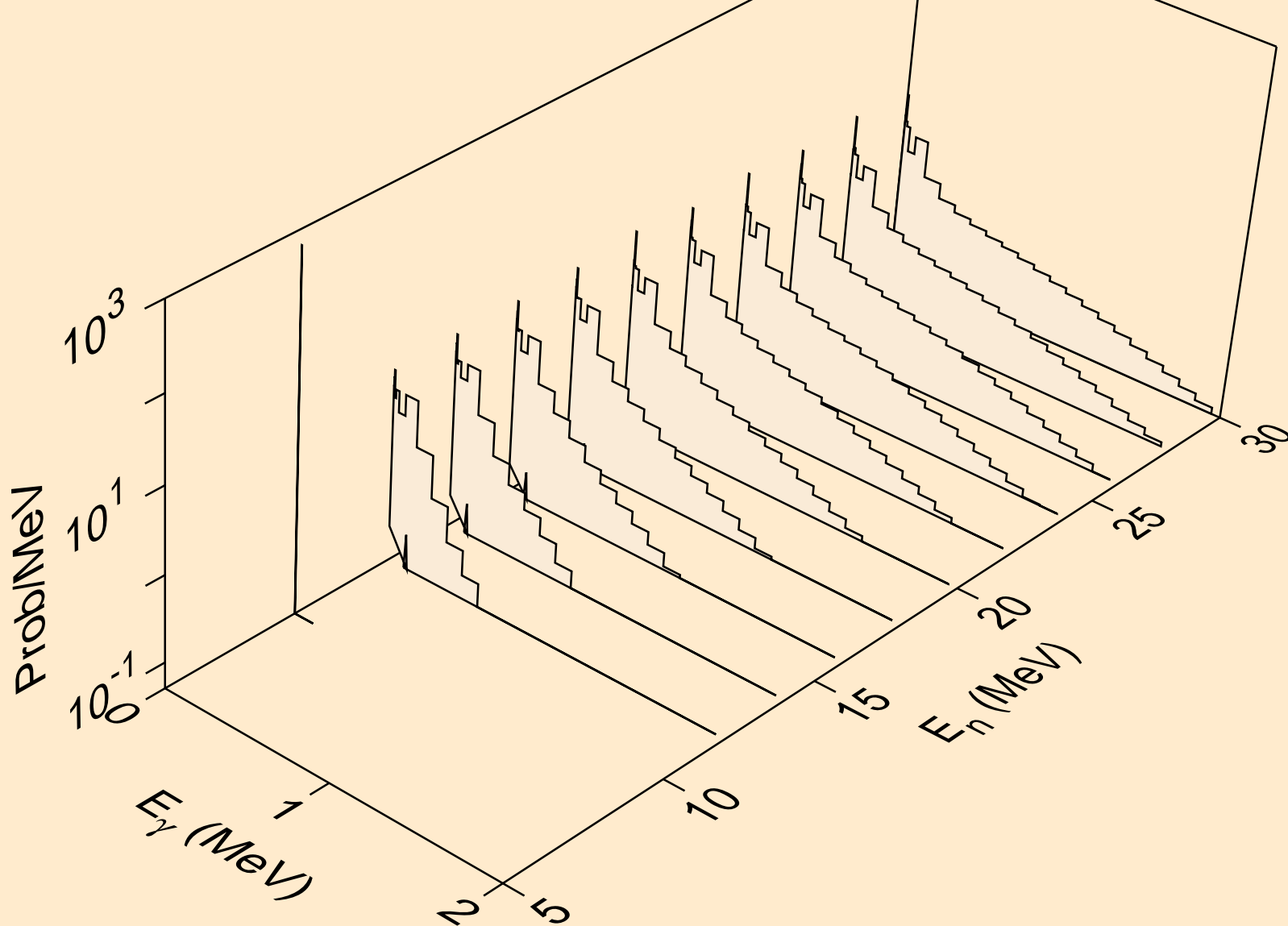

CM249 NEUTRON ACER TENDL-2019 LIBRARY; T=293.16K  
Photon emission for (n,n\*)d

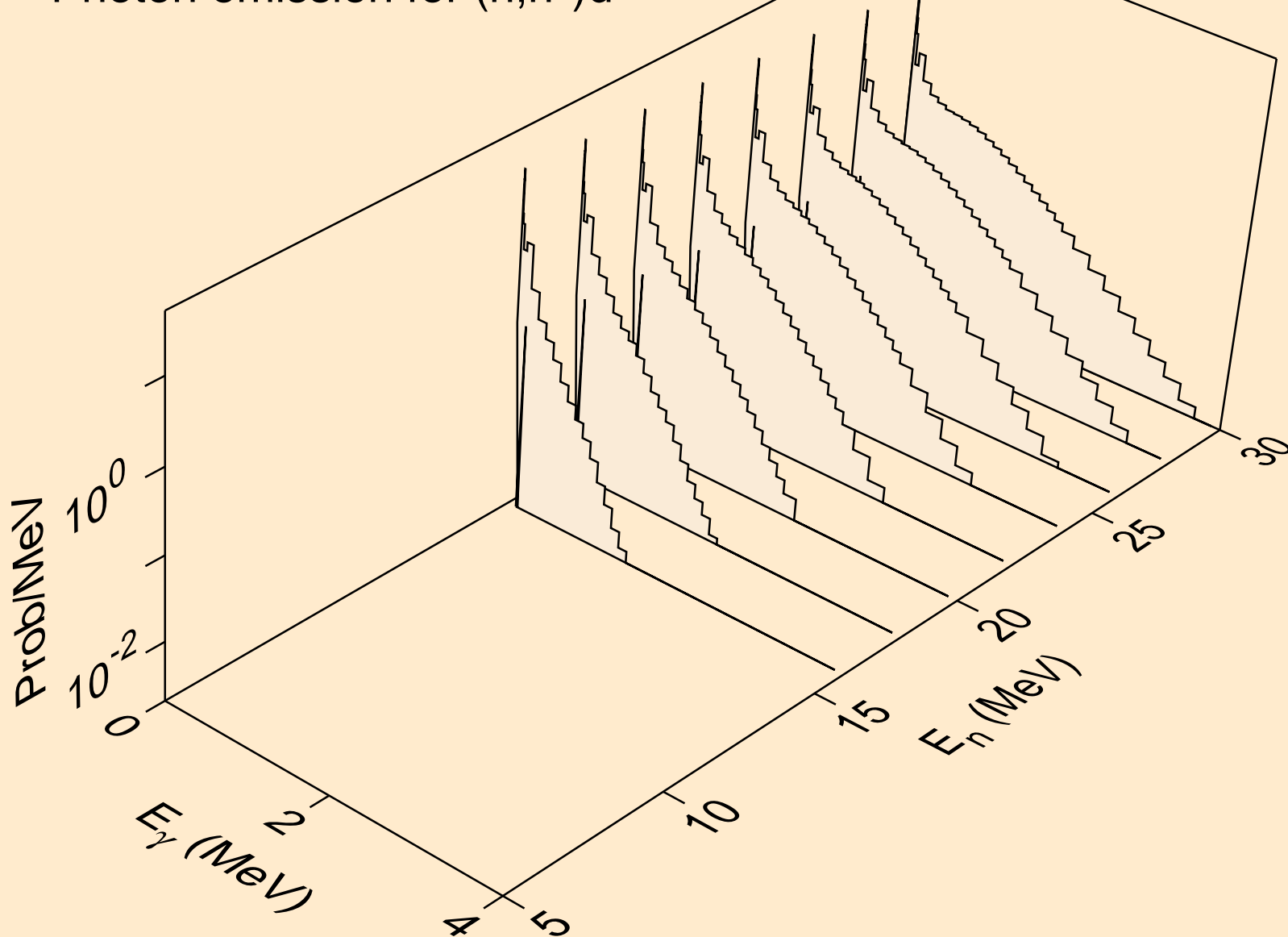

CM249 NEUTRON ACER TENDL-2019 LIBRARY; T=293.16K  
Photon emission for (n,n\*)t

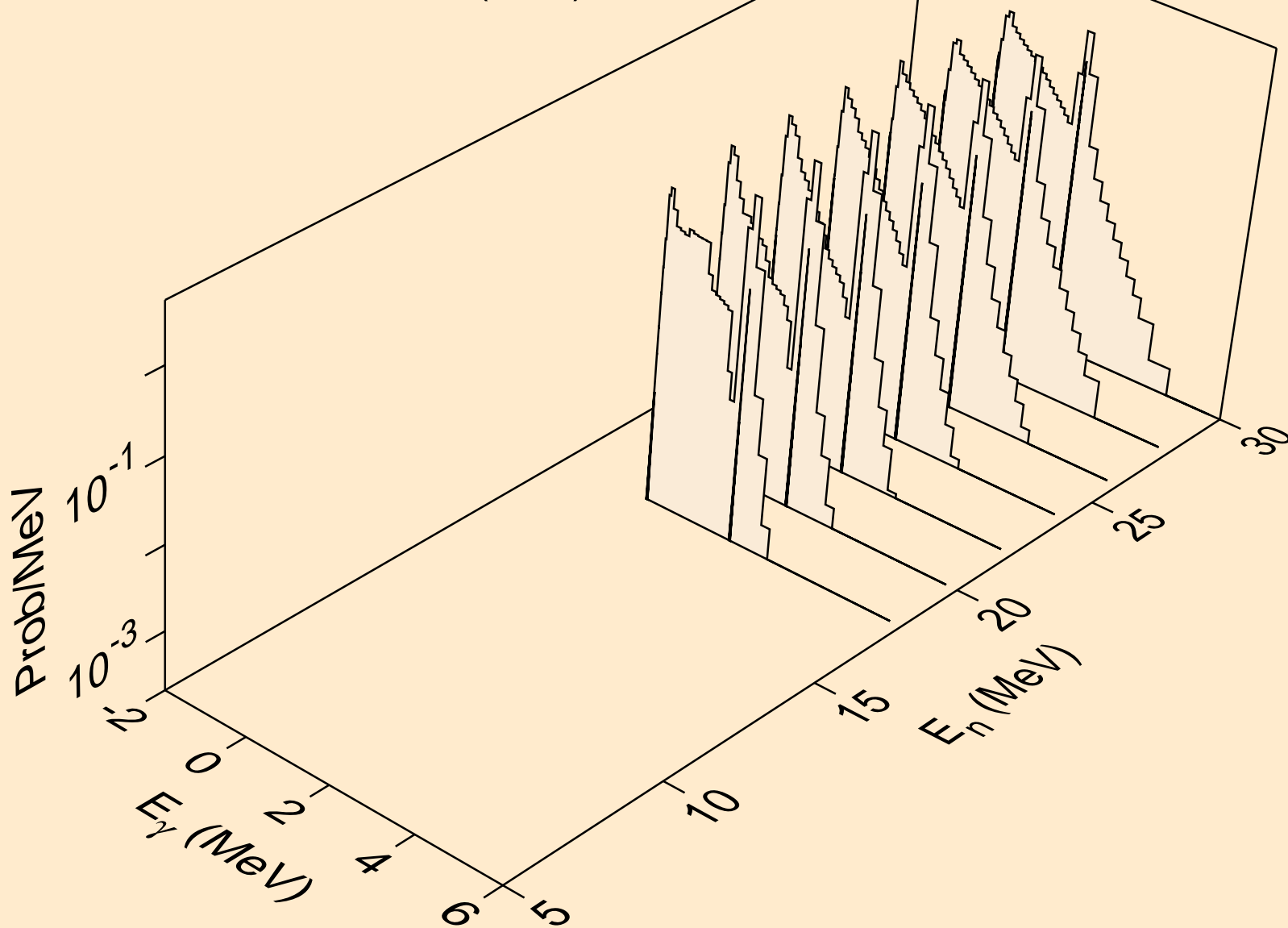

CM249 NEUTRON ACER TENDL-2019 LIBRARY; T=293.16K  
Photon emission for (n,n\*)he3

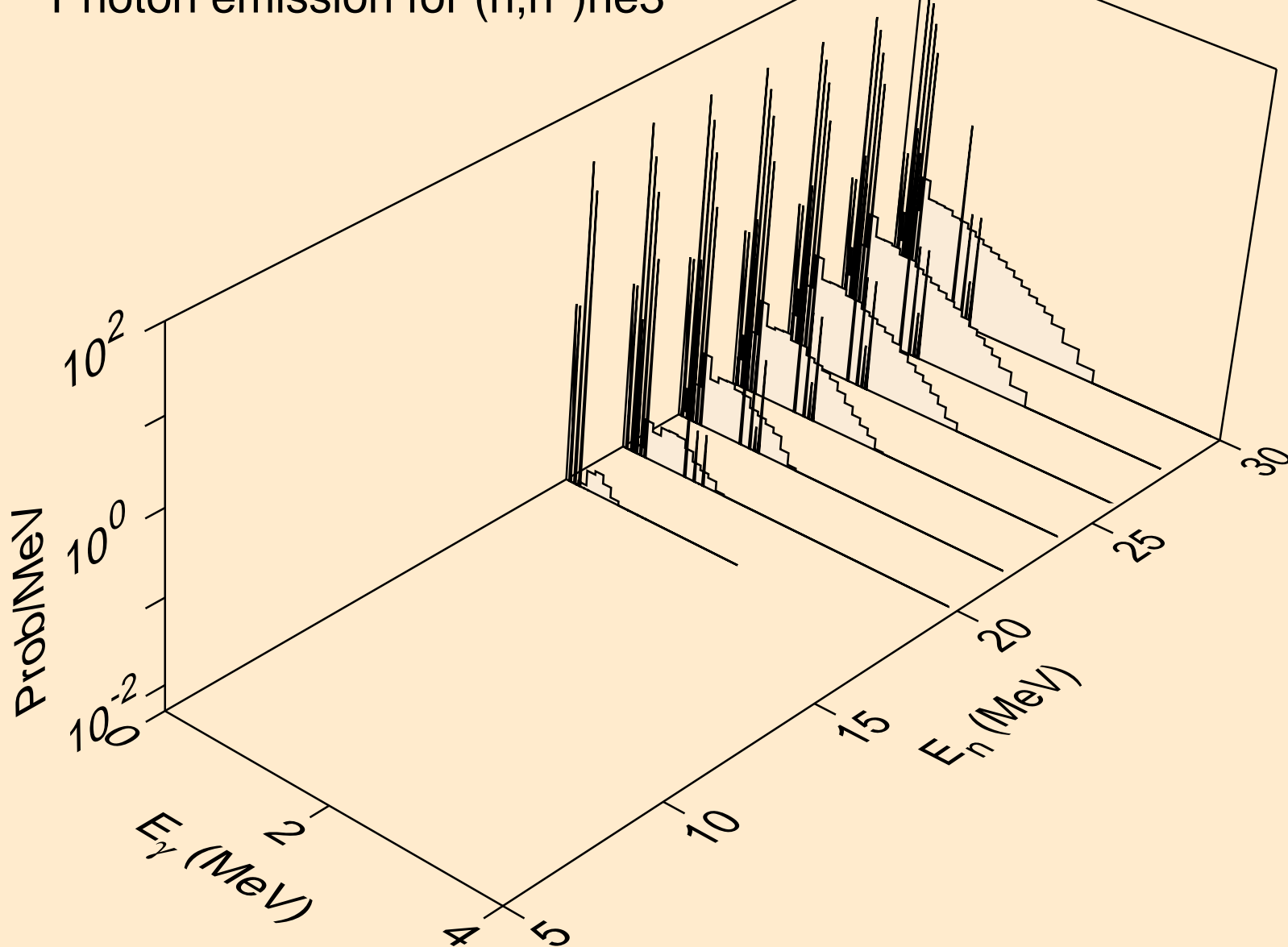

CM249 NEUTRON ACER TENDL-2019 LIBRARY; T=293.16K  
Photon emission for (n,4n)

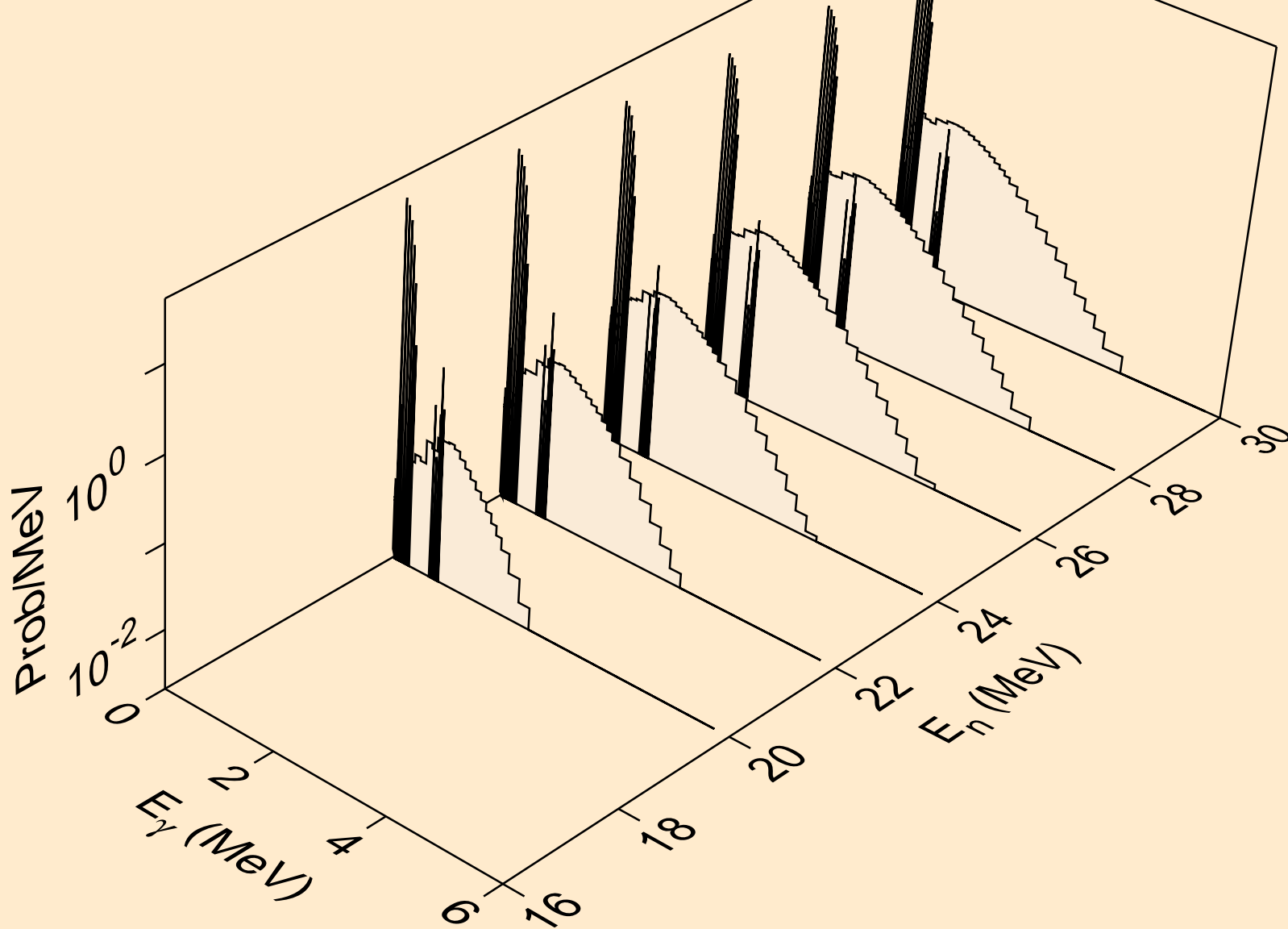

CM249 NEUTRON ACER TENDL-2019 LIBRARY; T=293.16K  
Photon emission for (n,2np)

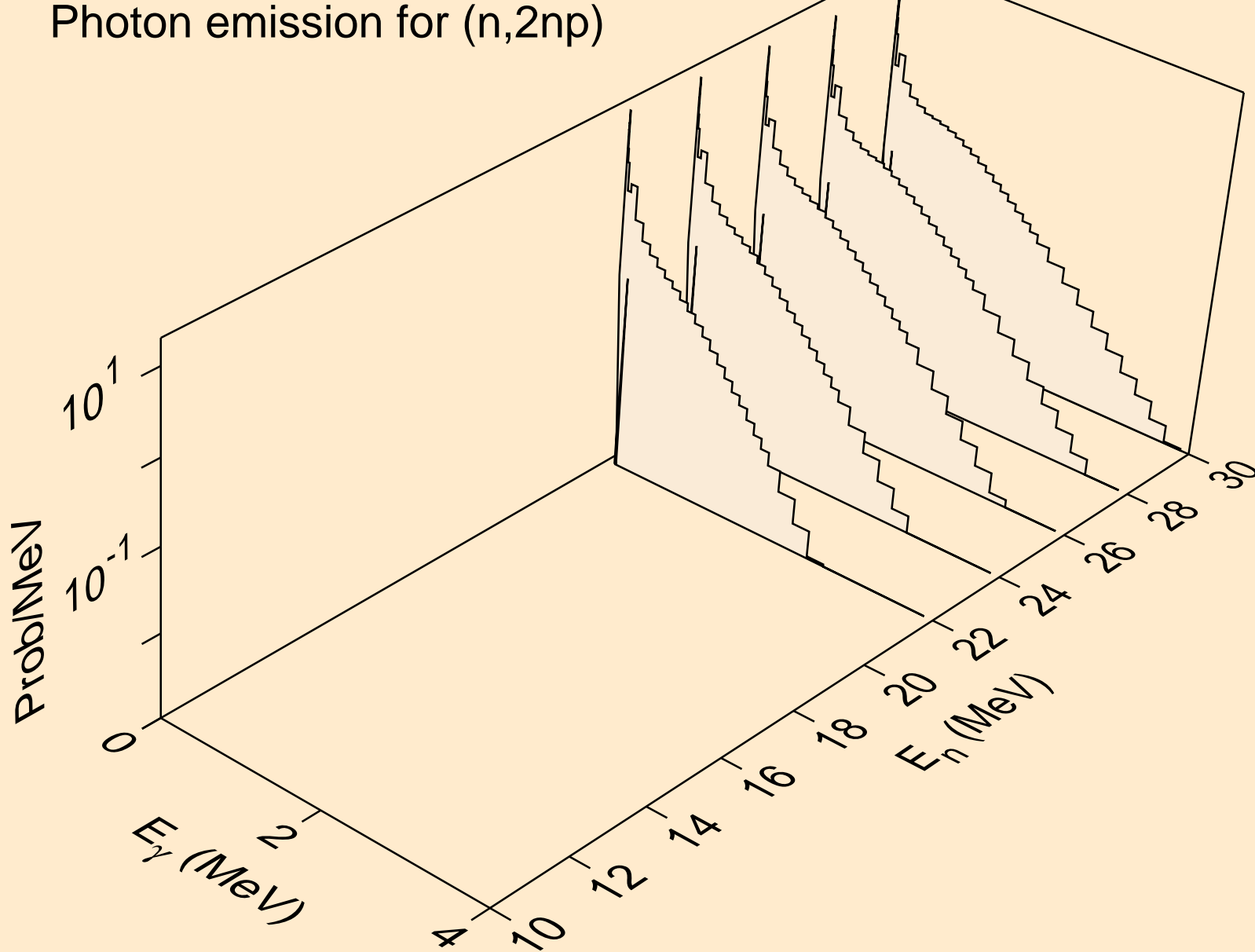

CM249 NEUTRON ACER TENDL-2019 LIBRARY; T=293.16K  
Photon emission for (n,3np)

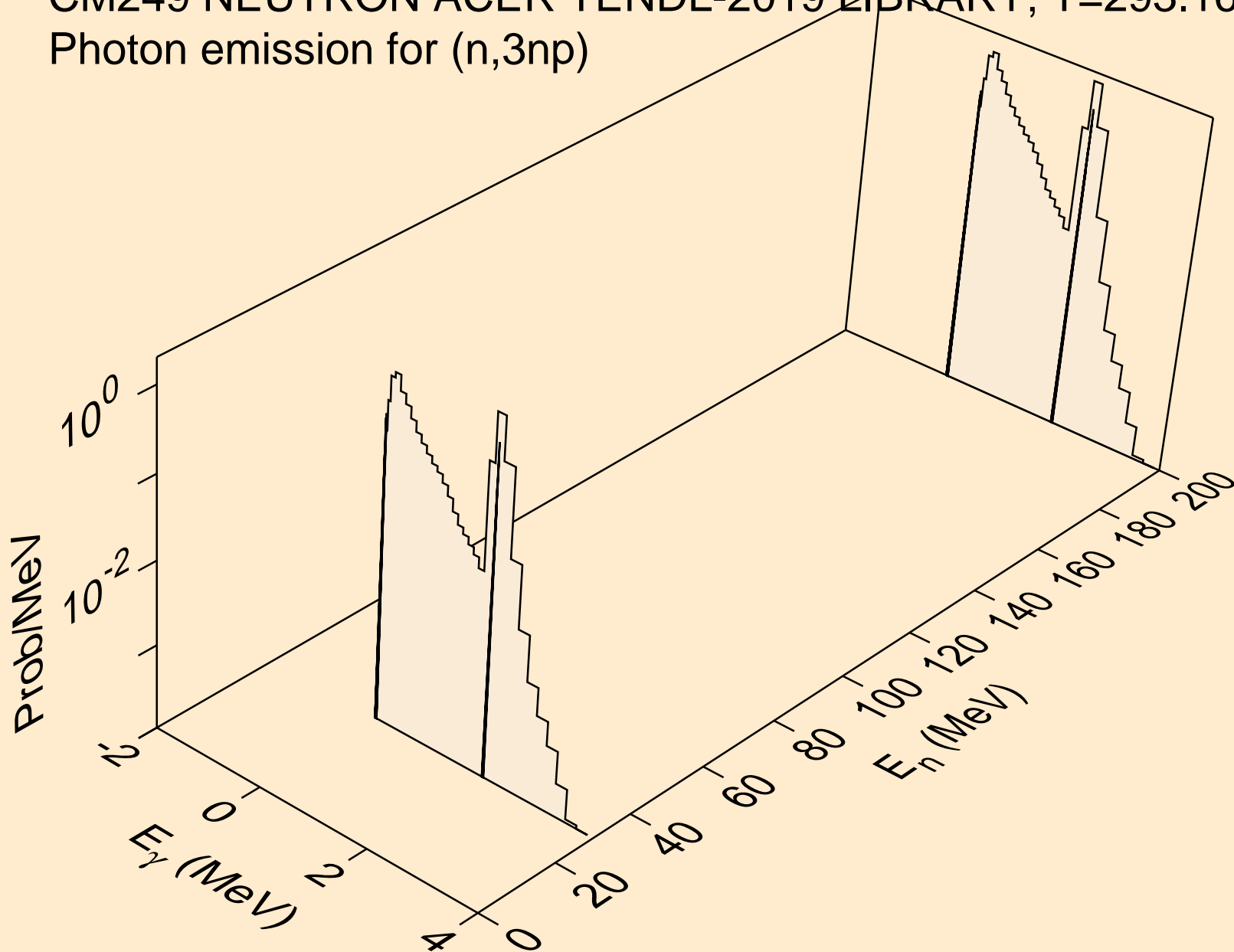

CM249 NEUTRON ACER TENDL-2019 LIBRARY; T=293.16K  
Photon emission for (n,2np)

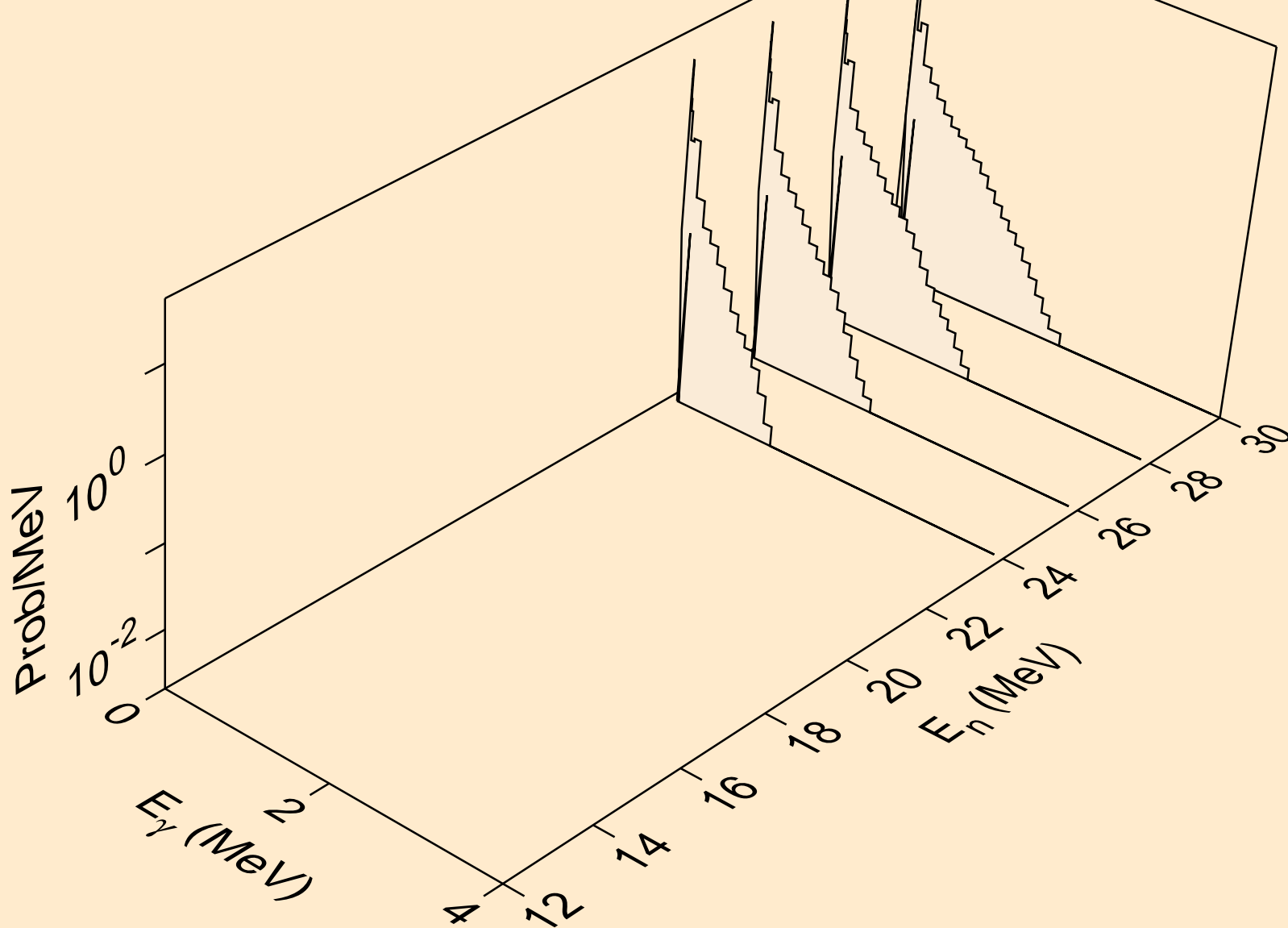

CM249 NEUTRON ACER TENDL-2019 LIBRARY; T=293.16K  
Photon emission for (n,n\*c)

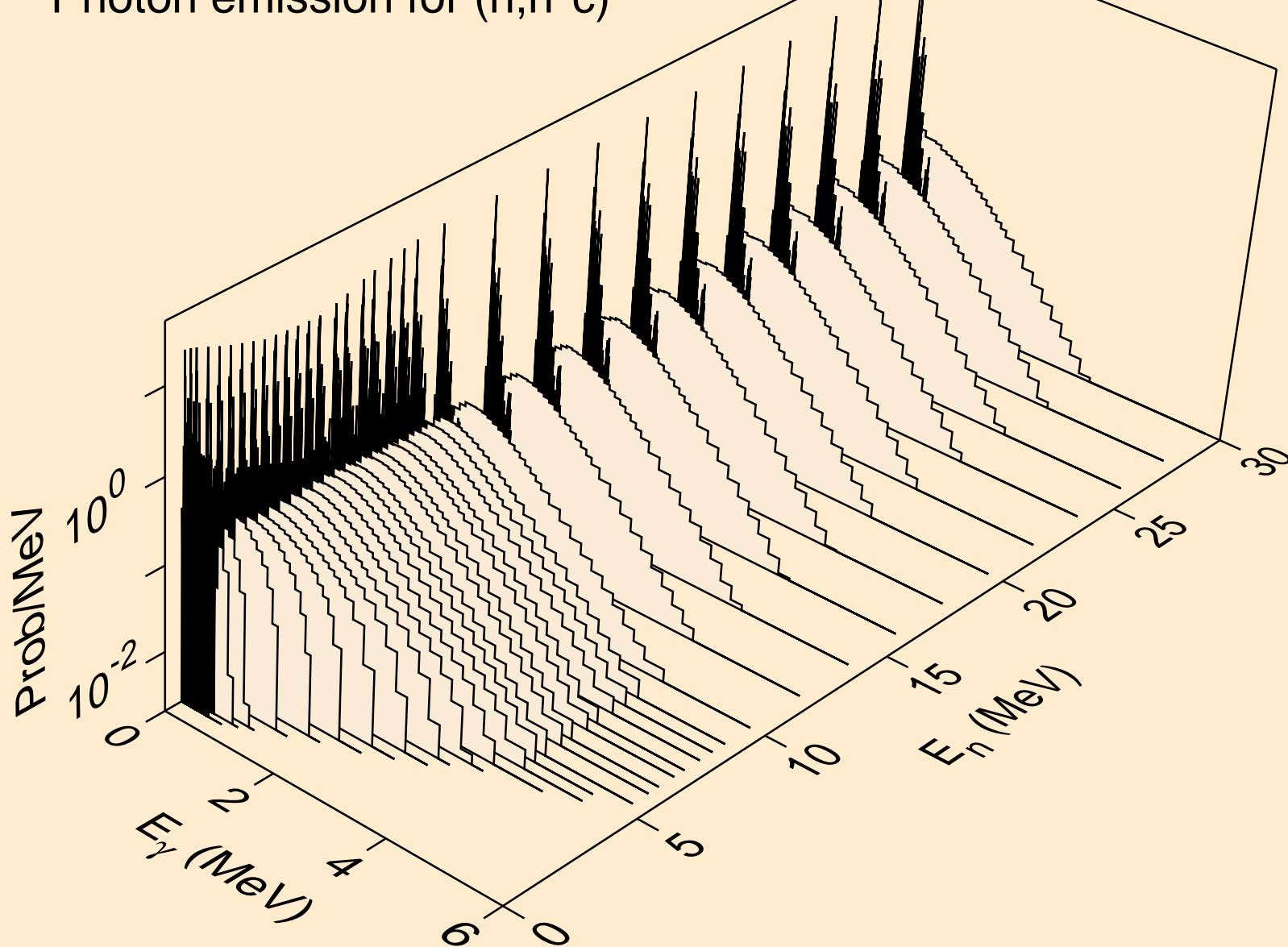

CM249 NEUTRON ACER TENDL-2019 LIBRARY; T=293.16K  
Photon emission for (n,gma)

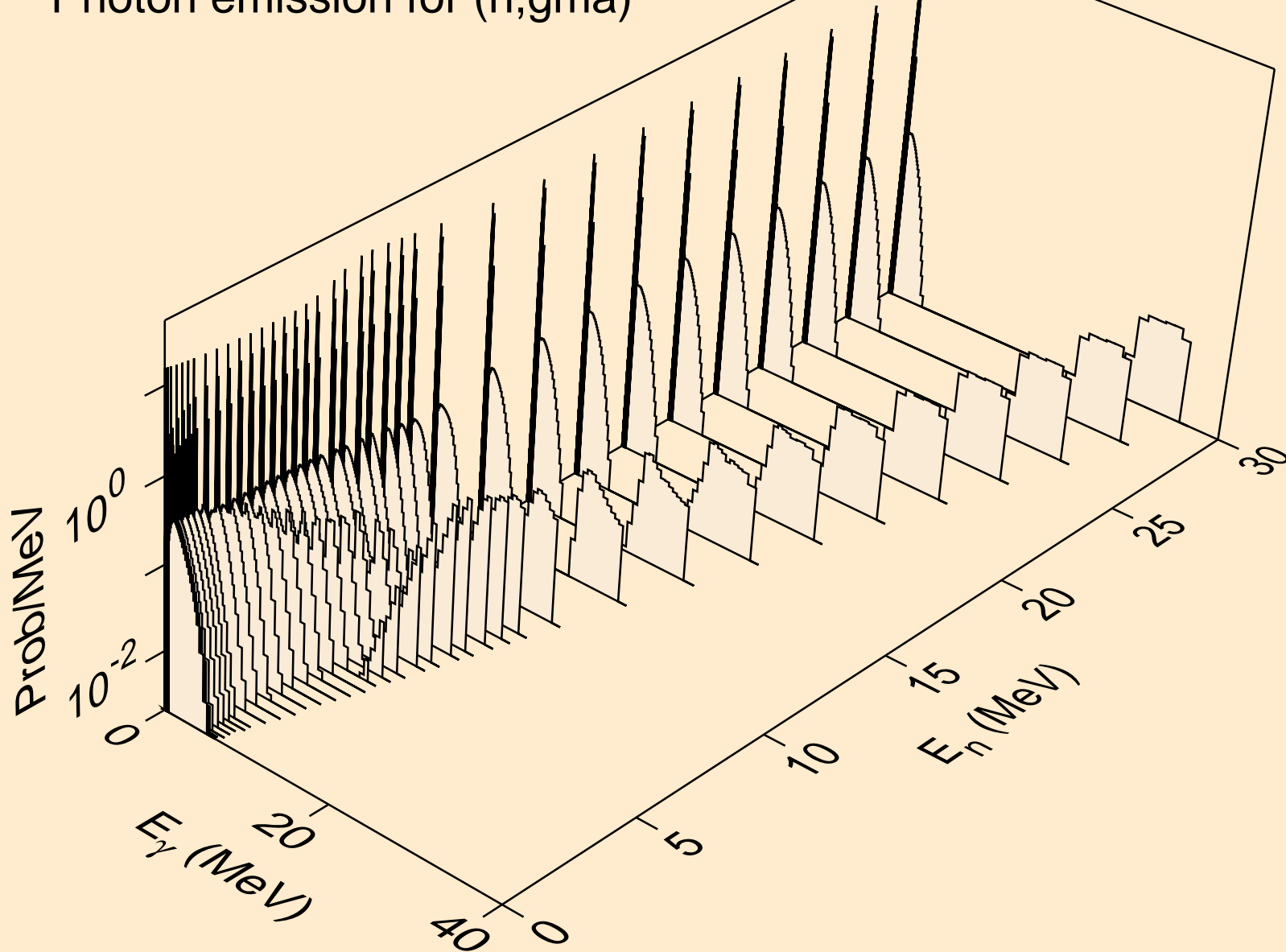

CM249 NEUTRON ACER TENDL-2019 LIBRARY; T=293.16K  
Photon emission for (n,p)

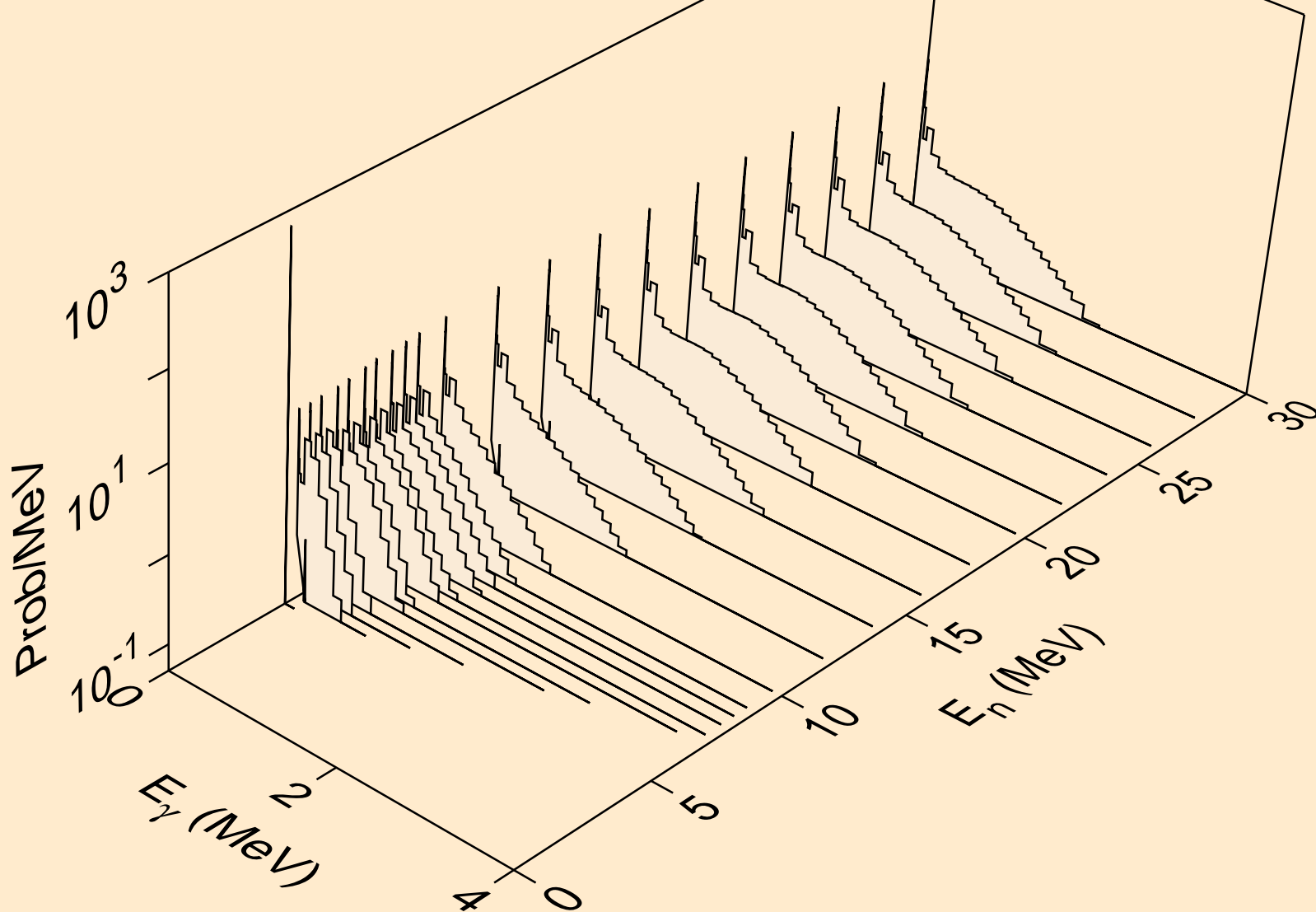

CM249 NEUTRON ACER TENDL-2019 LIBRARY; T=293.16K  
Photon emission for (n,d)

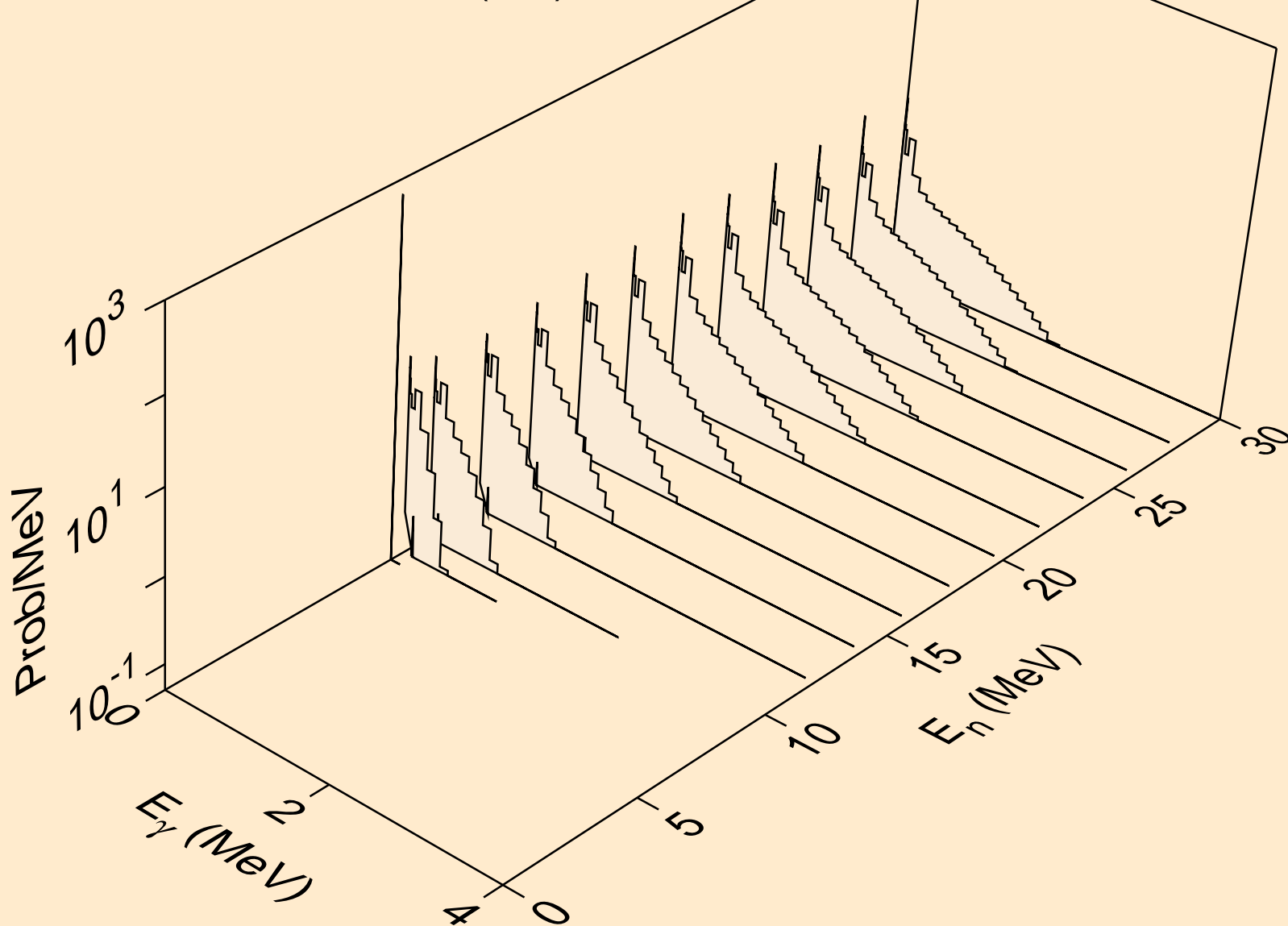

CM249 NEUTRON ACER TENDL-2019 LIBRARY; T=293.16K  
Photon emission for (n,t)

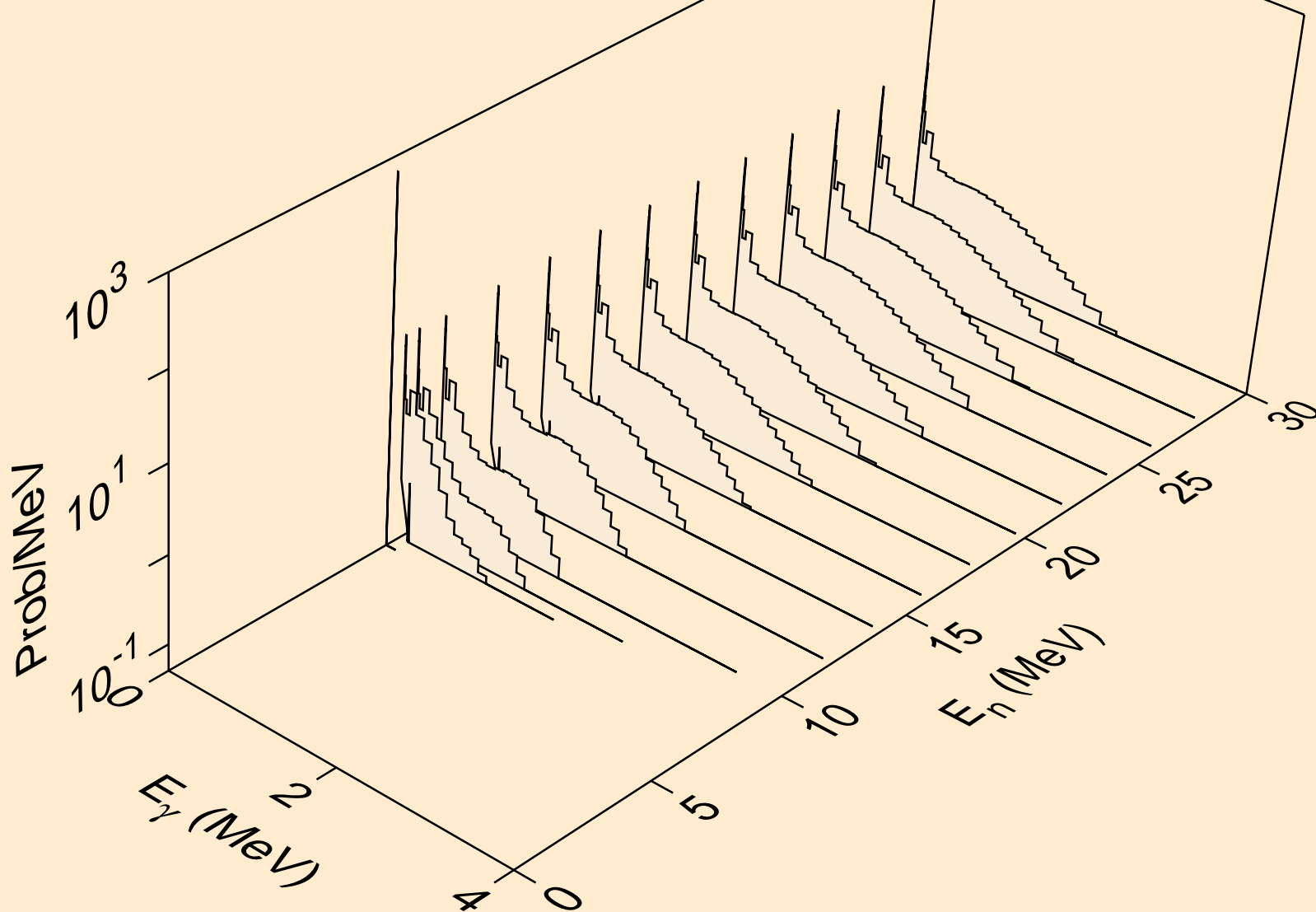

CM249 NEUTRON ACER TENDL-2019 LIBRARY; T=293.16K  
Photon emission for (n,he3)

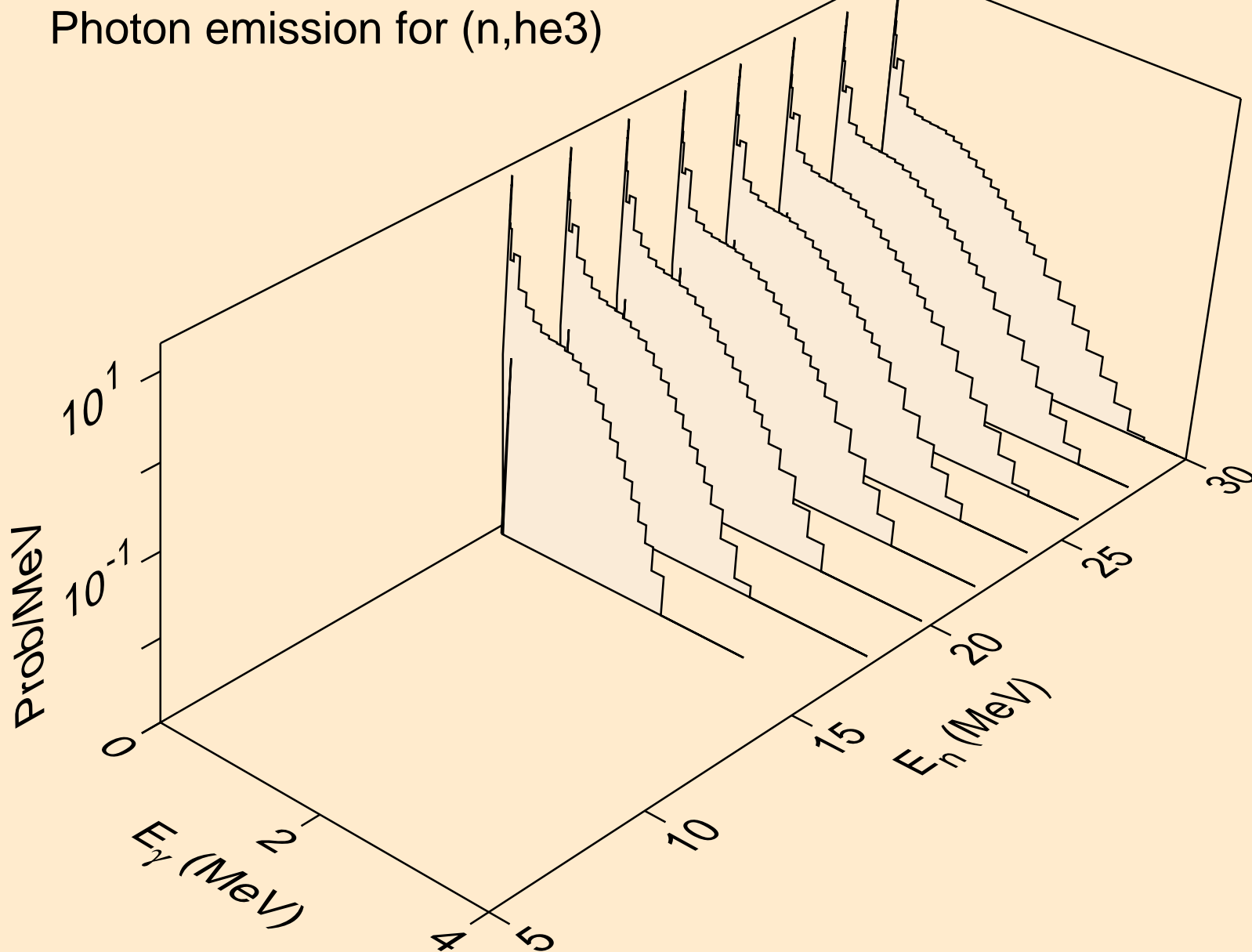

CM249 NEUTRON ACER TENDL-2019 LIBRARY; T=293.16K  
Photon emission for (n,a)

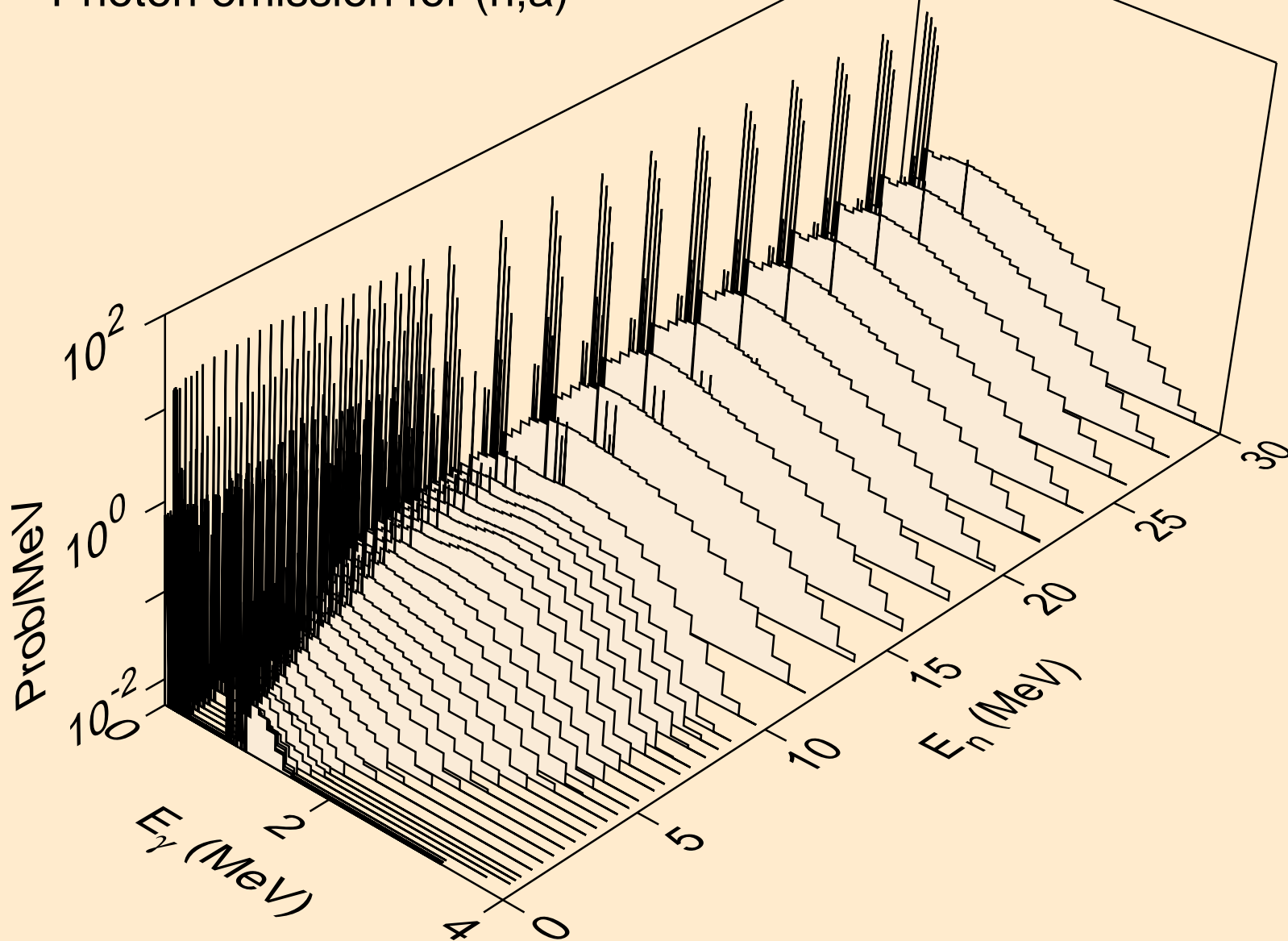

CM249 NEUTRON ACER TENDL-2019 LIBRARY; T=293.16K  
Photon emission for (n,2p)

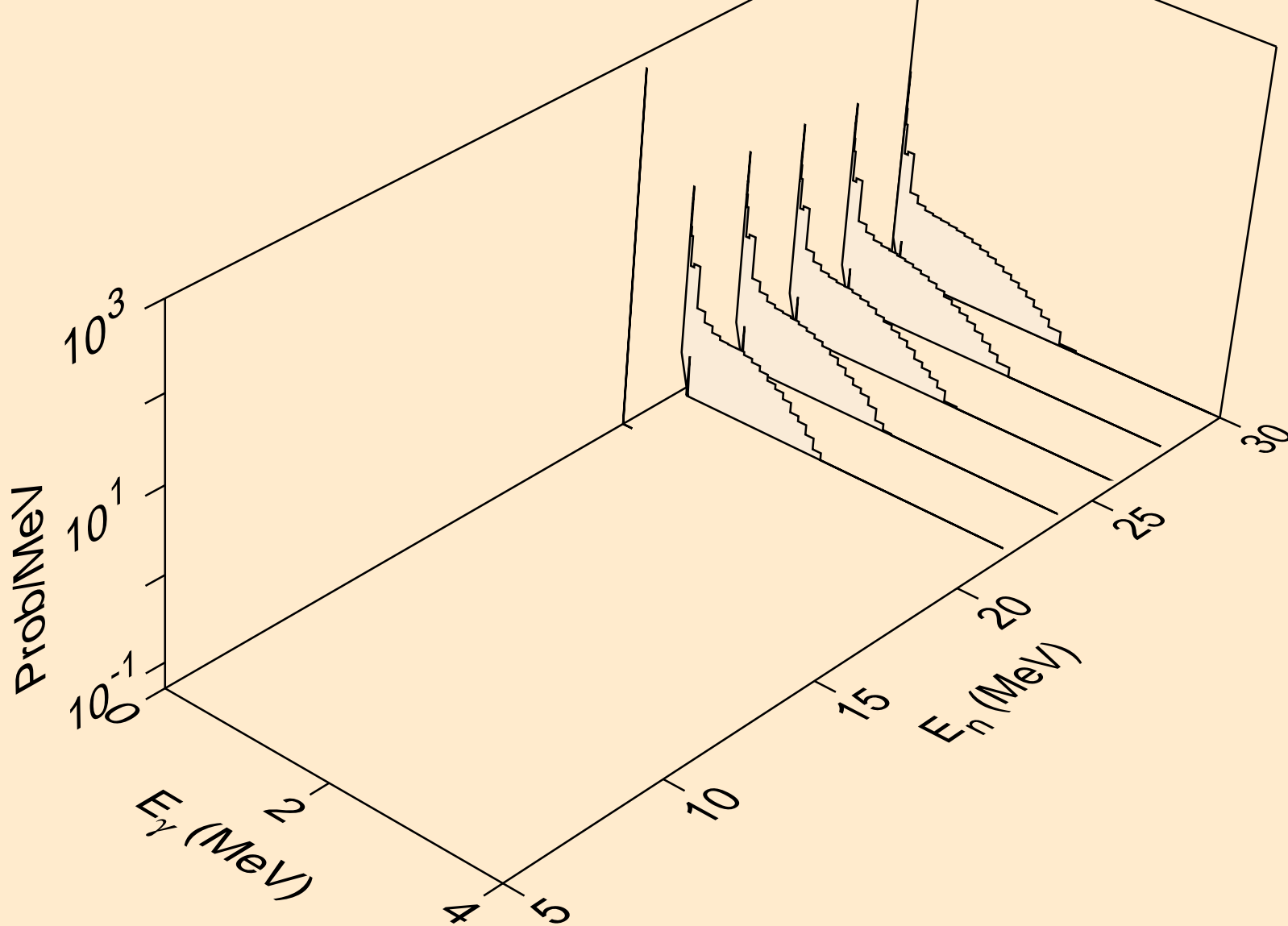

CM249 NEUTRON ACER TENDL-2019 LIBRARY; T=293.16K  
thermal capture photon spectrum

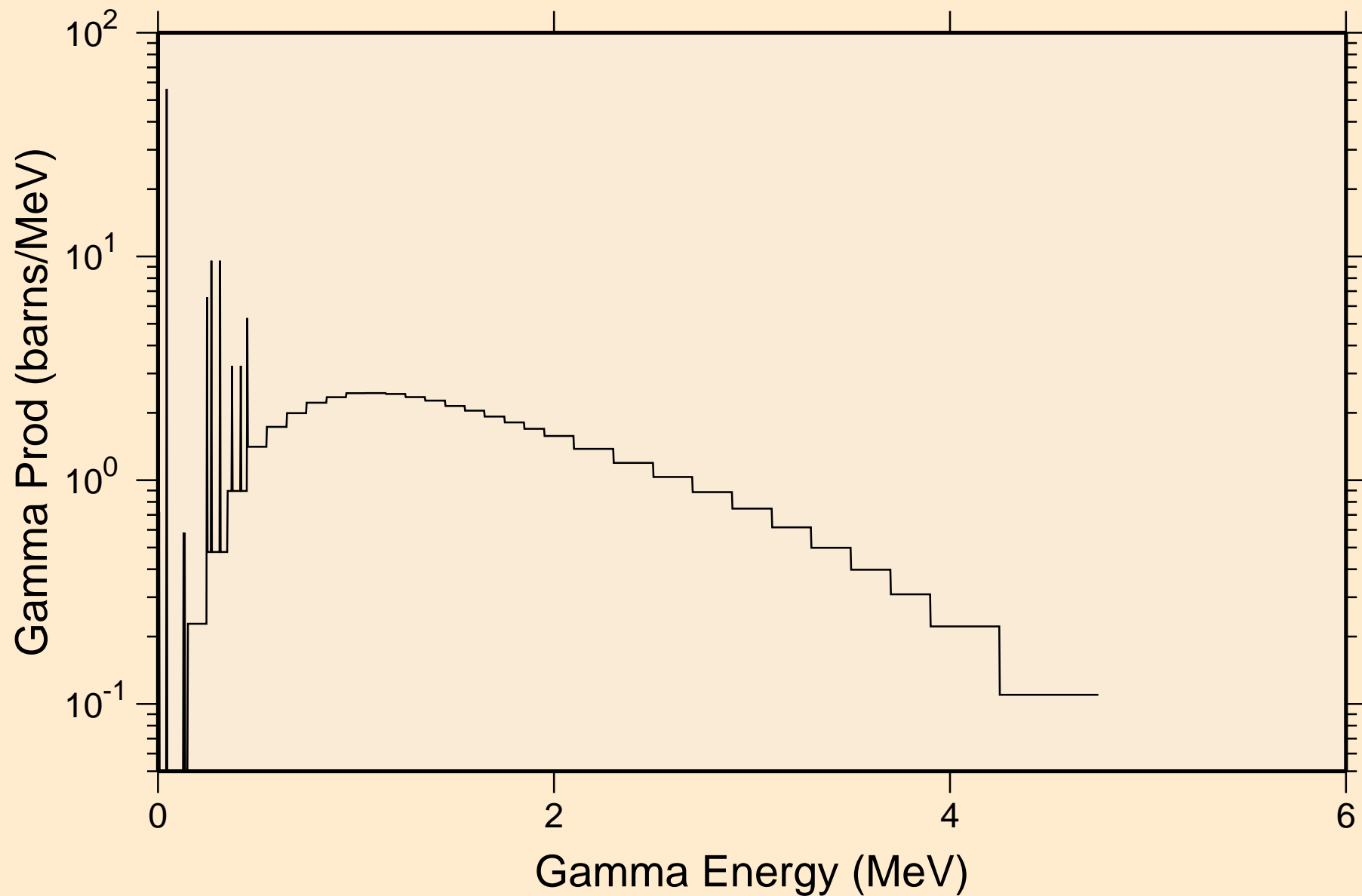

CM249 NEUTRON ACER TENDL-2019 LIBRARY; T=293.16K  
14 MeV photon spectrum

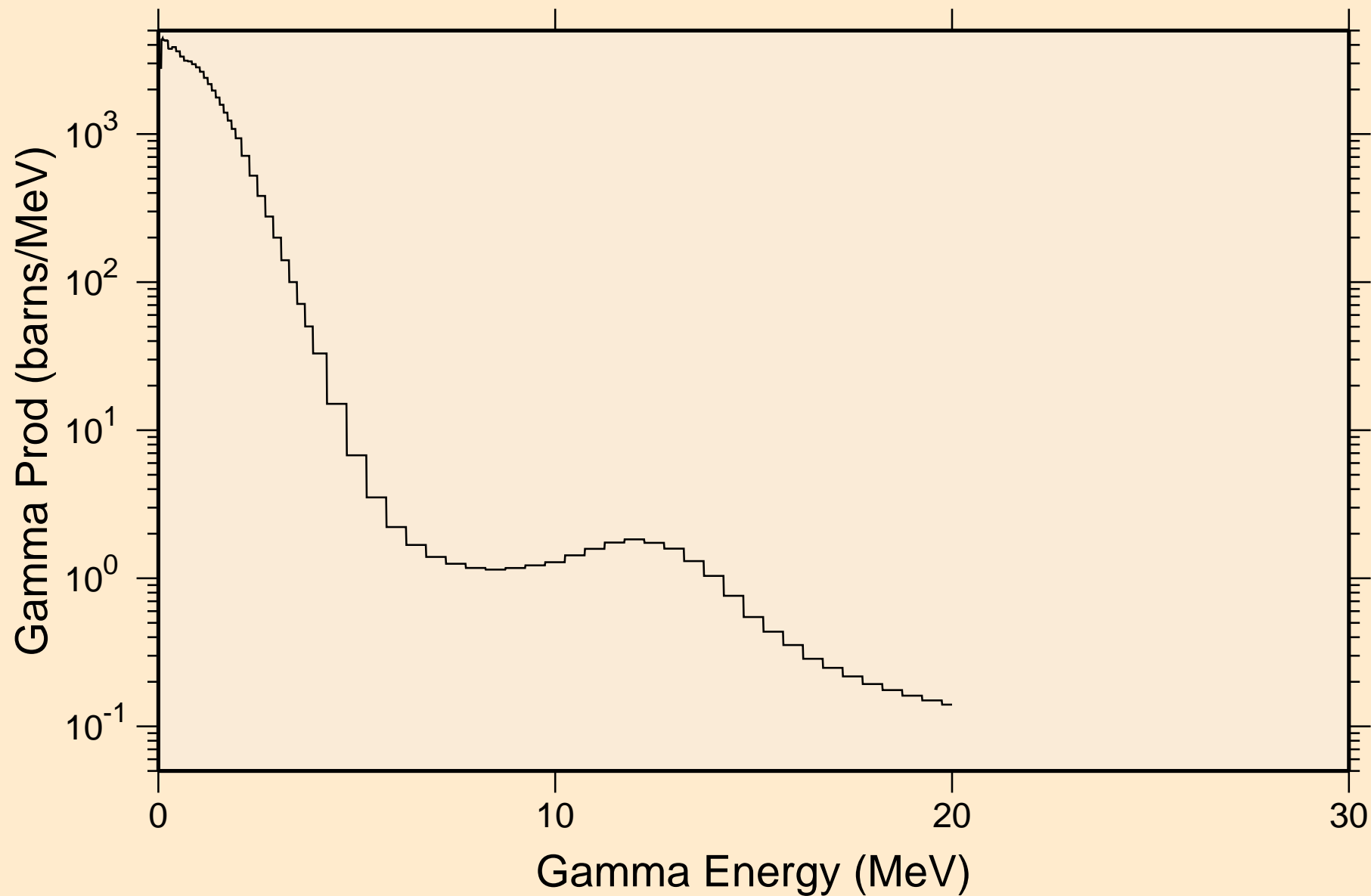

CM249 NEUTRON ACER TENDL-2019 LIBRARY; T=293.16K  
Particle heating contributions

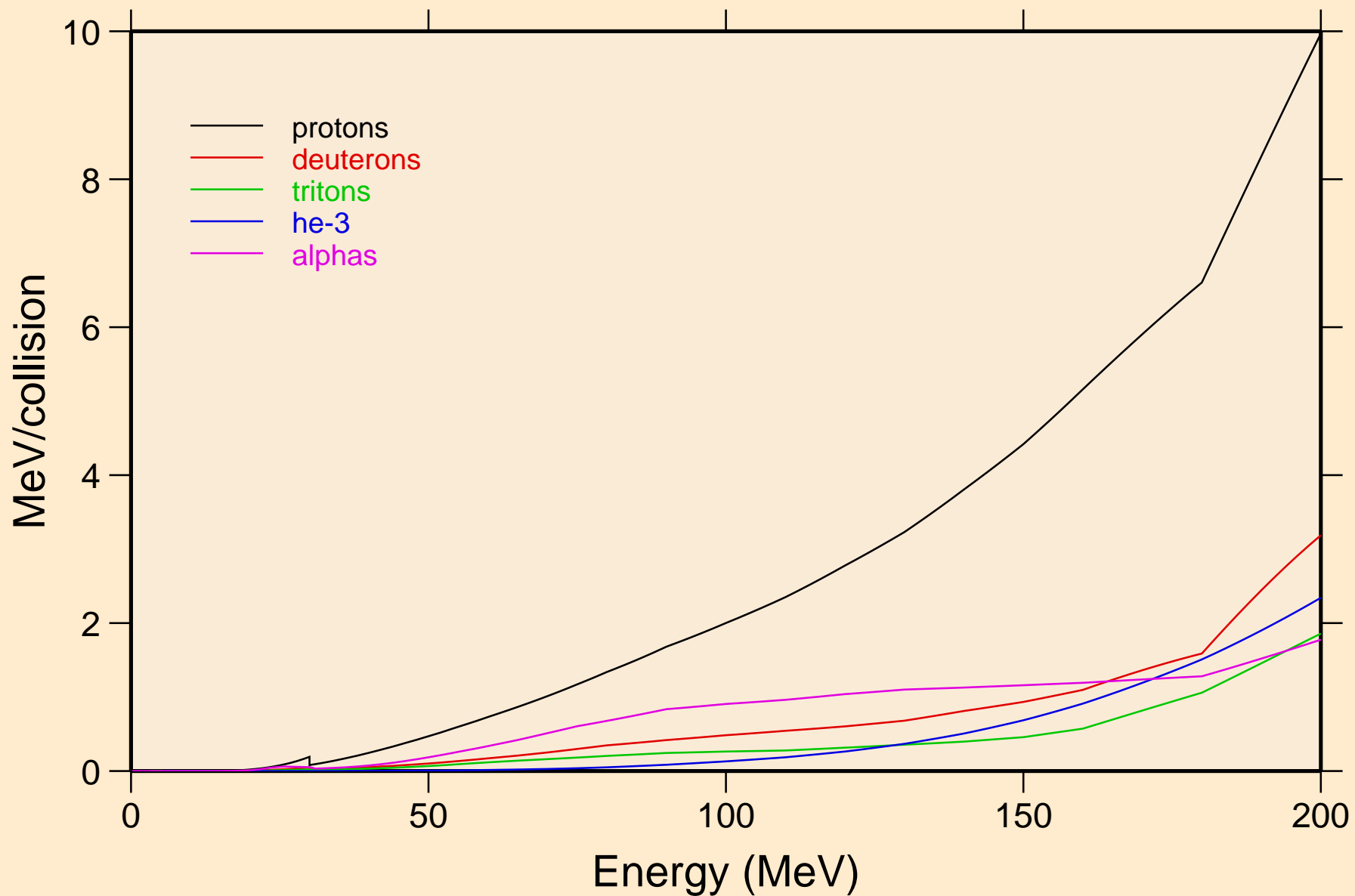

CM249 NEUTRON ACER TENDL-2019 LIBRARY; T=293.16K  
Recoil Heating

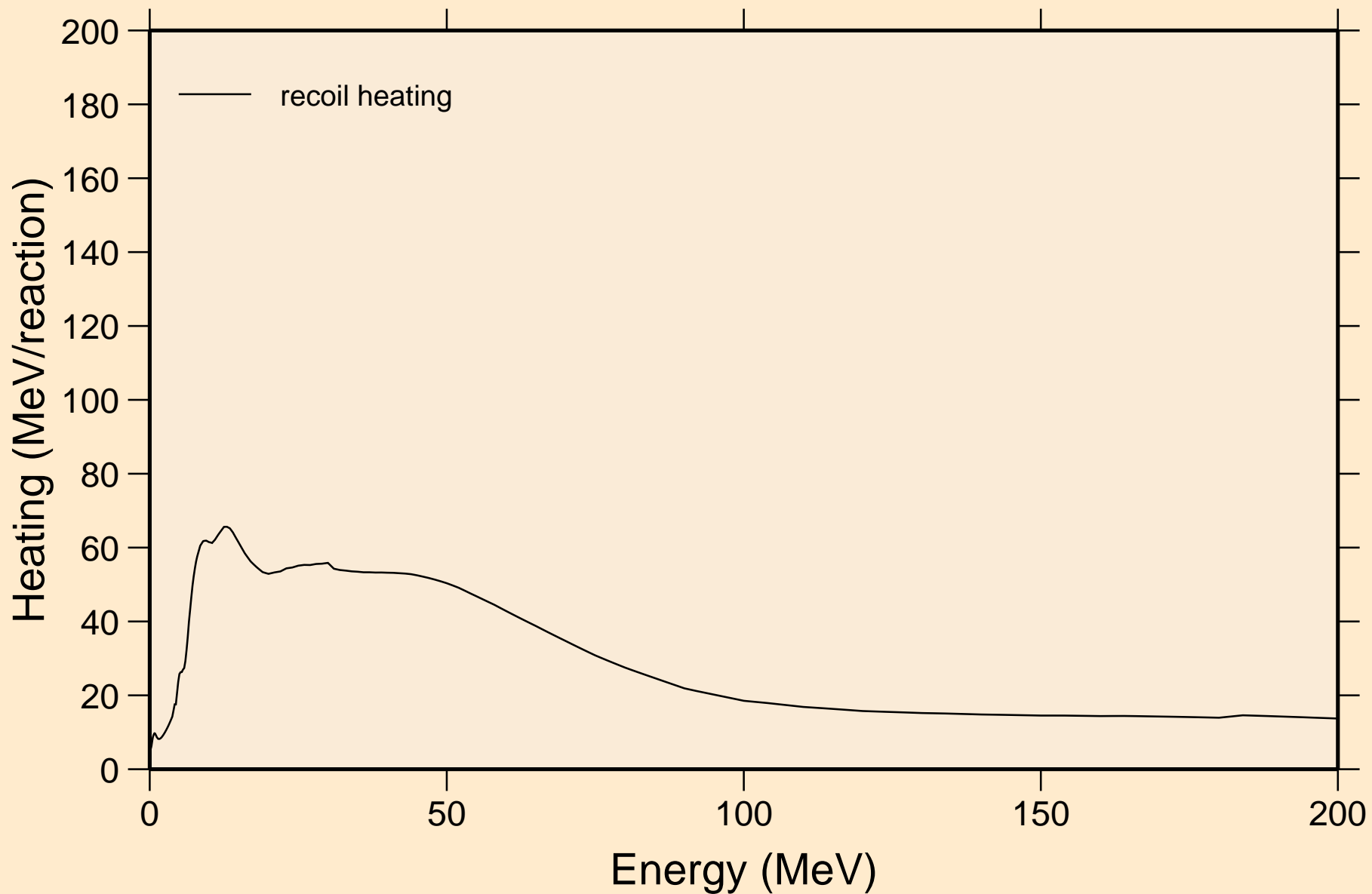

CM249 NEUTRON ACER TENDL-2019 LIBRARY; T=293.16K  
Particle production cross sections

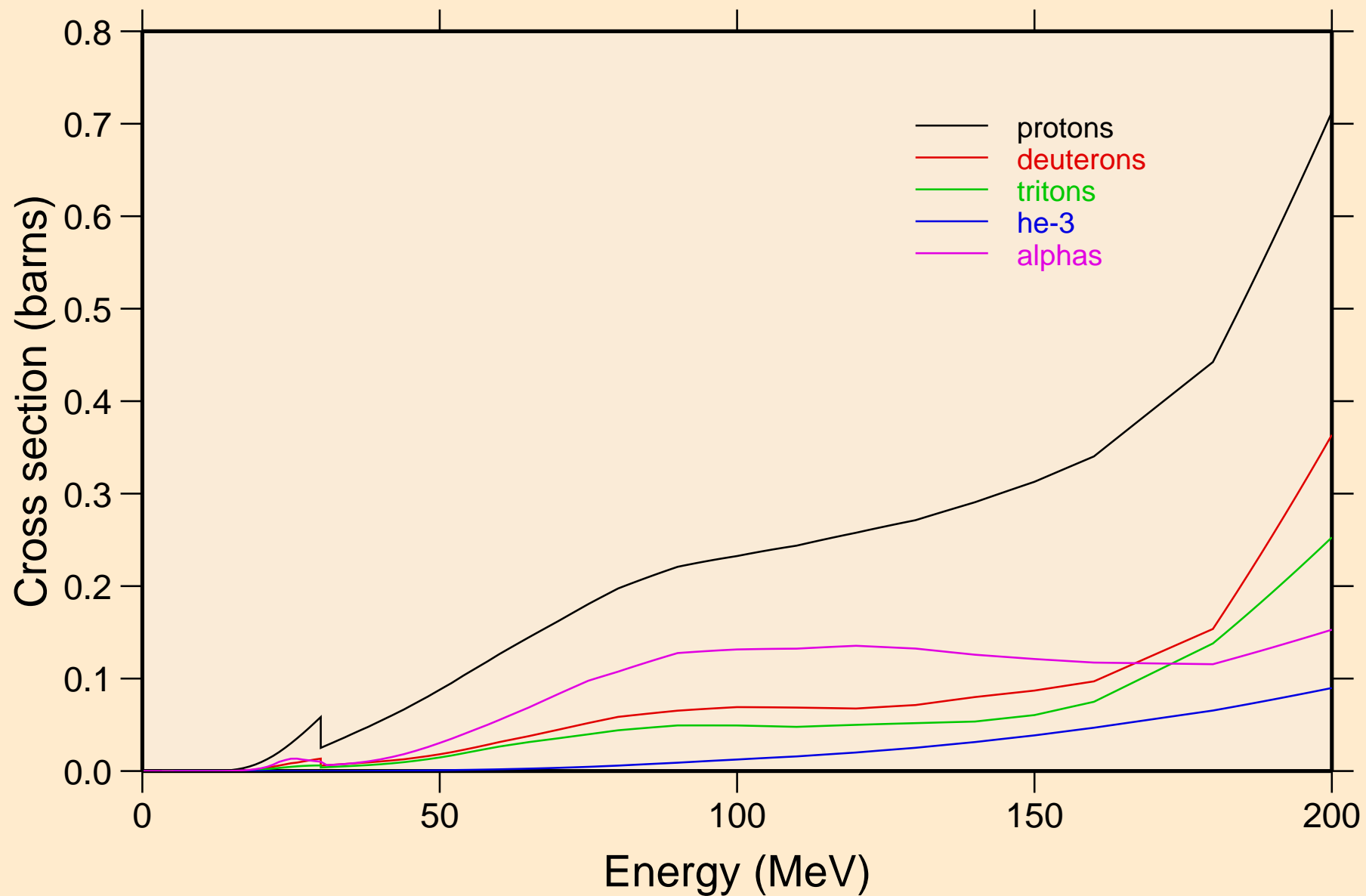

CM249 NEUTRON ACER TENDL-2019 LIBRARY; T=293.16K  
protons from (n,x)

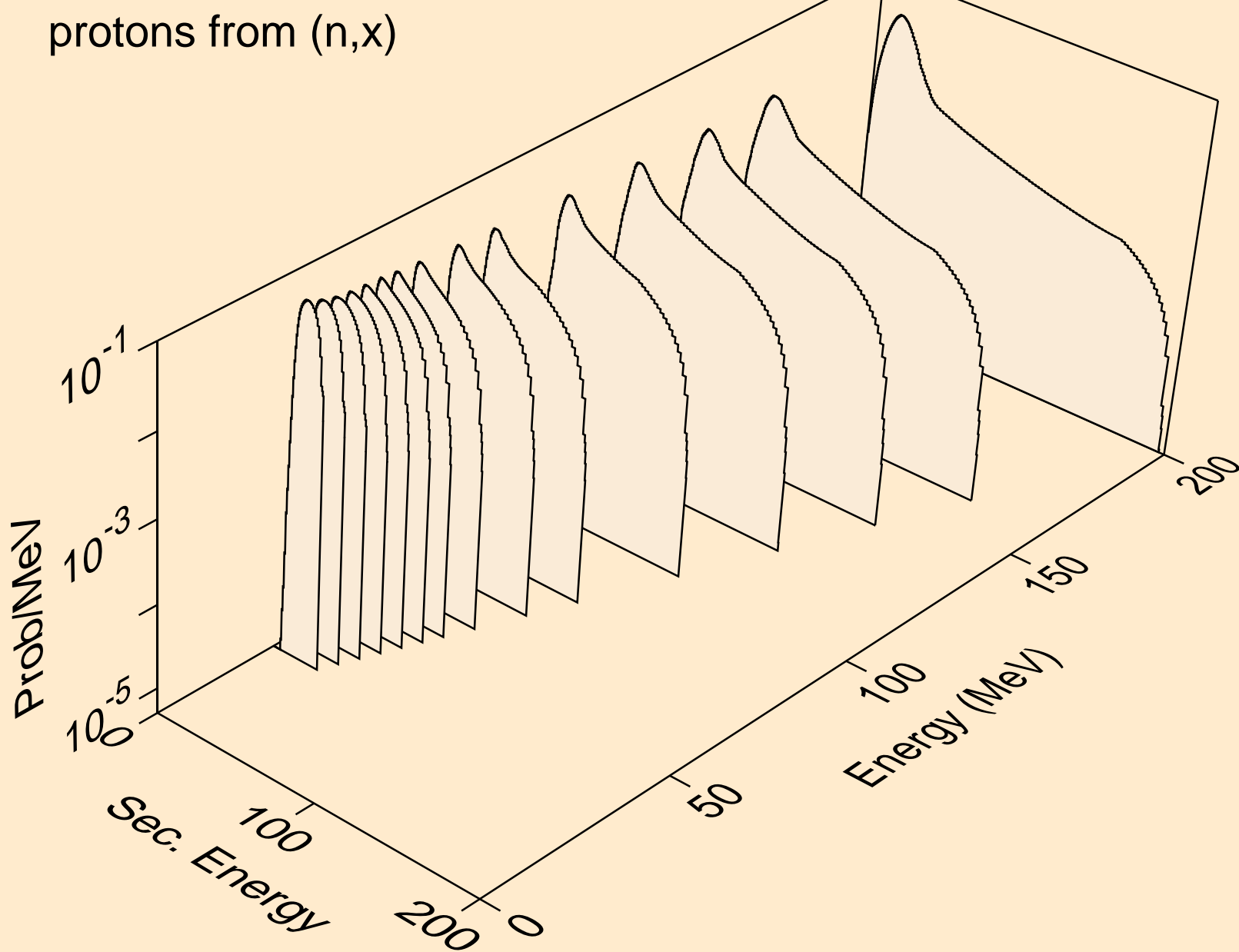

CM249 NEUTRON ACER TENDL-2019 LIBRARY; T=293.16K  
protons from (n,n\*)p

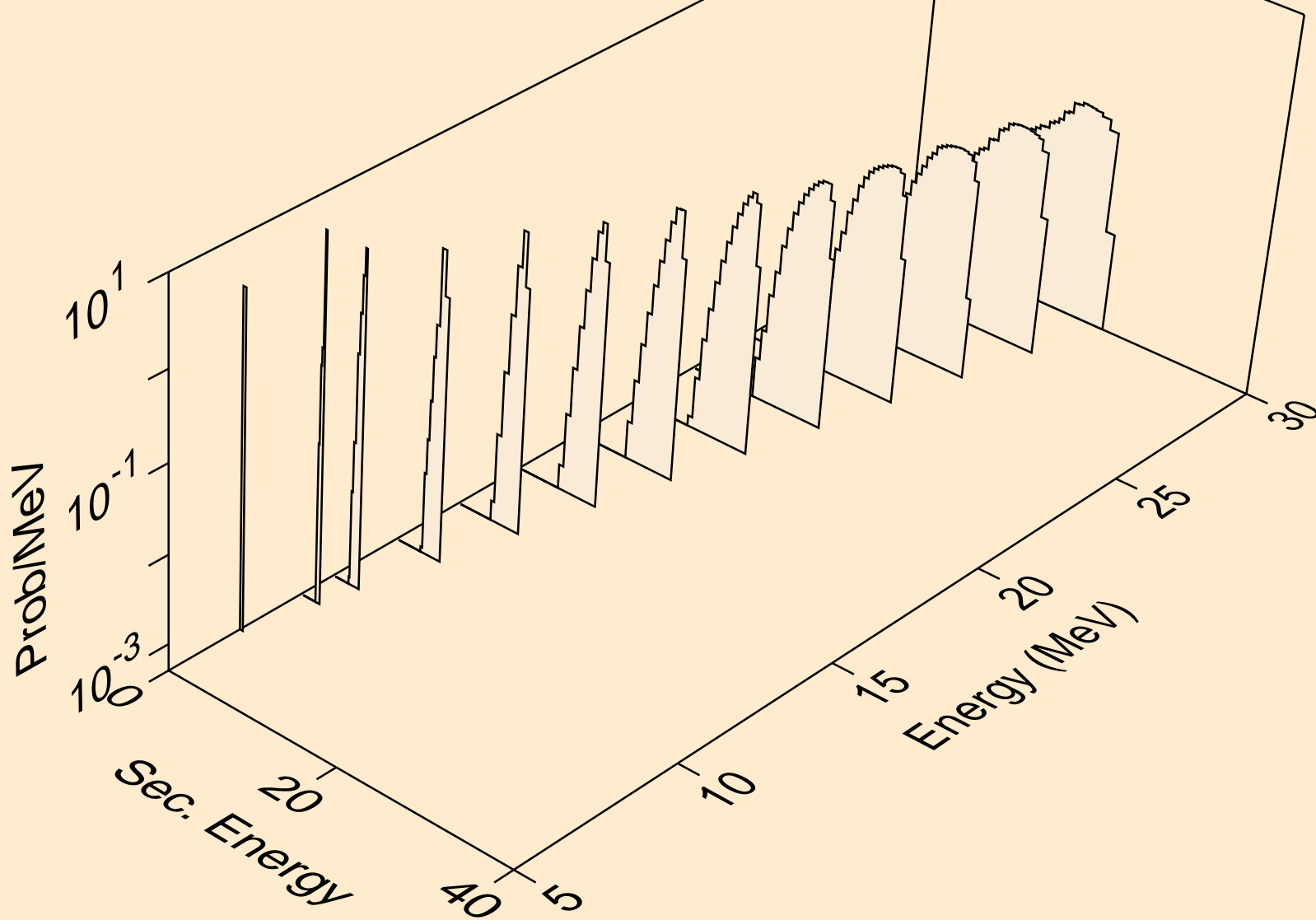

CM249 NEUTRON ACER TENDL-2019 LIBRARY; T=293.16K  
protons from (n,2np)

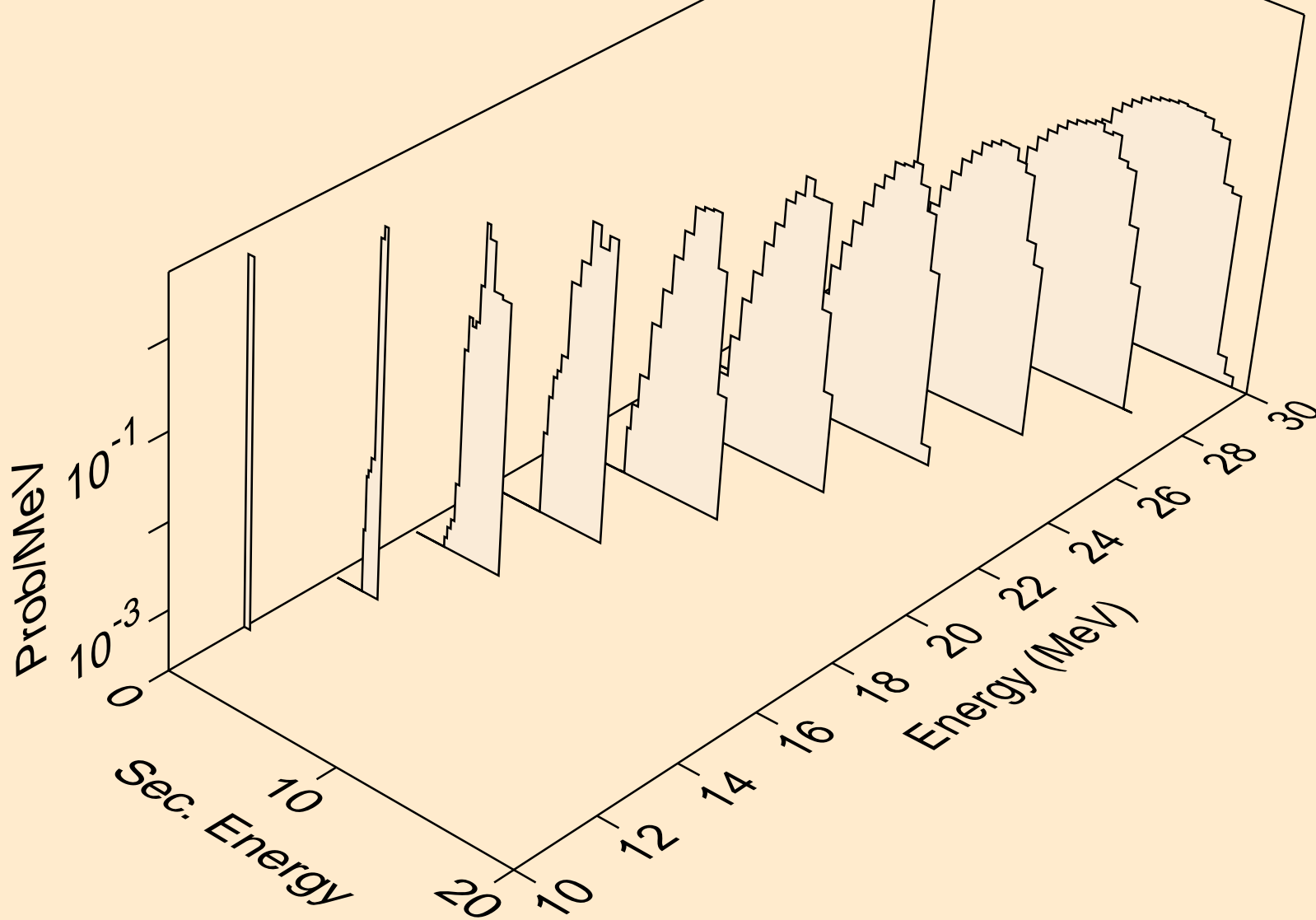

CM249 NEUTRON ACER TENDL-2019 LIBRARY; T=293.16K  
protons from (n,3np)

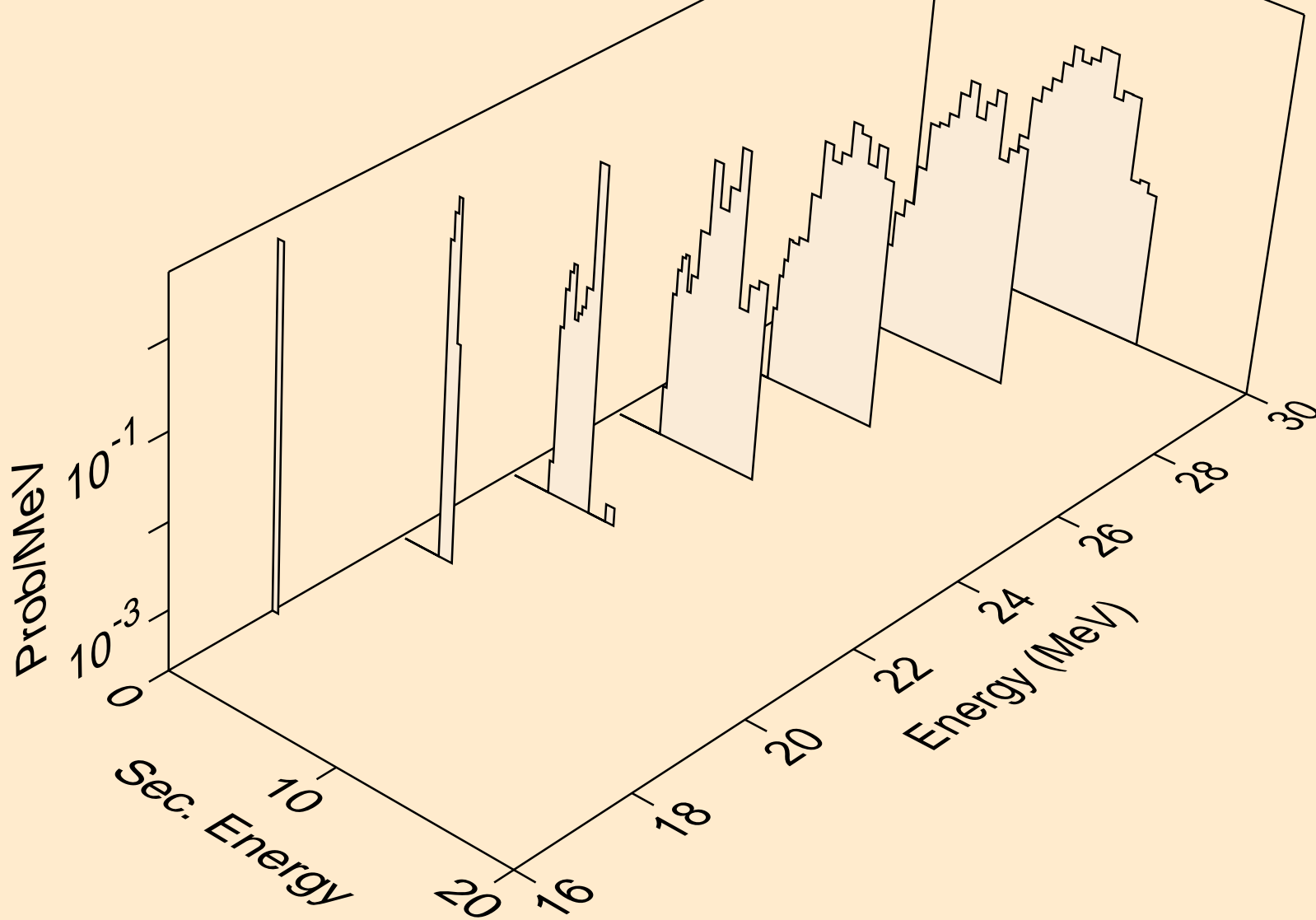

CM249 NEUTRON ACER TENDL-2019 LIBRARY; T=293.16K  
protons from (n,2np)

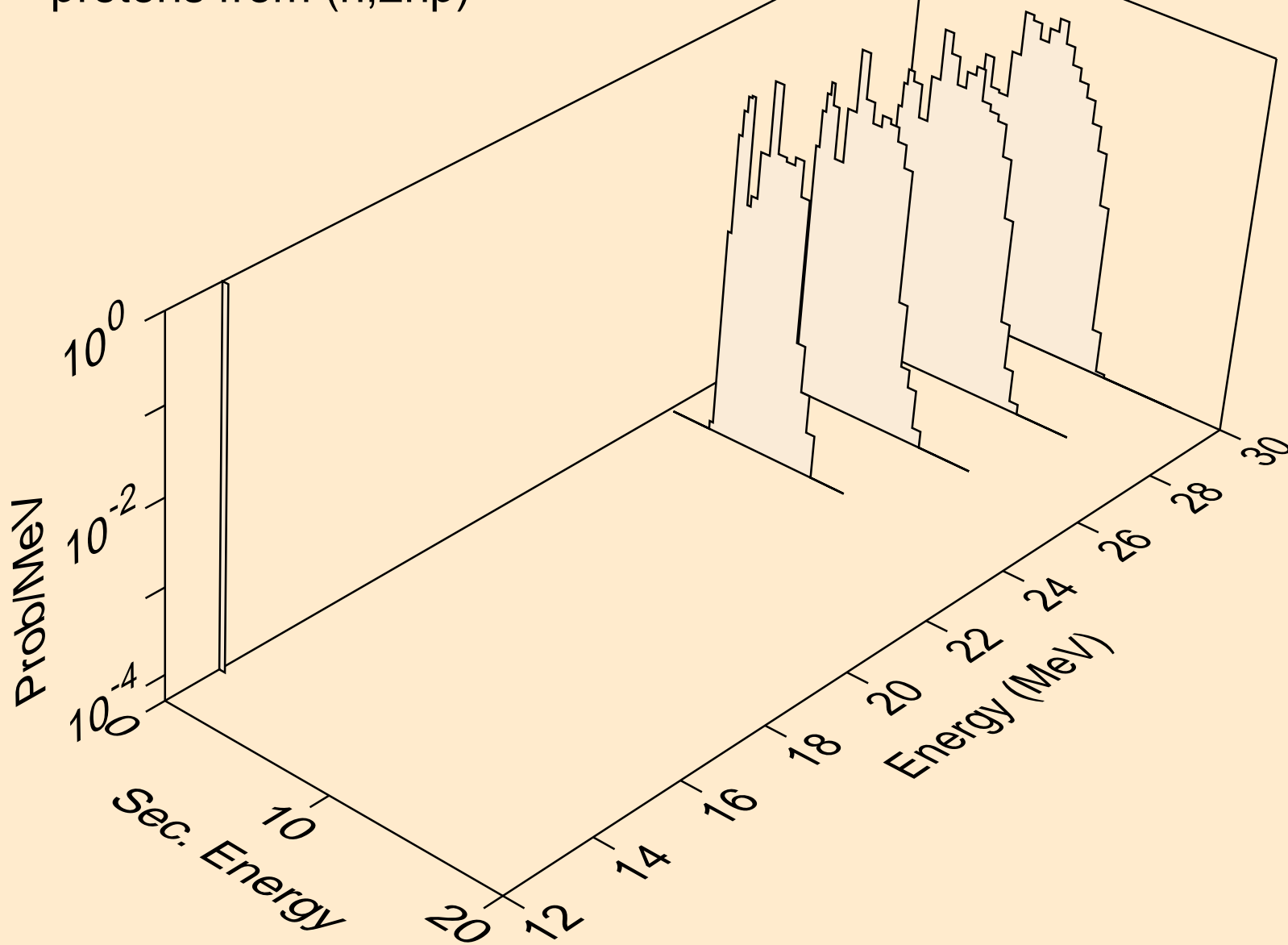

CM249 NEUTRON ACER TENDL-2019 LIBRARY; T=293.16K  
protons from (n,p)

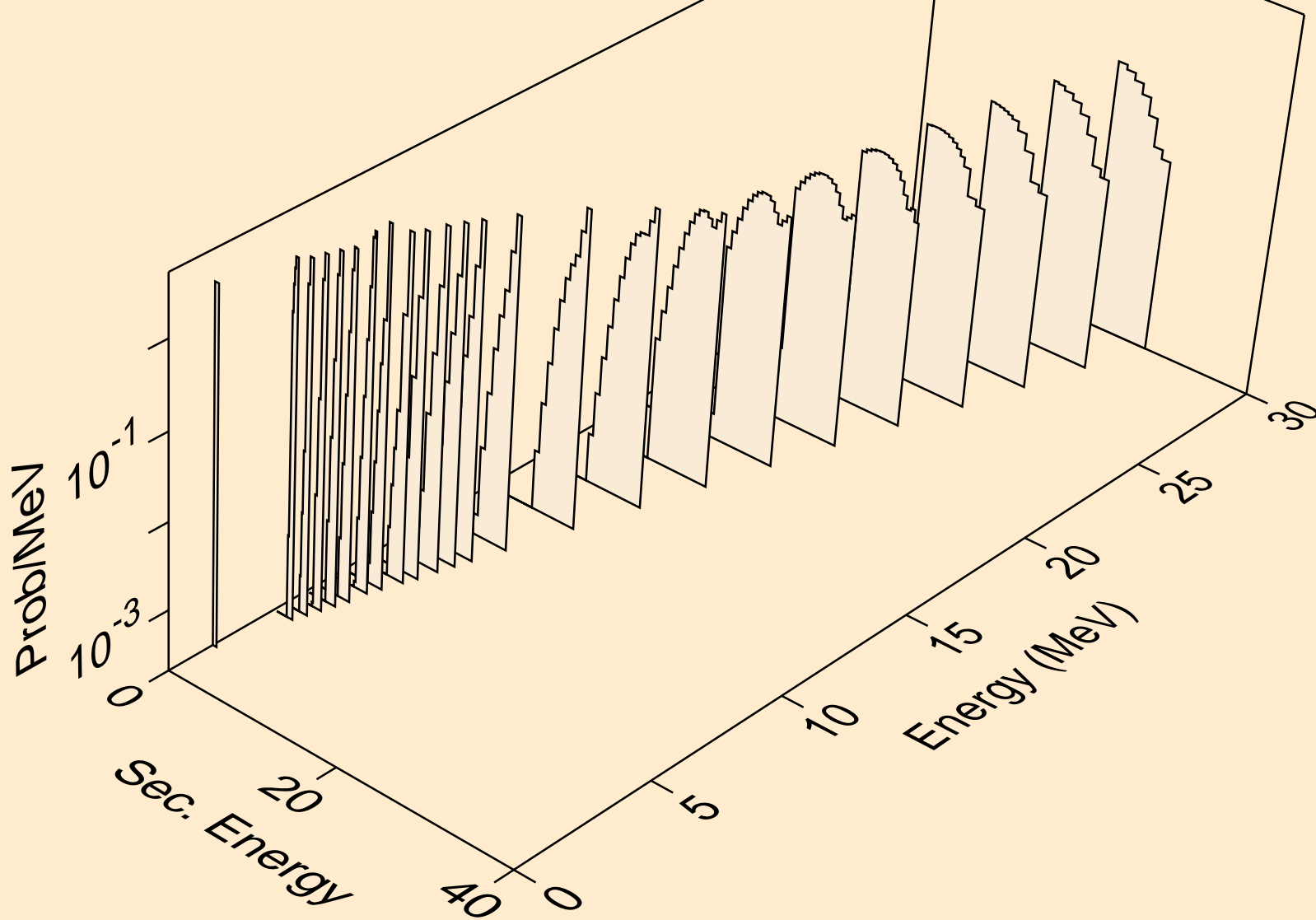

CM249 NEUTRON ACER TENDL-2019 LIBRARY; T=293.16K  
protons from (n,2p)

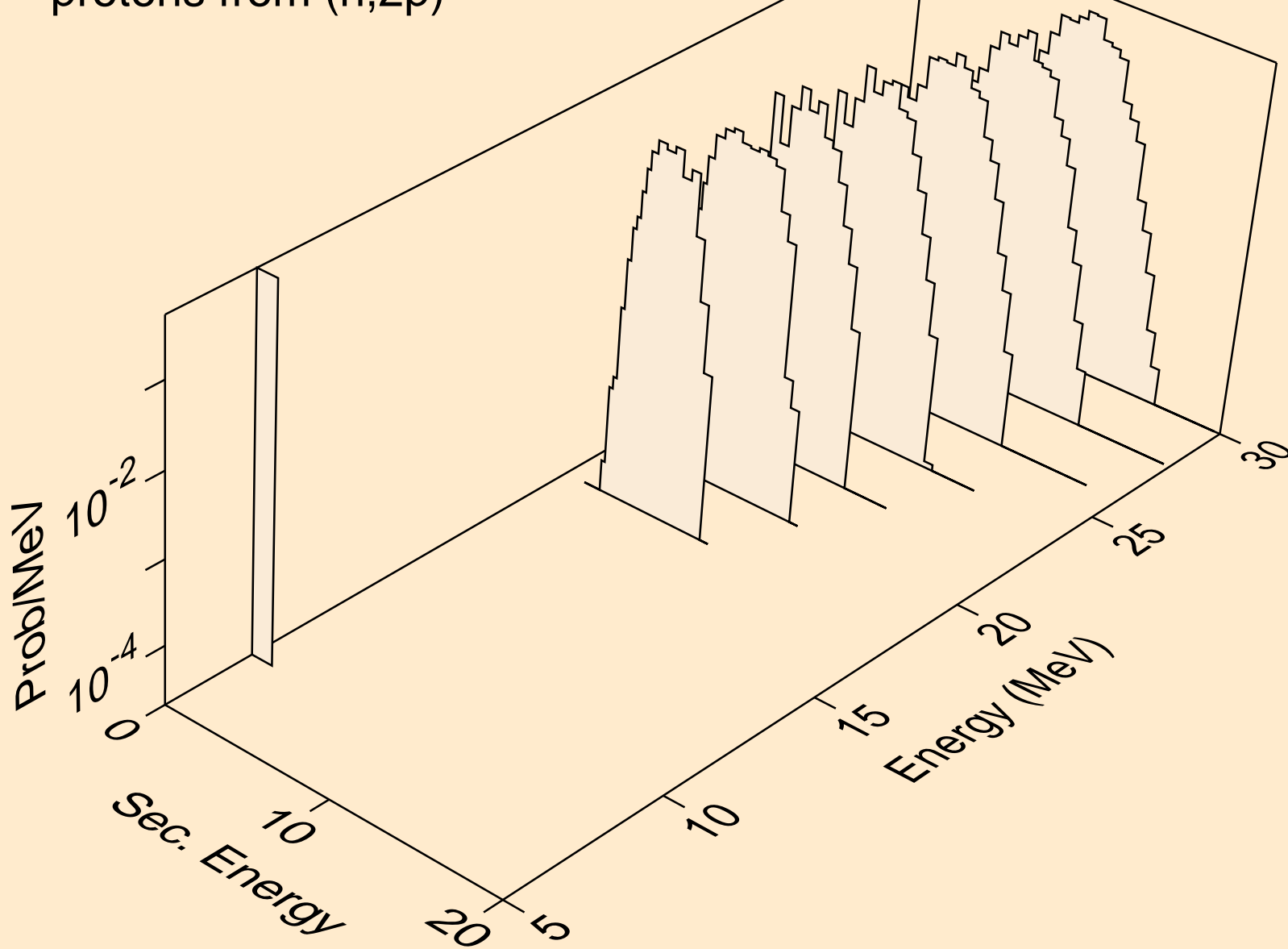

CM249 NEUTRON ACER TENDL-2019 LIBRARY; T=293.16K  
deuterons from (n,x)

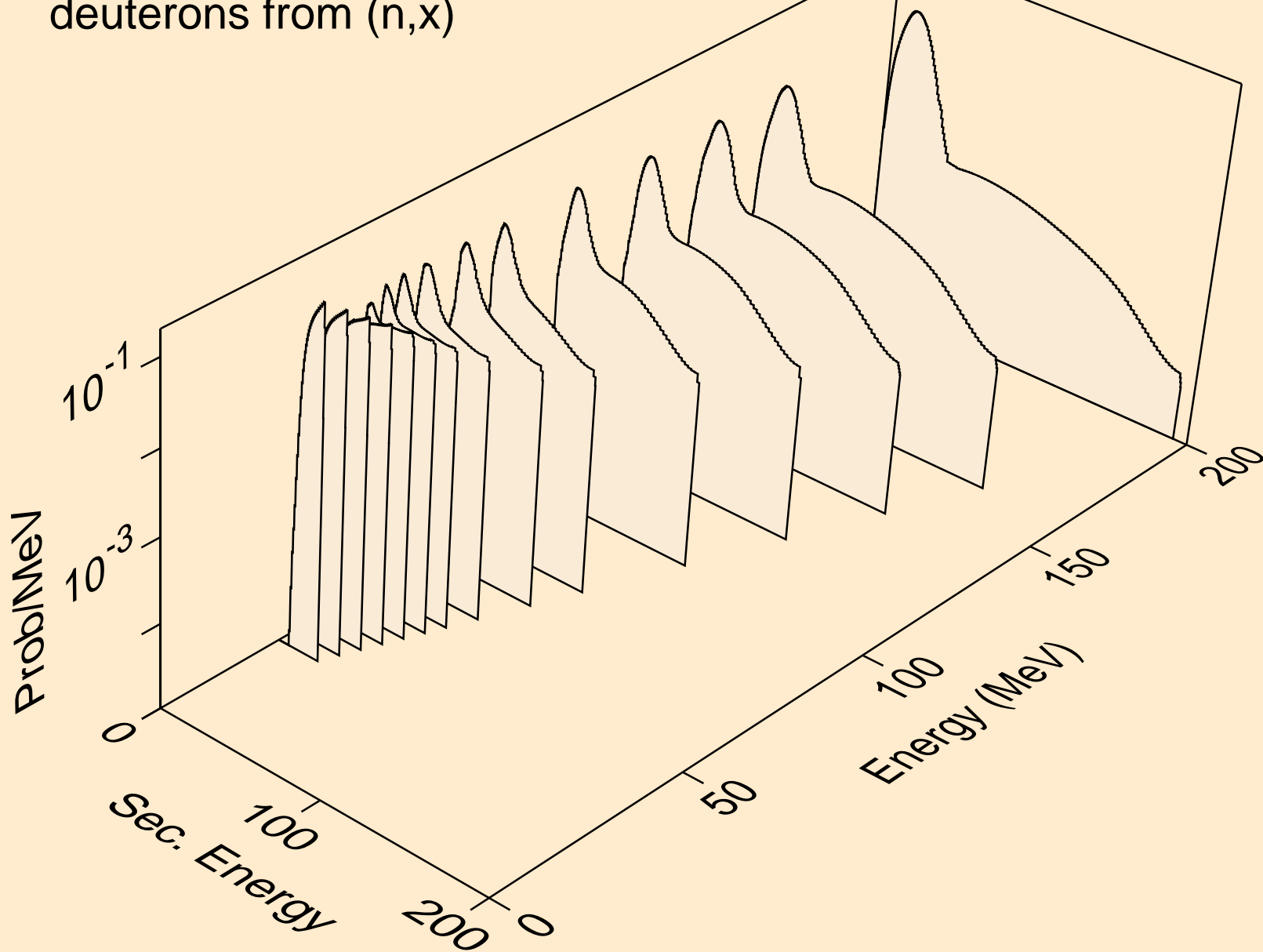

CM249 NEUTRON ACER TENDL-2019 LIBRARY; T=293.16K  
deuterons from (n,2nd)

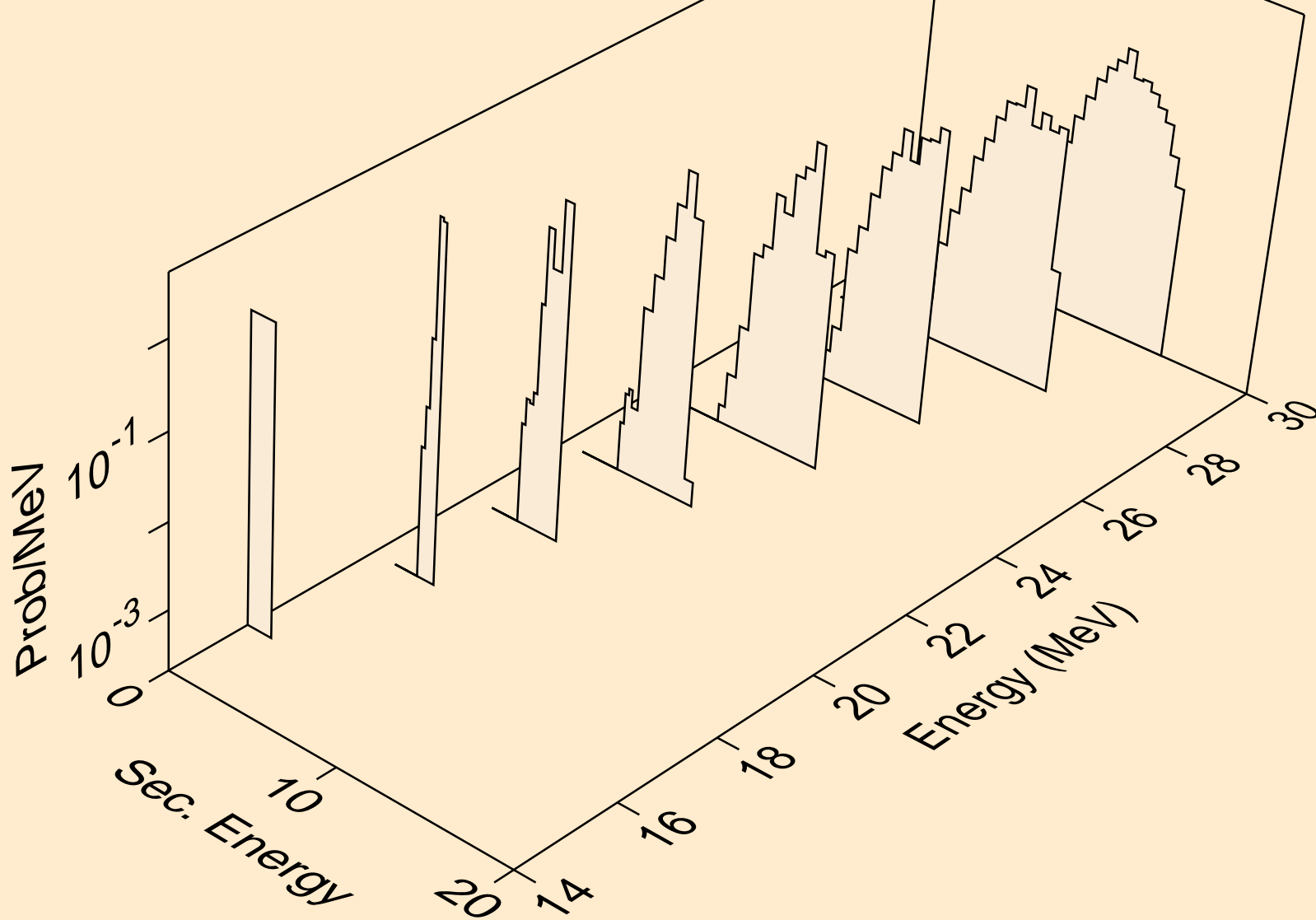

CM249 NEUTRON ACER TENDL-2019 LIBRARY; T=293.16K  
deuterons from (n,n\*)d

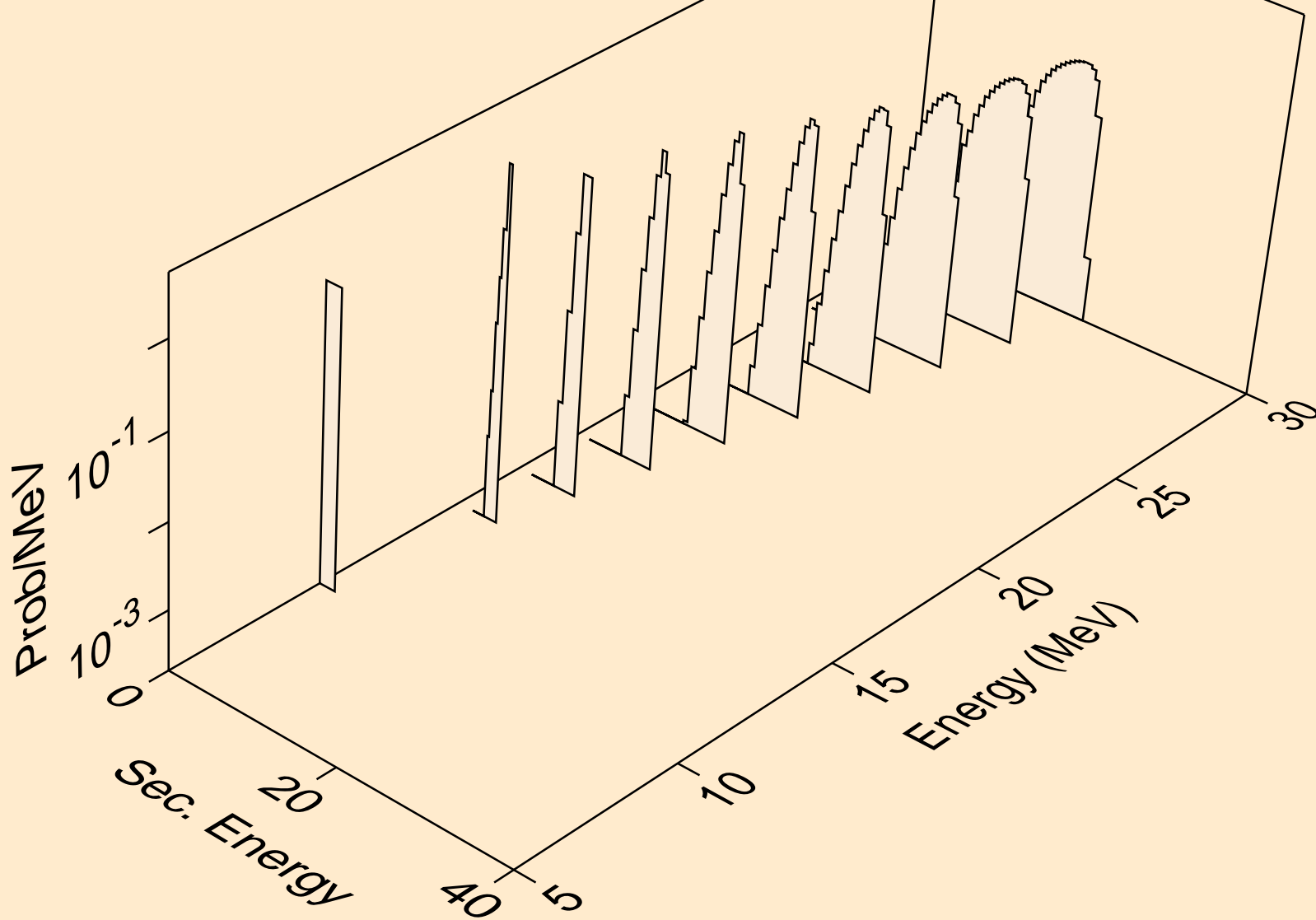

CM249 NEUTRON ACER TENDL-2019 LIBRARY; T=293.16K  
deuterons from (n,d)

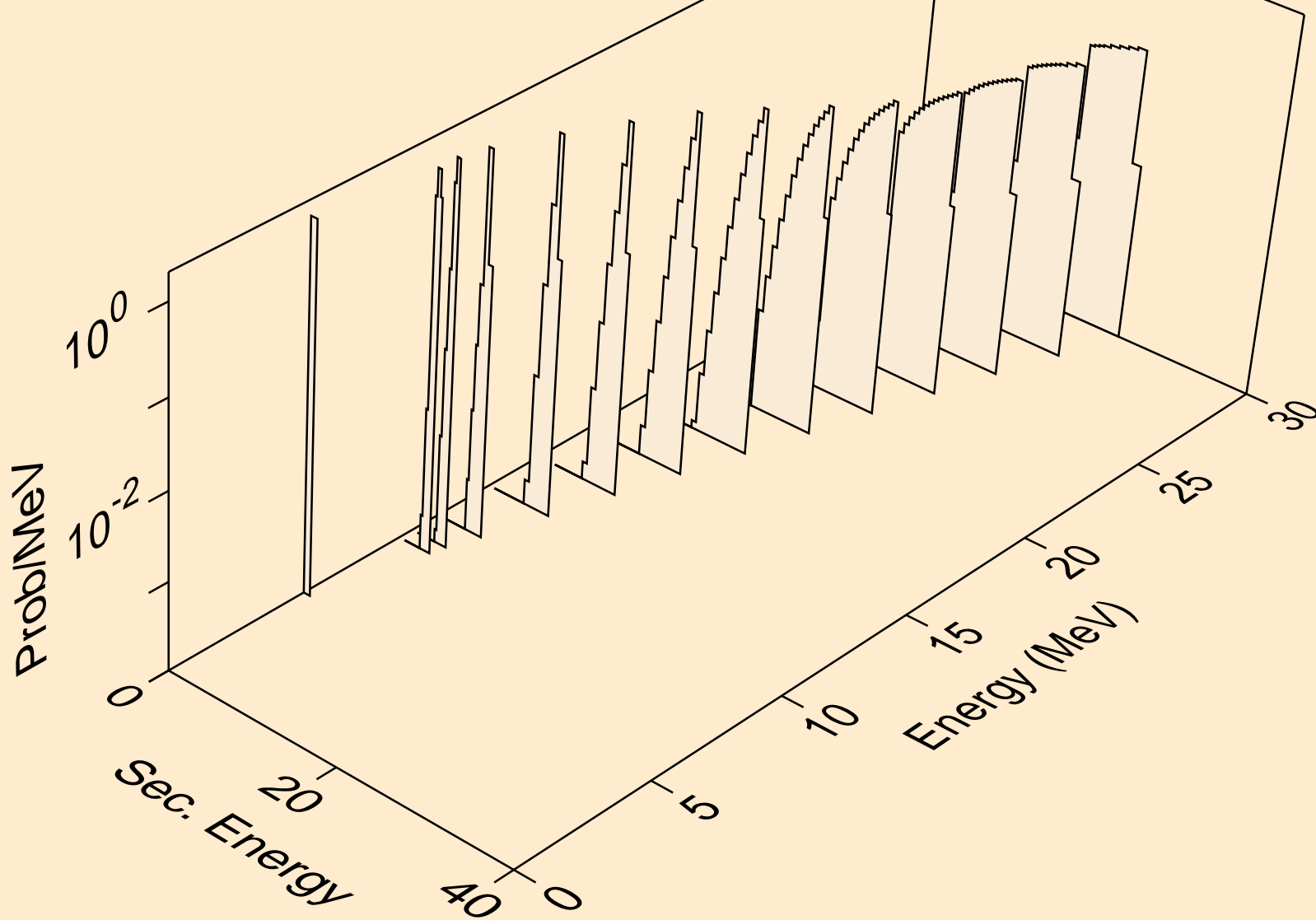

CM249 NEUTRON ACER TENDL-2019 LIBRARY; T=293.16K  
tritons from (n,x)

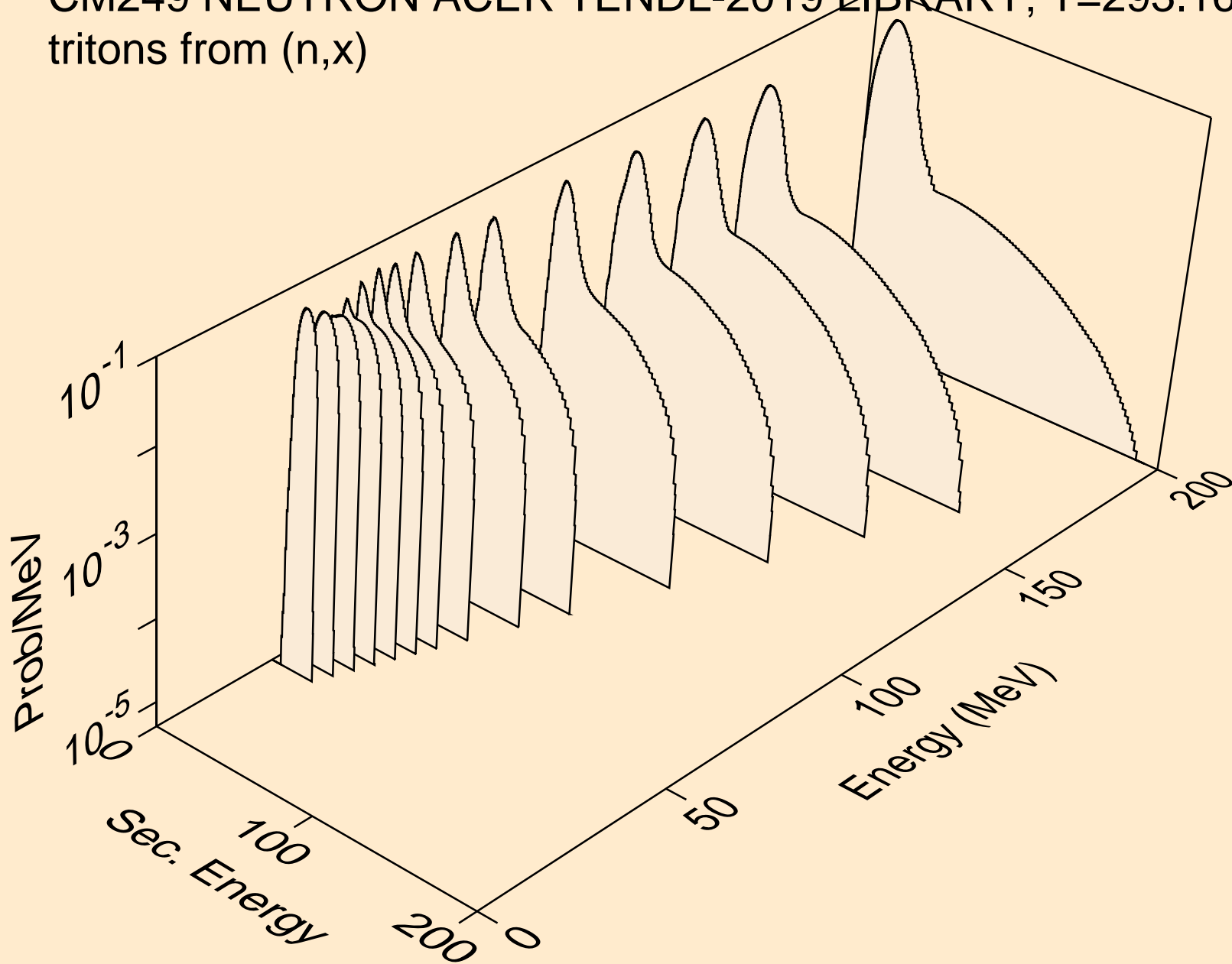

CM249 NEUTRON ACER TENDL-2019 LIBRARY; T=293.16K  
tritons from (n,n\*)t

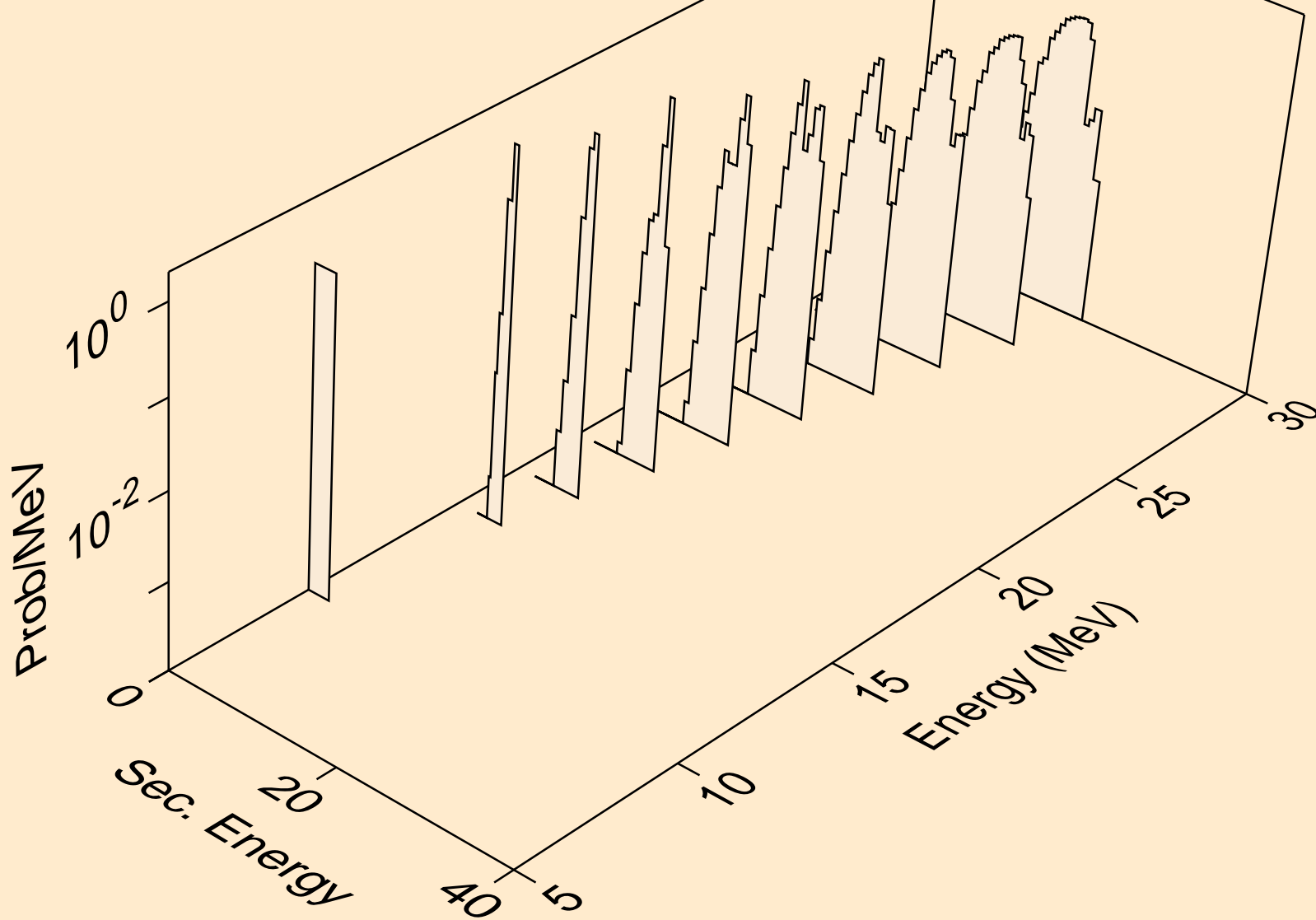

CM249 NEUTRON ACER TENDL-2019 LIBRARY; T=293.16K  
tritons from (n,t)

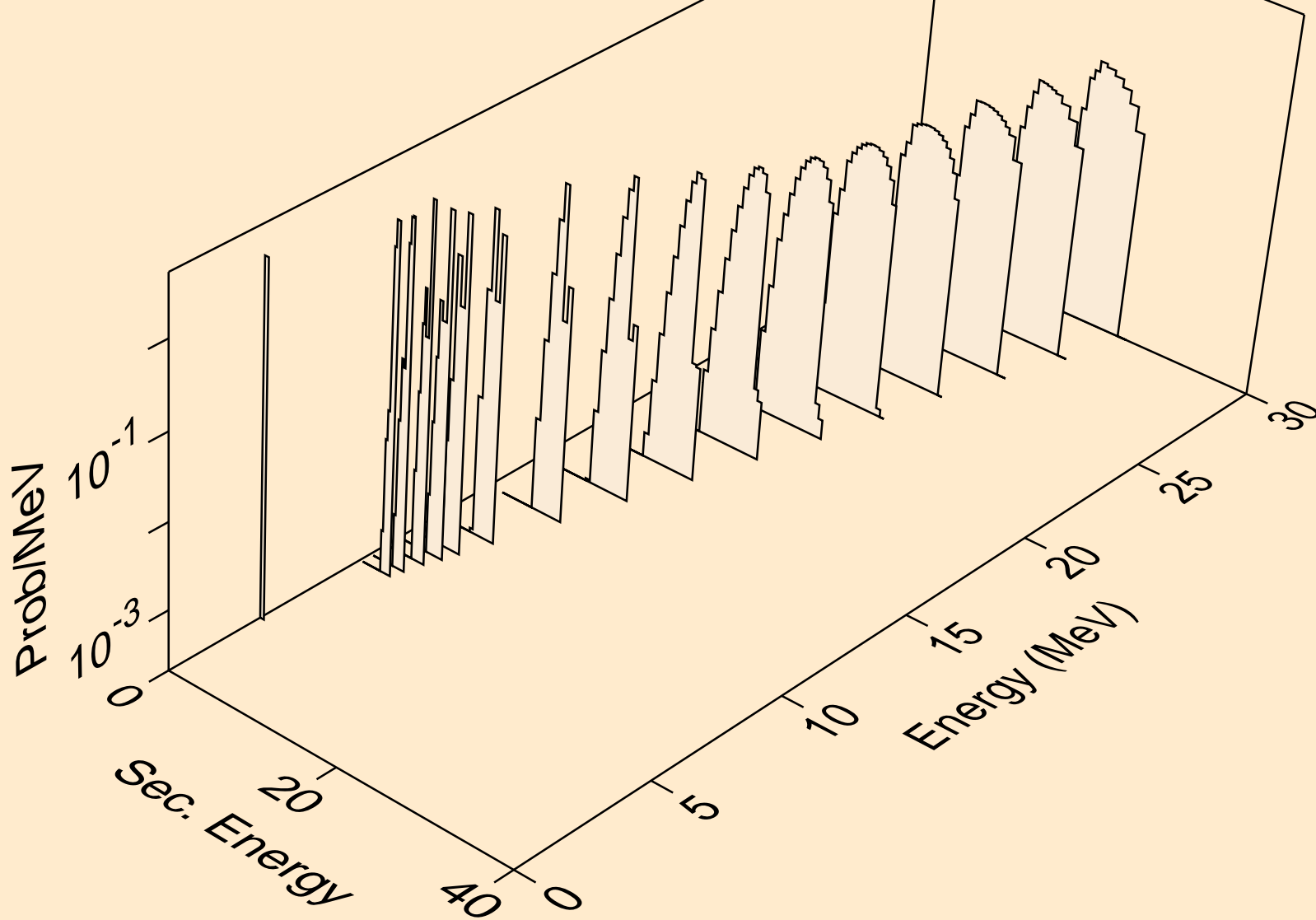

CM249 NEUTRON ACER TENDL-2019 LIBRARY; T=293.16K  
he3s from (n,x)

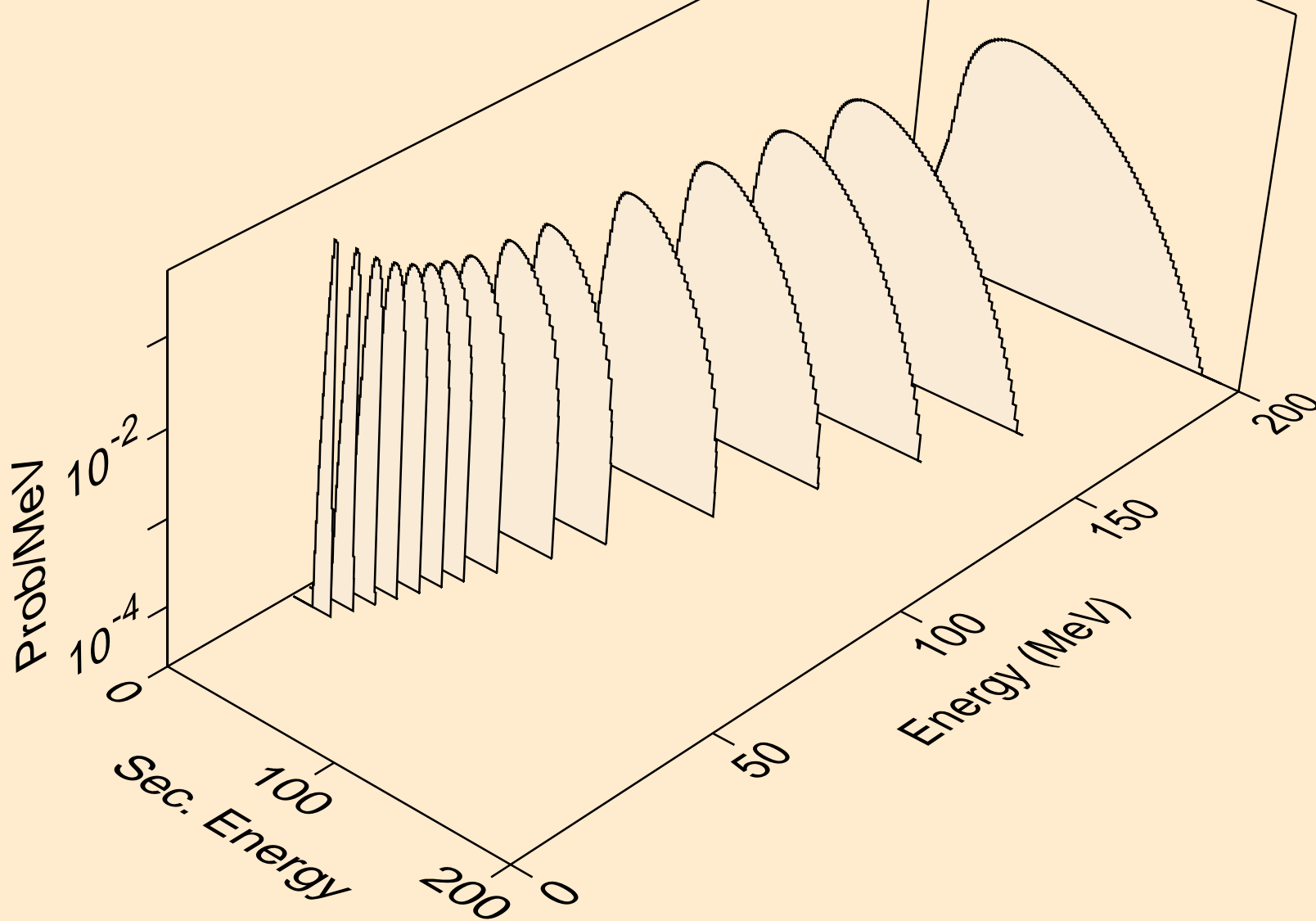

CM249 NEUTRON ACER TENDL-2019 LIBRARY; T=293.16K  
he3s from (n,n\*)he3

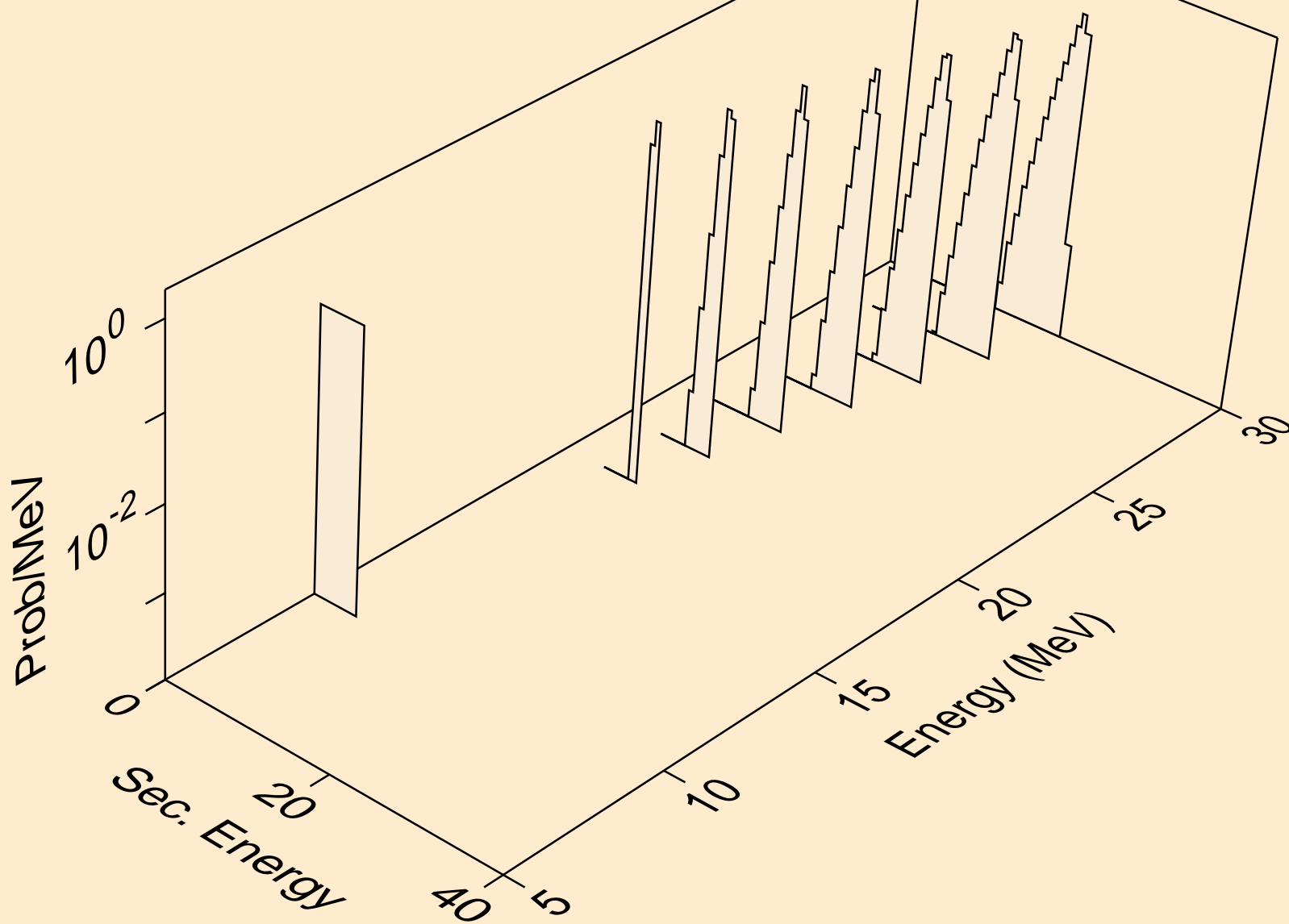

CM249 NEUTRON ACER TENDL-2019 LIBRARY; T=293.16K  
he3s from (n,he3)

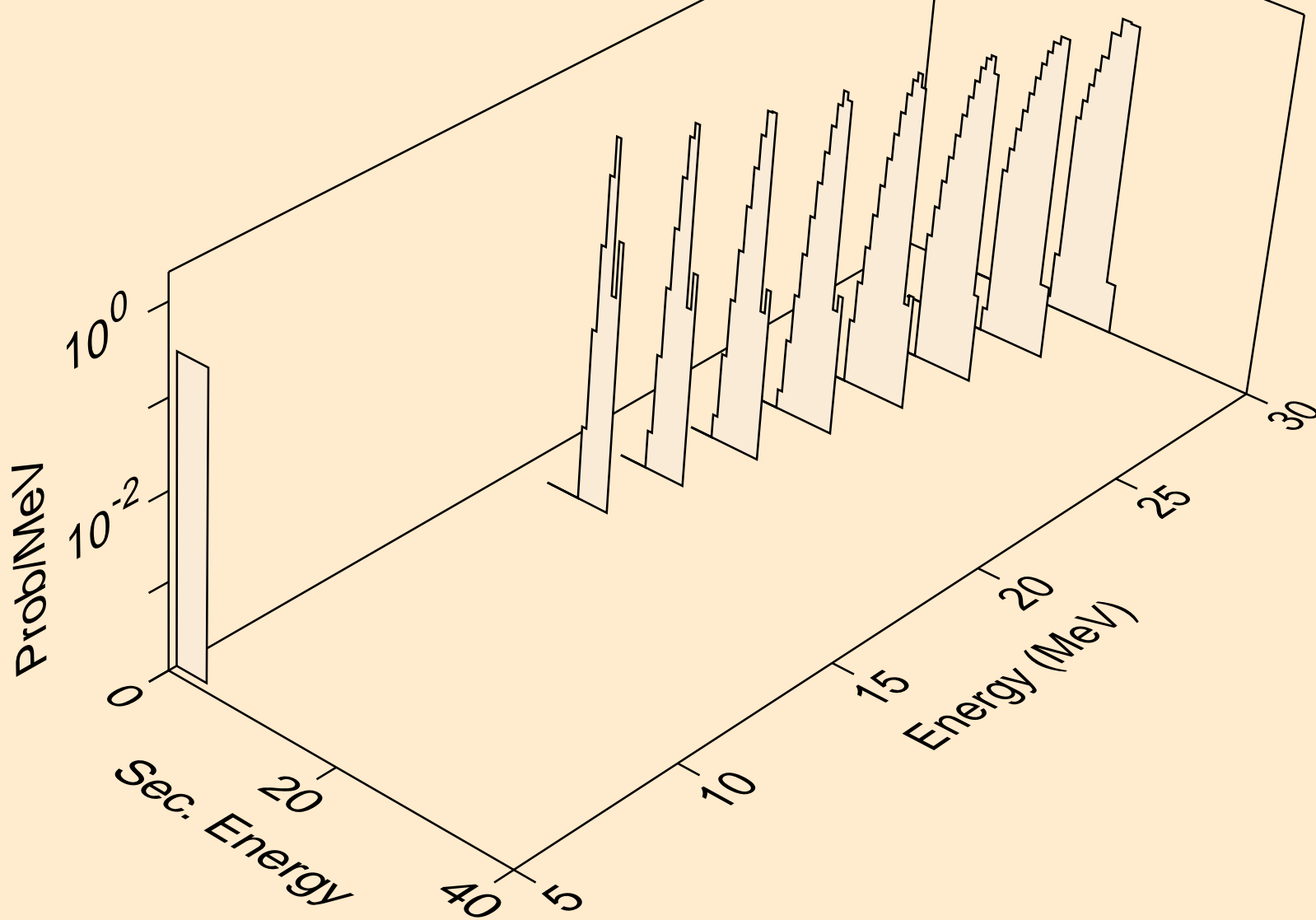

CM249 NEUTRON ACER TENDL-2019 LIBRARY; T=293.16K  
alphas from (n,x)

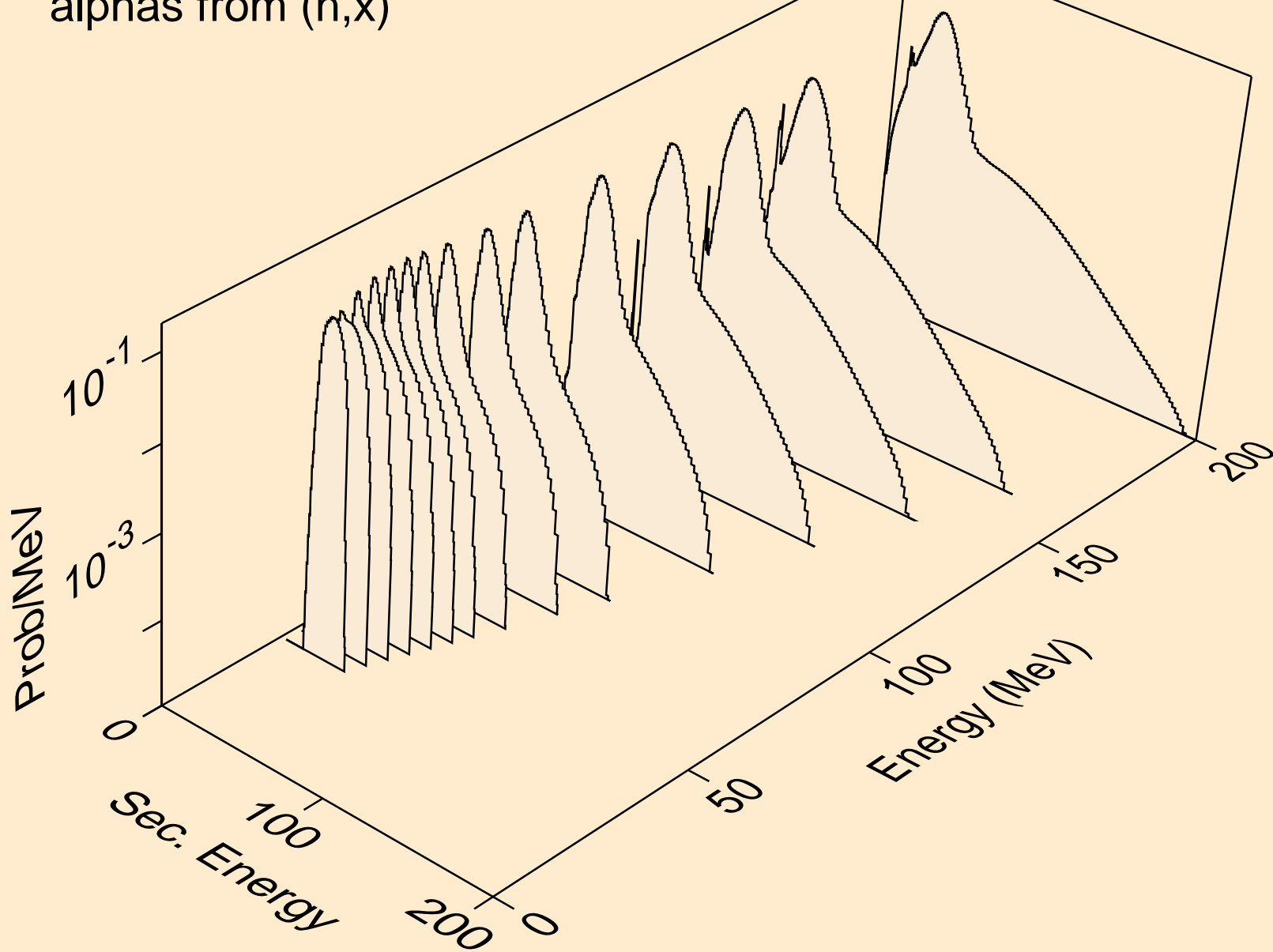

CM249 NEUTRON ACER TENDL-2019 LIBRARY; T=293.16K  
alphas from (n,n\*)a

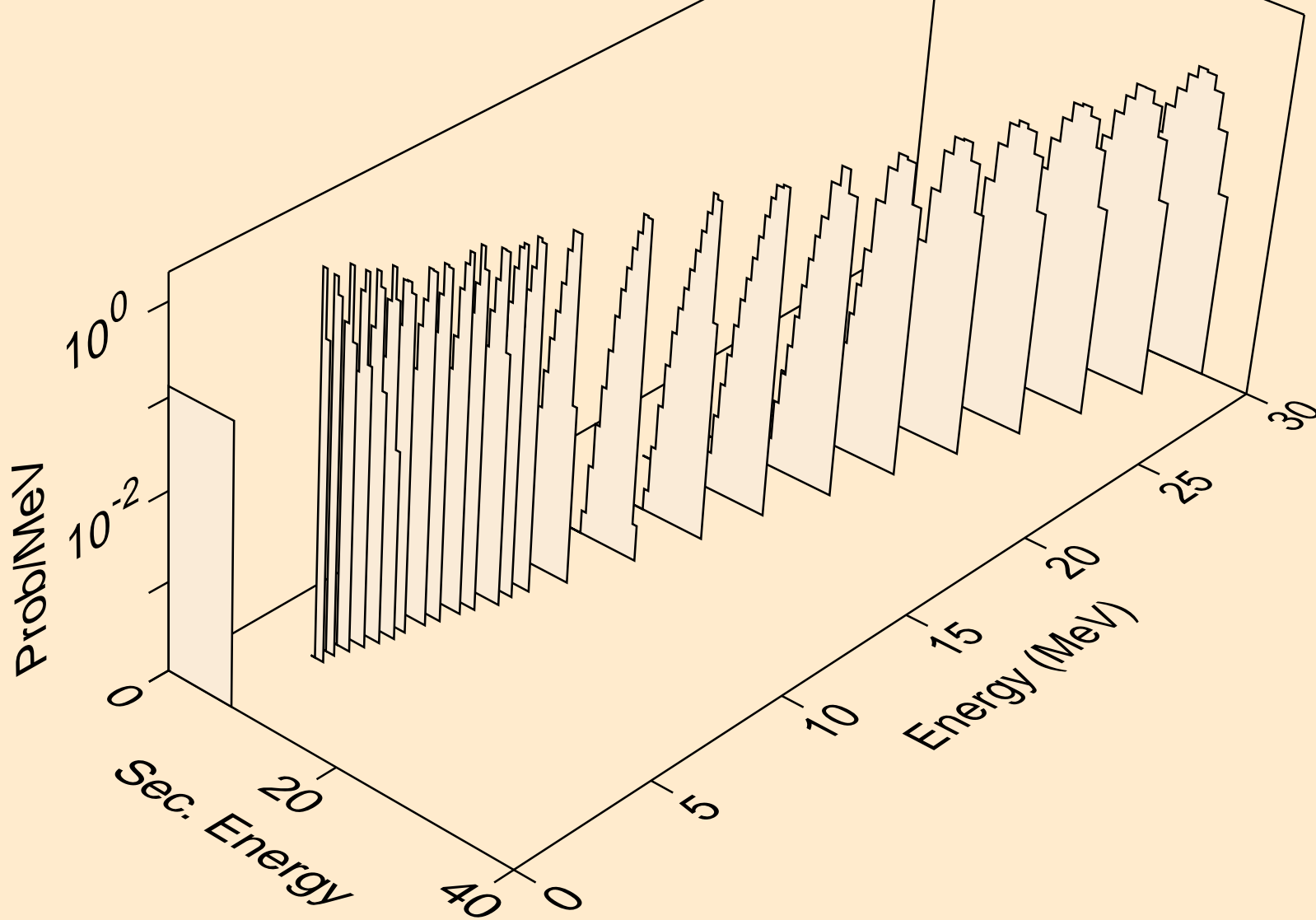

CM249 NEUTRON ACER TENDL-2019 LIBRARY; T=293.16K  
alphas from (n,2n)a

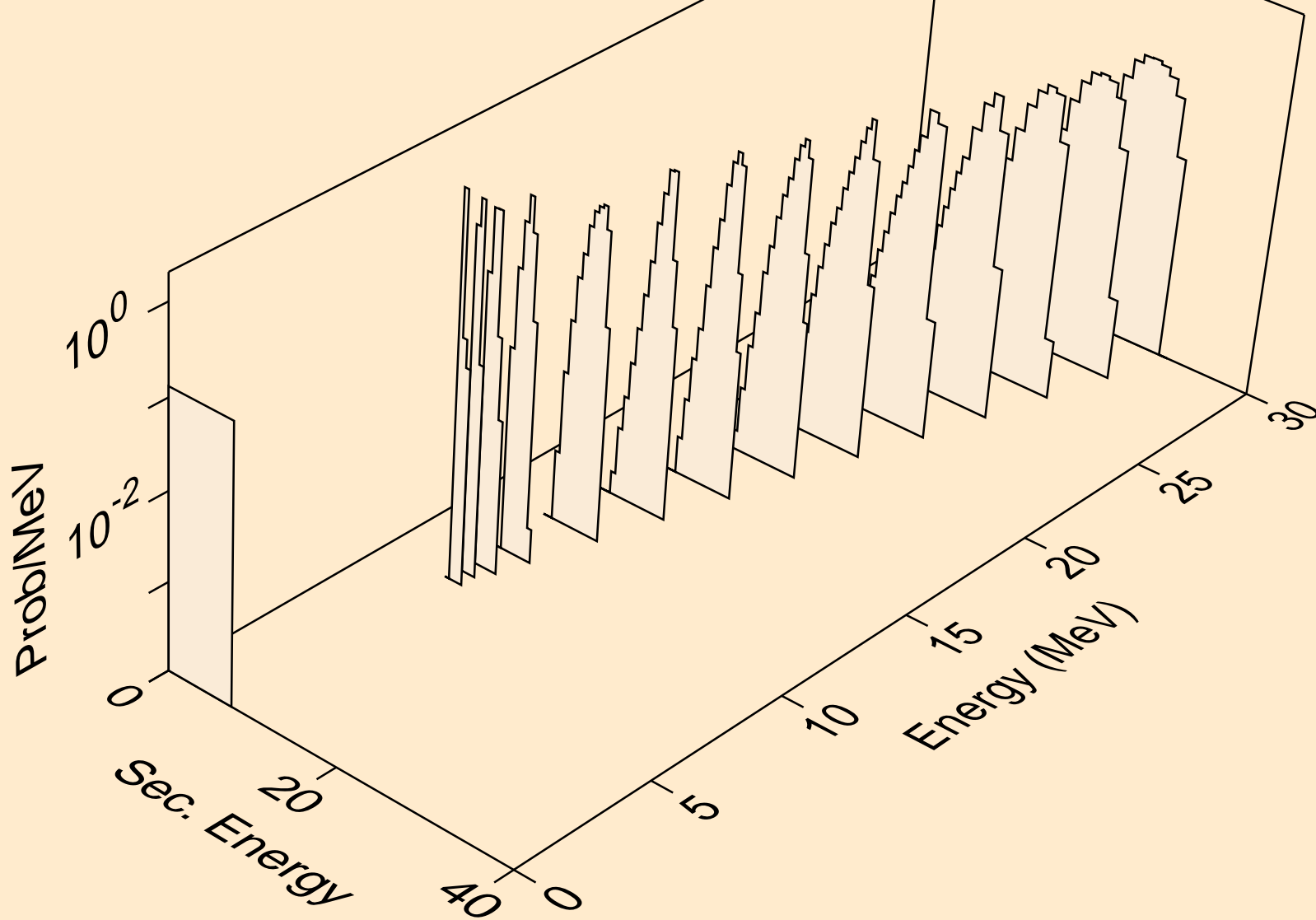

CM249 NEUTRON ACER TENDL-2019 LIBRARY; T=293.16K  
alphas from (n,3n)a

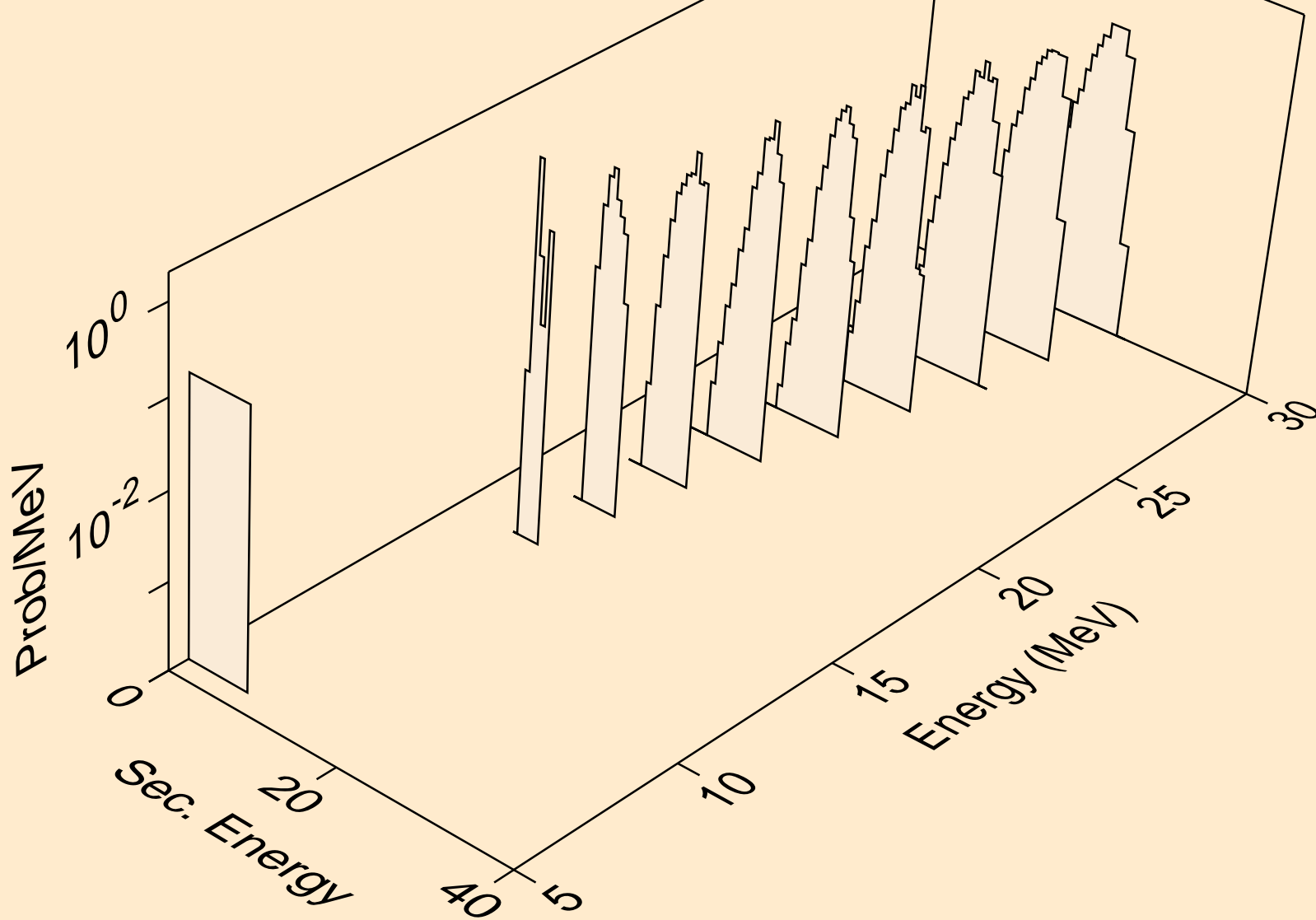

CM249 NEUTRON ACER TENDL-2019 LIBRARY; T=293.16K  
alphas from (n,a)

