

GD155 NEUTRON ACER TENDL-2019 LIBRARY; T=293.16K

Principal cross sections

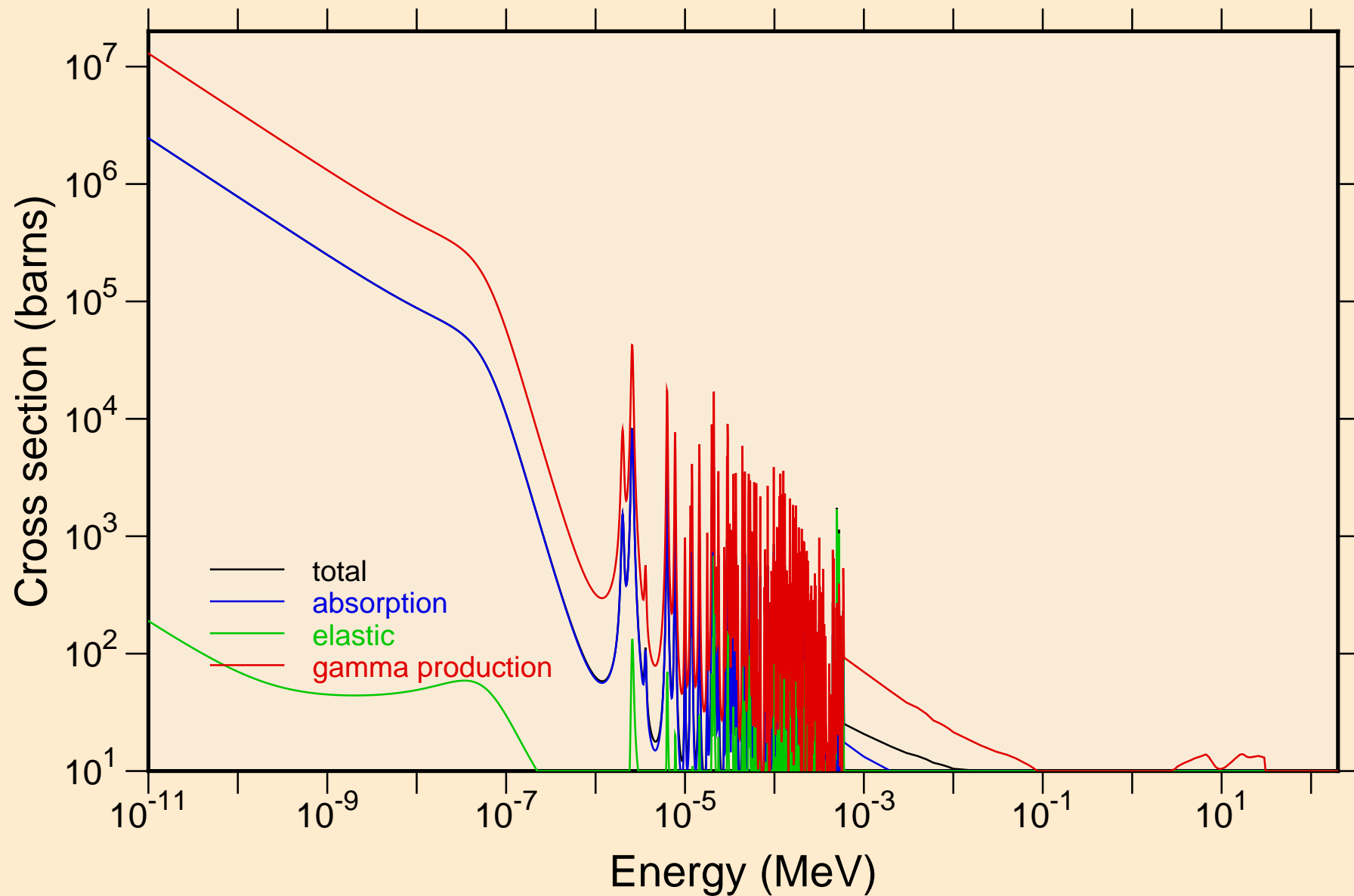

GD155 NEUTRON ACER TENDL-2019 LIBRARY; T=293.16K
resonance total cross section

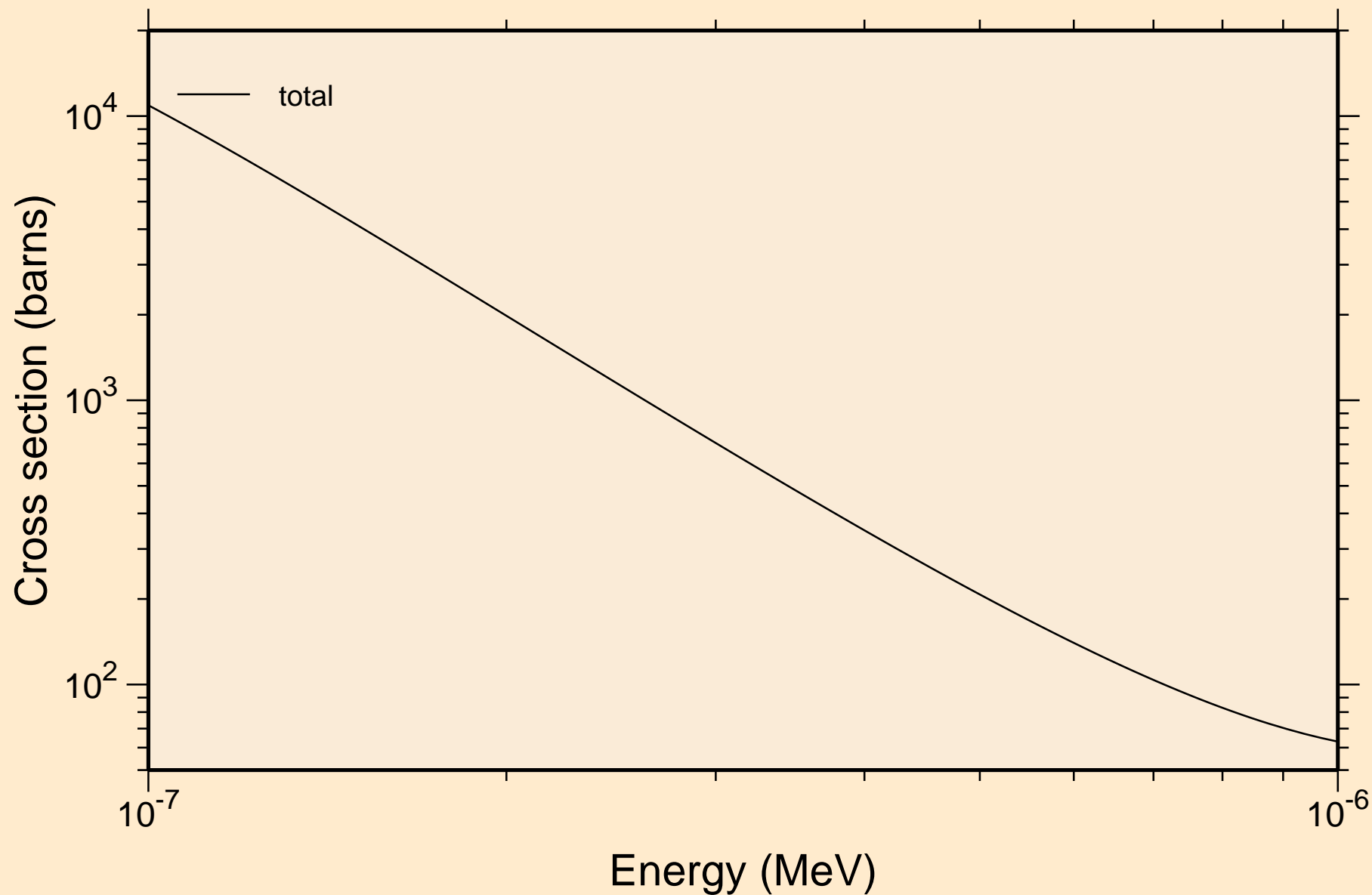

GD155 NEUTRON ACER TENDL-2019 LIBRARY; T=293.16K
resonance total cross section

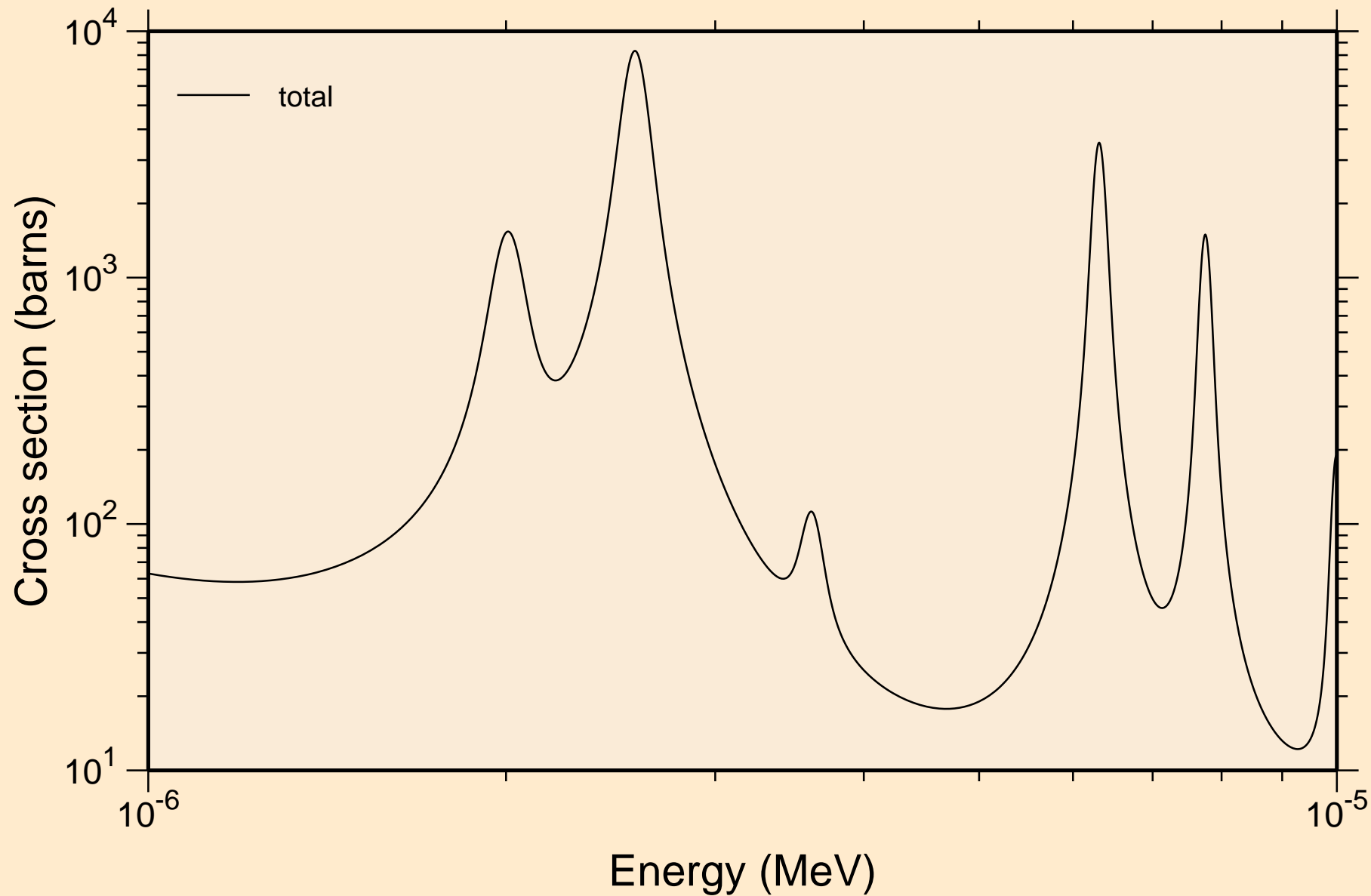

GD155 NEUTRON ACER TENDL-2019 LIBRARY; T=293.16K
resonance total cross section

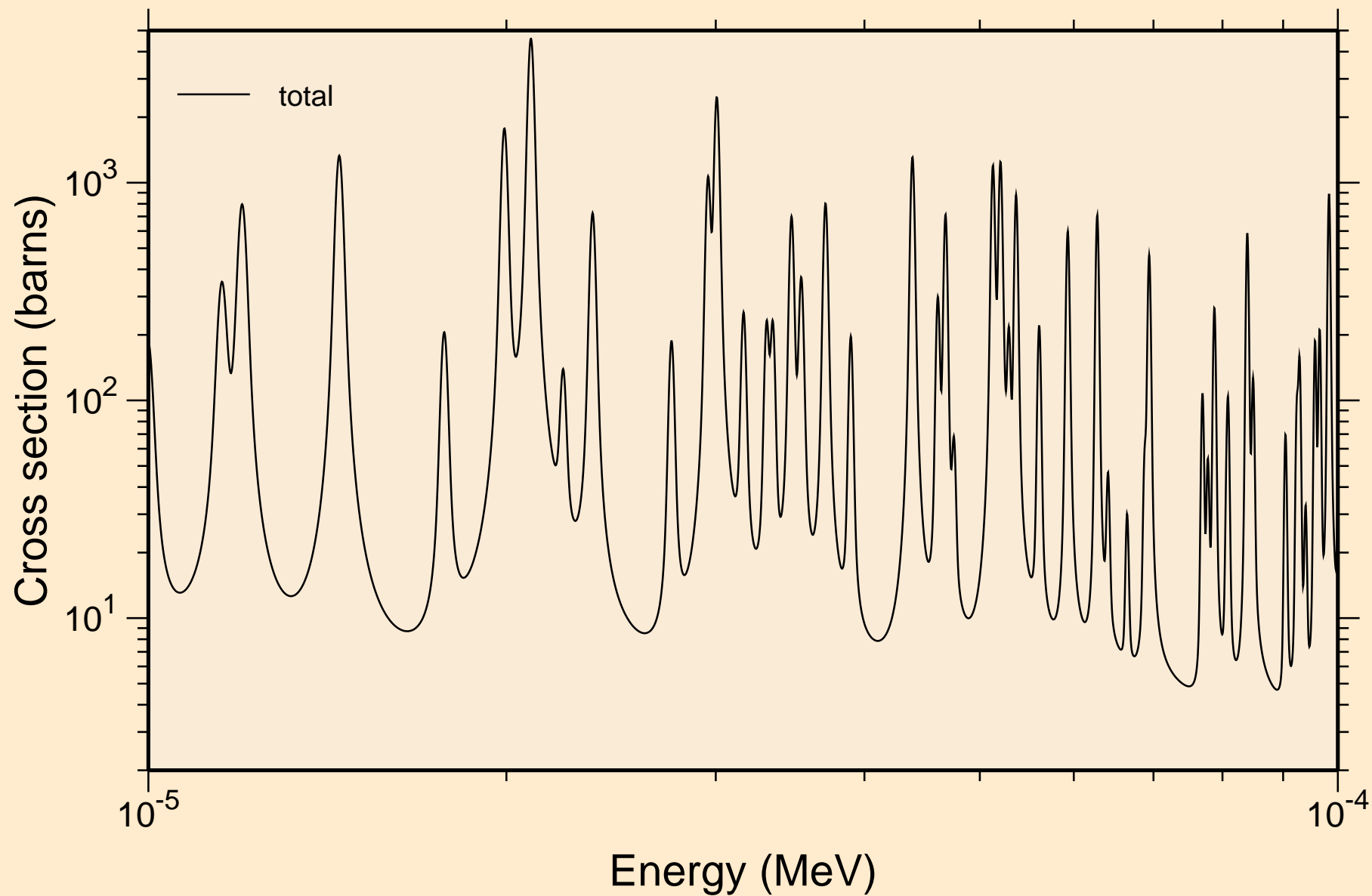

GD155 NEUTRON ACER TENDL-2019 LIBRARY; T=293.16K
resonance total cross section

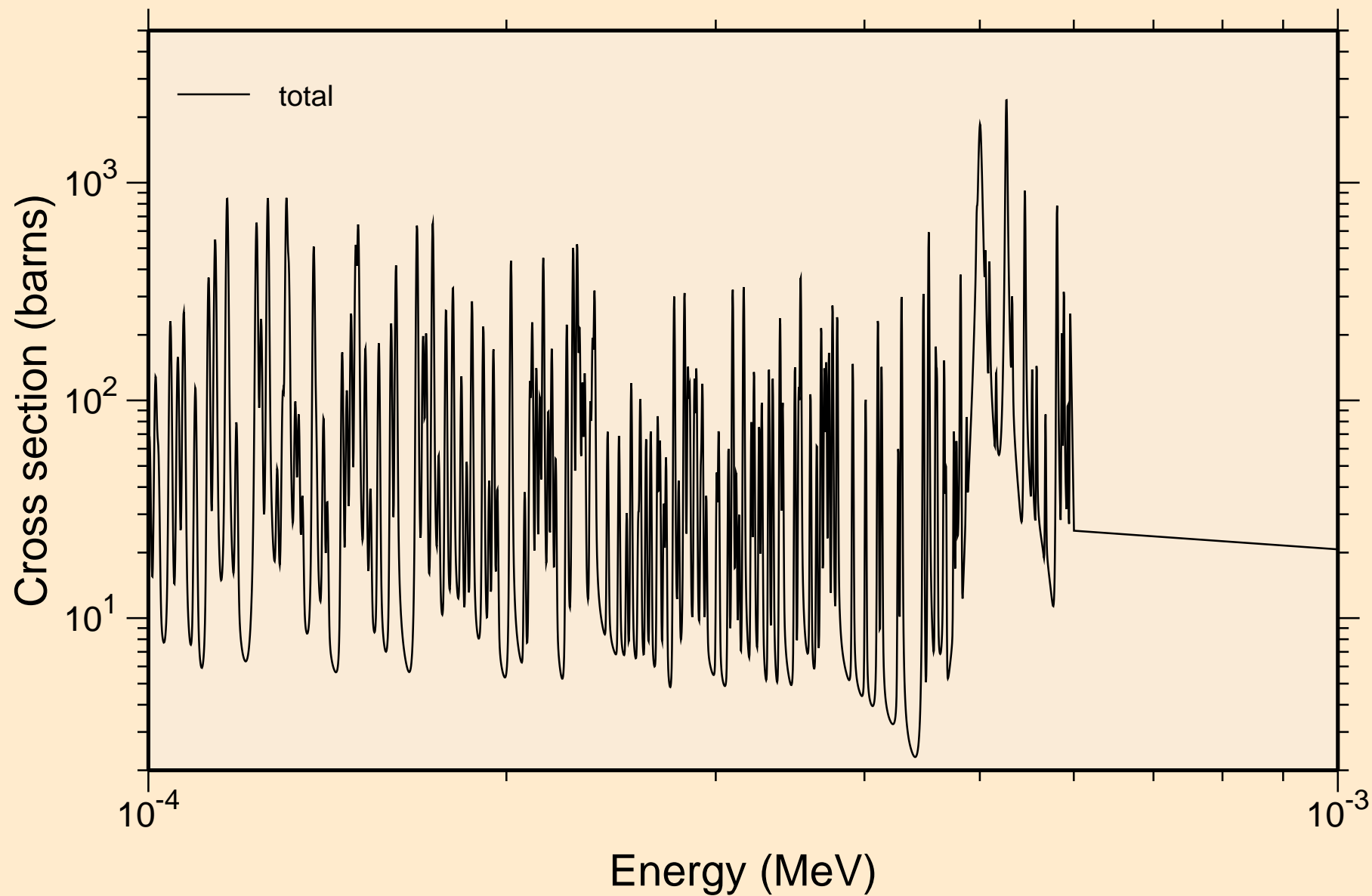

GD155 NEUTRON ACER TENDL-2019 LIBRARY; T=293.16K
resonance total cross section

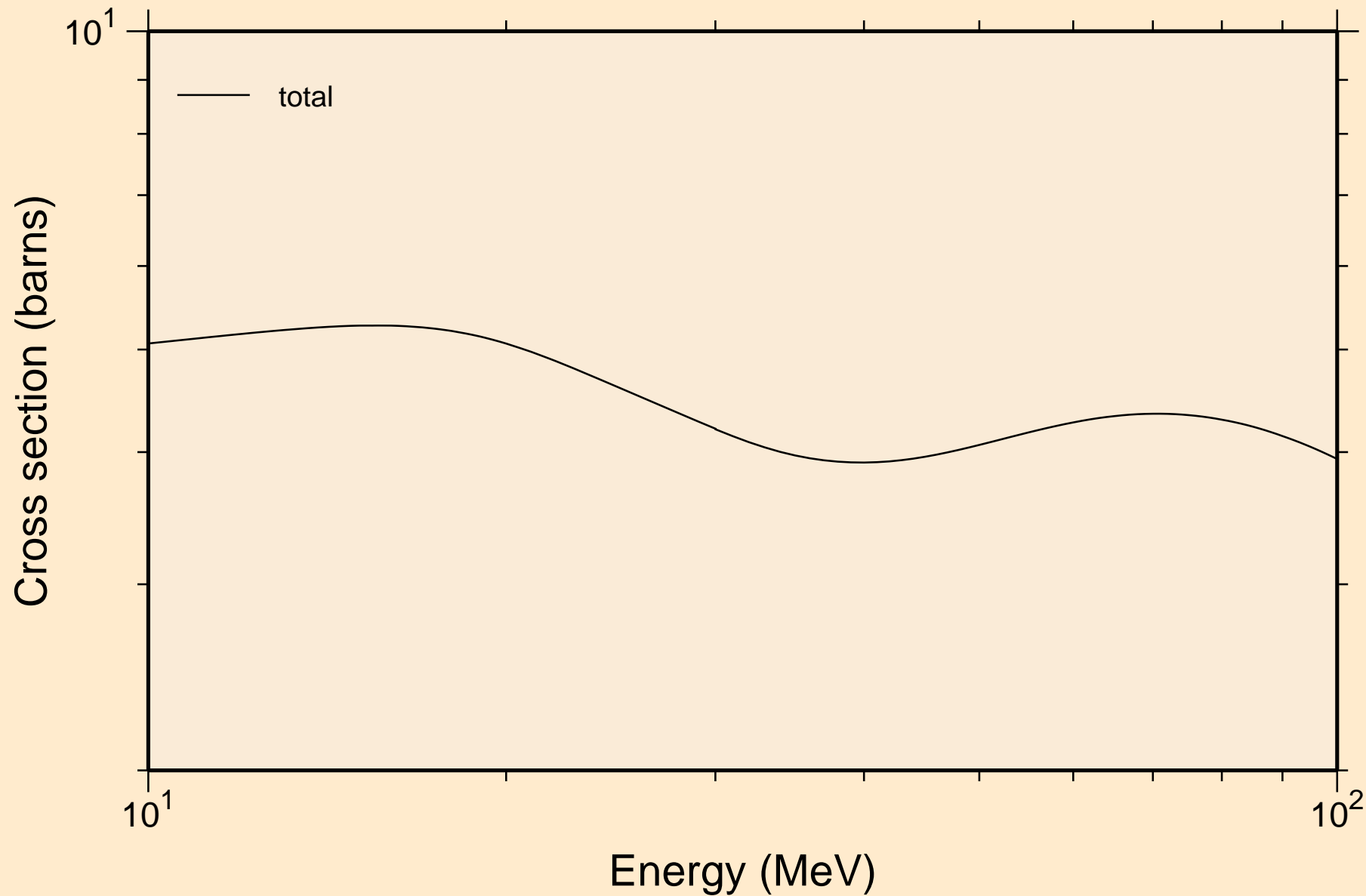

GD155 NEUTRON ACER TENDL-2019 LIBRARY; T=293.16K
resonance absorption cross sections

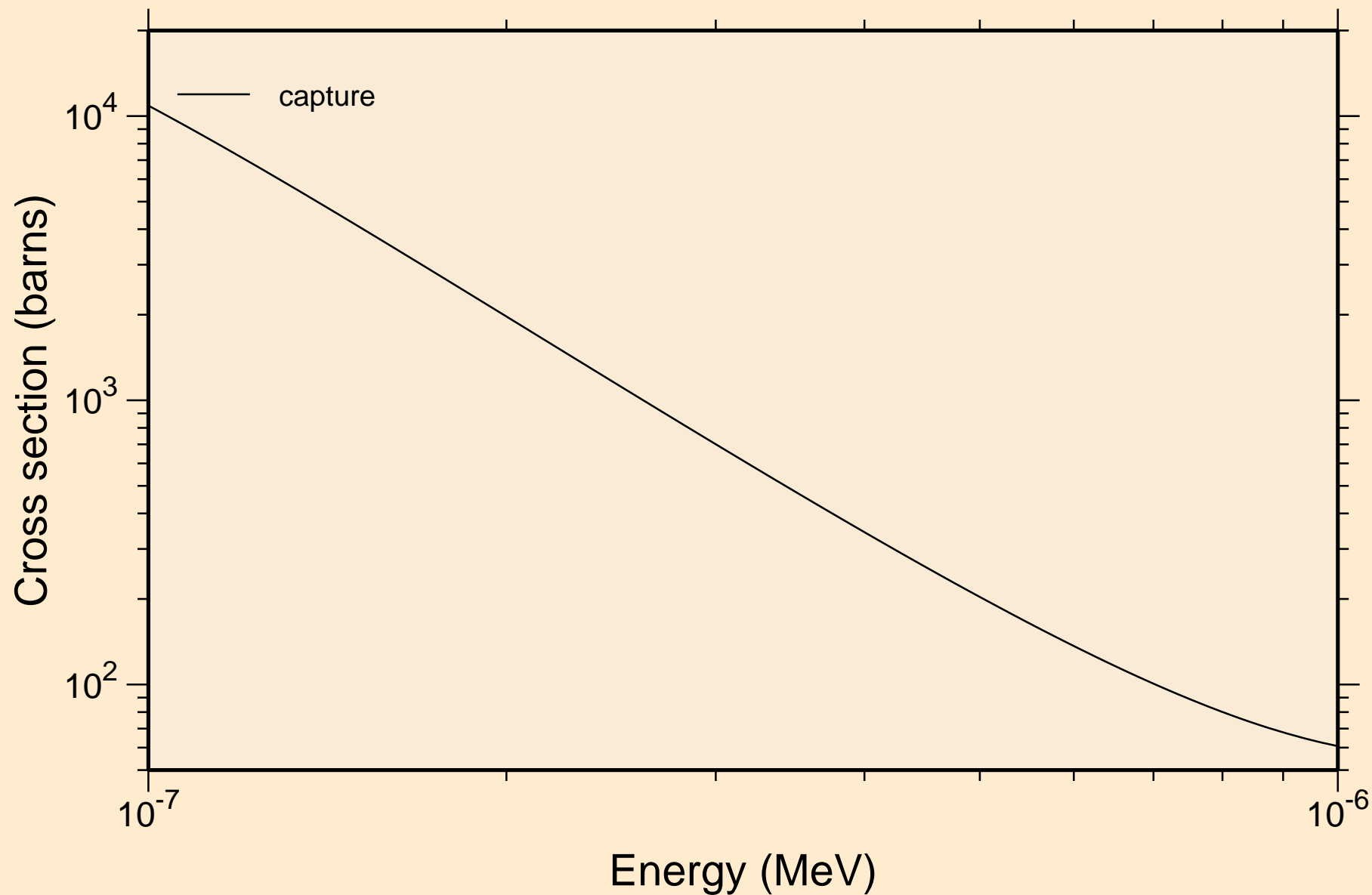

GD155 NEUTRON ACER TENDL-2019 LIBRARY; T=293.16K
resonance absorption cross sections

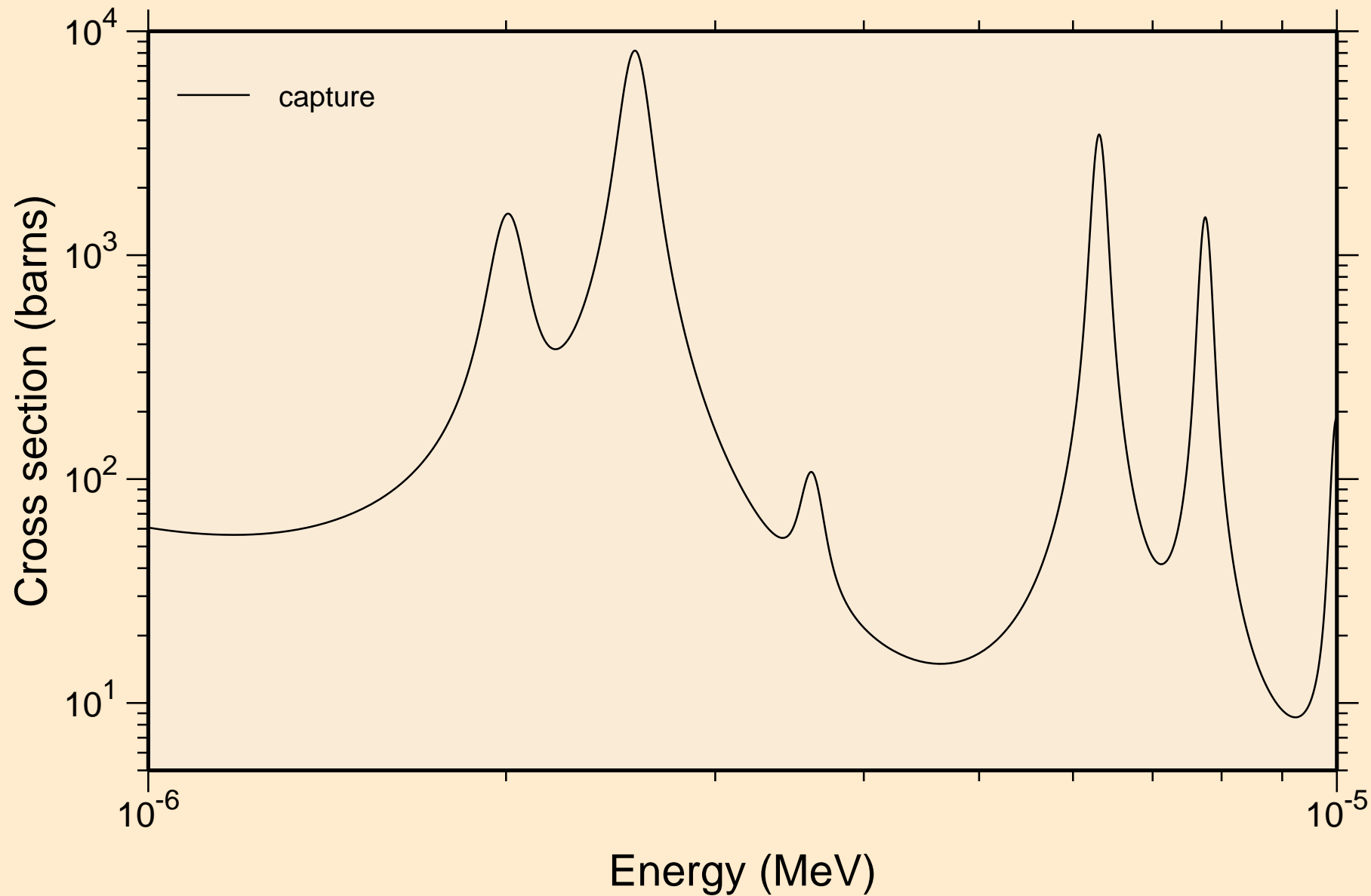

GD155 NEUTRON ACER TENDL-2019 LIBRARY; T=293.16K
resonance absorption cross sections

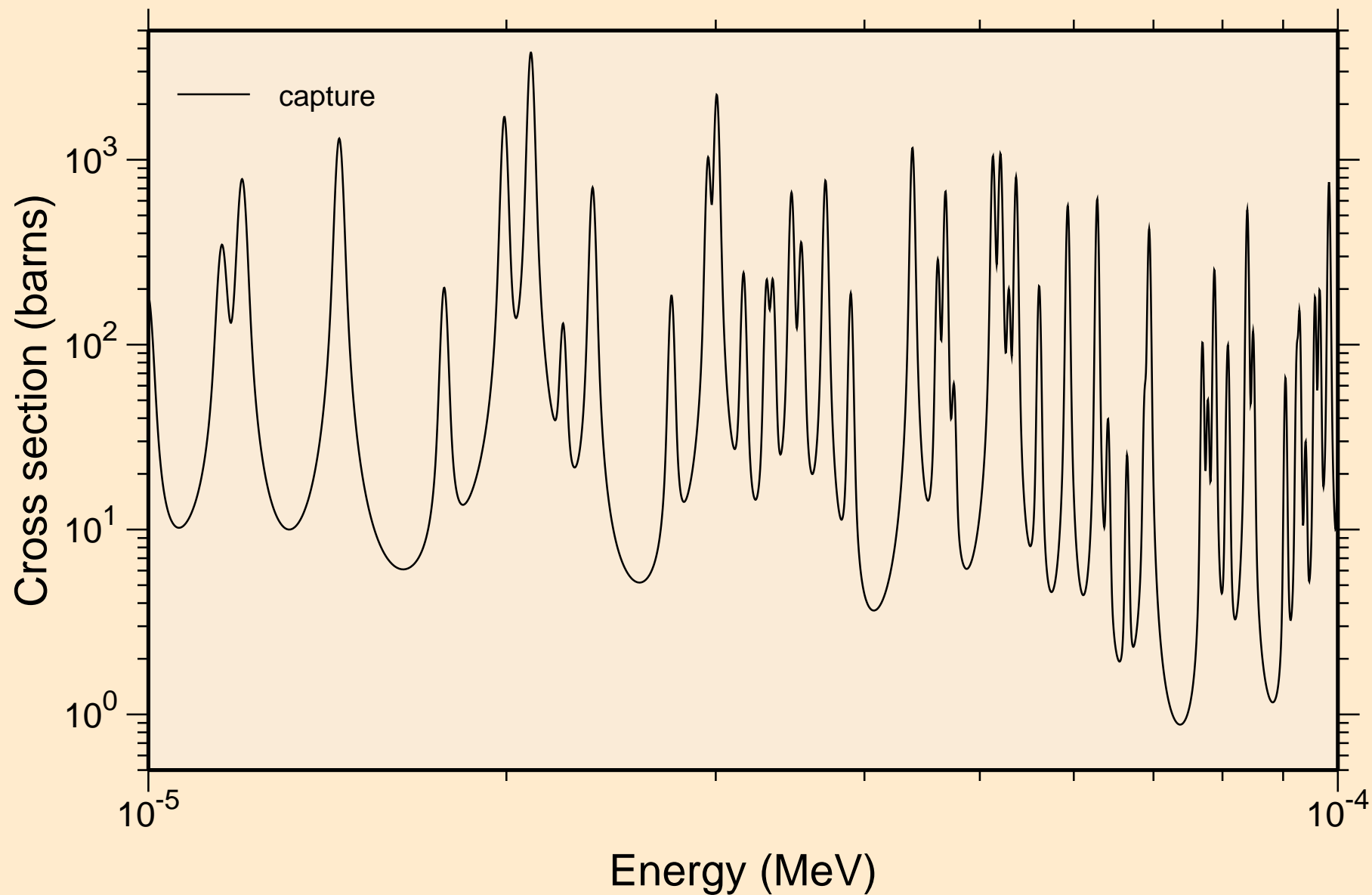

GD155 NEUTRON ACER TENDL-2019 LIBRARY; T=293.16K
resonance absorption cross sections

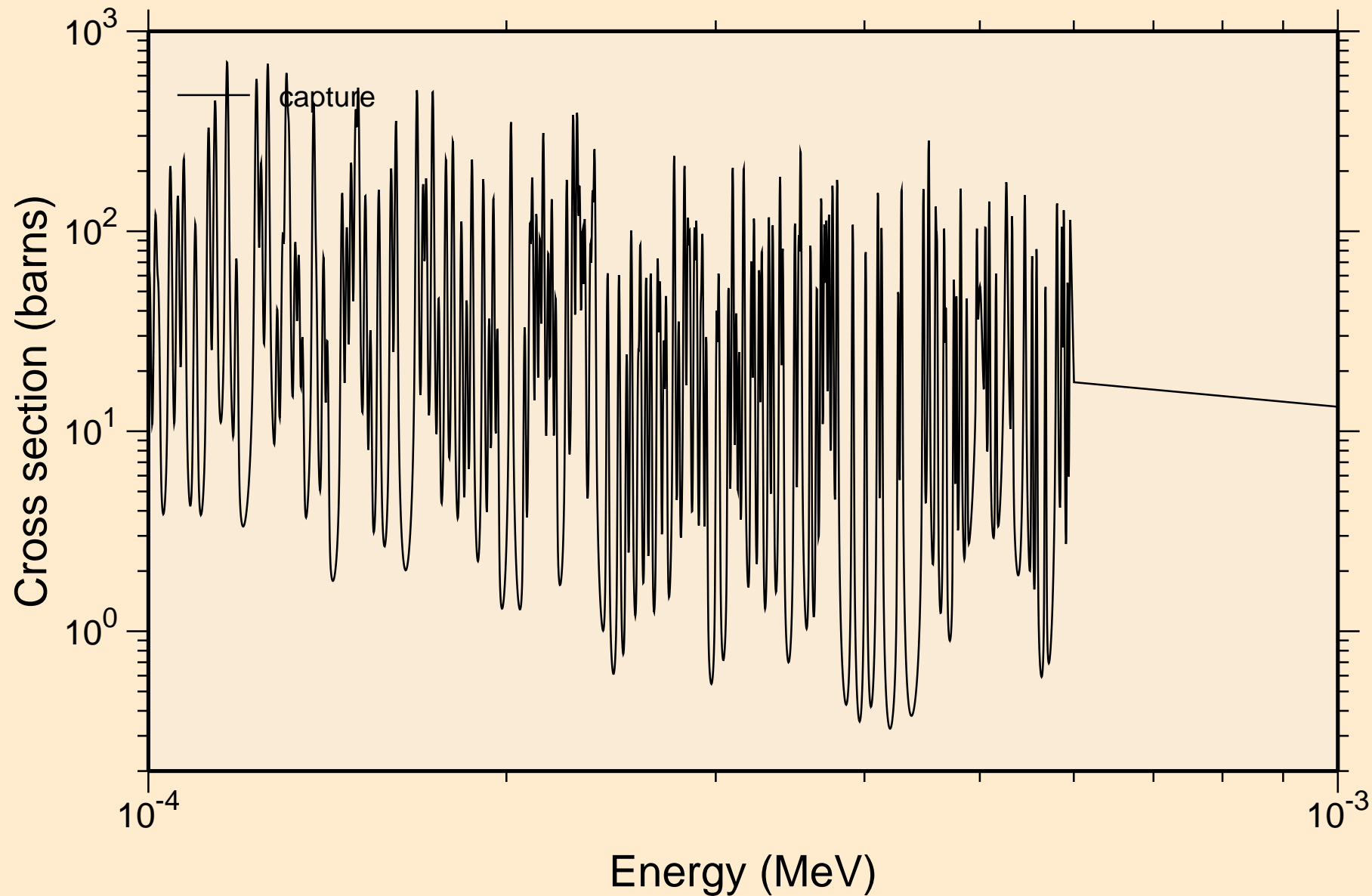

GD155 NEUTRON ACER TENDL-2019 LIBRARY; T=293.16K
resonance absorption cross sections

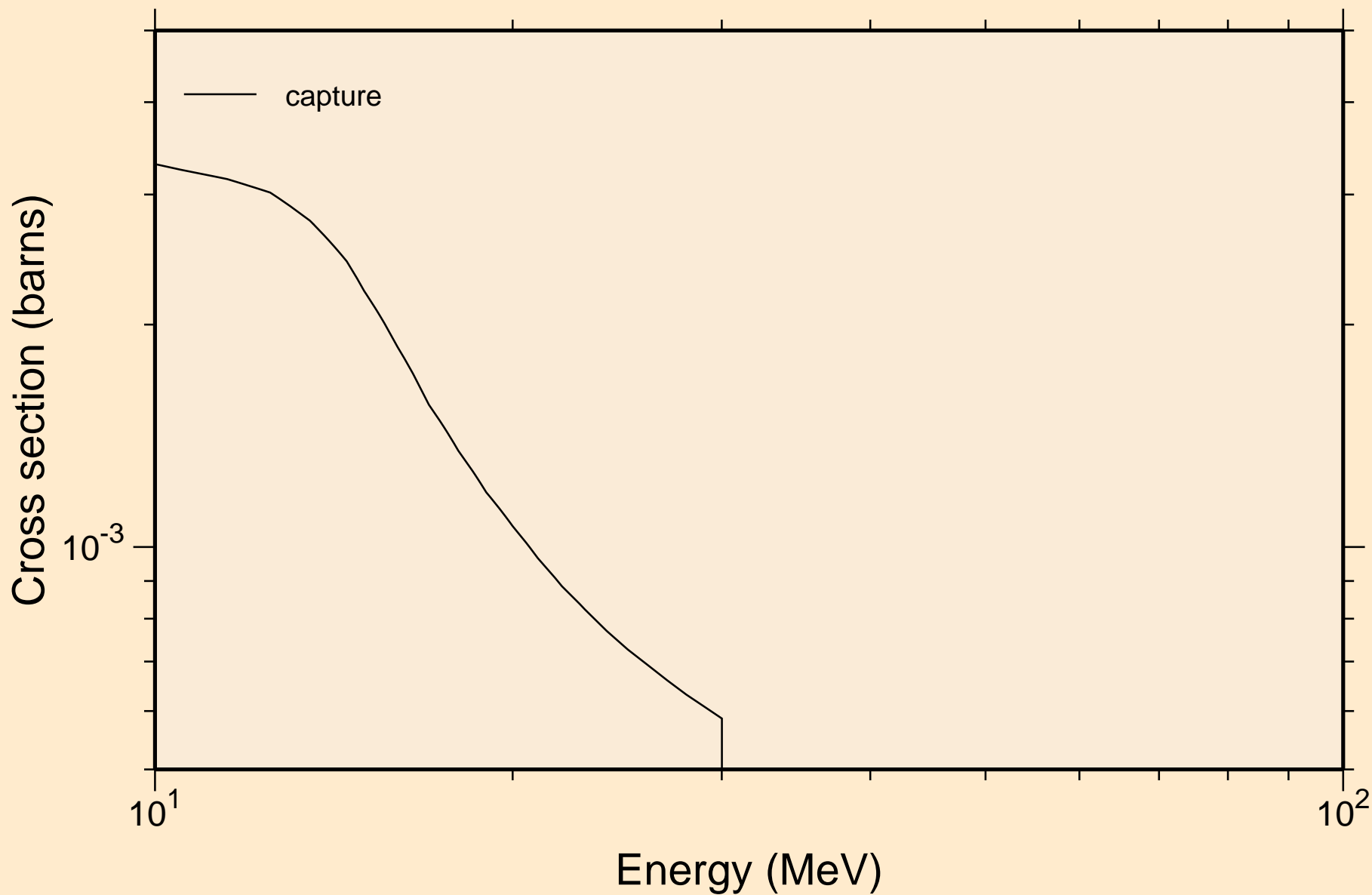

GD155 NEUTRON ACER TENDL-2019 LIBRARY; T=293.16K
Heating

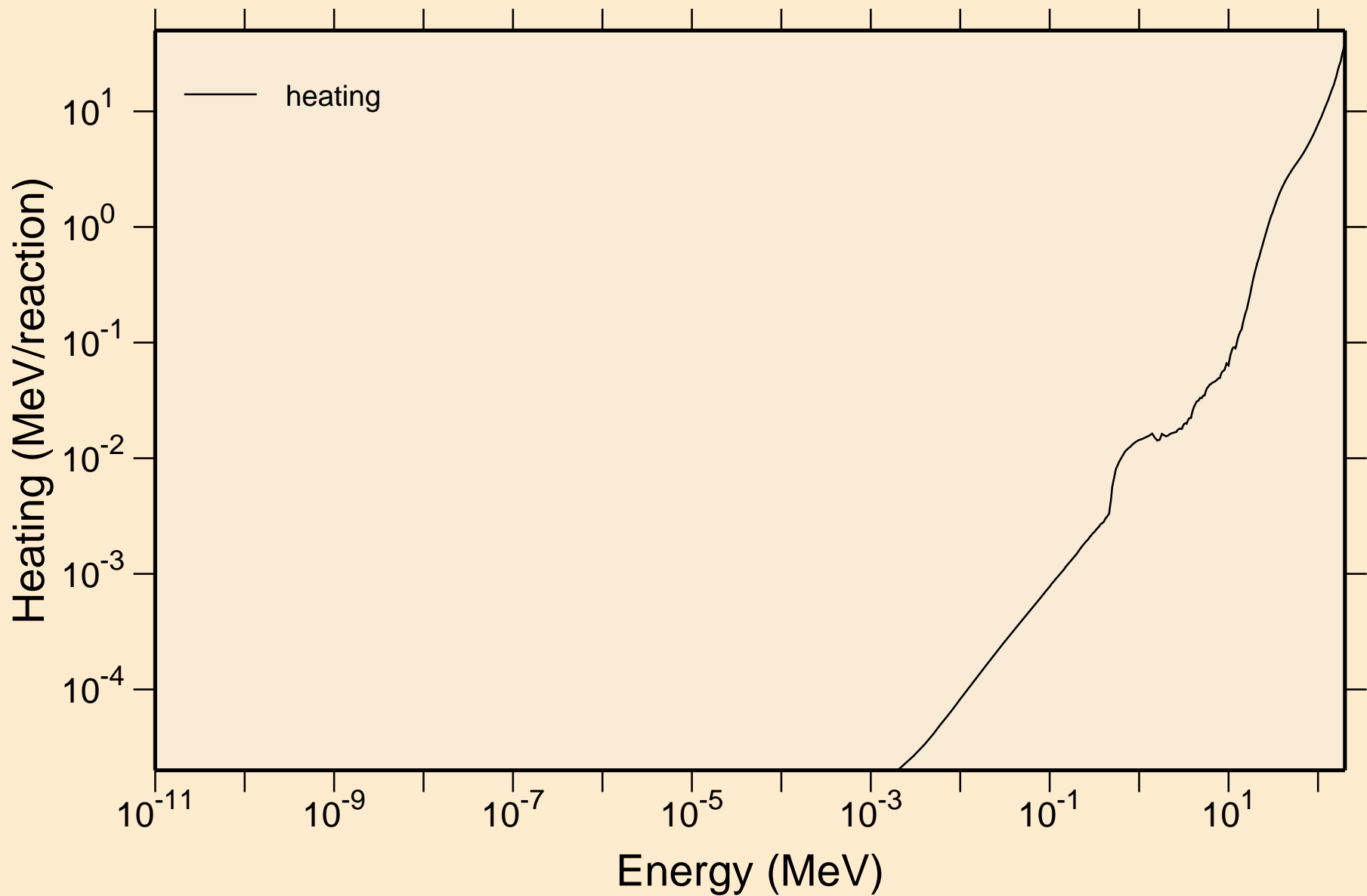

GD155 NEUTRON ACER TENDL-2019 LIBRARY; T=293.16K Damage

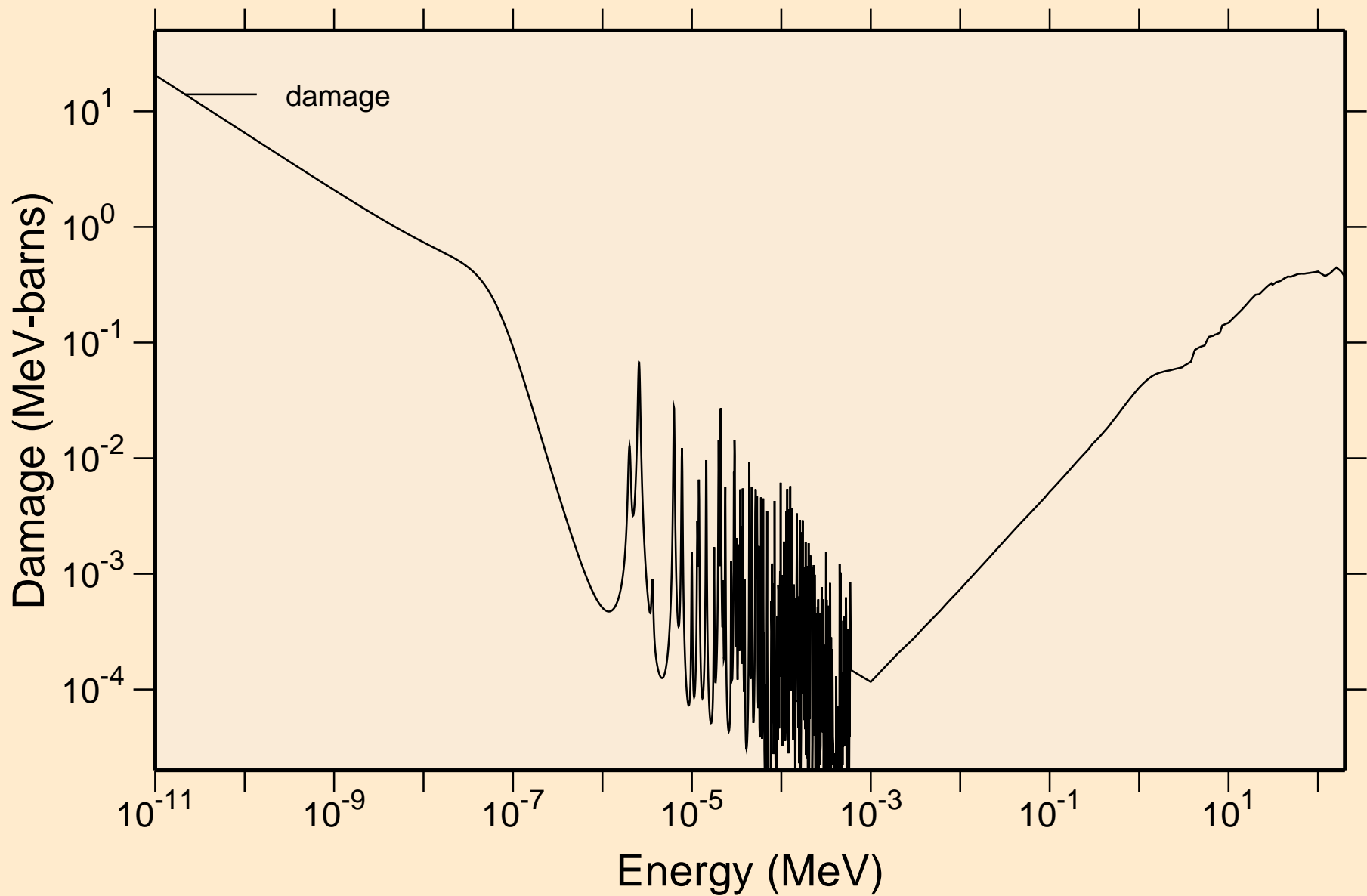

GD155 NEUTRON ACER TENDL-2019 LIBRARY; T=293.16K
Non-threshold reactions

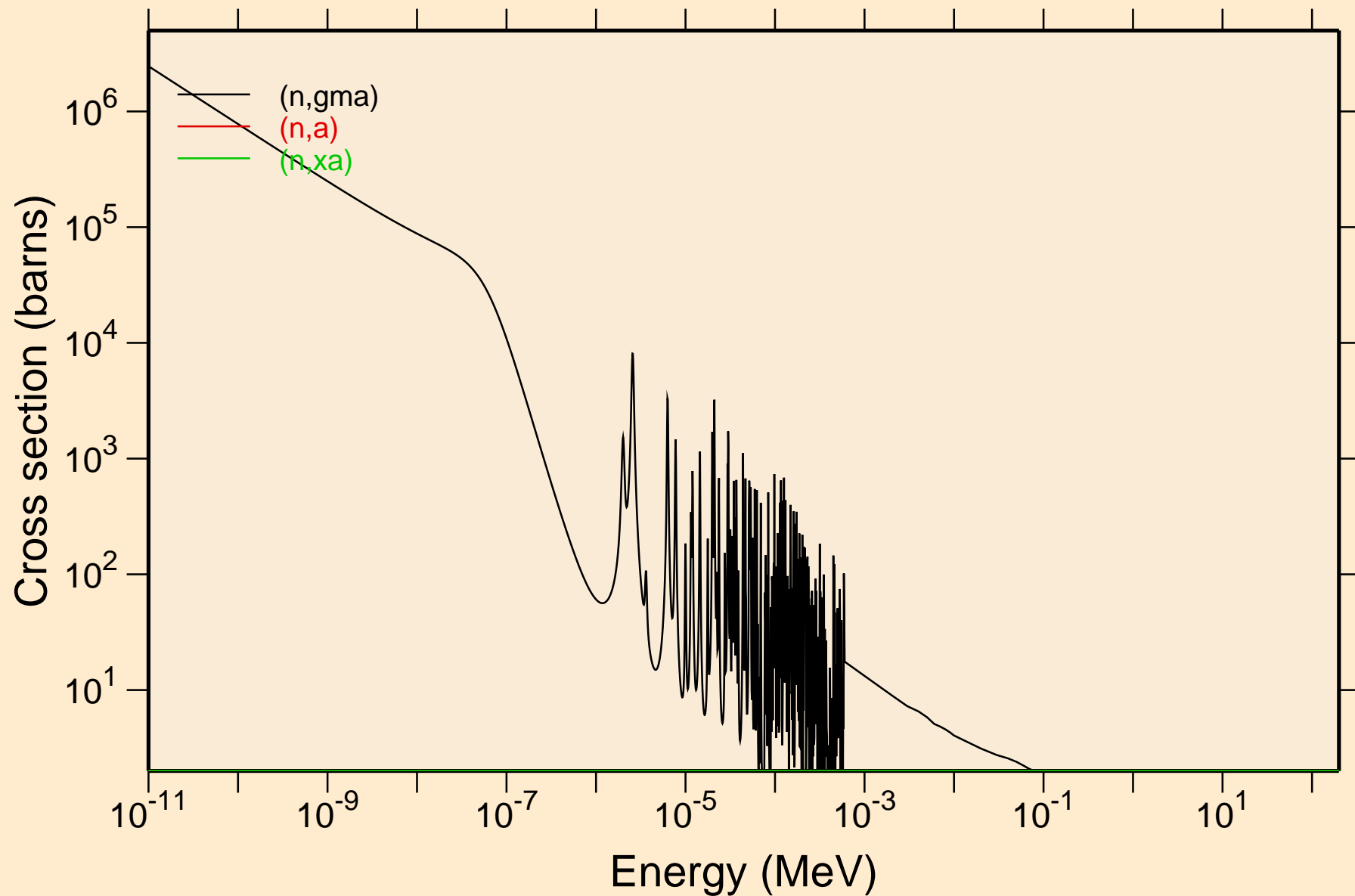

GD155 NEUTRON ACER TENDL-2019 LIBRARY; T=293.16K

Principal cross sections

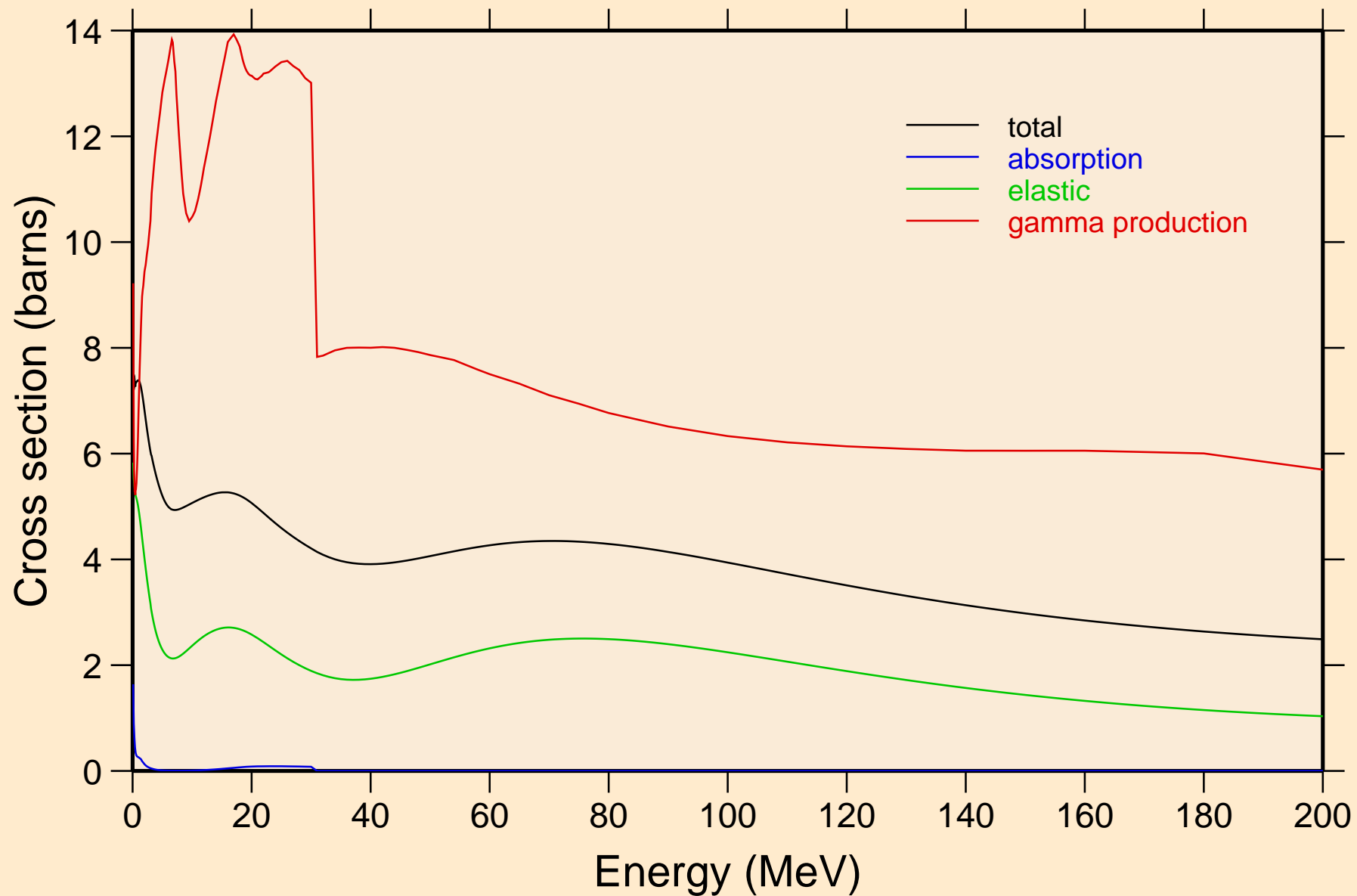

GD155 NEUTRON ACER TENDL-2019 LIBRARY; T=293.16K
Heating

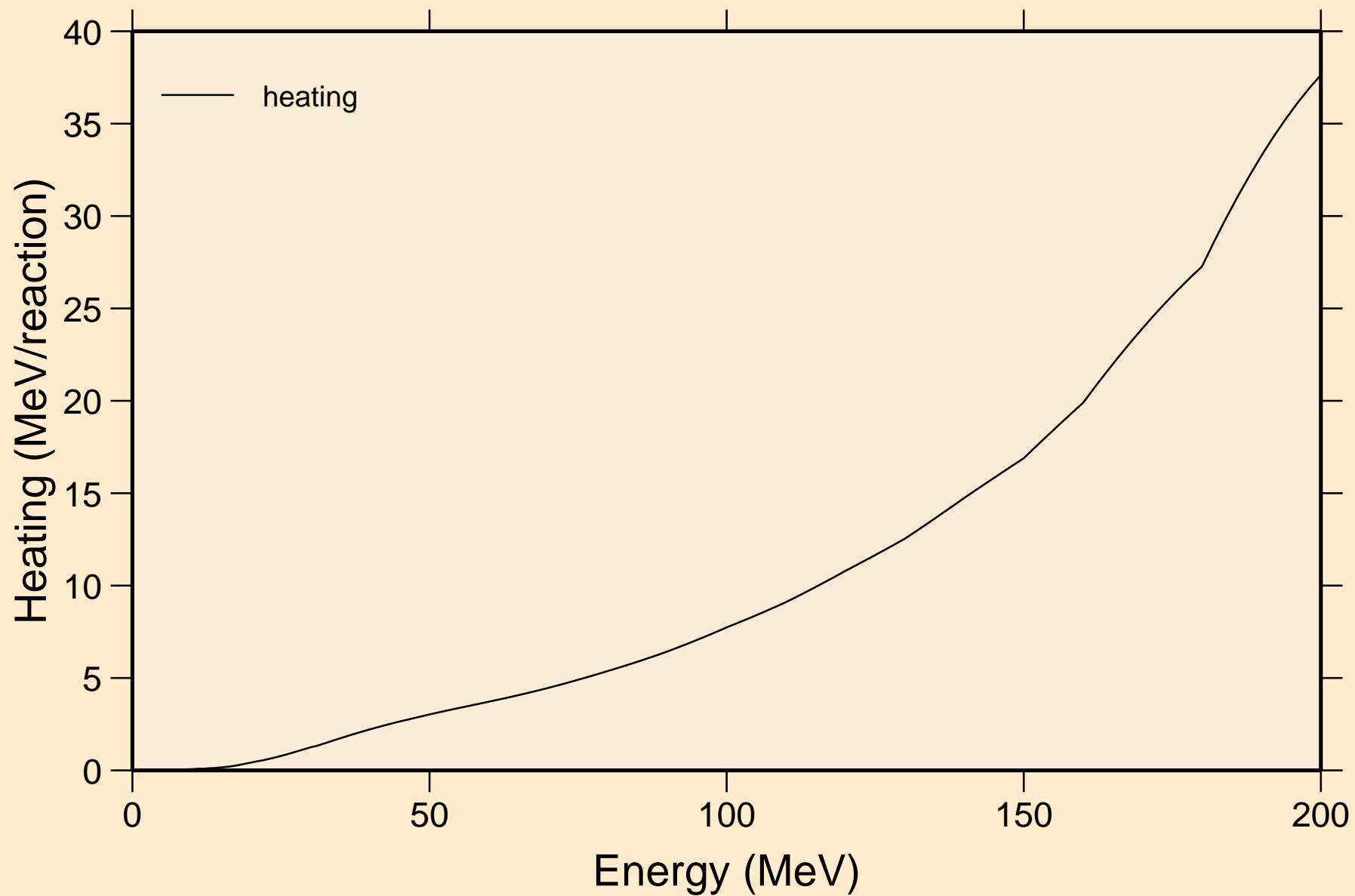

GD155 NEUTRON ACER TENDL-2019 LIBRARY; T=293.16K Damage

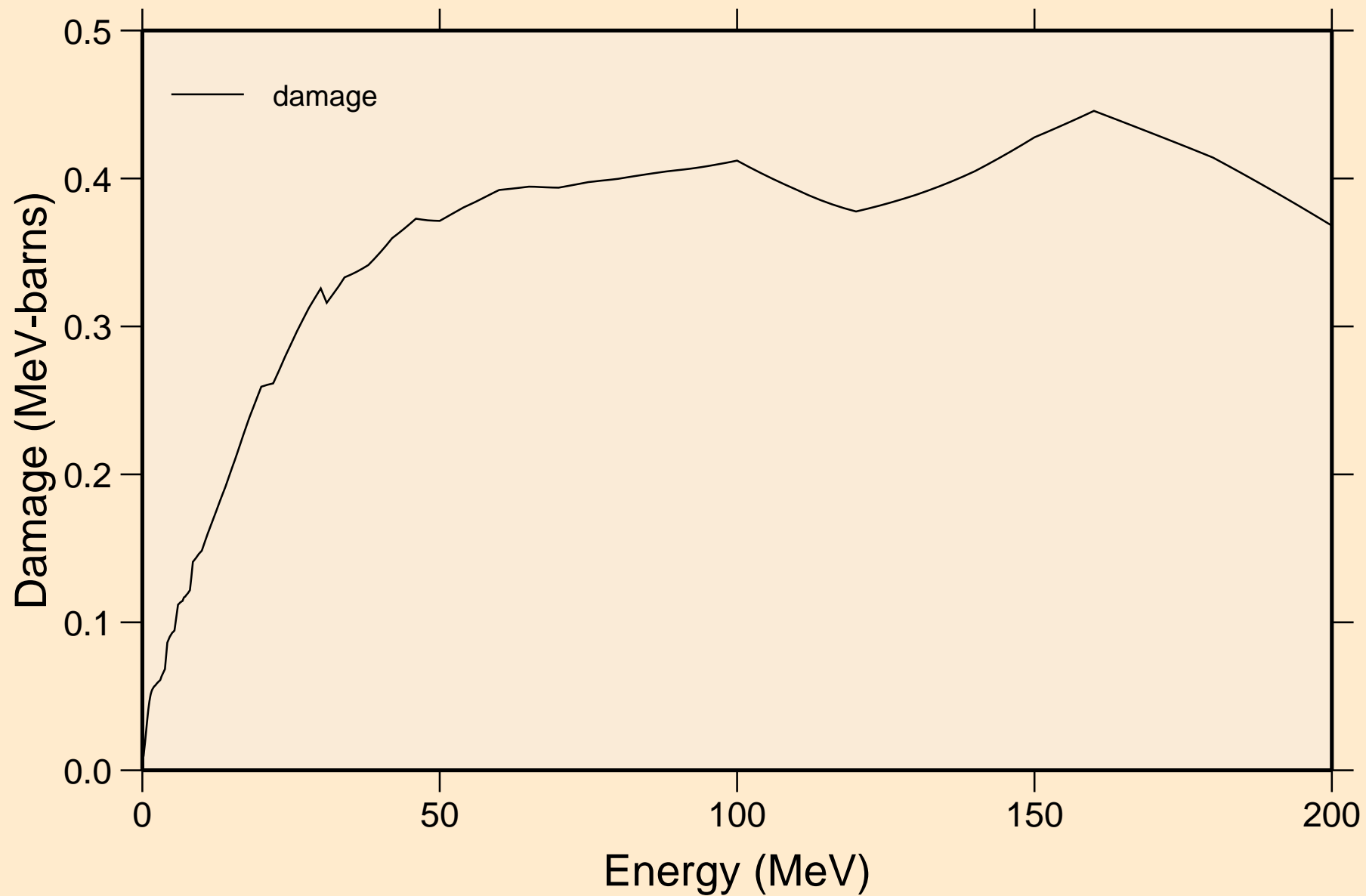

GD155 NEUTRON ACER TENDL-2019 LIBRARY; T=293.16K
Non-threshold reactions

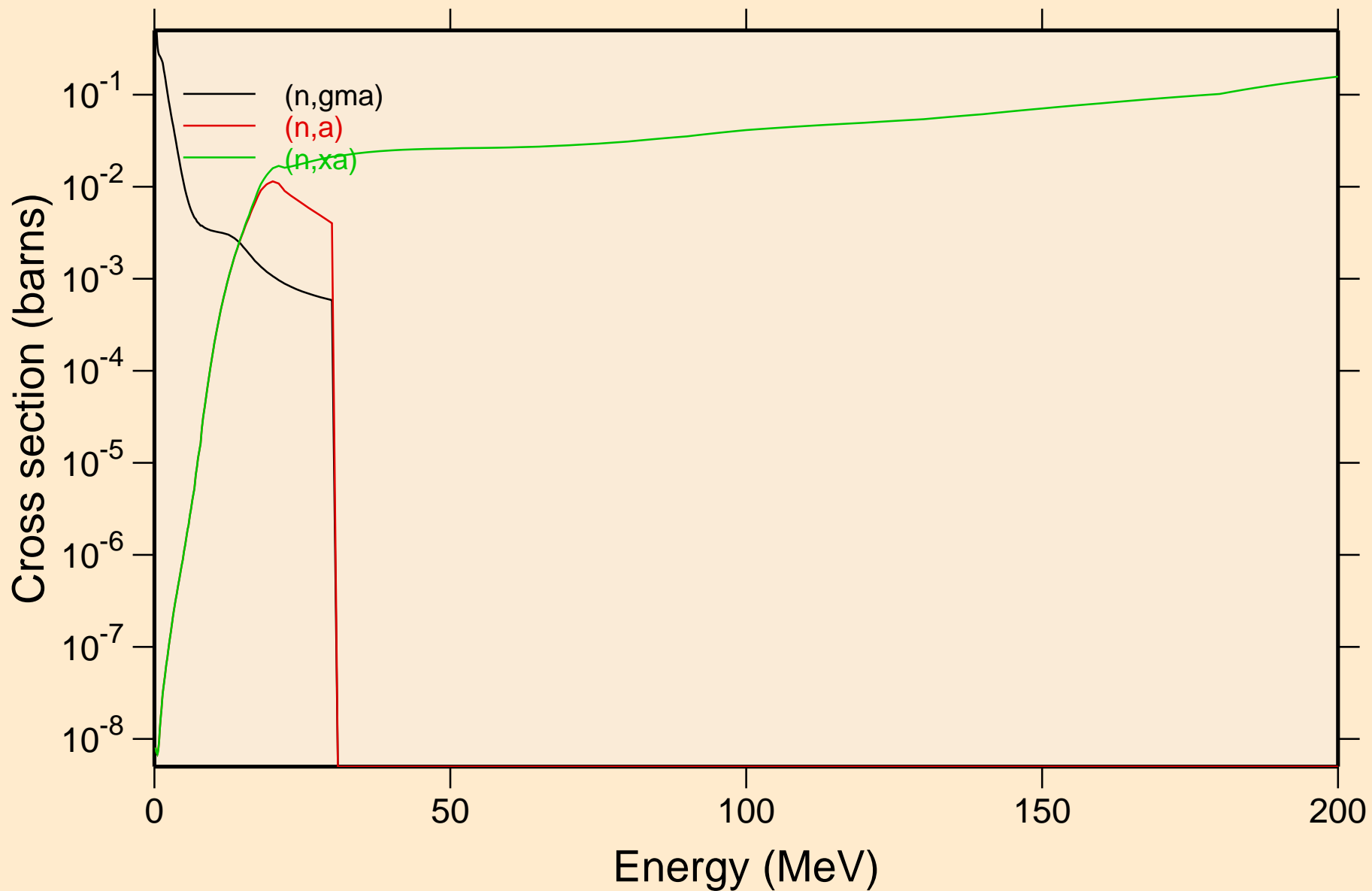

GD155 NEUTRON ACER TENDL-2019 LIBRARY; T=293.16K

Inelastic levels

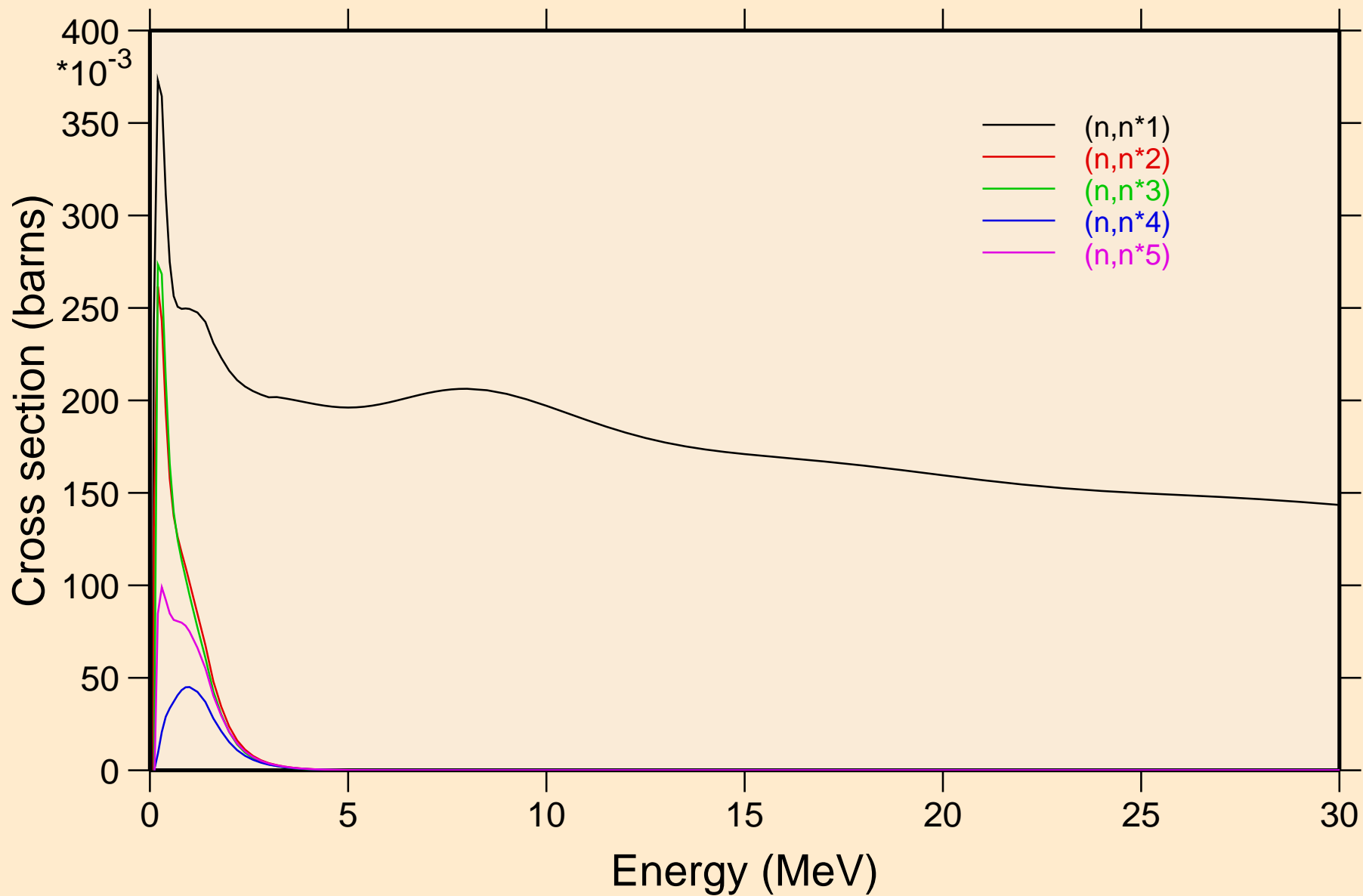

GD155 NEUTRON ACER TENDL-2019 LIBRARY; T=293.16K
Inelastic levels

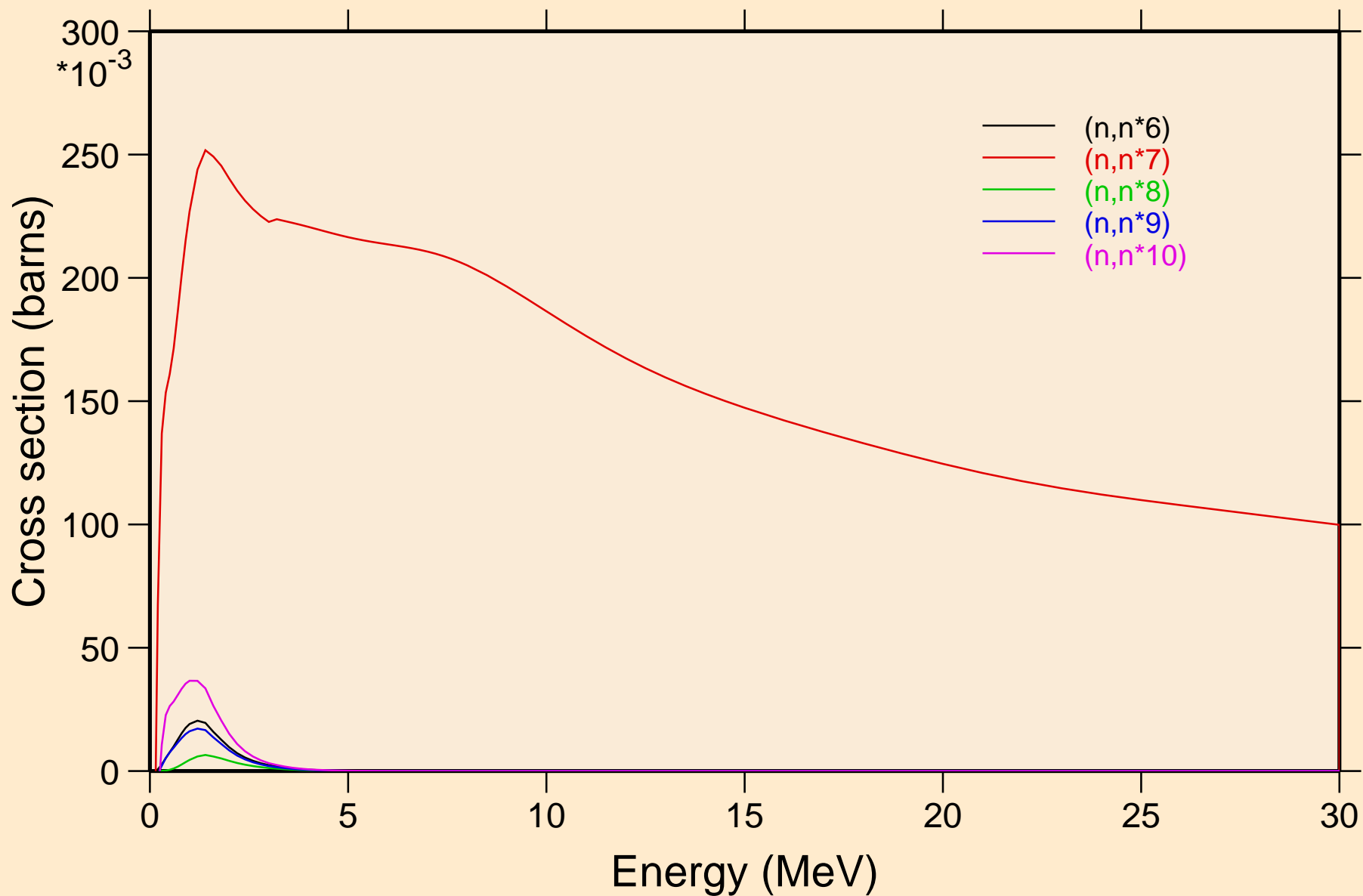

GD155 NEUTRON ACER TENDL-2019 LIBRARY; T=293.16K
Inelastic levels

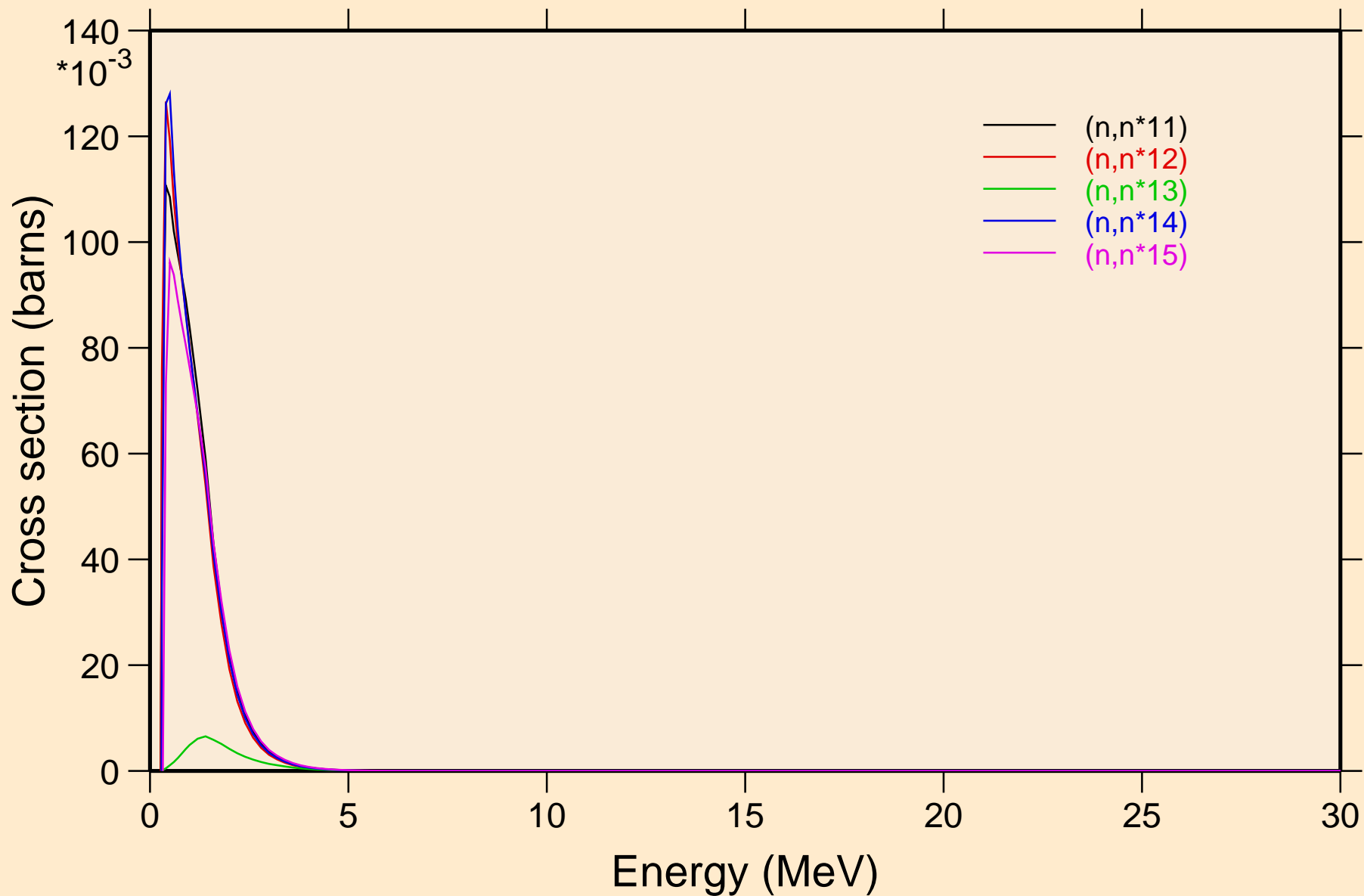

GD155 NEUTRON ACER TENDL-2019 LIBRARY; T=293.16K
Inelastic levels

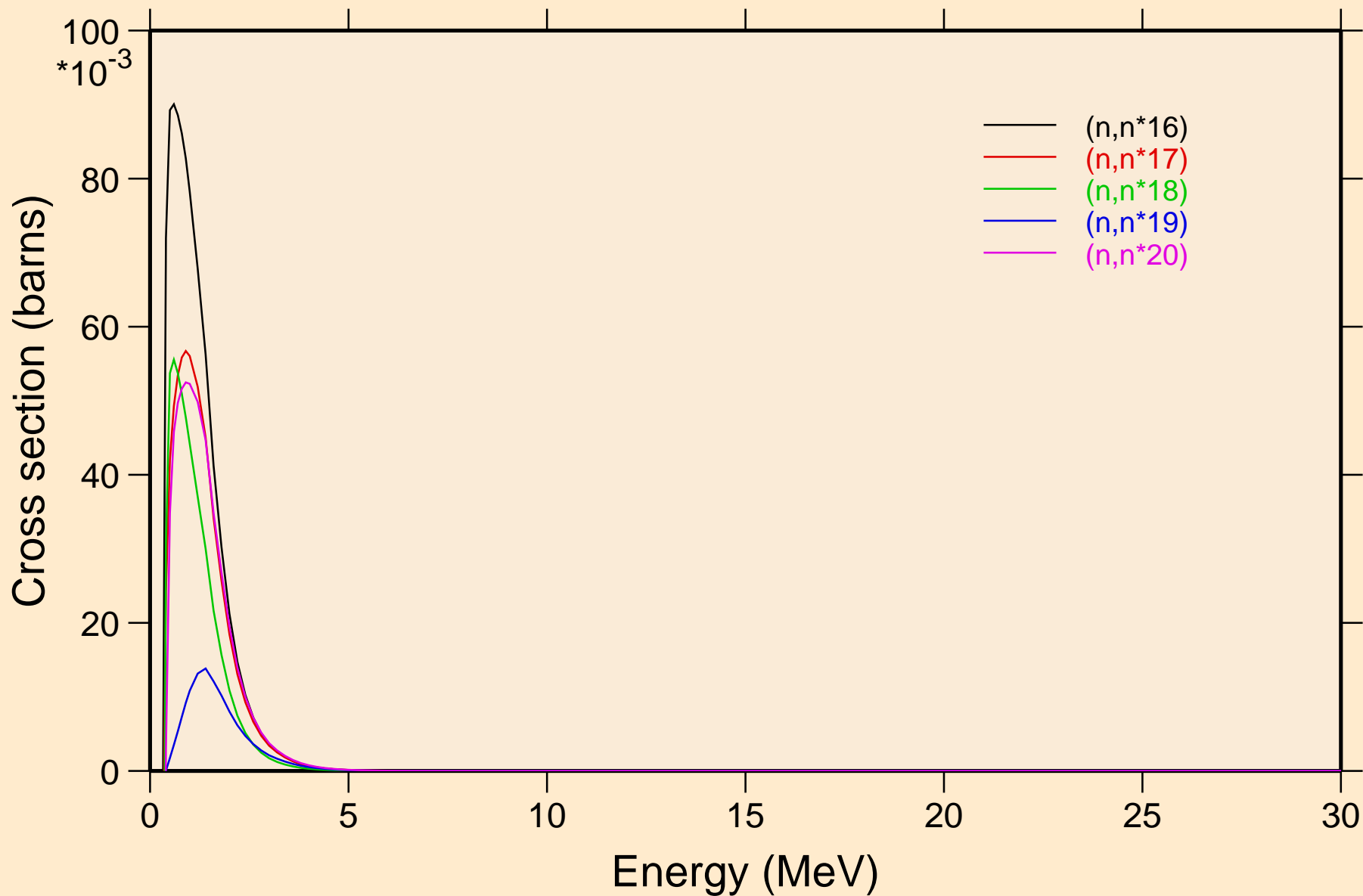

GD155 NEUTRON ACER TENDL-2019 LIBRARY; T=293.16K
Inelastic levels

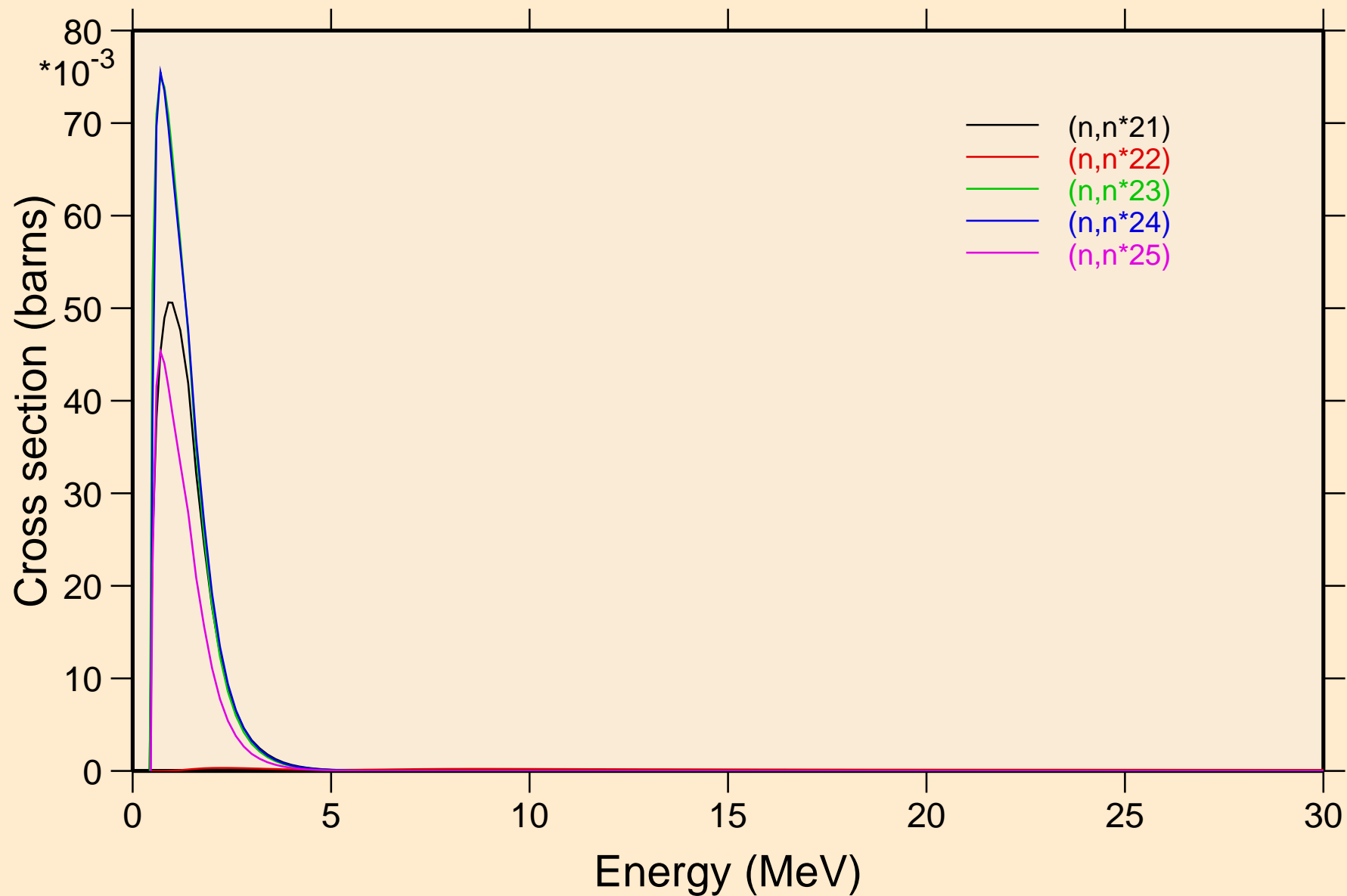

GD155 NEUTRON ACER TENDL-2019 LIBRARY; T=293.16K
Inelastic levels

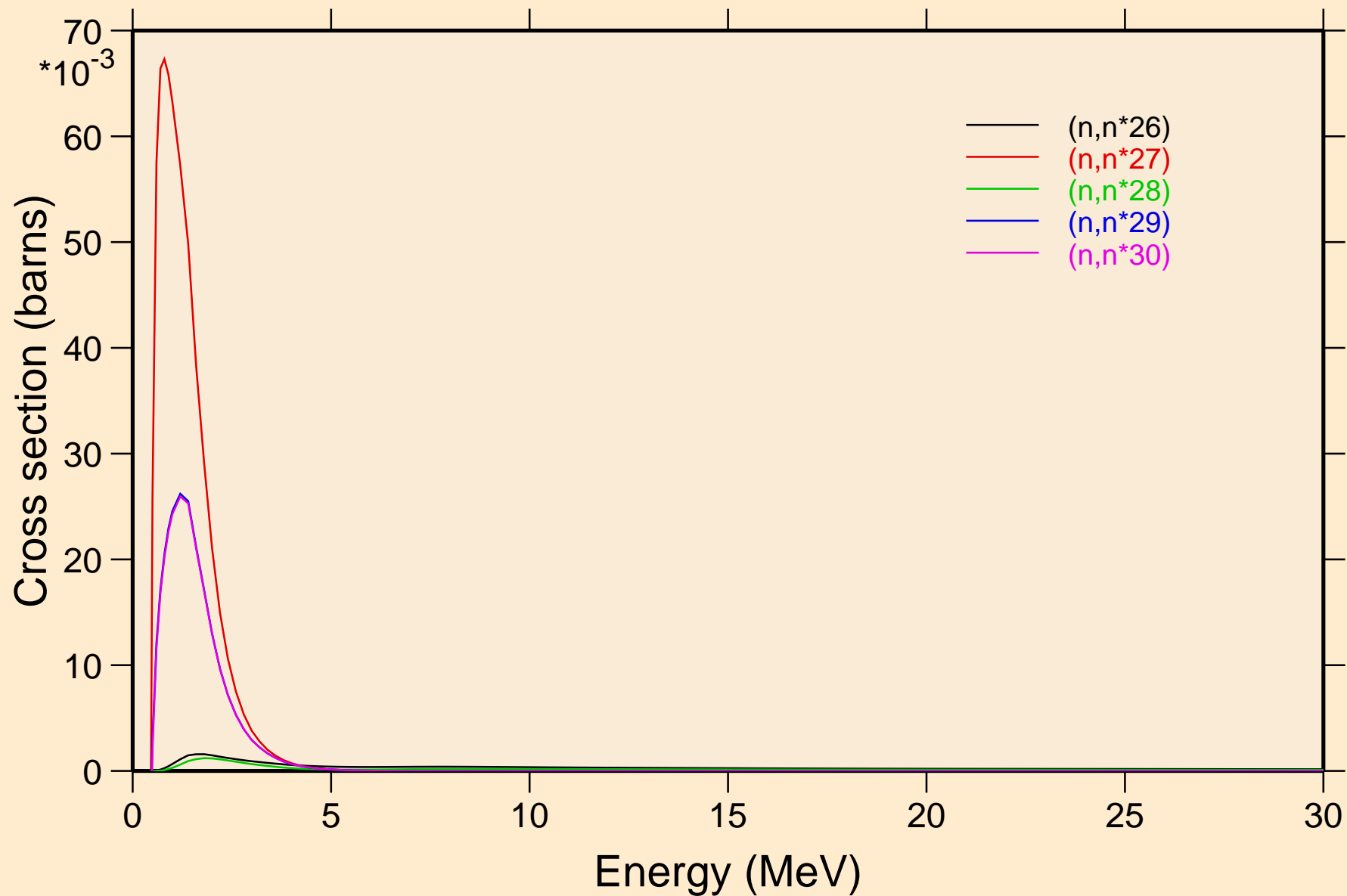

GD155 NEUTRON ACER TENDL-2019 LIBRARY; T=293.16K

Threshold reactions

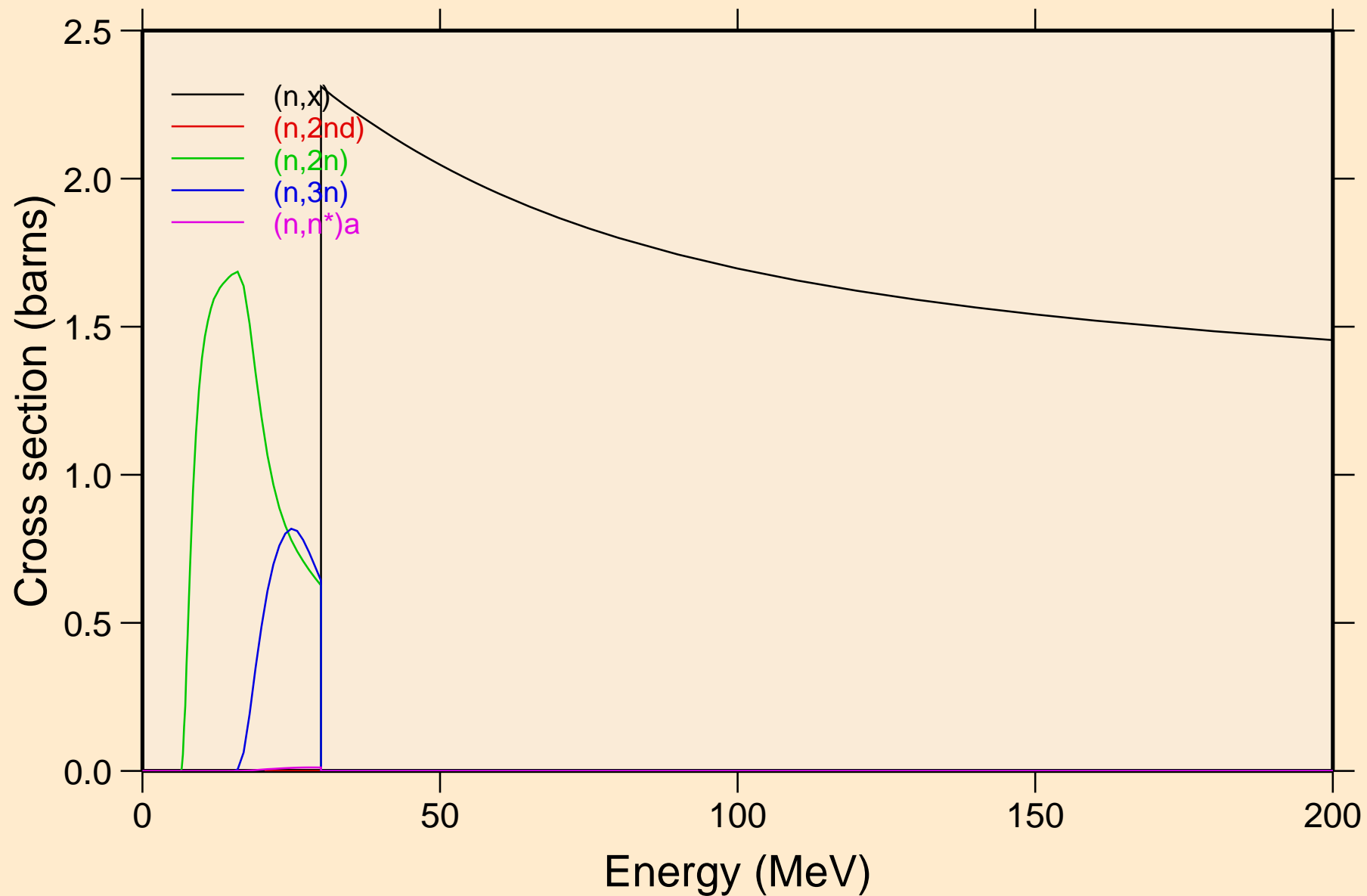

GD155 NEUTRON ACER TENDL-2019 LIBRARY; T=293.16K

Threshold reactions

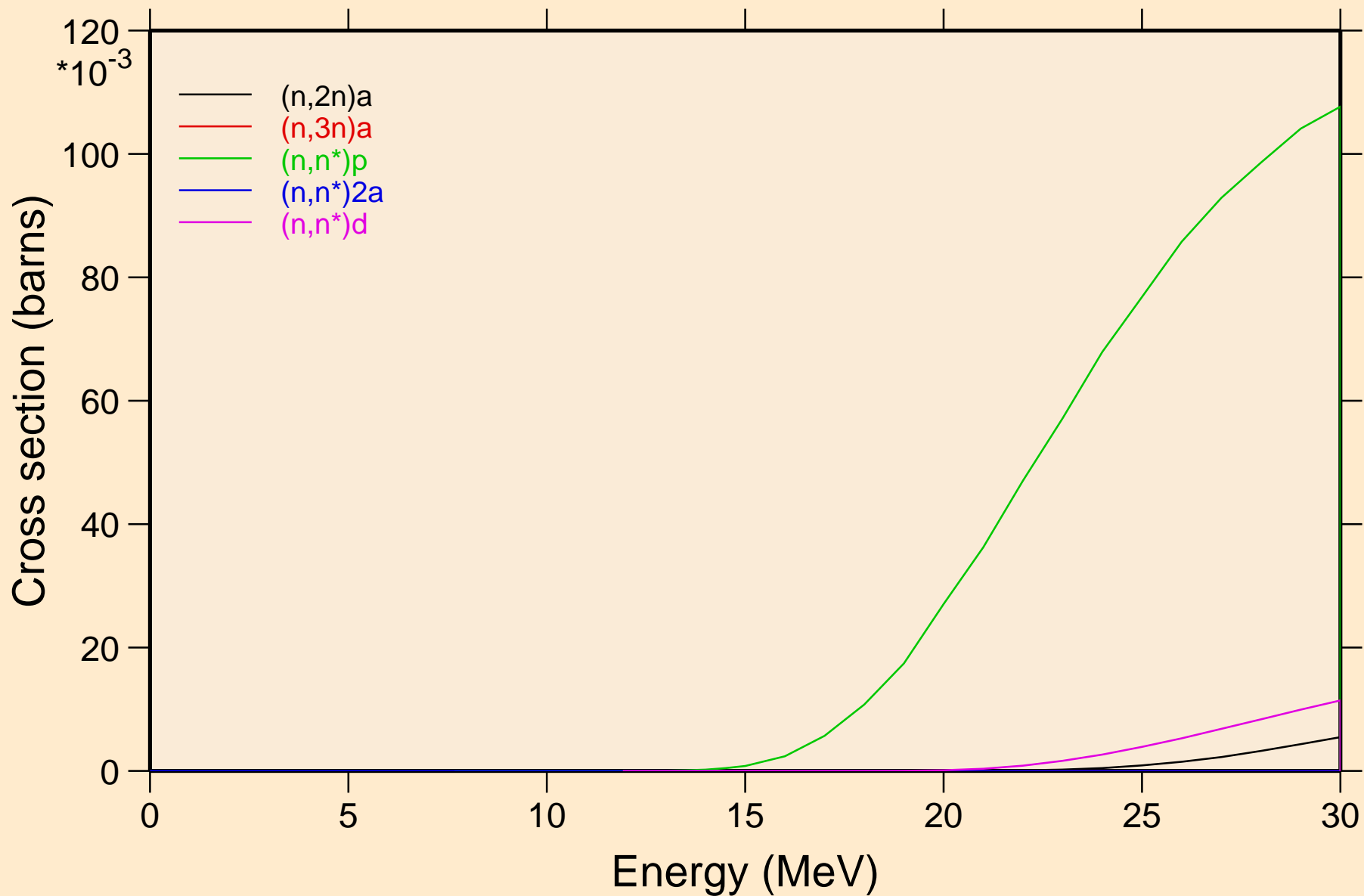

GD155 NEUTRON ACER TENDL-2019 LIBRARY; T=293.16K

Threshold reactions

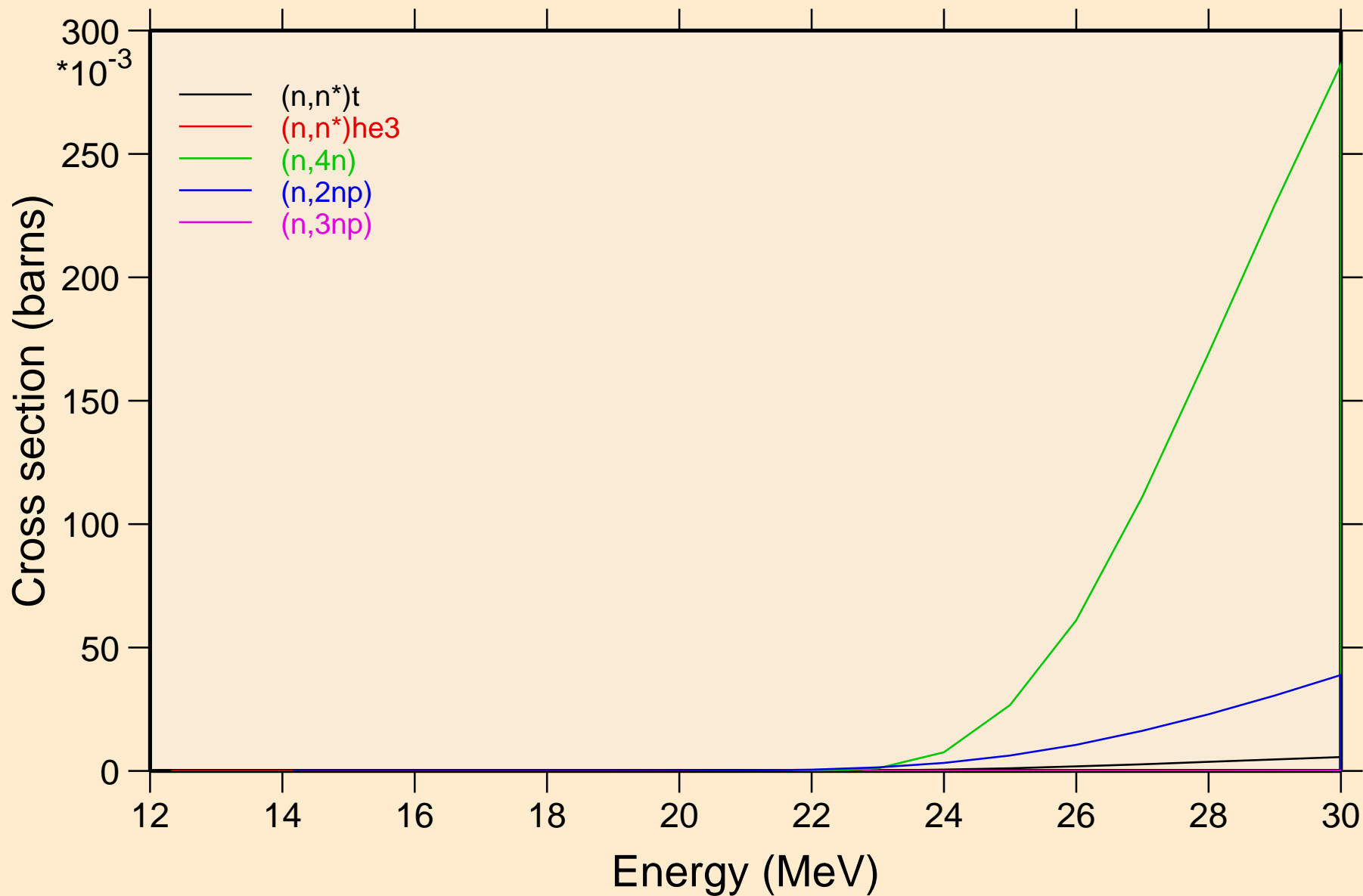

GD155 NEUTRON ACER TENDL-2019 LIBRARY; T=293.16K

Threshold reactions

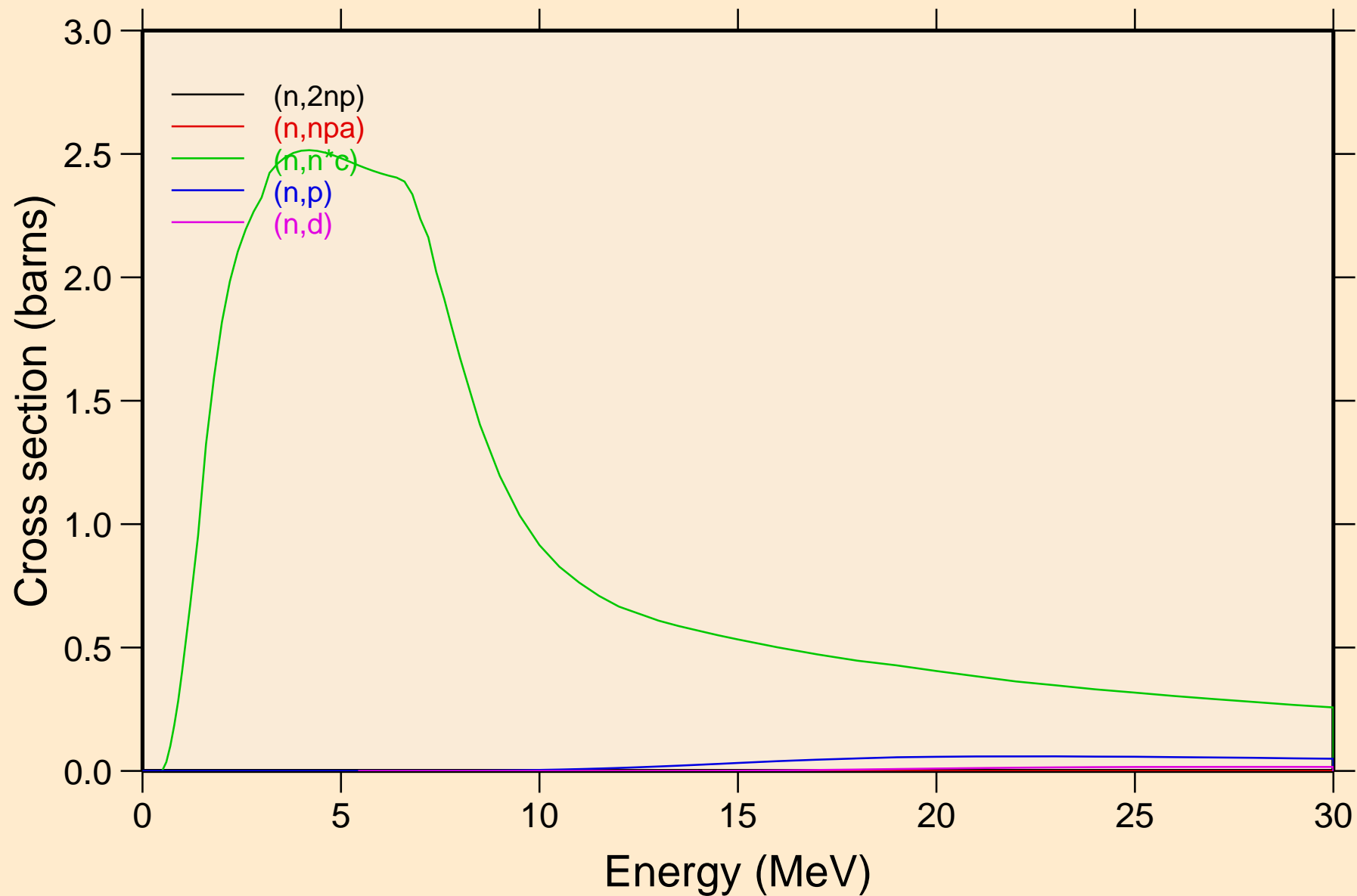

GD155 NEUTRON ACER TENDL-2019 LIBRARY; T=293.16K
Threshold reactions

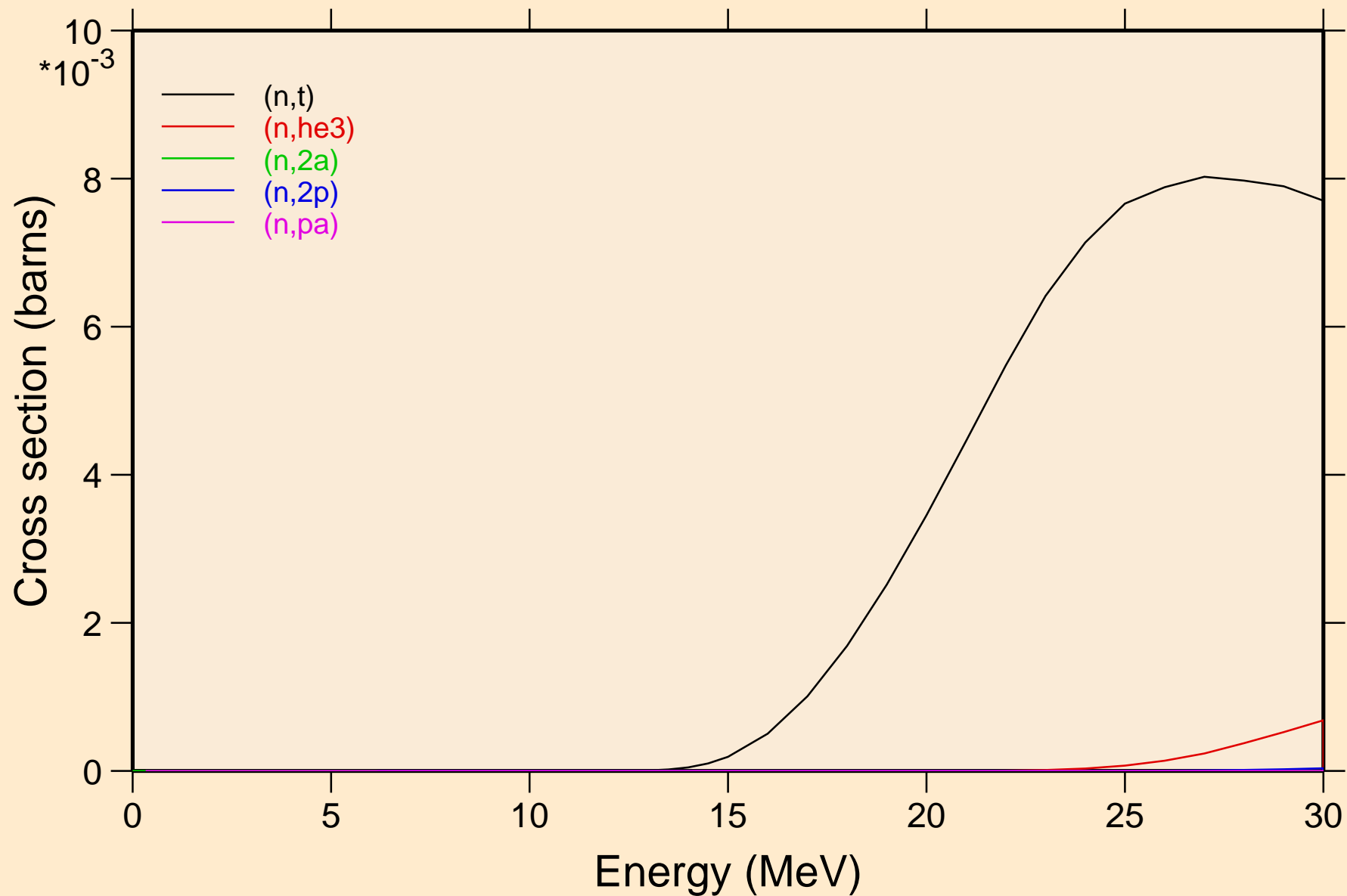

GD155 NEUTRON ACER TENDL-2019 LIBRARY; T=293.16K
Threshold reactions

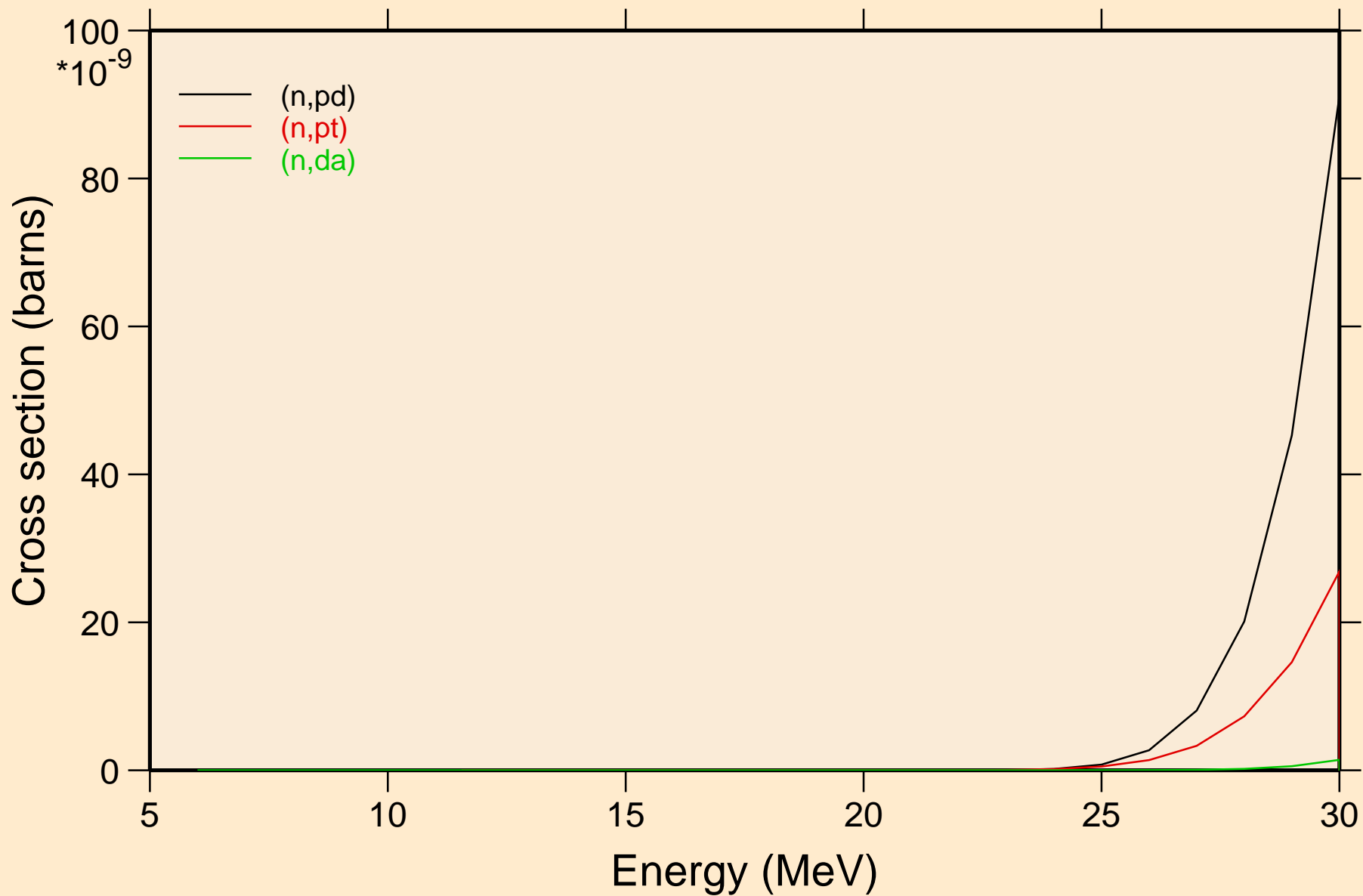

GD155 NEUTRON ACER TENDL-2019 LIBRARY; T=293.16K

Threshold reactions

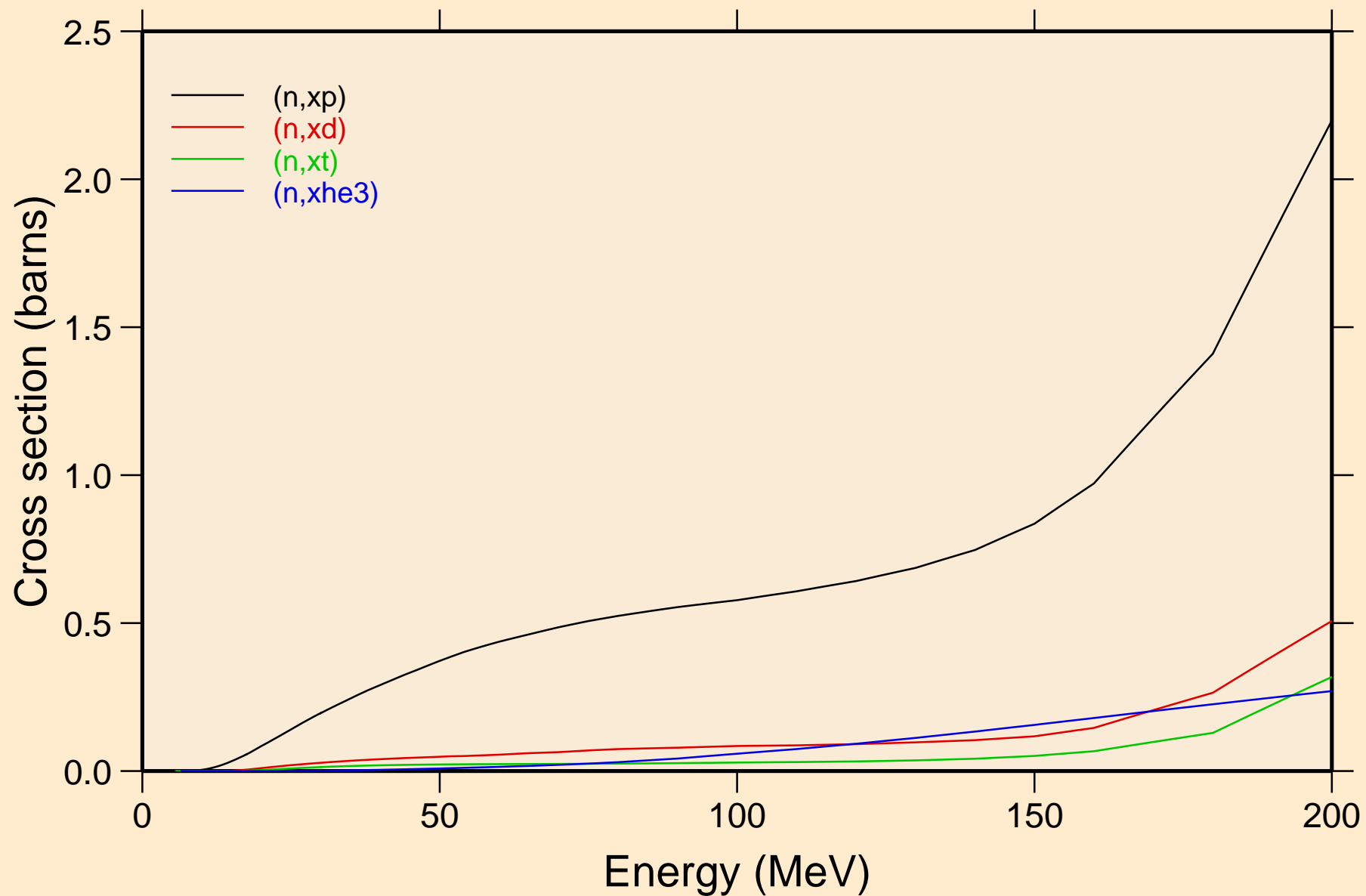

GD155 NEUTRON ACER TENDL-2019 LIBRARY; T=293.16K
angular distribution for elastic

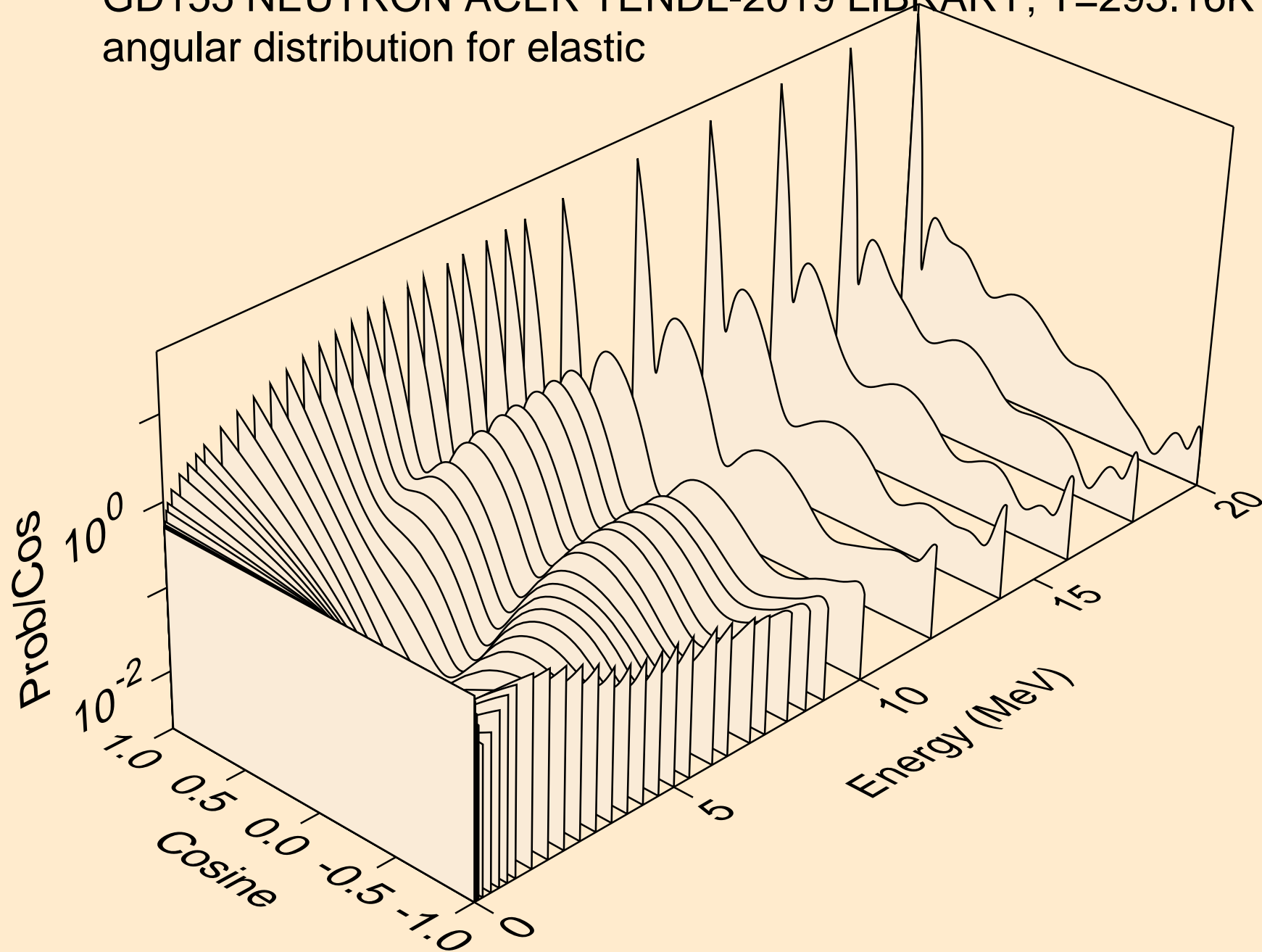

GD155 NEUTRON ACER TENDL-2019 LIBRARY; T=293.16K
angular distribution for elastic

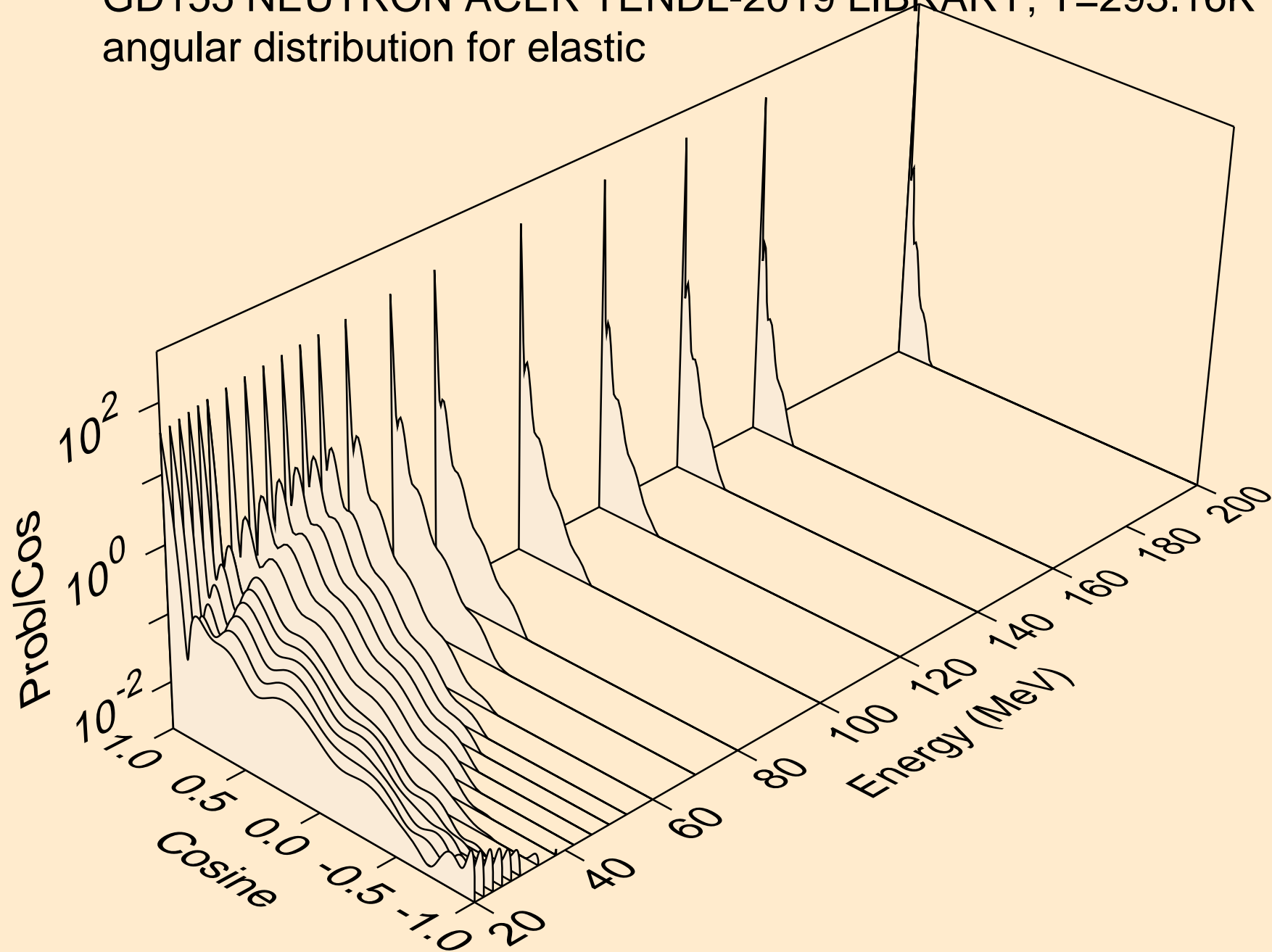

GD155 NEUTRON ACER TENDL-2019 LIBRARY; T=293.16K
angular distribution for (n,n*1)

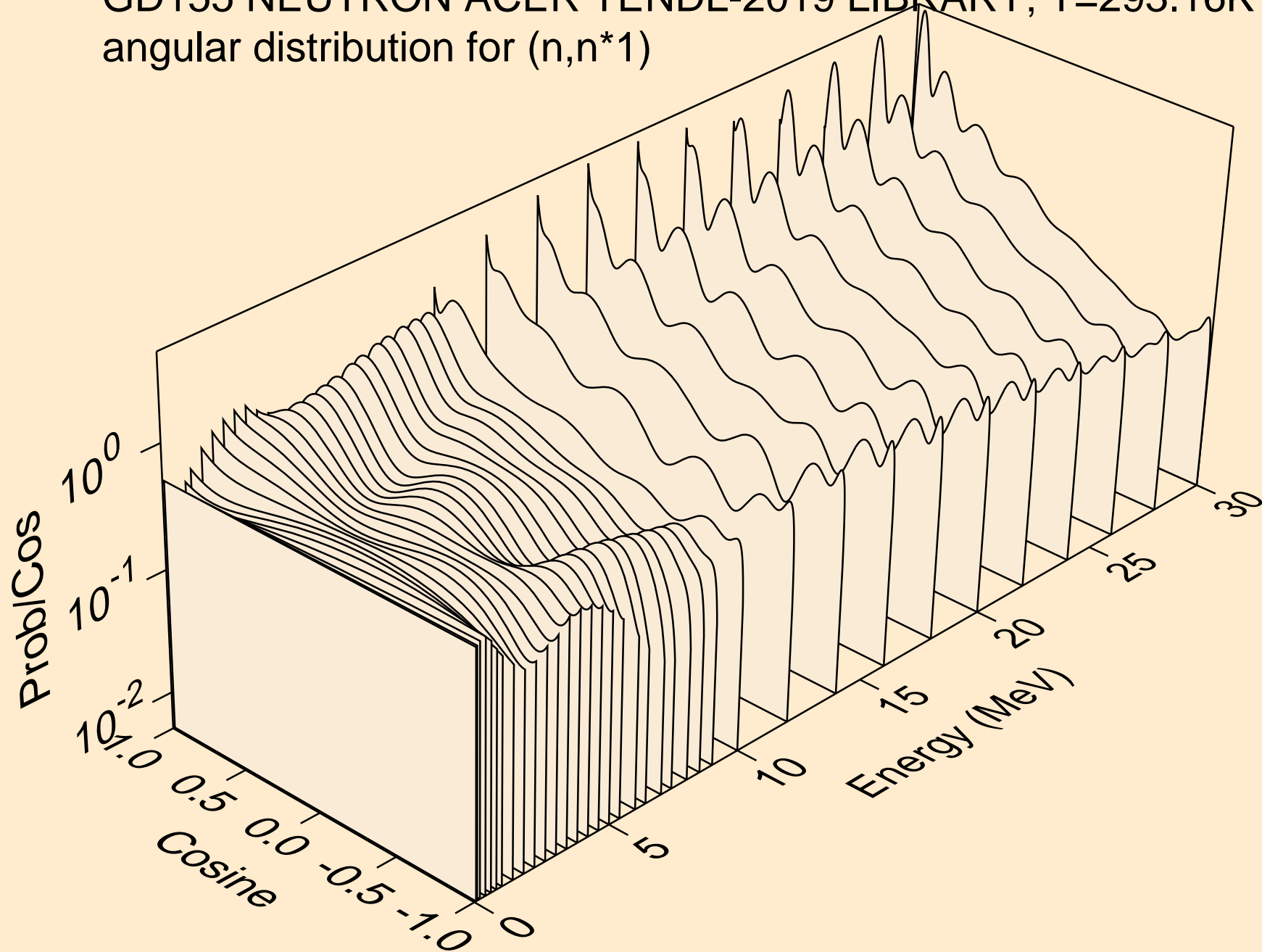

GD155 NEUTRON ACER TENDL-2019 LIBRARY; T=293.16K
angular distribution for (n,n*2)

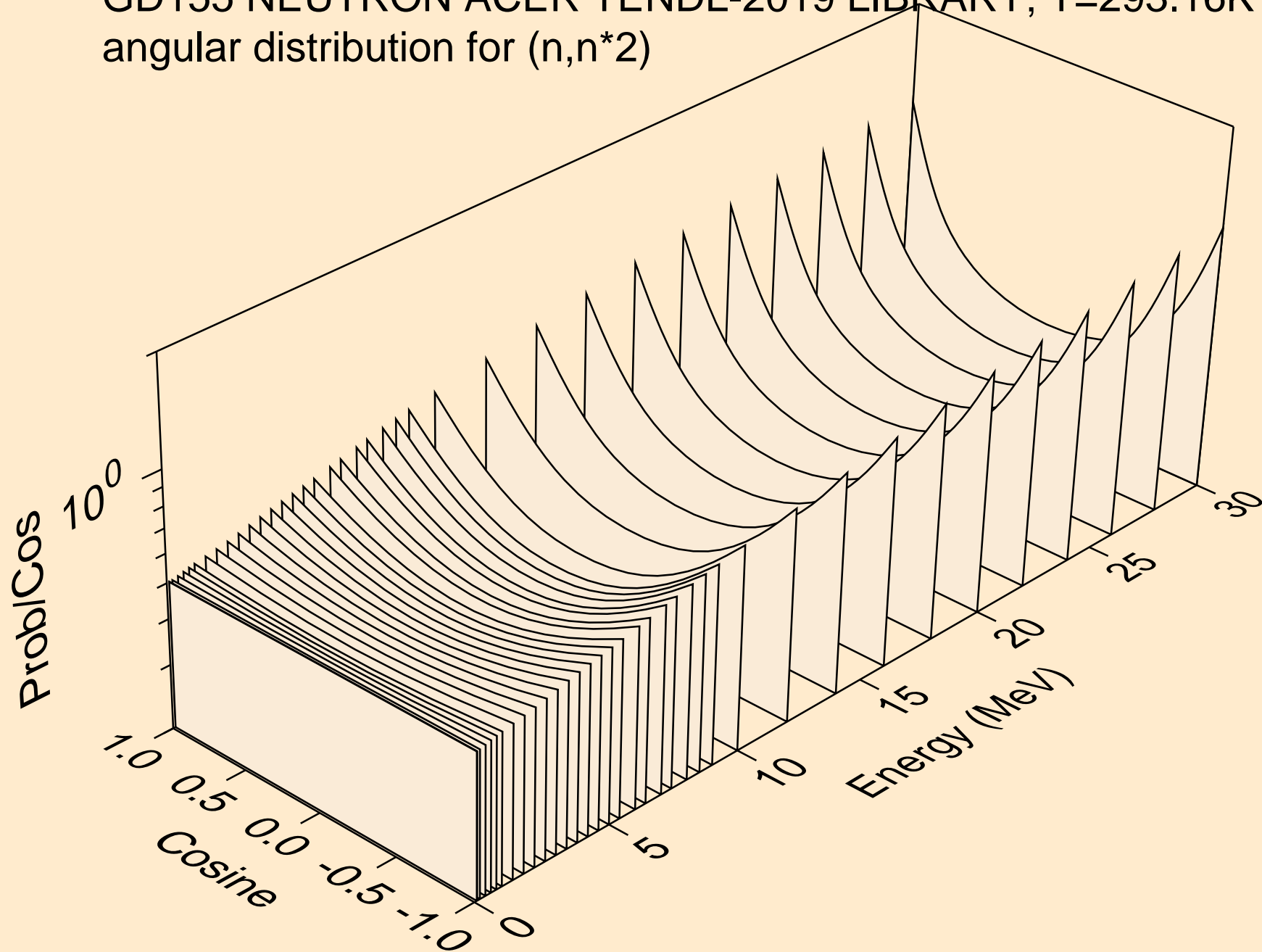

GD155 NEUTRON ACER TENDL-2019 LIBRARY; T=293.16K
angular distribution for (n,n*3)

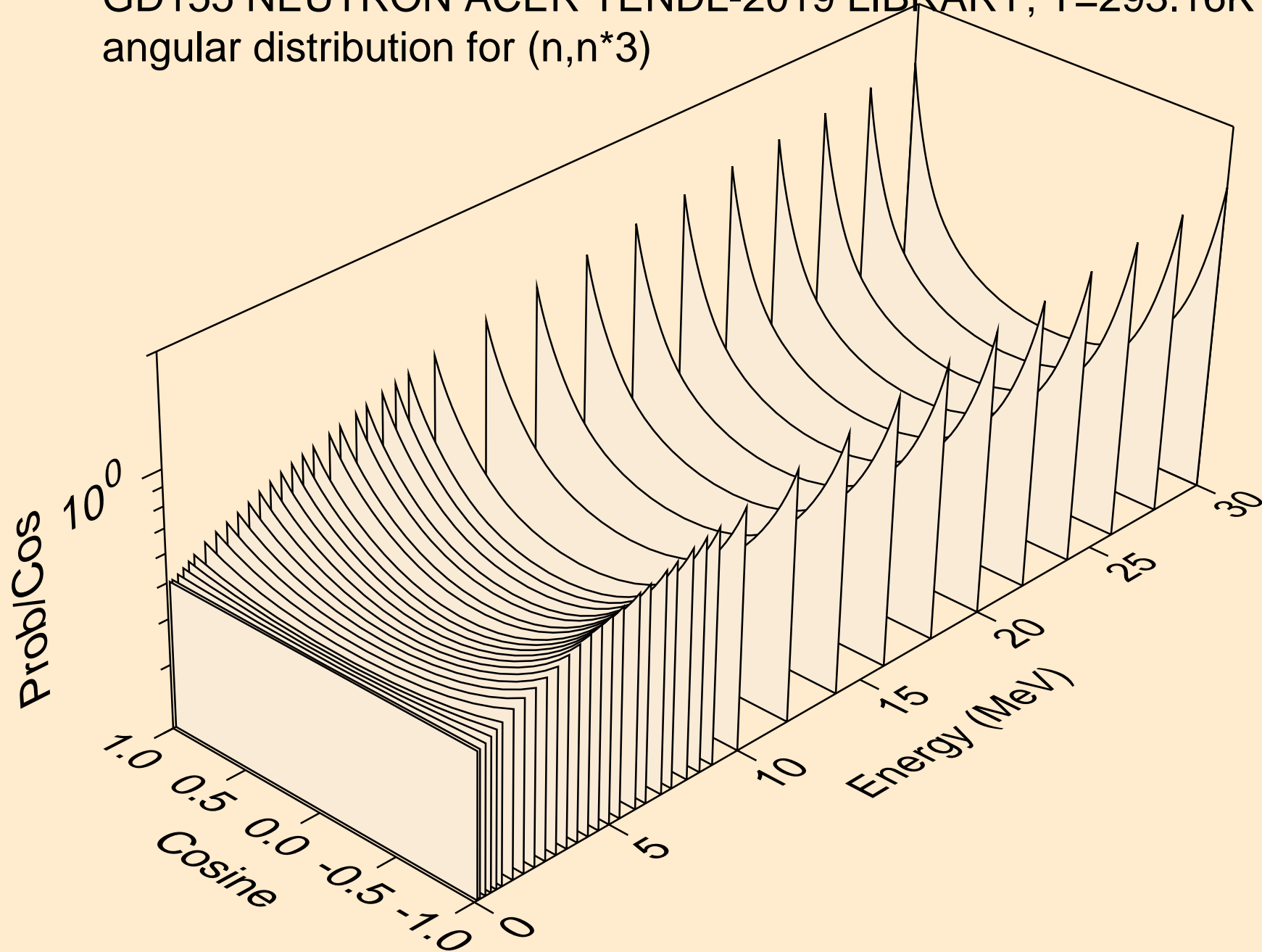

GD155 NEUTRON ACER TENDL-2019 LIBRARY; T=293.16K
angular distribution for (n,n*4)

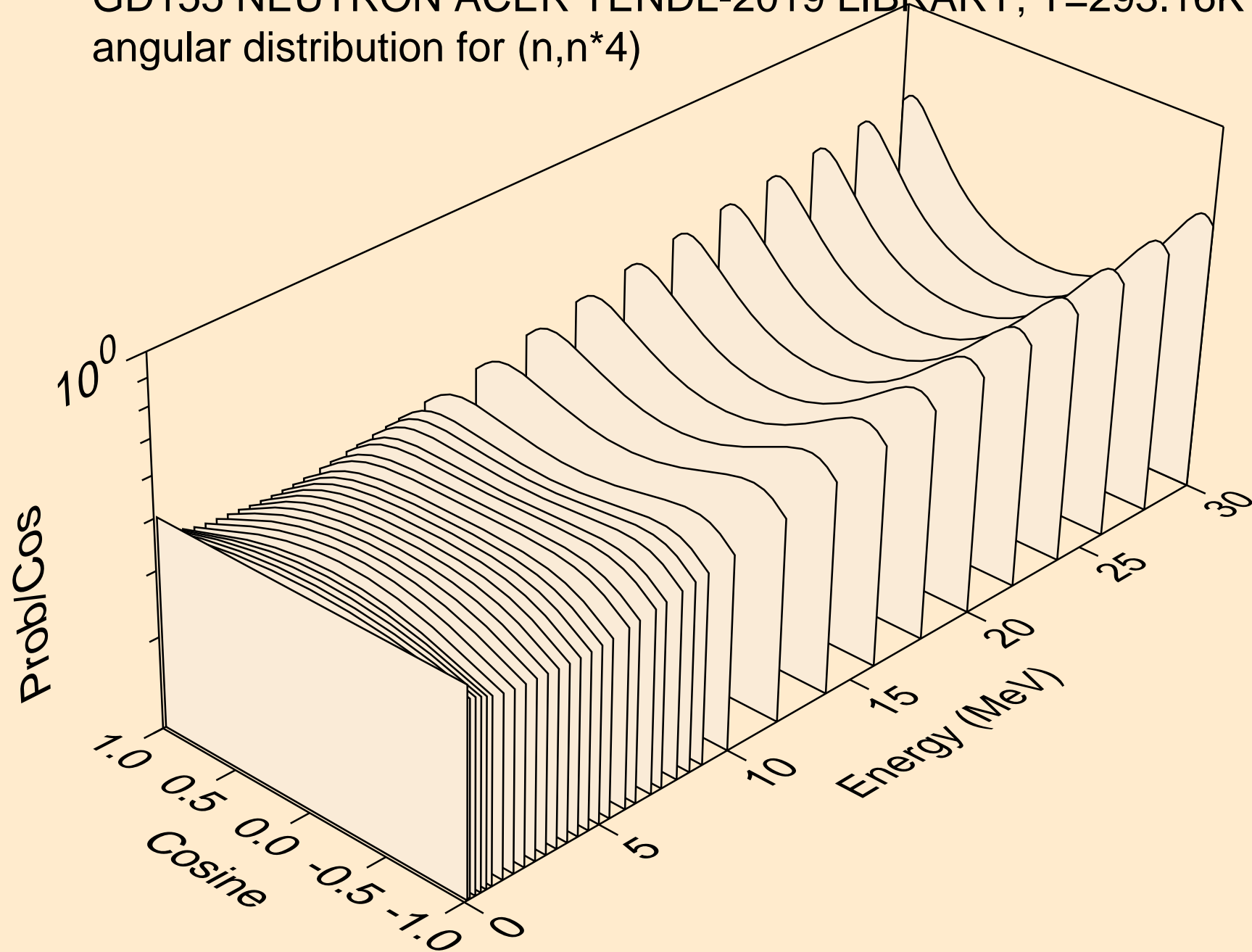

GD155 NEUTRON ACER TENDL-2019 LIBRARY; T=293.16K
angular distribution for (n,n*5)

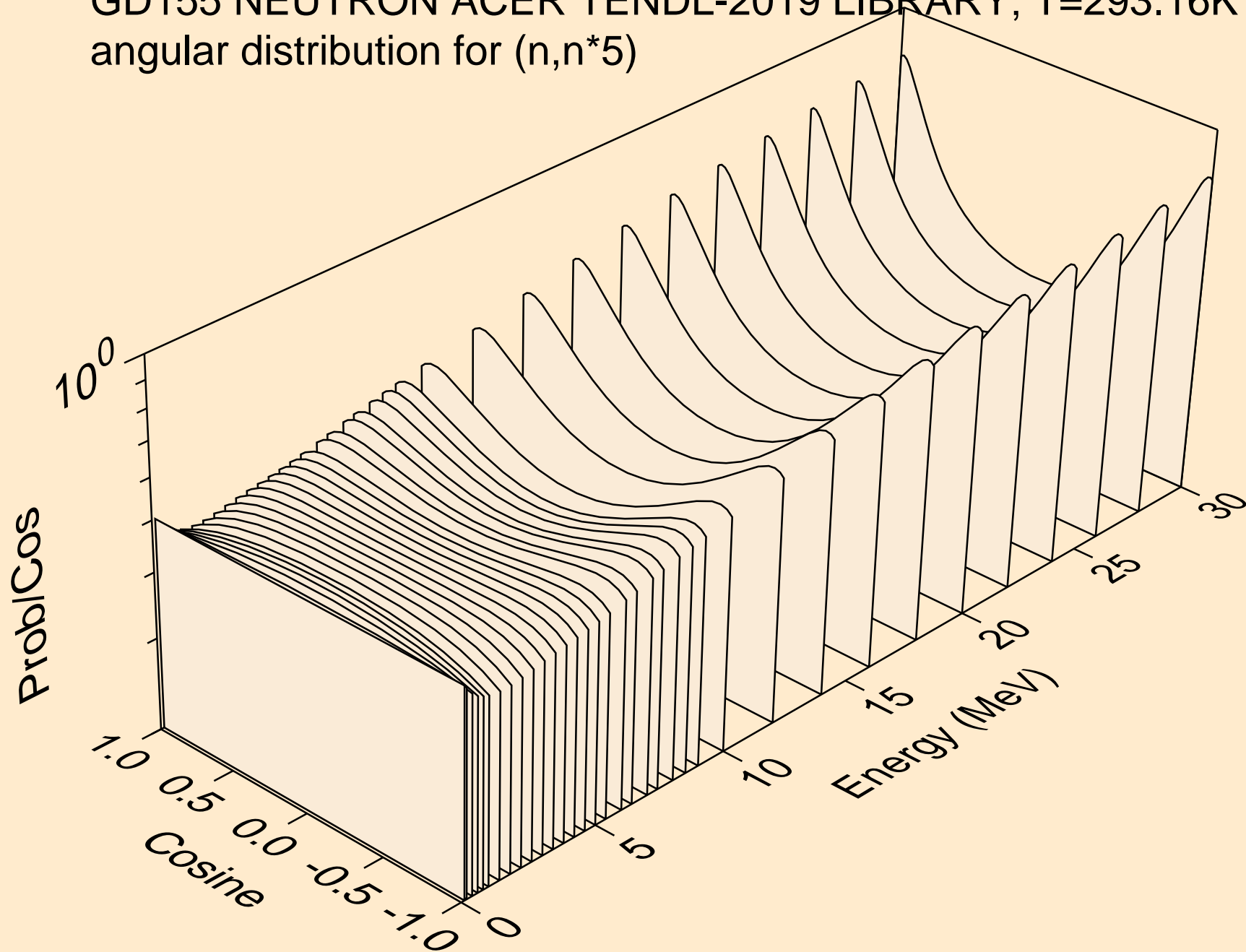

GD155 NEUTRON ACER TENDL-2019 LIBRARY; T=293.16K
angular distribution for (n,n*6)

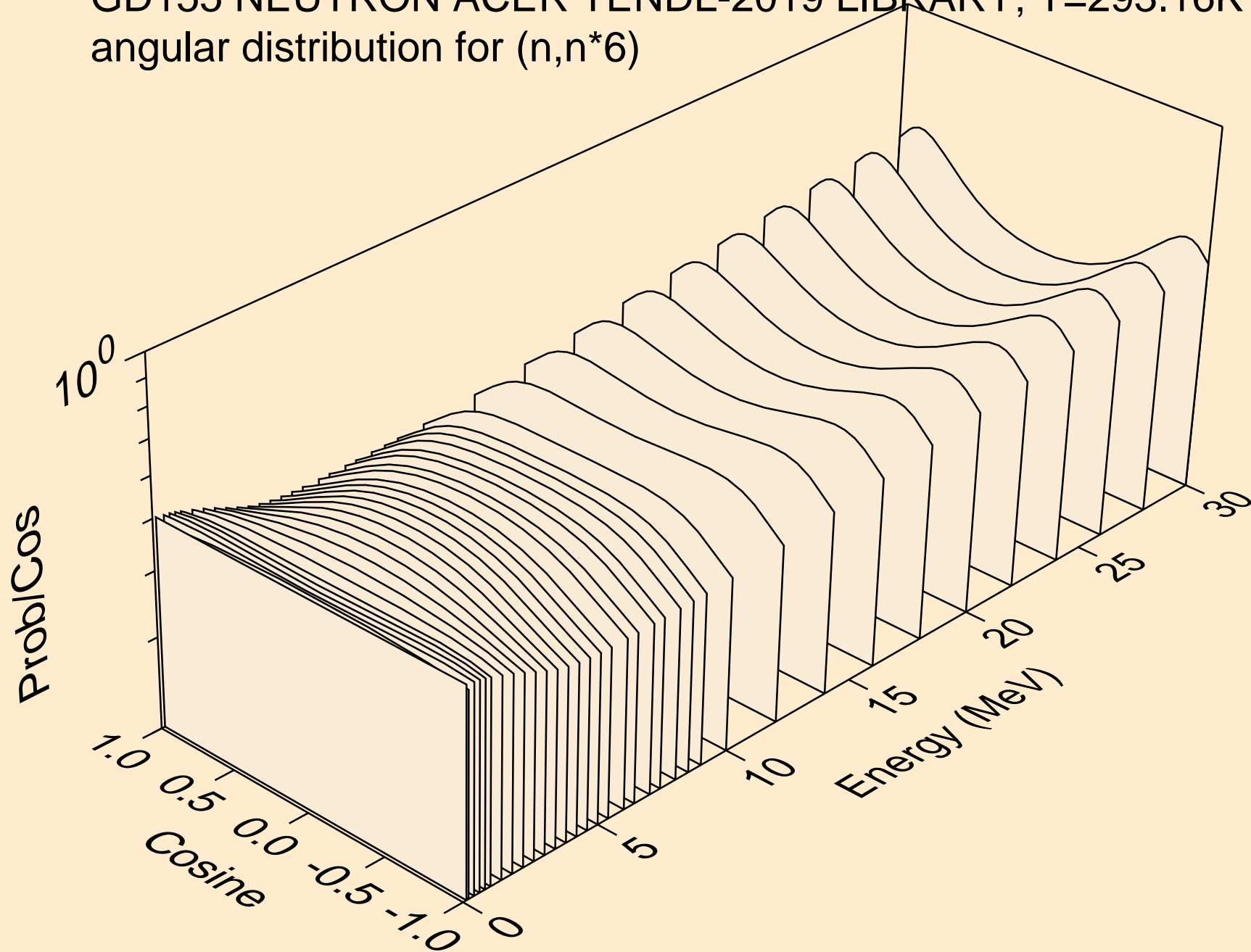

GD155 NEUTRON ACER TENDL-2019 LIBRARY; T=293.16K
angular distribution for (n,n*7)

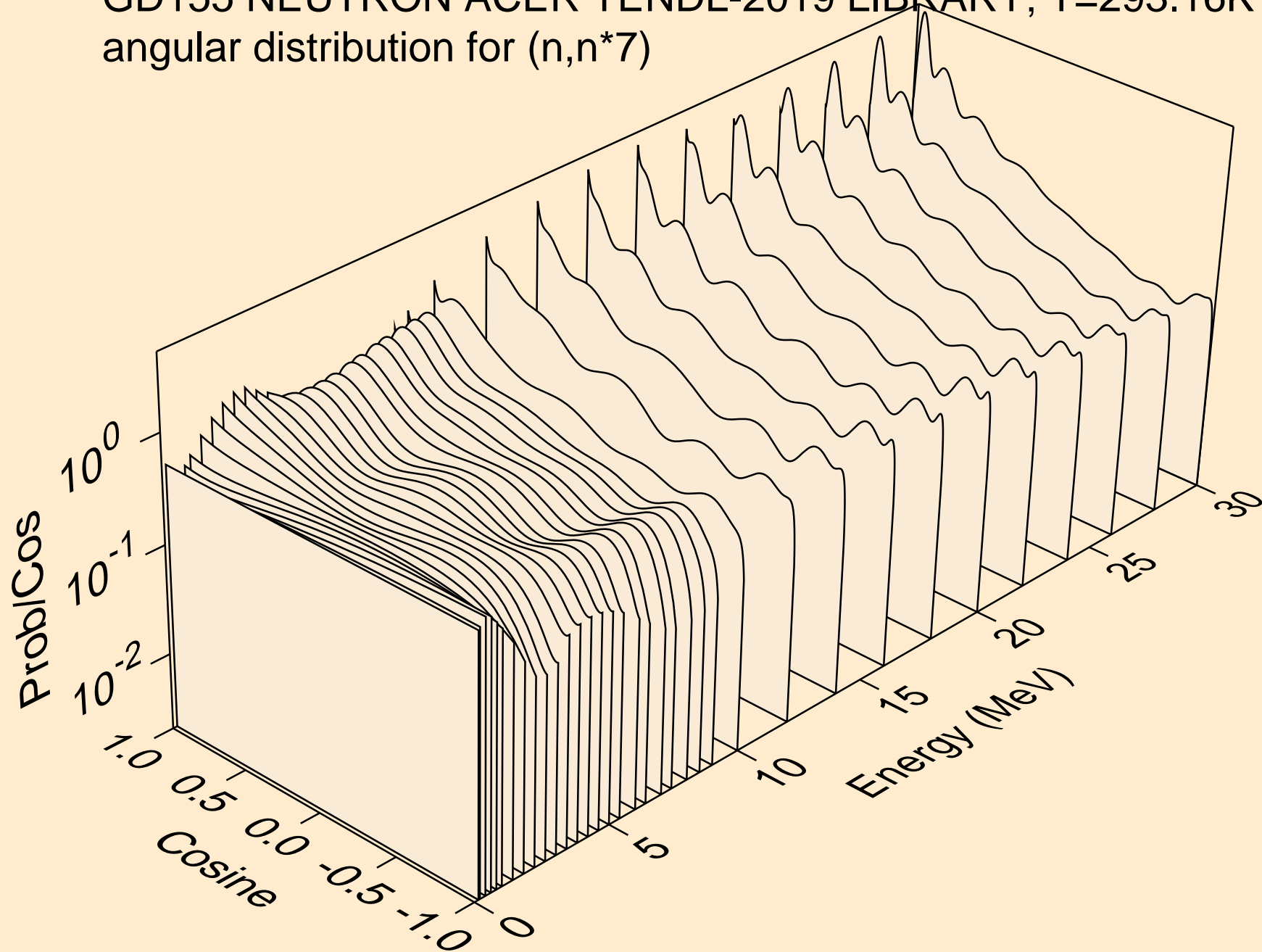

GD155 NEUTRON ACER TENDL-2019 LIBRARY; T=293.16K
angular distribution for (n,n*8)

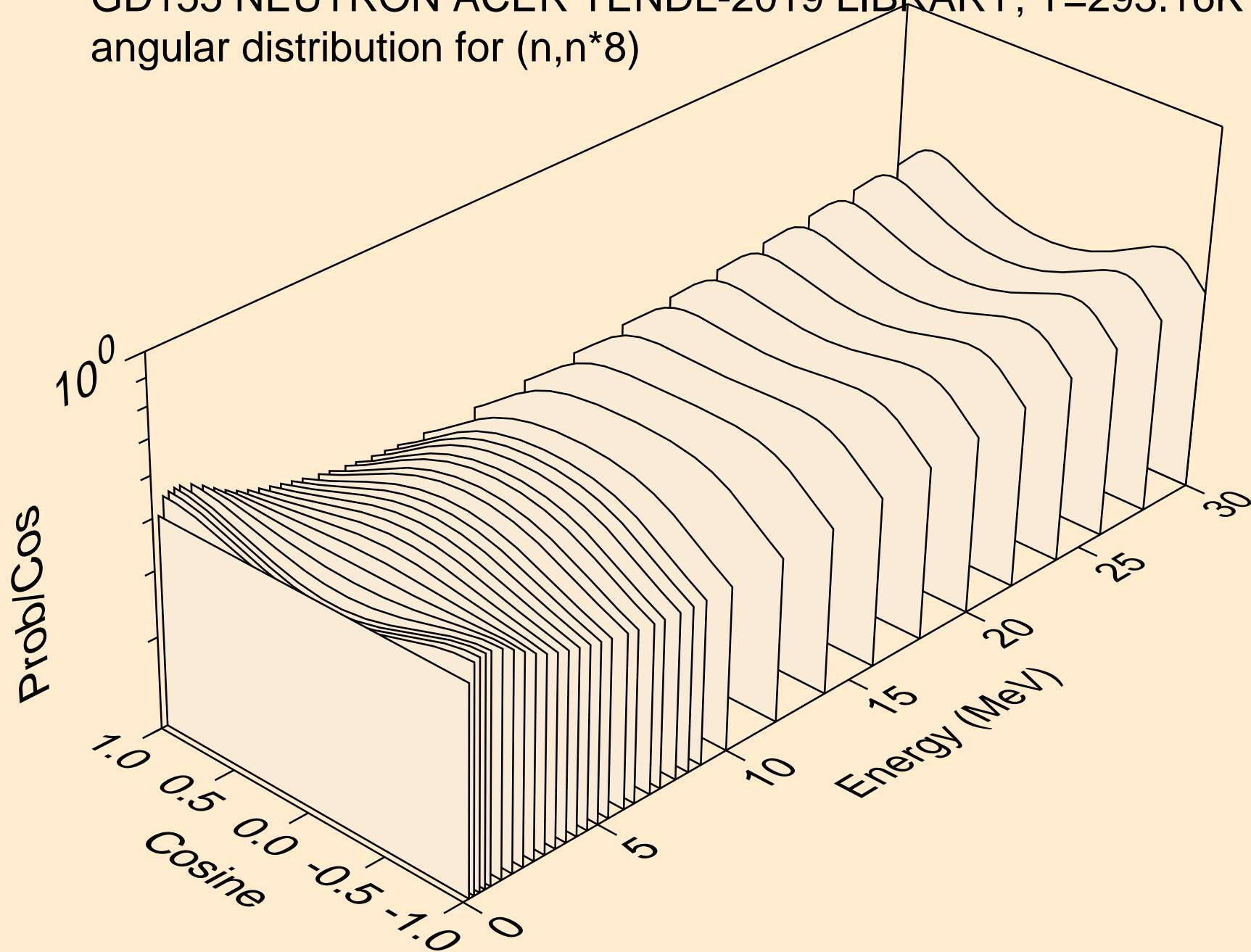

GD155 NEUTRON ACER TENDL-2019 LIBRARY; T=293.16K
angular distribution for (n,n*9)

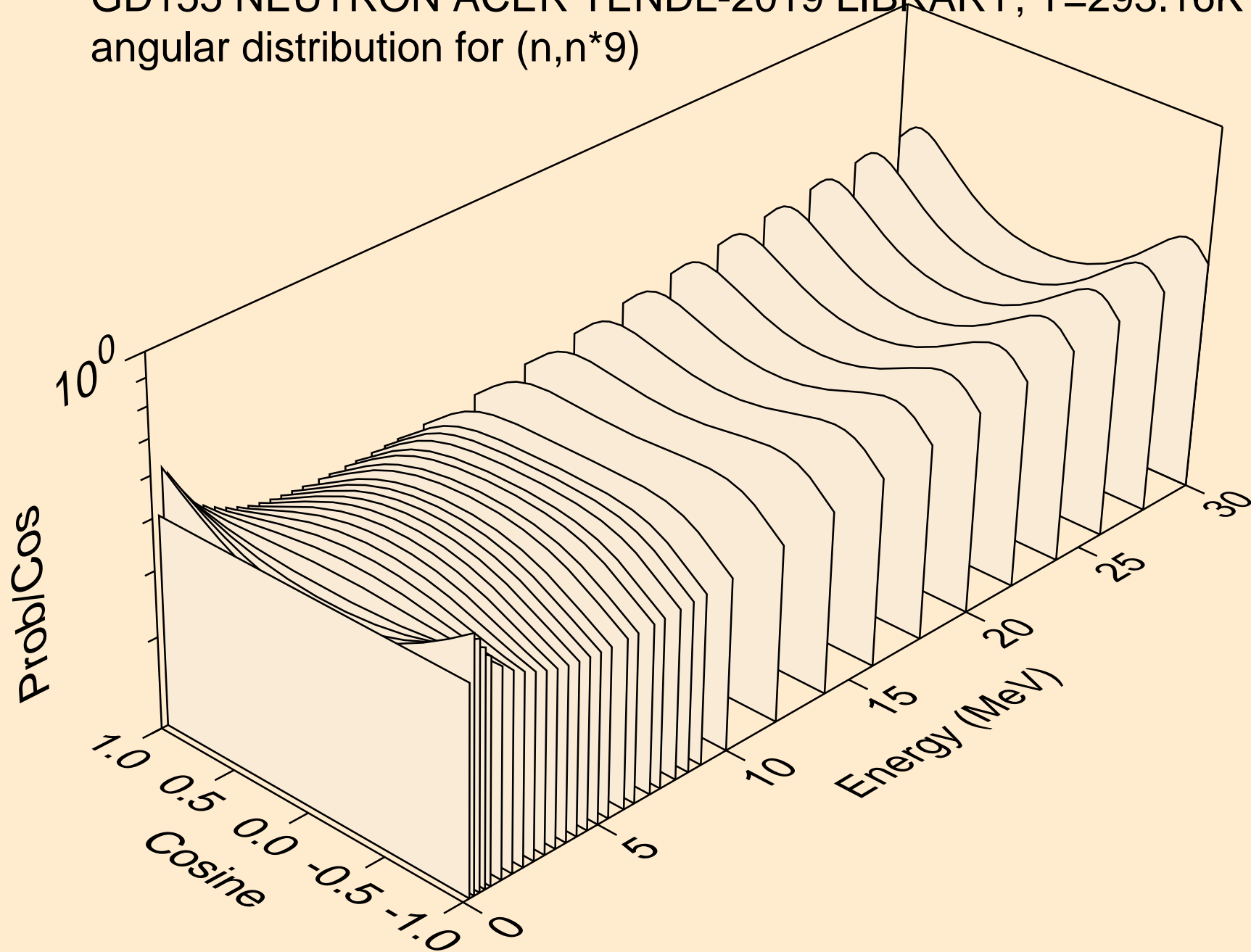

GD155 NEUTRON ACER TENDL-2019 LIBRARY; T=293.16K
angular distribution for (n,n*10)

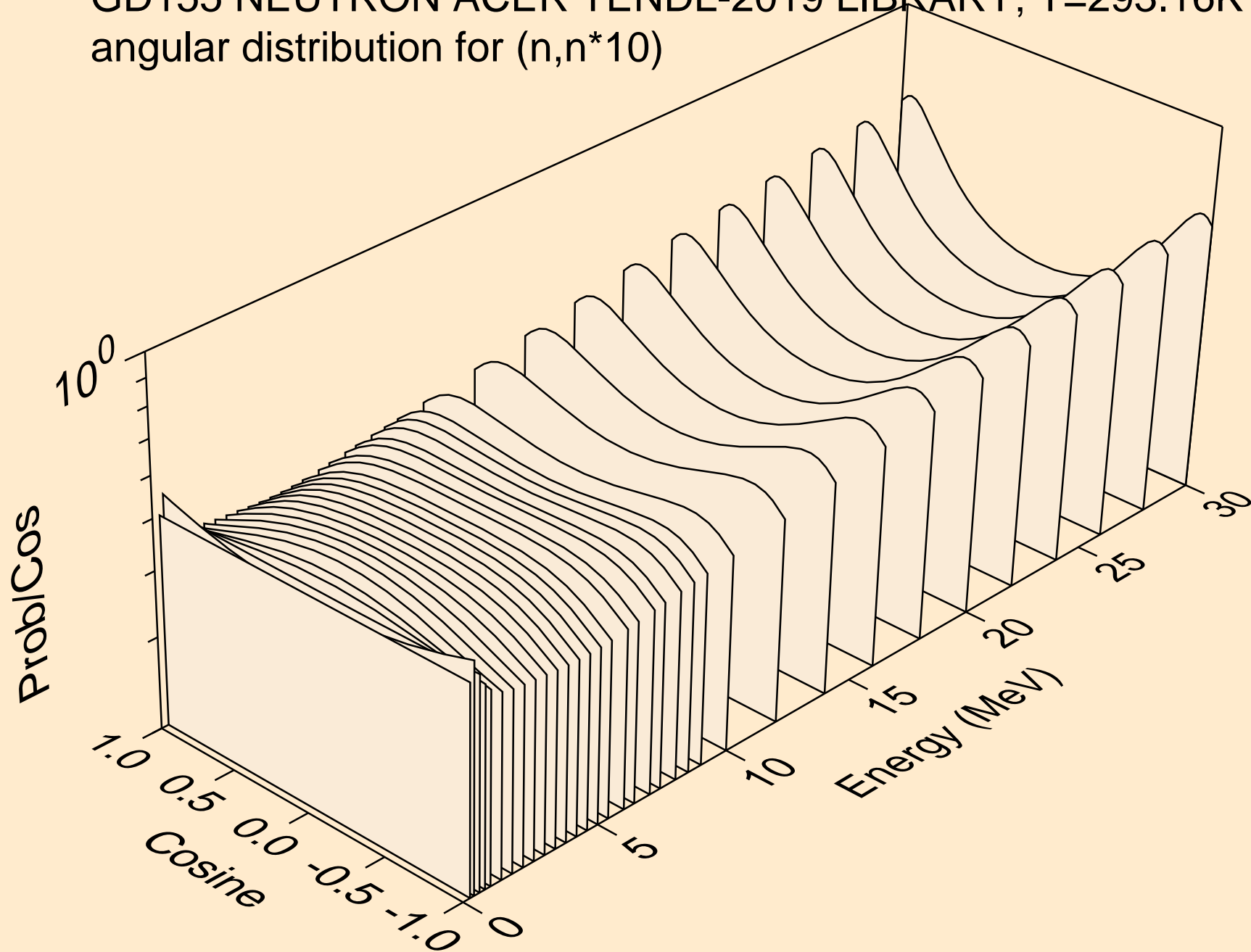

GD155 NEUTRON ACER TENDL-2019 LIBRARY; T=293.16K
angular distribution for (n,n*11)

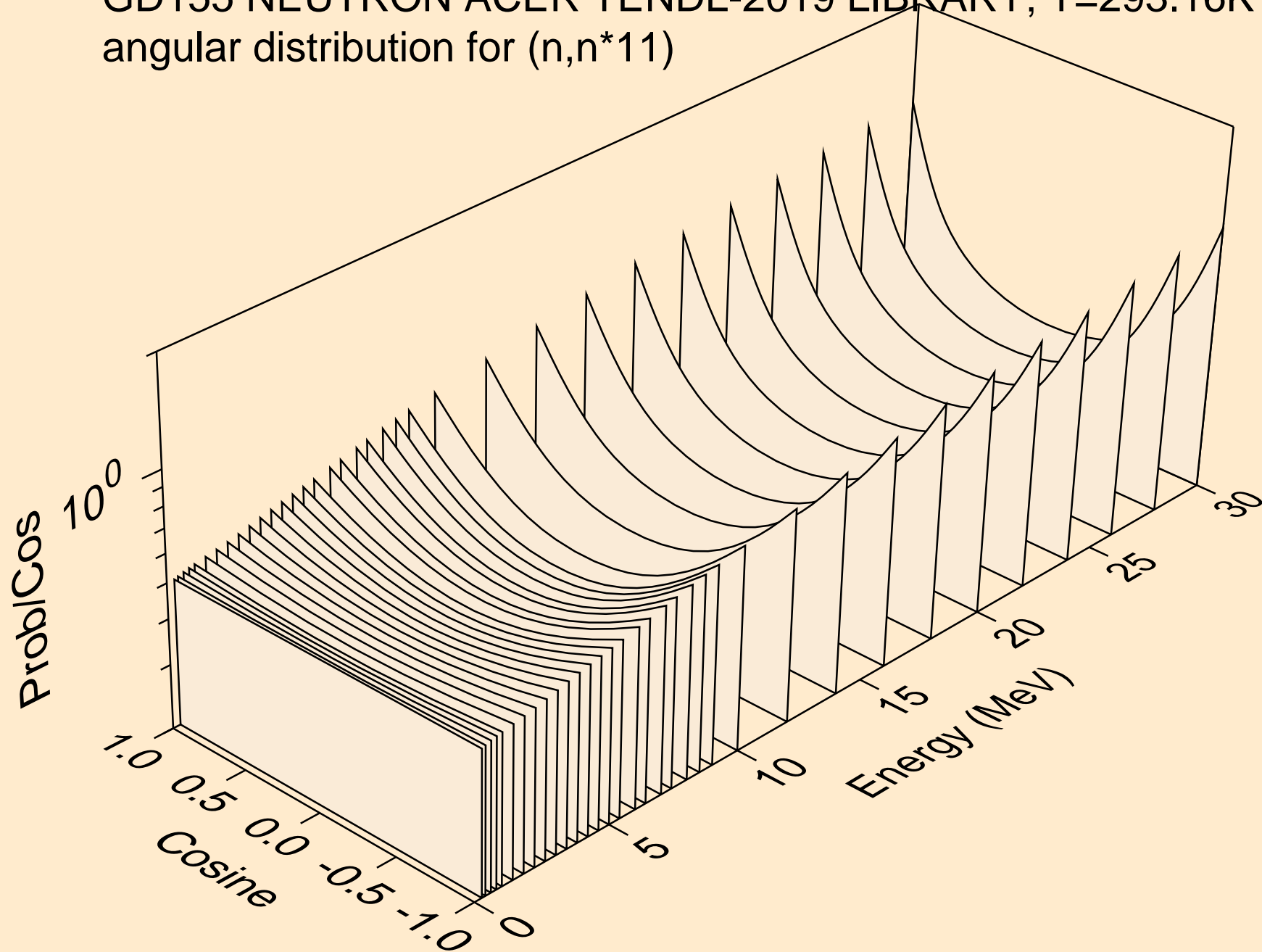

GD155 NEUTRON ACER TENDL-2019 LIBRARY; T=293.16K
angular distribution for (n,n*12)

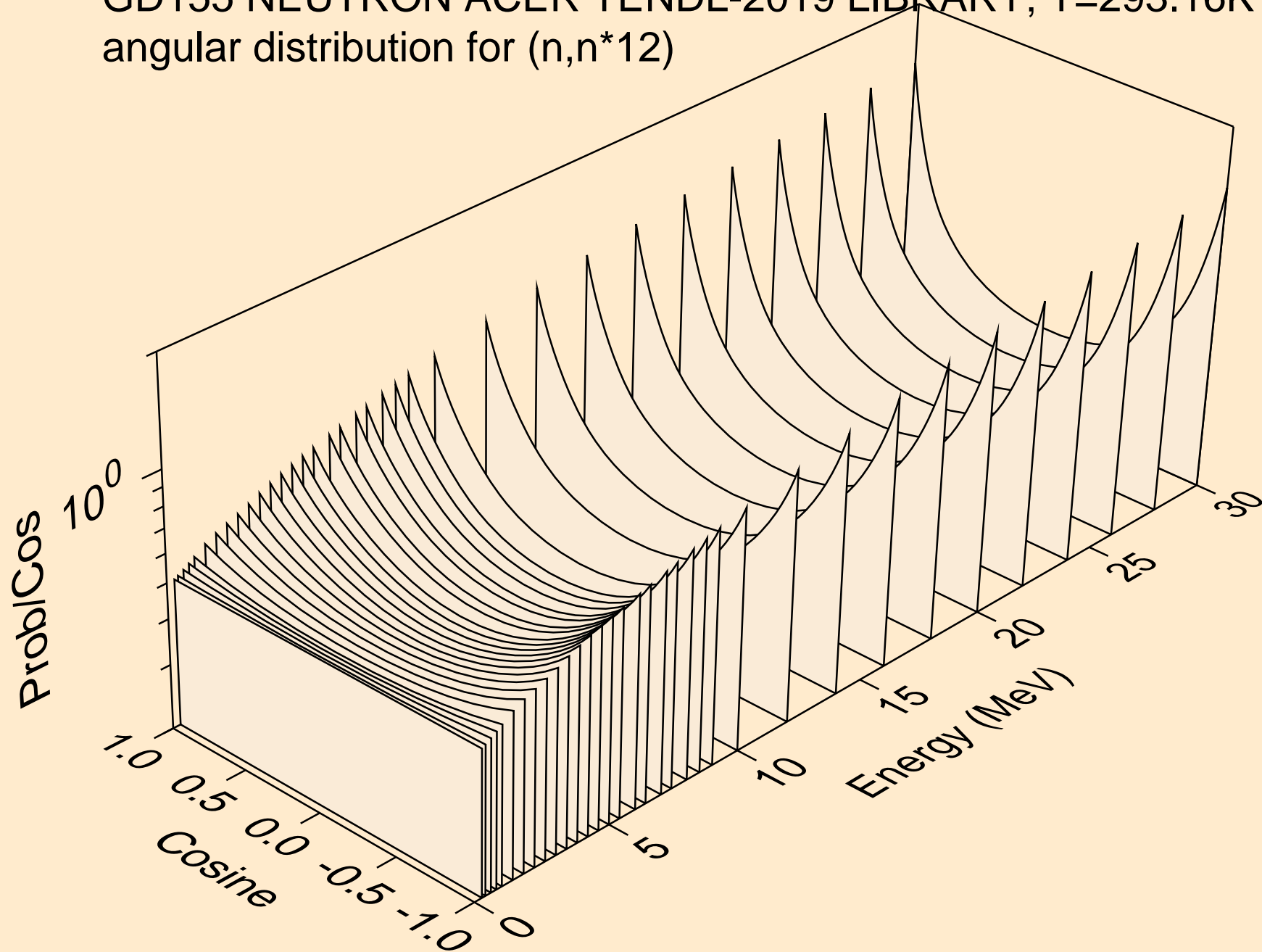

GD155 NEUTRON ACER TENDL-2019 LIBRARY; T=293.16K
angular distribution for (n,n*13)

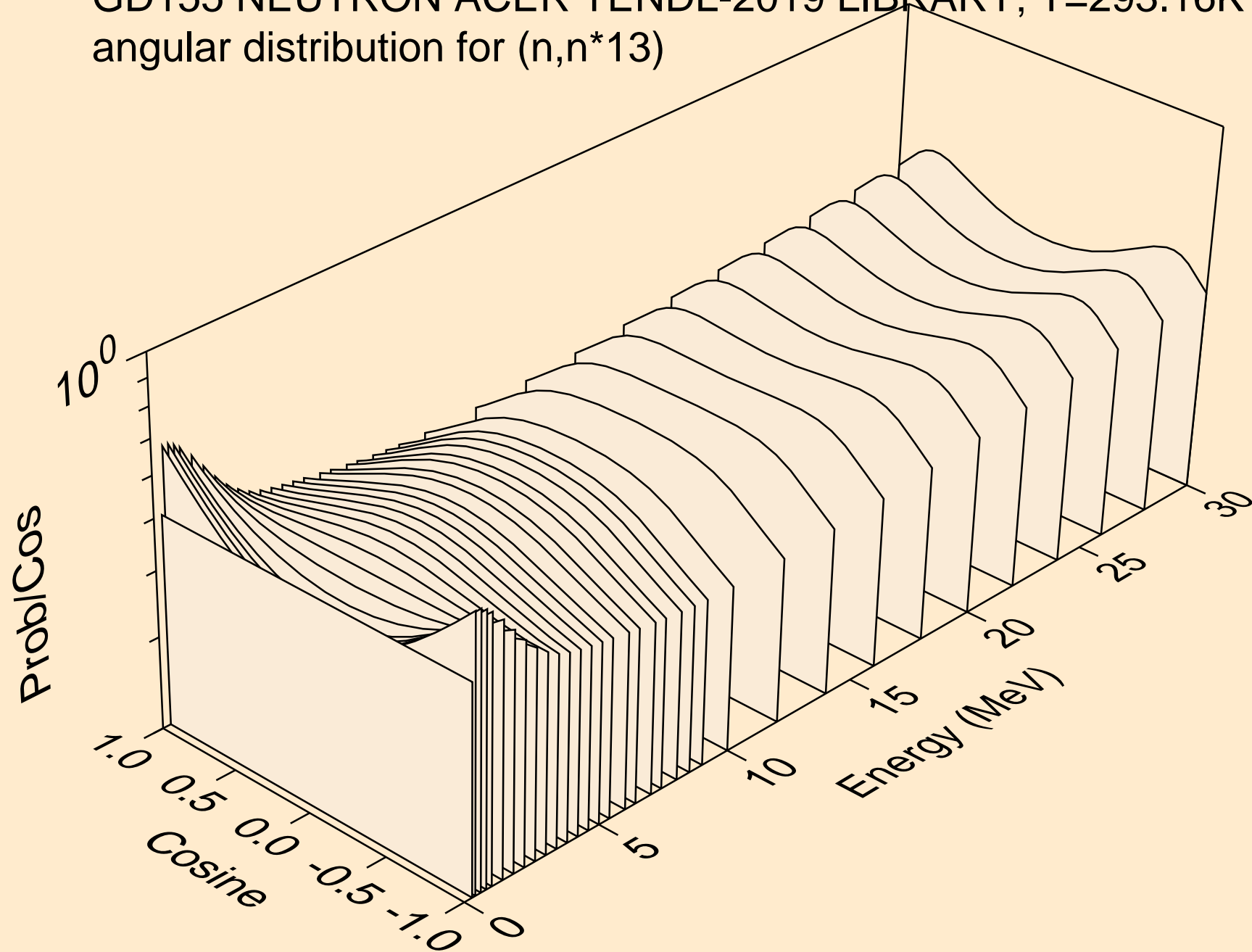

GD155 NEUTRON ACER TENDL-2019 LIBRARY; T=293.16K
angular distribution for (n,n*14)

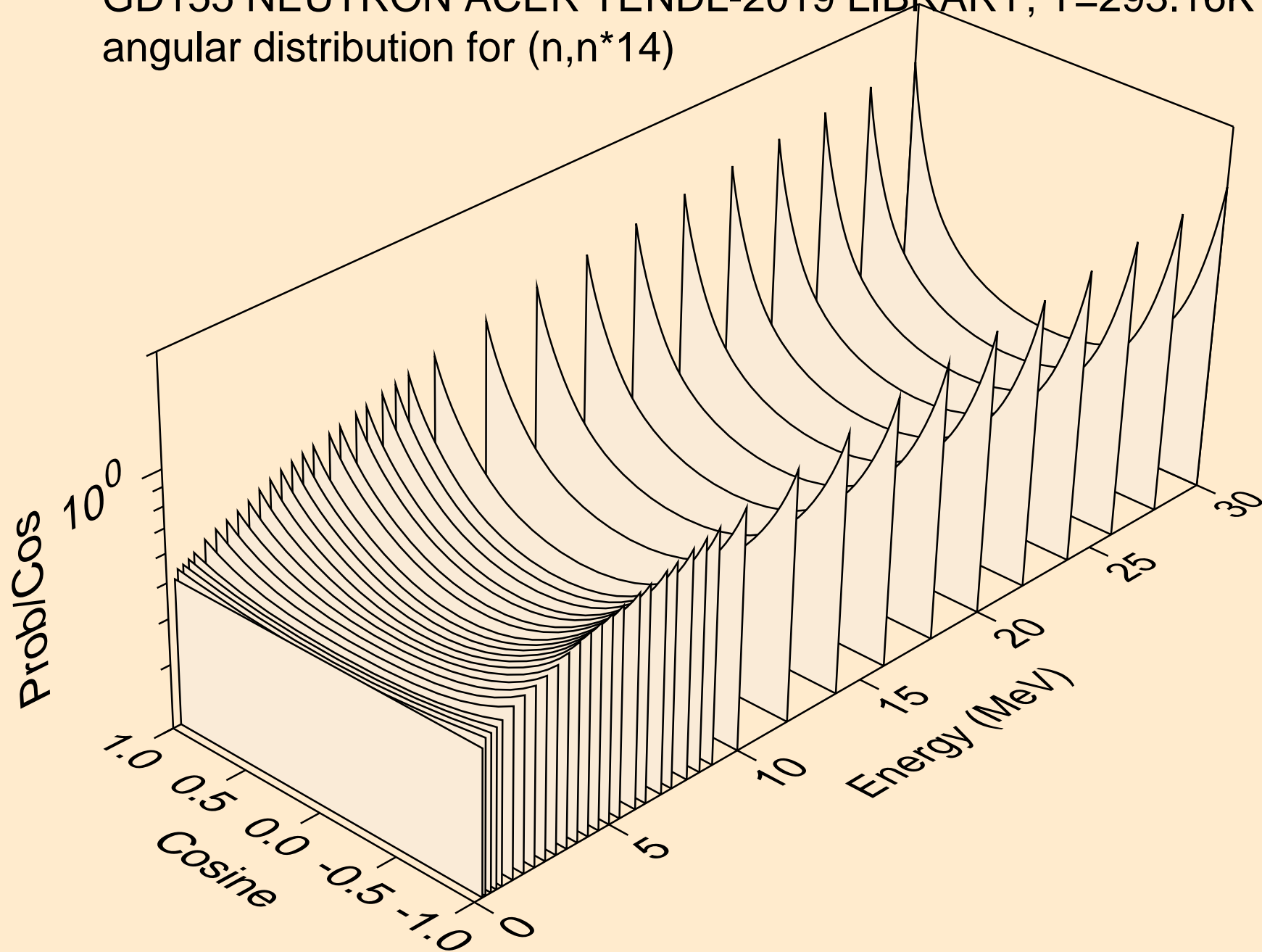

GD155 NEUTRON ACER TENDL-2019 LIBRARY; T=293.16K
angular distribution for (n,n*15)

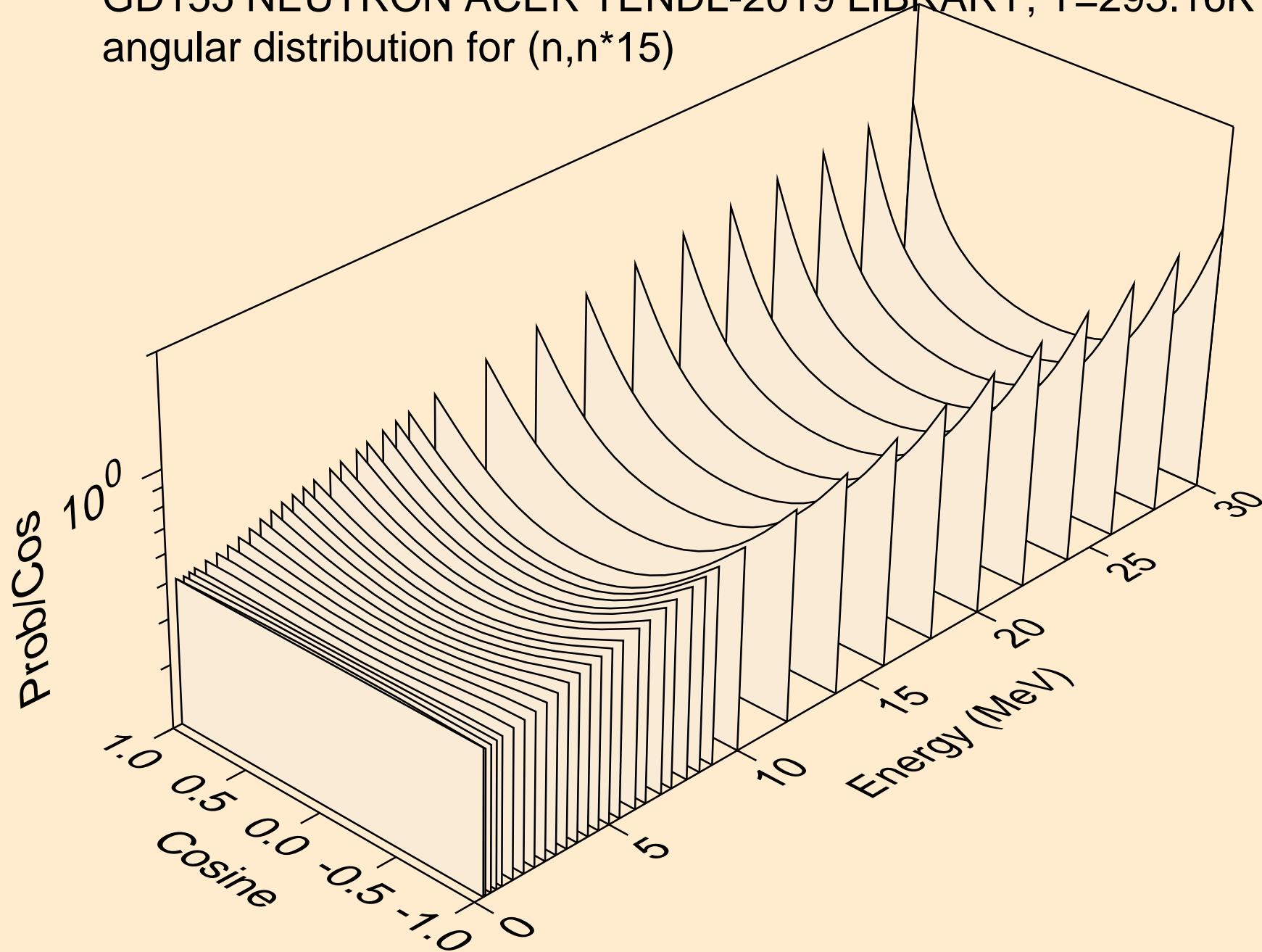

GD155 NEUTRON ACER TENDL-2019 LIBRARY; T=293.16K
angular distribution for (n,n*16)

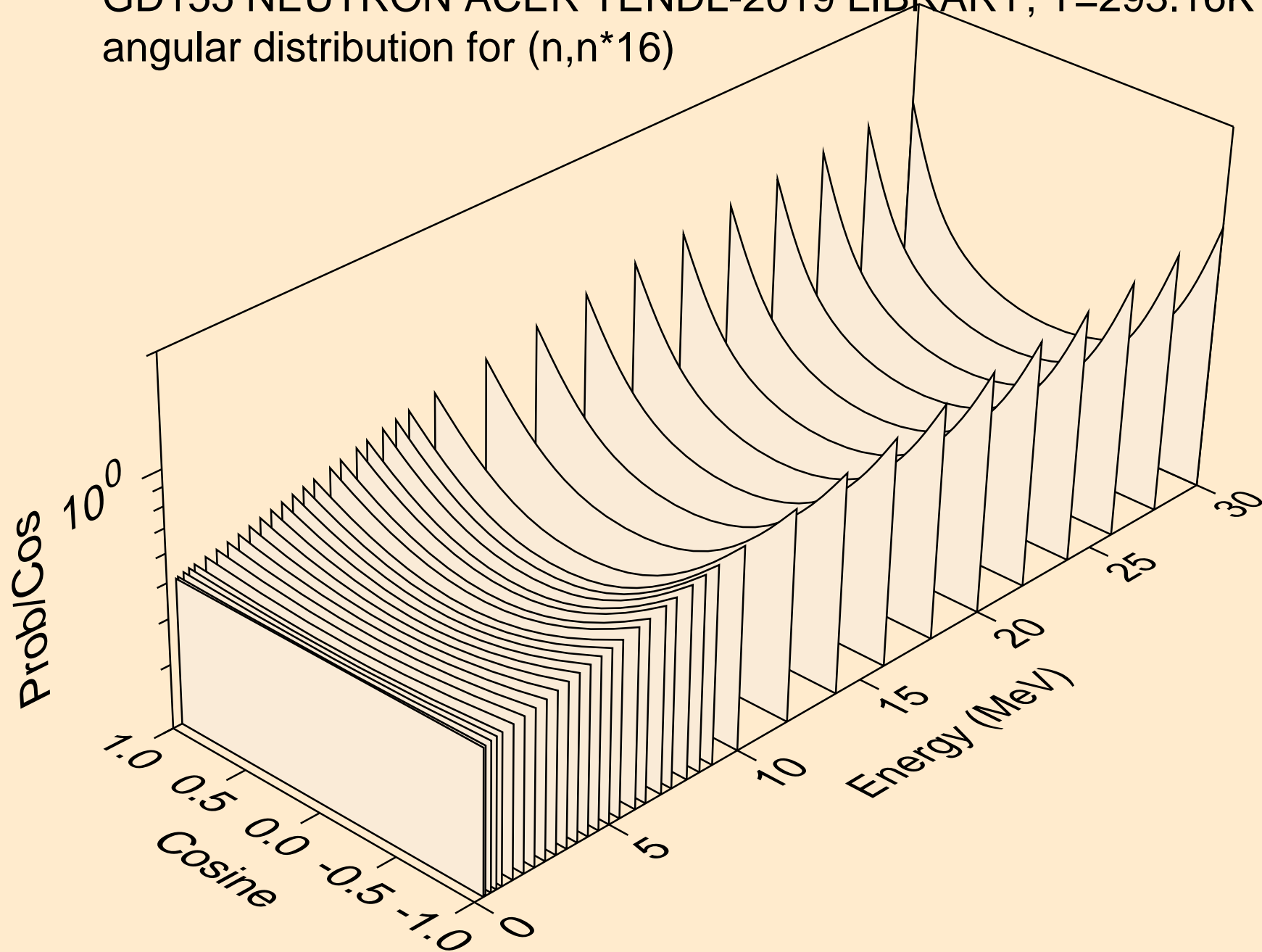

GD155 NEUTRON ACER TENDL-2019 LIBRARY; T=293.16K
angular distribution for (n,n*17)

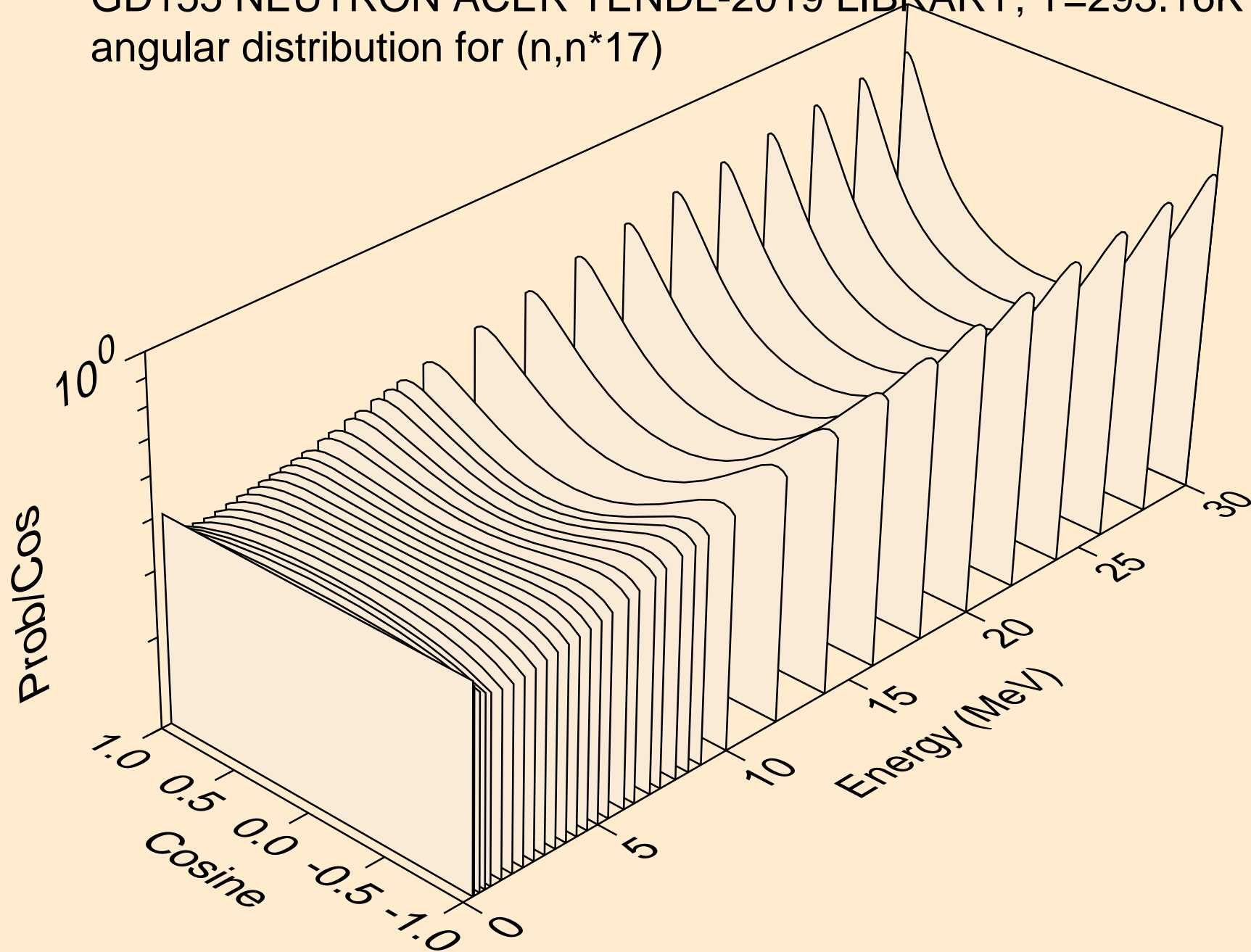

GD155 NEUTRON ACER TENDL-2019 LIBRARY; T=293.16K
angular distribution for (n,n*18)

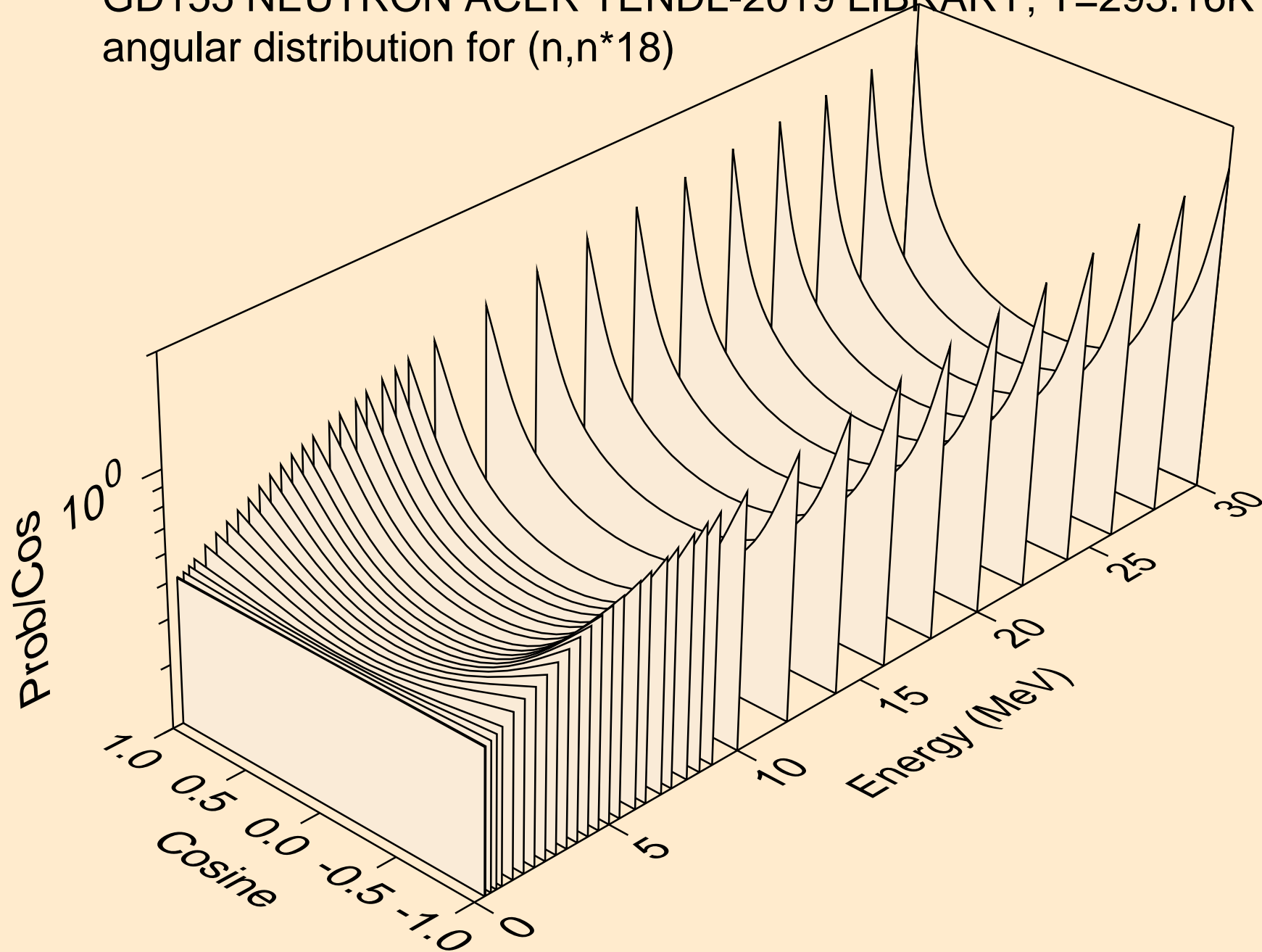

GD155 NEUTRON ACER TENDL-2019 LIBRARY; T=293.16K
angular distribution for (n,n*19)

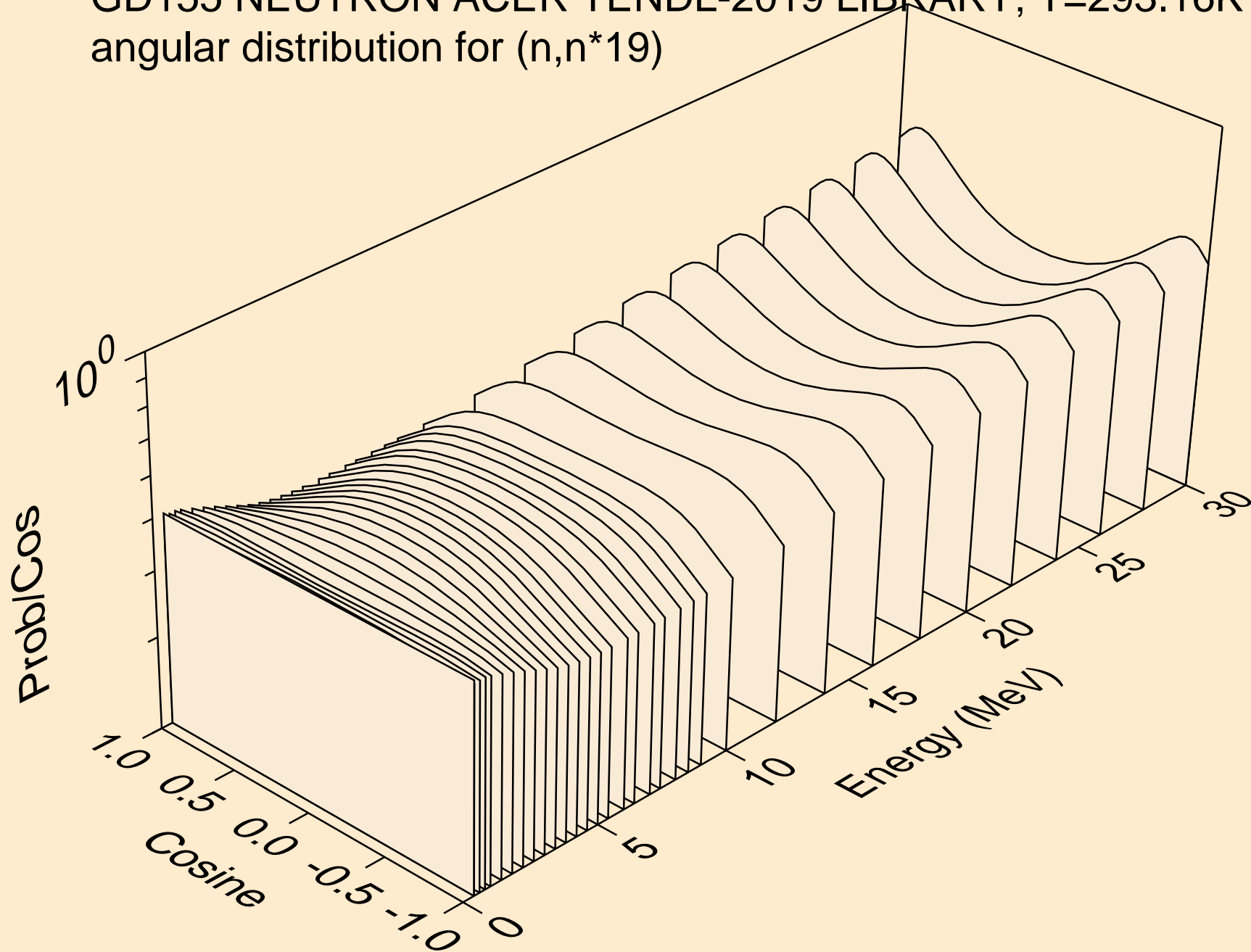

GD155 NEUTRON ACER TENDL-2019 LIBRARY; T=293.16K
angular distribution for (n,n*20)

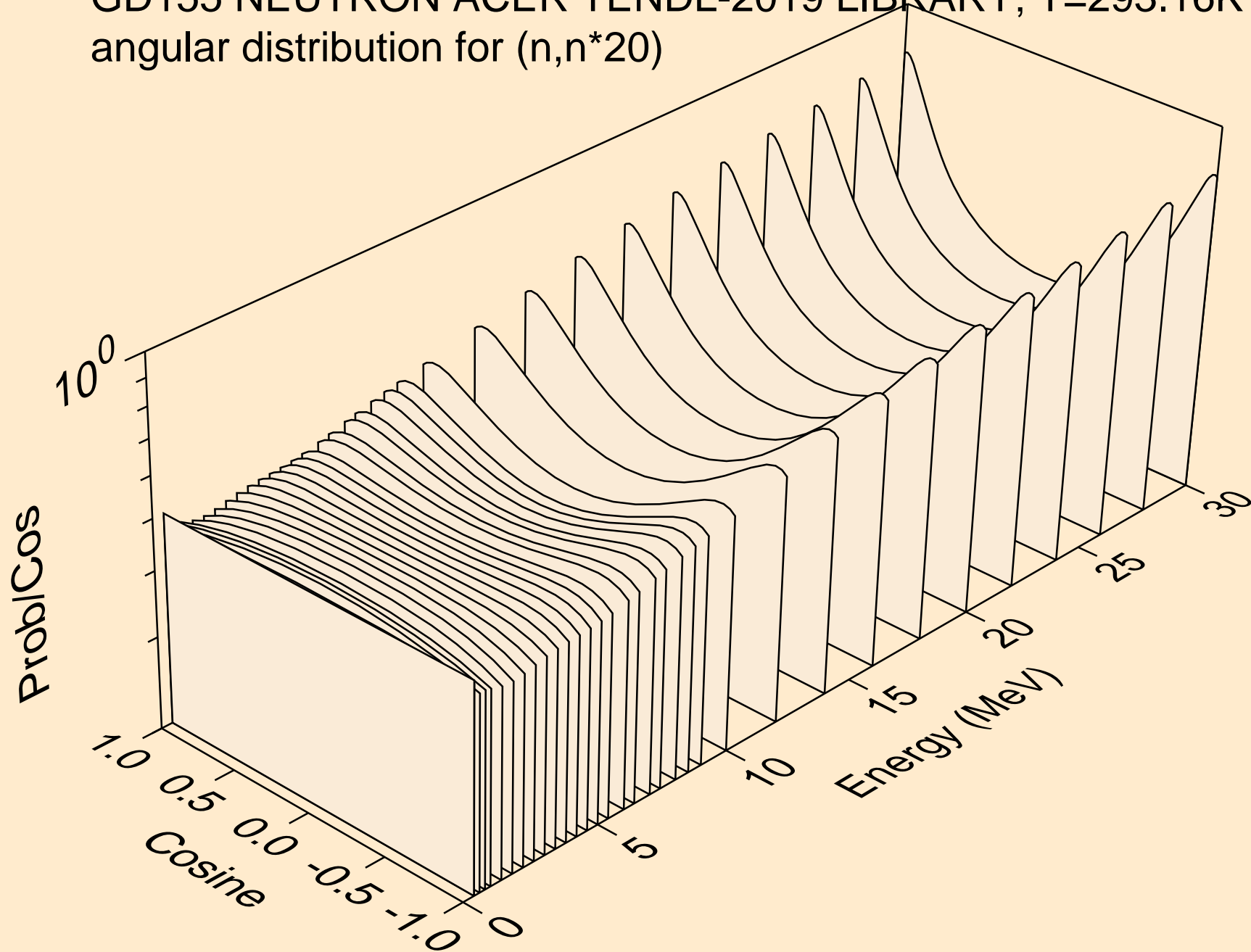

GD155 NEUTRON ACER TENDL-2019 LIBRARY; T=293.16K
angular distribution for (n,n*21)

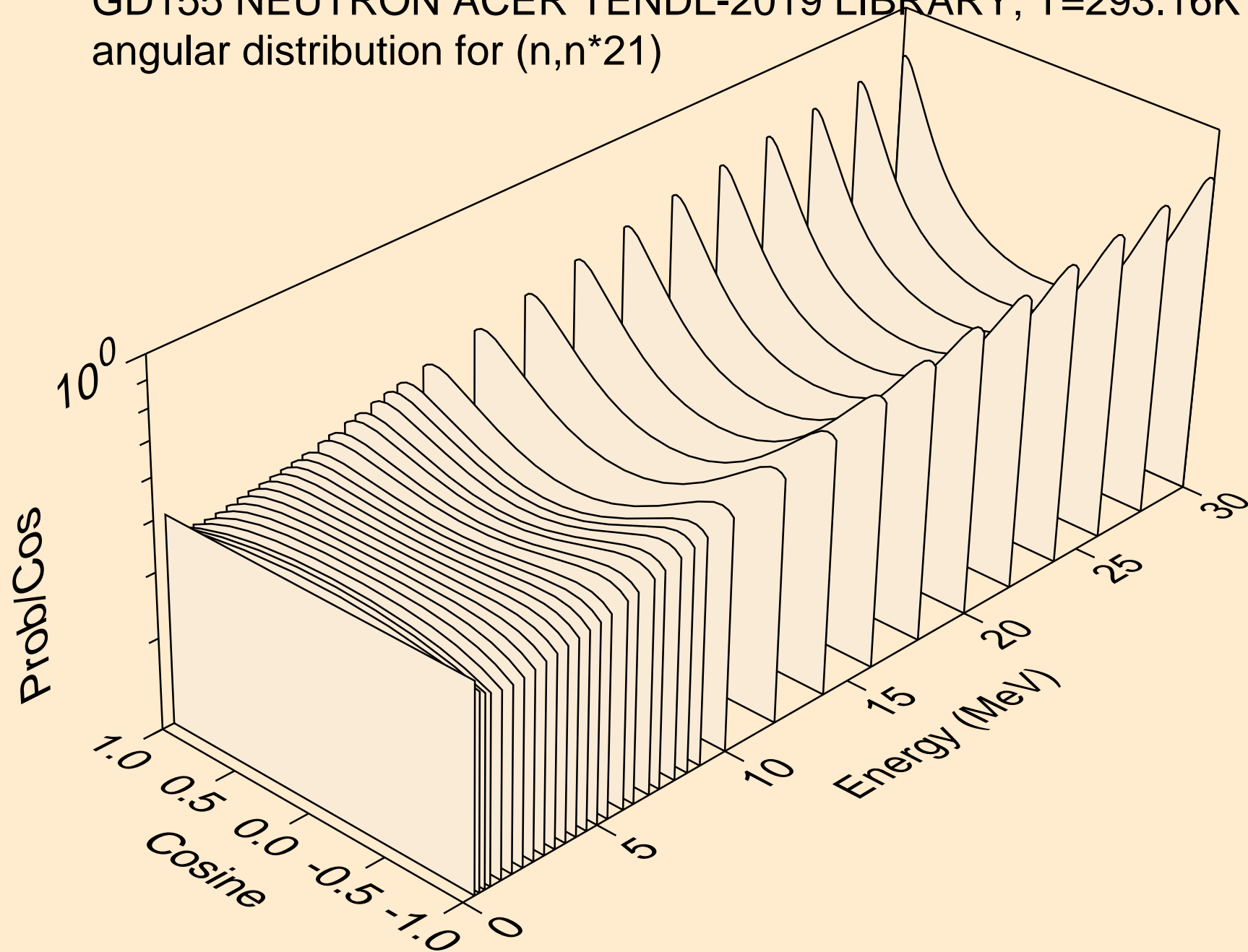

GD155 NEUTRON ACER TENDL-2019 LIBRARY; T=293.16K
angular distribution for (n,n*22)

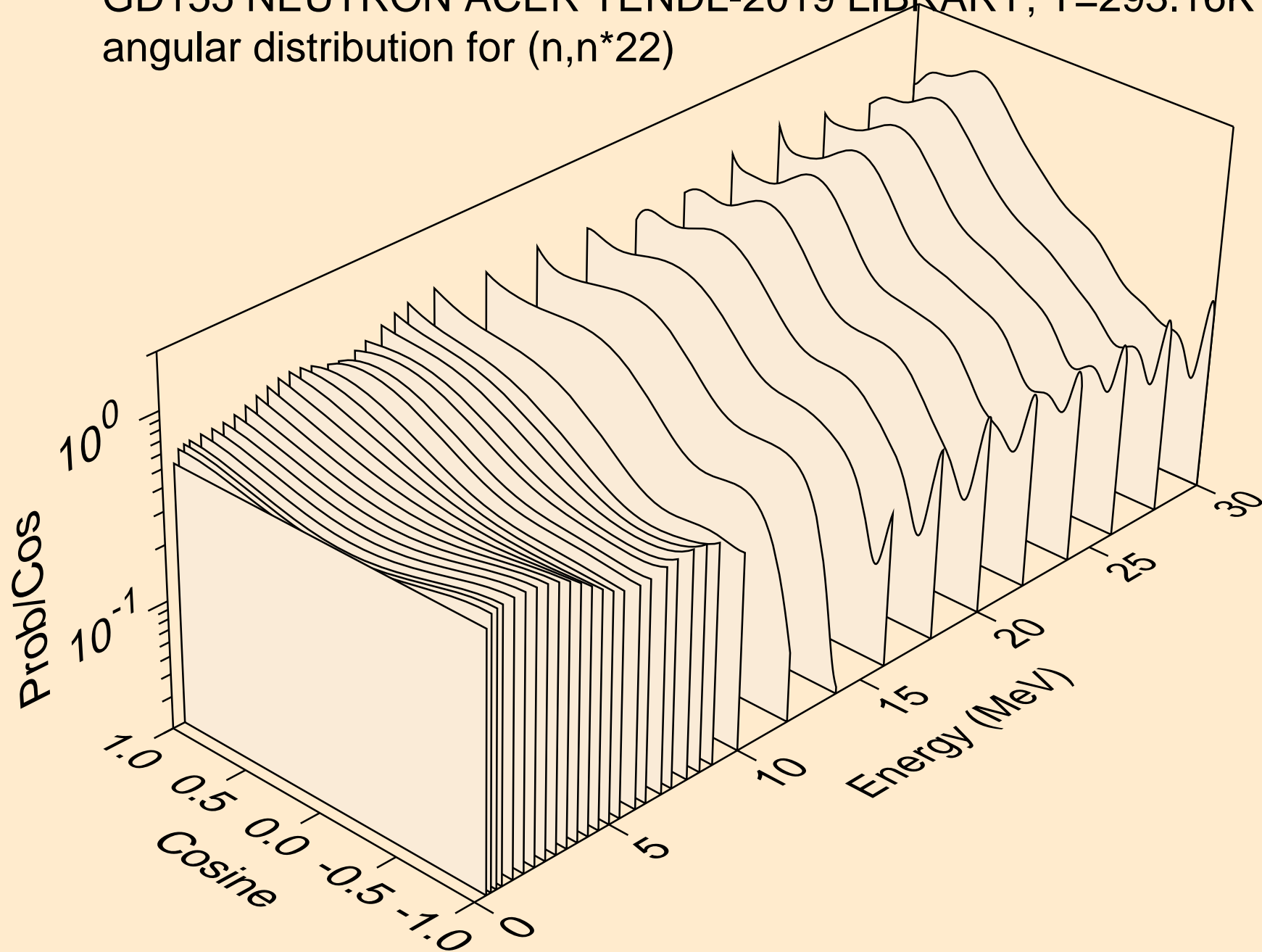

GD155 NEUTRON ACER TENDL-2019 LIBRARY; T=293.16K
angular distribution for (n,n*23)

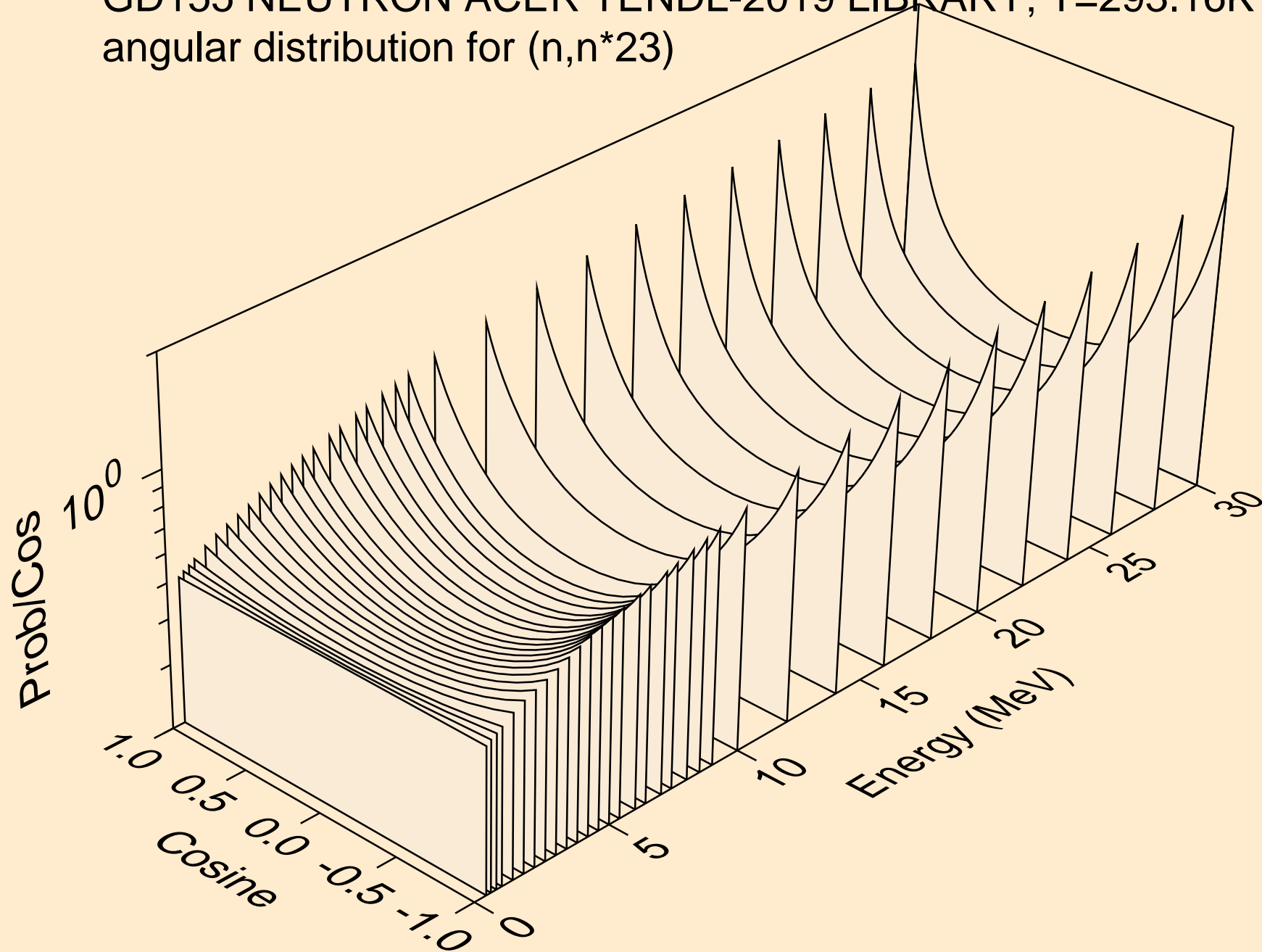

GD155 NEUTRON ACER TENDL-2019 LIBRARY; T=293.16K
angular distribution for (n,n*24)

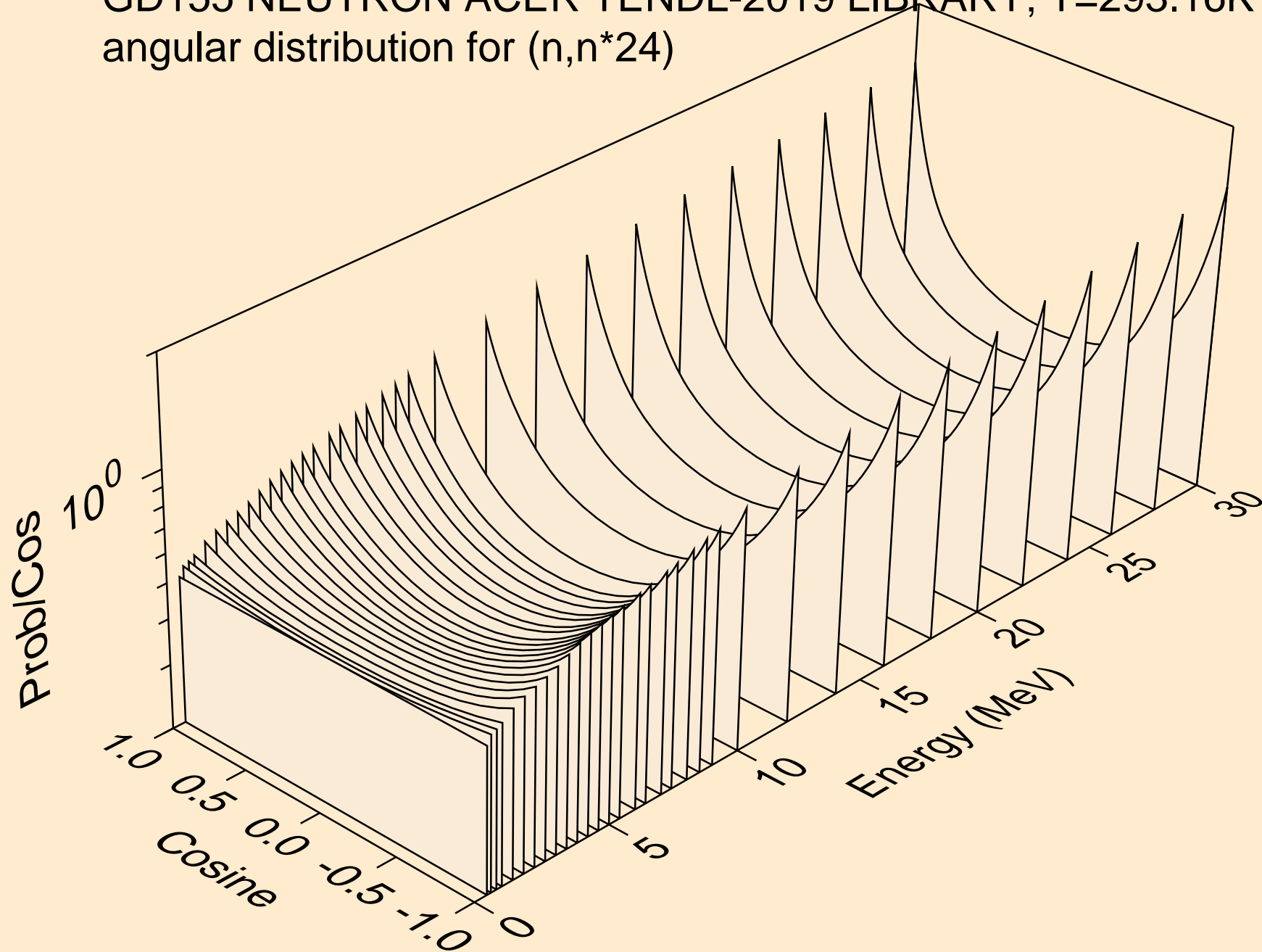

GD155 NEUTRON ACER TENDL-2019 LIBRARY; T=293.16K
angular distribution for (n,n*25)

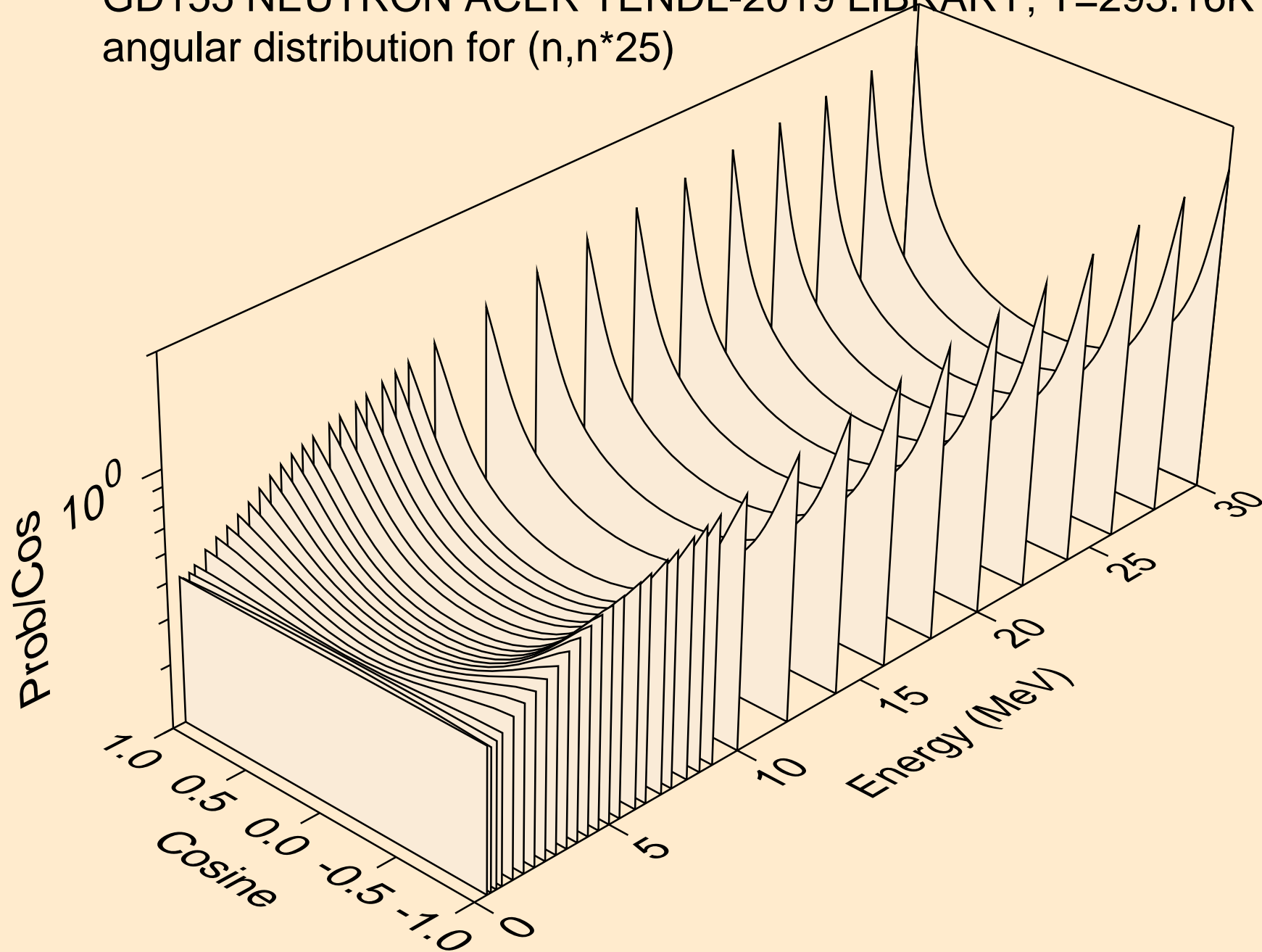

GD155 NEUTRON ACER TENDL-2019 LIBRARY; T=293.16K
angular distribution for (n,n*26)

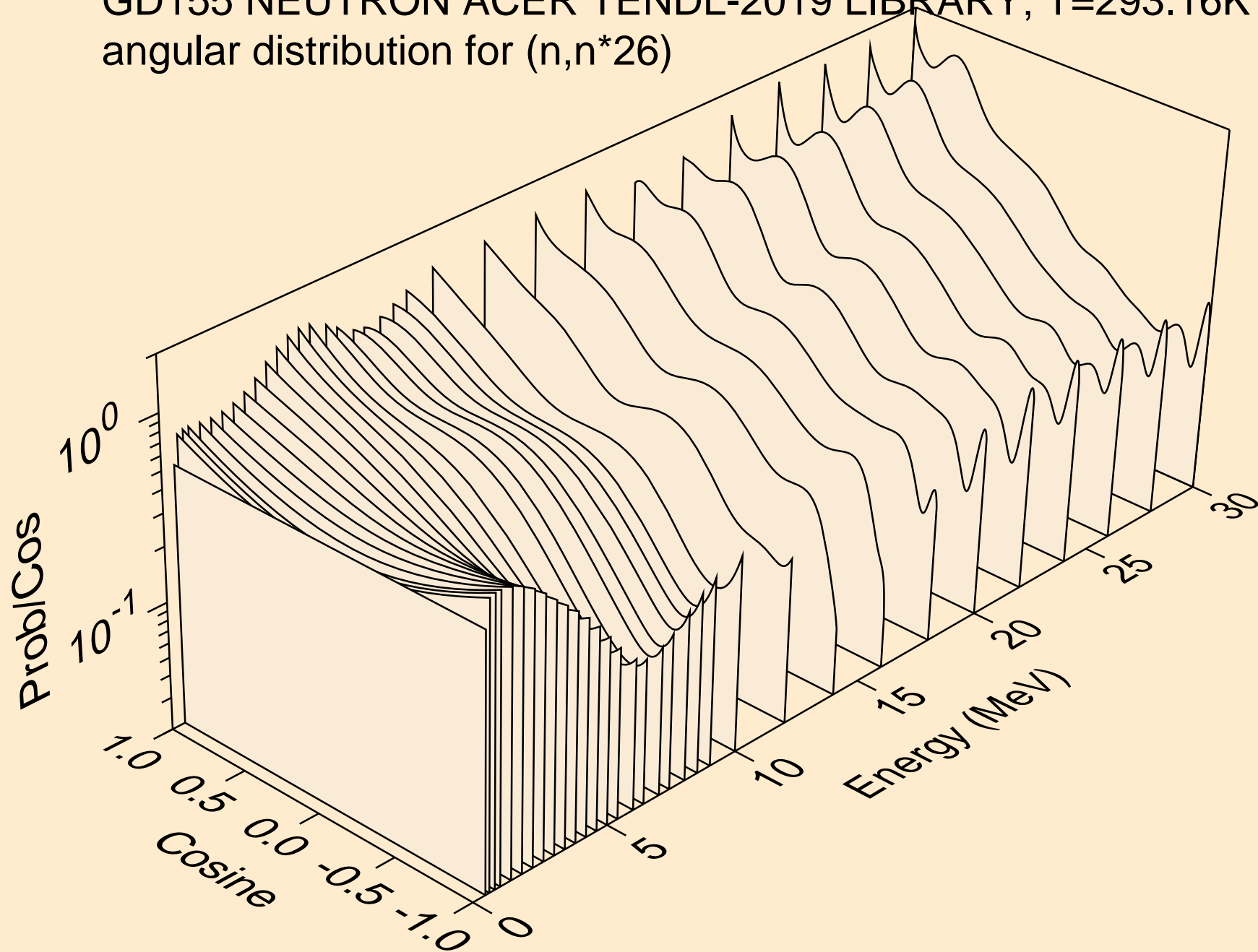

GD155 NEUTRON ACER TENDL-2019 LIBRARY; T=293.16K
angular distribution for (n,n*27)

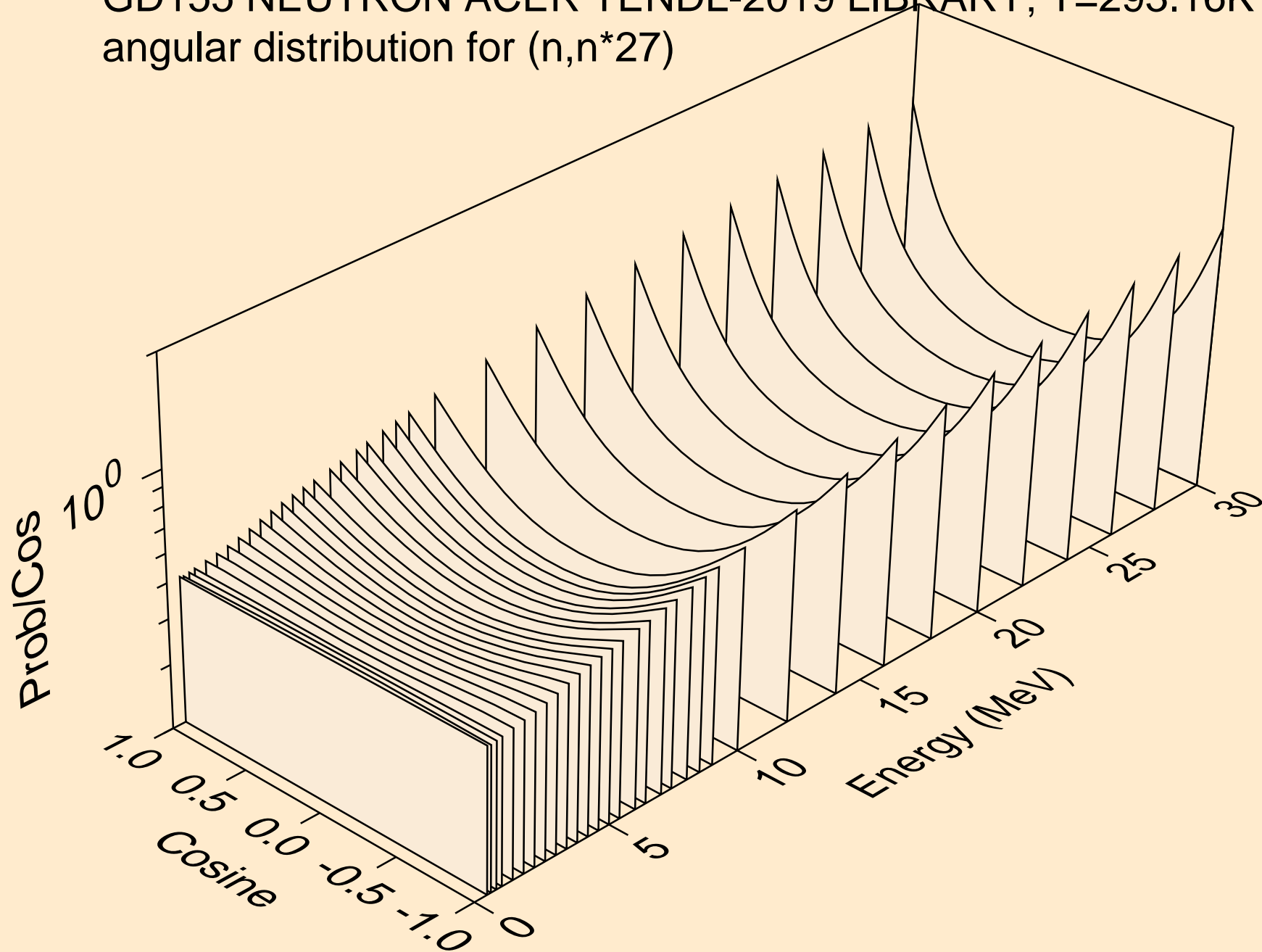

GD155 NEUTRON ACER TENDL-2019 LIBRARY; T=293.16K
angular distribution for (n,n*28)

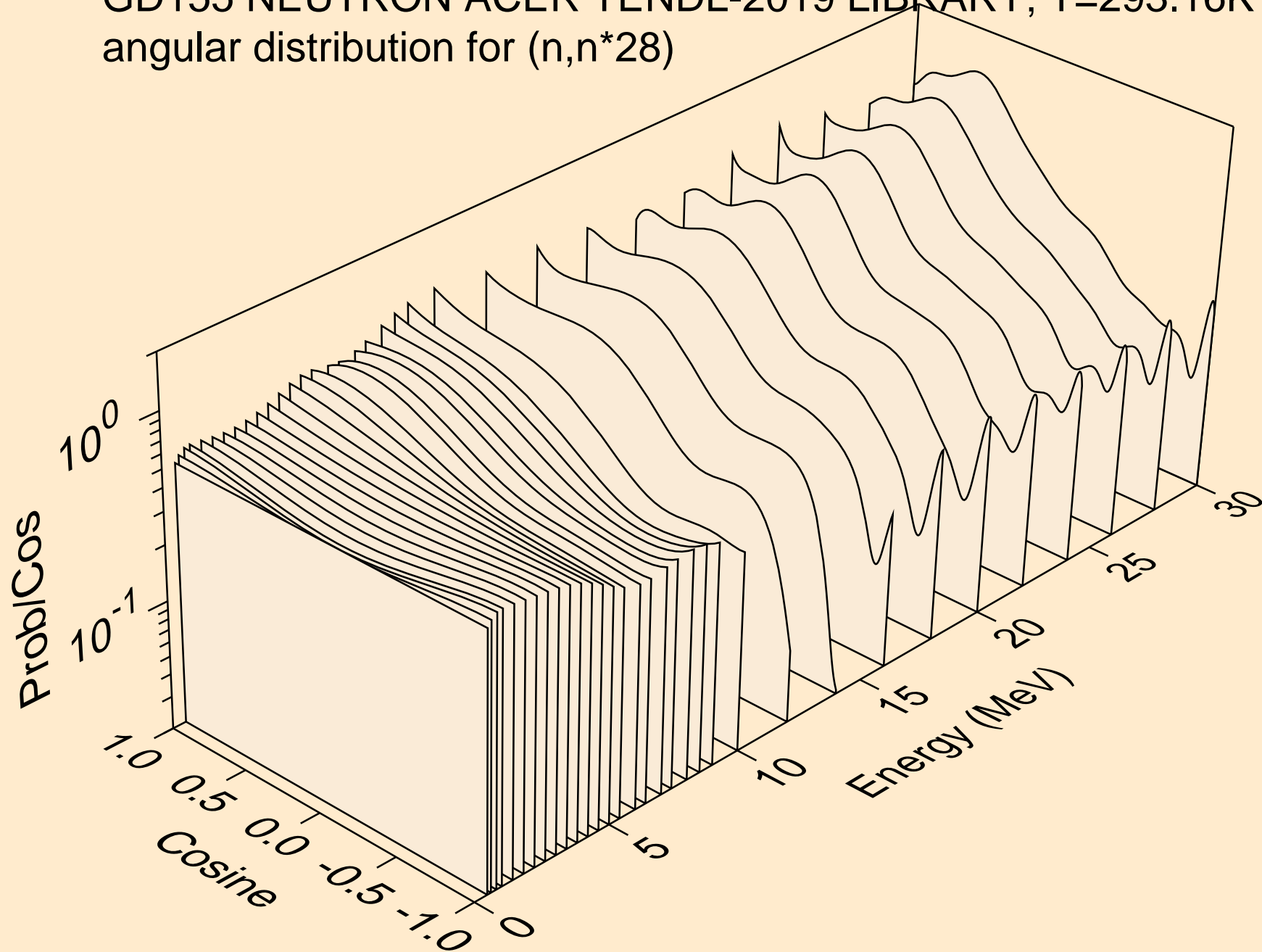

GD155 NEUTRON ACER TENDL-2019 LIBRARY; T=293.16K
angular distribution for (n,n*29)

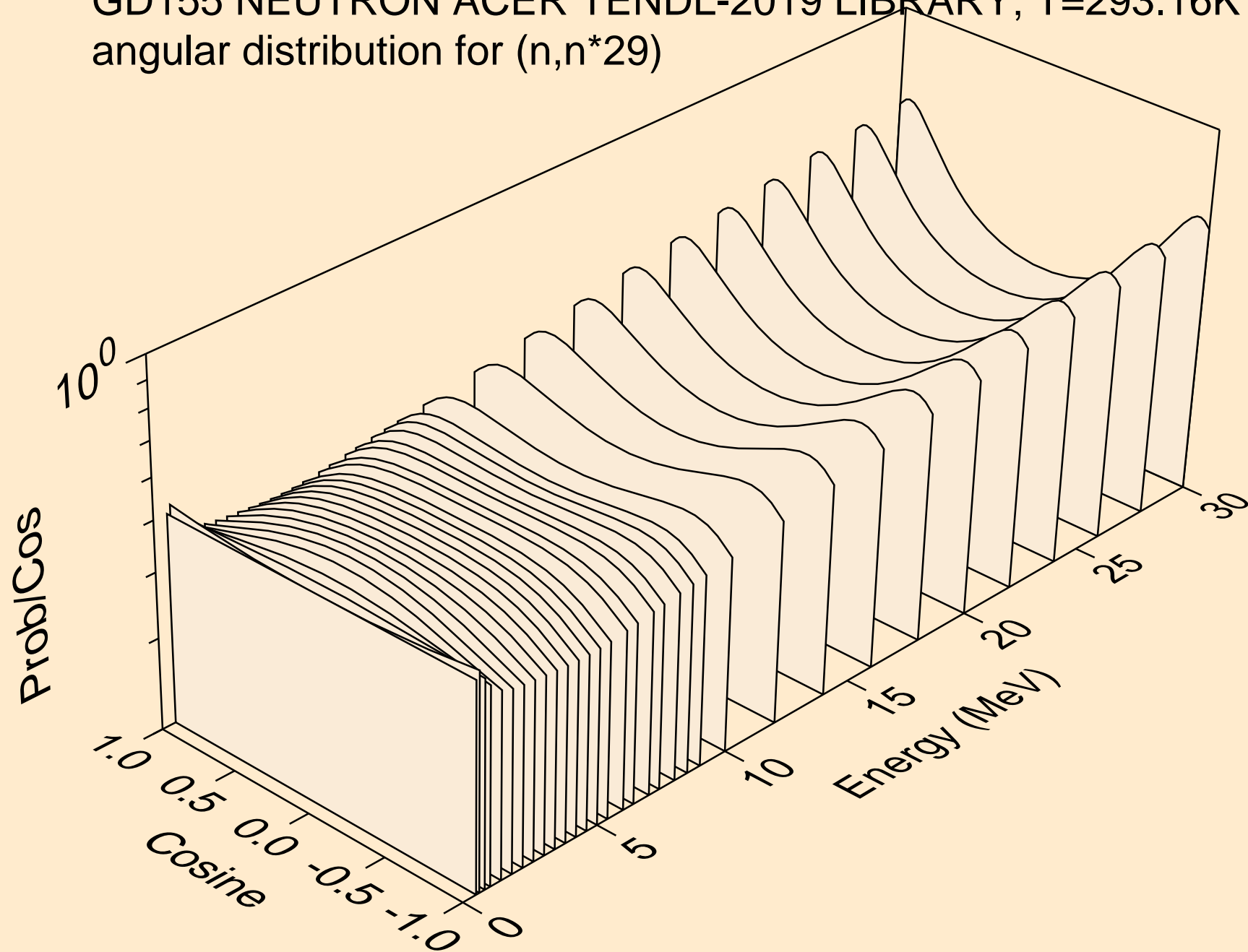

GD155 NEUTRON ACER TENDL-2019 LIBRARY; T=293.16K
angular distribution for (n,n*30)

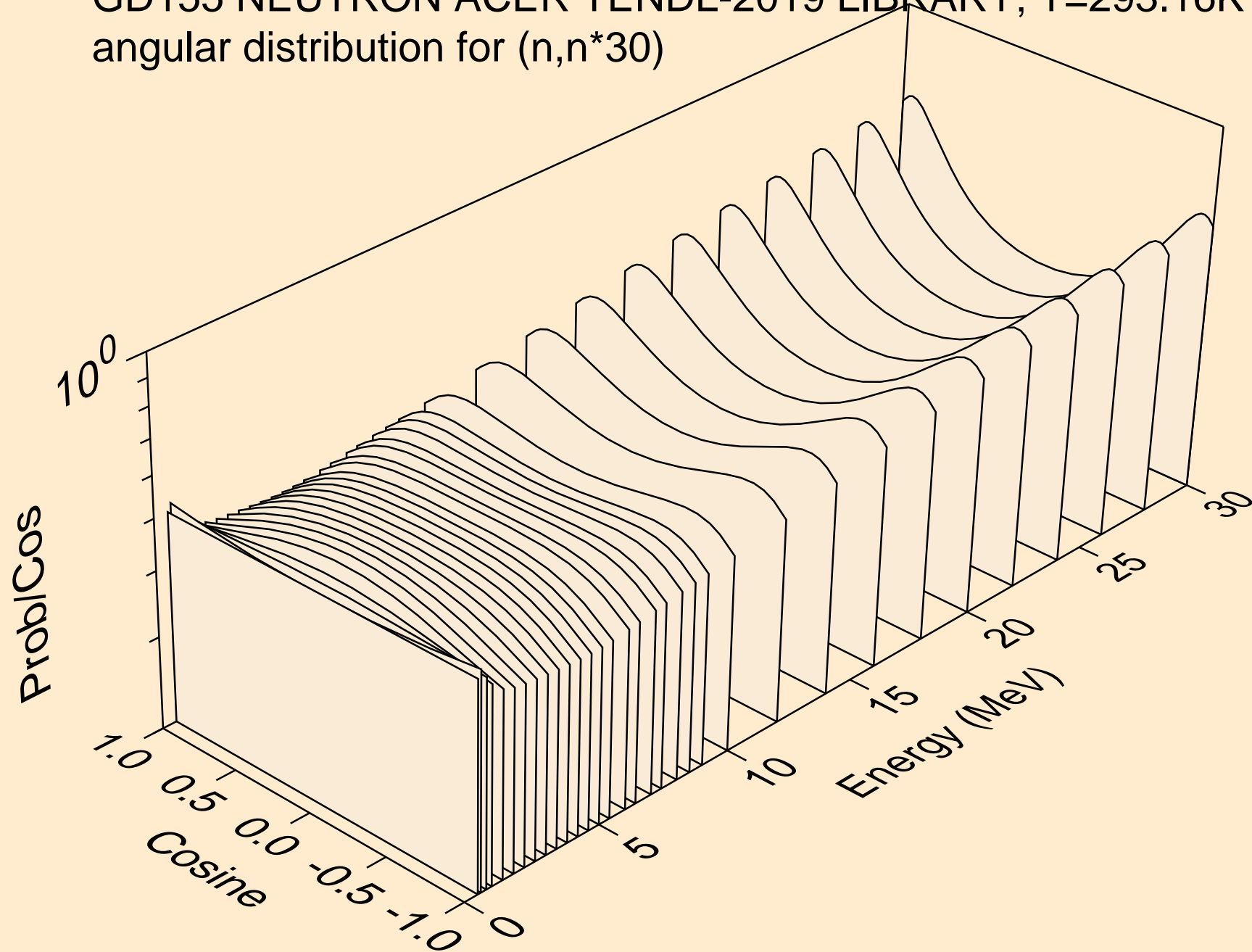

GD155 NEUTRON ACER TENDL-2019 LIBRARY; T=293.16K
Neutron emission for (n,x)

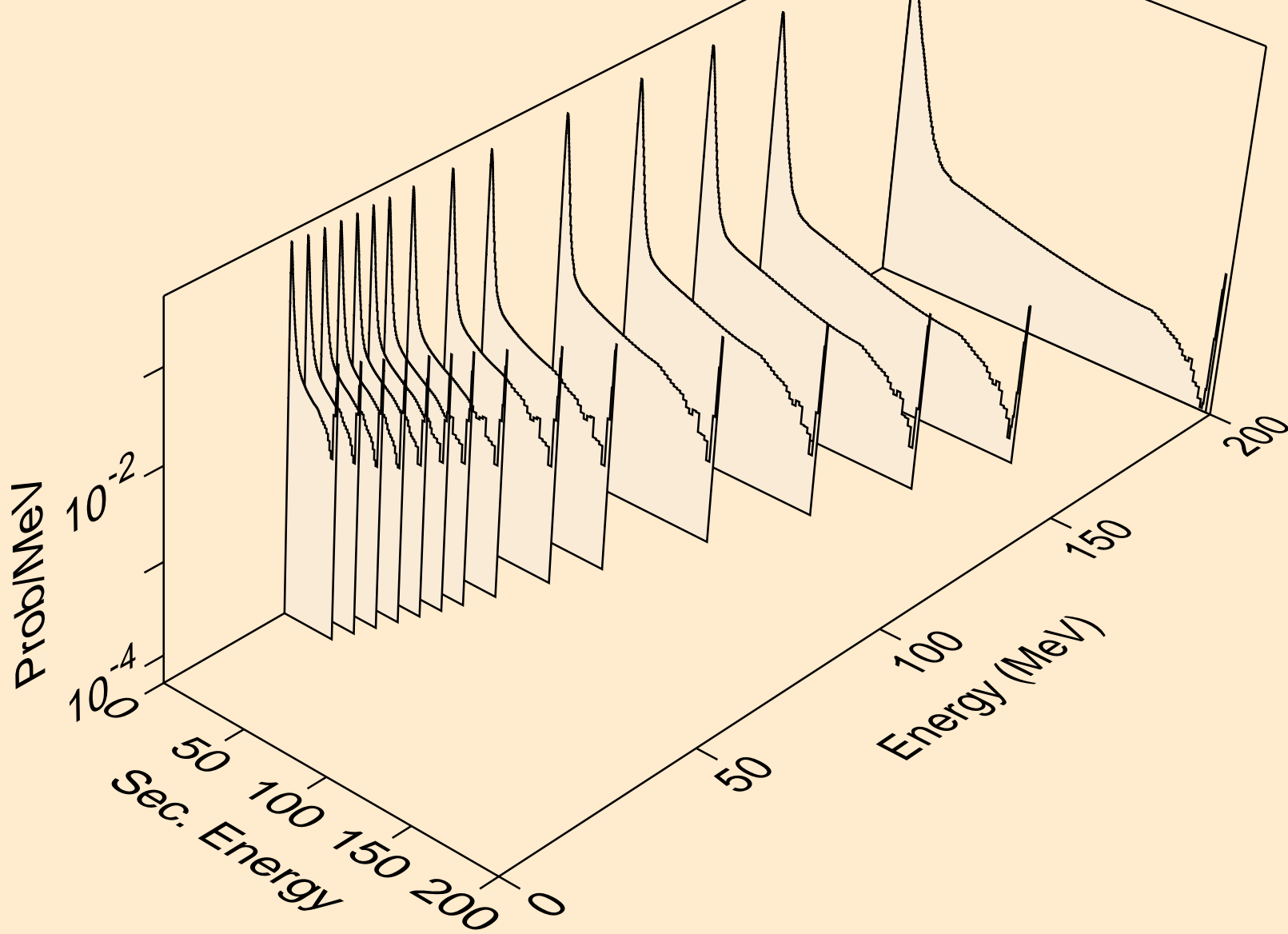

GD155 NEUTRON ACER TENDL-2019 LIBRARY; T=293.16K
Neutron emission for (n,2nd)

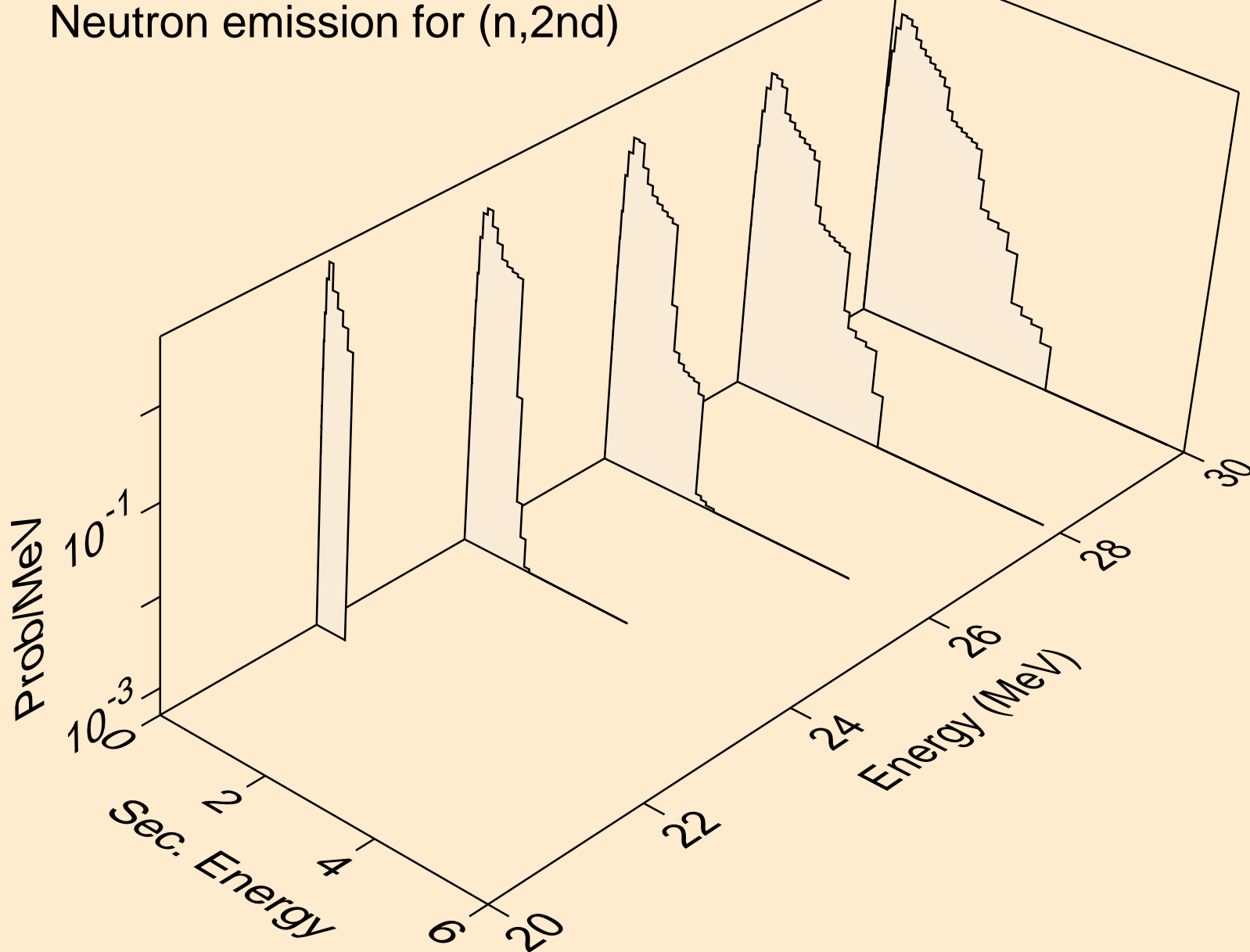

GD155 NEUTRON ACER TENDL-2019 LIBRARY; T=293.16K
Neutron emission for (n,2n)

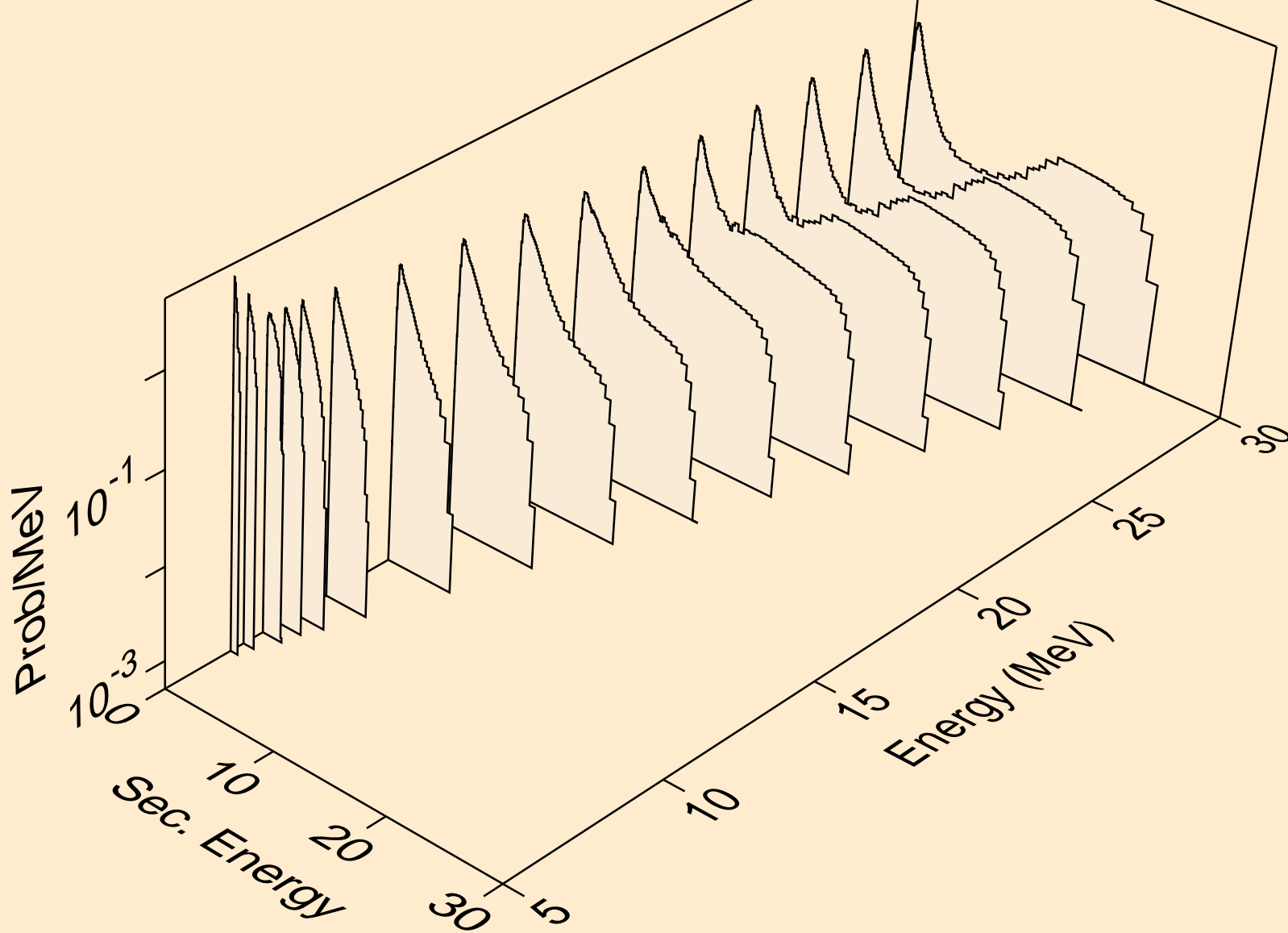

GD155 NEUTRON ACER TENDL-2019 LIBRARY; T=293.16K
Neutron emission for (n,3n)

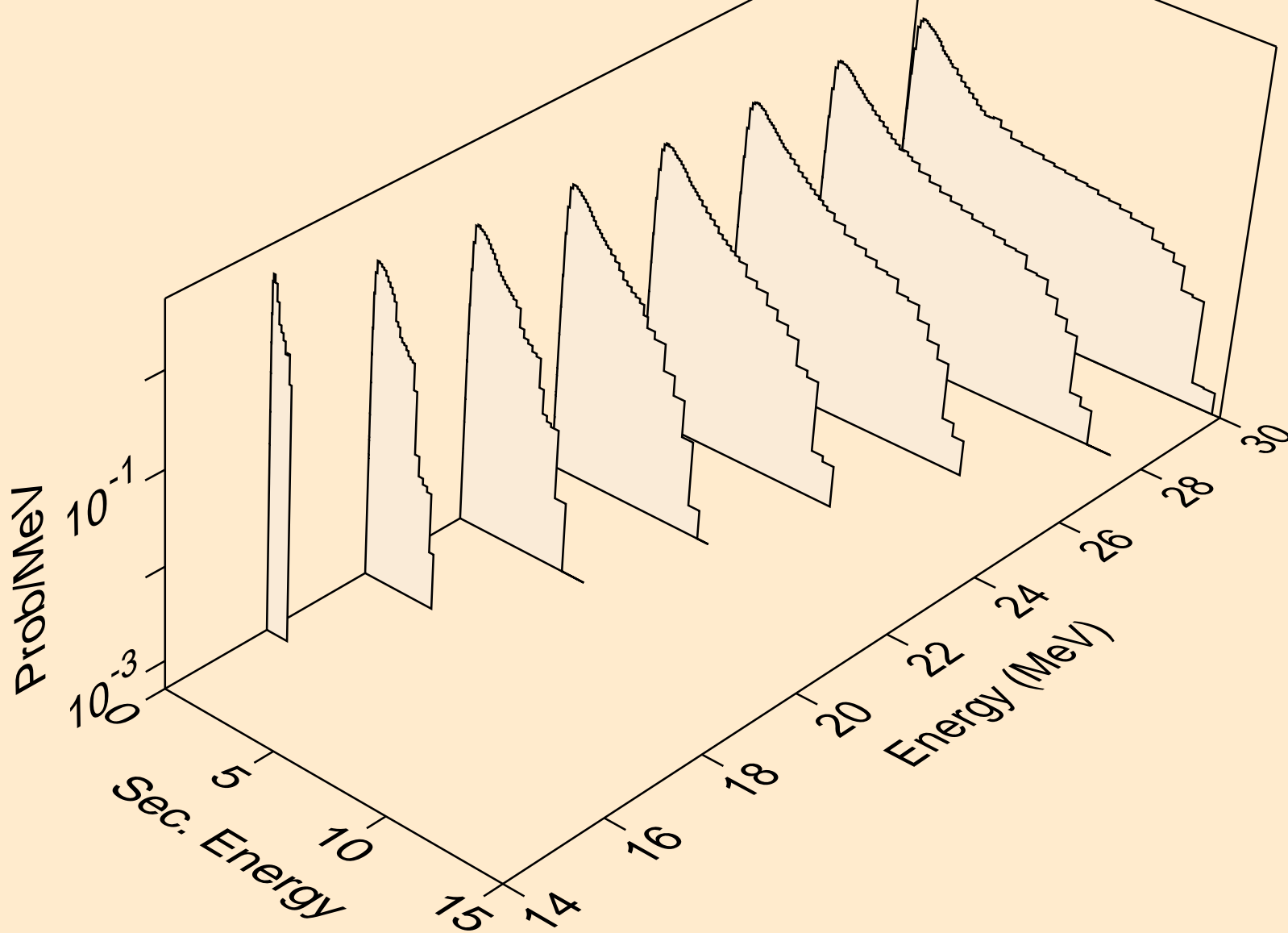

GD155 NEUTRON ACER TENDL-2019 LIBRARY; T=293.16K
Neutron emission for (n,n*)a

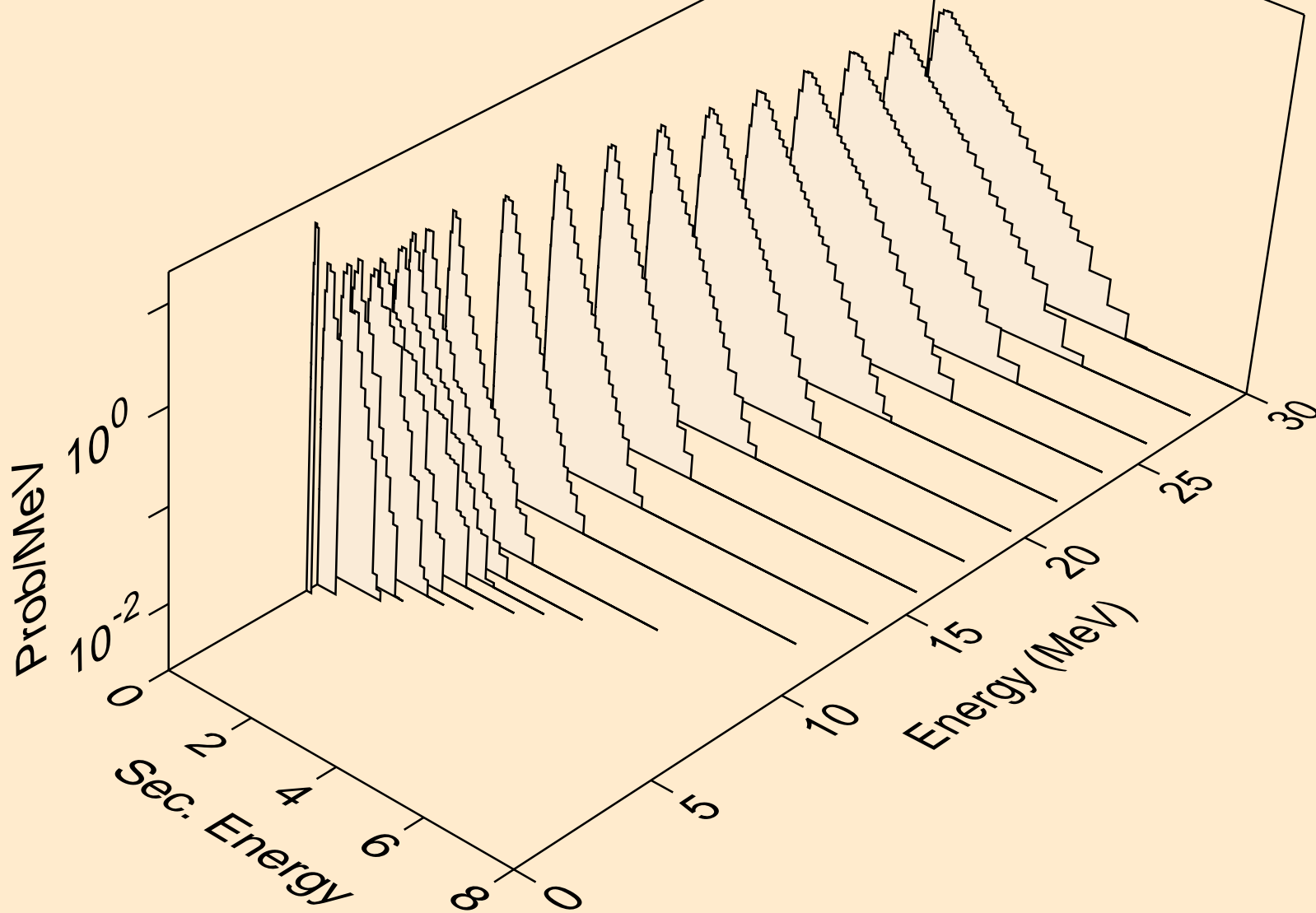

GD155 NEUTRON ACER TENDL-2019 LIBRARY; T=293.16K
Neutron emission for (n,2n)a

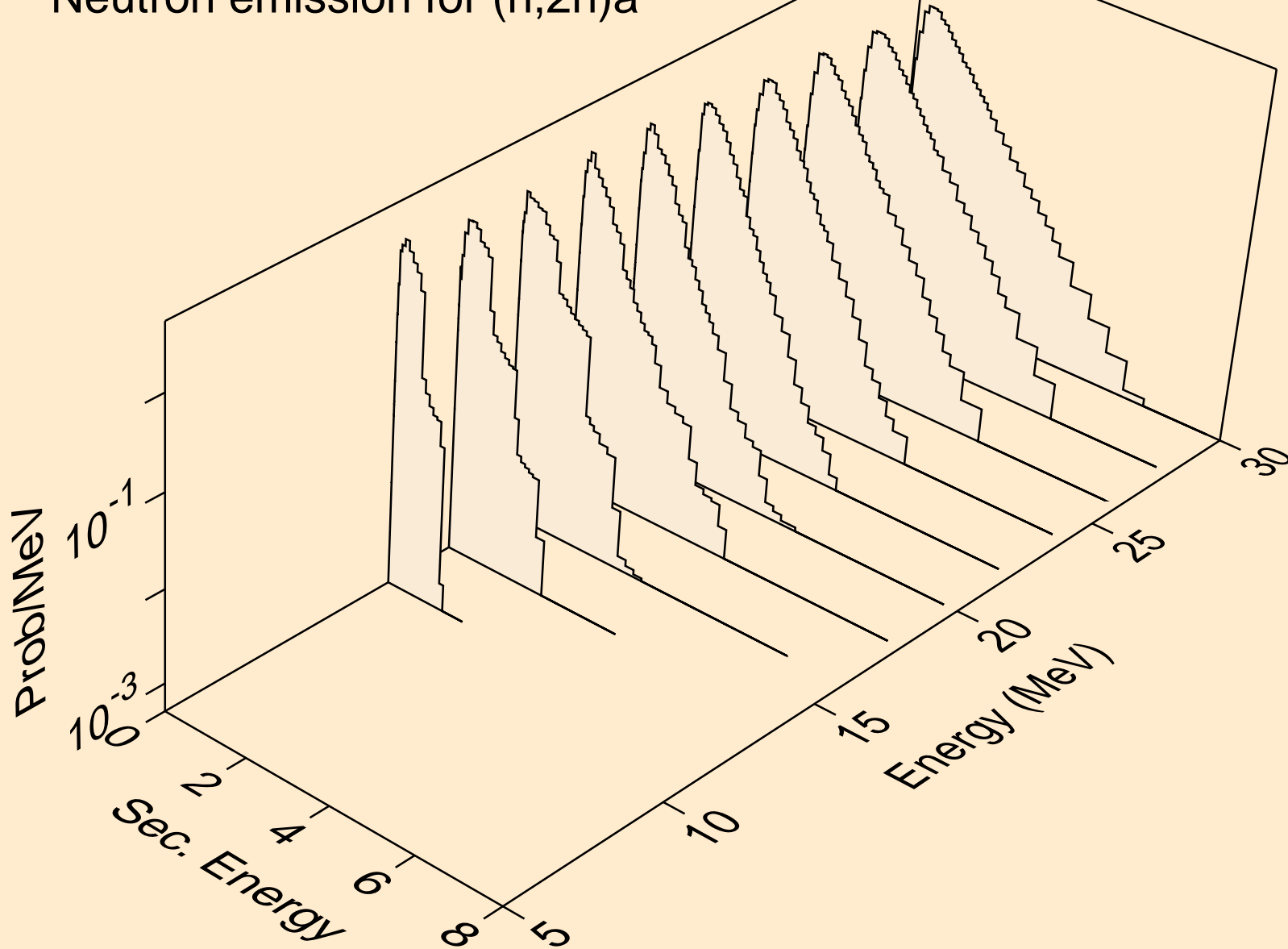

GD155 NEUTRON ACER TENDL-2019 LIBRARY; T=293.16K
Neutron emission for (n,3n)a

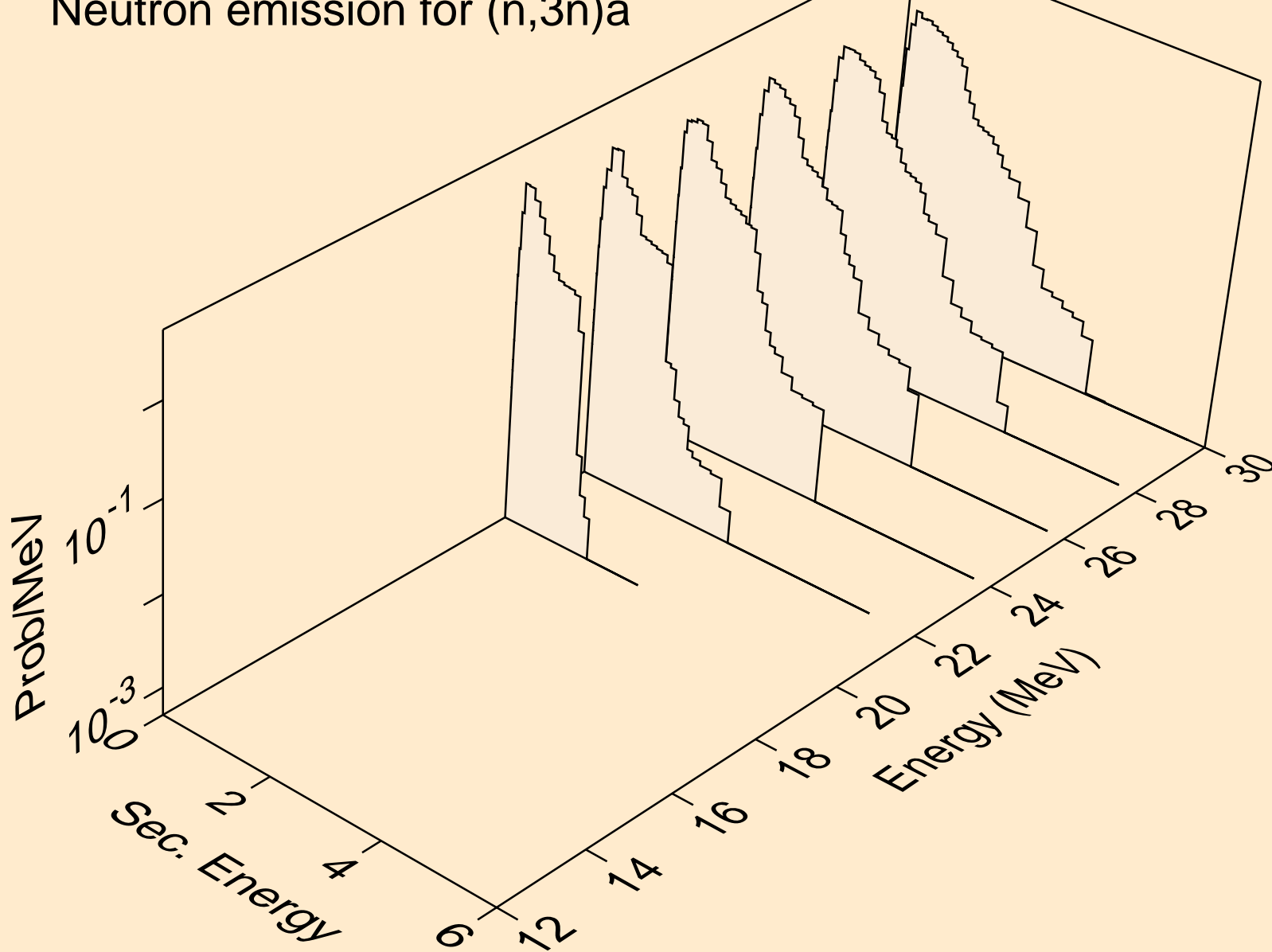

GD155 NEUTRON ACER TENDL-2019 LIBRARY; T=293.16K
Neutron emission for (n,n*)p

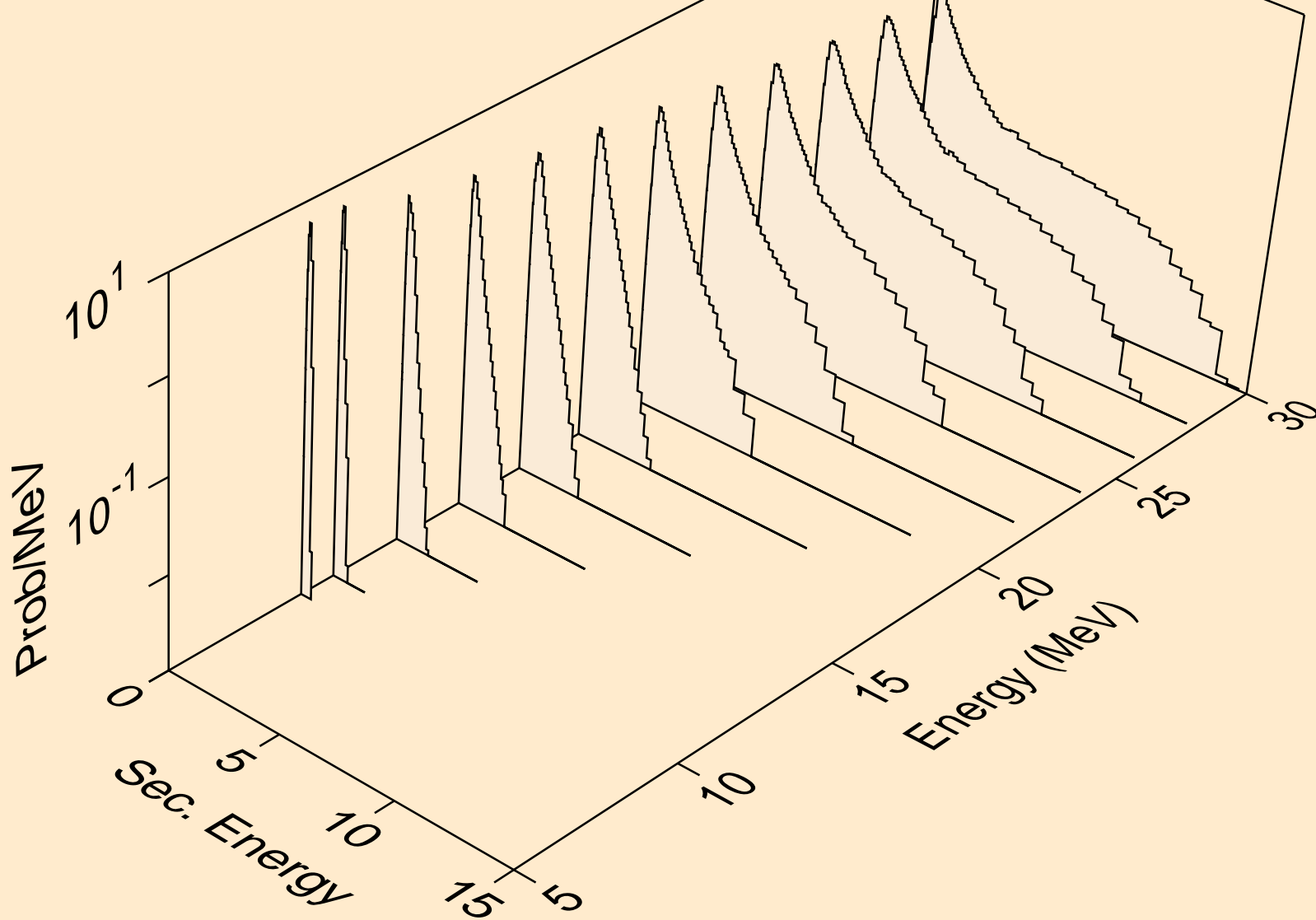

GD155 NEUTRON ACER TENDL-2019 LIBRARY; T=293.16K
Neutron emission for (n,n*)2a

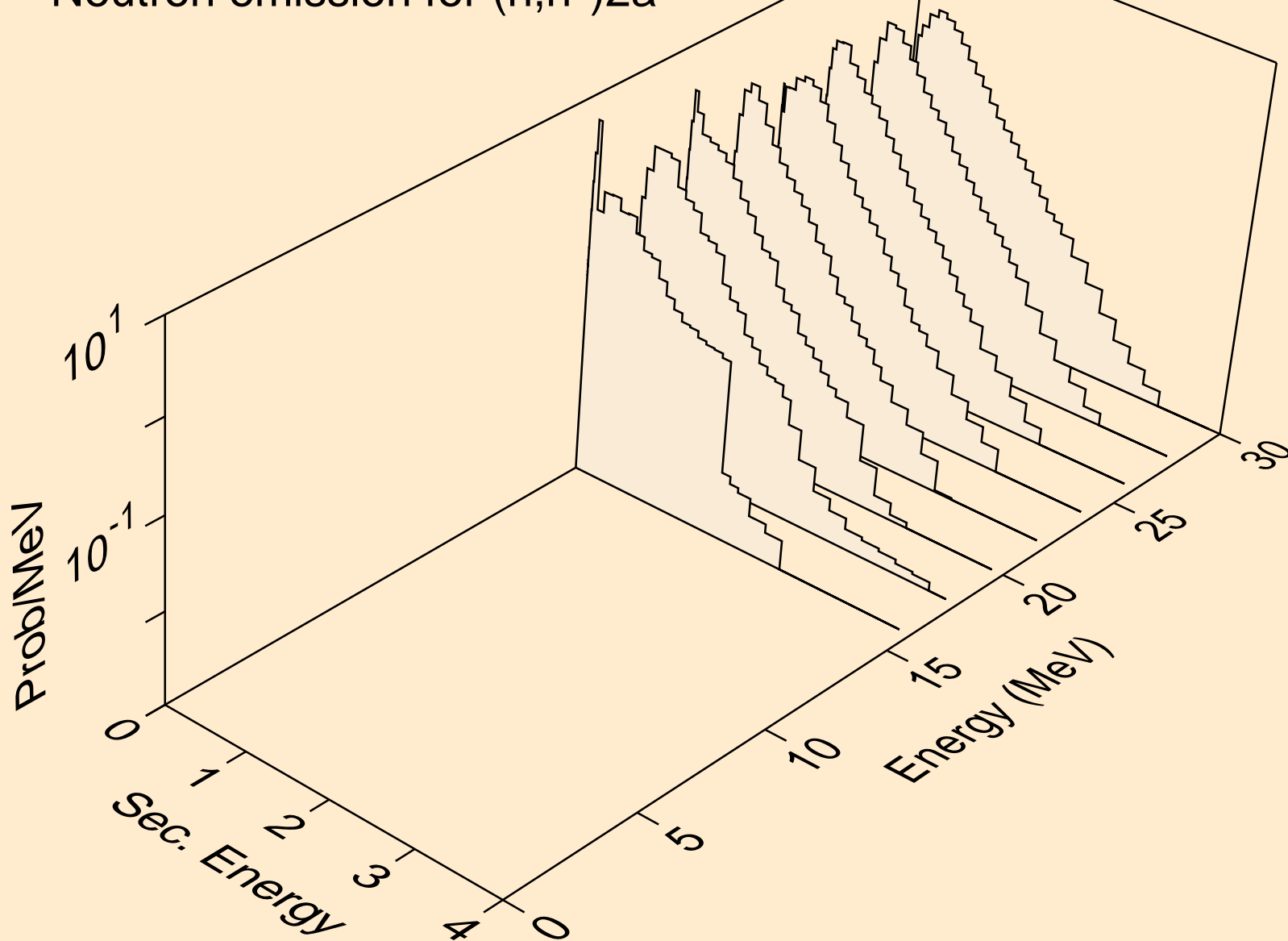

GD155 NEUTRON ACER TENDL-2019 LIBRARY; T=293.16K
Neutron emission for (n,n*)d

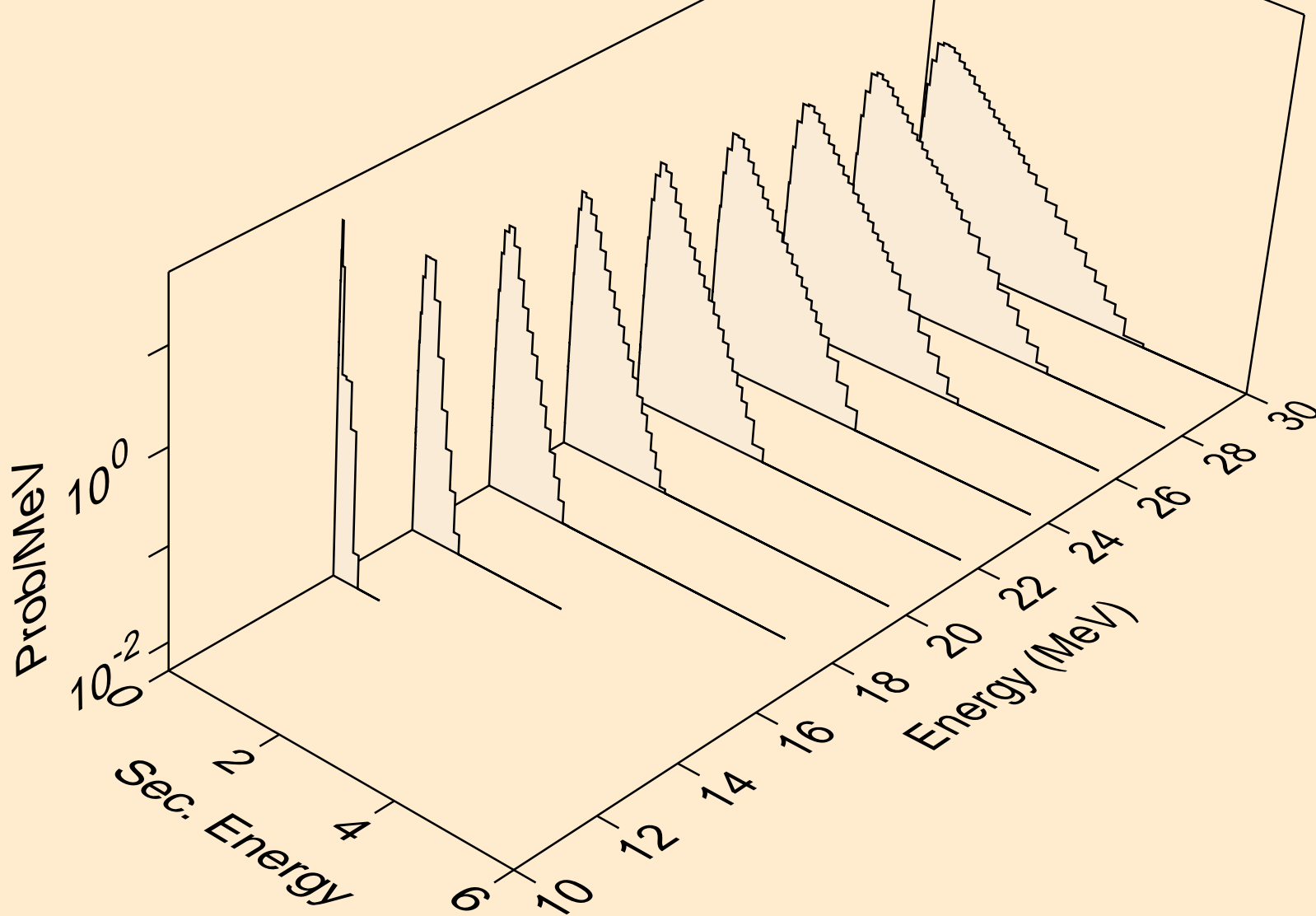

GD155 NEUTRON ACER TENDL-2019 LIBRARY; T=293.16K
Neutron emission for (n,n*)t

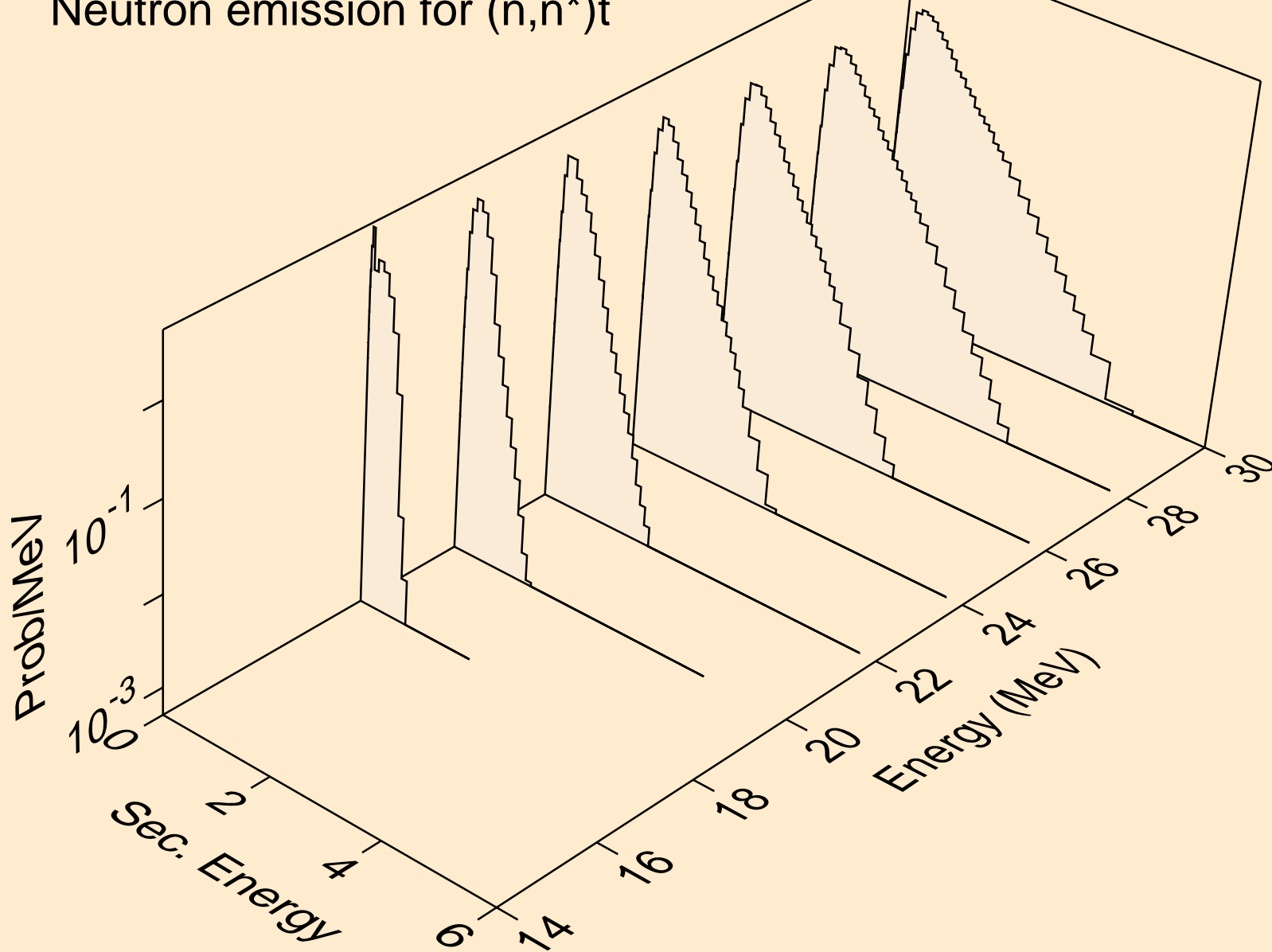

GD155 NEUTRON ACER TENDL-2019 LIBRARY; T=293.16K
Neutron emission for (n,n*)he3

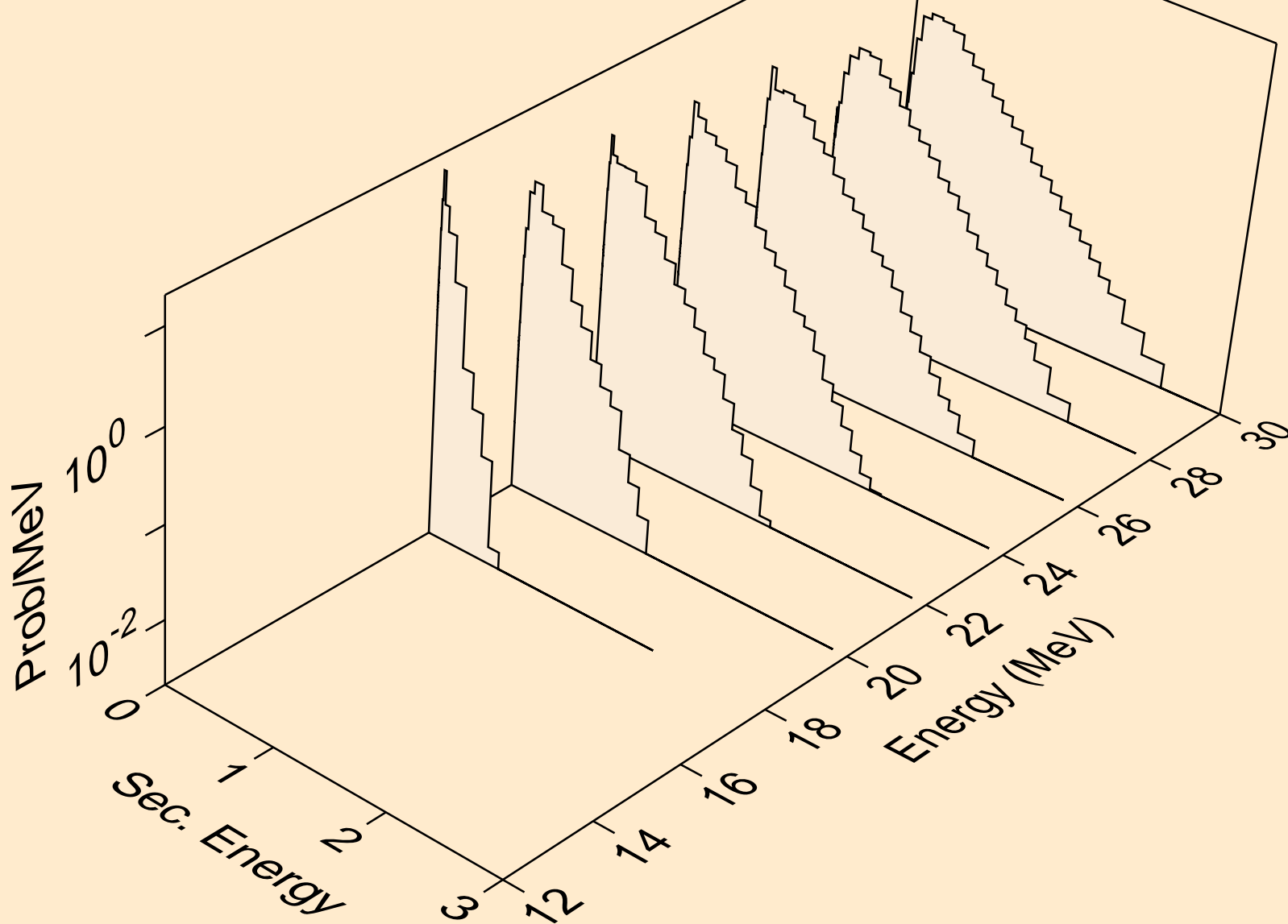

GD155 NEUTRON ACER TENDL-2019 LIBRARY; T=293.16K
Neutron emission for (n,4n)

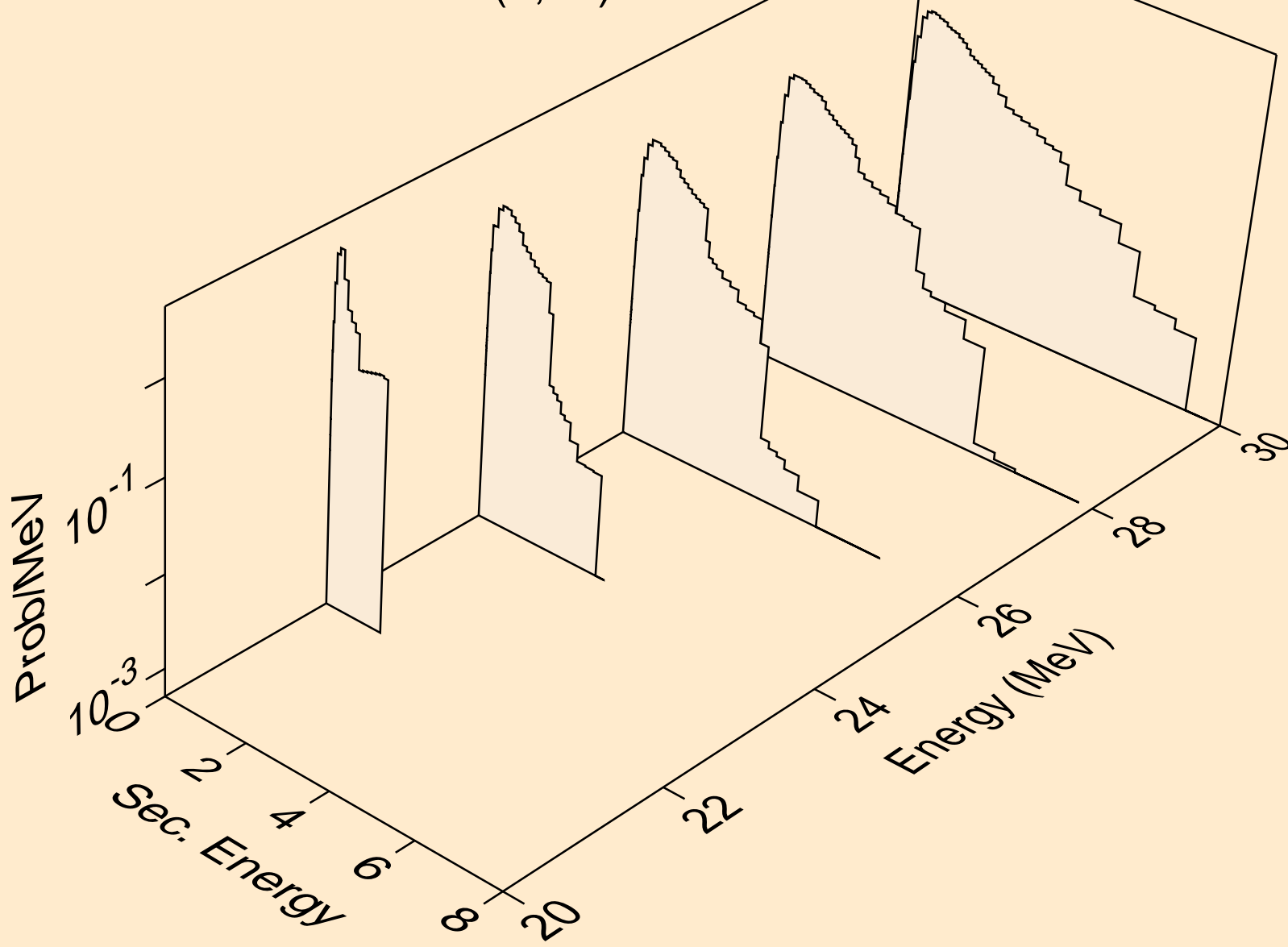

GD155 NEUTRON ACER TENDL-2019 LIBRARY; T=293.16K
Neutron emission for (n,2np)

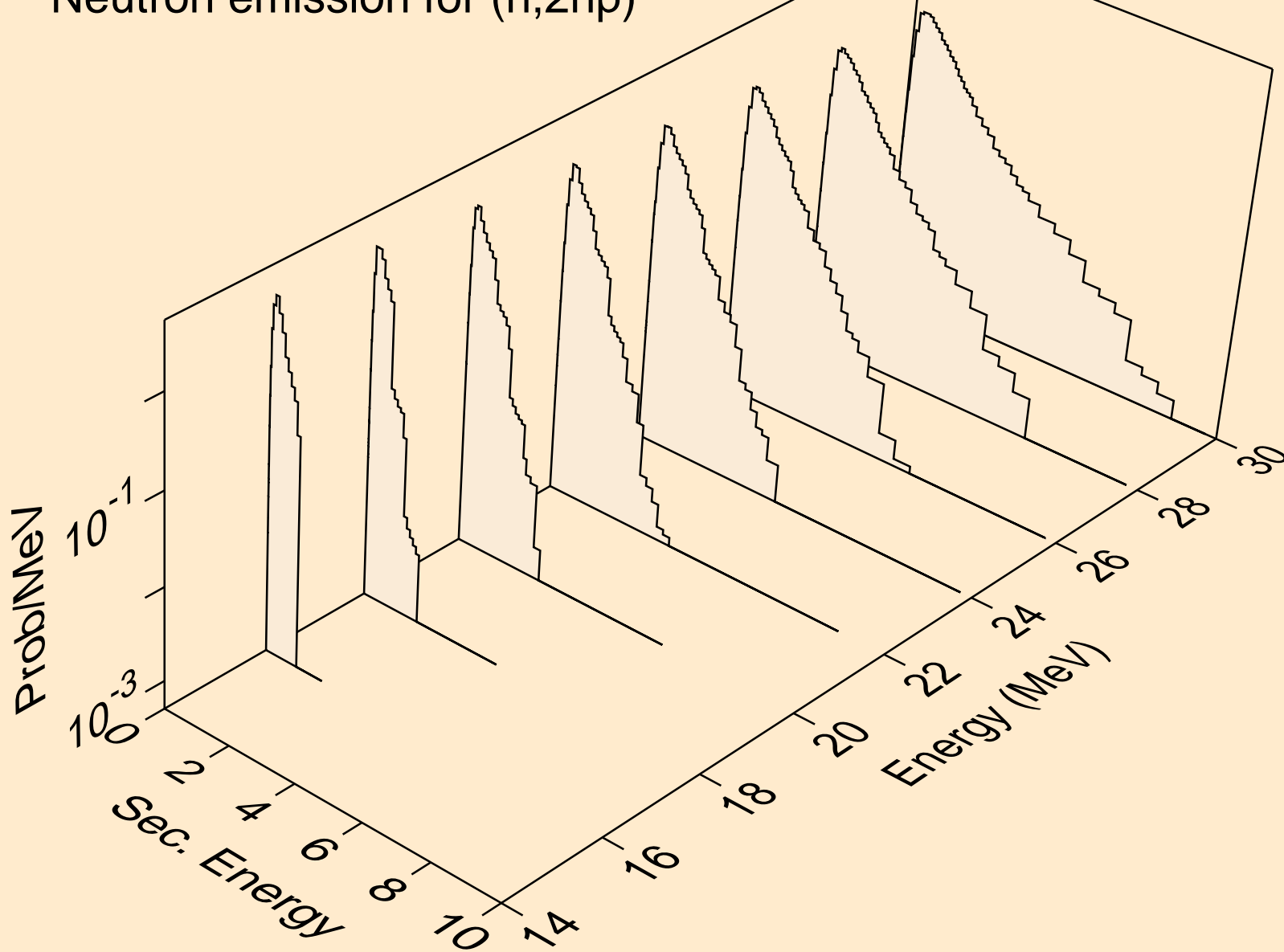

GD155 NEUTRON ACER TENDL-2019 LIBRARY; T=293.16K
Neutron emission for (n,3np)

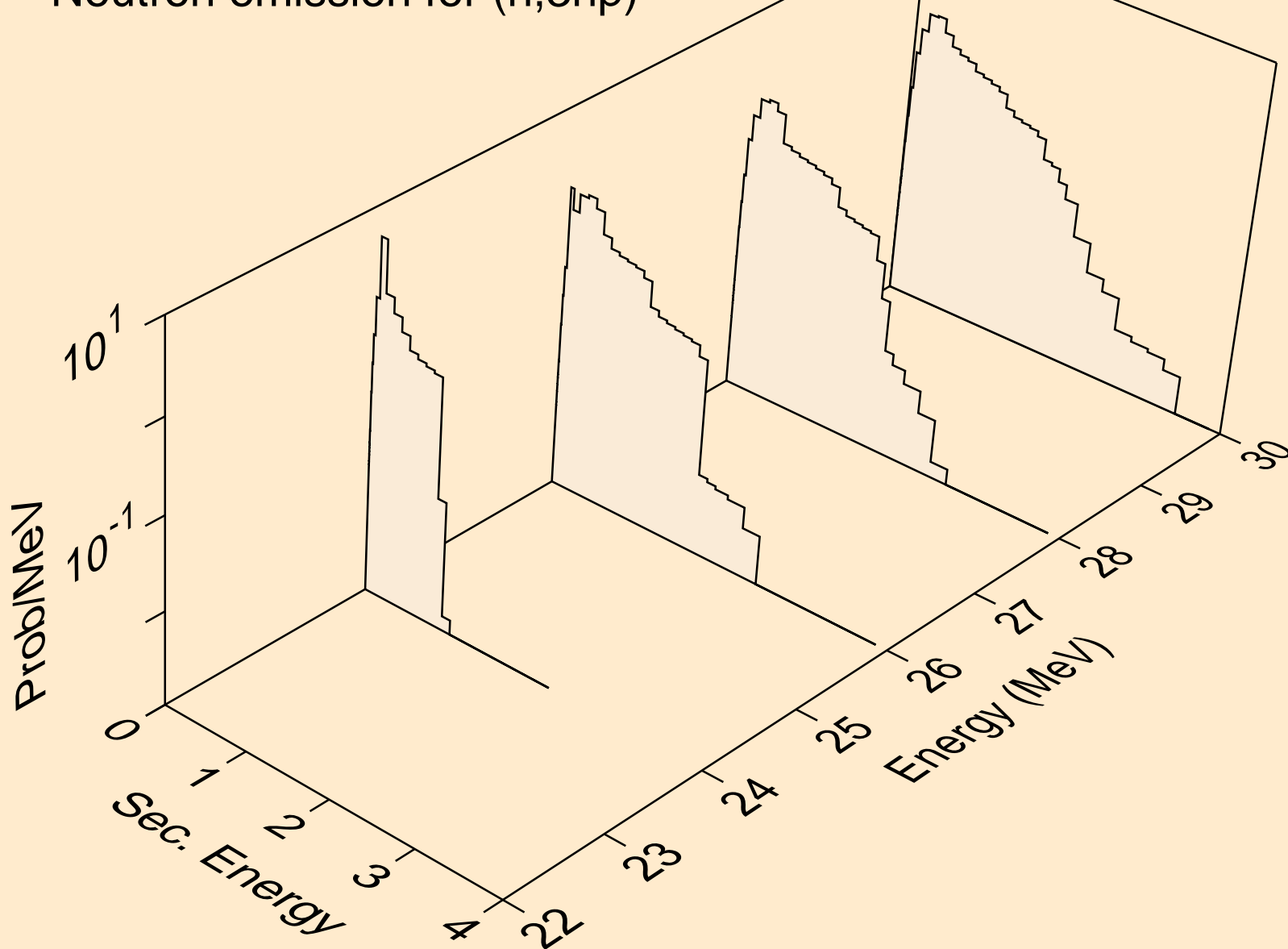

GD155 NEUTRON ACER TENDL-2019 LIBRARY; T=293.16K
Neutron emission for (n,2np)

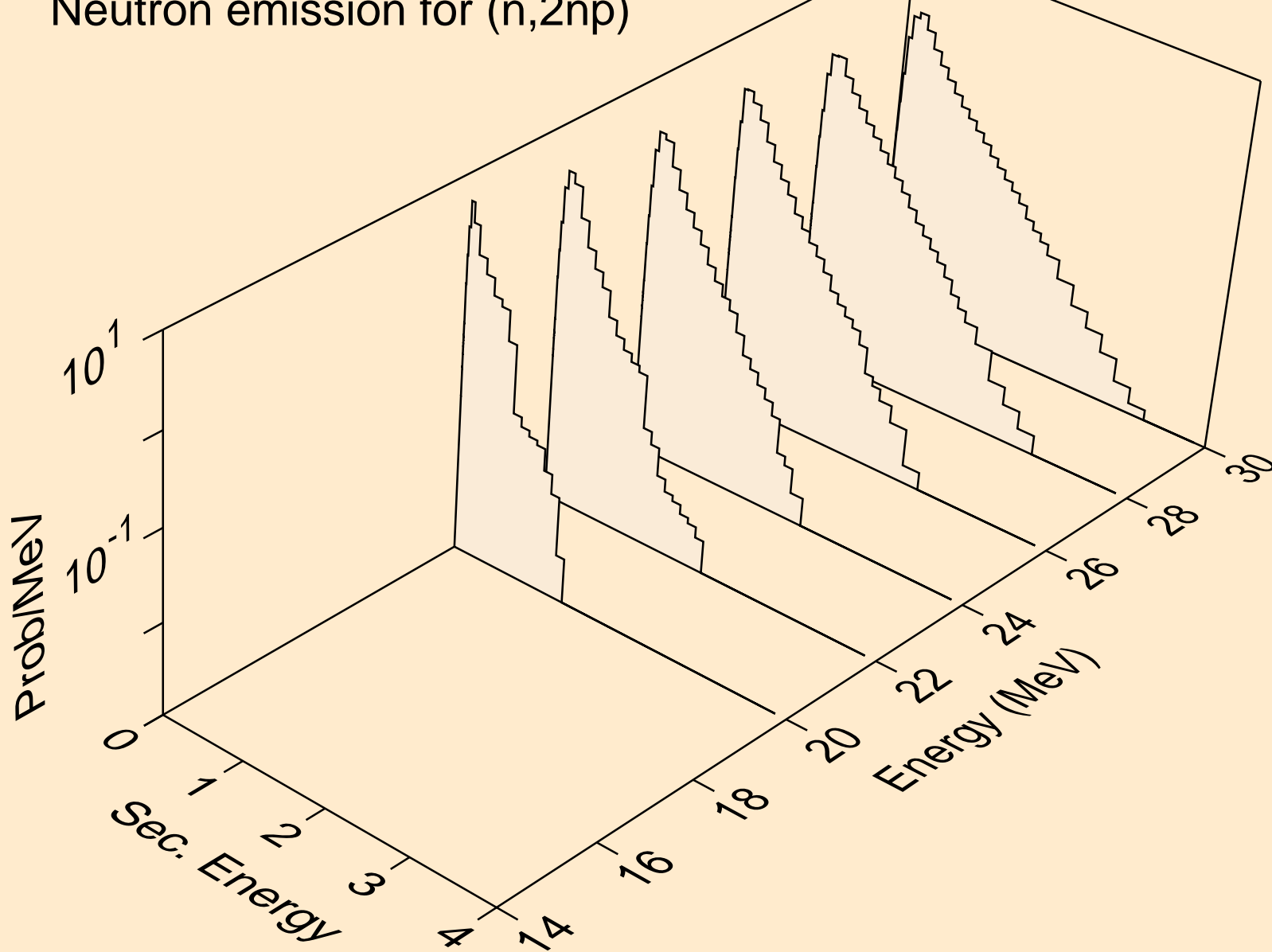

GD155 NEUTRON ACER TENDL-2019 LIBRARY; T=293.16K
Neutron emission for (n,npa)

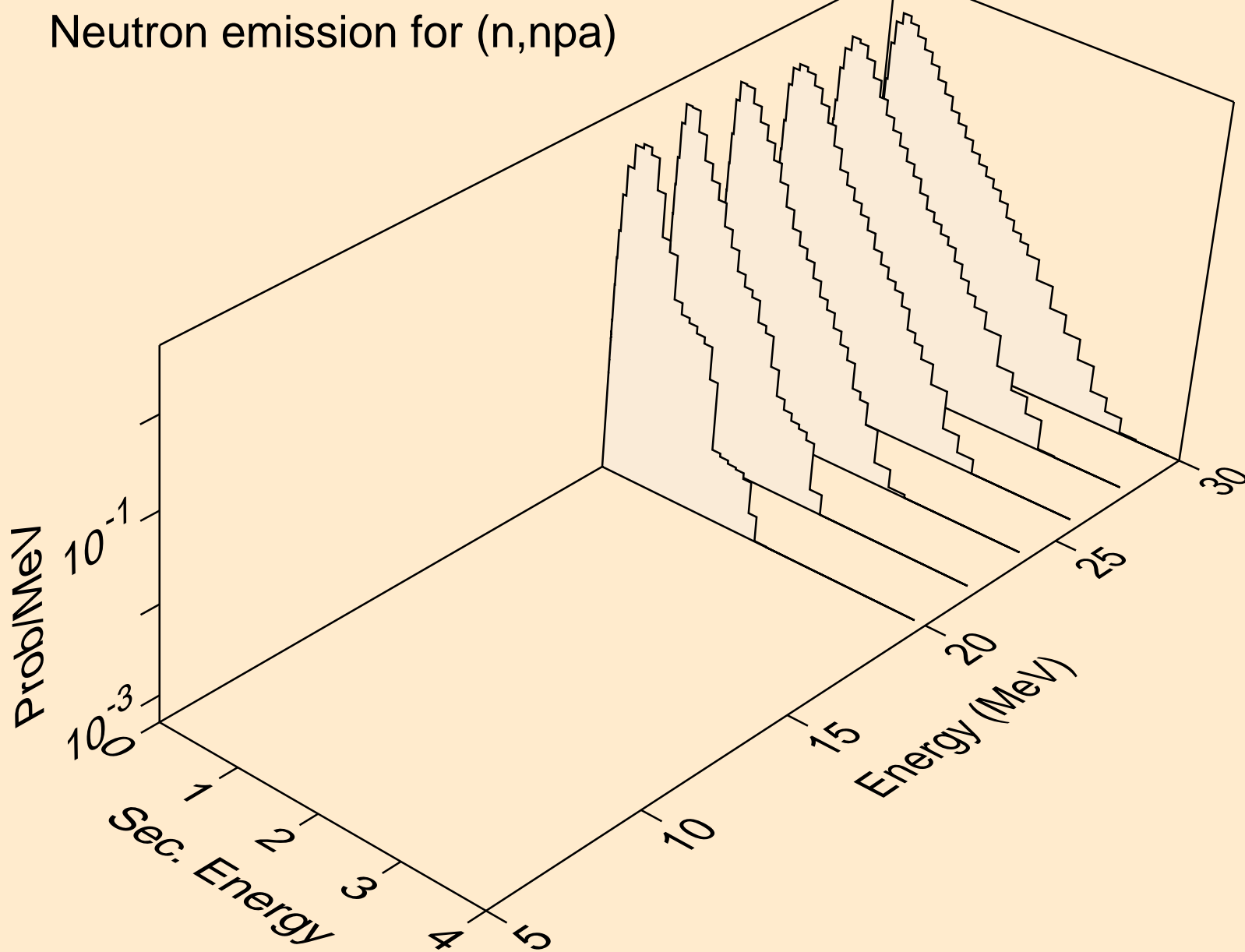

GD155 NEUTRON ACER TENDL-2019 LIBRARY; T=293.16K
Neutron emission for (n,n*c)

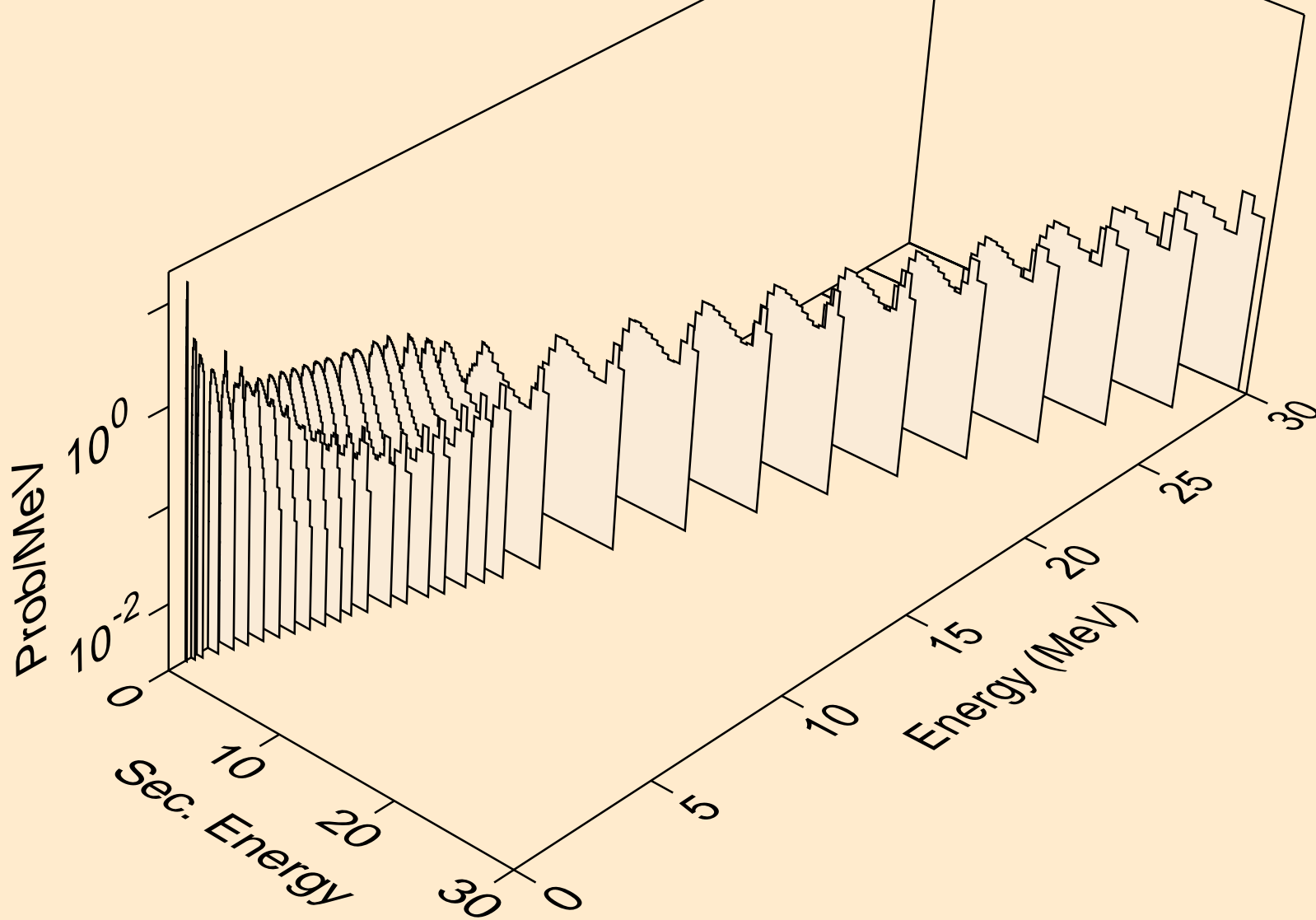

GD155 NEUTRON ACER TENDL-2019 LIBRARY; T=293.16K
Photon emission for (n,x)

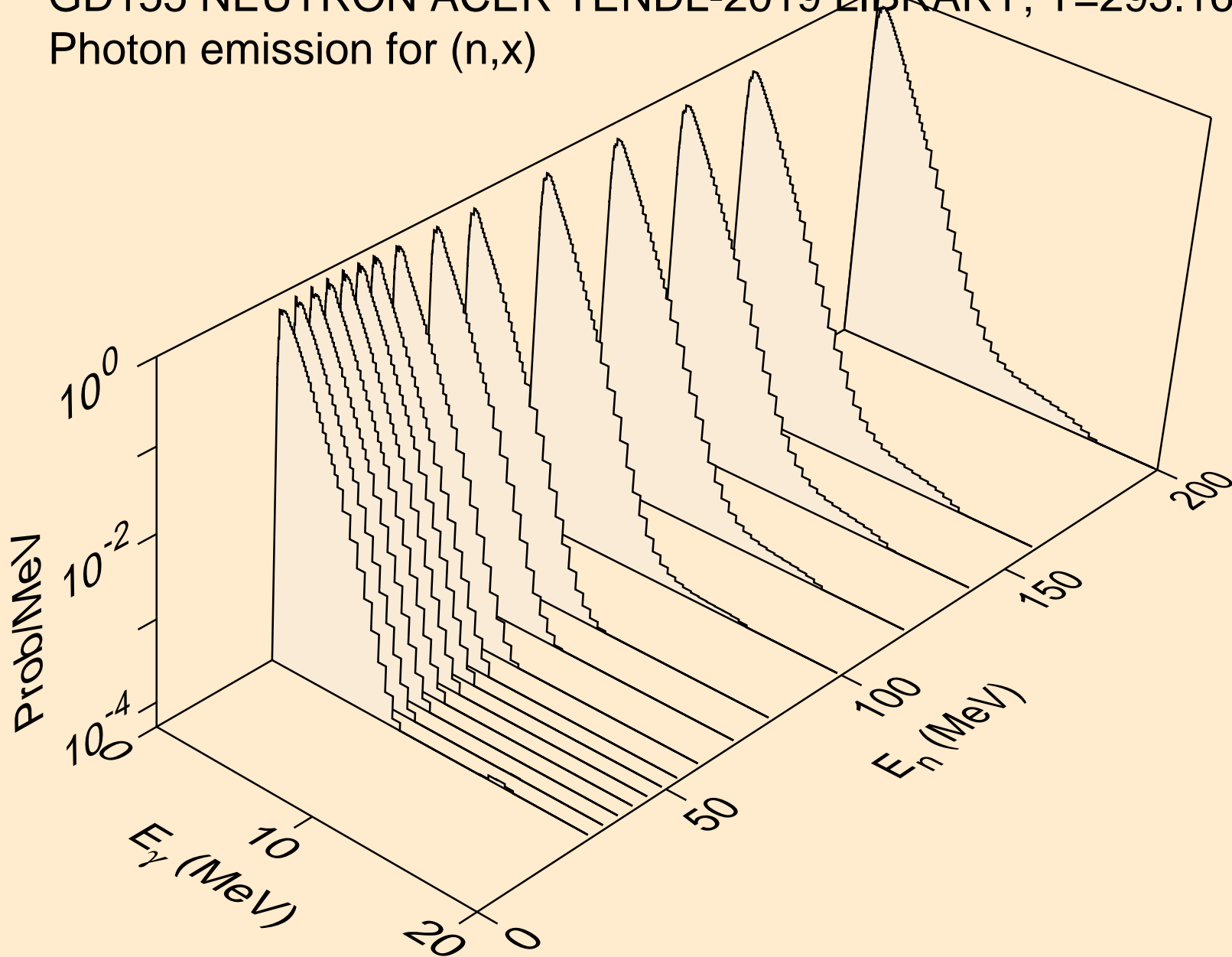

GD155 NEUTRON ACER TENDL-2019 LIBRARY; T=293.16K
Photon emission for (n,2nd)

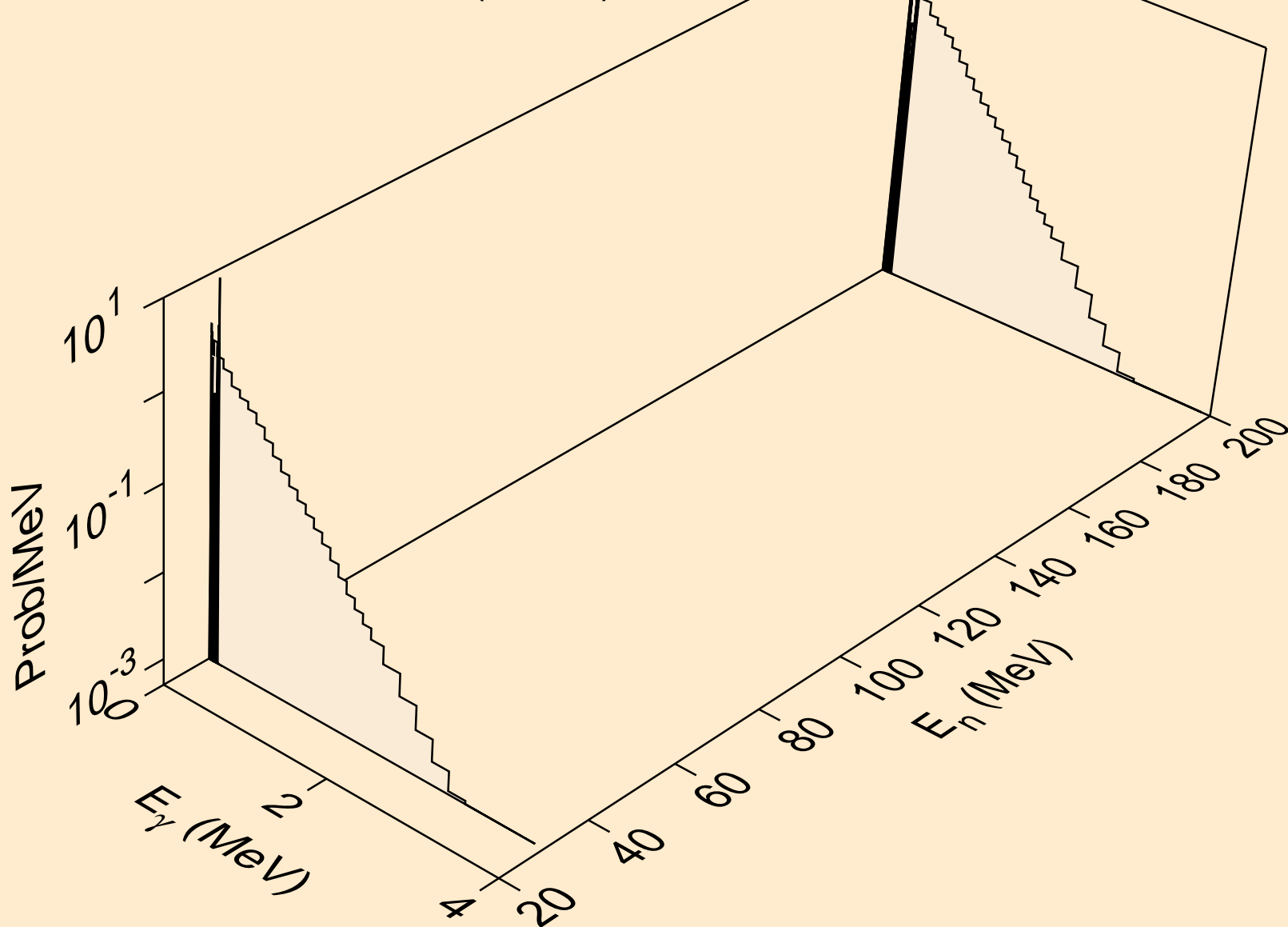

GD155 NEUTRON ACER TENDL-2019 LIBRARY; T=293.16K
Photon emission for (n,2n)

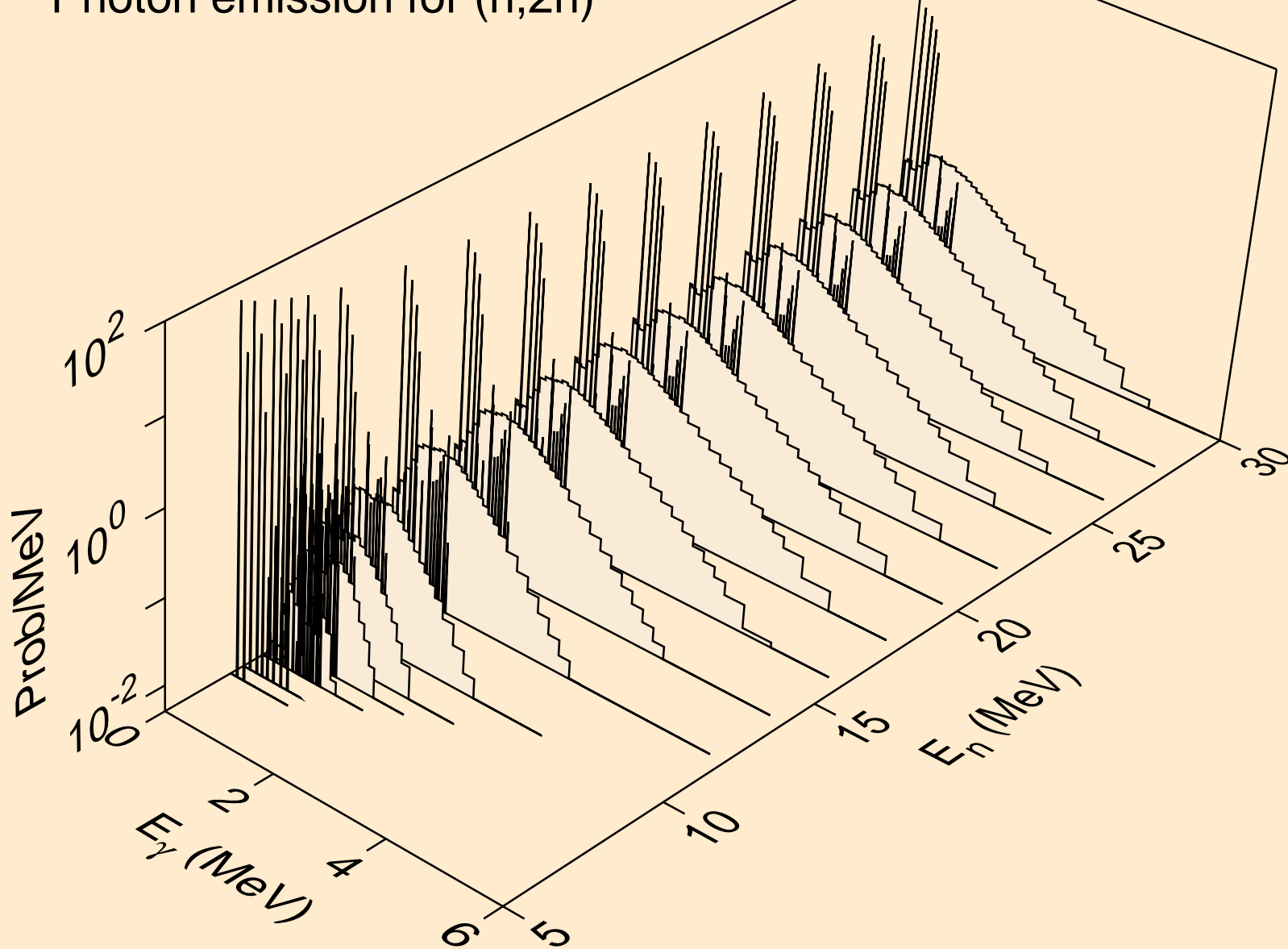

GD155 NEUTRON ACER TENDL-2019 LIBRARY; T=293.16K
Photon emission for (n,3n)

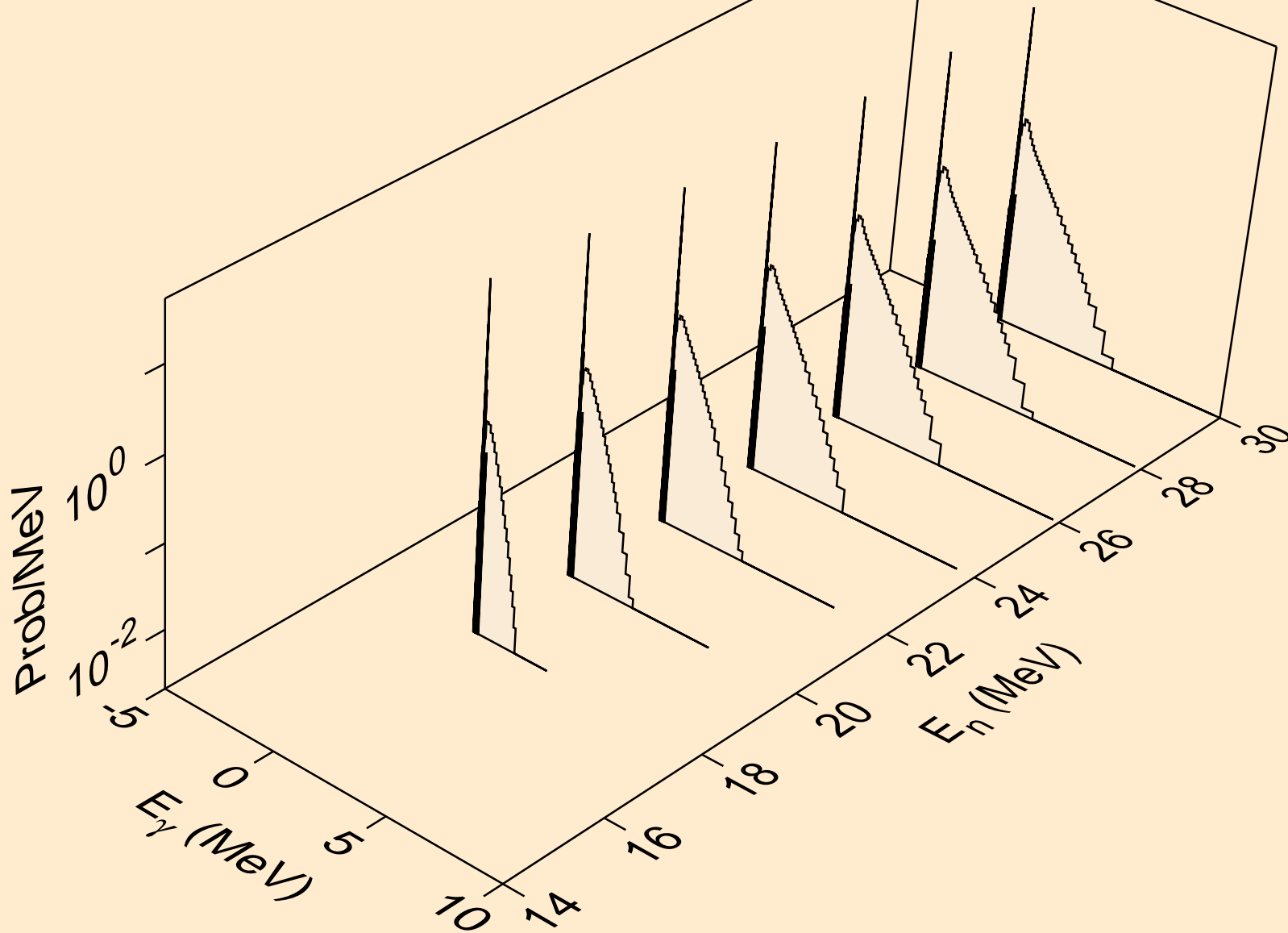

GD155 NEUTRON ACER TENDL-2019 LIBRARY; T=293.16K
Photon emission for (n,n*)a

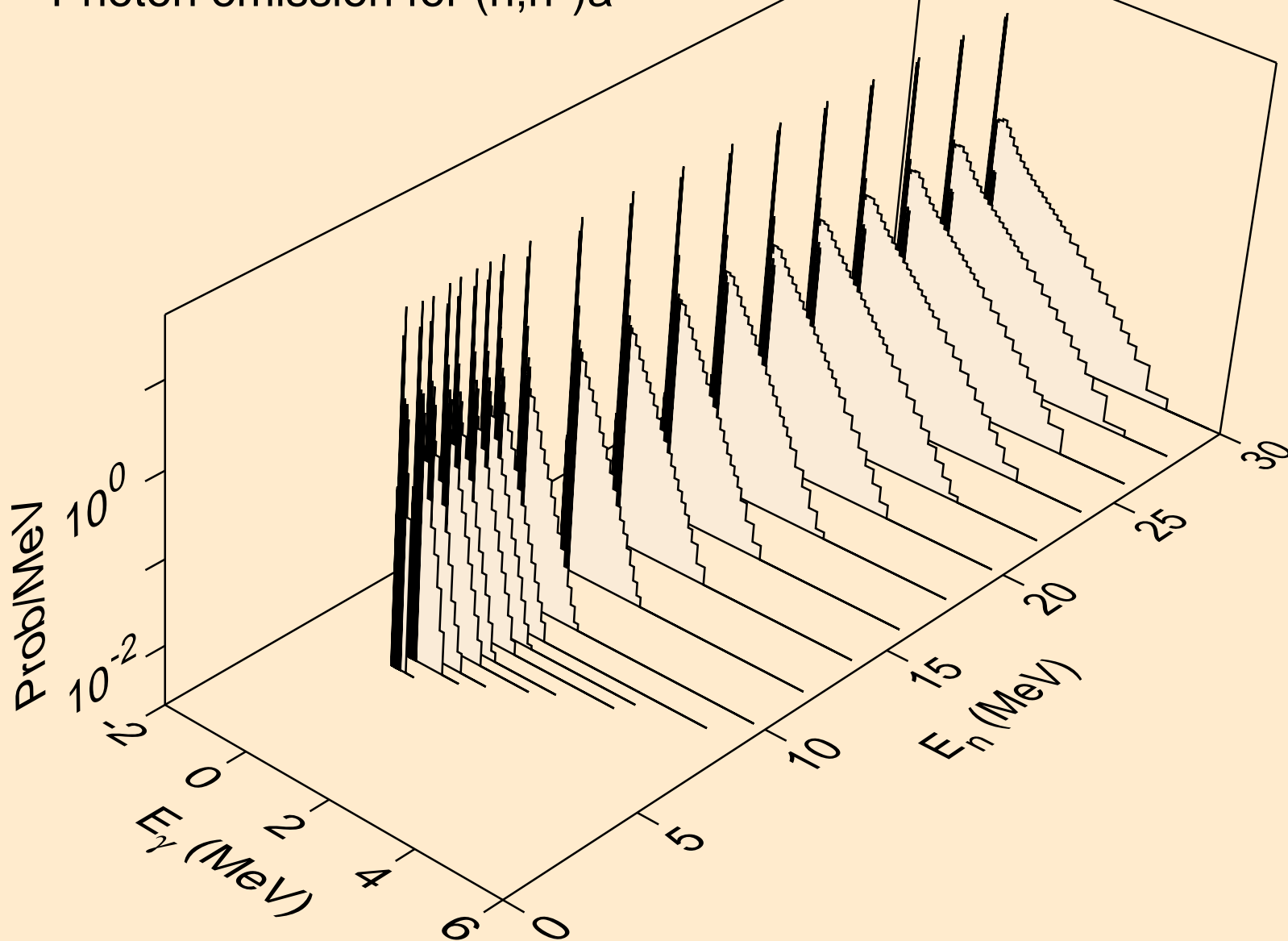

GD155 NEUTRON ACER TENDL-2019 LIBRARY; T=293.16K
Photon emission for (n,2n)a

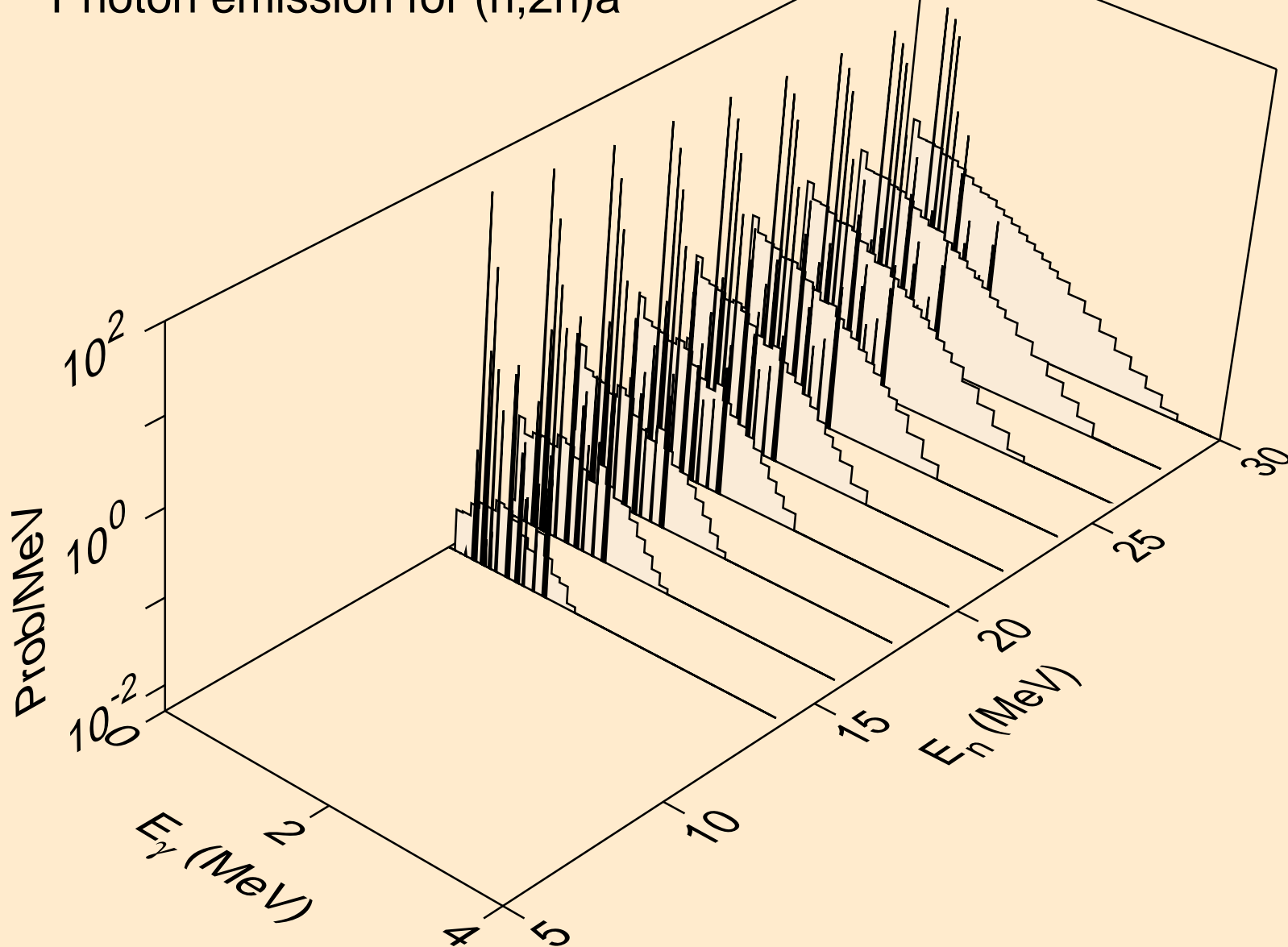

GD155 NEUTRON ACER TENDL-2019 LIBRARY; T=293.16K
Photon emission for (n,3n)a

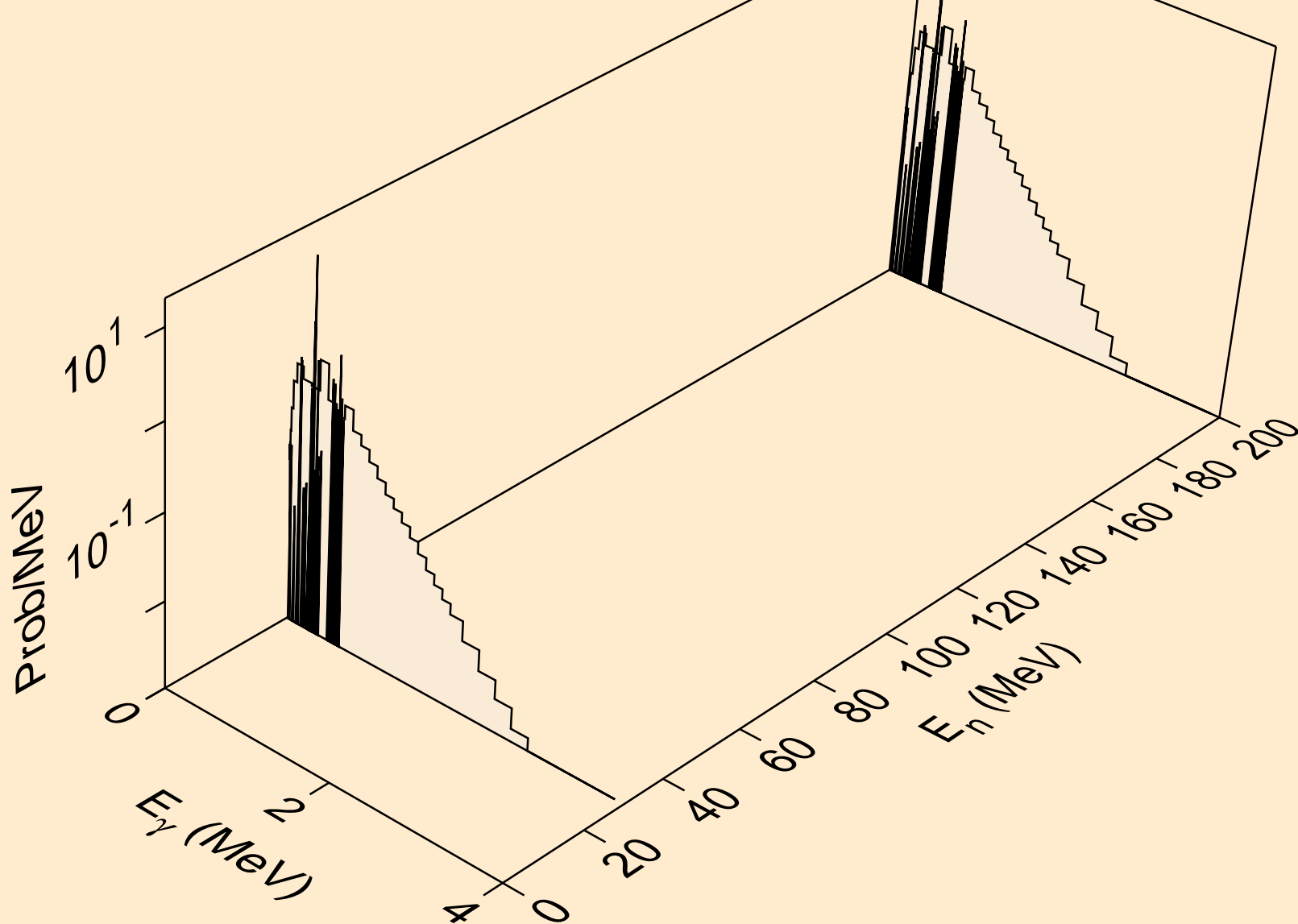

GD155 NEUTRON ACER TENDL-2019 LIBRARY; T=293.16K
Photon emission for (n,n*)p

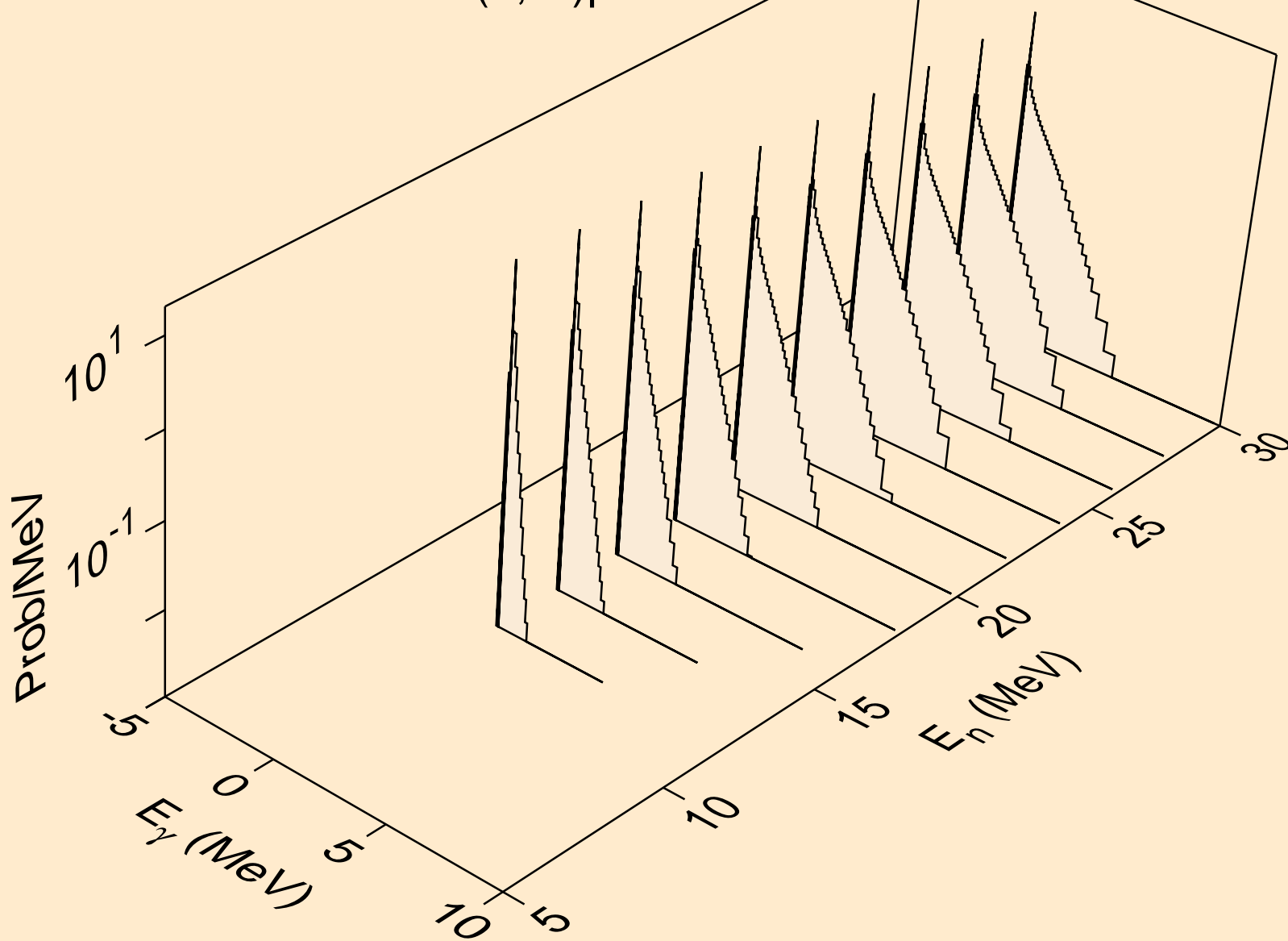

GD155 NEUTRON ACER TENDL-2019 LIBRARY; T=293.16K
Photon emission for (n,n*)2a

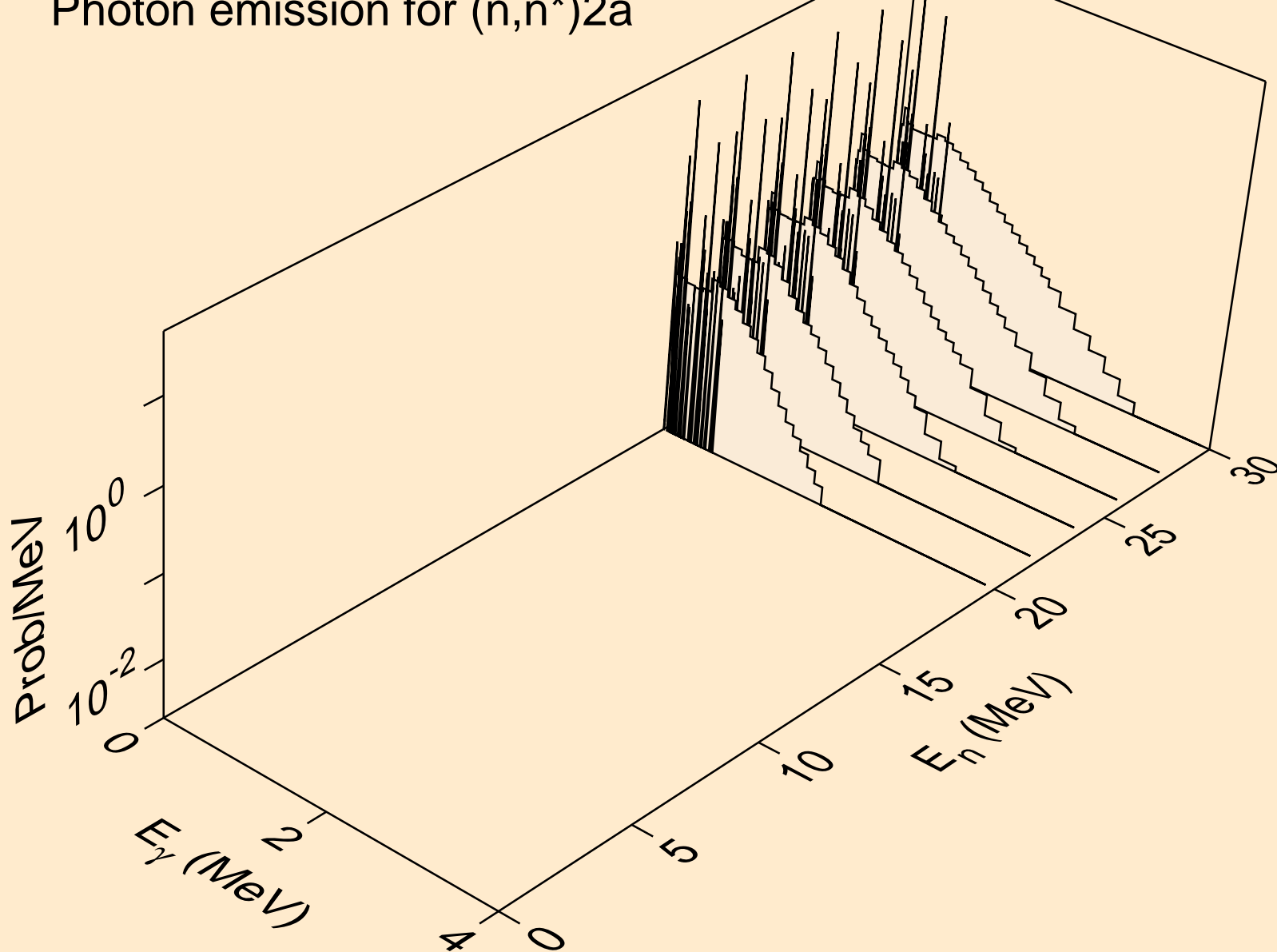

GD155 NEUTRON ACER TENDL-2019 LIBRARY; T=293.16K
Photon emission for (n,n*)d

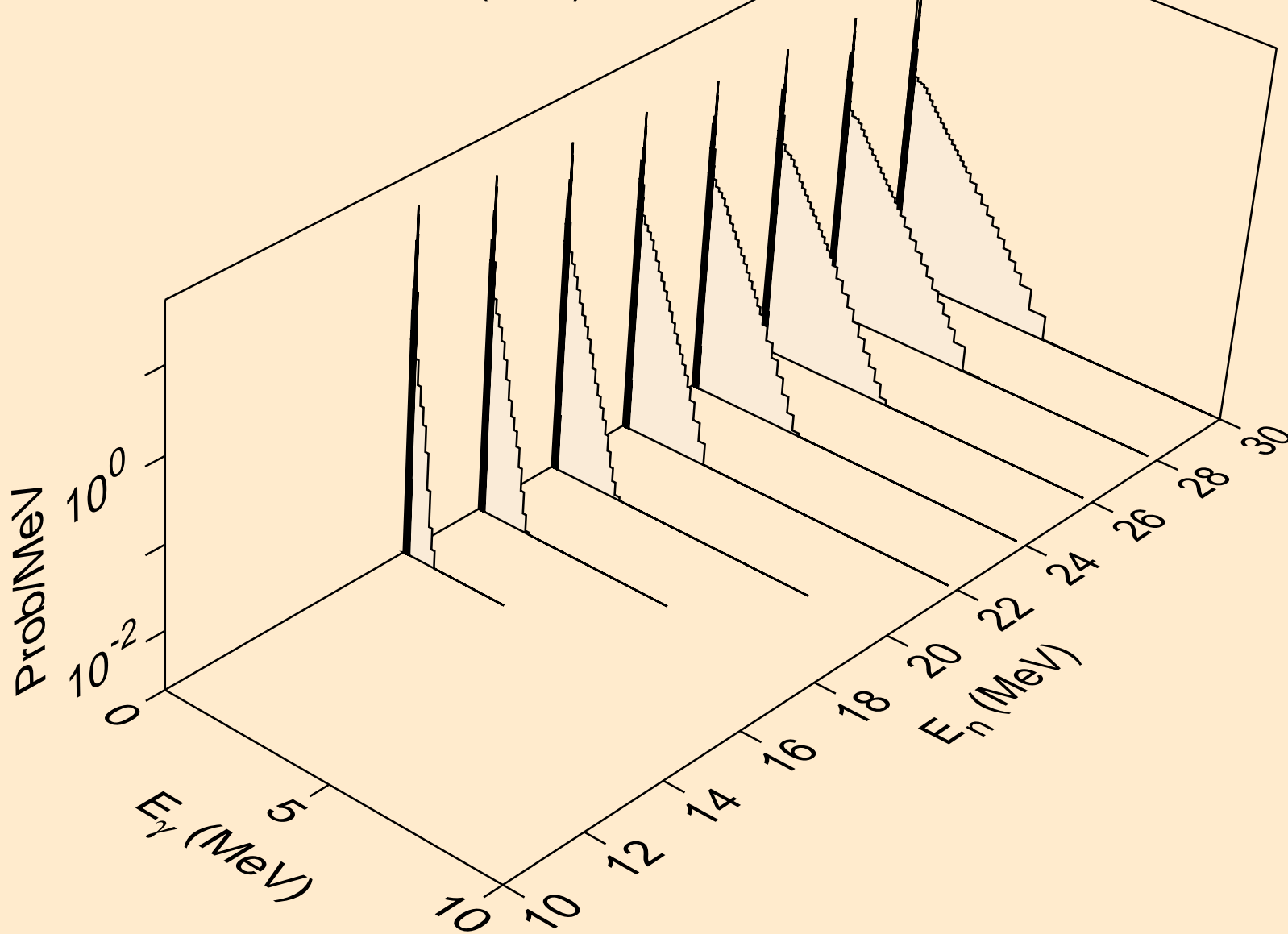

GD155 NEUTRON ACER TENDL-2019 LIBRARY; T=293.16K
Photon emission for (n,n*)t

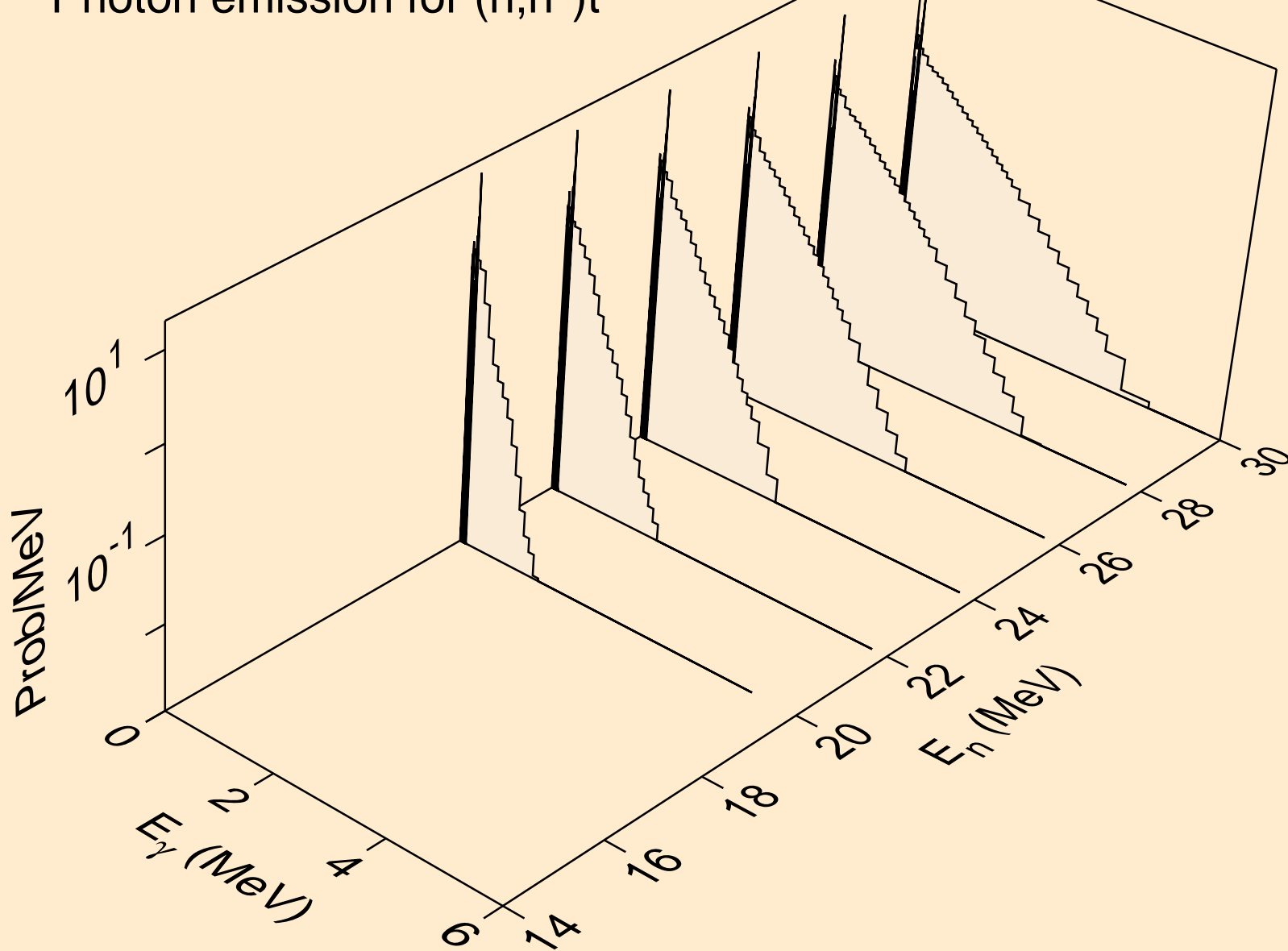

GD155 NEUTRON ACER TENDL-2019 LIBRARY; T=293.16K
Photon emission for (n,n*)he3

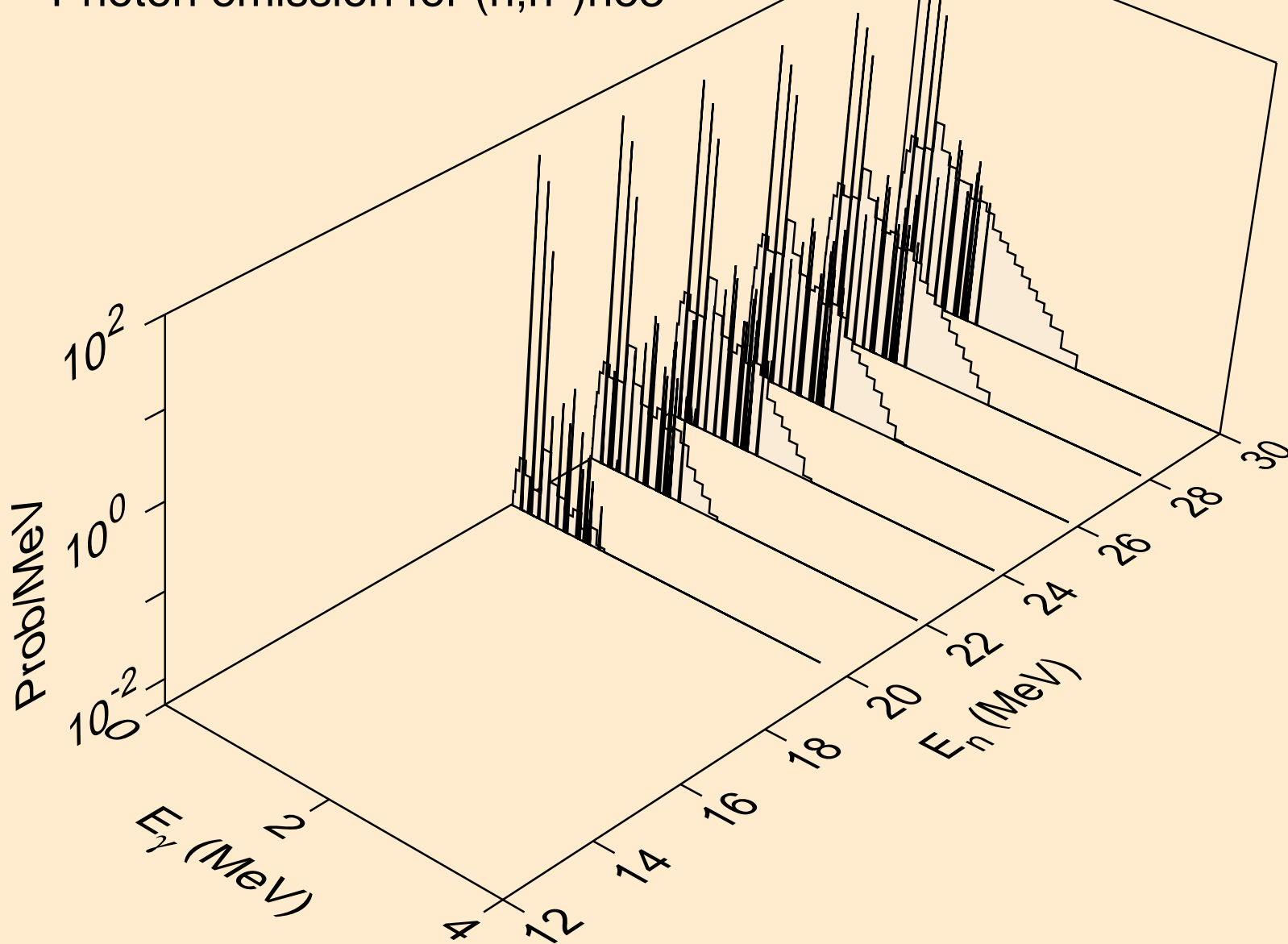

GD155 NEUTRON ACER TENDL-2019 LIBRARY; T=293.16K
Photon emission for (n,4n)

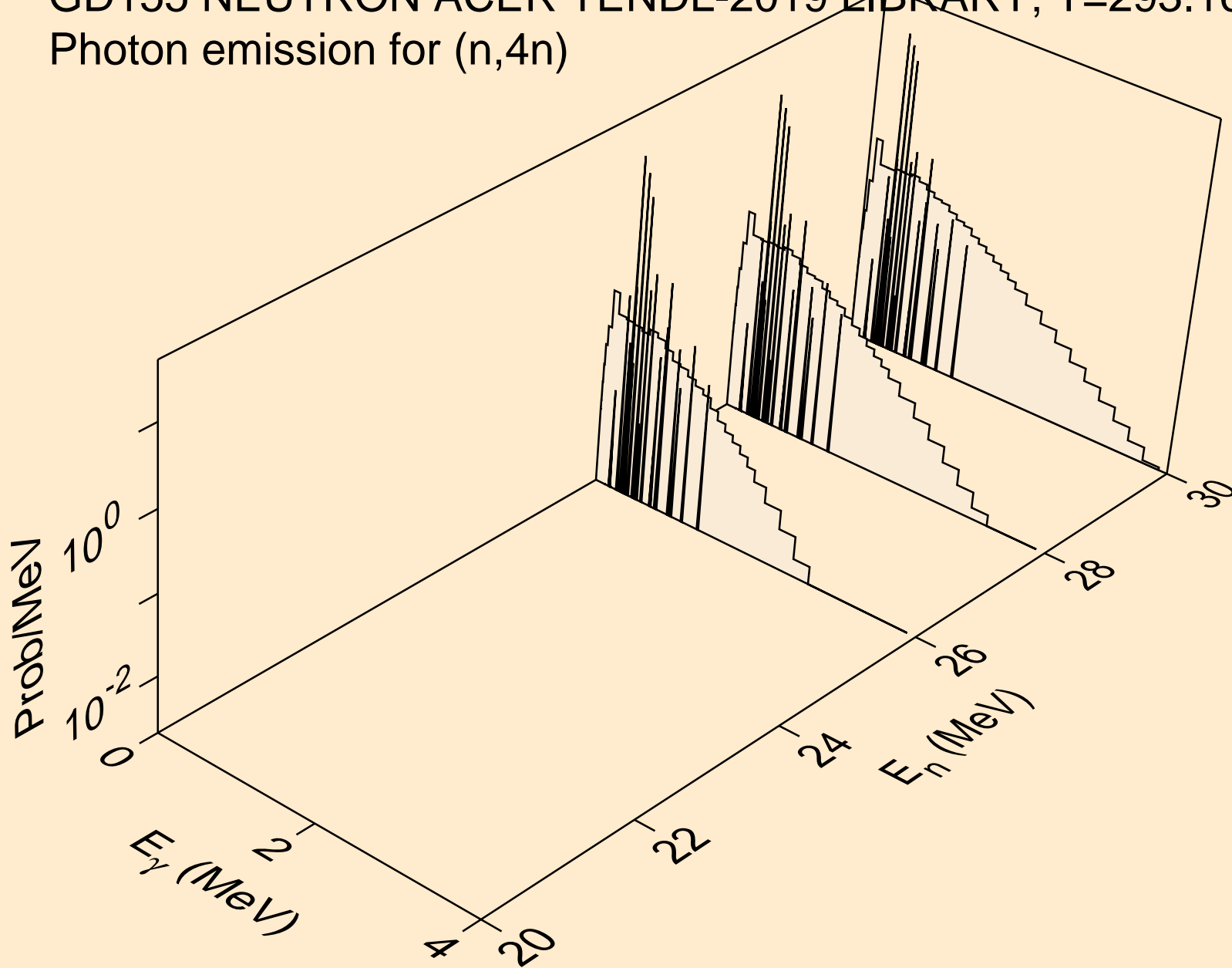

GD155 NEUTRON ACER TENDL-2019 LIBRARY; T=293.16K
Photon emission for (n,2np)

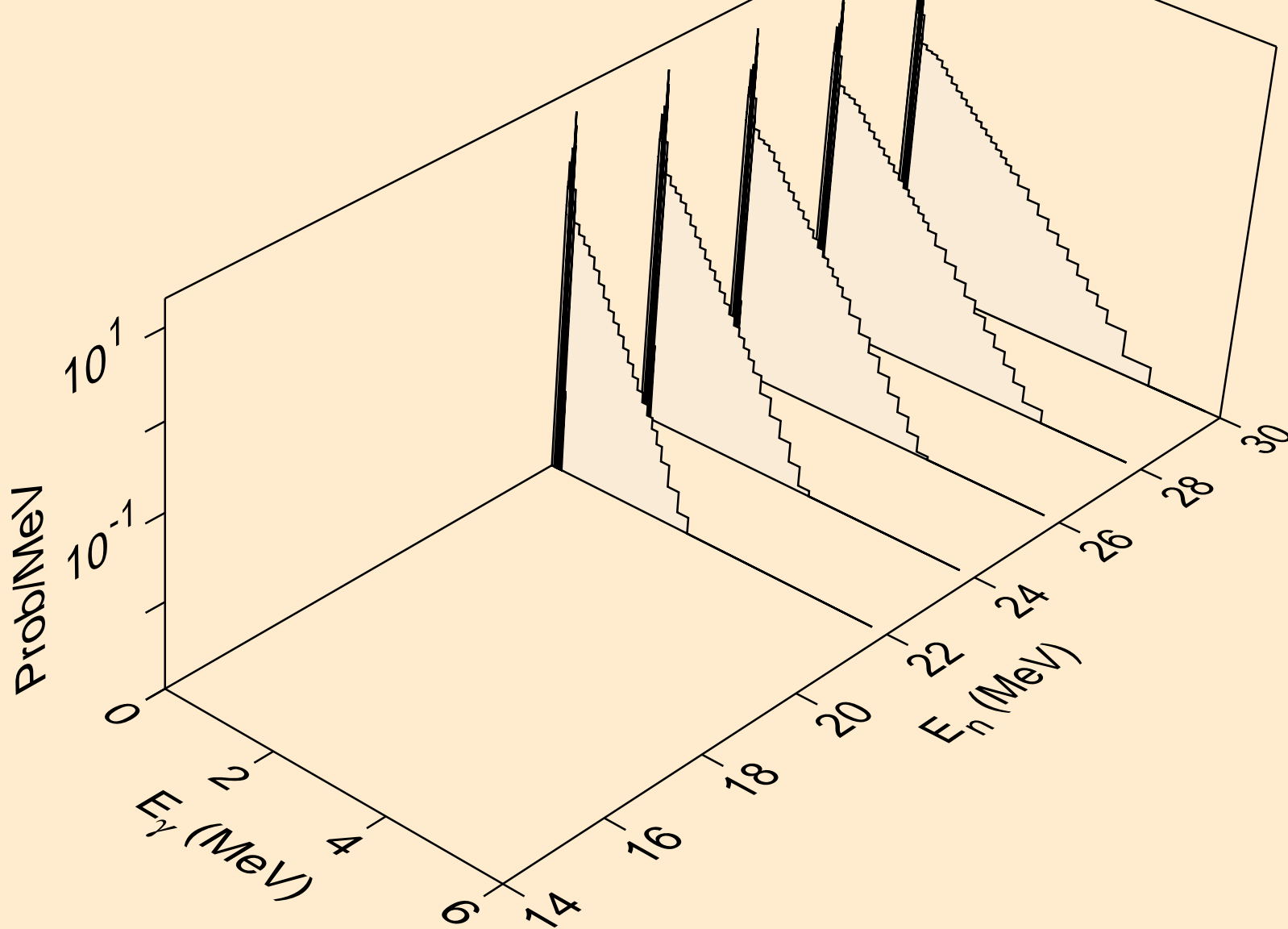

GD155 NEUTRON ACER TENDL-2019 LIBRARY; T=293.16K
Photon emission for (n,3np)

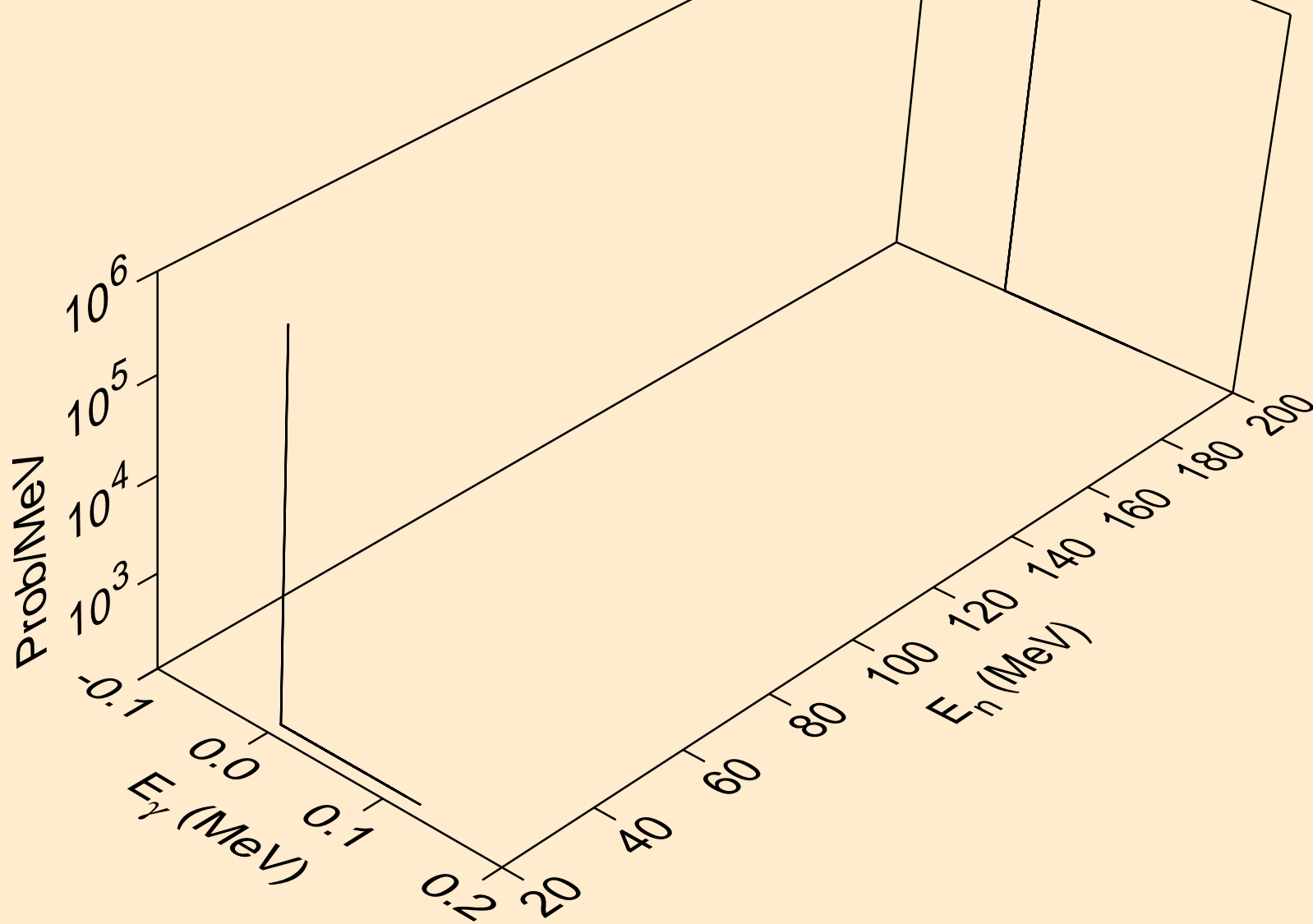

GD155 NEUTRON ACER TENDL-2019 LIBRARY; T=293.16K
Photon emission for (n,2np)

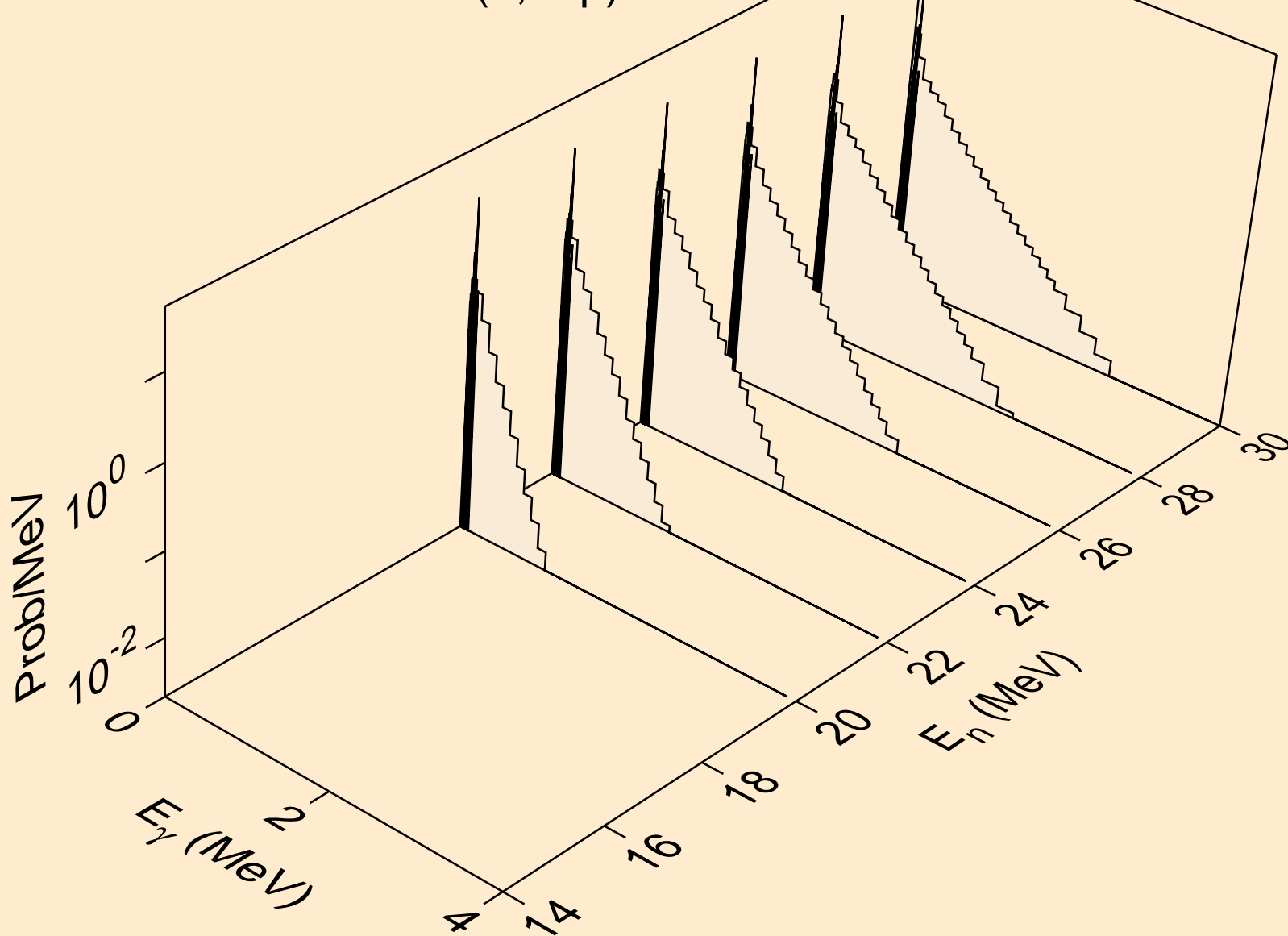

GD155 NEUTRON ACER TENDL-2019 LIBRARY; T=293.16K
Photon emission for (n,npa)

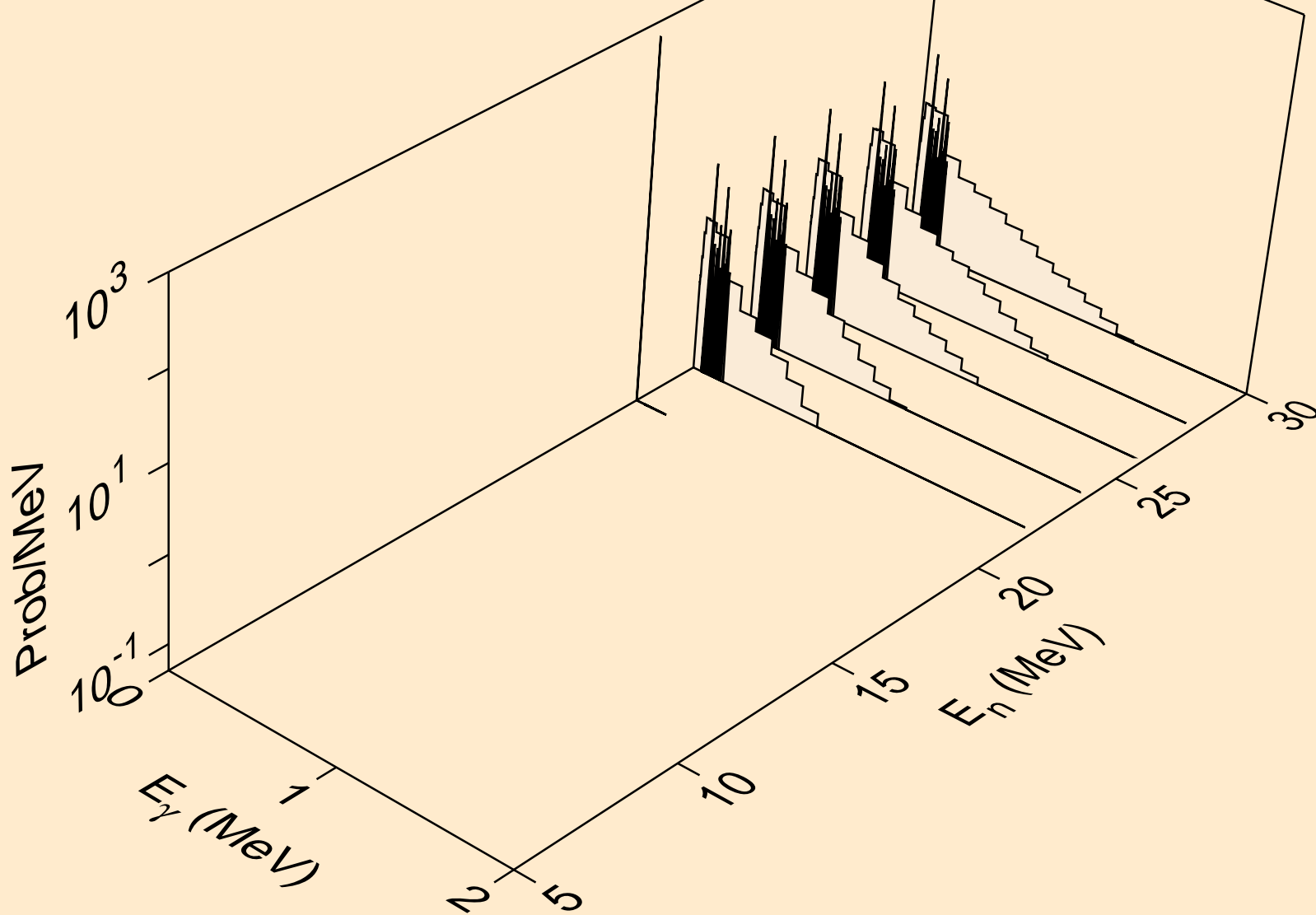

GD155 NEUTRON ACER TENDL-2019 LIBRARY; T=293.16K
Photon emission for (n,n*c)

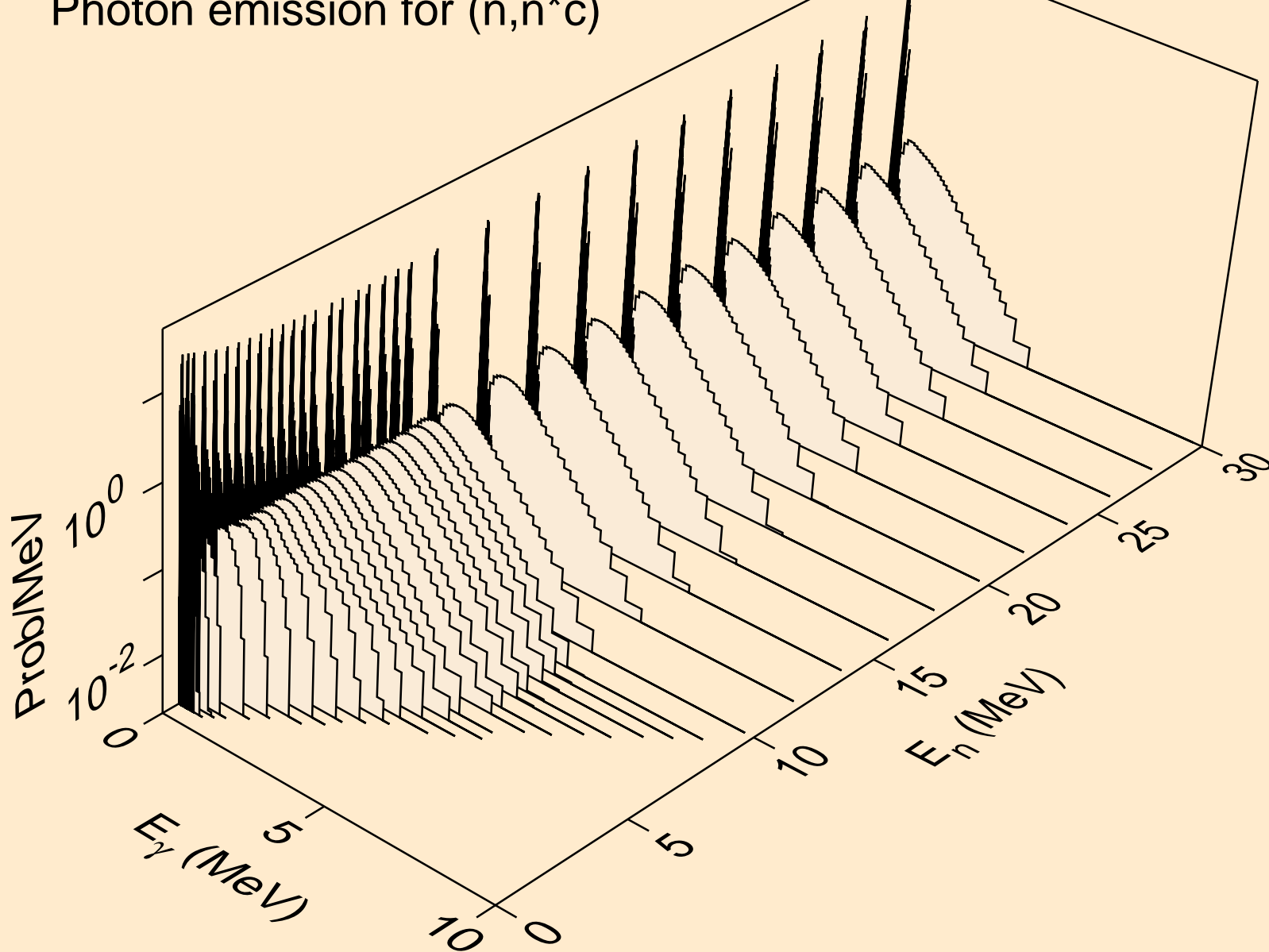

GD155 NEUTRON ACER TENDL-2019 LIBRARY; T=293.16K
Photon emission for (n,gma)

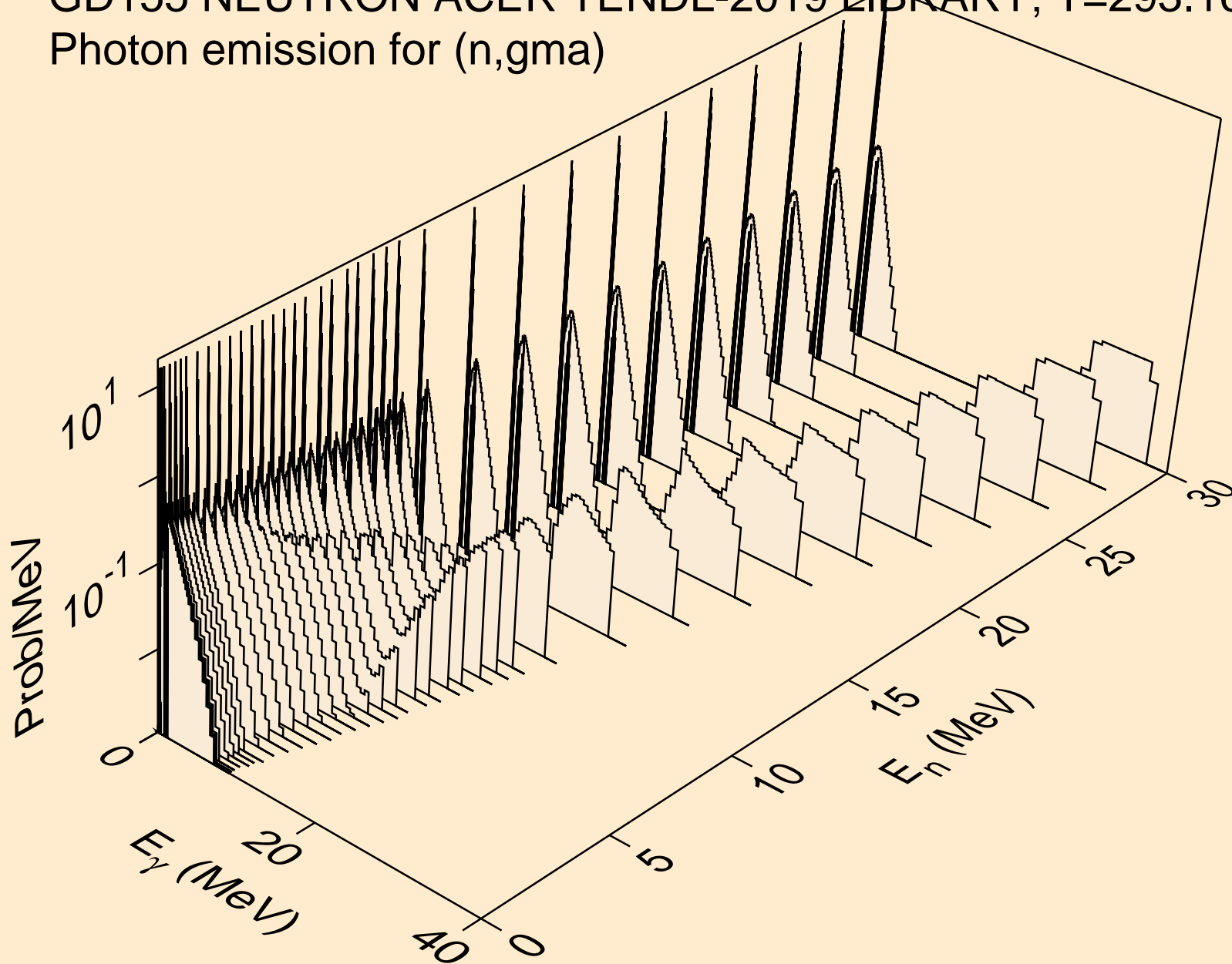

GD155 NEUTRON ACER TENDL-2019 LIBRARY; T=293.16K
Photon emission for (n,p)

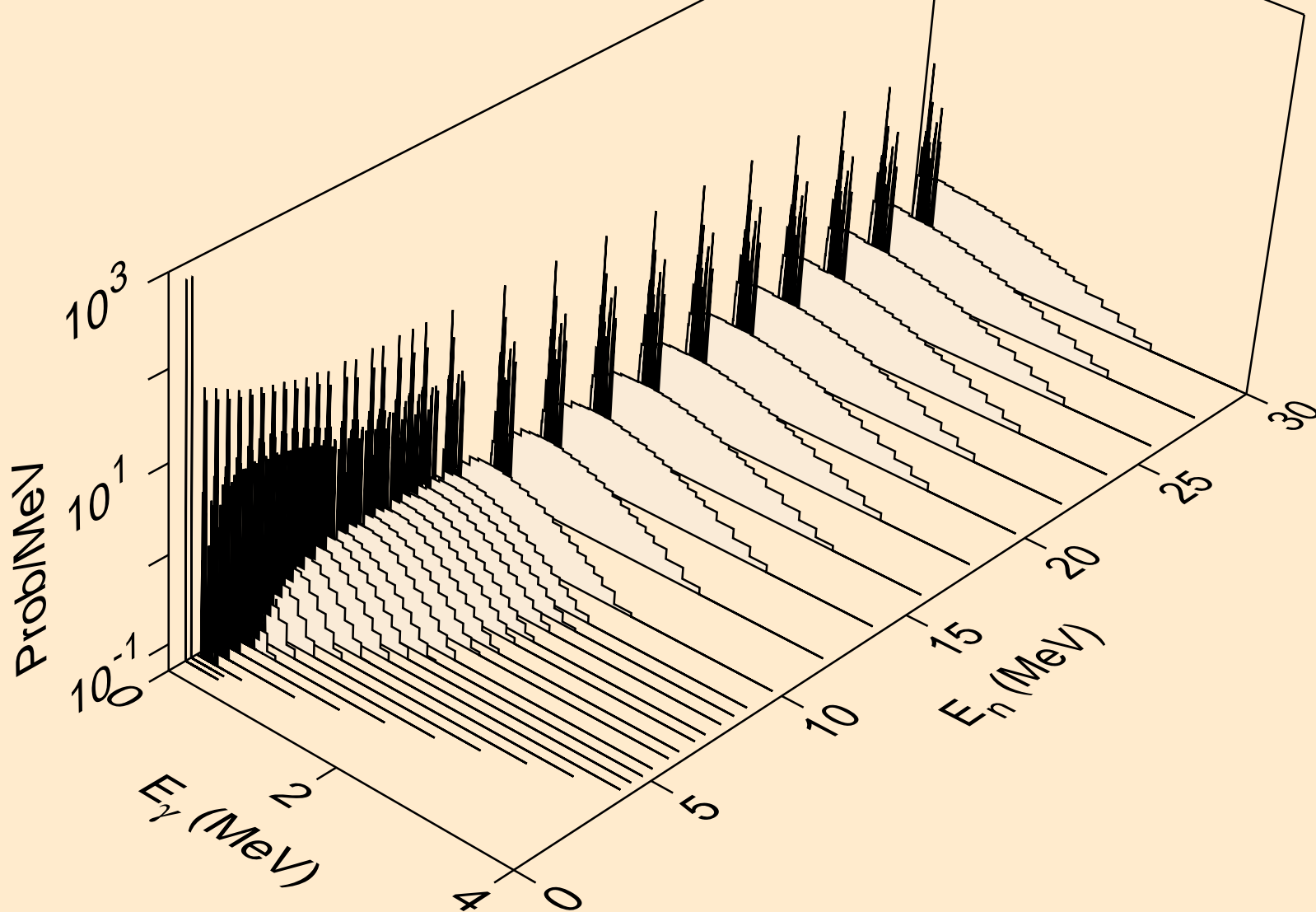

GD155 NEUTRON ACER TENDL-2019 LIBRARY; T=293.16K
Photon emission for (n,d)

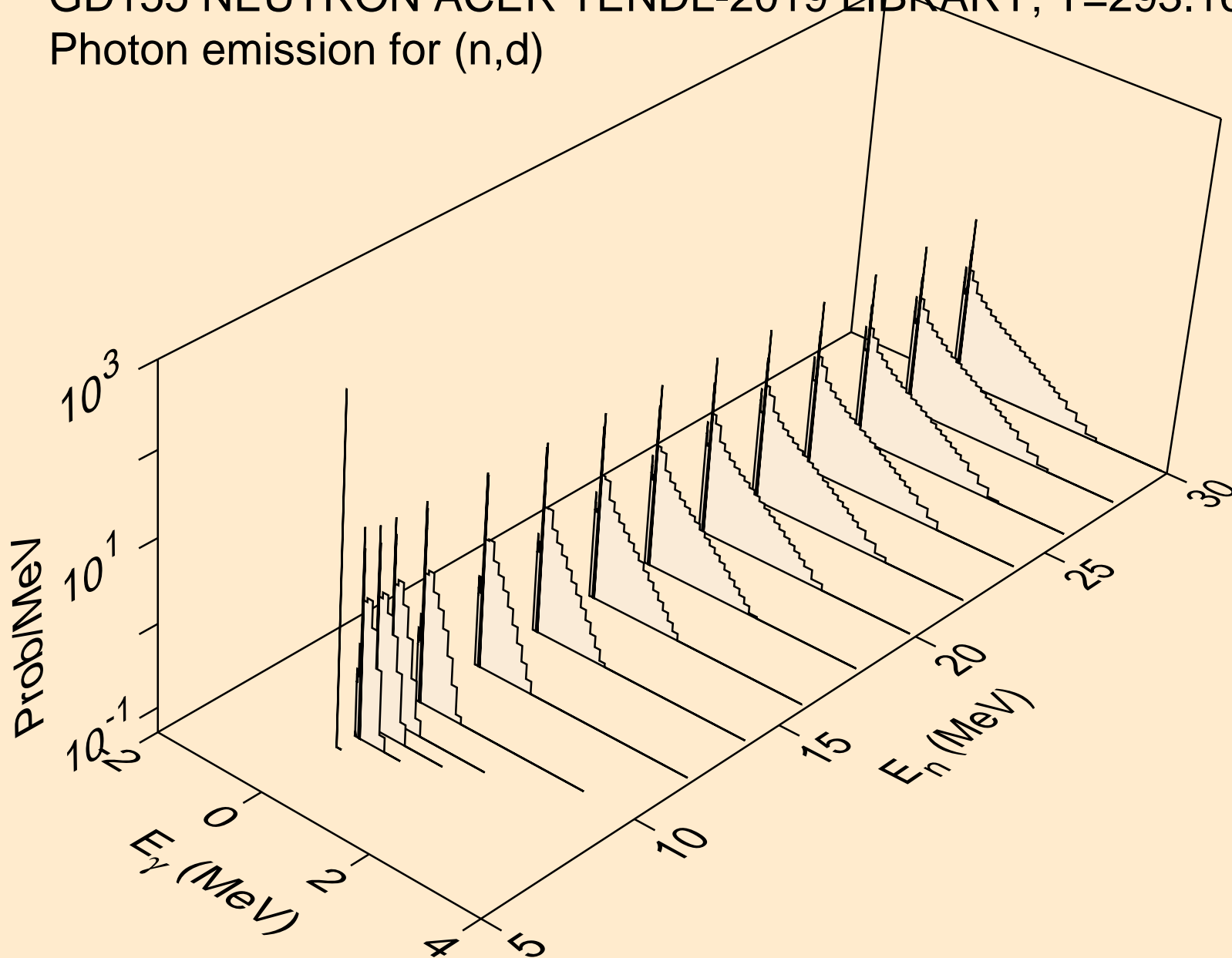

GD155 NEUTRON ACER TENDL-2019 LIBRARY; T=293.16K
Photon emission for (n,t)

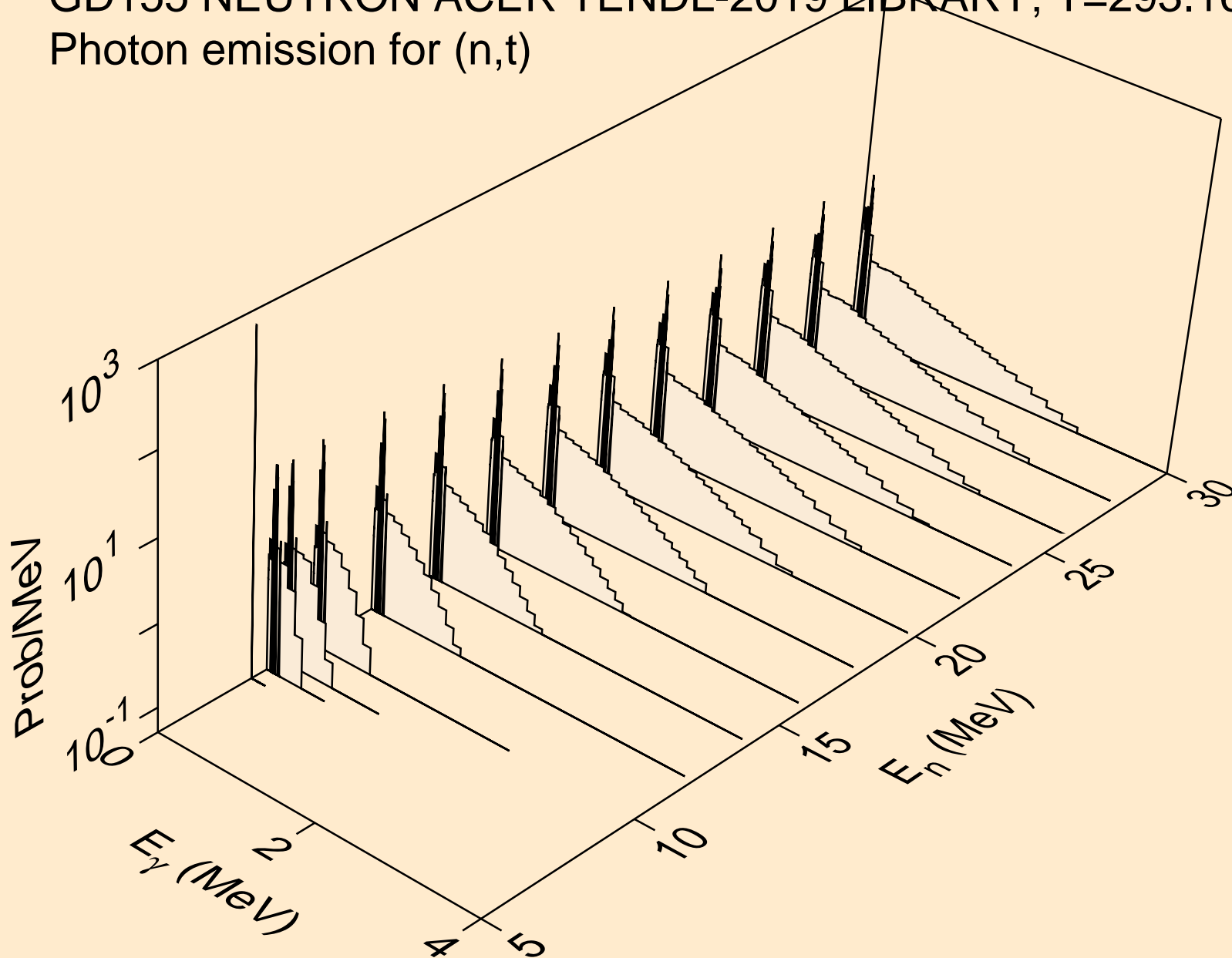

GD155 NEUTRON ACER TENDL-2019 LIBRARY; T=293.16K
Photon emission for (n,he3)

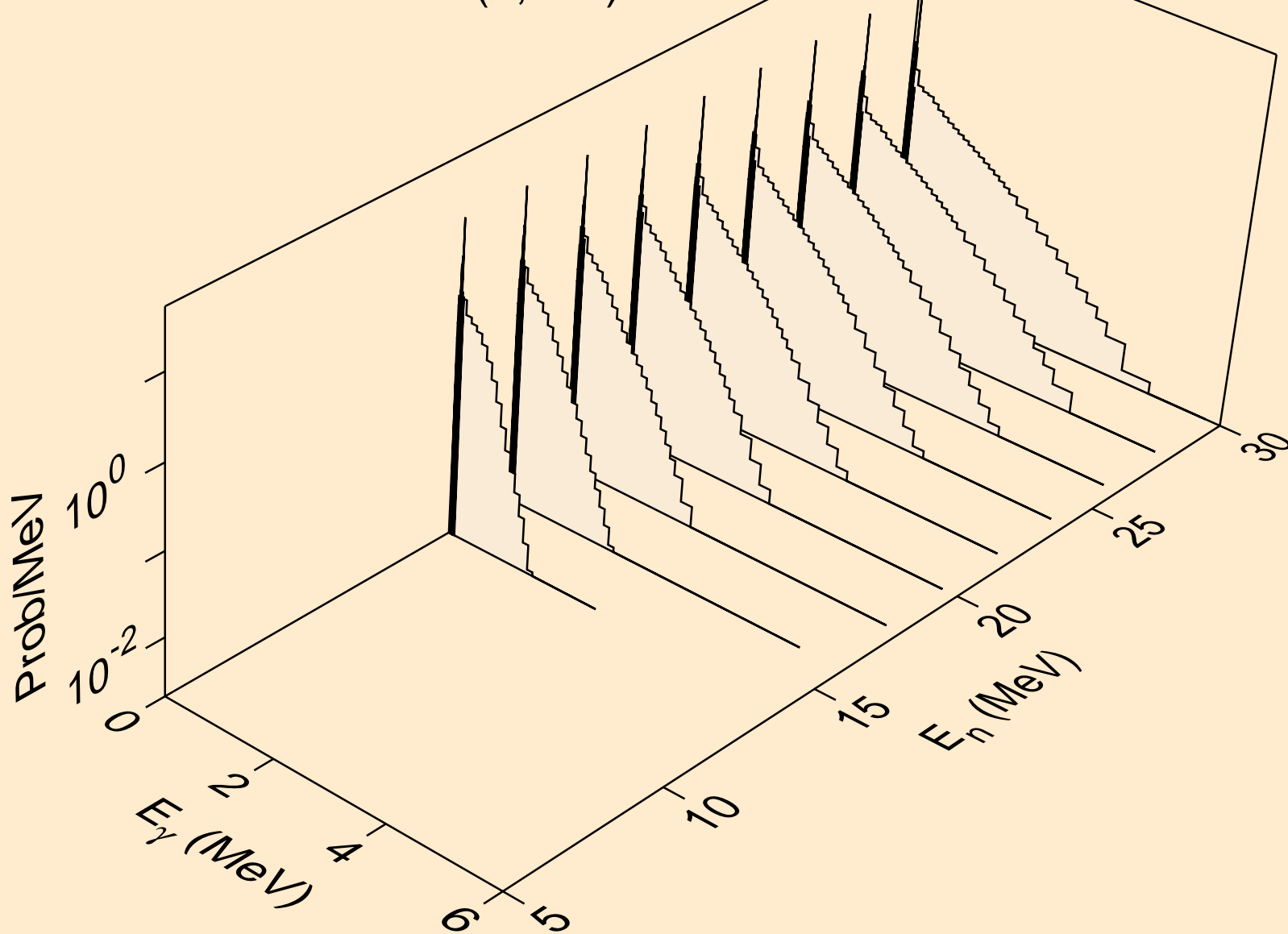

GD155 NEUTRON ACER TENDL-2019 LIBRARY; T=293.16K
Photon emission for (n,a)

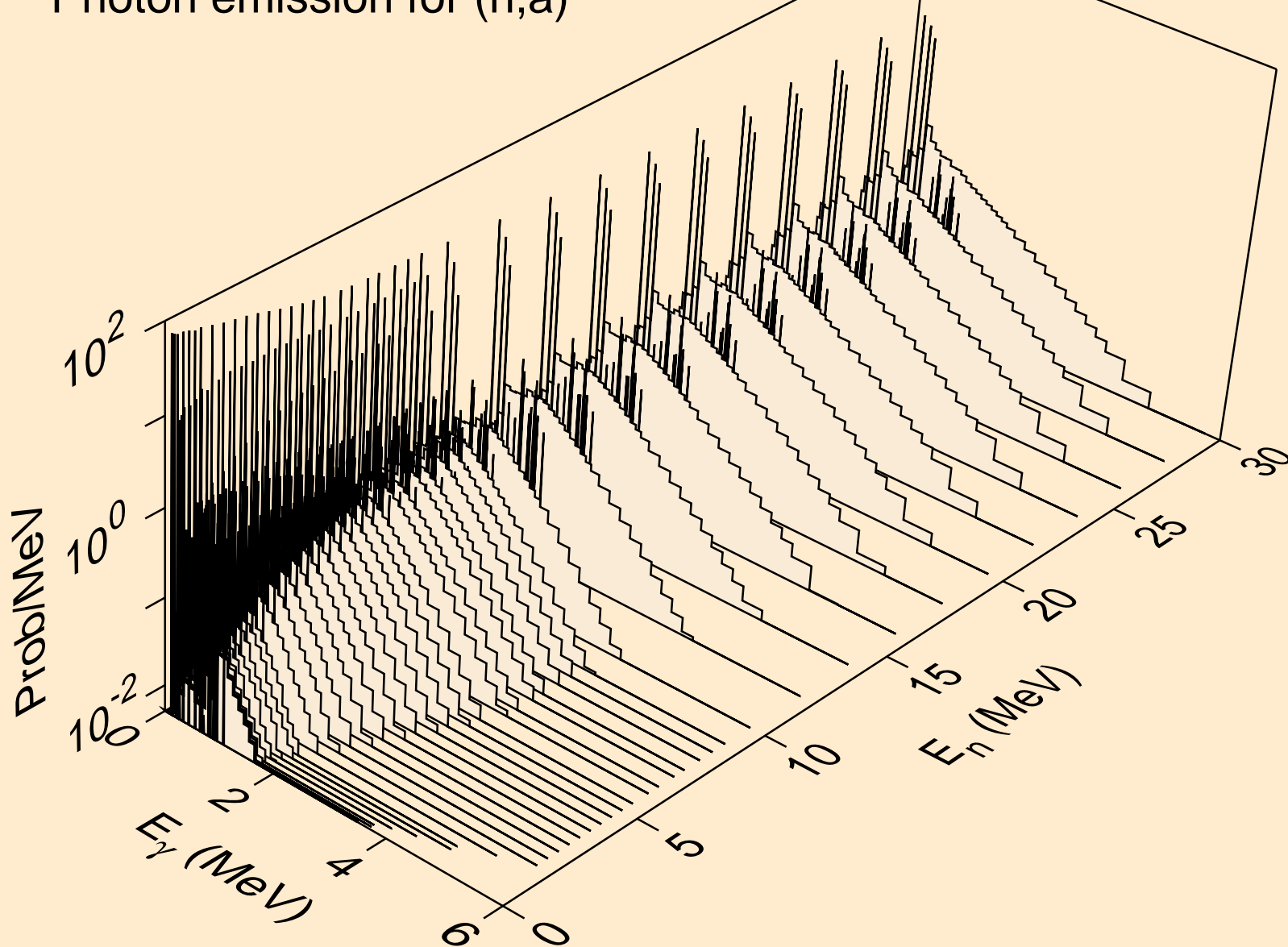

GD155 NEUTRON ACER TENDL-2019 LIBRARY; T=293.16K
Photon emission for (n,2a)

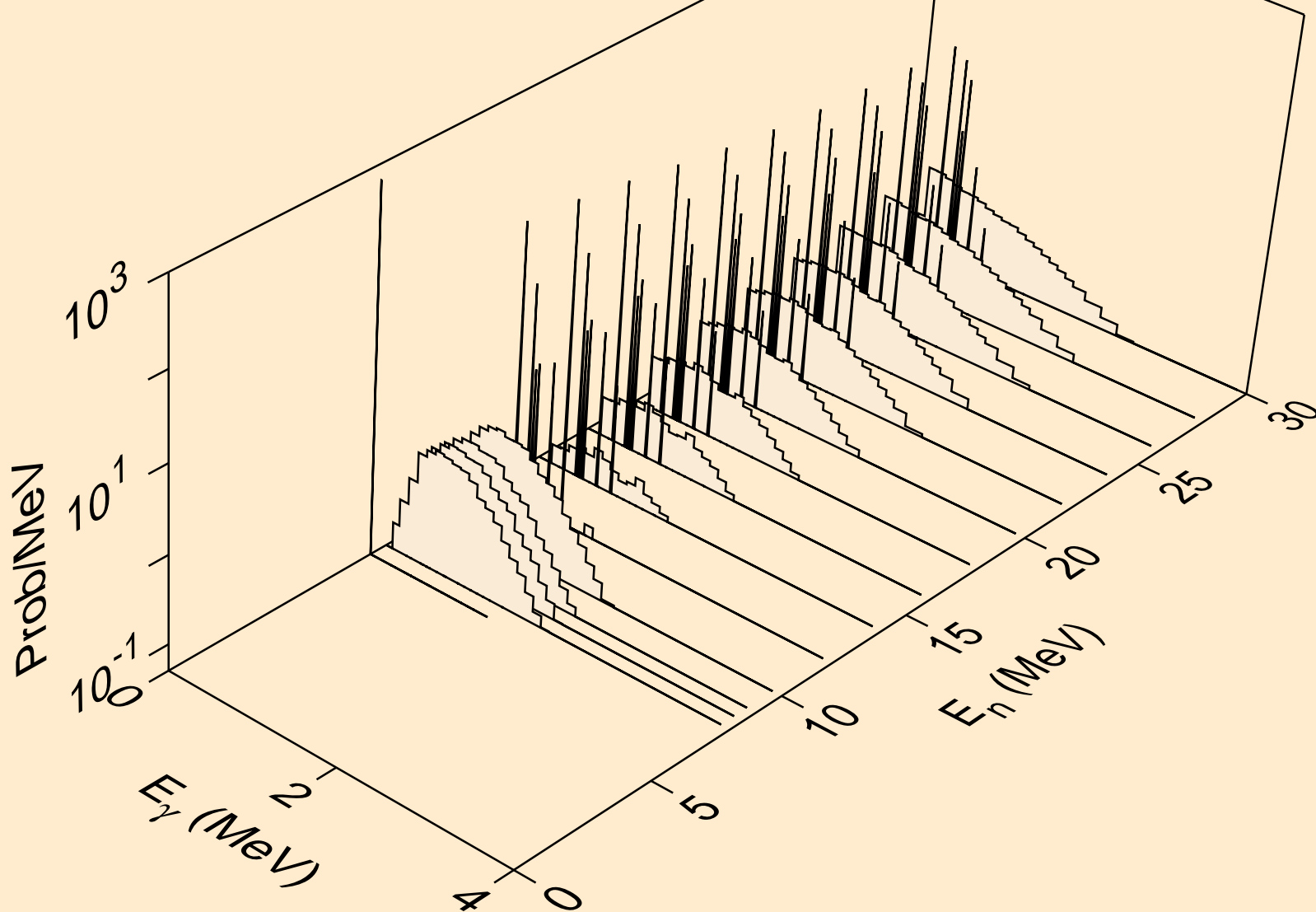

GD155 NEUTRON ACER TENDL-2019 LIBRARY; T=293.16K
Photon emission for (n,2p)

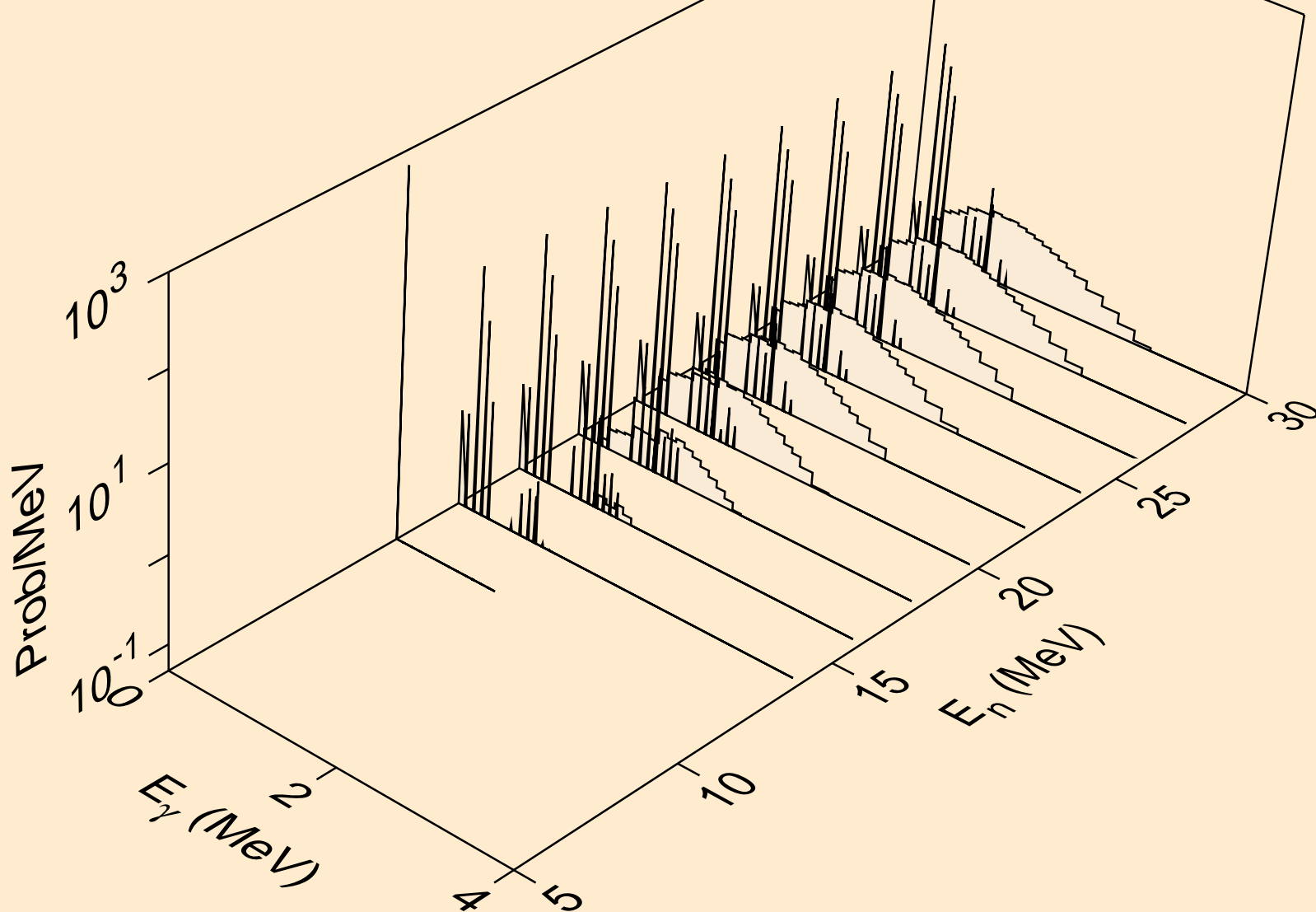

GD155 NEUTRON ACER TENDL-2019 LIBRARY; T=293.16K
Photon emission for (n,p α)

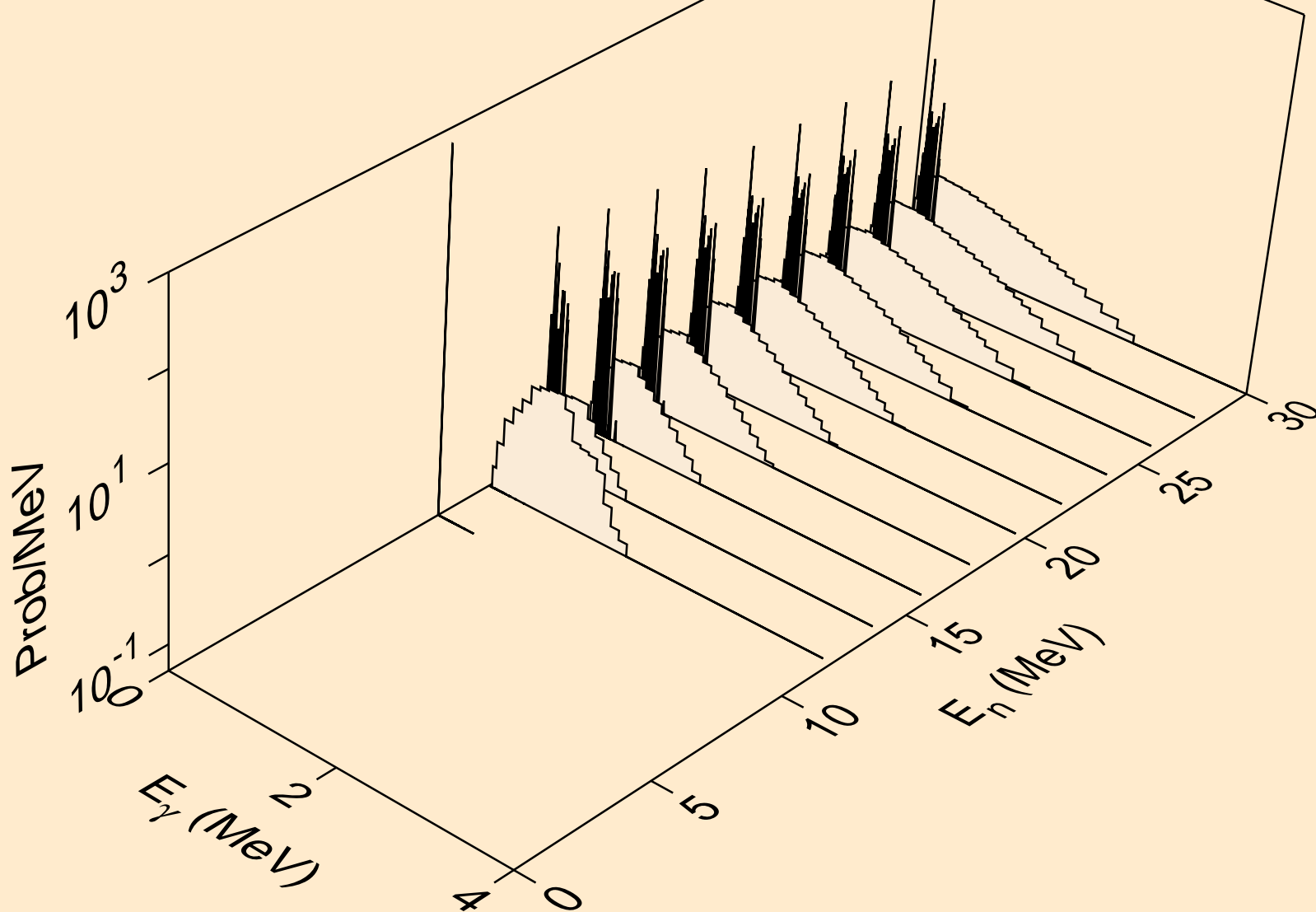

GD155 NEUTRON ACER TENDL-2019 LIBRARY; T=293.16K
Photon emission for (n,pd)

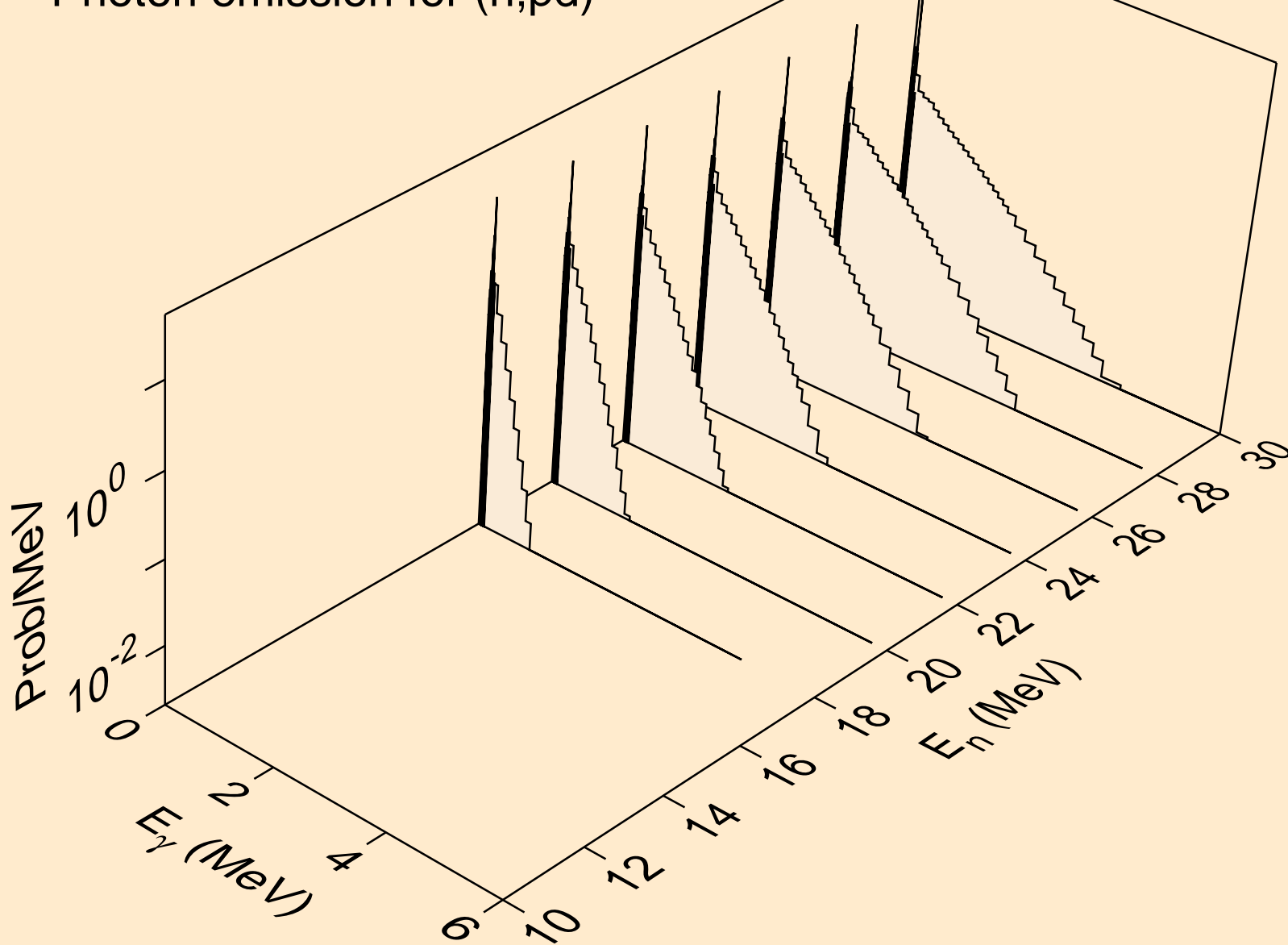

GD155 NEUTRON ACER TENDL-2019 LIBRARY; T=293.16K
Photon emission for (n,pt)

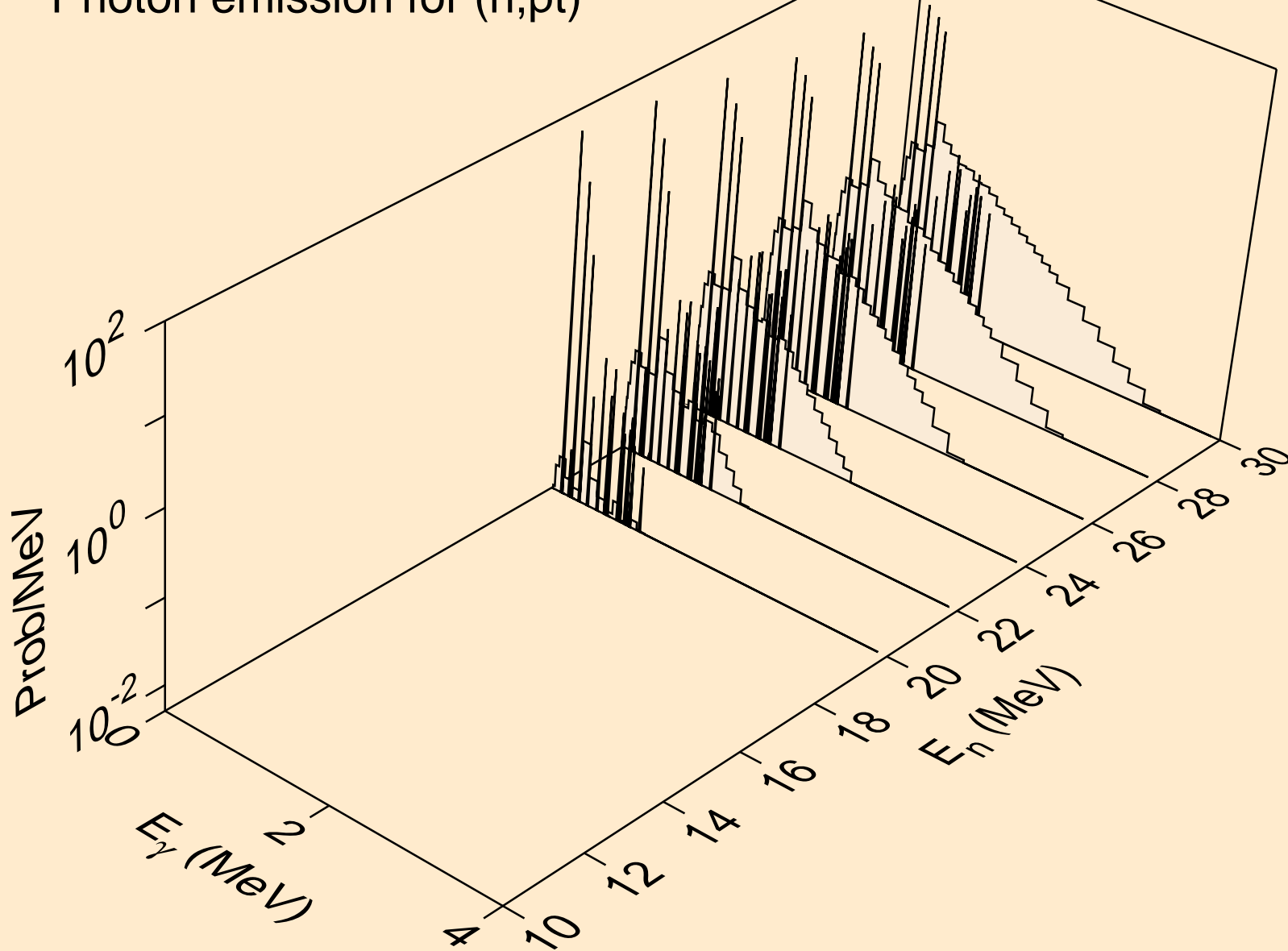

GD155 NEUTRON ACER TENDL-2019 LIBRARY; T=293.16K
Photon emission for (n,da)

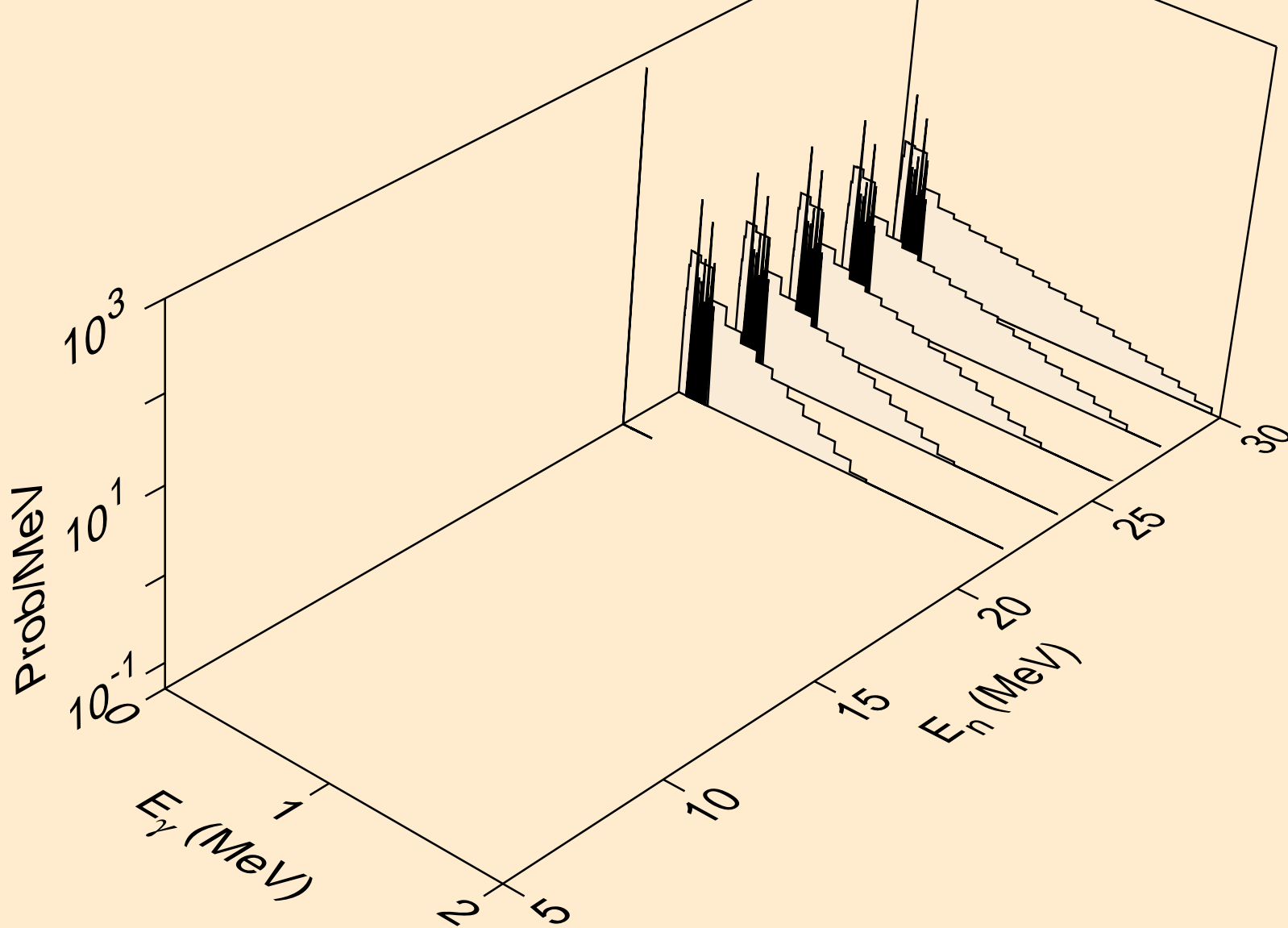

GD155 NEUTRON ACER TENDL-2019 LIBRARY; T=293.16K
thermal capture photon spectrum

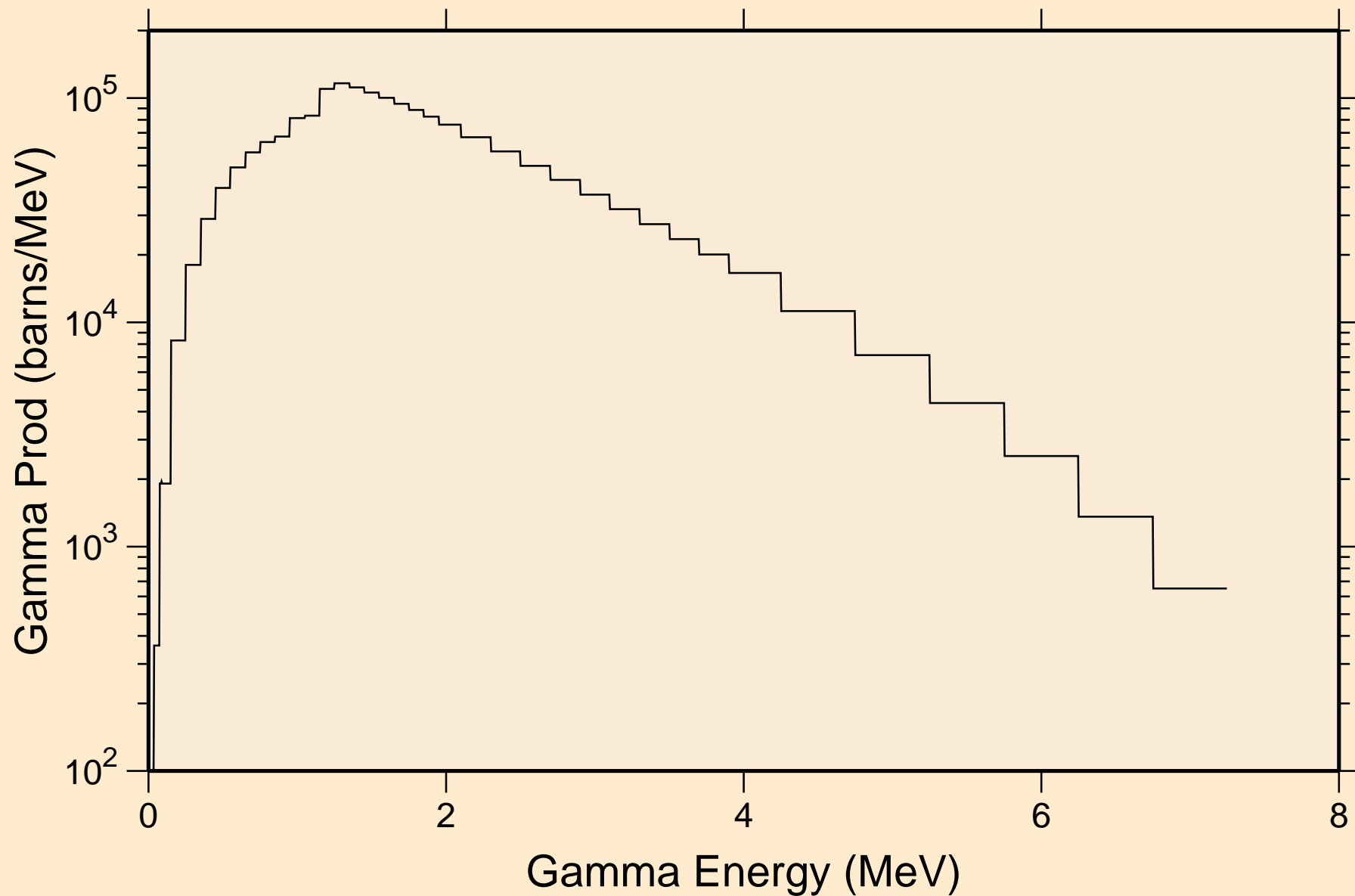

GD155 NEUTRON ACER TENDL-2019 LIBRARY; T=293.16K
14 MeV photon spectrum

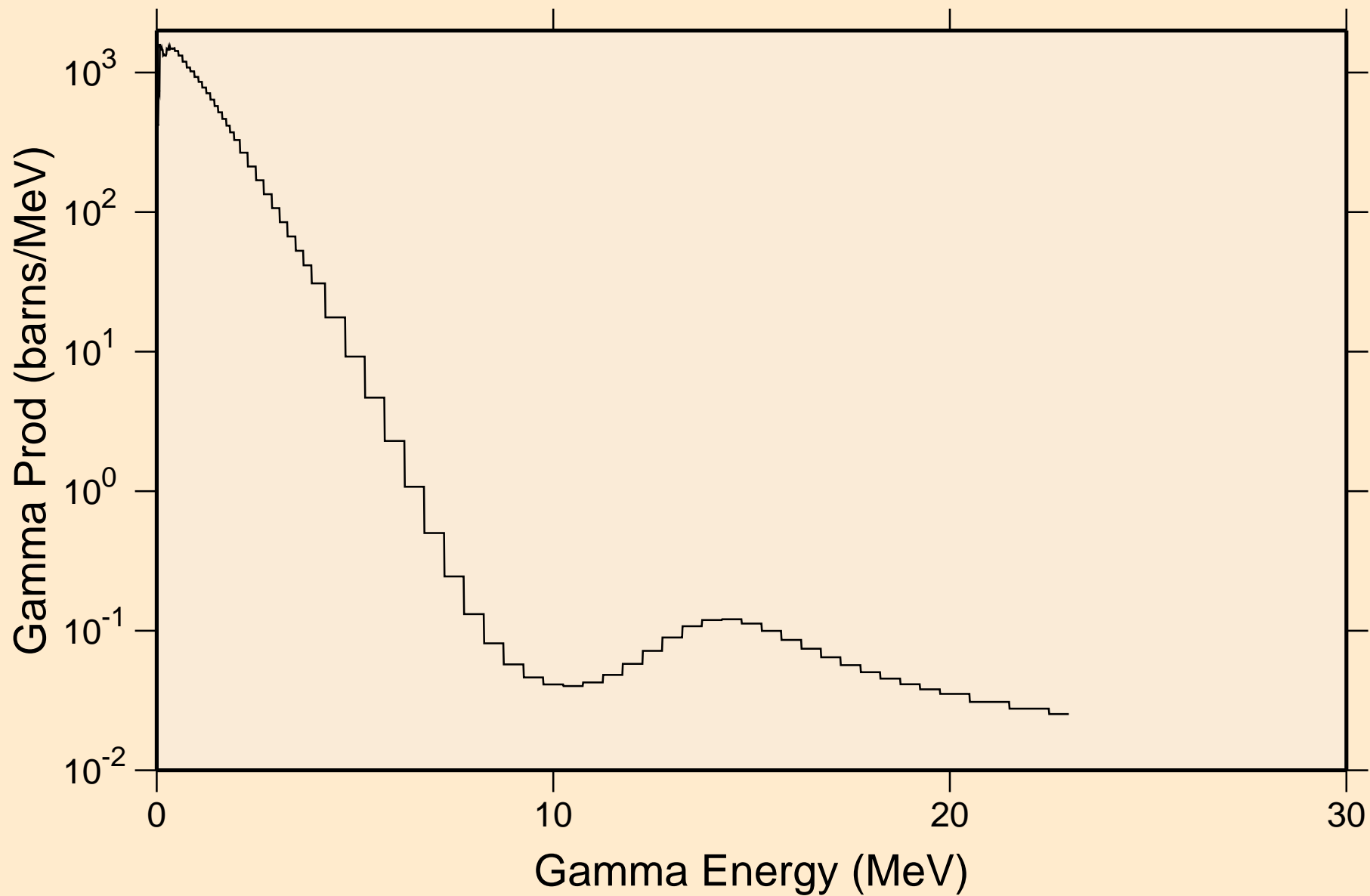

GD155 NEUTRON ACER TENDL-2019 LIBRARY; T=293.16K

Particle heating contributions

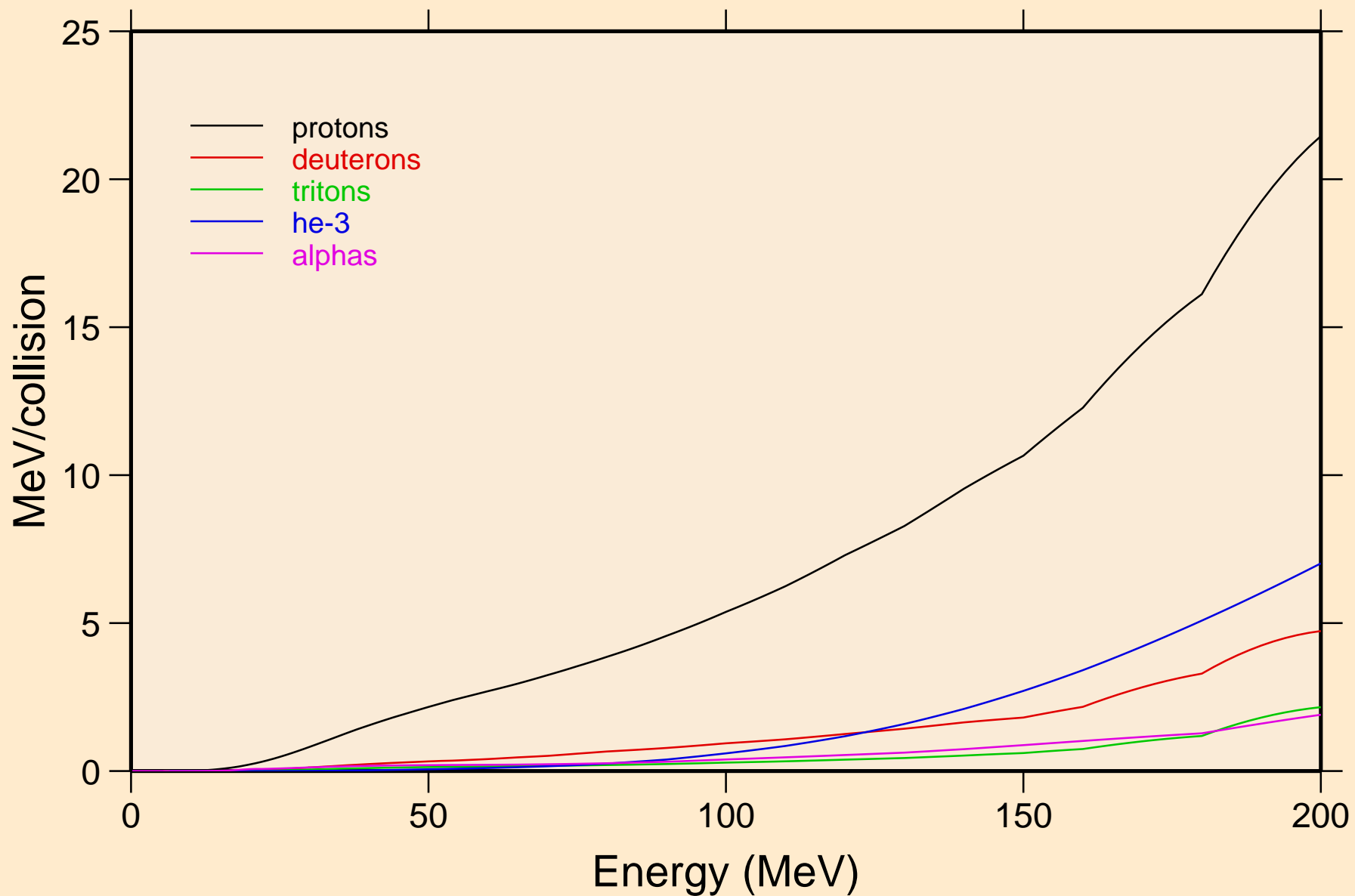

GD155 NEUTRON ACER TENDL-2019 LIBRARY; T=293.16K
Recoil Heating

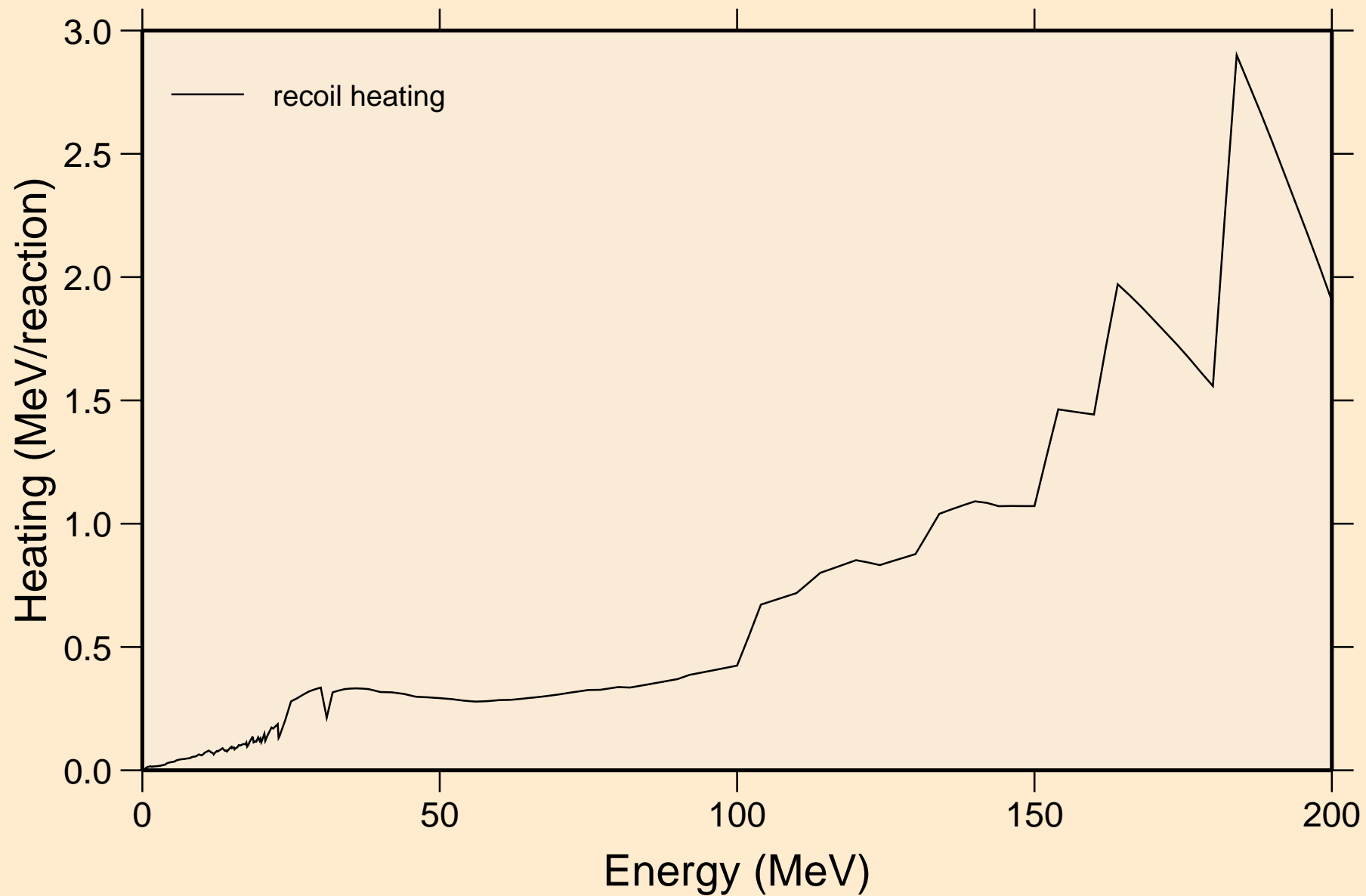

GD155 NEUTRON ACER TENDL-2019 LIBRARY; T=293.16K
Particle production cross sections

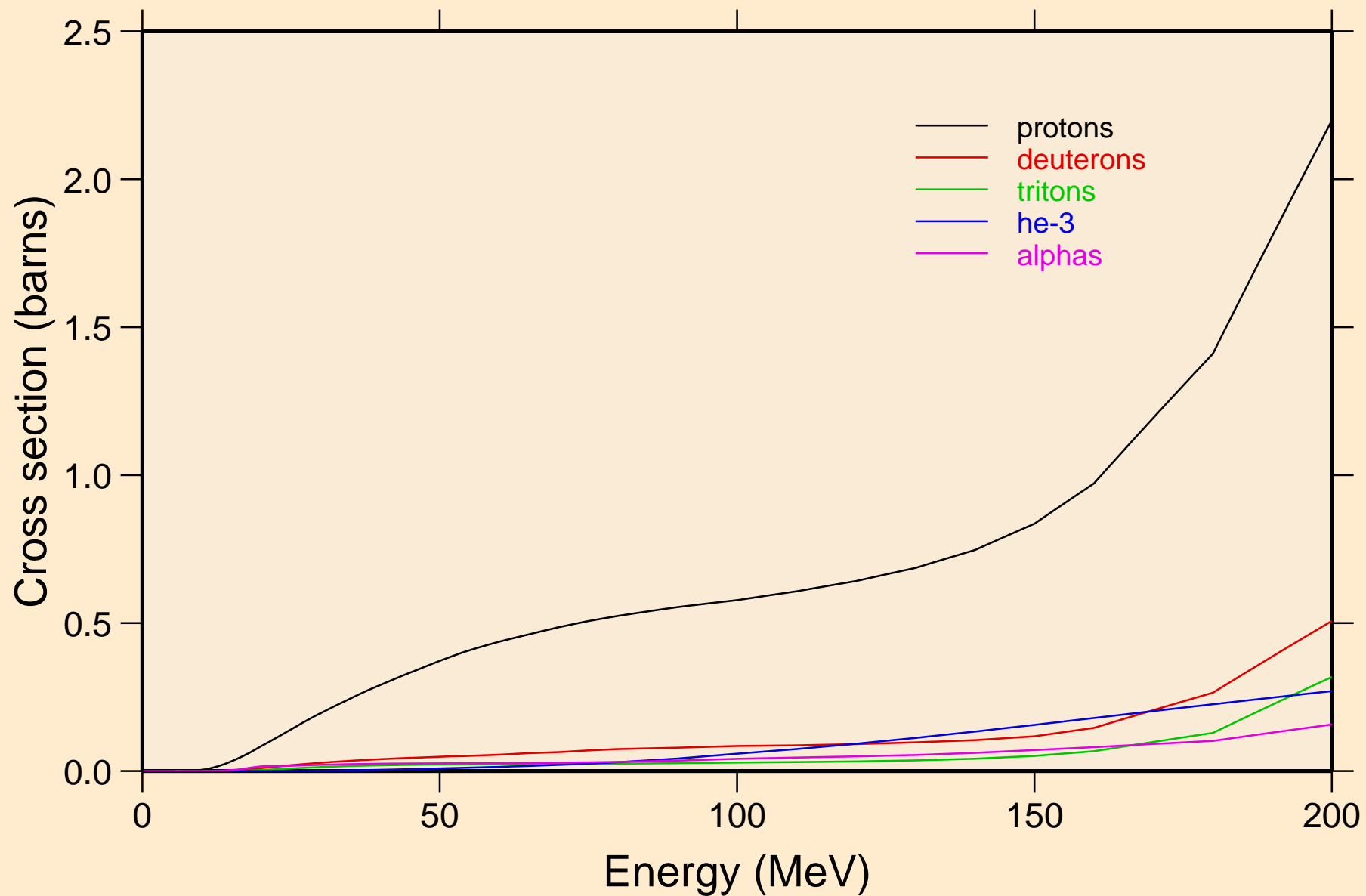

GD155 NEUTRON ACER TENDL-2019 LIBRARY; T=293.16K
protons from (n,x)

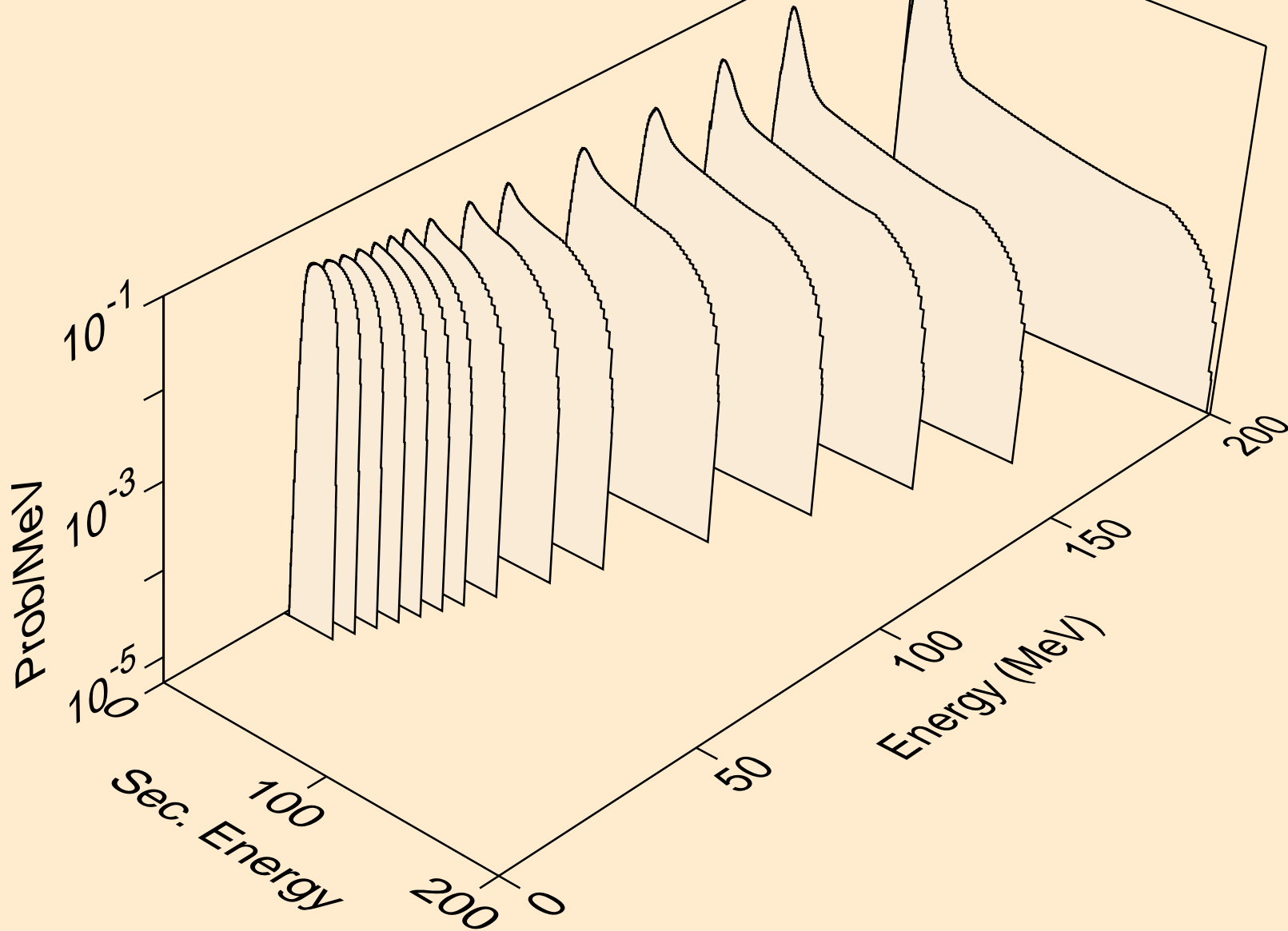

GD155 NEUTRON ACER TENDL-2019 LIBRARY; T=293.16K
protons from (n,n*)p

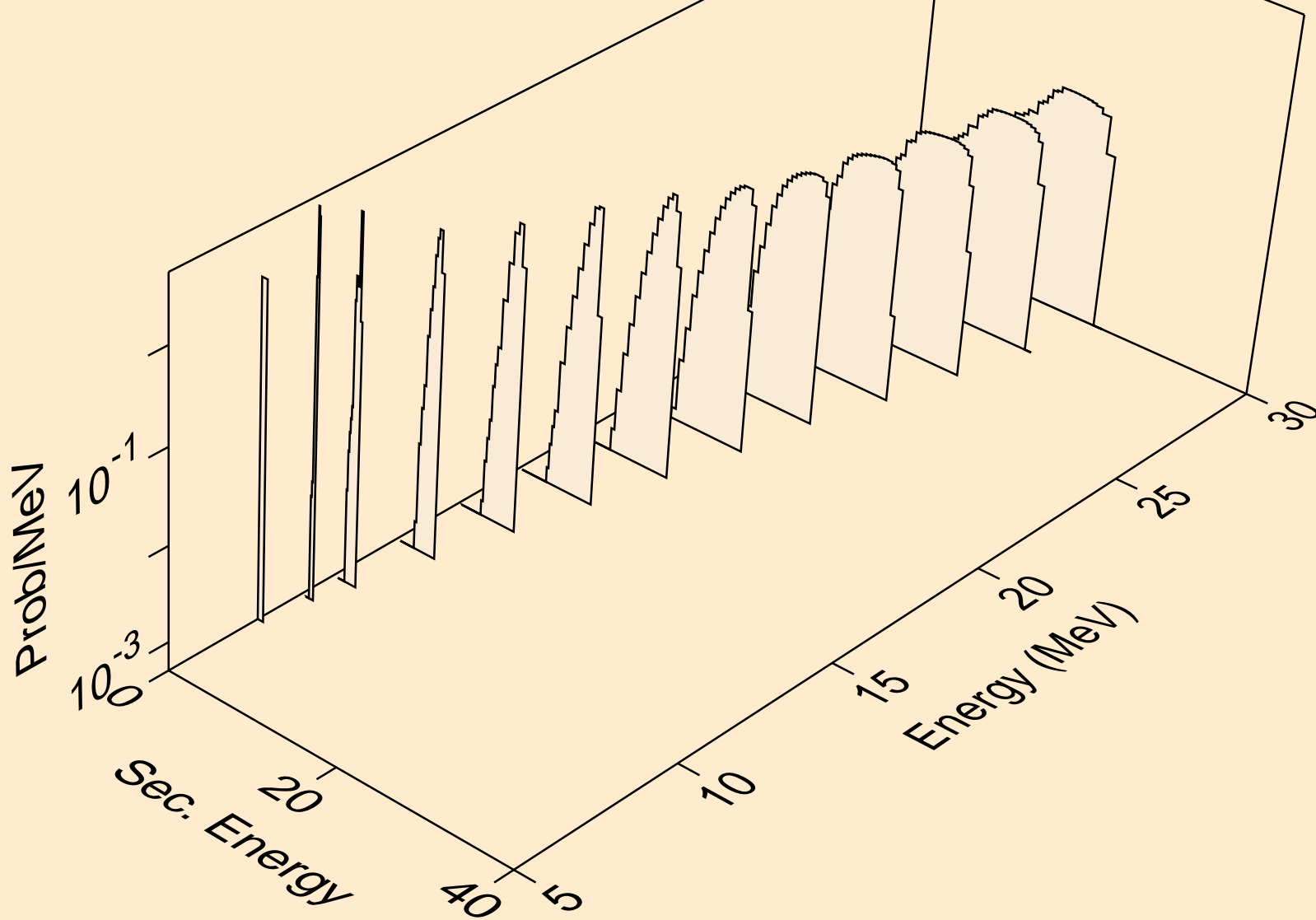

GD155 NEUTRON ACER TENDL-2019 LIBRARY; T=293.16K
protons from (n,2np)

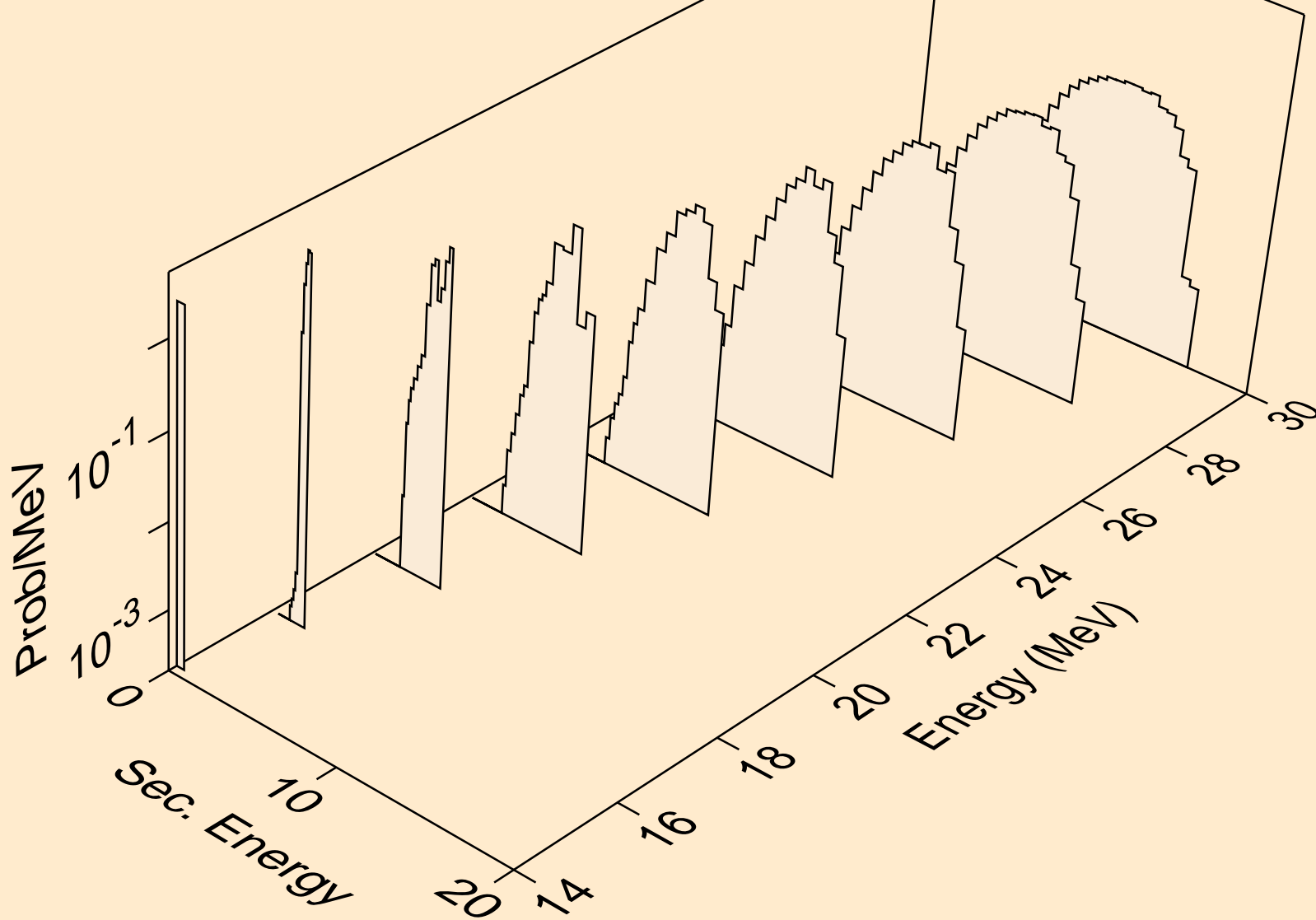

GD155 NEUTRON ACER TENDL-2019 LIBRARY; T=293.16K
protons from (n,3np)

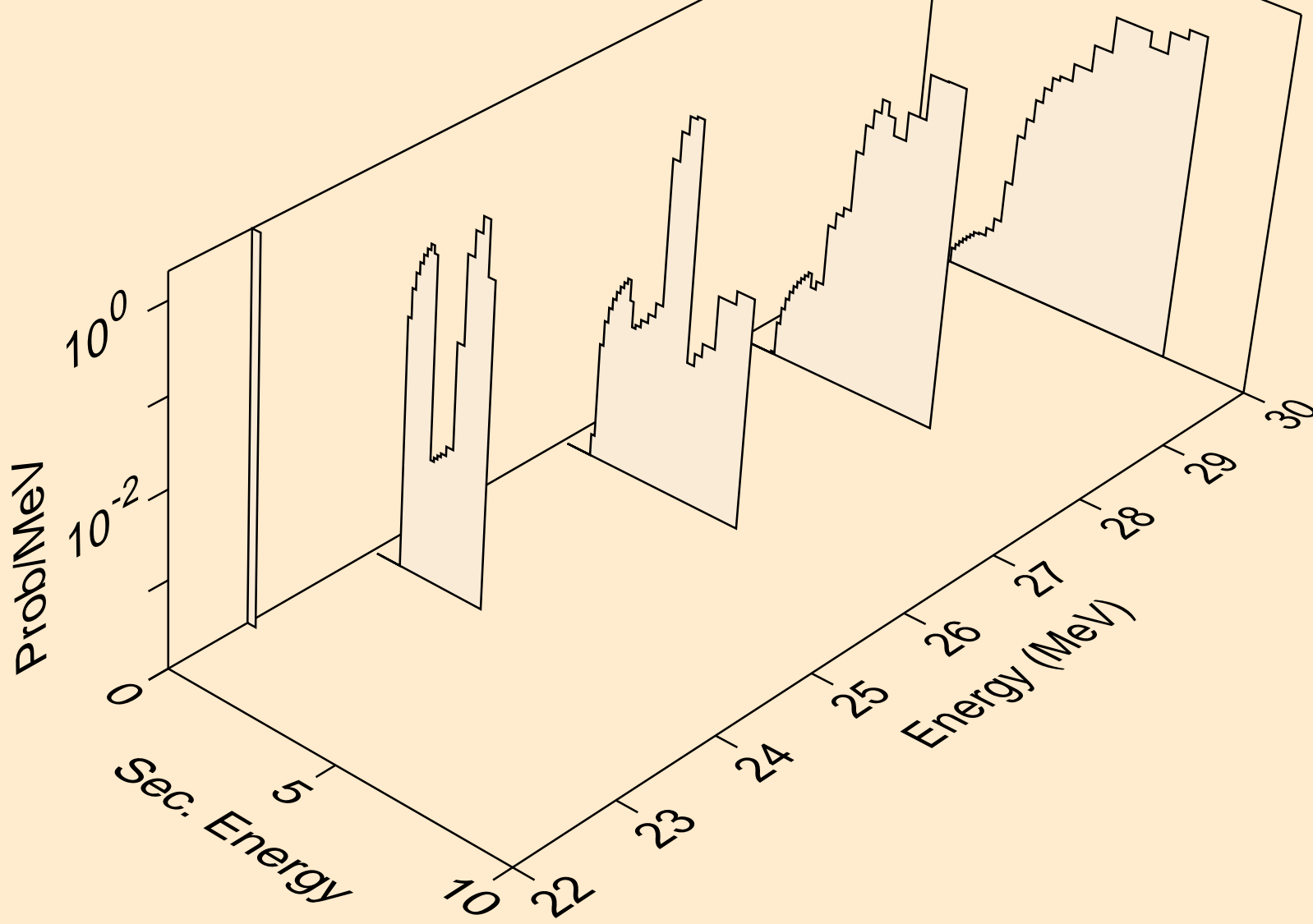

GD155 NEUTRON ACER TENDL-2019 LIBRARY; T=293.16K
protons from (n,2np)

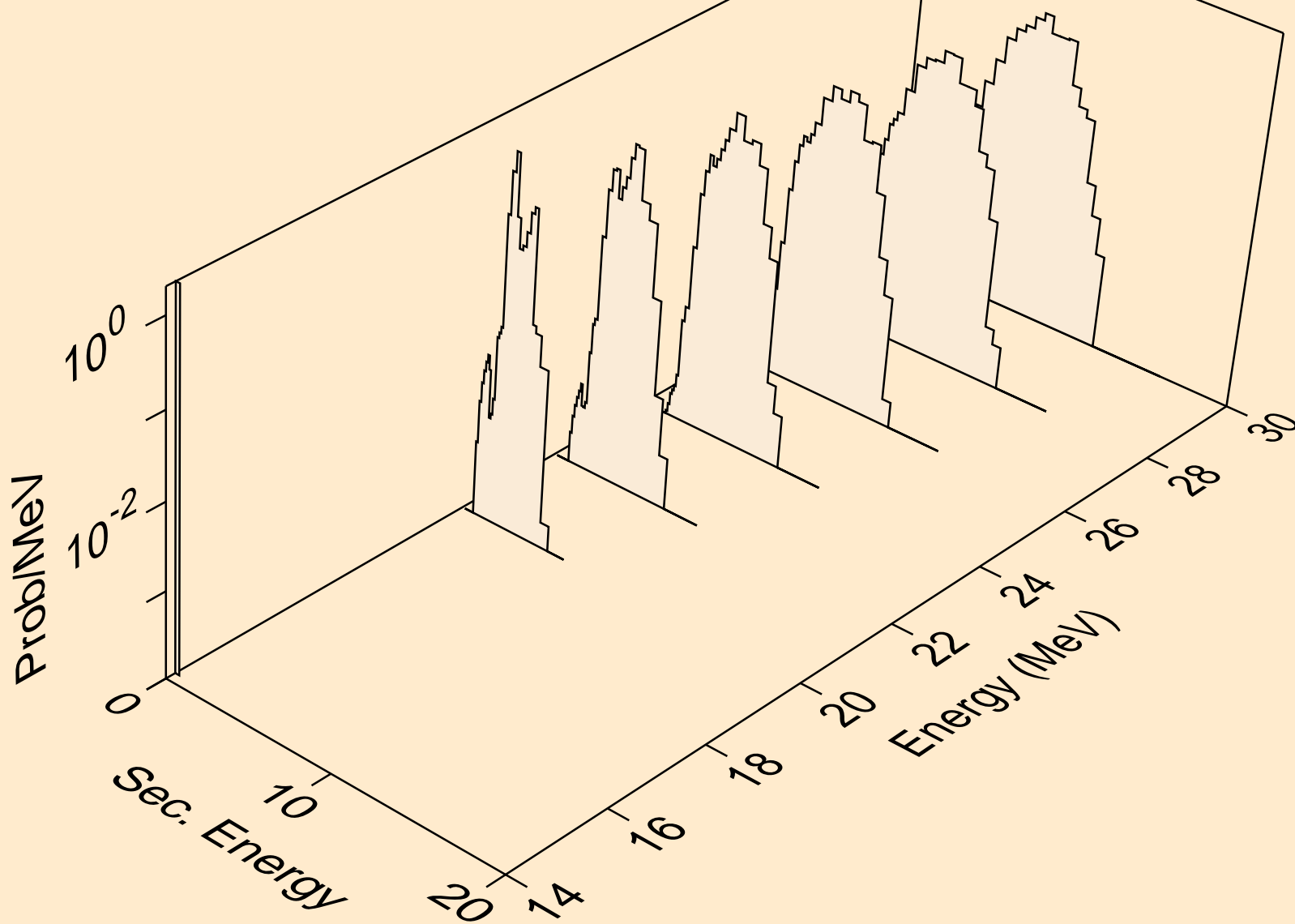

GD155 NEUTRON ACER TENDL-2019 LIBRARY; T=293.16K
protons from (n,npa)

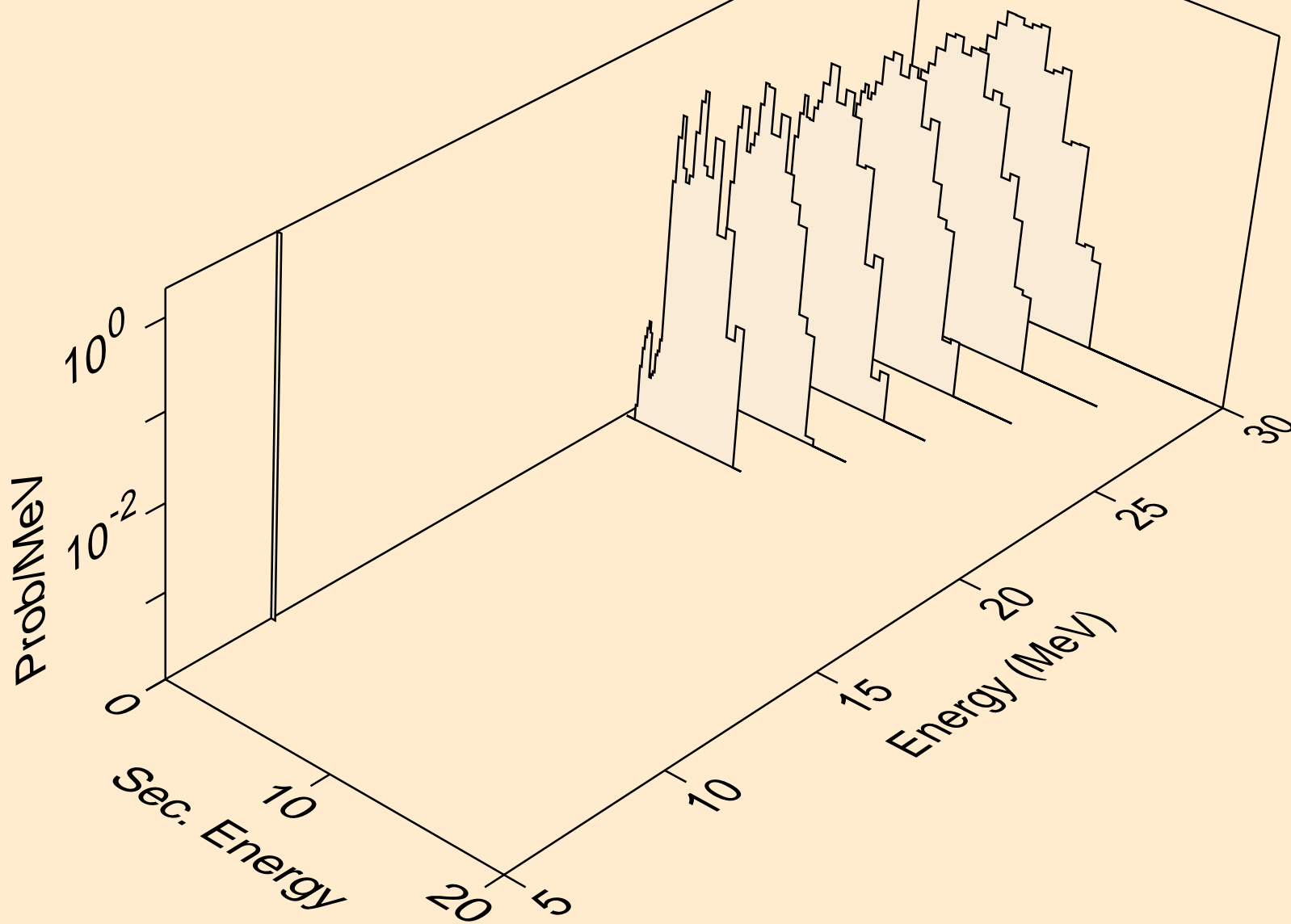

GD155 NEUTRON ACER TENDL-2019 LIBRARY; T=293.16K
protons from (n,p)

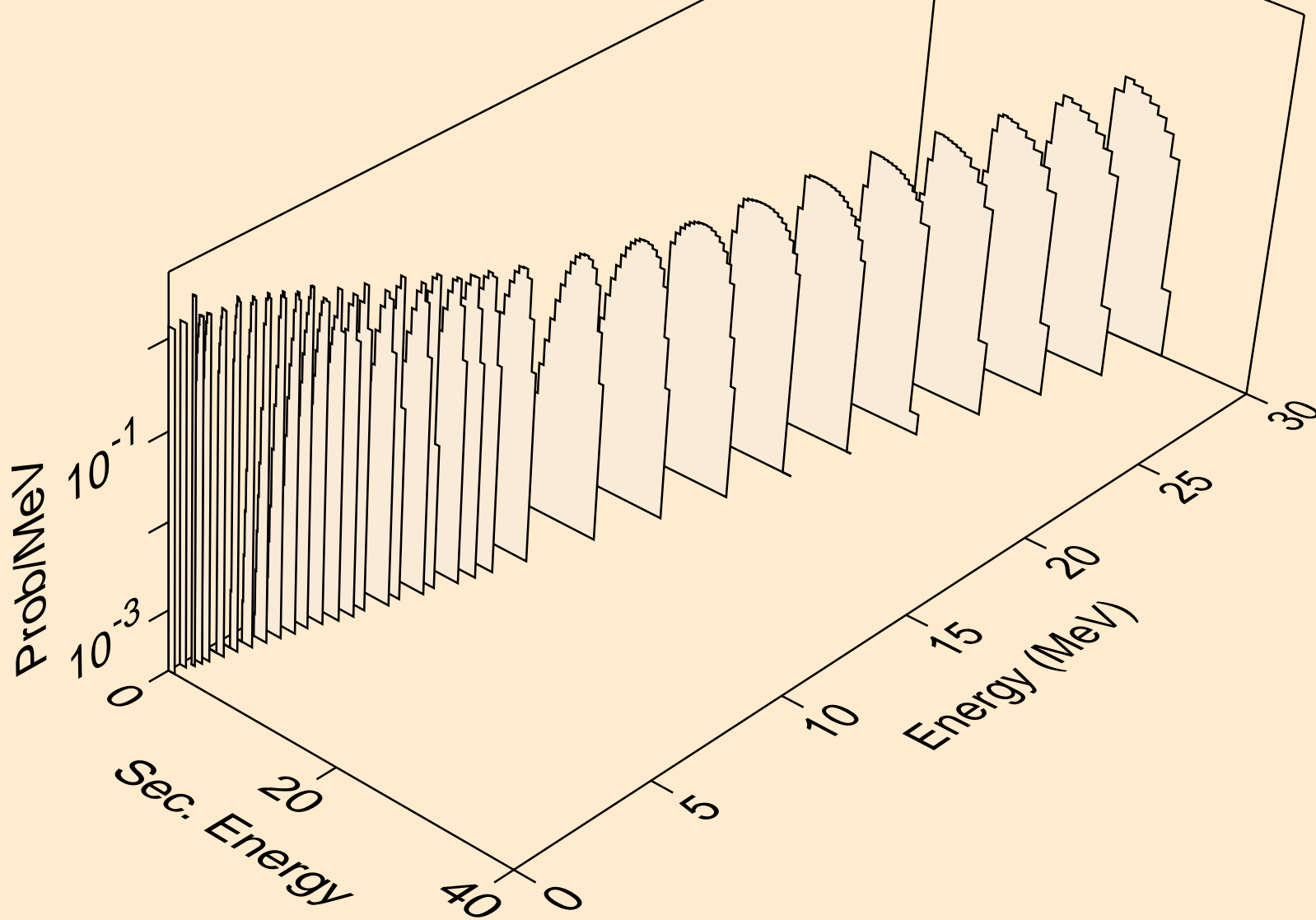

GD155 NEUTRON ACER TENDL-2019 LIBRARY; T=293.16K
protons from (n,2p)

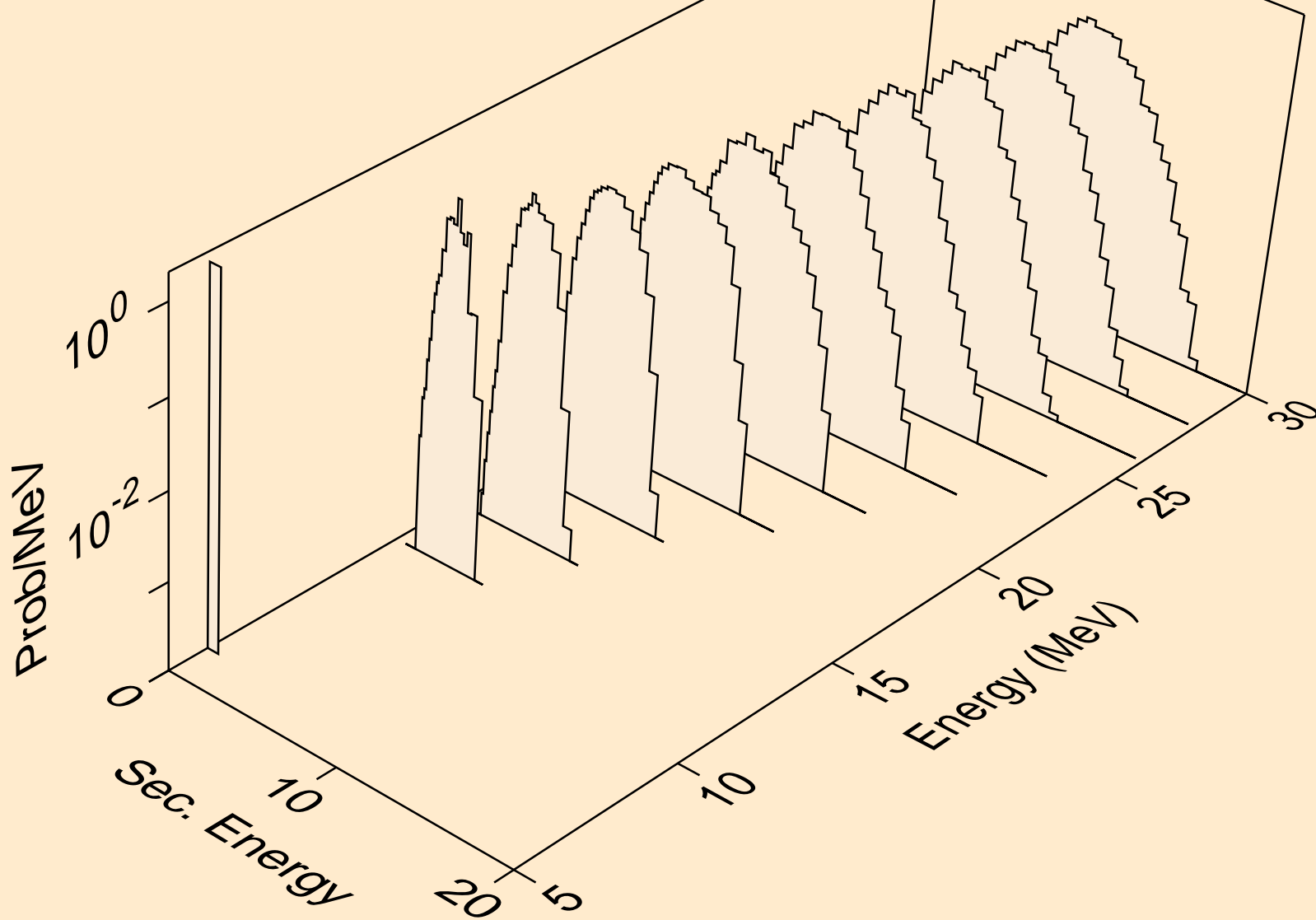

GD155 NEUTRON ACER TENDL-2019 LIBRARY; T=293.16K
protons from (n,p)

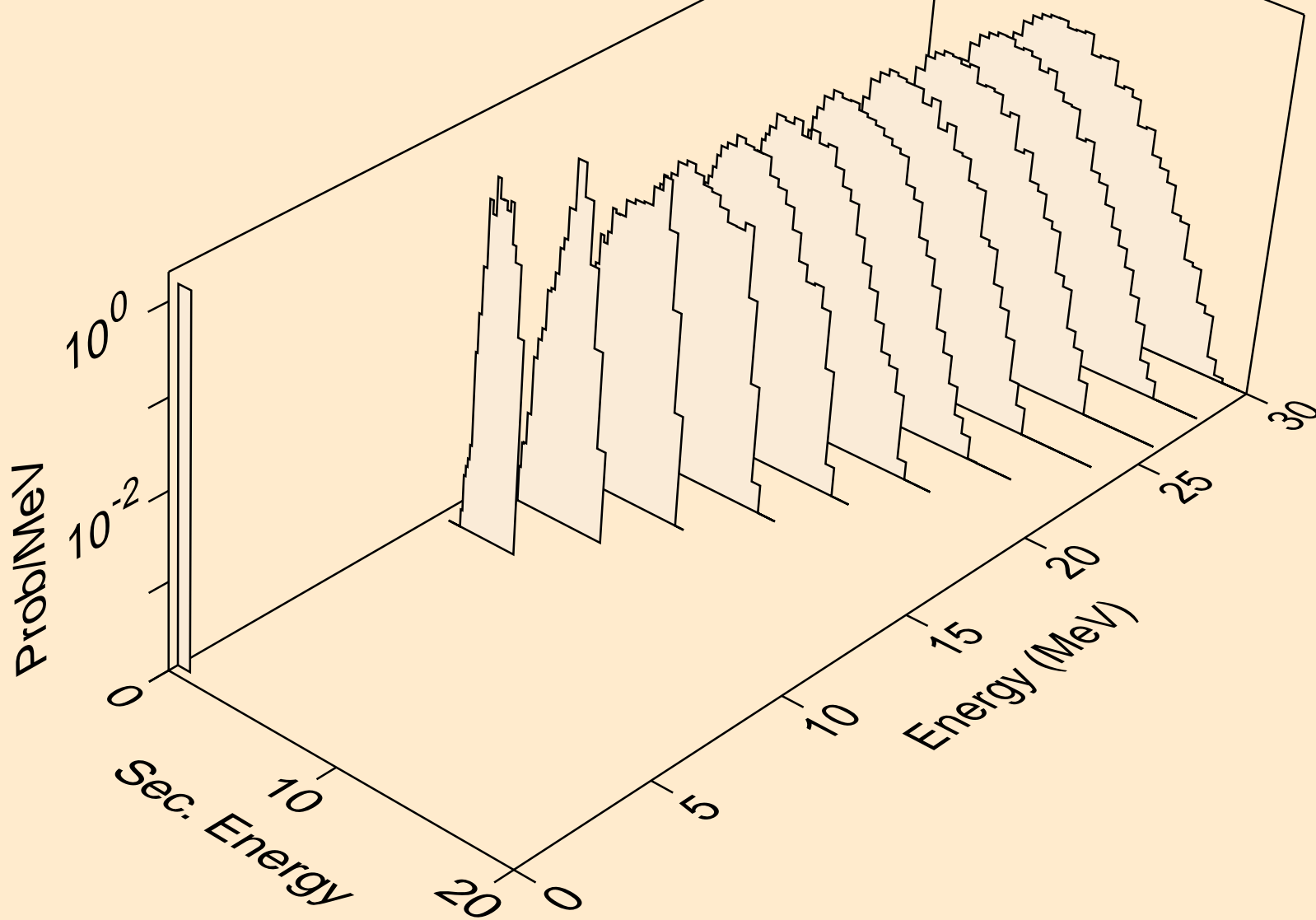

GD155 NEUTRON ACER TENDL-2019 LIBRARY; T=293.16K
protons from (n,pd)

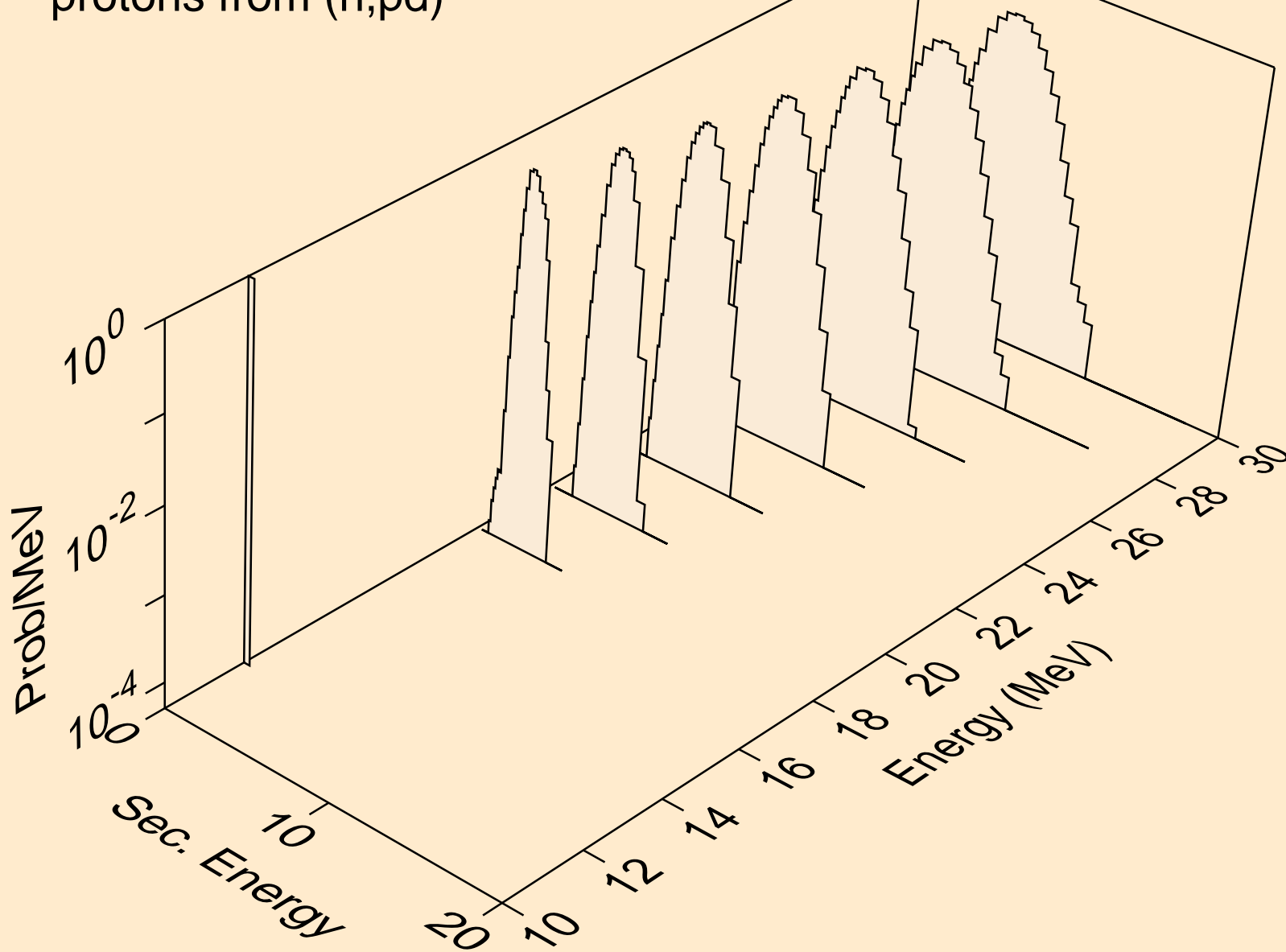

GD155 NEUTRON ACER TENDL-2019 LIBRARY; T=293.16K
protons from (n,pt)

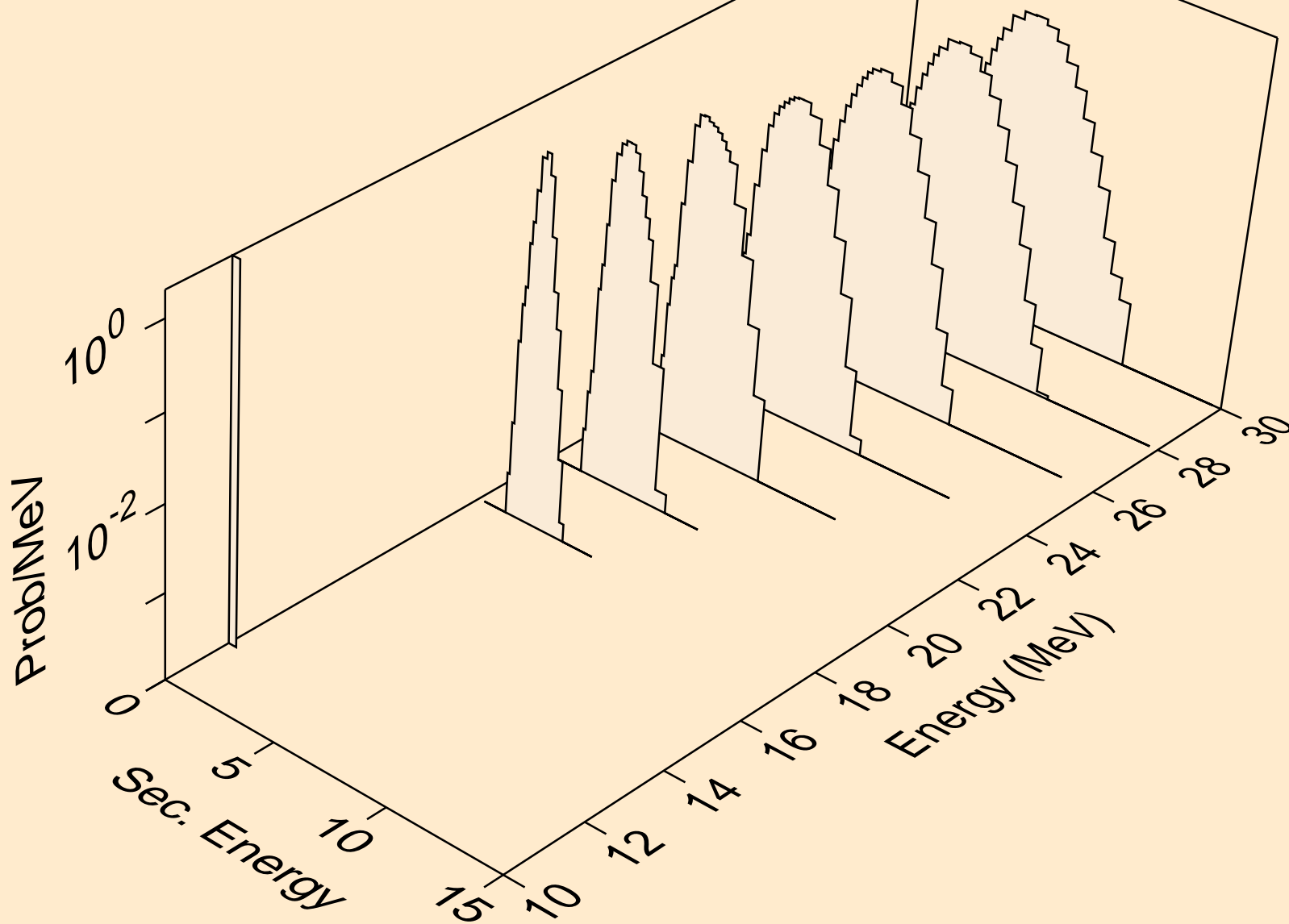

GD155 NEUTRON ACER TENDL-2019 LIBRARY; T=293.16K
deuterons from (n,x)

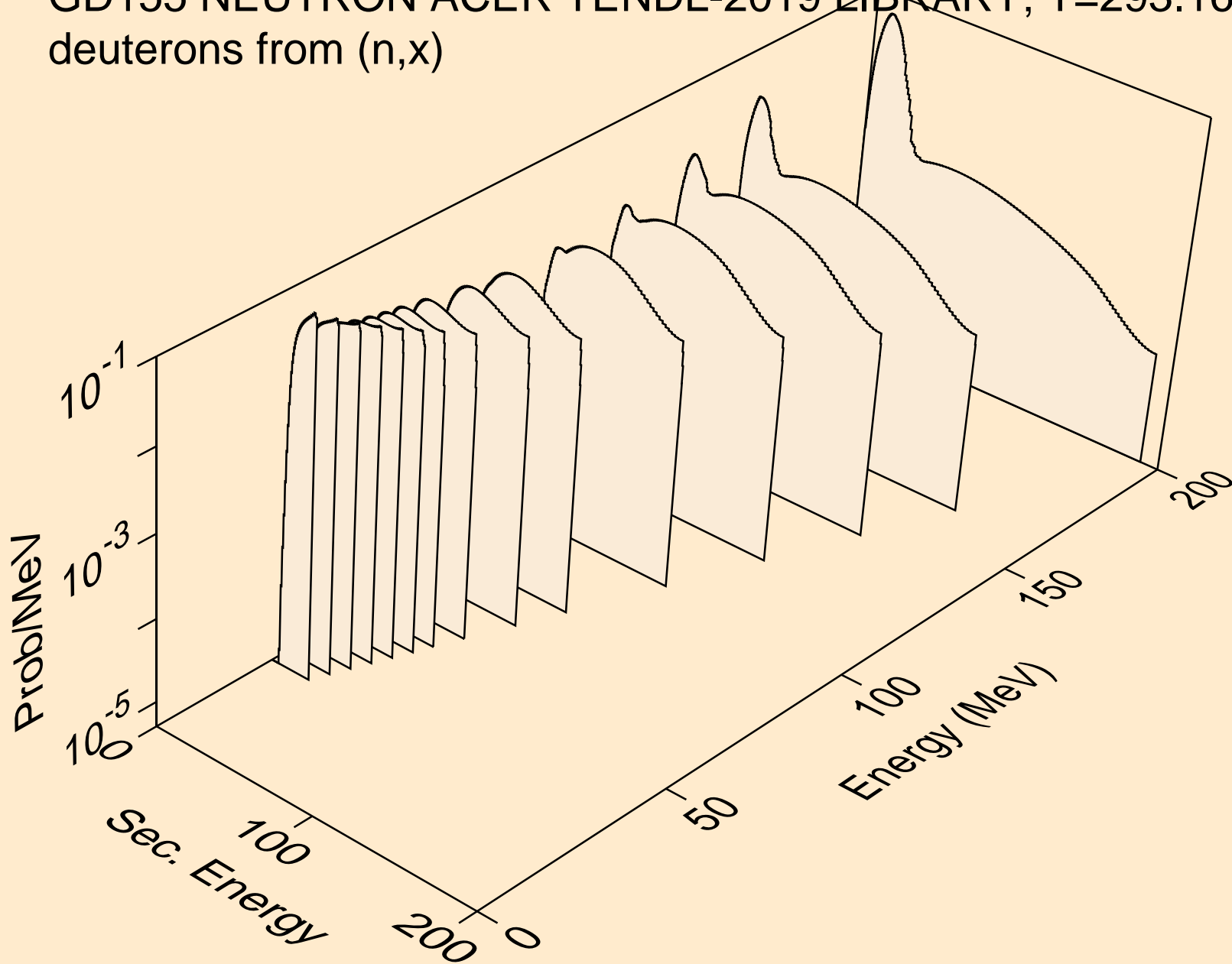

GD155 NEUTRON ACER TENDL-2019 LIBRARY; T=293.16K
deuterons from (n,2nd)

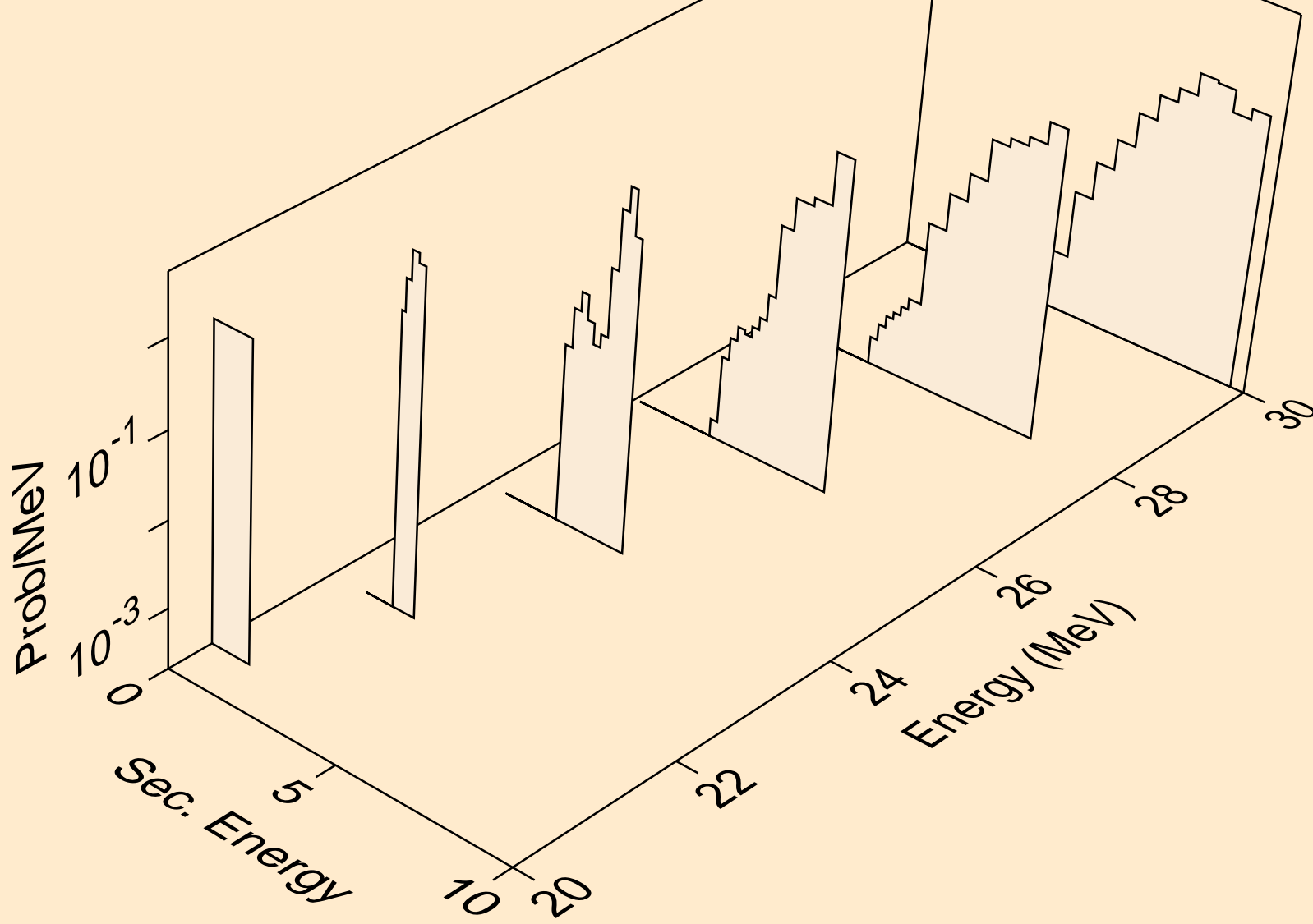

GD155 NEUTRON ACER TENDL-2019 LIBRARY; T=293.16K
deuterons from (n,n*)d

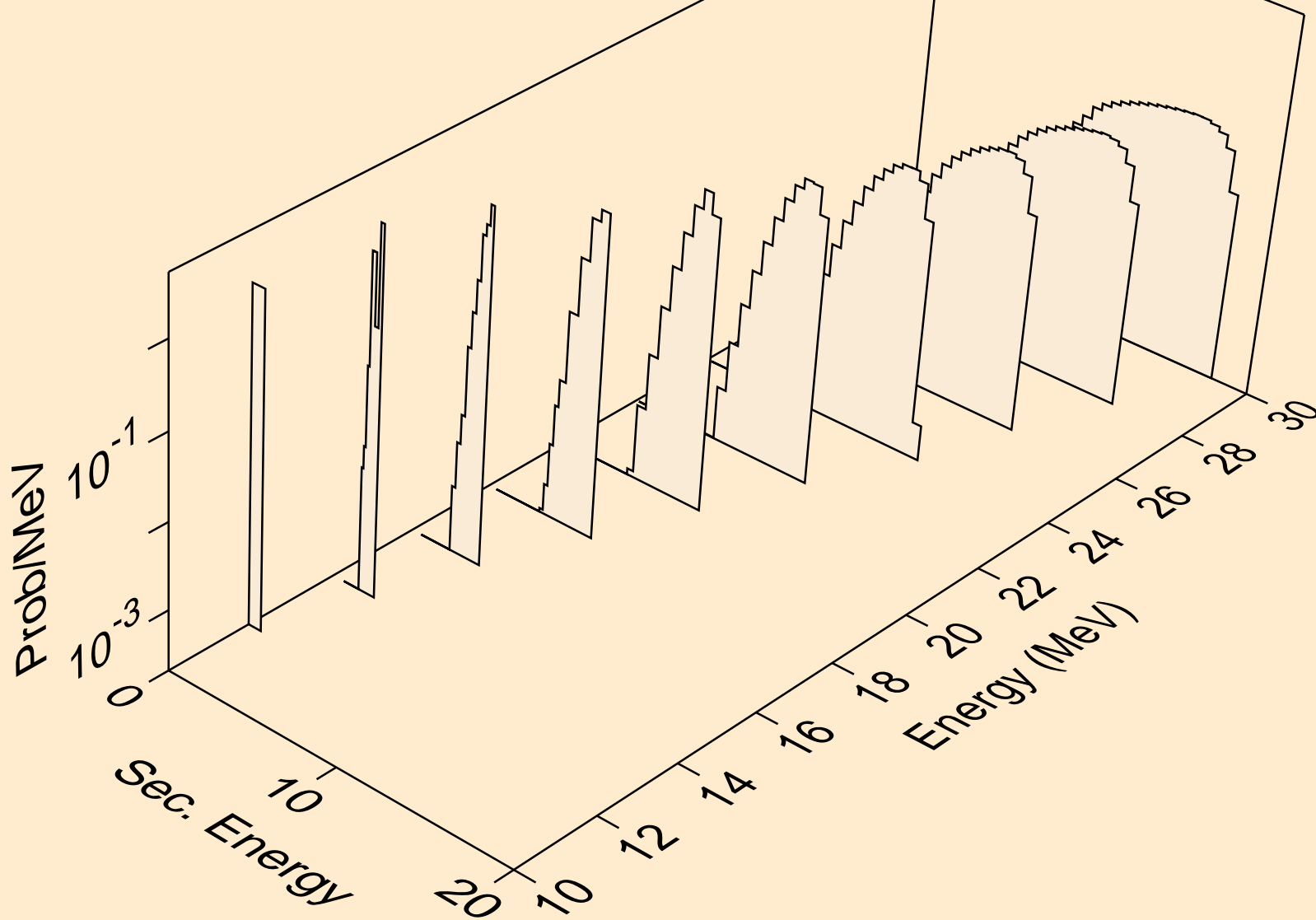

GD155 NEUTRON ACER TENDL-2019 LIBRARY; T=293.16K
deuterons from (n,d)

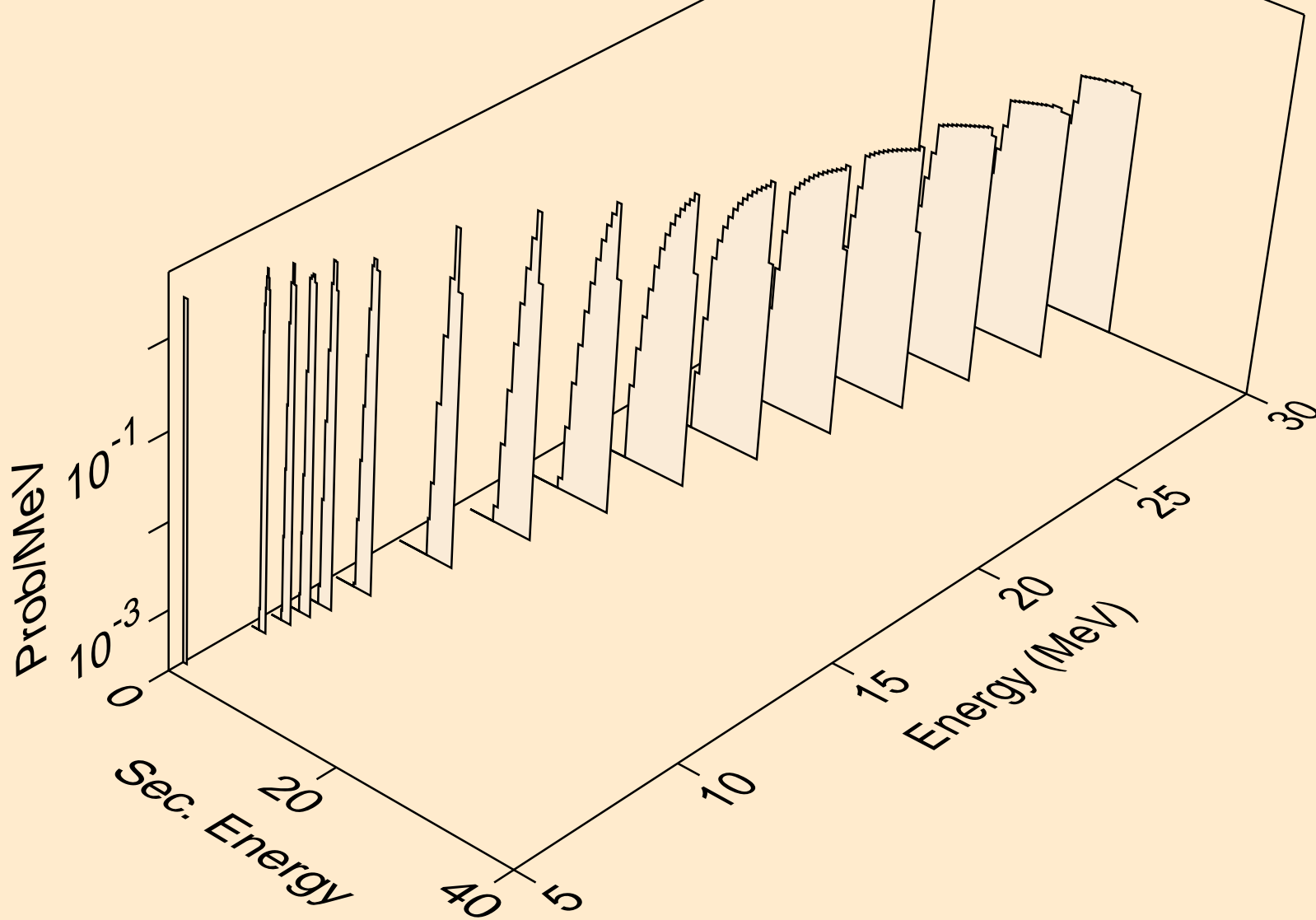

GD155 NEUTRON ACER TENDL-2019 LIBRARY; T=293.16K
deuterons from (n,pd)

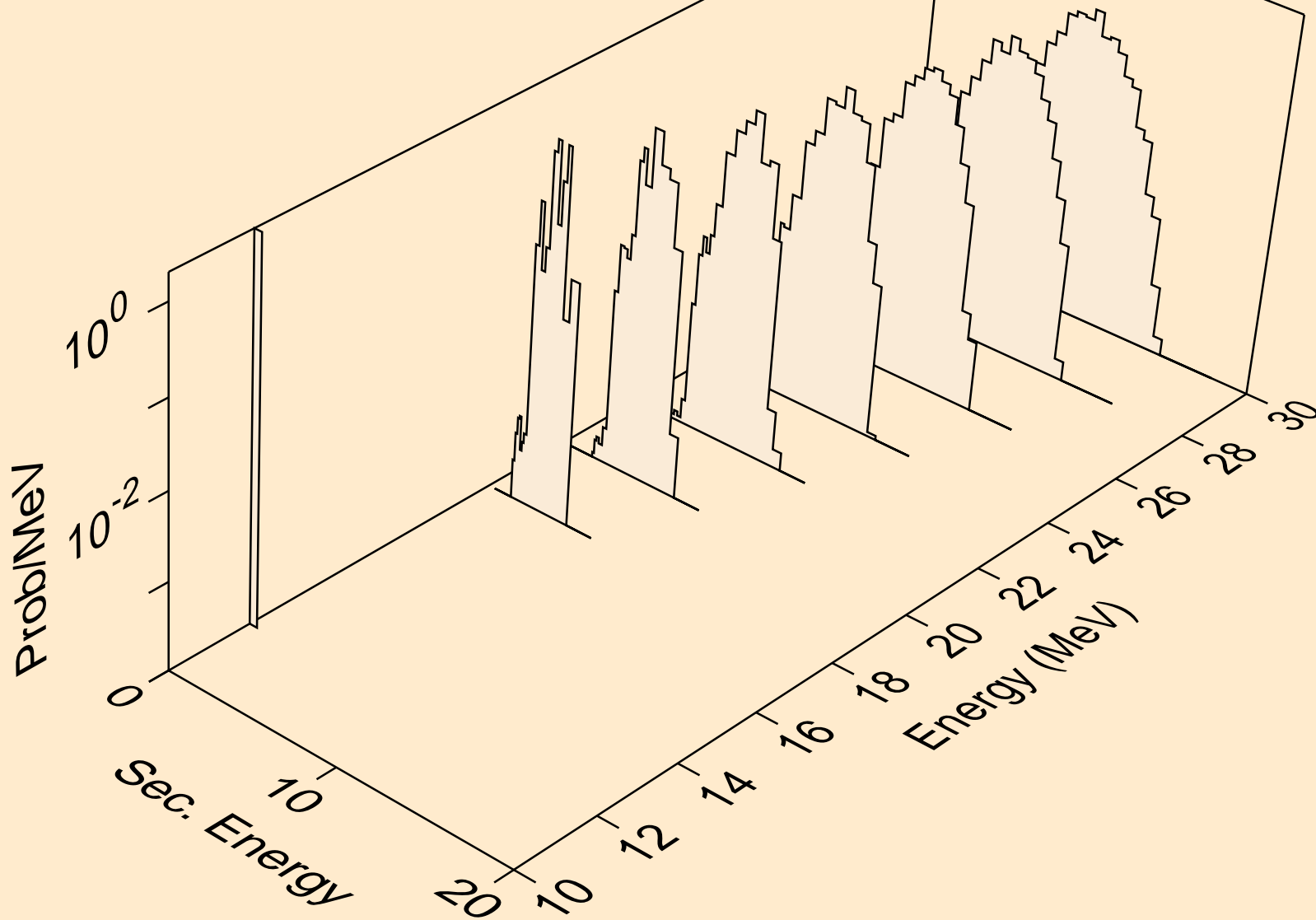

GD155 NEUTRON ACER TENDL-2019 LIBRARY; T=293.16K
deuterons from (n,da)

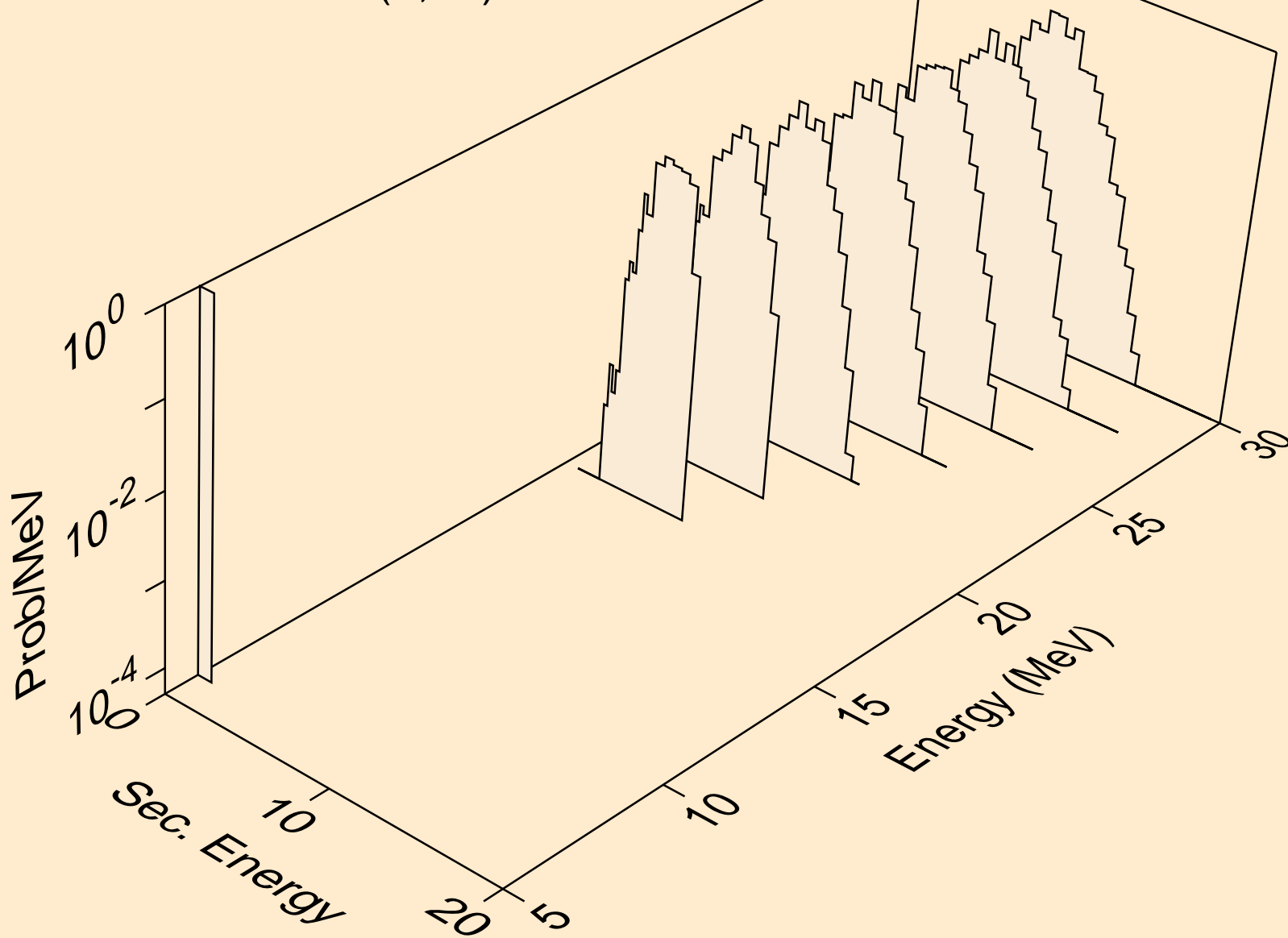

GD155 NEUTRON ACER TENDL-2019 LIBRARY; T=293.16K
tritons from (n,x)

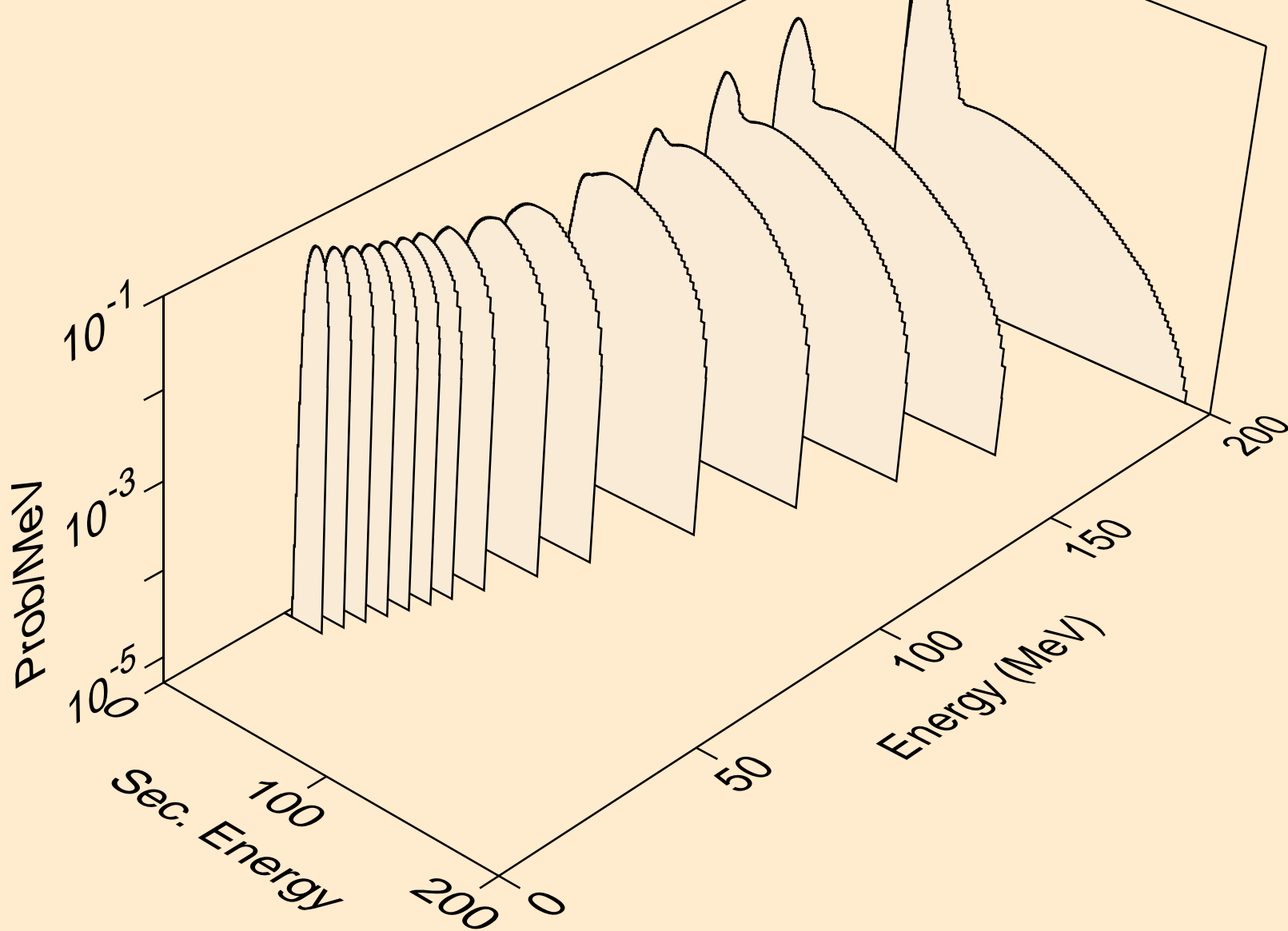

GD155 NEUTRON ACER TENDL-2019 LIBRARY; T=293.16K
tritons from (n,n*)t

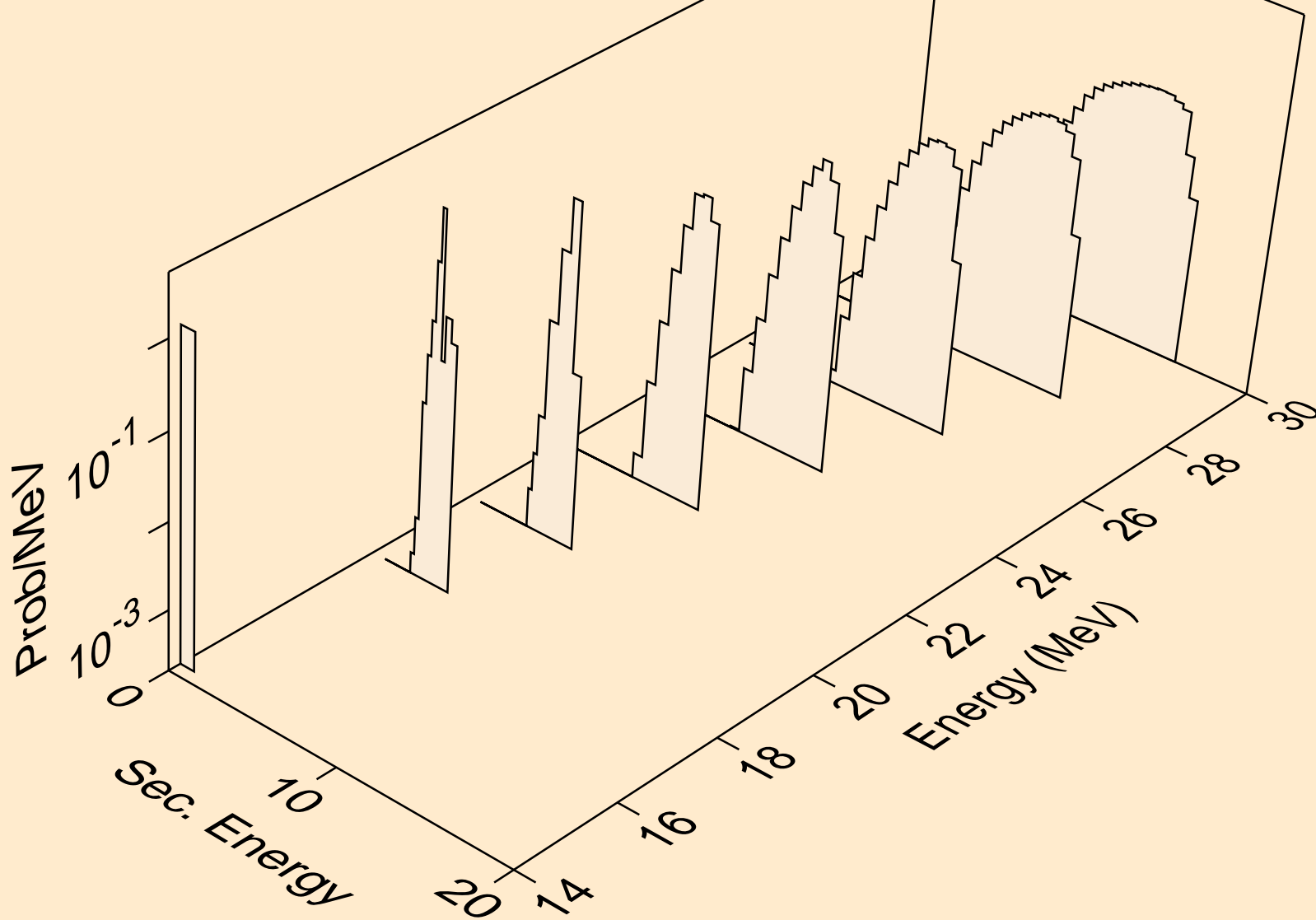

GD155 NEUTRON ACER TENDL-2019 LIBRARY; T=293.16K
tritons from (n,t)

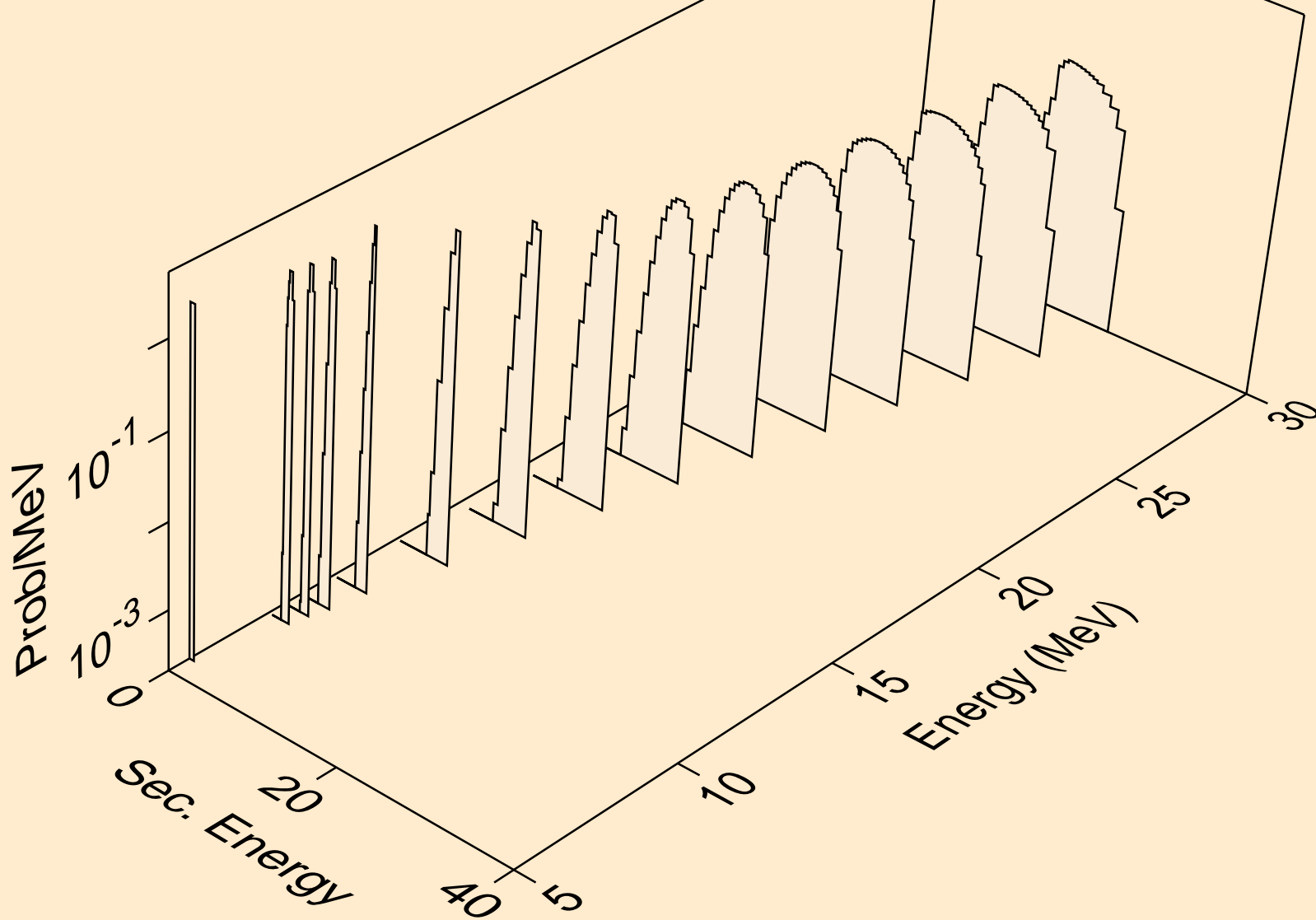

GD155 NEUTRON ACER TENDL-2019 LIBRARY; T=293.16K
tritons from (n,pt)

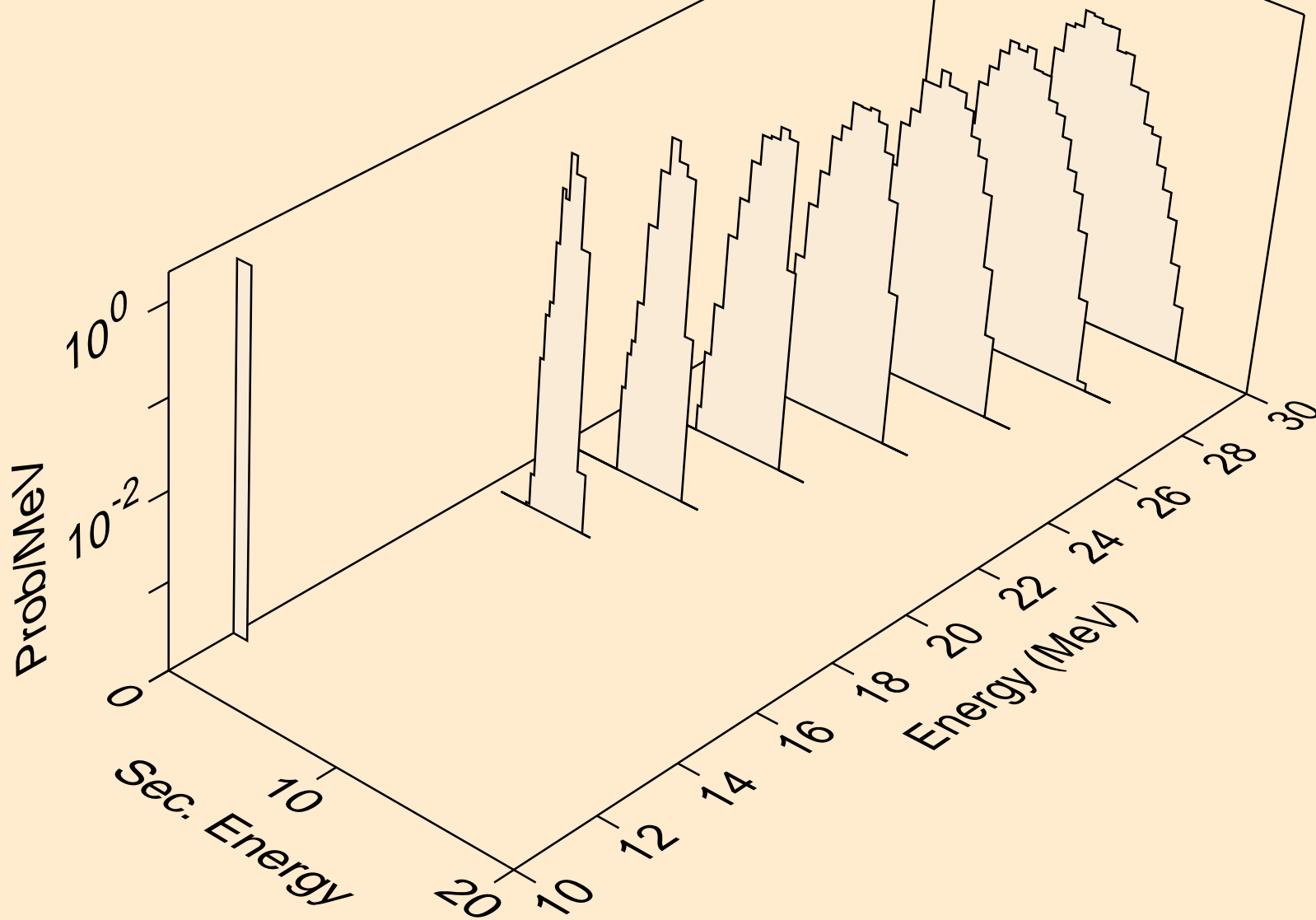

GD155 NEUTRON ACER TENDL-2019 LIBRARY; T=293.16K
he3s from (n,x)

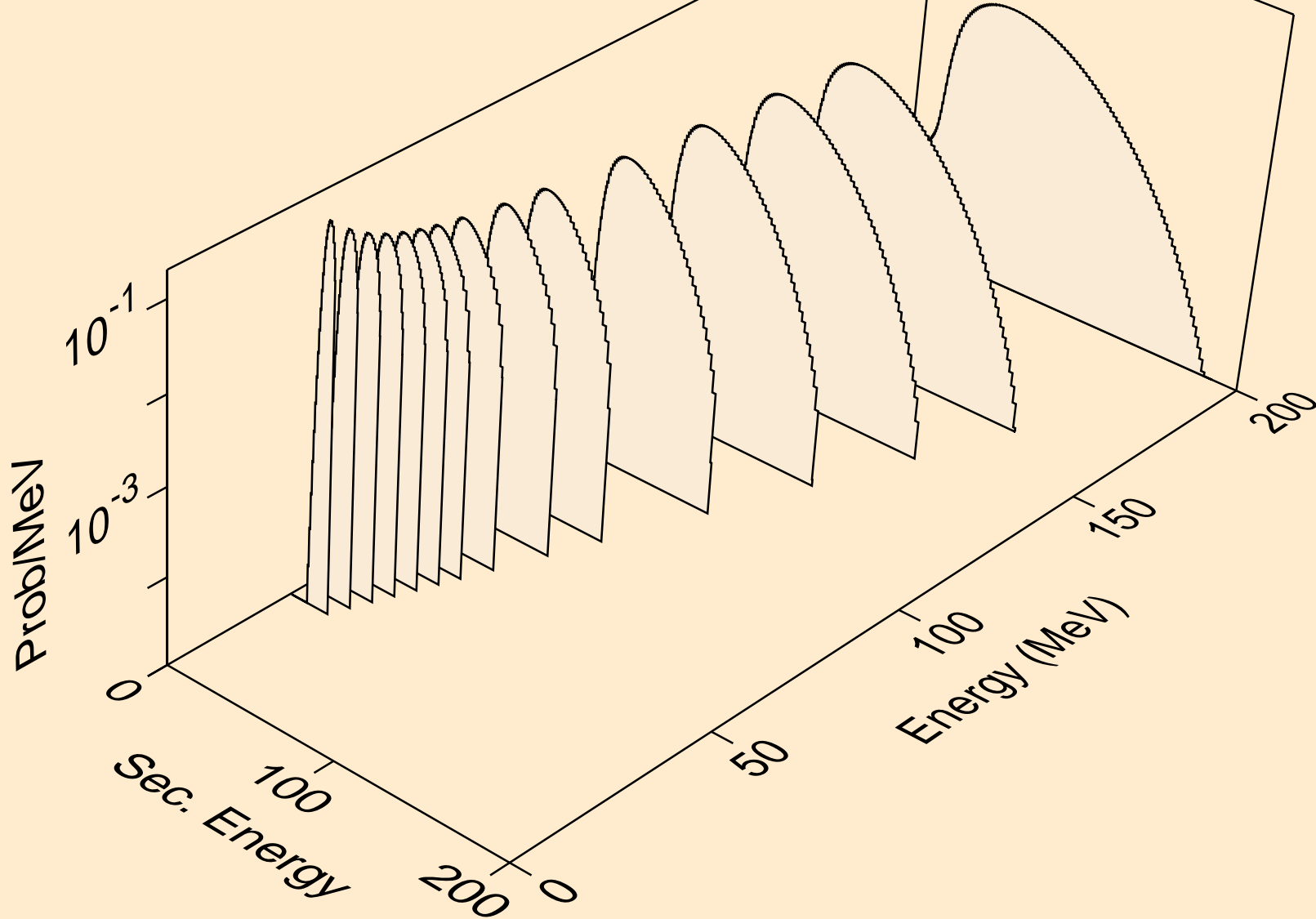

GD155 NEUTRON ACER TENDL-2019 LIBRARY; T=293.16K
he3s from (n,n*)he3

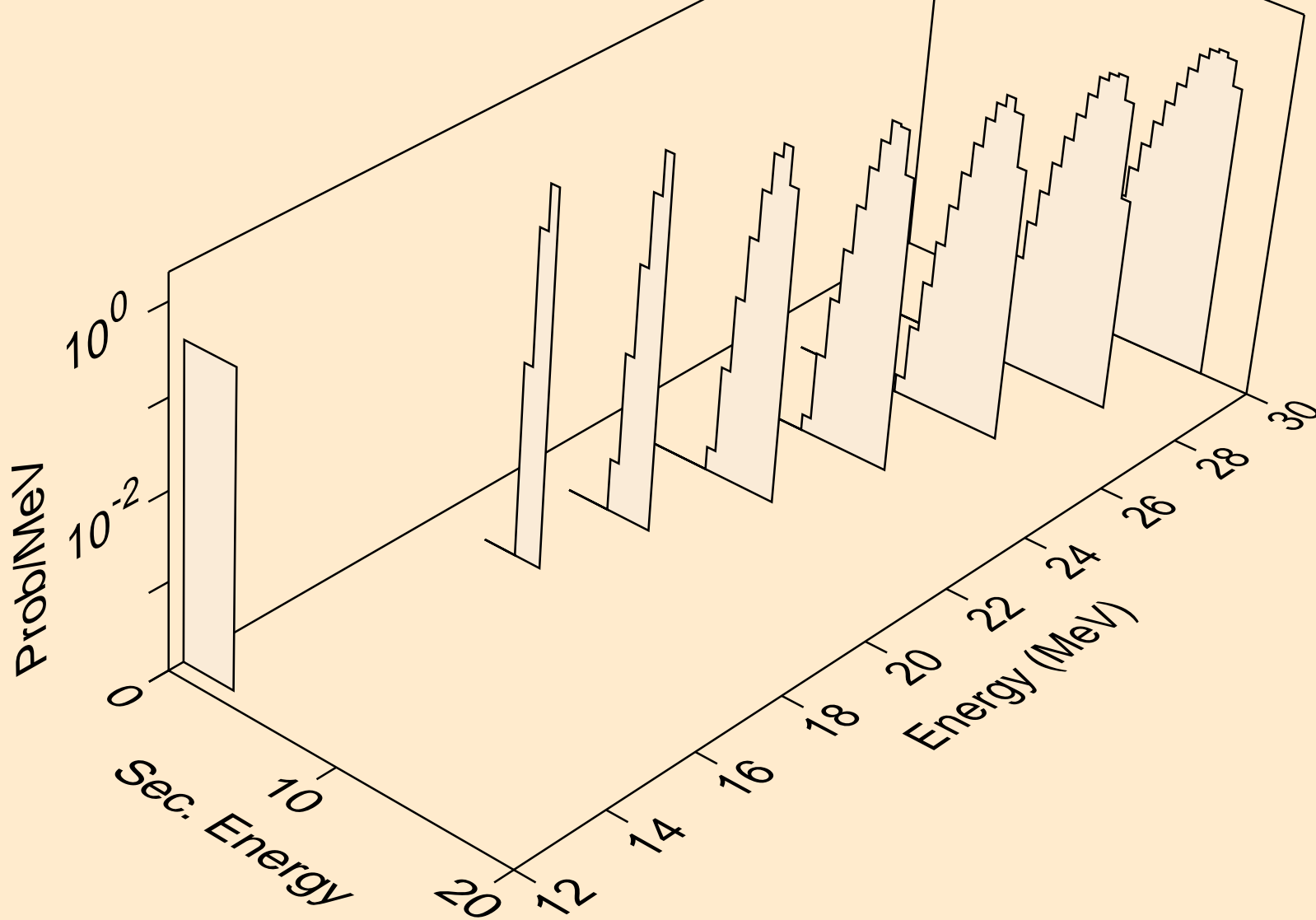

GD155 NEUTRON ACER TENDL-2019 LIBRARY; T=293.16K
he3s from (n,he3)

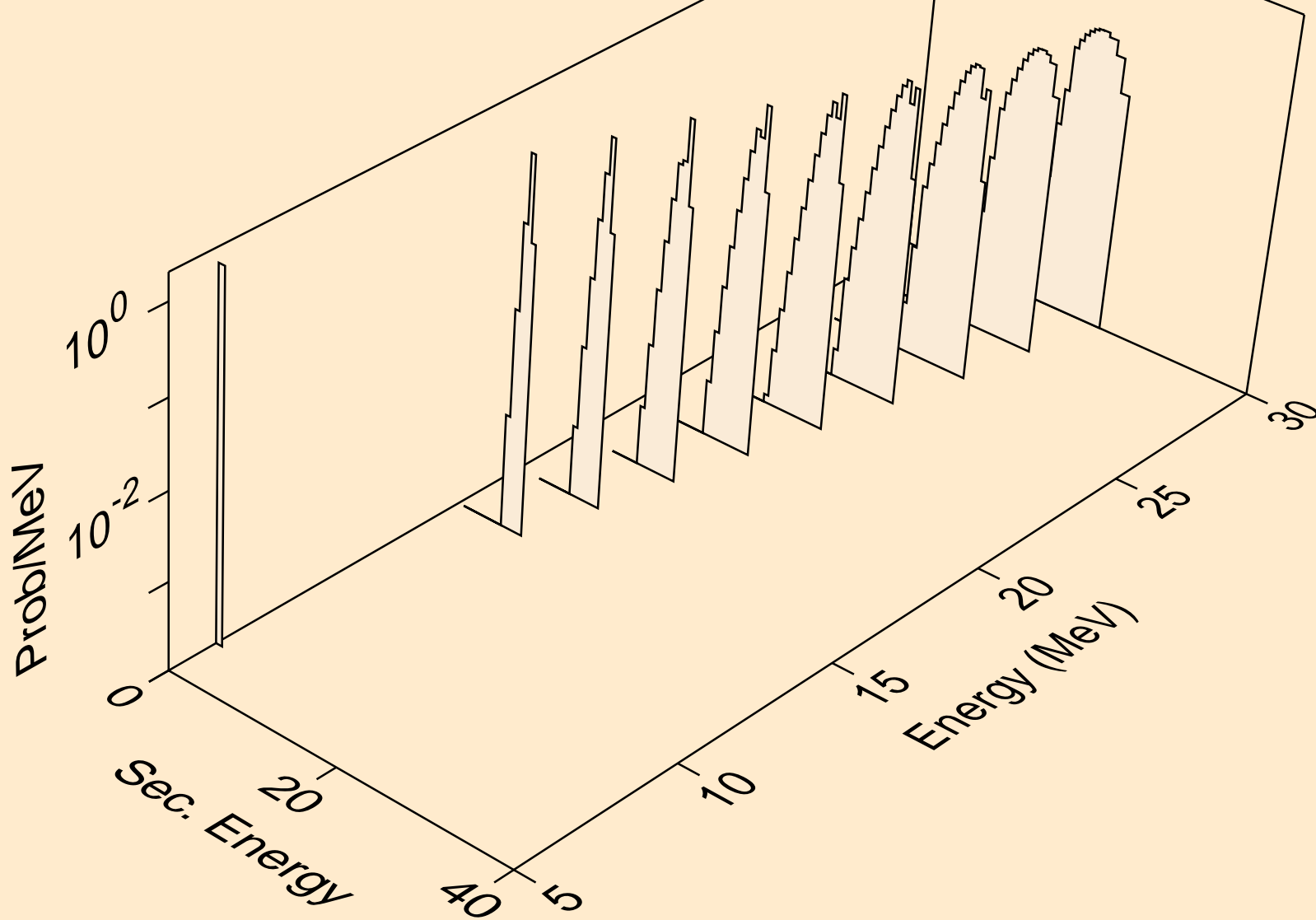

GD155 NEUTRON ACER TENDL-2019 LIBRARY; T=293.16K
alphas from (n,x)

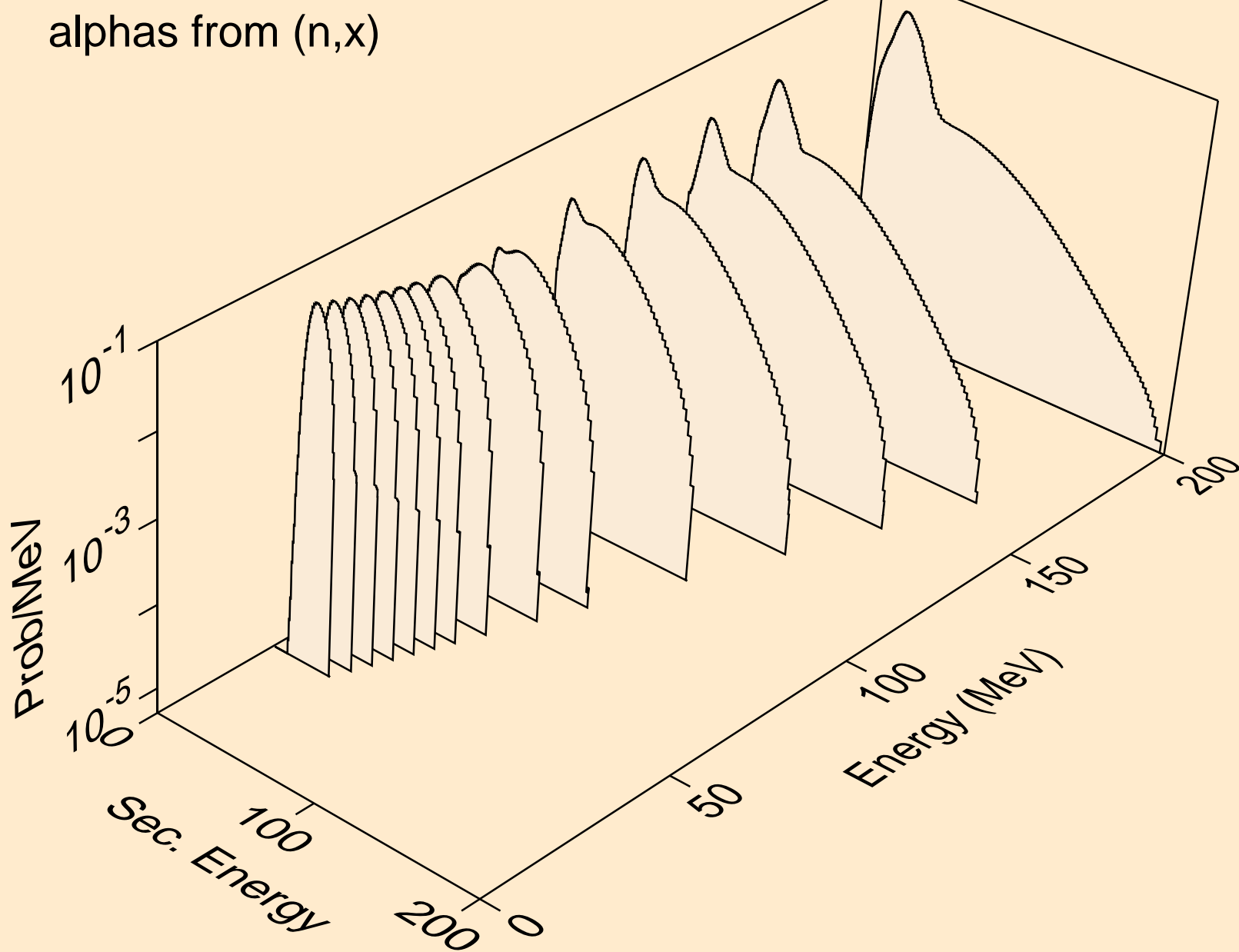

GD155 NEUTRON ACER TENDL-2019 LIBRARY; T=293.16K
alphas from (n,n*)a

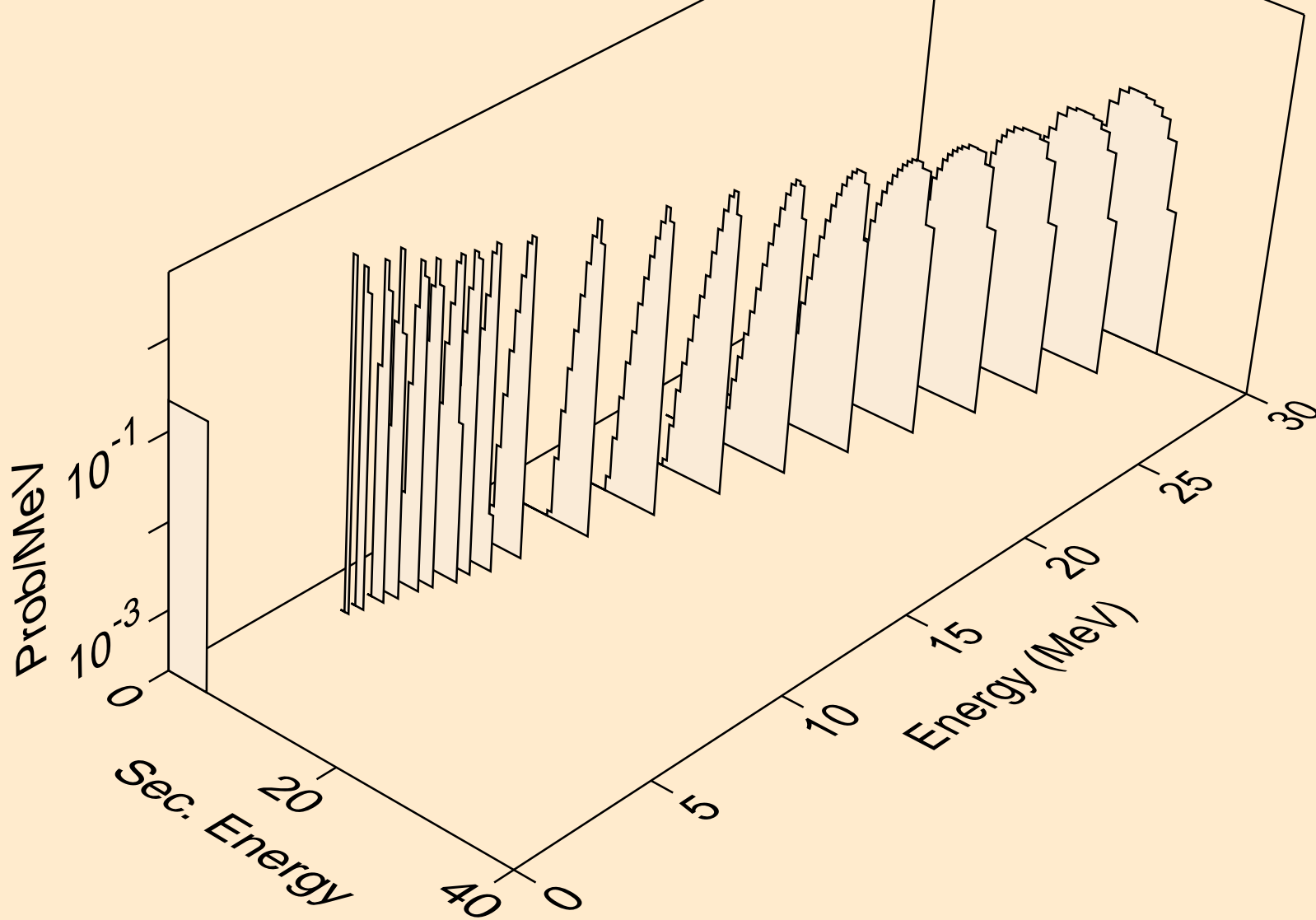

GD155 NEUTRON ACER TENDL-2019 LIBRARY; T=293.16K
alphas from (n,2n)a

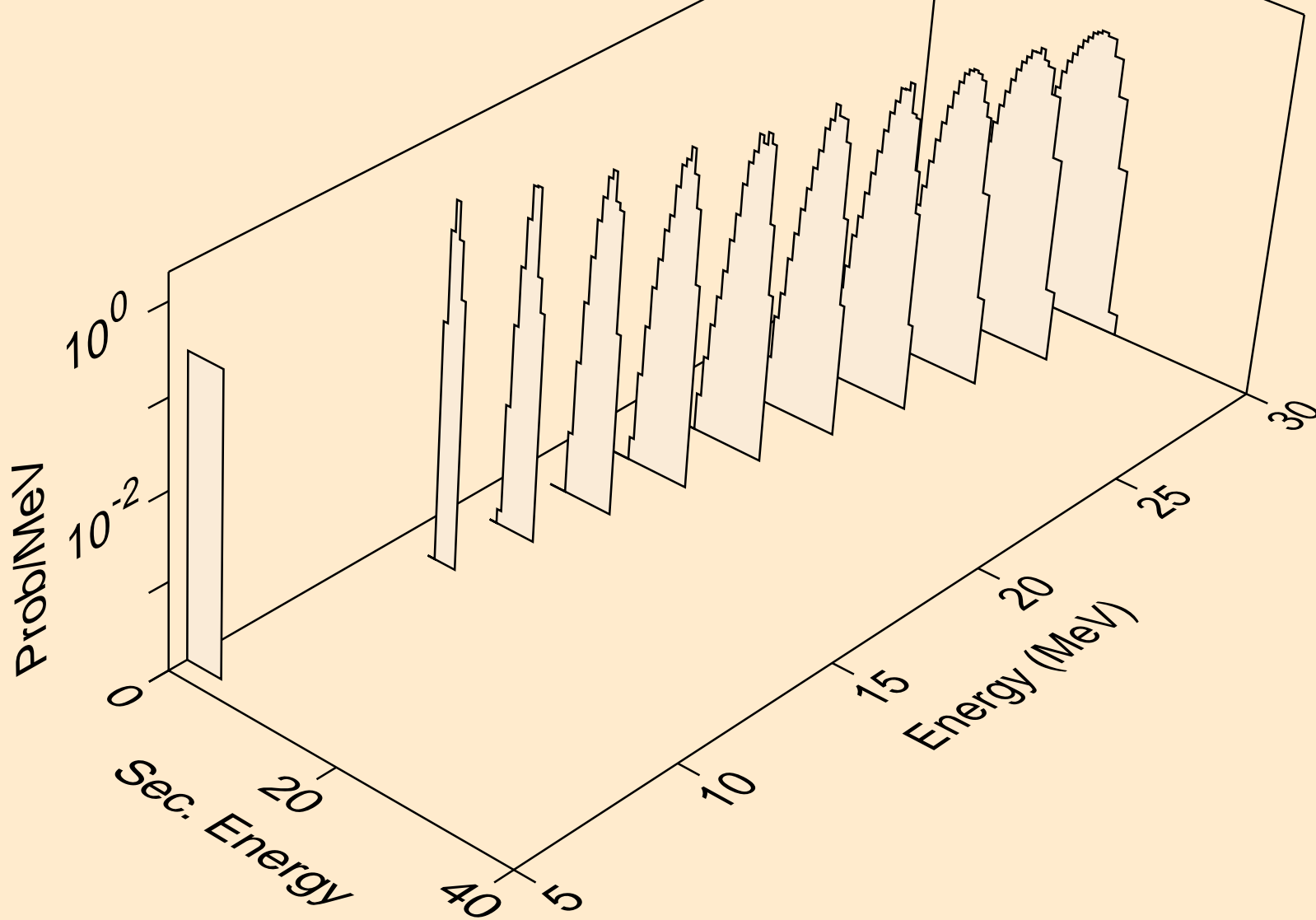

GD155 NEUTRON ACER TENDL-2019 LIBRARY; T=293.16K
alphas from (n,3n)a

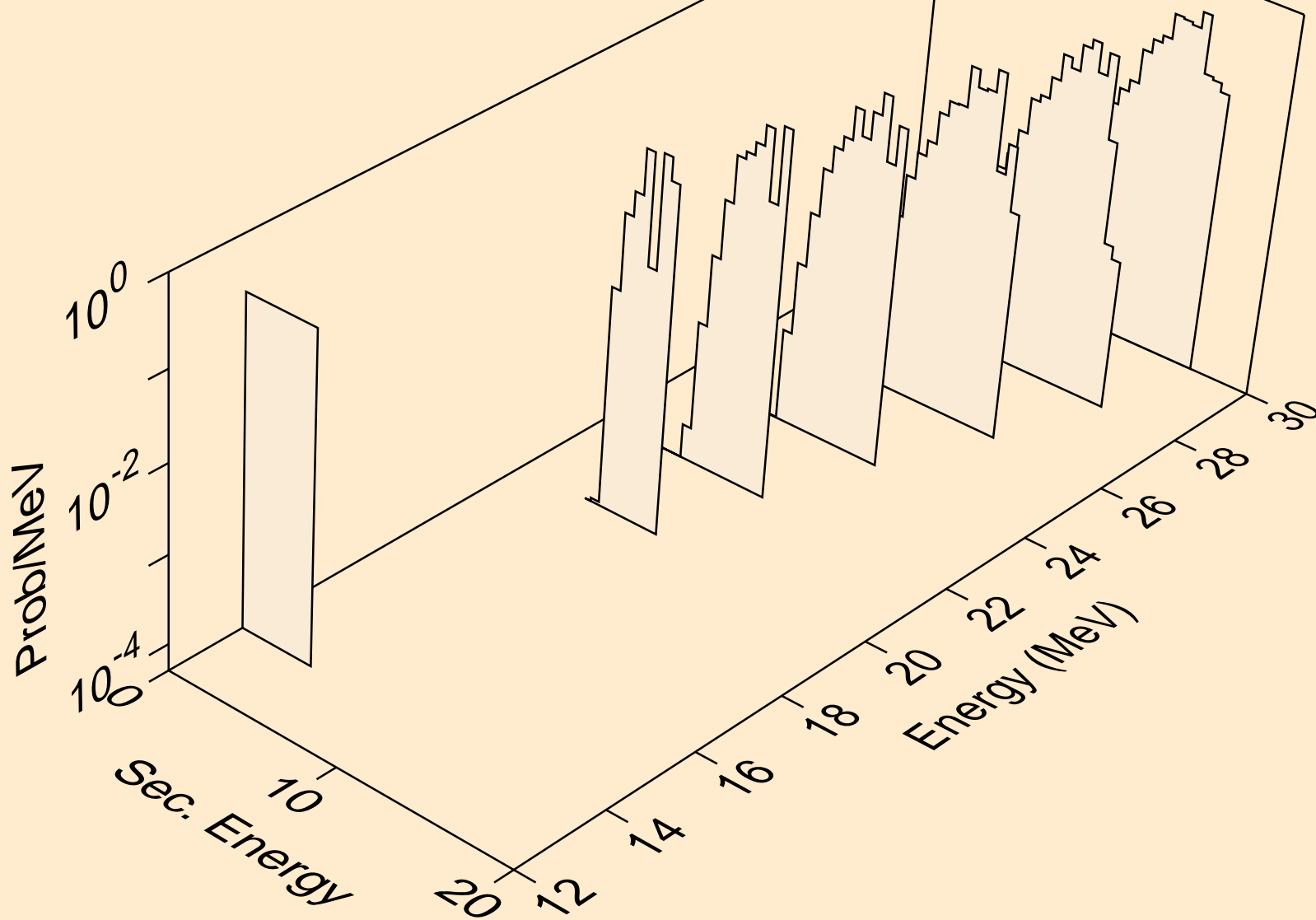

GD155 NEUTRON ACER TENDL-2019 LIBRARY; T=293.16K
alphas from (n,n*)2a

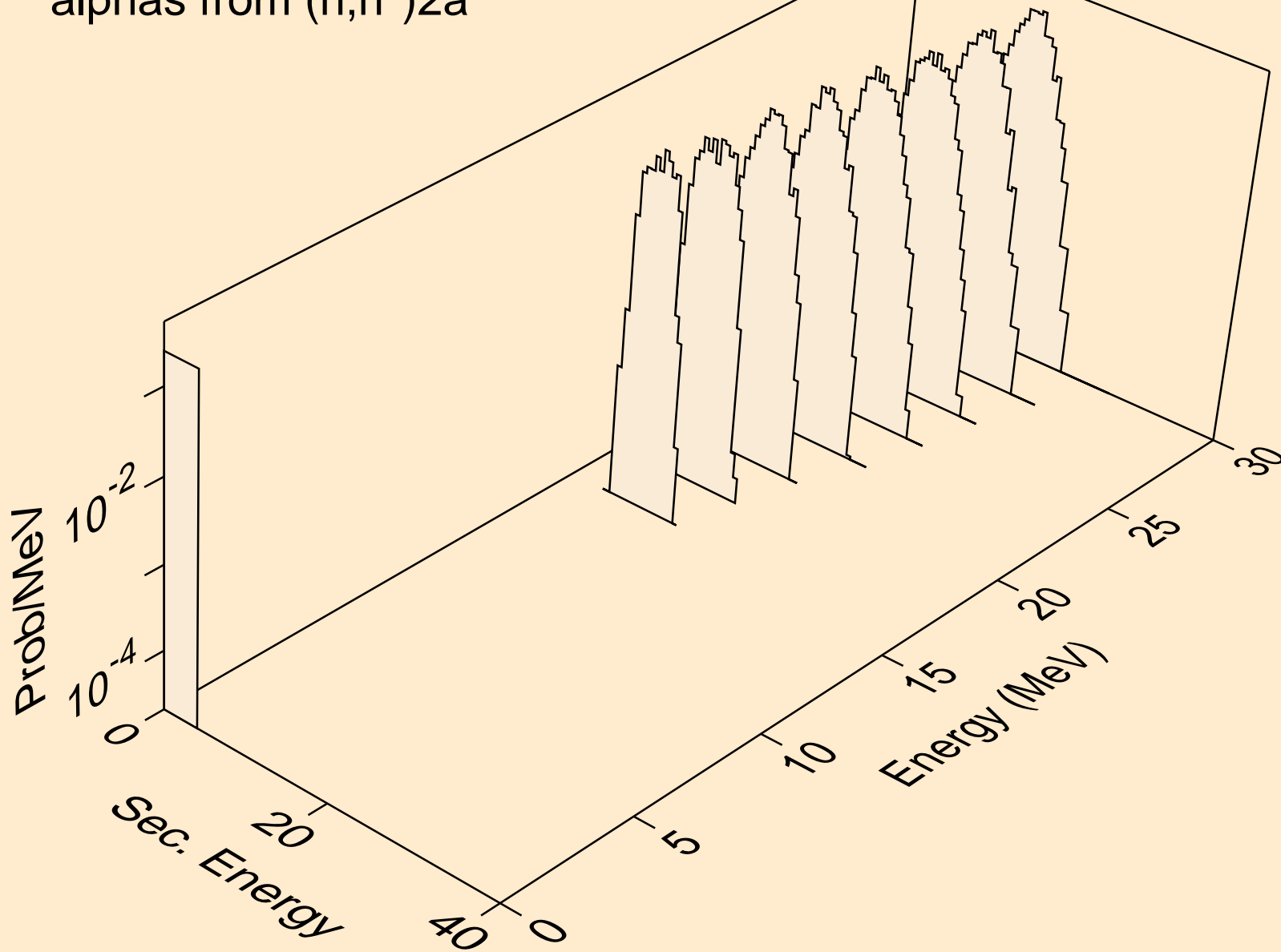

GD155 NEUTRON ACER TENDL-2019 LIBRARY; T=293.16K
alphas from (n,npa)

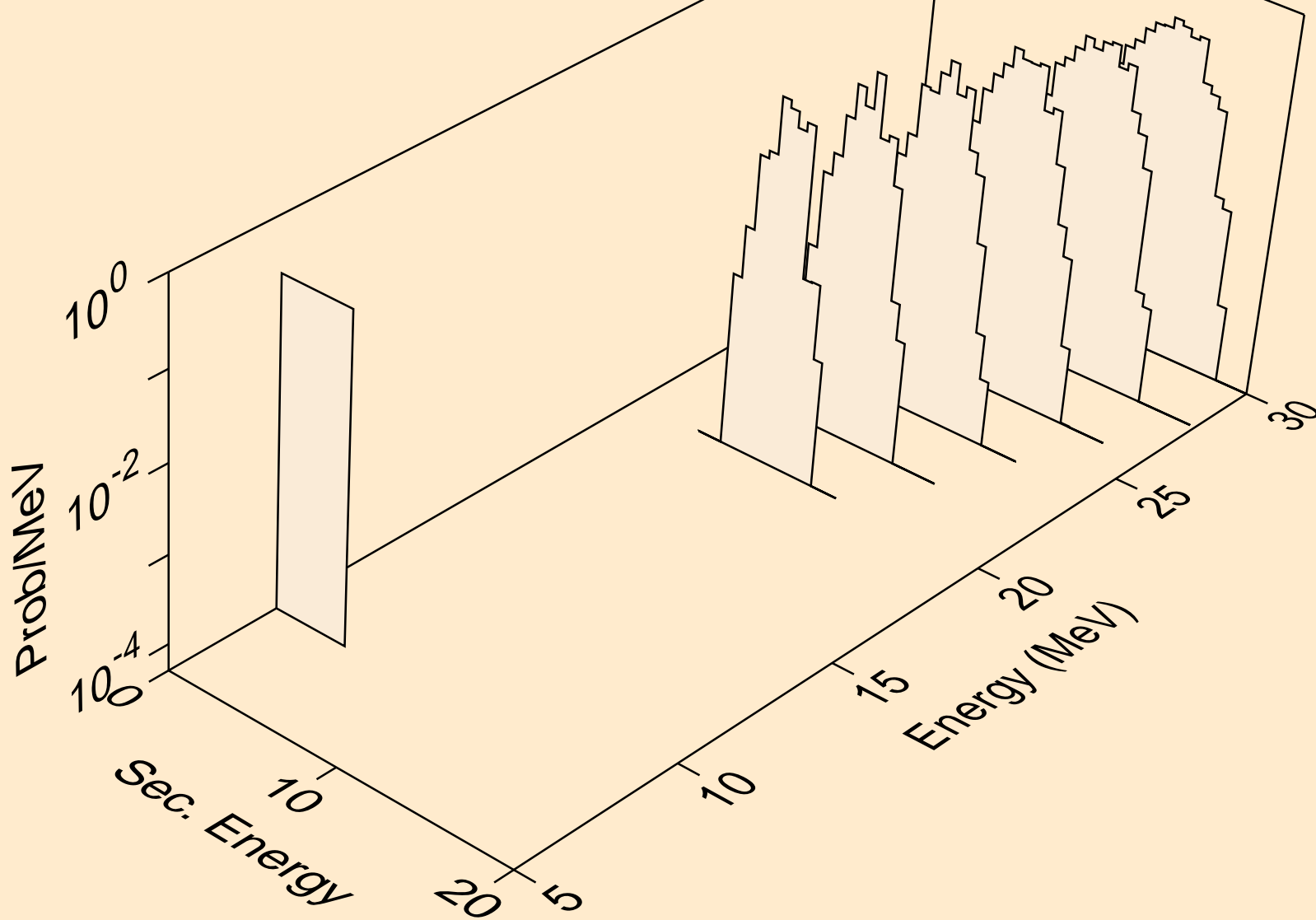

GD155 NEUTRON ACER TENDL-2019 LIBRARY; T=293.16K
alphas from (n,a)

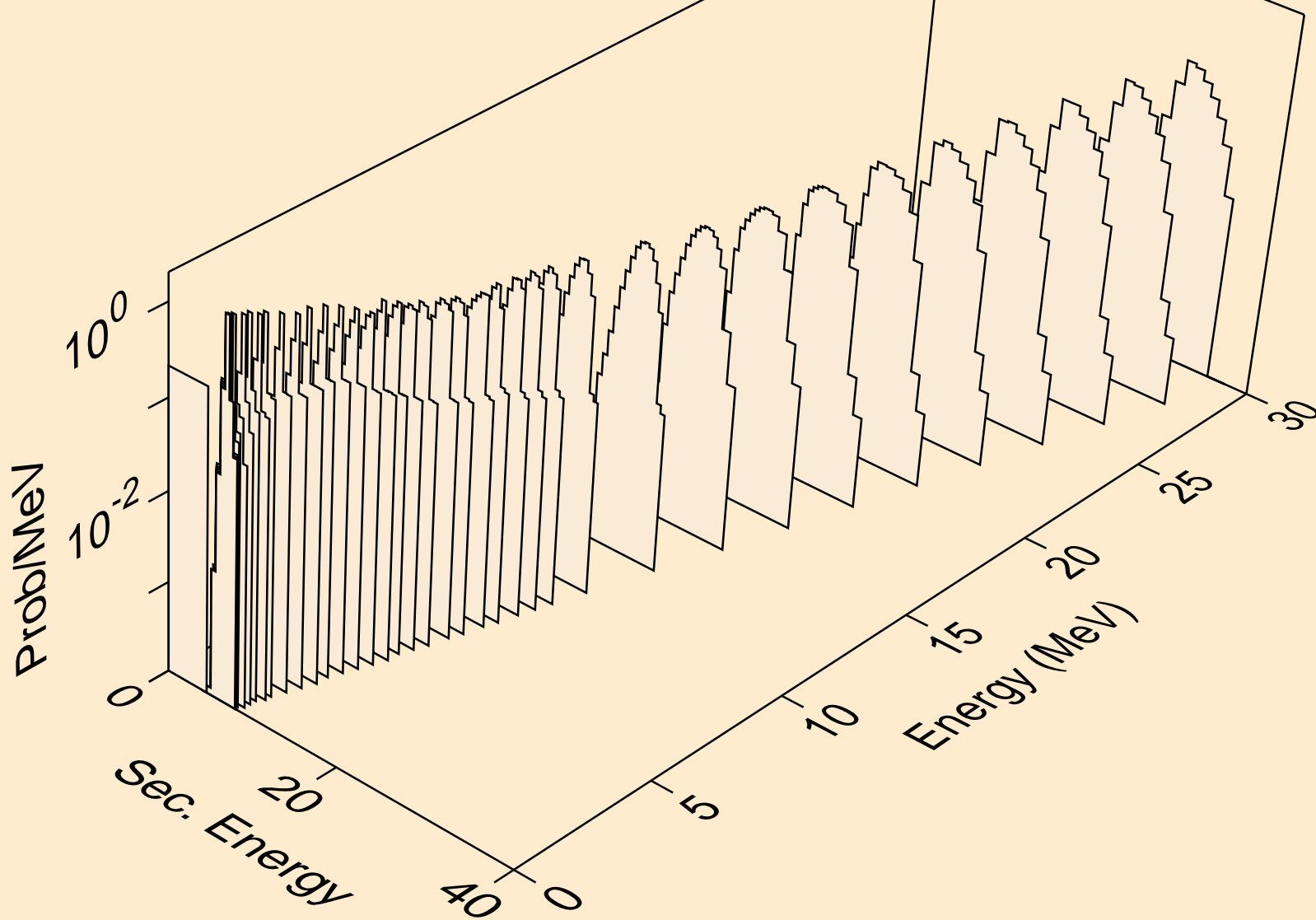

GD155 NEUTRON ACER TENDL-2019 LIBRARY; T=293.16K
alphas from (n,2a)

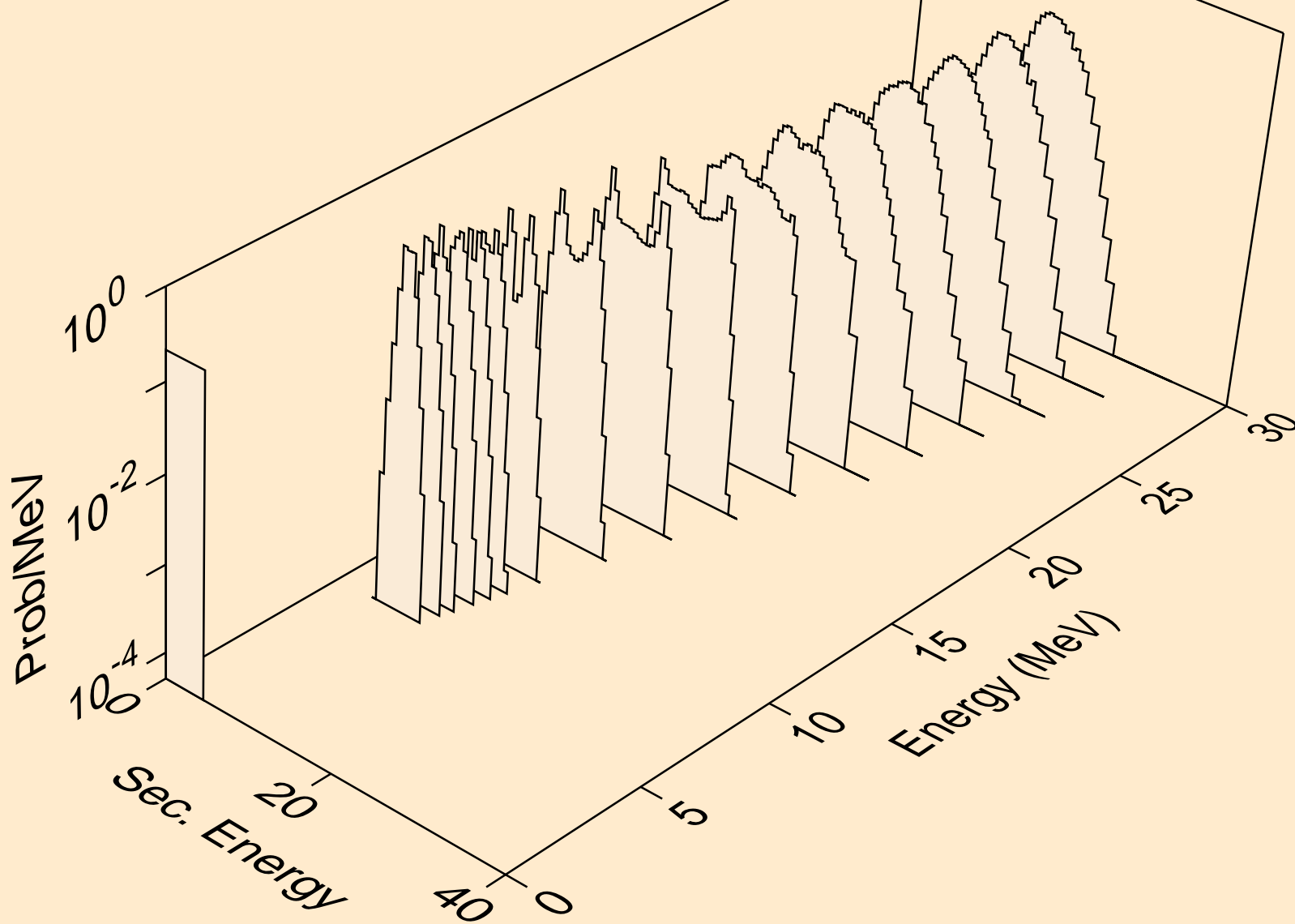

GD155 NEUTRON ACER TENDL-2019 LIBRARY; T=293.16K
alphas from (n,pa)

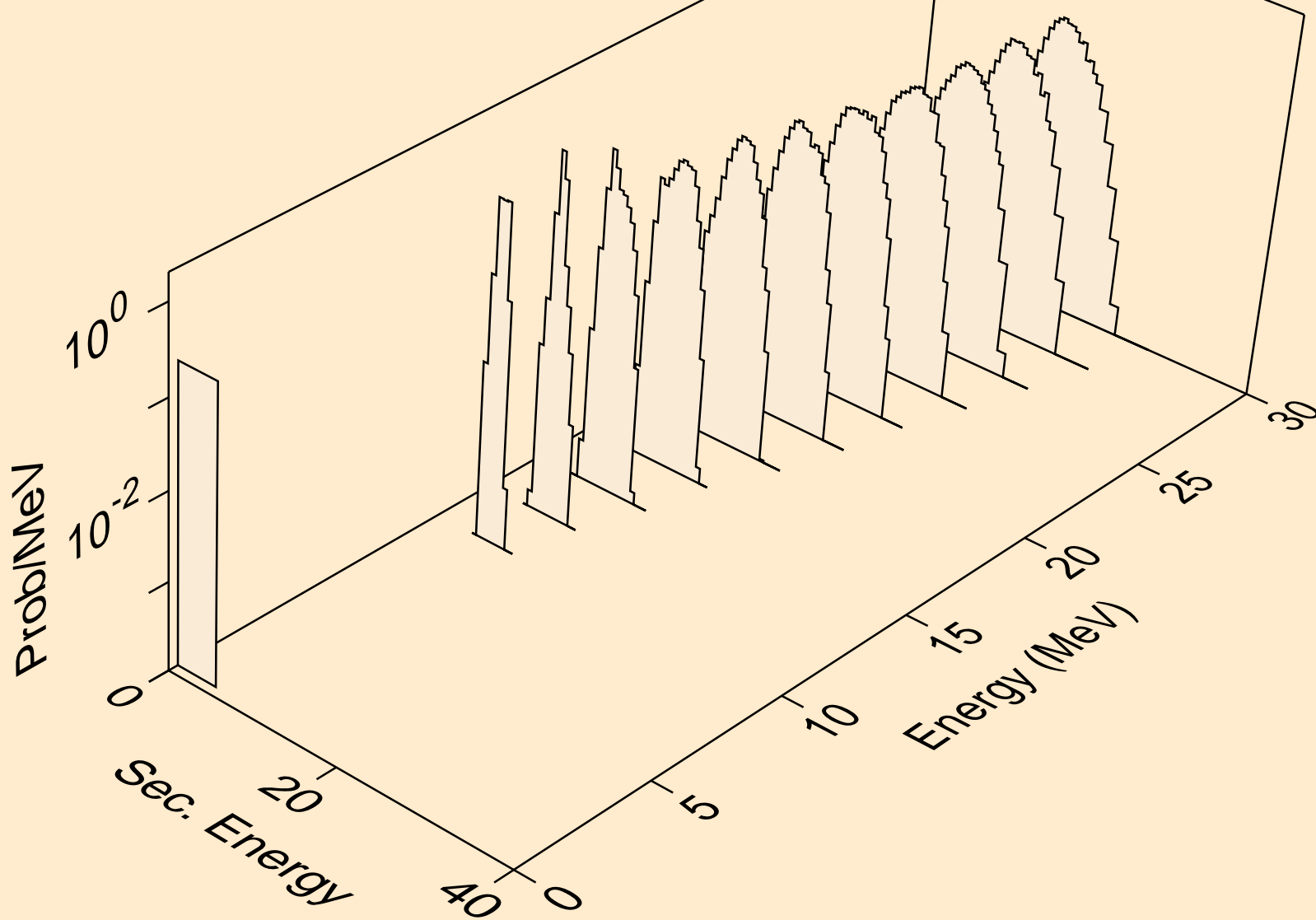

GD155 NEUTRON ACER TENDL-2019 LIBRARY; T=293.16K
alphas from (n,da)

