

LR260 NEUTRON ACER TENDL-2019 LIBRARY; T=293.16K
Principal cross sections

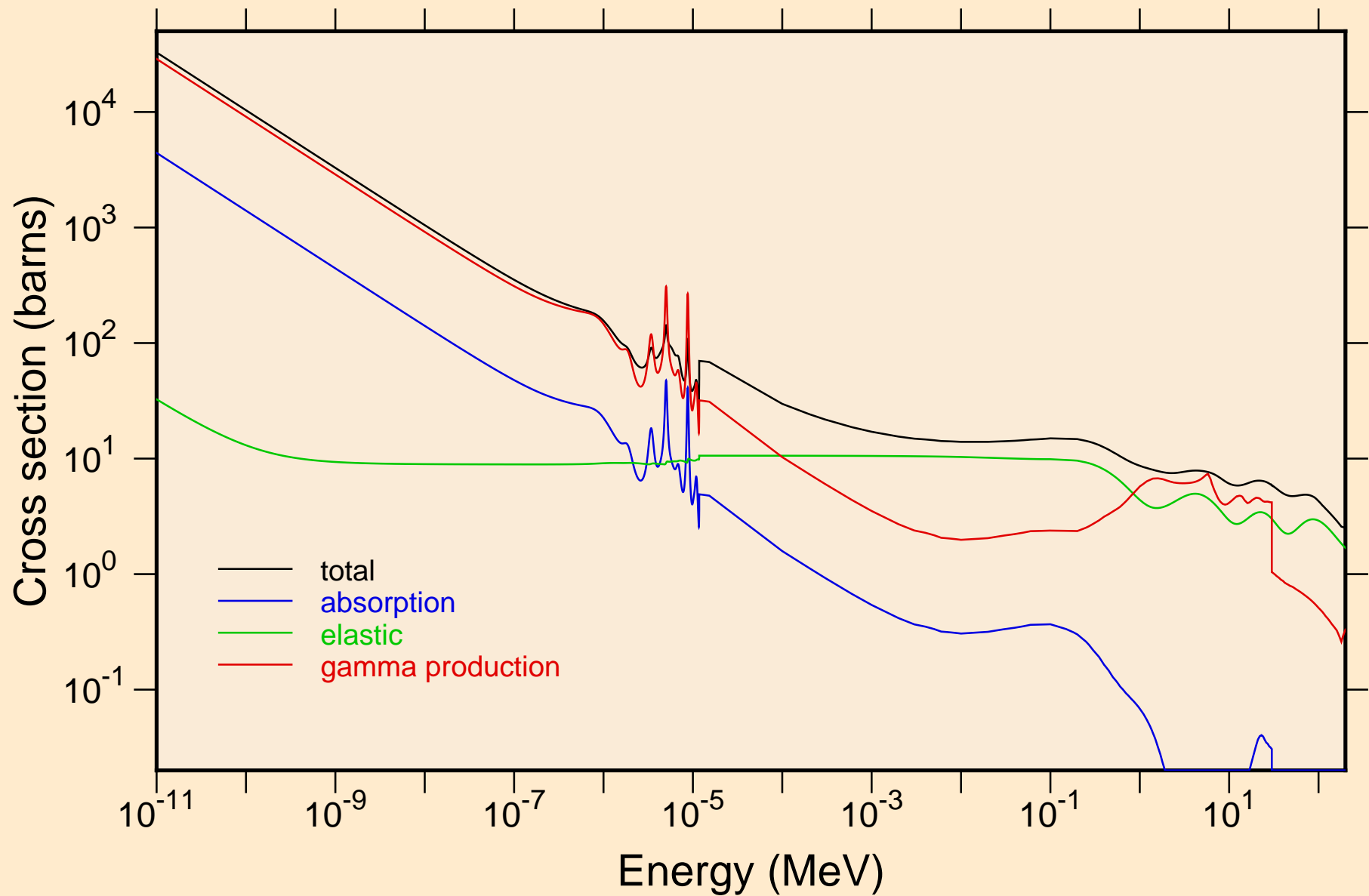

LR260 NEUTRON ACER TENDL-2019 LIBRARY; T=293.16K
Heating

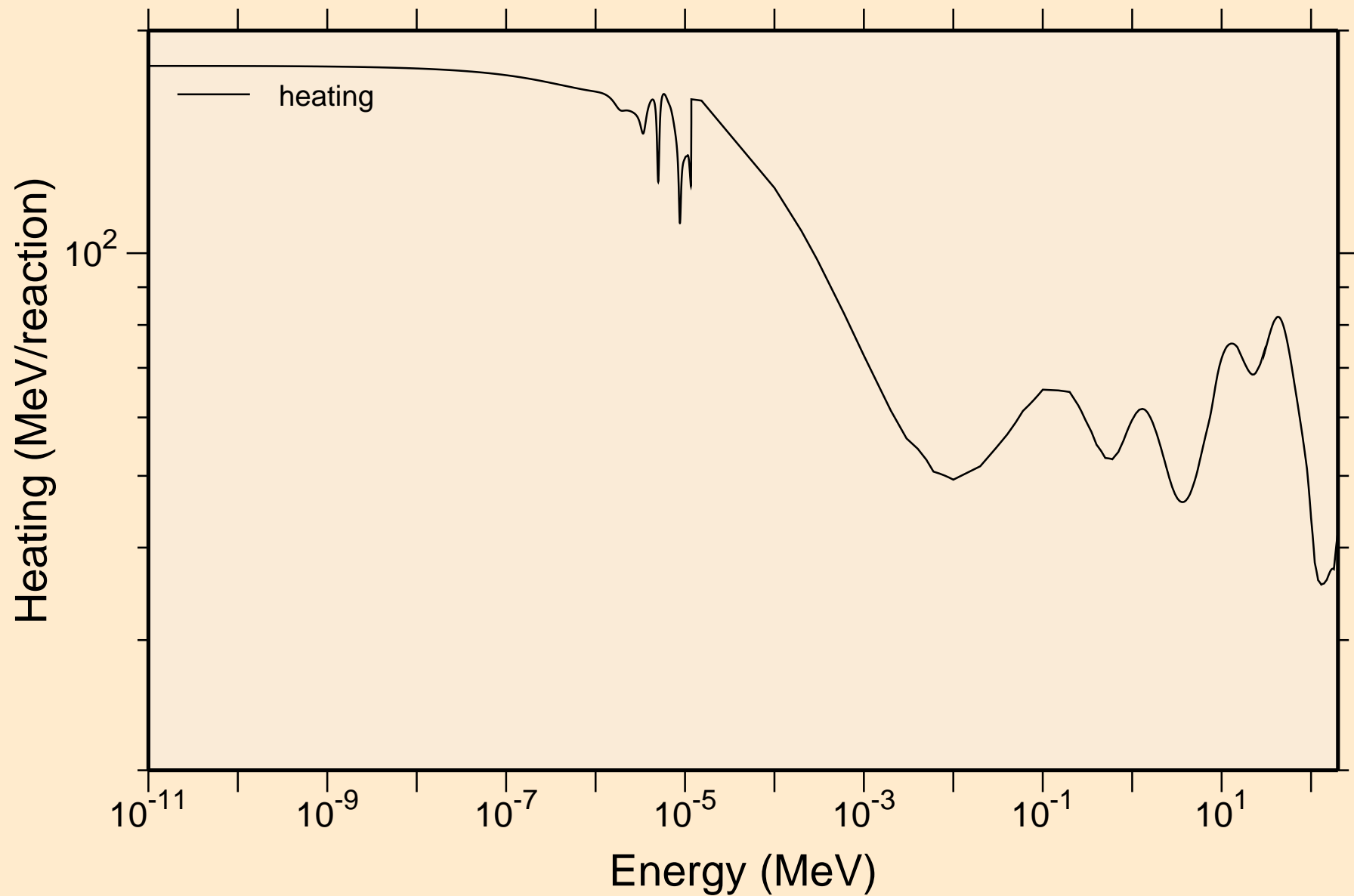

LR260 NEUTRON ACER TENDL-2019 LIBRARY; T=293.16K
Damage

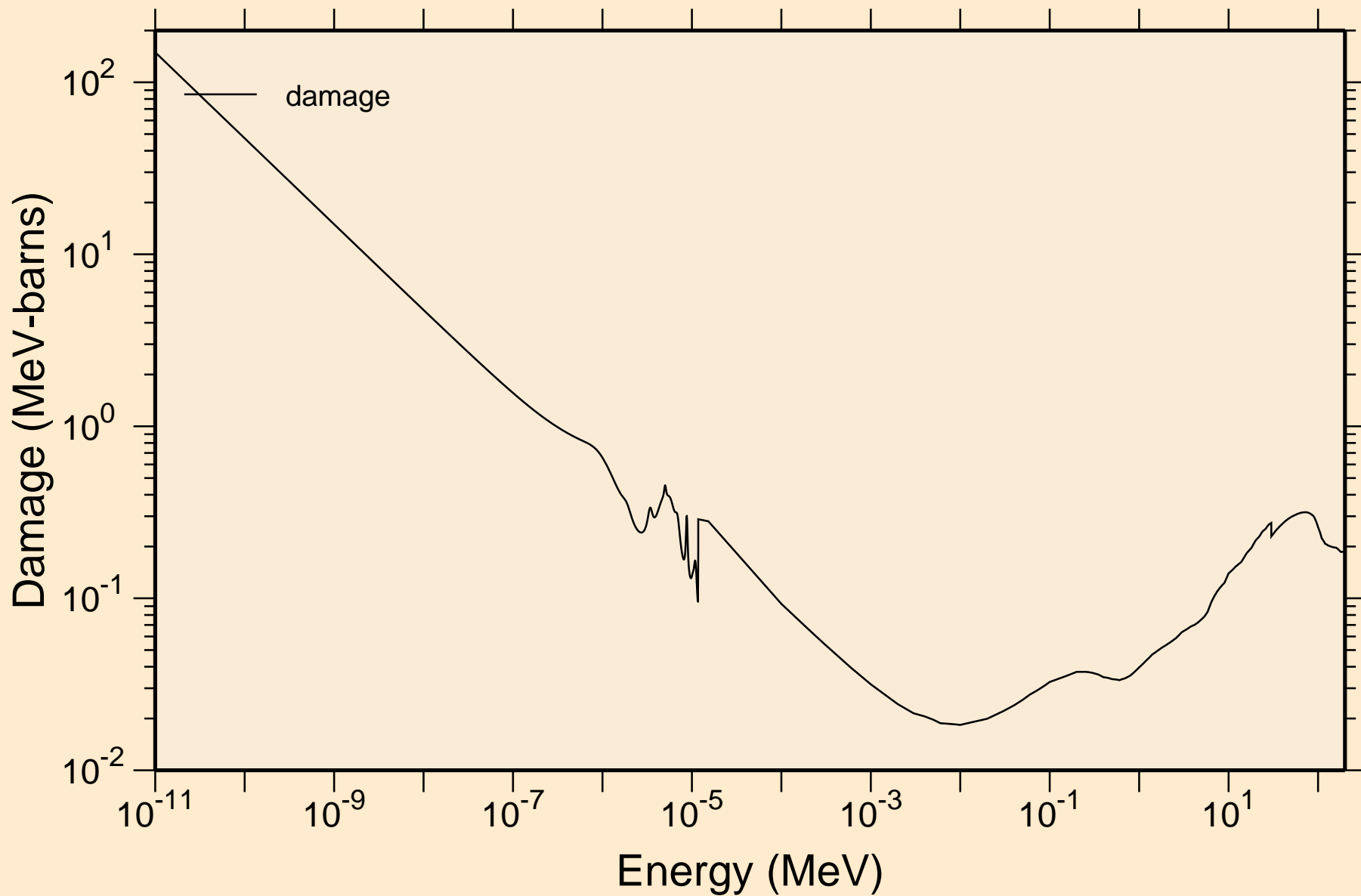

LR260 NEUTRON ACER TENDL-2019 LIBRARY; T=293.16K
Non-threshold reactions

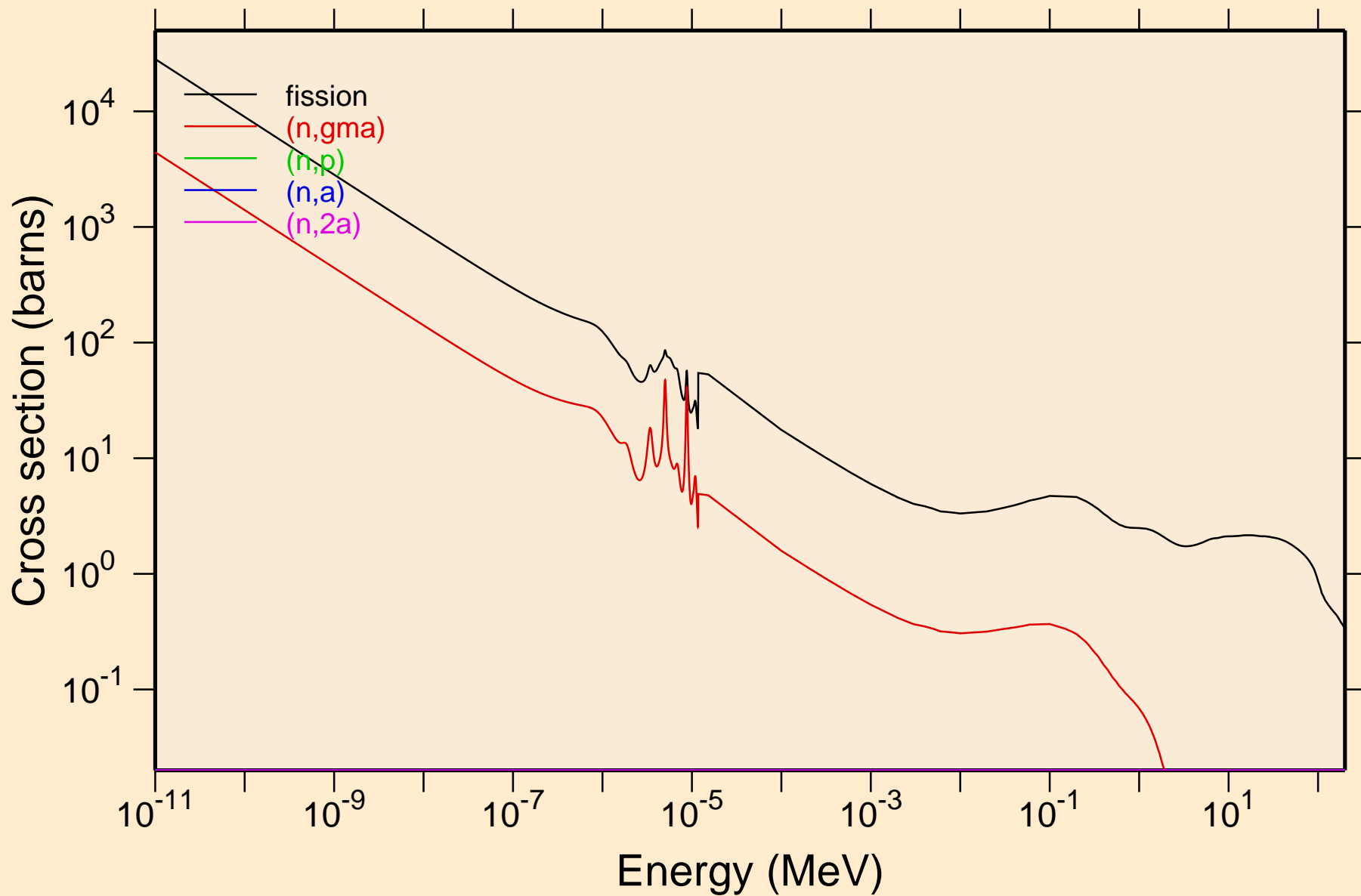

LR260 NEUTRON ACER TENDL-2019 LIBRARY; T=293.16K
Non-threshold reactions

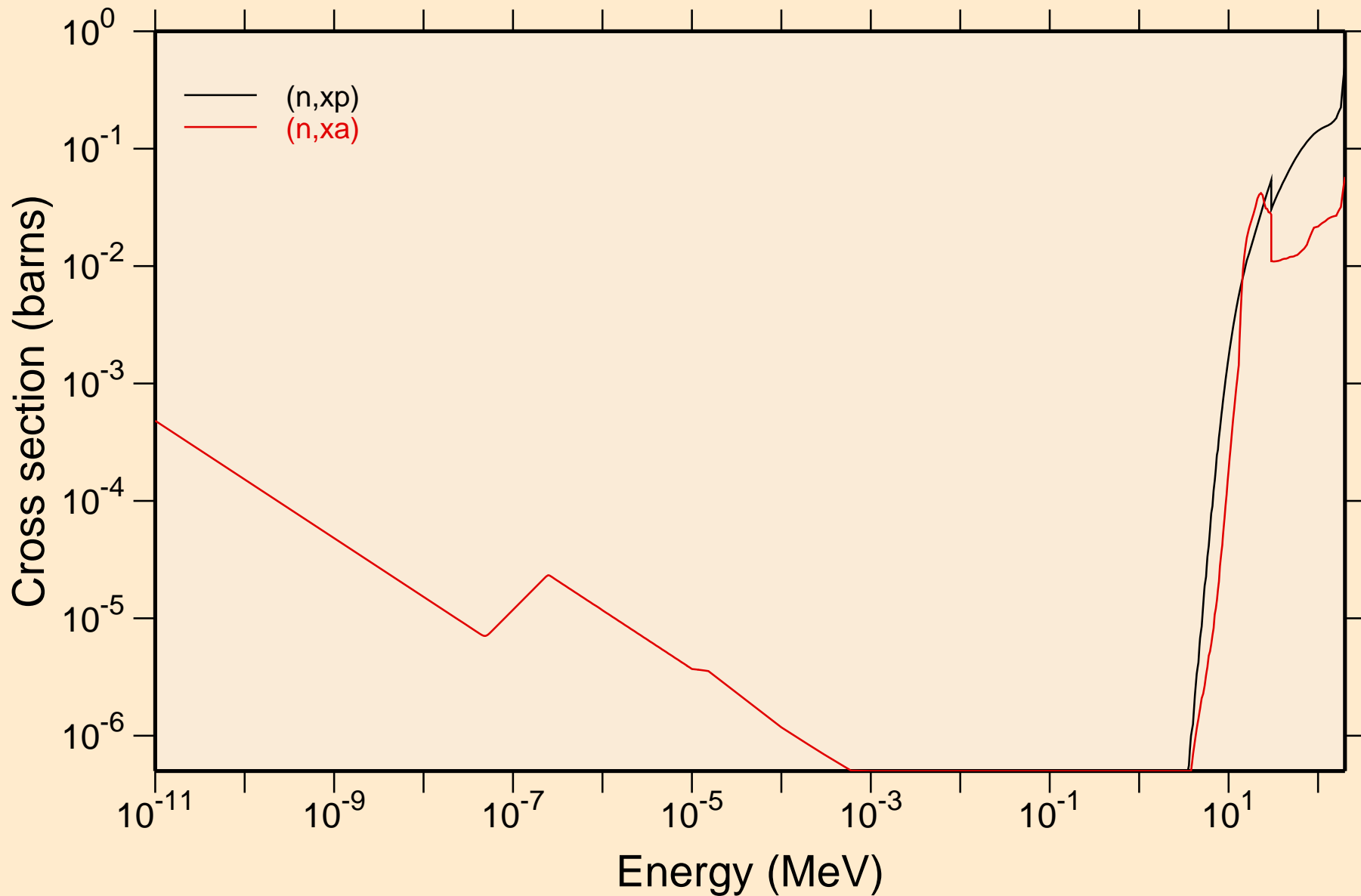

LR260 NEUTRON ACER TENDL-2019 LIBRARY; T=293.16K
Principal cross sections

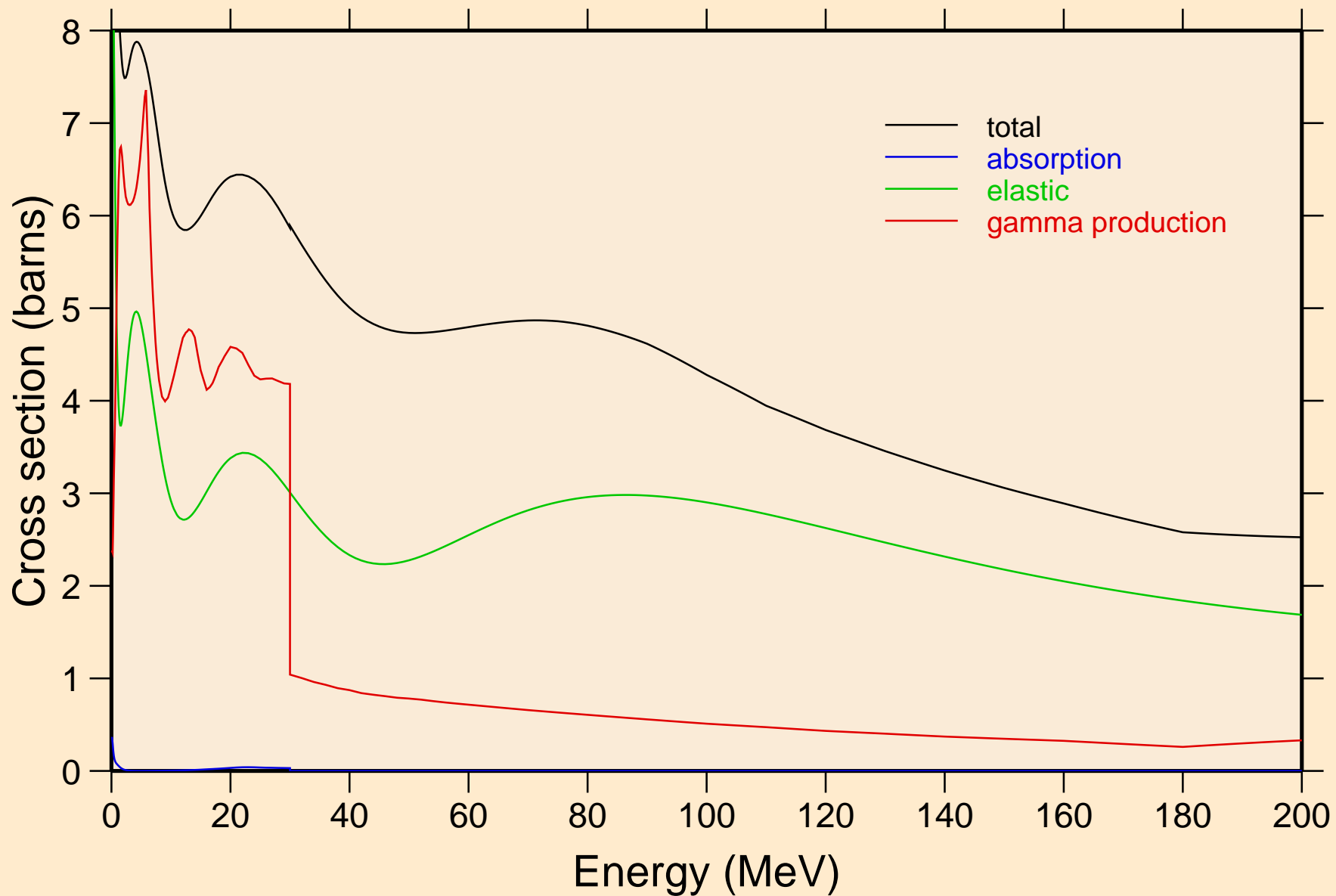

LR260 NEUTRON ACER TENDL-2019 LIBRARY; T=293.16K
Heating

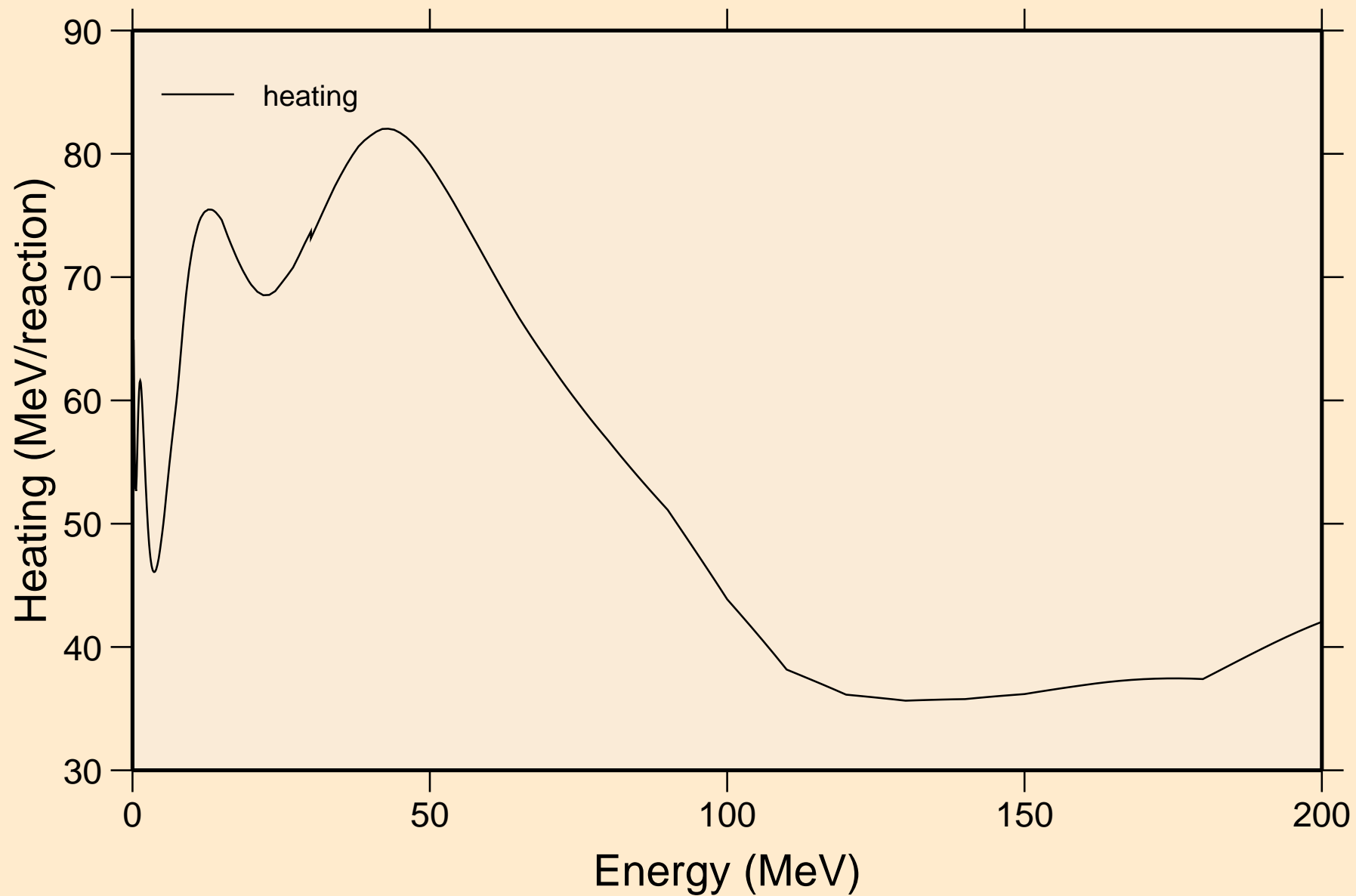

LR260 NEUTRON ACER TENDL-2019 LIBRARY; T=293.16K
Damage

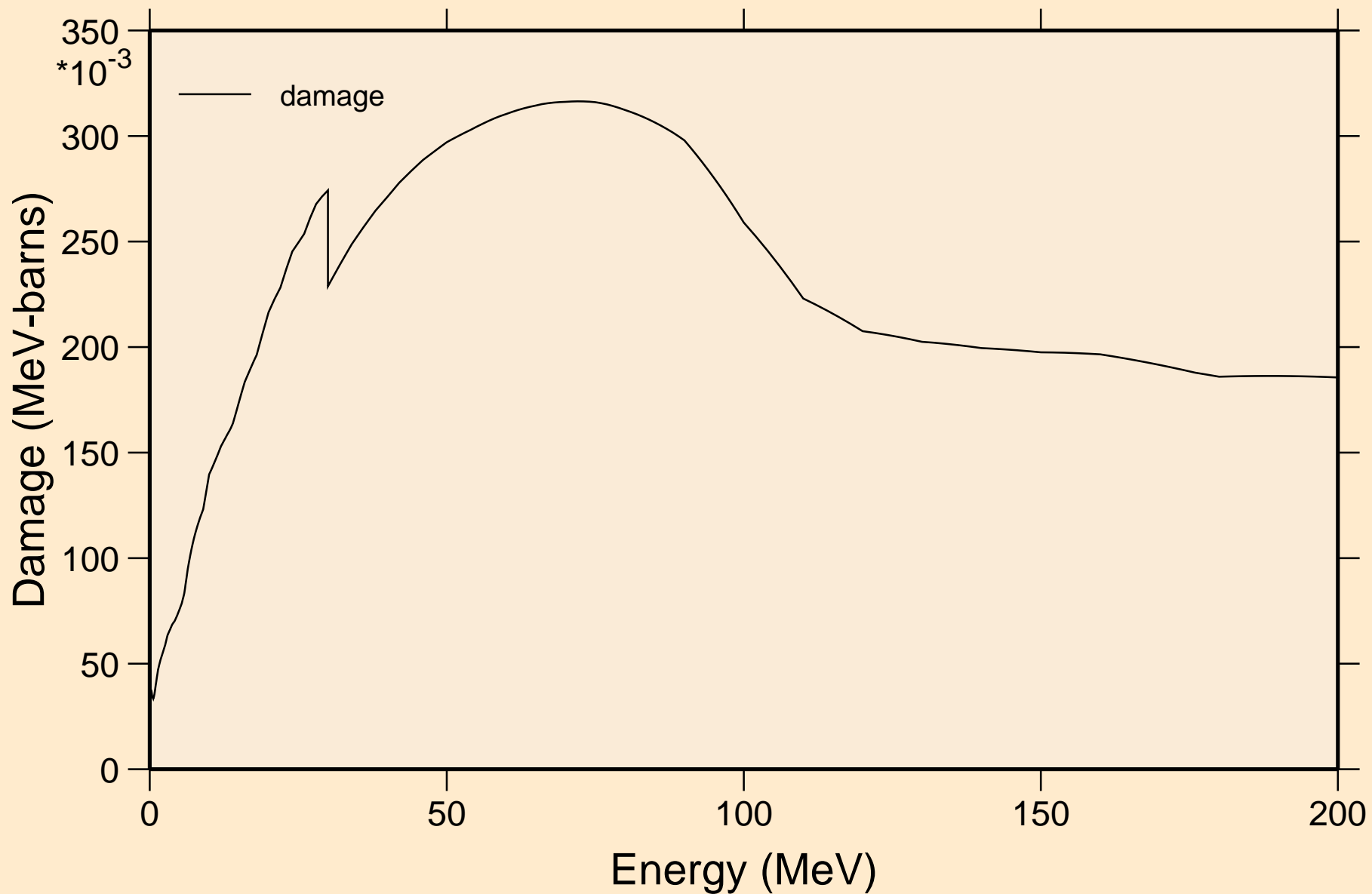

LR260 NEUTRON ACER TENDL-2019 LIBRARY; T=293.16K
Non-threshold reactions

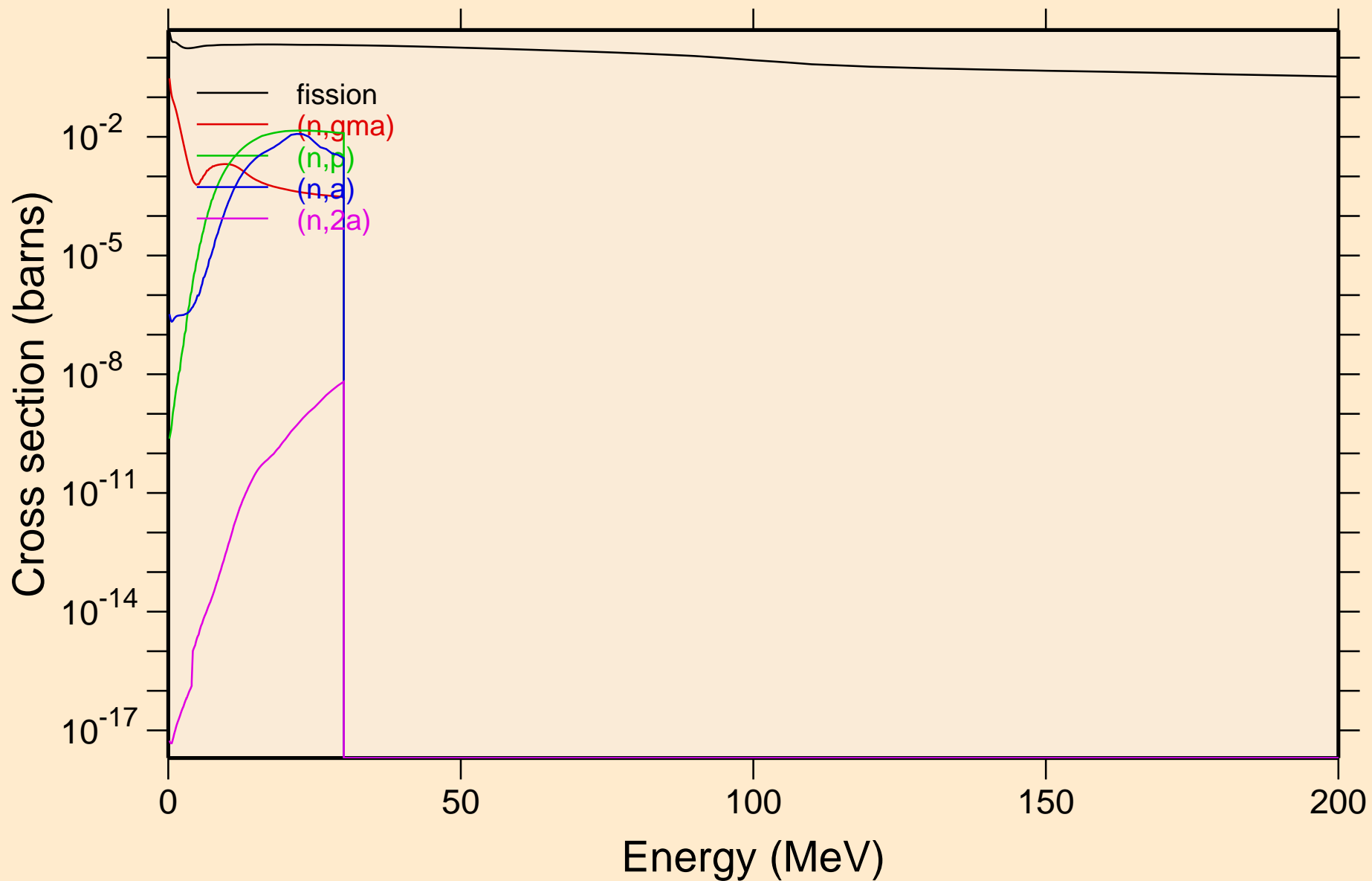

LR260 NEUTRON ACER TENDL-2019 LIBRARY; T=293.16K
Non-threshold reactions

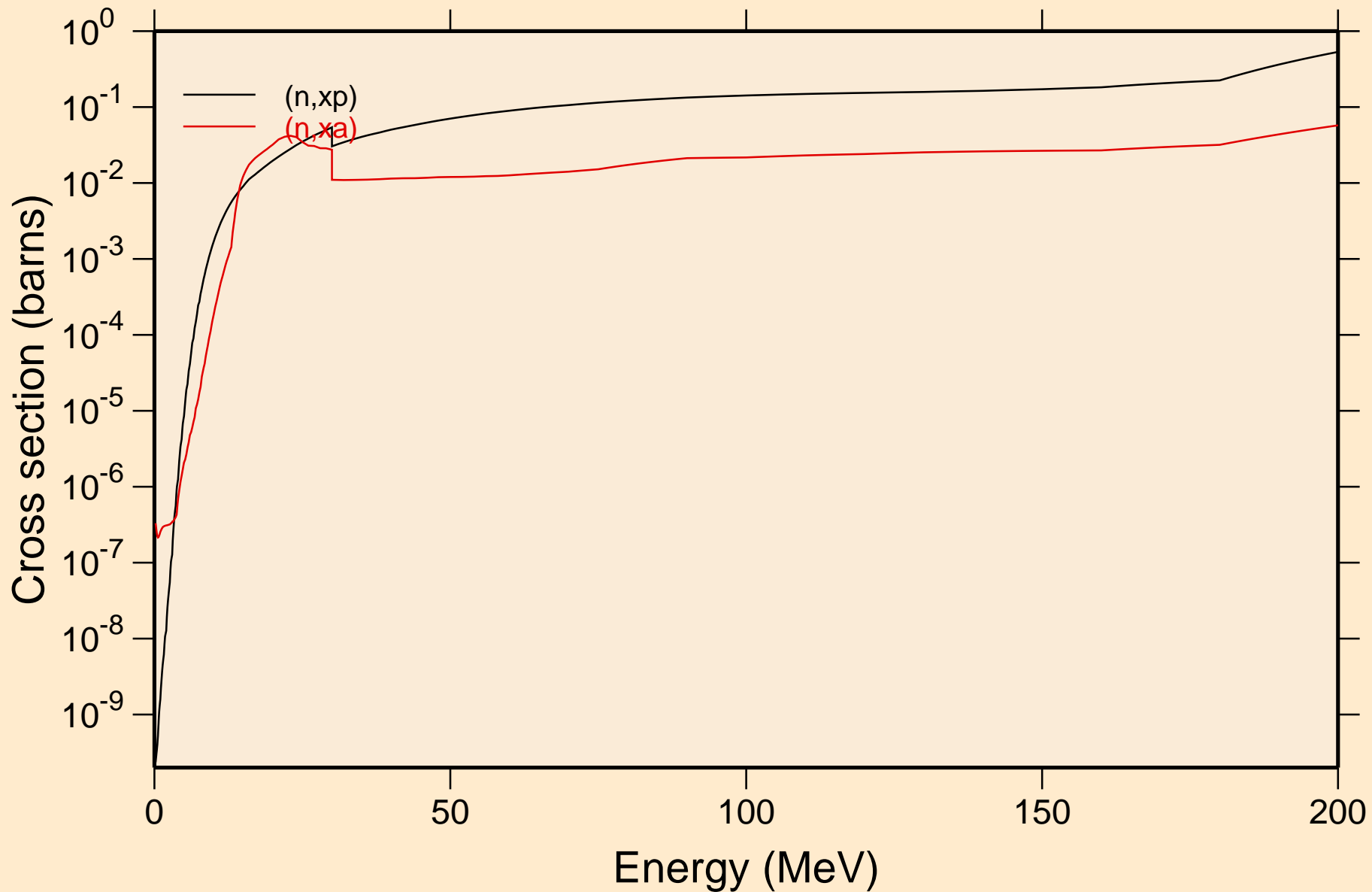

LR260 NEUTRON ACER TENDL-2019 LIBRARY; T=293.16K
Inelastic levels

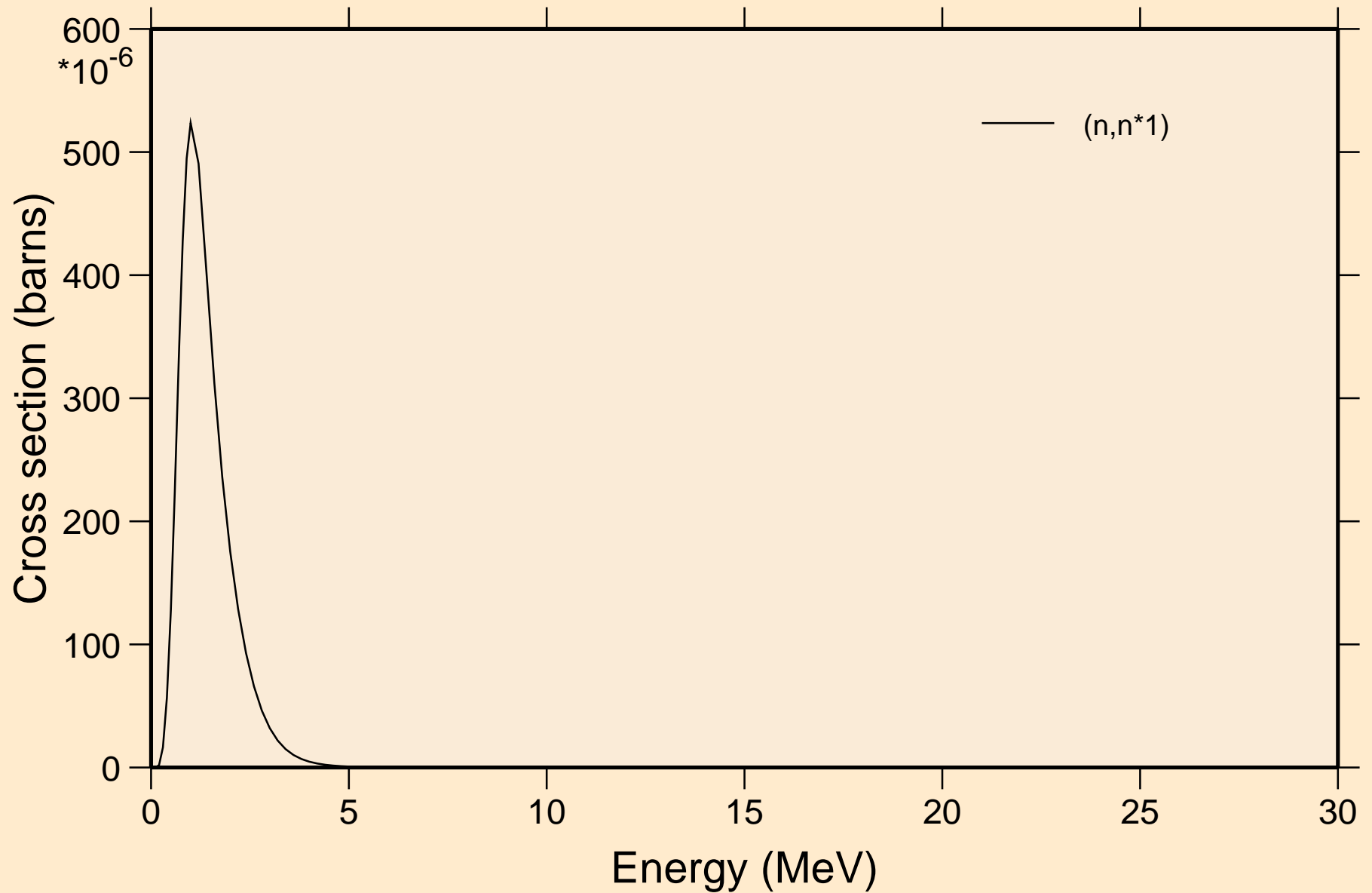

LR260 NEUTRON ACER TENDL-2019 LIBRARY; T=293.16K
Threshold reactions

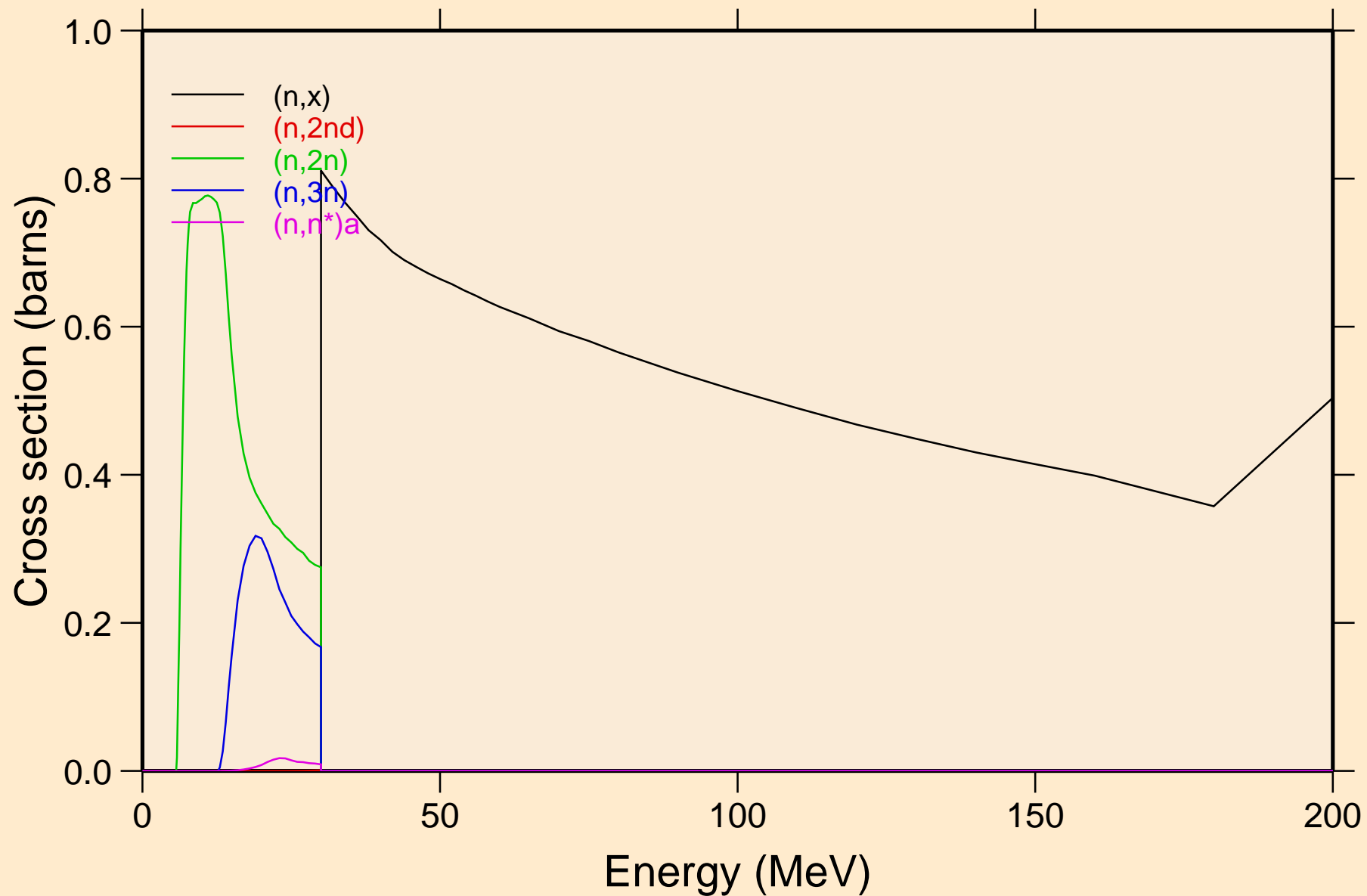

LR260 NEUTRON ACER TENDL-2019 LIBRARY; T=293.16K
Threshold reactions

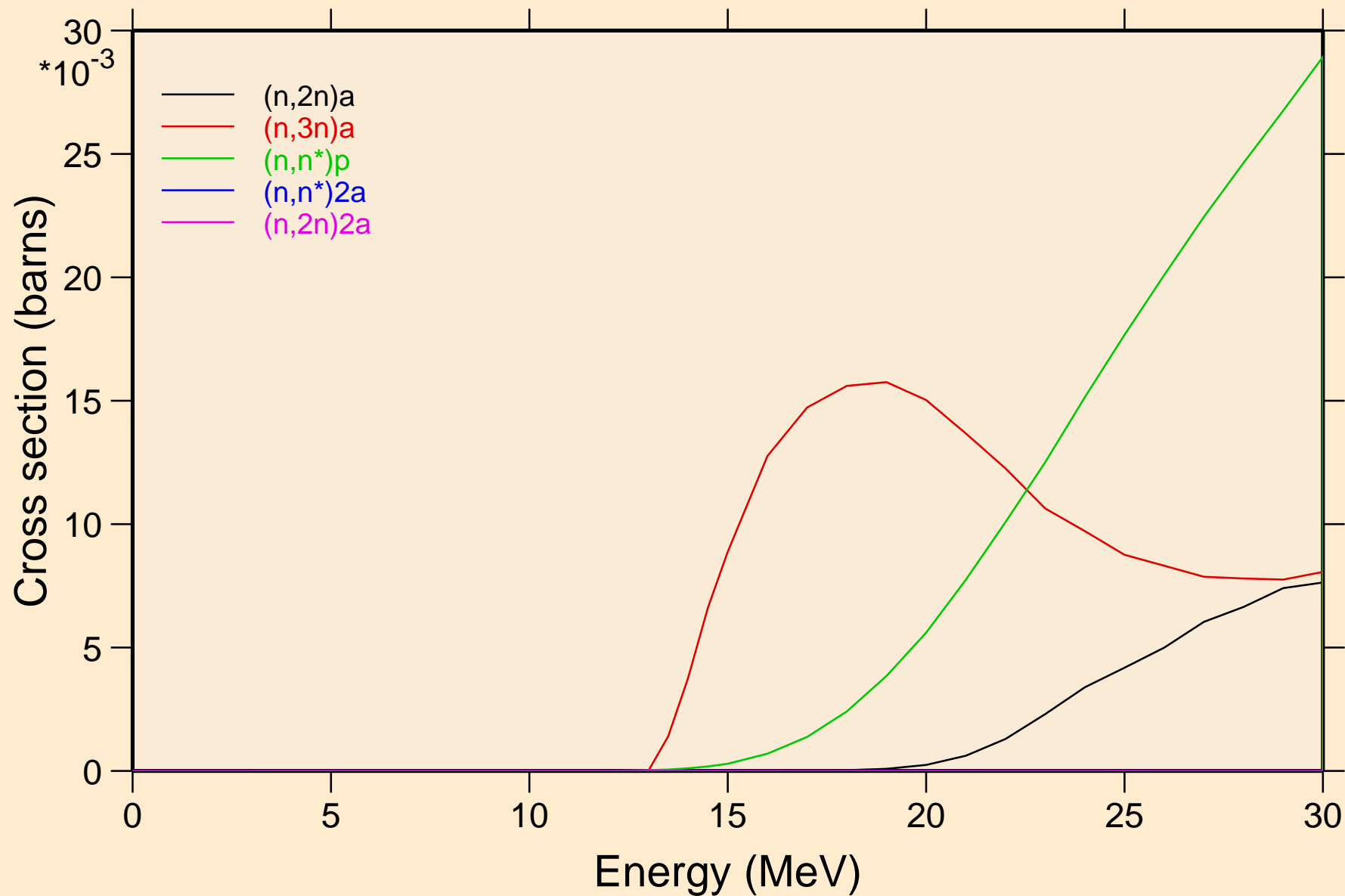

LR260 NEUTRON ACER TENDL-2019 LIBRARY; T=293.16K
Threshold reactions

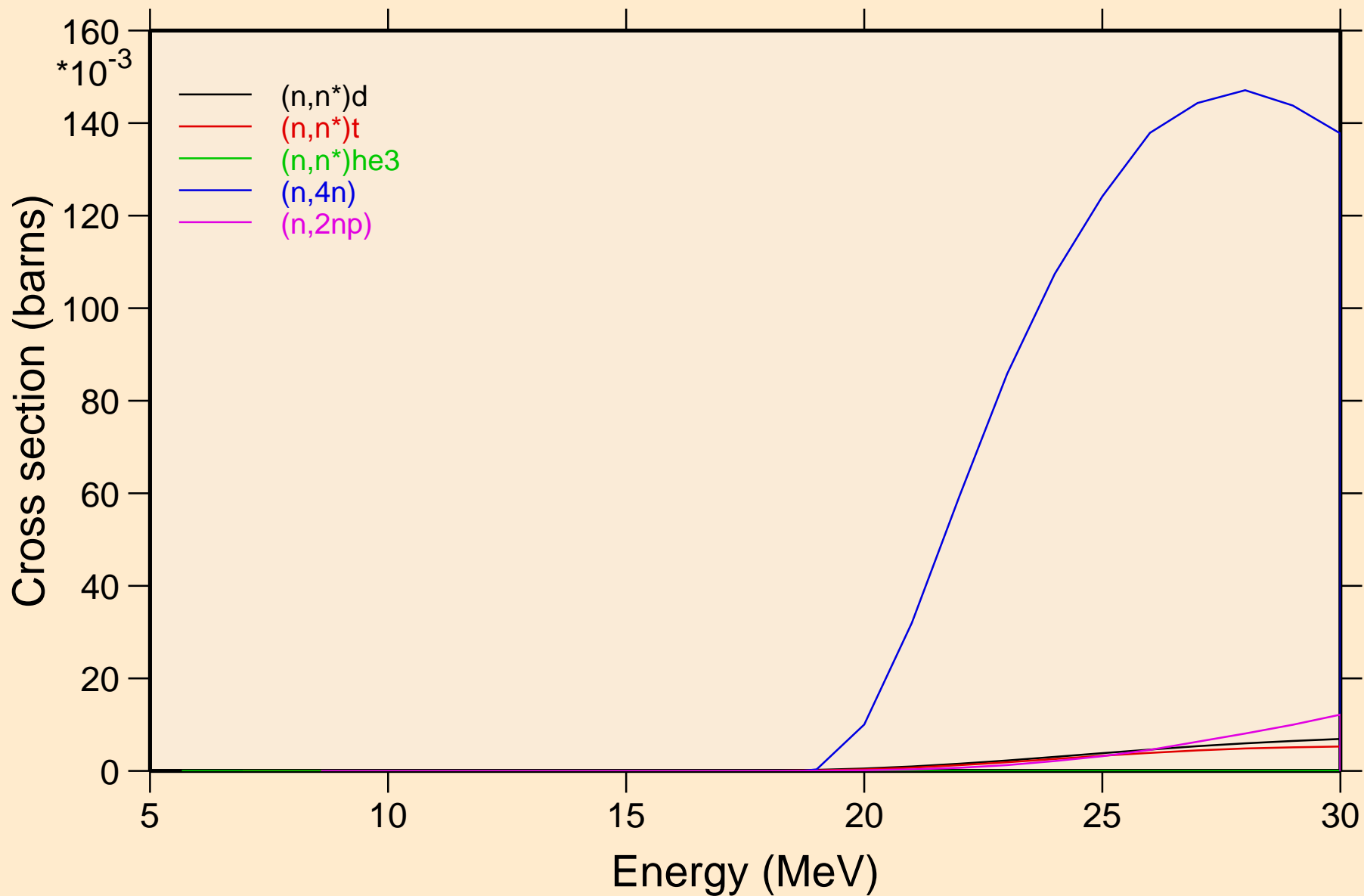

LR260 NEUTRON ACER TENDL-2019 LIBRARY; T=293.16K
Threshold reactions

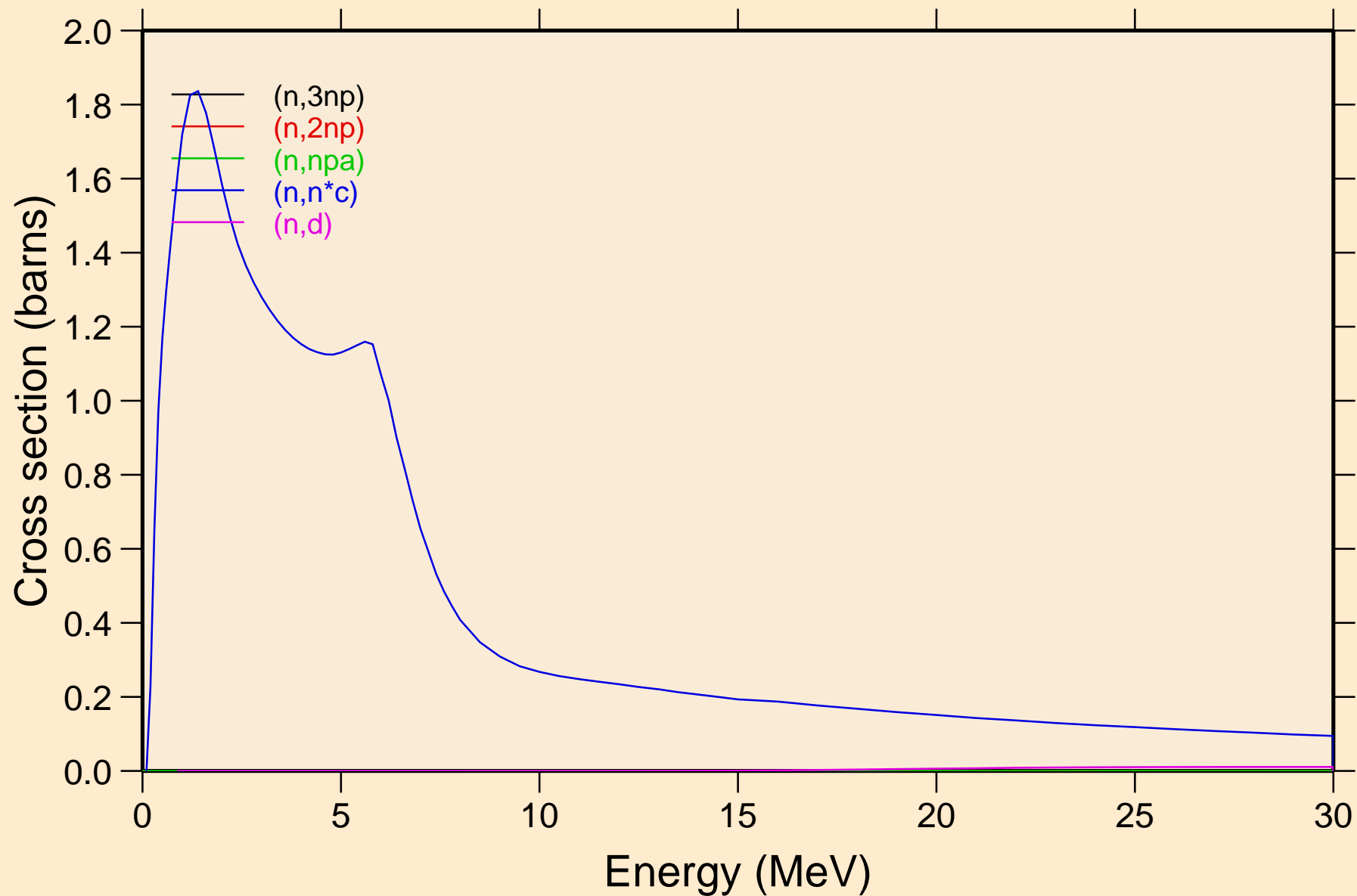

LR260 NEUTRON ACER TENDL-2019 LIBRARY; T=293.16K
Threshold reactions

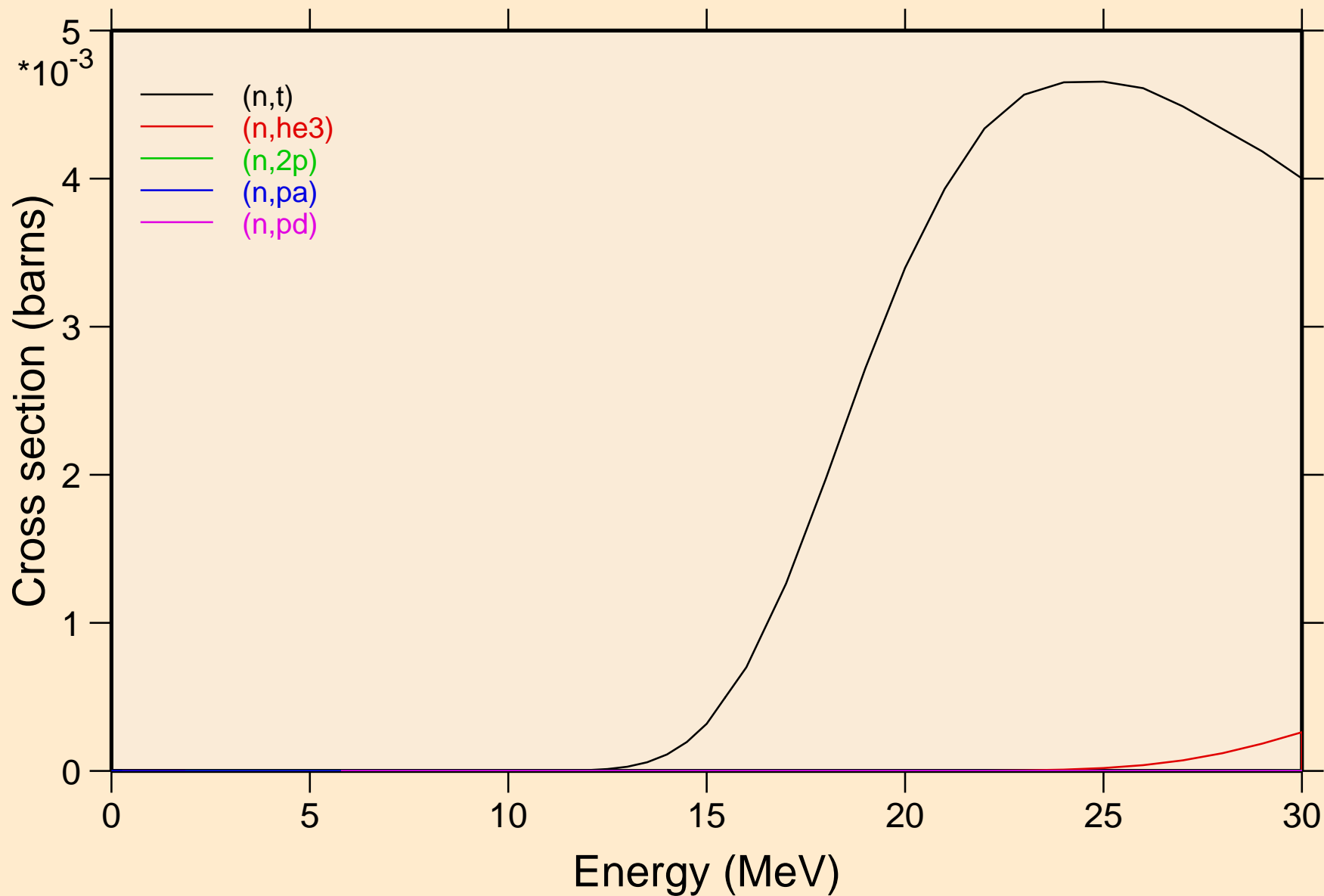

LR260 NEUTRON ACER TENDL-2019 LIBRARY; T=293.16K
Threshold reactions

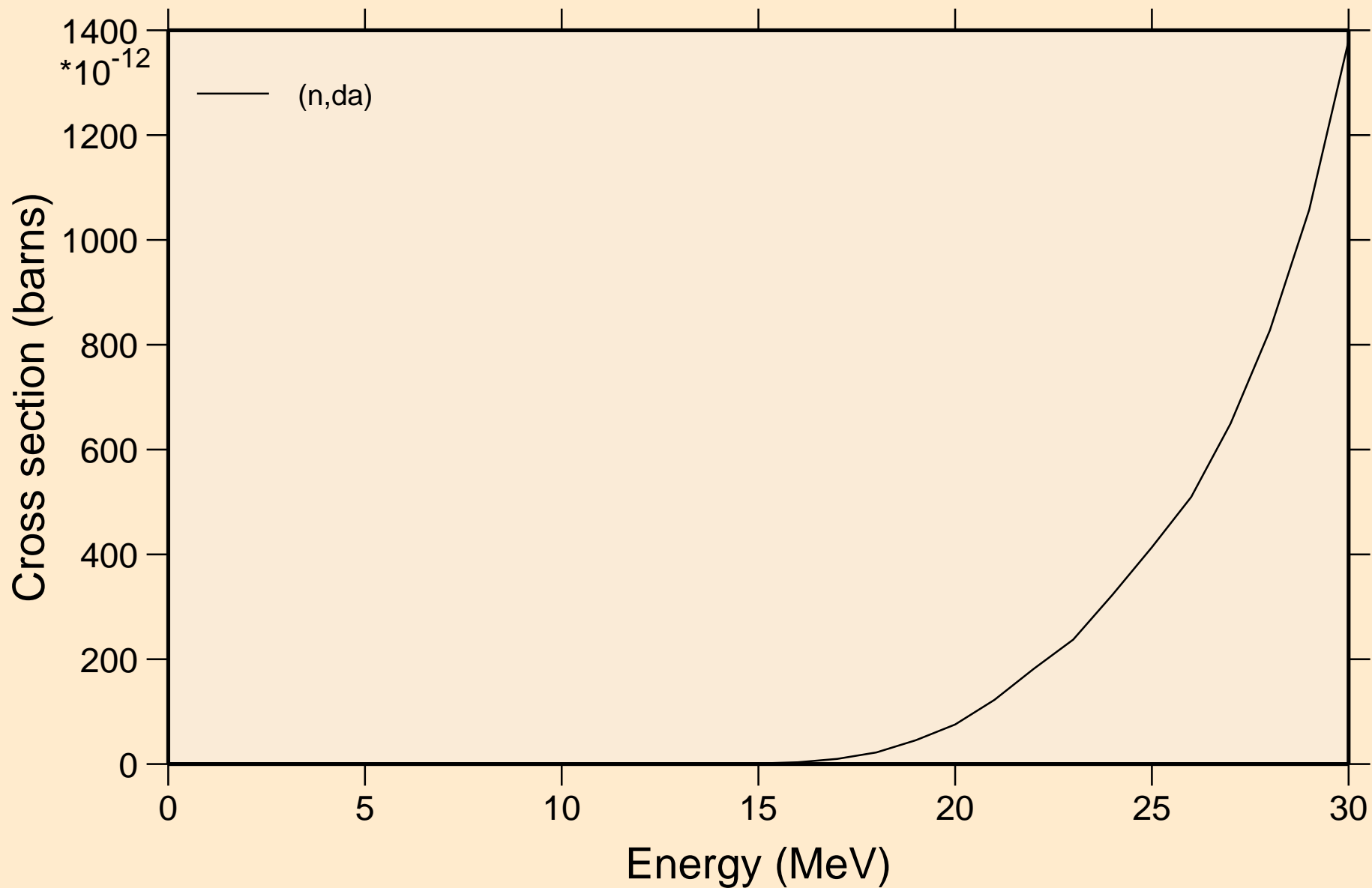

LR260 NEUTRON ACER TENDL-2019 LIBRARY; T=293.16K
Threshold reactions

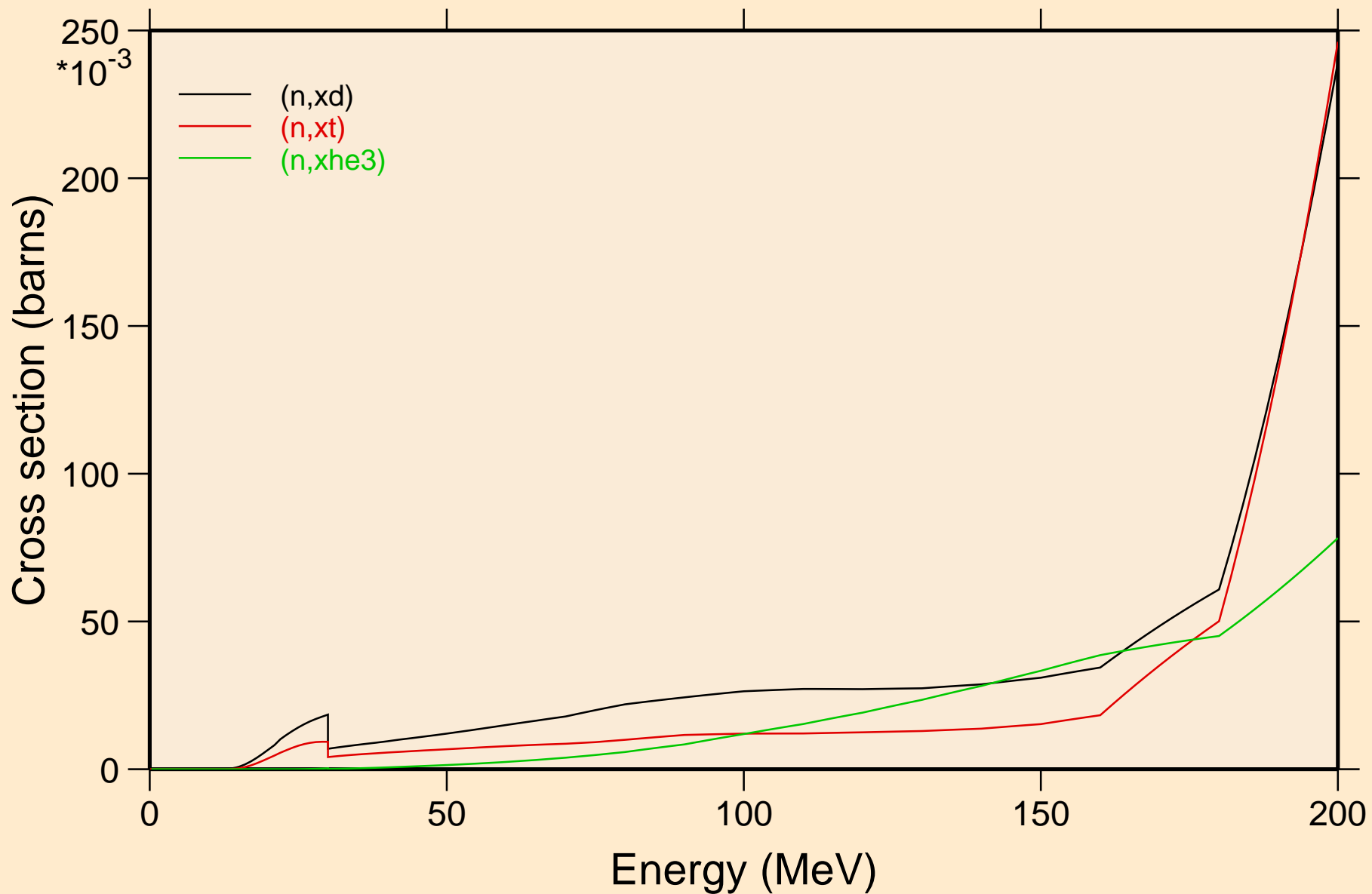

LR260 NEUTRON ACER TENDL-2019 LIBRARY; T=293.16K
angular distribution for elastic

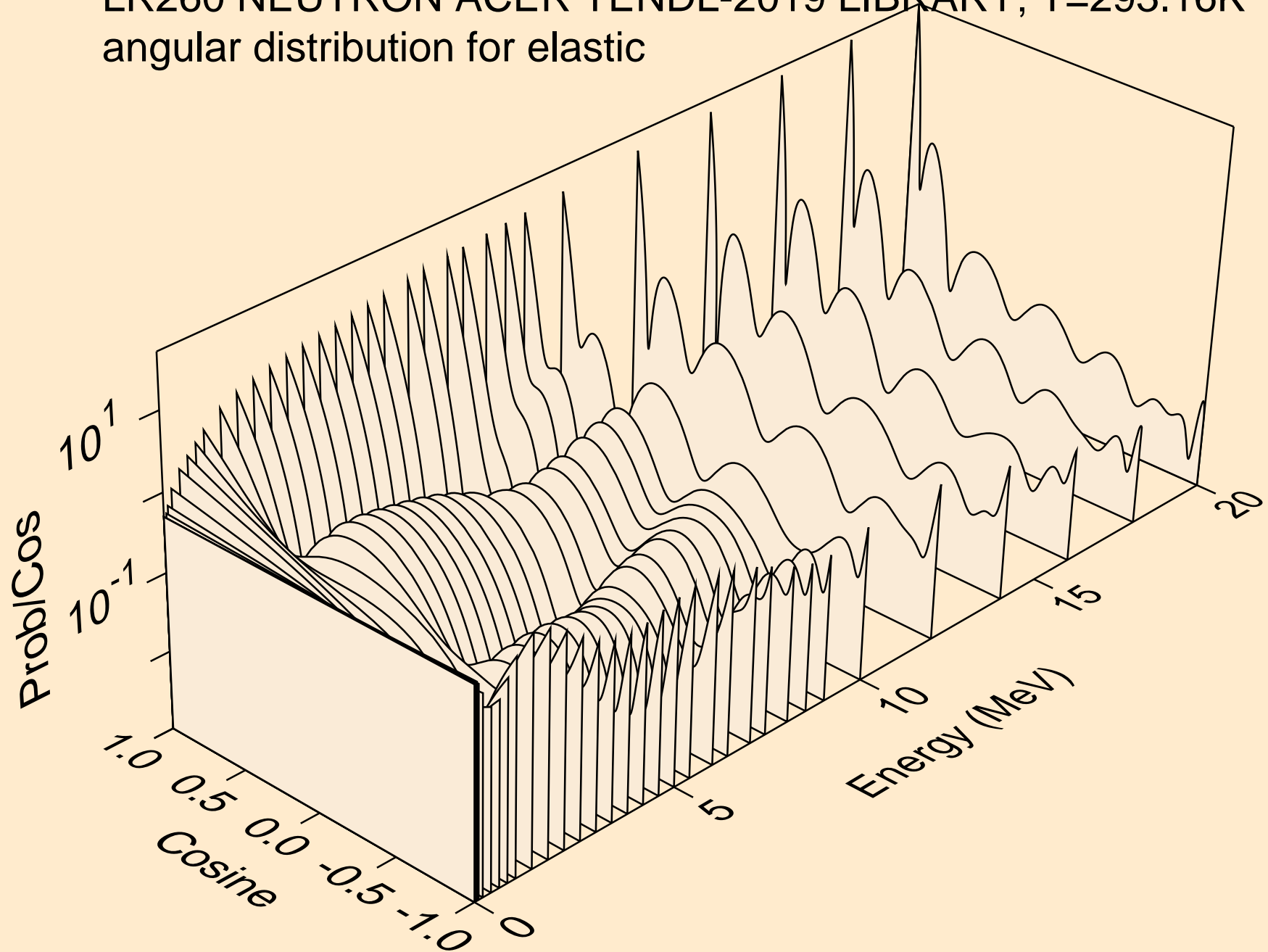

LR260 NEUTRON ACER TENDL-2019 LIBRARY; T=293.16K
angular distribution for elastic

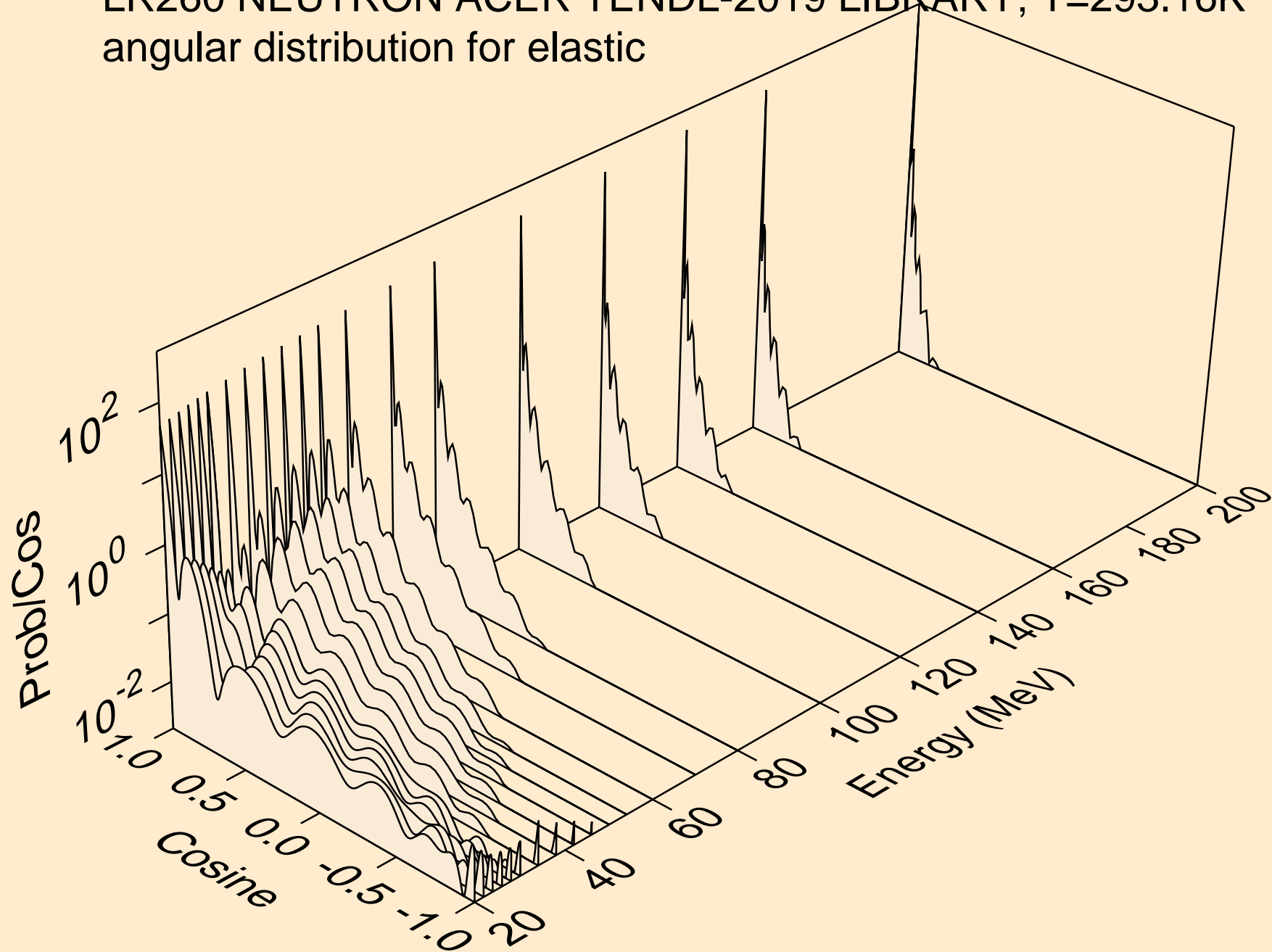

LR260 NEUTRON ACER TENDL-2019 LIBRARY; T=293.16K
angular distribution for (n,n*1)

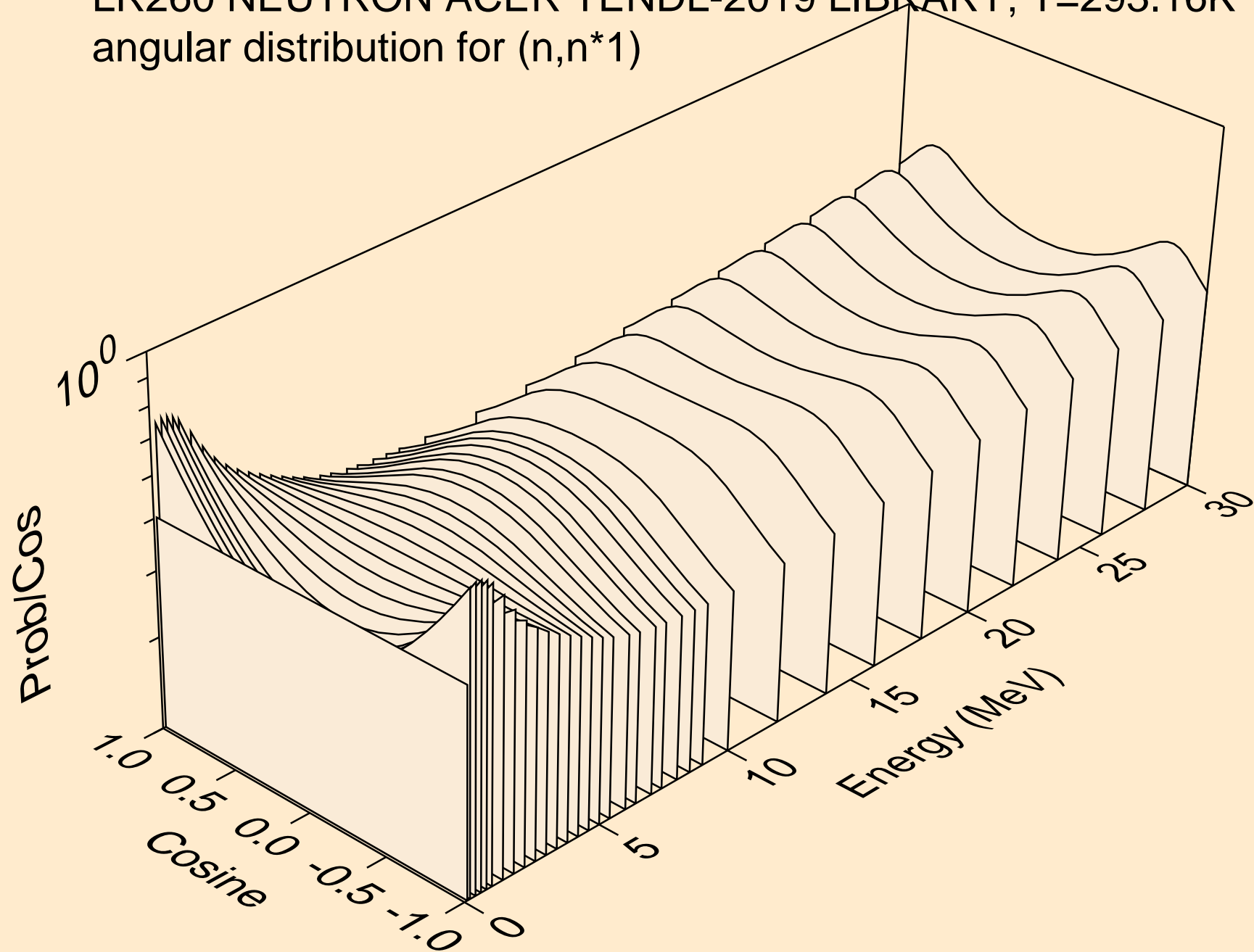

LR260 NEUTRON ACER TENDL-2019 LIBRARY; T=293.16K
Total fission nubar

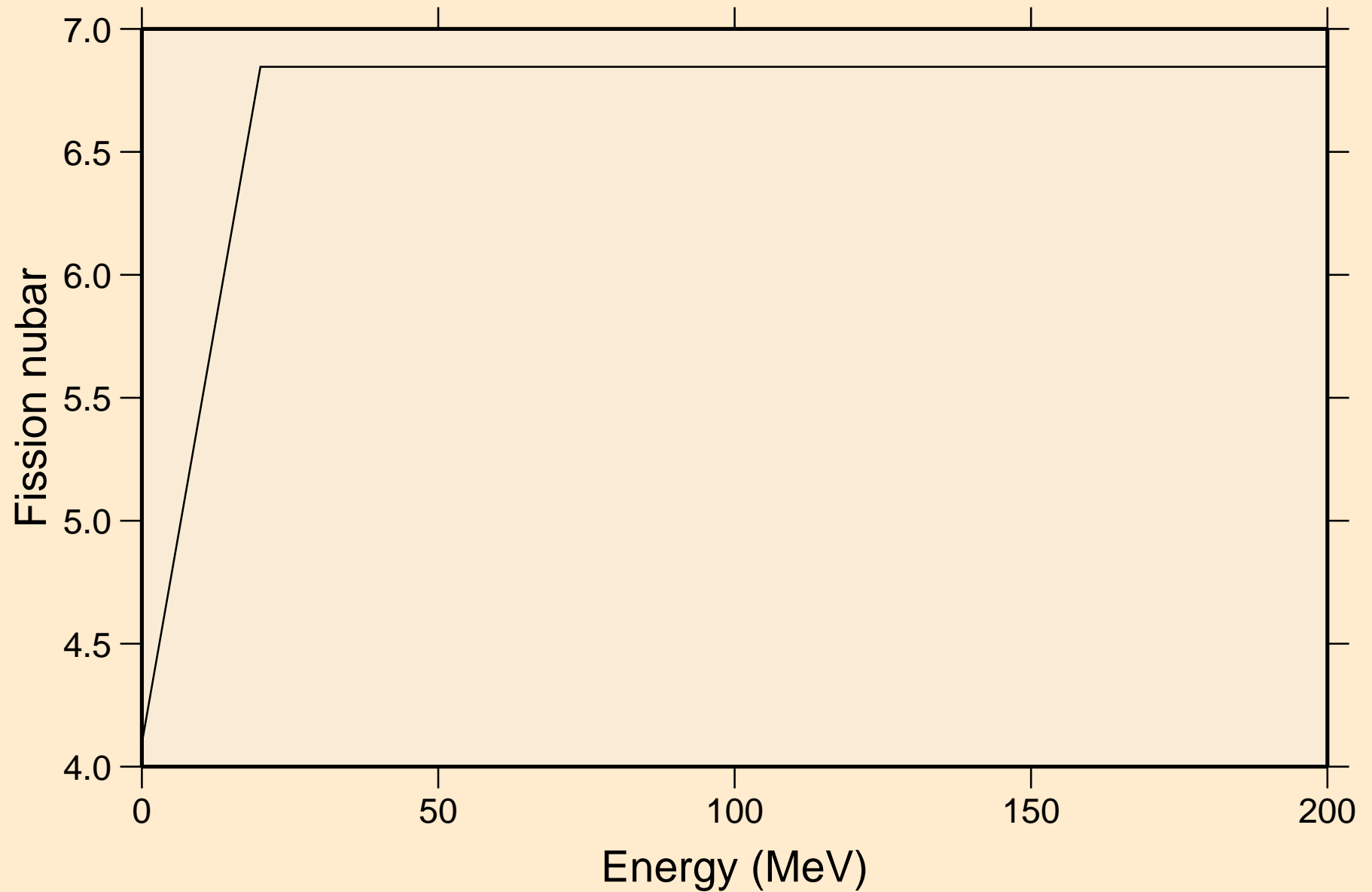

LR260 NEUTRON ACER TENDL-2019 LIBRARY; T=293.16K
Neutron emission for (n,x)

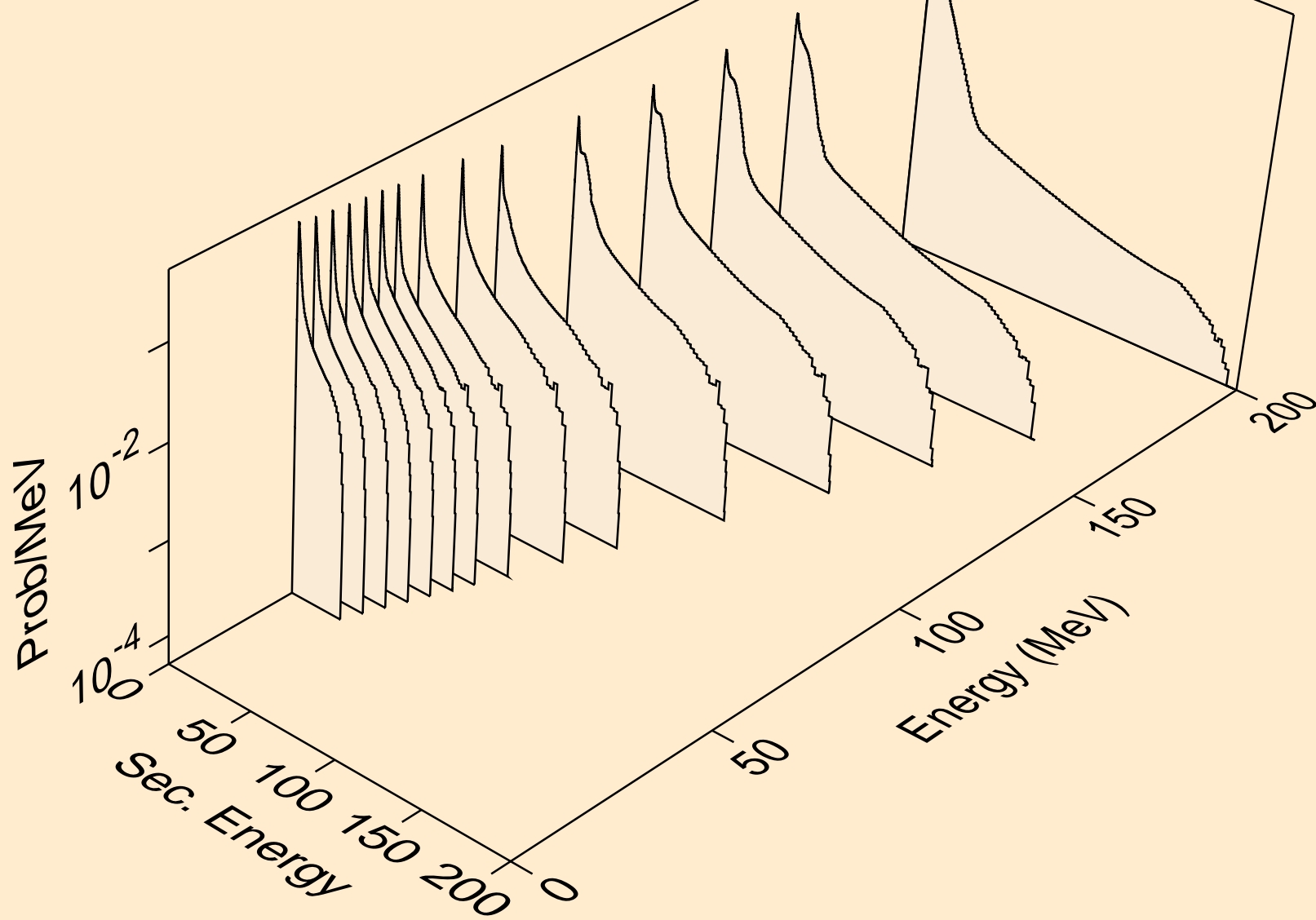

LR260 NEUTRON ACER TENDL-2019 LIBRARY; T=293.16K
Neutron emission for (n,2nd)

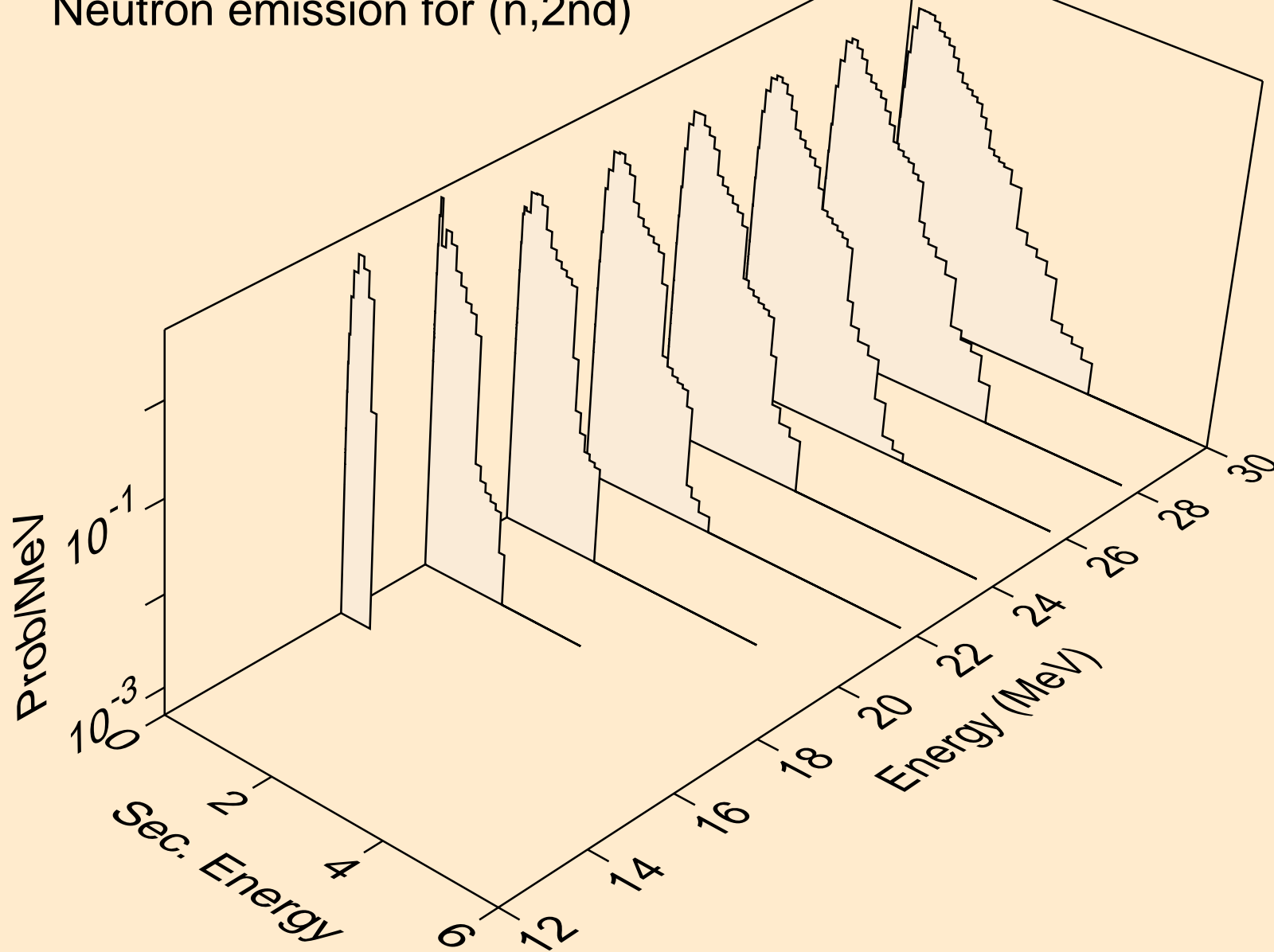

LR260 NEUTRON ACER TENDL-2019 LIBRARY; T=293.16K
Neutron emission for (n,2n)

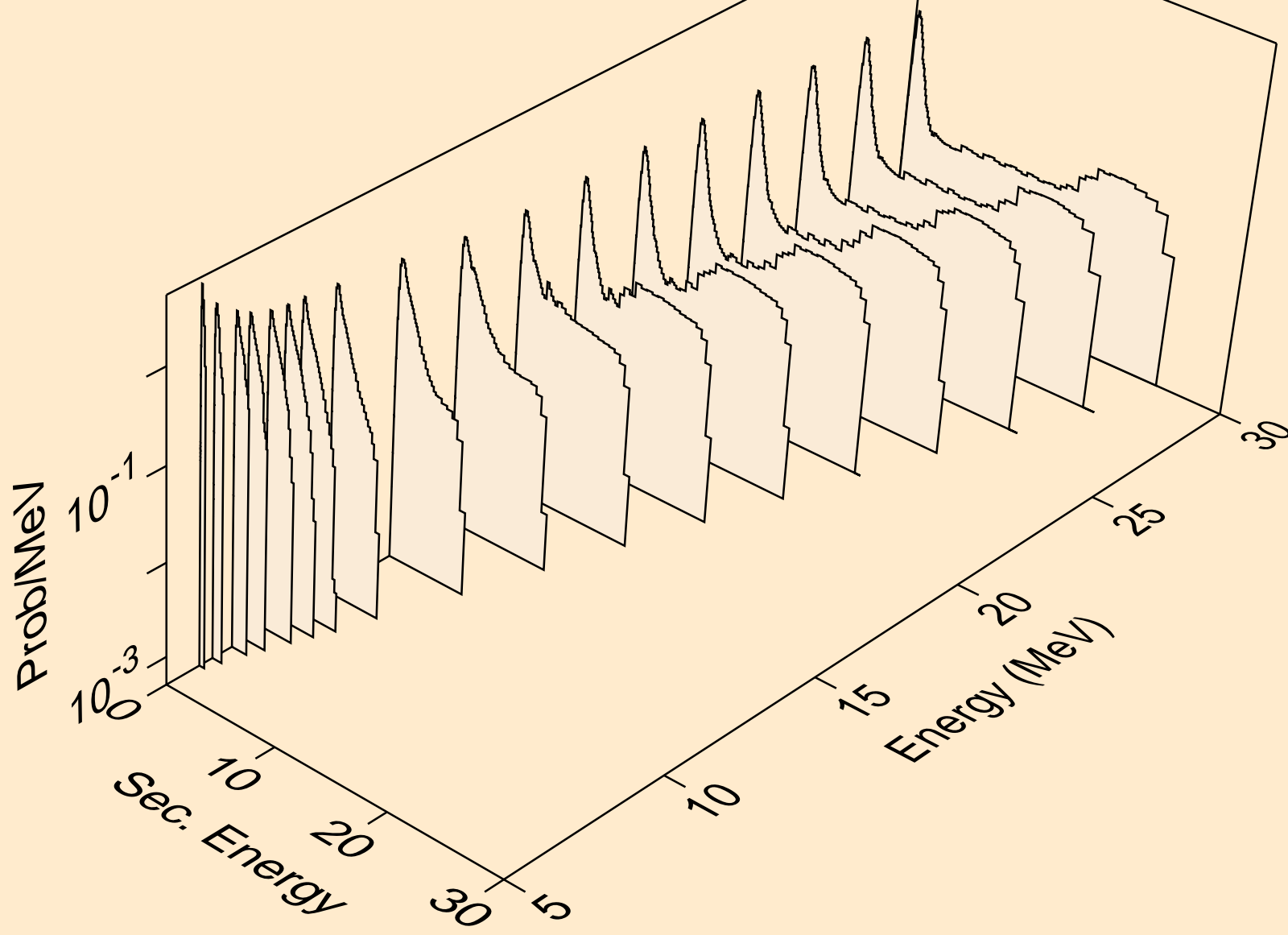

LR260 NEUTRON ACER TENDL-2019 LIBRARY; T=293.16K
Neutron emission for (n,3n)

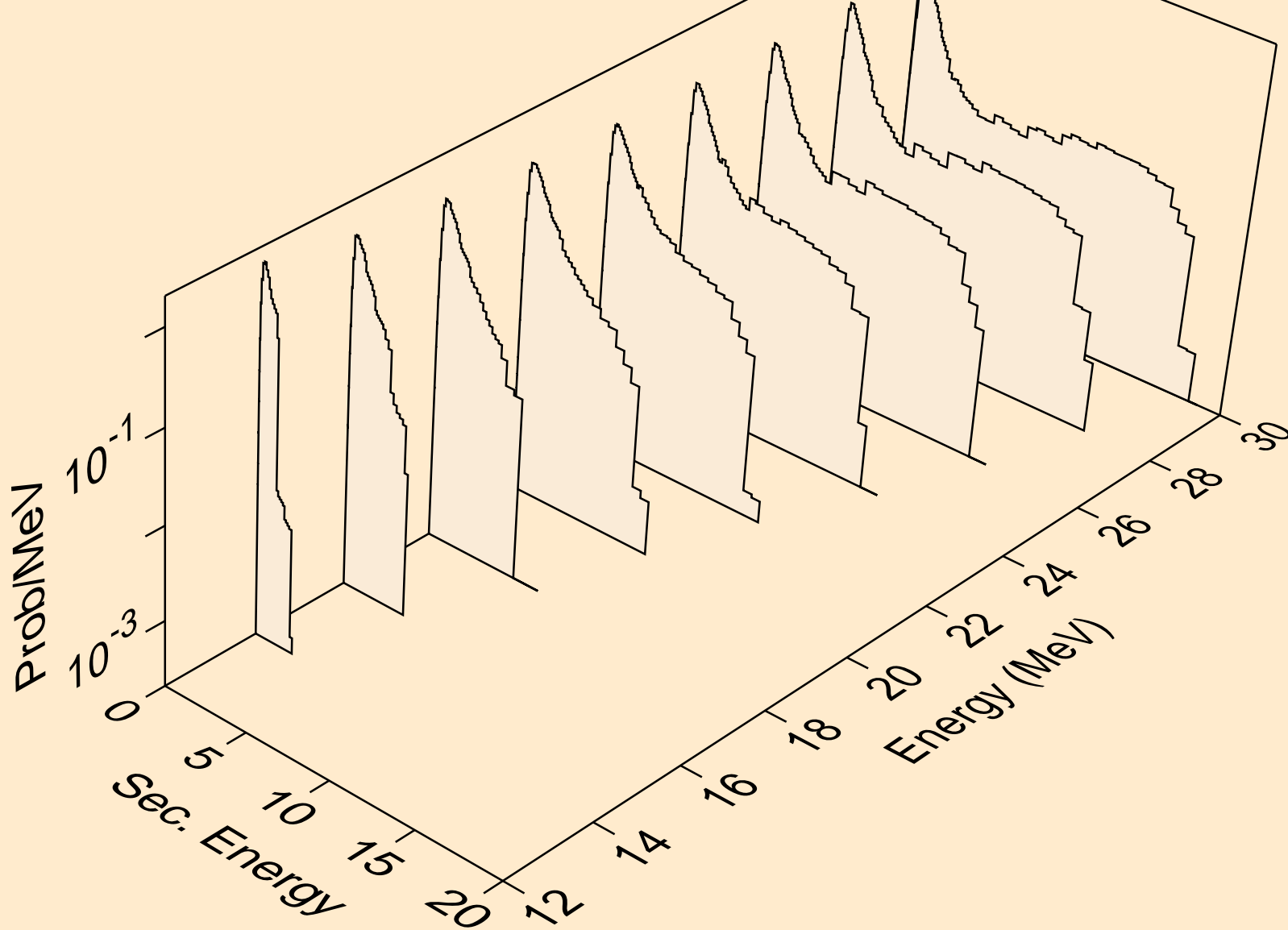

LR260 NEUTRON ACER TENDL-2019 LIBRARY; T=293.16K
Neutron emission for fission

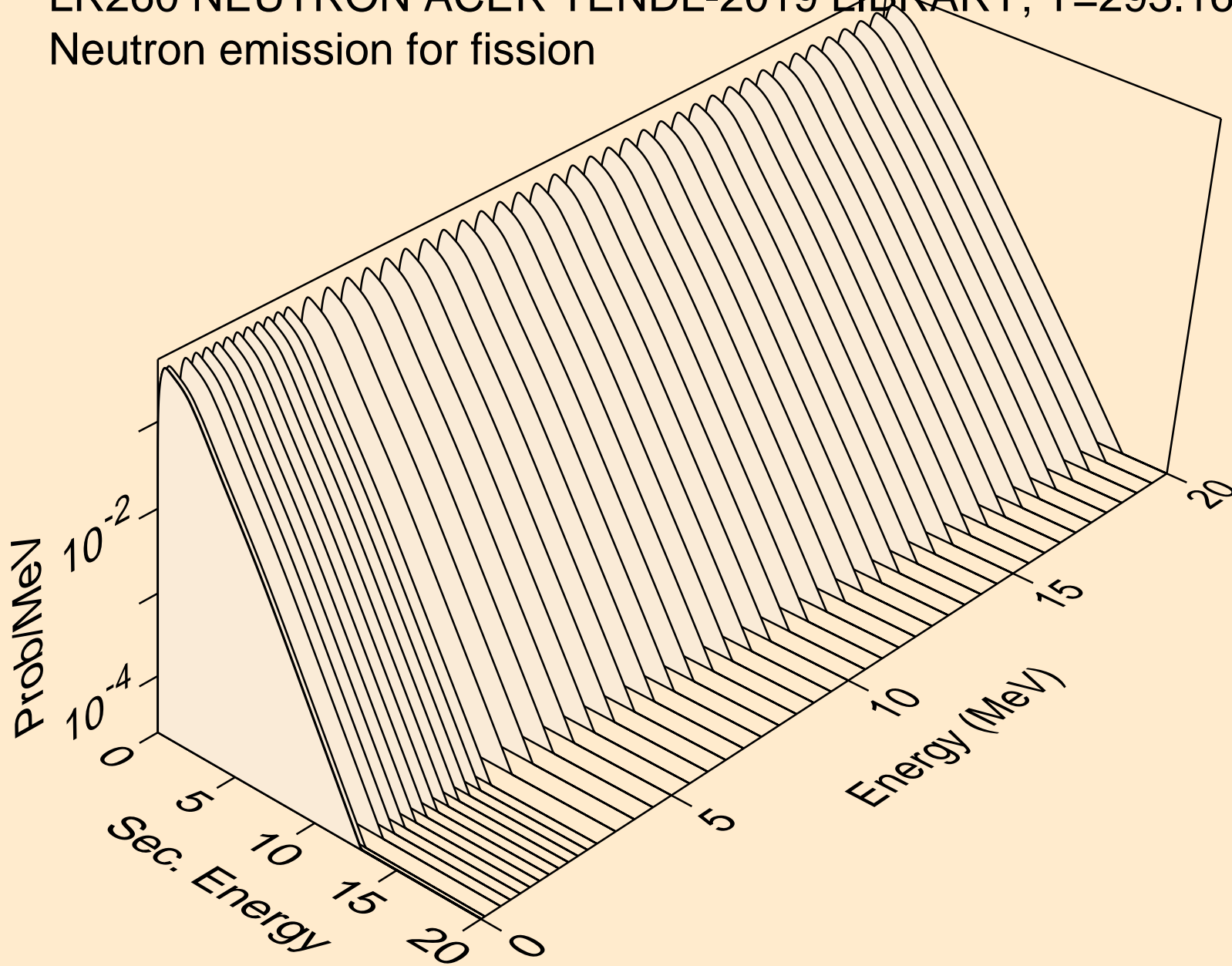

LR260 NEUTRON ACER TENDL-2019 LIBRARY; T=293.16K
Neutron emission for (n,n*)a

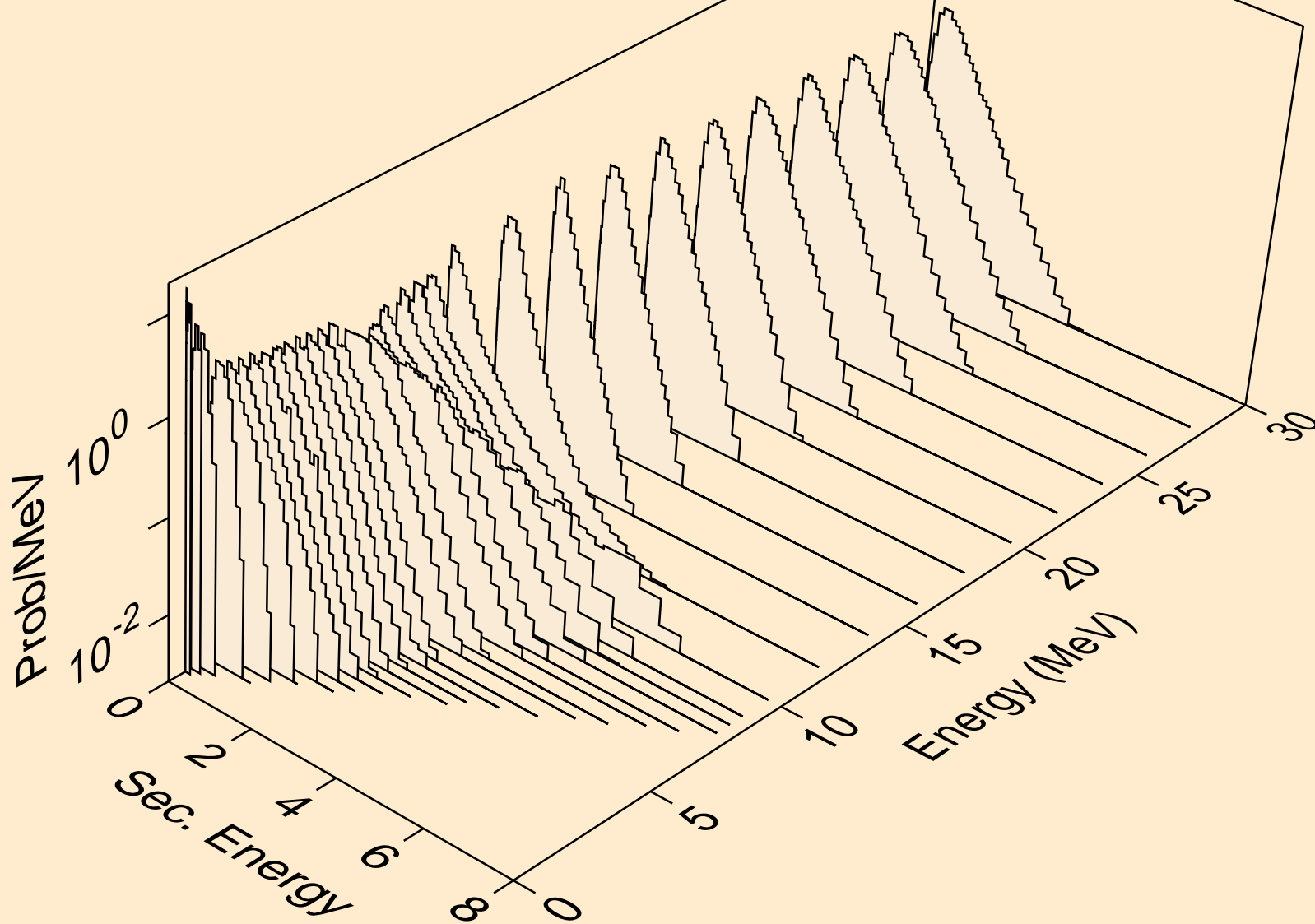

LR260 NEUTRON ACER TENDL-2019 LIBRARY; T=293.16K
Neutron emission for (n,2n)a

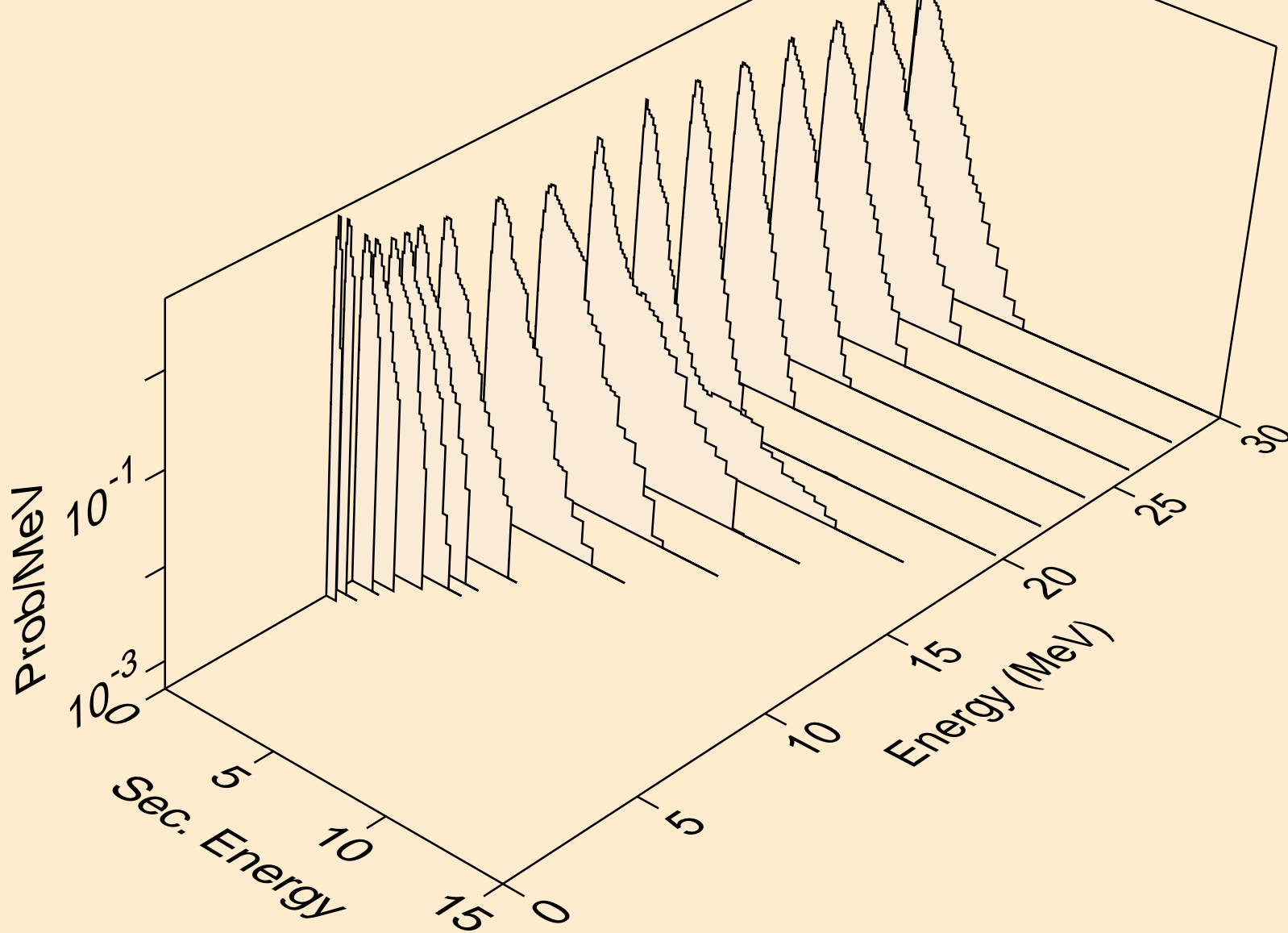

LR260 NEUTRON ACER TENDL-2019 LIBRARY; T=293.16K
Neutron emission for (n,3n)a

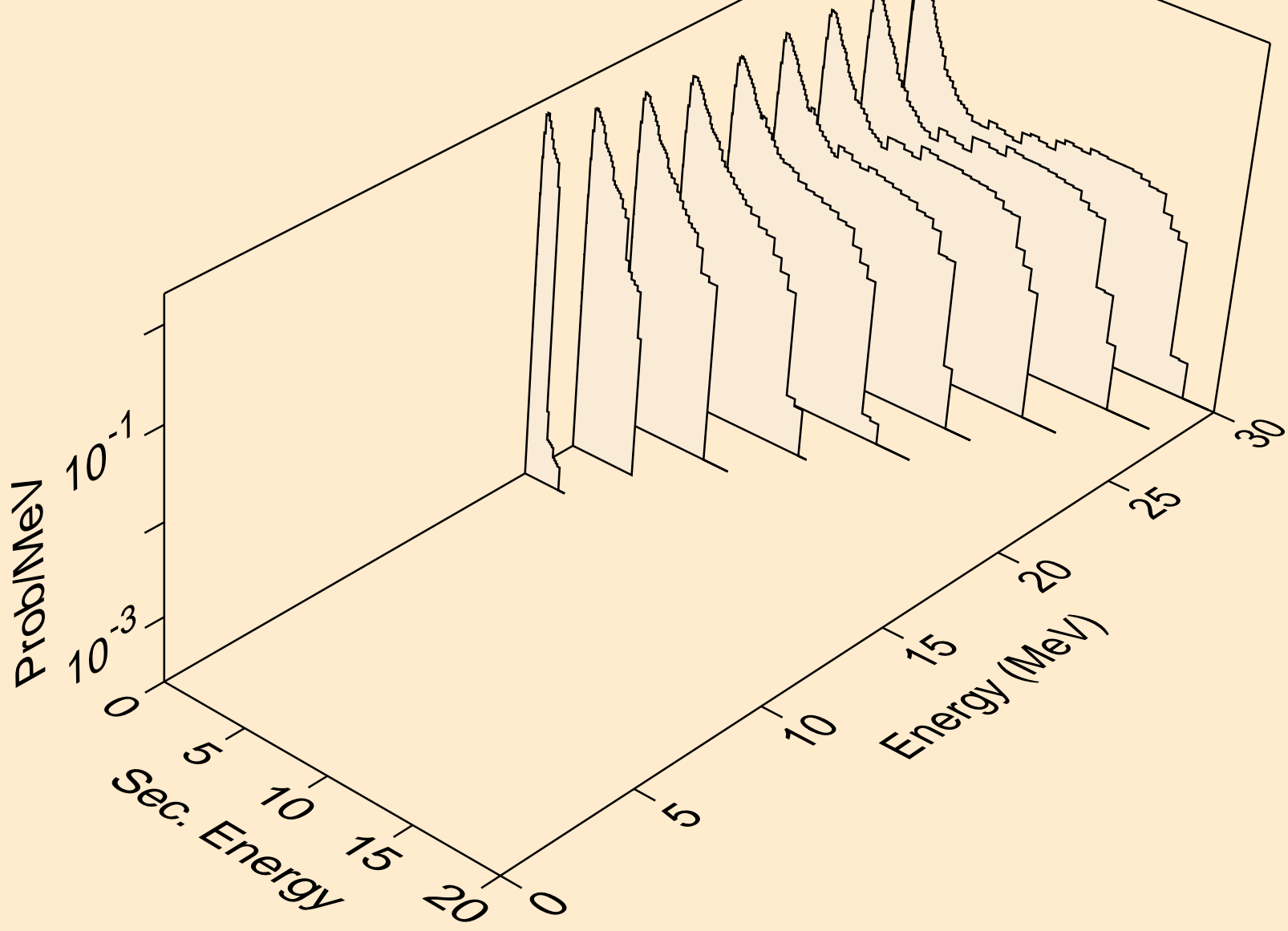

LR260 NEUTRON ACER TENDL-2019 LIBRARY; T=293.16K
Neutron emission for (n,n*)p

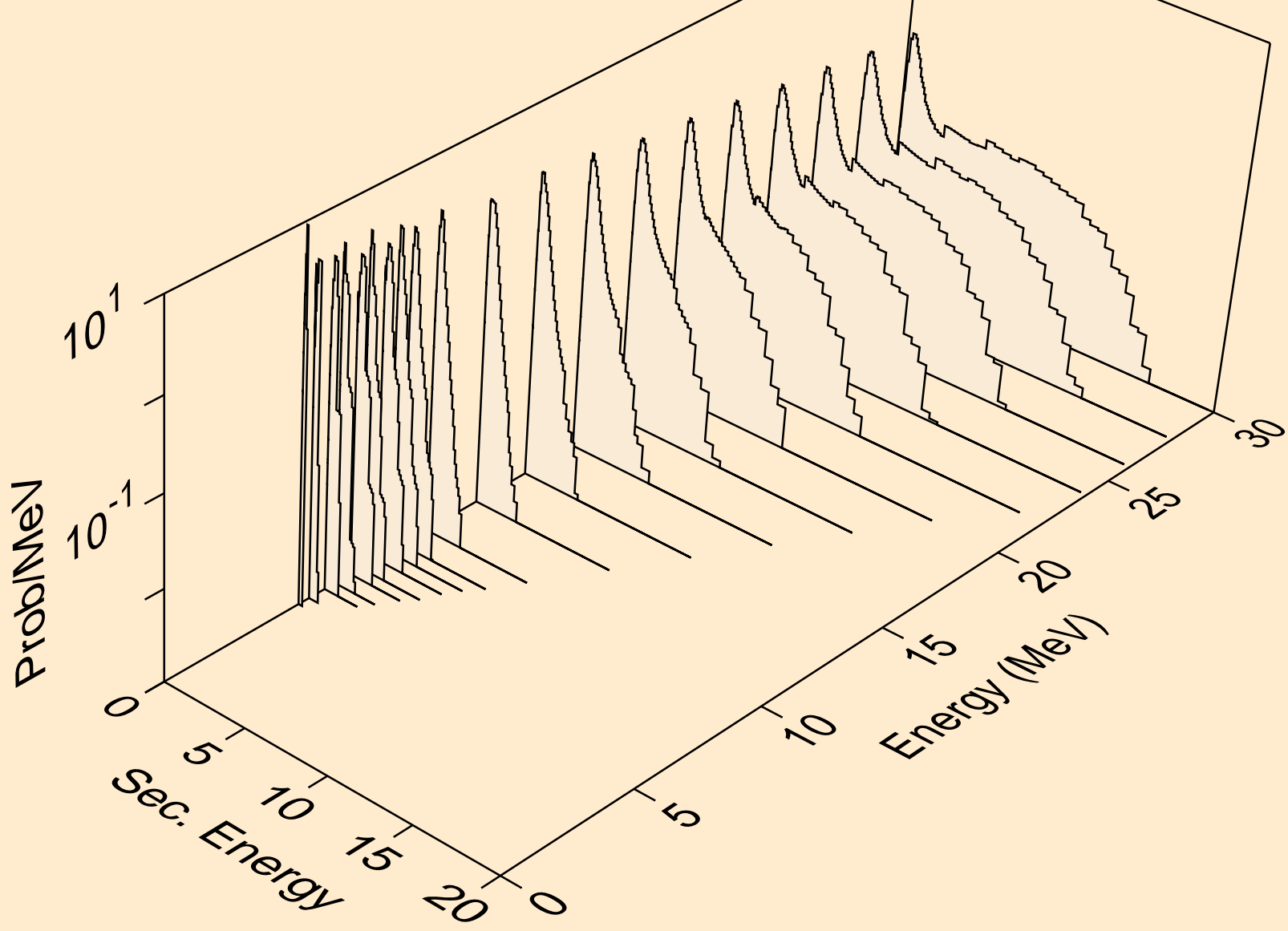

LR260 NEUTRON ACER TENDL-2019 LIBRARY; T=293.16K
Neutron emission for (n,n*)2a

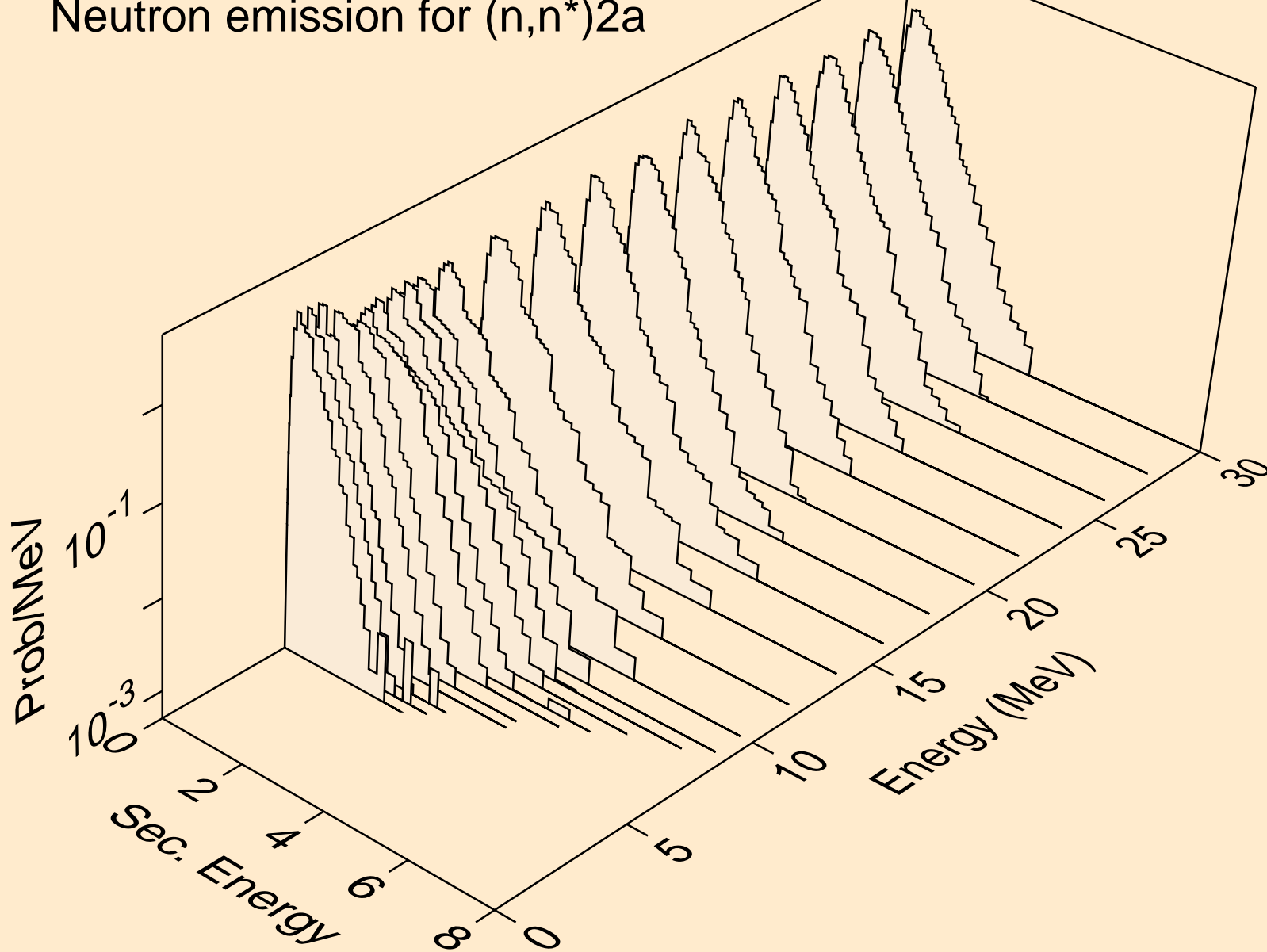

LR260 NEUTRON ACER TENDL-2019 LIBRARY; T=293.16K
Neutron emission for (n,2n)2a

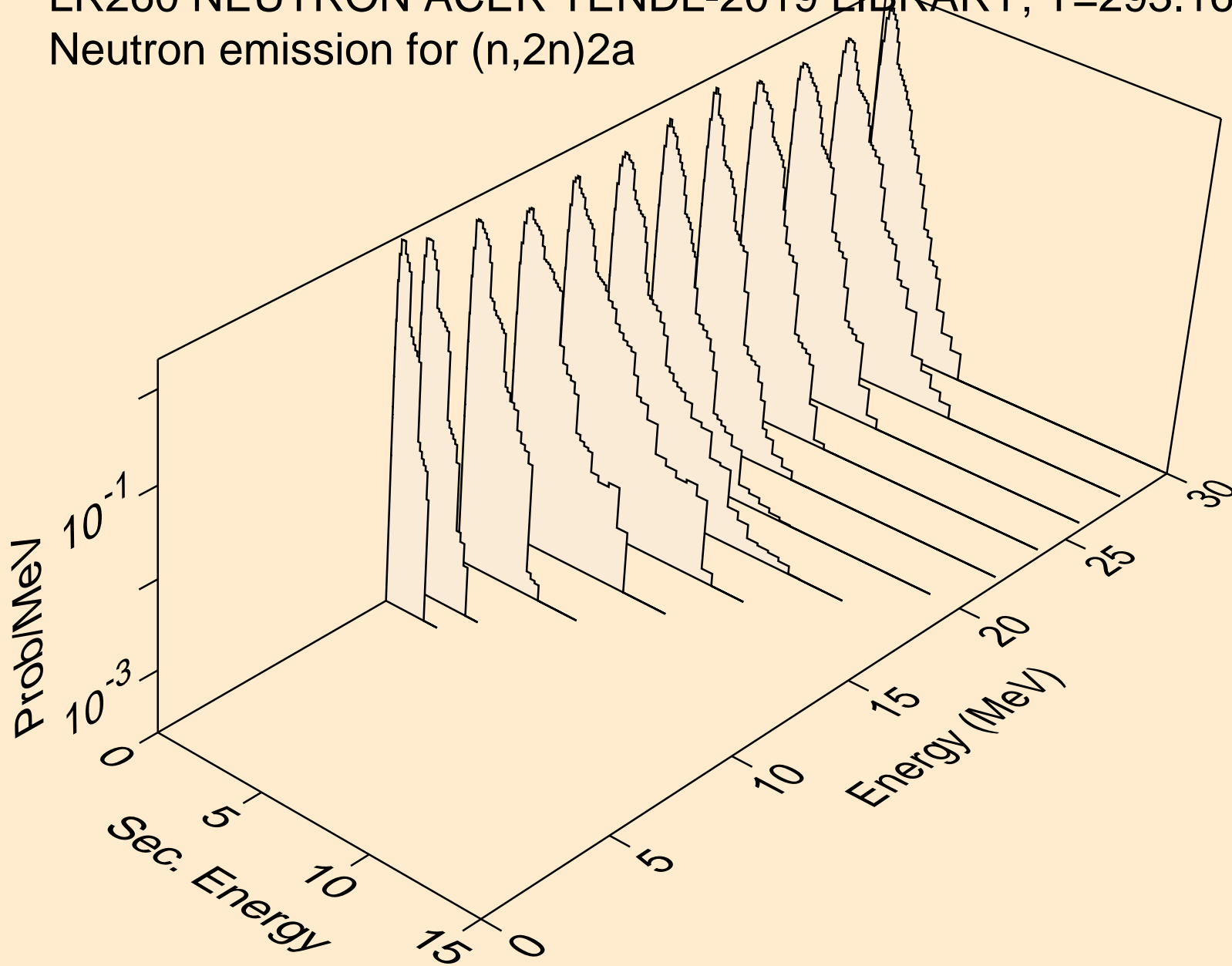

LR260 NEUTRON ACER TENDL-2019 LIBRARY; T=293.16K
Neutron emission for (n,n*)d

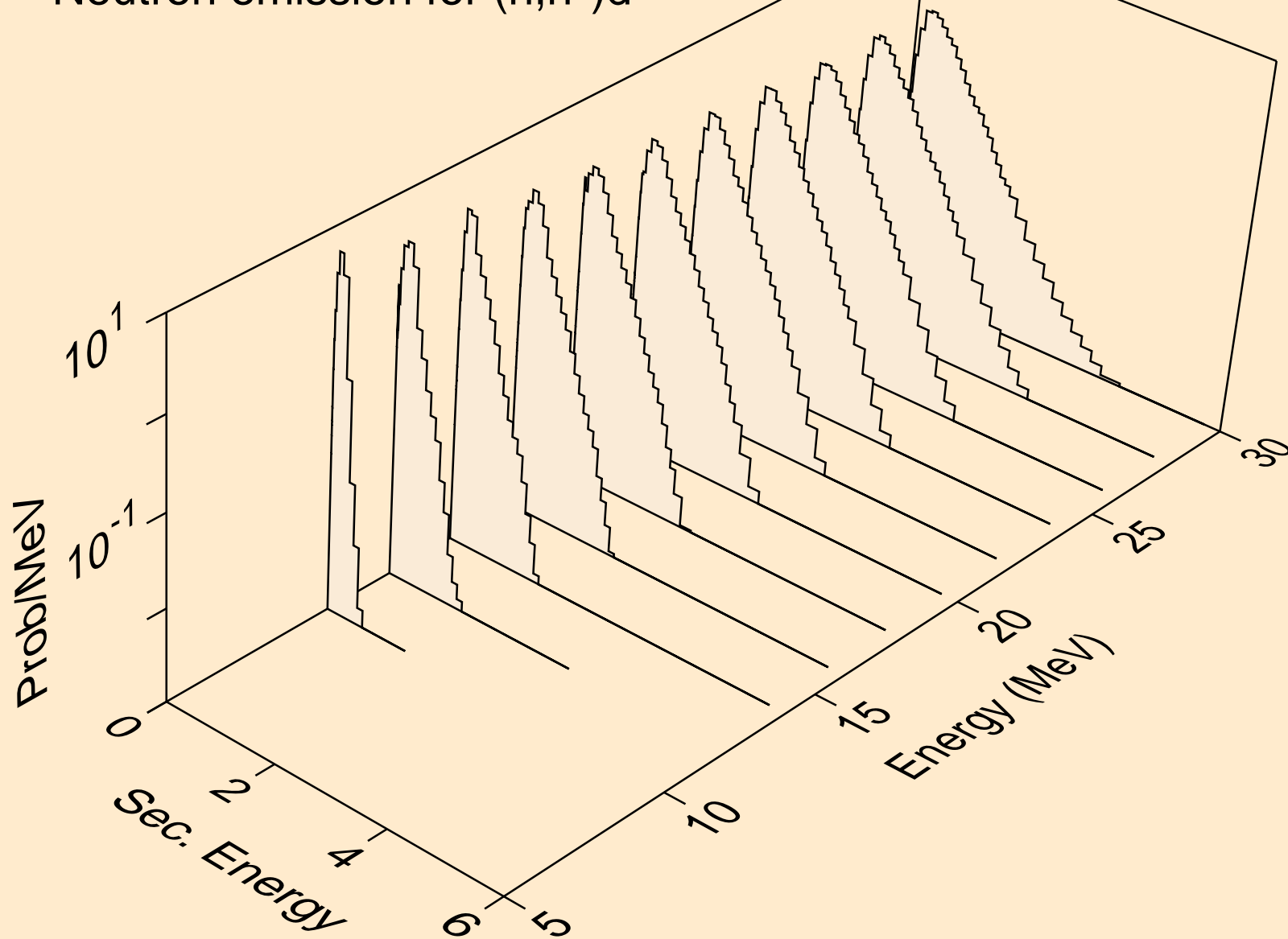

LR260 NEUTRON ACER TENDL-2019 LIBRARY; T=293.16K
Neutron emission for (n,n*)t

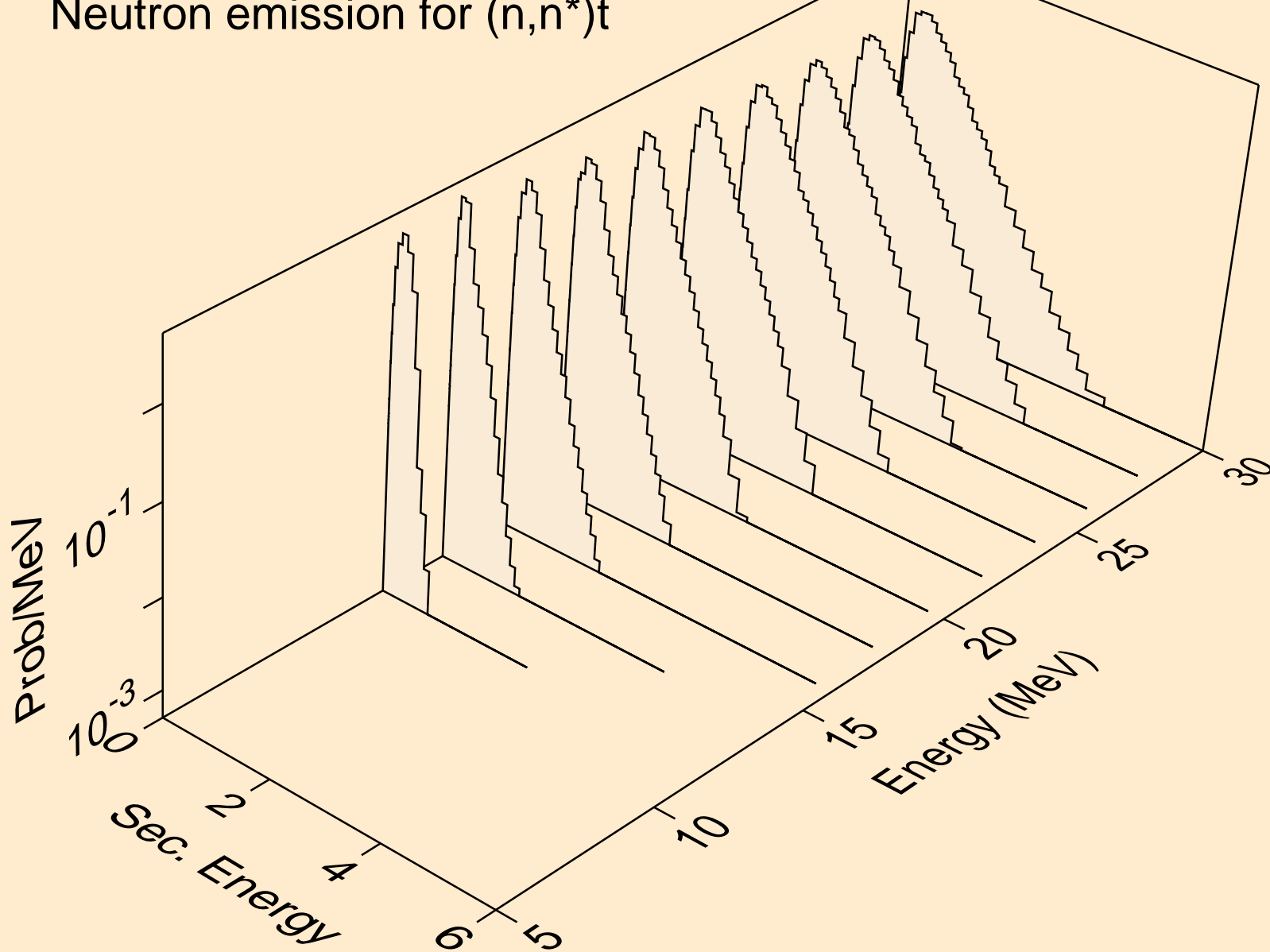

LR260 NEUTRON ACER TENDL-2019 LIBRARY; T=293.16K
Neutron emission for (n,n*)he3

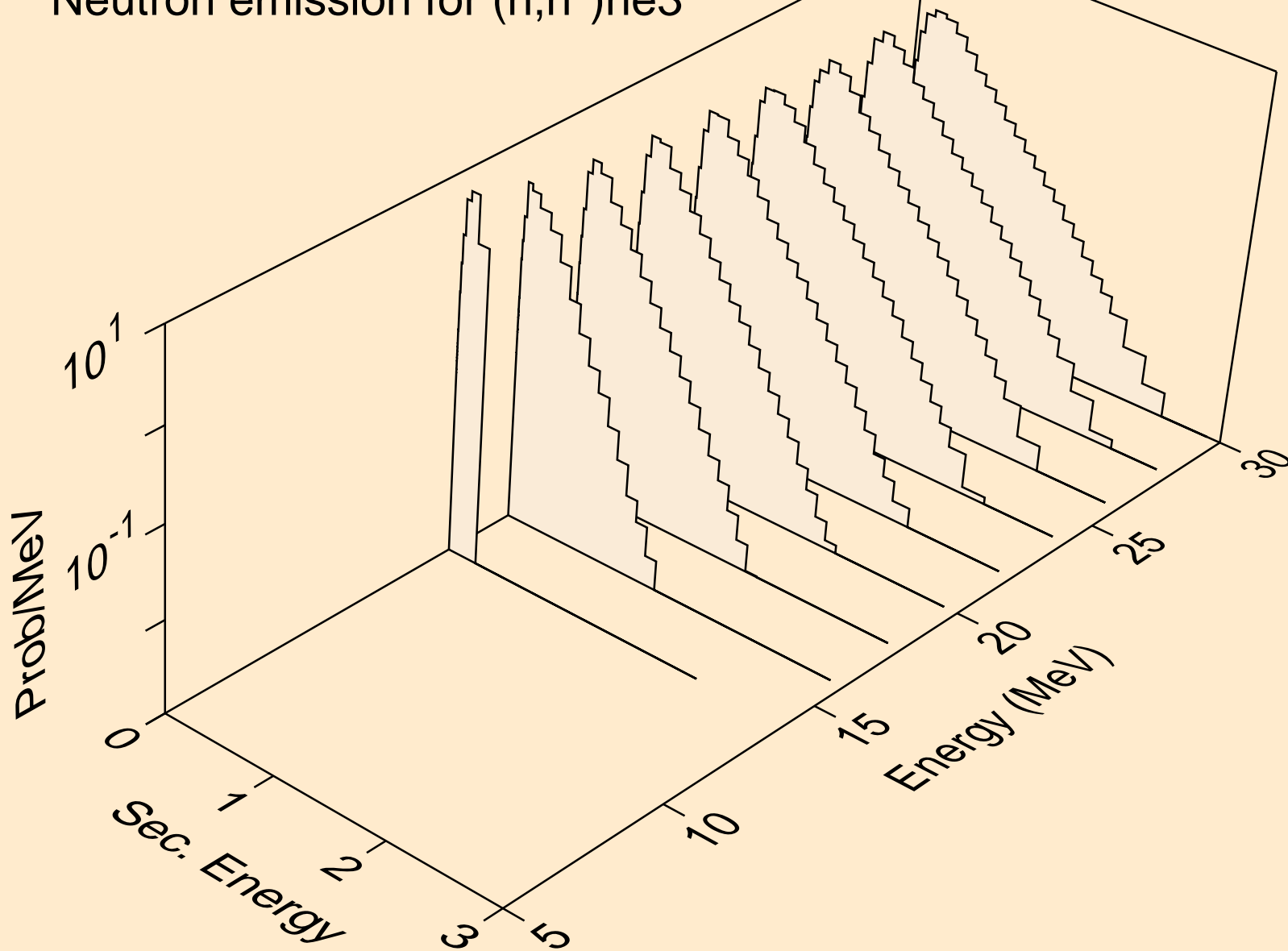

LR260 NEUTRON ACER TENDL-2019 LIBRARY; T=293.16K
Neutron emission for (n,4n)

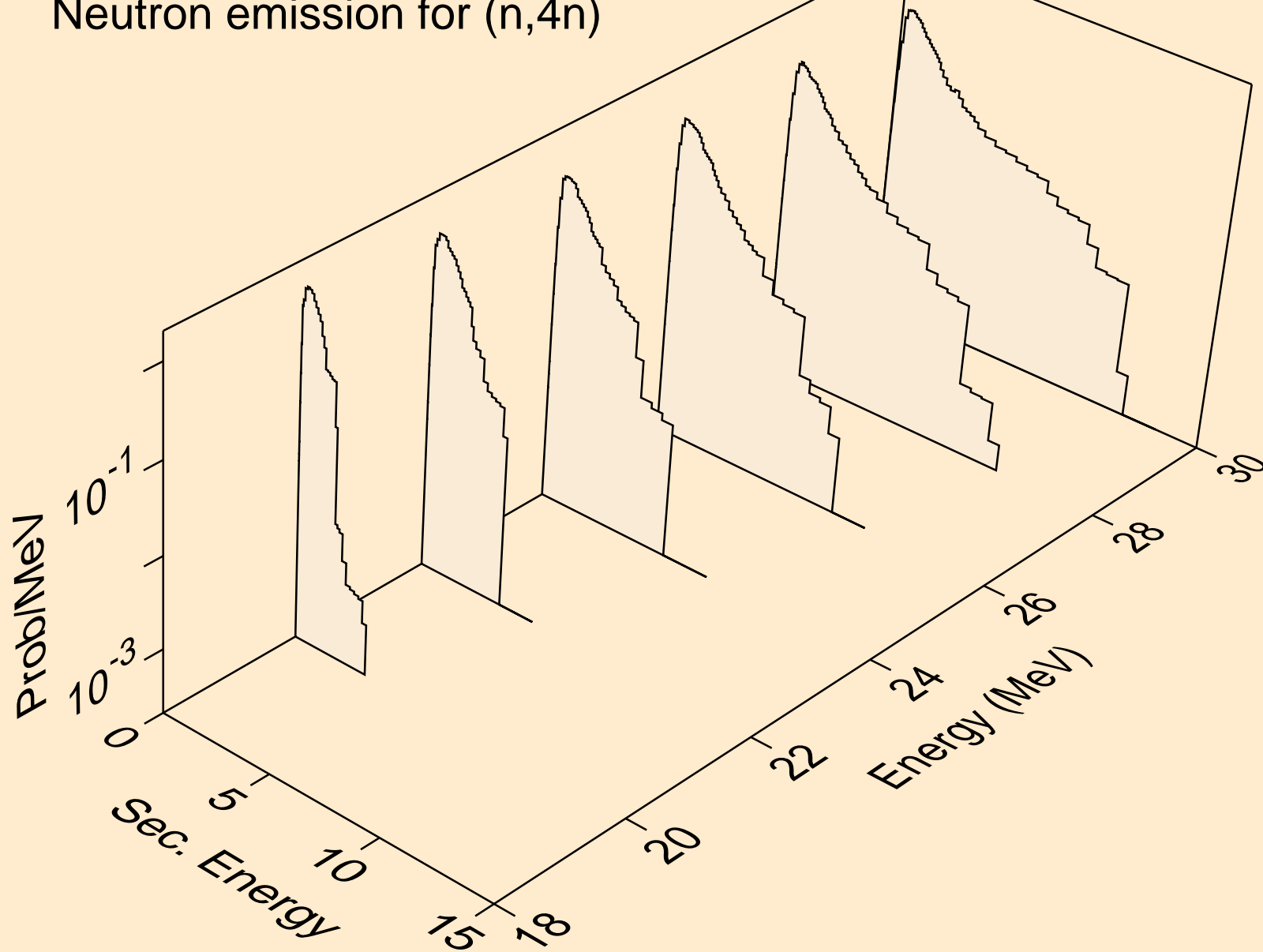

LR260 NEUTRON ACER TENDL-2019 LIBRARY; T=293.16K
Neutron emission for (n,2np)

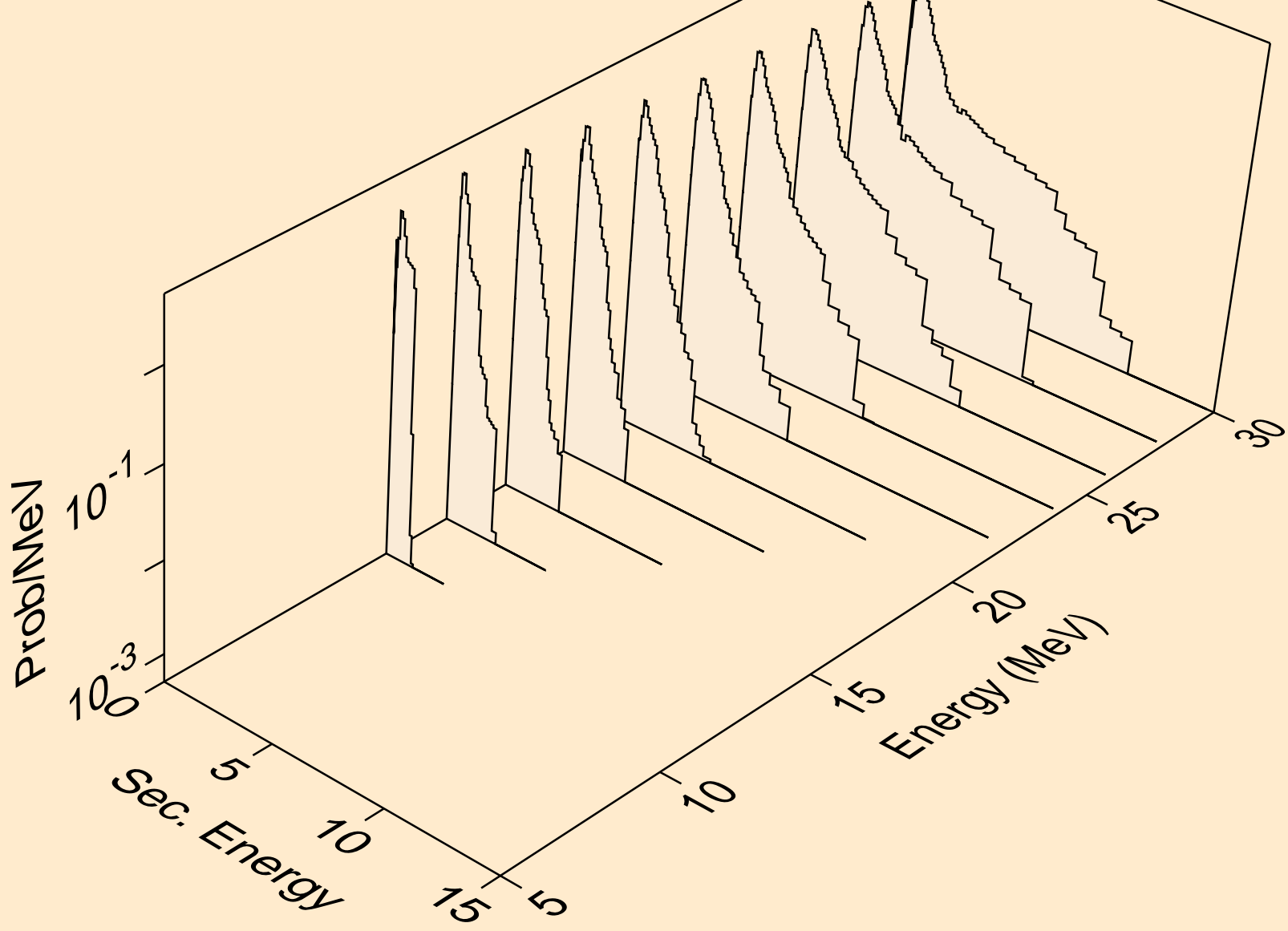

LR260 NEUTRON ACER TENDL-2019 LIBRARY; T=293.16K
Neutron emission for (n,3np)

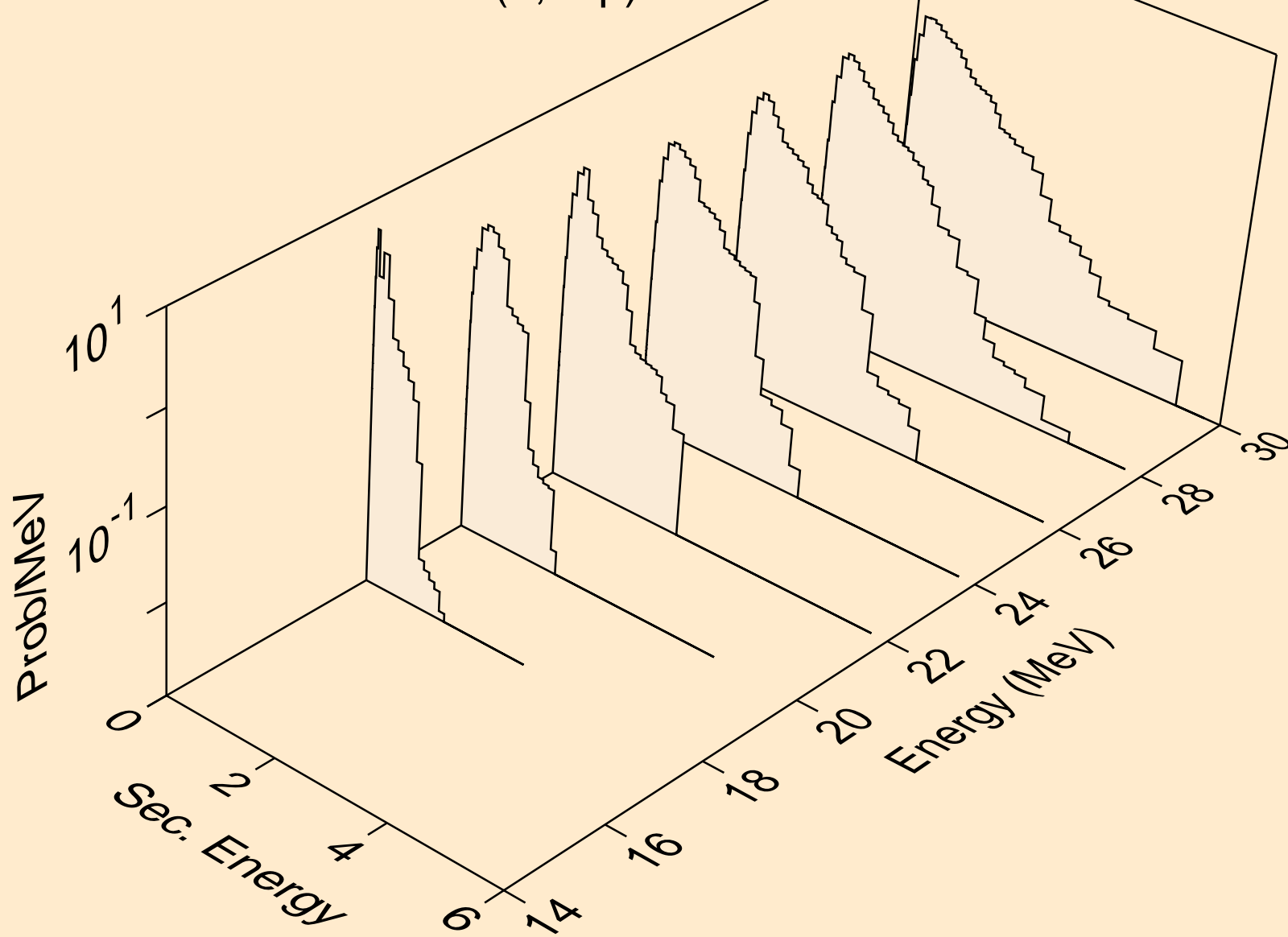

LR260 NEUTRON ACER TENDL-2019 LIBRARY; T=293.16K
Neutron emission for (n,2np)

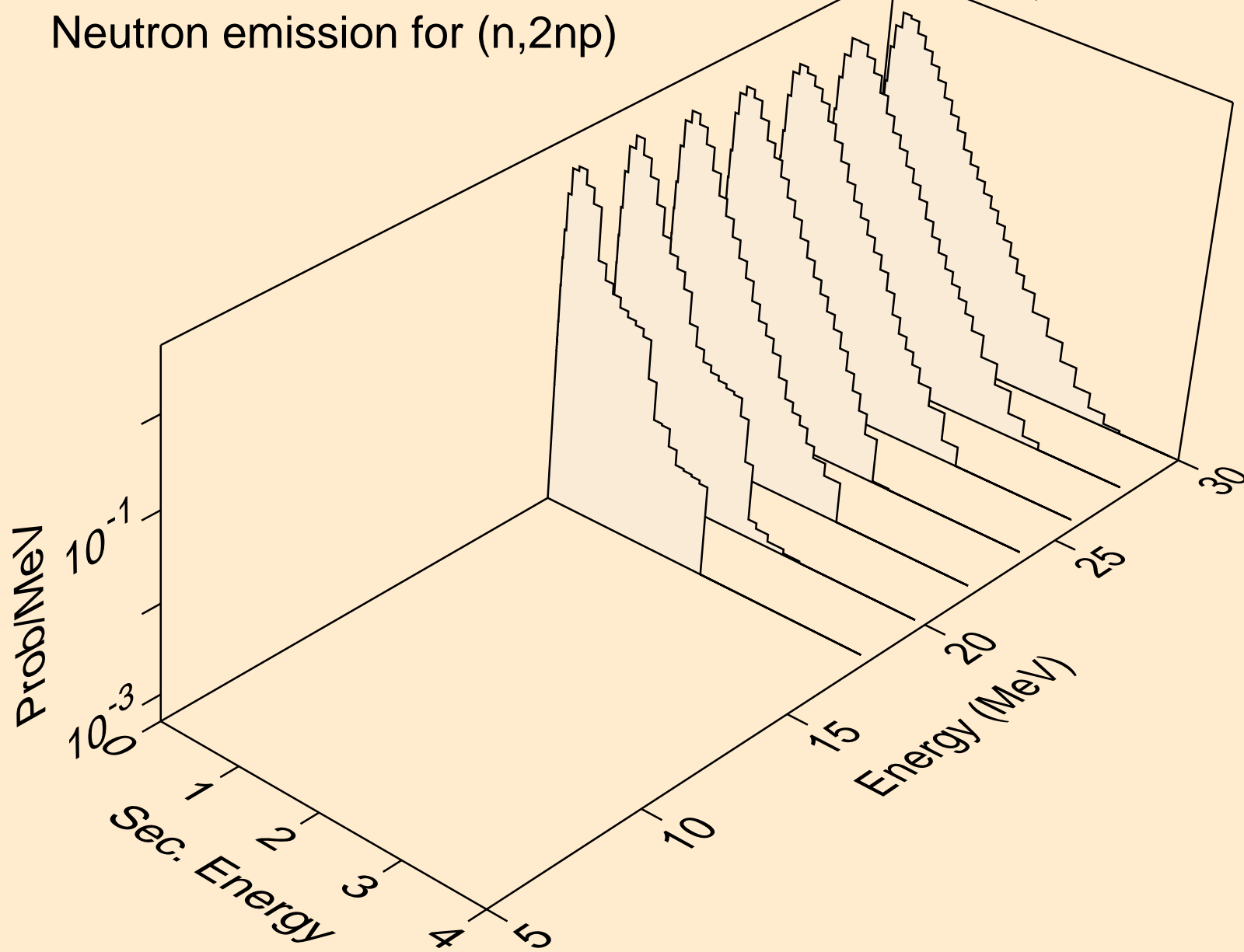

LR260 NEUTRON ACER TENDL-2019 LIBRARY; T=293.16K
Neutron emission for (n,npa)

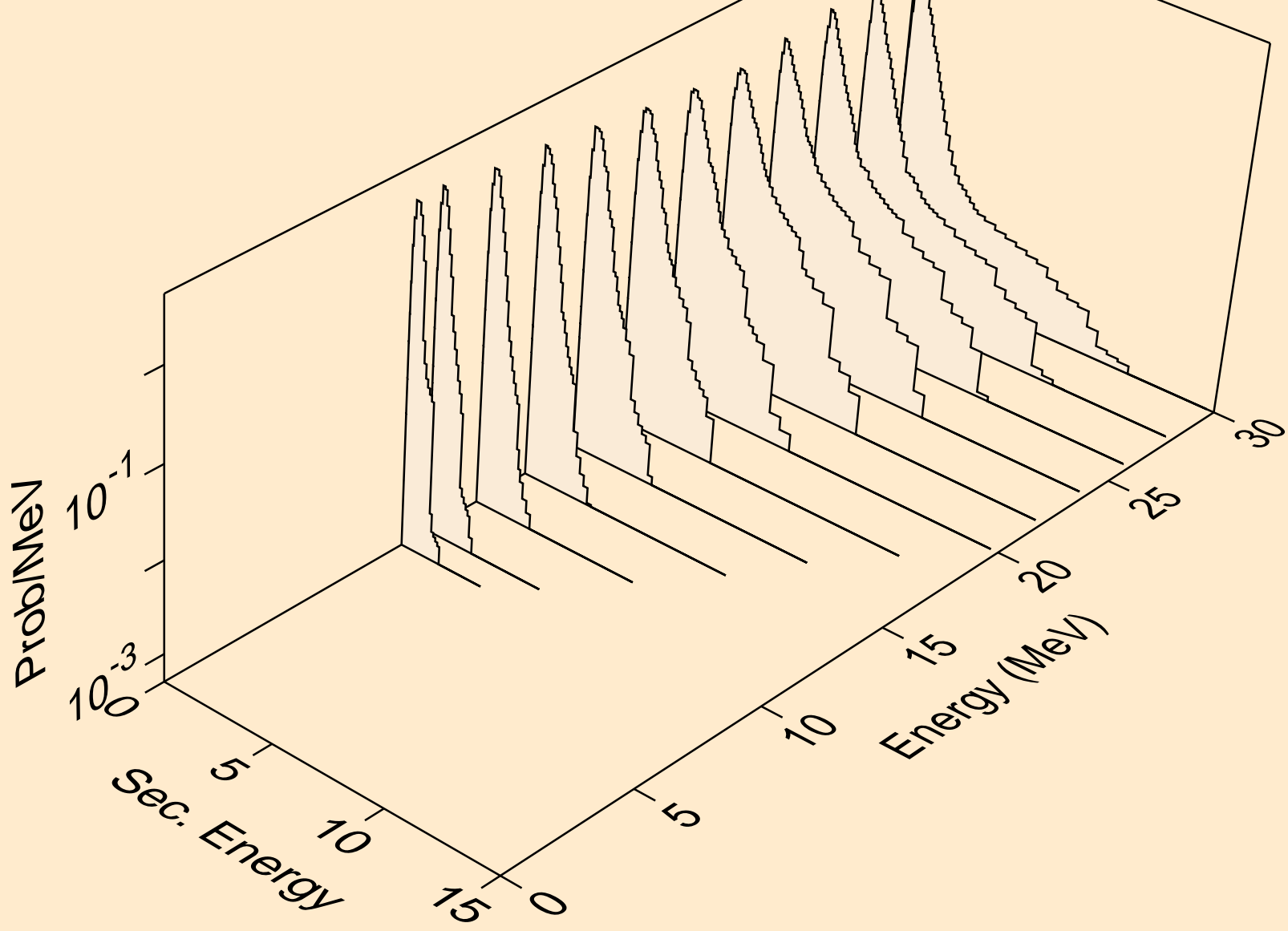

LR260 NEUTRON ACER TENDL-2019 LIBRARY; T=293.16K
Neutron emission for (n,n*c)

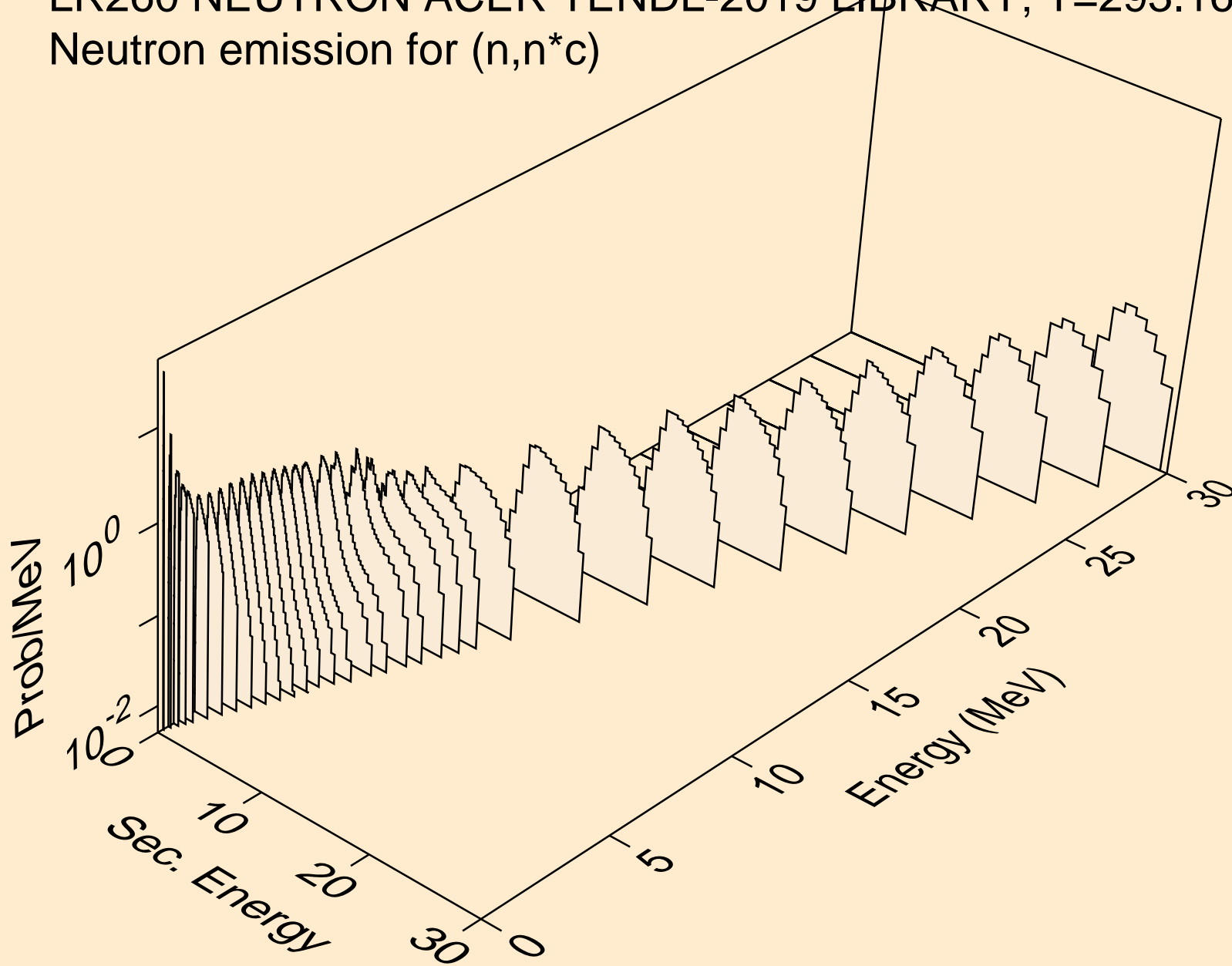

LR260 NEUTRON ACER TENDL-2019 LIBRARY; T=293.16K

Delayed nubar

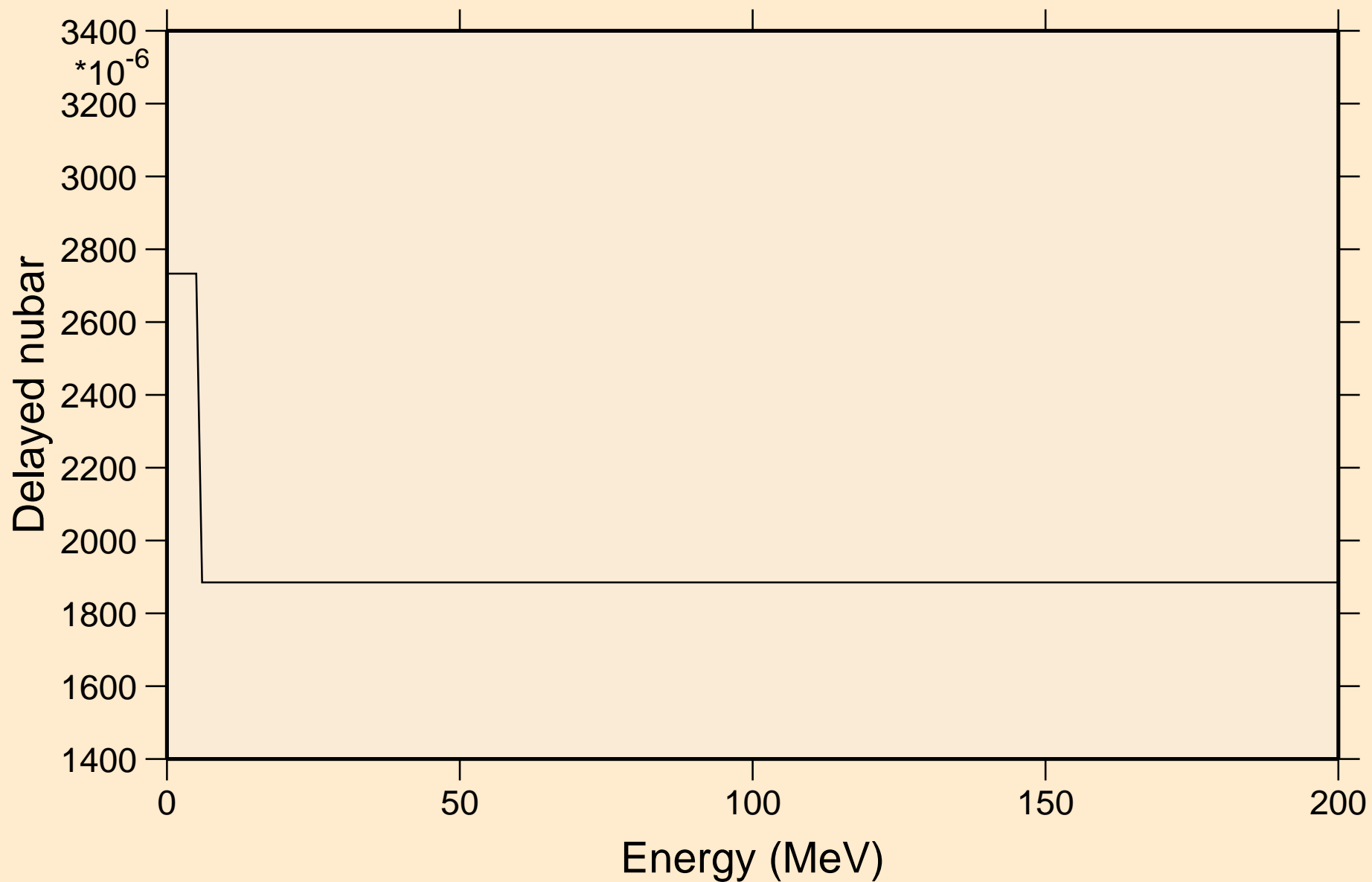

LR260 NEUTRON ACER TENDL-2019 LIBRARY; T=293.16K
Delayed neutron spectra

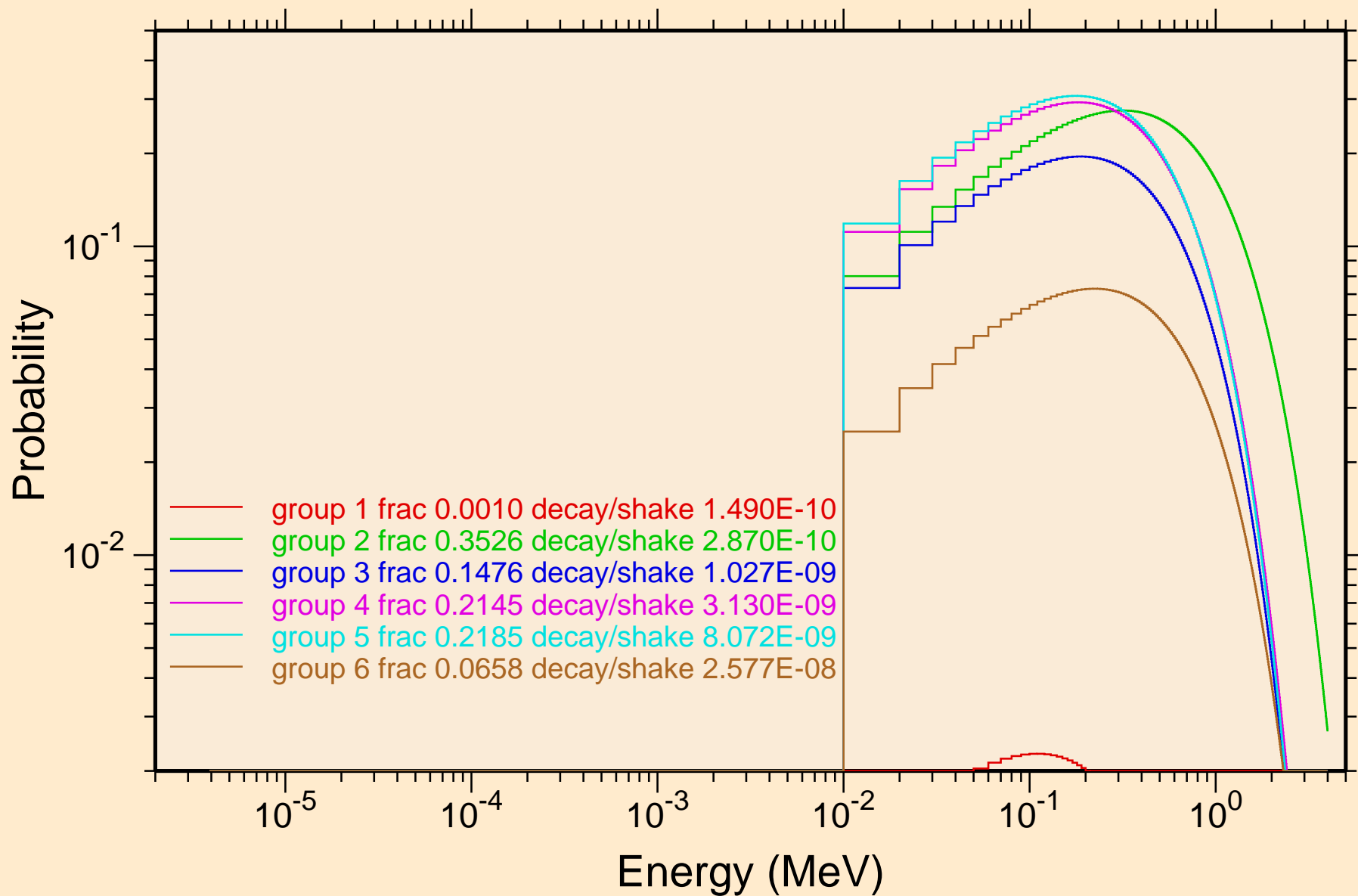

LR260 NEUTRON ACER TENDL-2019 LIBRARY; T=293.16K
Photon emission for (n,x)

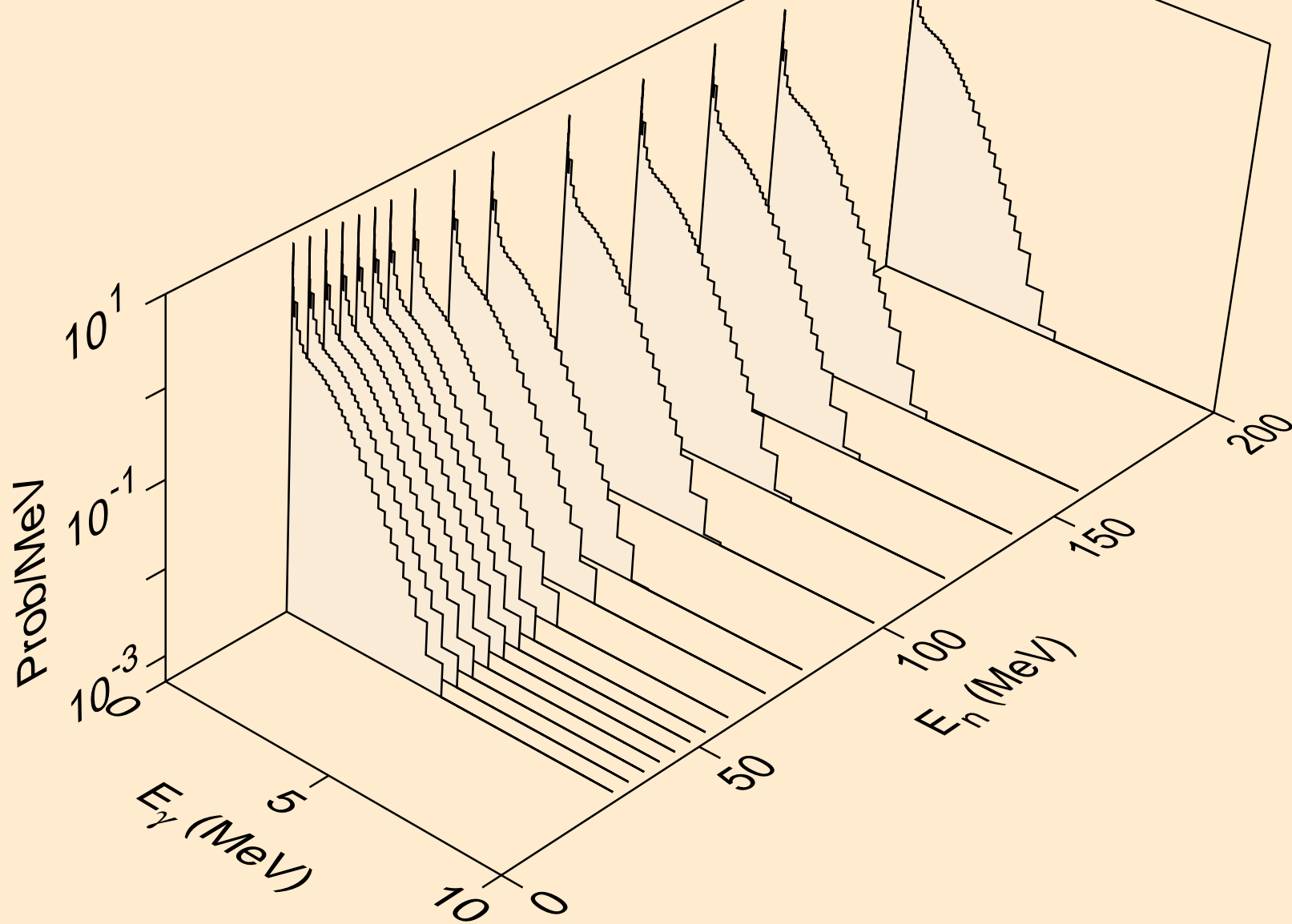

LR260 NEUTRON ACER TENDL-2019 LIBRARY; T=293.16K
Photon emission for (n,2nd)

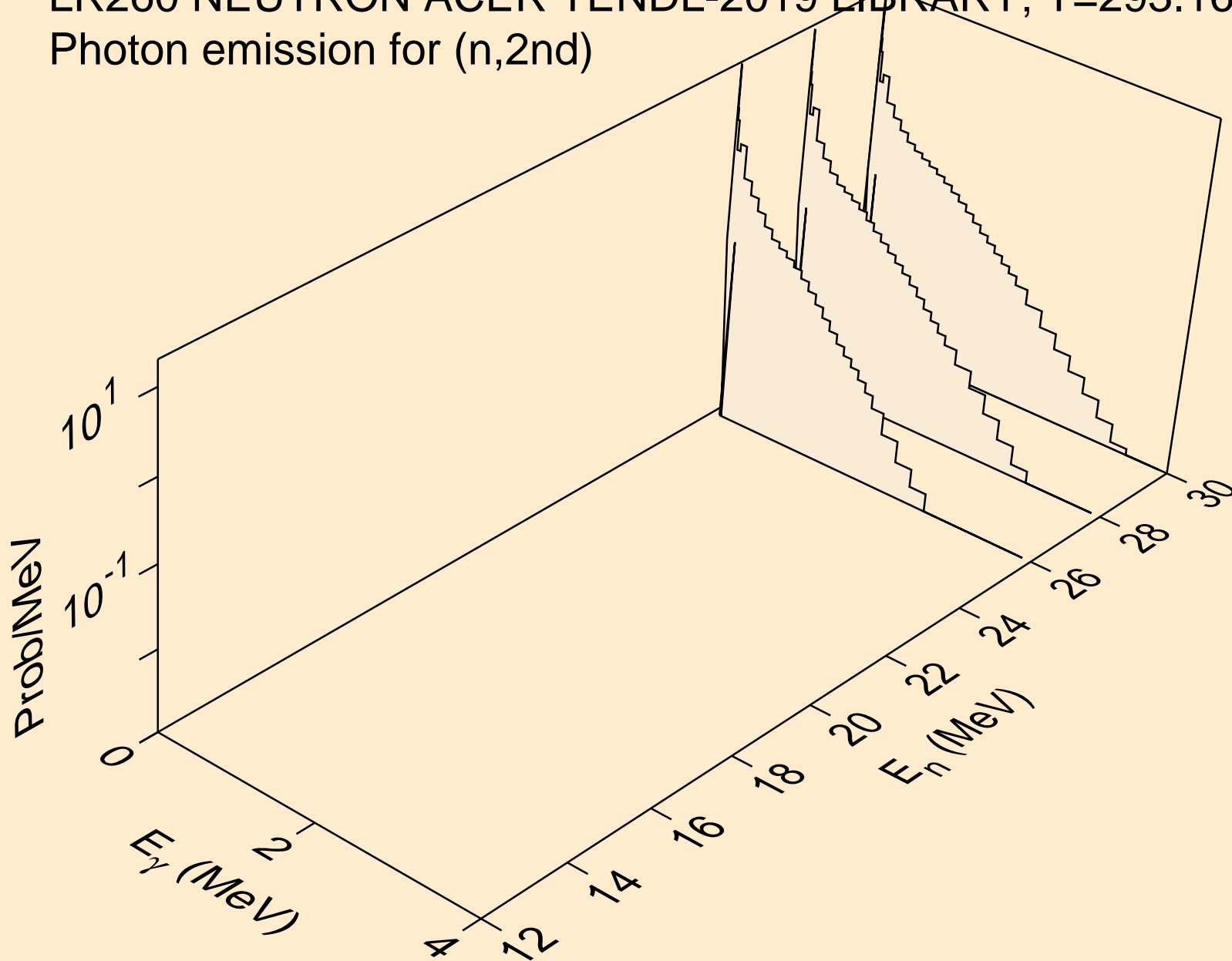

LR260 NEUTRON ACER TENDL-2019 LIBRARY; T=293.16K
Photon emission for (n,2n)

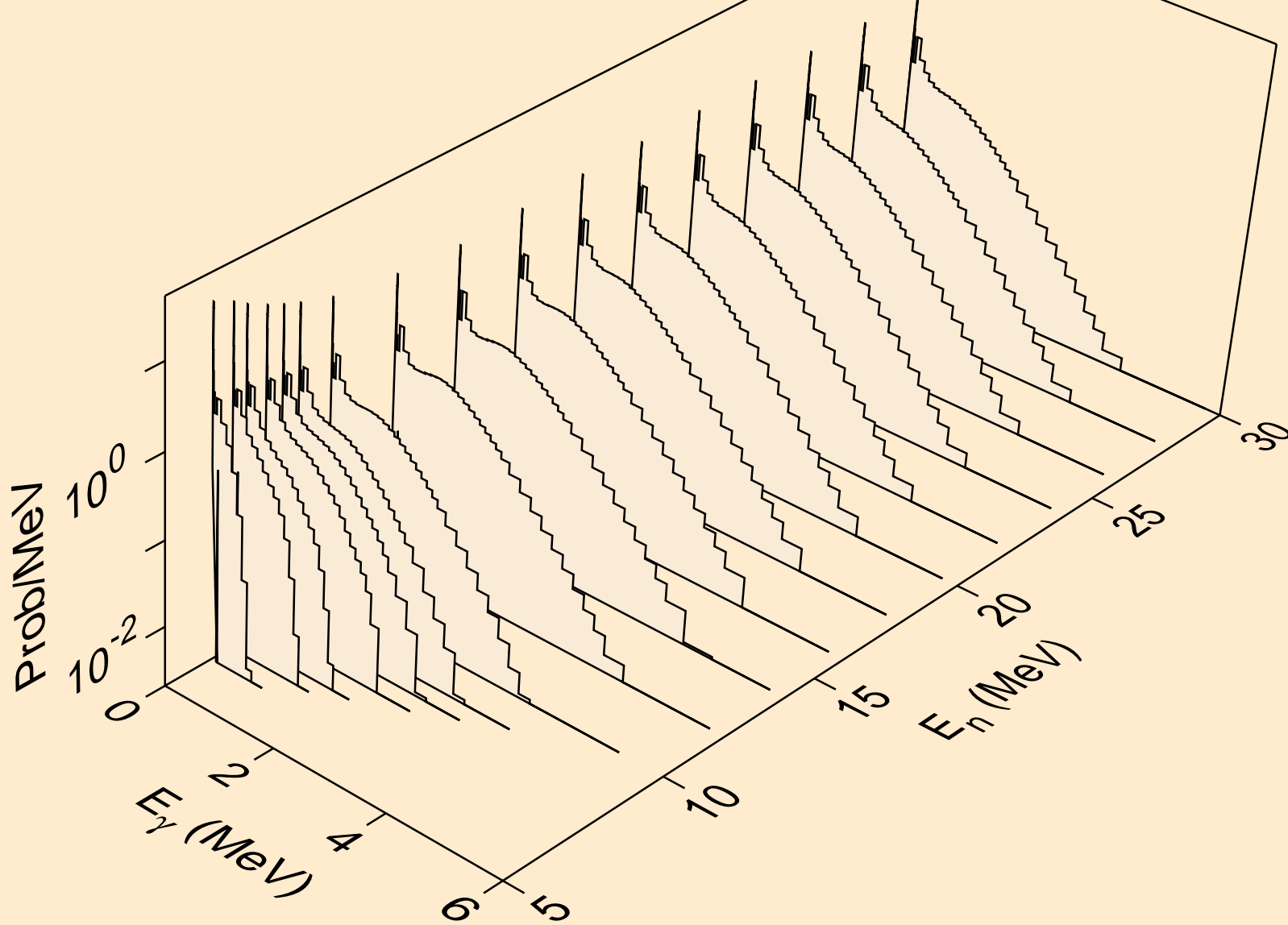

LR260 NEUTRON ACER TENDL-2019 LIBRARY; T=293.16K
Photon emission for (n,3n)

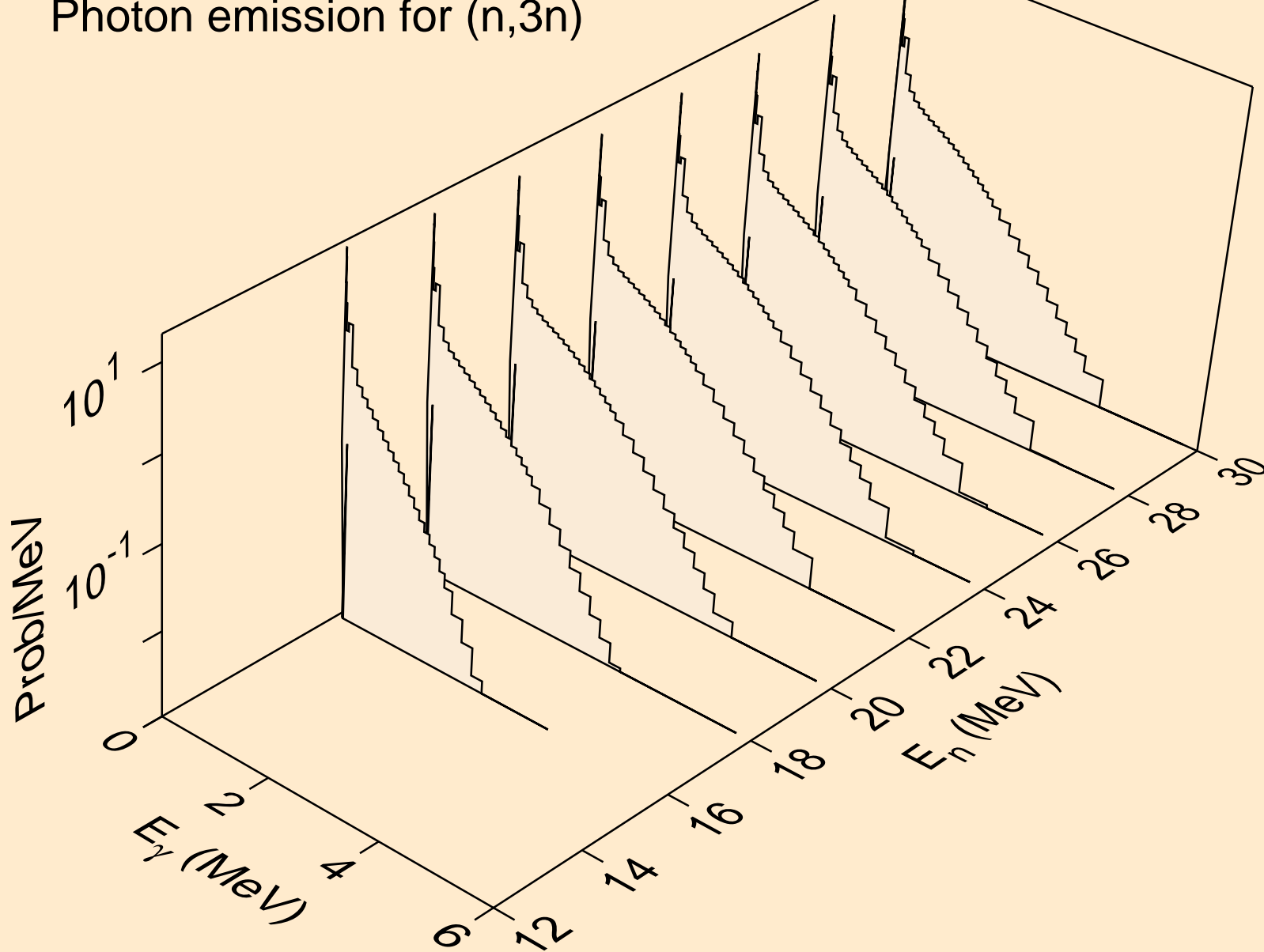

LR260 NEUTRON ACER TENDL-2019 LIBRARY; T=293.16K
Photon emission for (n,n*)a

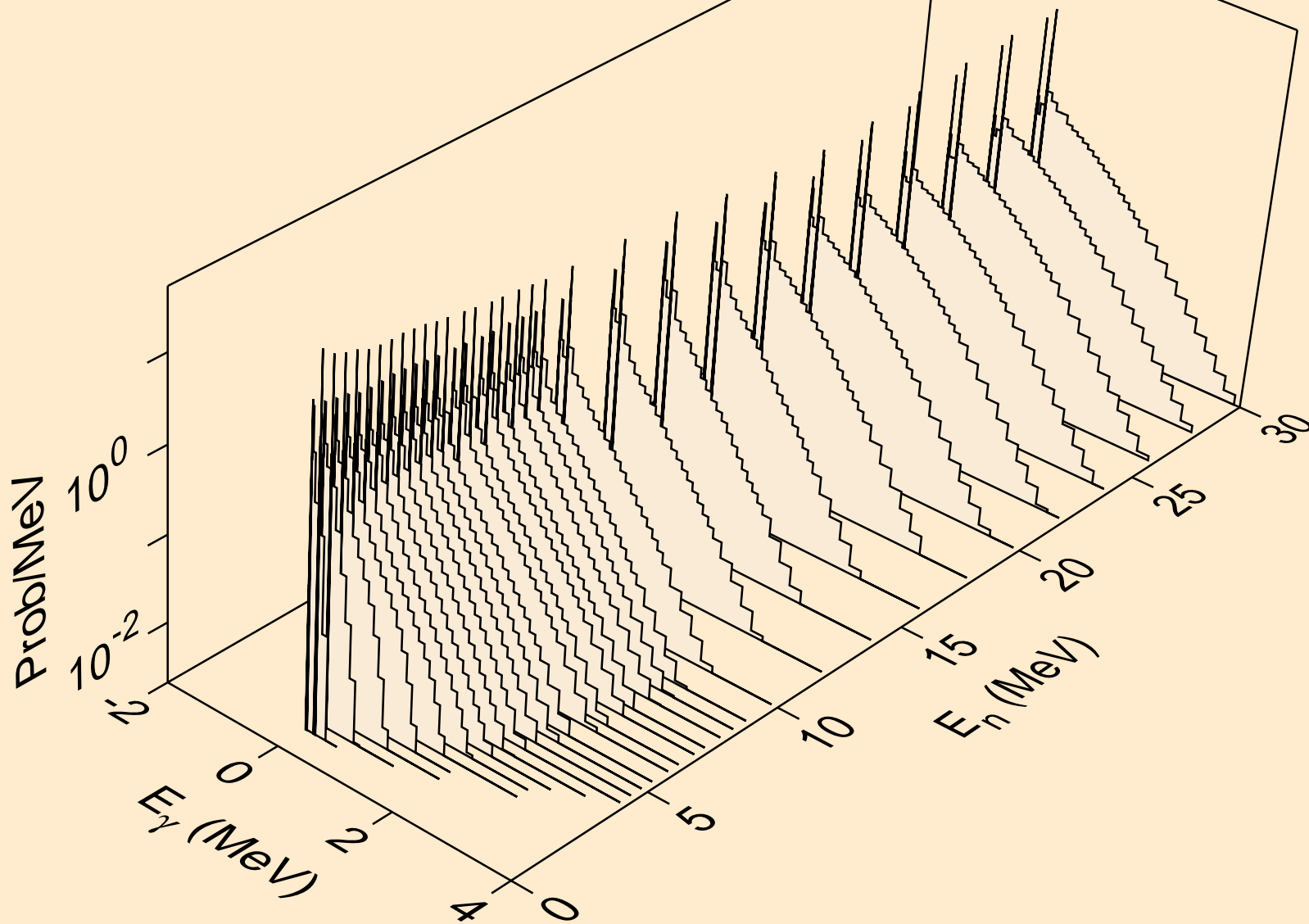

LR260 NEUTRON ACER TENDL-2019 LIBRARY; T=293.16K
Photon emission for (n,2n)a

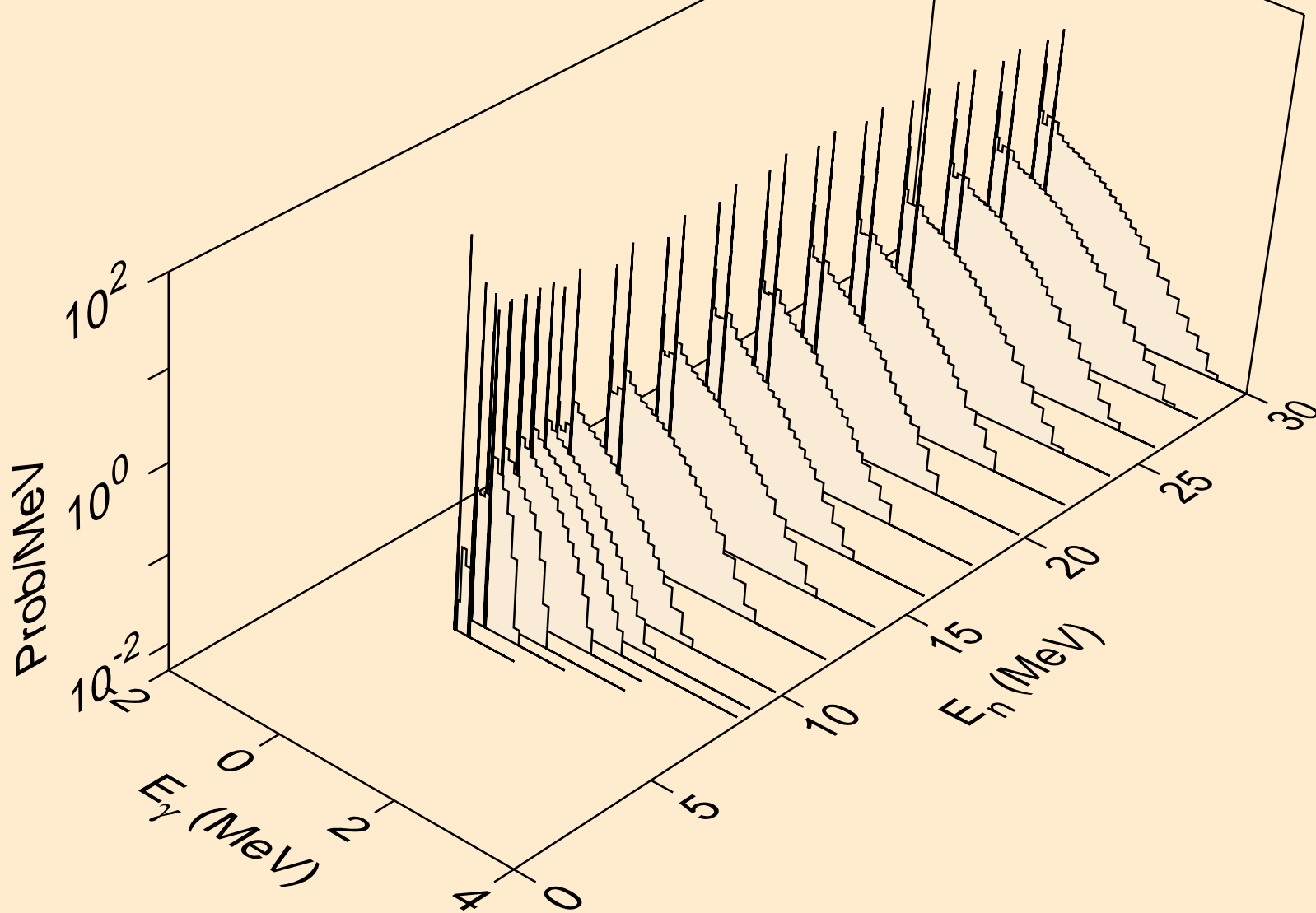

LR260 NEUTRON ACER TENDL-2019 LIBRARY; T=293.16K
Photon emission for (n,3n)a

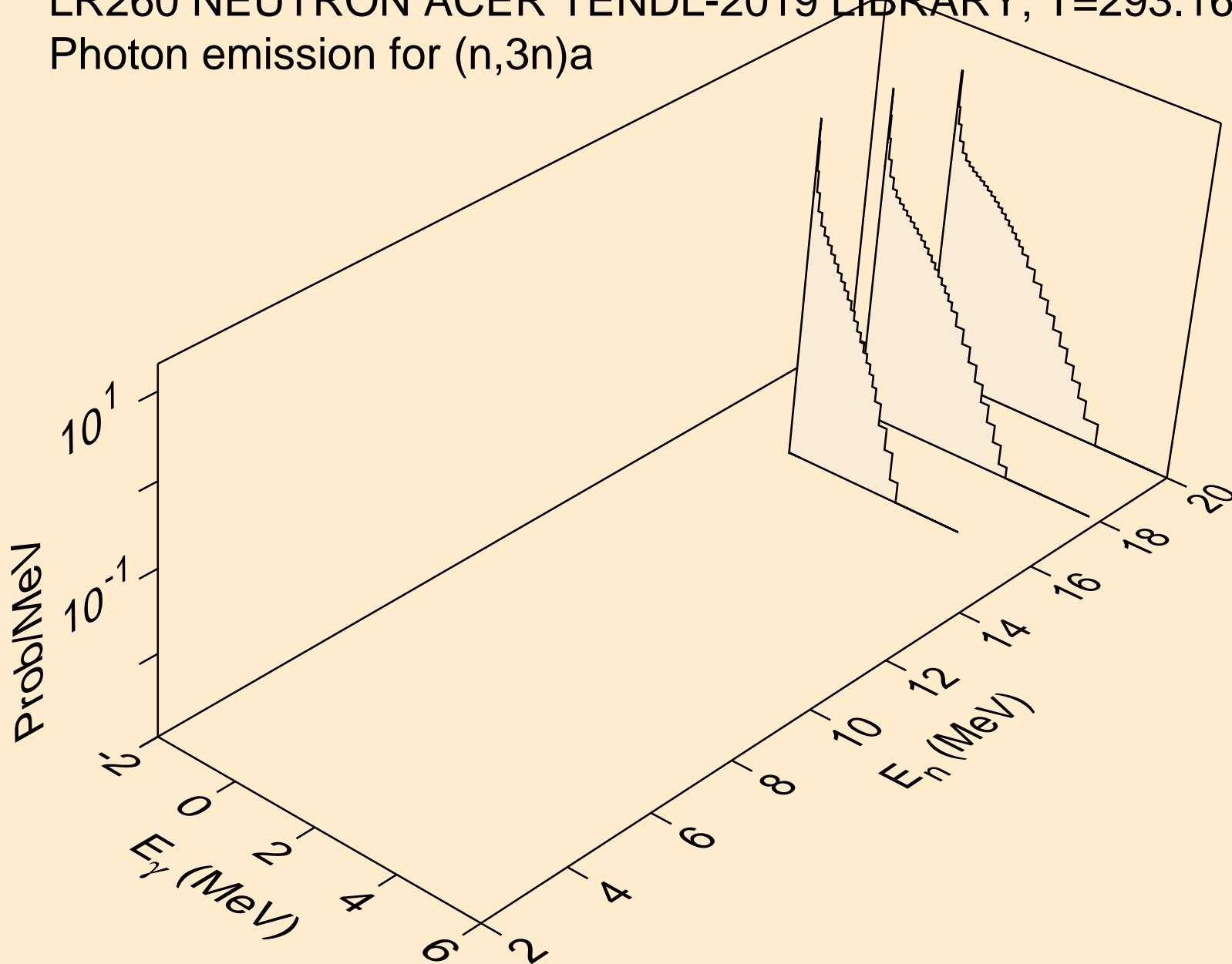

LR260 NEUTRON ACER TENDL-2019 LIBRARY; T=293.16K
Photon emission for (n,n*)p

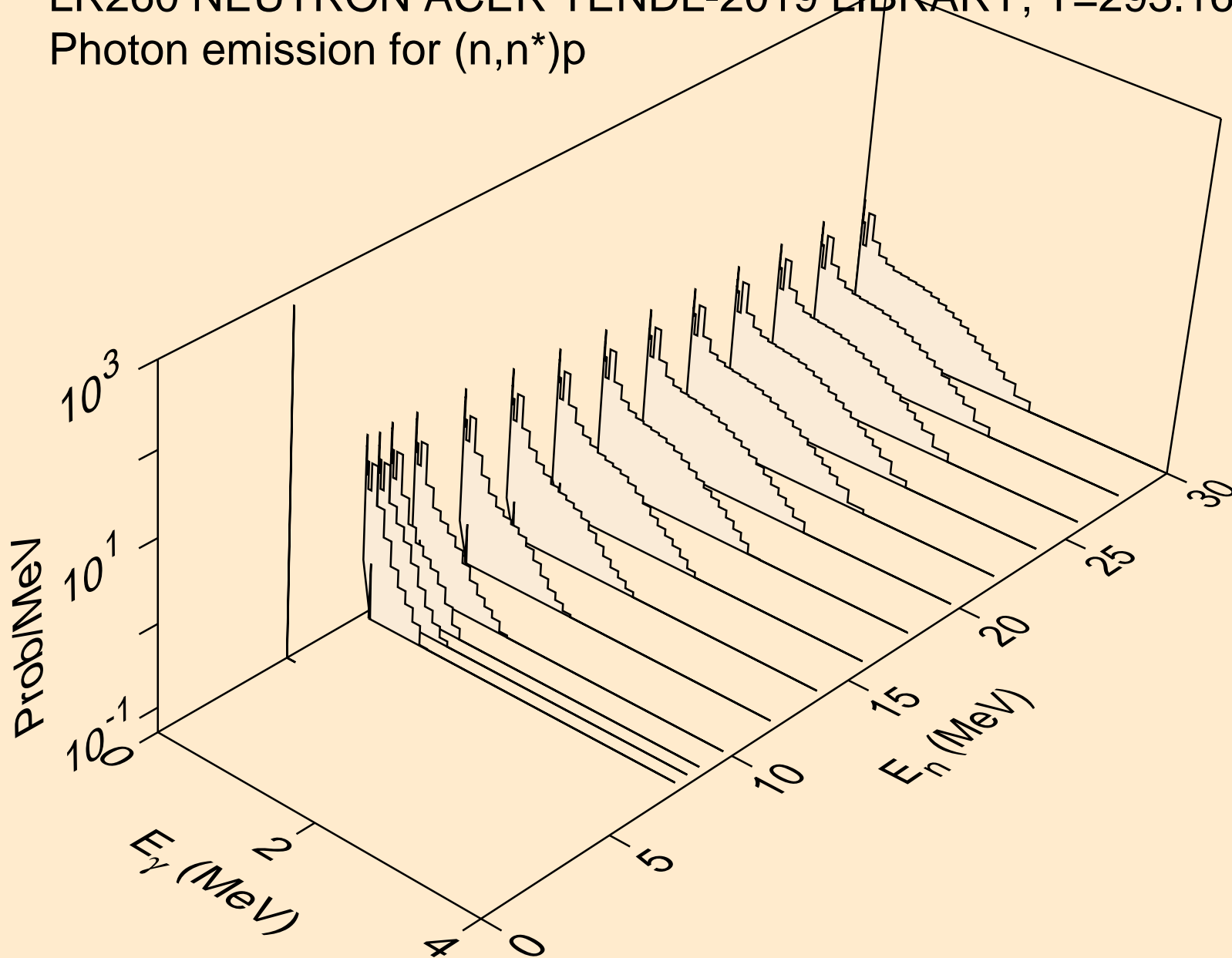

LR260 NEUTRON ACER TENDL-2019 LIBRARY; T=293.16K
Photon emission for (n,n*)2a

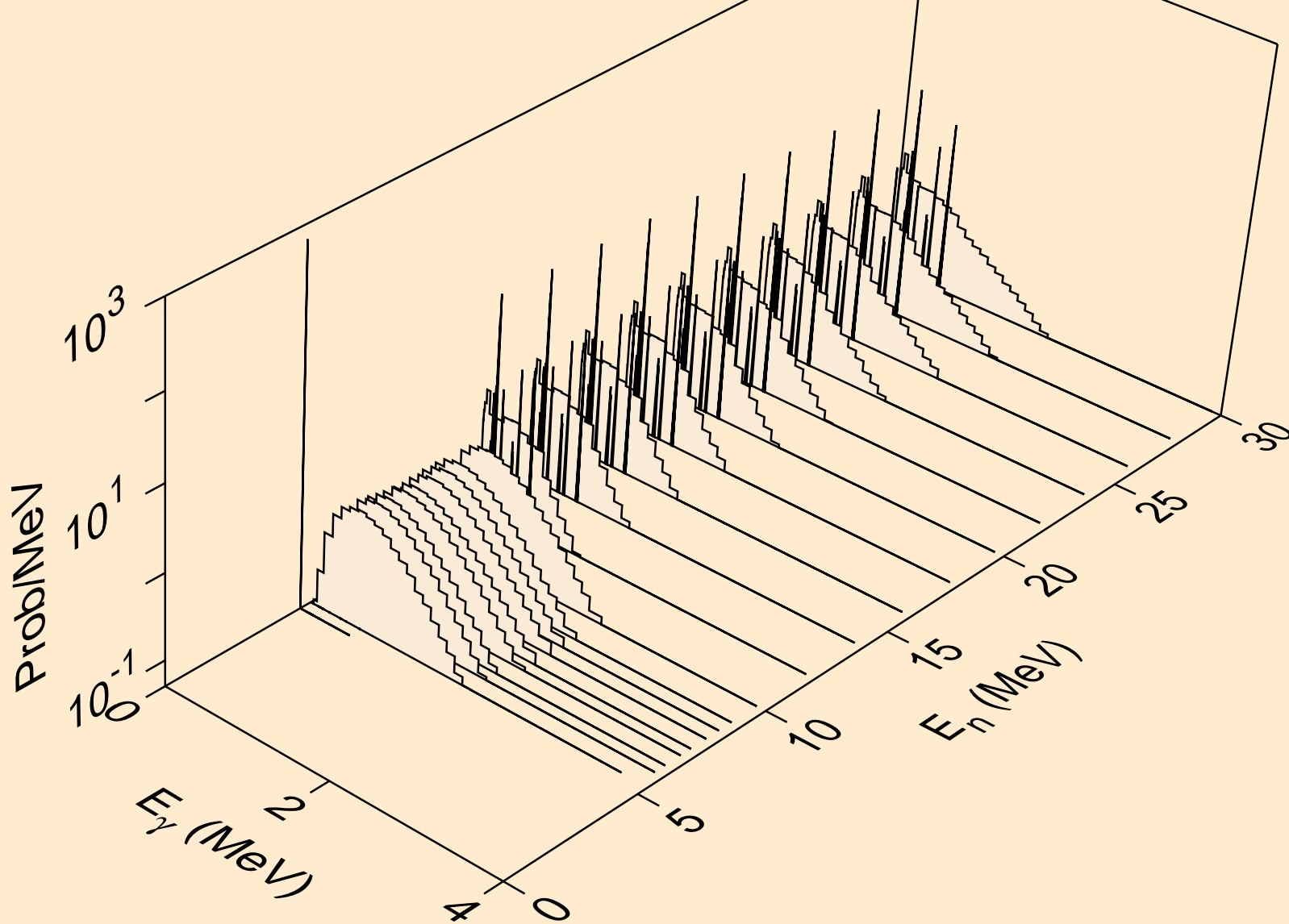

LR260 NEUTRON ACER TENDL-2019 LIBRARY; T=293.16K
Photon emission for (n,2n)2a

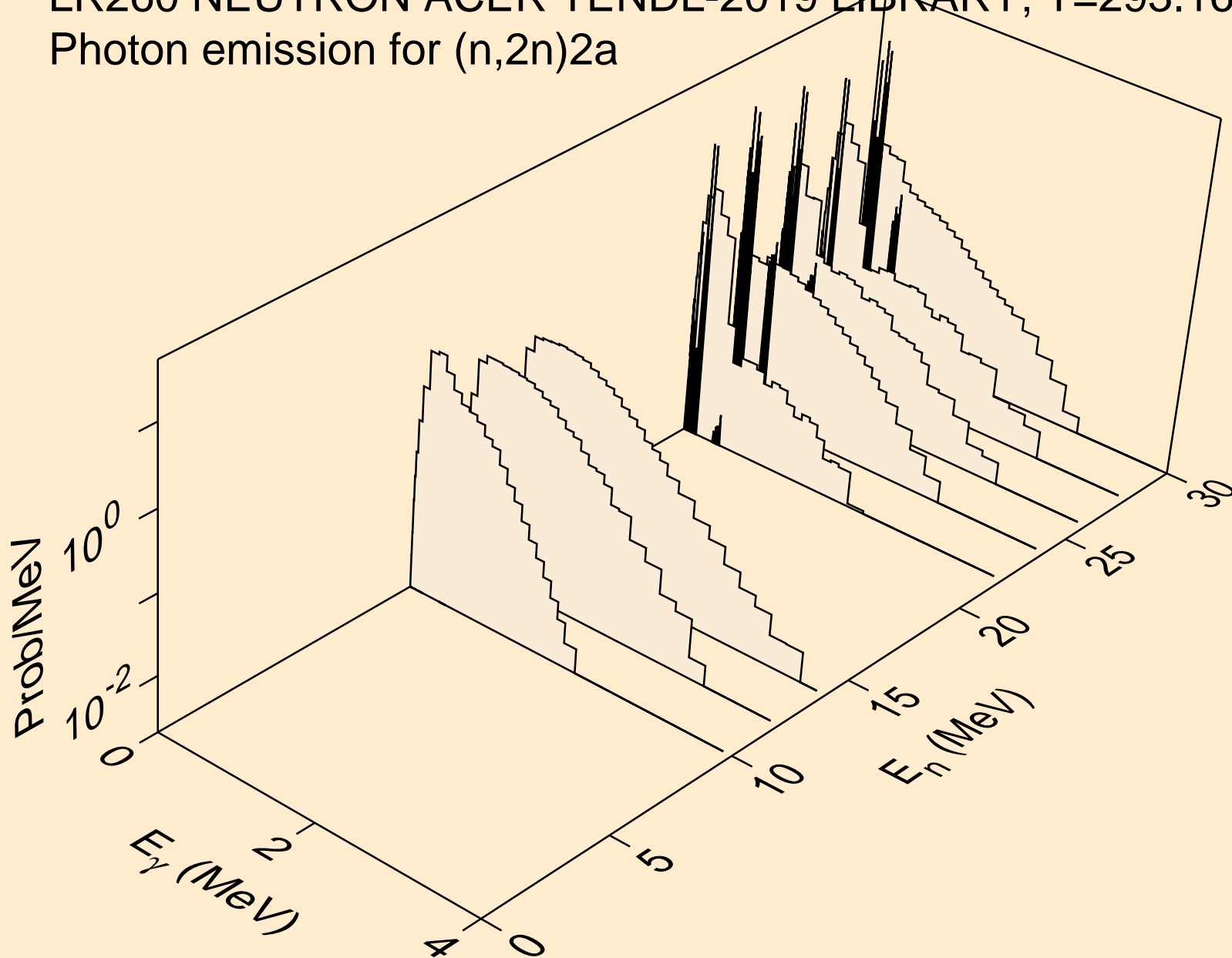

LR260 NEUTRON ACER TENDL-2019 LIBRARY; T=293.16K
Photon emission for (n,n*)d

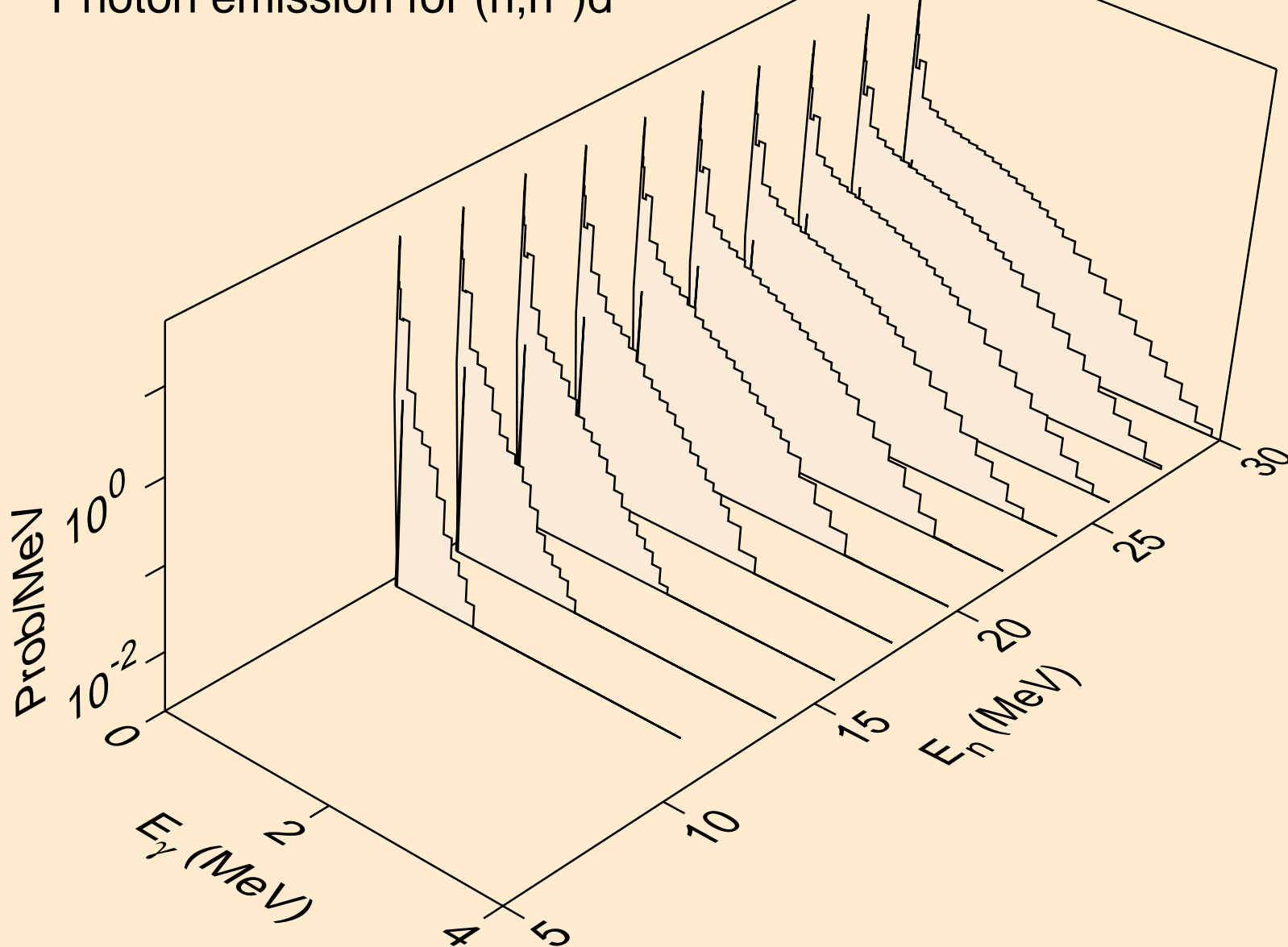

LR260 NEUTRON ACER TENDL-2019 LIBRARY; T=293.16K
Photon emission for (n,n*)t

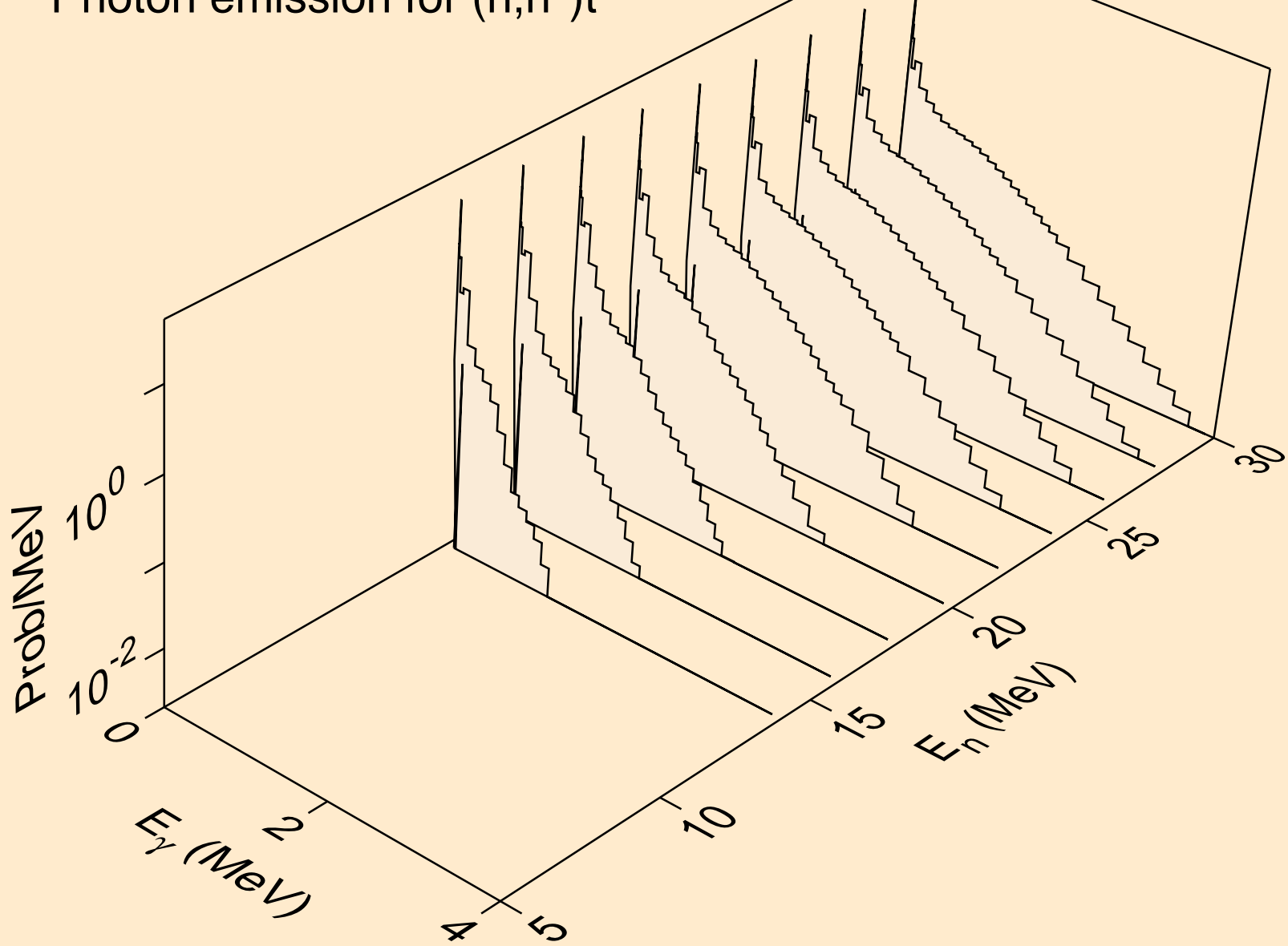

LR260 NEUTRON ACER TENDL-2019 LIBRARY; T=293.16K
Photon emission for (n,n*)he3

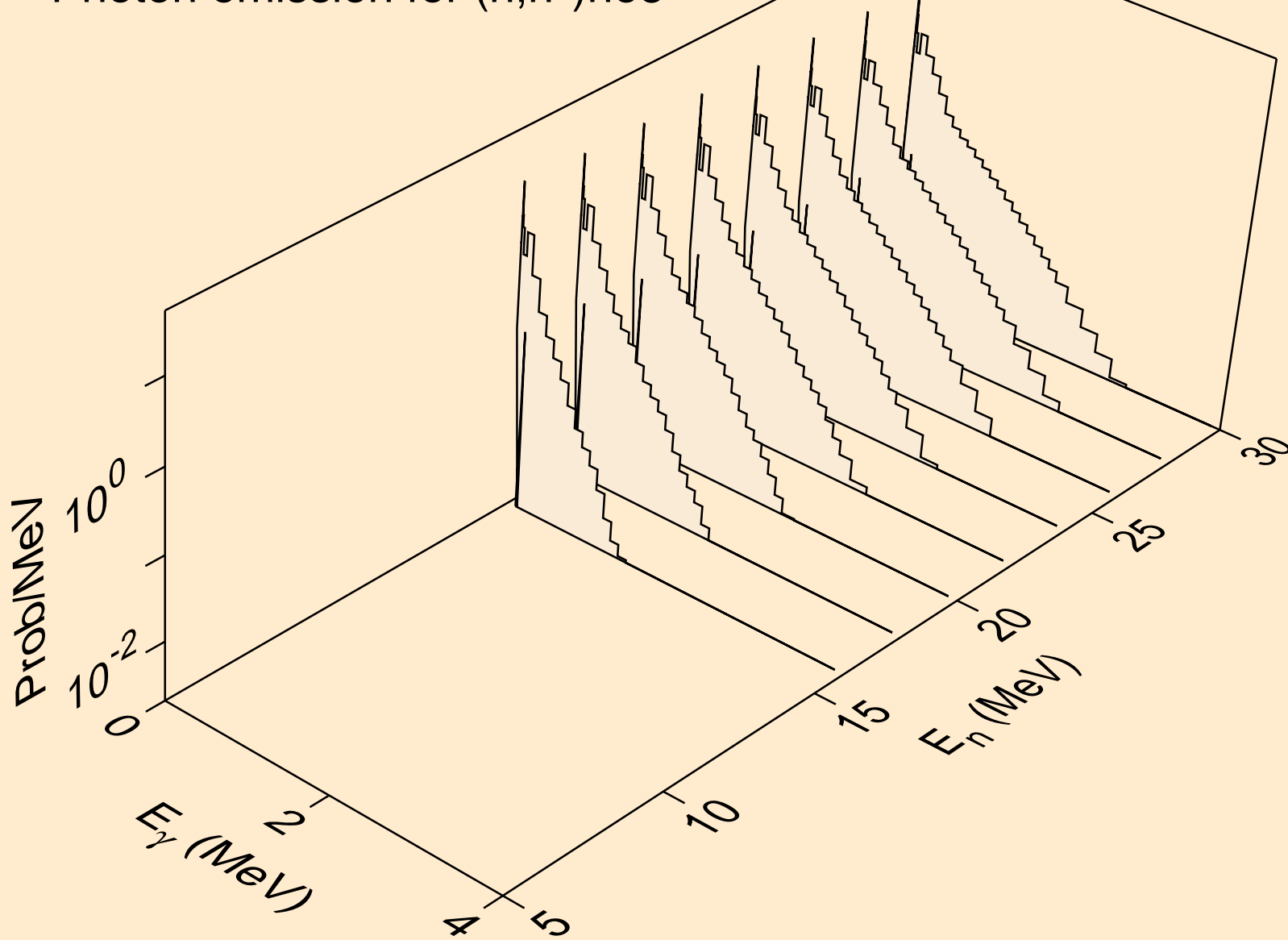

LR260 NEUTRON ACER TENDL-2019 LIBRARY; T=293.16K
Photon emission for (n,4n)

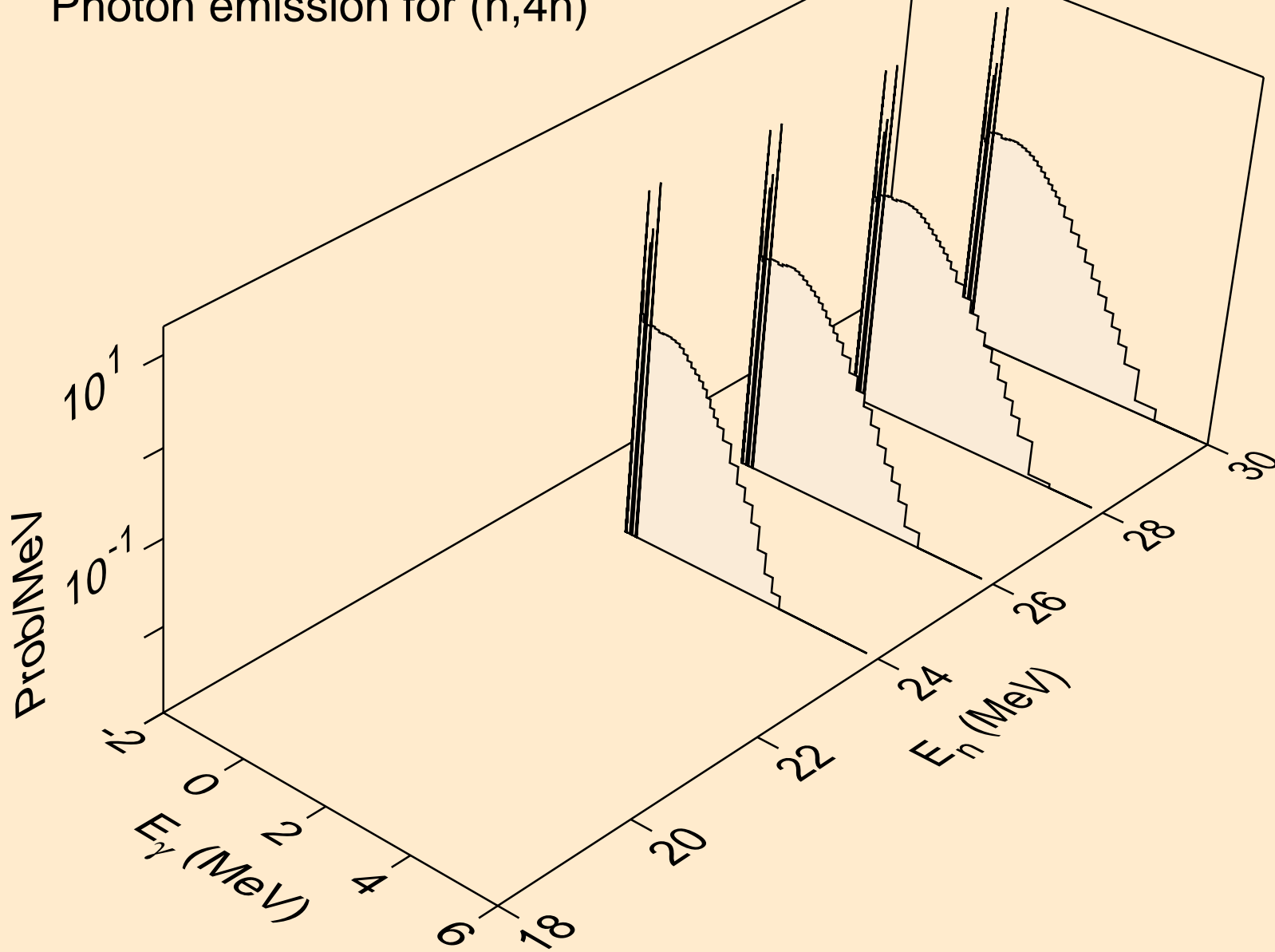

LR260 NEUTRON ACER TENDL-2019 LIBRARY; T=293.16K
Photon emission for (n,2np)

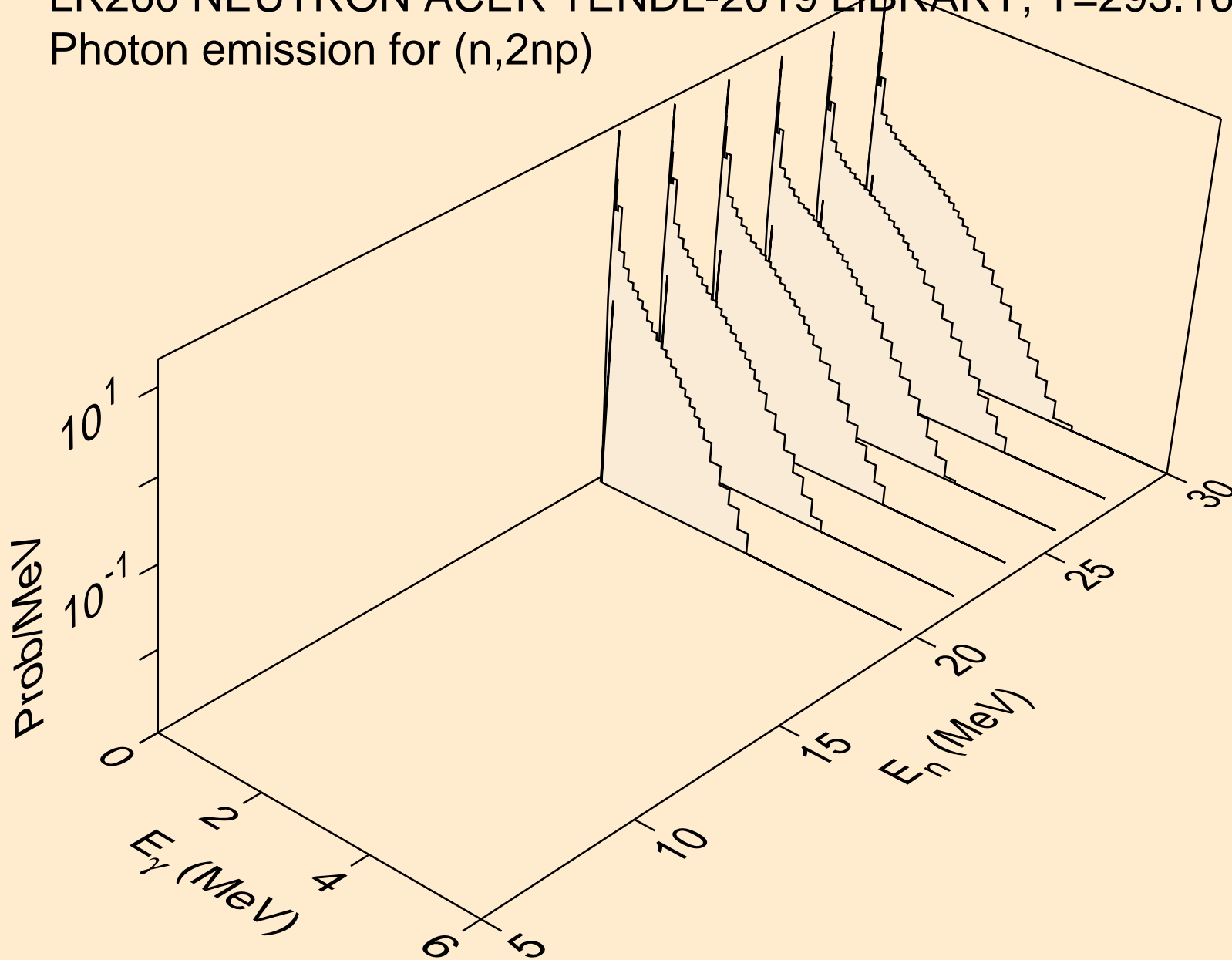

LR260 NEUTRON ACER TENDL-2019 LIBRARY; T=293.16K
Photon emission for (n,3np)

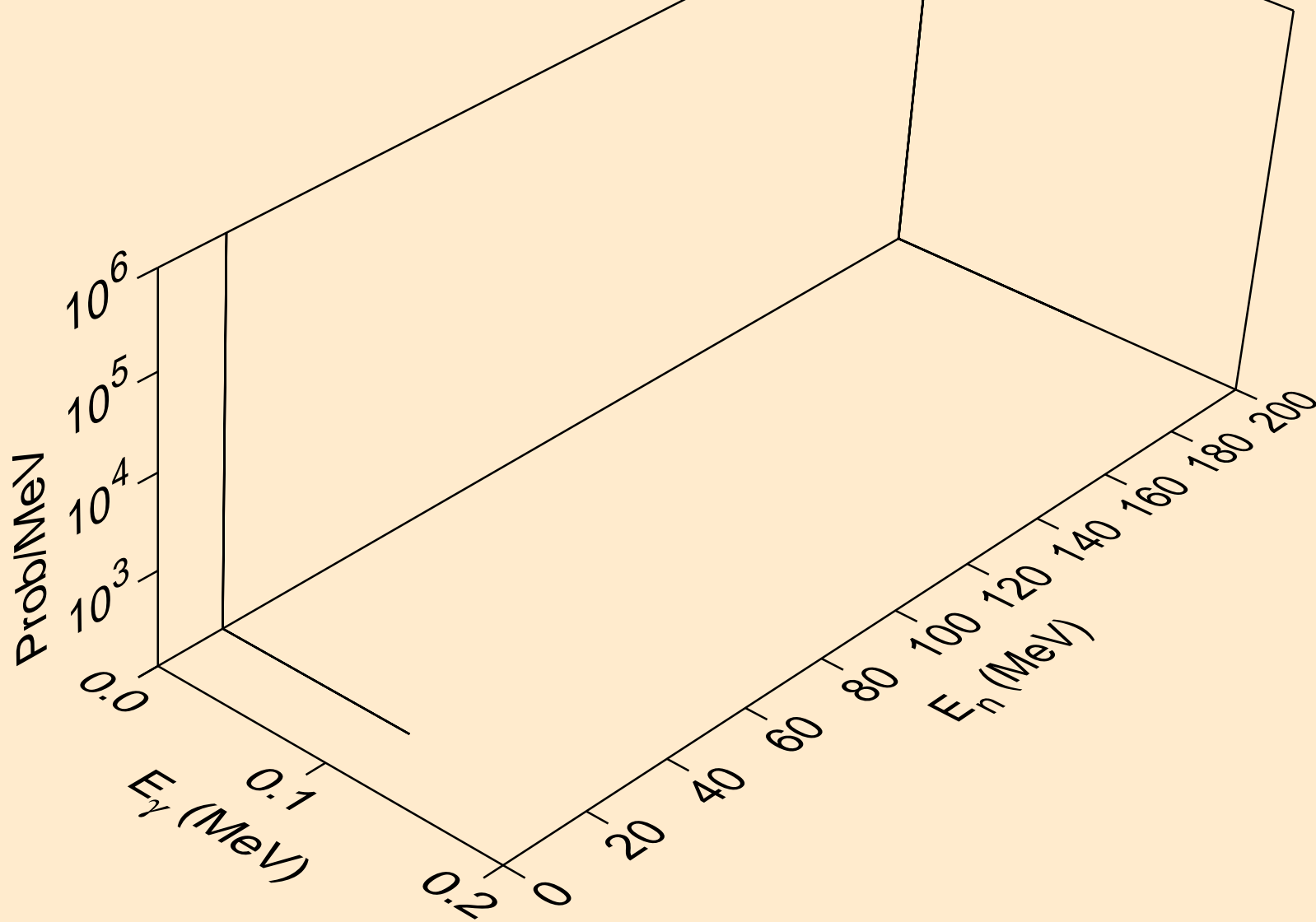

LR260 NEUTRON ACER TENDL-2019 LIBRARY; T=293.16K
Photon emission for (n,2np)

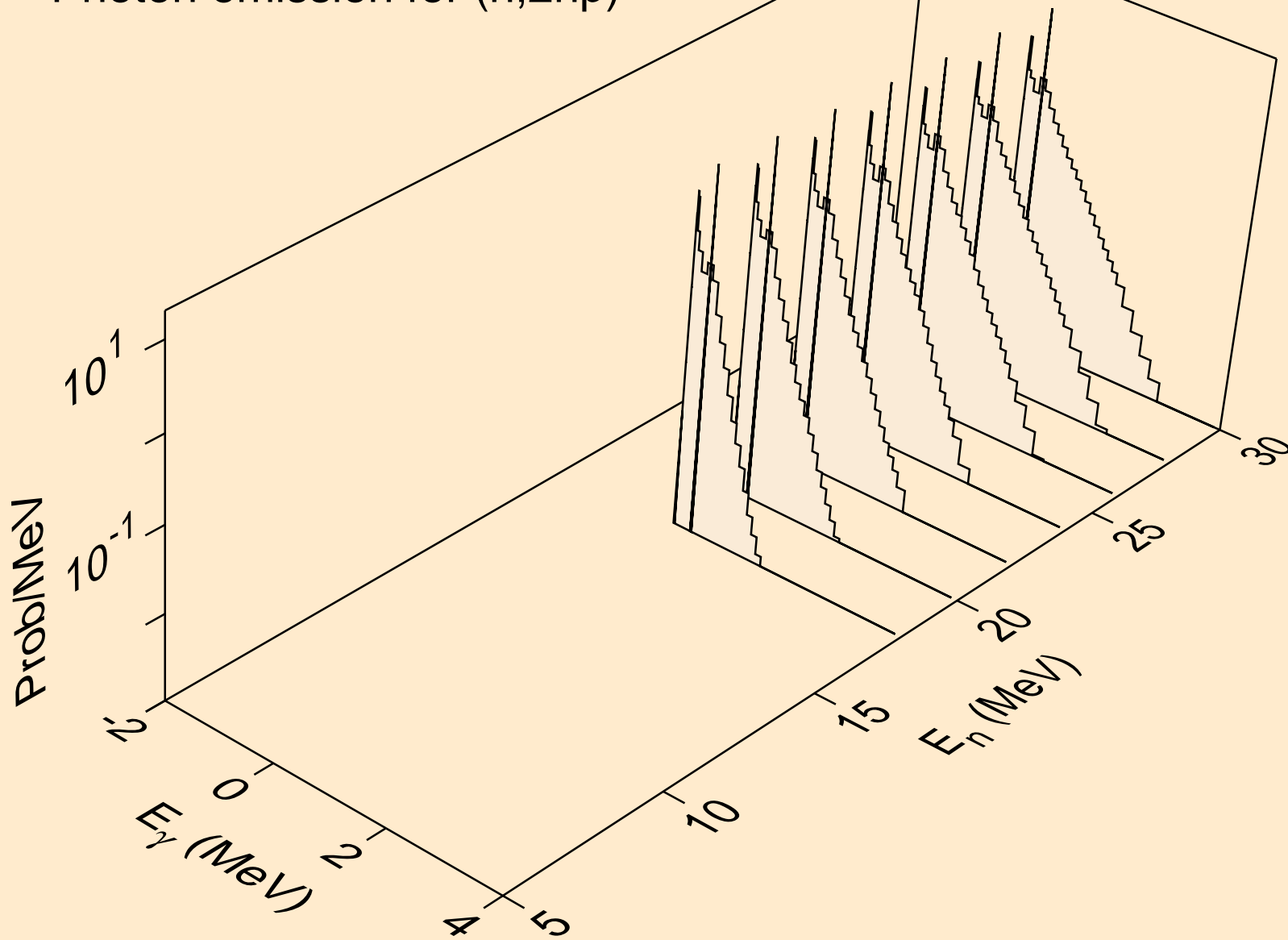

LR260 NEUTRON ACER TENDL-2019 LIBRARY; T=293.16K
Photon emission for (n,npa)

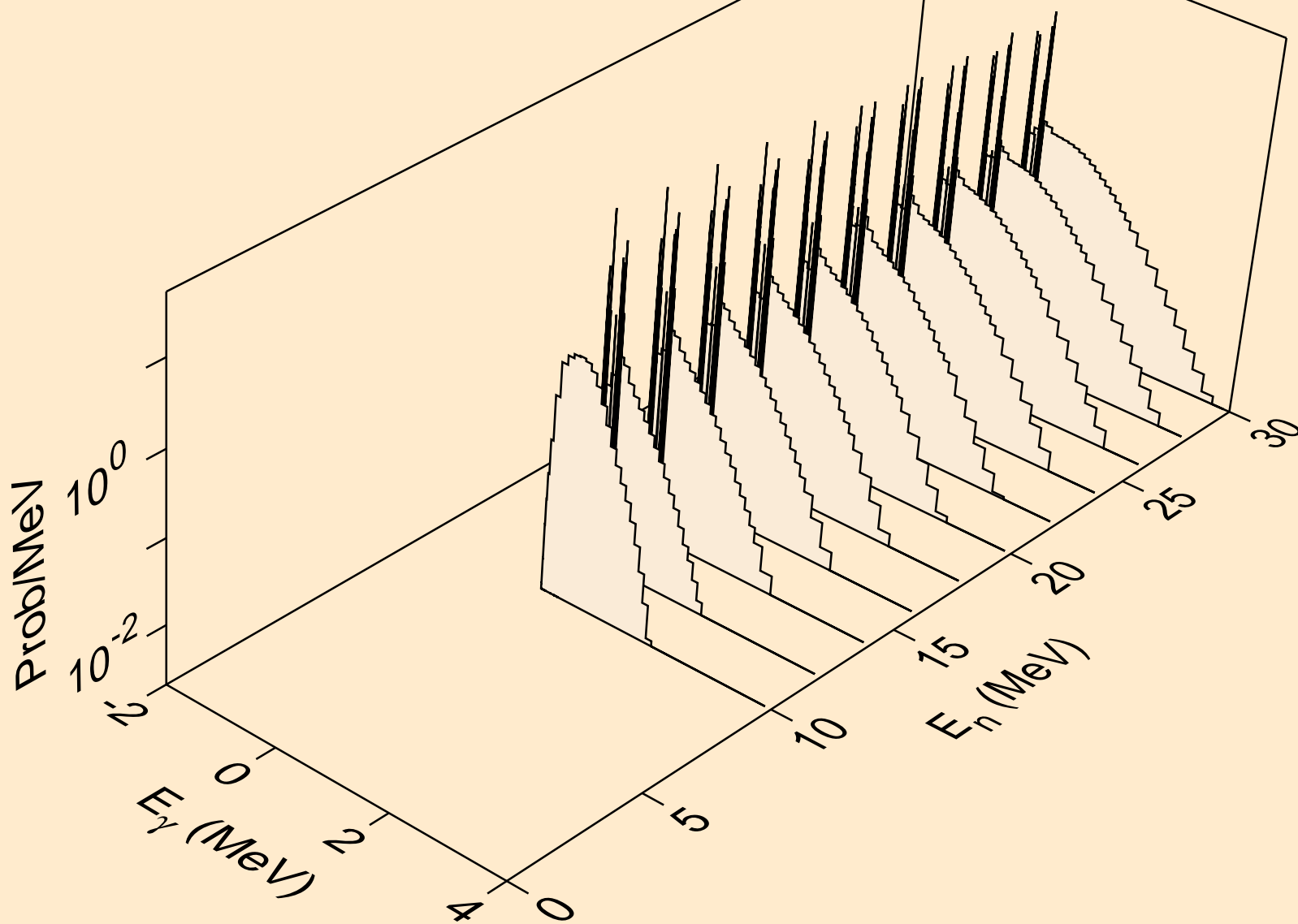

LR260 NEUTRON ACER TENDL-2019 LIBRARY; T=293.16K
Photon emission for (n,n*c)

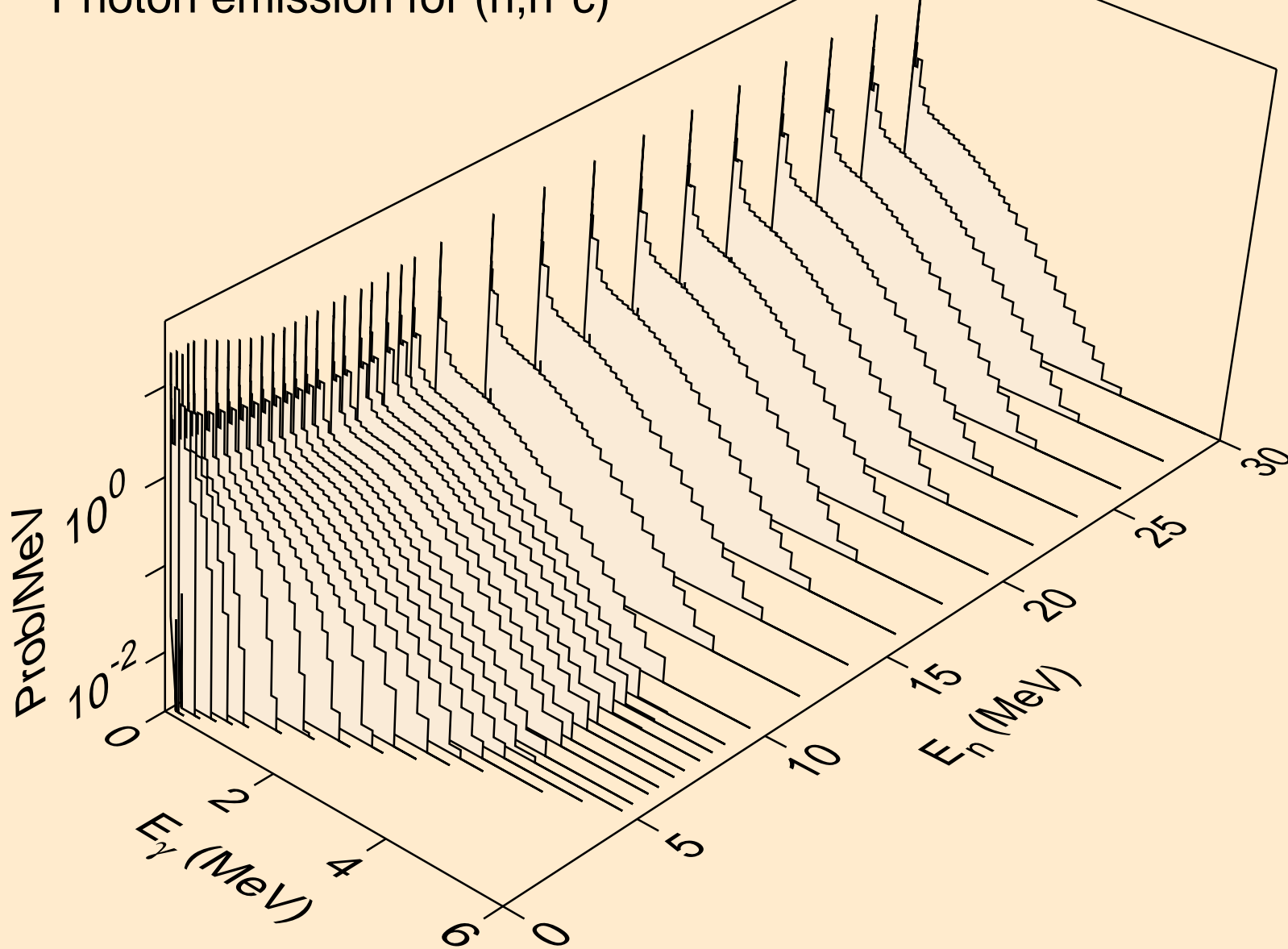

LR260 NEUTRON ACER TENDL-2019 LIBRARY; T=293.16K
Photon emission for (n,gma)

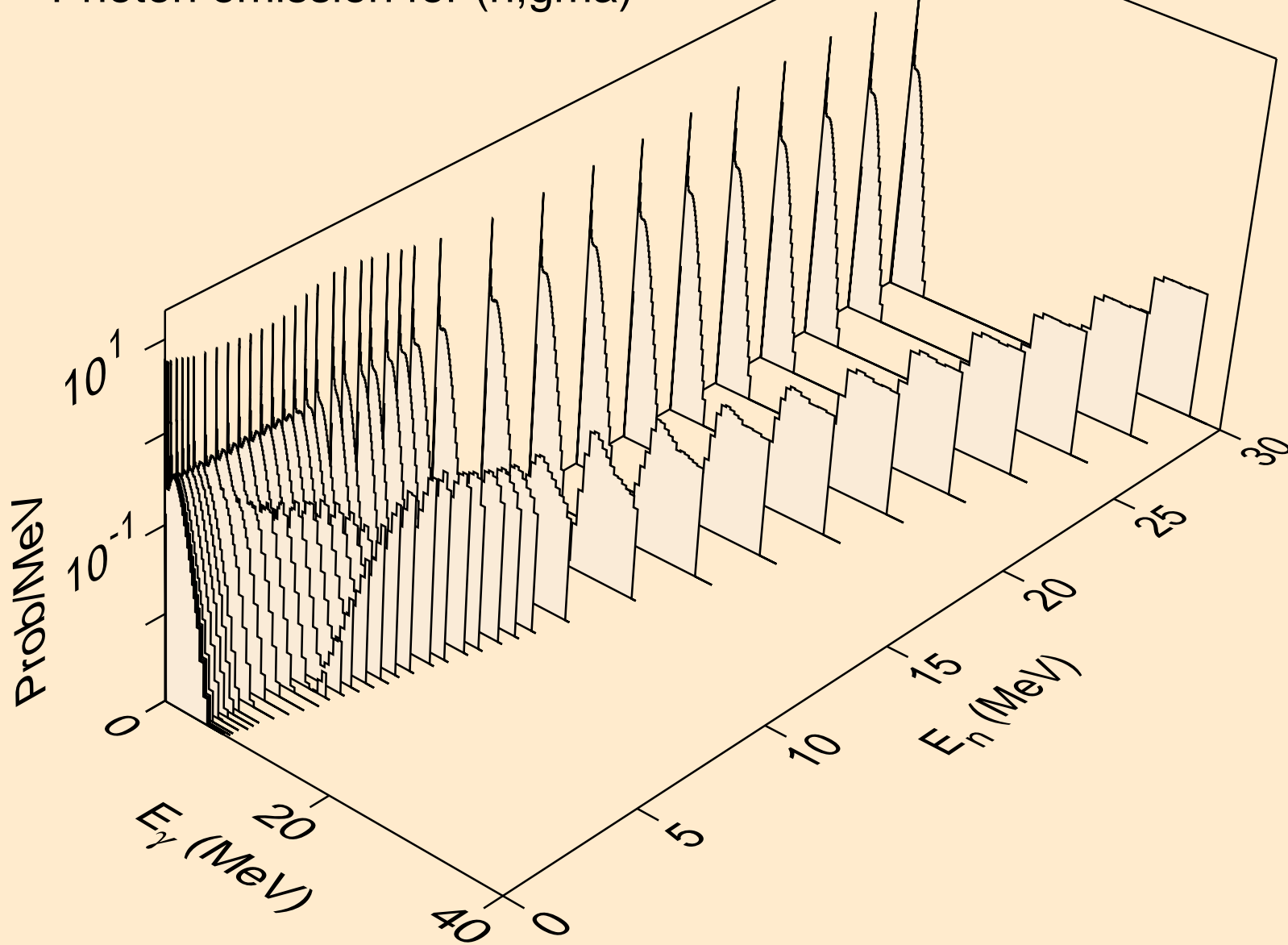

LR260 NEUTRON ACER TENDL-2019 LIBRARY; T=293.16K
Photon emission for (n,p)

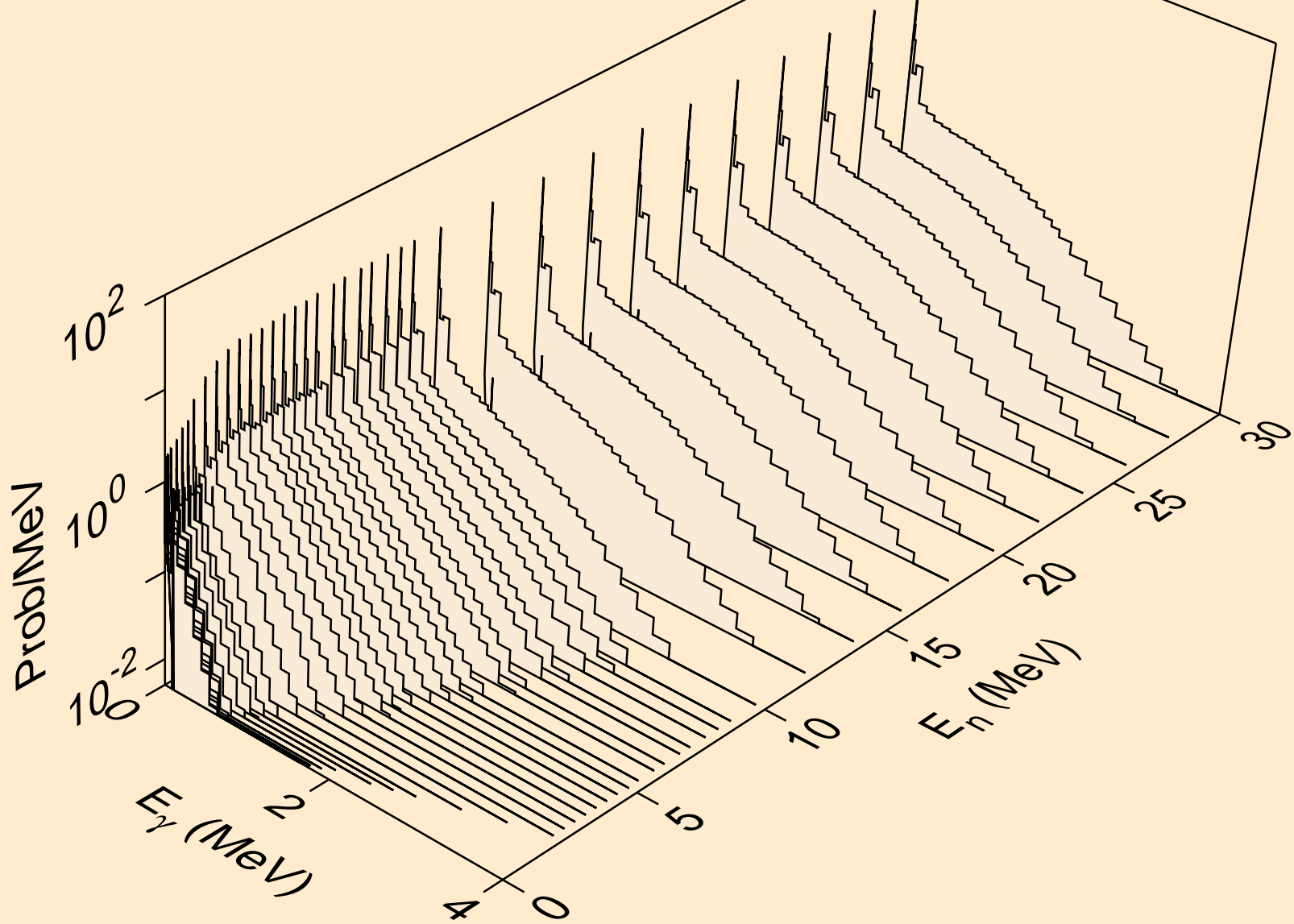

LR260 NEUTRON ACER TENDL-2019 LIBRARY; T=293.16K
Photon emission for (n,d)

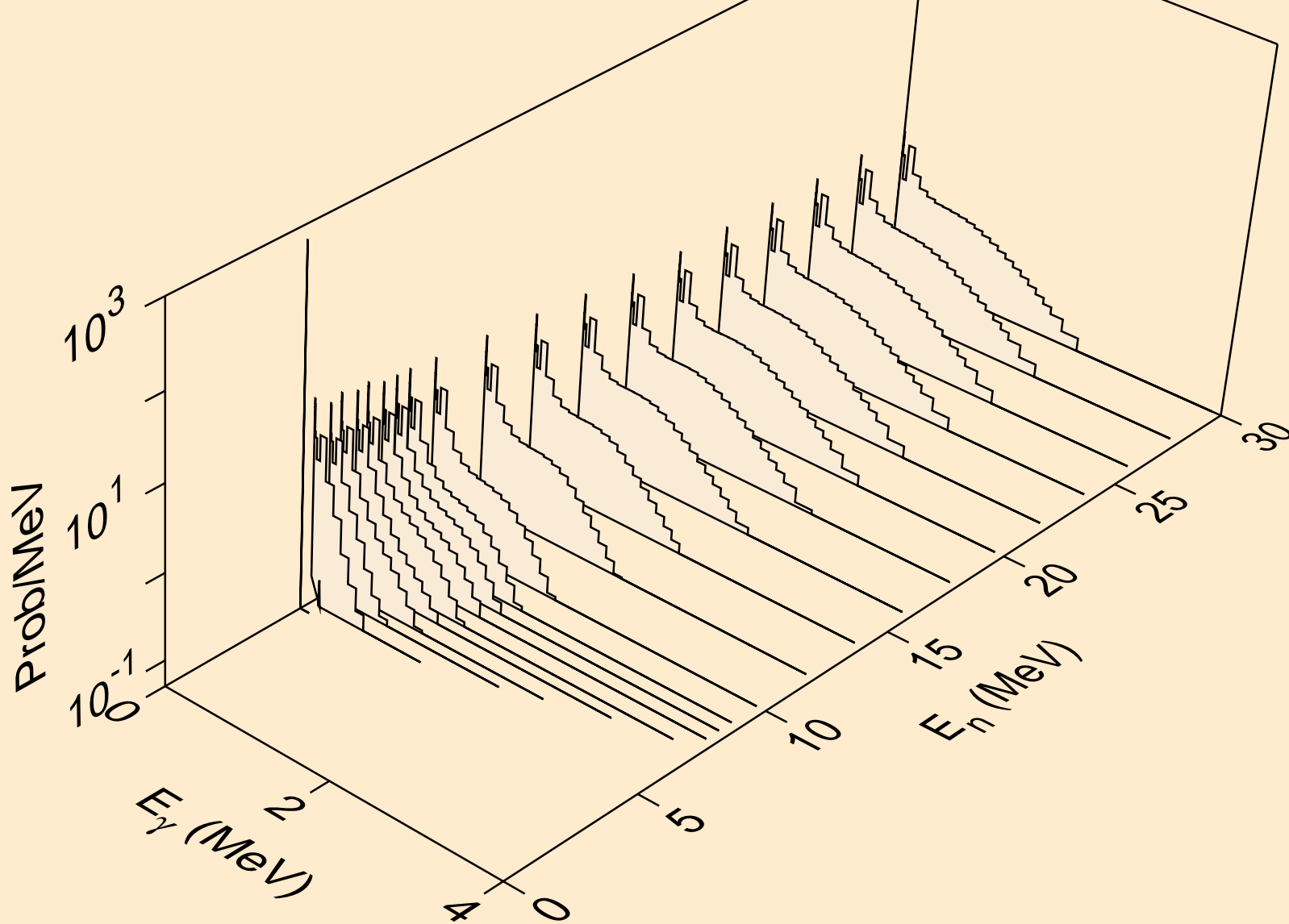

LR260 NEUTRON ACER TENDL-2019 LIBRARY; T=293.16K
Photon emission for (n,t)

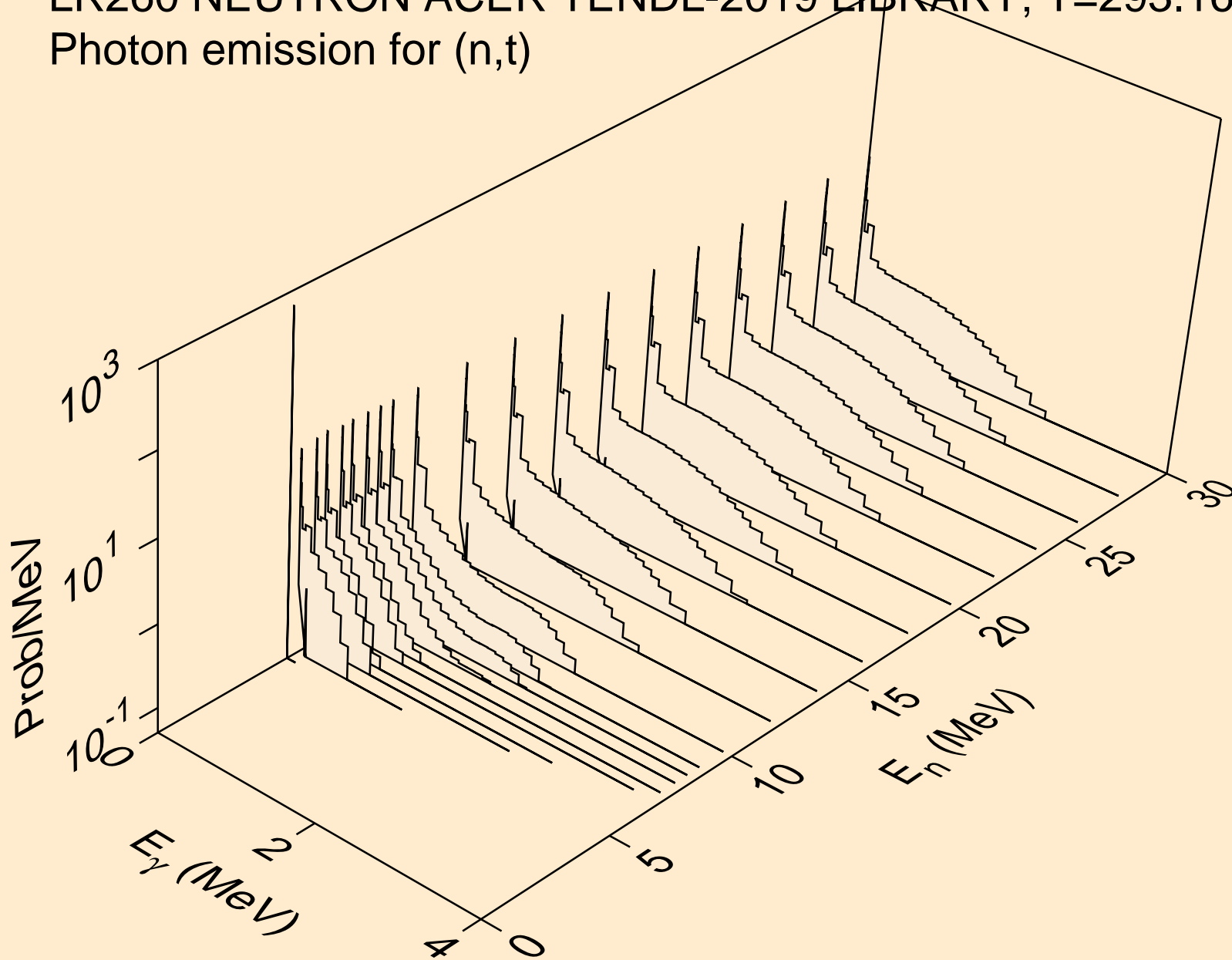

LR260 NEUTRON ACER TENDL-2019 LIBRARY; T=293.16K
Photon emission for (n,he3)

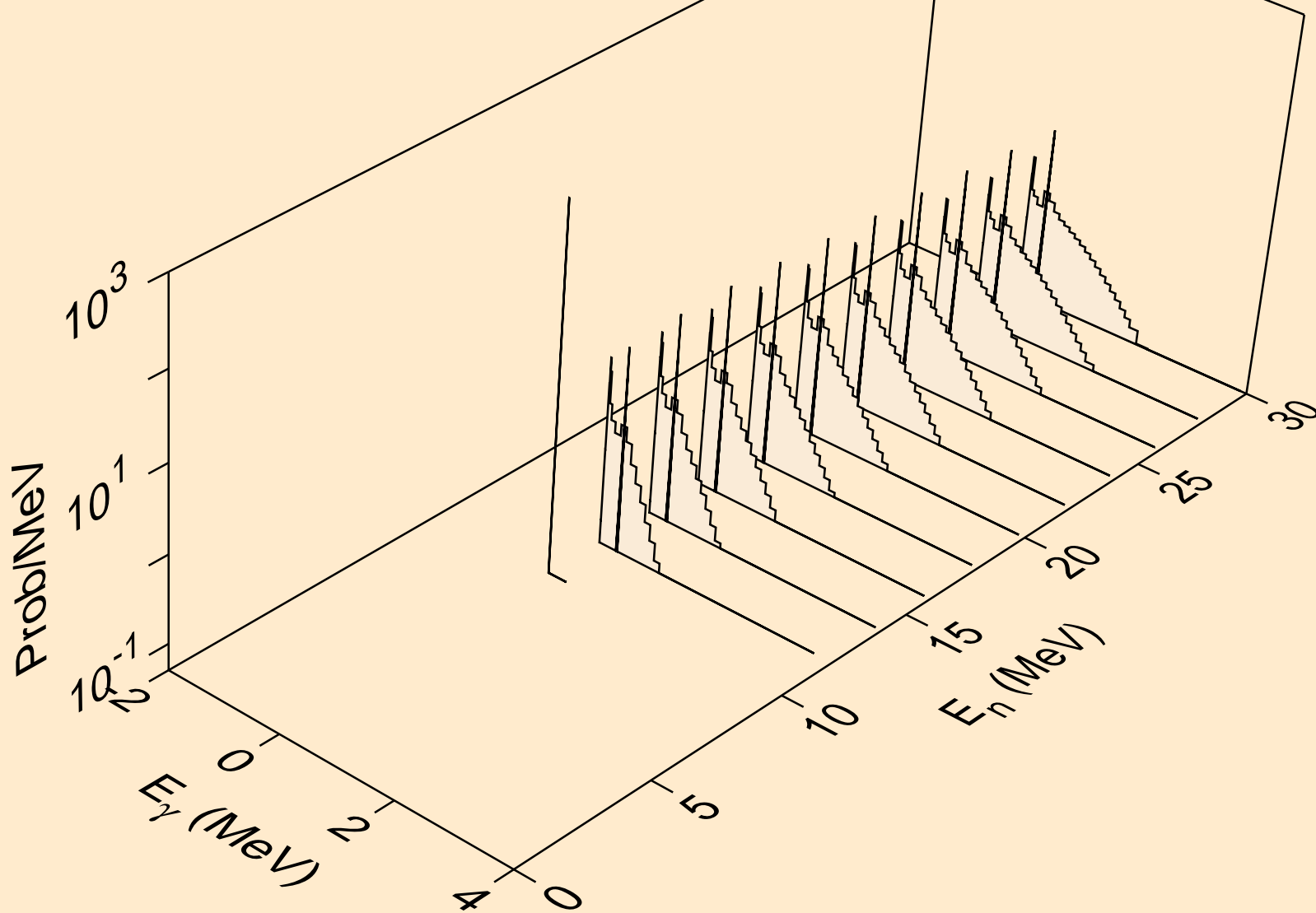

LR260 NEUTRON ACER TENDL-2019 LIBRARY; T=293.16K
Photon emission for (n,a)

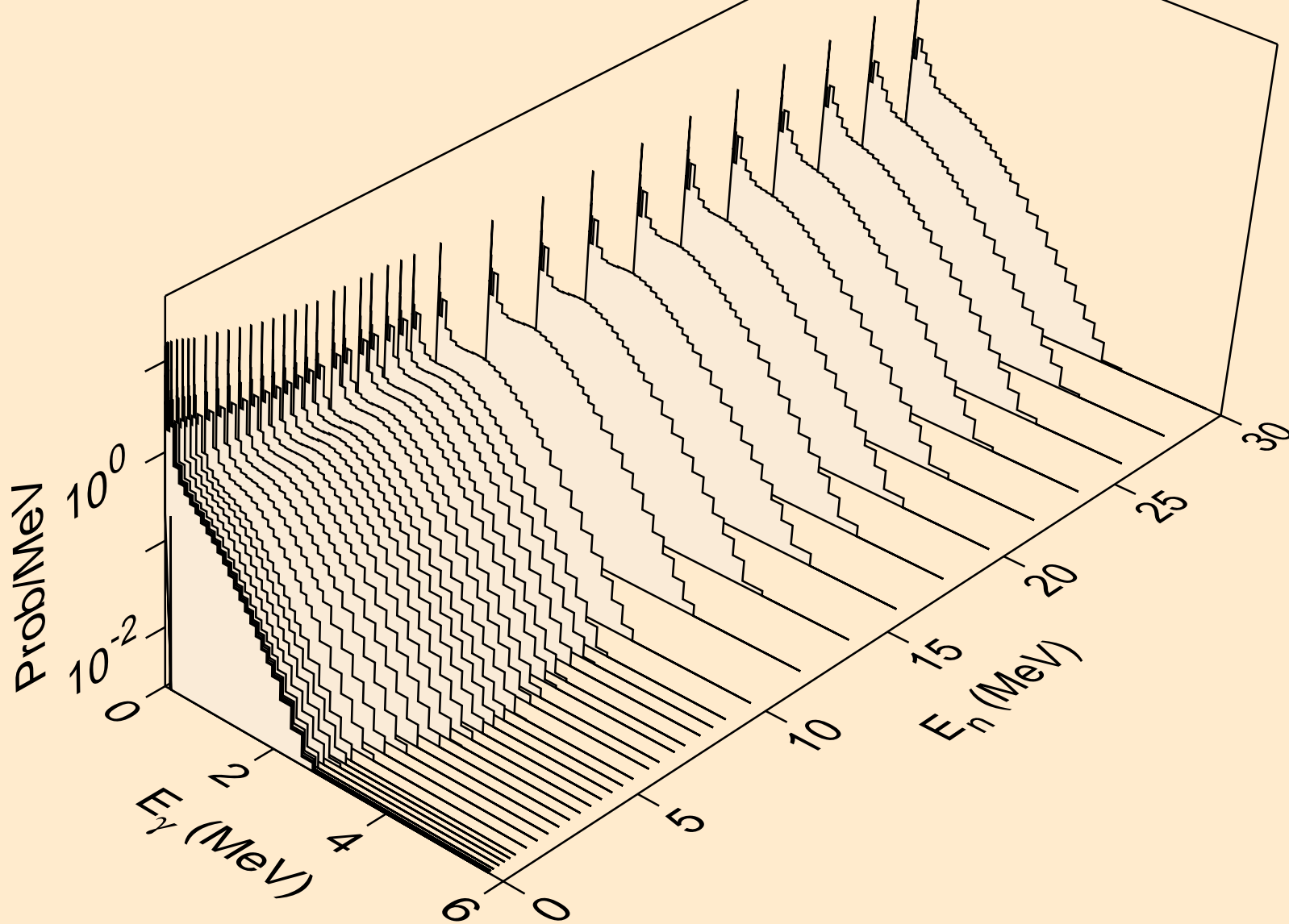

LR260 NEUTRON ACER TENDL-2019 LIBRARY; T=293.16K
Photon emission for (n,2a)

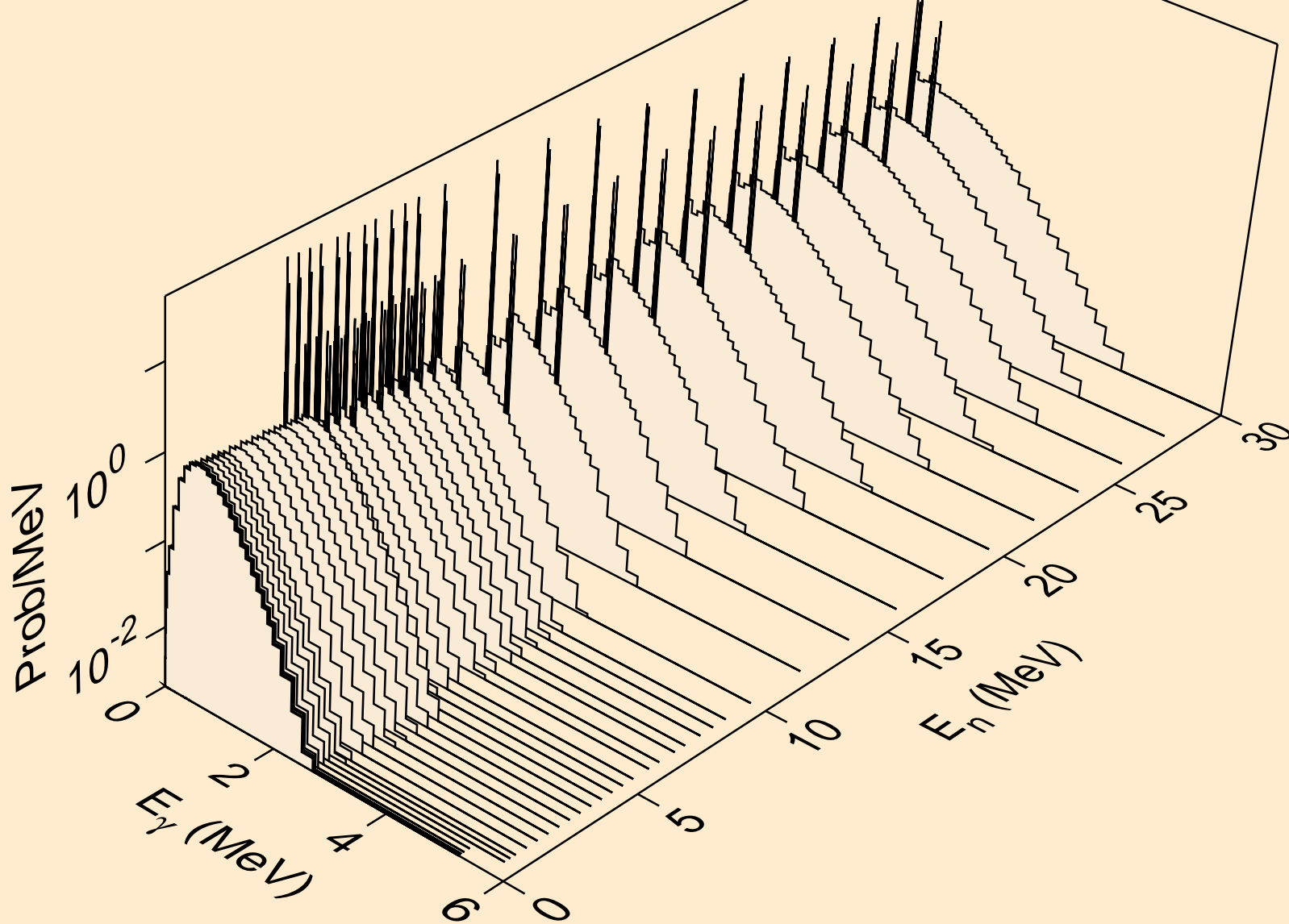

LR260 NEUTRON ACER TENDL-2019 LIBRARY; T=293.16K
Photon emission for (n,2p)

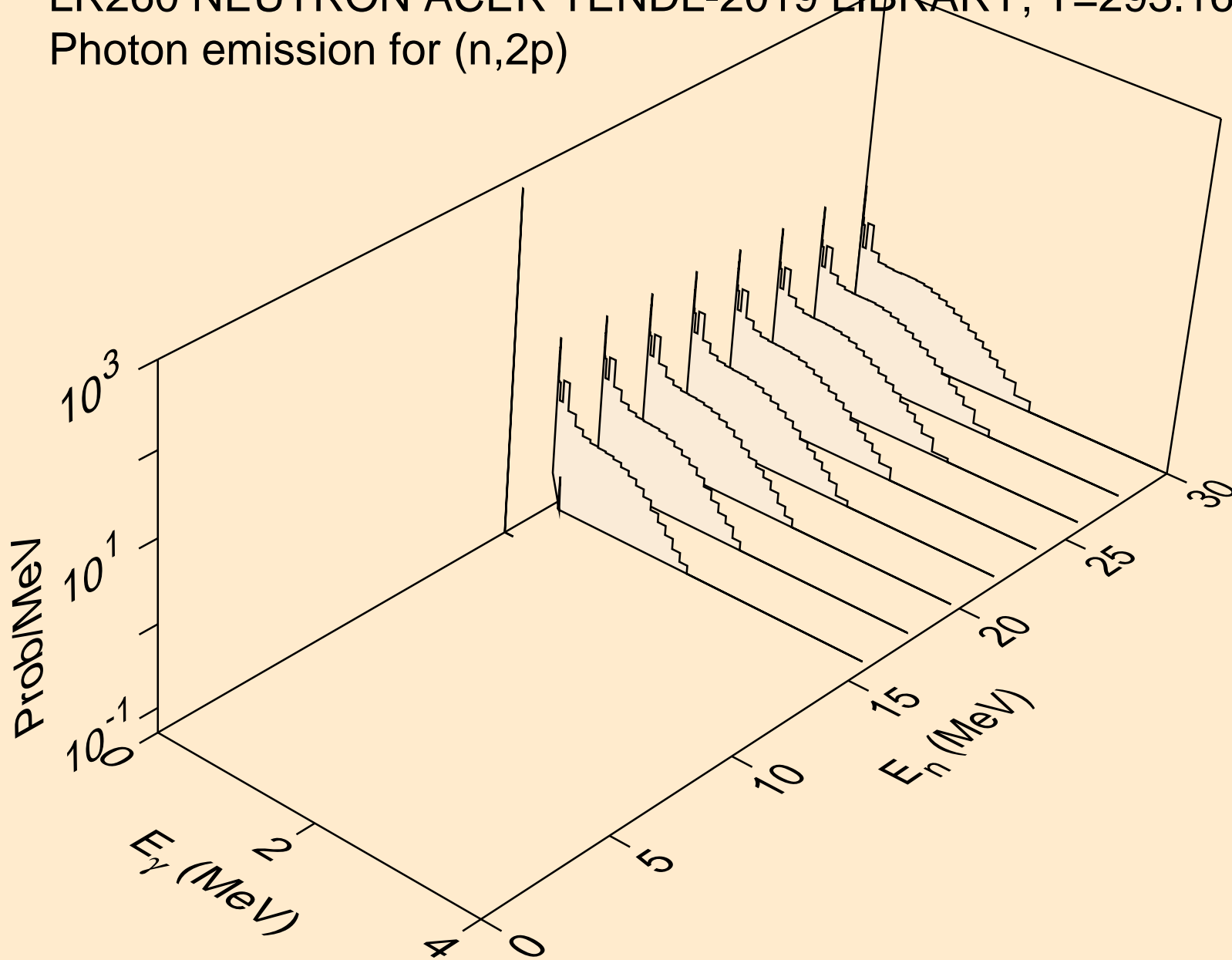

LR260 NEUTRON ACER TENDL-2019 LIBRARY; T=293.16K
Photon emission for (n,p α)

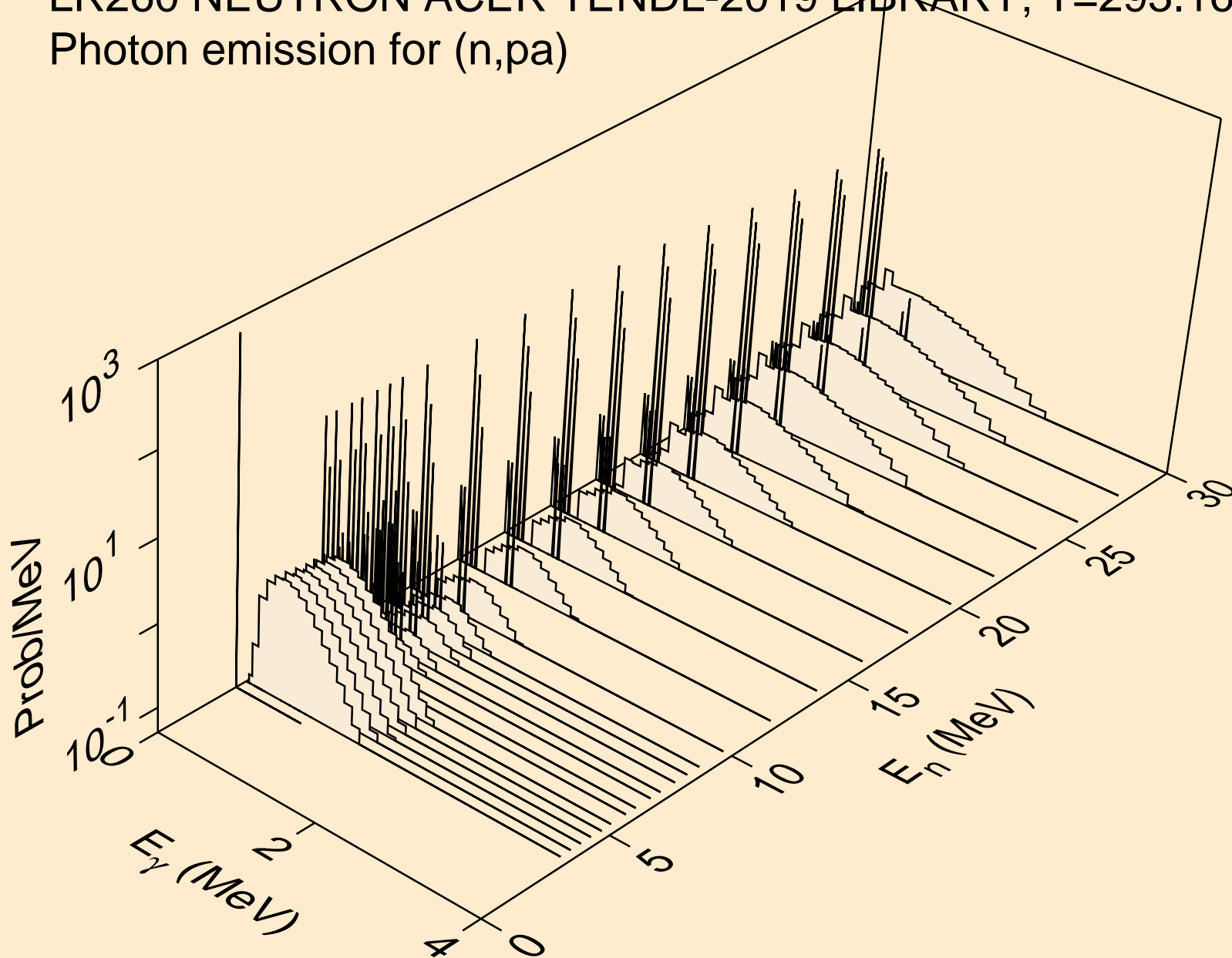

LR260 NEUTRON ACER TENDL-2019 LIBRARY; T=293.16K
Photon emission for (n,pd)

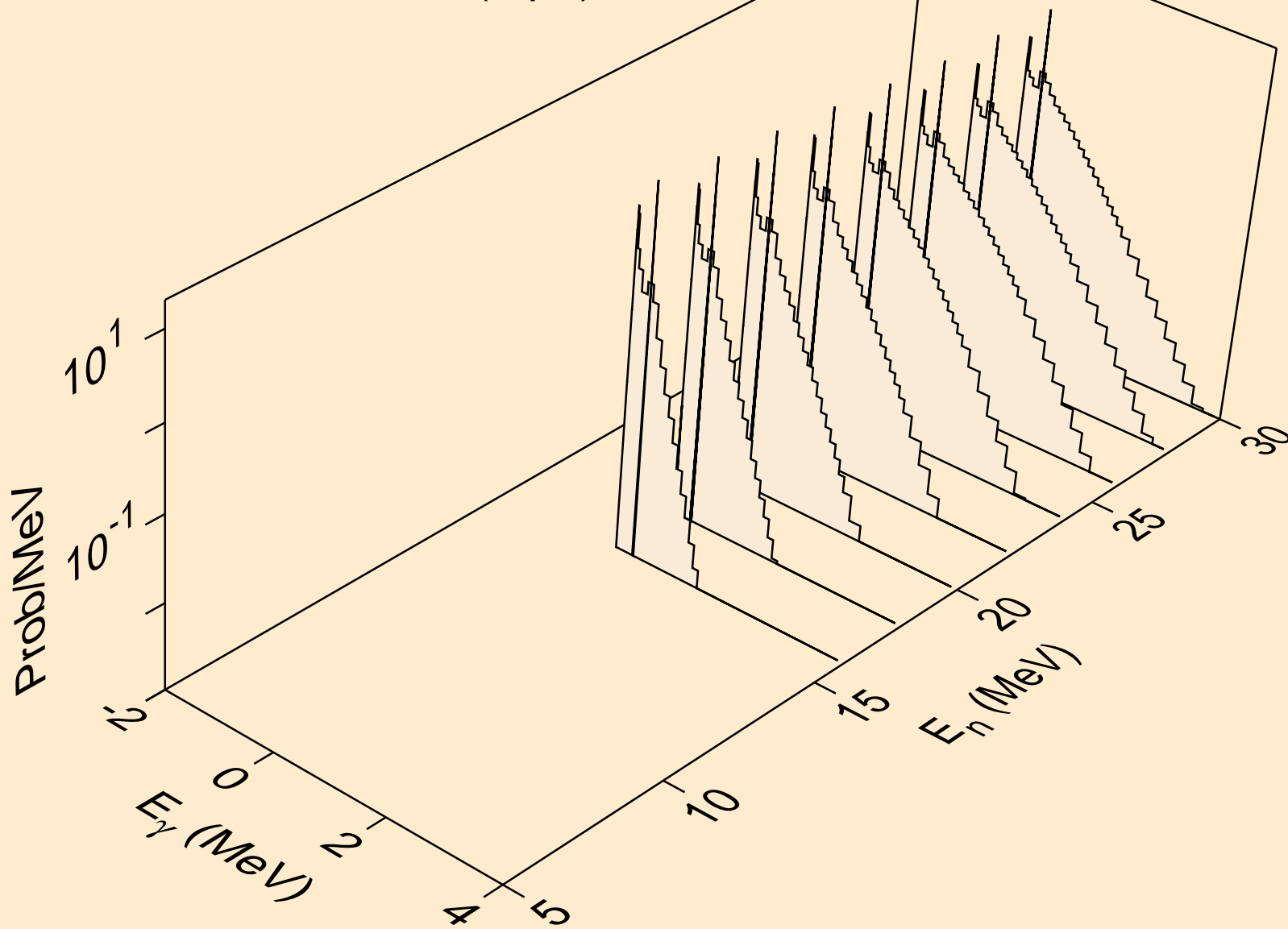

LR260 NEUTRON ACER TENDL-2019 LIBRARY; T=293.16K
Photon emission for (n,da)

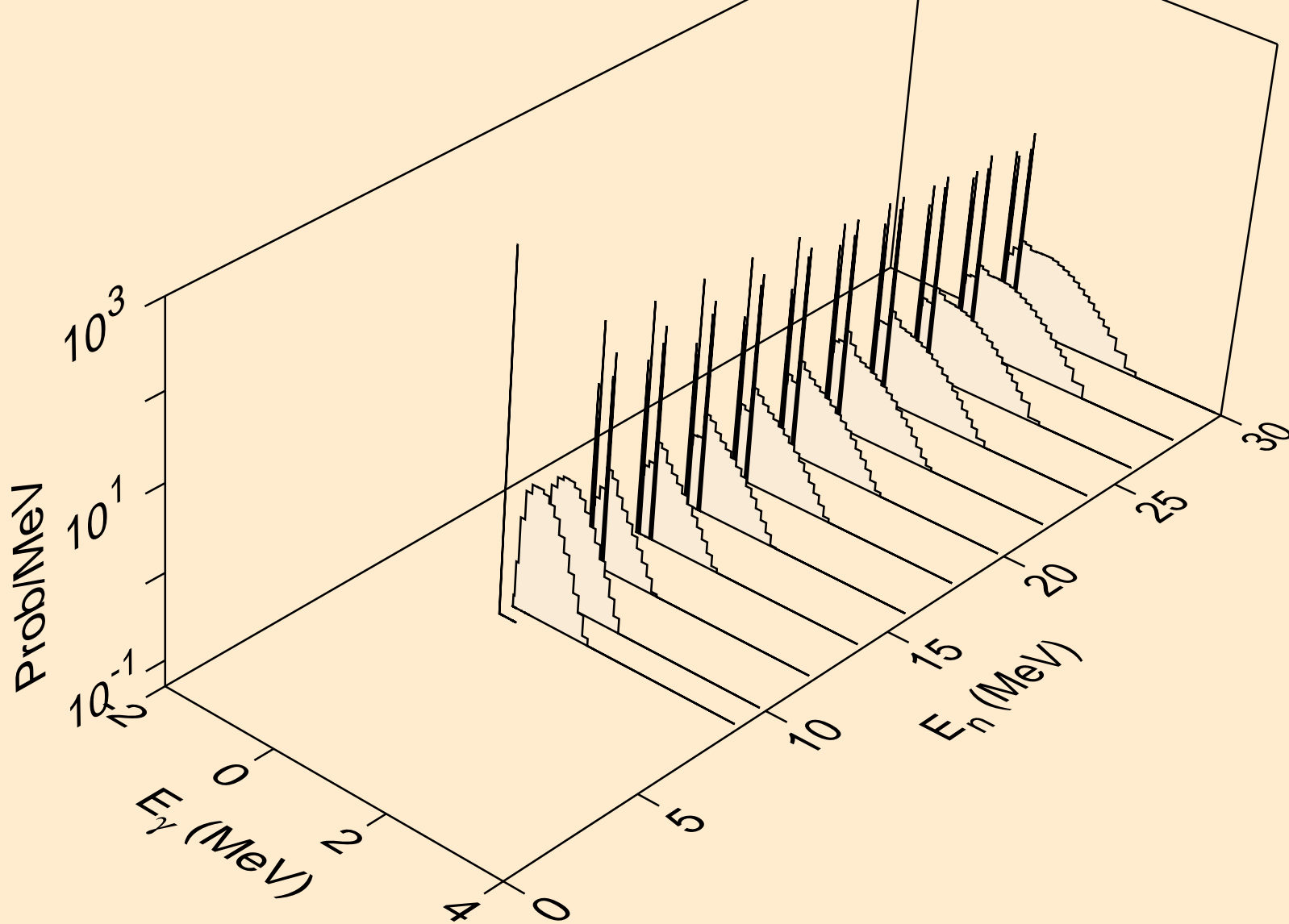

LR260 NEUTRON ACER TENDL-2019 LIBRARY; T=293.16K
thermal capture photon spectrum

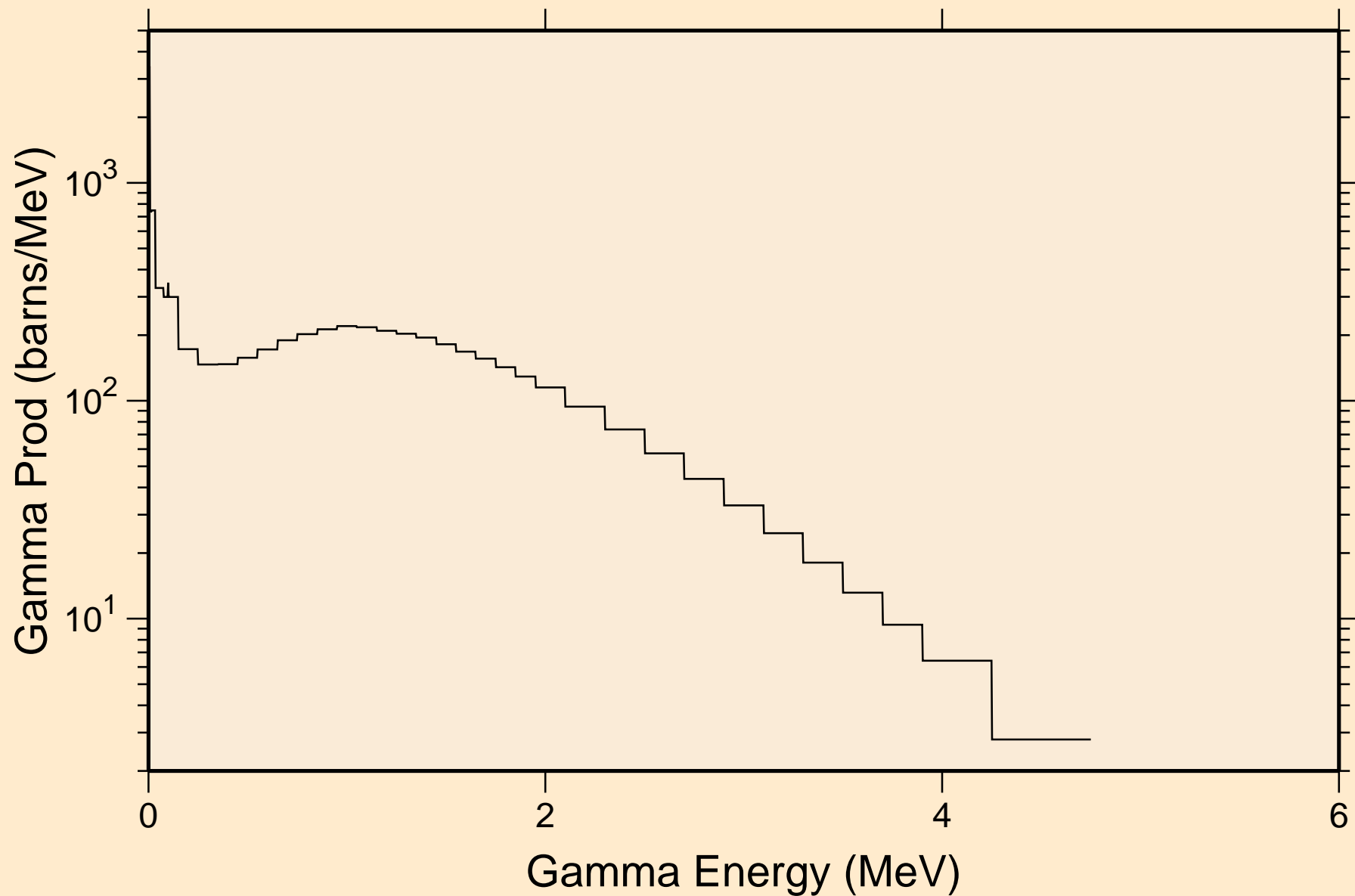

LR260 NEUTRON ACER TENDL-2019 LIBRARY; T=293.16K
14 MeV photon spectrum

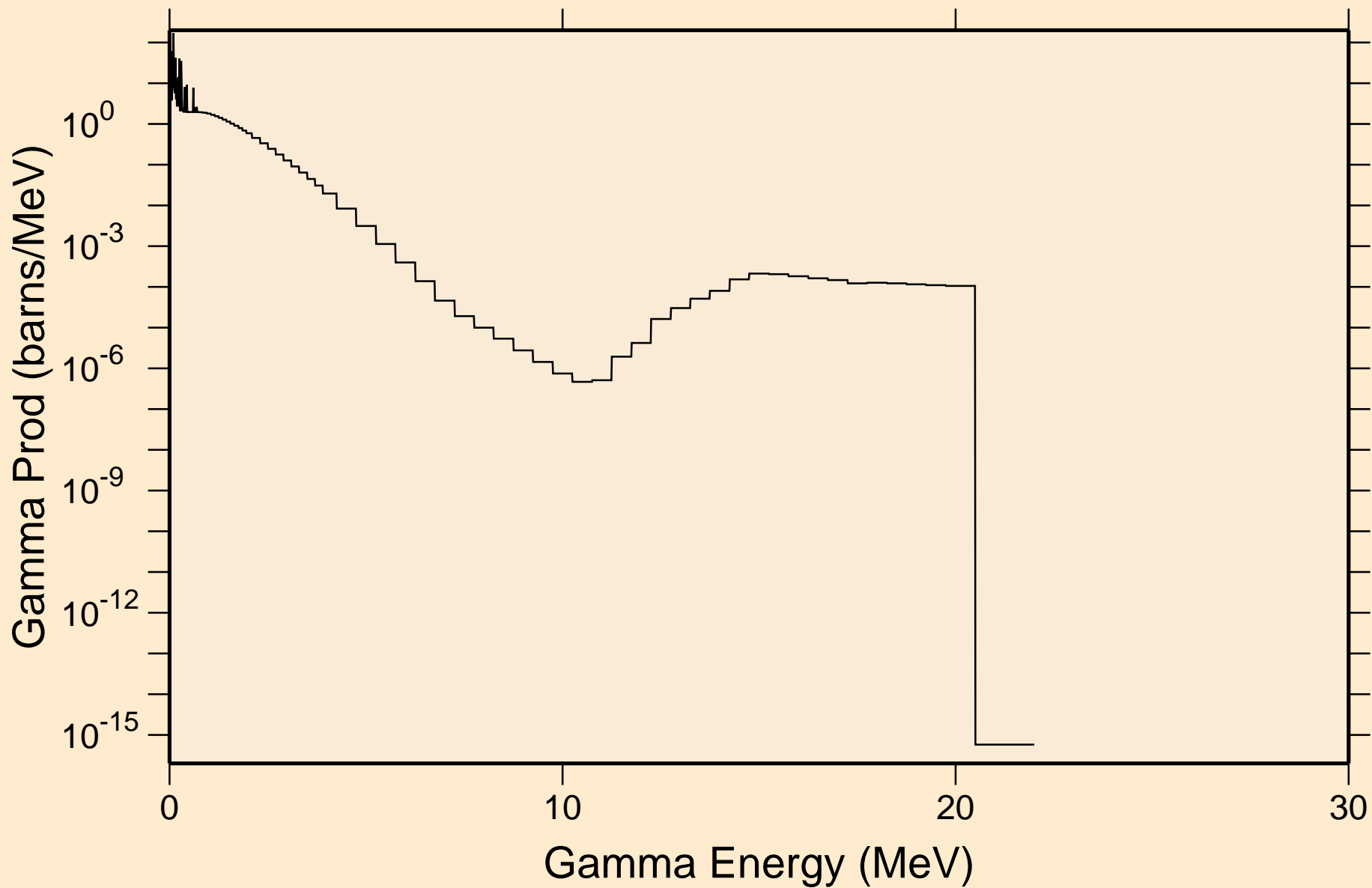

LR260 NEUTRON ACER TENDL-2019 LIBRARY; T=293.16K
Particle heating contributions

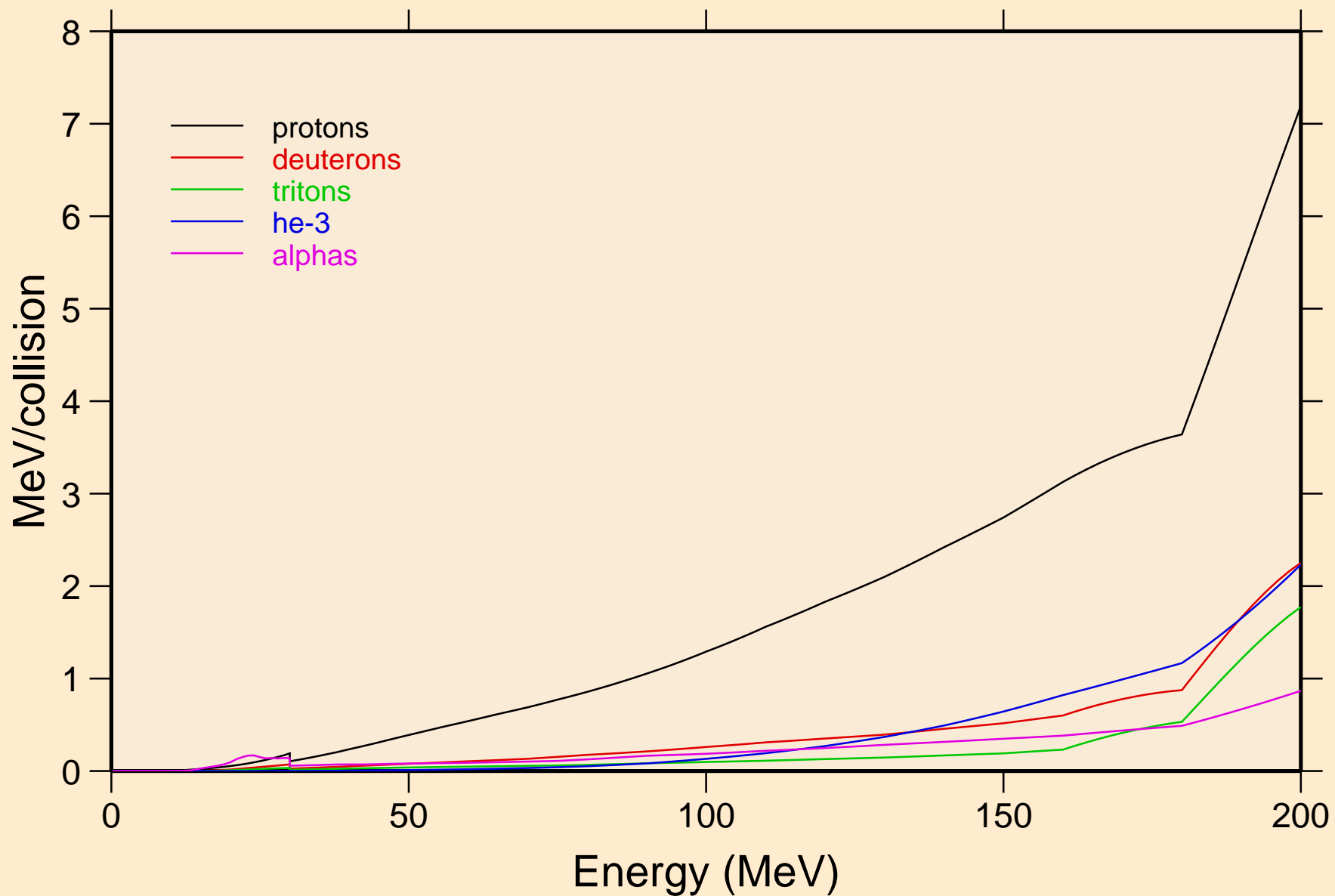

LR260 NEUTRON ACER TENDL-2019 LIBRARY; T=293.16K
Recoil Heating

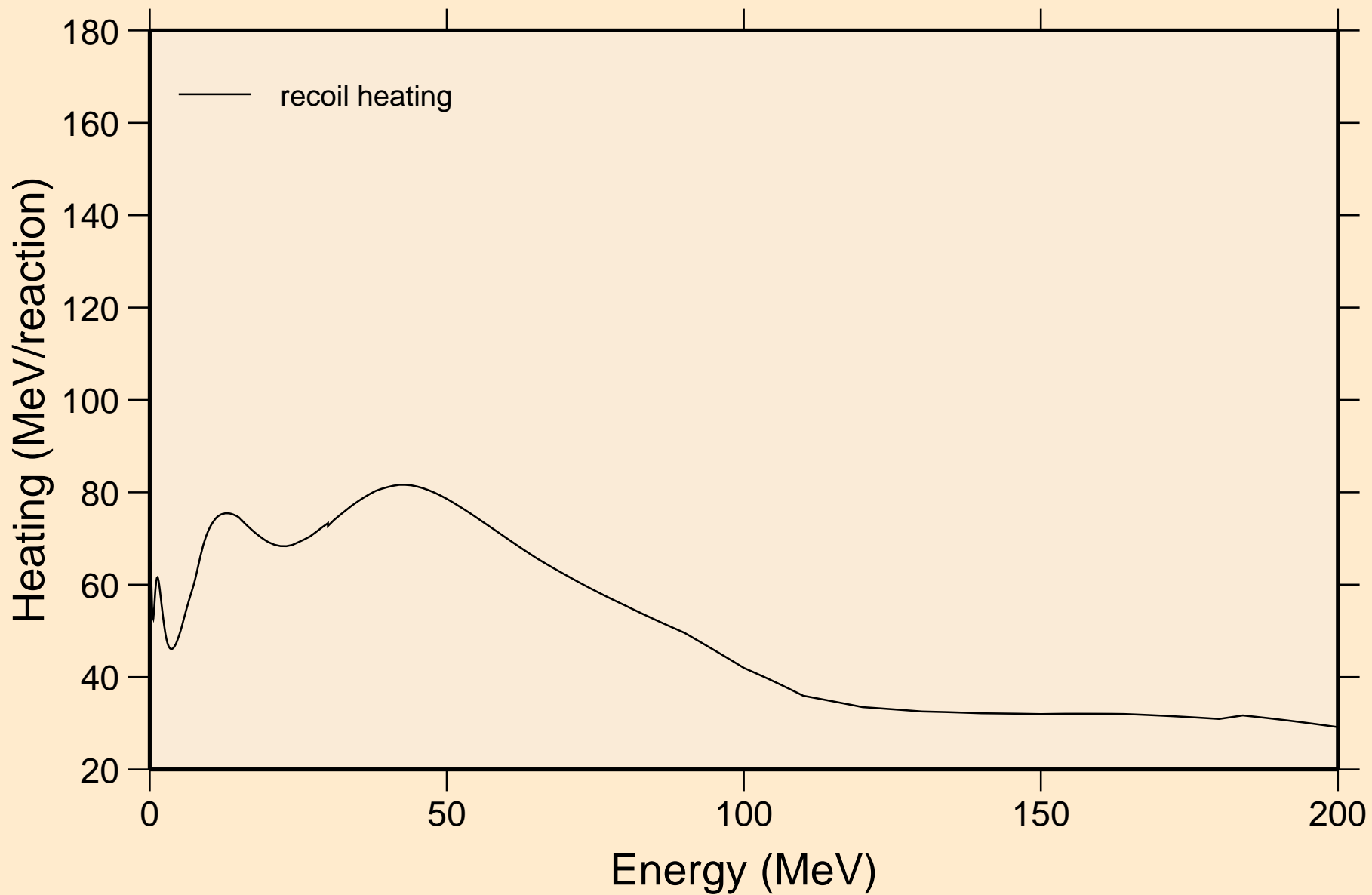

LR260 NEUTRON ACER TENDL-2019 LIBRARY; T=293.16K
Particle production cross sections

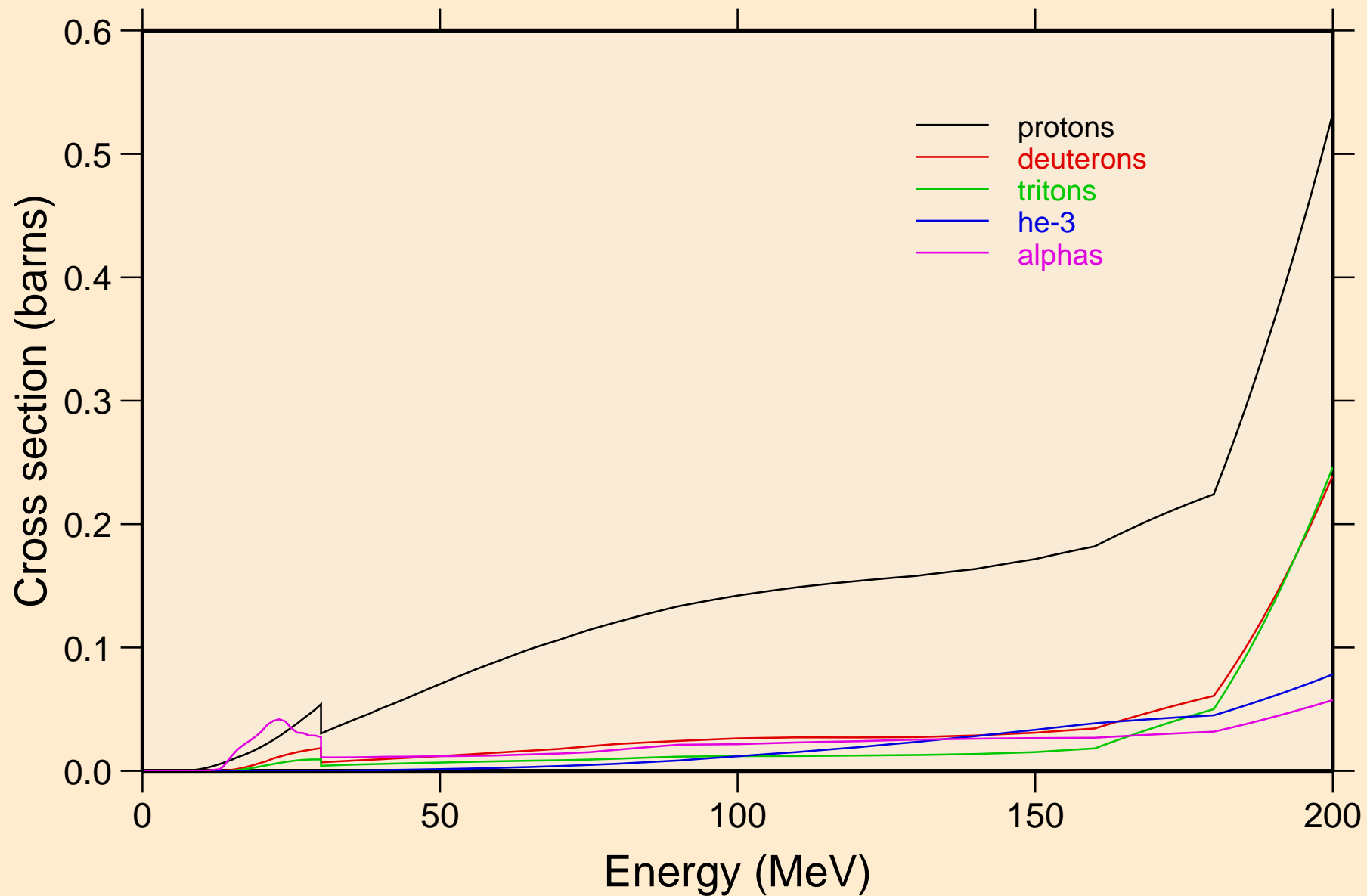

LR260 NEUTRON ACER TENDL-2019 LIBRARY; T=293.16K
protons from (n,x)

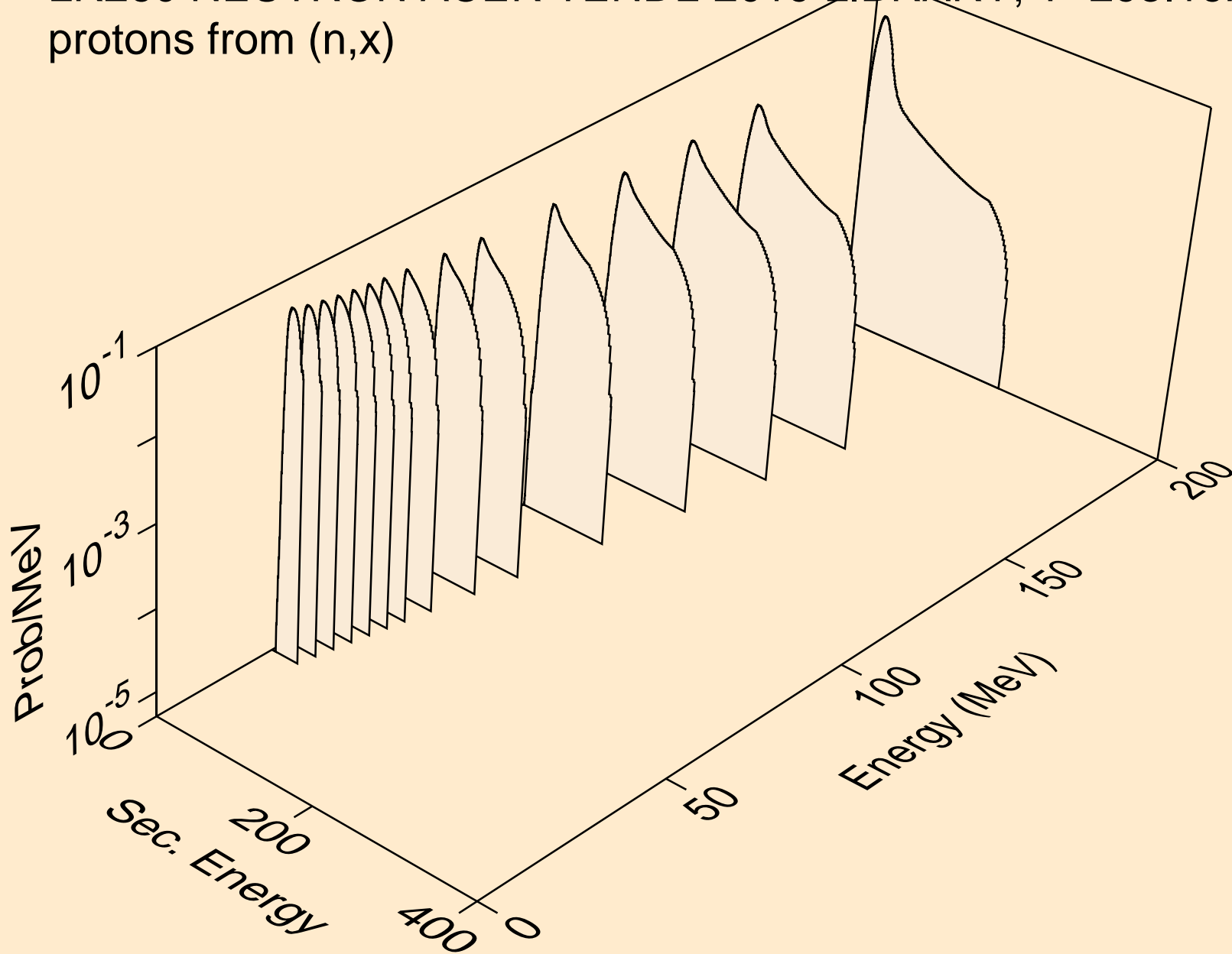

LR260 NEUTRON ACER TENDL-2019 LIBRARY; T=293.16K
protons from (n,n*)p

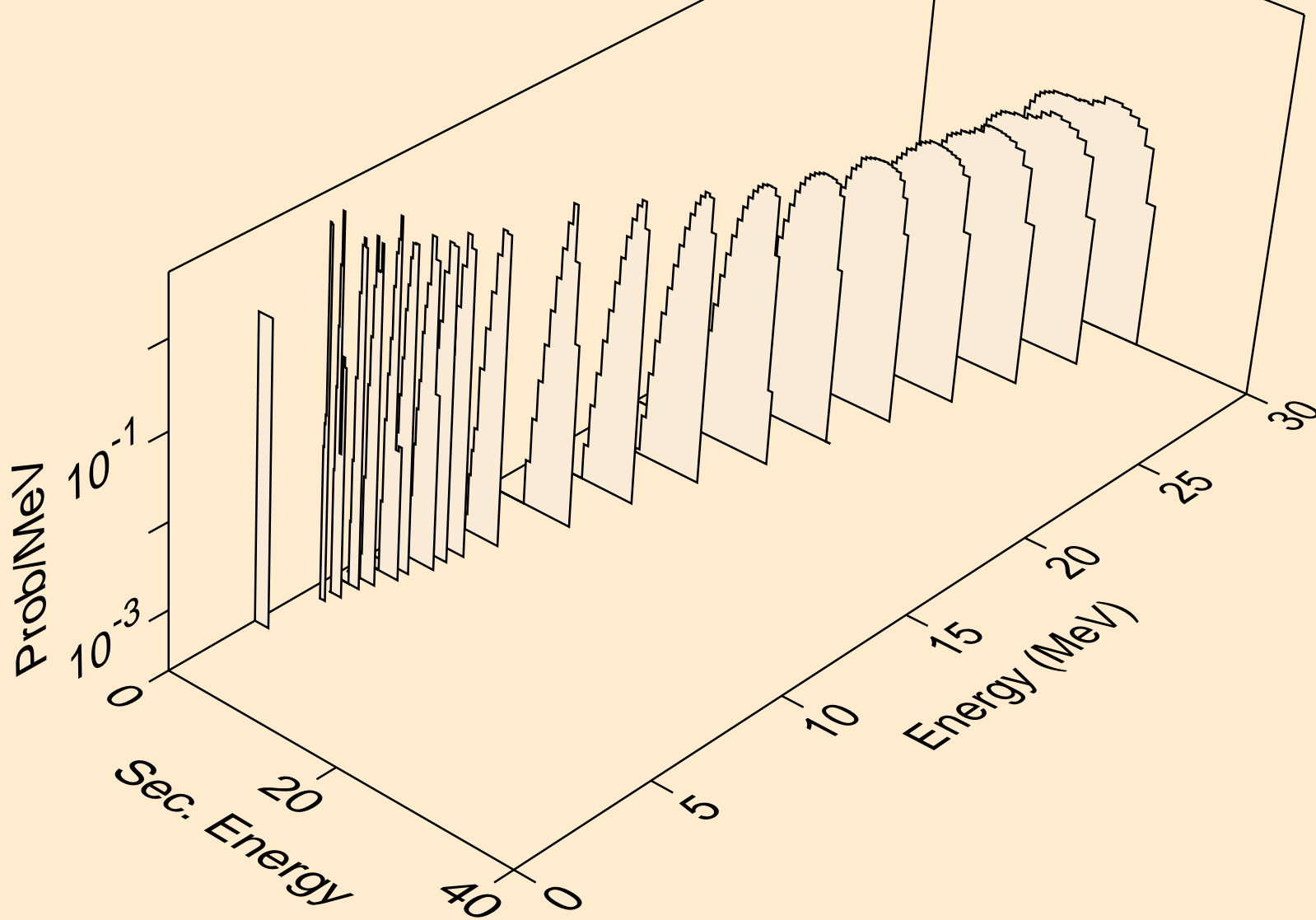

LR260 NEUTRON ACER TENDL-2019 LIBRARY; T=293.16K
protons from (n,2np)

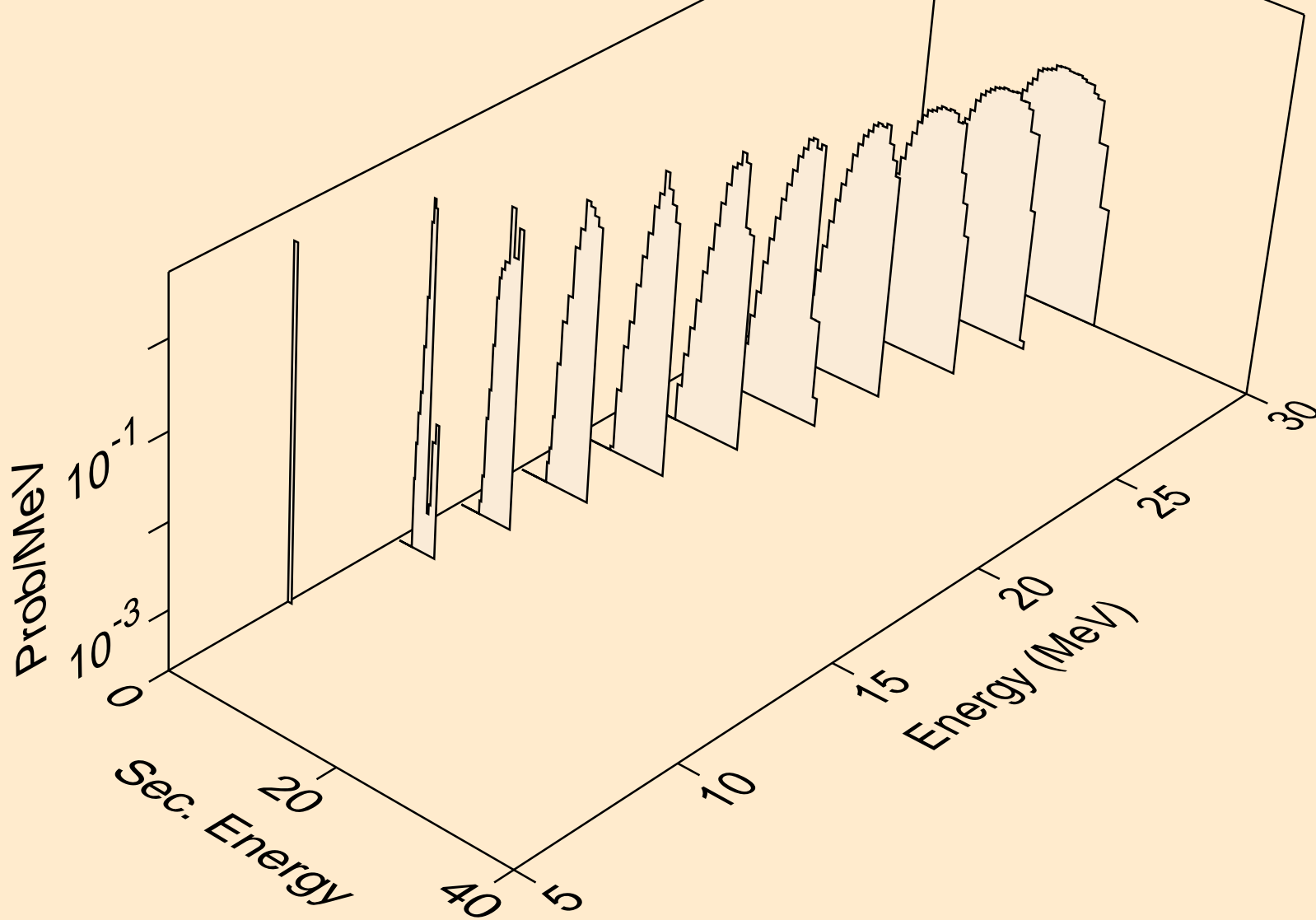

LR260 NEUTRON ACER TENDL-2019 LIBRARY; T=293.16K
protons from (n,3np)

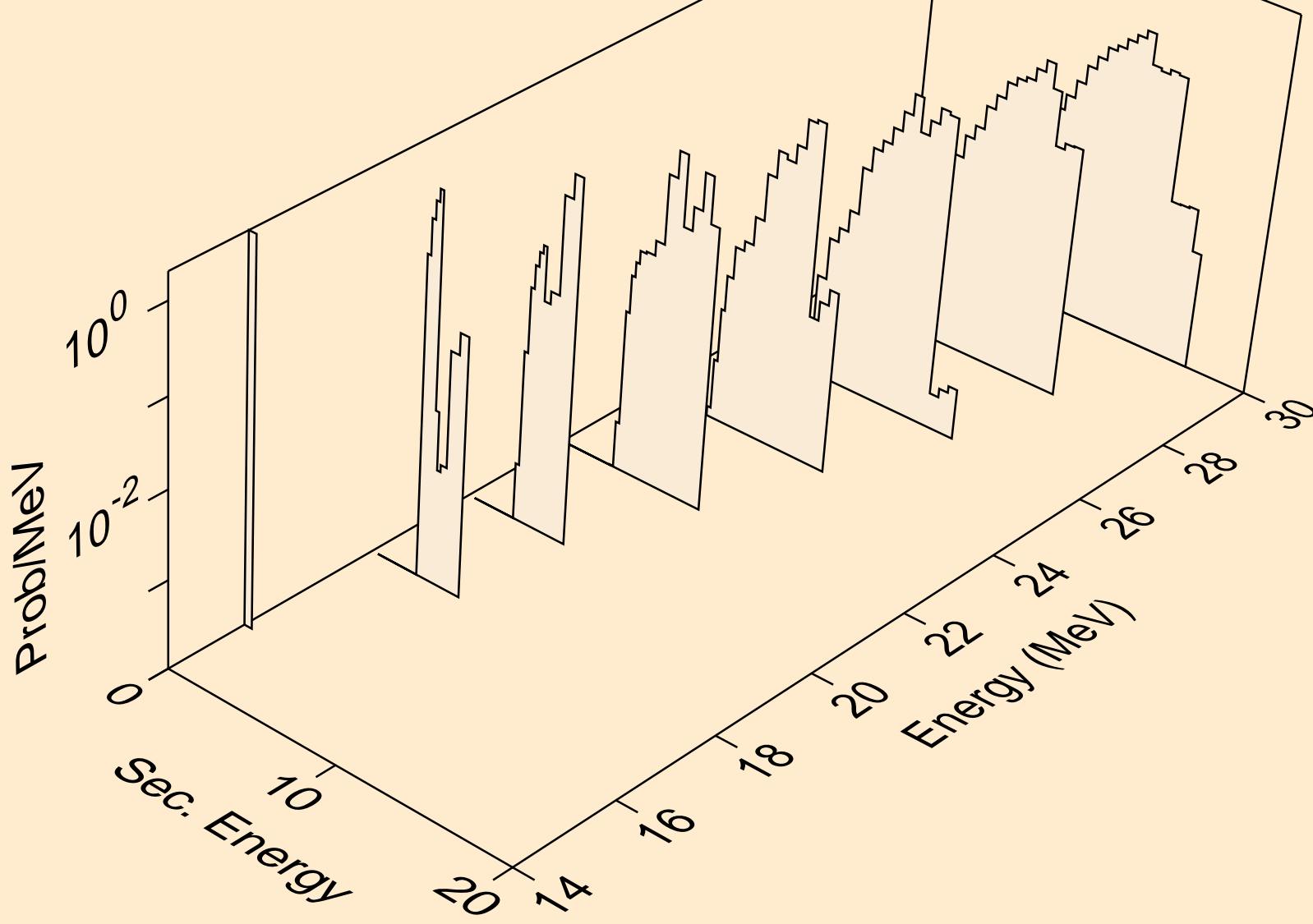

LR260 NEUTRON ACER TENDL-2019 LIBRARY; T=293.16K
protons from (n,2np)

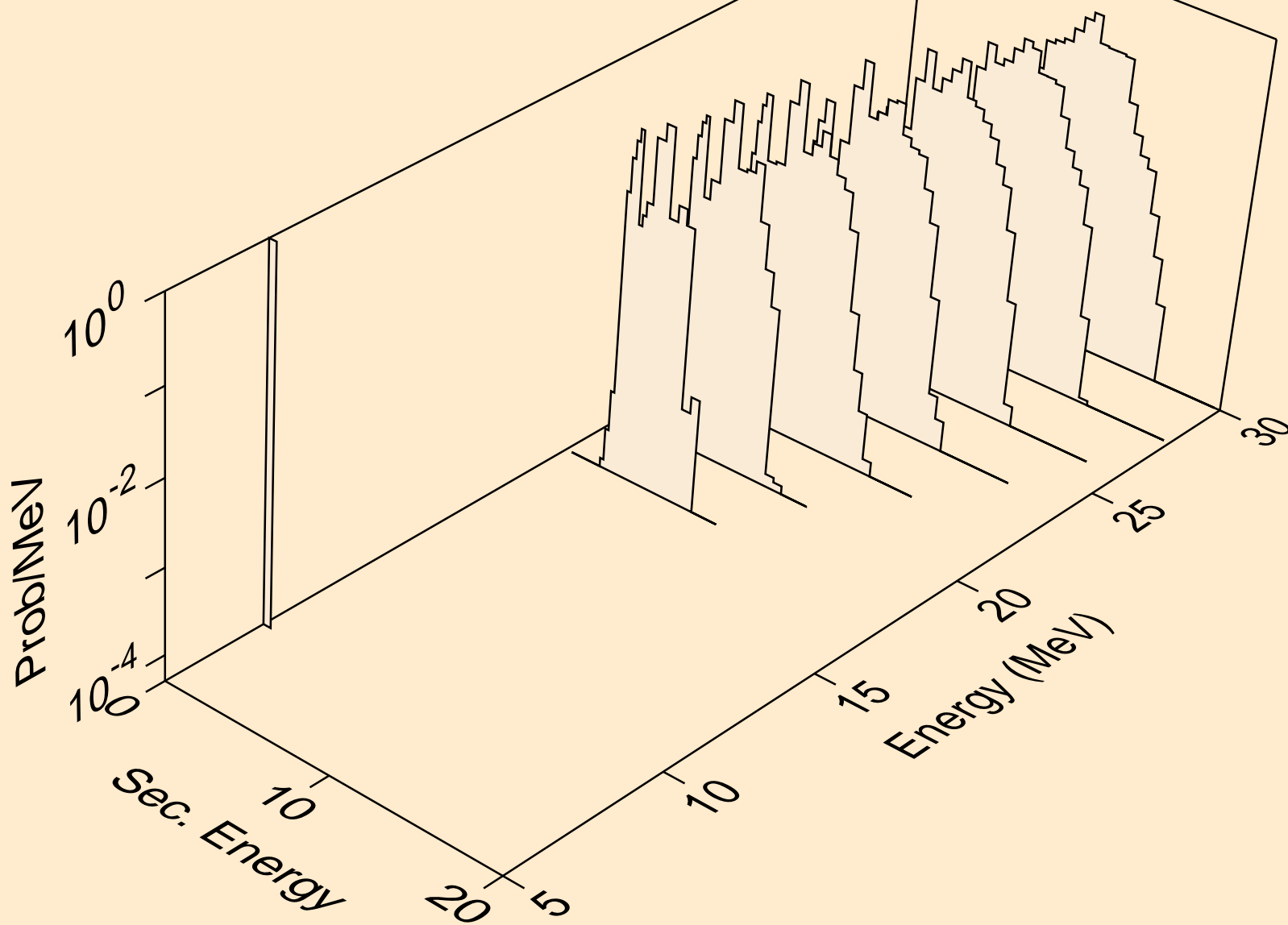

LR260 NEUTRON ACER TENDL-2019 LIBRARY; T=293.16K
protons from (n,npa)

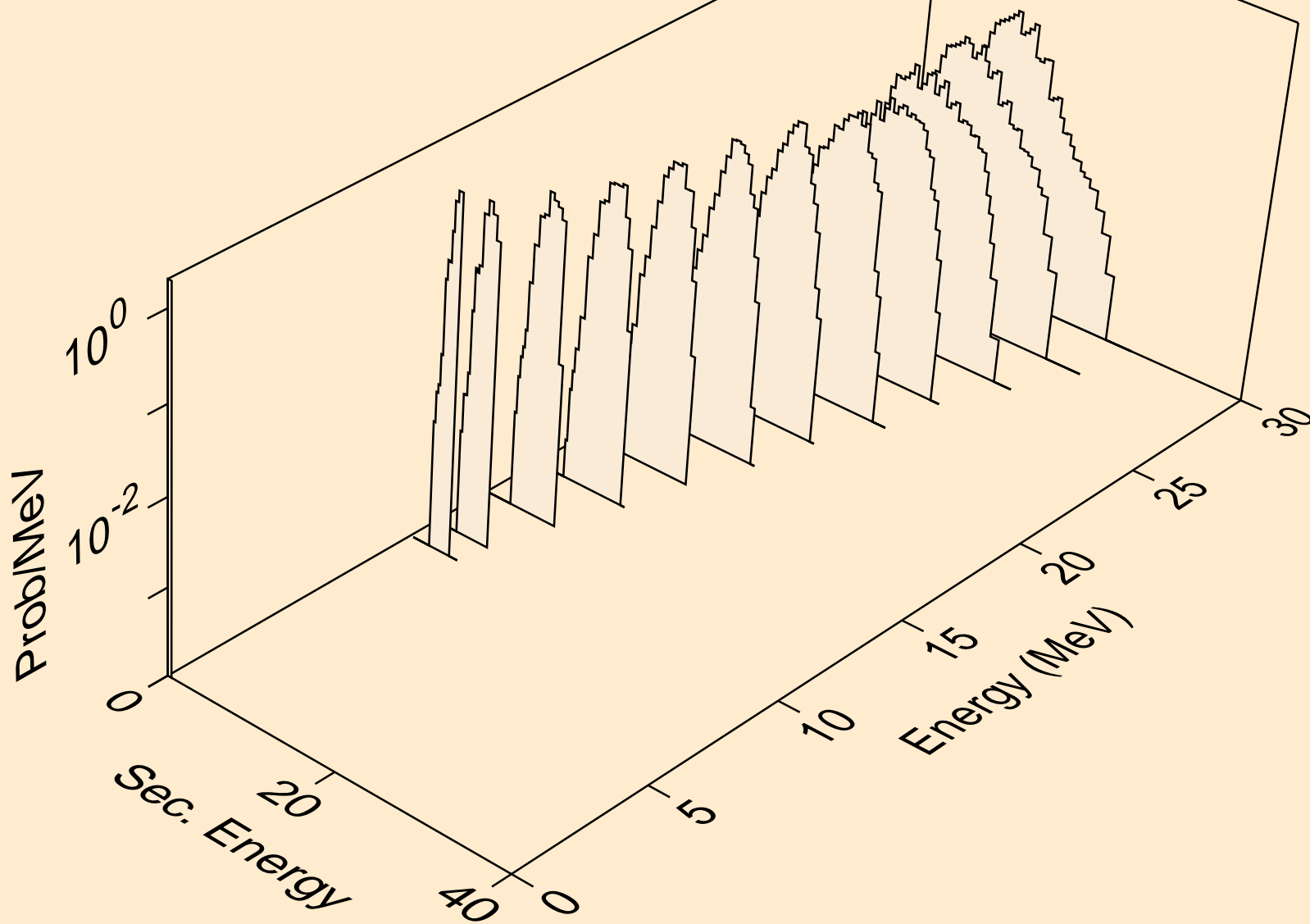

LR260 NEUTRON ACER TENDL-2019 LIBRARY; T=293.16K
protons from (n,p)

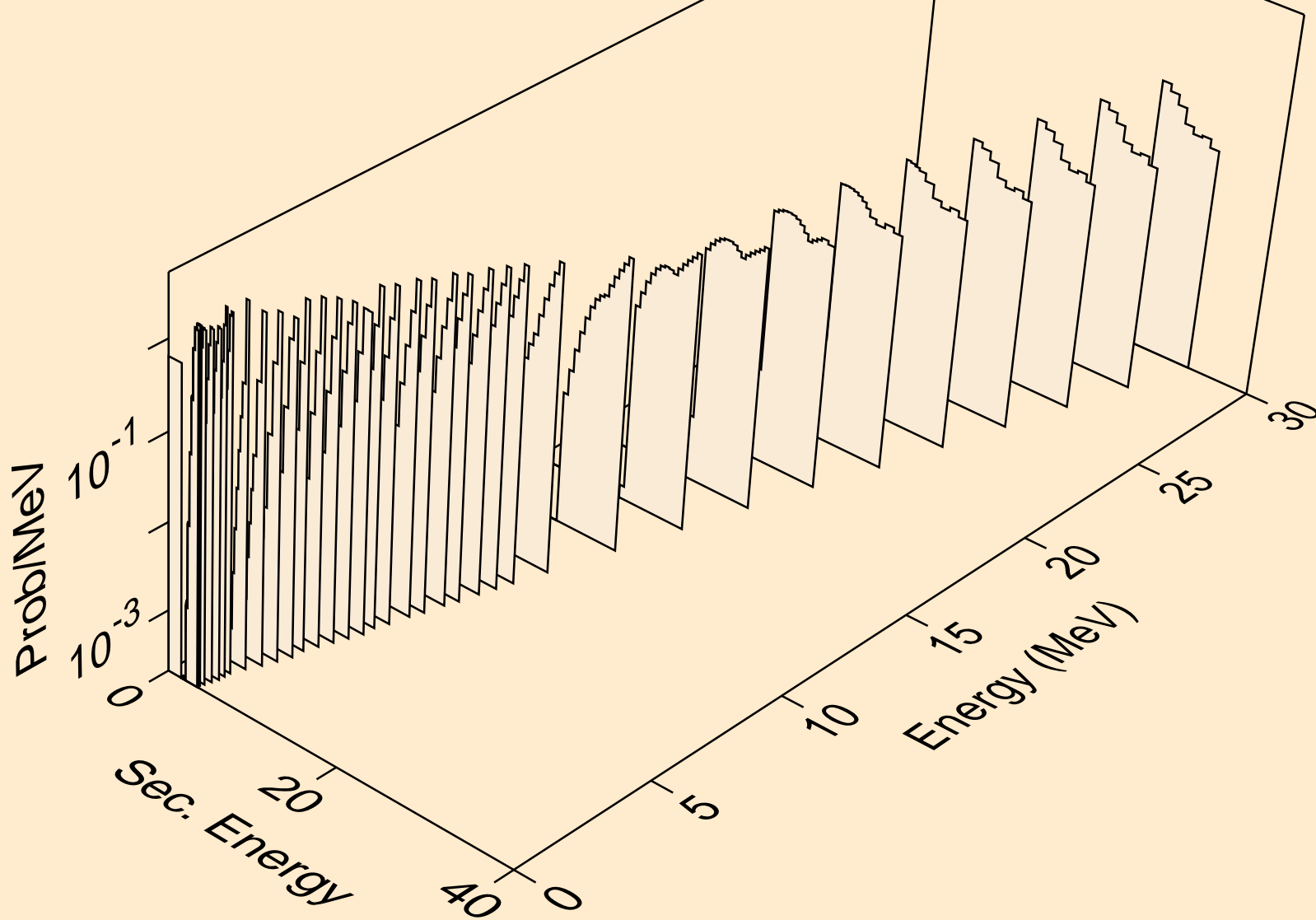

LR260 NEUTRON ACER TENDL-2019 LIBRARY; T=293.16K
protons from (n,2p)

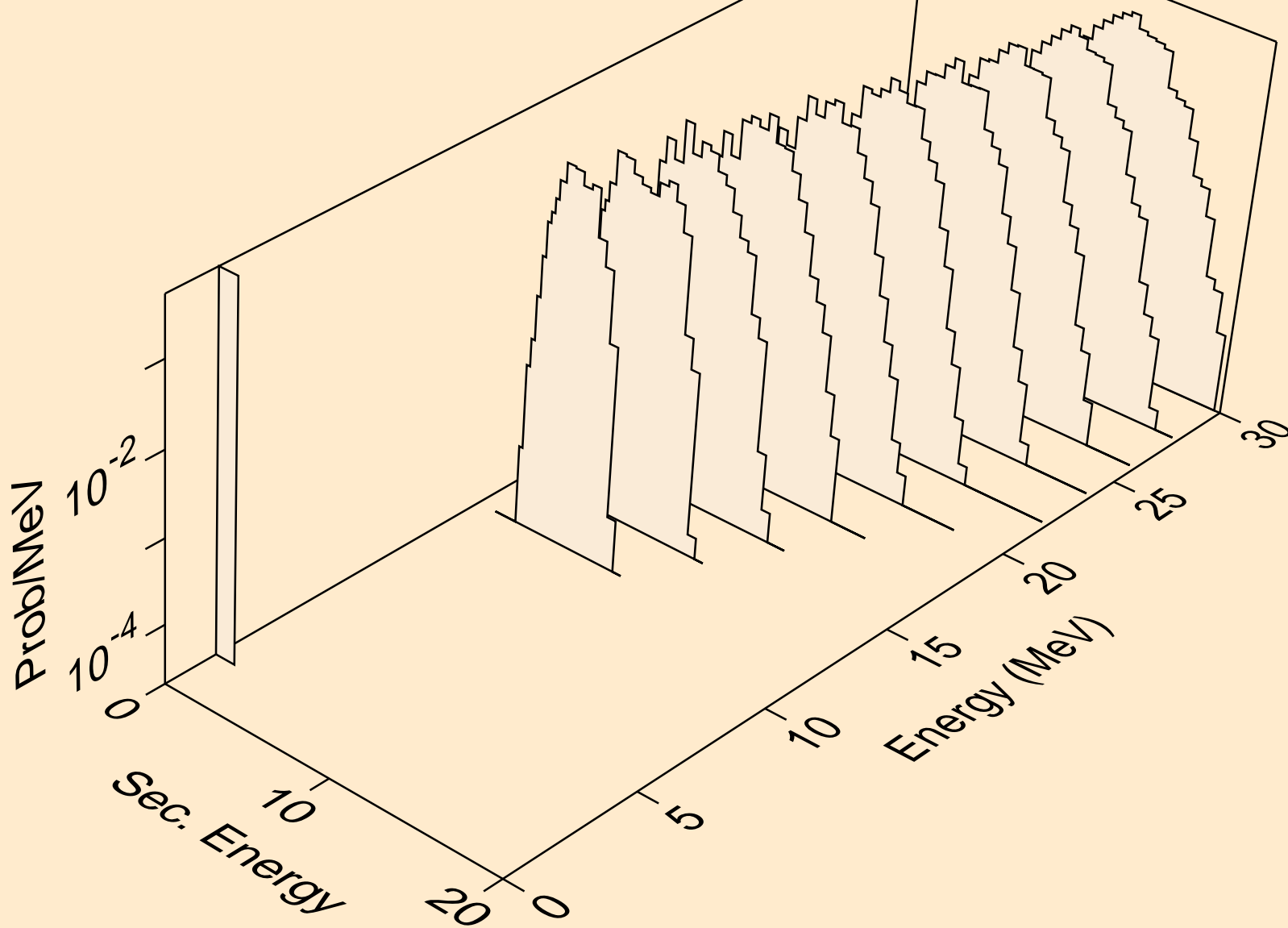

LR260 NEUTRON ACER TENDL-2019 LIBRARY; T=293.16K
protons from (n,p)

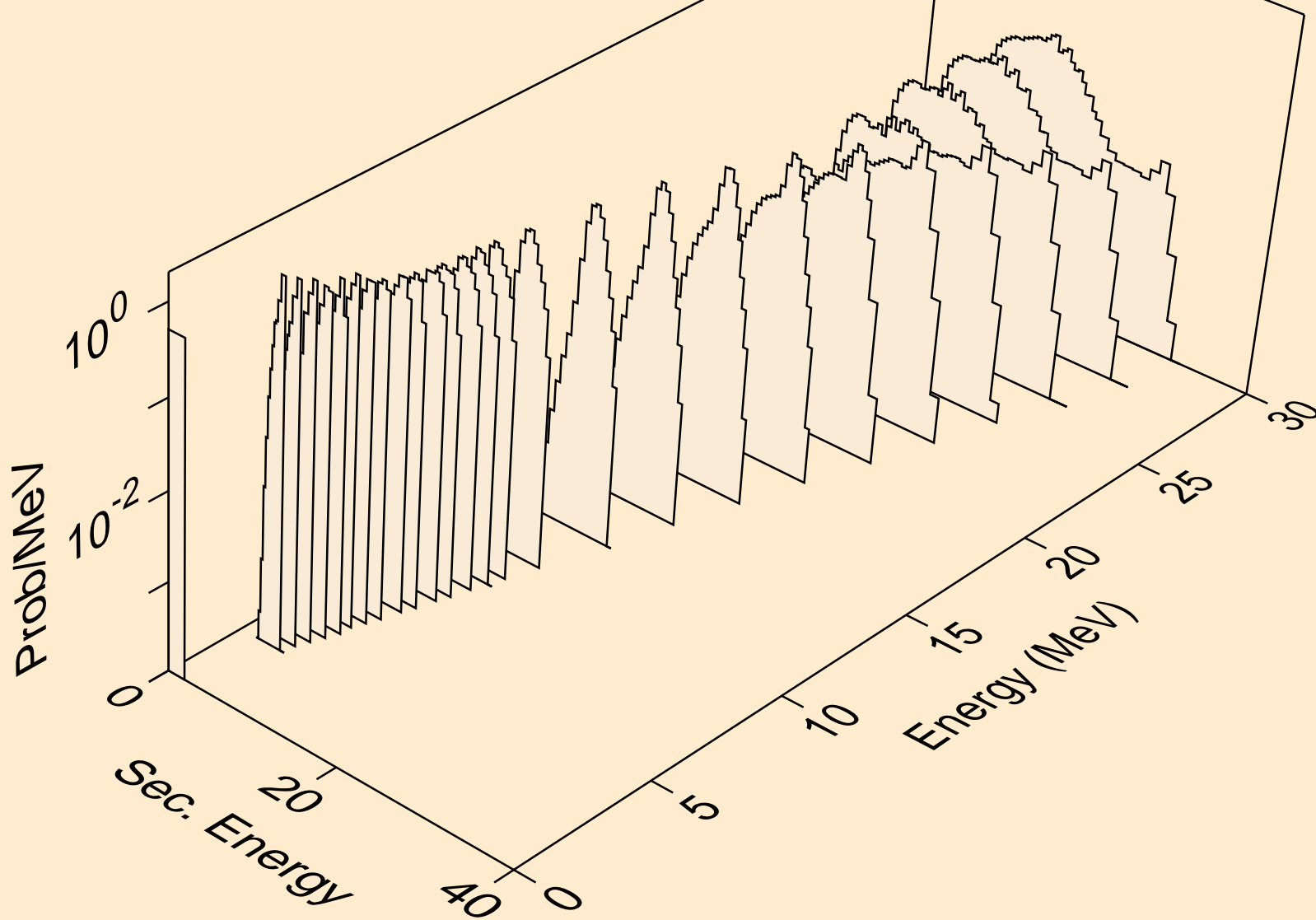

LR260 NEUTRON ACER TENDL-2019 LIBRARY; T=293.16K
protons from (n,pd)

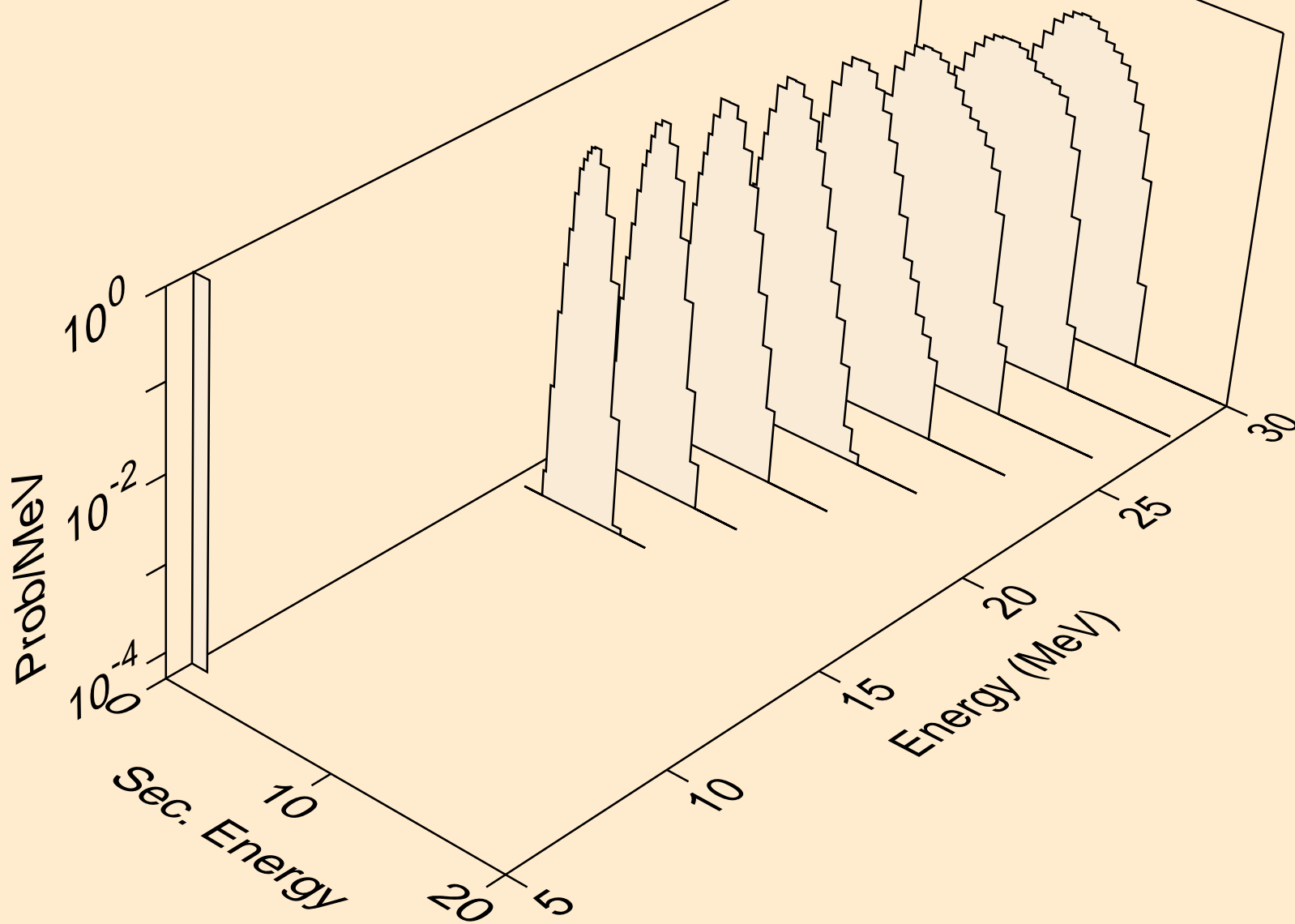

LR260 NEUTRON ACER TENDL-2019 LIBRARY; T=293.16K
deuterons from (n,x)

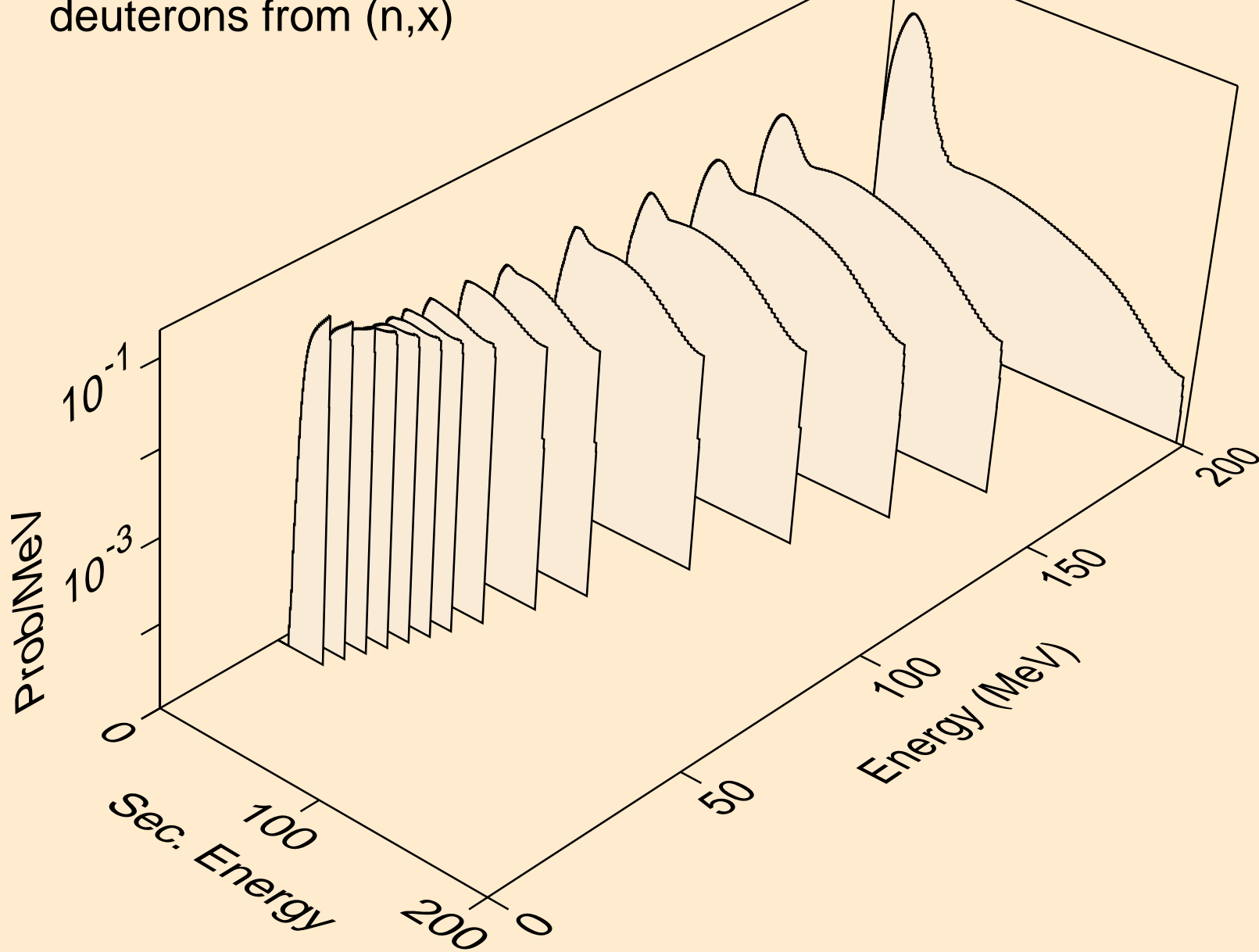

LR260 NEUTRON ACER TENDL-2019 LIBRARY; T=293.16K
deuterons from (n,2nd)

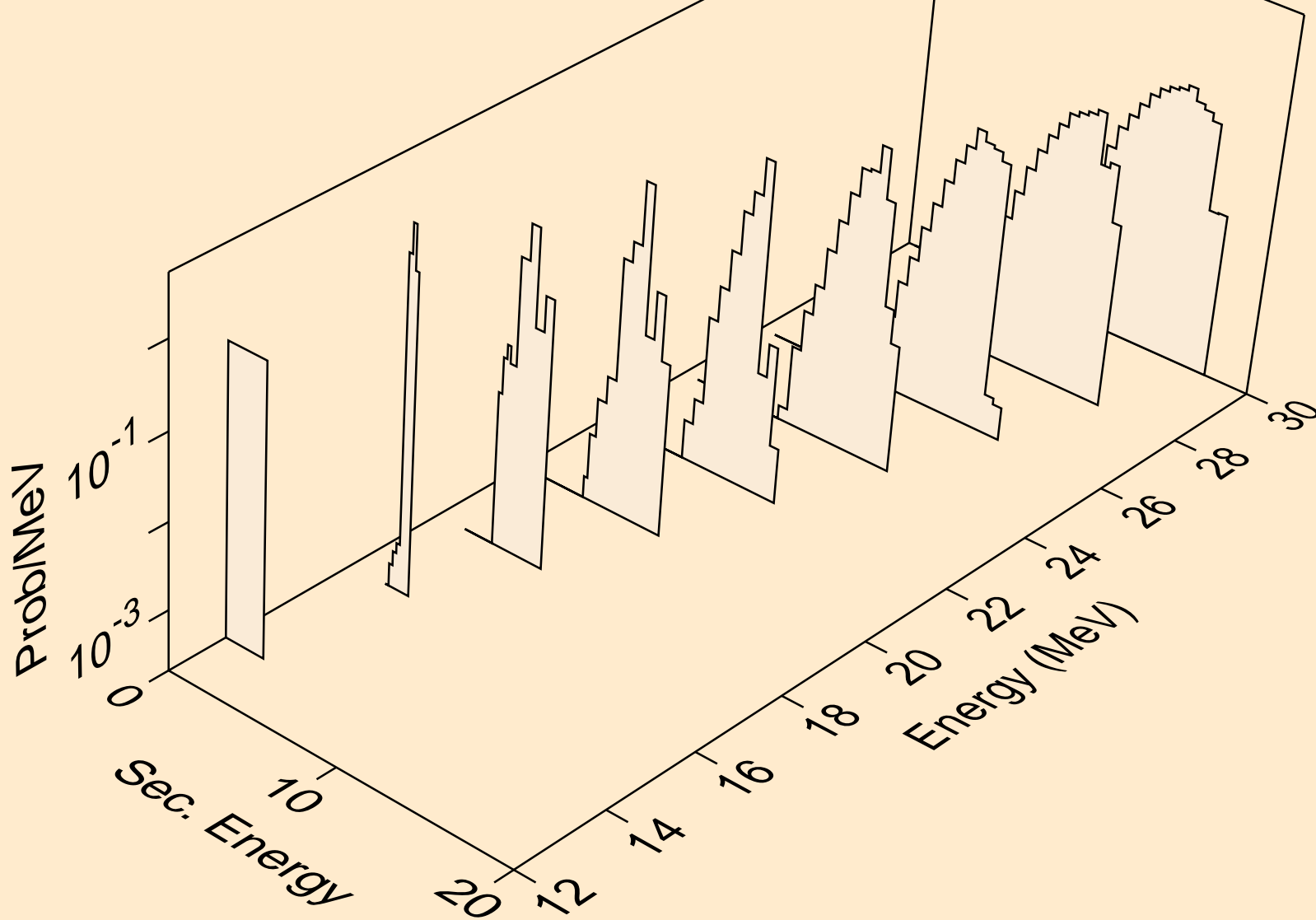

LR260 NEUTRON ACER TENDL-2019 LIBRARY; T=293.16K
deuterons from (n,n*)d

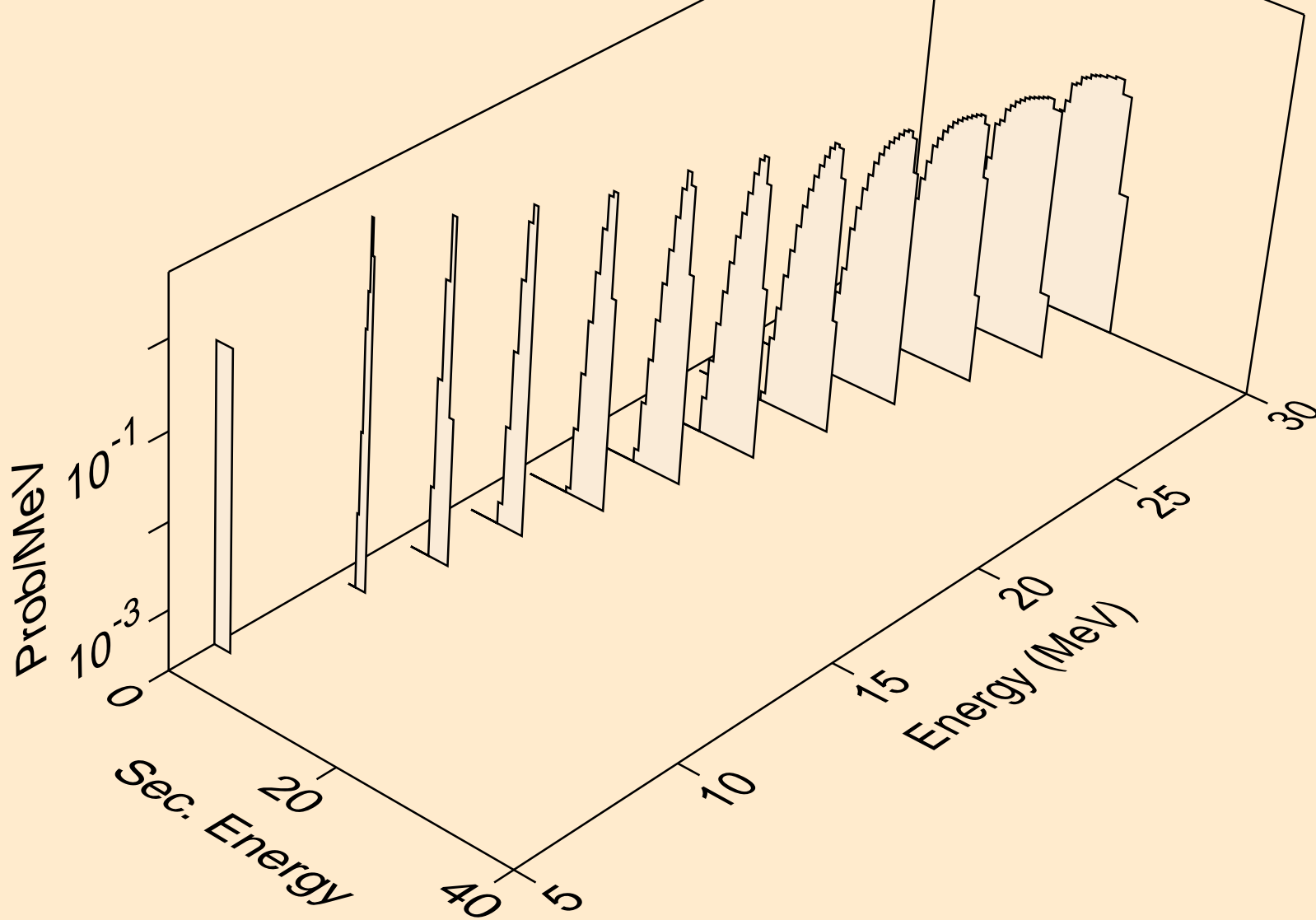

LR260 NEUTRON ACER TENDL-2019 LIBRARY; T=293.16K
deuterons from (n,d)

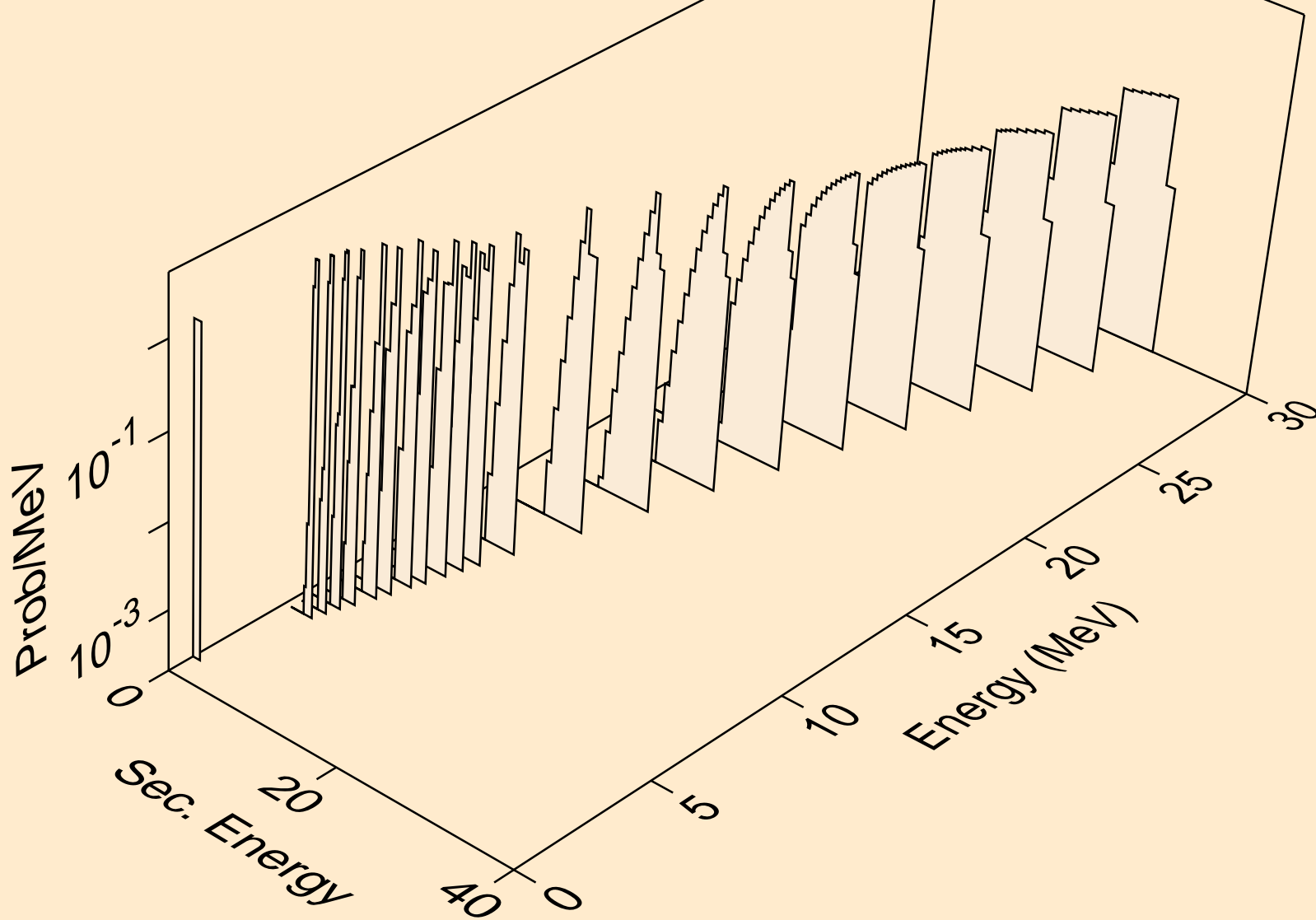

LR260 NEUTRON ACER TENDL-2019 LIBRARY; T=293.16K
deuterons from (n,pd)

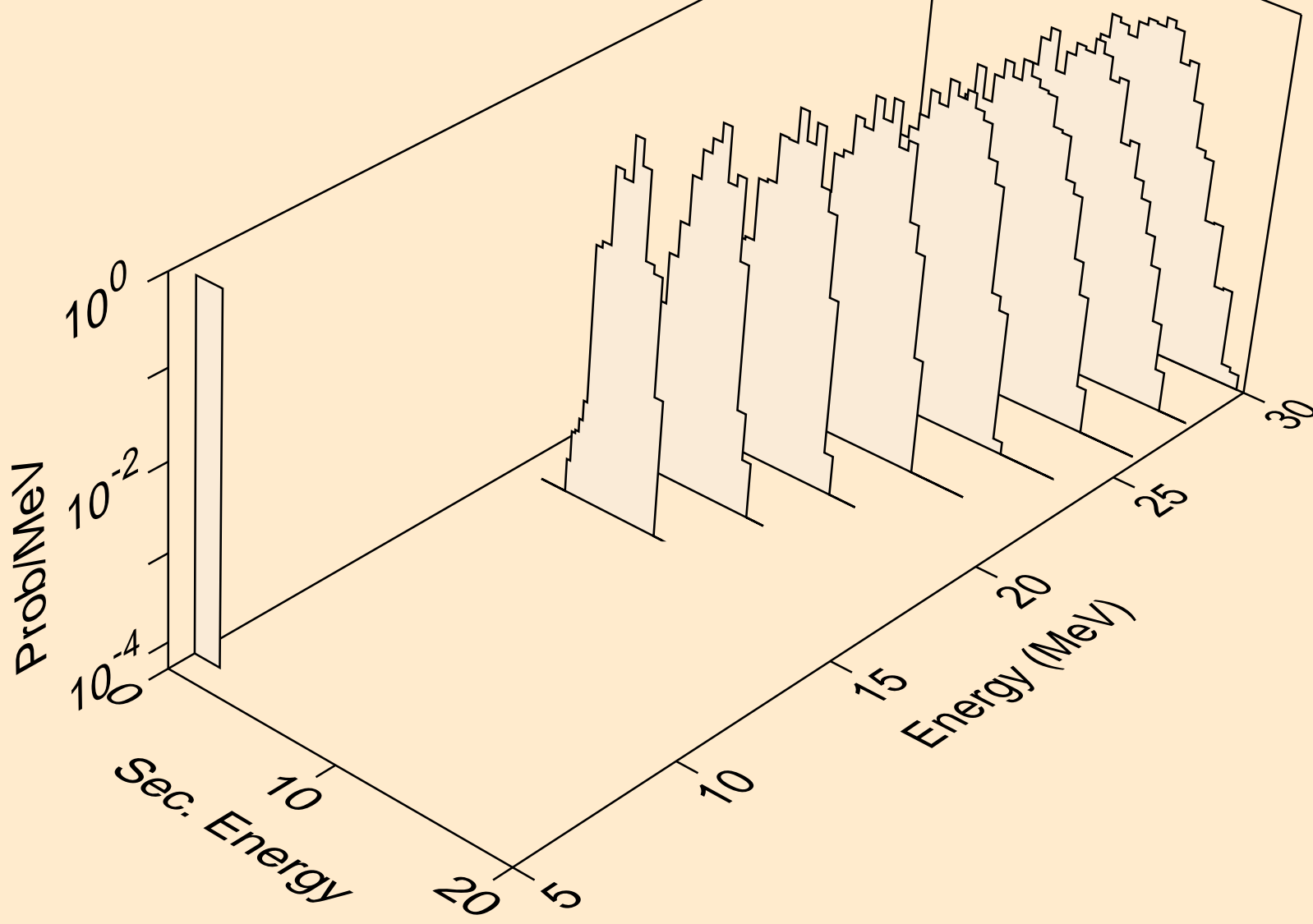

LR260 NEUTRON ACER TENDL-2019 LIBRARY; T=293.16K
deuterons from (n,da)

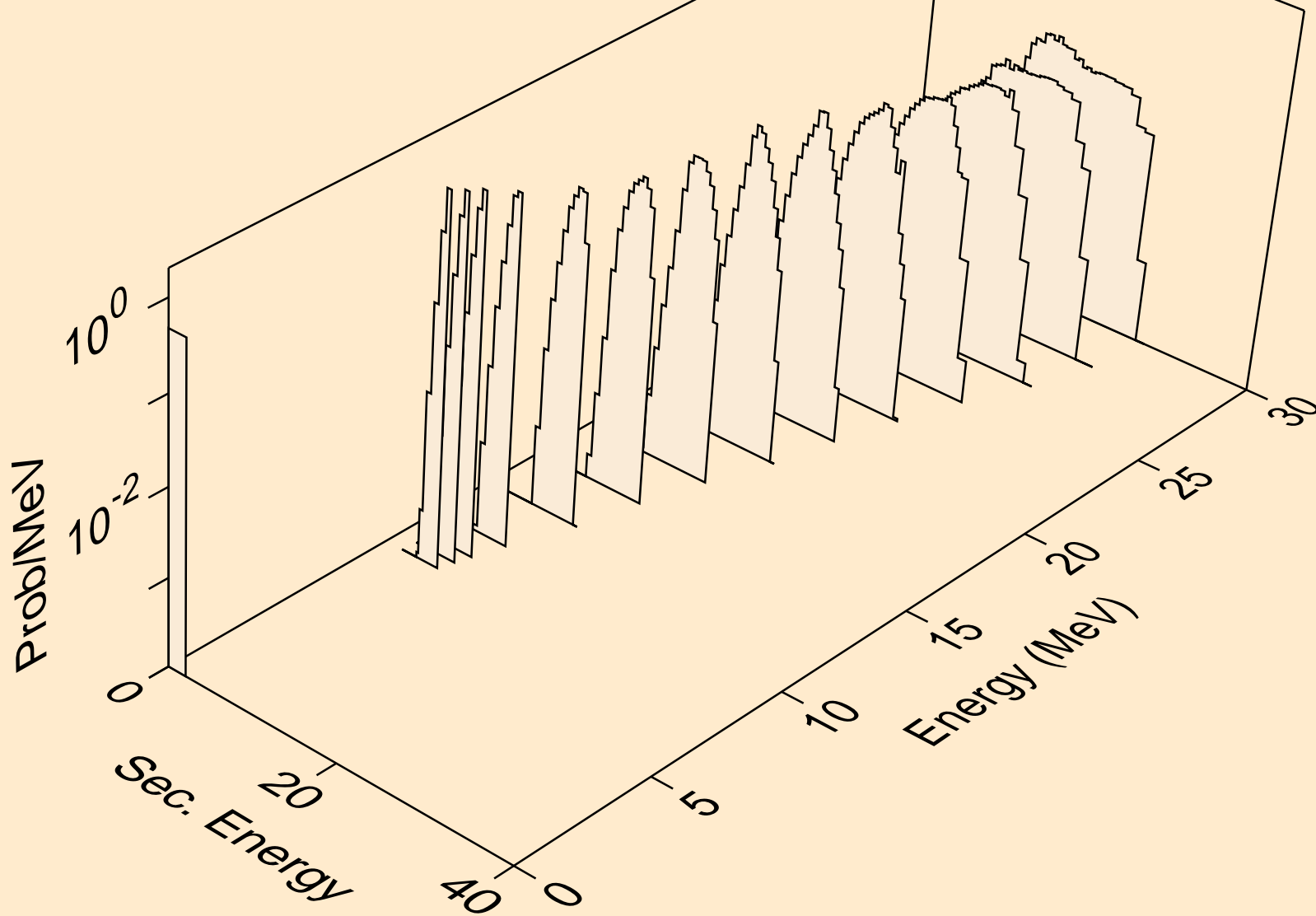

LR260 NEUTRON ACER TENDL-2019 LIBRARY; T=293.16K
tritons from (n,x)

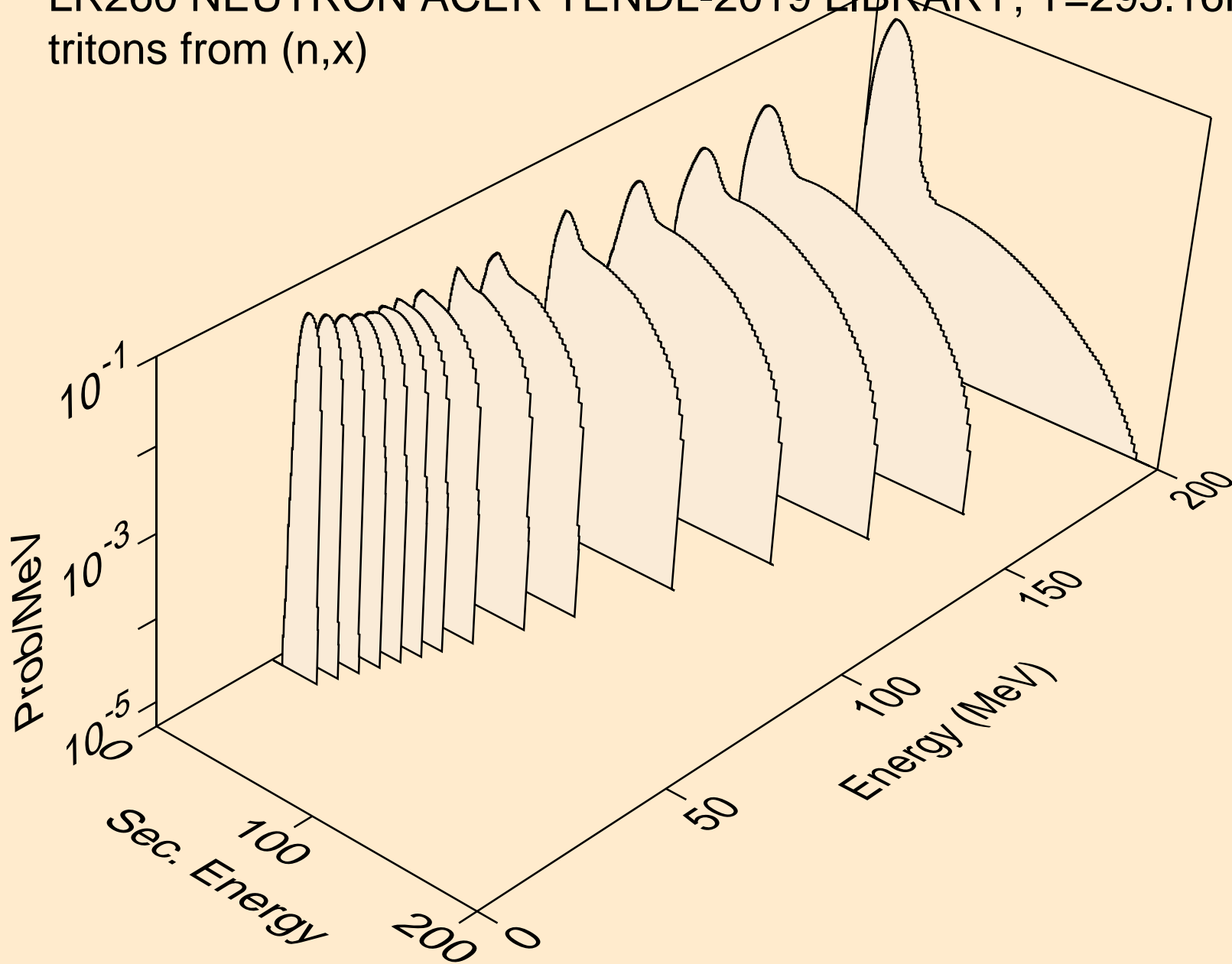

LR260 NEUTRON ACER TENDL-2019 LIBRARY; T=293.16K
tritons from (n,n*)t

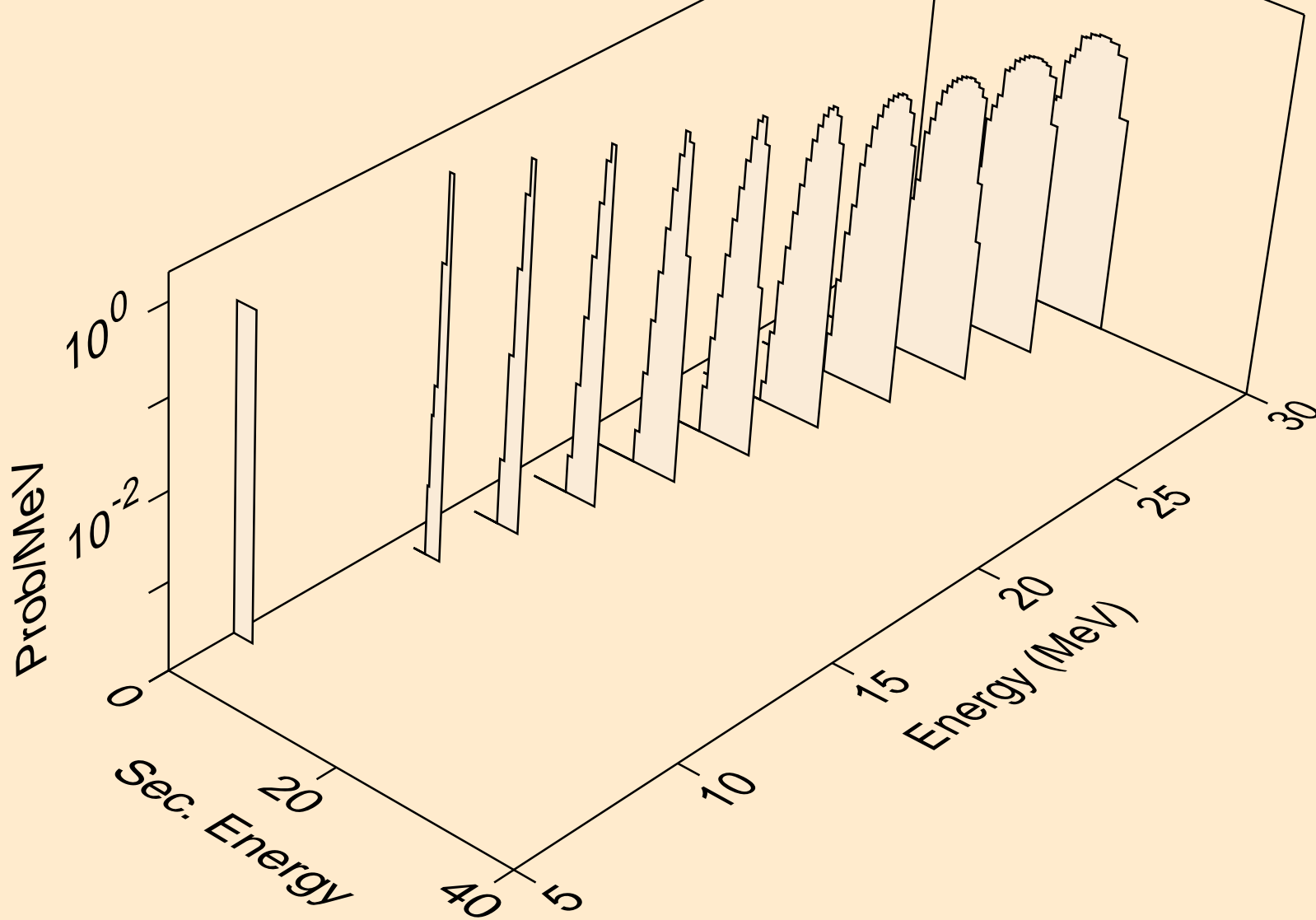

LR260 NEUTRON ACER TENDL-2019 LIBRARY; T=293.16K
tritons from (n,t)

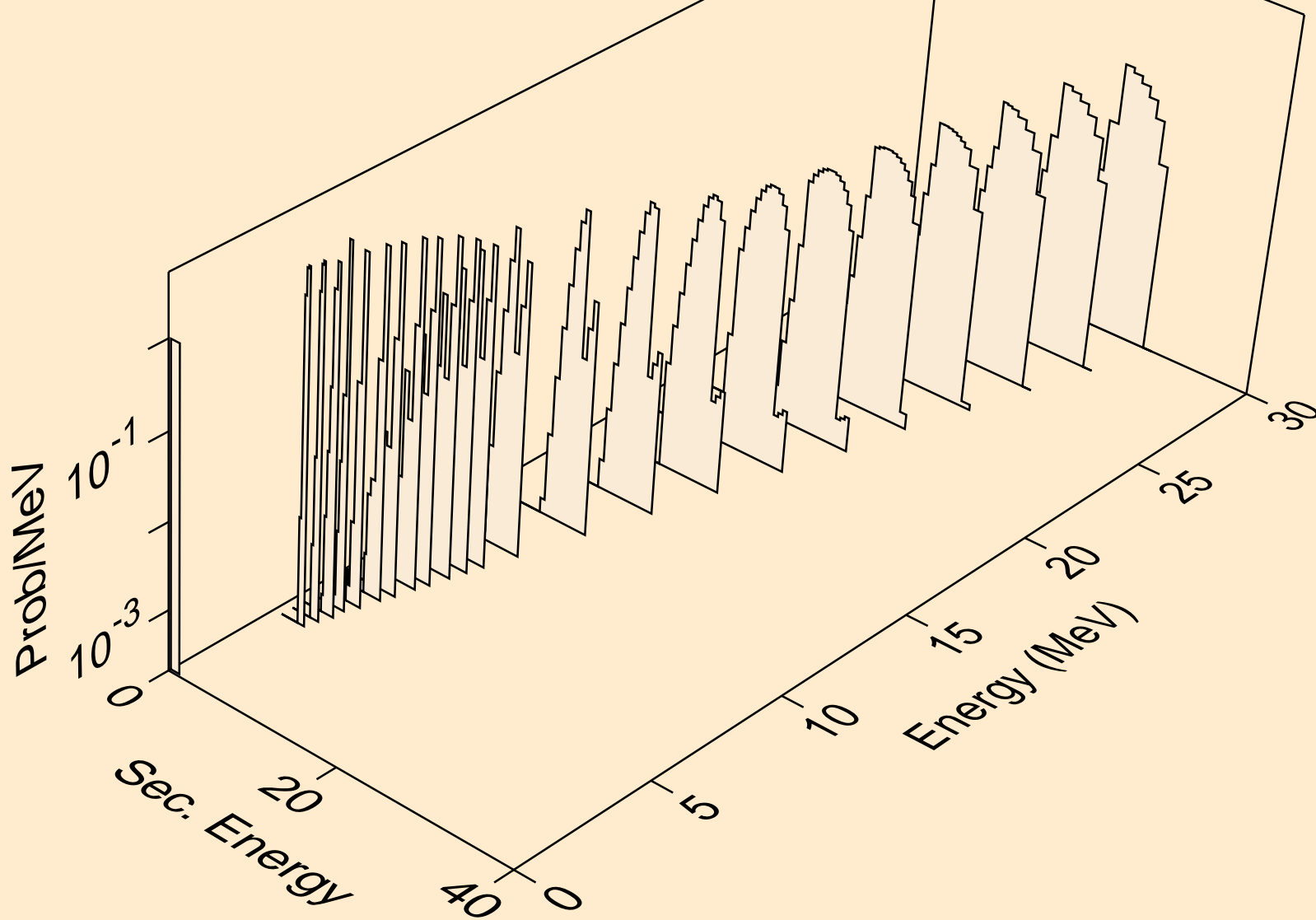

LR260 NEUTRON ACER TENDL-2019 LIBRARY; T=293.16K
he3s from (n,x)

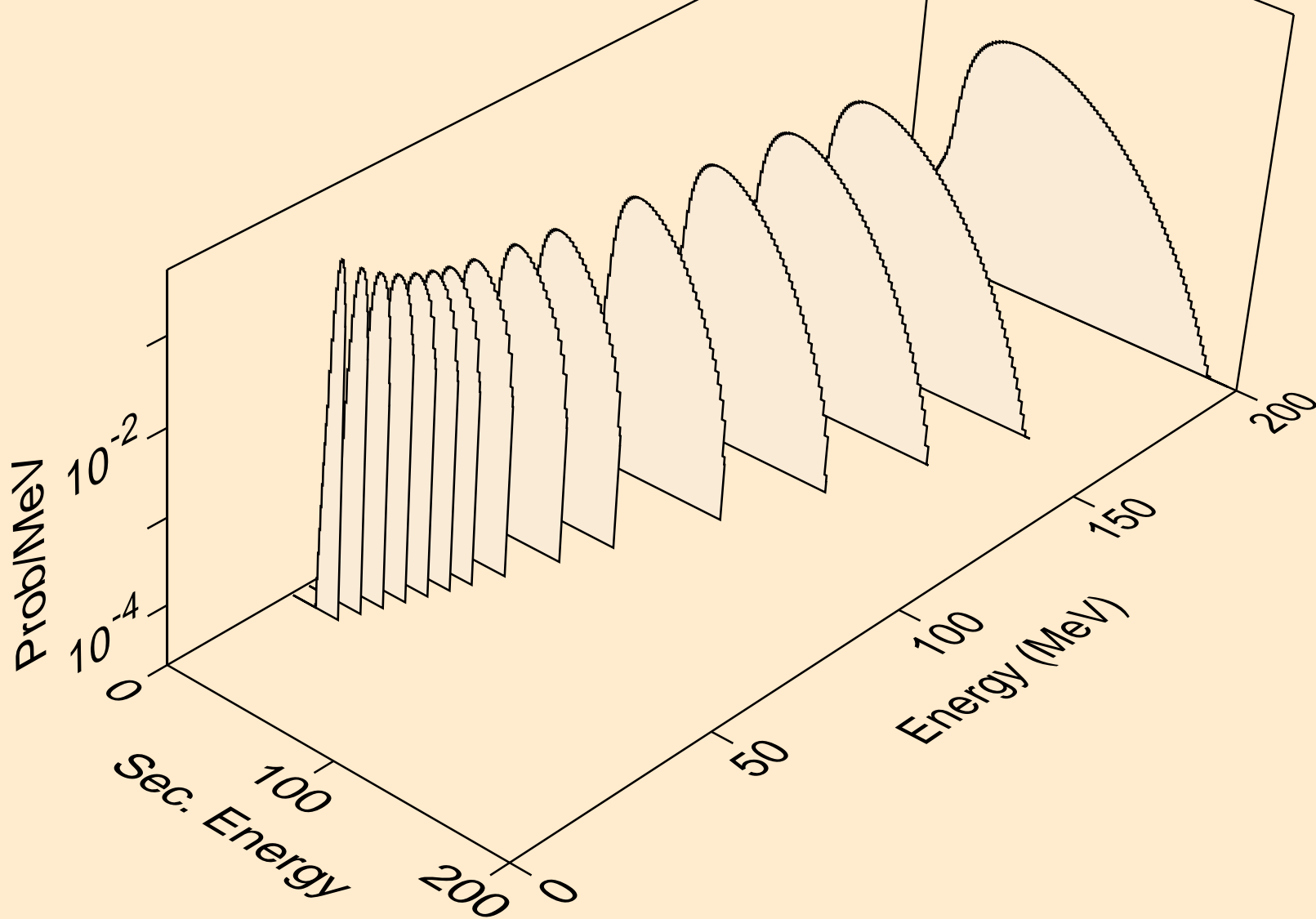

LR260 NEUTRON ACER TENDL-2019 LIBRARY; T=293.16K
he3s from (n,n*)he3

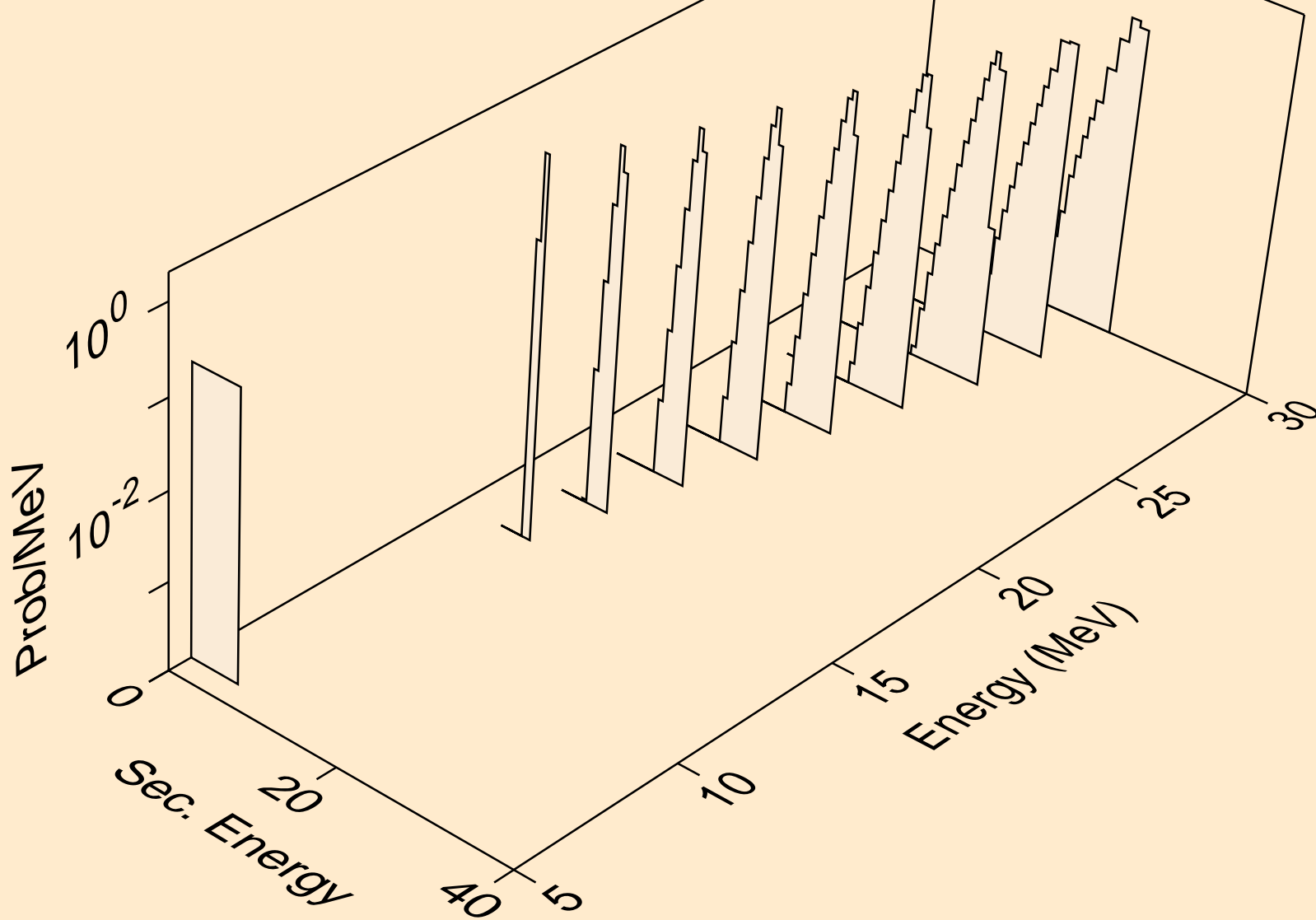

LR260 NEUTRON ACER TENDL-2019 LIBRARY; T=293.16K
he3s from (n,he3)

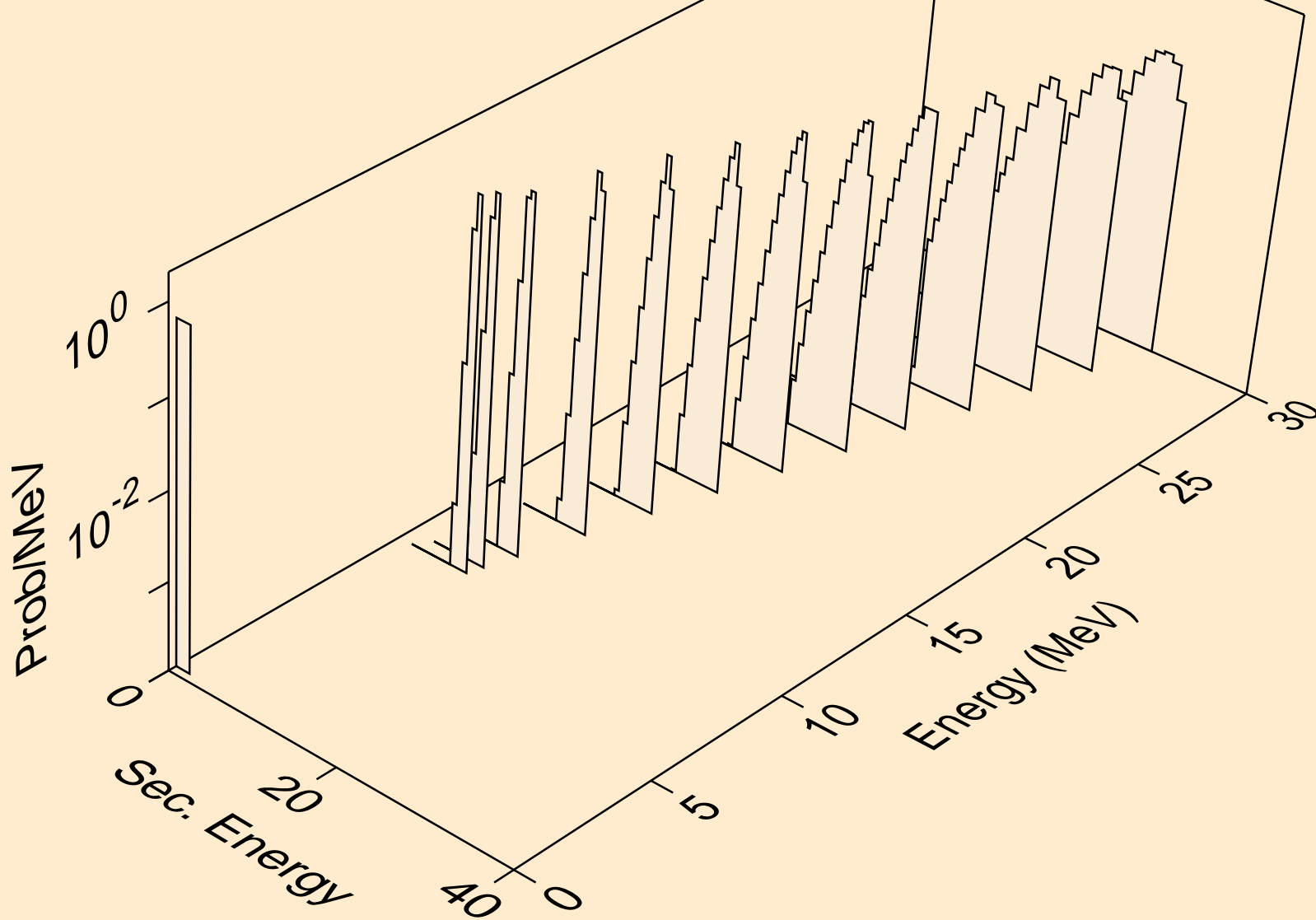

LR260 NEUTRON ACER TENDL-2019 LIBRARY; T=293.16K
alphas from (n,x)

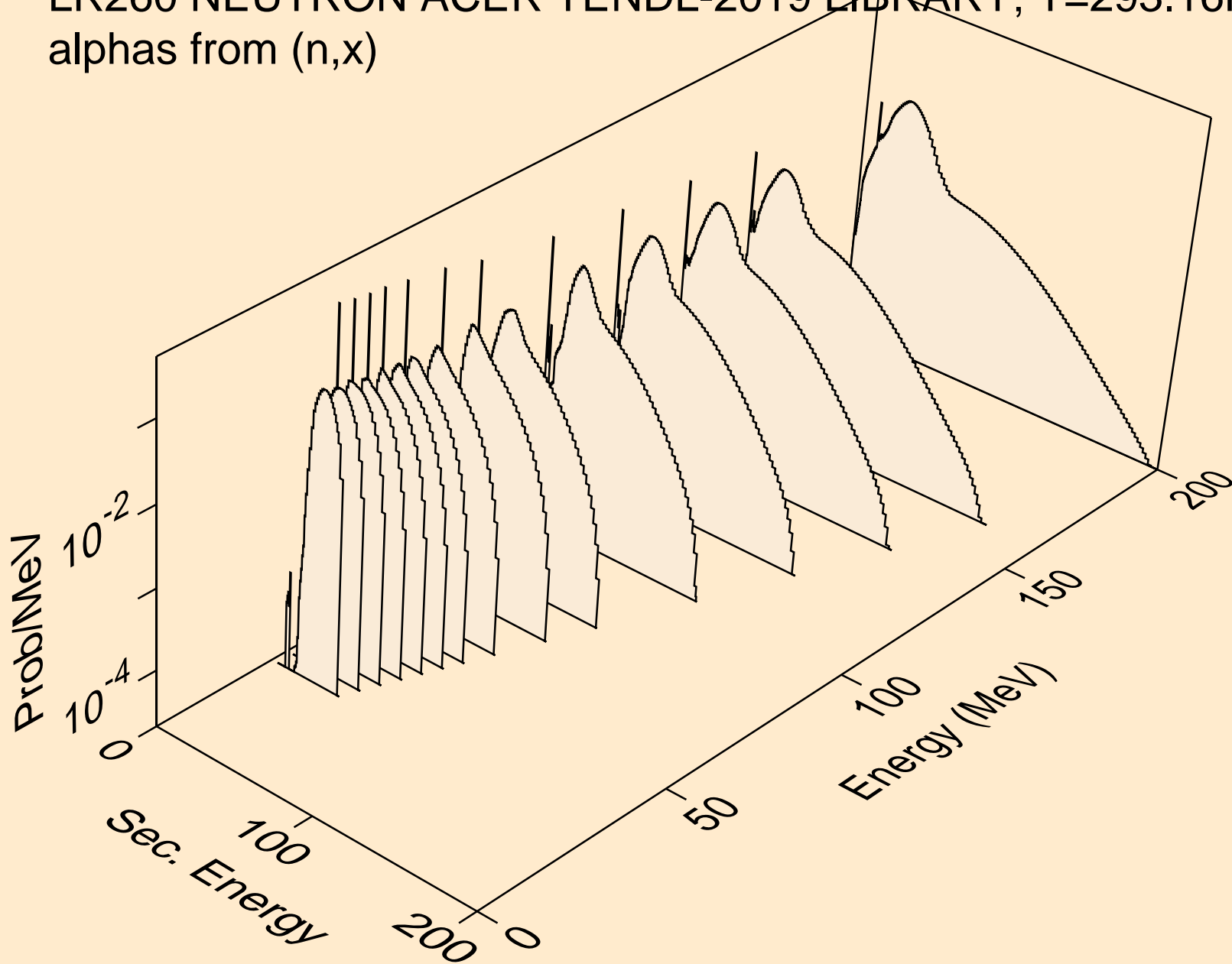

LR260 NEUTRON ACER TENDL-2019 LIBRARY; T=293.16K
alphas from (n,n*)a

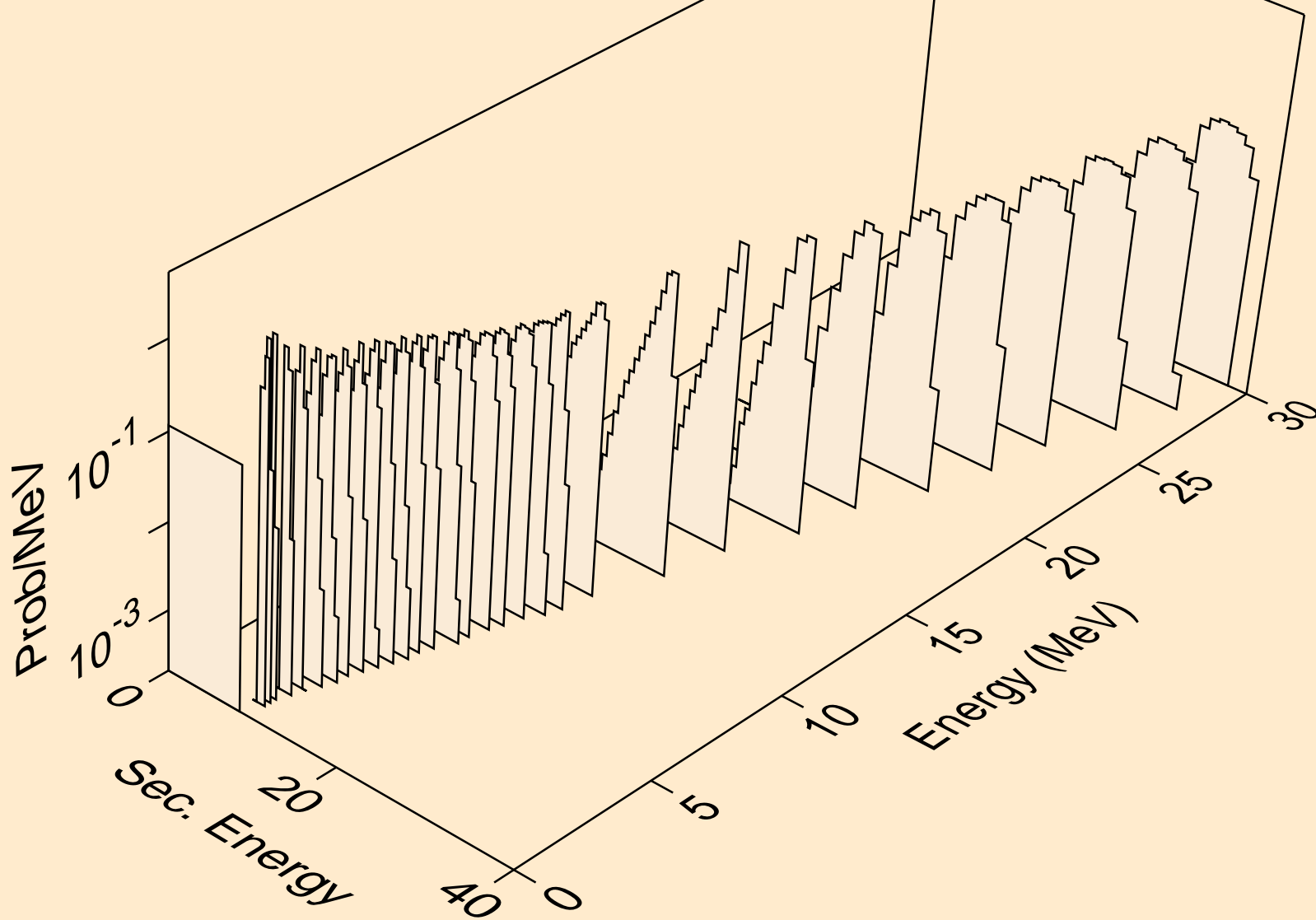

LR260 NEUTRON ACER TENDL-2019 LIBRARY; T=293.16K
alphas from (n,2n)a

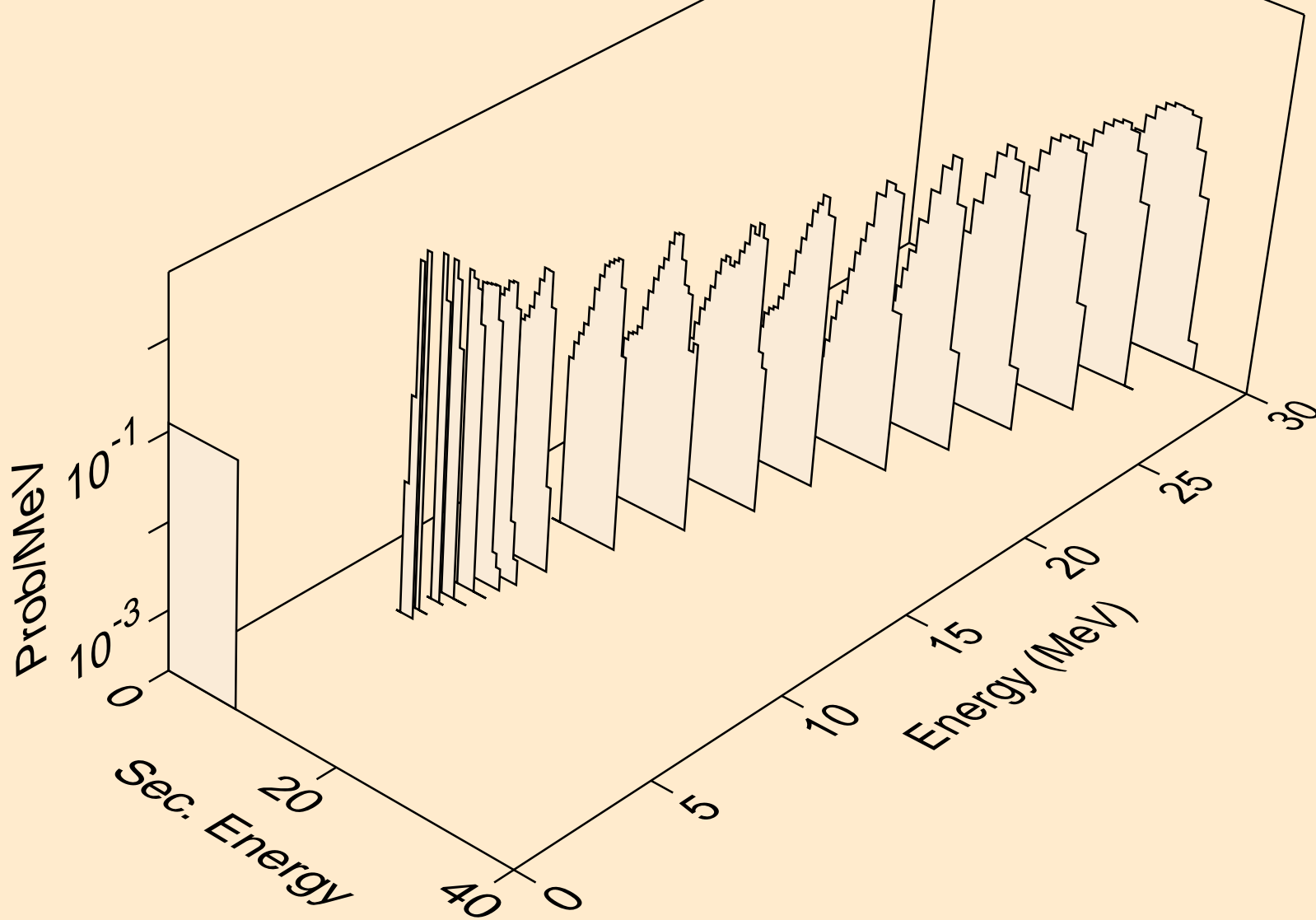

LR260 NEUTRON ACER TENDL-2019 LIBRARY; T=293.16K
alphas from (n,3n)a

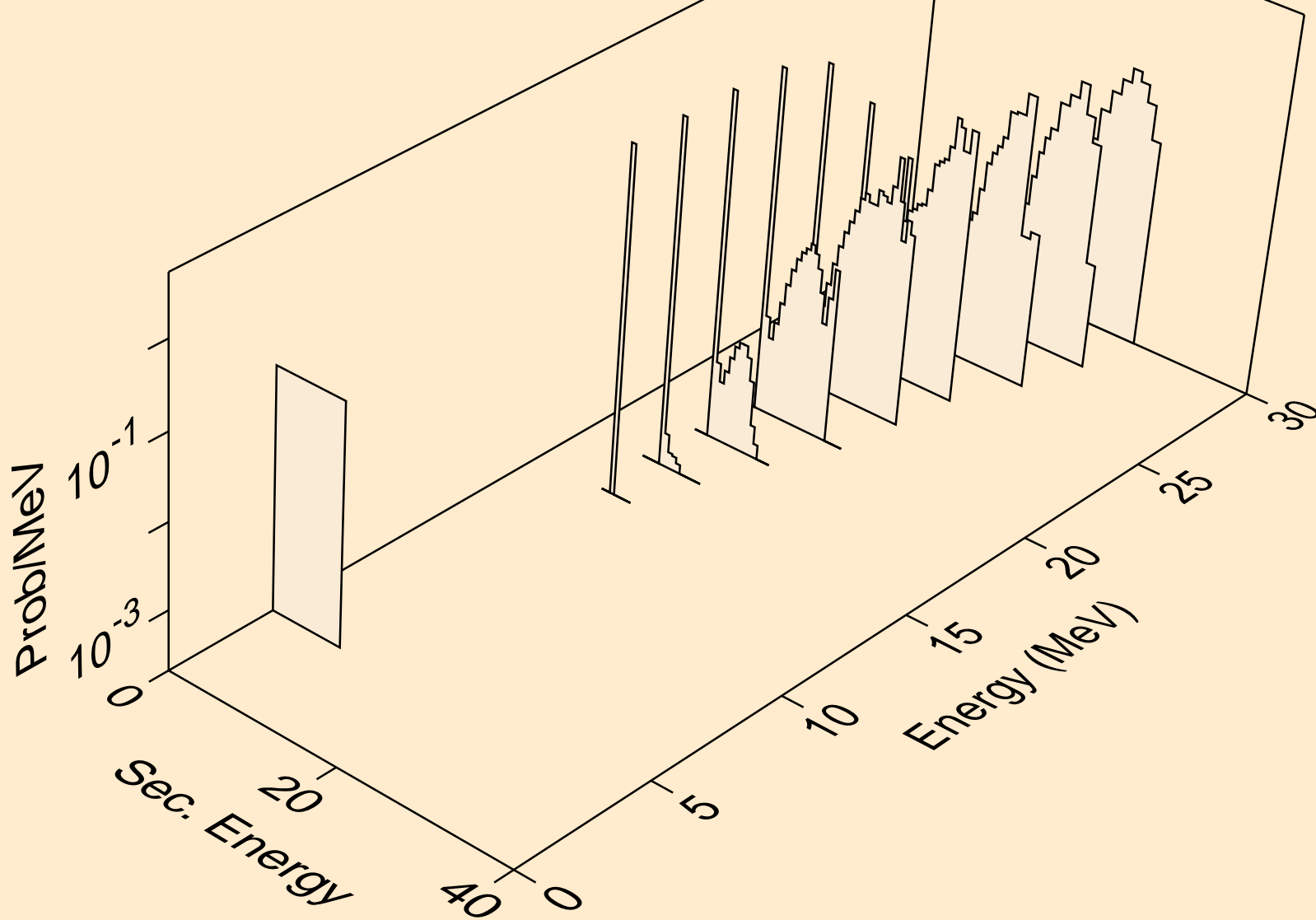

LR260 NEUTRON ACER TENDL-2019 LIBRARY; T=293.16K
alphas from (n,n*)2a

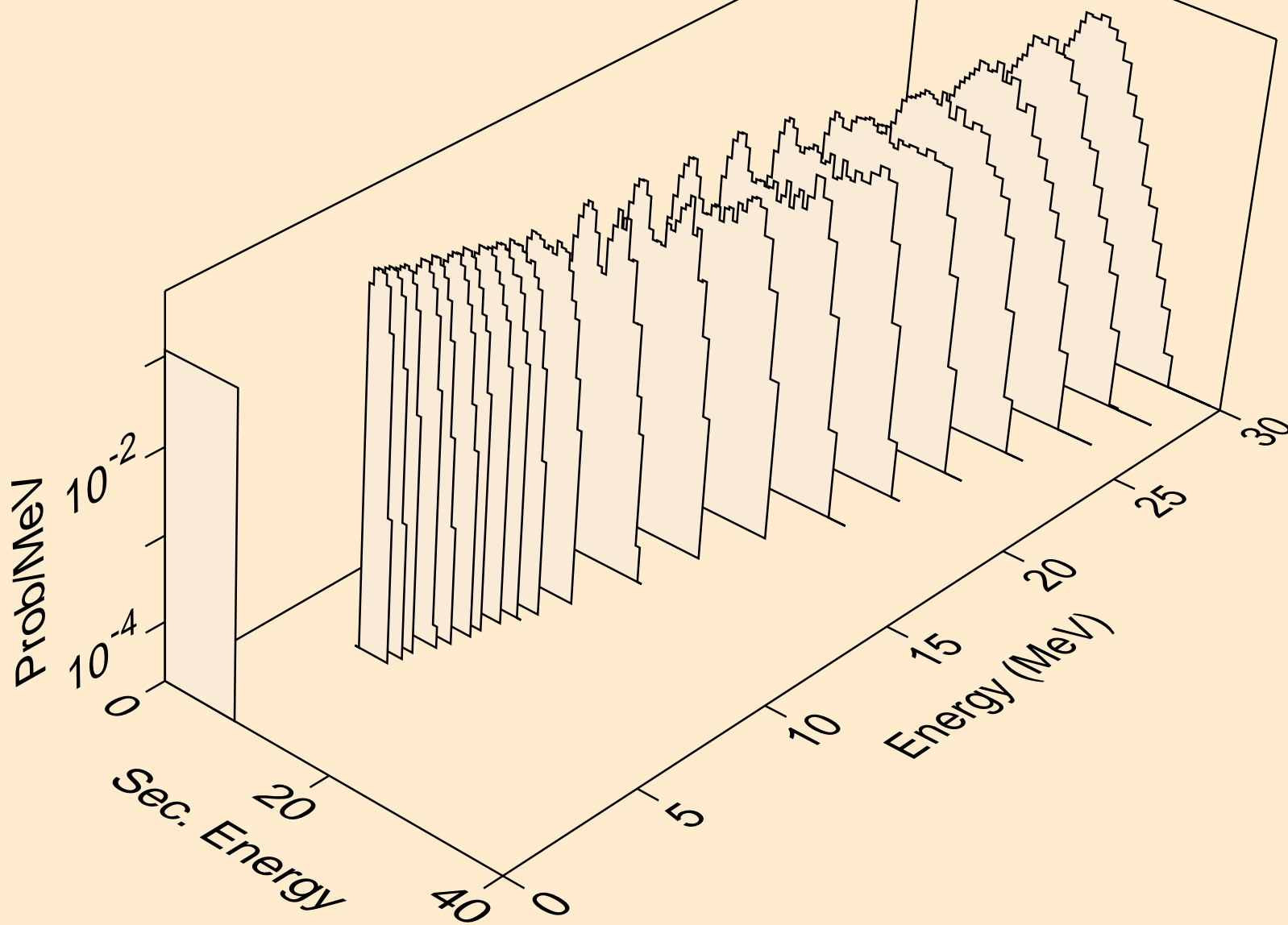

LR260 NEUTRON ACER TENDL-2019 LIBRARY; T=293.16K
alphas from (n,2n)2a

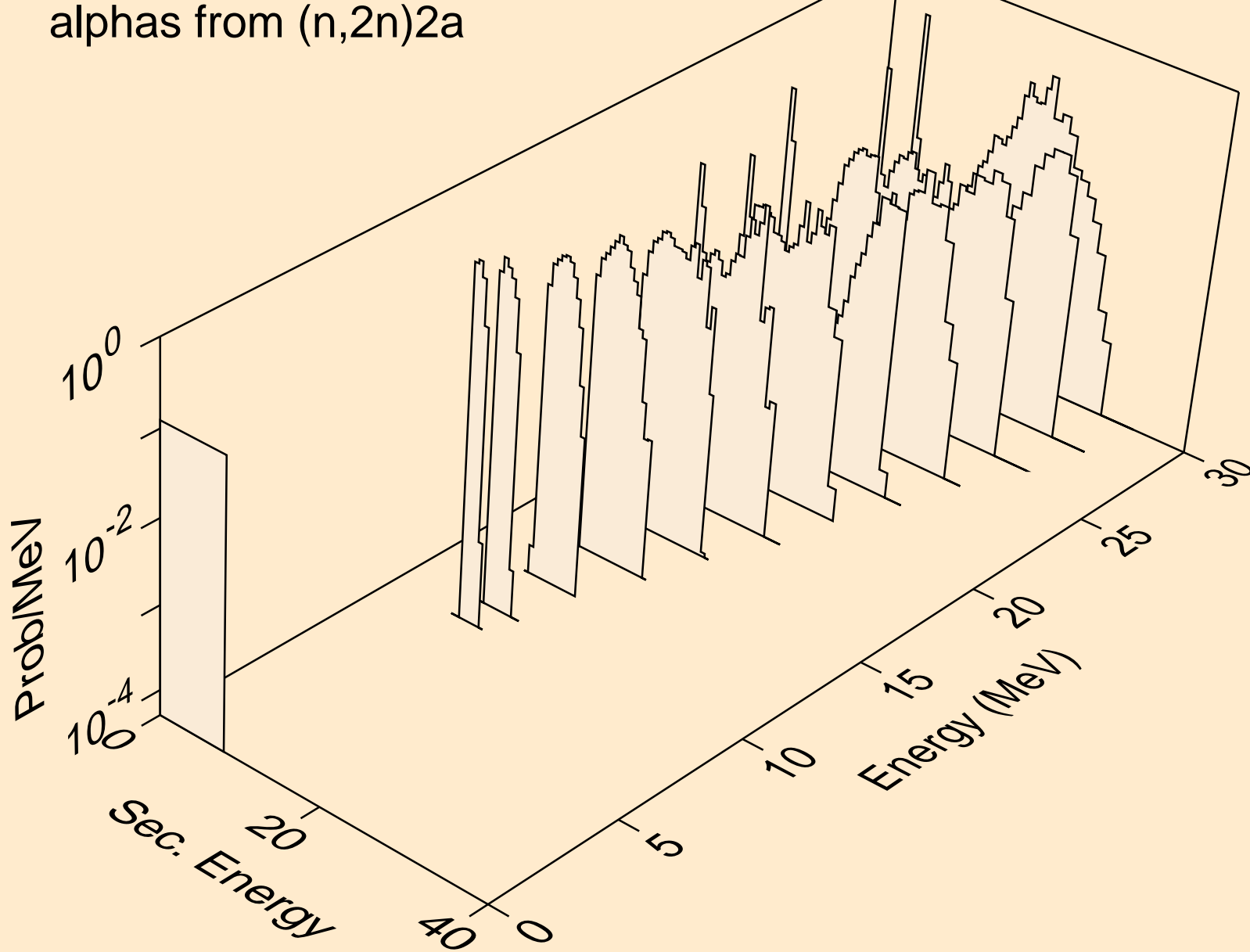

LR260 NEUTRON ACER TENDL-2019 LIBRARY; T=293.16K
alphas from (n,npa)

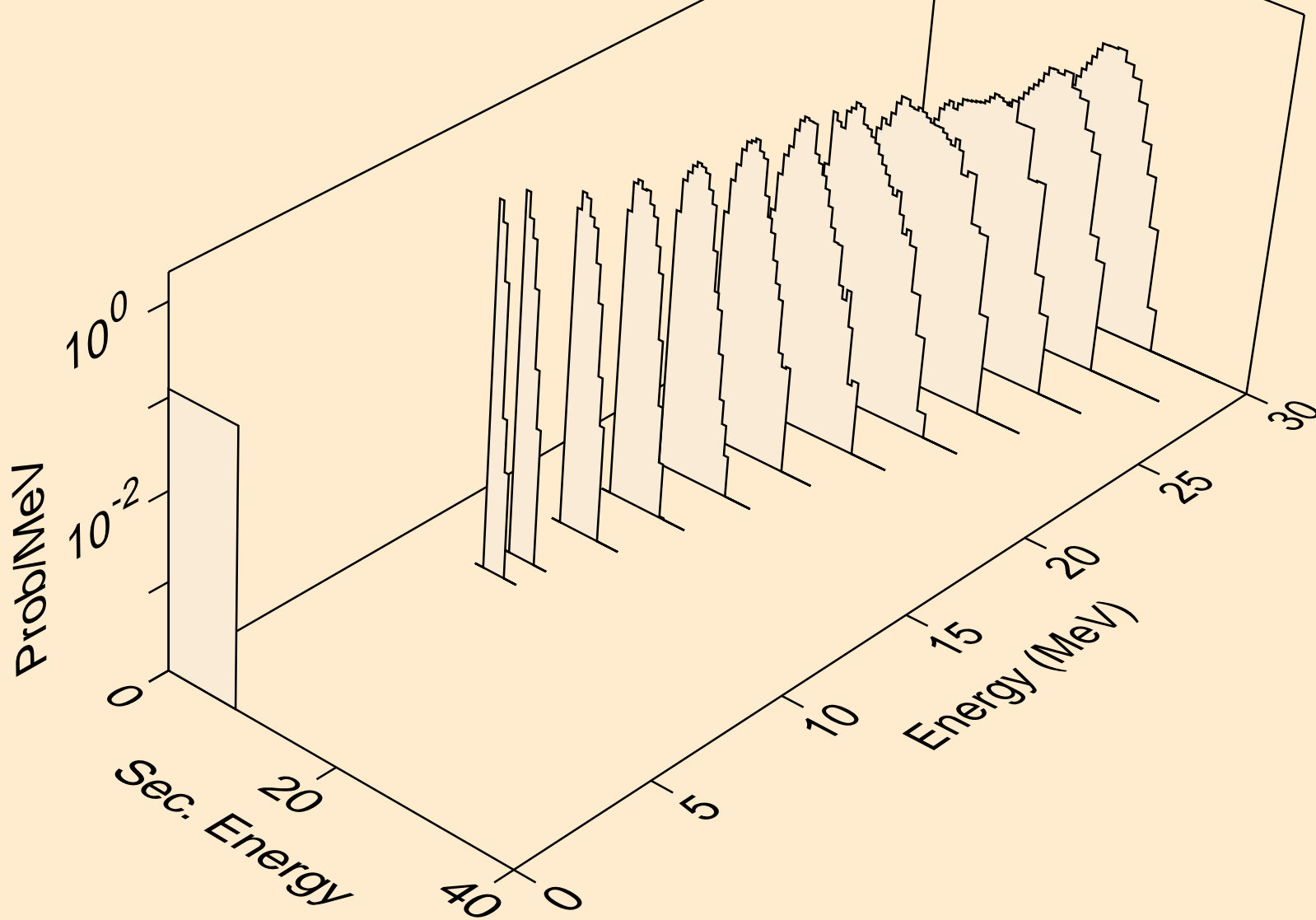

LR260 NEUTRON ACER TENDL-2019 LIBRARY; T=293.16K
alphas from (n,a)

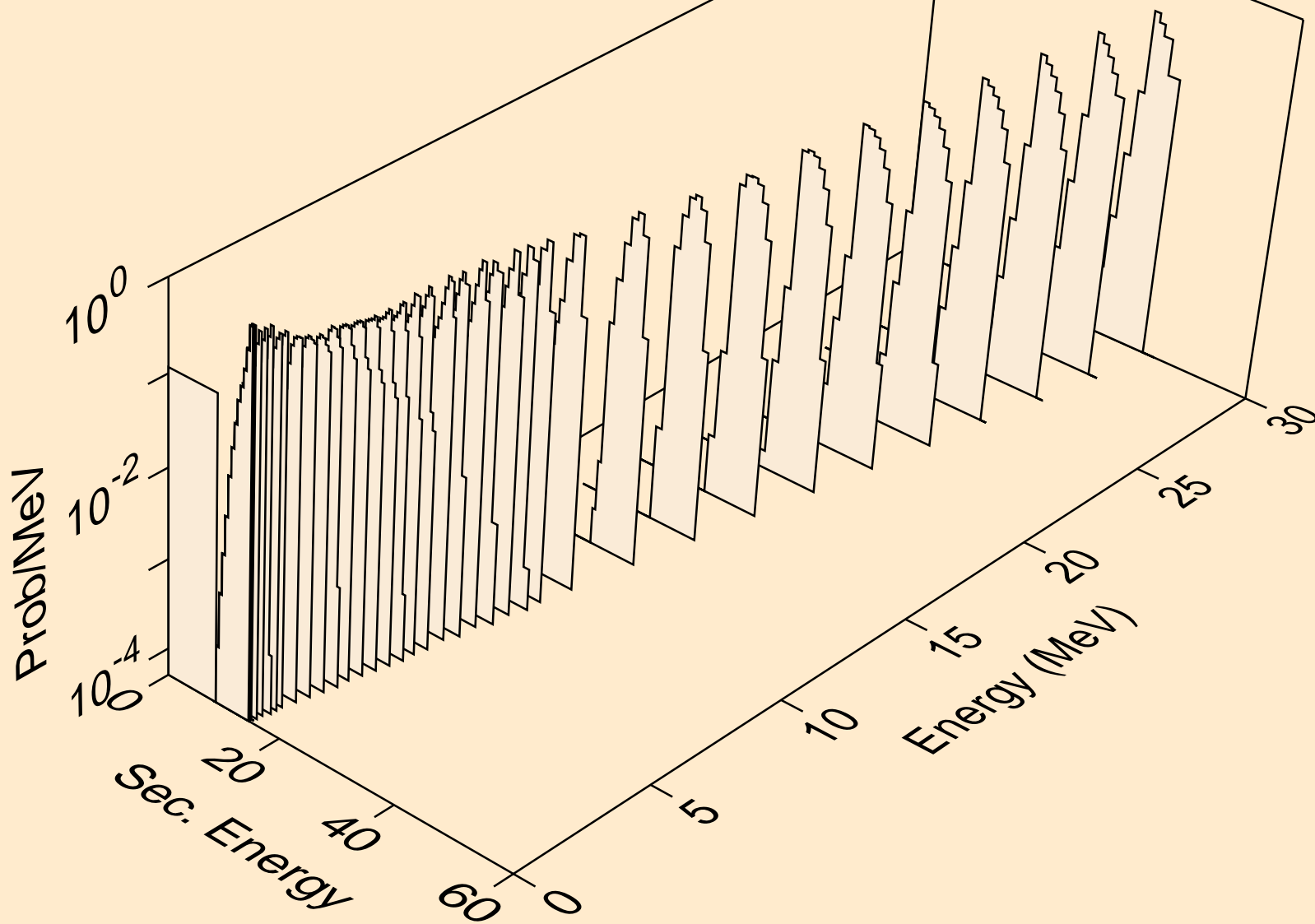

LR260 NEUTRON ACER TENDL-2019 LIBRARY; T=293.16K
alphas from (n,2a)

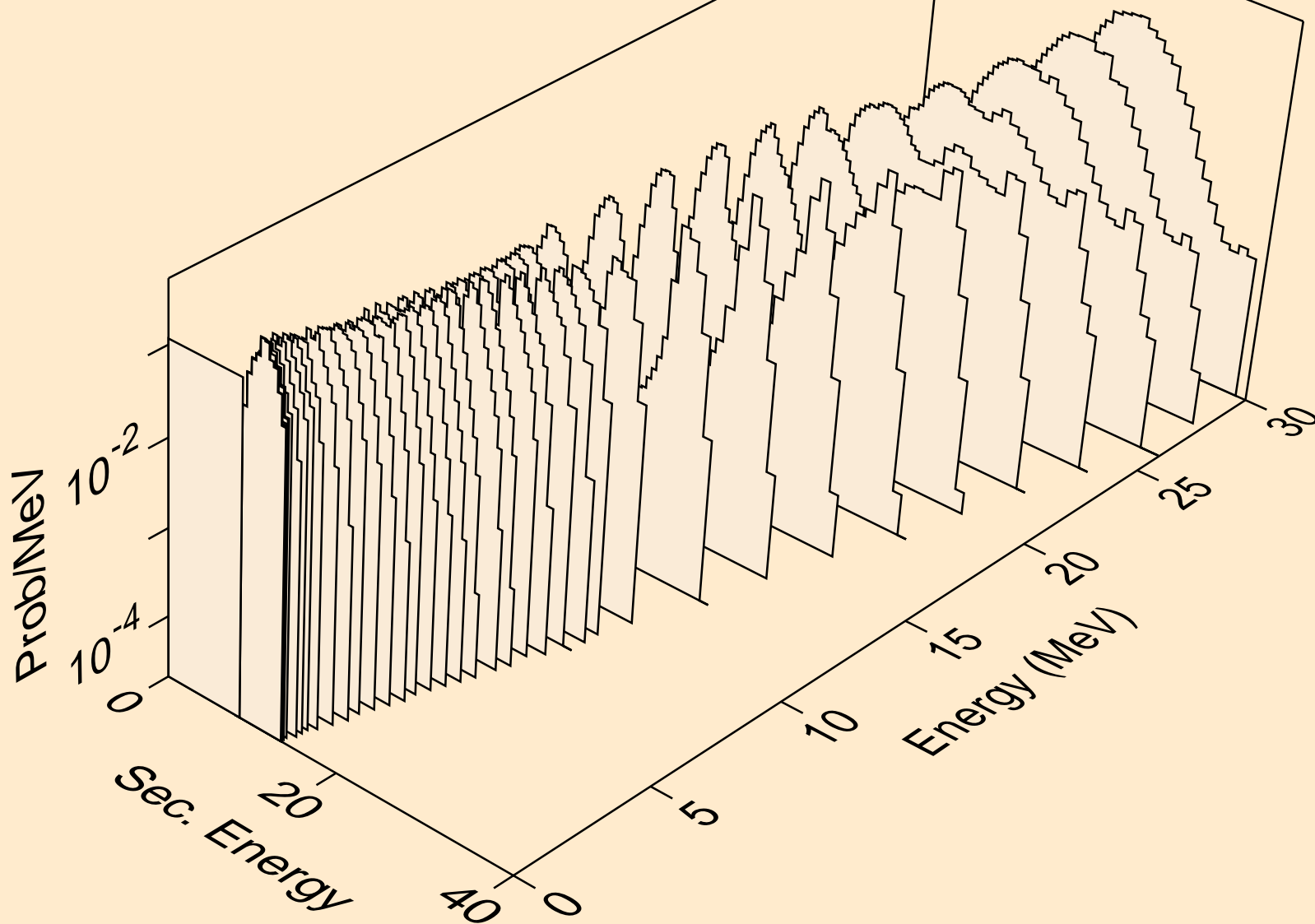

LR260 NEUTRON ACER TENDL-2019 LIBRARY; T=293.16K
alphas from (n,pa)

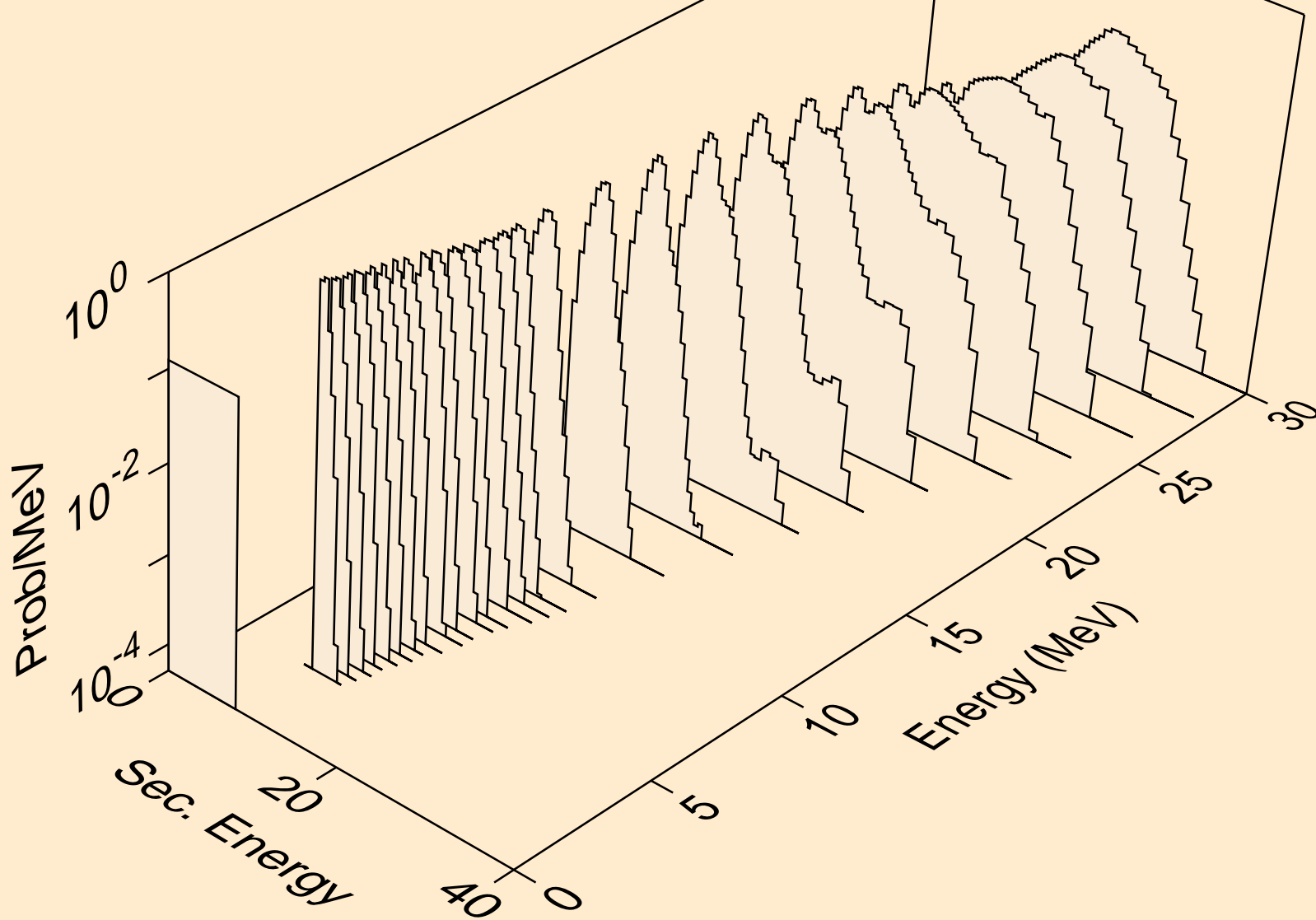

LR260 NEUTRON ACER TENDL-2019 LIBRARY; T=293.16K
alphas from (n,da)

