

LR265 NEUTRON ACER TENDL-2019 LIBRARY; T=293.16K
Principal cross sections

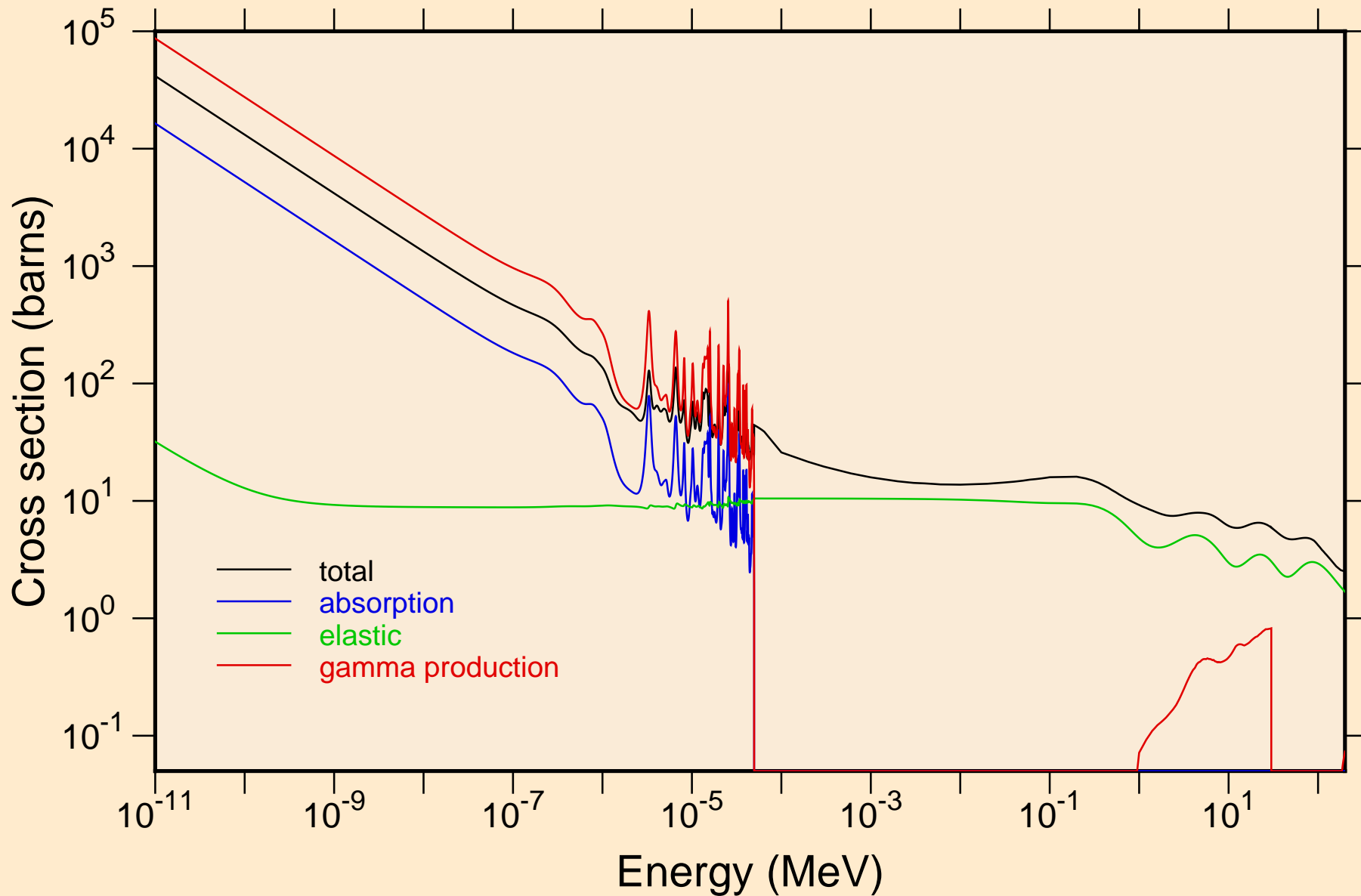

LR265 NEUTRON ACER TENDL-2019 LIBRARY; T=293.16K
resonance total cross section

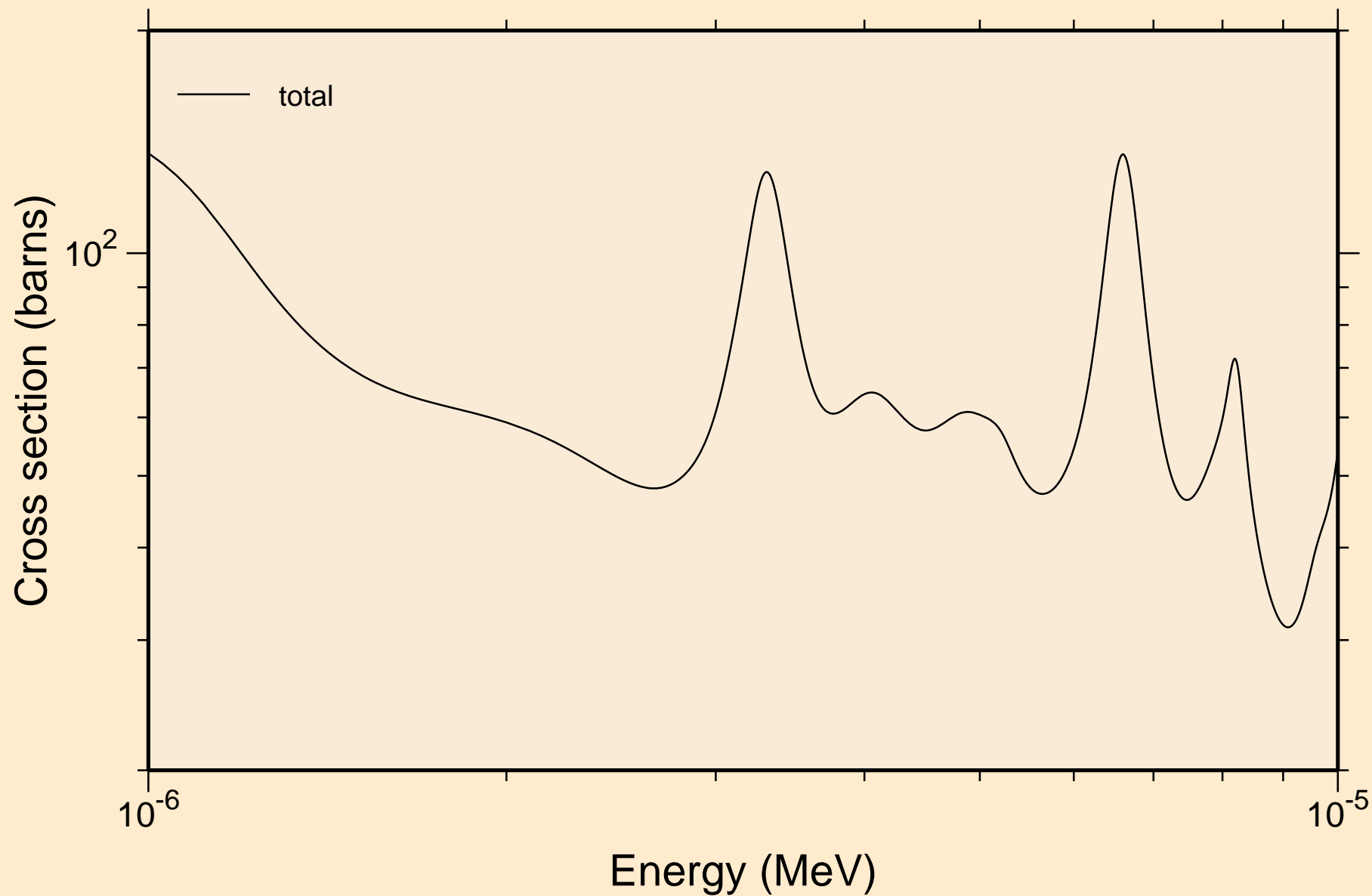

LR265 NEUTRON ACER TENDL-2019 LIBRARY; T=293.16K
resonance total cross section

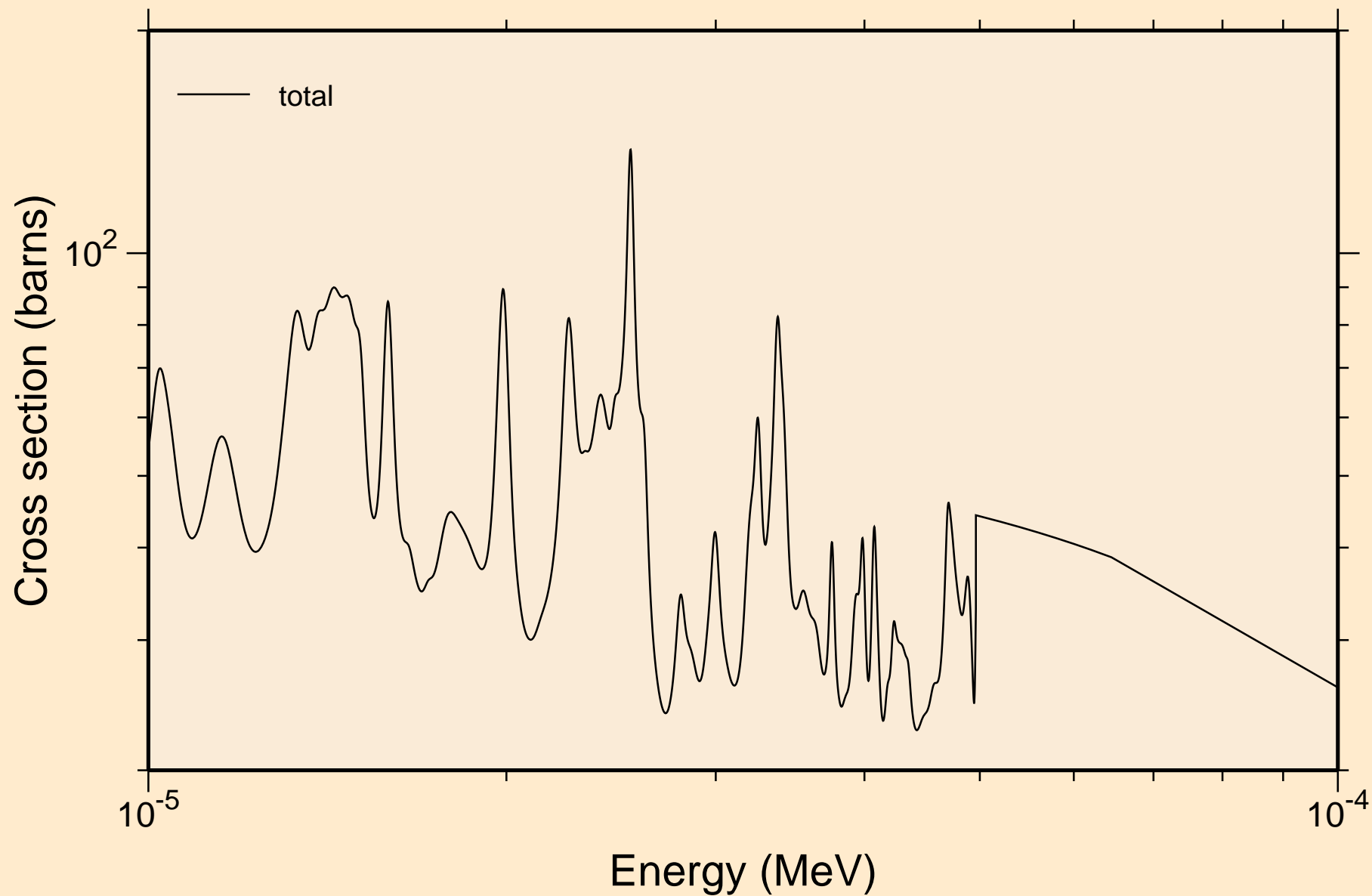

LR265 NEUTRON ACER TENDL-2019 LIBRARY; T=293.16K
resonance total cross section

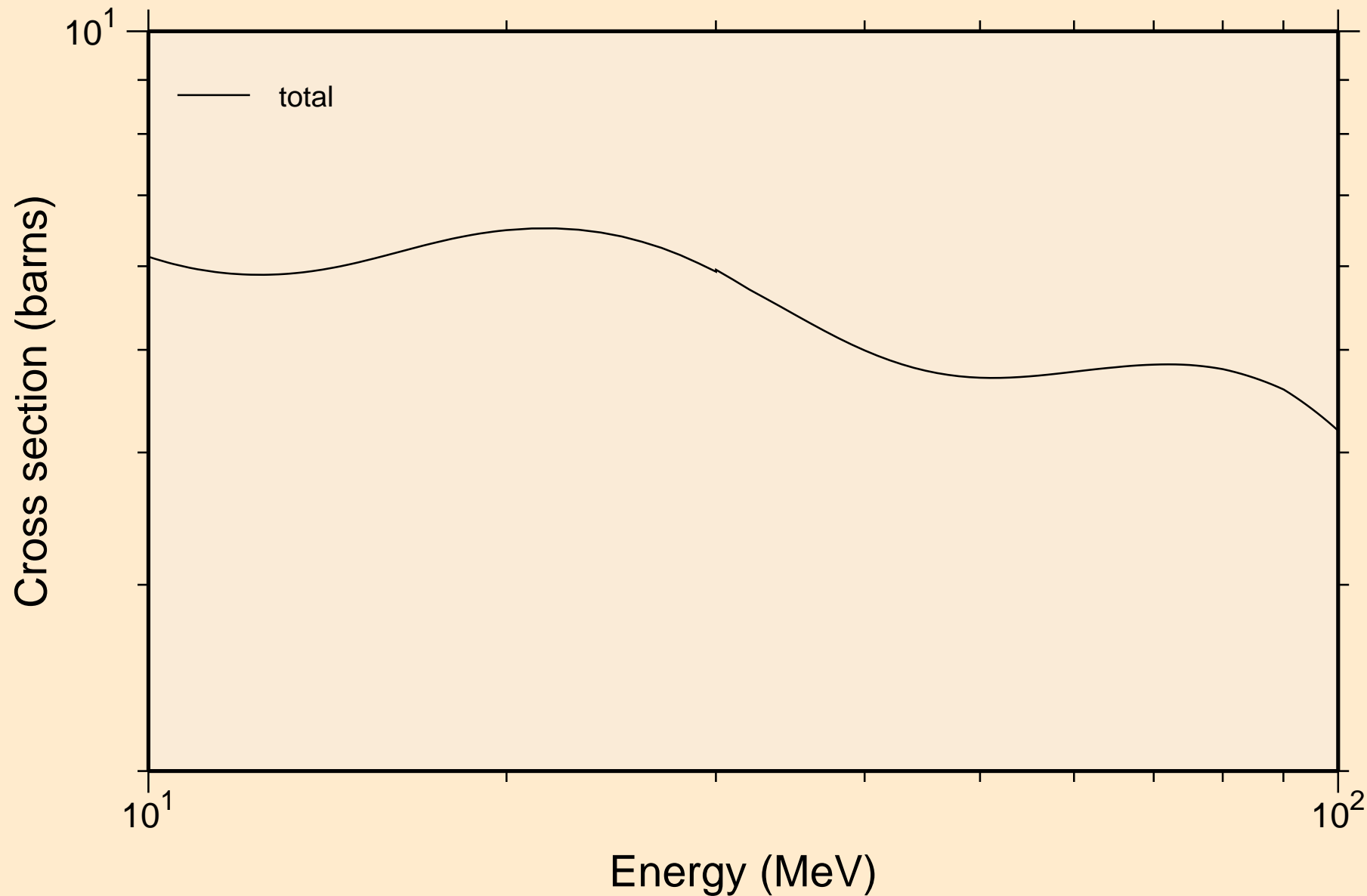

LR265 NEUTRON ACER TENDL-2019 LIBRARY; T=293.16K
resonance absorption cross sections

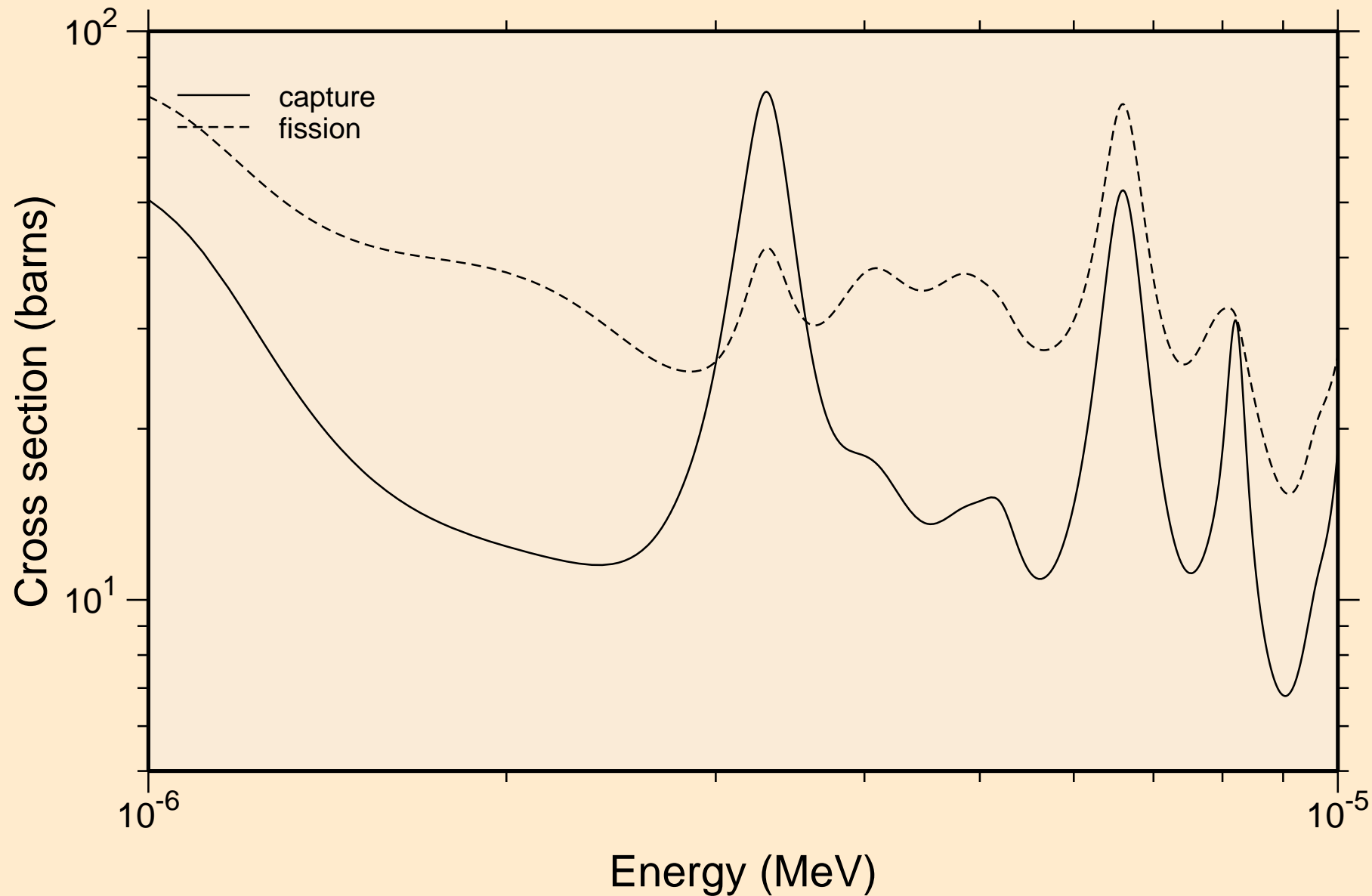

LR265 NEUTRON ACER TENDL-2019 LIBRARY; T=293.16K
resonance absorption cross sections

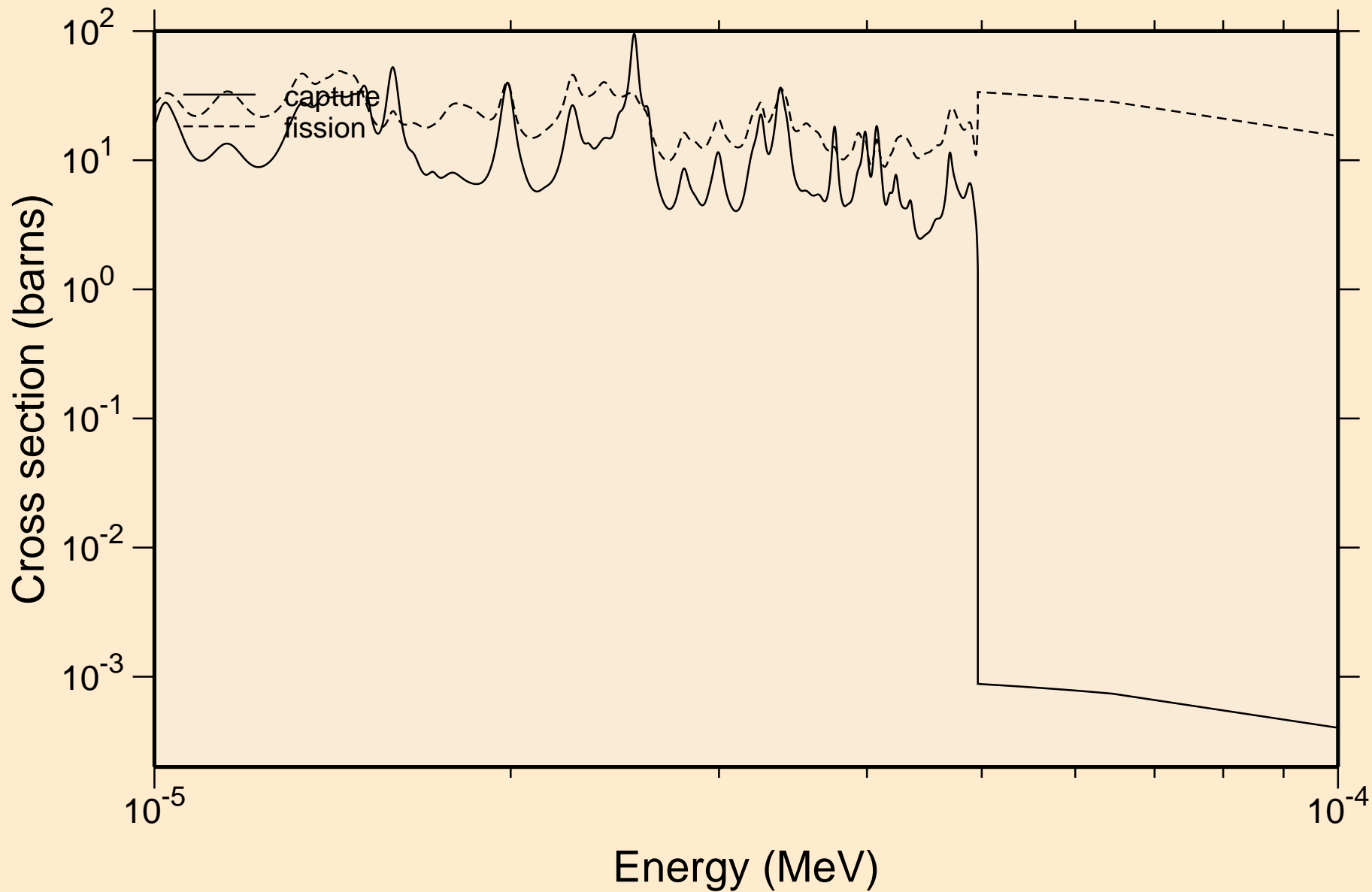

LR265 NEUTRON ACER TENDL-2019 LIBRARY; T=293.16K
resonance absorption cross sections

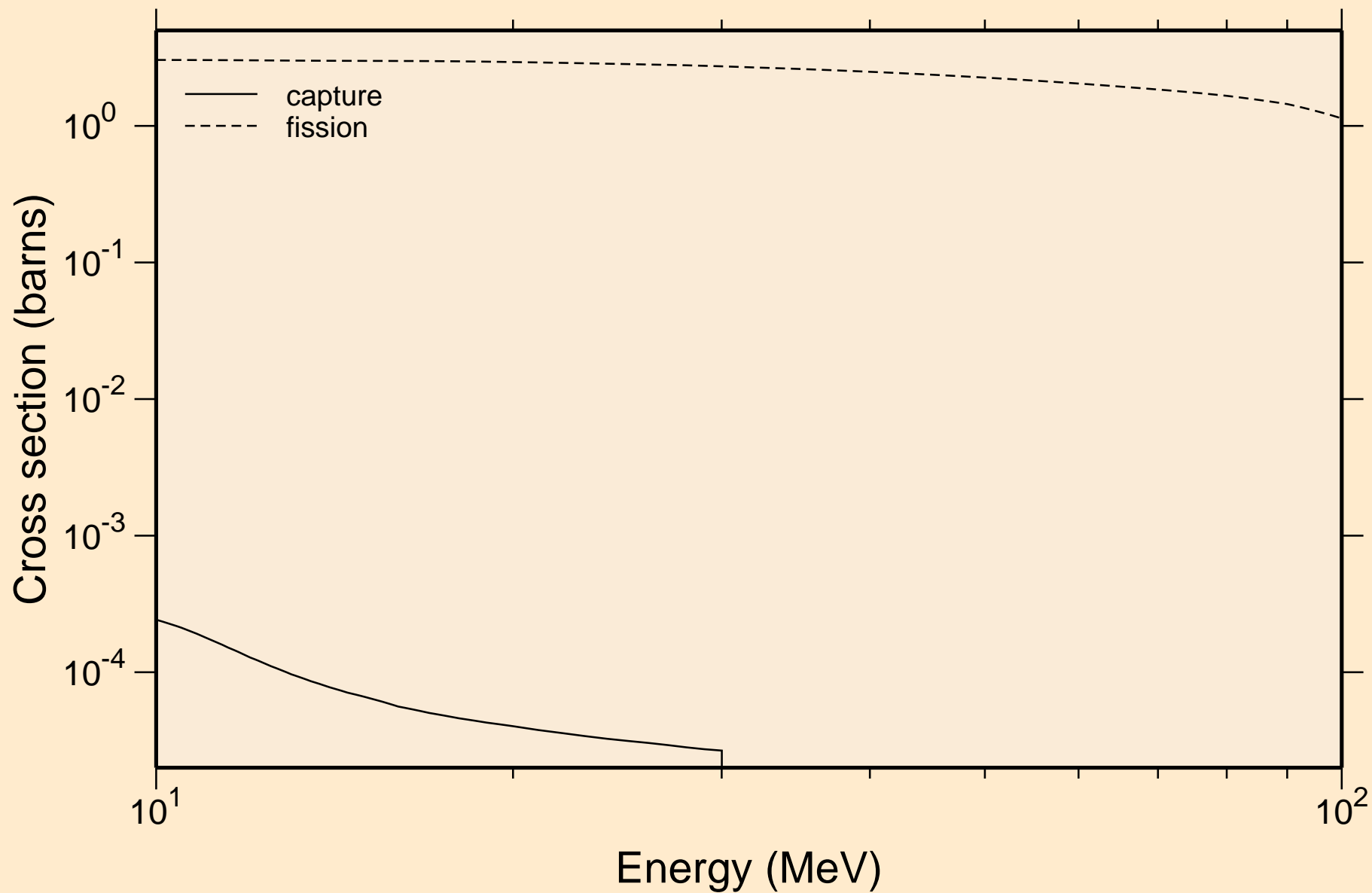

LR265 NEUTRON ACER TENDL-2019 LIBRARY; T=293.16K
Heating

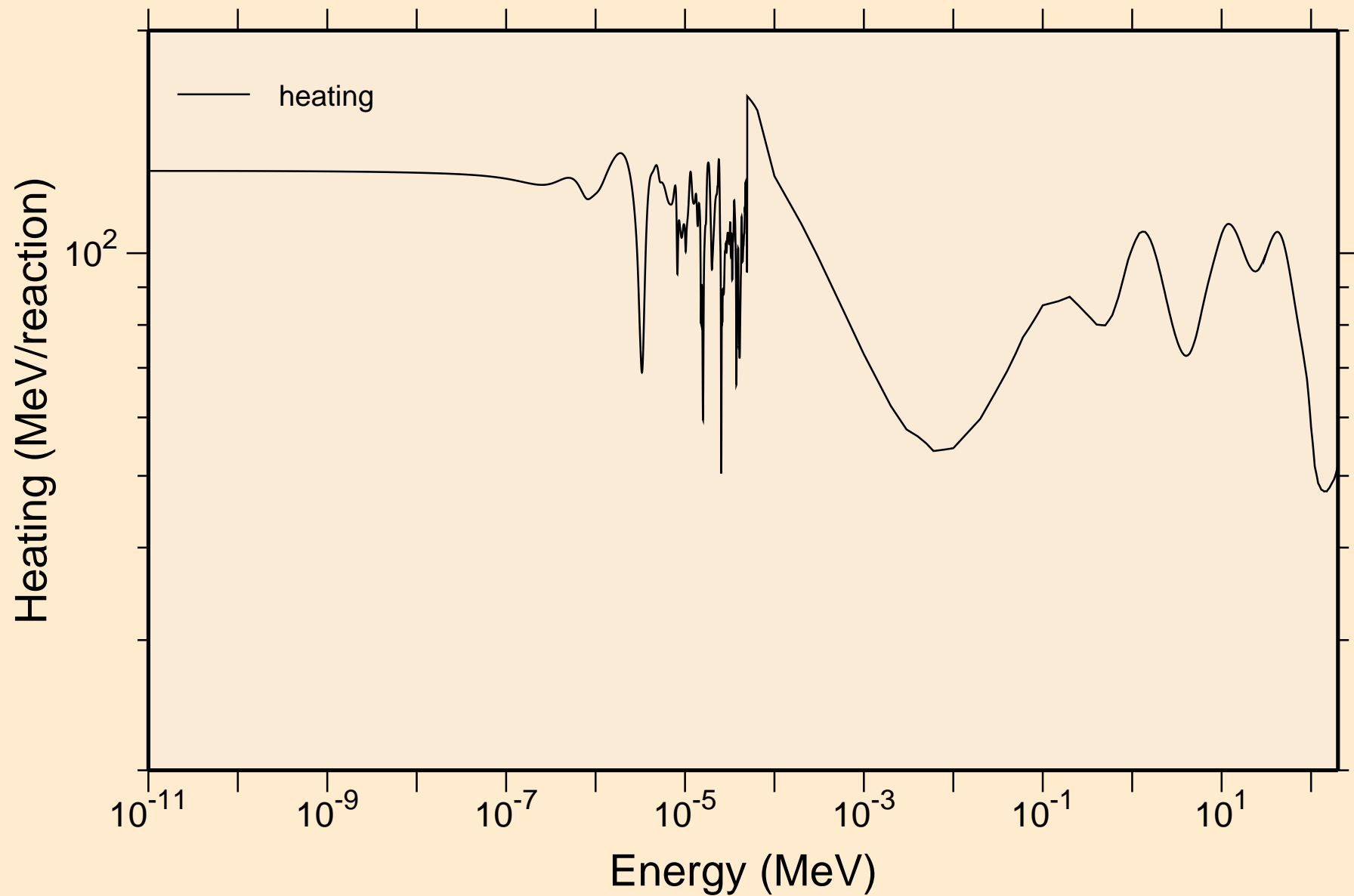

LR265 NEUTRON ACER TENDL-2019 LIBRARY; T=293.16K
Damage

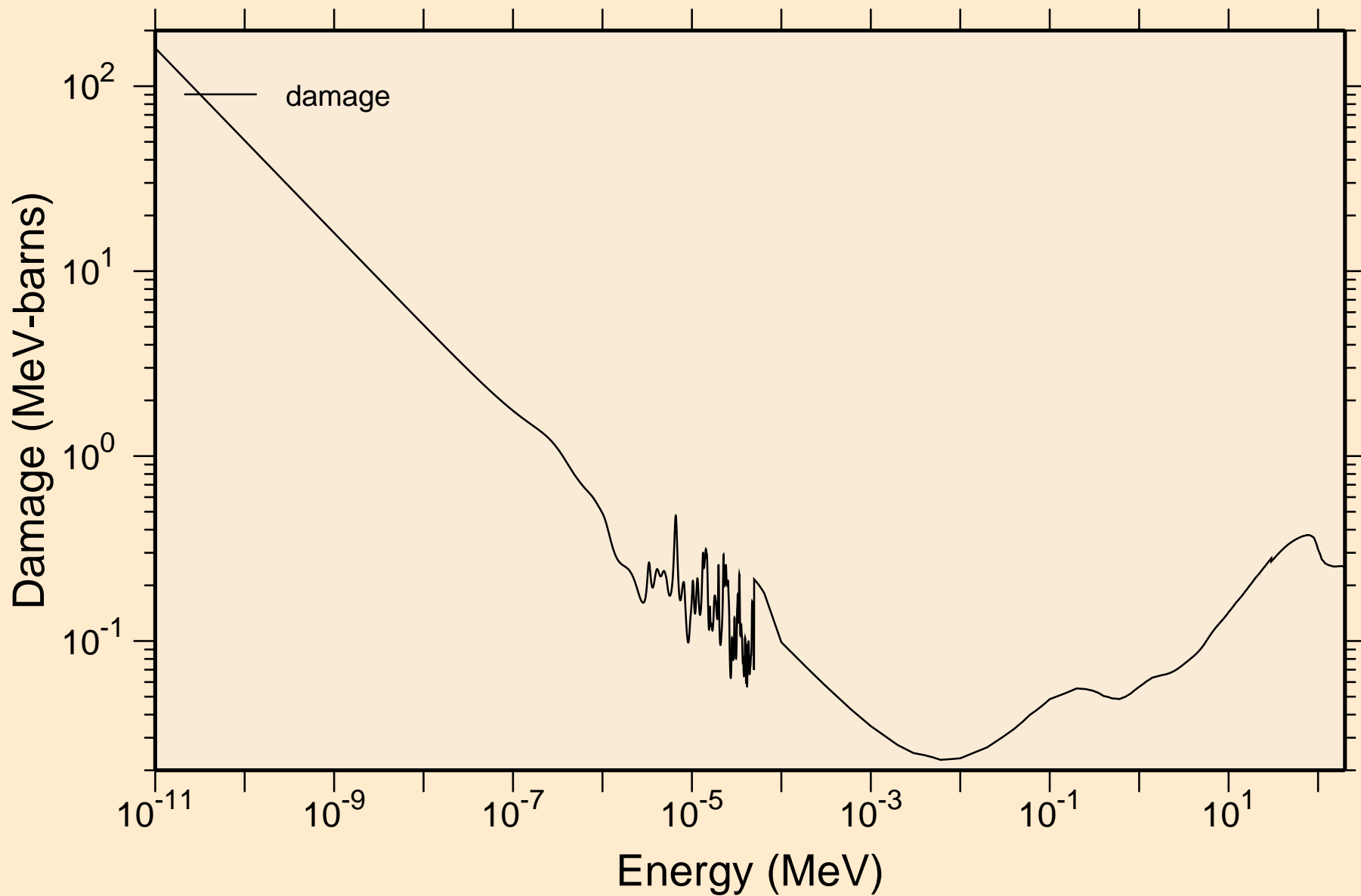

LR265 NEUTRON ACER TENDL-2019 LIBRARY; T=293.16K
Non-threshold reactions

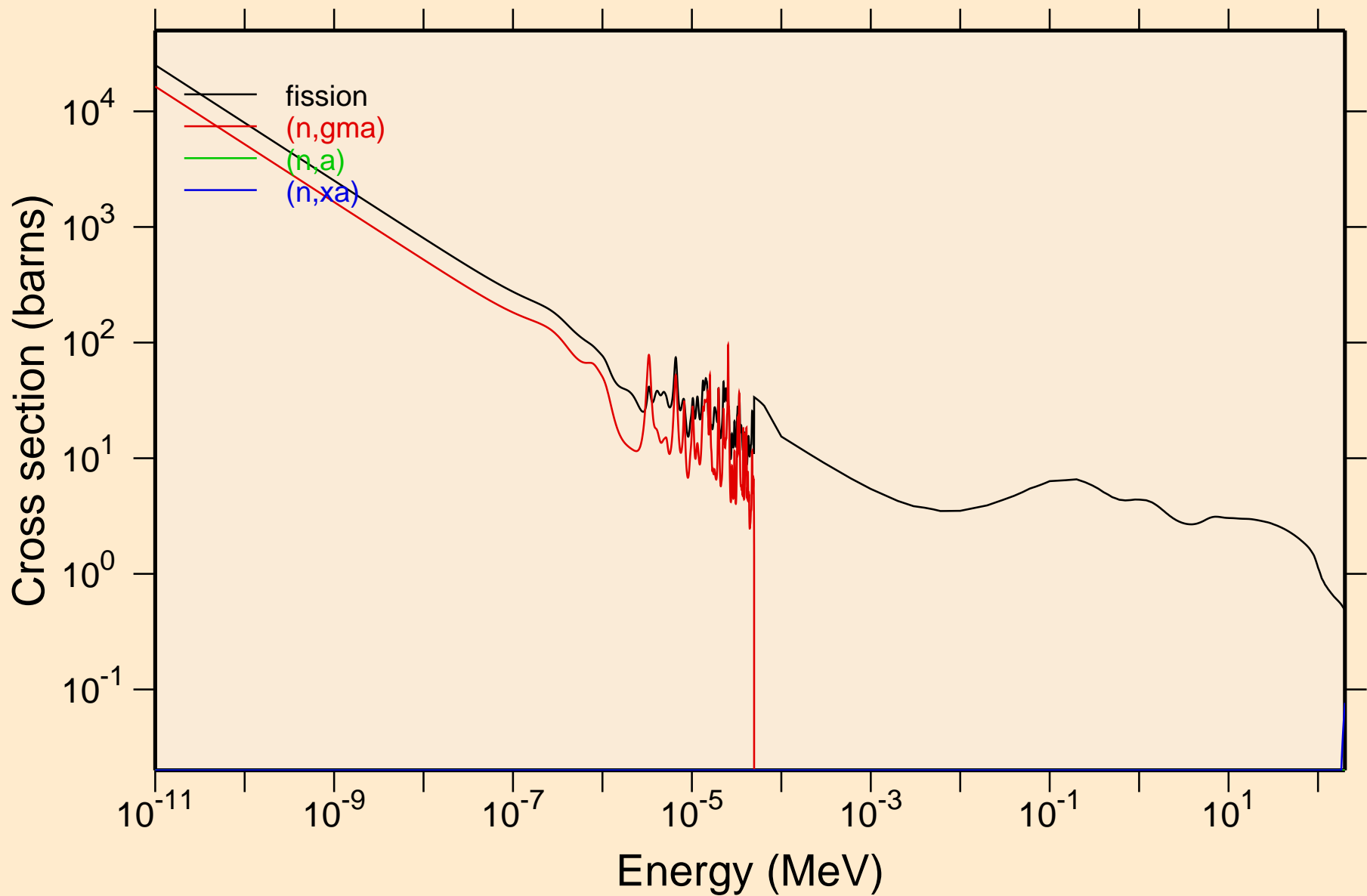

LR265 NEUTRON ACER TENDL-2019 LIBRARY; T=293.16K

Principal cross sections

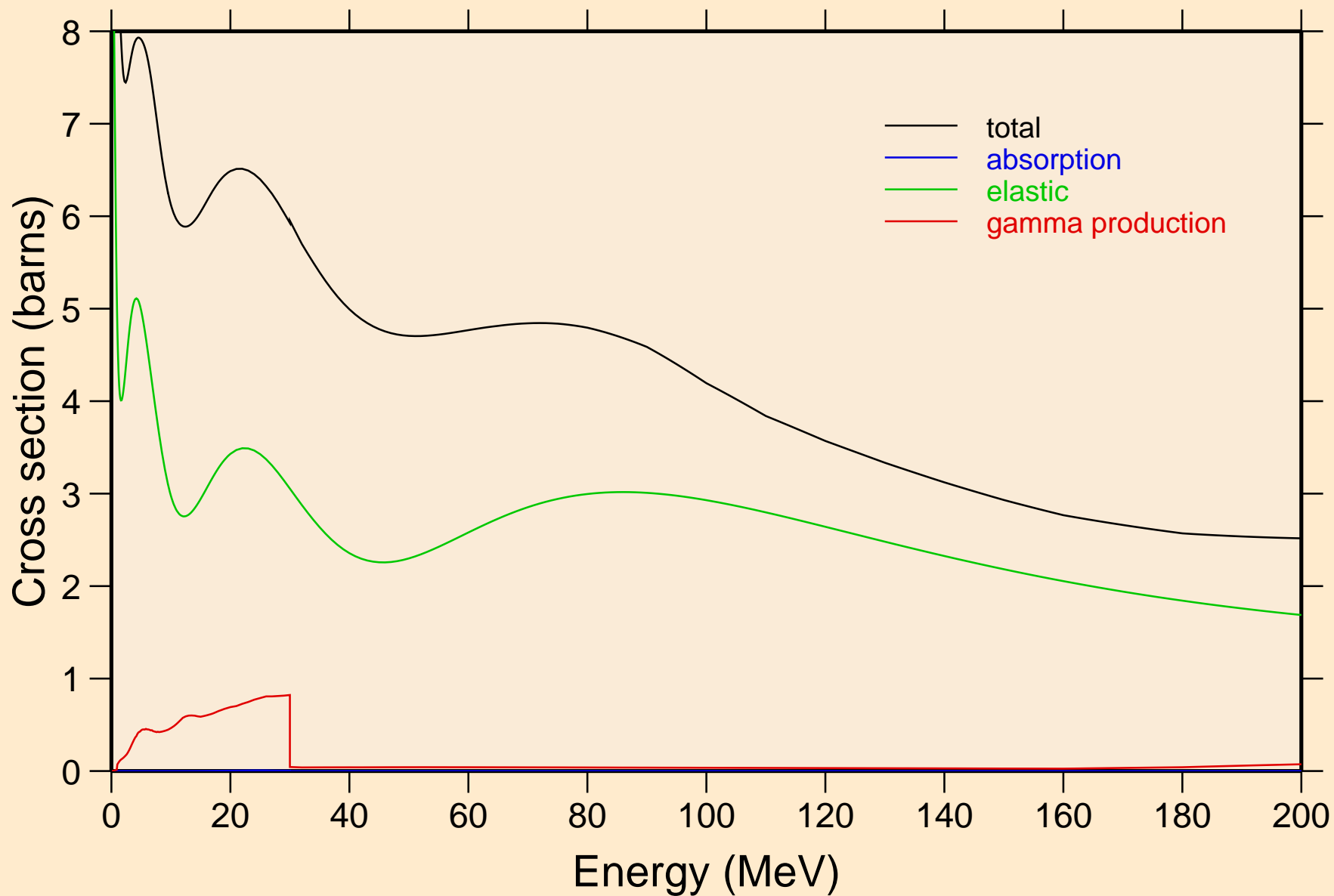

LR265 NEUTRON ACER TENDL-2019 LIBRARY; T=293.16K
Heating

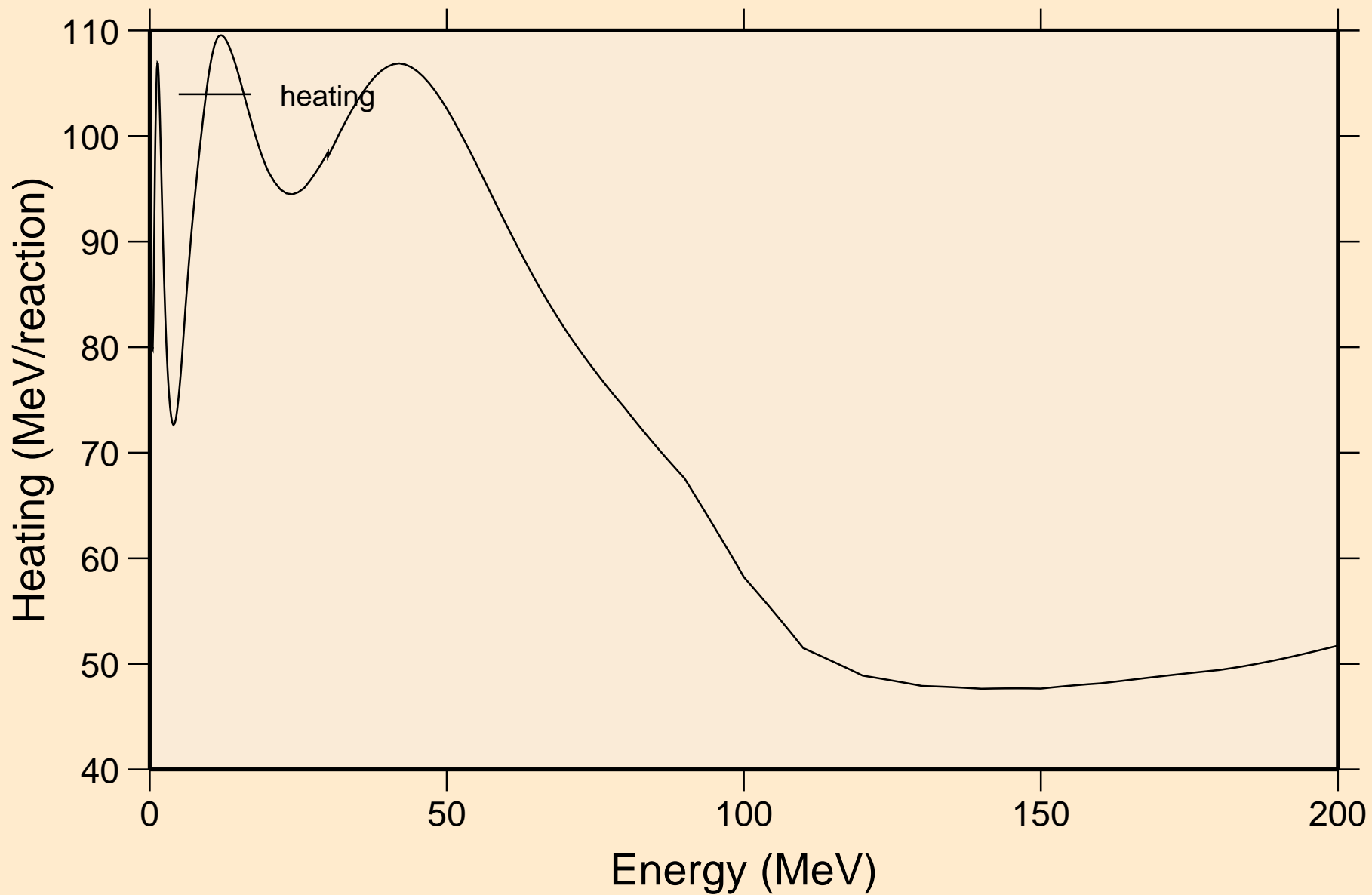

LR265 NEUTRON ACER TENDL-2019 LIBRARY; T=293.16K
Damage

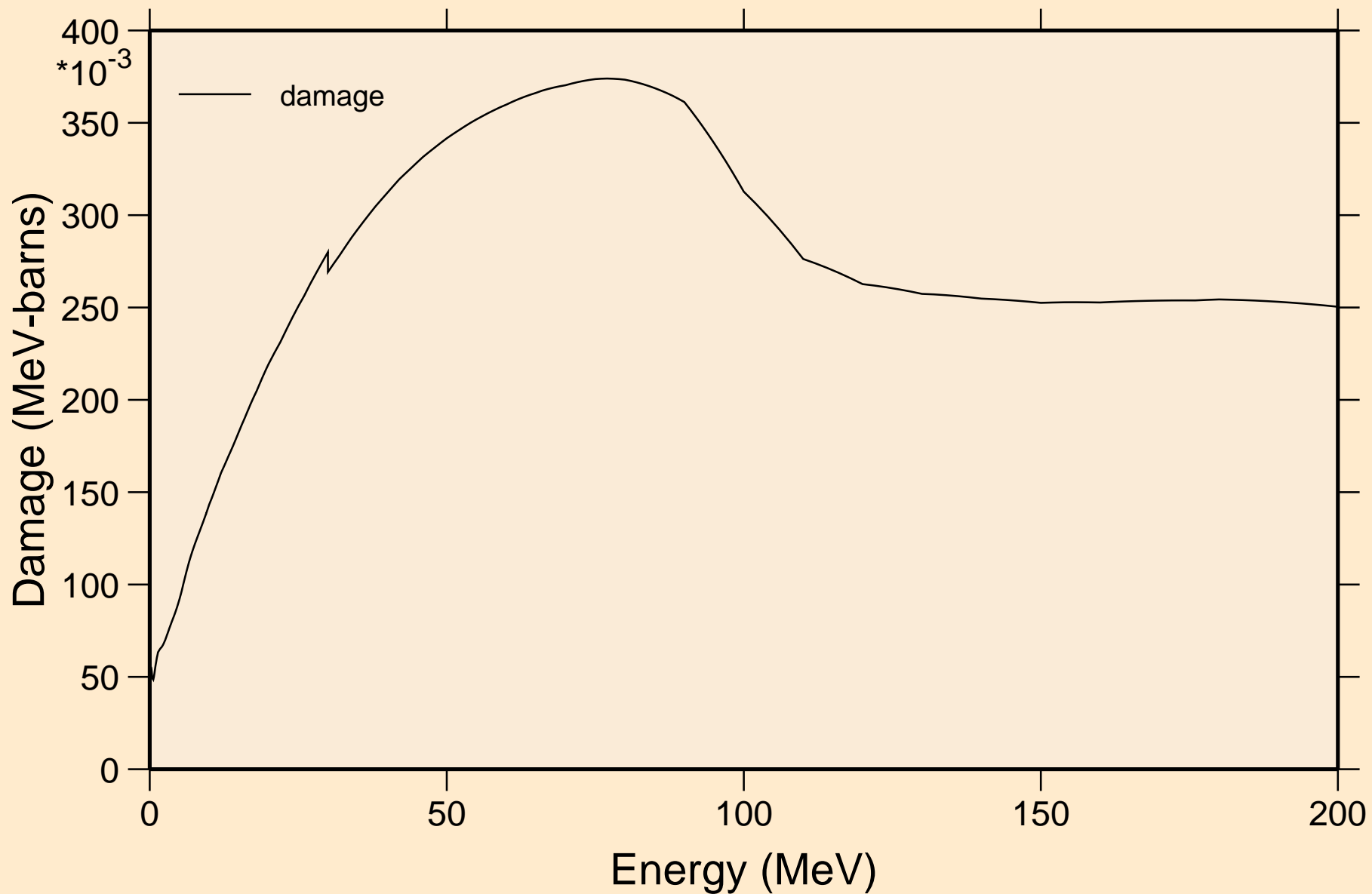

LR265 NEUTRON ACER TENDL-2019 LIBRARY; T=293.16K
Non-threshold reactions

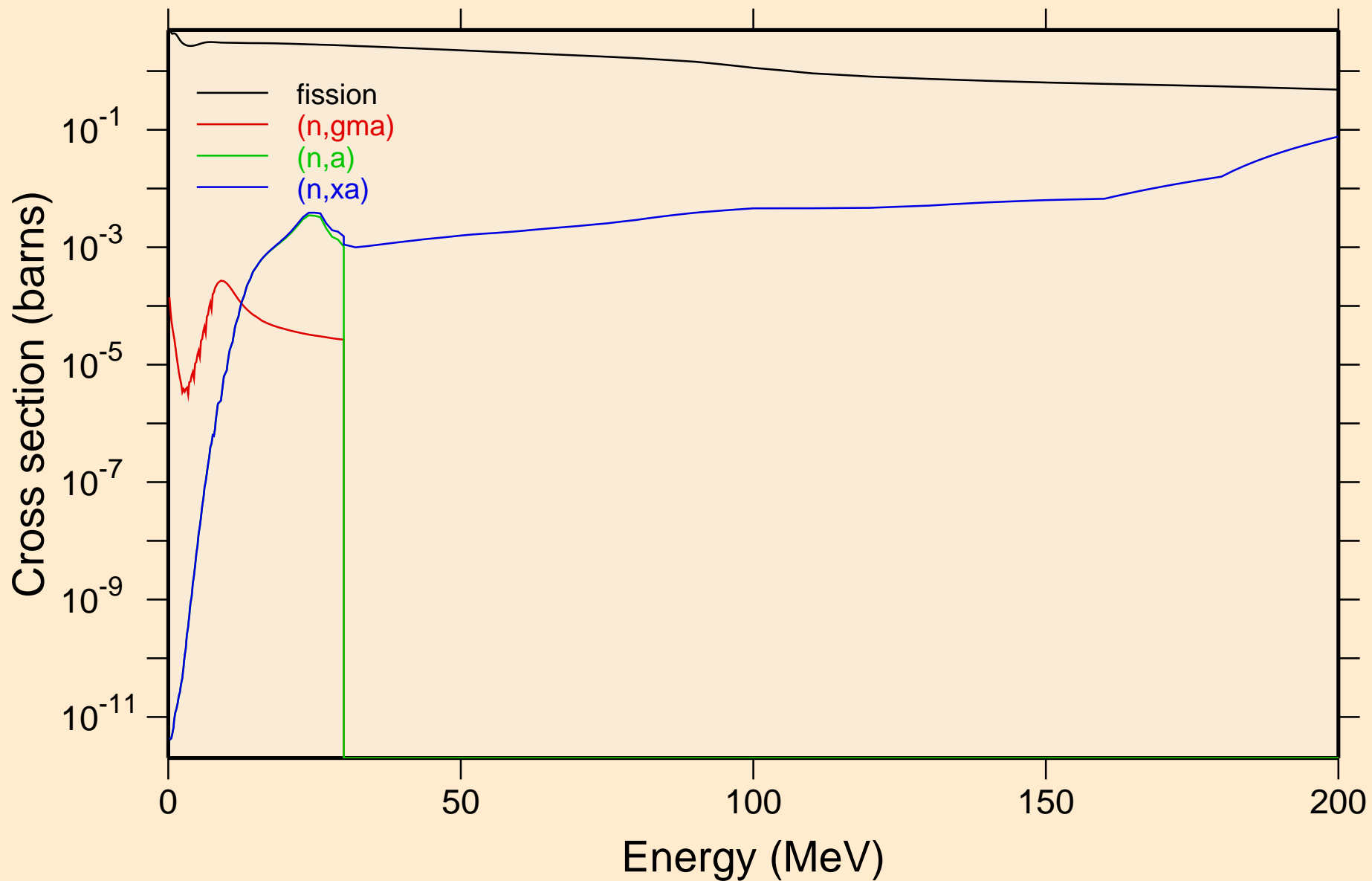

LR265 NEUTRON ACER TENDL-2019 LIBRARY; T=293.16K
Inelastic levels

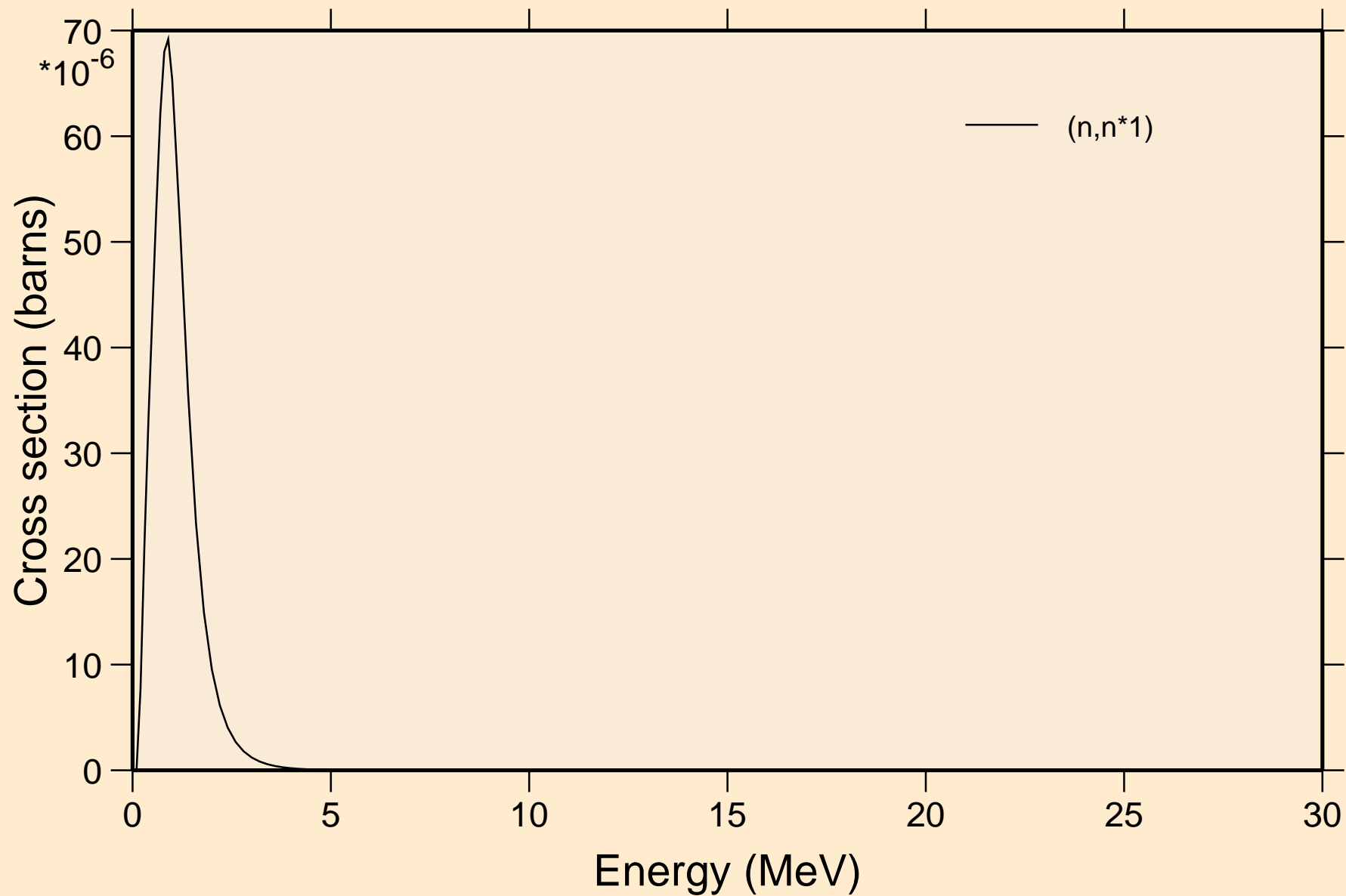

LR265 NEUTRON ACER TENDL-2019 LIBRARY; T=293.16K
Threshold reactions

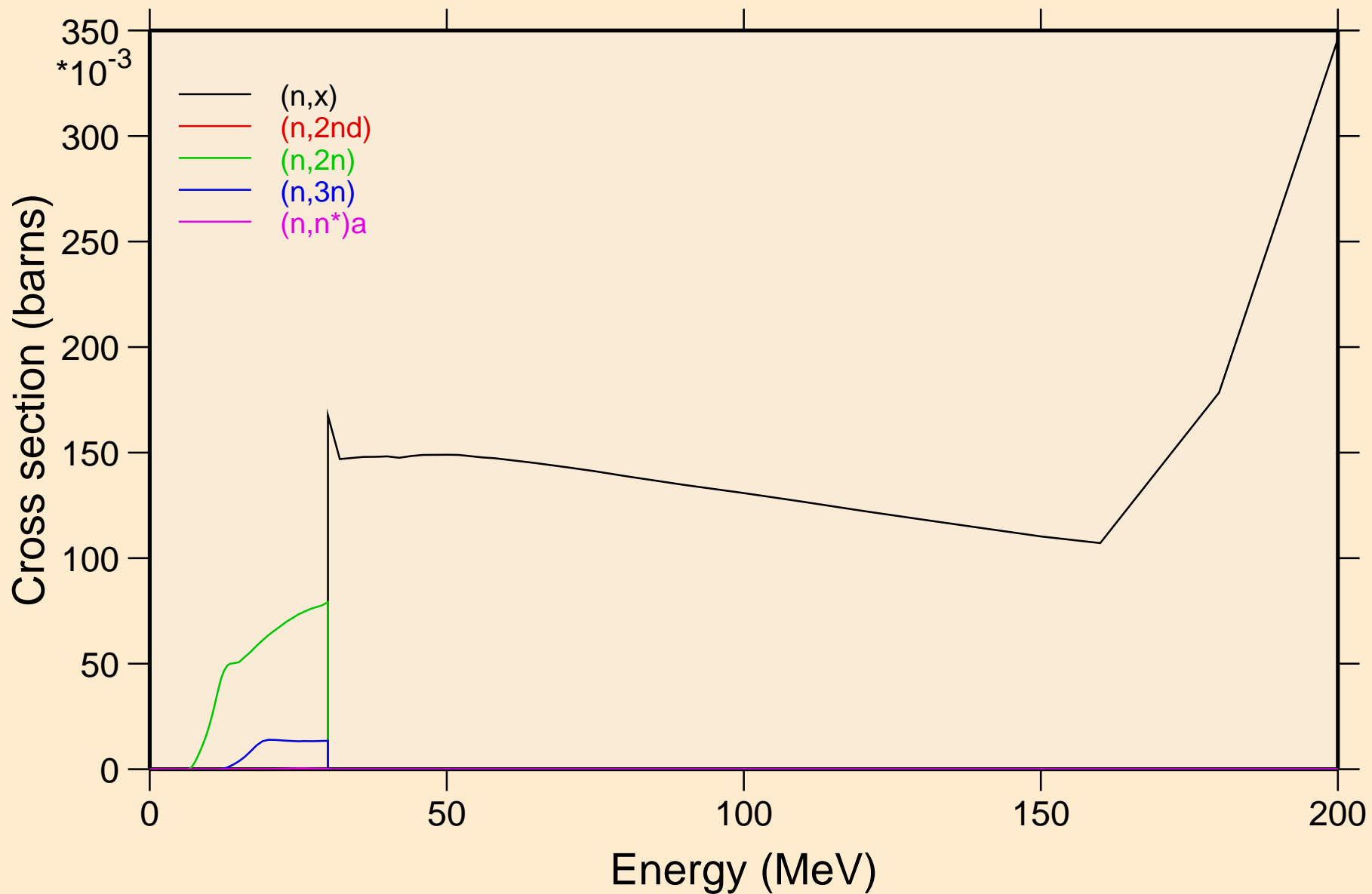

LR265 NEUTRON ACER TENDL-2019 LIBRARY; T=293.16K
Threshold reactions

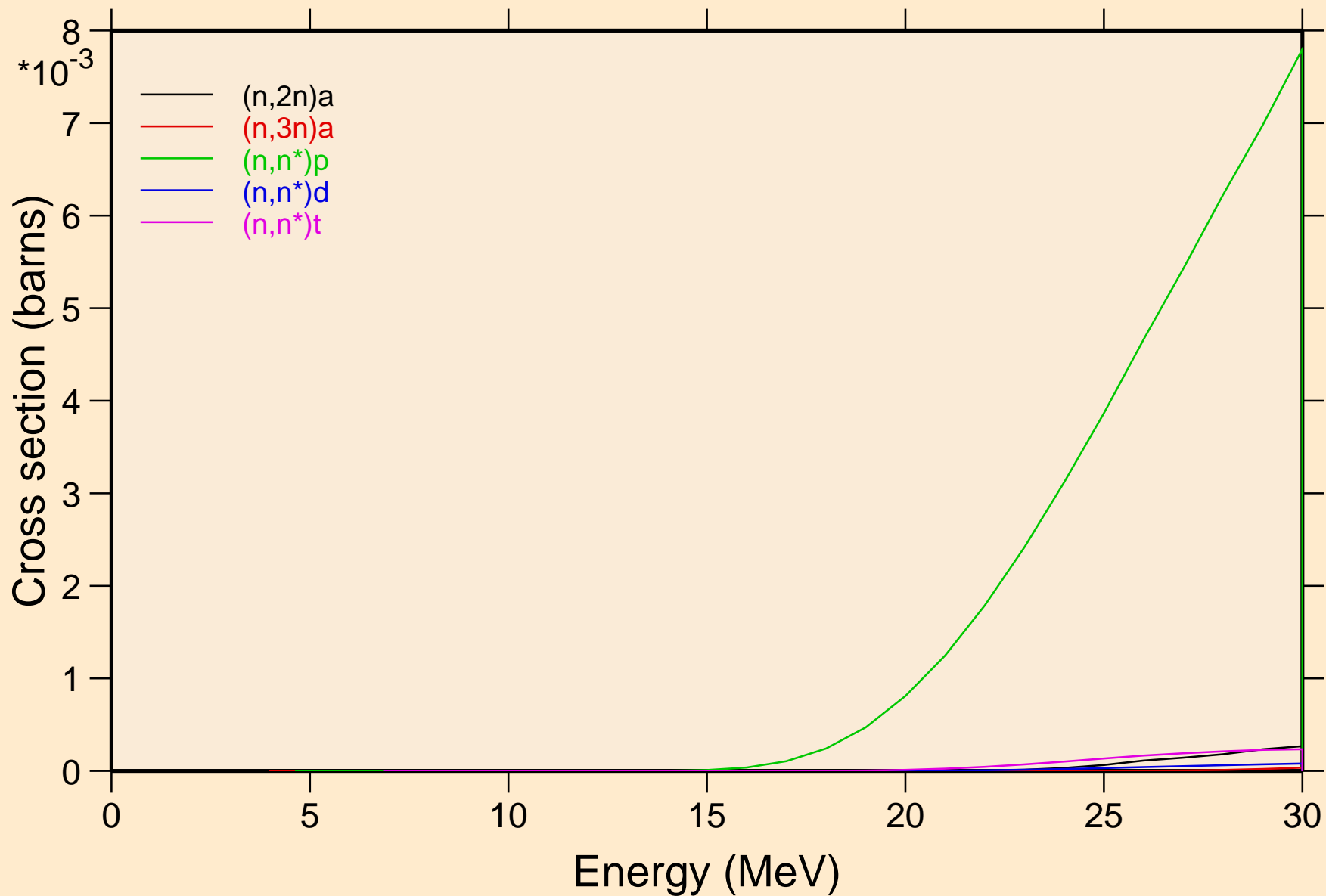

LR265 NEUTRON ACER TENDL-2019 LIBRARY; T=293.16K
Threshold reactions

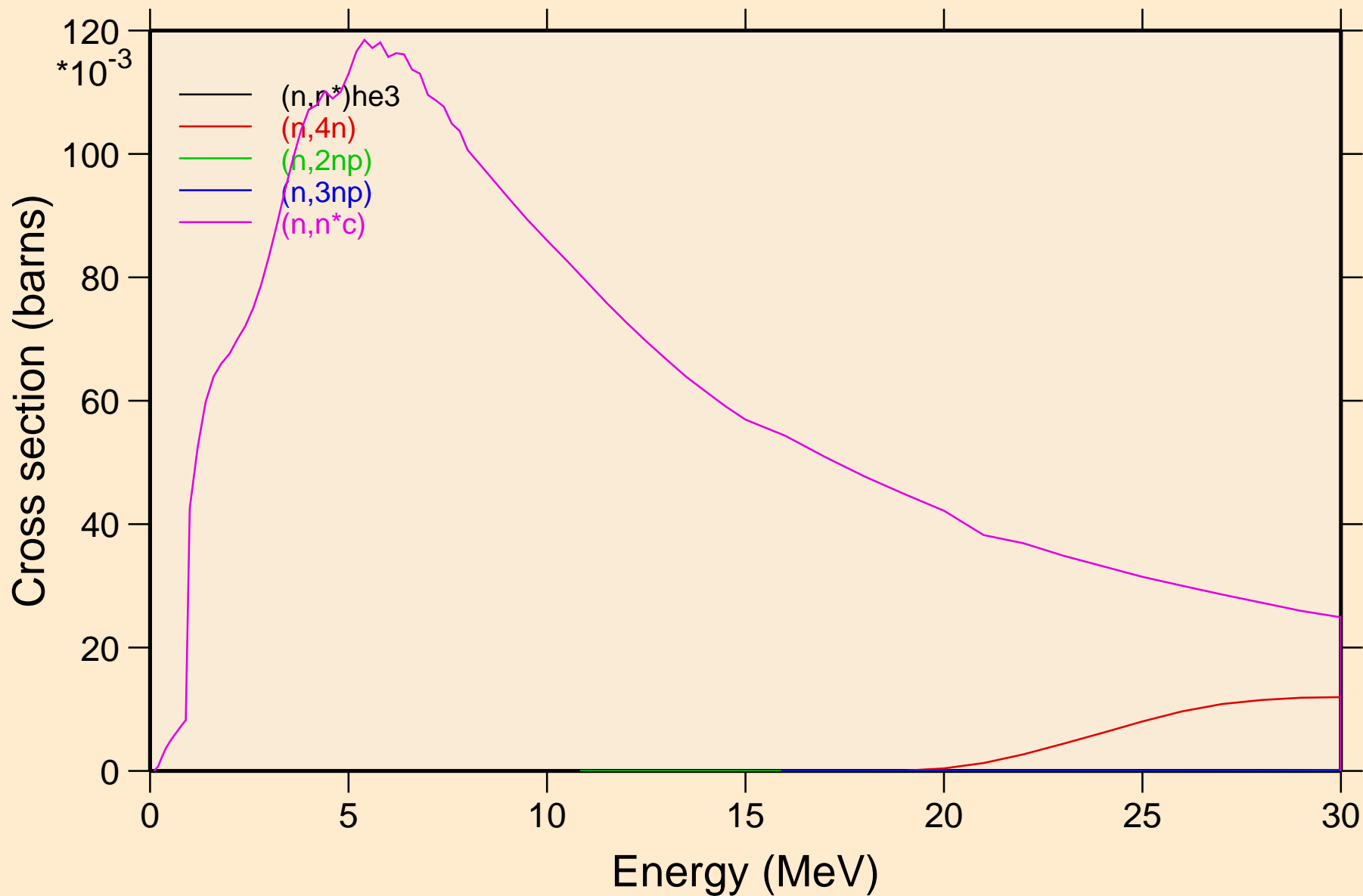

LR265 NEUTRON ACER TENDL-2019 LIBRARY; T=293.16K
Threshold reactions

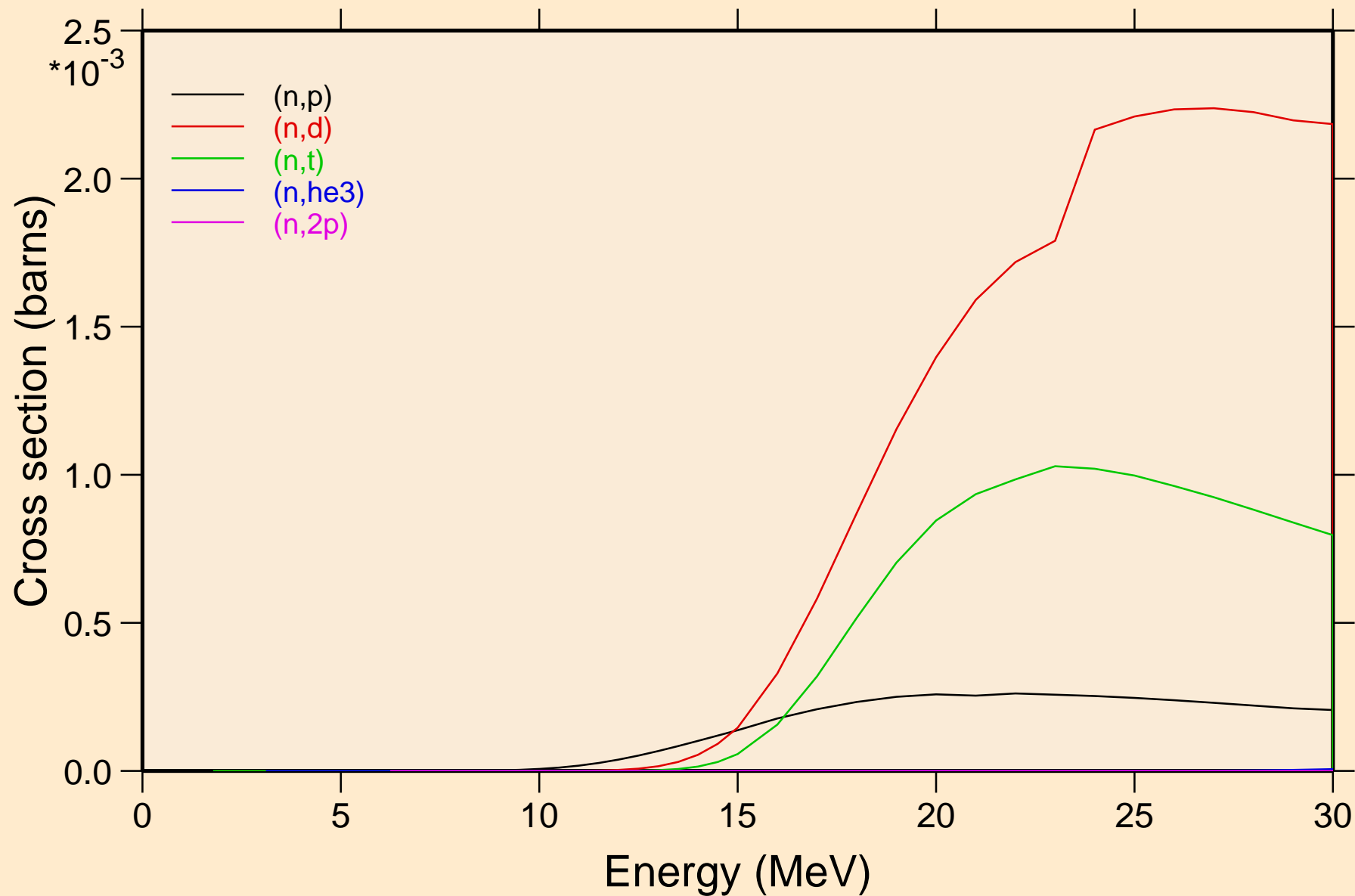

LR265 NEUTRON ACER TENDL-2019 LIBRARY; T=293.16K
Threshold reactions

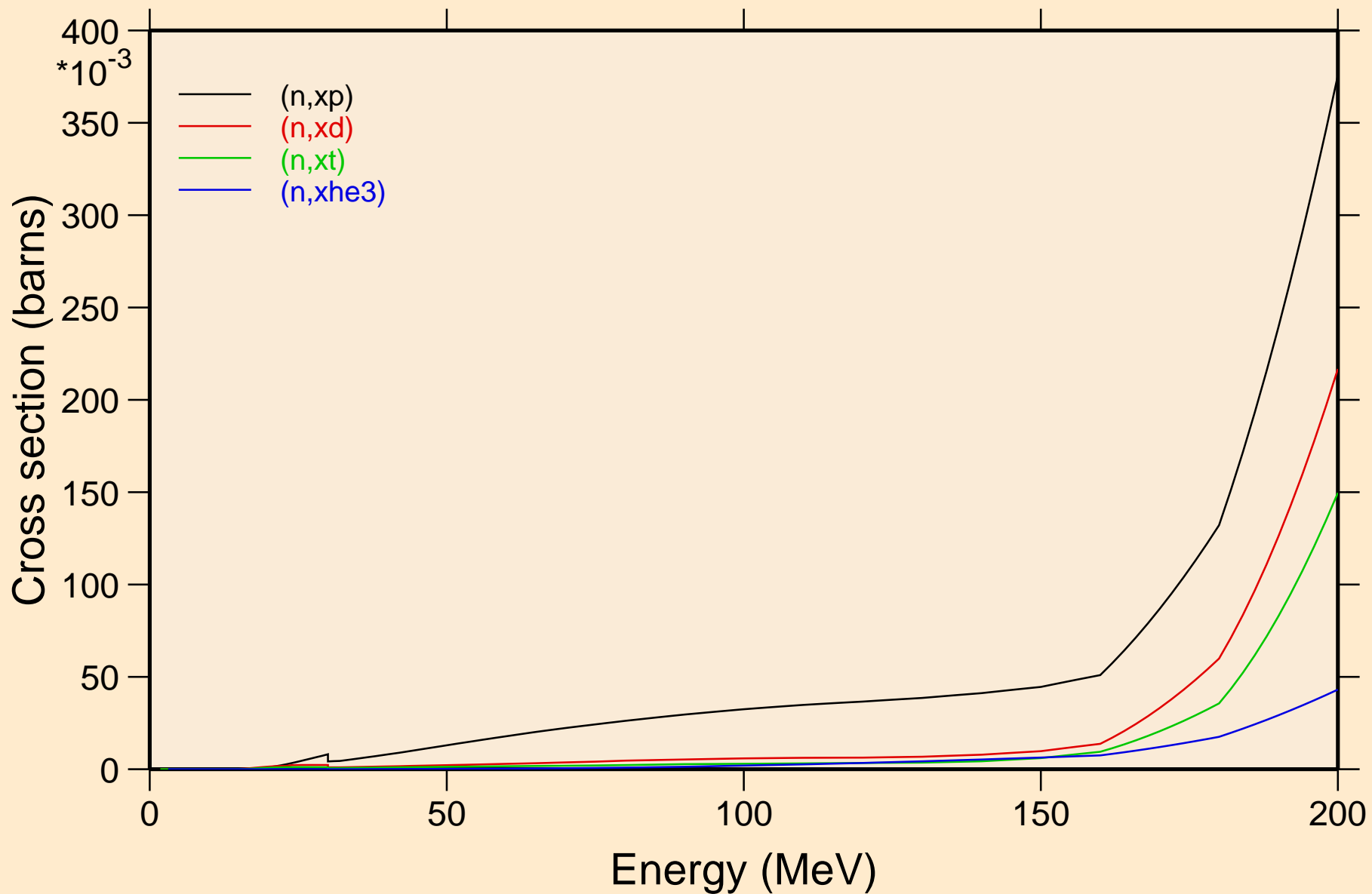

LR265 NEUTRON ACER TENDL-2019 LIBRARY; T=293.16K
angular distribution for elastic

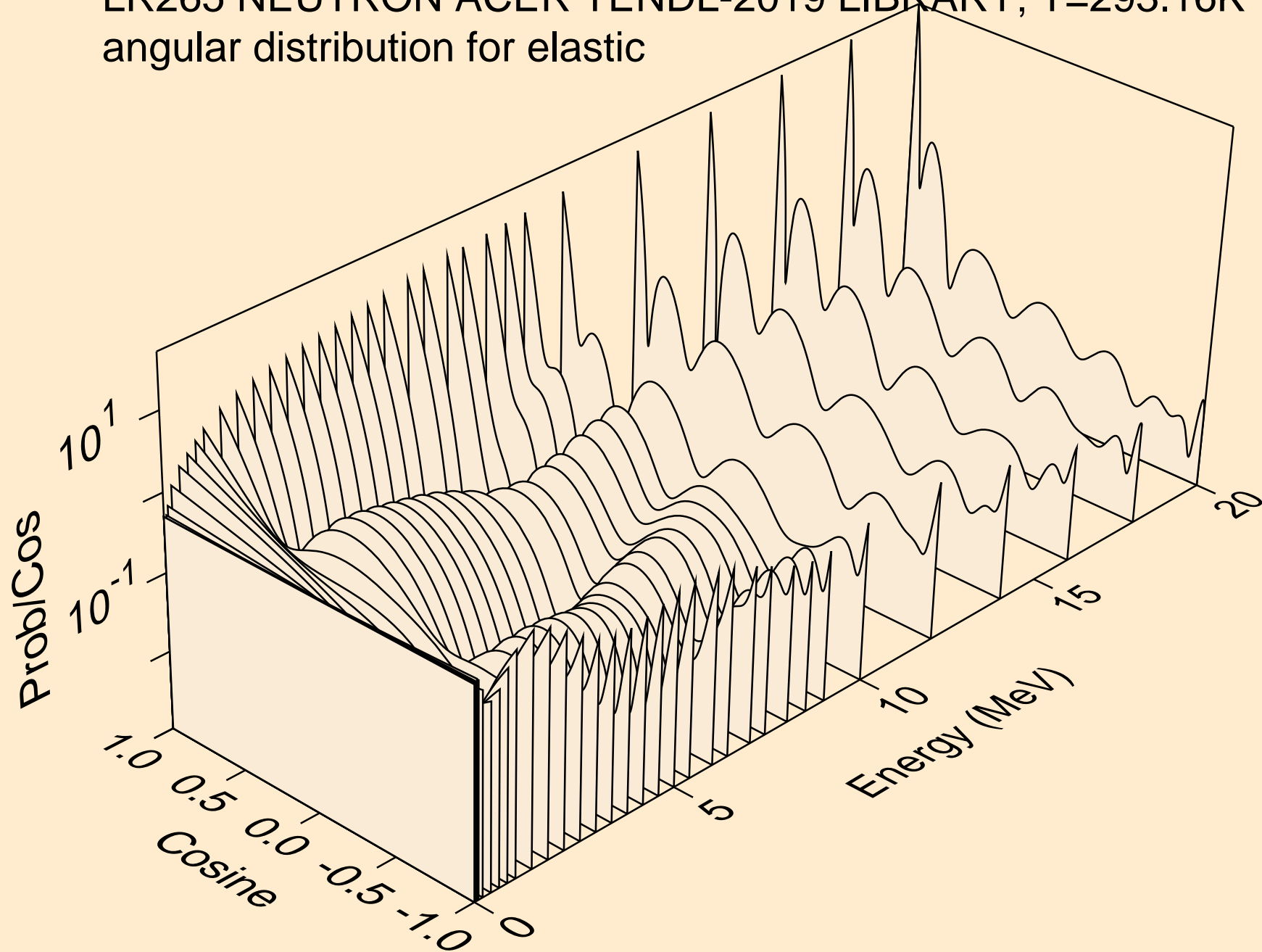

LR265 NEUTRON ACER TENDL-2019 LIBRARY; T=293.16K
angular distribution for elastic

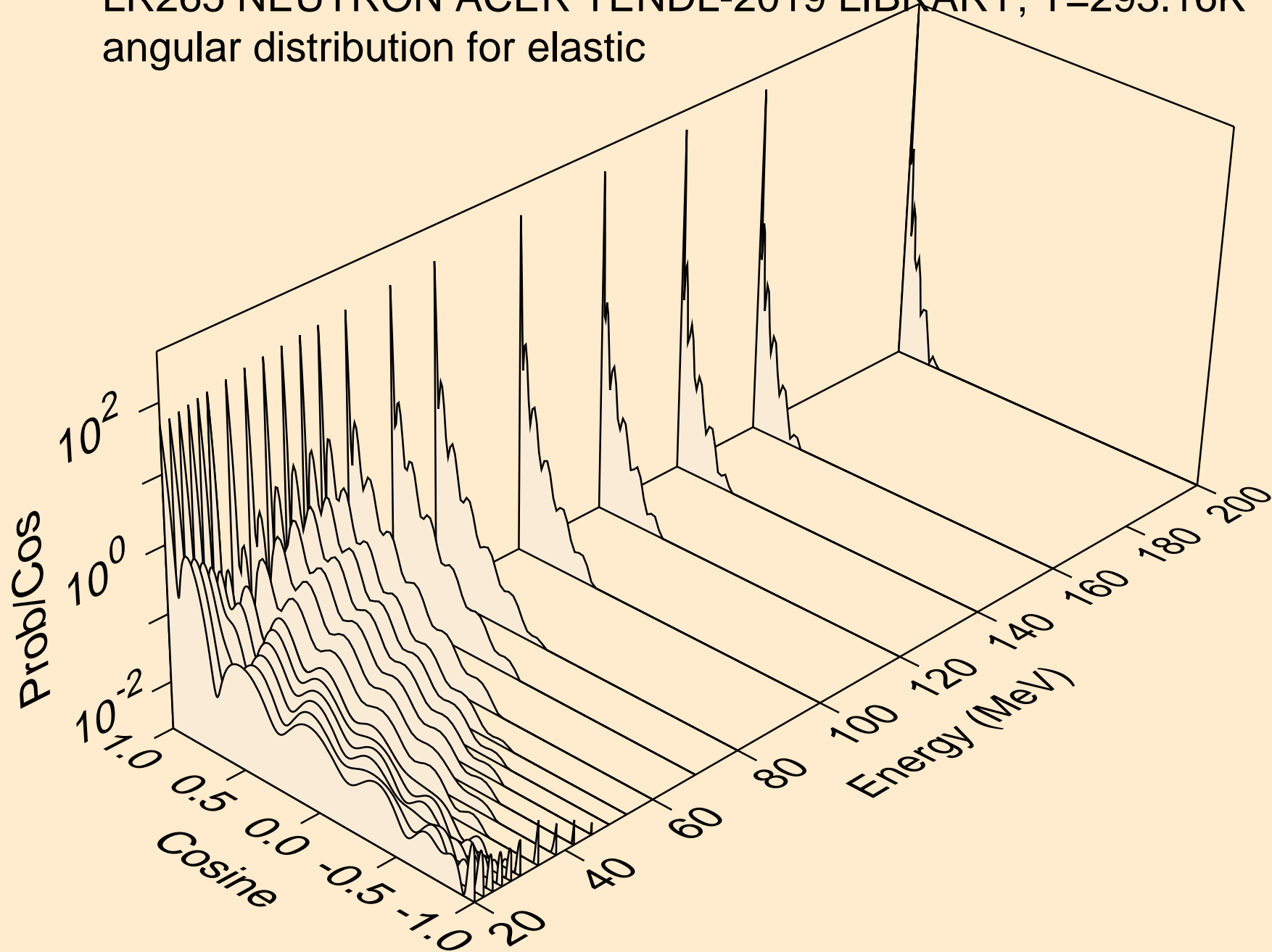

LR265 NEUTRON ACER TENDL-2019 LIBRARY; T=293.16K
angular distribution for (n,n*1)

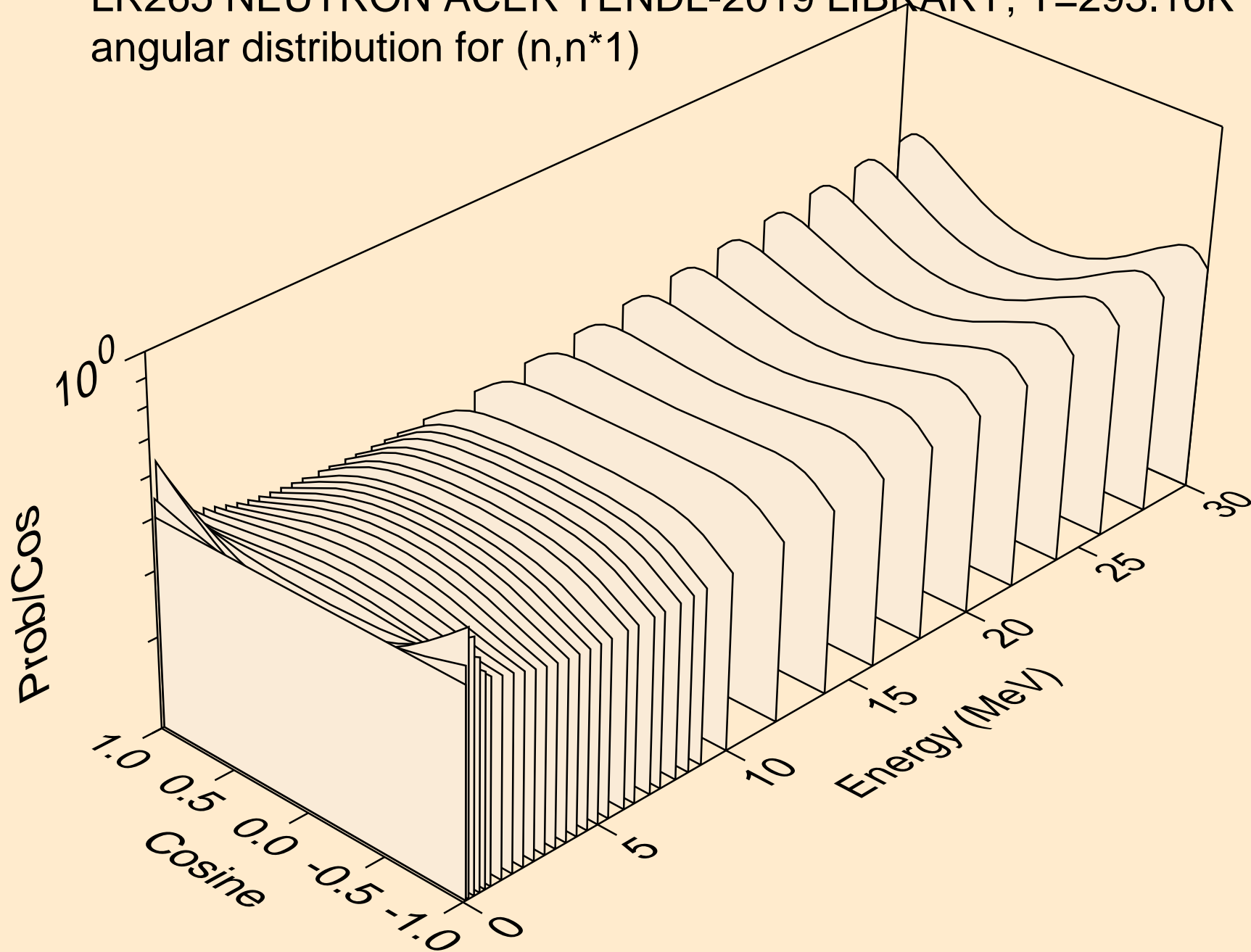

LR265 NEUTRON ACER TENDL-2019 LIBRARY; T=293.16K
Total fission nubar

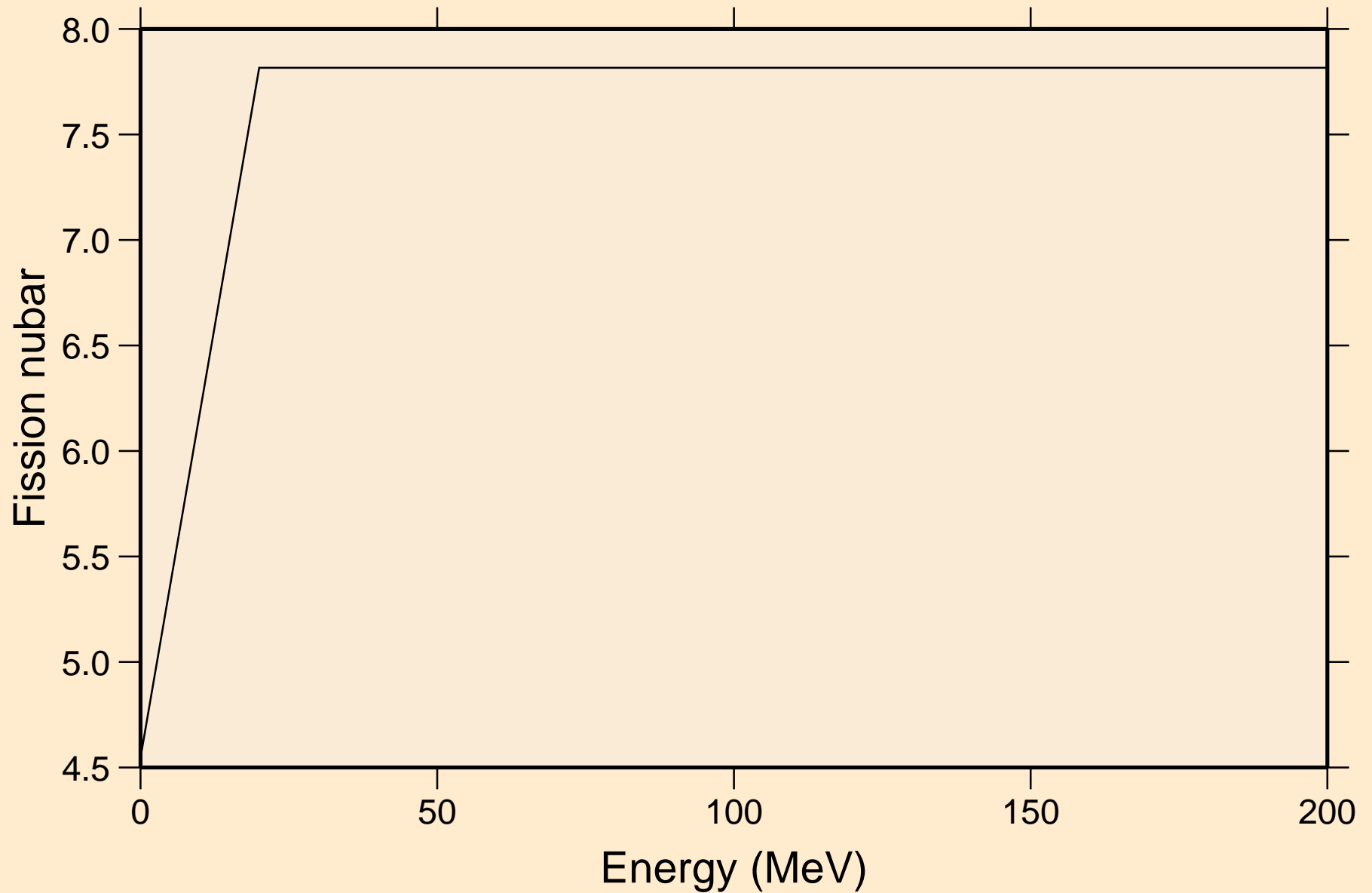

LR265 NEUTRON ACER TENDL-2019 LIBRARY; T=293.16K
Neutron emission for (n,x)

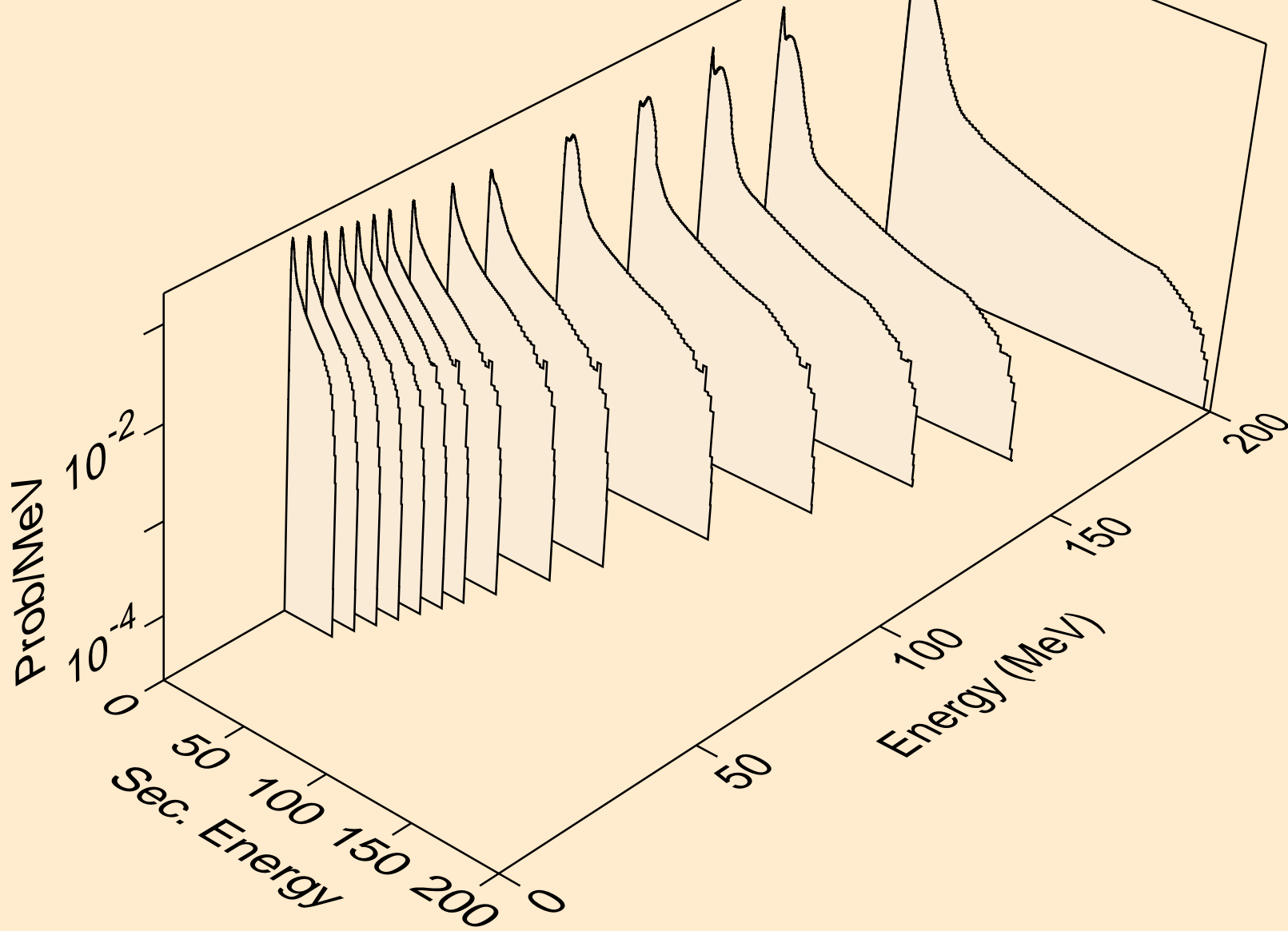

LR265 NEUTRON ACER TENDL-2019 LIBRARY; T=293.16K
Neutron emission for (n,2nd)

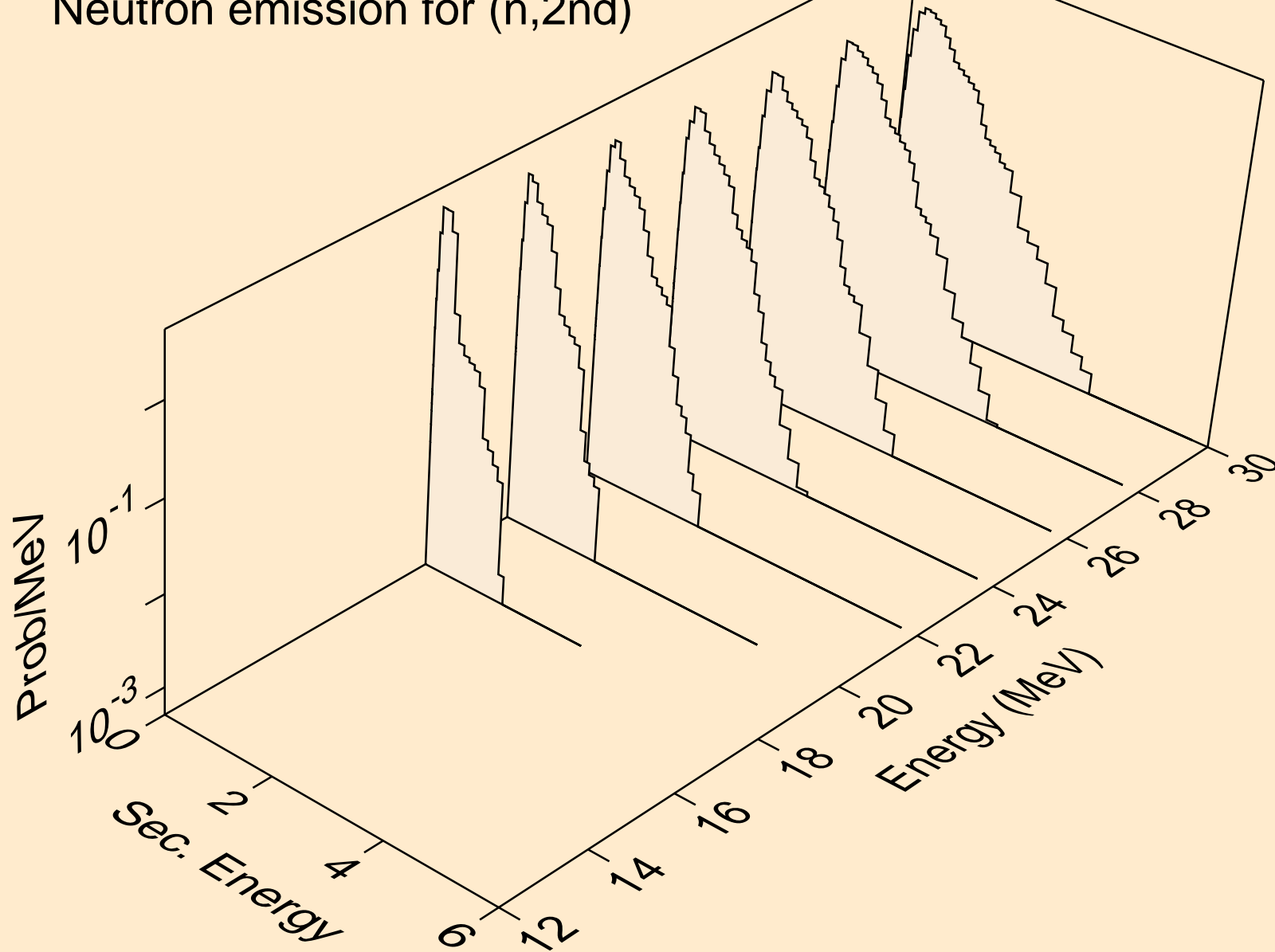

LR265 NEUTRON ACER TENDL-2019 LIBRARY; T=293.16K
Neutron emission for (n,2n)

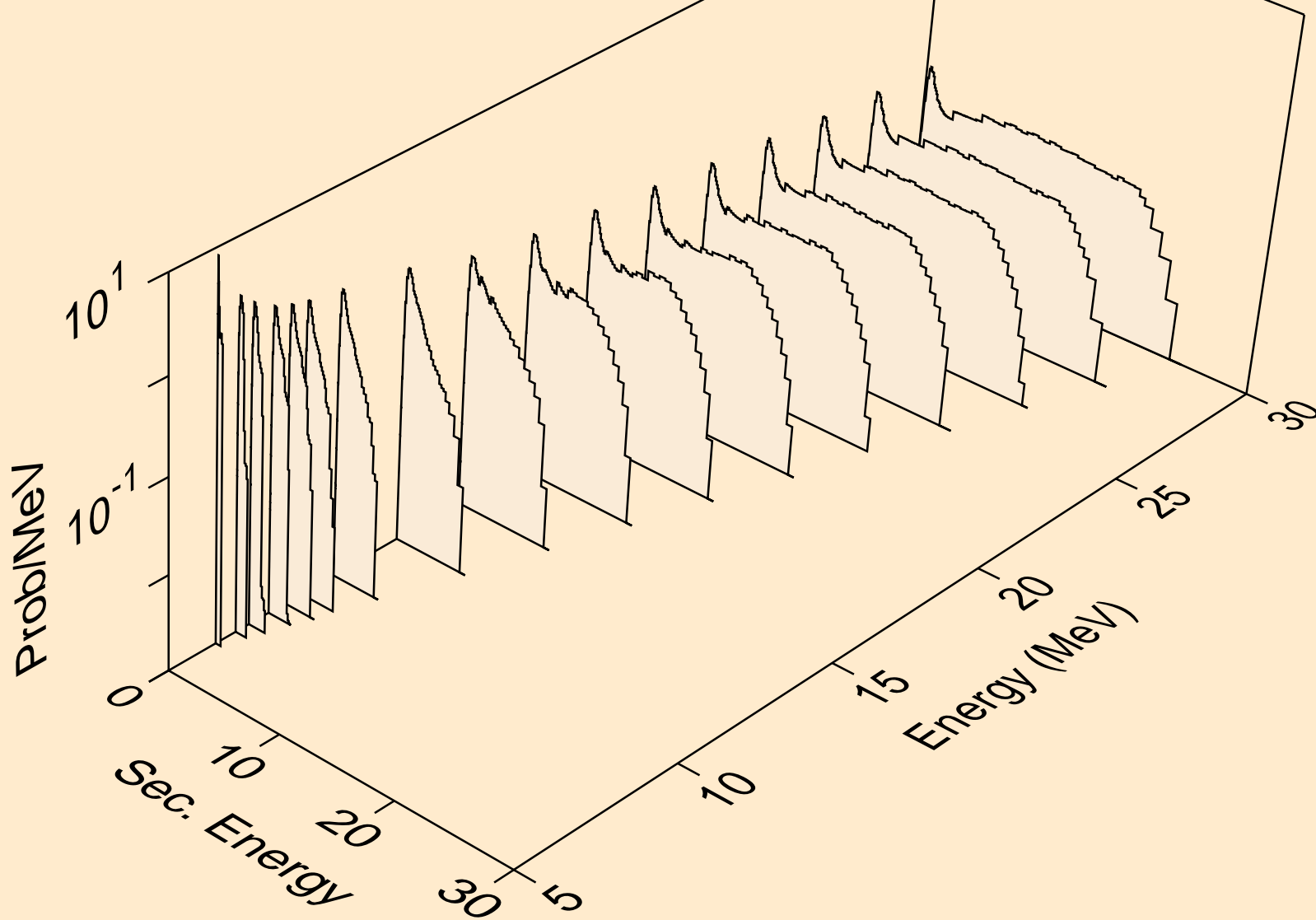

LR265 NEUTRON ACER TENDL-2019 LIBRARY; T=293.16K
Neutron emission for (n,3n)

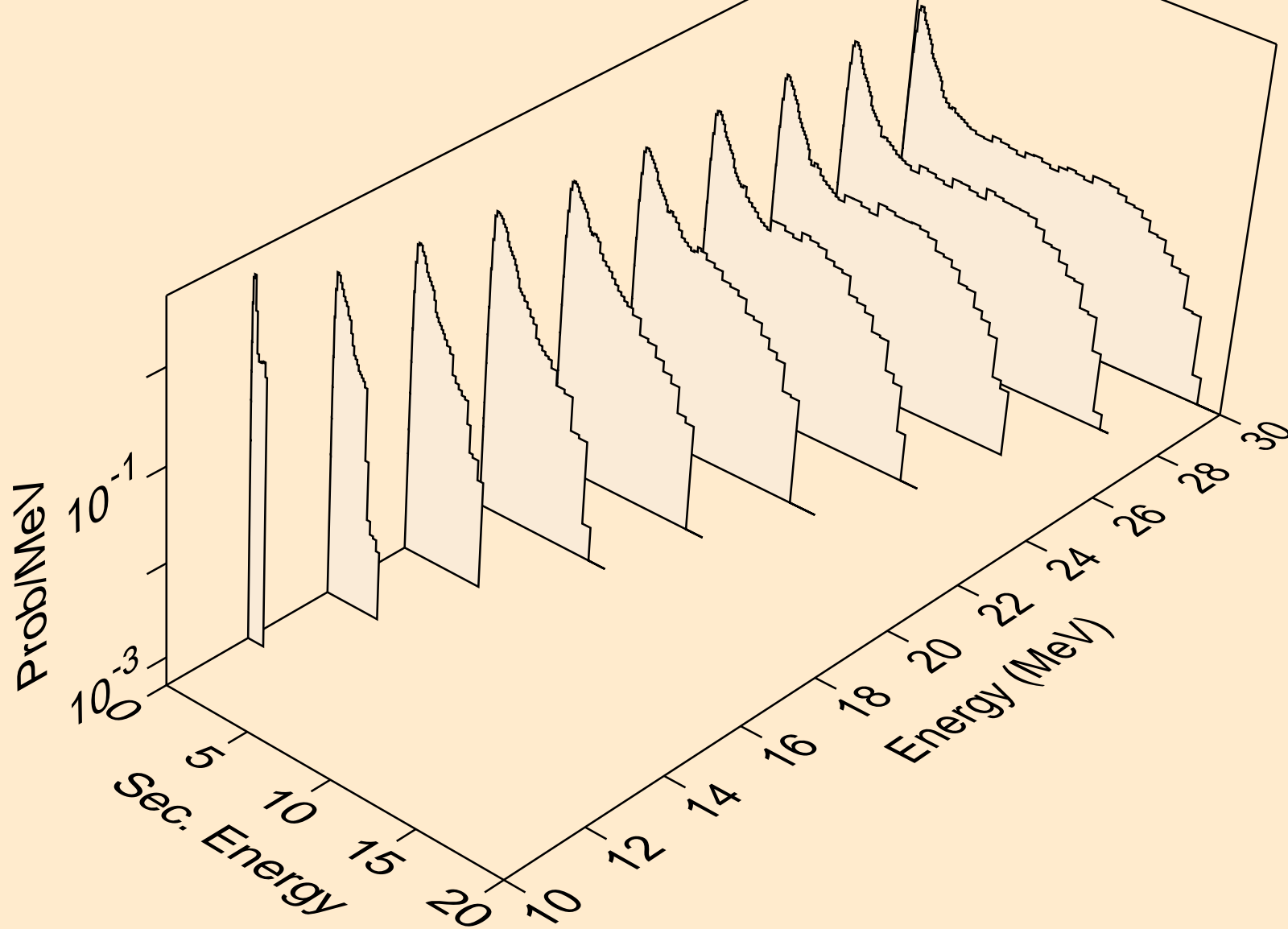

LR265 NEUTRON ACER TENDL-2019 LIBRARY; T=293.16K
Neutron emission for fission

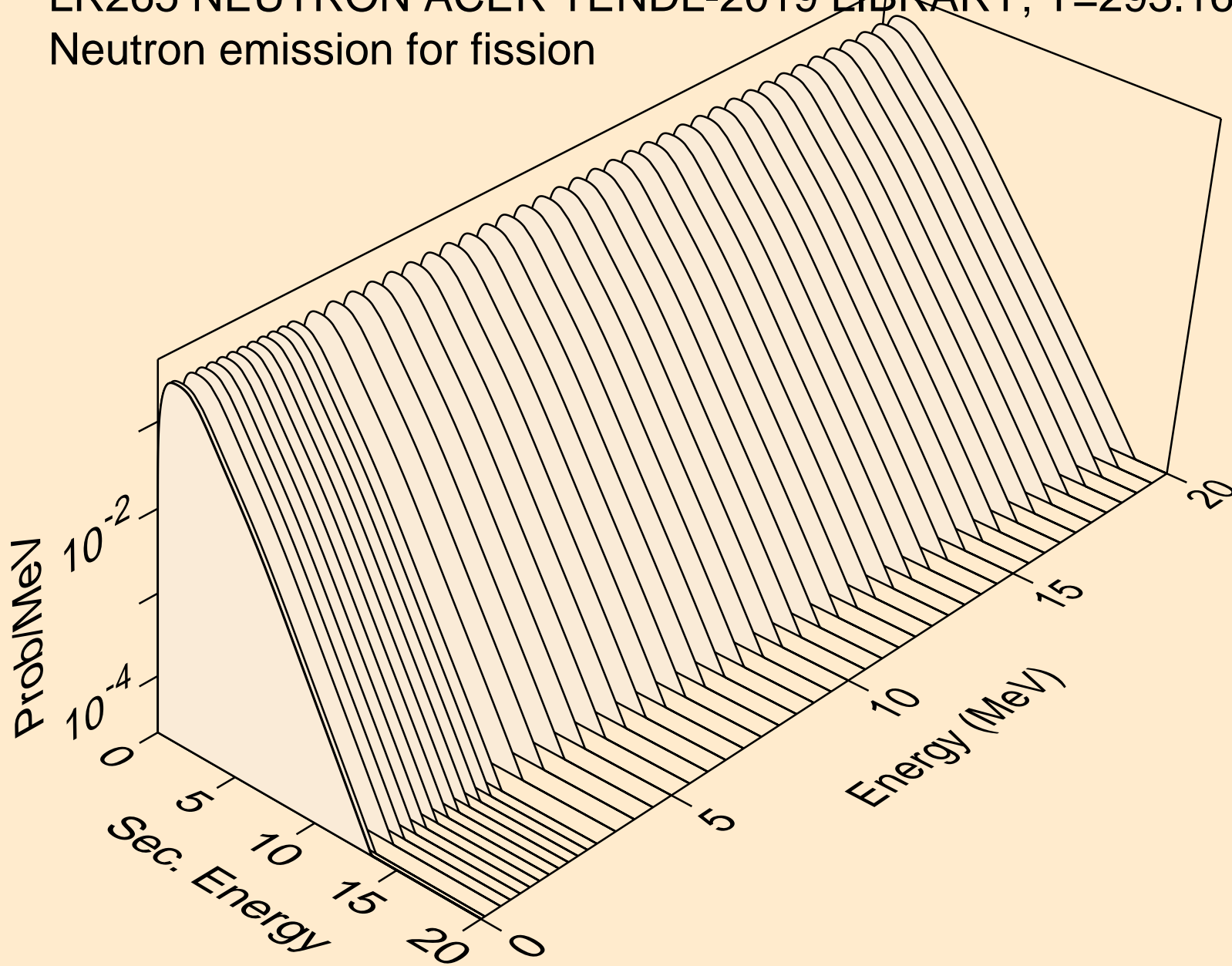

LR265 NEUTRON ACER TENDL-2019 LIBRARY; T=293.16K
Neutron emission for (n,n*)a

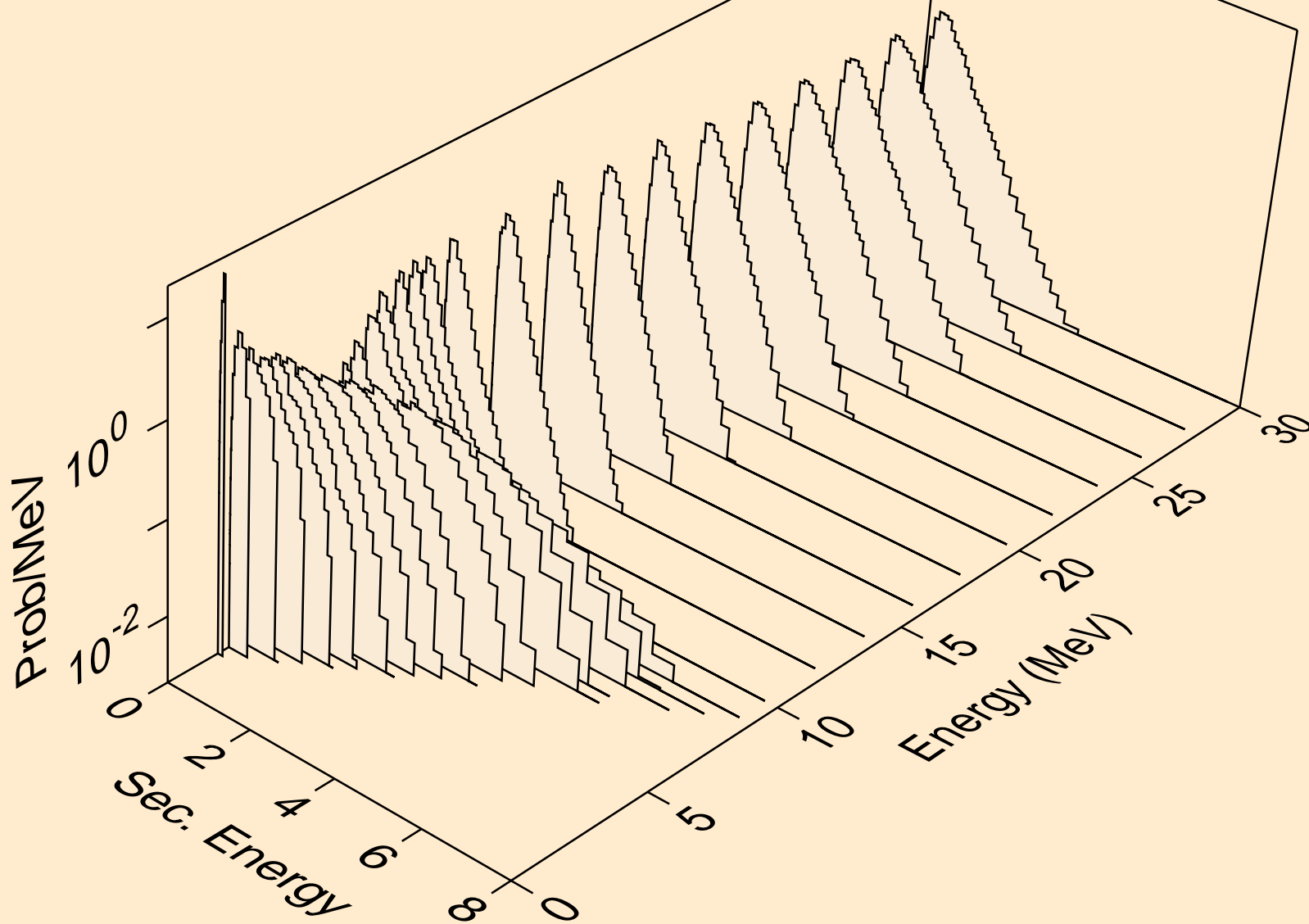

LR265 NEUTRON ACER TENDL-2019 LIBRARY; T=293.16K
Neutron emission for (n,2n)a

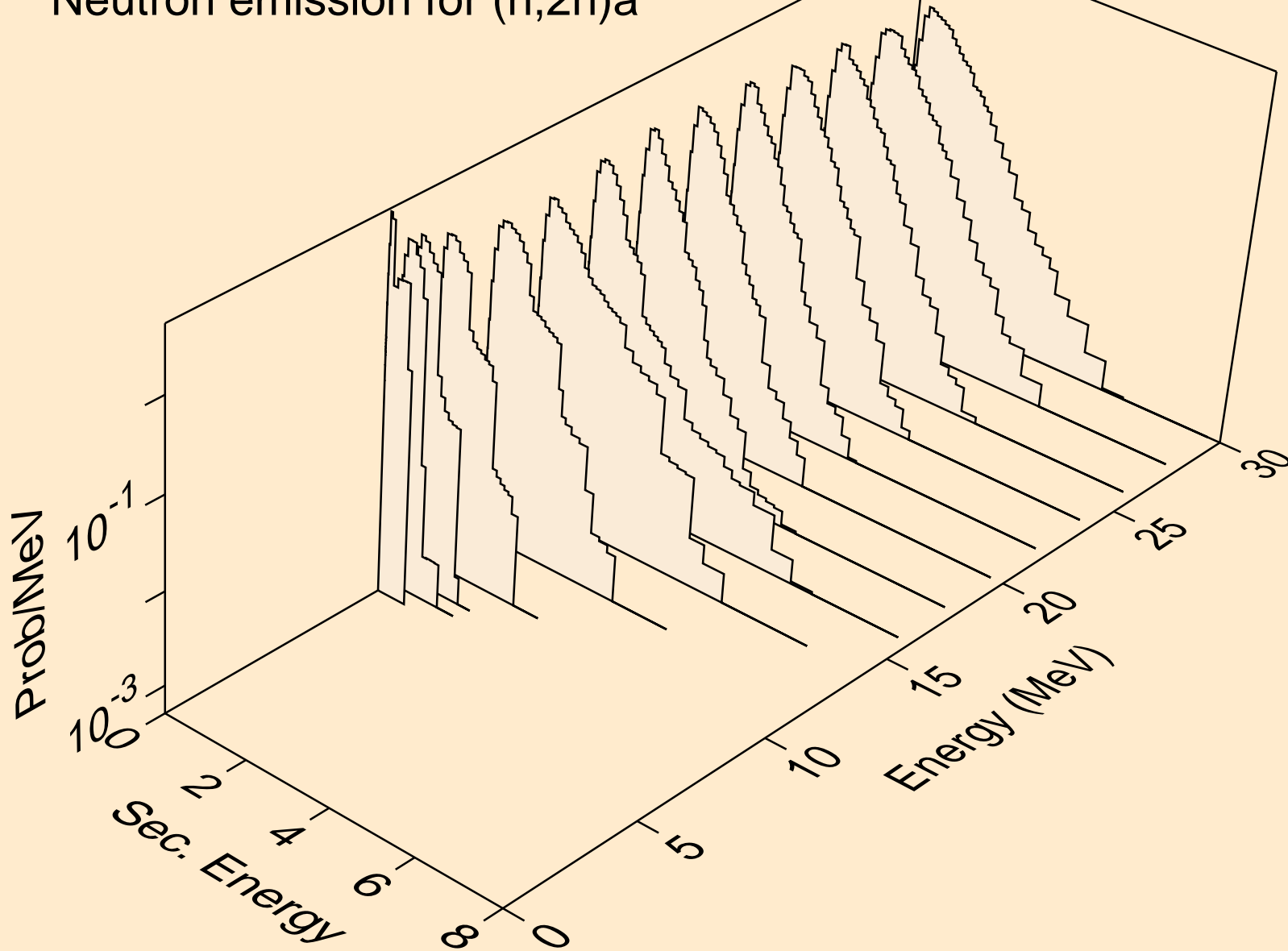

LR265 NEUTRON ACER TENDL-2019 LIBRARY; T=293.16K
Neutron emission for (n,3n)a

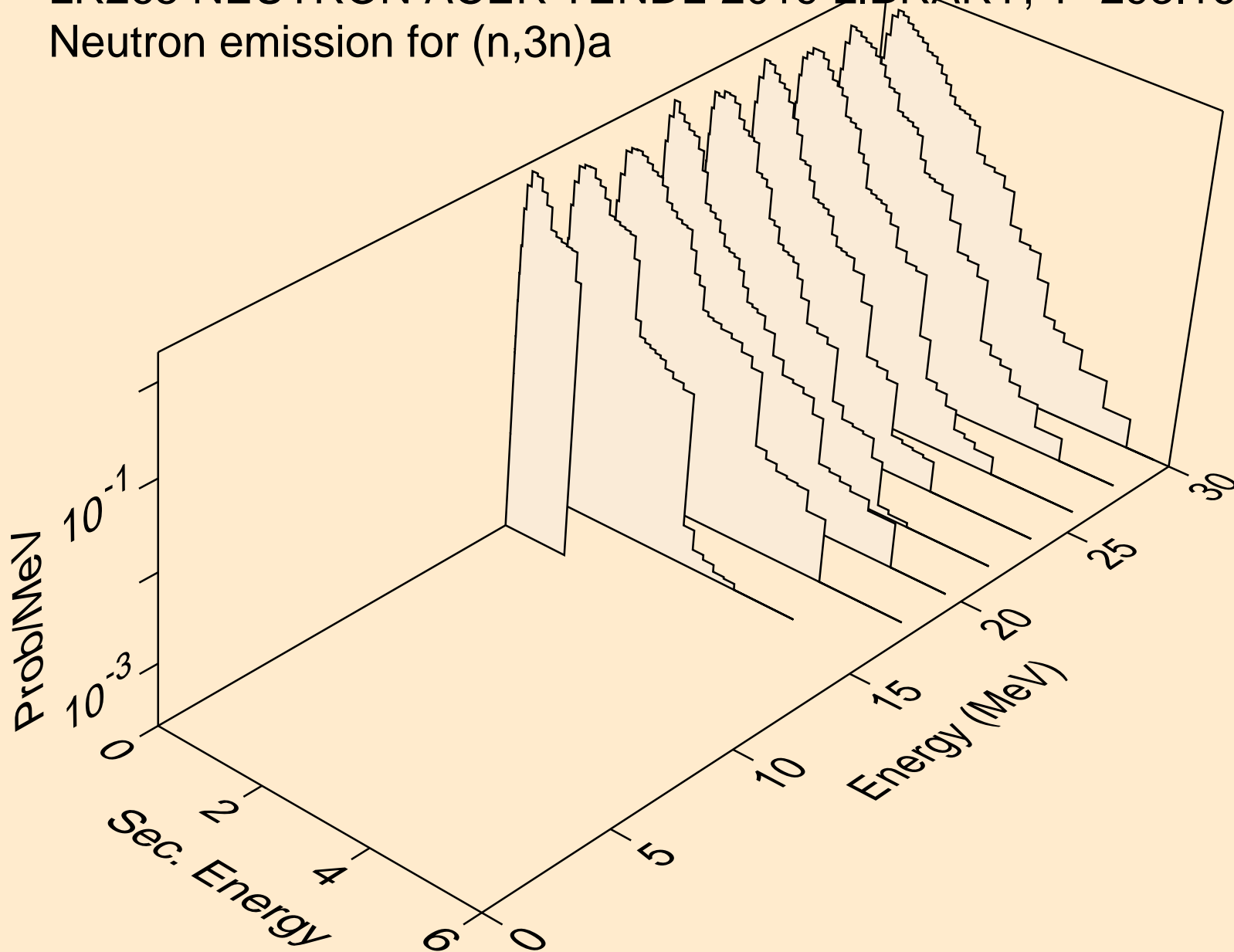

LR265 NEUTRON ACER TENDL-2019 LIBRARY; T=293.16K
Neutron emission for (n,n*)p

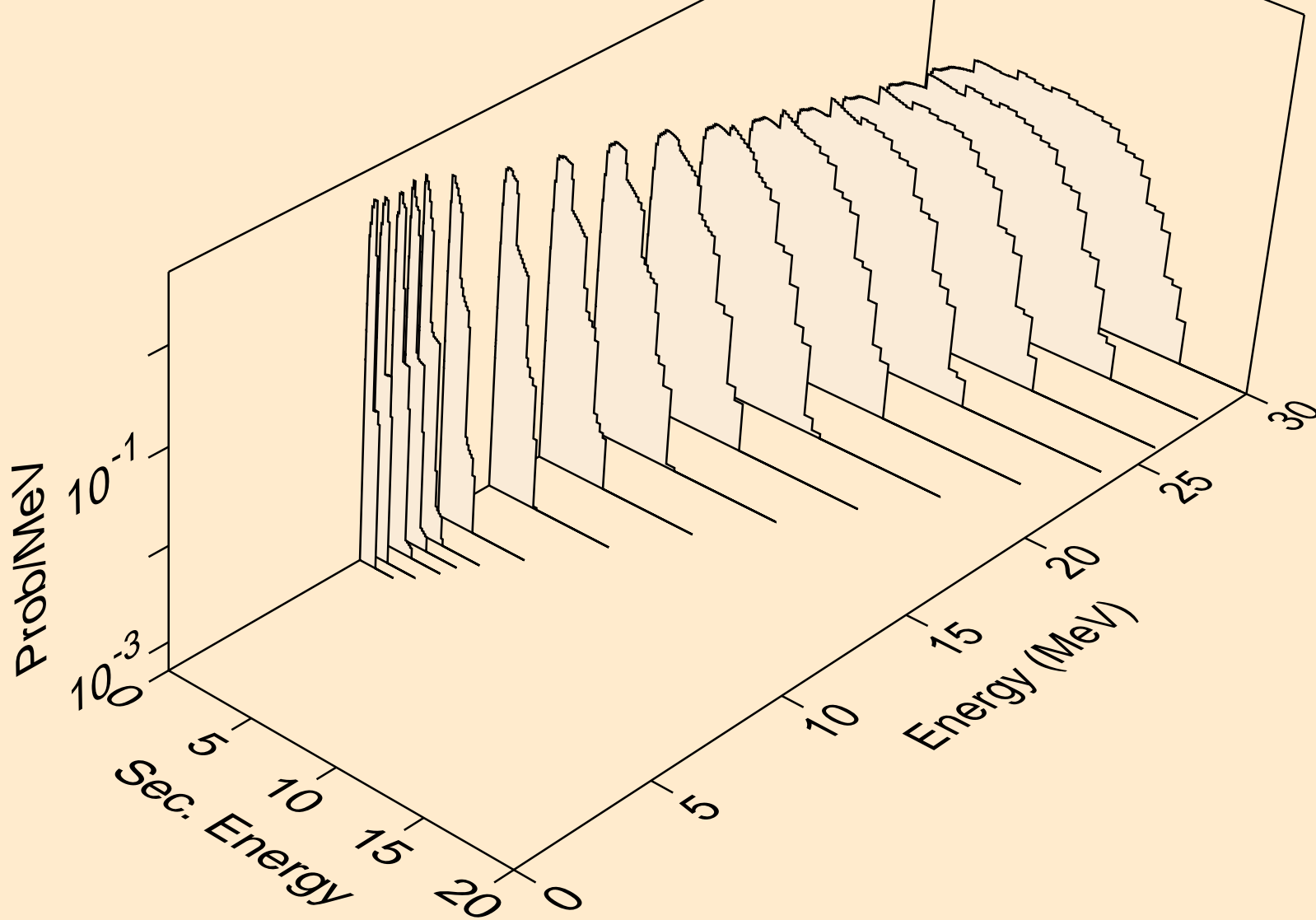

LR265 NEUTRON ACER TENDL-2019 LIBRARY; T=293.16K
Neutron emission for (n,n*)d

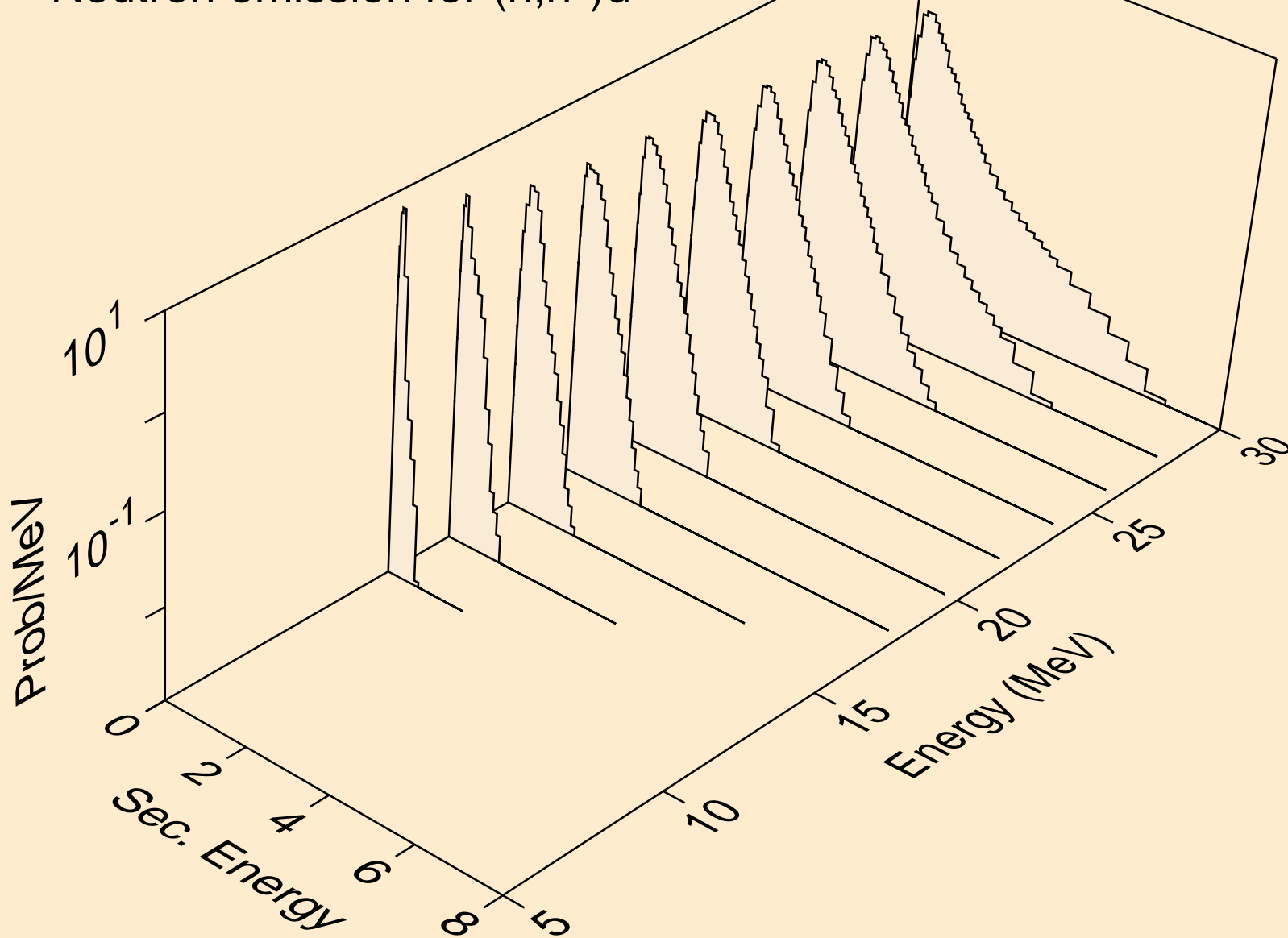

LR265 NEUTRON ACER TENDL-2019 LIBRARY; T=293.16K
Neutron emission for (n,n*)t

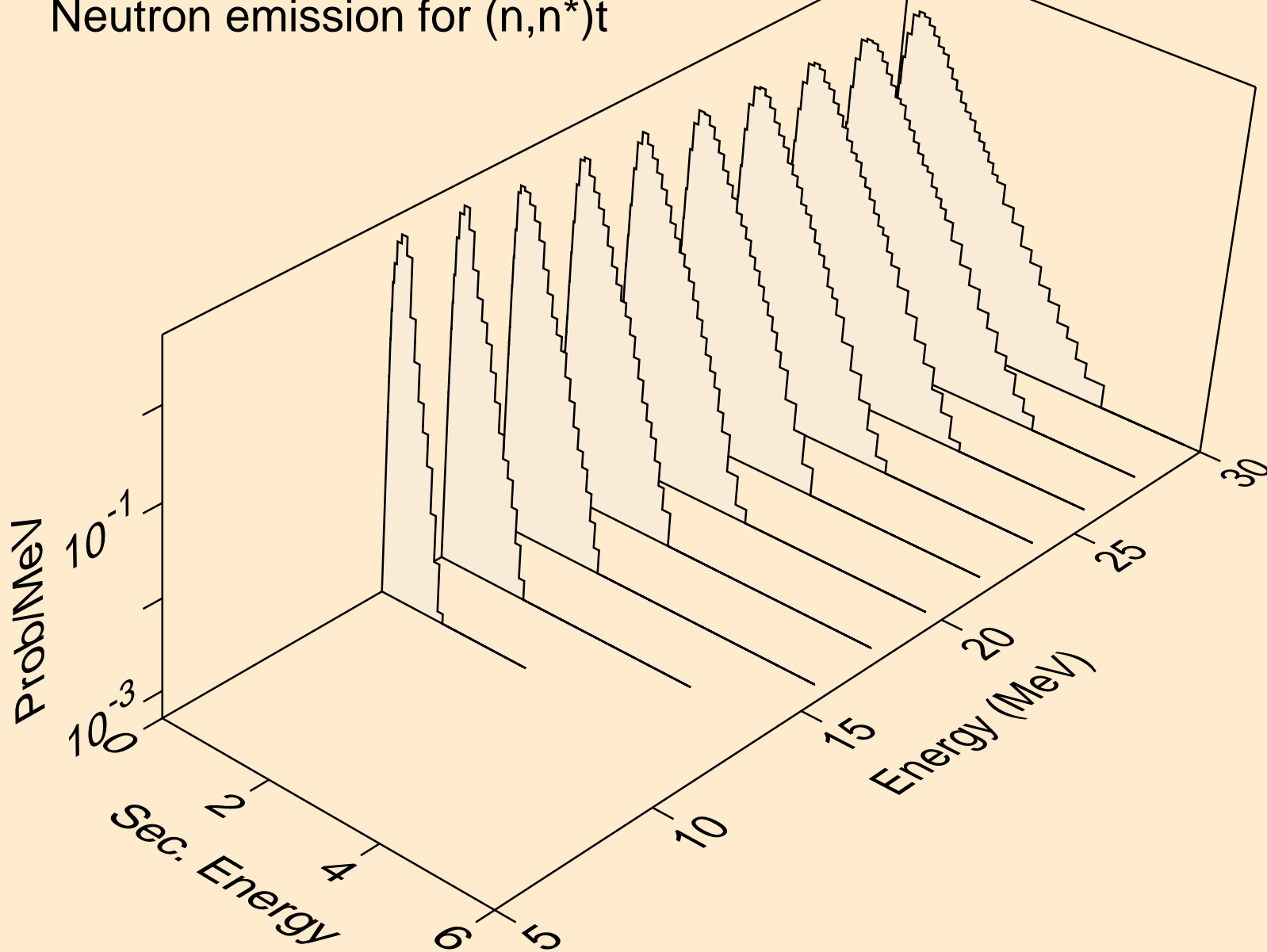

LR265 NEUTRON ACER TENDL-2019 LIBRARY; T=293.16K
Neutron emission for (n,n*)he3

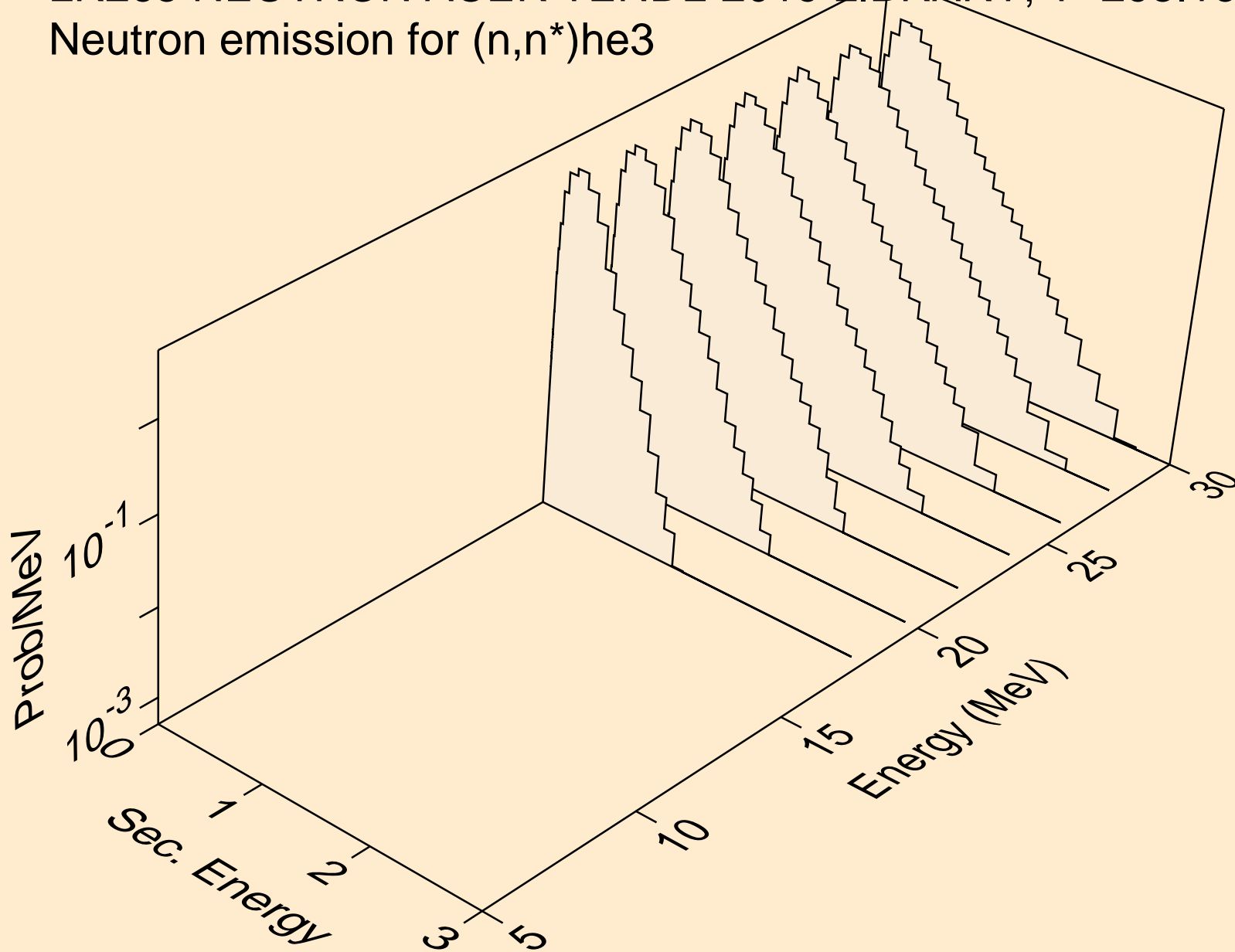

LR265 NEUTRON ACER TENDL-2019 LIBRARY; T=293.16K
Neutron emission for (n,4n)

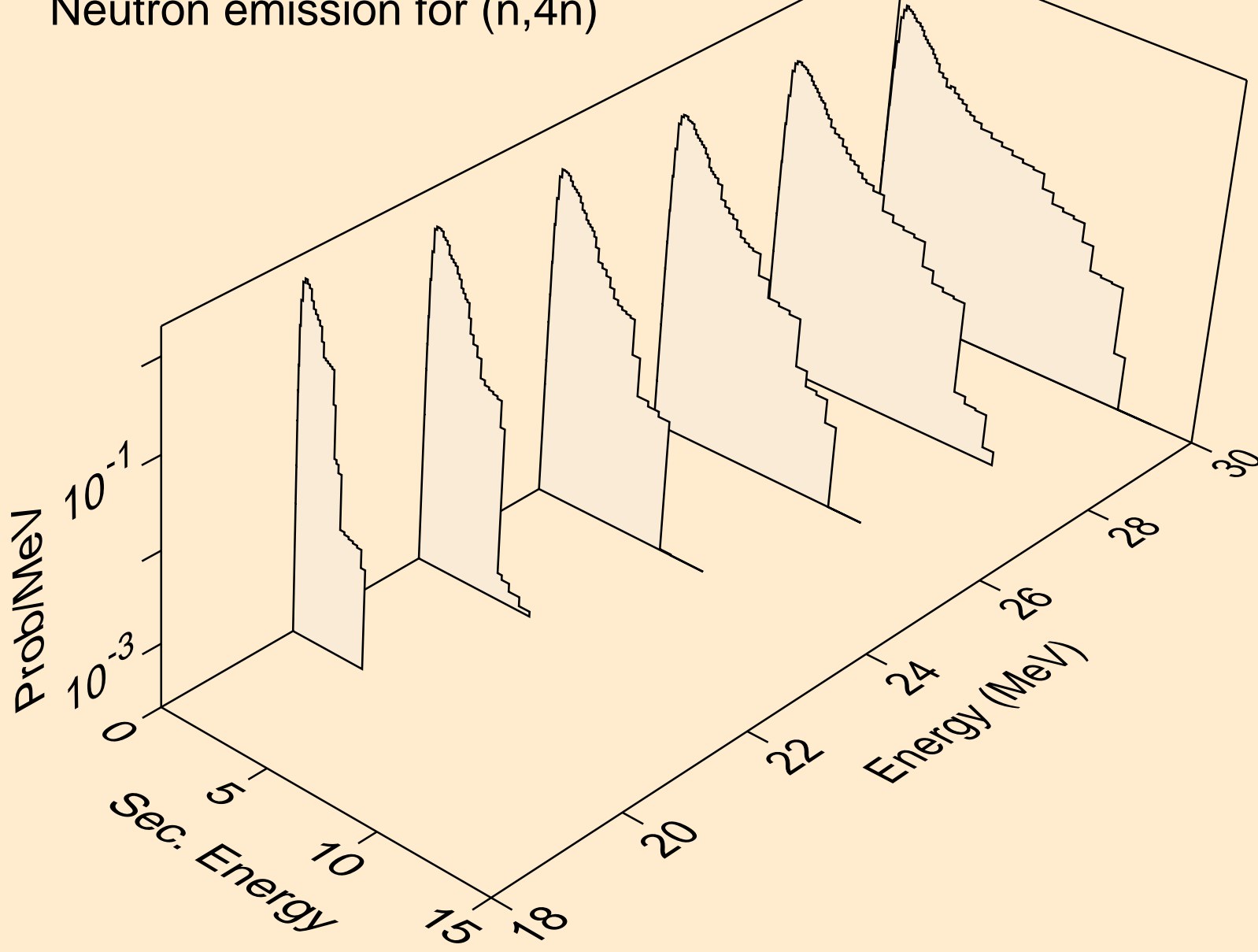

LR265 NEUTRON ACER TENDL-2019 LIBRARY; T=293.16K
Neutron emission for (n,2np)

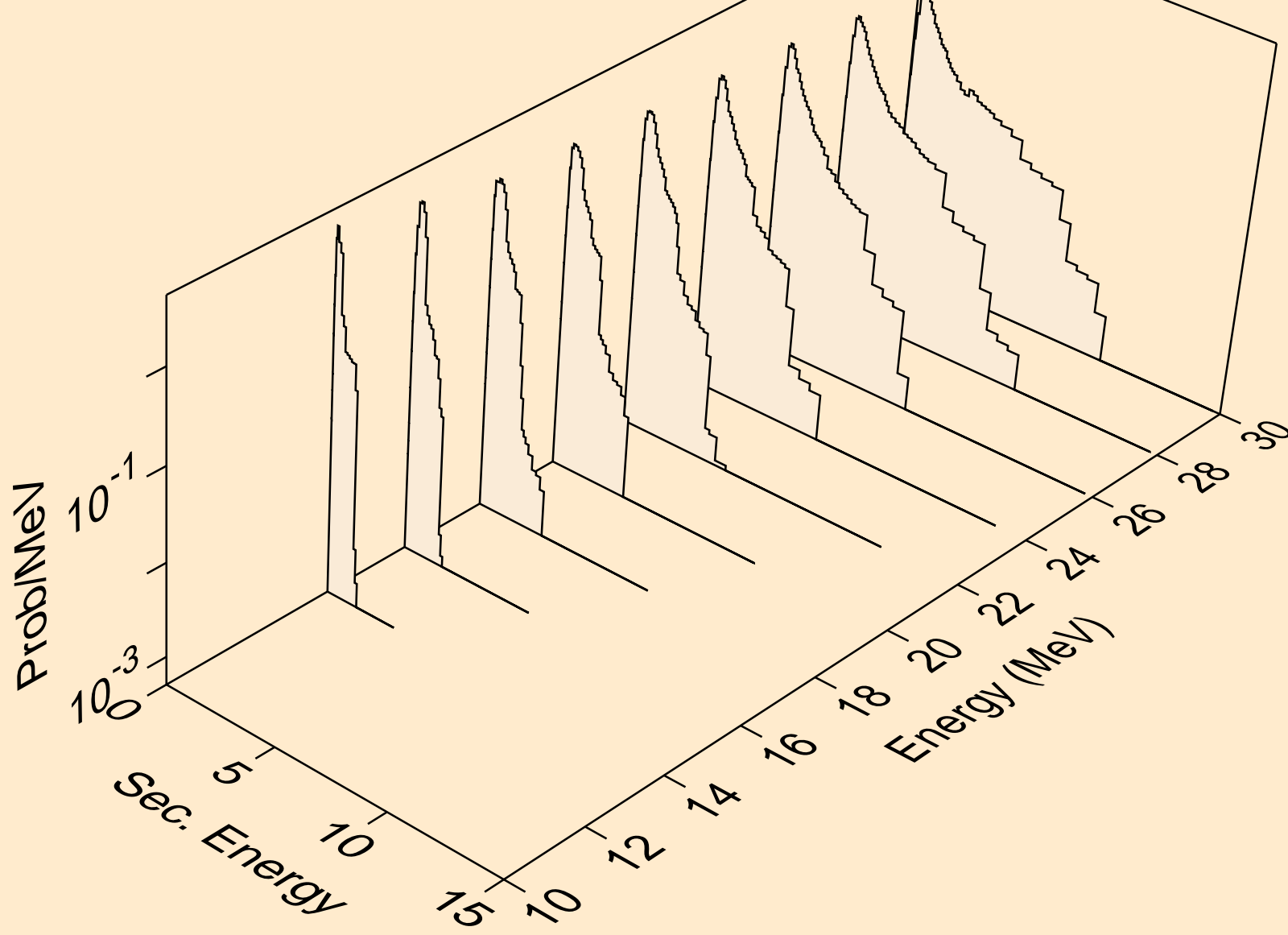

LR265 NEUTRON ACER TENDL-2019 LIBRARY; T=293.16K
Neutron emission for (n,3np)

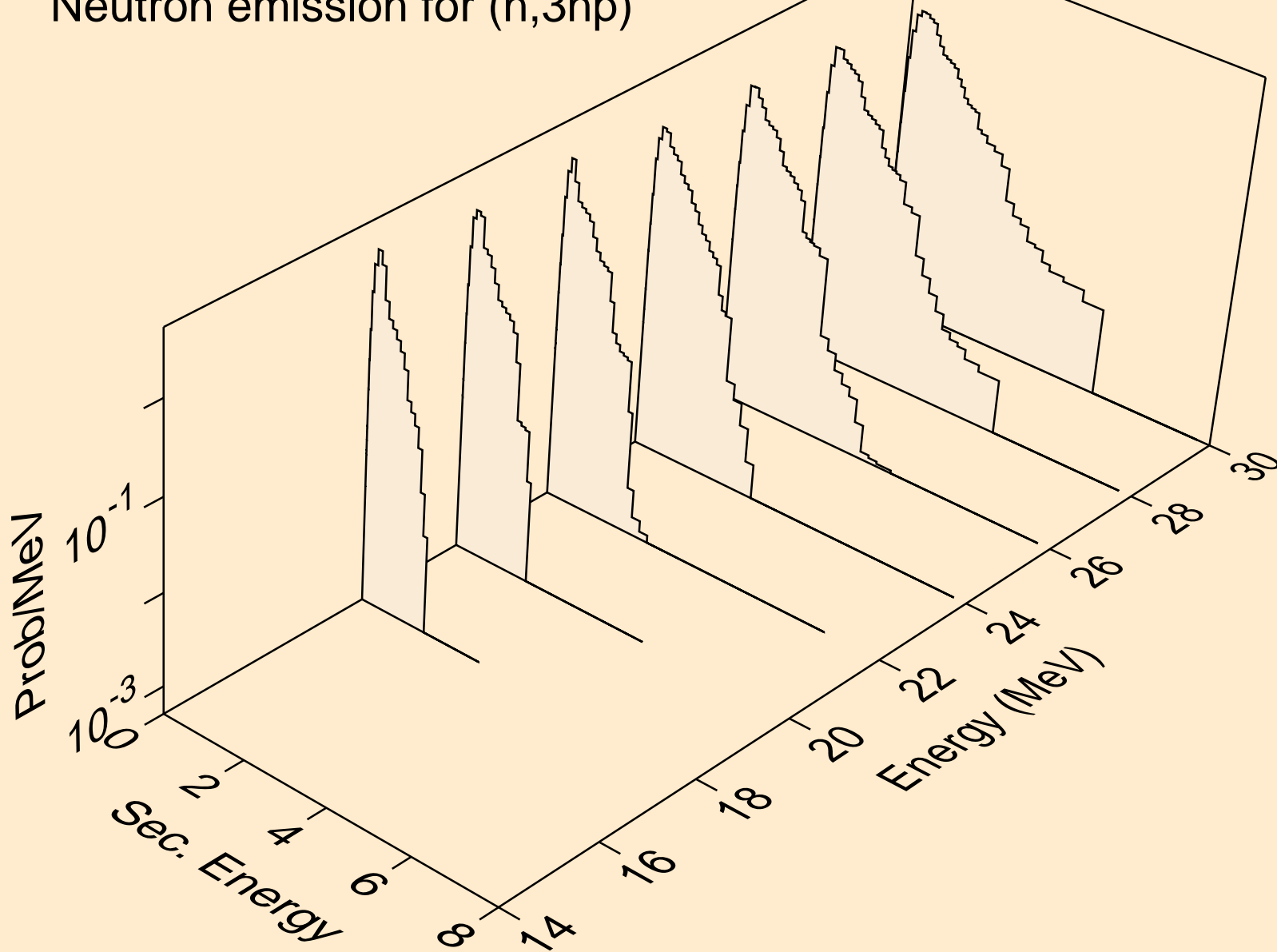

LR265 NEUTRON ACER TENDL-2019 LIBRARY; T=293.16K
Neutron emission for (n,n*c)

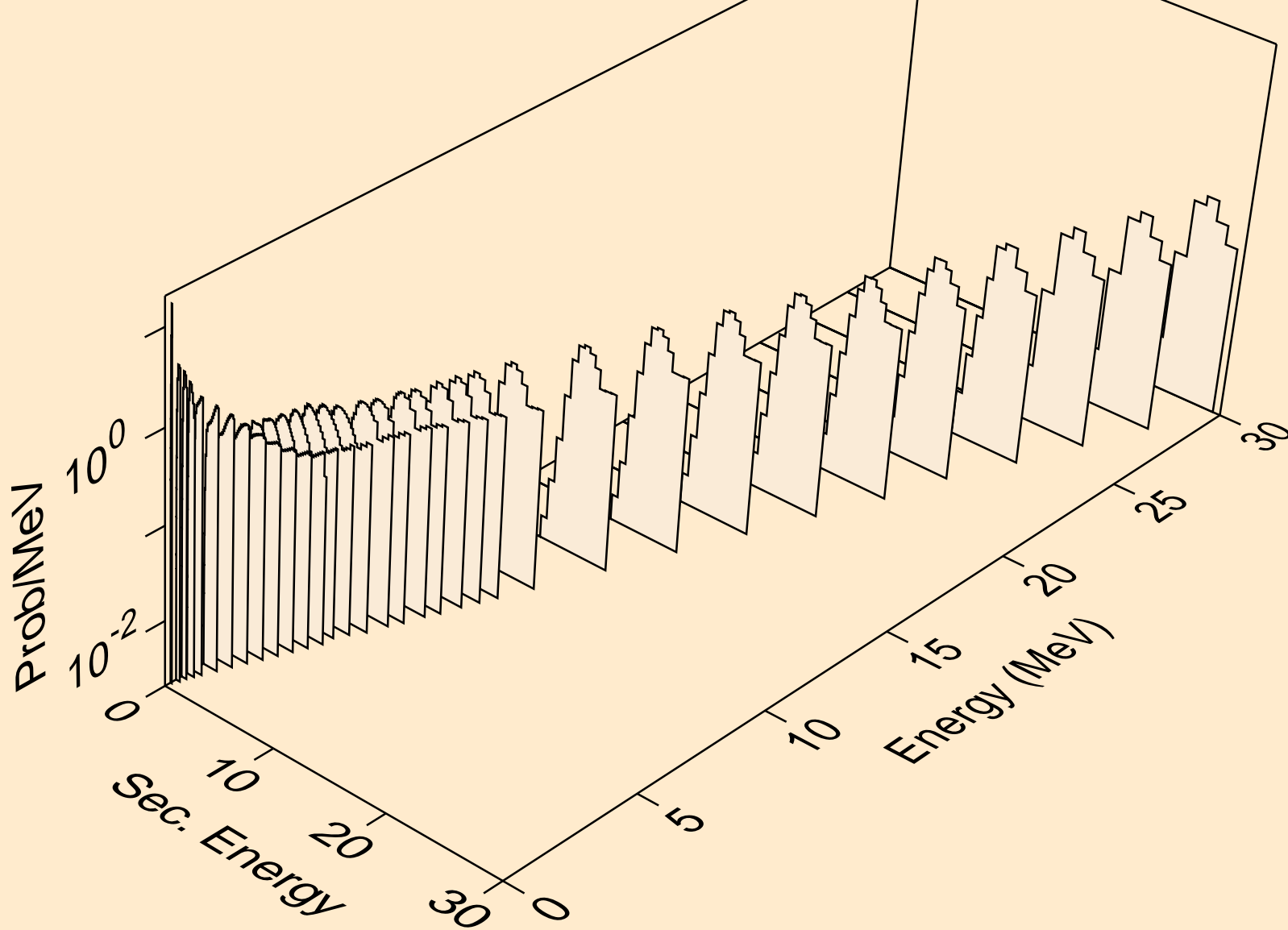

LR265 NEUTRON ACER TENDL-2019 LIBRARY; T=293.16K

Delayed nubar

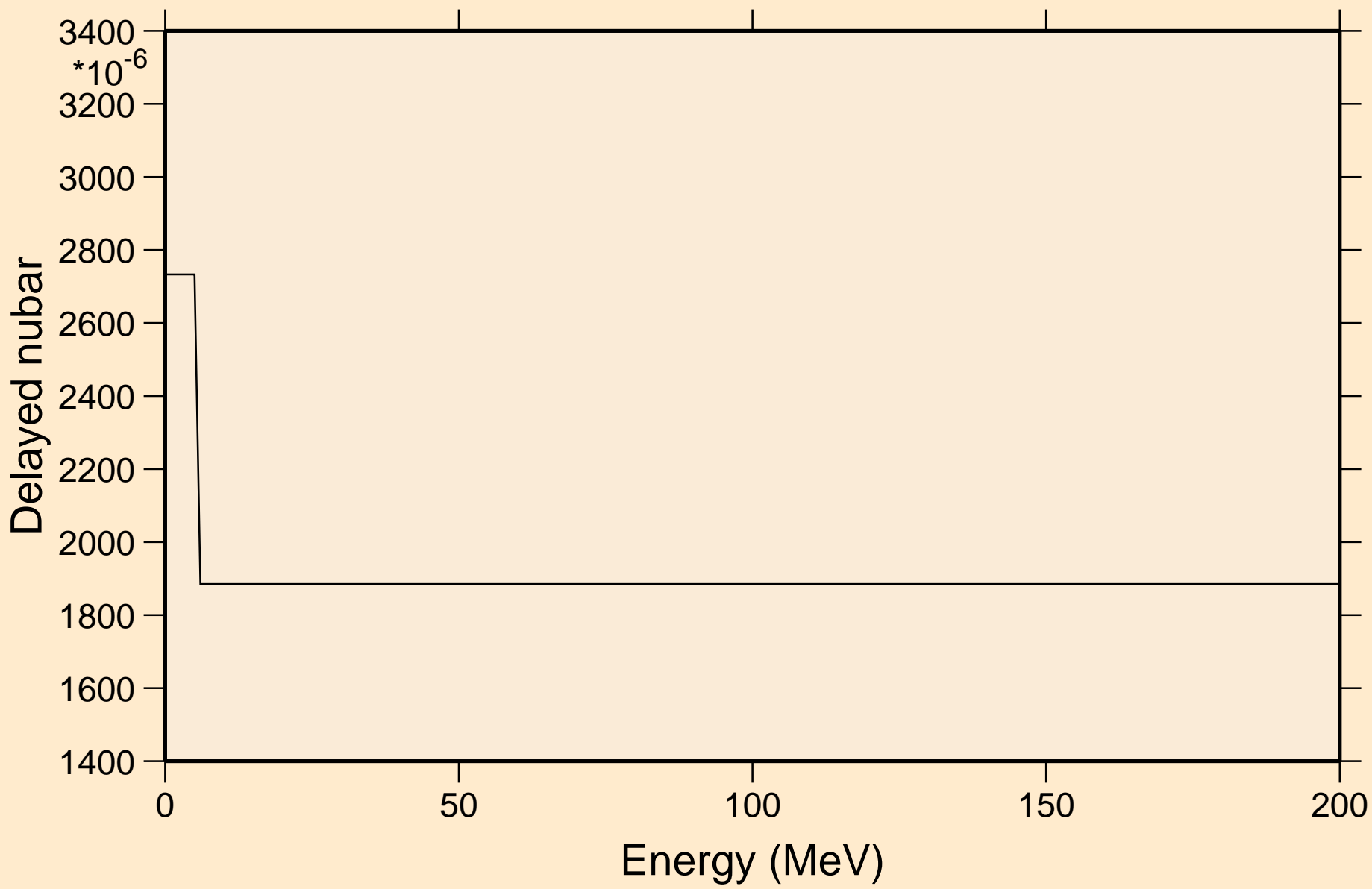

LR265 NEUTRON ACER TENDL-2019 LIBRARY; T=293.16K

Delayed neutron spectra

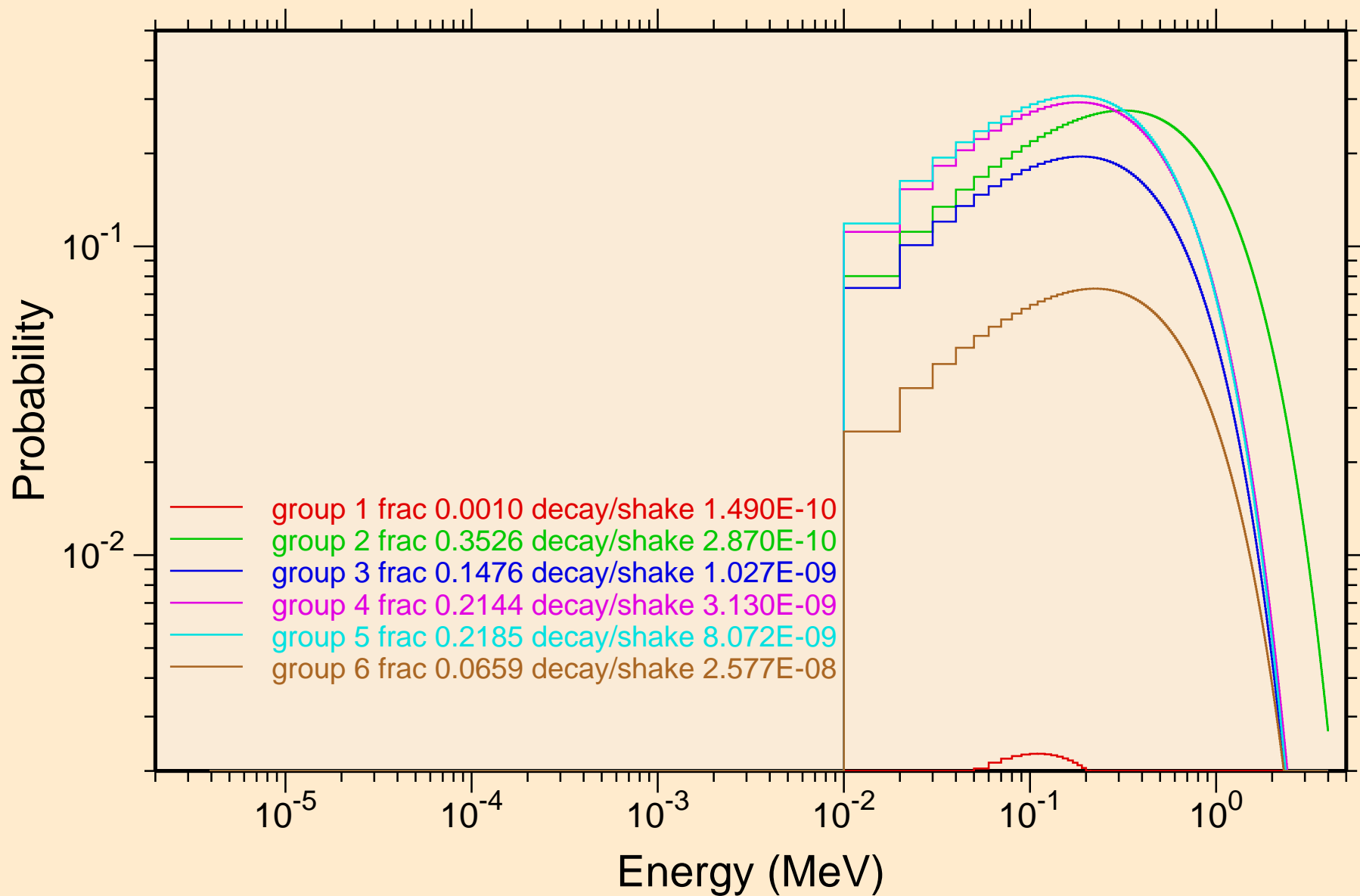

LR265 NEUTRON ACER TENDL-2019 LIBRARY; T=293.16K
Photon emission for (n,x)

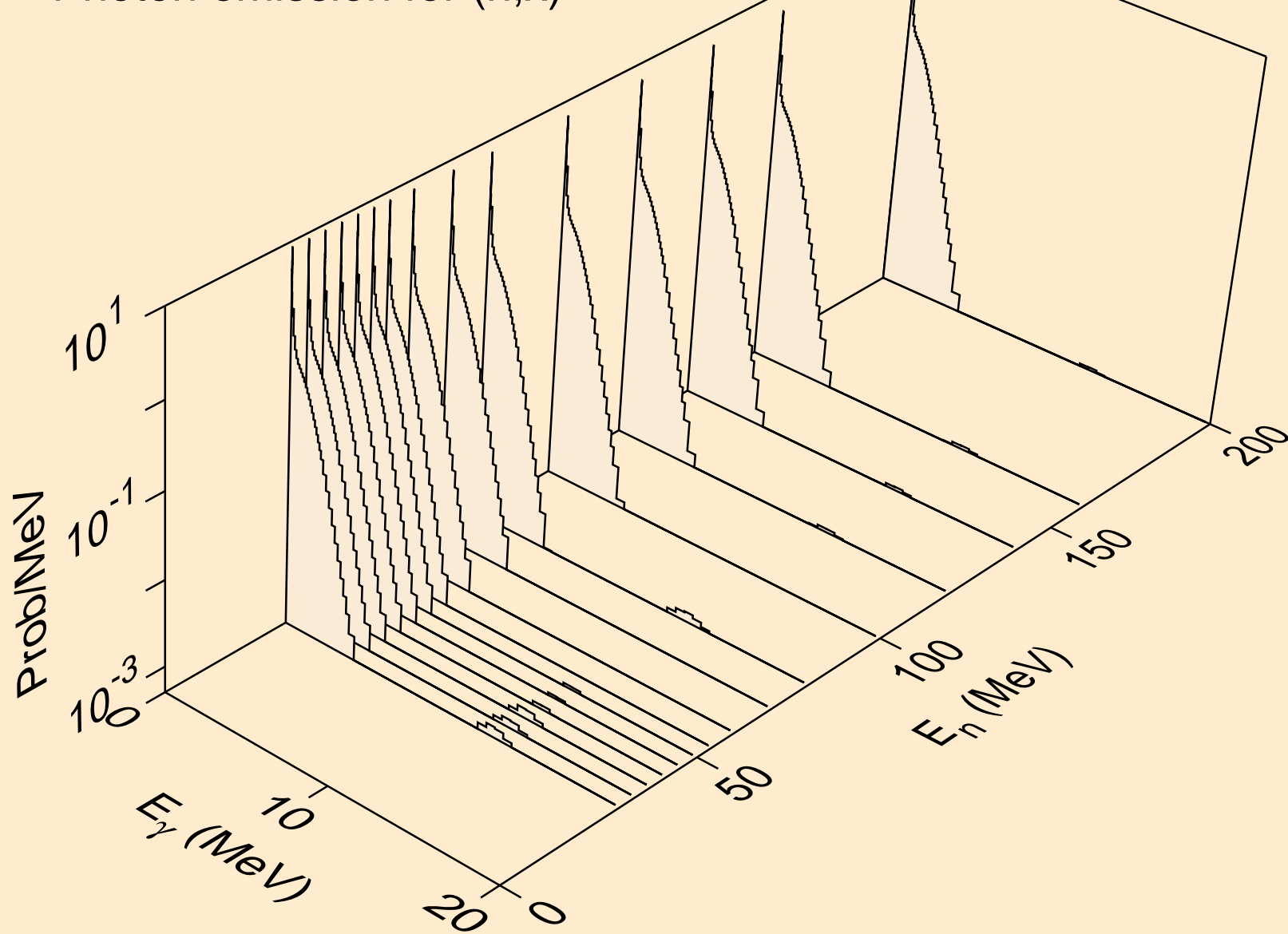

LR265 NEUTRON ACER TENDL-2019 LIBRARY; T=293.16K
Photon emission for (n,2nd)

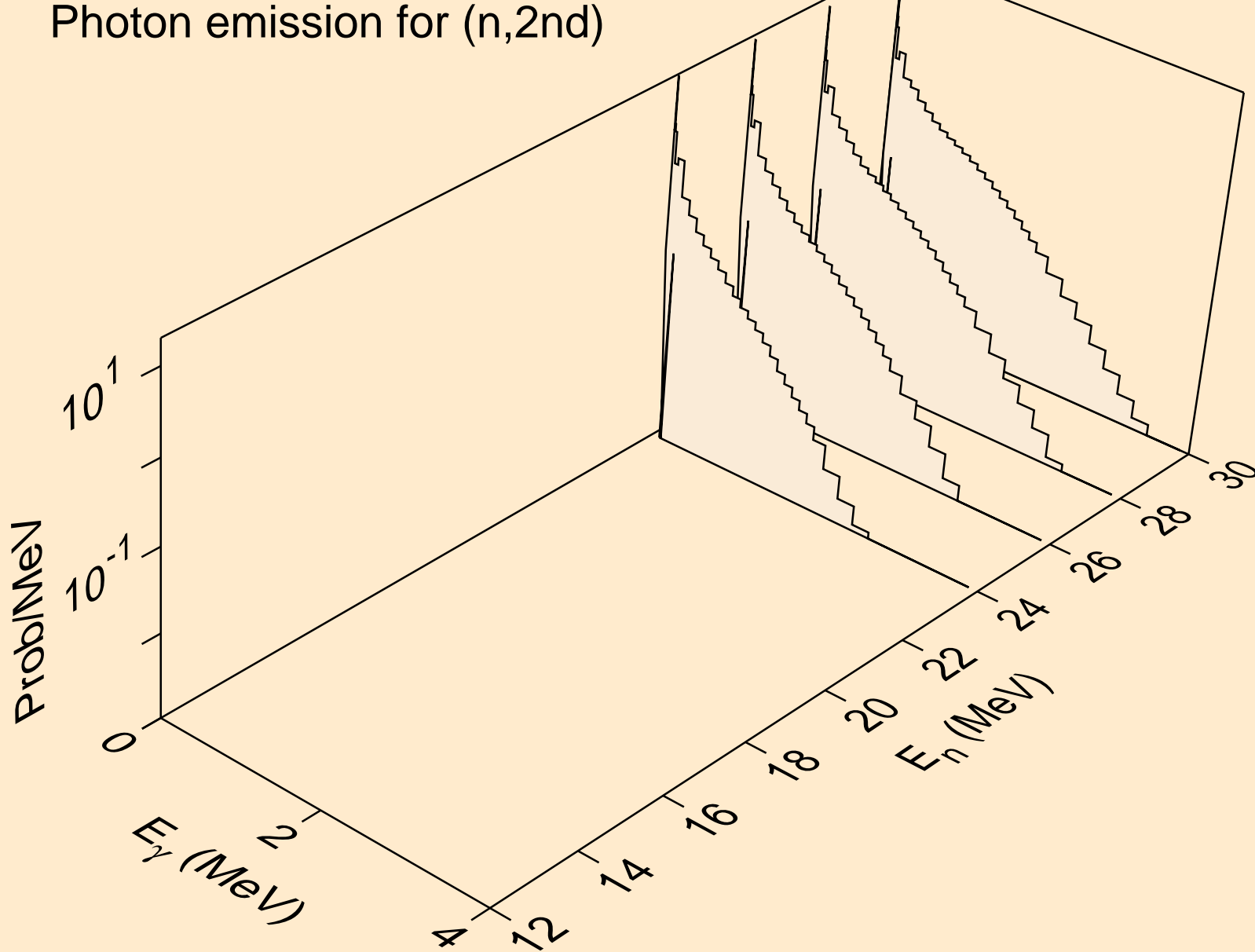

LR265 NEUTRON ACER TENDL-2019 LIBRARY; T=293.16K
Photon emission for (n,2n)

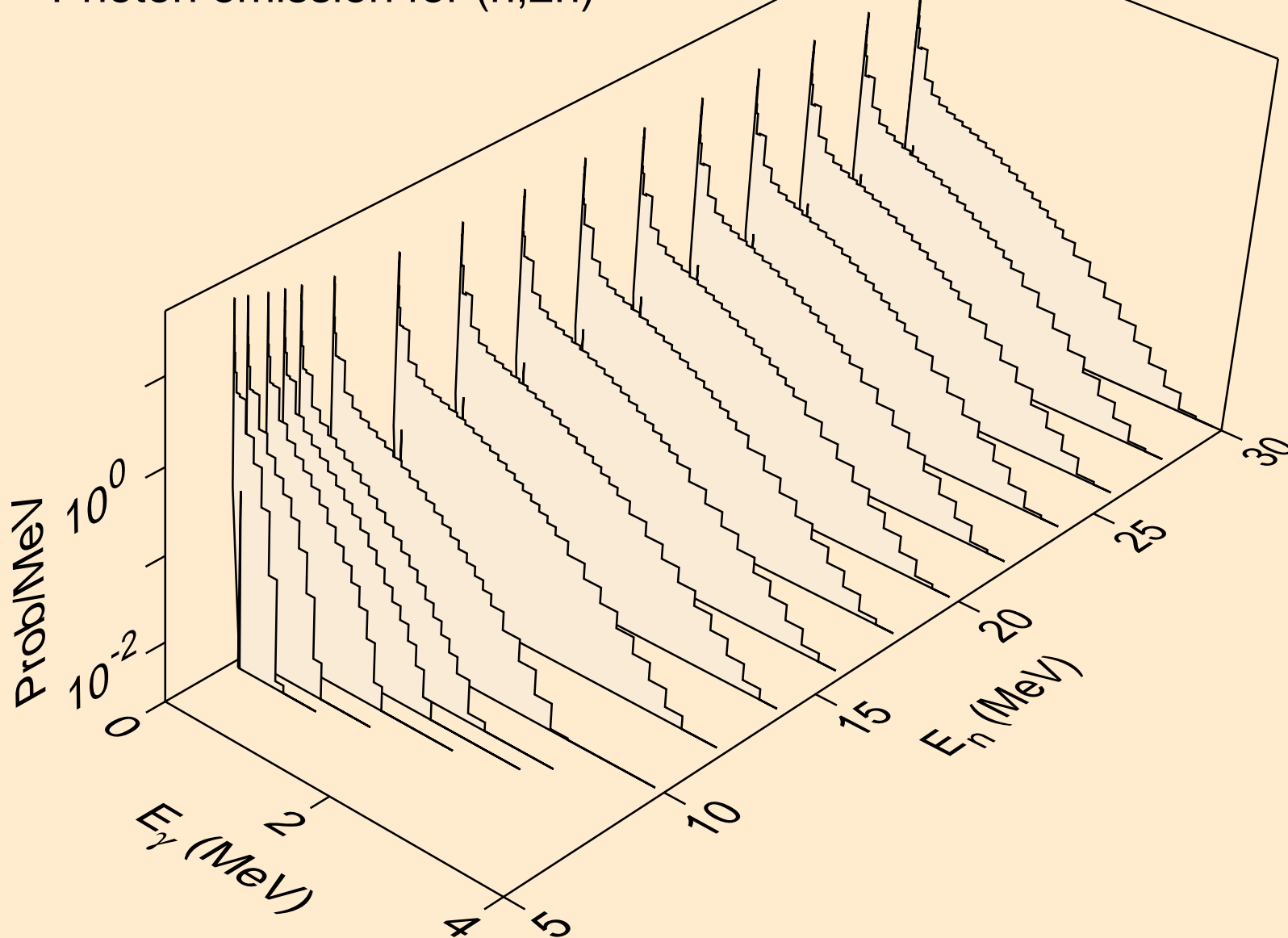

LR265 NEUTRON ACER TENDL-2019 LIBRARY; T=293.16K
Photon emission for (n,3n)

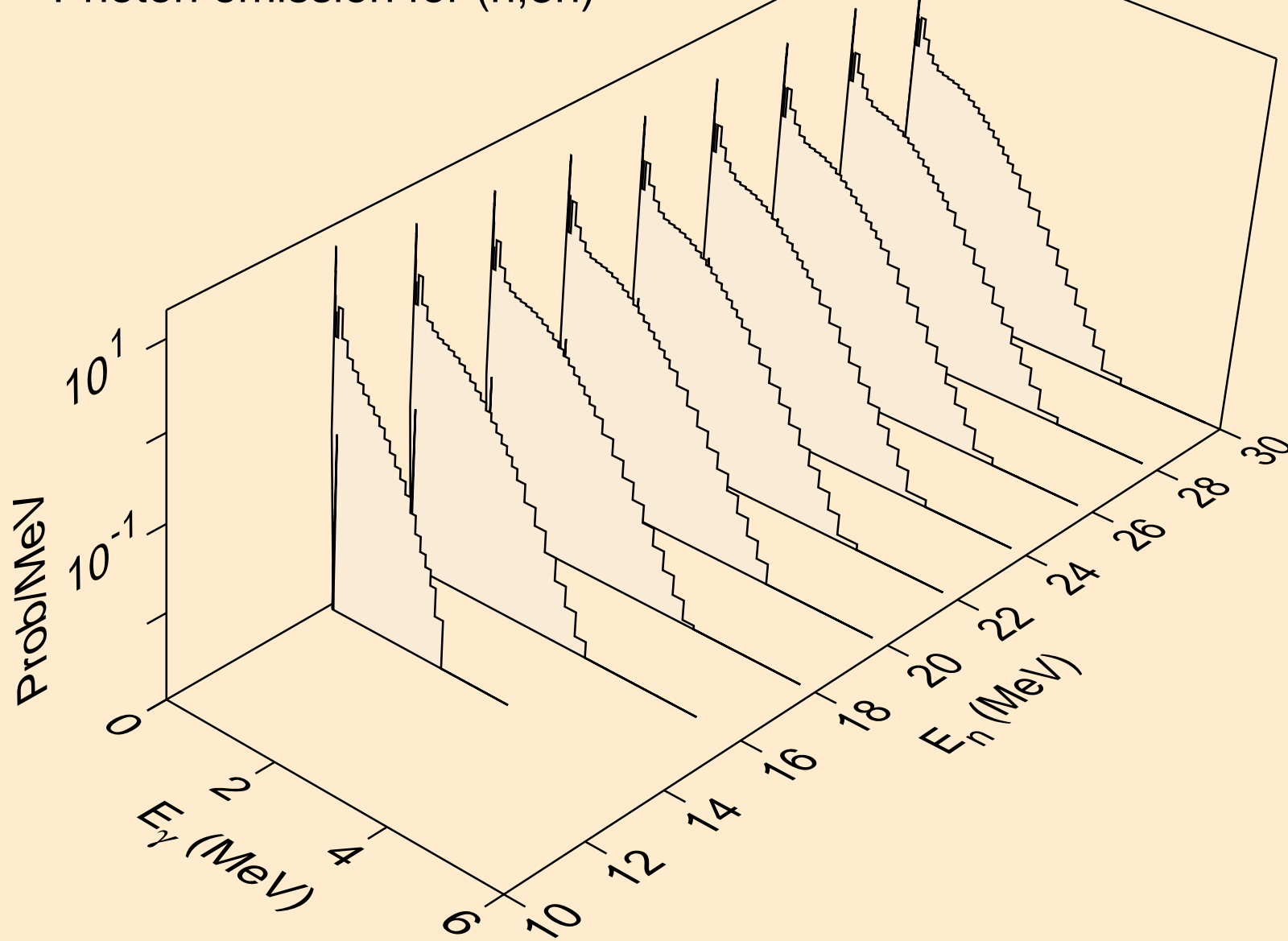

LR265 NEUTRON ACER TENDL-2019 LIBRARY; T=293.16K
Photon emission for (n,n*)a

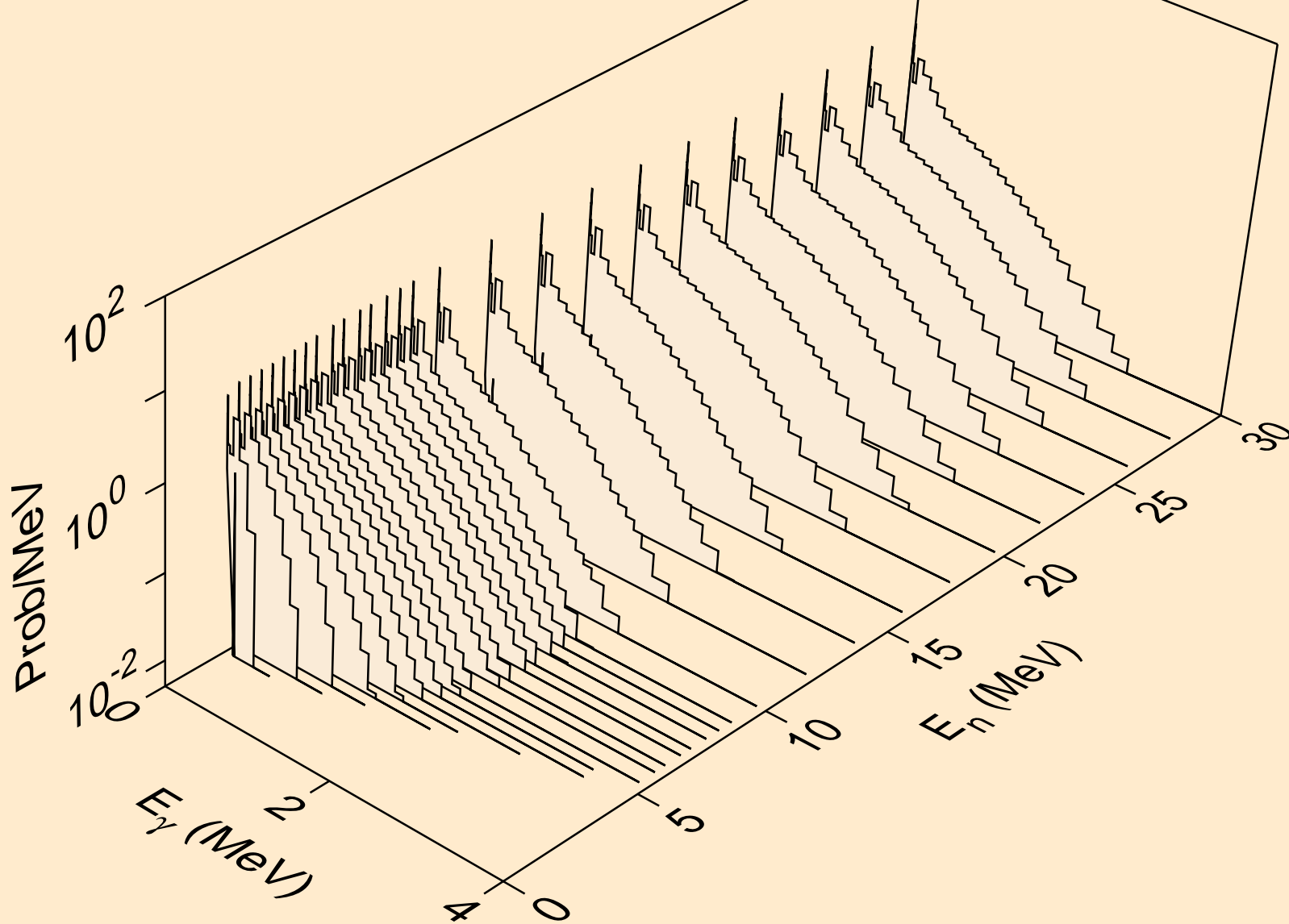

LR265 NEUTRON ACER TENDL-2019 LIBRARY; T=293.16K
Photon emission for (n,2n)a

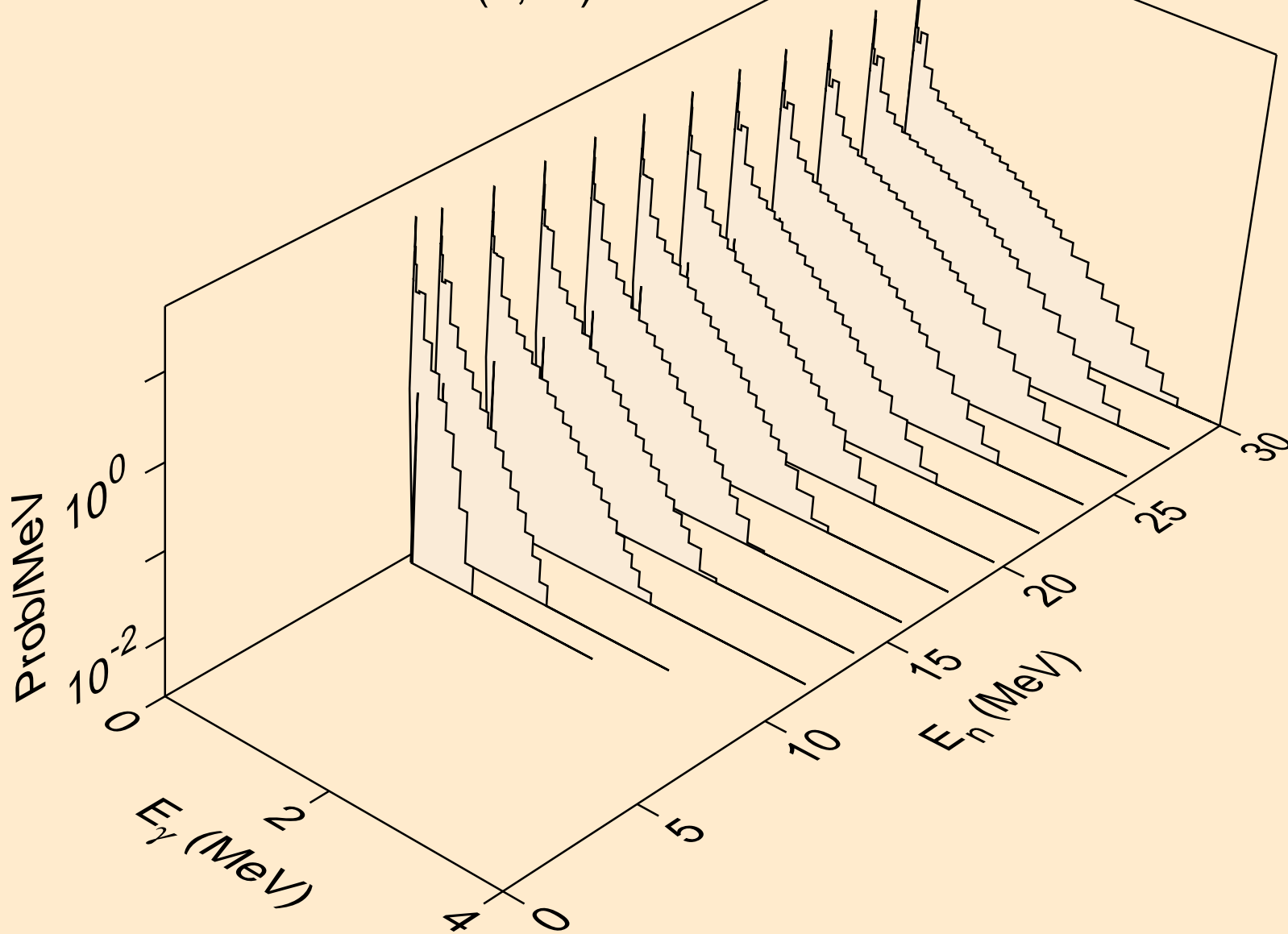

LR265 NEUTRON ACER TENDL-2019 LIBRARY; T=293.16K
Photon emission for (n,3n)a

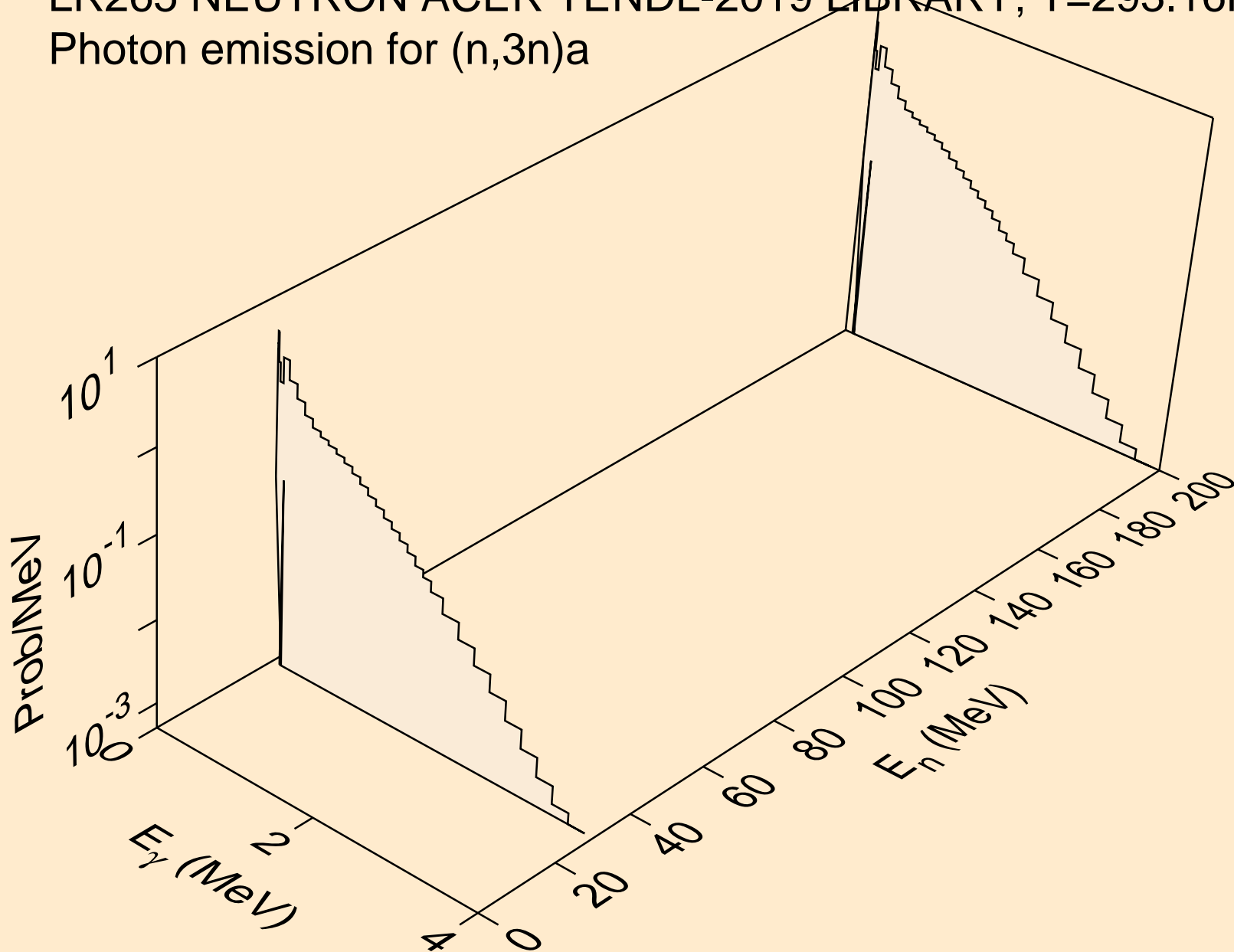

LR265 NEUTRON ACER TENDL-2019 LIBRARY; T=293.16K
Photon emission for (n,n*)p

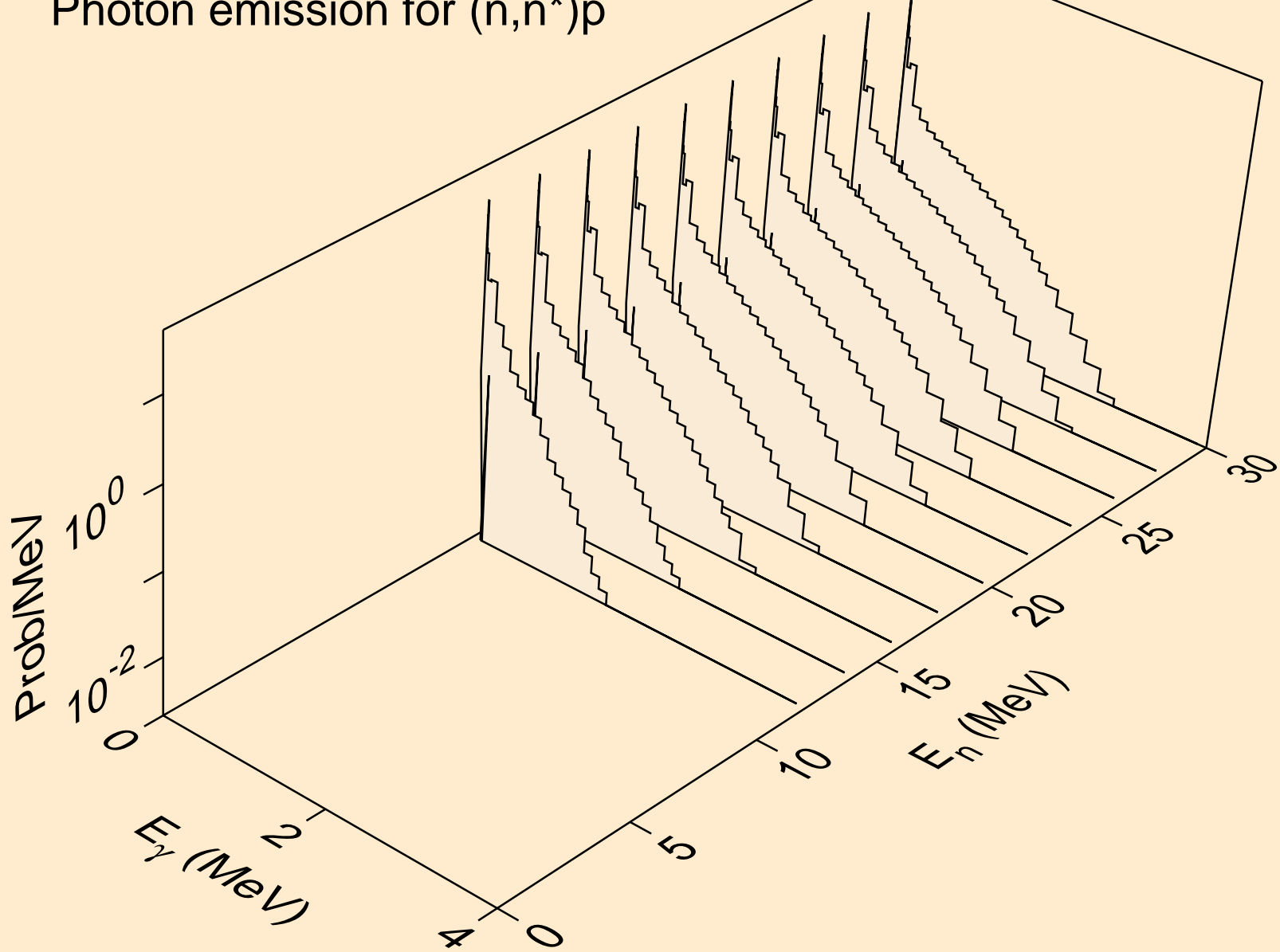

LR265 NEUTRON ACER TENDL-2019 LIBRARY; T=293.16K
Photon emission for (n,n*)d

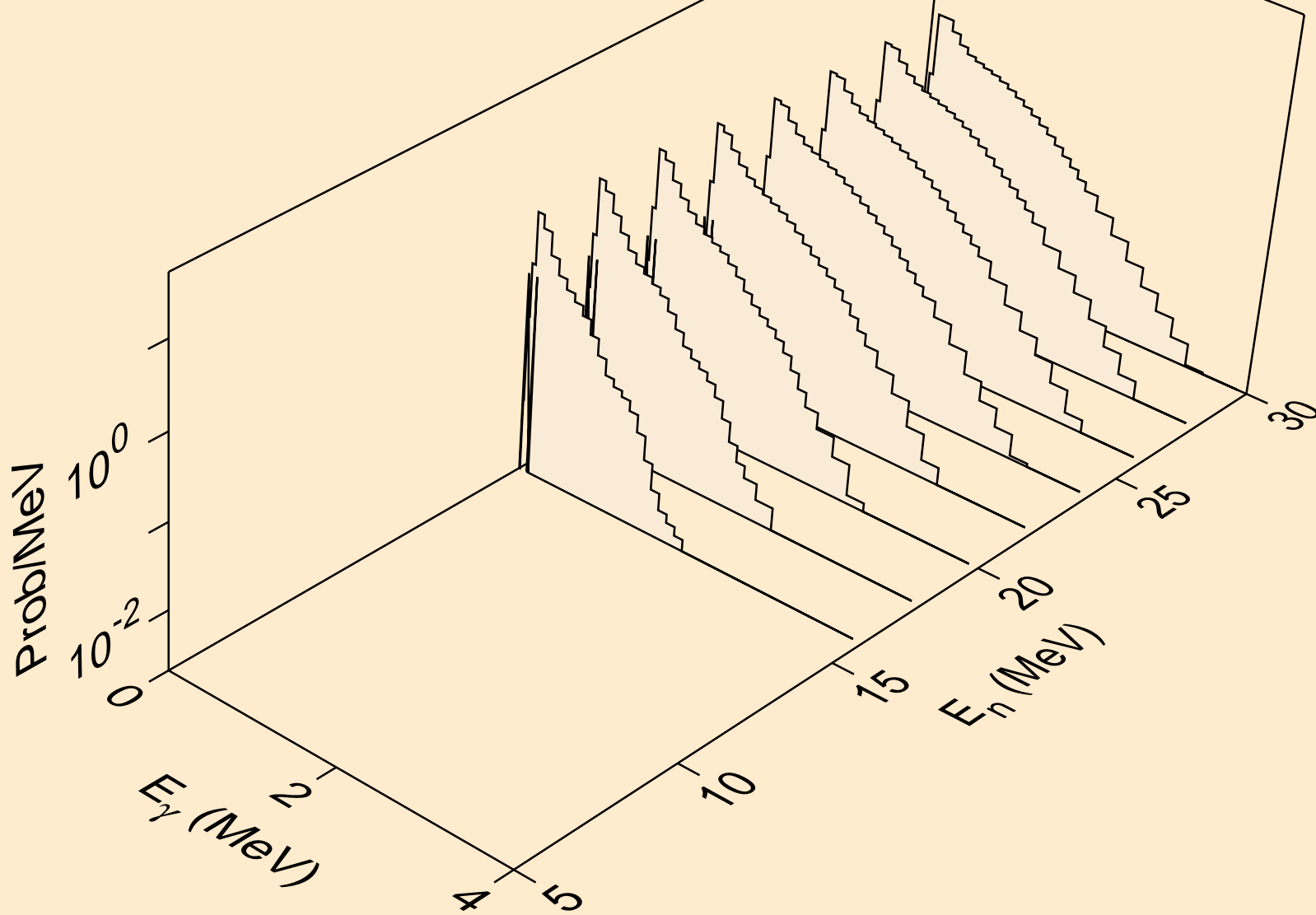

LR265 NEUTRON ACER TENDL-2019 LIBRARY; T=293.16K
Photon emission for (n,n*)t

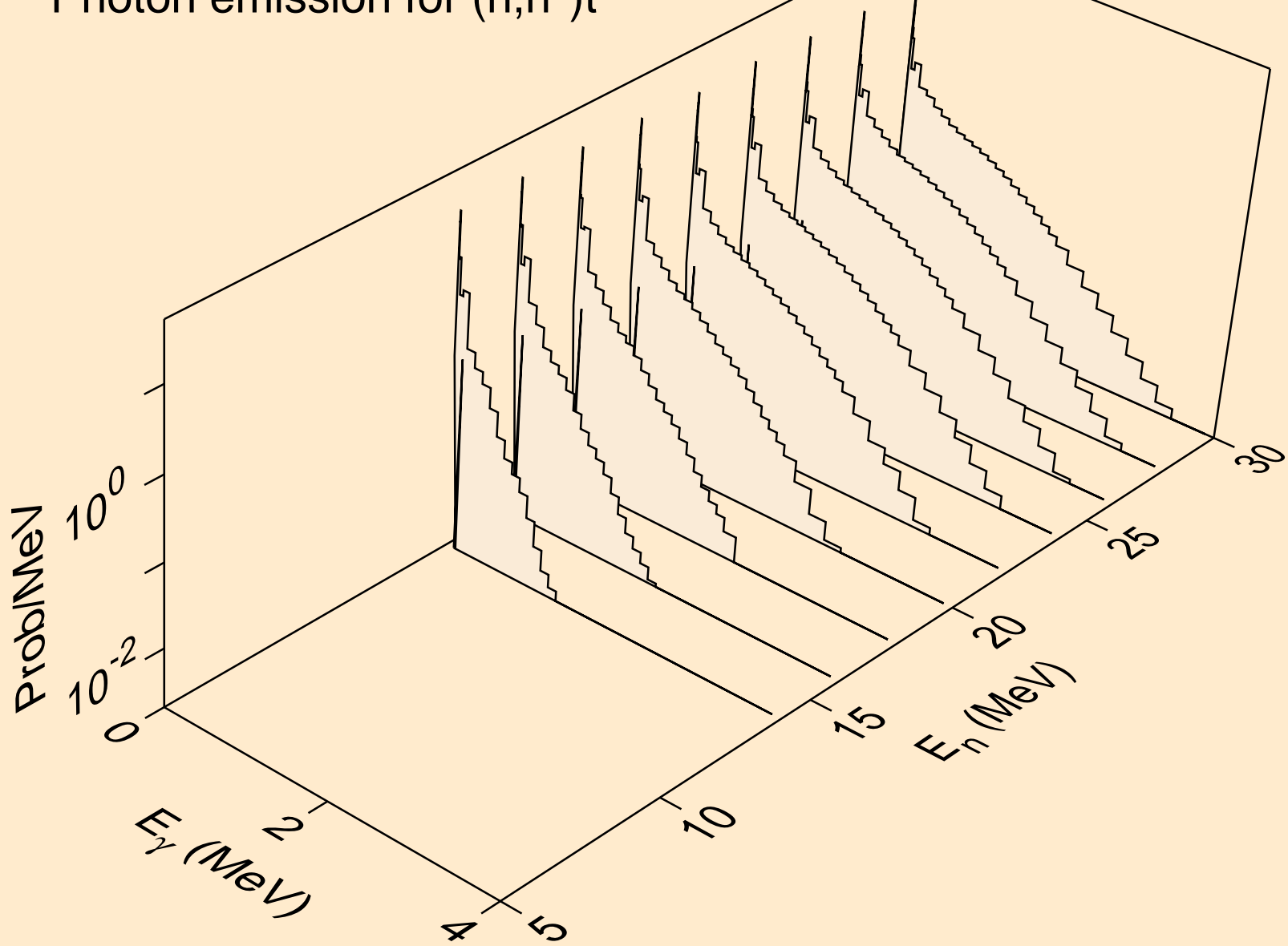

LR265 NEUTRON ACER TENDL-2019 LIBRARY; T=293.16K
Photon emission for (n,n*)he3

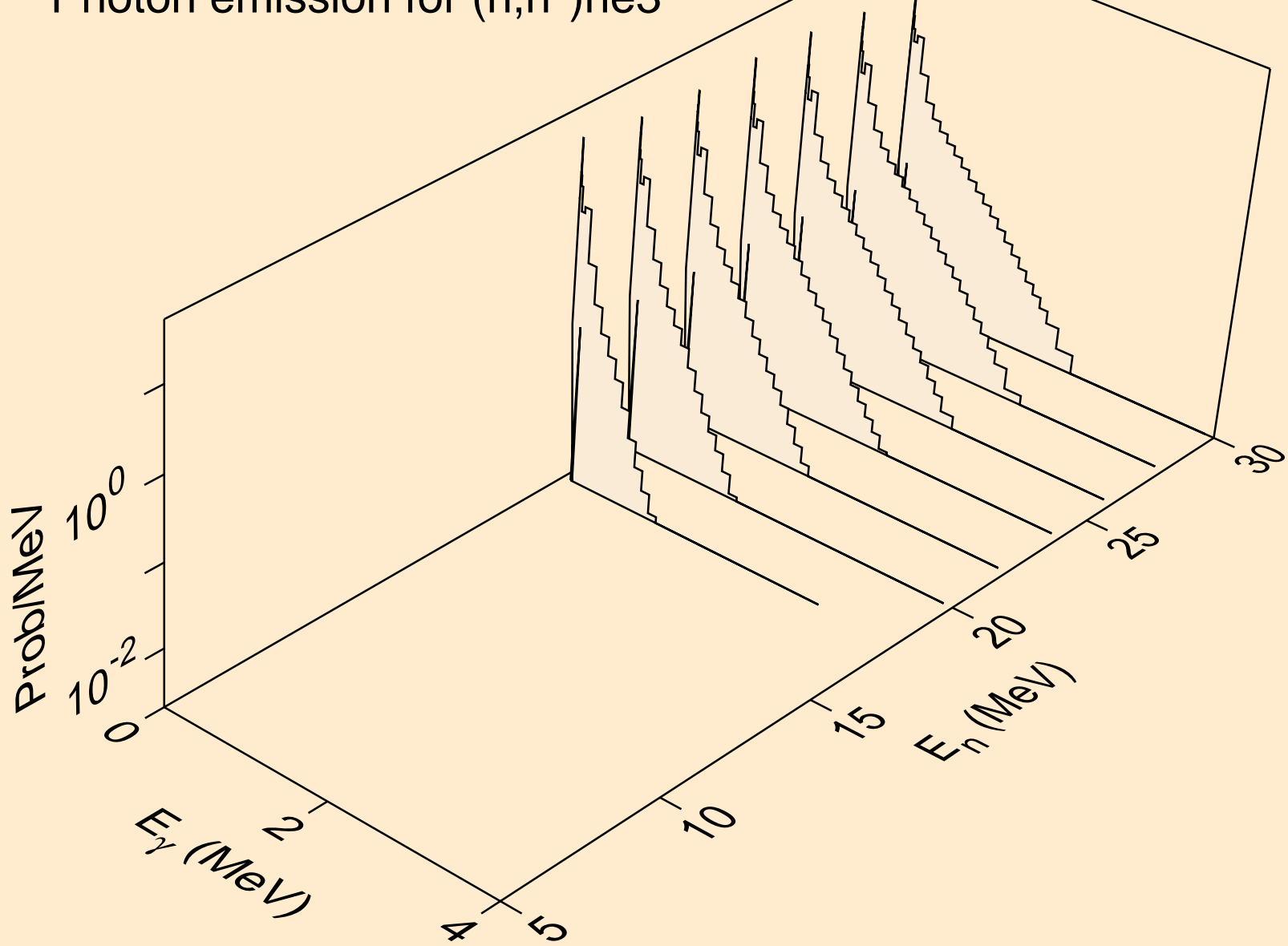

LR265 NEUTRON ACER TENDL-2019 LIBRARY; T=293.16K
Photon emission for (n,4n)

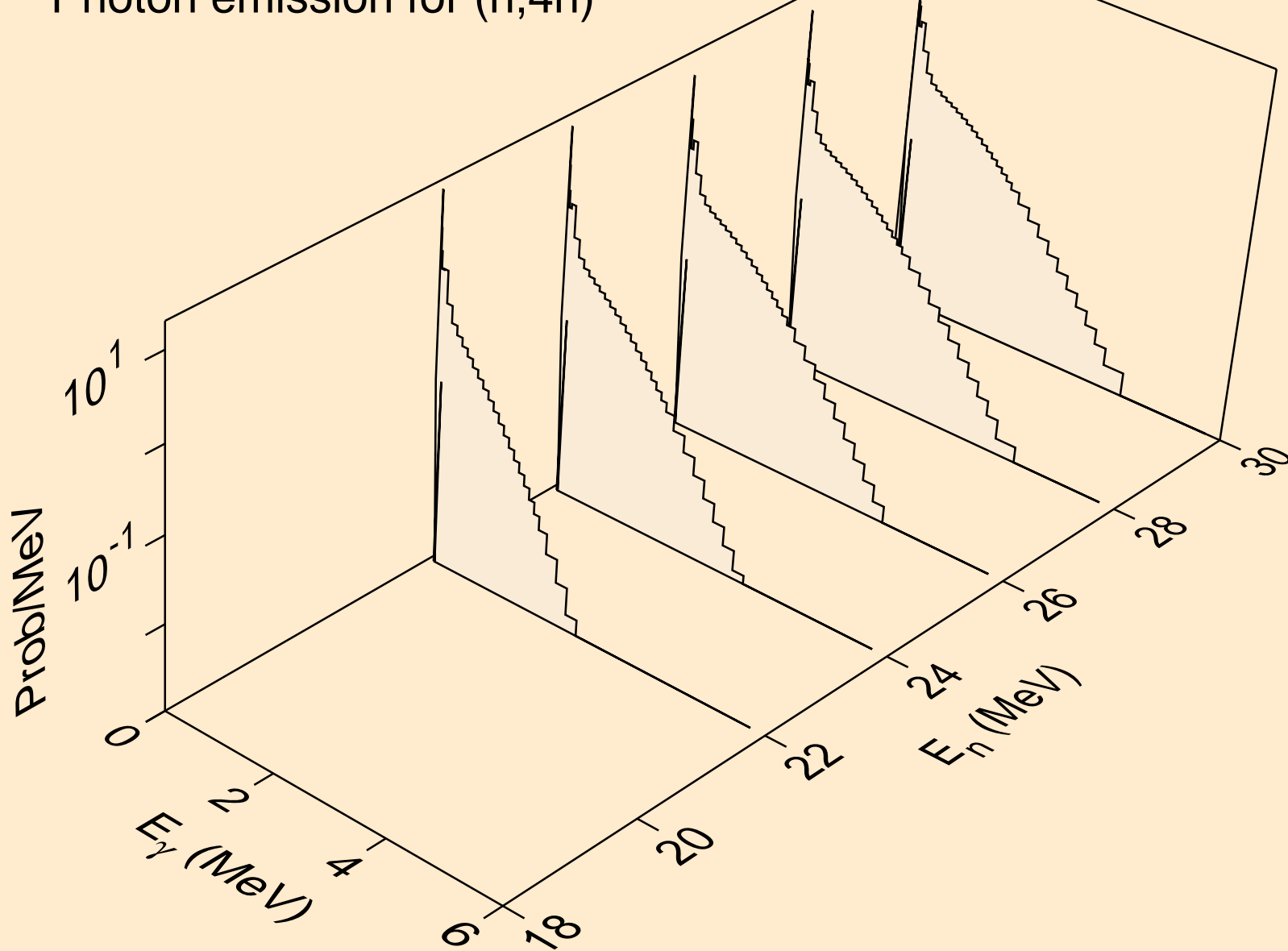

LR265 NEUTRON ACER TENDL-2019 LIBRARY; T=293.16K
Photon emission for (n,2np)

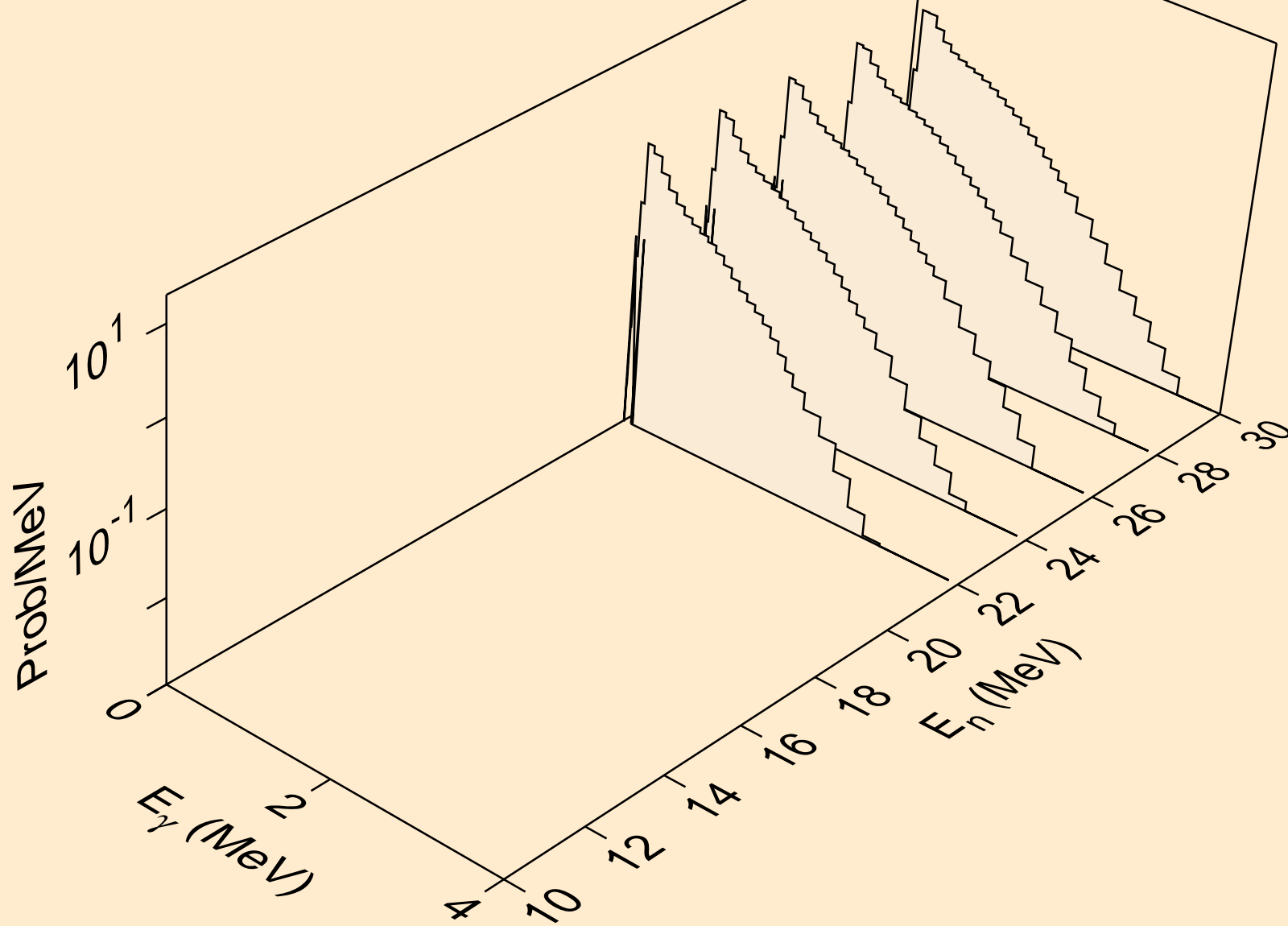

LR265 NEUTRON ACER TENDL-2019 LIBRARY; T=293.16K
Photon emission for (n,3np)

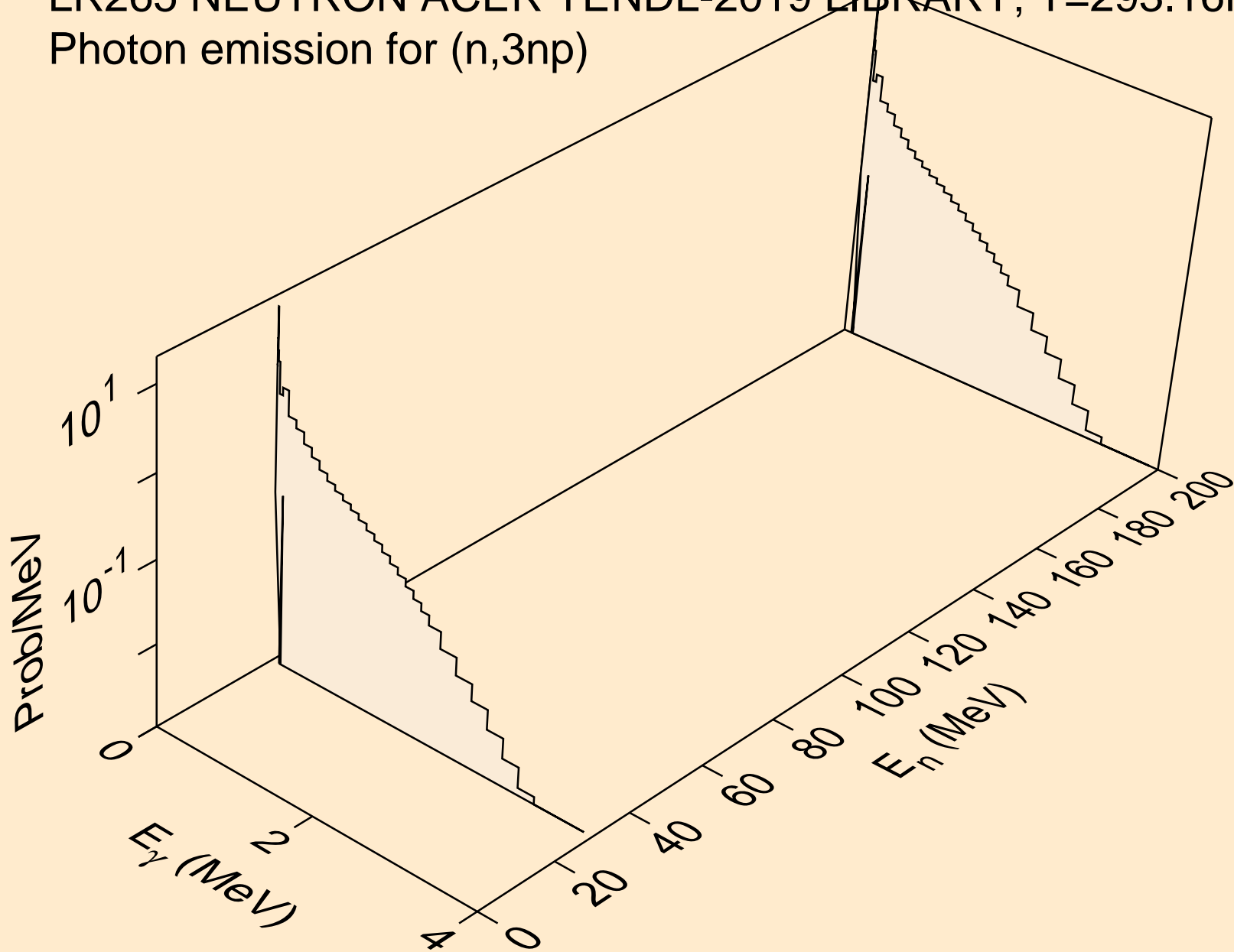

LR265 NEUTRON ACER TENDL-2019 LIBRARY; T=293.16K
Photon emission for (n,n*c)

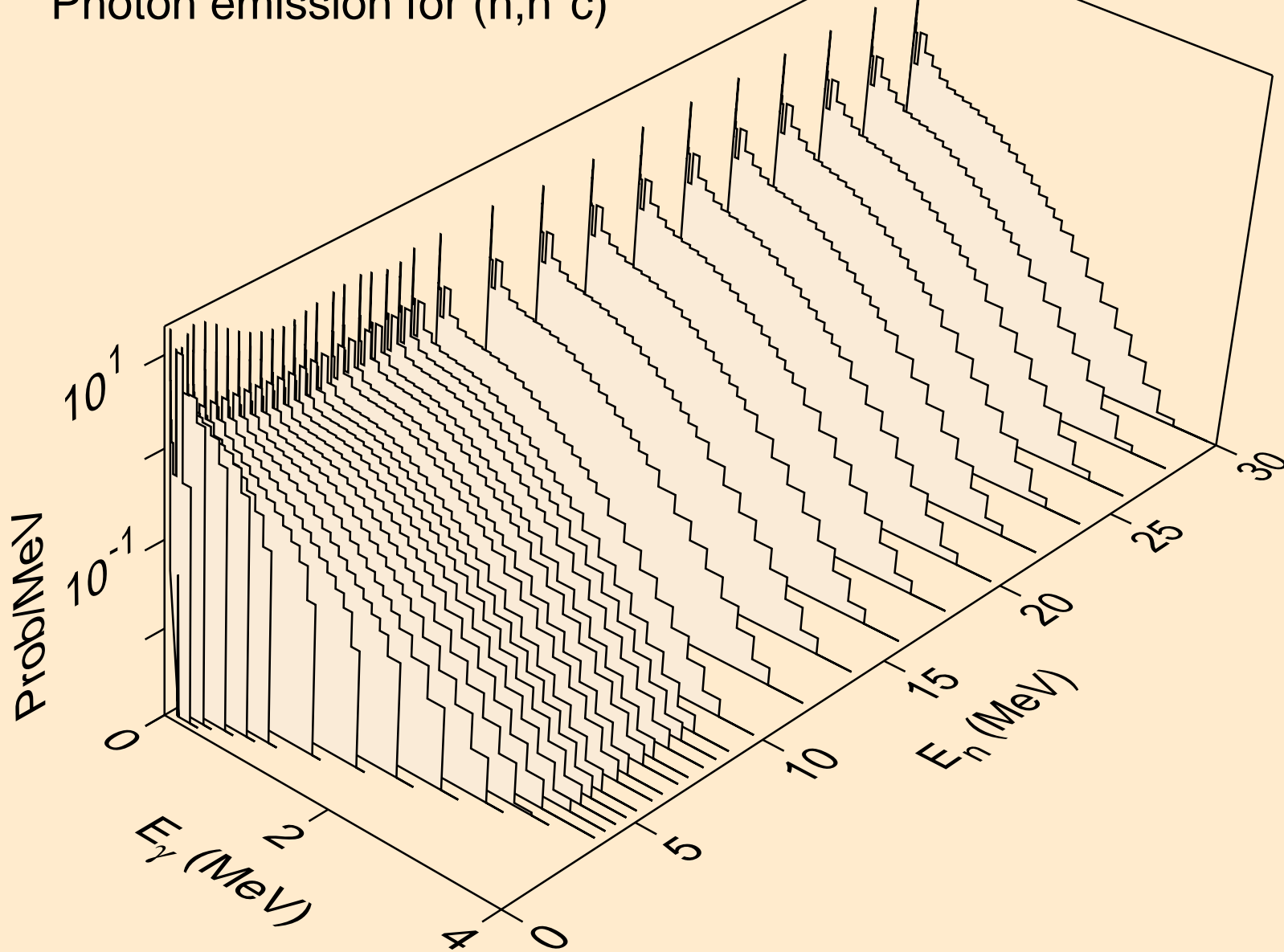

LR265 NEUTRON ACER TENDL-2019 LIBRARY; T=293.16K
Photon emission for (n,gma)

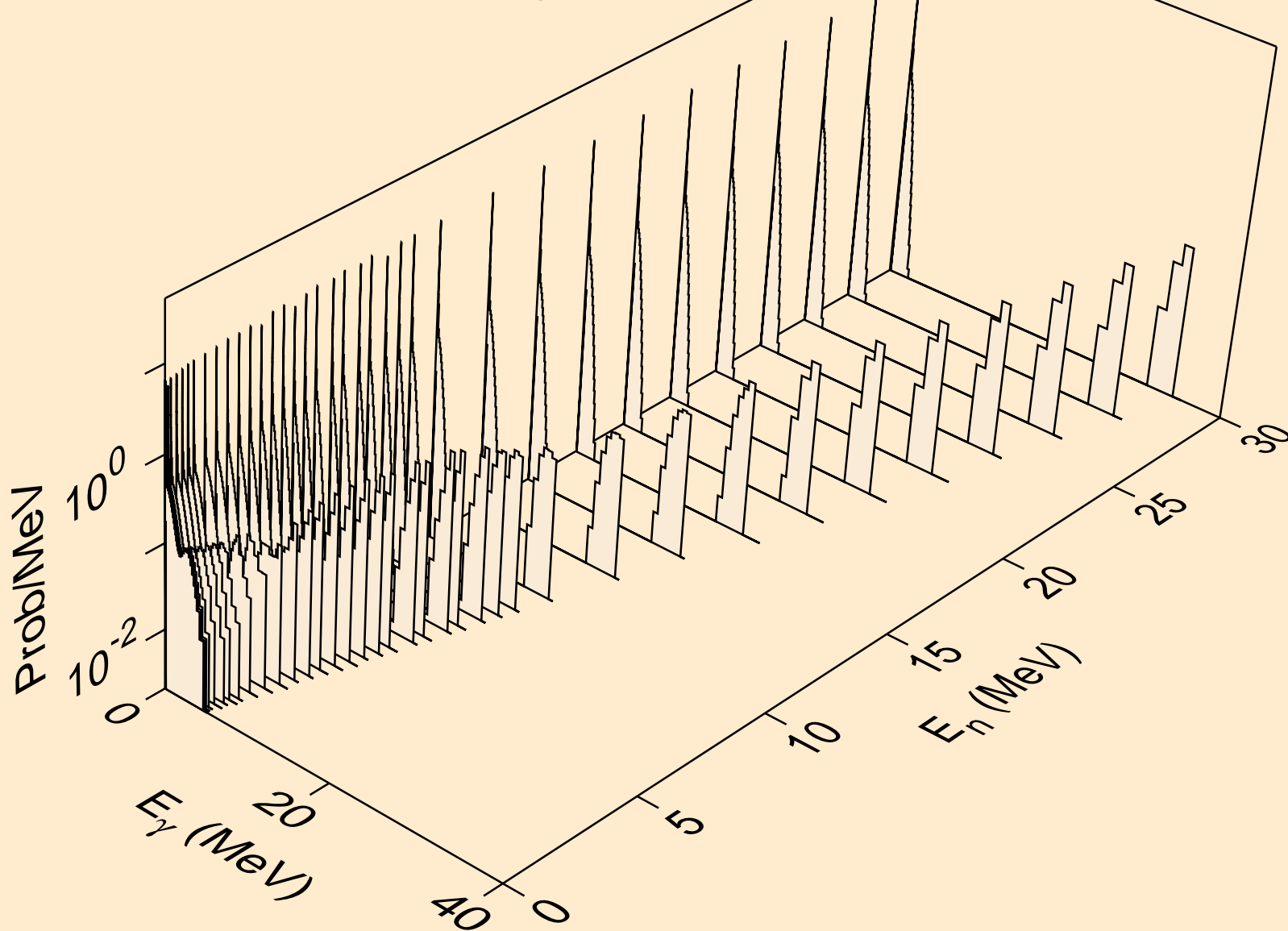

LR265 NEUTRON ACER TENDL-2019 LIBRARY; T=293.16K
Photon emission for (n,p)

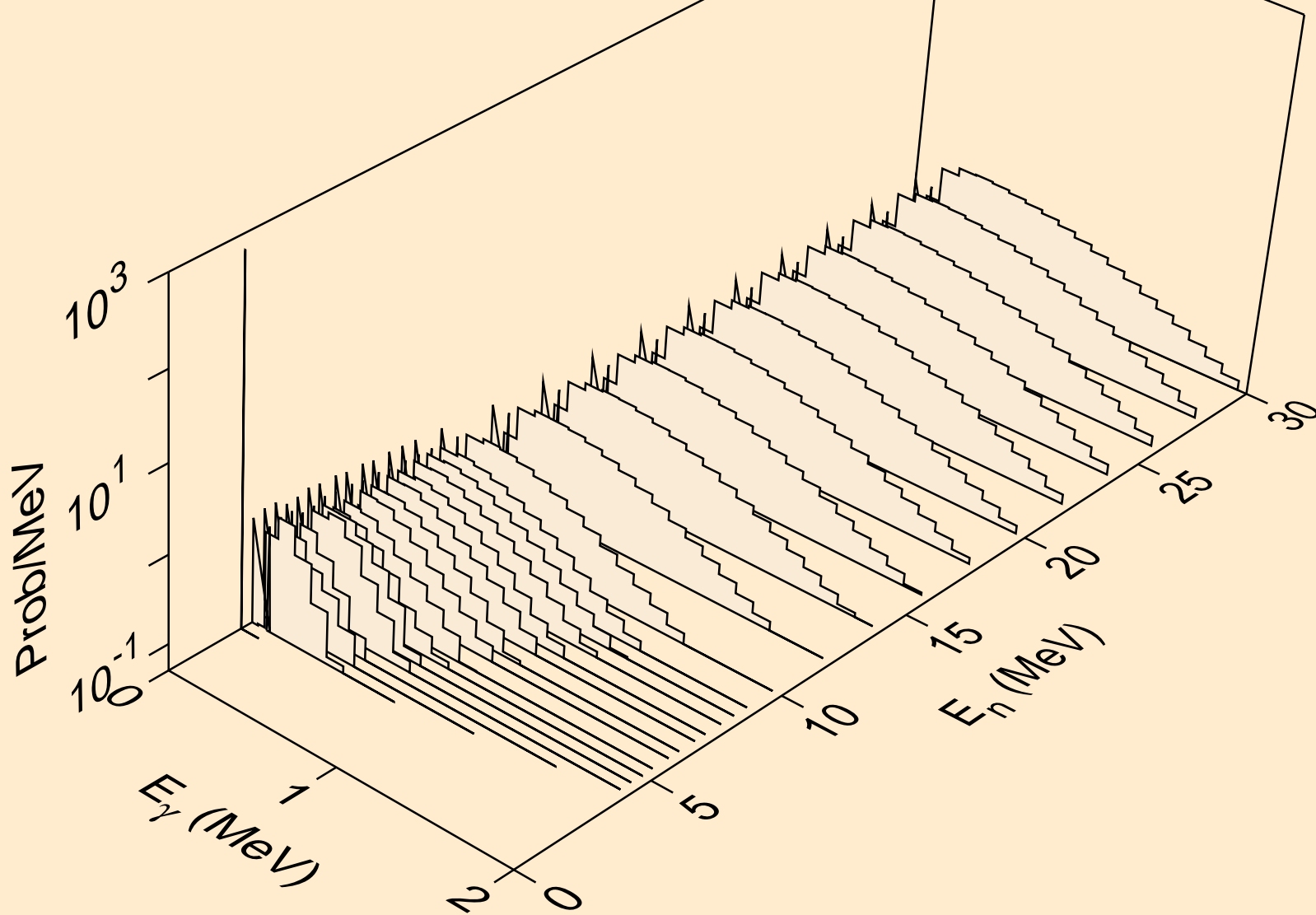

LR265 NEUTRON ACER TENDL-2019 LIBRARY; T=293.16K
Photon emission for (n,d)

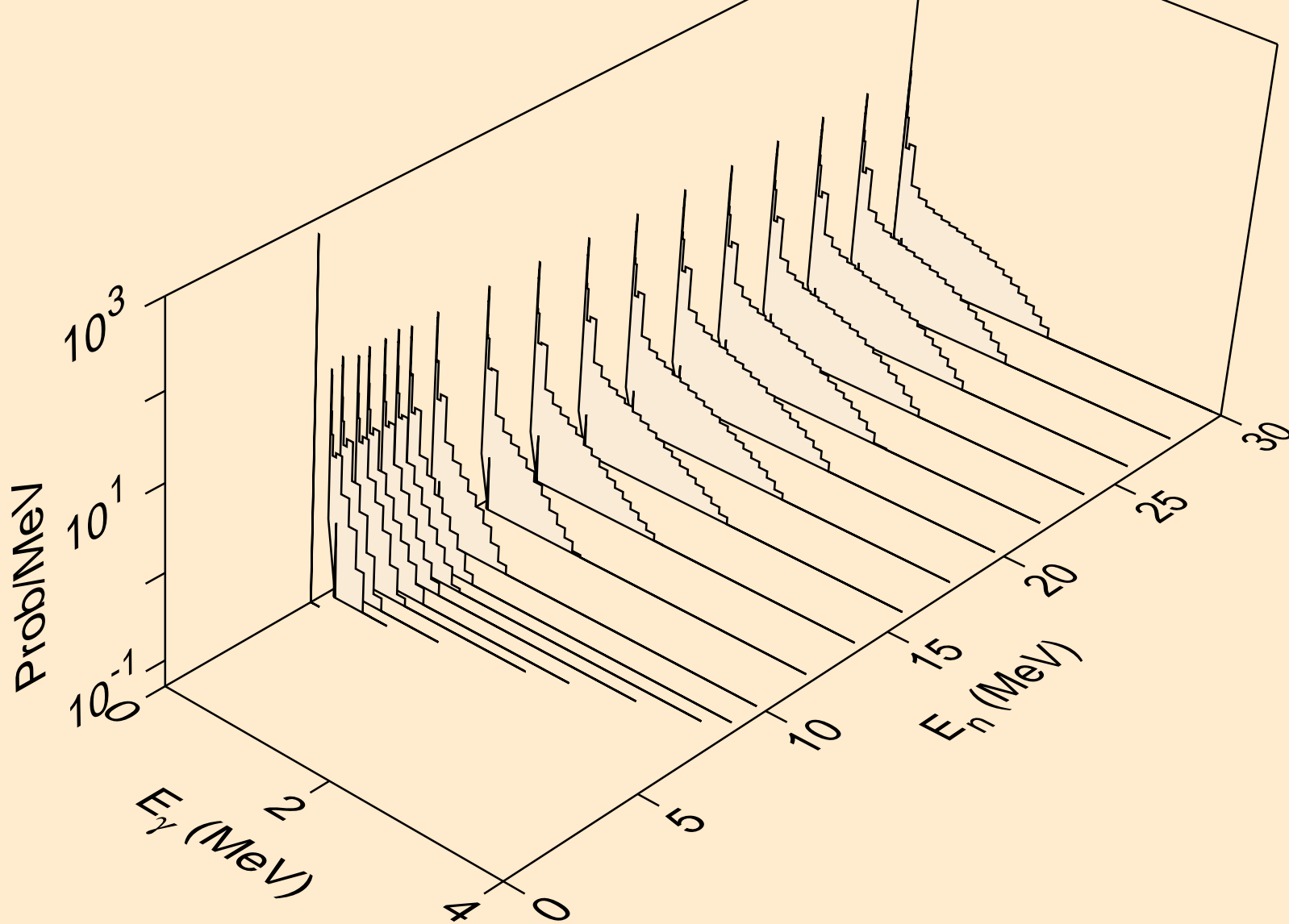

LR265 NEUTRON ACER TENDL-2019 LIBRARY; T=293.16K
Photon emission for (n,t)

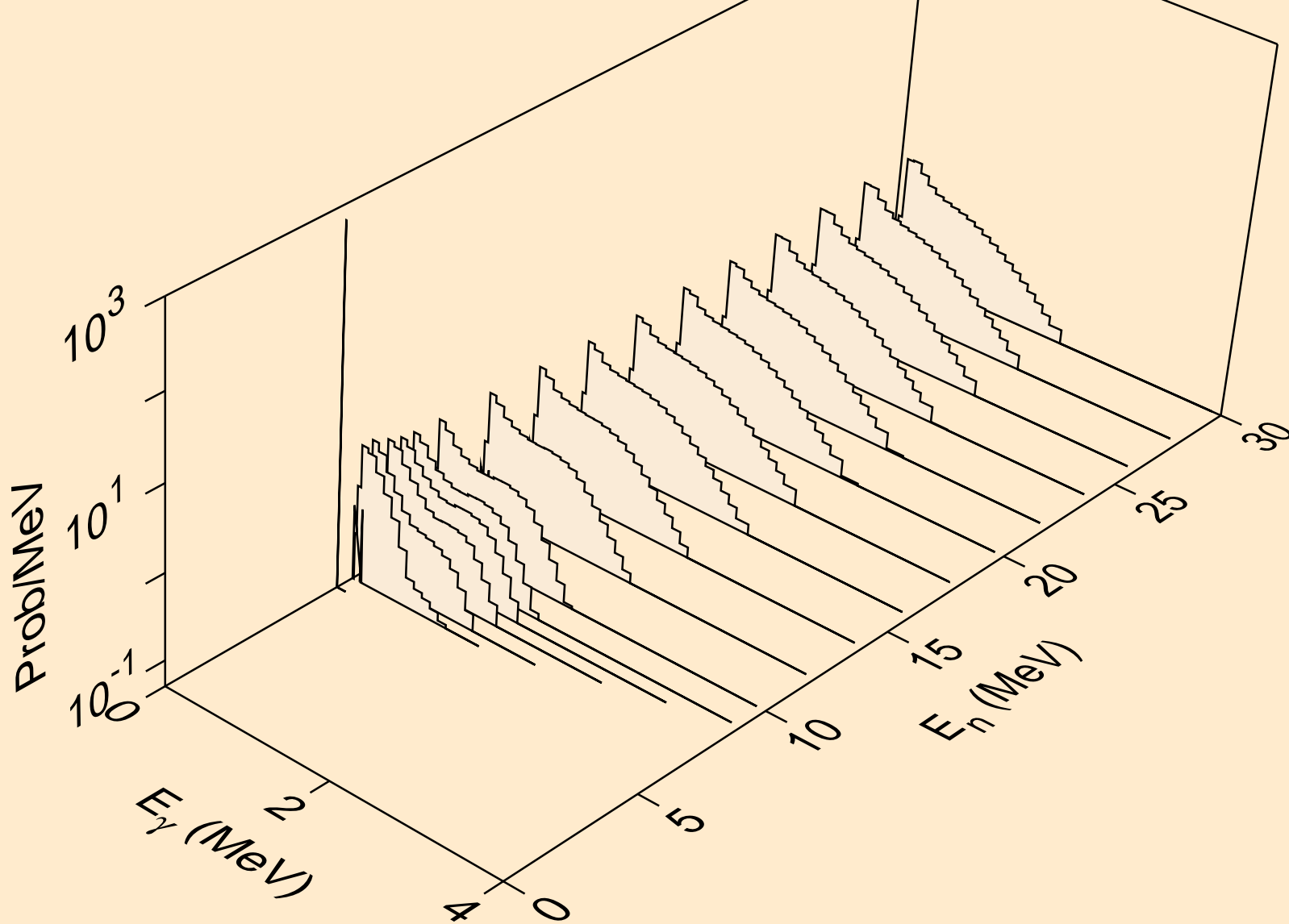

LR265 NEUTRON ACER TENDL-2019 LIBRARY; T=293.16K
Photon emission for (n,he3)

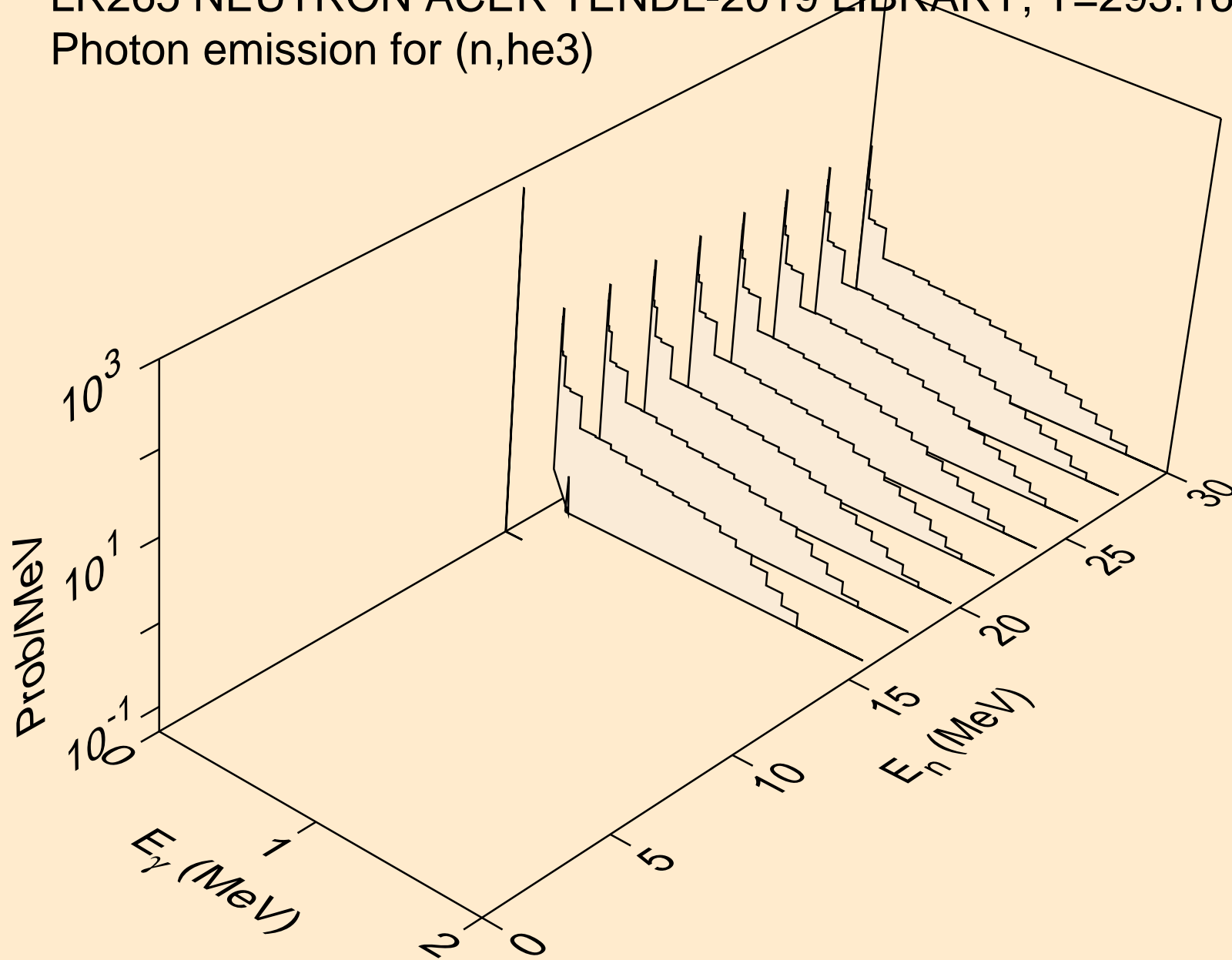

LR265 NEUTRON ACER TENDL-2019 LIBRARY; T=293.16K
Photon emission for (n,a)

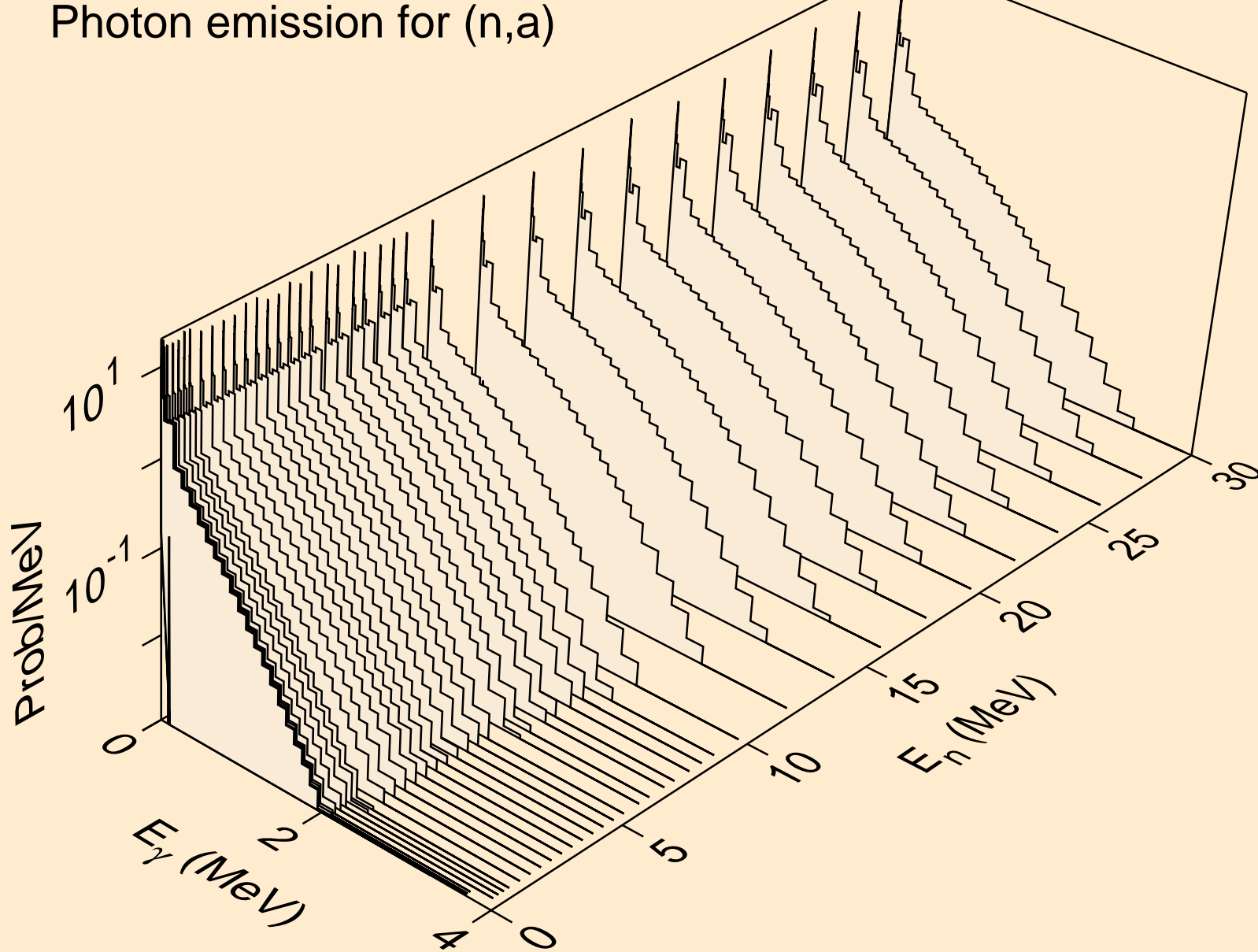

LR265 NEUTRON ACER TENDL-2019 LIBRARY; T=293.16K
Photon emission for (n,2p)

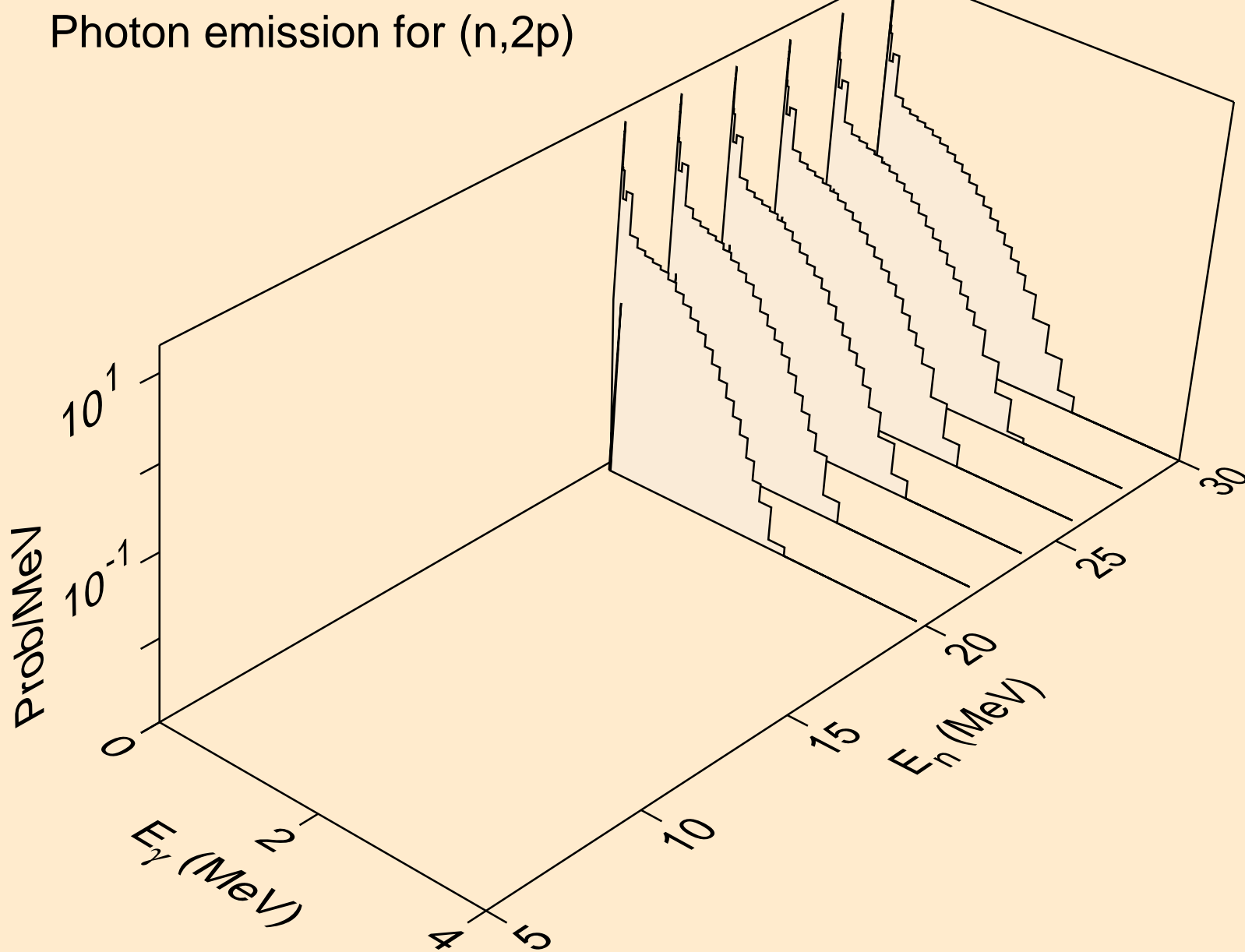

LR265 NEUTRON ACER TENDL-2019 LIBRARY; T=293.16K
thermal capture photon spectrum

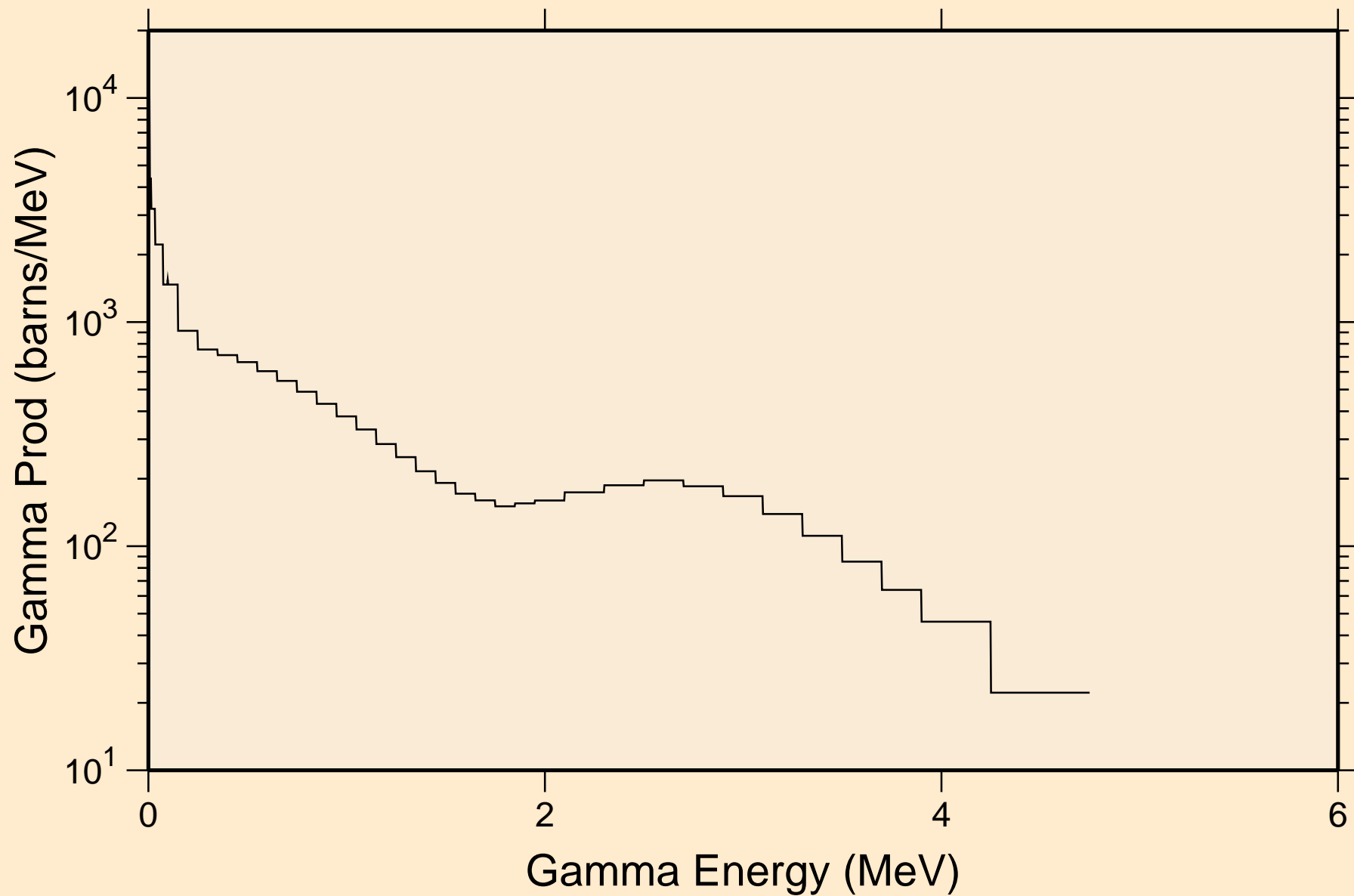

LR265 NEUTRON ACER TENDL-2019 LIBRARY; T=293.16K
14 MeV photon spectrum

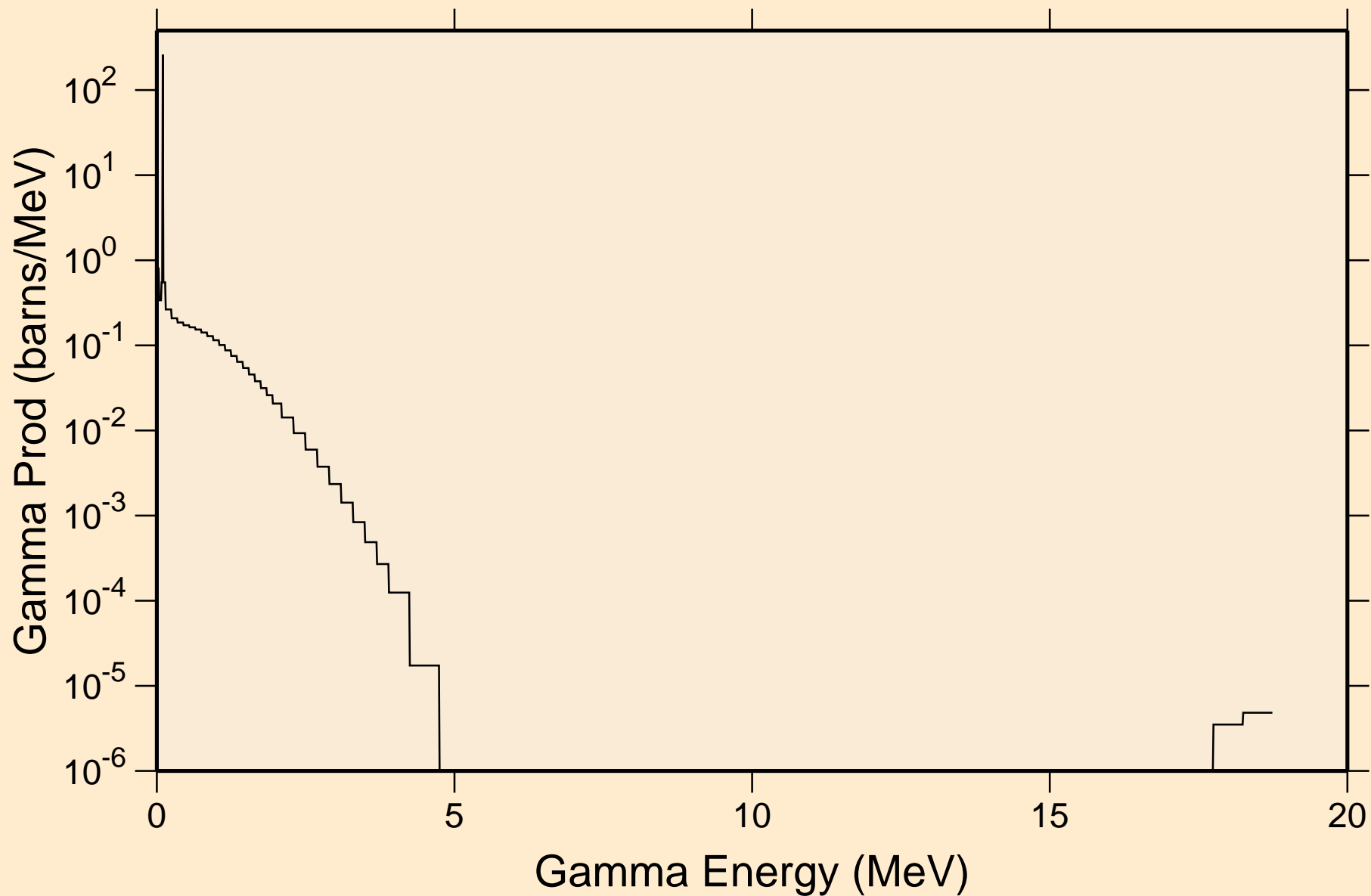

LR265 NEUTRON ACER TENDL-2019 LIBRARY; T=293.16K
Particle heating contributions

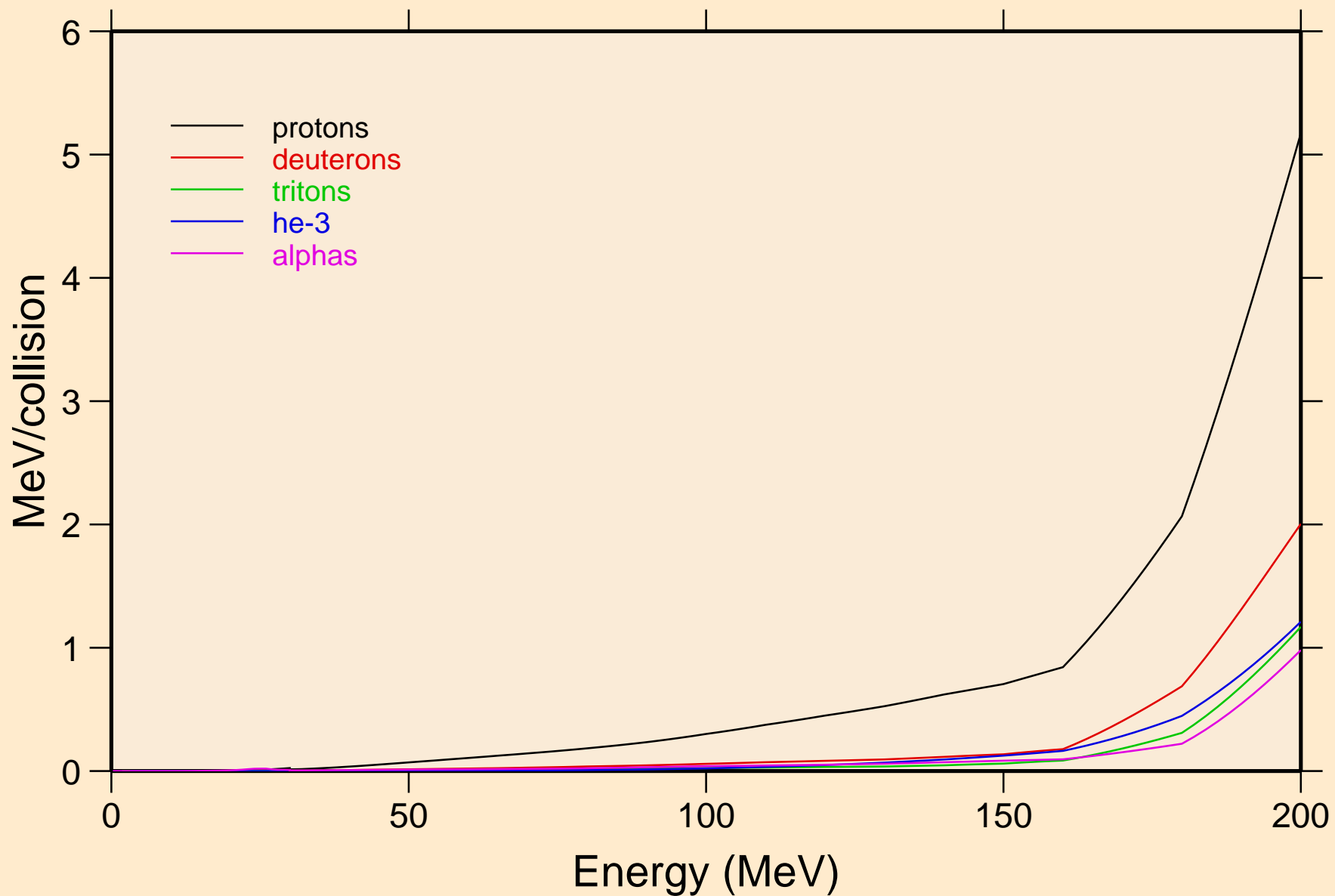

LR265 NEUTRON ACER TENDL-2019 LIBRARY; T=293.16K
Recoil Heating

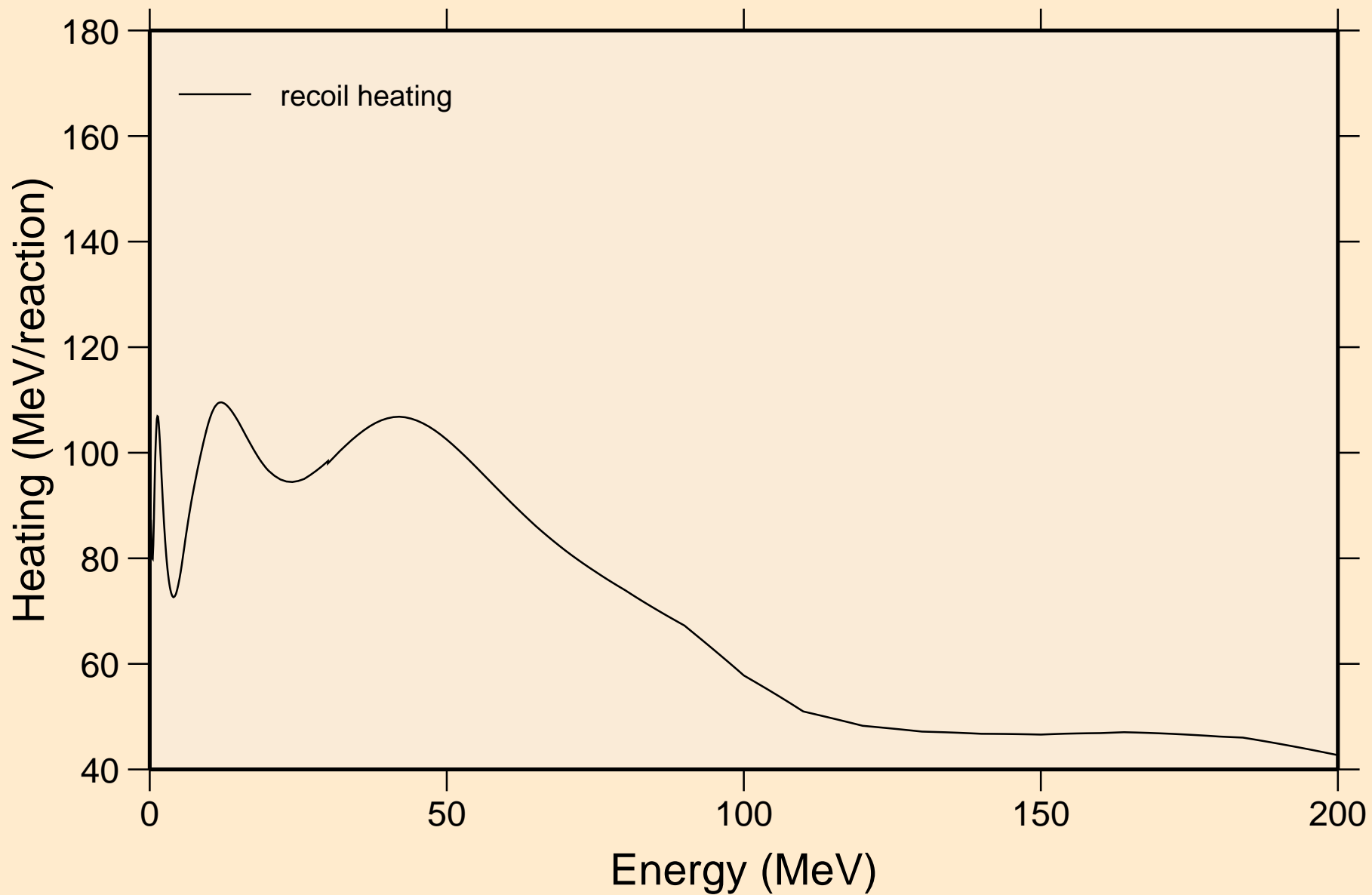

LR265 NEUTRON ACER TENDL-2019 LIBRARY; T=293.16K

Particle production cross sections

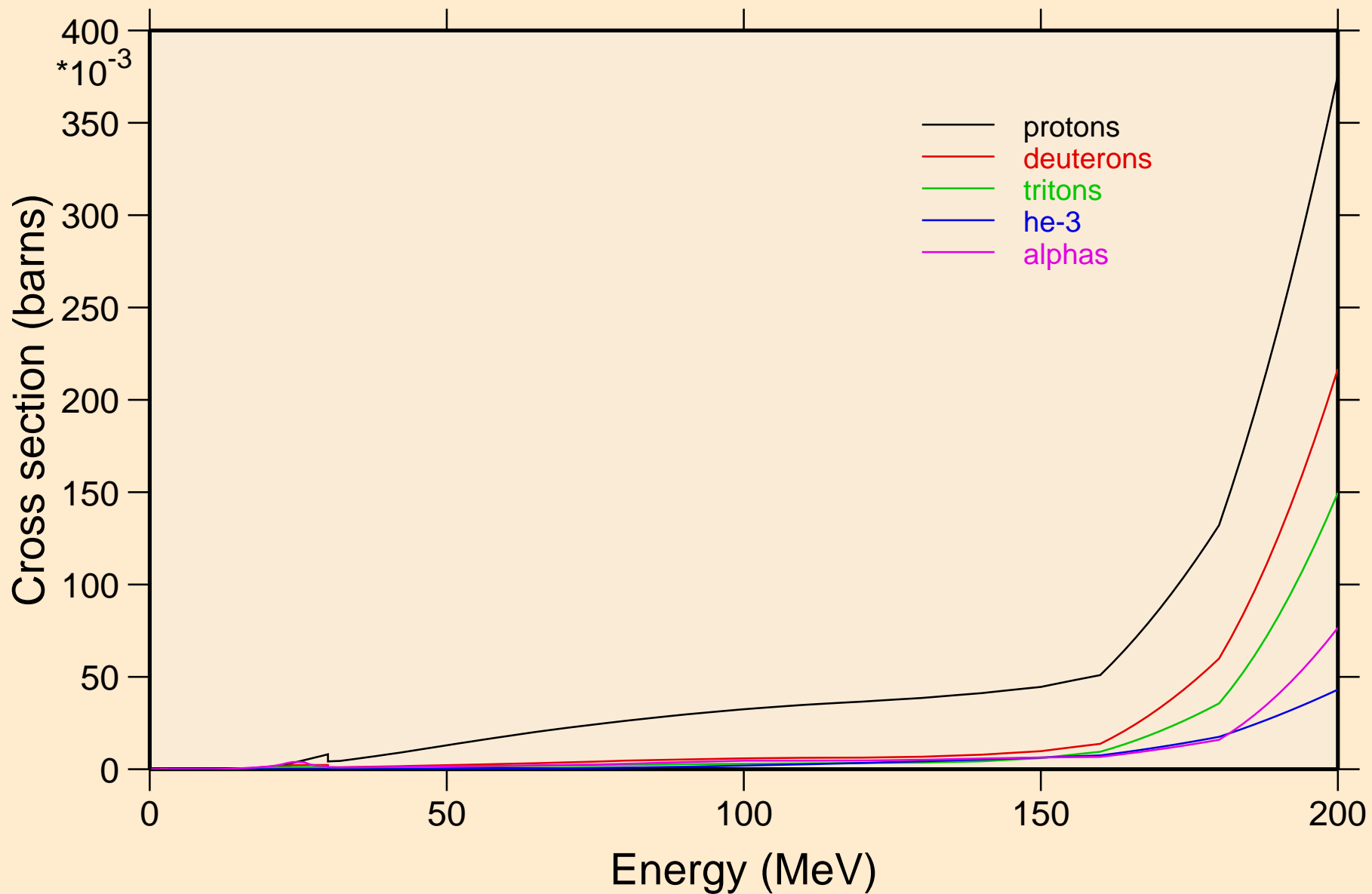

LR265 NEUTRON ACER TENDL-2019 LIBRARY; T=293.16K
protons from (n,x)

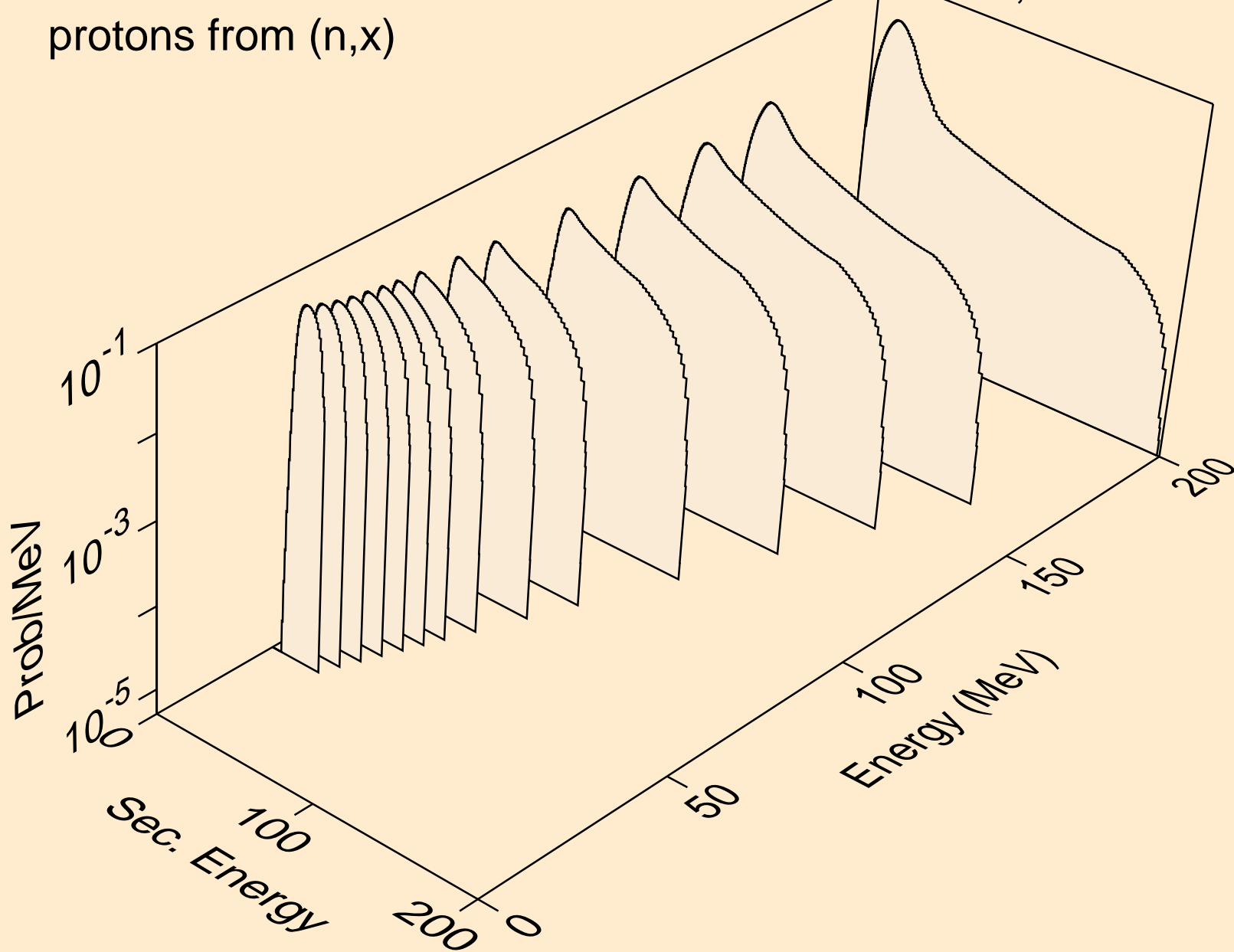

LR265 NEUTRON ACER TENDL-2019 LIBRARY; T=293.16K
protons from (n,n*)p

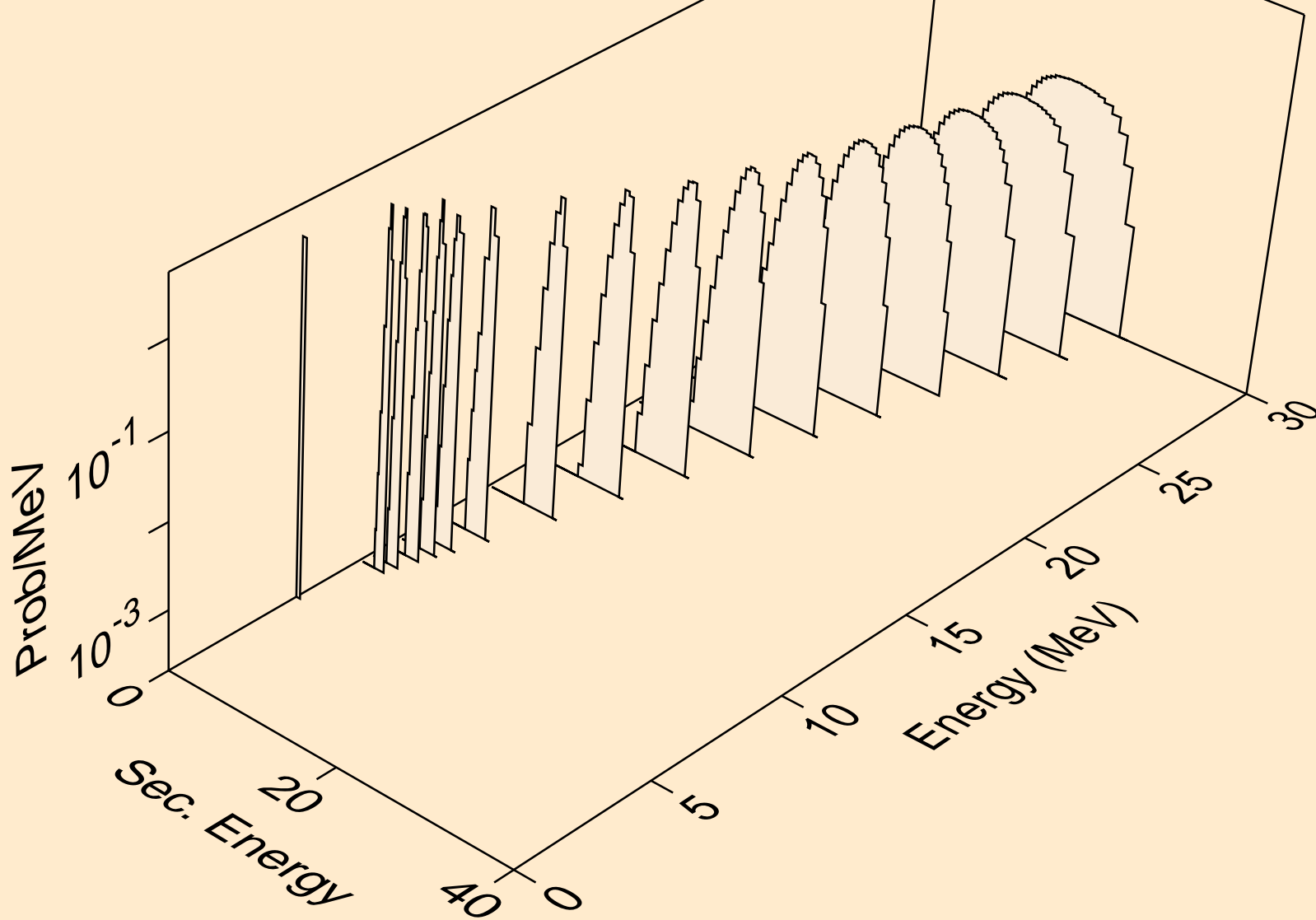

LR265 NEUTRON ACER TENDL-2019 LIBRARY; T=293.16K
protons from (n,2np)

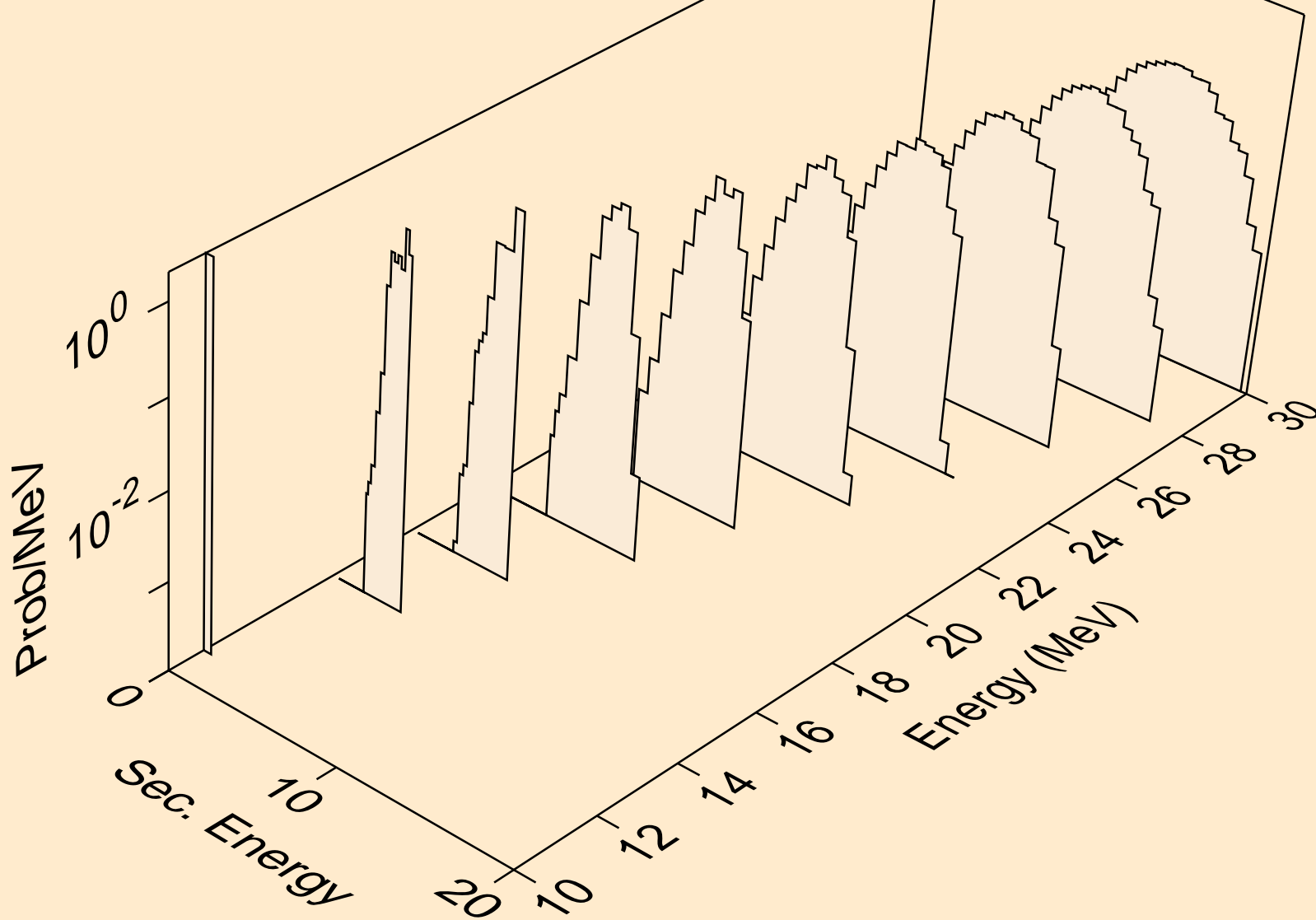

LR265 NEUTRON ACER TENDL-2019 LIBRARY; T=293.16K
protons from (n,3np)

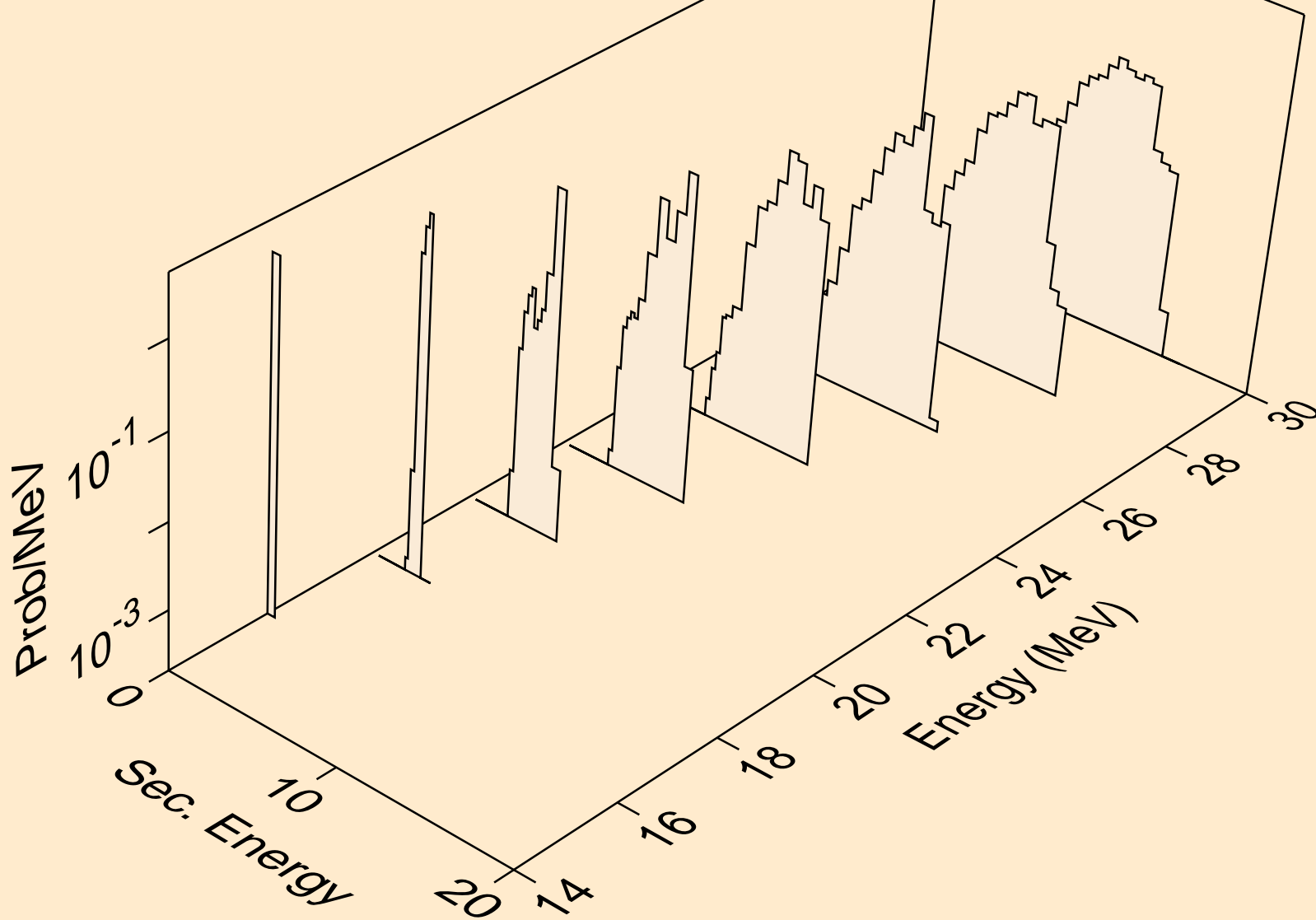

LR265 NEUTRON ACER TENDL-2019 LIBRARY; T=293.16K
protons from (n,p)

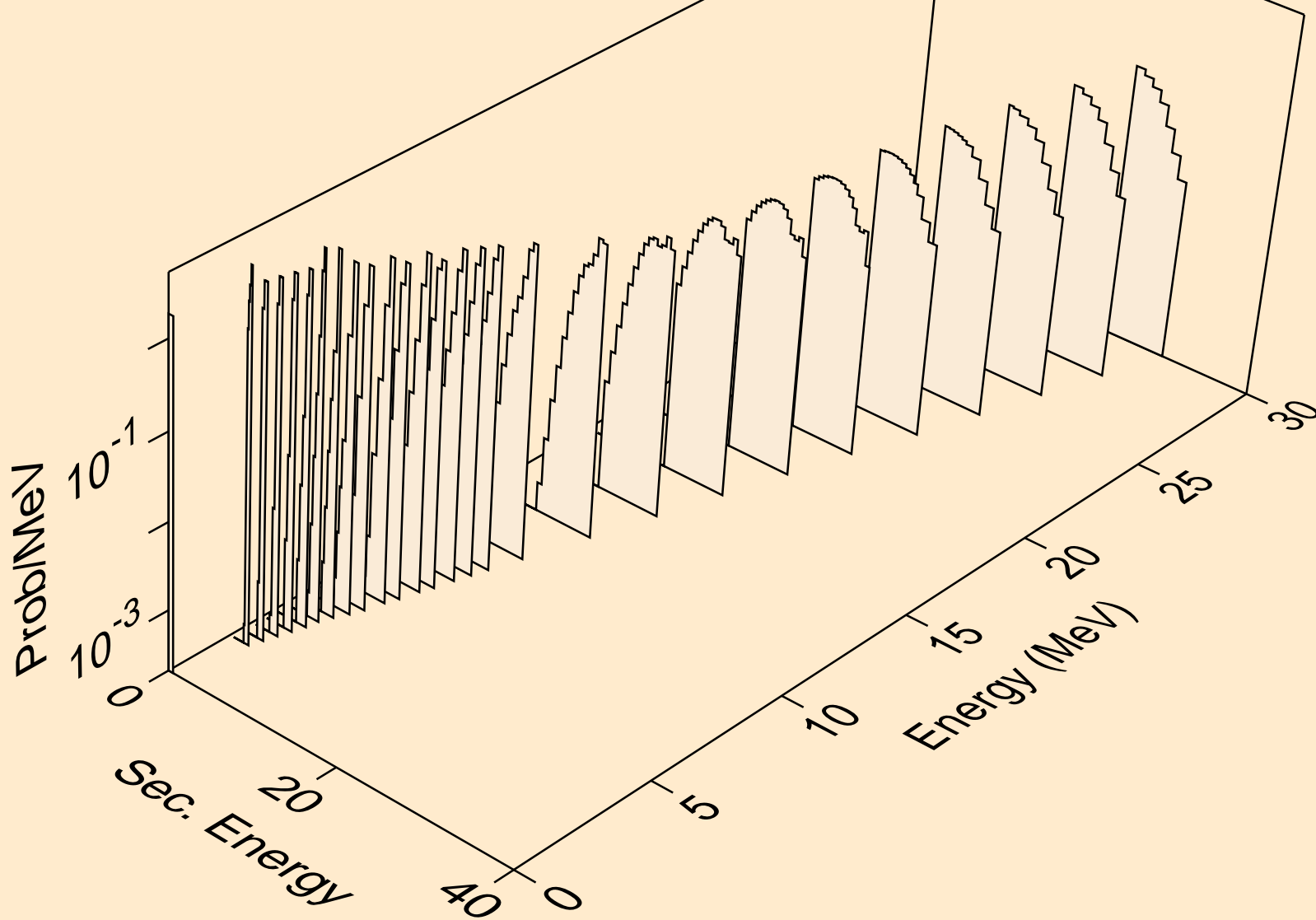

LR265 NEUTRON ACER TENDL-2019 LIBRARY; T=293.16K
protons from (n,2p)

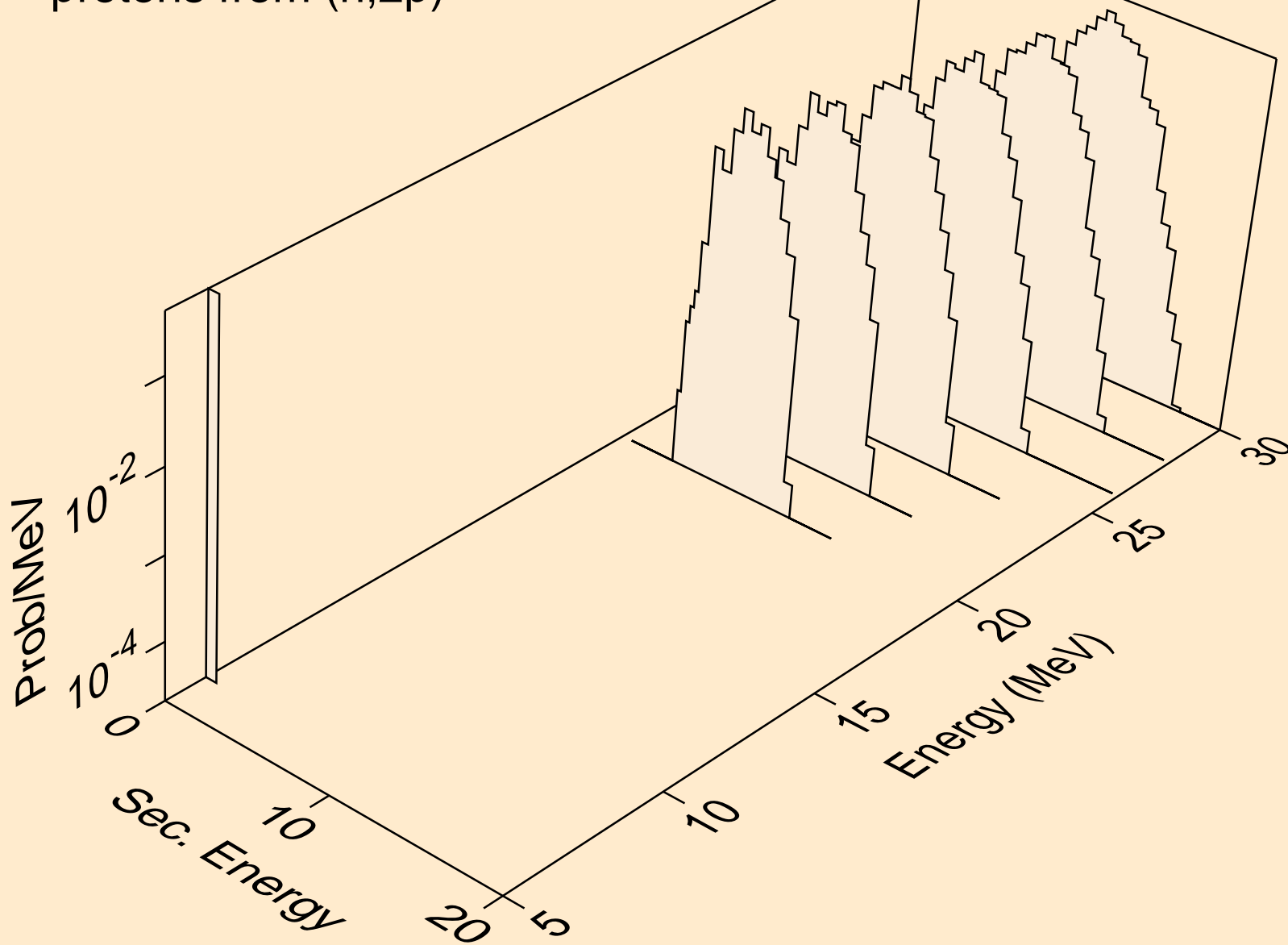

LR265 NEUTRON ACER TENDL-2019 LIBRARY; T=293.16K
deuterons from (n,x)

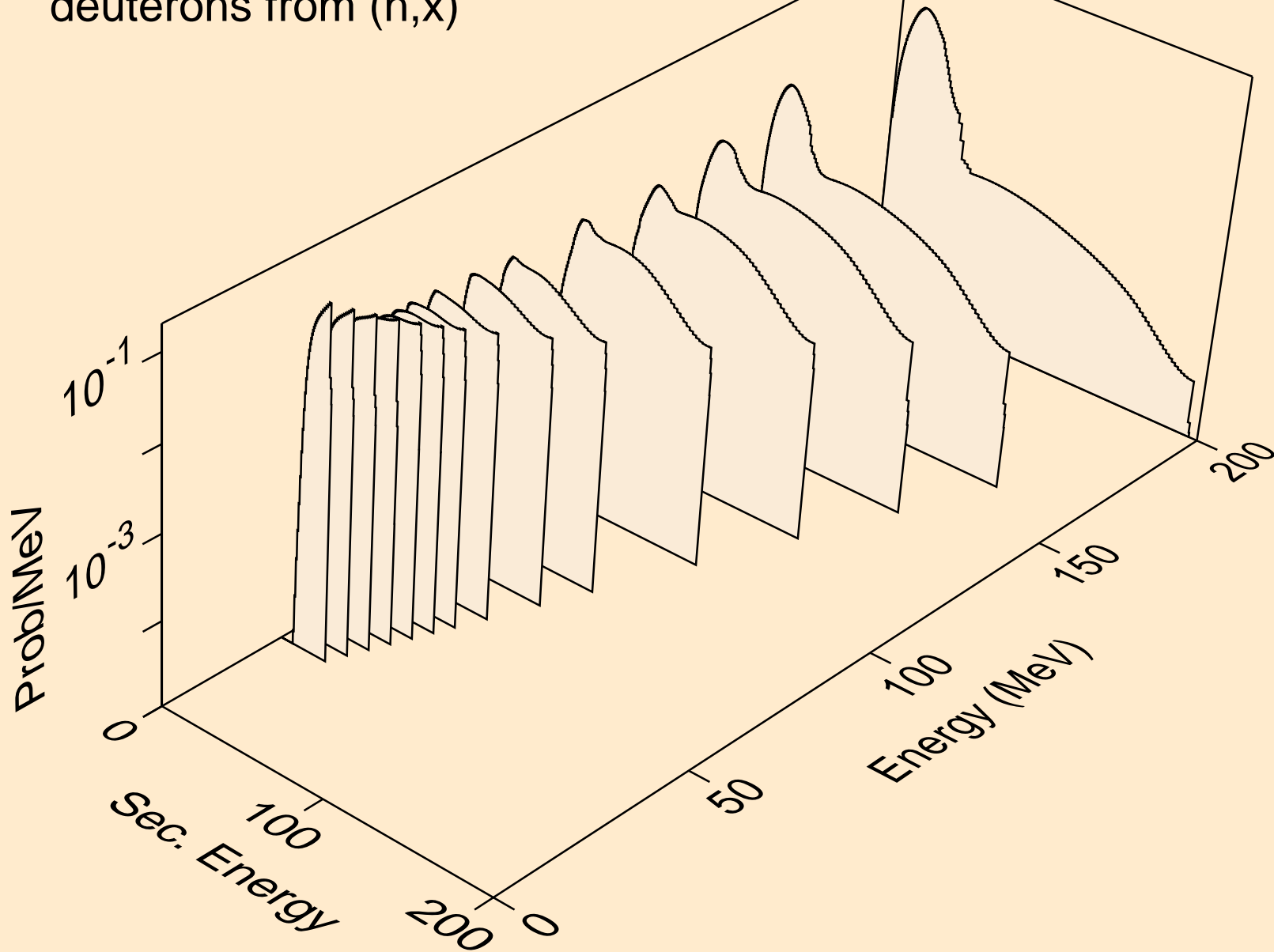

LR265 NEUTRON ACER TENDL-2019 LIBRARY; T=293.16K
deuterons from (n,2nd)

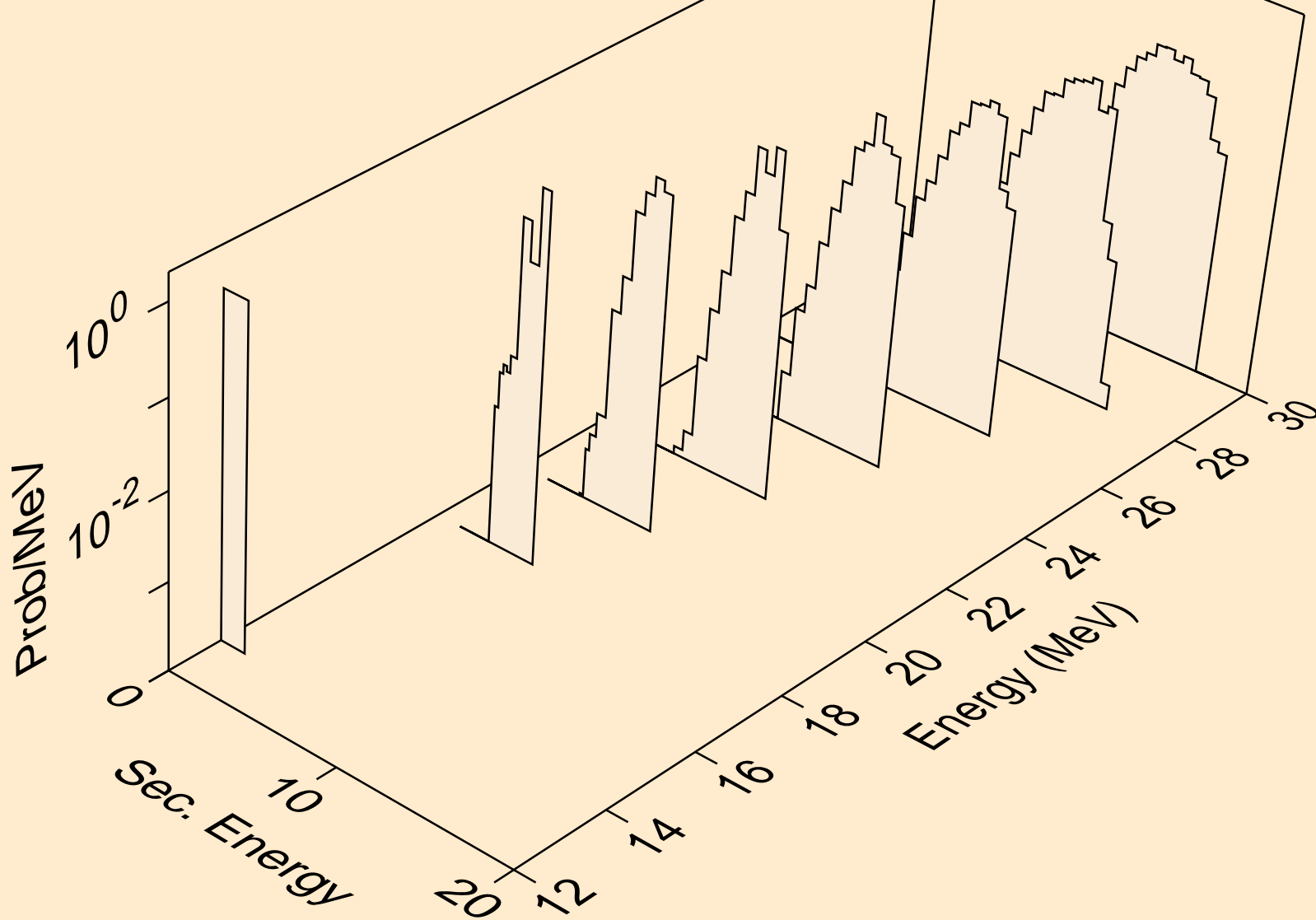

LR265 NEUTRON ACER TENDL-2019 LIBRARY; T=293.16K
deuterons from (n,n*)d

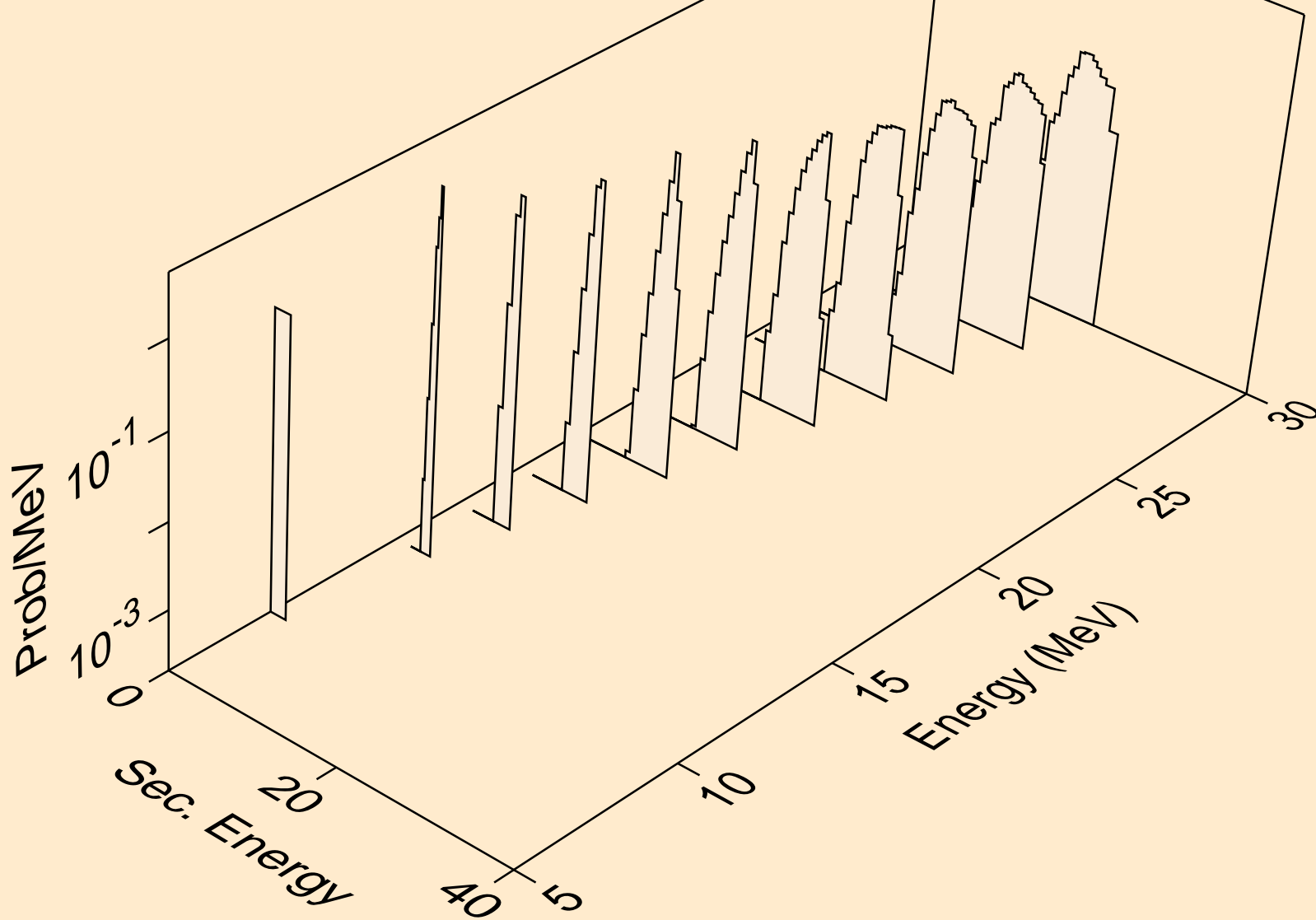

LR265 NEUTRON ACER TENDL-2019 LIBRARY; T=293.16K
deuterons from (n,d)

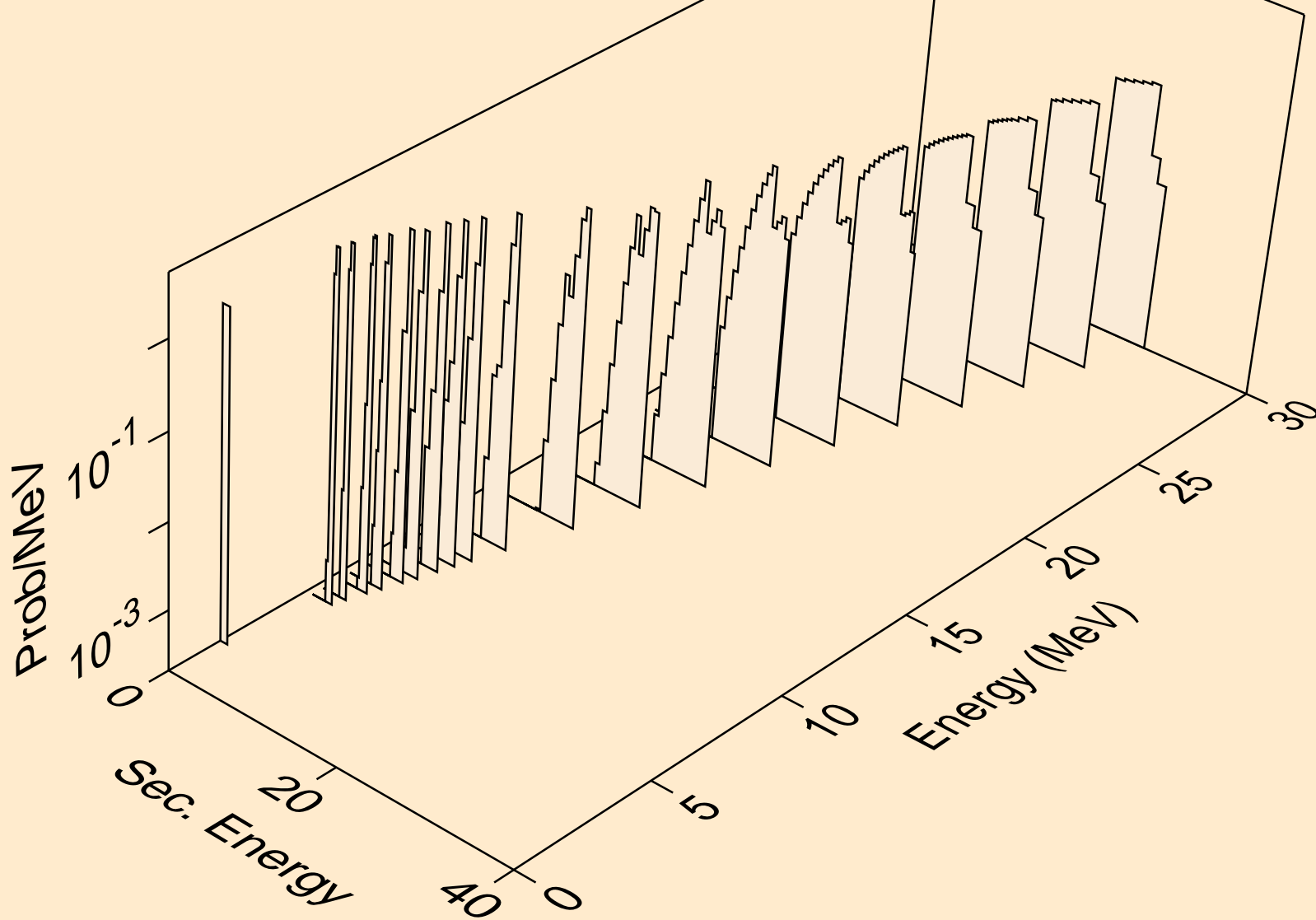

LR265 NEUTRON ACER TENDL-2019 LIBRARY; T=293.16K
tritons from (n,x)

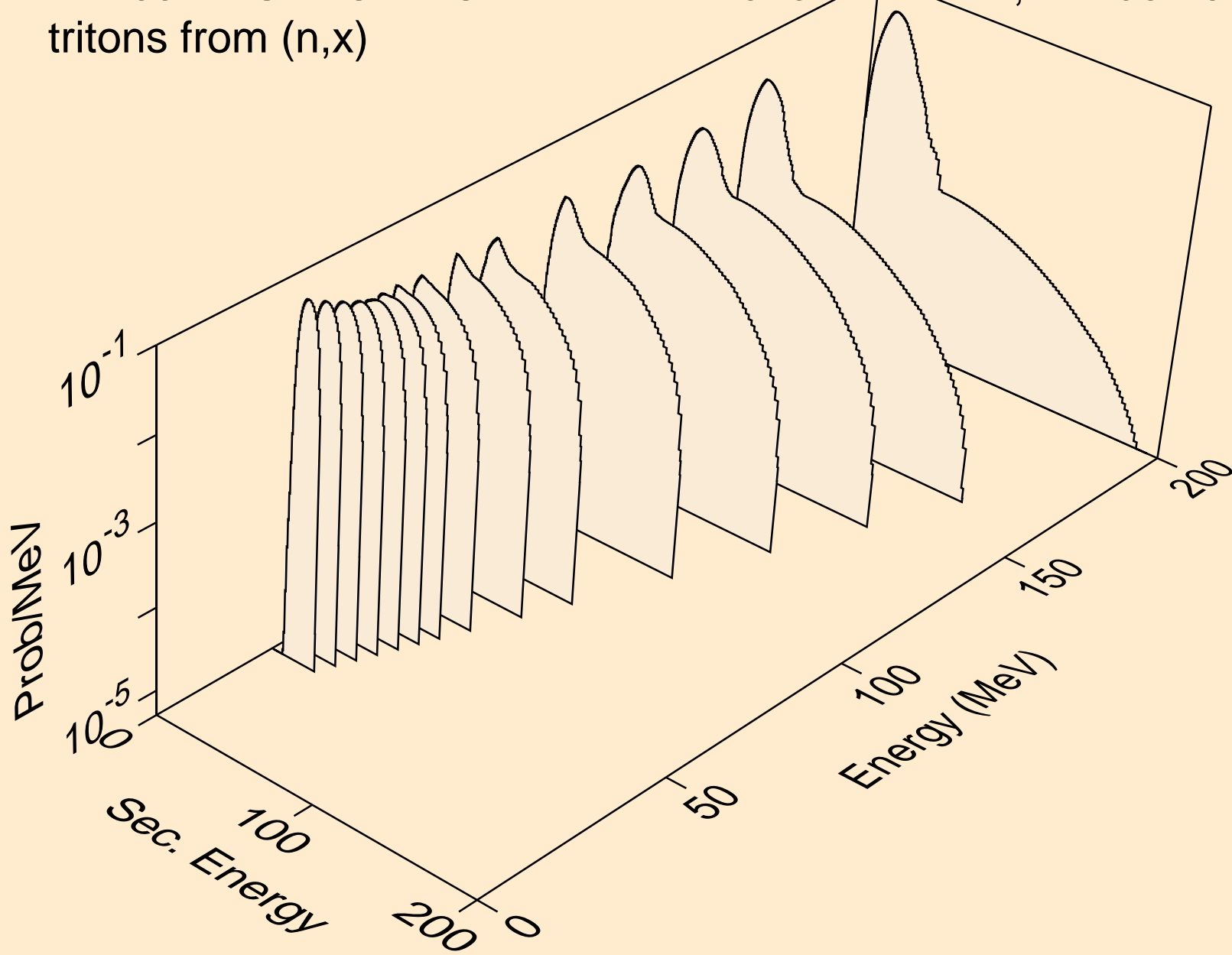

LR265 NEUTRON ACER TENDL-2019 LIBRARY; T=293.16K
tritons from (n,n*)t

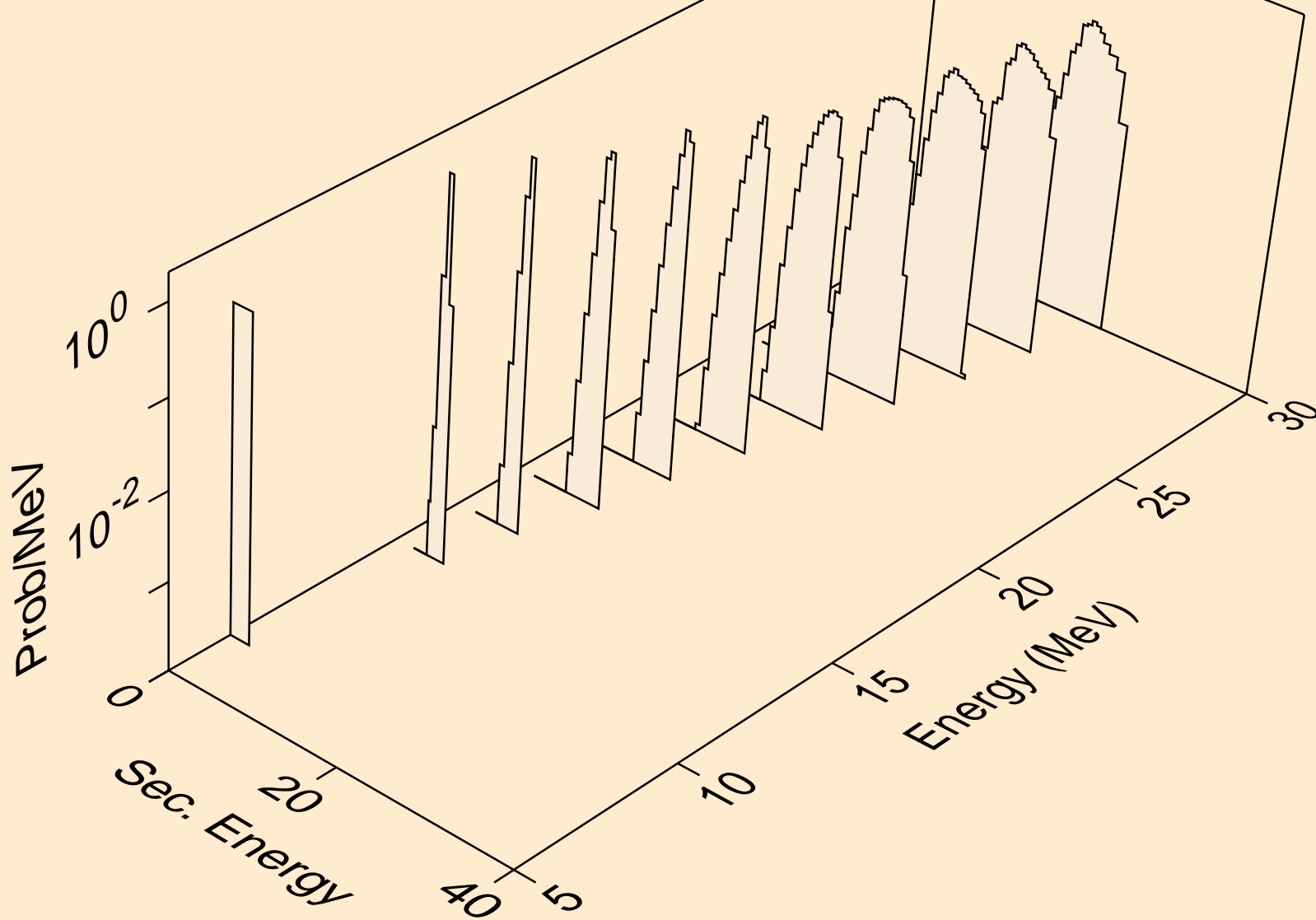

LR265 NEUTRON ACER TENDL-2019 LIBRARY; T=293.16K
tritons from (n,t)

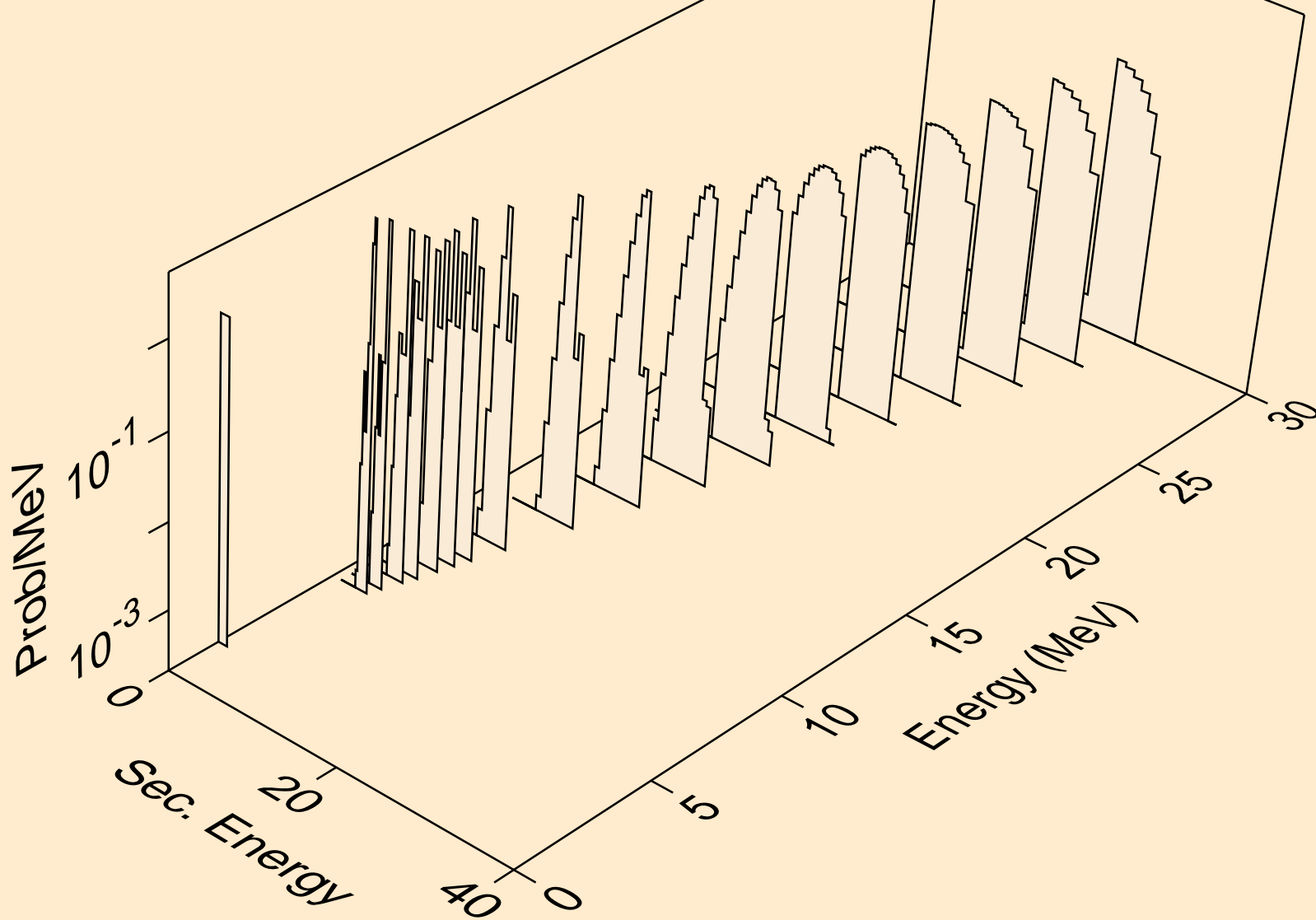

LR265 NEUTRON ACER TENDL-2019 LIBRARY; T=293.16K
he3s from (n,x)

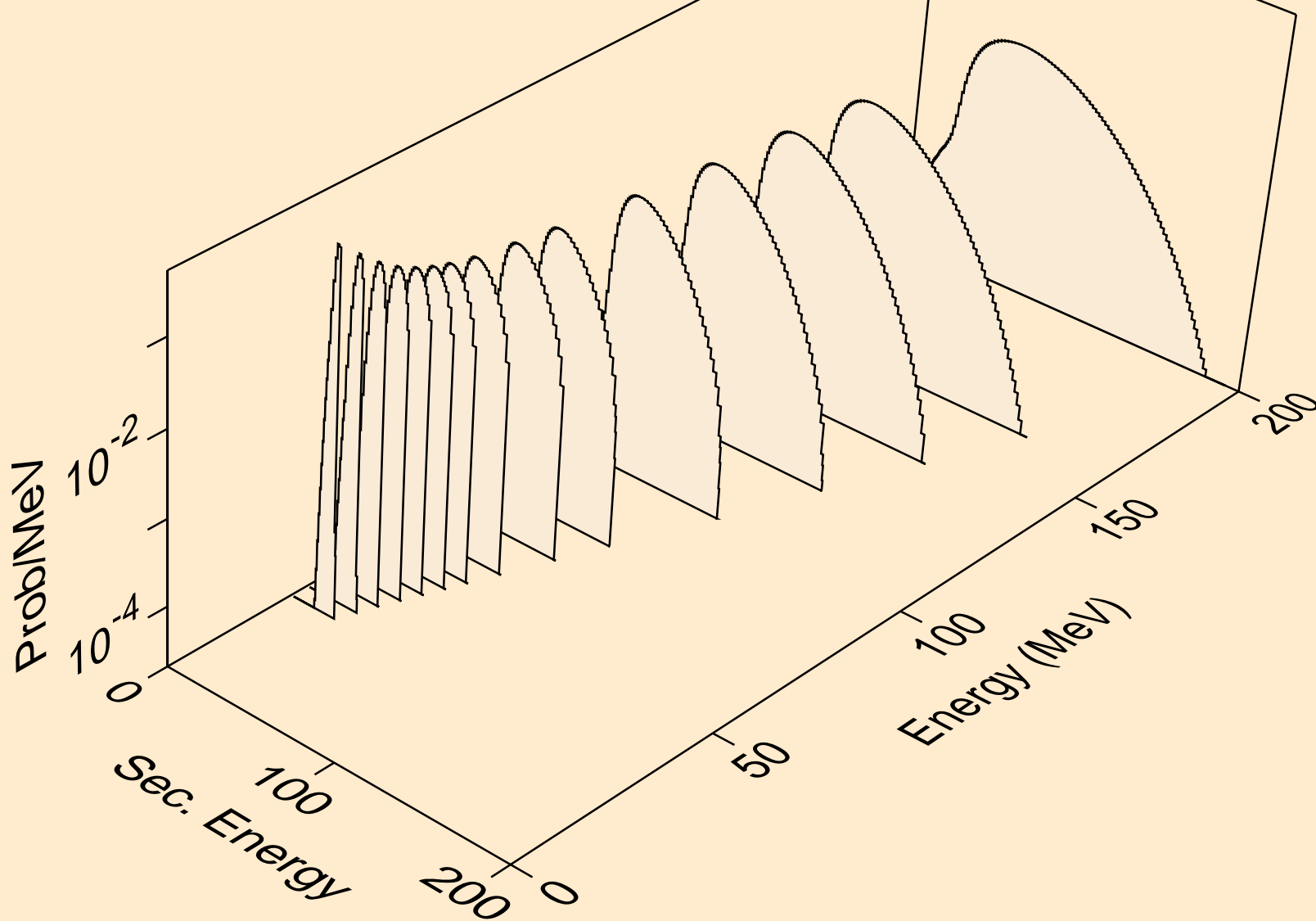

LR265 NEUTRON ACER TENDL-2019 LIBRARY; T=293.16K
he3s from (n,n*)he3

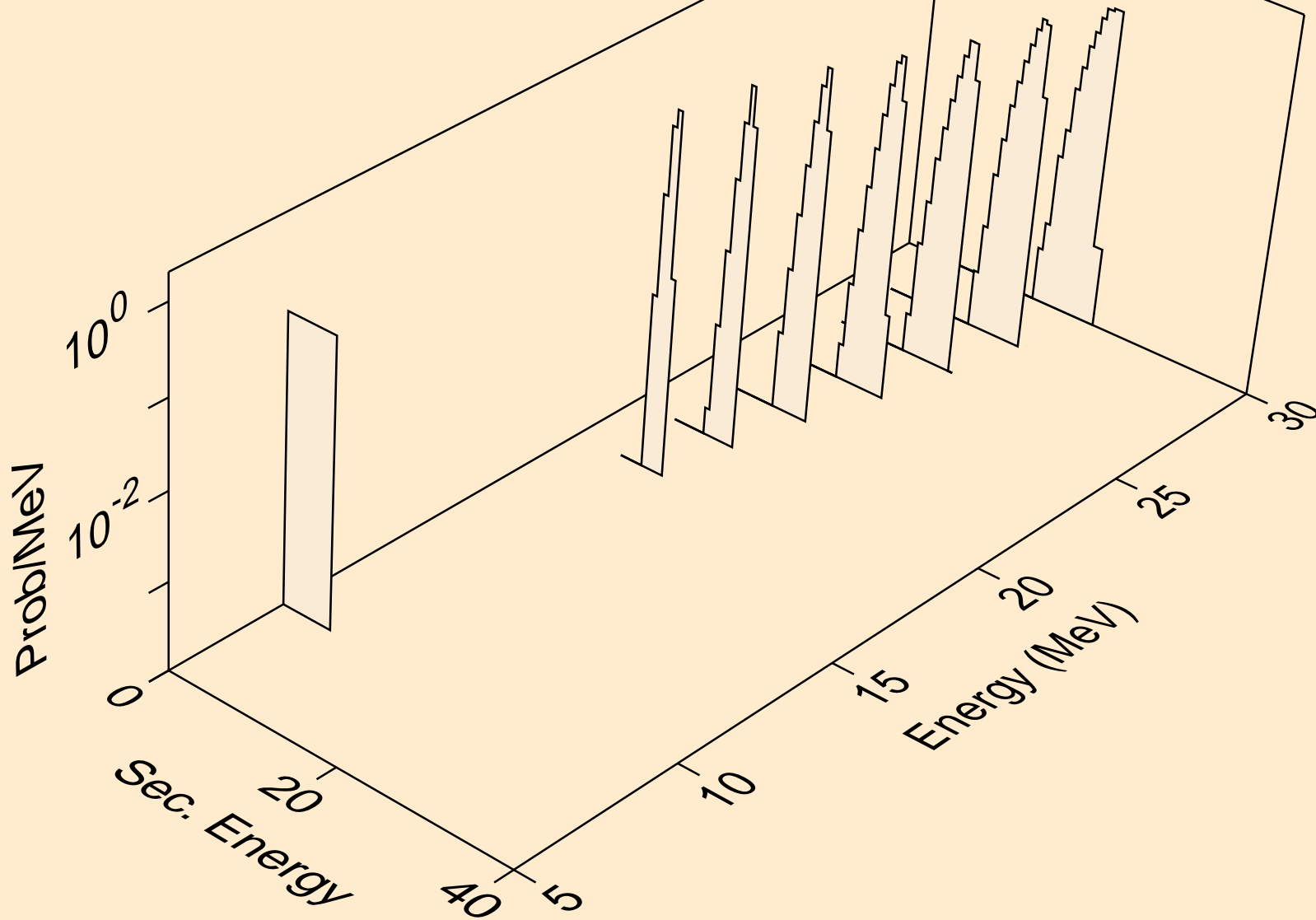

LR265 NEUTRON ACER TENDL-2019 LIBRARY; T=293.16K
he3s from (n,he3)

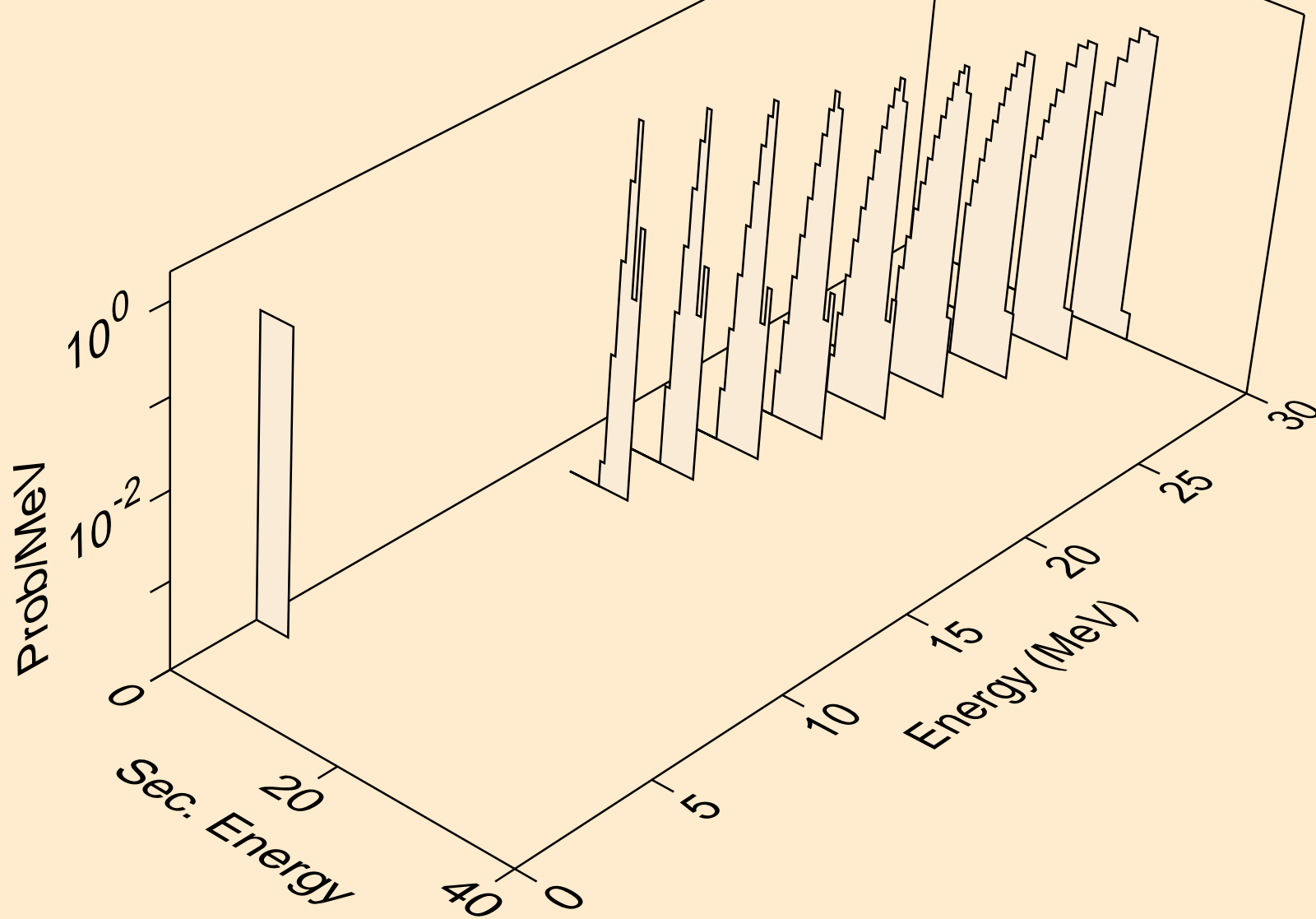

LR265 NEUTRON ACER TENDL-2019 LIBRARY; T=293.16K
alphas from (n,x)

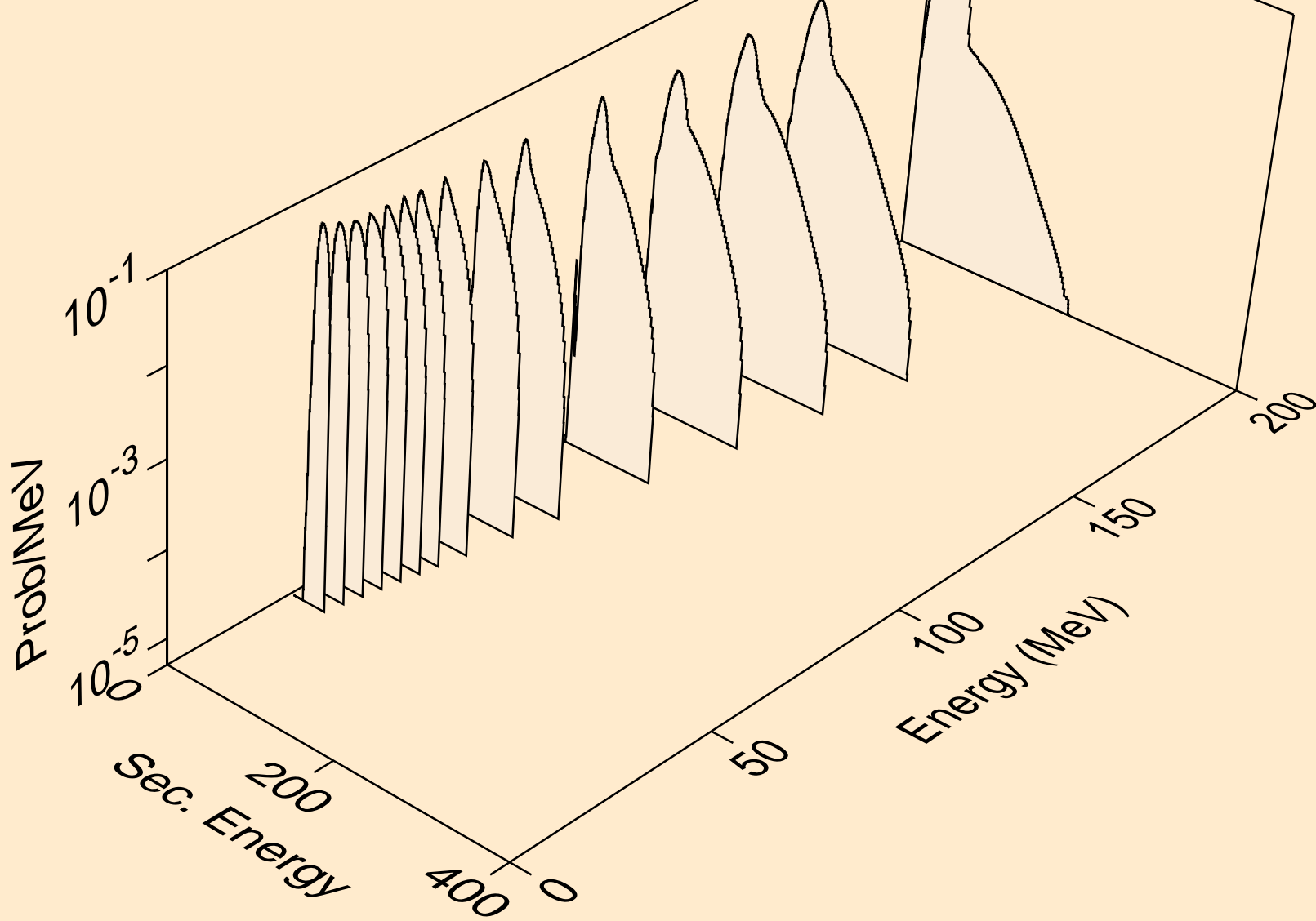

LR265 NEUTRON ACER TENDL-2019 LIBRARY; T=293.16K
alphas from (n,n*)a

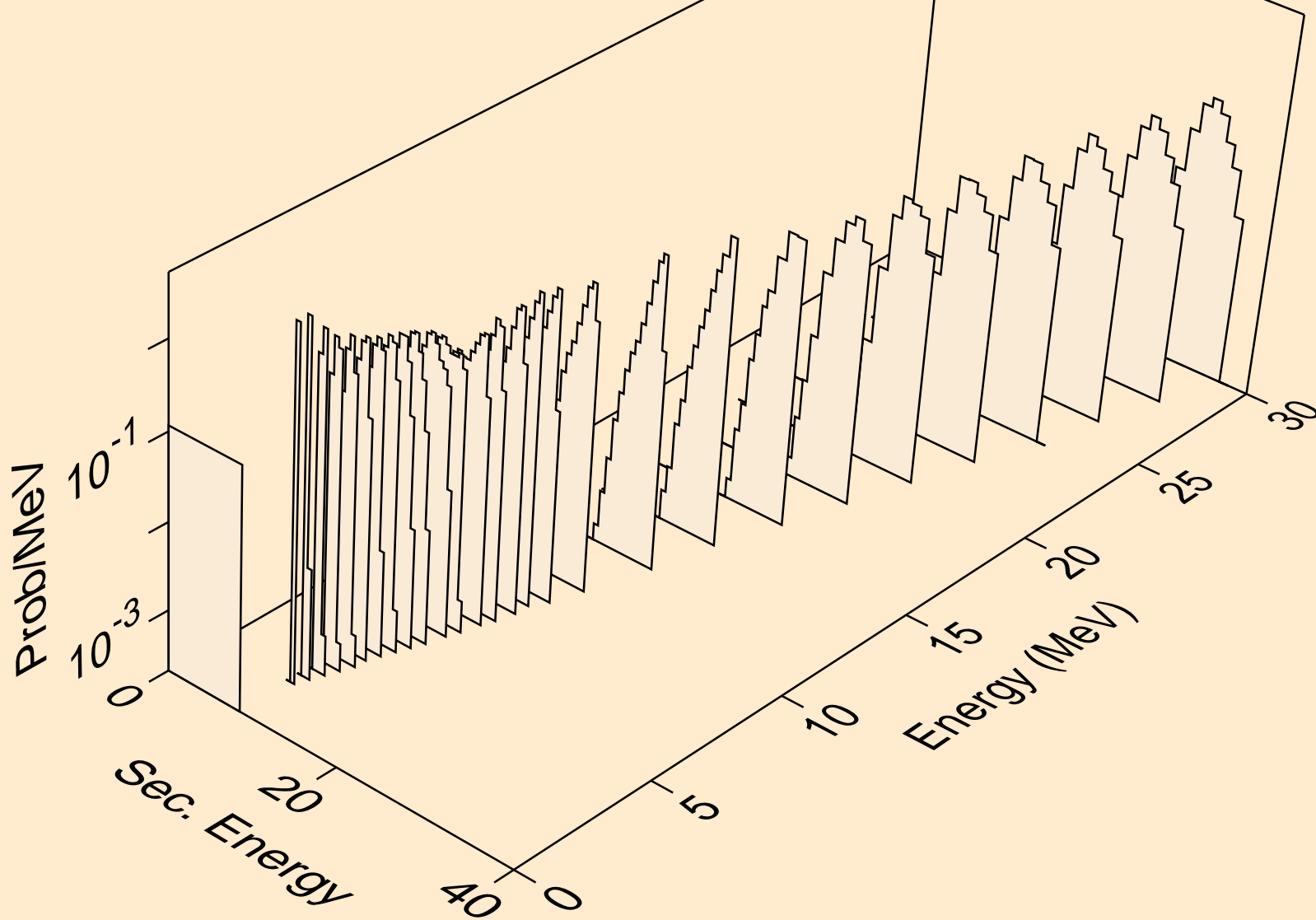

LR265 NEUTRON ACER TENDL-2019 LIBRARY; T=293.16K
alphas from (n,2n)a

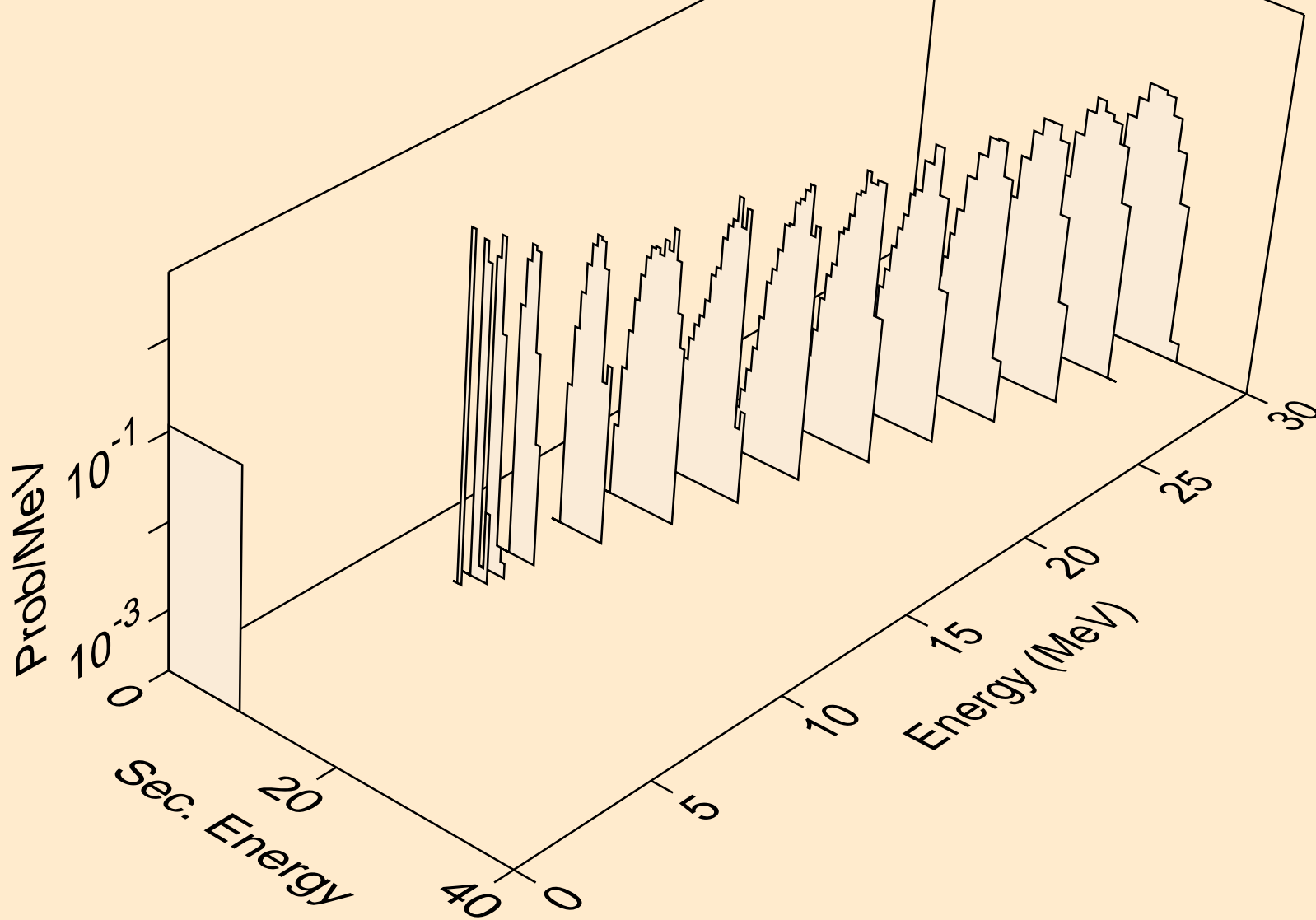

LR265 NEUTRON ACER TENDL-2019 LIBRARY; T=293.16K
alphas from (n,3n)a

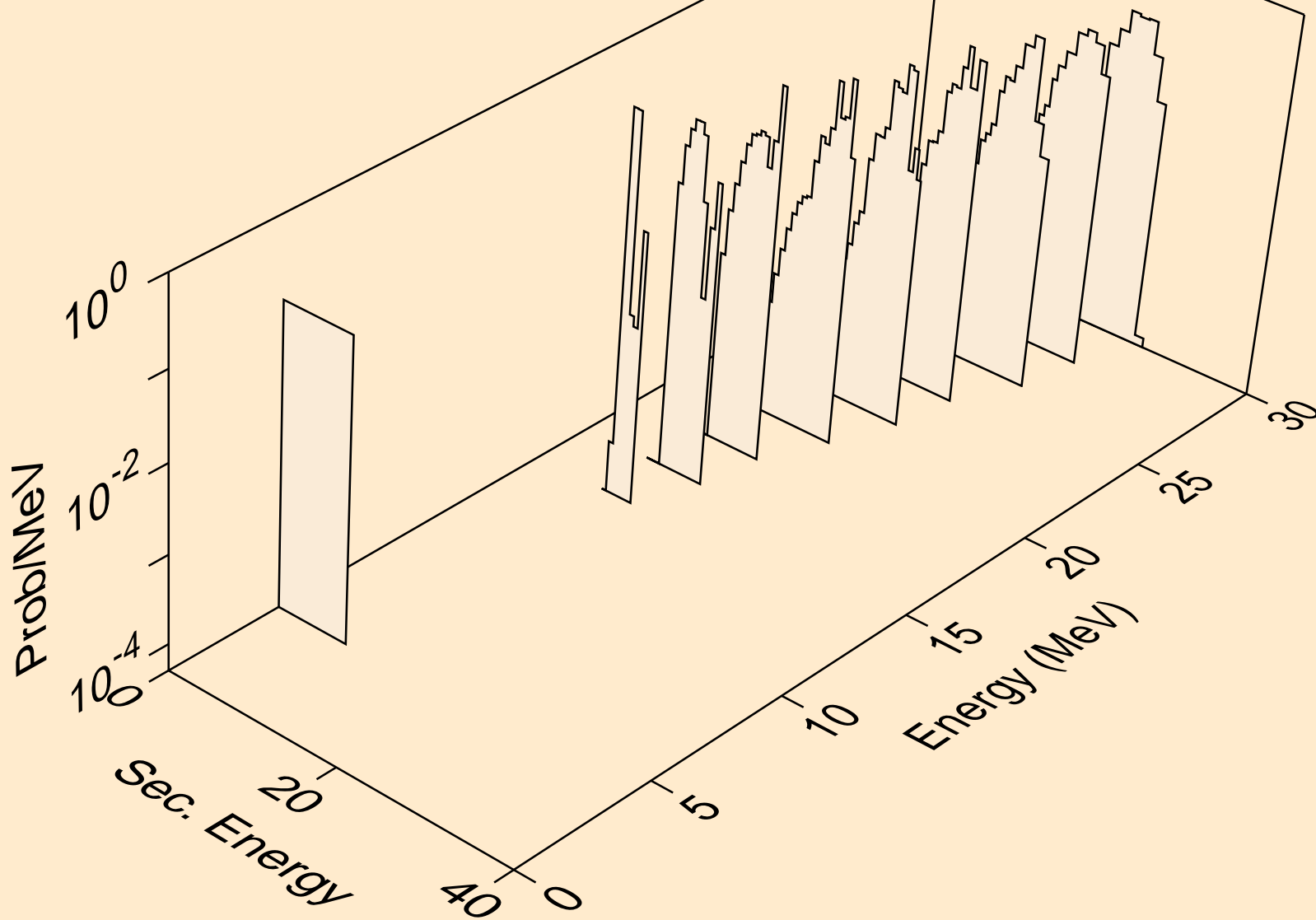

LR265 NEUTRON ACER TENDL-2019 LIBRARY; T=293.16K
alphas from (n,a)

