

LR266 NEUTRON ACER TENDL-2019 LIBRARY; T=293.16K
Principal cross sections

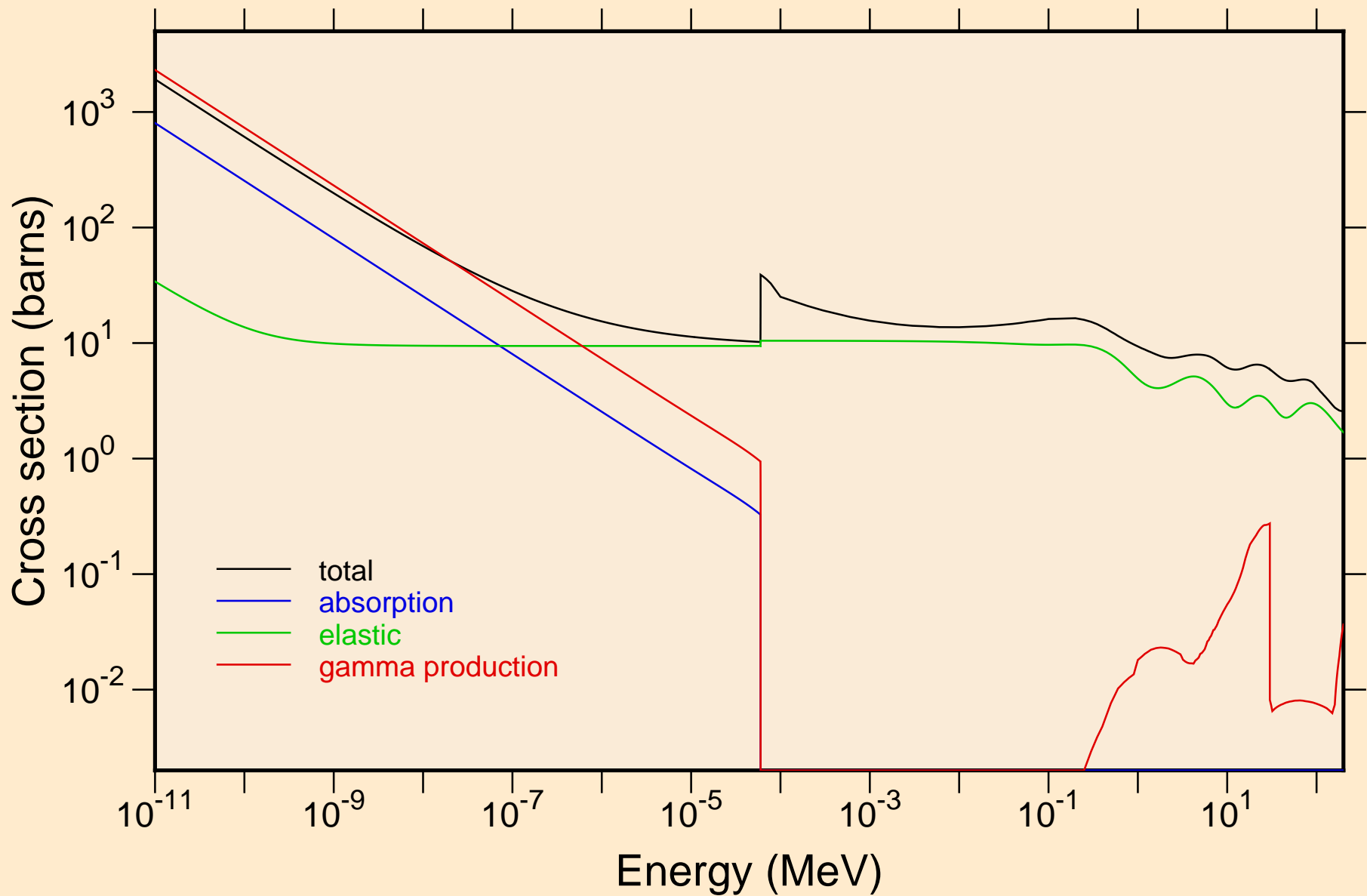

LR266 NEUTRON ACER TENDL-2019 LIBRARY; T=293.16K
Heating

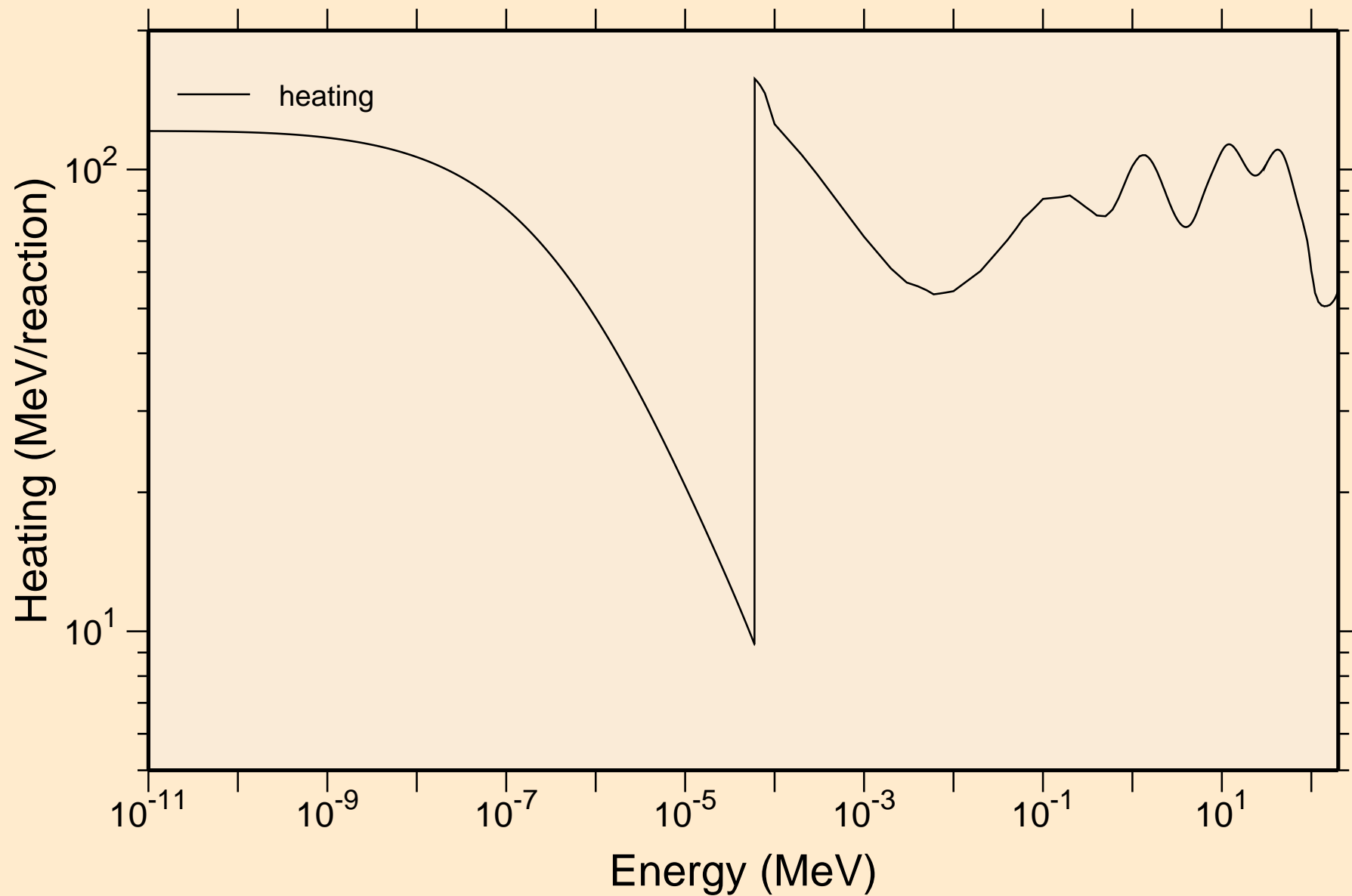

LR266 NEUTRON ACER TENDL-2019 LIBRARY; T=293.16K
Damage

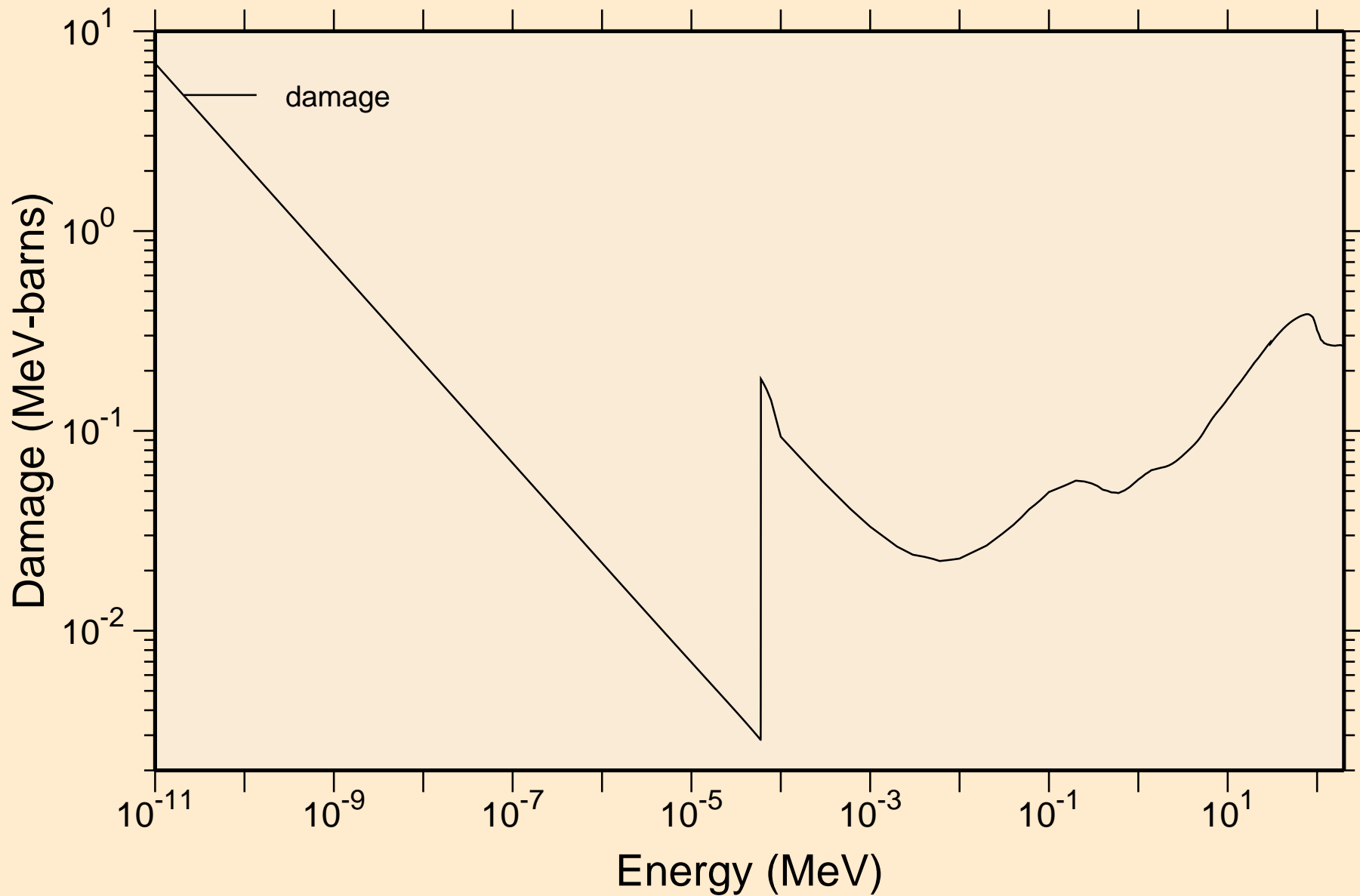

LR266 NEUTRON ACER TENDL-2019 LIBRARY; T=293.16K
Non-threshold reactions

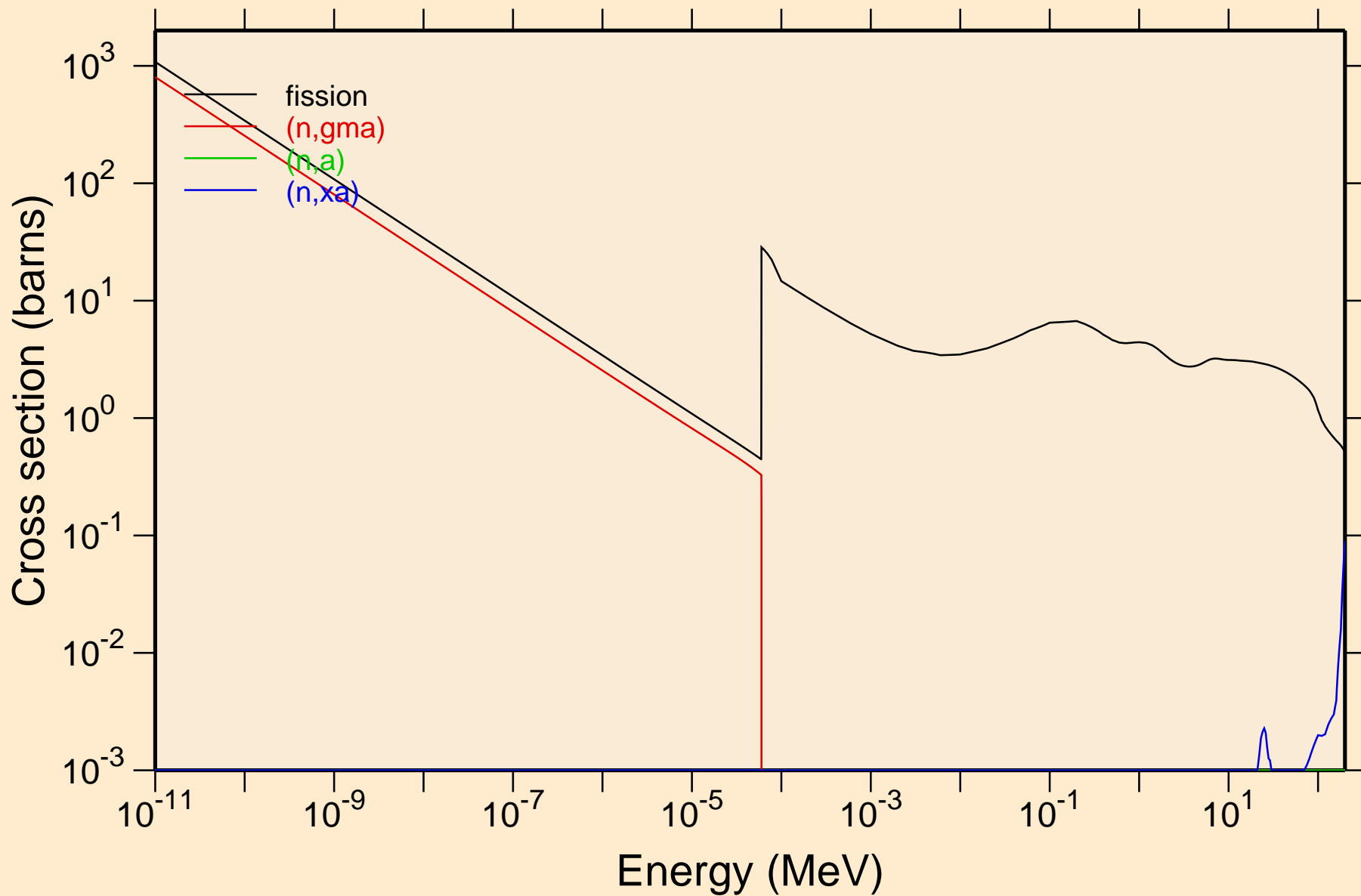

LR266 NEUTRON ACER TENDL-2019 LIBRARY; T=293.16K
Principal cross sections

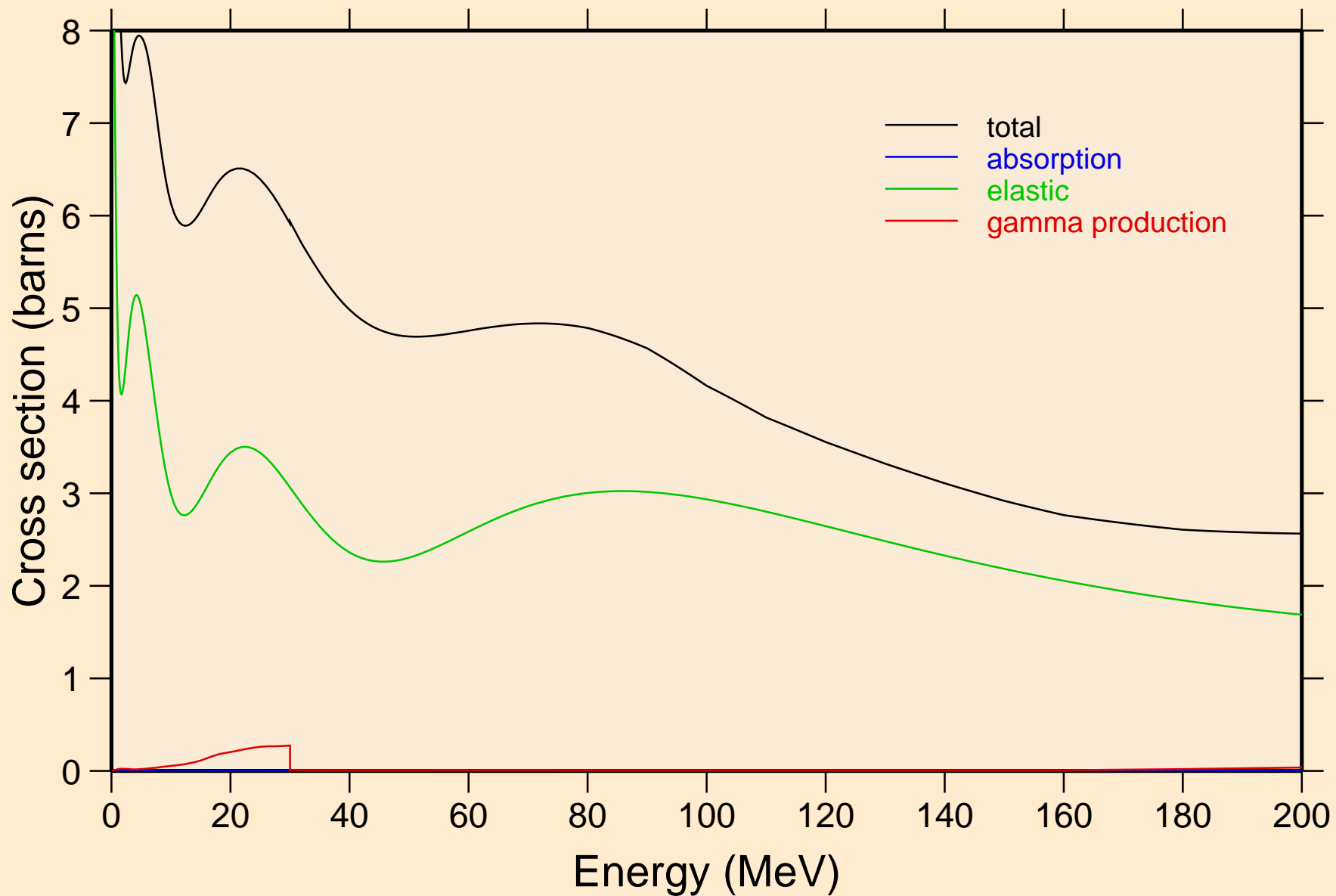

LR266 NEUTRON ACER TENDL-2019 LIBRARY; T=293.16K
Heating

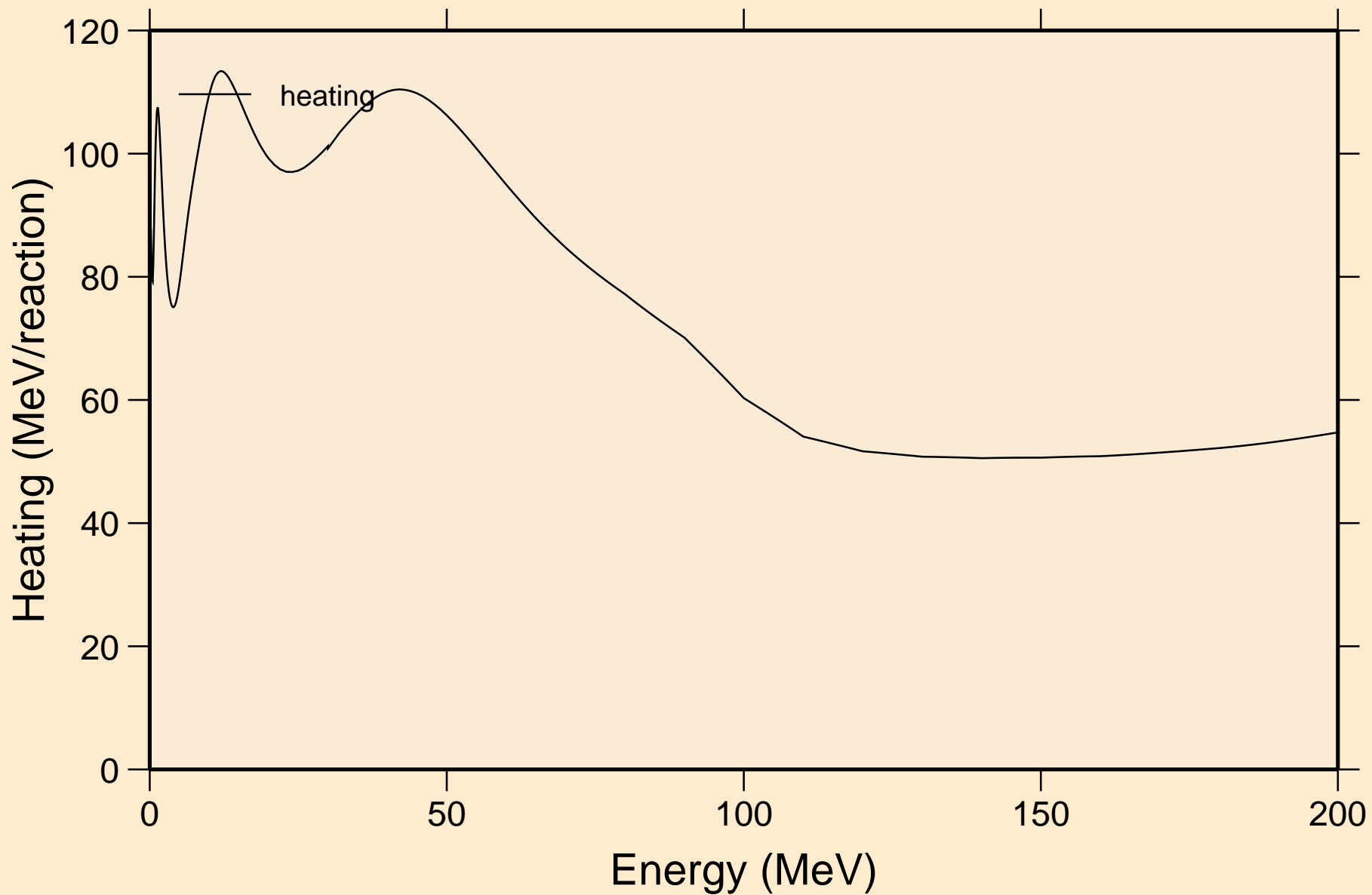

LR266 NEUTRON ACER TENDL-2019 LIBRARY; T=293.16K
Damage

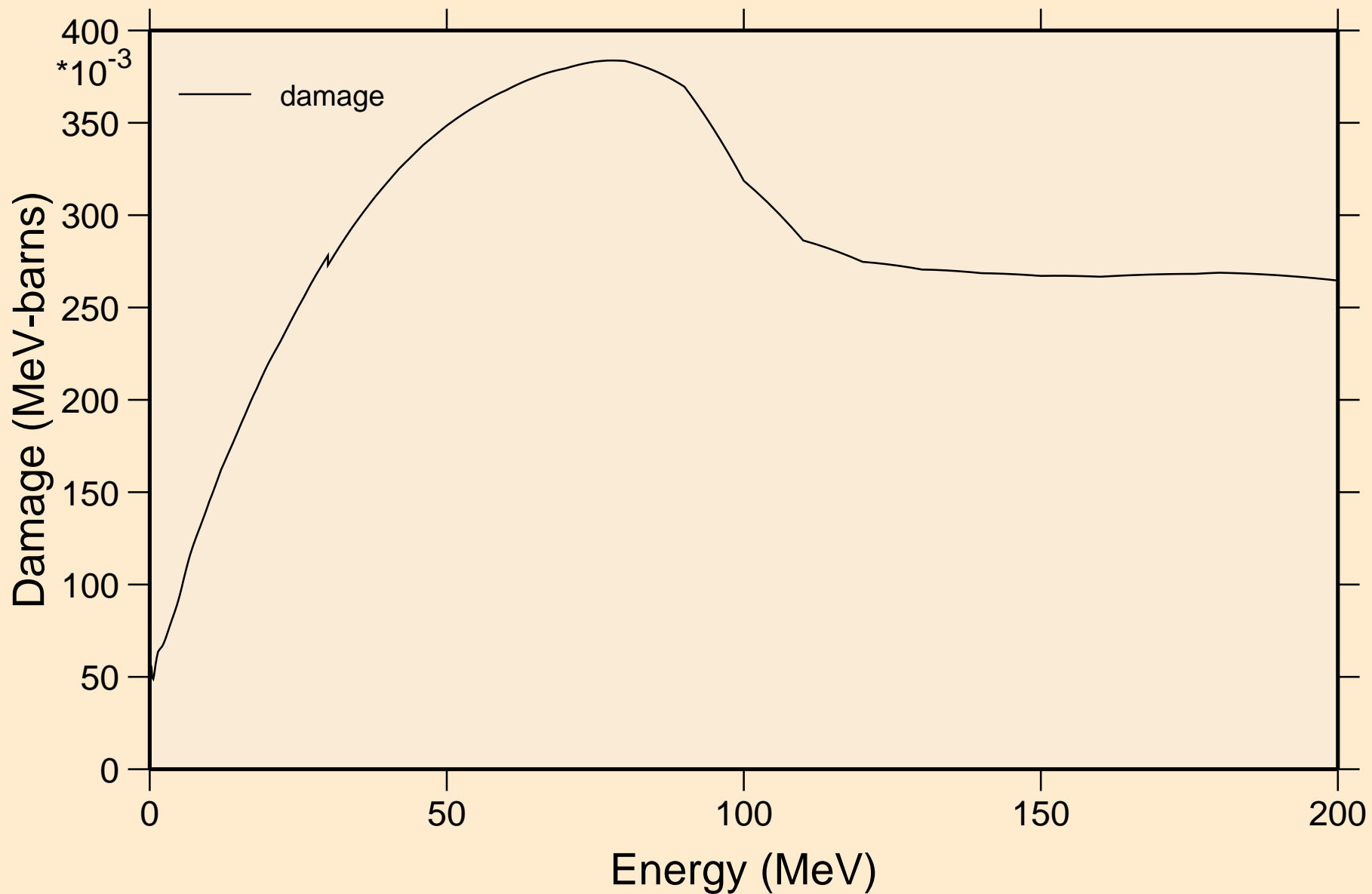

LR266 NEUTRON ACER TENDL-2019 LIBRARY; T=293.16K
Non-threshold reactions

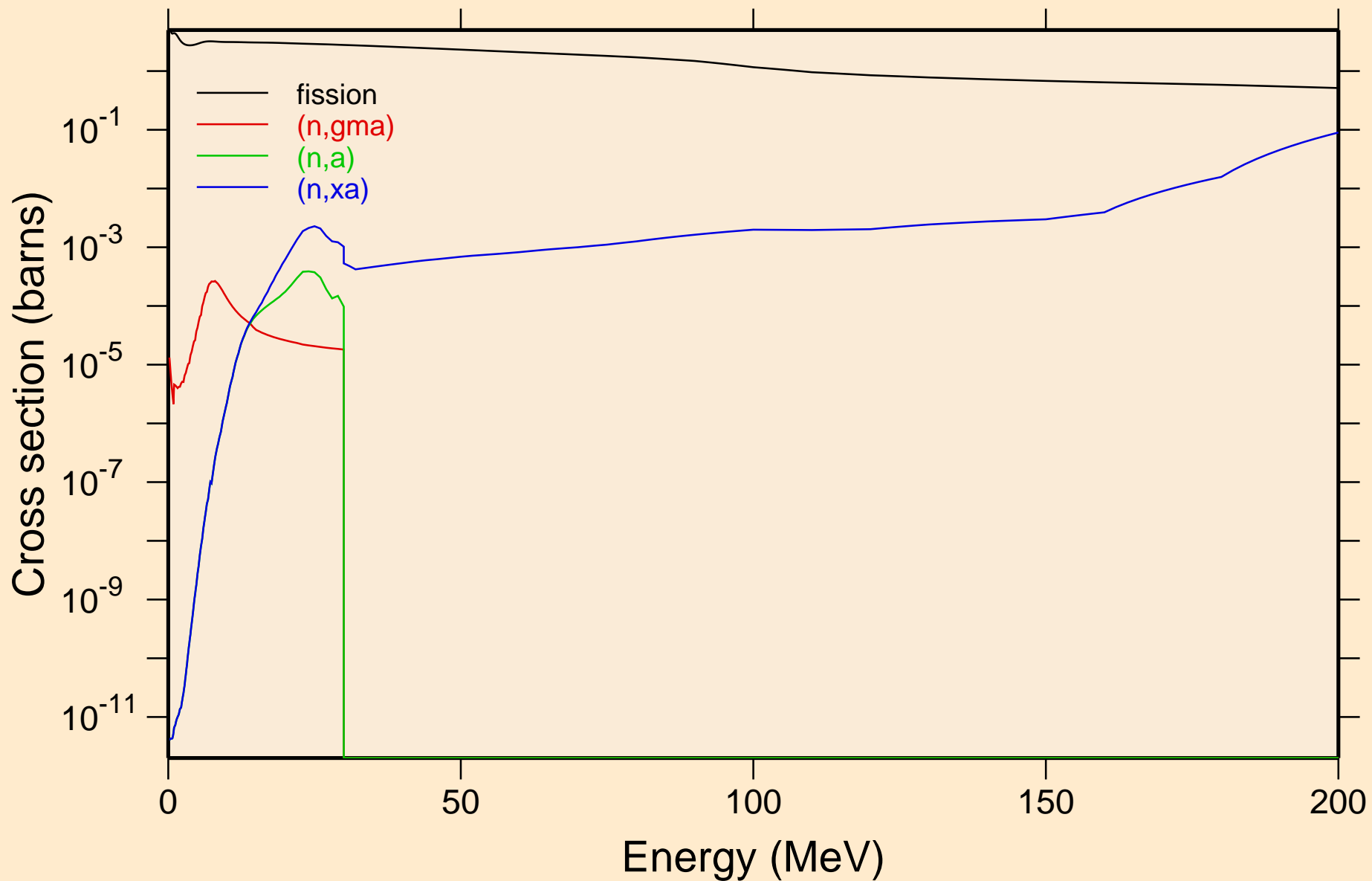

LR266 NEUTRON ACER TENDL-2019 LIBRARY; T=293.16K
Inelastic levels

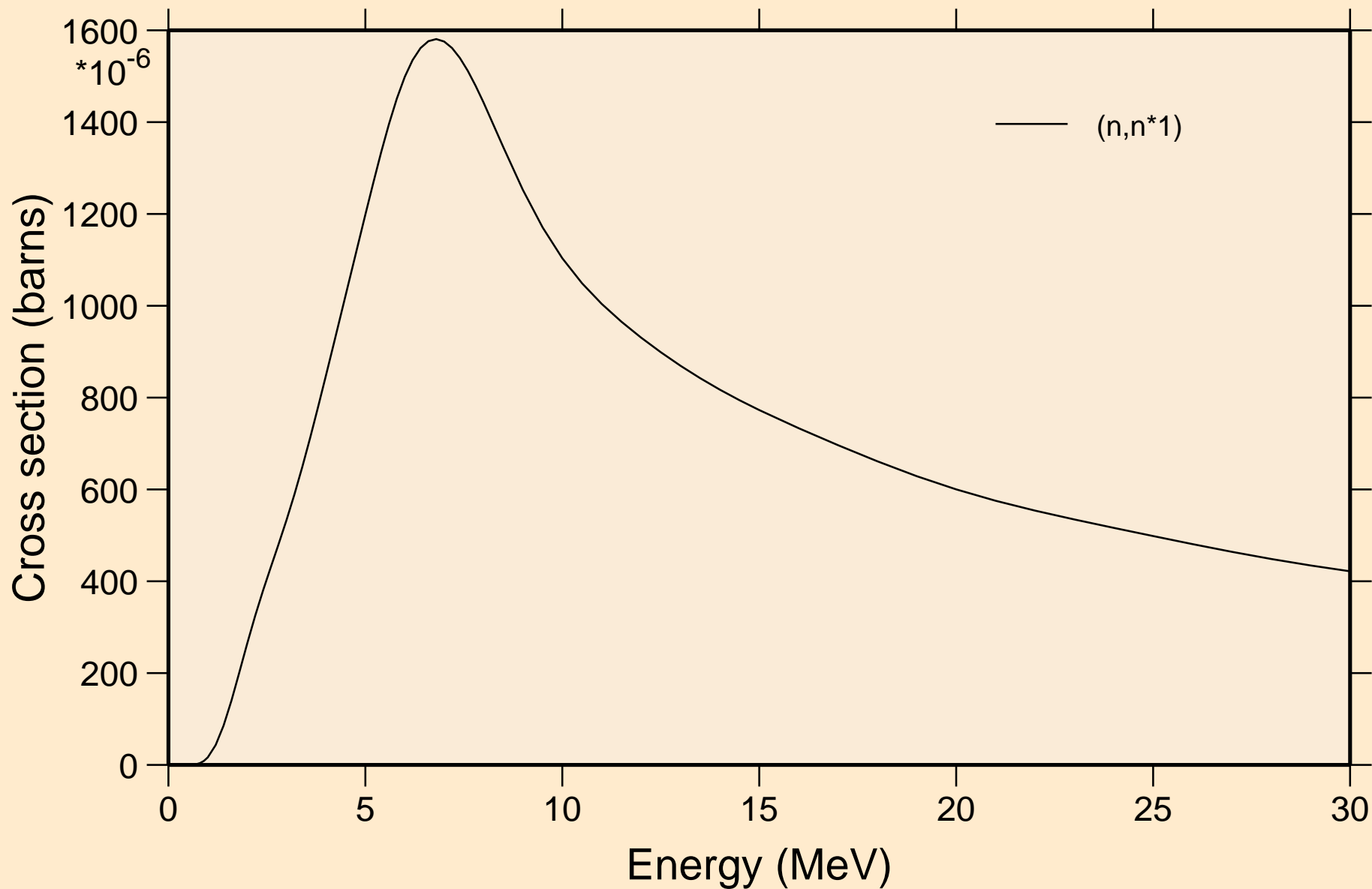

LR266 NEUTRON ACER TENDL-2019 LIBRARY; T=293.16K
Threshold reactions

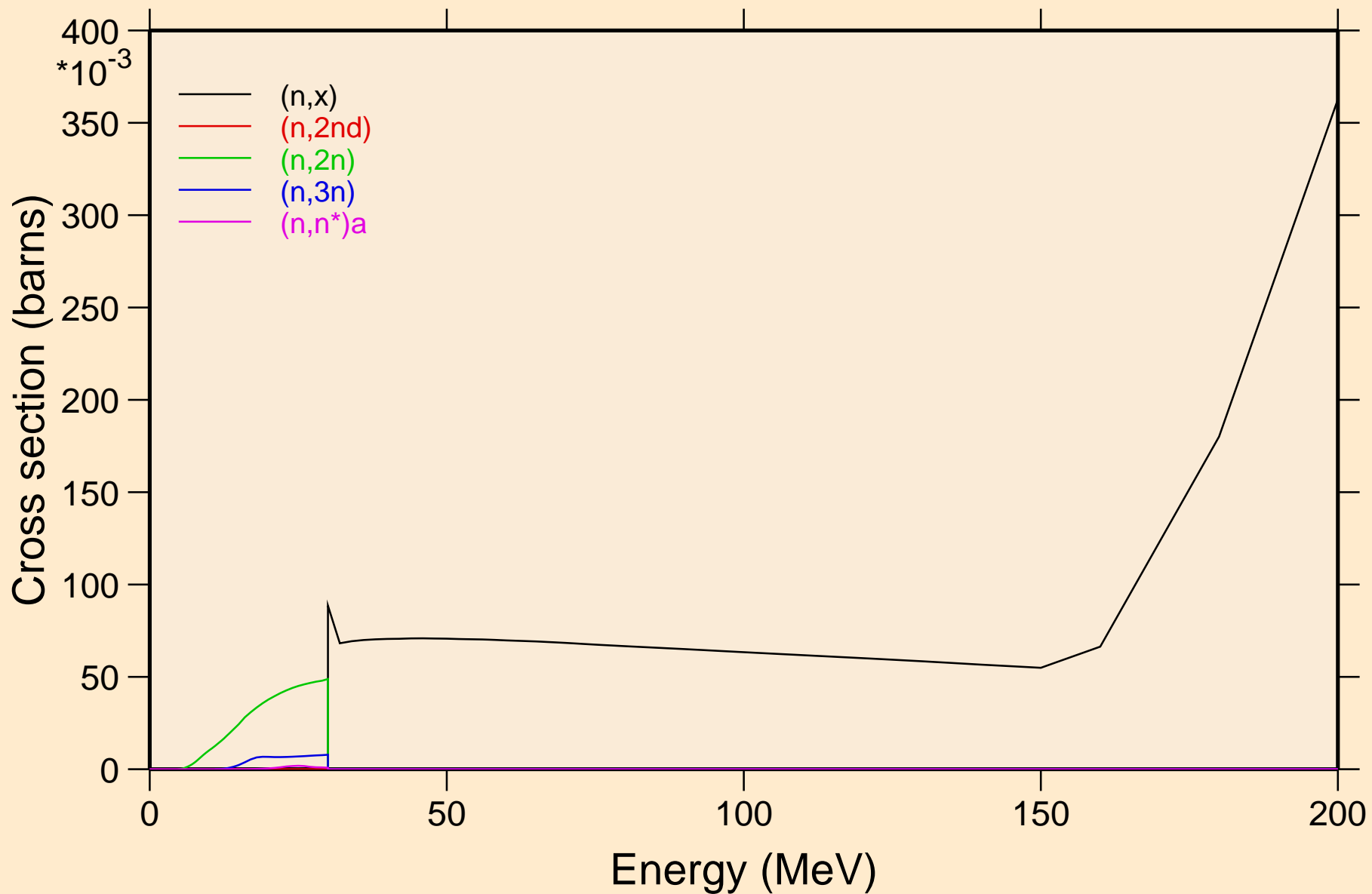

LR266 NEUTRON ACER TENDL-2019 LIBRARY; T=293.16K
Threshold reactions

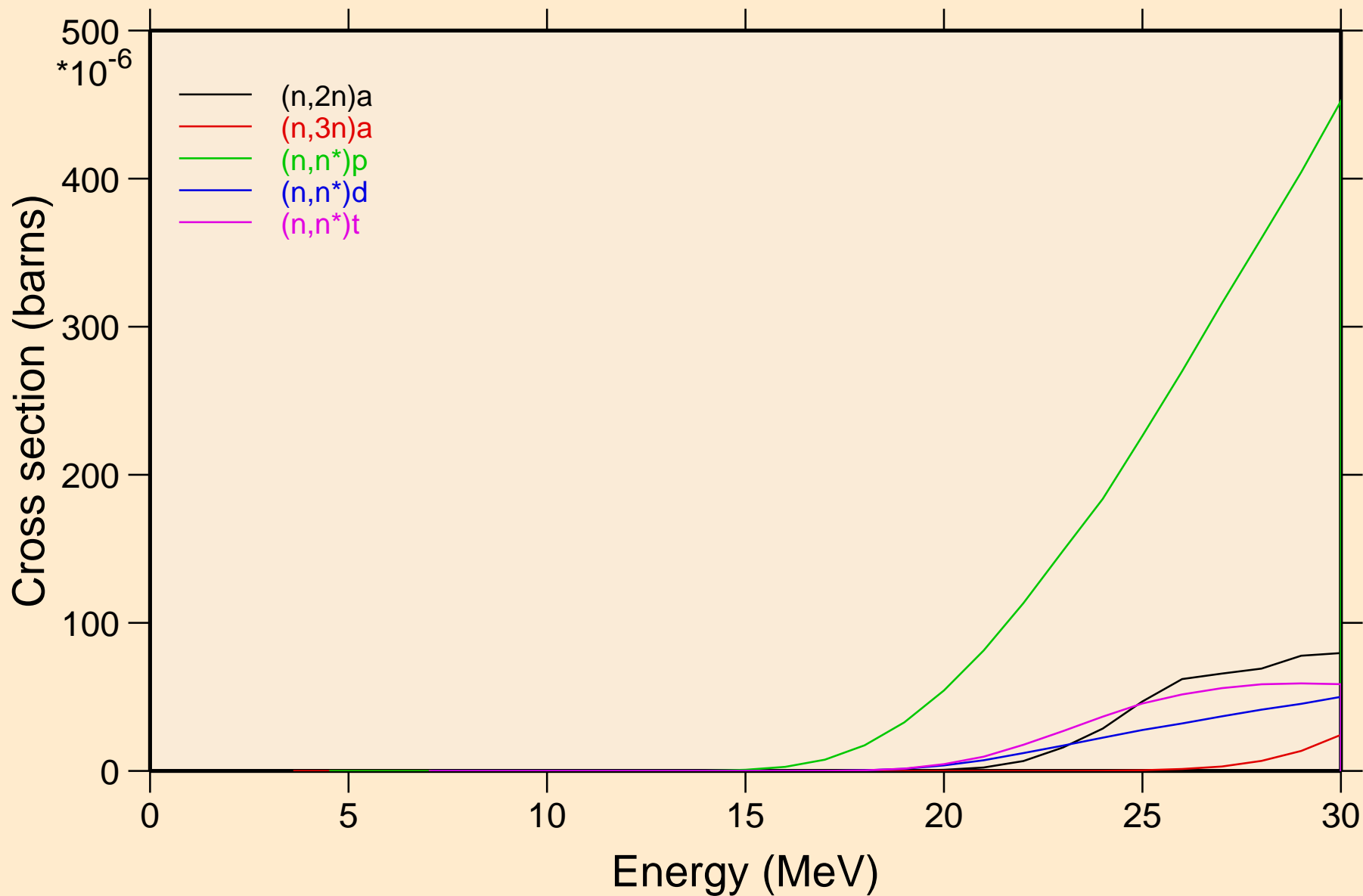

LR266 NEUTRON ACER TENDL-2019 LIBRARY; T=293.16K
Threshold reactions

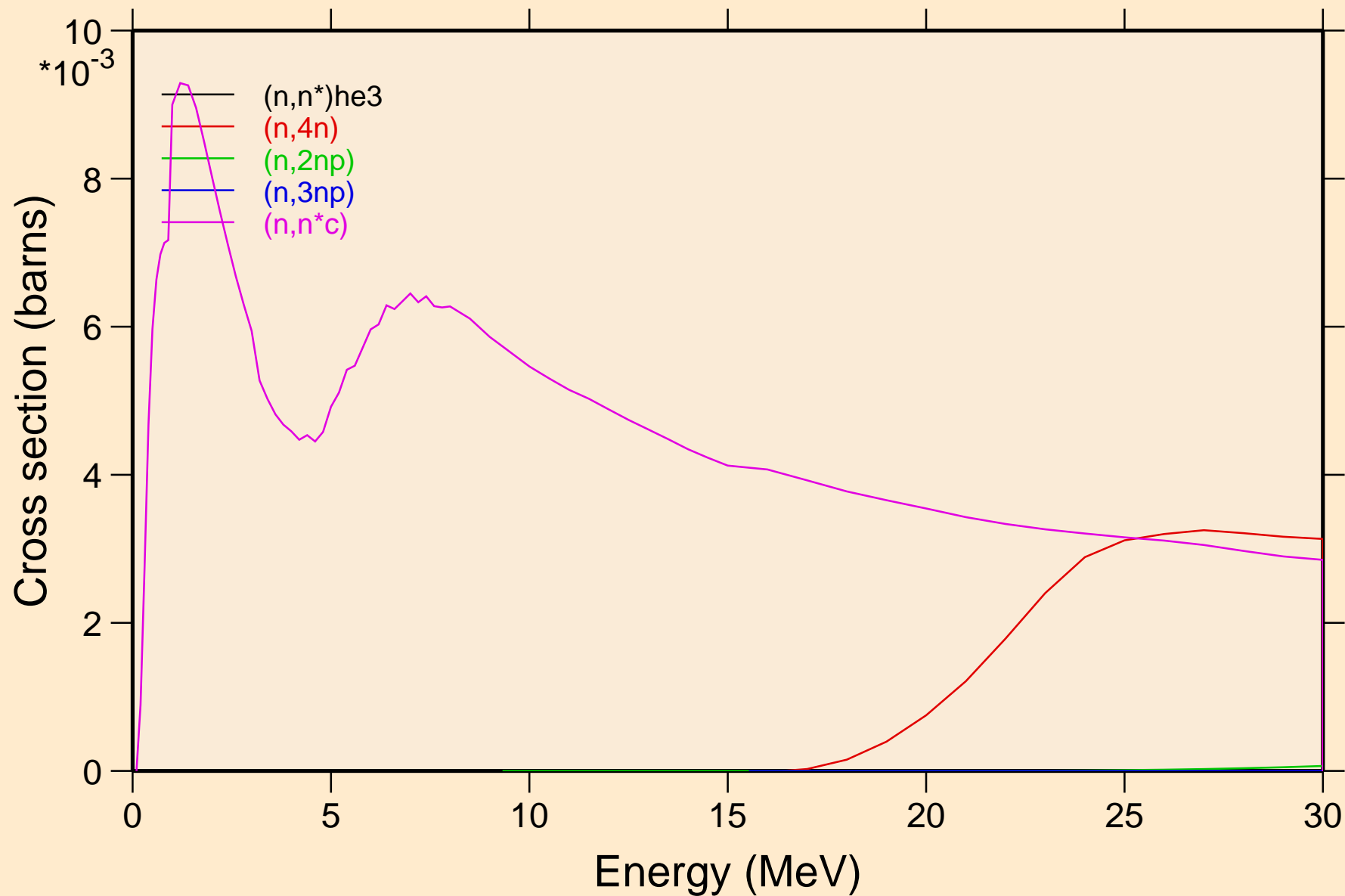

LR266 NEUTRON ACER TENDL-2019 LIBRARY; T=293.16K
Threshold reactions

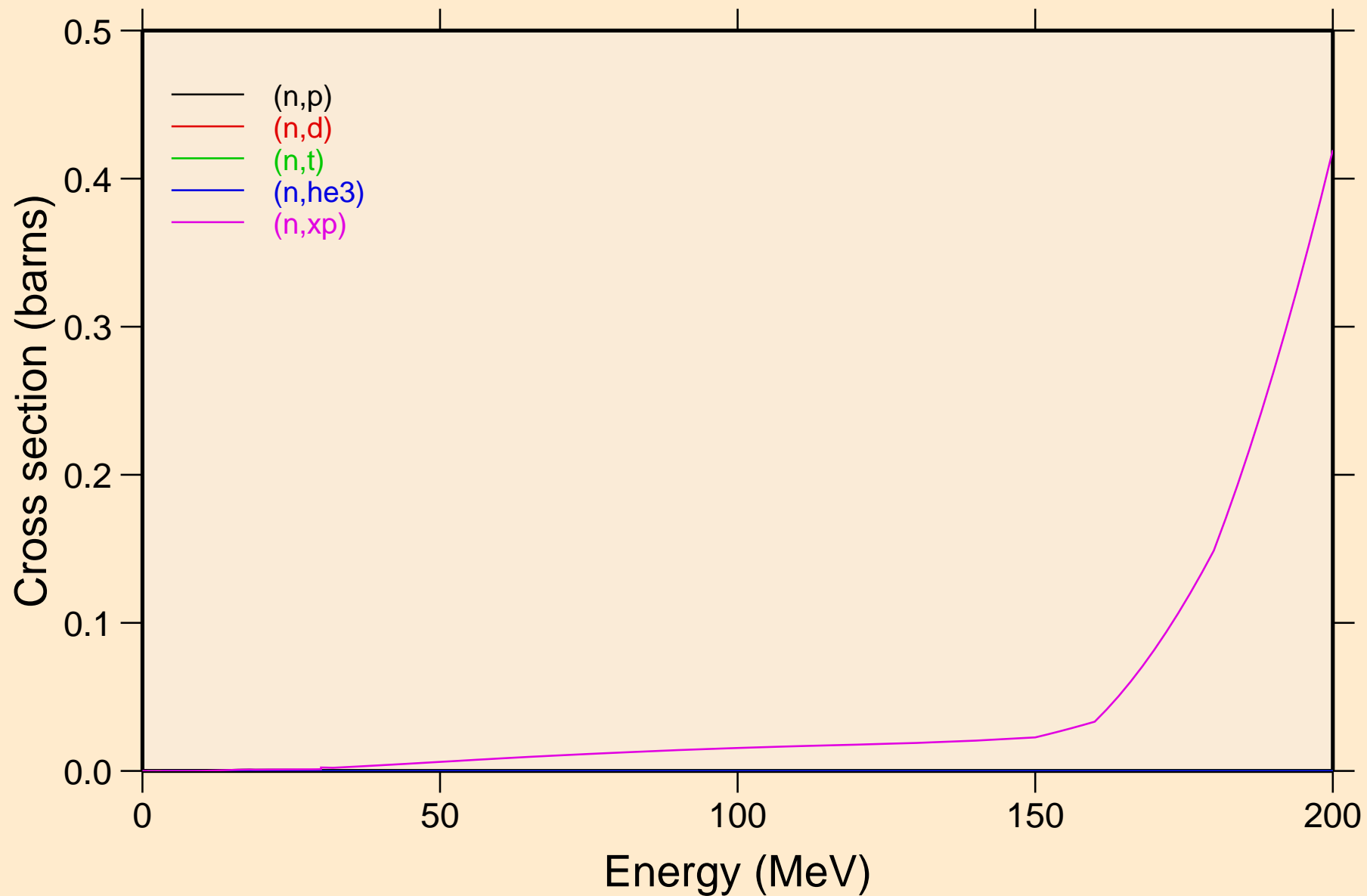

LR266 NEUTRON ACER TENDL-2019 LIBRARY; T=293.16K
Threshold reactions

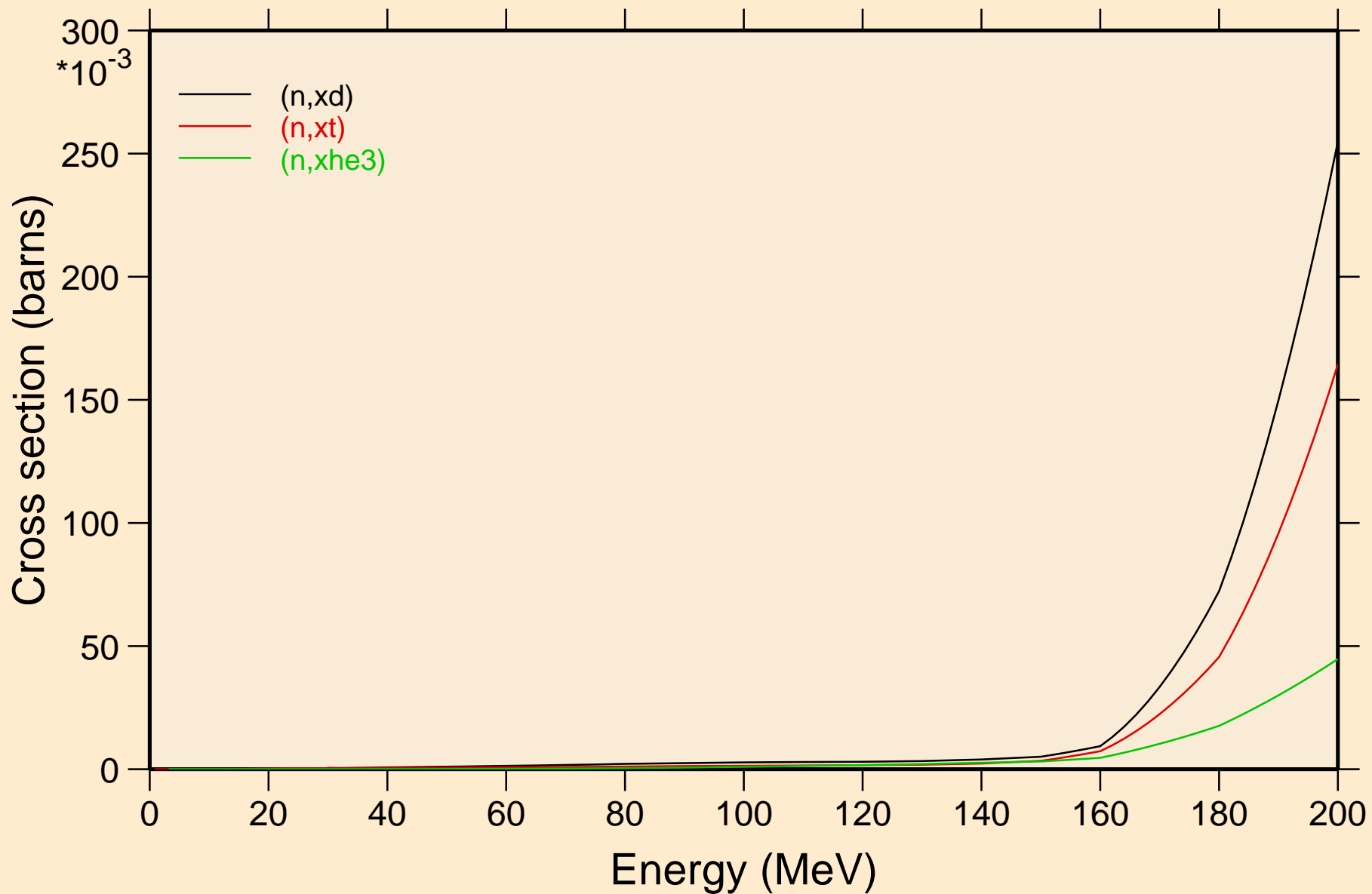

LR266 NEUTRON ACER TENDL-2019 LIBRARY; T=293.16K
angular distribution for elastic

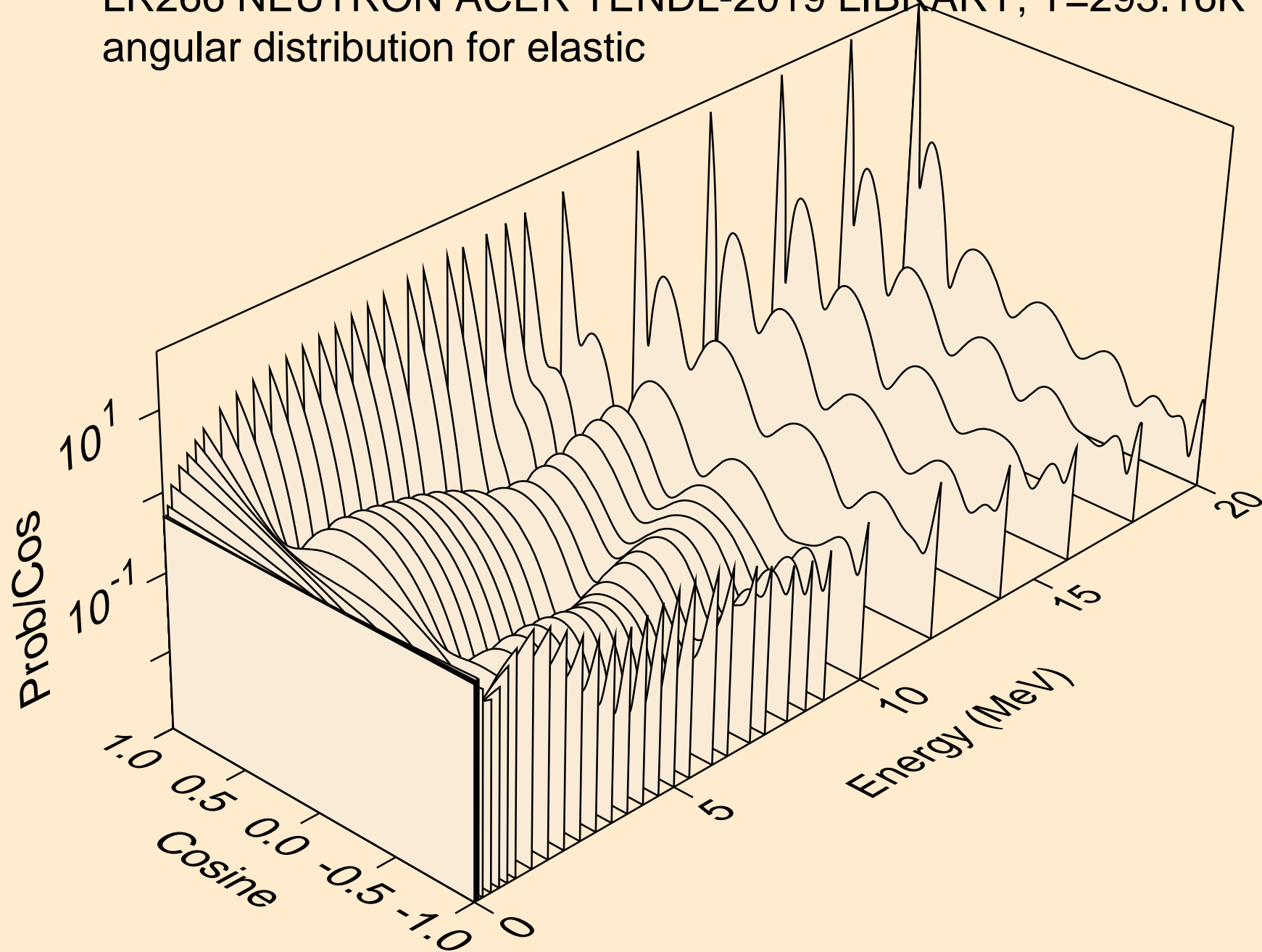

LR266 NEUTRON ACER TENDL-2019 LIBRARY; T=293.16K
angular distribution for elastic

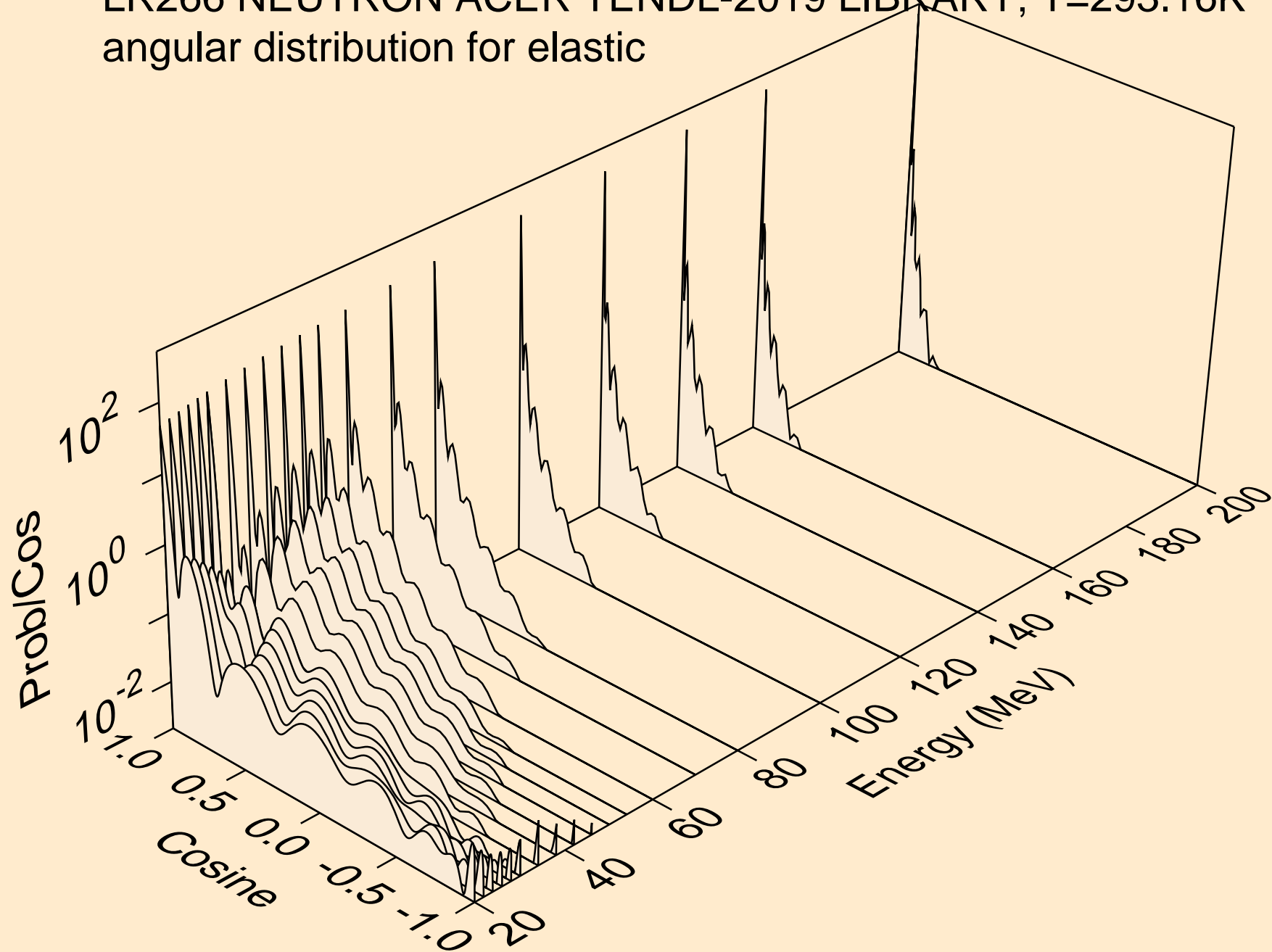

LR266 NEUTRON ACER TENDL-2019 LIBRARY; T=293.16K
angular distribution for (n,n*1)

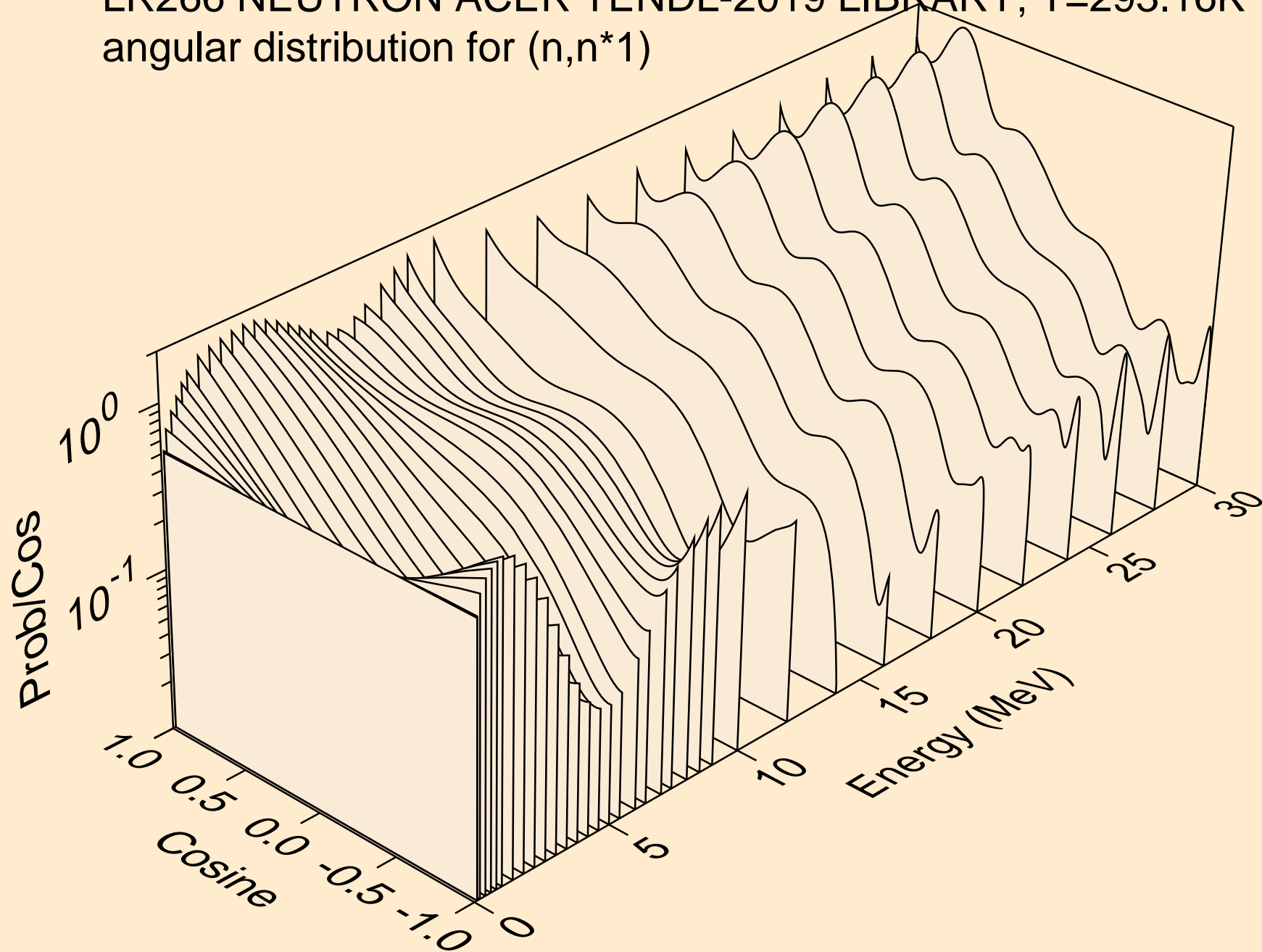

LR266 NEUTRON ACER TENDL-2019 LIBRARY; T=293.16K
Total fission nuubar

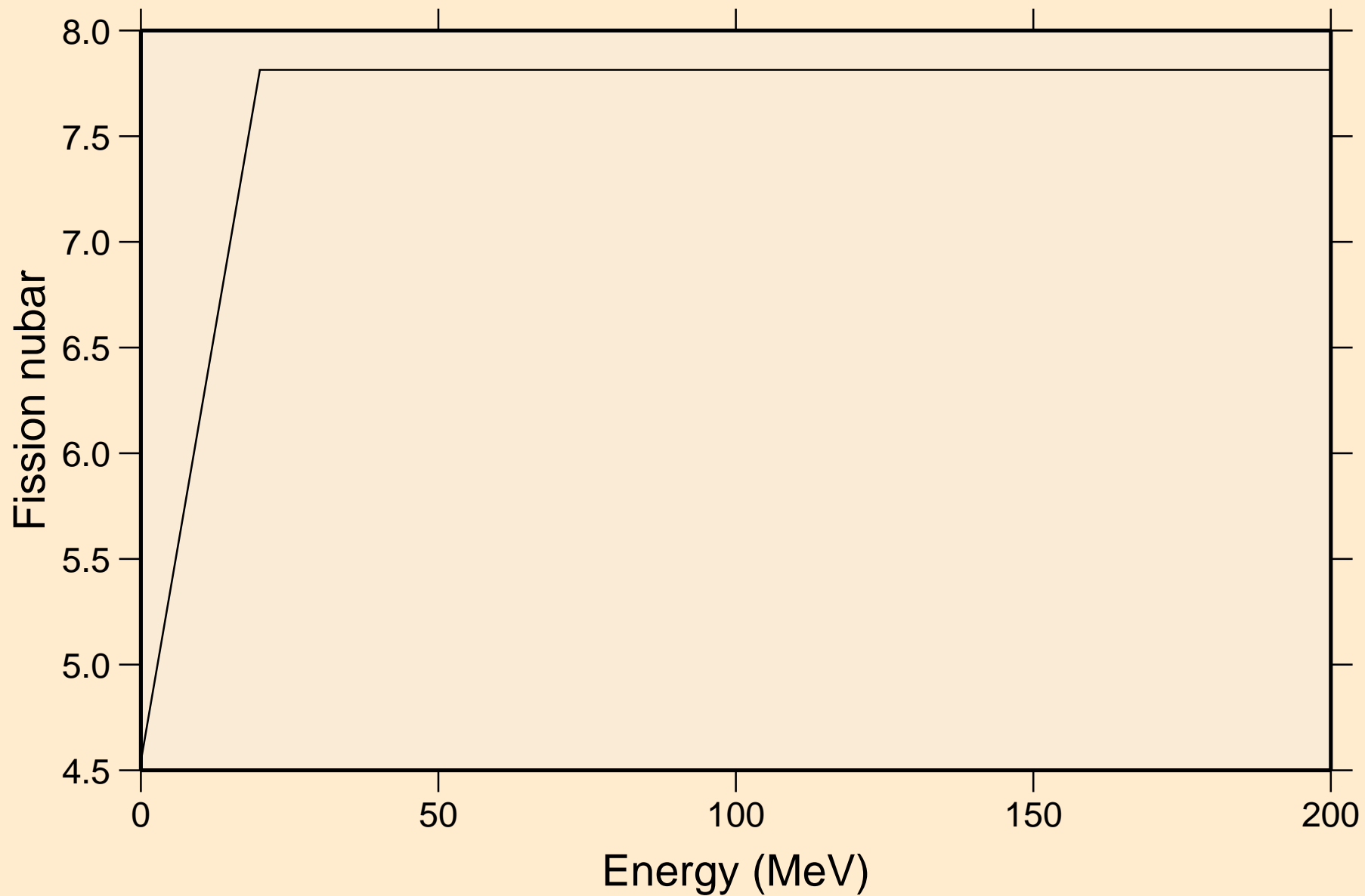

LR266 NEUTRON ACER TENDL-2019 LIBRARY; T=293.16K
Neutron emission for (n,x)

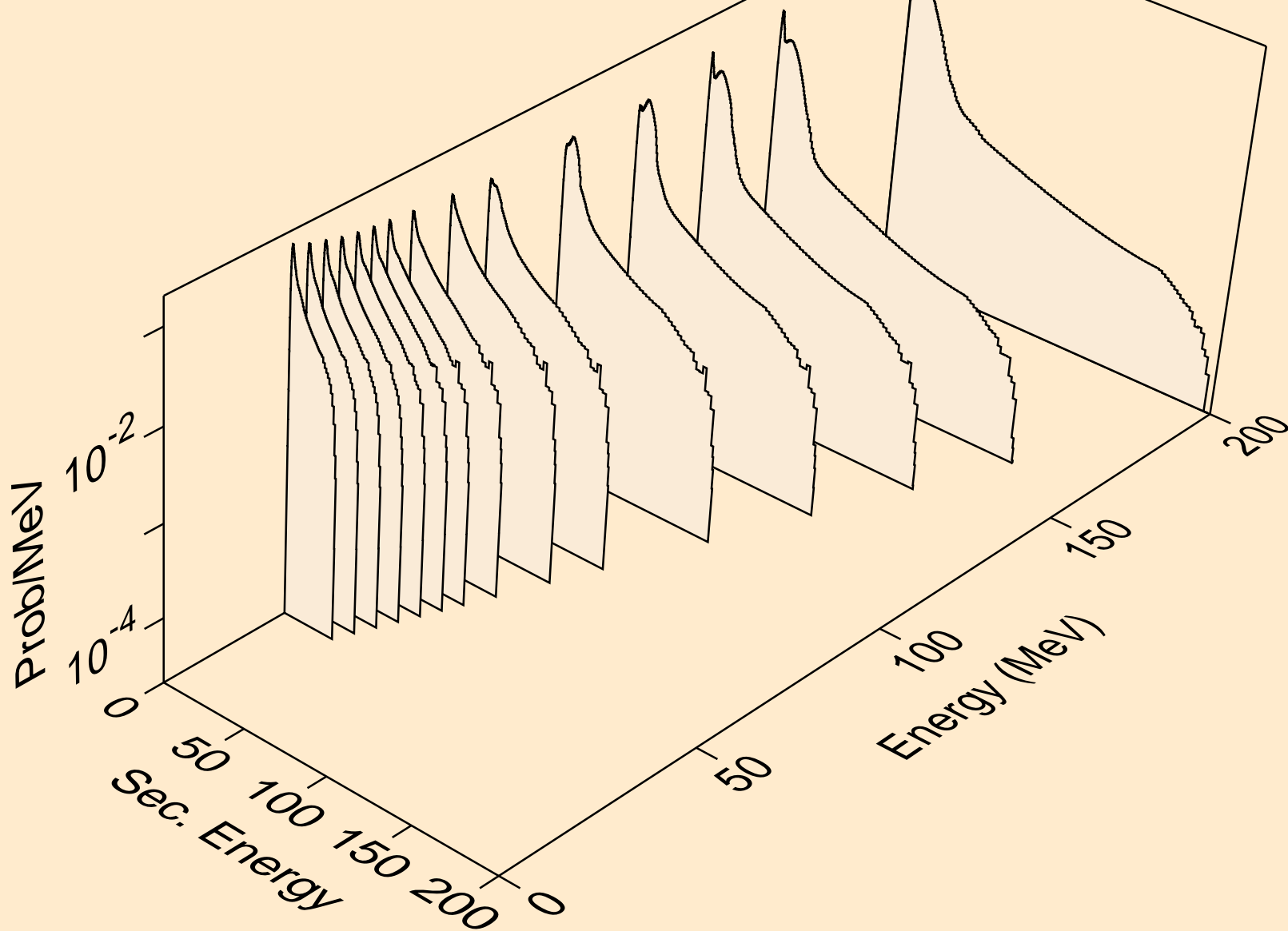

LR266 NEUTRON ACER TENDL-2019 LIBRARY; T=293.16K
Neutron emission for (n,2nd)

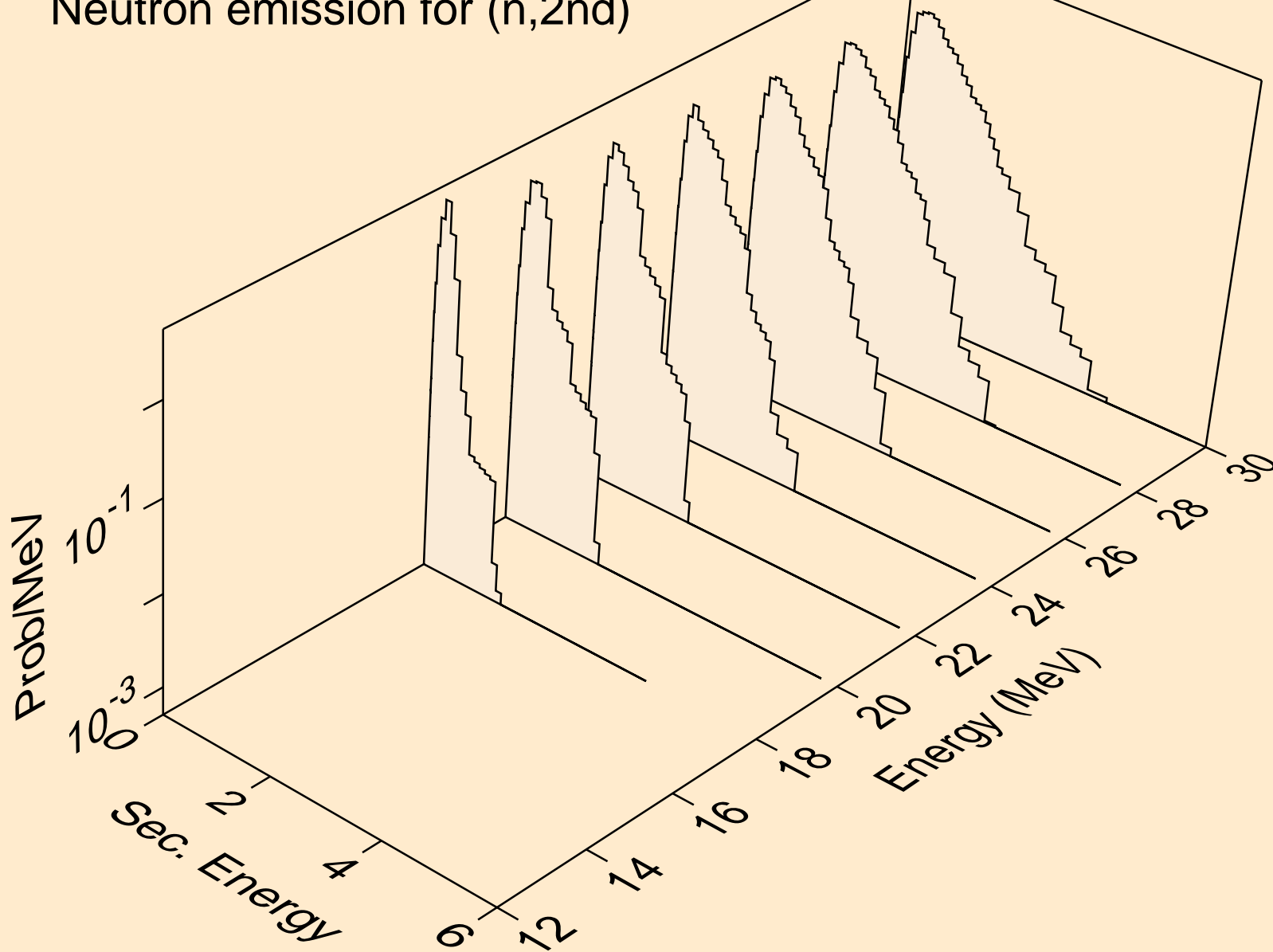

LR266 NEUTRON ACER TENDL-2019 LIBRARY; T=293.16K
Neutron emission for (n,2n)

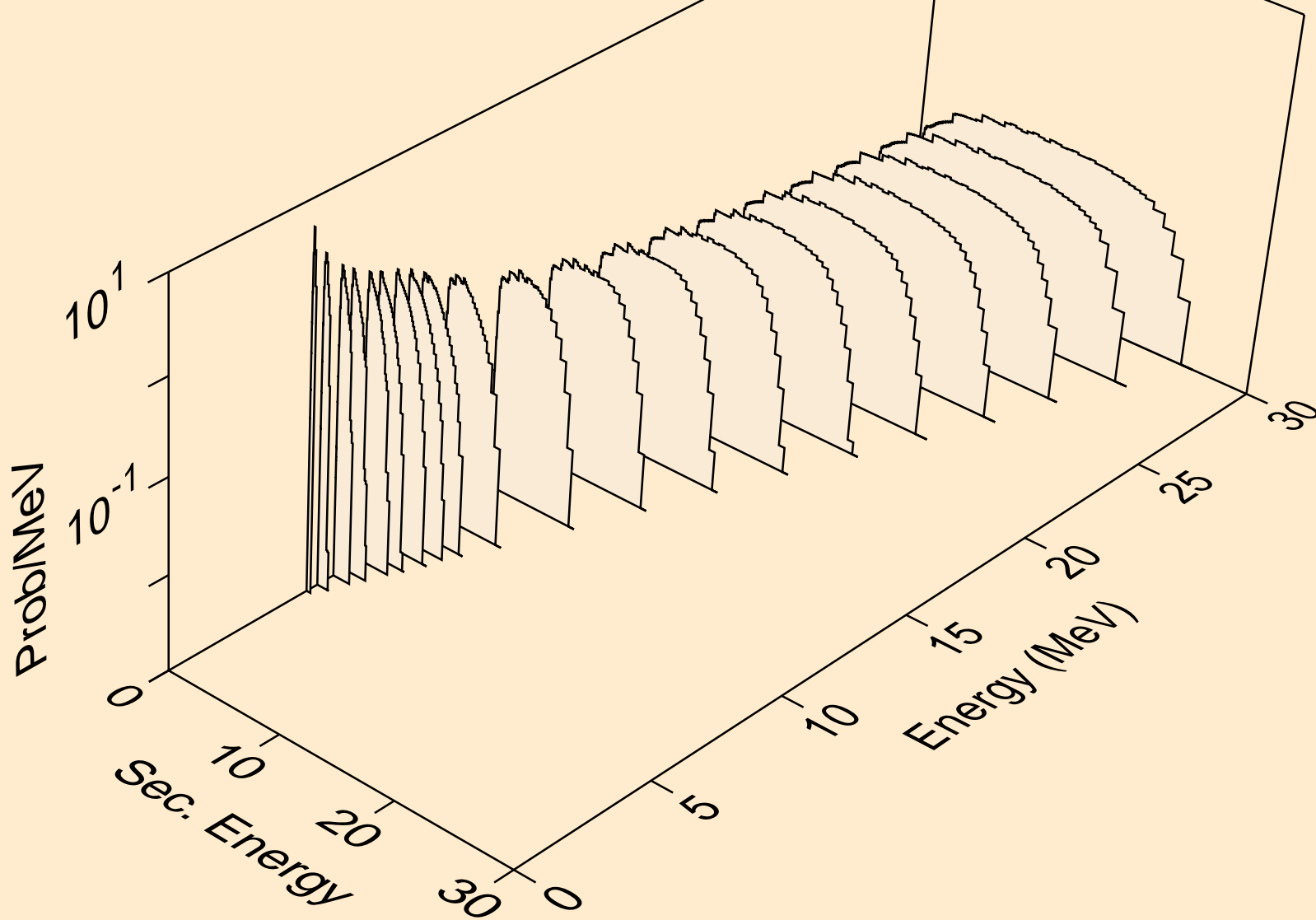

LR266 NEUTRON ACER TENDL-2019 LIBRARY; T=293.16K
Neutron emission for (n,3n)

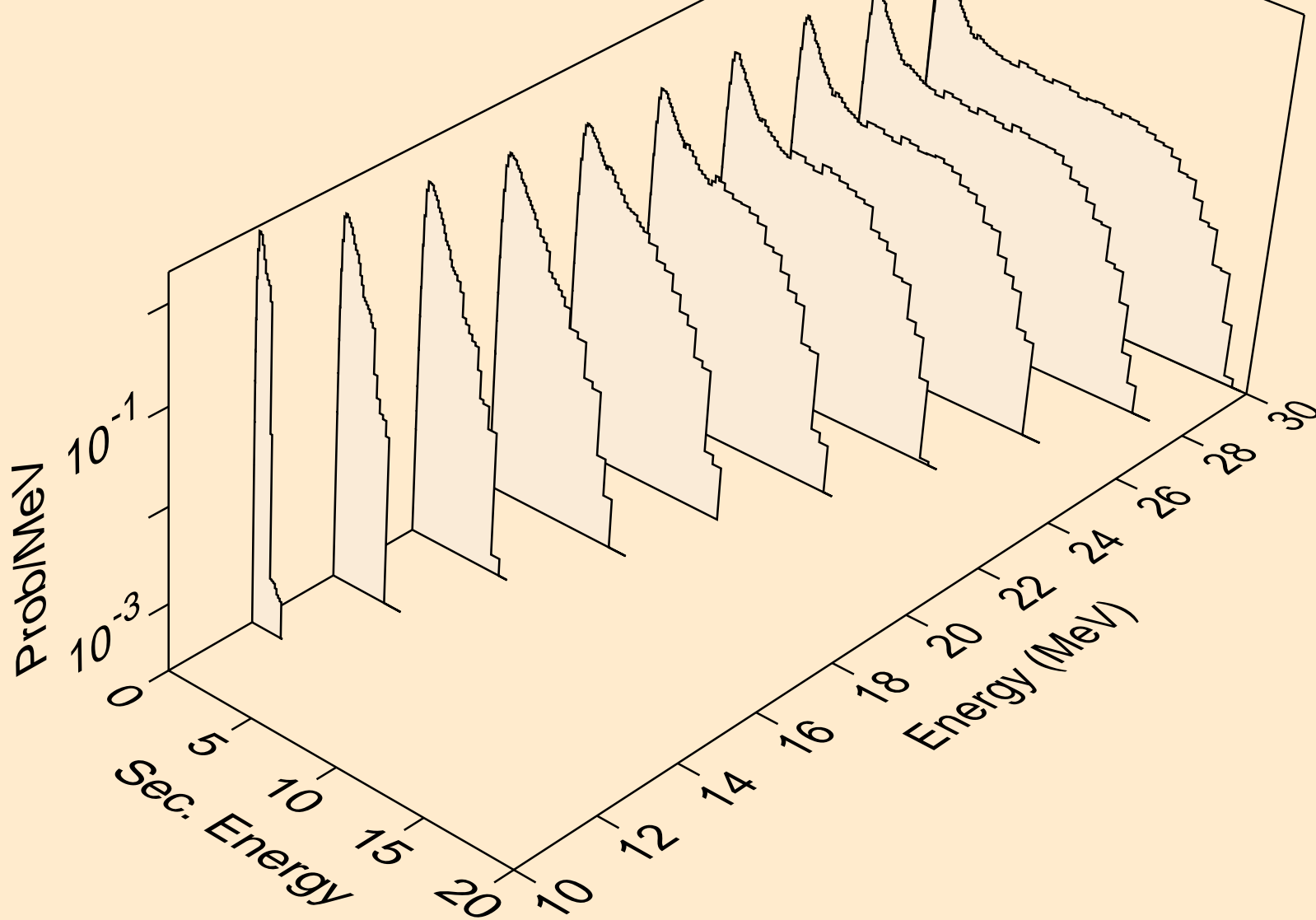

LR266 NEUTRON ACER TENDL-2019 LIBRARY; T=293.16K
Neutron emission for fission

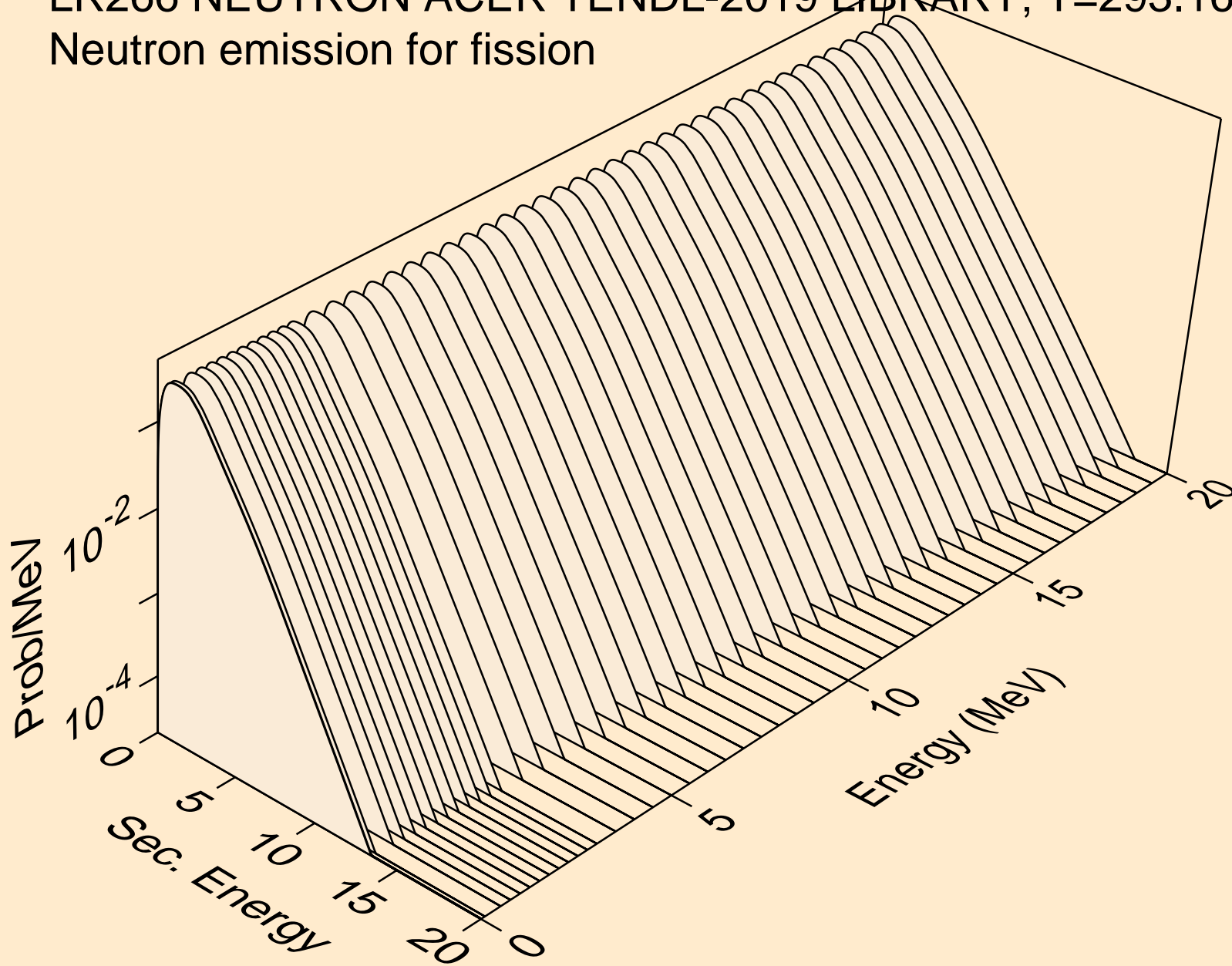

LR266 NEUTRON ACER TENDL-2019 LIBRARY; T=293.16K
Neutron emission for (n,n*)a

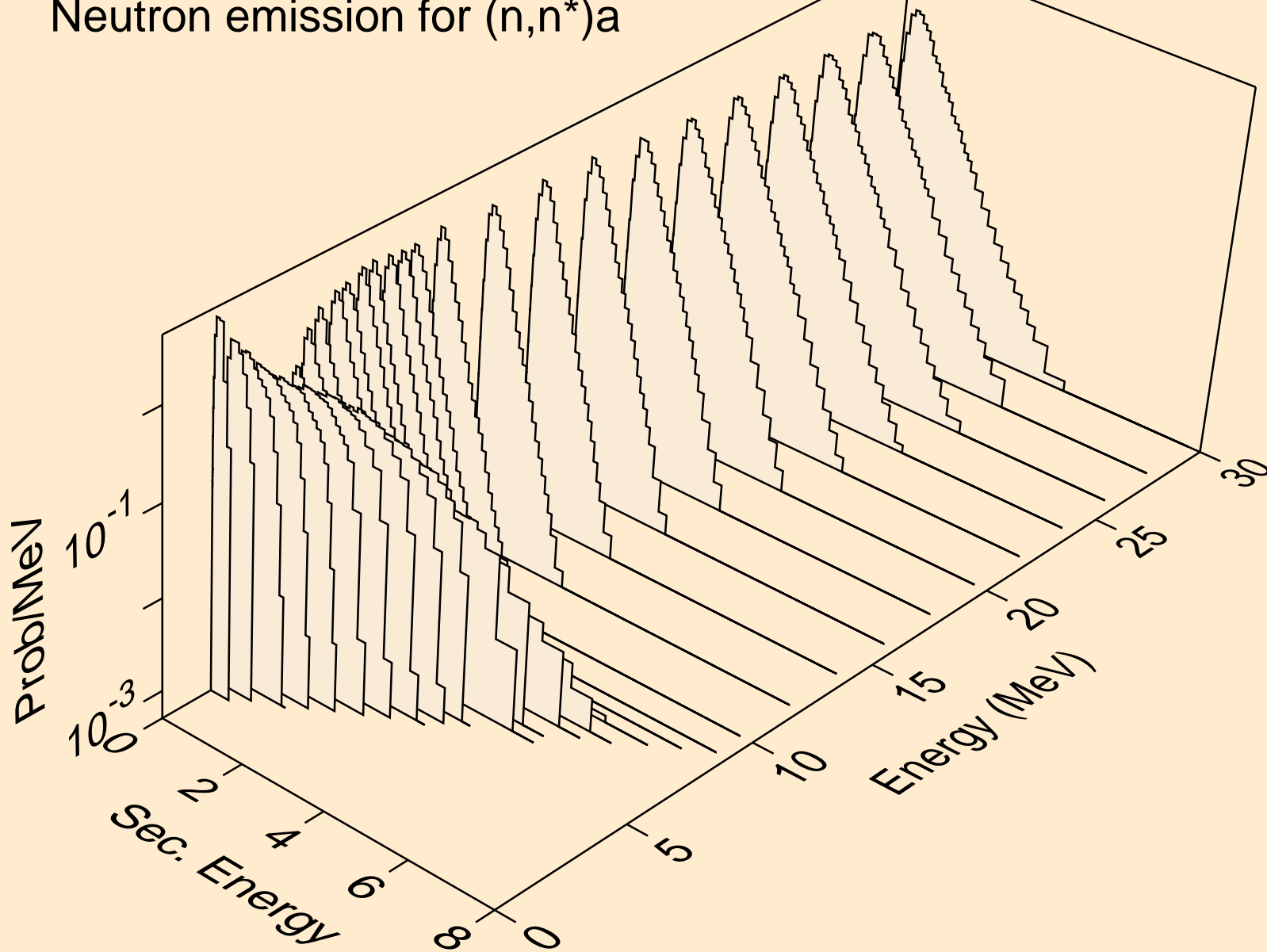

LR266 NEUTRON ACER TENDL-2019 LIBRARY; T=293.16K
Neutron emission for (n,2n)a

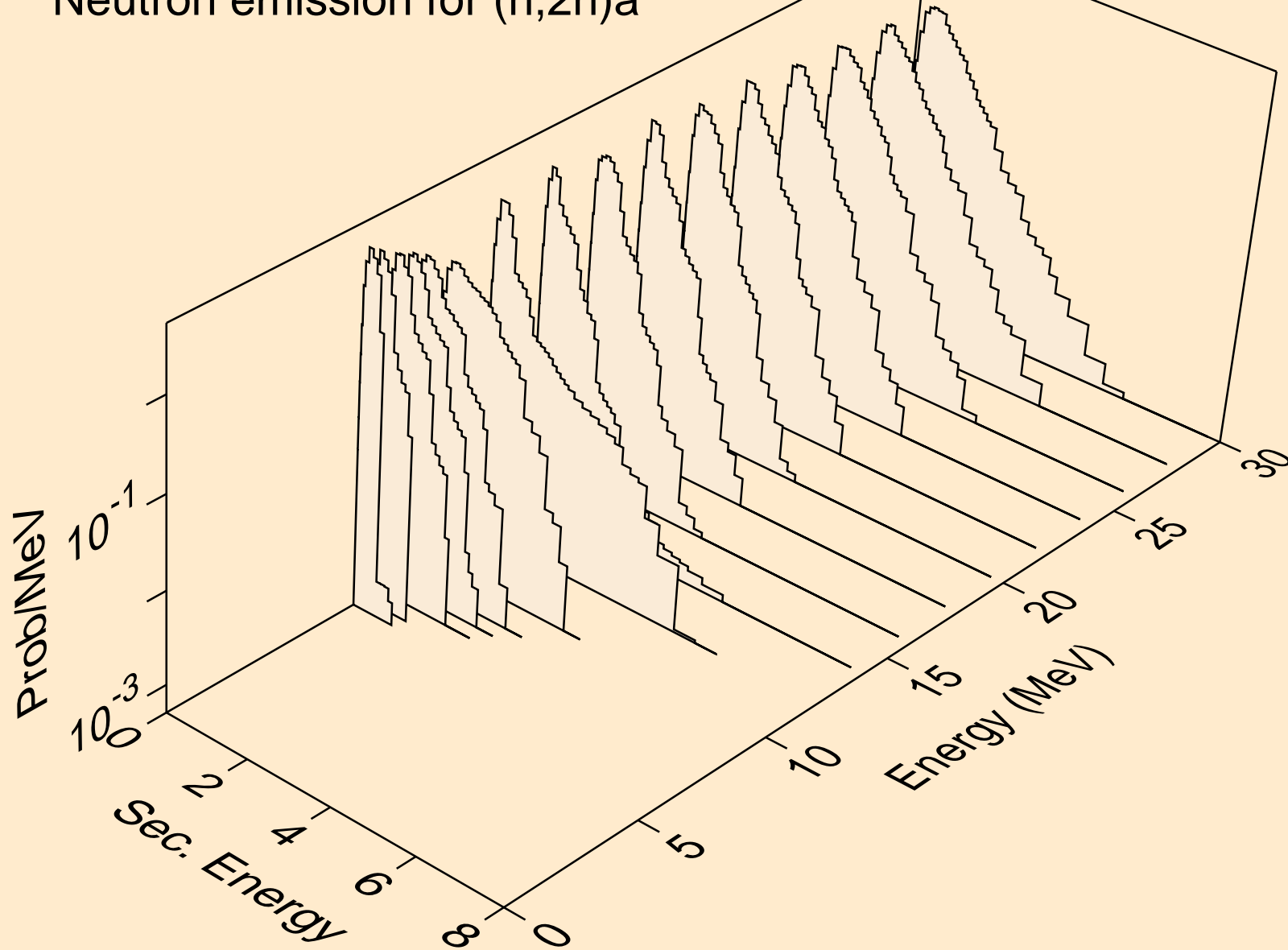

LR266 NEUTRON ACER TENDL-2019 LIBRARY; T=293.16K
Neutron emission for (n,3n)a

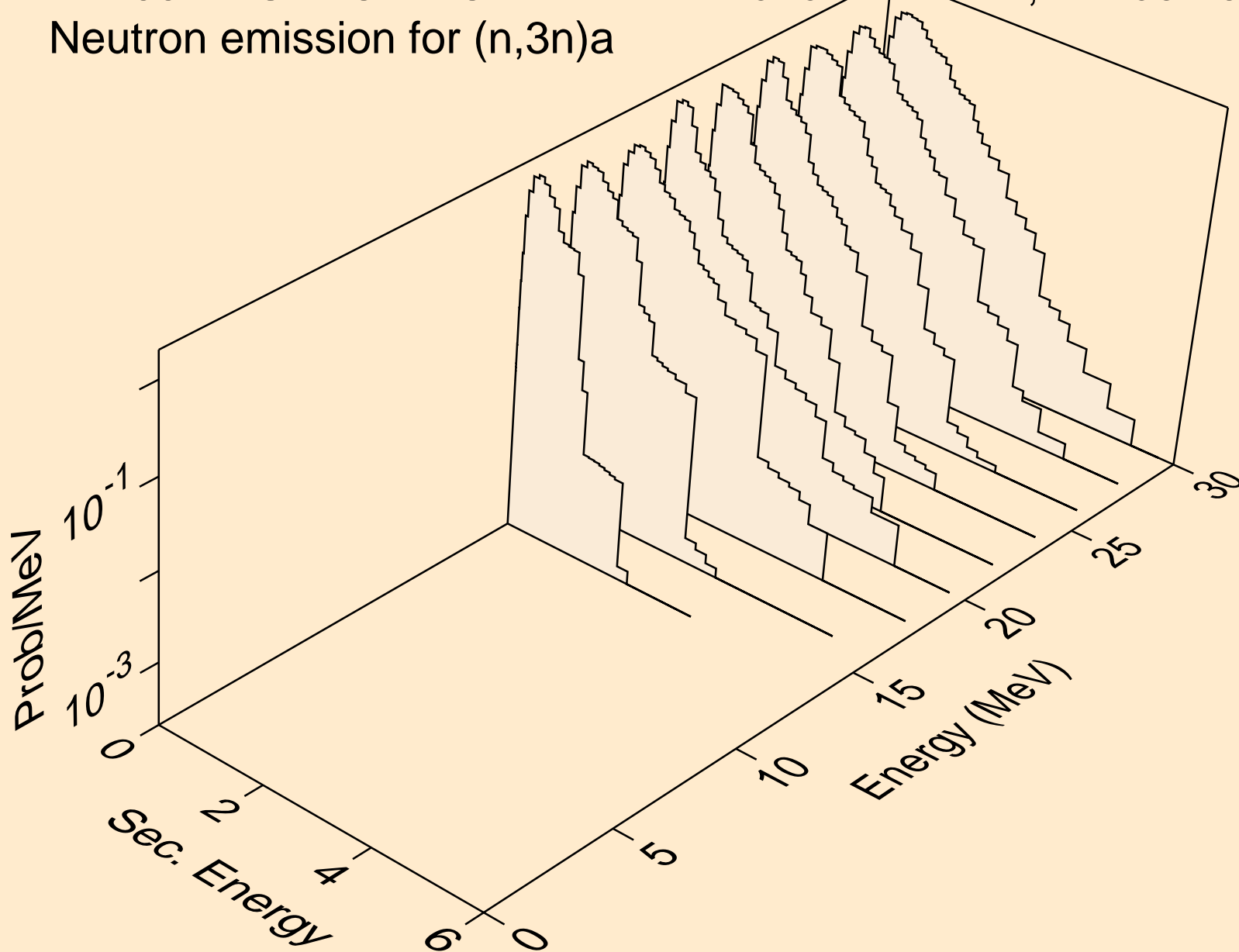

LR266 NEUTRON ACER TENDL-2019 LIBRARY; T=293.16K
Neutron emission for (n,n*)p

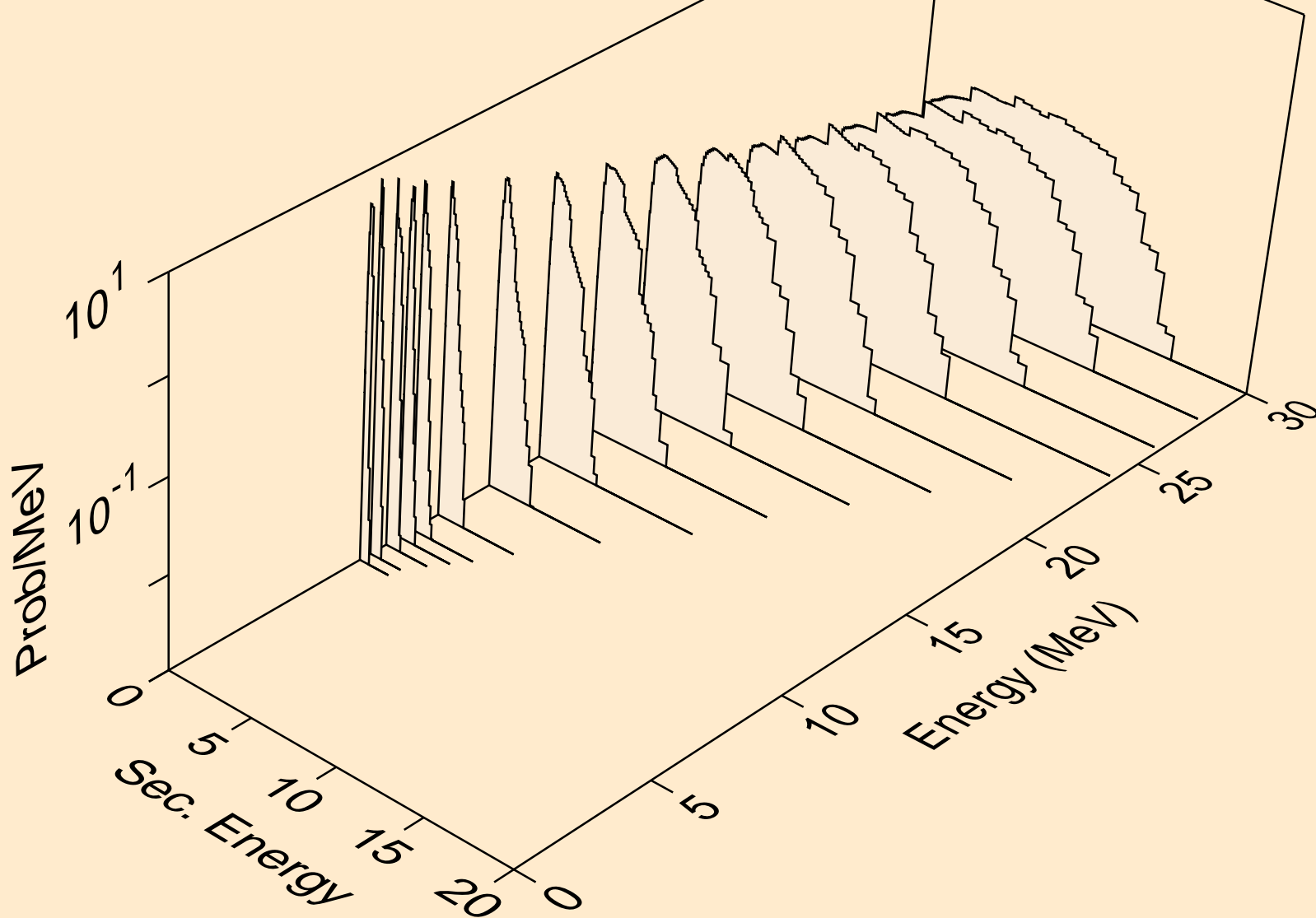

LR266 NEUTRON ACER TENDL-2019 LIBRARY; T=293.16K
Neutron emission for (n,n*)d

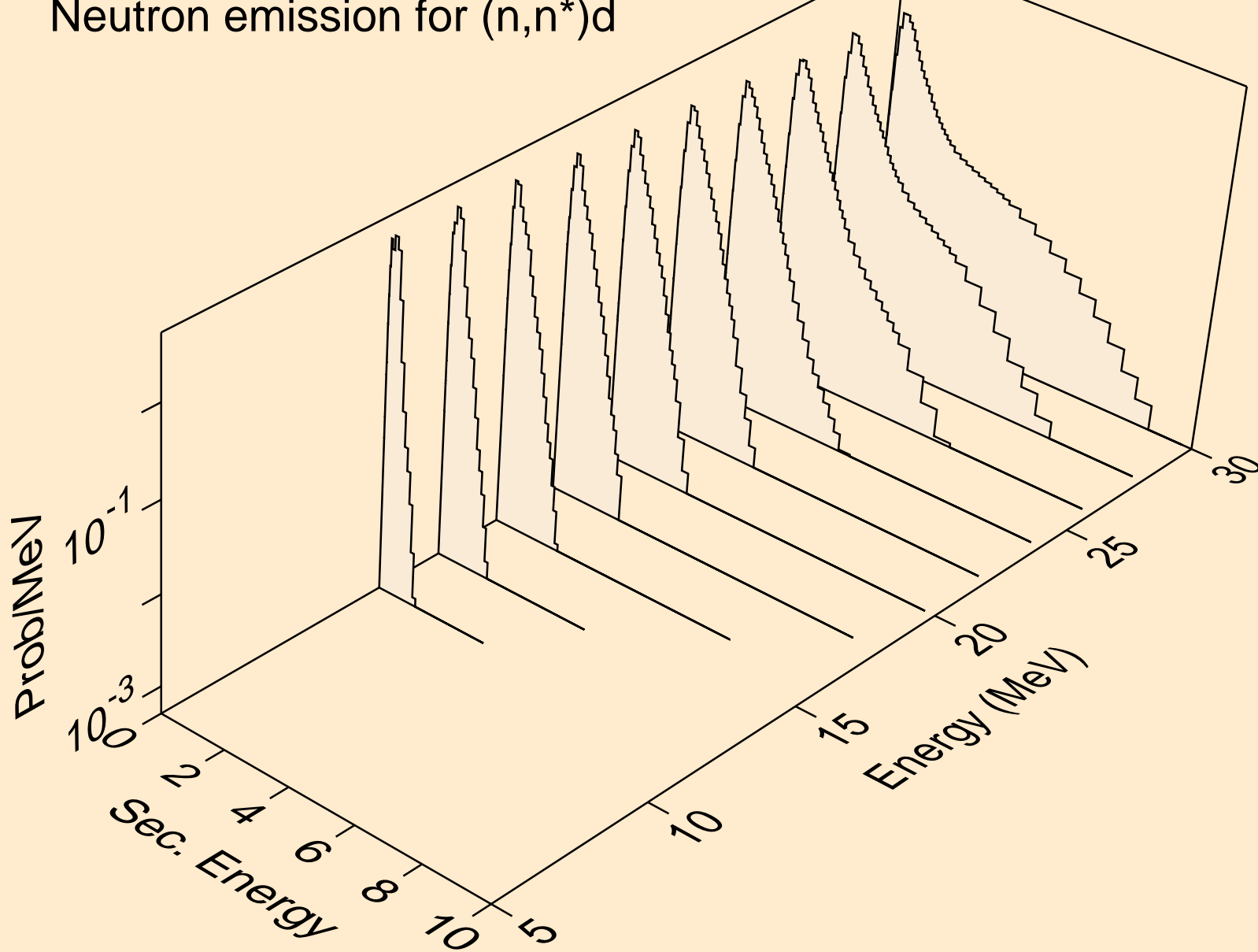

LR266 NEUTRON ACER TENDL-2019 LIBRARY; T=293.16K
Neutron emission for (n,n*)t

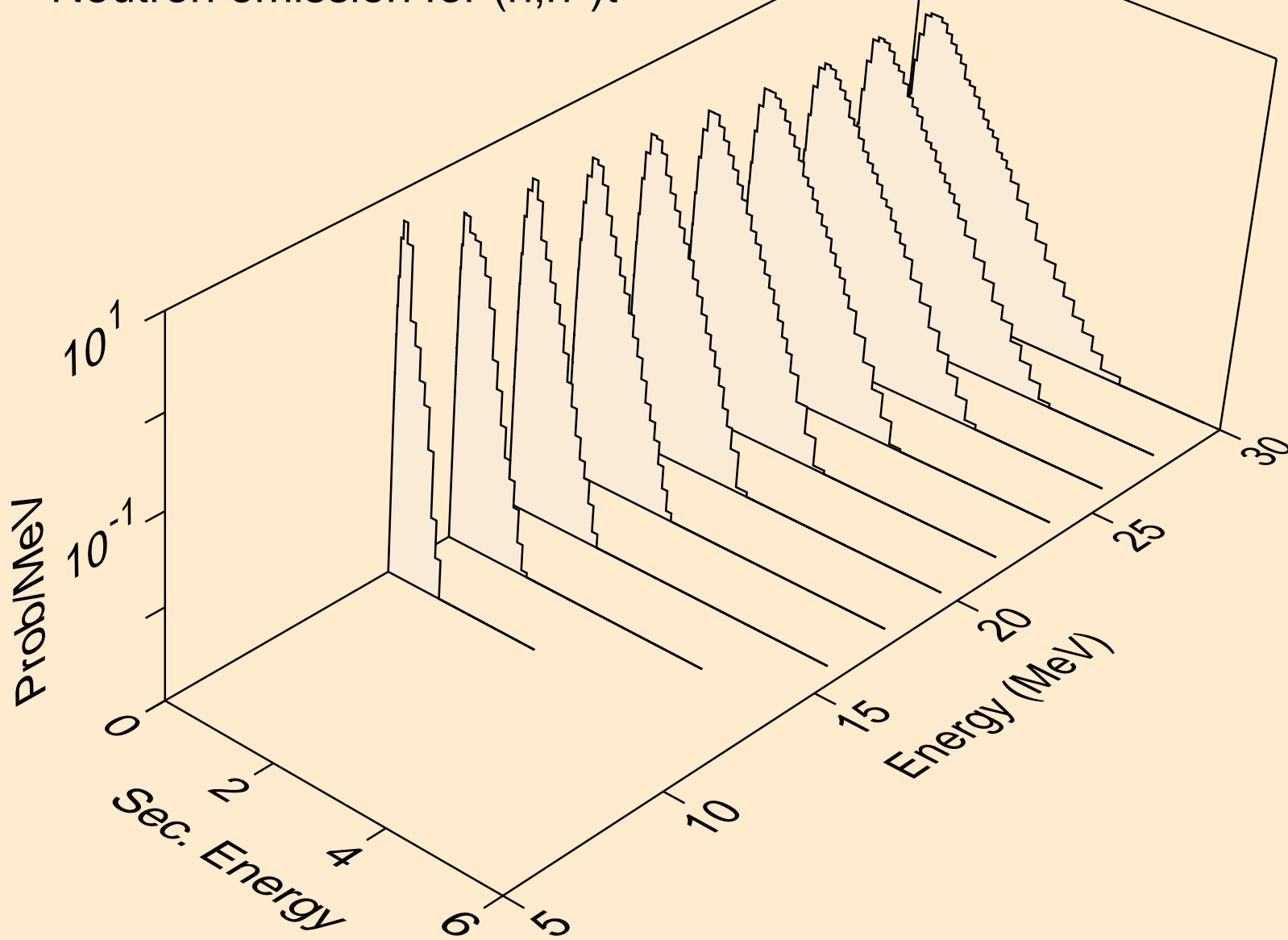

LR266 NEUTRON ACER TENDL-2019 LIBRARY; T=293.16K
Neutron emission for (n,n*)he3

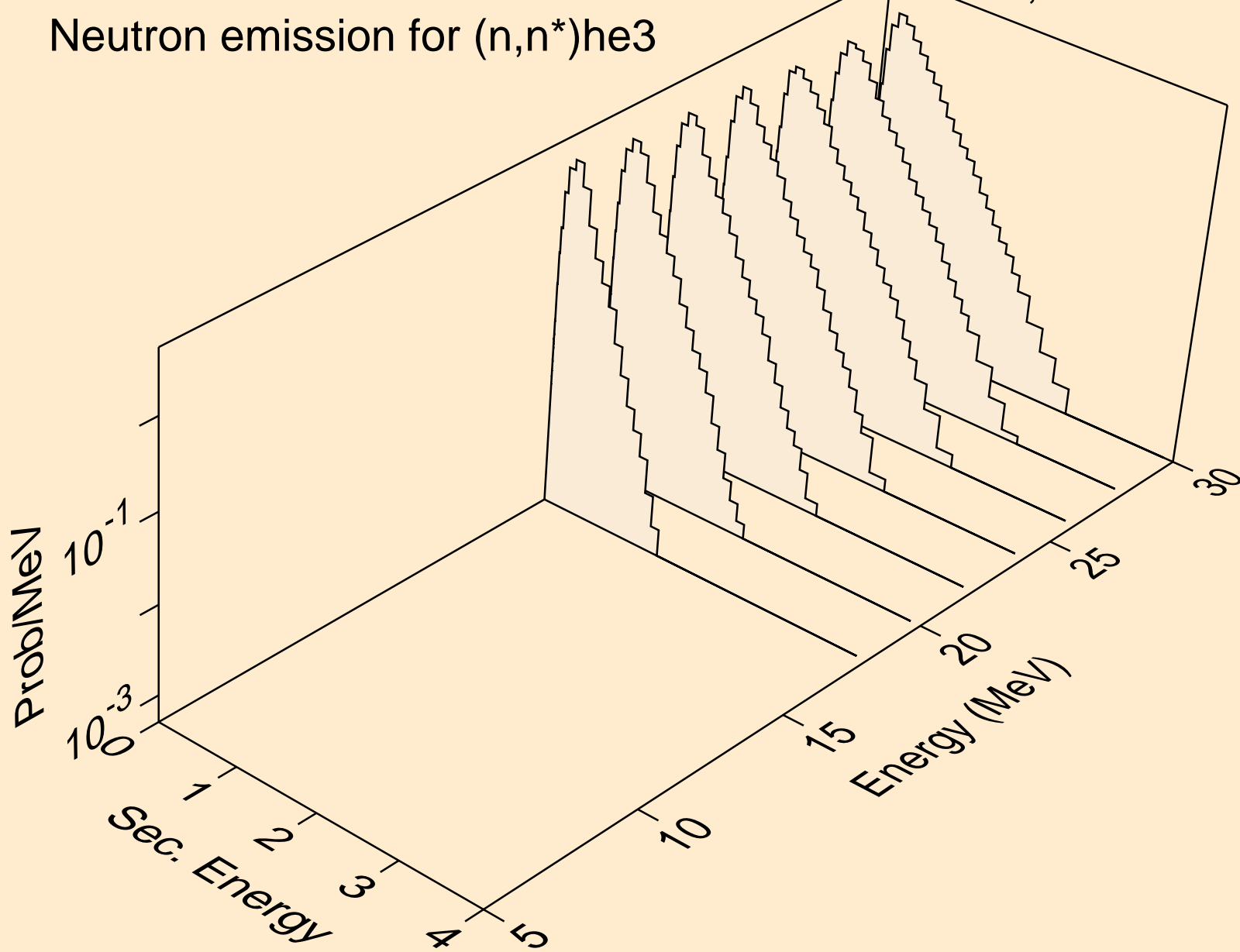

LR266 NEUTRON ACER TENDL-2019 LIBRARY; T=293.16K
Neutron emission for (n,4n)

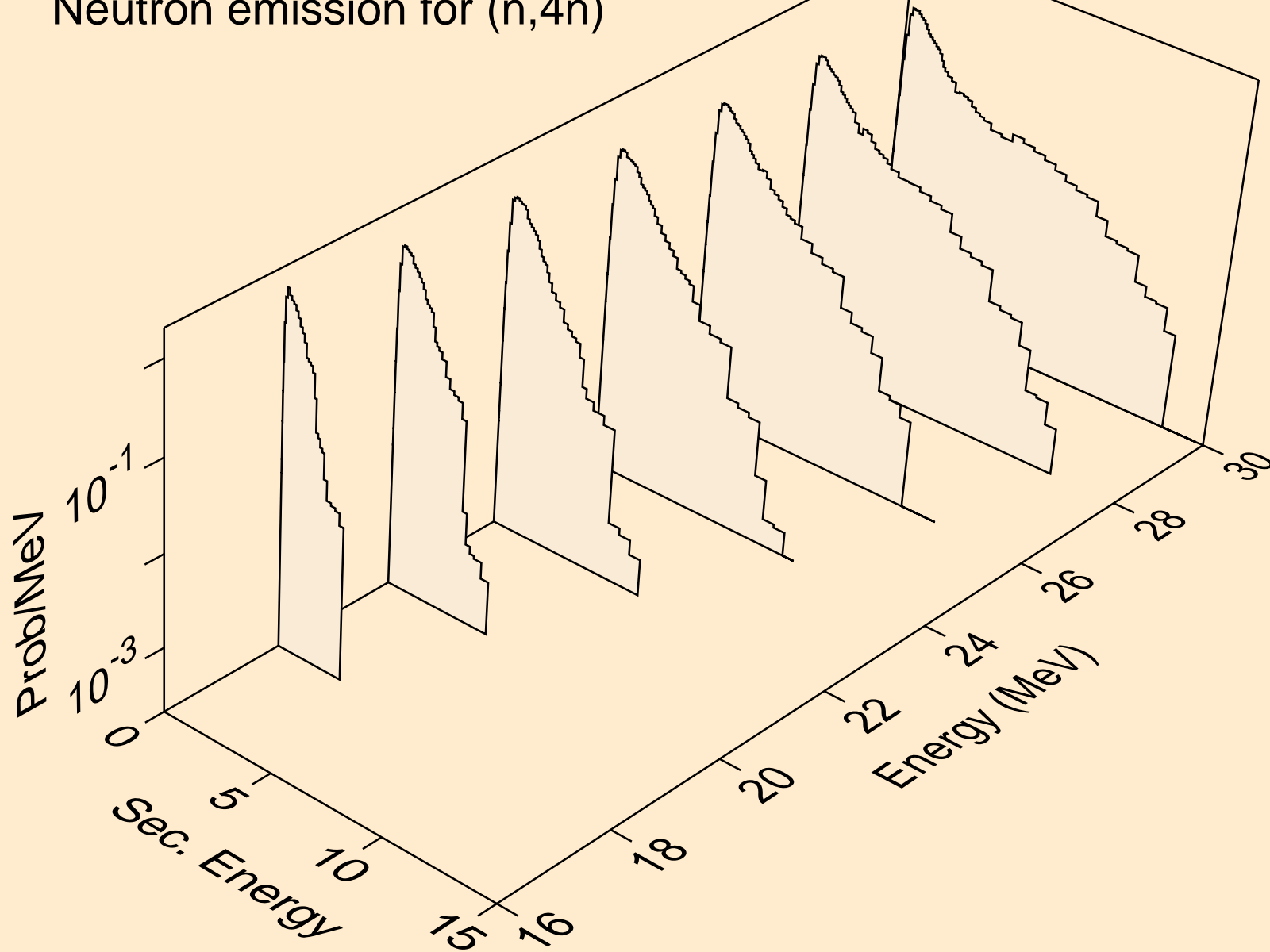

LR266 NEUTRON ACER TENDL-2019 LIBRARY; T=293.16K
Neutron emission for (n,2np)

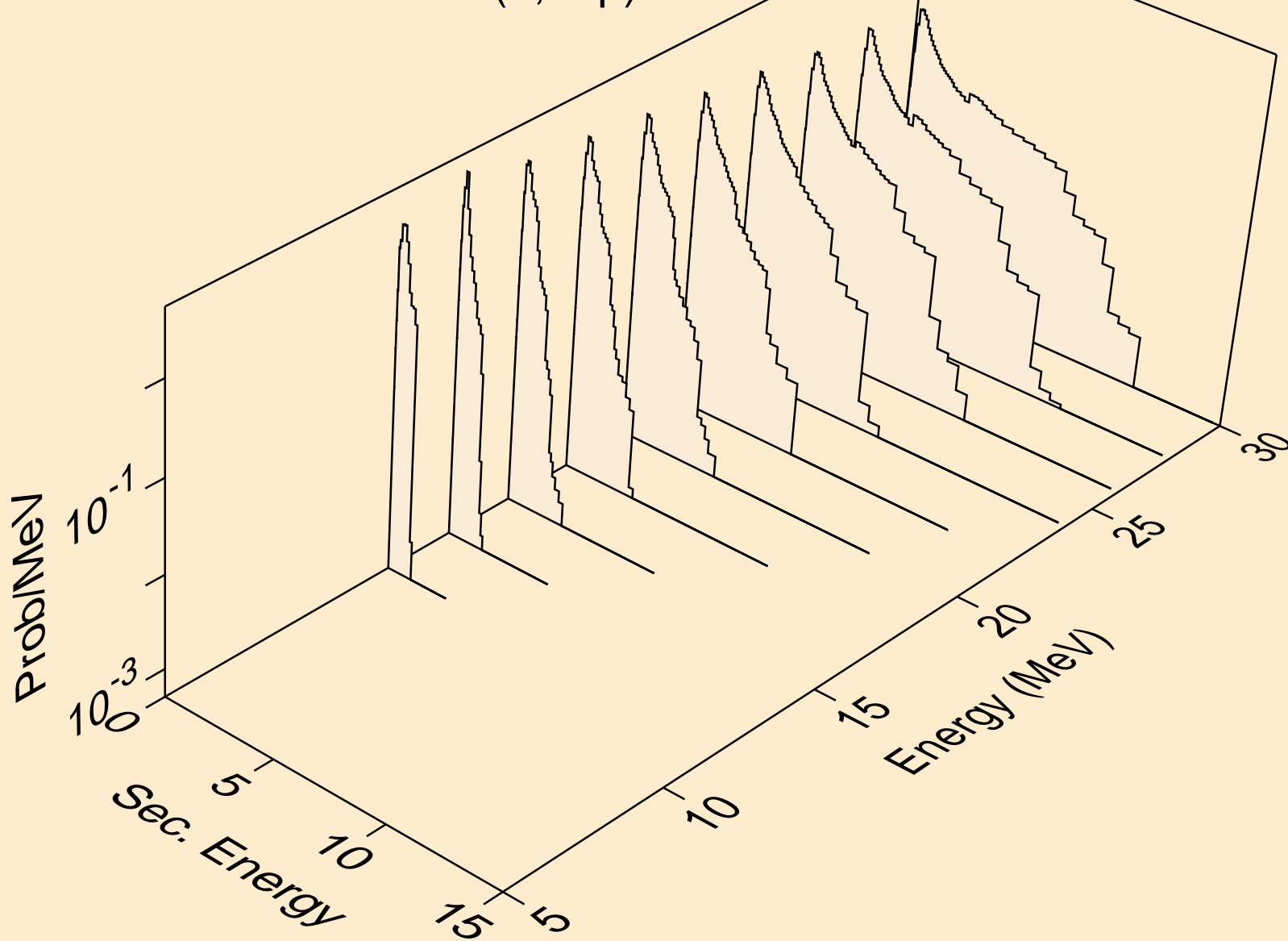

LR266 NEUTRON ACER TENDL-2019 LIBRARY; T=293.16K
Neutron emission for (n,3np)

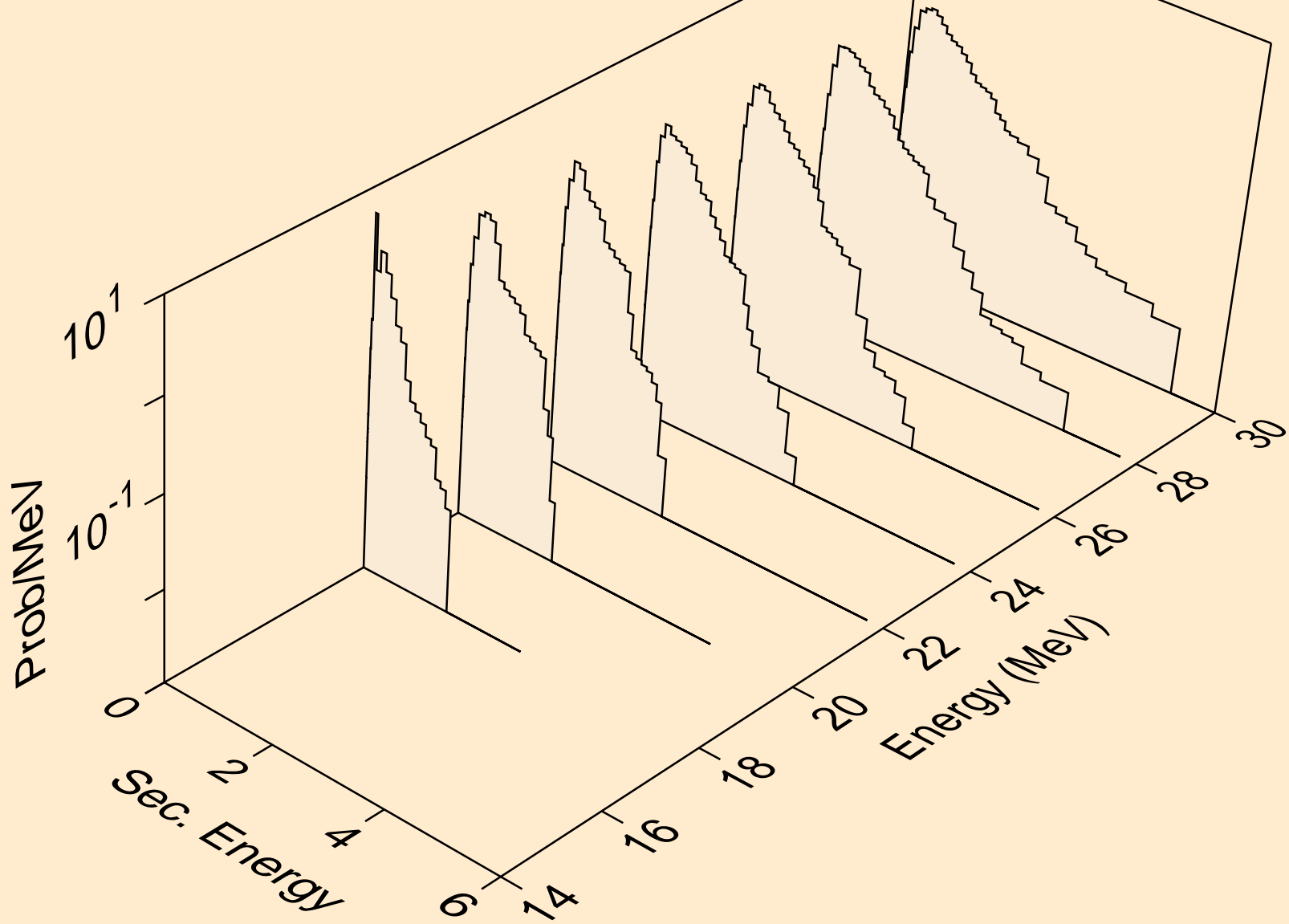

LR266 NEUTRON ACER TENDL-2019 LIBRARY; T=293.16K
Neutron emission for (n,n*c)

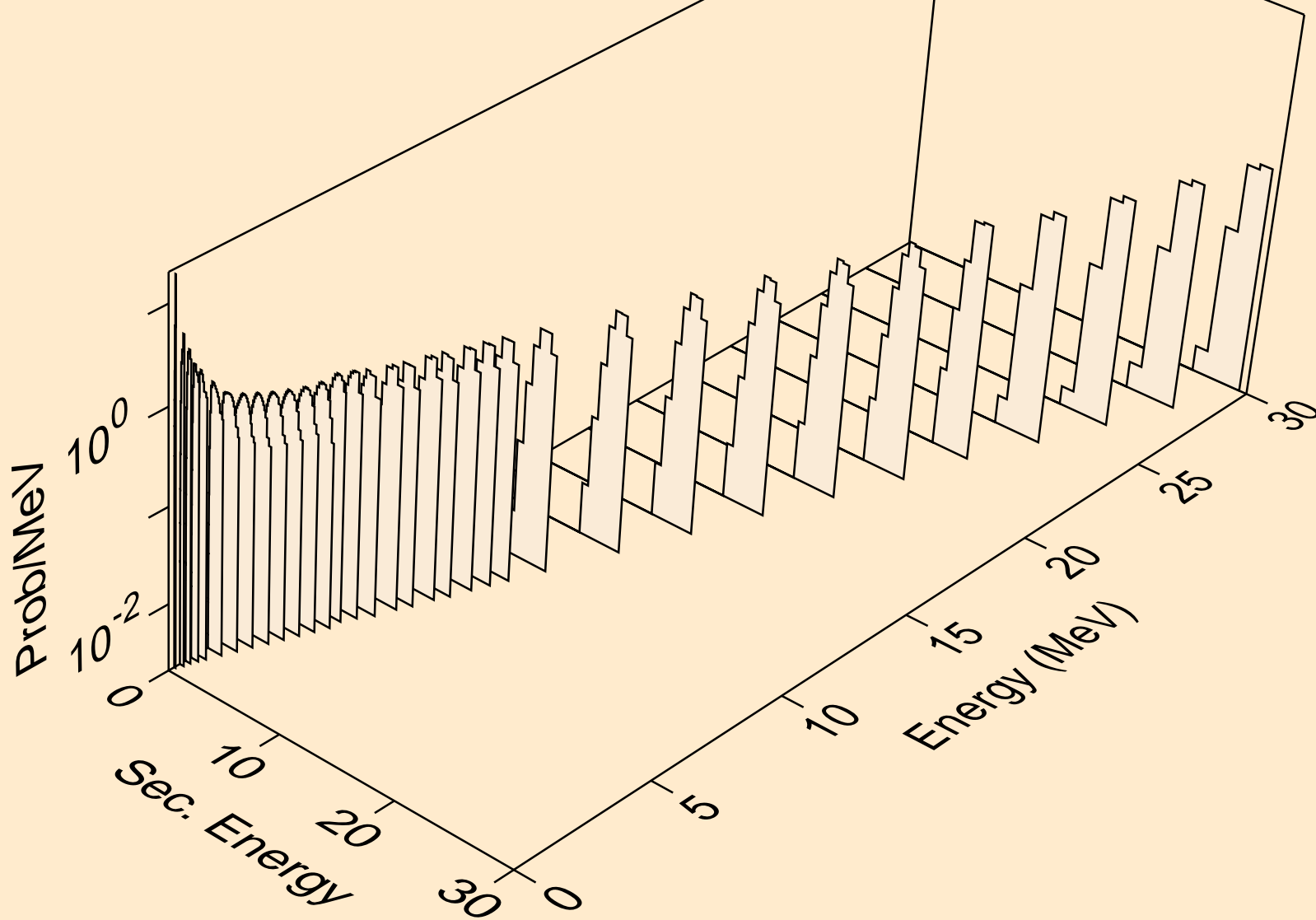

LR266 NEUTRON ACER TENDL-2019 LIBRARY; T=293.16K

Delayed nubar

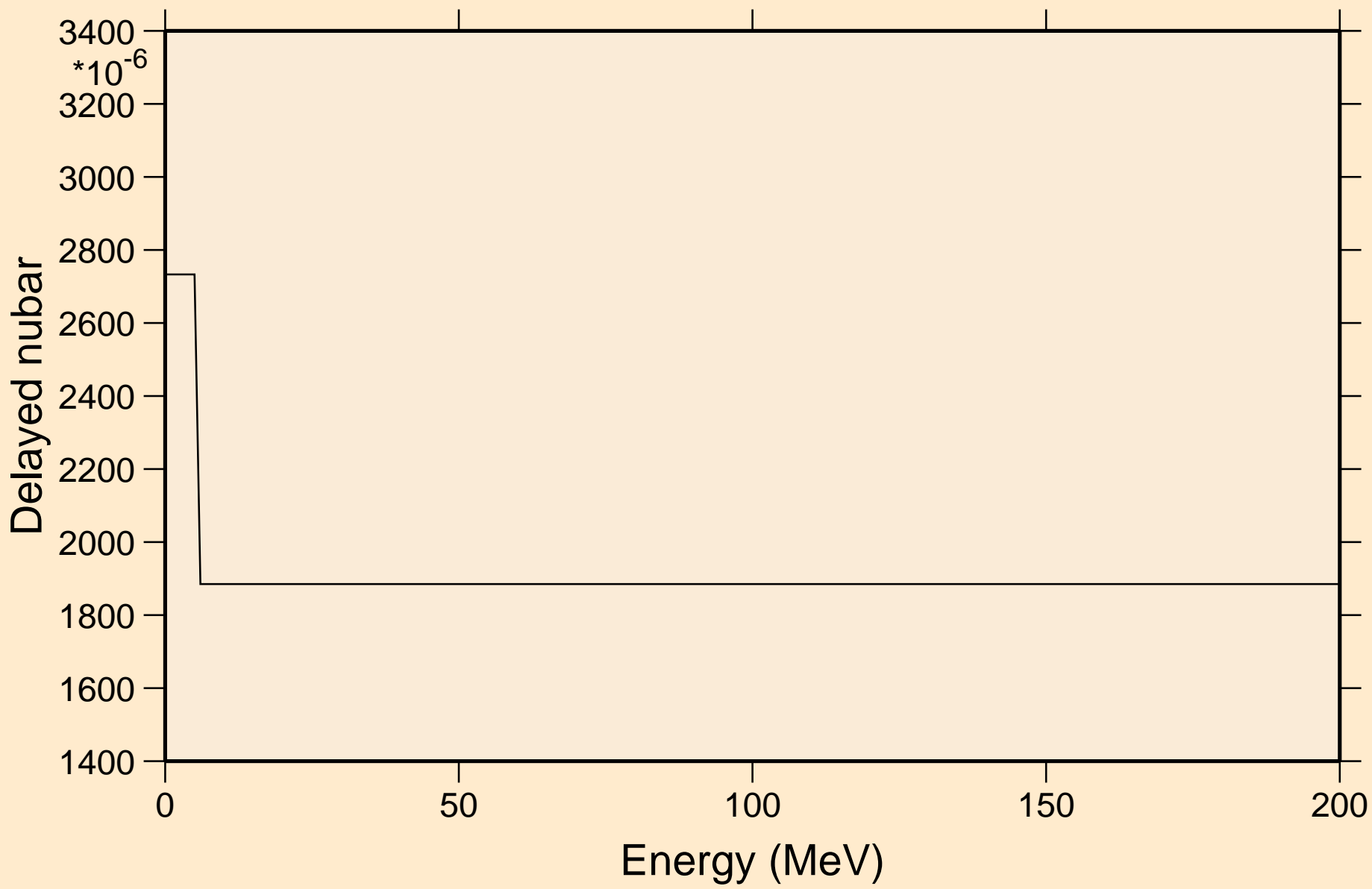

LR266 NEUTRON ACER TENDL-2019 LIBRARY; T=293.16K

Delayed neutron spectra

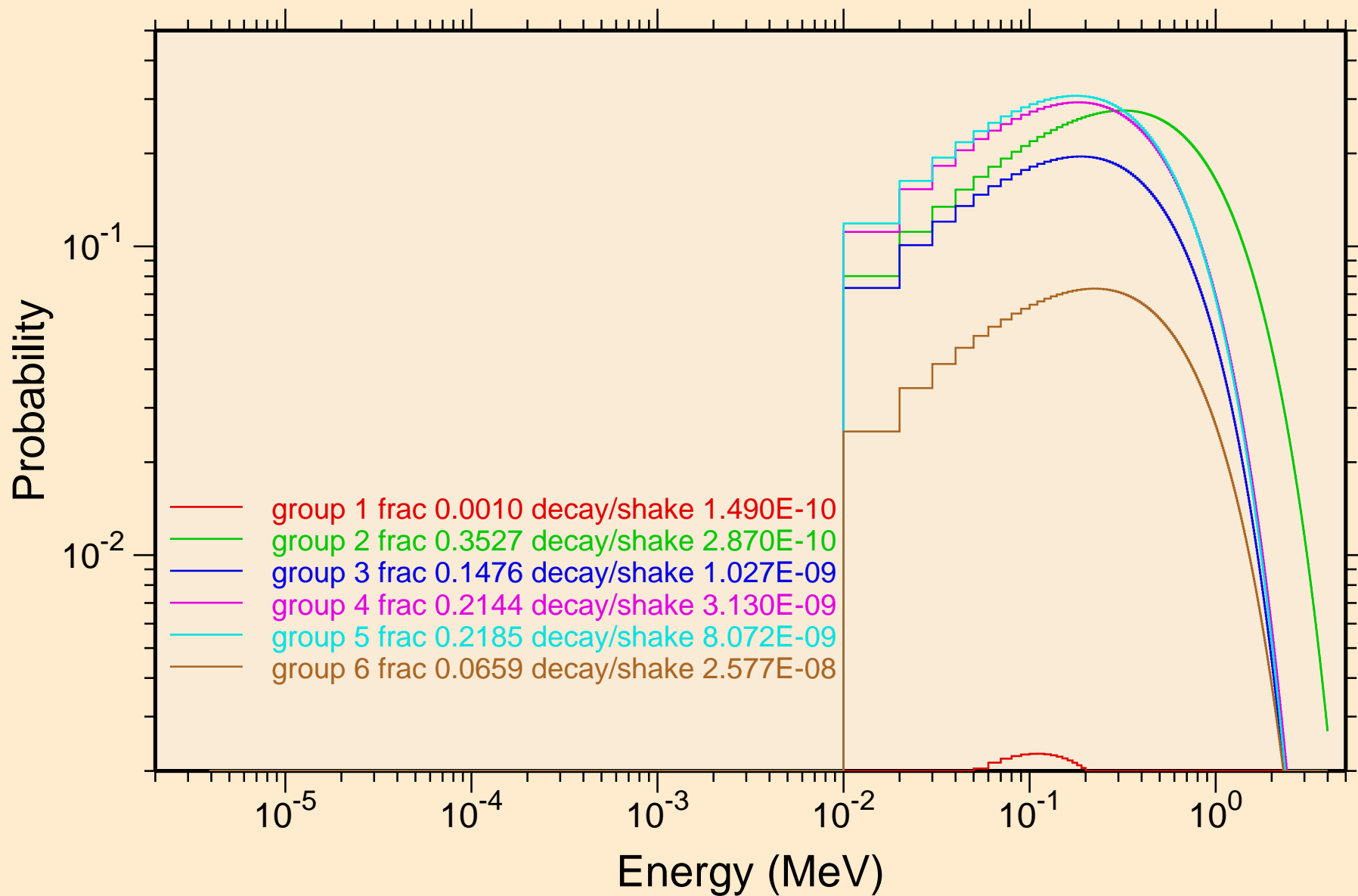

LR266 NEUTRON ACER TENDL-2019 LIBRARY; T=293.16K
Photon emission for (n,x)

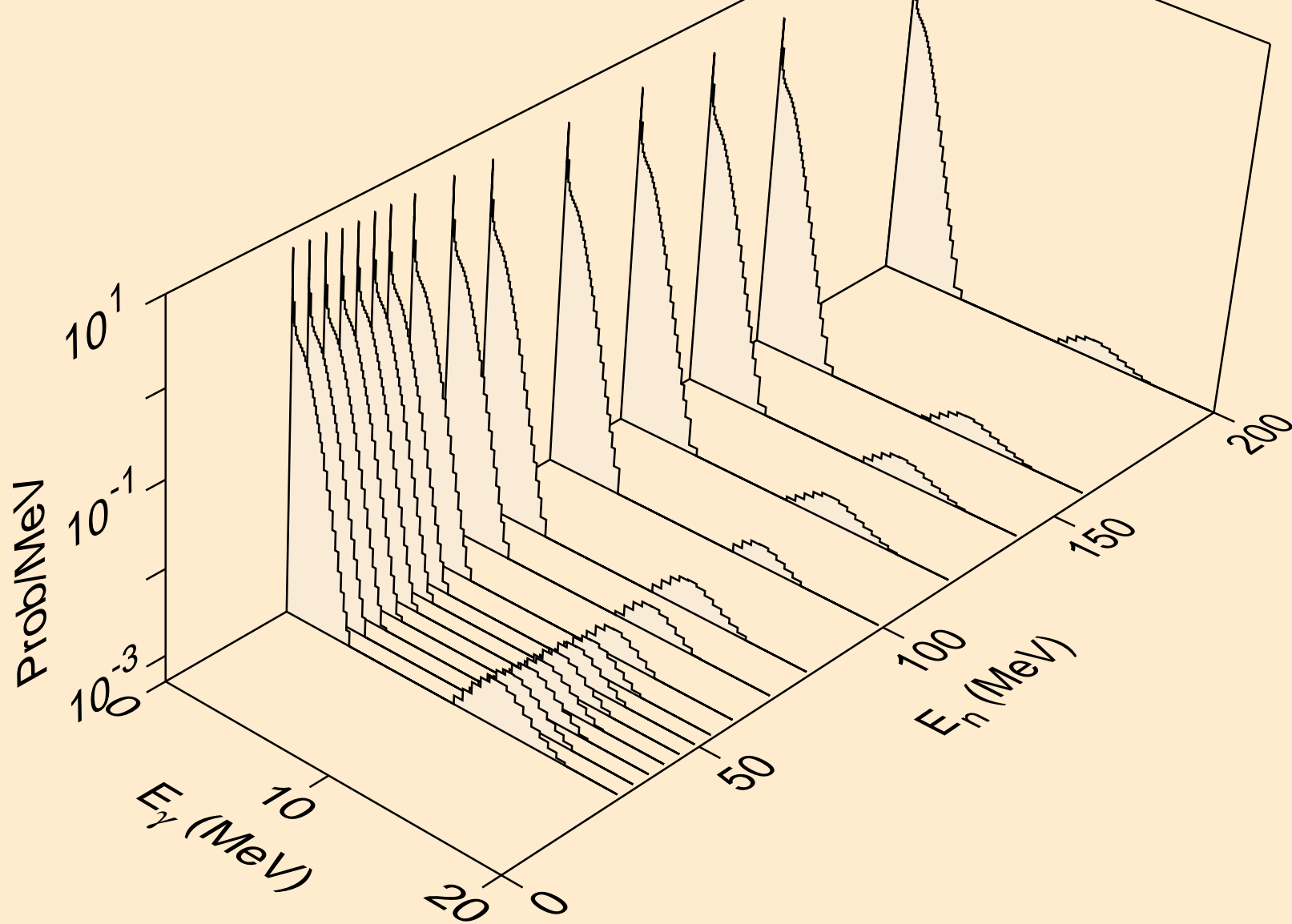

LR266 NEUTRON ACER TENDL-2019 LIBRARY; T=293.16K
Photon emission for (n,2nd)

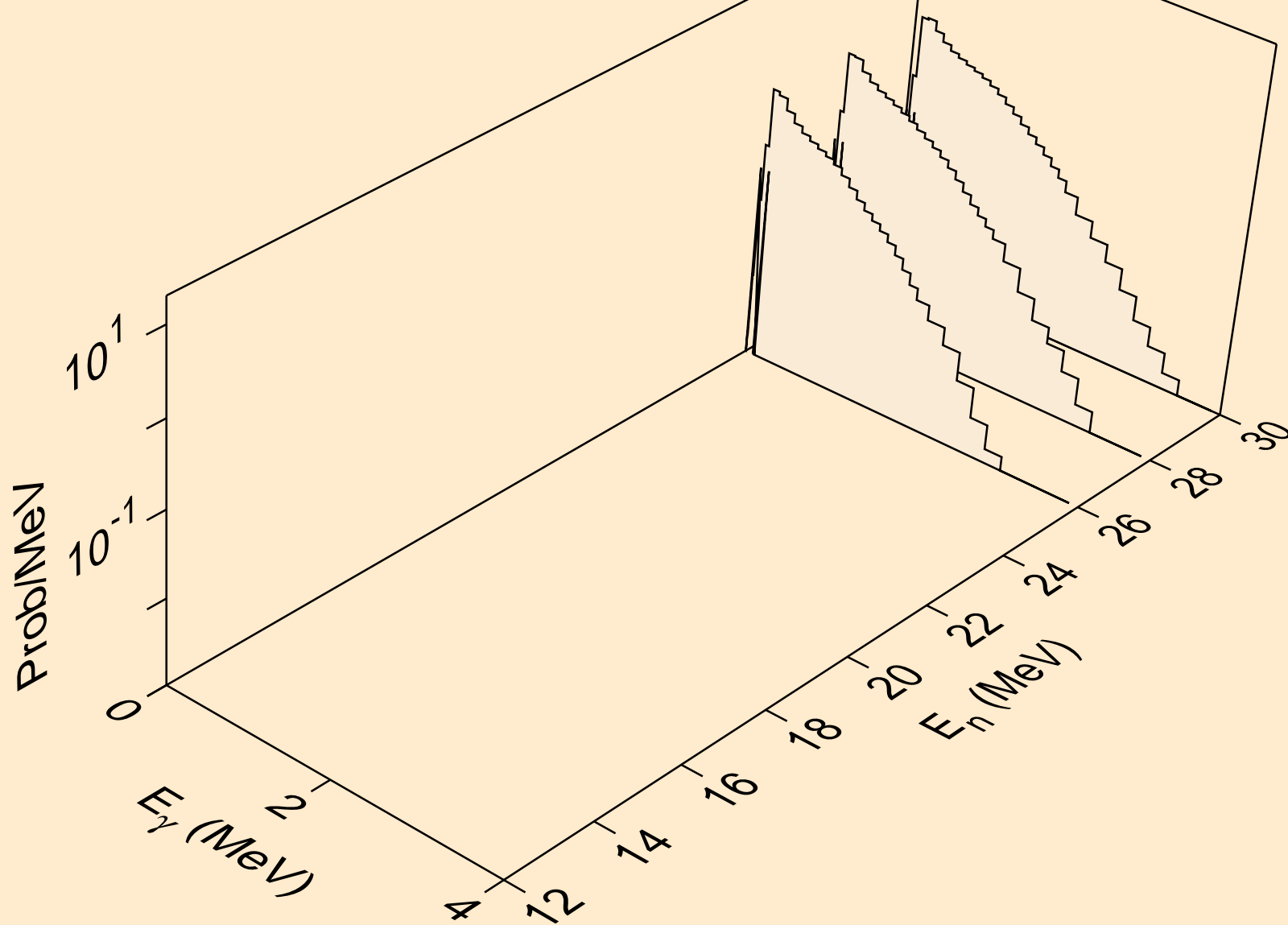

LR266 NEUTRON ACER TENDL-2019 LIBRARY; T=293.16K
Photon emission for (n,2n)

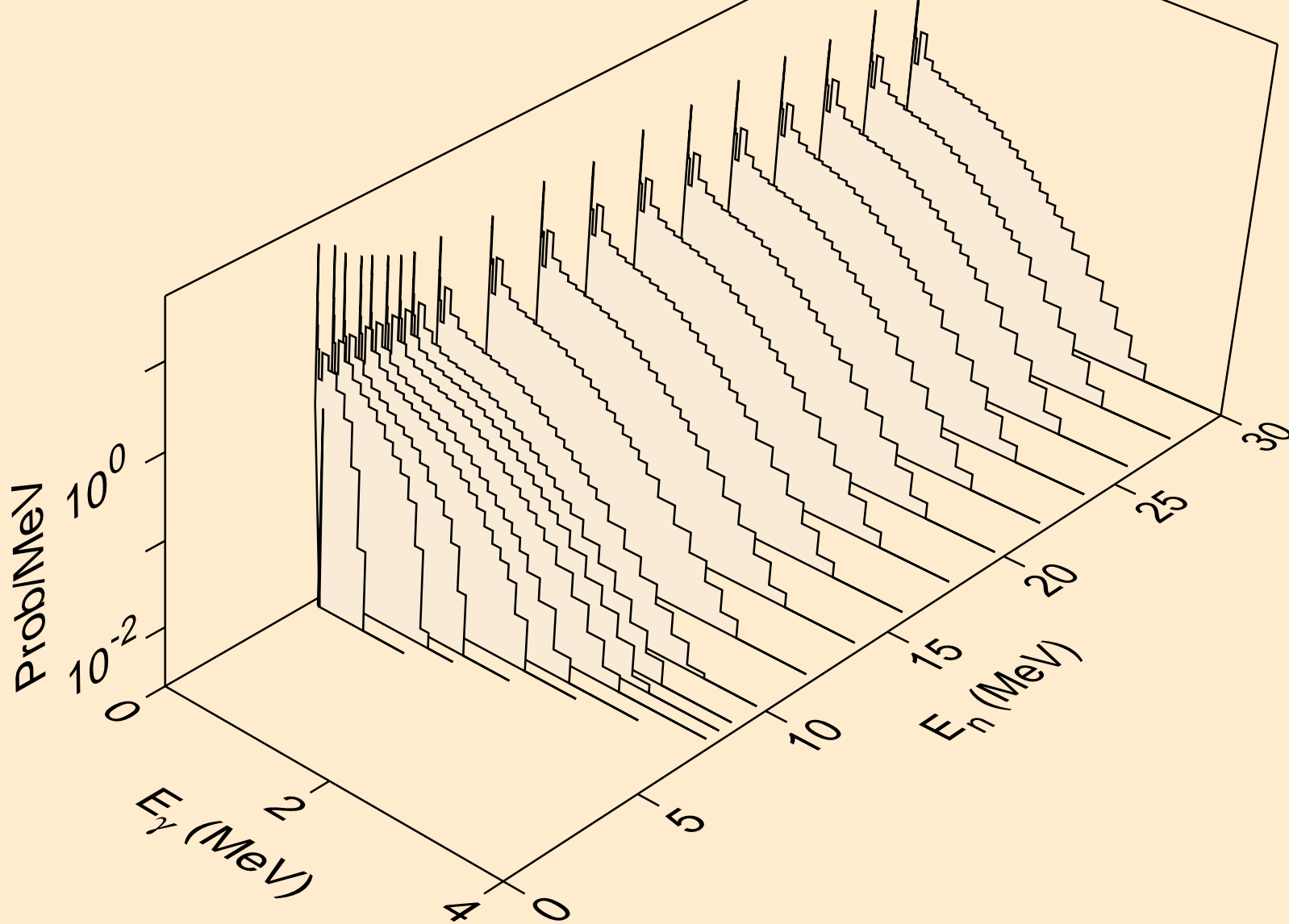

LR266 NEUTRON ACER TENDL-2019 LIBRARY; T=293.16K
Photon emission for (n,3n)

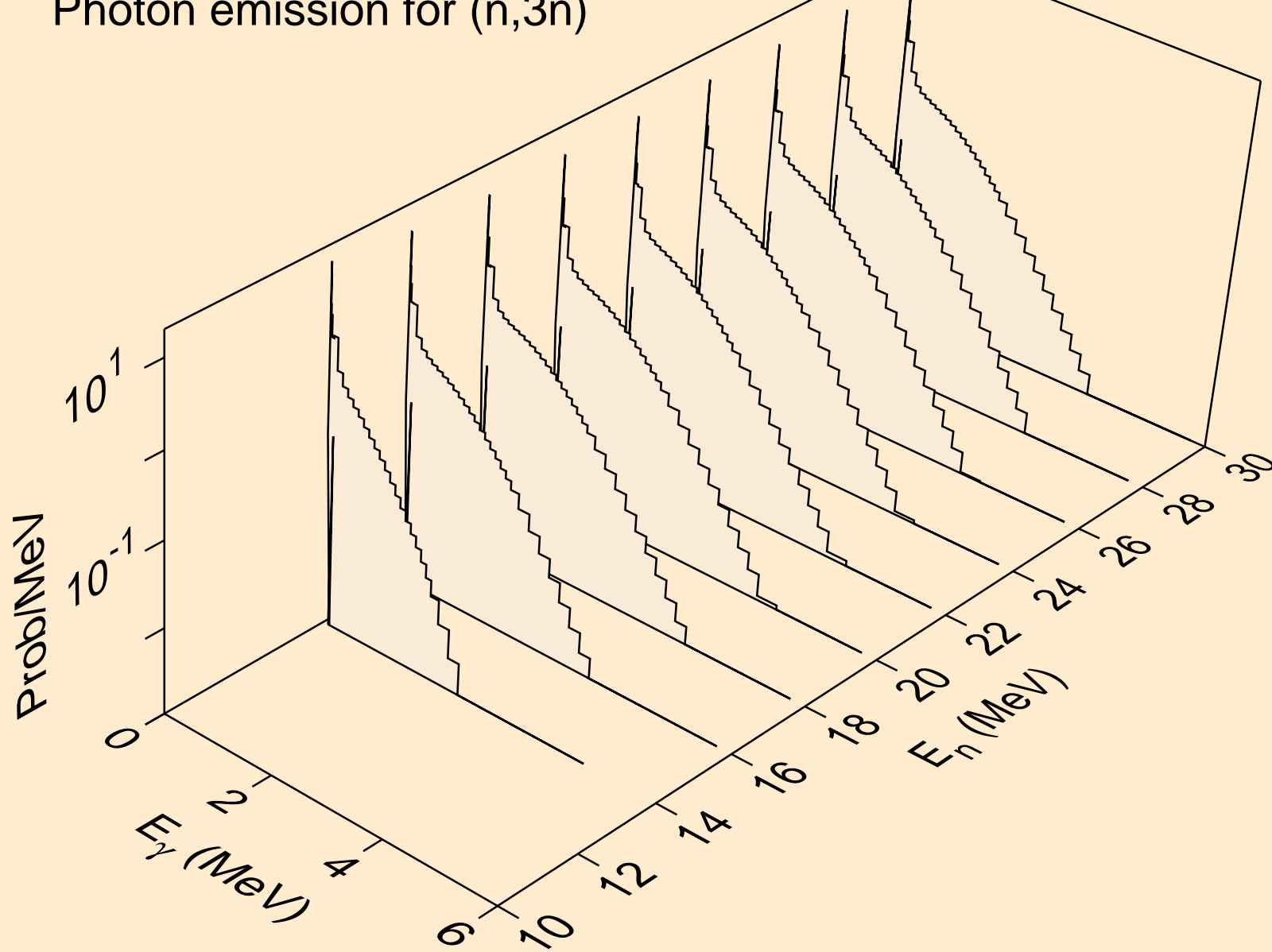

LR266 NEUTRON ACER TENDL-2019 LIBRARY; T=293.16K
Photon emission for (n,n*)a

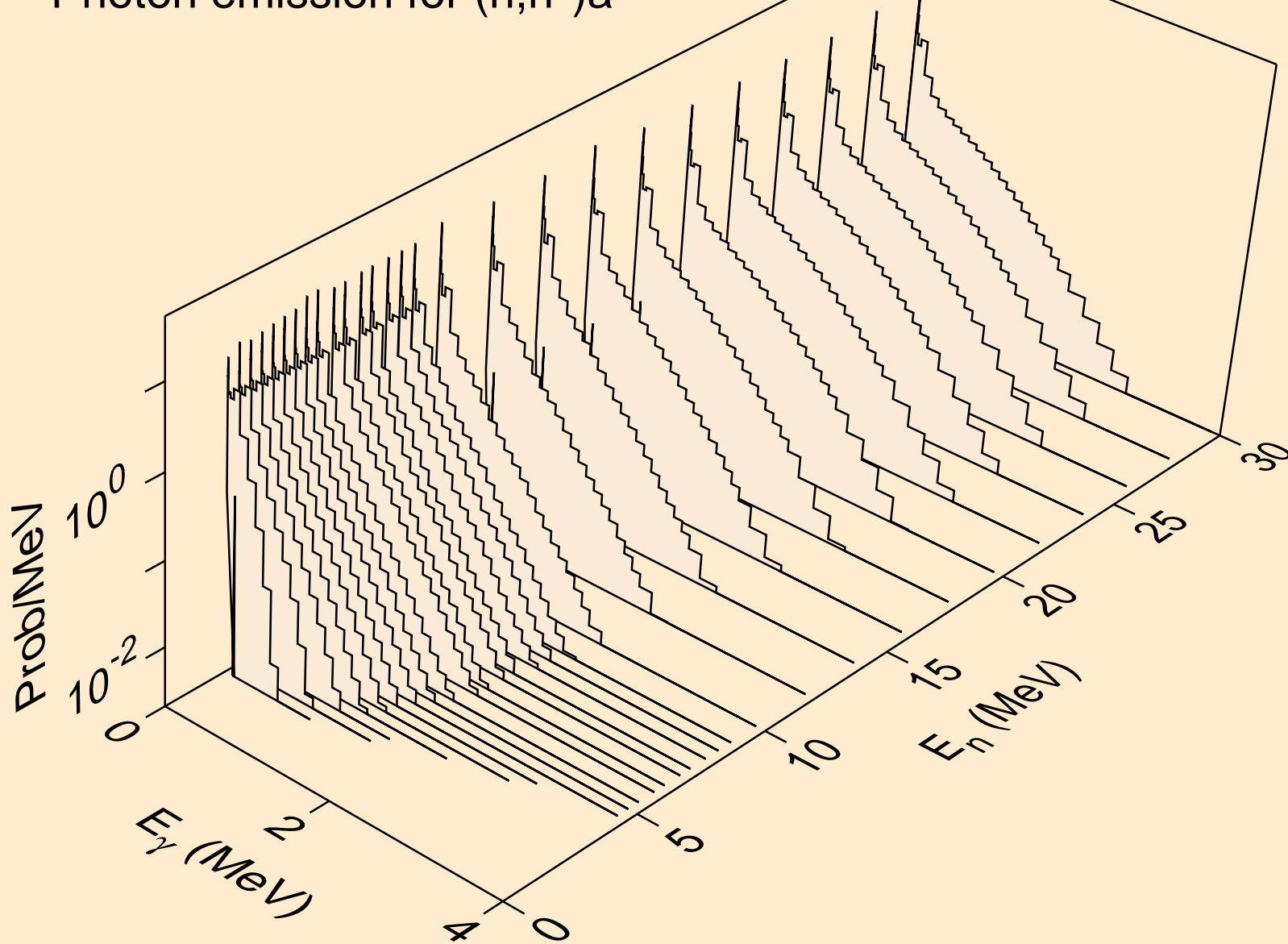

LR266 NEUTRON ACER TENDL-2019 LIBRARY; T=293.16K
Photon emission for (n,2n) α

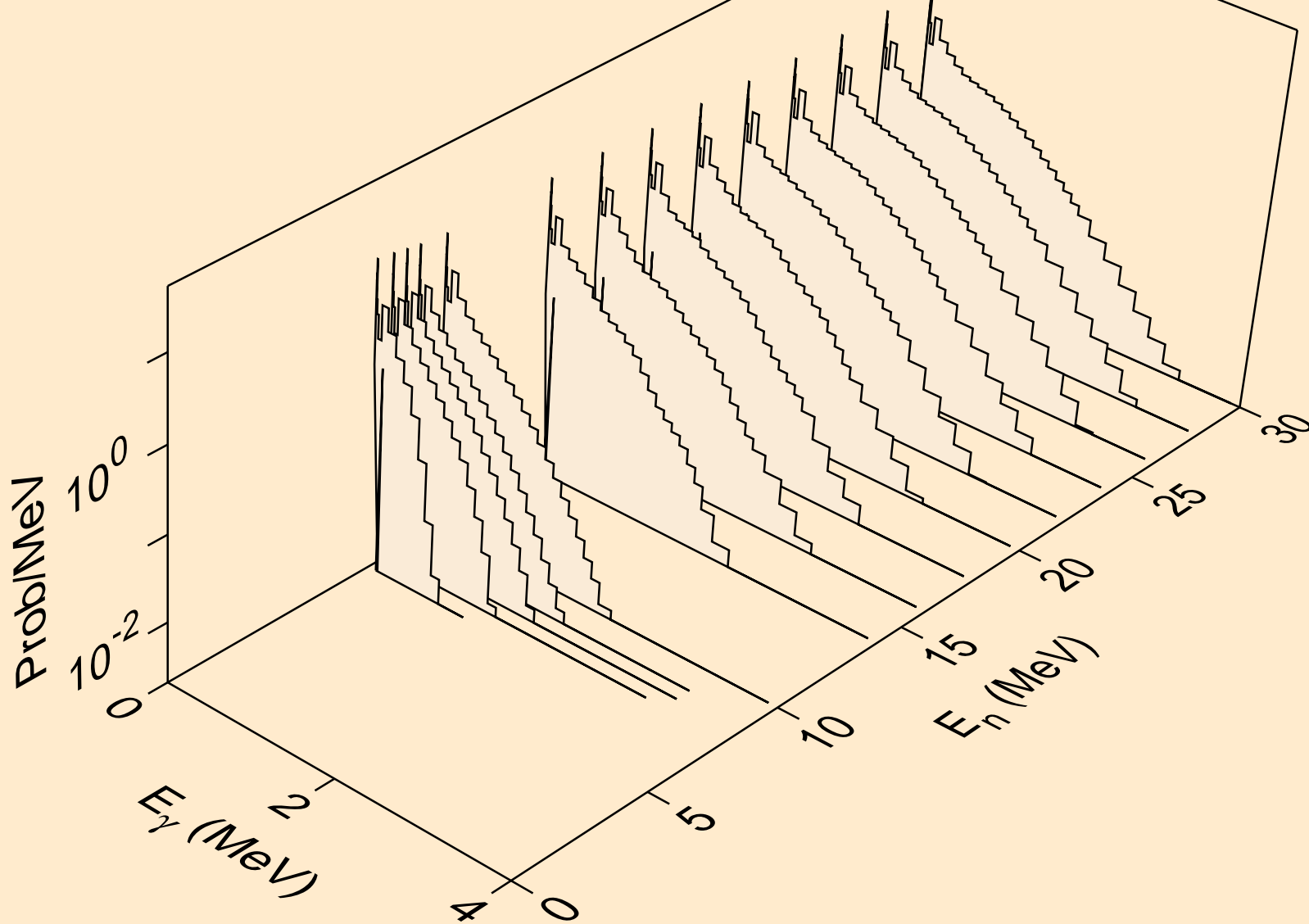

LR266 NEUTRON ACER TENDL-2019 LIBRARY; T=293.16K
Photon emission for (n,3n)a

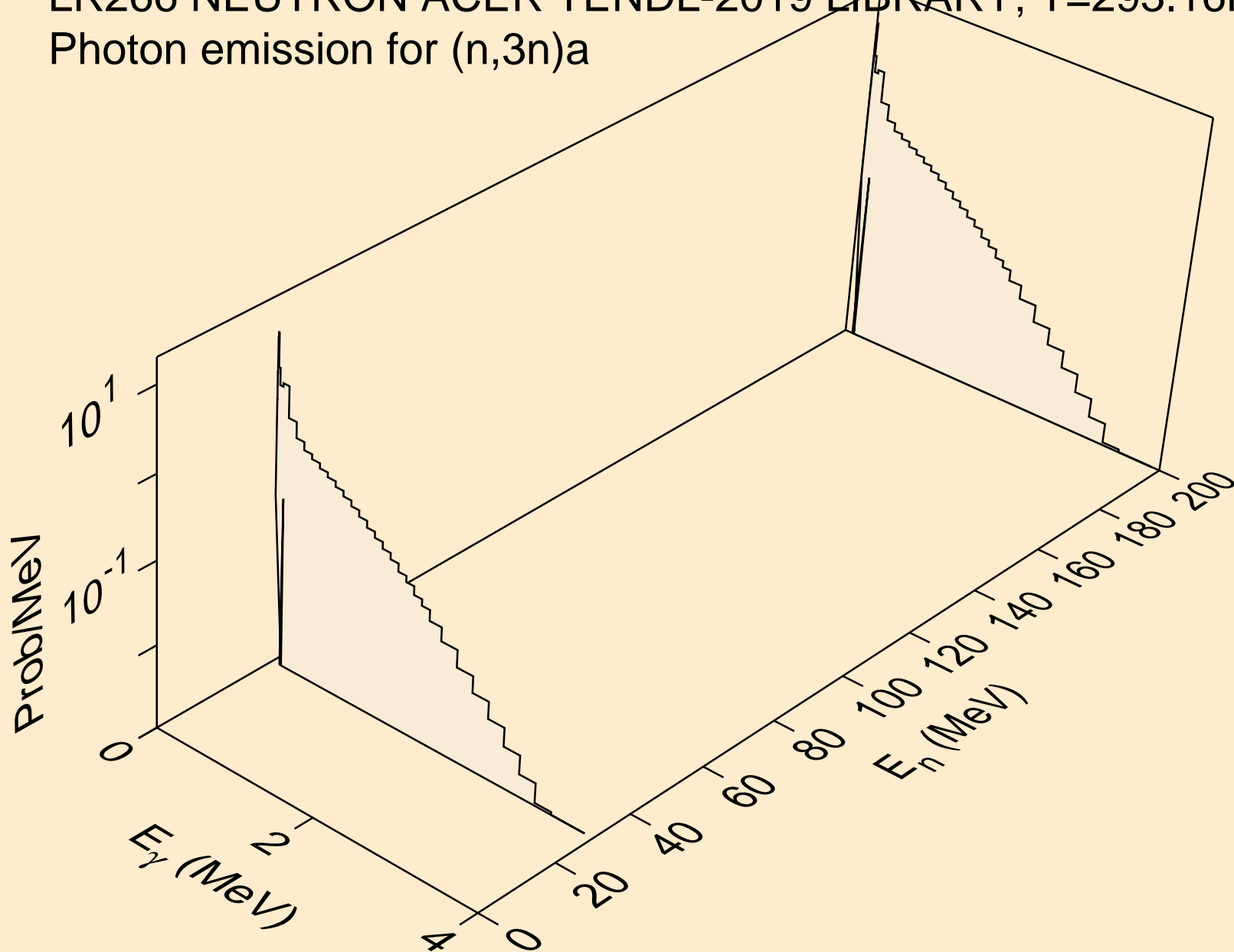

LR266 NEUTRON ACER TENDL-2019 LIBRARY; T=293.16K
Photon emission for (n,n*)p

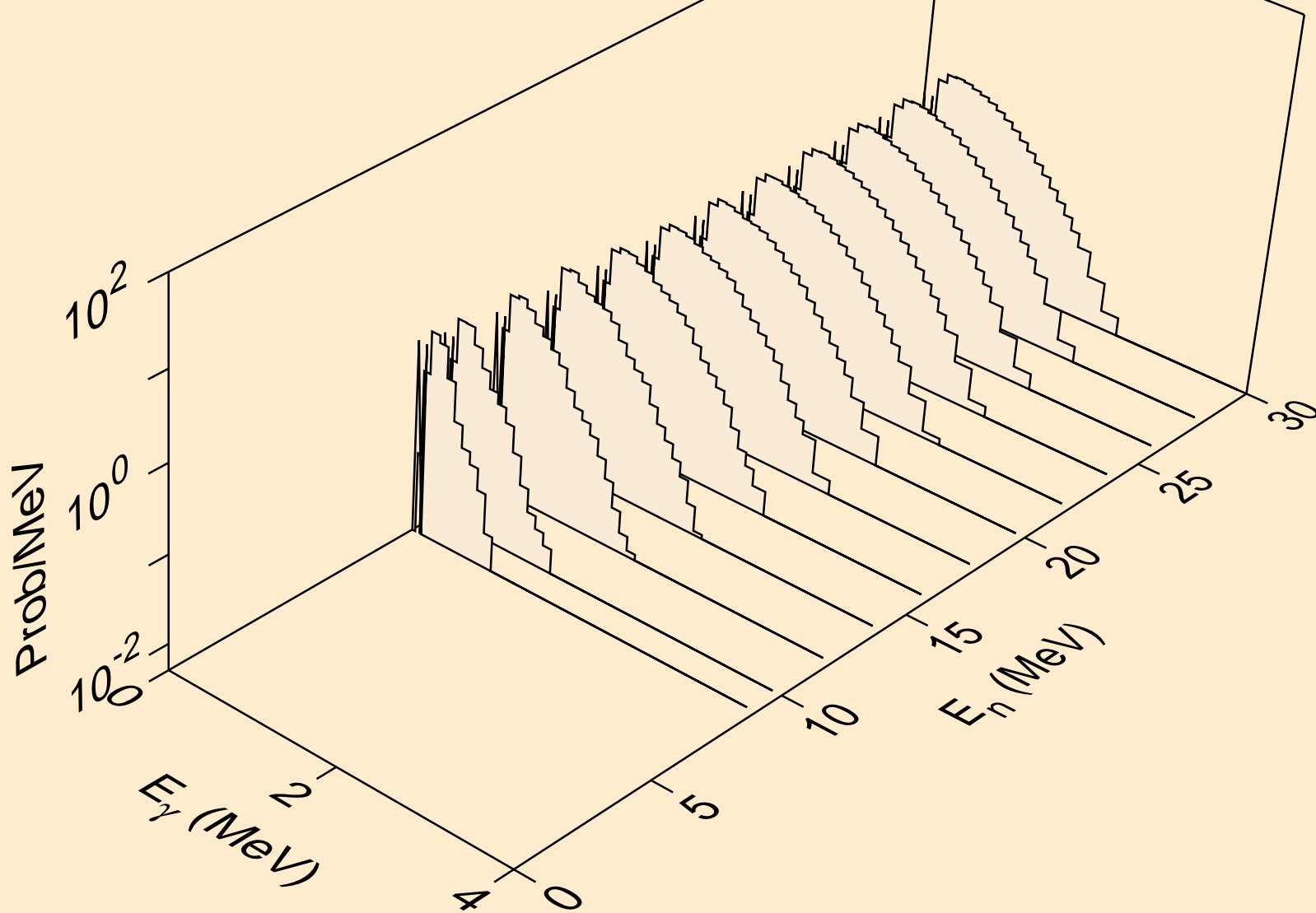

LR266 NEUTRON ACER TENDL-2019 LIBRARY; T=293.16K
Photon emission for (n,n*)d

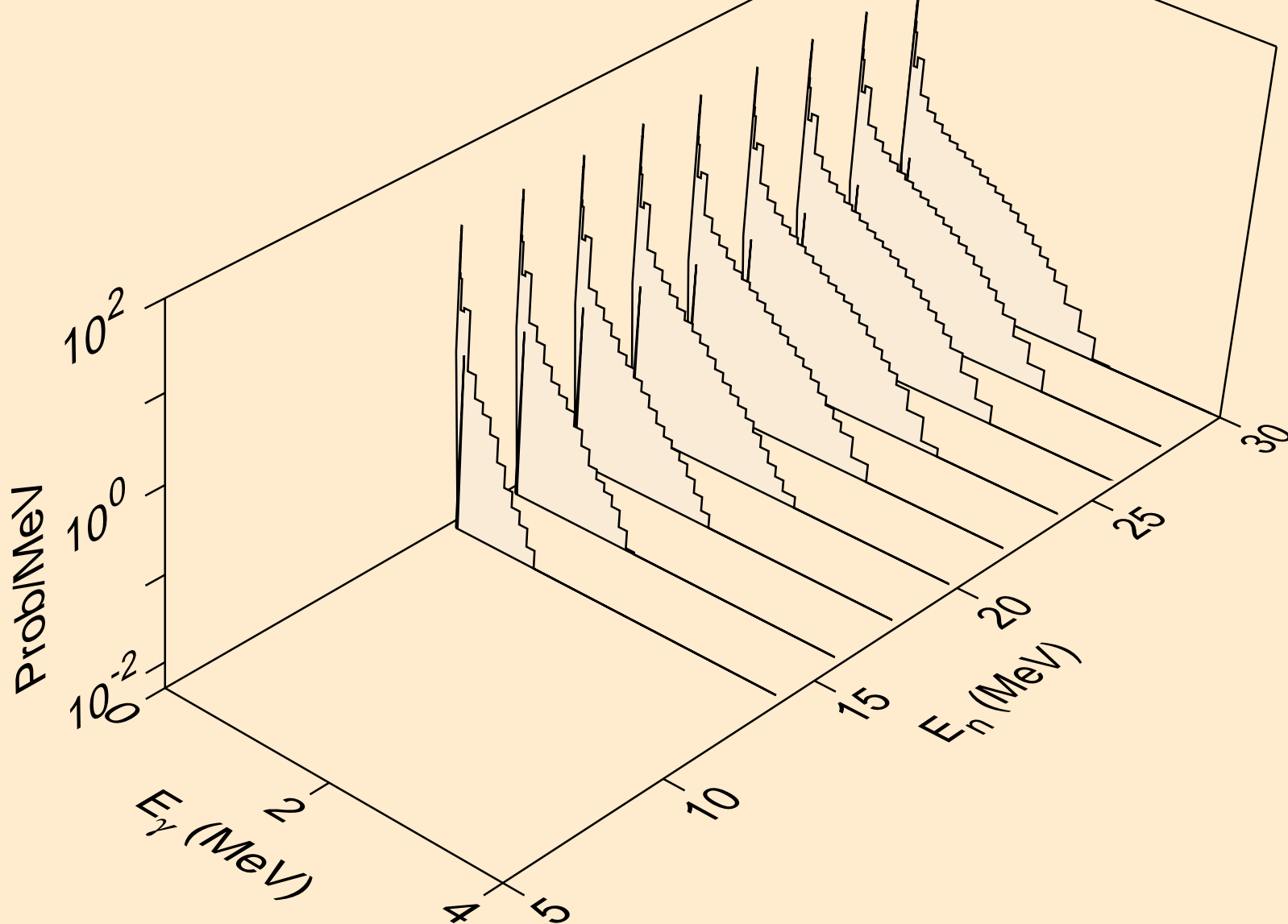

LR266 NEUTRON ACER TENDL-2019 LIBRARY; T=293.16K
Photon emission for (n,n*)t

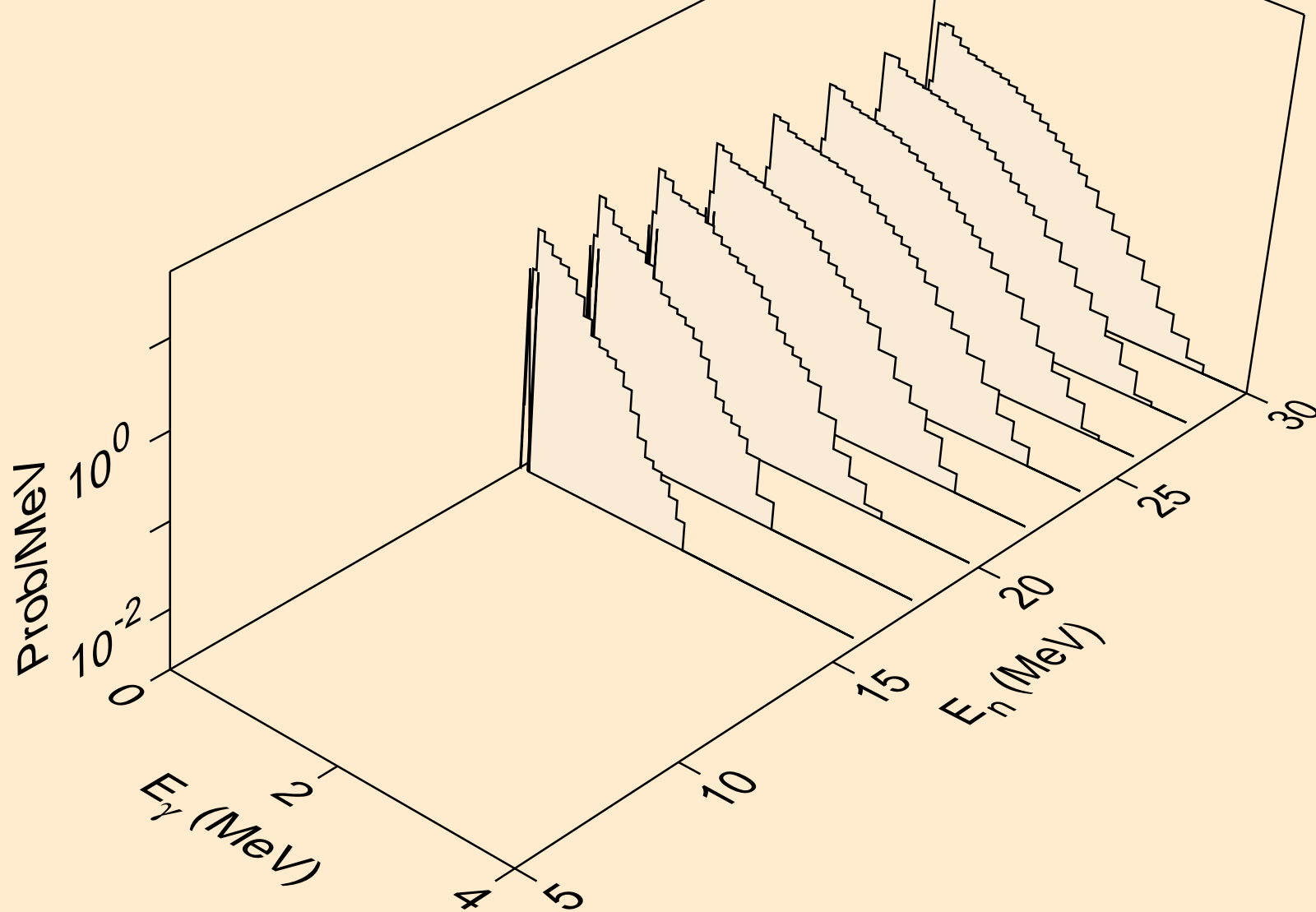

LR266 NEUTRON ACER TENDL-2019 LIBRARY; T=293.16K
Photon emission for (n,n*)he3

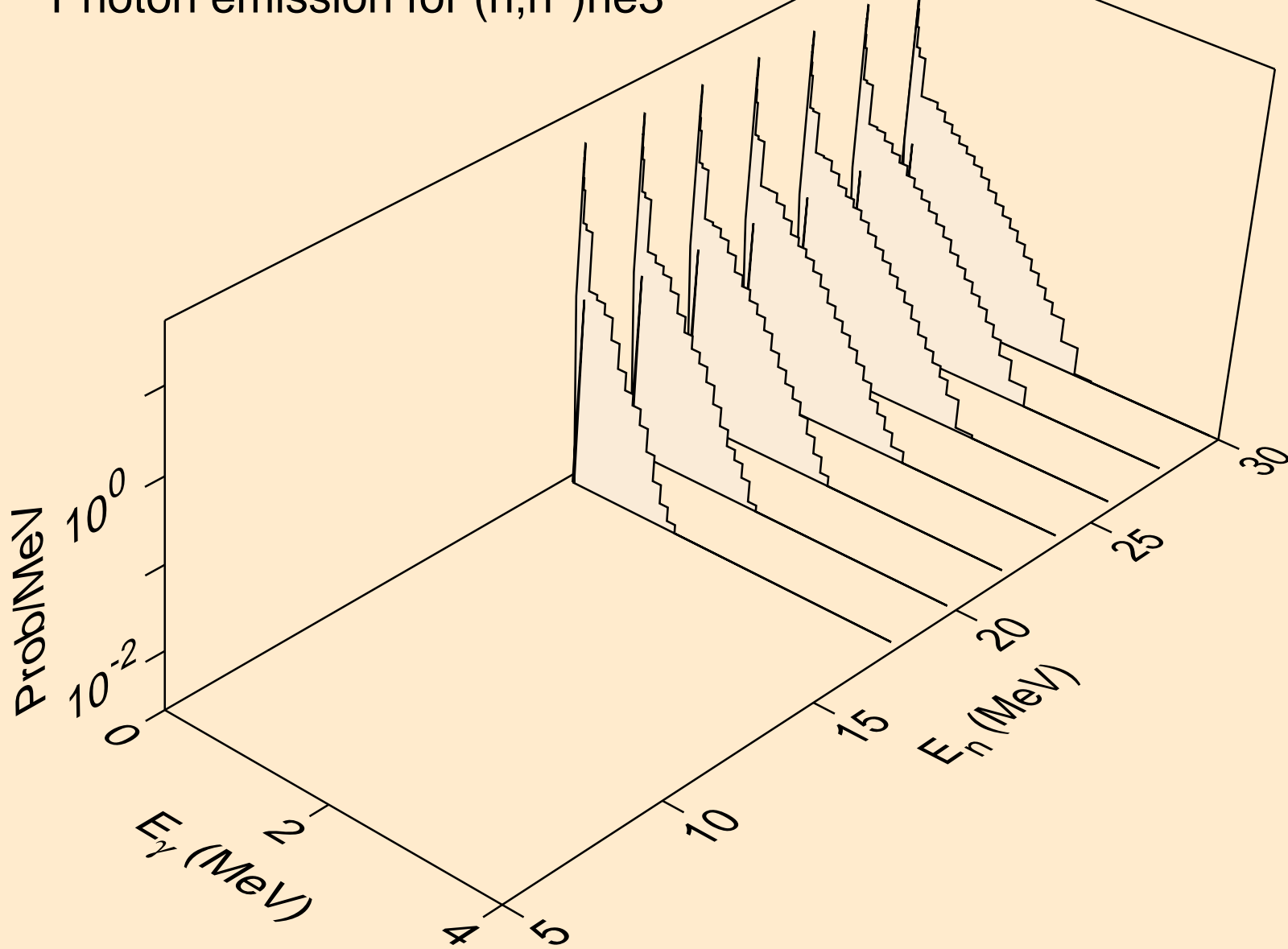

LR266 NEUTRON ACER TENDL-2019 LIBRARY; T=293.16K
Photon emission for (n,4n)

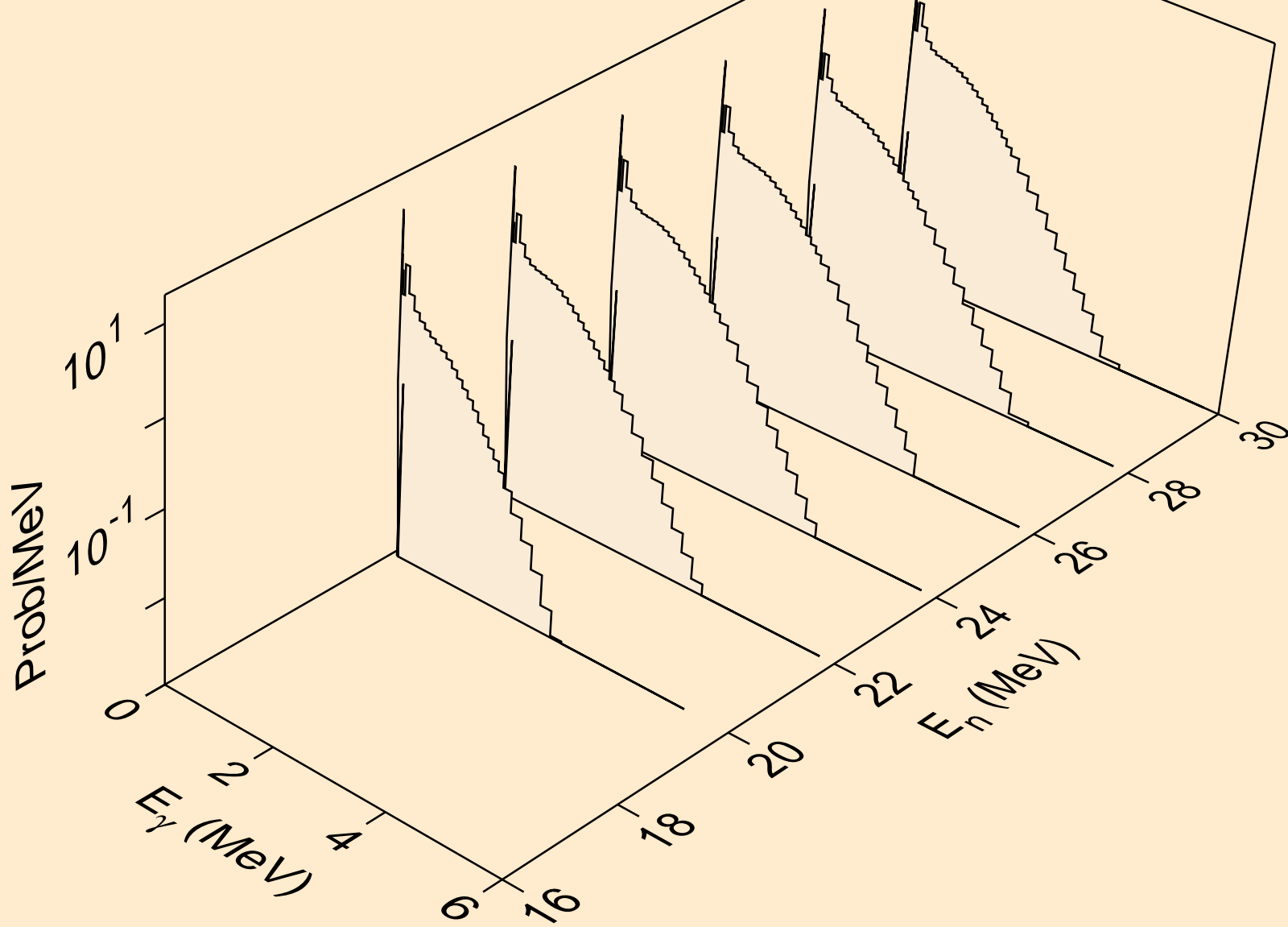

LR266 NEUTRON ACER TENDL-2019 LIBRARY; T=293.16K
Photon emission for (n,2np)

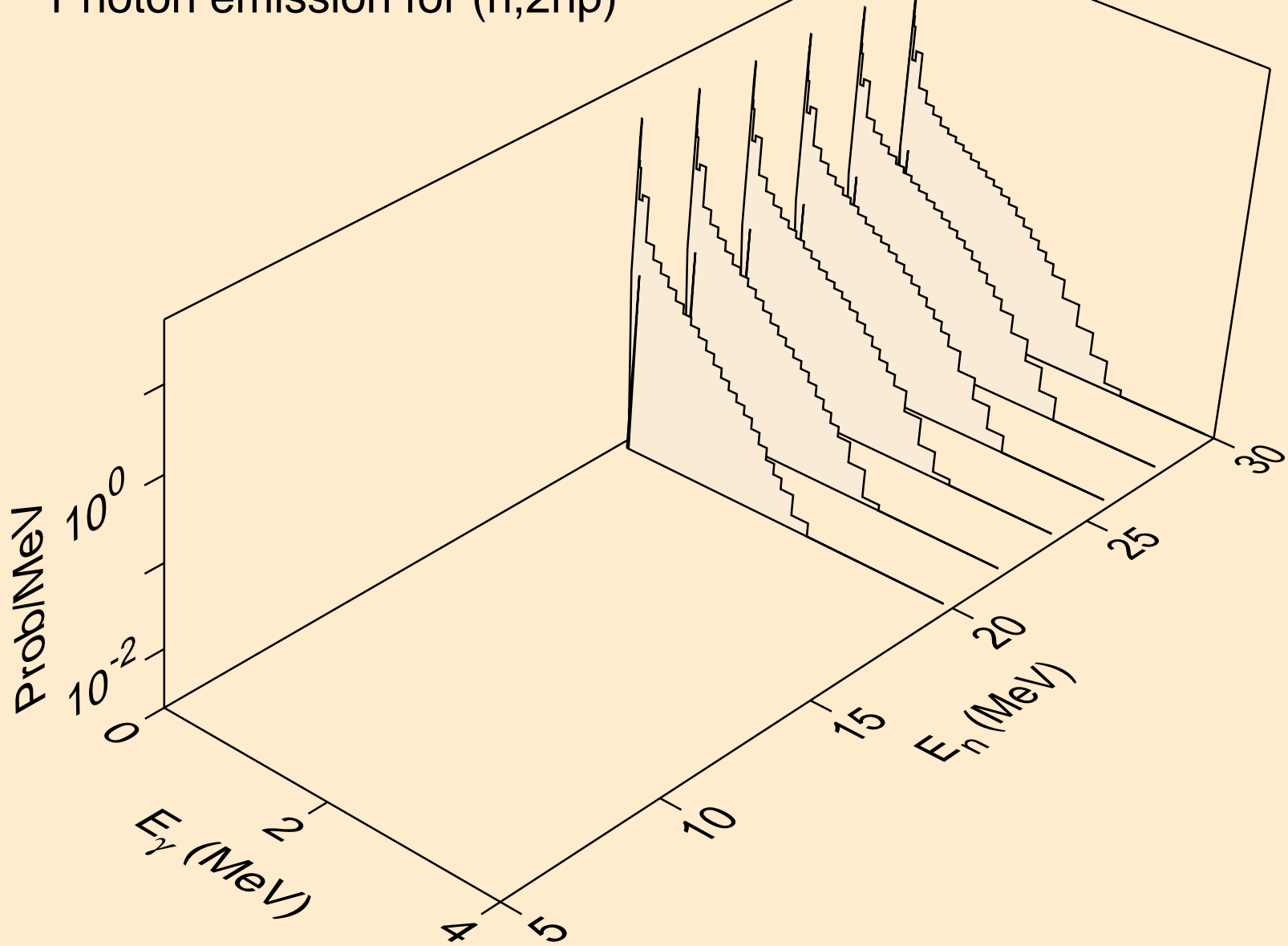

LR266 NEUTRON ACER TENDL-2019 LIBRARY; T=293.16K
Photon emission for (n,3np)

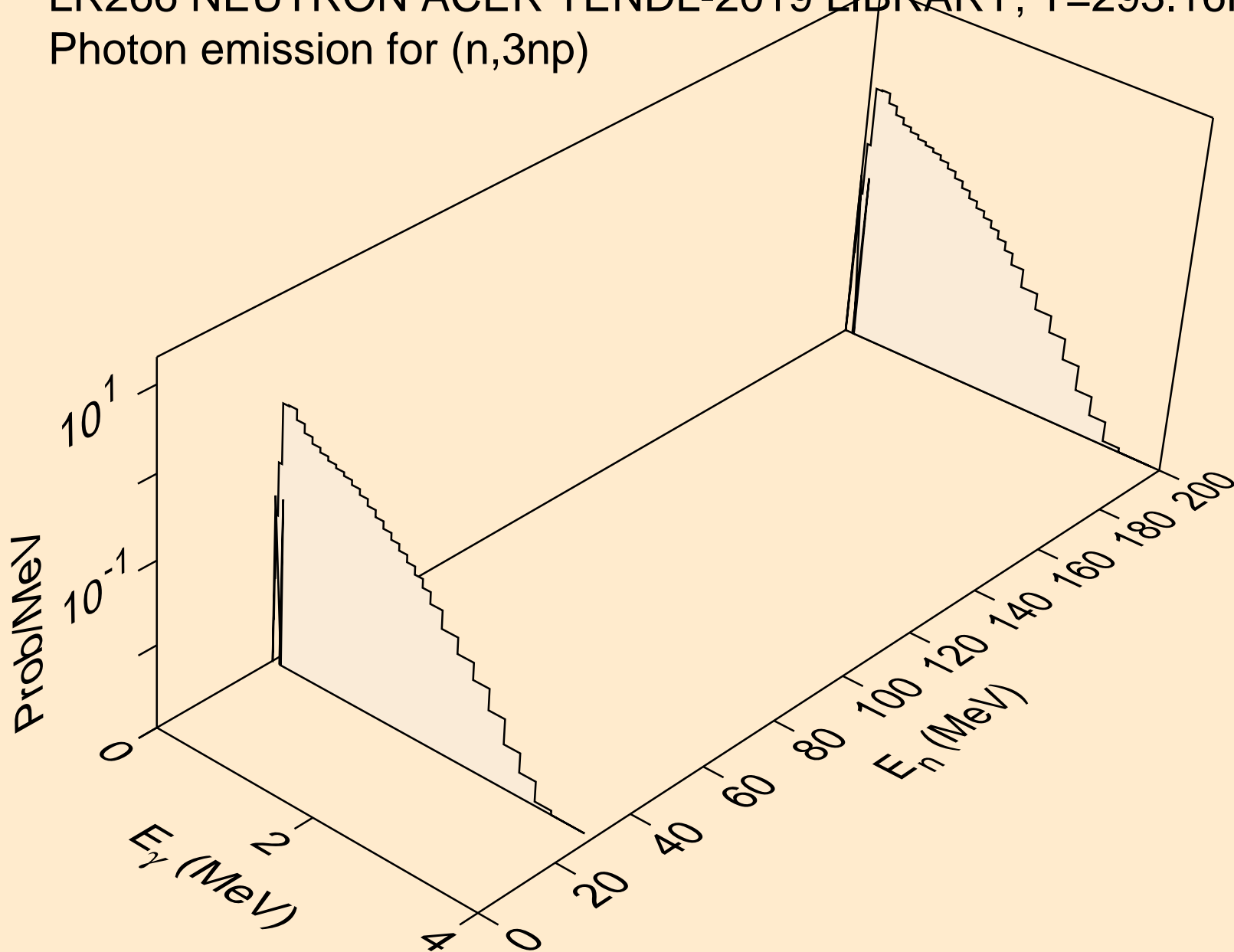

LR266 NEUTRON ACER TENDL-2019 LIBRARY; T=293.16K
Photon emission for (n,n*c)

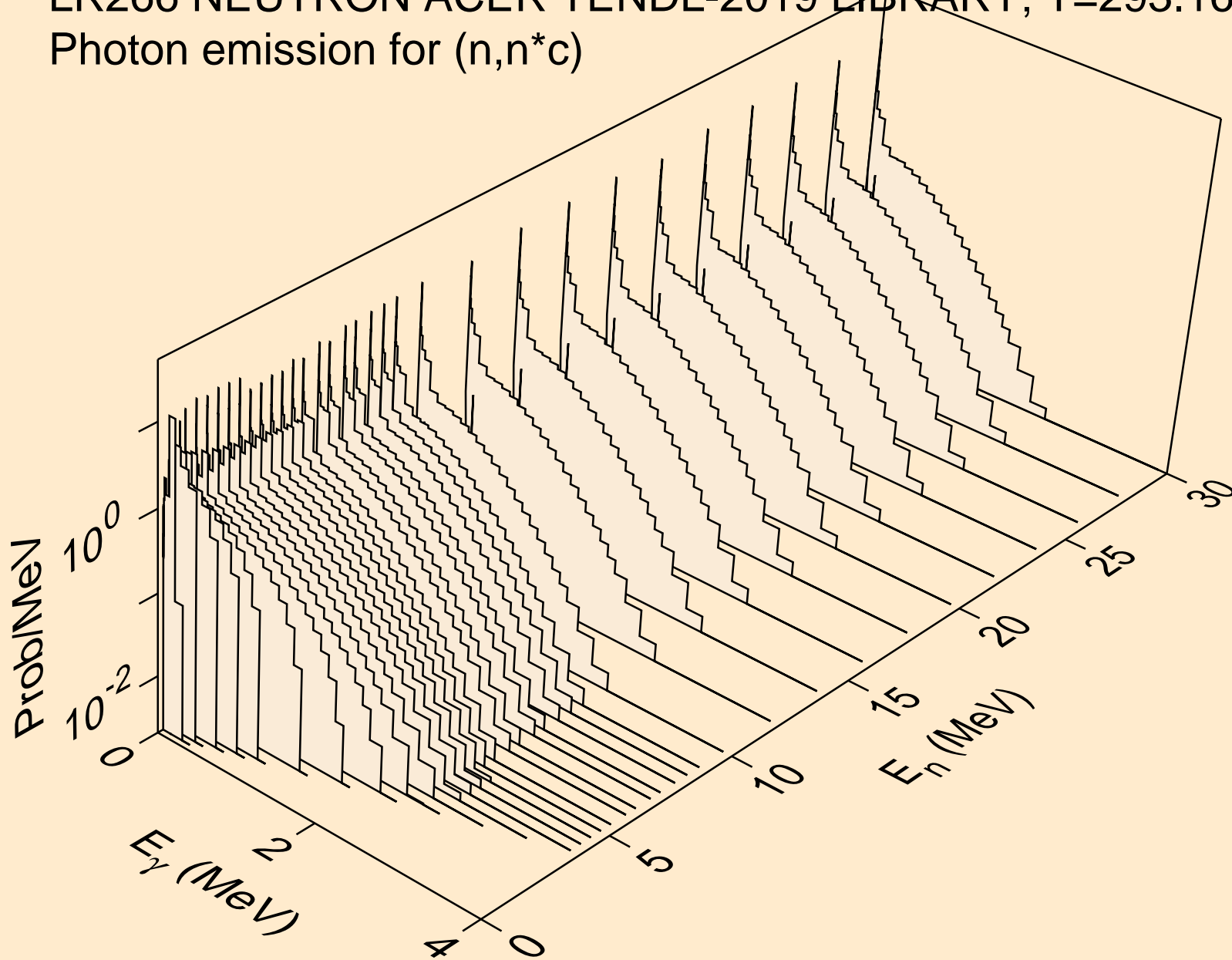

LR266 NEUTRON ACER TENDL-2019 LIBRARY; T=293.16K
Photon emission for (n,gma)

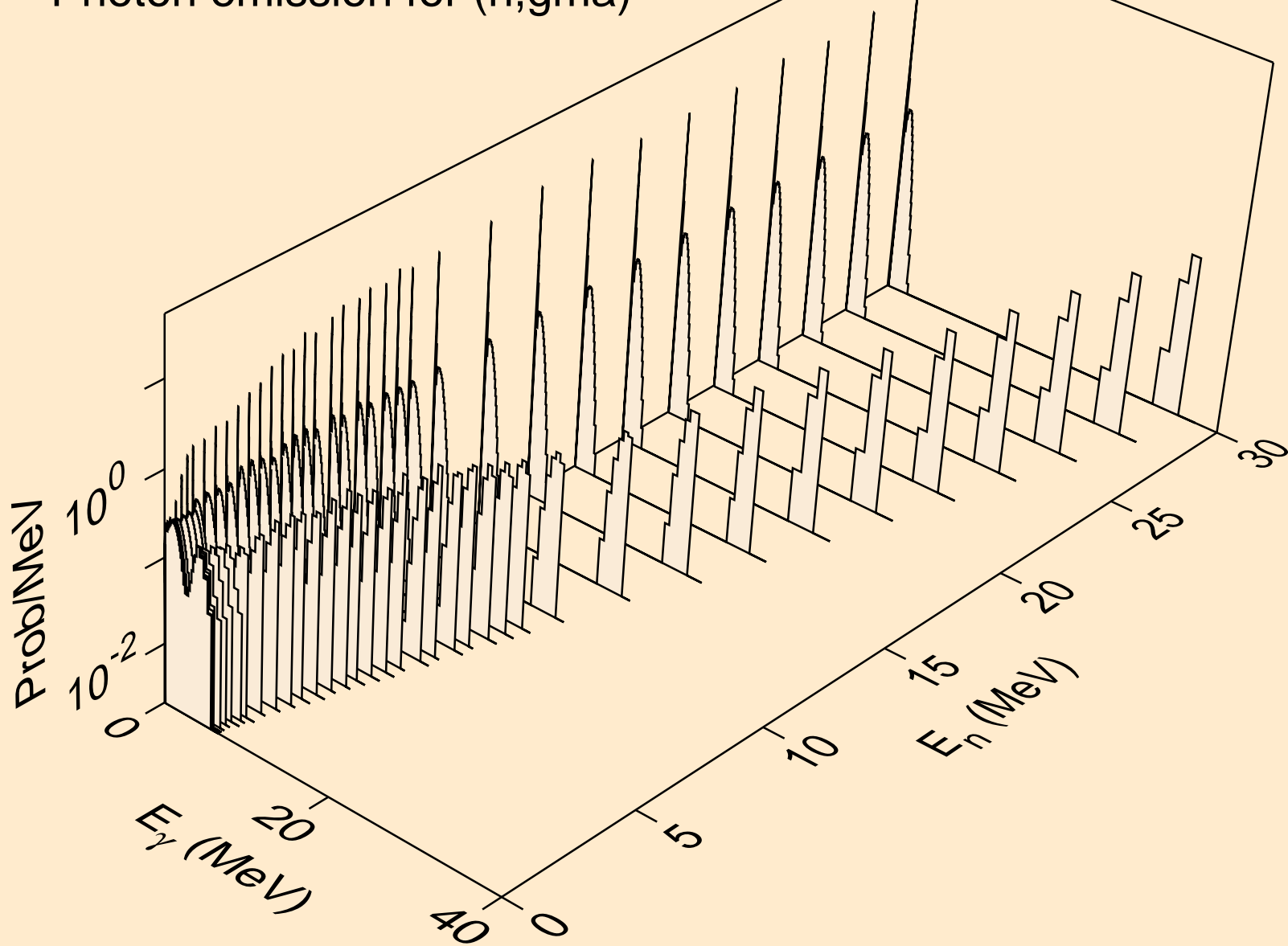

LR266 NEUTRON ACER TENDL-2019 LIBRARY; T=293.16K
Photon emission for (n,p)

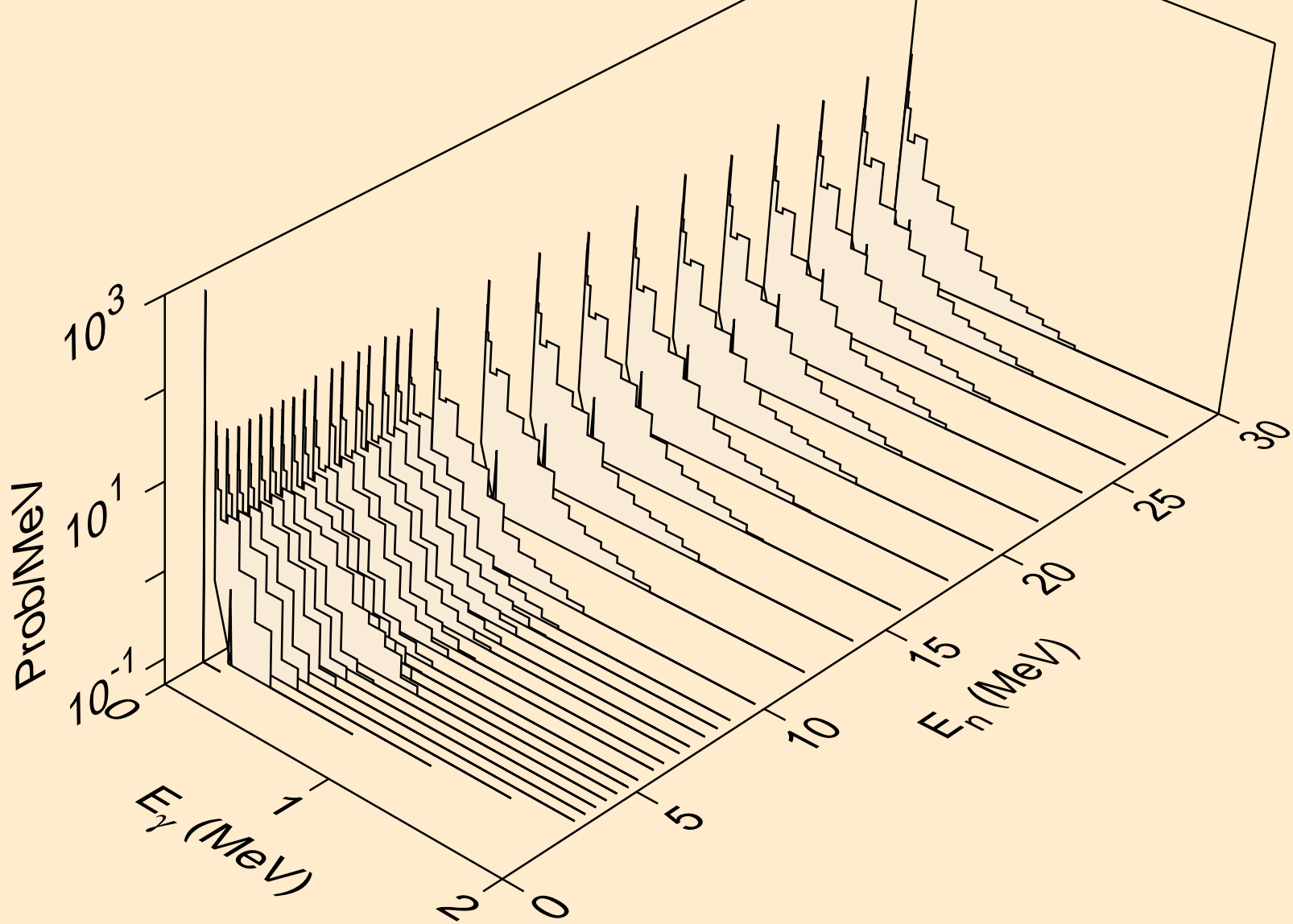

LR266 NEUTRON ACER TENDL-2019 LIBRARY; T=293.16K
Photon emission for (n,d)

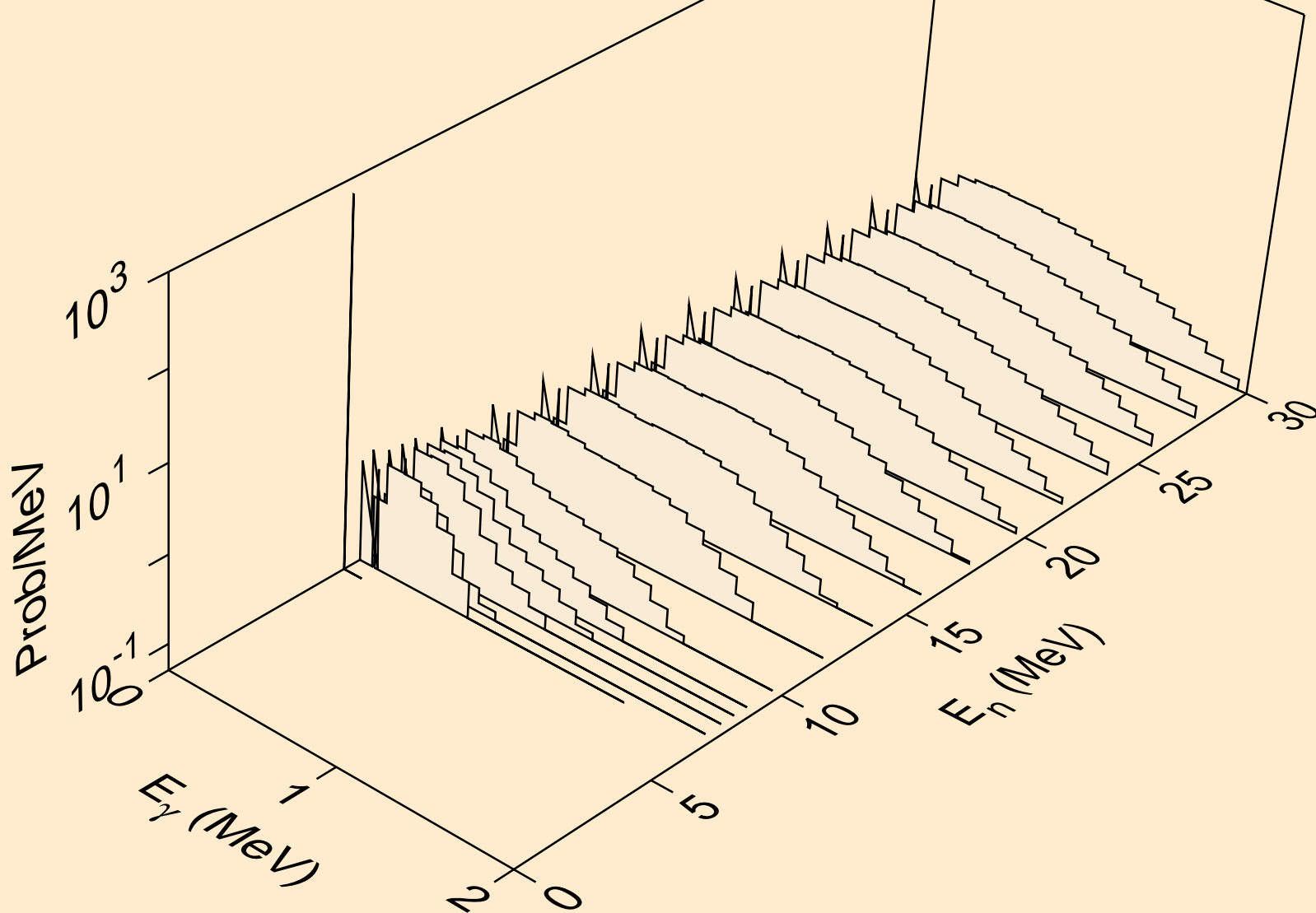

LR266 NEUTRON ACER TENDL-2019 LIBRARY; T=293.16K
Photon emission for (n,t)

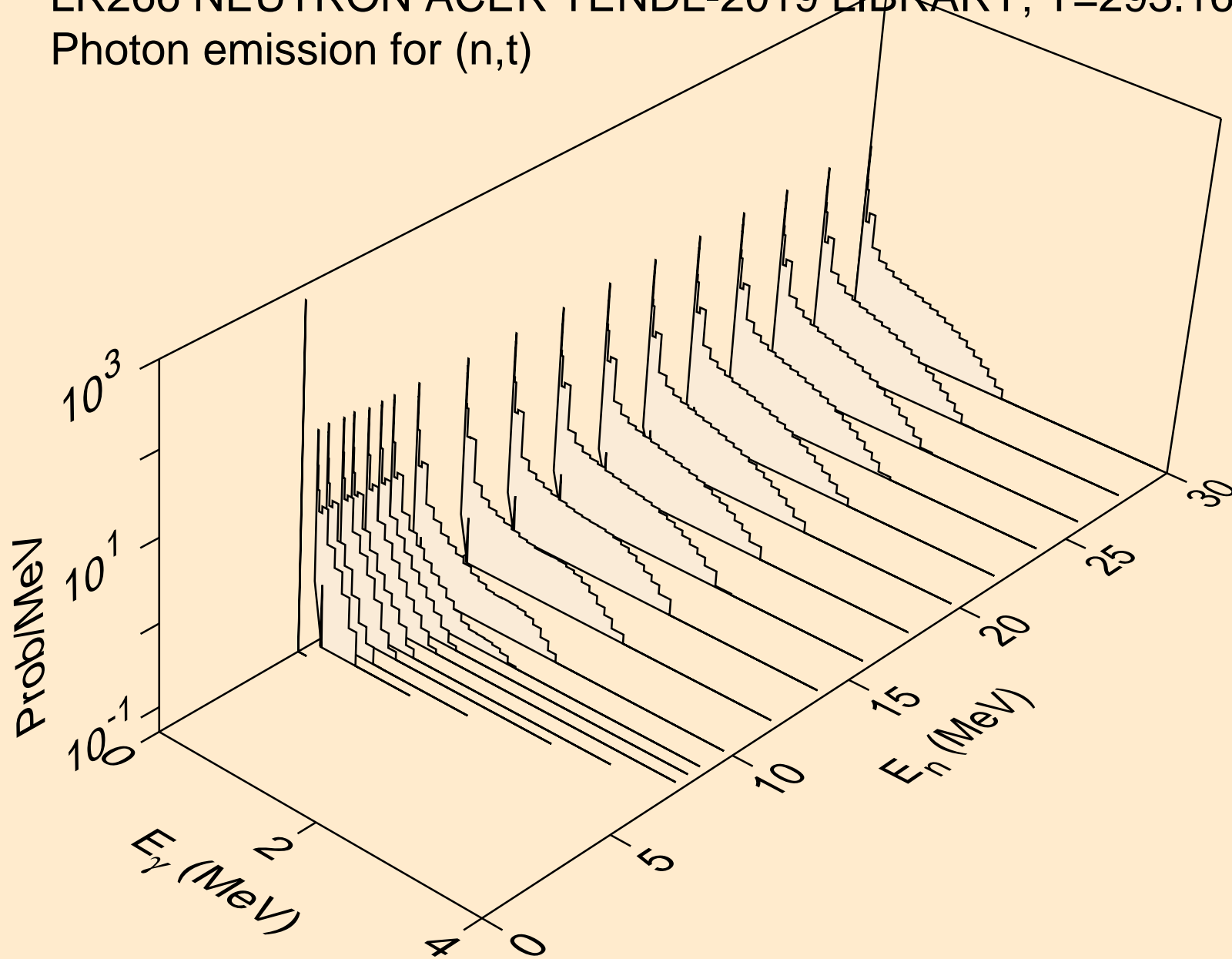

LR266 NEUTRON ACER TENDL-2019 LIBRARY; T=293.16K
Photon emission for (n,he3)

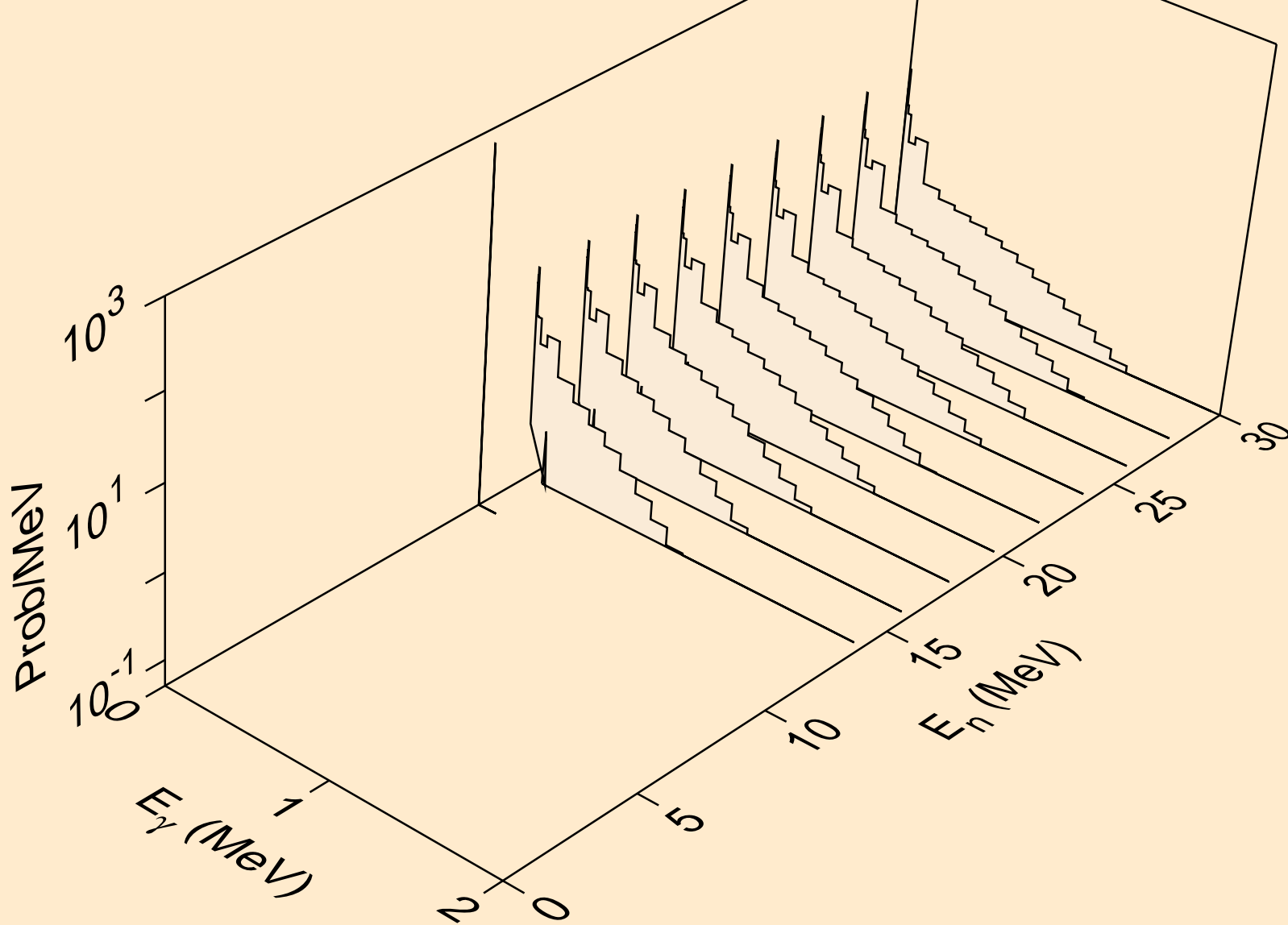

LR266 NEUTRON ACER TENDL-2019 LIBRARY; T=293.16K
Photon emission for (n,a)

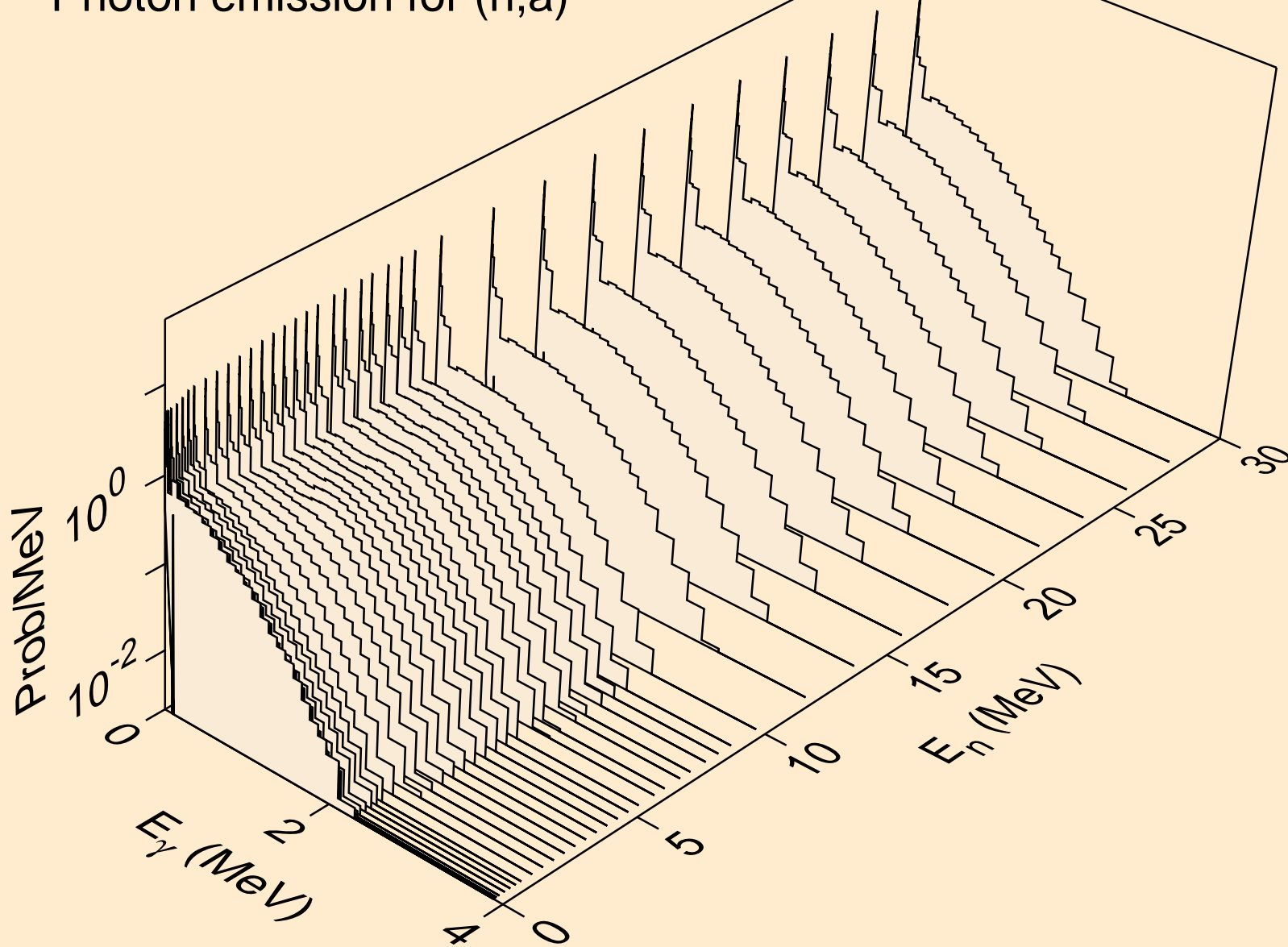

LR266 NEUTRON ACER TENDL-2019 LIBRARY; T=293.16K
thermal capture photon spectrum

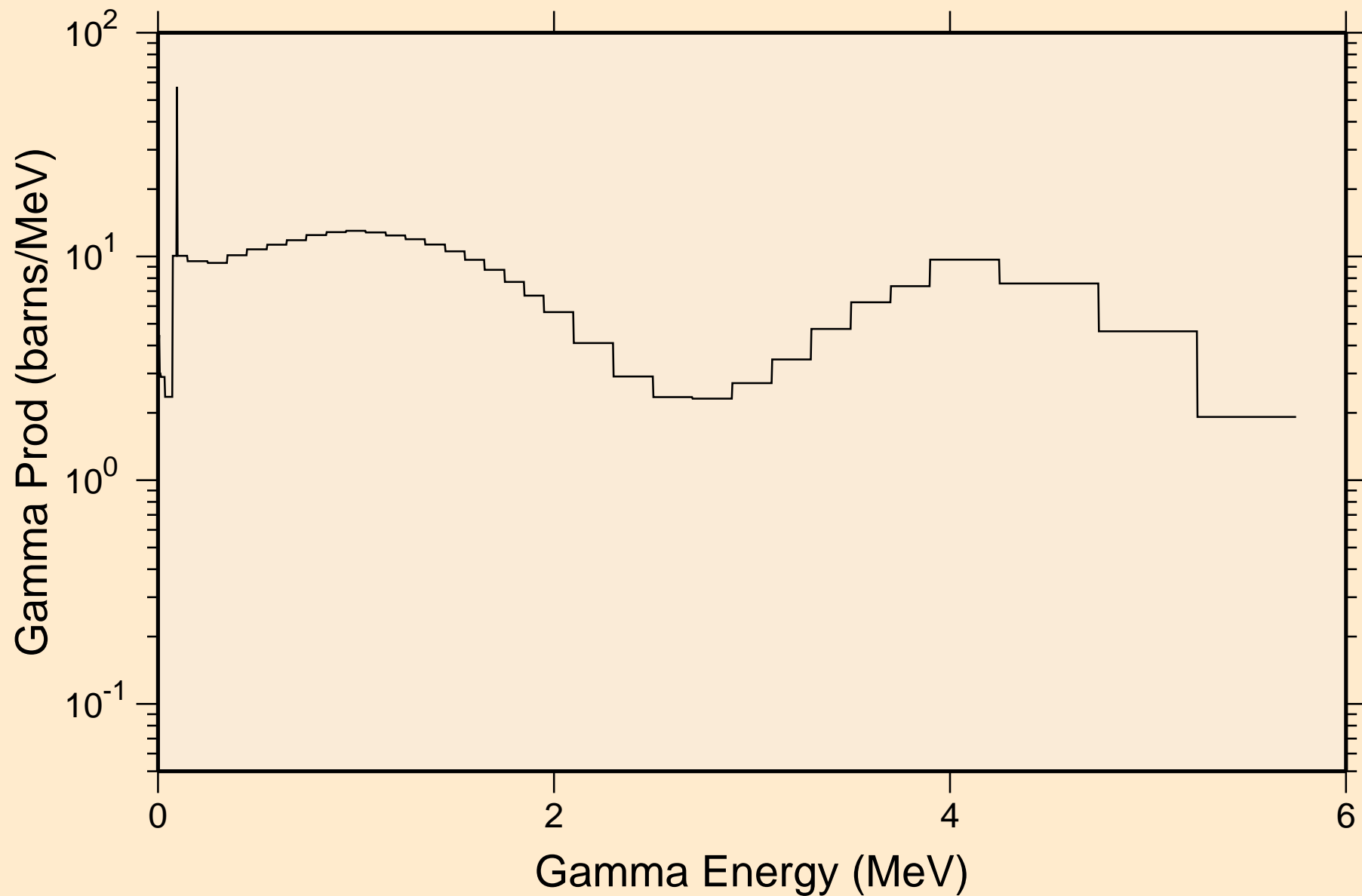

LR266 NEUTRON ACER TENDL-2019 LIBRARY; T=293.16K
14 MeV photon spectrum

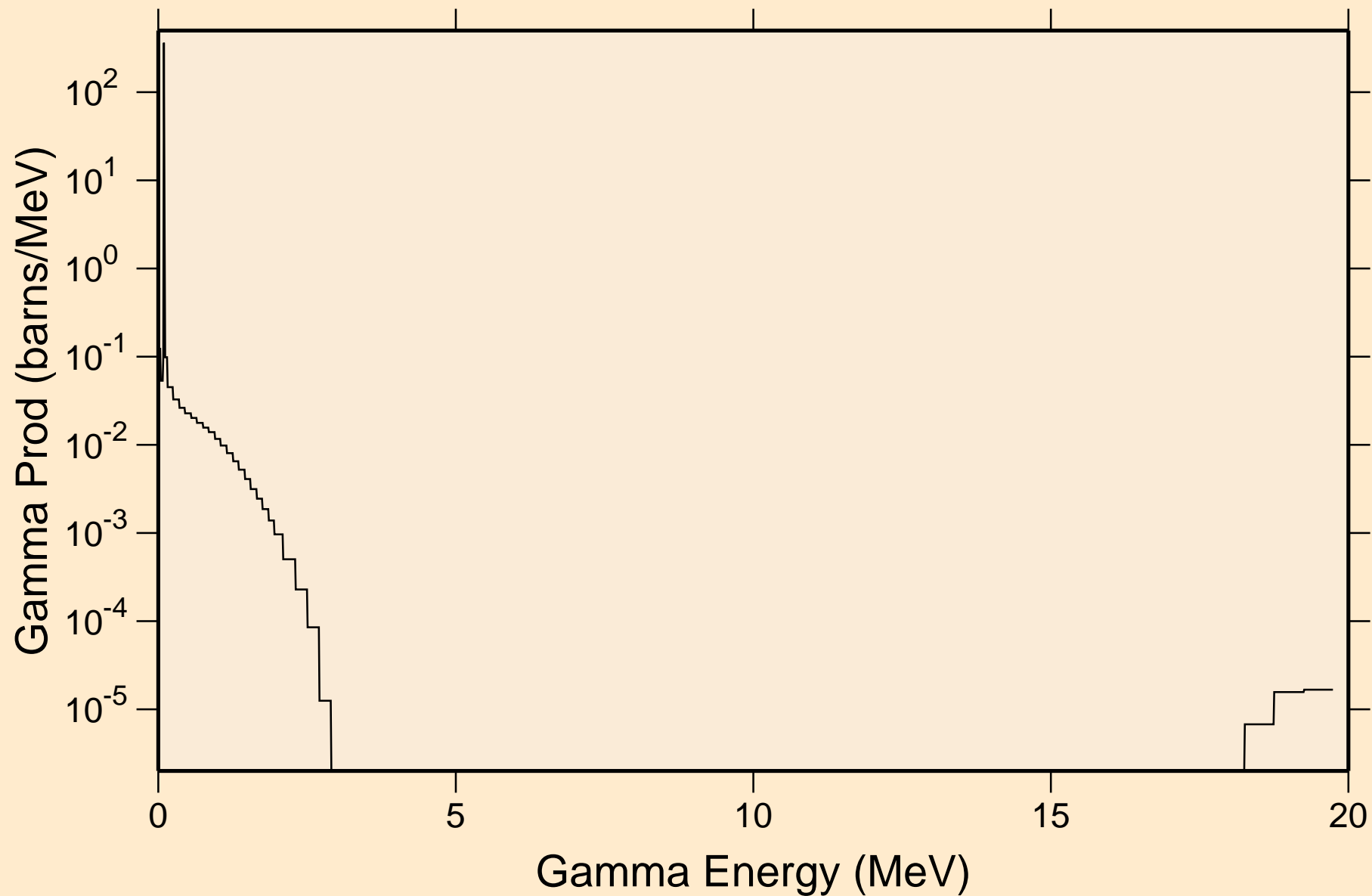

LR266 NEUTRON ACER TENDL-2019 LIBRARY; T=293.16K
Particle heating contributions

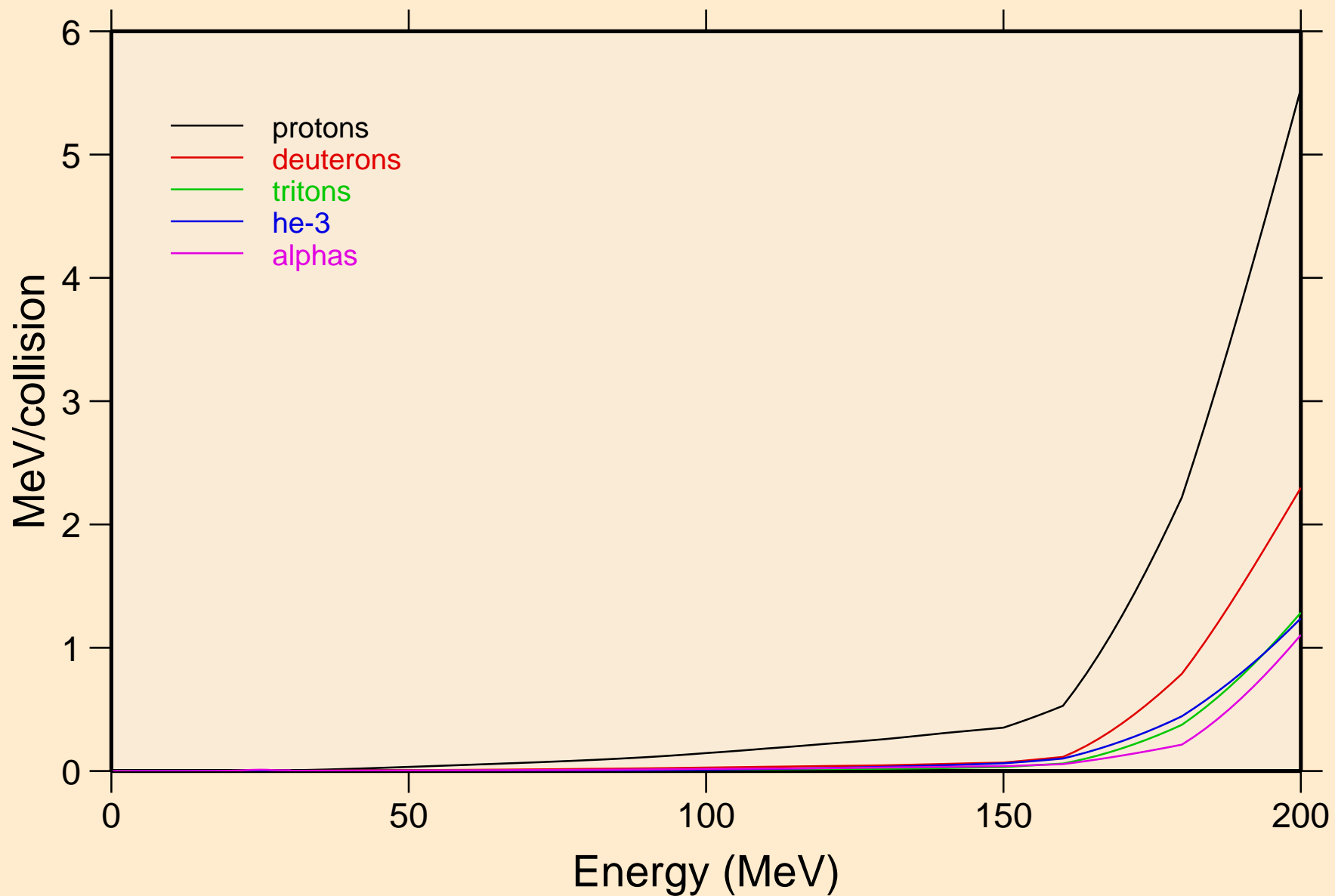

LR266 NEUTRON ACER TENDL-2019 LIBRARY; T=293.16K
Recoil Heating

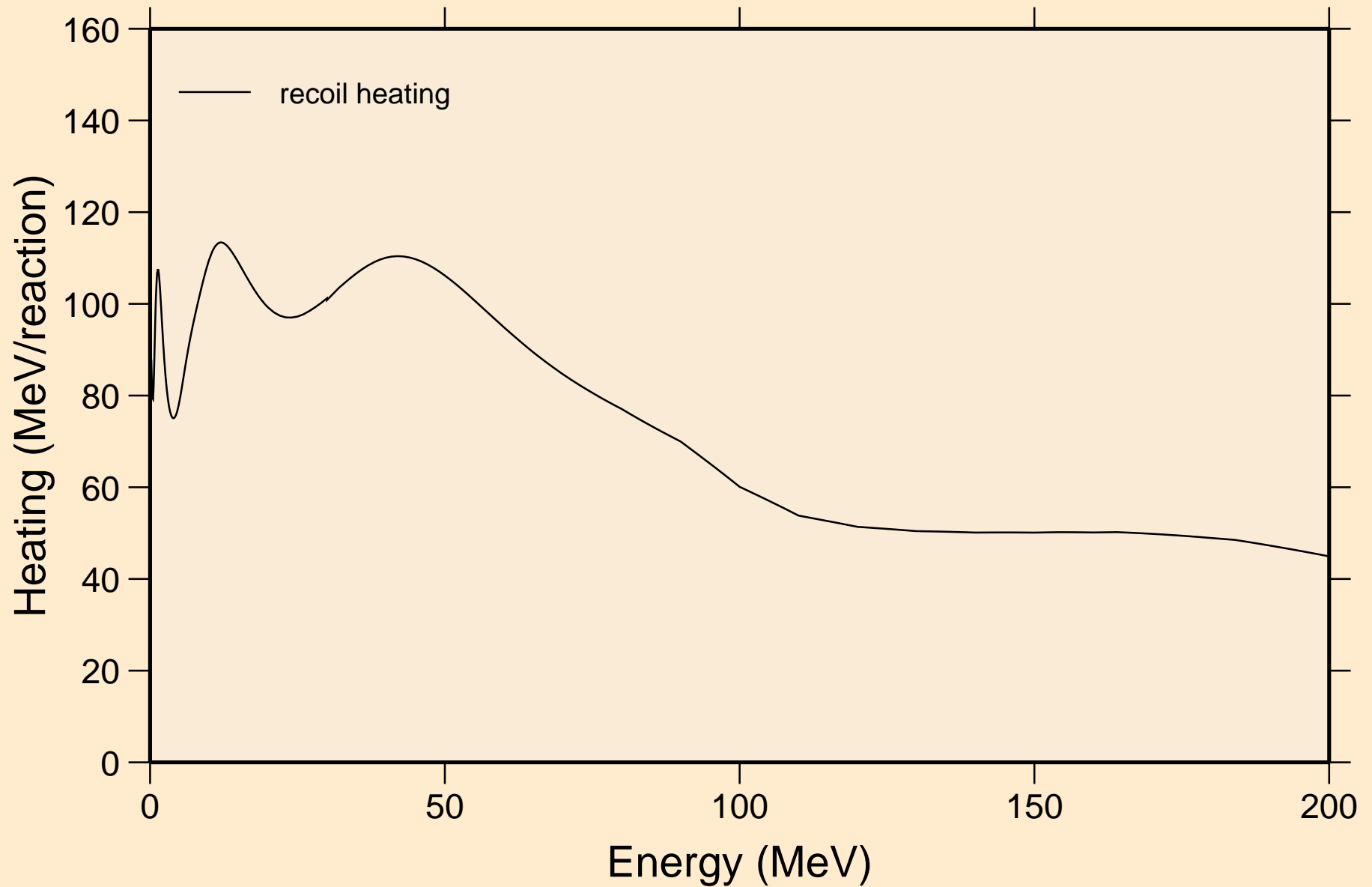

LR266 NEUTRON ACER TENDL-2019 LIBRARY; T=293.16K
Particle production cross sections

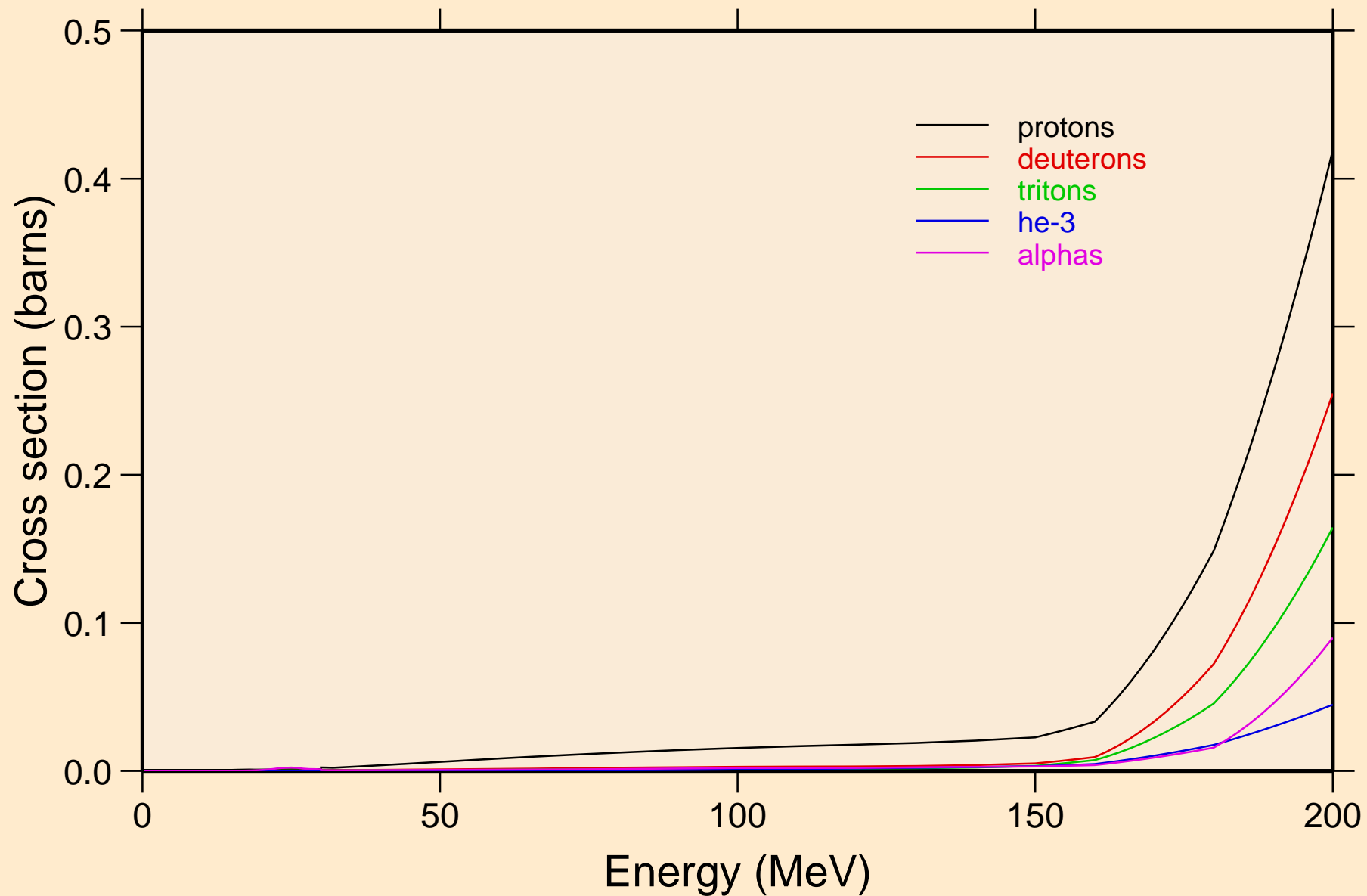

LR266 NEUTRON ACER TENDL-2019 LIBRARY; T=293.16K
protons from (n,x)

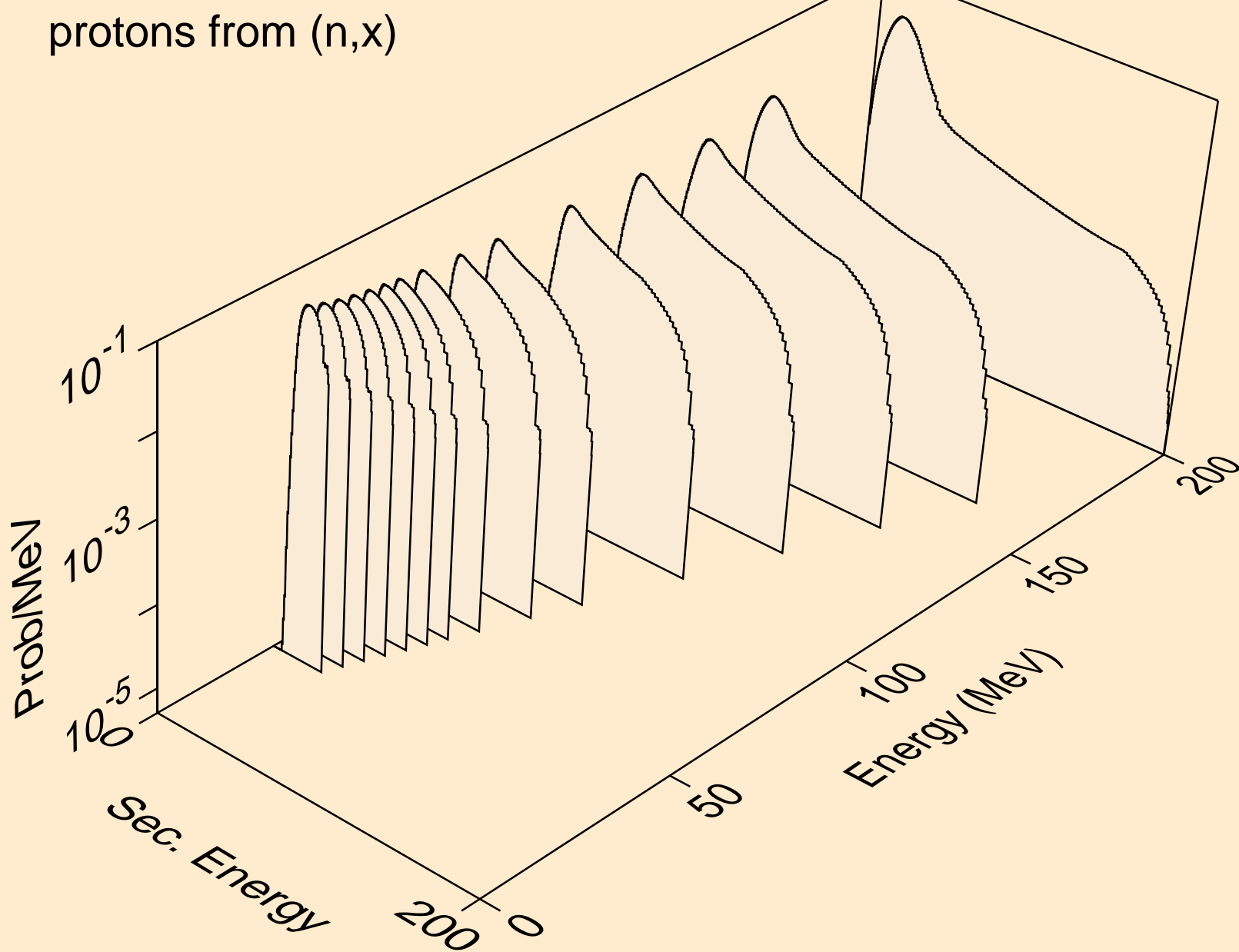

LR266 NEUTRON ACER TENDL-2019 LIBRARY; T=293.16K
protons from (n,n*)p

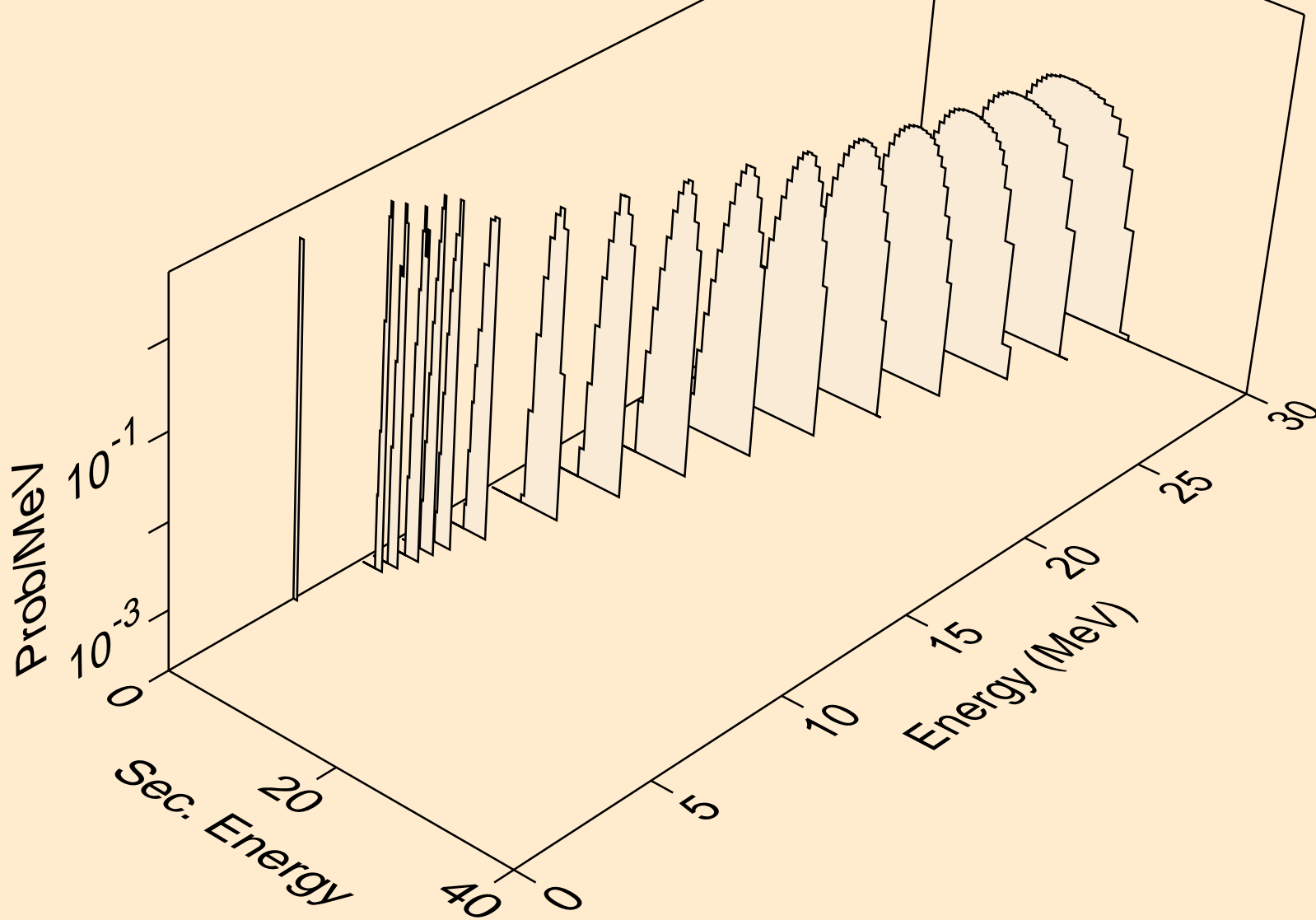

LR266 NEUTRON ACER TENDL-2019 LIBRARY; T=293.16K
protons from (n,2np)

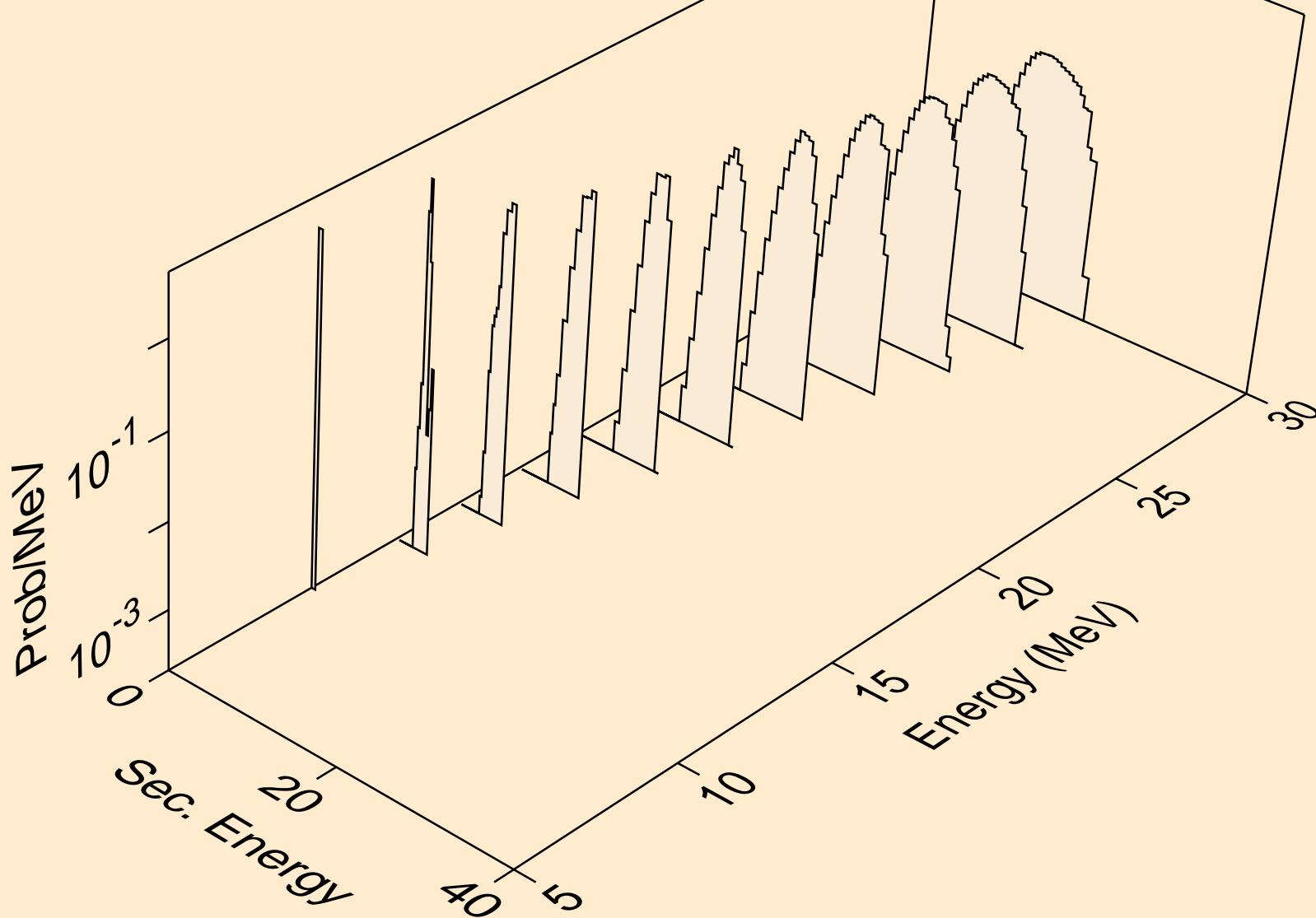

LR266 NEUTRON ACER TENDL-2019 LIBRARY; T=293.16K
protons from (n,3np)

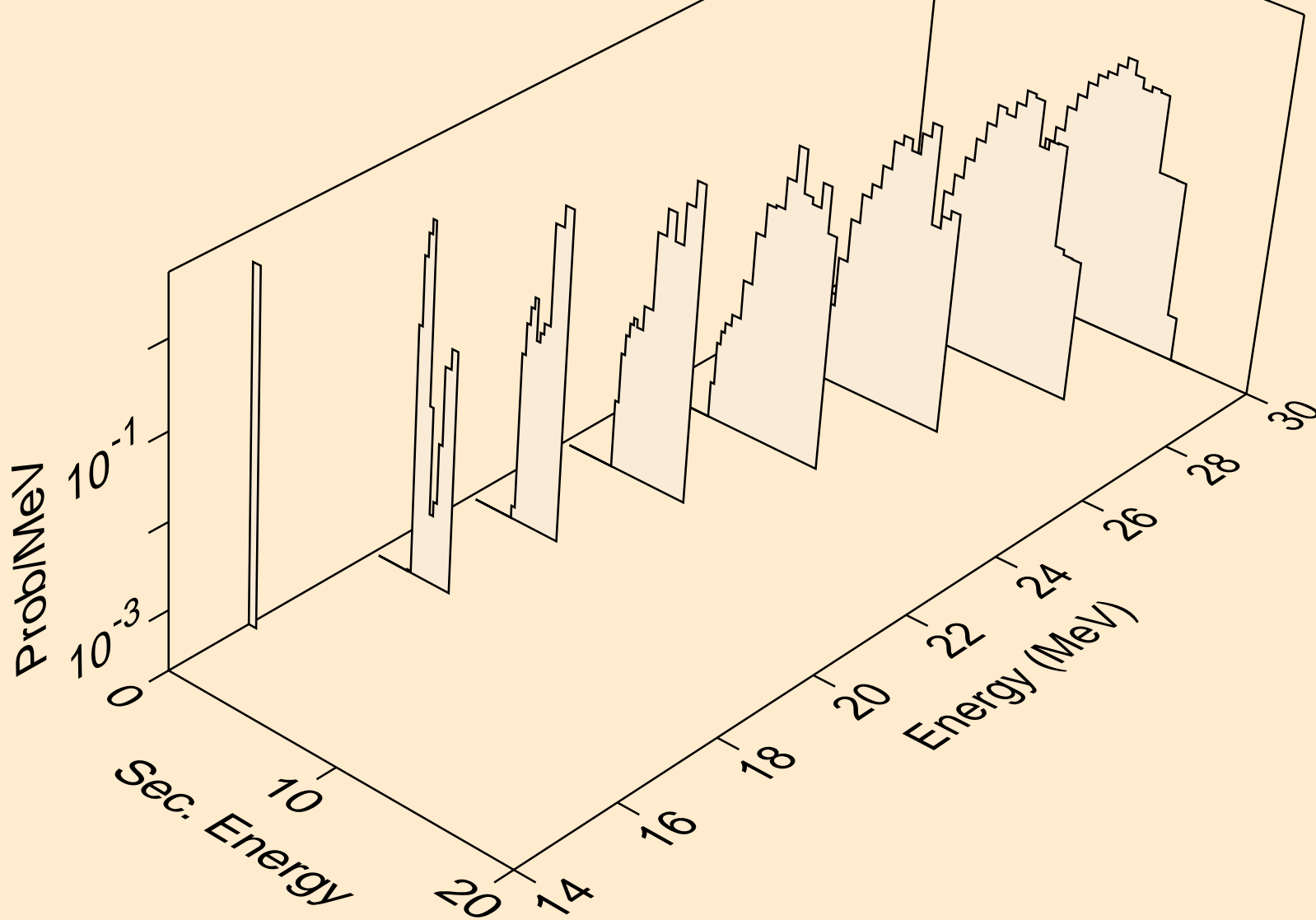

LR266 NEUTRON ACER TENDL-2019 LIBRARY; T=293.16K
protons from (n,p)

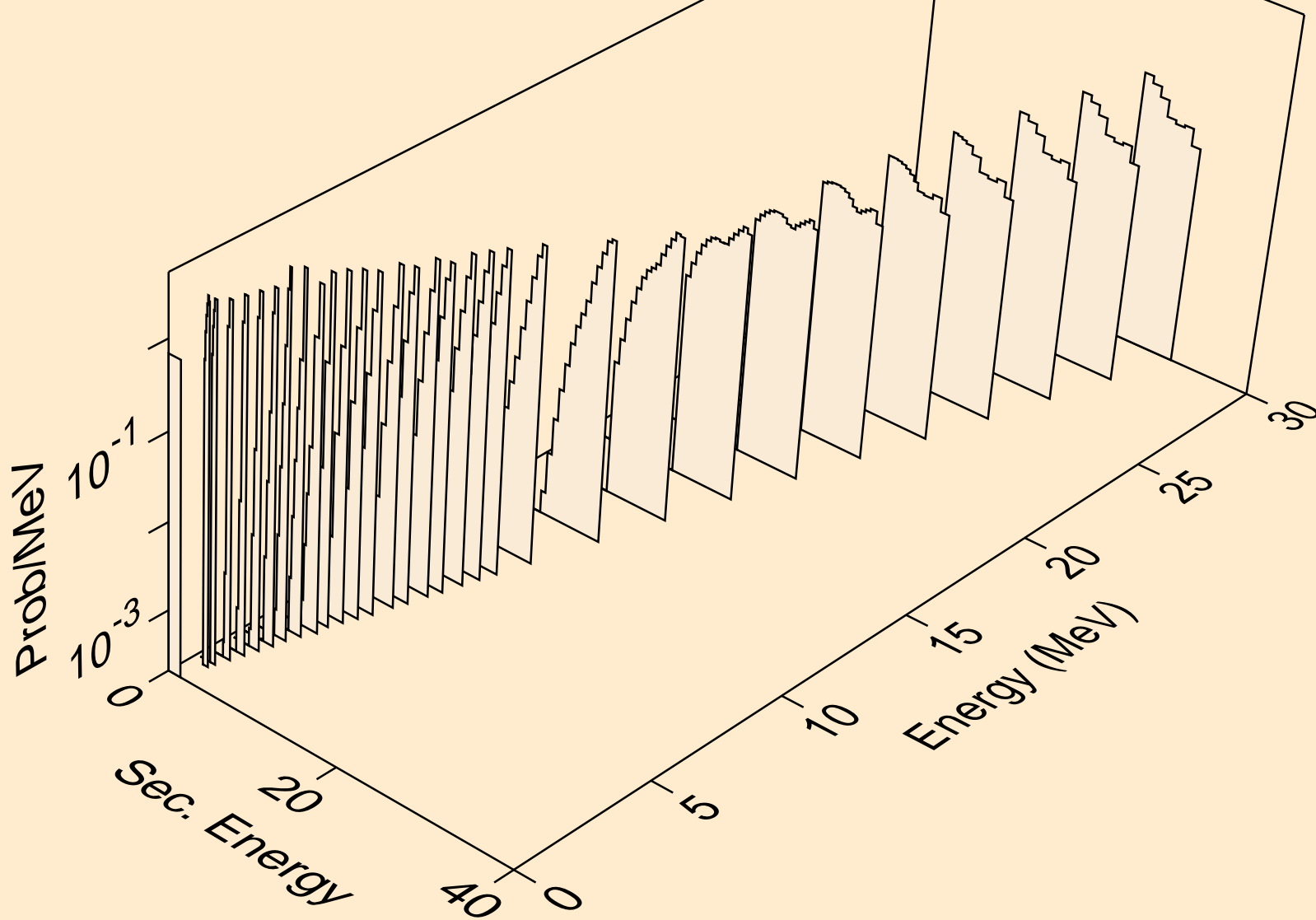

LR266 NEUTRON ACER TENDL-2019 LIBRARY; T=293.16K
deuterons from (n,x)

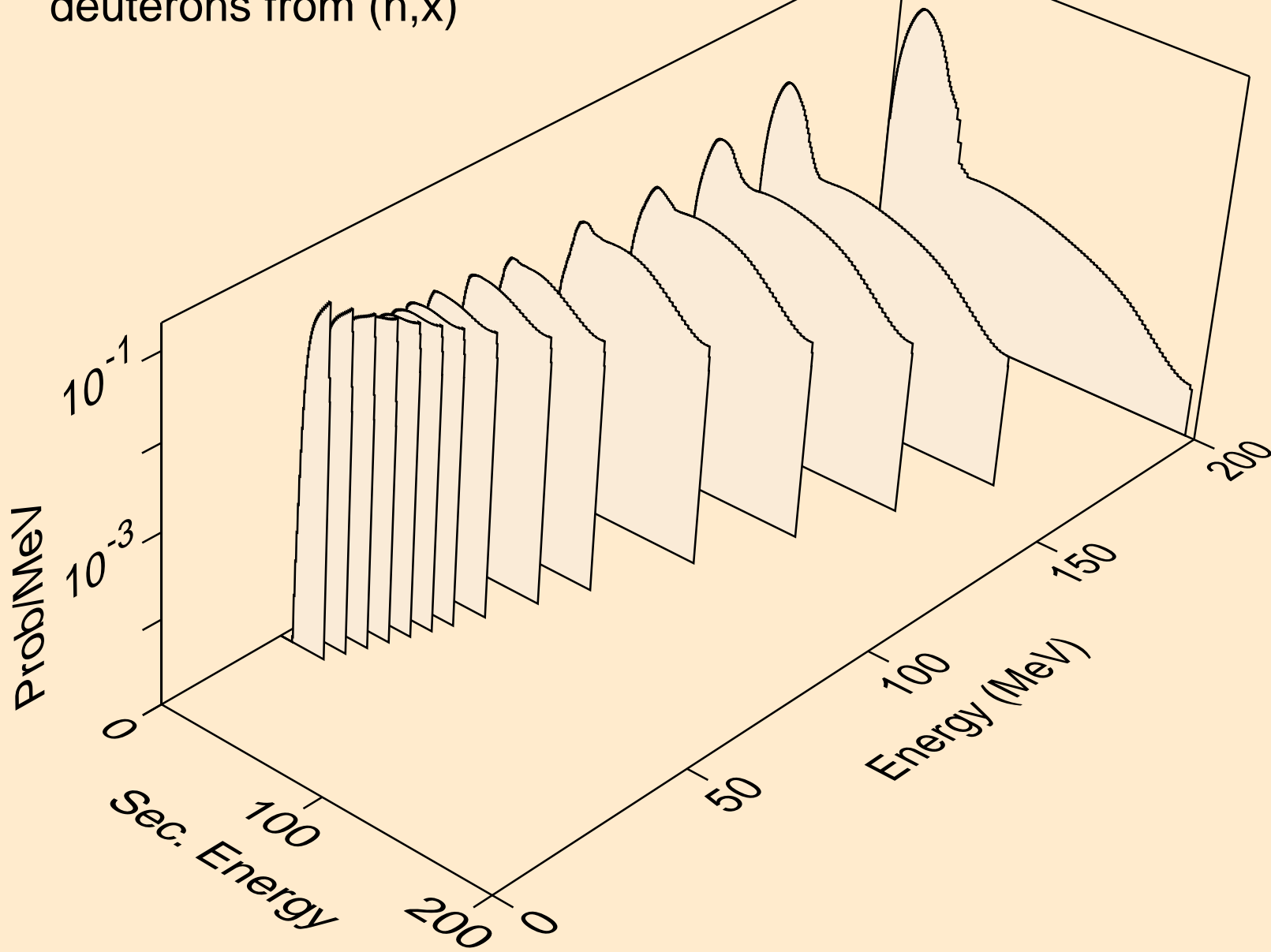

LR266 NEUTRON ACER TENDL-2019 LIBRARY; T=293.16K
deuterons from (n,2nd)

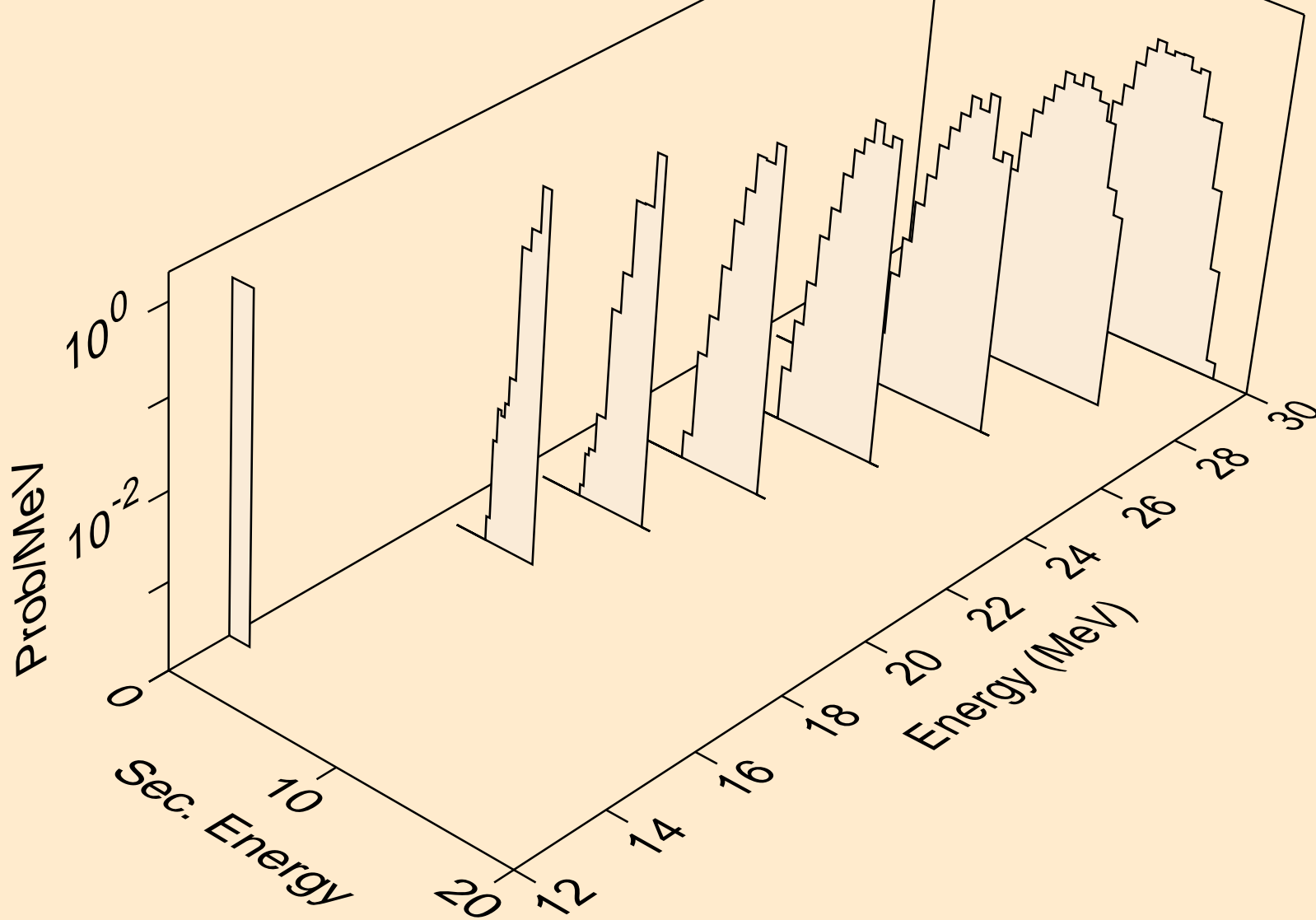

LR266 NEUTRON ACER TENDL-2019 LIBRARY; T=293.16K
deuterons from (n,n*)d

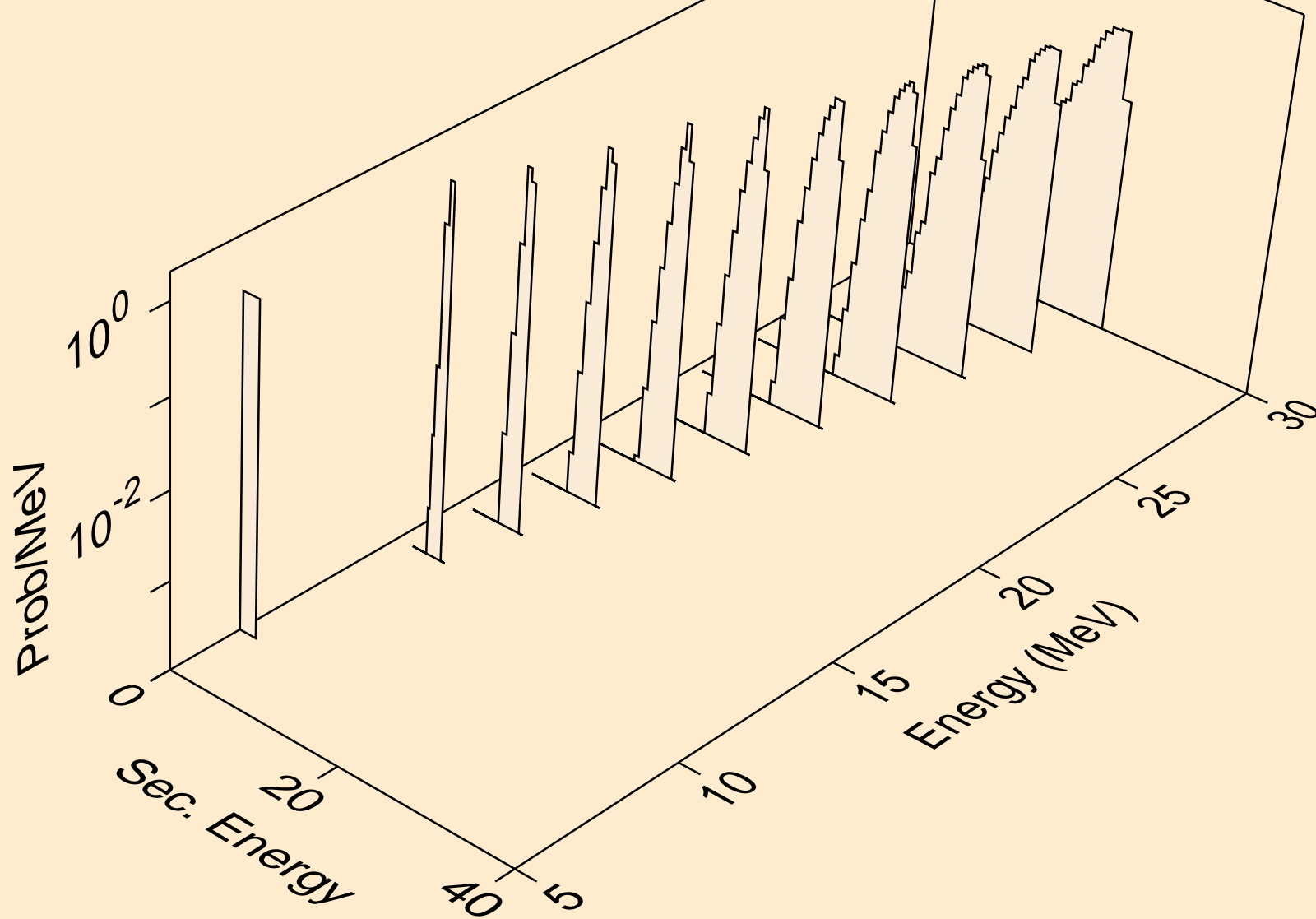

LR266 NEUTRON ACER TENDL-2019 LIBRARY; T=293.16K
deuterons from (n,d)

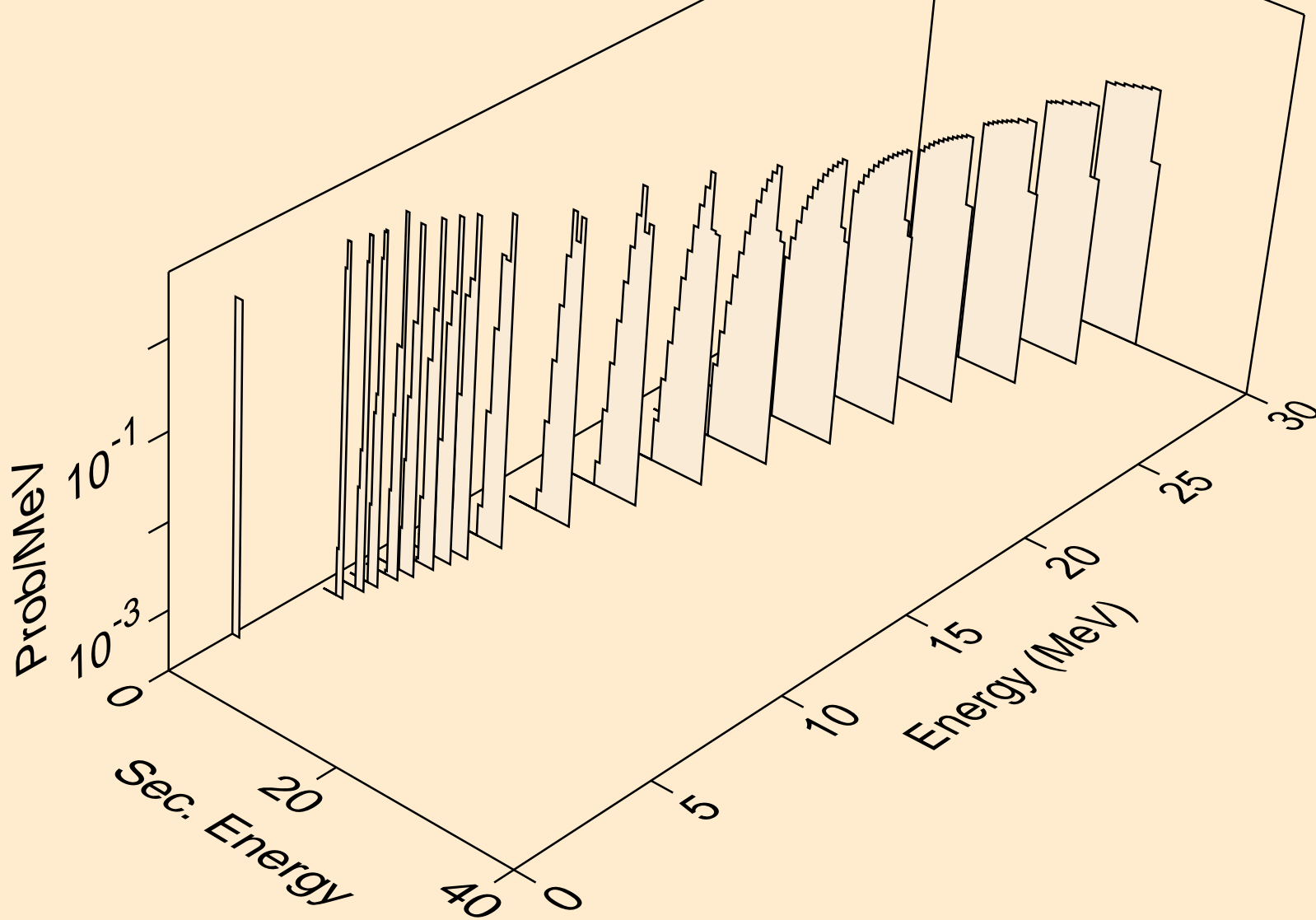

LR266 NEUTRON ACER TENDL-2019 LIBRARY; T=293.16K
tritons from (n,x)

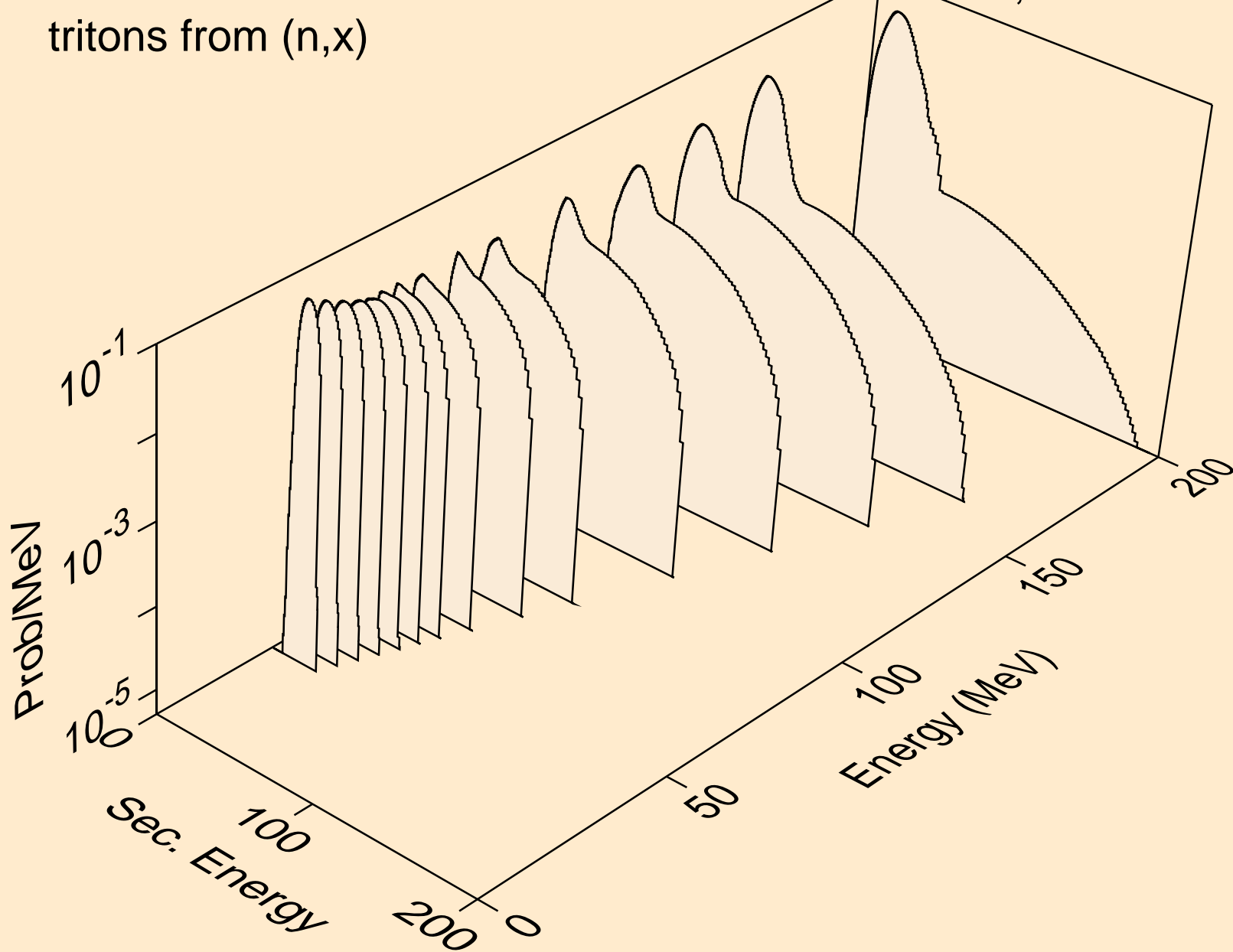

LR266 NEUTRON ACER TENDL-2019 LIBRARY; T=293.16K
tritons from (n,n*)t

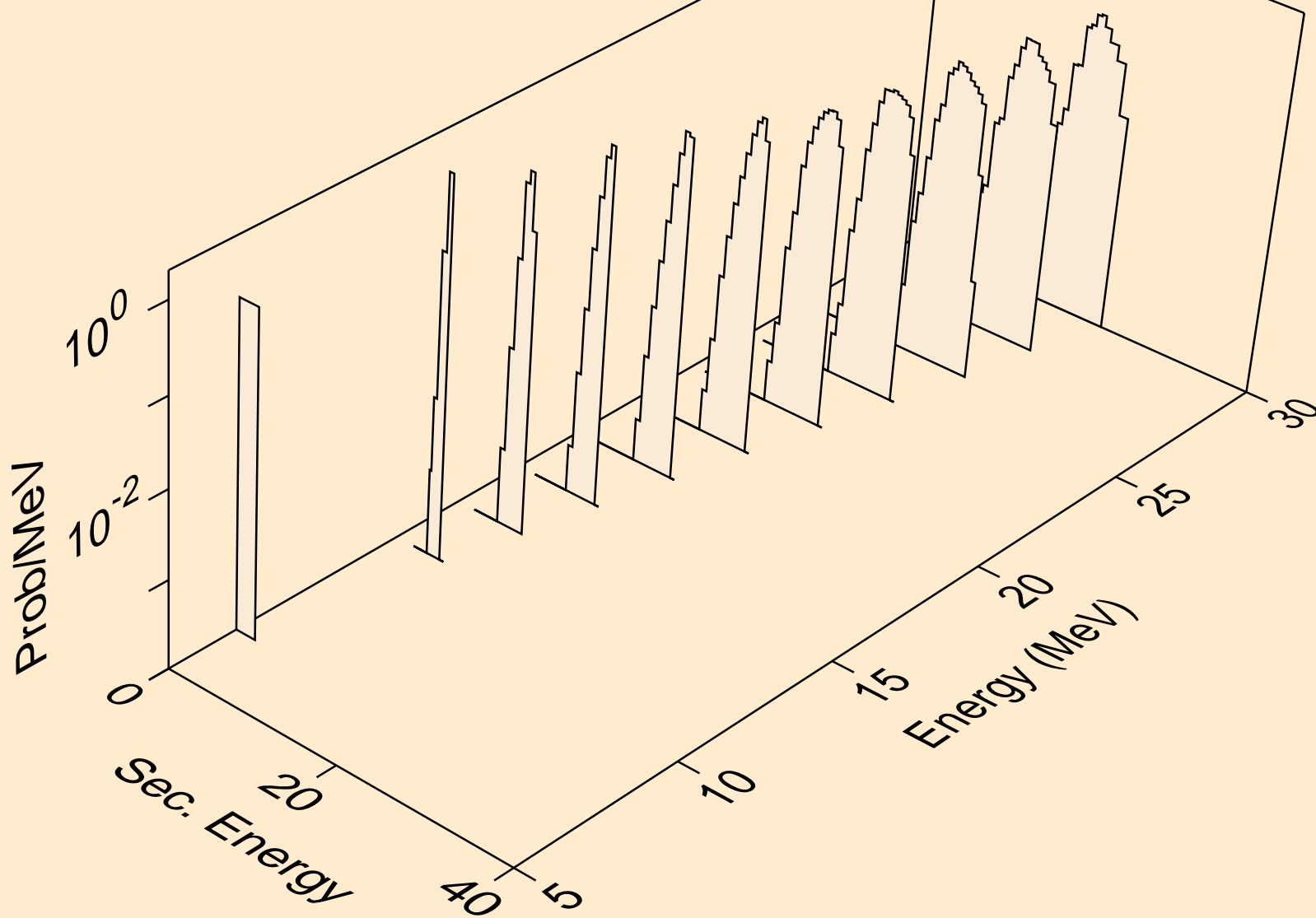

LR266 NEUTRON ACER TENDL-2019 LIBRARY; T=293.16K
tritons from (n,t)

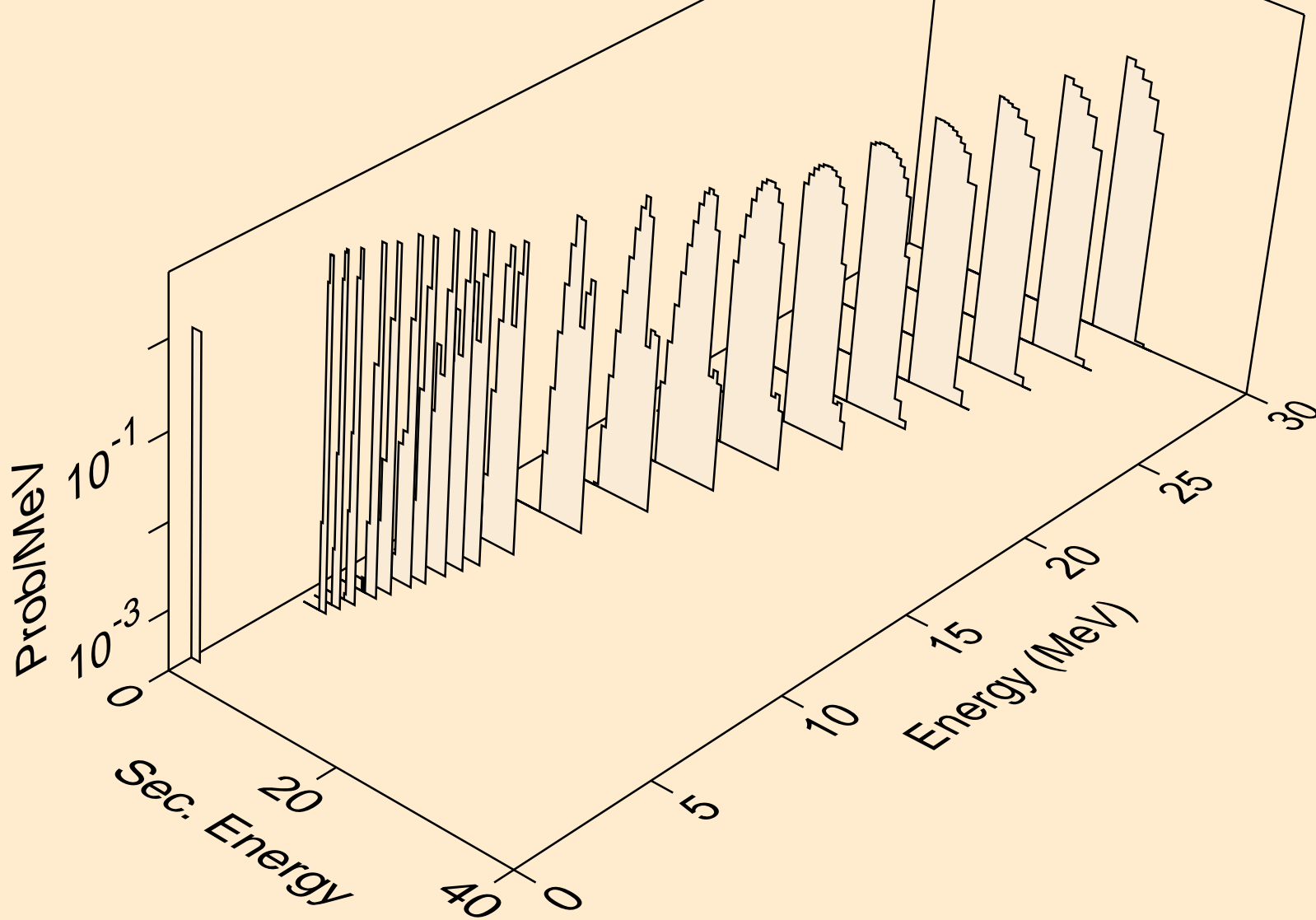

LR266 NEUTRON ACER TENDL-2019 LIBRARY; T=293.16K
he3s from (n,x)

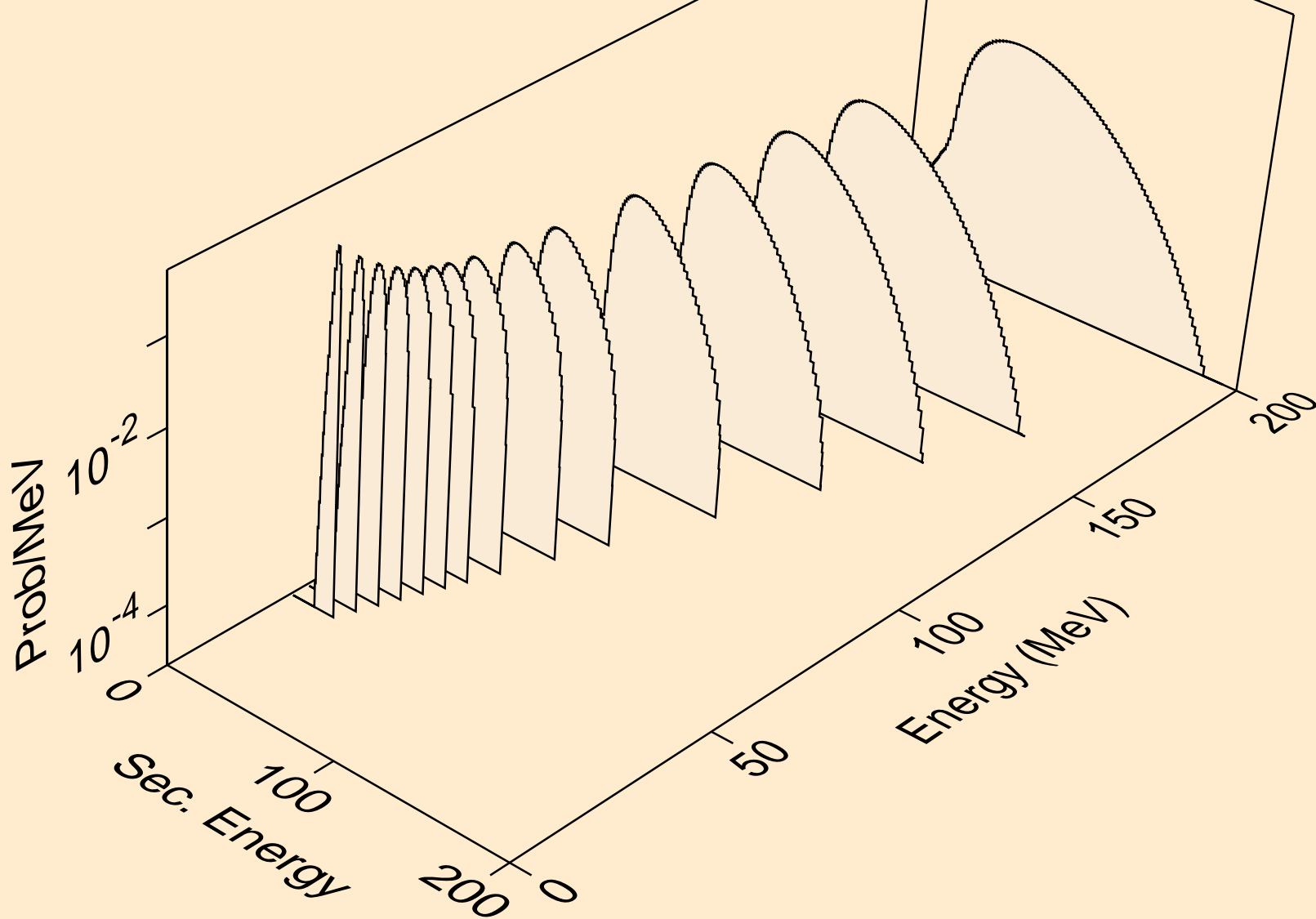

LR266 NEUTRON ACER TENDL-2019 LIBRARY; T=293.16K
he3s from (n,n*)he3

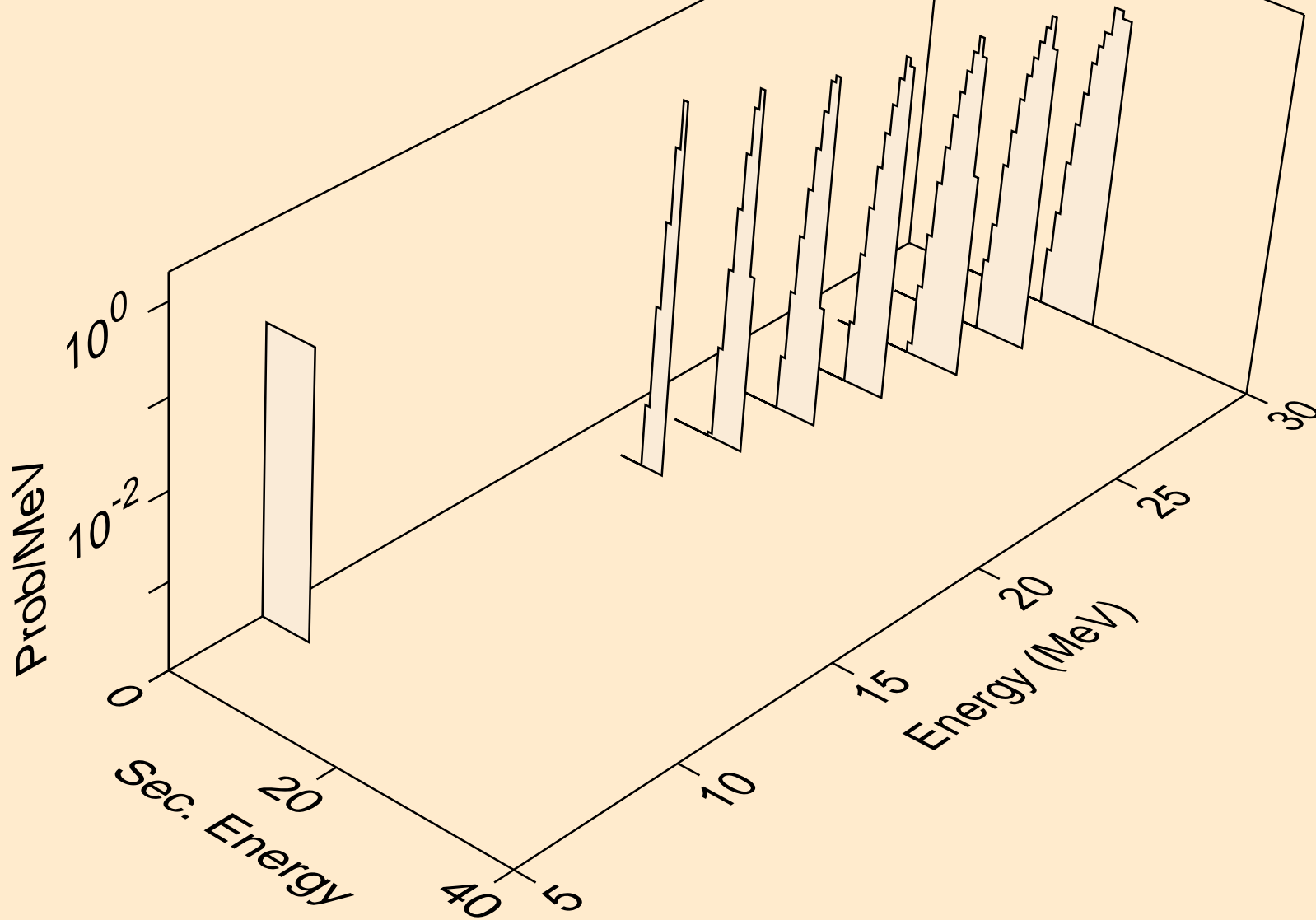

LR266 NEUTRON ACER TENDL-2019 LIBRARY; T=293.16K
he3s from (n,he3)

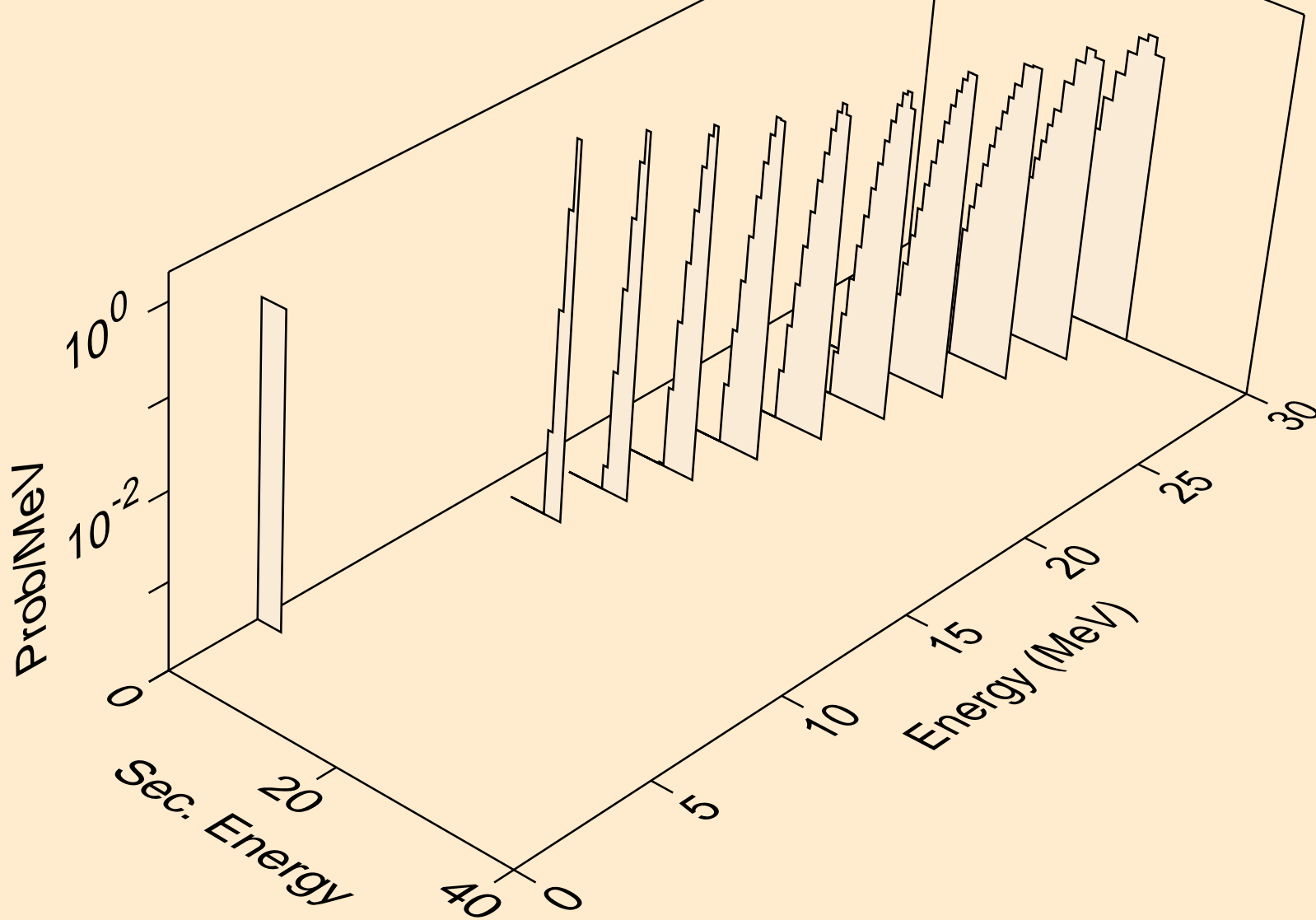

LR266 NEUTRON ACER TENDL-2019 LIBRARY; T=293.16K
alphas from (n,x)

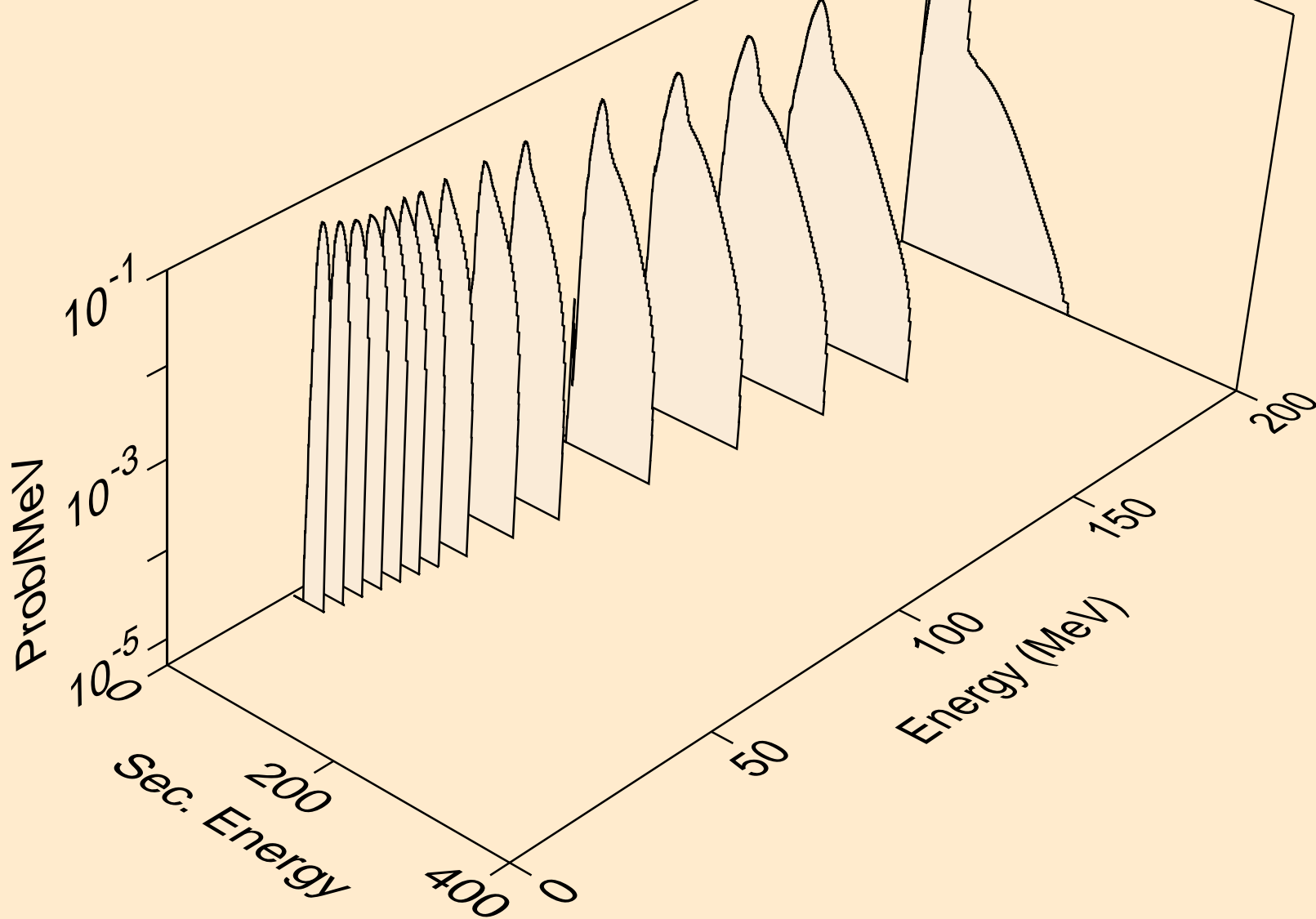

LR266 NEUTRON ACER TENDL-2019 LIBRARY; T=293.16K
alphas from (n,n*)a

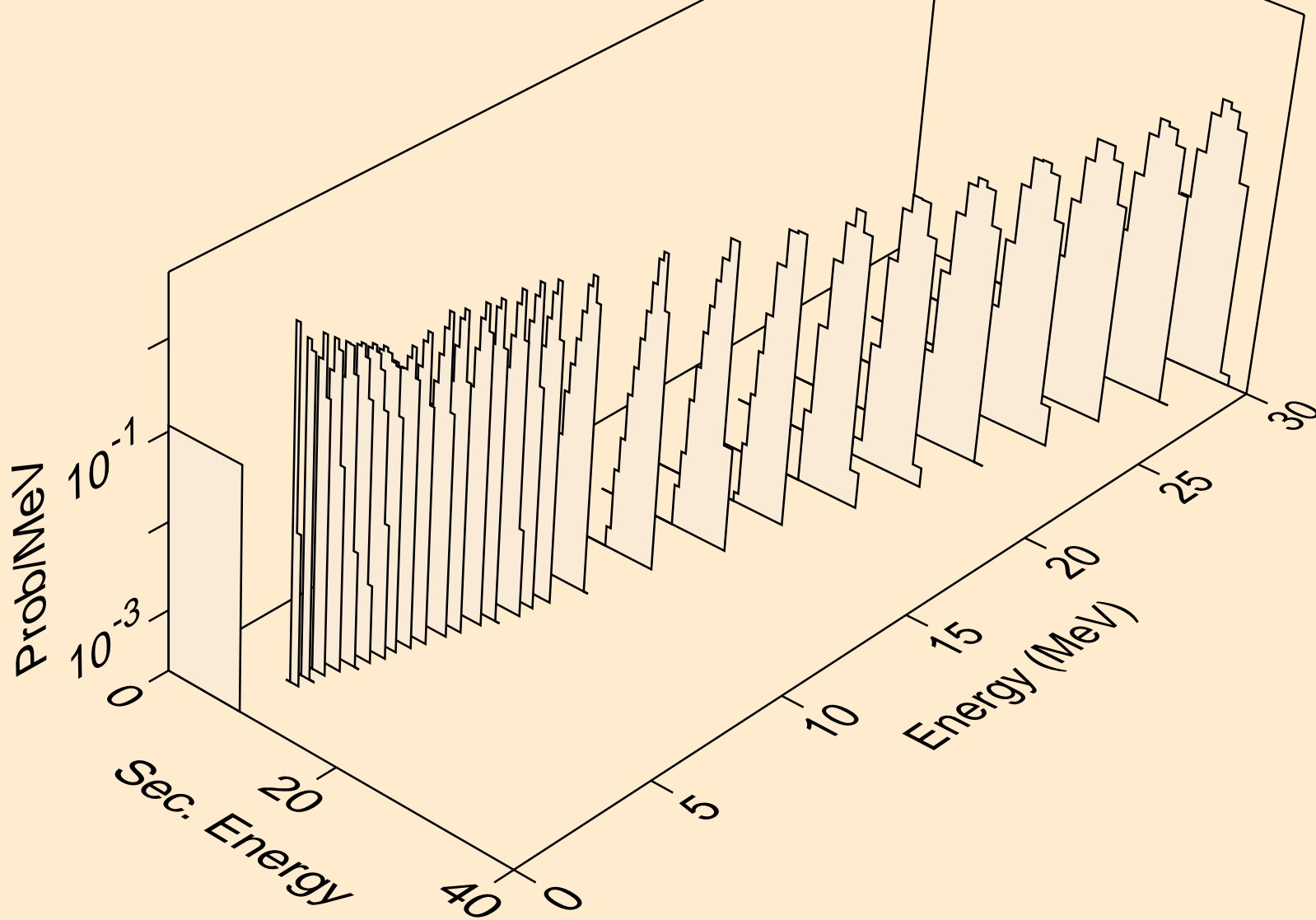

LR266 NEUTRON ACER TENDL-2019 LIBRARY; T=293.16K
alphas from (n,2n)a

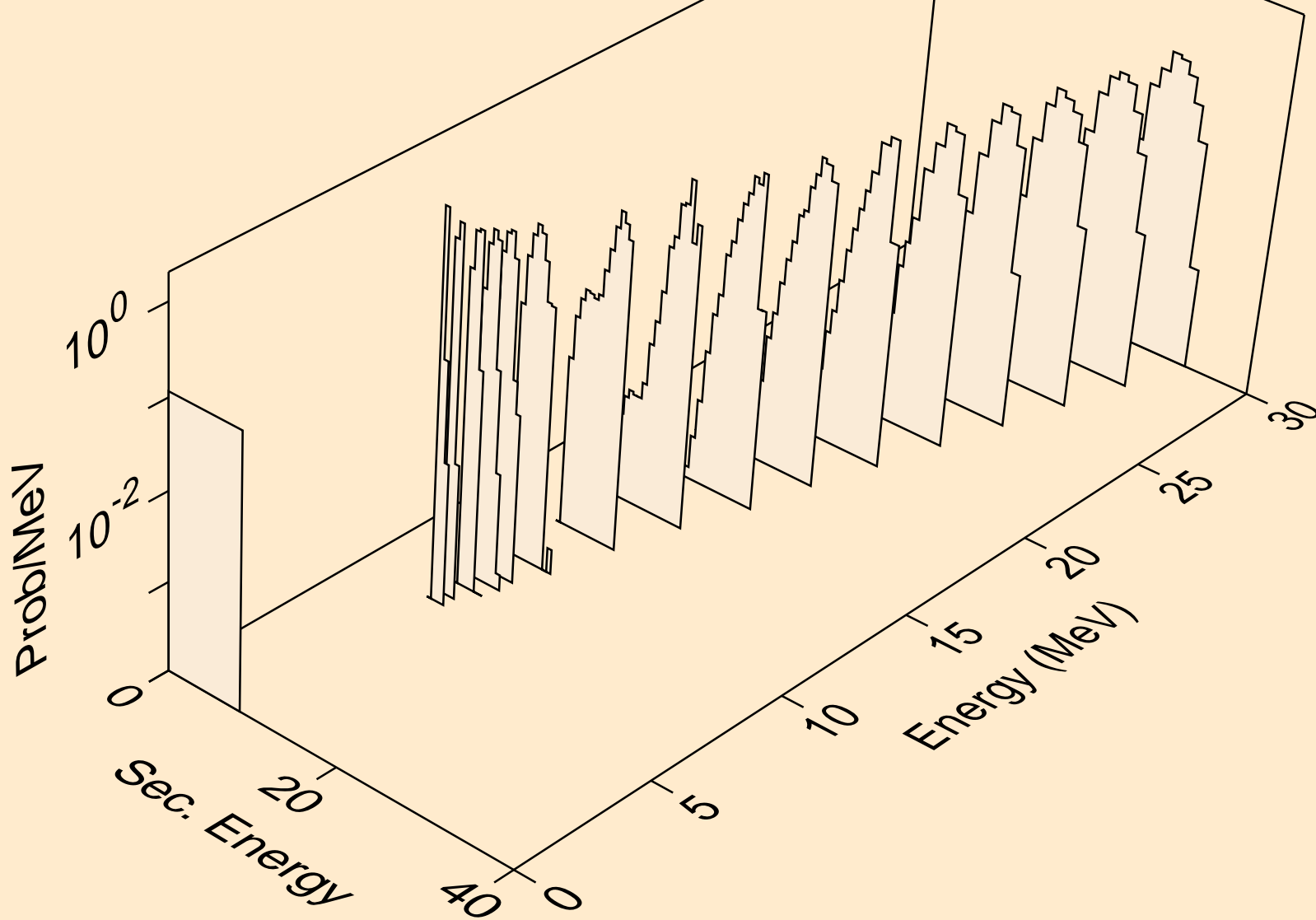

LR266 NEUTRON ACER TENDL-2019 LIBRARY; T=293.16K
alphas from (n,3n)a

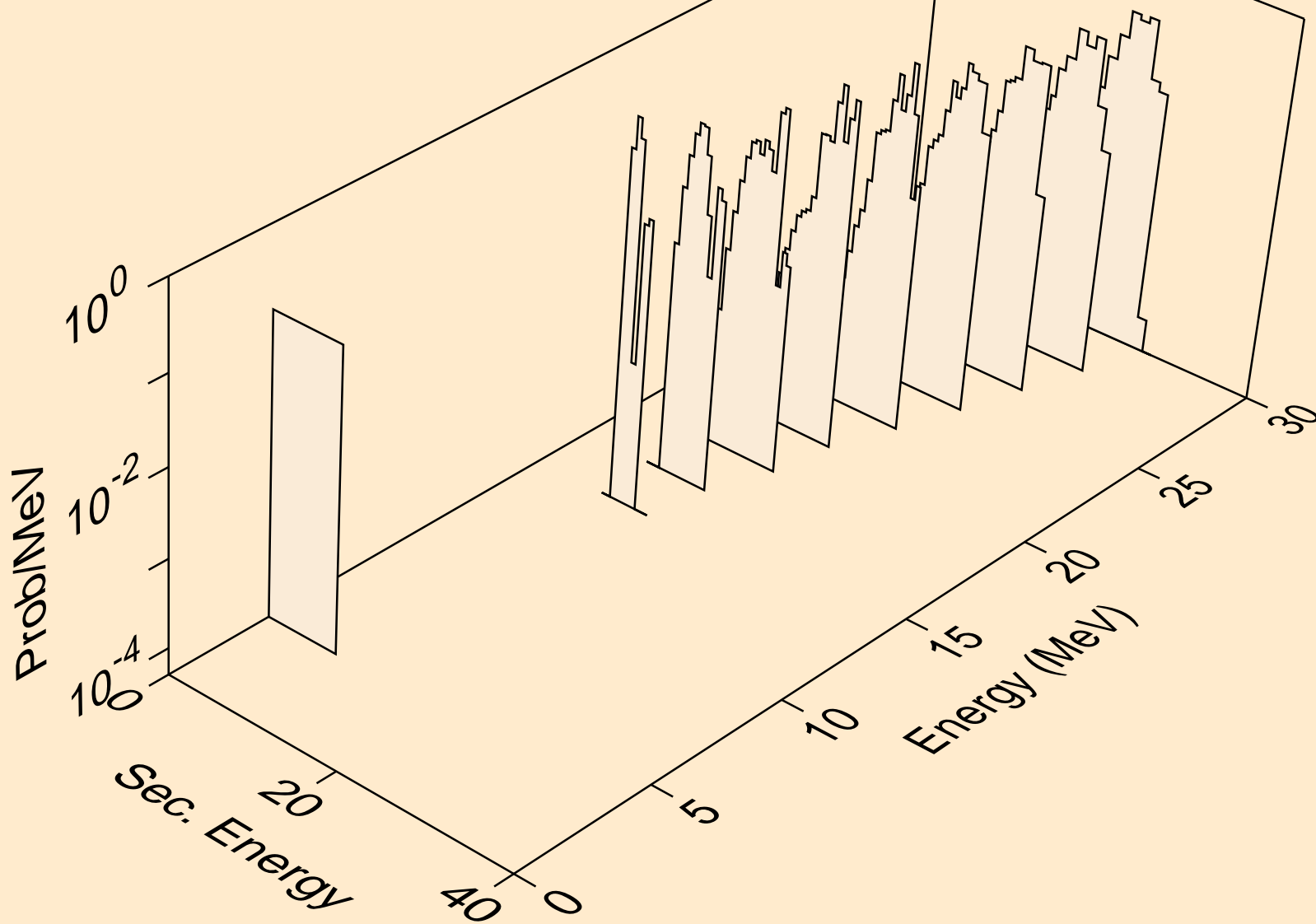

LR266 NEUTRON ACER TENDL-2019 LIBRARY; T=293.16K
alphas from (n,a)

