

LU159 NEUTRON ACER TENDL-2019 LIBRARY; T=293.16K
Principal cross sections

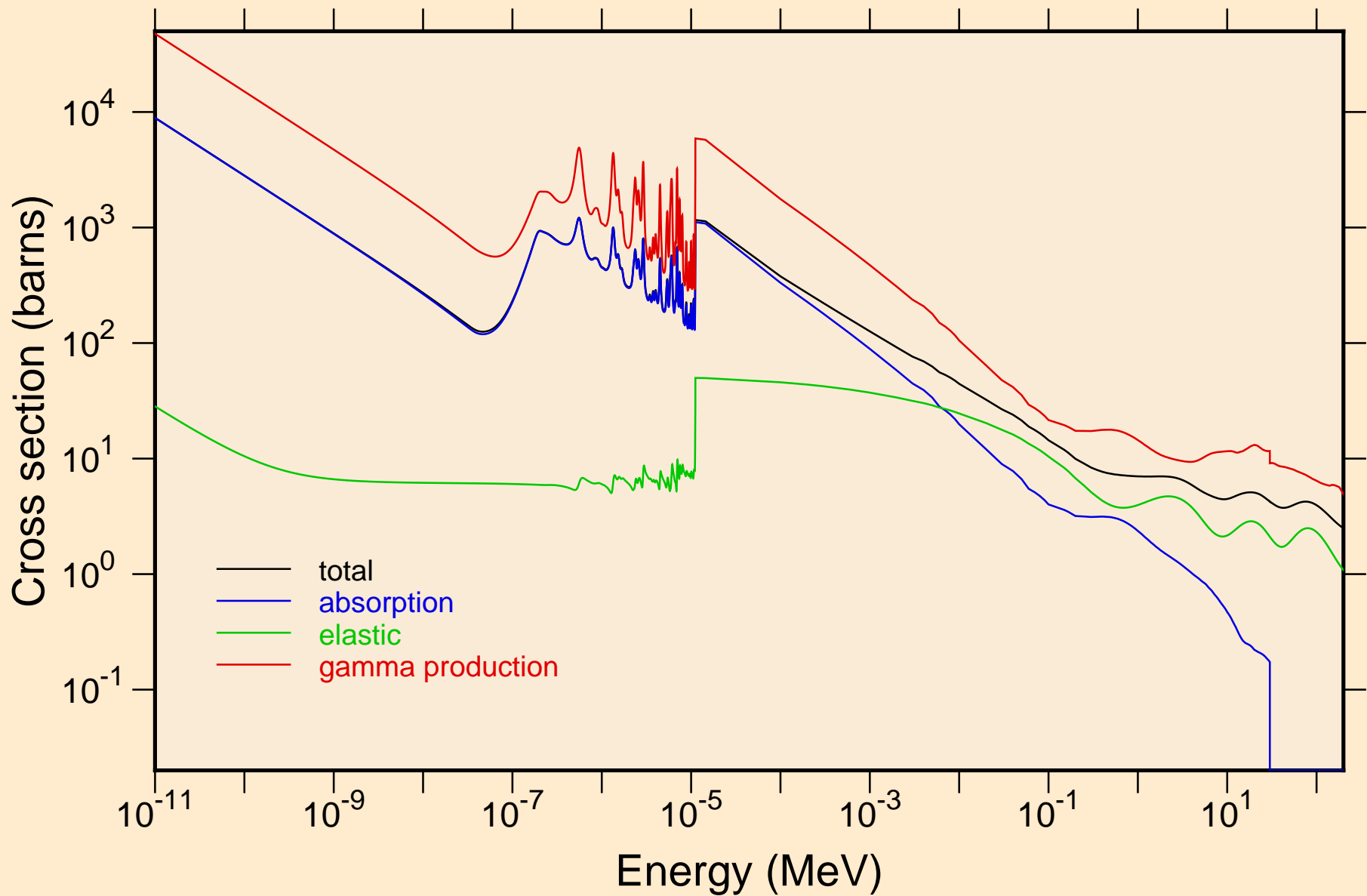

LU159 NEUTRON ACER TENDL-2019 LIBRARY; T=293.16K
resonance total cross section

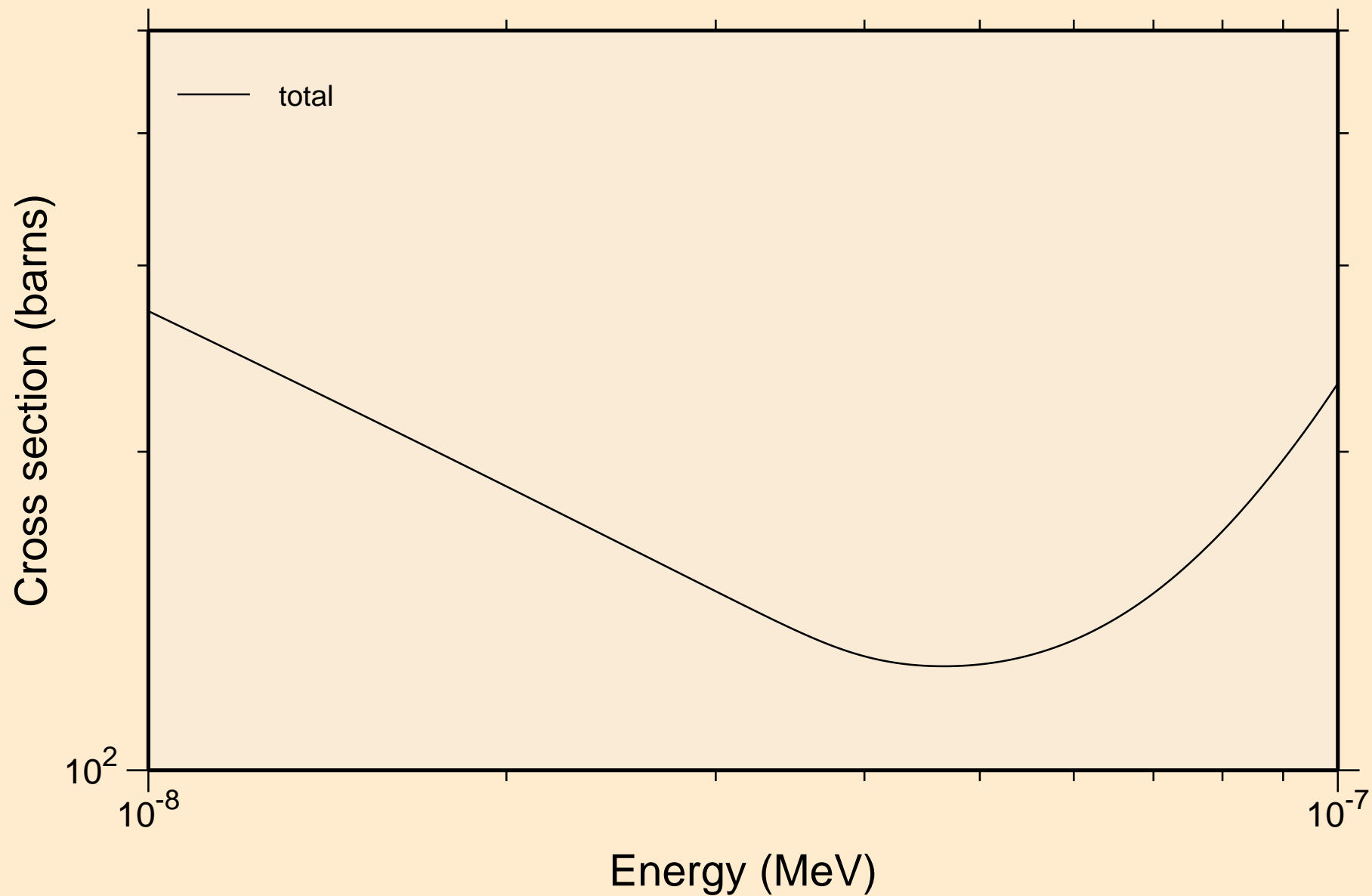

LU159 NEUTRON ACER TENDL-2019 LIBRARY; T=293.16K
resonance total cross section

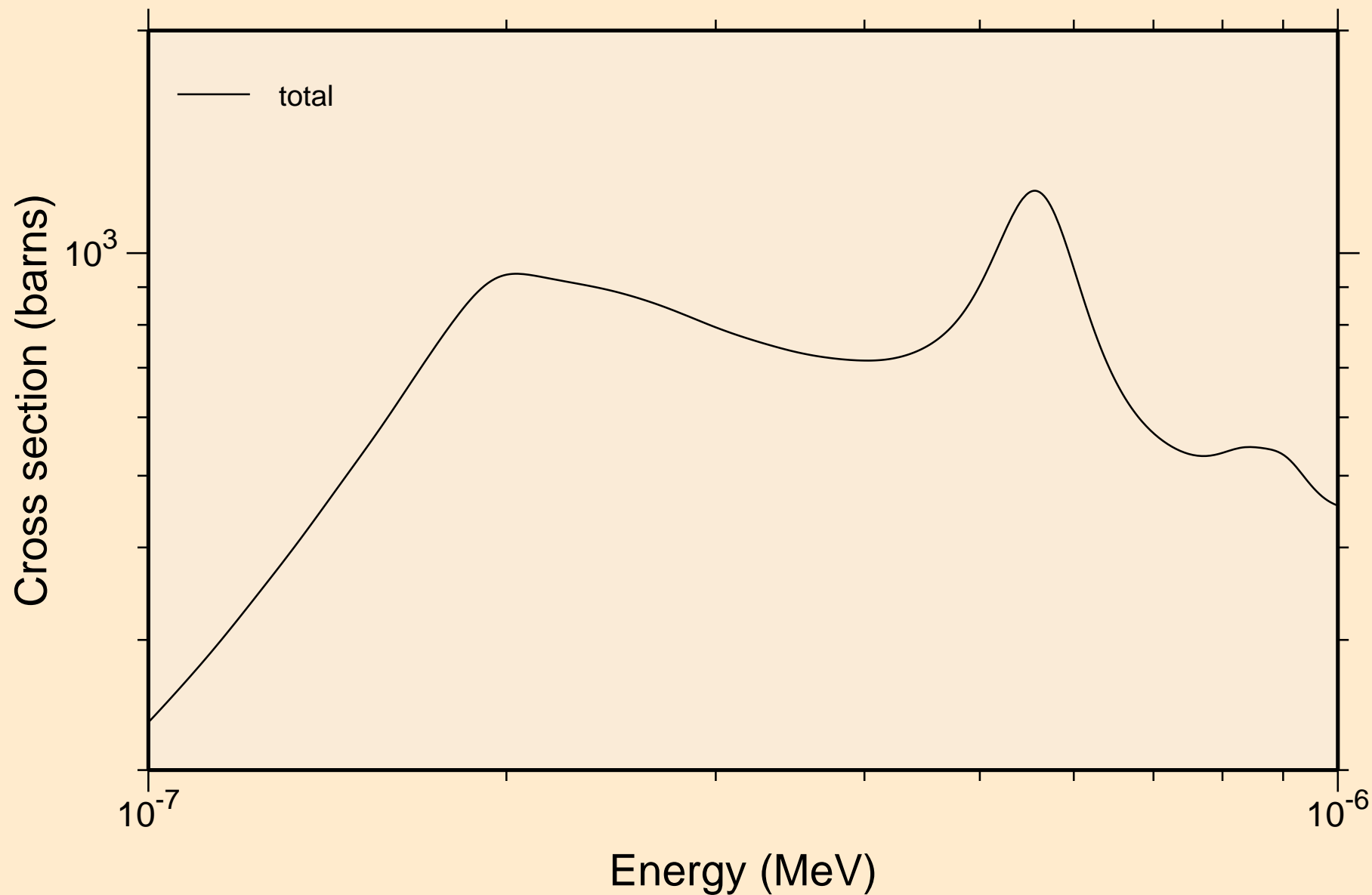

LU159 NEUTRON ACER TENDL-2019 LIBRARY; T=293.16K
resonance total cross section

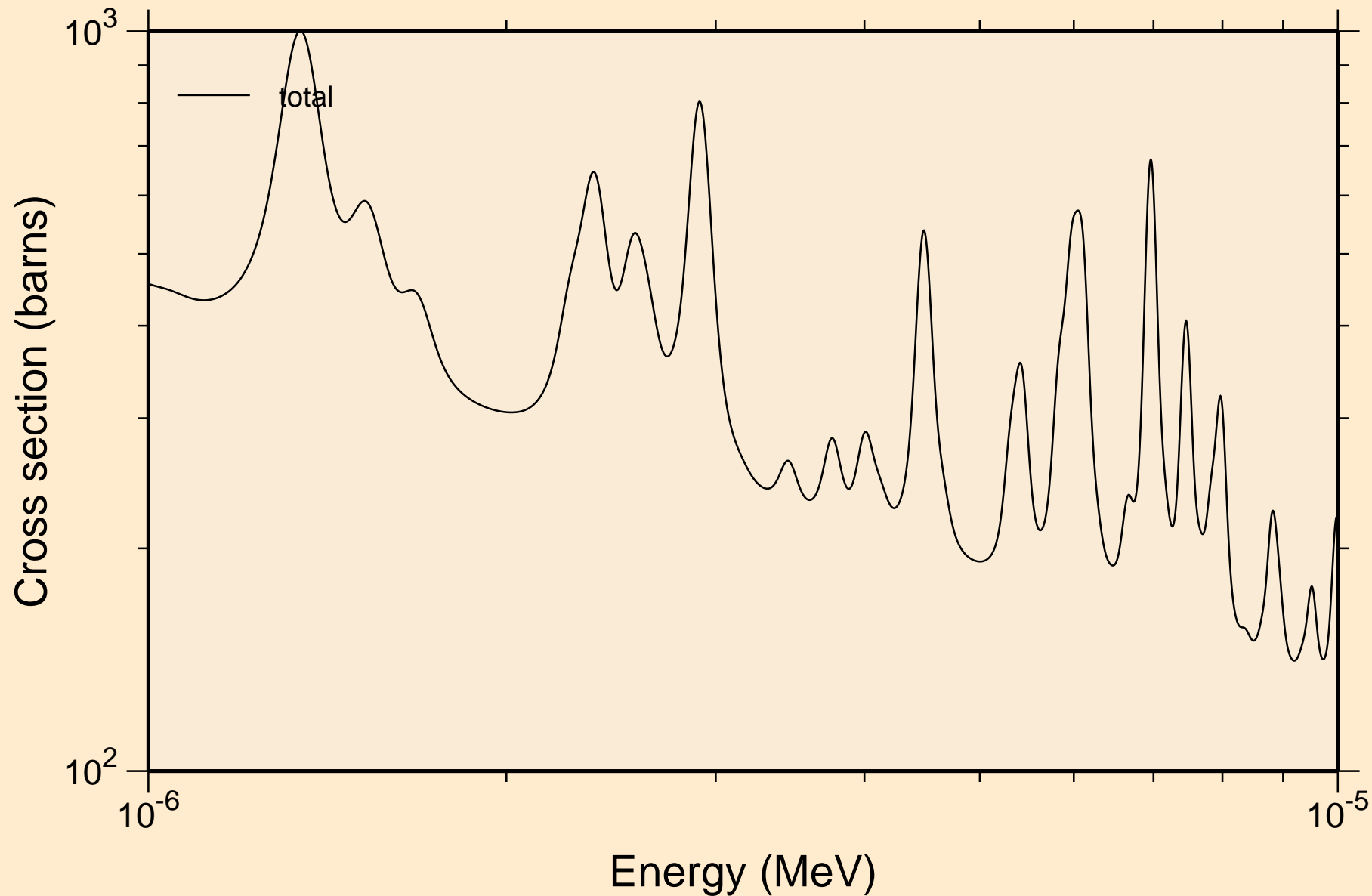

LU159 NEUTRON ACER TENDL-2019 LIBRARY; T=293.16K
resonance total cross section

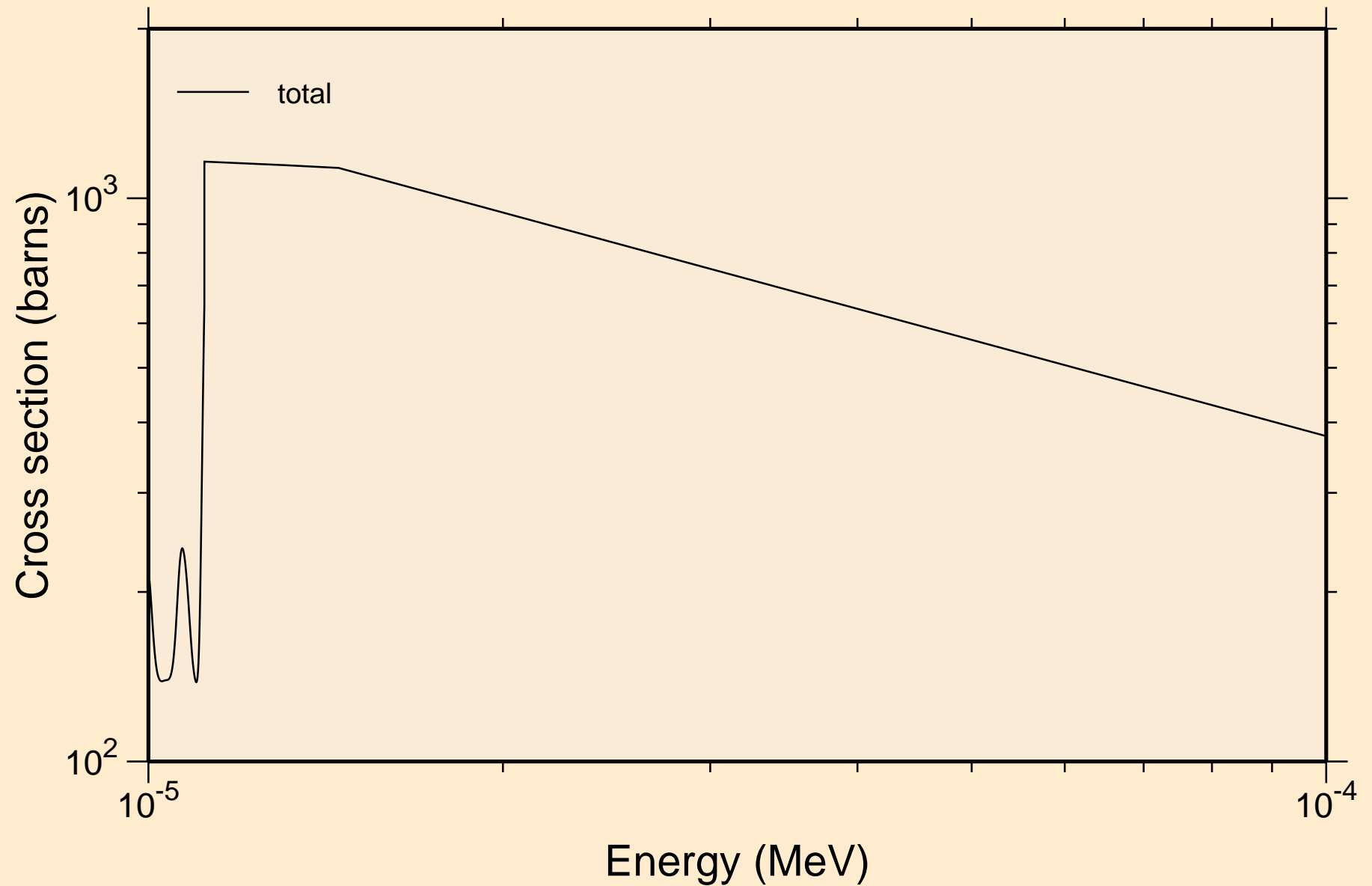

LU159 NEUTRON ACER TENDL-2019 LIBRARY; T=293.16K
resonance total cross section

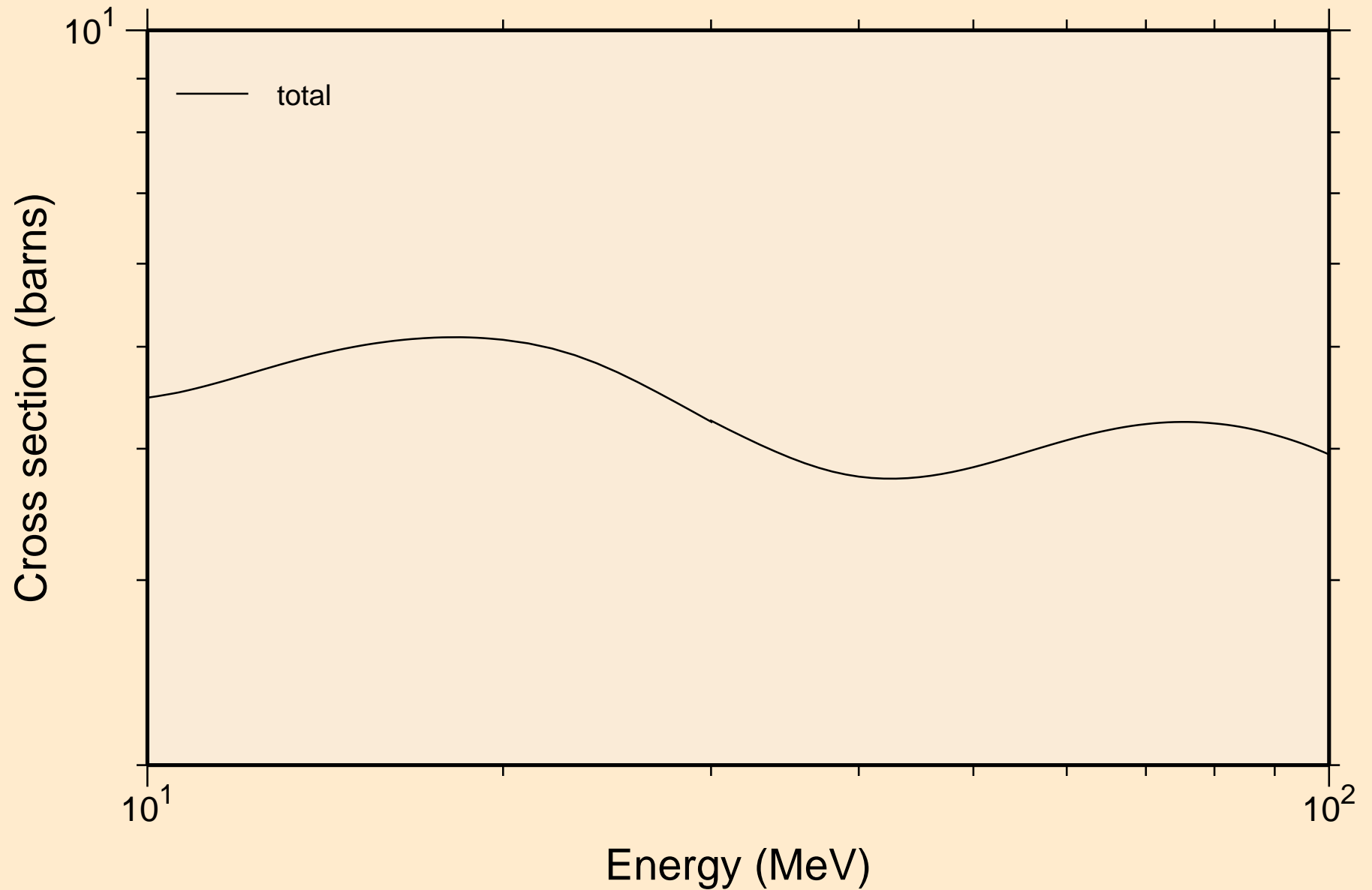

LU159 NEUTRON ACER TENDL-2019 LIBRARY; T=293.16K
resonance absorption cross sections

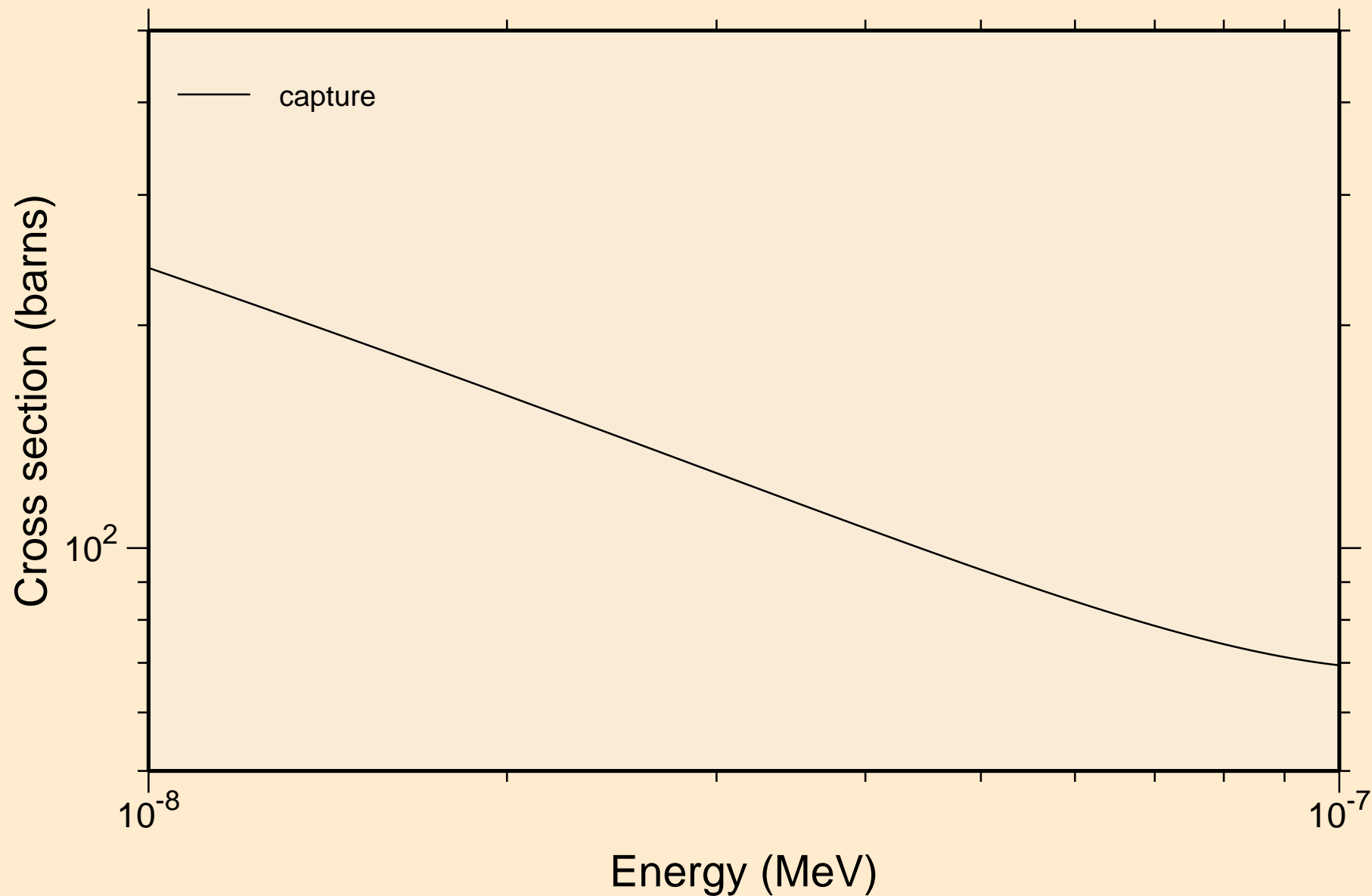

LU159 NEUTRON ACER TENDL-2019 LIBRARY; T=293.16K
resonance absorption cross sections

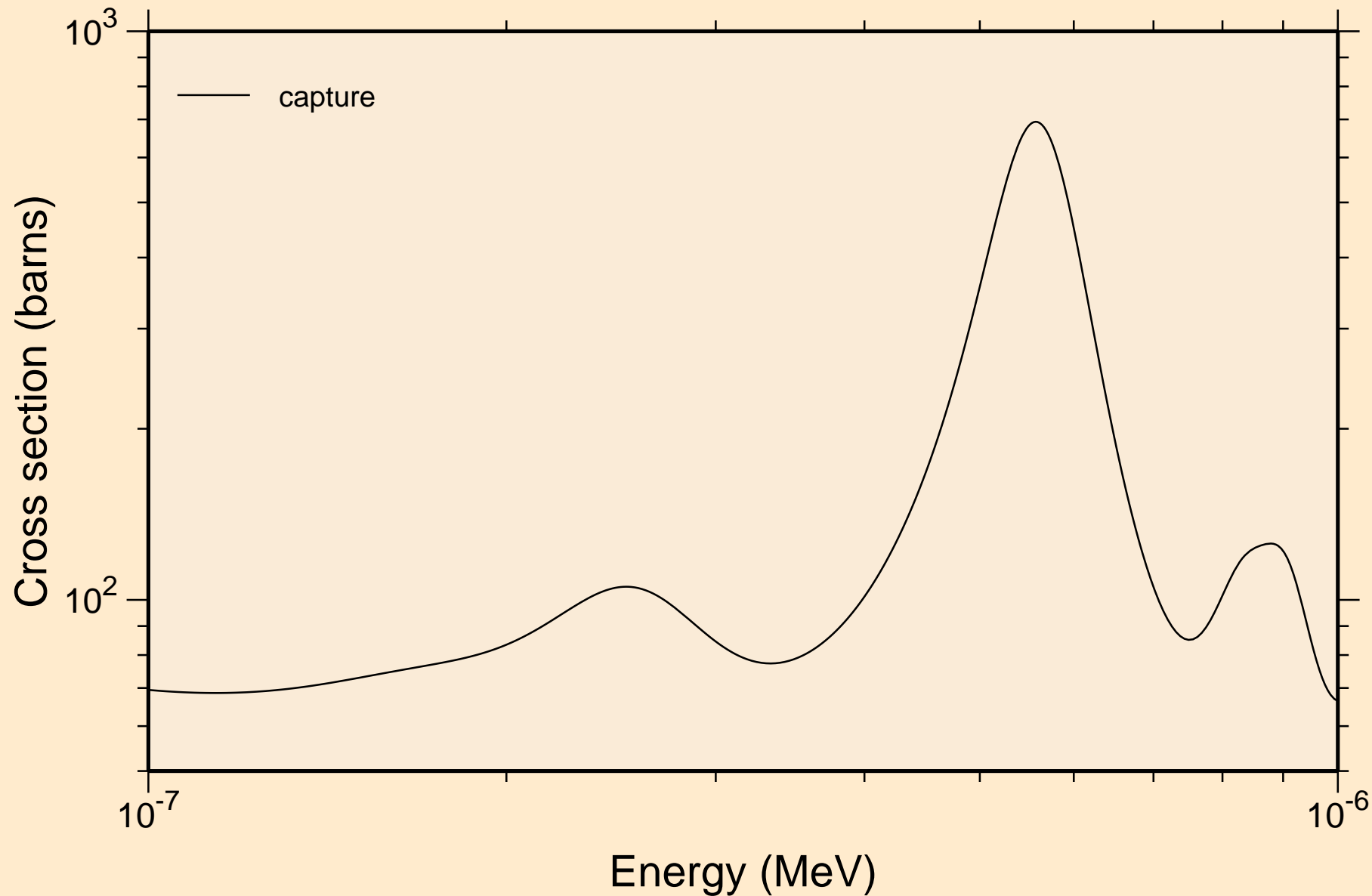

LU159 NEUTRON ACER TENDL-2019 LIBRARY; T=293.16K
resonance absorption cross sections

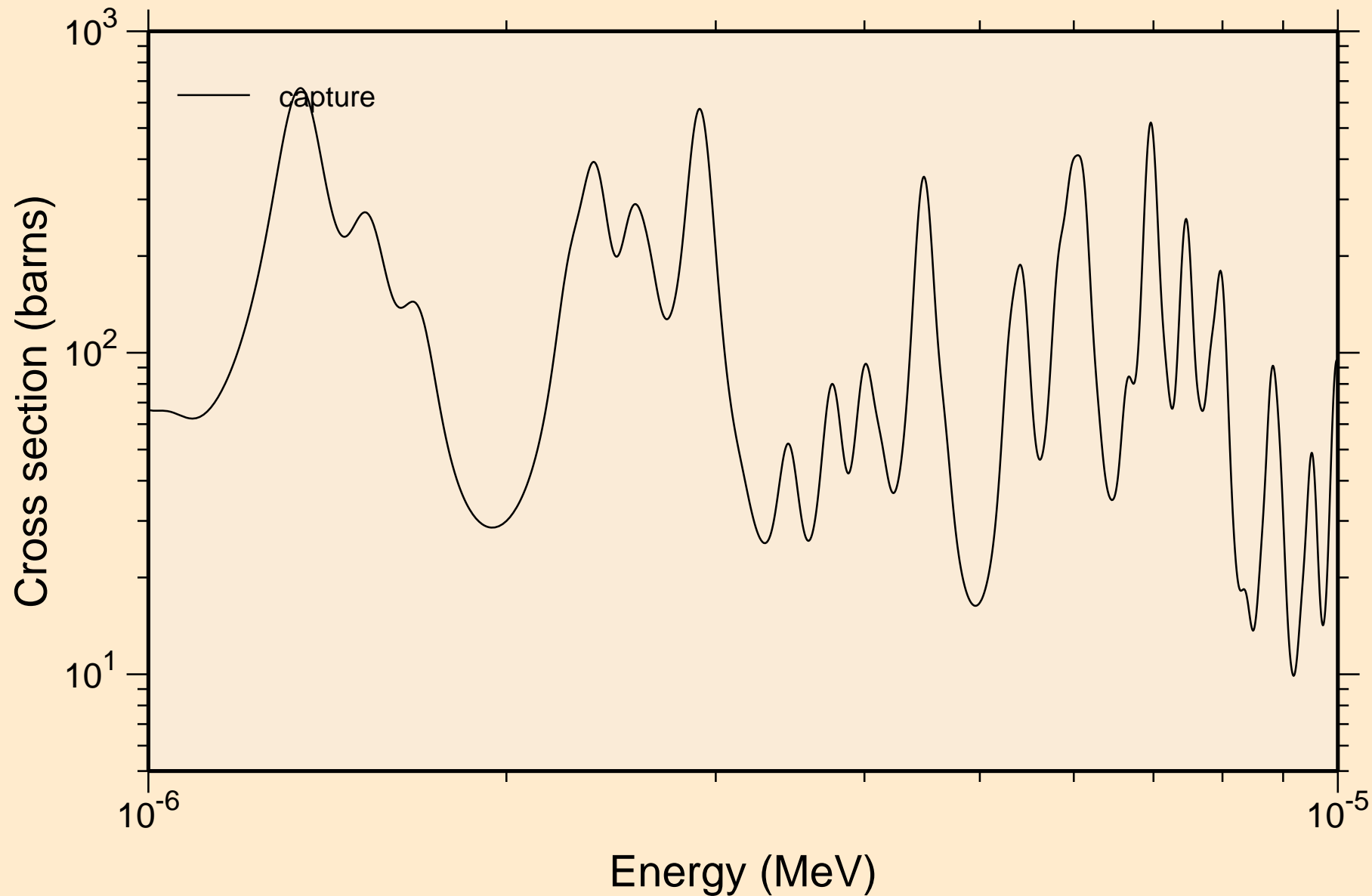

LU159 NEUTRON ACER TENDL-2019 LIBRARY; T=293.16K
resonance absorption cross sections

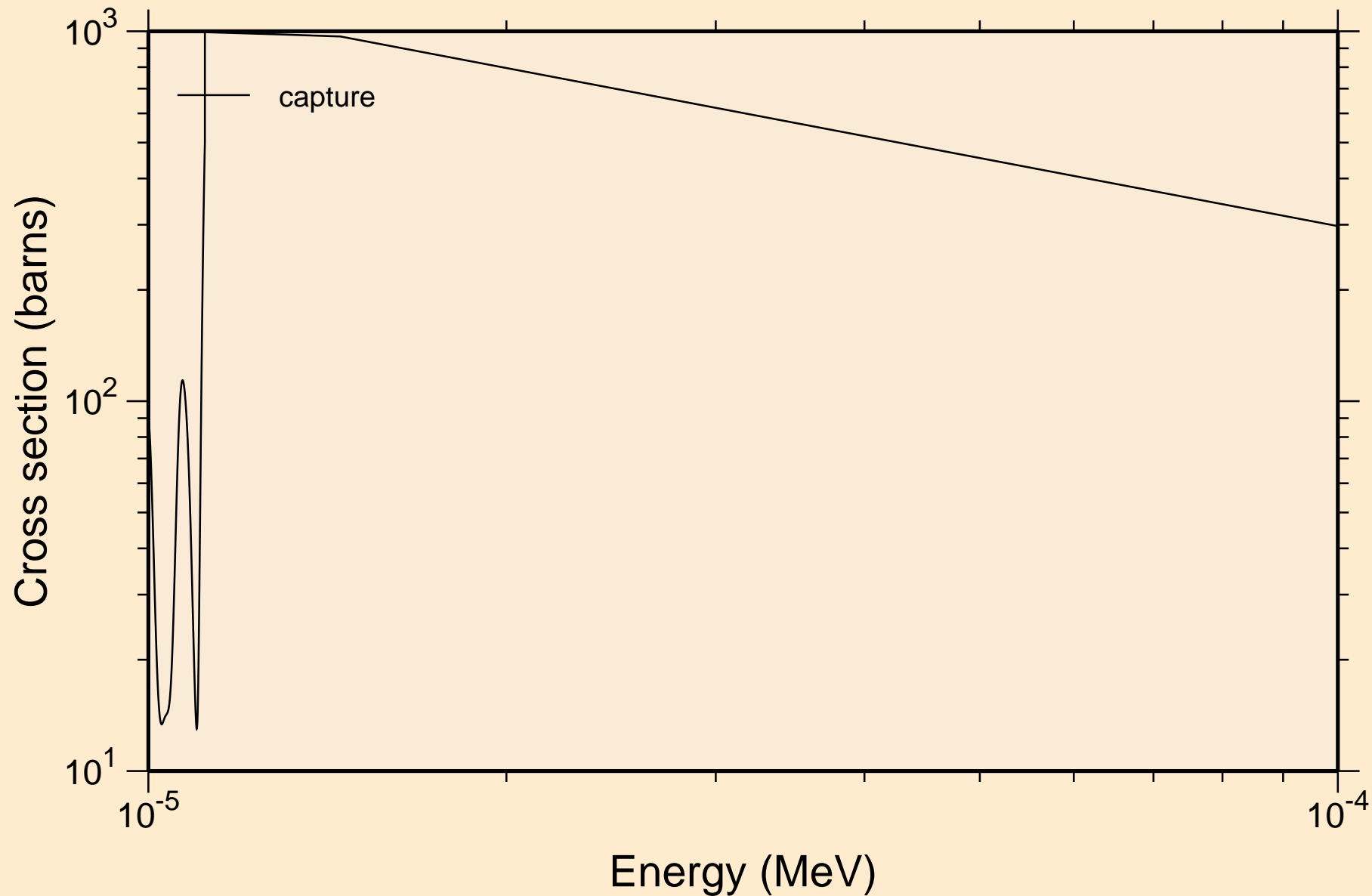

LU159 NEUTRON ACER TENDL-2019 LIBRARY; T=293.16K
resonance absorption cross sections

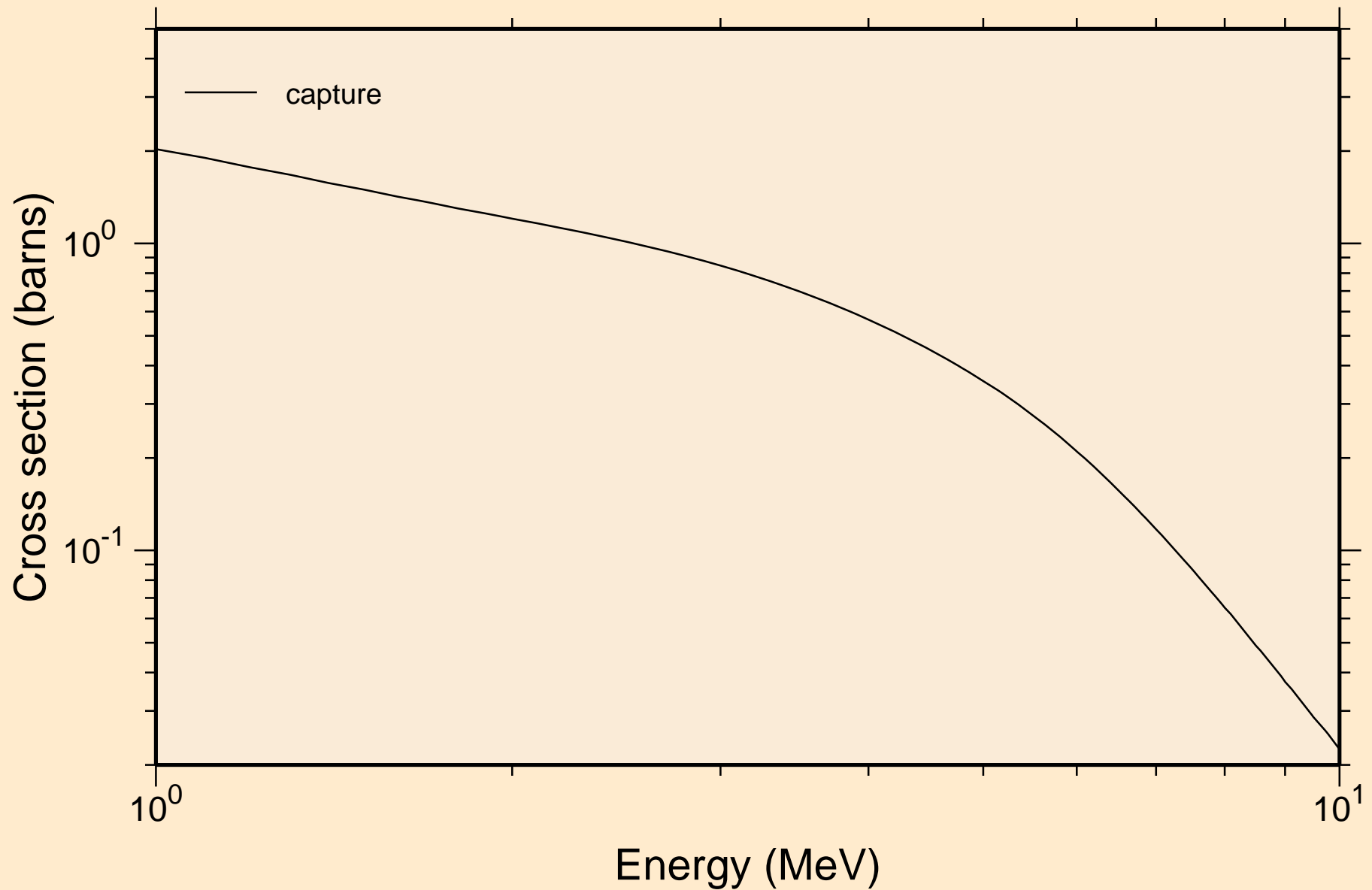

LU159 NEUTRON ACER TENDL-2019 LIBRARY; T=293.16K
Heating

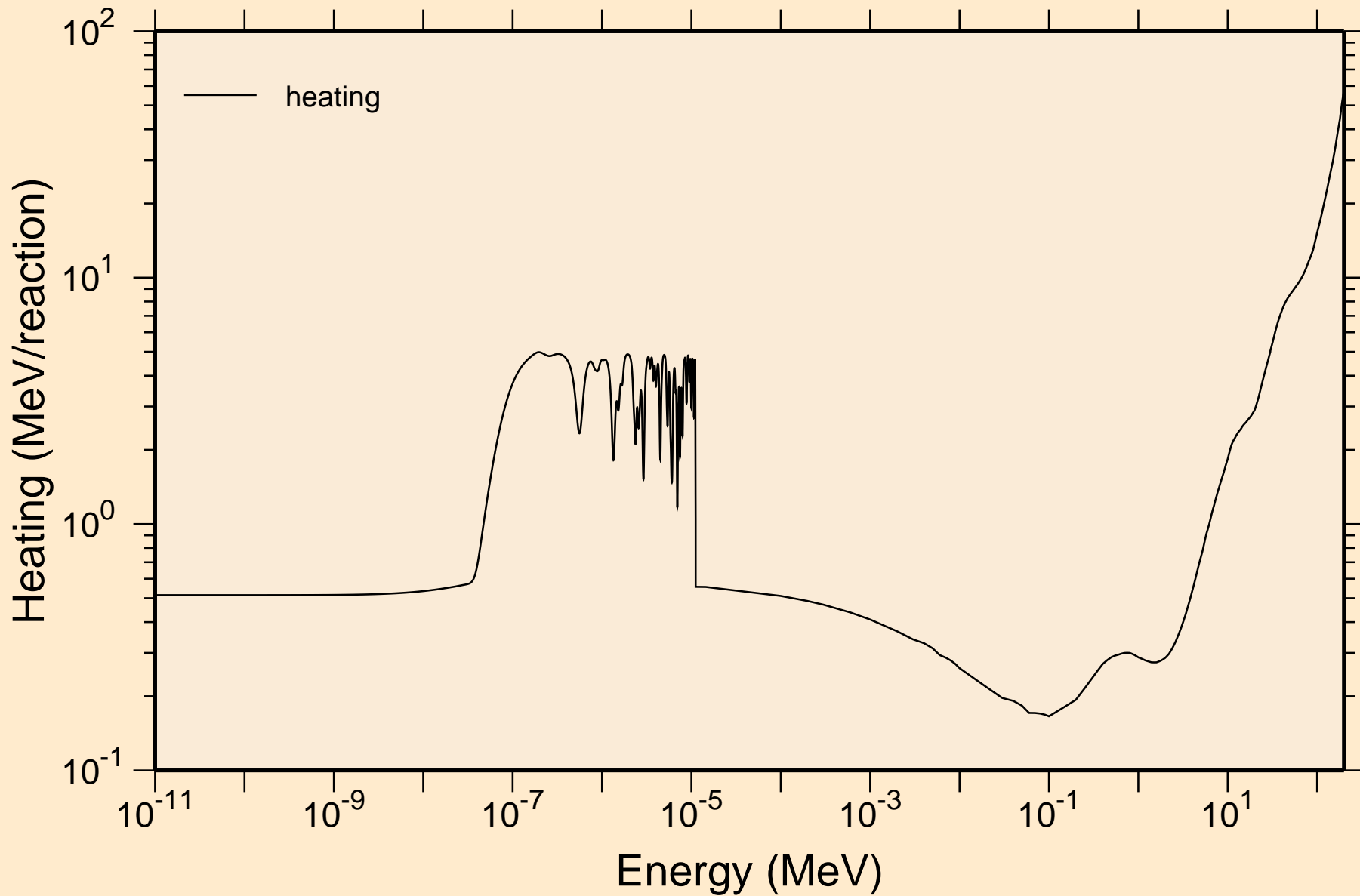

LU159 NEUTRON ACER TENDL-2019 LIBRARY; T=293.16K
Damage

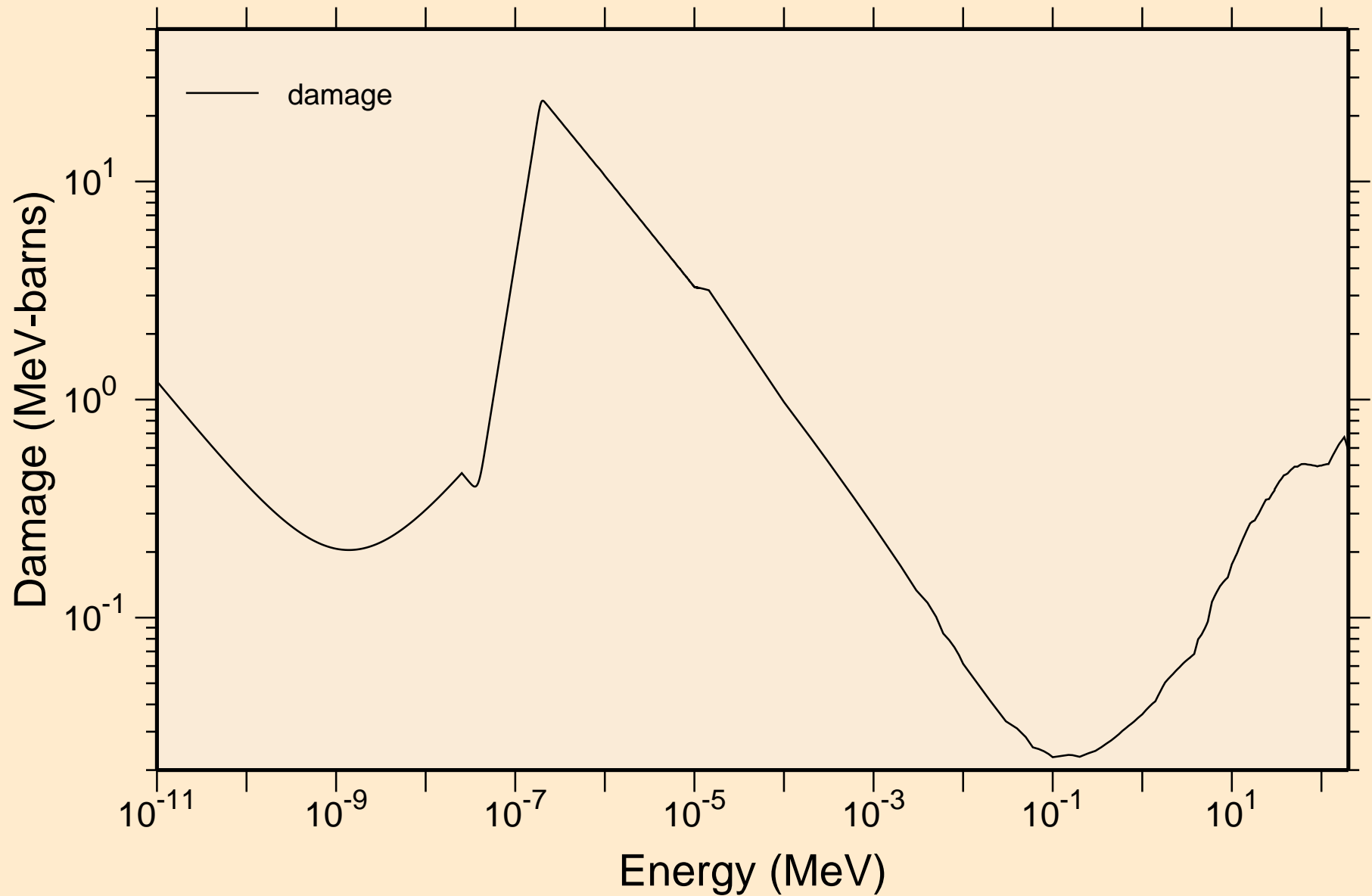

LU159 NEUTRON ACER TENDL-2019 LIBRARY; T=293.16K
Non-threshold reactions

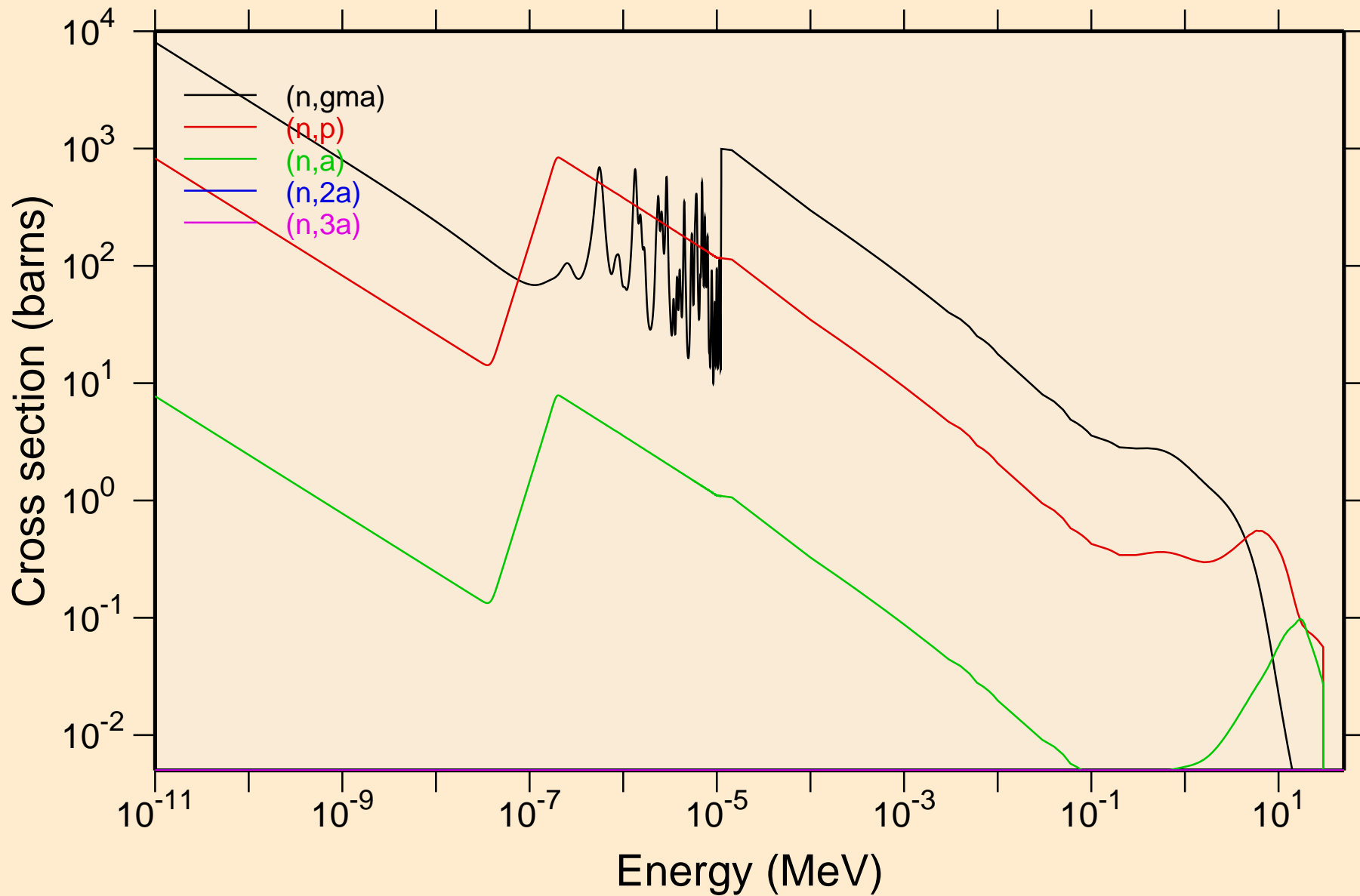

LU159 NEUTRON ACER TENDL-2019 LIBRARY; T=293.16K
Non-threshold reactions

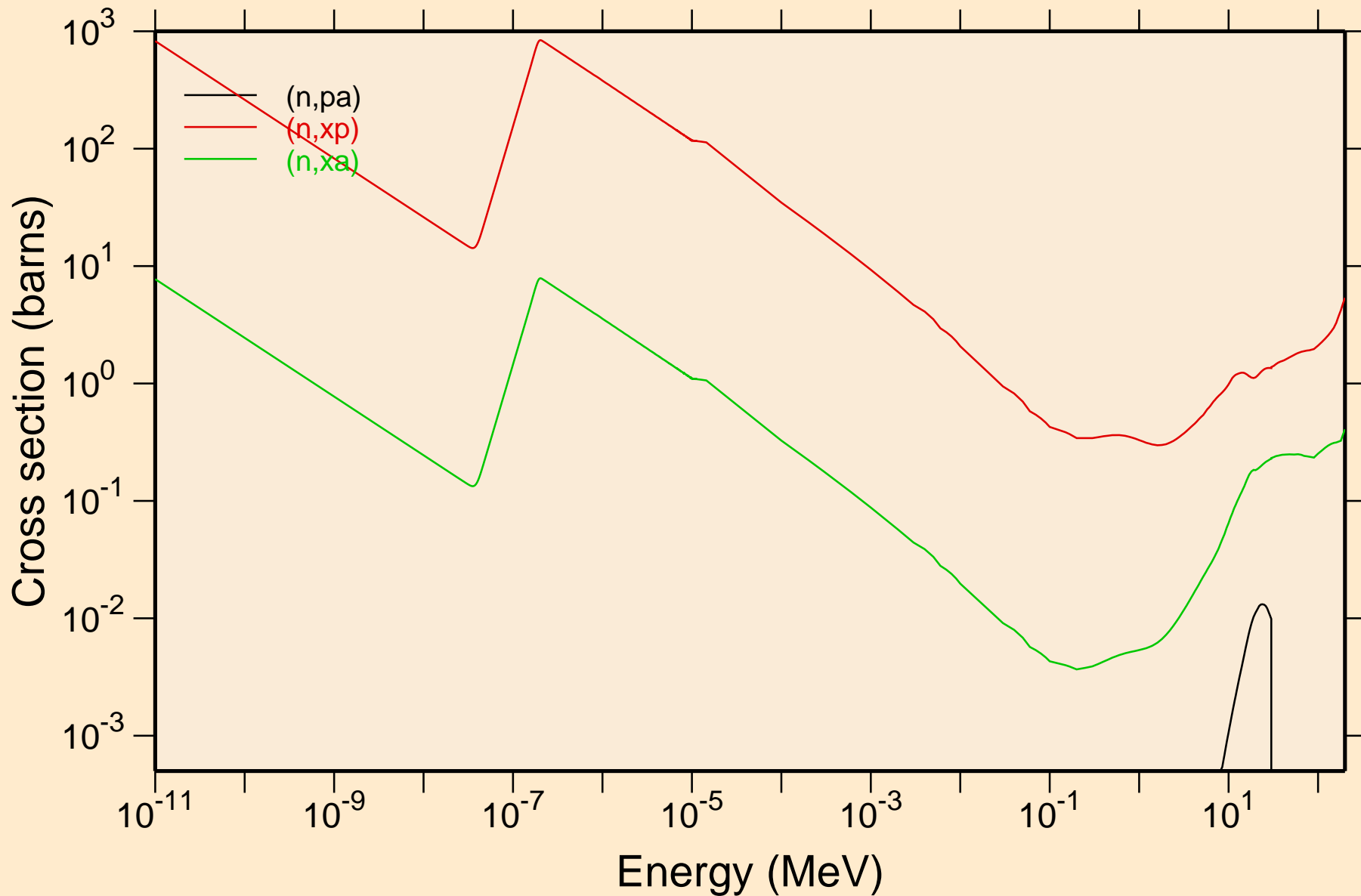

LU159 NEUTRON ACER TENDL-2019 LIBRARY; T=293.16K
Principal cross sections

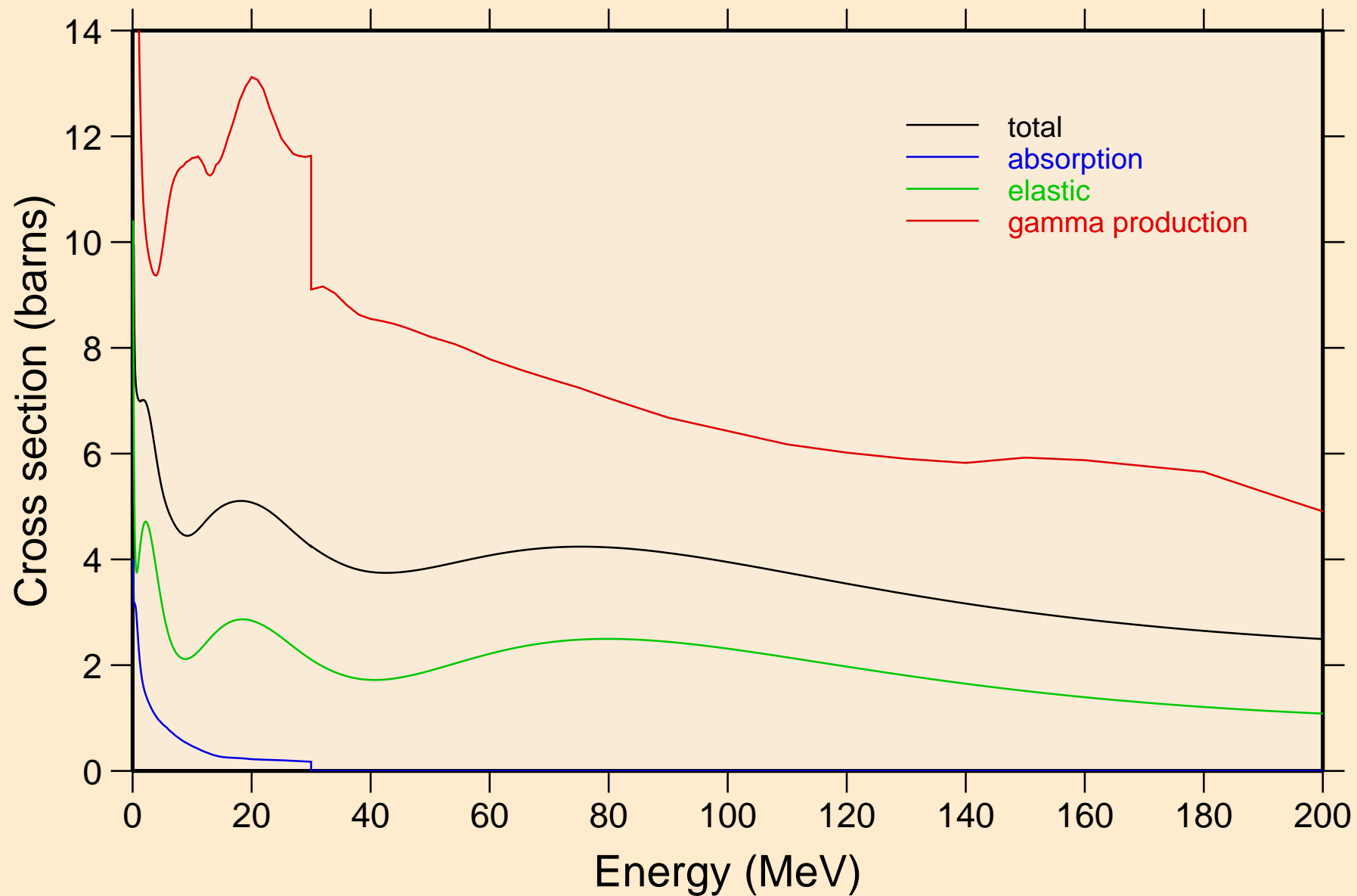

LU159 NEUTRON ACER TENDL-2019 LIBRARY; T=293.16K
Heating

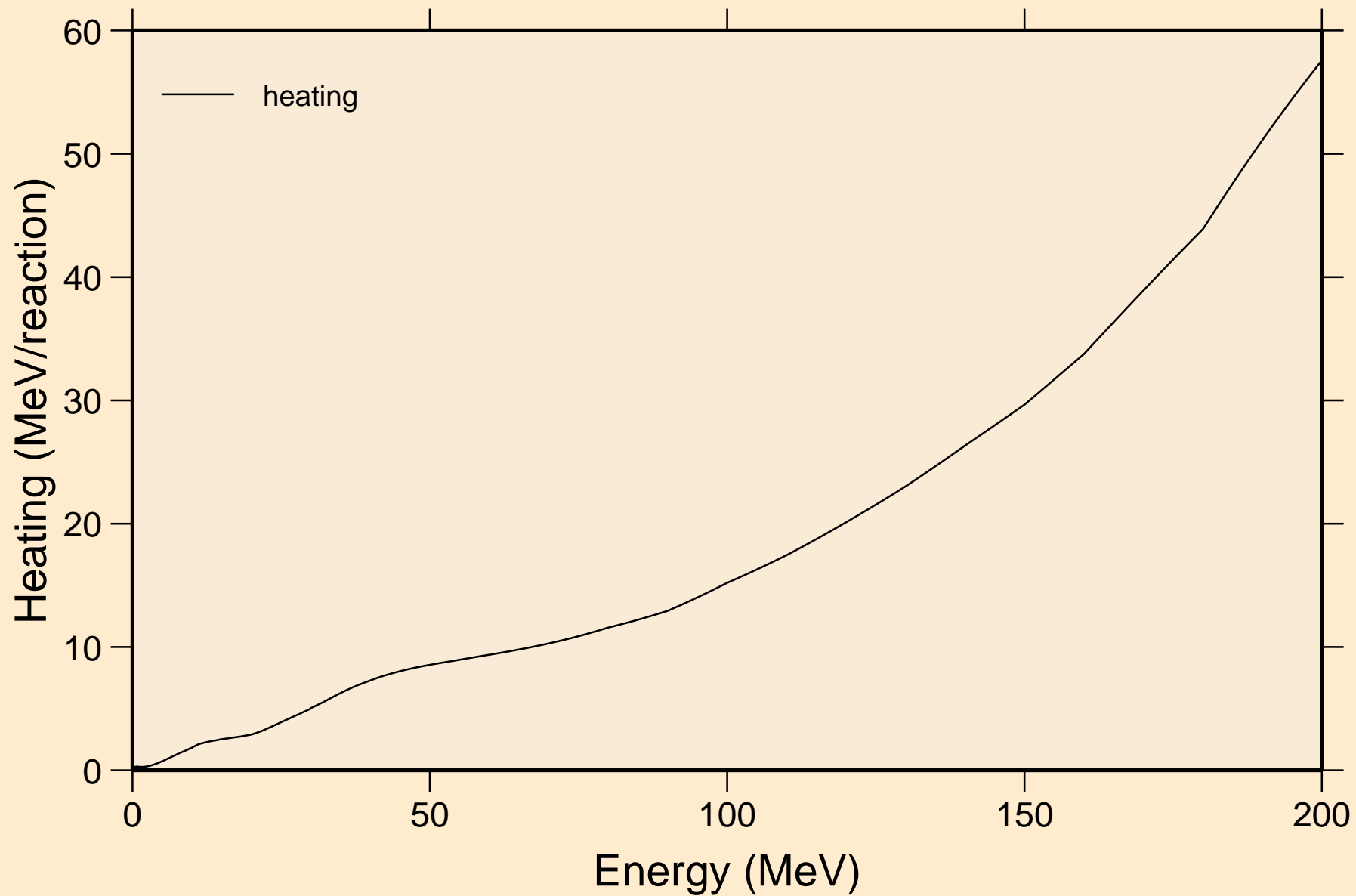

LU159 NEUTRON ACER TENDL-2019 LIBRARY; T=293.16K
Damage

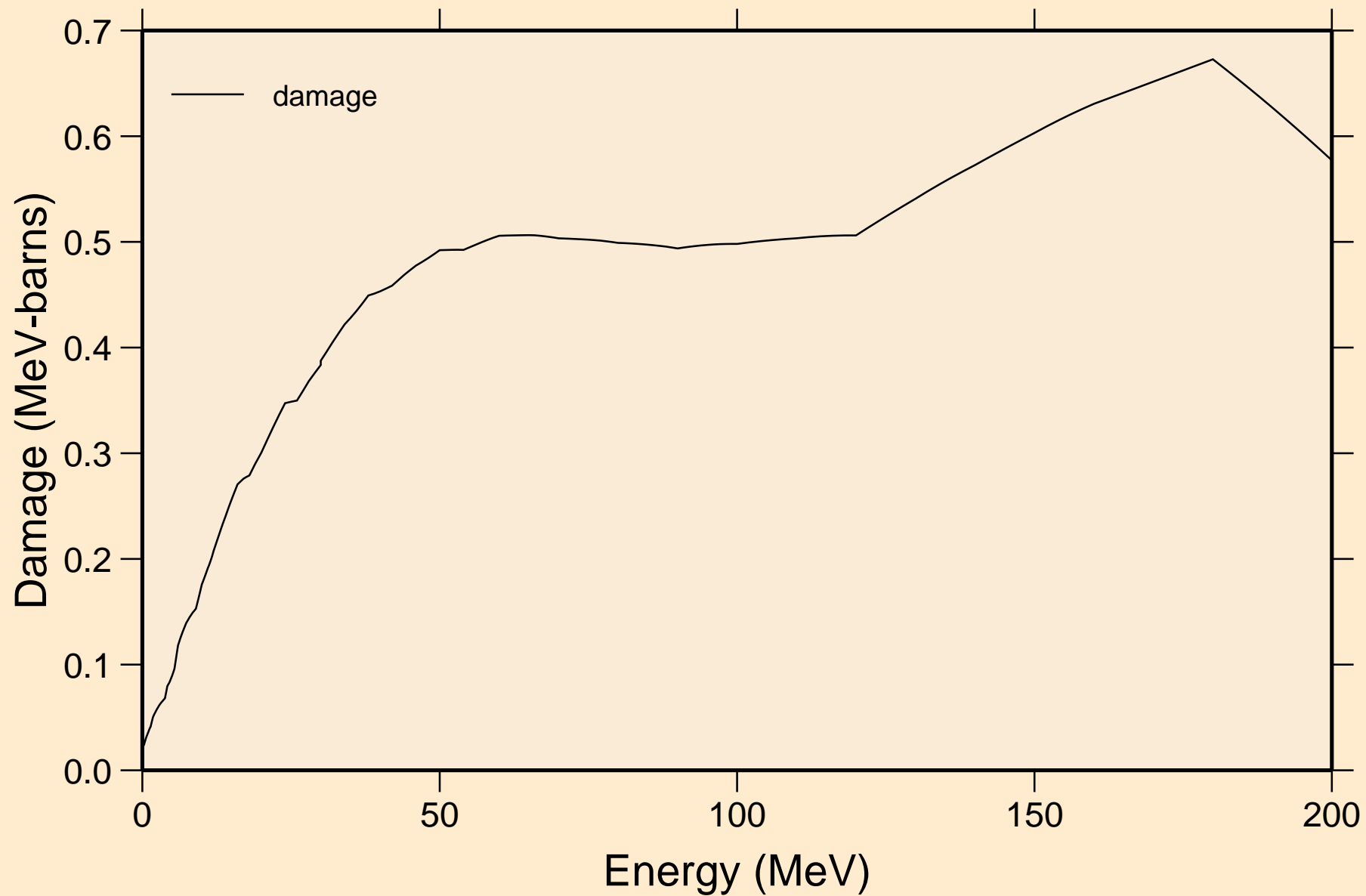

LU159 NEUTRON ACER TENDL-2019 LIBRARY; T=293.16K
Non-threshold reactions

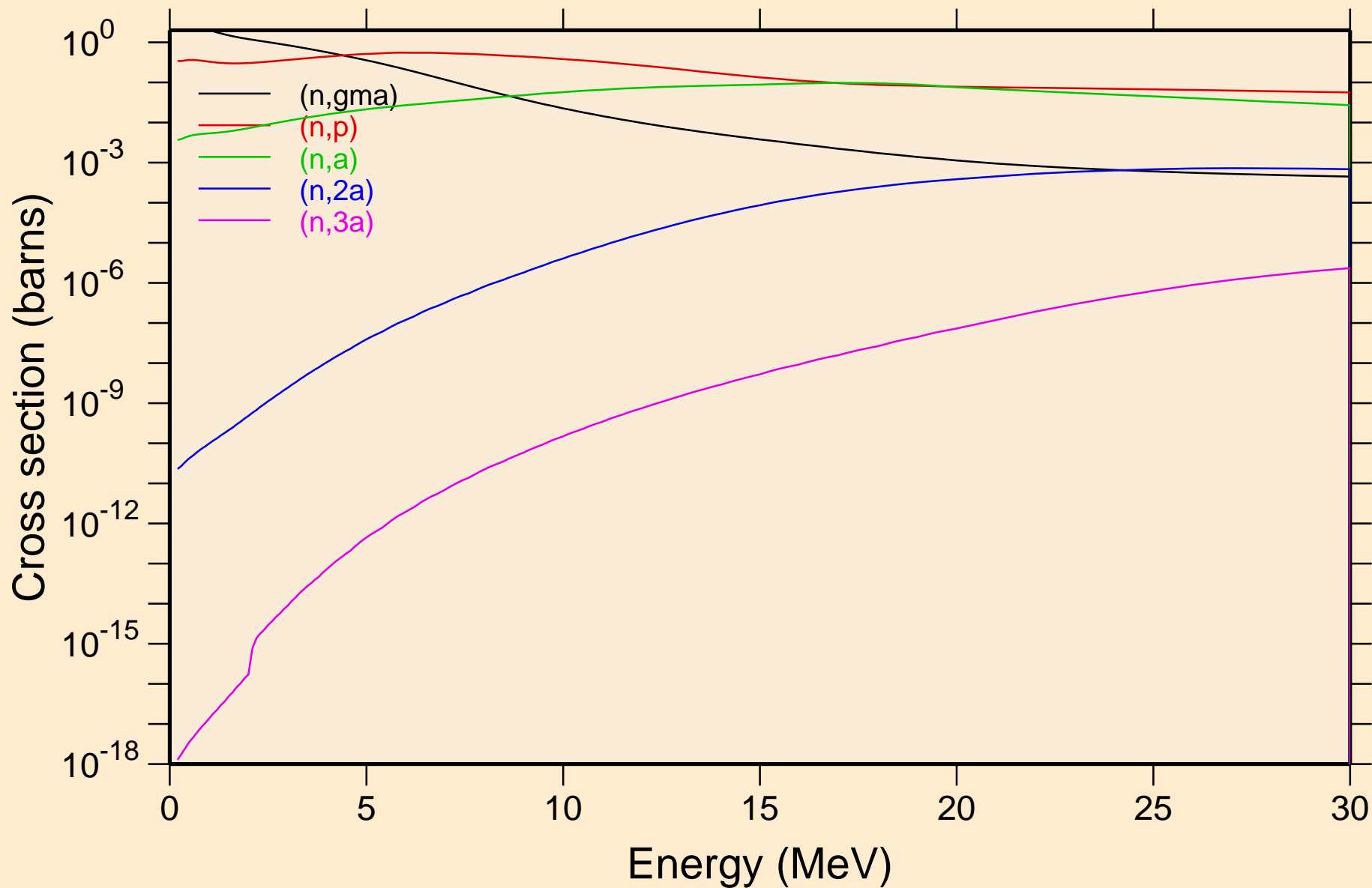

LU159 NEUTRON ACER TENDL-2019 LIBRARY; T=293.16K
Non-threshold reactions

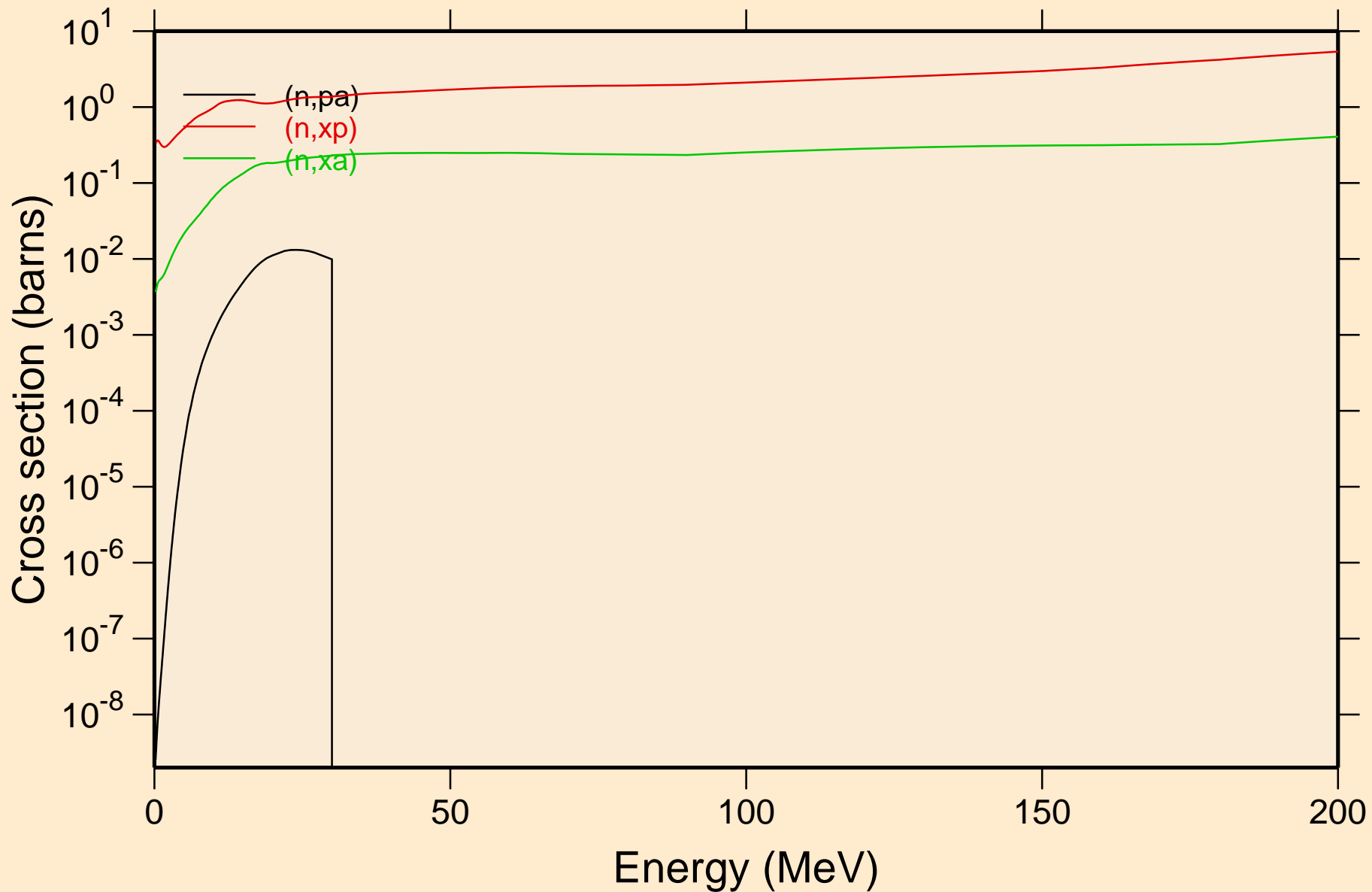

LU159 NEUTRON ACER TENDL-2019 LIBRARY; T=293.16K
Inelastic levels

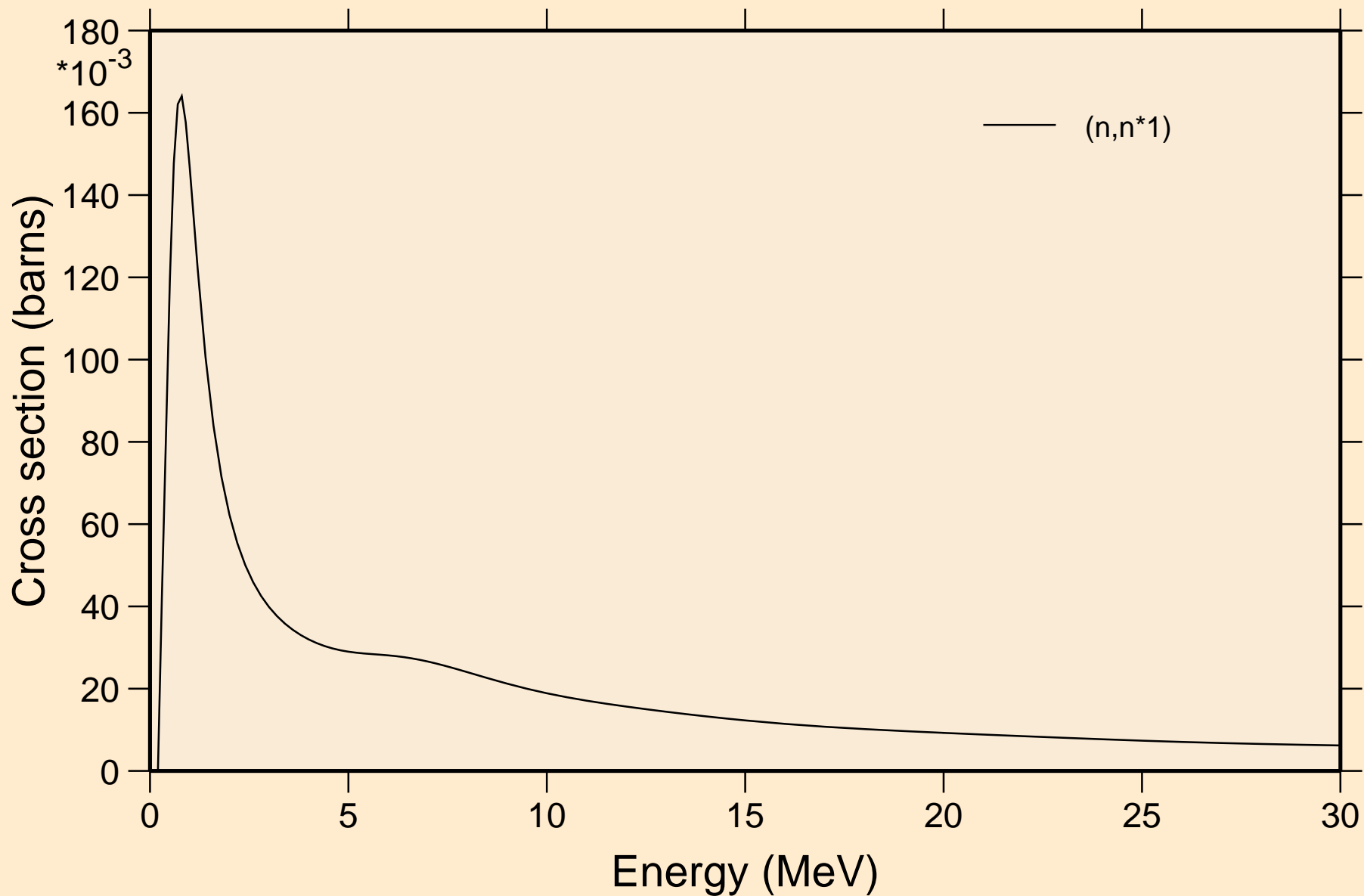

LU159 NEUTRON ACER TENDL-2019 LIBRARY; T=293.16K
Threshold reactions

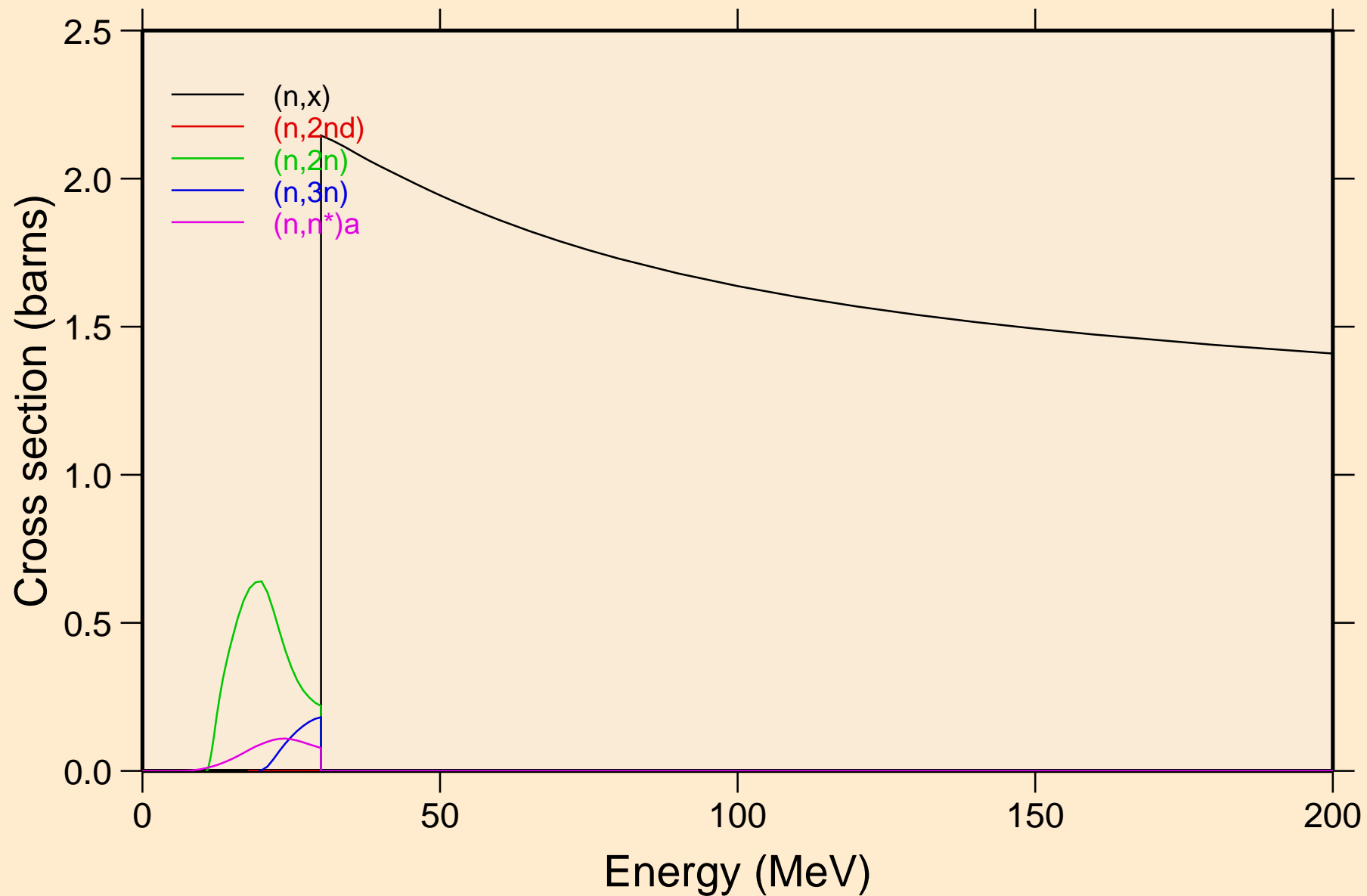

LU159 NEUTRON ACER TENDL-2019 LIBRARY; T=293.16K
Threshold reactions

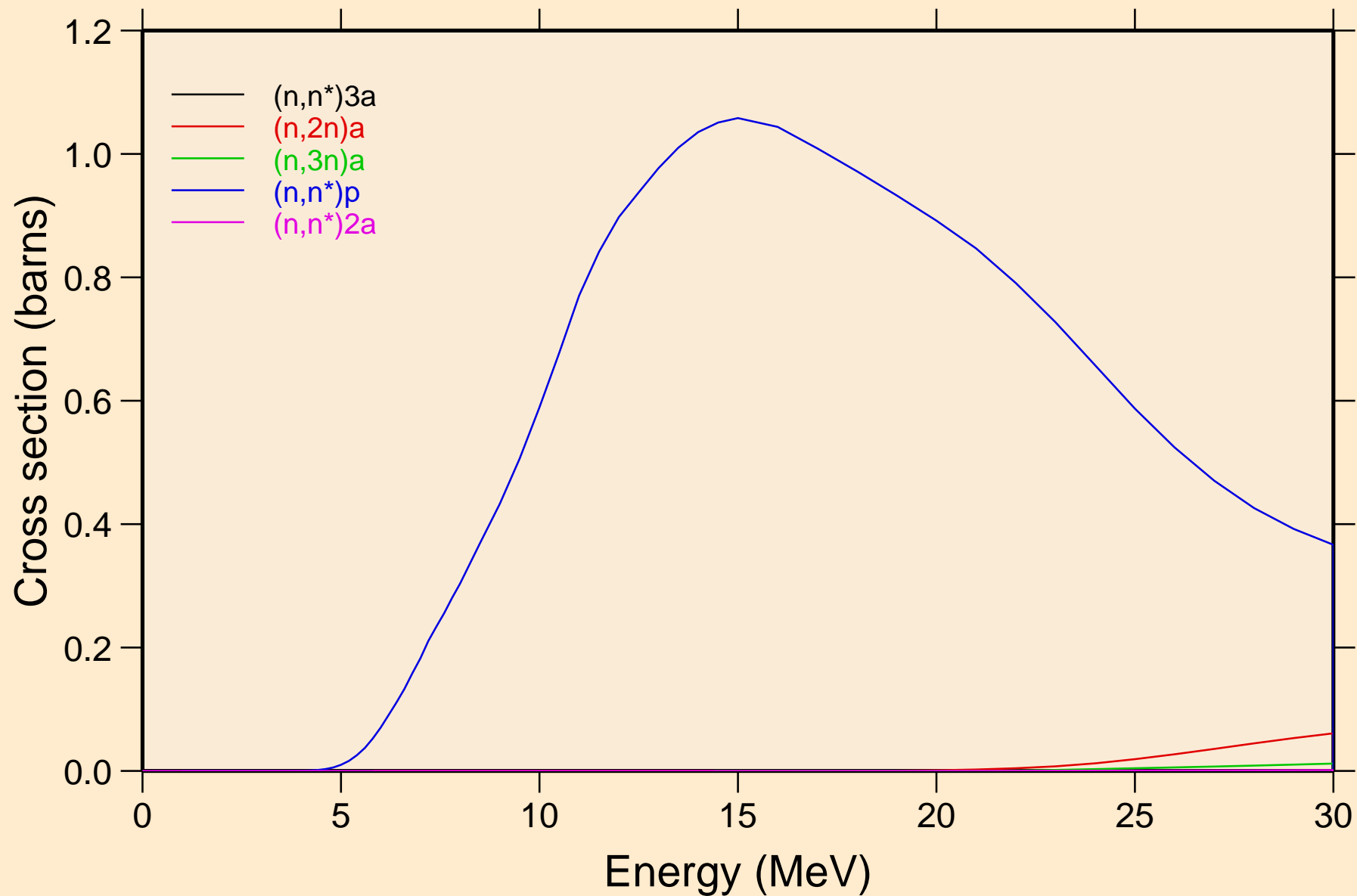

LU159 NEUTRON ACER TENDL-2019 LIBRARY; T=293.16K
Threshold reactions

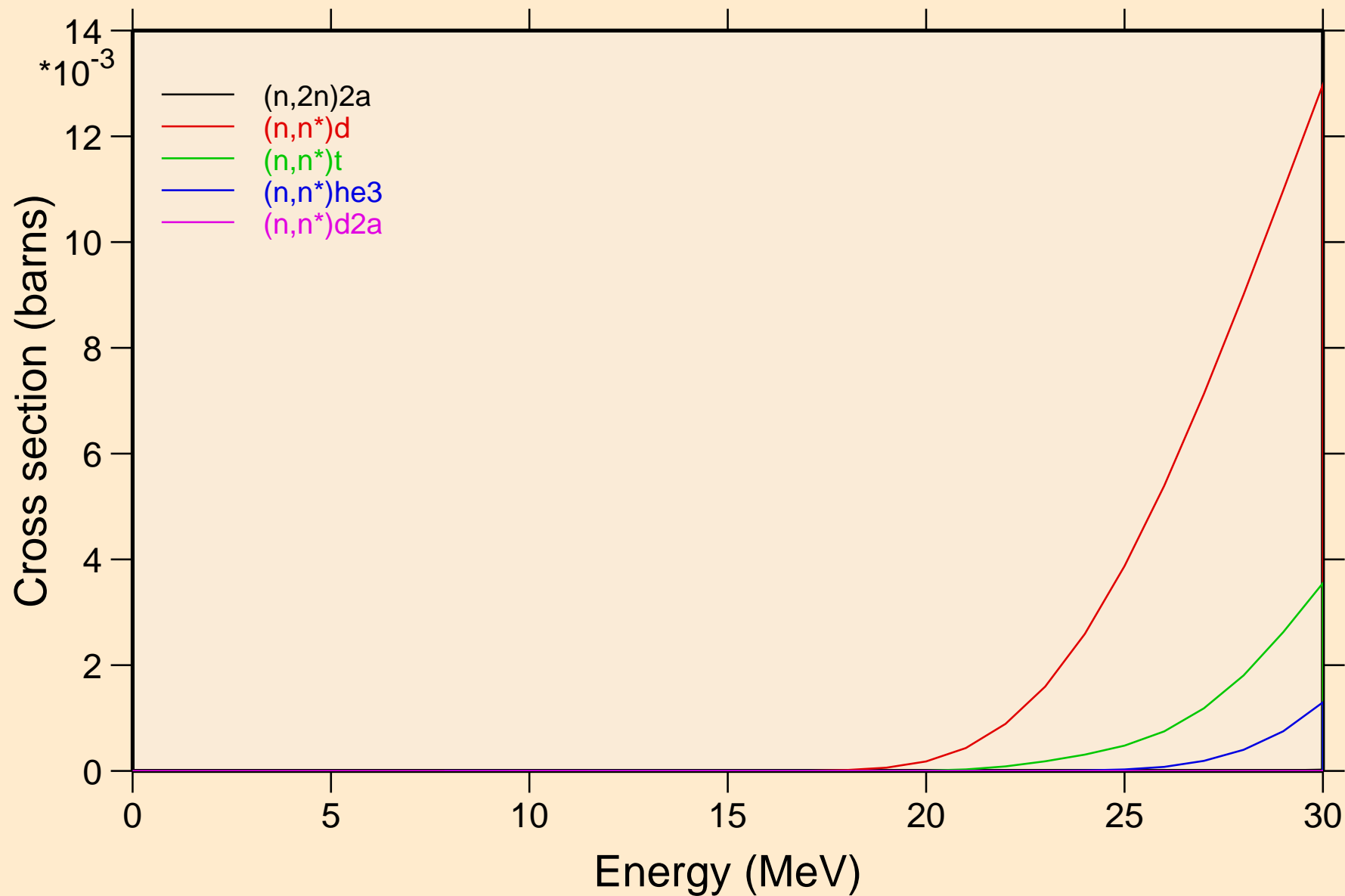

LU159 NEUTRON ACER TENDL-2019 LIBRARY; T=293.16K
Threshold reactions

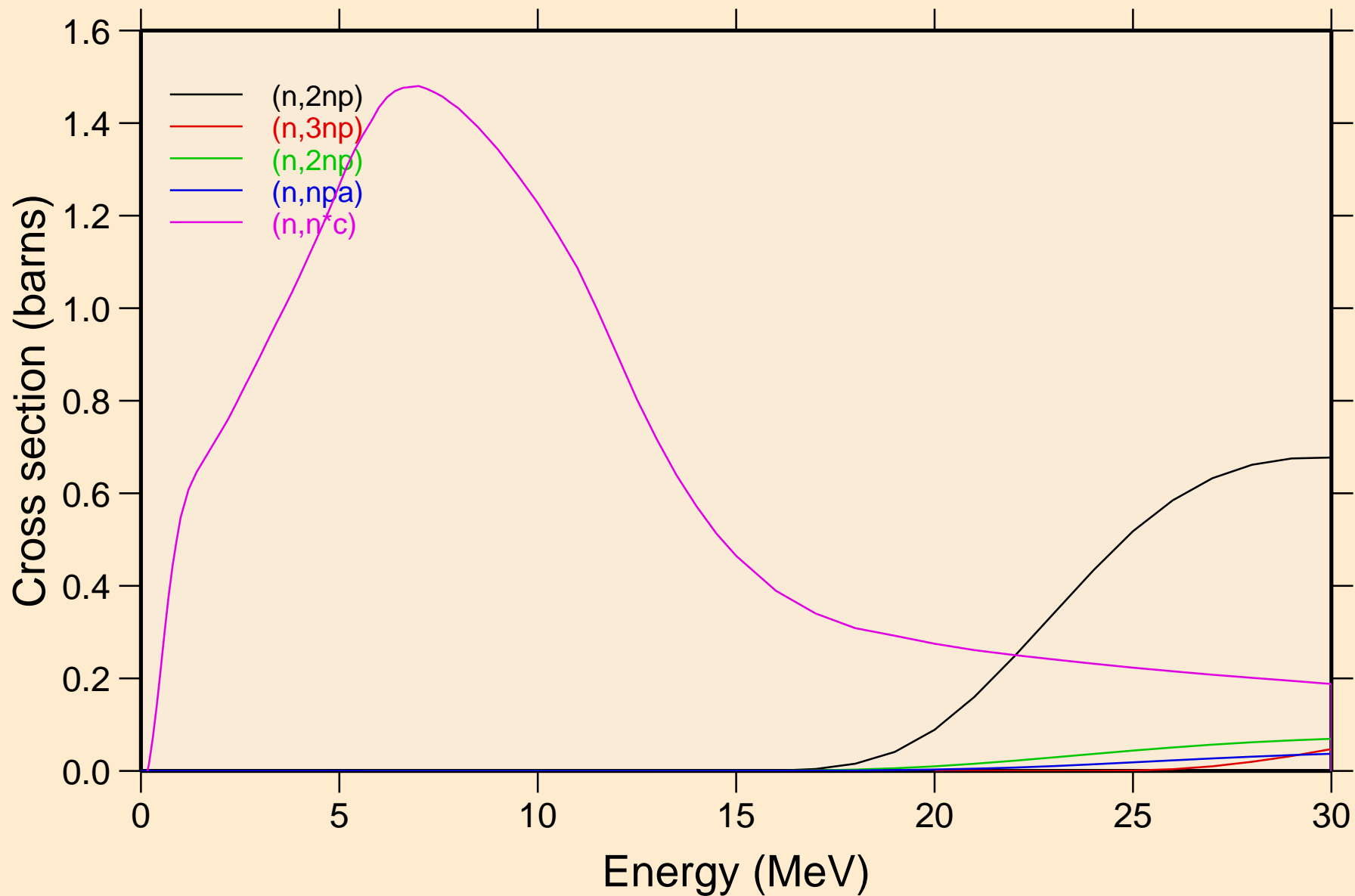

LU159 NEUTRON ACER TENDL-2019 LIBRARY; T=293.16K
Threshold reactions

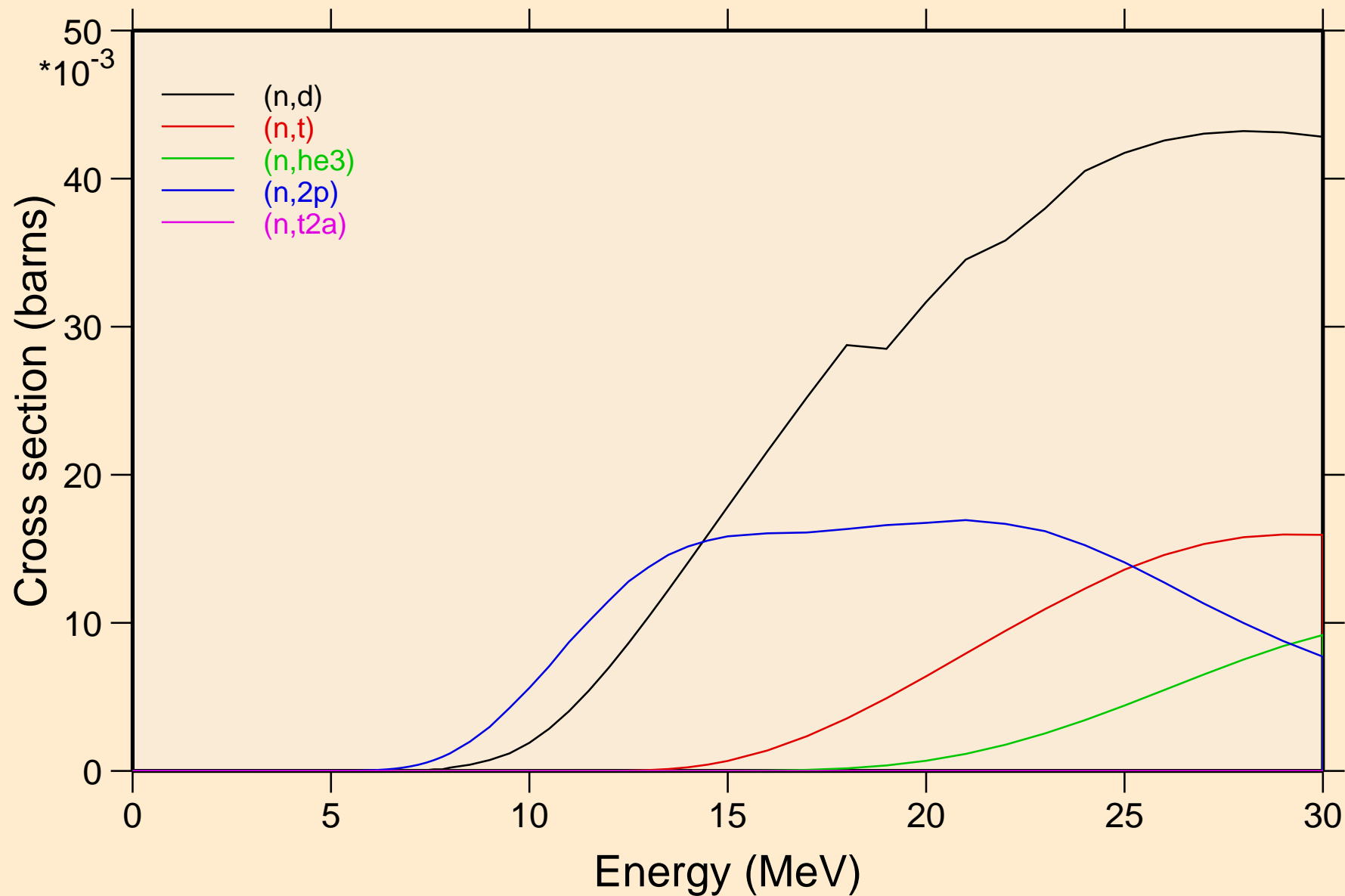

LU159 NEUTRON ACER TENDL-2019 LIBRARY; T=293.16K
Threshold reactions

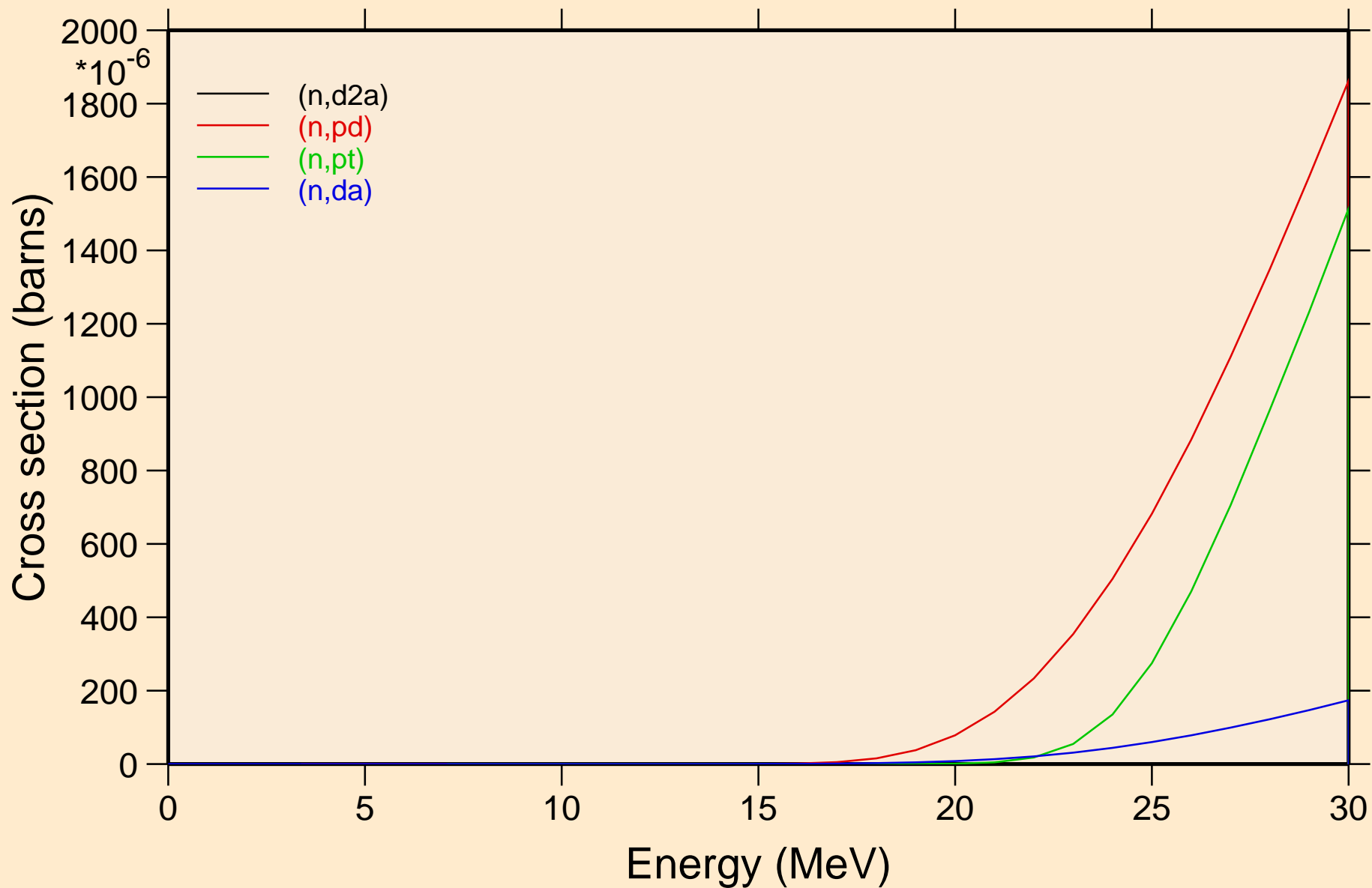

LU159 NEUTRON ACER TENDL-2019 LIBRARY; T=293.16K
Threshold reactions

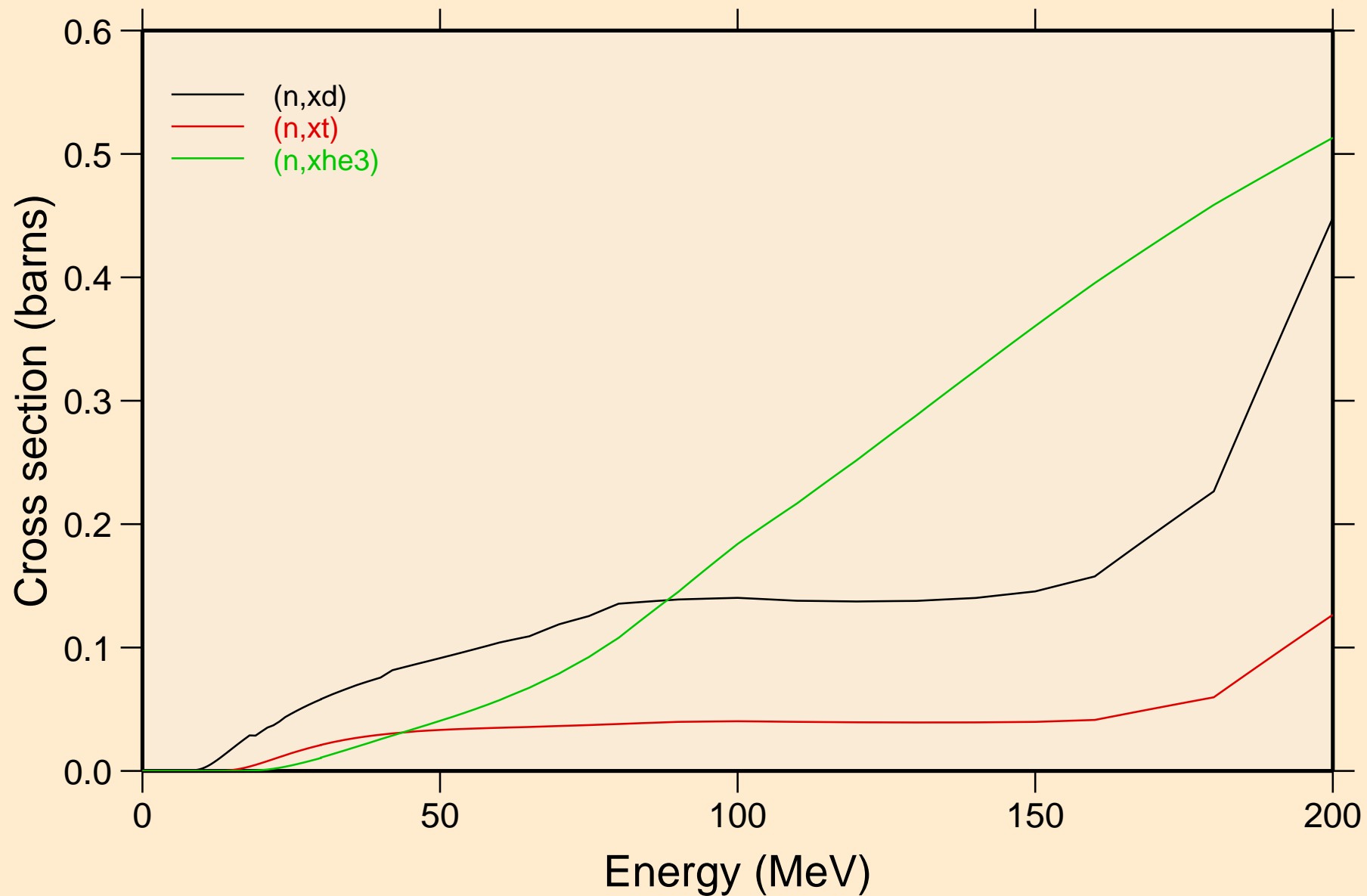

LU159 NEUTRON ACER TENDL-2019 LIBRARY; T=293.16K
angular distribution for elastic

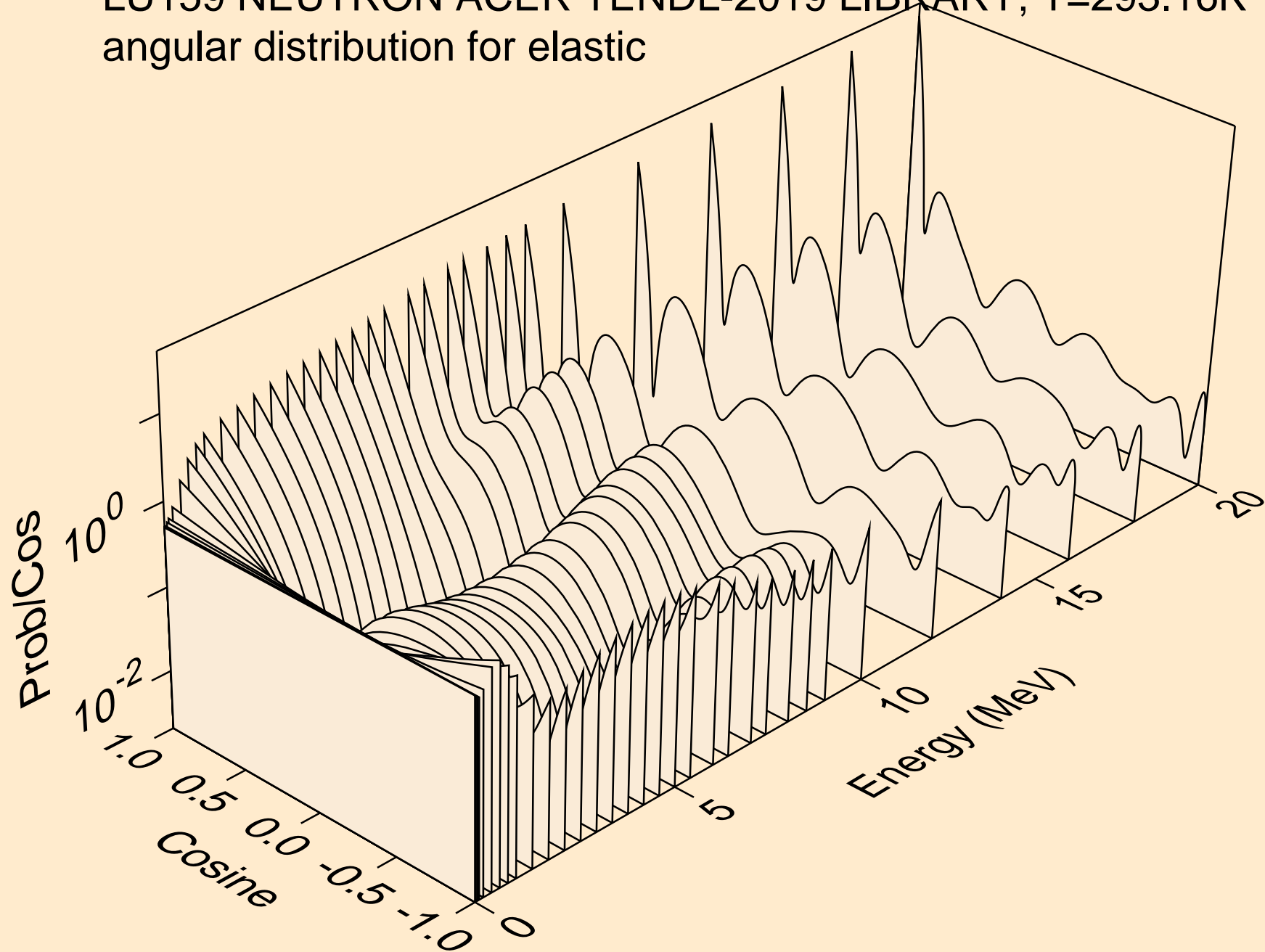

LU159 NEUTRON ACER TENDL-2019 LIBRARY; T=293.16K
angular distribution for elastic

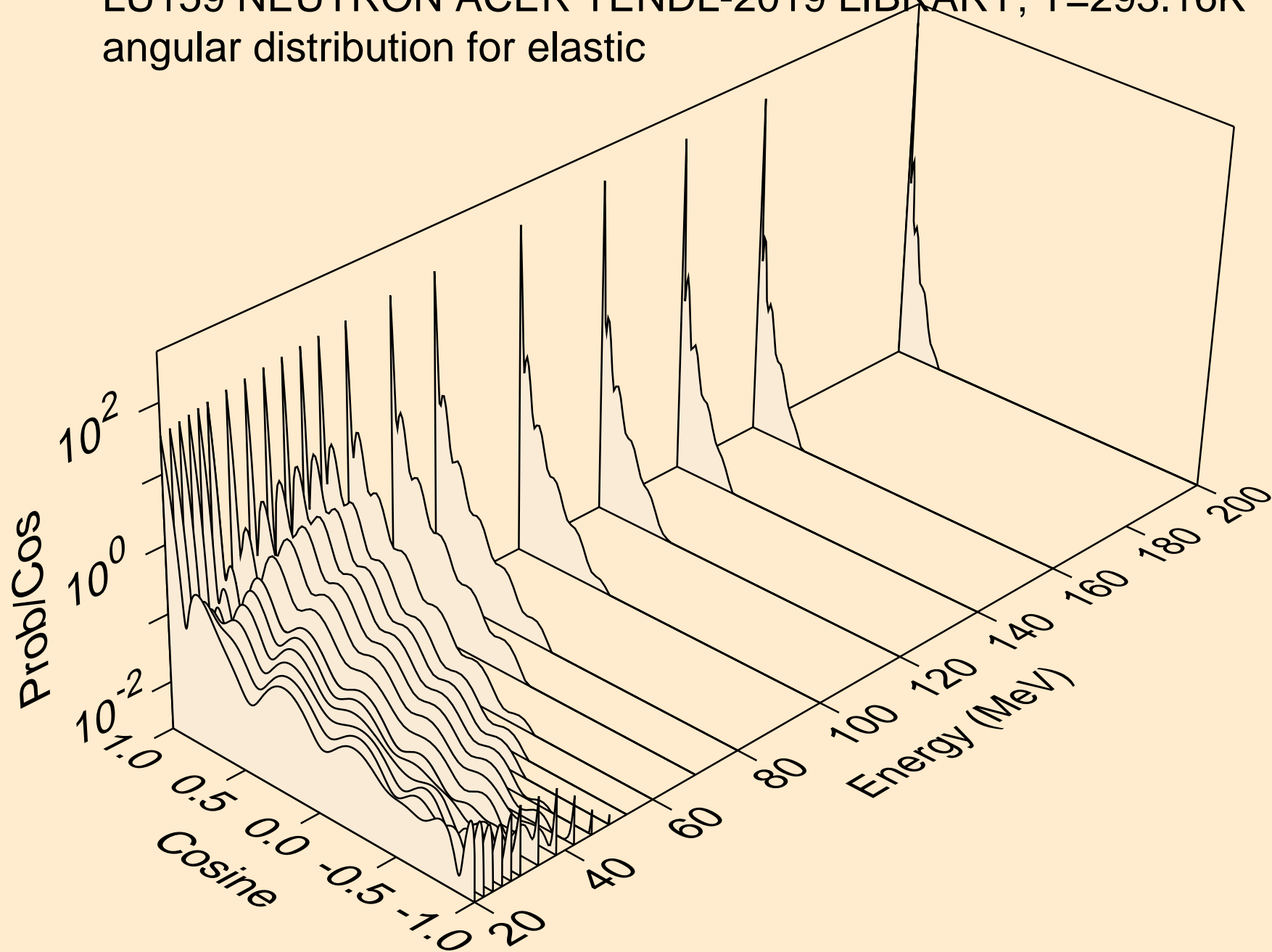

LU159 NEUTRON ACER TENDL-2019 LIBRARY; T=293.16K
angular distribution for (n,n*1)

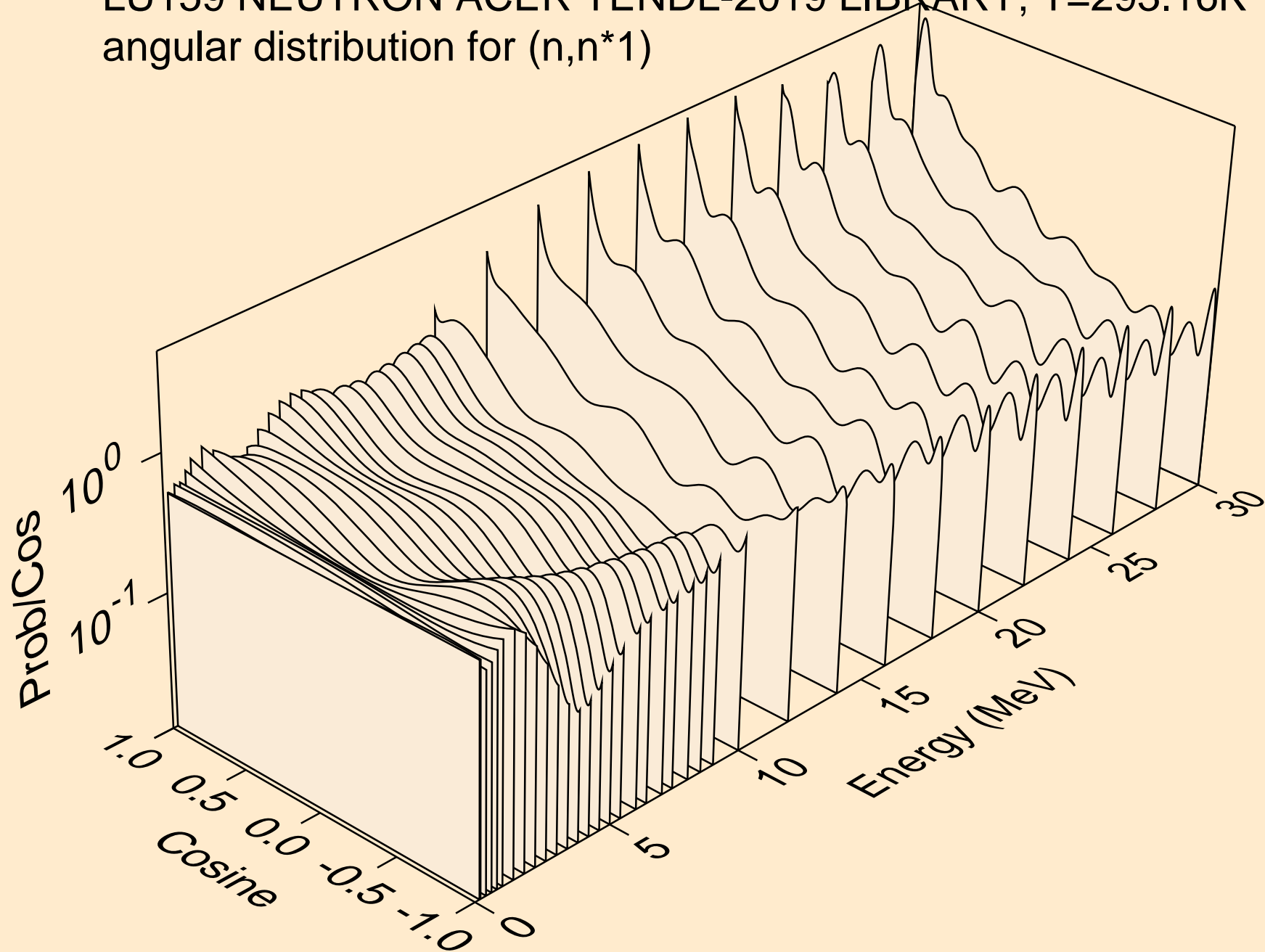

LU159 NEUTRON ACER TENDL-2019 LIBRARY; T=293.16K
Neutron emission for (n,x)

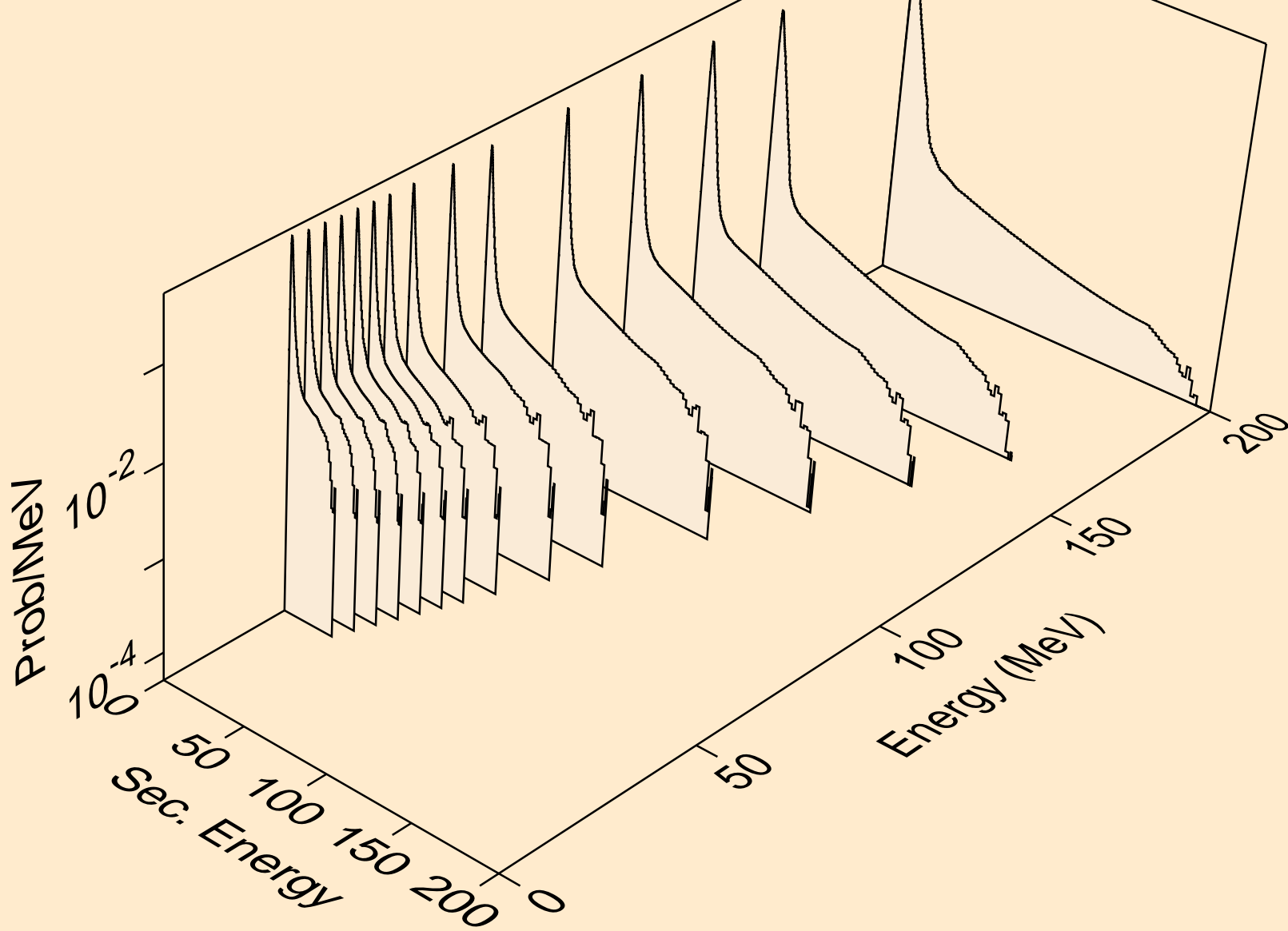

LU159 NEUTRON ACER TENDL-2019 LIBRARY; T=293.16K
Neutron emission for (n,2nd)

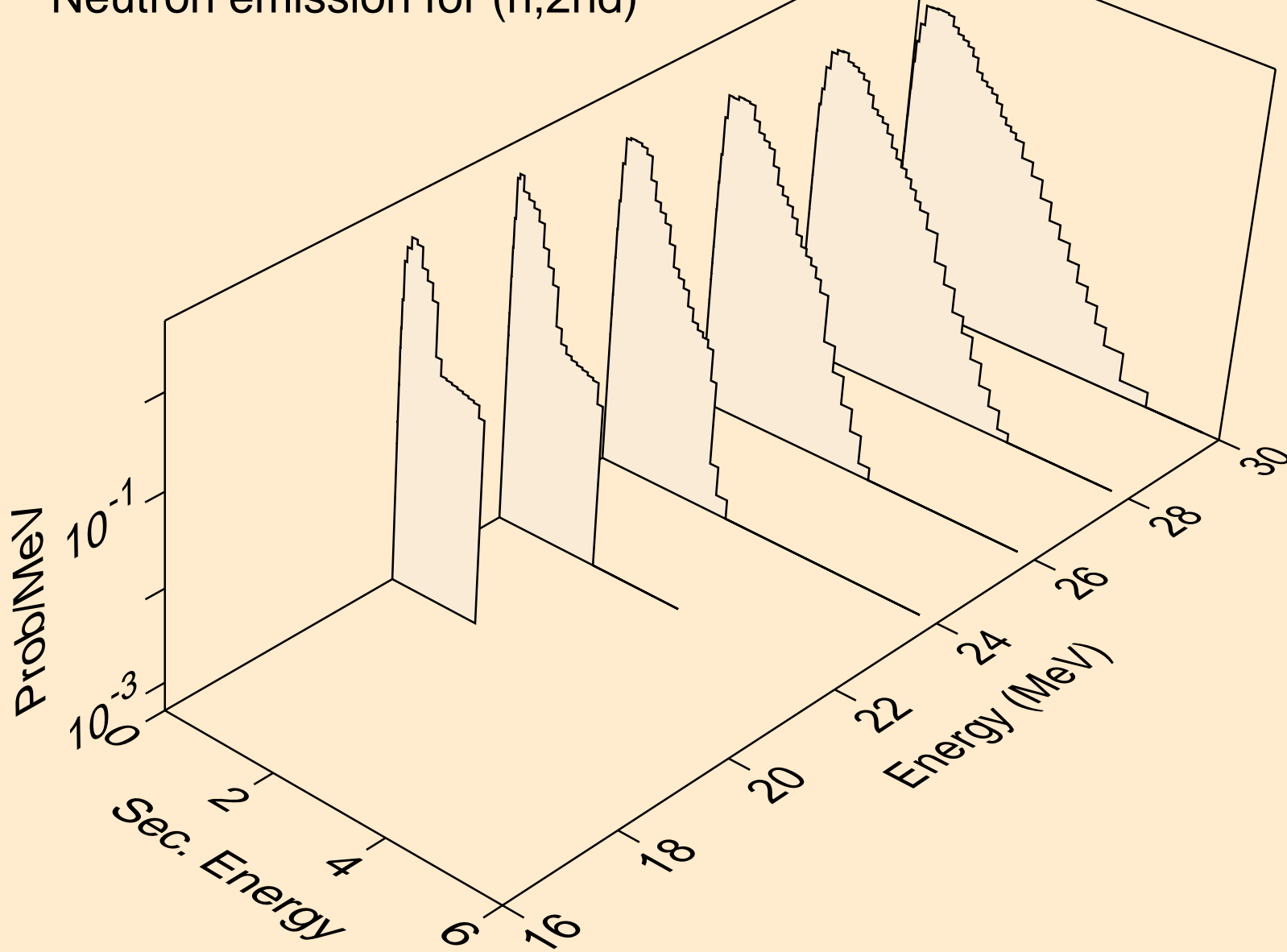

LU159 NEUTRON ACER TENDL-2019 LIBRARY; T=293.16K
Neutron emission for (n,2n)

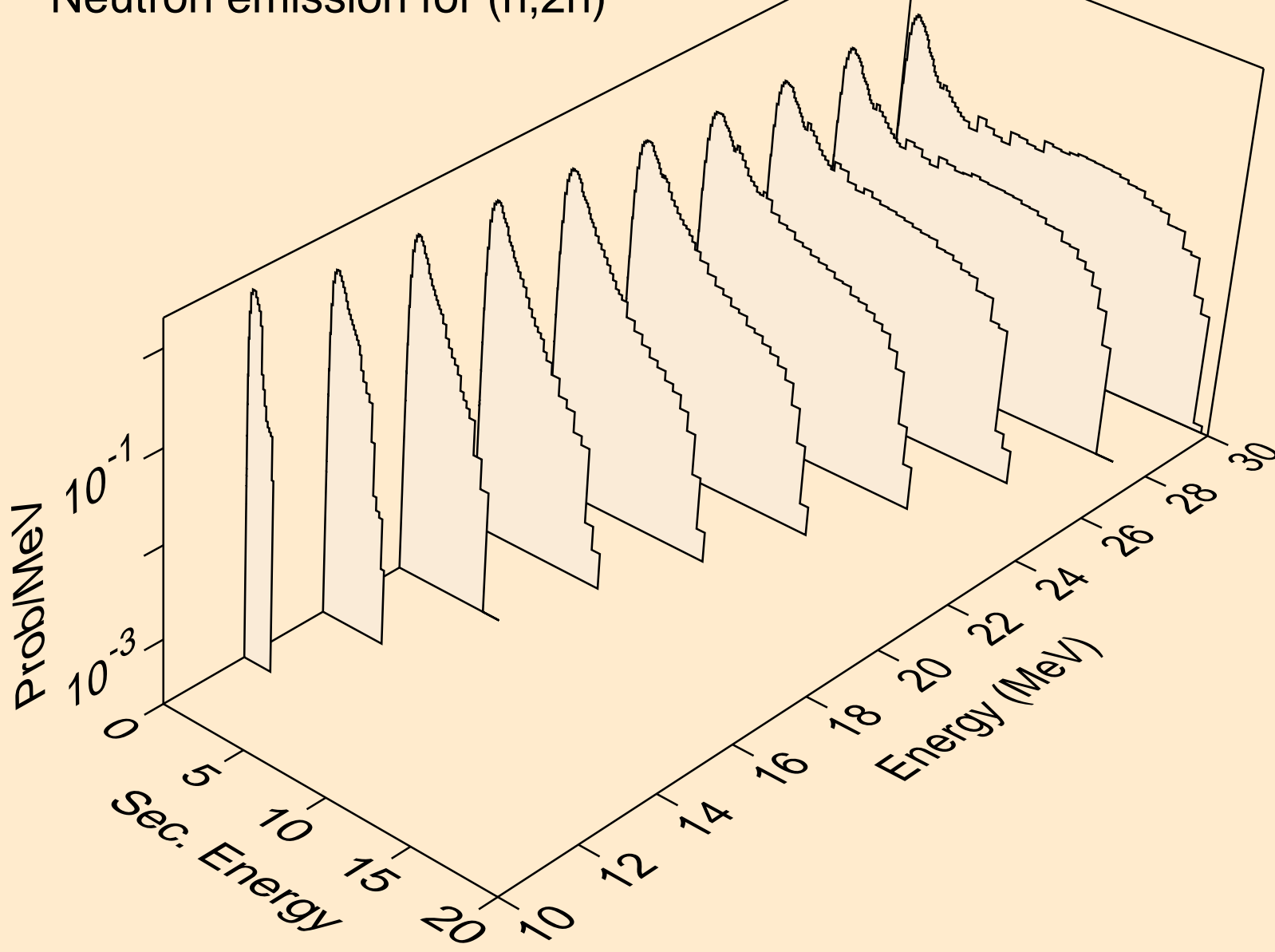

LU159 NEUTRON ACER TENDL-2019 LIBRARY; T=293.16K
Neutron emission for (n,3n)

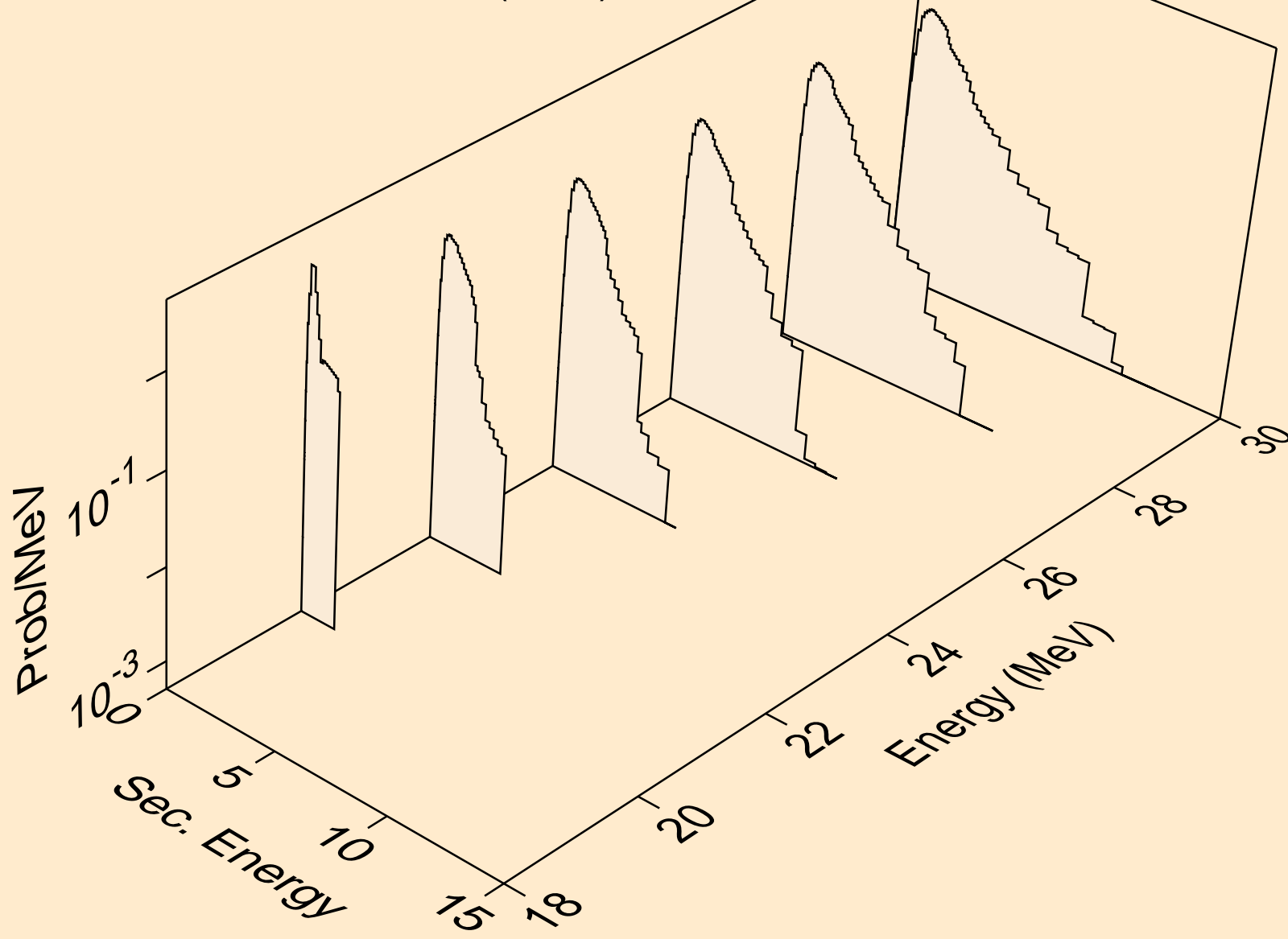

LU159 NEUTRON ACER TENDL-2019 LIBRARY; T=293.16K
Neutron emission for (n,n*)a

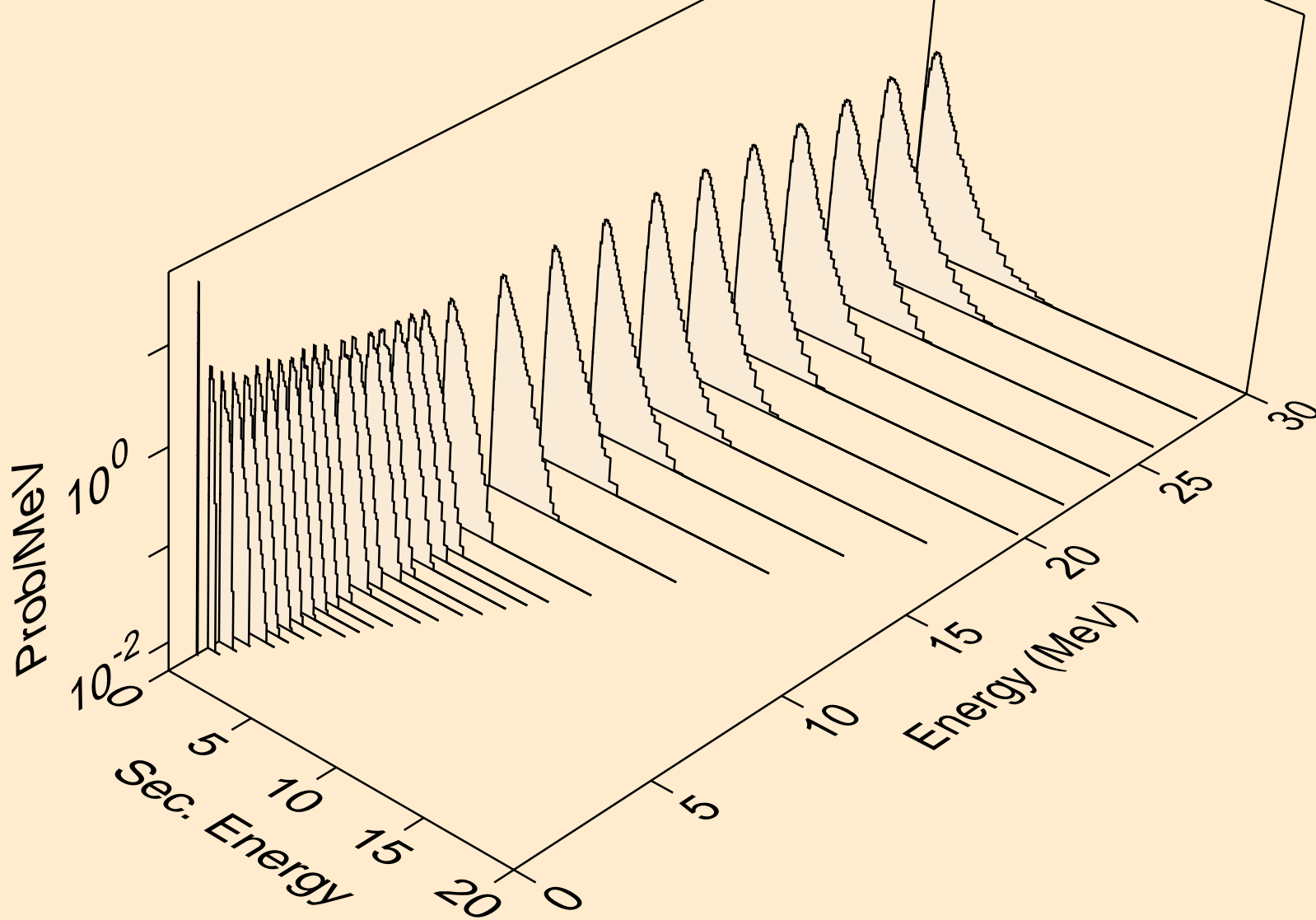

LU159 NEUTRON ACER TENDL-2019 LIBRARY; T=293.16K
Neutron emission for (n,n*)3a

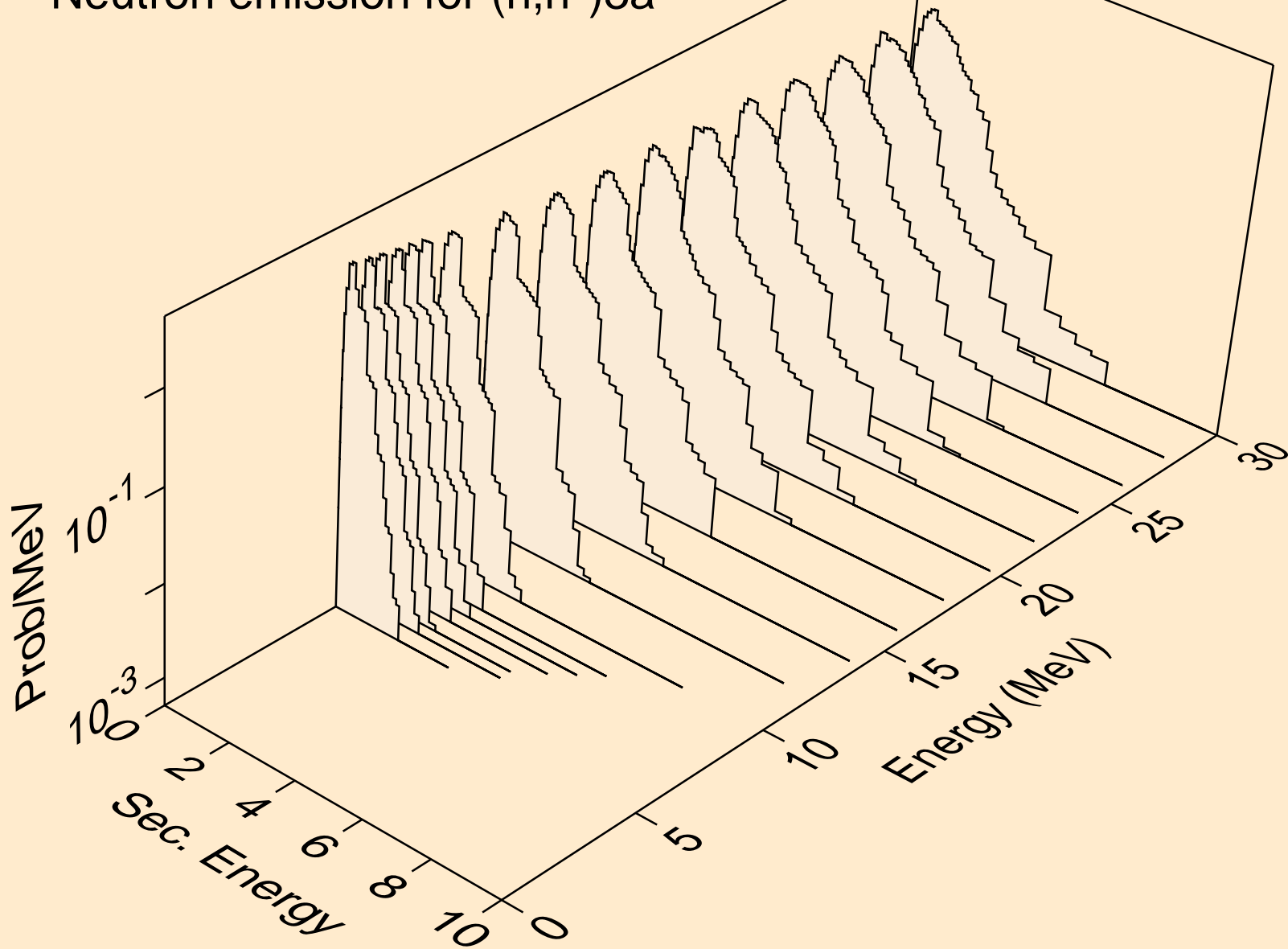

LU159 NEUTRON ACER TENDL-2019 LIBRARY; T=293.16K
Neutron emission for (n,2n)a

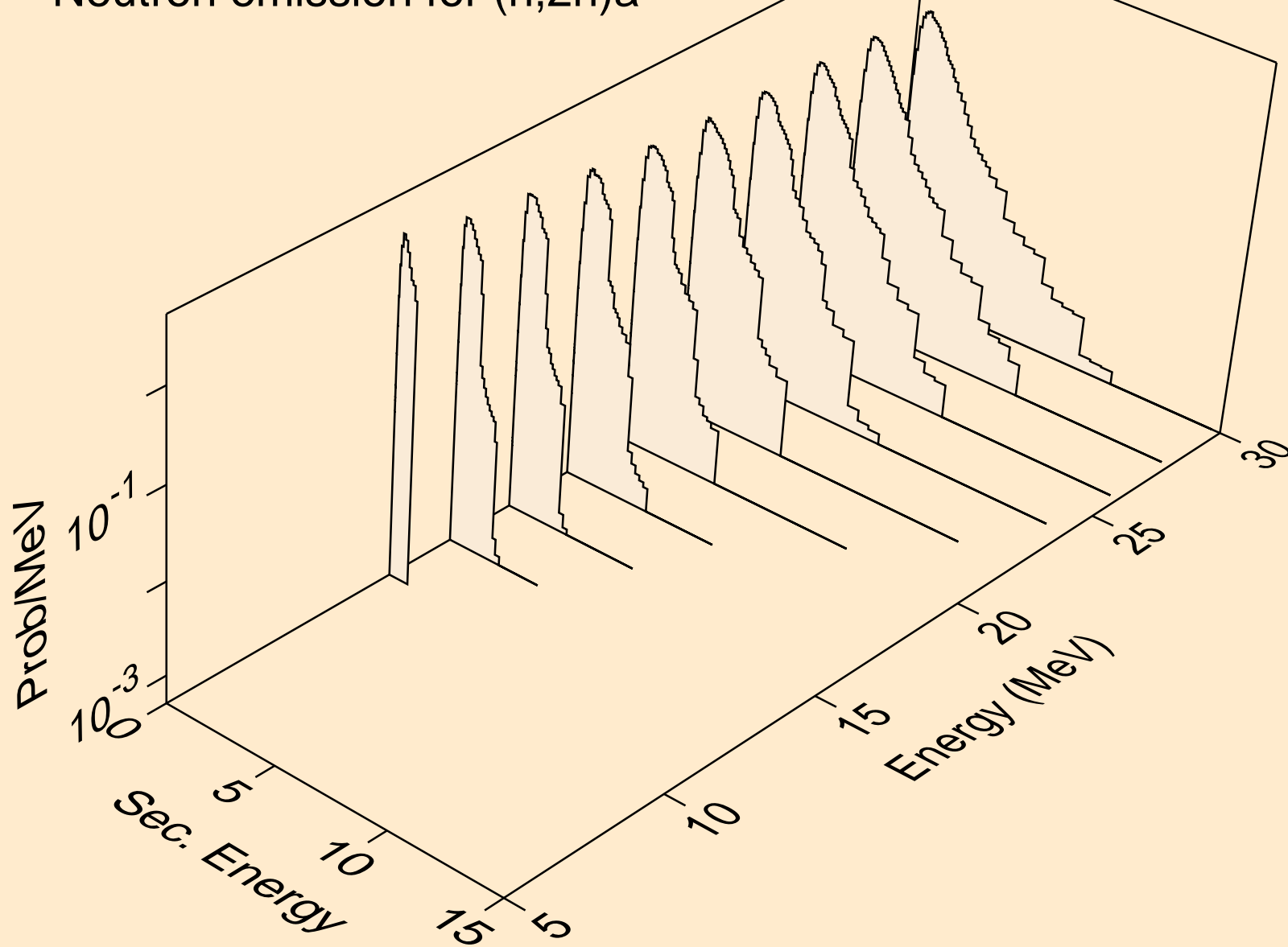

LU159 NEUTRON ACER TENDL-2019 LIBRARY; T=293.16K
Neutron emission for (n,3n)a

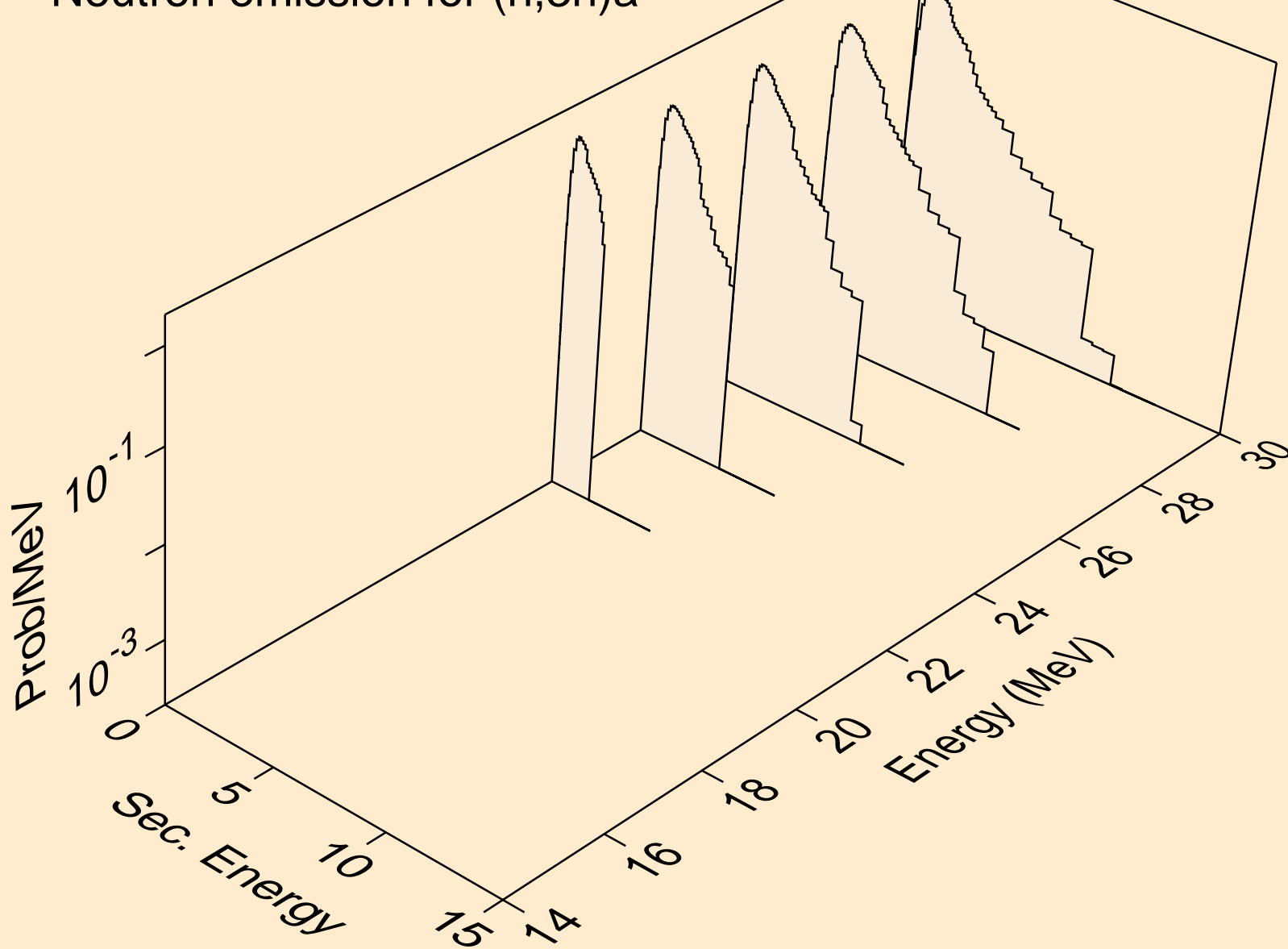

LU159 NEUTRON ACER TENDL-2019 LIBRARY; T=293.16K
Neutron emission for (n,n*)p

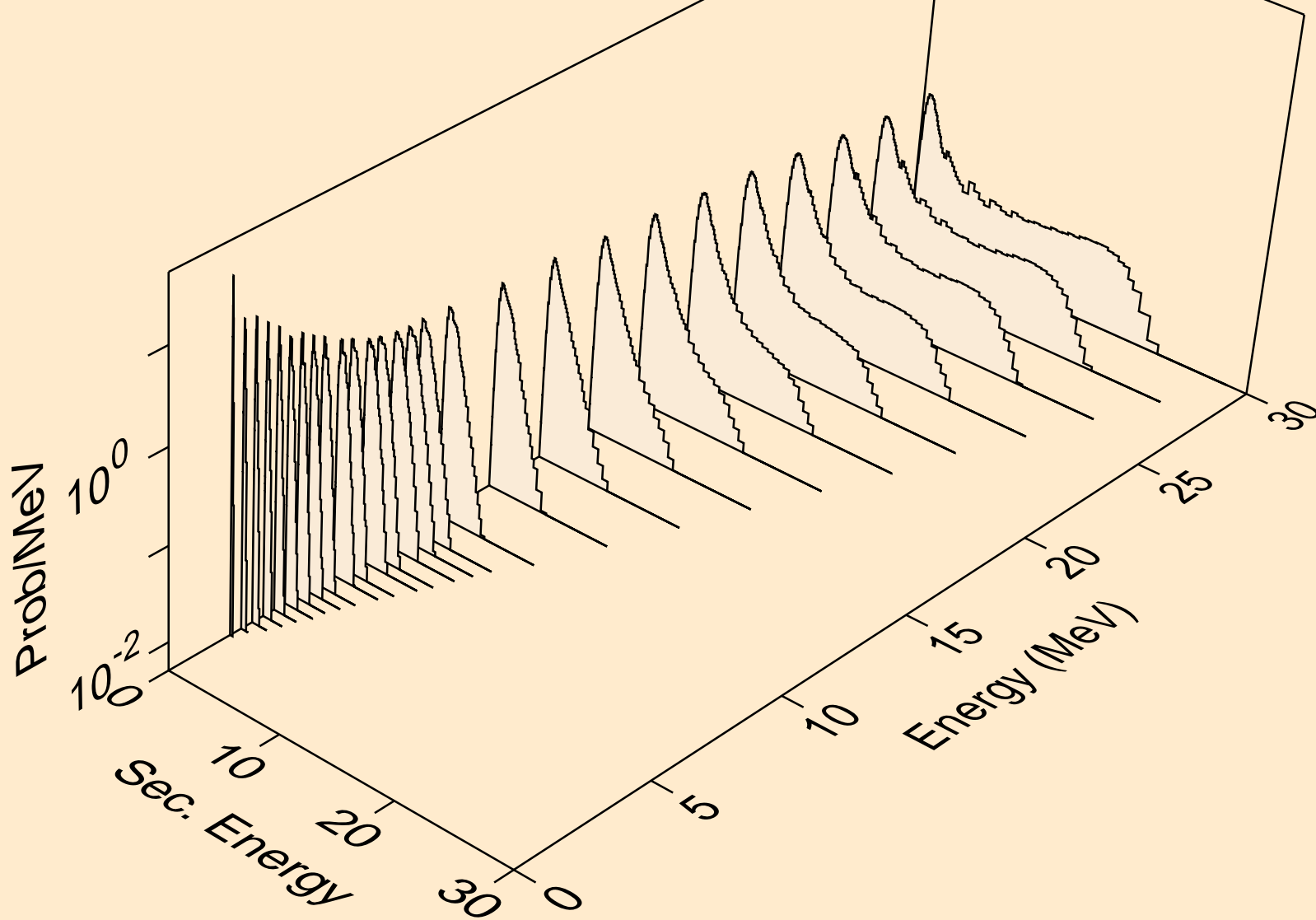

LU159 NEUTRON ACER TENDL-2019 LIBRARY; T=293.16K
Neutron emission for (n,n*)2a

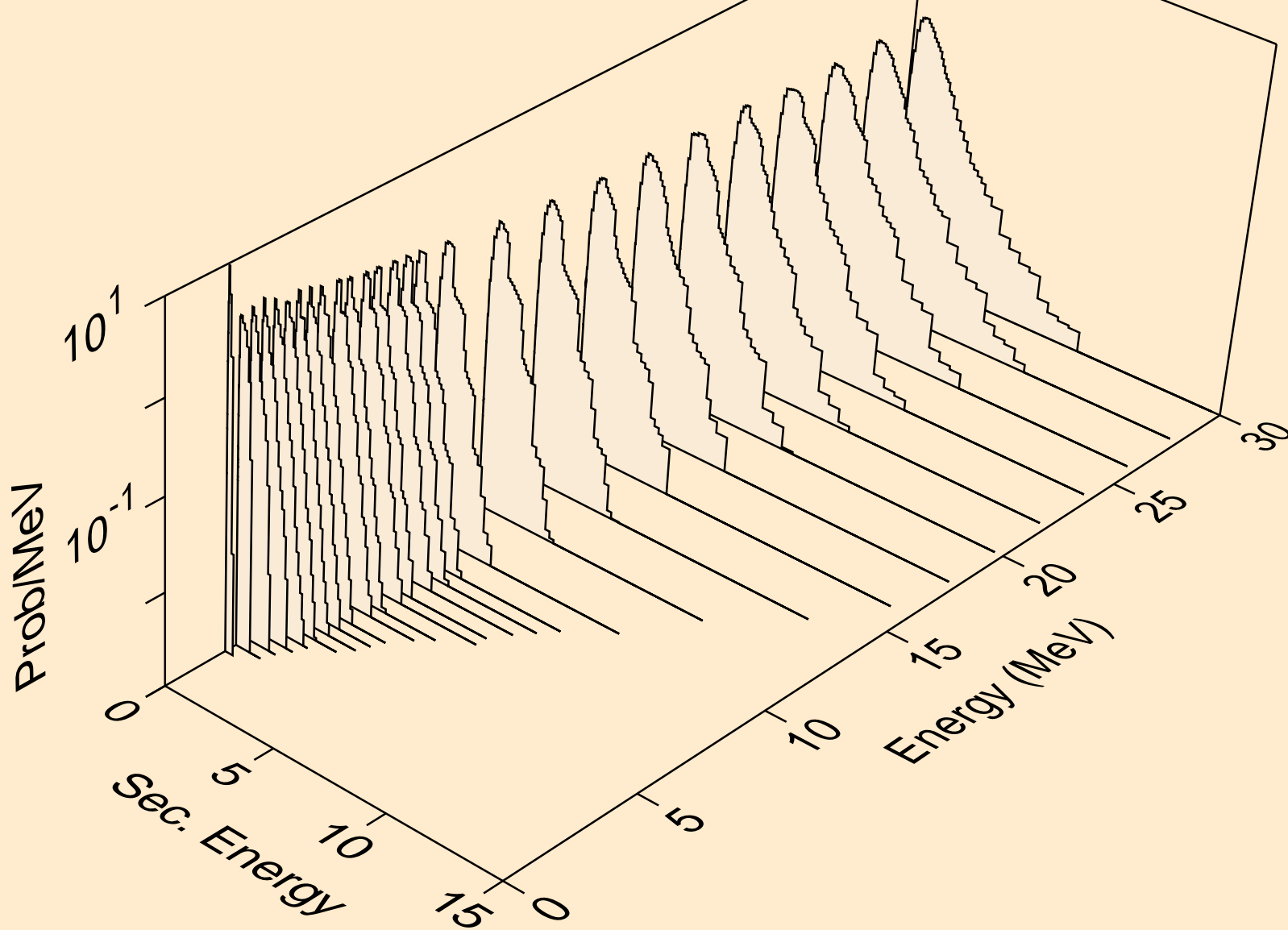

LU159 NEUTRON ACER TENDL-2019 LIBRARY; T=293.16K
Neutron emission for (n,2n)2a

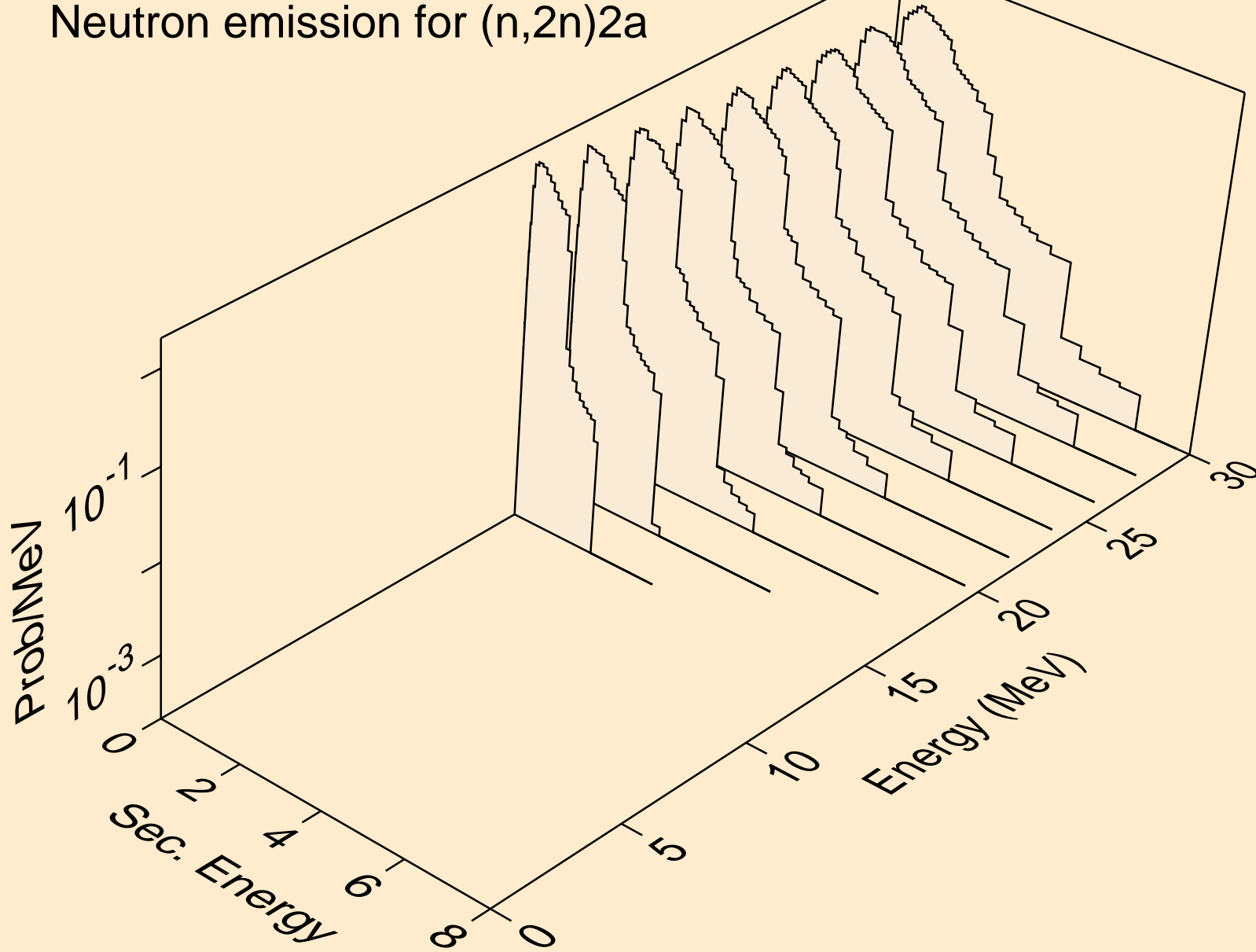

LU159 NEUTRON ACER TENDL-2019 LIBRARY; T=293.16K
Neutron emission for (n,n*)d

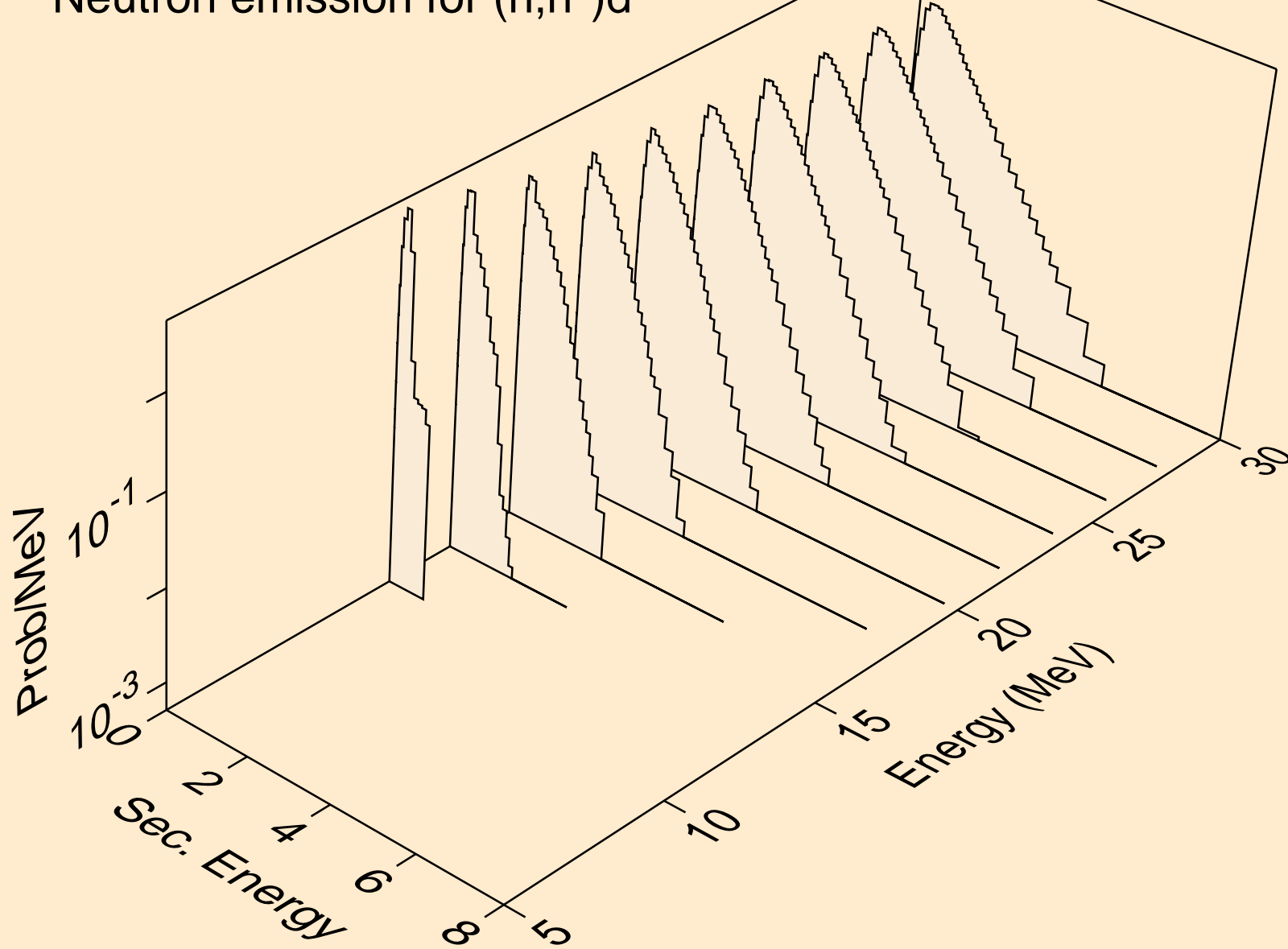

LU159 NEUTRON ACER TENDL-2019 LIBRARY; T=293.16K
Neutron emission for (n,n*)t

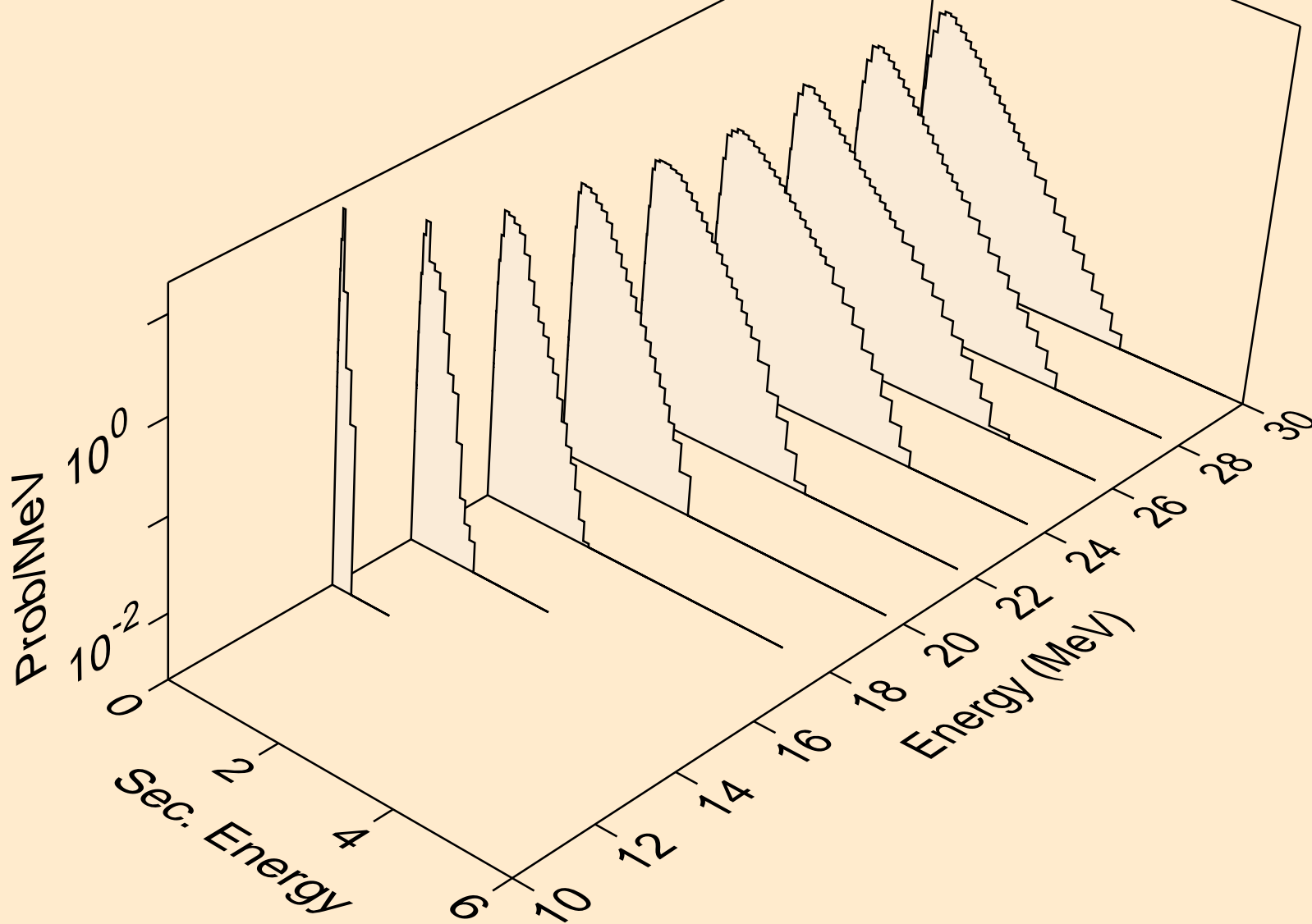

LU159 NEUTRON ACER TENDL-2019 LIBRARY; T=293.16K
Neutron emission for (n,n*)he3

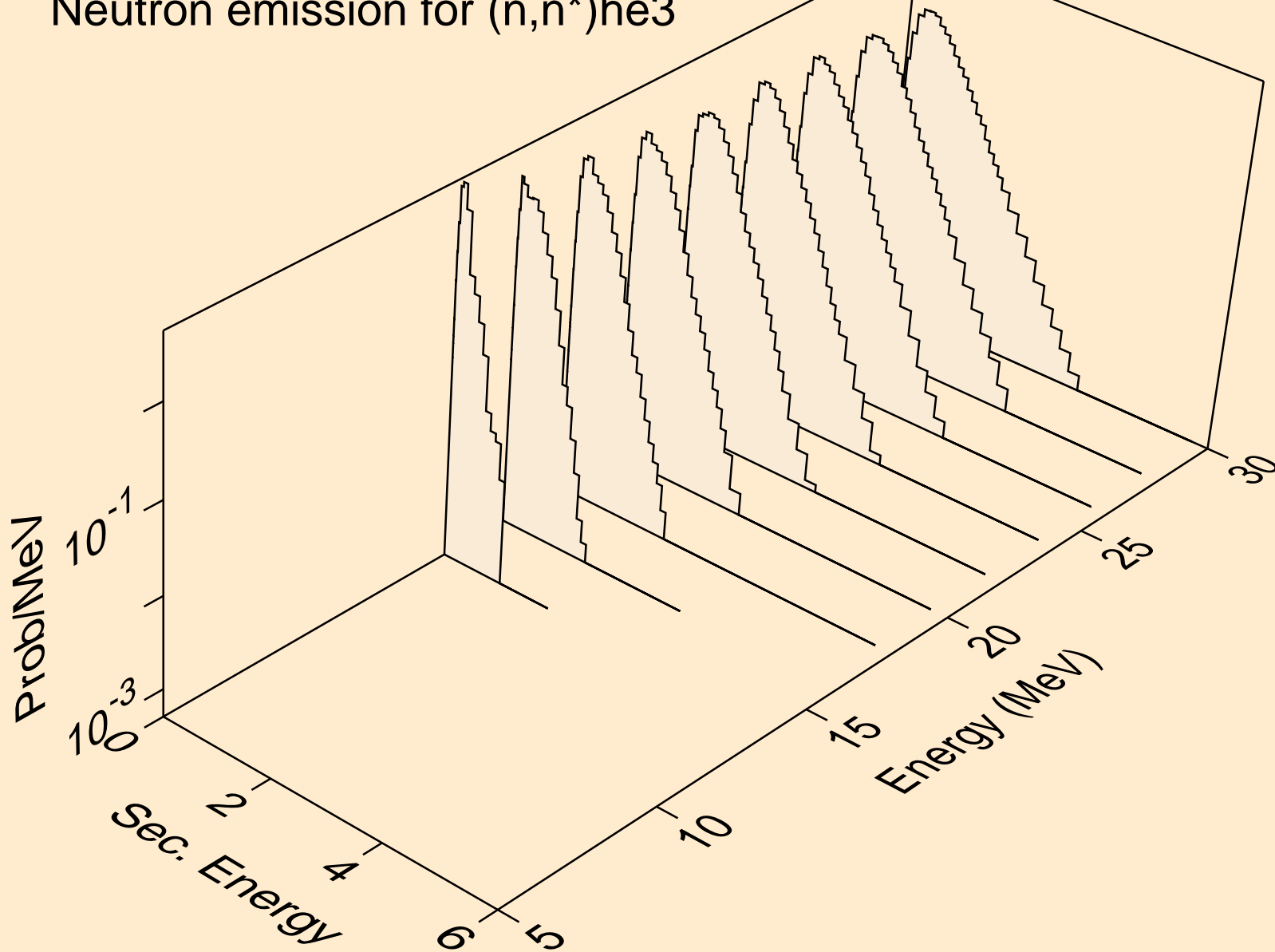

LU159 NEUTRON ACER TENDL-2019 LIBRARY; T=293.16K
Neutron emission for (n,n*)d2a

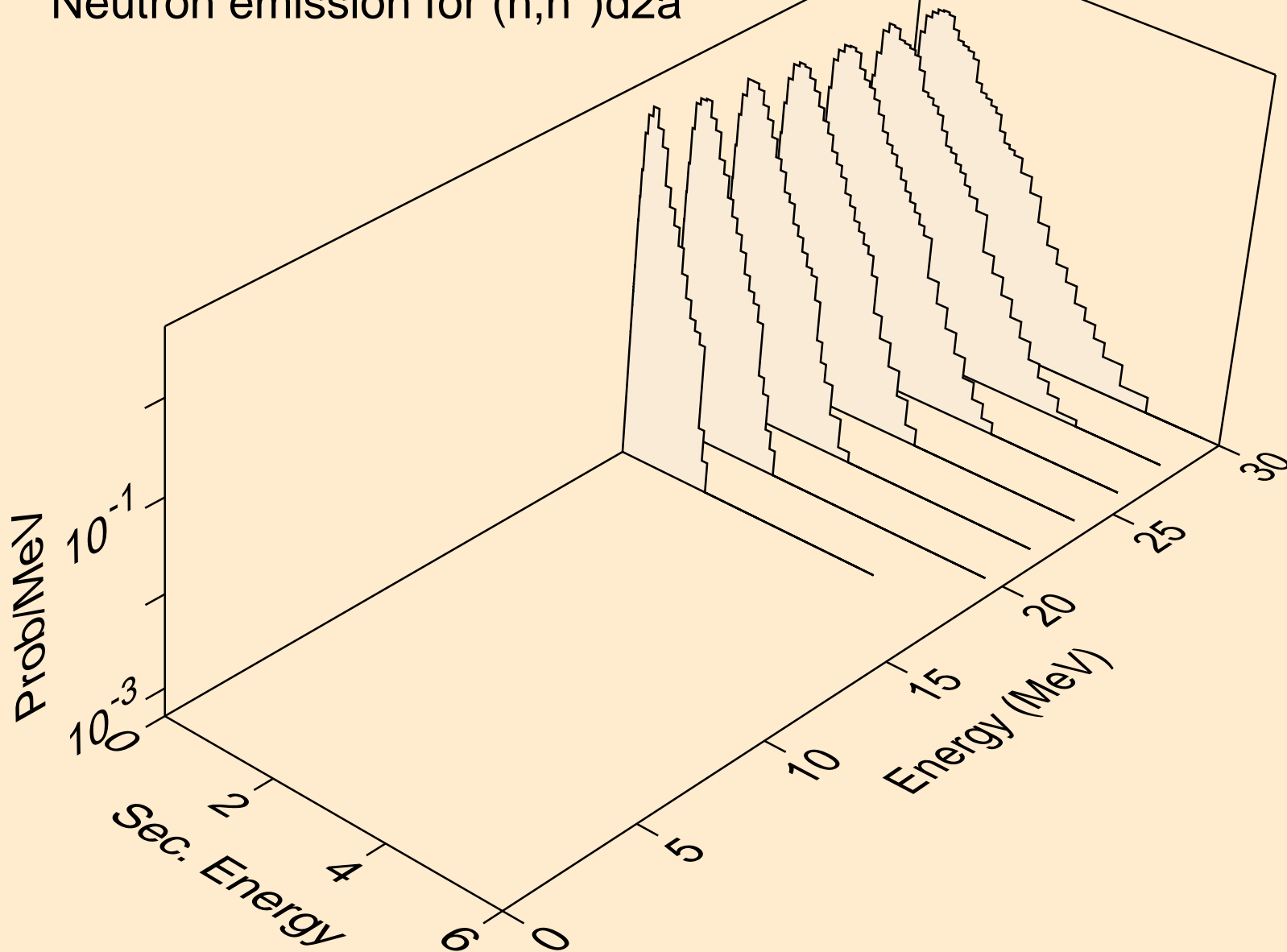

LU159 NEUTRON ACER TENDL-2019 LIBRARY; T=293.16K
Neutron emission for (n,2np)

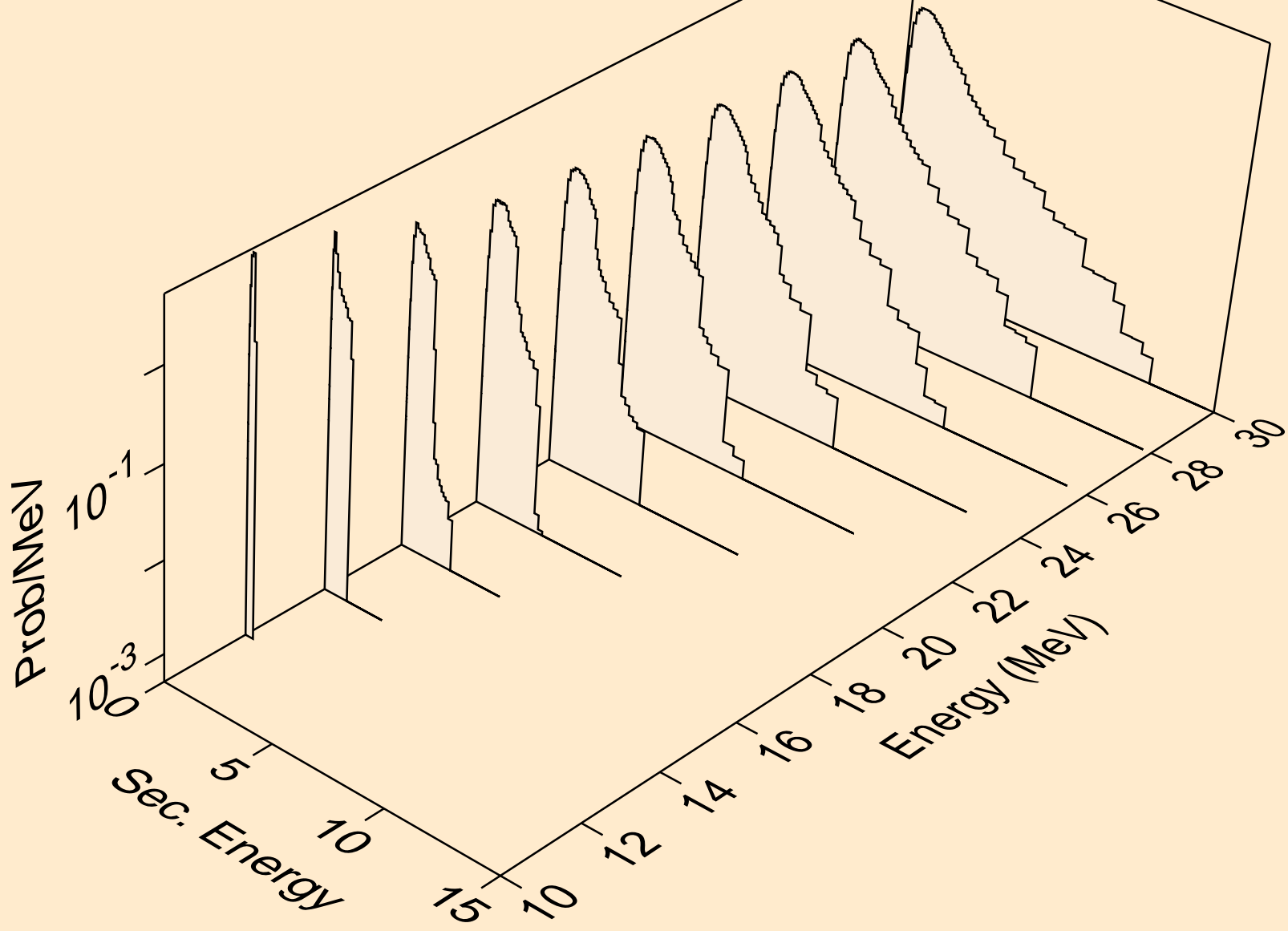

LU159 NEUTRON ACER TENDL-2019 LIBRARY; T=293.16K
Neutron emission for (n,3np)

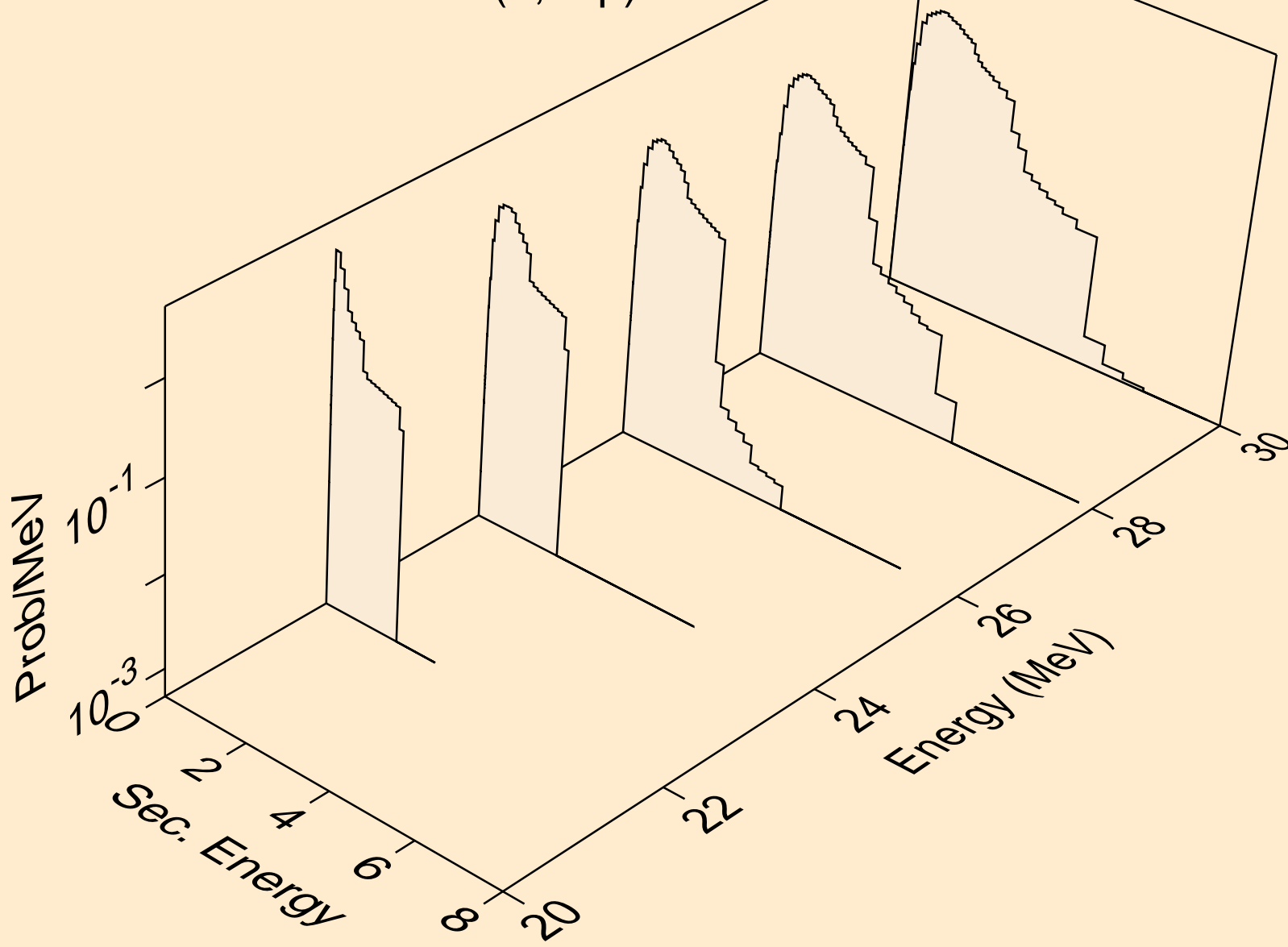

LU159 NEUTRON ACER TENDL-2019 LIBRARY; T=293.16K
Neutron emission for (n,2np)

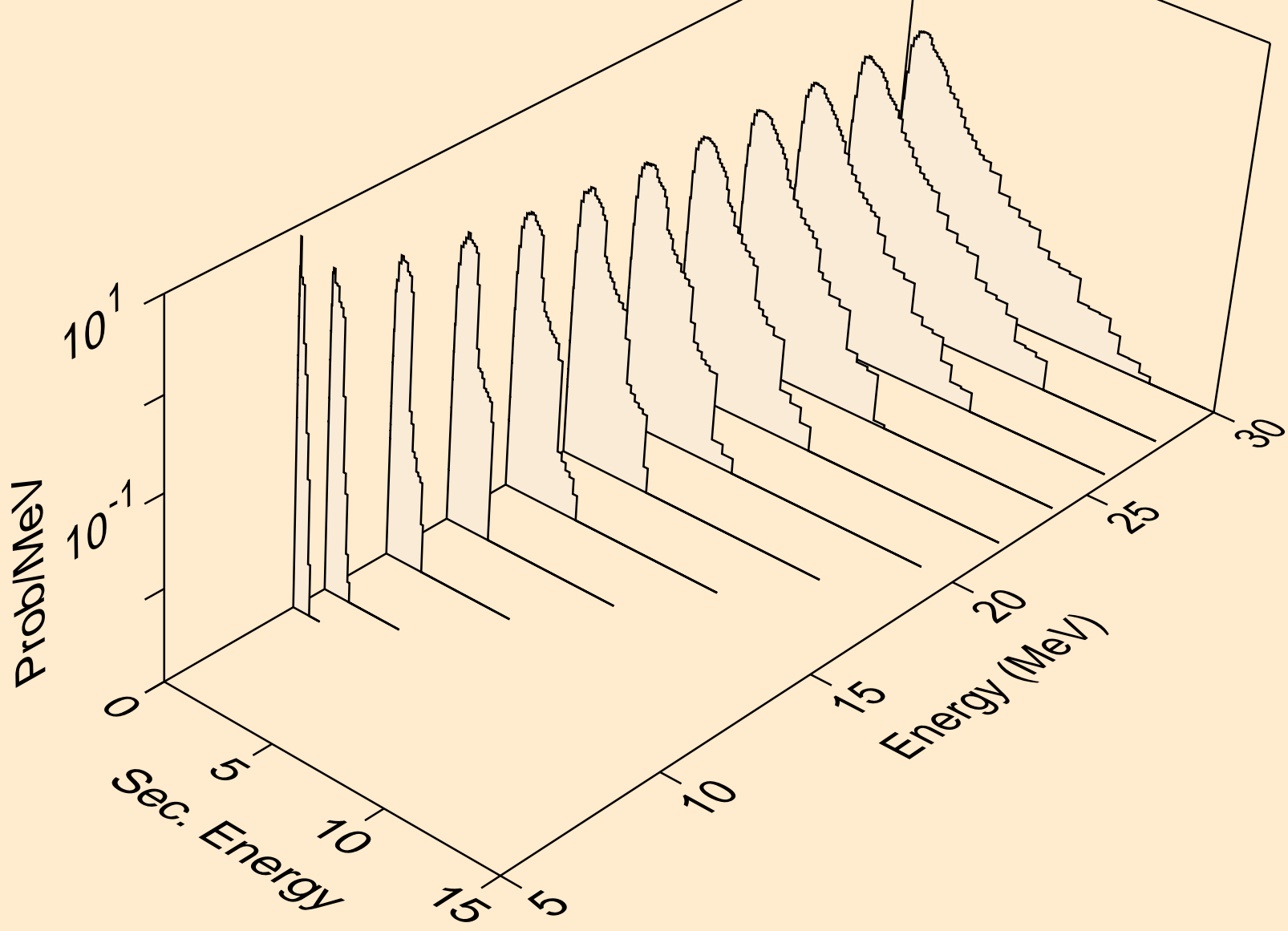

LU159 NEUTRON ACER TENDL-2019 LIBRARY; T=293.16K
Neutron emission for (n,npa)

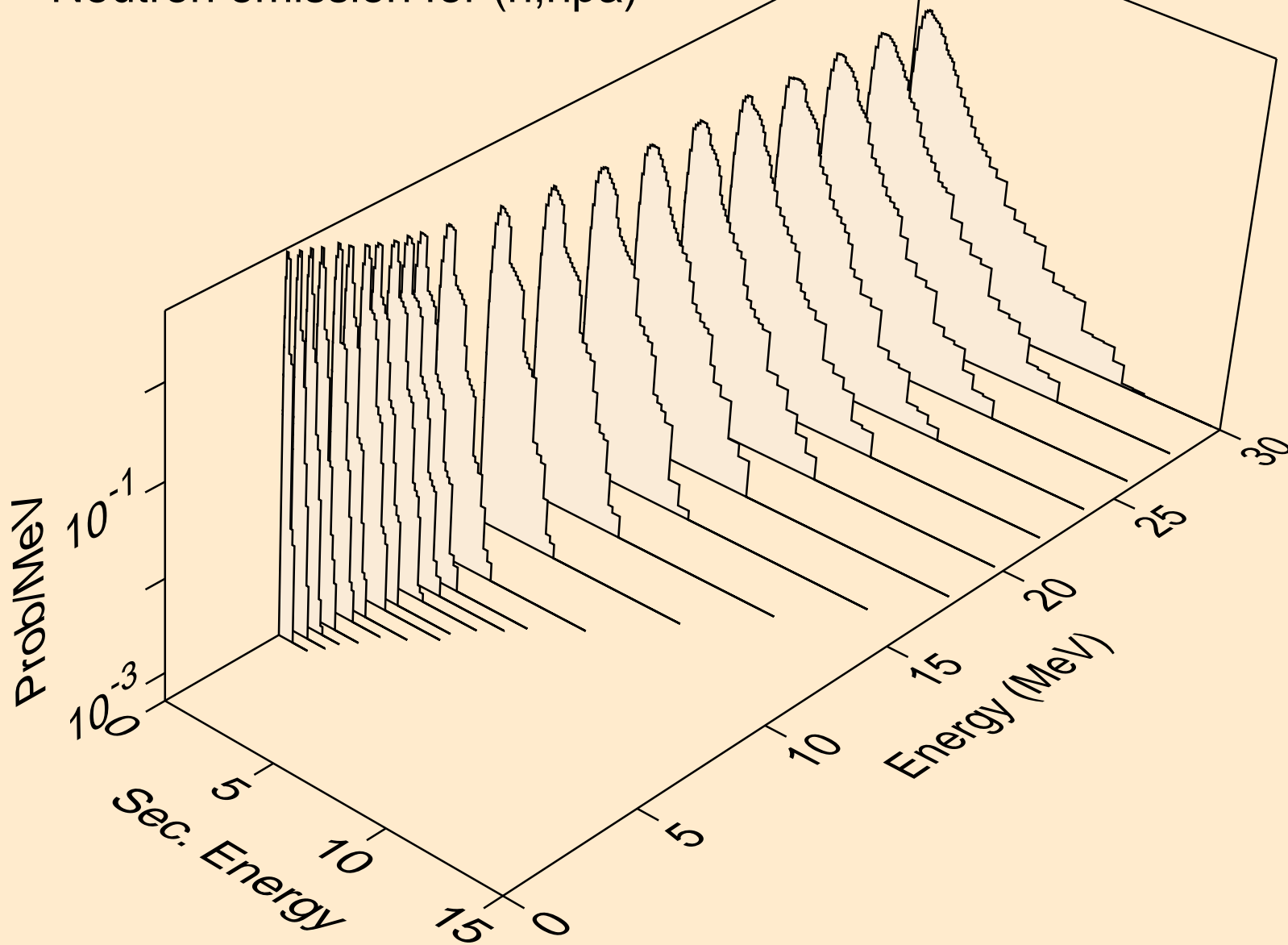

LU159 NEUTRON ACER TENDL-2019 LIBRARY; T=293.16K
Neutron emission for (n,n*c)

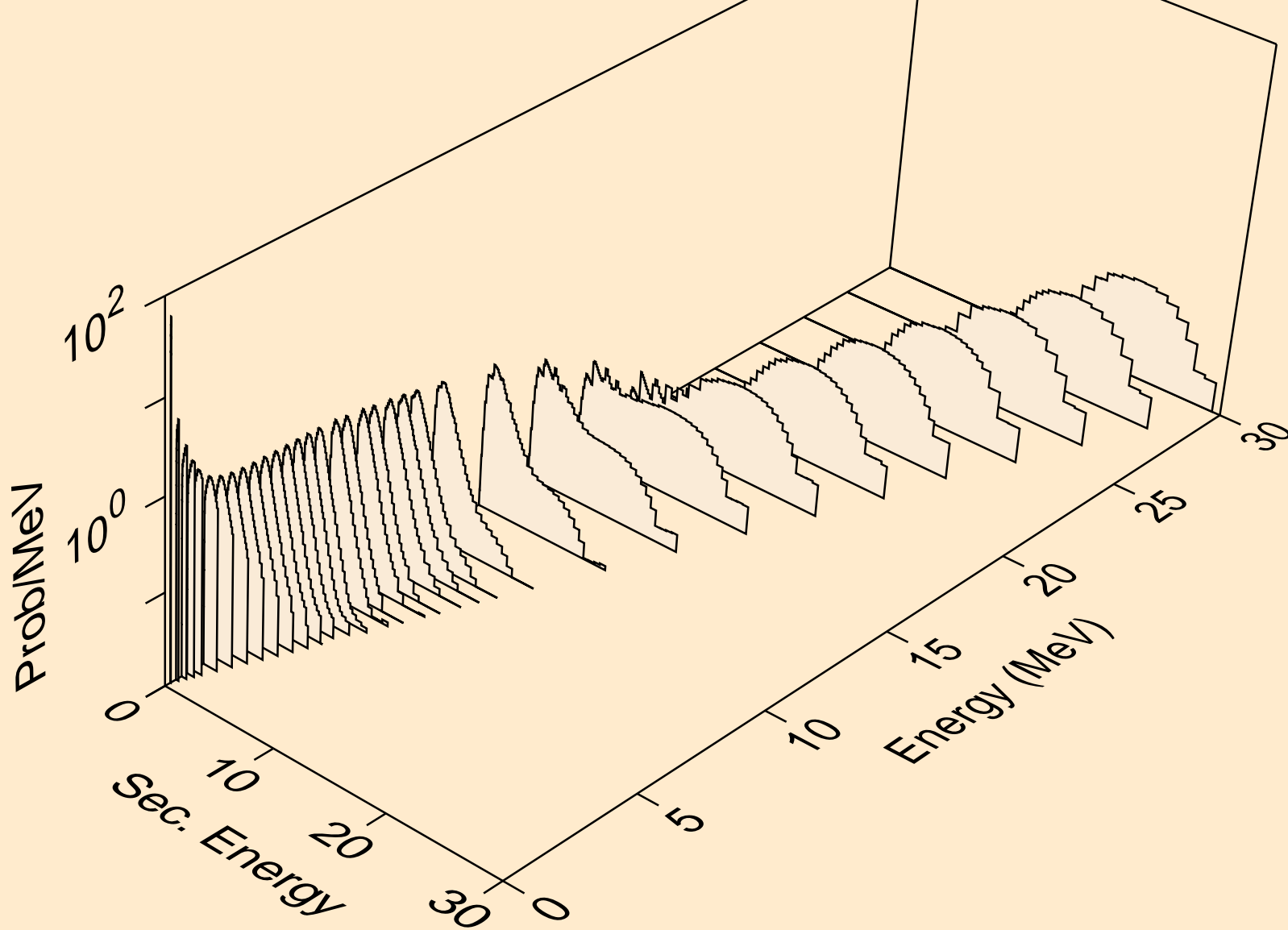

LU159 NEUTRON ACER TENDL-2019 LIBRARY; T=293.16K
Photon emission for (n,x)

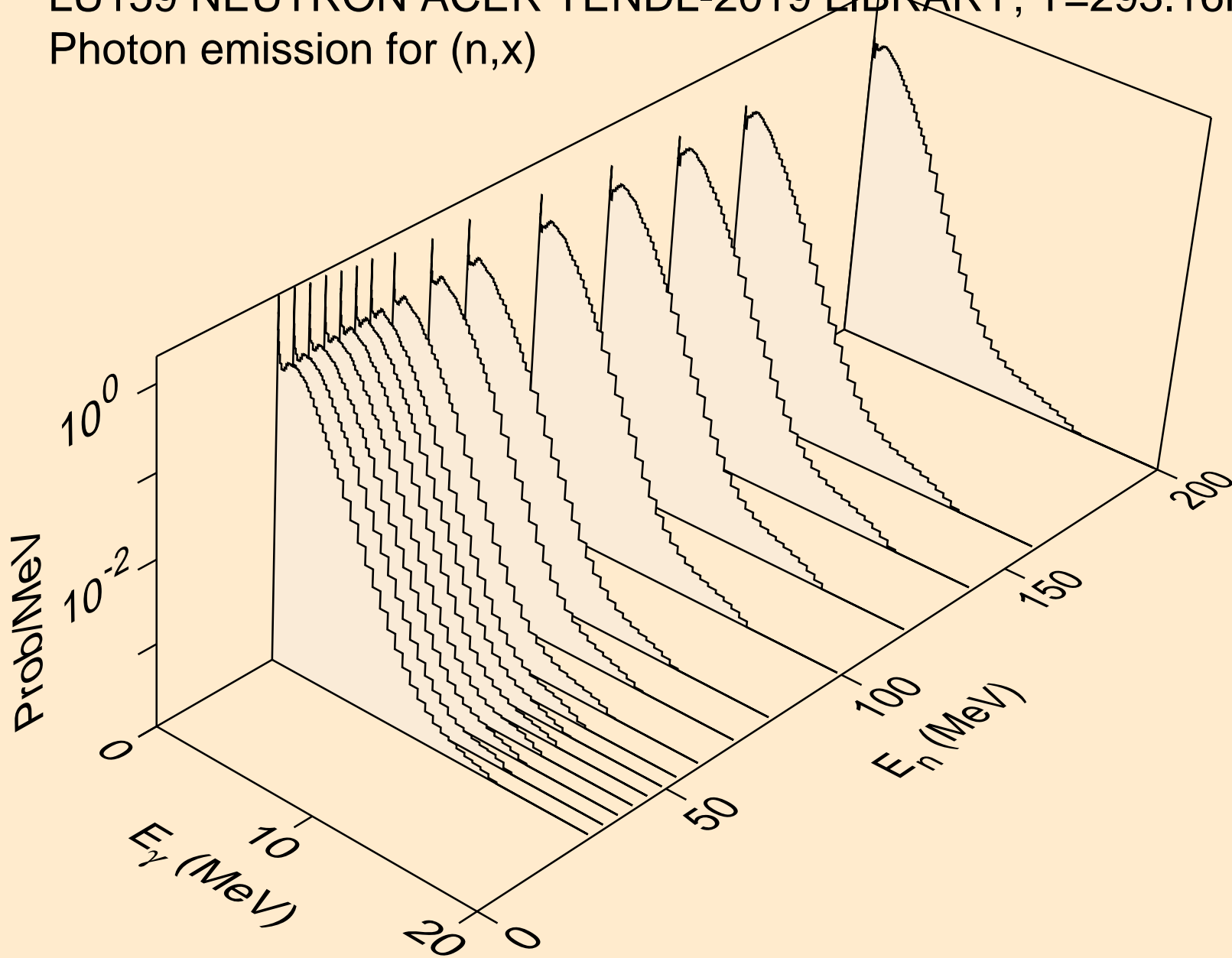

LU159 NEUTRON ACER TENDL-2019 LIBRARY; T=293.16K
Photon emission for (n,2nd)

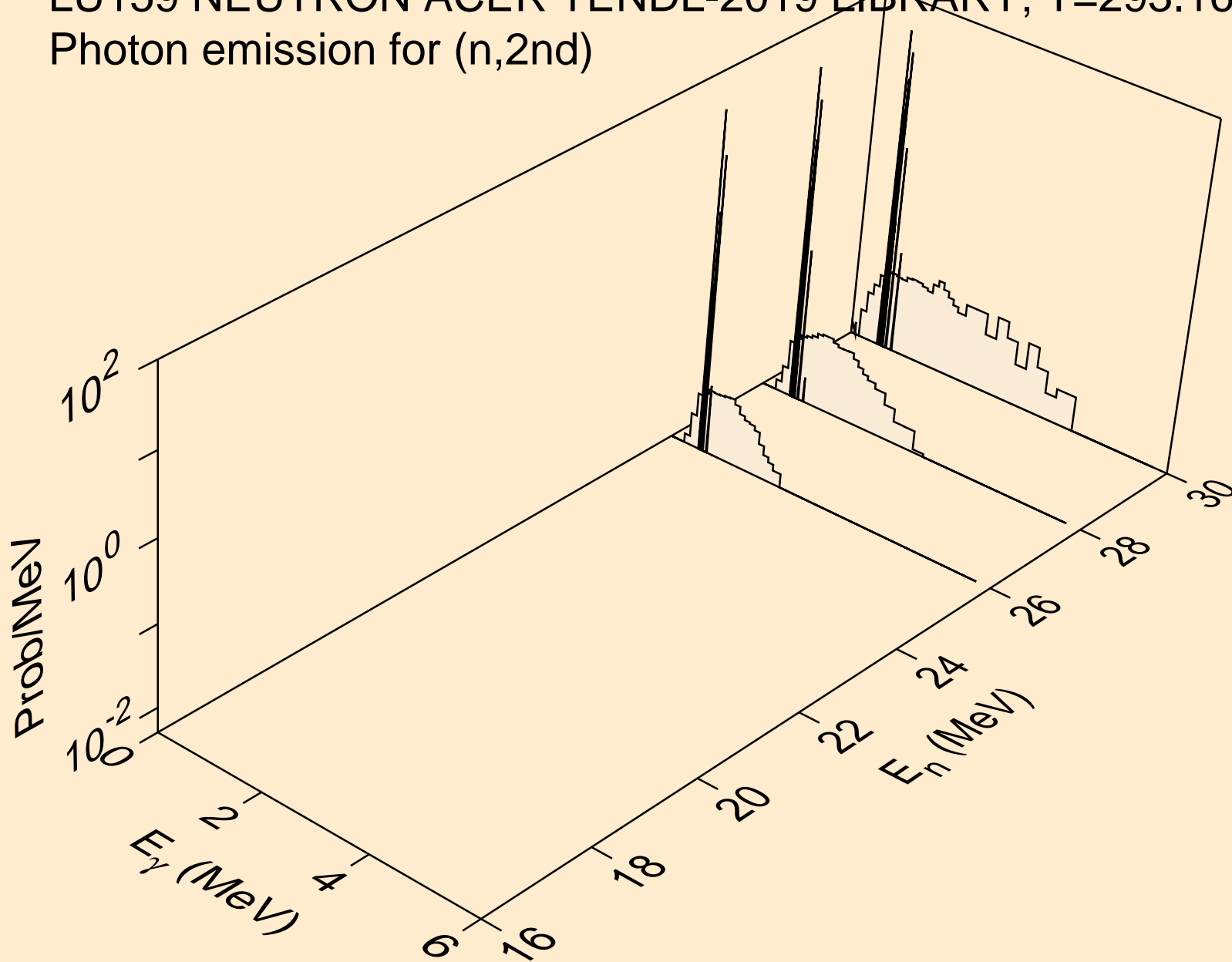

LU159 NEUTRON ACER TENDL-2019 LIBRARY; T=293.16K
Photon emission for (n,2n)

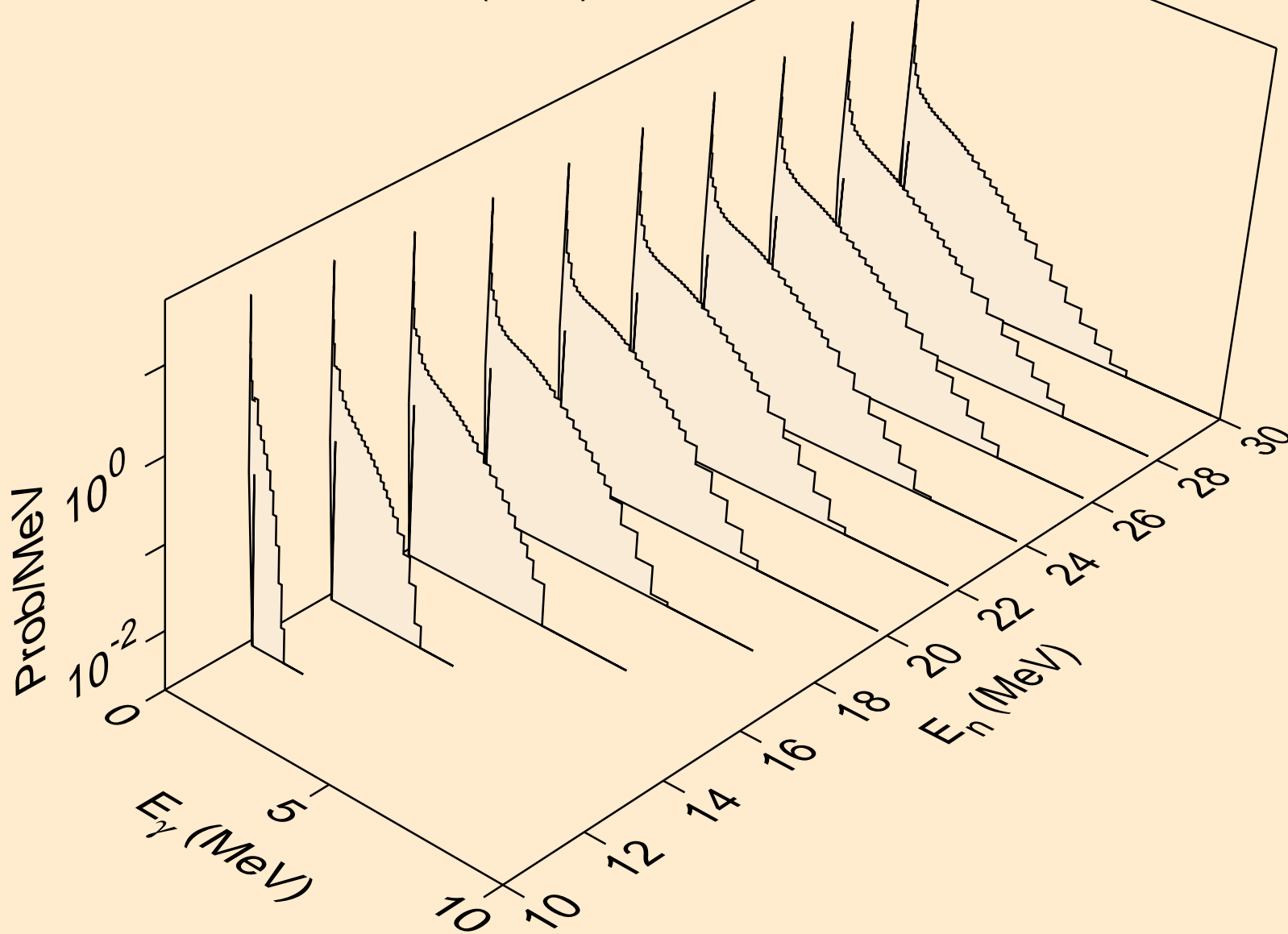

LU159 NEUTRON ACER TENDL-2019 LIBRARY; T=293.16K
Photon emission for (n,3n)

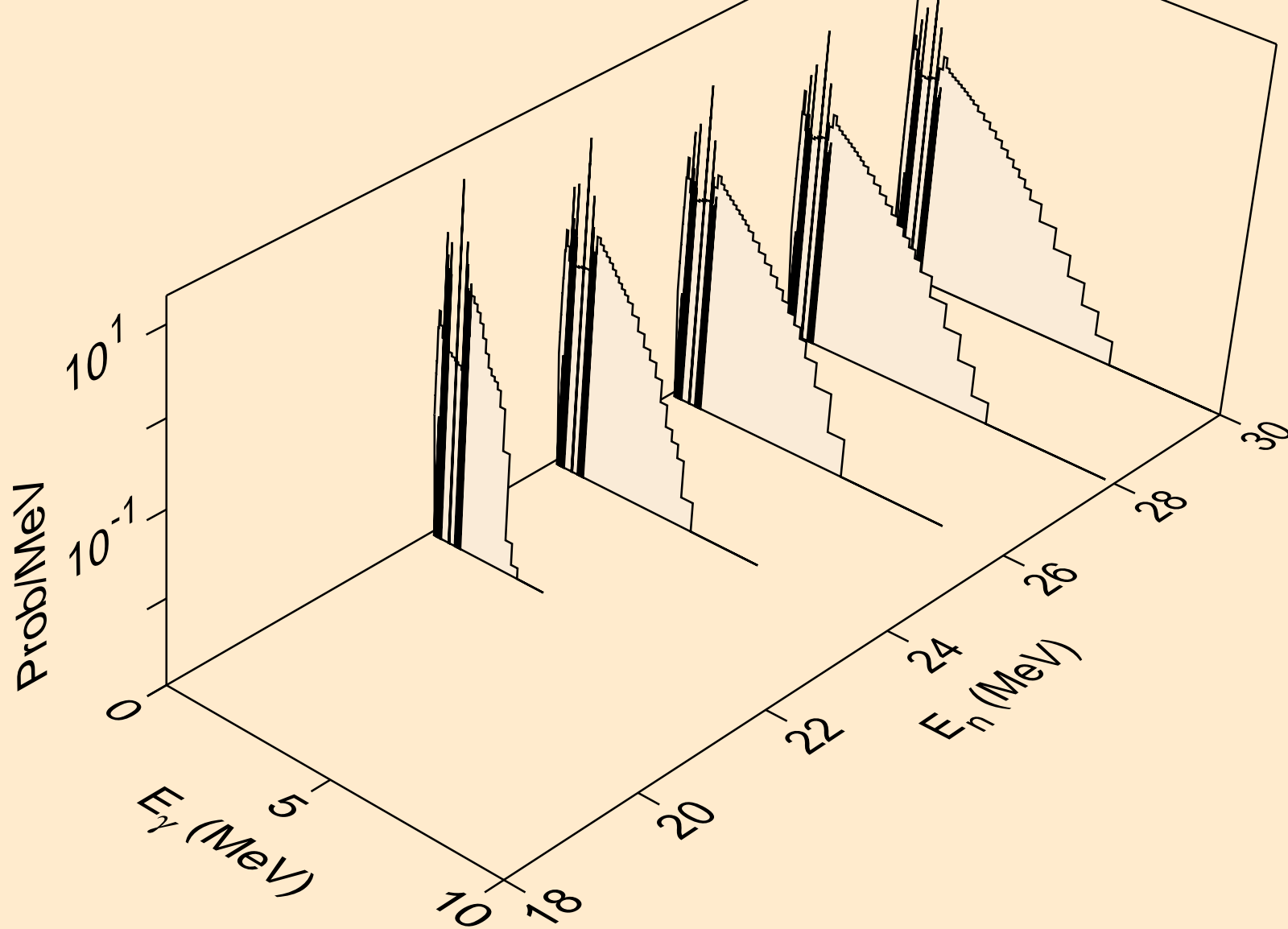

LU159 NEUTRON ACER TENDL-2019 LIBRARY; T=293.16K
Photon emission for (n,n*)a

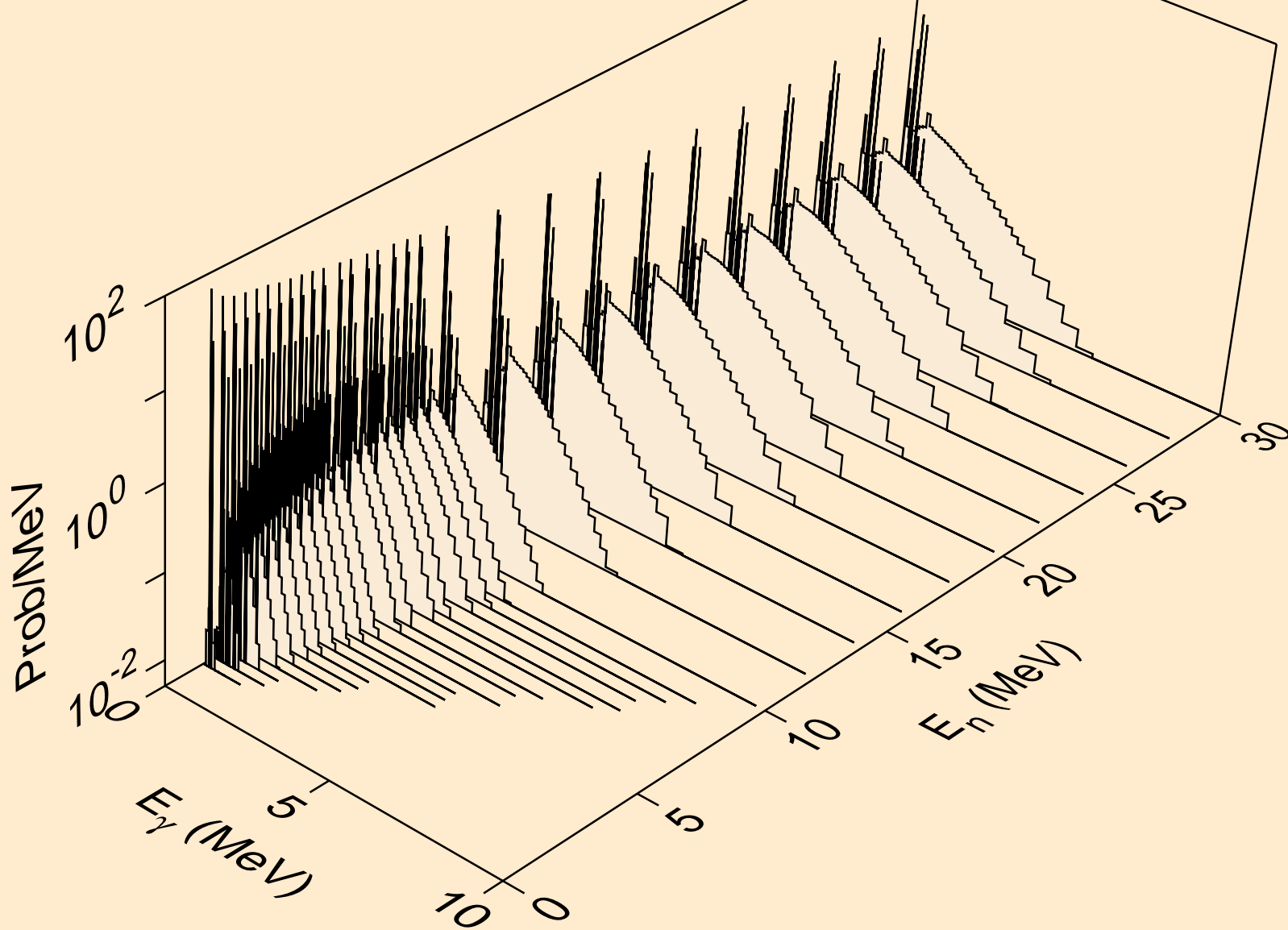

LU159 NEUTRON ACER TENDL-2019 LIBRARY; T=293.16K
Photon emission for (n,n*)3a

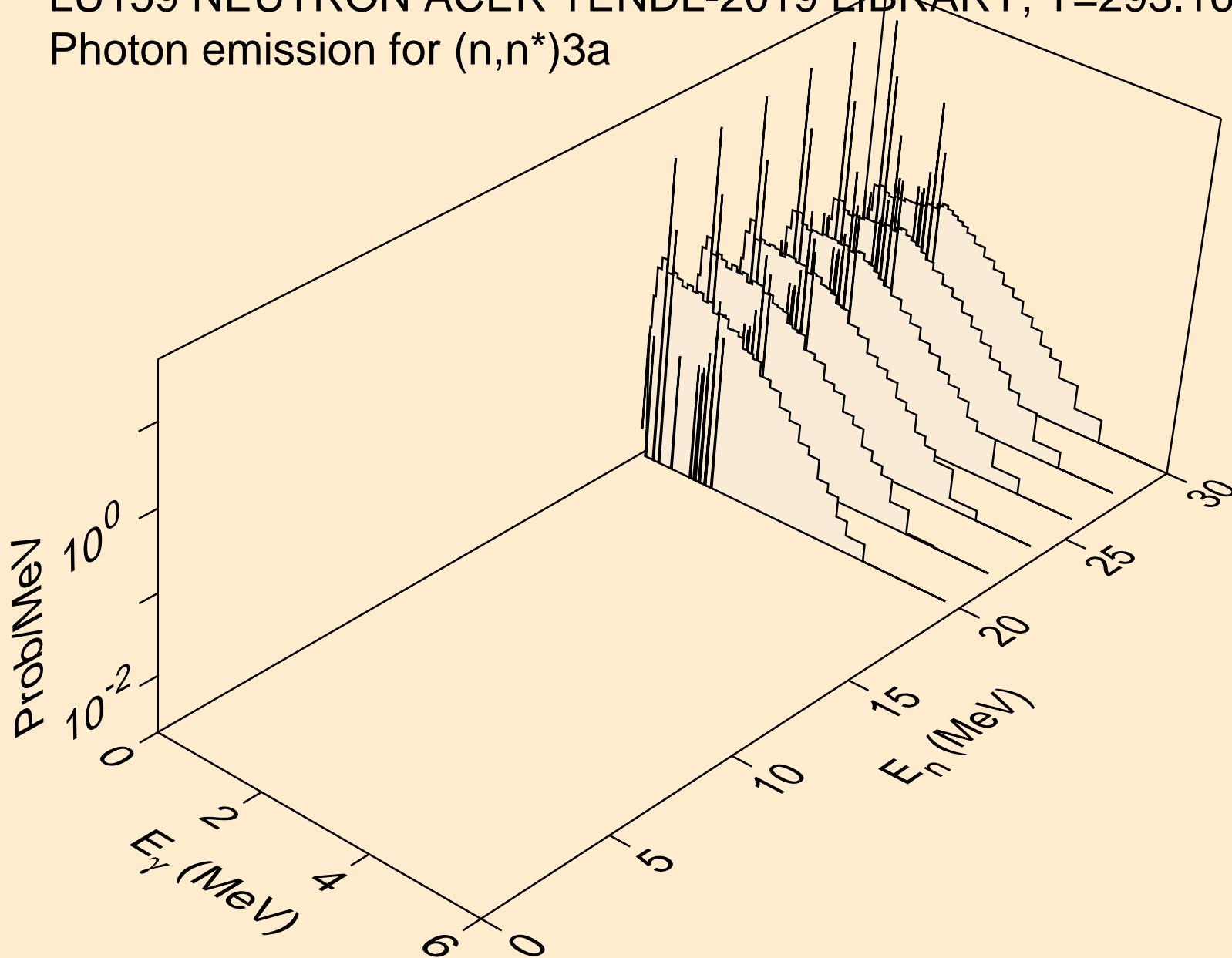

LU159 NEUTRON ACER TENDL-2019 LIBRARY; T=293.16K
Photon emission for (n,2n)a

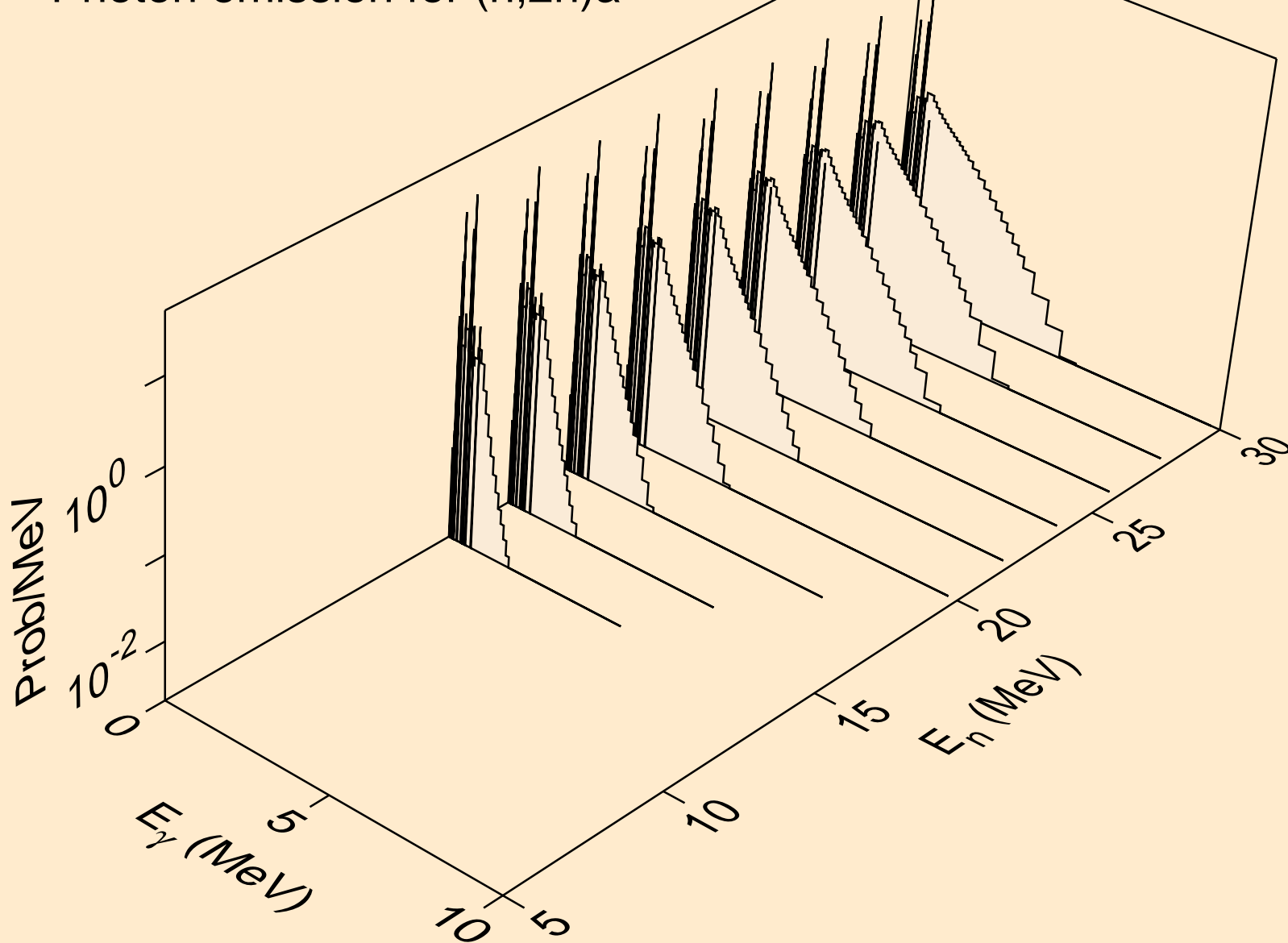

LU159 NEUTRON ACER TENDL-2019 LIBRARY; T=293.16K
Photon emission for (n,3n)a

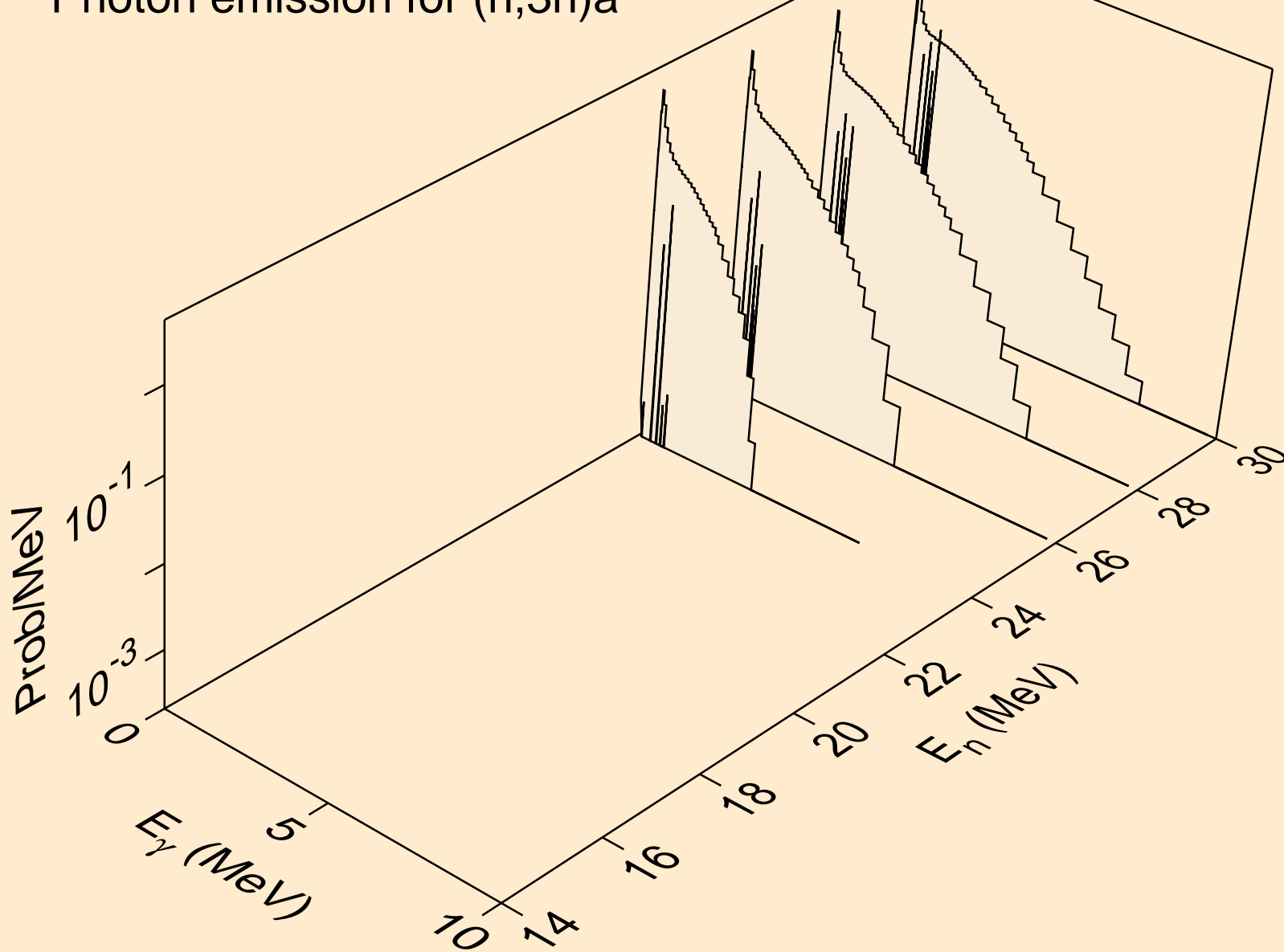

LU159 NEUTRON ACER TENDL-2019 LIBRARY; T=293.16K
Photon emission for (n,n*)p

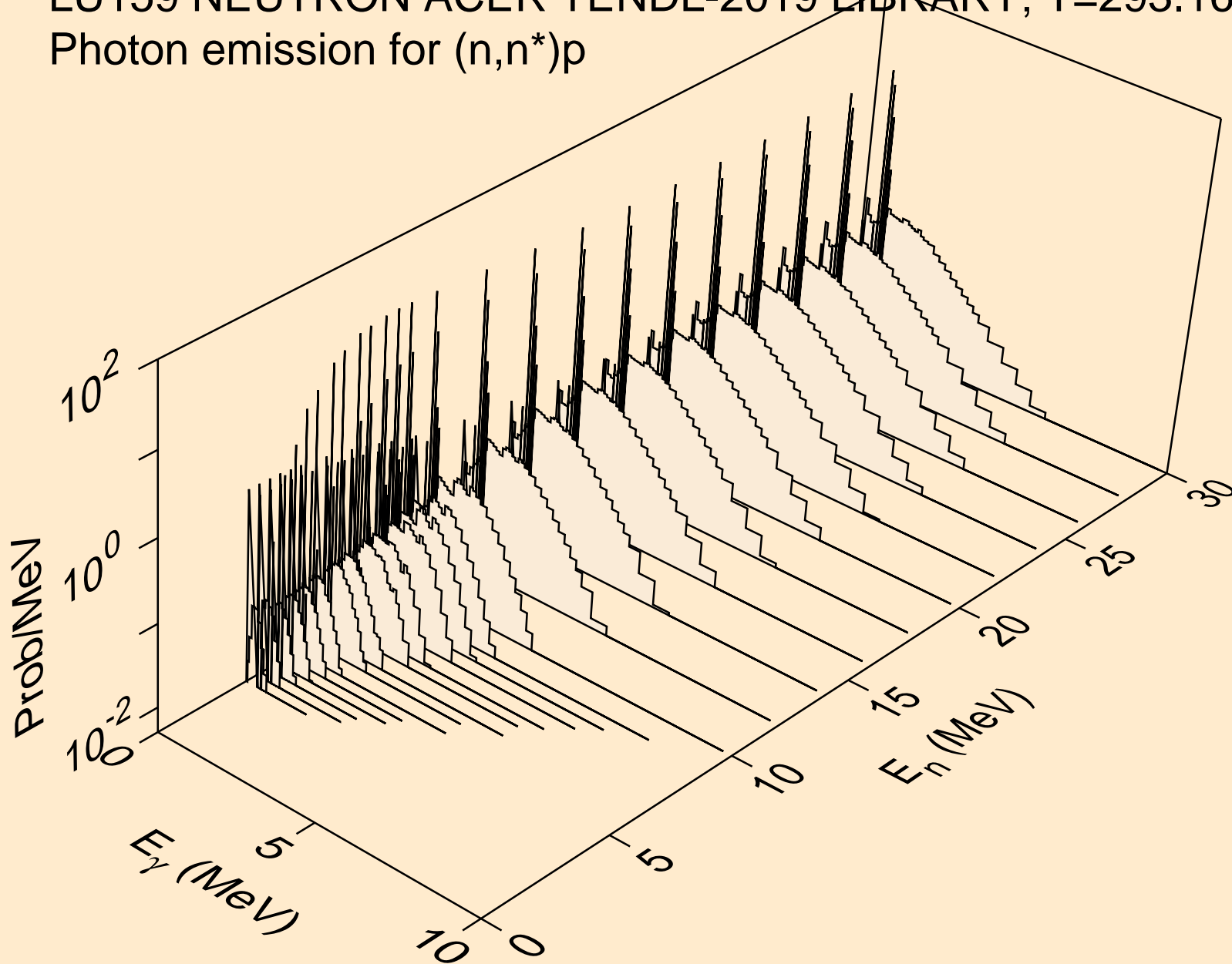

LU159 NEUTRON ACER TENDL-2019 LIBRARY; T=293.16K
Photon emission for (n,n*)2a

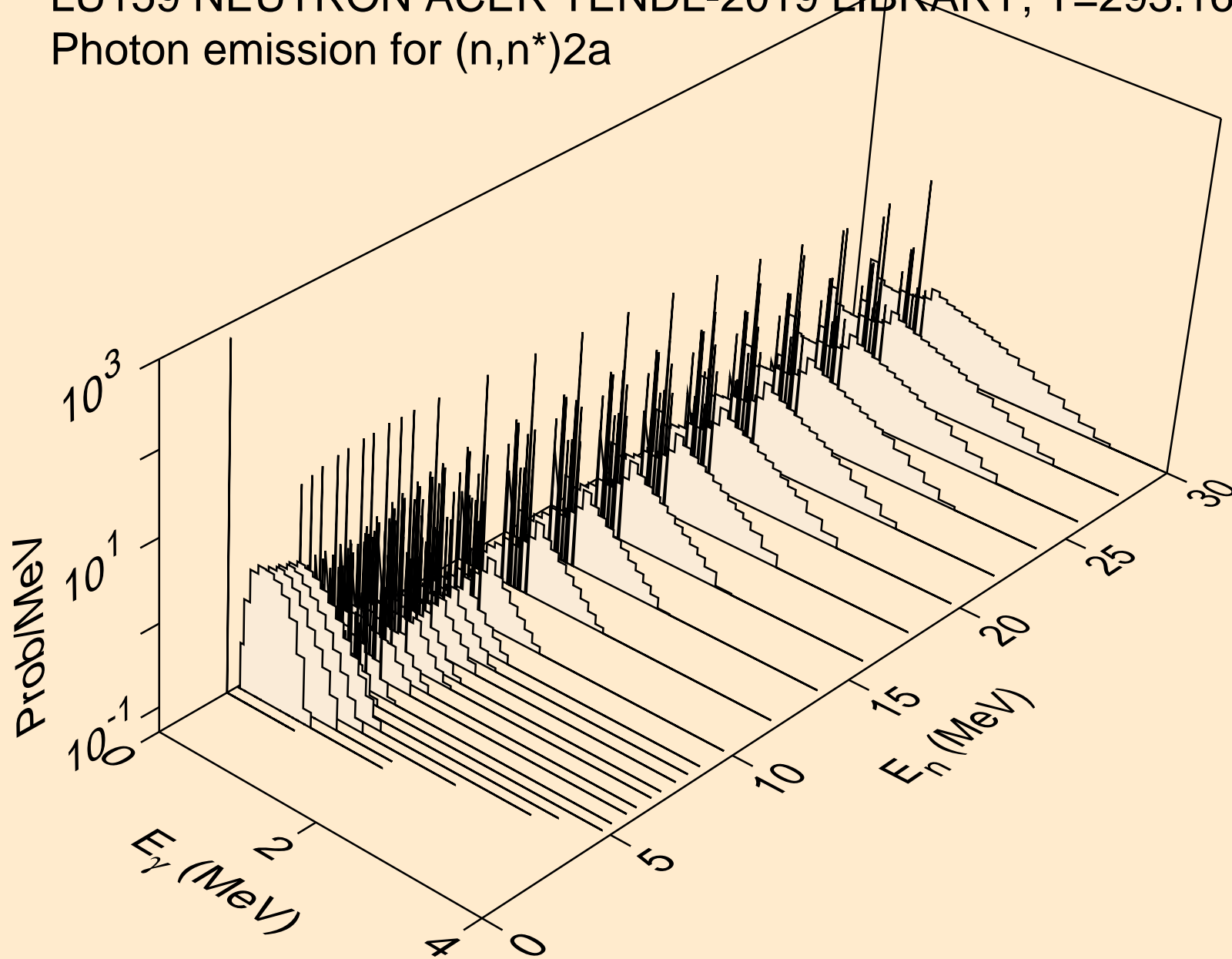

LU159 NEUTRON ACER TENDL-2019 LIBRARY; T=293.16K
Photon emission for (n,2n)2a

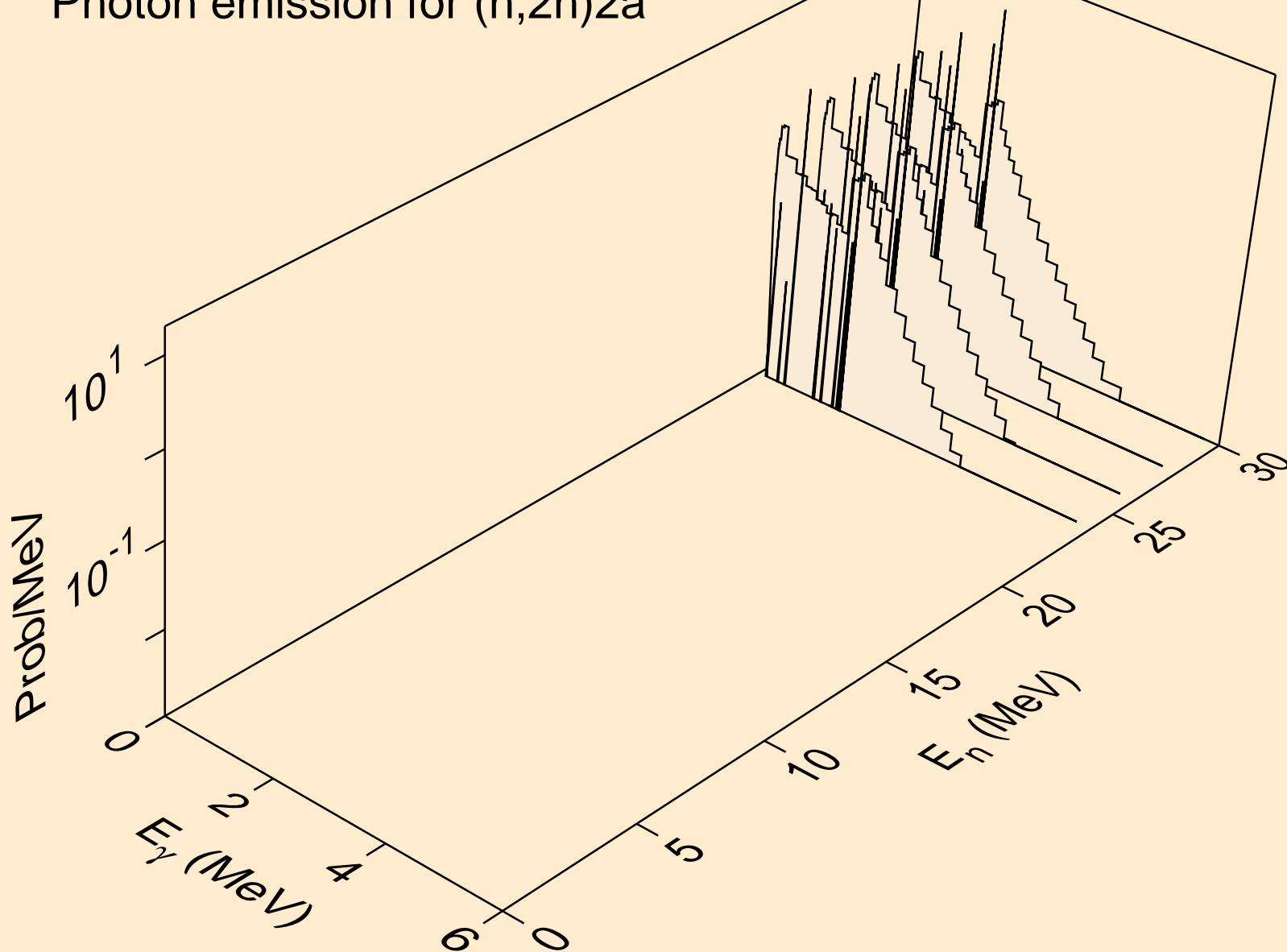

LU159 NEUTRON ACER TENDL-2019 LIBRARY; T=293.16K
Photon emission for (n,n*)d

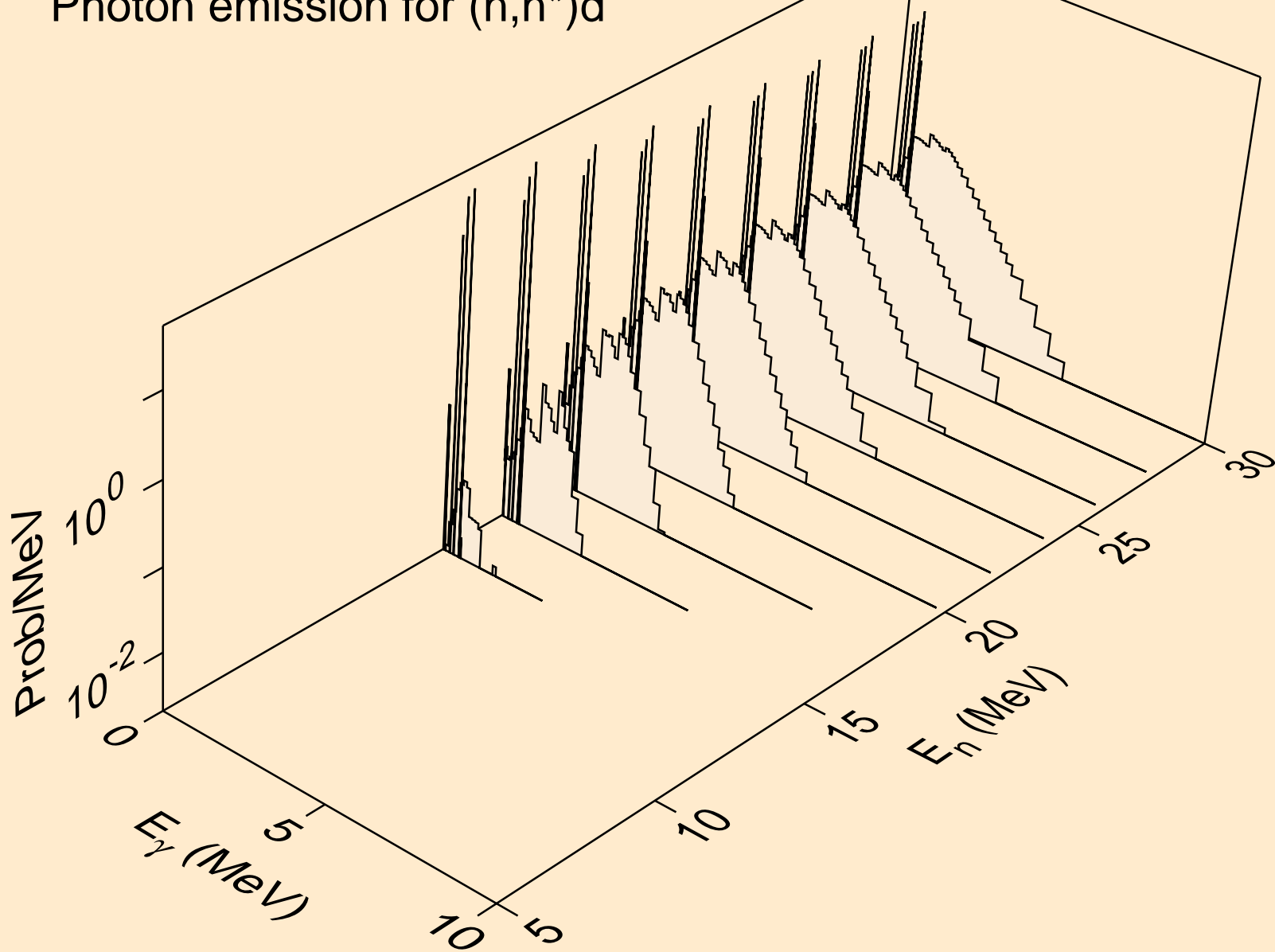

LU159 NEUTRON ACER TENDL-2019 LIBRARY; T=293.16K
Photon emission for (n,n*)t

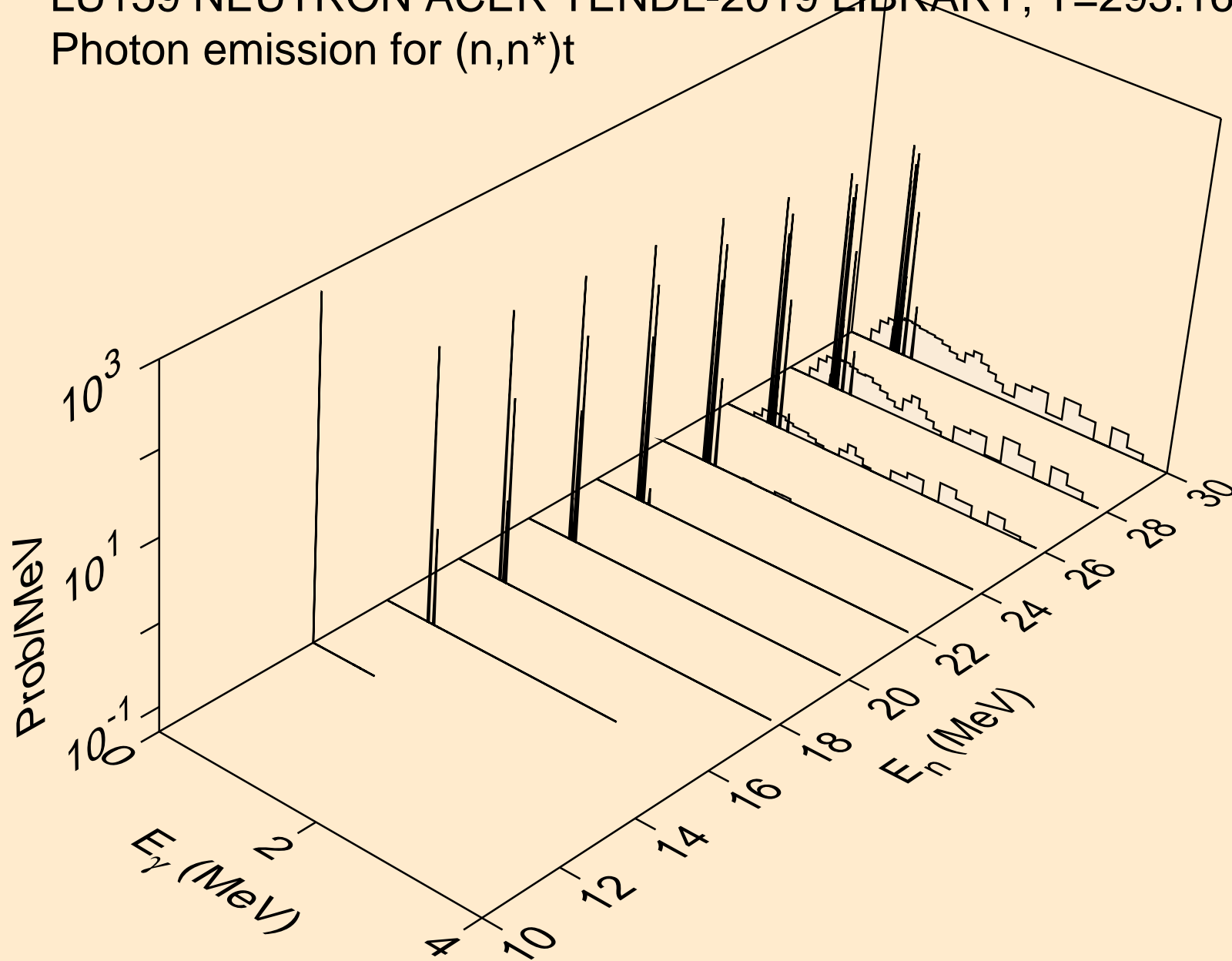

LU159 NEUTRON ACER TENDL-2019 LIBRARY; T=293.16K
Photon emission for (n,n*)he3

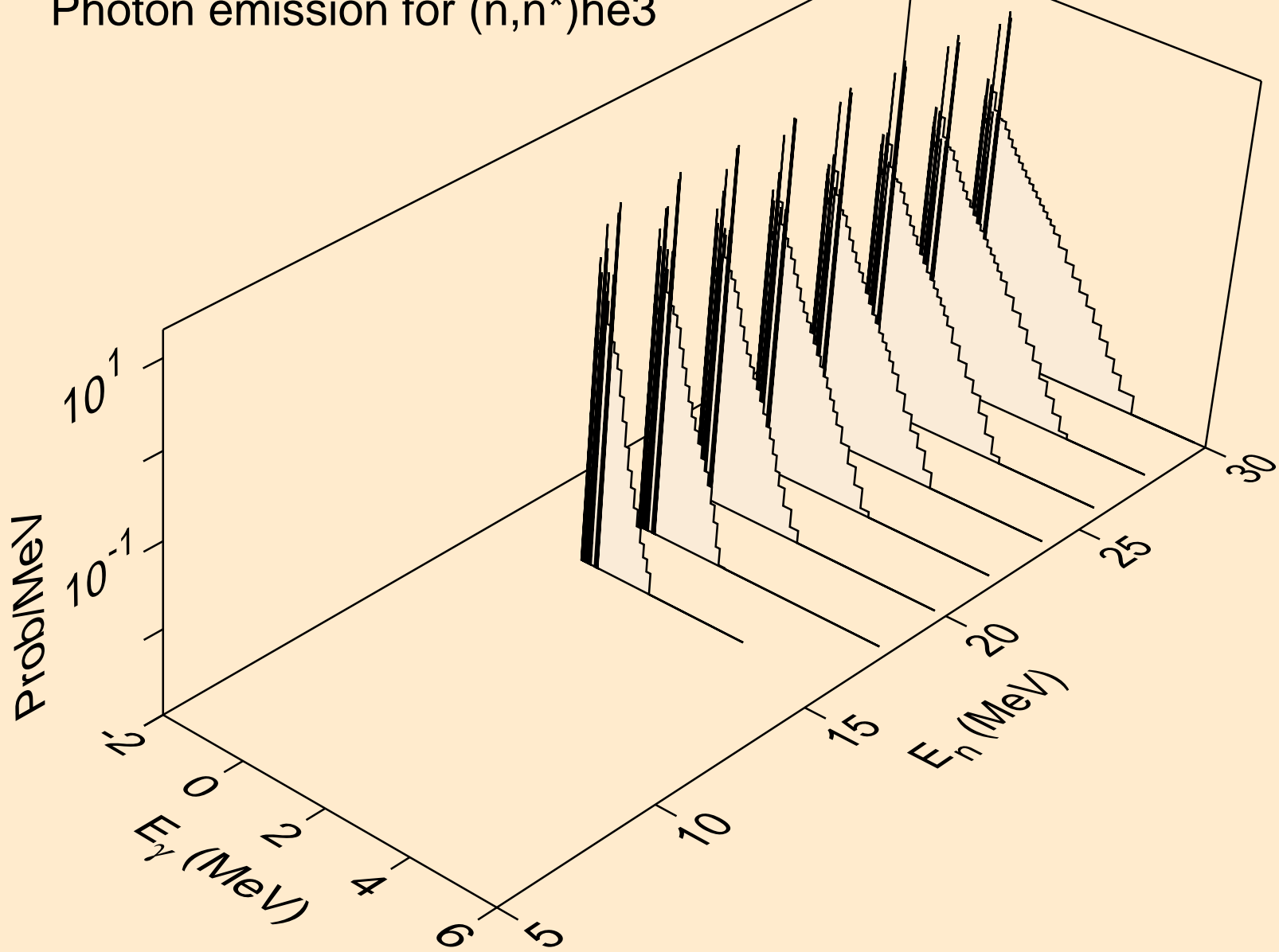

LU159 NEUTRON ACER TENDL-2019 LIBRARY; T=293.16K
Photon emission for (n,n*)d2a

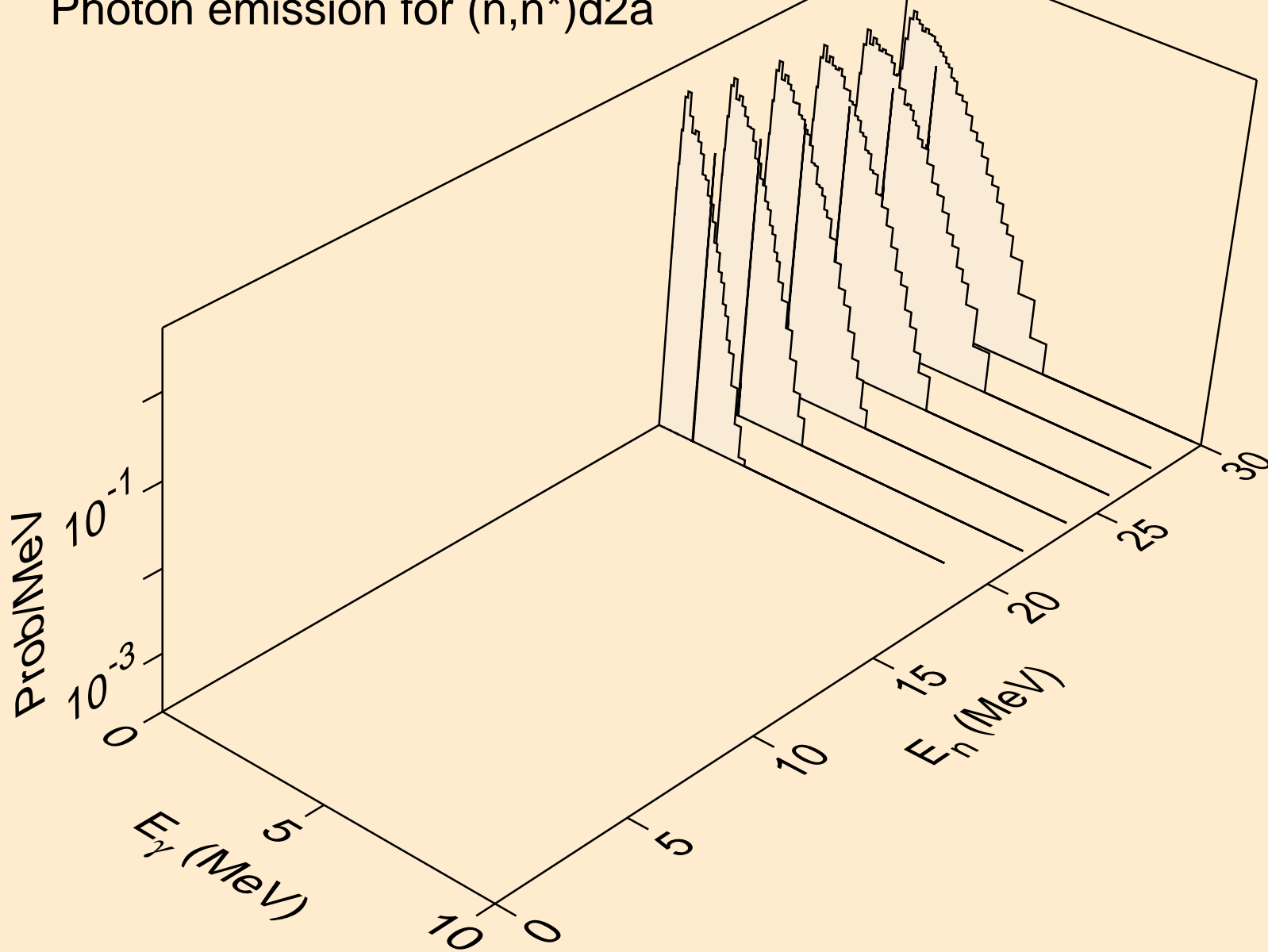

LU159 NEUTRON ACER TENDL-2019 LIBRARY; T=293.16K
Photon emission for (n,2np)

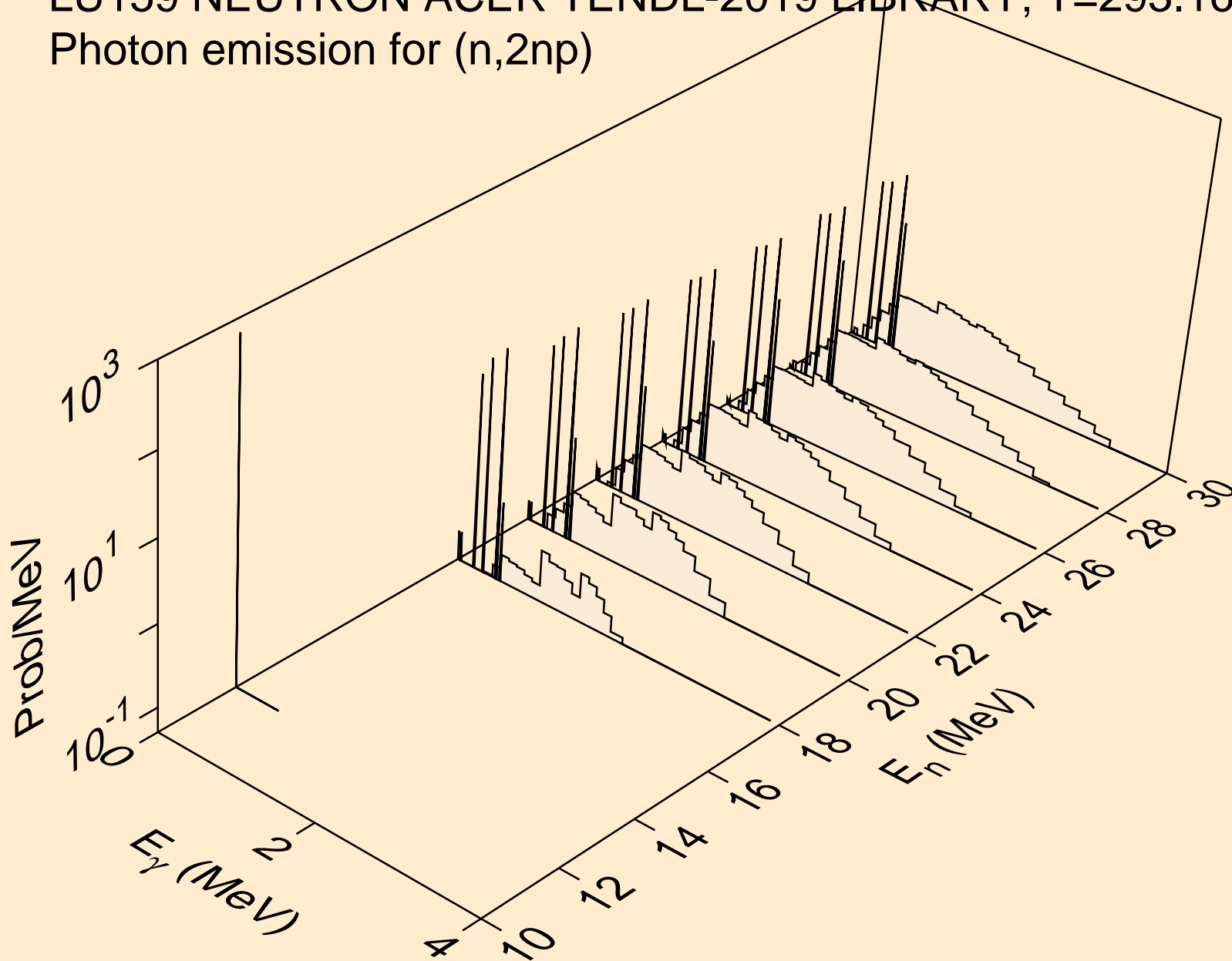

LU159 NEUTRON ACER TENDL-2019 LIBRARY; T=293.16K
Photon emission for (n,3np)

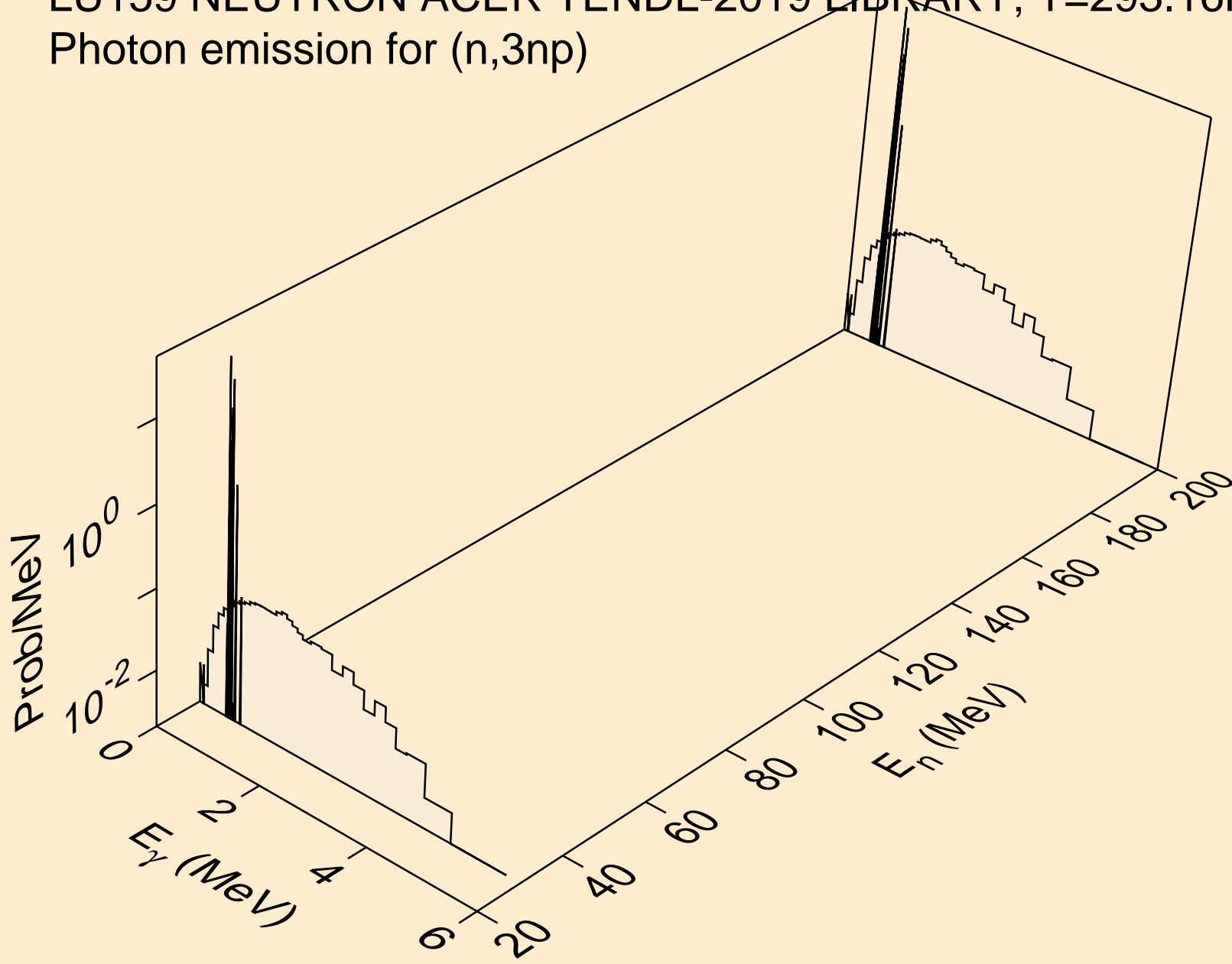

LU159 NEUTRON ACER TENDL-2019 LIBRARY; T=293.16K
Photon emission for (n,2np)

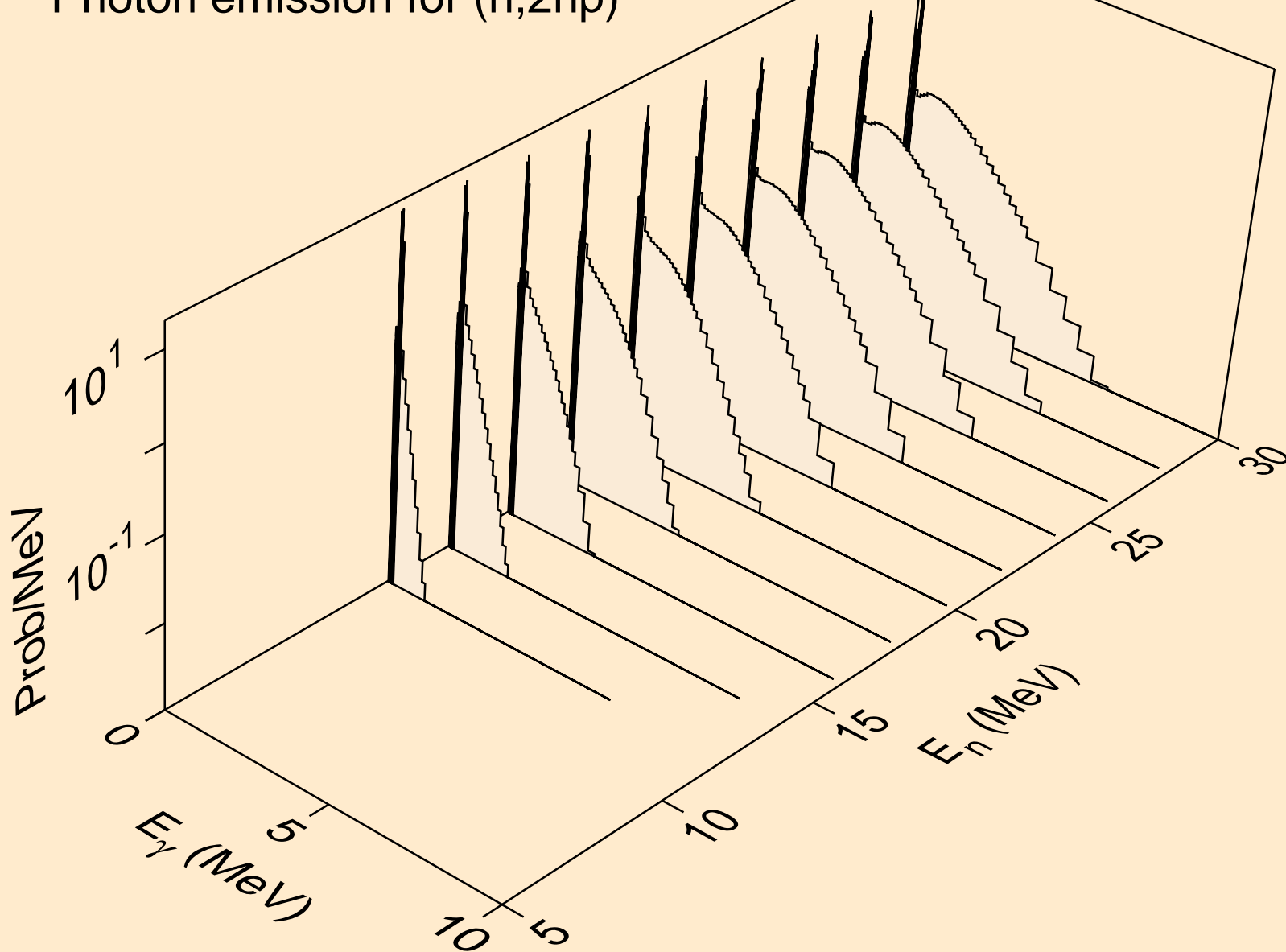

LU159 NEUTRON ACER TENDL-2019 LIBRARY; T=293.16K
Photon emission for (n,npa)

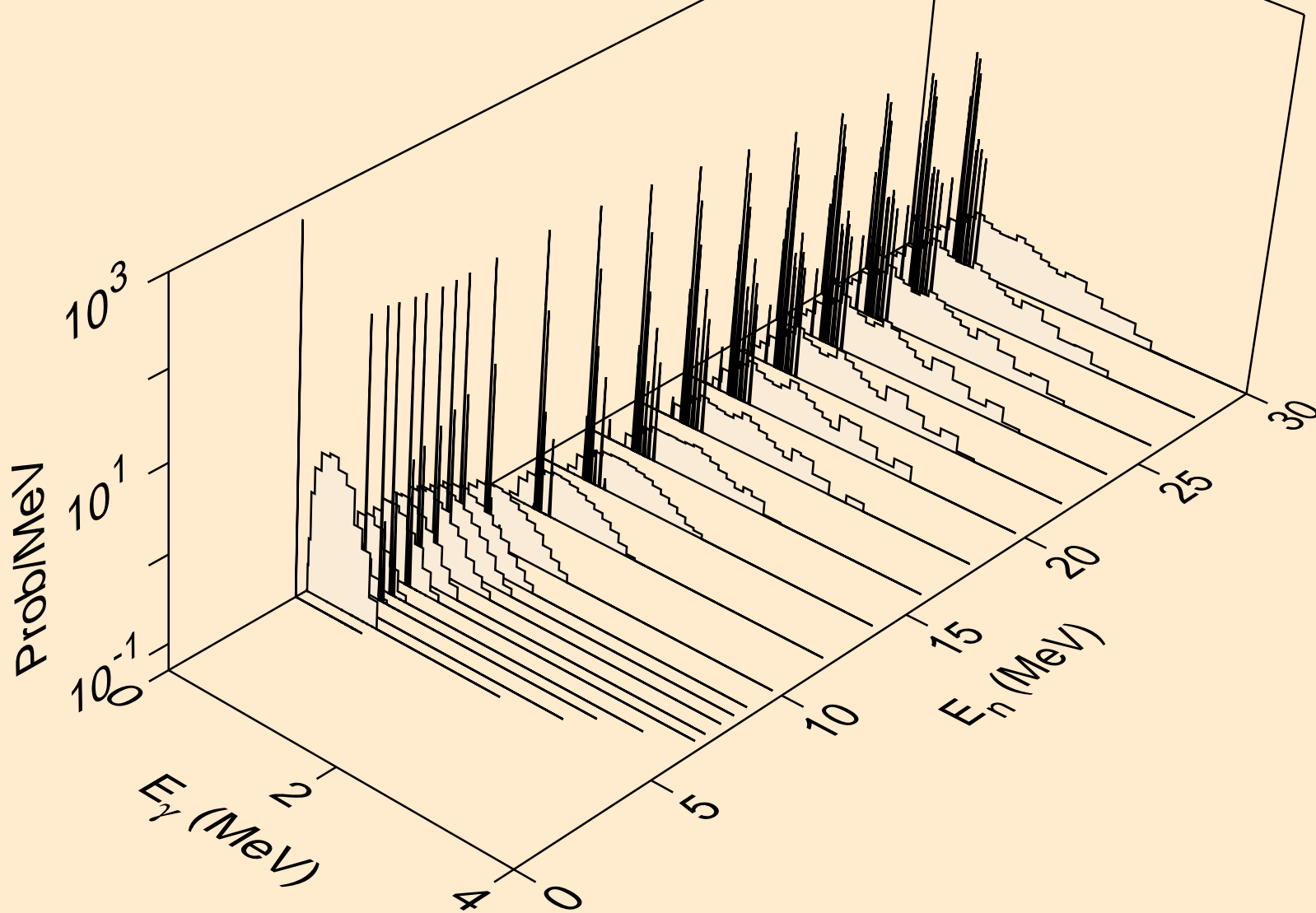

LU159 NEUTRON ACER TENDL-2019 LIBRARY; T=293.16K
Photon emission for (n,n*c)

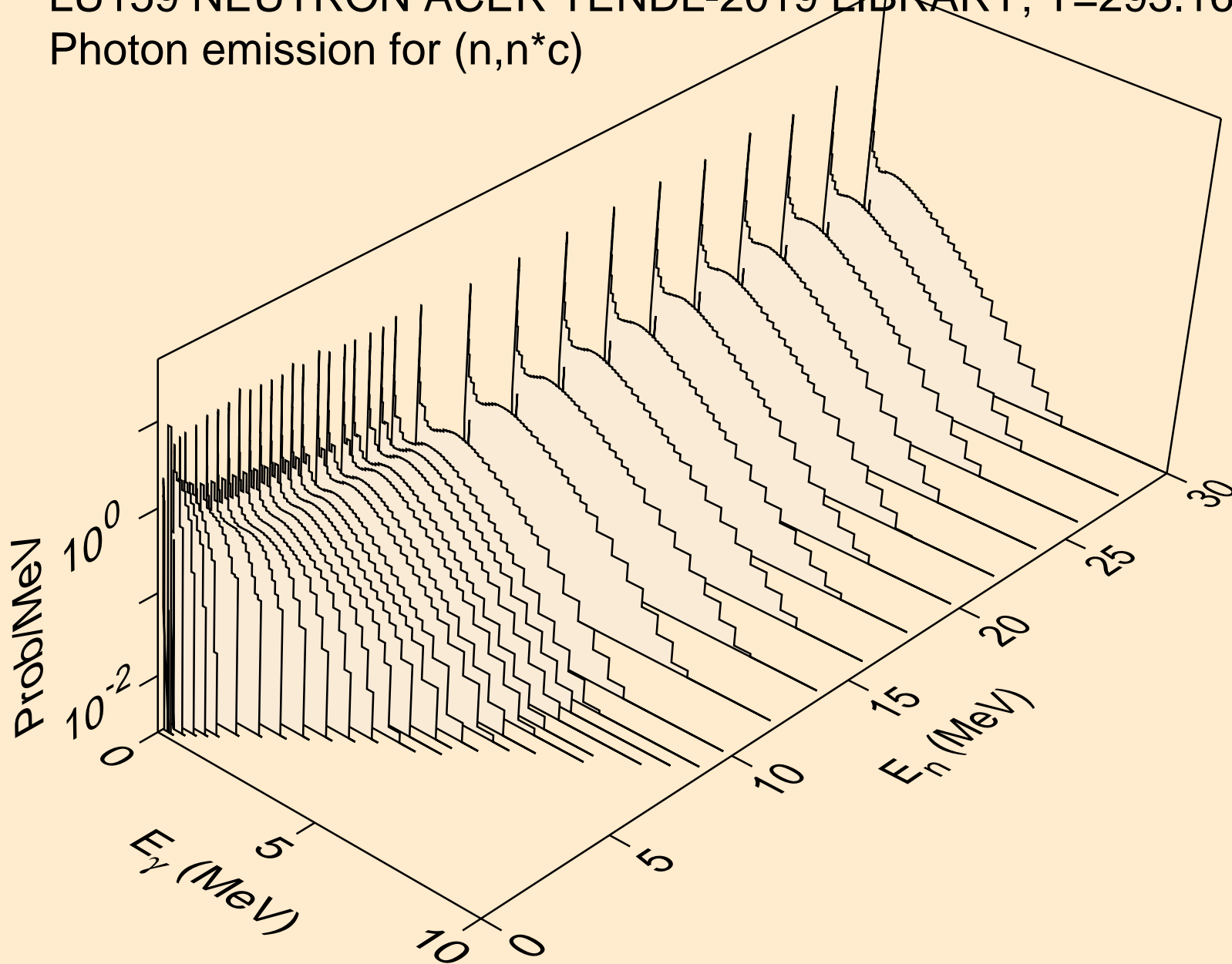

LU159 NEUTRON ACER TENDL-2019 LIBRARY; T=293.16K
Photon emission for (n,gma)

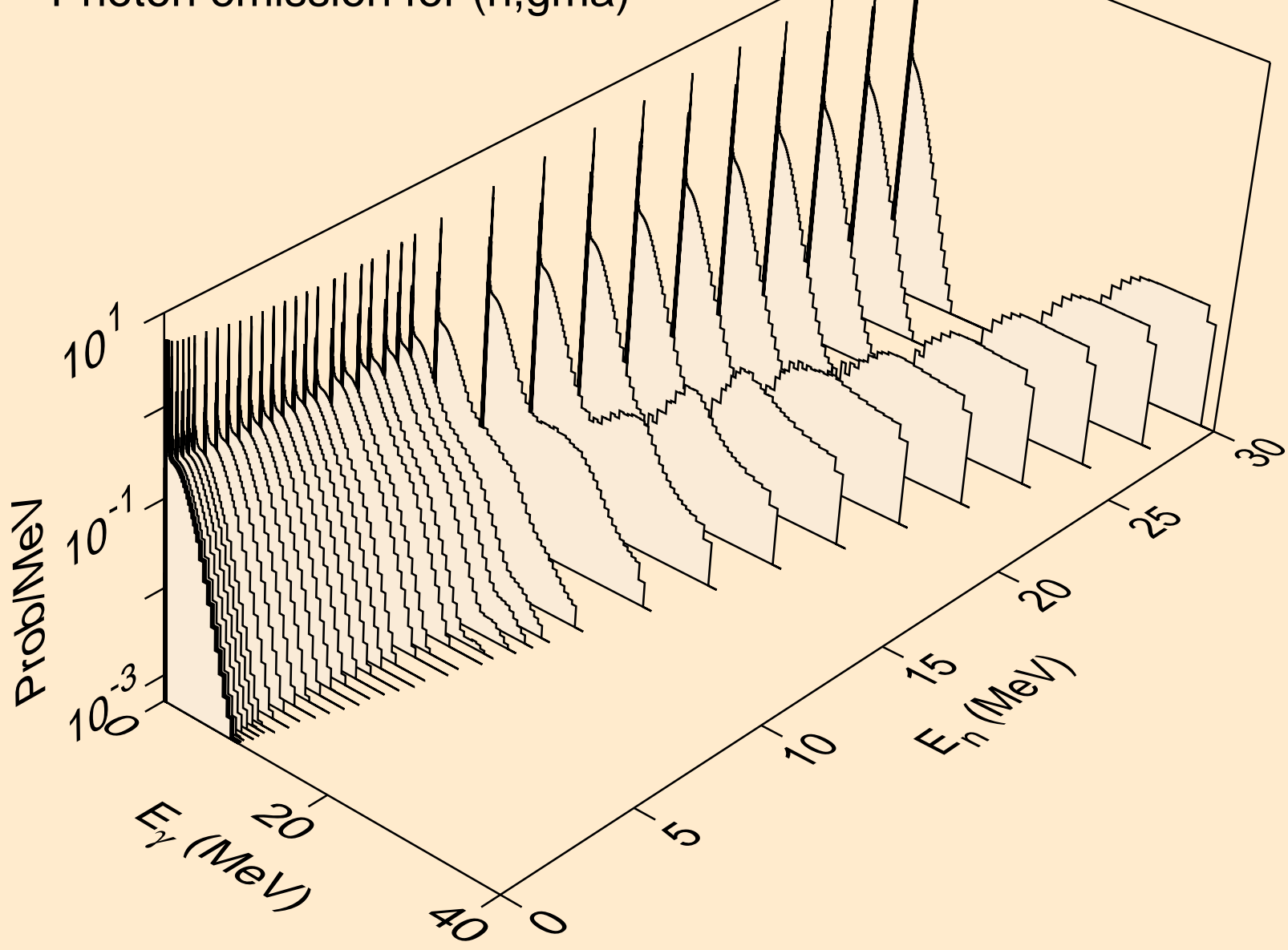

LU159 NEUTRON ACER TENDL-2019 LIBRARY; T=293.16K
Photon emission for (n,p)

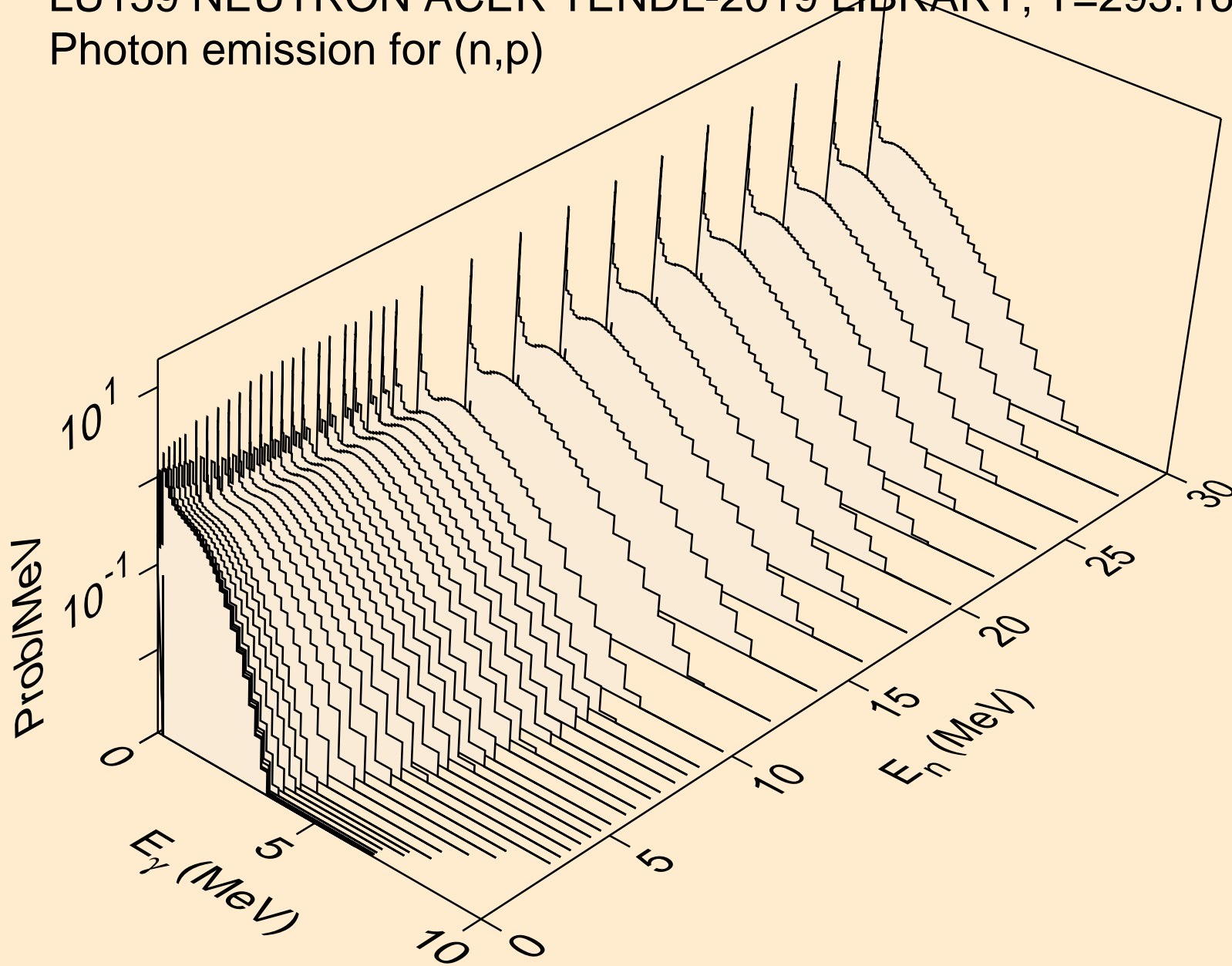

LU159 NEUTRON ACER TENDL-2019 LIBRARY; T=293.16K
Photon emission for (n,d)

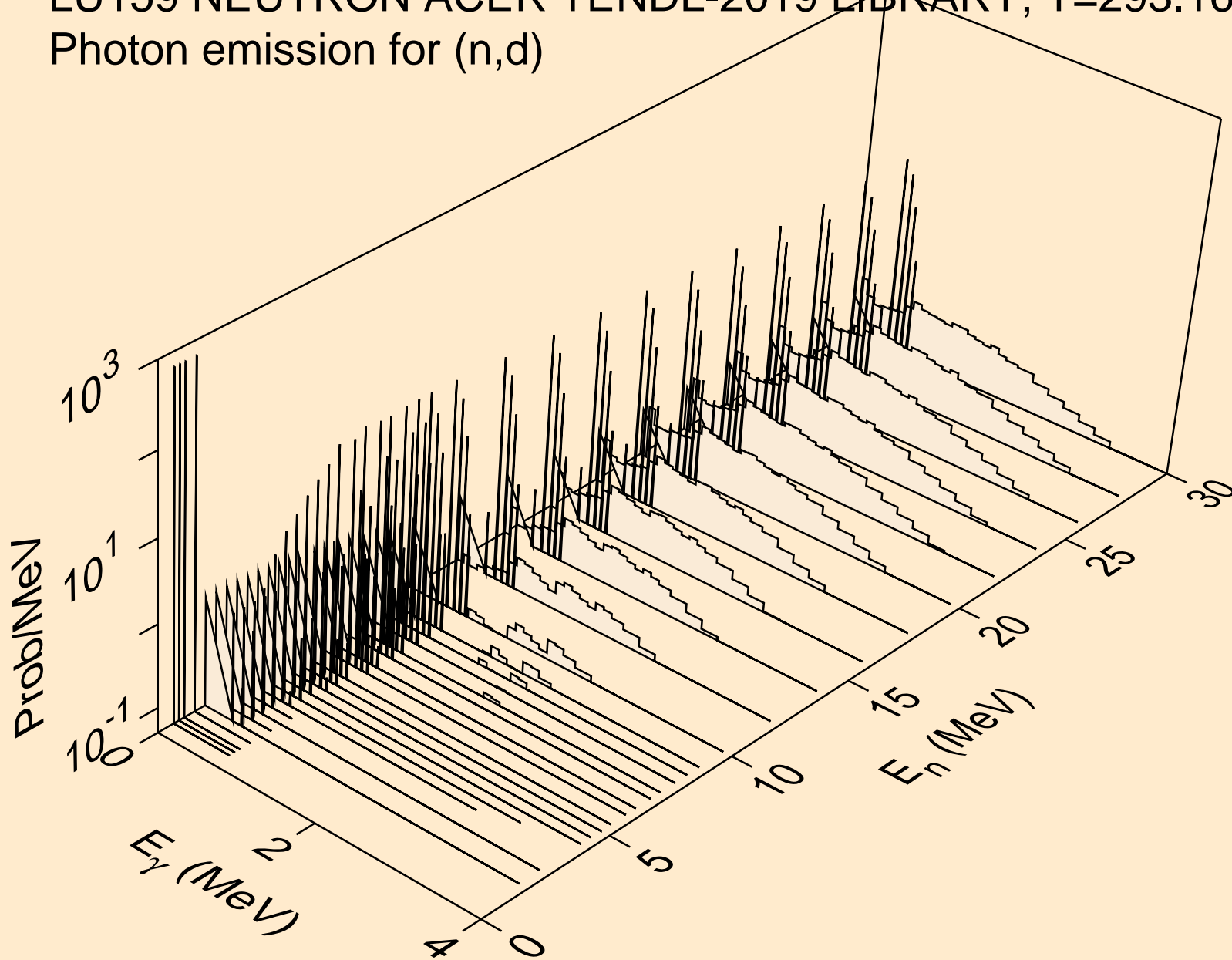

LU159 NEUTRON ACER TENDL-2019 LIBRARY; T=293.16K
Photon emission for (n,t)

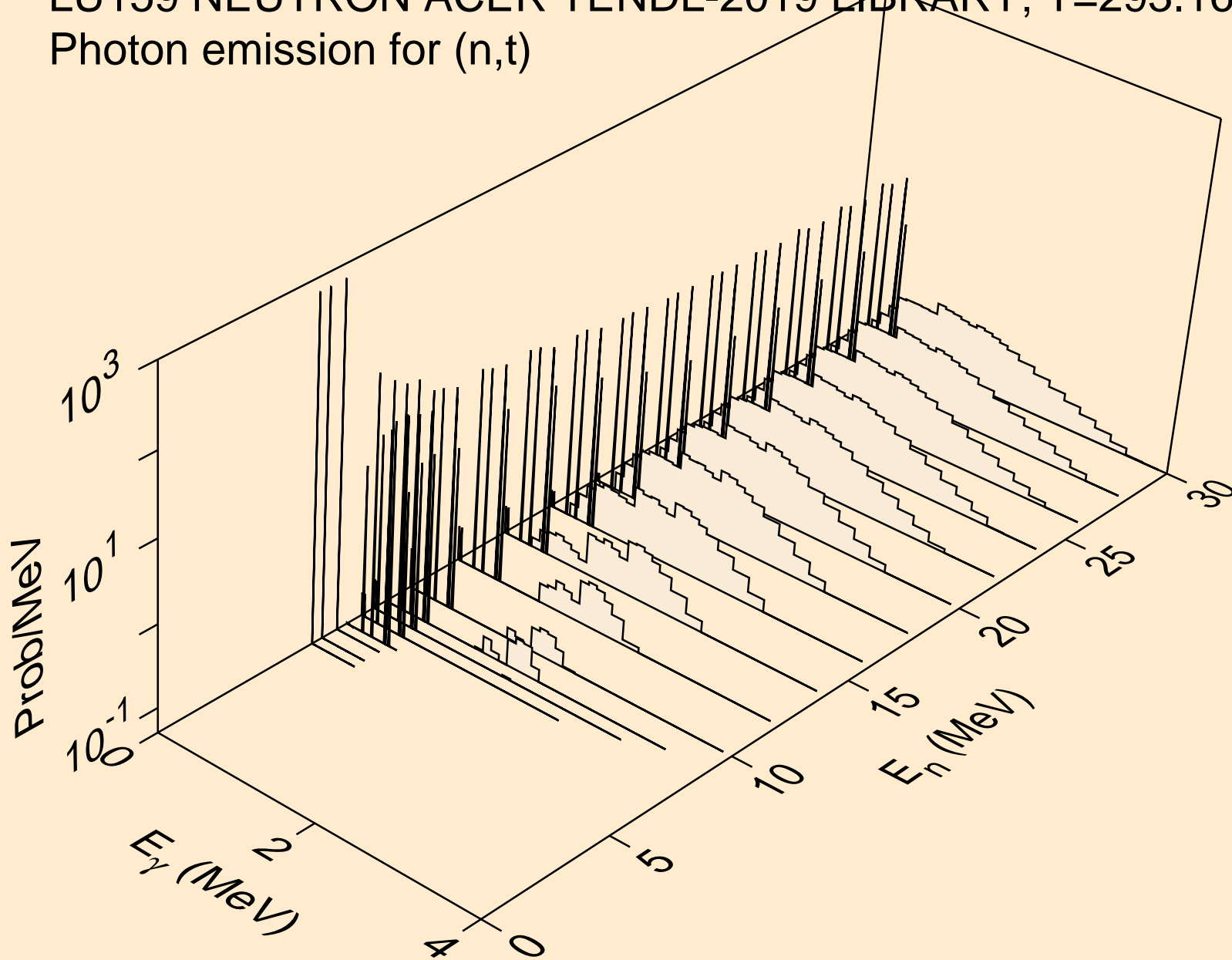

LU159 NEUTRON ACER TENDL-2019 LIBRARY; T=293.16K
Photon emission for (n,he3)

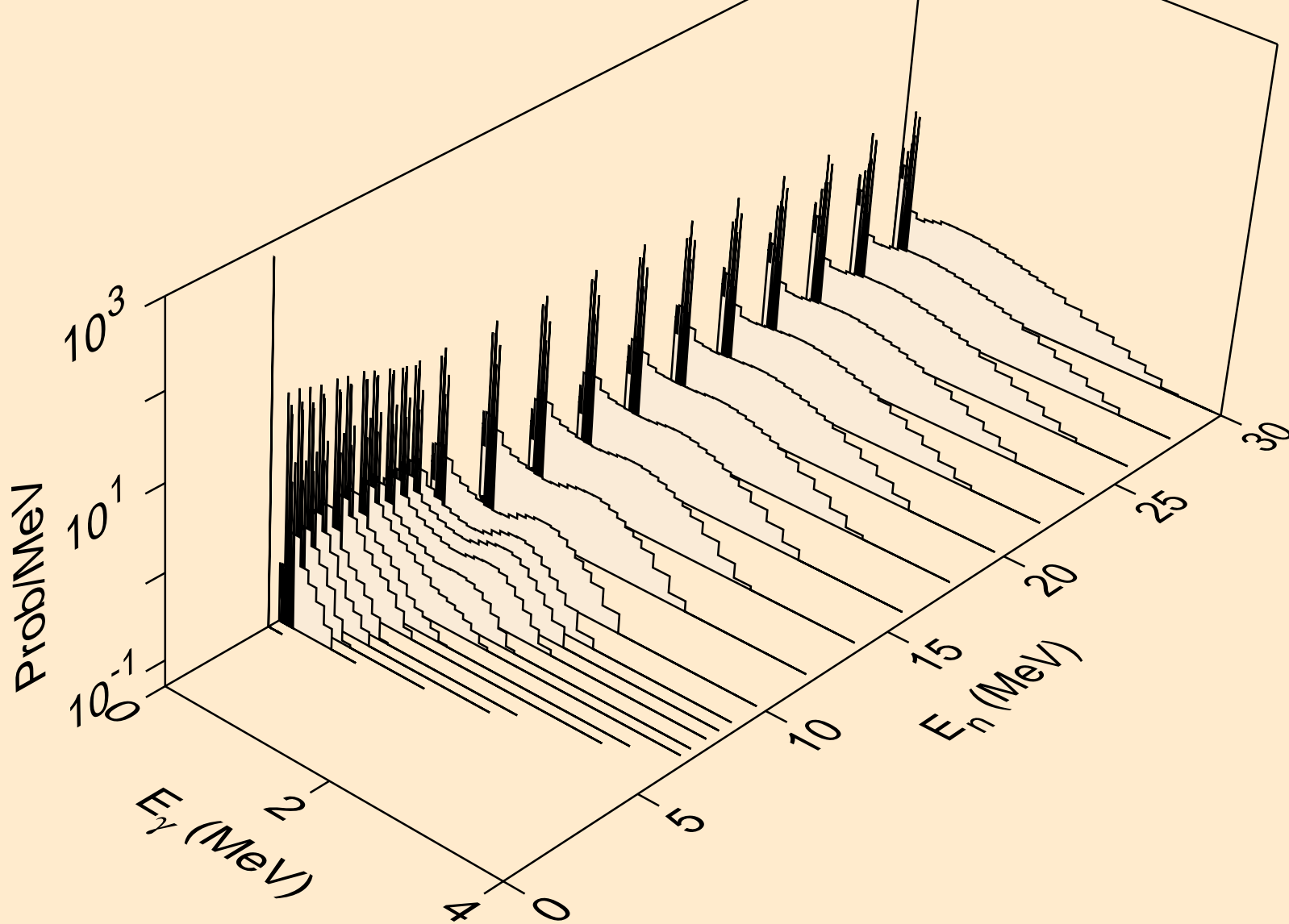

LU159 NEUTRON ACER TENDL-2019 LIBRARY; T=293.16K
Photon emission for (n,a)

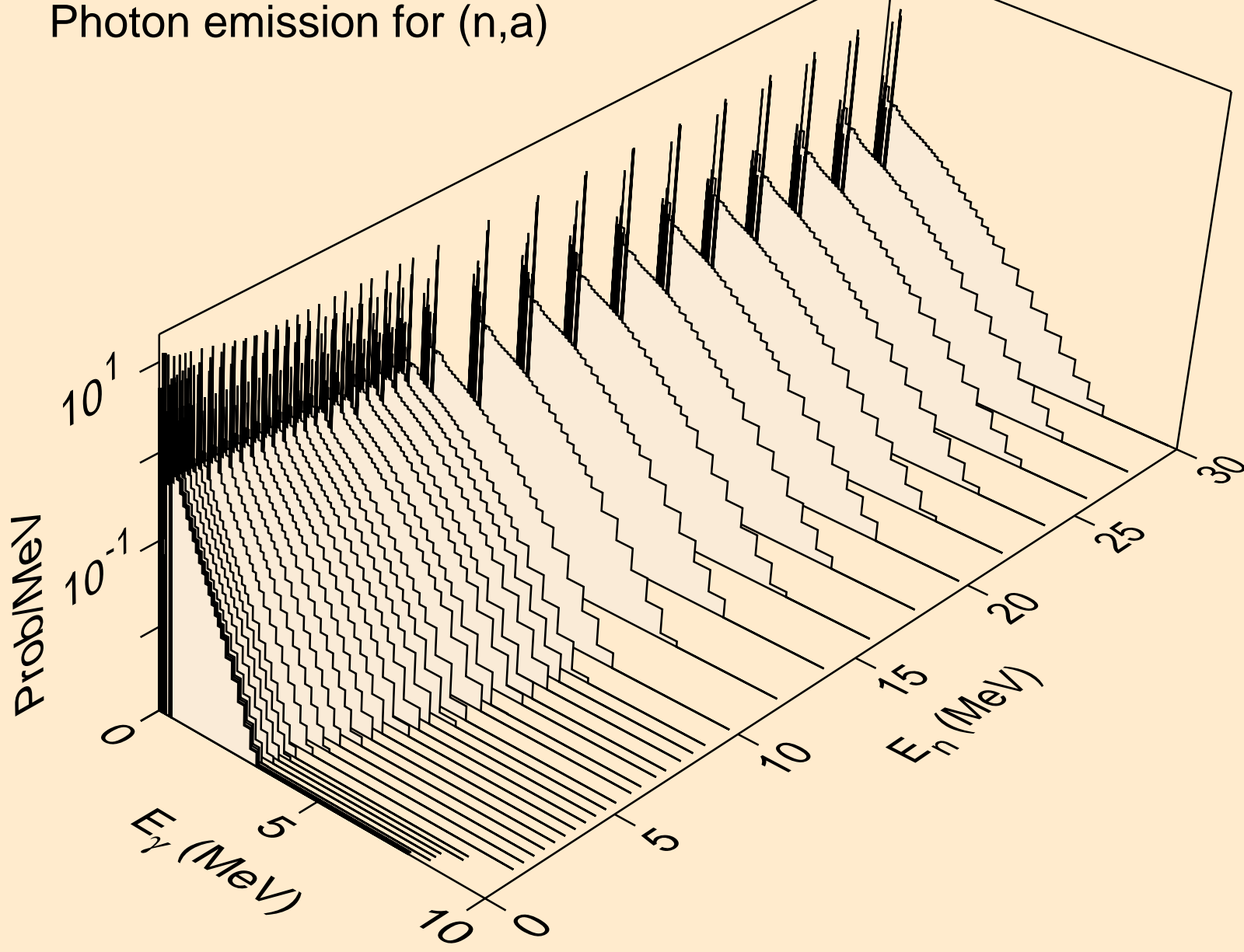

LU159 NEUTRON ACER TENDL-2019 LIBRARY; T=293.16K
Photon emission for (n,2a)

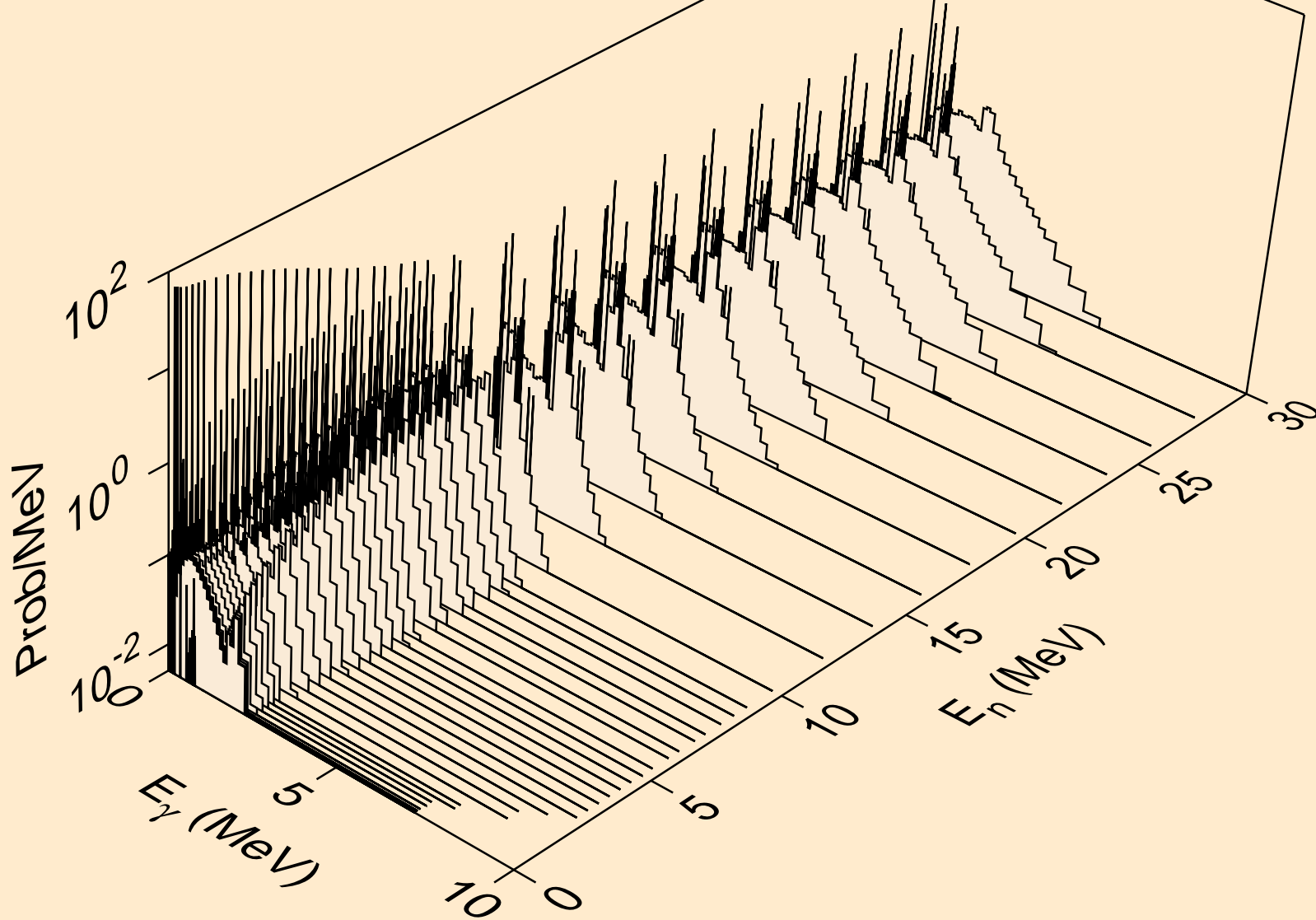

LU159 NEUTRON ACER TENDL-2019 LIBRARY; T=293.16K
Photon emission for (n,3a)

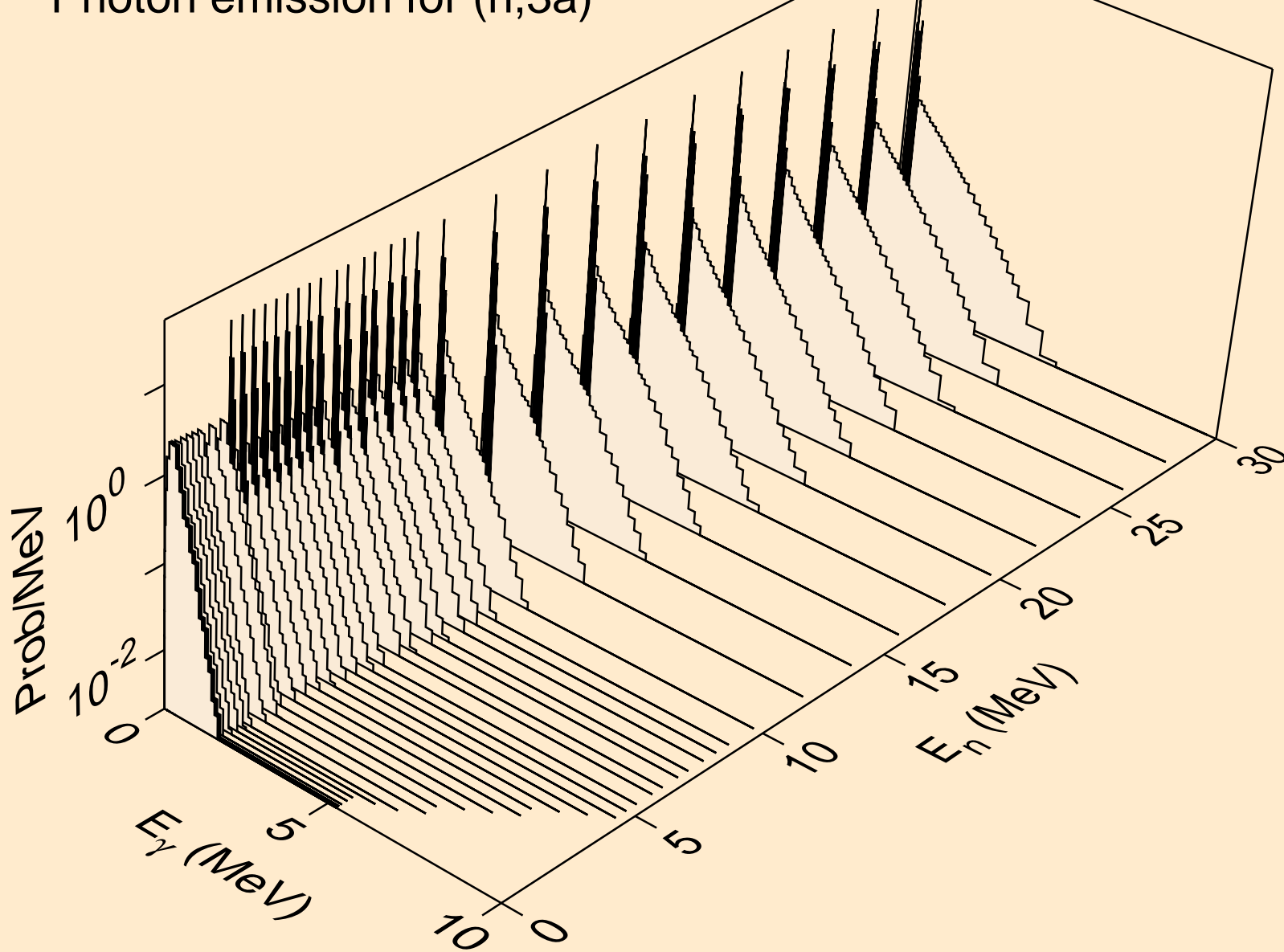

LU159 NEUTRON ACER TENDL-2019 LIBRARY; T=293.16K
Photon emission for (n,2p)

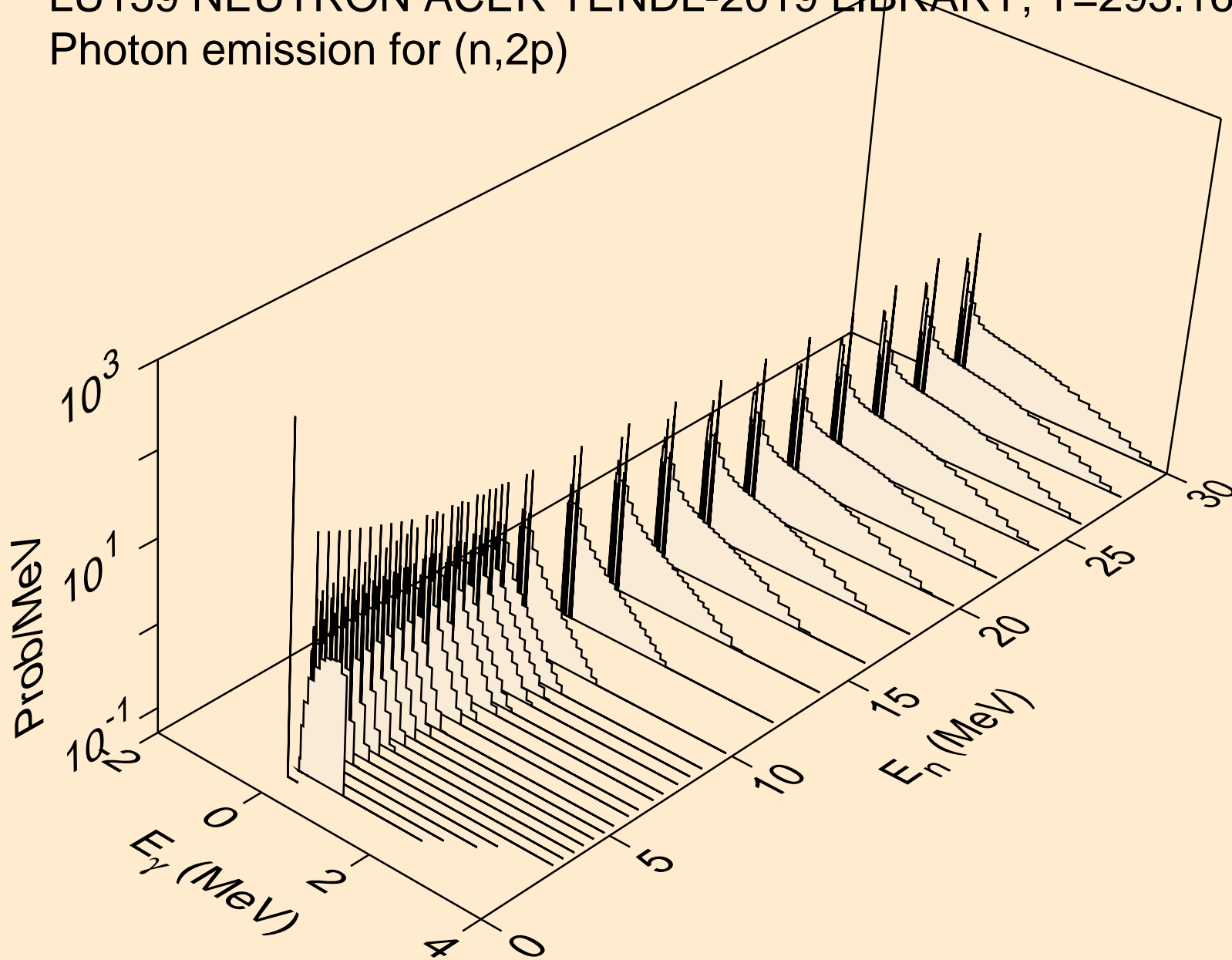

LU159 NEUTRON ACER TENDL-2019 LIBRARY; T=293.16K
Photon emission for (n,p α)

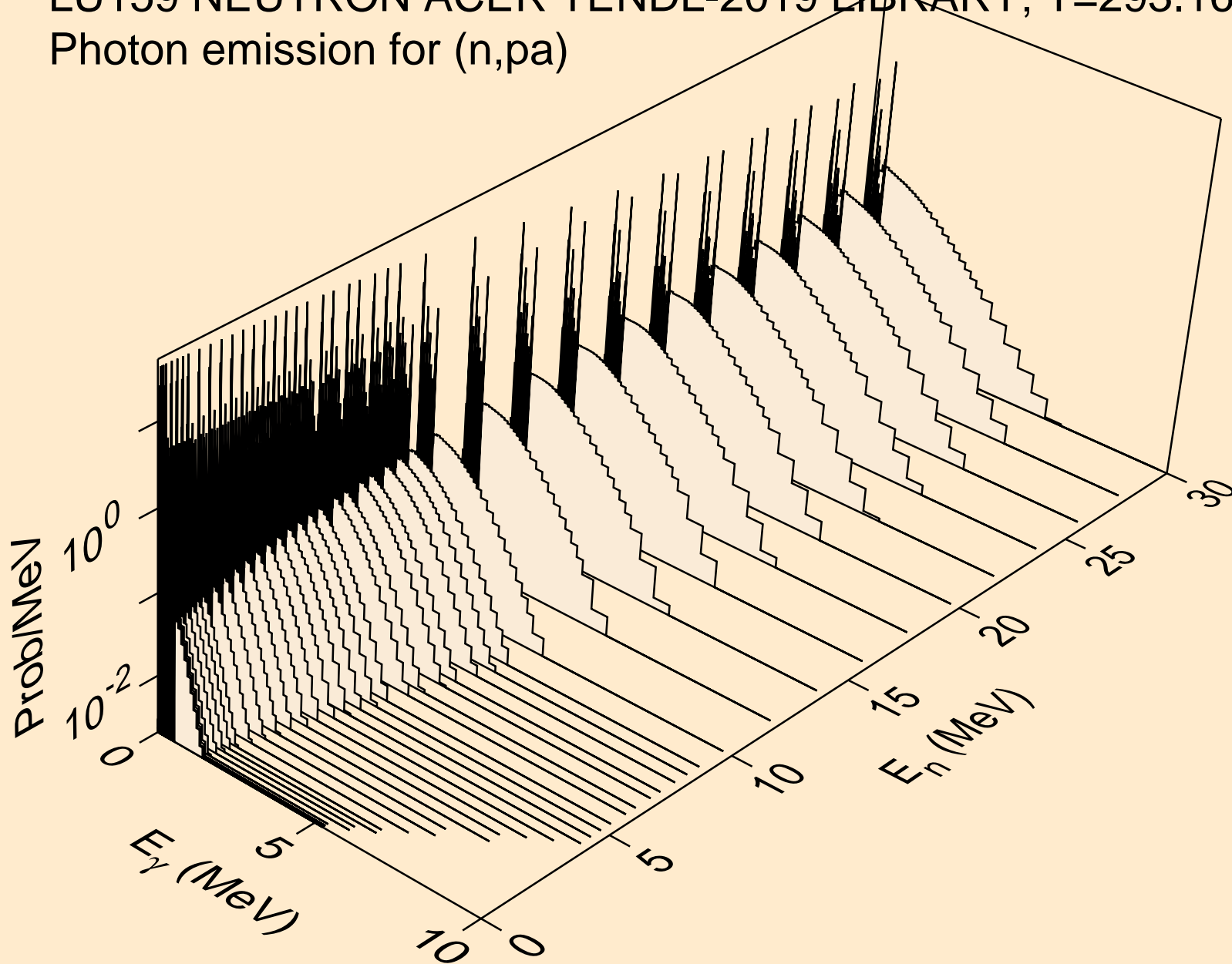

LU159 NEUTRON ACER TENDL-2019 LIBRARY; T=293.16K
Photon emission for (n,t2a)

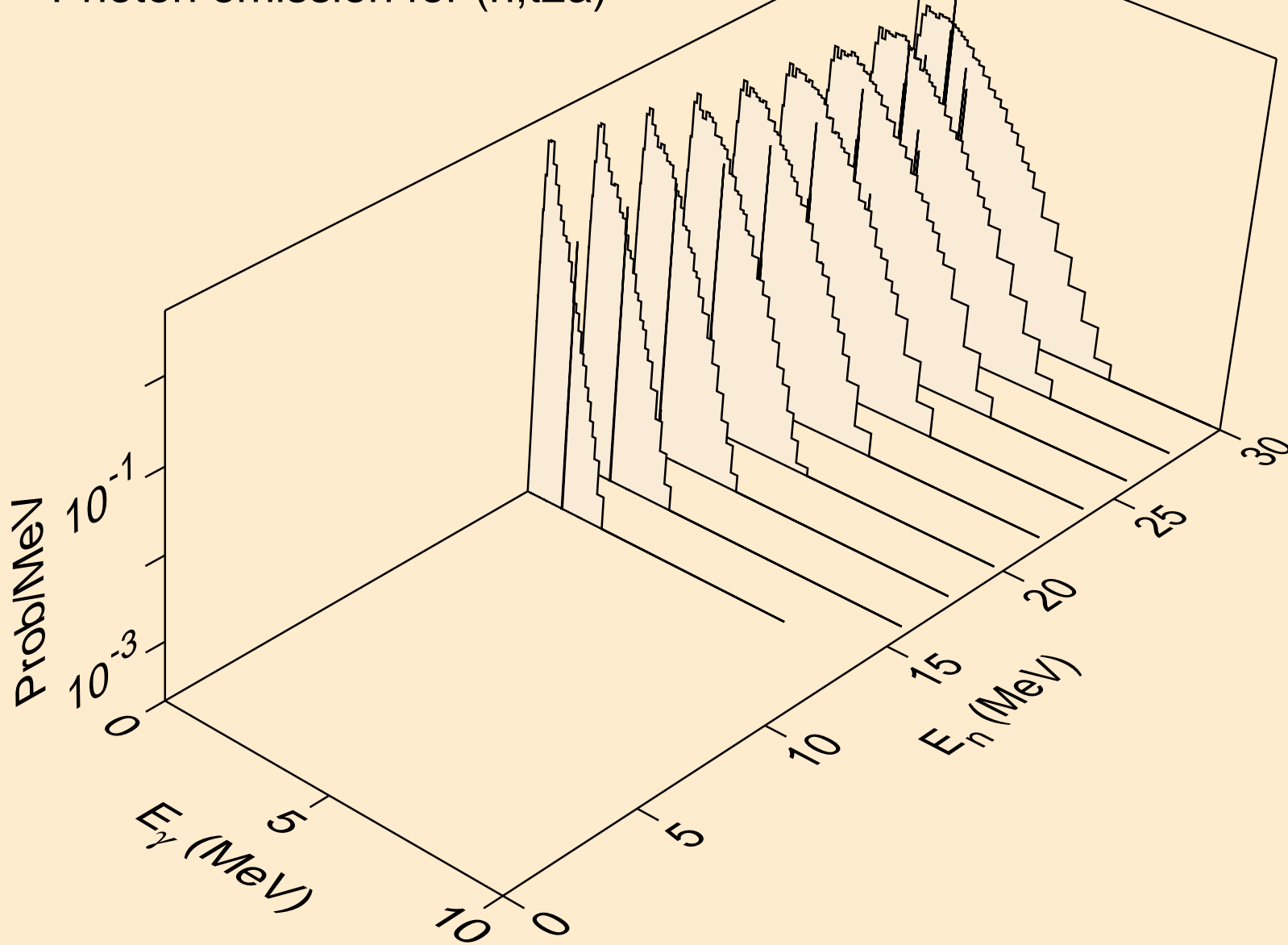

LU159 NEUTRON ACER TENDL-2019 LIBRARY; T=293.16K
Photon emission for (n,d2a)

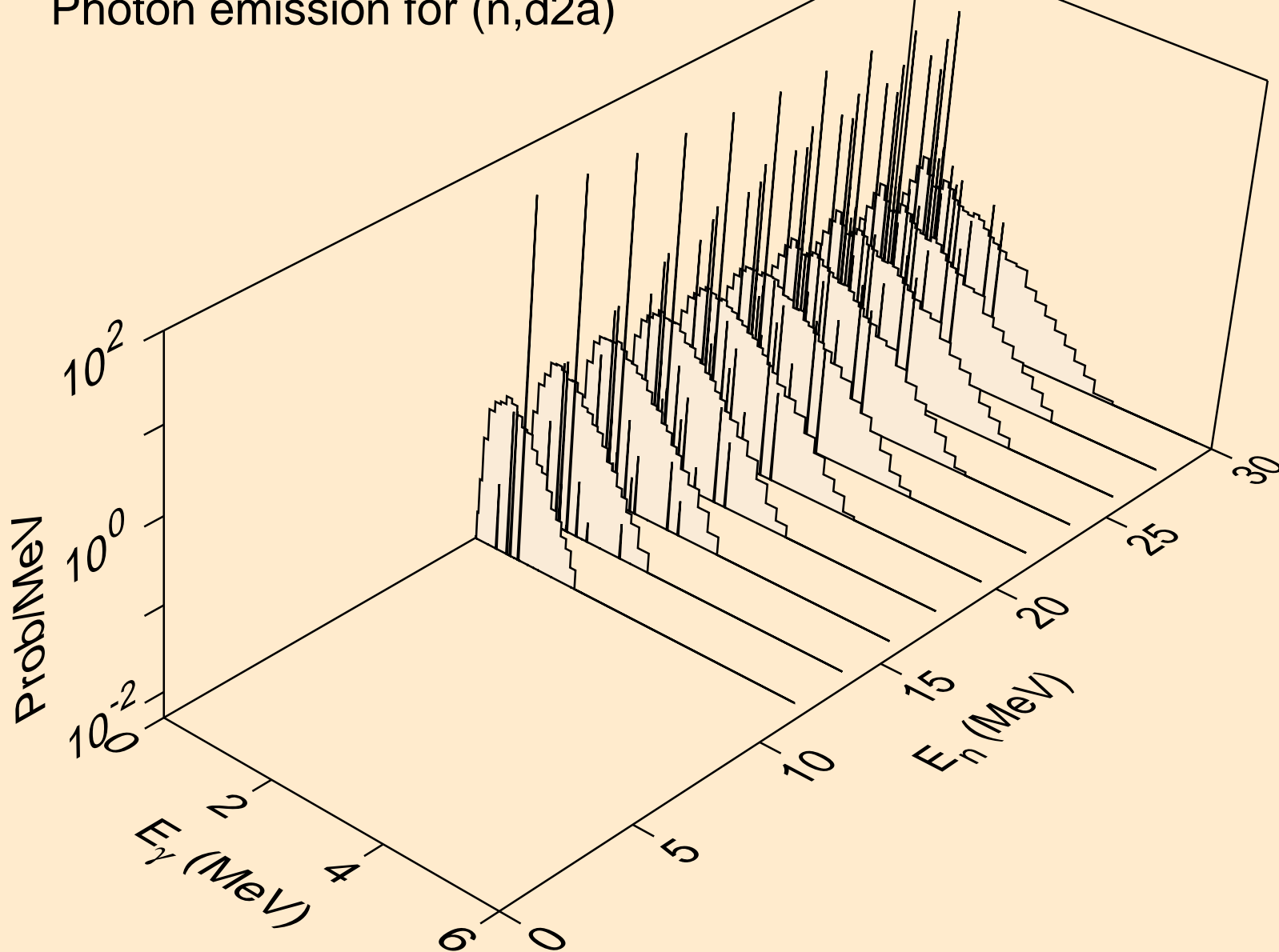

LU159 NEUTRON ACER TENDL-2019 LIBRARY; T=293.16K
Photon emission for (n,pd)

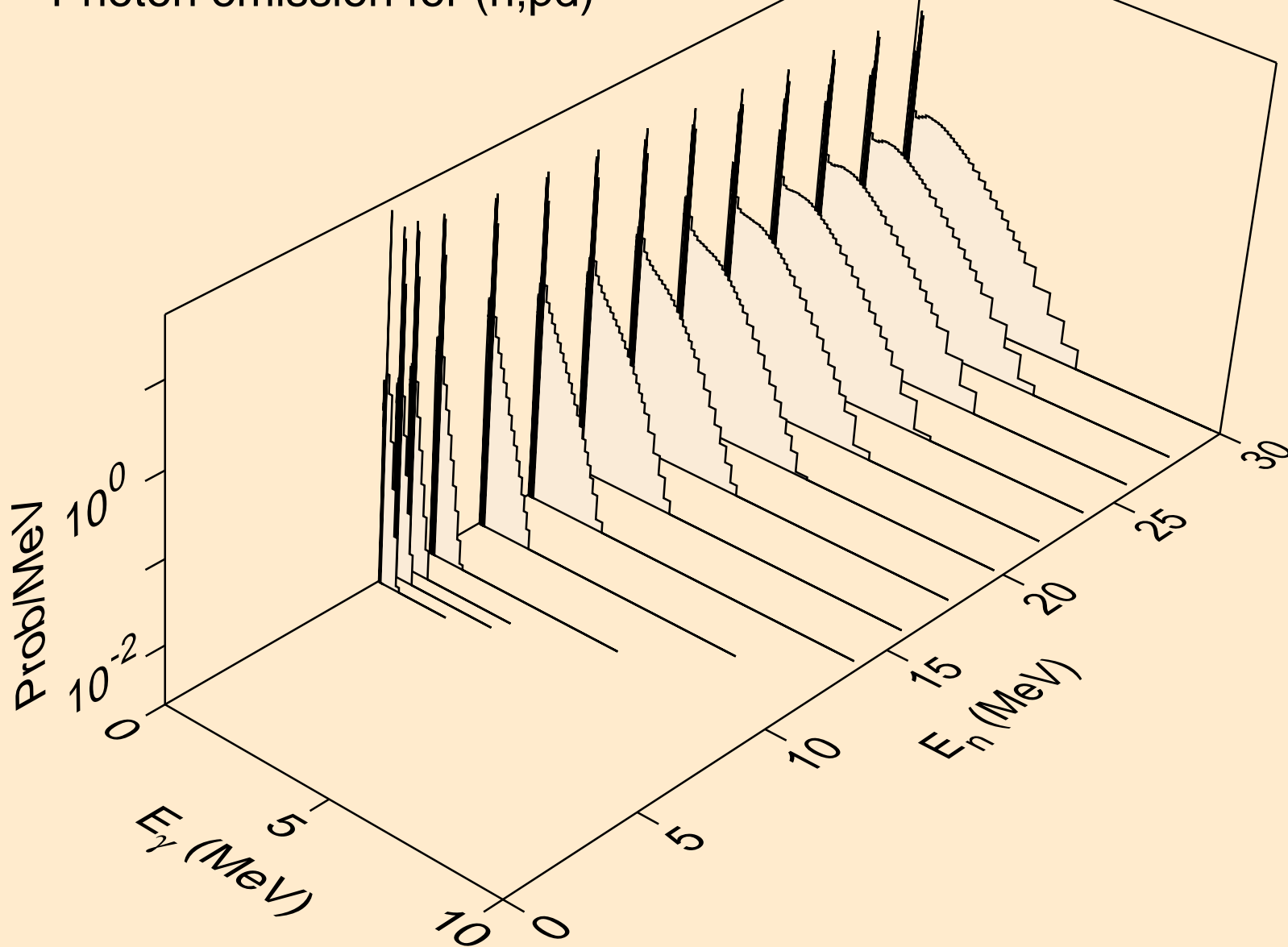

LU159 NEUTRON ACER TENDL-2019 LIBRARY; T=293.16K
Photon emission for (n,pt)

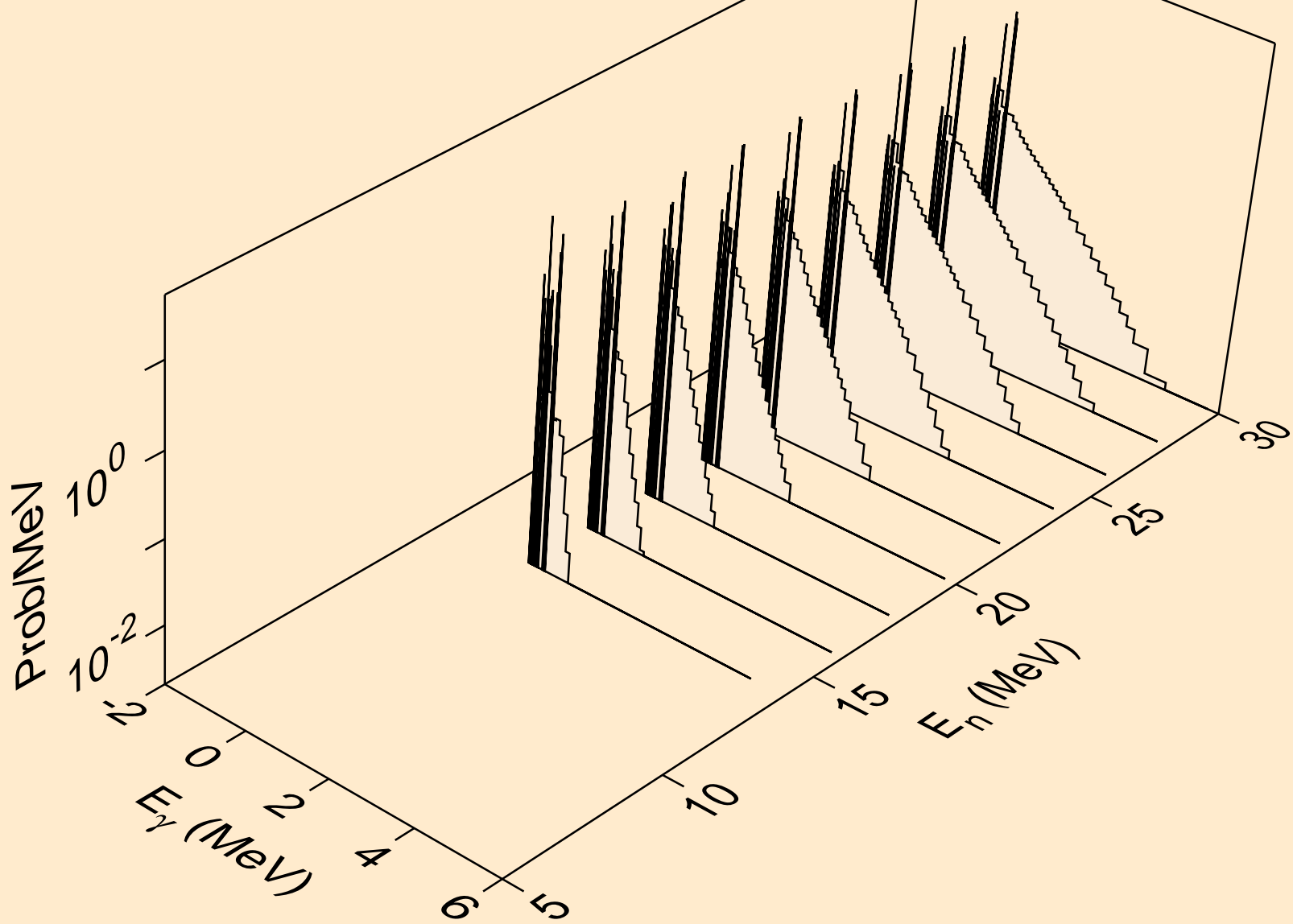

LU159 NEUTRON ACER TENDL-2019 LIBRARY; T=293.16K
Photon emission for (n,da)

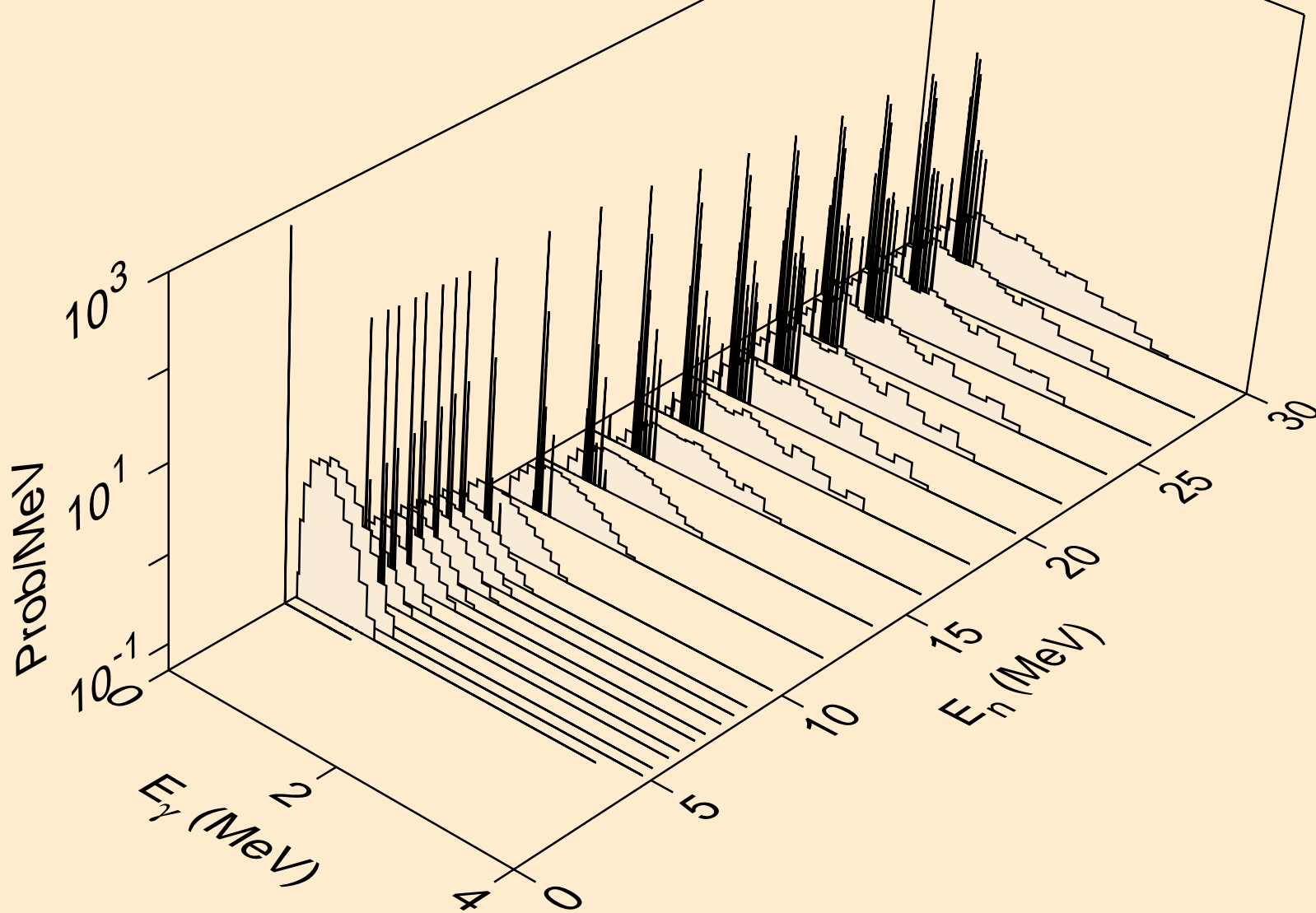

LU159 NEUTRON ACER TENDL-2019 LIBRARY; T=293.16K
thermal capture photon spectrum

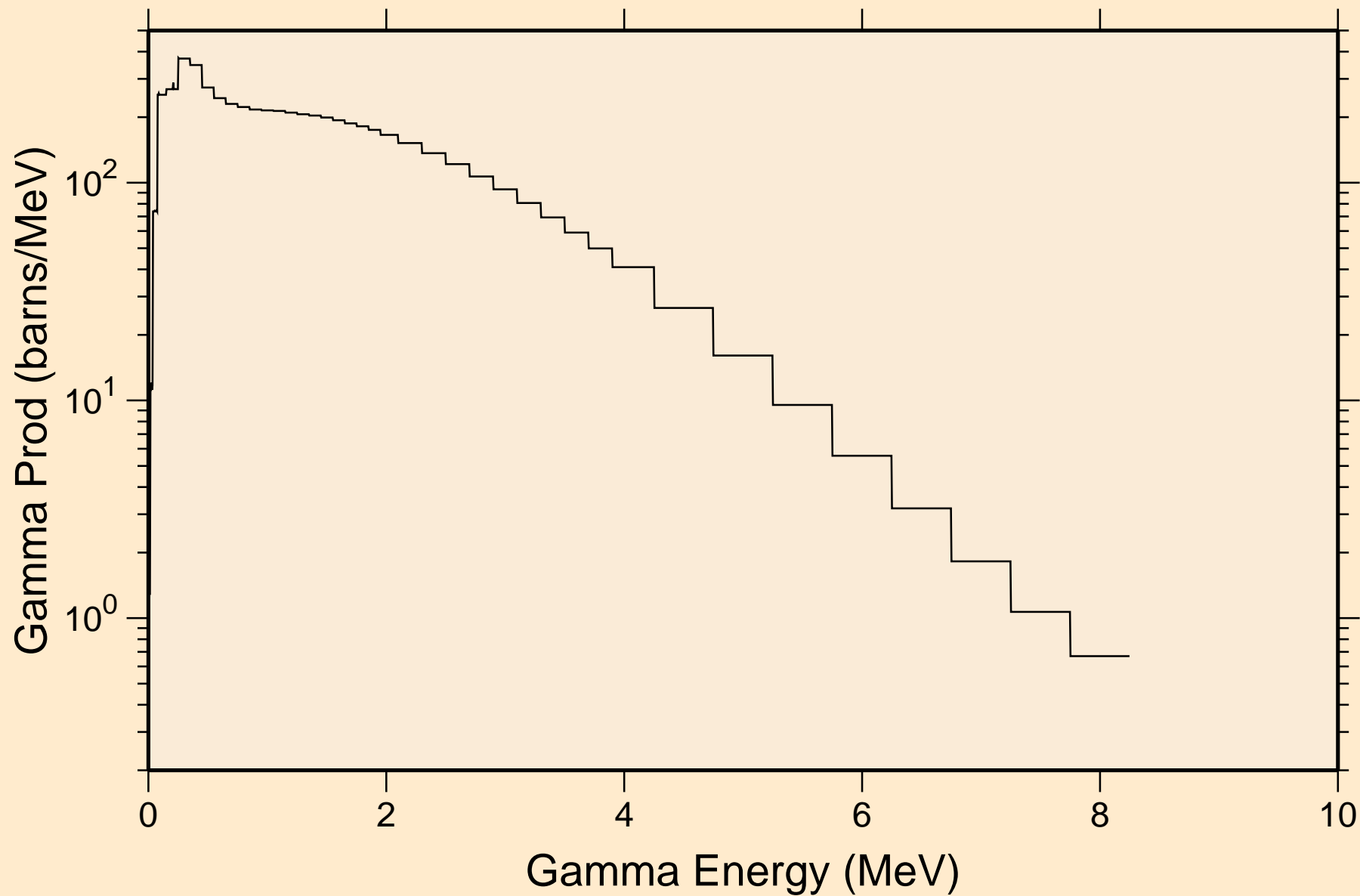

LU159 NEUTRON ACER TENDL-2019 LIBRARY; T=293.16K
14 MeV photon spectrum

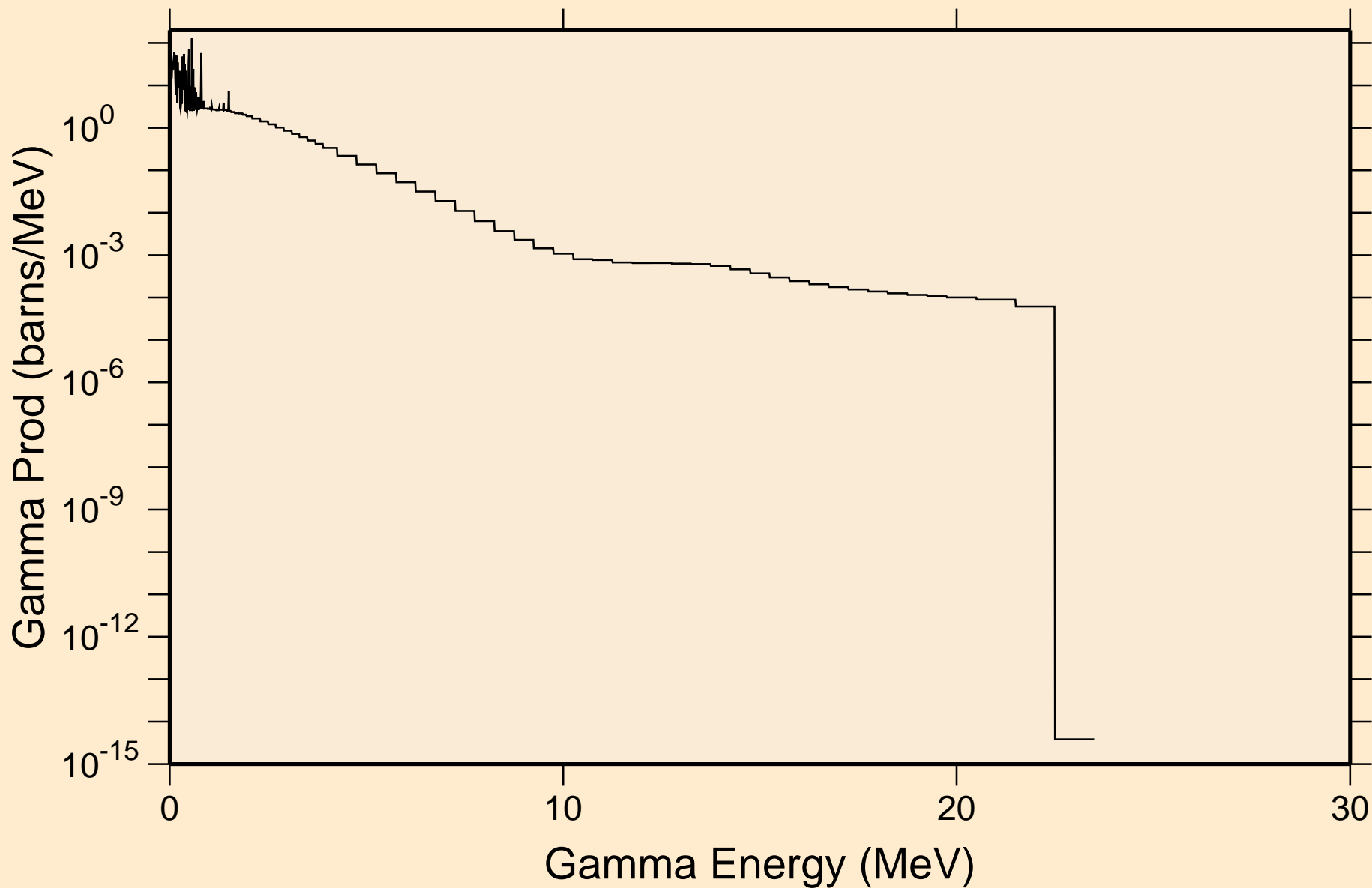

LU159 NEUTRON ACER TENDL-2019 LIBRARY; T=293.16K

Particle heating contributions

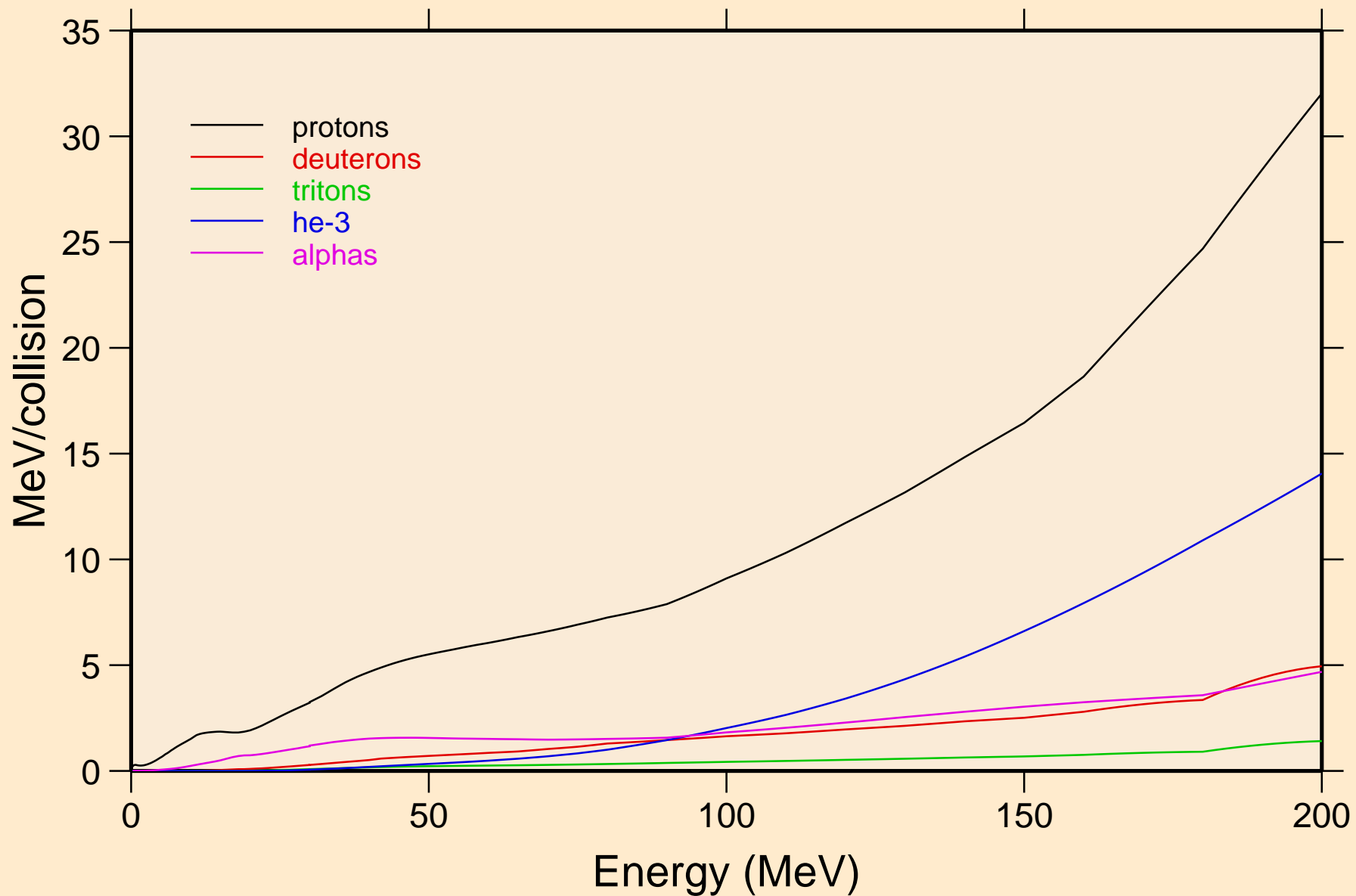

LU159 NEUTRON ACER TENDL-2019 LIBRARY; T=293.16K
Recoil Heating

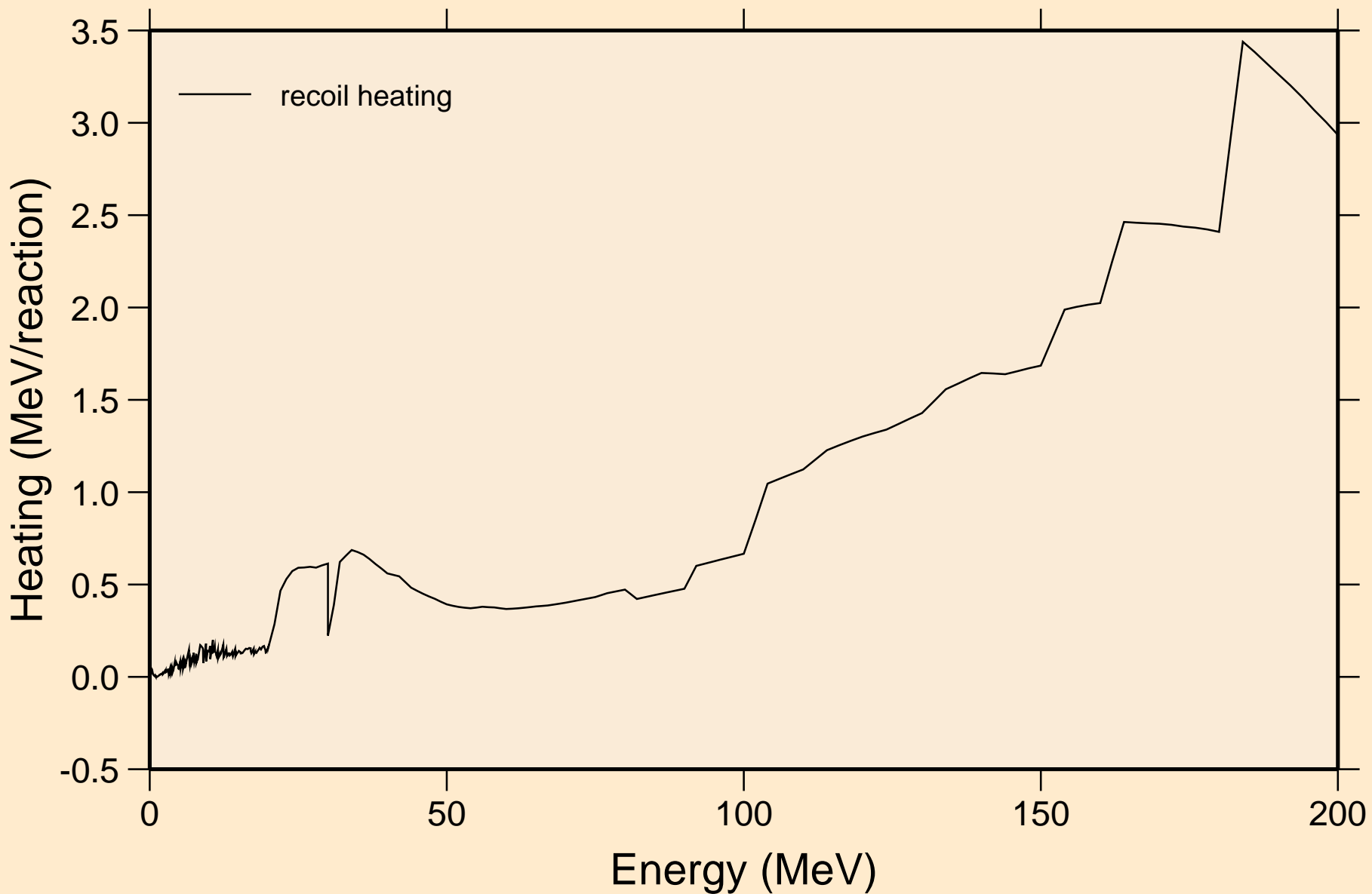

LU159 NEUTRON ACER TENDL-2019 LIBRARY; T=293.16K
Particle production cross sections

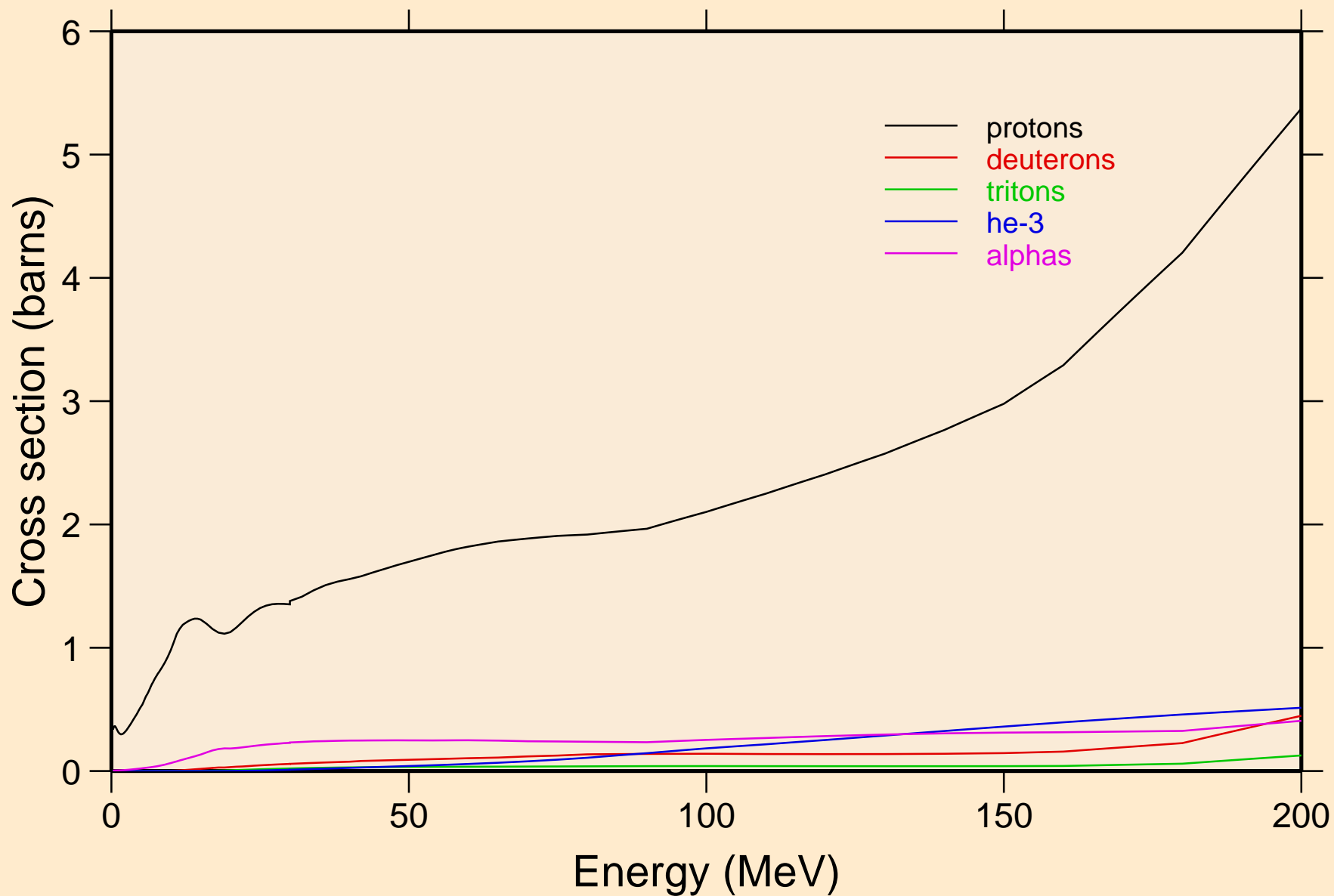

LU159 NEUTRON ACER TENDL-2019 LIBRARY; T=293.16K
protons from (n,x)

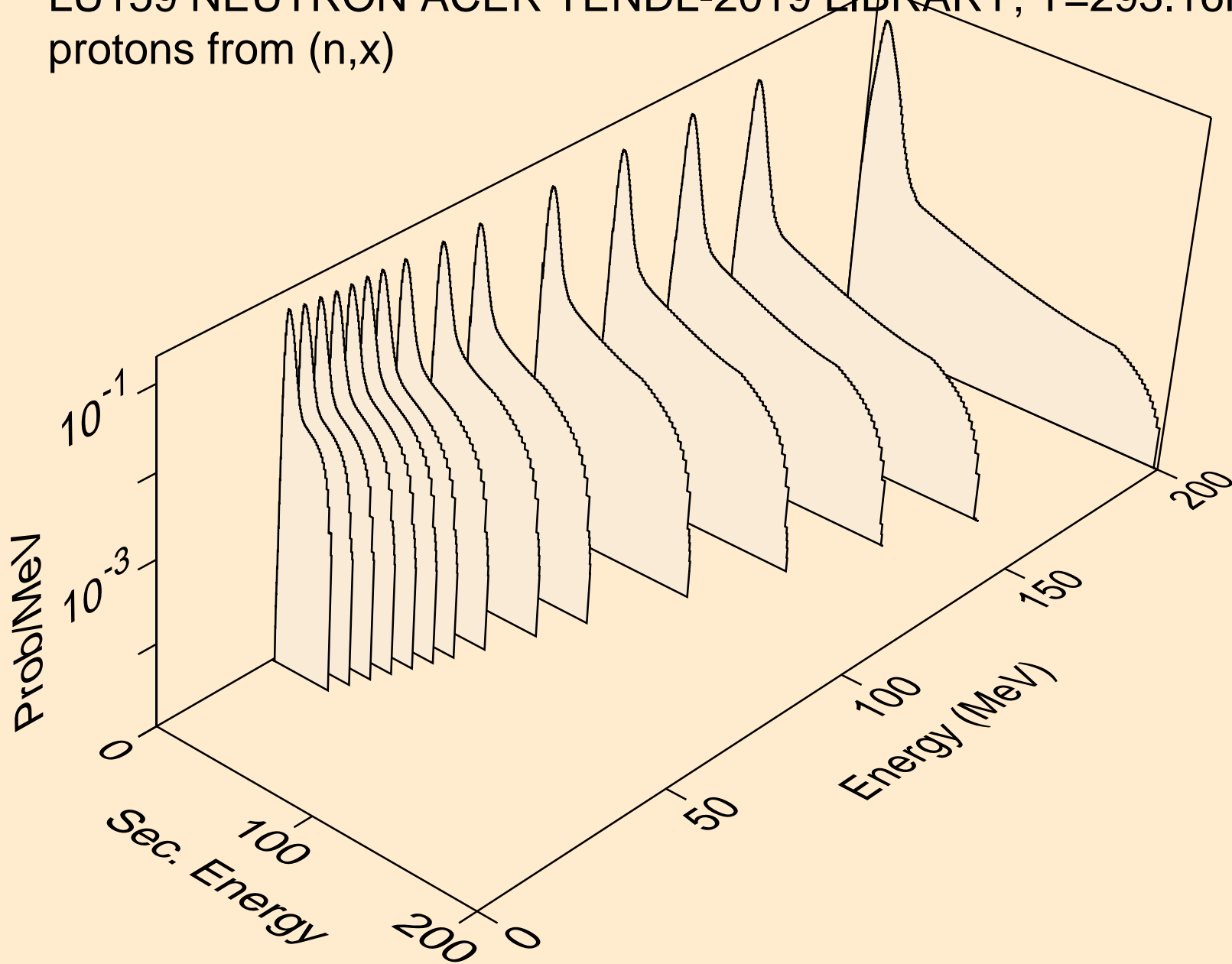

LU159 NEUTRON ACER TENDL-2019 LIBRARY; T=293.16K
protons from (n,n*)p

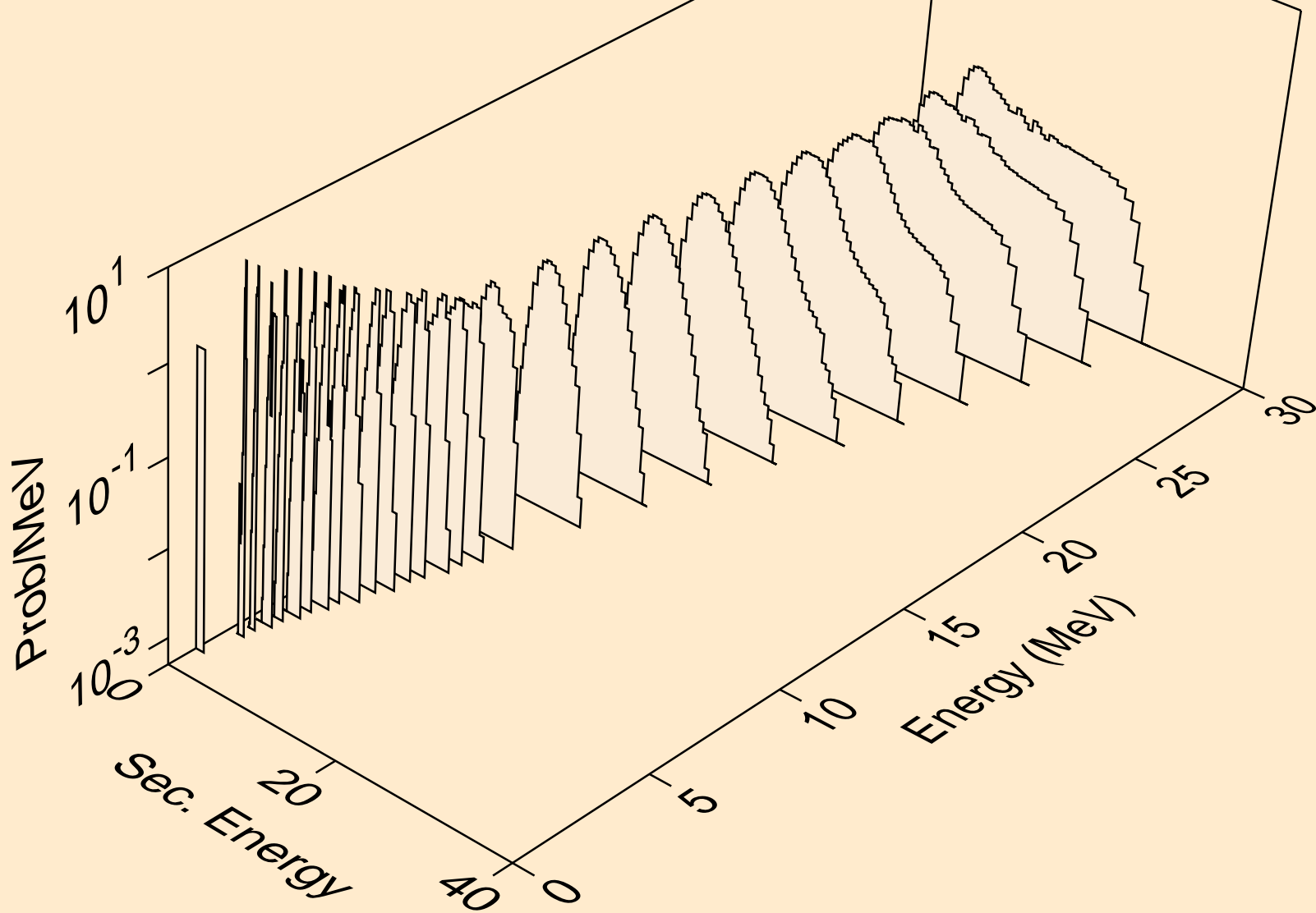

LU159 NEUTRON ACER TENDL-2019 LIBRARY; T=293.16K
protons from (n,2np)

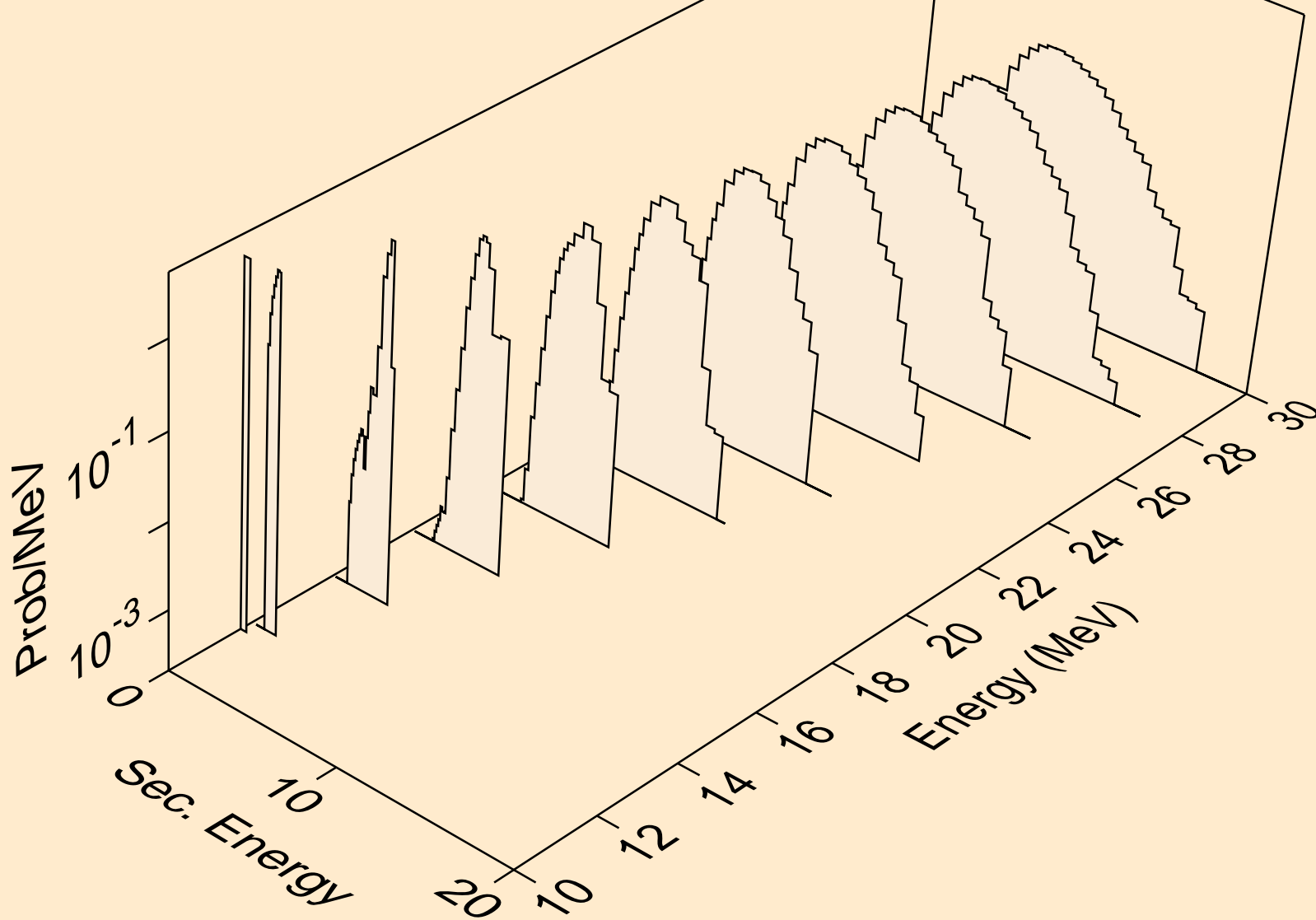

LU159 NEUTRON ACER TENDL-2019 LIBRARY; T=293.16K
protons from (n,3np)

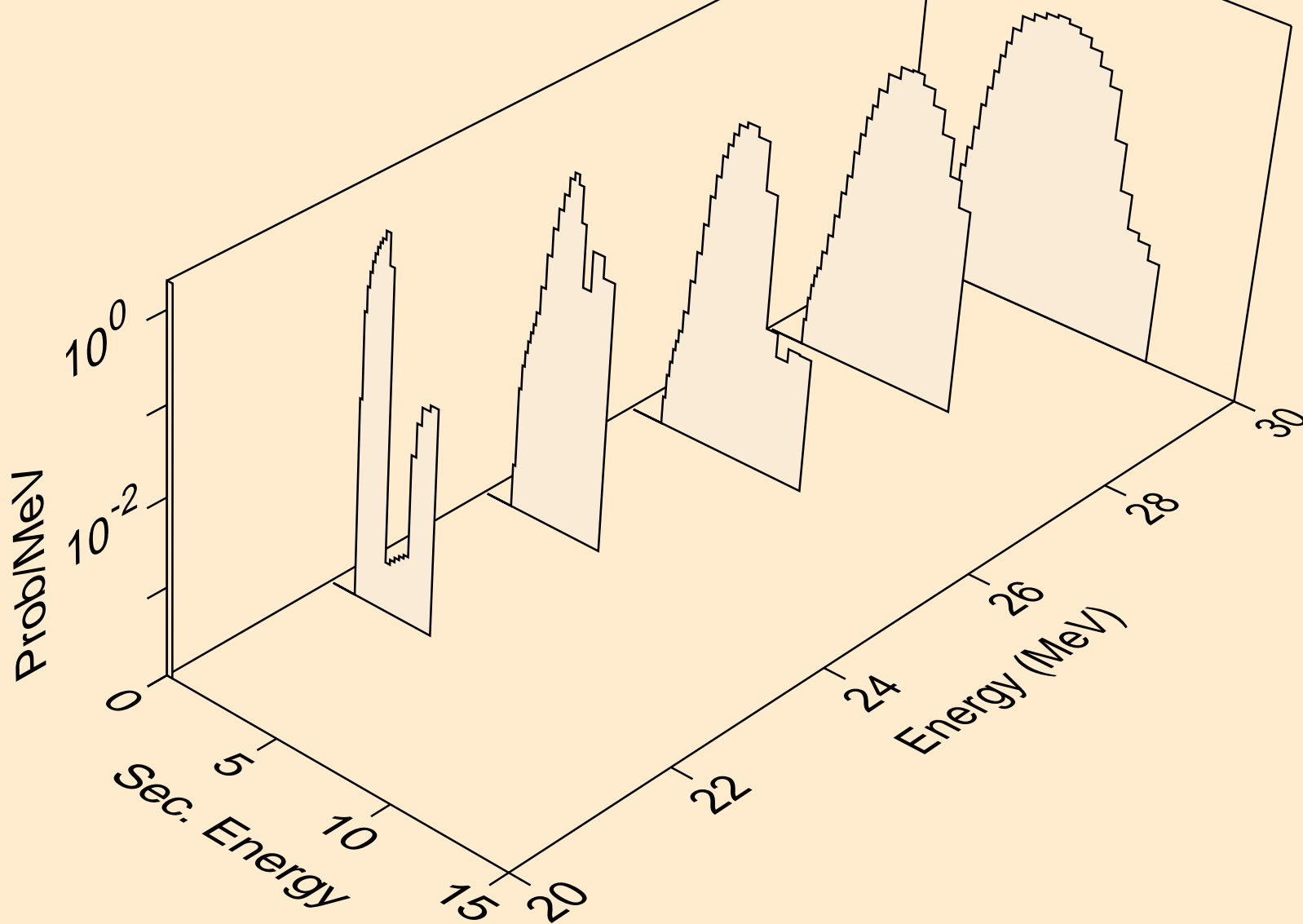

LU159 NEUTRON ACER TENDL-2019 LIBRARY; T=293.16K
protons from (n,2np)

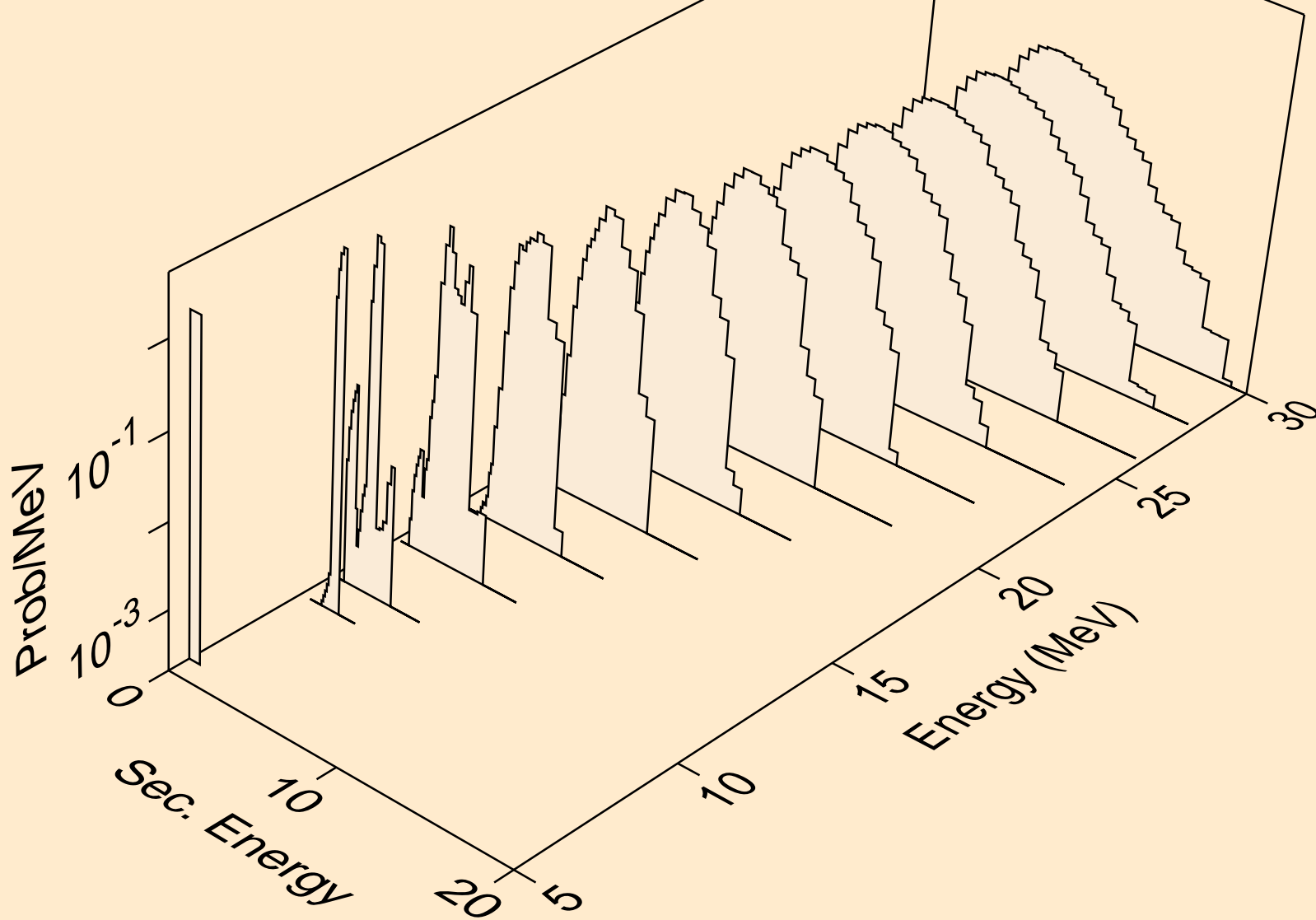

LU159 NEUTRON ACER TENDL-2019 LIBRARY; T=293.16K
protons from (n,npa)

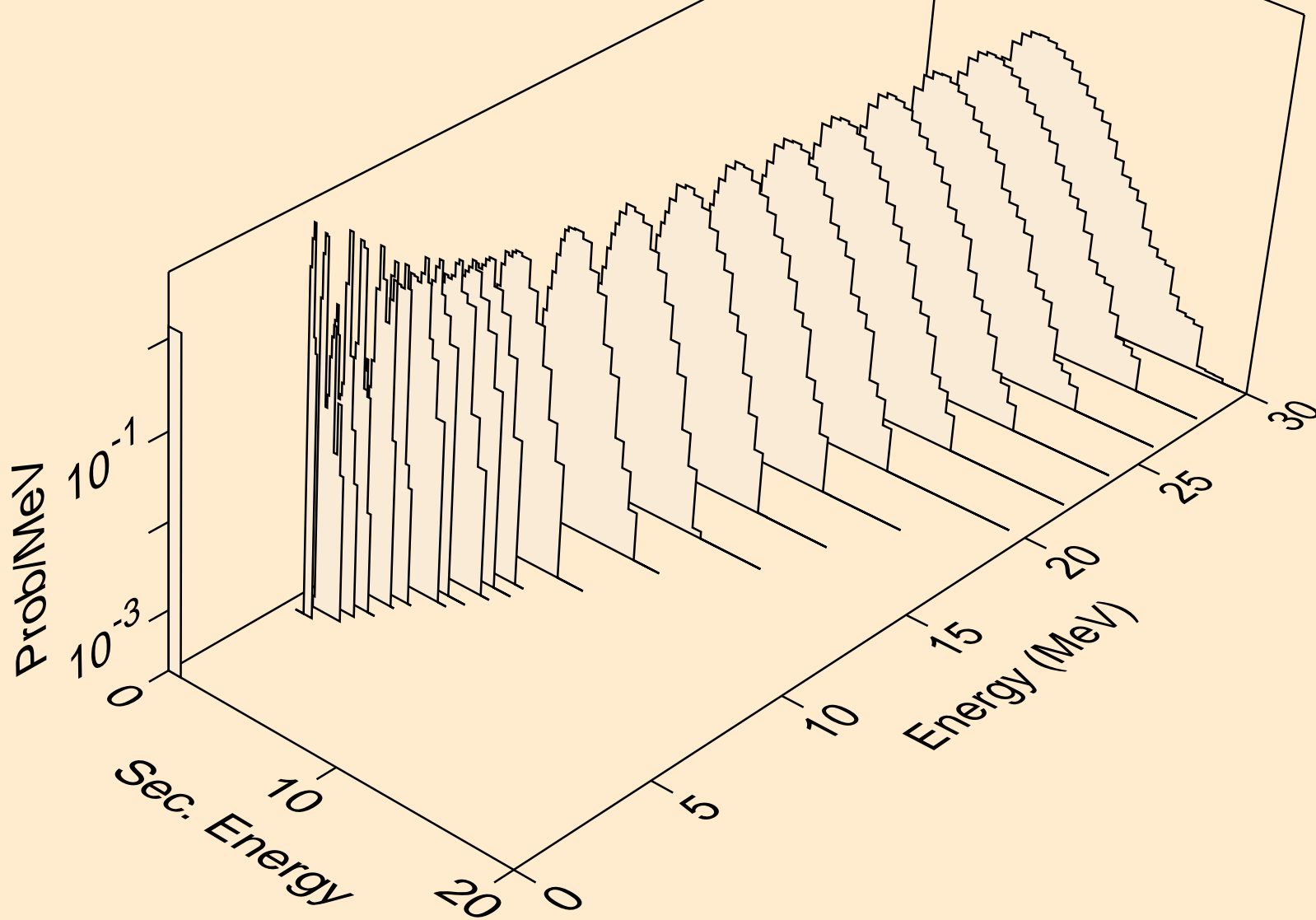

LU159 NEUTRON ACER TENDL-2019 LIBRARY; T=293.16K
protons from (n,p)

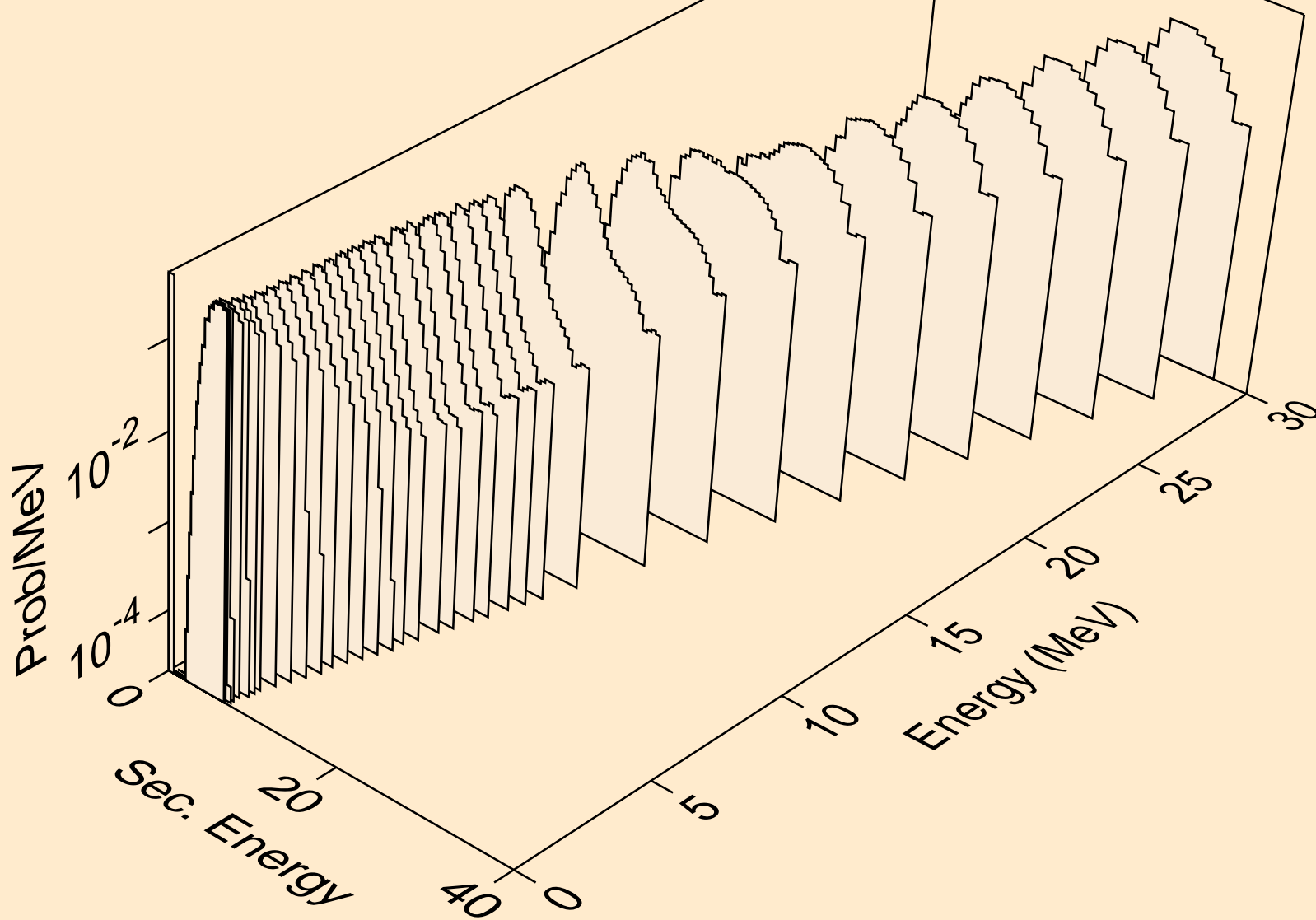

LU159 NEUTRON ACER TENDL-2019 LIBRARY; T=293.16K
protons from (n,2p)

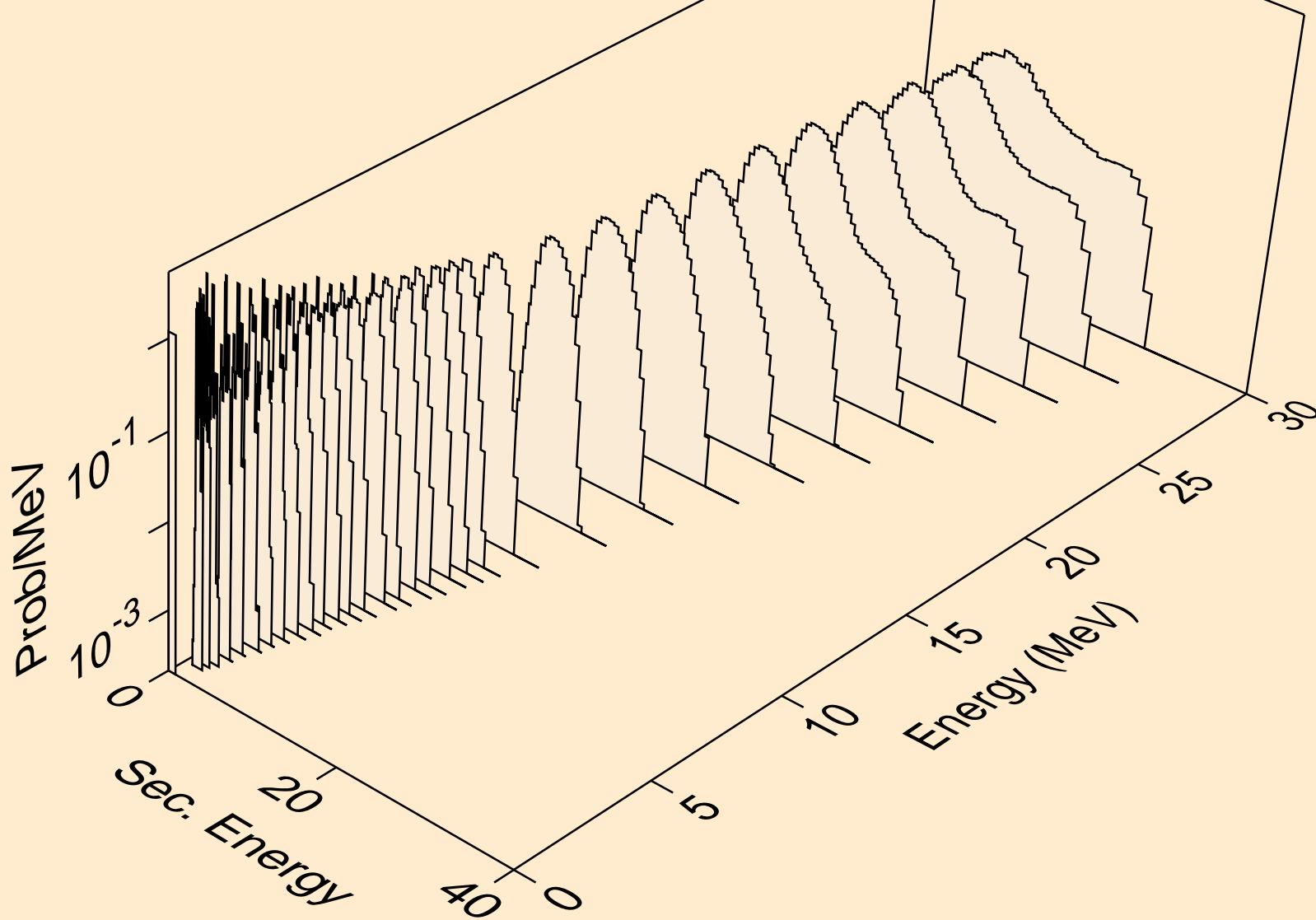

LU159 NEUTRON ACER TENDL-2019 LIBRARY; T=293.16K
protons from (n,p)

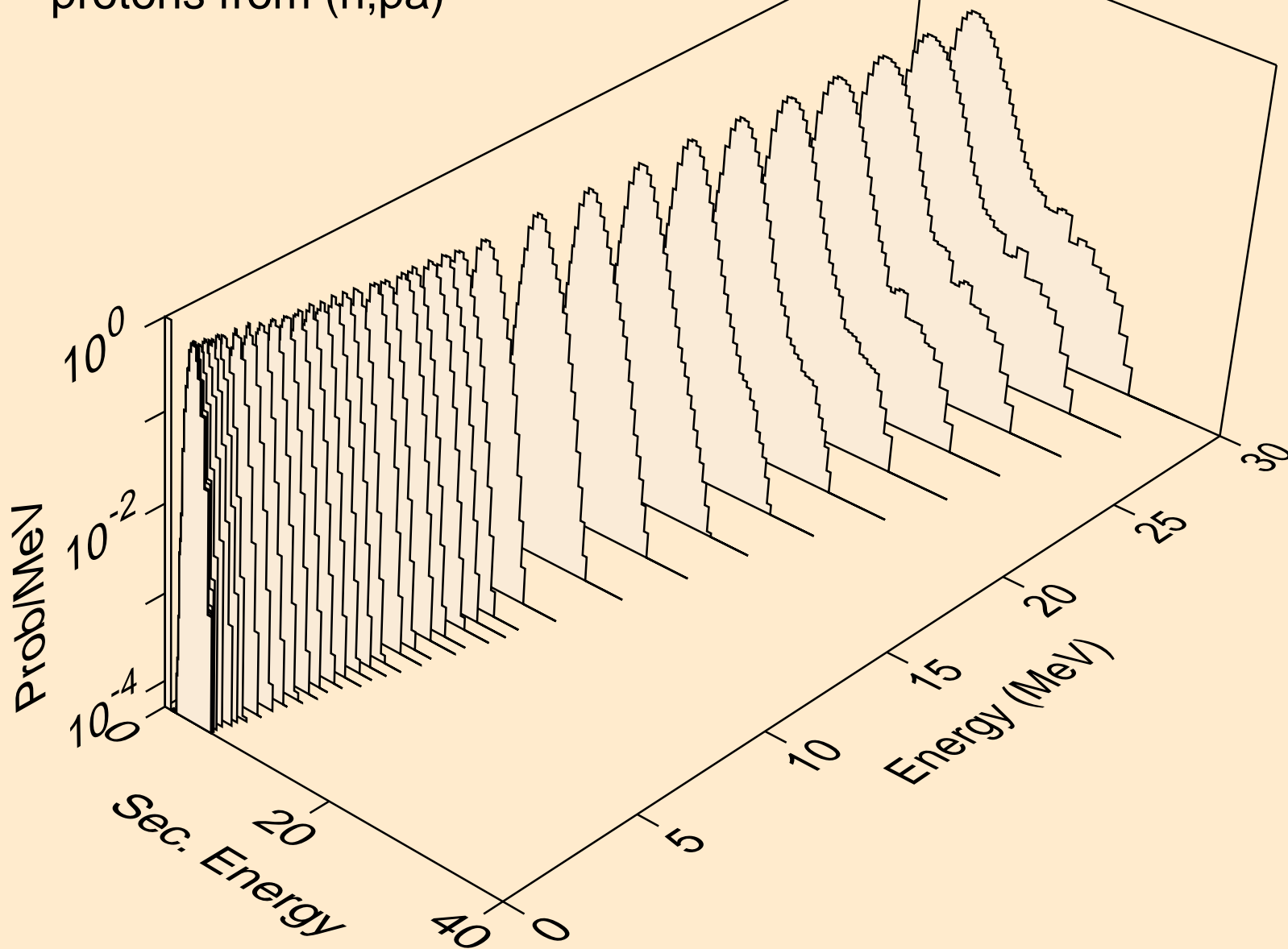

LU159 NEUTRON ACER TENDL-2019 LIBRARY; T=293.16K
protons from (n,pd)

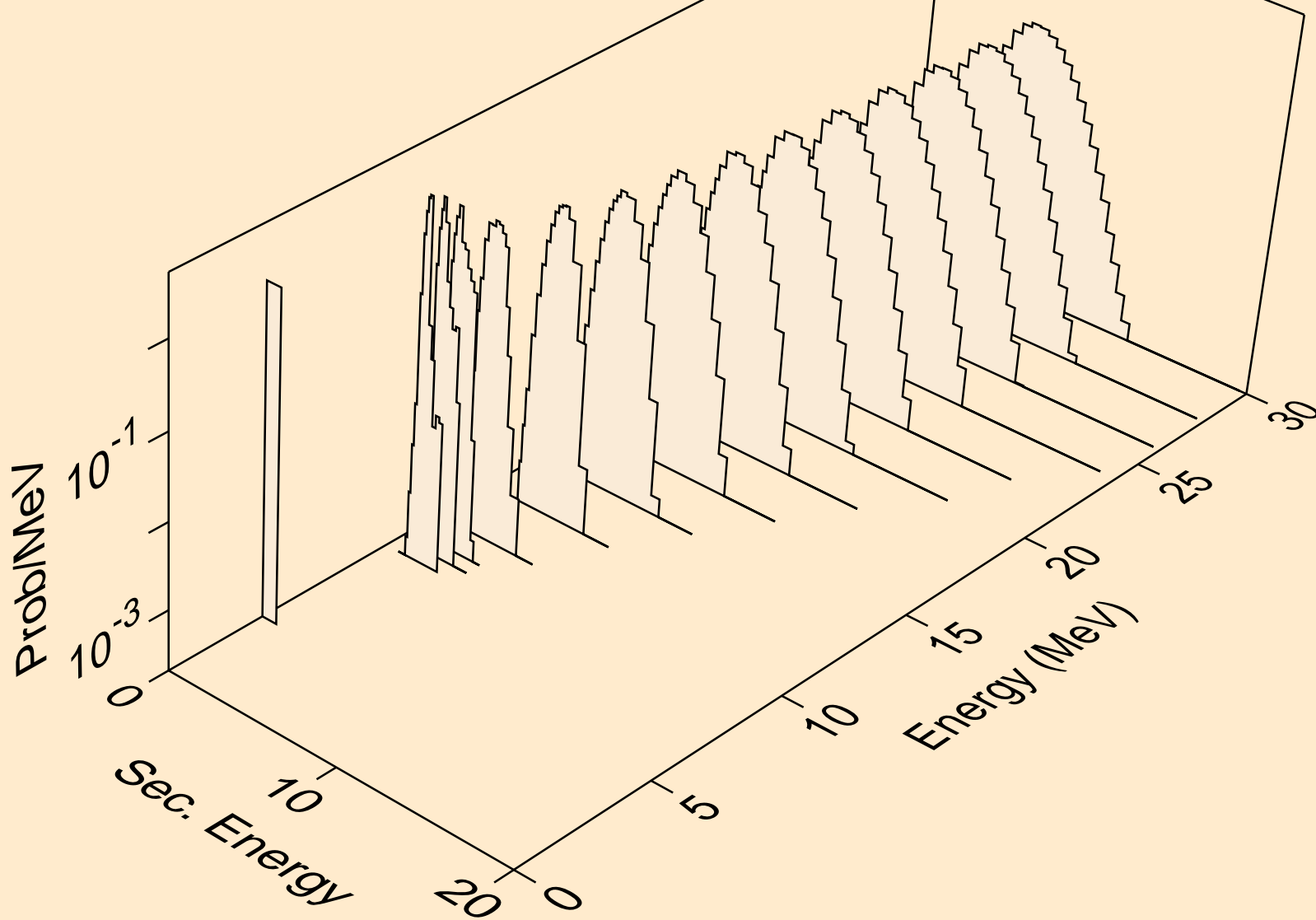

LU159 NEUTRON ACER TENDL-2019 LIBRARY; T=293.16K
protons from (n,pt)

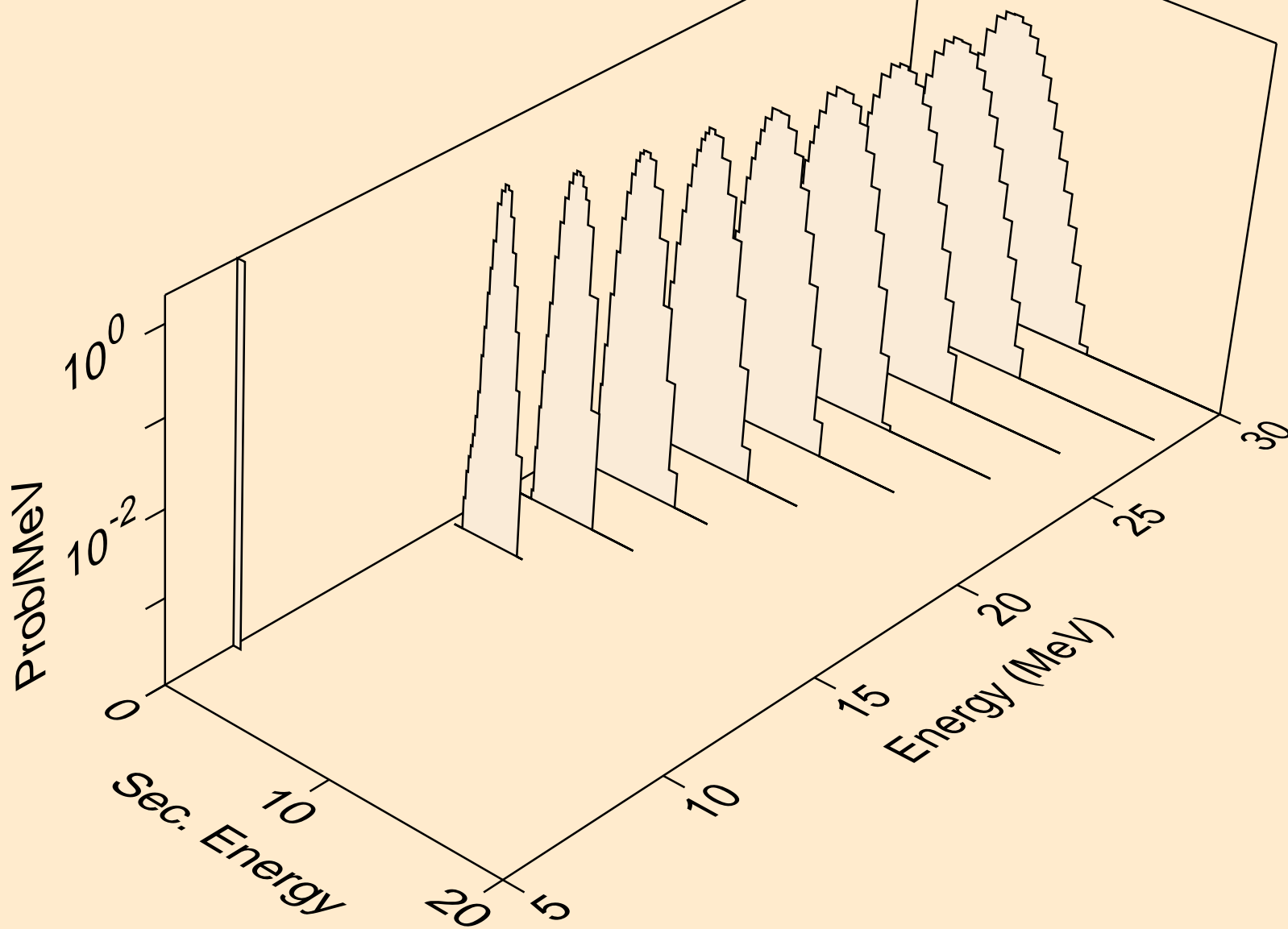

LU159 NEUTRON ACER TENDL-2019 LIBRARY; T=293.16K
deuterons from (n,x)

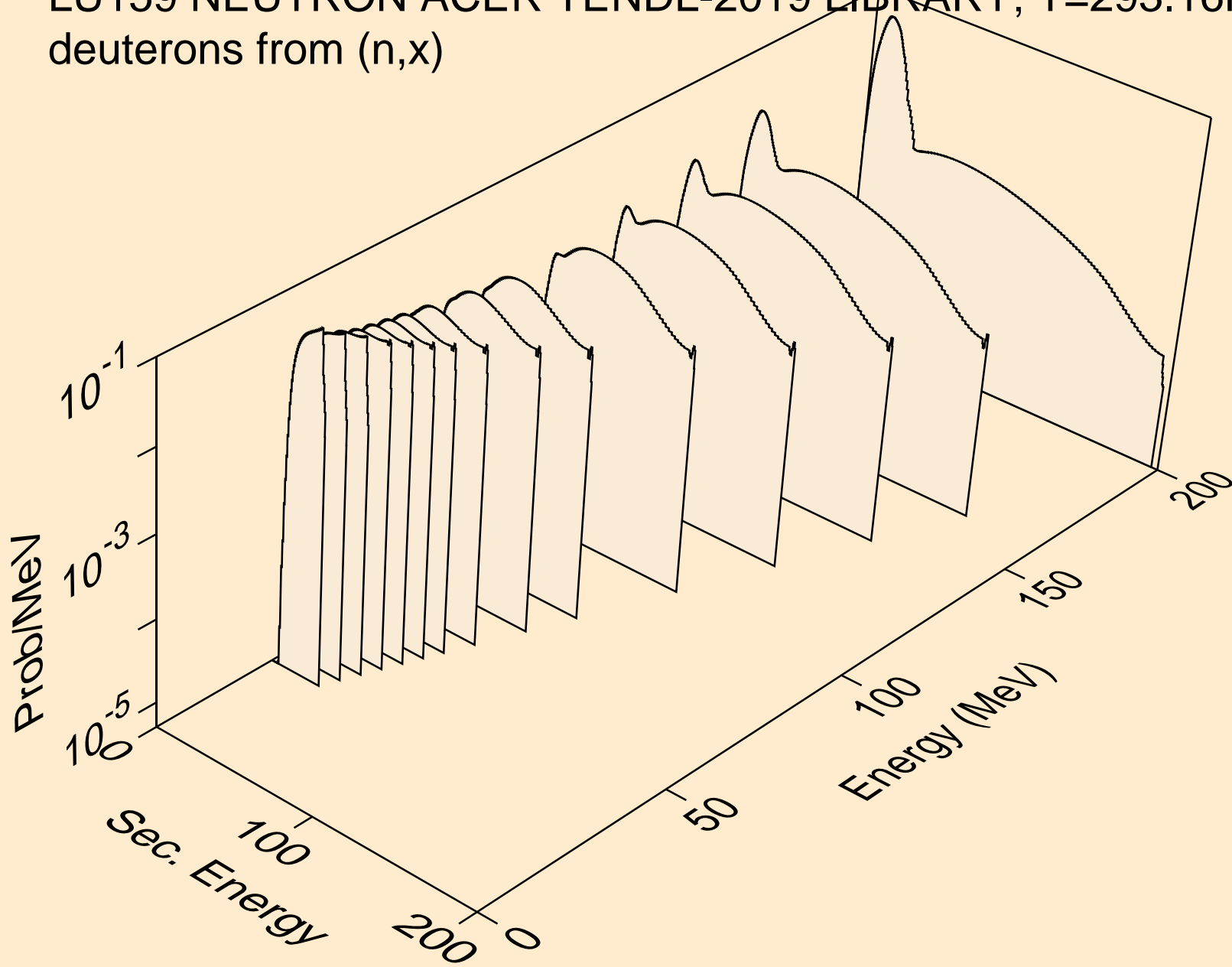

LU159 NEUTRON ACER TENDL-2019 LIBRARY; T=293.16K
deuterons from (n,2nd)

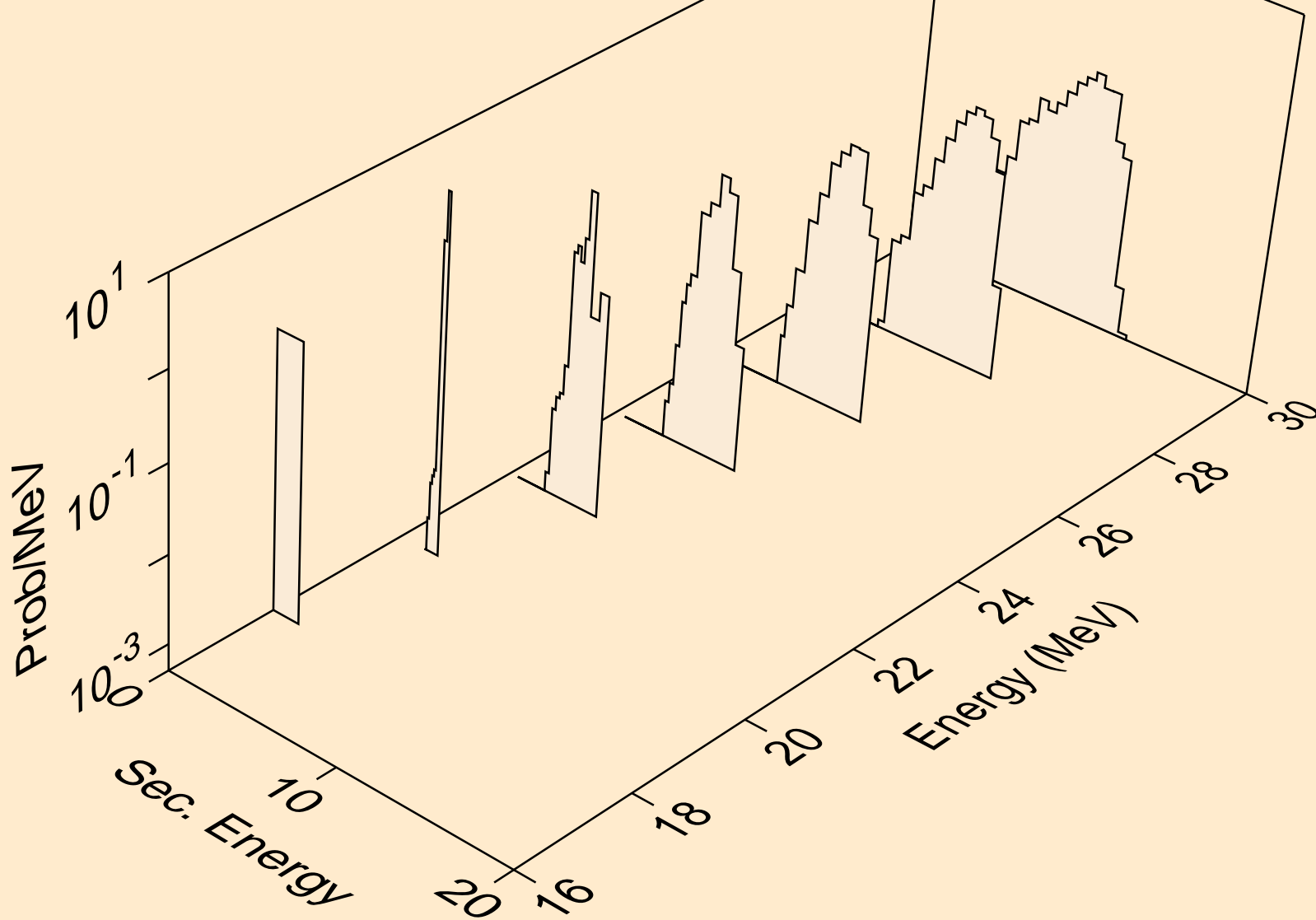

LU159 NEUTRON ACER TENDL-2019 LIBRARY; T=293.16K
deuterons from (n,n*)d

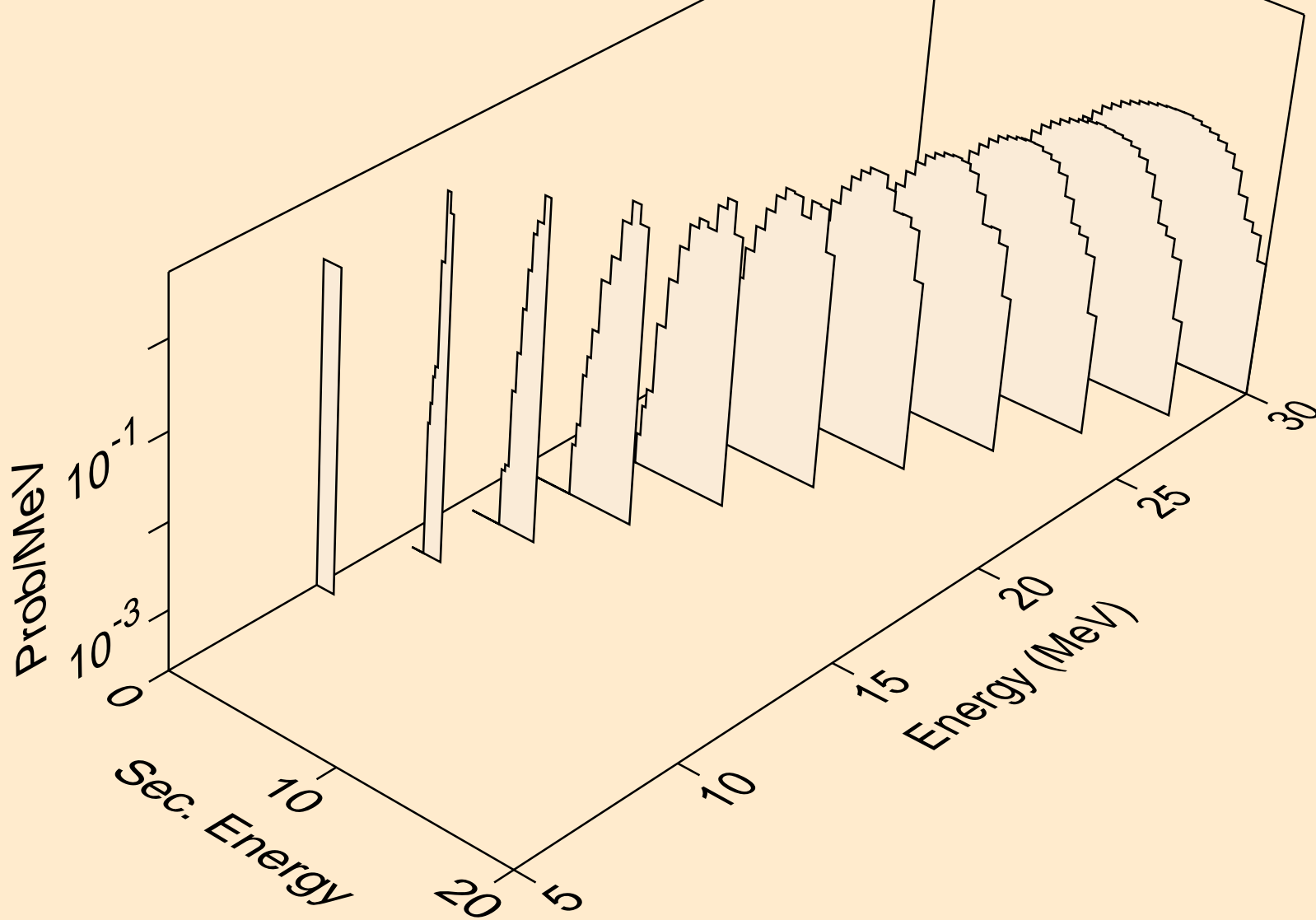

LU159 NEUTRON ACER TENDL-2019 LIBRARY; T=293.16K
deuterons from (n,n*)d2a

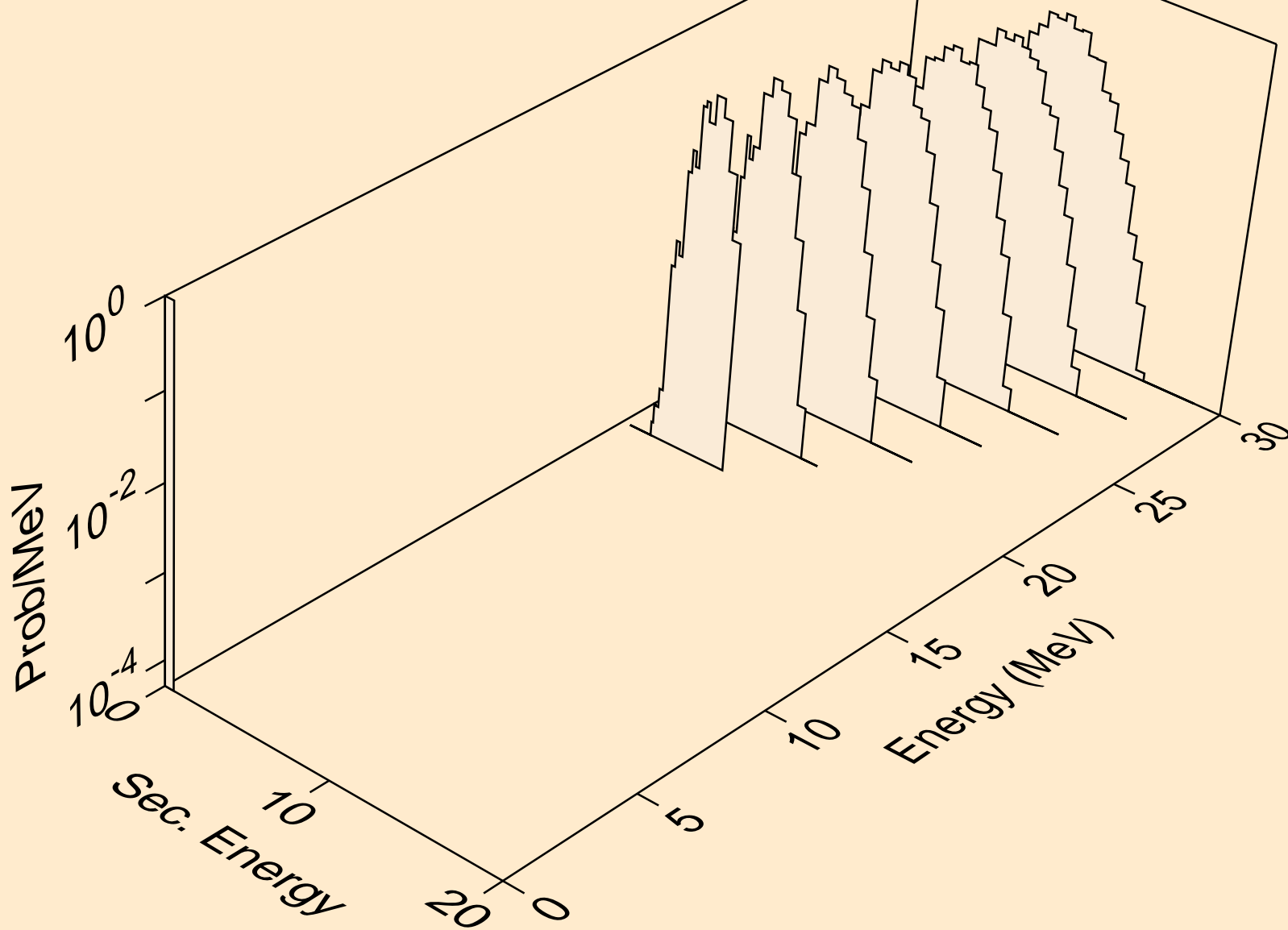

LU159 NEUTRON ACER TENDL-2019 LIBRARY; T=293.16K
deuterons from (n,d)

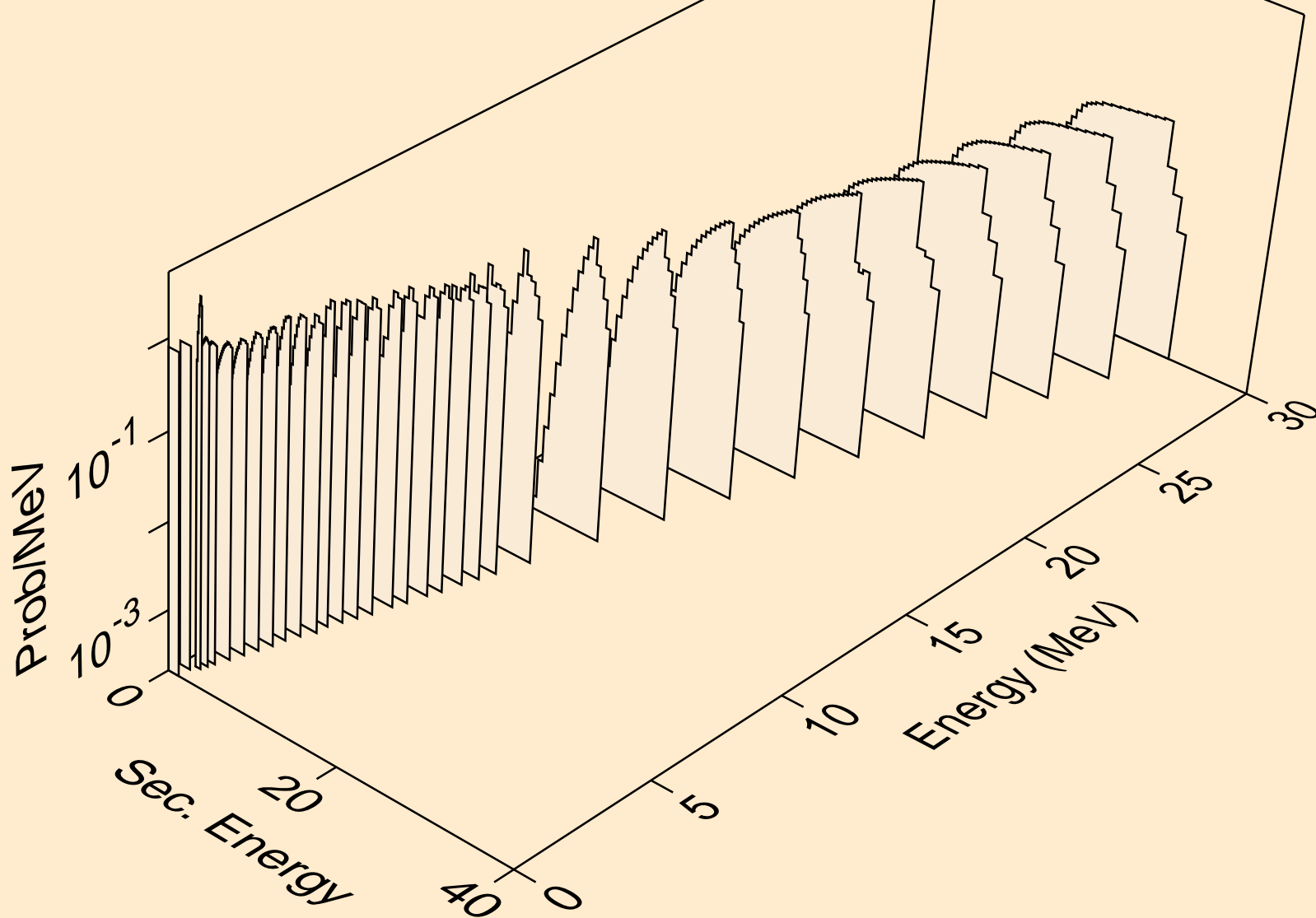

LU159 NEUTRON ACER TENDL-2019 LIBRARY; T=293.16K
deuterons from (n,d2a)

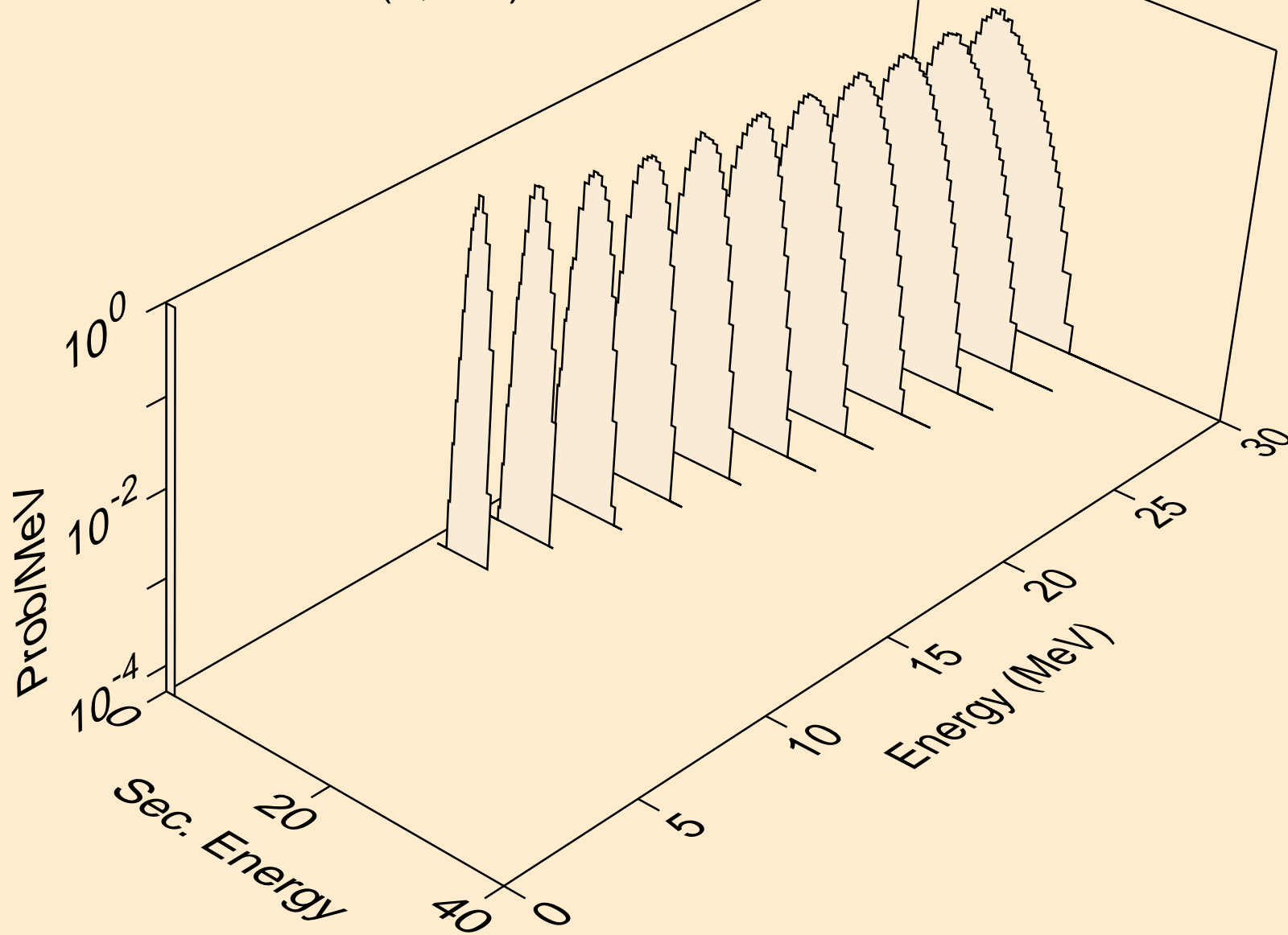

LU159 NEUTRON ACER TENDL-2019 LIBRARY; T=293.16K
deuterons from (n,pd)

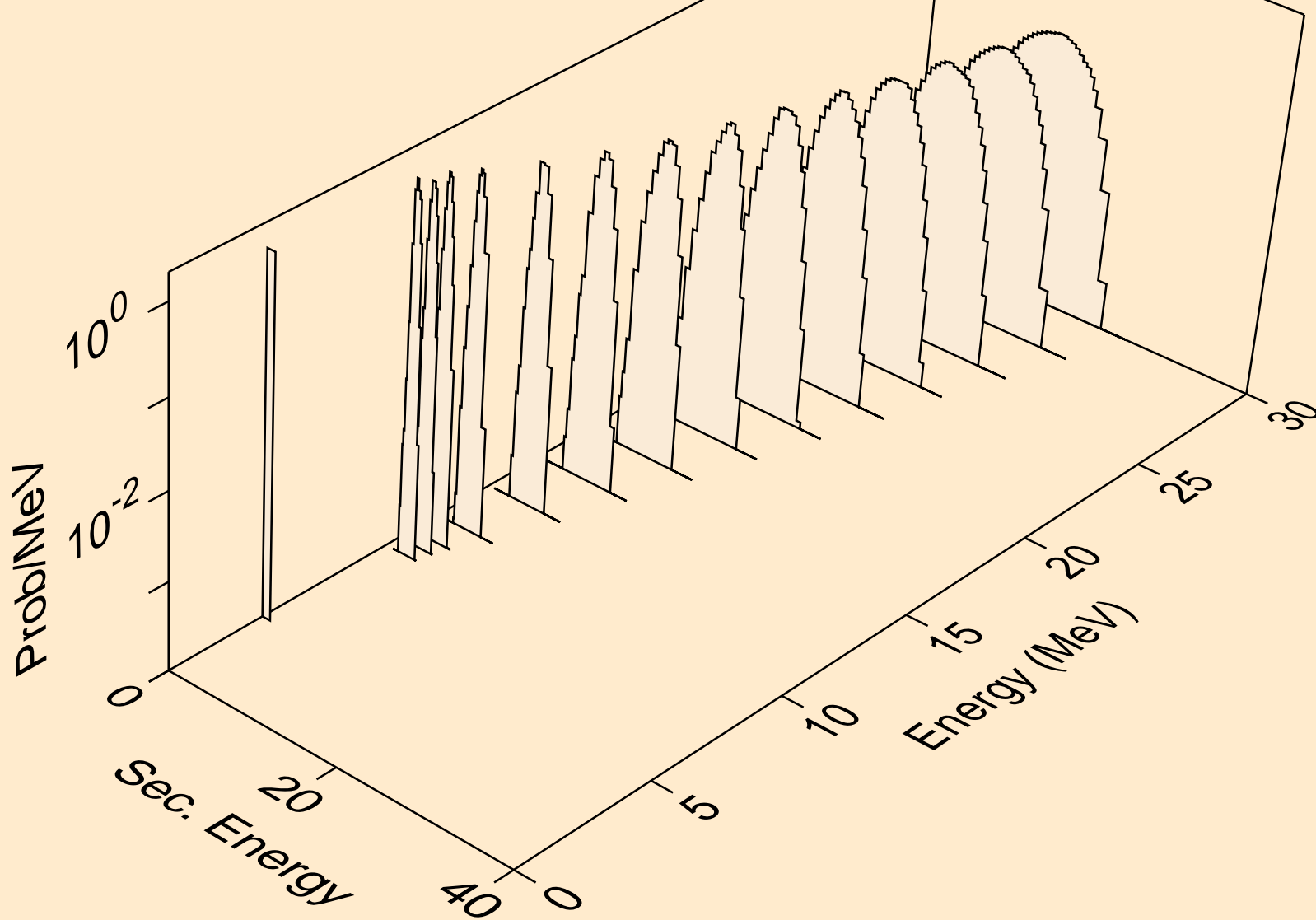

LU159 NEUTRON ACER TENDL-2019 LIBRARY; T=293.16K
deuterons from (n,da)

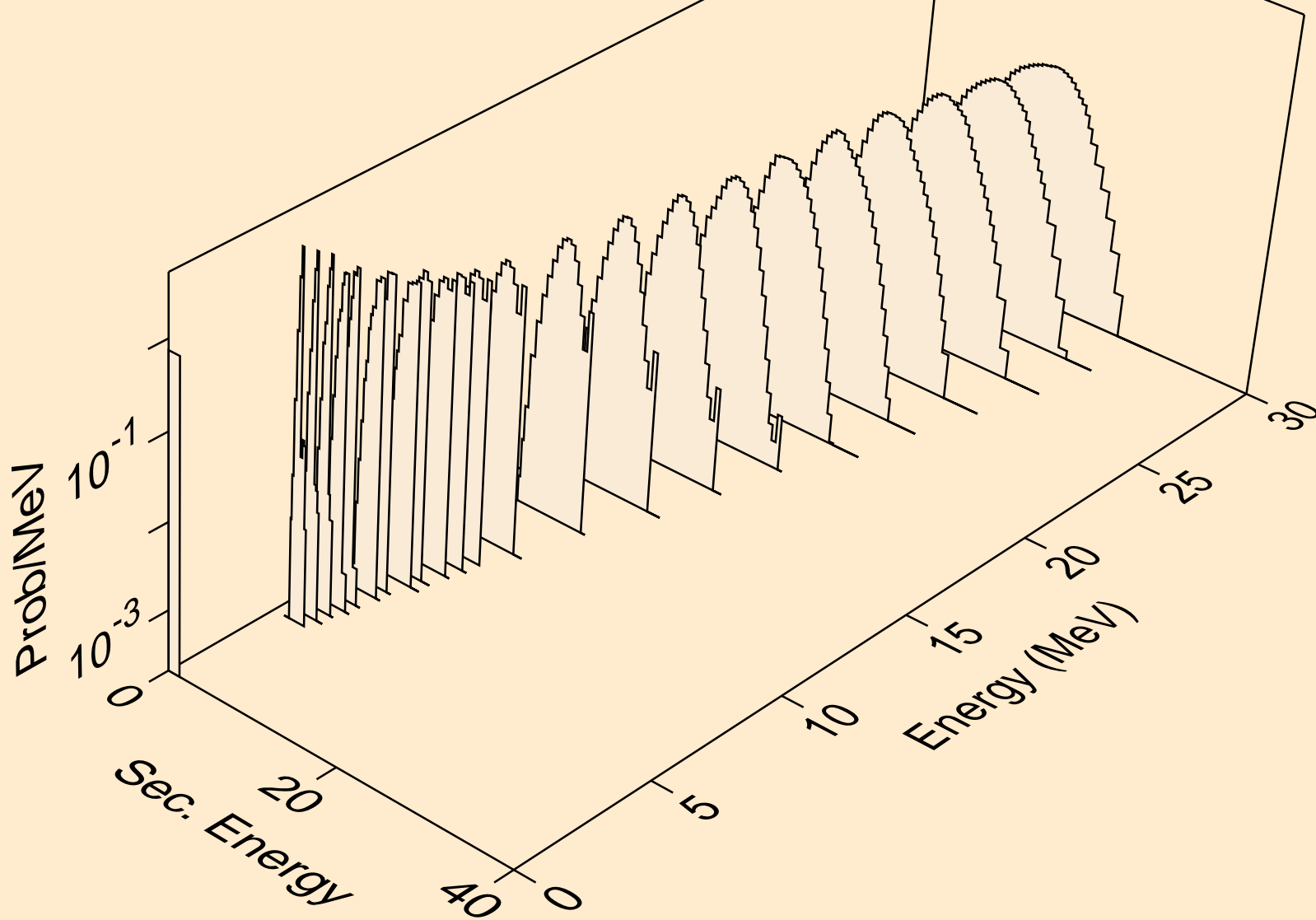

LU159 NEUTRON ACER TENDL-2019 LIBRARY; T=293.16K
tritons from (n,x)

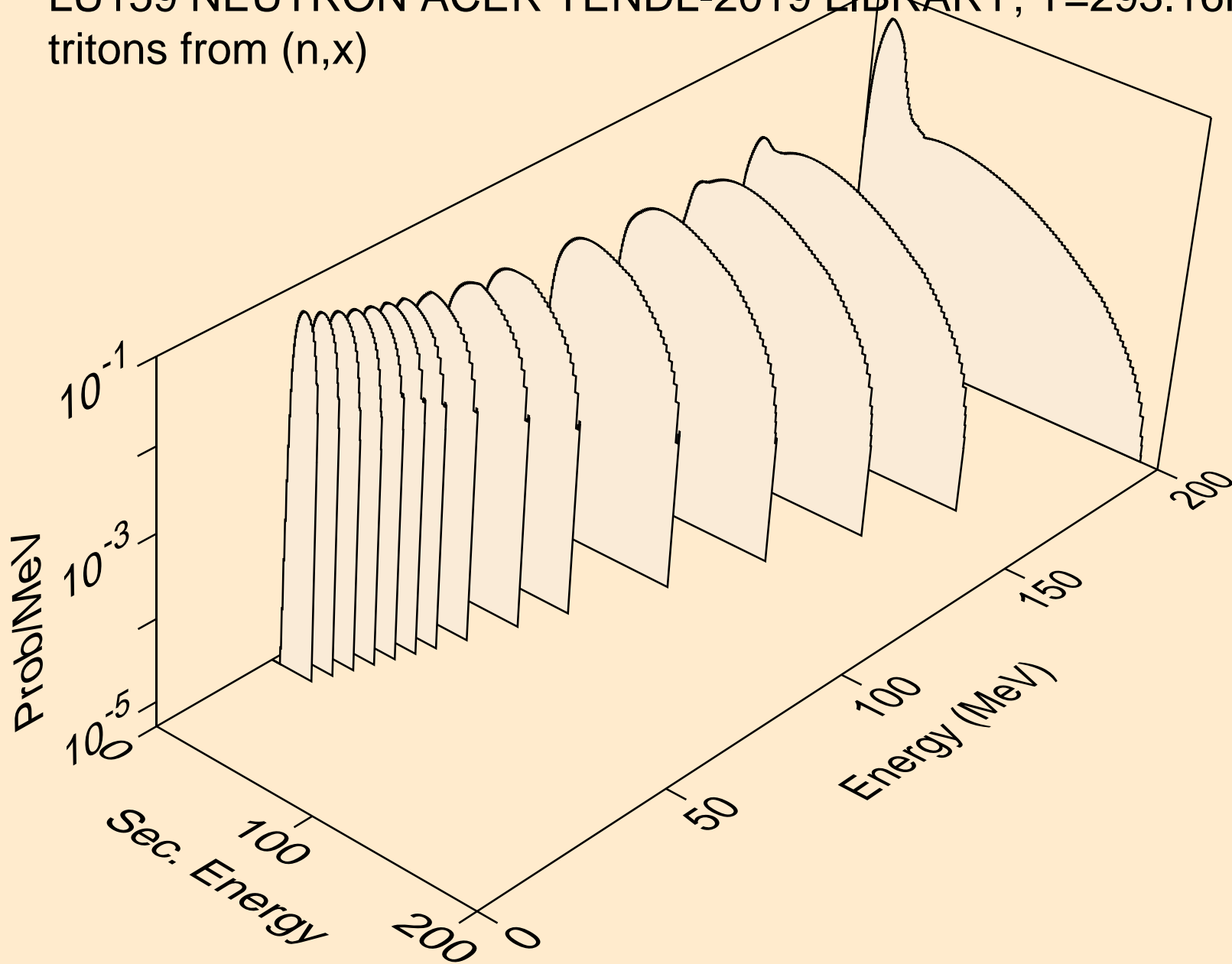

LU159 NEUTRON ACER TENDL-2019 LIBRARY; T=293.16K
tritons from (n,n*)t

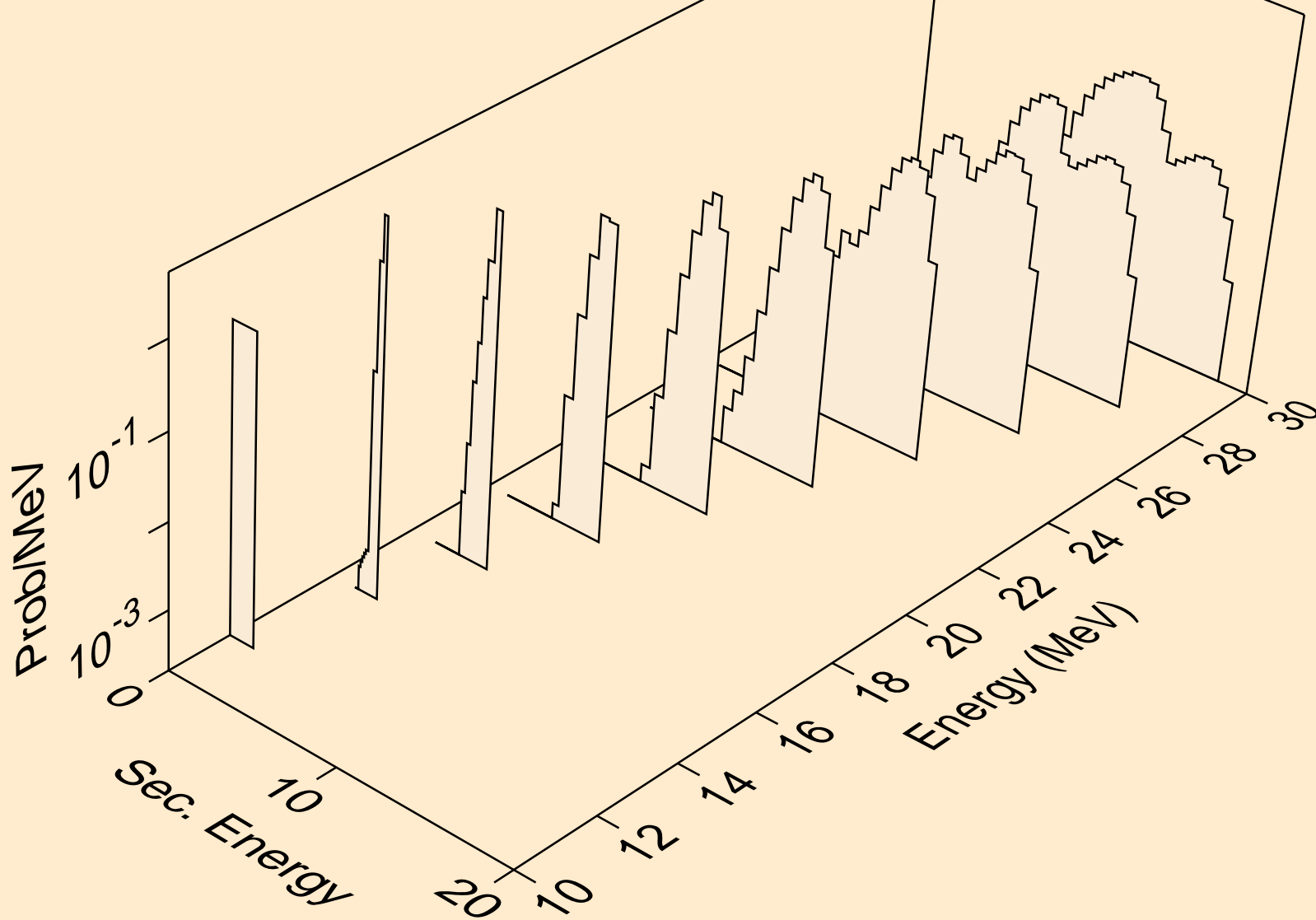

LU159 NEUTRON ACER TENDL-2019 LIBRARY; T=293.16K
tritons from (n,t)

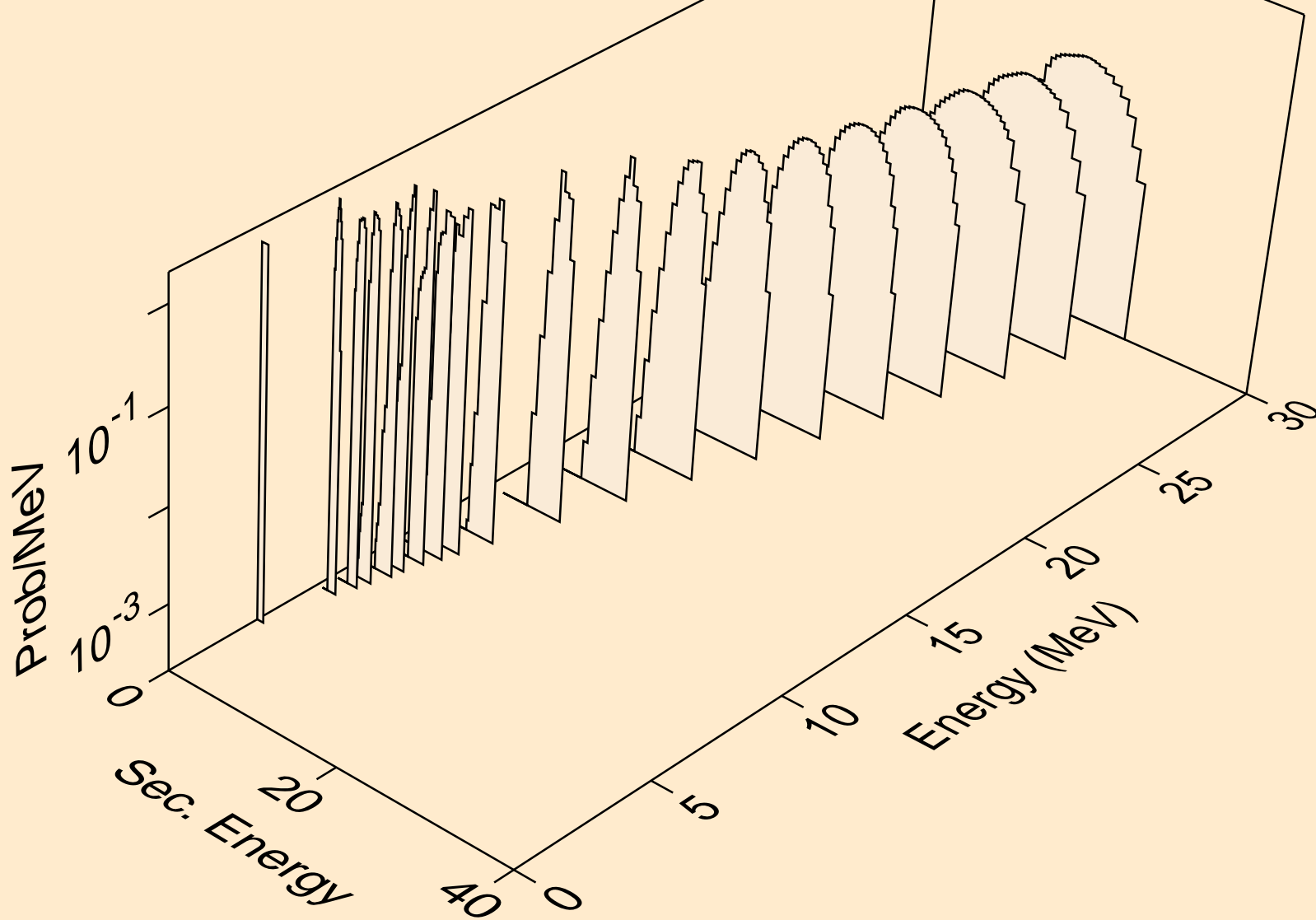

LU159 NEUTRON ACER TENDL-2019 LIBRARY; T=293.16K
tritons from (n,t2a)

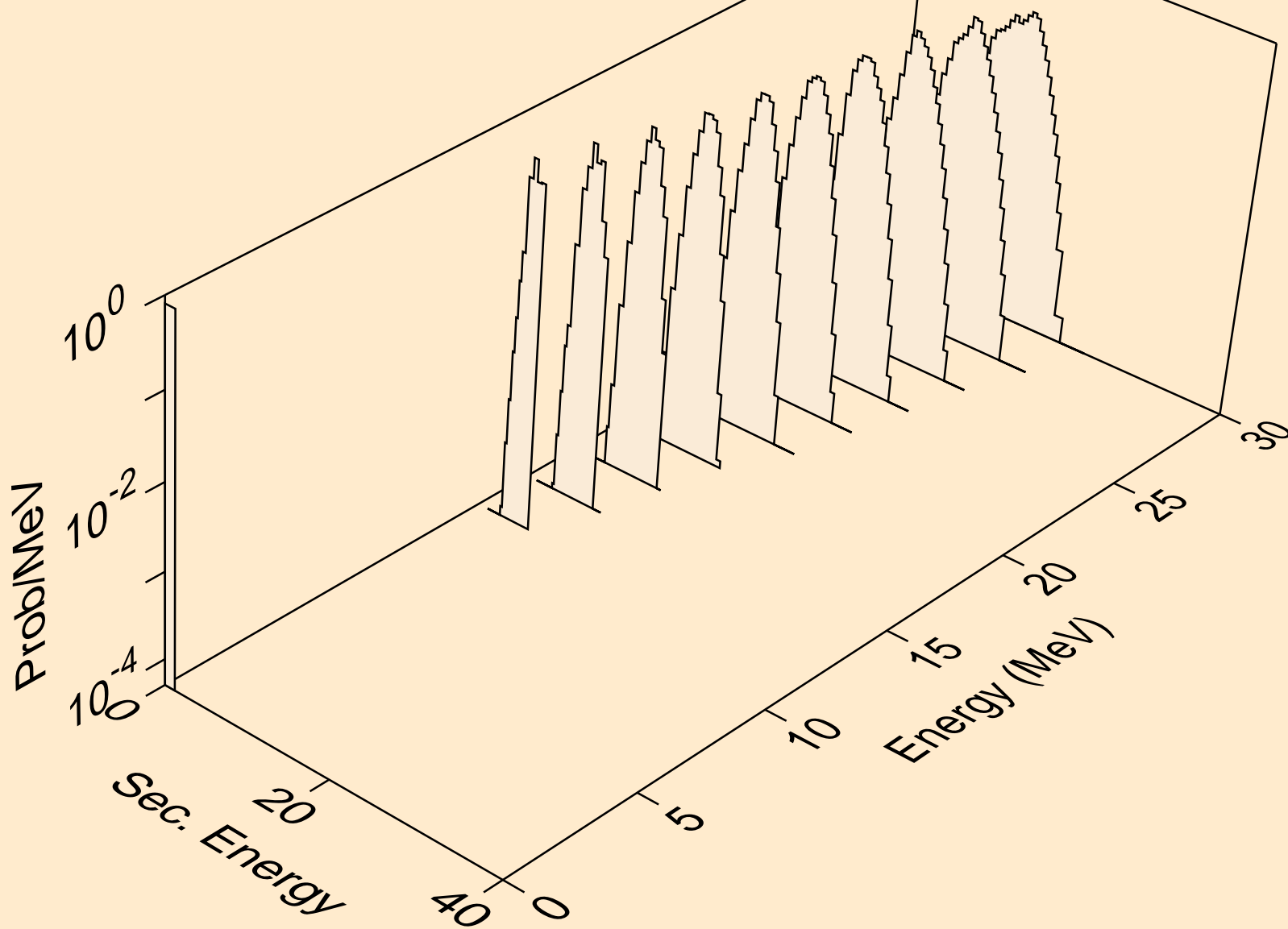

LU159 NEUTRON ACER TENDL-2019 LIBRARY; T=293.16K
tritons from (n,pt)

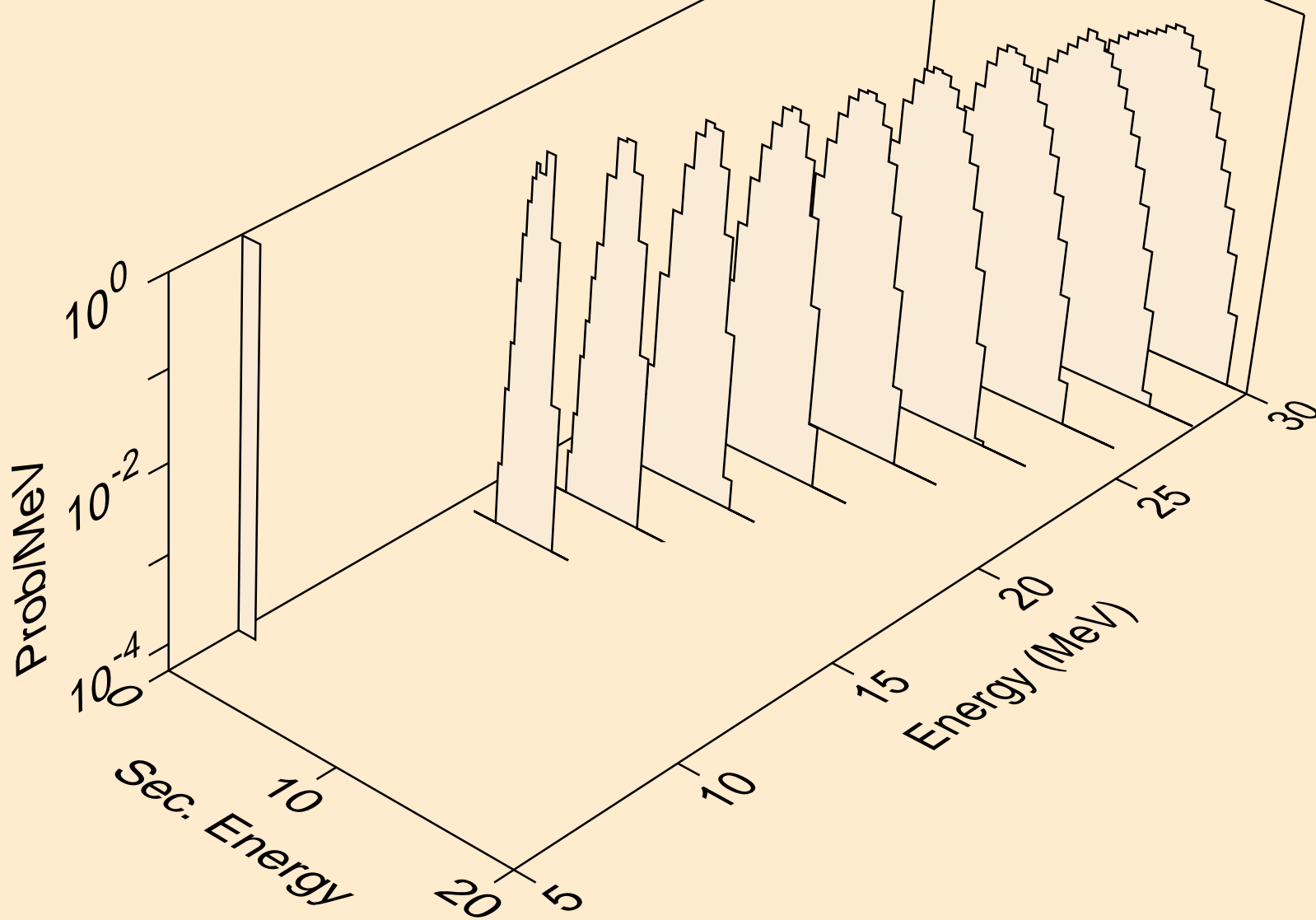

LU159 NEUTRON ACER TENDL-2019 LIBRARY; T=293.16K
he3s from (n,x)

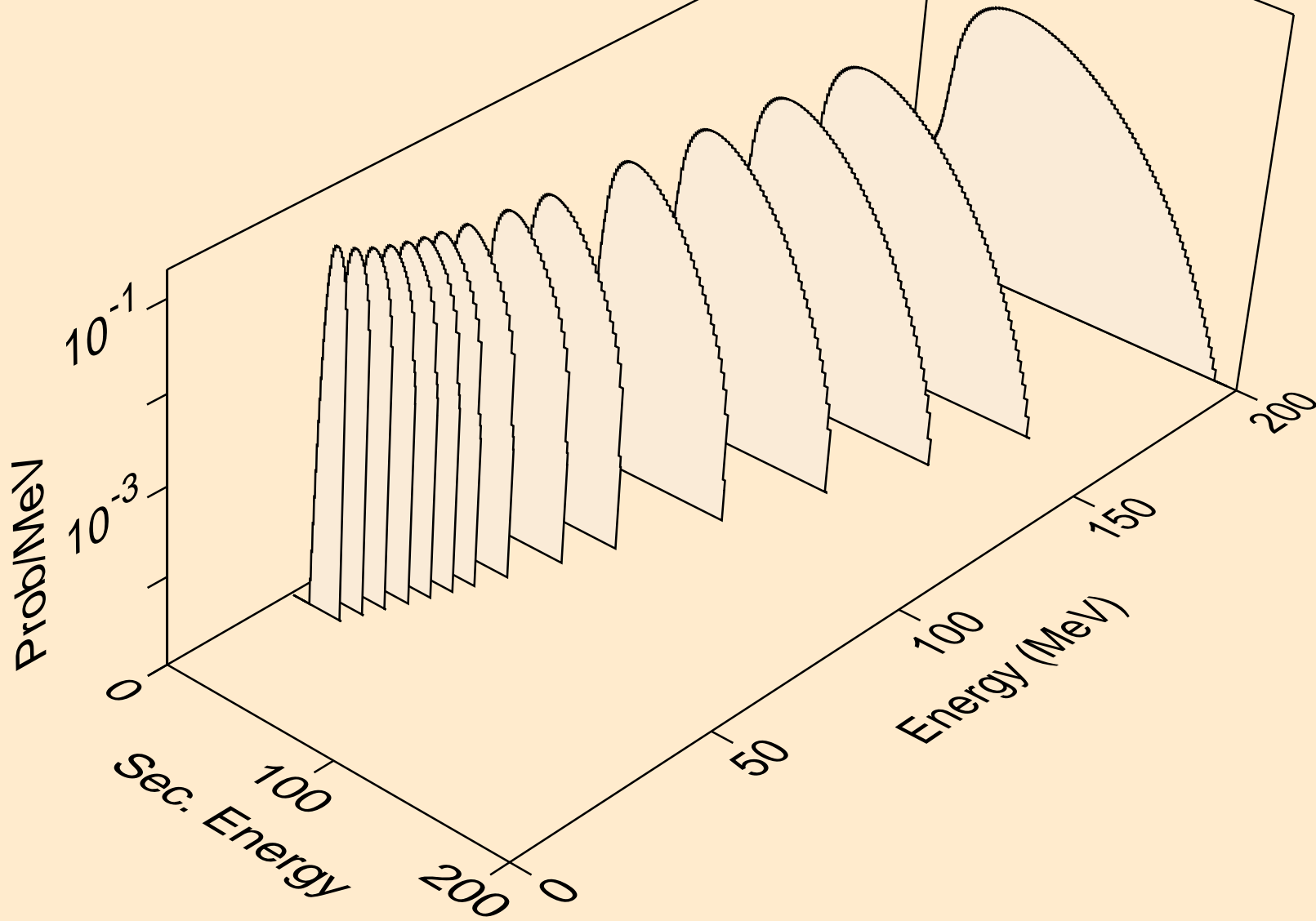

LU159 NEUTRON ACER TENDL-2019 LIBRARY; T=293.16K
he3s from (n,n*)he3

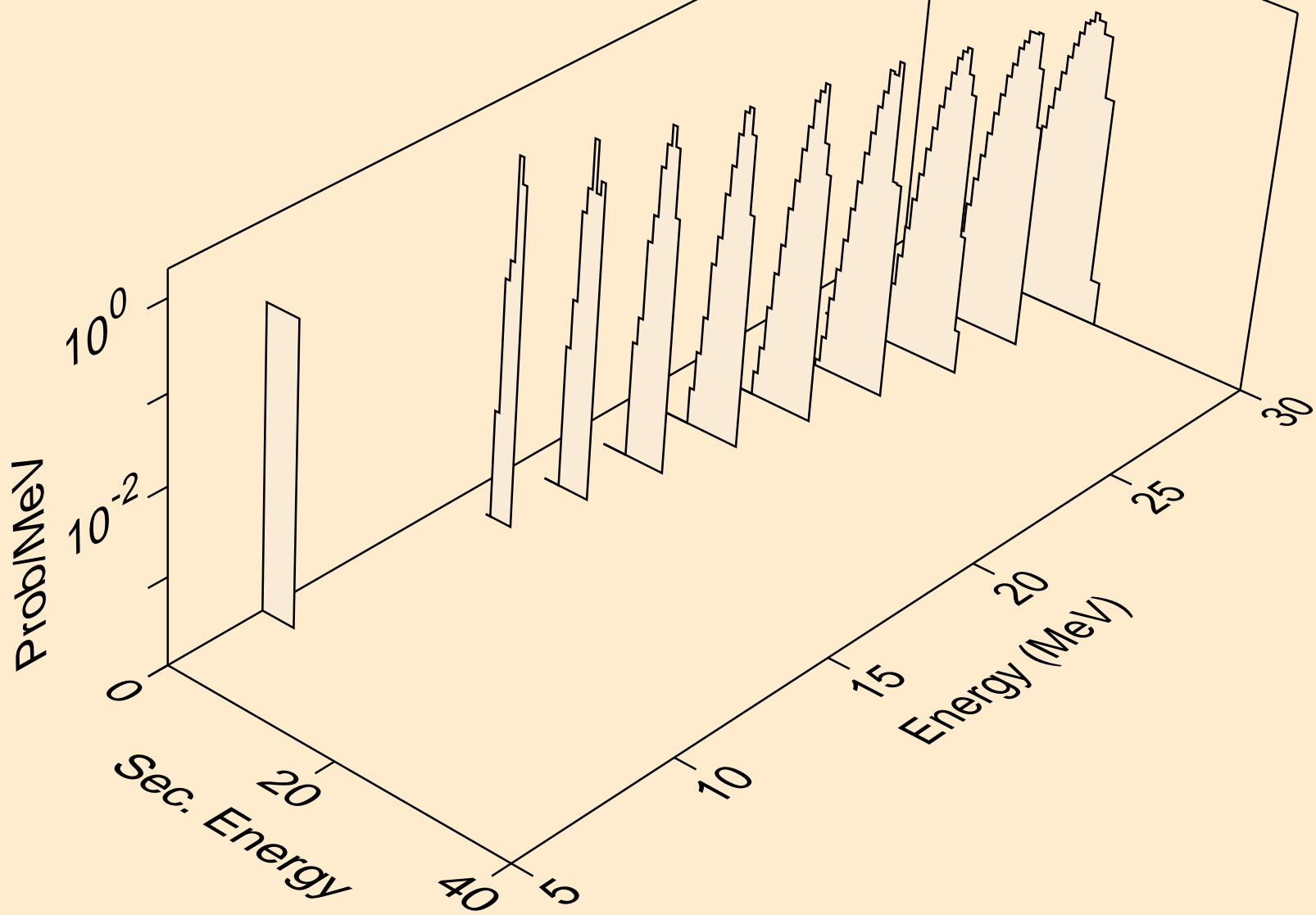

LU159 NEUTRON ACER TENDL-2019 LIBRARY; T=293.16K
he3s from (n,he3)

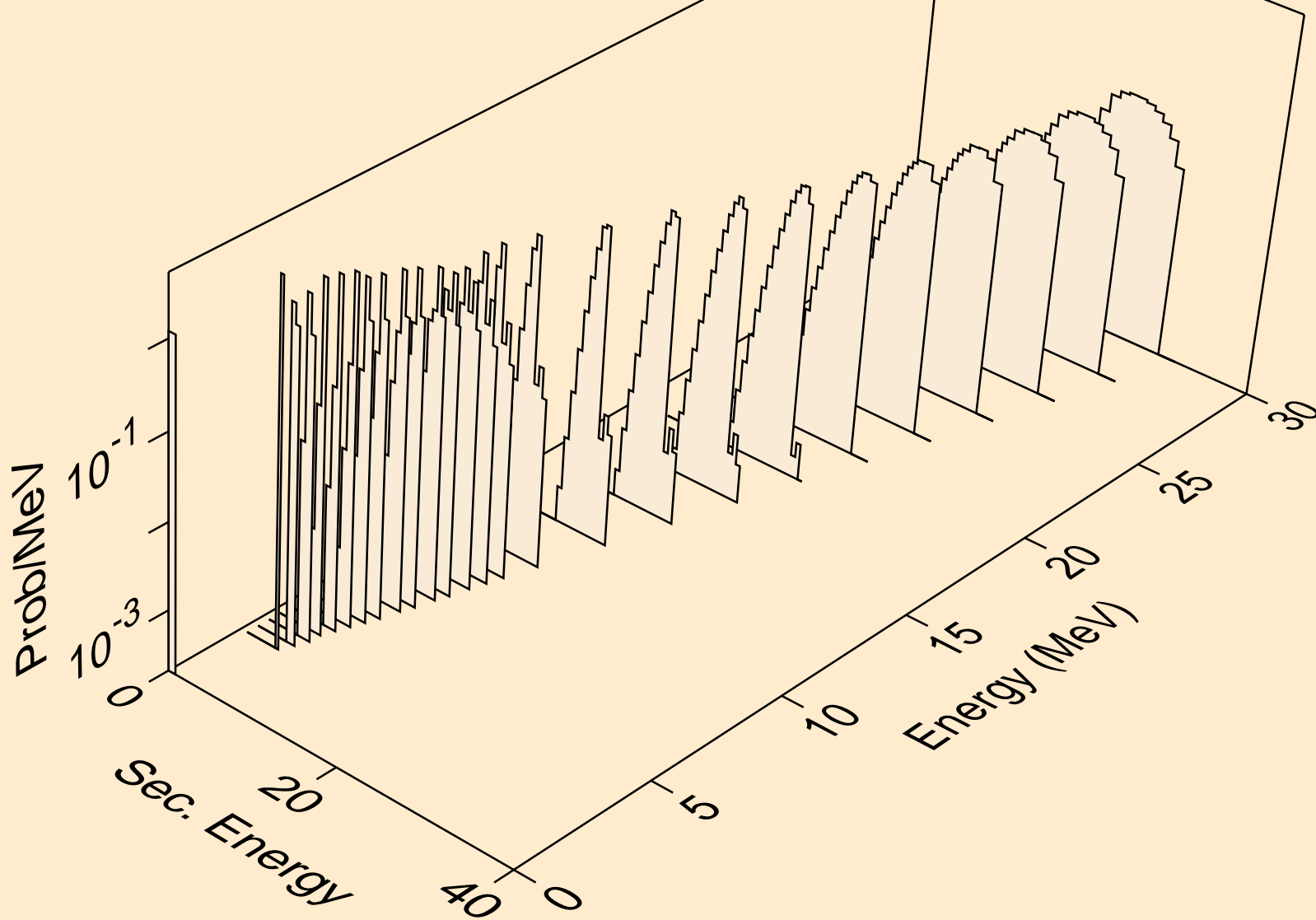

LU159 NEUTRON ACER TENDL-2019 LIBRARY; T=293.16K
alphas from (n,x)

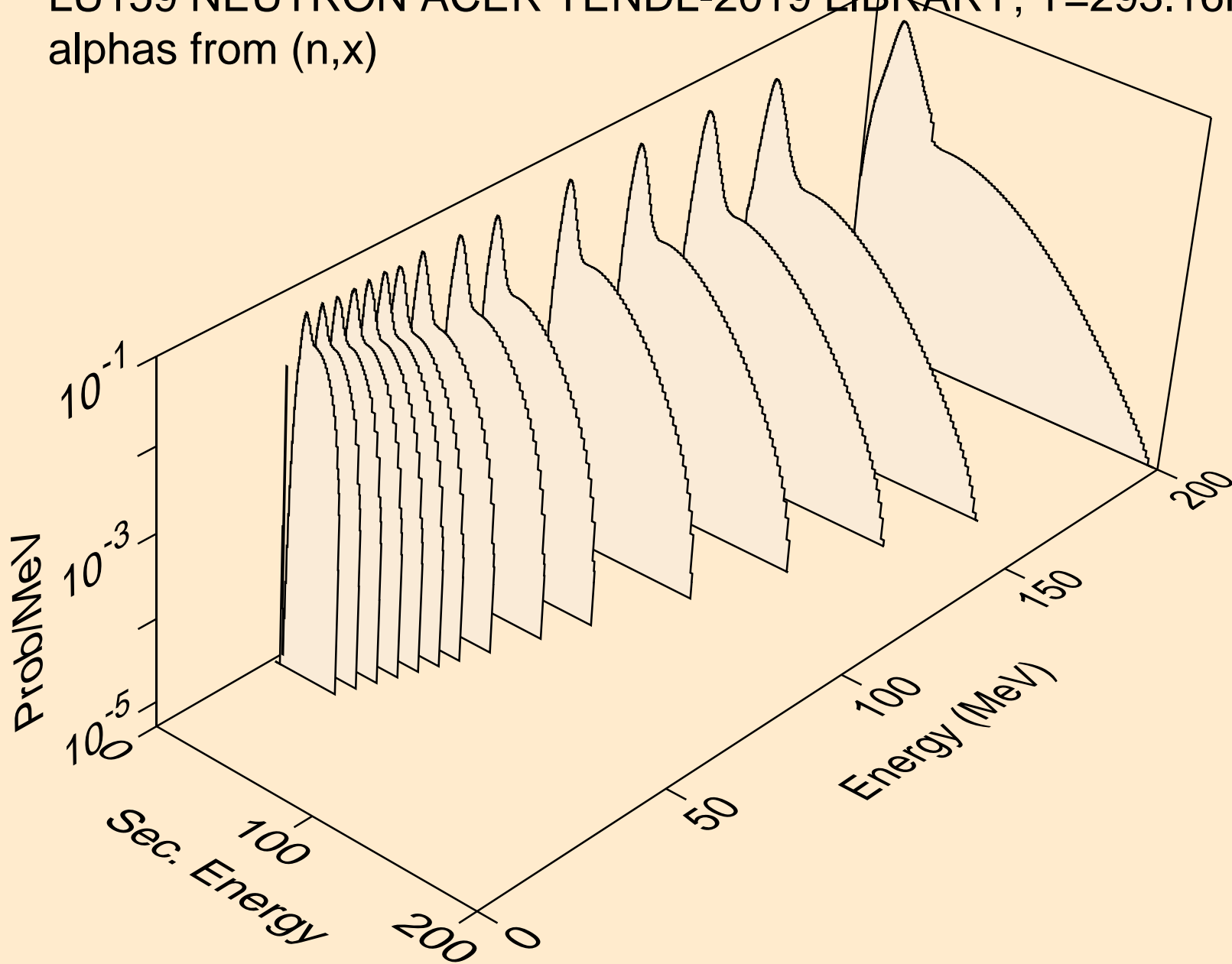

LU159 NEUTRON ACER TENDL-2019 LIBRARY; T=293.16K
alphas from (n,n*)a

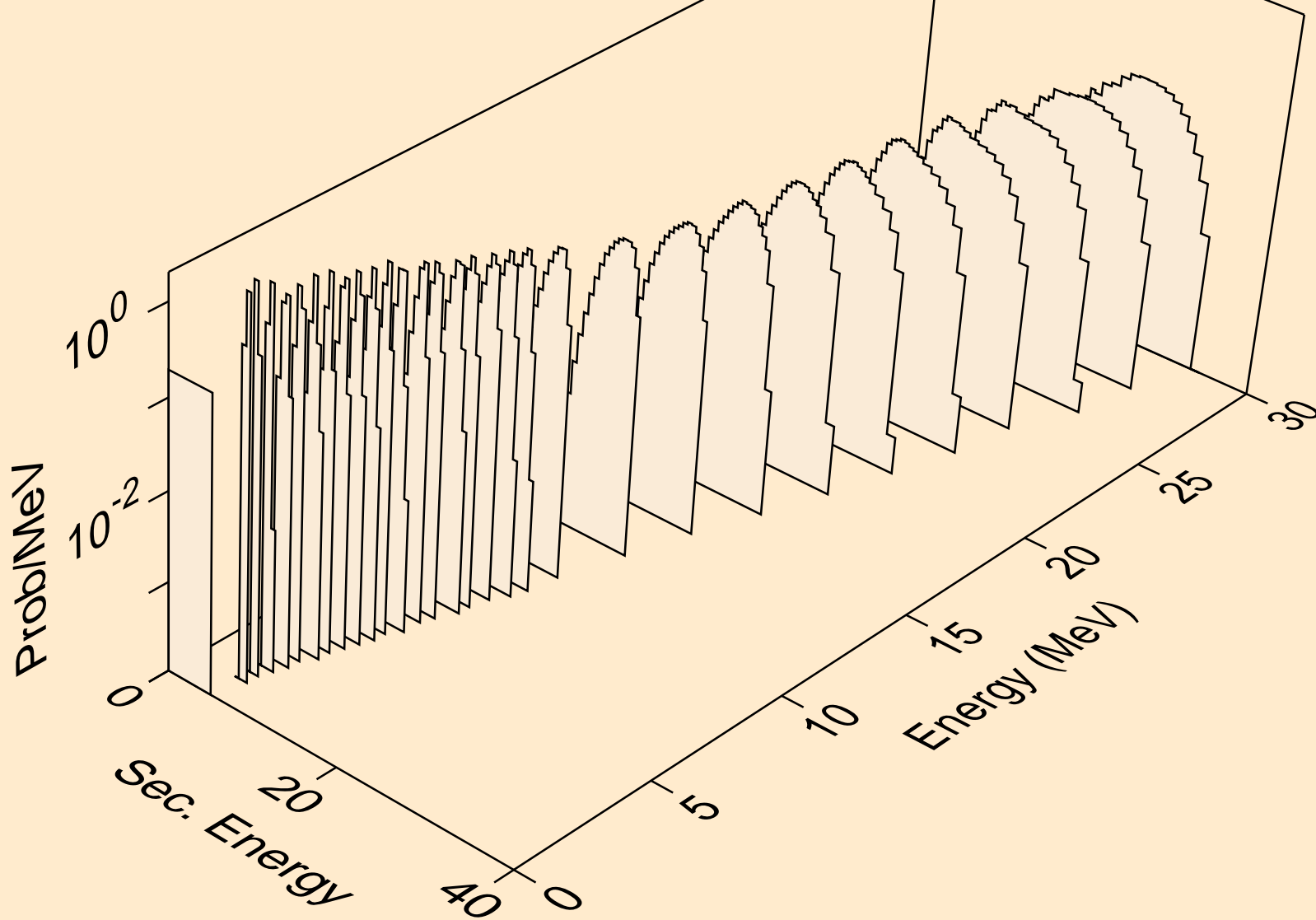

LU159 NEUTRON ACER TENDL-2019 LIBRARY; T=293.16K
alphas from (n,n*)3a

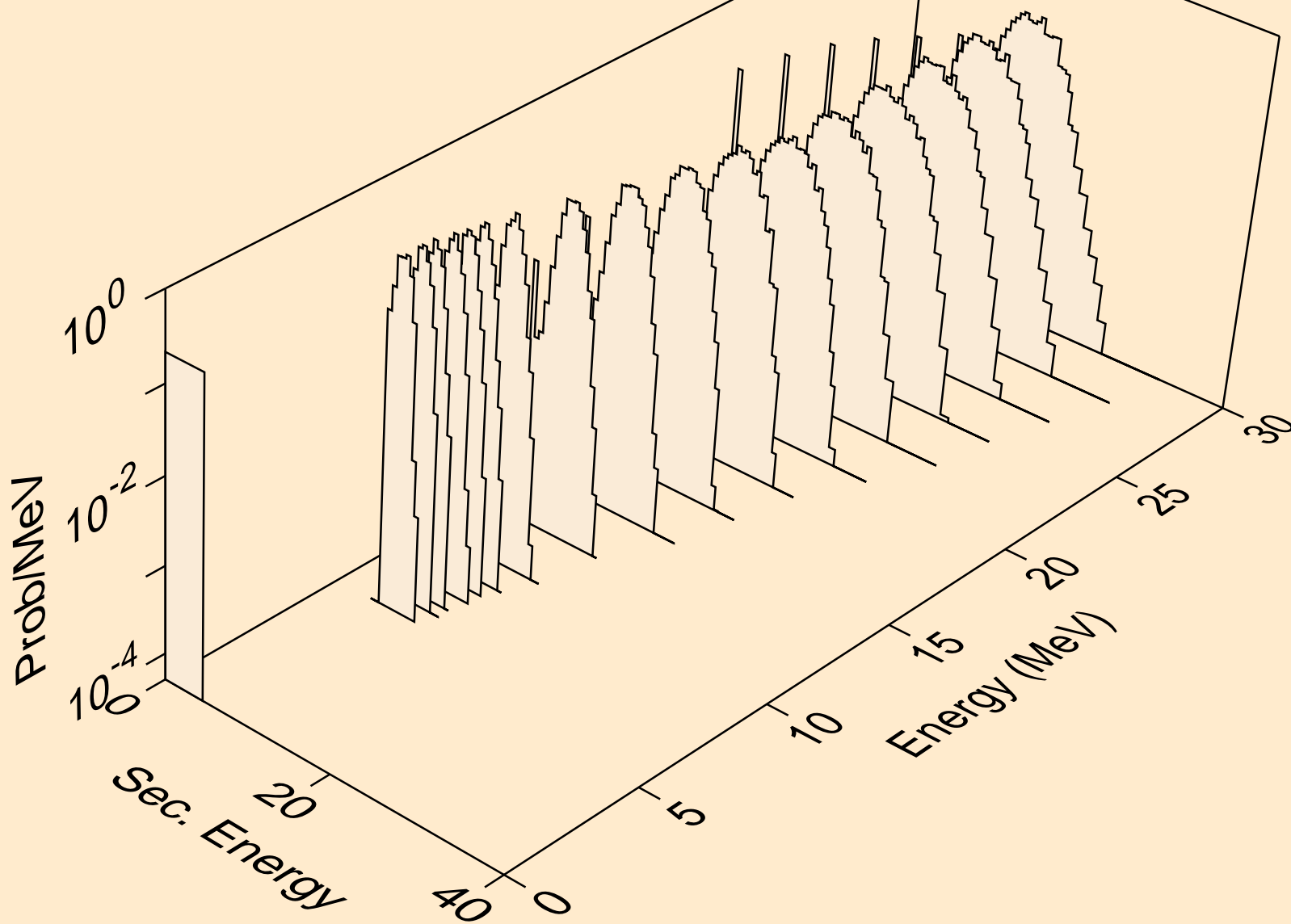

LU159 NEUTRON ACER TENDL-2019 LIBRARY; T=293.16K
alphas from (n,2n)a

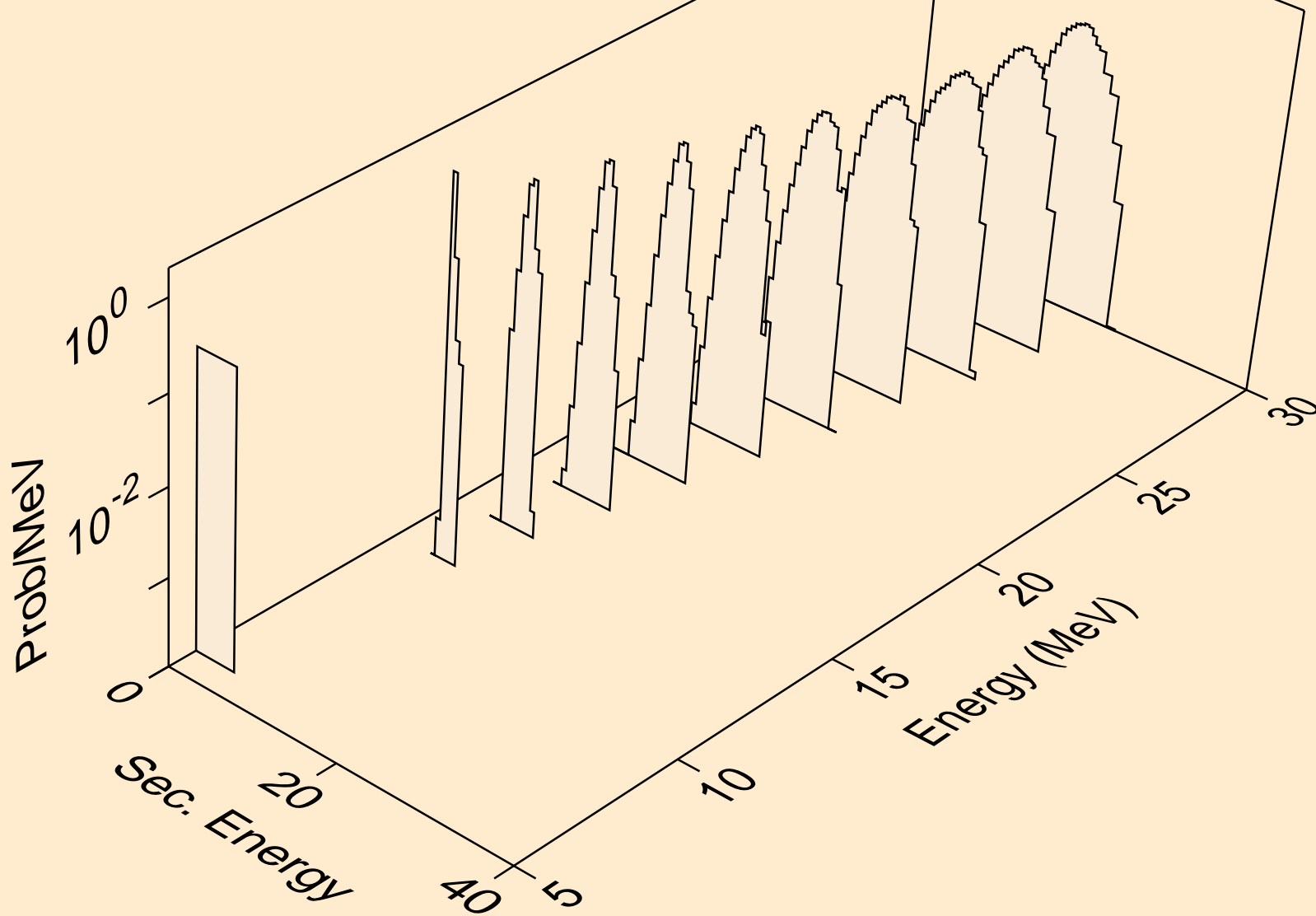

LU159 NEUTRON ACER TENDL-2019 LIBRARY; T=293.16K
alphas from (n,3n)a

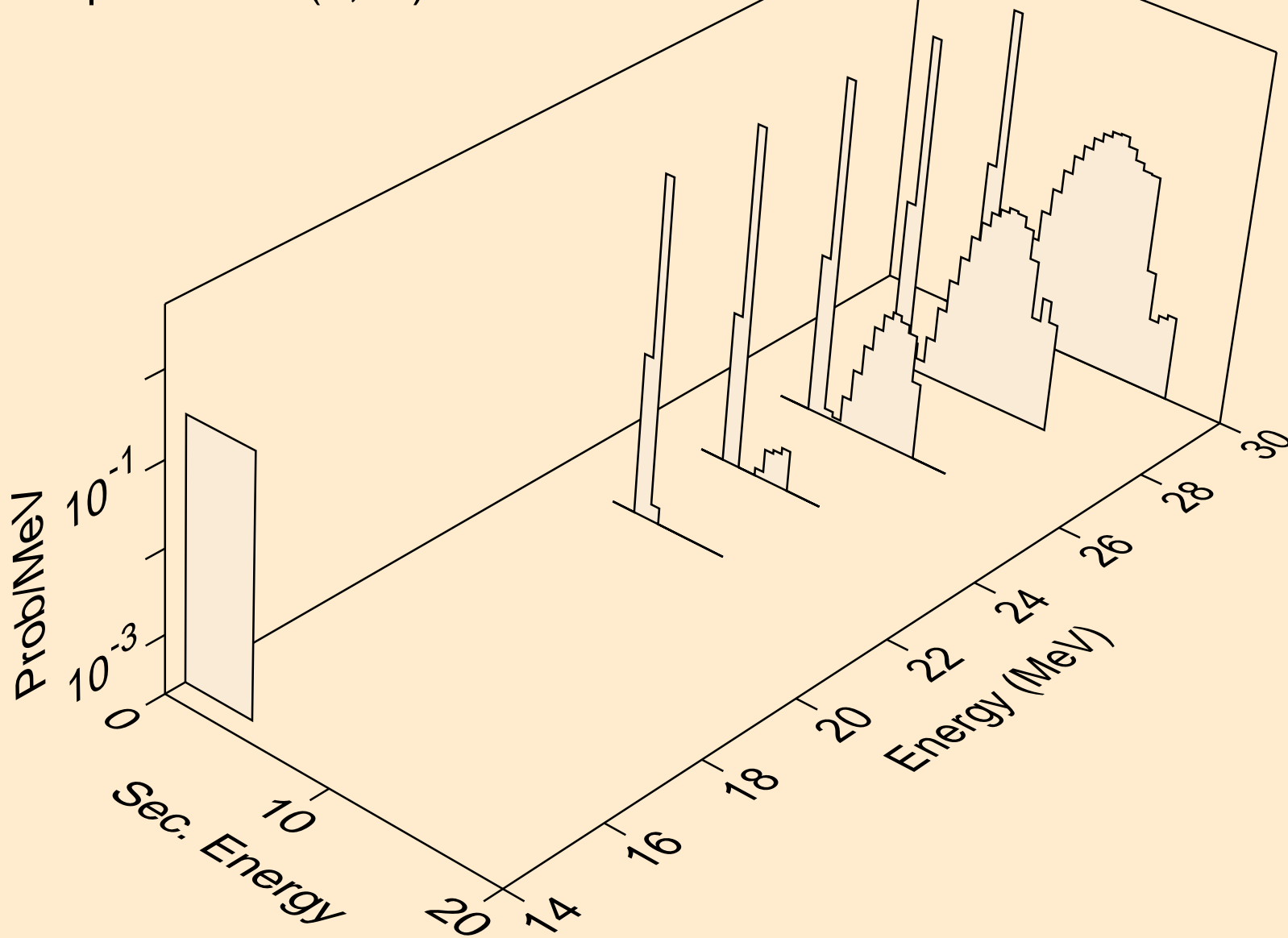

LU159 NEUTRON ACER TENDL-2019 LIBRARY; T=293.16K
alphas from (n,n*)2a

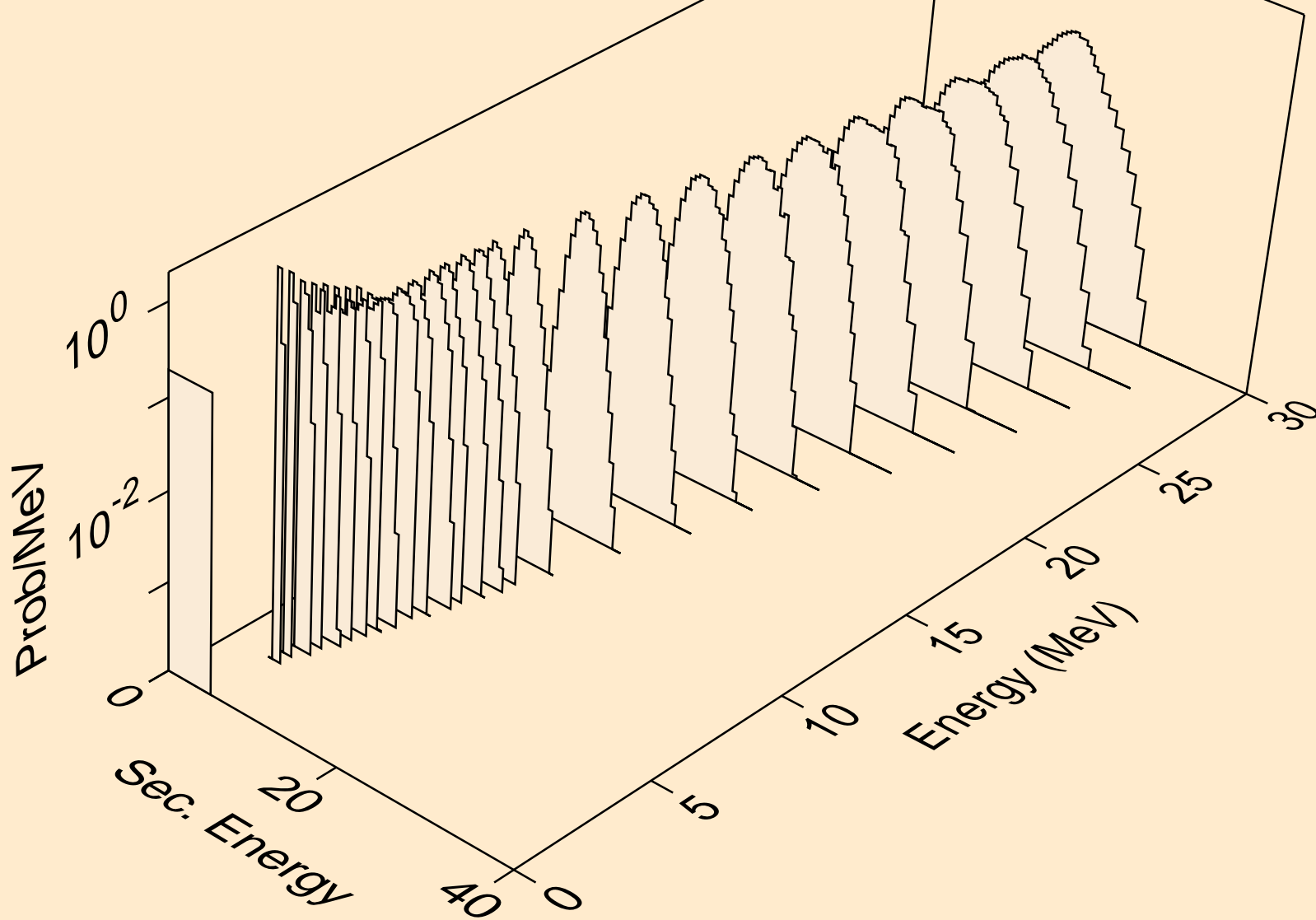

LU159 NEUTRON ACER TENDL-2019 LIBRARY; T=293.16K
alphas from (n,2n)2a

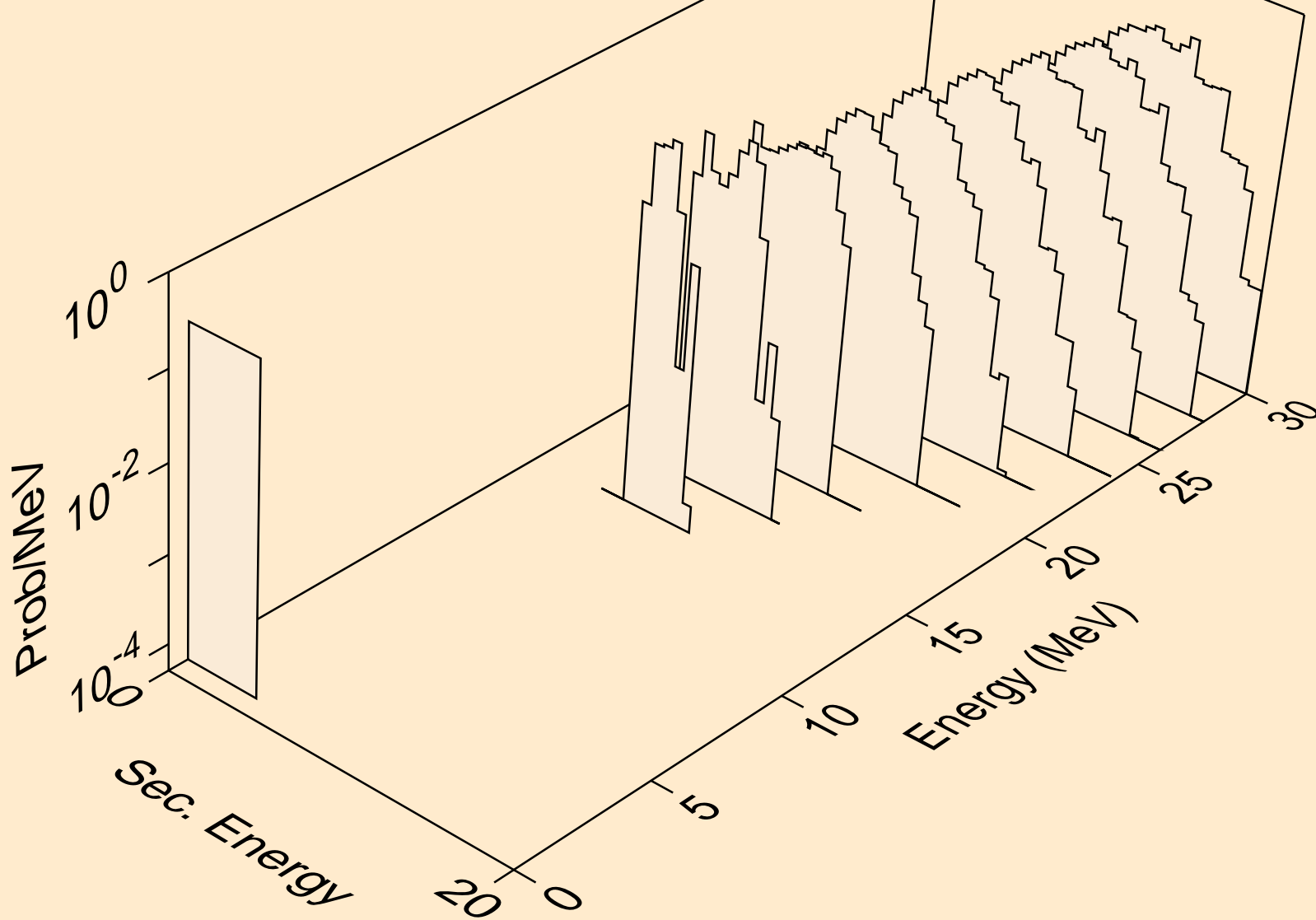

LU159 NEUTRON ACER TENDL-2019 LIBRARY; T=293.16K
alphas from (n,n*)d2a

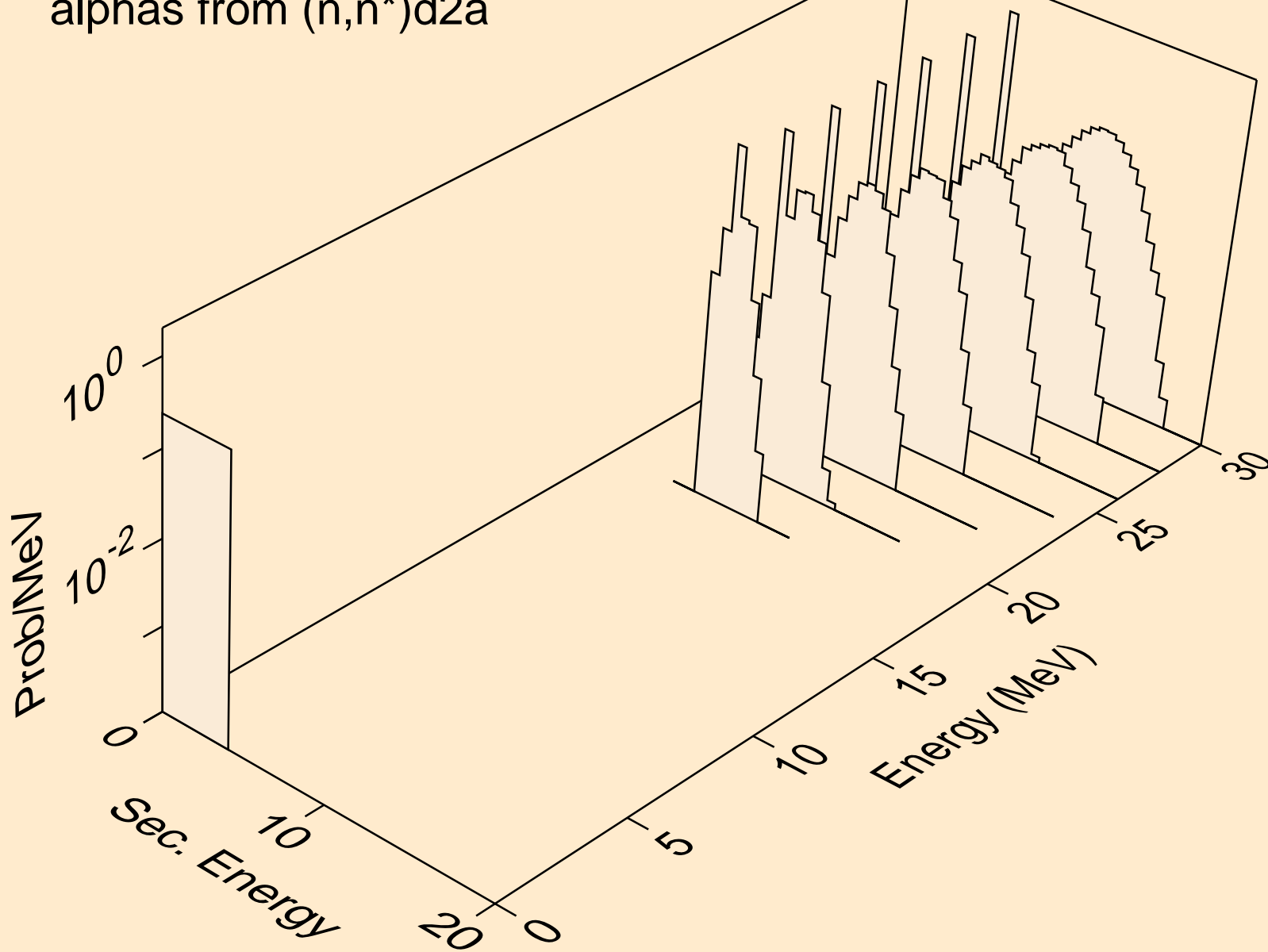

LU159 NEUTRON ACER TENDL-2019 LIBRARY; T=293.16K
alphas from (n,npa)

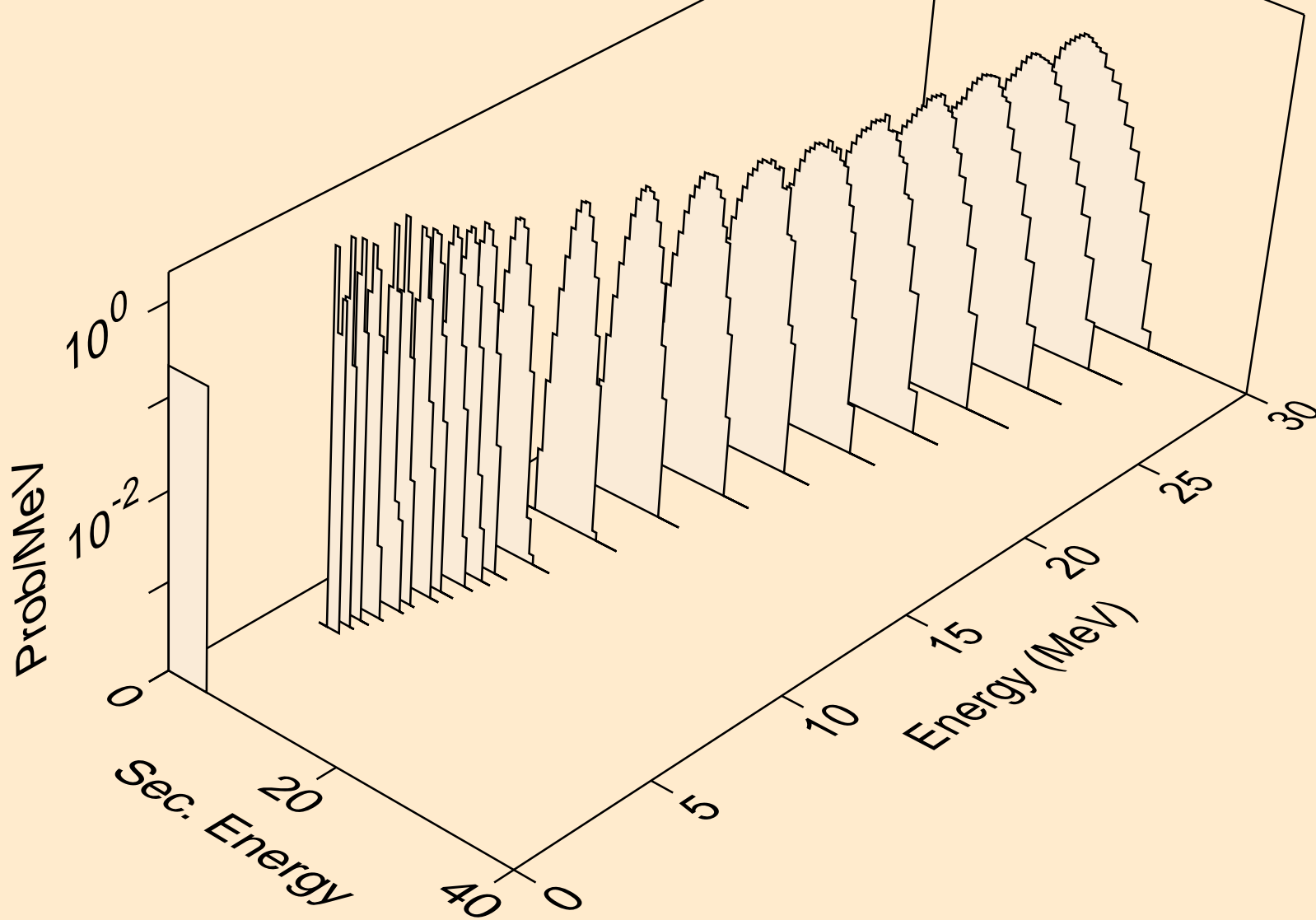

LU159 NEUTRON ACER TENDL-2019 LIBRARY; T=293.16K
alphas from (n,a)

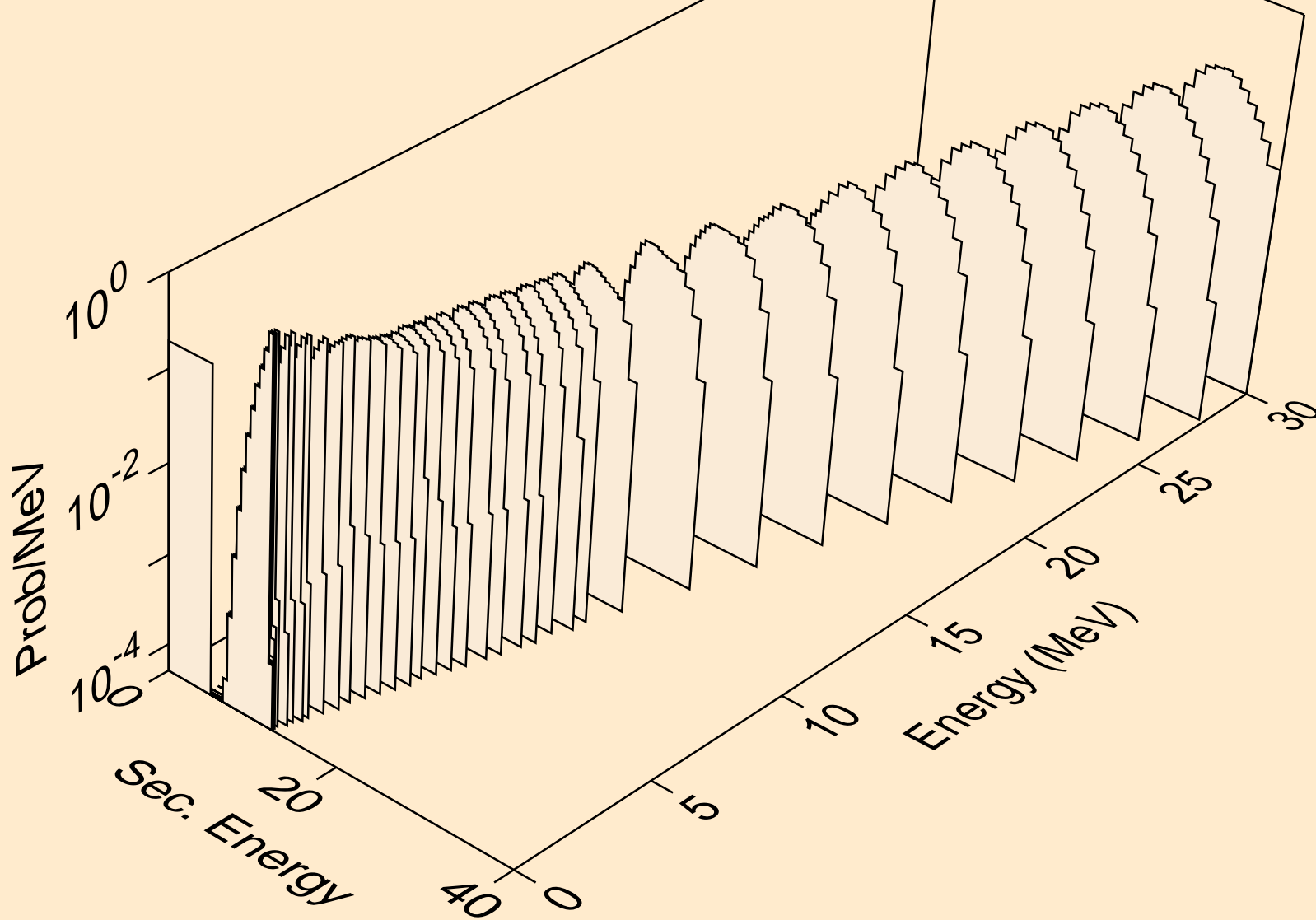

LU159 NEUTRON ACER TENDL-2019 LIBRARY; T=293.16K
alphas from (n,2a)

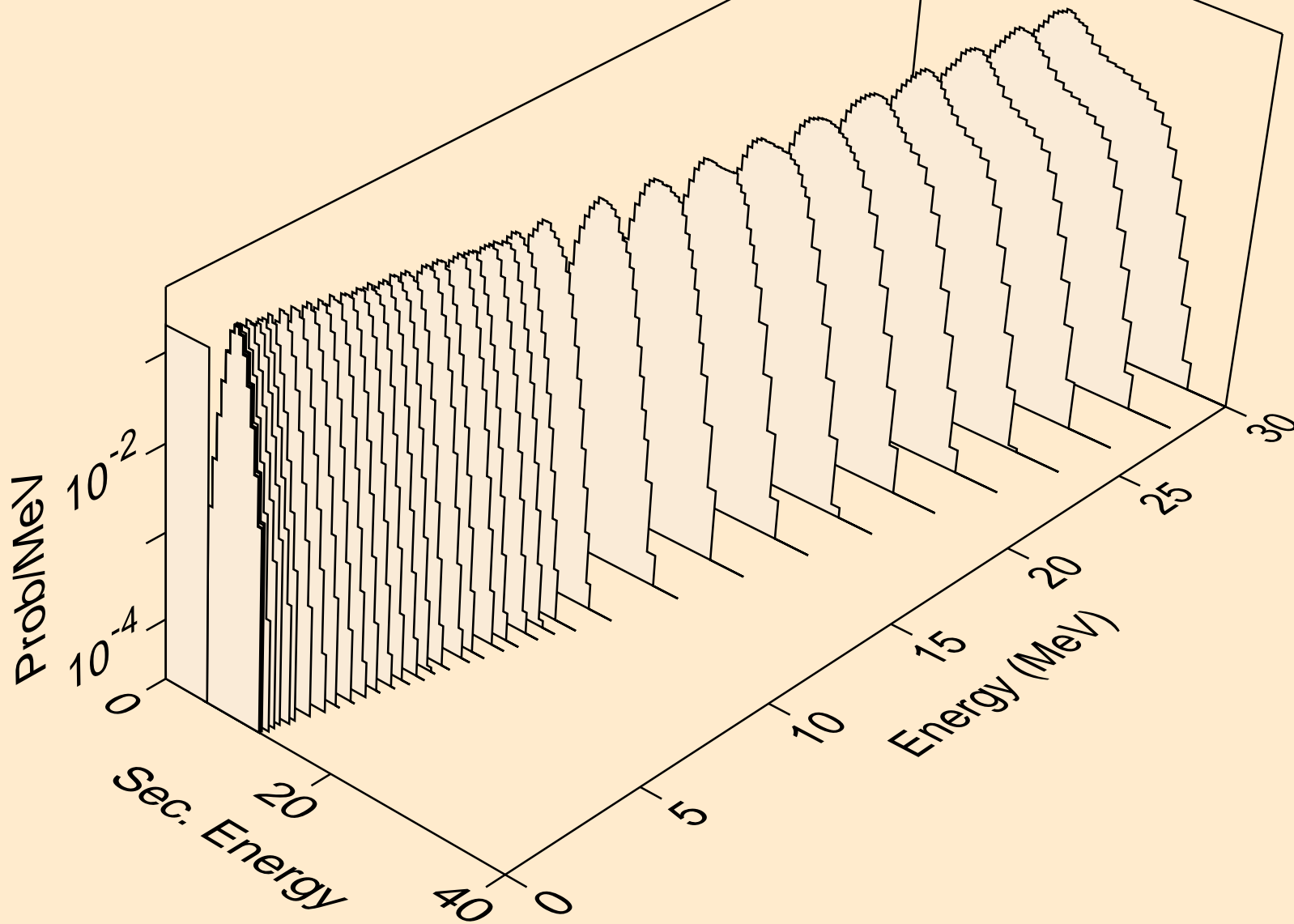

LU159 NEUTRON ACER TENDL-2019 LIBRARY; T=293.16K
alphas from (n,3a)

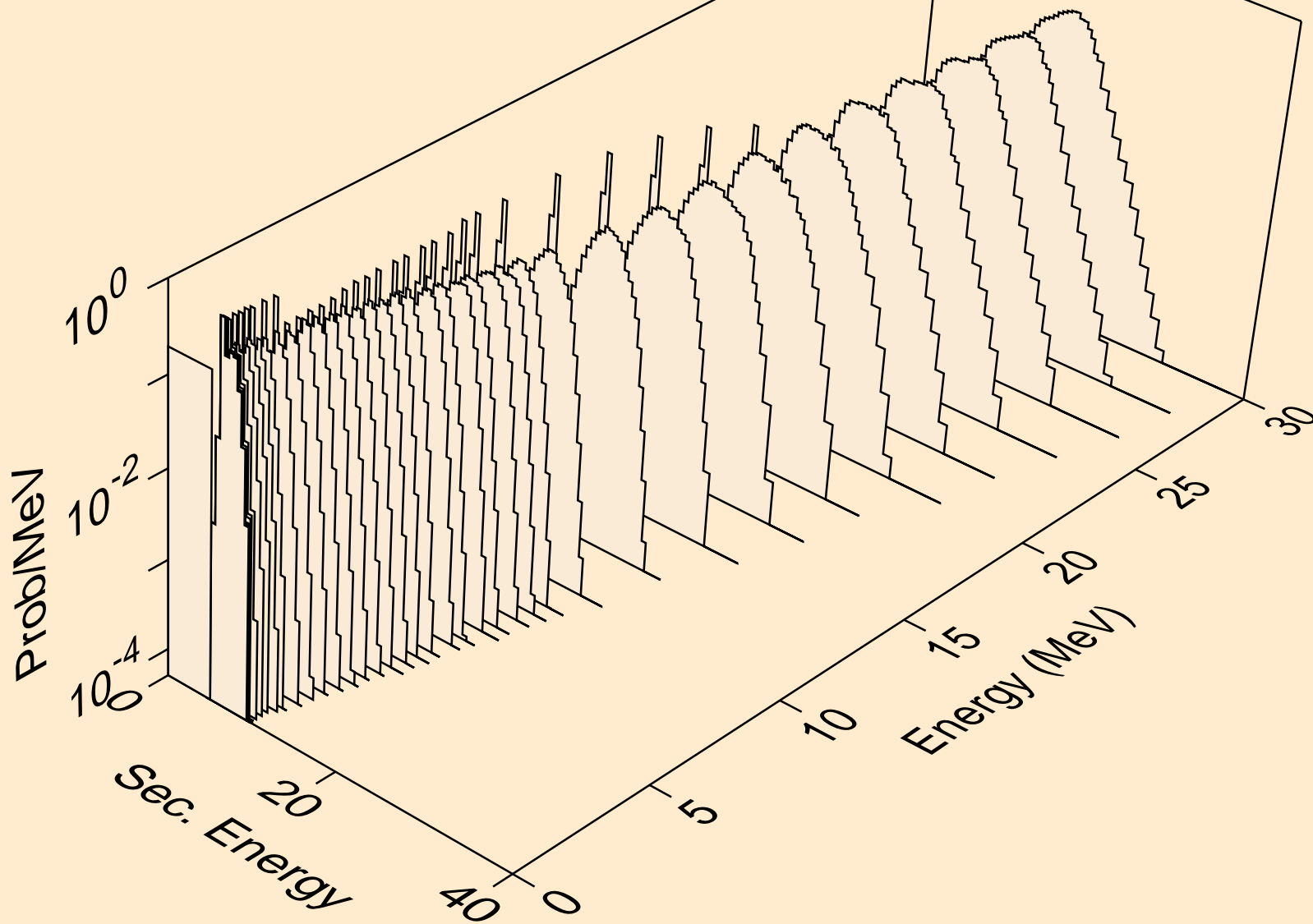

LU159 NEUTRON ACER TENDL-2019 LIBRARY; T=293.16K
alphas from (n,p)

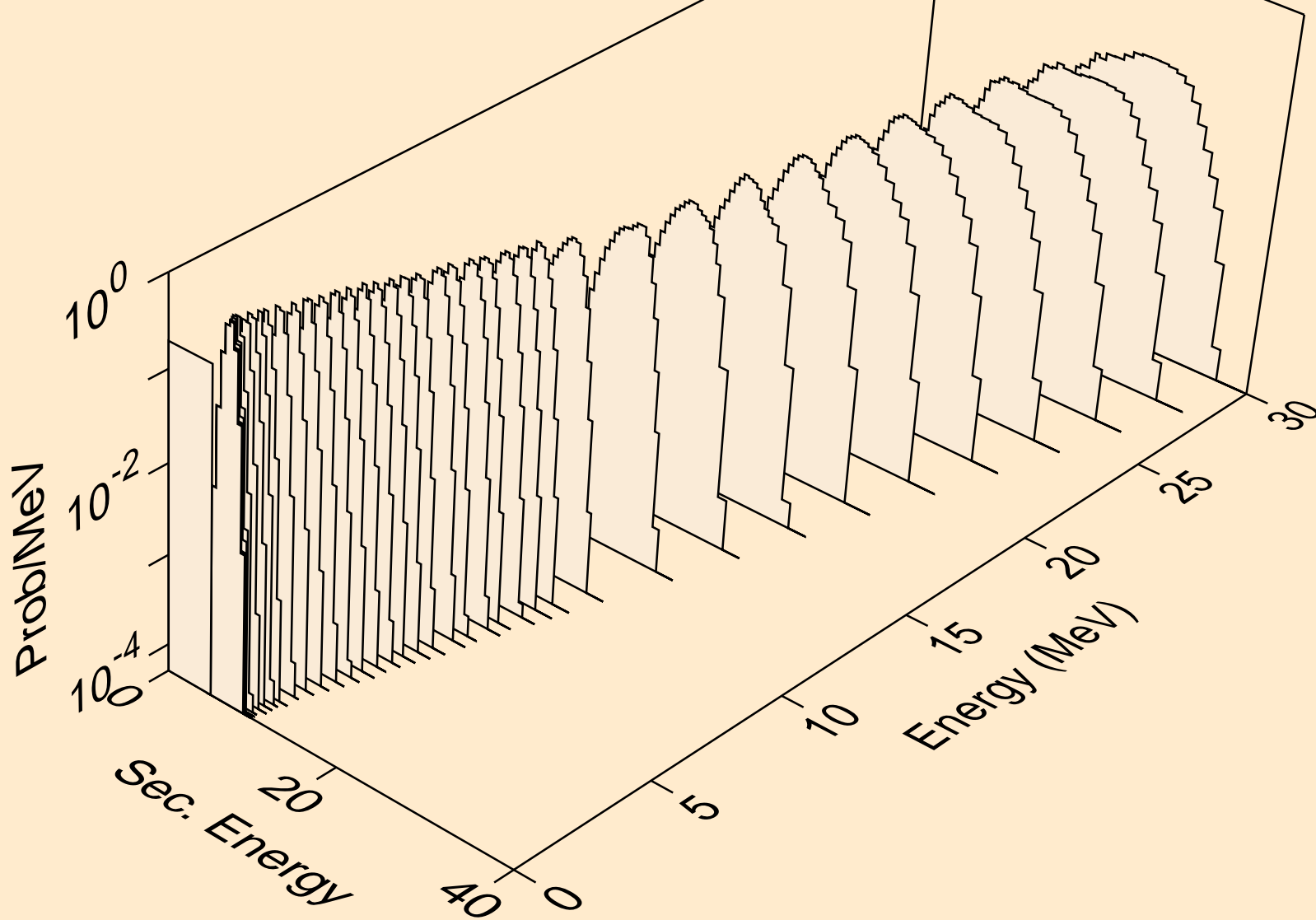

LU159 NEUTRON ACER TENDL-2019 LIBRARY; T=293.16K
alphas from (n,t2a)

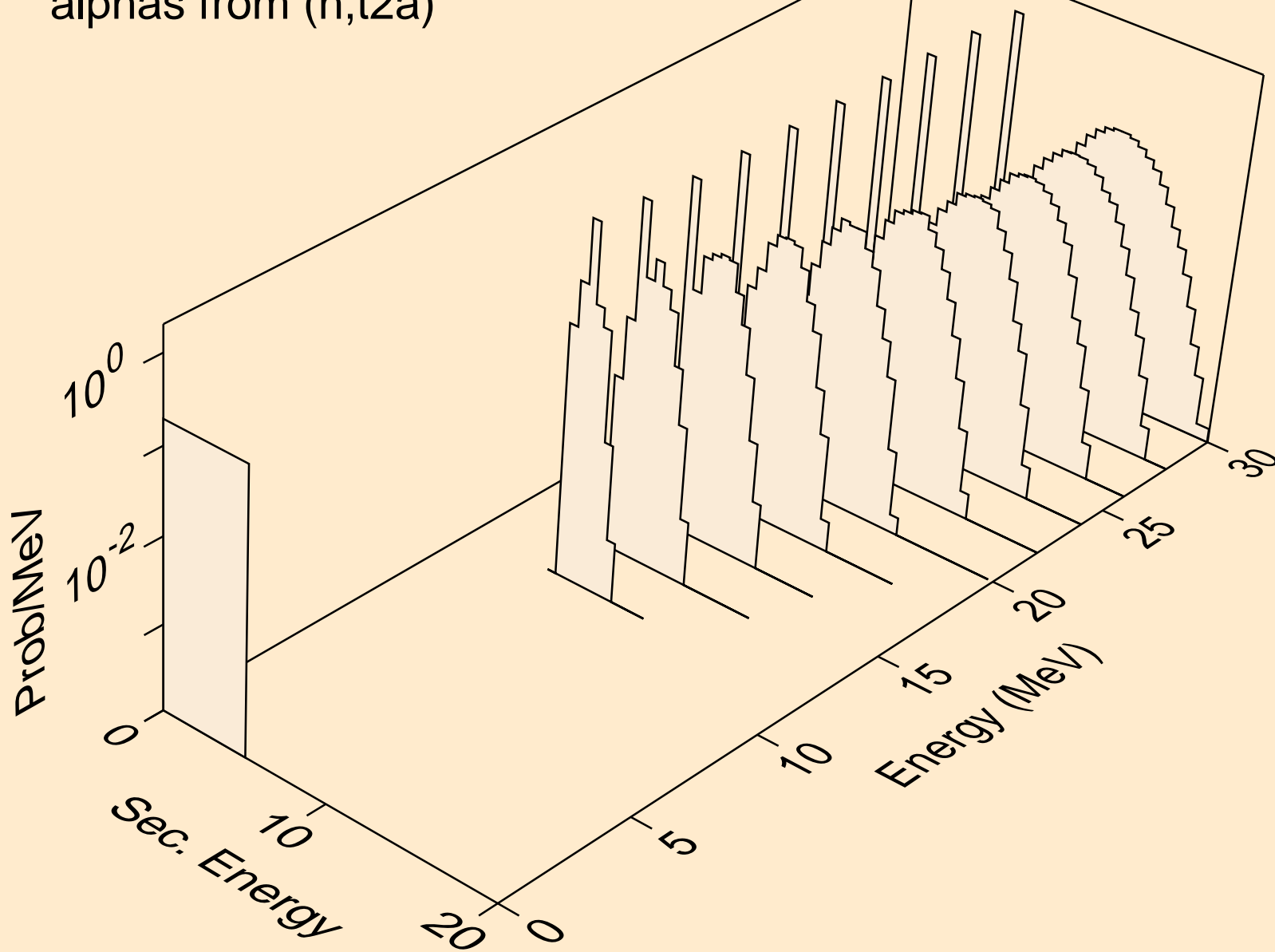

LU159 NEUTRON ACER TENDL-2019 LIBRARY; T=293.16K
alphas from (n,d2a)

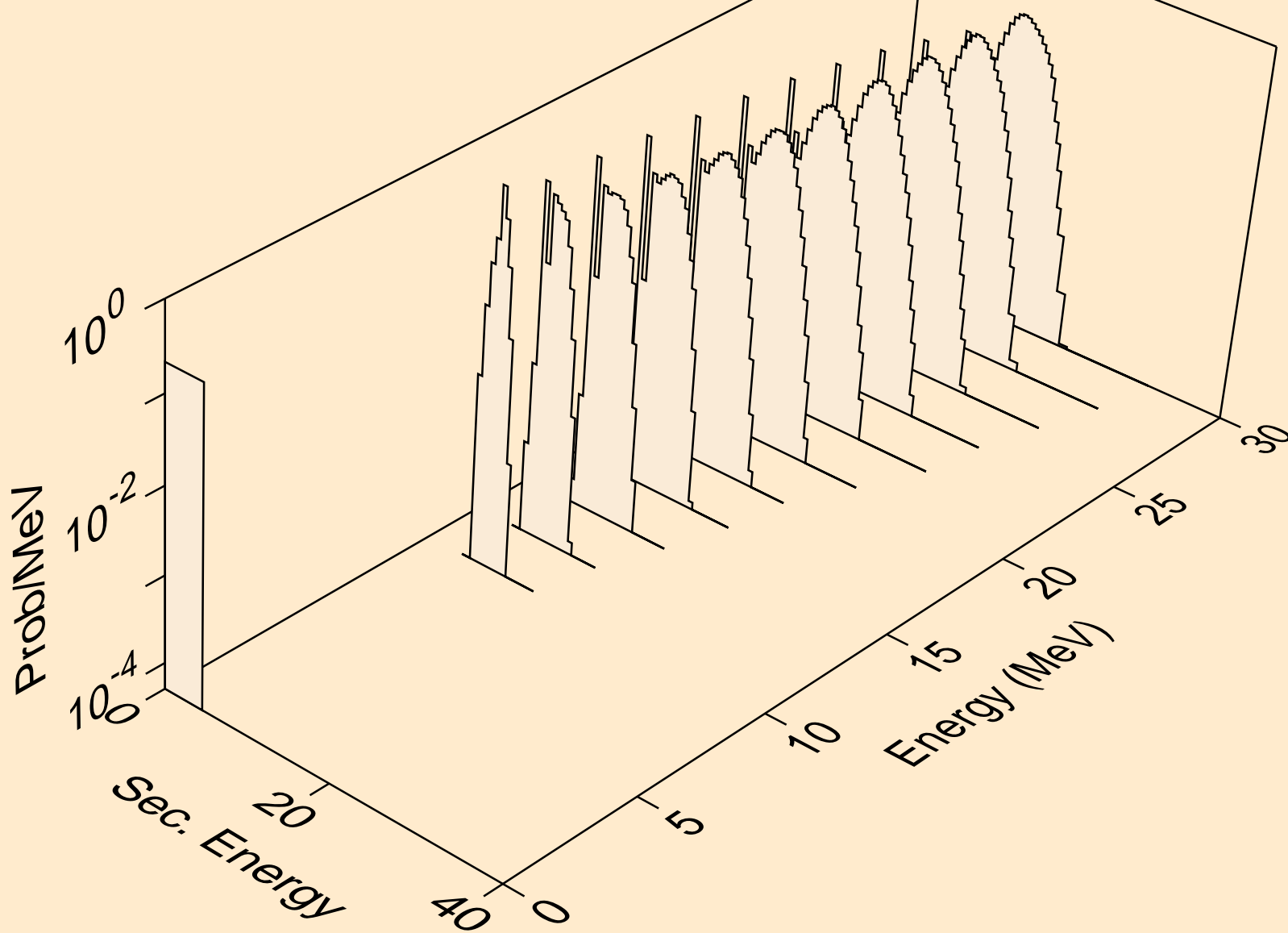

LU159 NEUTRON ACER TENDL-2019 LIBRARY; T=293.16K
alphas from (n,da)

