

ND128 NEUTRON ACER TENDL-2019 LIBRARY; T=293.16K  
Principal cross sections

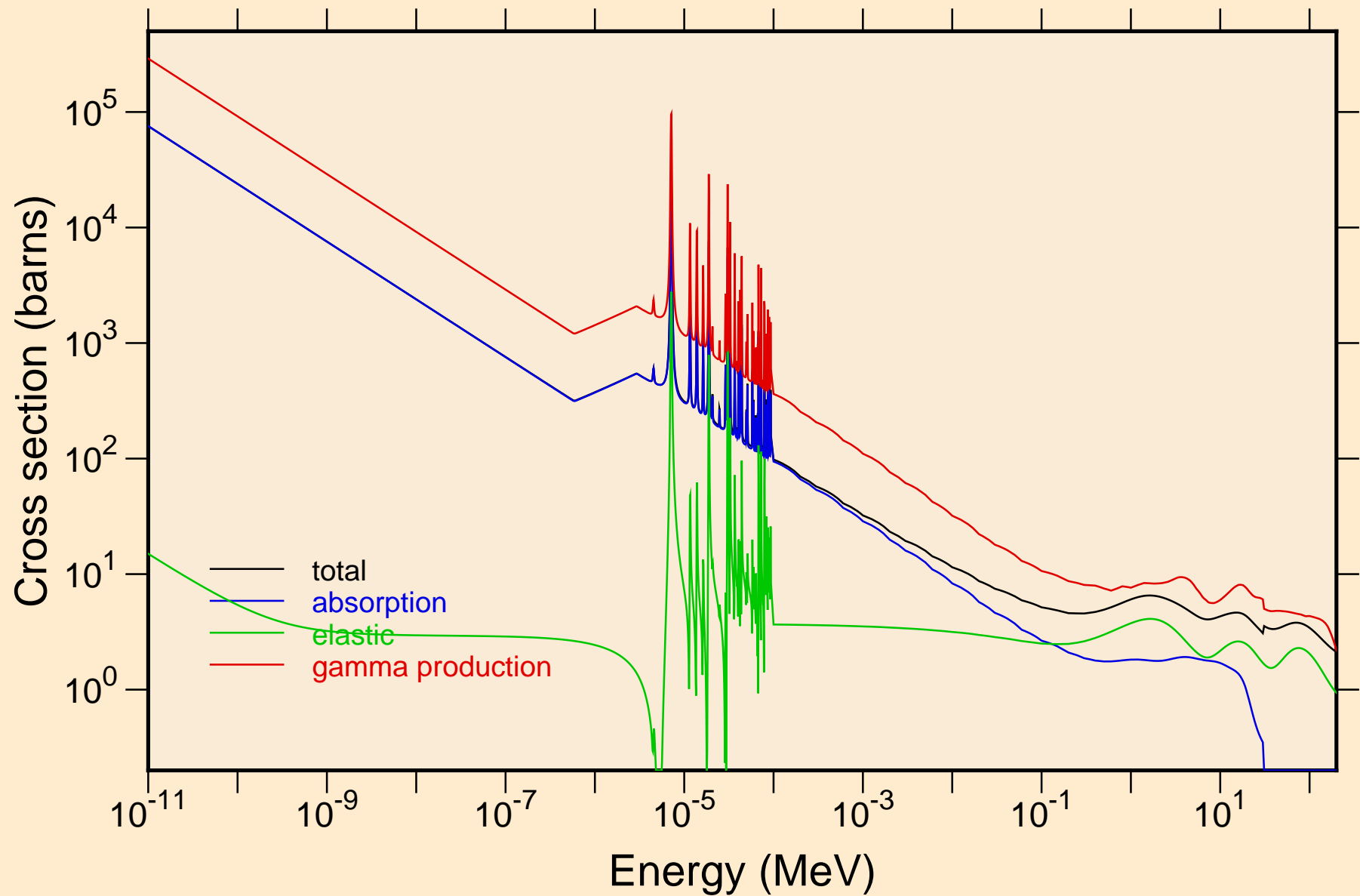

ND128 NEUTRON ACER TENDL-2019 LIBRARY; T=293.16K  
resonance total cross section

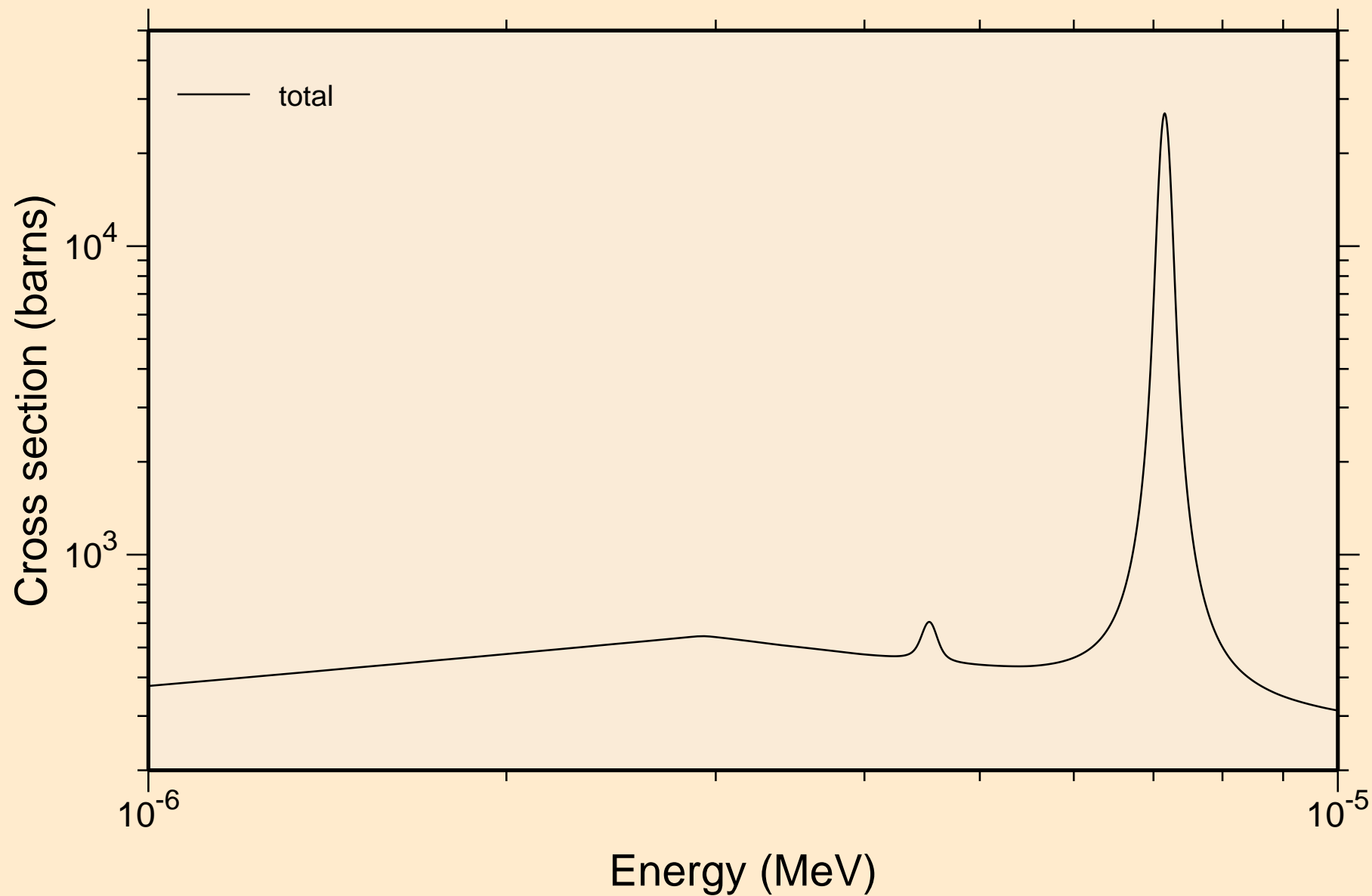

ND128 NEUTRON ACER TENDL-2019 LIBRARY; T=293.16K  
resonance total cross section

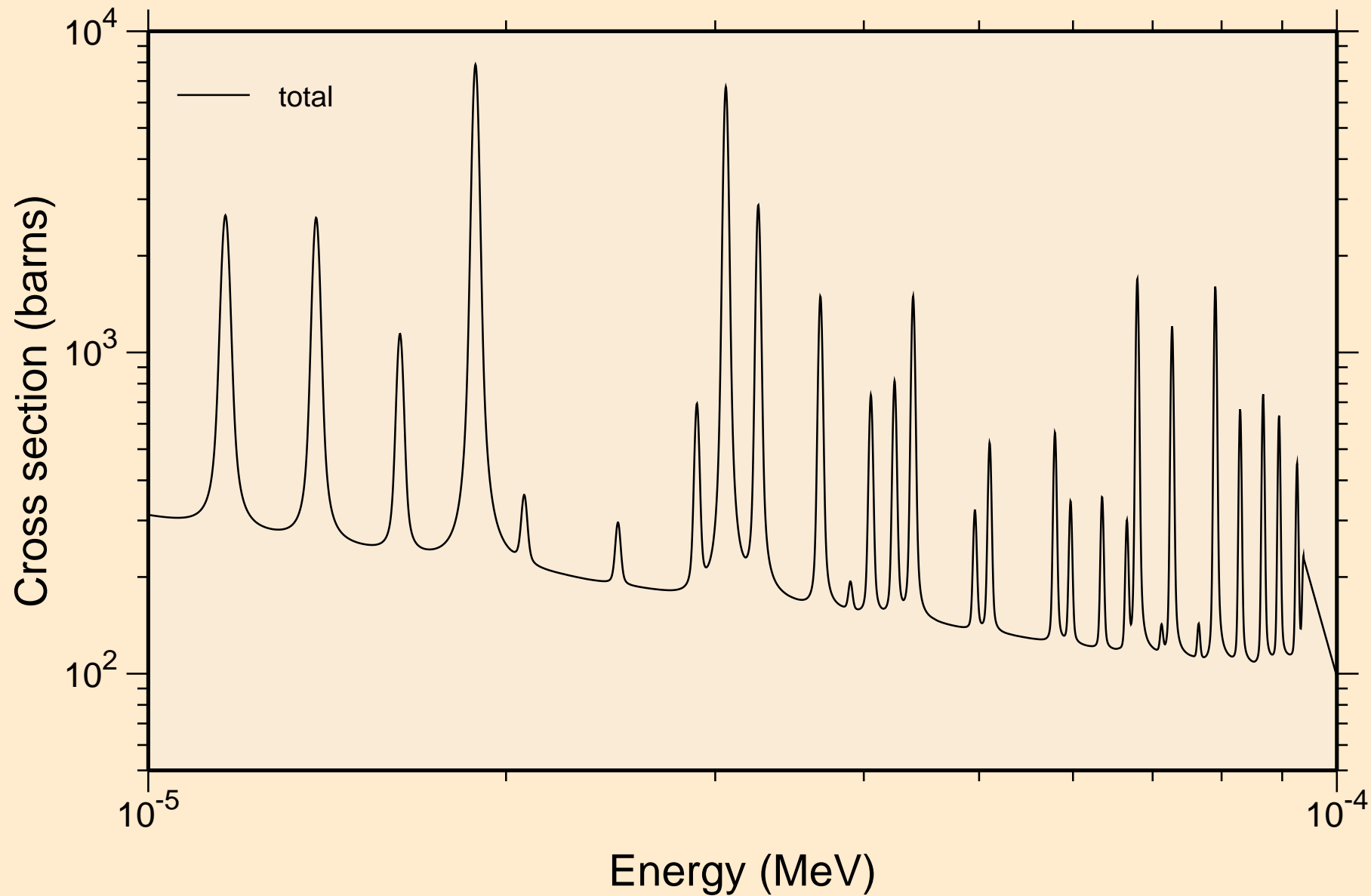

ND128 NEUTRON ACER TENDL-2019 LIBRARY; T=293.16K  
resonance total cross section

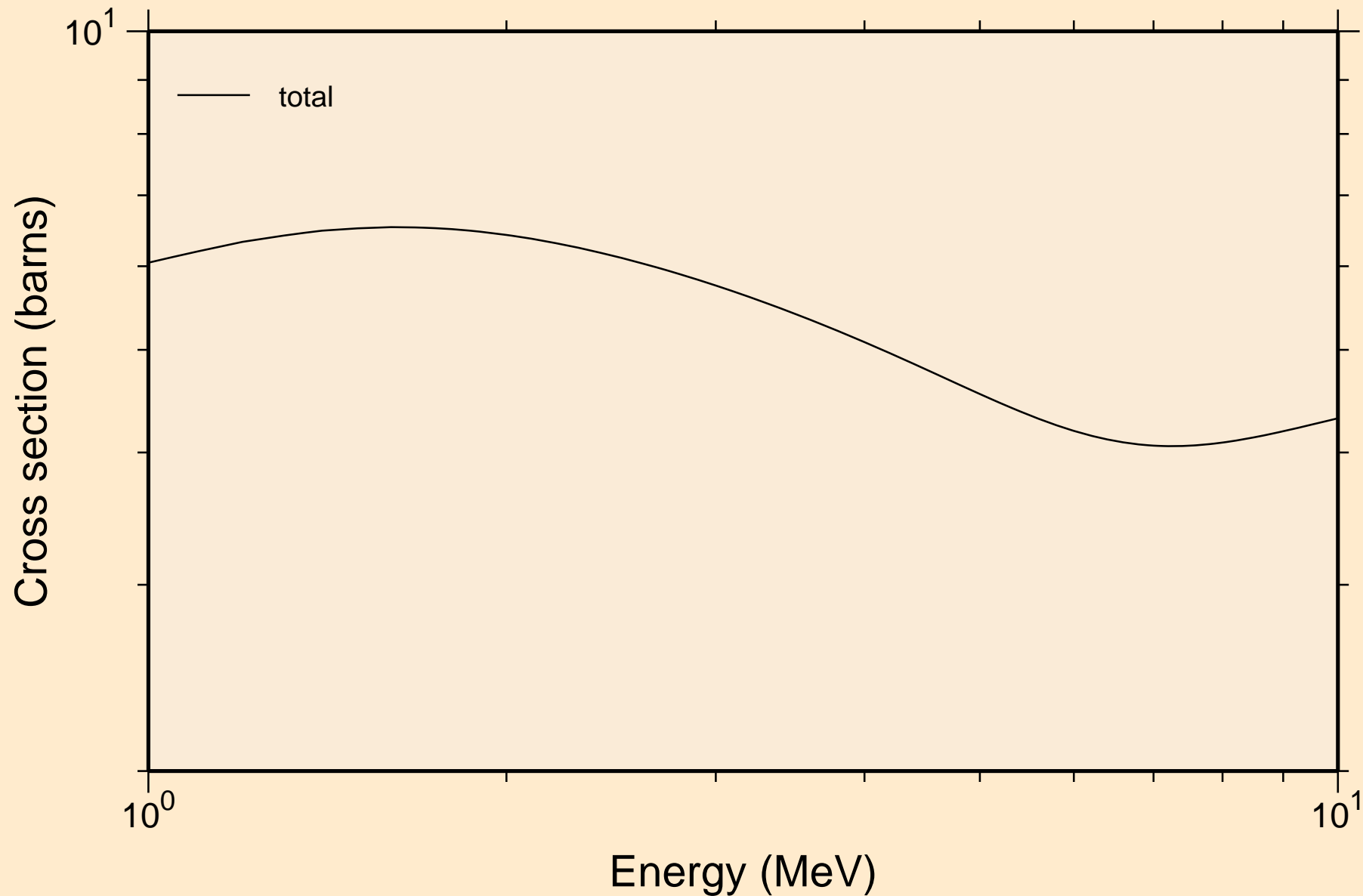

ND128 NEUTRON ACER TENDL-2019 LIBRARY; T=293.16K  
resonance absorption cross sections

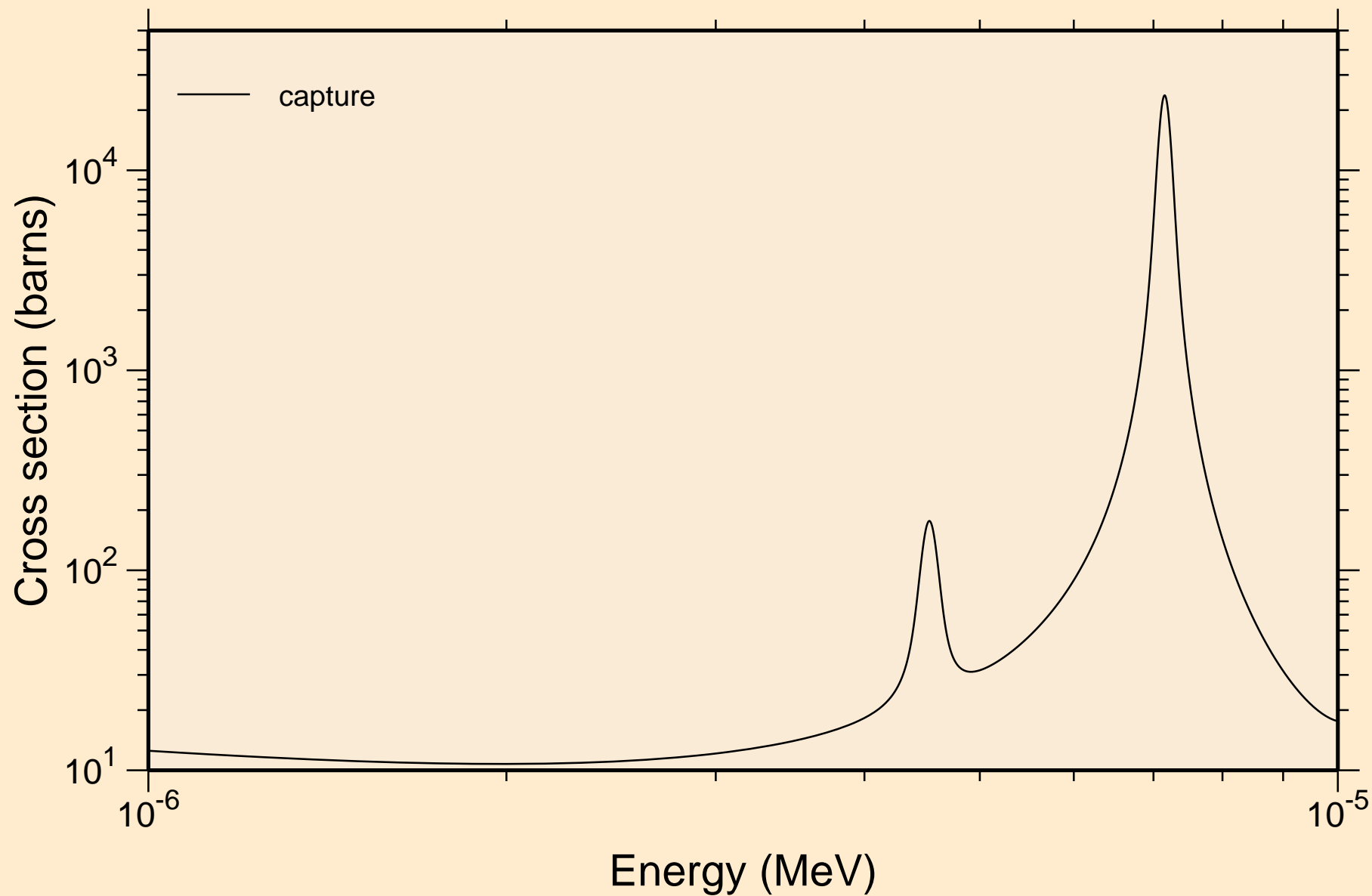

ND128 NEUTRON ACER TENDL-2019 LIBRARY; T=293.16K  
resonance absorption cross sections

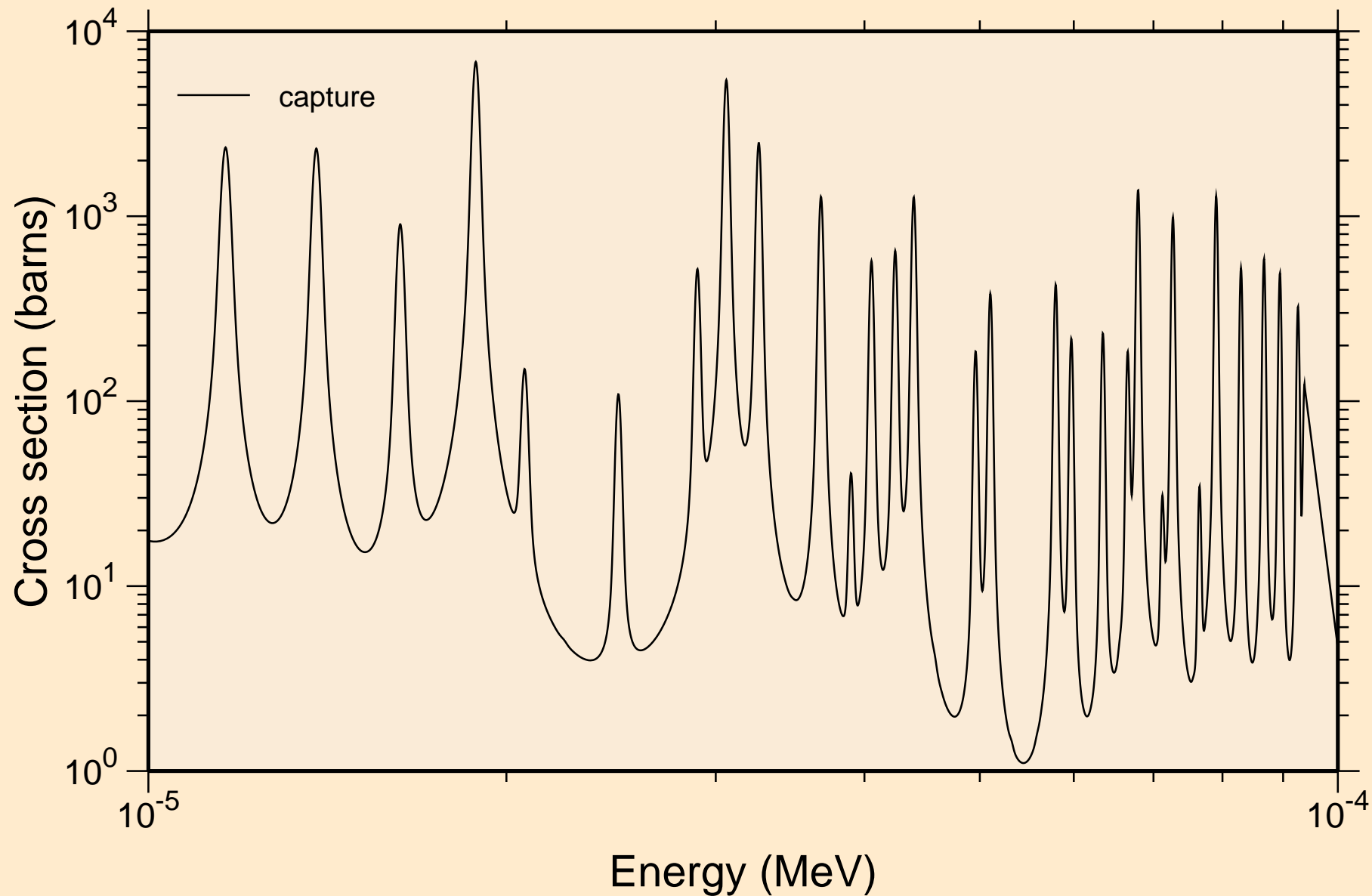

ND128 NEUTRON ACER TENDL-2019 LIBRARY; T=293.16K  
resonance absorption cross sections

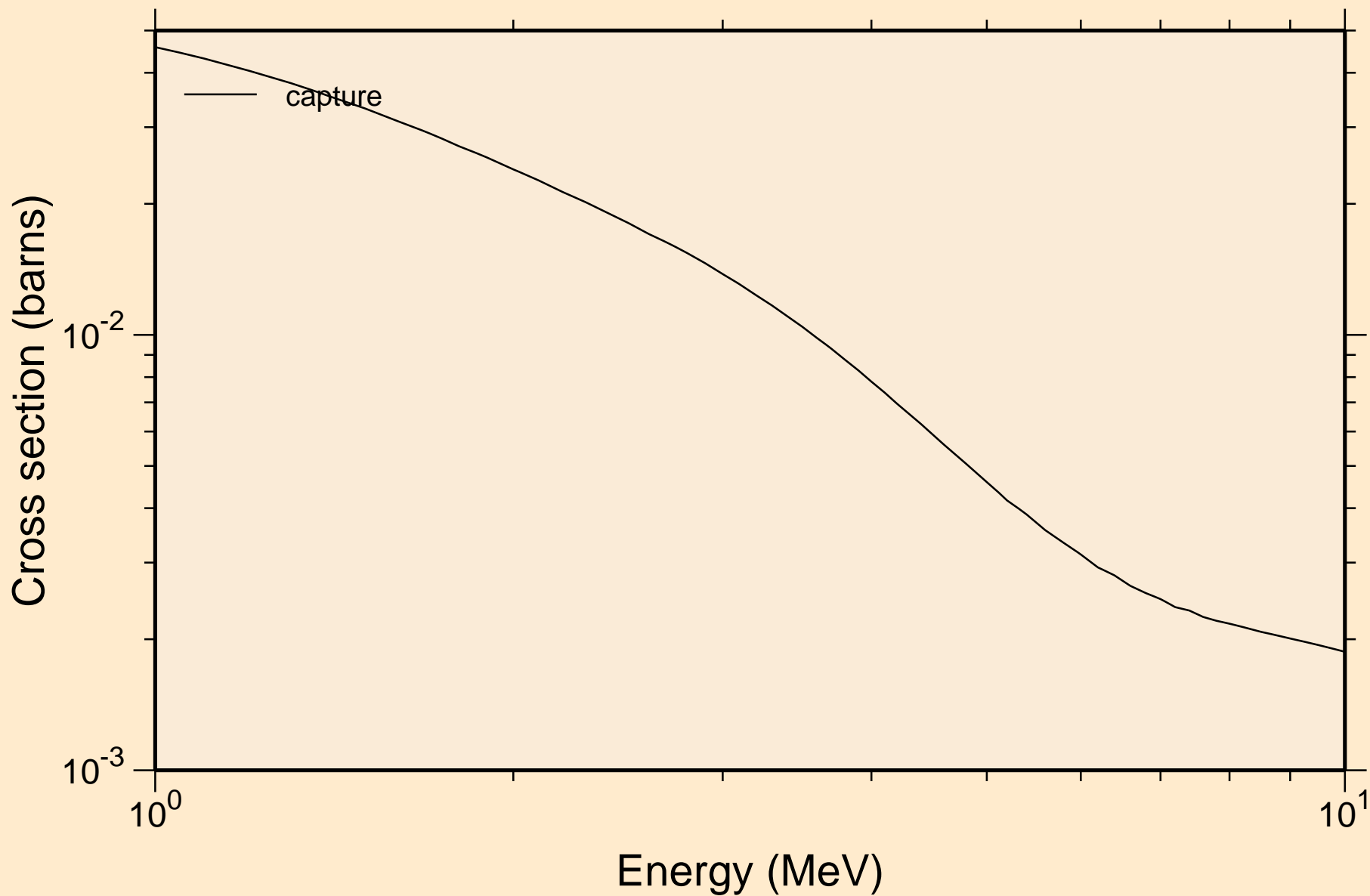

ND128 NEUTRON ACER TENDL-2019 LIBRARY; T=293.16K  
Heating

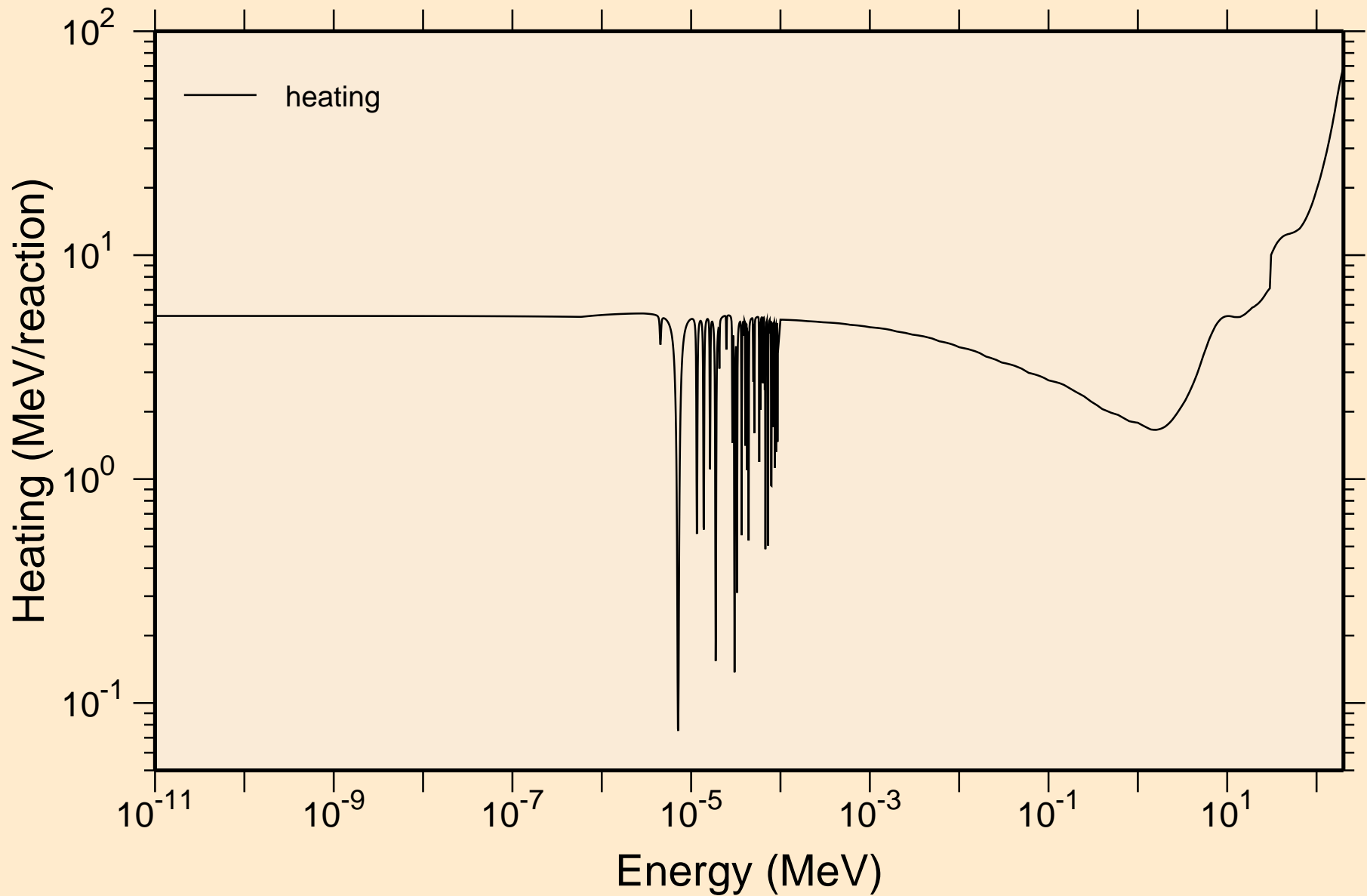

ND128 NEUTRON ACER TENDL-2019 LIBRARY; T=293.16K  
Damage

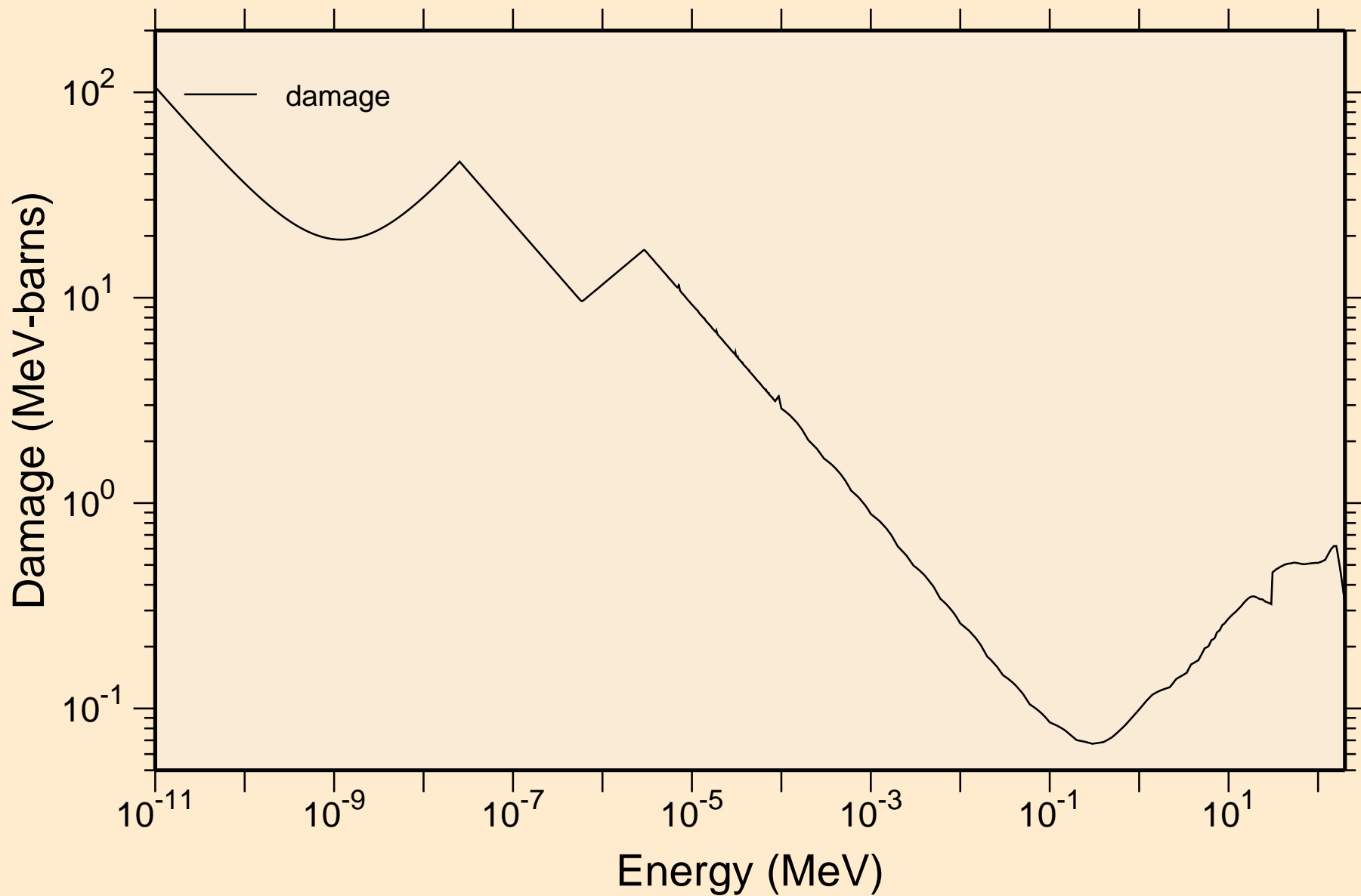

ND128 NEUTRON ACER TENDL-2019 LIBRARY; T=293.16K  
Non-threshold reactions

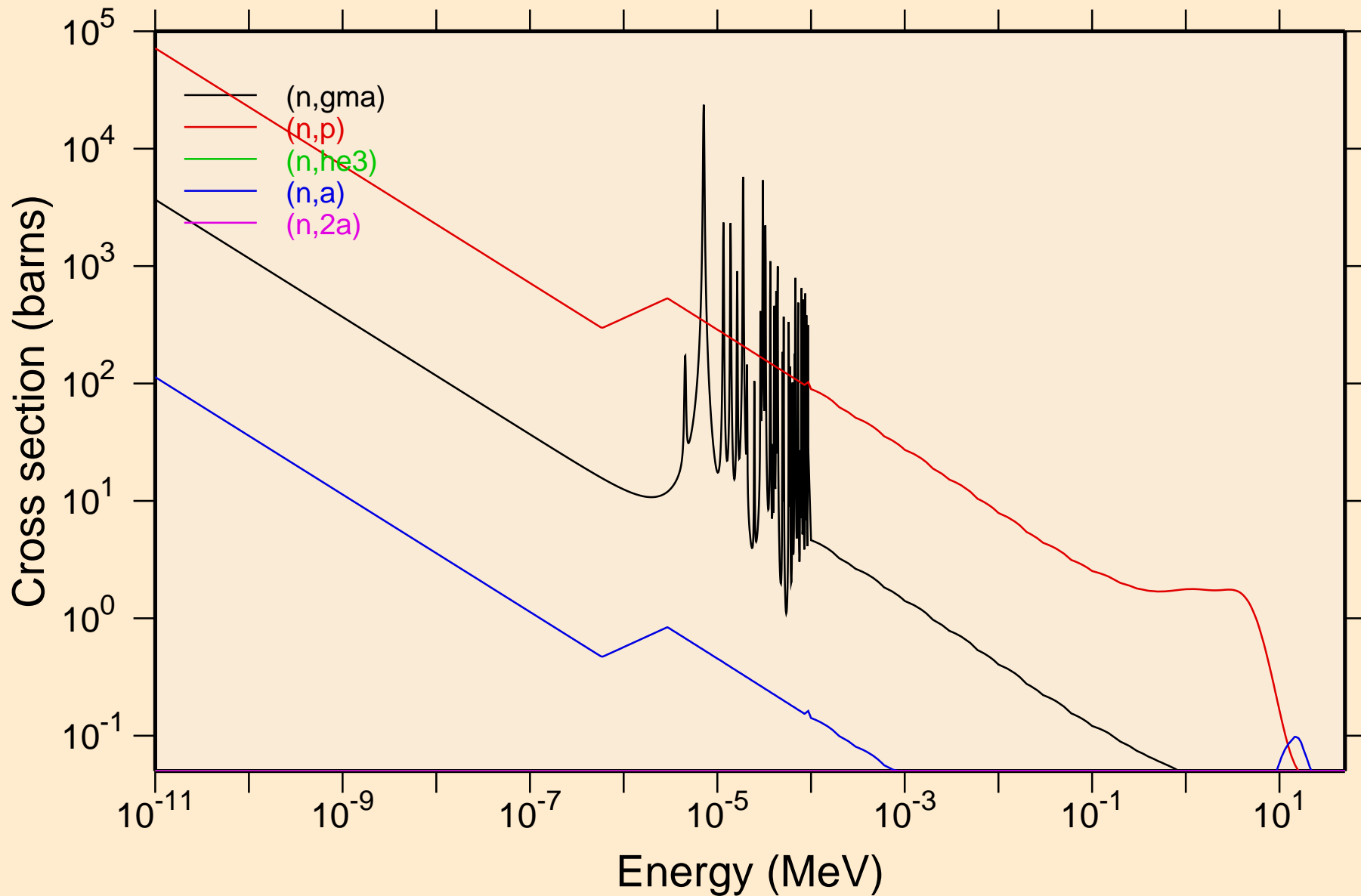

ND128 NEUTRON ACER TENDL-2019 LIBRARY; T=293.16K  
Non-threshold reactions

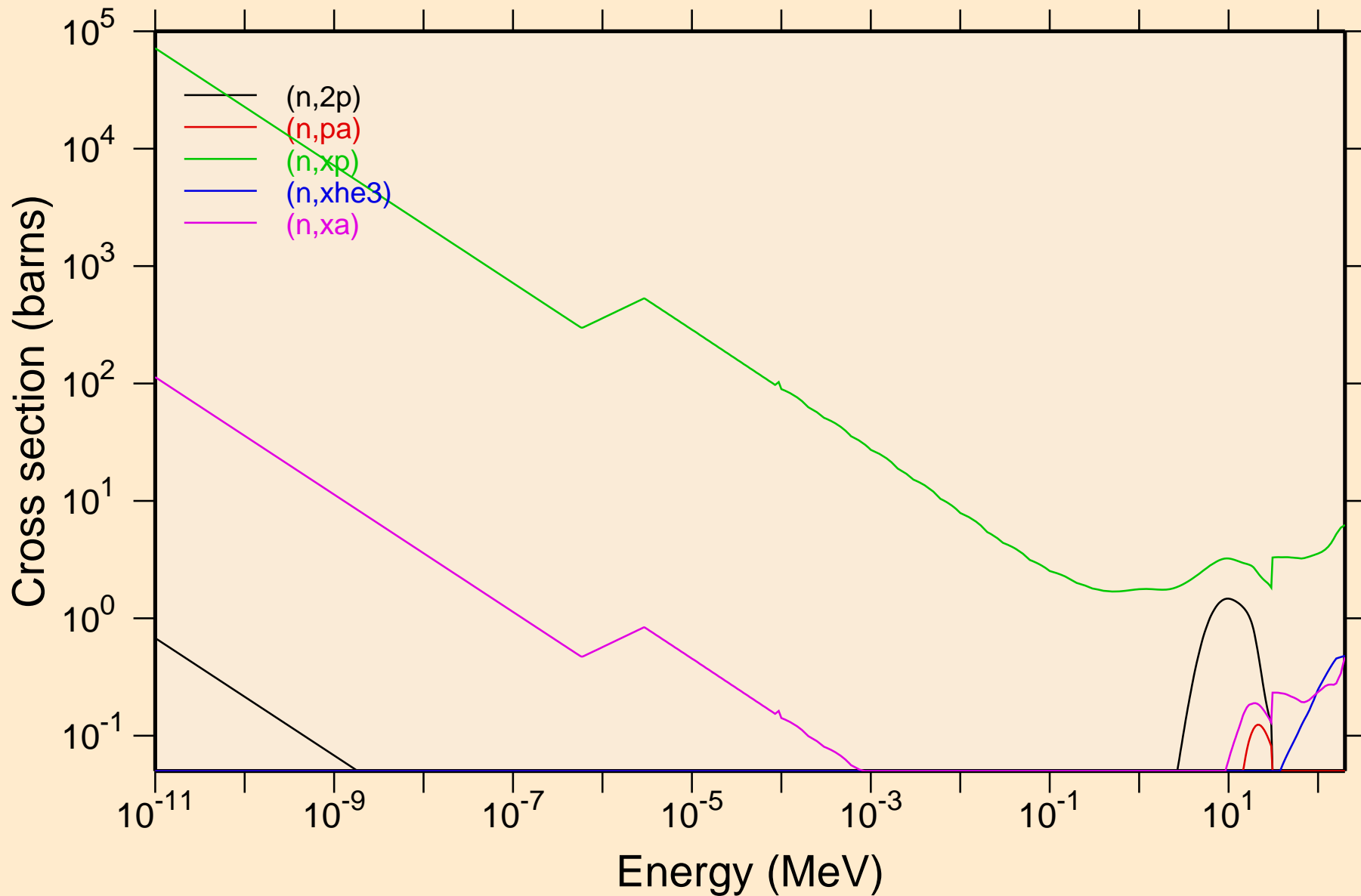

# ND128 NEUTRON ACER TENDL-2019 LIBRARY; T=293.16K

## Principal cross sections

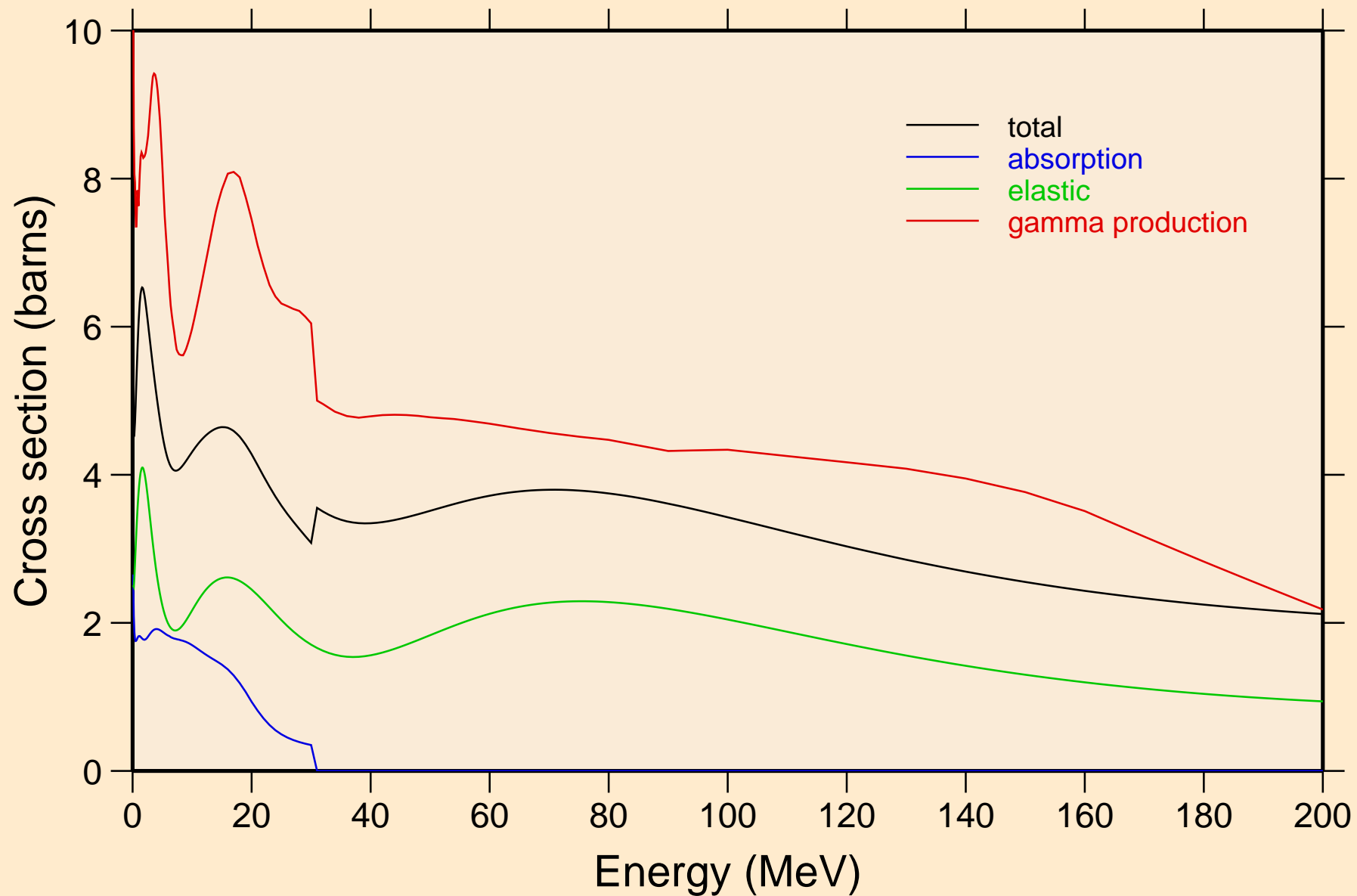

ND128 NEUTRON ACER TENDL-2019 LIBRARY; T=293.16K  
Heating

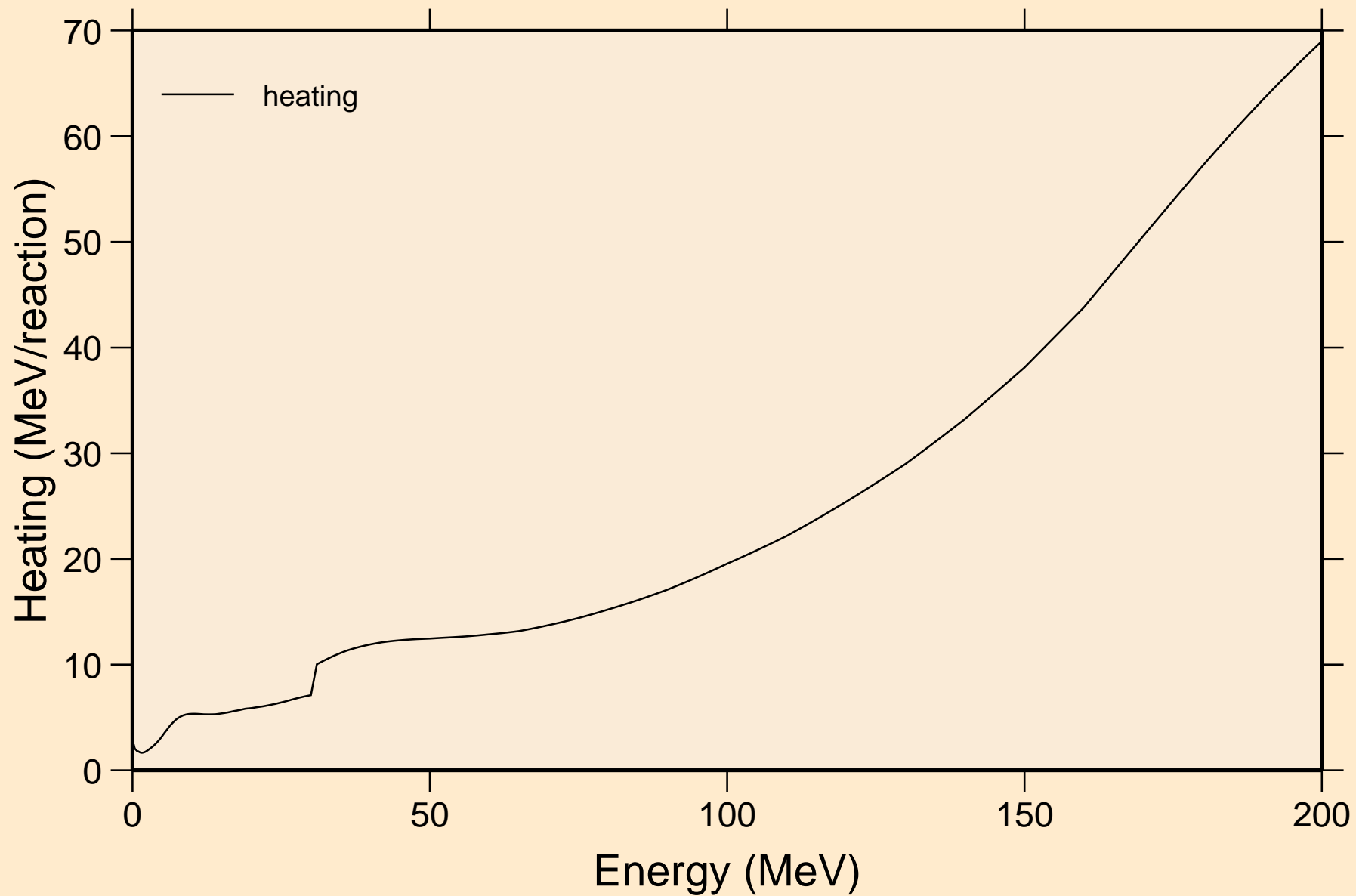

ND128 NEUTRON ACER TENDL-2019 LIBRARY; T=293.16K  
Damage

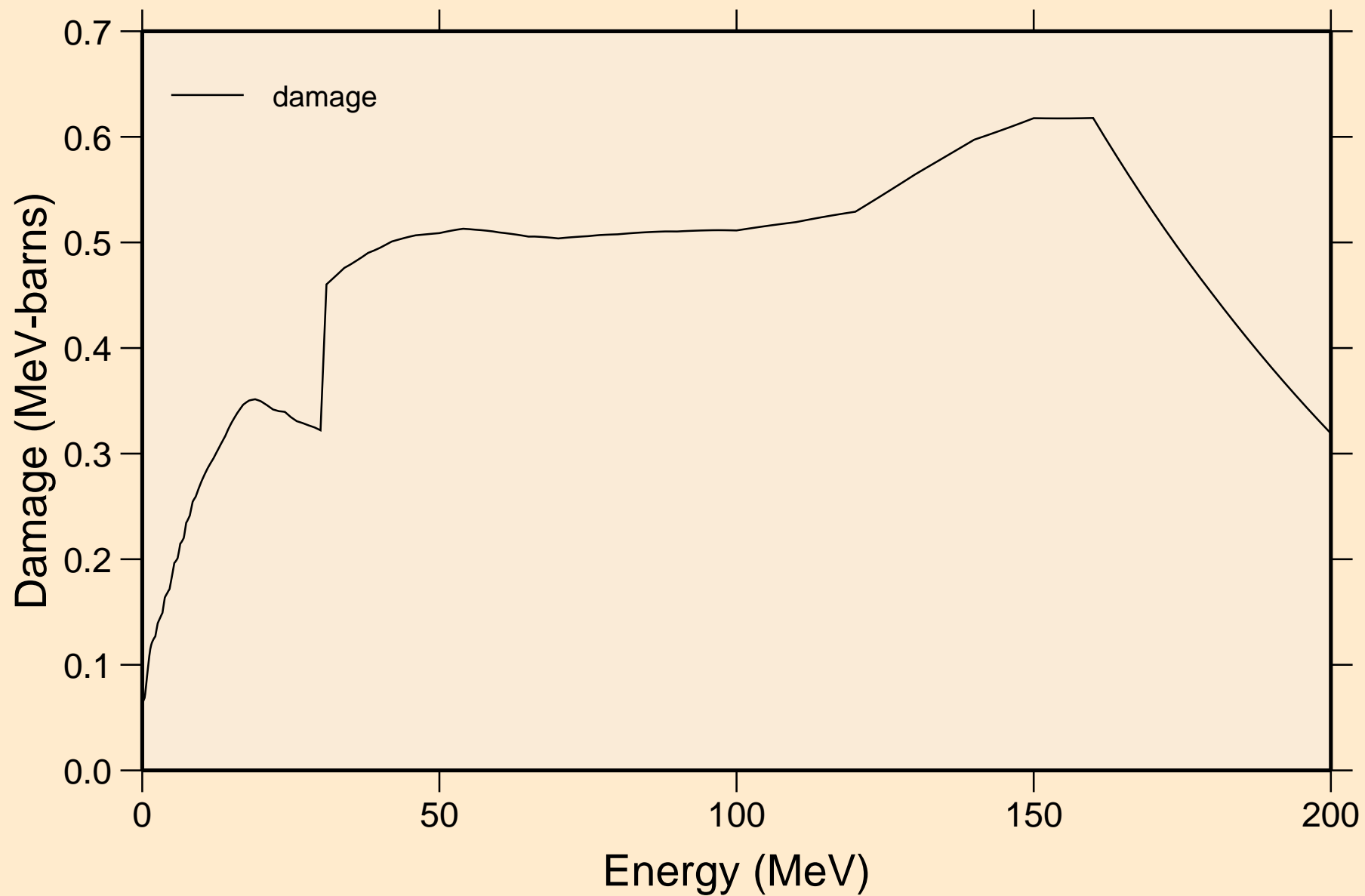

ND128 NEUTRON ACER TENDL-2019 LIBRARY; T=293.16K  
Non-threshold reactions

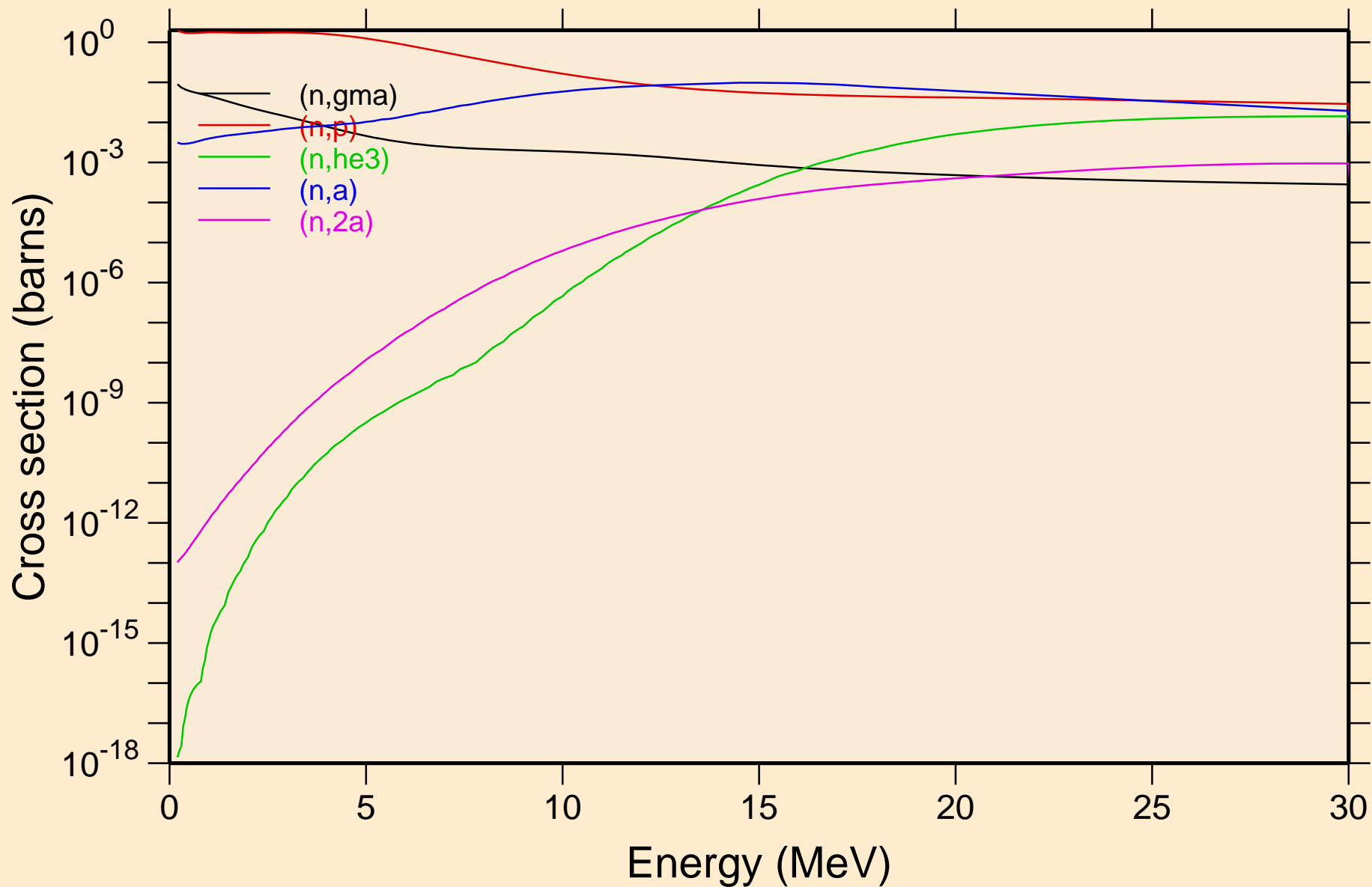

ND128 NEUTRON ACER TENDL-2019 LIBRARY; T=293.16K  
Non-threshold reactions

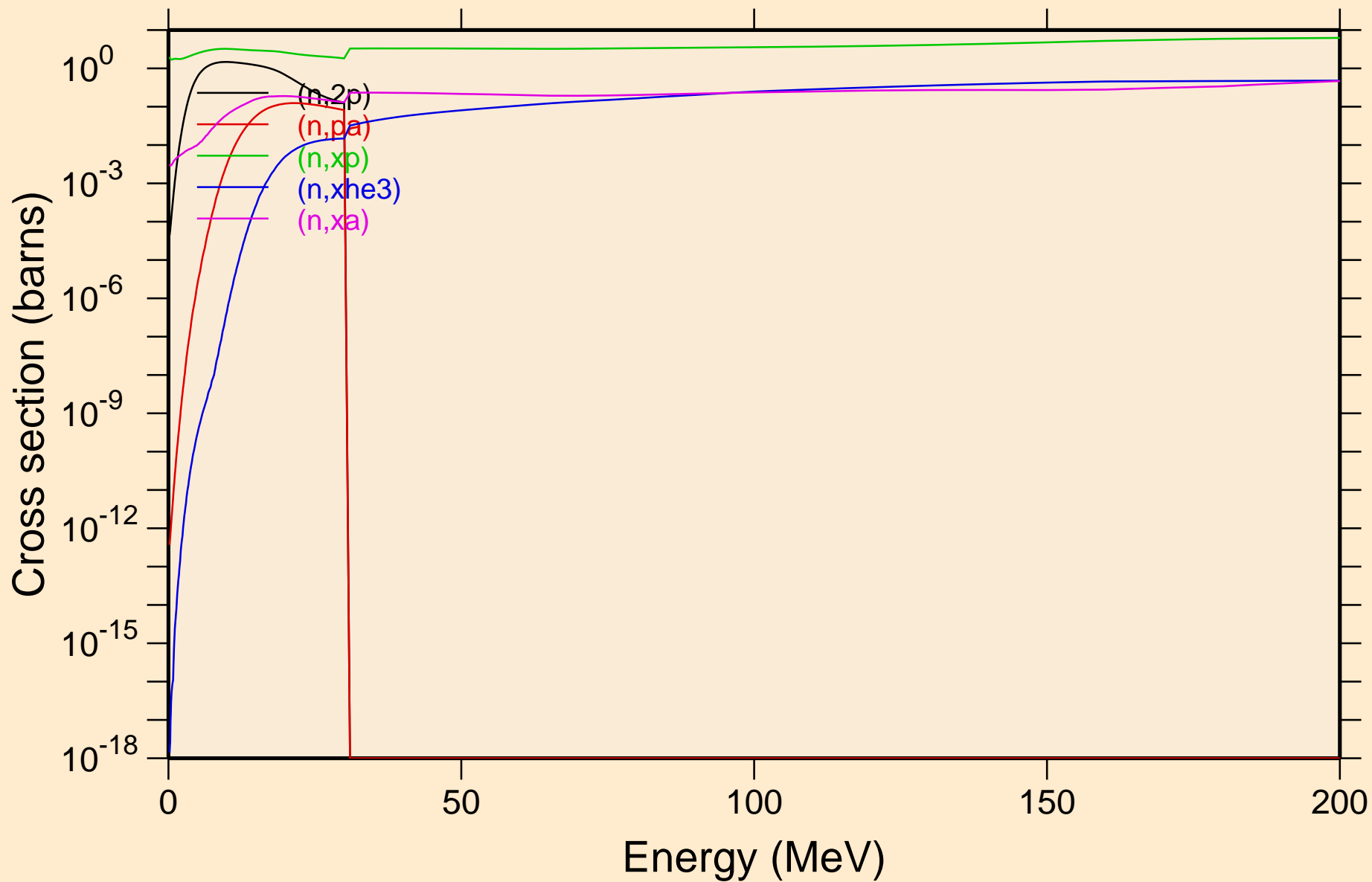

ND128 NEUTRON ACER TENDL-2019 LIBRARY; T=293.16K  
Inelastic levels

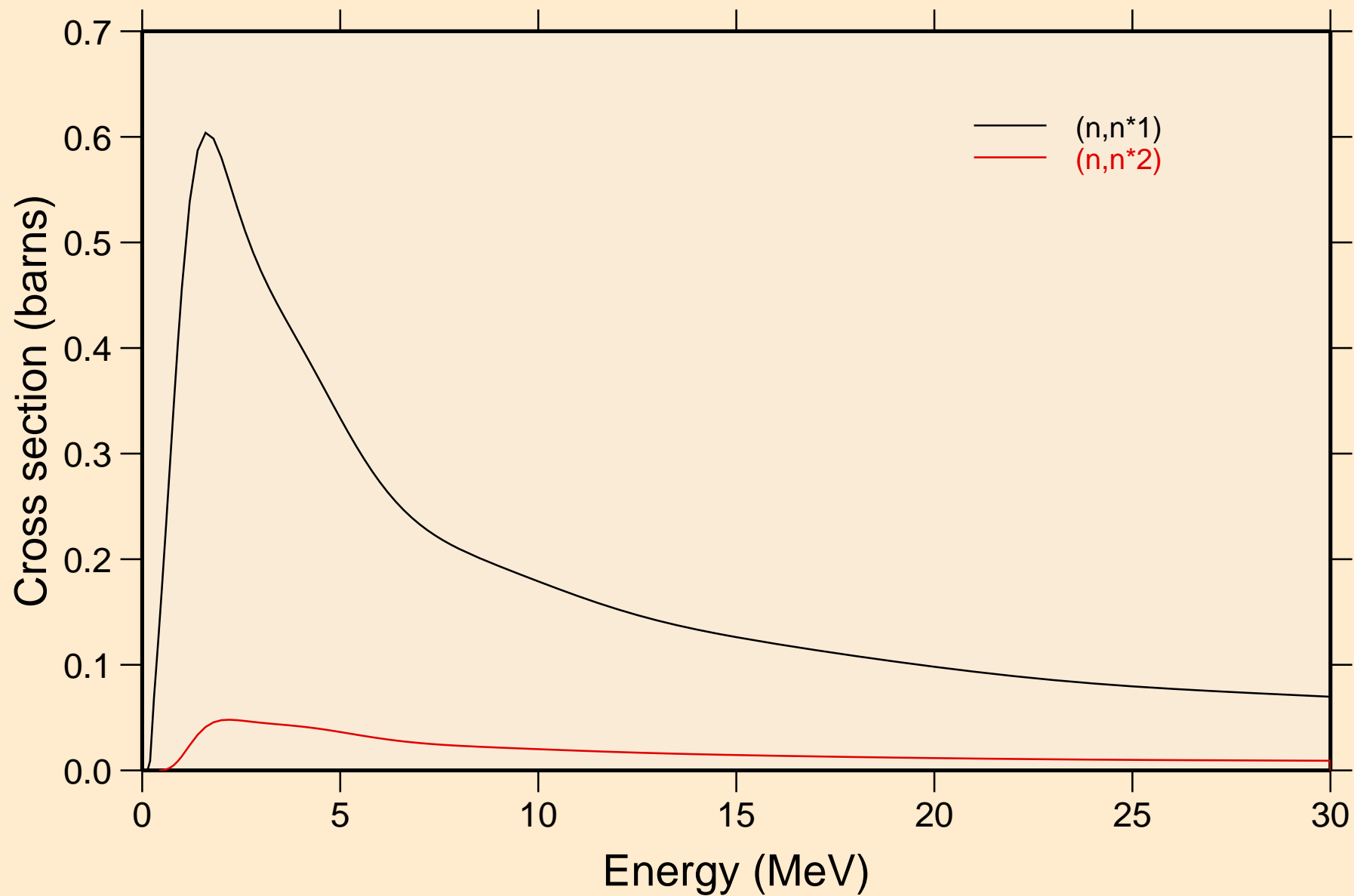

ND128 NEUTRON ACER TENDL-2019 LIBRARY; T=293.16K  
Threshold reactions

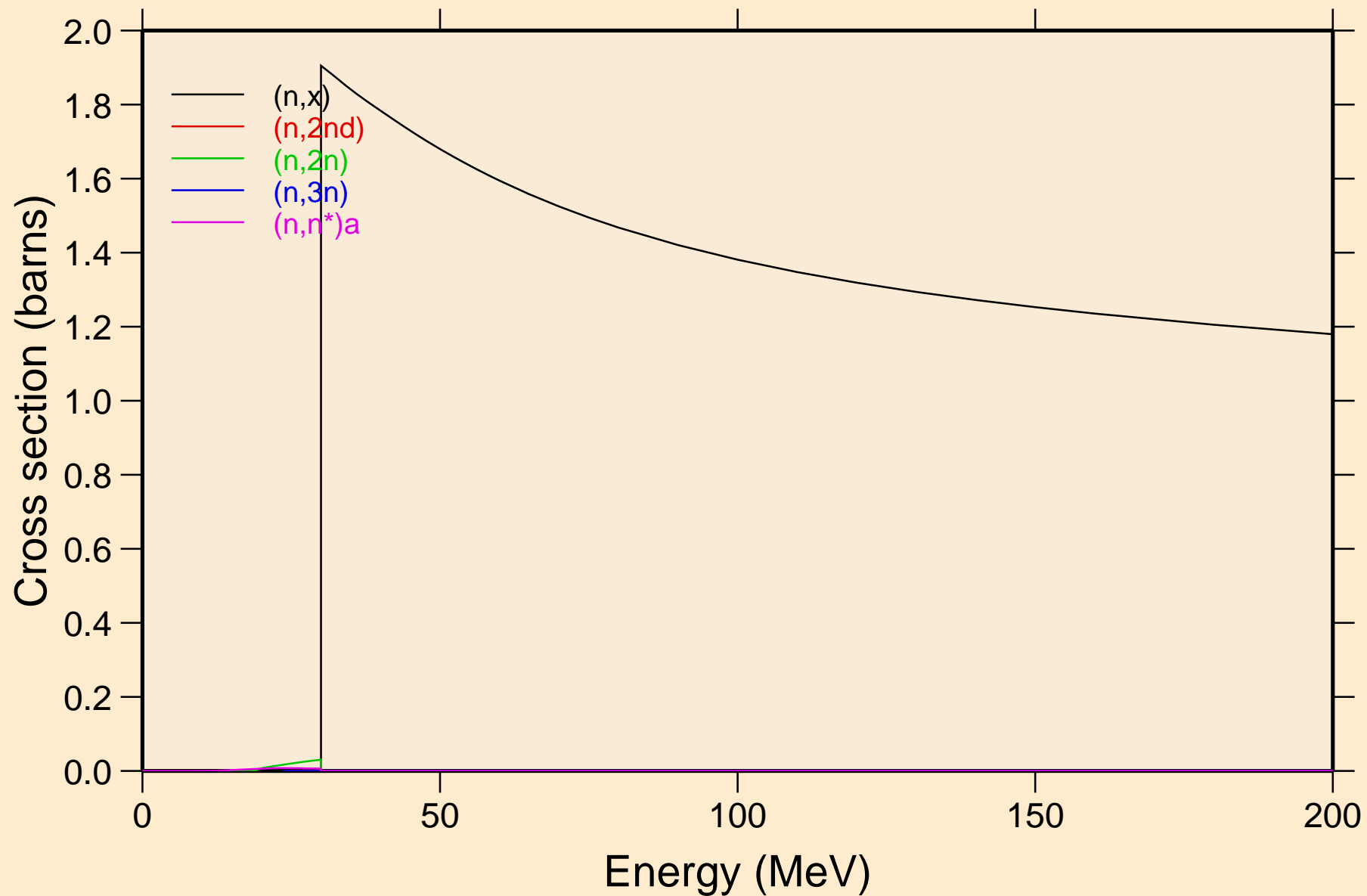

ND128 NEUTRON ACER TENDL-2019 LIBRARY; T=293.16K  
Threshold reactions

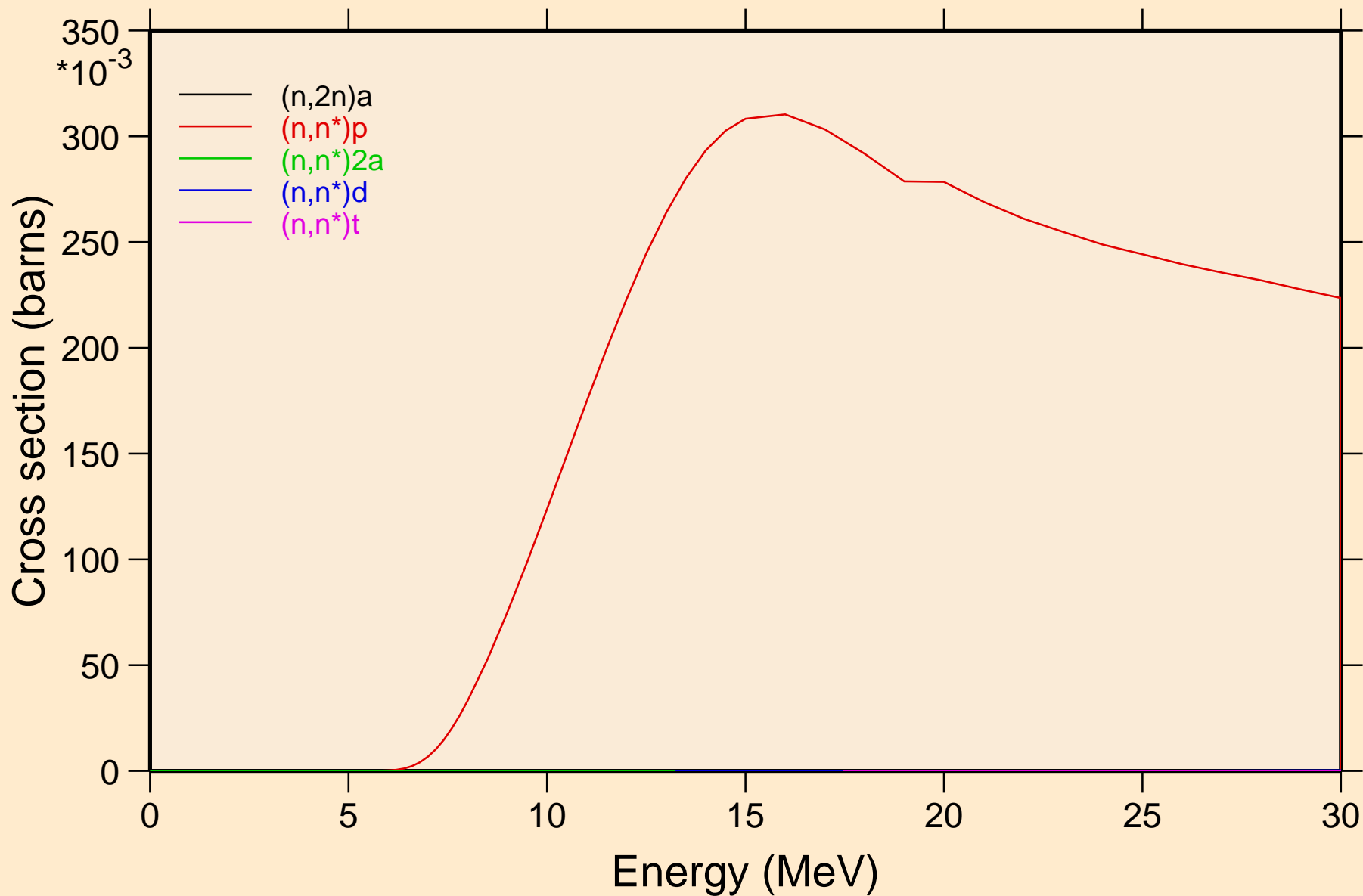

ND128 NEUTRON ACER TENDL-2019 LIBRARY; T=293.16K  
Threshold reactions

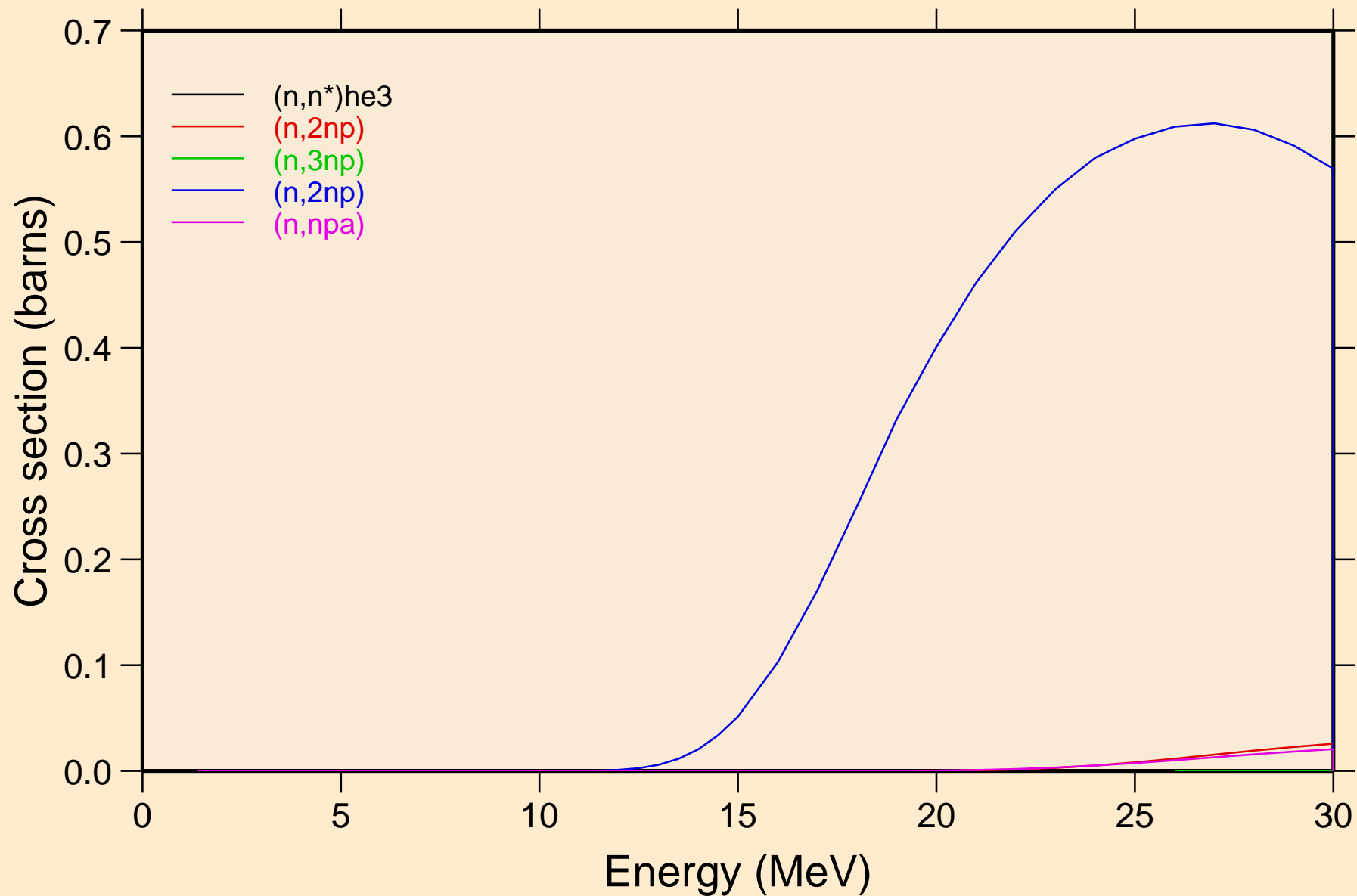

ND128 NEUTRON ACER TENDL-2019 LIBRARY; T=293.16K  
Threshold reactions

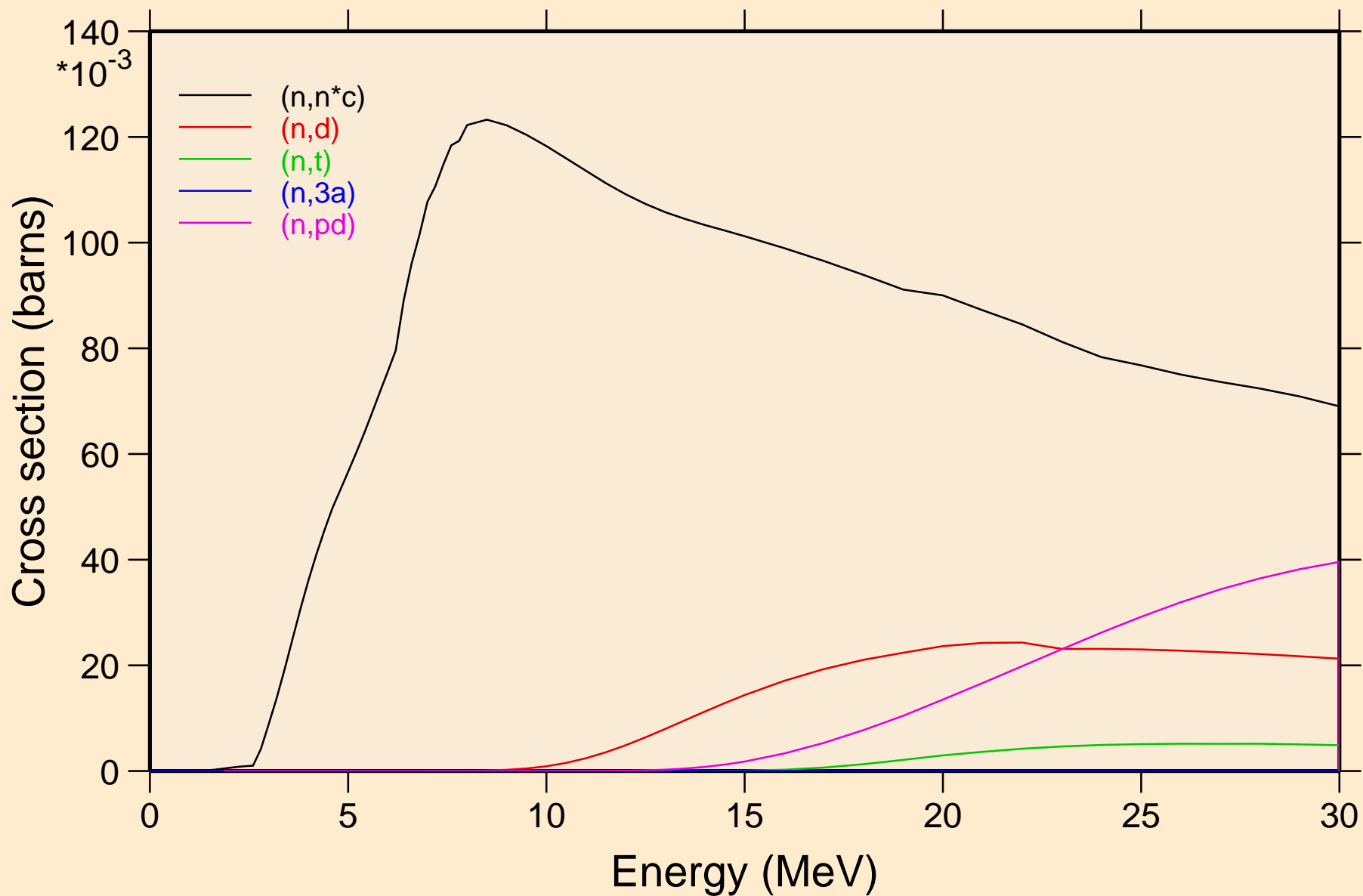

ND128 NEUTRON ACER TENDL-2019 LIBRARY; T=293.16K  
Threshold reactions

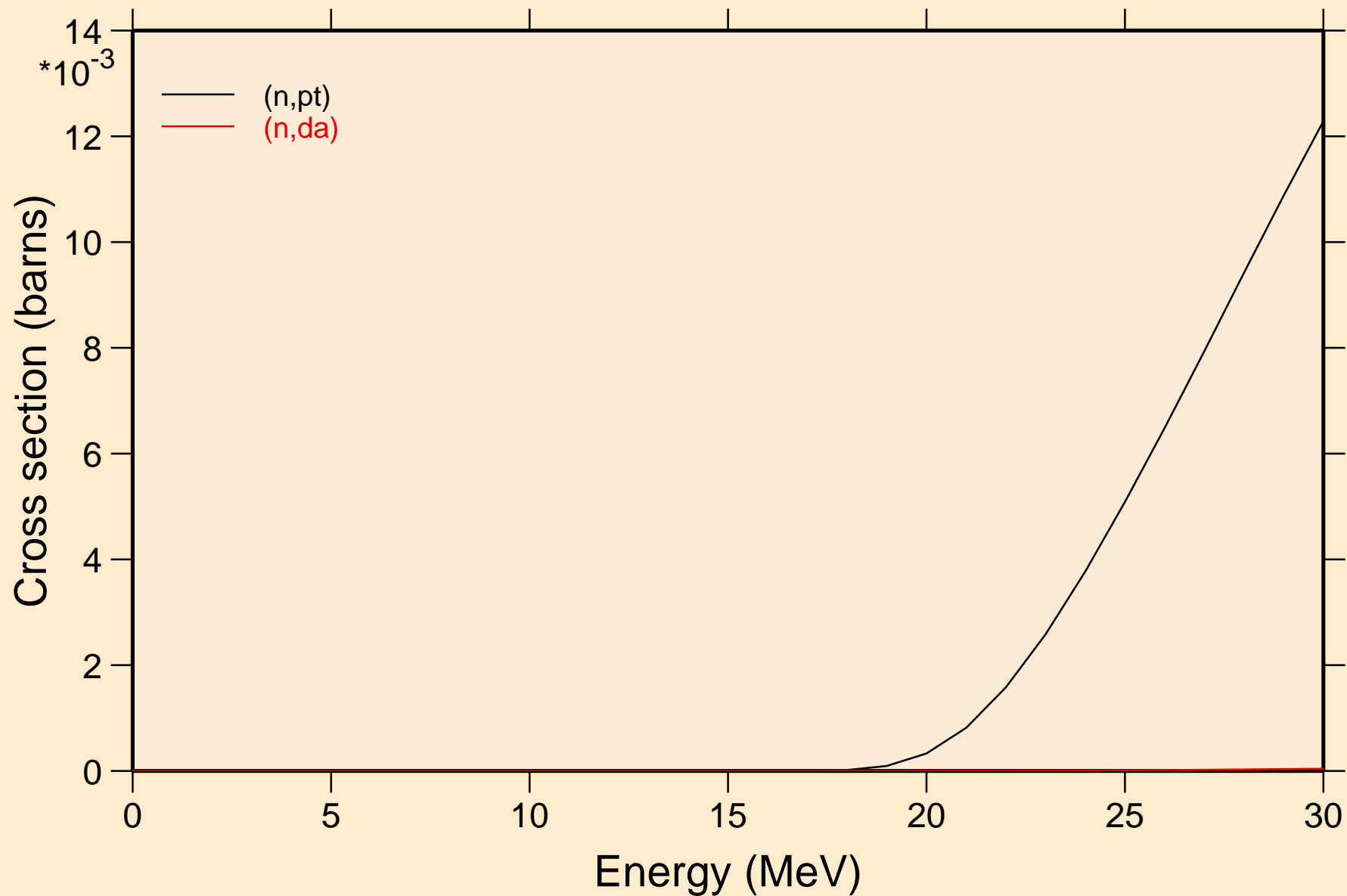

ND128 NEUTRON ACER TENDL-2019 LIBRARY; T=293.16K  
Threshold reactions

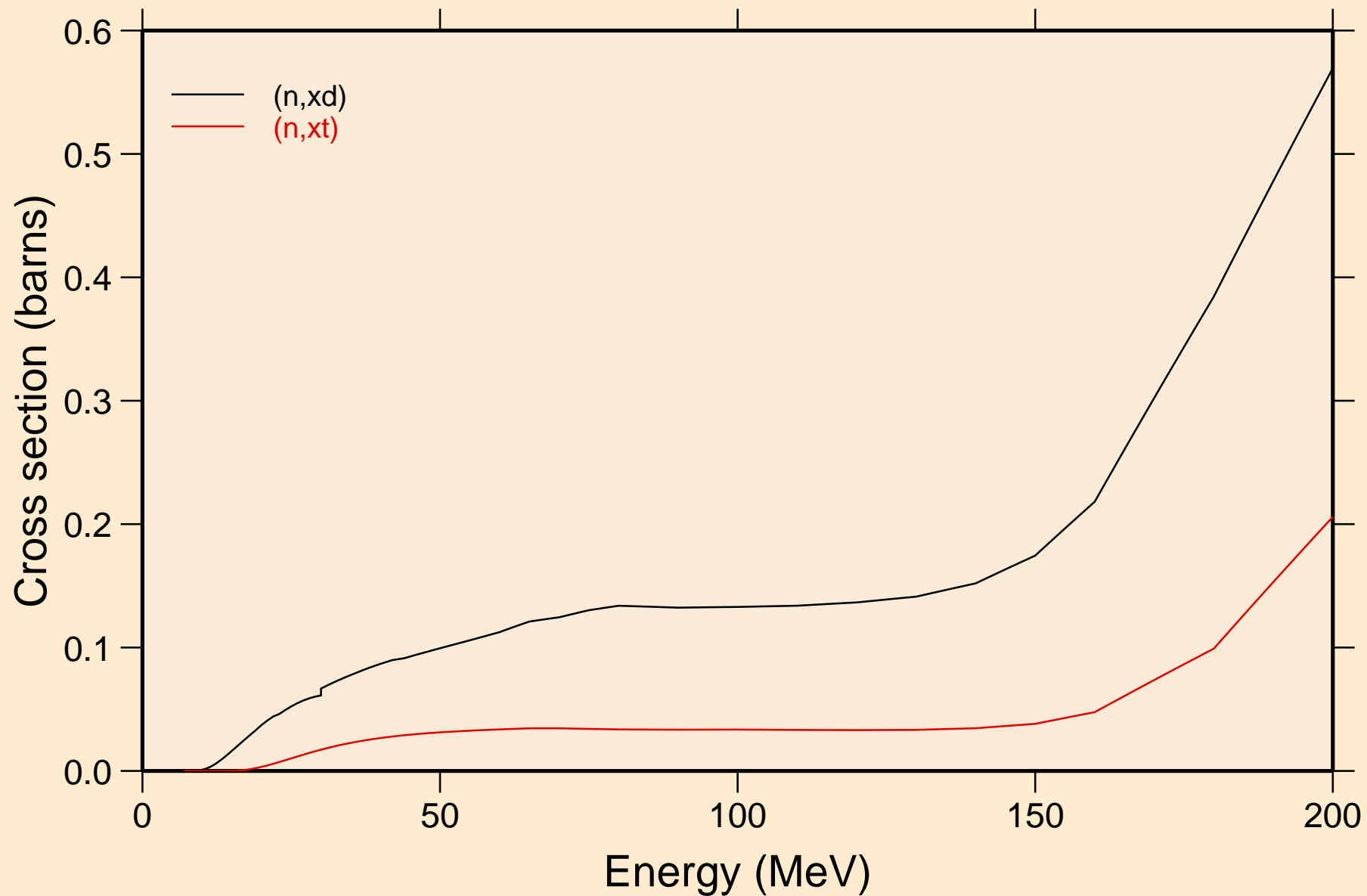

ND128 NEUTRON ACER TENDL-2019 LIBRARY; T=293.16K  
angular distribution for elastic

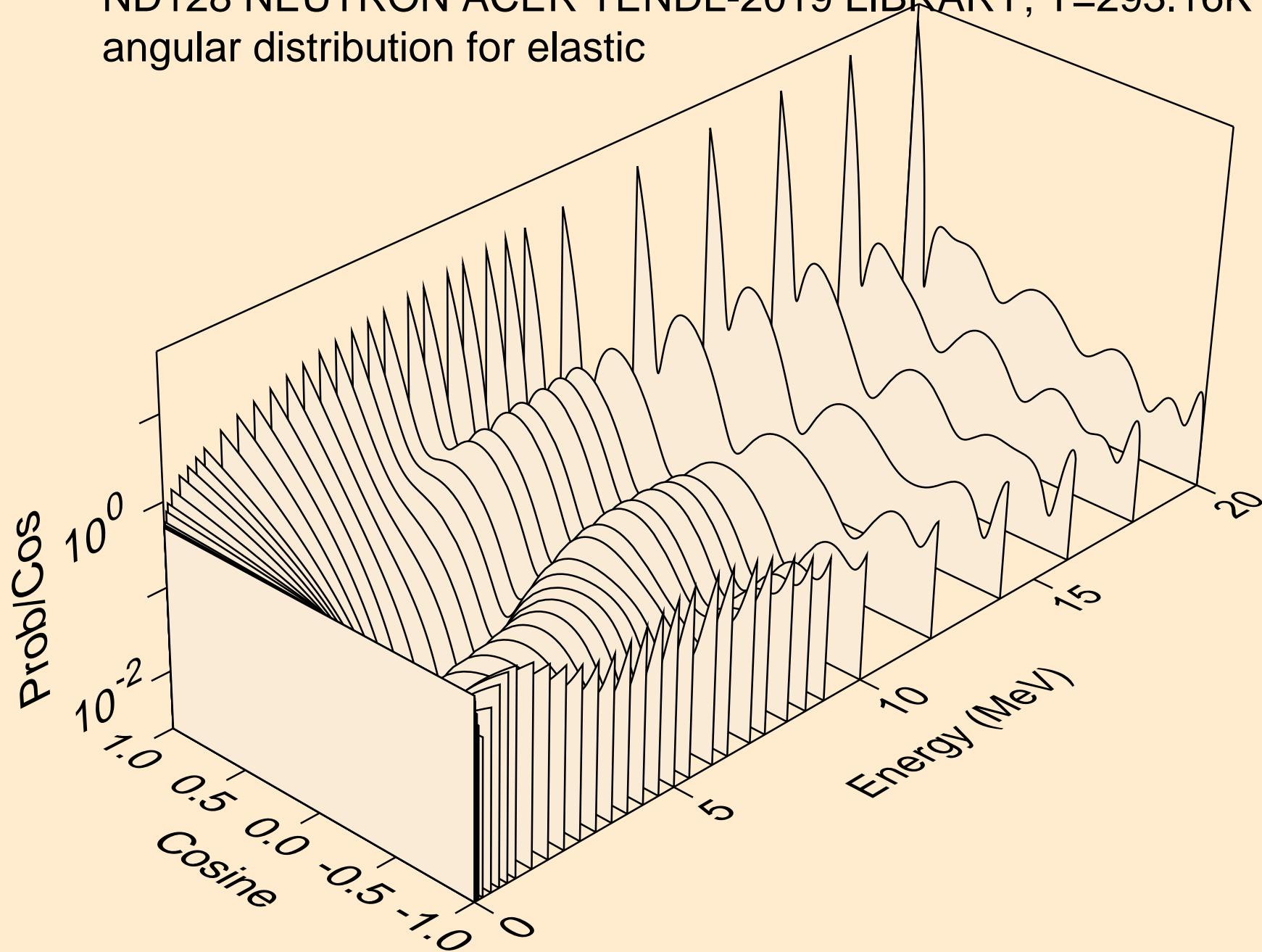

ND128 NEUTRON ACER TENDL-2019 LIBRARY; T=293.16K  
angular distribution for elastic

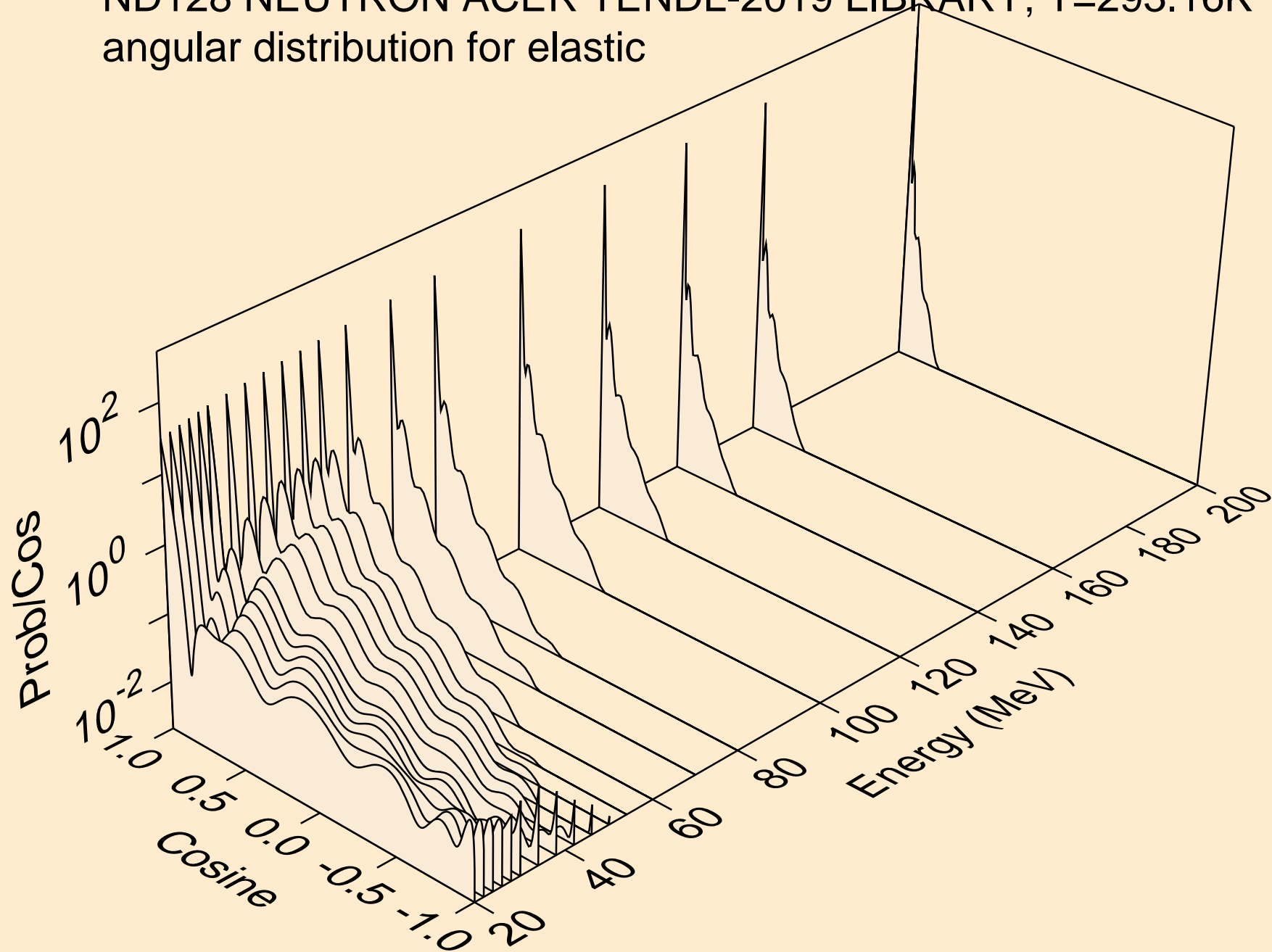

ND128 NEUTRON ACER TENDL-2019 LIBRARY; T=293.16K  
angular distribution for (n,n\*1)

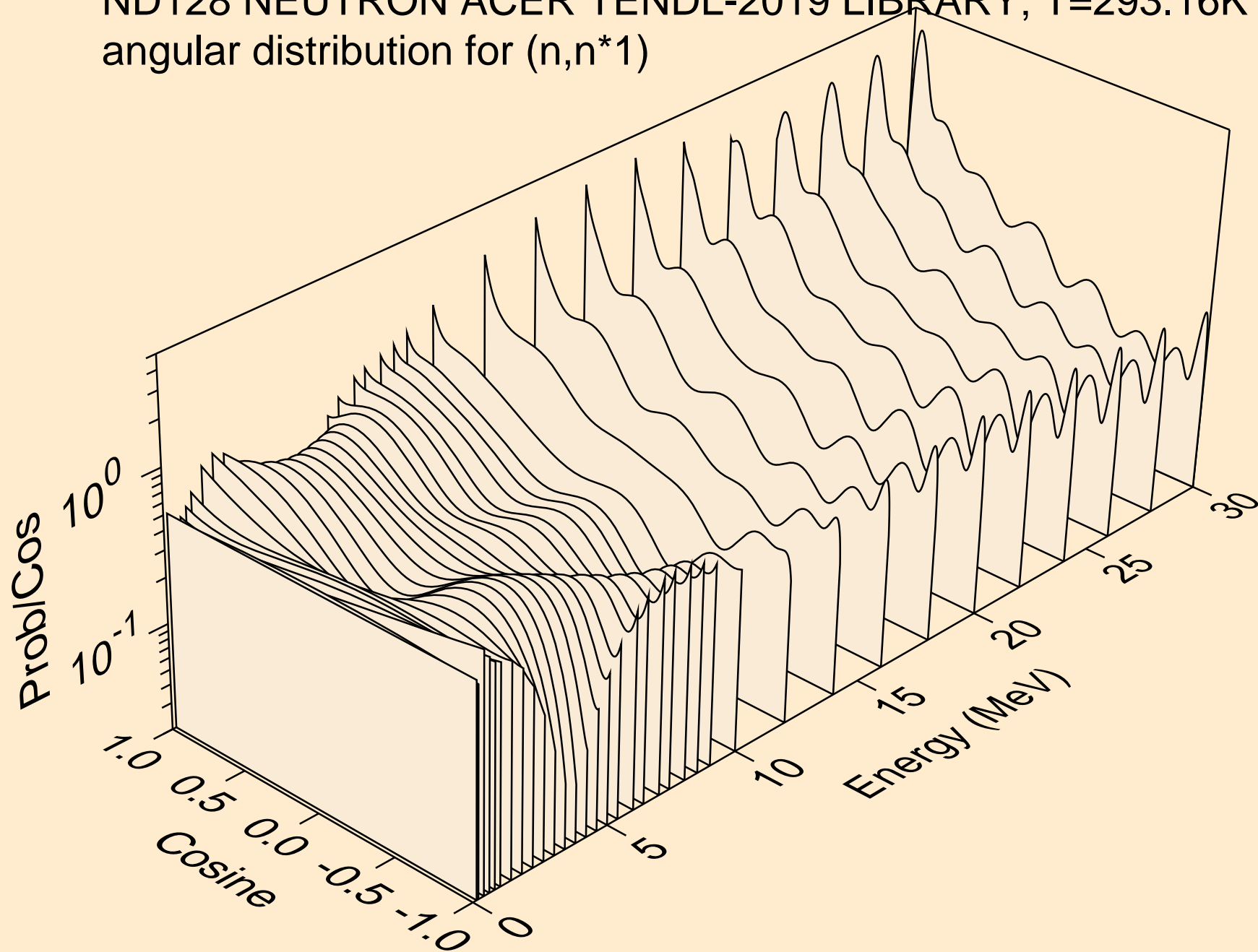

ND128 NEUTRON ACER TENDL-2019 LIBRARY; T=293.16K  
angular distribution for (n,n\*2)

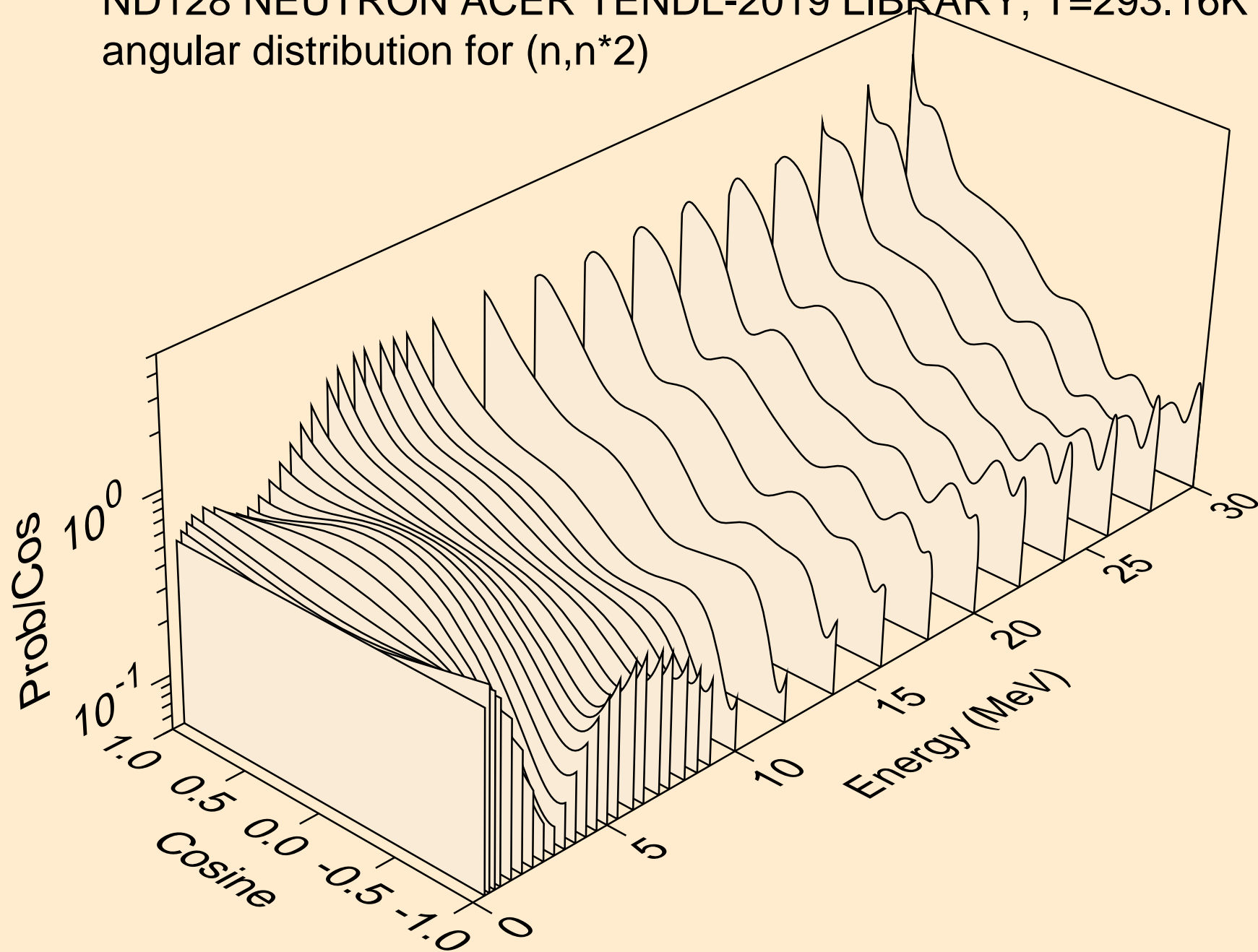

ND128 NEUTRON ACER TENDL-2019 LIBRARY; T=293.16K  
Neutron emission for (n,x)

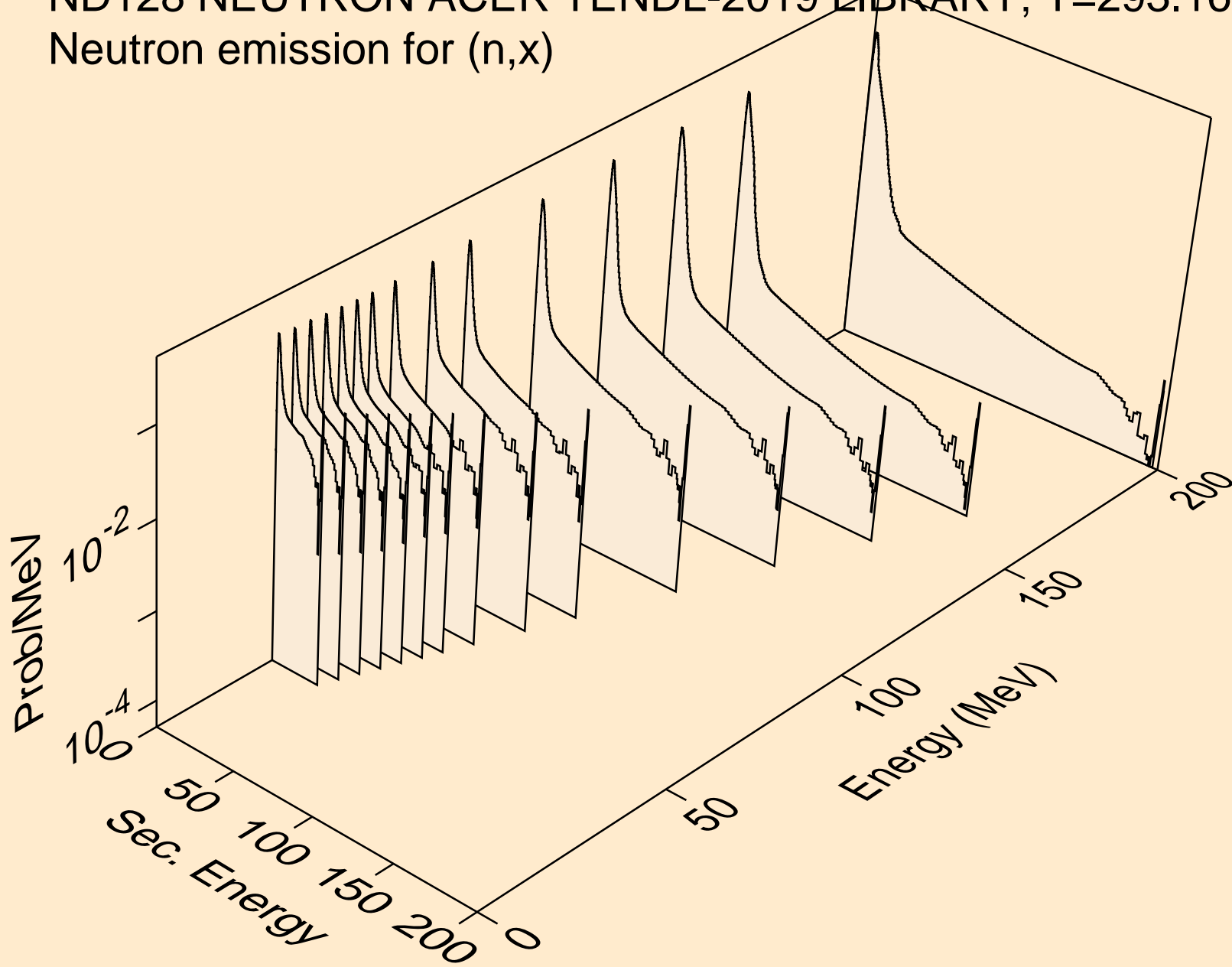

ND128 NEUTRON ACER TENDL-2019 LIBRARY; T=293.16K  
Neutron emission for (n,2nd)

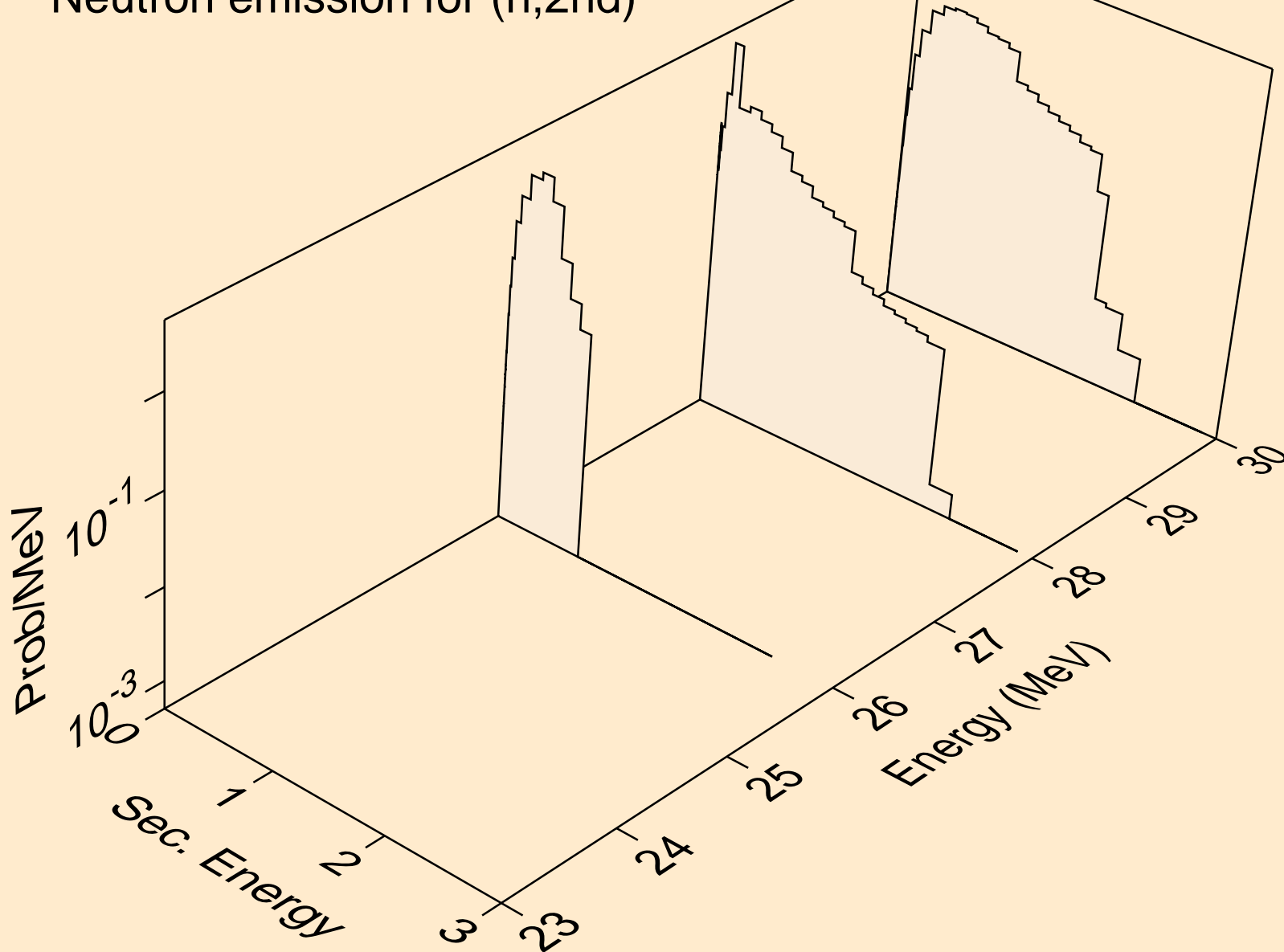

ND128 NEUTRON ACER TENDL-2019 LIBRARY; T=293.16K  
Neutron emission for (n,2n)

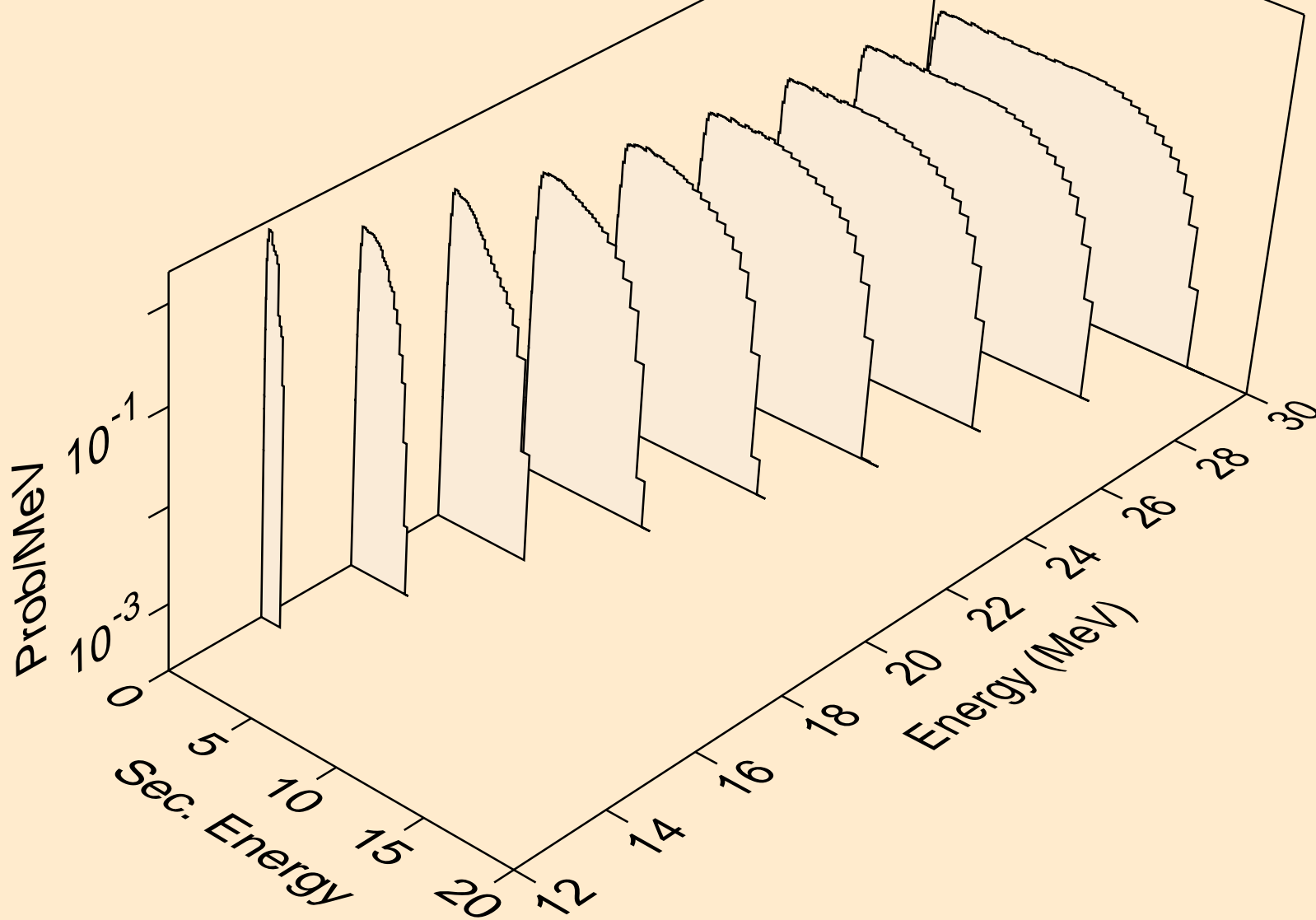

ND128 NEUTRON ACER TENDL-2019 LIBRARY; T=293.16K  
Neutron emission for (n,3n)

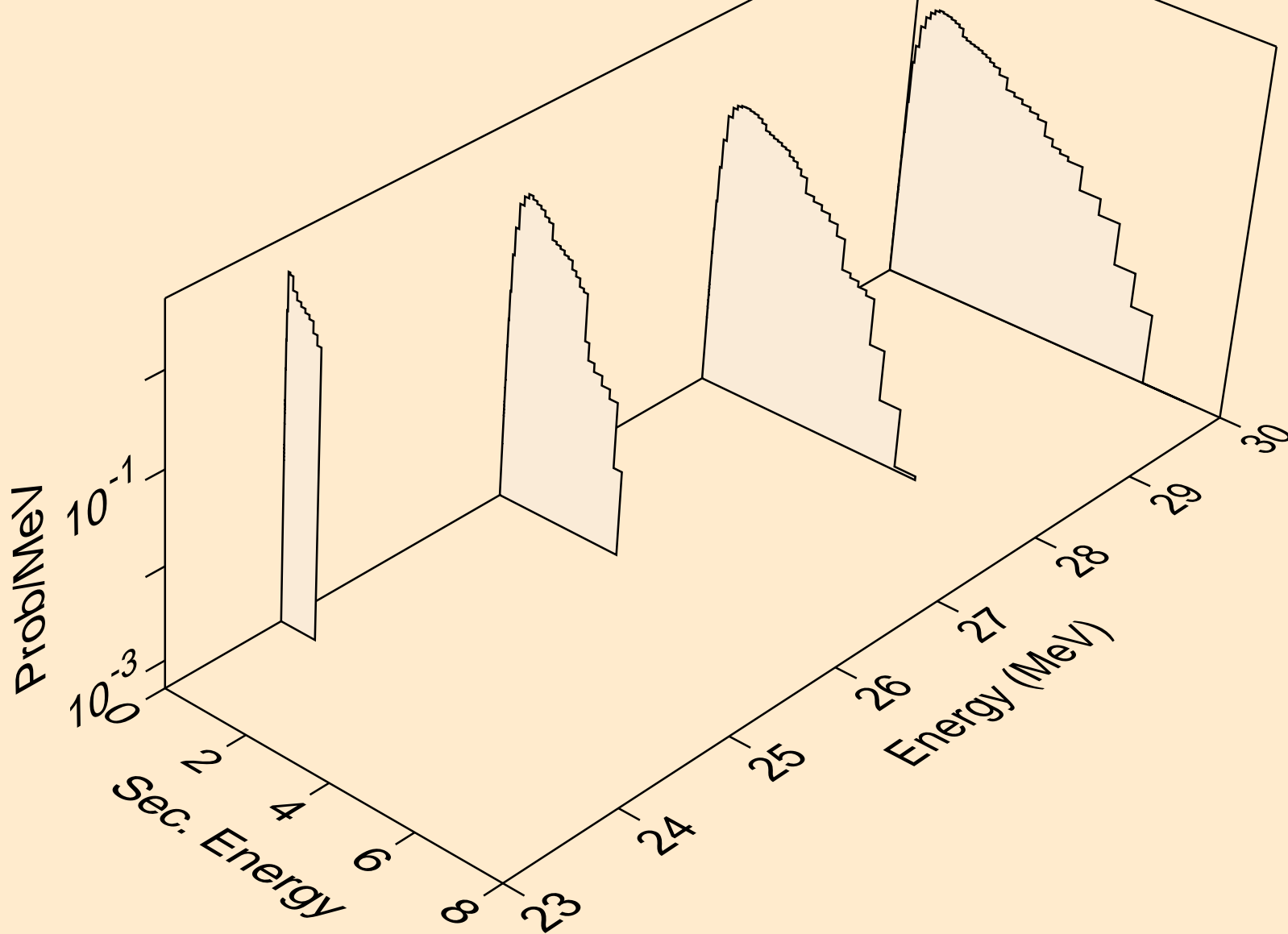

ND128 NEUTRON ACER TENDL-2019 LIBRARY; T=293.16K  
Neutron emission for (n,n\*)a

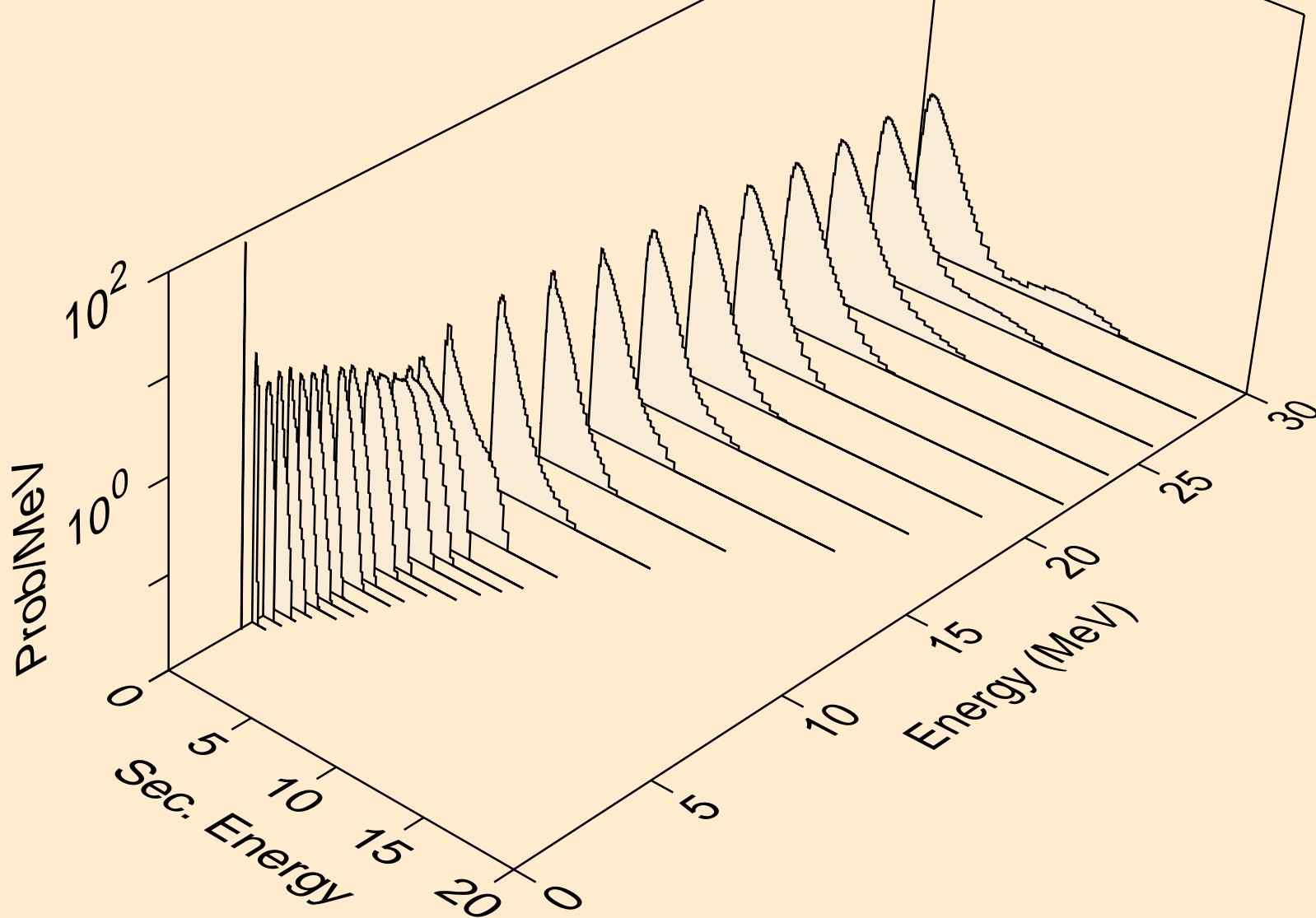

ND128 NEUTRON ACER TENDL-2019 LIBRARY; T=293.16K  
Neutron emission for (n,2n)a

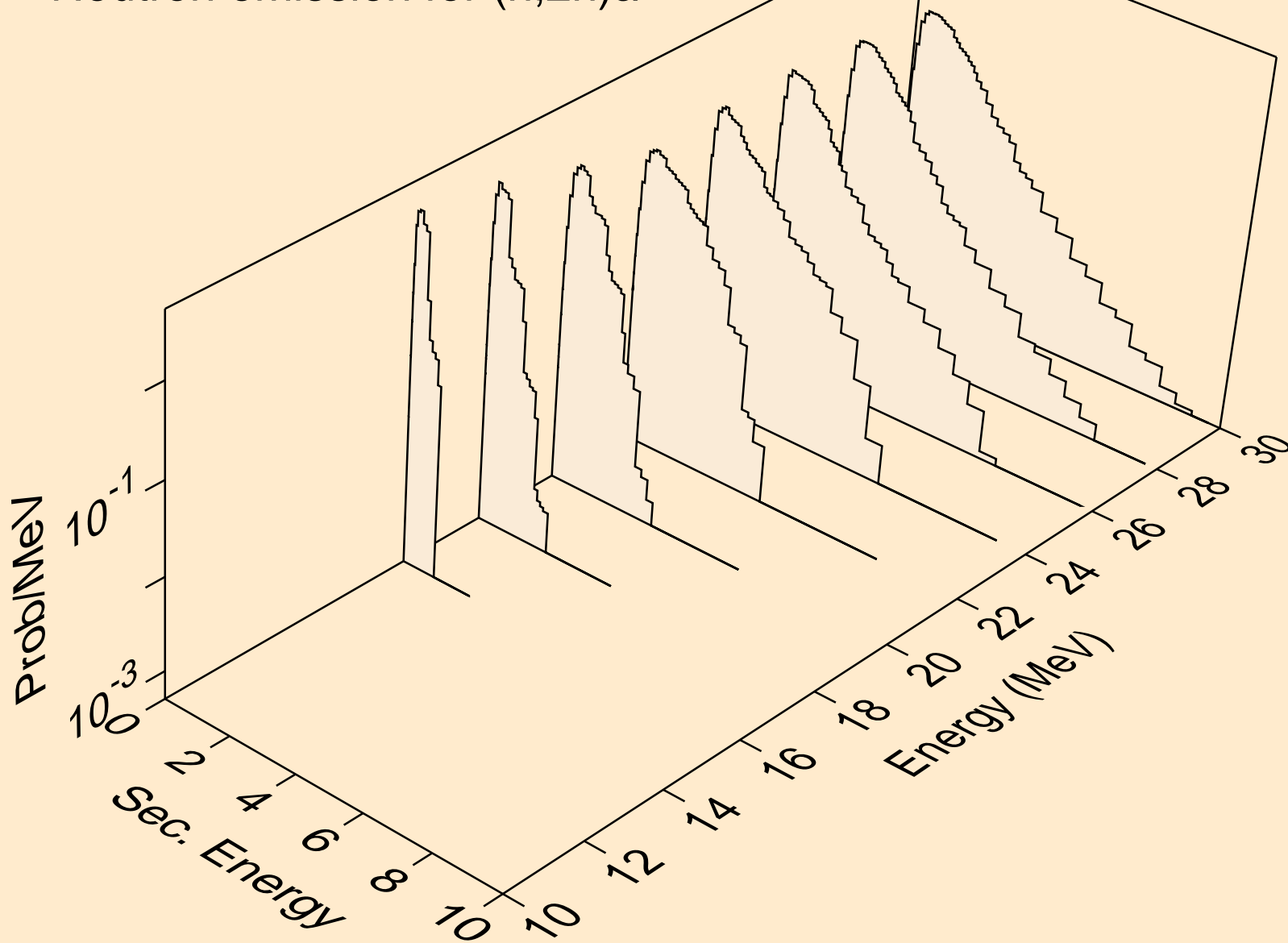

ND128 NEUTRON ACER TENDL-2019 LIBRARY; T=293.16K  
Neutron emission for (n,n\*)p

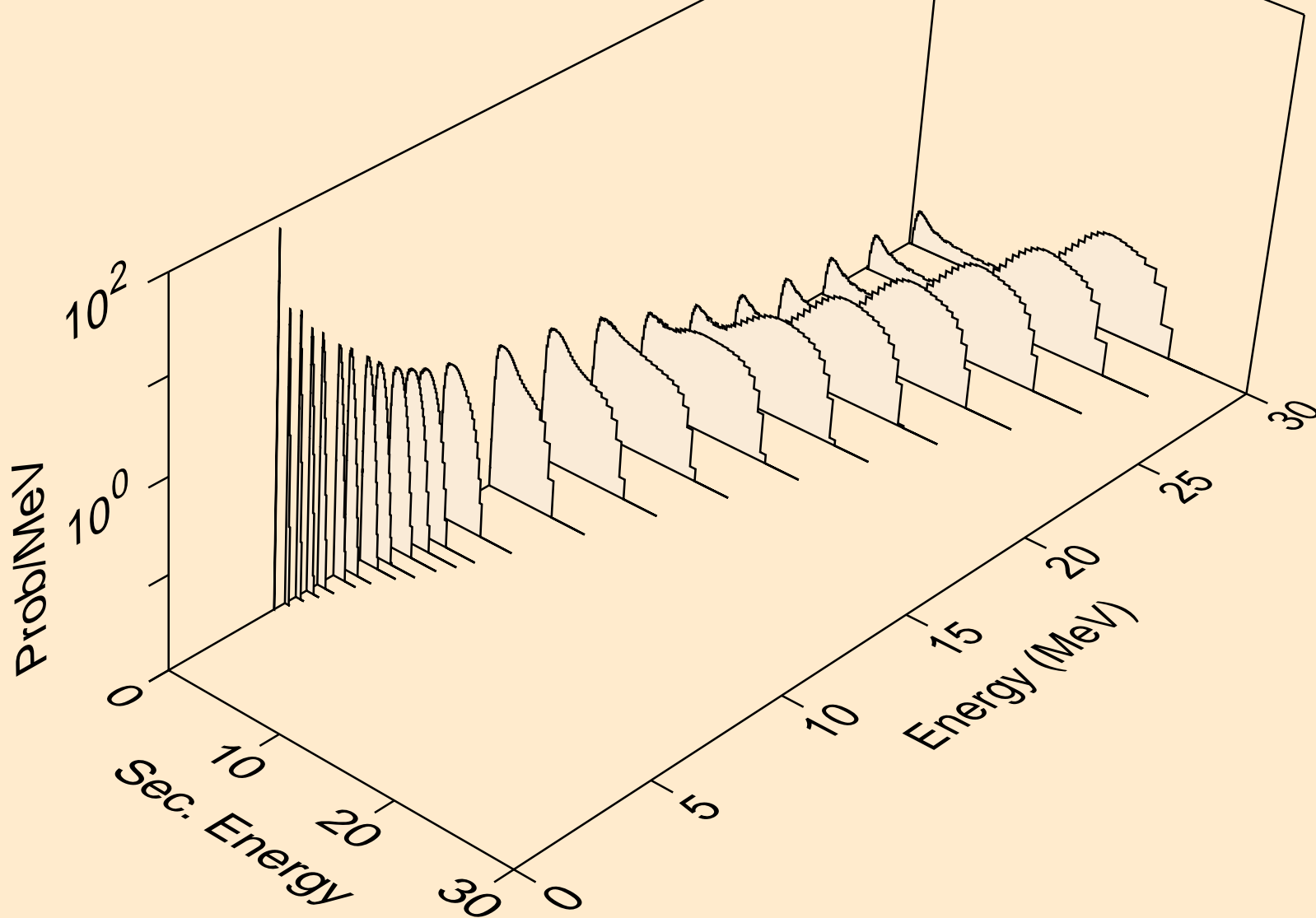

ND128 NEUTRON ACER TENDL-2019 LIBRARY; T=293.16K  
Neutron emission for (n,n\*)2a

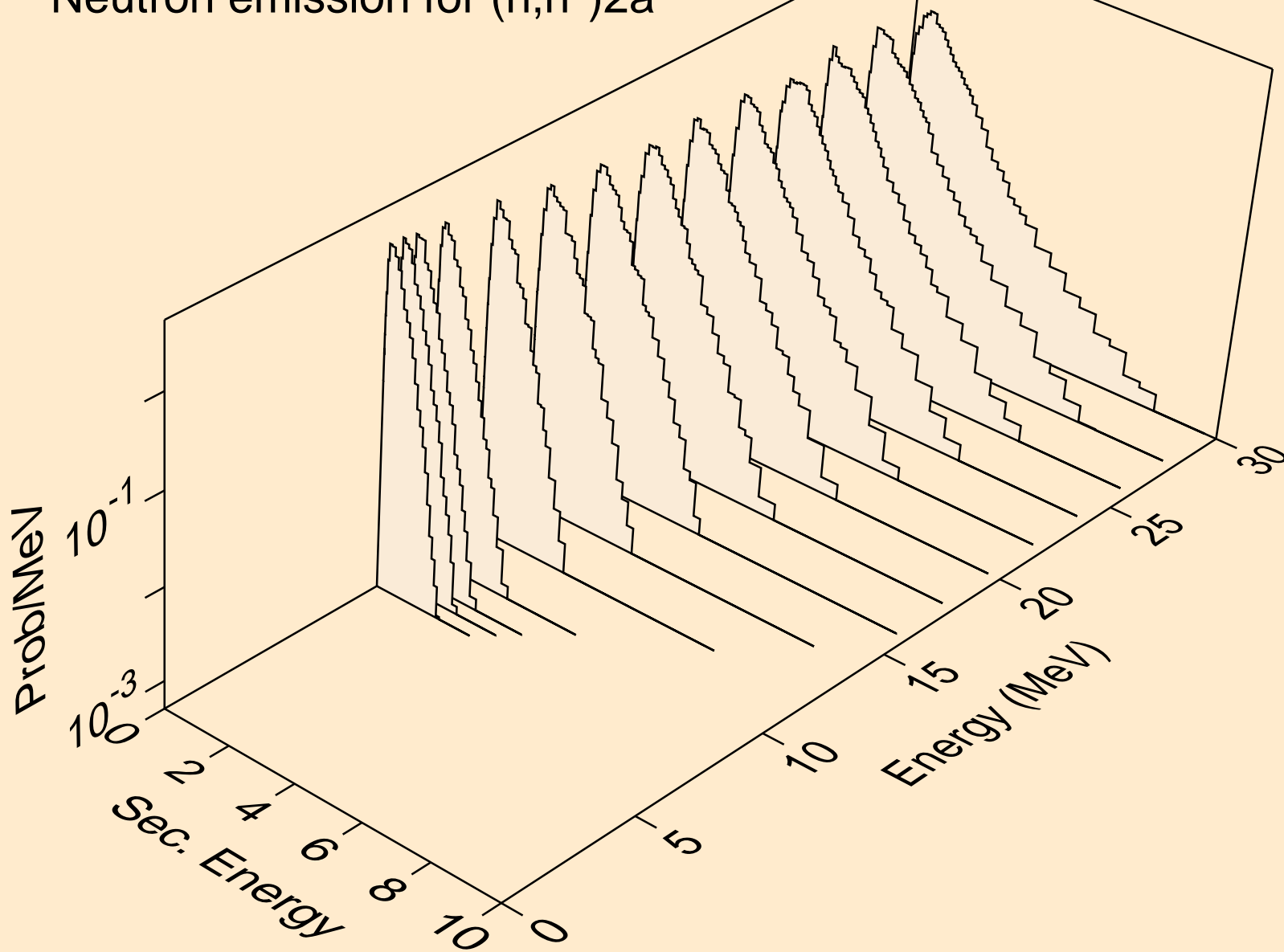

ND128 NEUTRON ACER TENDL-2019 LIBRARY; T=293.16K  
Neutron emission for (n,n\*)d

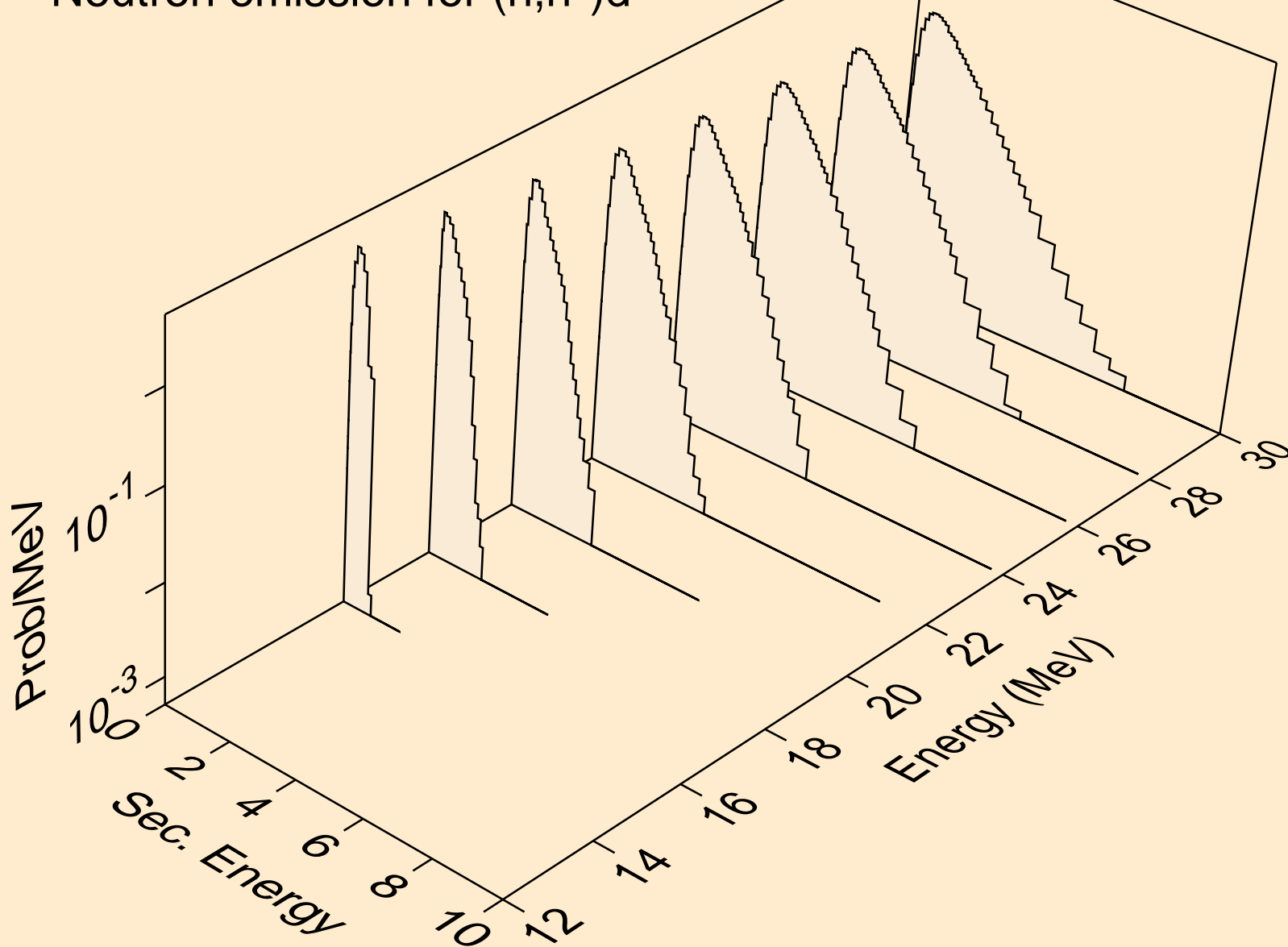

ND128 NEUTRON ACER TENDL-2019 LIBRARY; T=293.16K  
Neutron emission for (n,n\*)t

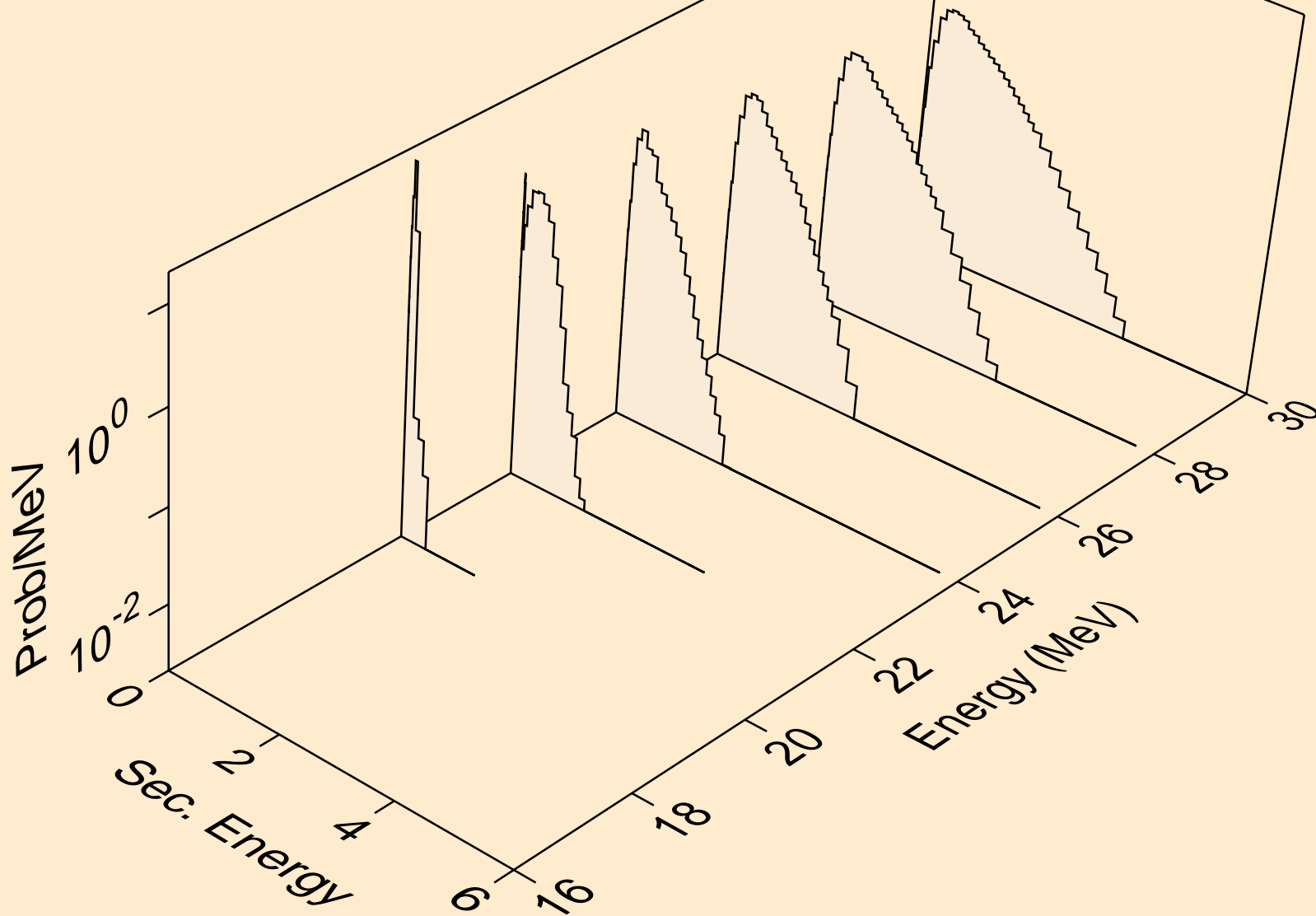

ND128 NEUTRON ACER TENDL-2019 LIBRARY; T=293.16K  
Neutron emission for (n,n\*)he3

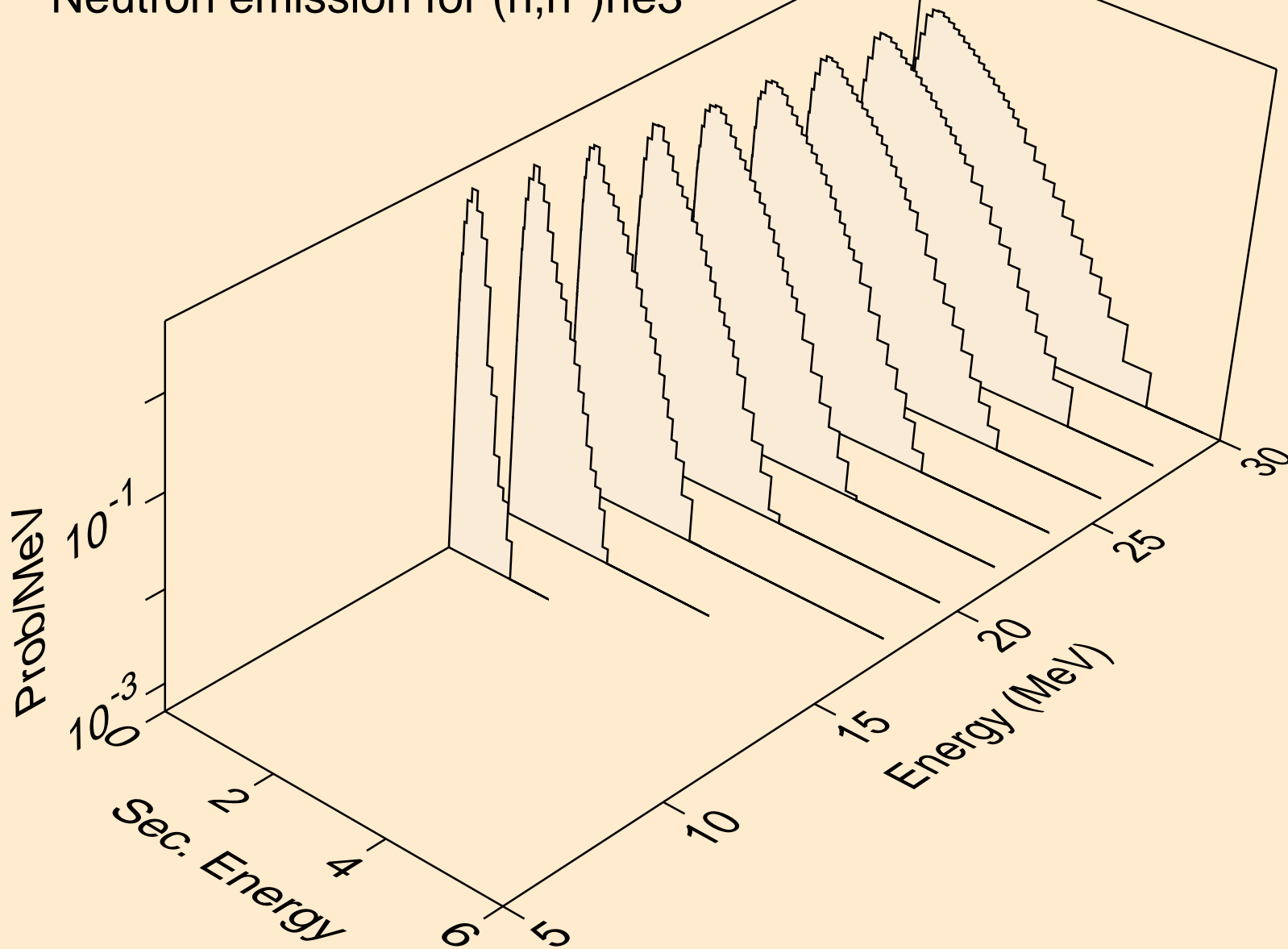

ND128 NEUTRON ACER TENDL-2019 LIBRARY; T=293.16K  
Neutron emission for (n,2np)

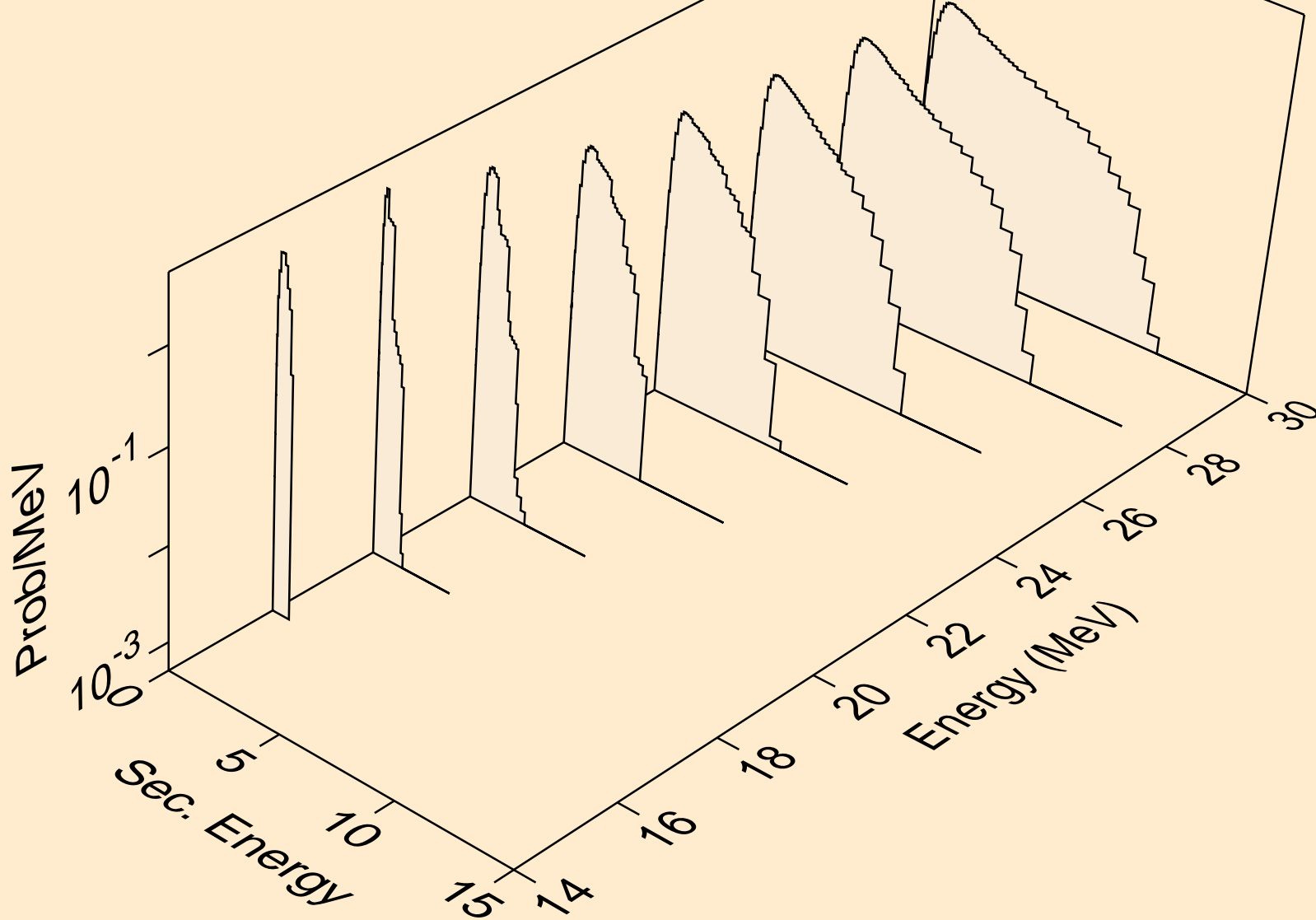

ND128 NEUTRON ACER TENDL-2019 LIBRARY; T=293.16K  
Neutron emission for (n,3np)

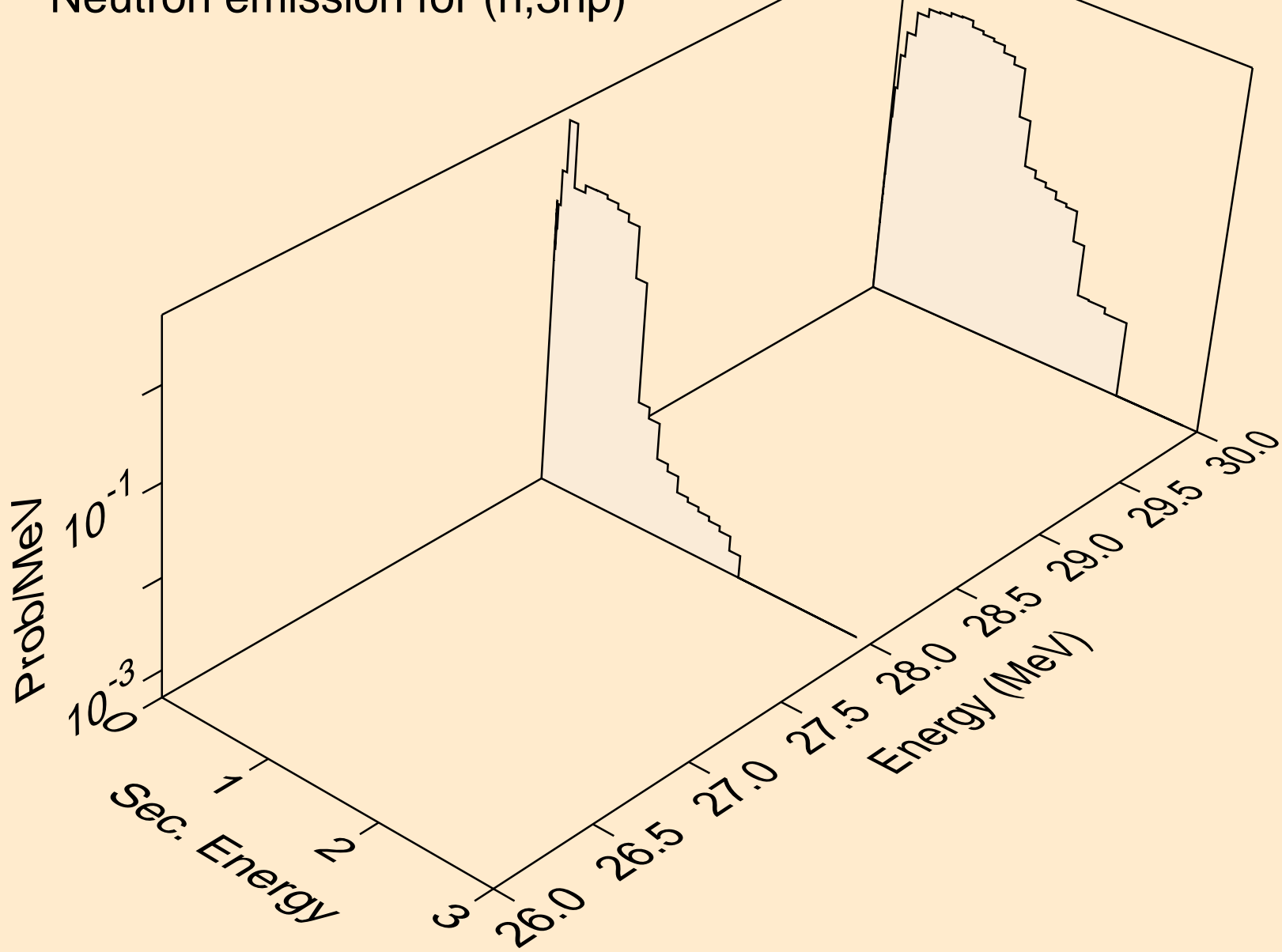

ND128 NEUTRON ACER TENDL-2019 LIBRARY; T=293.16K  
Neutron emission for (n,2np)

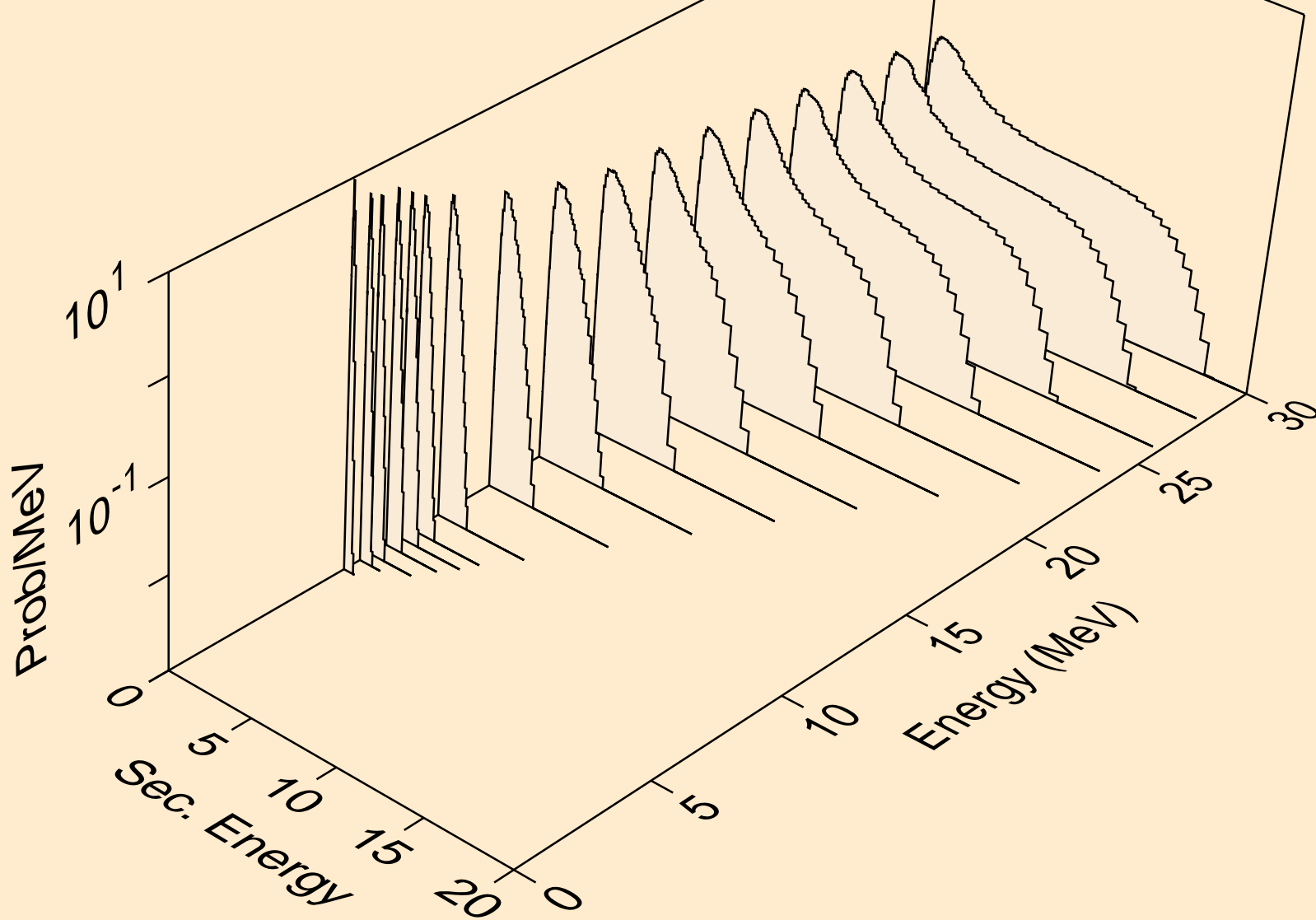

ND128 NEUTRON ACER TENDL-2019 LIBRARY; T=293.16K  
Neutron emission for (n,npa)

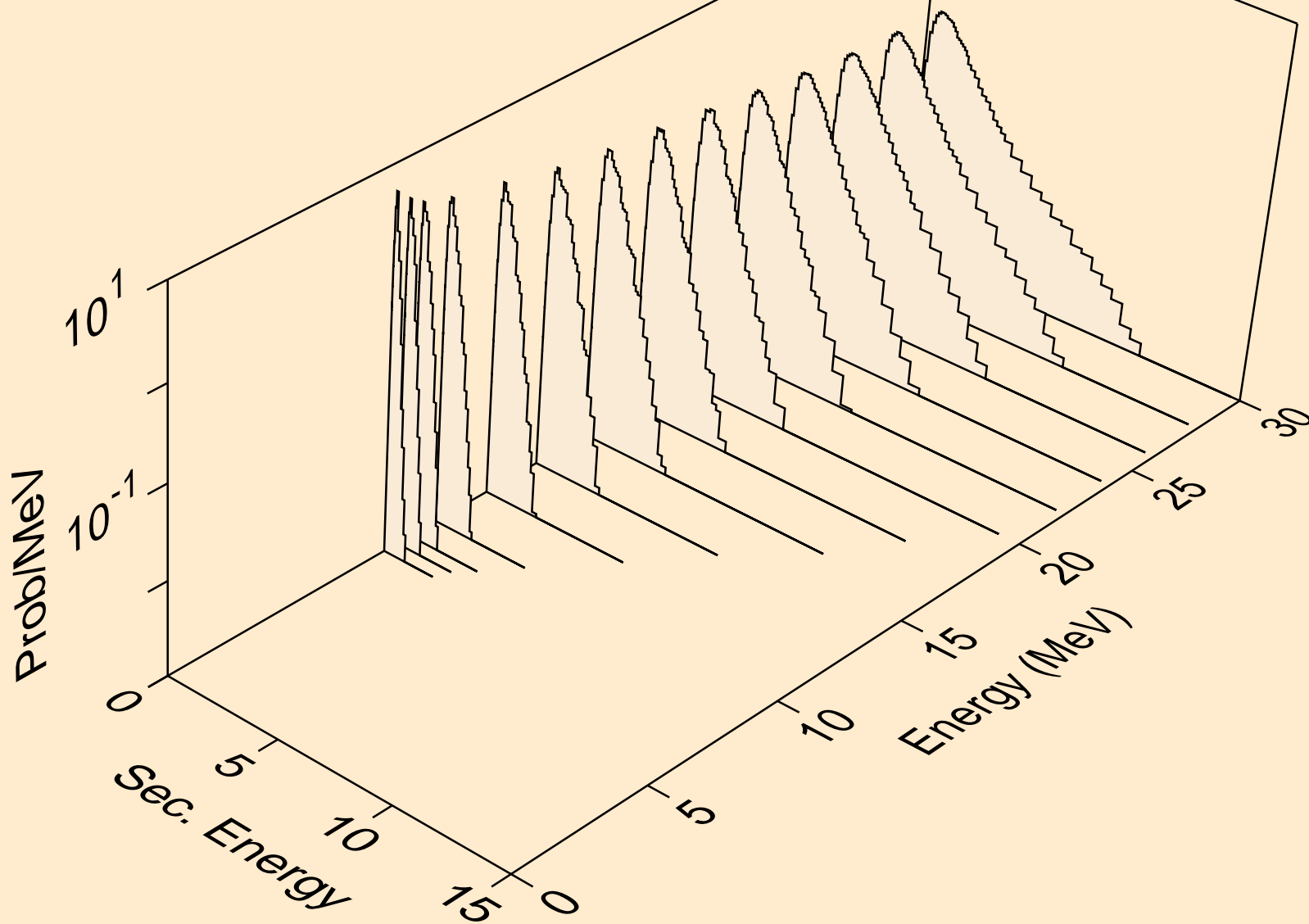

ND128 NEUTRON ACER TENDL-2019 LIBRARY; T=293.16K  
Neutron emission for (n,n\*c)

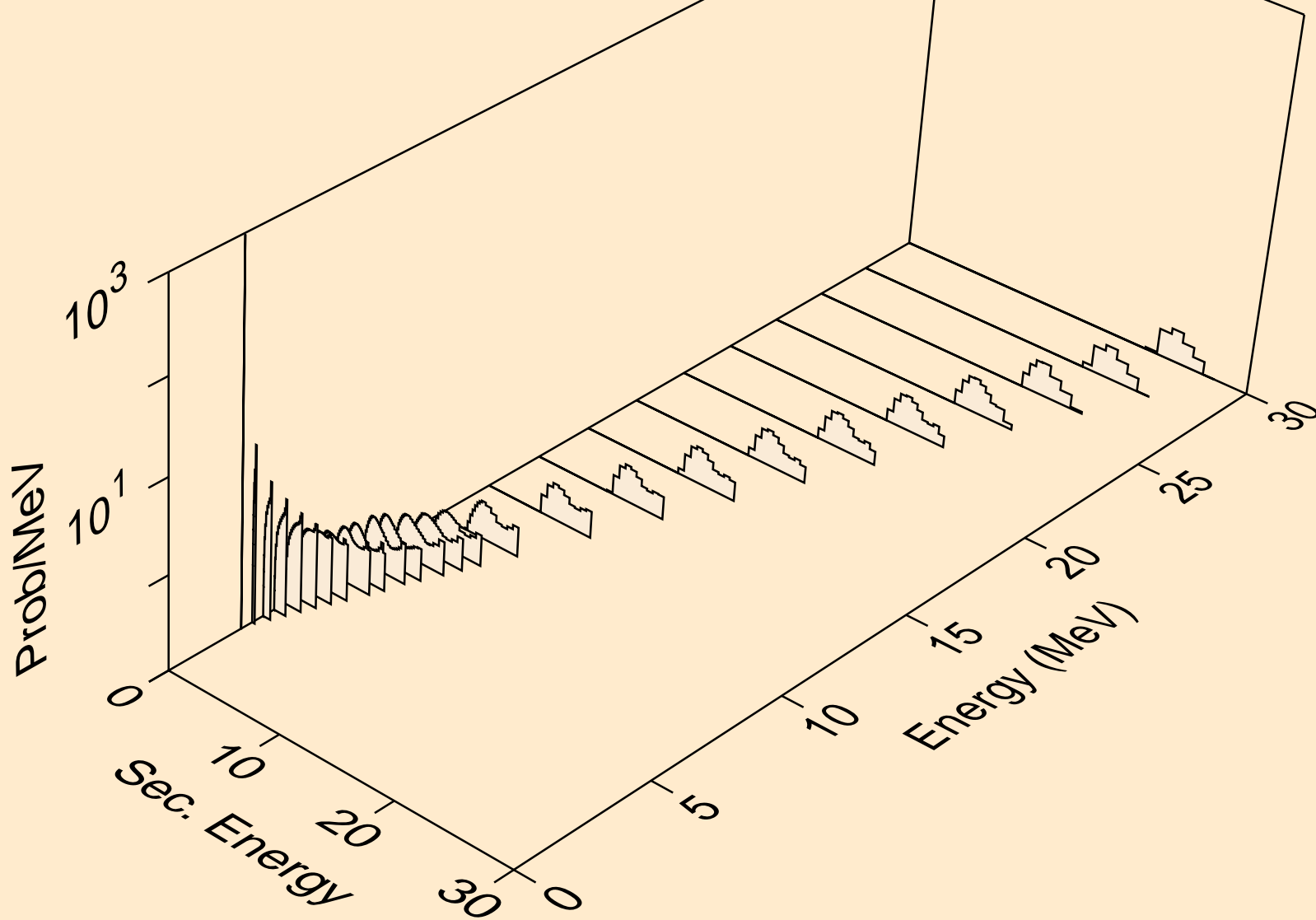

ND128 NEUTRON ACER TENDL-2019 LIBRARY; T=293.16K  
Photon emission for (n,x)

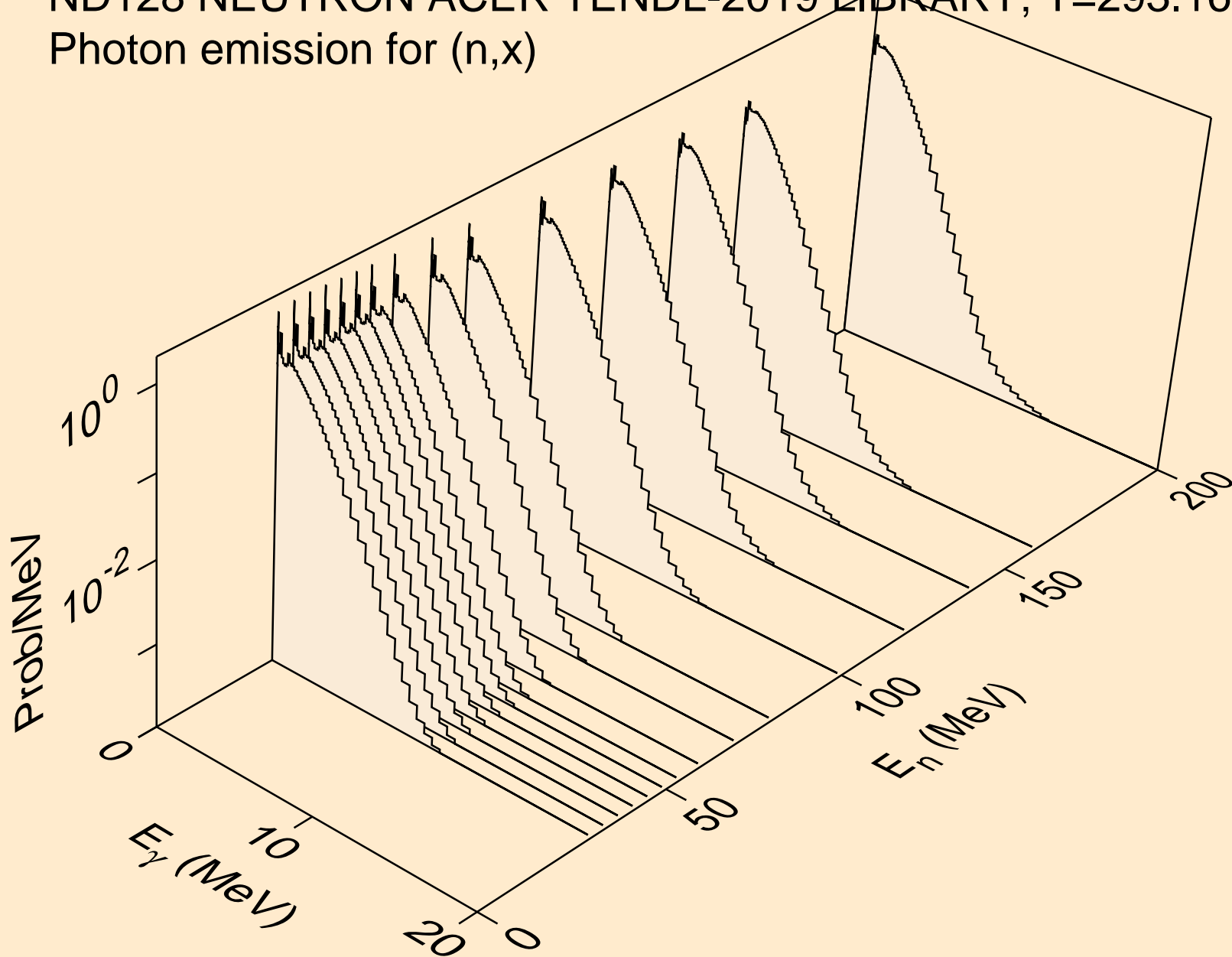

ND128 NEUTRON ACER TENDL-2019 LIBRARY; T=293.16K  
Photon emission for (n,2nd)

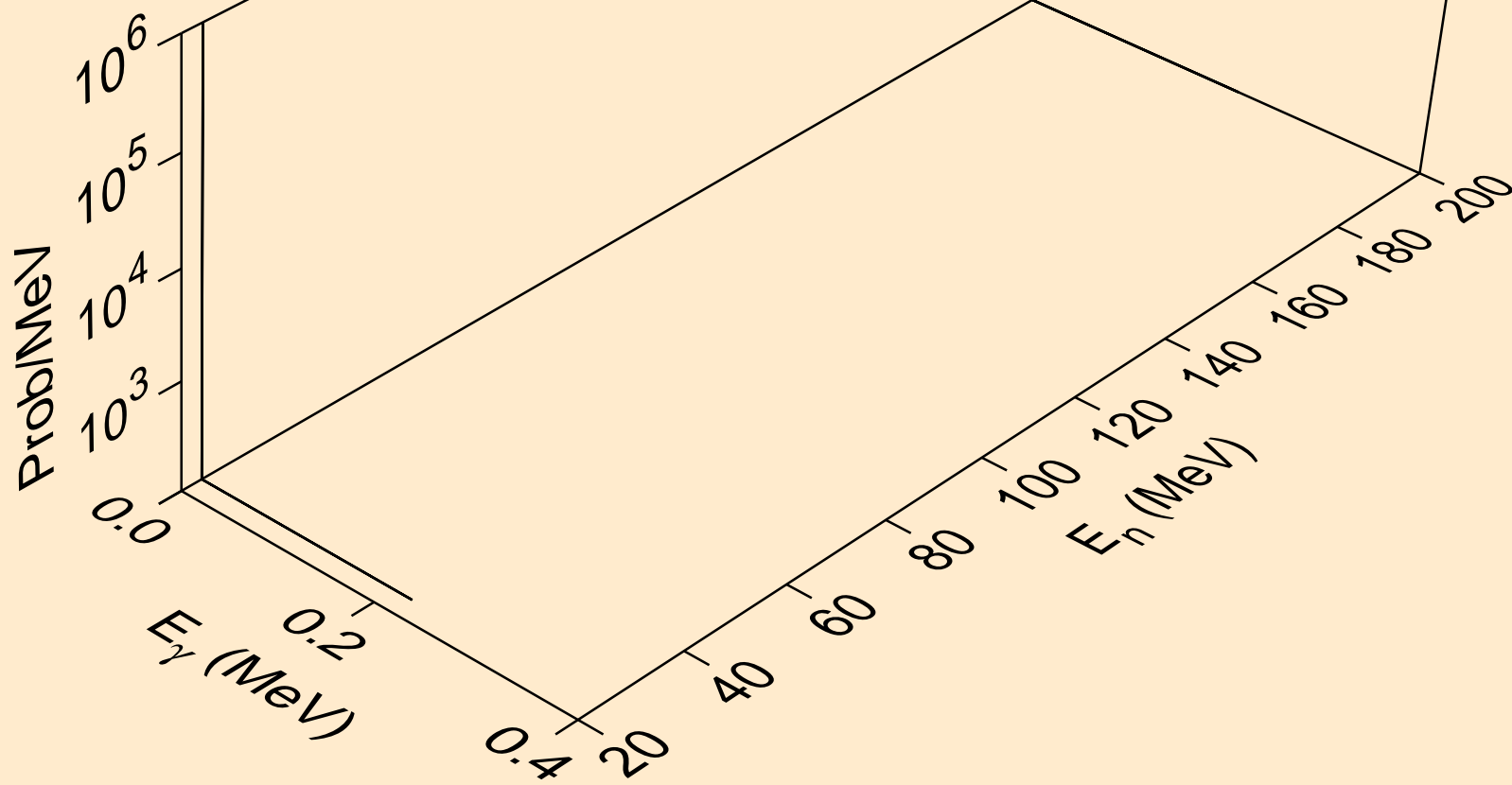

ND128 NEUTRON ACER TENDL-2019 LIBRARY; T=293.16K  
Photon emission for (n,2n)

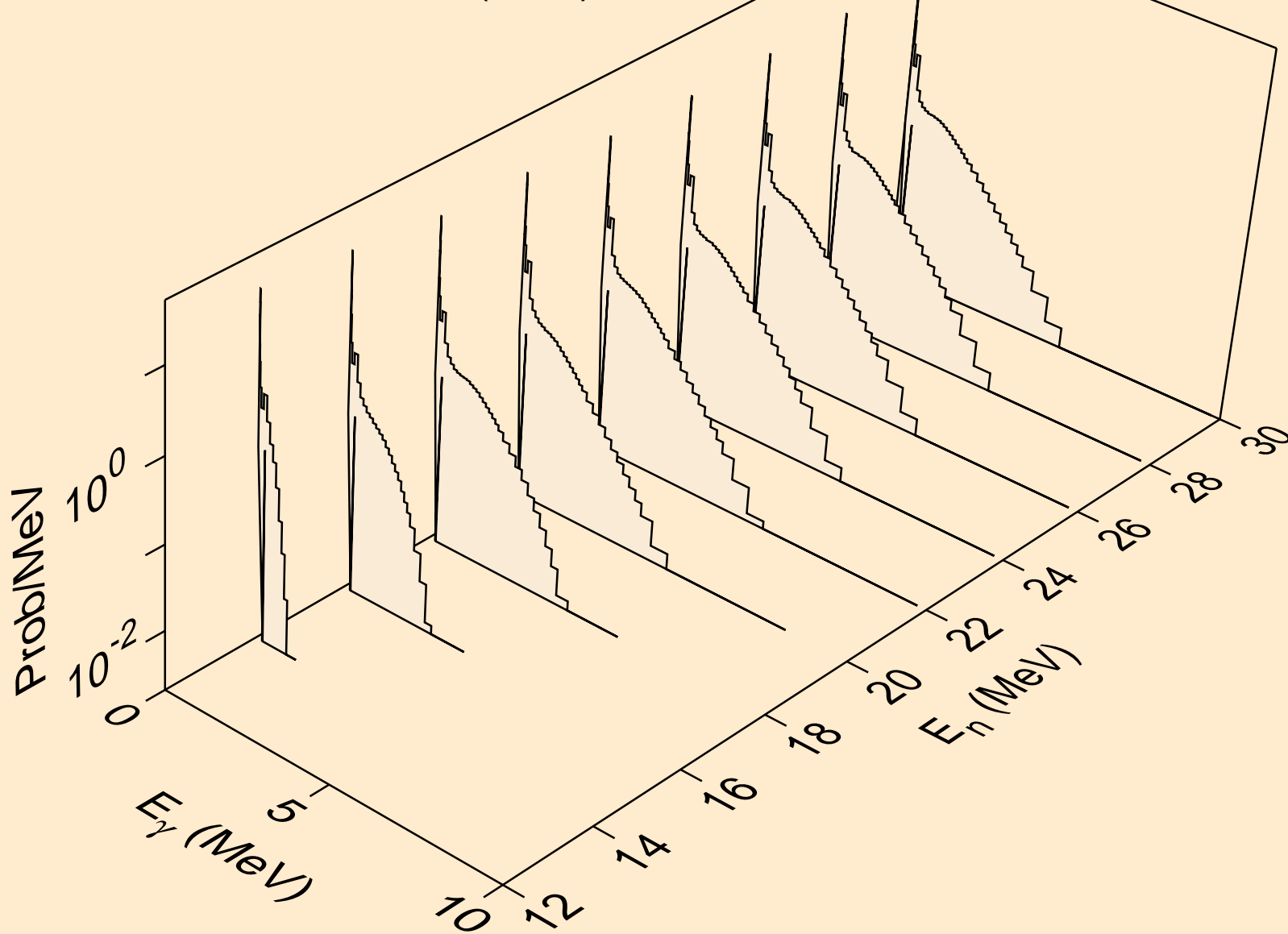

ND128 NEUTRON ACER TENDL-2019 LIBRARY; T=293.16K  
Photon emission for (n,3n)

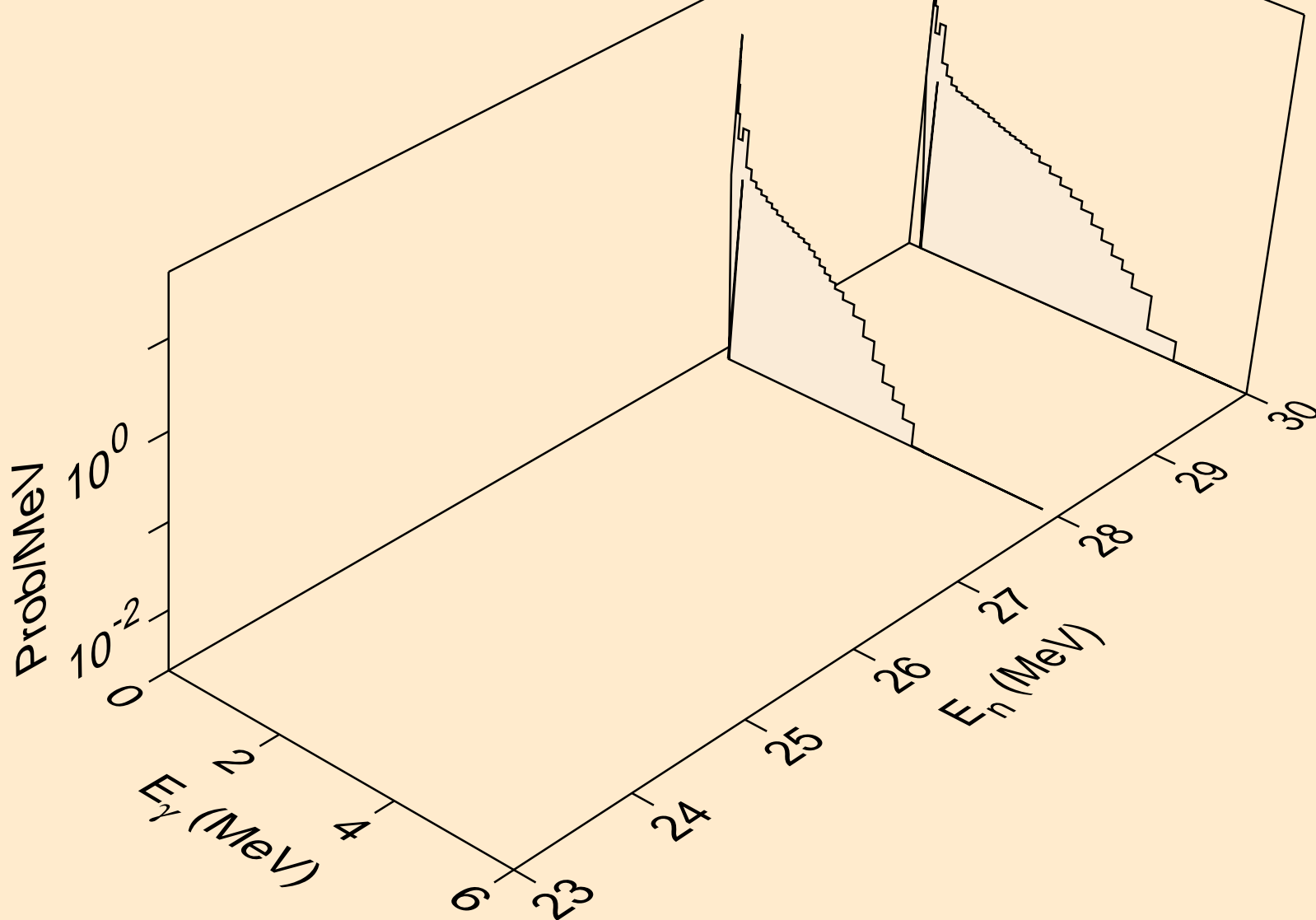

ND128 NEUTRON ACER TENDL-2019 LIBRARY; T=293.16K  
Photon emission for (n,n\*)a

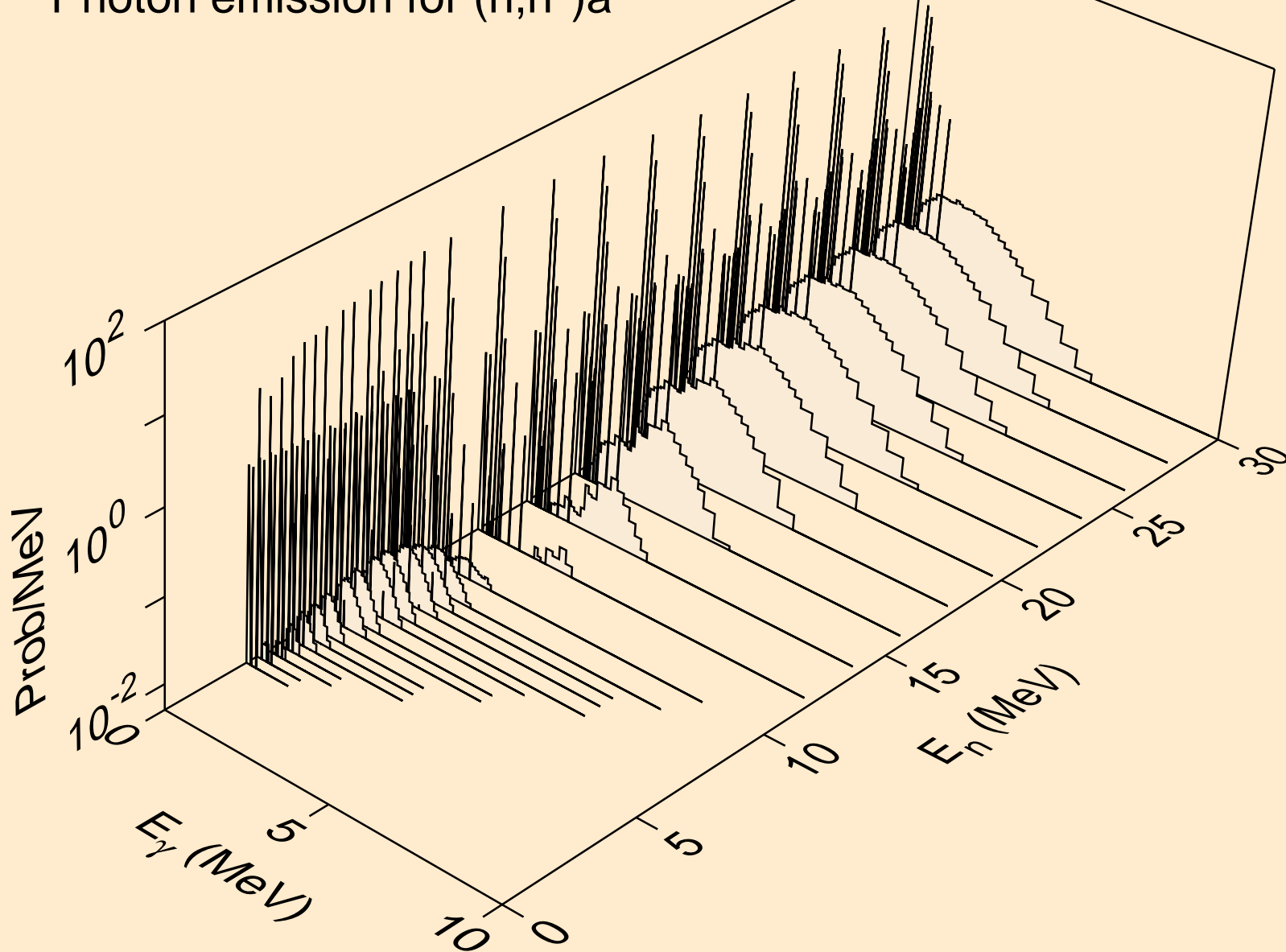

ND128 NEUTRON ACER TENDL-2019 LIBRARY; T=293.16K  
Photon emission for (n,2n)a

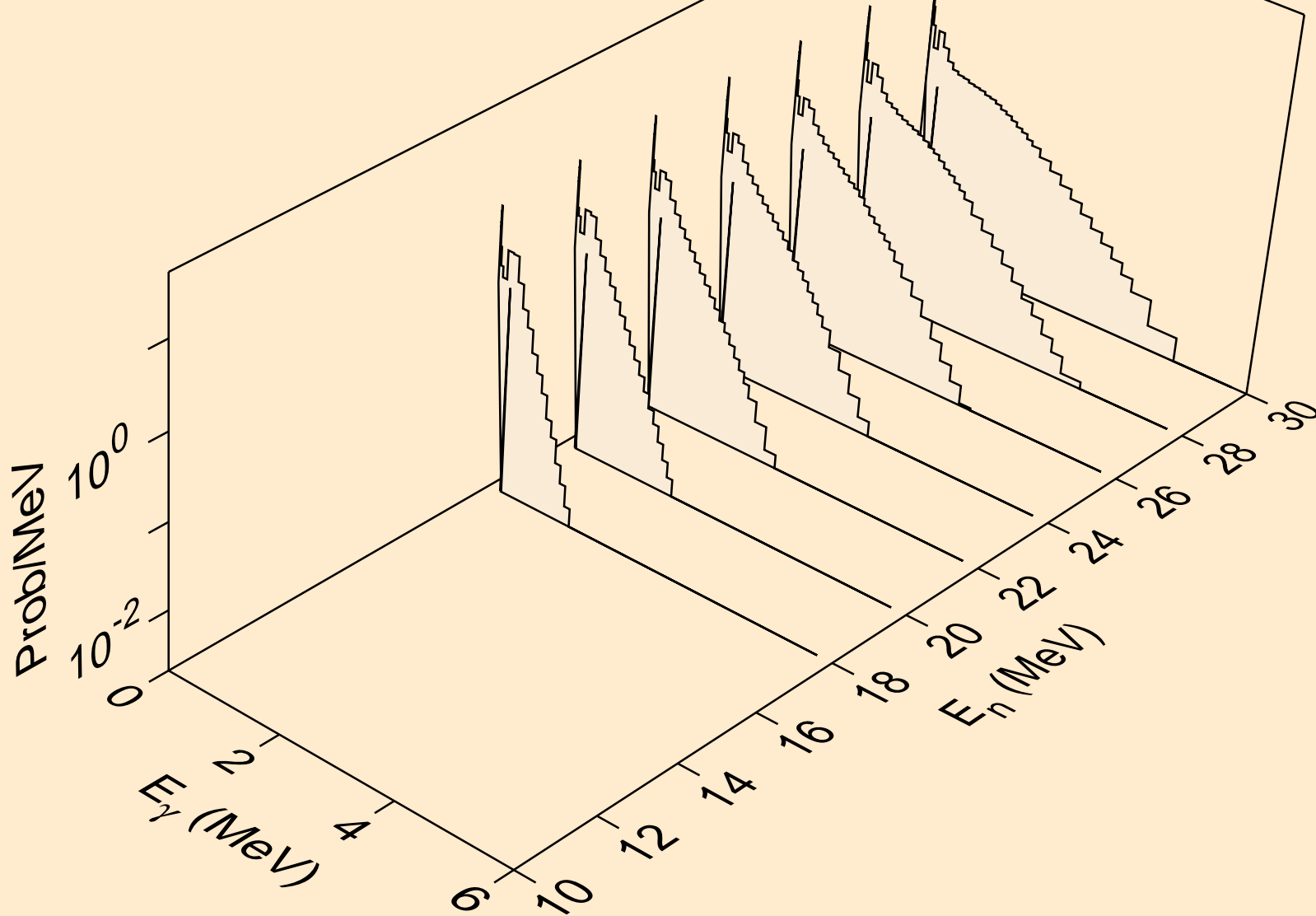

ND128 NEUTRON ACER TENDL-2019 LIBRARY; T=293.16K  
Photon emission for (n,n\*)p

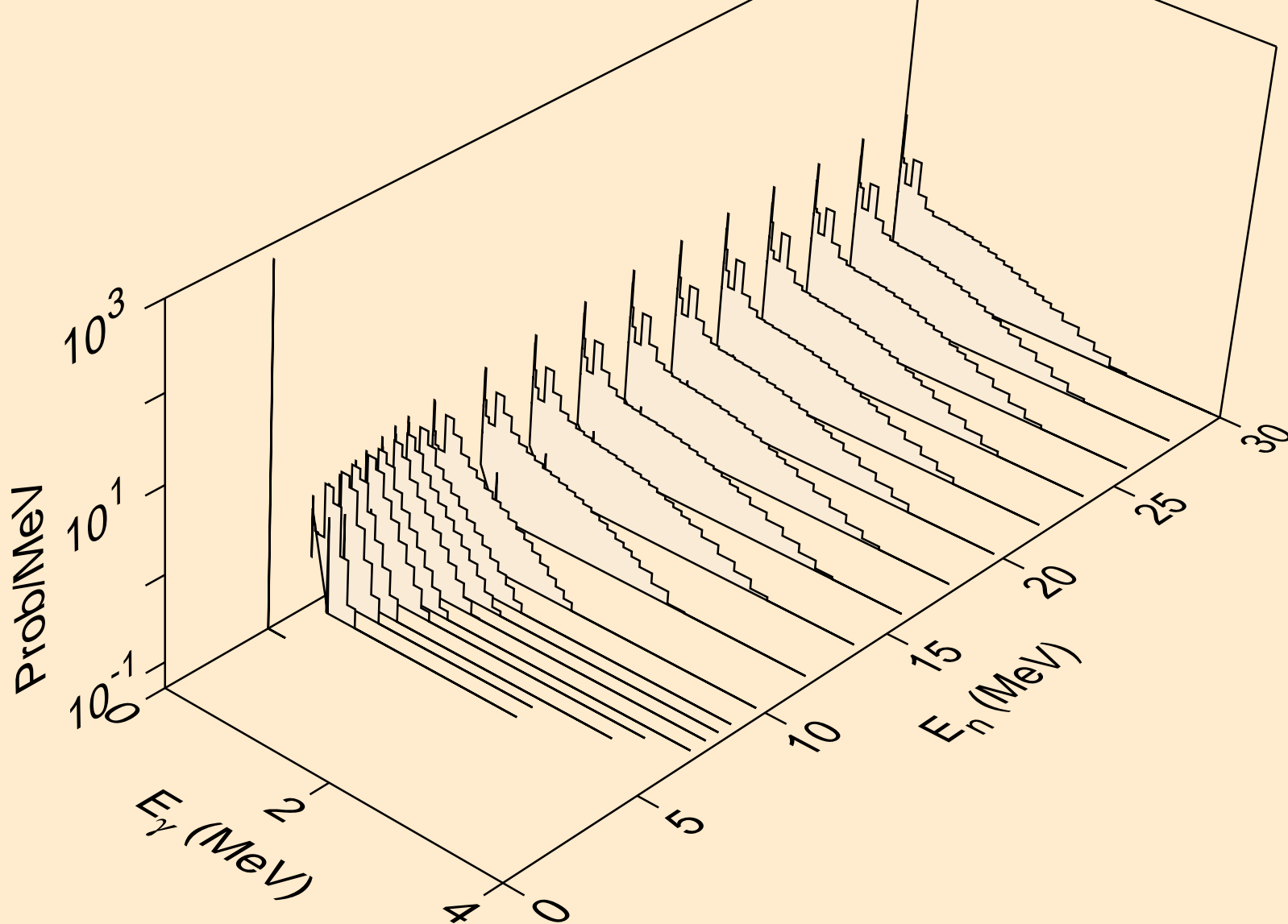

ND128 NEUTRON ACER TENDL-2019 LIBRARY; T=293.16K  
Photon emission for (n,n\*)2a

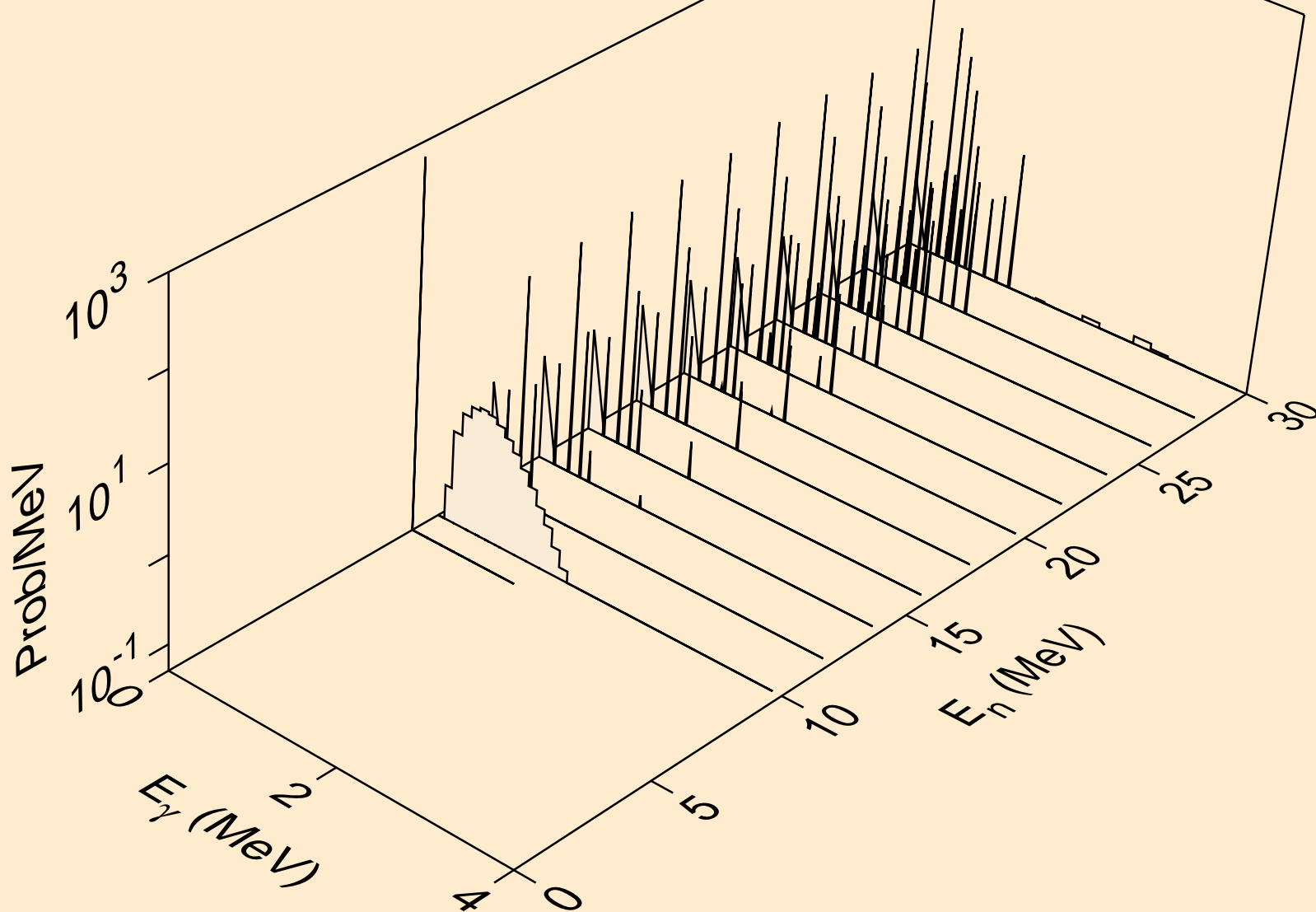

ND128 NEUTRON ACER TENDL-2019 LIBRARY; T=293.16K  
Photon emission for (n,n\*)d

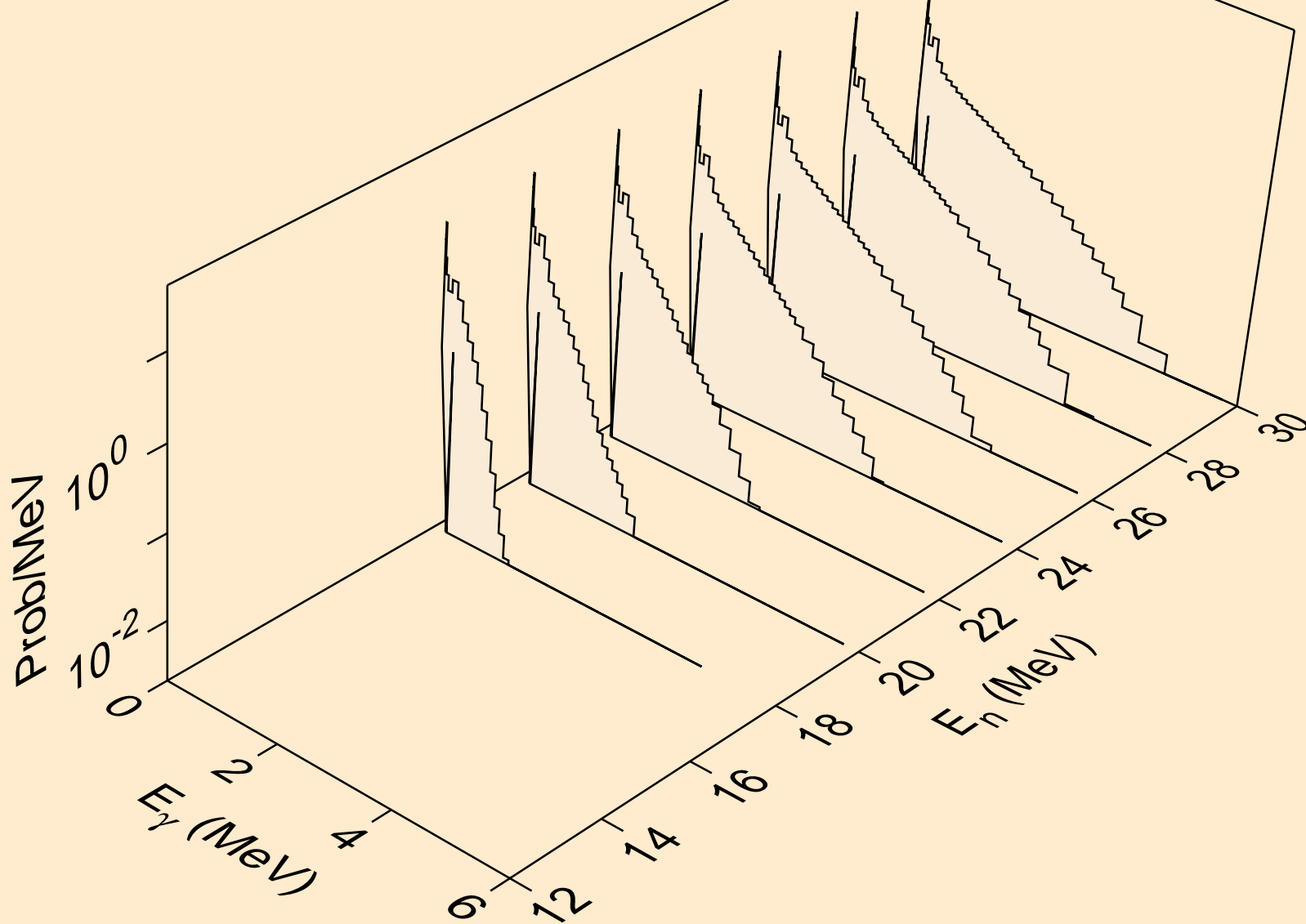

ND128 NEUTRON ACER TENDL-2019 LIBRARY; T=293.16K  
Photon emission for (n,n\*)t

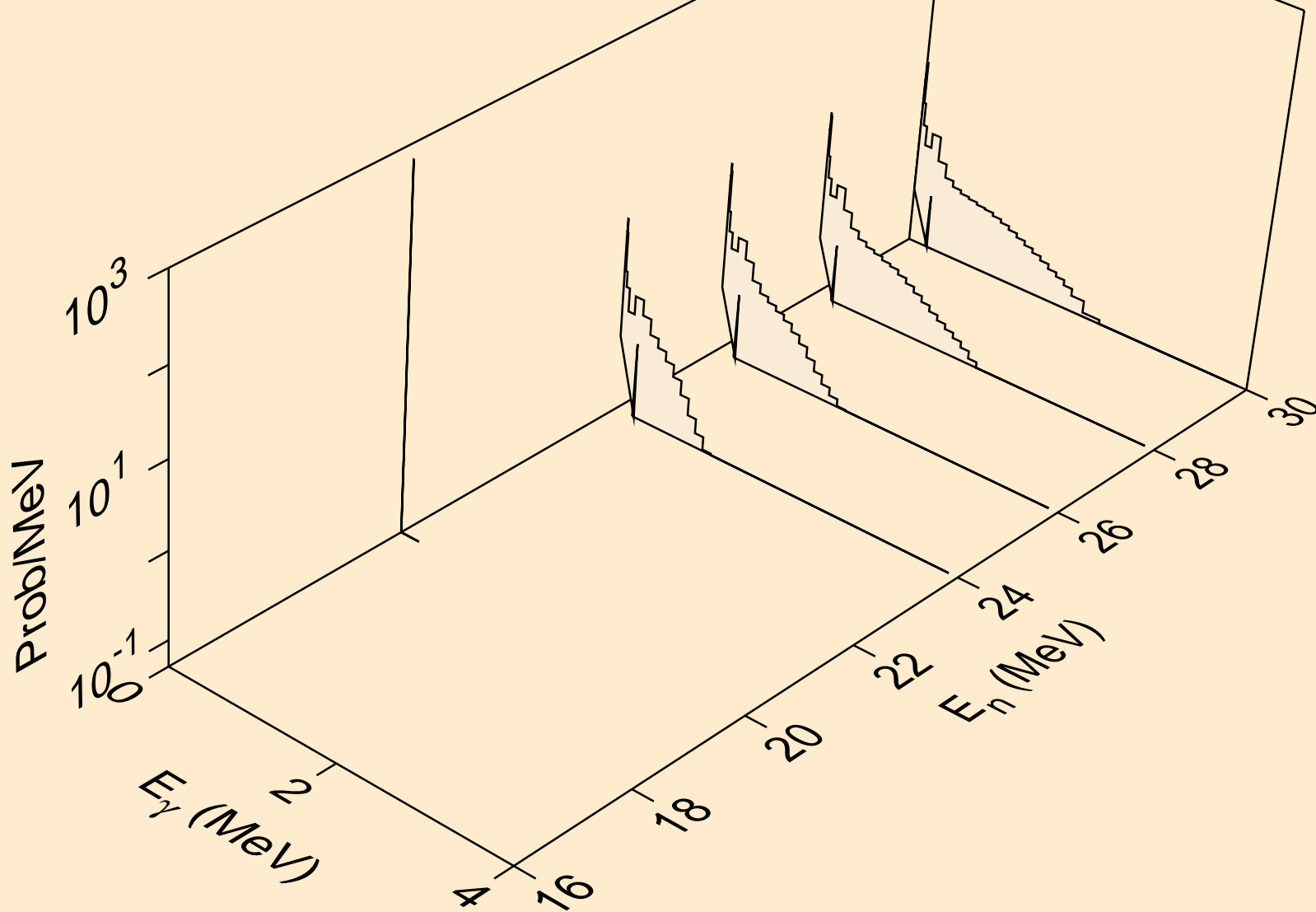

ND128 NEUTRON ACER TENDL-2019 LIBRARY; T=293.16K  
Photon emission for (n,n\*)he3

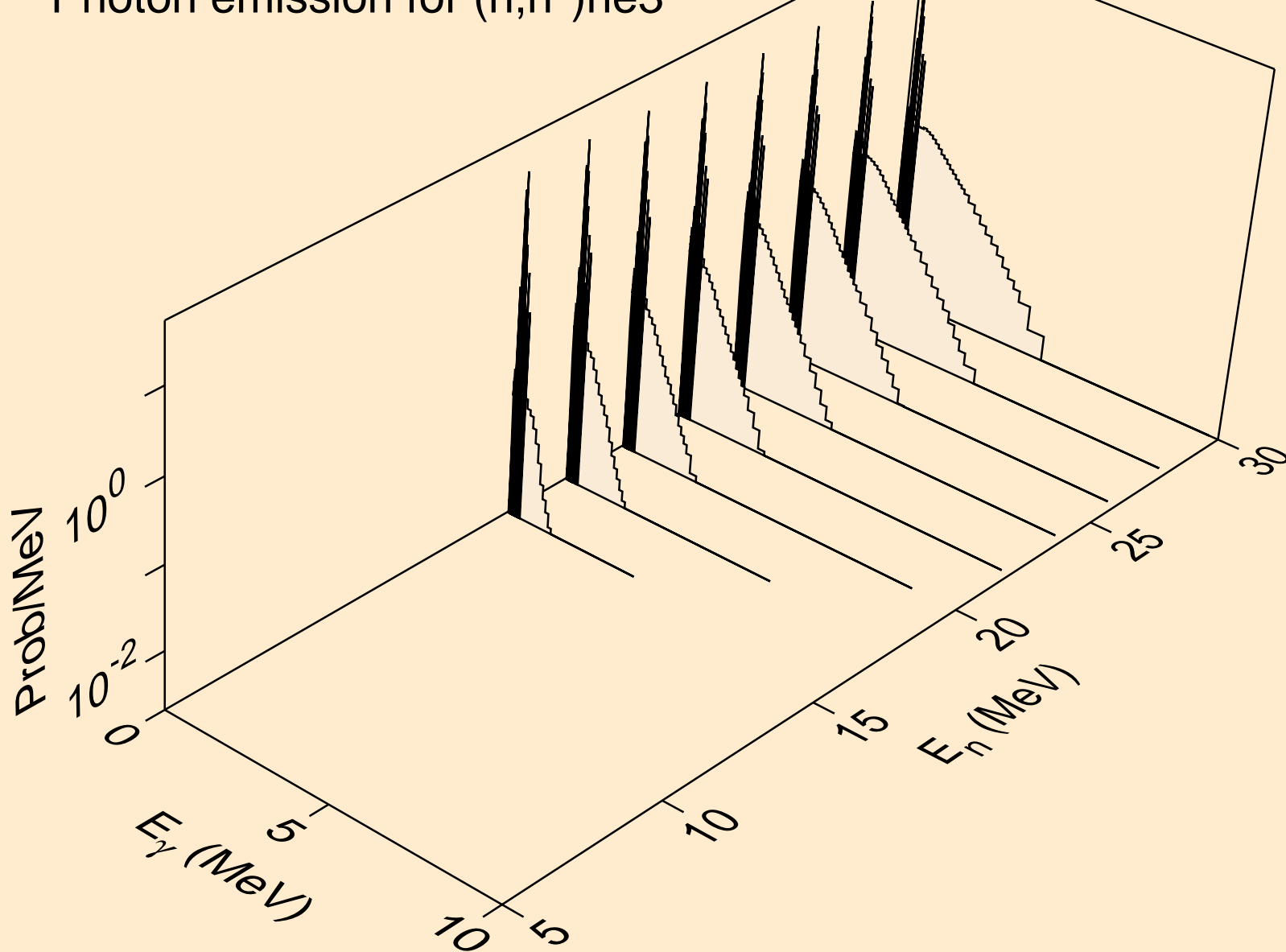

ND128 NEUTRON ACER TENDL-2019 LIBRARY; T=293.16K  
Photon emission for (n,2np)

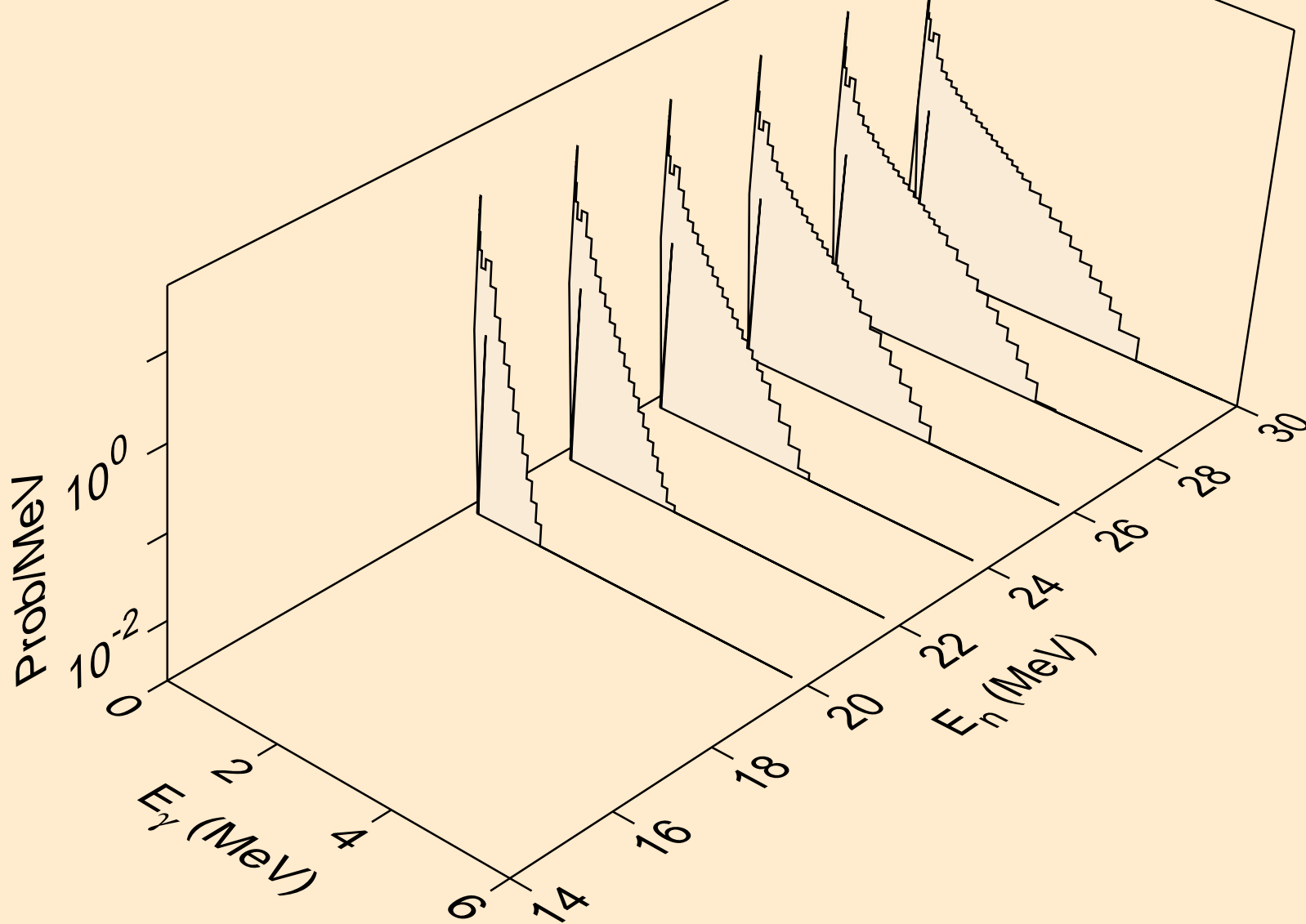

ND128 NEUTRON ACER TENDL-2019 LIBRARY; T=293.16K  
Photon emission for (n,3np)

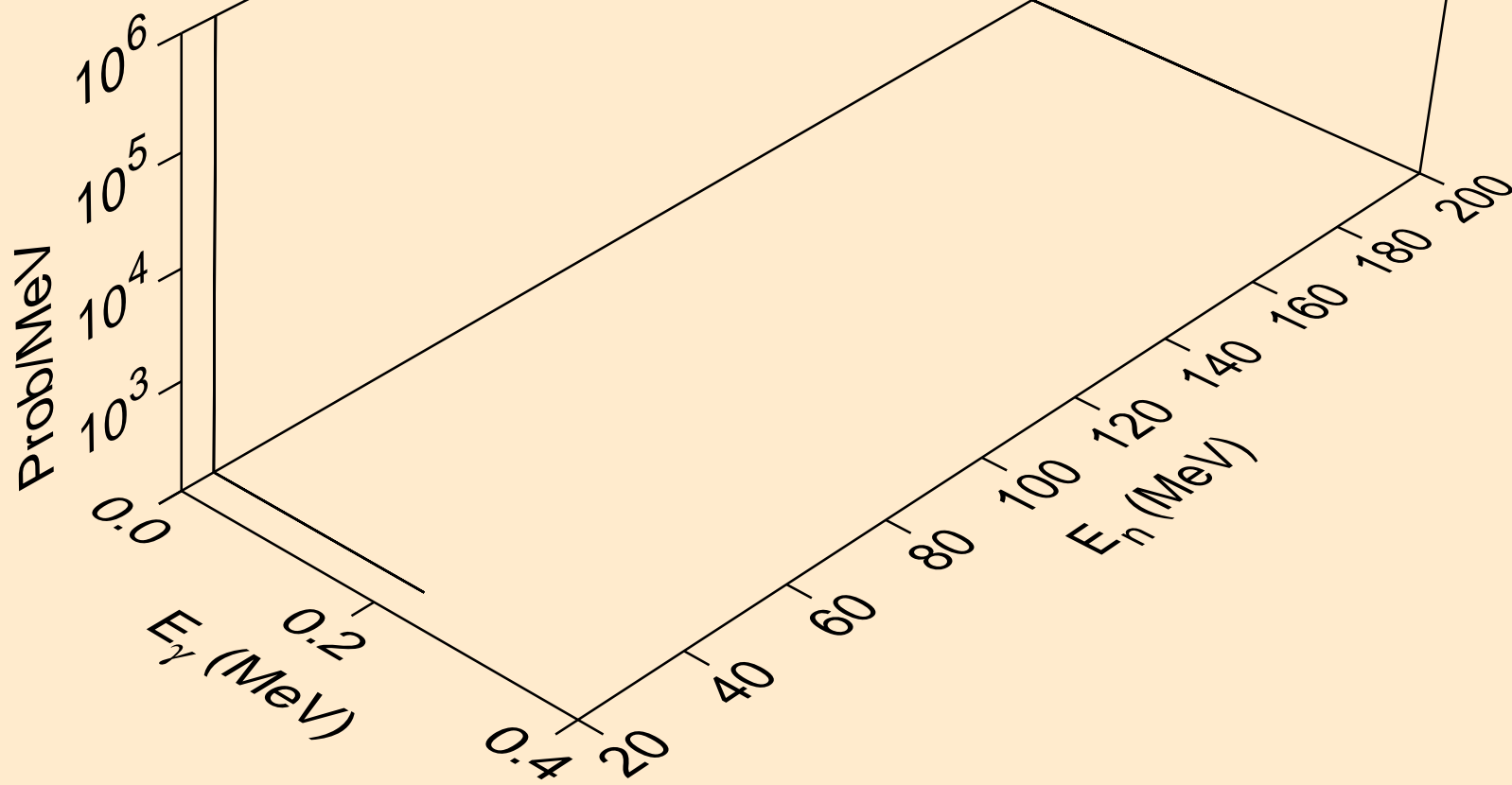

ND128 NEUTRON ACER TENDL-2019 LIBRARY; T=293.16K  
Photon emission for (n,2np)

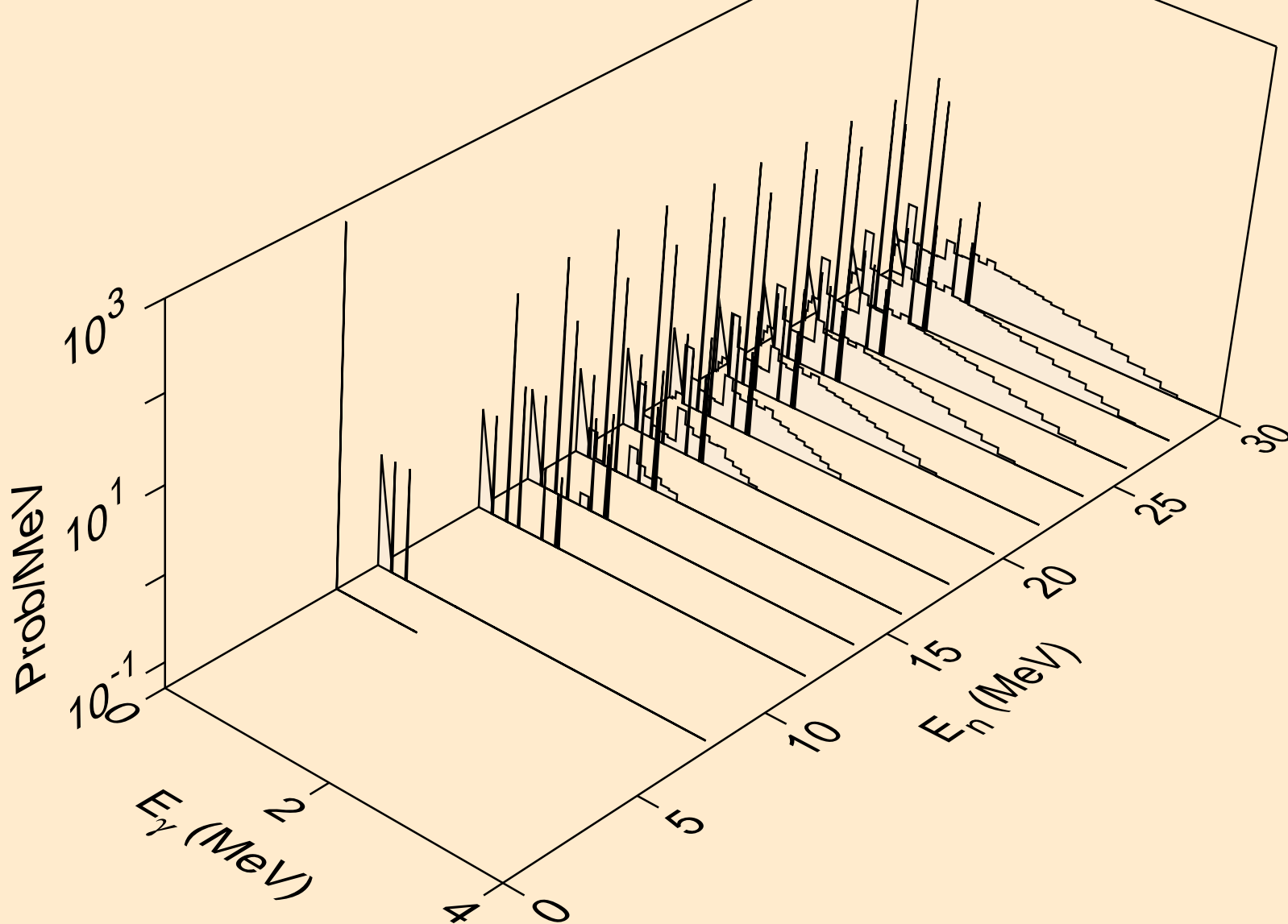

ND128 NEUTRON ACER TENDL-2019 LIBRARY; T=293.16K  
Photon emission for (n,npa)

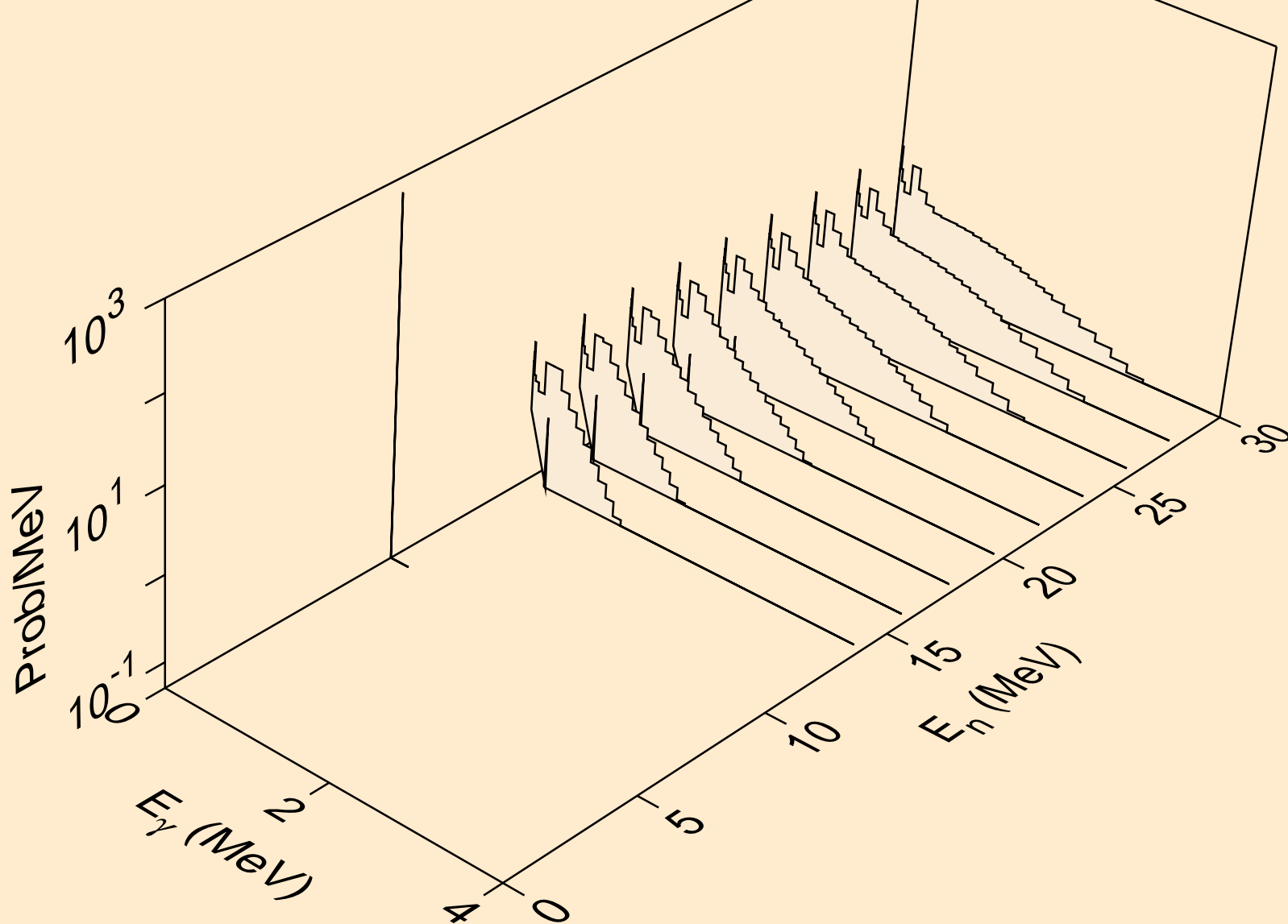

ND128 NEUTRON ACER TENDL-2019 LIBRARY; T=293.16K  
Photon emission for (n,n\*c)

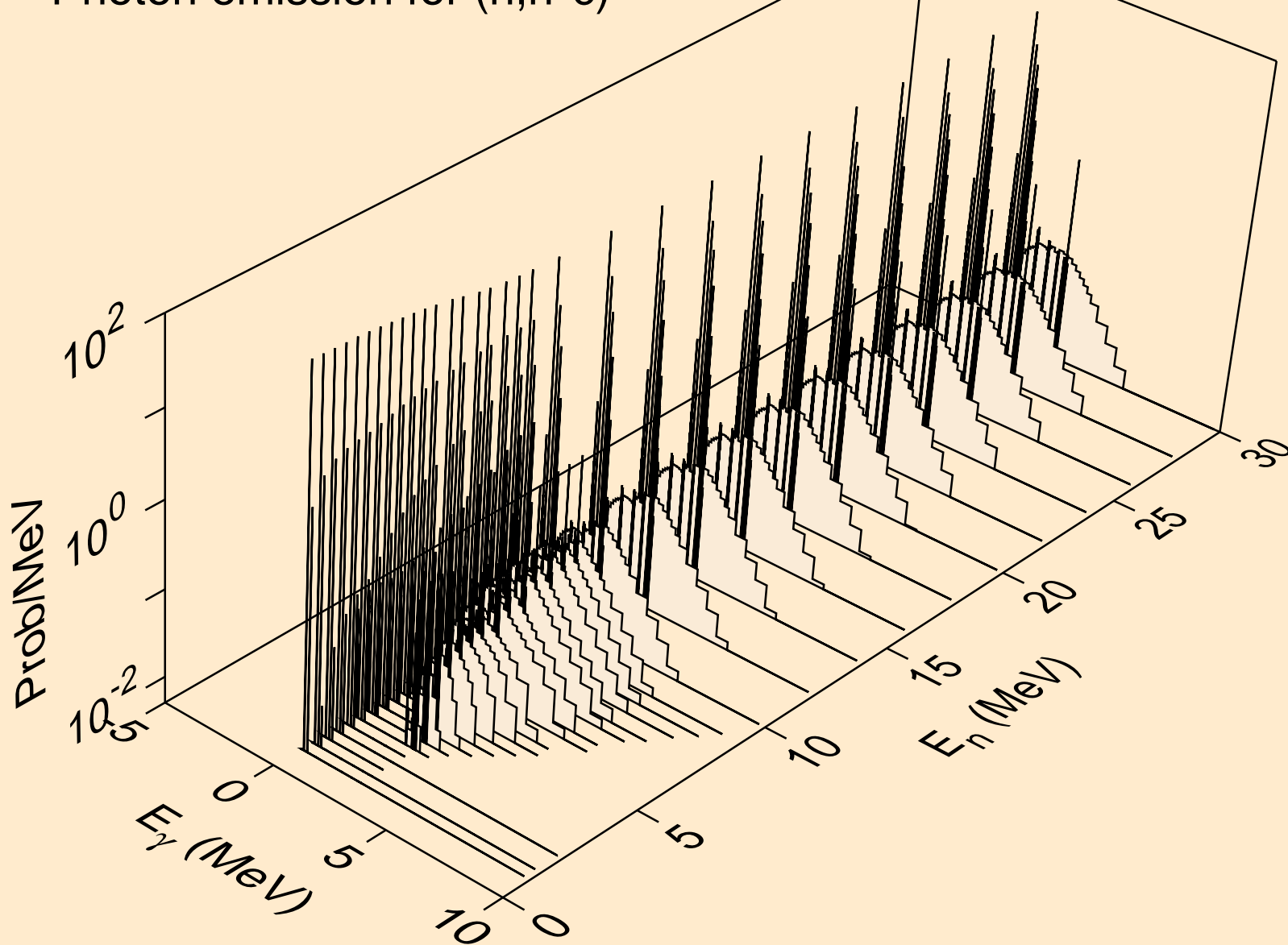

ND128 NEUTRON ACER TENDL-2019 LIBRARY; T=293.16K  
Photon emission for (n,gma)

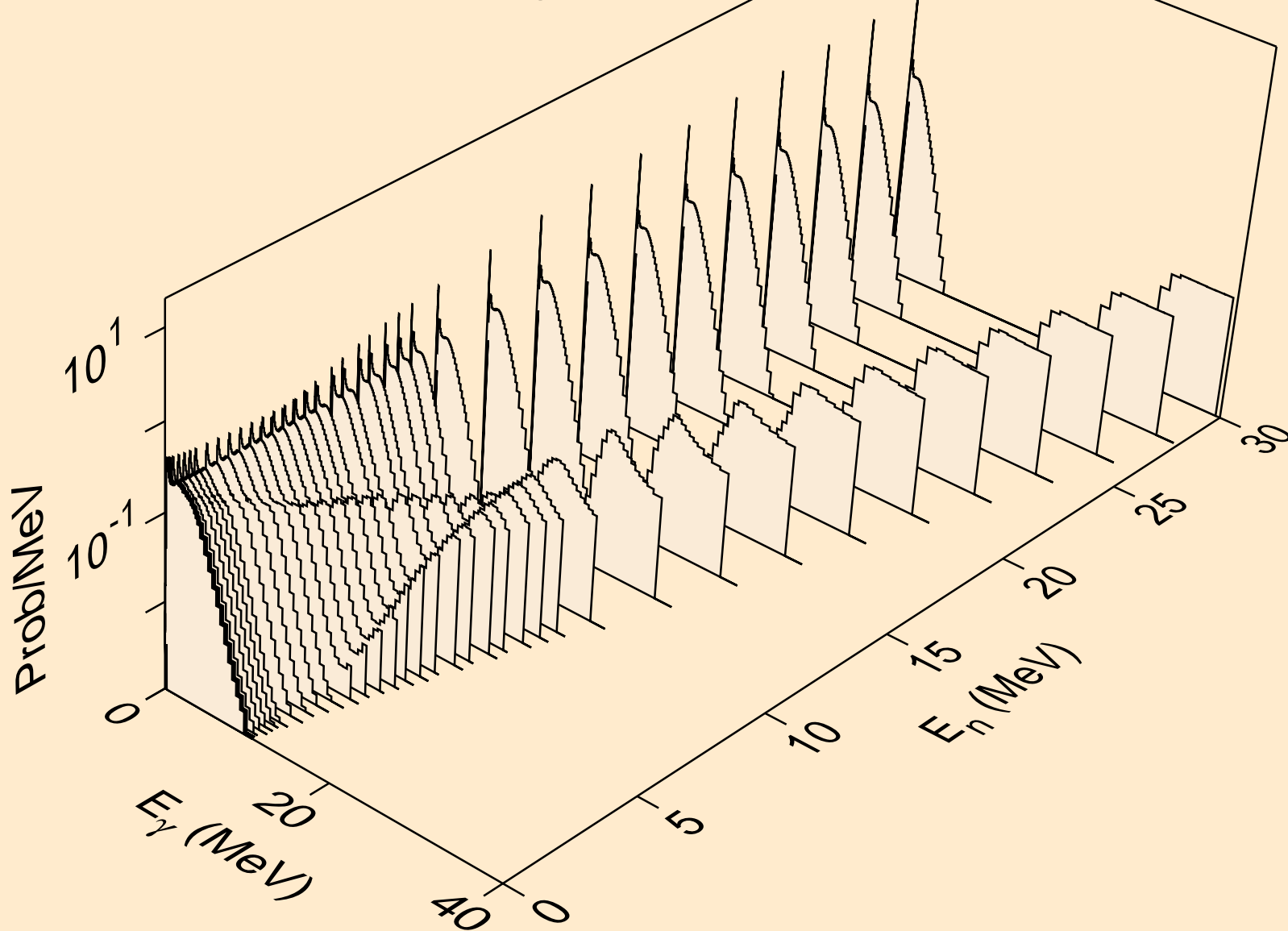

ND128 NEUTRON ACER TENDL-2019 LIBRARY; T=293.16K  
Photon emission for (n,p)

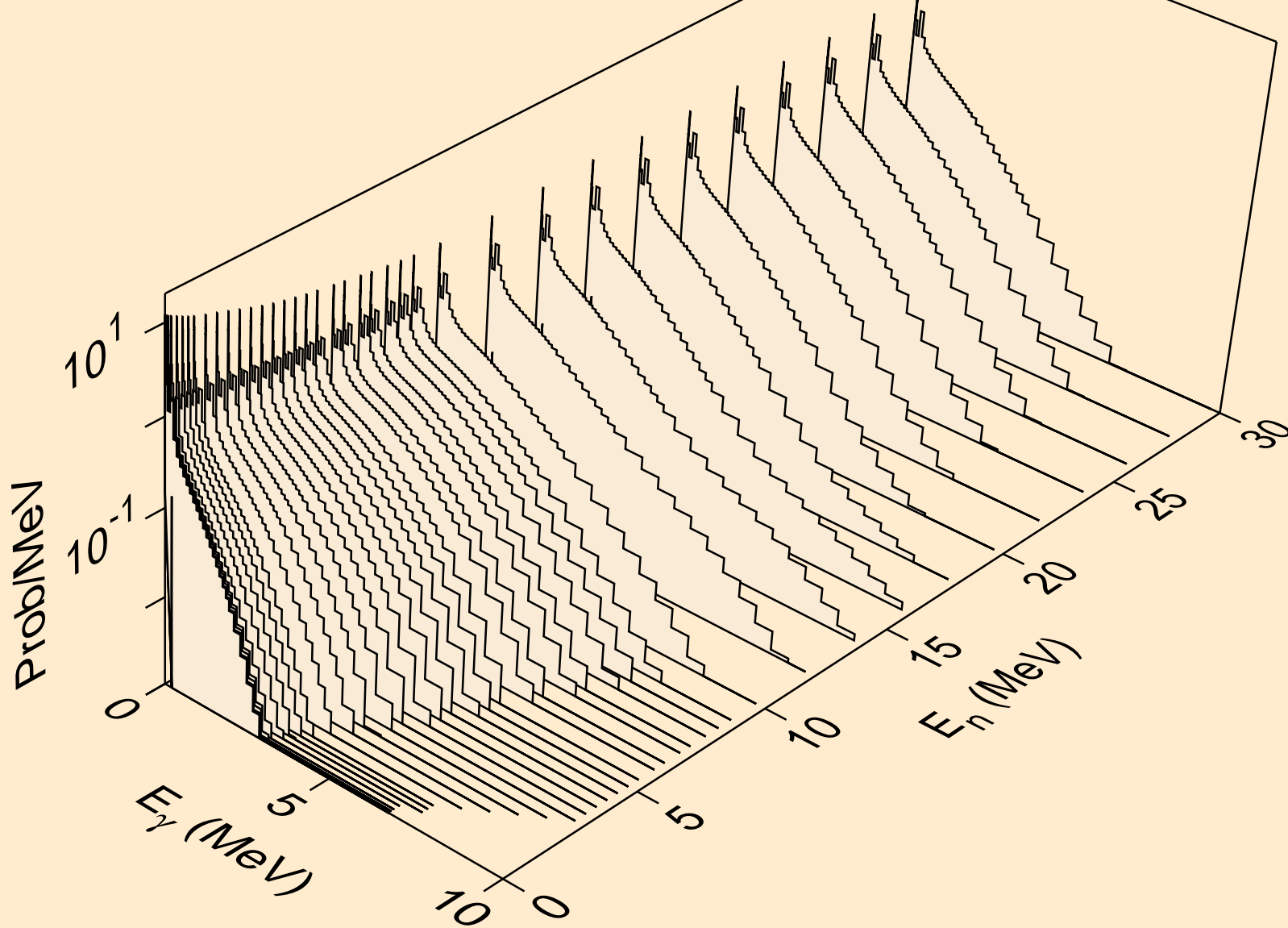

ND128 NEUTRON ACER TENDL-2019 LIBRARY; T=293.16K  
Photon emission for (n,d)

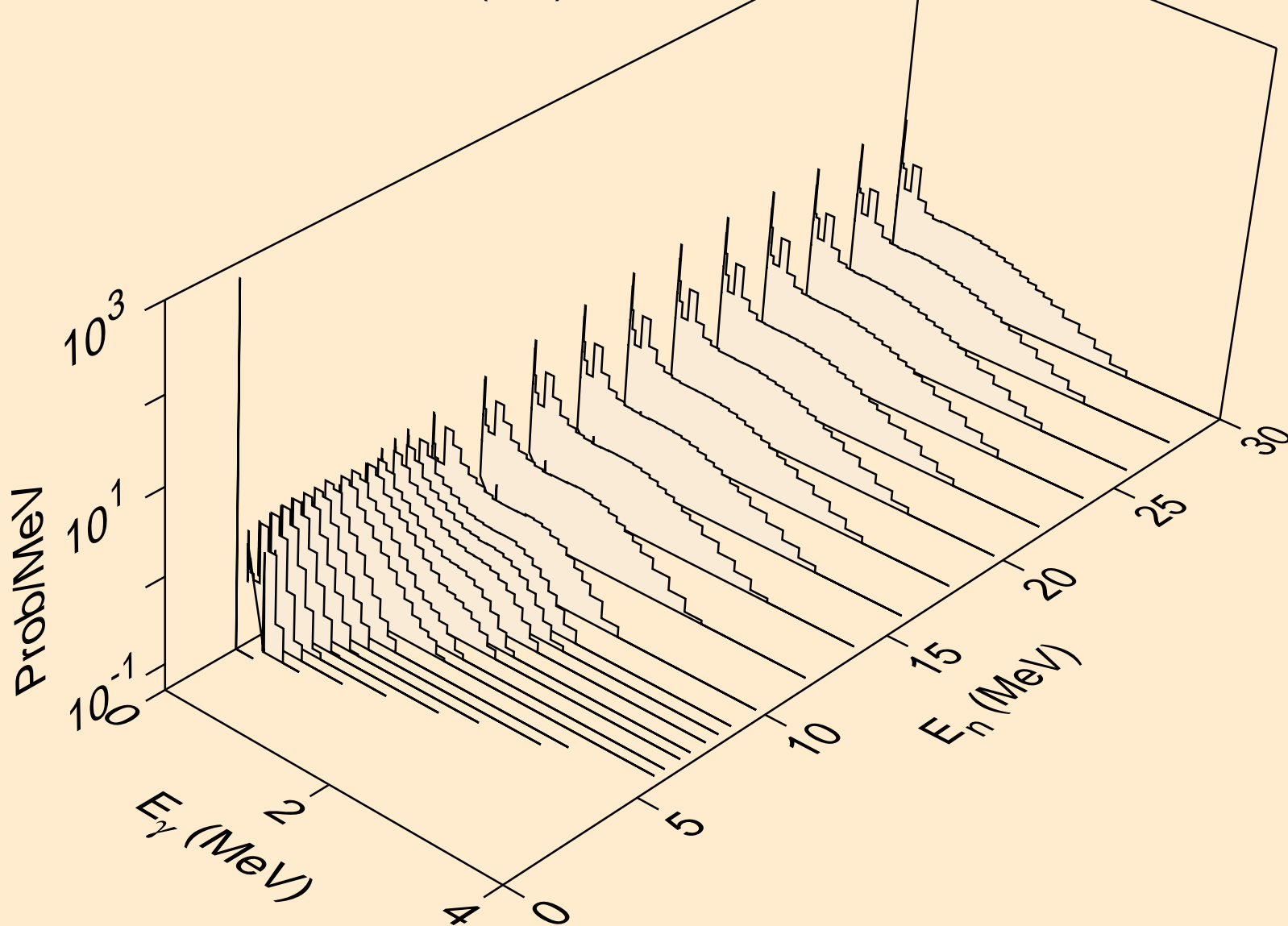

ND128 NEUTRON ACER TENDL-2019 LIBRARY; T=293.16K  
Photon emission for (n,t)

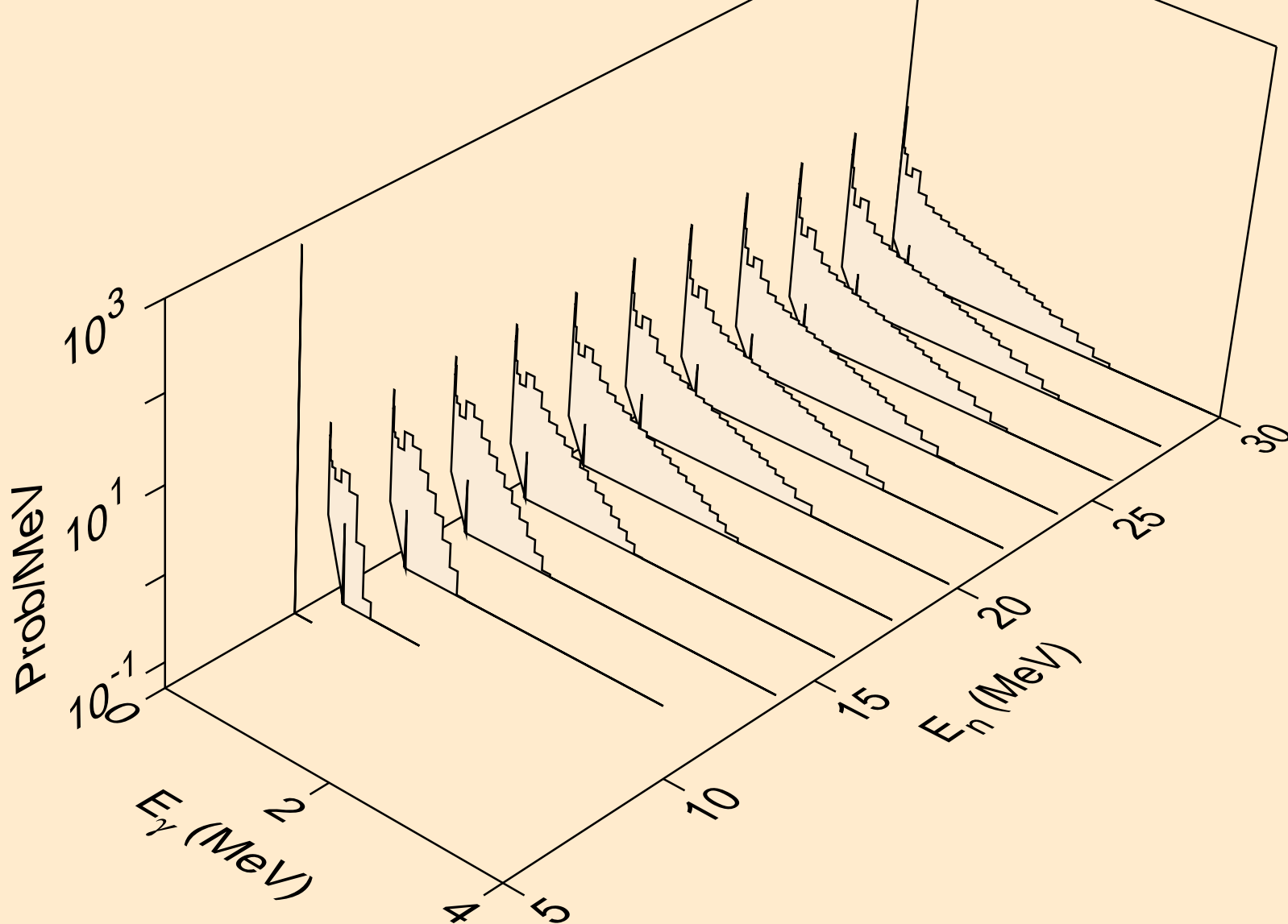

ND128 NEUTRON ACER TENDL-2019 LIBRARY; T=293.16K  
Photon emission for (n,he3)

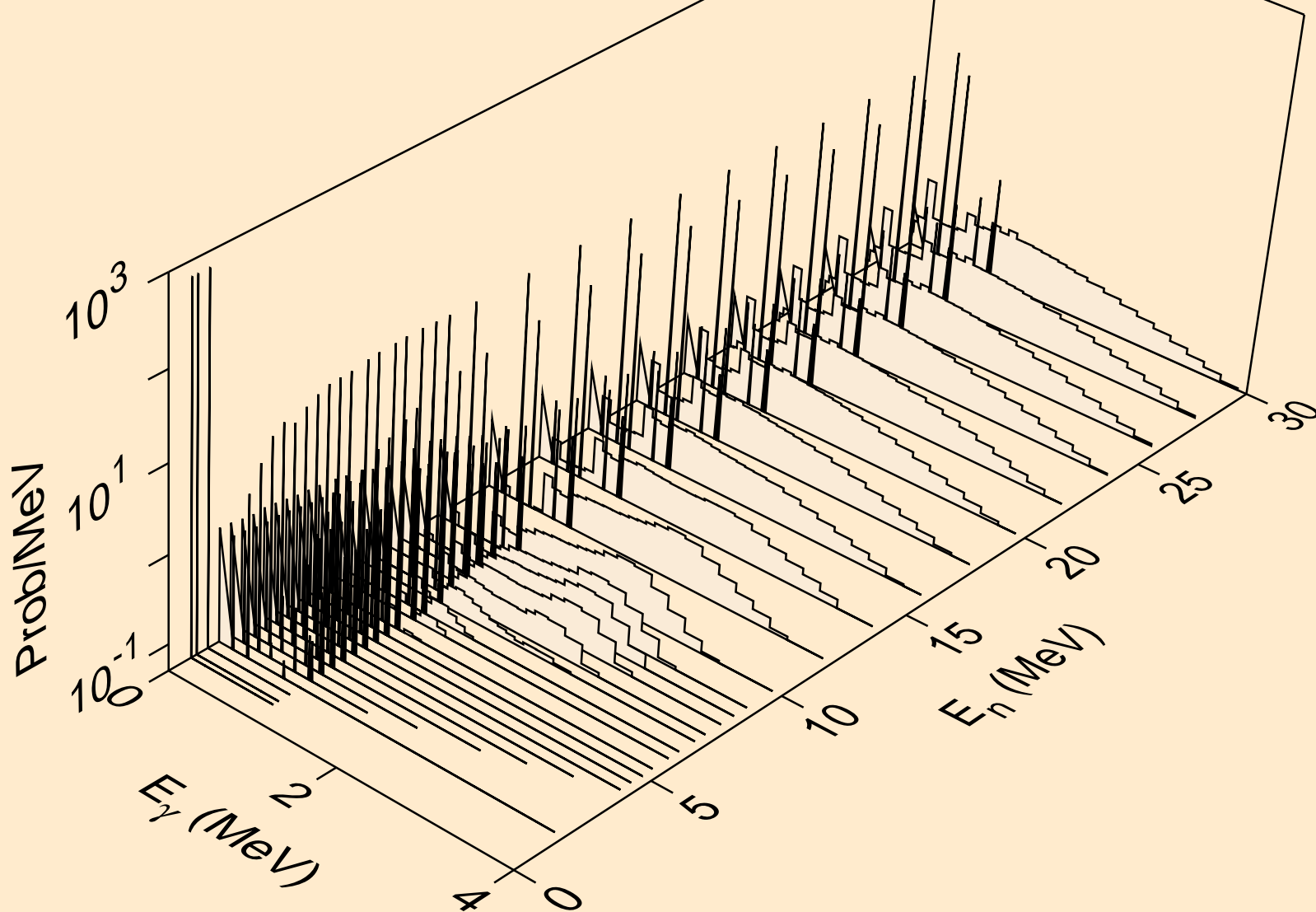

ND128 NEUTRON ACER TENDL-2019 LIBRARY; T=293.16K  
Photon emission for (n,a)

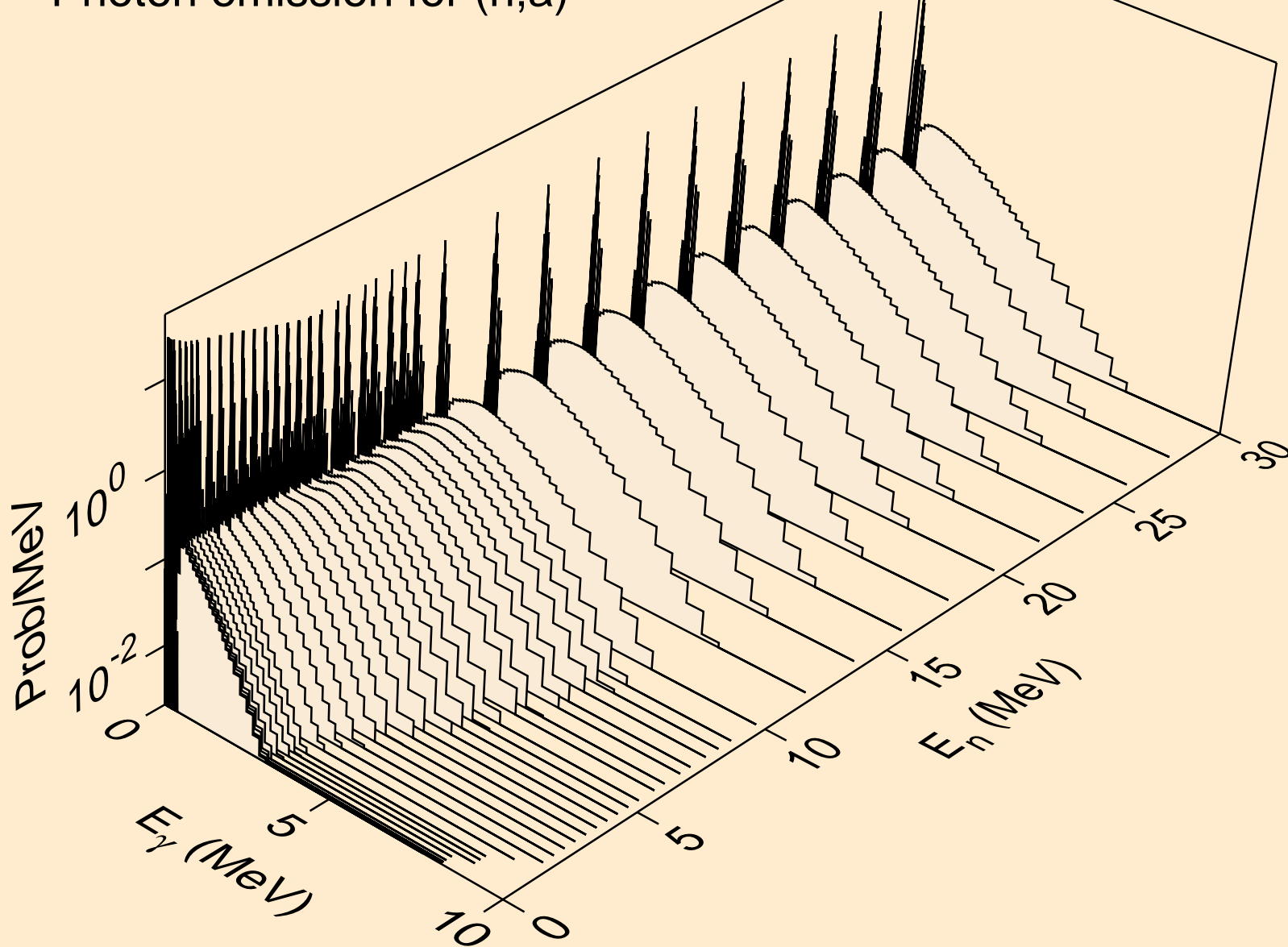

ND128 NEUTRON ACER TENDL-2019 LIBRARY; T=293.16K  
Photon emission for (n,2a)

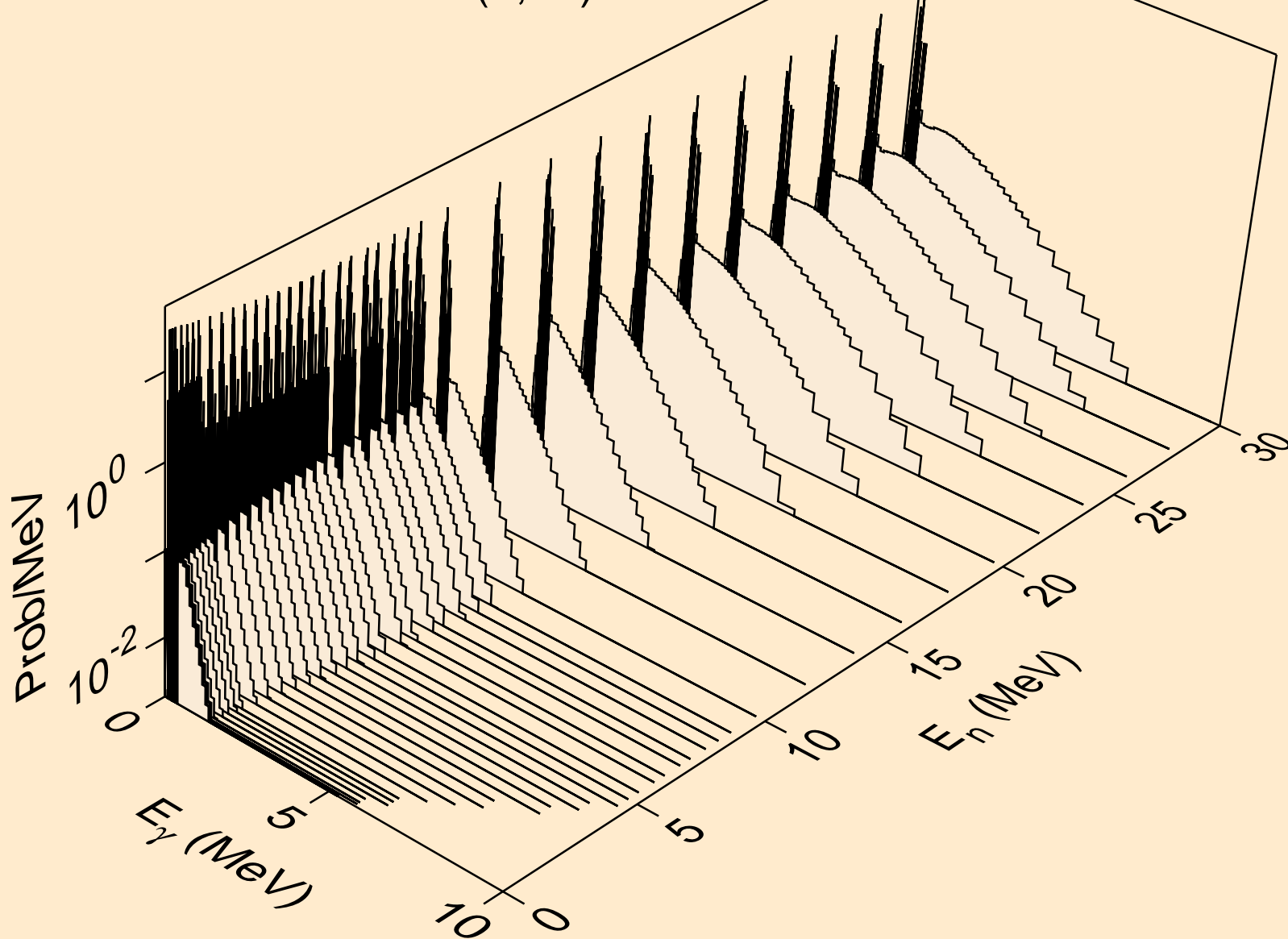

ND128 NEUTRON ACER TENDL-2019 LIBRARY; T=293.16K  
Photon emission for (n,3a)

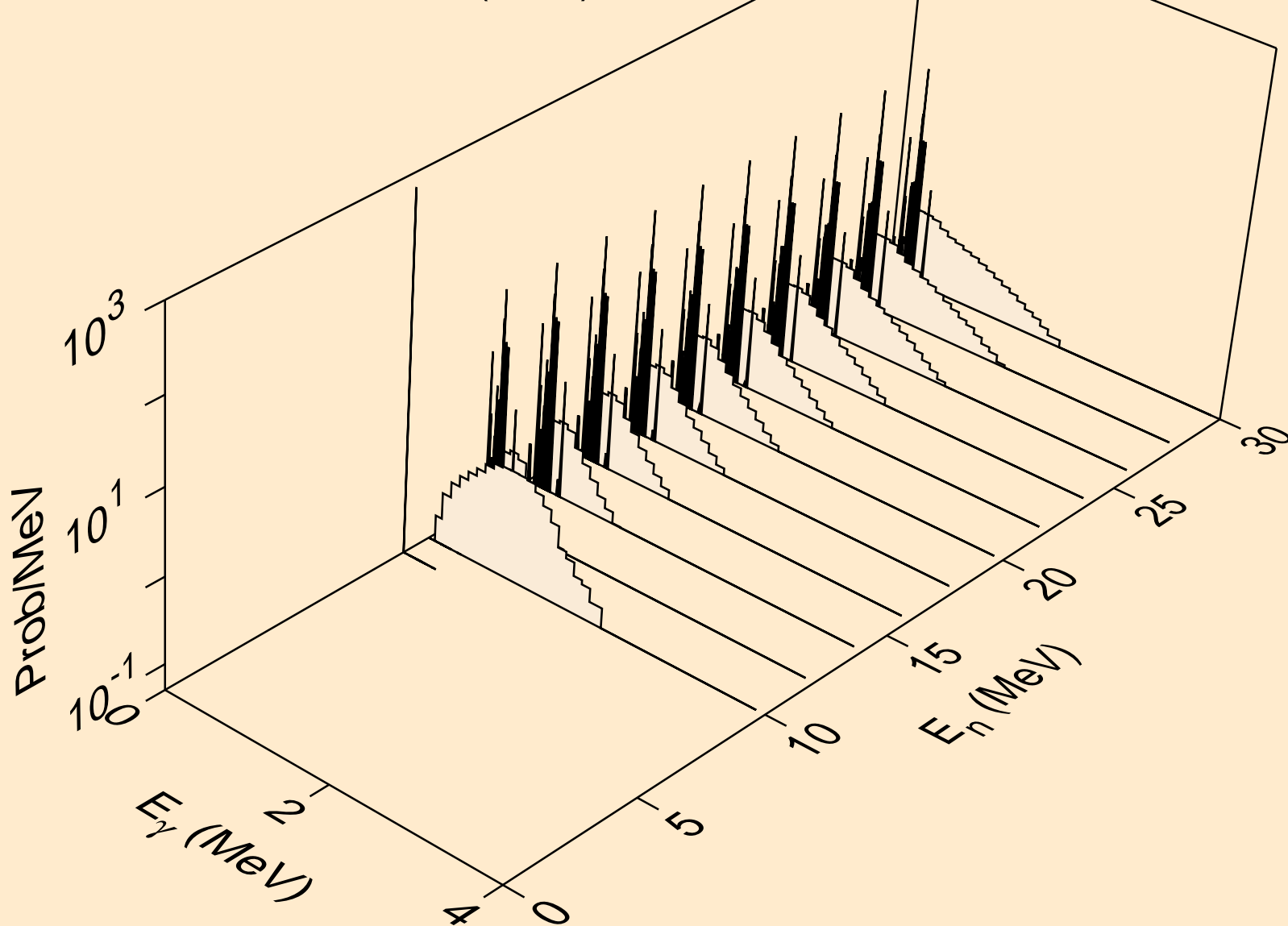

ND128 NEUTRON ACER TENDL-2019 LIBRARY; T=293.16K  
Photon emission for (n,2p)

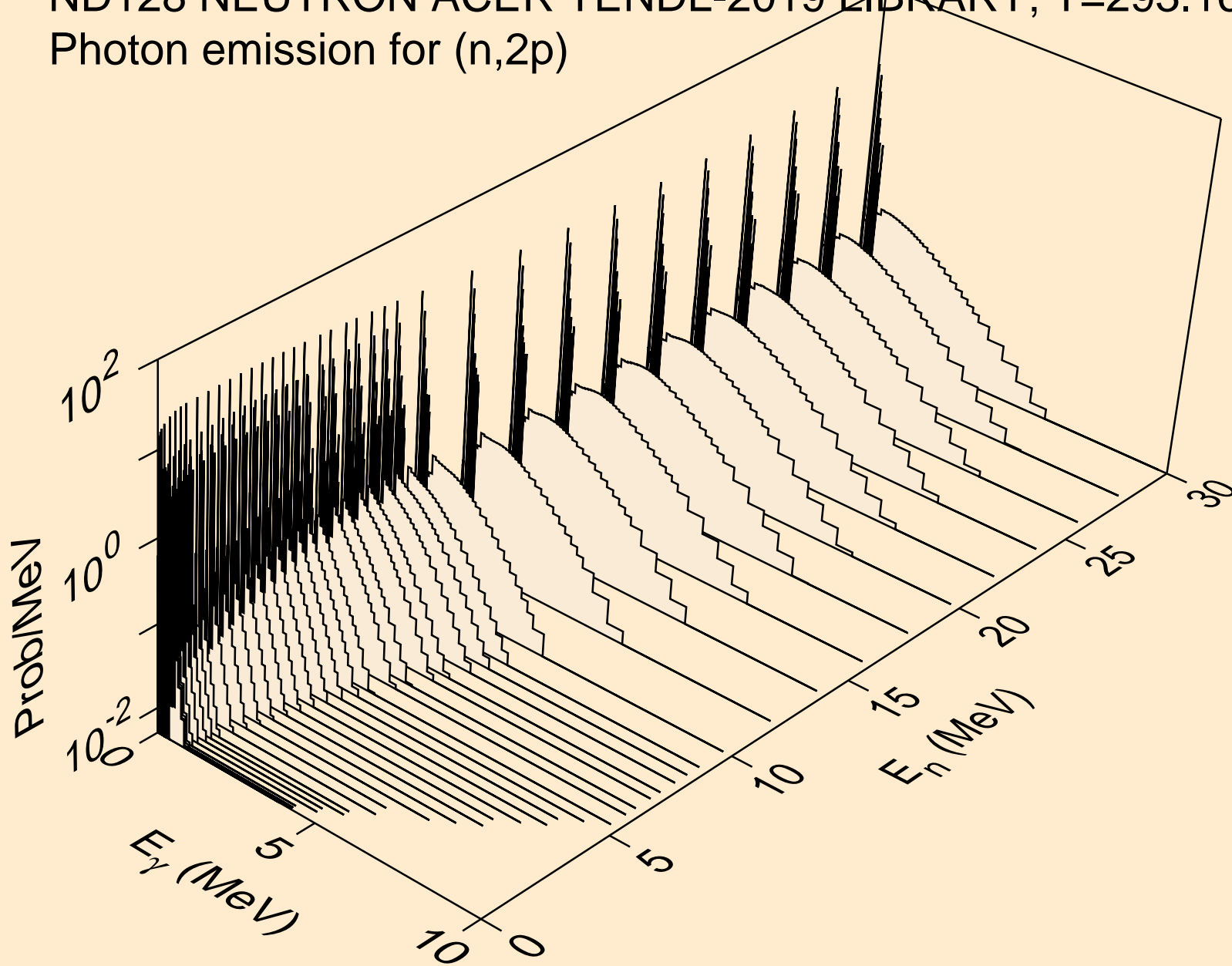

ND128 NEUTRON ACER TENDL-2019 LIBRARY; T=293.16K  
Photon emission for (n,p $\alpha$ )

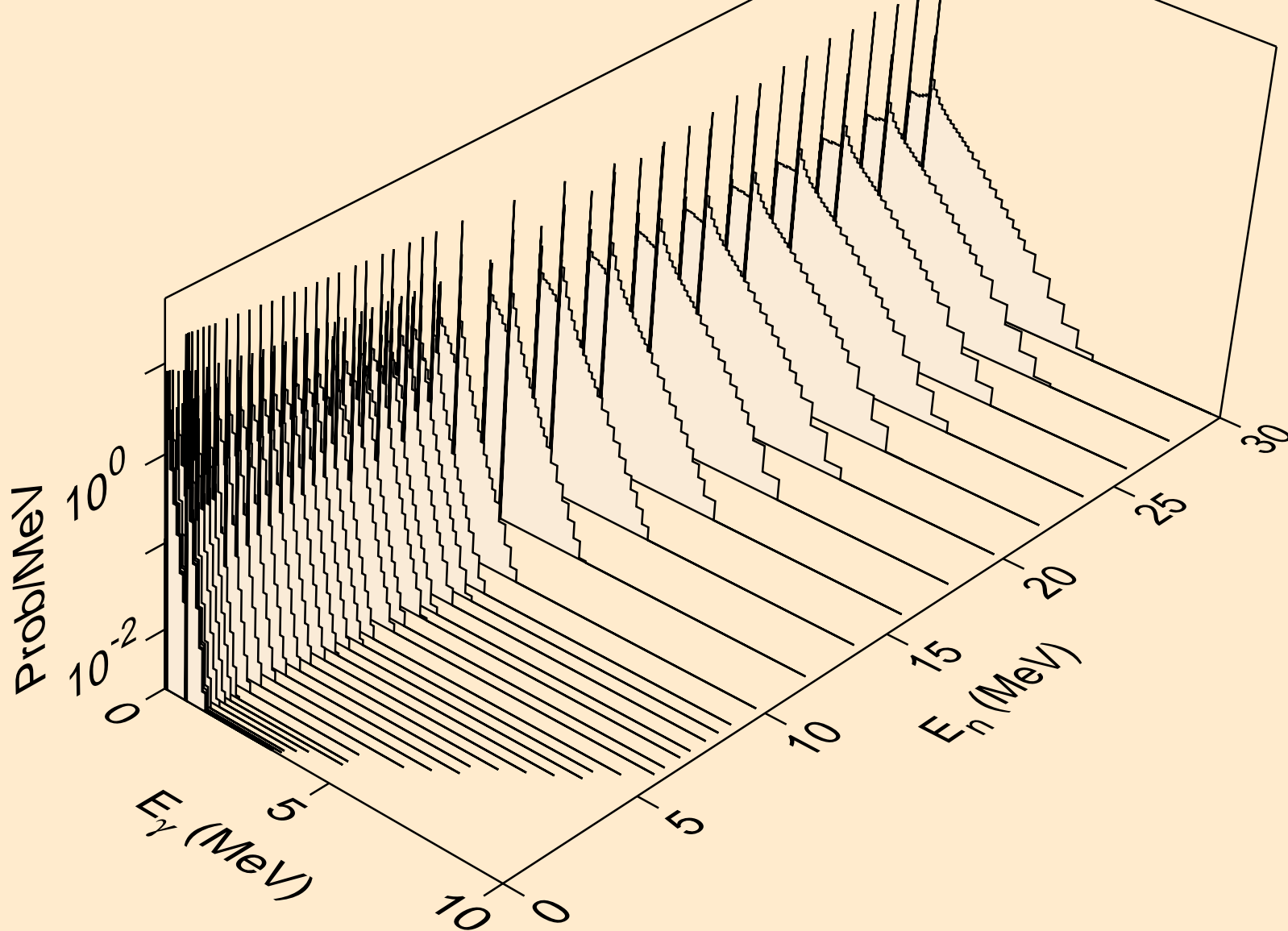

ND128 NEUTRON ACER TENDL-2019 LIBRARY; T=293.16K  
Photon emission for (n,pd)

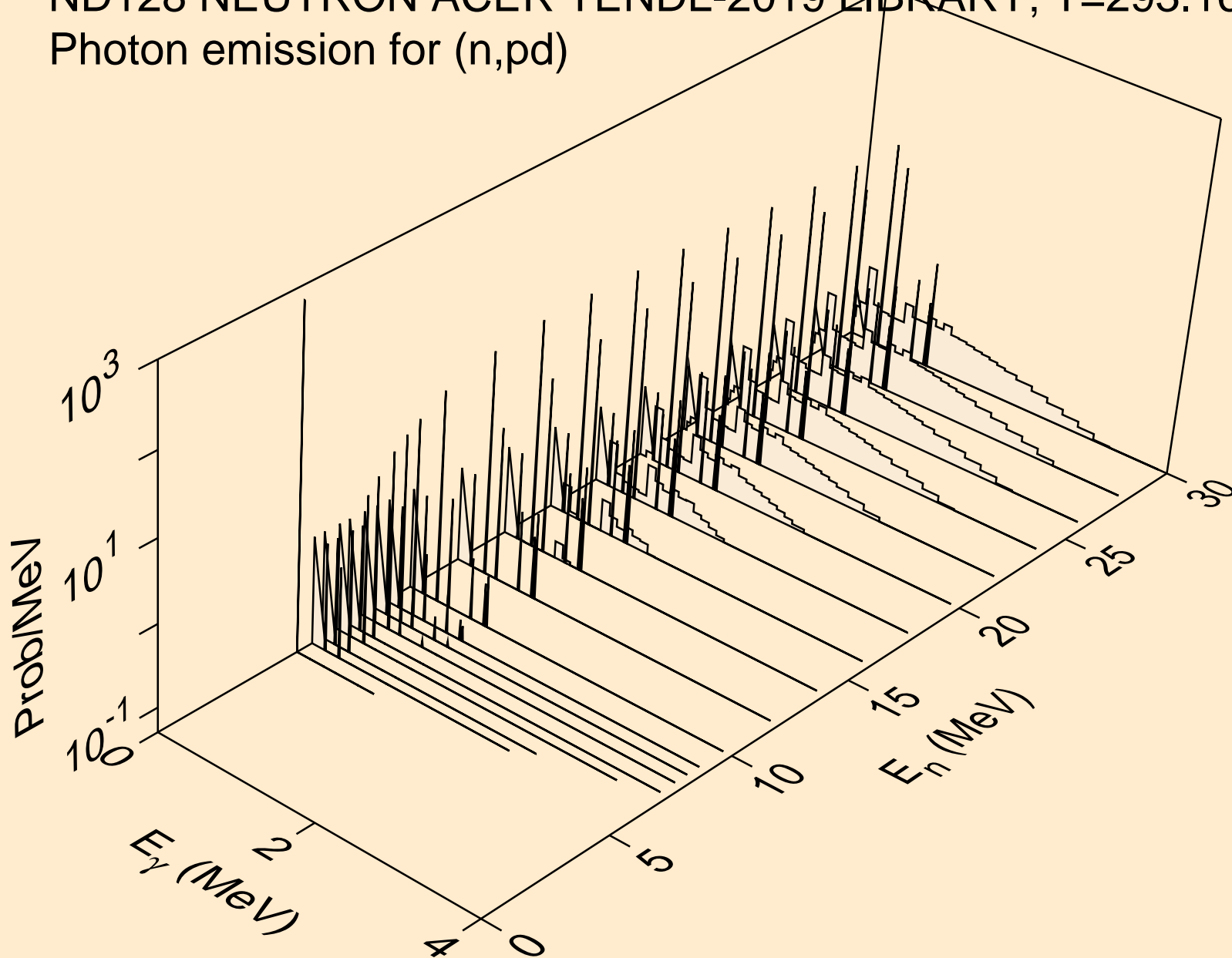

ND128 NEUTRON ACER TENDL-2019 LIBRARY; T=293.16K  
Photon emission for (n,pt)

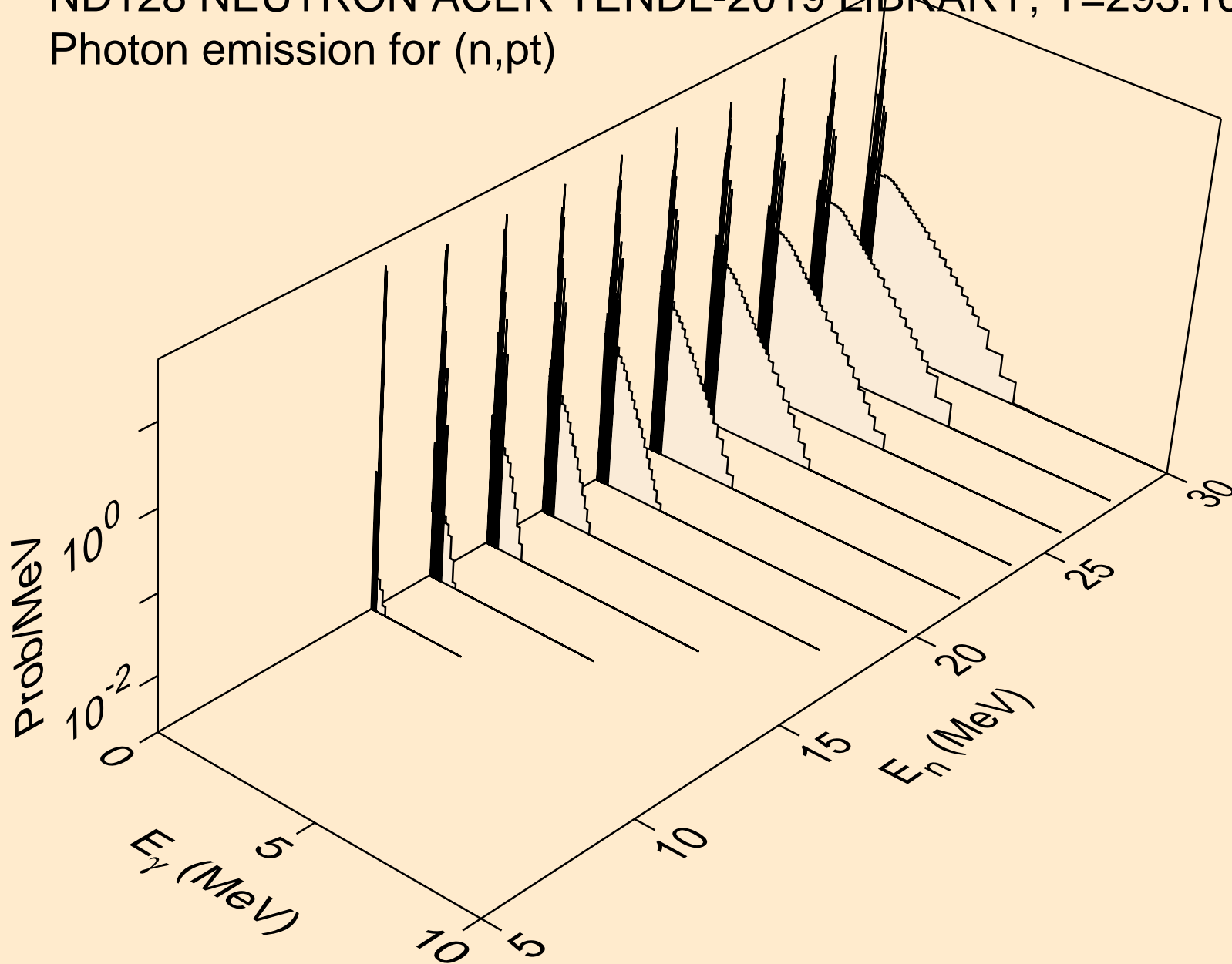

ND128 NEUTRON ACER TENDL-2019 LIBRARY; T=293.16K  
Photon emission for (n,da)

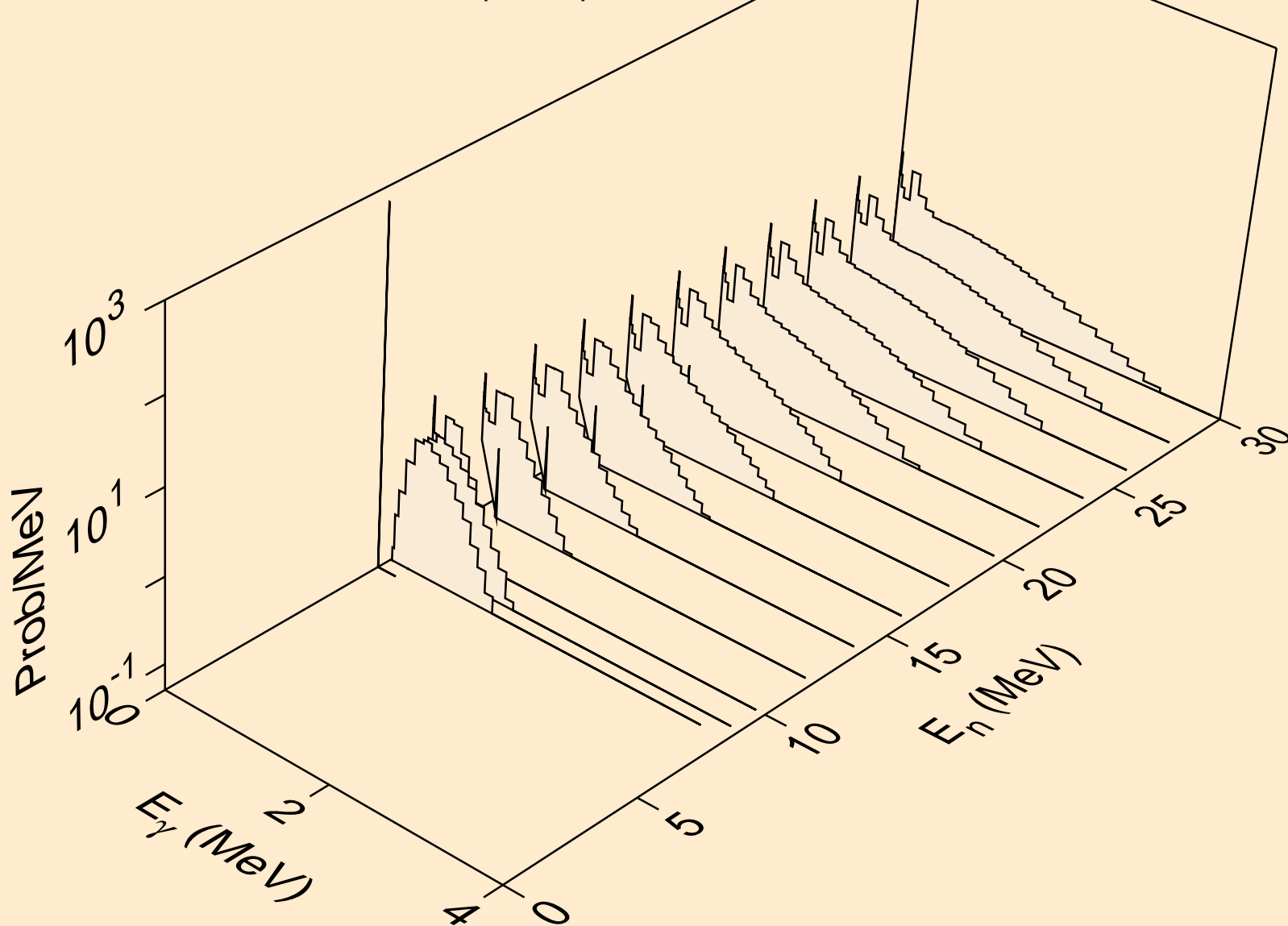

ND128 NEUTRON ACER TENDL-2019 LIBRARY; T=293.16K  
thermal capture photon spectrum

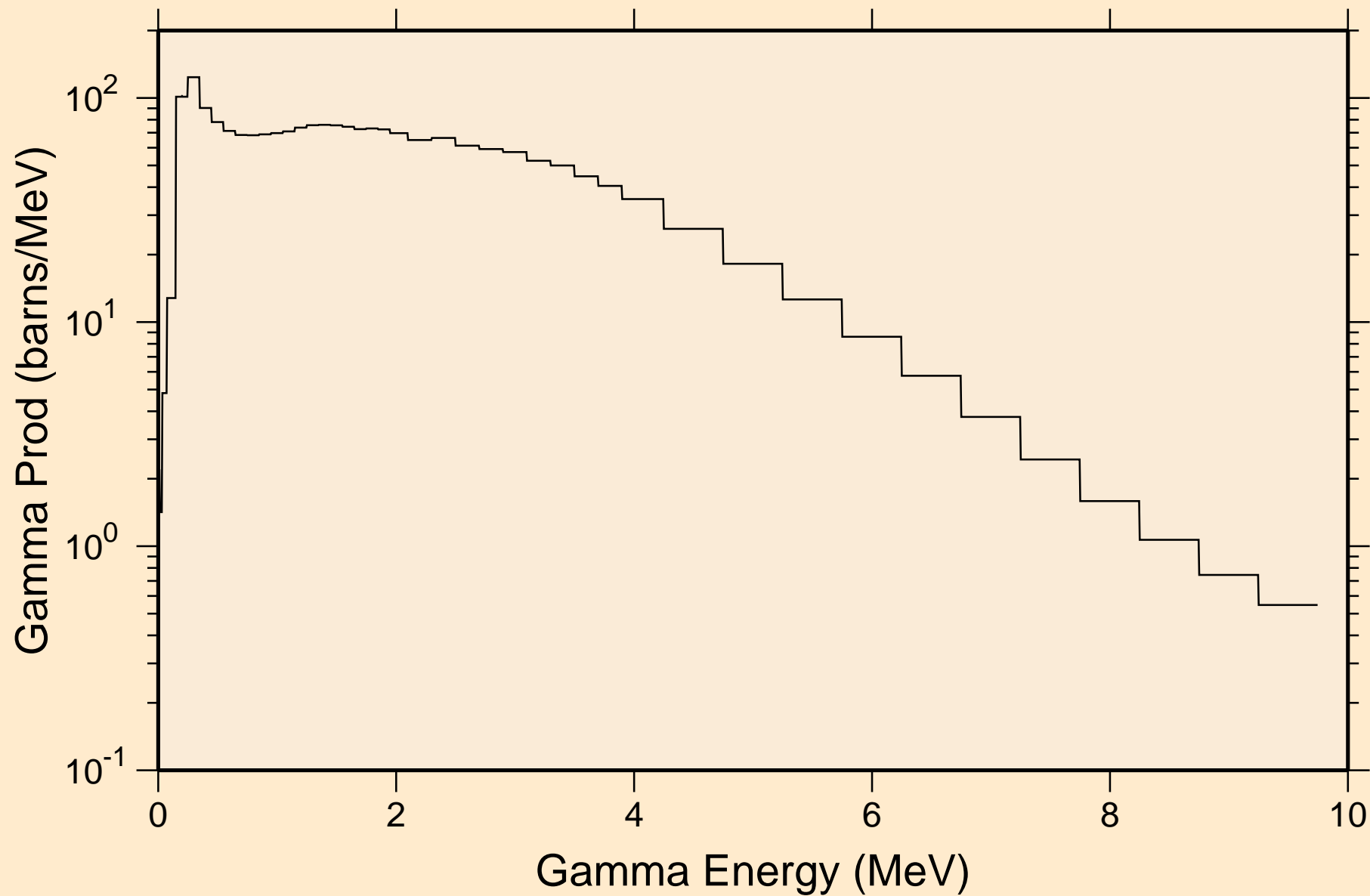

ND128 NEUTRON ACER TENDL-2019 LIBRARY; T=293.16K  
14 MeV photon spectrum

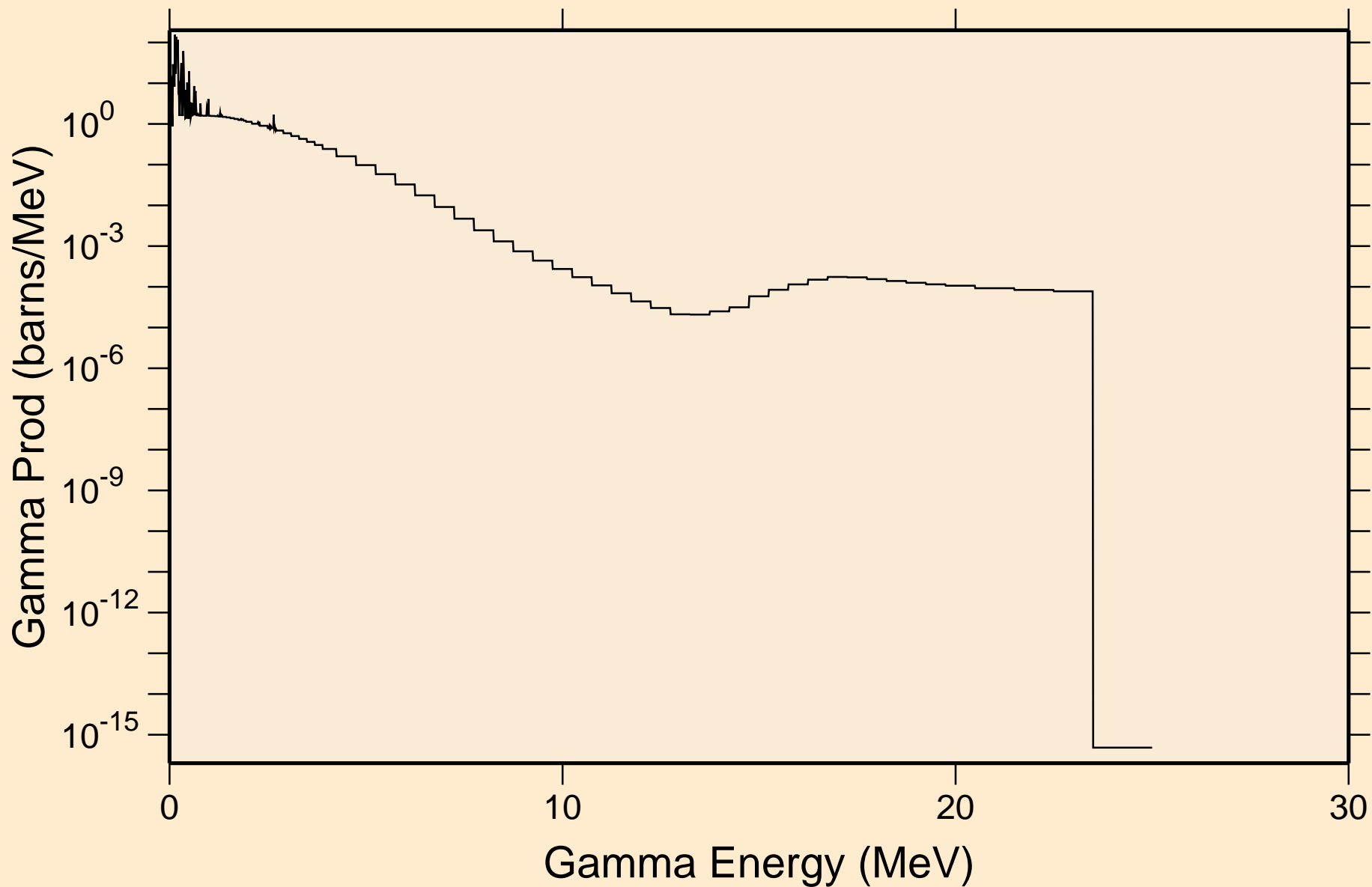

# ND128 NEUTRON ACER TENDL-2019 LIBRARY; T=293.16K

## Particle heating contributions

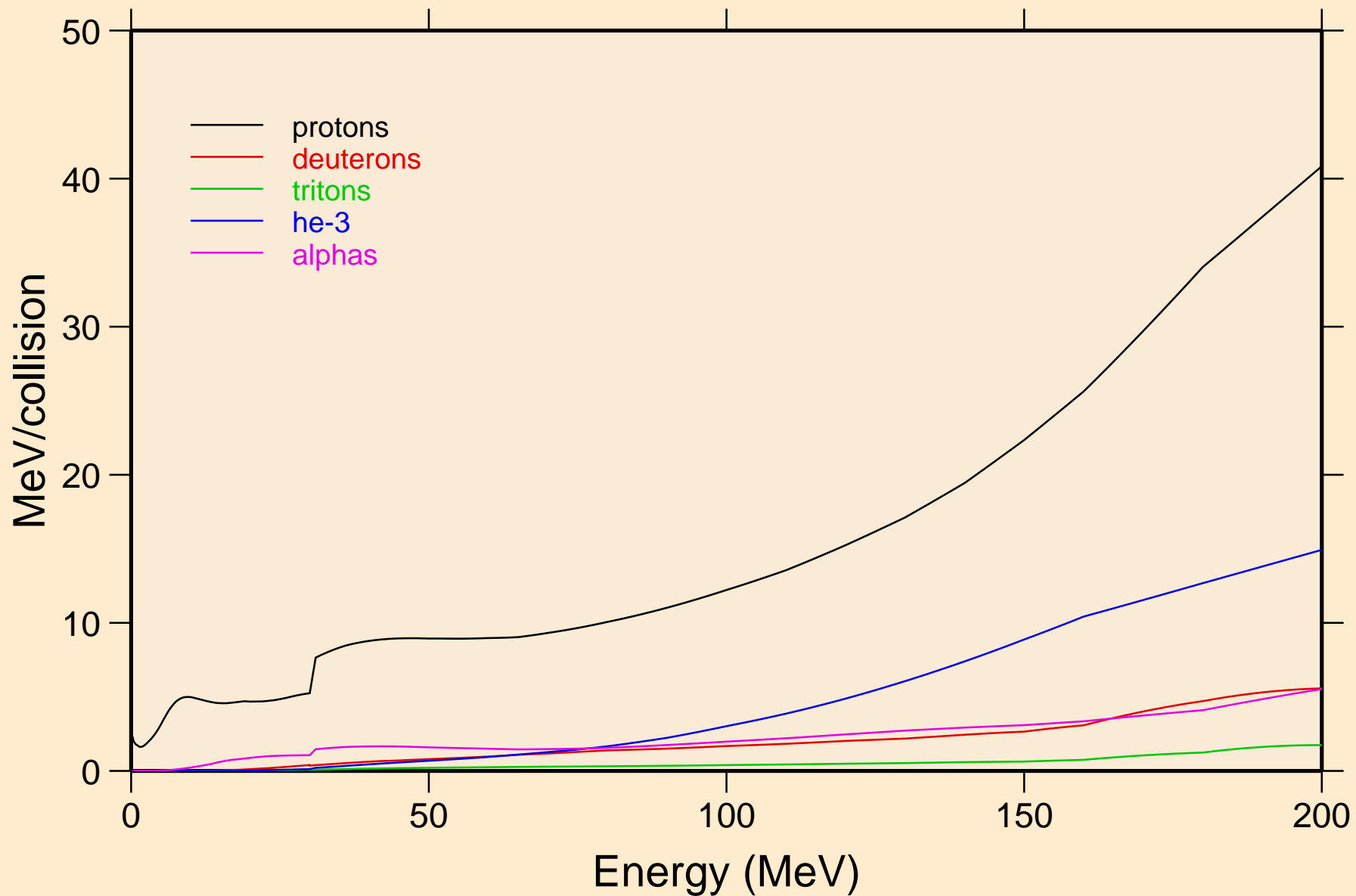

ND128 NEUTRON ACER TENDL-2019 LIBRARY; T=293.16K  
Recoil Heating

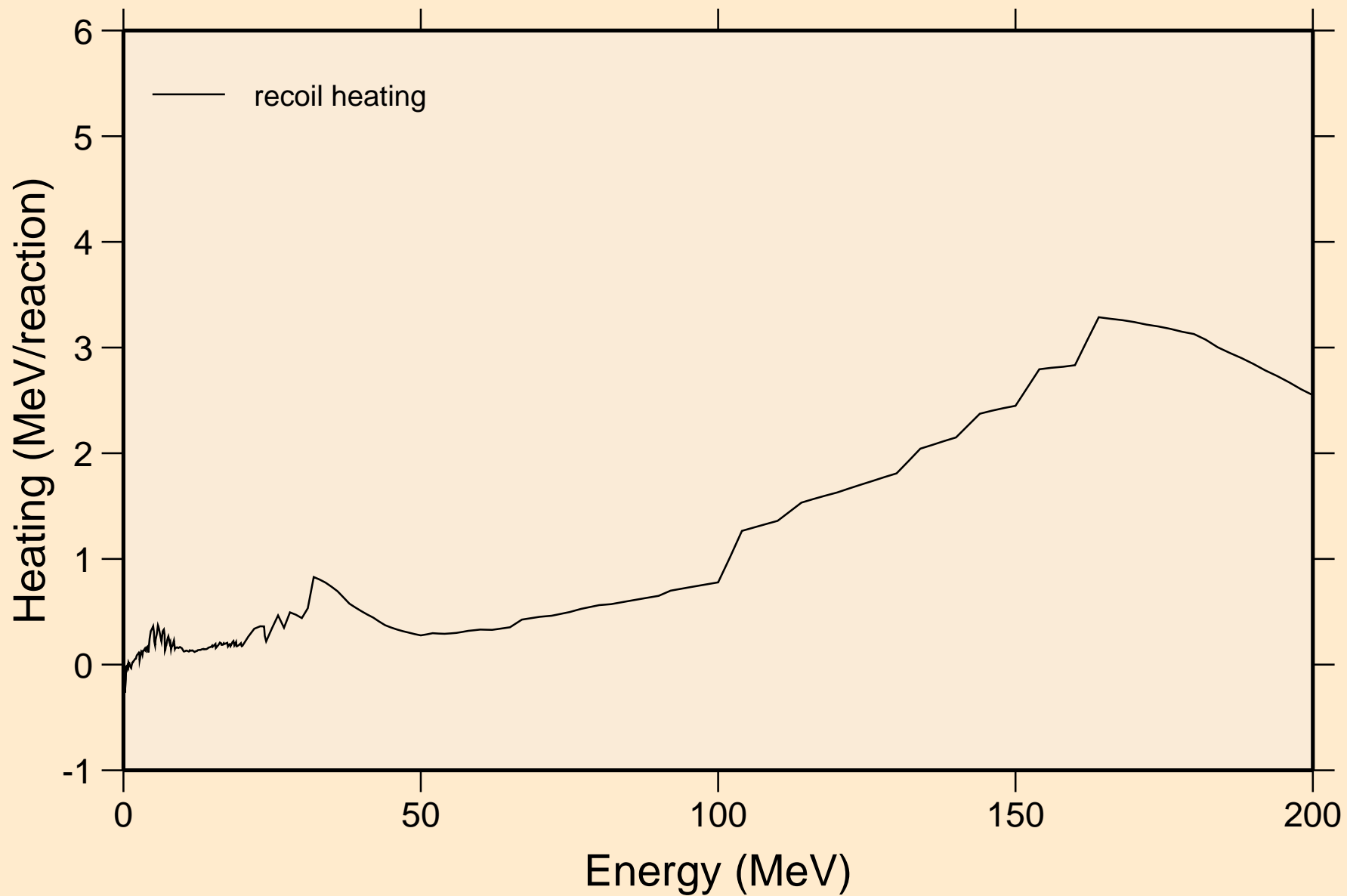

ND128 NEUTRON ACER TENDL-2019 LIBRARY; T=293.16K  
Particle production cross sections

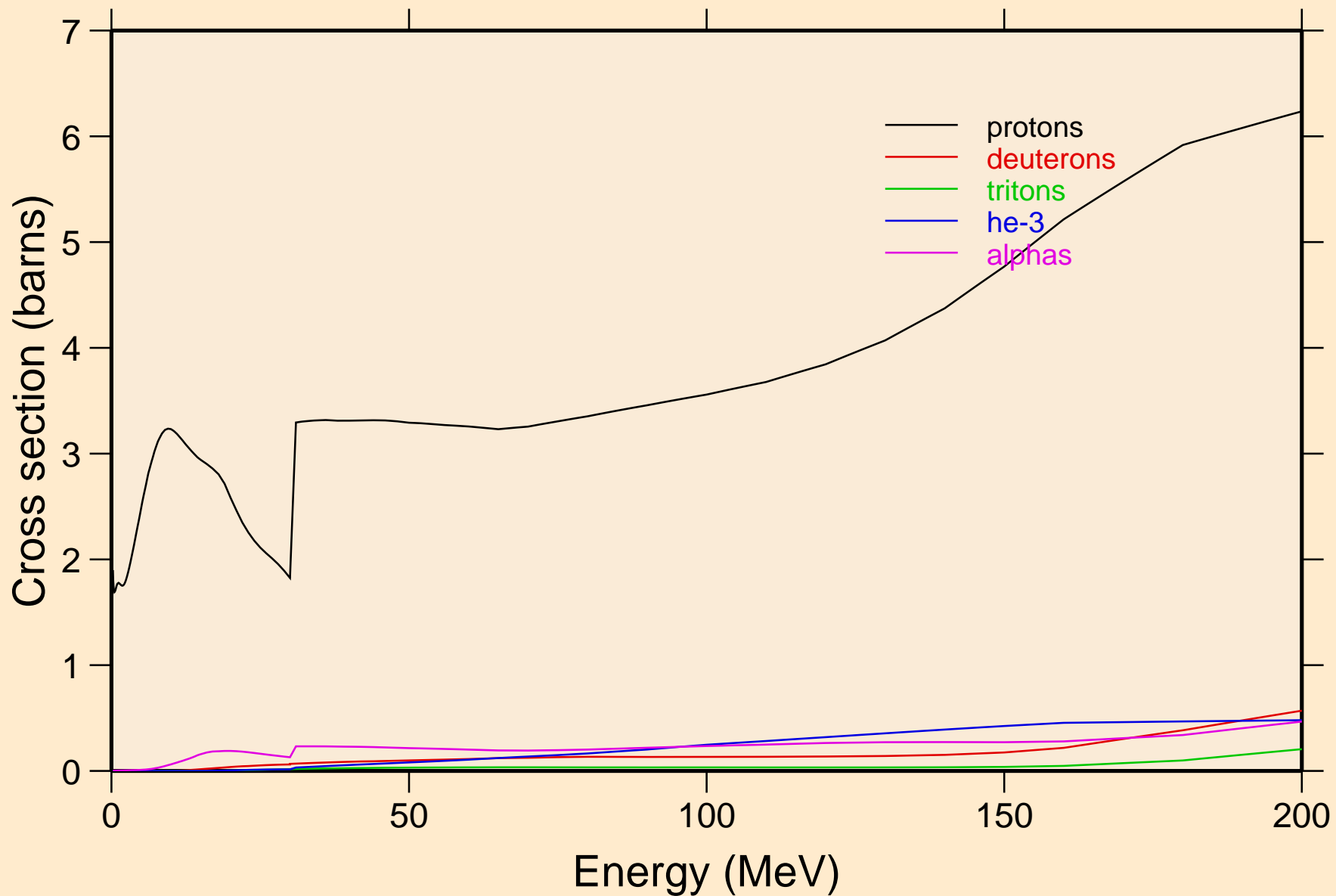

ND128 NEUTRON ACER TENDL-2019 LIBRARY; T=293.16K  
protons from (n,x)

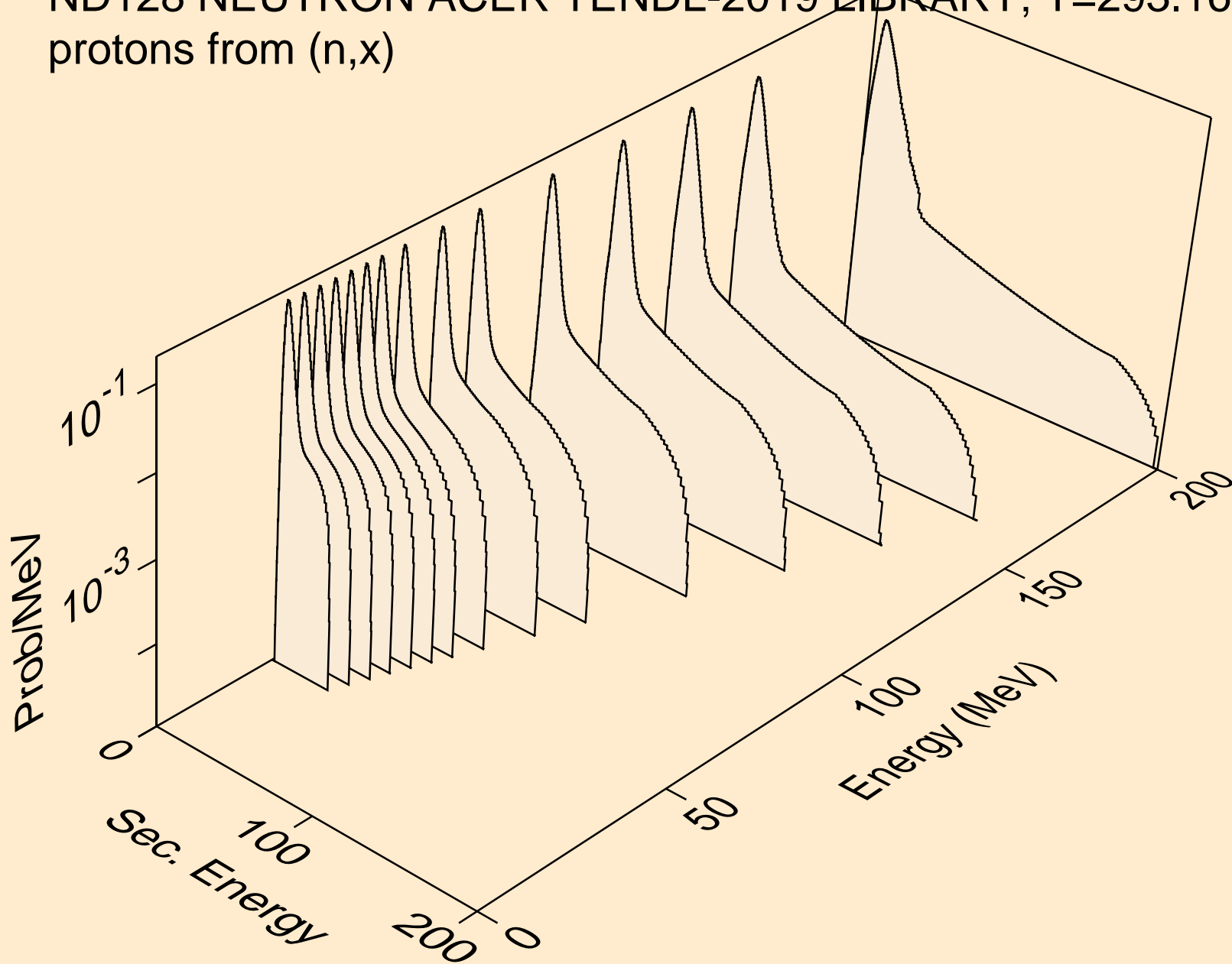

ND128 NEUTRON ACER TENDL-2019 LIBRARY; T=293.16K  
protons from (n,n\*)p

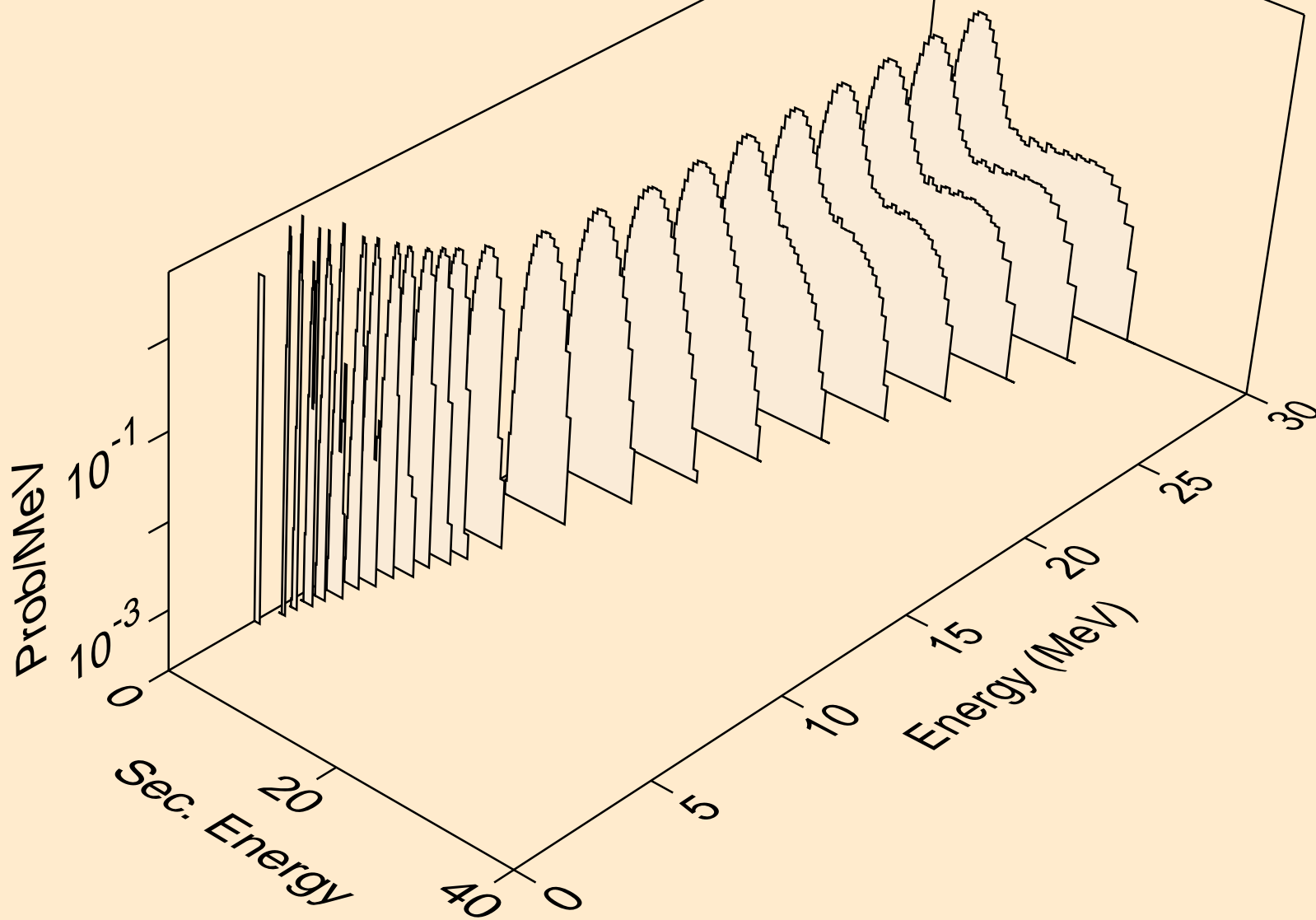

ND128 NEUTRON ACER TENDL-2019 LIBRARY; T=293.16K  
protons from (n,2np)

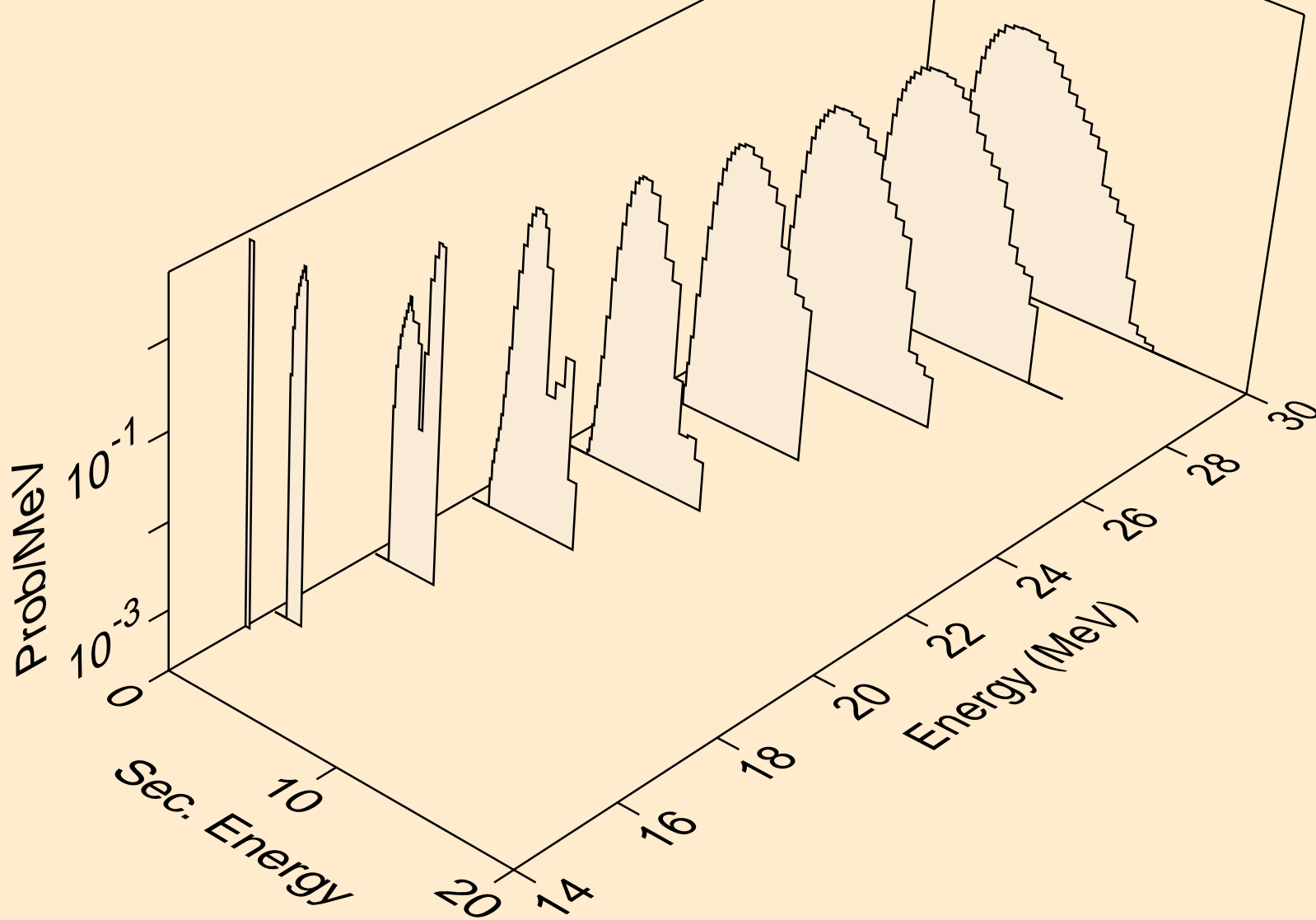

ND128 NEUTRON ACER TENDL-2019 LIBRARY; T=293.16K  
protons from (n,3np)

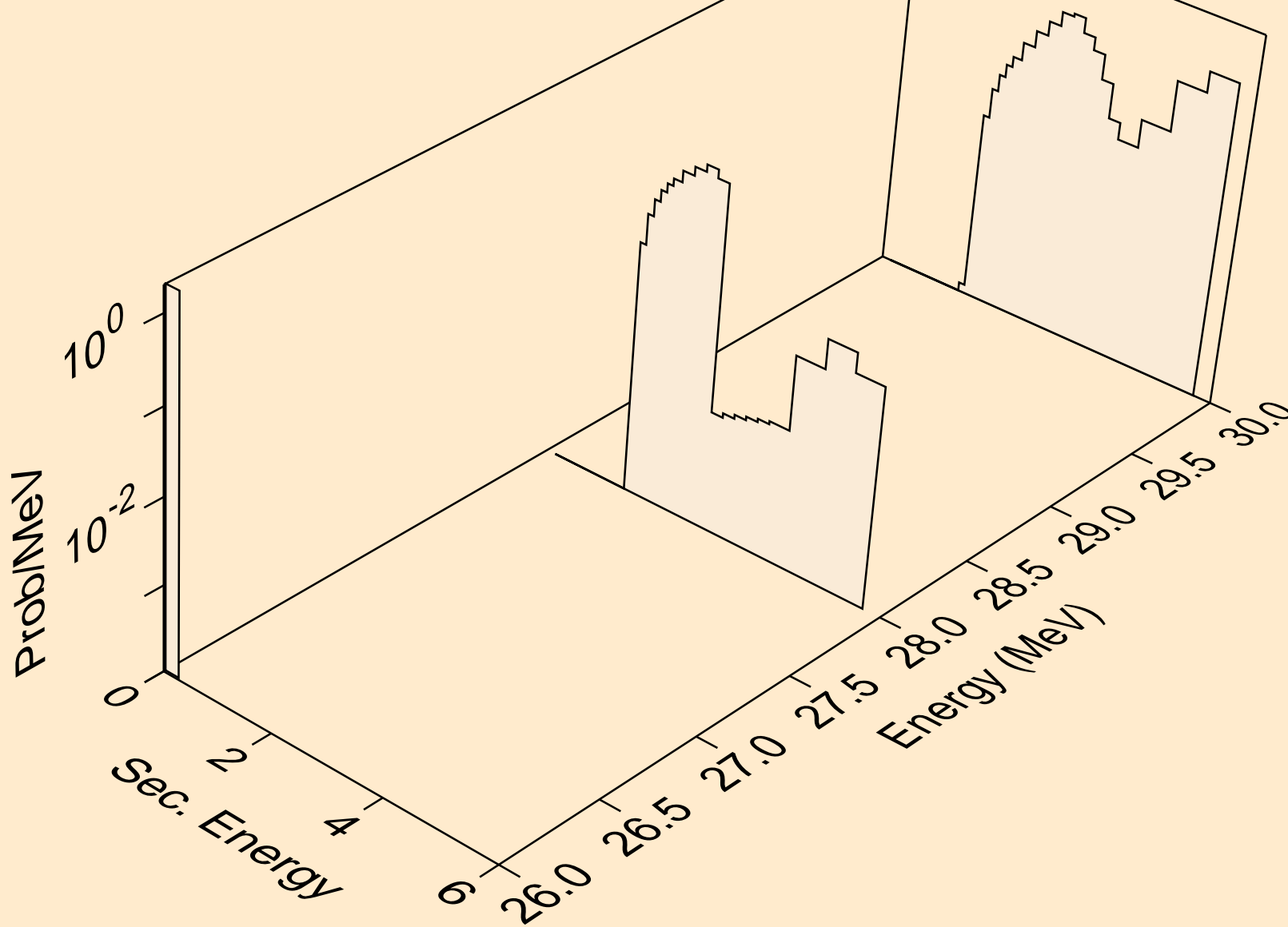

ND128 NEUTRON ACER TENDL-2019 LIBRARY; T=293.16K  
protons from (n,2np)

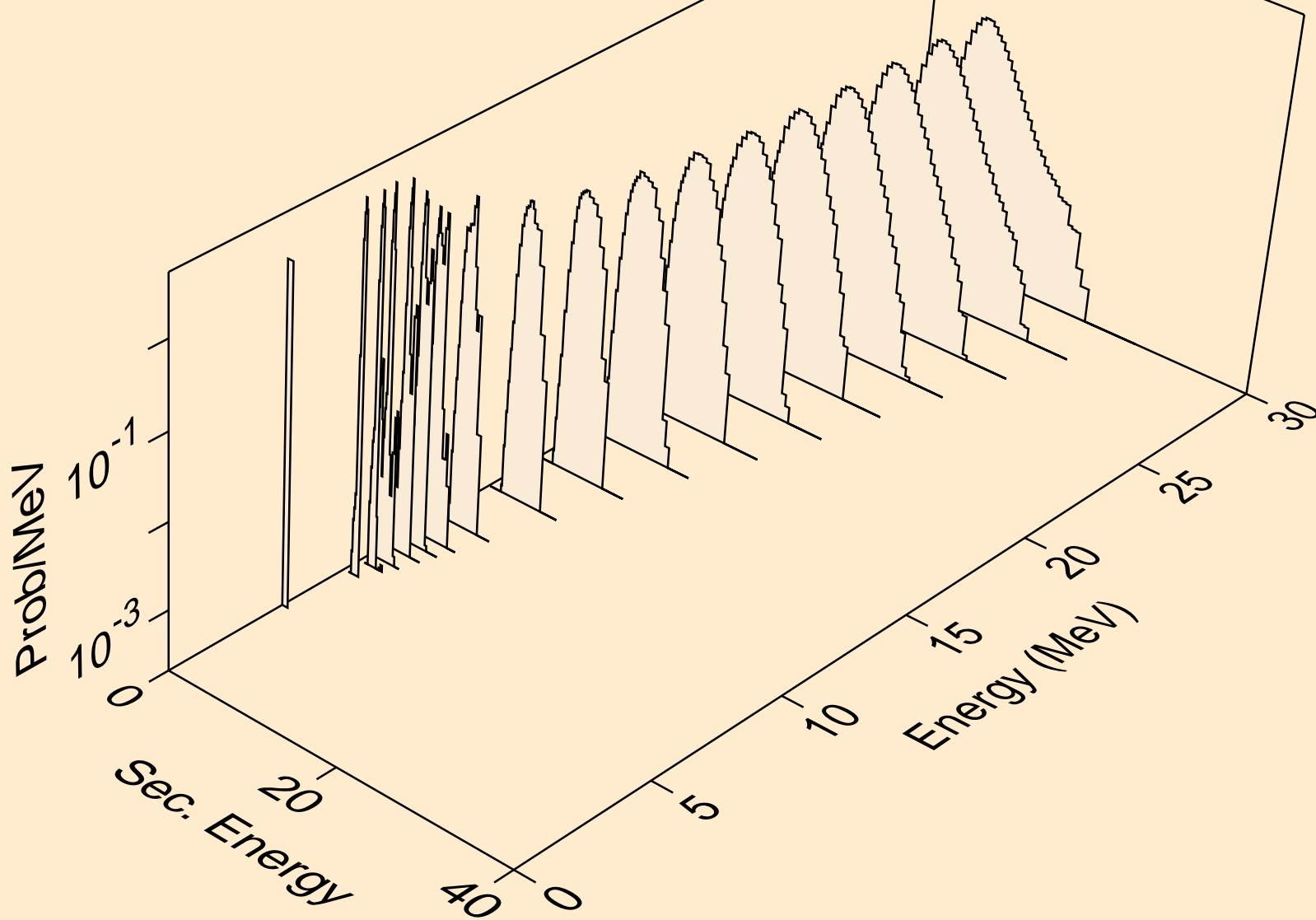

ND128 NEUTRON ACER TENDL-2019 LIBRARY; T=293.16K  
protons from (n,npa)

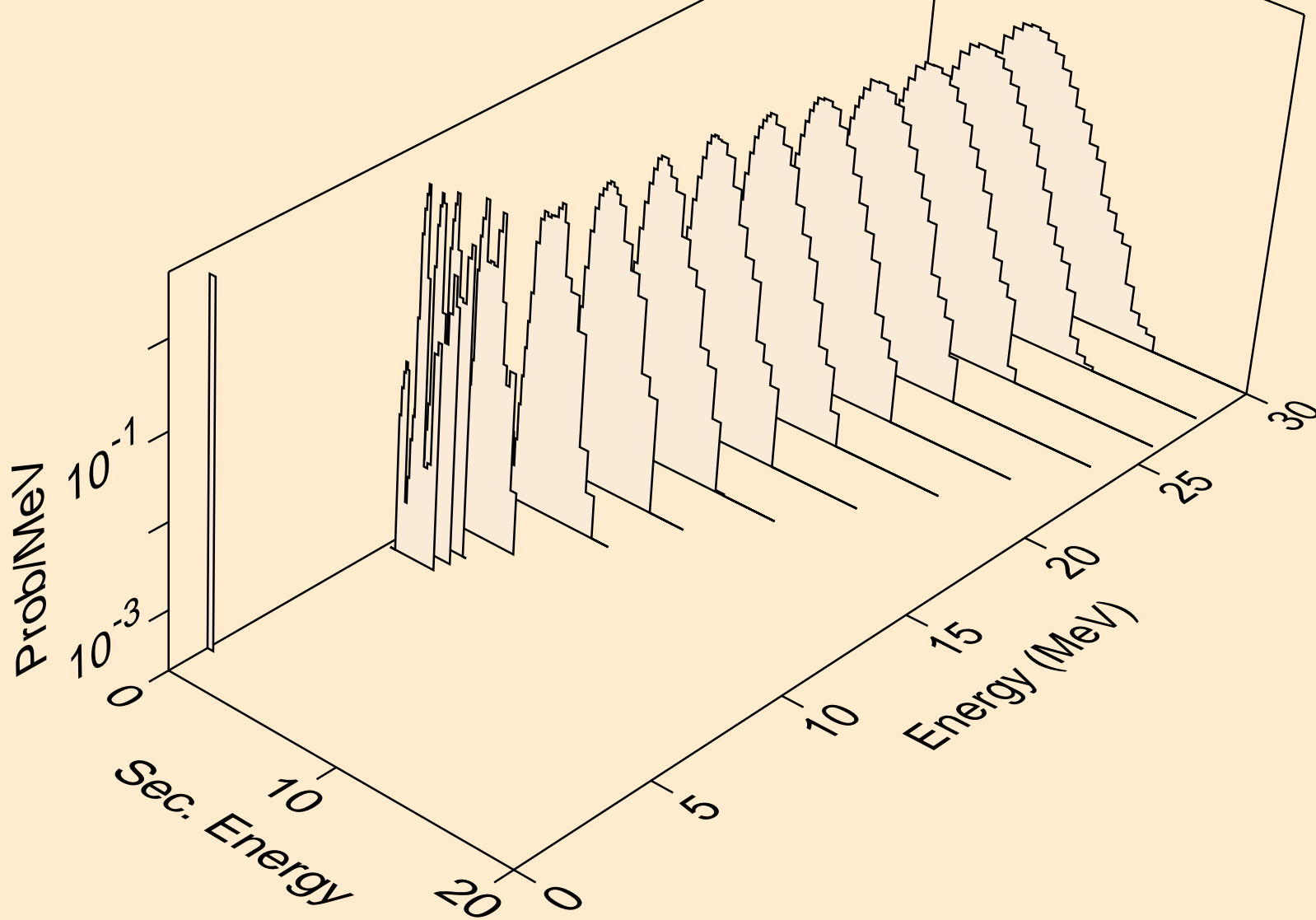

ND128 NEUTRON ACER TENDL-2019 LIBRARY; T=293.16K  
protons from (n,p)

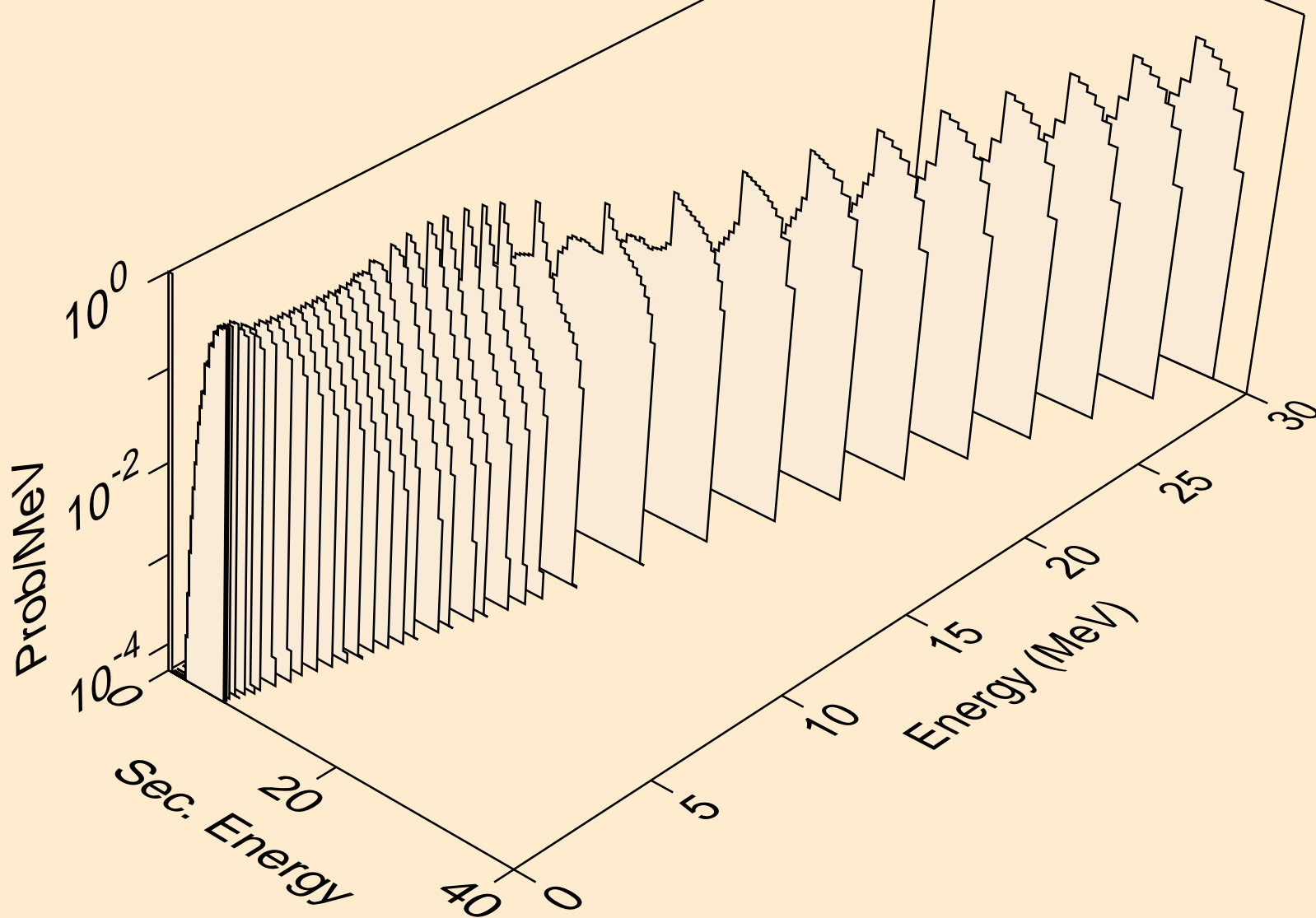

ND128 NEUTRON ACER TENDL-2019 LIBRARY; T=293.16K  
protons from (n,2p)

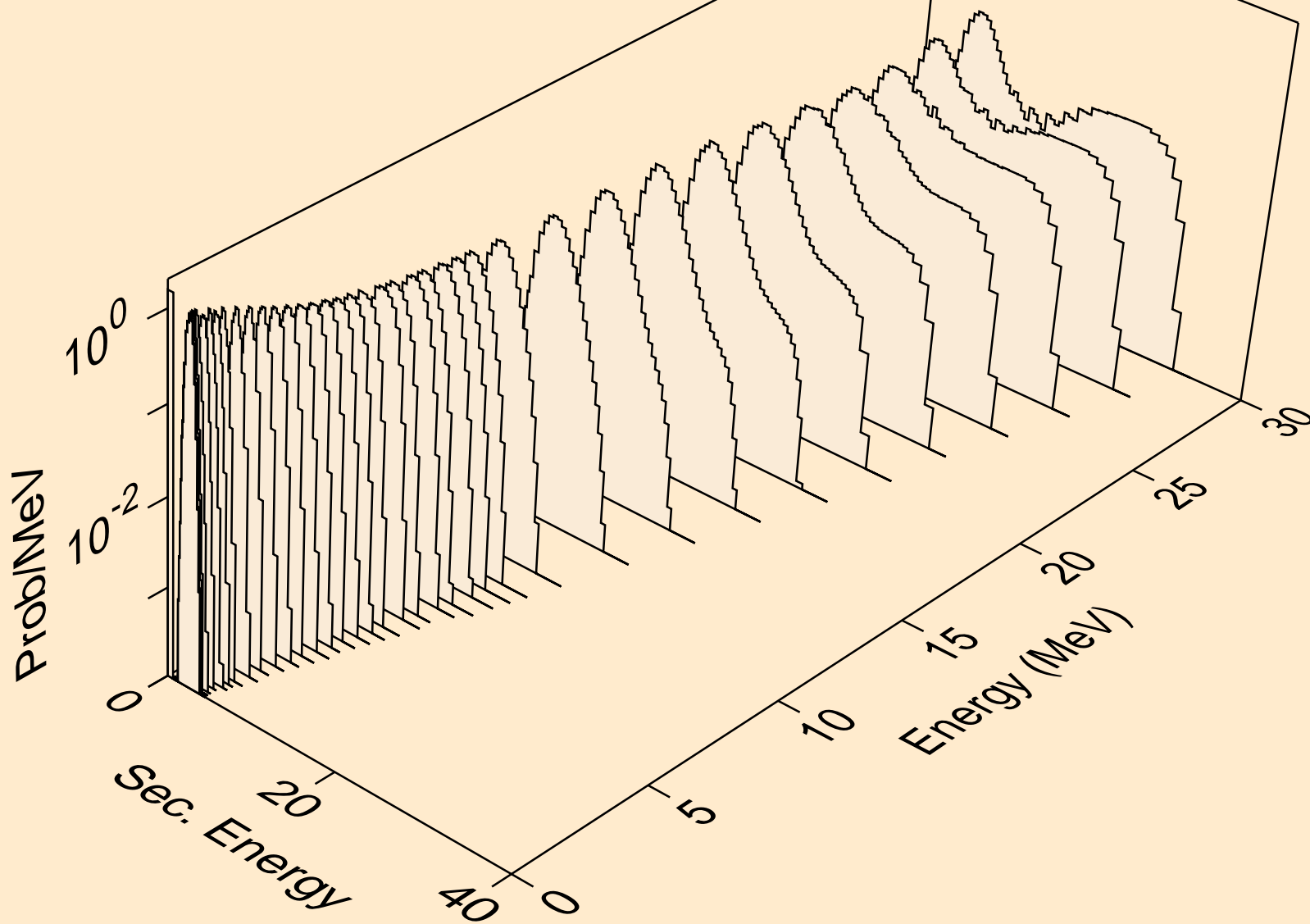

ND128 NEUTRON ACER TENDL-2019 LIBRARY; T=293.16K  
protons from (n,p)

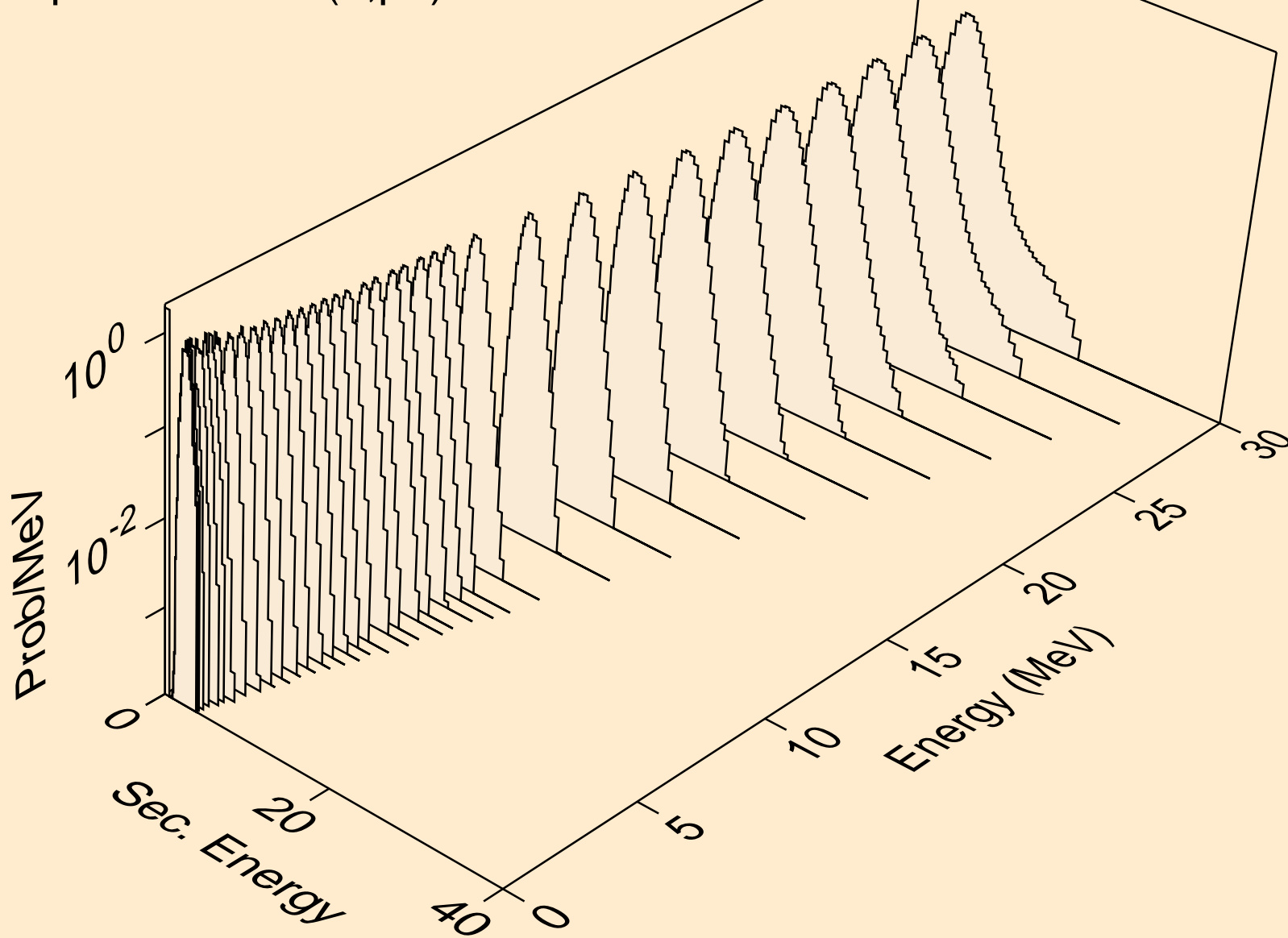

ND128 NEUTRON ACER TENDL-2019 LIBRARY; T=293.16K  
protons from (n,pd)

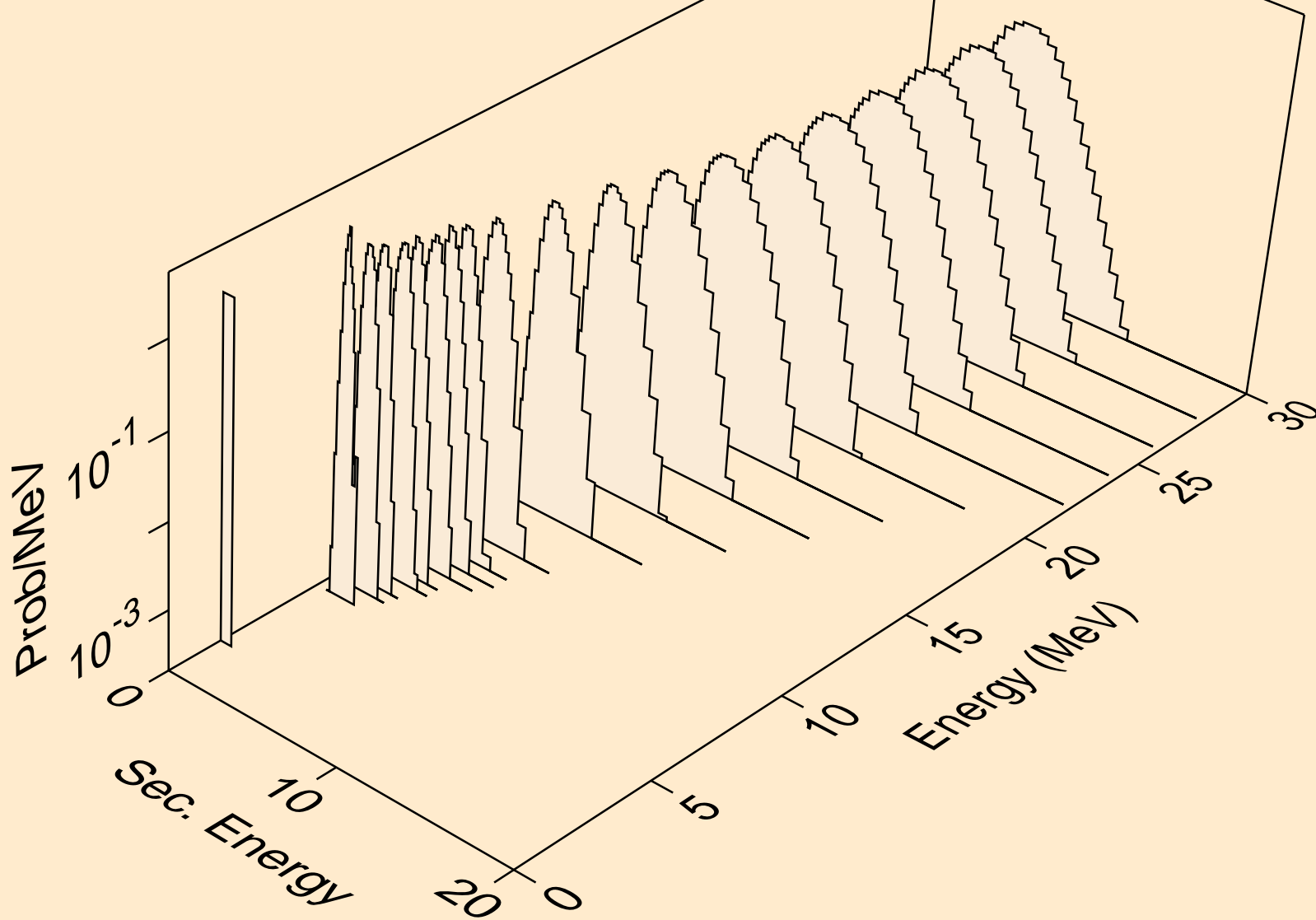

ND128 NEUTRON ACER TENDL-2019 LIBRARY; T=293.16K  
protons from (n,pt)

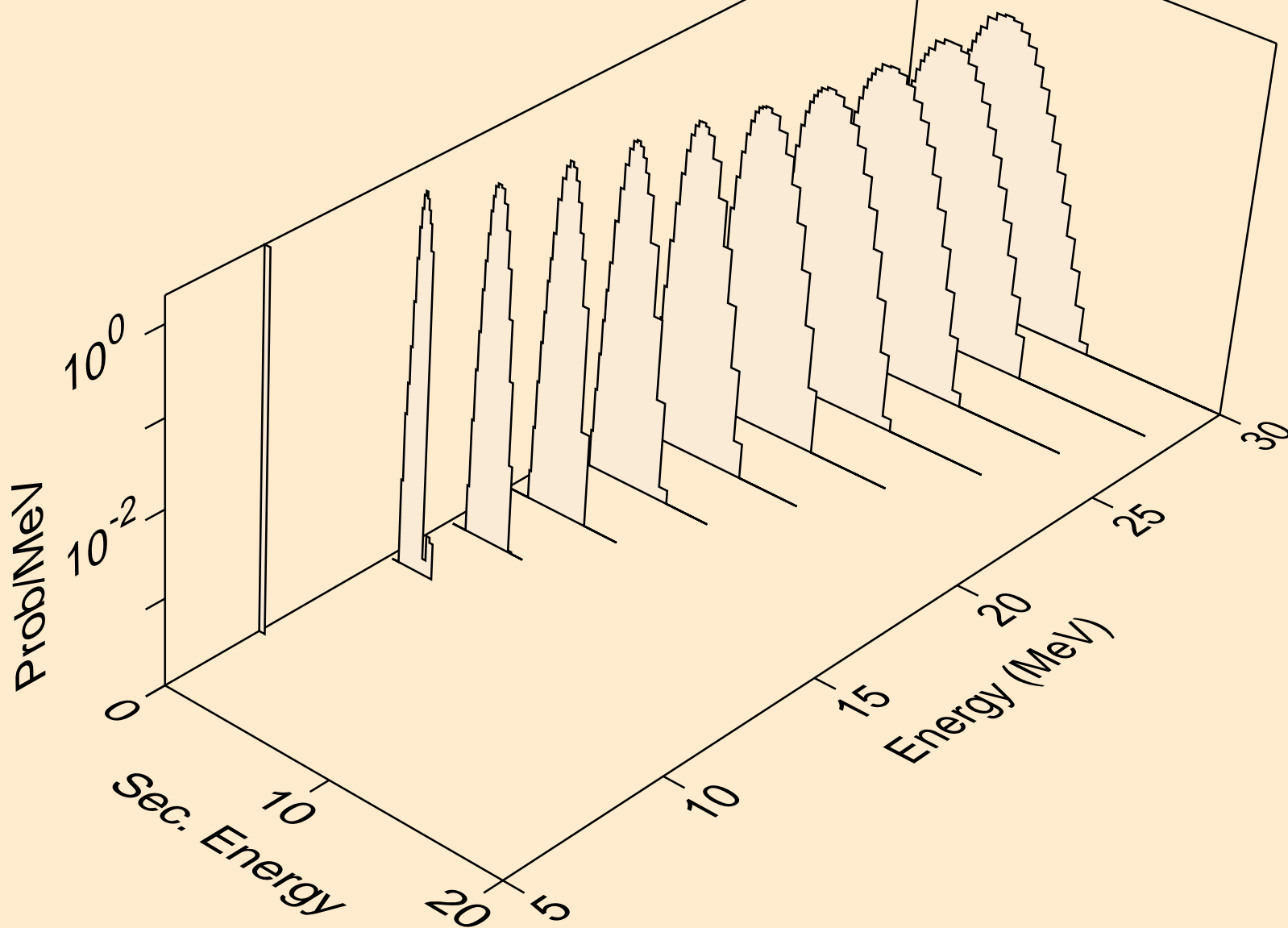

ND128 NEUTRON ACER TENDL-2019 LIBRARY; T=293.16K  
deuterons from (n,x)

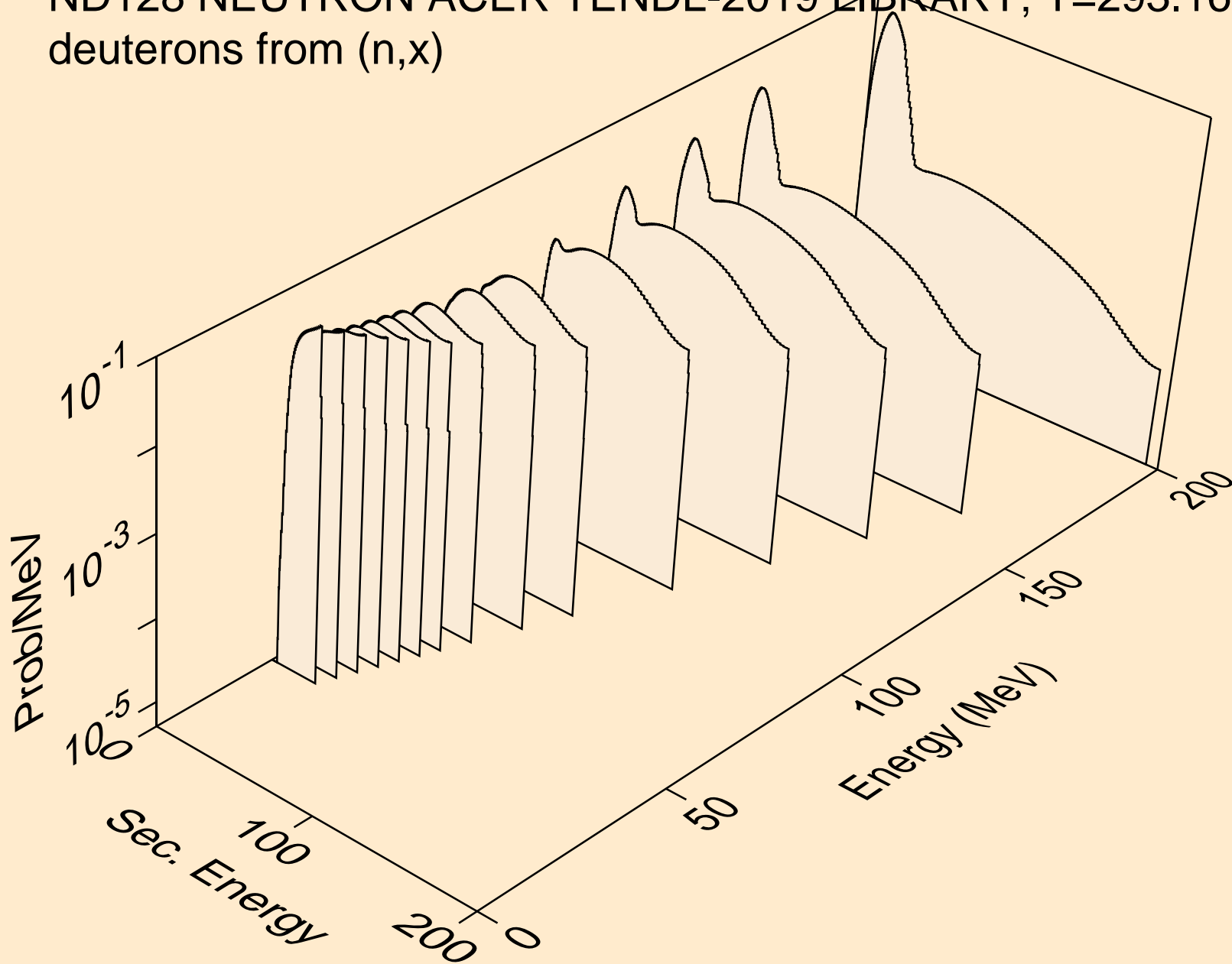

ND128 NEUTRON ACER TENDL-2019 LIBRARY; T=293.16K  
deuterons from (n,2nd)

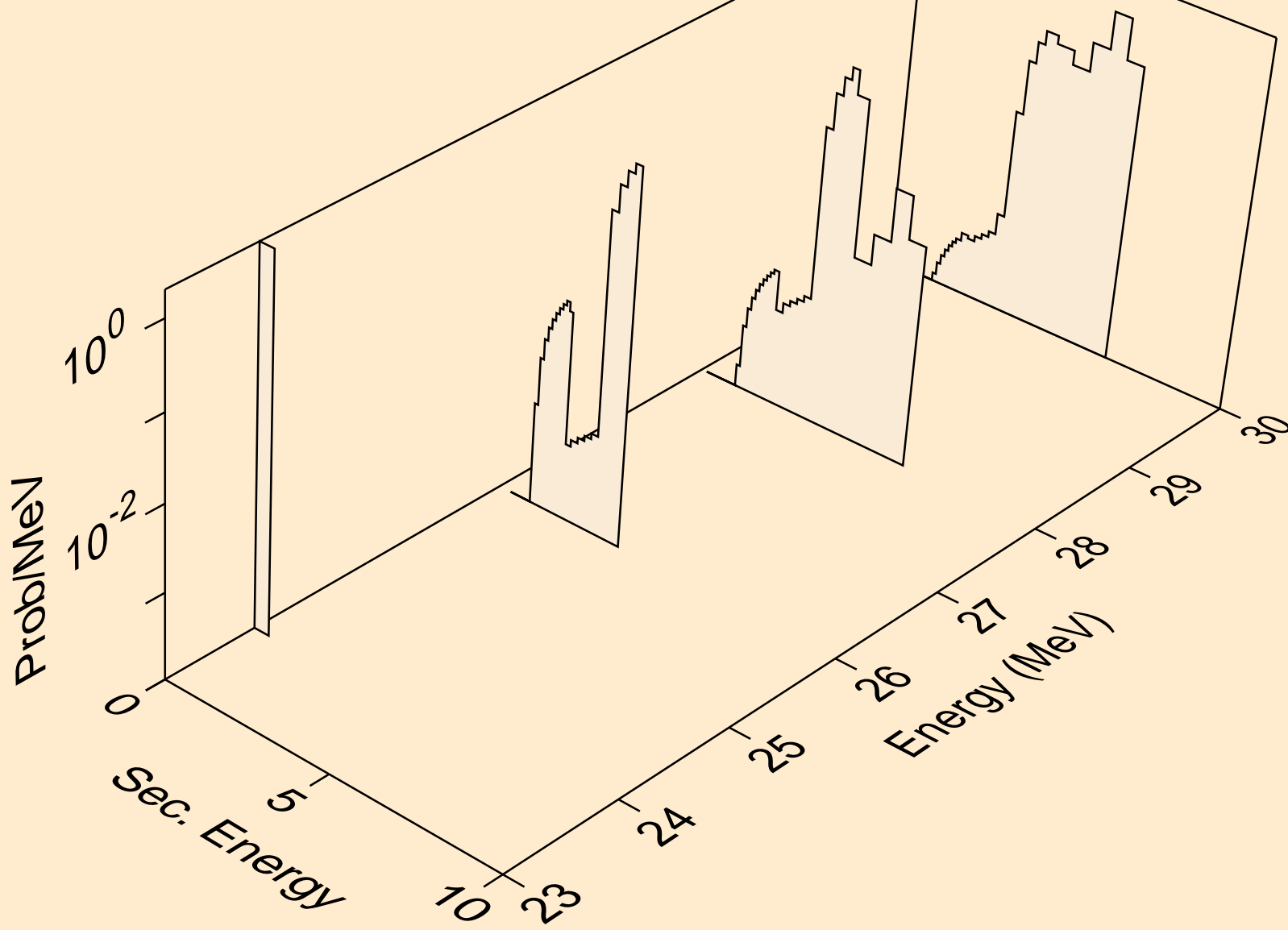

ND128 NEUTRON ACER TENDL-2019 LIBRARY; T=293.16K  
deuterons from (n,n\*)d

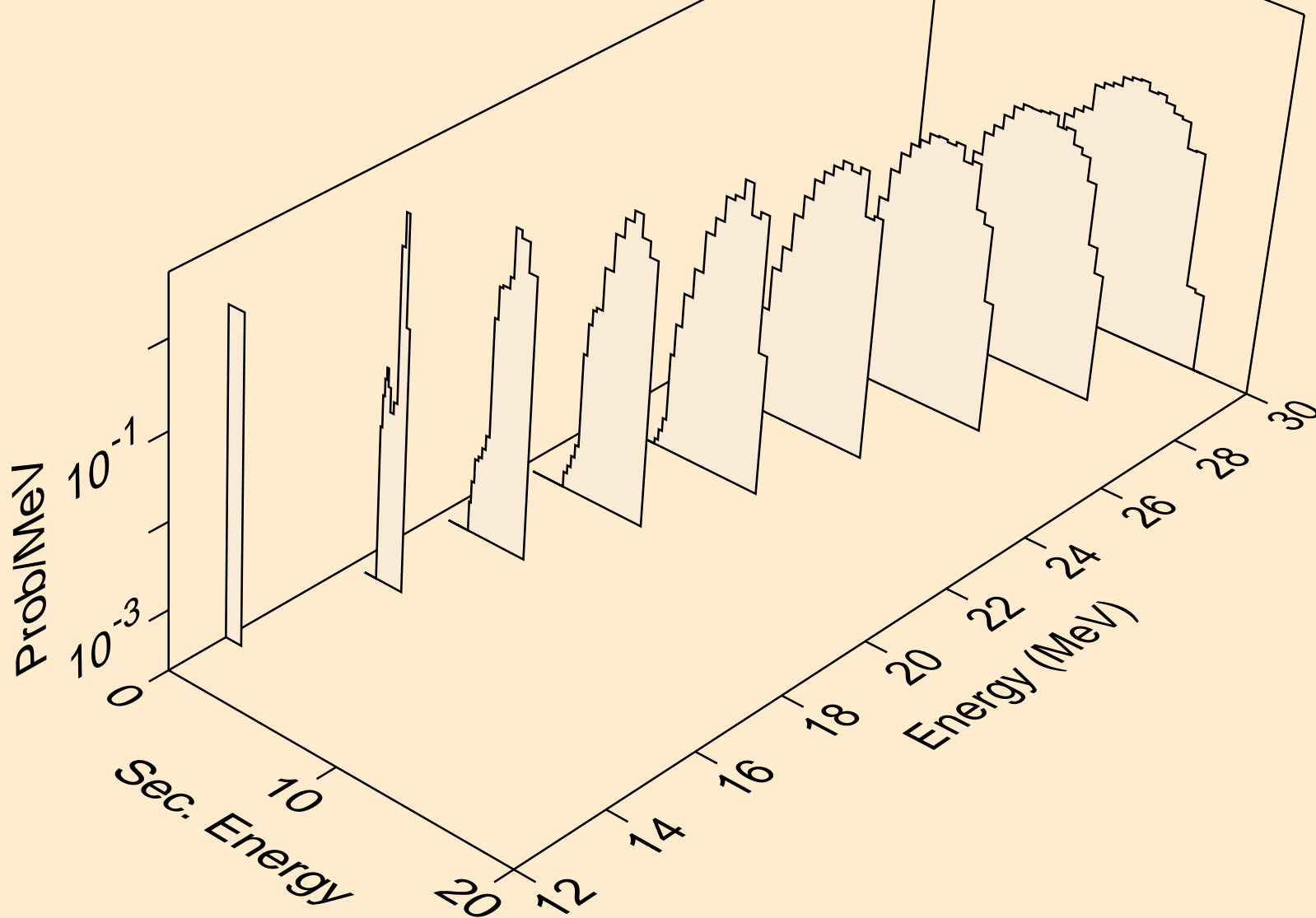

ND128 NEUTRON ACER TENDL-2019 LIBRARY; T=293.16K  
deuterons from (n,d)

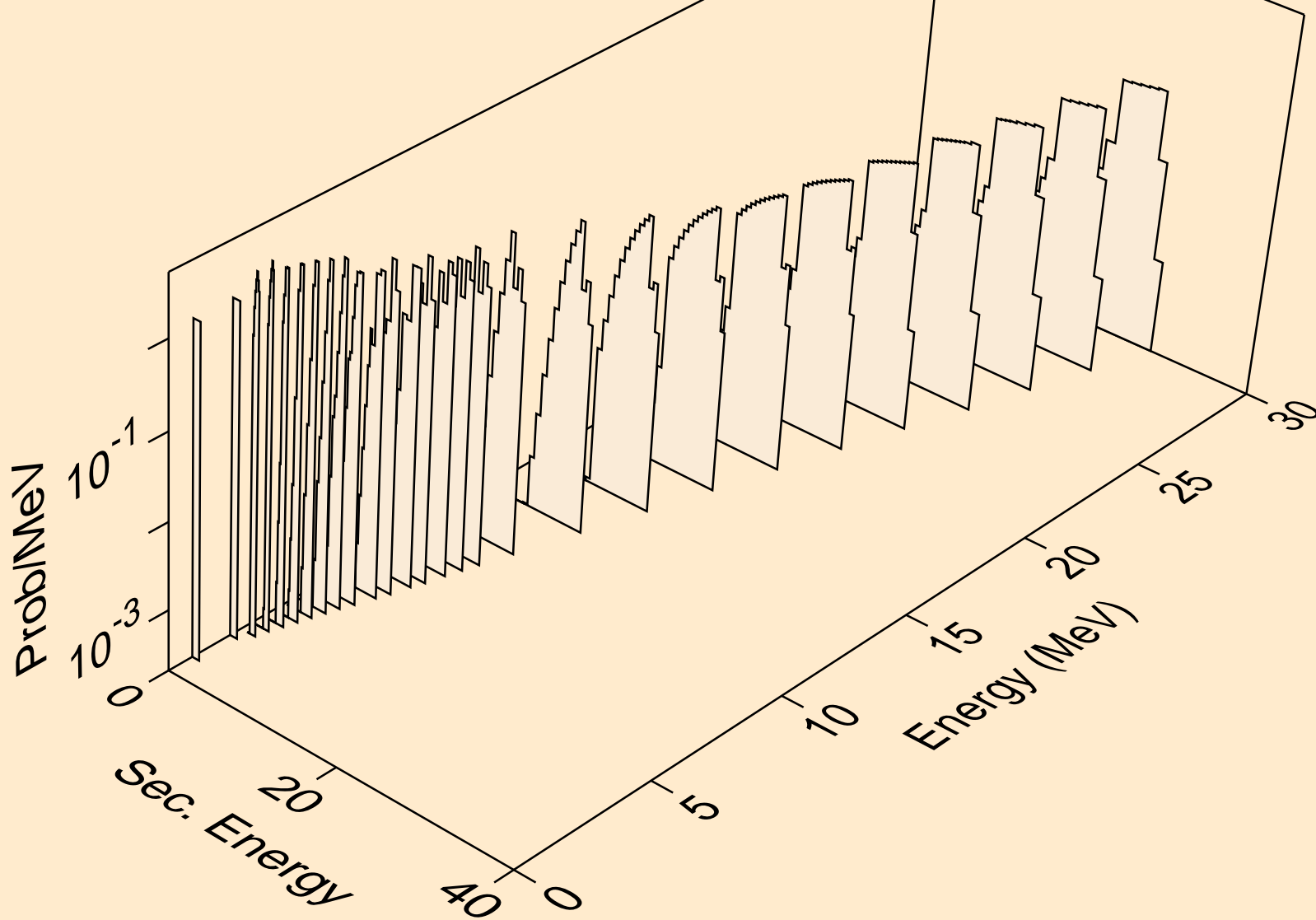

ND128 NEUTRON ACER TENDL-2019 LIBRARY; T=293.16K  
deuterons from (n,pd)

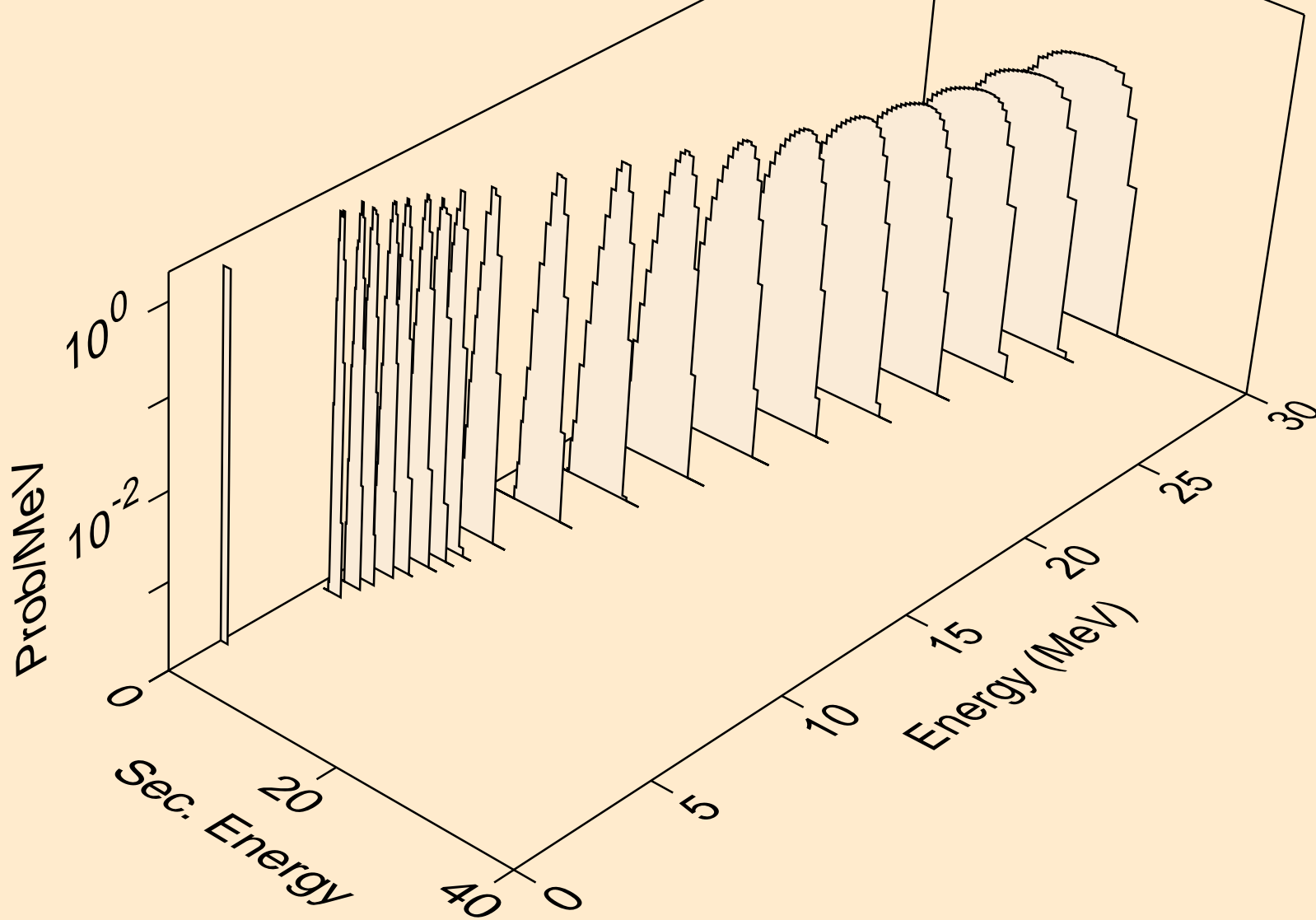

ND128 NEUTRON ACER TENDL-2019 LIBRARY; T=293.16K  
deuterons from (n,da)

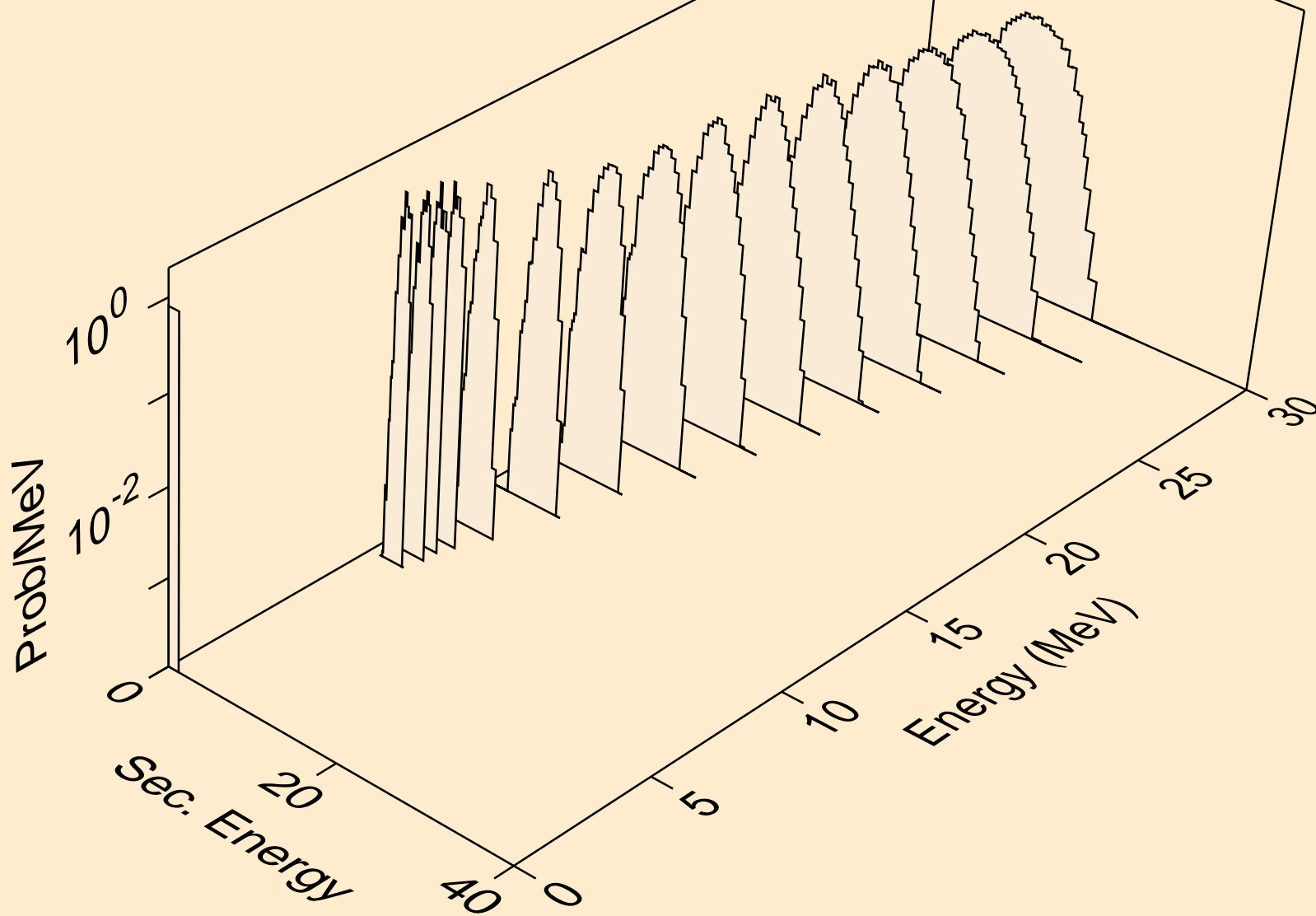

ND128 NEUTRON ACER TENDL-2019 LIBRARY; T=293.16K  
tritons from (n,x)

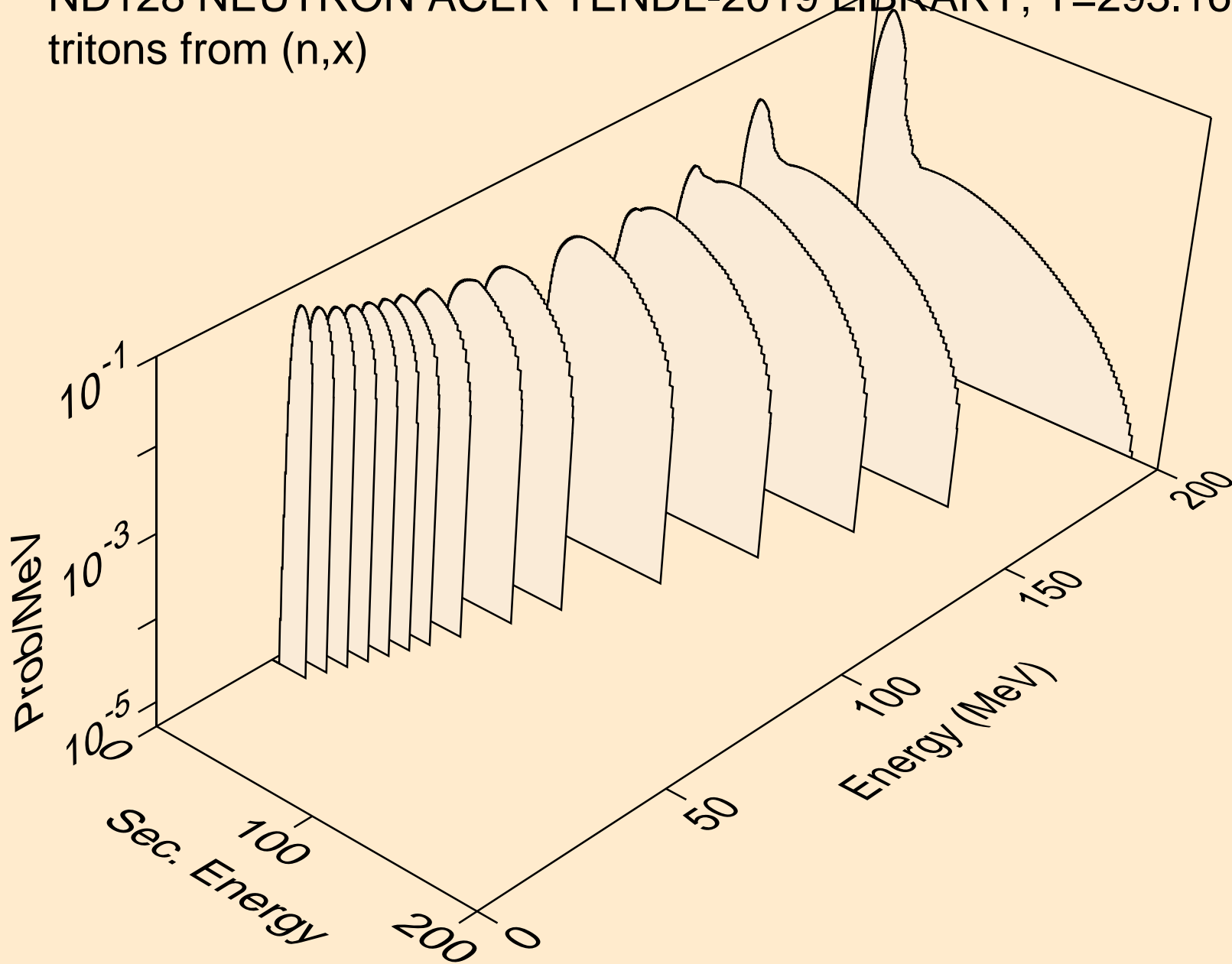

ND128 NEUTRON ACER TENDL-2019 LIBRARY; T=293.16K  
tritons from (n,n\*)t

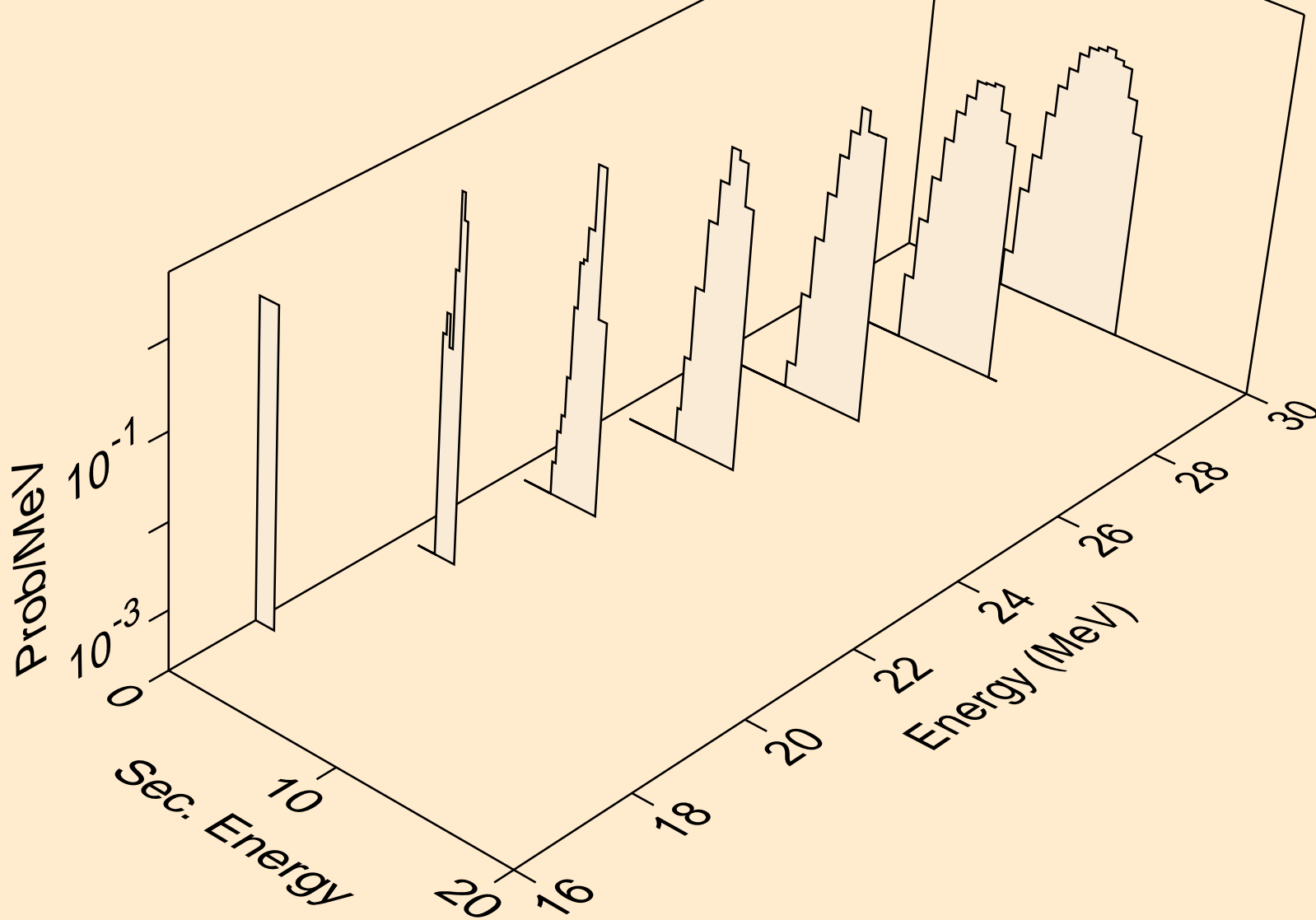

ND128 NEUTRON ACER TENDL-2019 LIBRARY; T=293.16K  
tritons from (n,t)

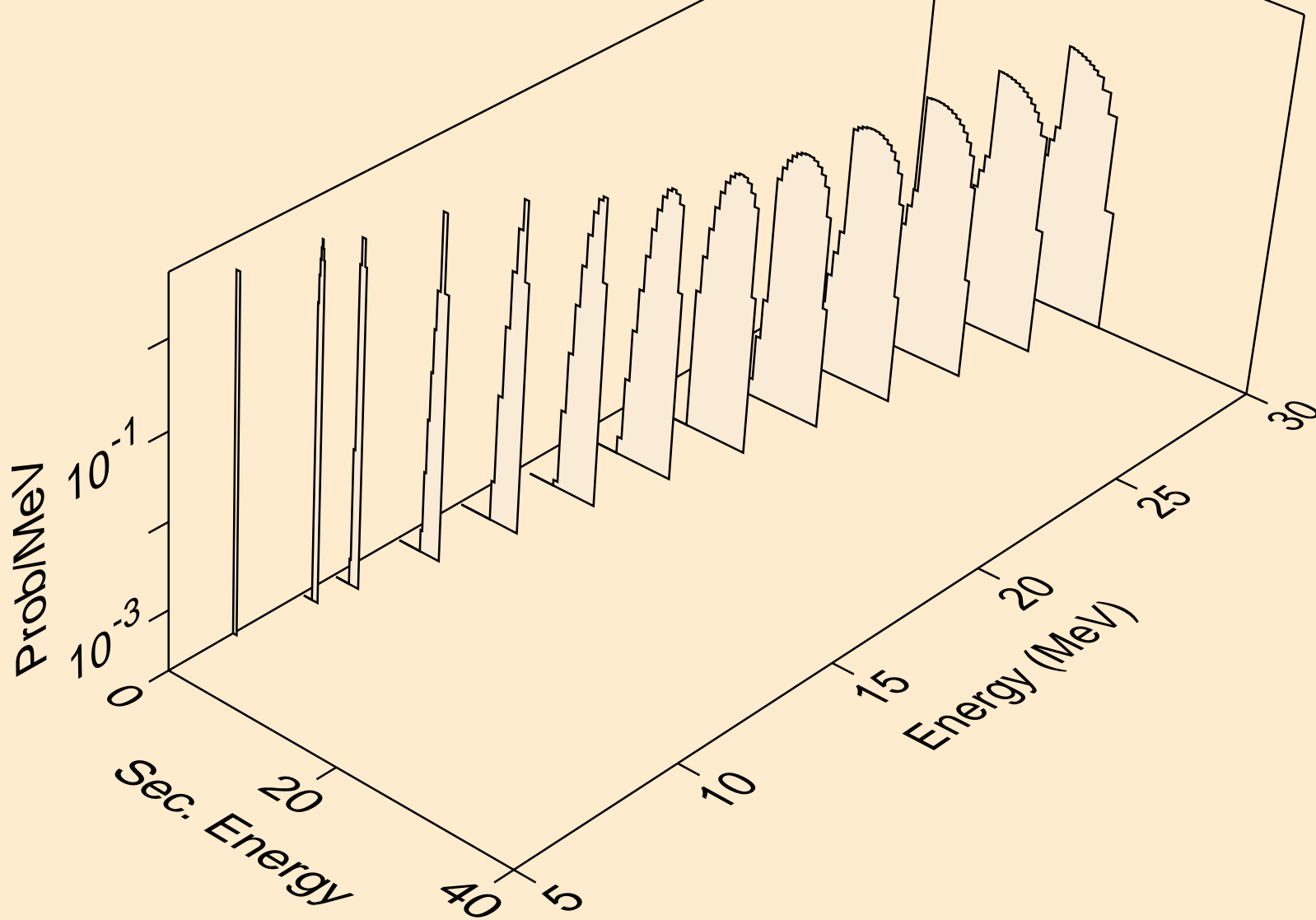

ND128 NEUTRON ACER TENDL-2019 LIBRARY; T=293.16K  
tritons from (n,pt)

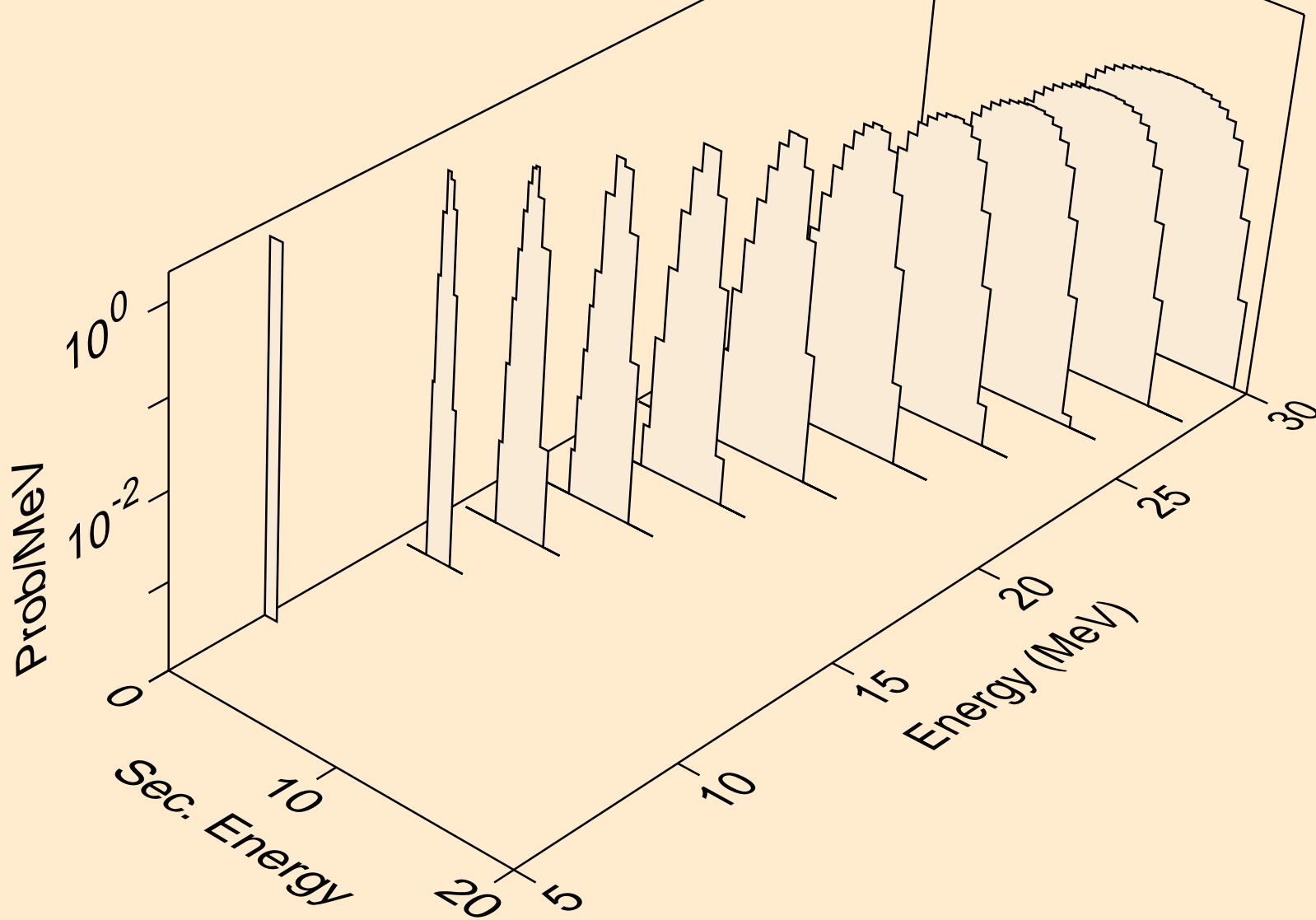

ND128 NEUTRON ACER TENDL-2019 LIBRARY; T=293.16K  
he3s from (n,x)

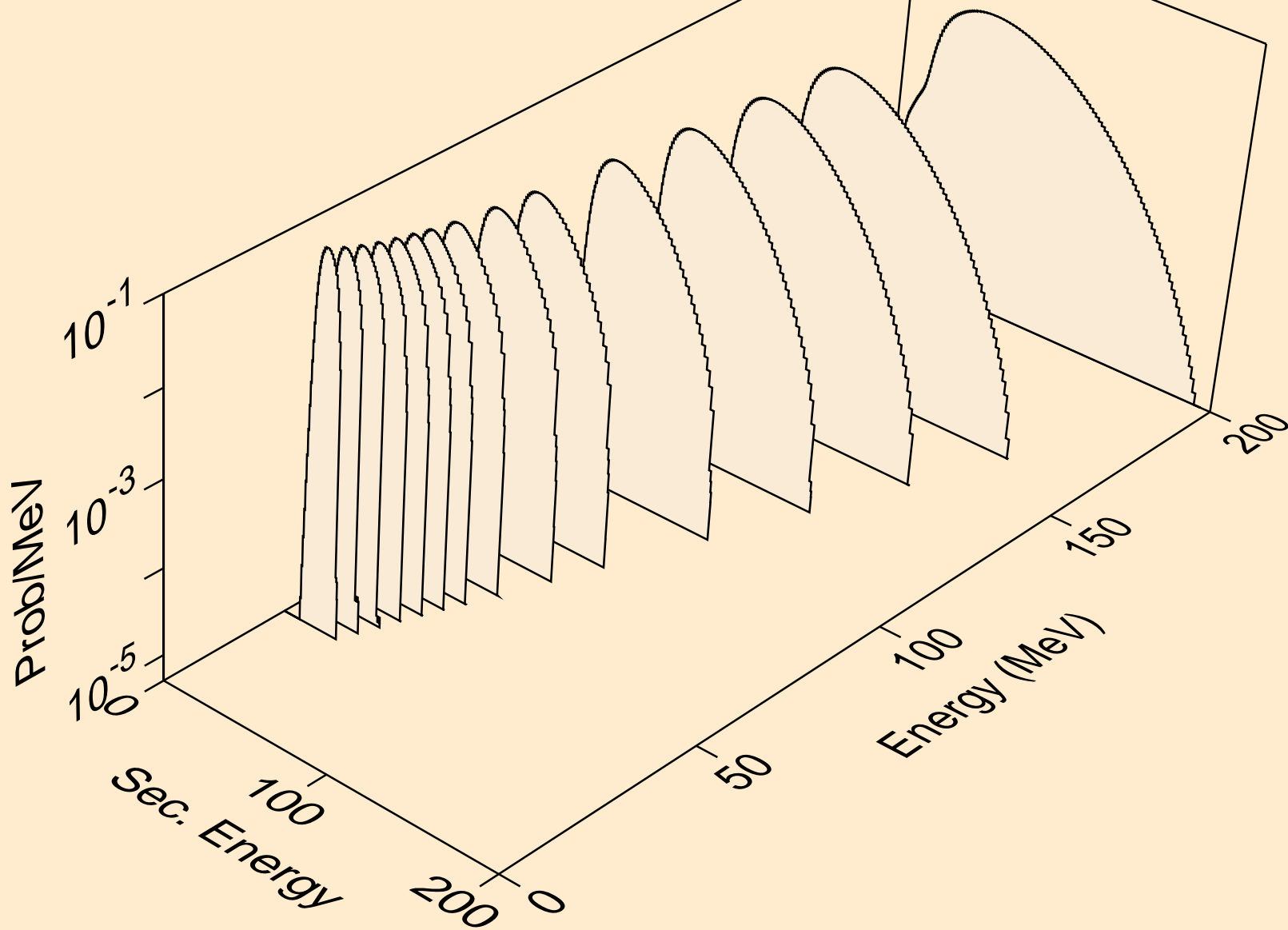

ND128 NEUTRON ACER TENDL-2019 LIBRARY; T=293.16K  
he3s from (n,n\*)he3

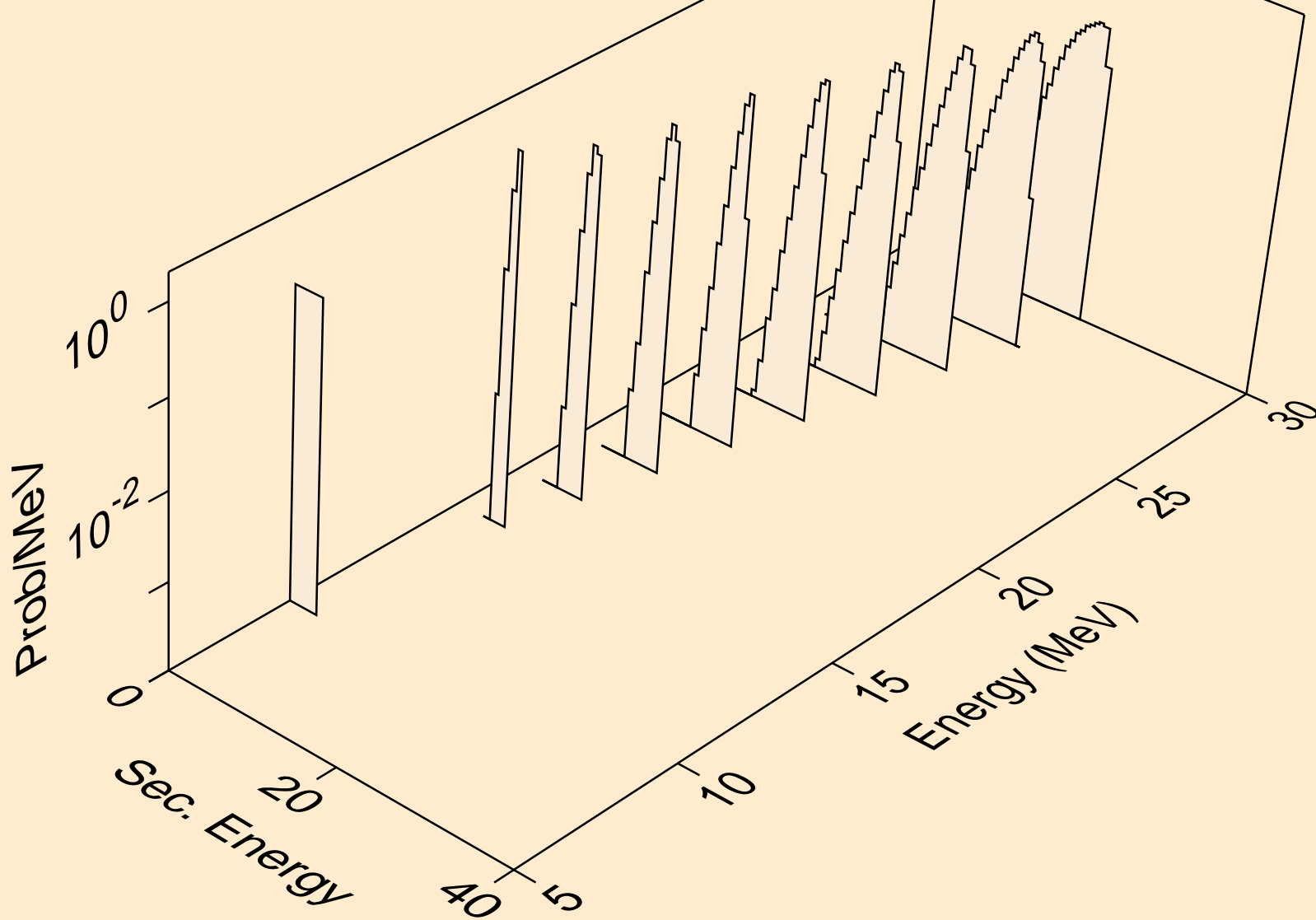

ND128 NEUTRON ACER TENDL-2019 LIBRARY; T=293.16K  
he3s from (n,he3)

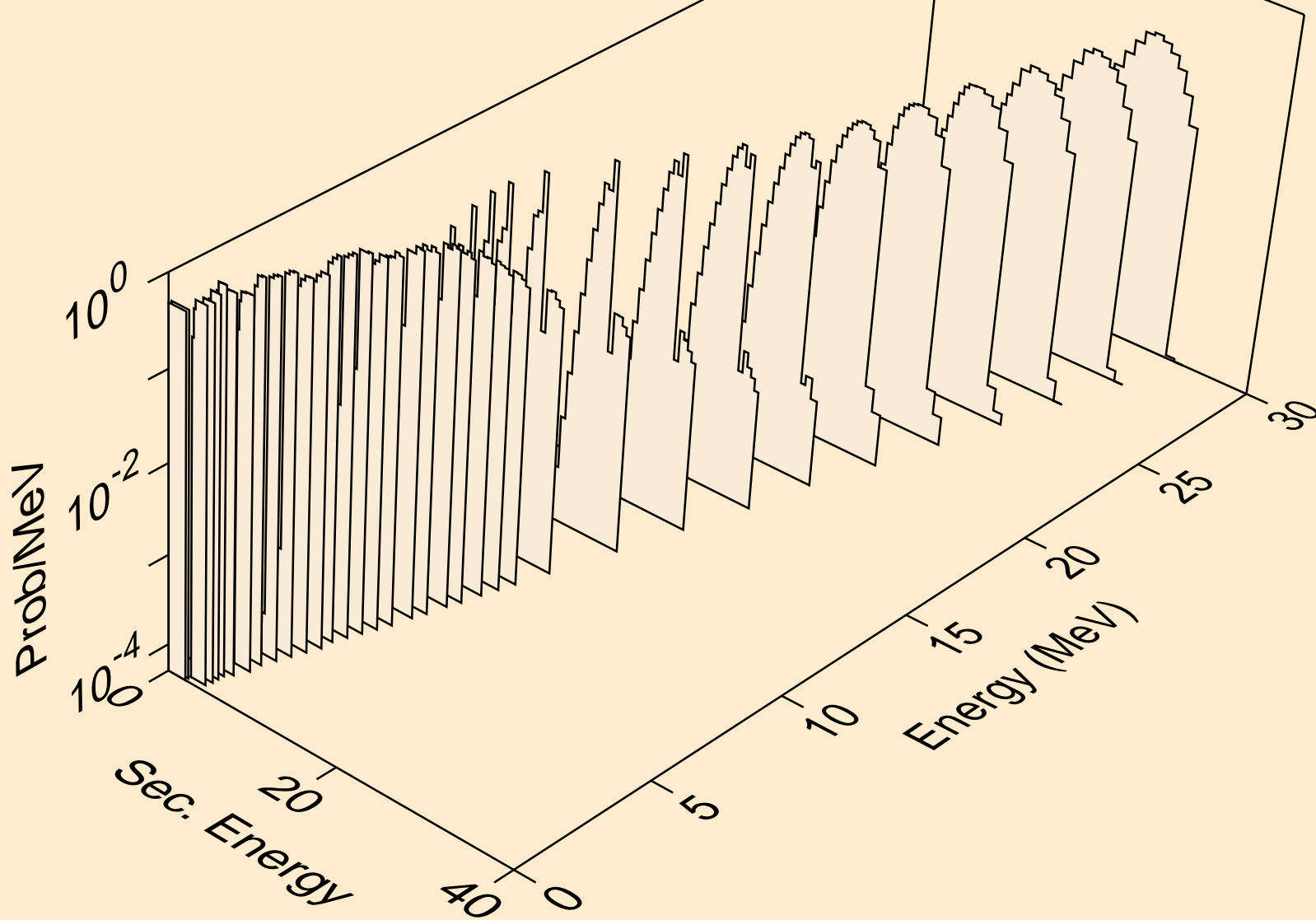

ND128 NEUTRON ACER TENDL-2019 LIBRARY; T=293.16K  
alphas from (n,x)

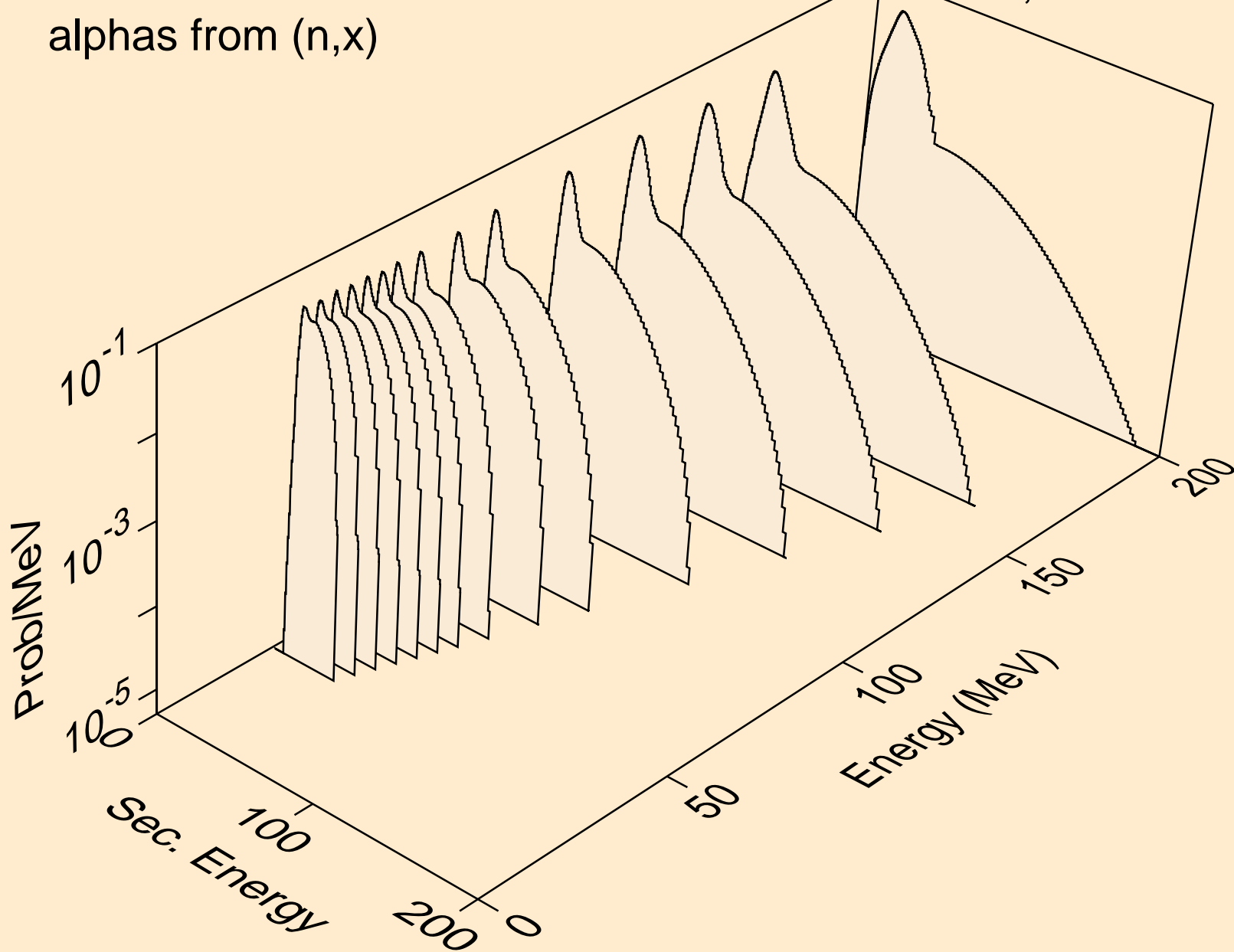

ND128 NEUTRON ACER TENDL-2019 LIBRARY; T=293.16K  
alphas from (n,n\*)a

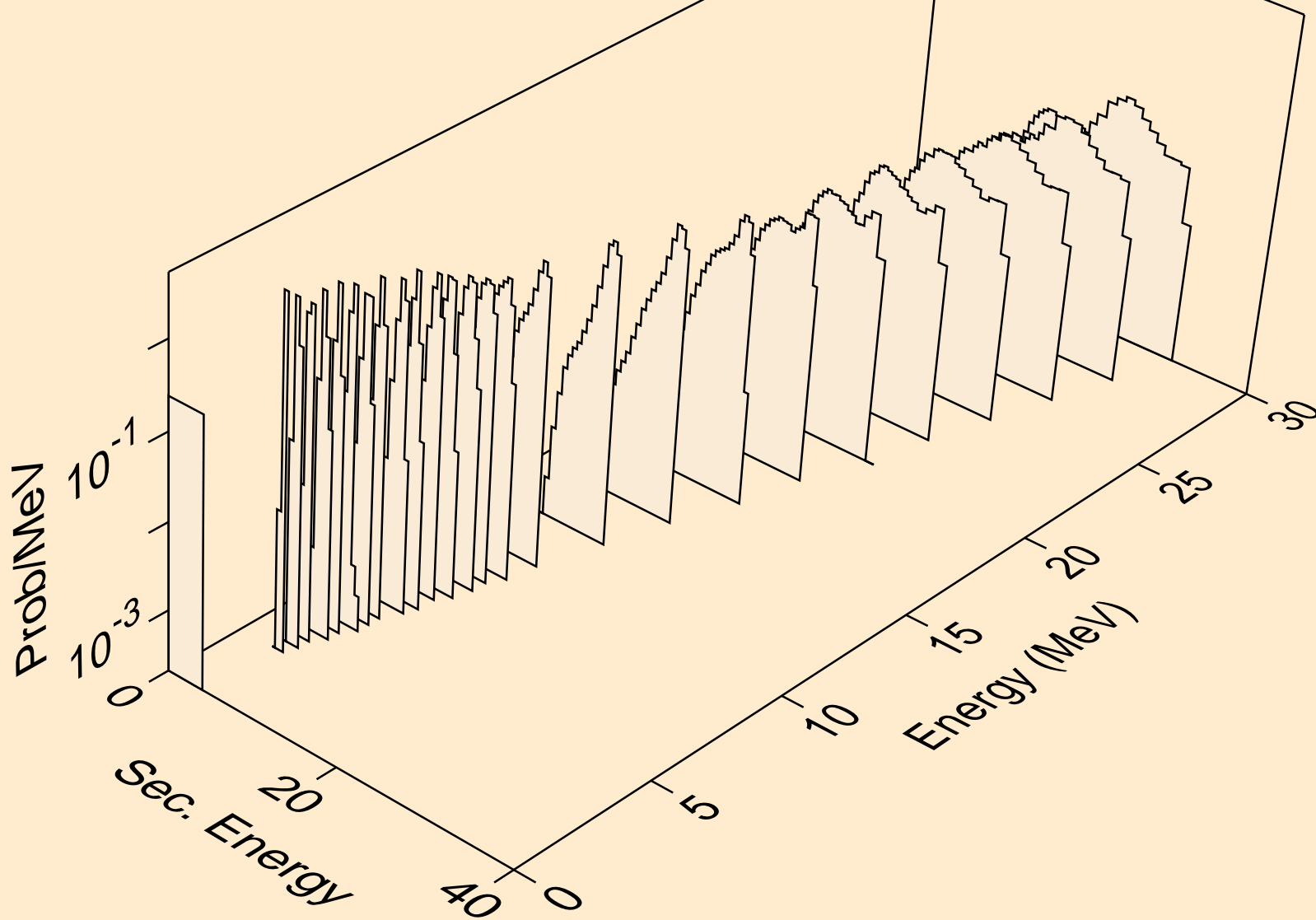

ND128 NEUTRON ACER TENDL-2019 LIBRARY; T=293.16K  
alphas from (n,2n)<sub>a</sub>

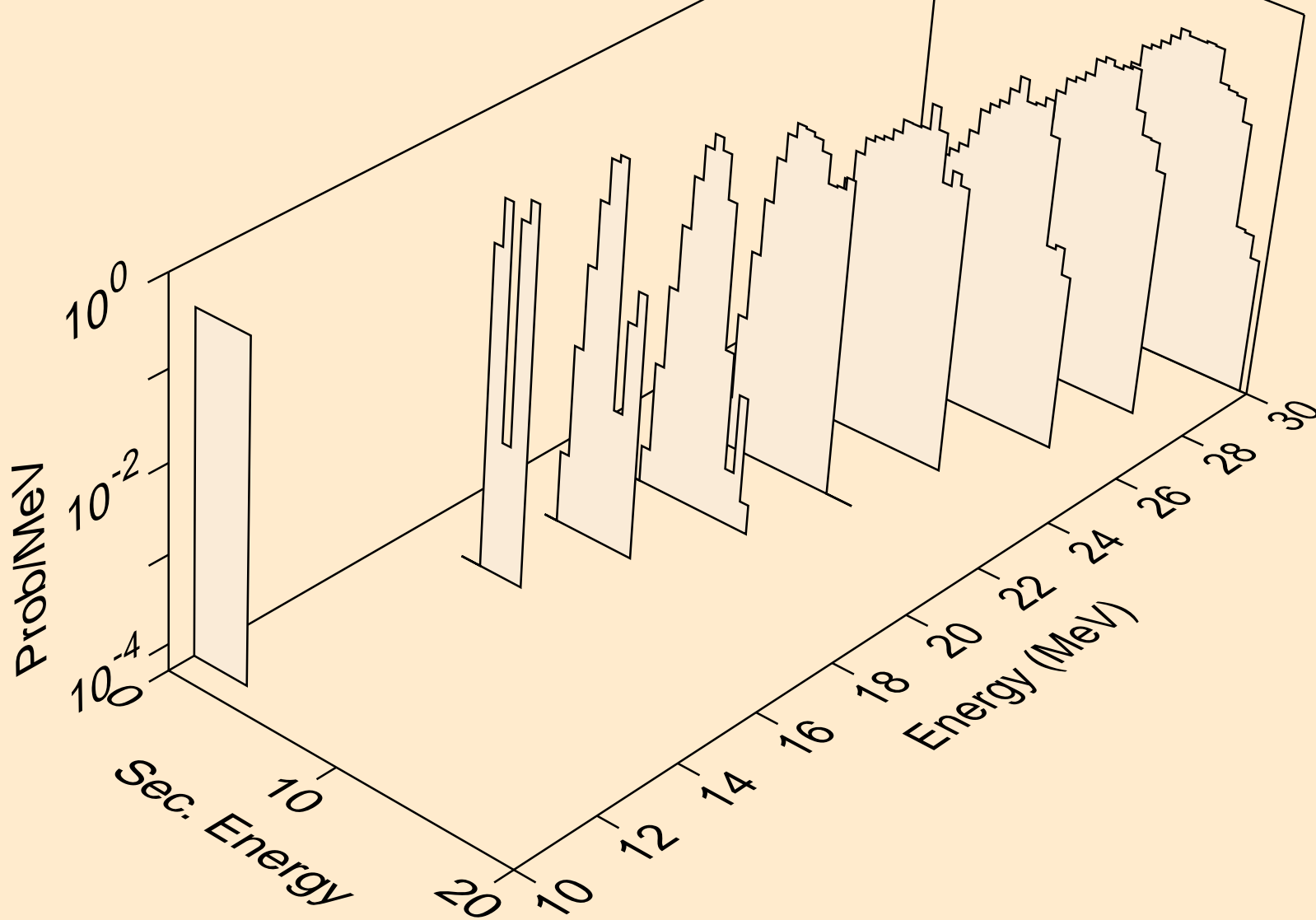

ND128 NEUTRON ACER TENDL-2019 LIBRARY; T=293.16K  
alphas from (n,n\*)2a

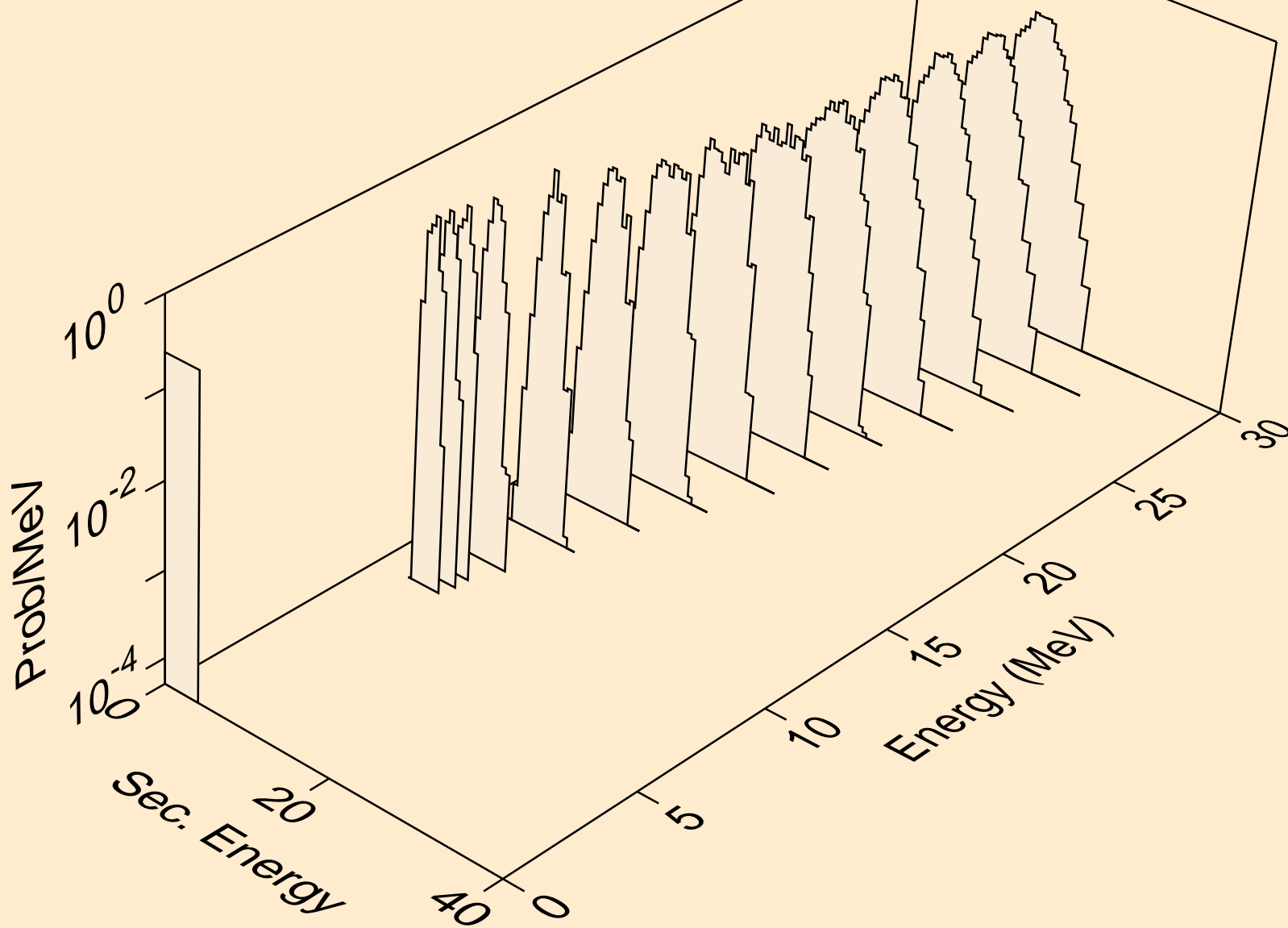

ND128 NEUTRON ACER TENDL-2019 LIBRARY; T=293.16K  
alphas from (n,npa)

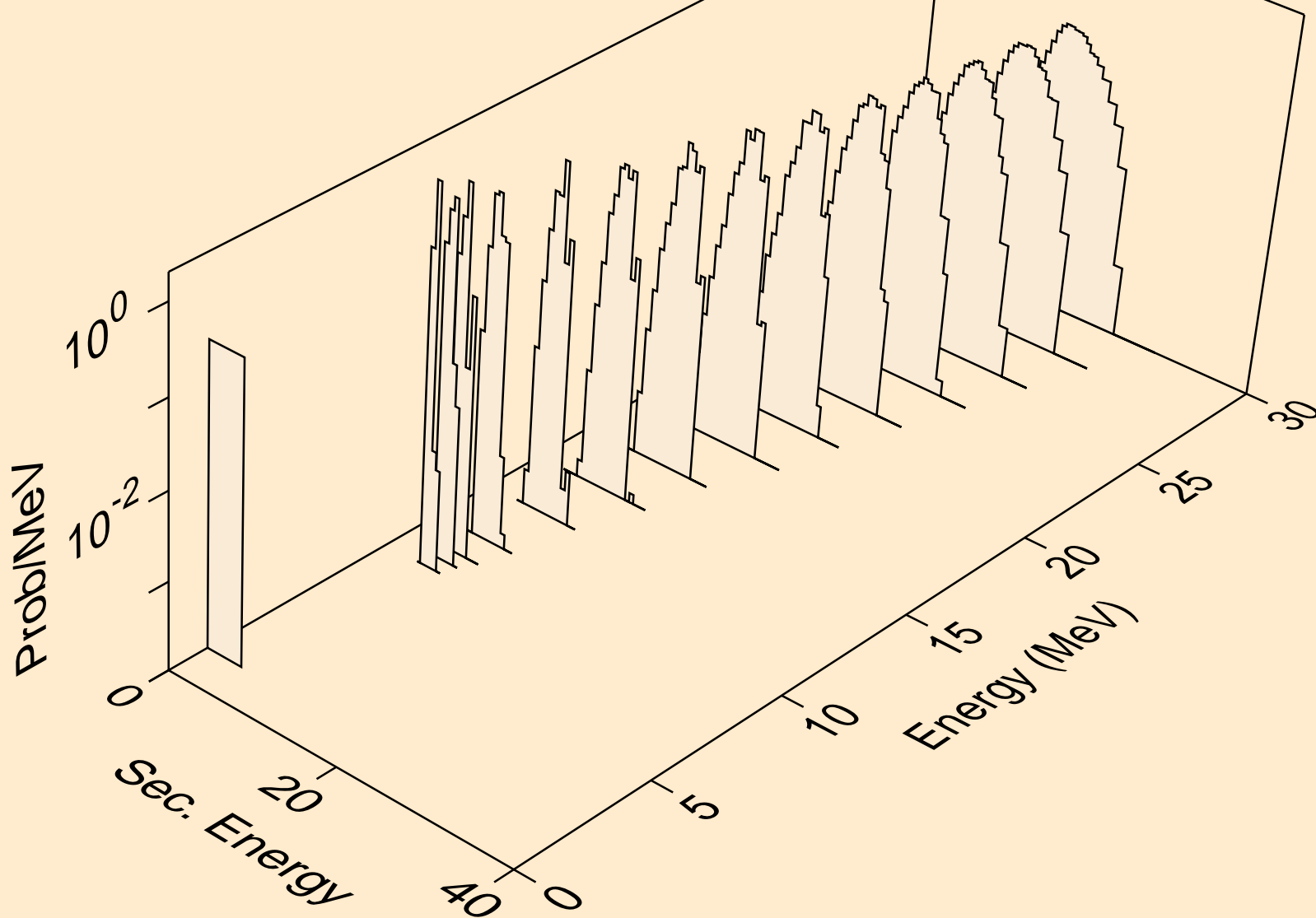

ND128 NEUTRON ACER TENDL-2019 LIBRARY; T=293.16K  
alphas from (n,a)

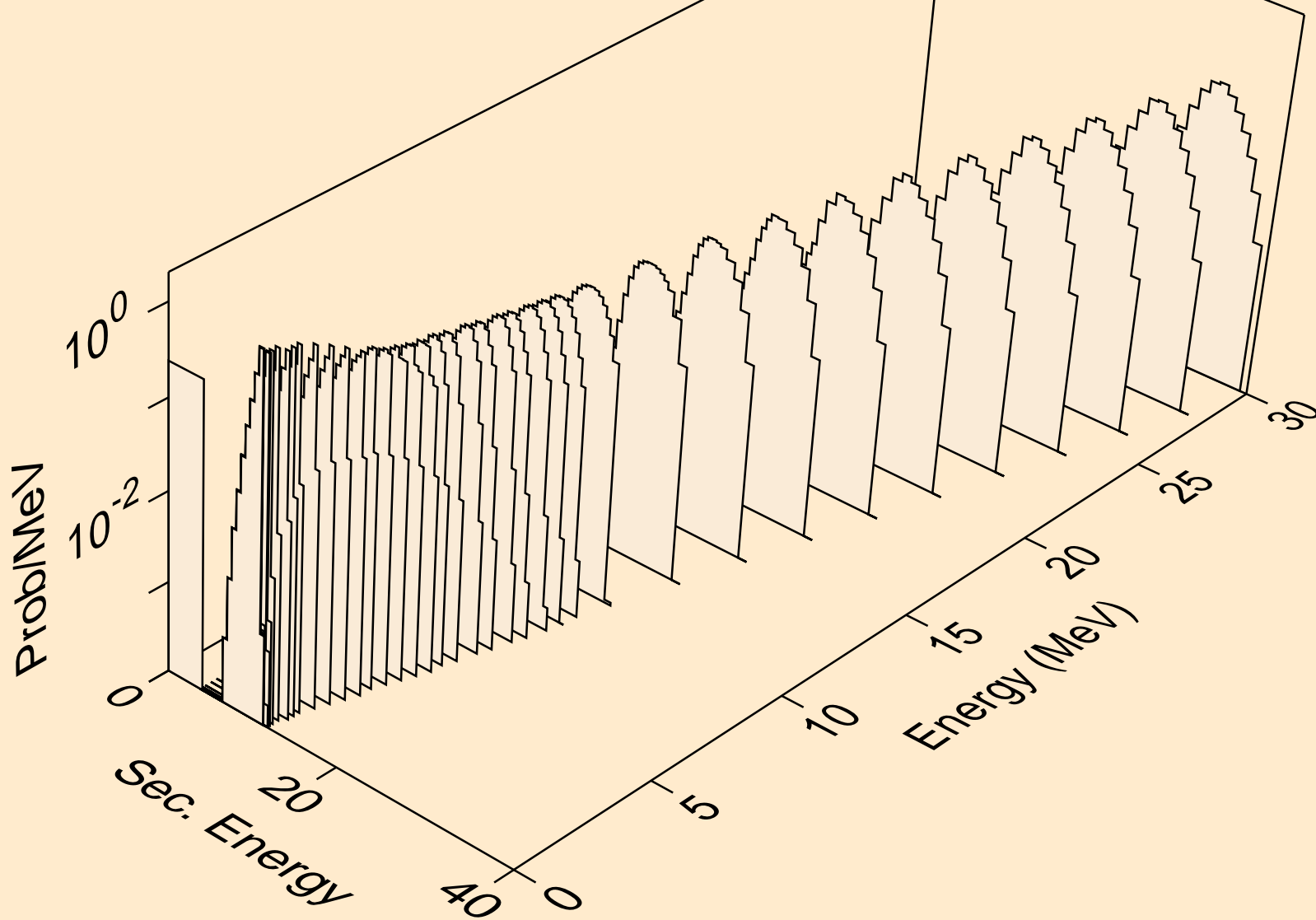

ND128 NEUTRON ACER TENDL-2019 LIBRARY; T=293.16K  
alphas from (n,2a)

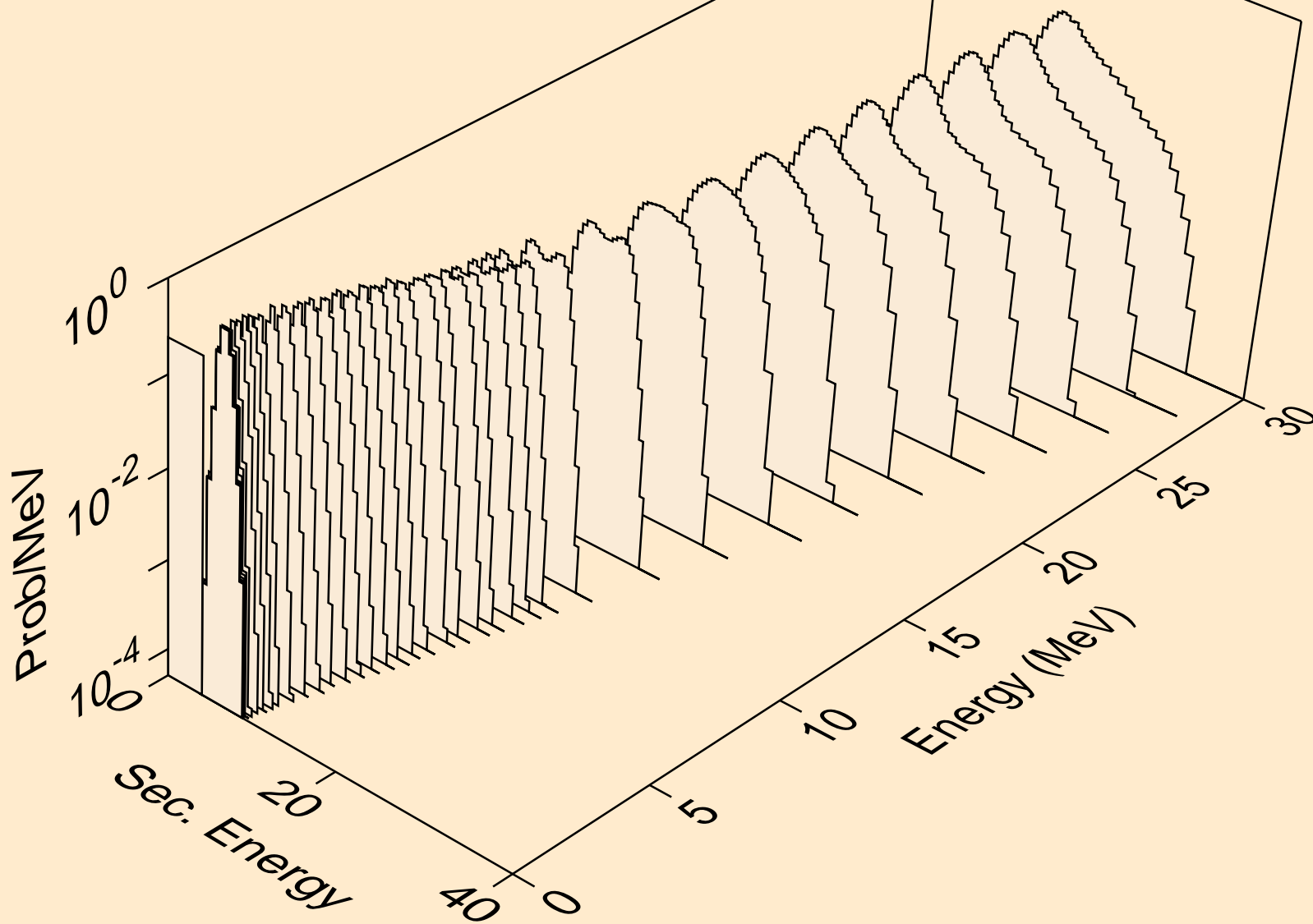

ND128 NEUTRON ACER TENDL-2019 LIBRARY; T=293.16K  
alphas from (n,3a)

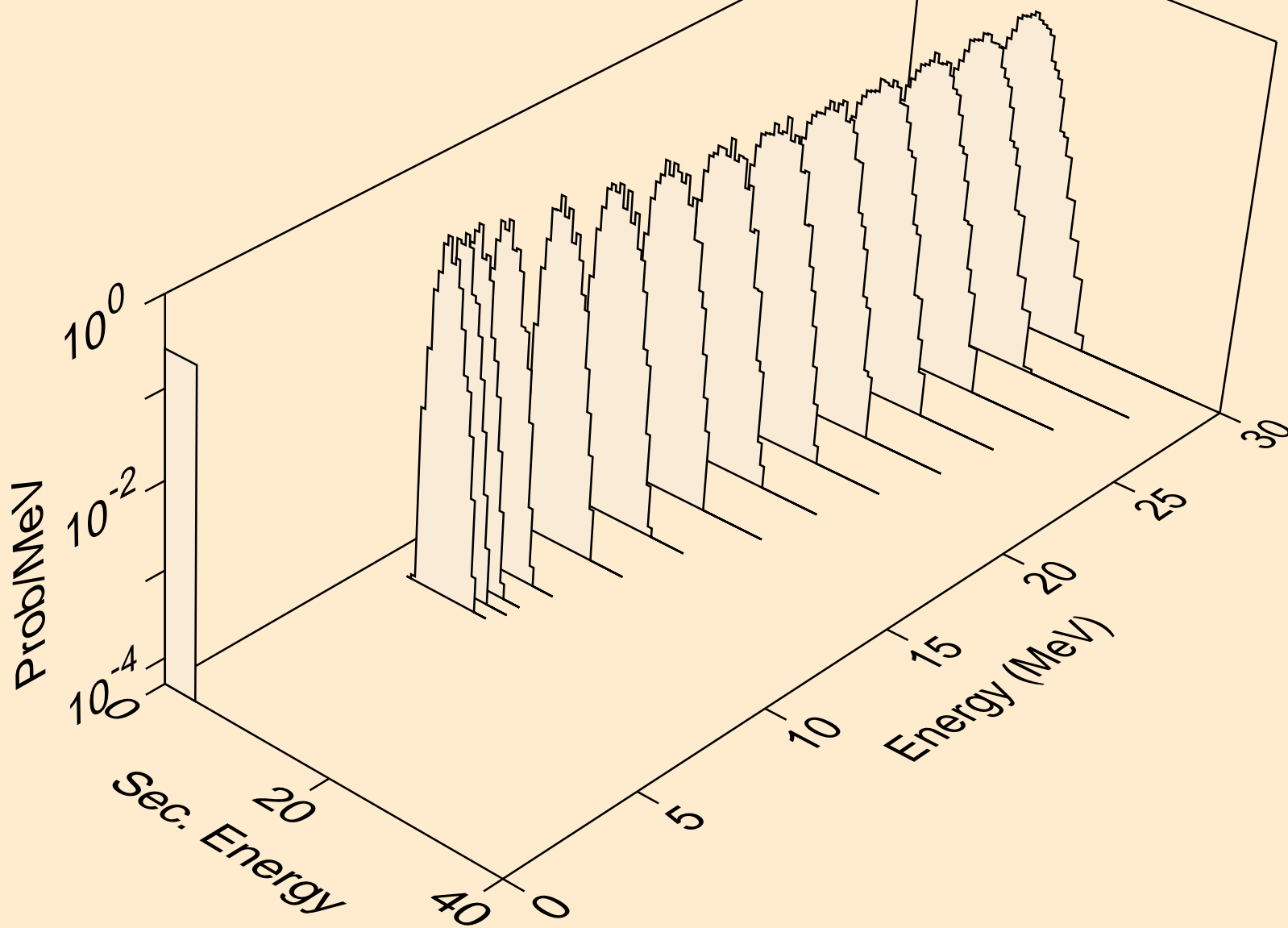

ND128 NEUTRON ACER TENDL-2019 LIBRARY; T=293.16K  
alphas from (n,pa)

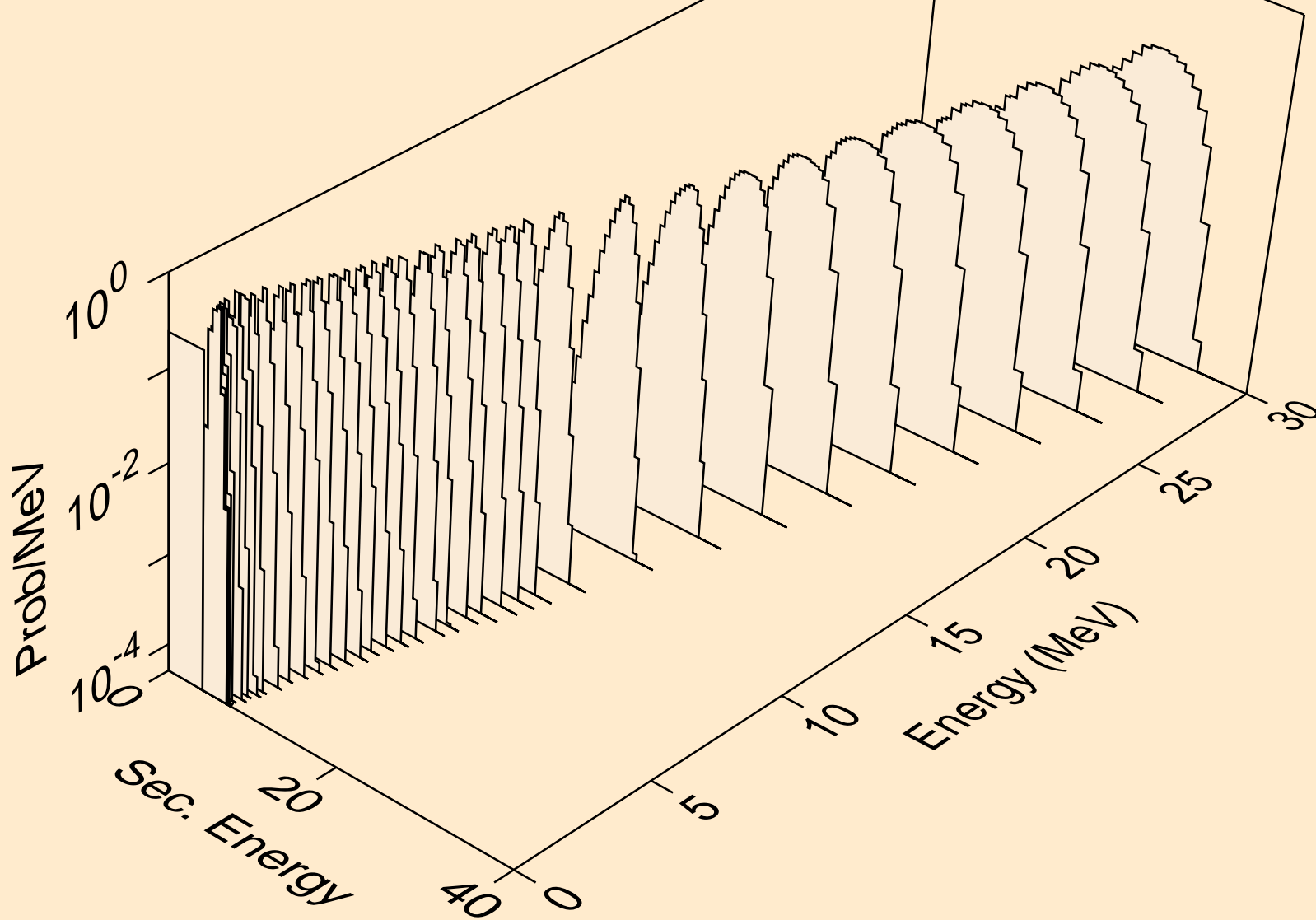

ND128 NEUTRON ACER TENDL-2019 LIBRARY; T=293.16K  
alphas from (n,da)

