

NO252 NEUTRON ACER TENDL-2019 LIBRARY; T=293.16K  
Principal cross sections

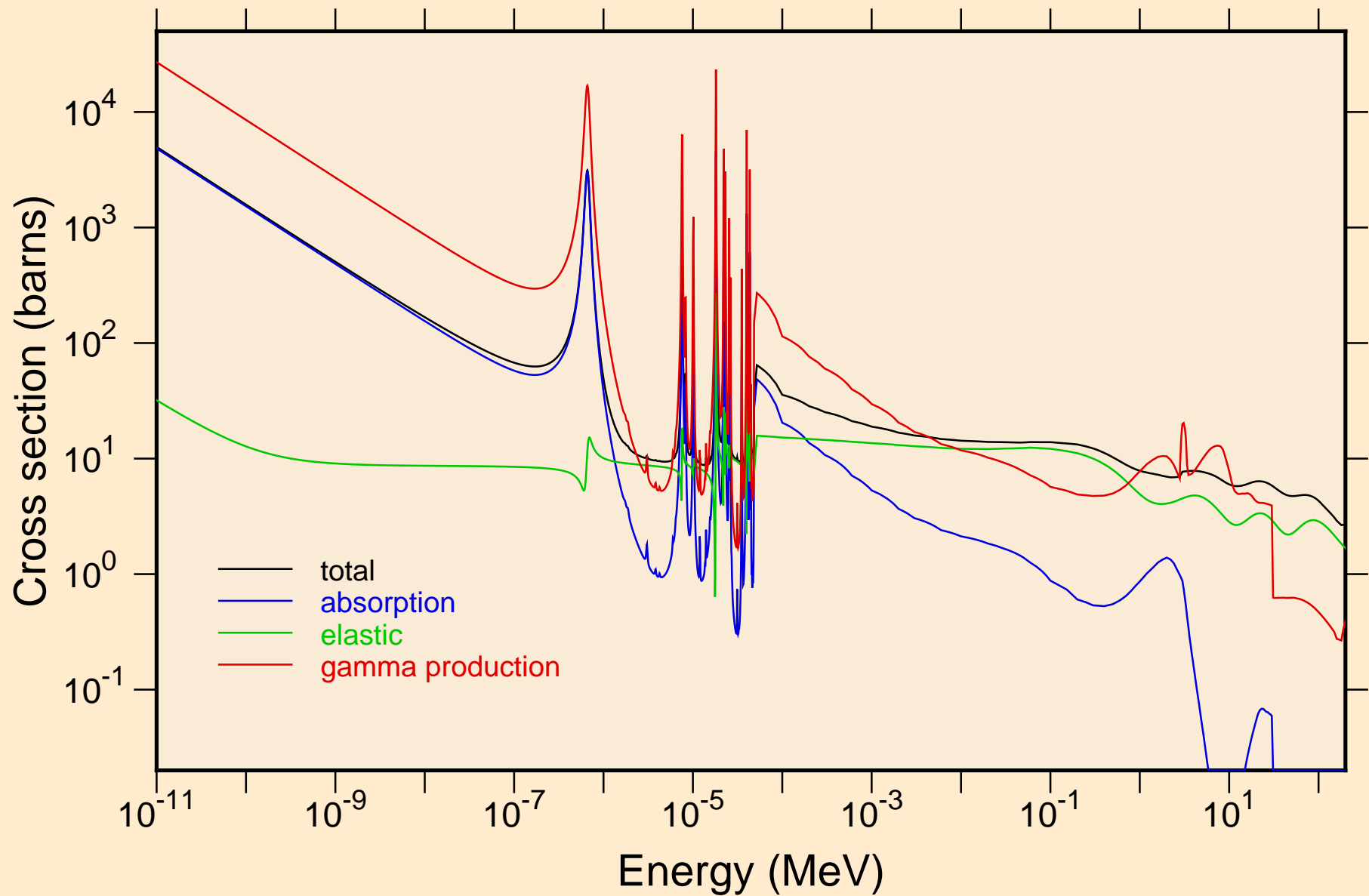

NO252 NEUTRON ACER TENDL-2019 LIBRARY; T=293.16K  
resonance total cross section

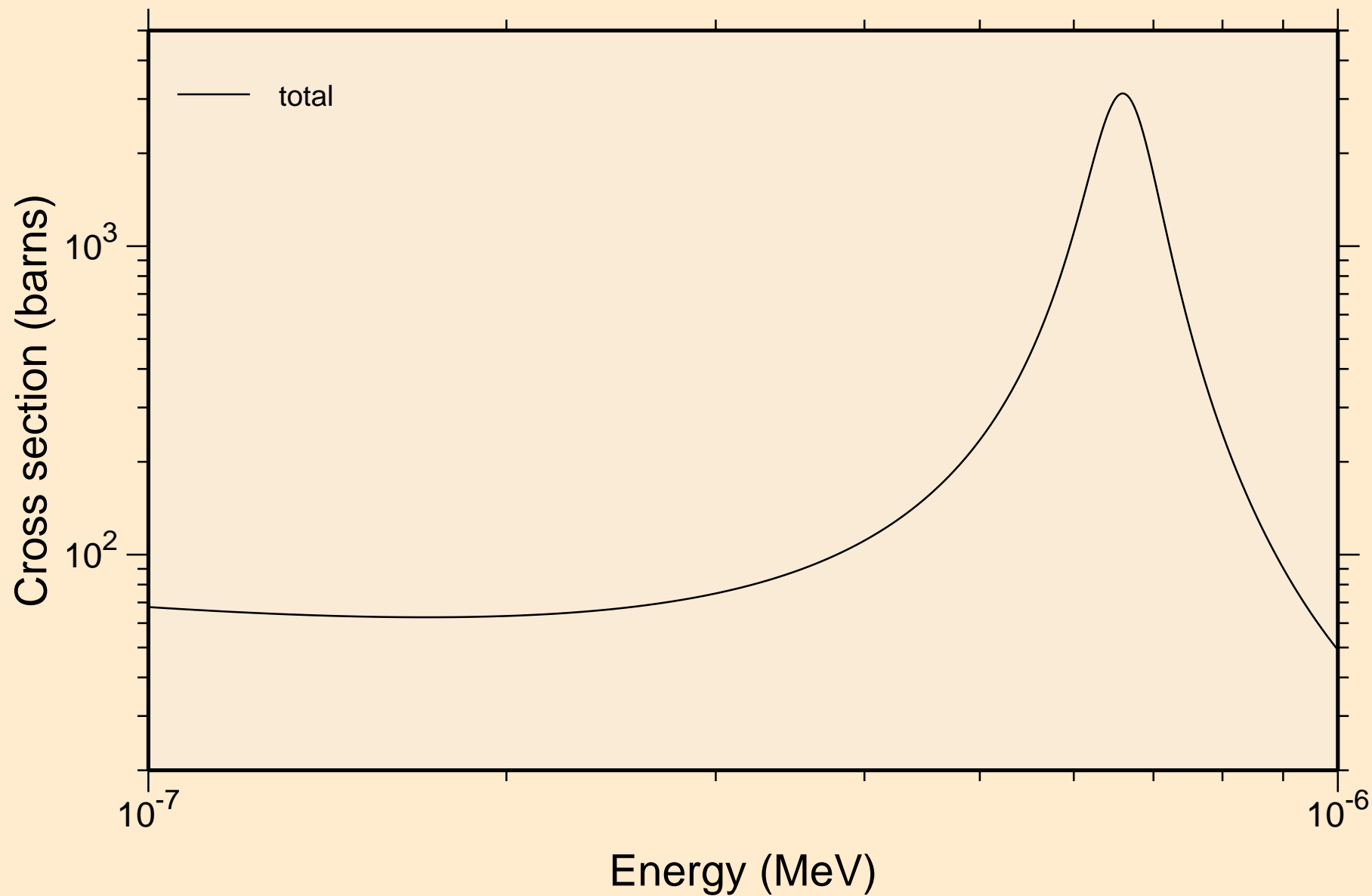

NO252 NEUTRON ACER TENDL-2019 LIBRARY; T=293.16K  
resonance total cross section

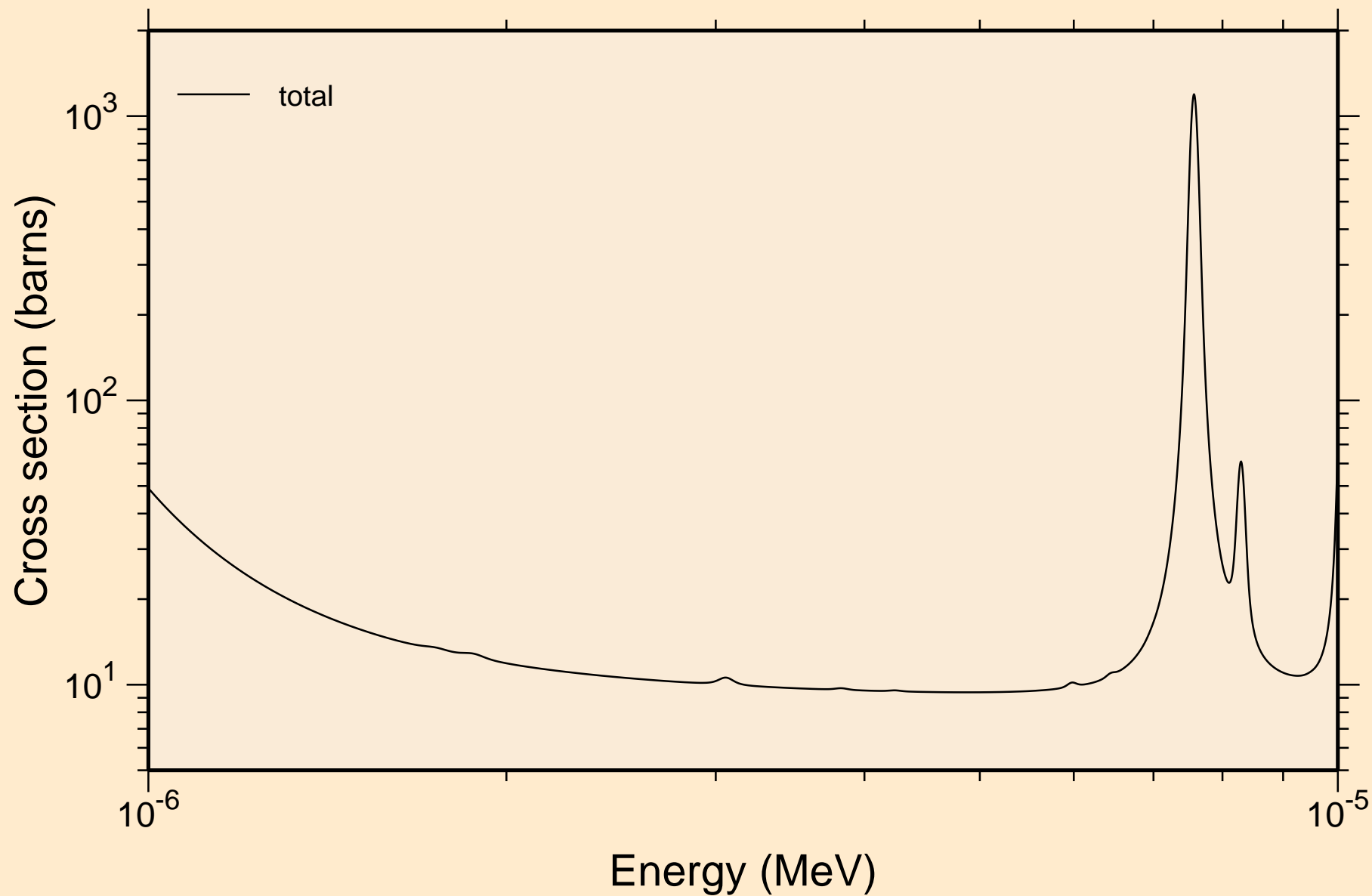

NO252 NEUTRON ACER TENDL-2019 LIBRARY; T=293.16K  
resonance total cross section

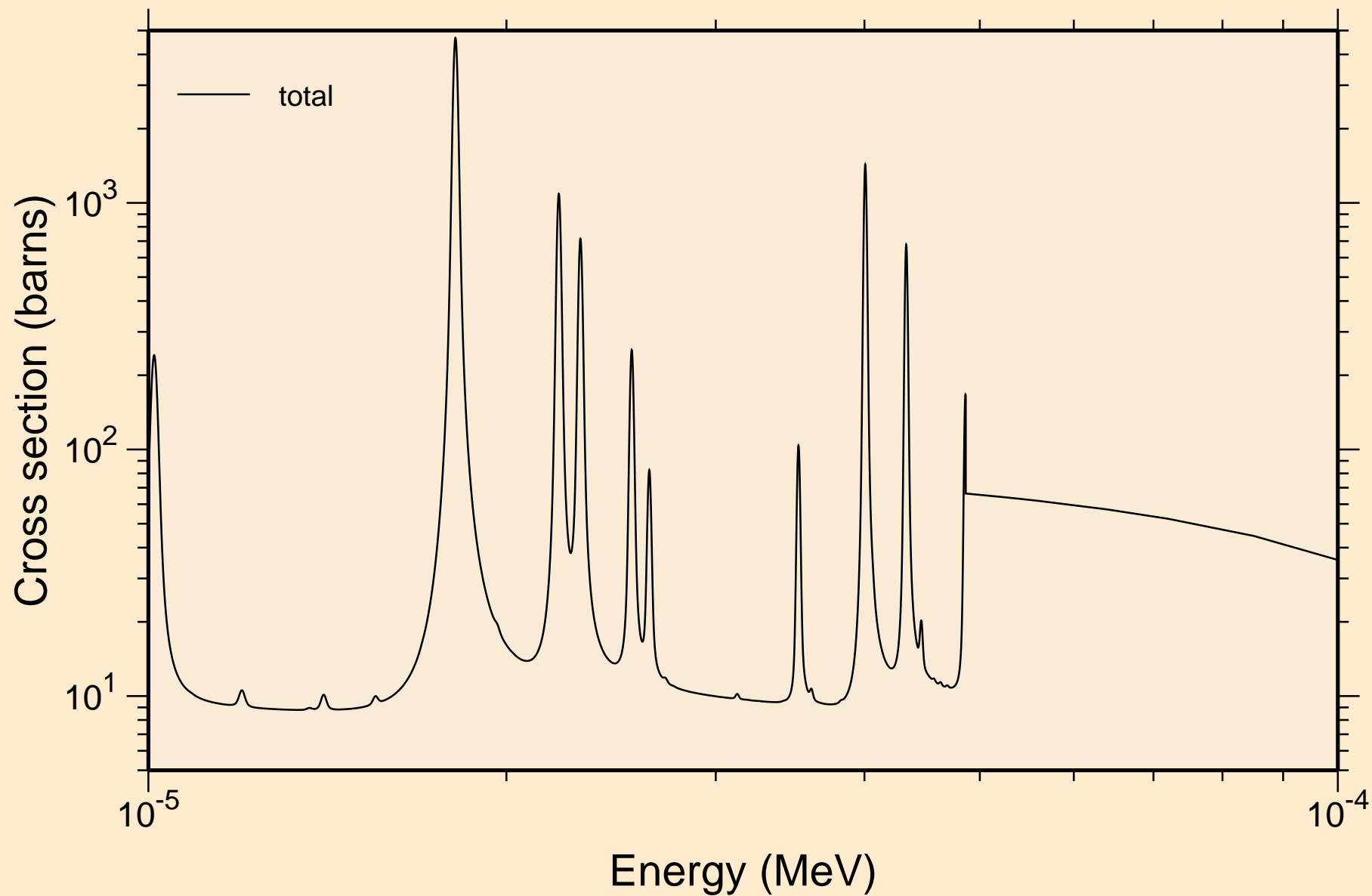

NO252 NEUTRON ACER TENDL-2019 LIBRARY; T=293.16K  
resonance total cross section

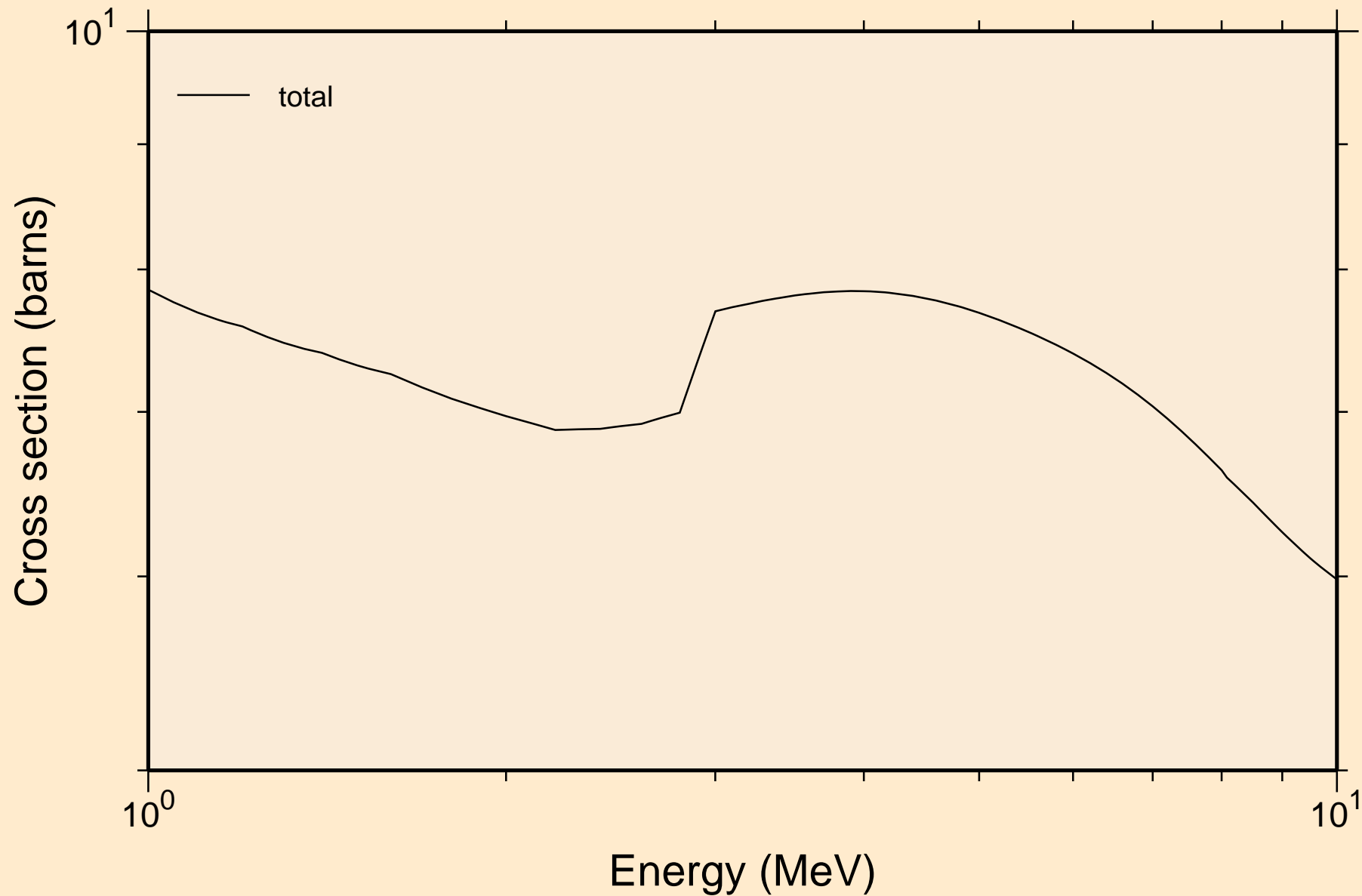

NO252 NEUTRON ACER TENDL-2019 LIBRARY; T=293.16K  
resonance absorption cross sections

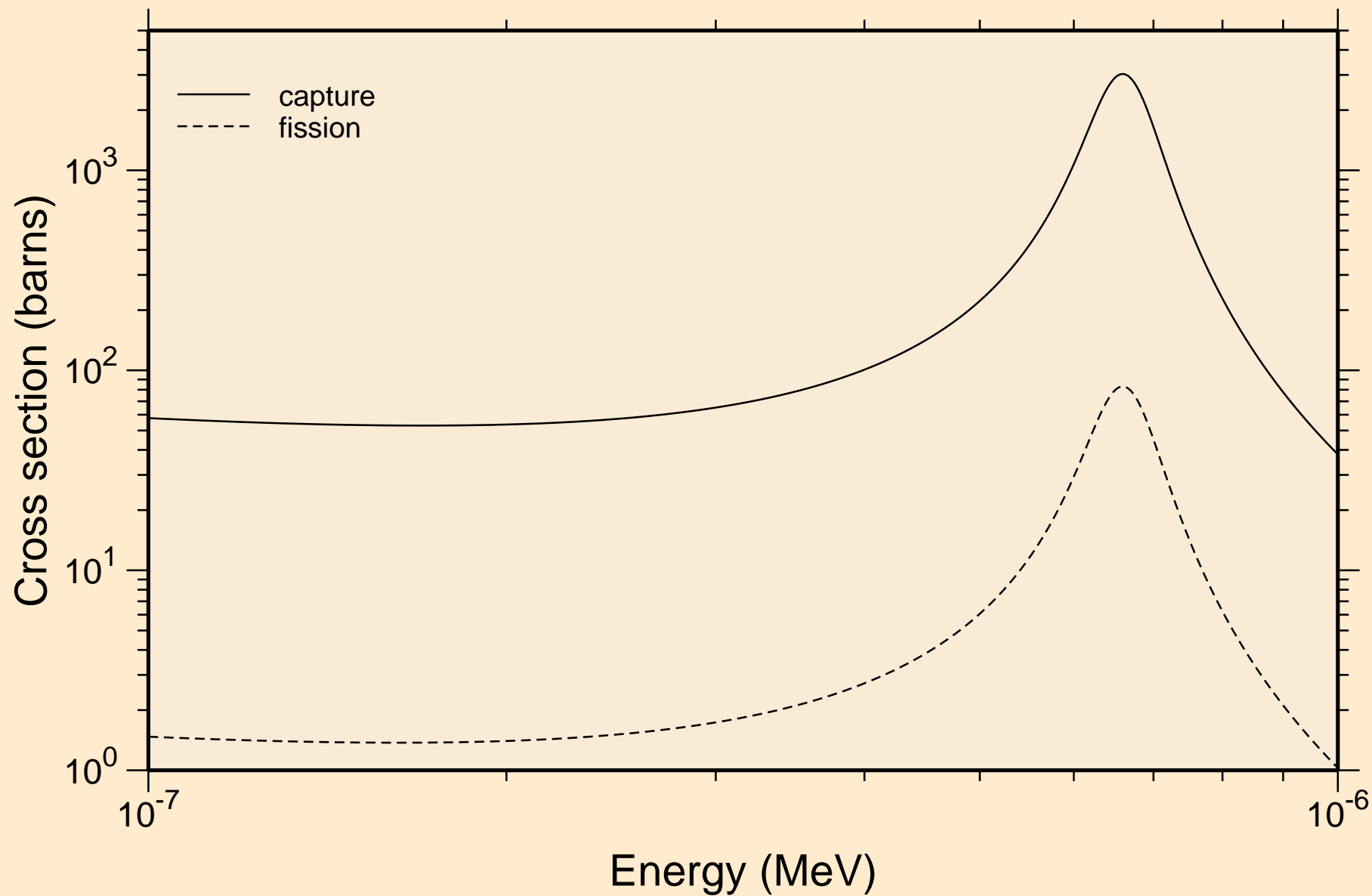

NO252 NEUTRON ACER TENDL-2019 LIBRARY; T=293.16K  
resonance absorption cross sections

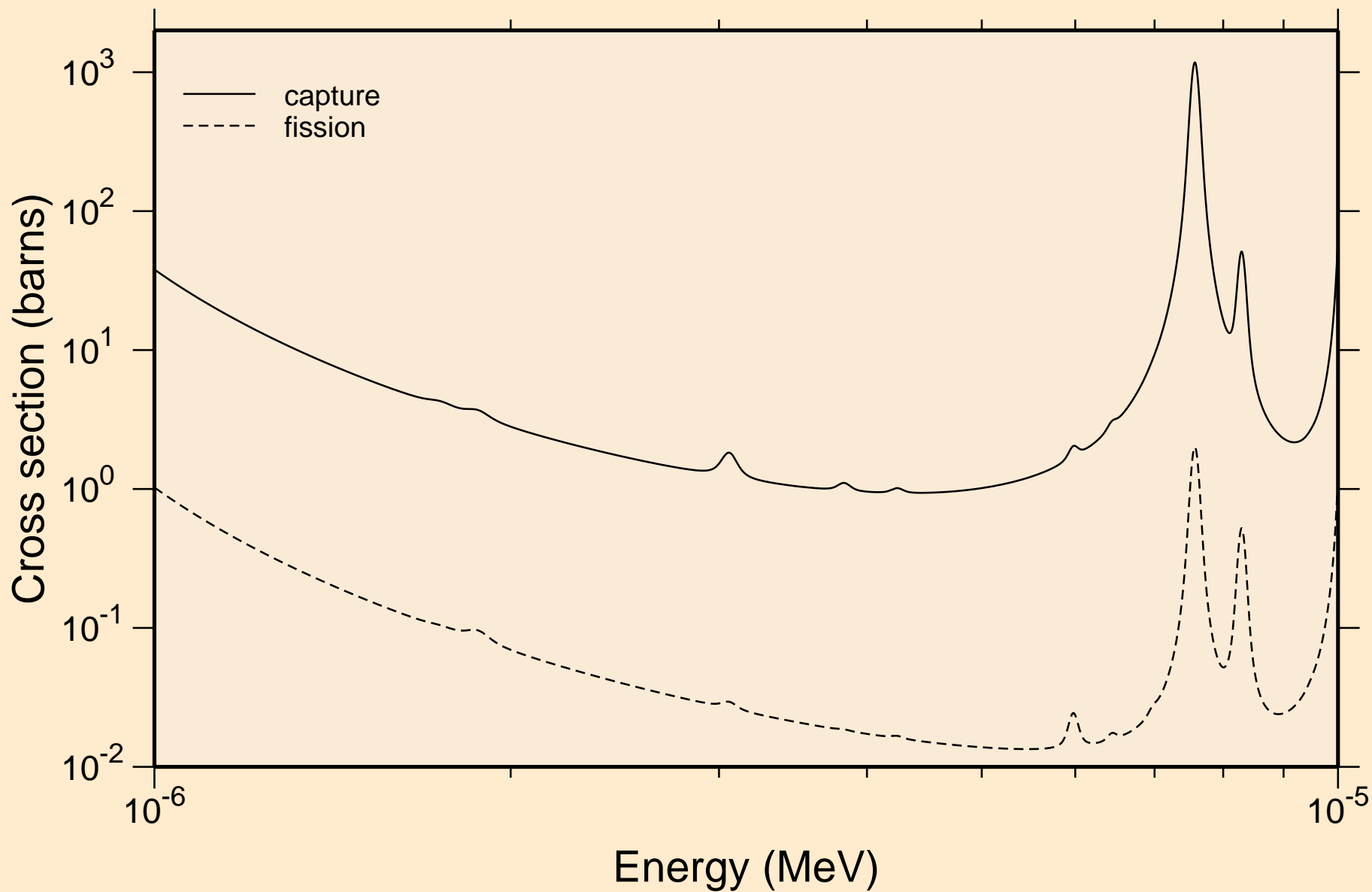

NO252 NEUTRON ACER TENDL-2019 LIBRARY; T=293.16K  
resonance absorption cross sections

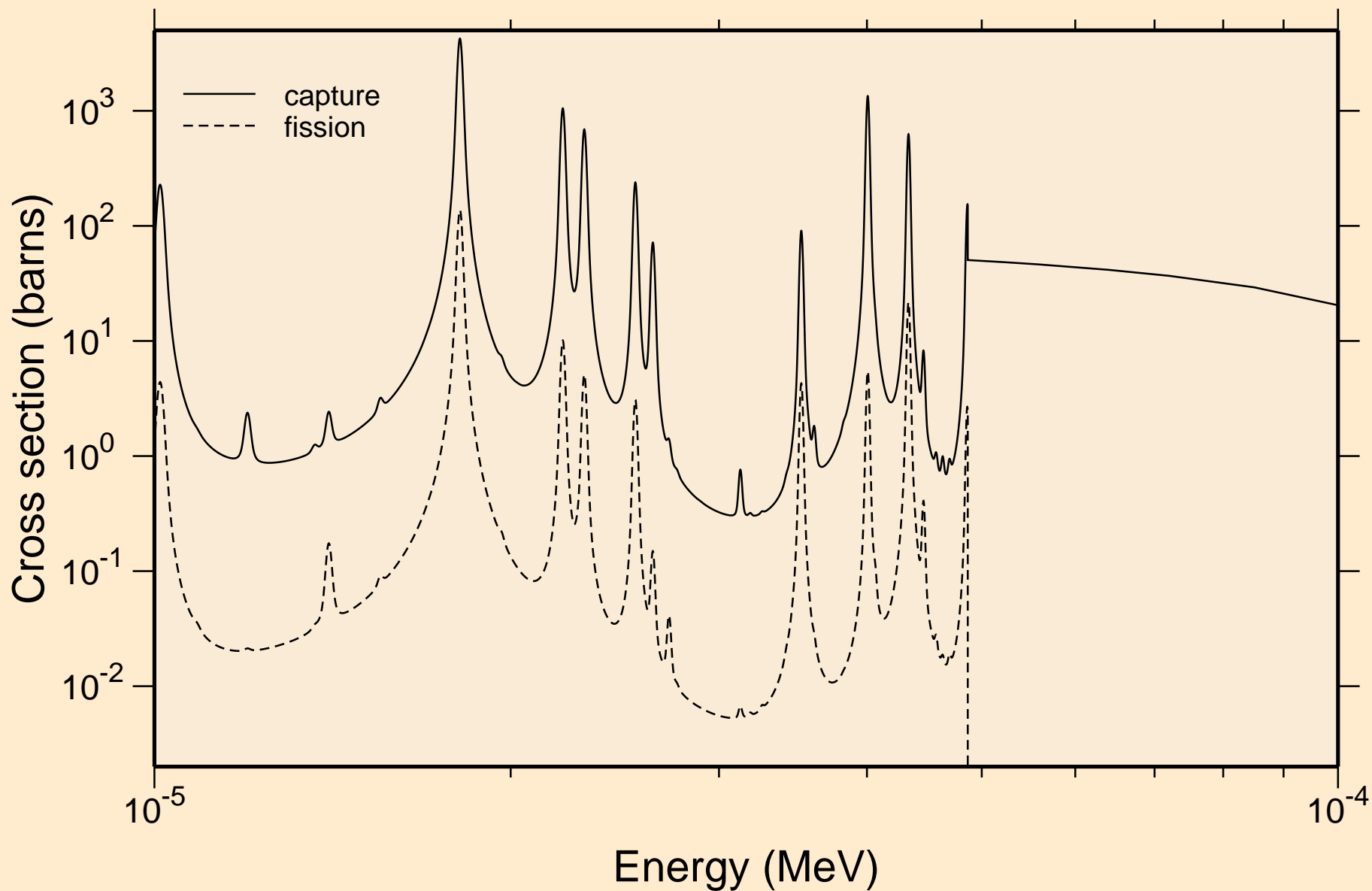

NO252 NEUTRON ACER TENDL-2019 LIBRARY; T=293.16K  
resonance absorption cross sections

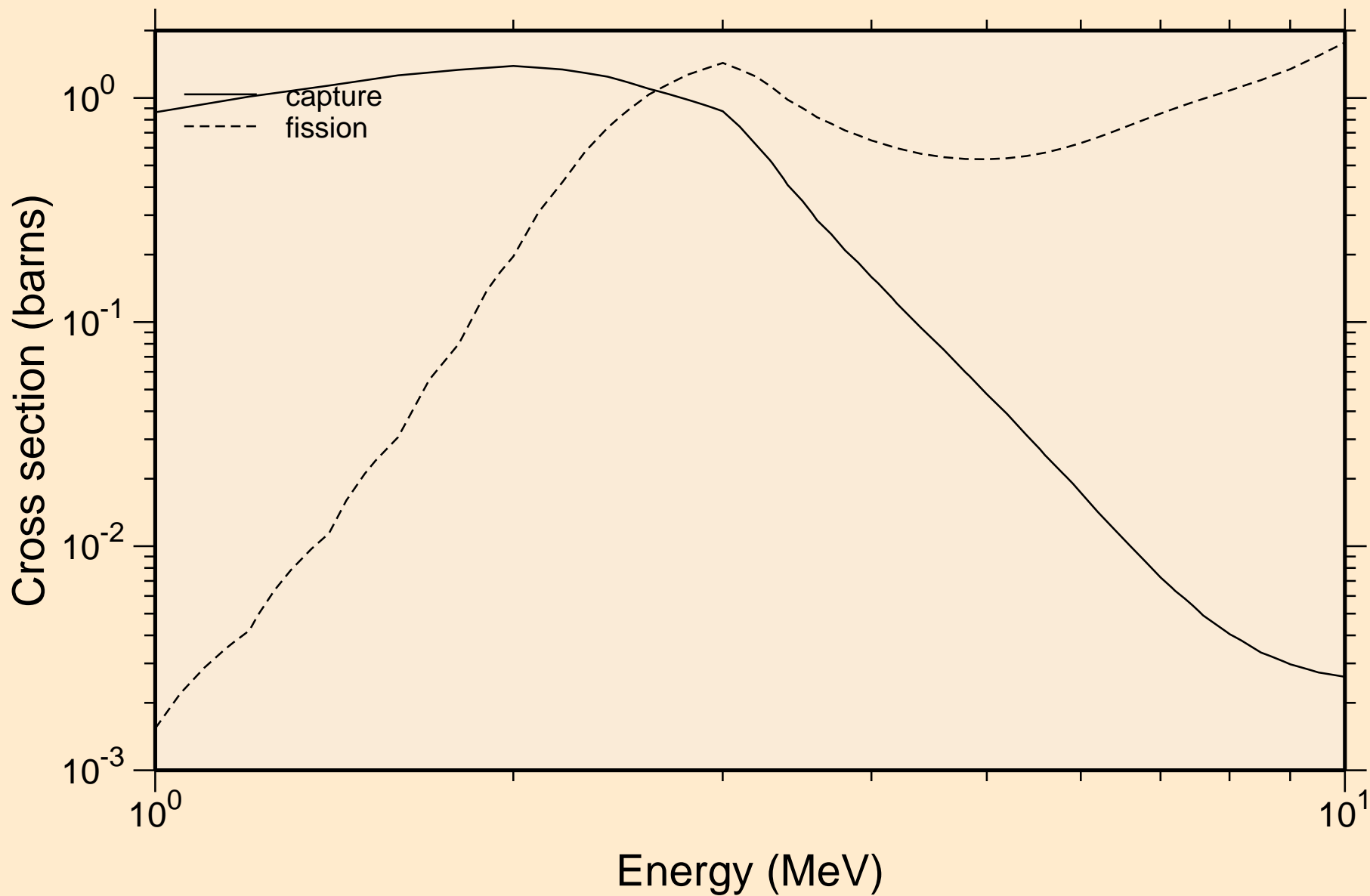

NO252 NEUTRON ACER TENDL-2019 LIBRARY; T=293.16K  
Heating

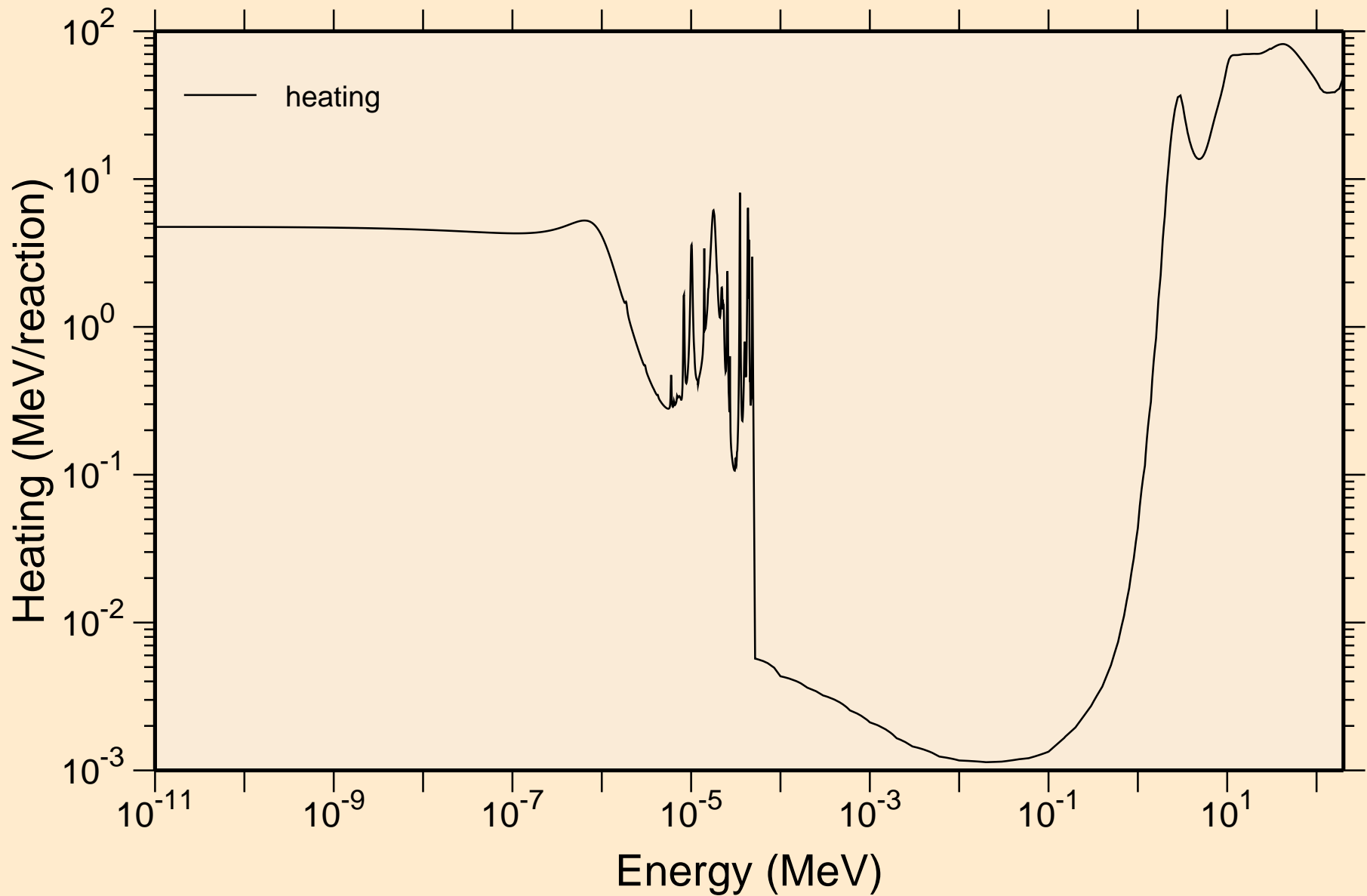

# NO252 NEUTRON ACER TENDL-2019 LIBRARY; T=293.16K Damage

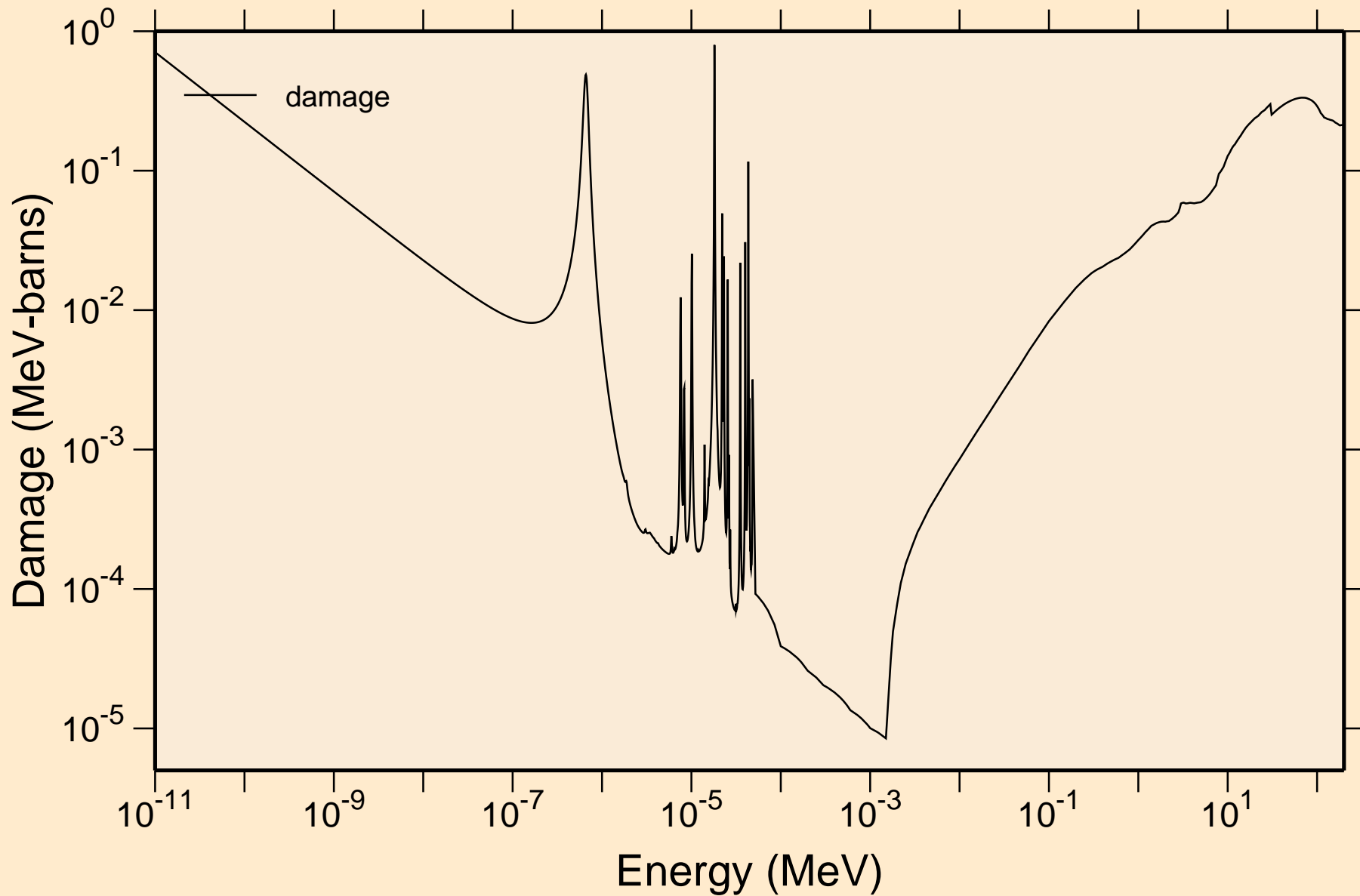

NO252 NEUTRON ACER TENDL-2019 LIBRARY; T=293.16K  
Non-threshold reactions

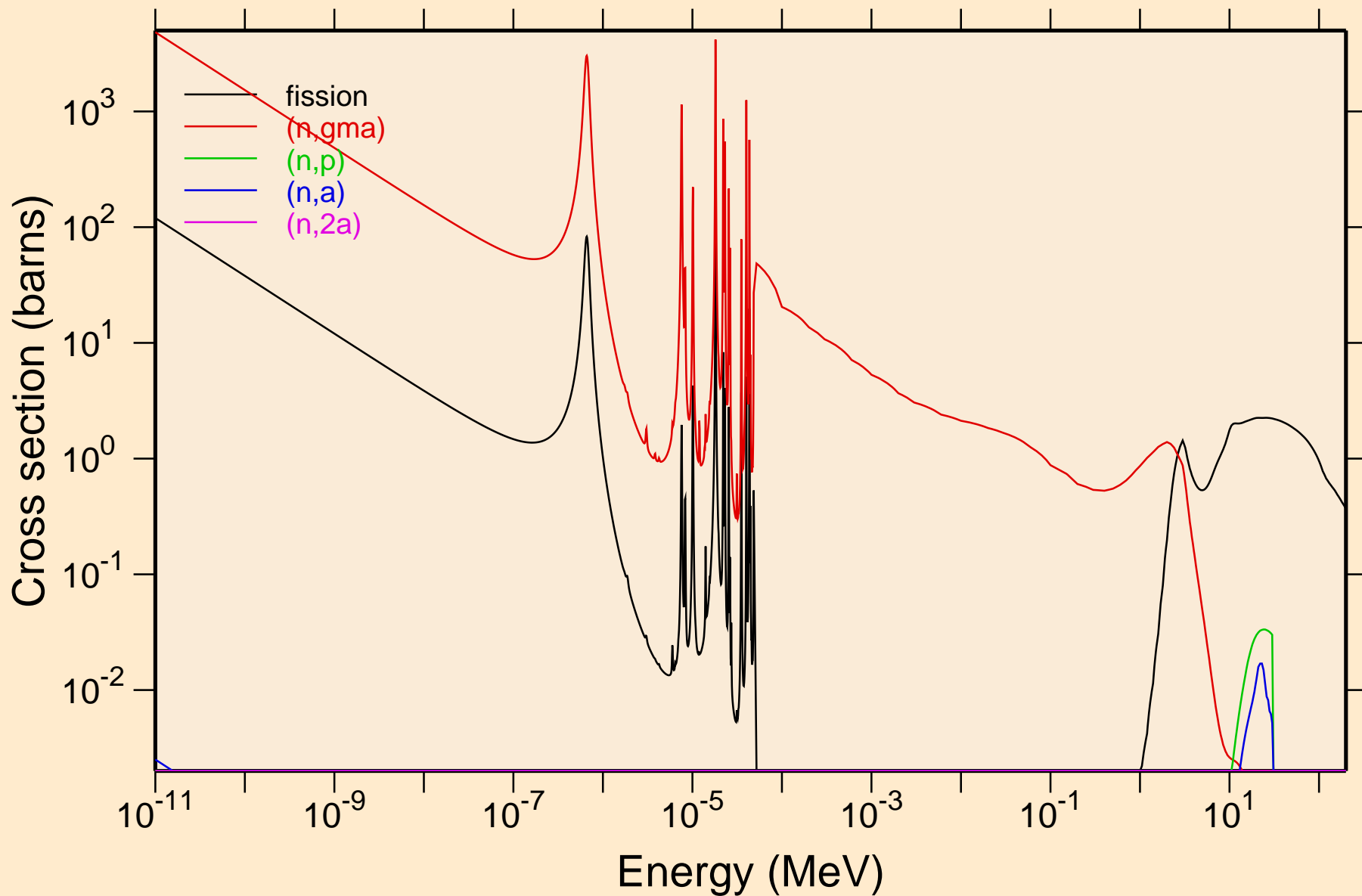

NO252 NEUTRON ACER TENDL-2019 LIBRARY; T=293.16K  
Non-threshold reactions

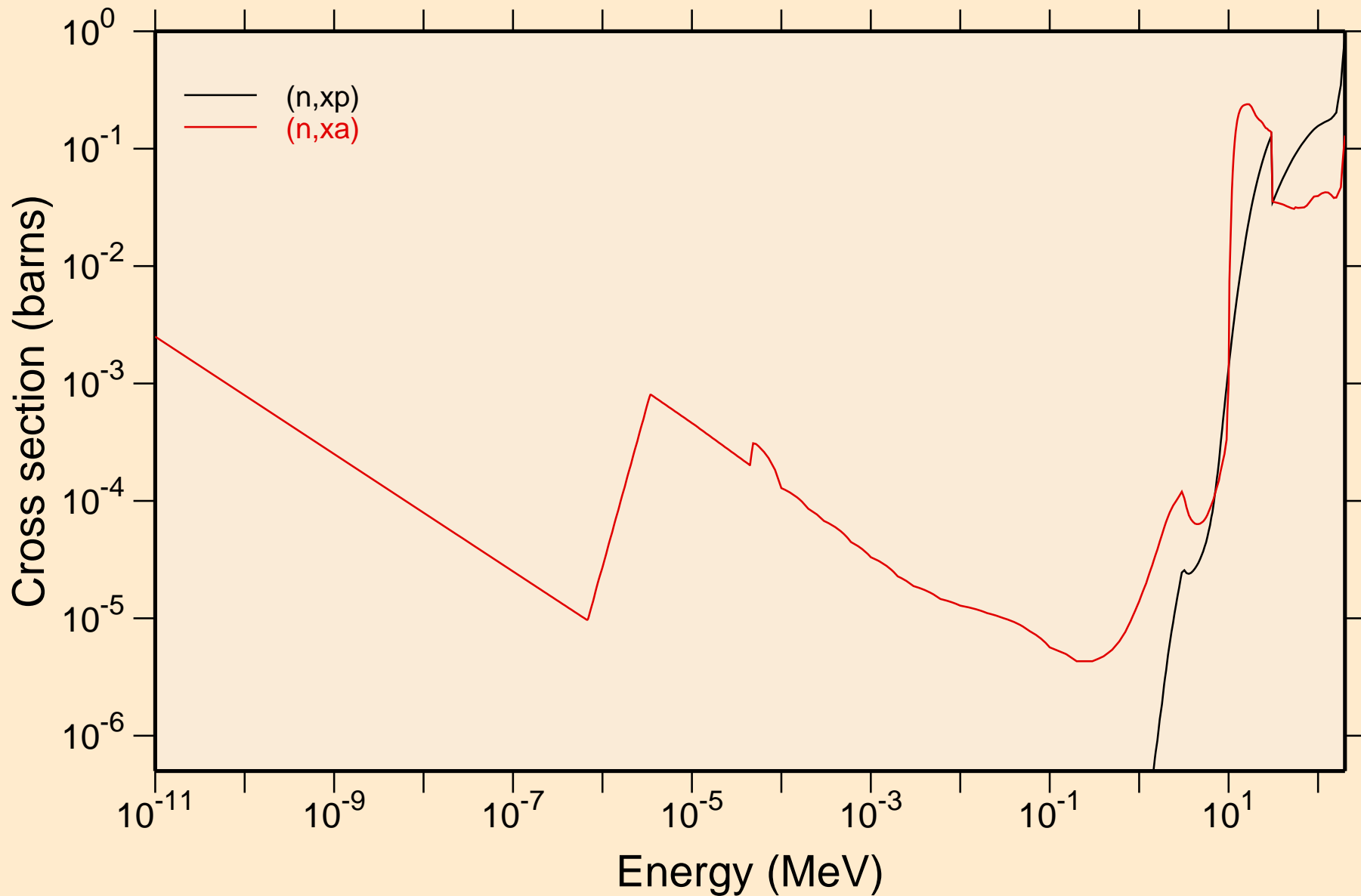

NO252 NEUTRON ACER TENDL-2019 LIBRARY; T=293.16K  
Principal cross sections

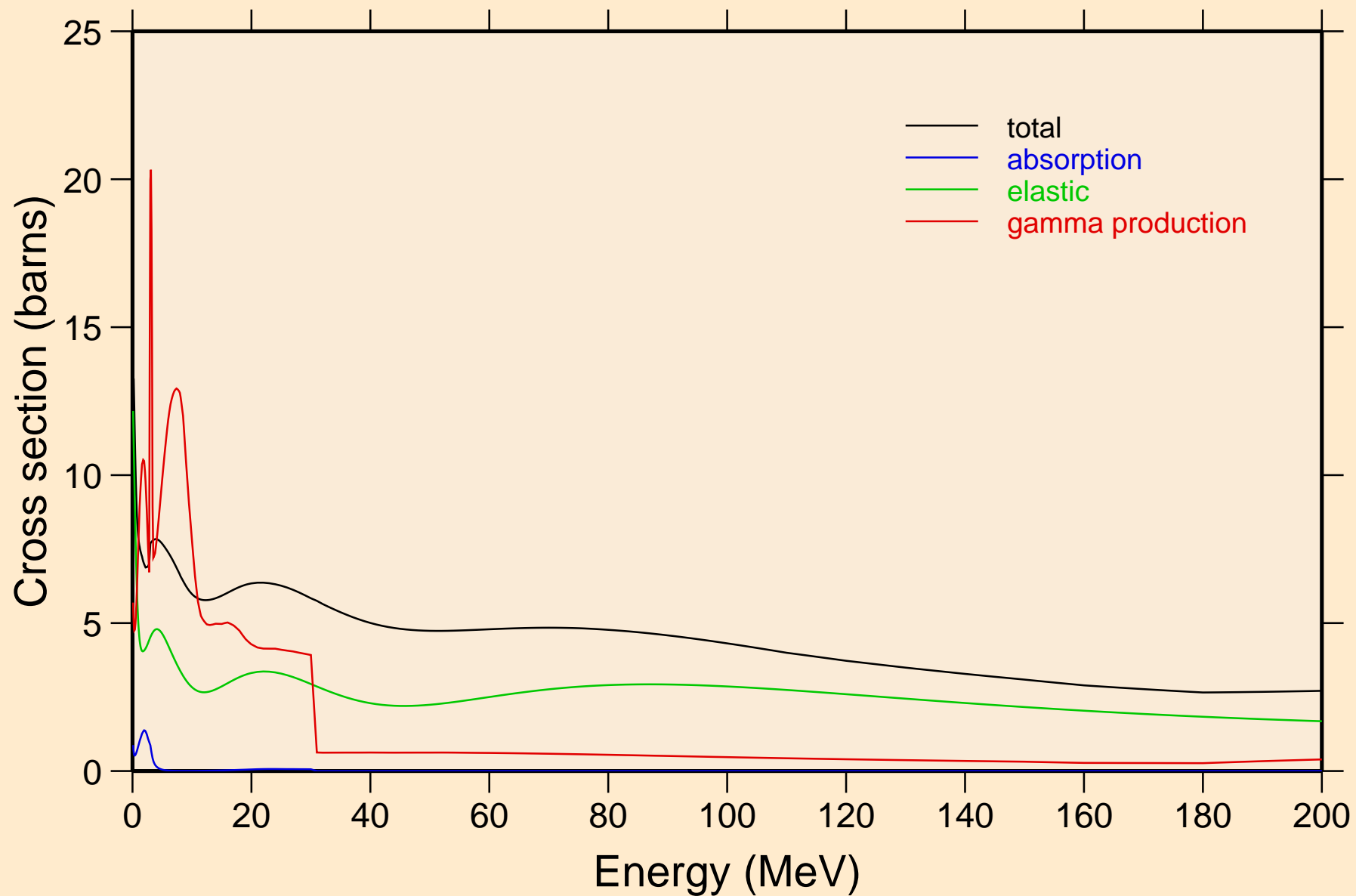

NO252 NEUTRON ACER TENDL-2019 LIBRARY; T=293.16K  
Heating

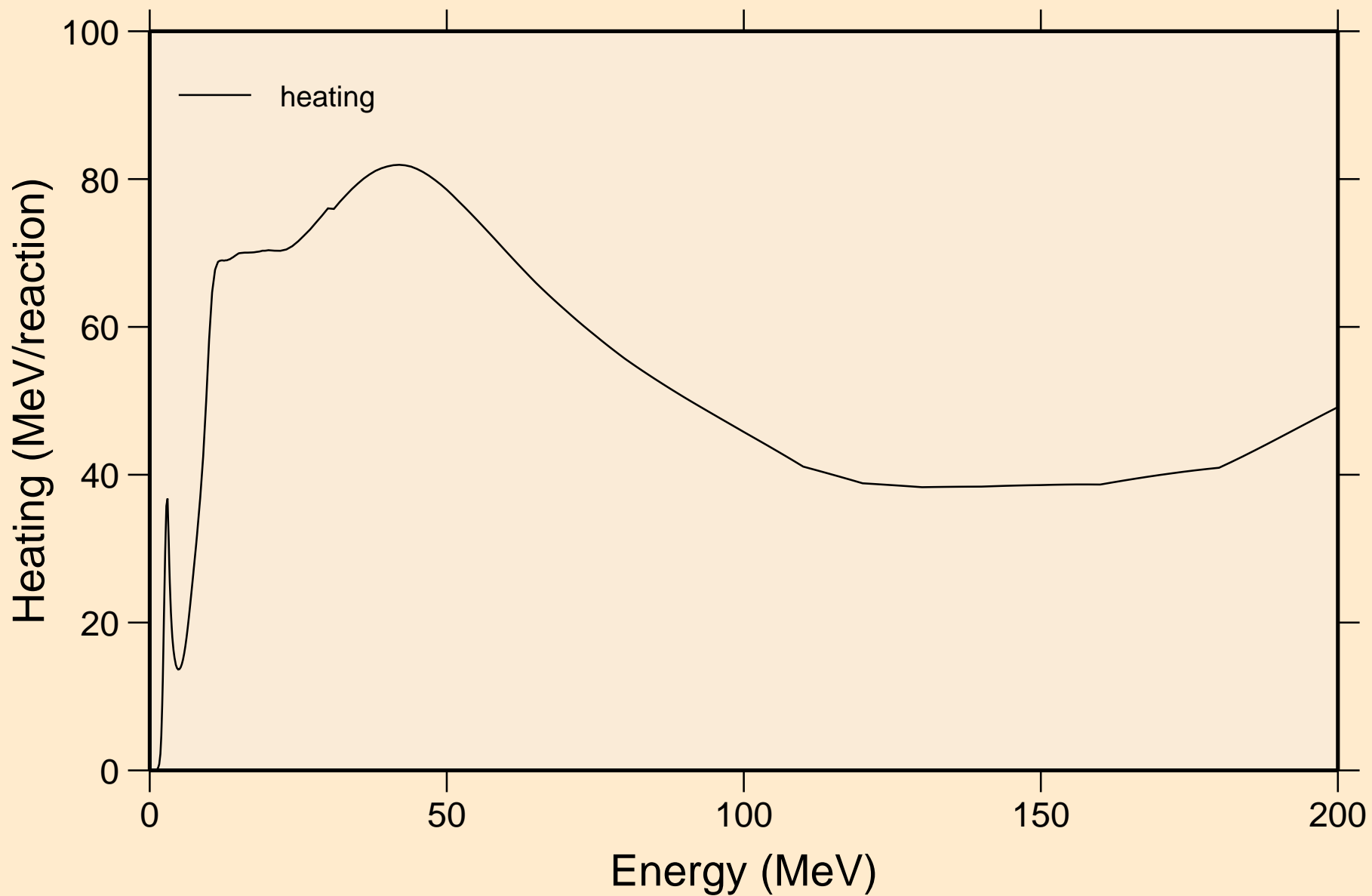

NO252 NEUTRON ACER TENDL-2019 LIBRARY; T=293.16K  
Damage

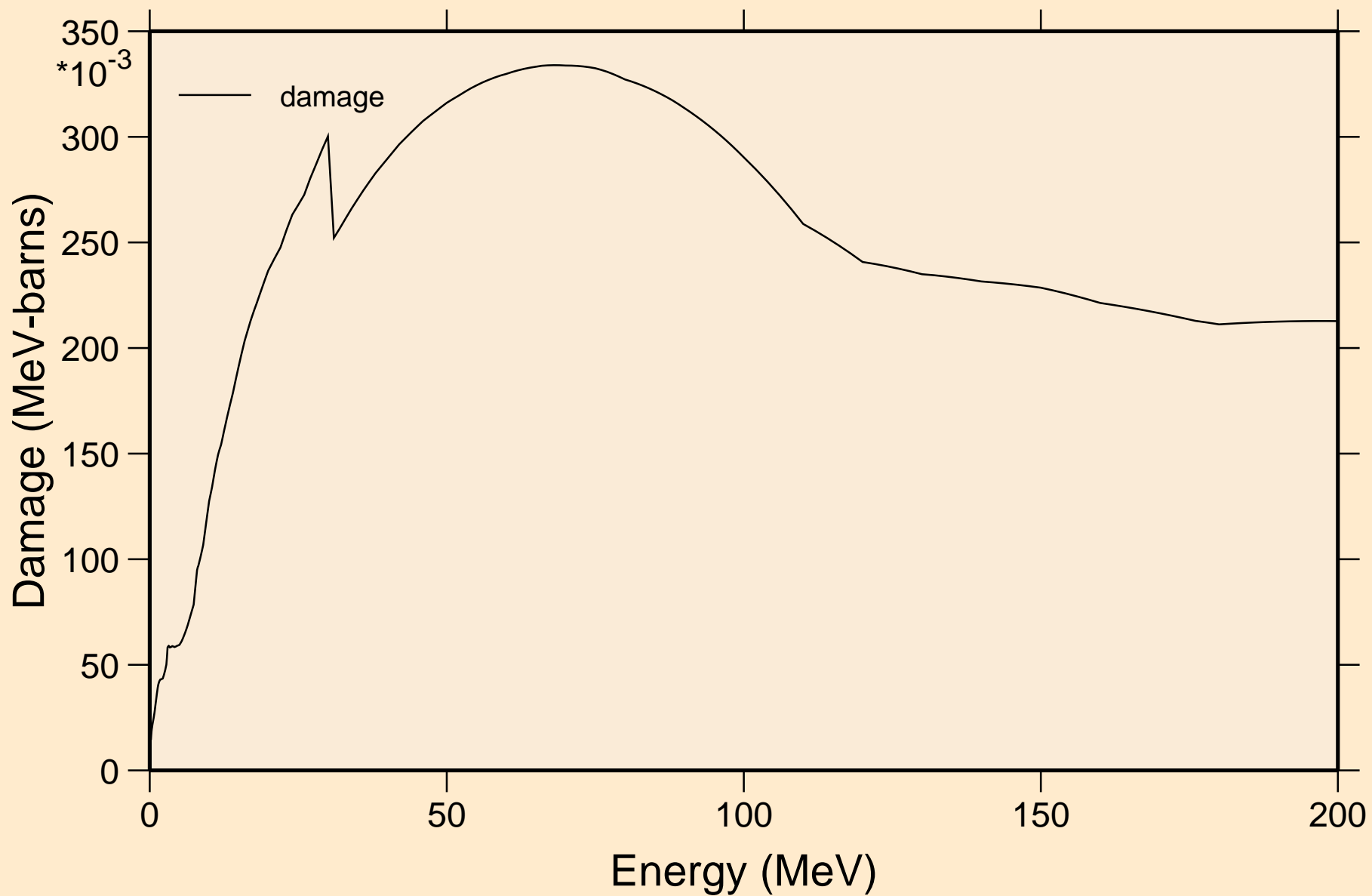

NO252 NEUTRON ACER TENDL-2019 LIBRARY; T=293.16K  
Non-threshold reactions

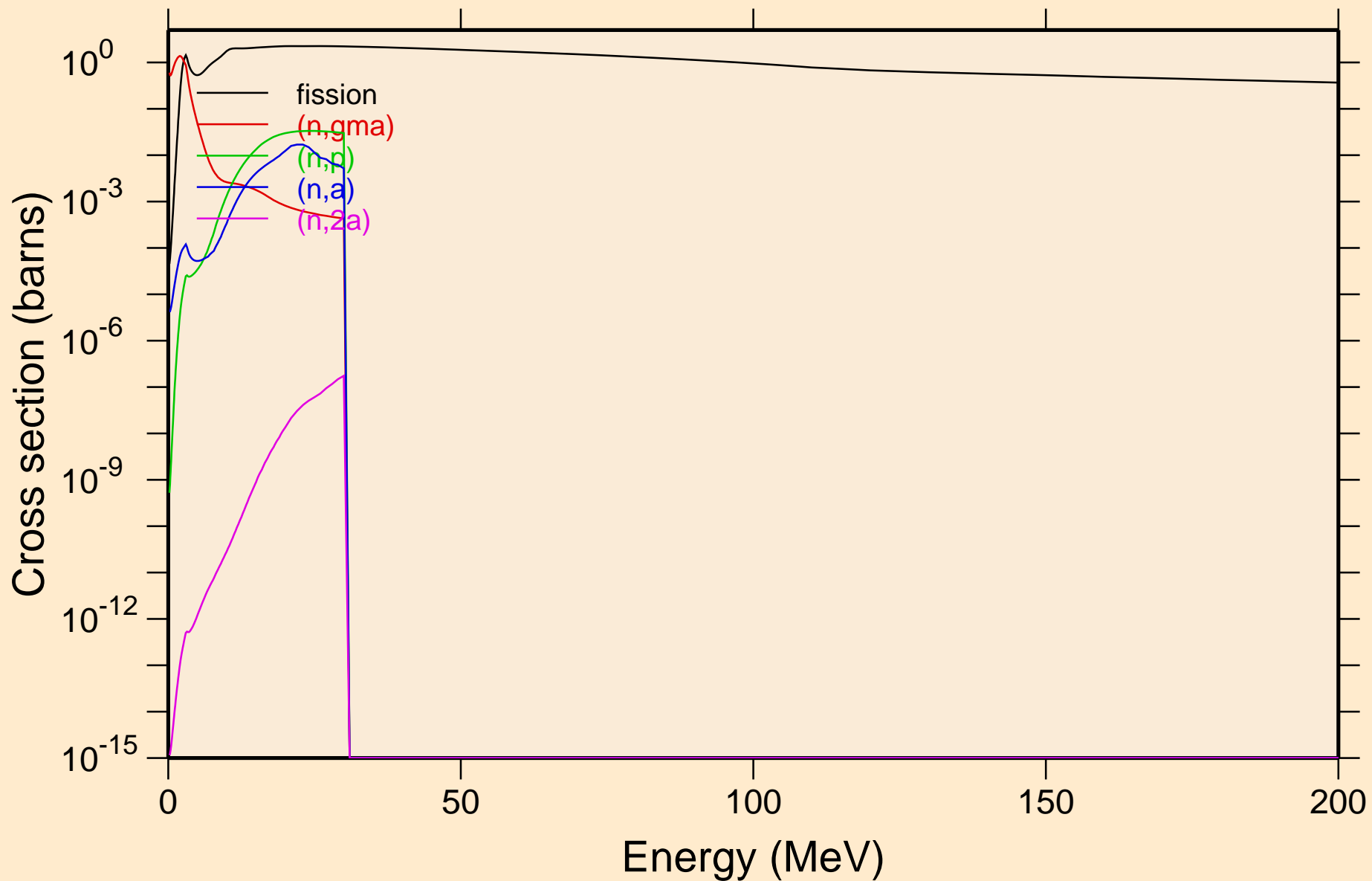

NO252 NEUTRON ACER TENDL-2019 LIBRARY; T=293.16K  
Non-threshold reactions

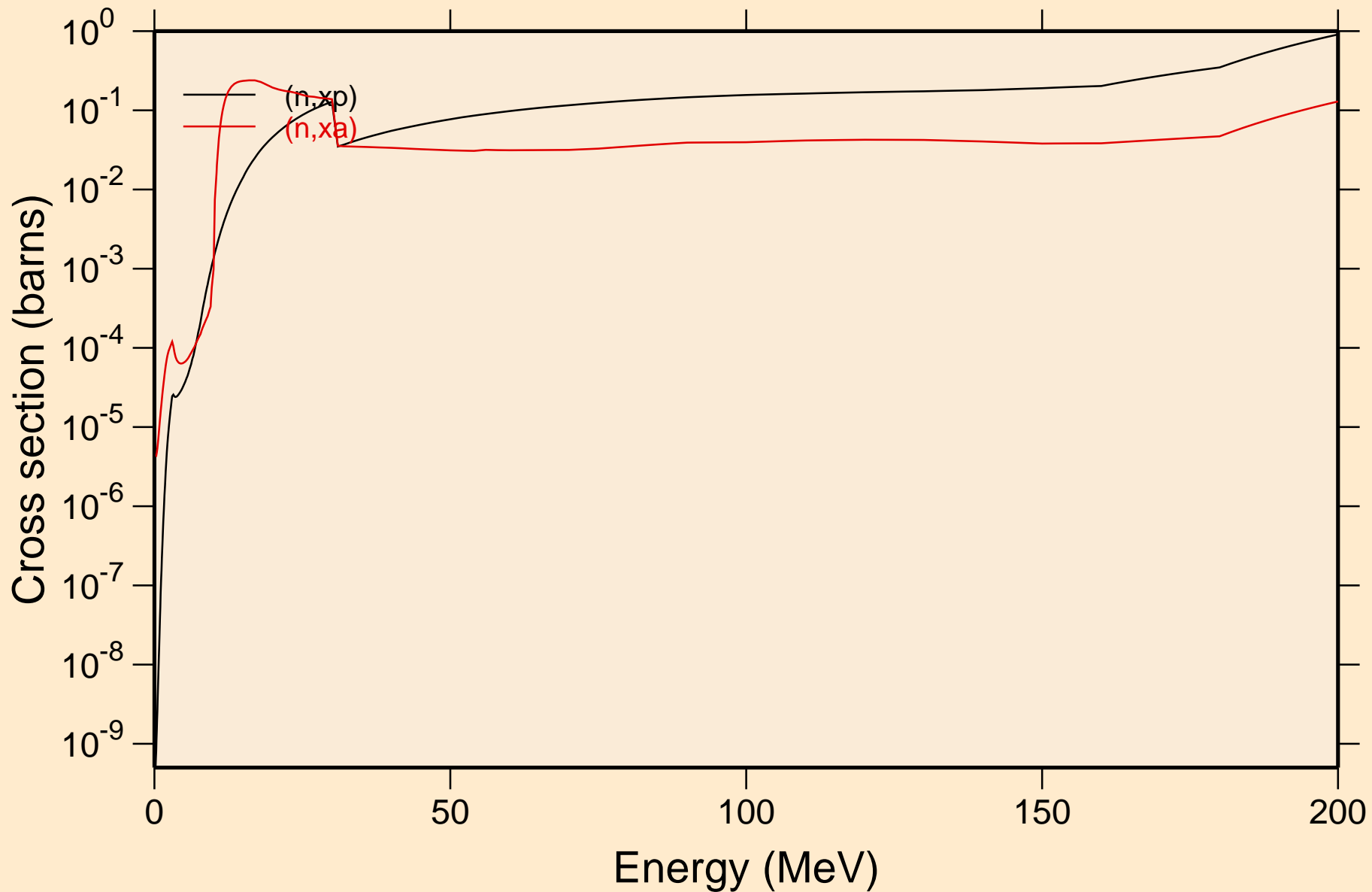

NO252 NEUTRON ACER TENDL-2019 LIBRARY; T=293.16K  
Inelastic levels

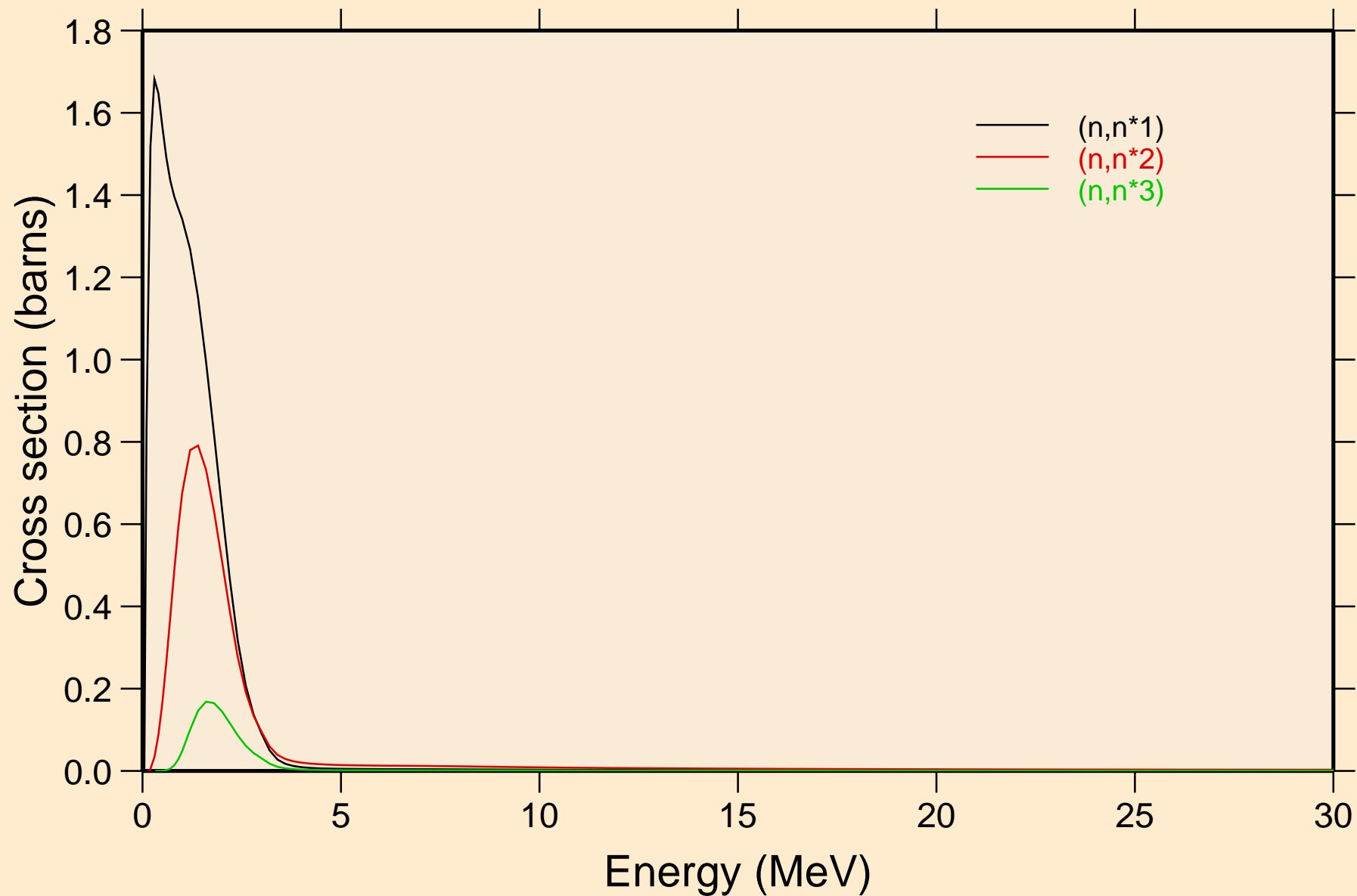

# NO252 NEUTRON ACER TENDL-2019 LIBRARY; T=293.16K

## Threshold reactions

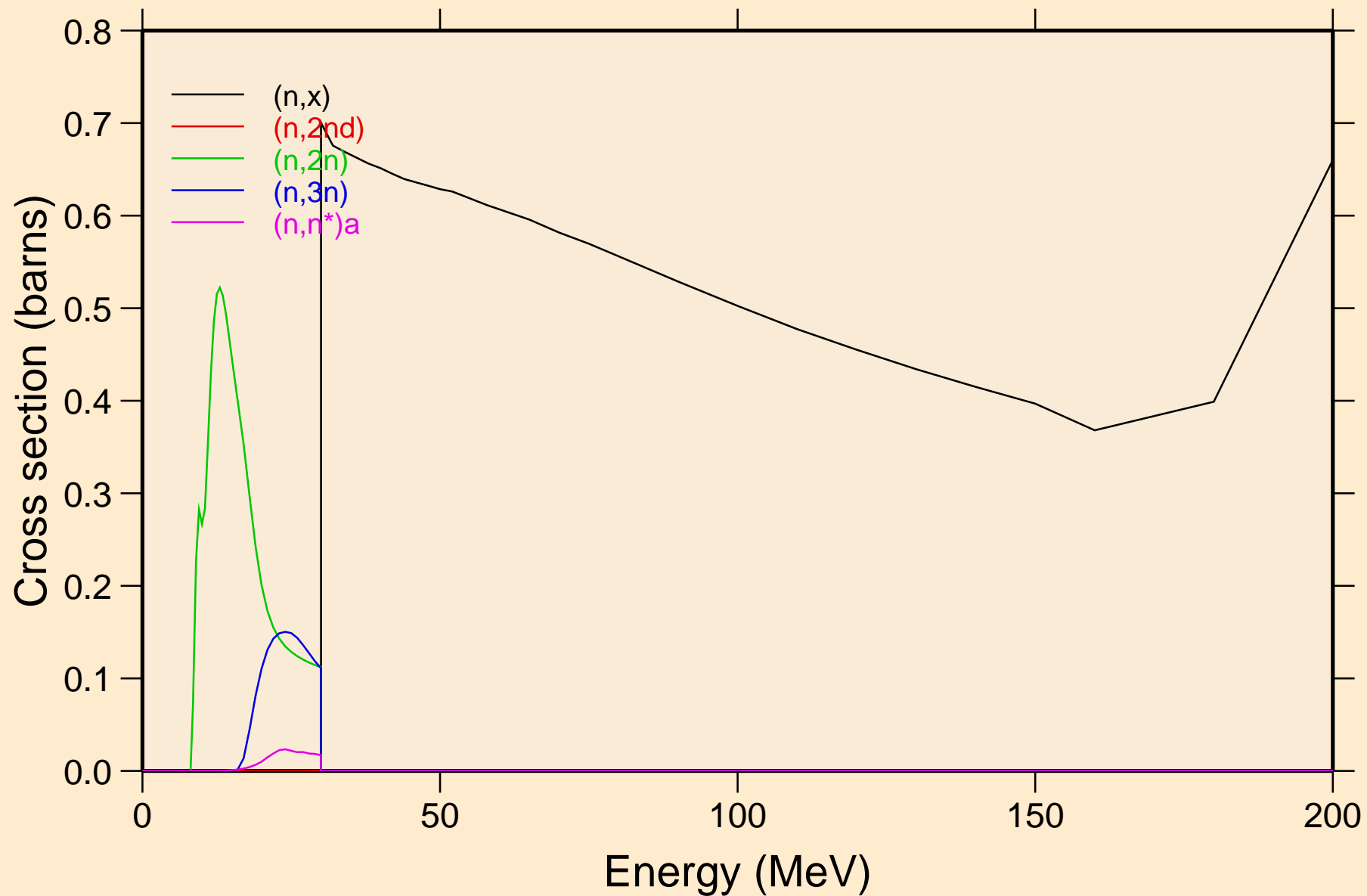

NO252 NEUTRON ACER TENDL-2019 LIBRARY; T=293.16K  
Threshold reactions

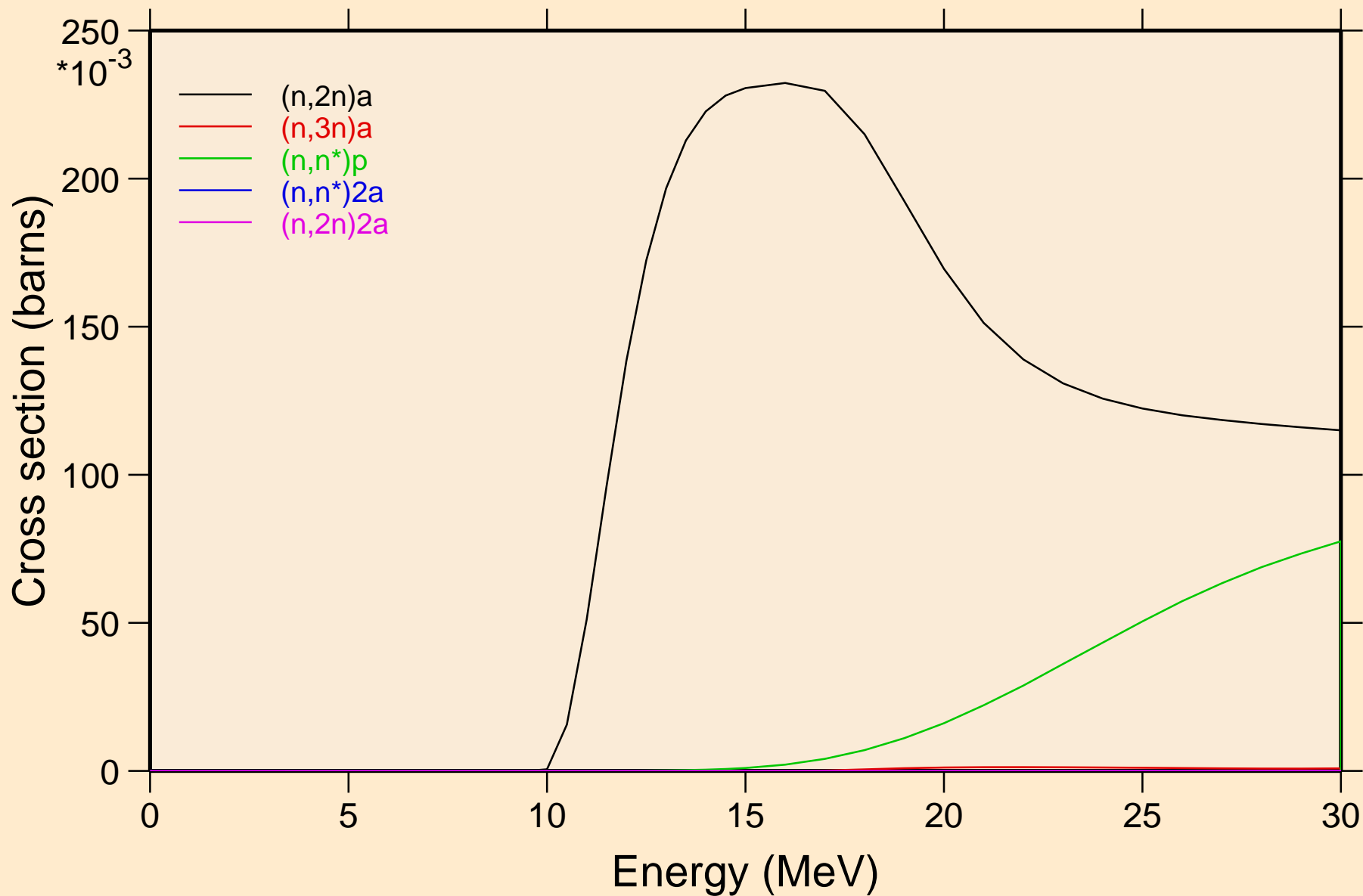

NO252 NEUTRON ACER TENDL-2019 LIBRARY; T=293.16K  
Threshold reactions

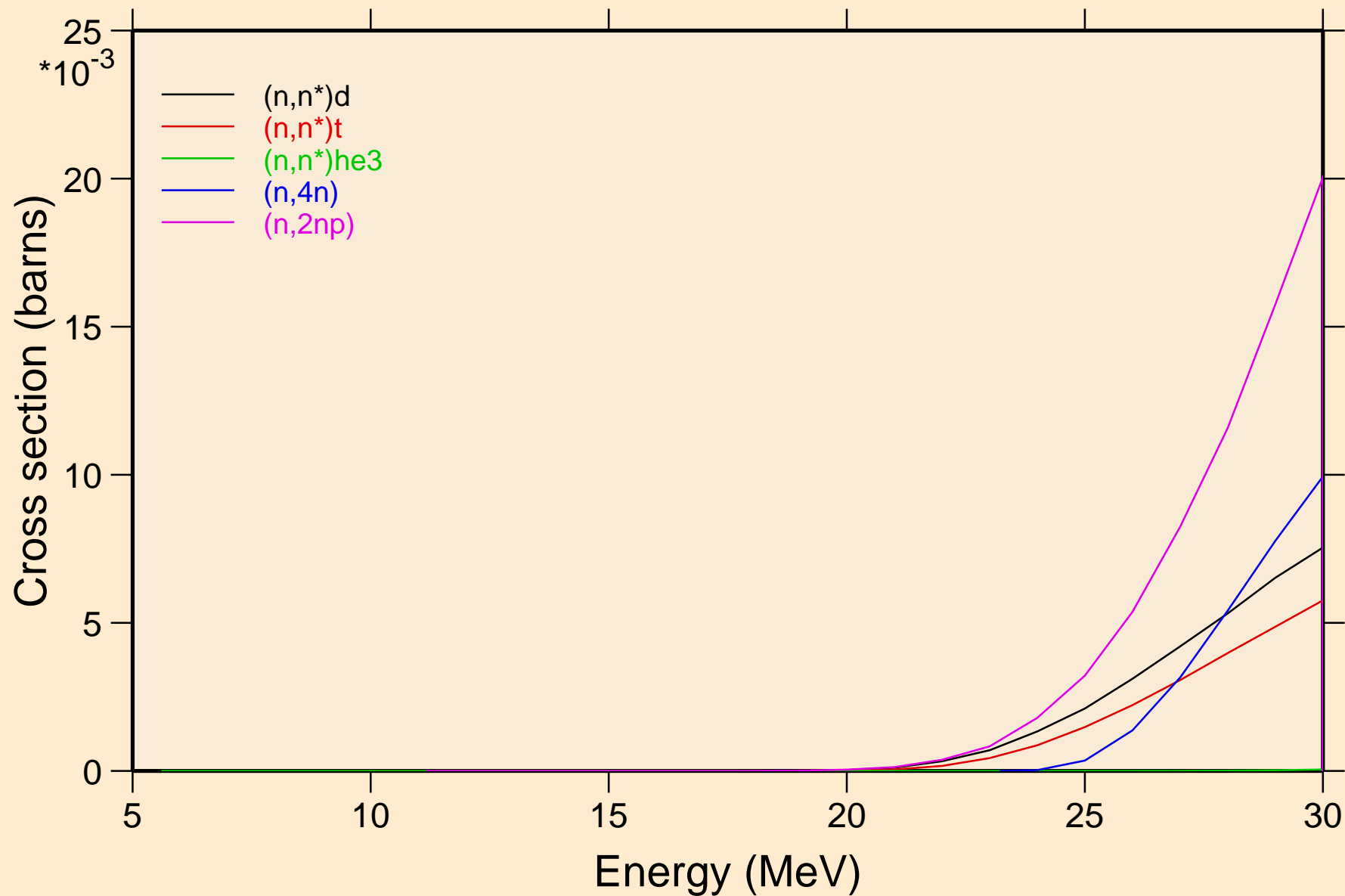

NO252 NEUTRON ACER TENDL-2019 LIBRARY; T=293.16K  
Threshold reactions

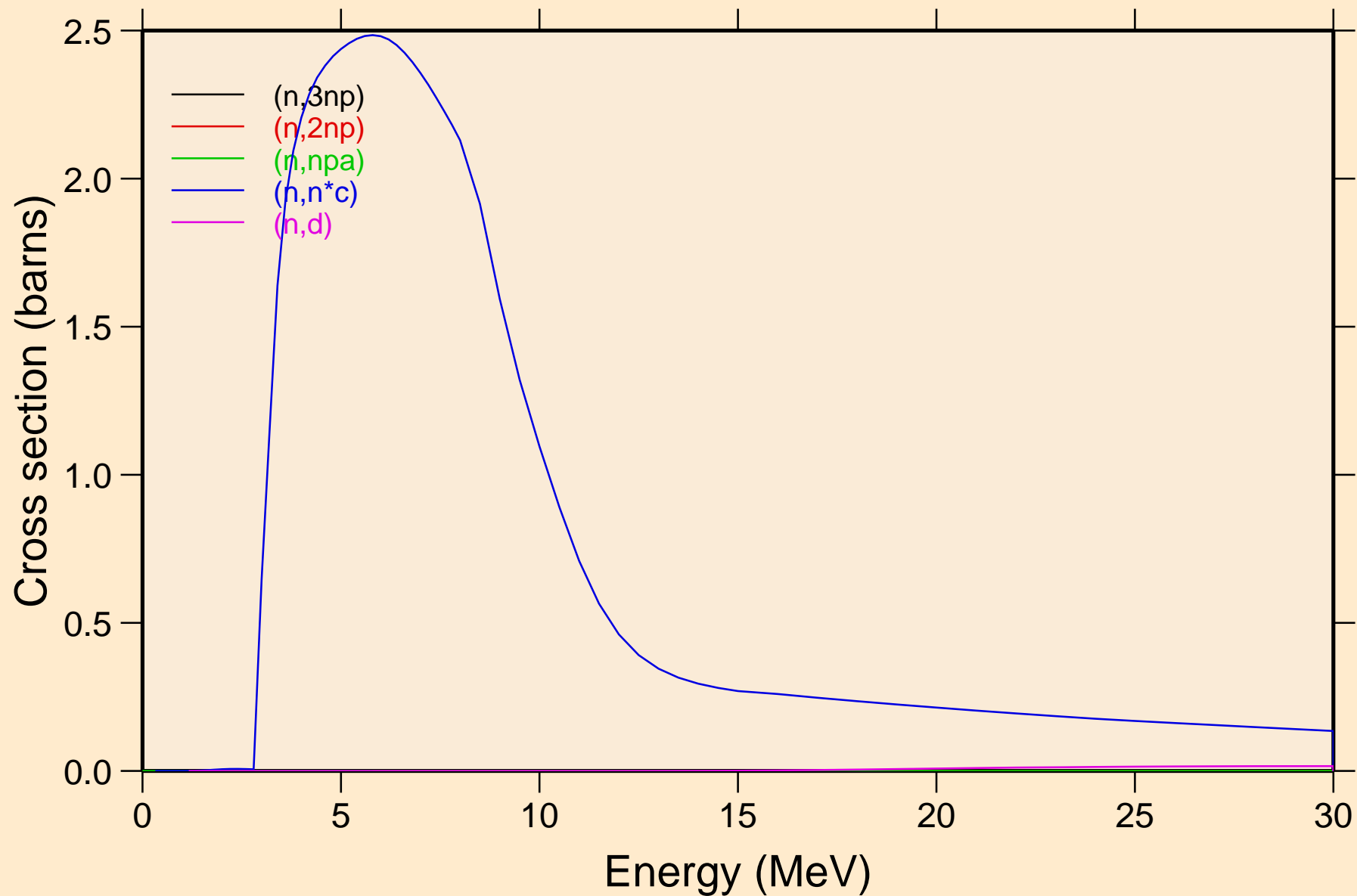

NO252 NEUTRON ACER TENDL-2019 LIBRARY; T=293.16K  
Threshold reactions

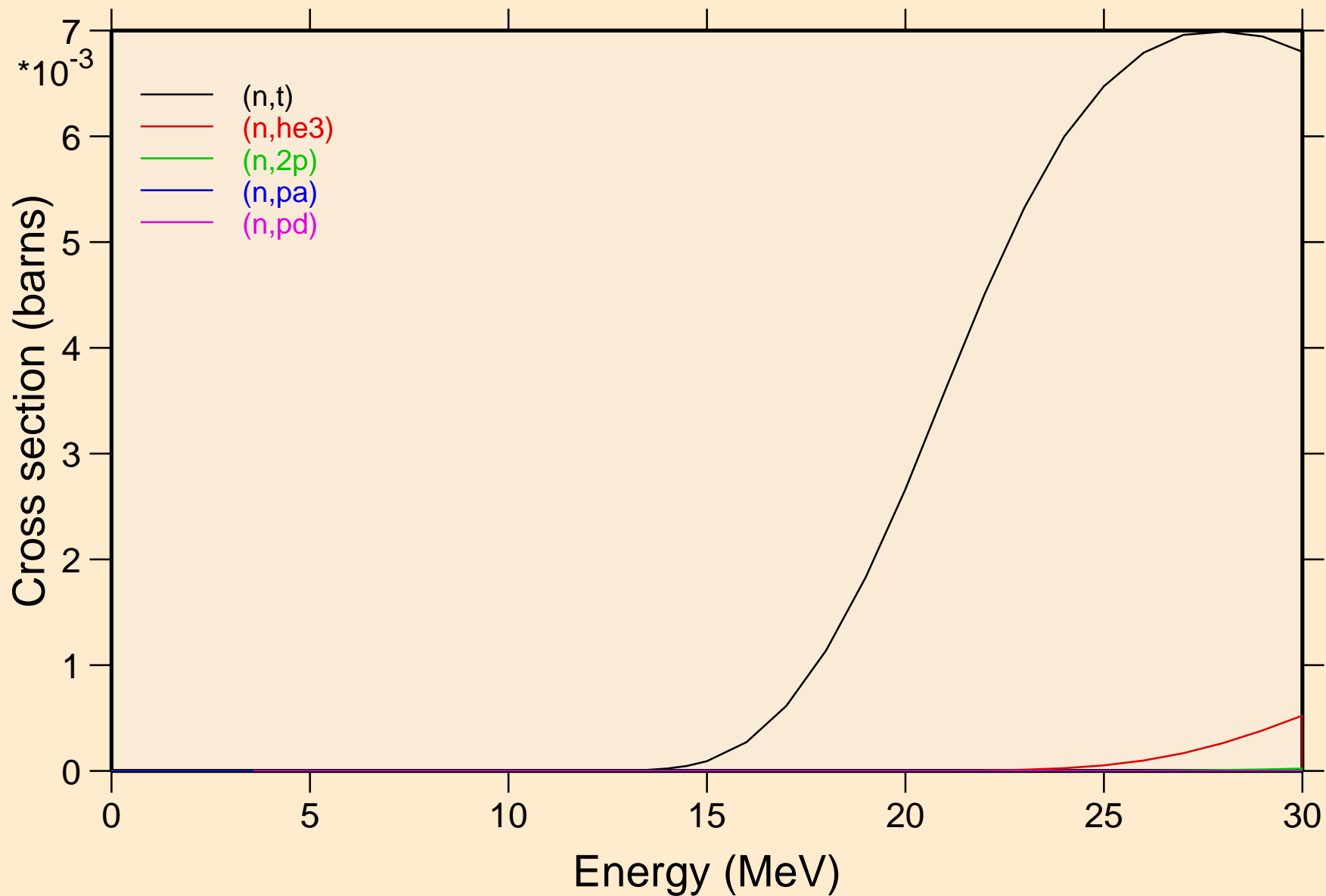

NO252 NEUTRON ACER TENDL-2019 LIBRARY; T=293.16K  
Threshold reactions

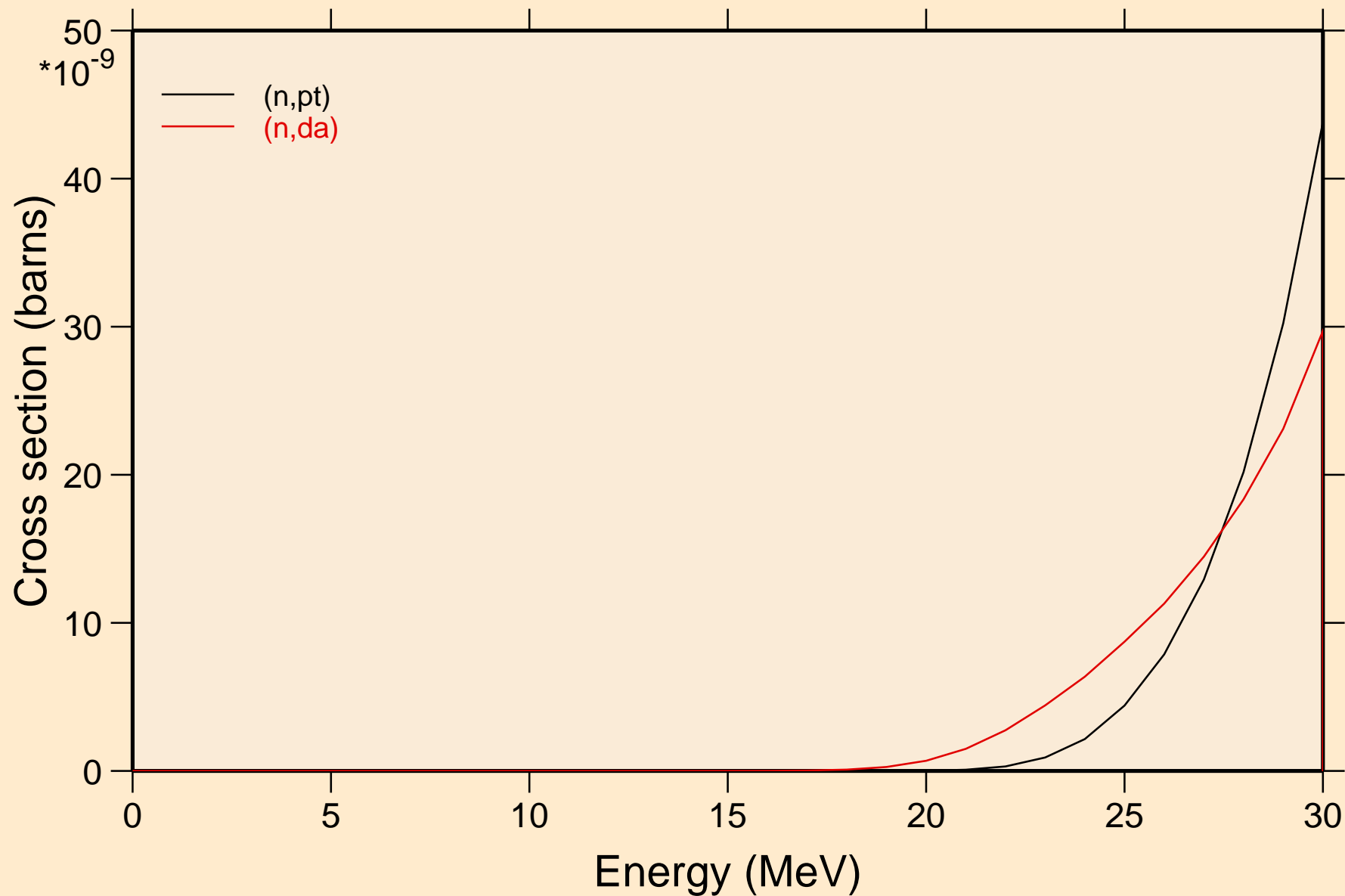

NO252 NEUTRON ACER TENDL-2019 LIBRARY; T=293.16K  
Threshold reactions

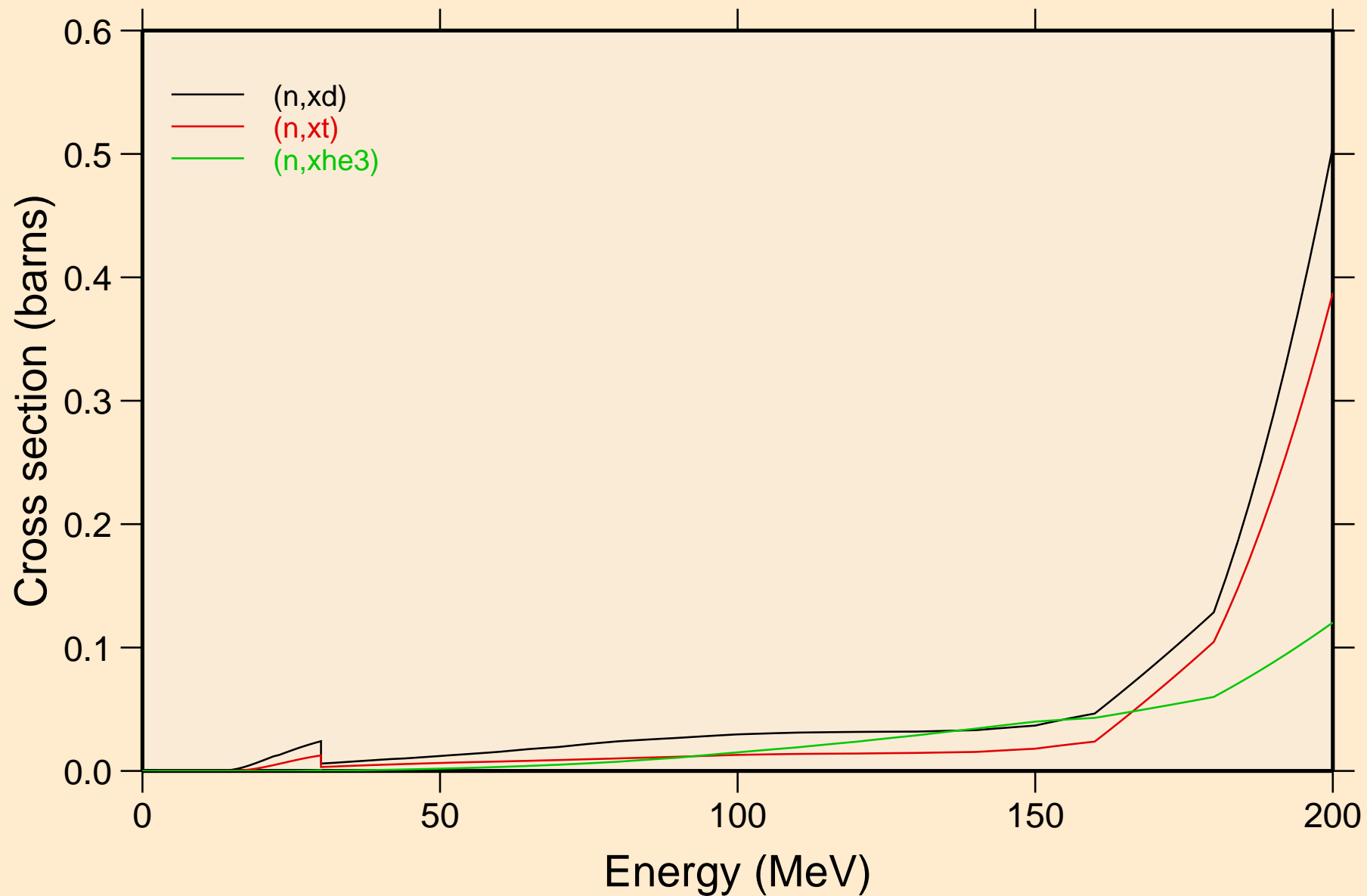

NO252 NEUTRON ACER TENDL-2019 LIBRARY; T=293.16K  
angular distribution for elastic

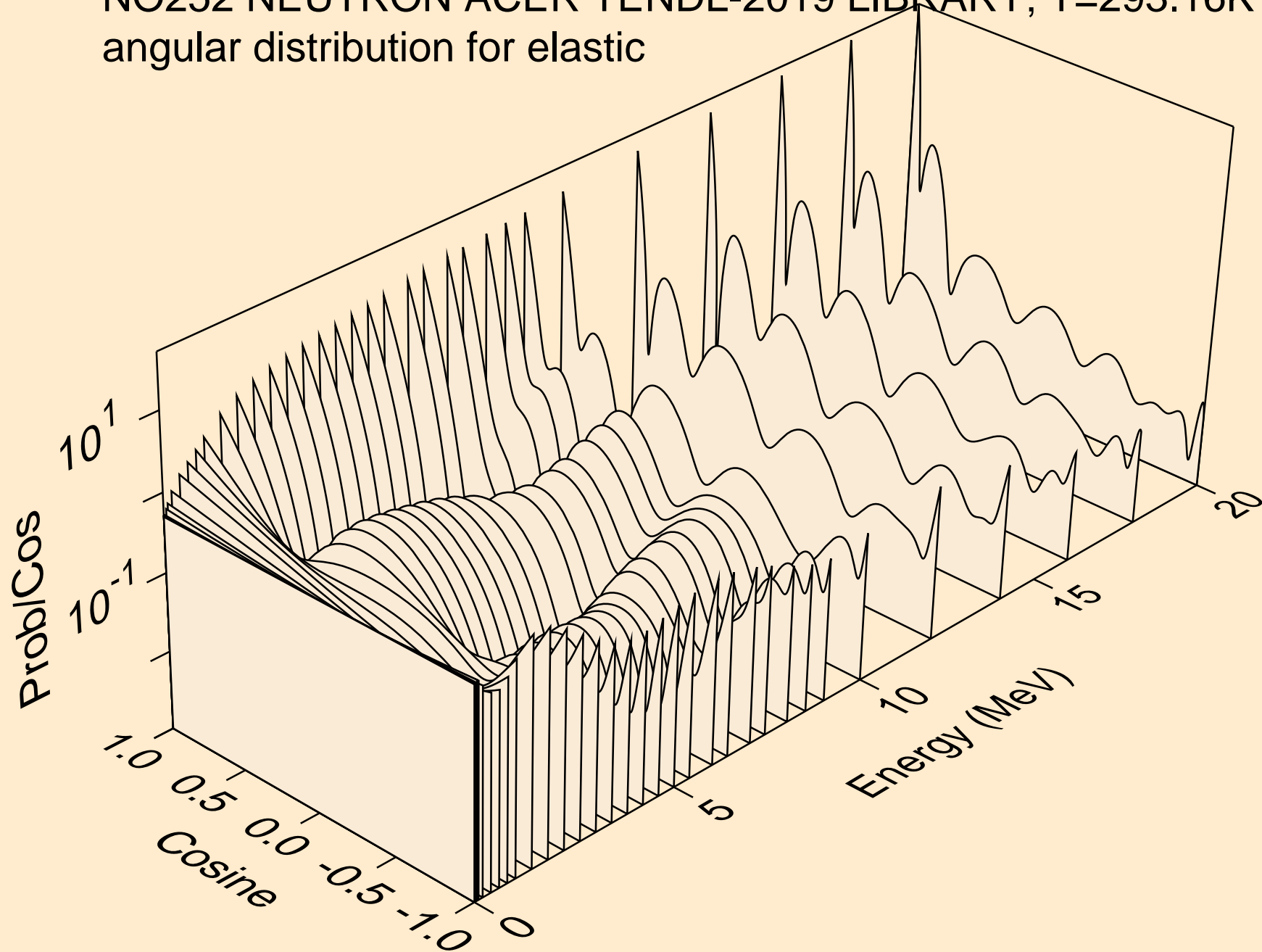

NO252 NEUTRON ACER TENDL-2019 LIBRARY; T=293.16K  
angular distribution for elastic

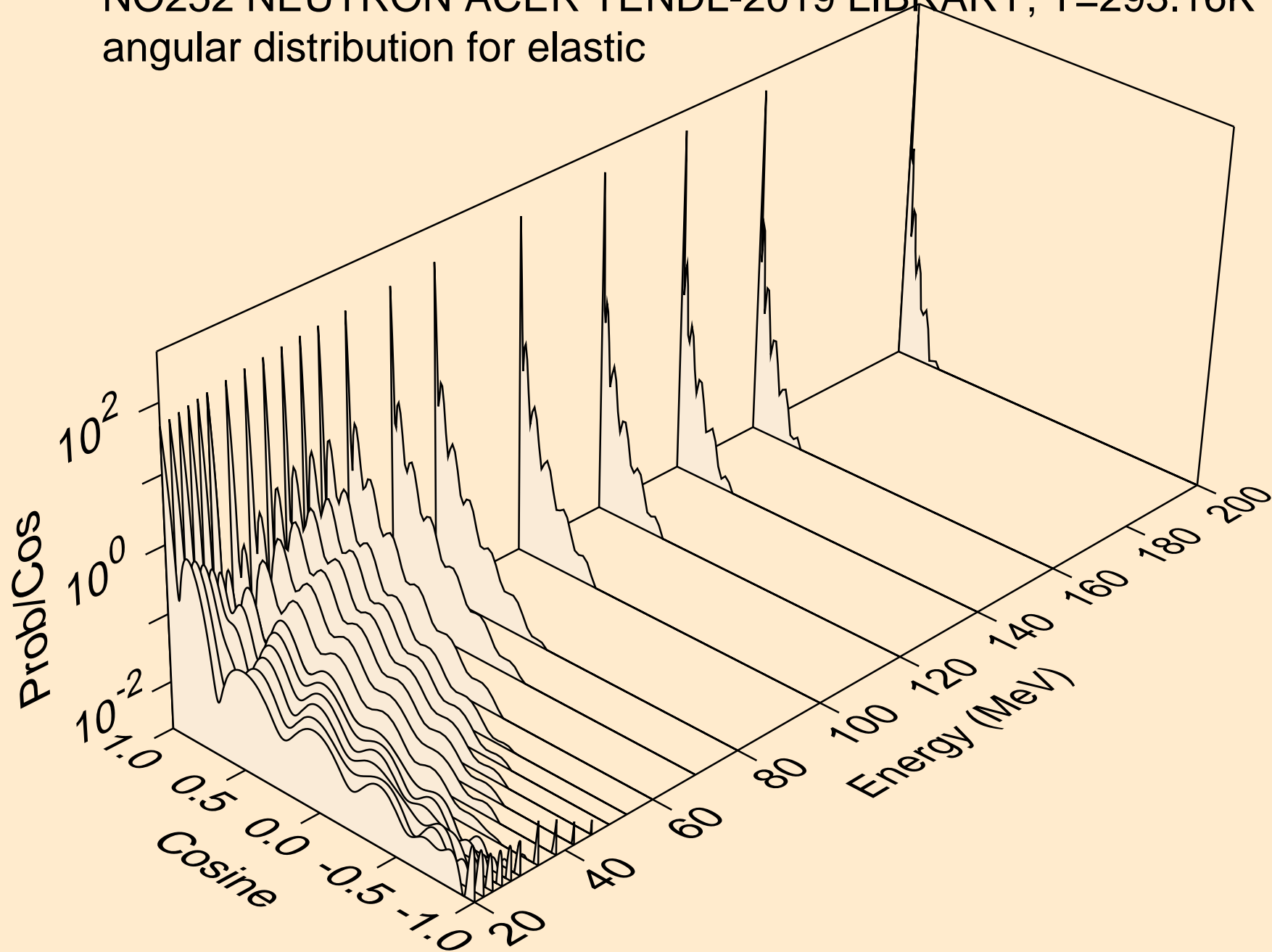

NO252 NEUTRON ACER TENDL-2019 LIBRARY; T=293.16K  
angular distribution for (n,n\*1)

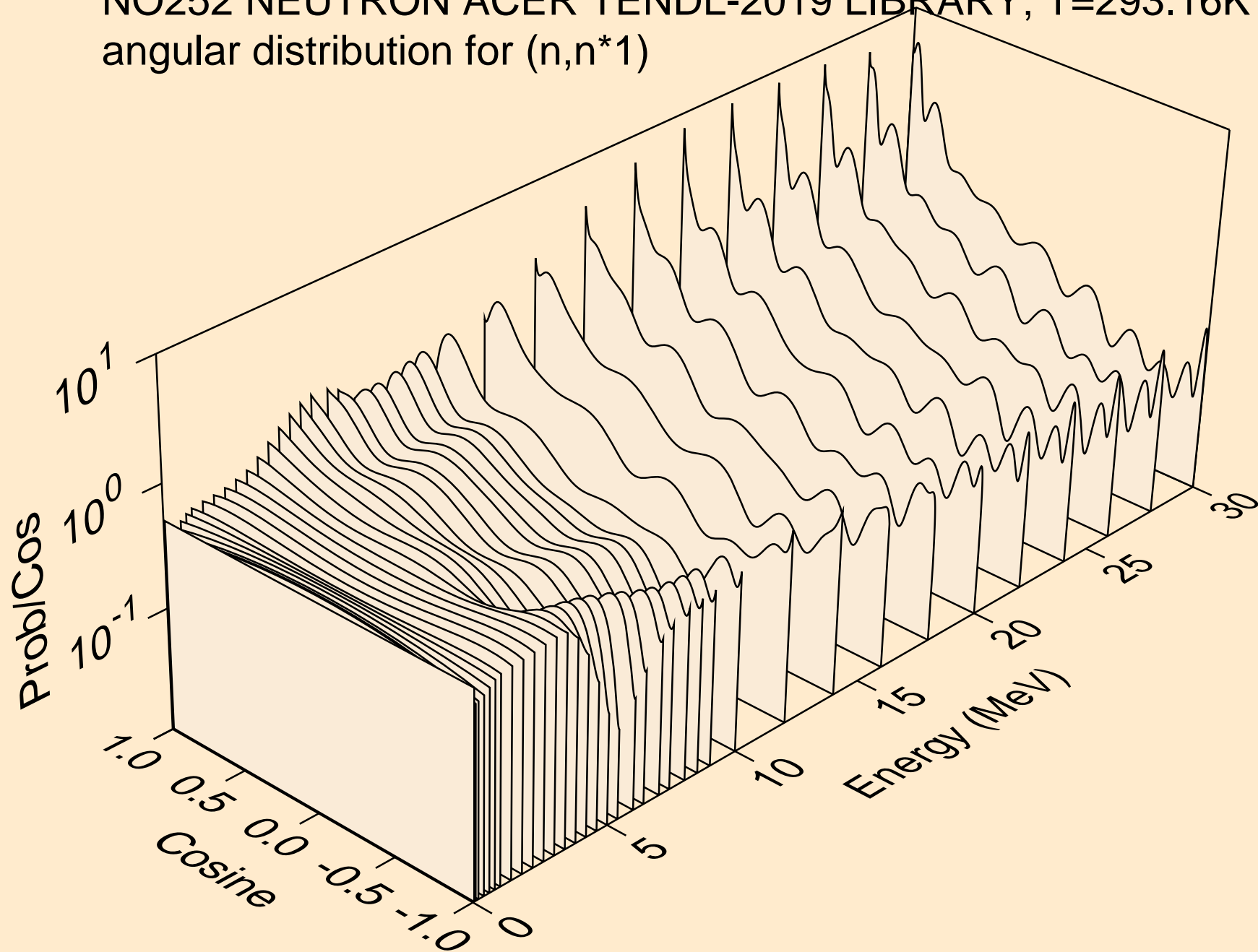

NO252 NEUTRON ACER TENDL-2019 LIBRARY; T=293.16K  
angular distribution for (n,n\*2)

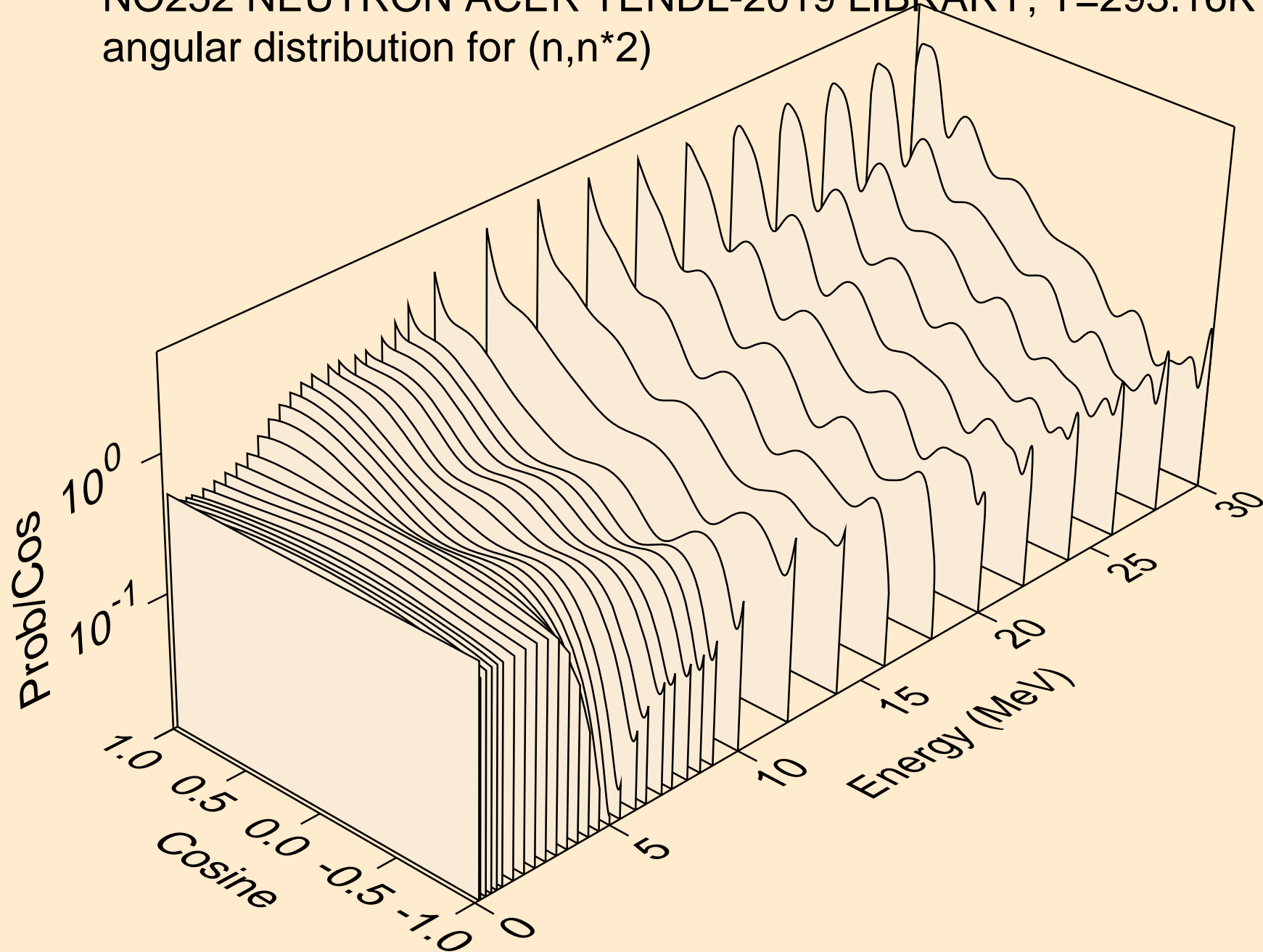

NO252 NEUTRON ACER TENDL-2019 LIBRARY; T=293.16K  
angular distribution for (n,n\*3)

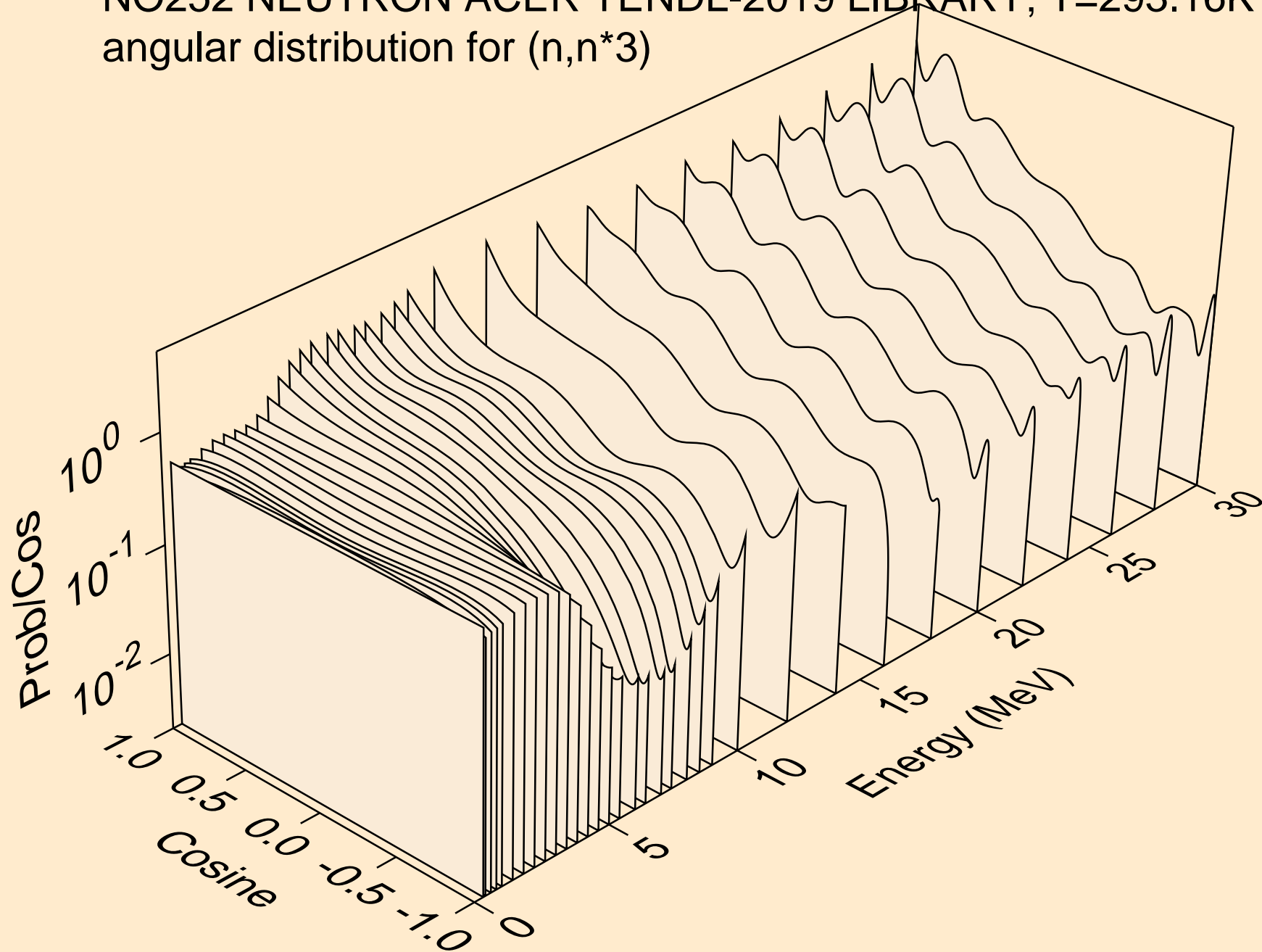

NO252 NEUTRON ACER TENDL-2019 LIBRARY; T=293.16K  
Total fission nubar

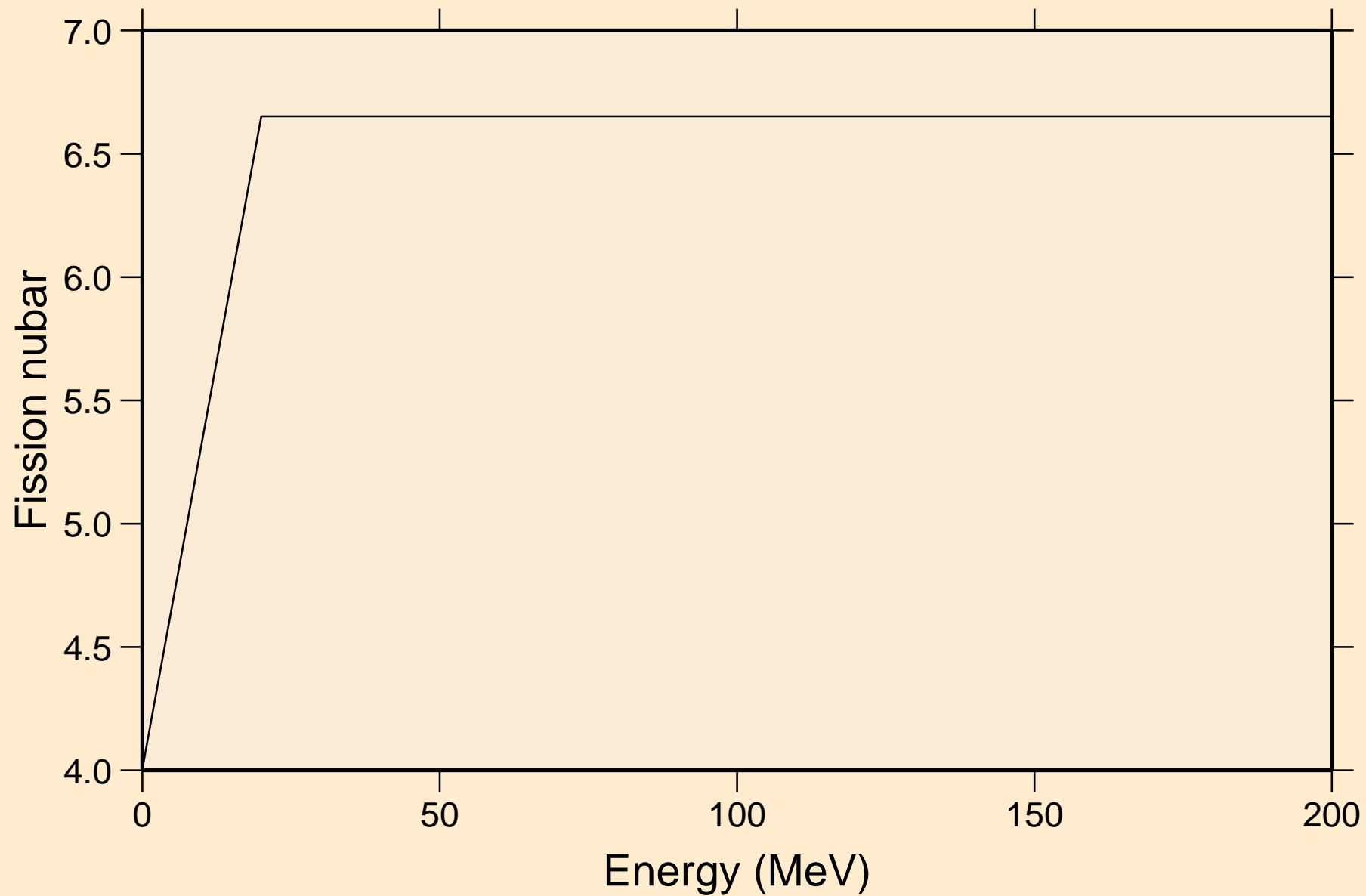

NO252 NEUTRON ACER TENDL-2019 LIBRARY; T=293.16K  
Neutron emission for (n,x)

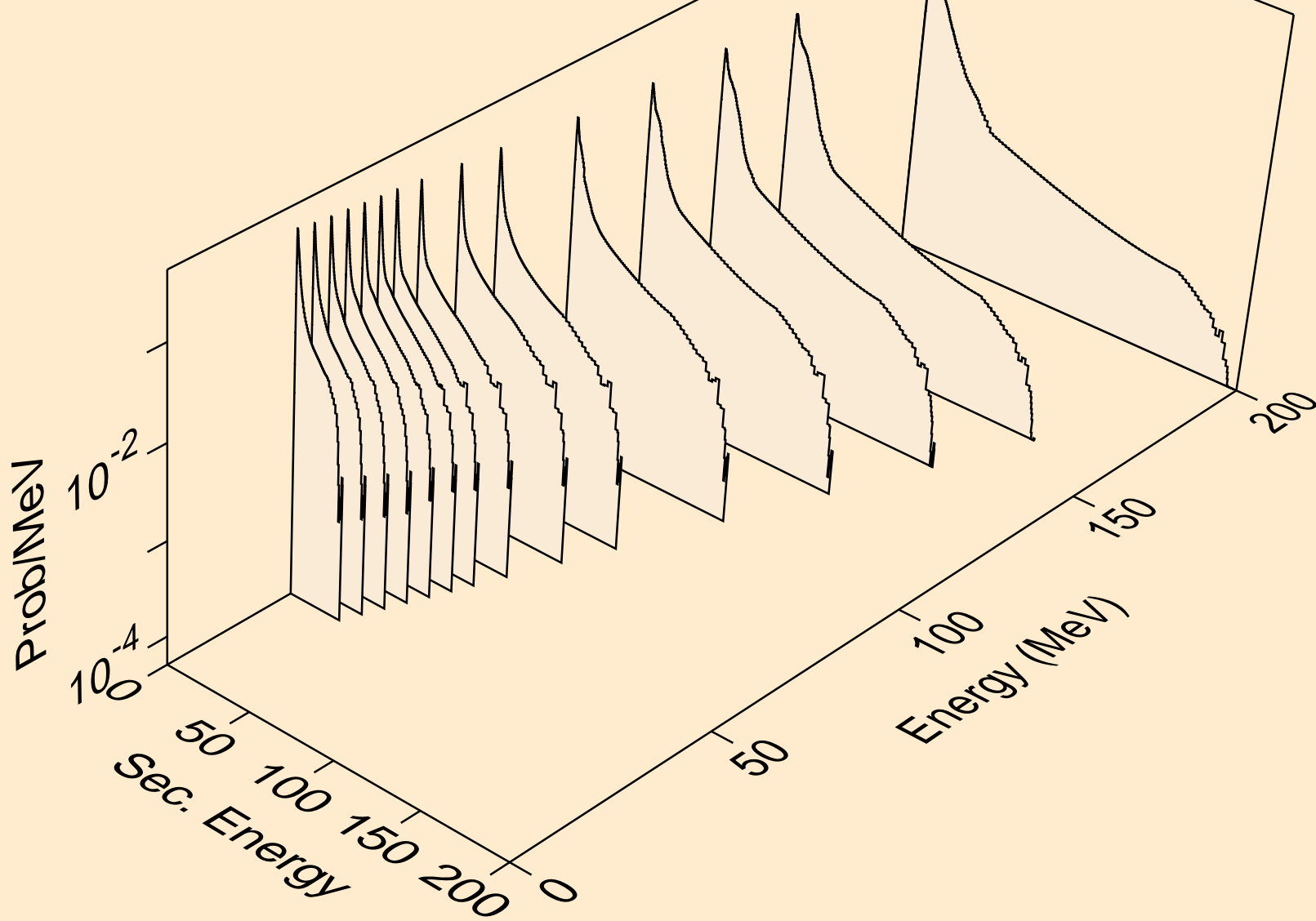

NO252 NEUTRON ACER TENDL-2019 LIBRARY; T=293.16K  
Neutron emission for (n,2nd)

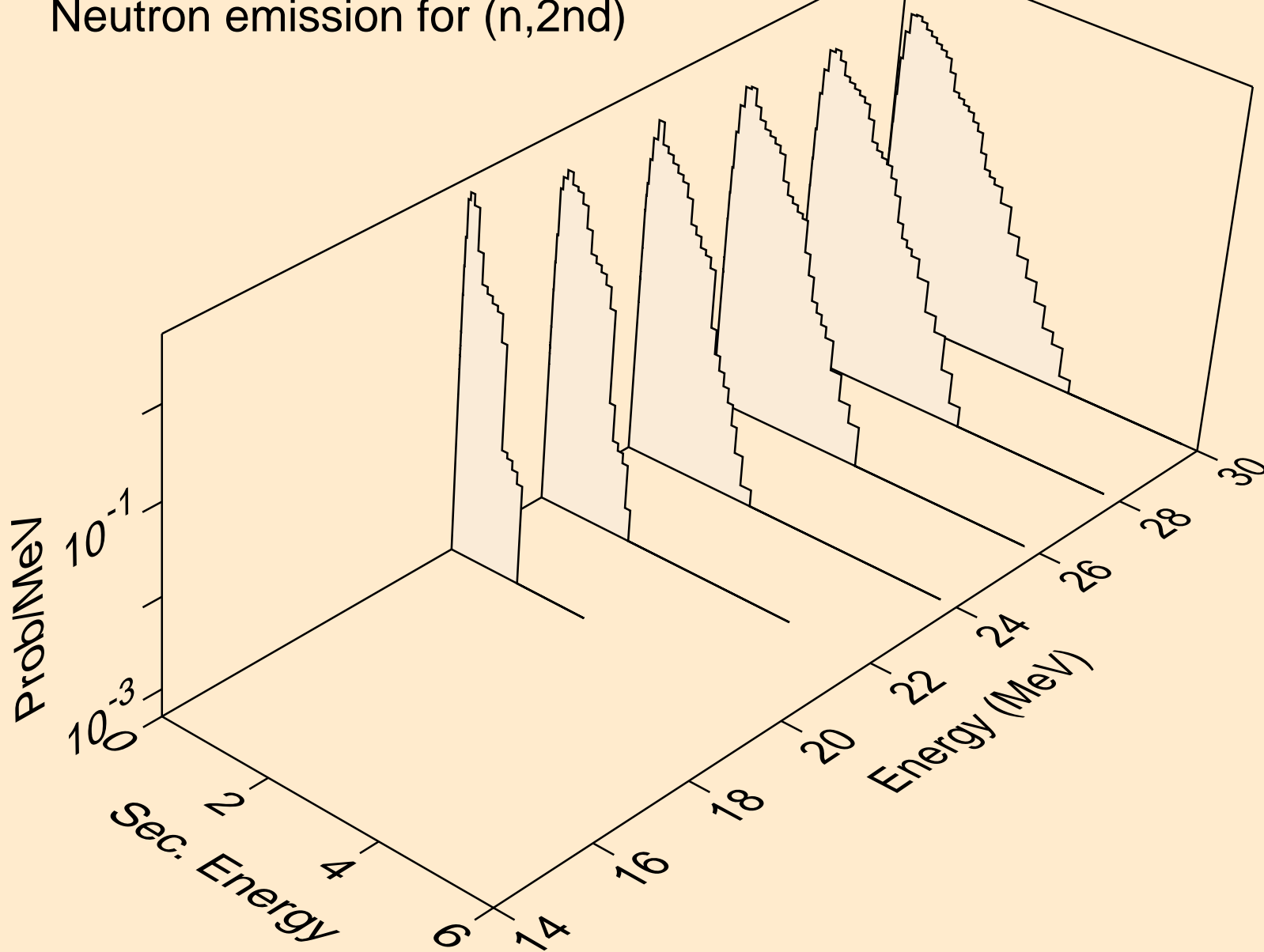

NO252 NEUTRON ACER TENDL-2019 LIBRARY; T=293.16K  
Neutron emission for (n,2n)

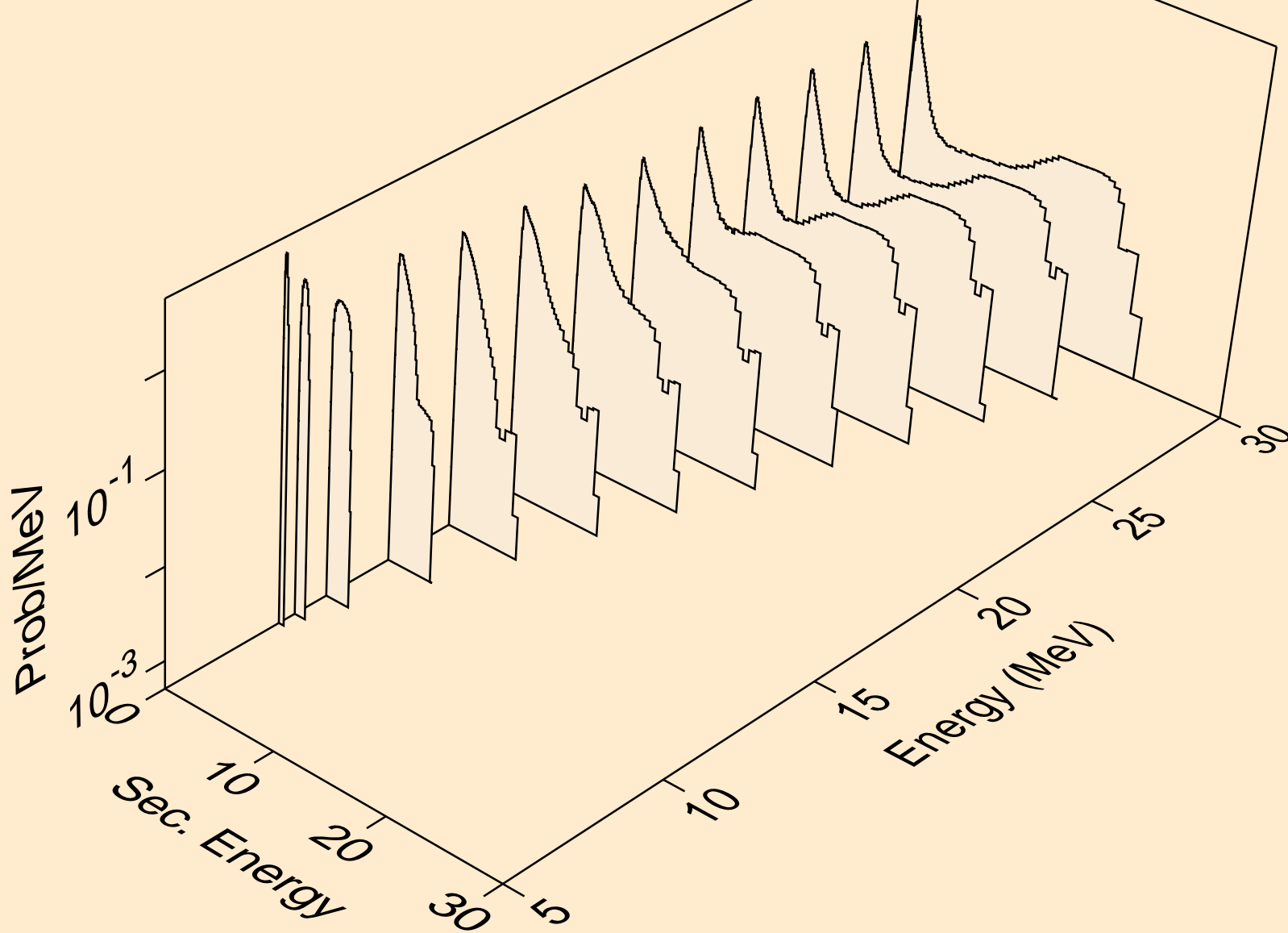

NO252 NEUTRON ACER TENDL-2019 LIBRARY; T=293.16K  
Neutron emission for (n,3n)

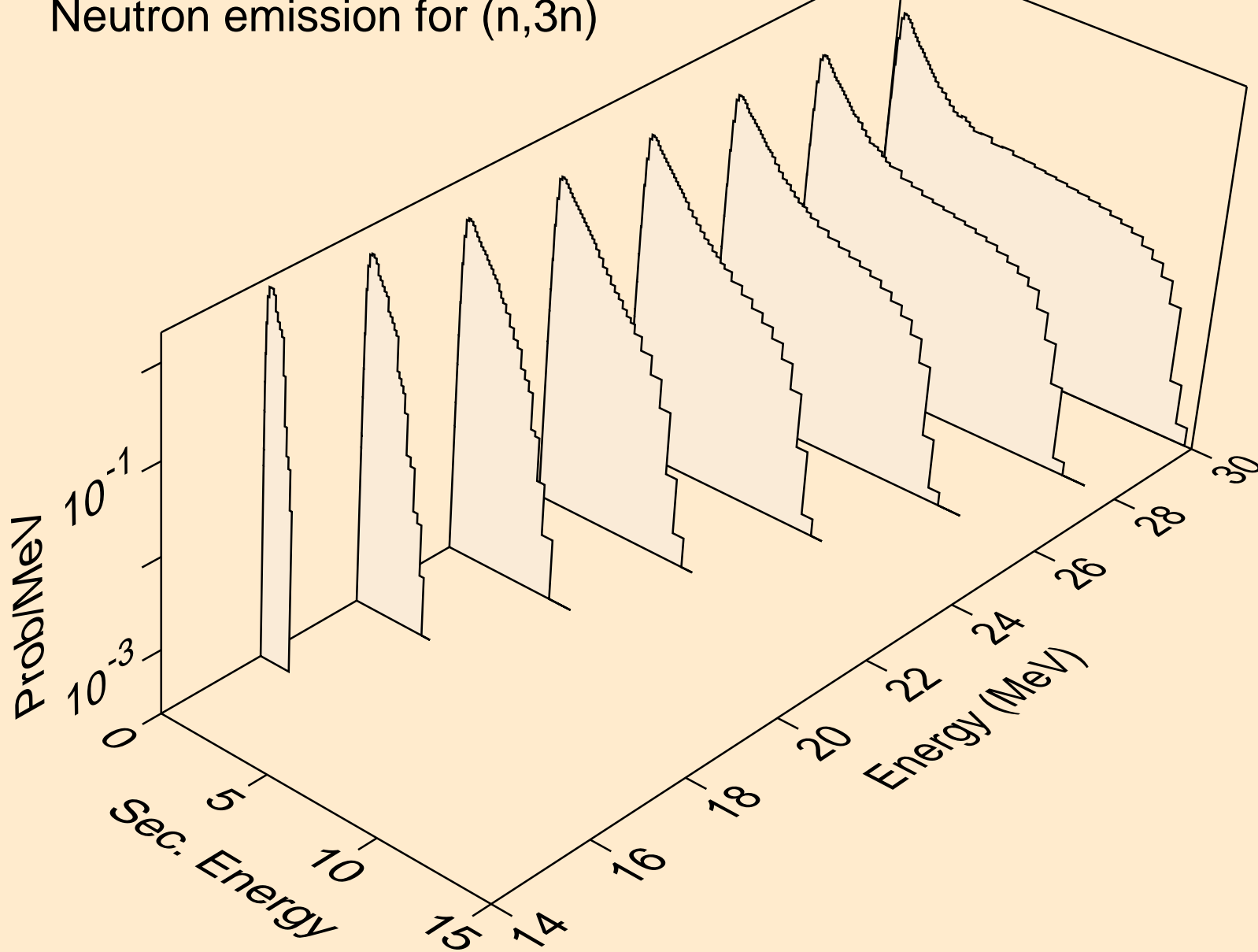

NO252 NEUTRON ACER TENDL-2019 LIBRARY; T=293.16K  
Neutron emission for fission

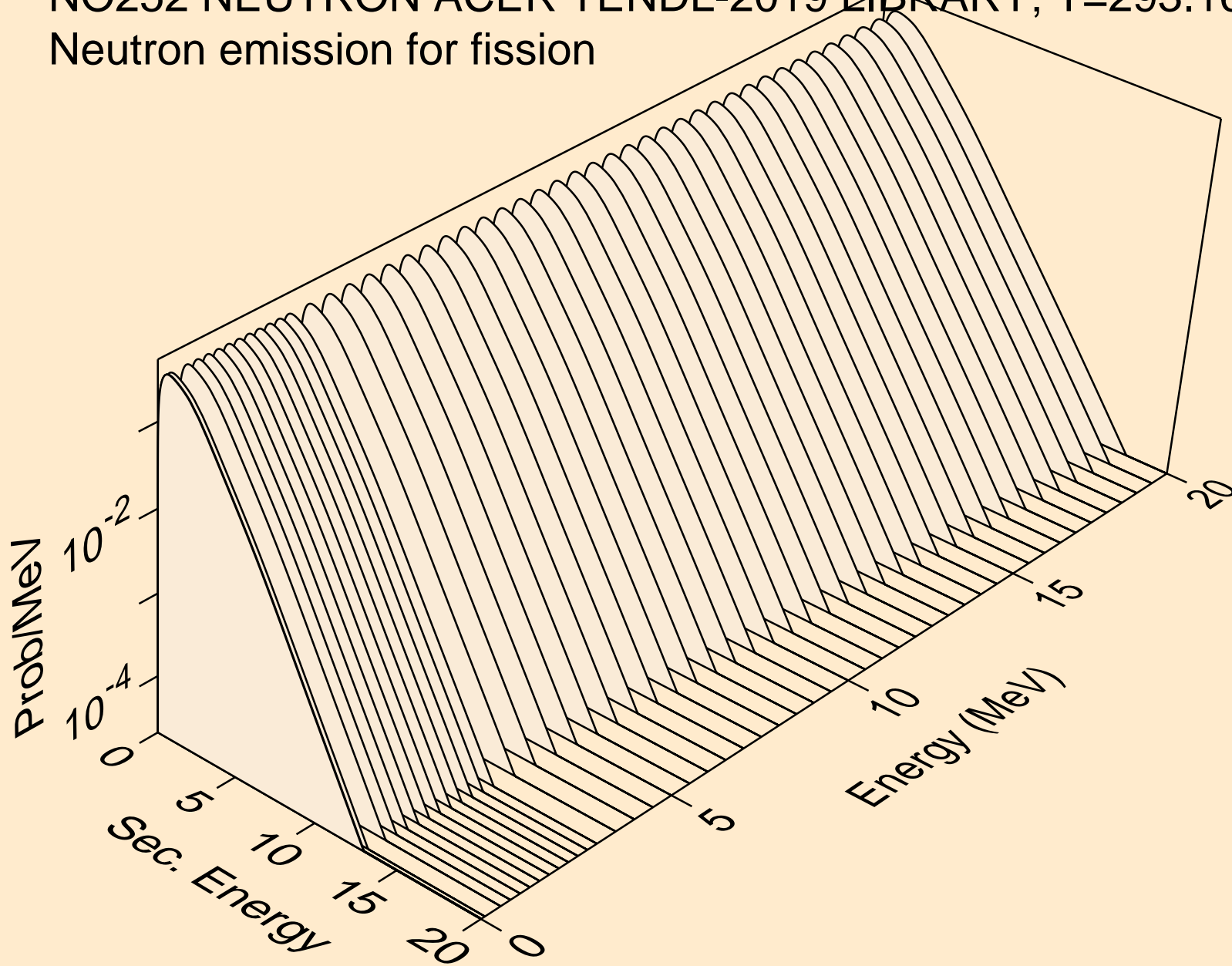

NO252 NEUTRON ACER TENDL-2019 LIBRARY; T=293.16K  
Neutron emission for (n,n\*)a

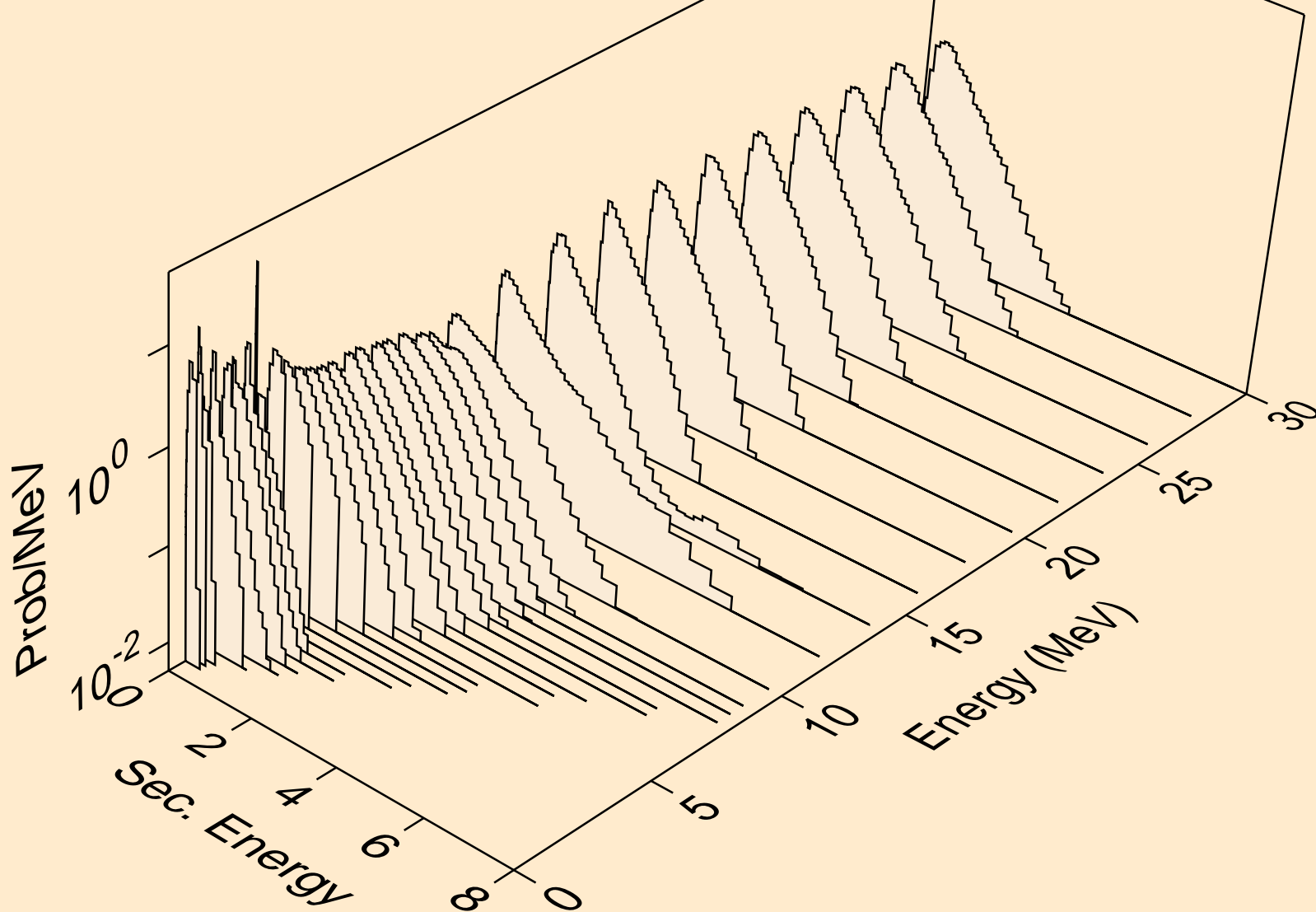

NO252 NEUTRON ACER TENDL-2019 LIBRARY; T=293.16K  
Neutron emission for (n,2n)a

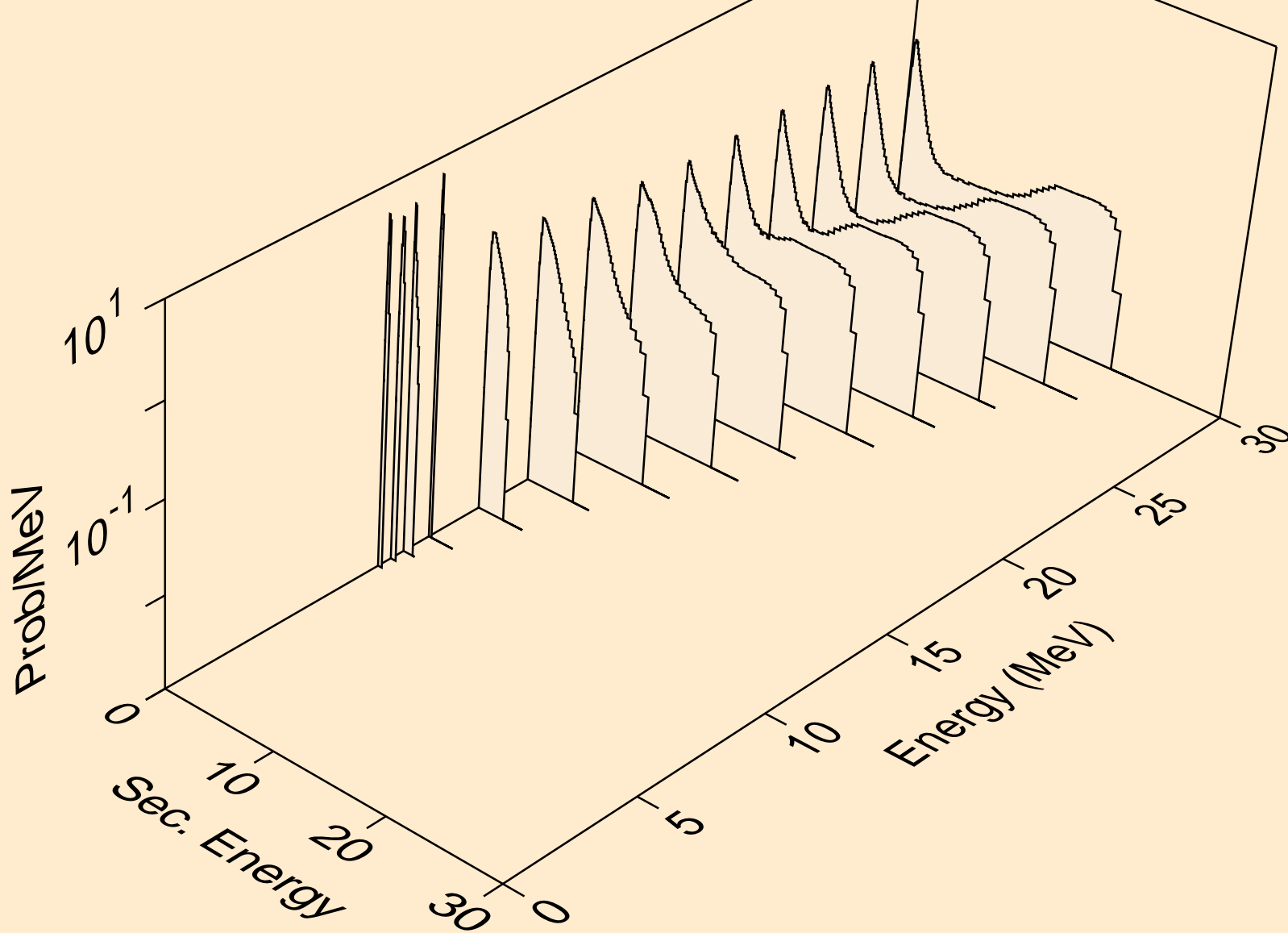

NO252 NEUTRON ACER TENDL-2019 LIBRARY; T=293.16K  
Neutron emission for (n,3n)a

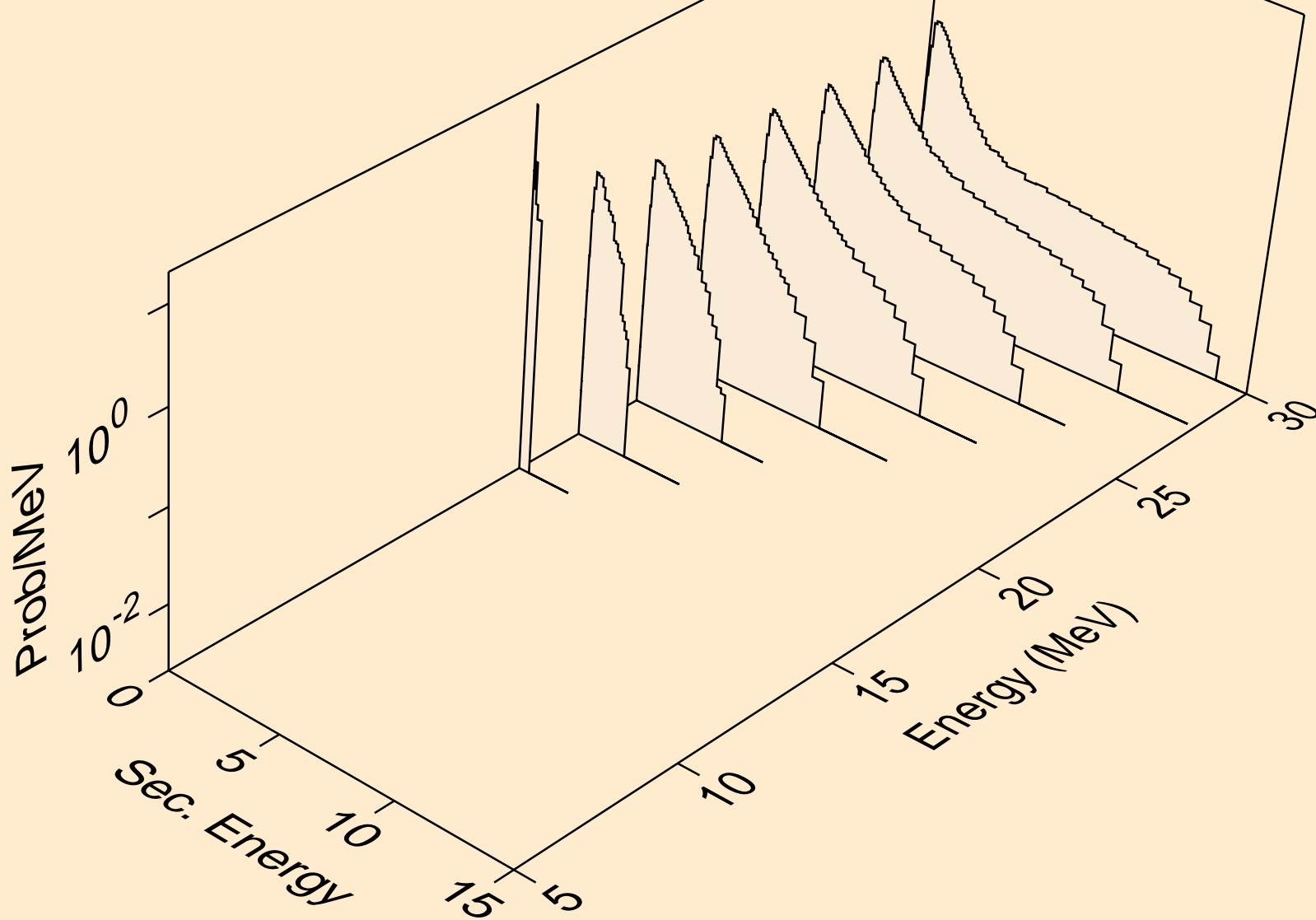

NO252 NEUTRON ACER TENDL-2019 LIBRARY; T=293.16K  
Neutron emission for (n,n\*)p

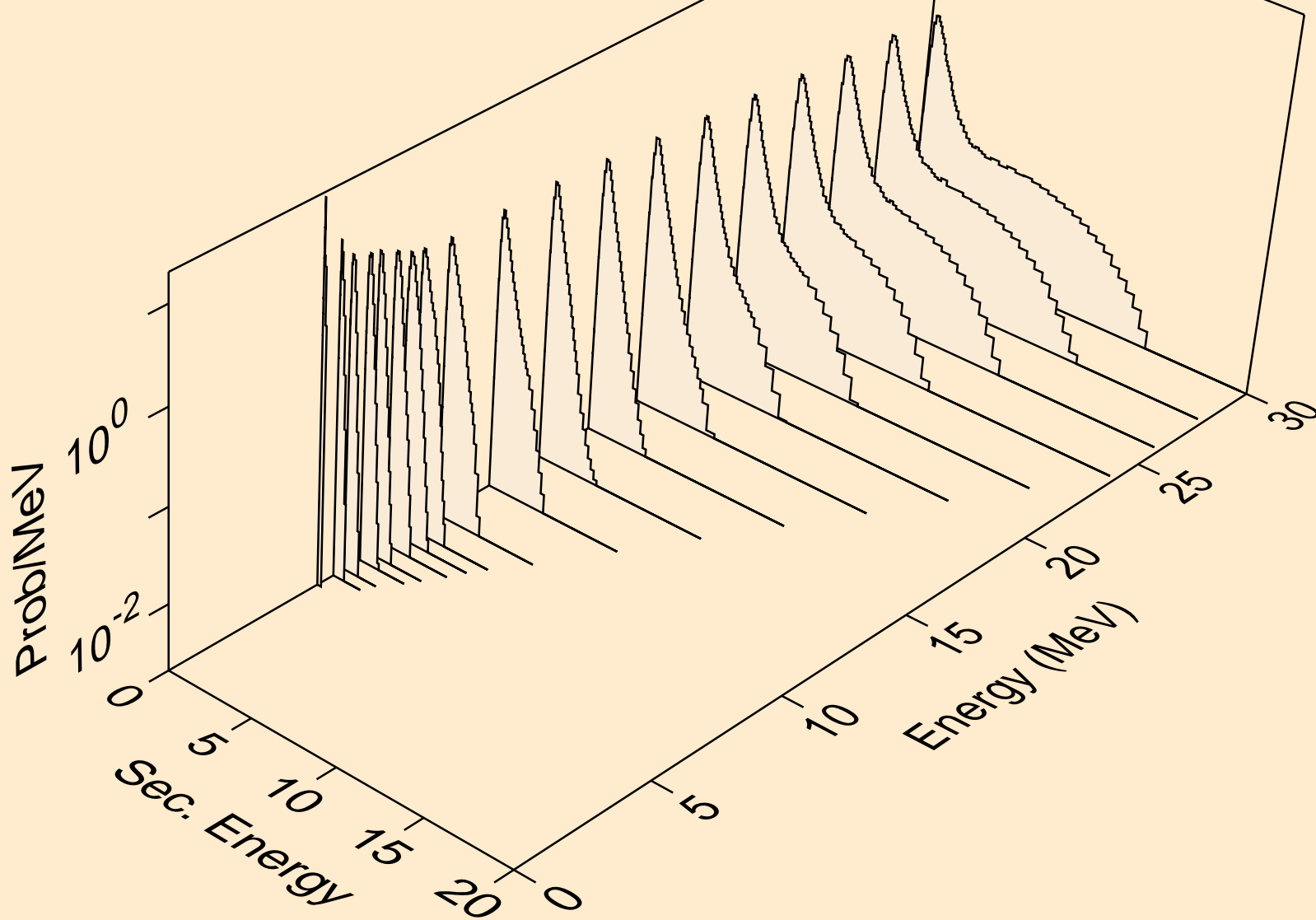

NO252 NEUTRON ACER TENDL-2019 LIBRARY; T=293.16K  
Neutron emission for (n,n\*)2a

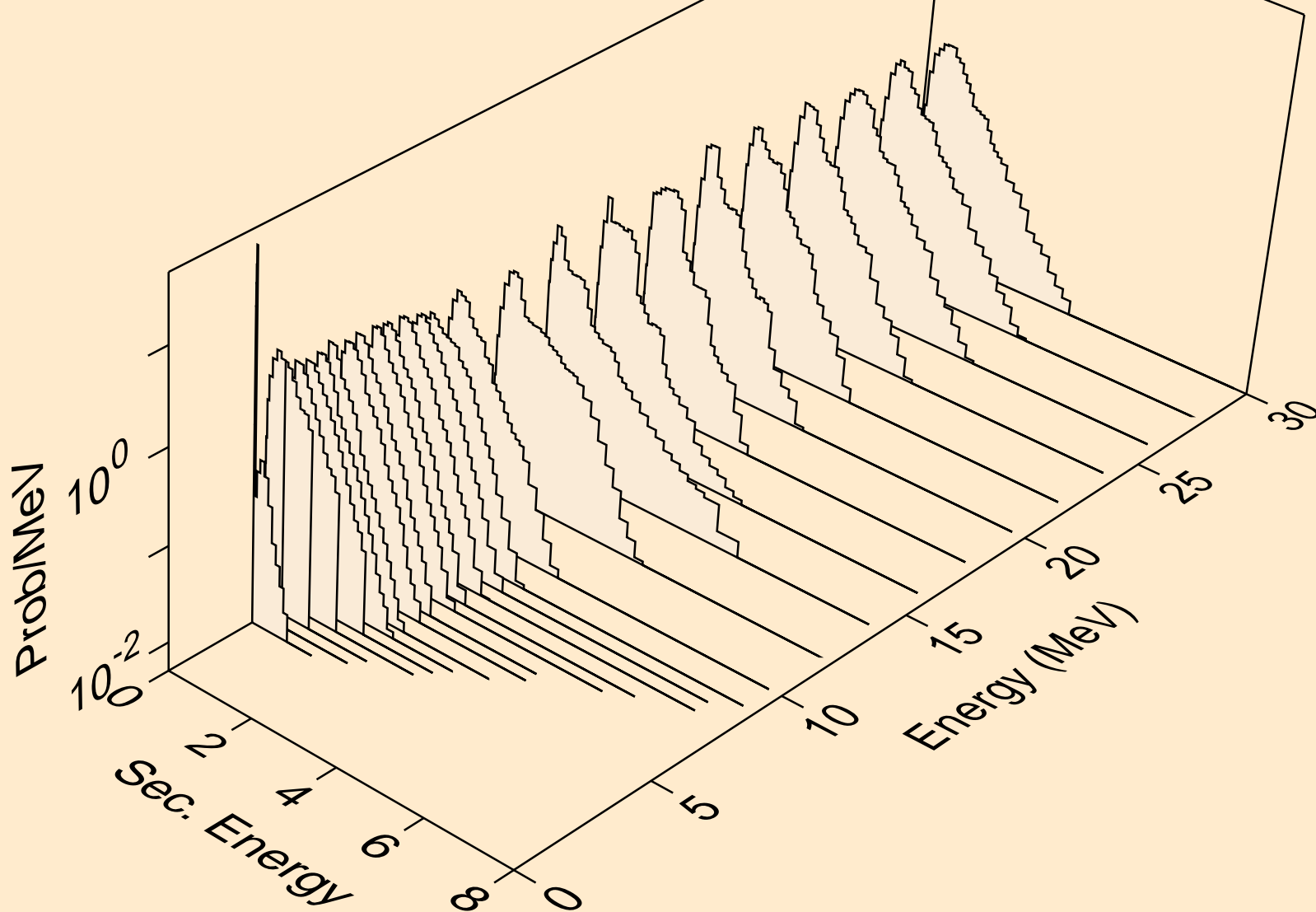

NO252 NEUTRON ACER TENDL-2019 LIBRARY; T=293.16K  
Neutron emission for (n,2n)2a

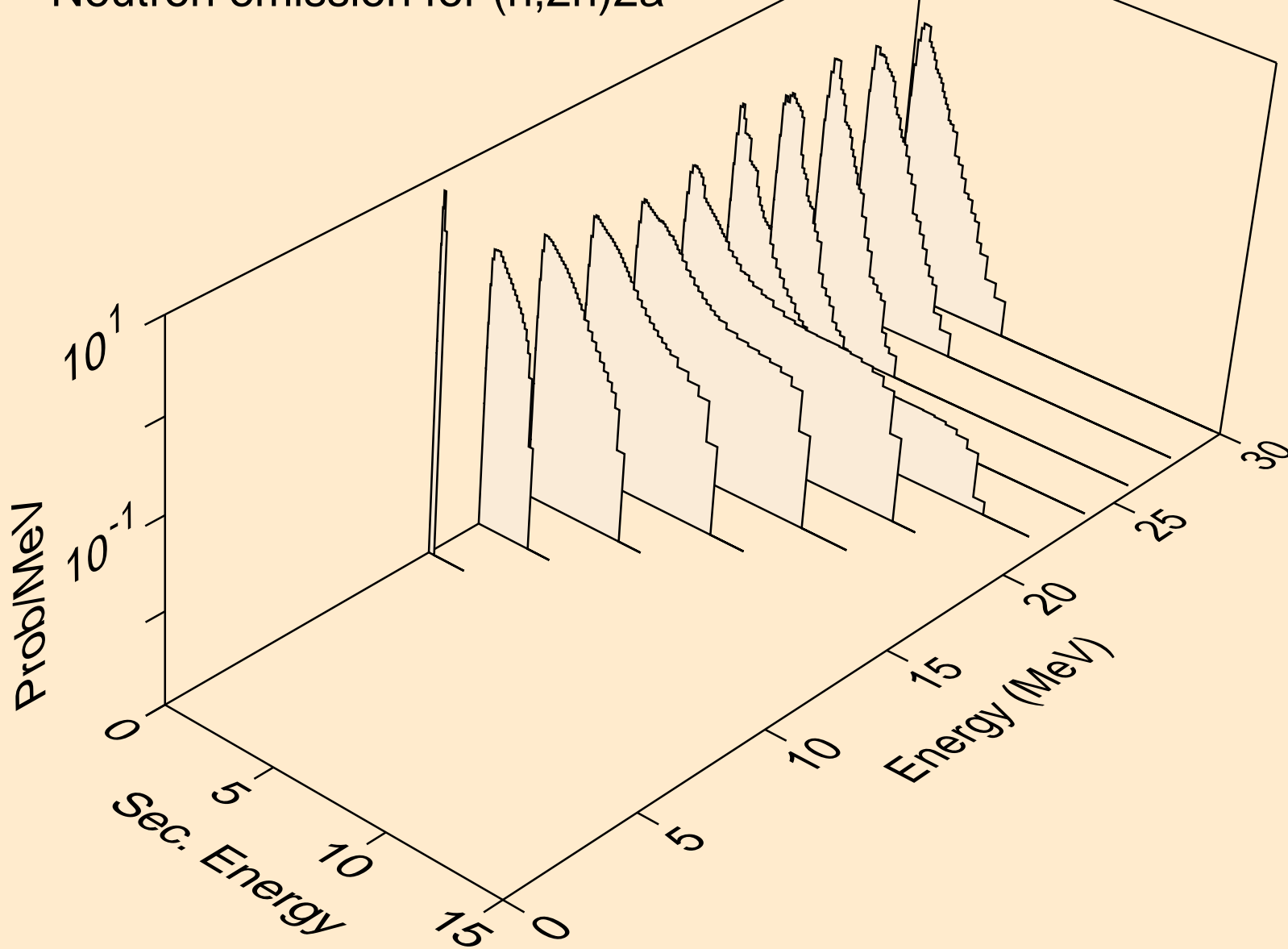

NO252 NEUTRON ACER TENDL-2019 LIBRARY; T=293.16K  
Neutron emission for (n,n\*)d

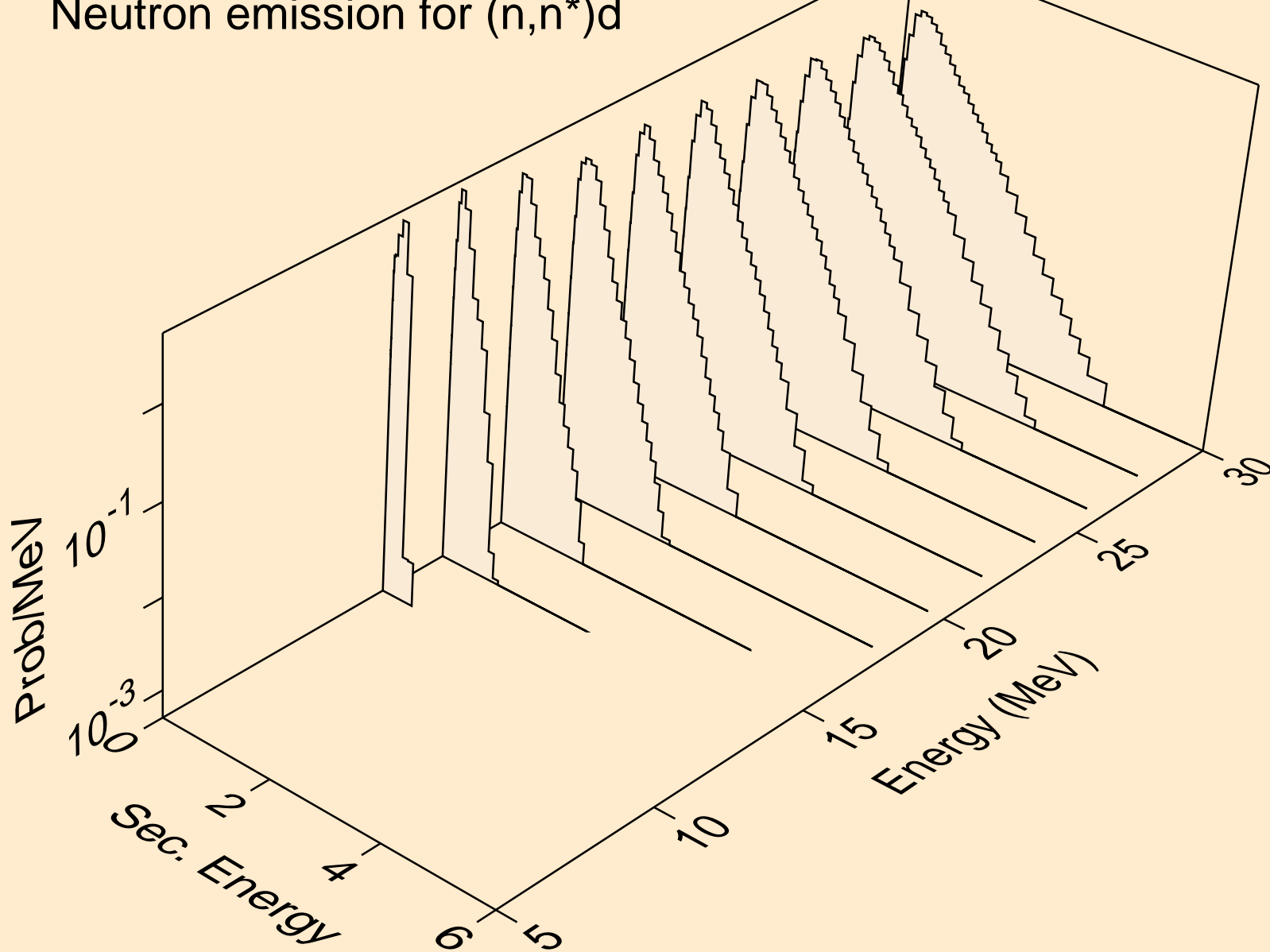

NO252 NEUTRON ACER TENDL-2019 LIBRARY; T=293.16K  
Neutron emission for (n,n\*)t

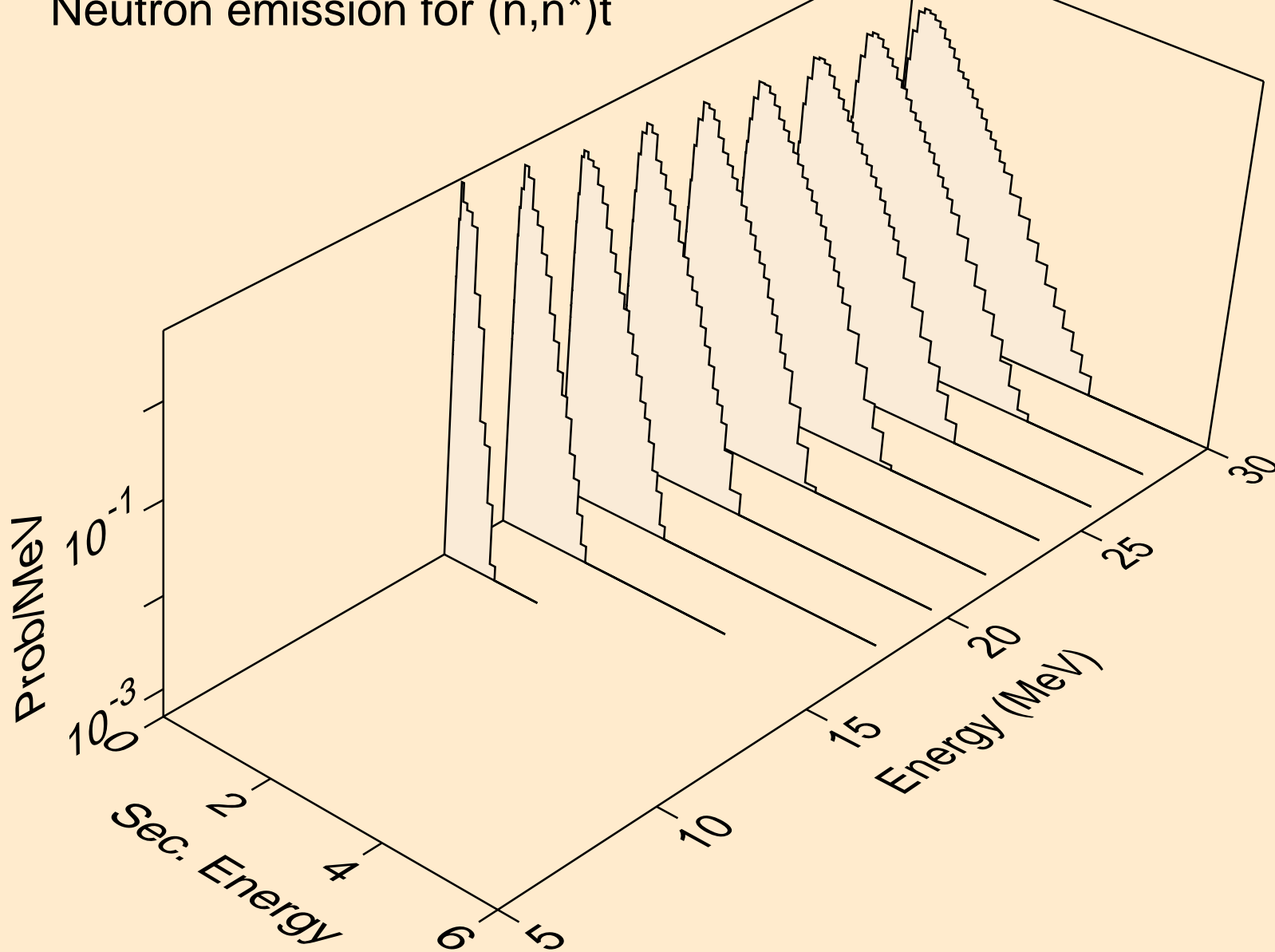

NO252 NEUTRON ACER TENDL-2019 LIBRARY; T=293.16K  
Neutron emission for (n,n\*)he3

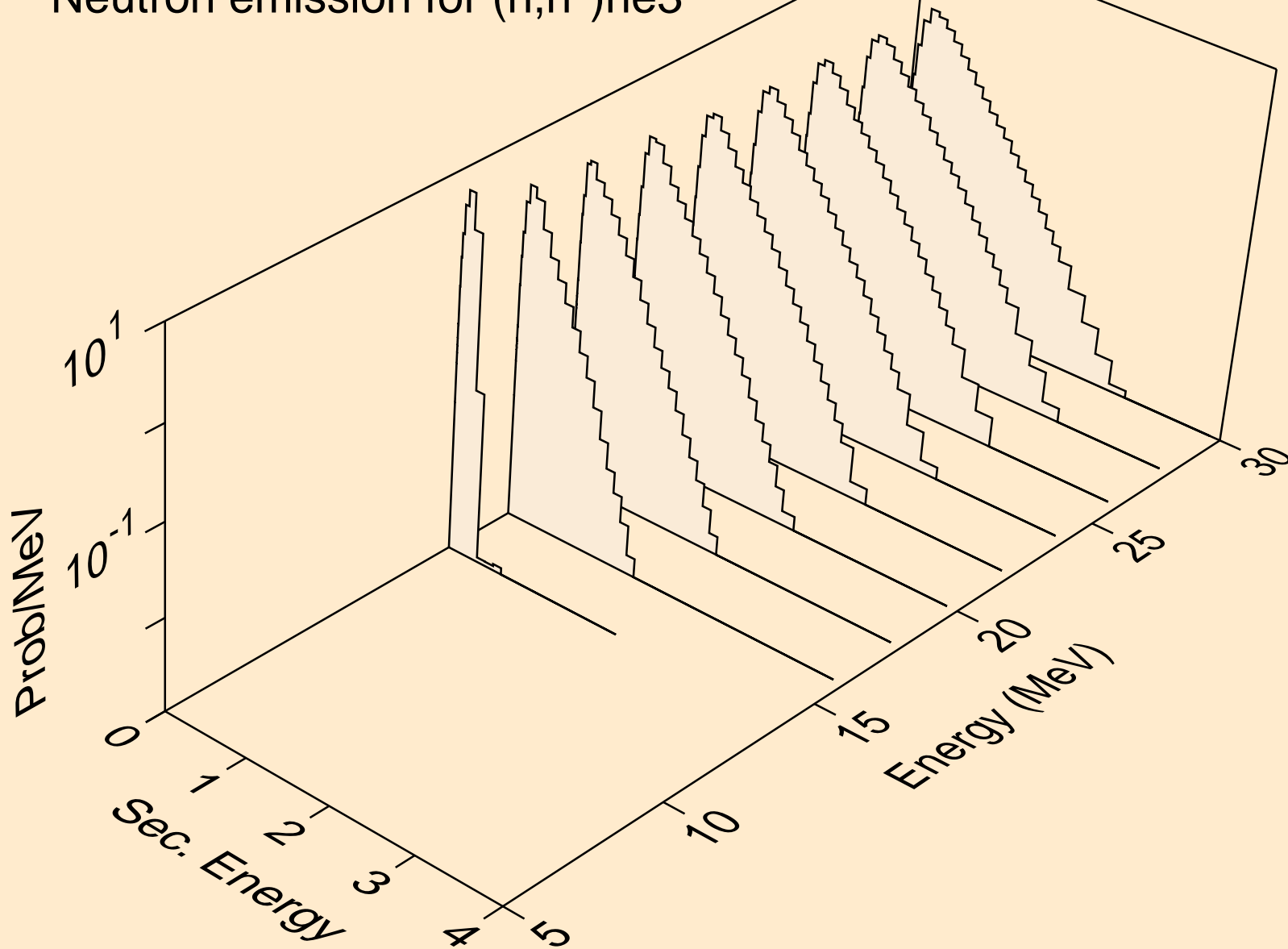

NO252 NEUTRON ACER TENDL-2019 LIBRARY; T=293.16K  
Neutron emission for (n,4n)

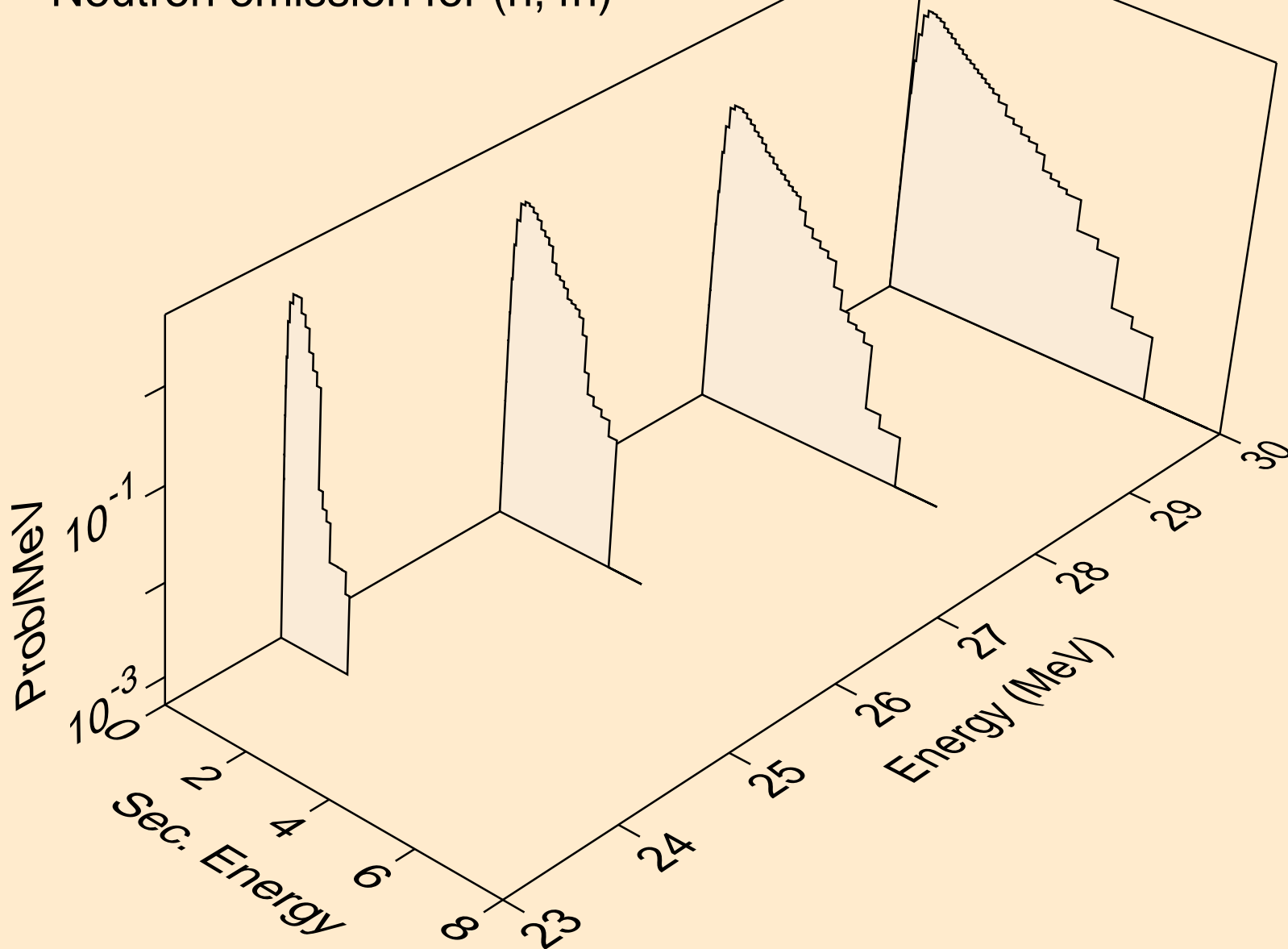

NO252 NEUTRON ACER TENDL-2019 LIBRARY; T=293.16K  
Neutron emission for (n,2np)

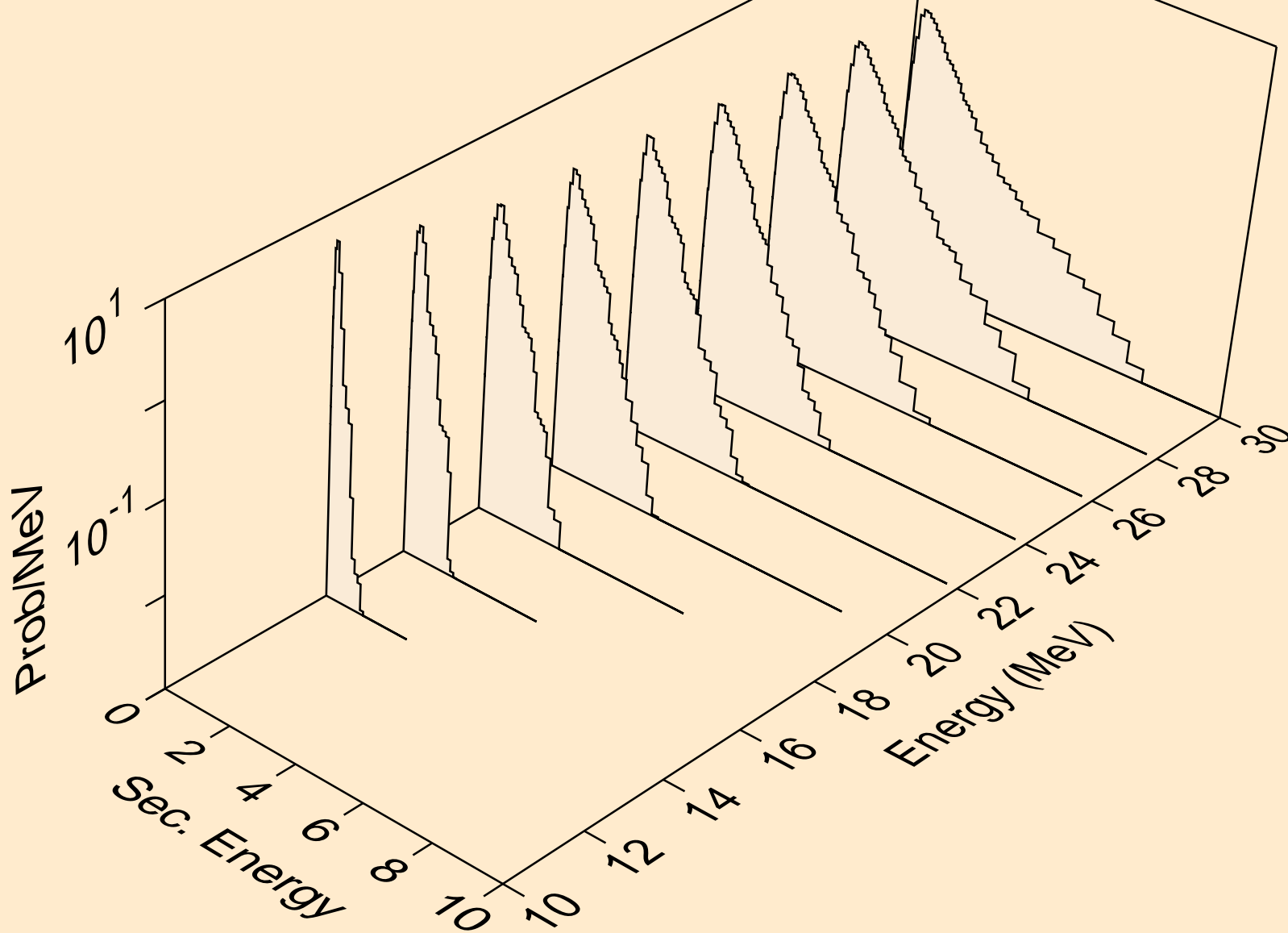

NO252 NEUTRON ACER TENDL-2019 LIBRARY; T=293.16K  
Neutron emission for (n,3np)

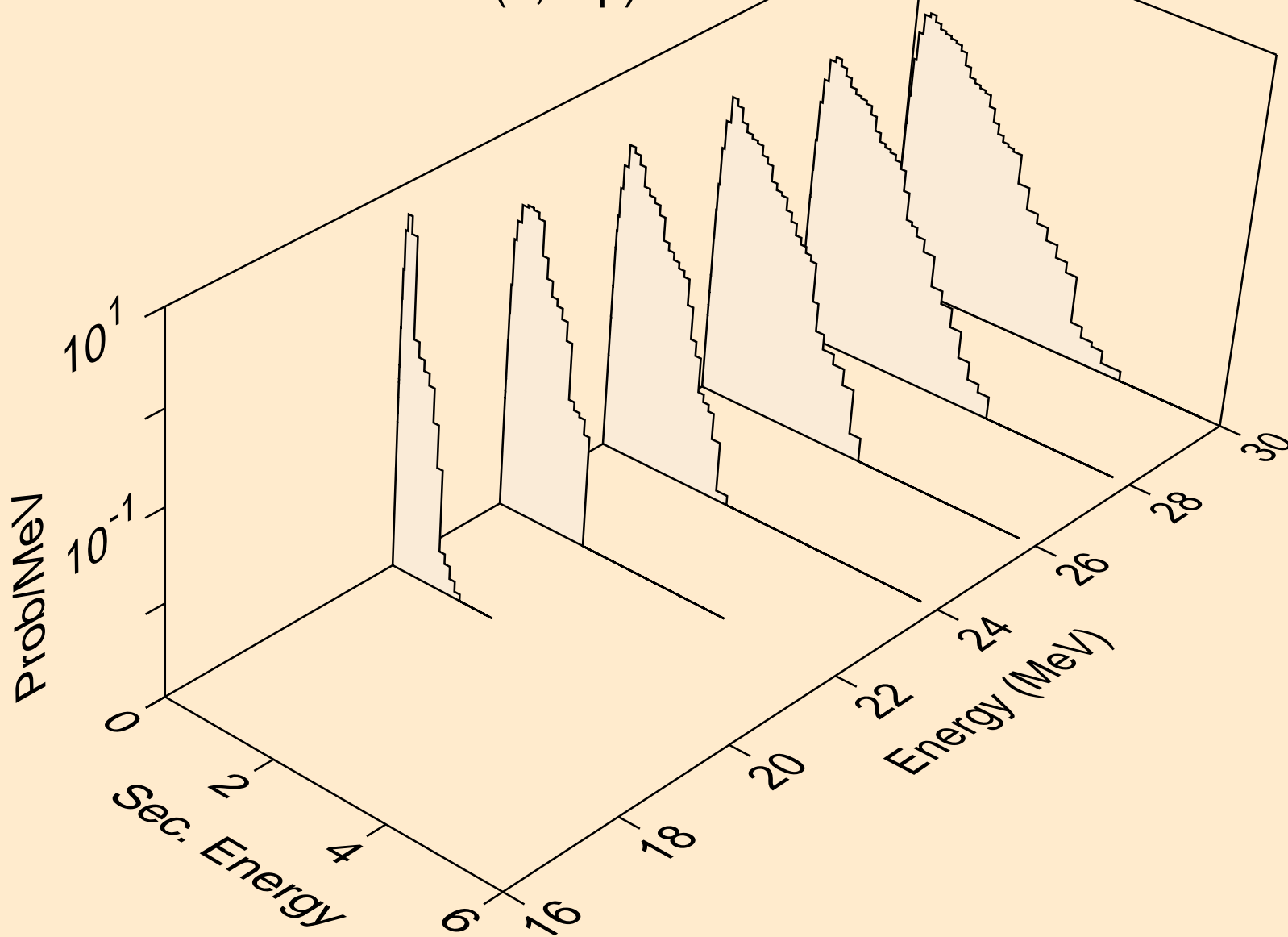

NO252 NEUTRON ACER TENDL-2019 LIBRARY; T=293.16K  
Neutron emission for (n,2np)

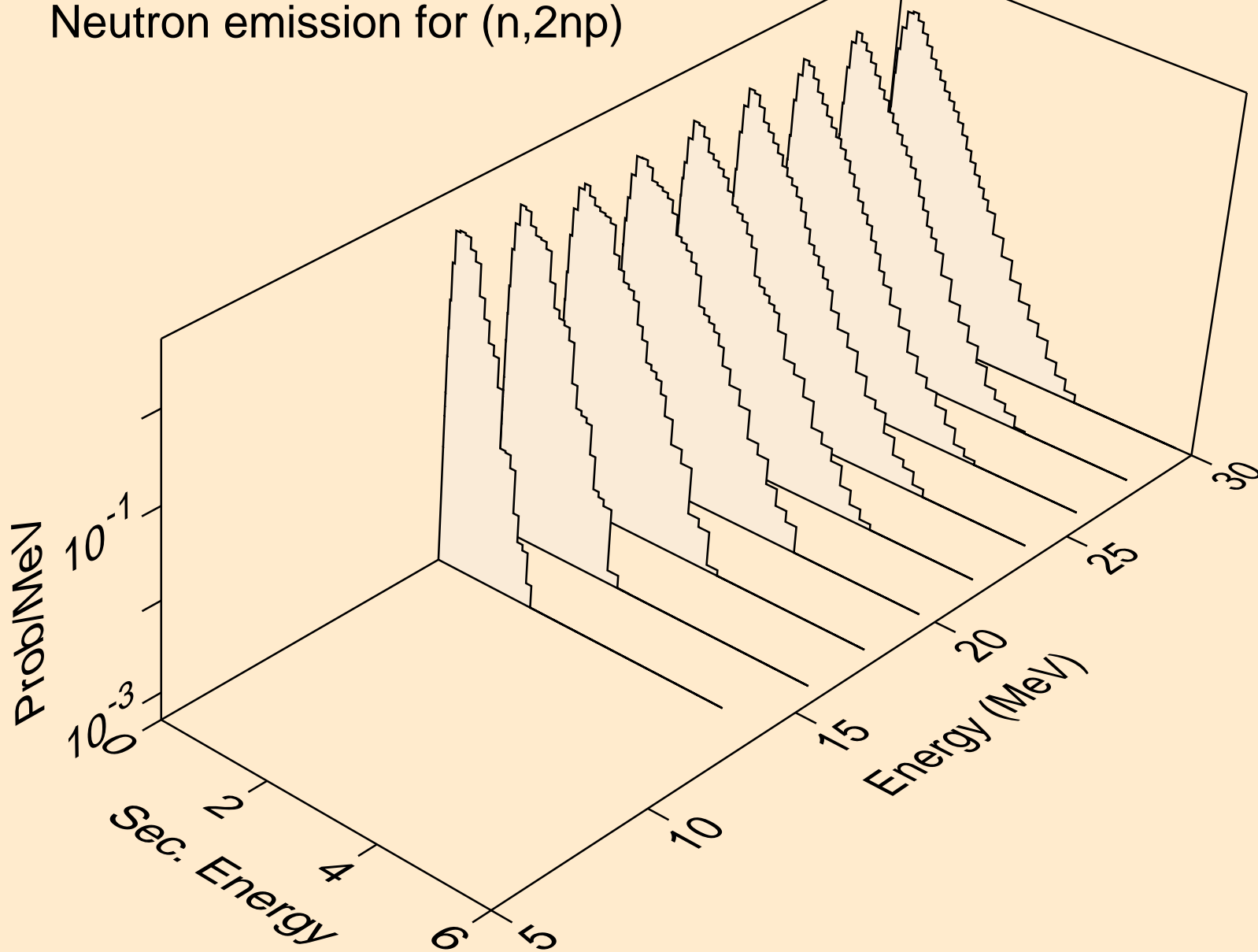

NO252 NEUTRON ACER TENDL-2019 LIBRARY; T=293.16K  
Neutron emission for (n,npa)

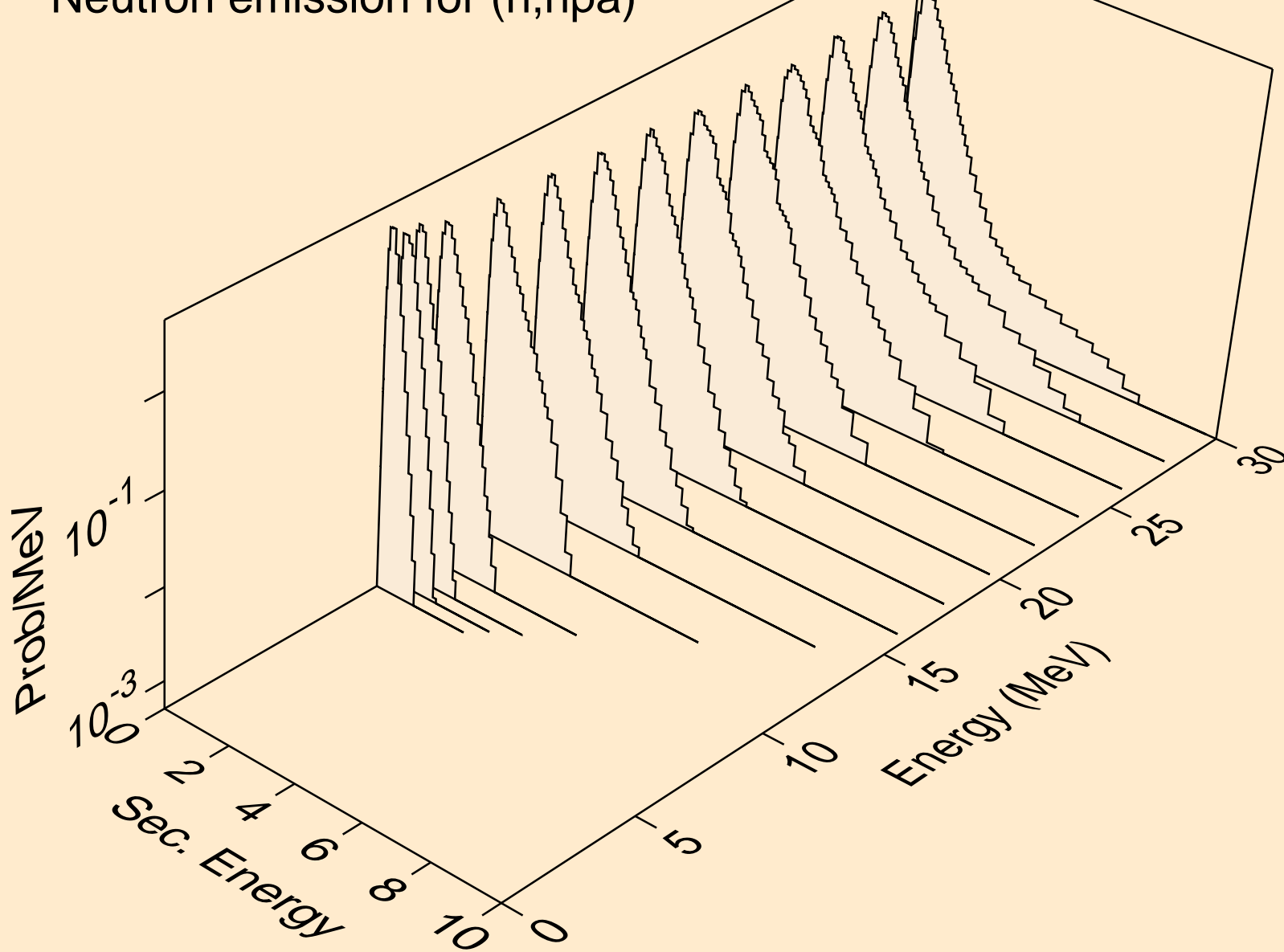

NO252 NEUTRON ACER TENDL-2019 LIBRARY; T=293.16K  
Neutron emission for (n,n\*c)

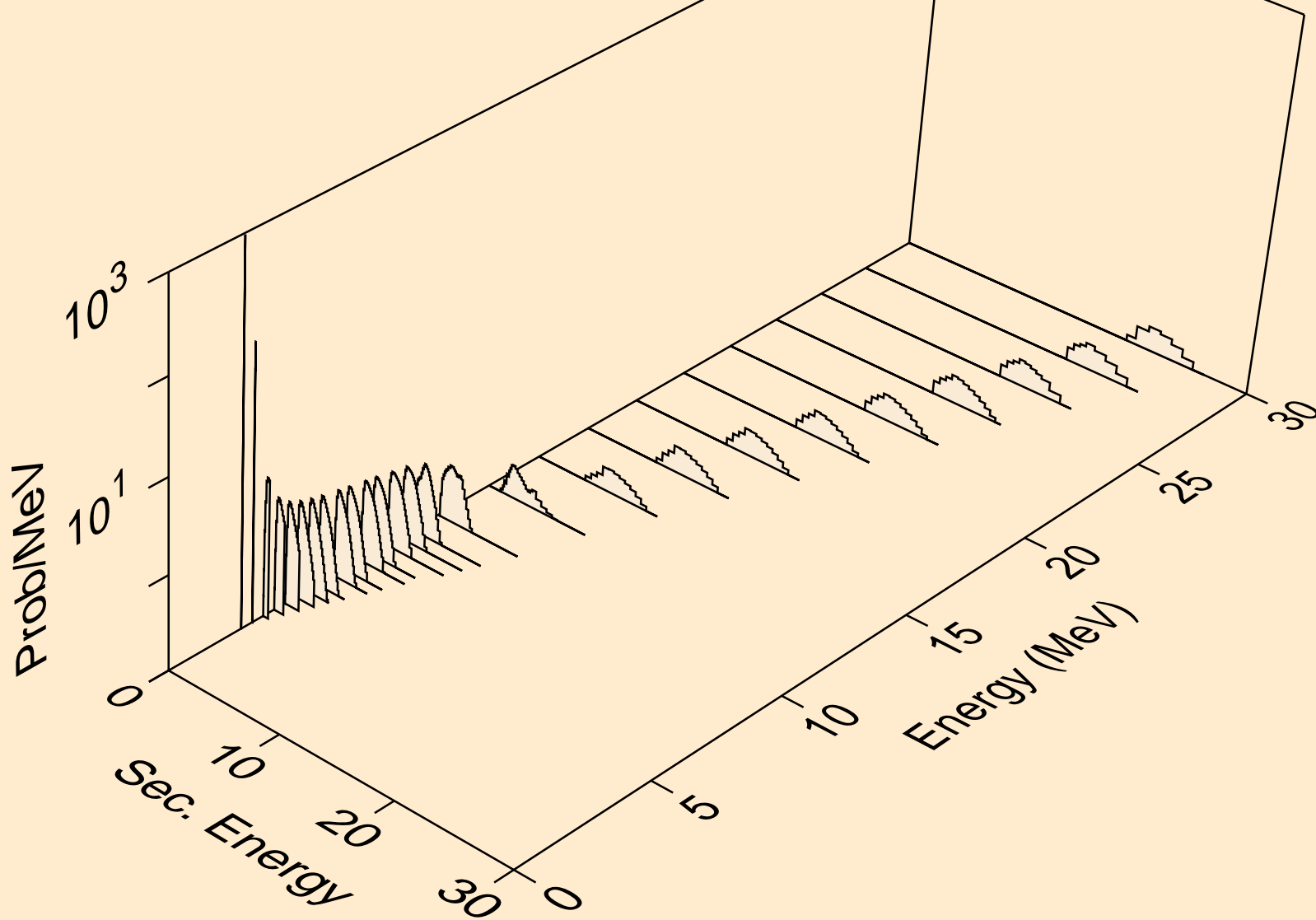

NO252 NEUTRON ACER TENDL-2019 LIBRARY; T=293.16K

Delayed nubar

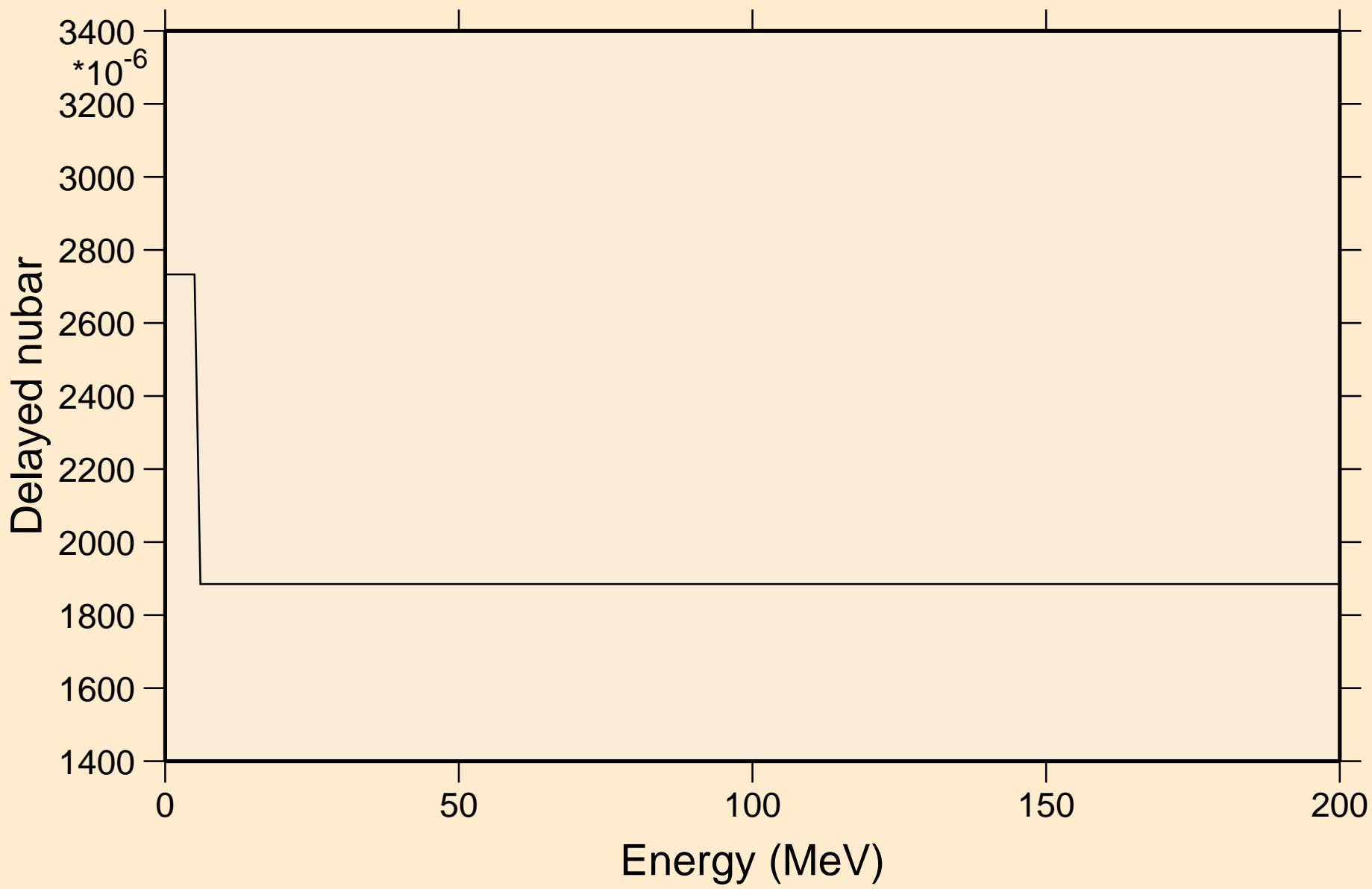

# NO252 NEUTRON ACER TENDL-2019 LIBRARY; T=293.16K

## Delayed neutron spectra

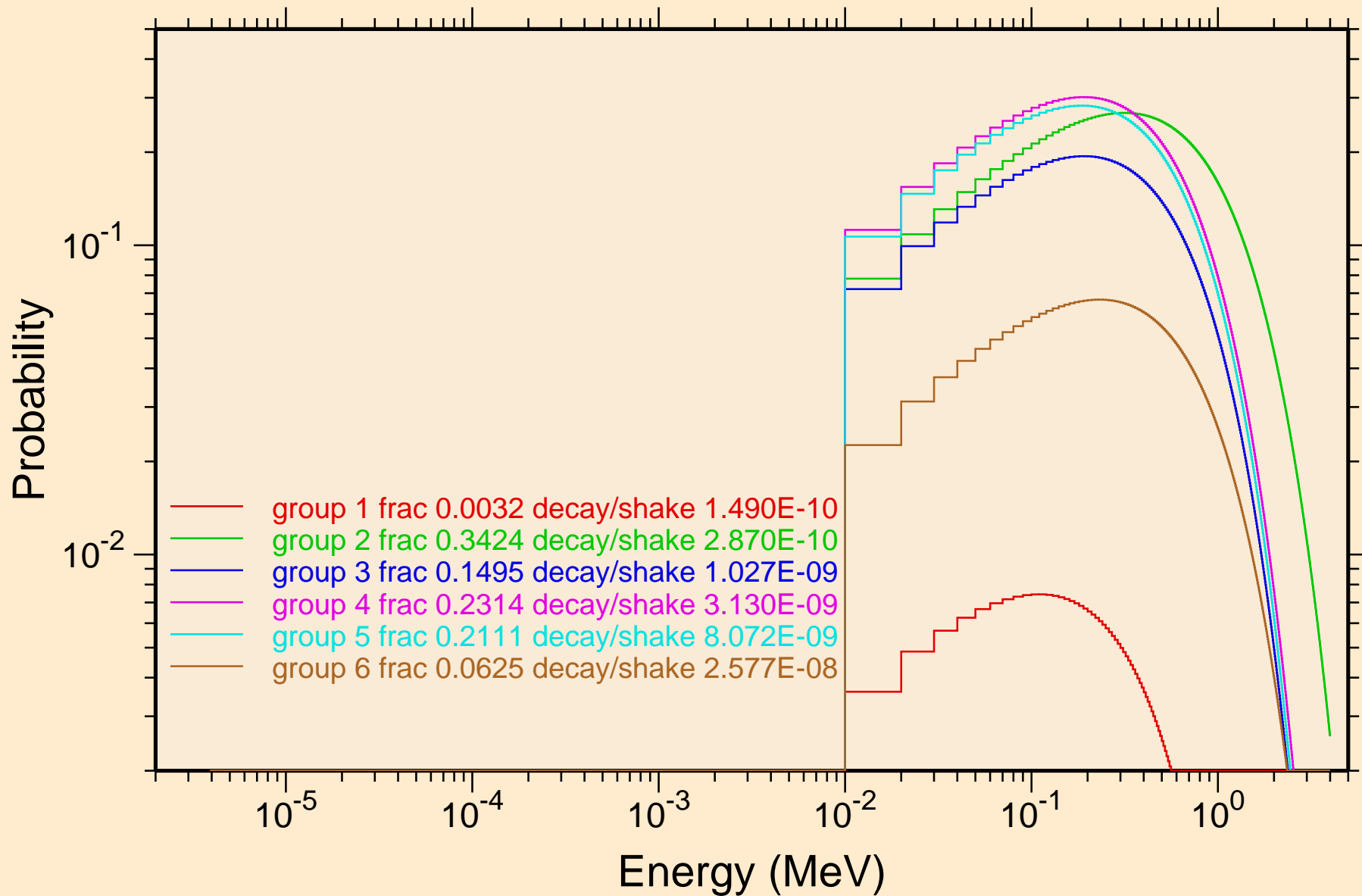

NO252 NEUTRON ACER TENDL-2019 LIBRARY; T=293.16K  
Photon emission for (n,x)

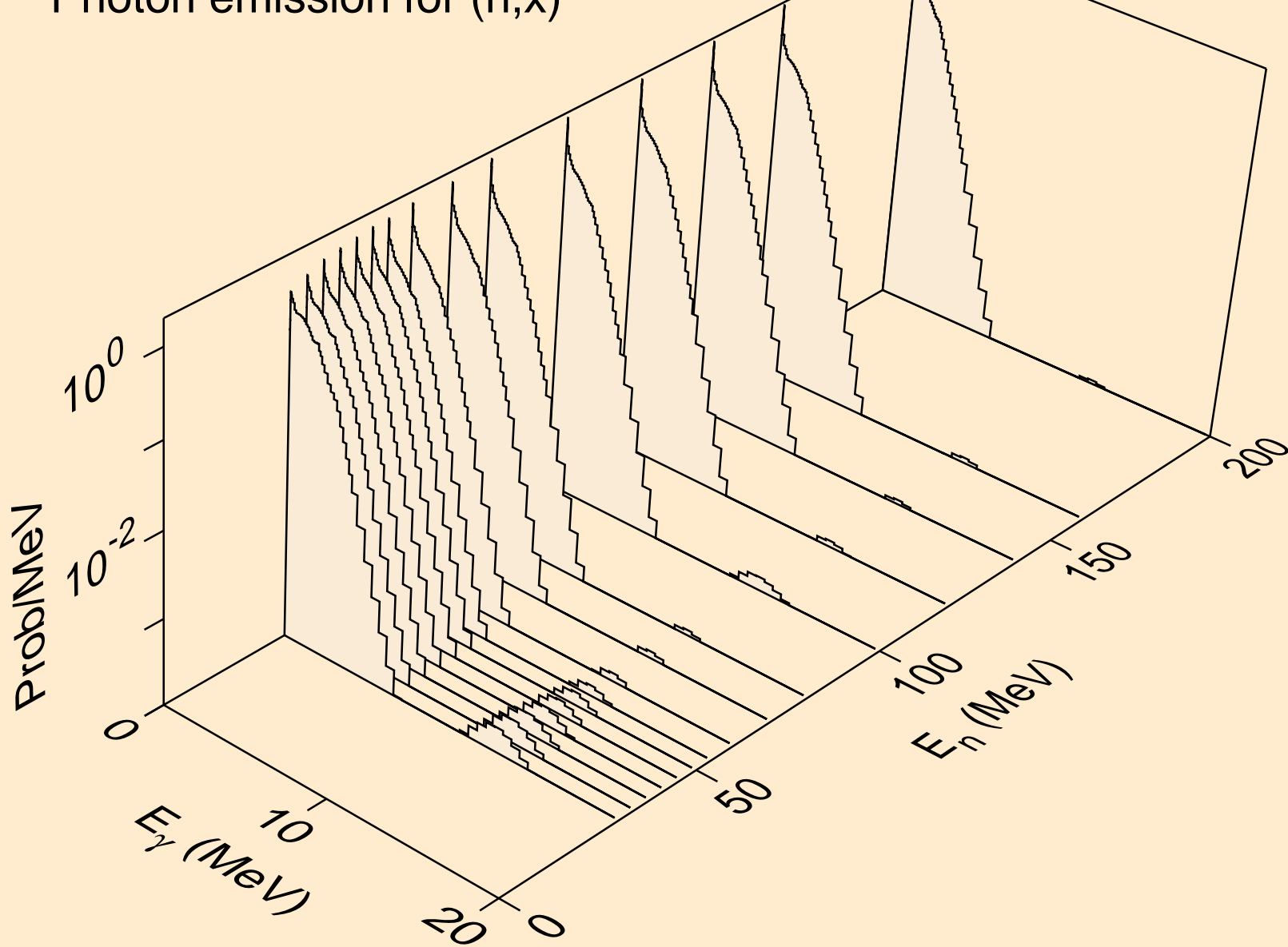

NO252 NEUTRON ACER TENDL-2019 LIBRARY; T=293.16K  
Photon emission for (n,2nd)

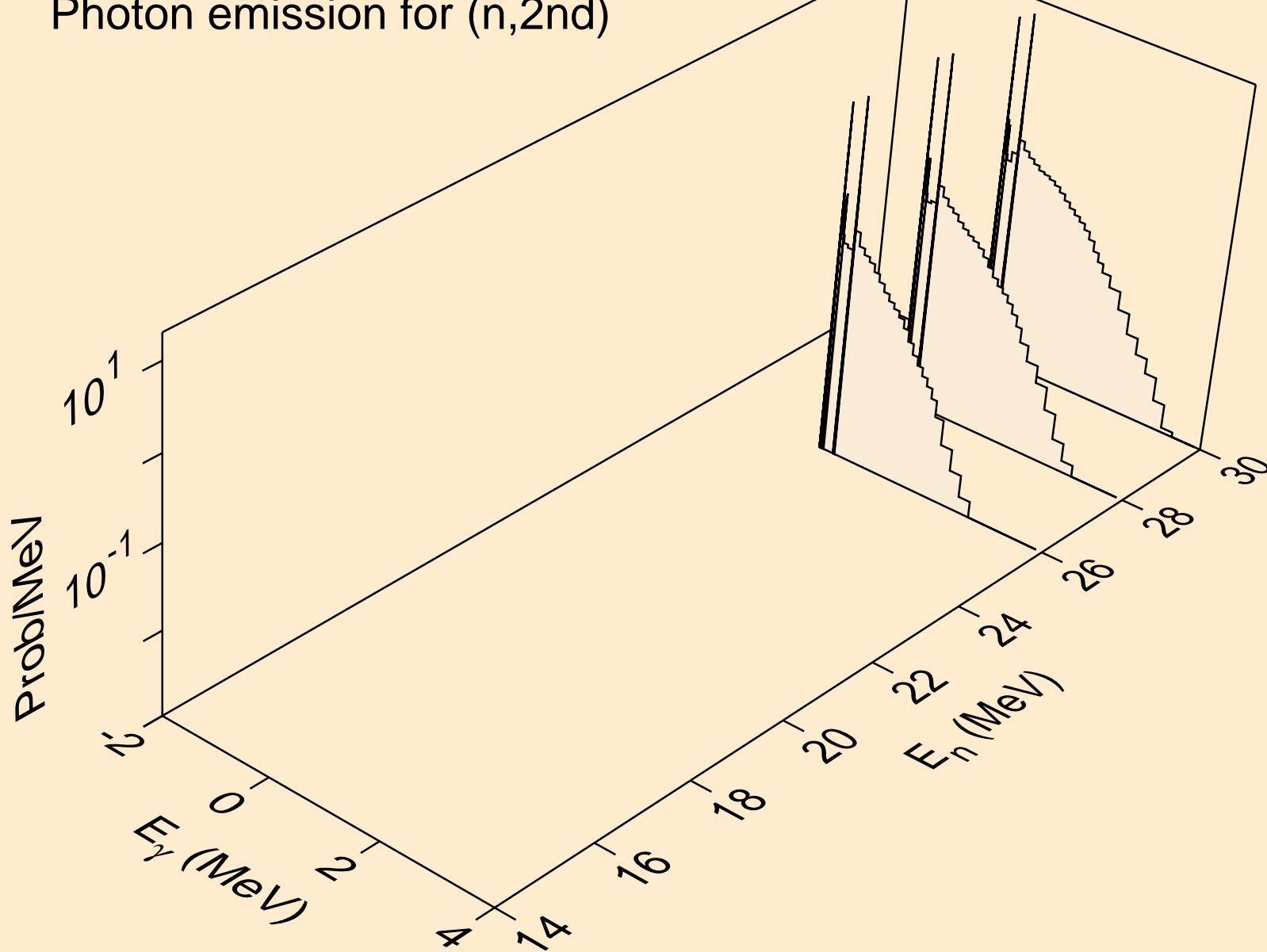

NO252 NEUTRON ACER TENDL-2019 LIBRARY; T=293.16K  
Photon emission for (n,2n)

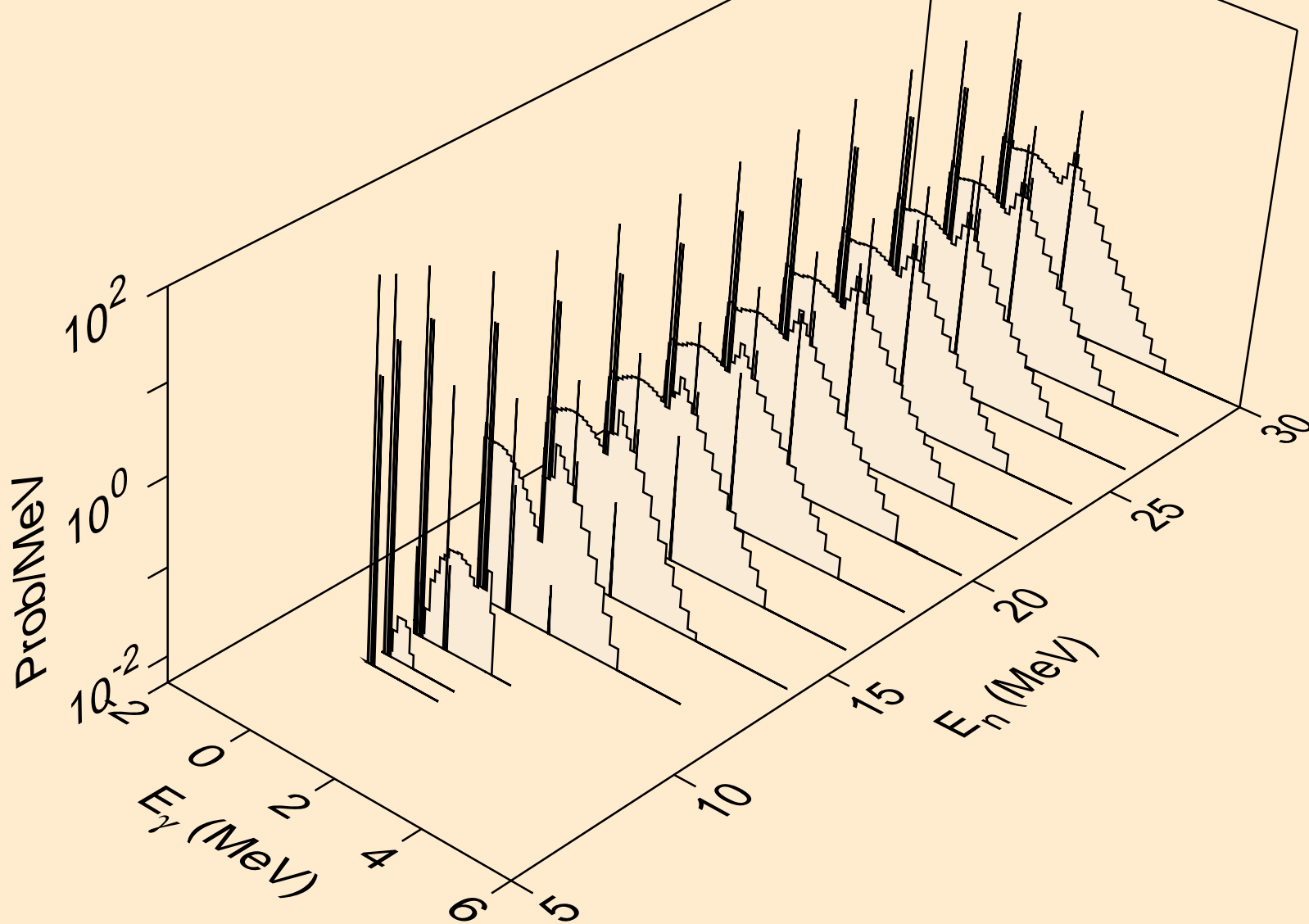

NO252 NEUTRON ACER TENDL-2019 LIBRARY; T=293.16K  
Photon emission for (n,3n)

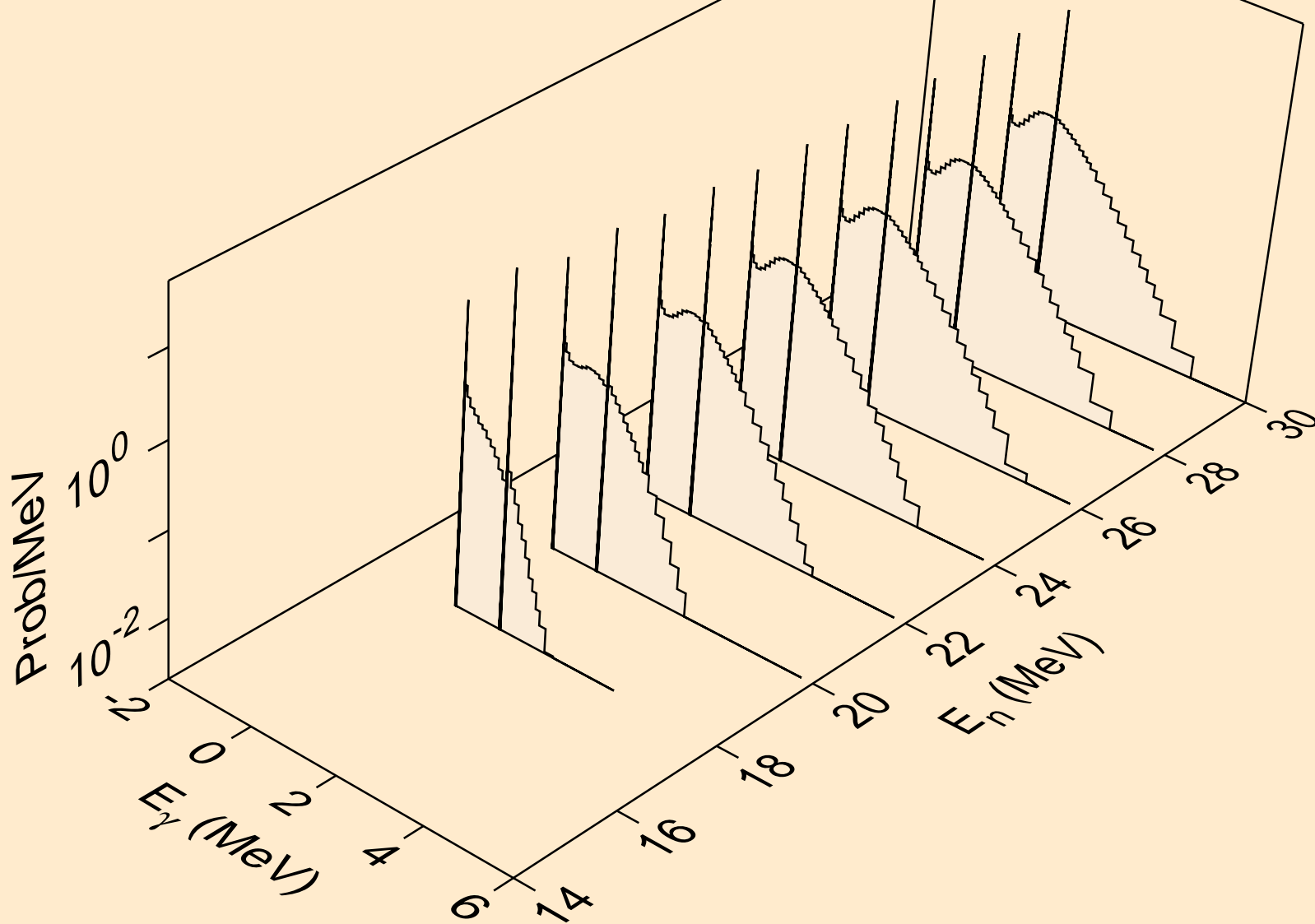

NO252 NEUTRON ACER TENDL-2019 LIBRARY; T=293.16K  
Photon emission for (n,n\*)a

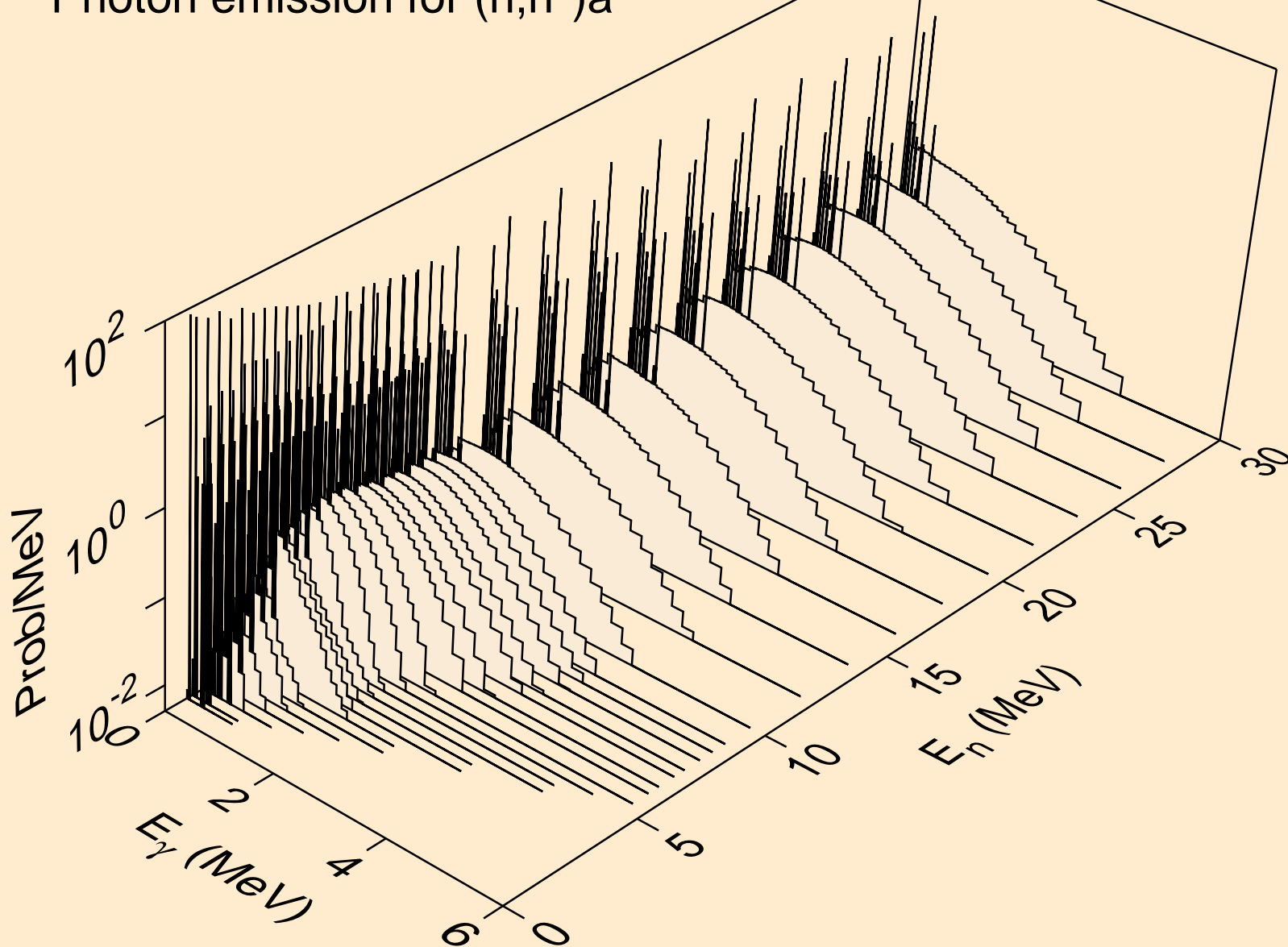

NO252 NEUTRON ACER TENDL-2019 LIBRARY; T=293.16K  
Photon emission for (n,2n)a

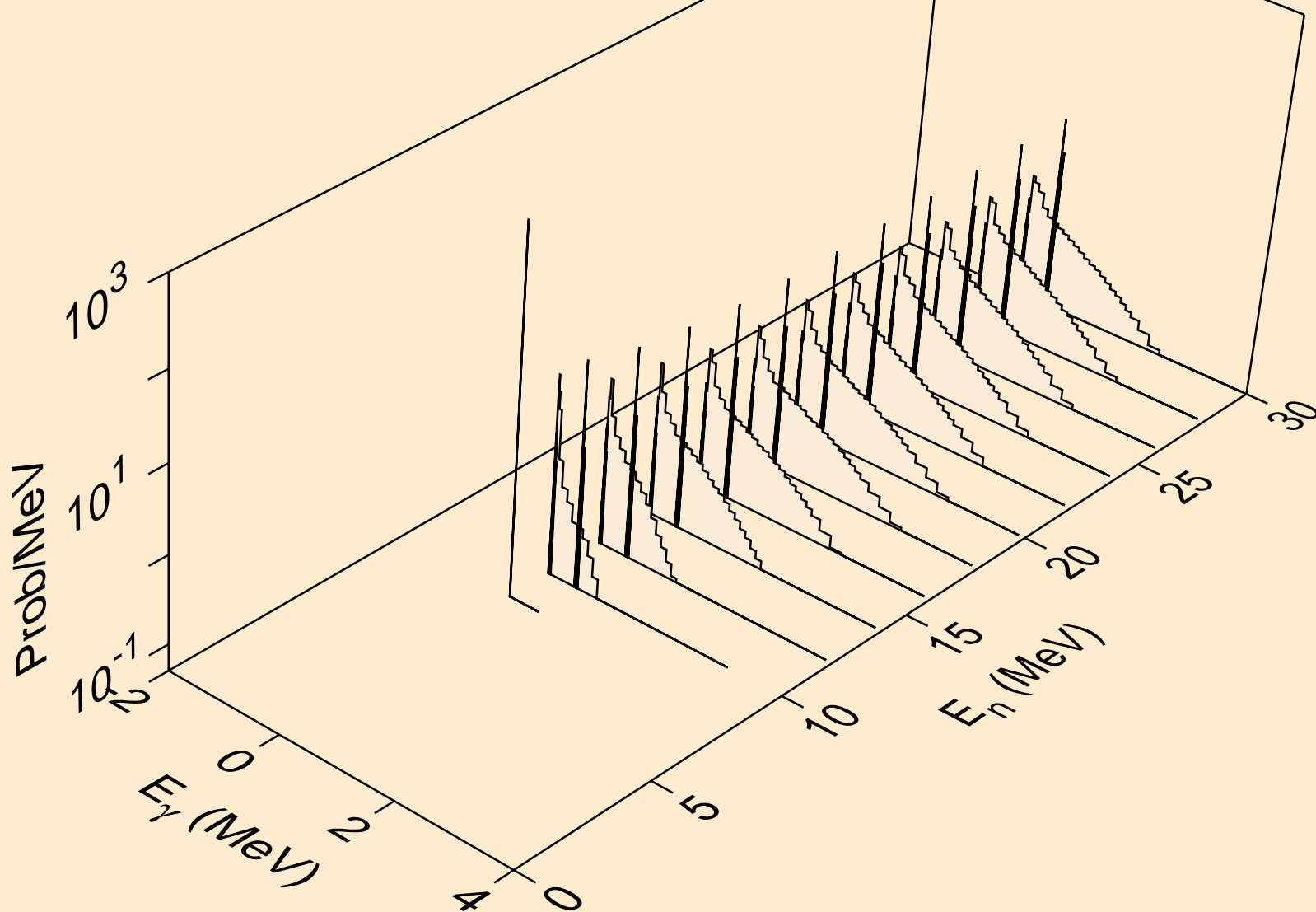

NO252 NEUTRON ACER TENDL-2019 LIBRARY; T=293.16K  
Photon emission for (n,3n)a

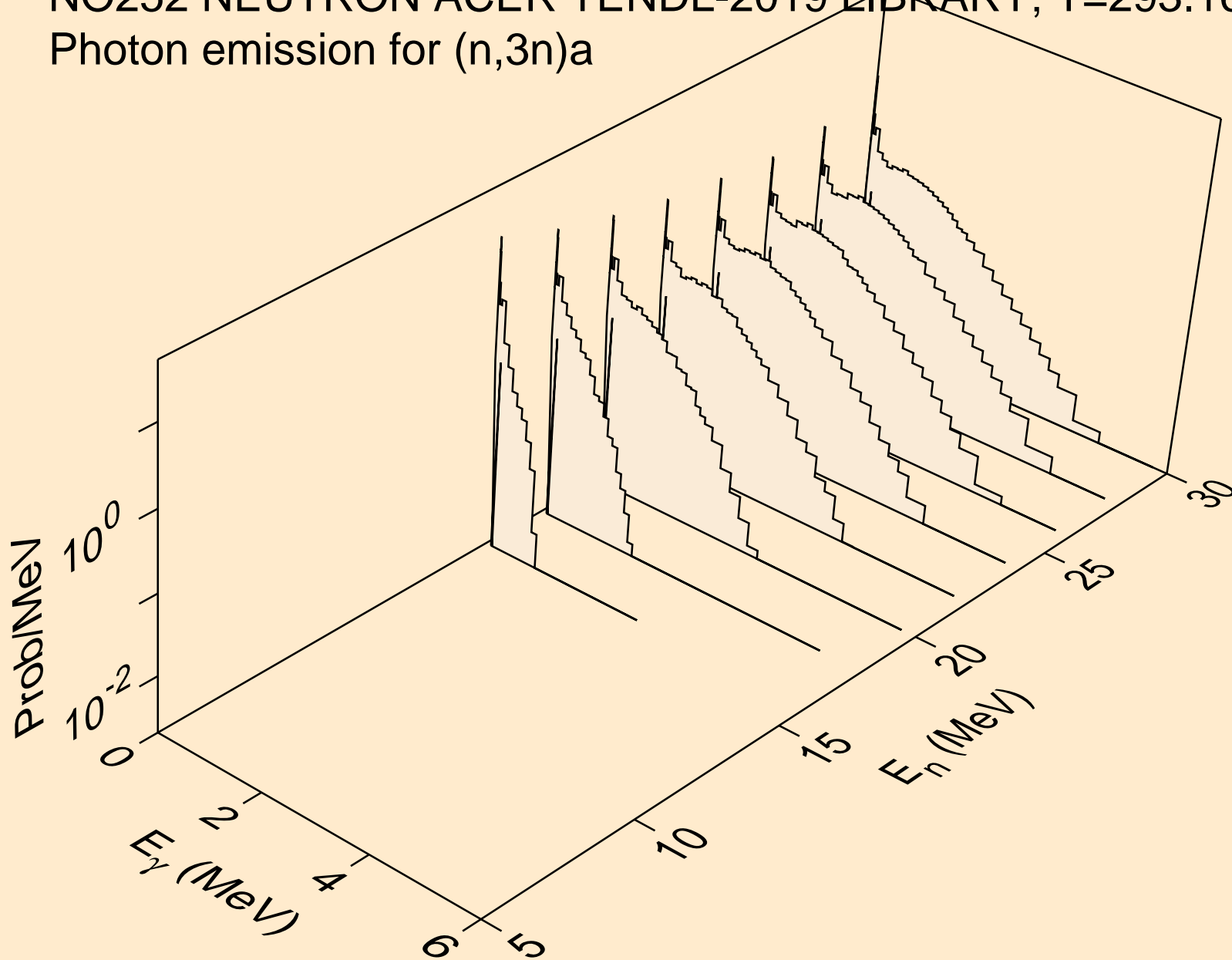

NO252 NEUTRON ACER TENDL-2019 LIBRARY; T=293.16K  
Photon emission for (n,n\*)p

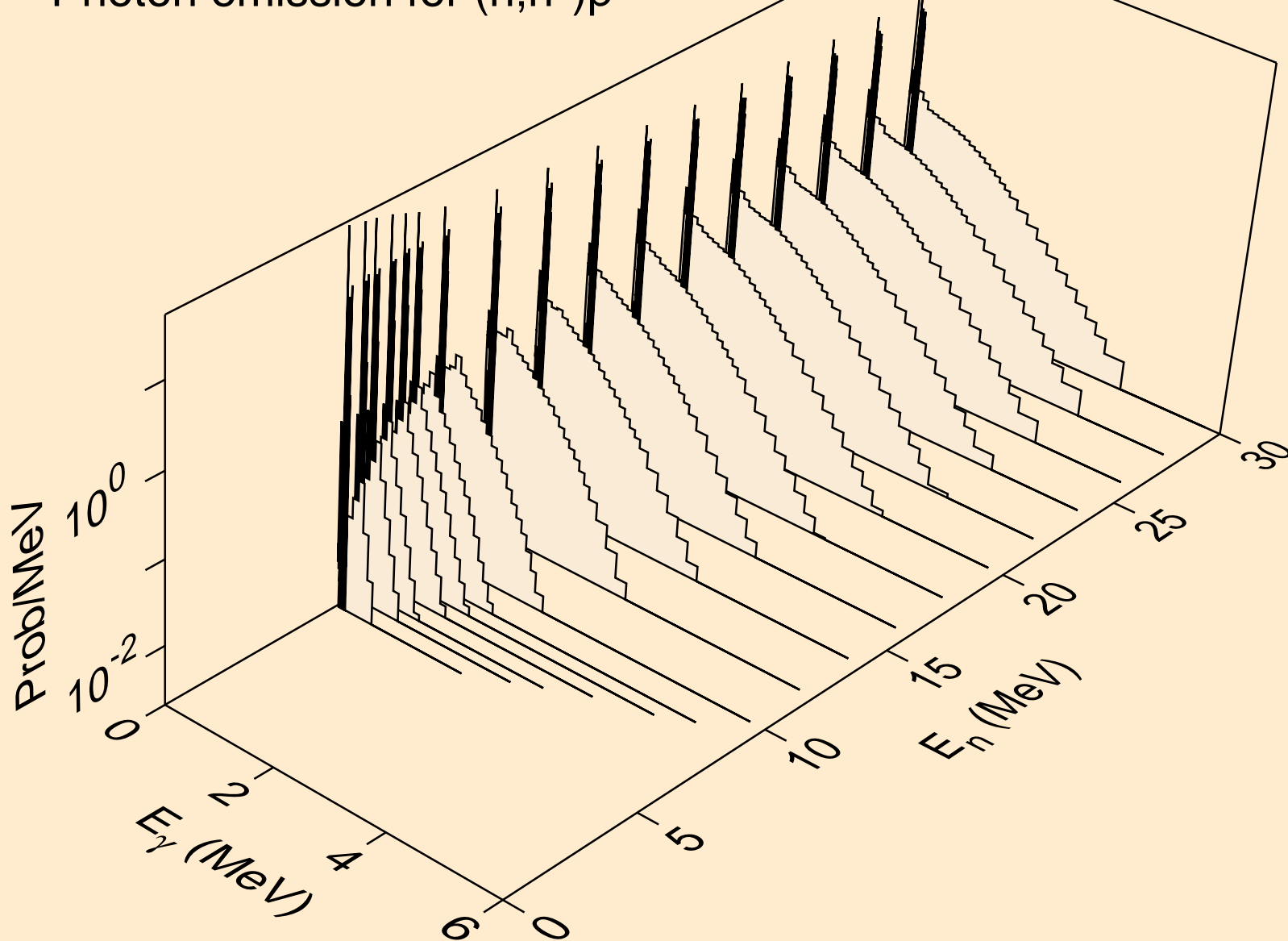

NO252 NEUTRON ACER TENDL-2019 LIBRARY; T=293.16K  
Photon emission for (n,n\*)2a

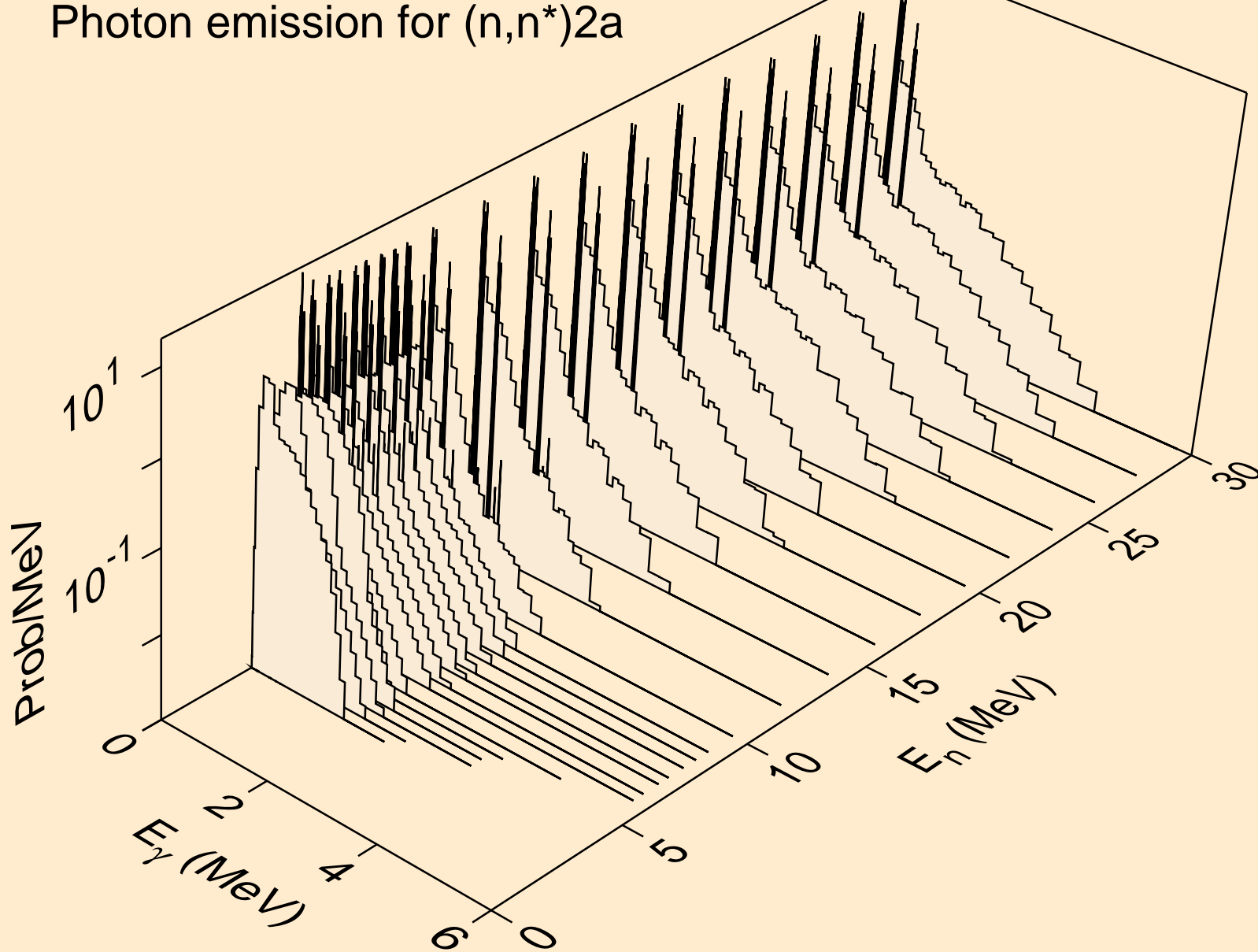

NO252 NEUTRON ACER TENDL-2019 LIBRARY; T=293.16K  
Photon emission for (n,2n)2a

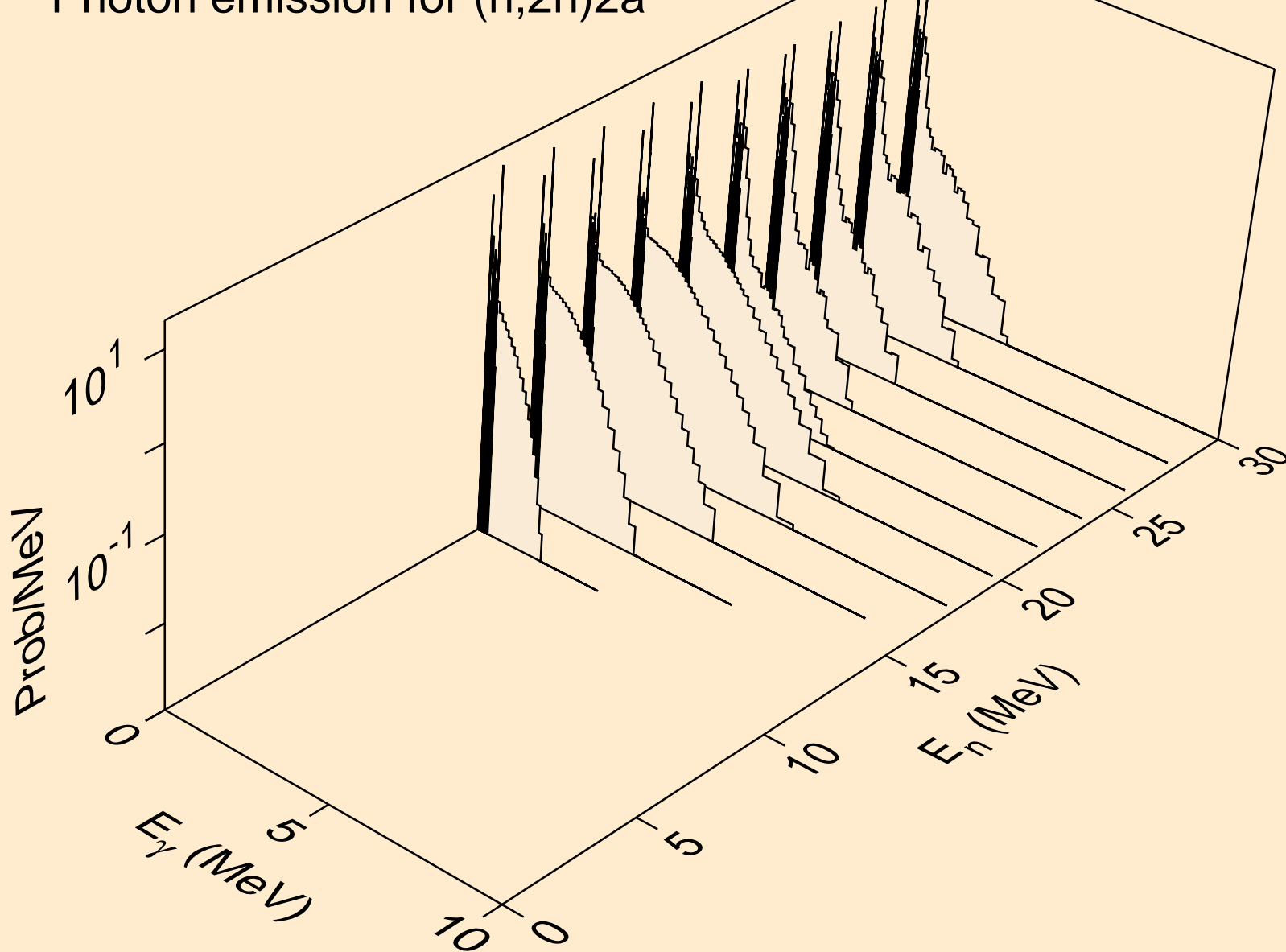

NO252 NEUTRON ACER TENDL-2019 LIBRARY; T=293.16K  
Photon emission for (n,n\*)d

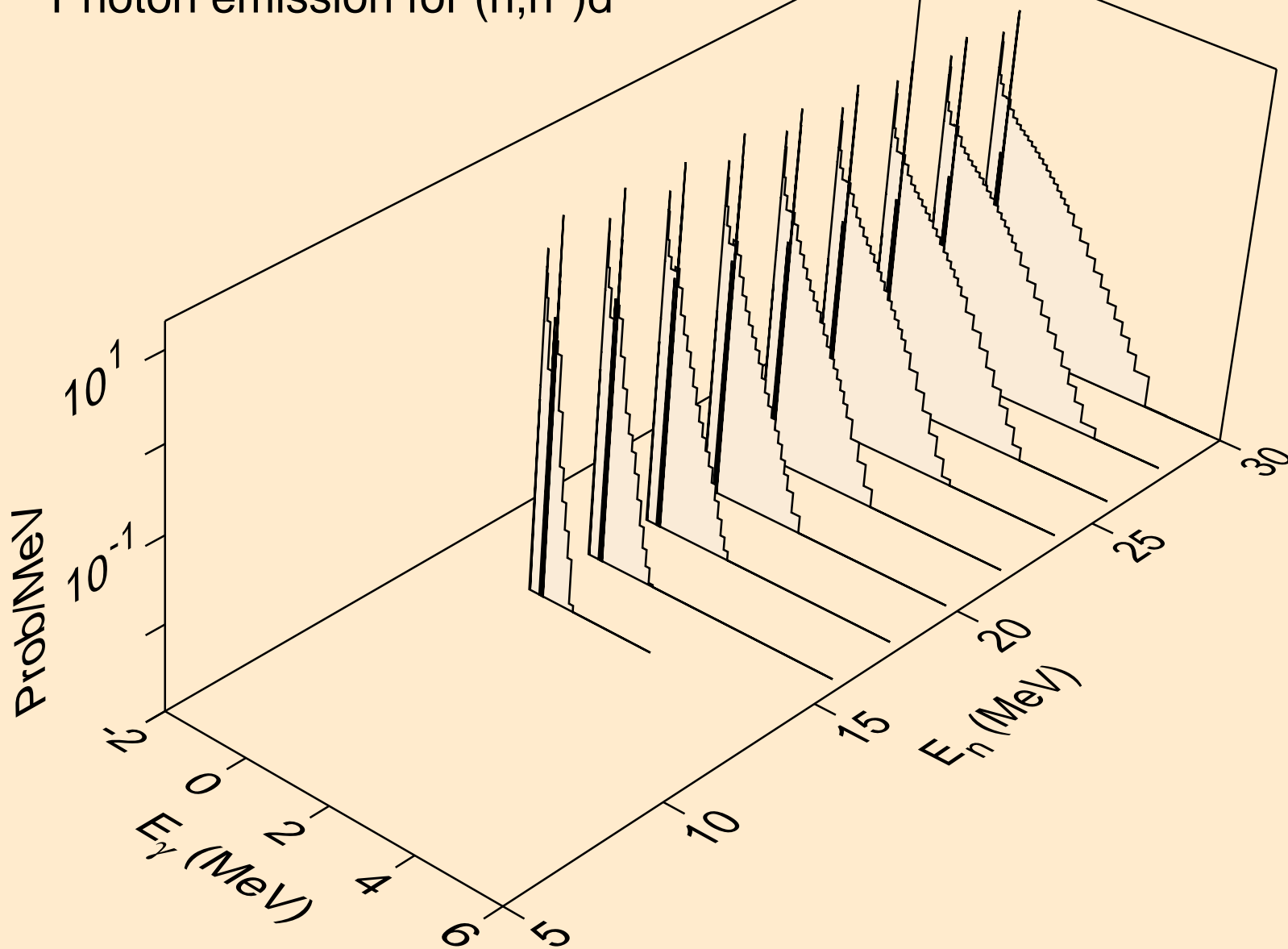

NO252 NEUTRON ACER TENDL-2019 LIBRARY; T=293.16K  
Photon emission for (n,n\*)t

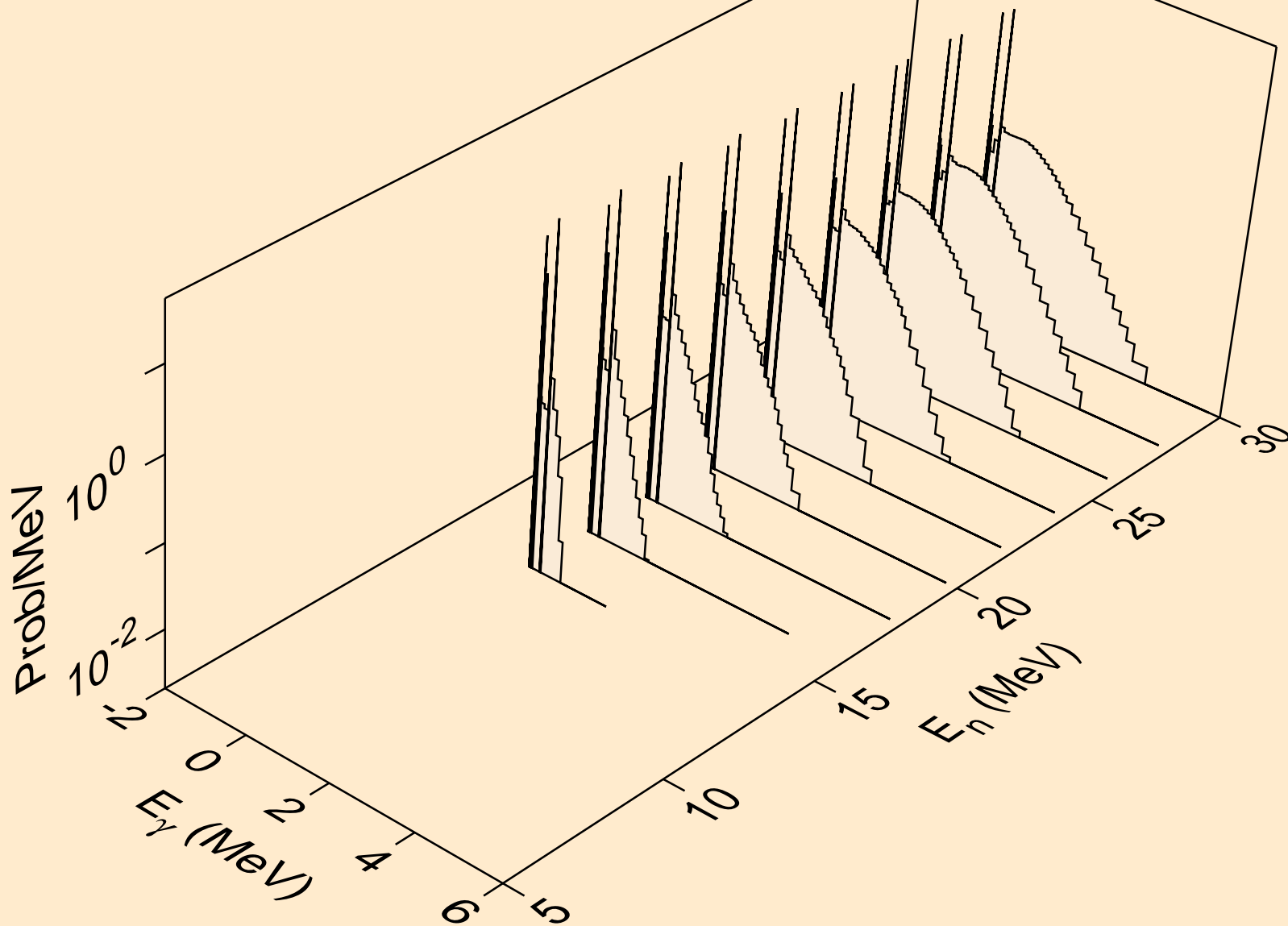

NO252 NEUTRON ACER TENDL-2019 LIBRARY; T=293.16K  
Photon emission for (n,n\*)he3

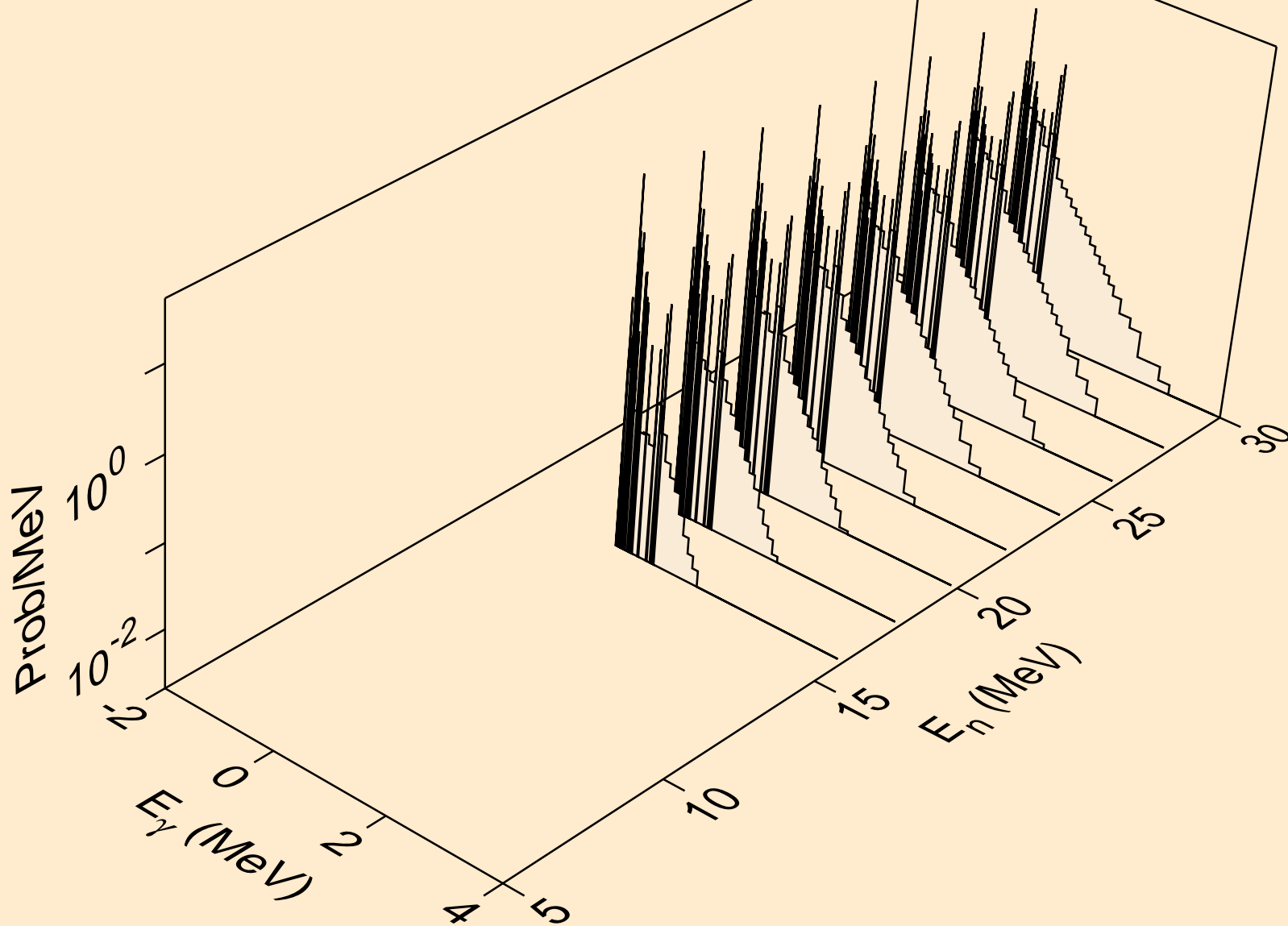

NO252 NEUTRON ACER TENDL-2019 LIBRARY; T=293.16K  
Photon emission for (n,4n)

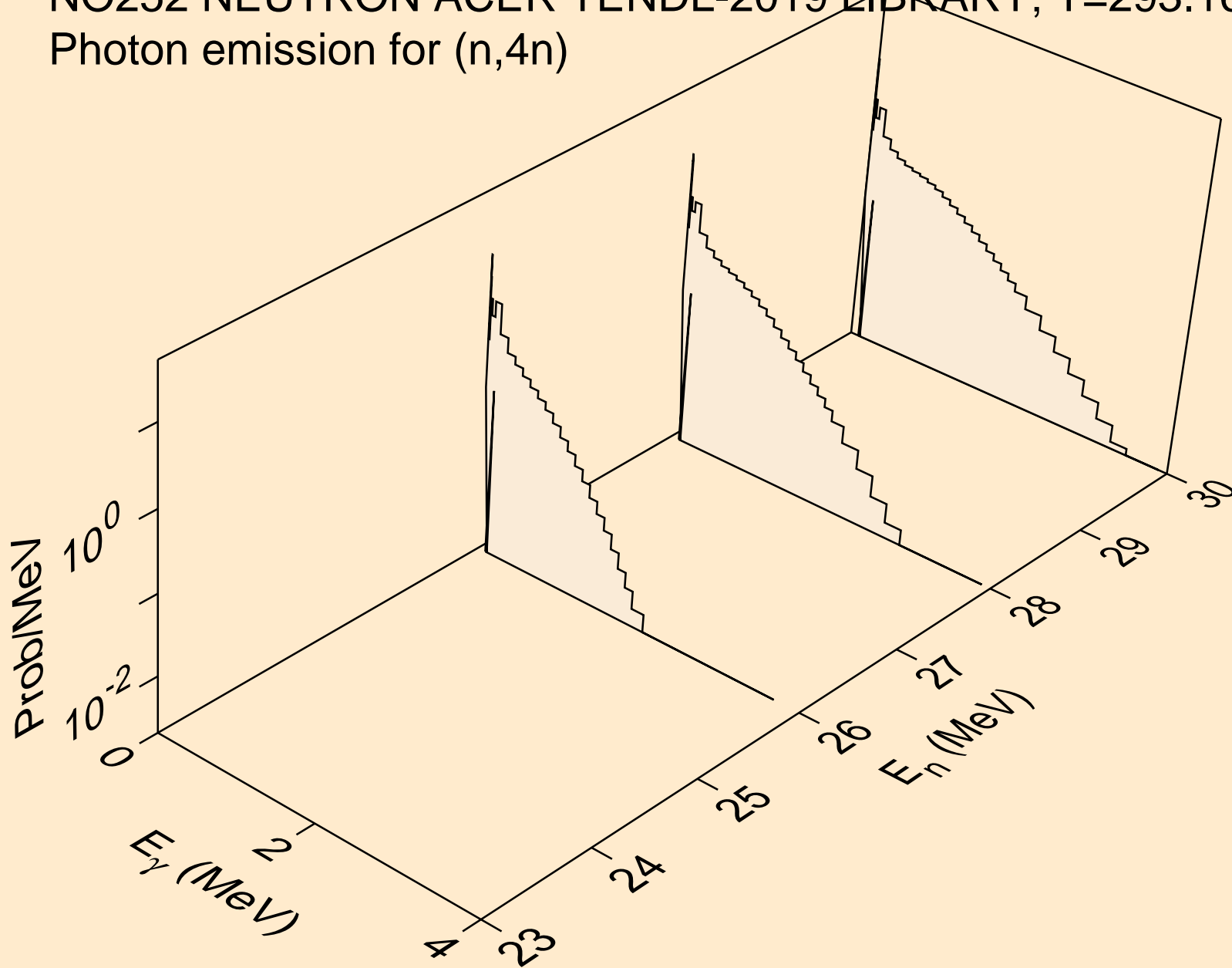

NO252 NEUTRON ACER TENDL-2019 LIBRARY; T=293.16K  
Photon emission for (n,2np)

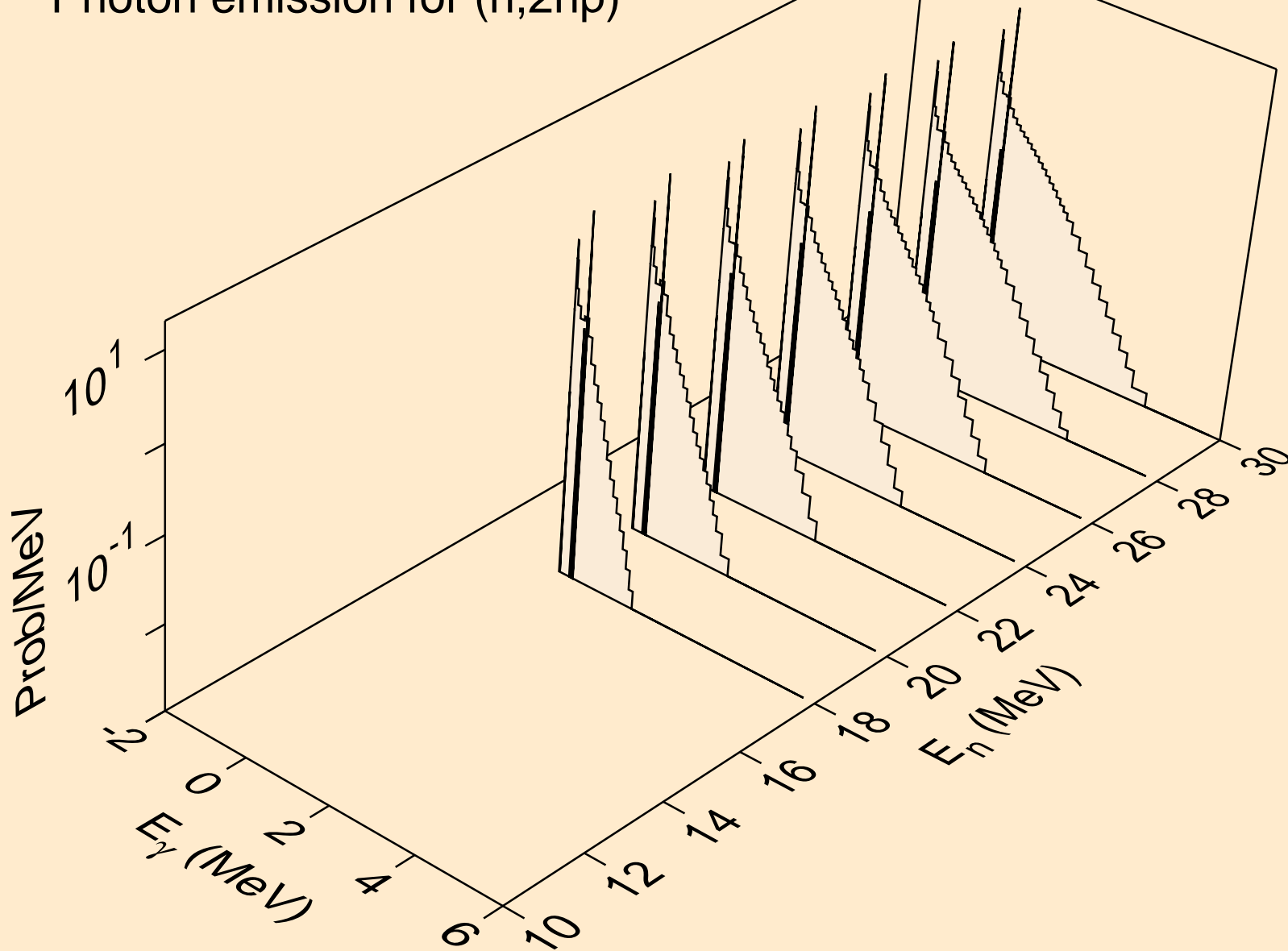

NO252 NEUTRON ACER TENDL-2019 LIBRARY; T=293.16K  
Photon emission for (n,3np)

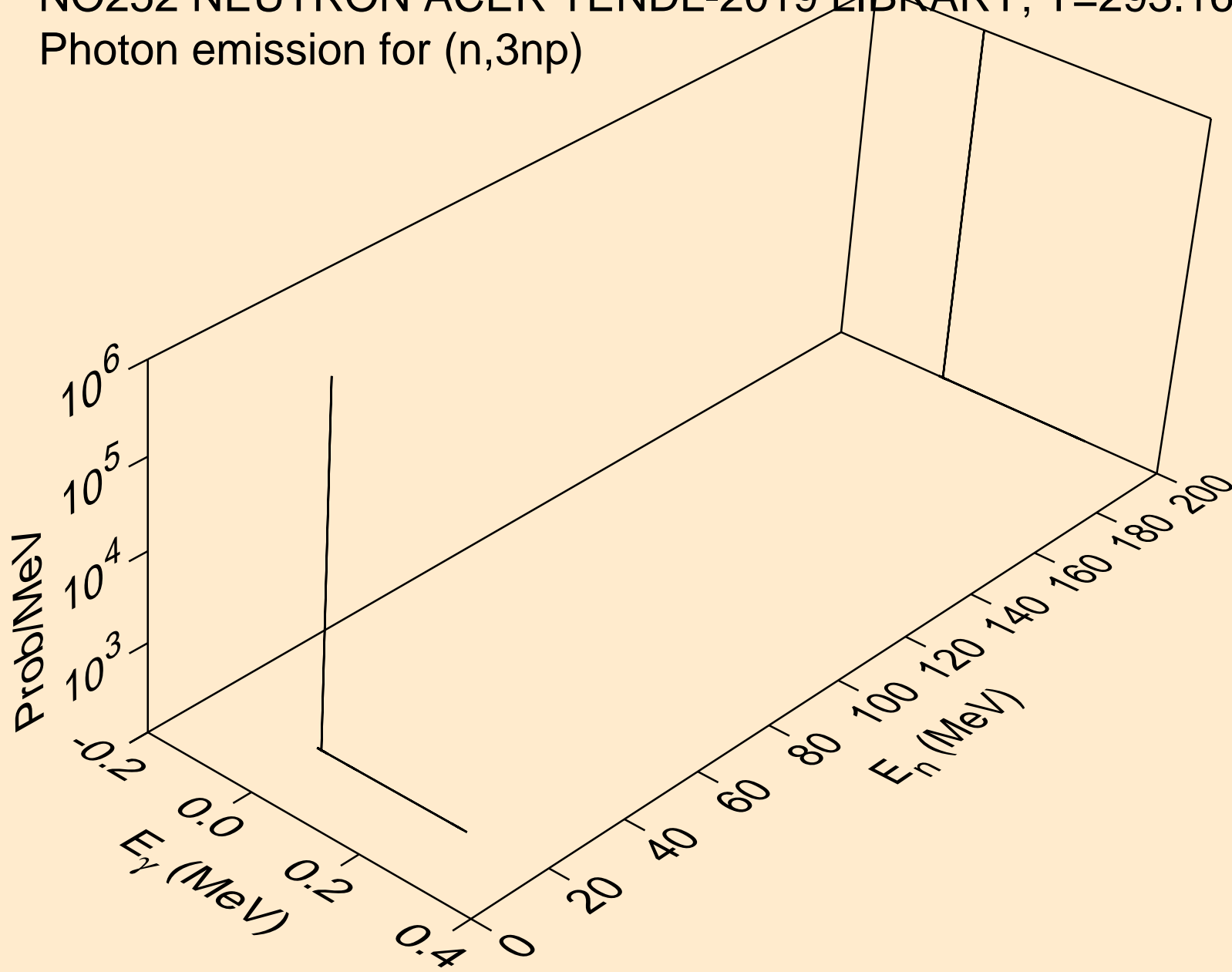

NO252 NEUTRON ACER TENDL-2019 LIBRARY; T=293.16K  
Photon emission for (n,2np)

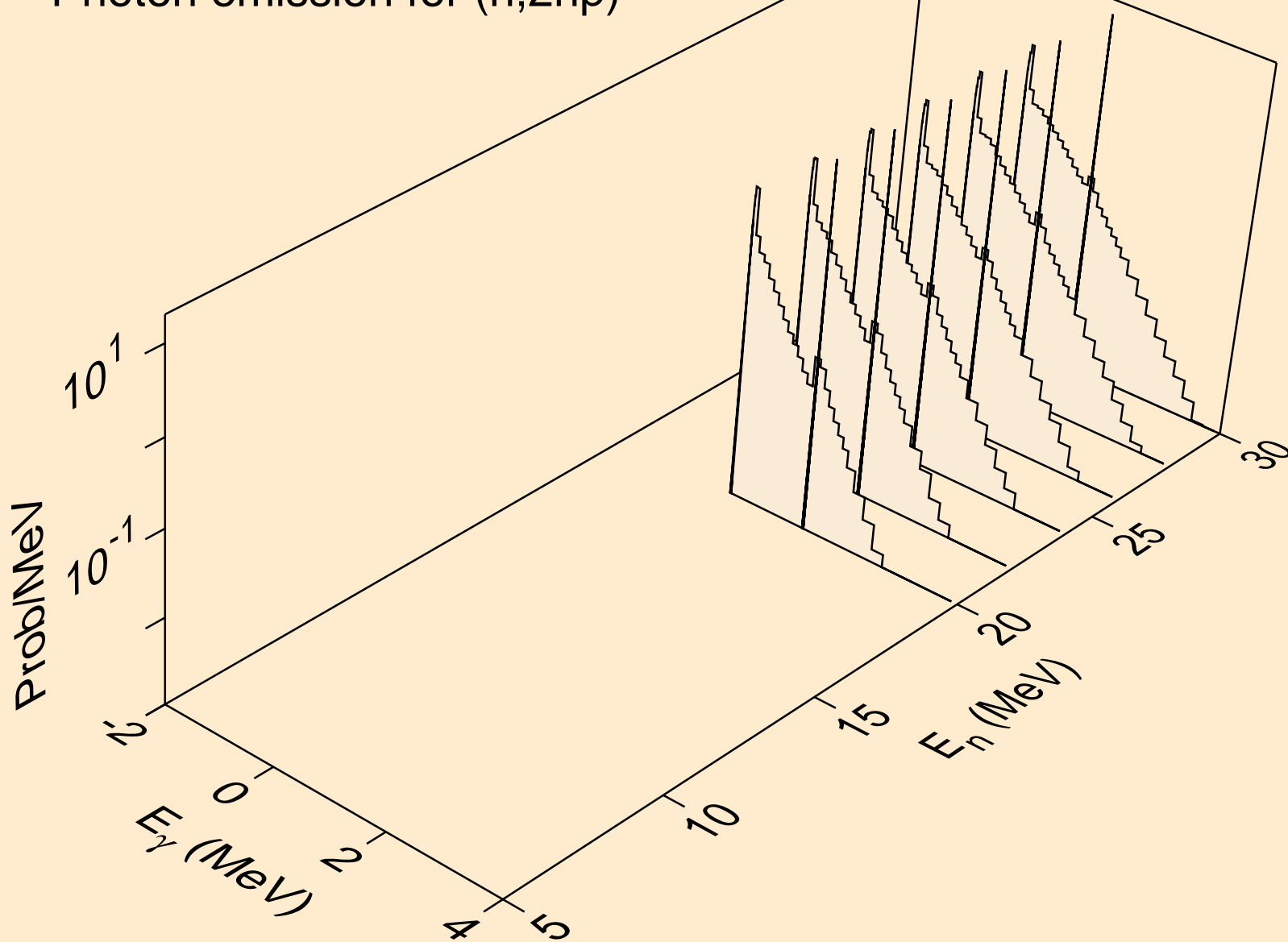

NO252 NEUTRON ACER TENDL-2019 LIBRARY; T=293.16K  
Photon emission for (n,npa)

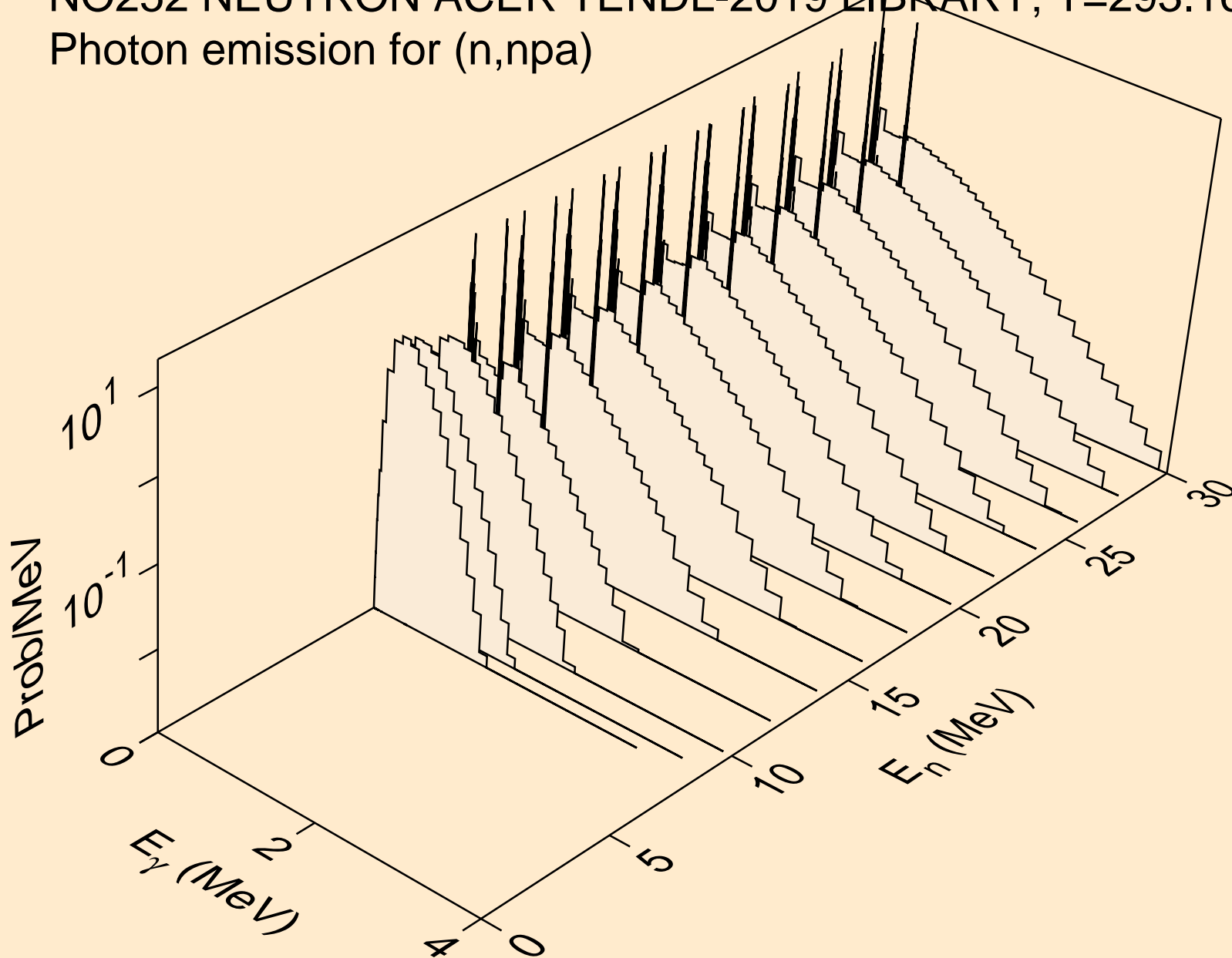

NO252 NEUTRON ACER TENDL-2019 LIBRARY; T=293.16K  
Photon emission for (n,n\*c)

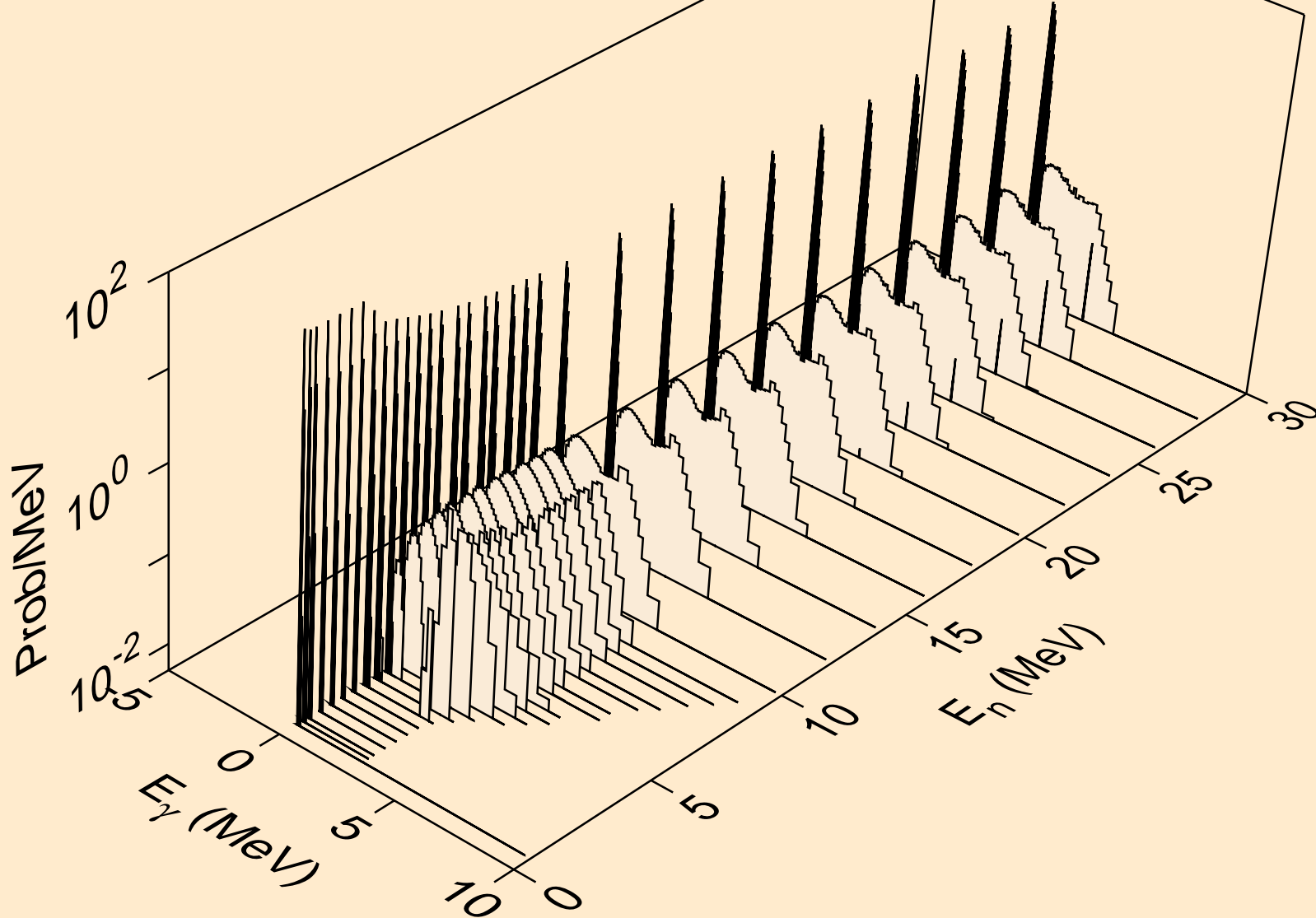

NO252 NEUTRON ACER TENDL-2019 LIBRARY; T=293.16K  
Photon emission for (n,gma)

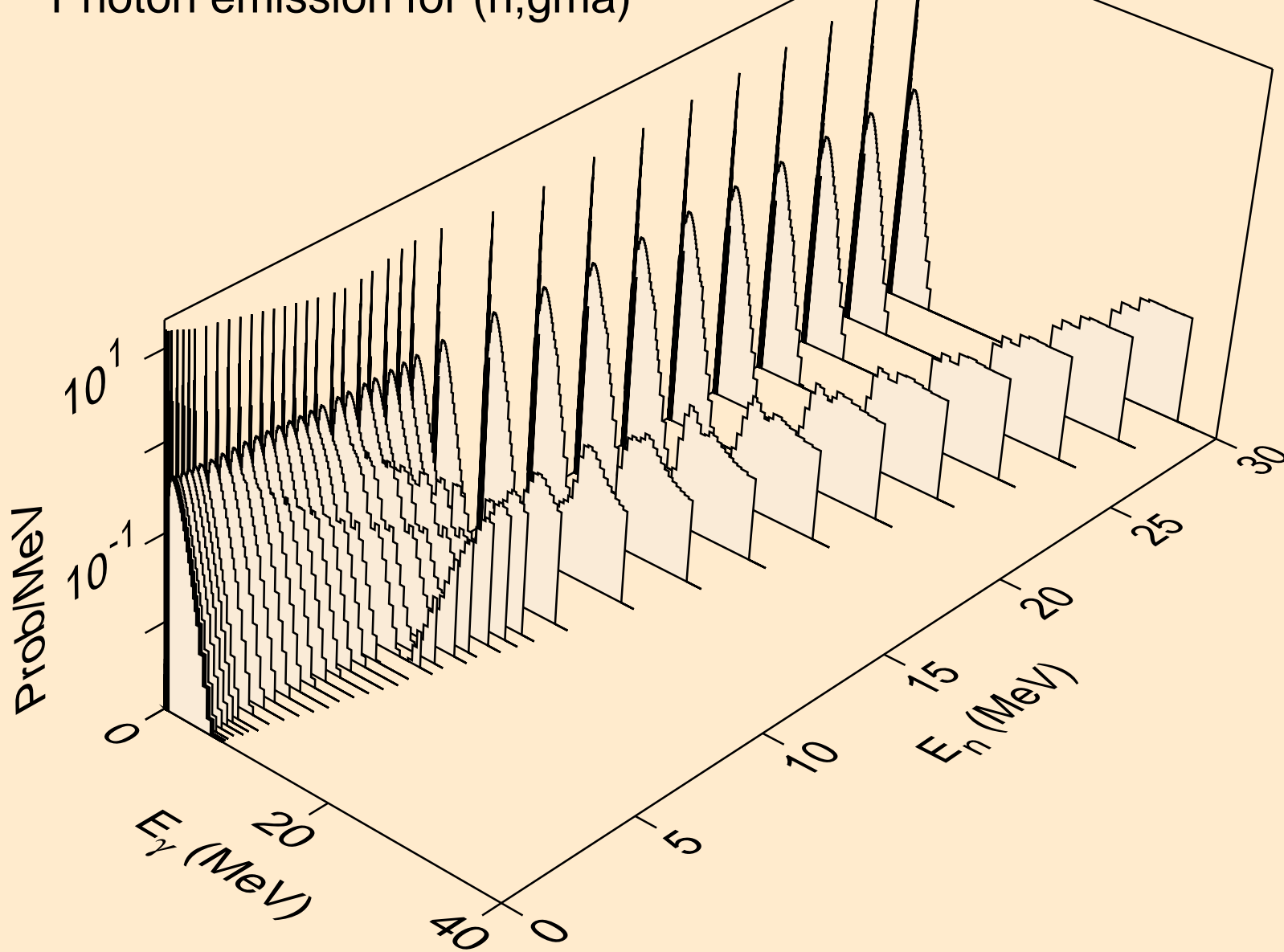

NO252 NEUTRON ACER TENDL-2019 LIBRARY; T=293.16K  
Photon emission for (n,p)

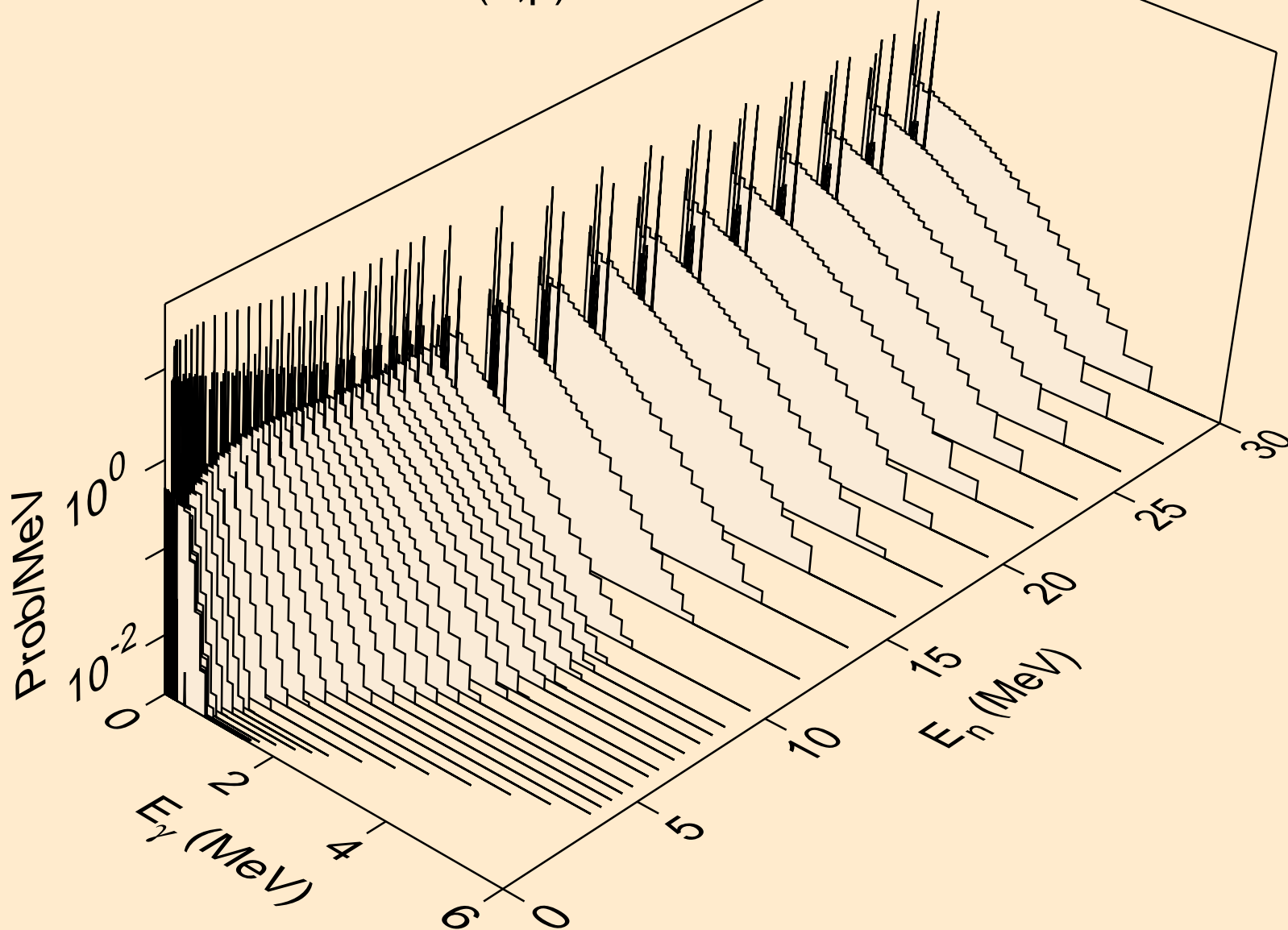

NO252 NEUTRON ACER TENDL-2019 LIBRARY; T=293.16K  
Photon emission for (n,d)

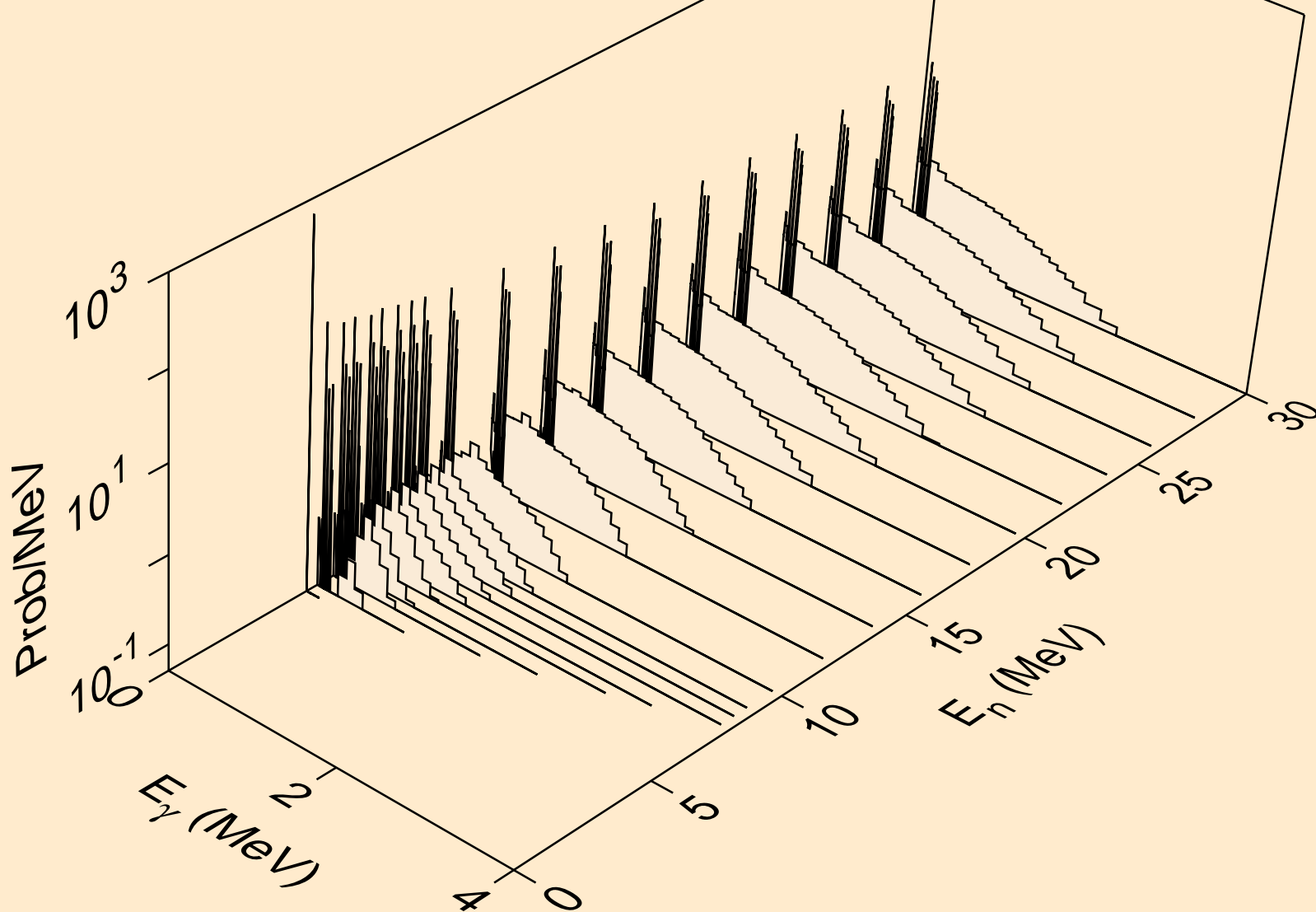

NO252 NEUTRON ACER TENDL-2019 LIBRARY; T=293.16K  
Photon emission for (n,t)

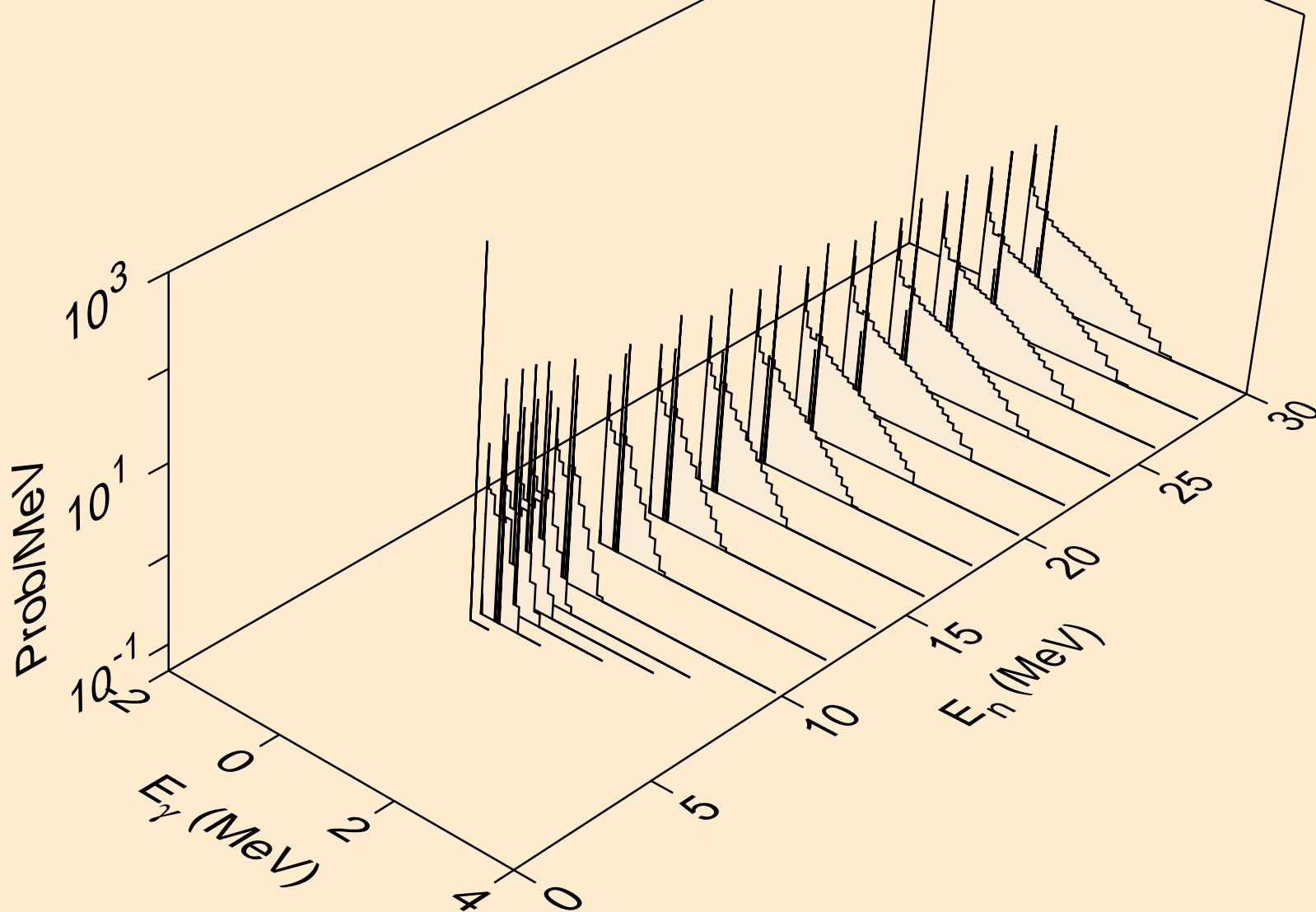

NO252 NEUTRON ACER TENDL-2019 LIBRARY; T=293.16K  
Photon emission for (n,he3)

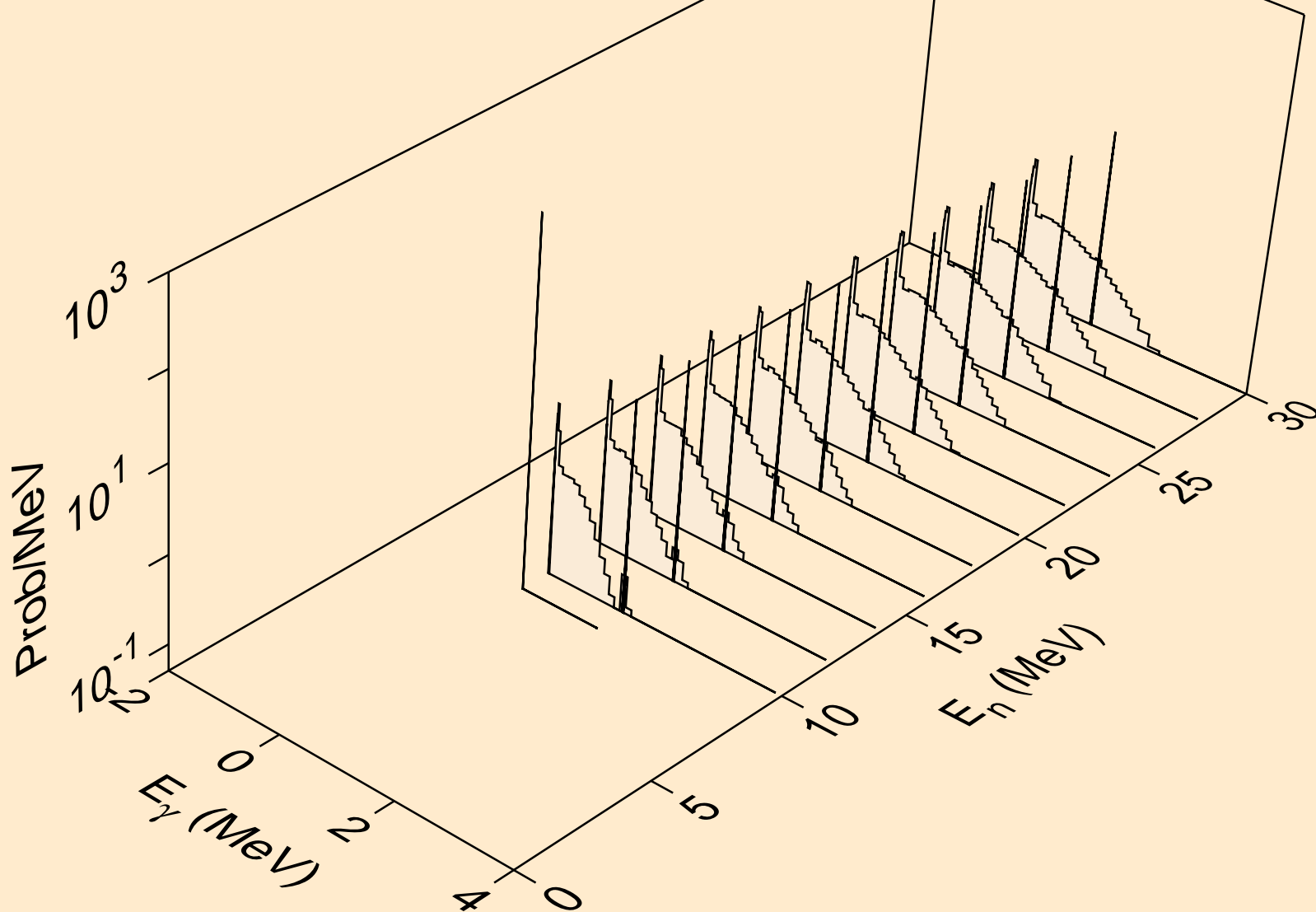

NO252 NEUTRON ACER TENDL-2019 LIBRARY; T=293.16K  
Photon emission for (n,a)

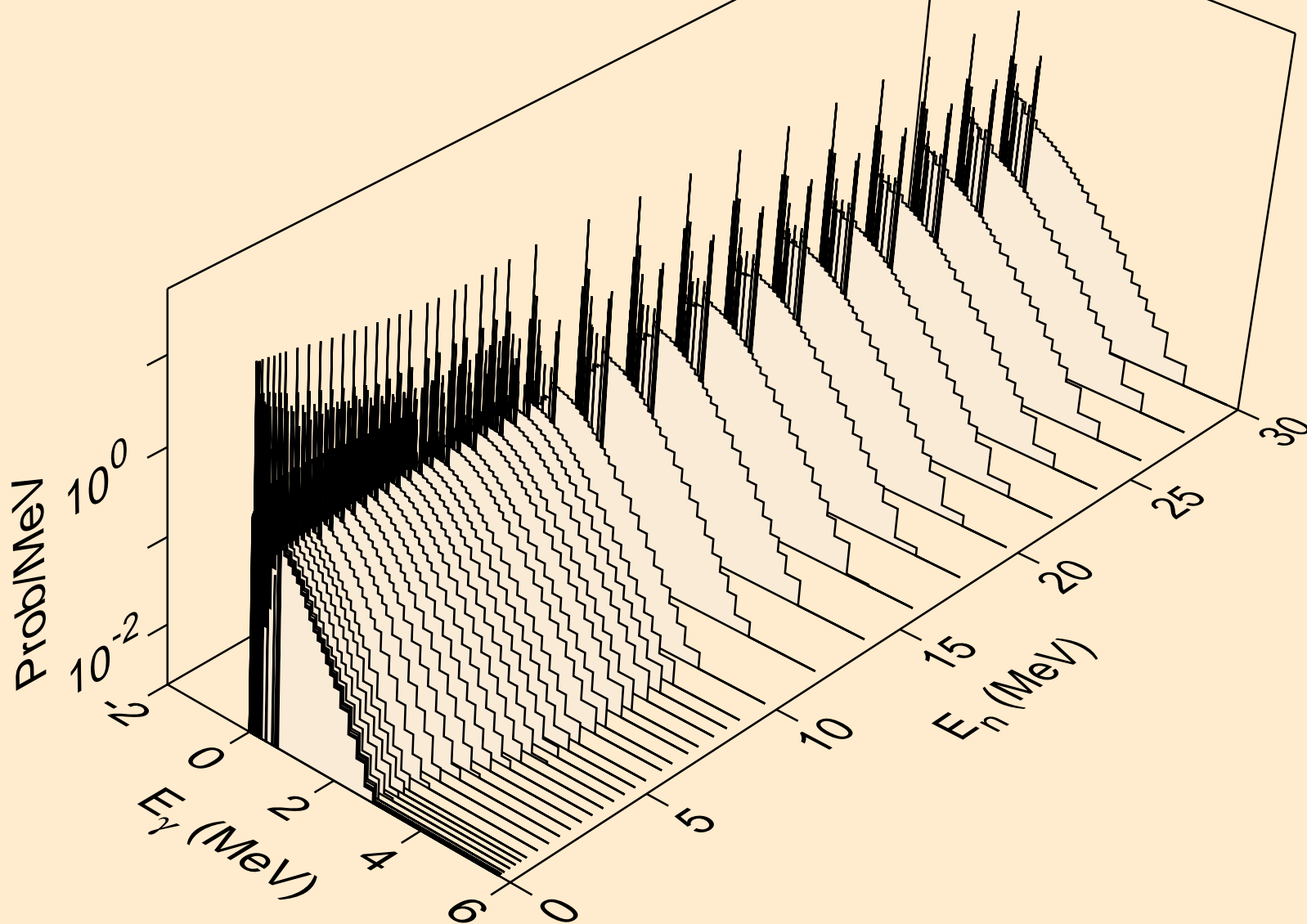

NO252 NEUTRON ACER TENDL-2019 LIBRARY; T=293.16K  
Photon emission for (n,2a)

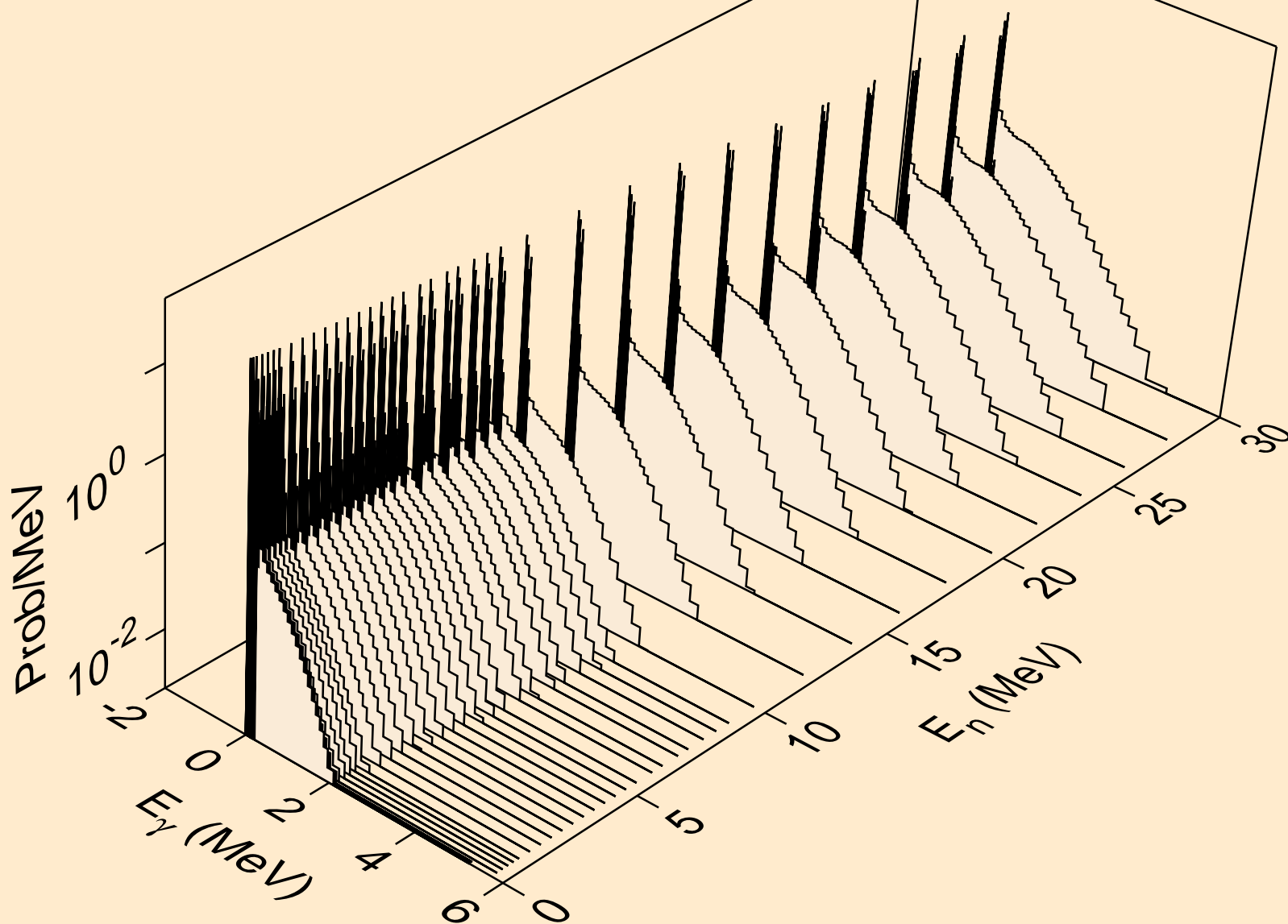

NO252 NEUTRON ACER TENDL-2019 LIBRARY; T=293.16K  
Photon emission for (n,2p)

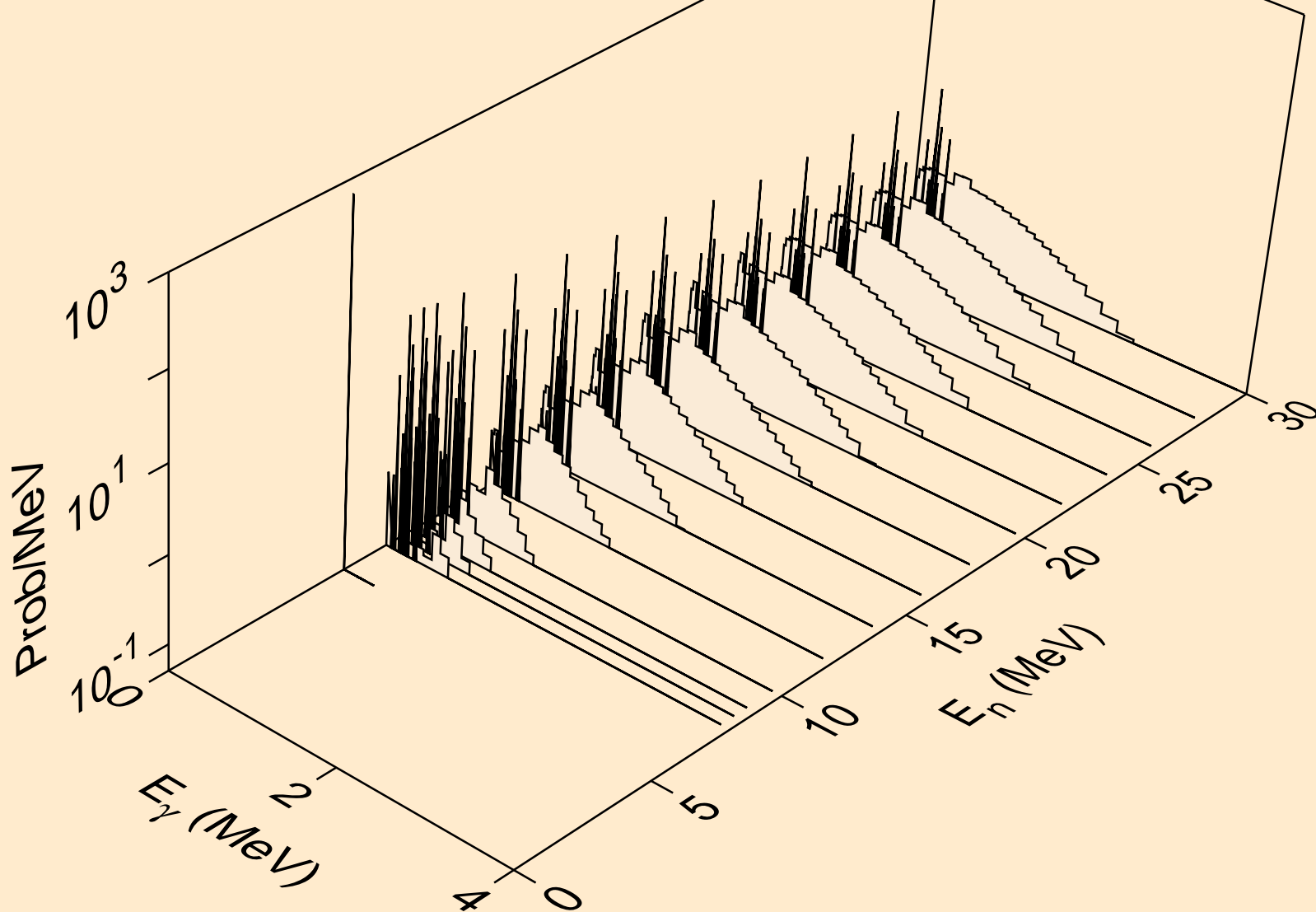

NO252 NEUTRON ACER TENDL-2019 LIBRARY; T=293.16K  
Photon emission for (n,p $\alpha$ )

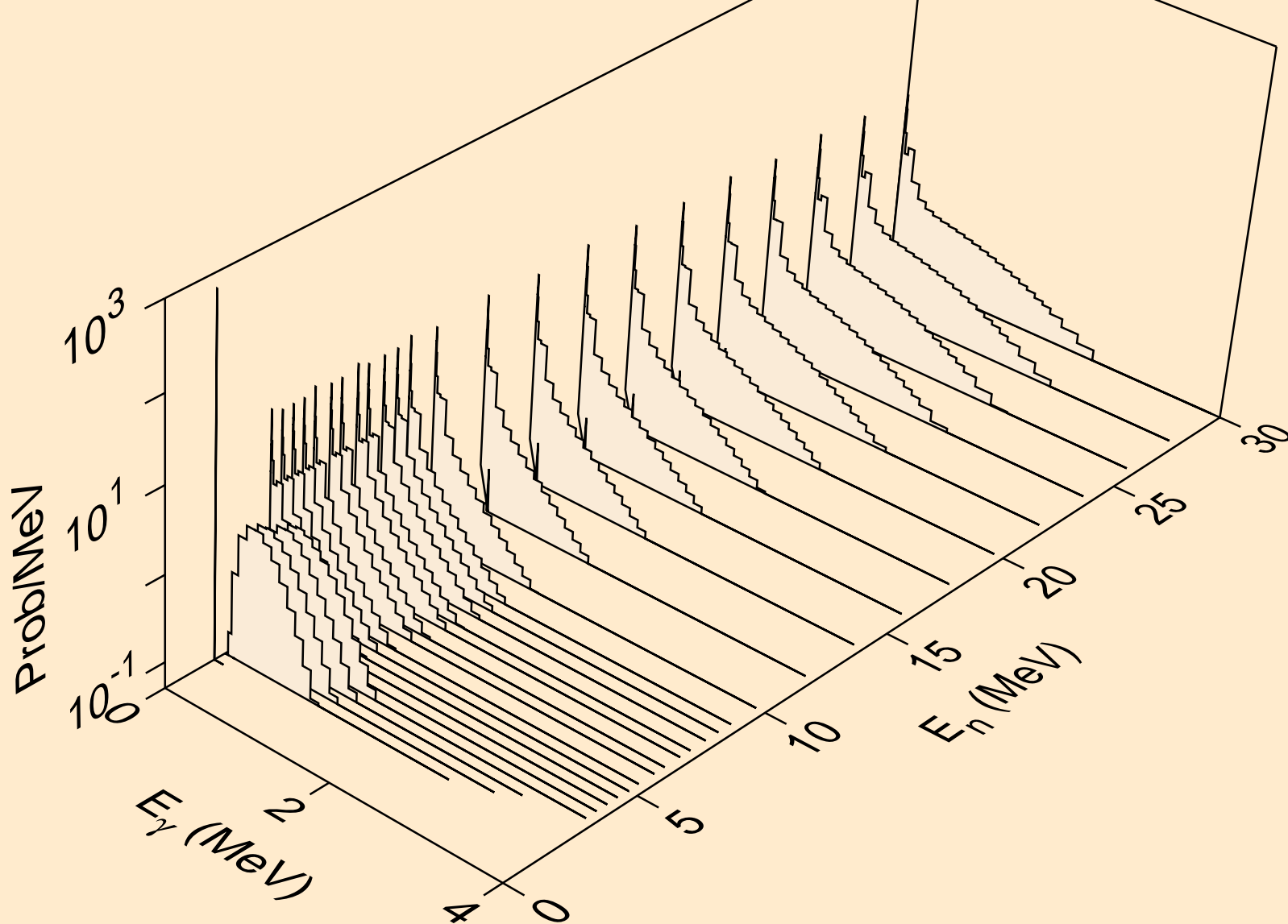

NO252 NEUTRON ACER TENDL-2019 LIBRARY; T=293.16K  
Photon emission for (n,pd)

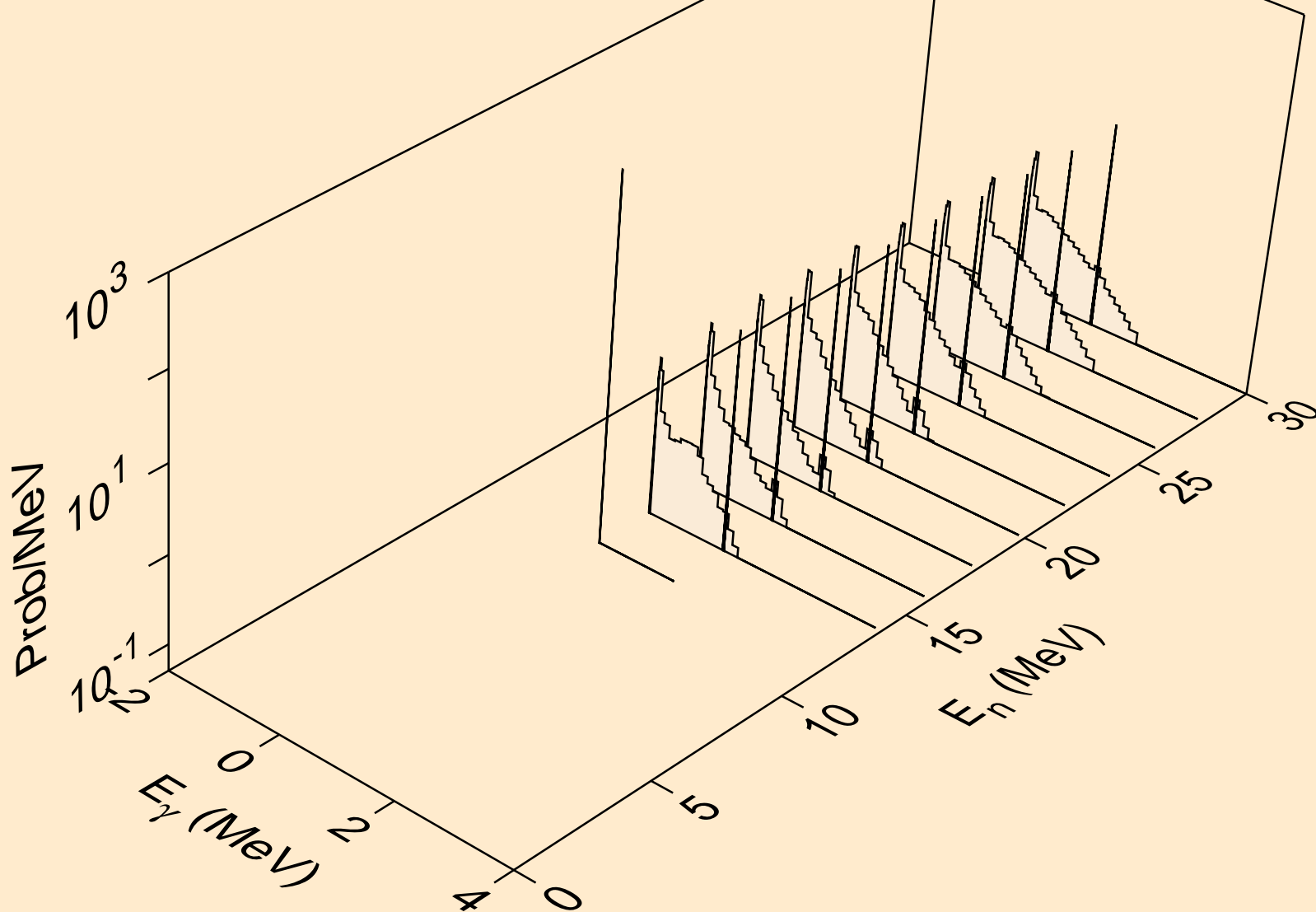

NO252 NEUTRON ACER TENDL-2019 LIBRARY; T=293.16K  
Photon emission for (n,pt)

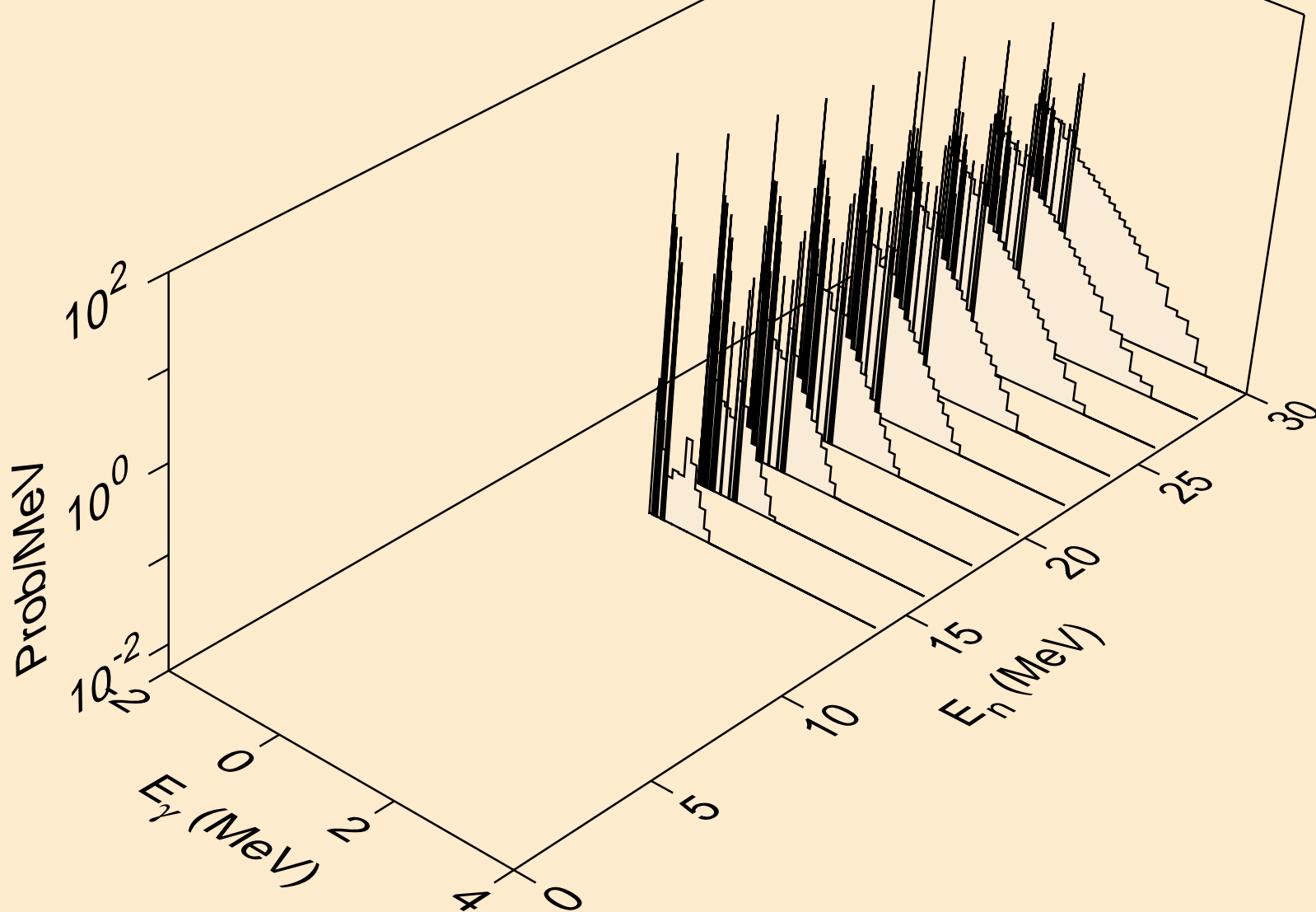

NO252 NEUTRON ACER TENDL-2019 LIBRARY; T=293.16K  
Photon emission for (n,da)

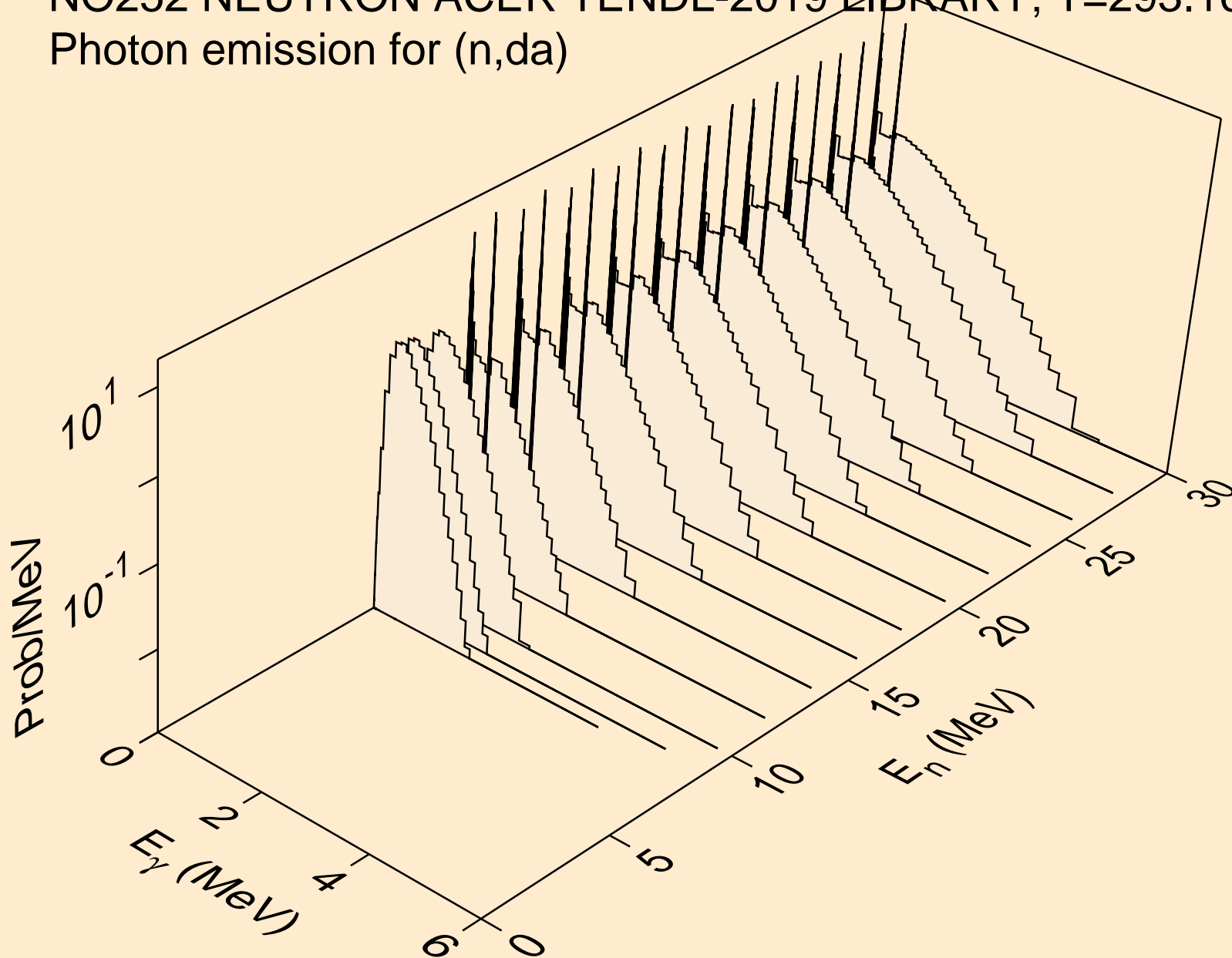

NO252 NEUTRON ACER TENDL-2019 LIBRARY; T=293.16K  
thermal capture photon spectrum

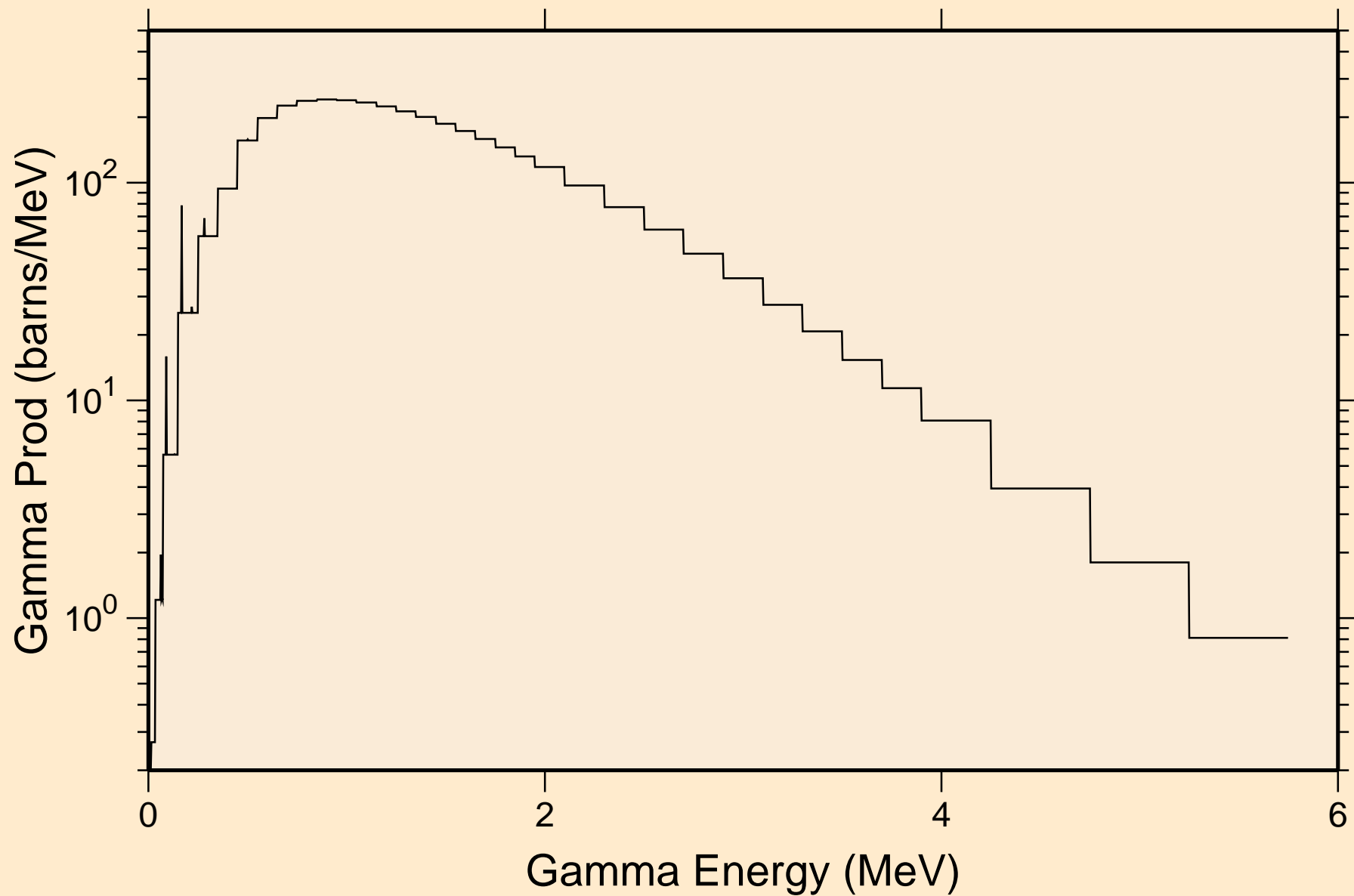

NO252 NEUTRON ACER TENDL-2019 LIBRARY; T=293.16K  
14 MeV photon spectrum

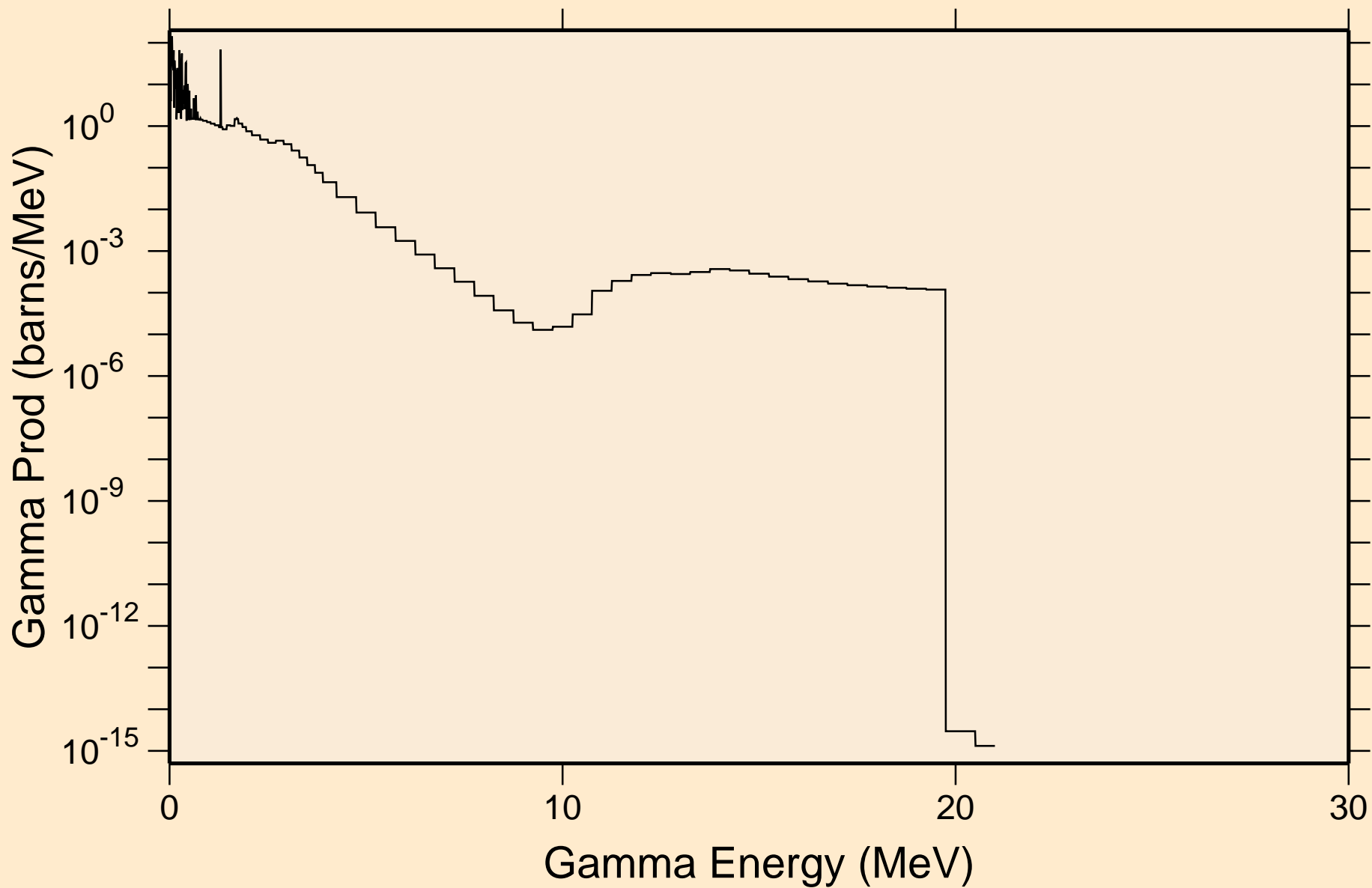

NO252 NEUTRON ACER TENDL-2019 LIBRARY; T=293.16K  
Particle heating contributions

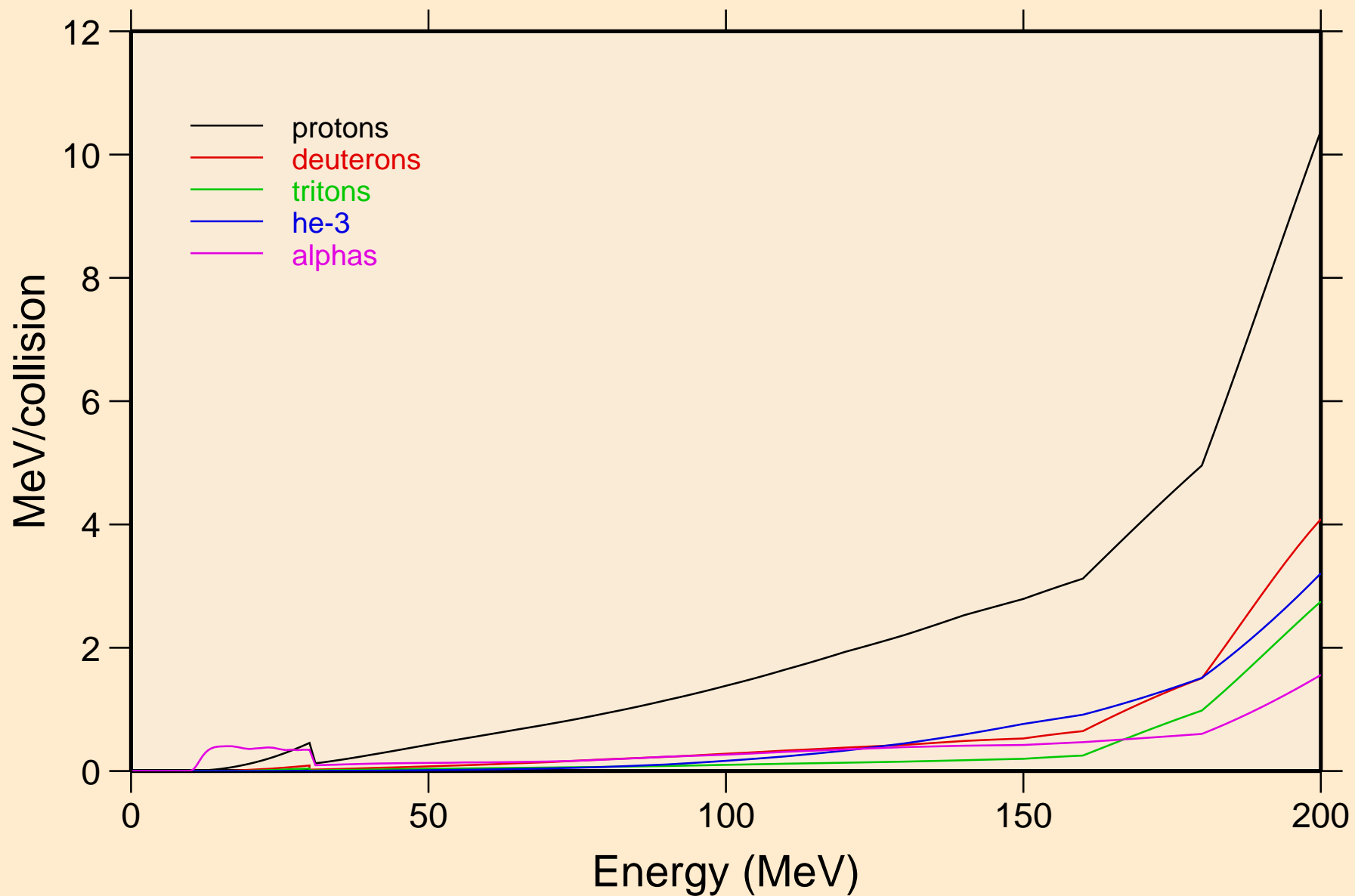

NO252 NEUTRON ACER TENDL-2019 LIBRARY; T=293.16K  
Recoil Heating

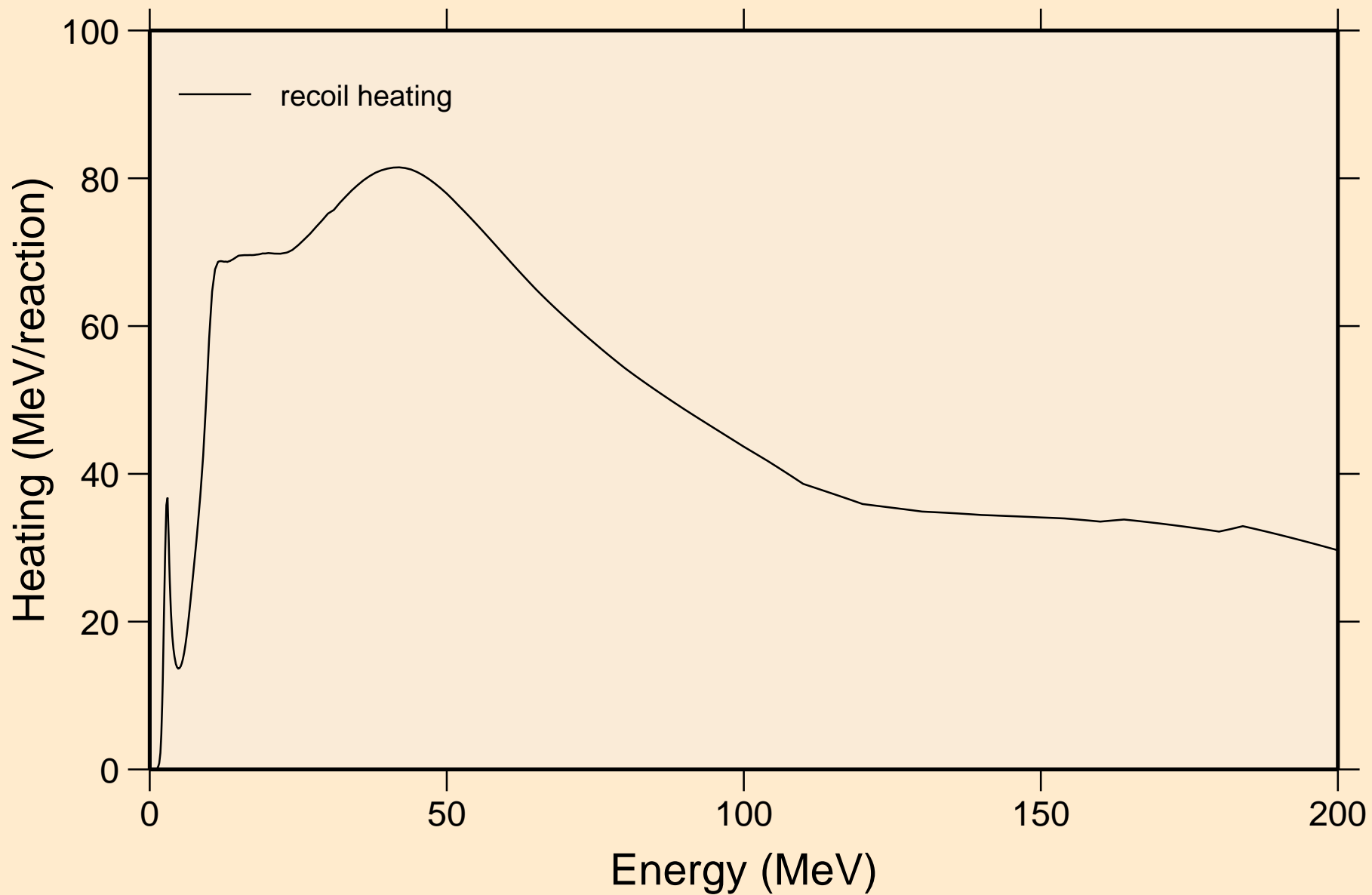

NO252 NEUTRON ACER TENDL-2019 LIBRARY; T=293.16K  
Particle production cross sections

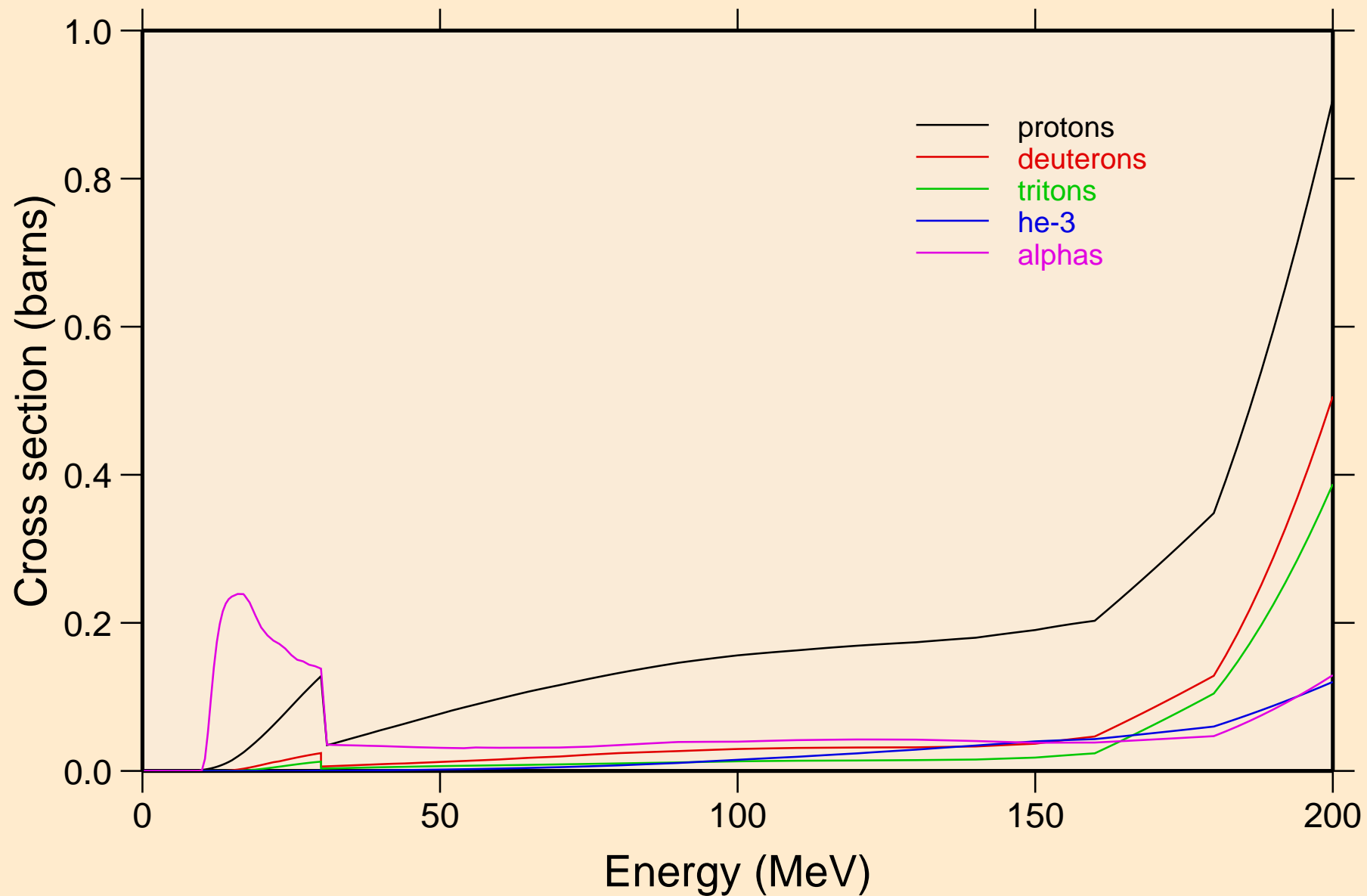

NO252 NEUTRON ACER TENDL-2019 LIBRARY; T=293.16K  
protons from (n,x)

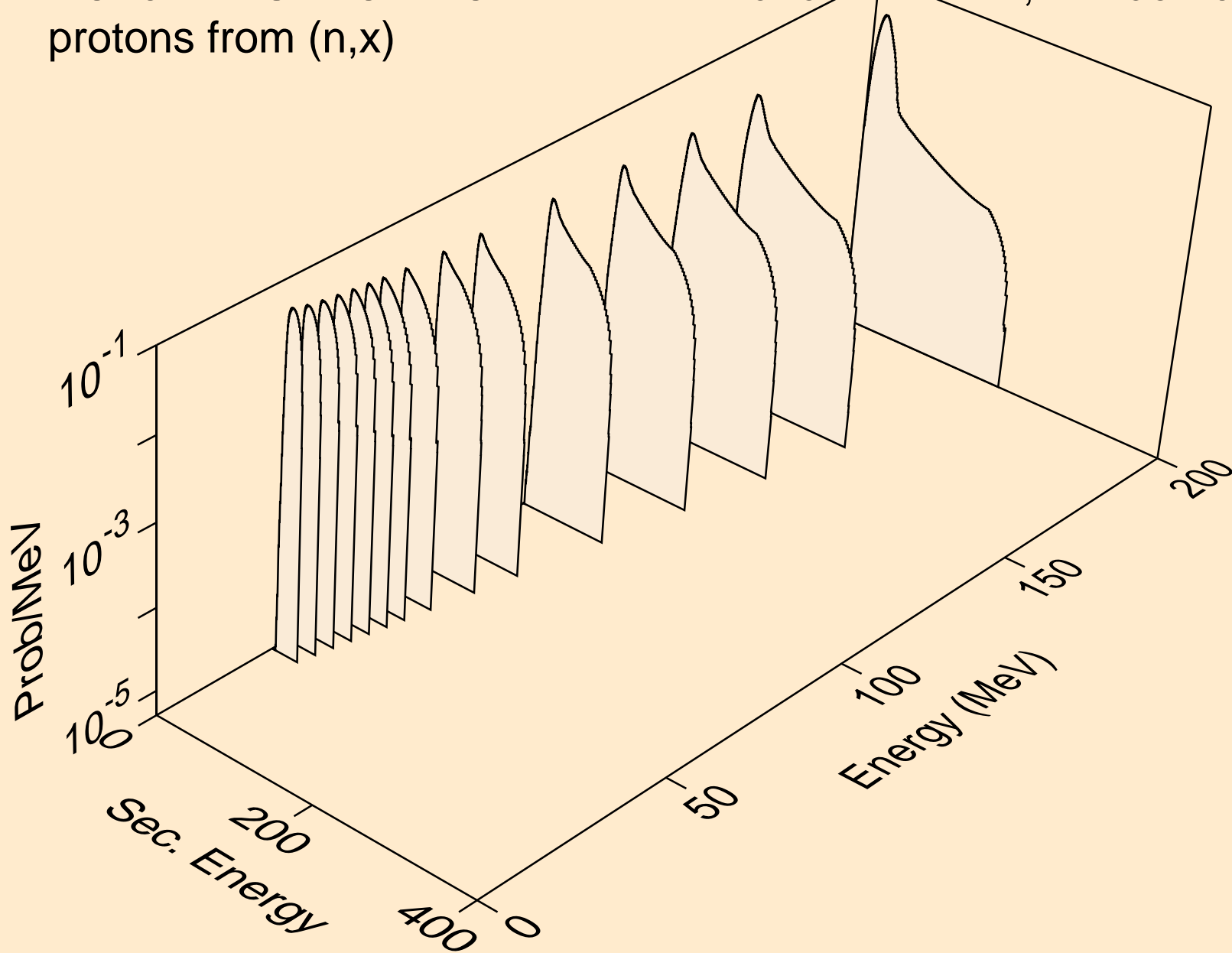

NO252 NEUTRON ACER TENDL-2019 LIBRARY; T=293.16K  
protons from (n,n\*)p

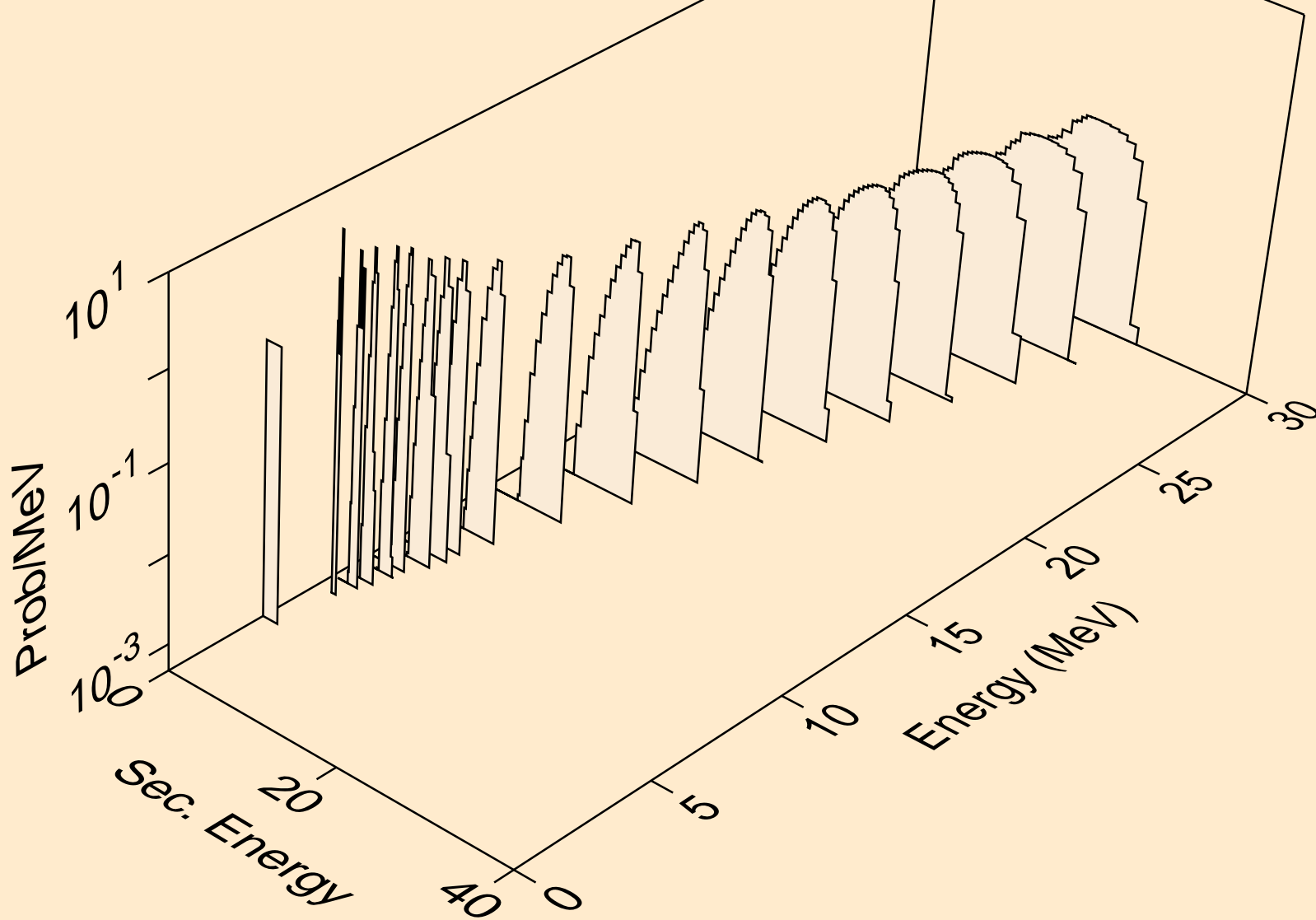

NO252 NEUTRON ACER TENDL-2019 LIBRARY; T=293.16K  
protons from (n,2np)

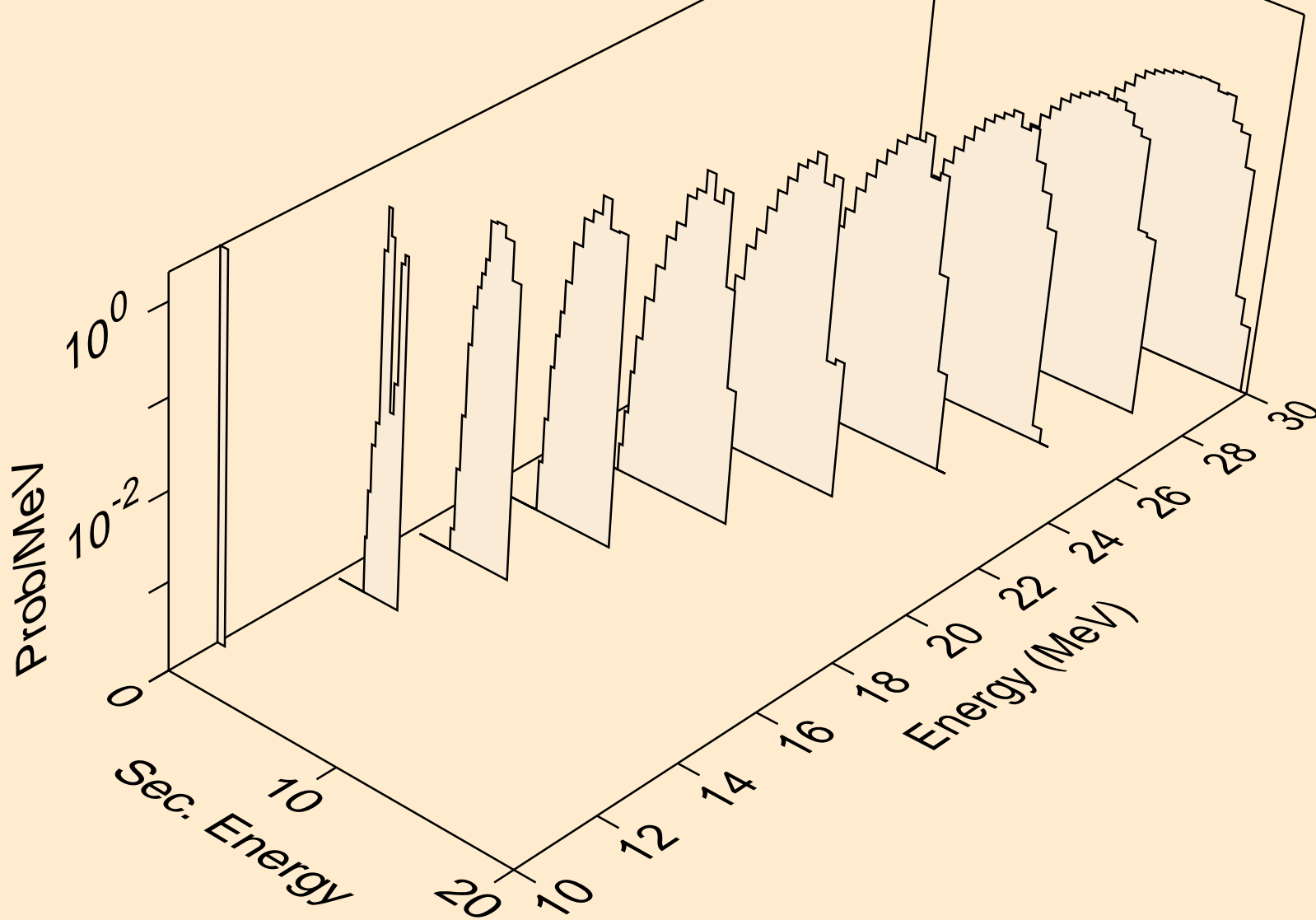

NO252 NEUTRON ACER TENDL-2019 LIBRARY; T=293.16K  
protons from (n,3np)

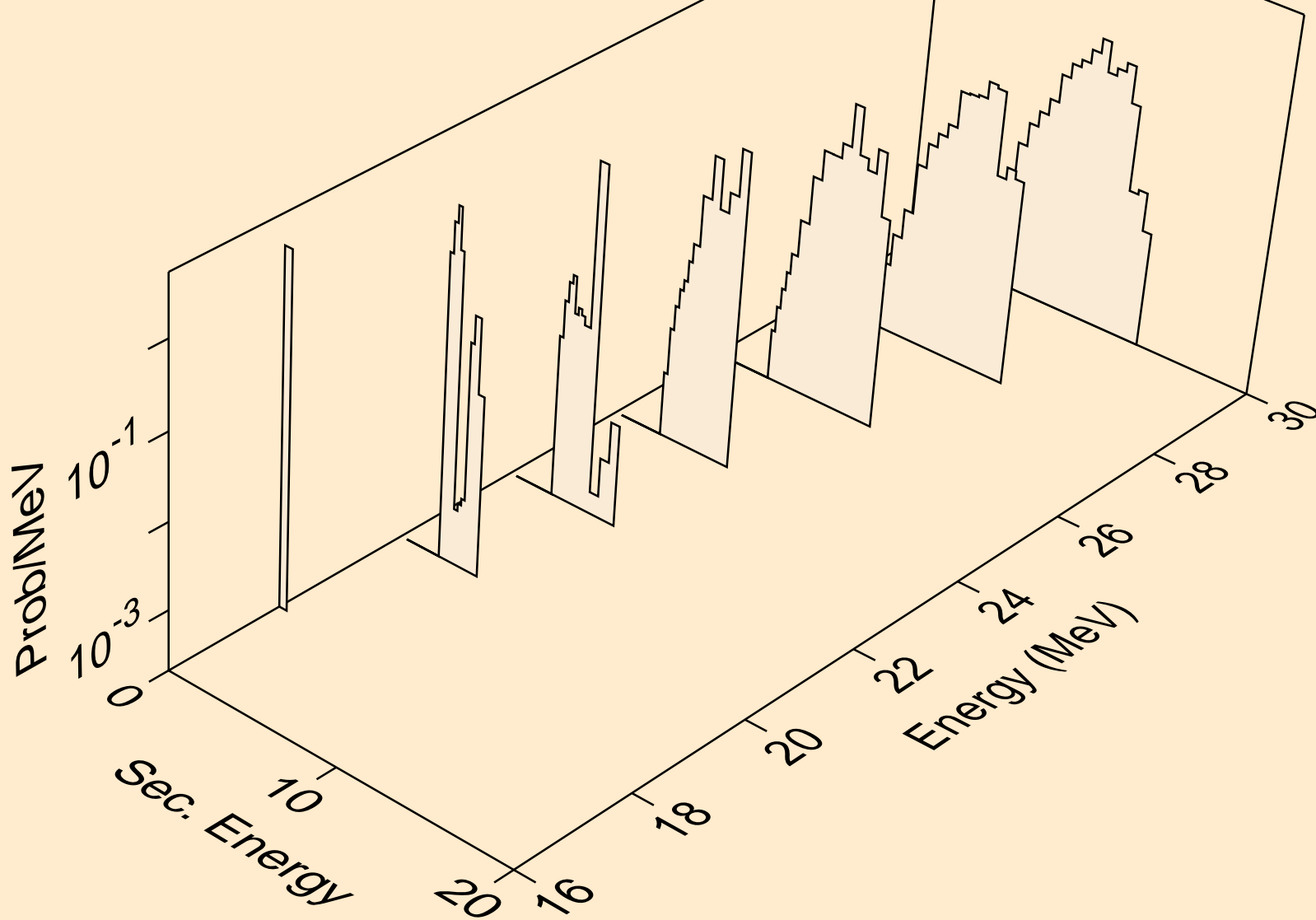

NO252 NEUTRON ACER TENDL-2019 LIBRARY; T=293.16K  
protons from (n,2np)

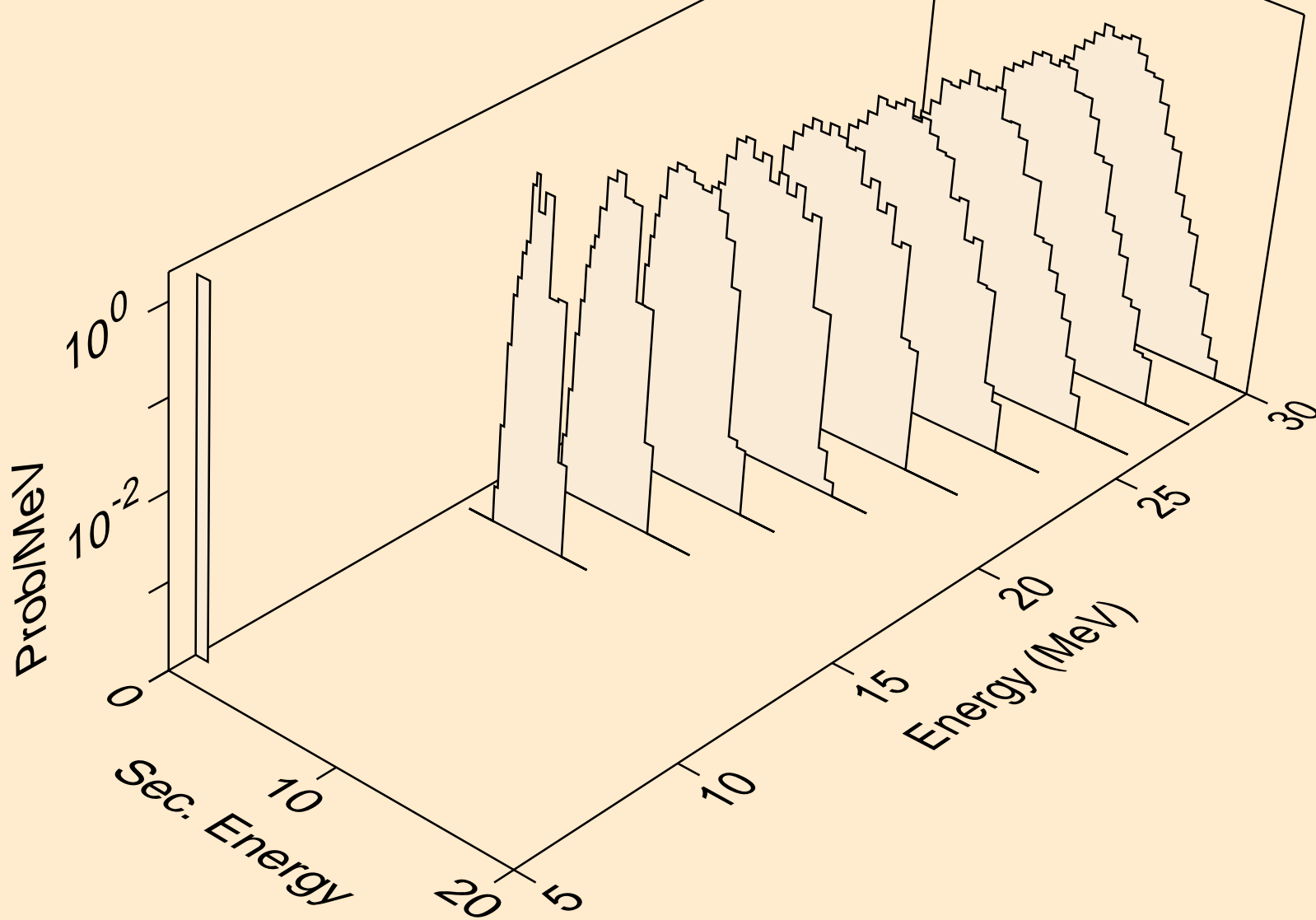

NO252 NEUTRON ACER TENDL-2019 LIBRARY; T=293.16K  
protons from (n,npa)

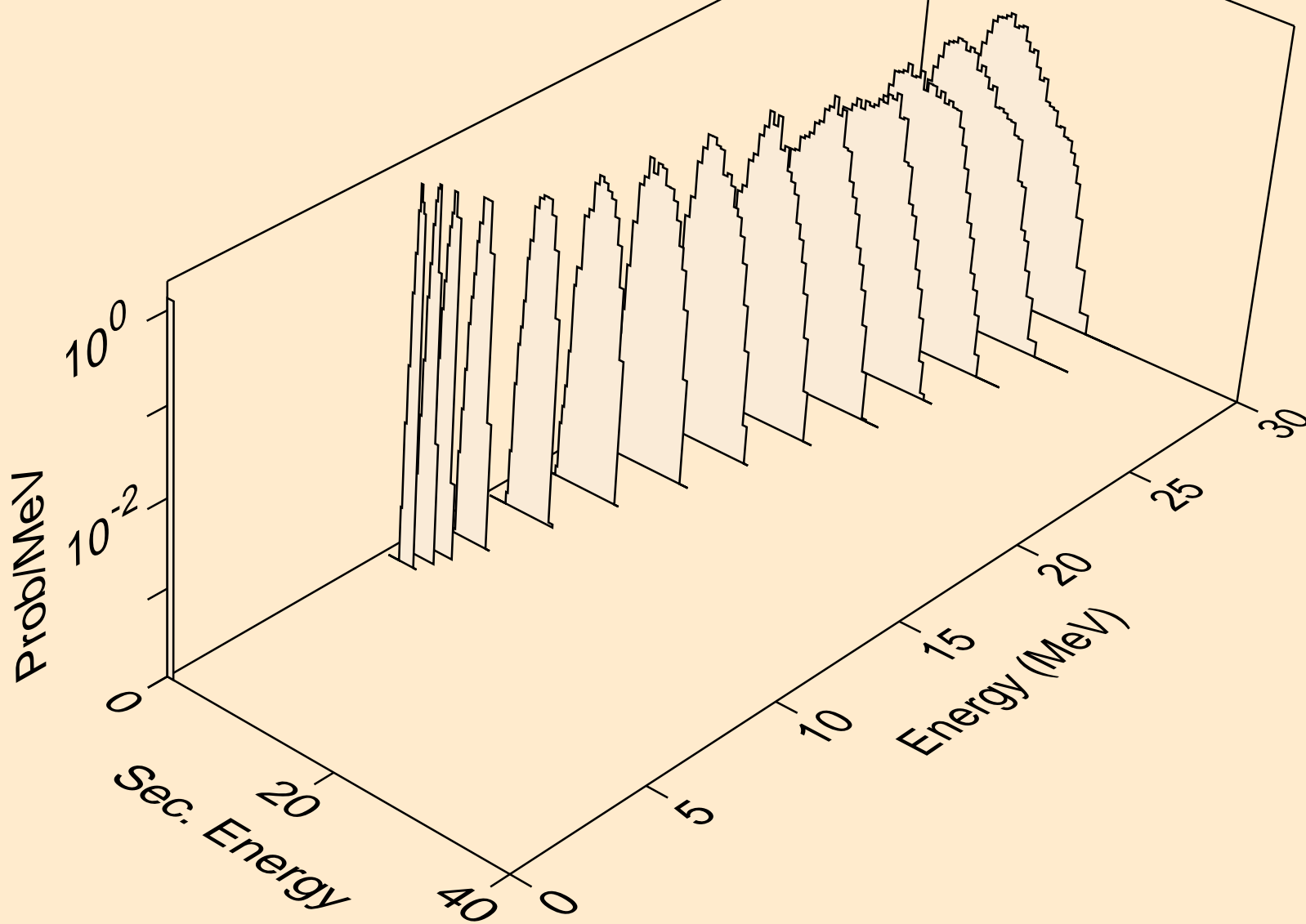

NO252 NEUTRON ACER TENDL-2019 LIBRARY; T=293.16K  
protons from (n,p)

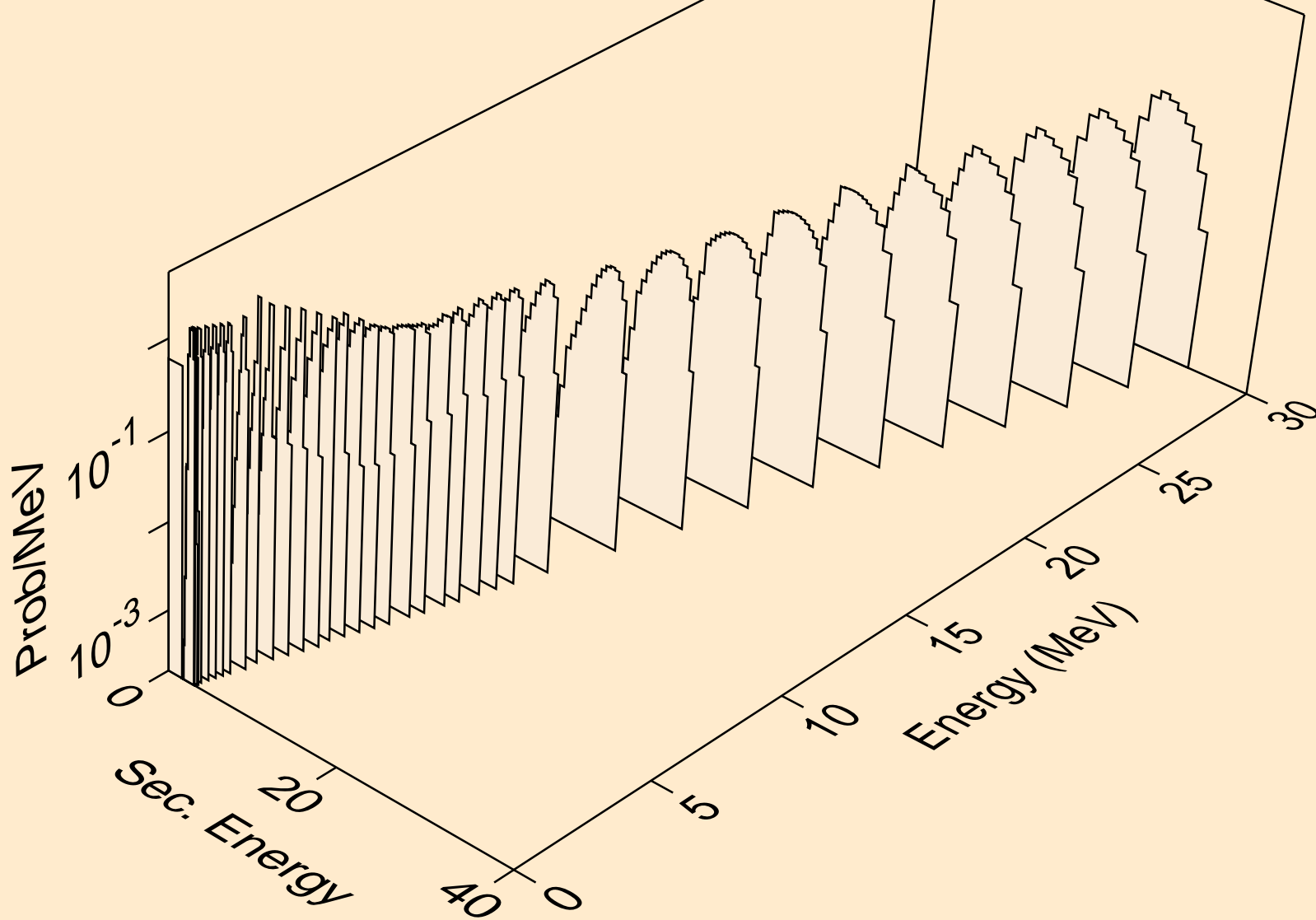

NO252 NEUTRON ACER TENDL-2019 LIBRARY; T=293.16K  
protons from (n,2p)

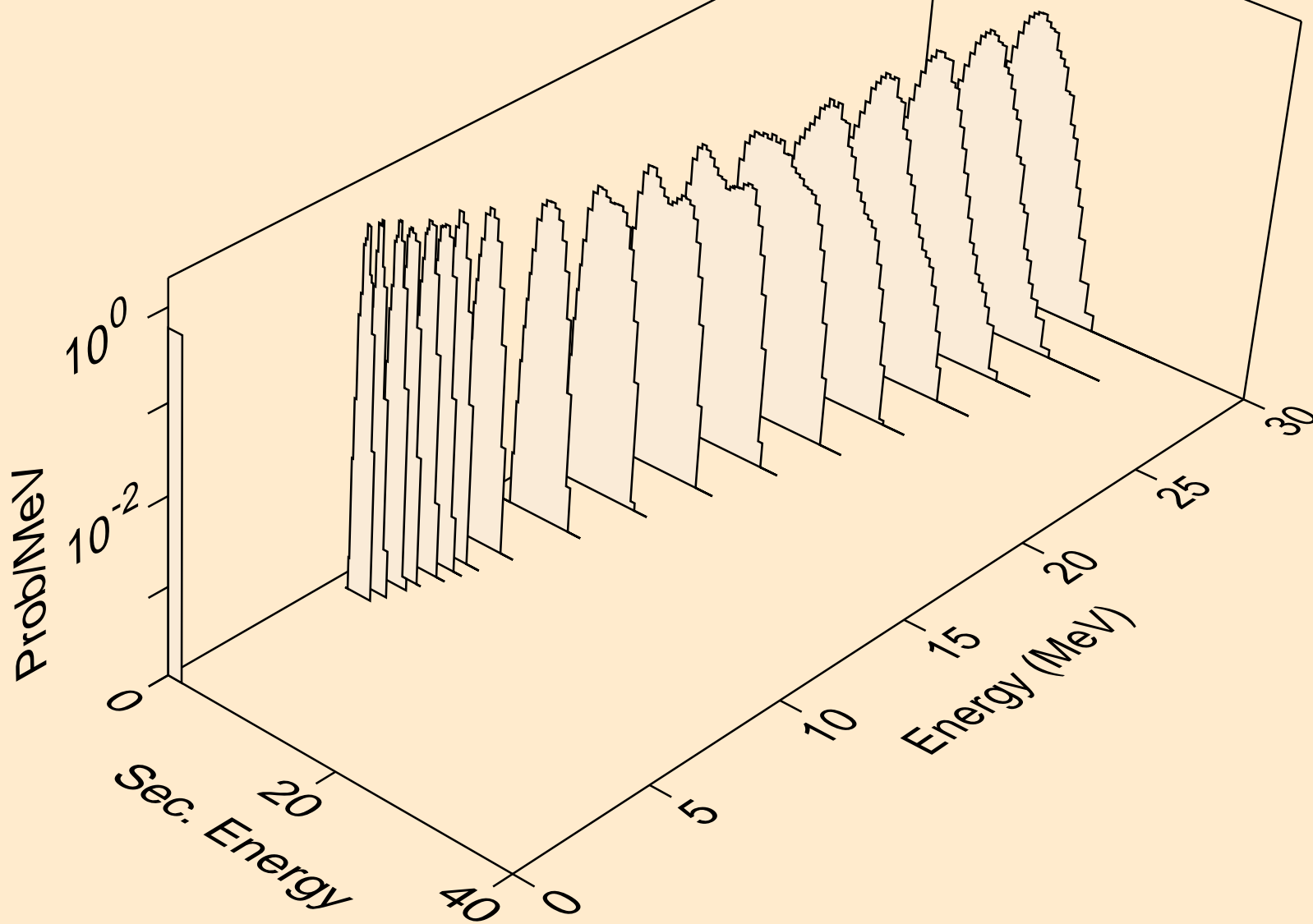

NO252 NEUTRON ACER TENDL-2019 LIBRARY; T=293.16K  
protons from (n,p)

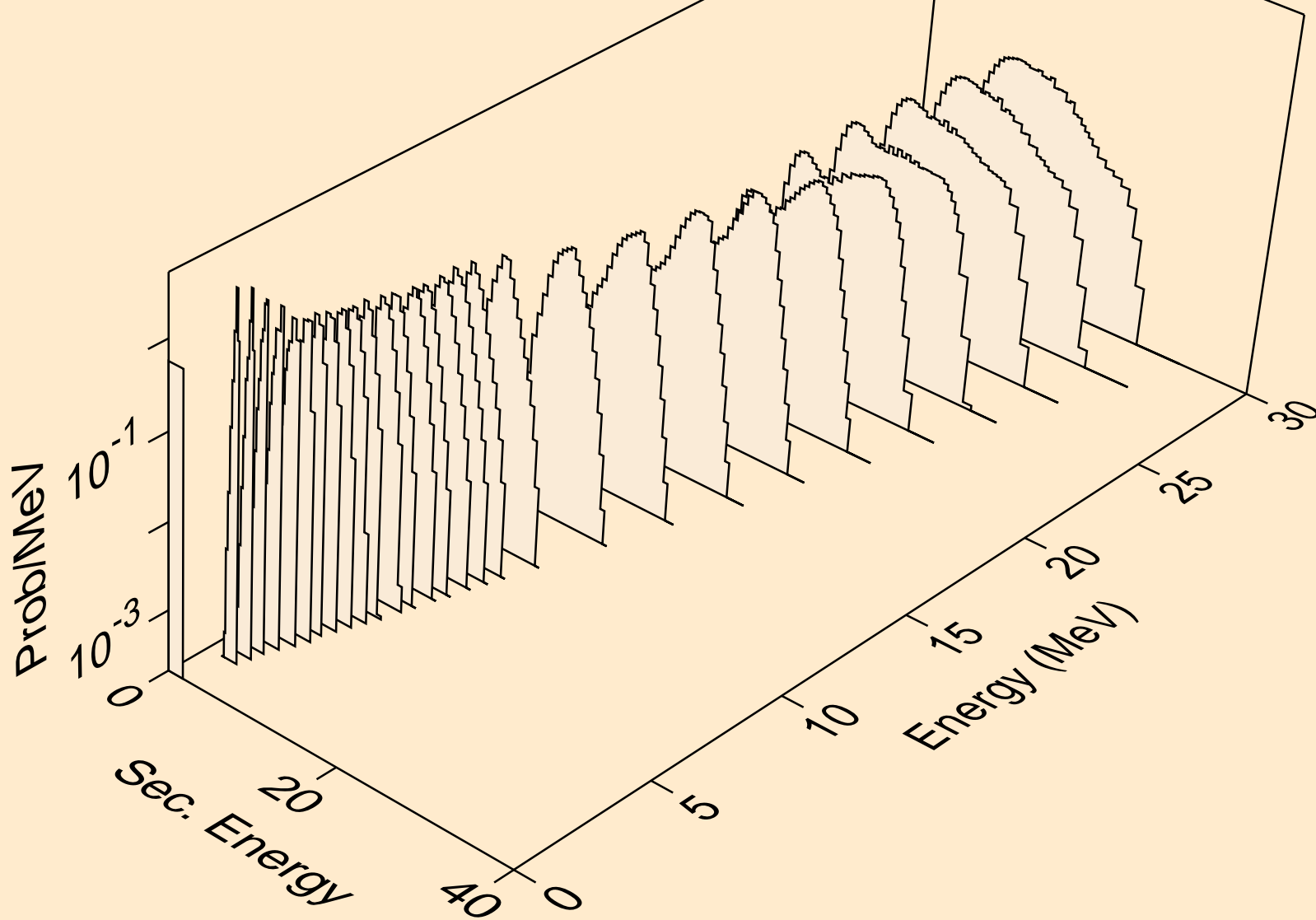

NO252 NEUTRON ACER TENDL-2019 LIBRARY; T=293.16K  
protons from (n,pd)

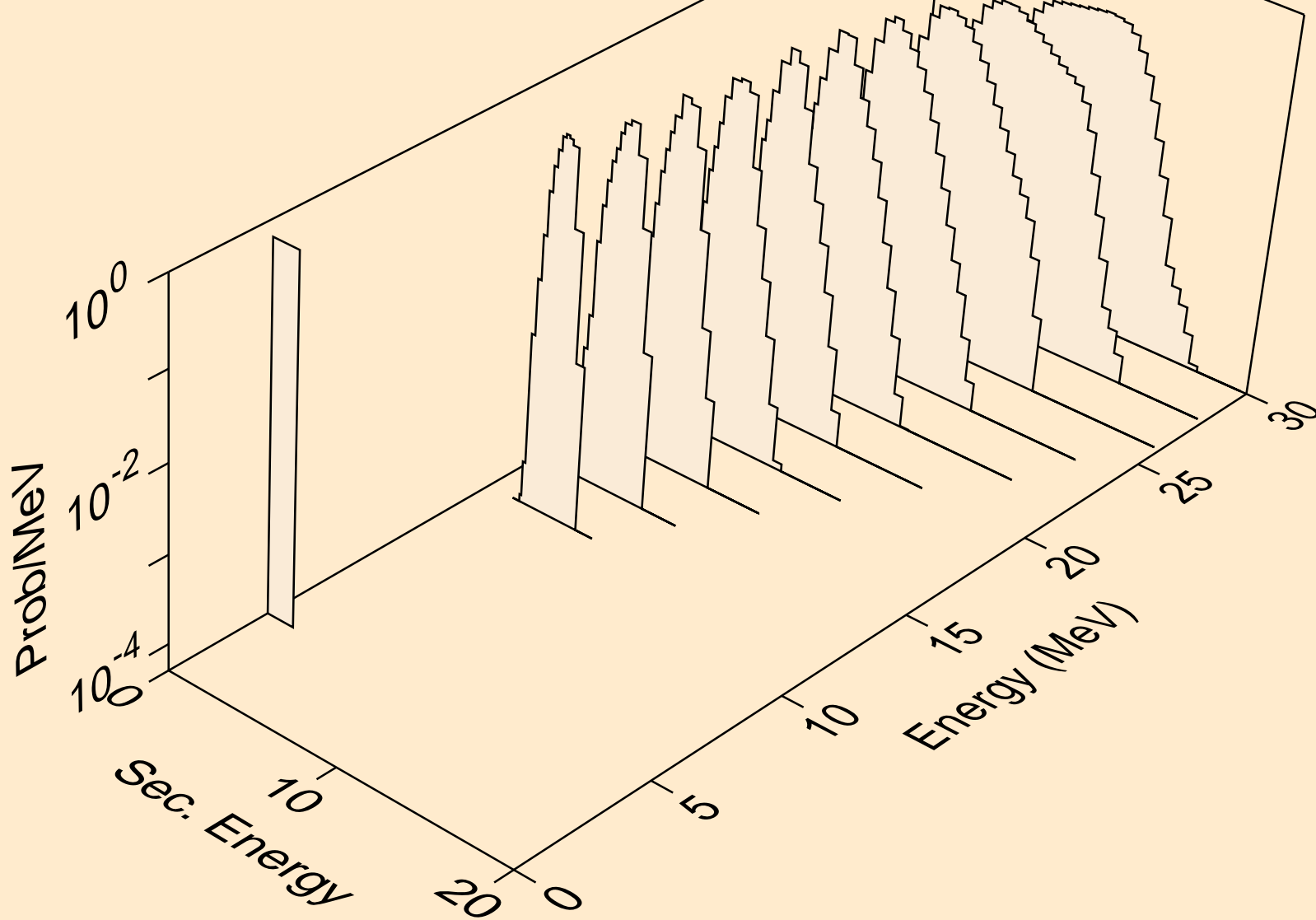

NO252 NEUTRON ACER TENDL-2019 LIBRARY; T=293.16K  
protons from (n,pt)

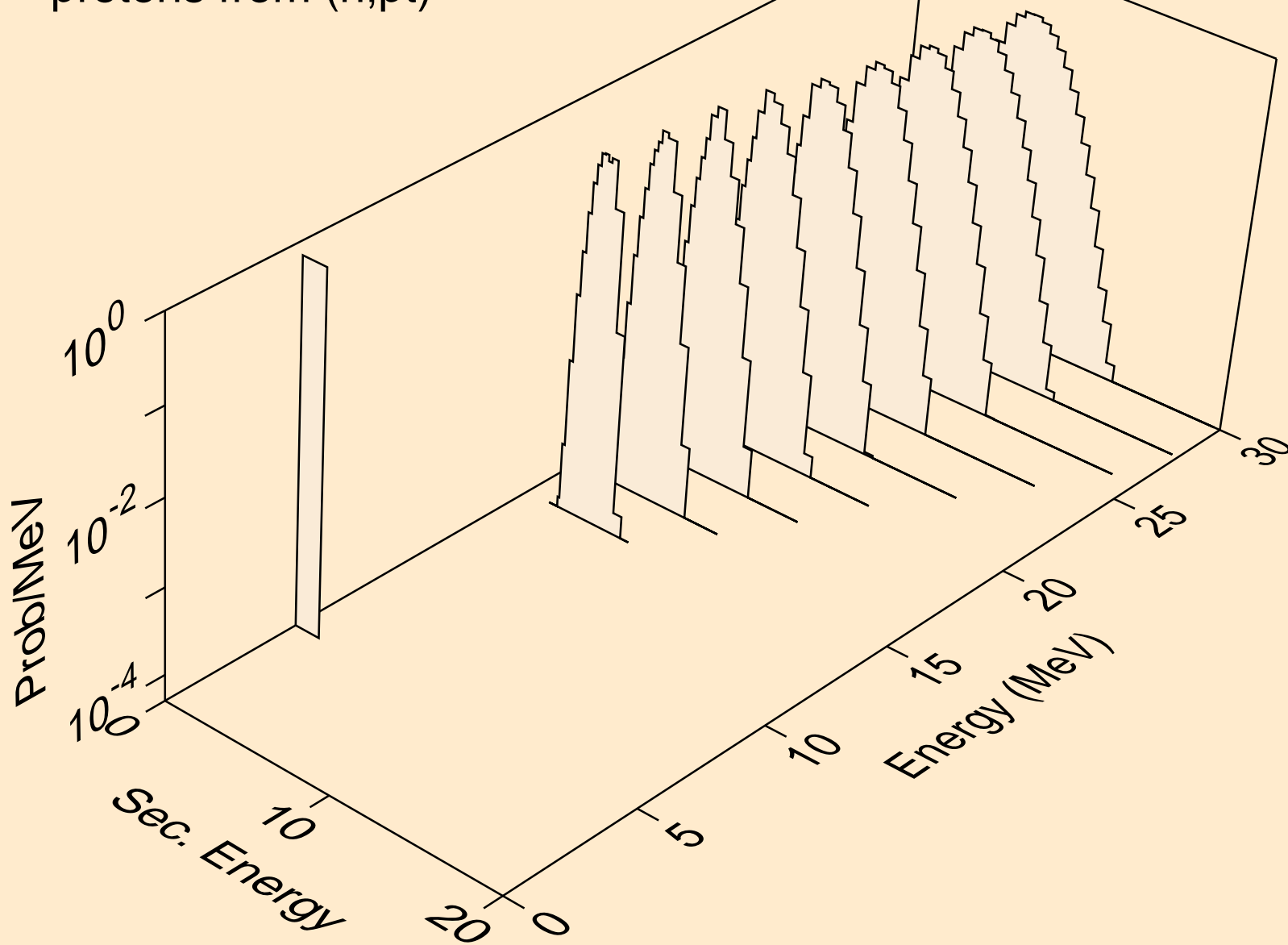

NO252 NEUTRON ACER TENDL-2019 LIBRARY; T=293.16K  
deuterons from (n,x)

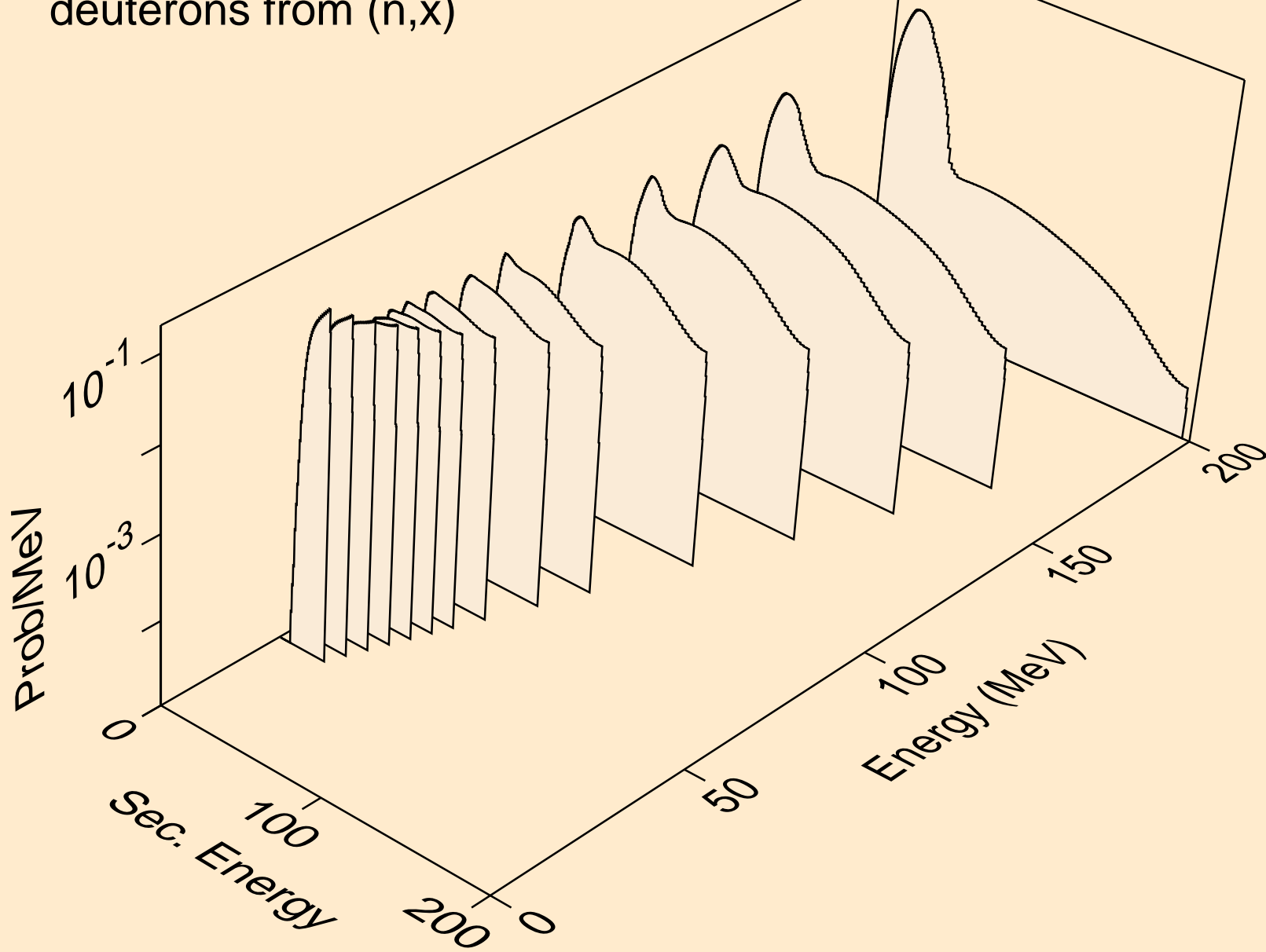

NO252 NEUTRON ACER TENDL-2019 LIBRARY; T=293.16K  
deuterons from (n,2nd)

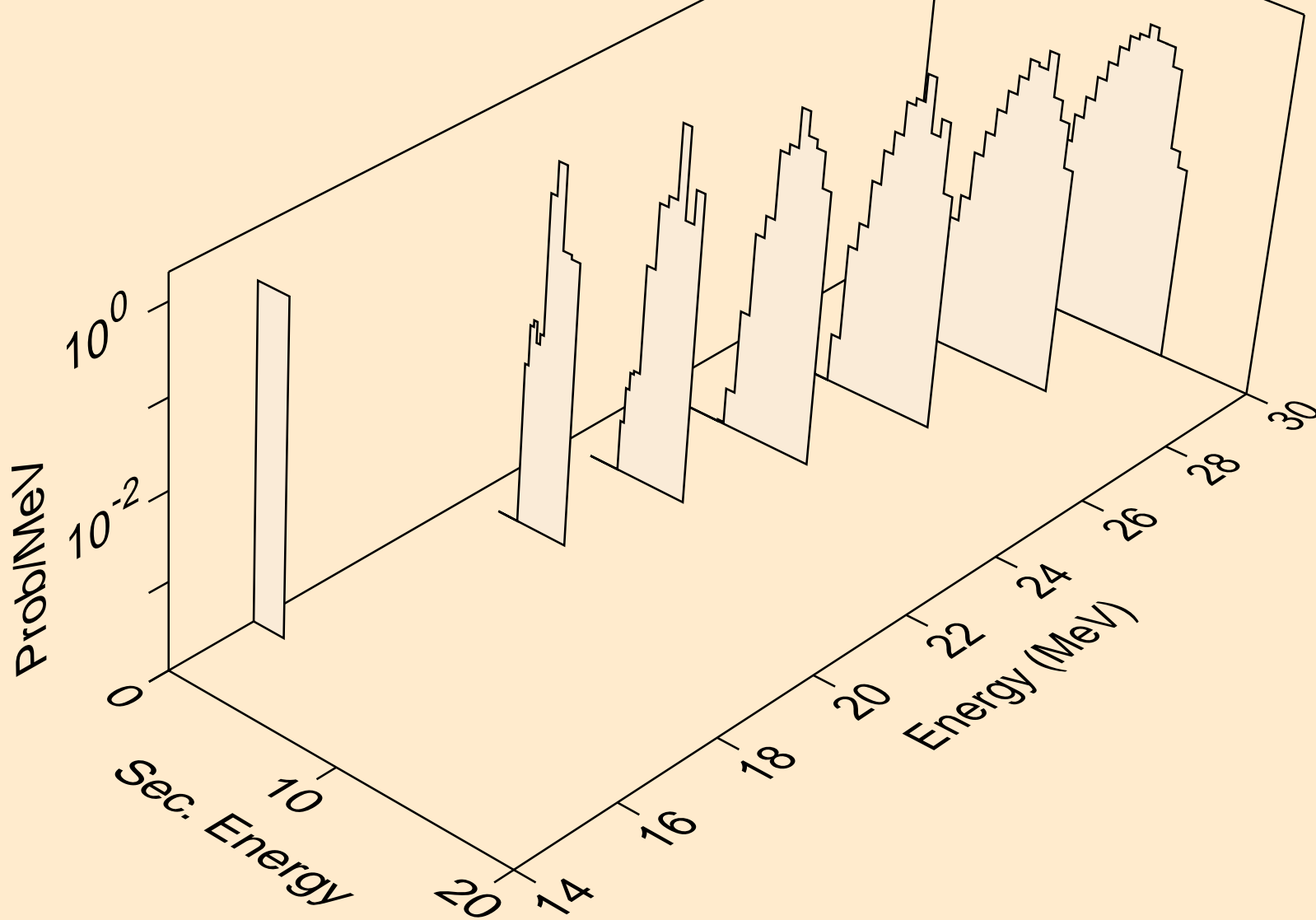

NO252 NEUTRON ACER TENDL-2019 LIBRARY; T=293.16K  
deuterons from (n,n\*)d

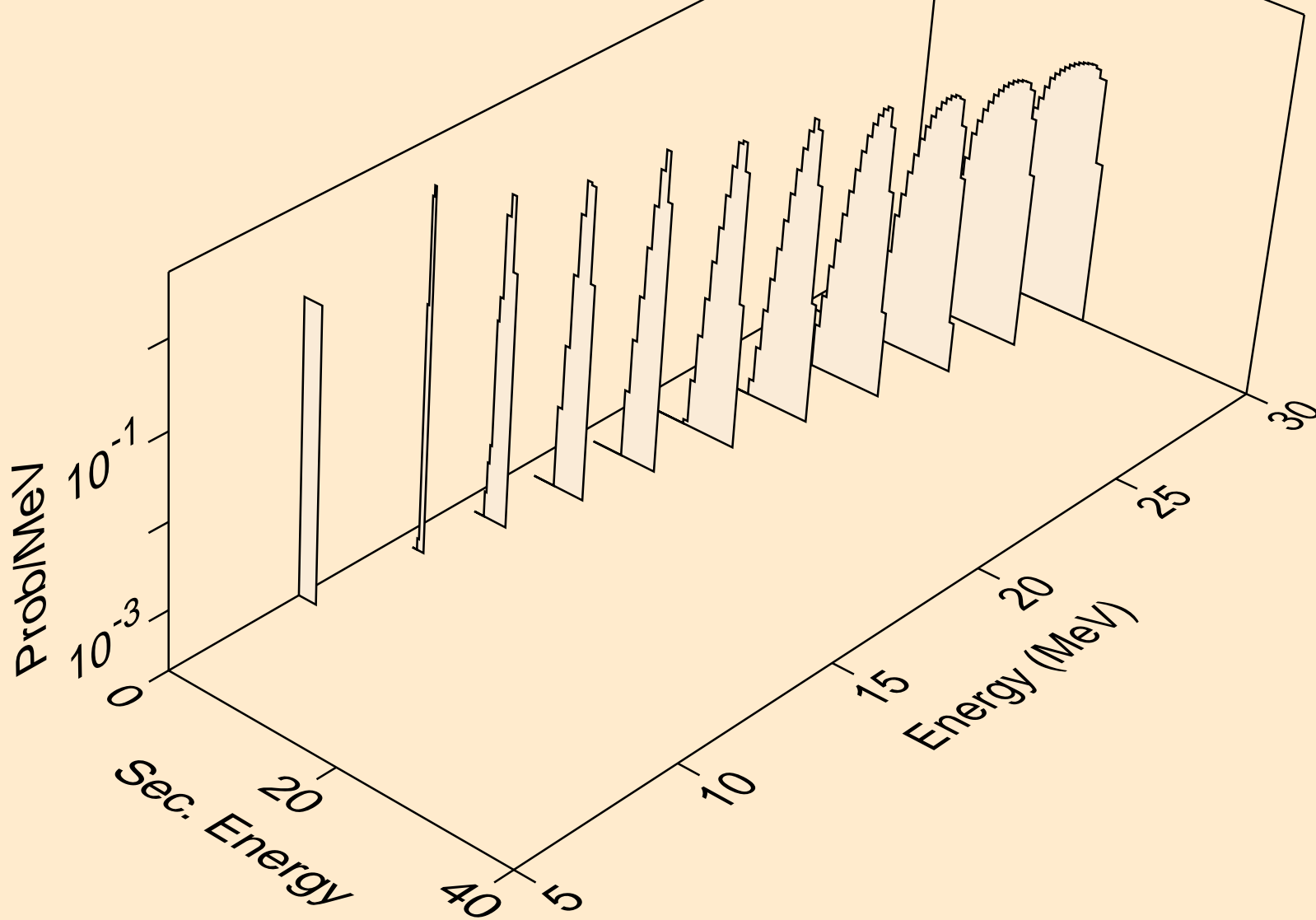

NO252 NEUTRON ACER TENDL-2019 LIBRARY; T=293.16K  
deuterons from (n,d)

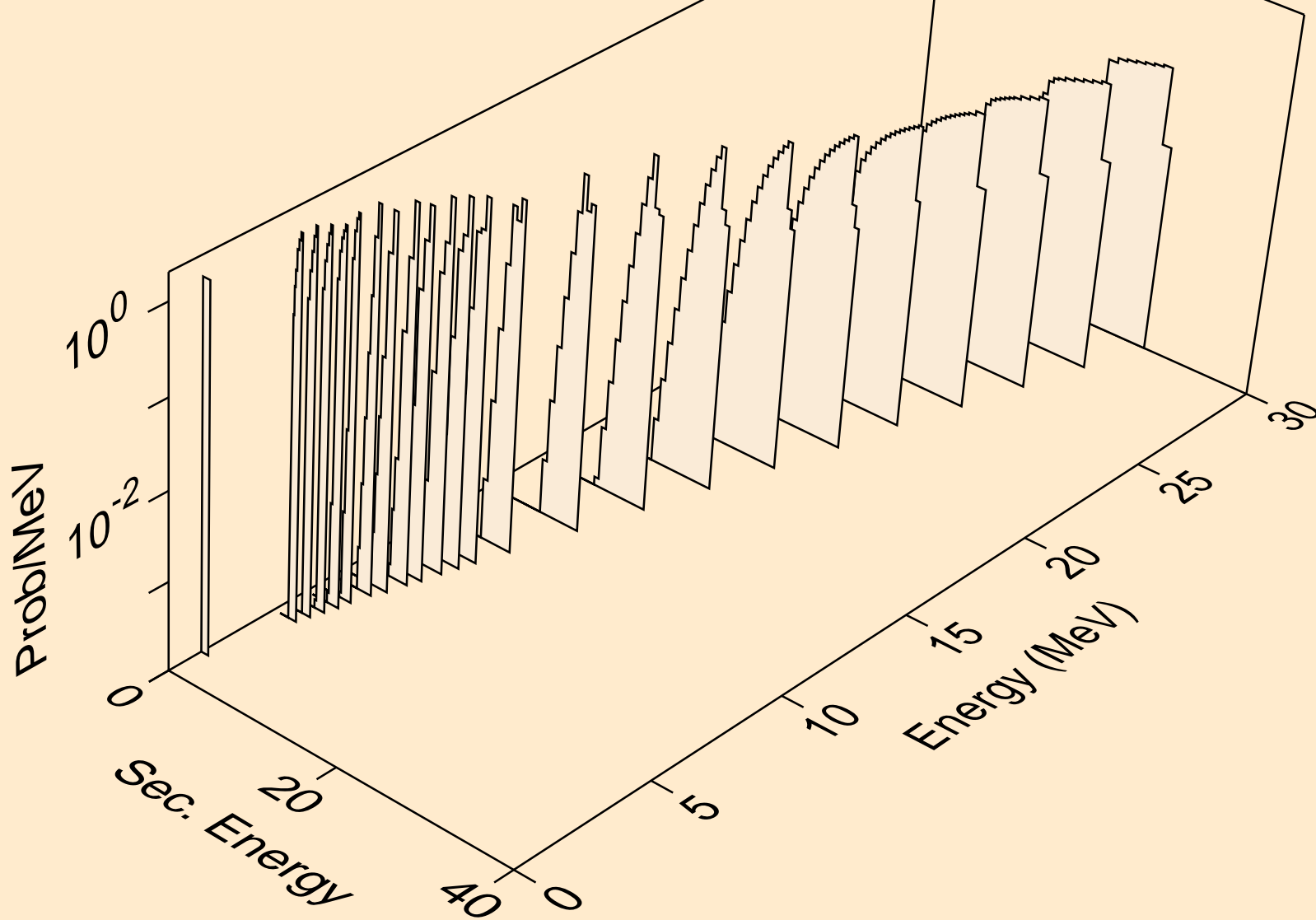

NO252 NEUTRON ACER TENDL-2019 LIBRARY; T=293.16K  
deuterons from (n,pd)

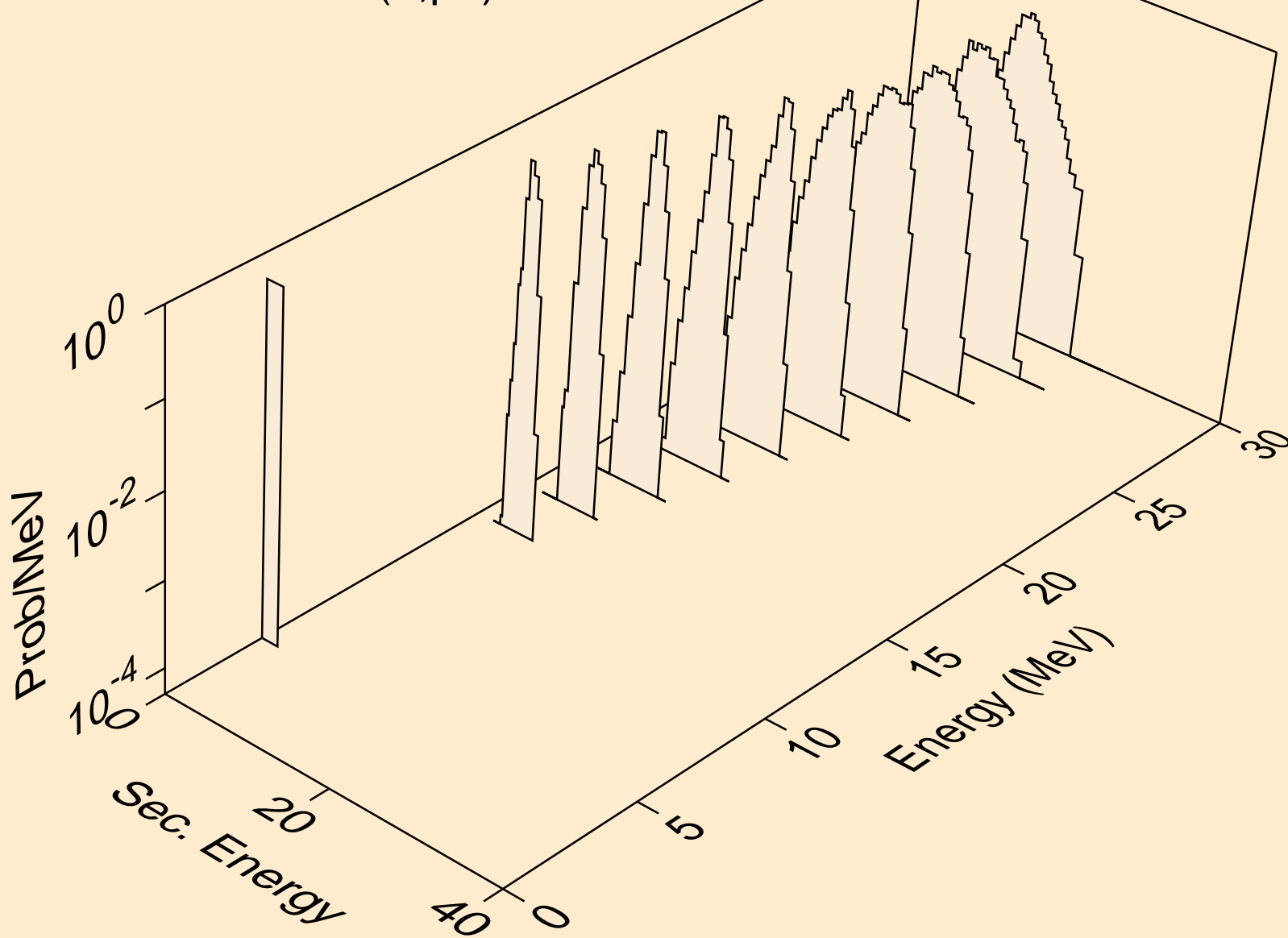

NO252 NEUTRON ACER TENDL-2019 LIBRARY; T=293.16K  
deuterons from (n,da)

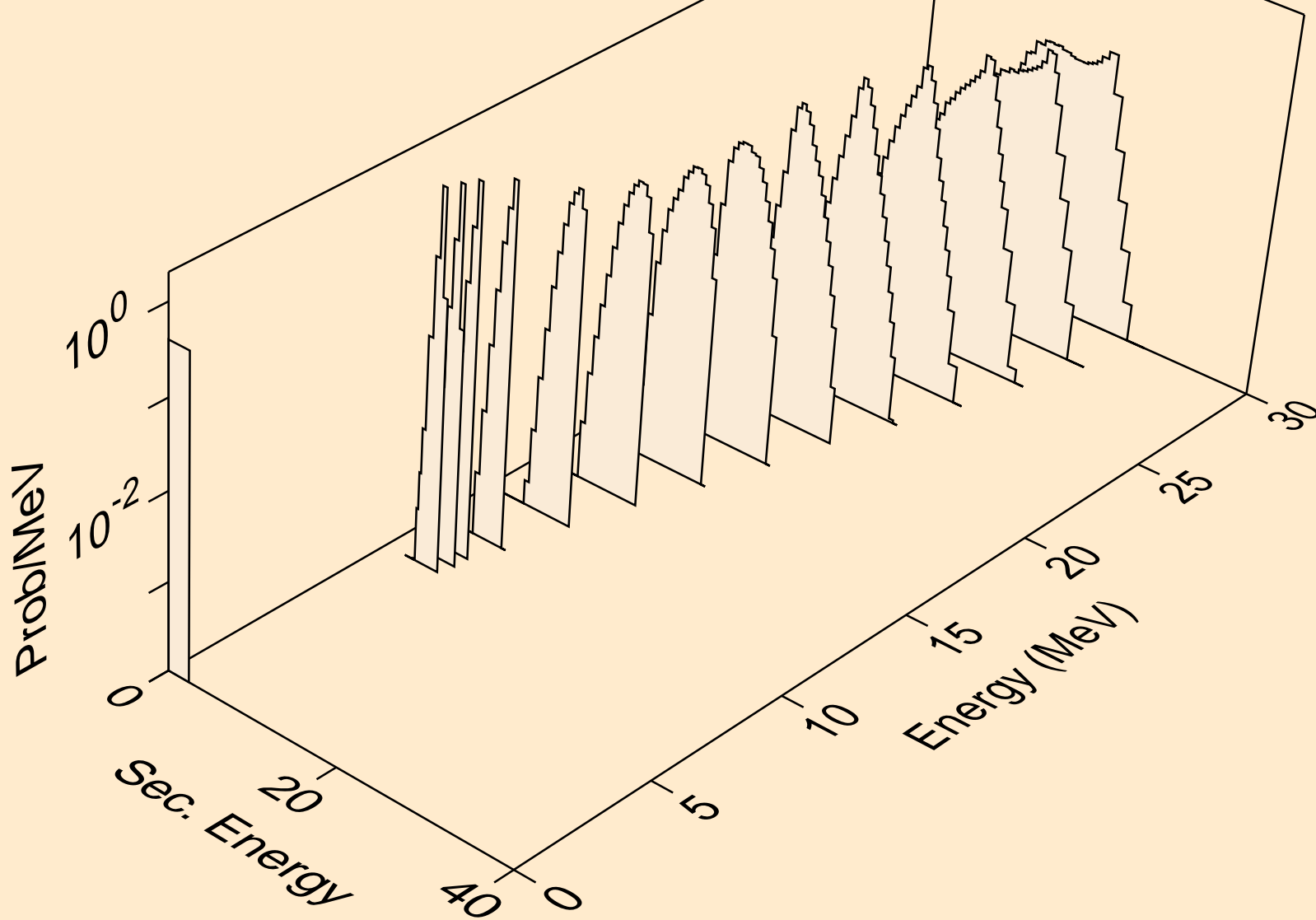

NO252 NEUTRON ACER TENDL-2019 LIBRARY; T=293.16K  
tritons from (n,x)

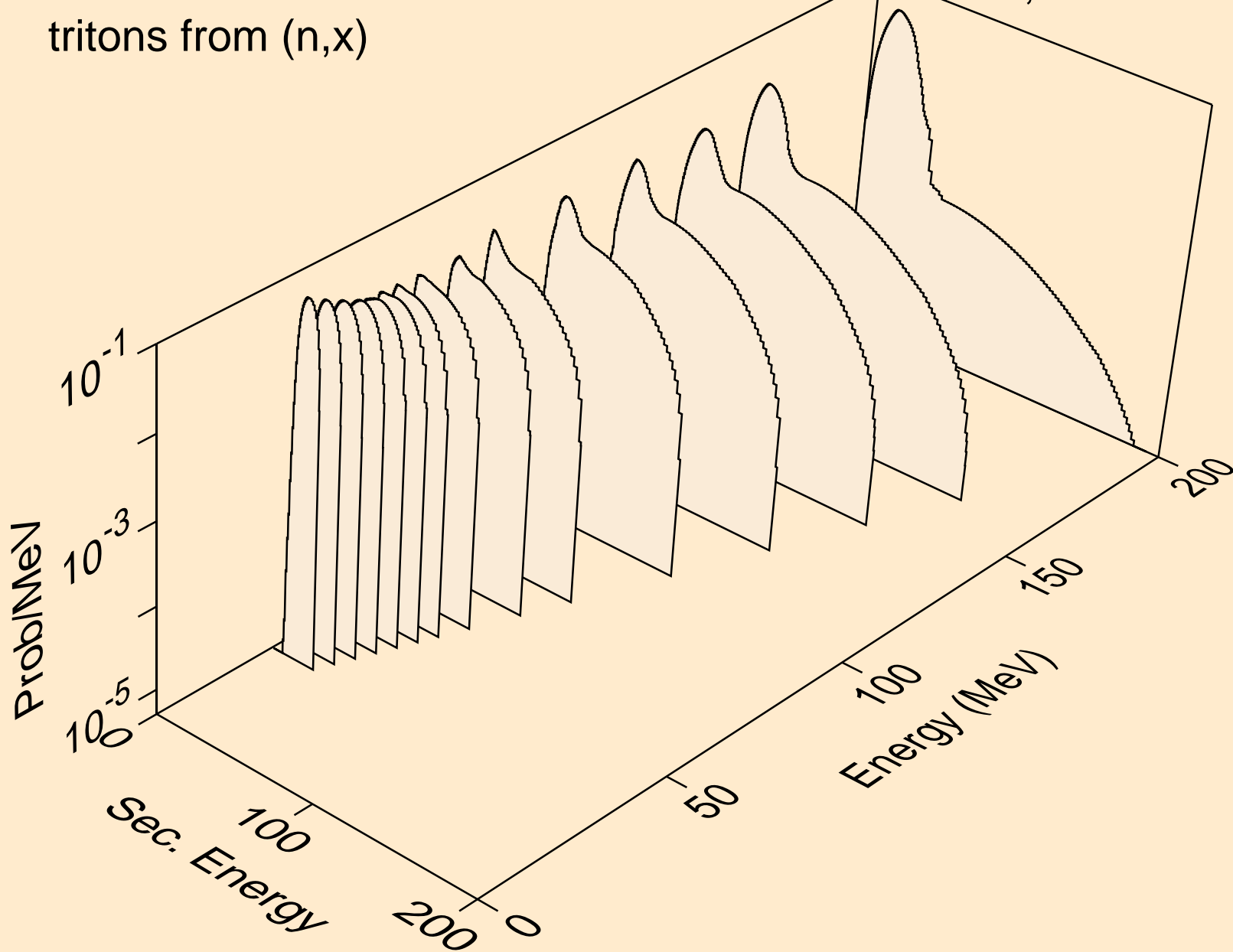

NO252 NEUTRON ACER TENDL-2019 LIBRARY; T=293.16K  
tritons from (n,n\*)t

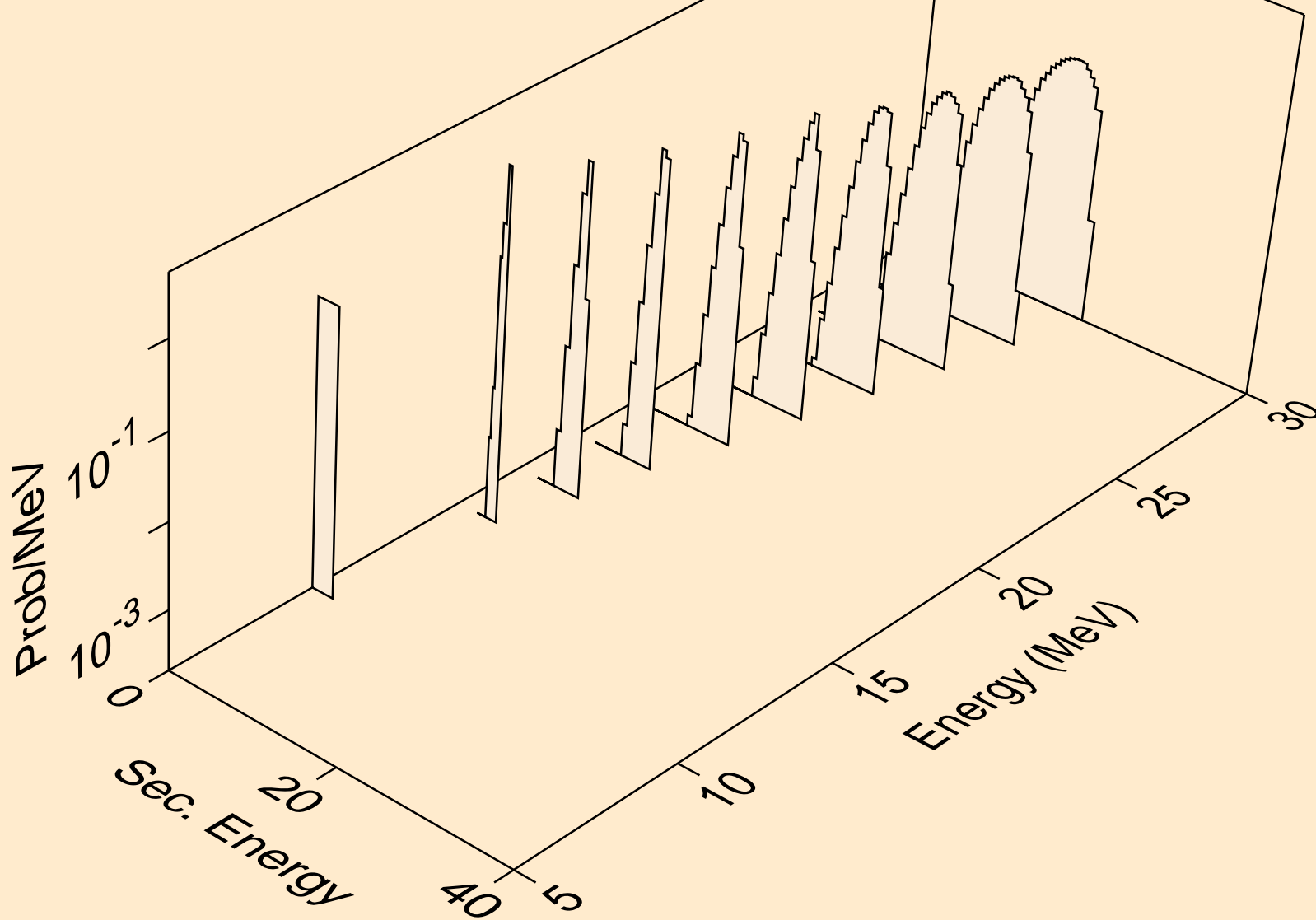

NO252 NEUTRON ACER TENDL-2019 LIBRARY; T=293.16K  
tritons from (n,t)

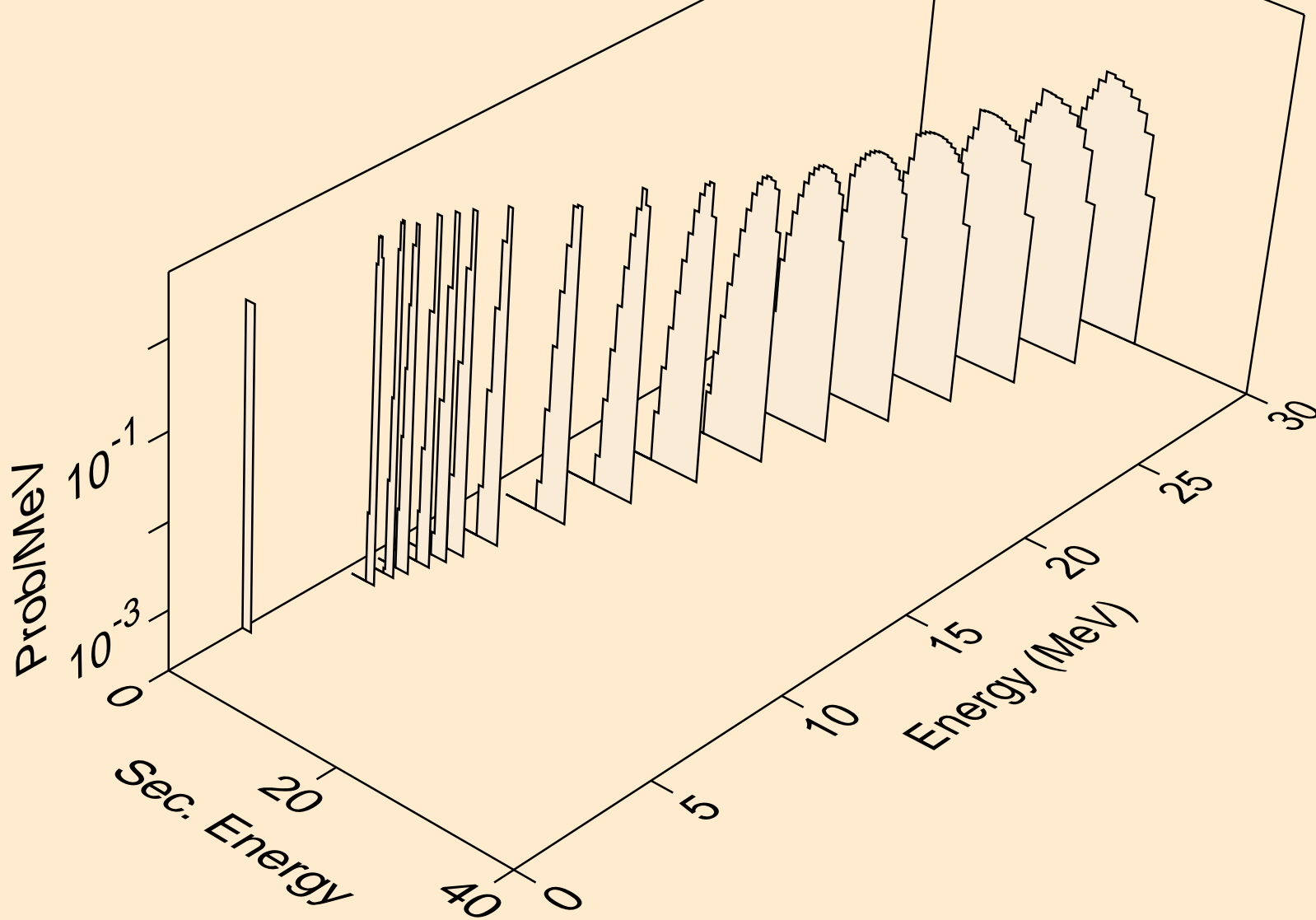

NO252 NEUTRON ACER TENDL-2019 LIBRARY; T=293.16K  
tritons from (n,pt)

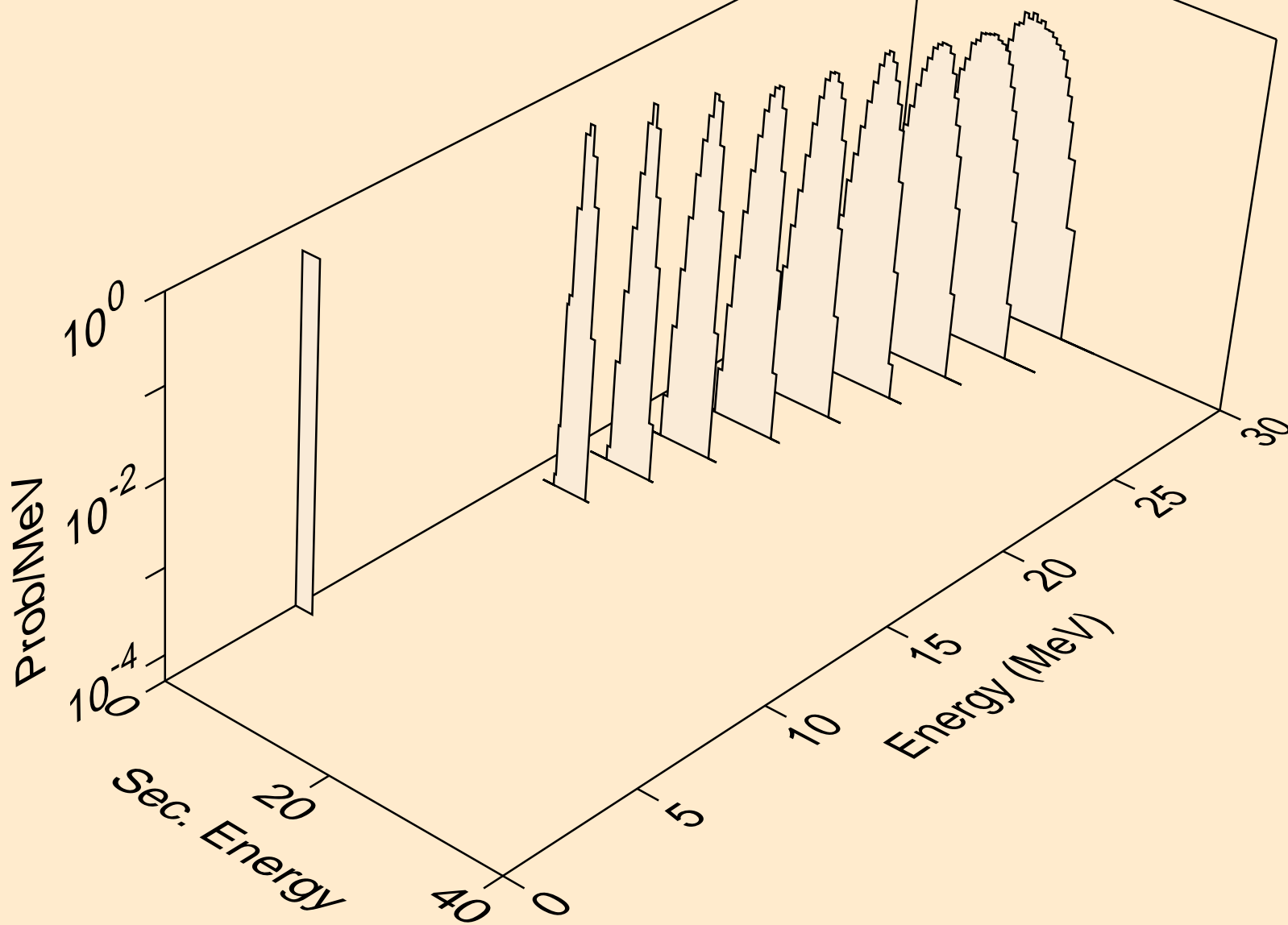

NO252 NEUTRON ACER TENDL-2019 LIBRARY; T=293.16K  
he3s from (n,x)

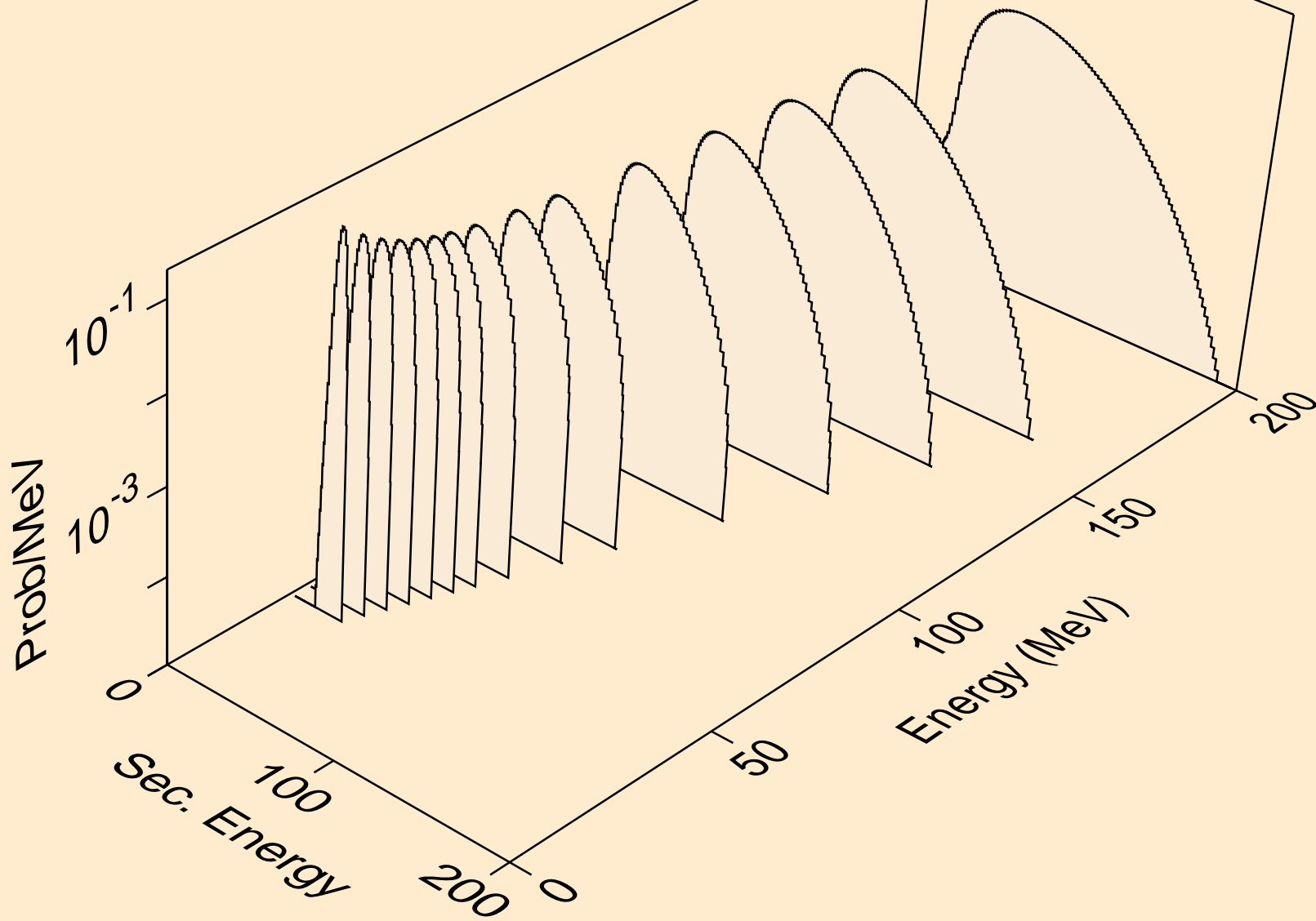

NO252 NEUTRON ACER TENDL-2019 LIBRARY; T=293.16K  
he3s from (n,n\*)he3

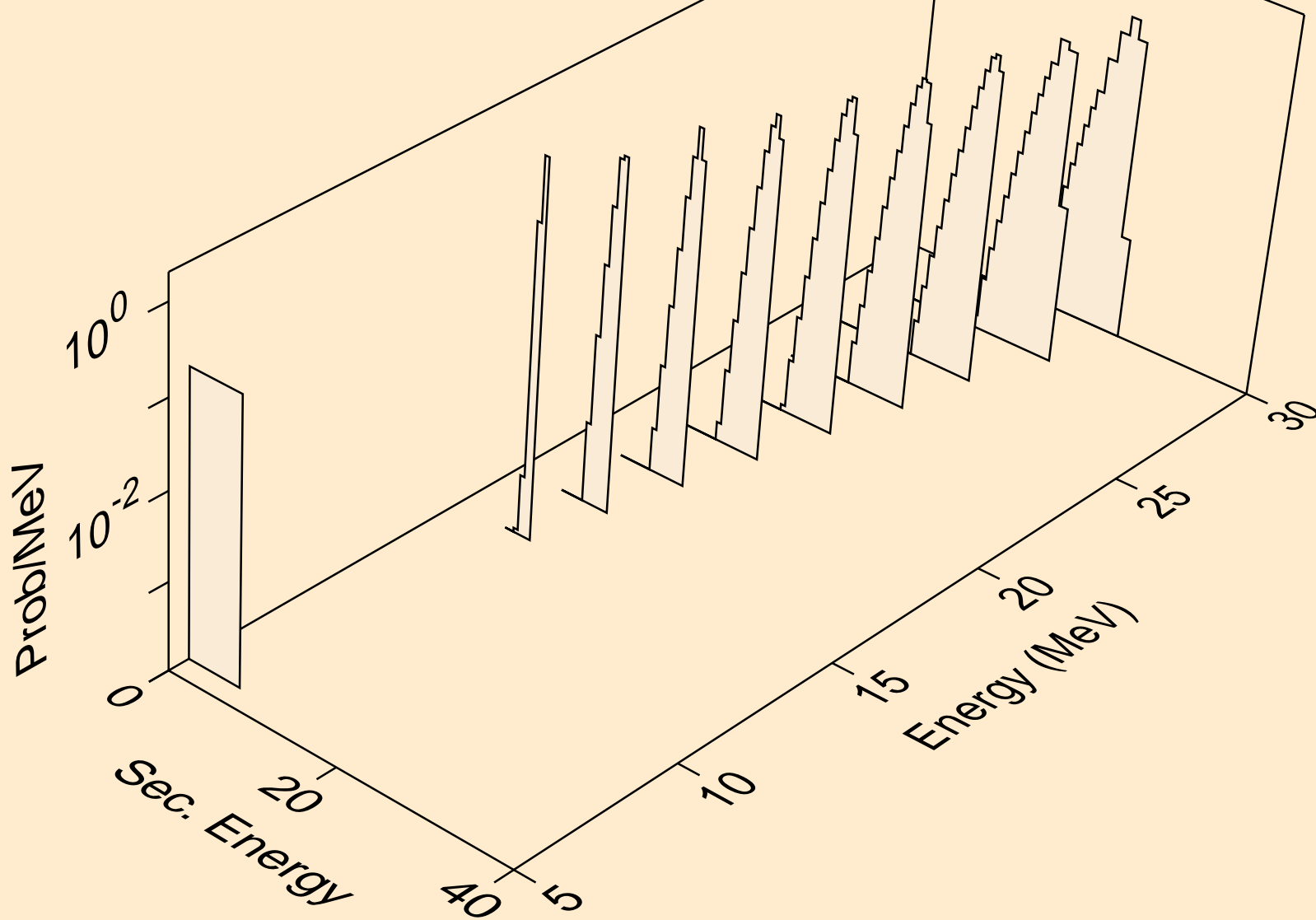

NO252 NEUTRON ACER TENDL-2019 LIBRARY; T=293.16K  
he3s from (n,he3)

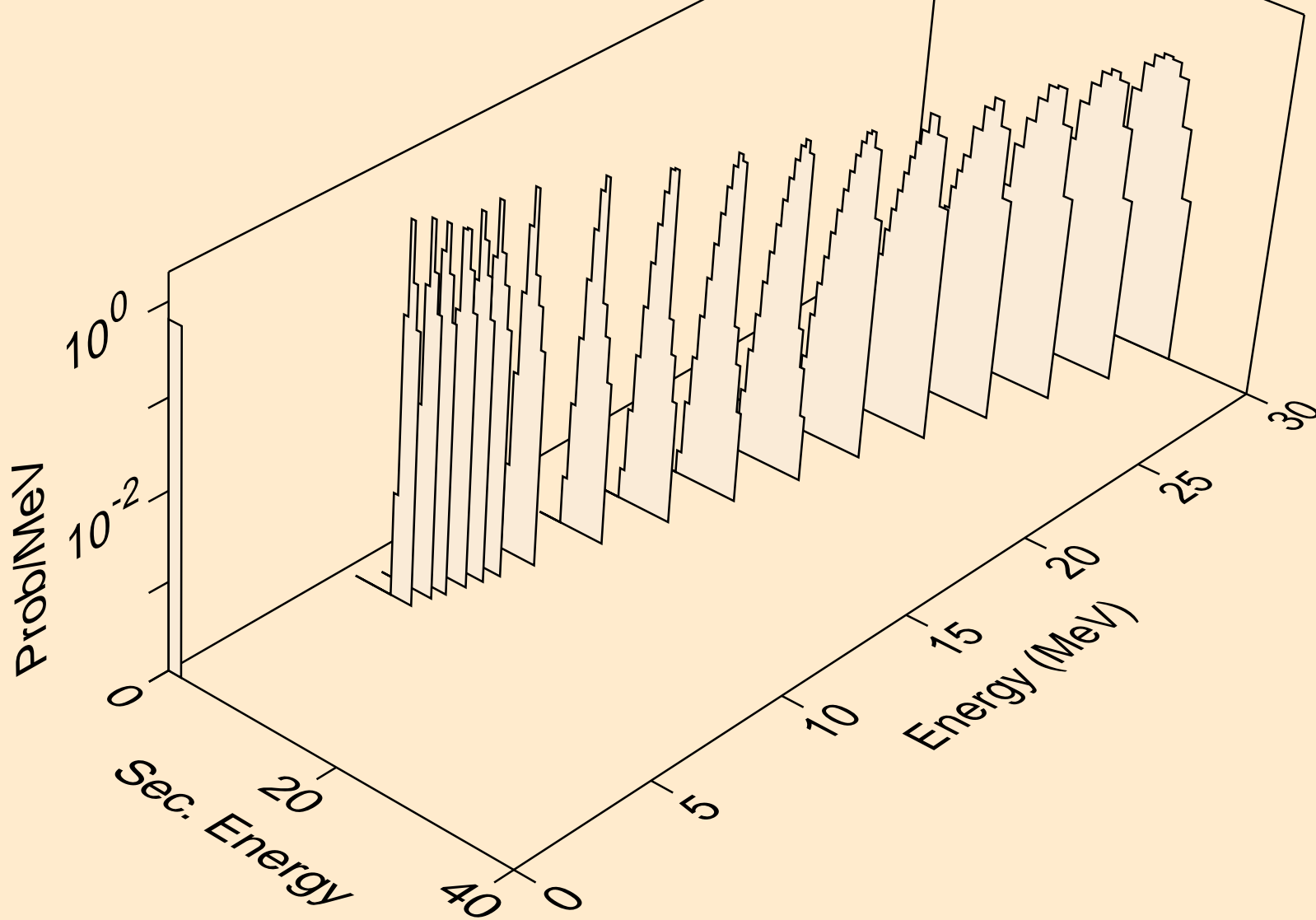

NO252 NEUTRON ACER TENDL-2019 LIBRARY; T=293.16K  
alphas from (n,x)

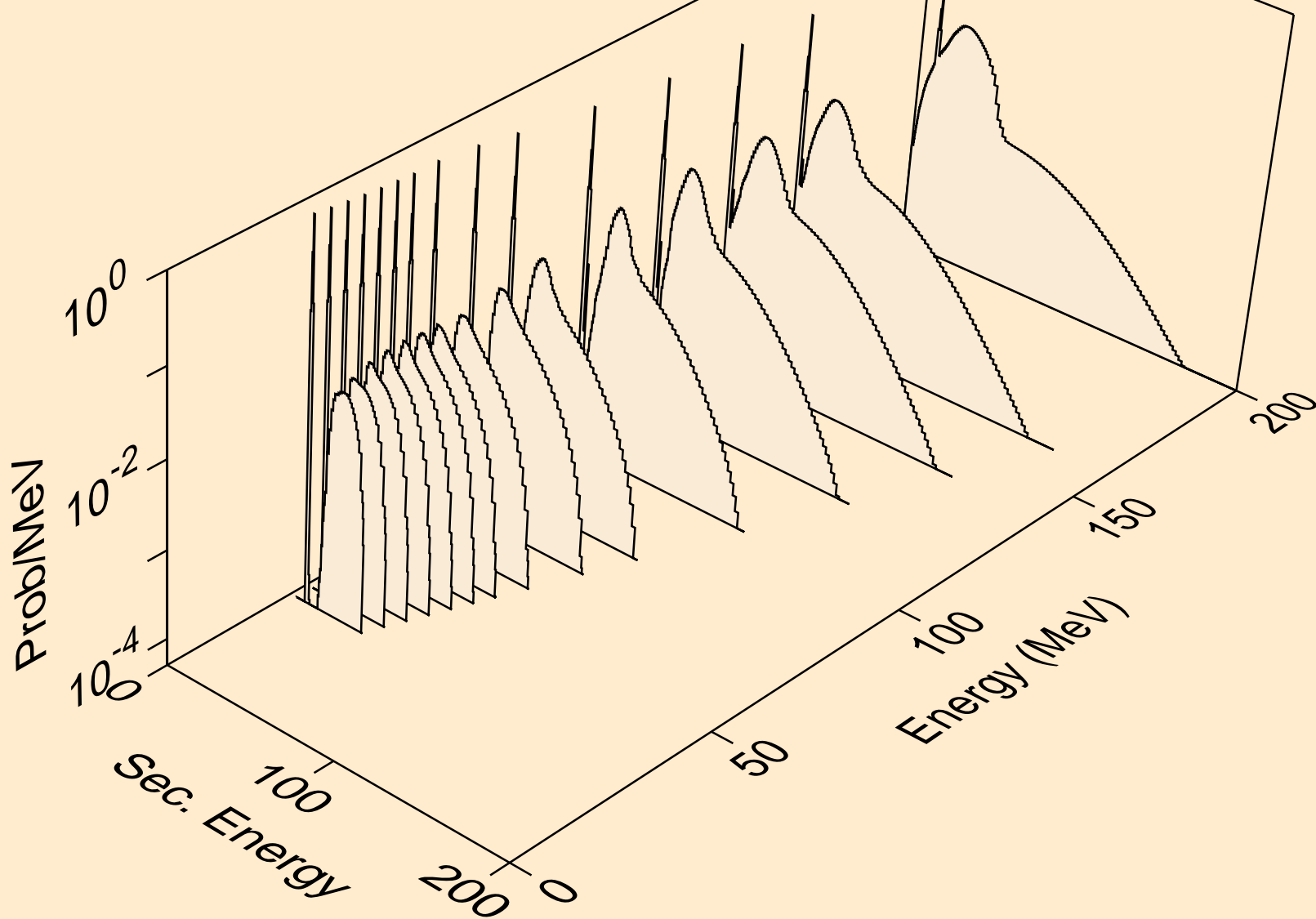

NO252 NEUTRON ACER TENDL-2019 LIBRARY; T=293.16K  
alphas from (n,n\*)a

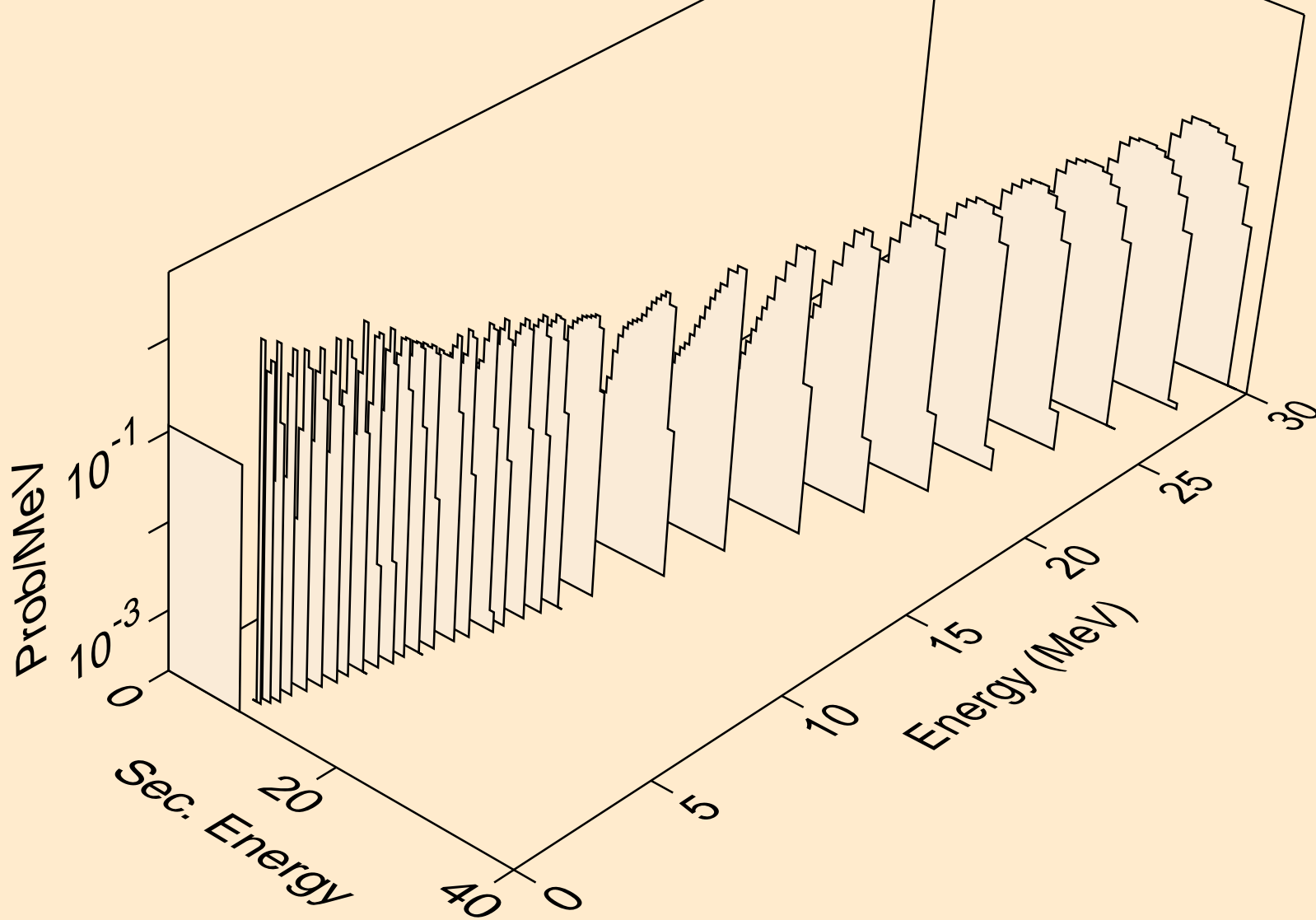

NO252 NEUTRON ACER TENDL-2019 LIBRARY; T=293.16K  
alphas from (n,2n)a

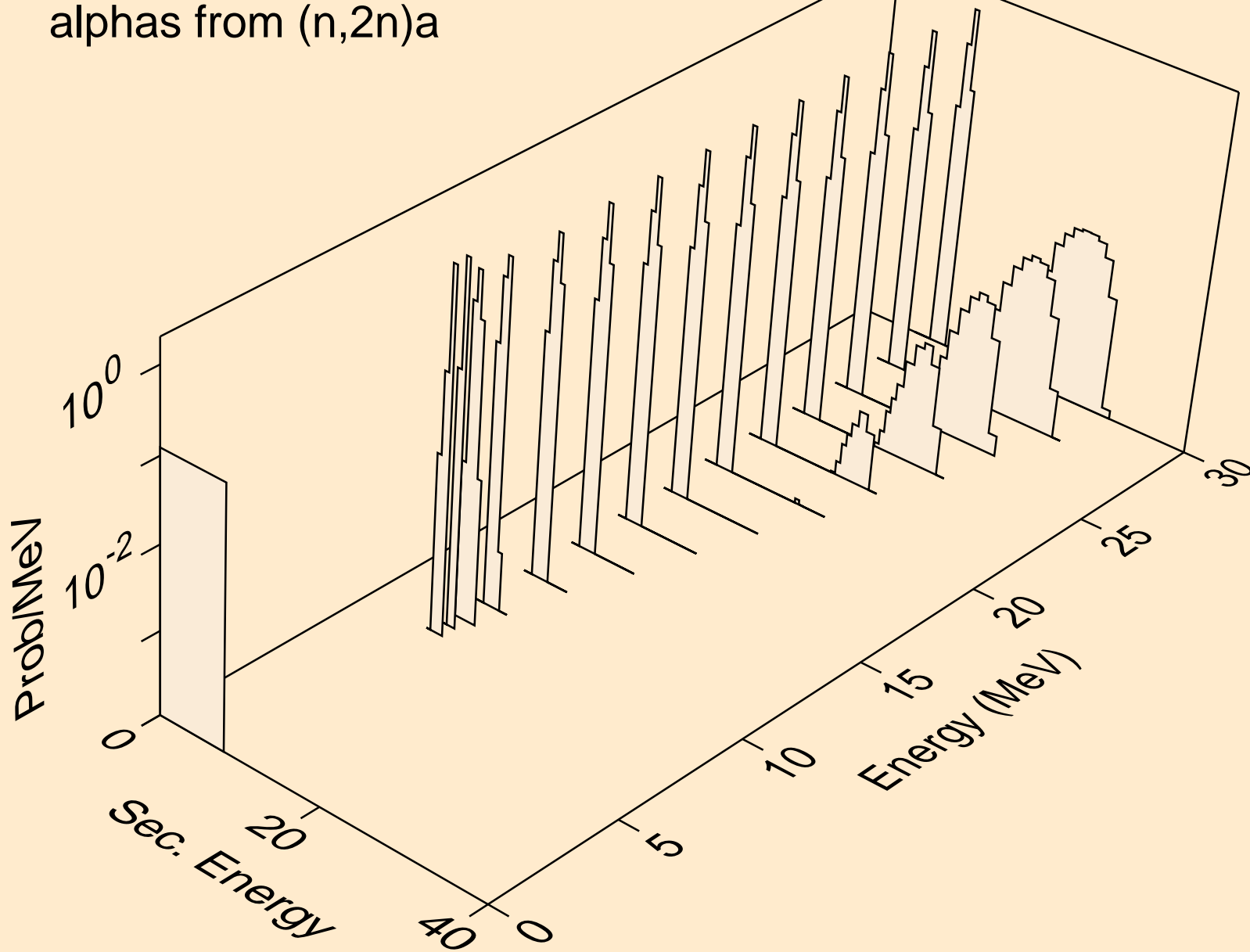

NO252 NEUTRON ACER TENDL-2019 LIBRARY; T=293.16K  
alphas from (n,3n)a

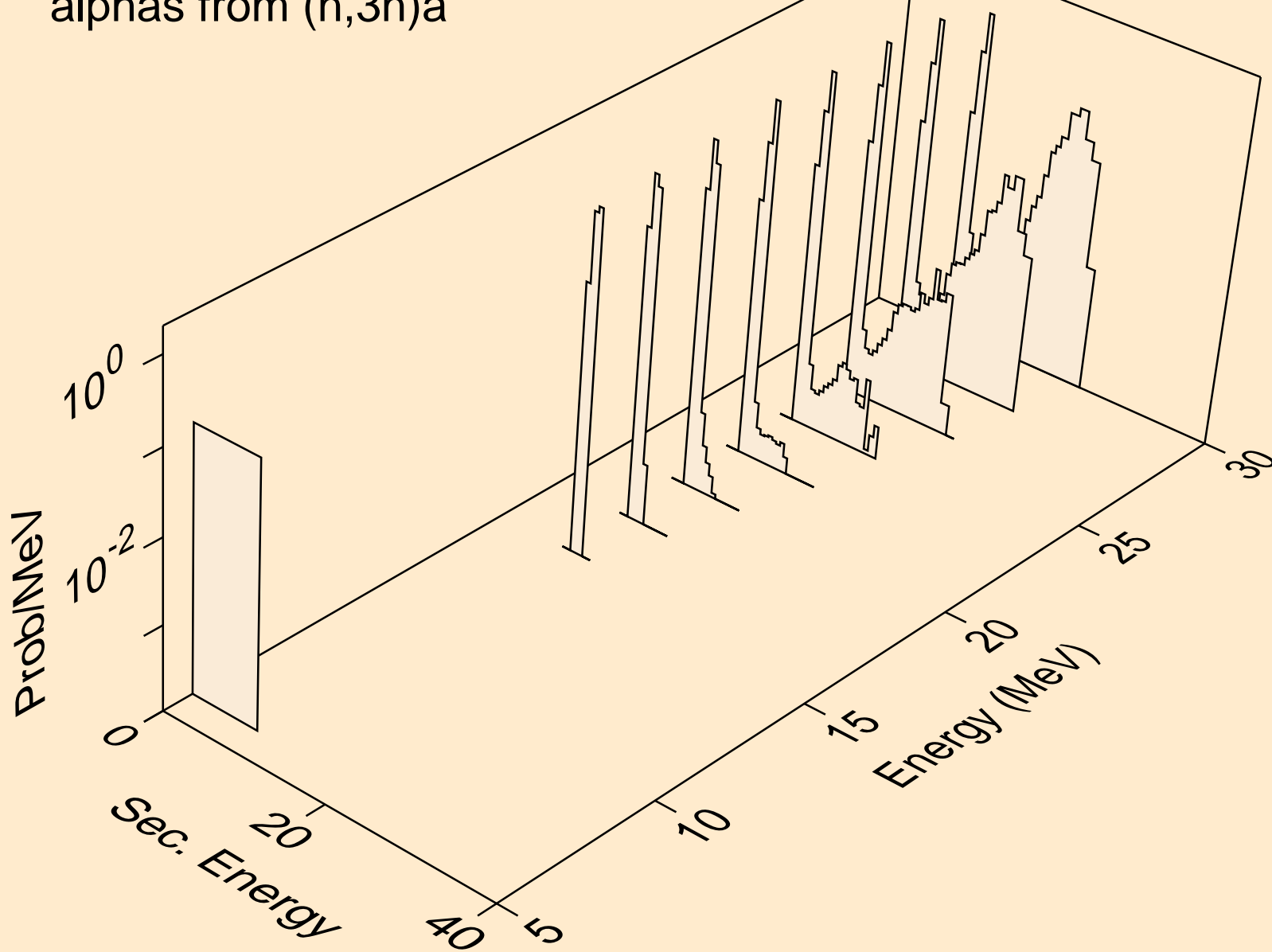

NO252 NEUTRON ACER TENDL-2019 LIBRARY; T=293.16K  
alphas from (n,n\*)2a

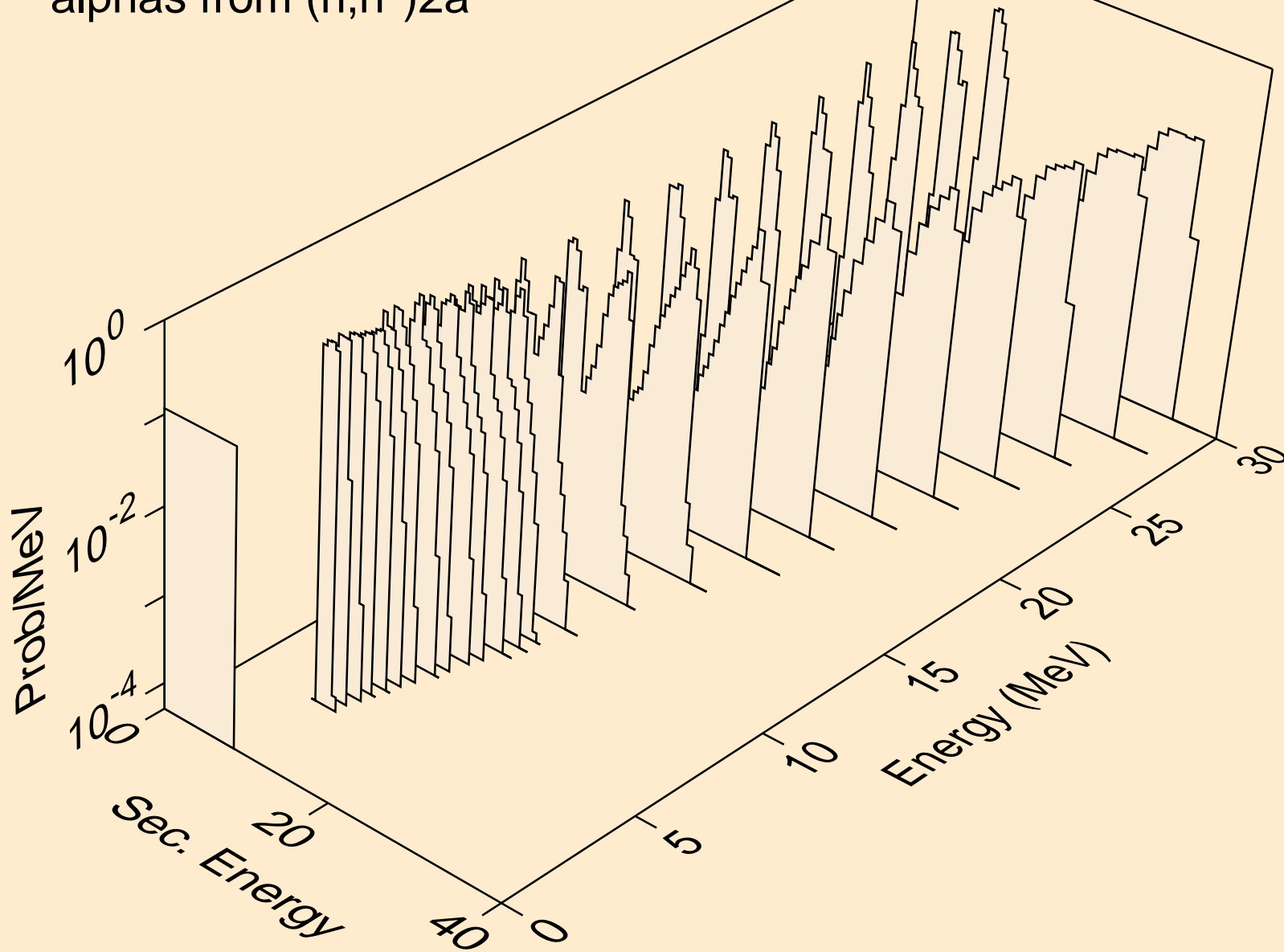

NO252 NEUTRON ACER TENDL-2019 LIBRARY; T=293.16K  
alphas from (n,2n)2a

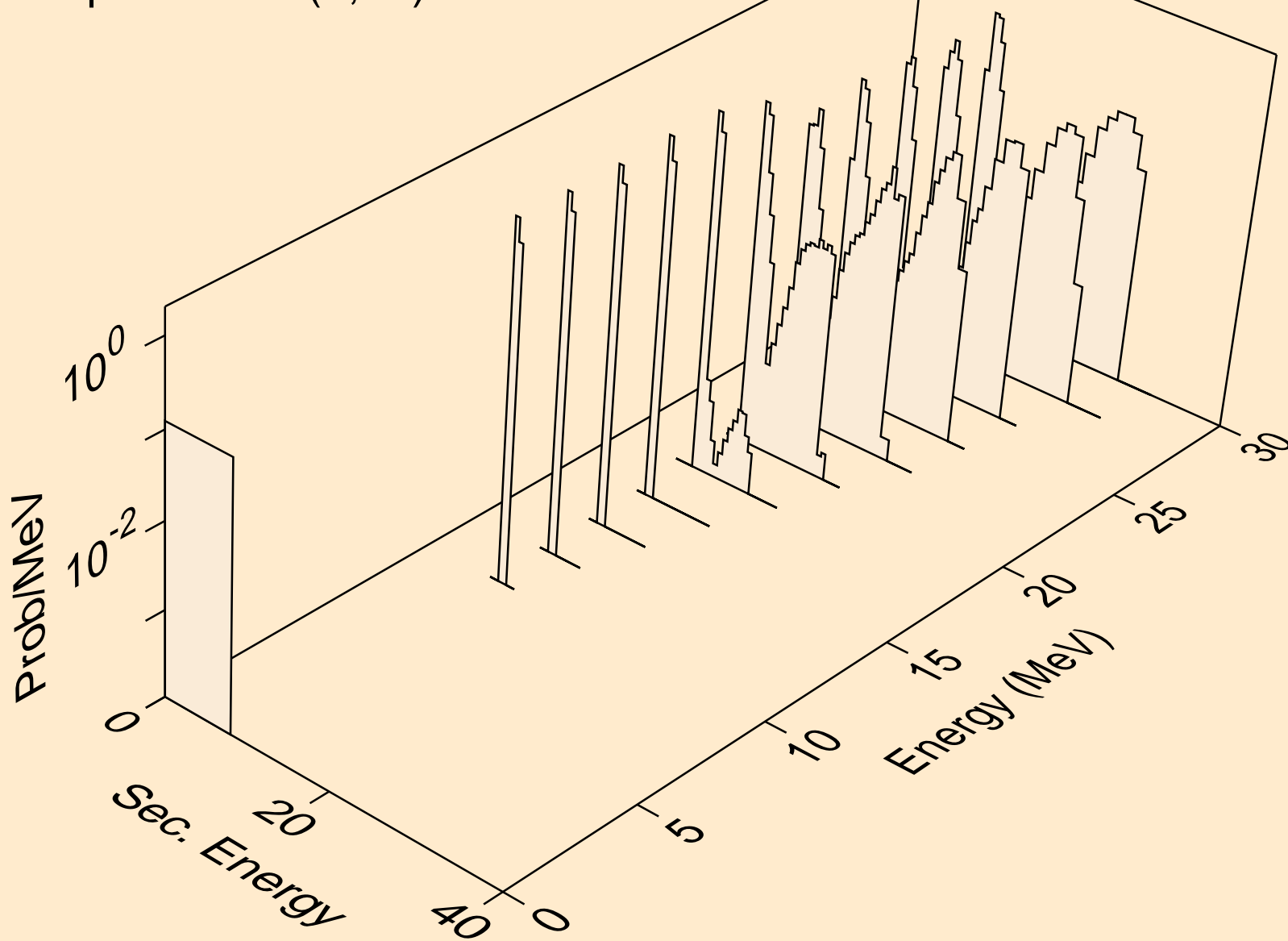

NO252 NEUTRON ACER TENDL-2019 LIBRARY; T=293.16K  
alphas from (n,npa)

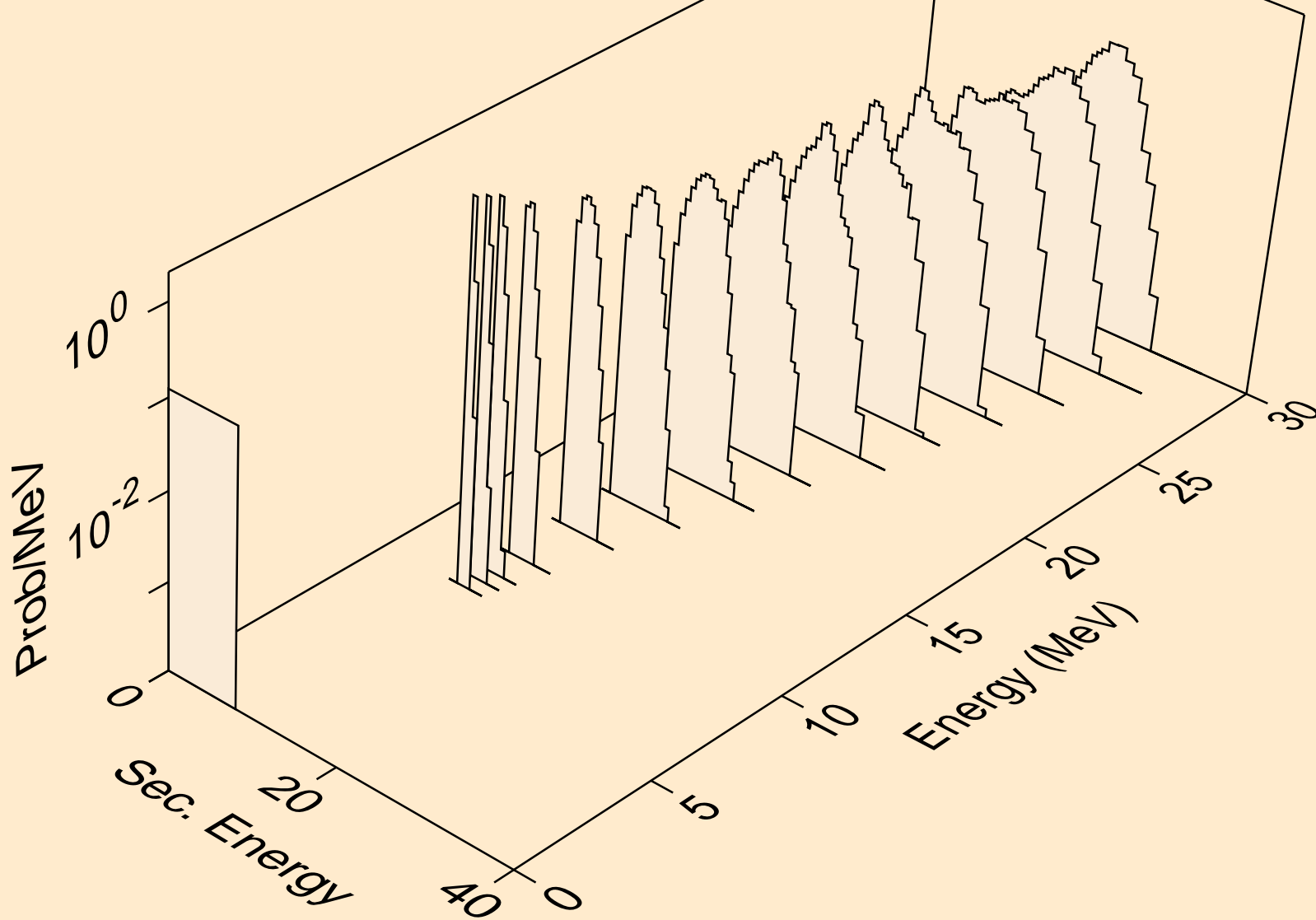

NO252 NEUTRON ACER TENDL-2019 LIBRARY; T=293.16K  
alphas from (n,a)

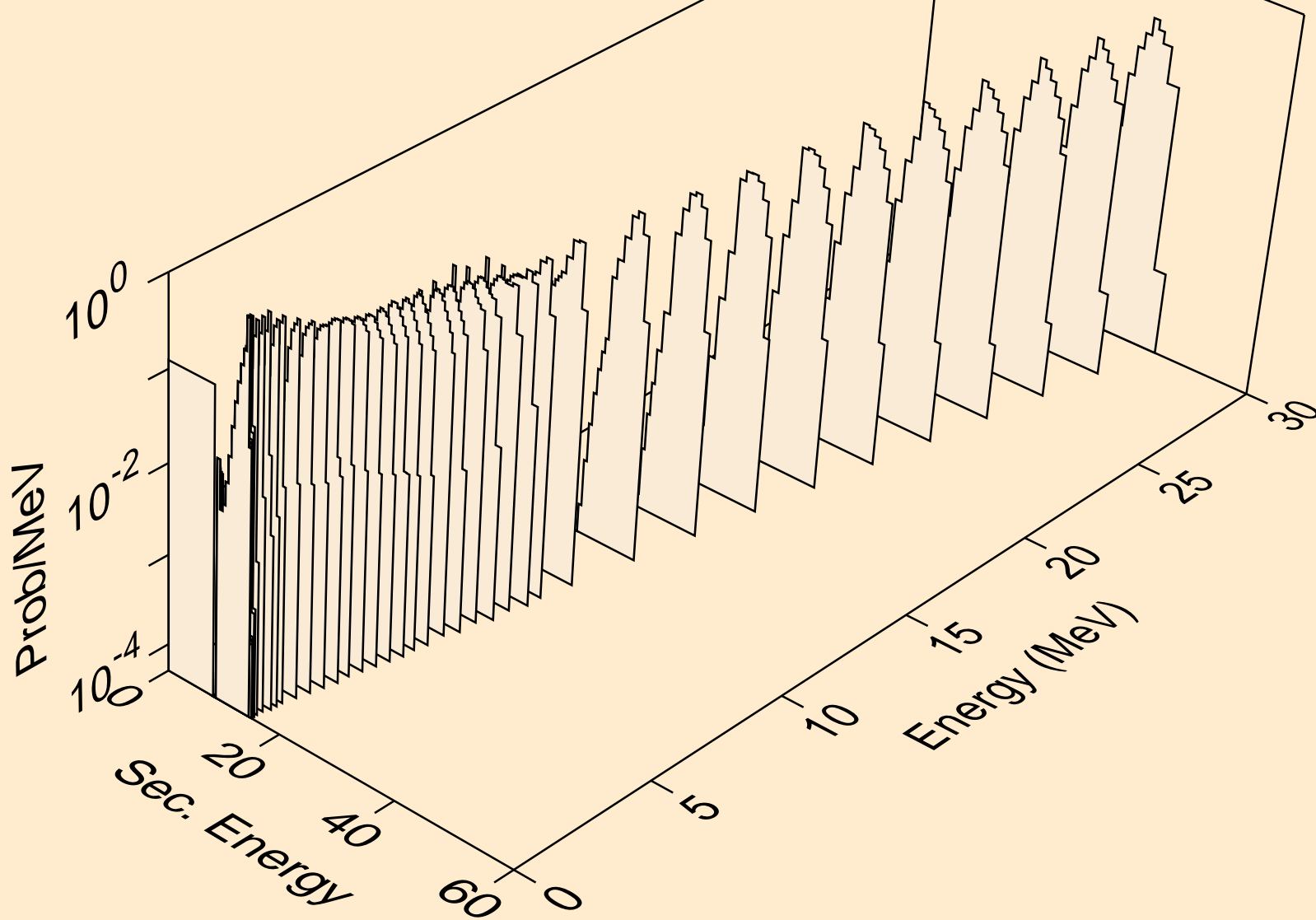

NO252 NEUTRON ACER TENDL-2019 LIBRARY; T=293.16K  
alphas from (n,2a)

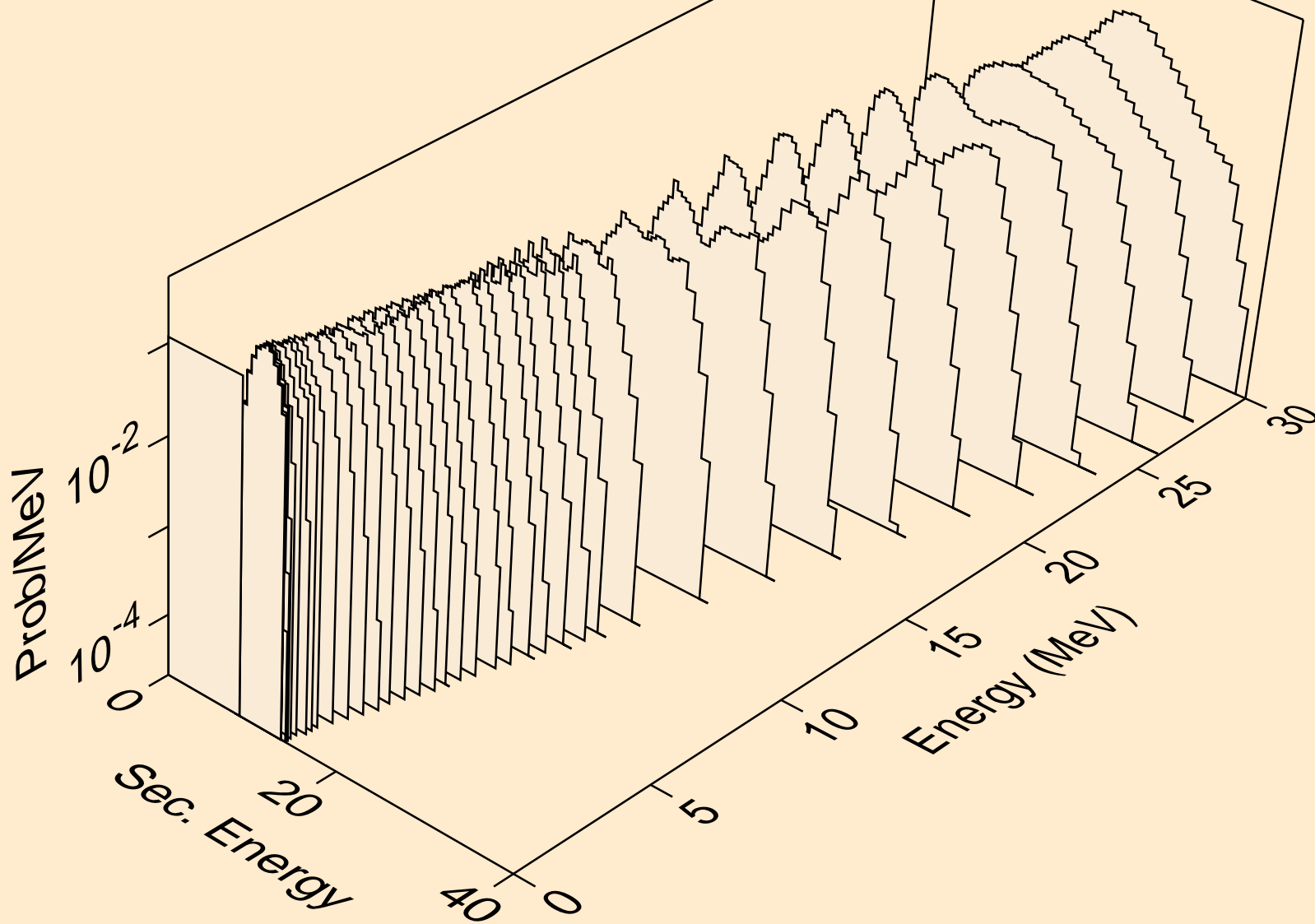

NO252 NEUTRON ACER TENDL-2019 LIBRARY; T=293.16K  
alphas from (n,pa)

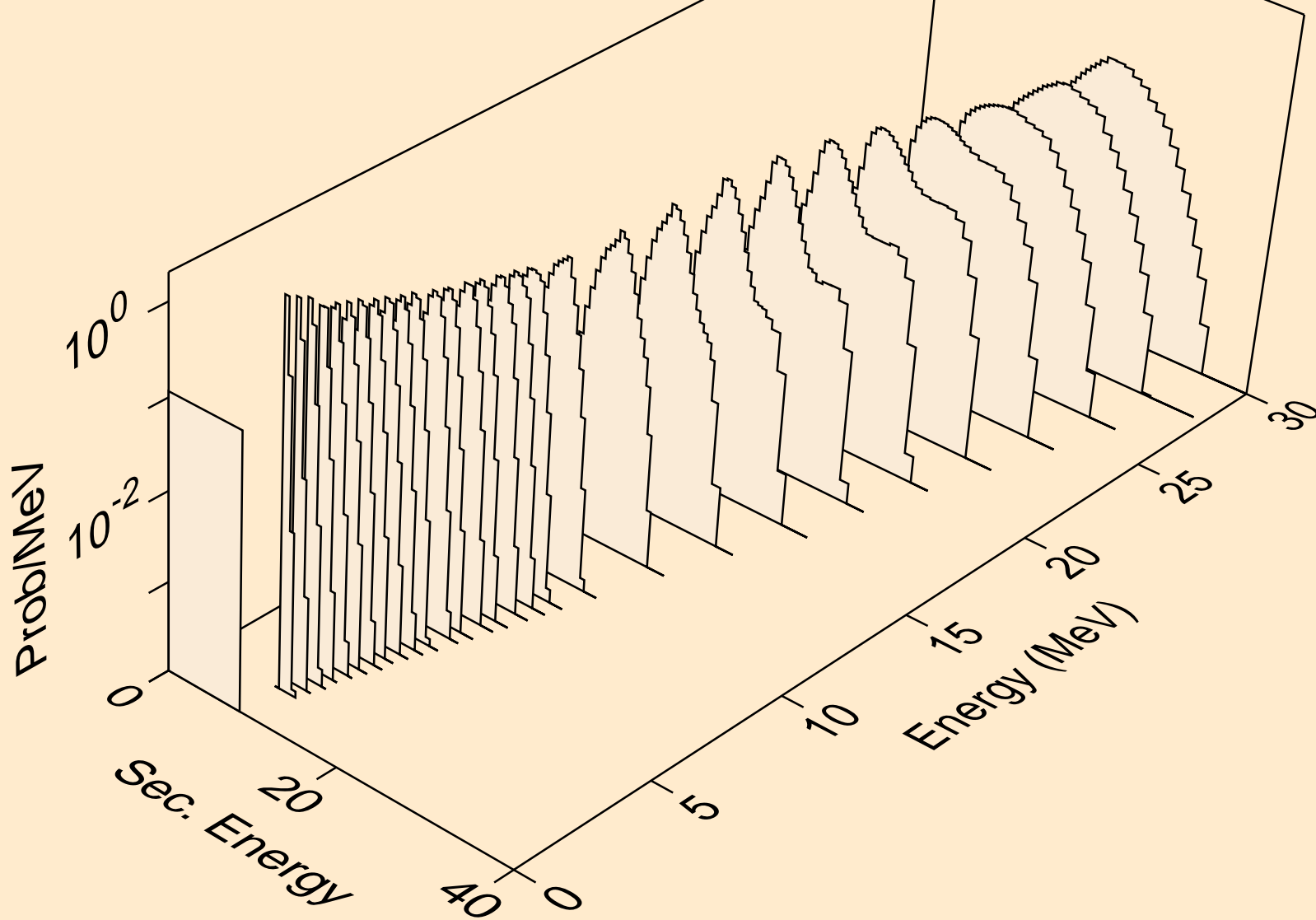

NO252 NEUTRON ACER TENDL-2019 LIBRARY; T=293.16K  
alphas from (n,da)

