

# U231 NEUTRON ACER TENDL-2019 LIBRARY; T=293.16K

## Principal cross sections

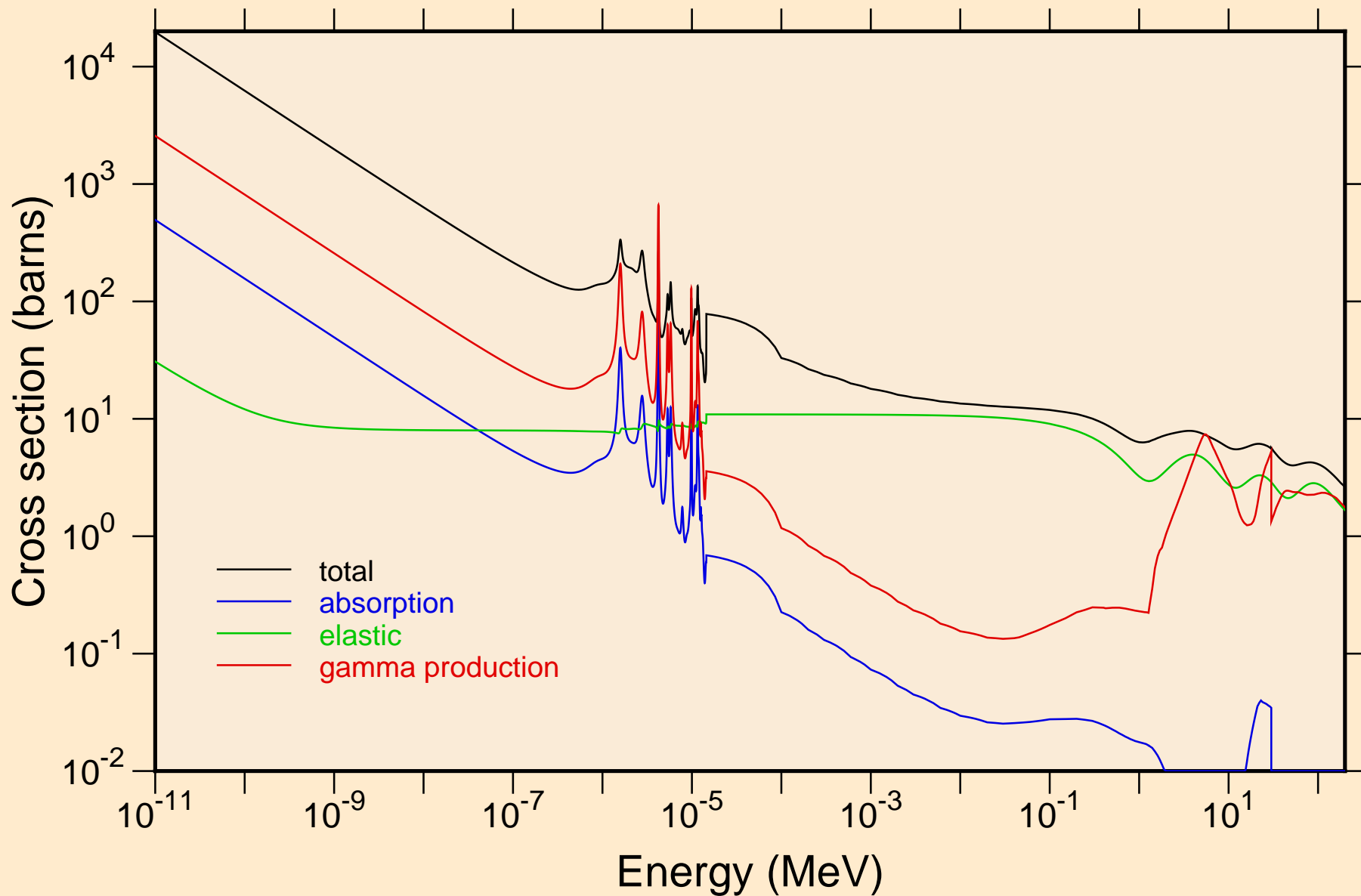

U231 NEUTRON ACER TENDL-2019 LIBRARY; T=293.16K  
resonance total cross section

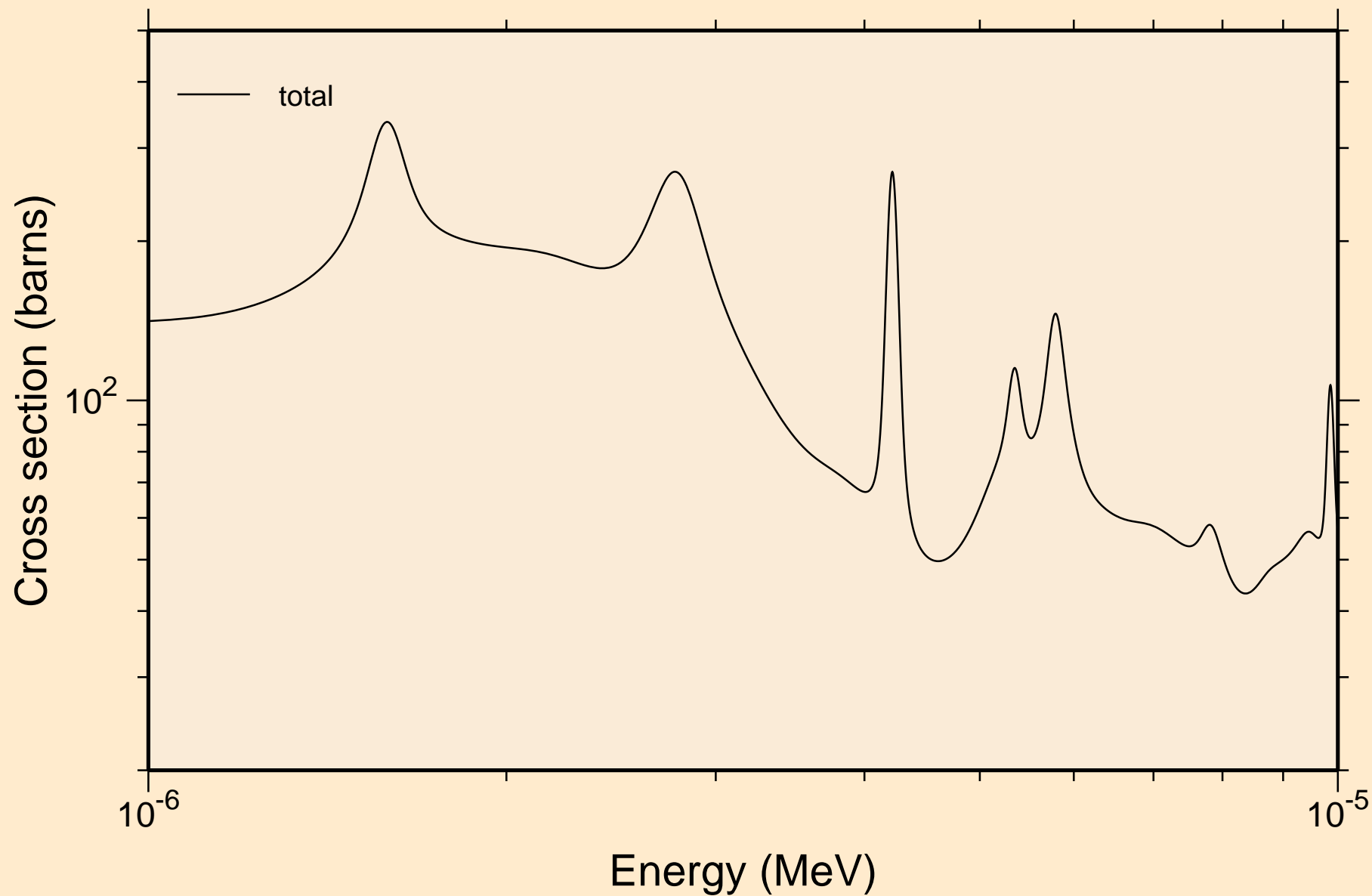

U231 NEUTRON ACER TENDL-2019 LIBRARY; T=293.16K  
resonance total cross section

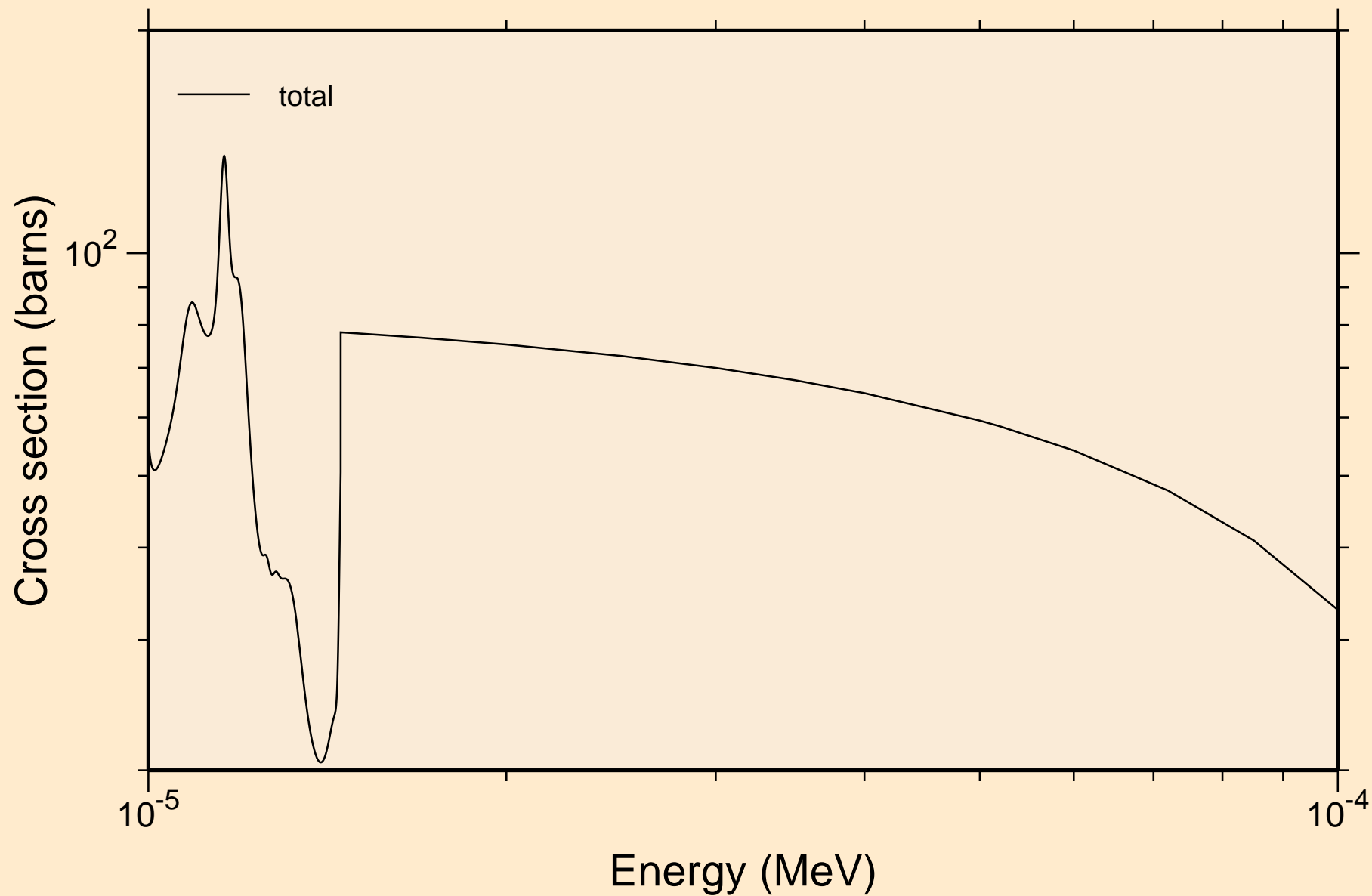

U231 NEUTRON ACER TENDL-2019 LIBRARY; T=293.16K  
resonance total cross section

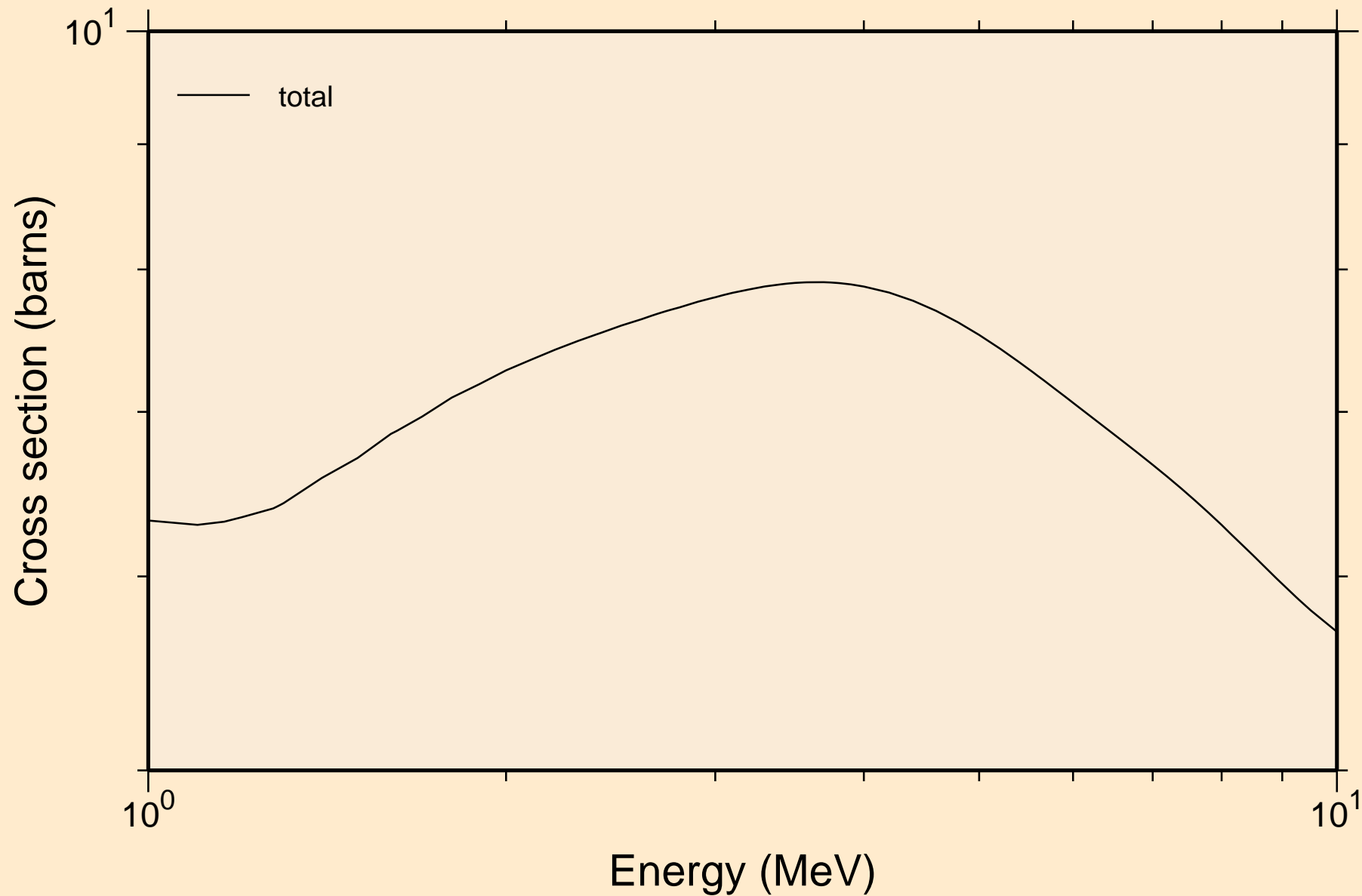

U231 NEUTRON ACER TENDL-2019 LIBRARY; T=293.16K  
resonance absorption cross sections

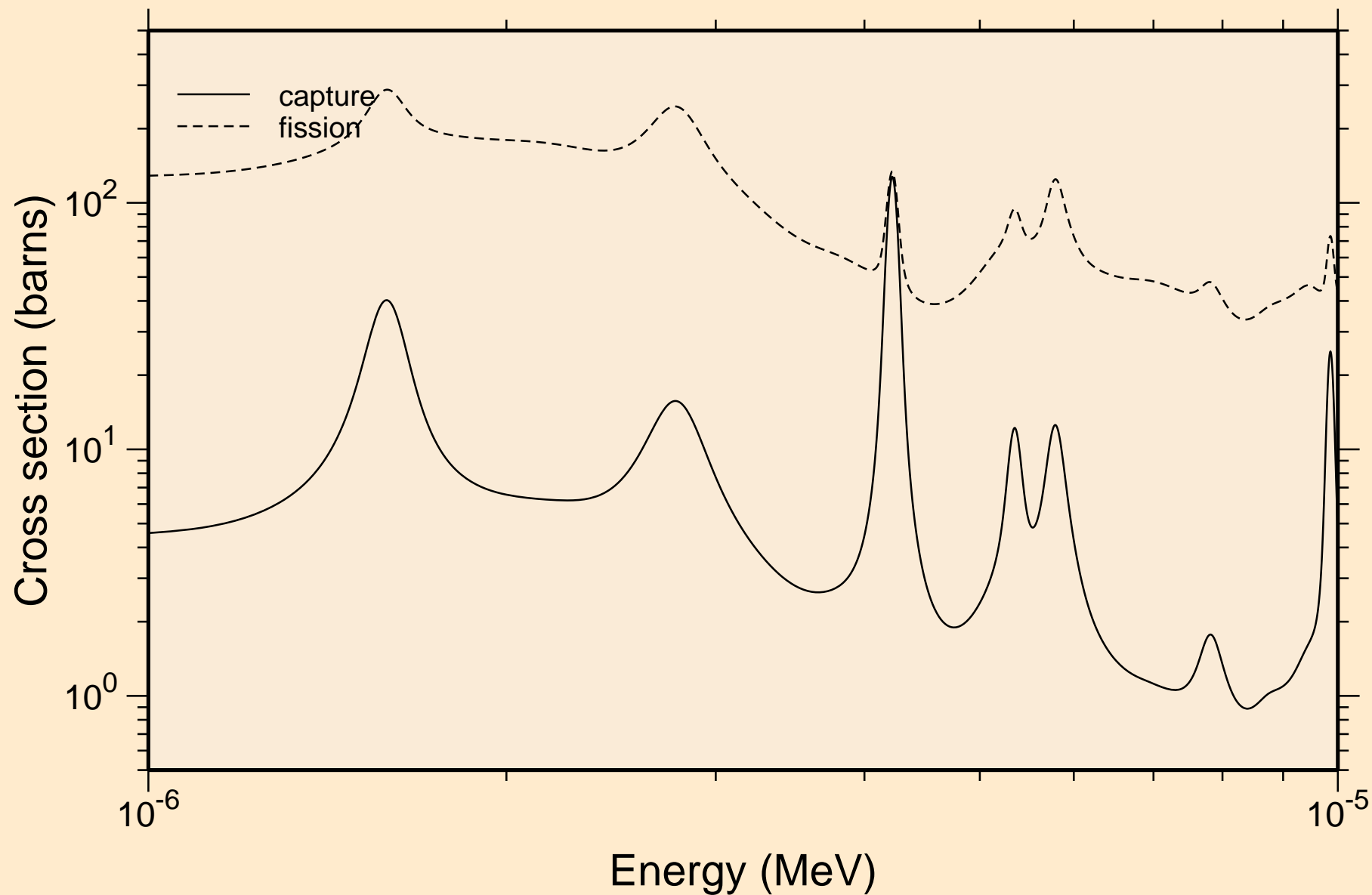

U231 NEUTRON ACER TENDL-2019 LIBRARY; T=293.16K  
resonance absorption cross sections

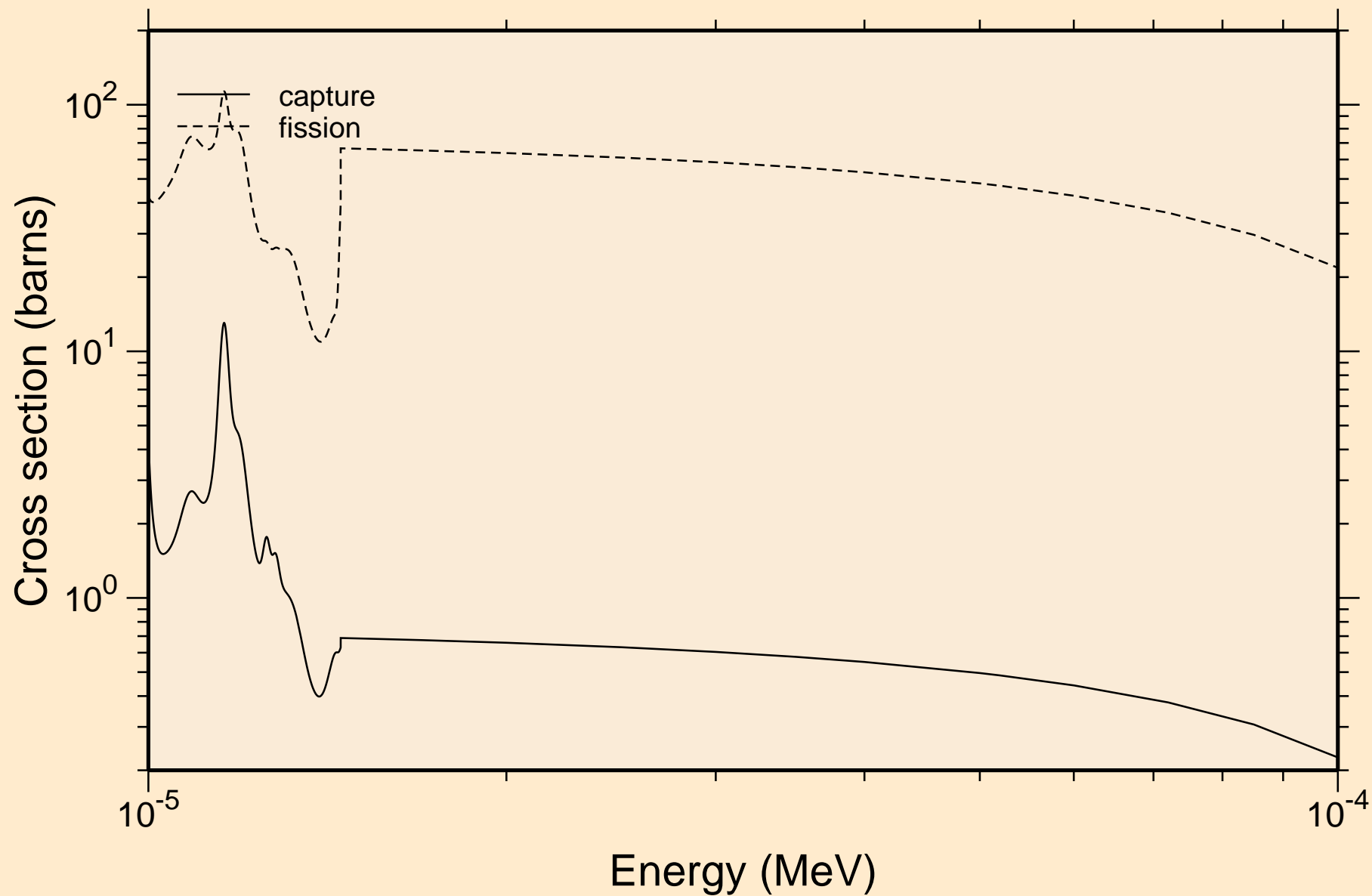

U231 NEUTRON ACER TENDL-2019 LIBRARY; T=293.16K  
resonance absorption cross sections

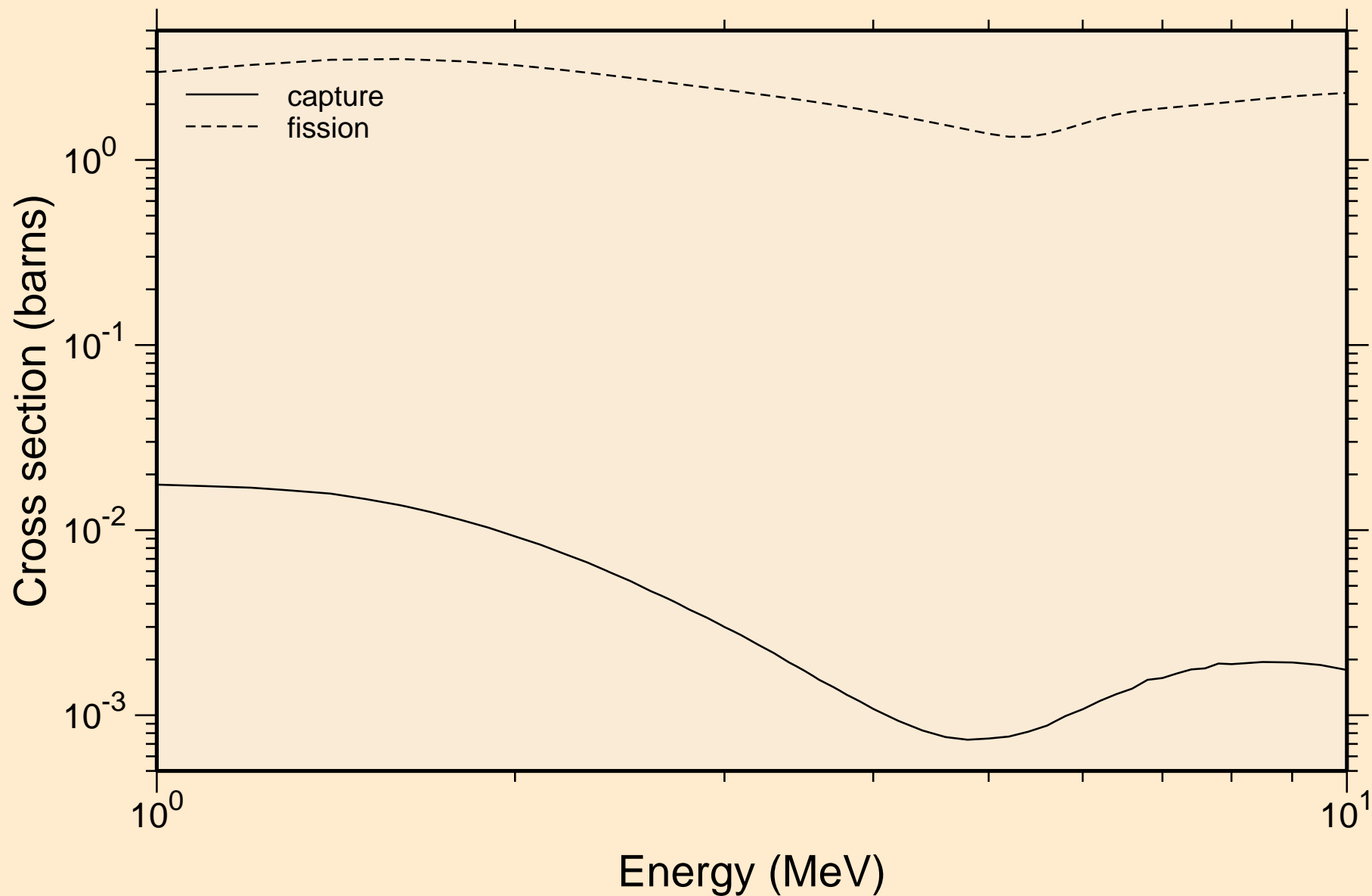

U231 NEUTRON ACER TENDL-2019 LIBRARY; T=293.16K  
Heating

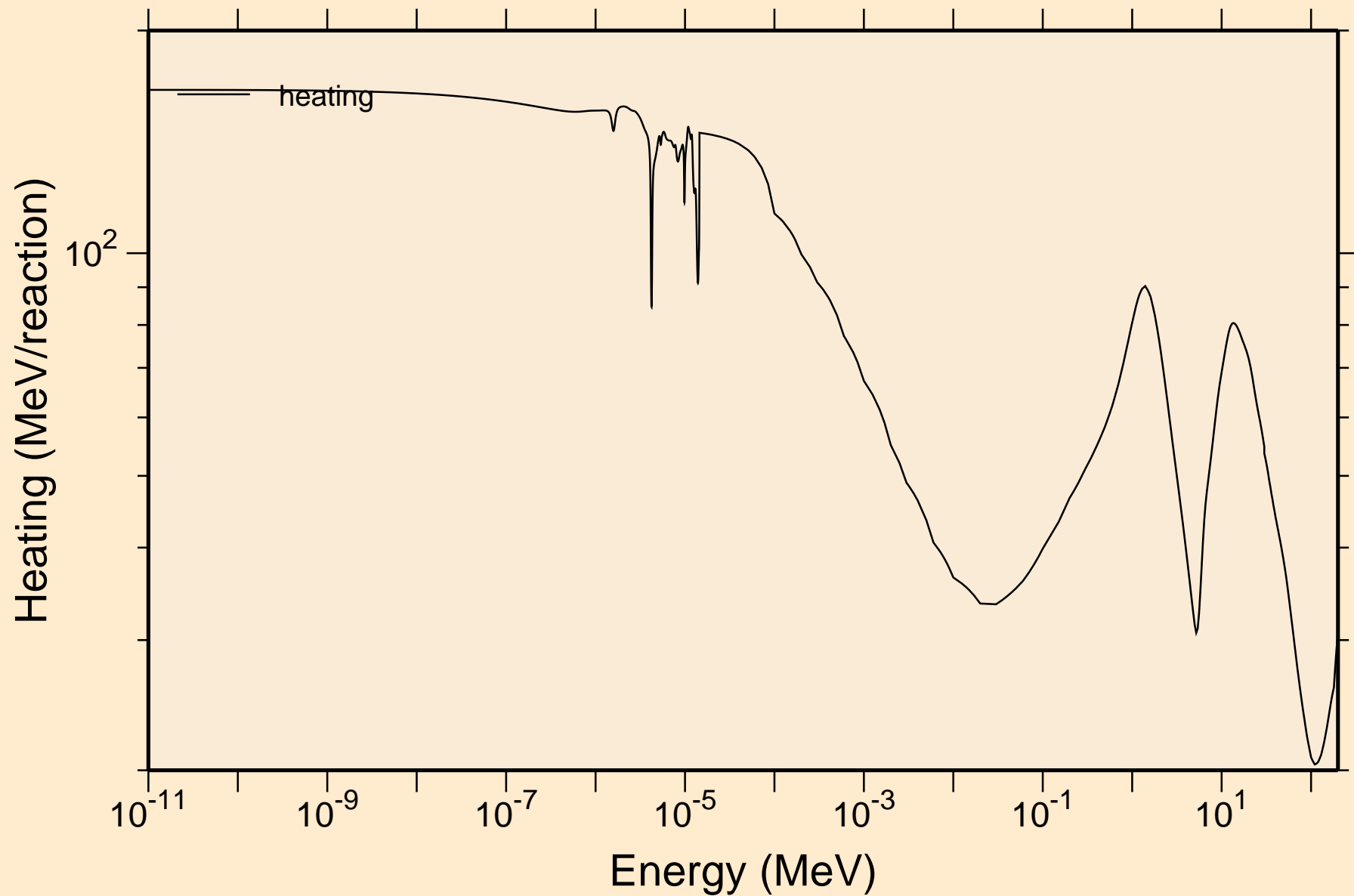

U231 NEUTRON ACER TENDL-2019 LIBRARY; T=293.16K  
Damage

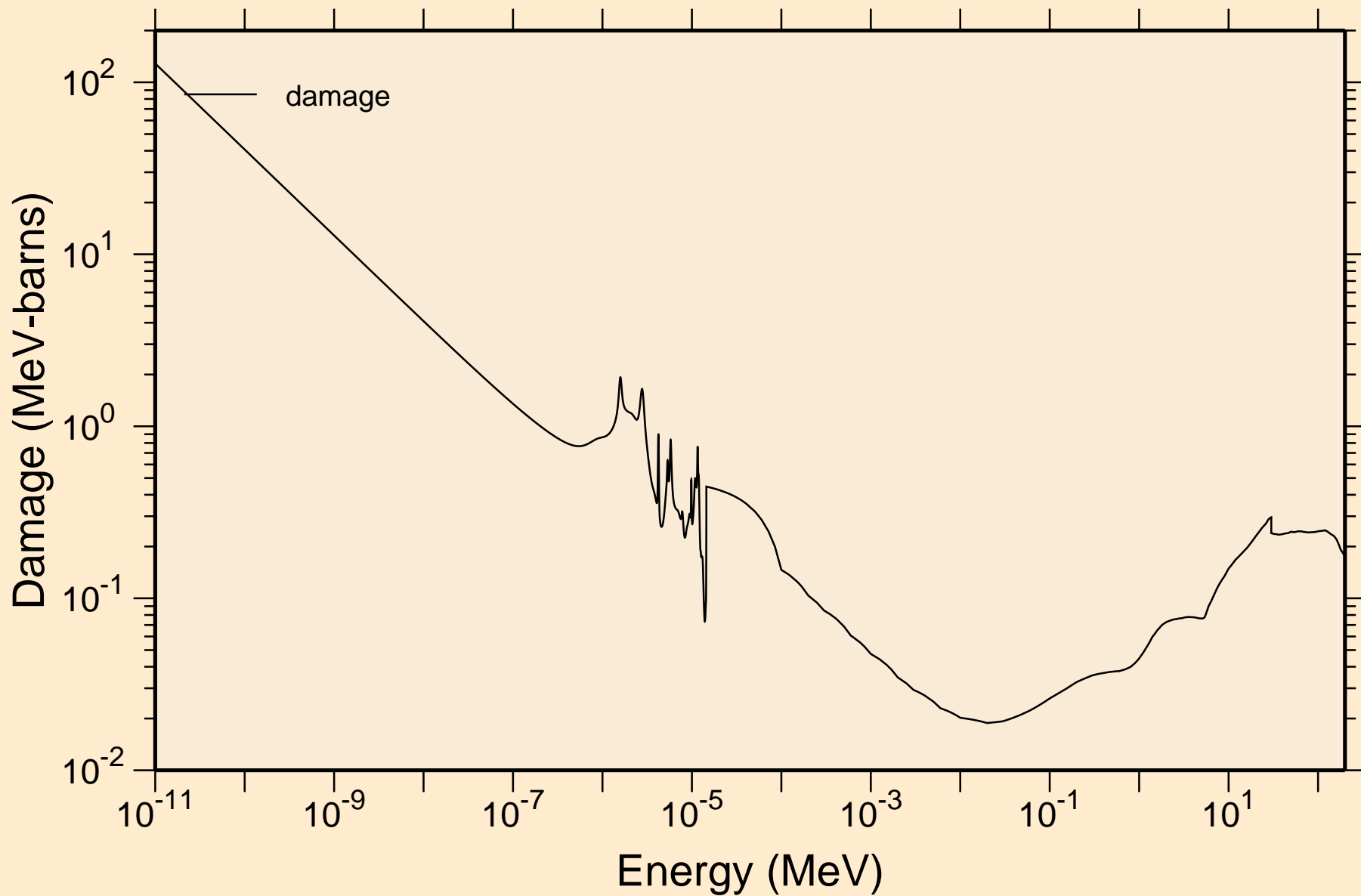

U231 NEUTRON ACER TENDL-2019 LIBRARY; T=293.16K  
Non-threshold reactions

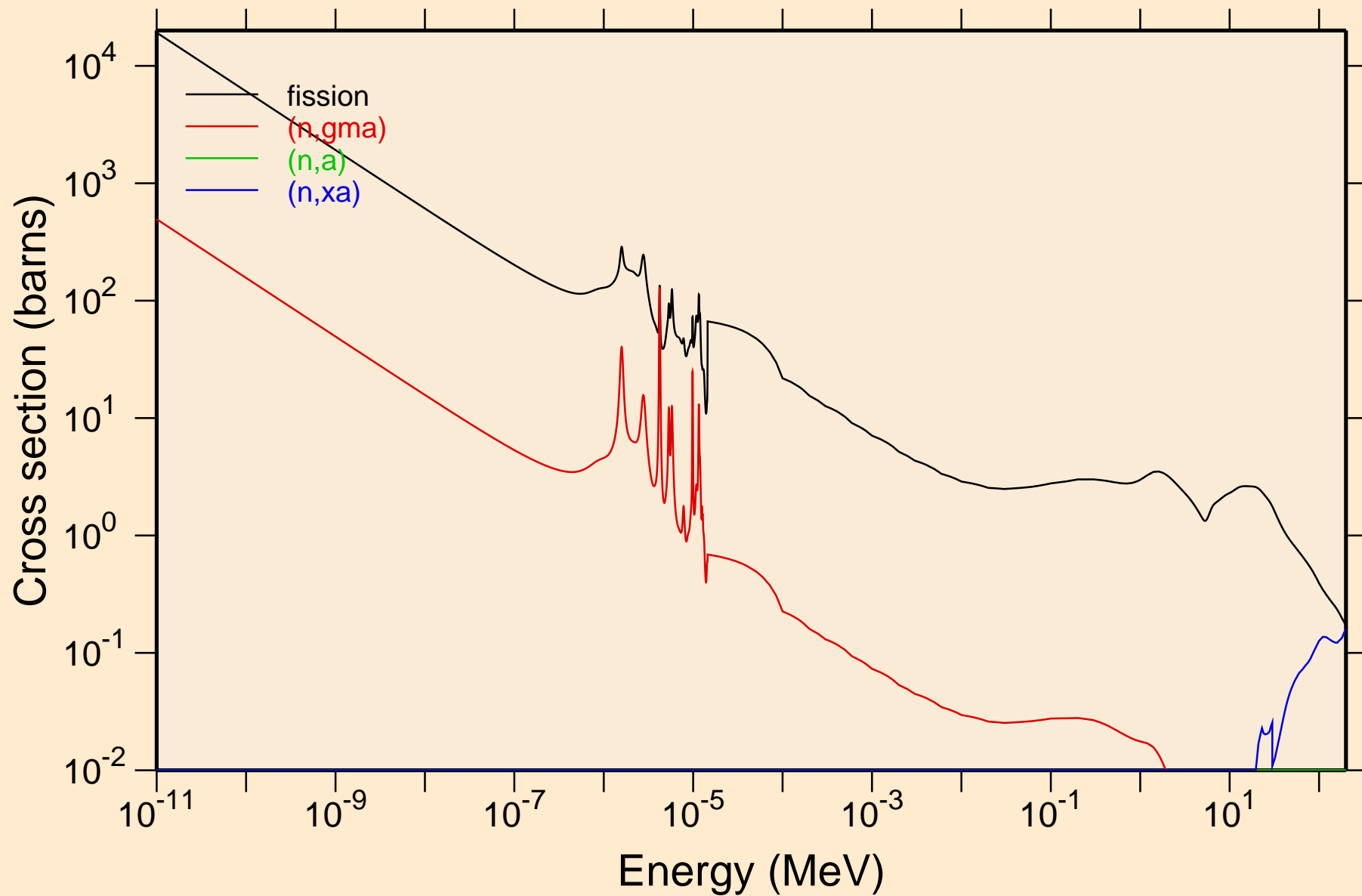

U231 NEUTRON ACER TENDL-2019 LIBRARY; T=293.16K  
Principal cross sections

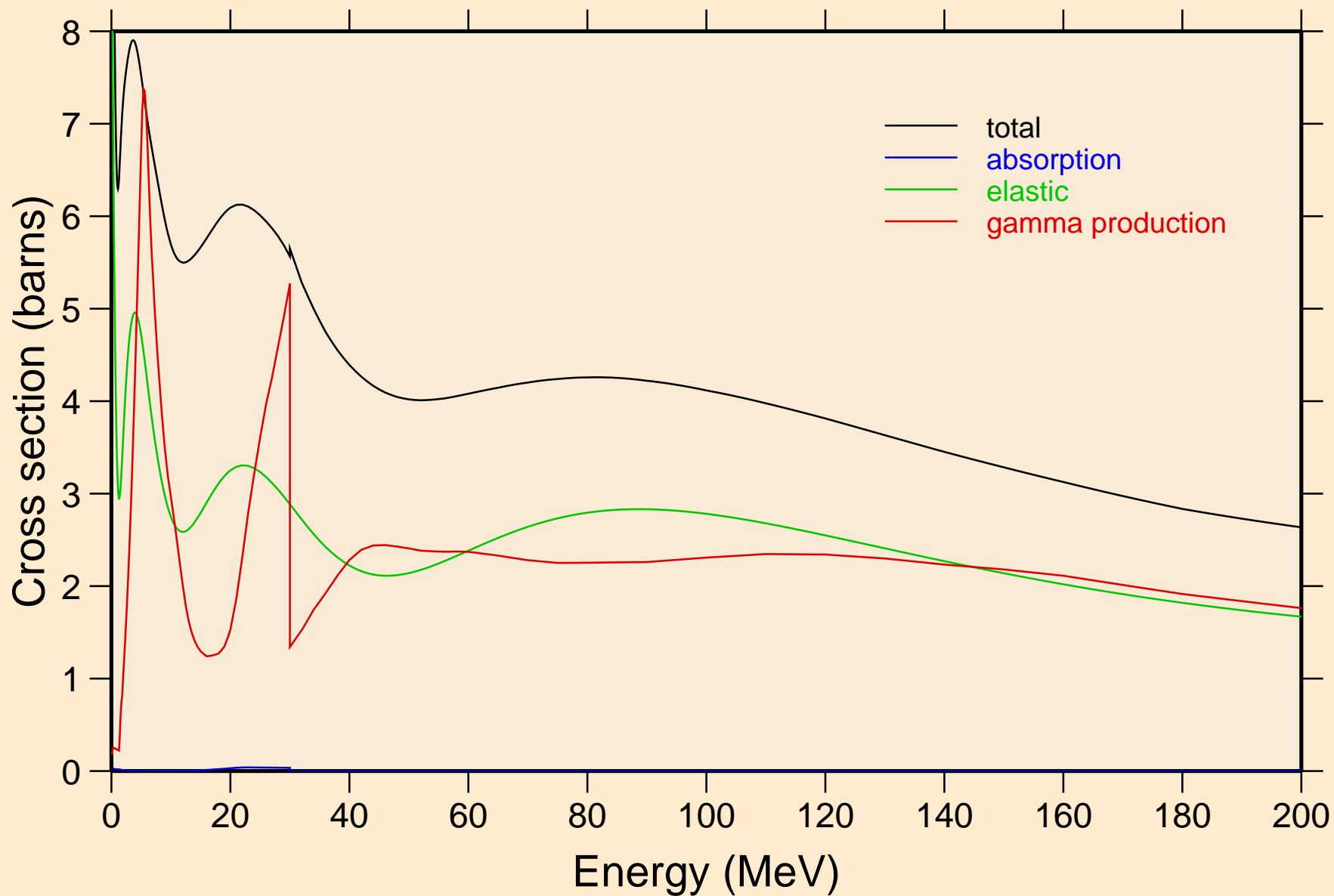

U231 NEUTRON ACER TENDL-2019 LIBRARY; T=293.16K  
Heating

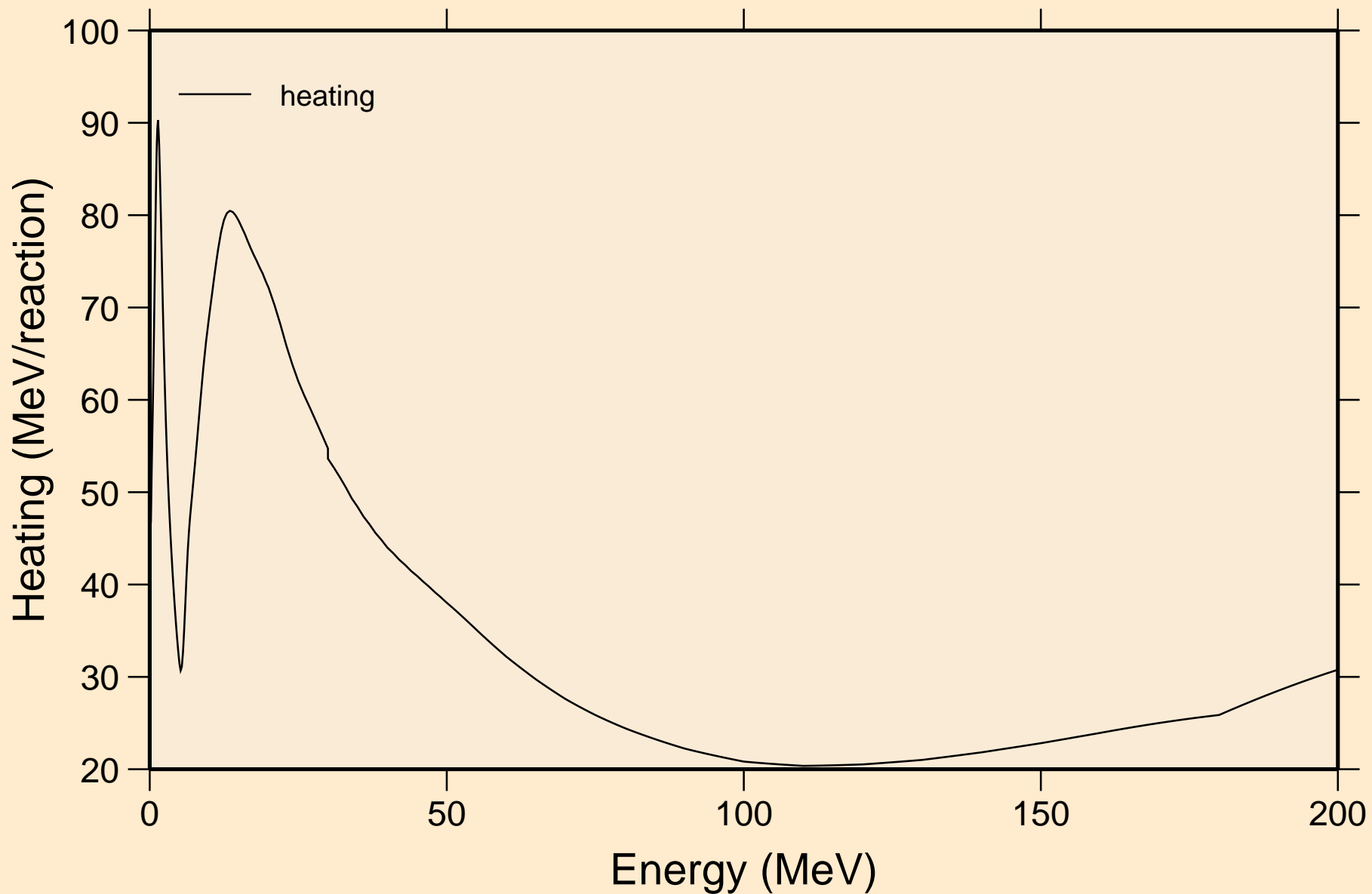

U231 NEUTRON ACER TENDL-2019 LIBRARY; T=293.16K  
Damage

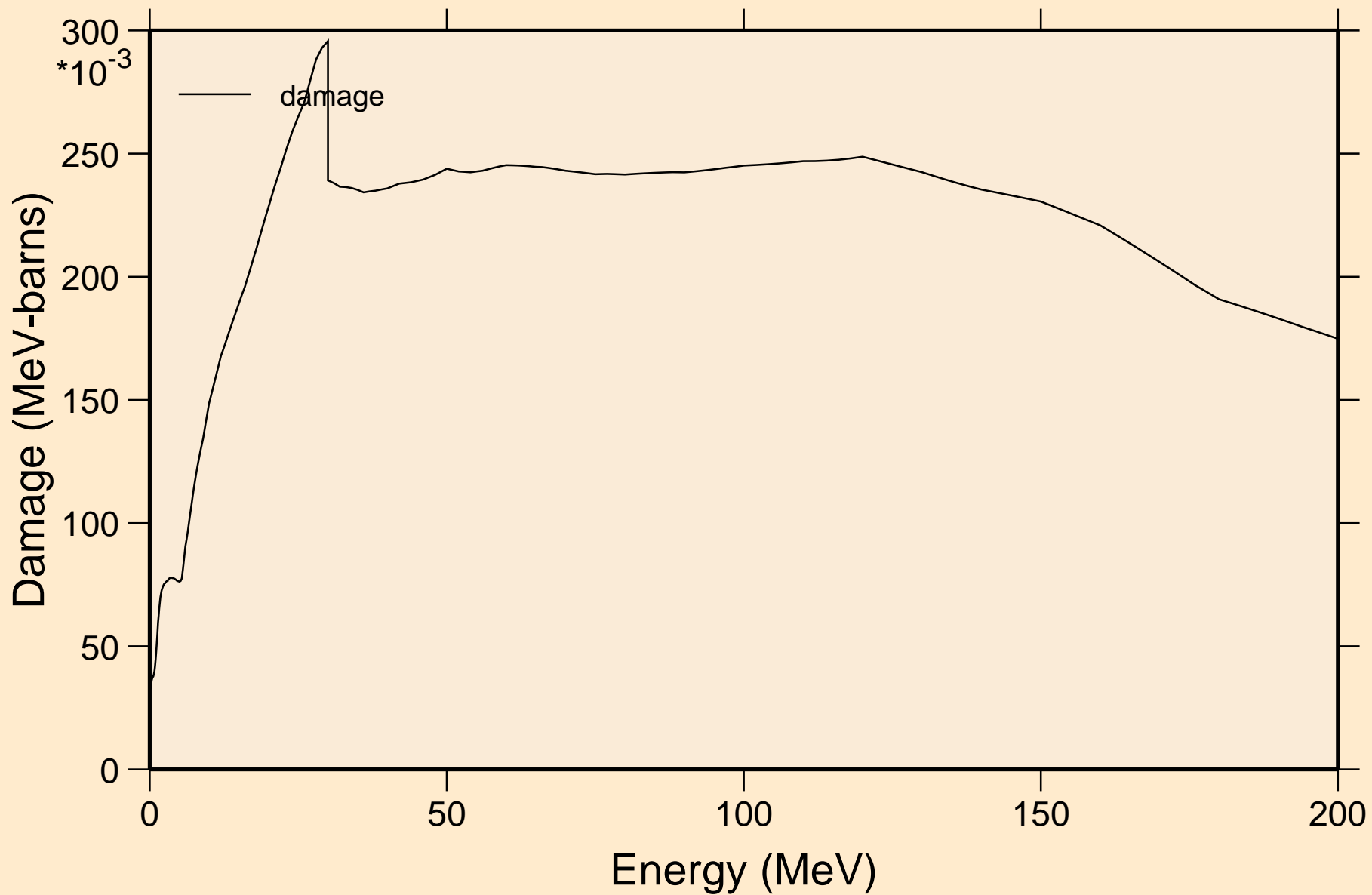

U231 NEUTRON ACER TENDL-2019 LIBRARY; T=293.16K  
Non-threshold reactions

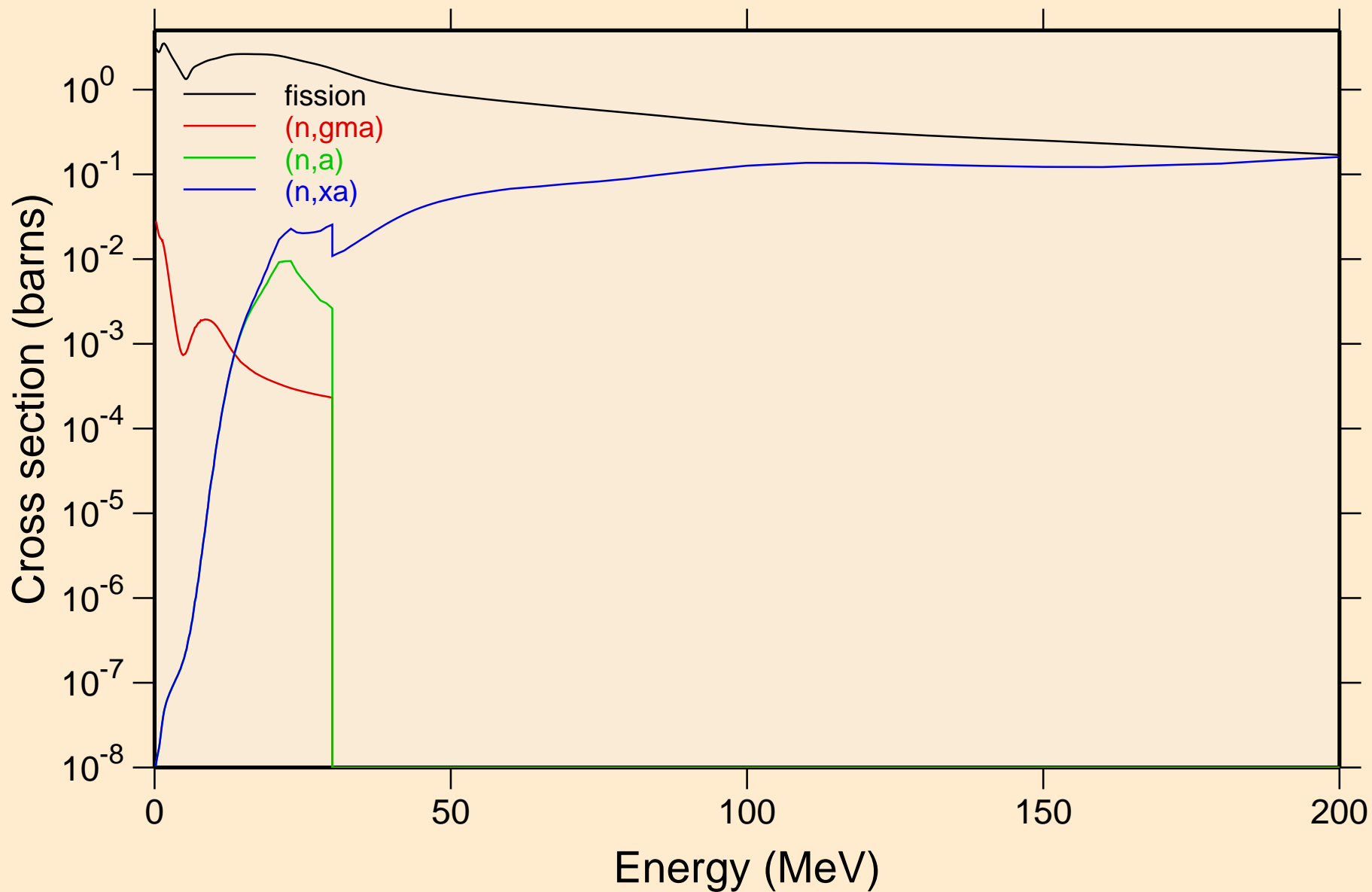

U231 NEUTRON ACER TENDL-2019 LIBRARY; T=293.16K  
Inelastic levels

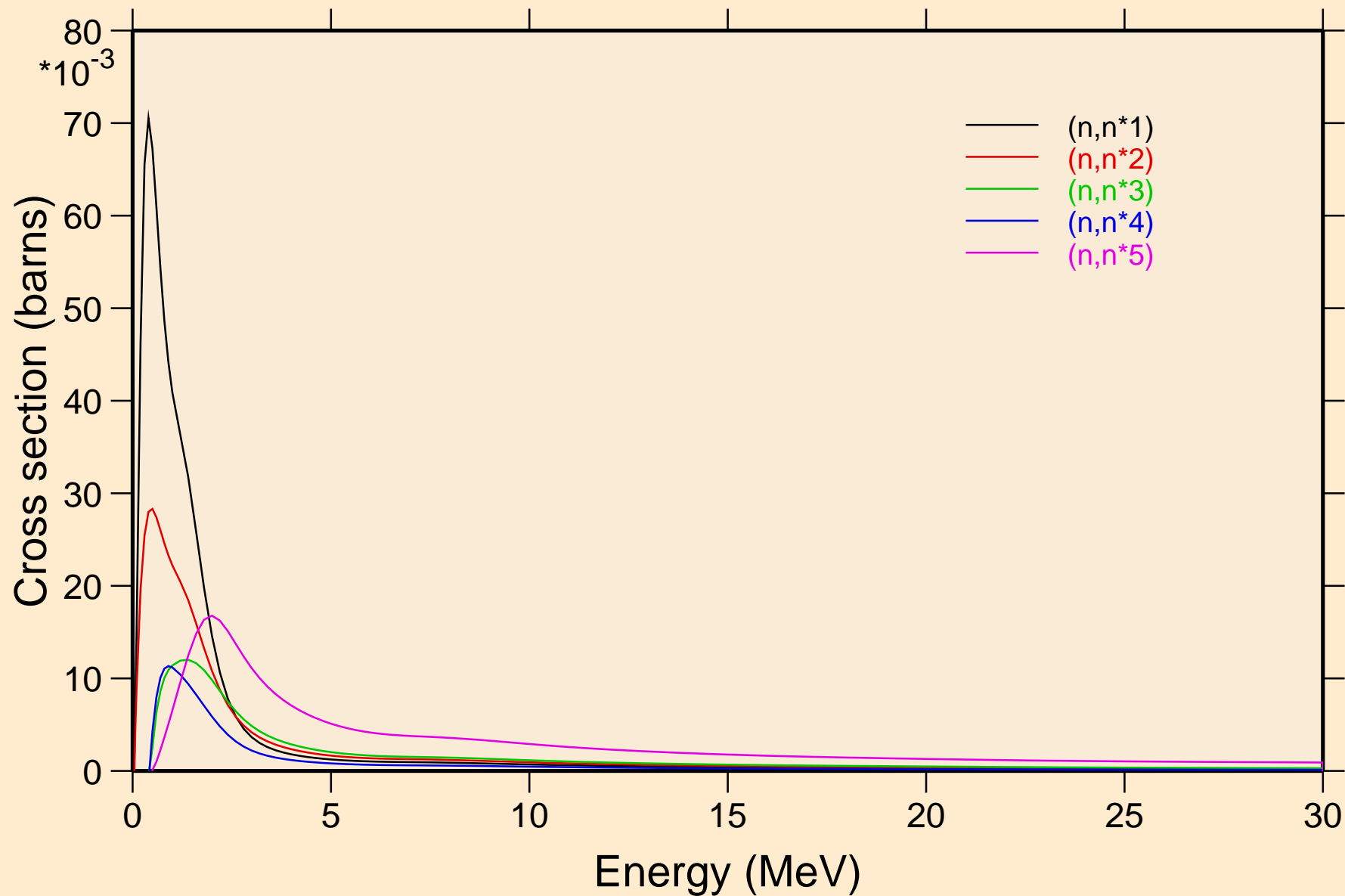

U231 NEUTRON ACER TENDL-2019 LIBRARY; T=293.16K  
Inelastic levels

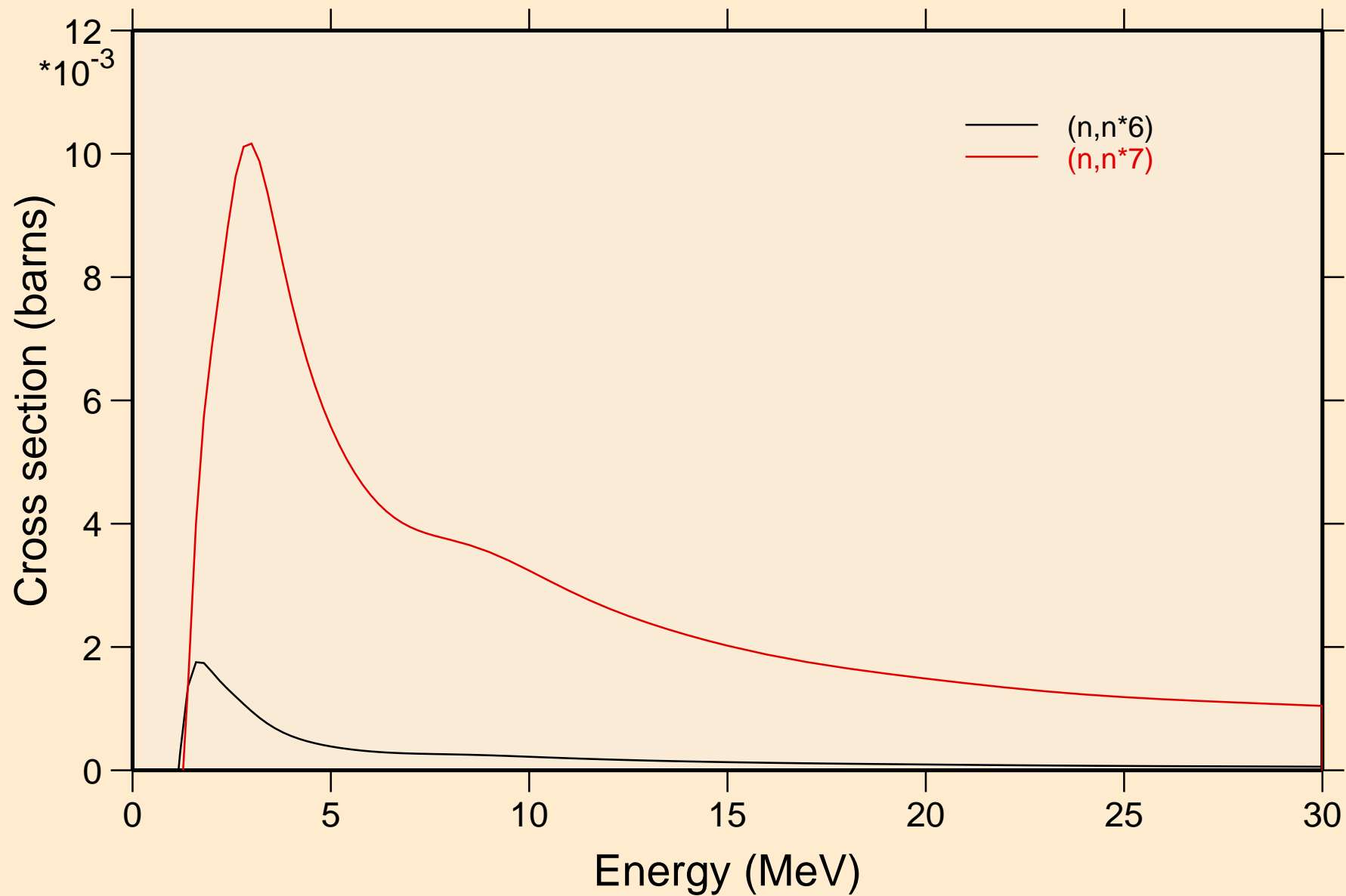

# U231 NEUTRON ACER TENDL-2019 LIBRARY; T=293.16K

## Threshold reactions

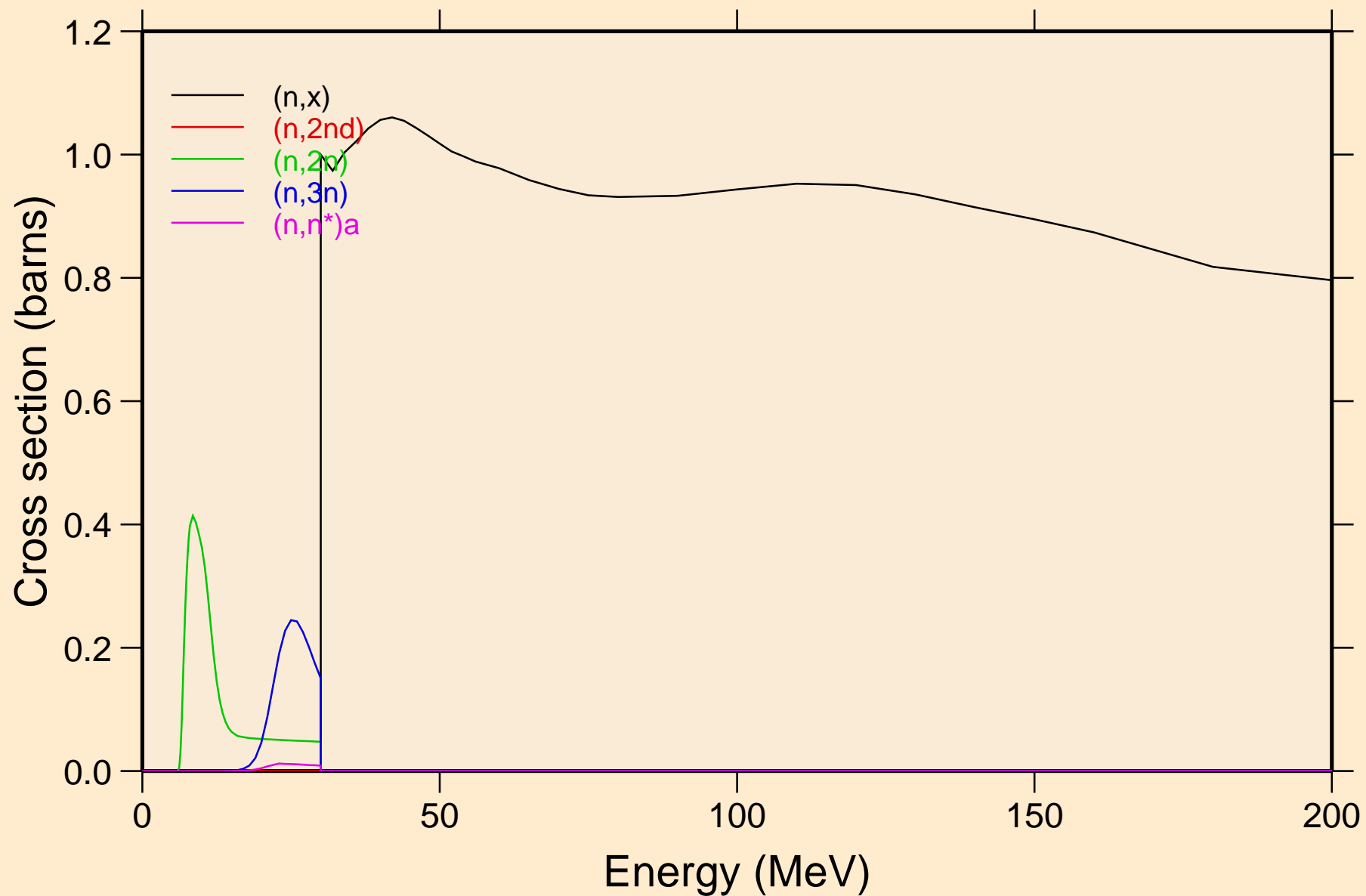

U231 NEUTRON ACER TENDL-2019 LIBRARY; T=293.16K  
Threshold reactions

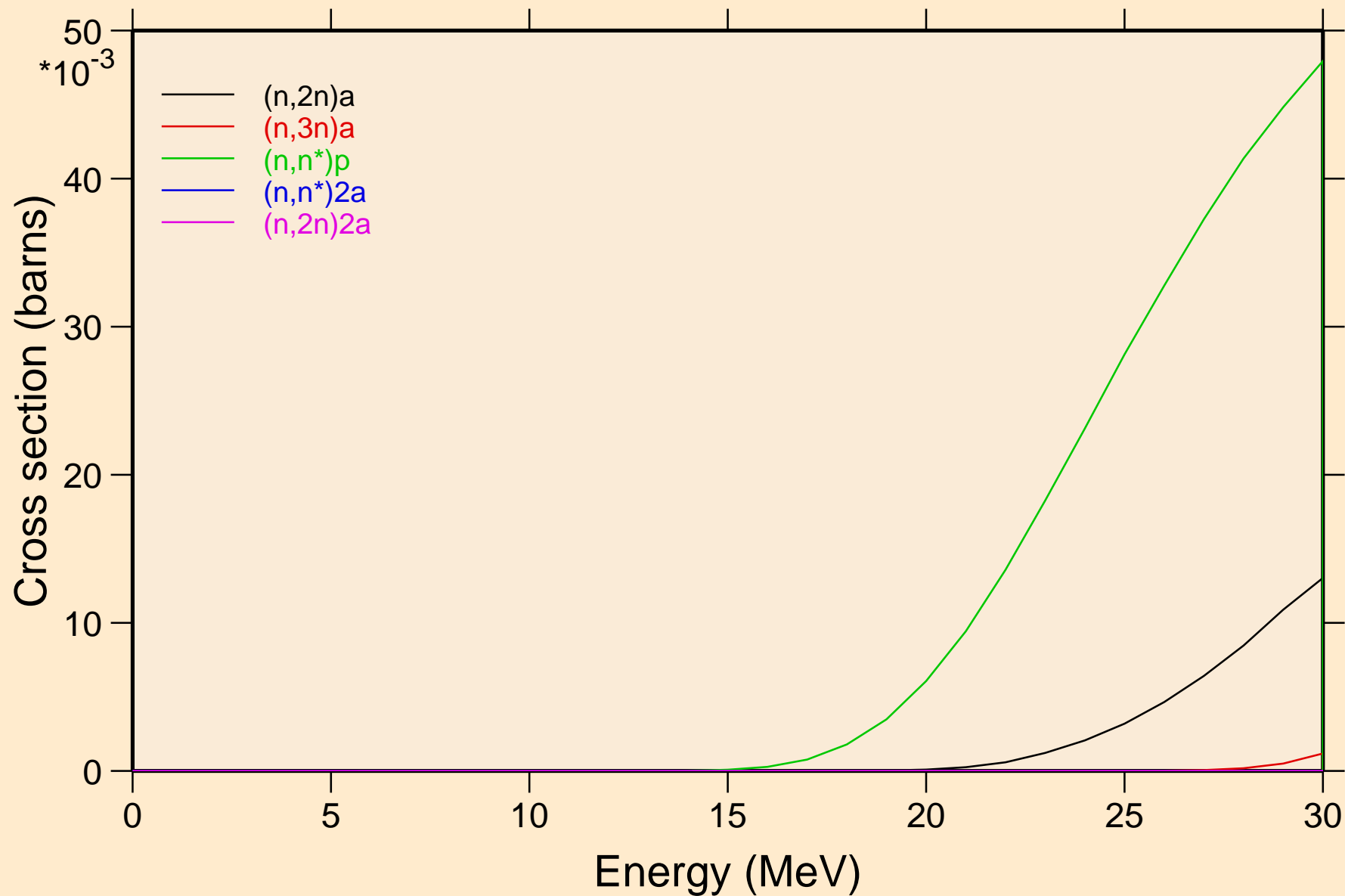

U231 NEUTRON ACER TENDL-2019 LIBRARY; T=293.16K  
Threshold reactions

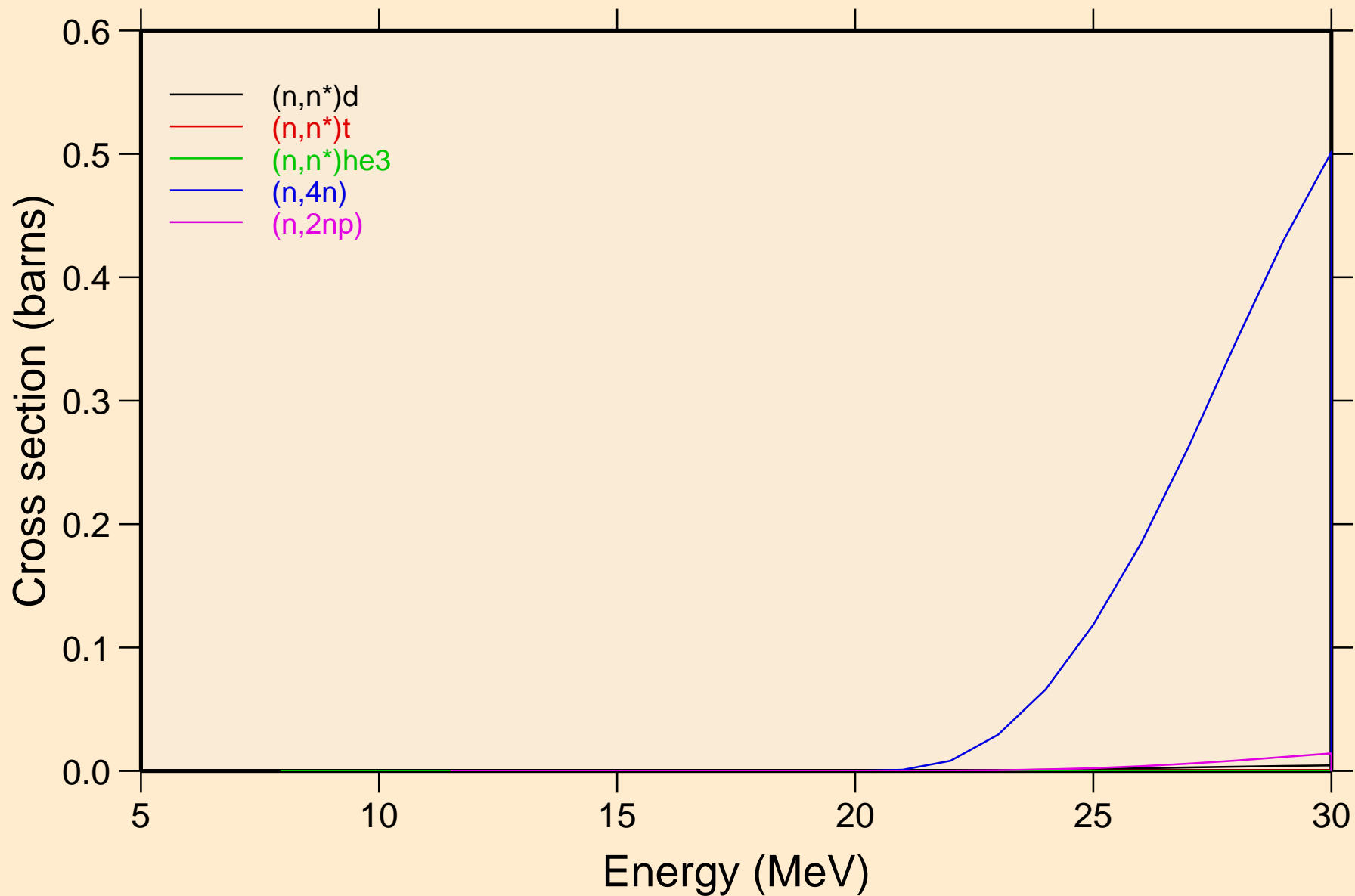

U231 NEUTRON ACER TENDL-2019 LIBRARY; T=293.16K  
Threshold reactions

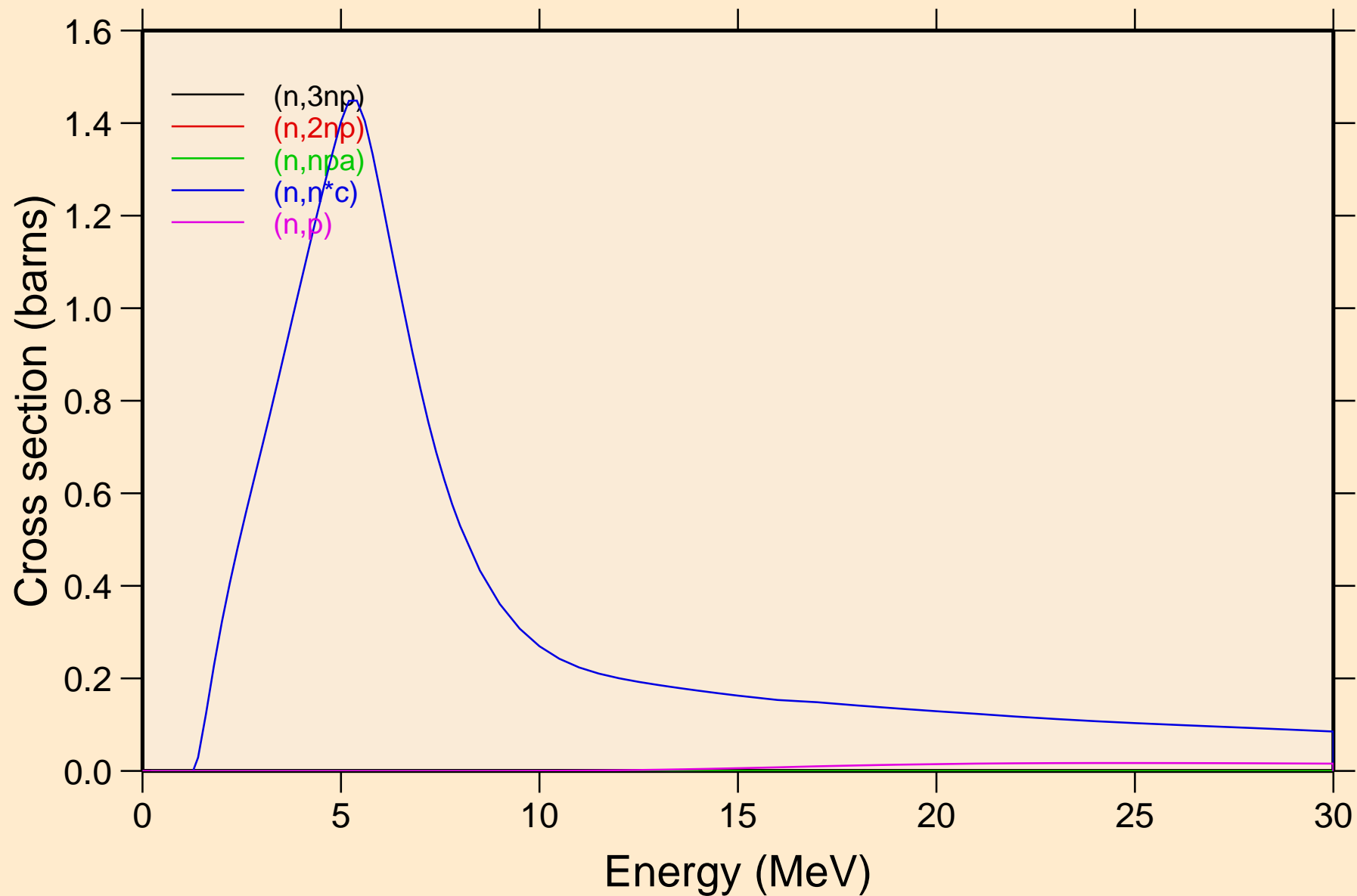

U231 NEUTRON ACER TENDL-2019 LIBRARY; T=293.16K  
Threshold reactions

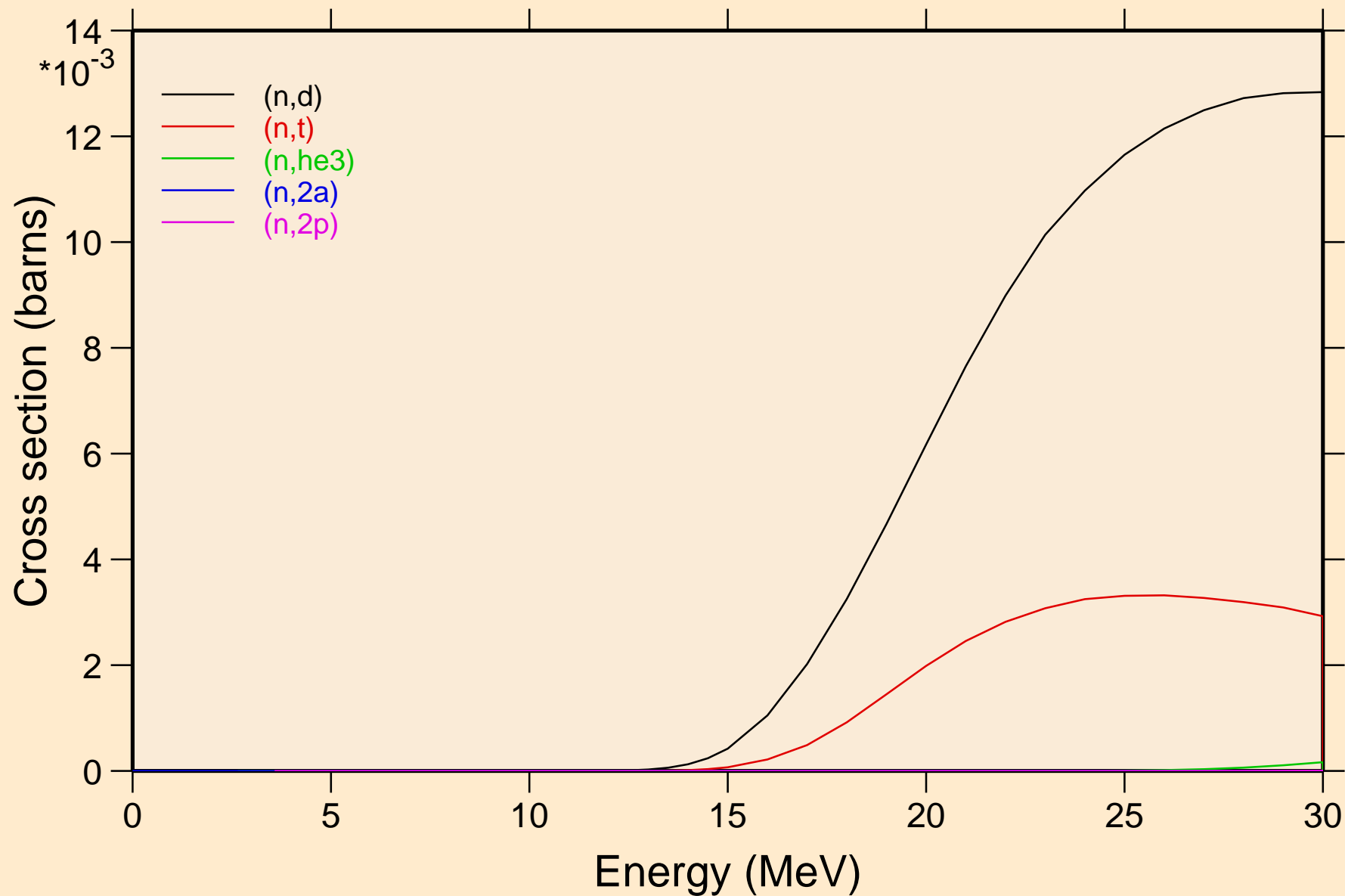

U231 NEUTRON ACER TENDL-2019 LIBRARY; T=293.16K  
Threshold reactions

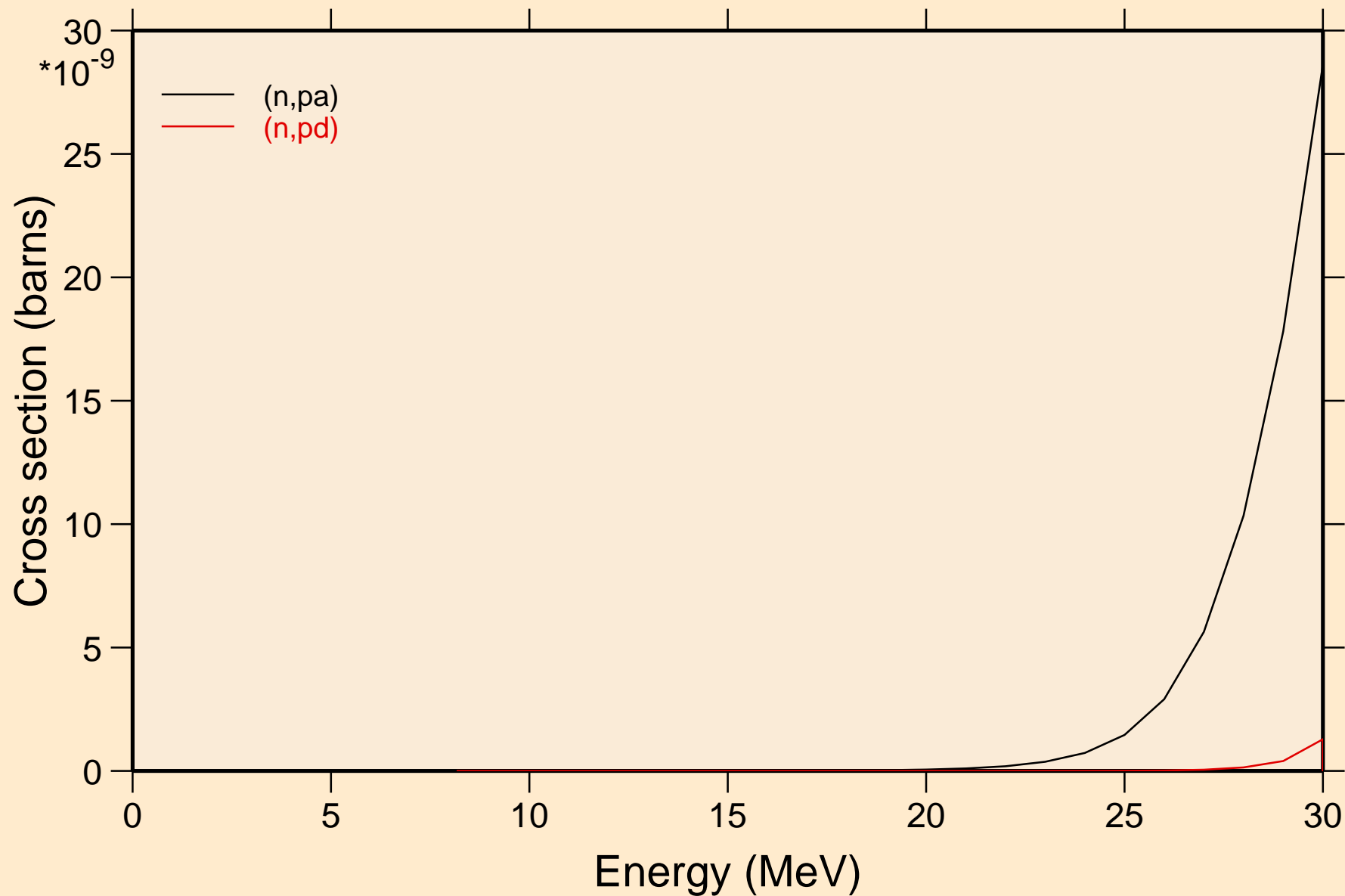

U231 NEUTRON ACER TENDL-2019 LIBRARY; T=293.16K  
Threshold reactions

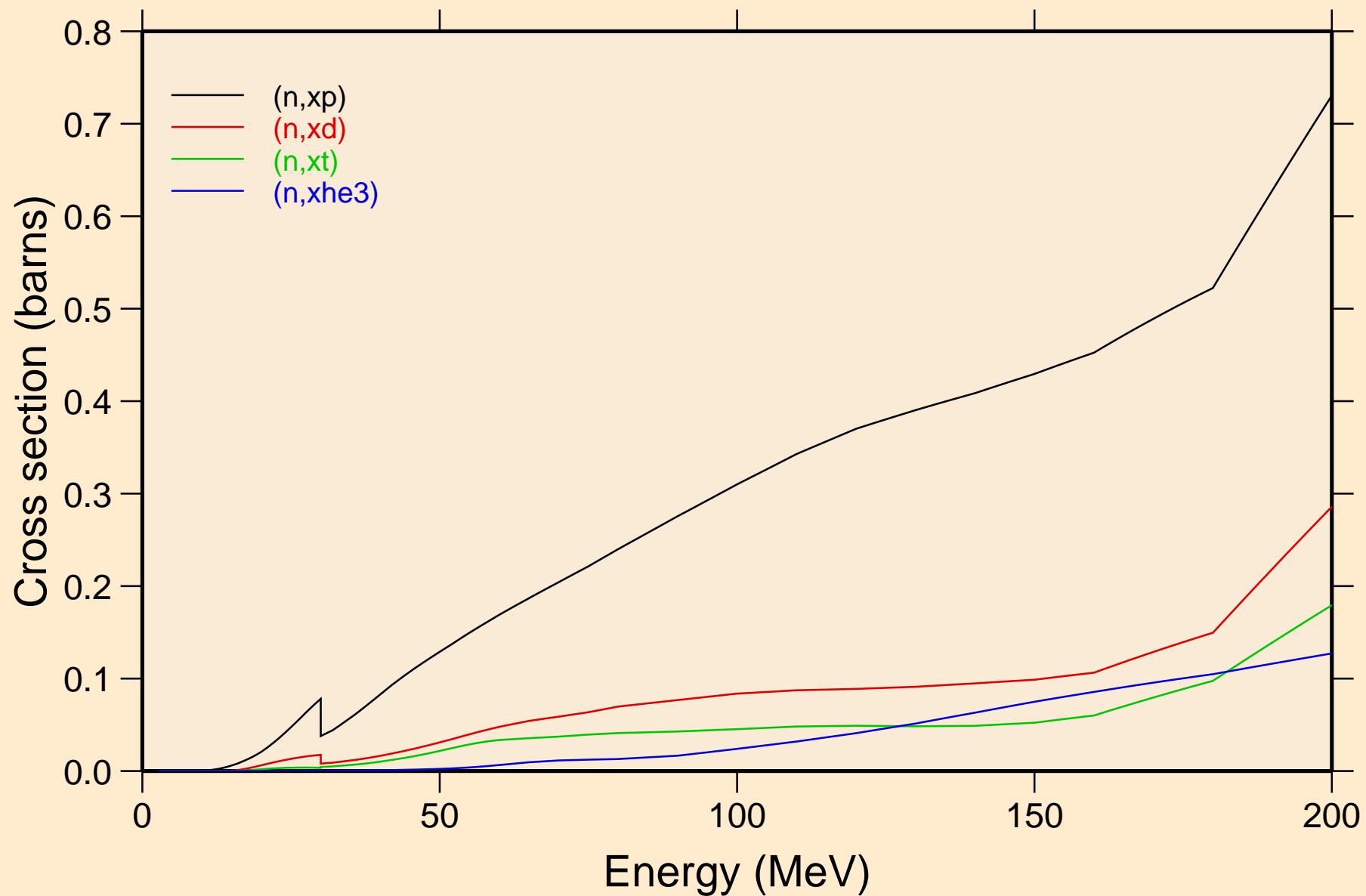

U231 NEUTRON ACER TENDL-2019 LIBRARY; T=293.16K  
angular distribution for elastic

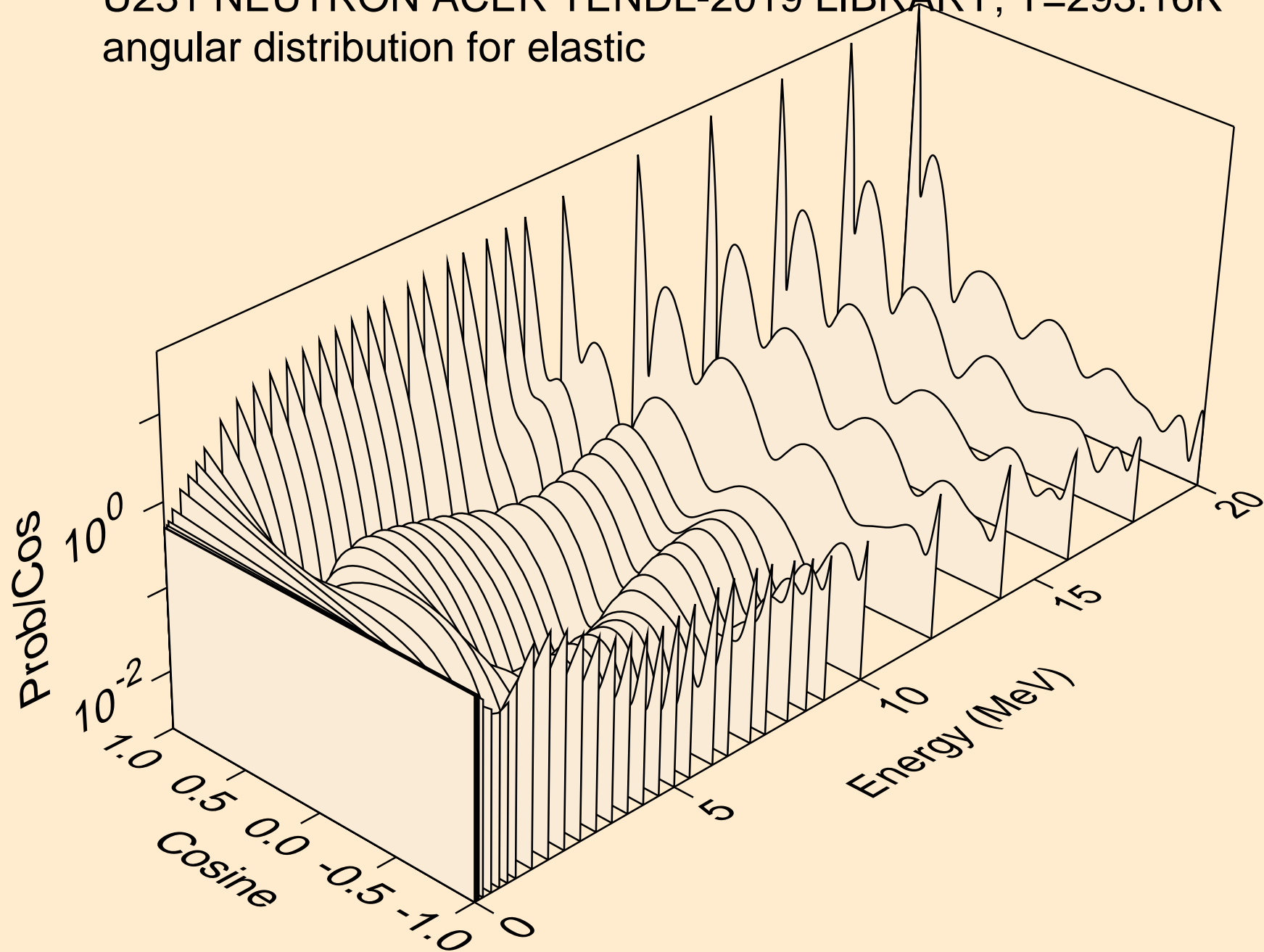

U231 NEUTRON ACER TENDL-2019 LIBRARY; T=293.16K  
angular distribution for elastic

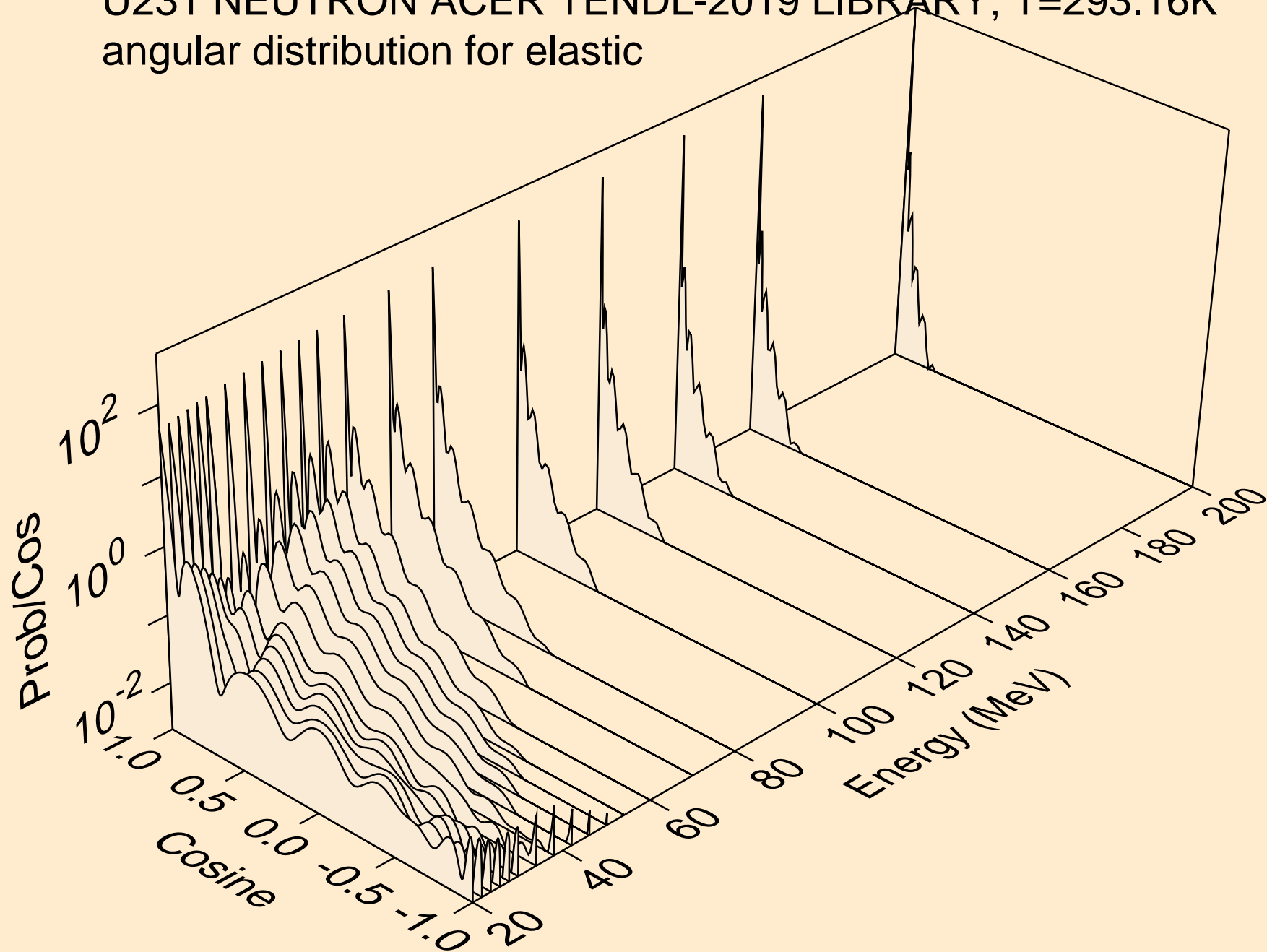

U231 NEUTRON ACER TENDL-2019 LIBRARY; T=293.16K  
angular distribution for (n,n\*1)

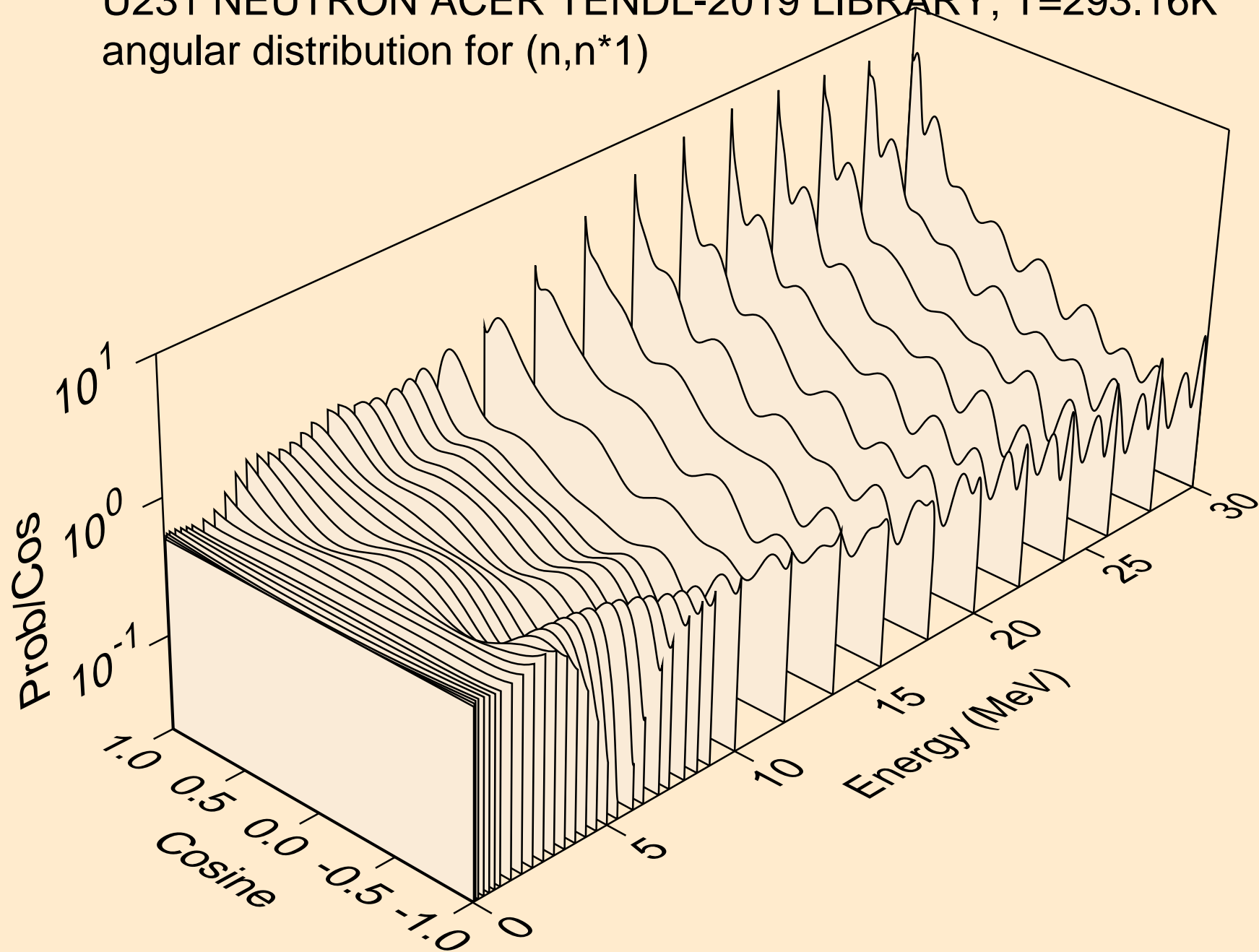

U231 NEUTRON ACER TENDL-2019 LIBRARY; T=293.16K  
angular distribution for (n,n\*2)

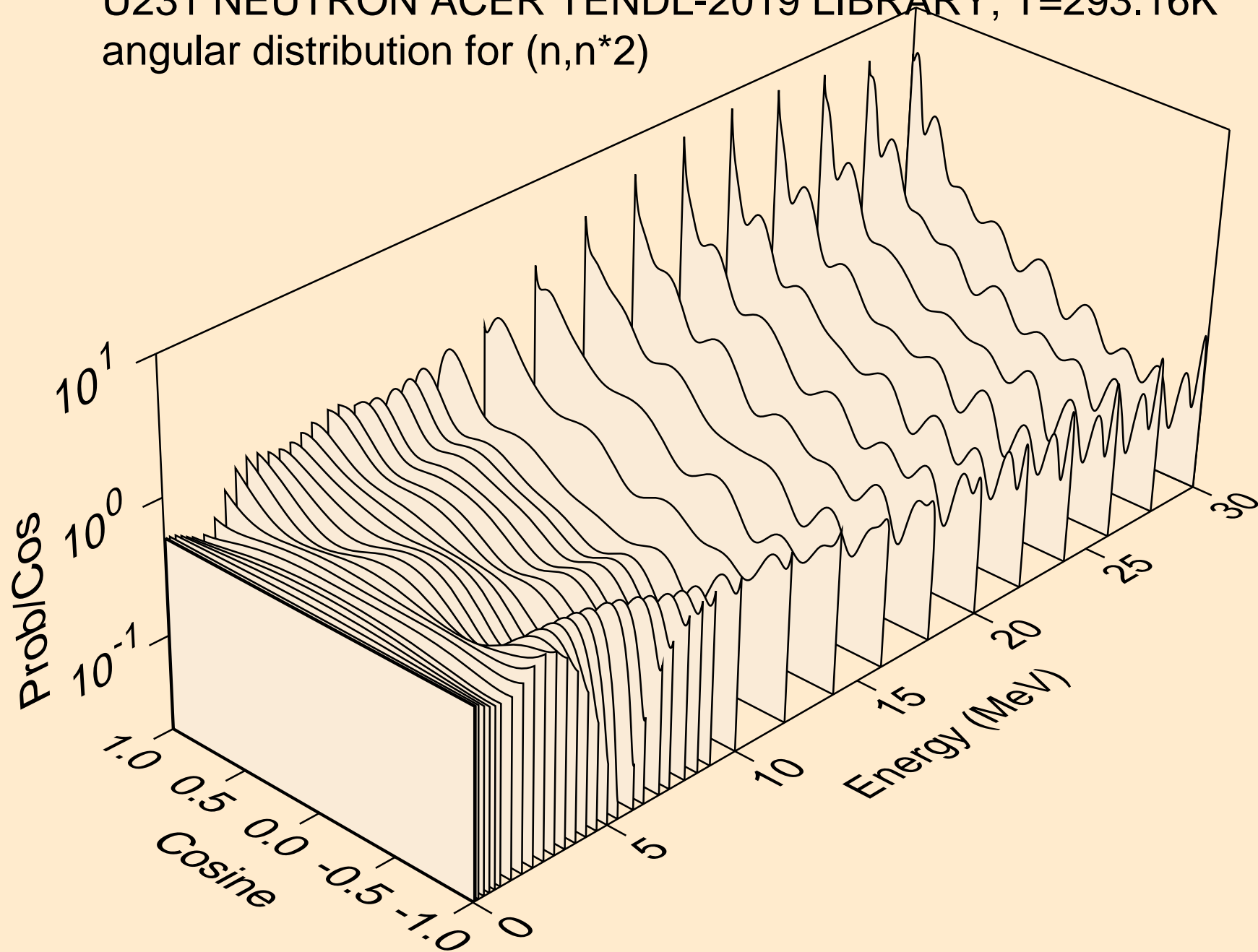

U231 NEUTRON ACER TENDL-2019 LIBRARY; T=293.16K  
angular distribution for (n,n\*3)

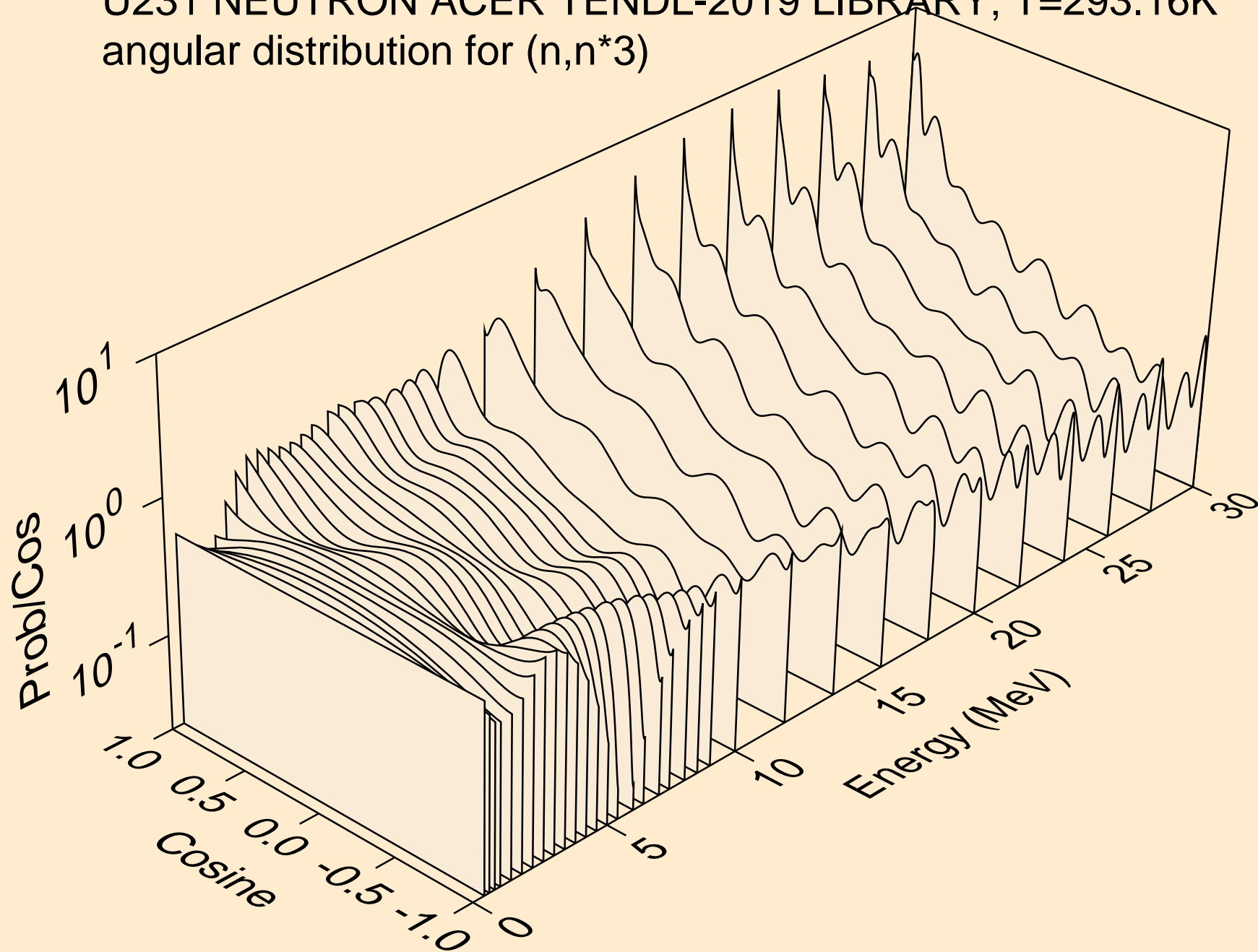

U231 NEUTRON ACER TENDL-2019 LIBRARY; T=293.16K  
angular distribution for (n,n\*4)

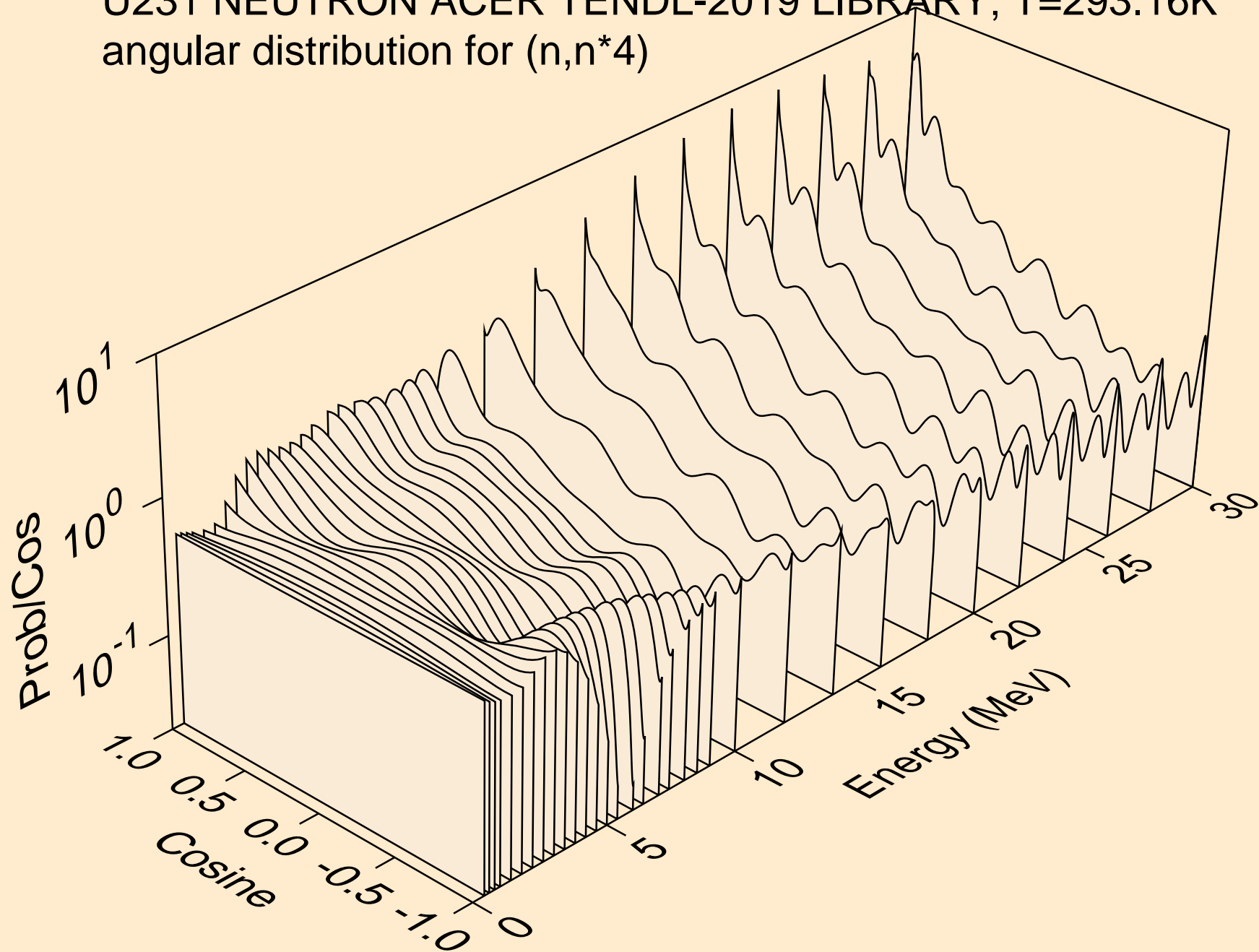

U231 NEUTRON ACER TENDL-2019 LIBRARY; T=293.16K  
angular distribution for (n,n\*5)

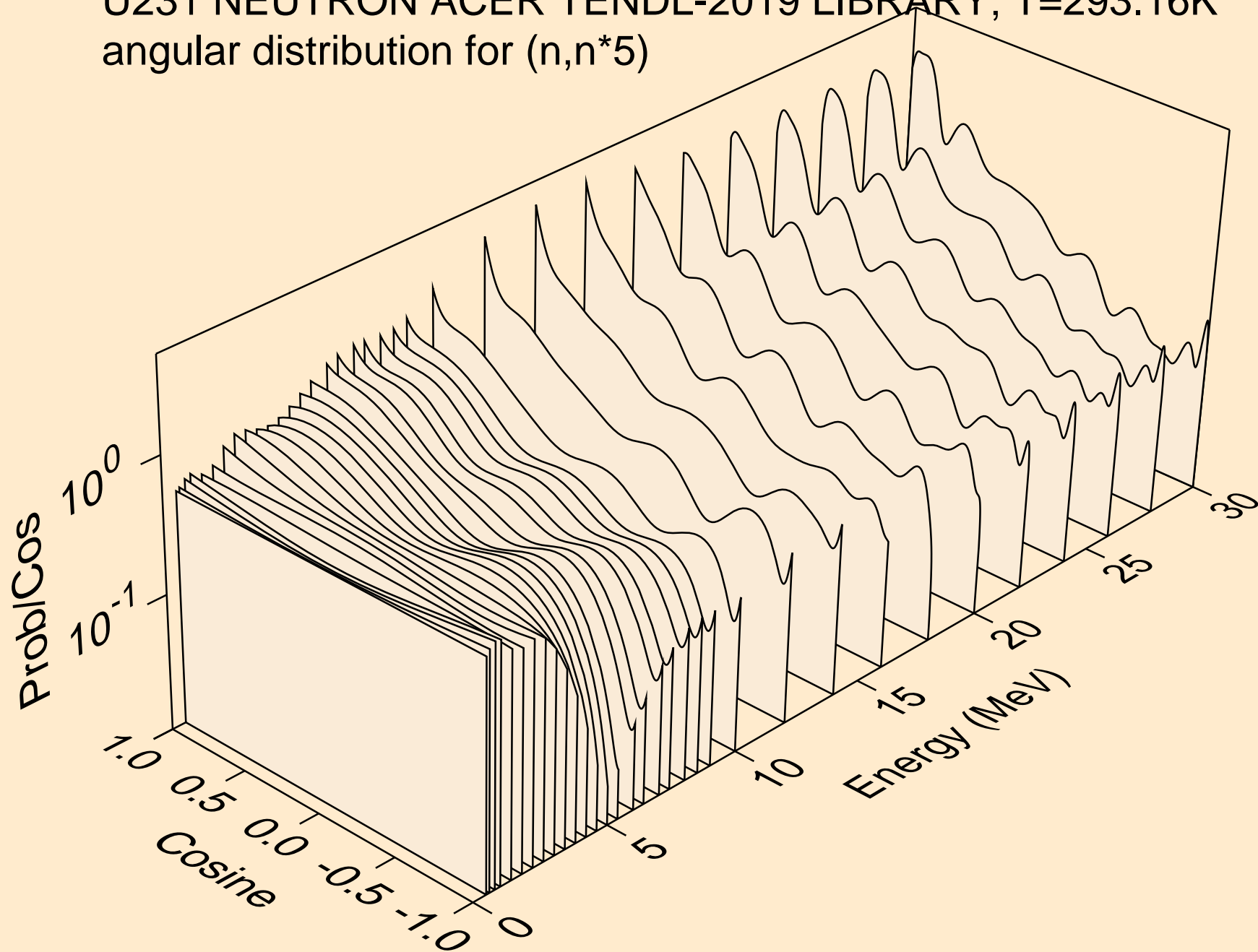

U231 NEUTRON ACER TENDL-2019 LIBRARY; T=293.16K  
angular distribution for (n,n\*6)

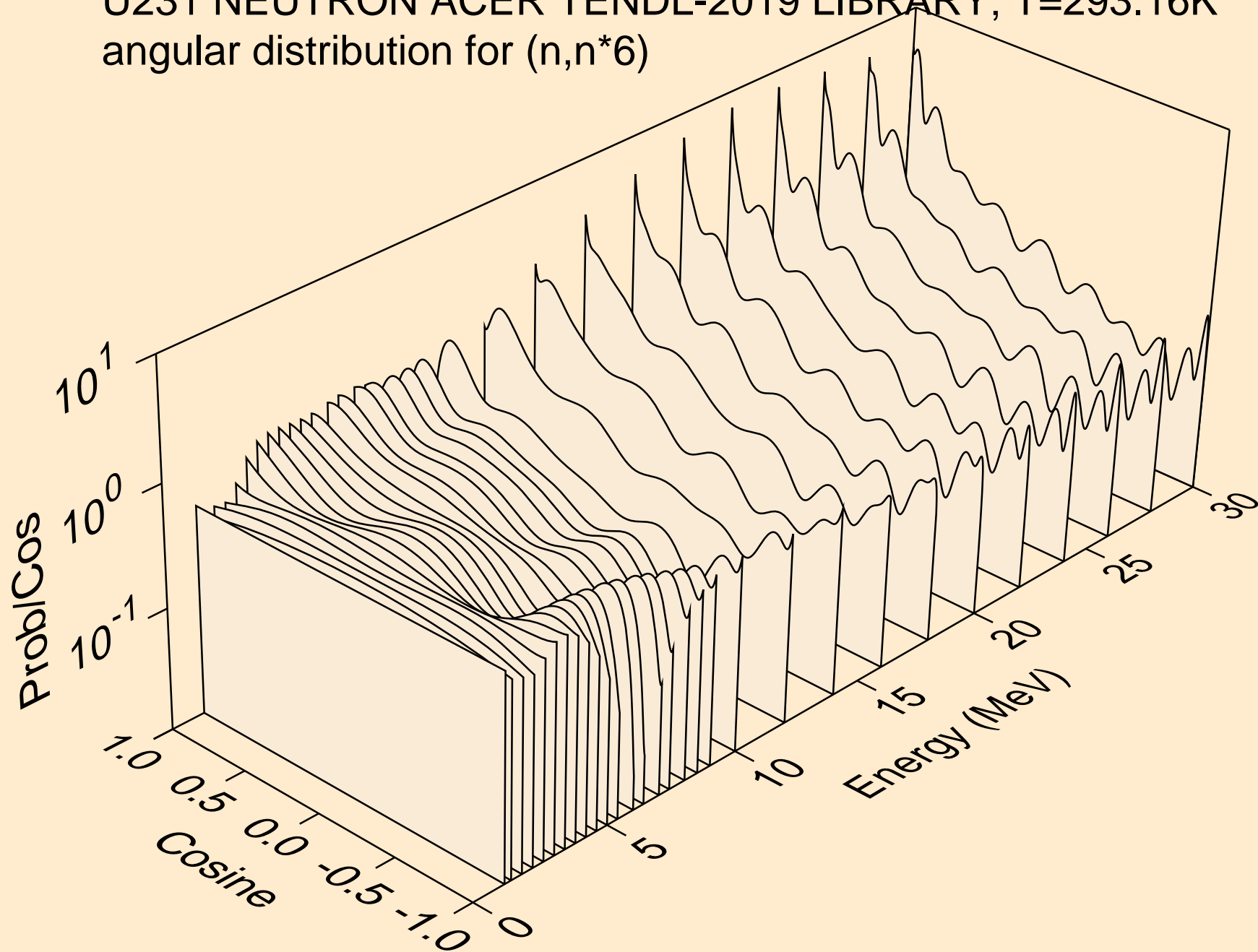

U231 NEUTRON ACER TENDL-2019 LIBRARY; T=293.16K  
angular distribution for (n,n\*7)

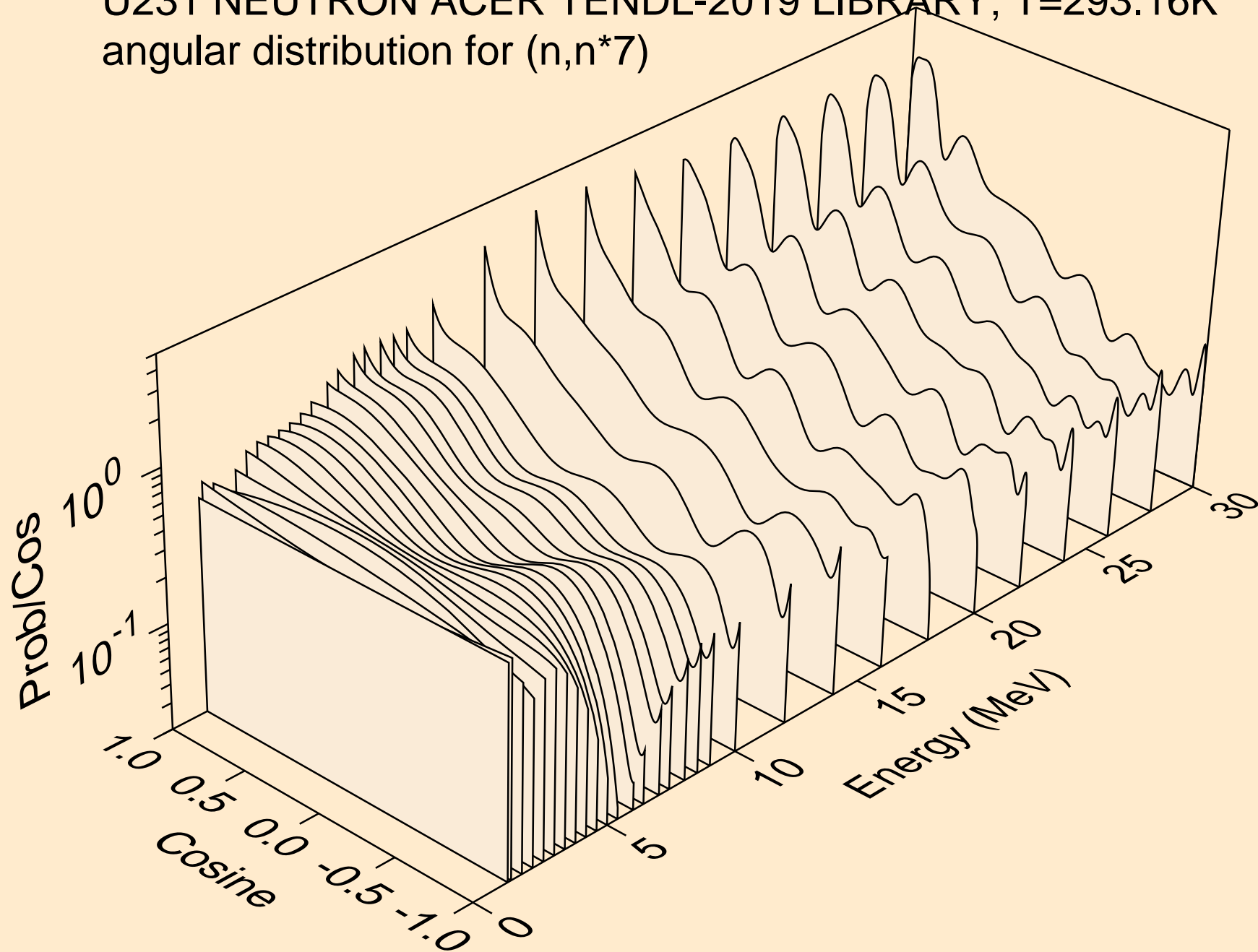

U231 NEUTRON ACER TENDL-2019 LIBRARY; T=293.16K  
Total fission nubar

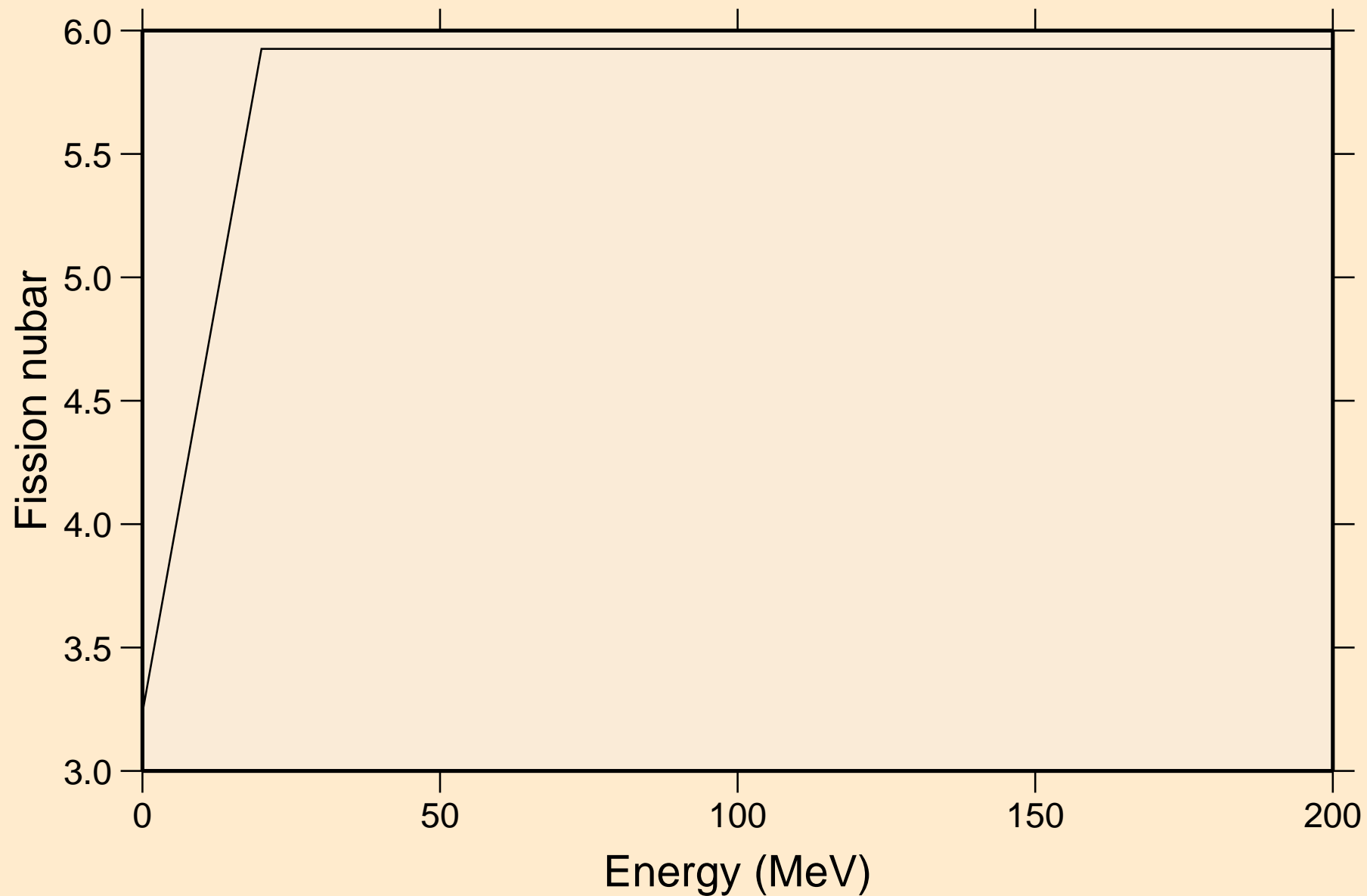

U231 NEUTRON ACER TENDL-2019 LIBRARY; T=293.16K  
Neutron emission for (n,x)

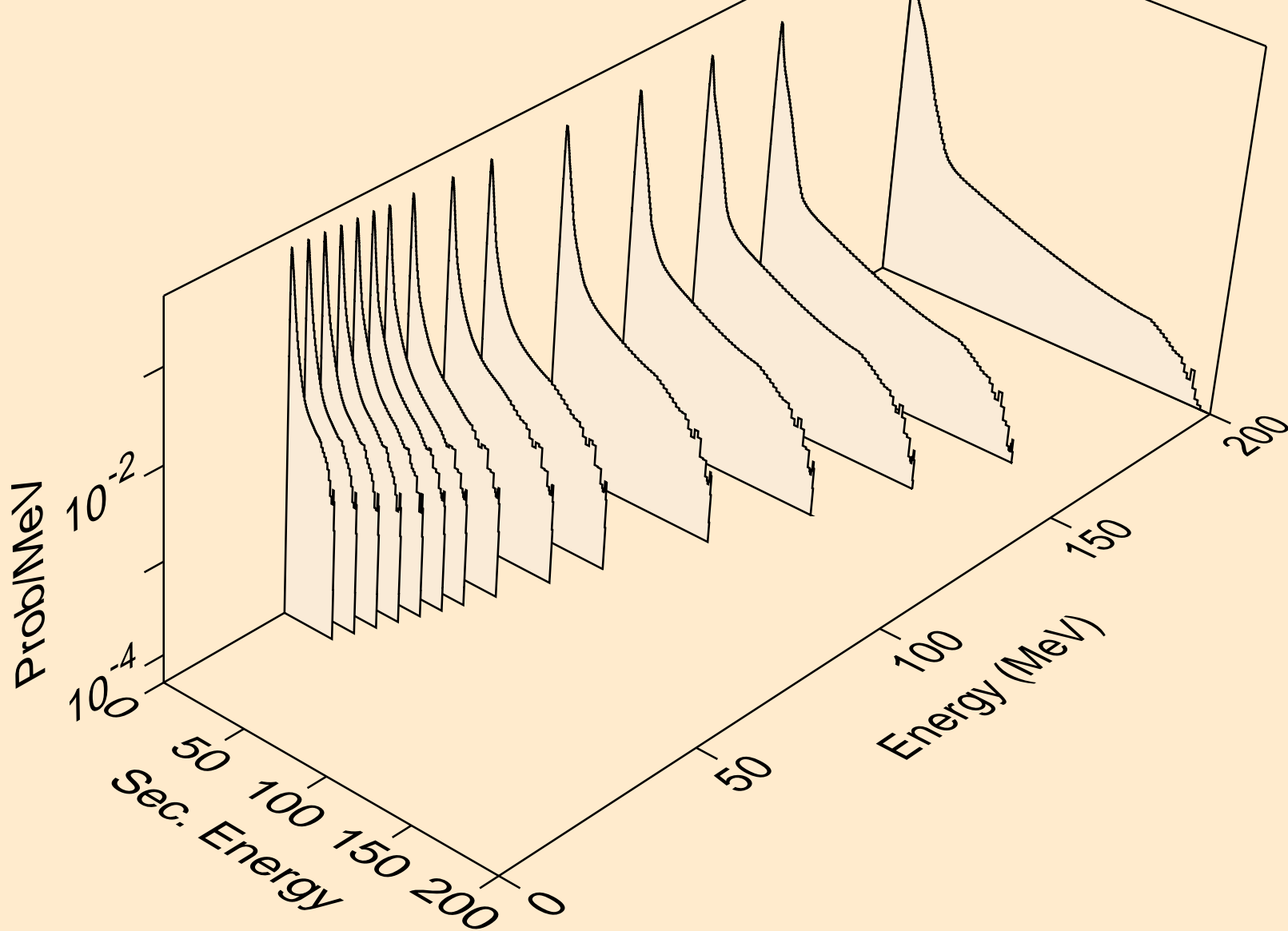

U231 NEUTRON ACER TENDL-2019 LIBRARY; T=293.16K  
Neutron emission for (n,2nd)

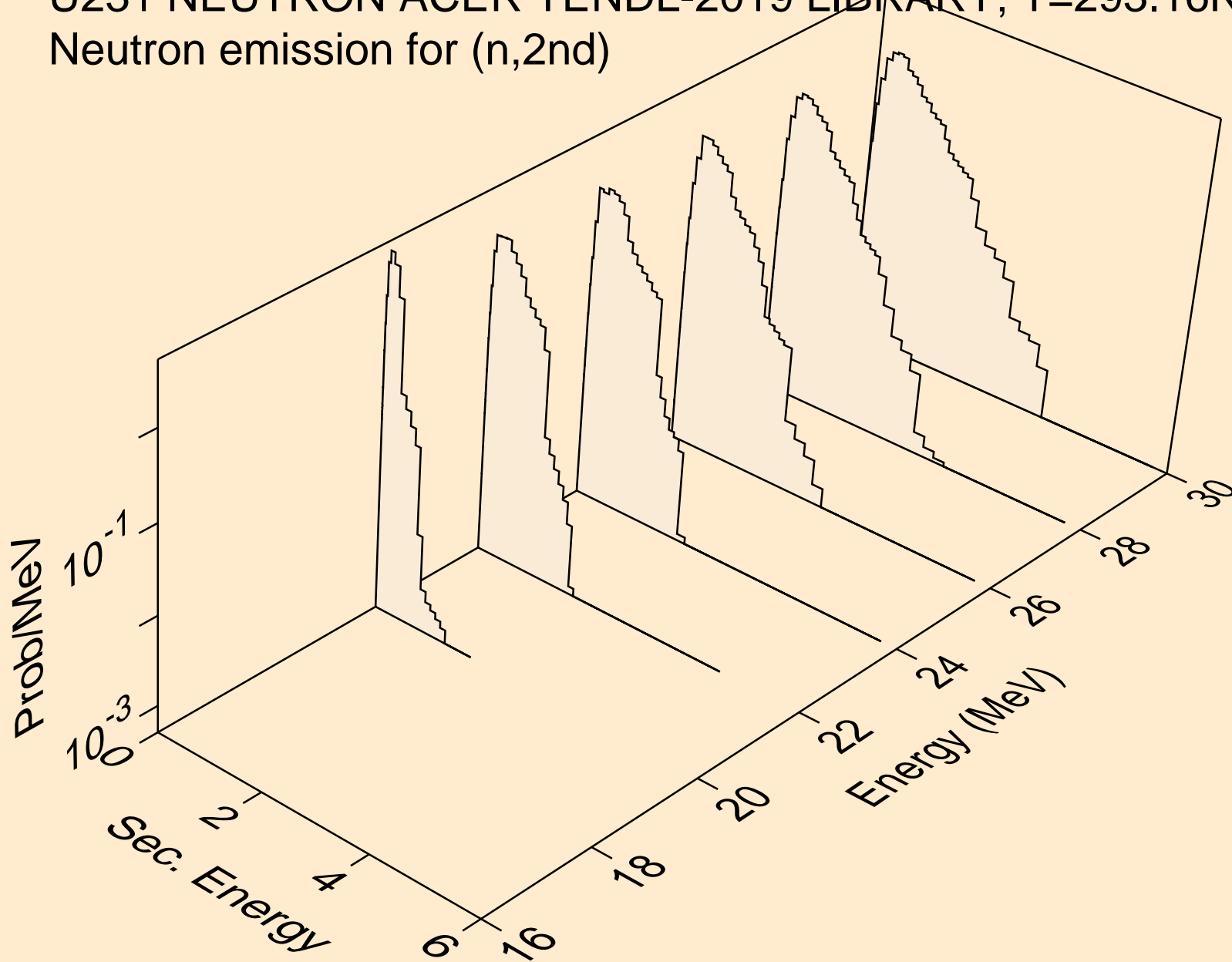

U231 NEUTRON ACER TENDL-2019 LIBRARY; T=293.16K  
Neutron emission for (n,2n)

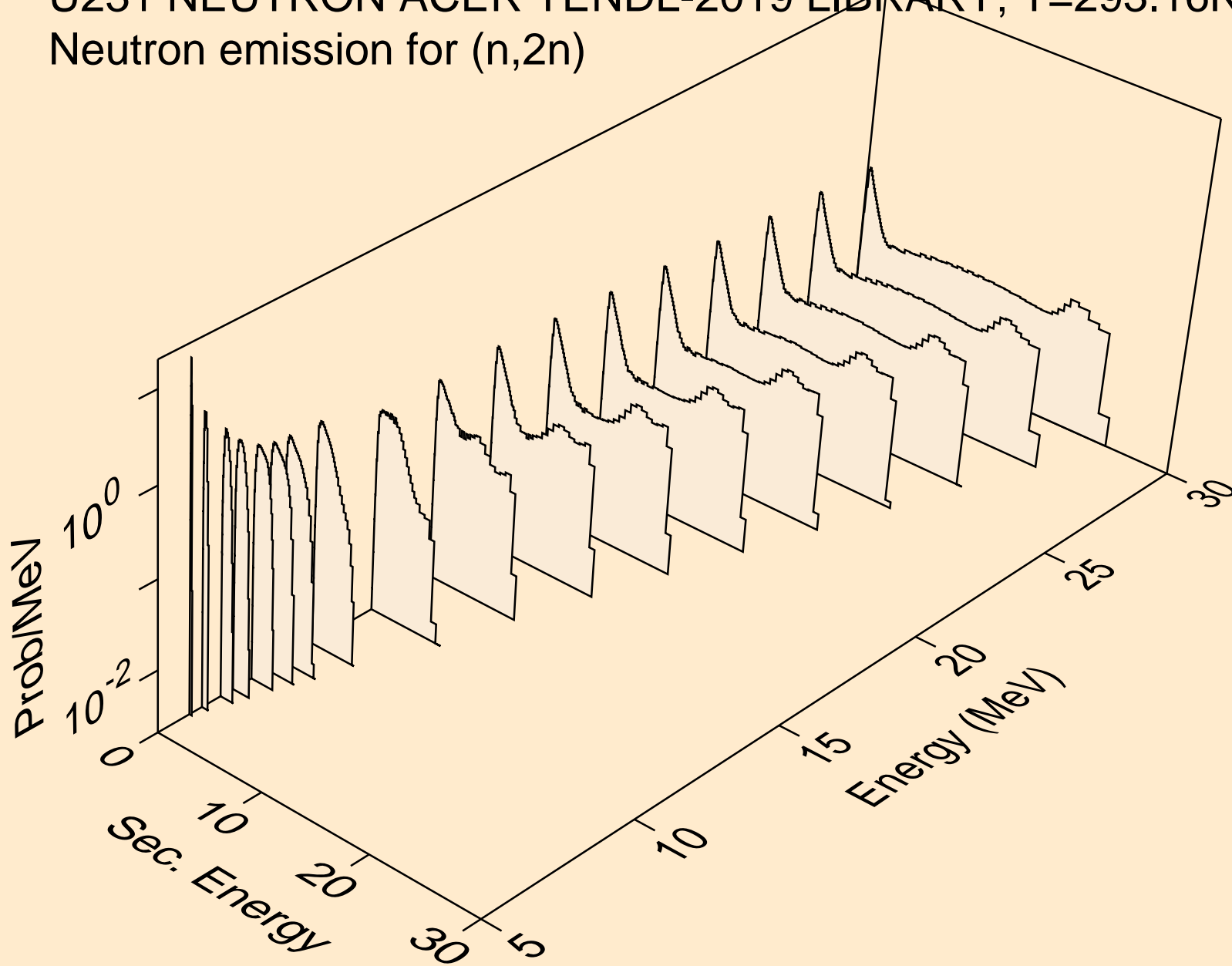

U231 NEUTRON ACER TENDL-2019 LIBRARY; T=293.16K  
Neutron emission for (n,3n)

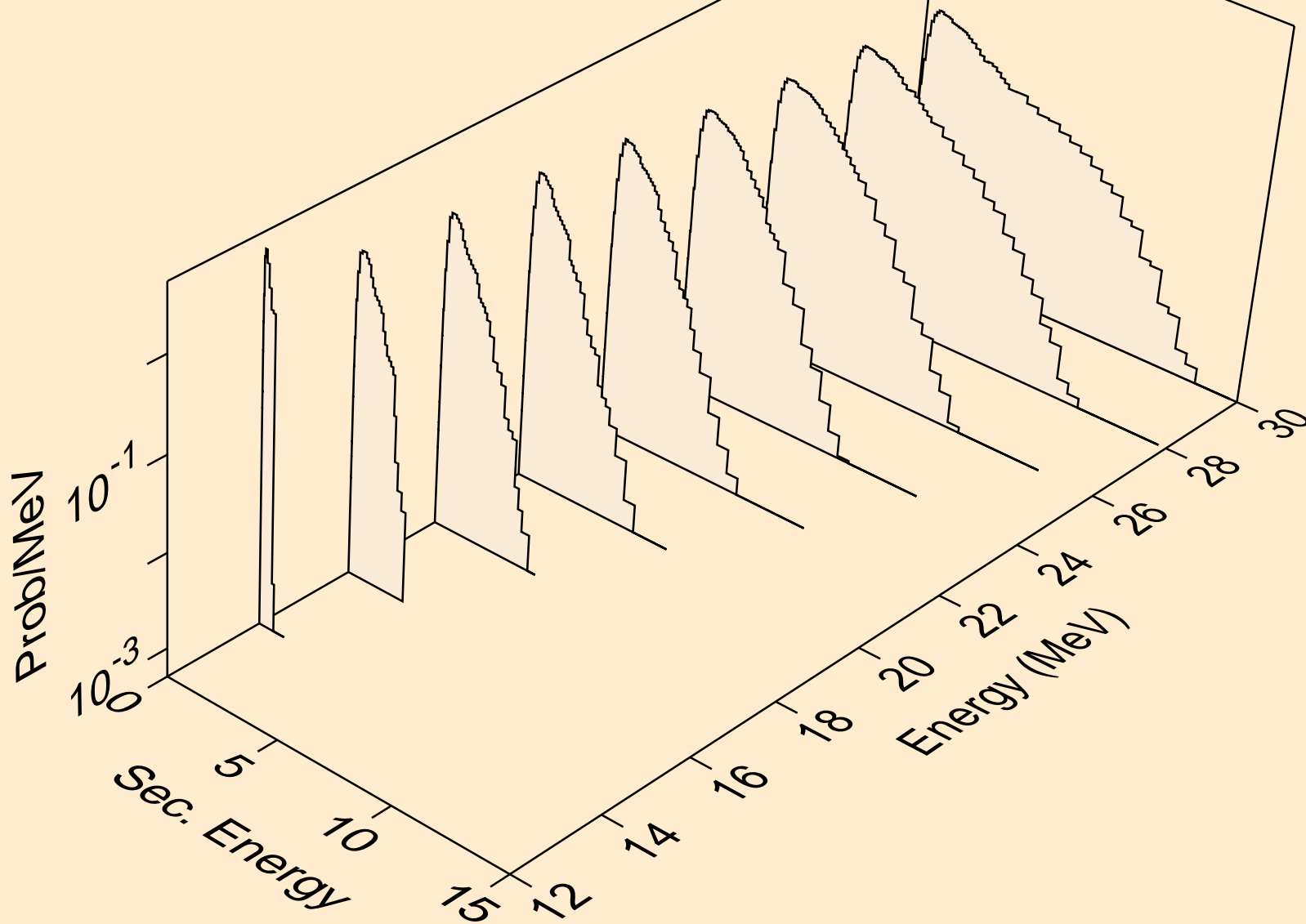

U231 NEUTRON ACER TENDL-2019 LIBRARY; T=293.16K  
Neutron emission for fission

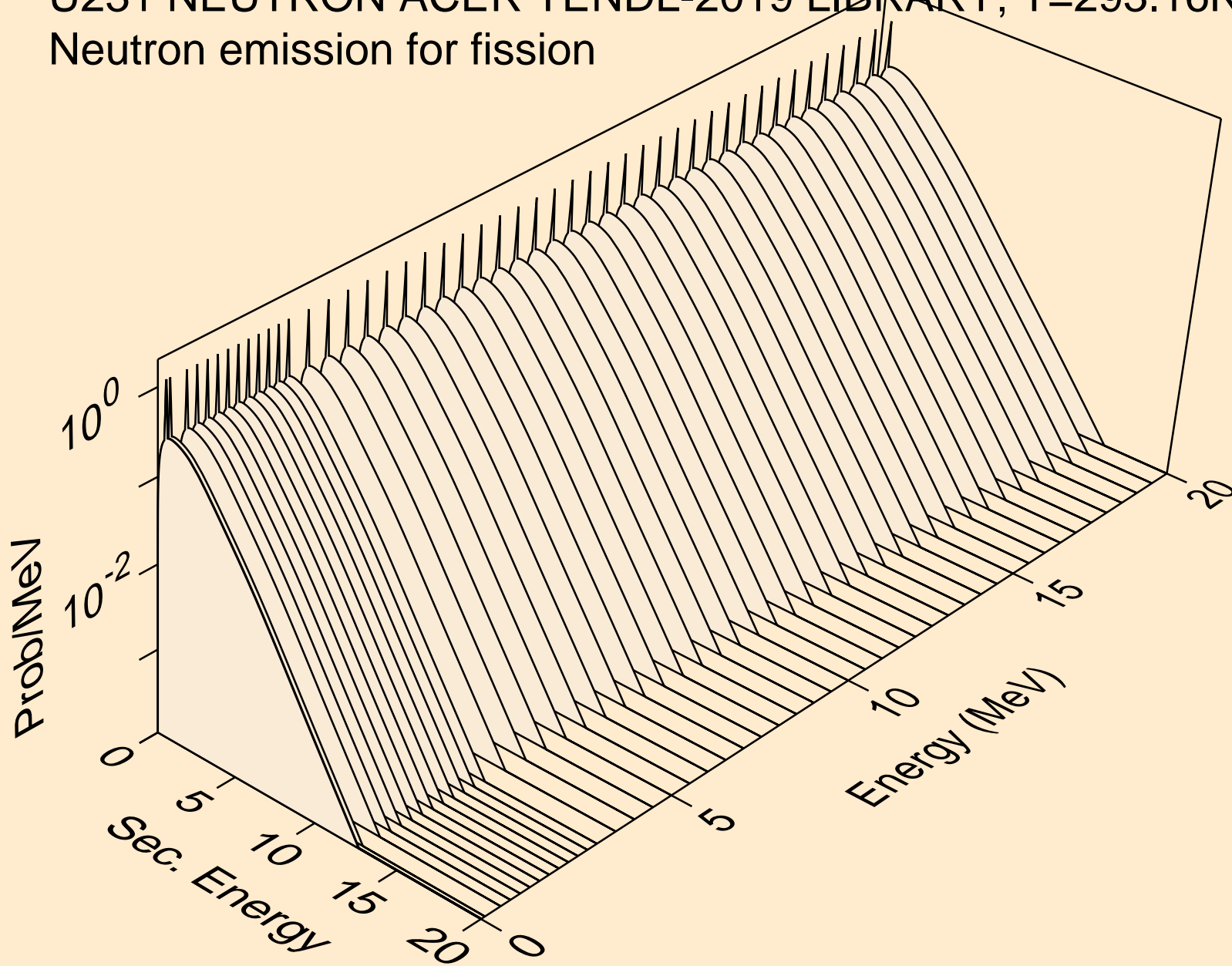

U231 NEUTRON ACER TENDL-2019 LIBRARY; T=293.16K  
Neutron emission for (n,n\*)a

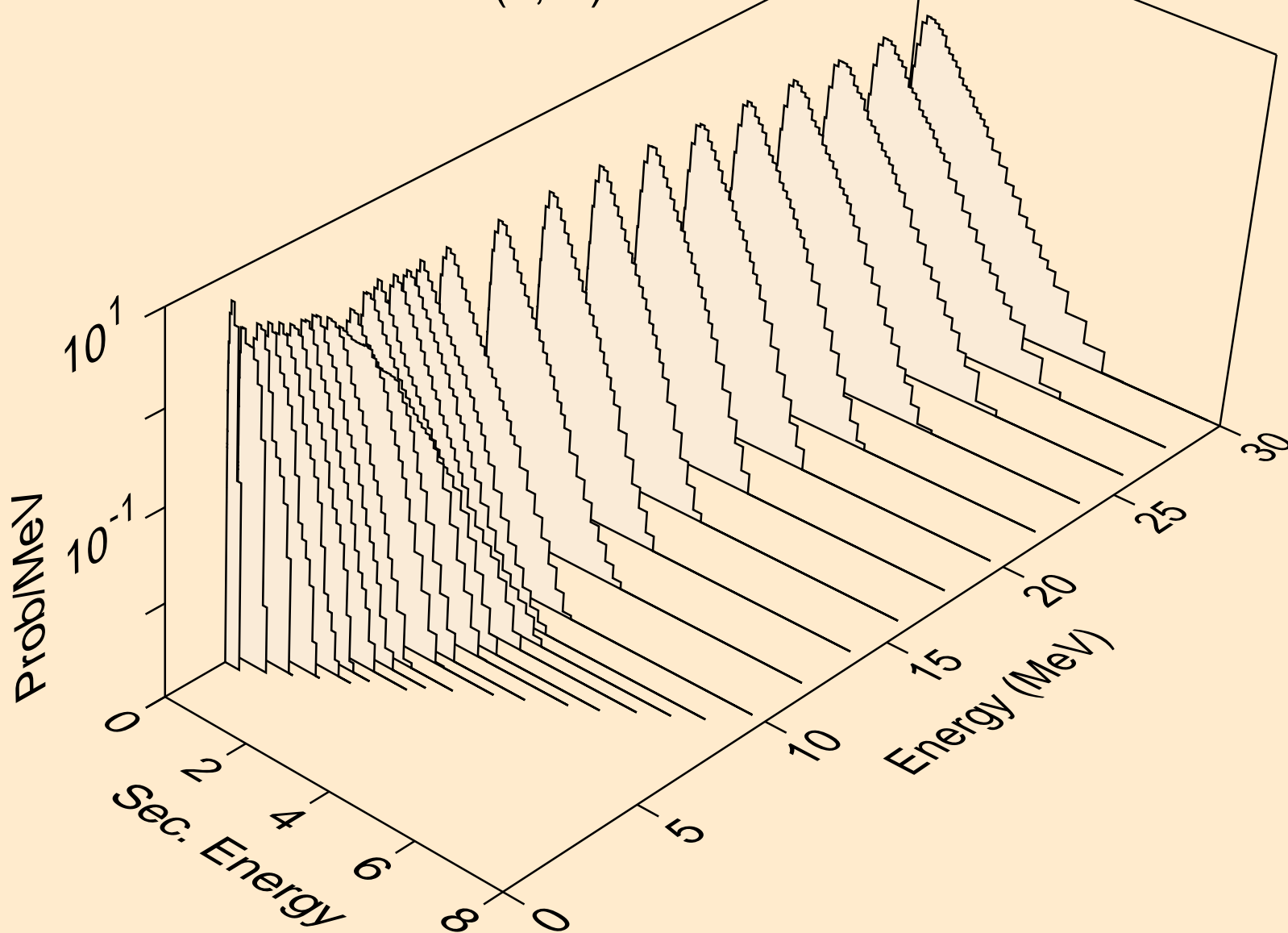

U231 NEUTRON ACER TENDL-2019 LIBRARY; T=293.16K  
Neutron emission for (n,2n)a

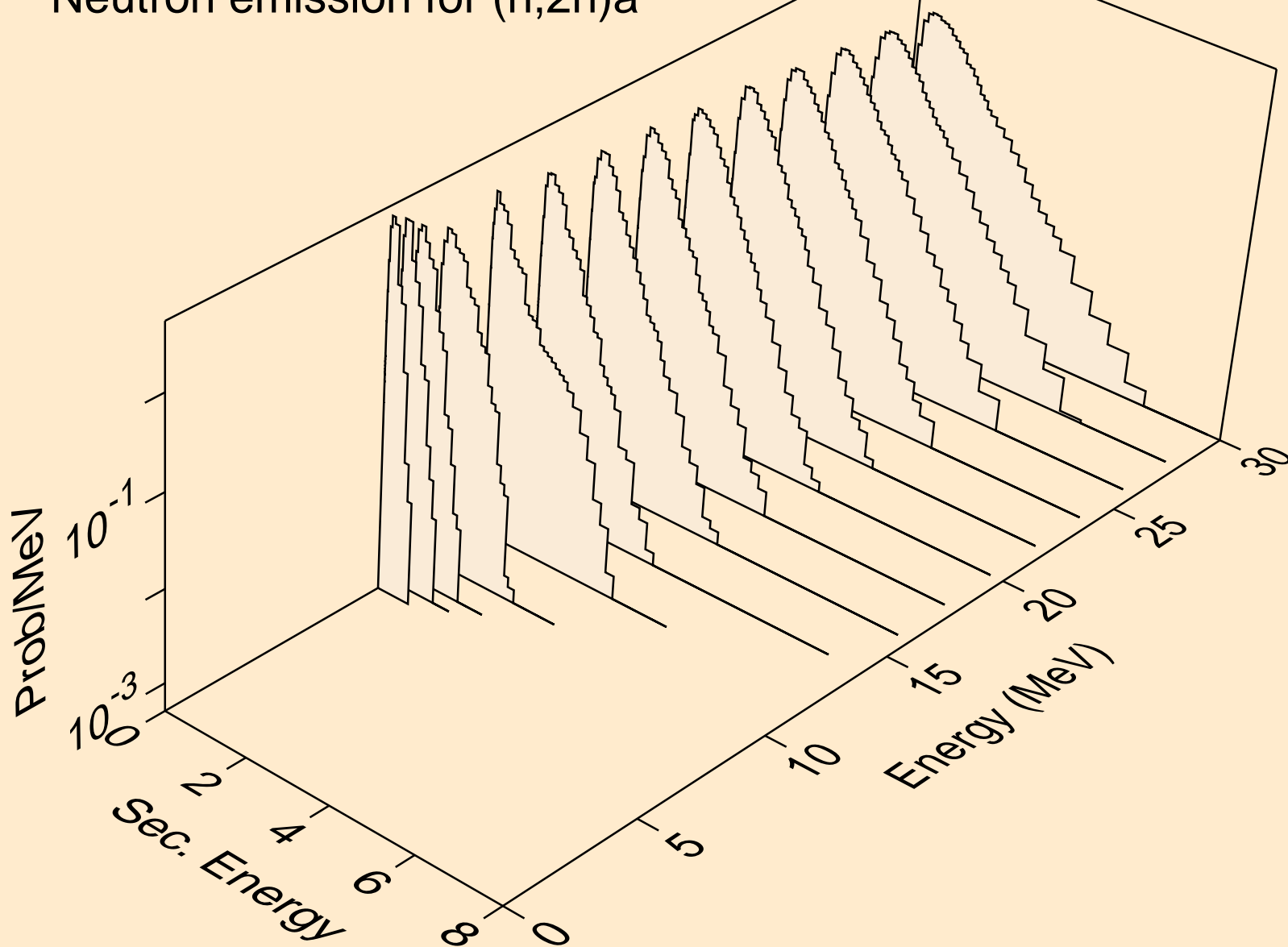

U231 NEUTRON ACER TENDL-2019 LIBRARY; T=293.16K  
Neutron emission for (n,3n)a

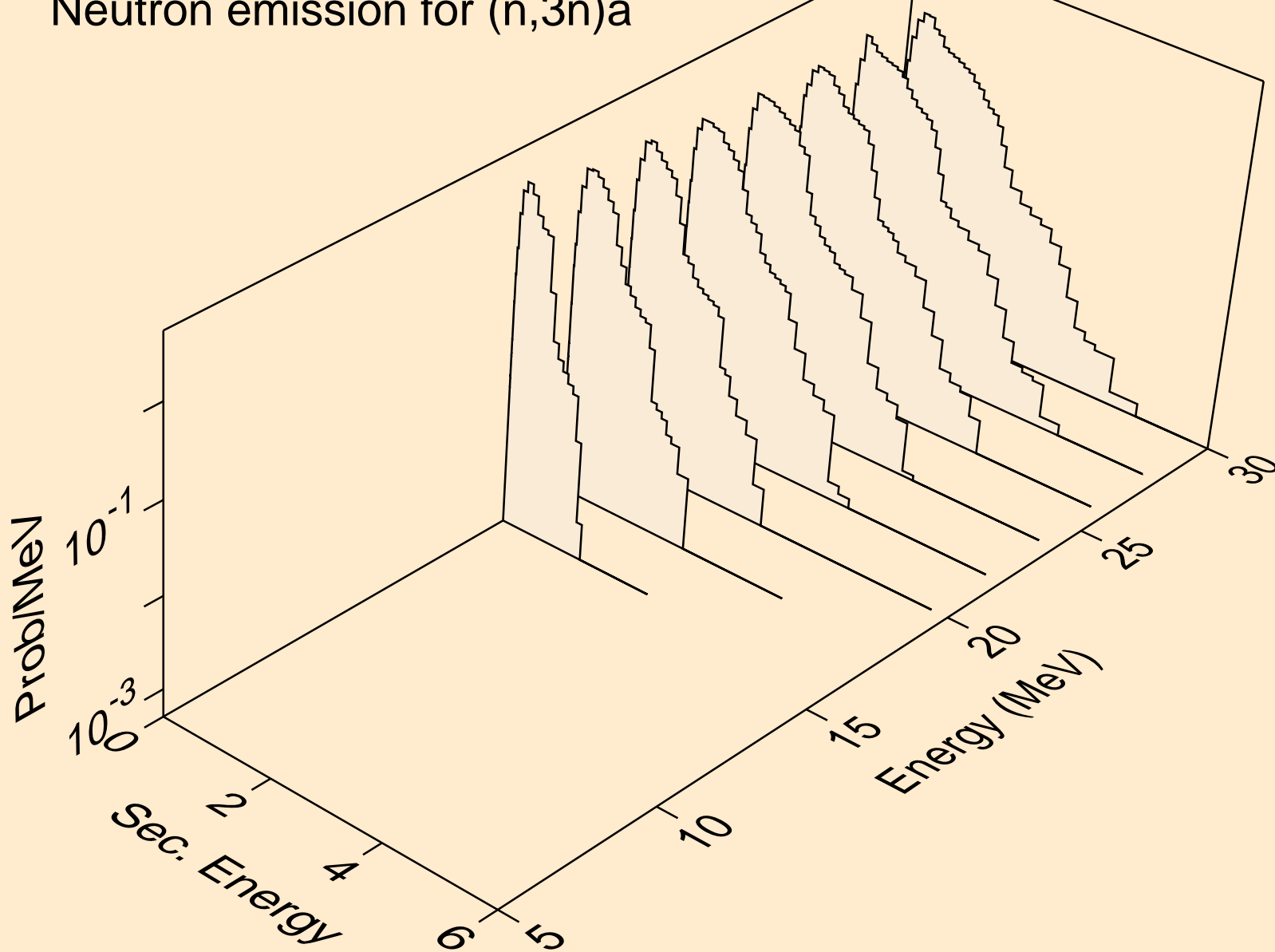

U231 NEUTRON ACER TENDL-2019 LIBRARY; T=293.16K  
Neutron emission for (n,n\*)p

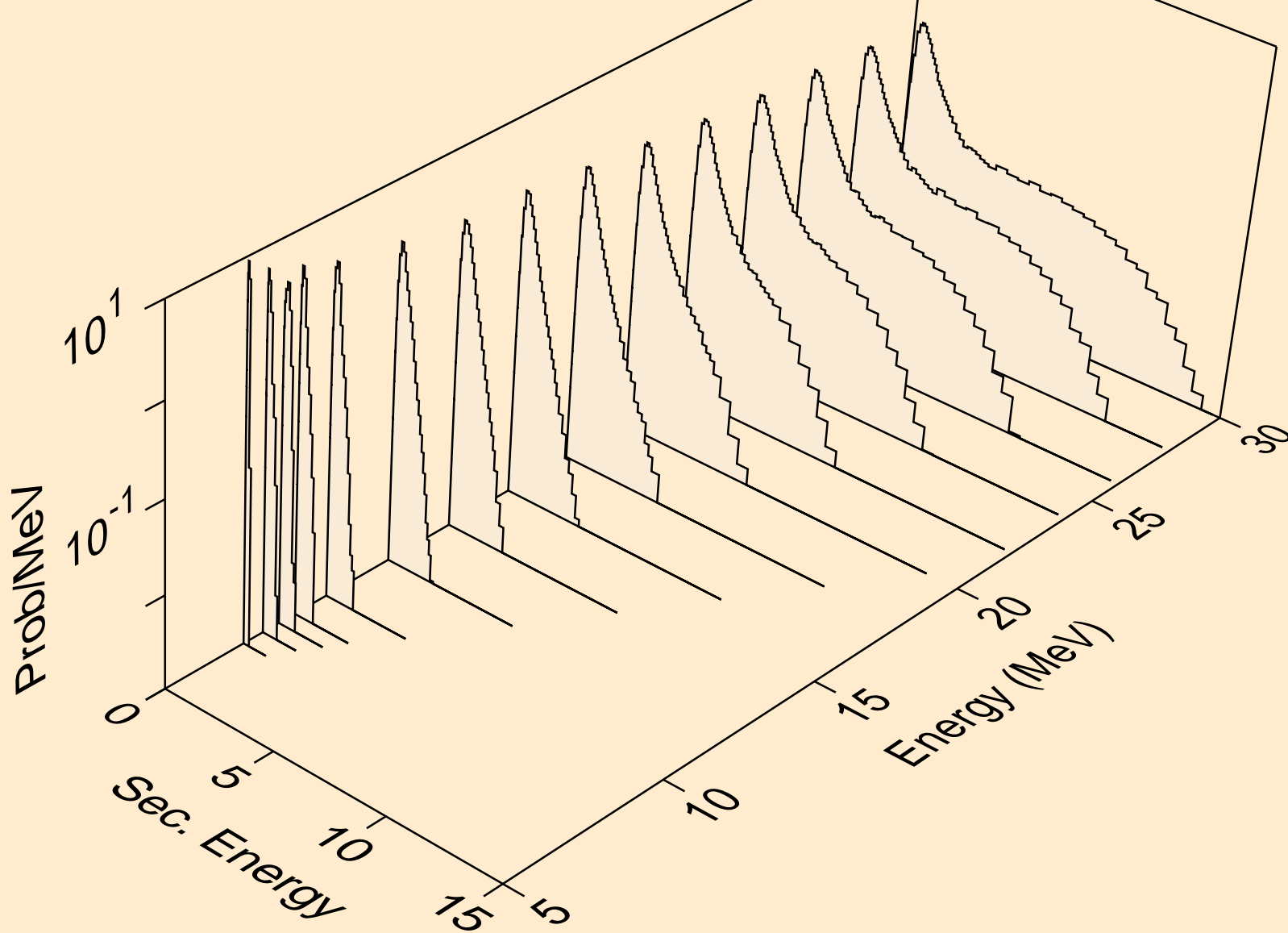

U231 NEUTRON ACER TENDL-2019 LIBRARY; T=293.16K  
Neutron emission for (n,n\*)2a

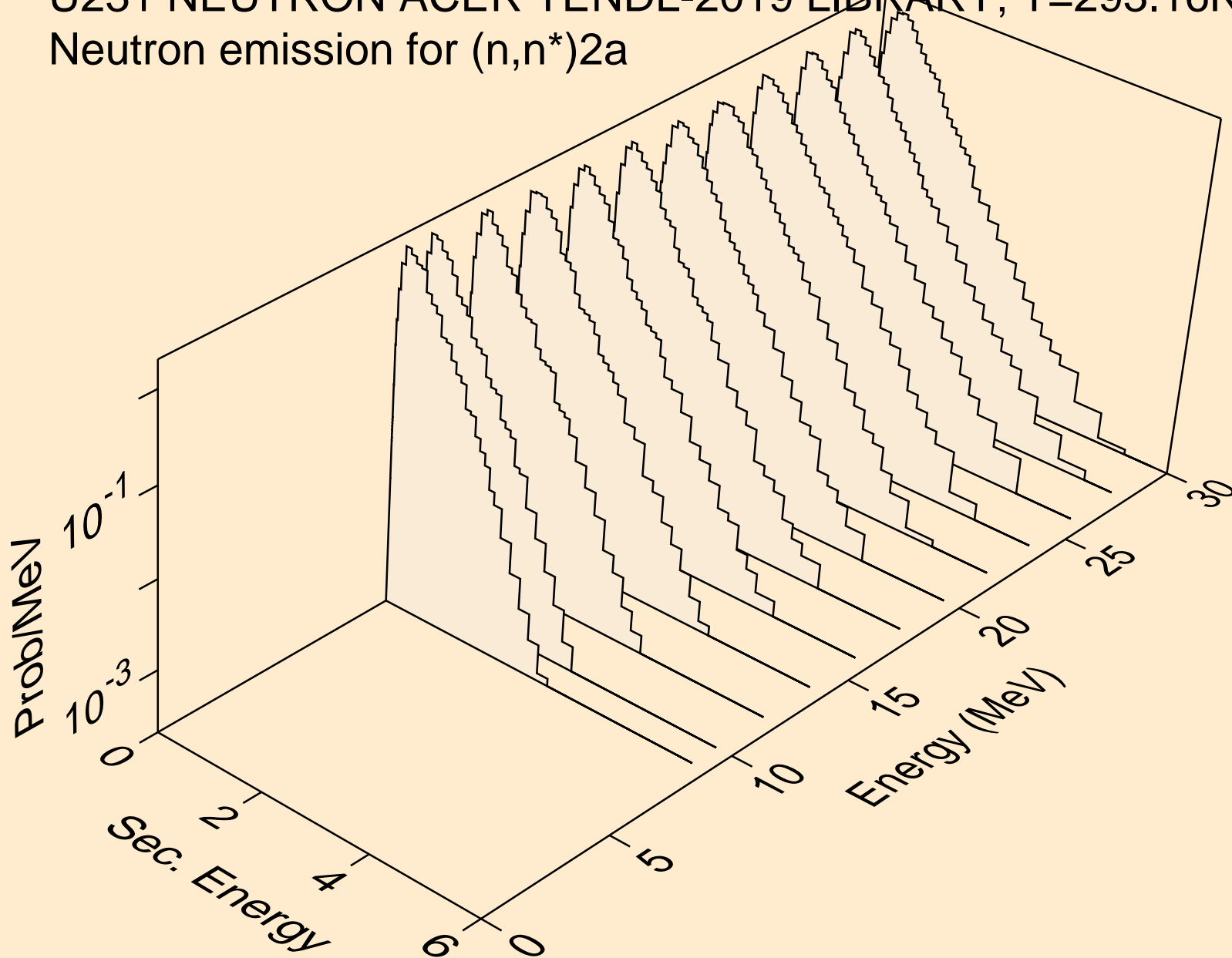

U231 NEUTRON ACER TENDL-2019 LIBRARY; T=293.16K  
Neutron emission for (n,2n)2a

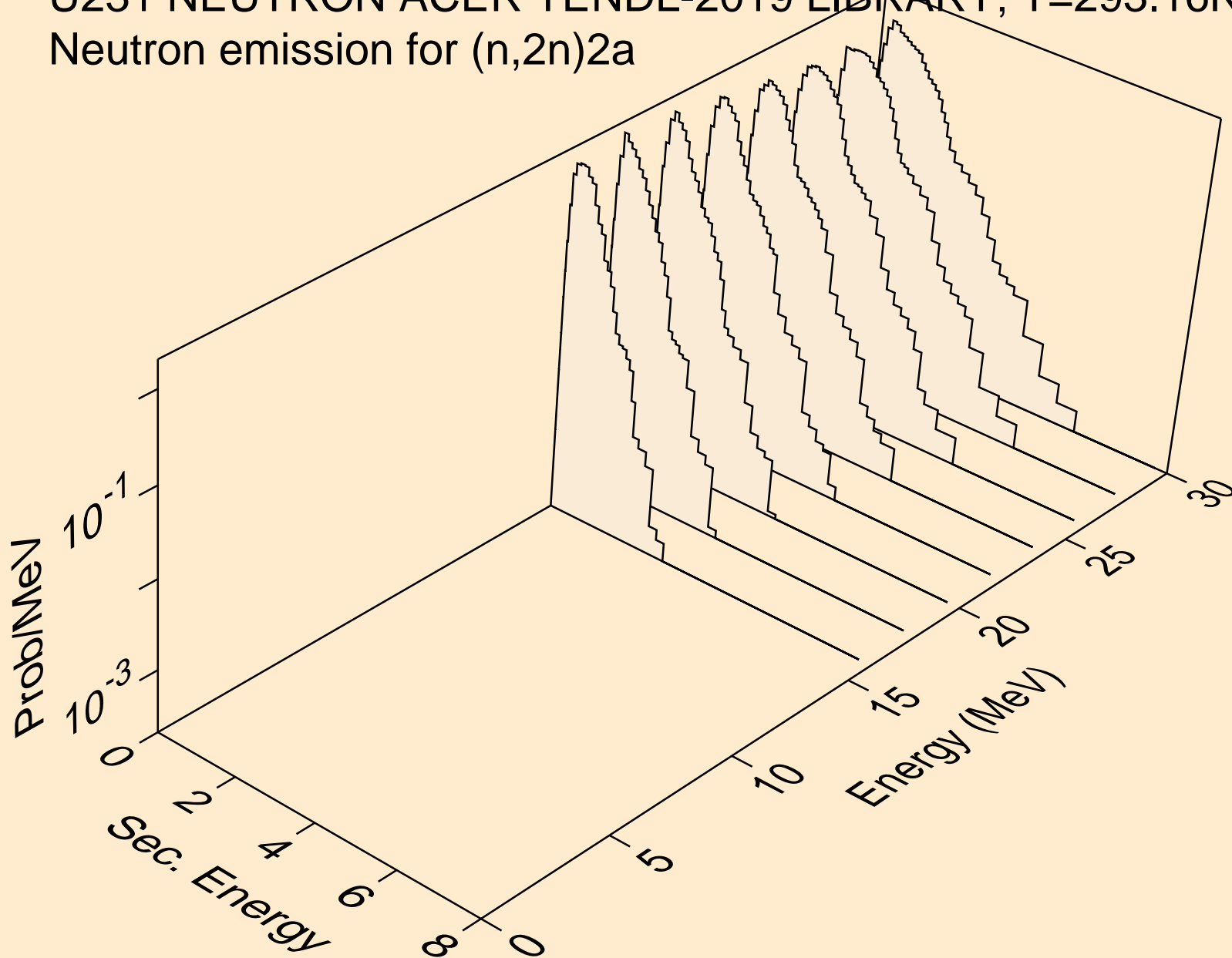

U231 NEUTRON ACER TENDL-2019 LIBRARY; T=293.16K  
Neutron emission for (n,n\*)d

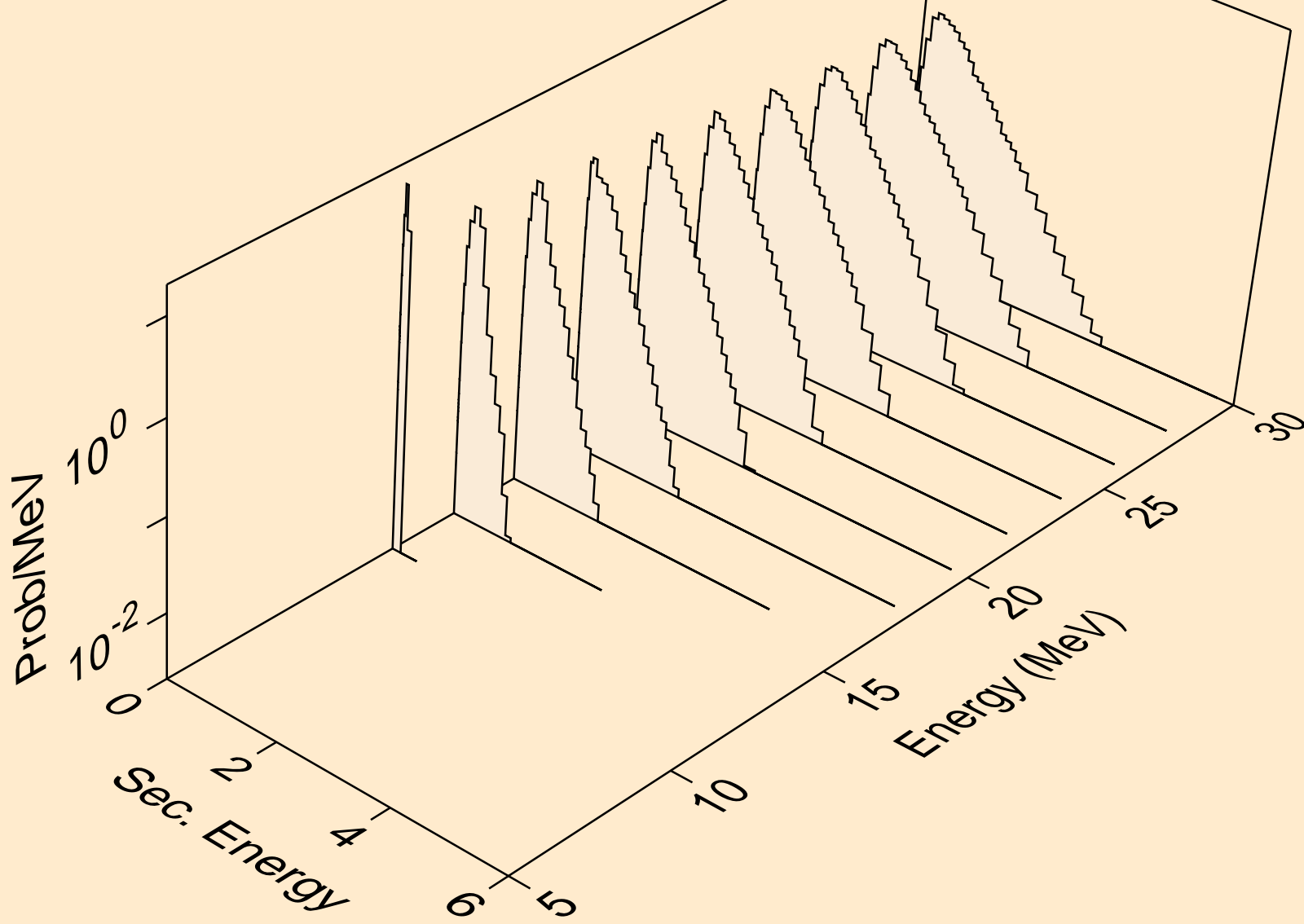

U231 NEUTRON ACER TENDL-2019 LIBRARY; T=293.16K  
Neutron emission for (n,n\*)t



U231 NEUTRON ACER TENDL-2019 LIBRARY; T=293.16K  
Neutron emission for (n,n\*)he3

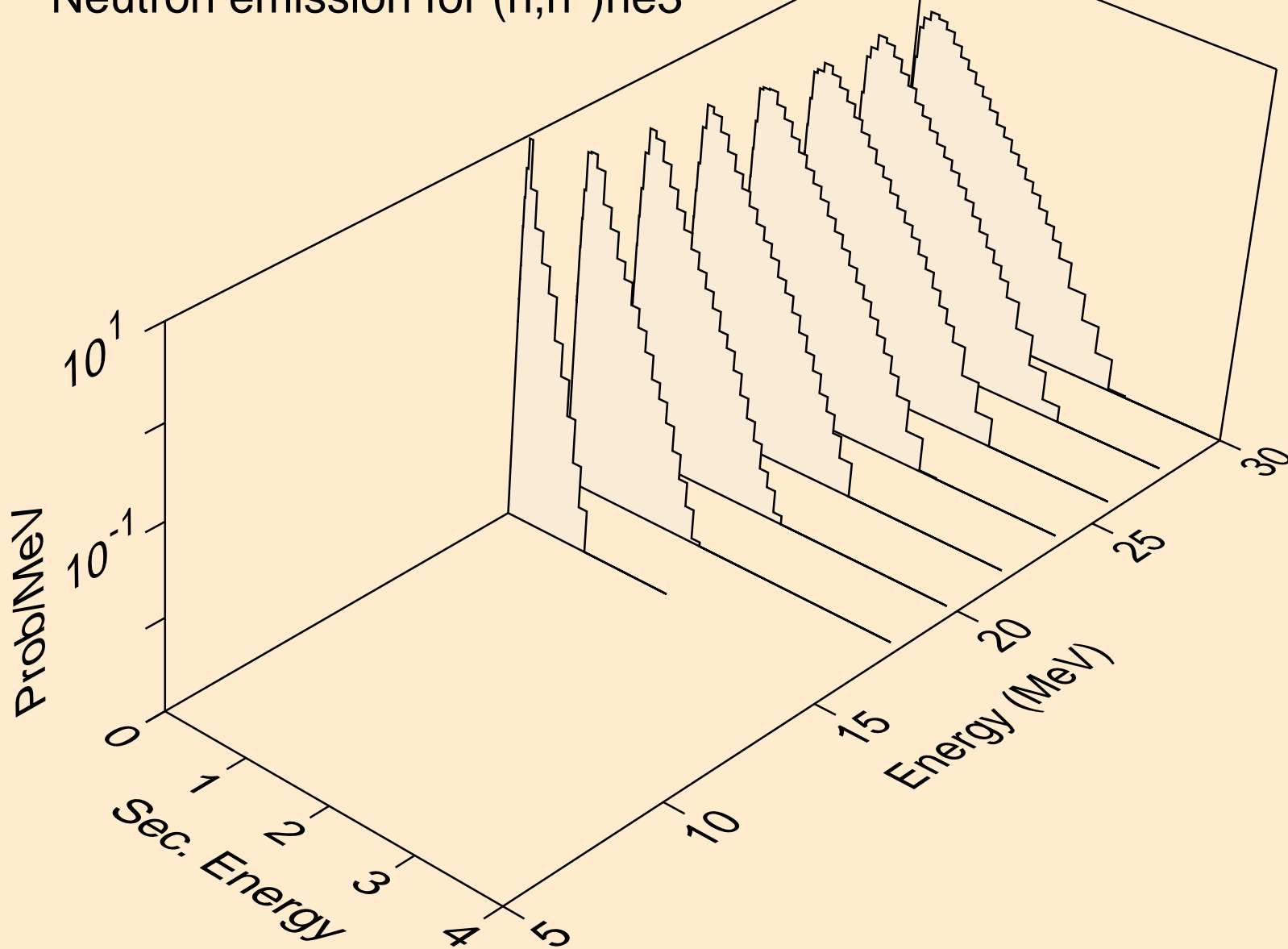

U231 NEUTRON ACER TENDL-2019 LIBRARY; T=293.16K  
Neutron emission for (n,4n)

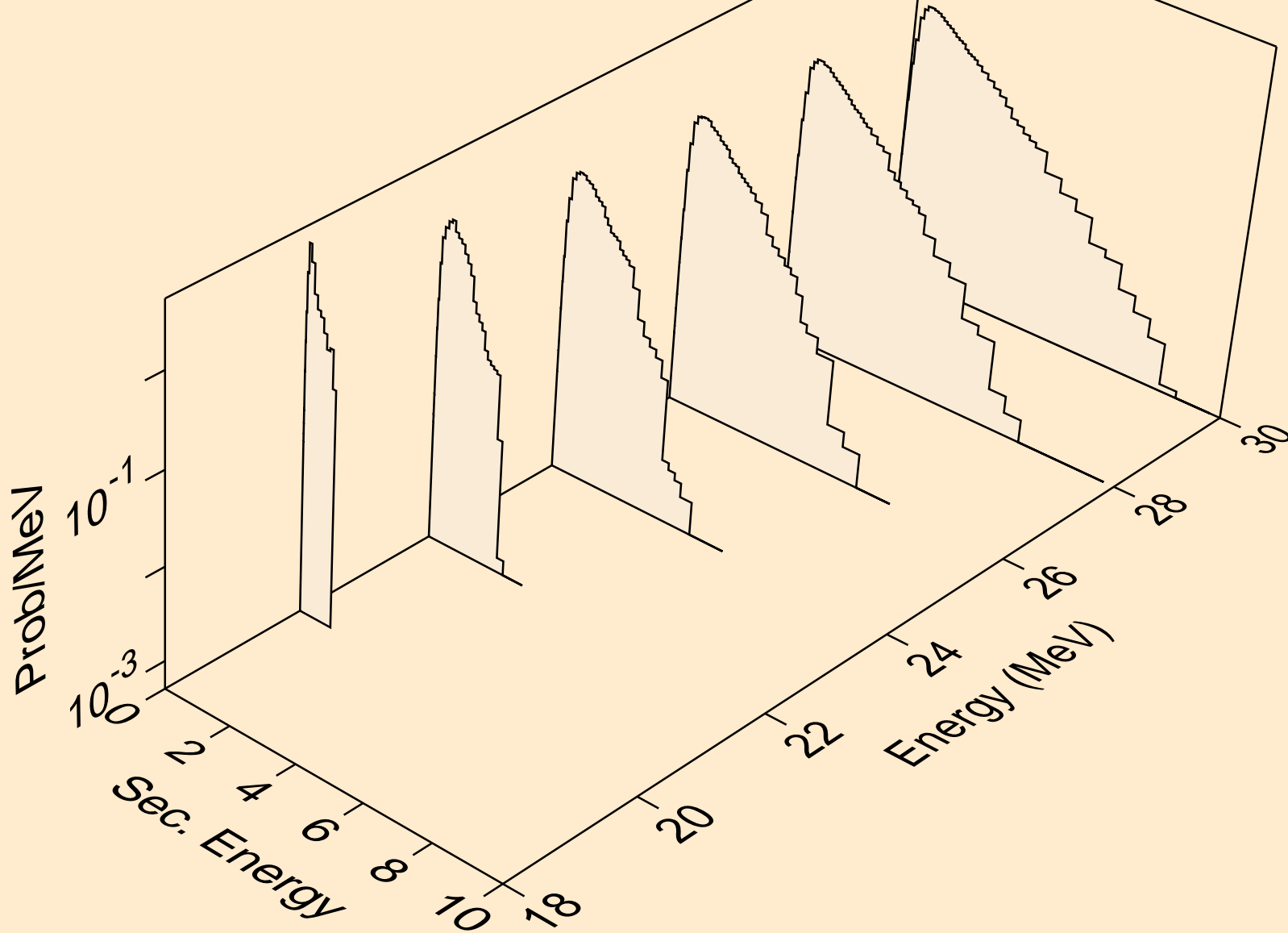

U231 NEUTRON ACER TENDL-2019 LIBRARY; T=293.16K  
Neutron emission for (n,2np)

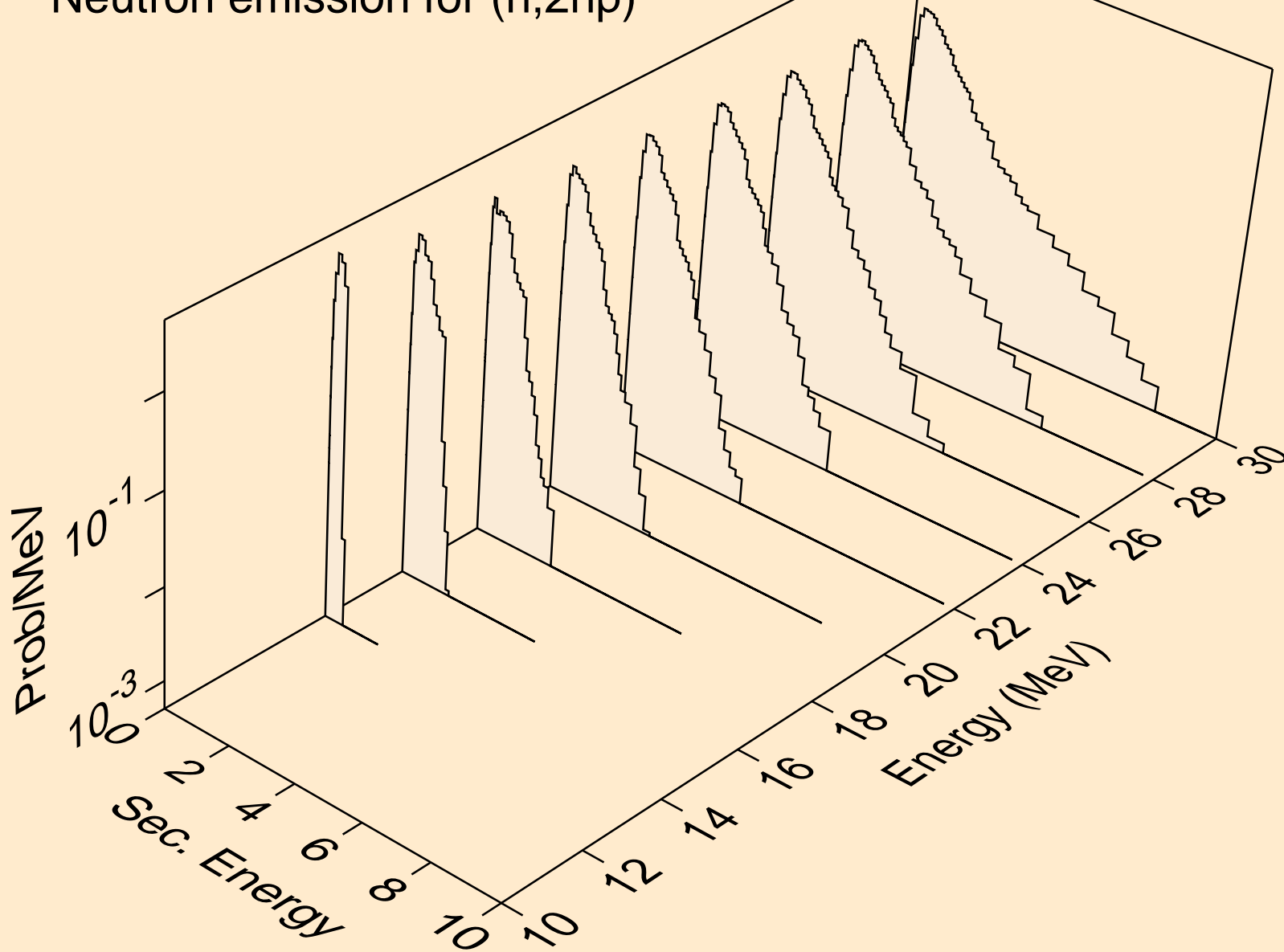

U231 NEUTRON ACER TENDL-2019 LIBRARY; T=293.16K  
Neutron emission for (n,3np)

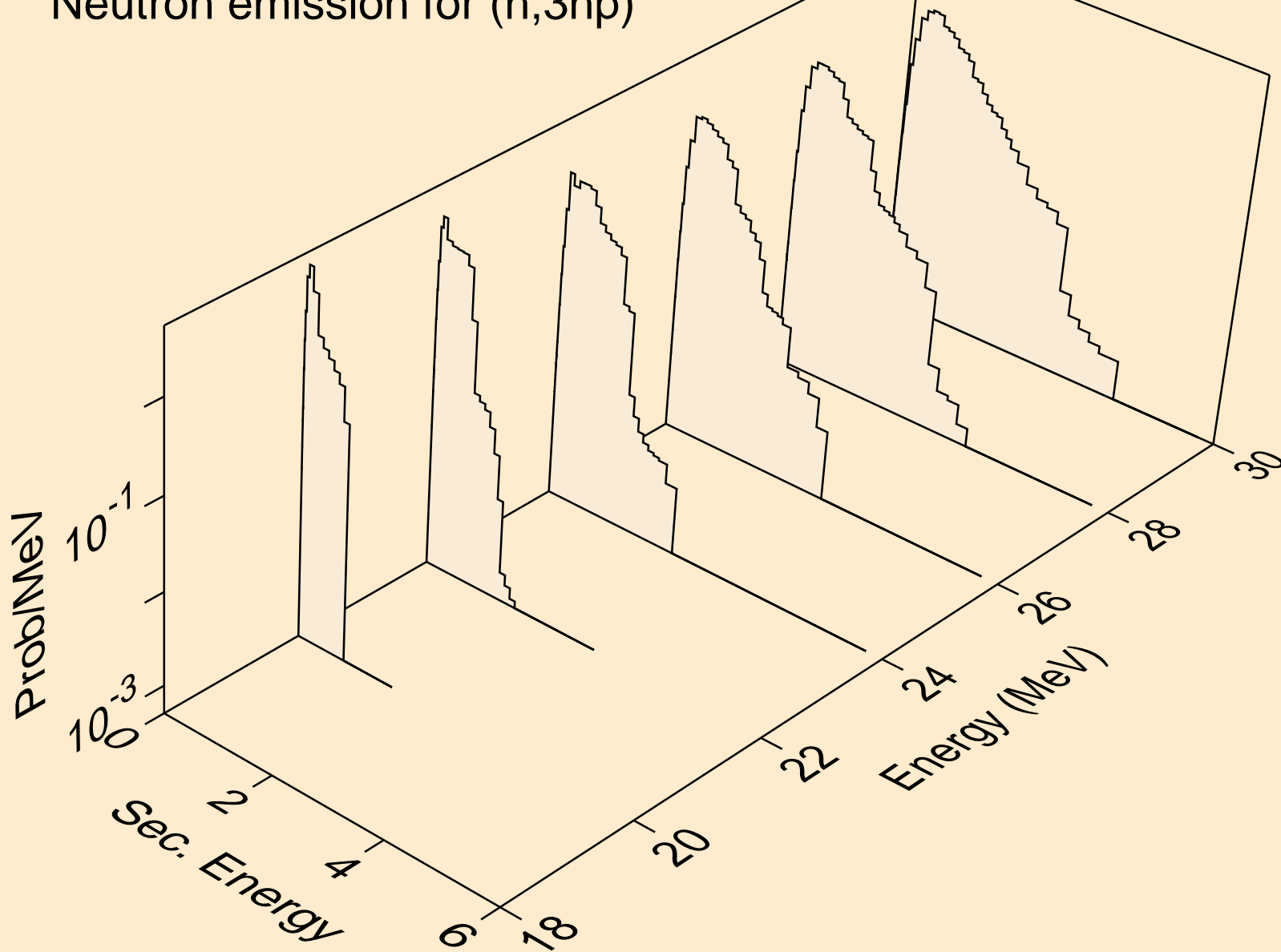

U231 NEUTRON ACER TENDL-2019 LIBRARY; T=293.16K  
Neutron emission for (n,2np)

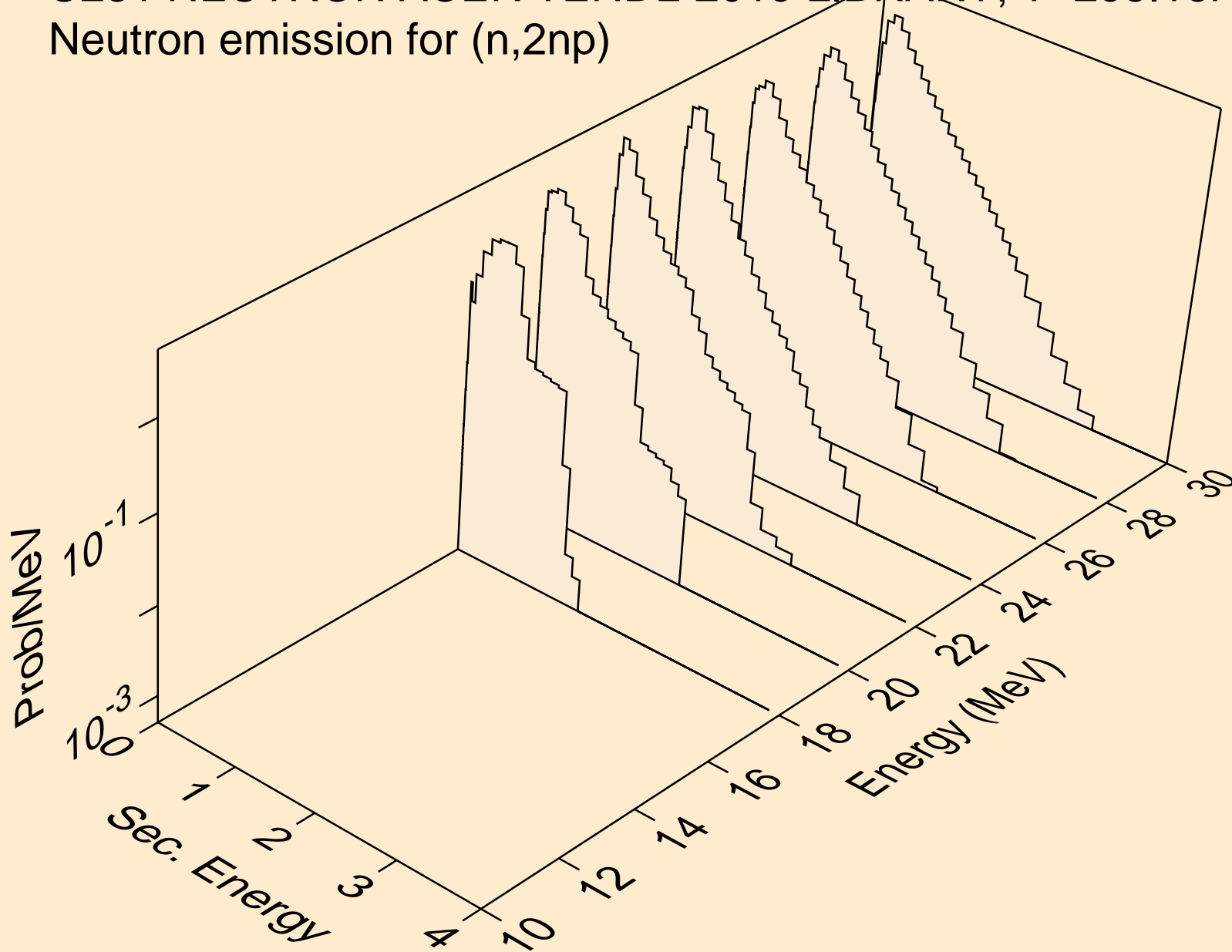

U231 NEUTRON ACER TENDL-2019 LIBRARY; T=293.16K  
Neutron emission for (n,npa)

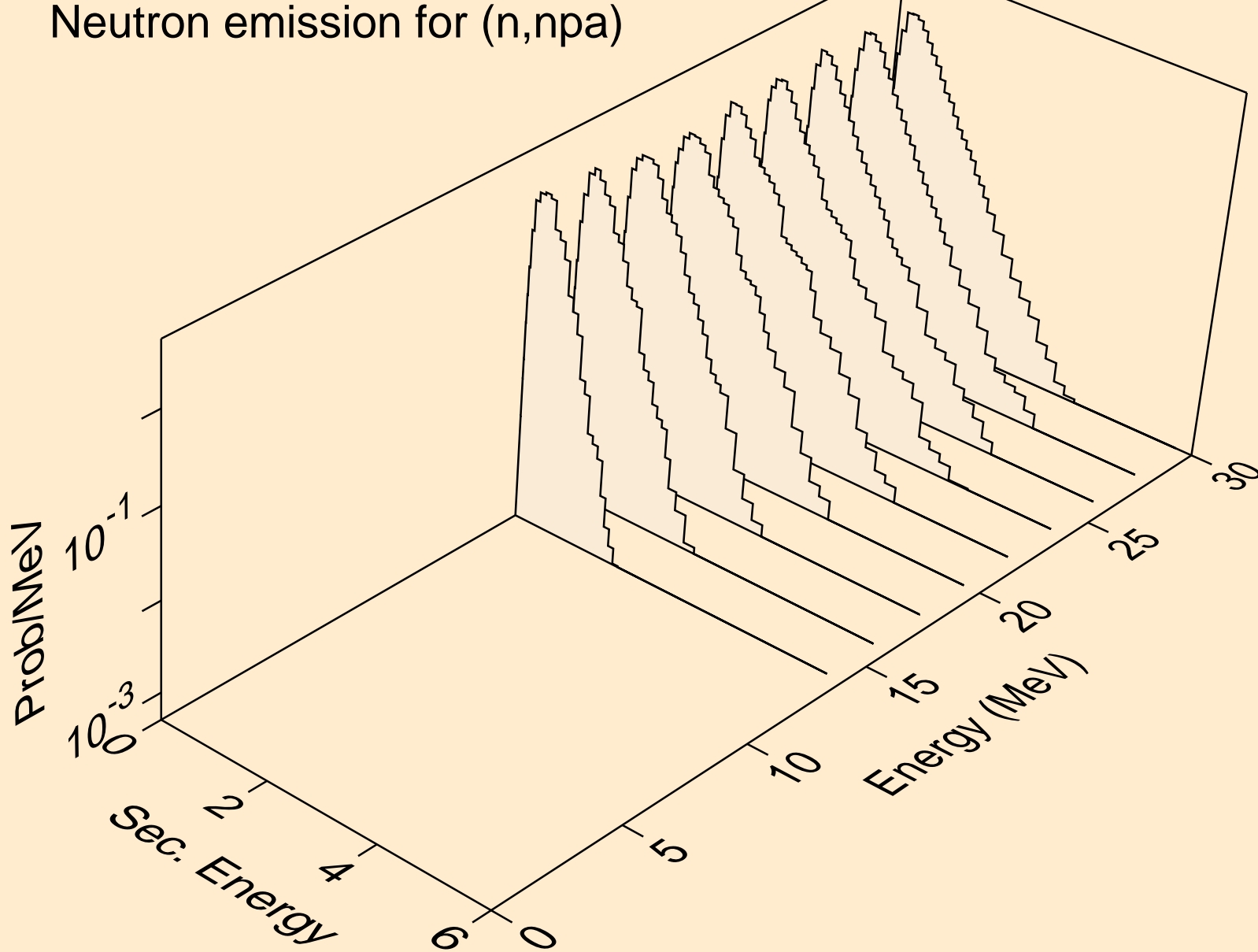

U231 NEUTRON ACER TENDL-2019 LIBRARY; T=293.16K  
Neutron emission for (n,n\*c)

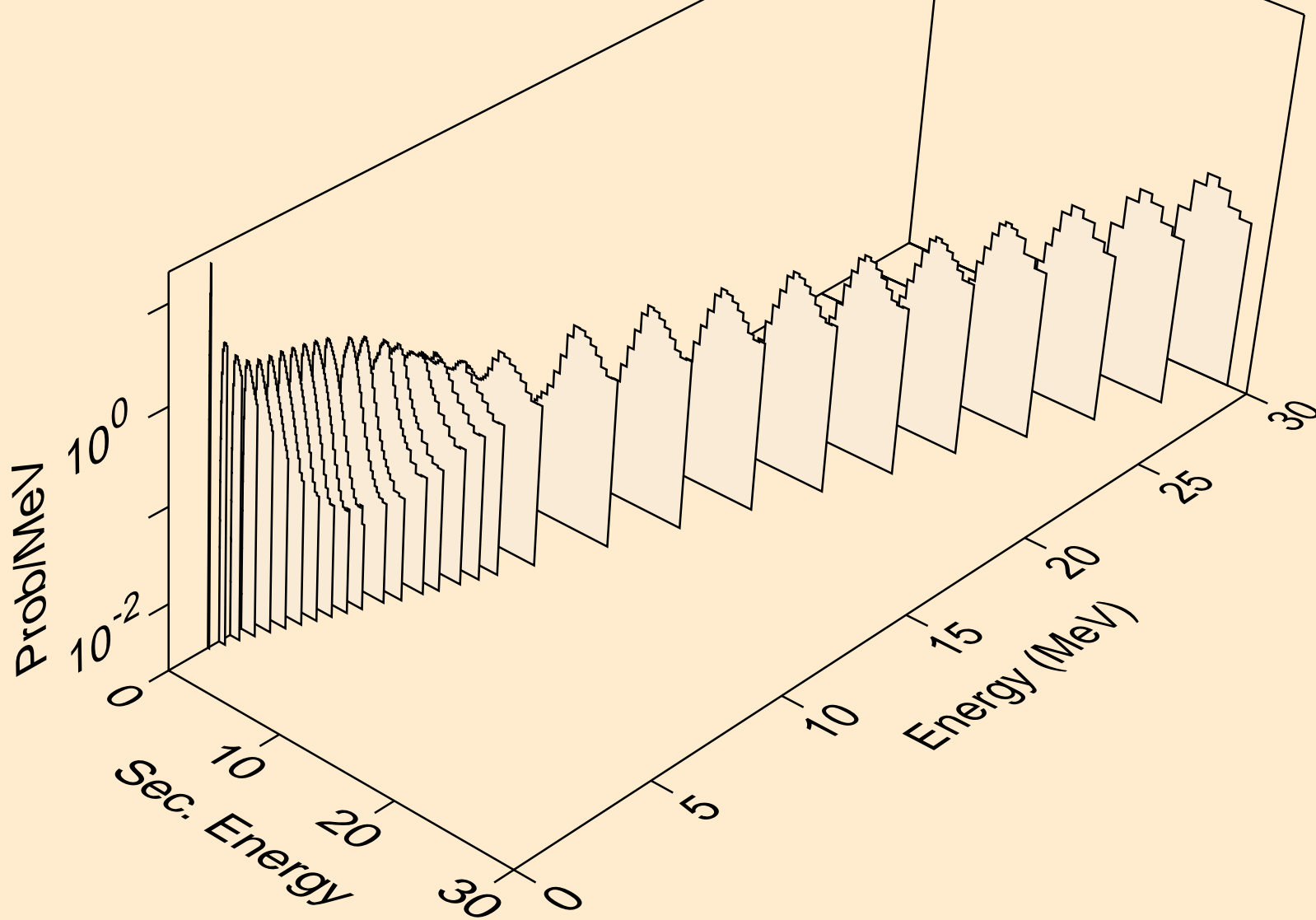

U231 NEUTRON ACER TENDL-2019 LIBRARY; T=293.16K  
Delayed nubar

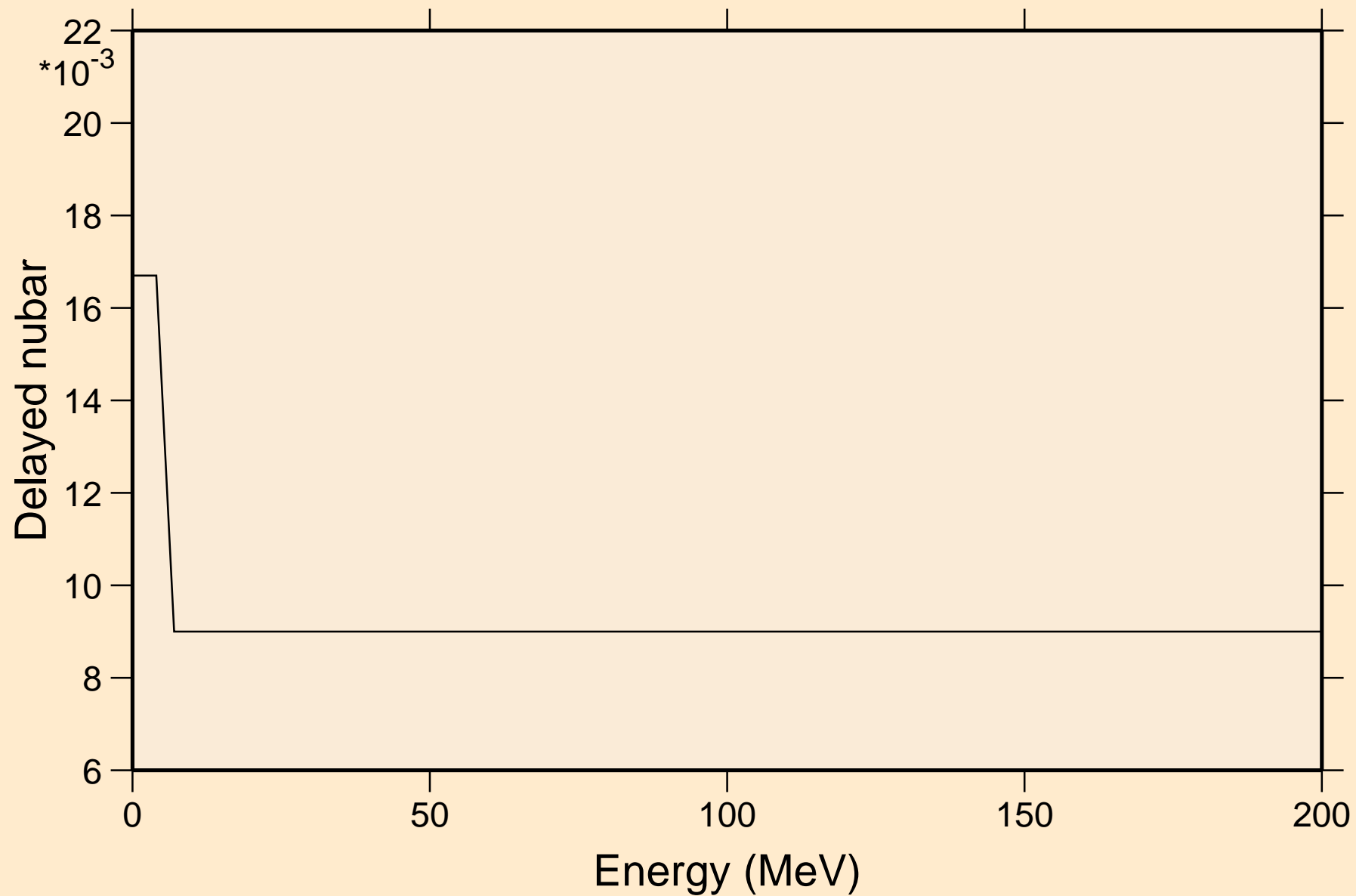

# U231 NEUTRON ACER TENDL-2019 LIBRARY; T=293.16K

## Delayed neutron spectra

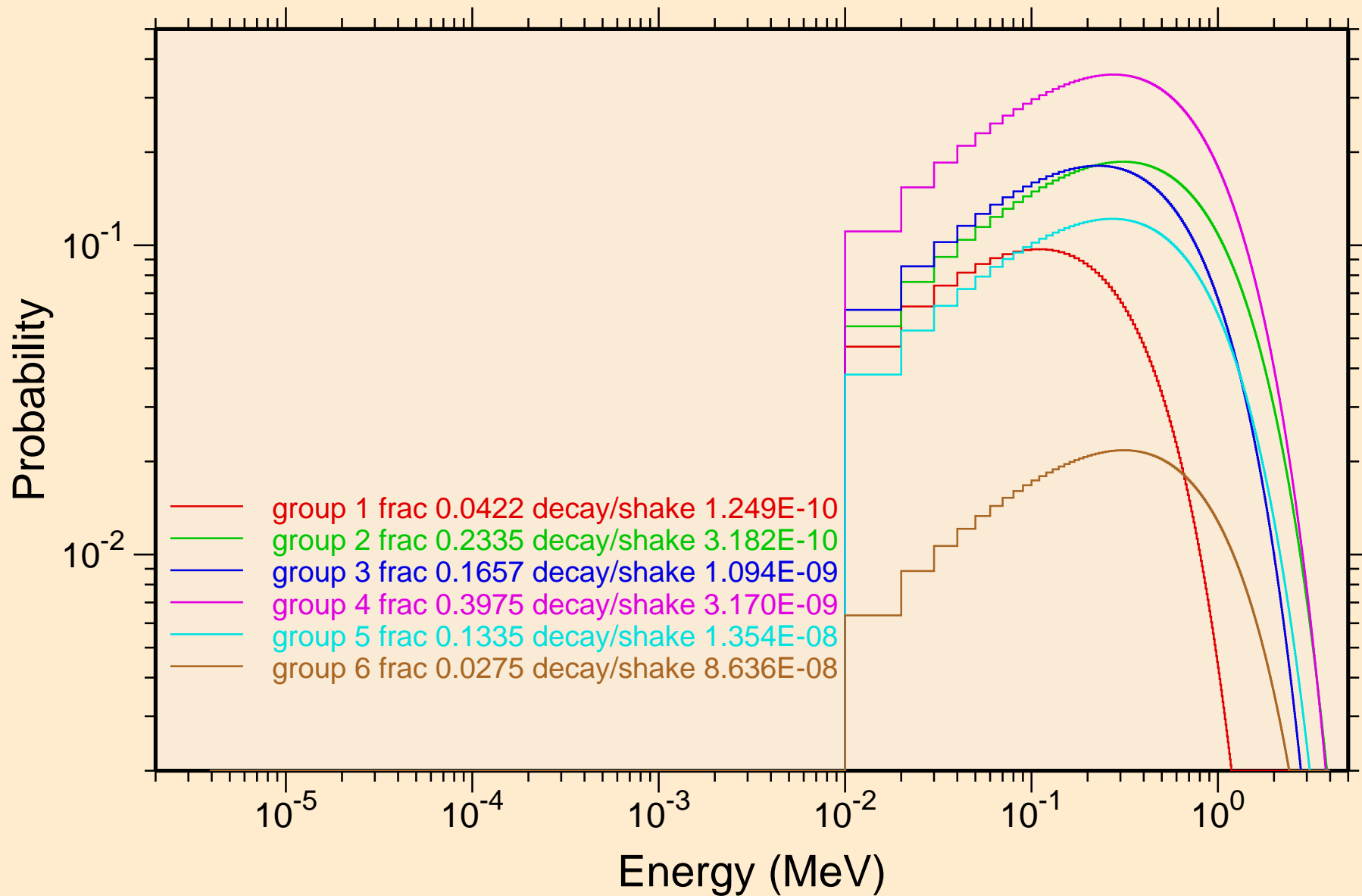

U231 NEUTRON ACER TENDL-2019 LIBRARY; T=293.16K  
Photon emission for (n,x)

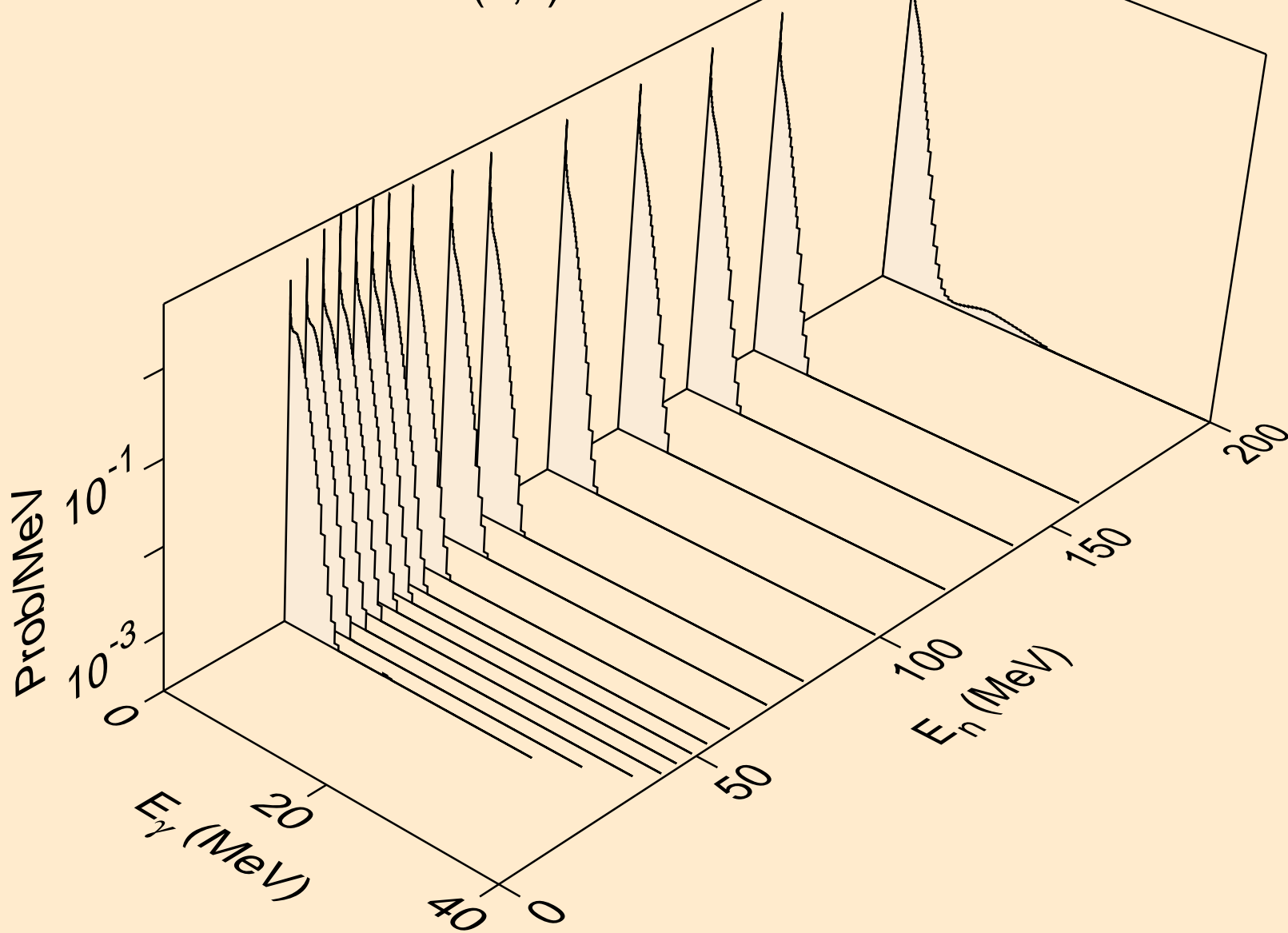

U231 NEUTRON ACER TENDL-2019 LIBRARY; T=293.16K  
Photon emission for (n,2nd)

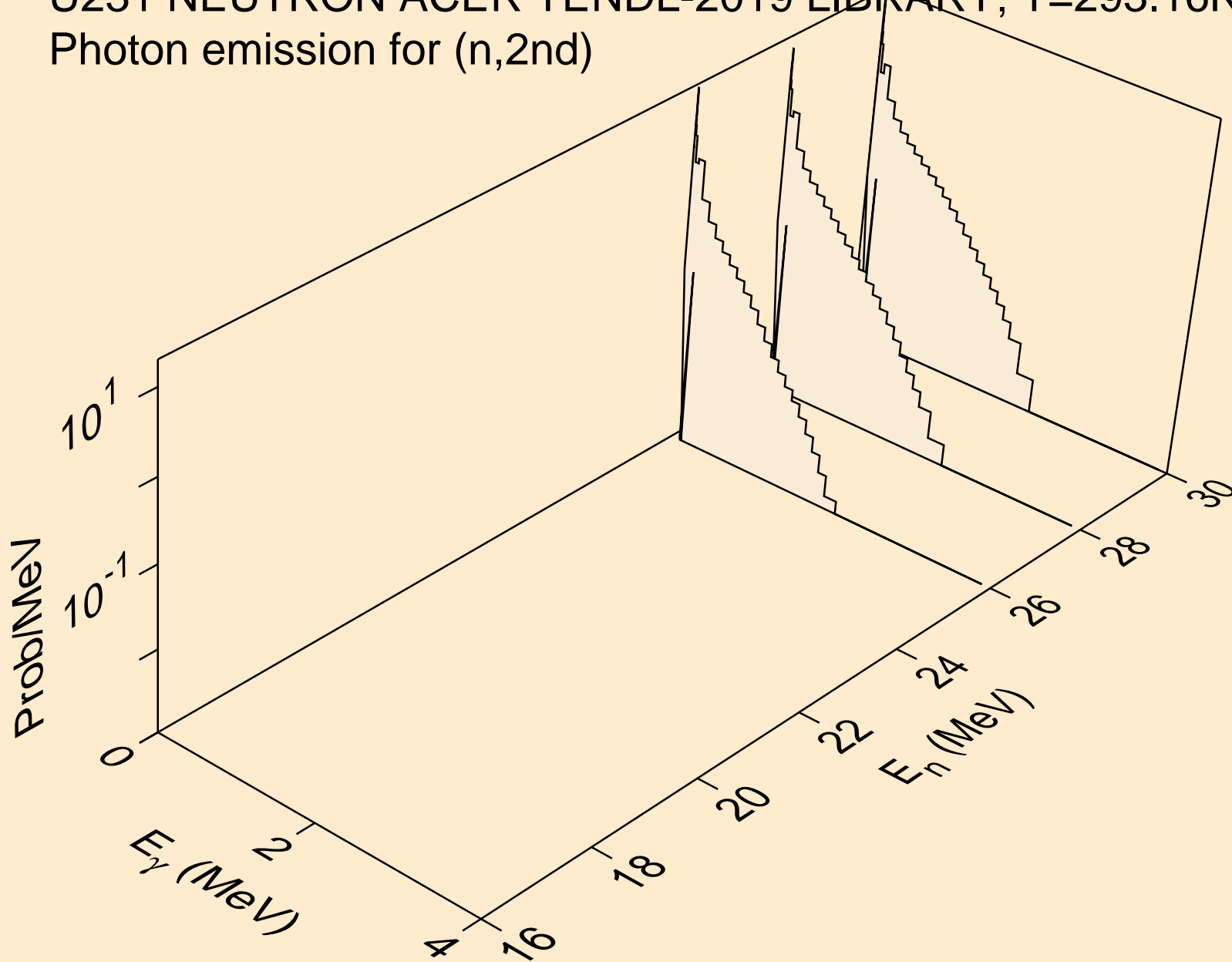

U231 NEUTRON ACER TENDL-2019 LIBRARY; T=293.16K  
Photon emission for (n,2n)

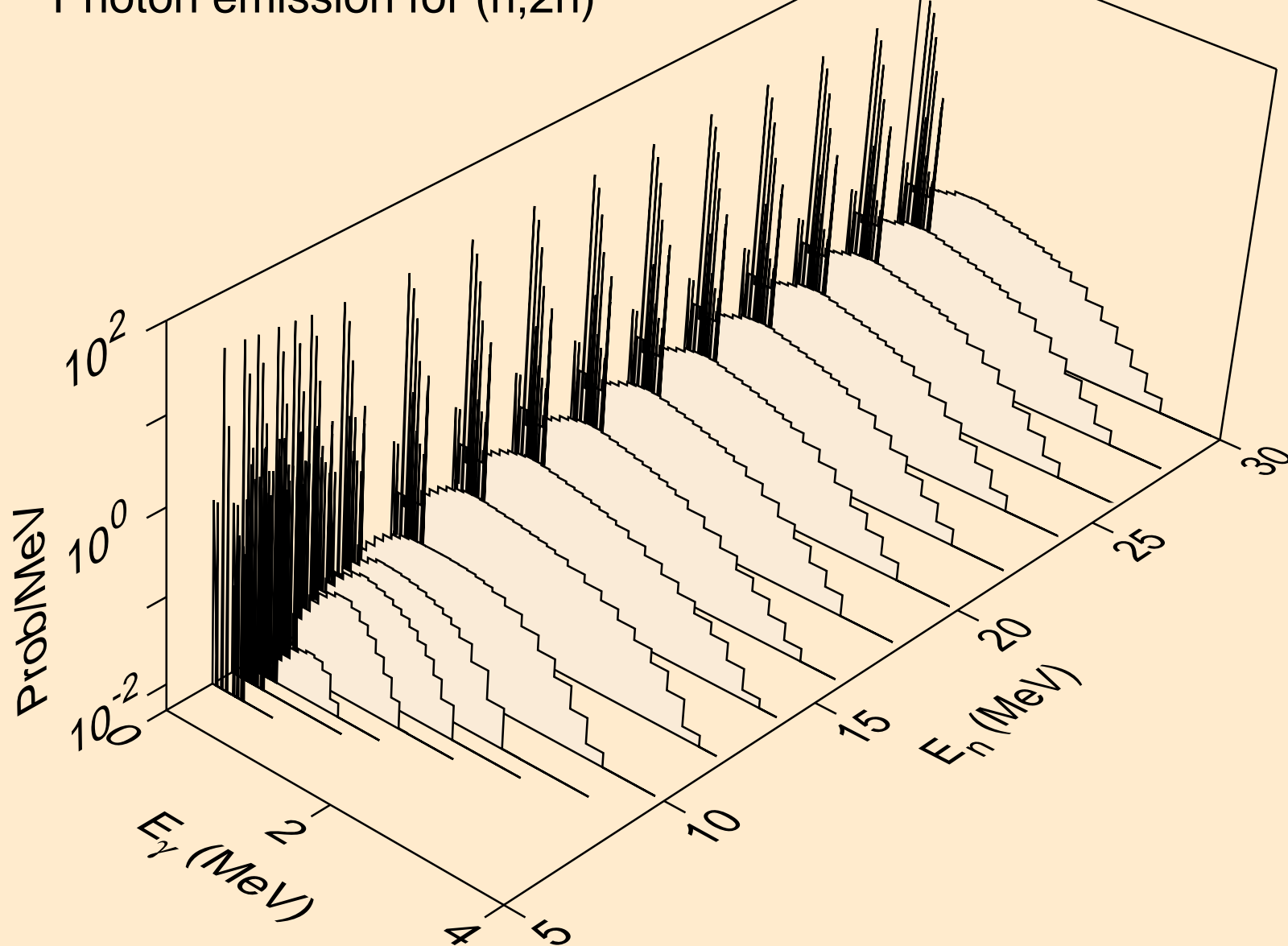

U231 NEUTRON ACER TENDL-2019 LIBRARY; T=293.16K  
Photon emission for (n,3n)

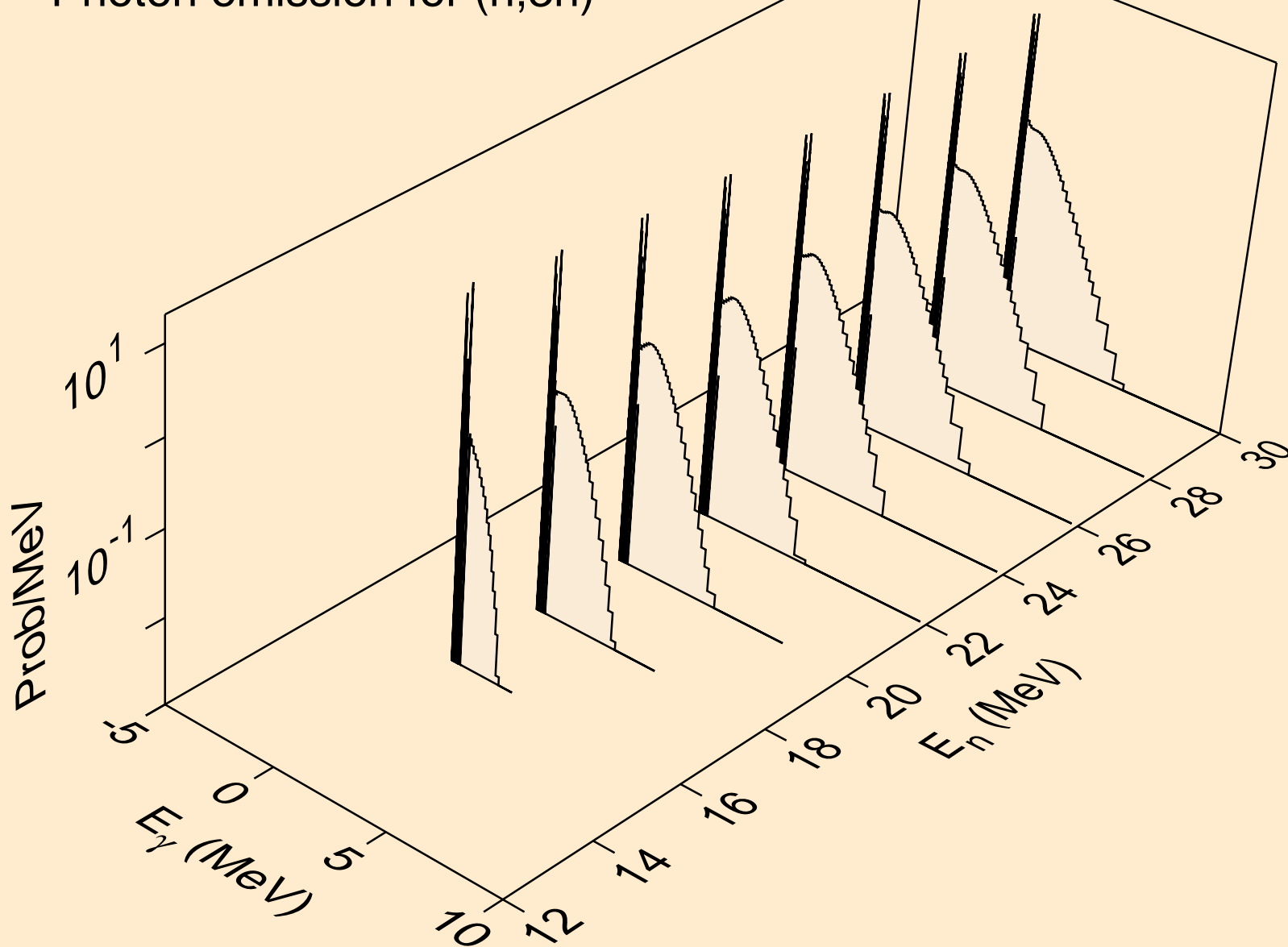

U231 NEUTRON ACER TENDL-2019 LIBRARY; T=293.16K  
Photon emission for (n,n\*)a

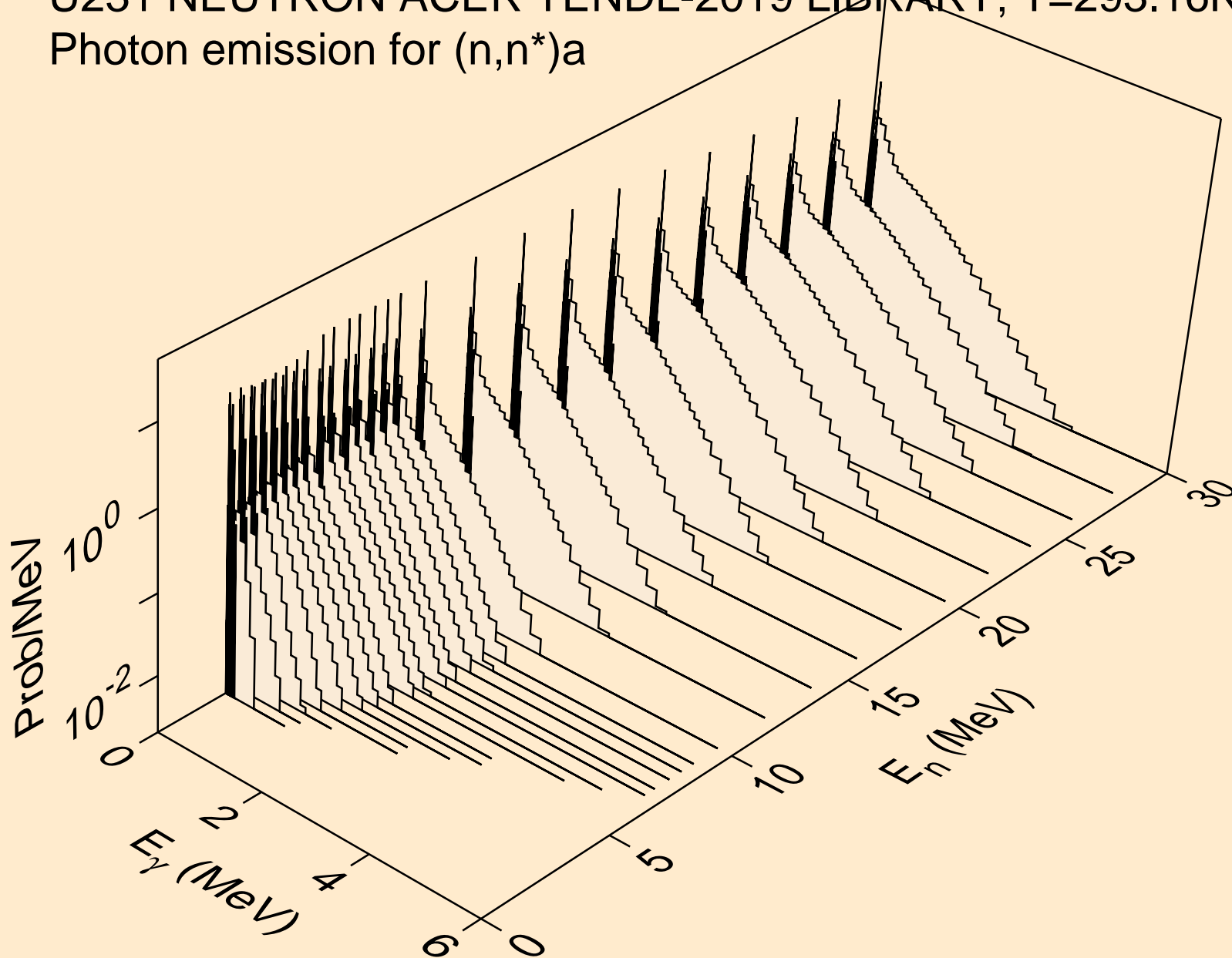

U231 NEUTRON ACER TENDL-2019 LIBRARY; T=293.16K  
Photon emission for (n,2n)a

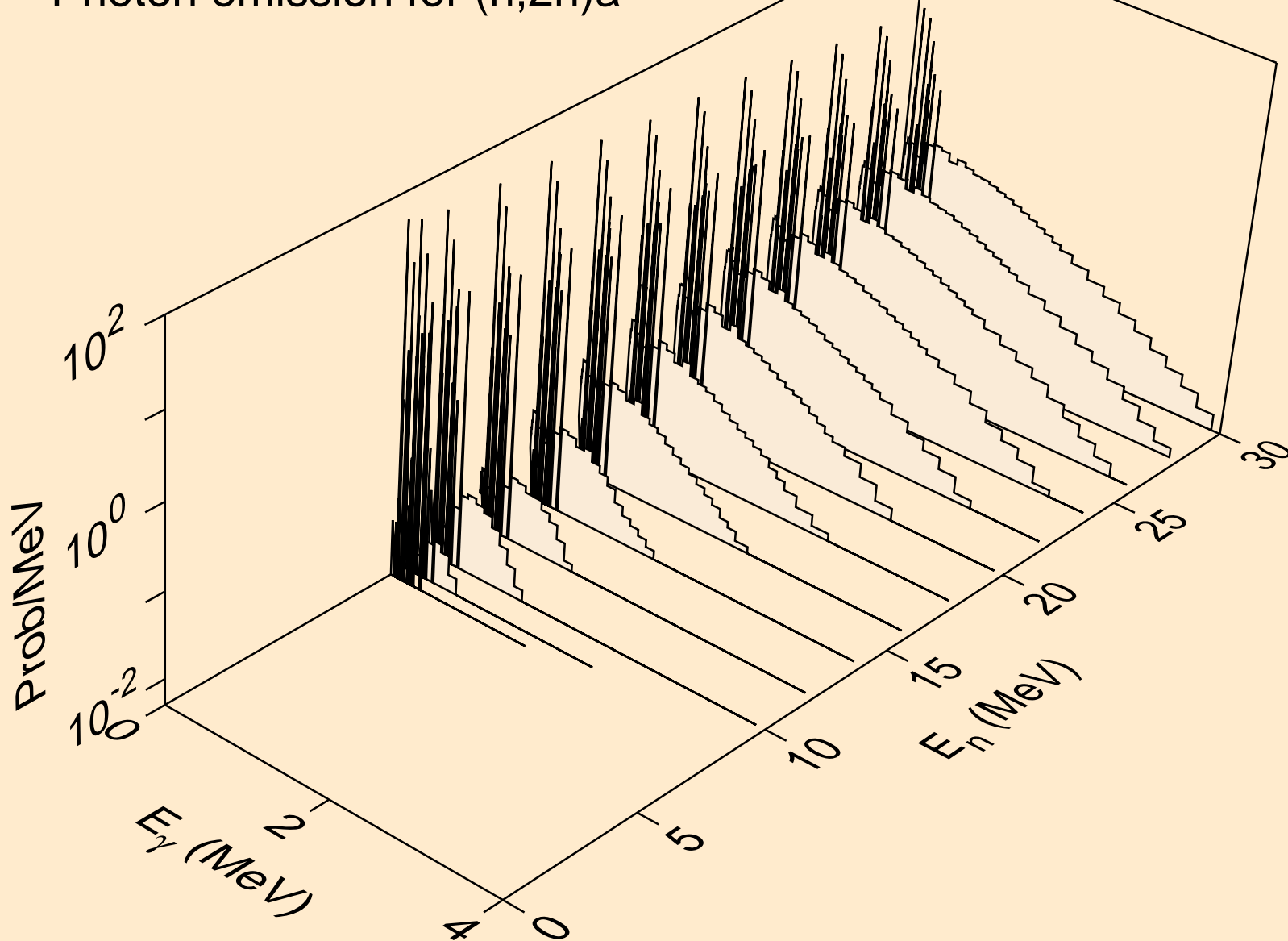

U231 NEUTRON ACER TENDL-2019 LIBRARY; T=293.16K  
Photon emission for (n,3n)a

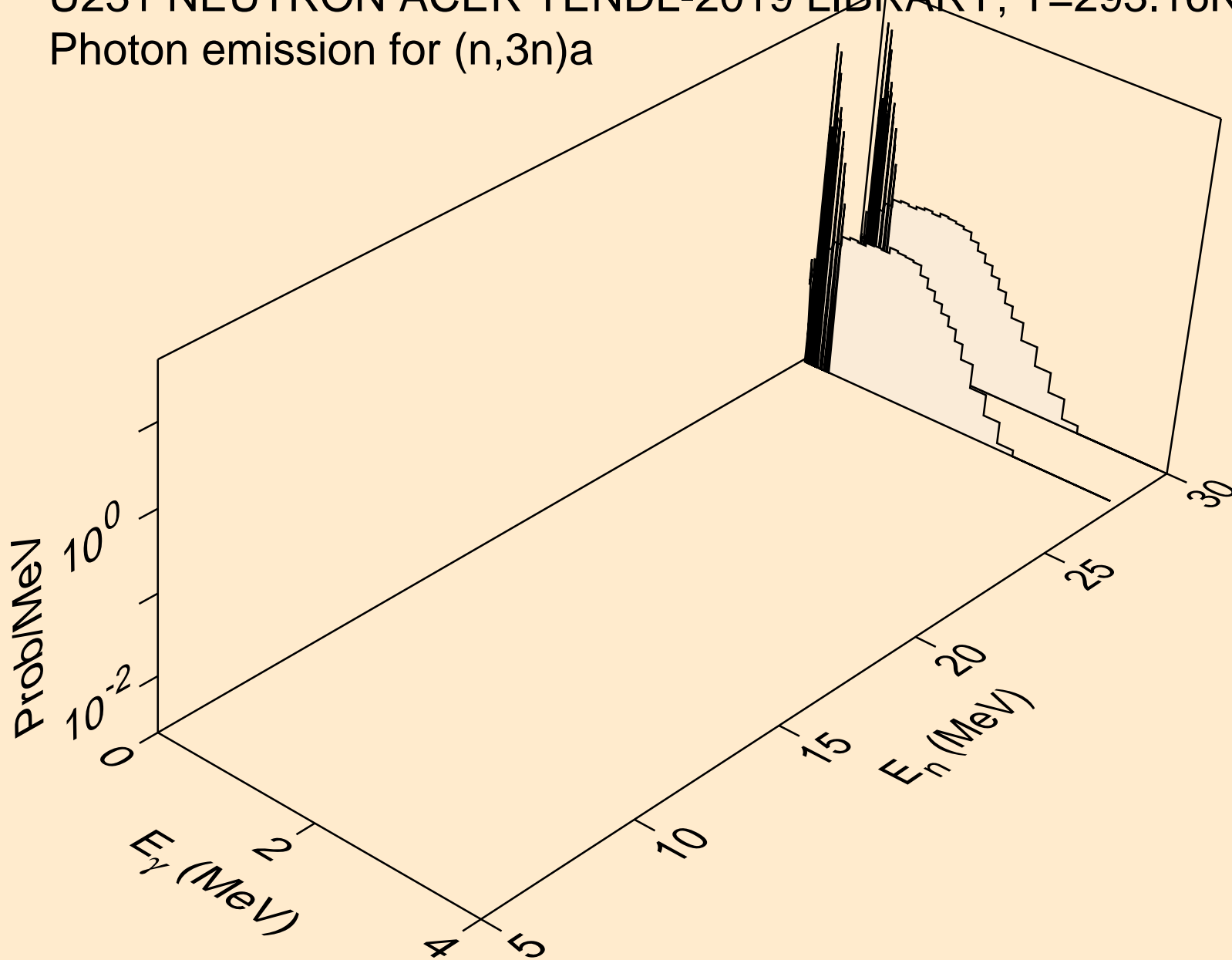

U231 NEUTRON ACER TENDL-2019 LIBRARY; T=293.16K  
Photon emission for (n,n\*)p

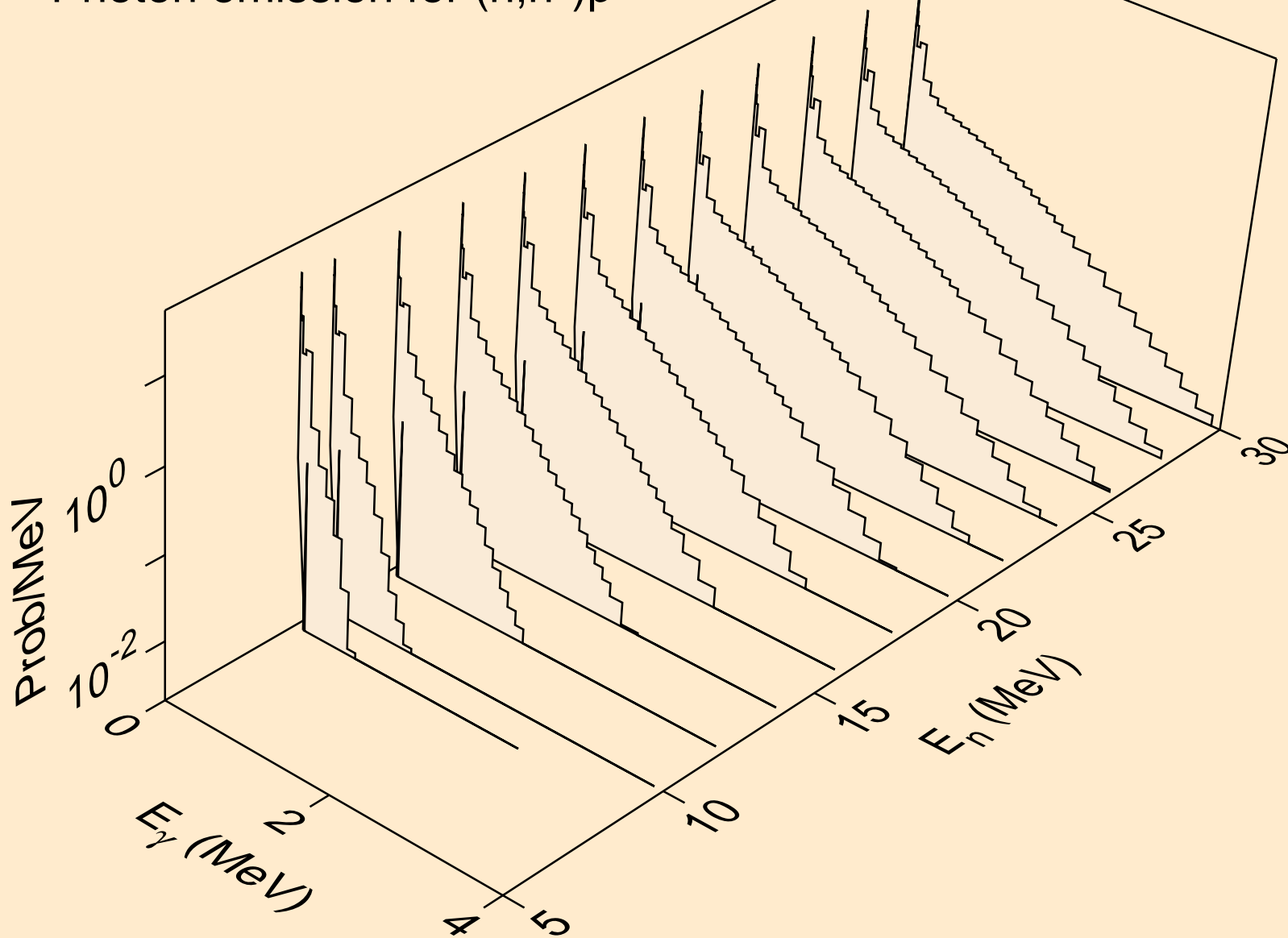

U231 NEUTRON ACER TENDL-2019 LIBRARY; T=293.16K  
Photon emission for (n,n\*)2a

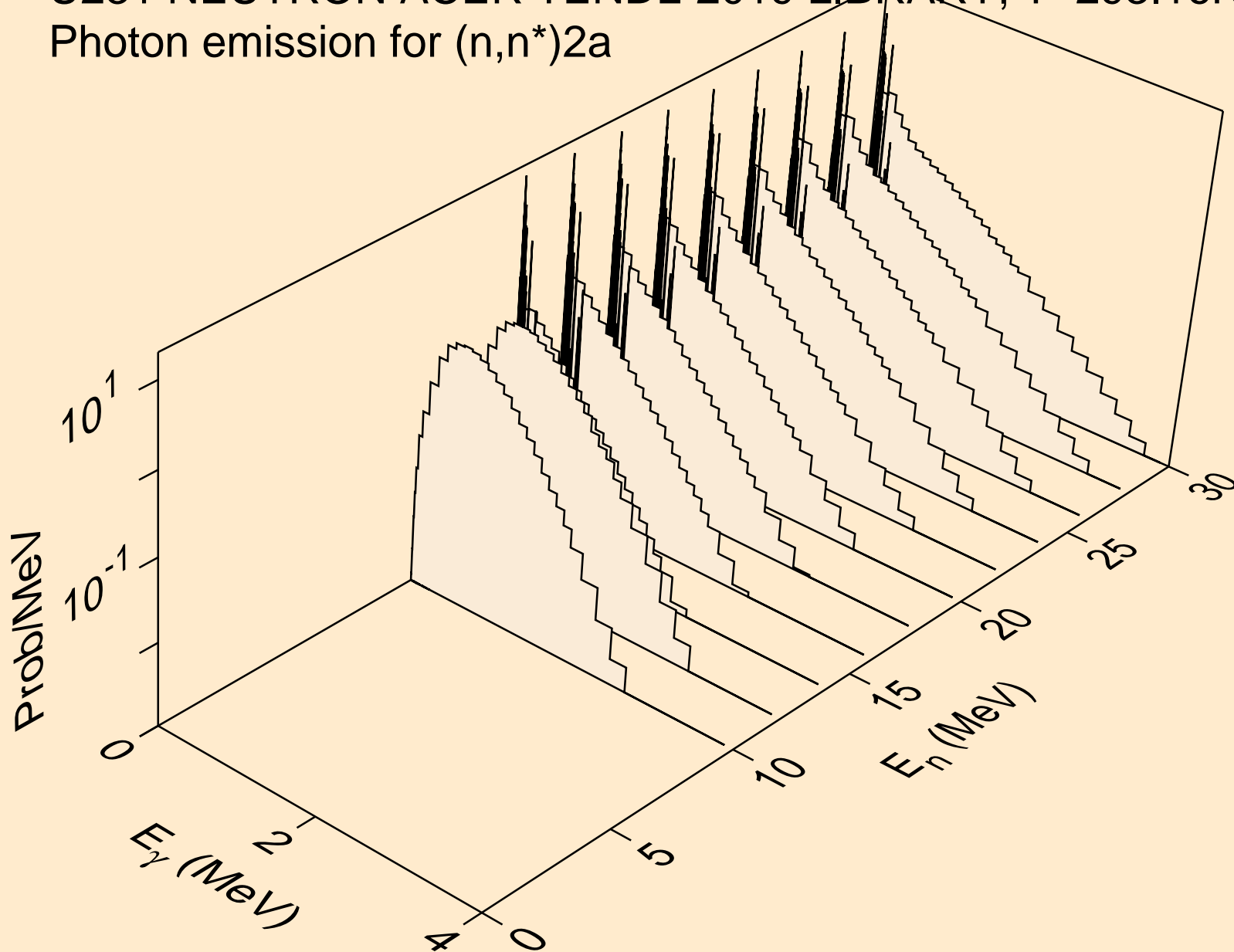

U231 NEUTRON ACER TENDL-2019 LIBRARY; T=293.16K  
Photon emission for (n,2n)2a

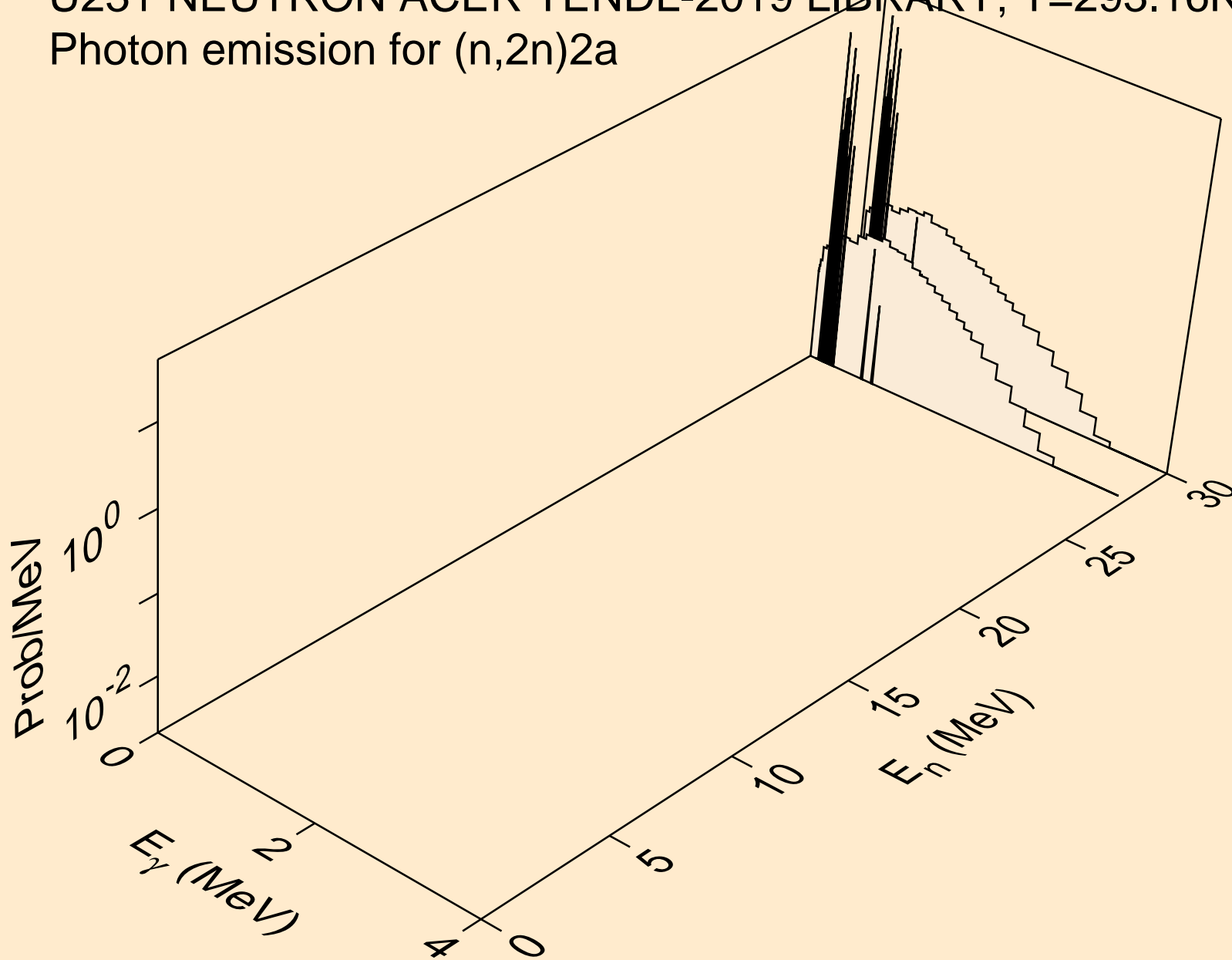

U231 NEUTRON ACER TENDL-2019 LIBRARY; T=293.16K  
Photon emission for (n,n\*)d

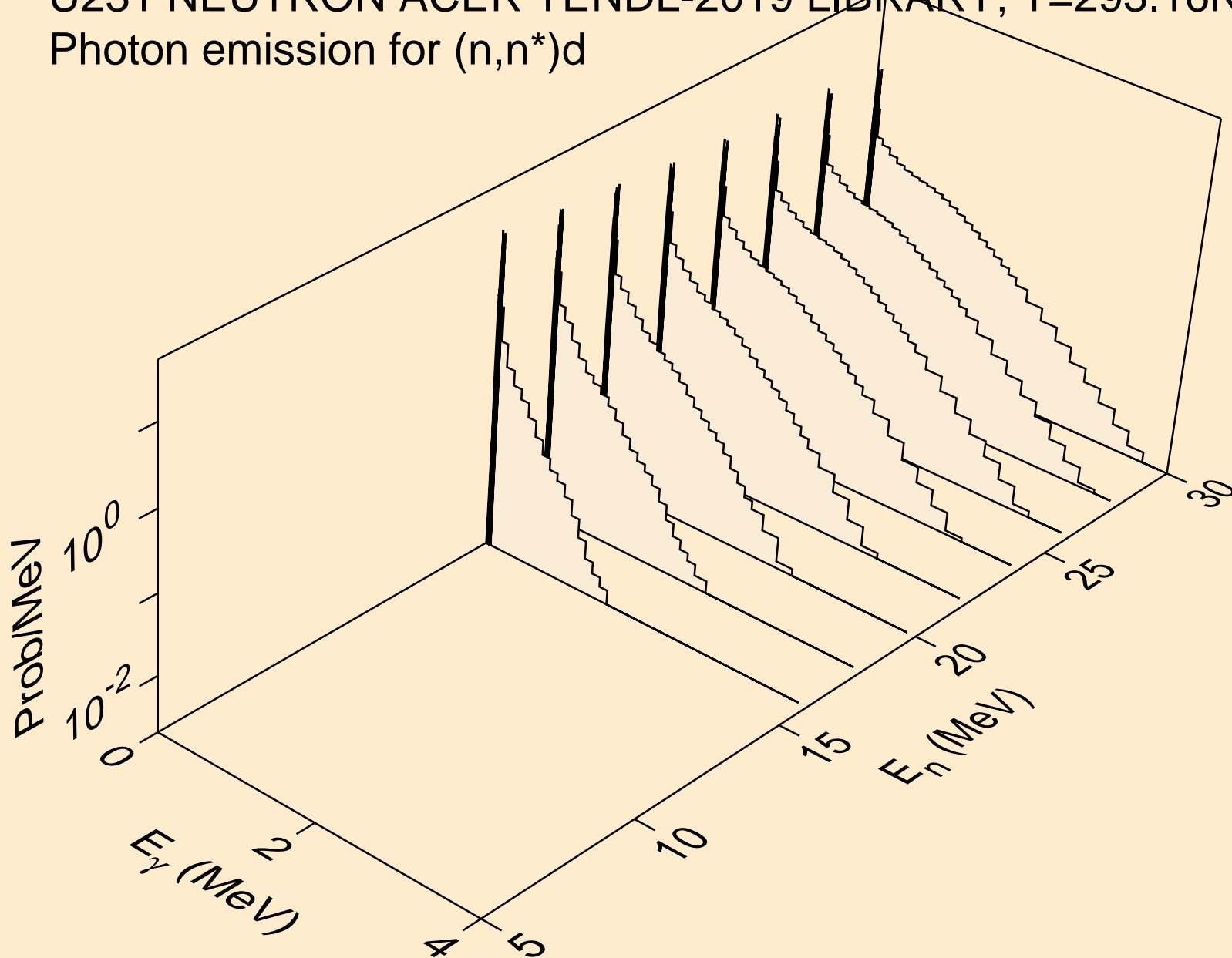

U231 NEUTRON ACER TENDL-2019 LIBRARY; T=293.16K  
Photon emission for (n,n\*)t

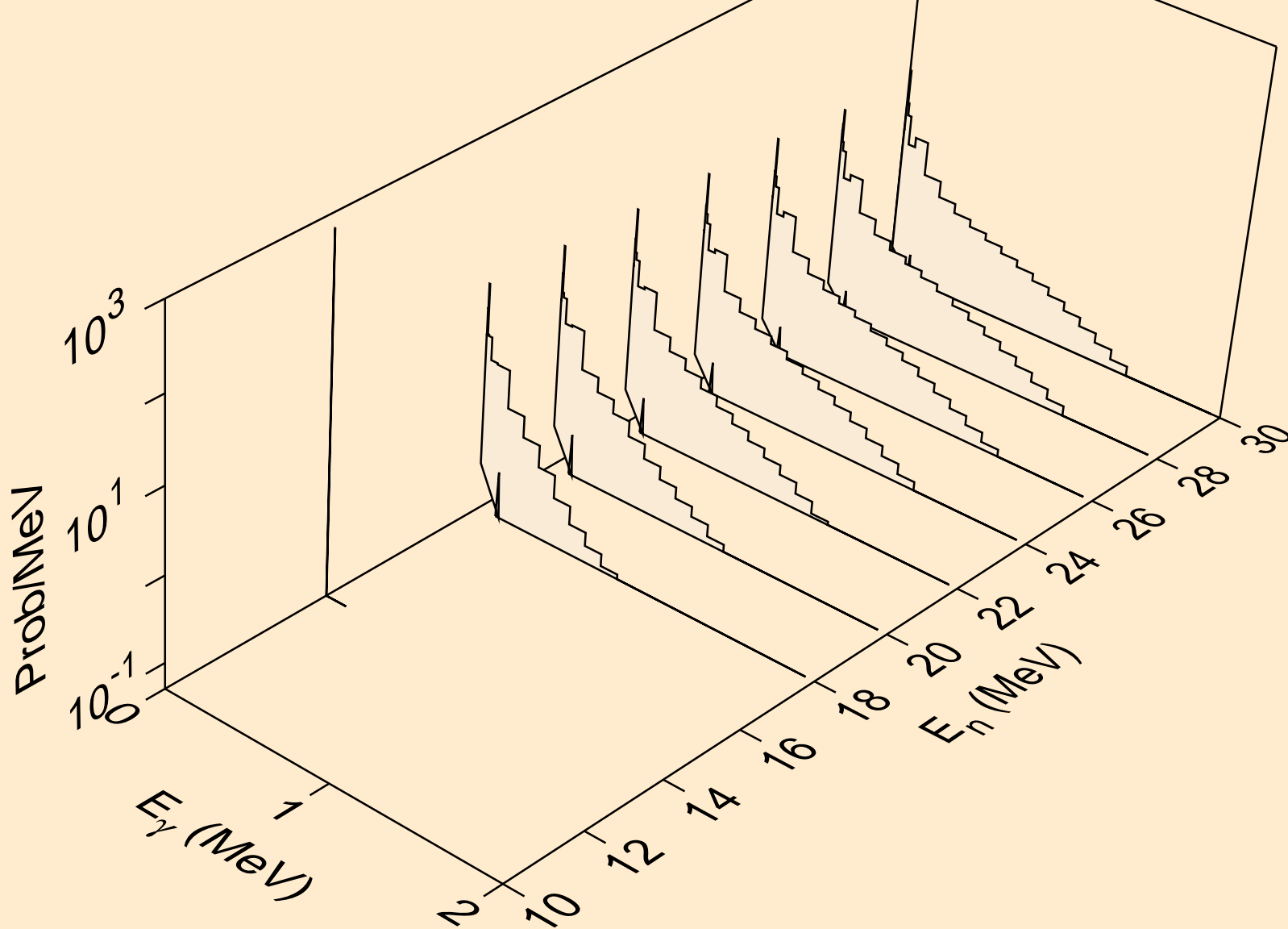

U231 NEUTRON ACER TENDL-2019 LIBRARY; T=293.16K  
Photon emission for (n,n\*)he3

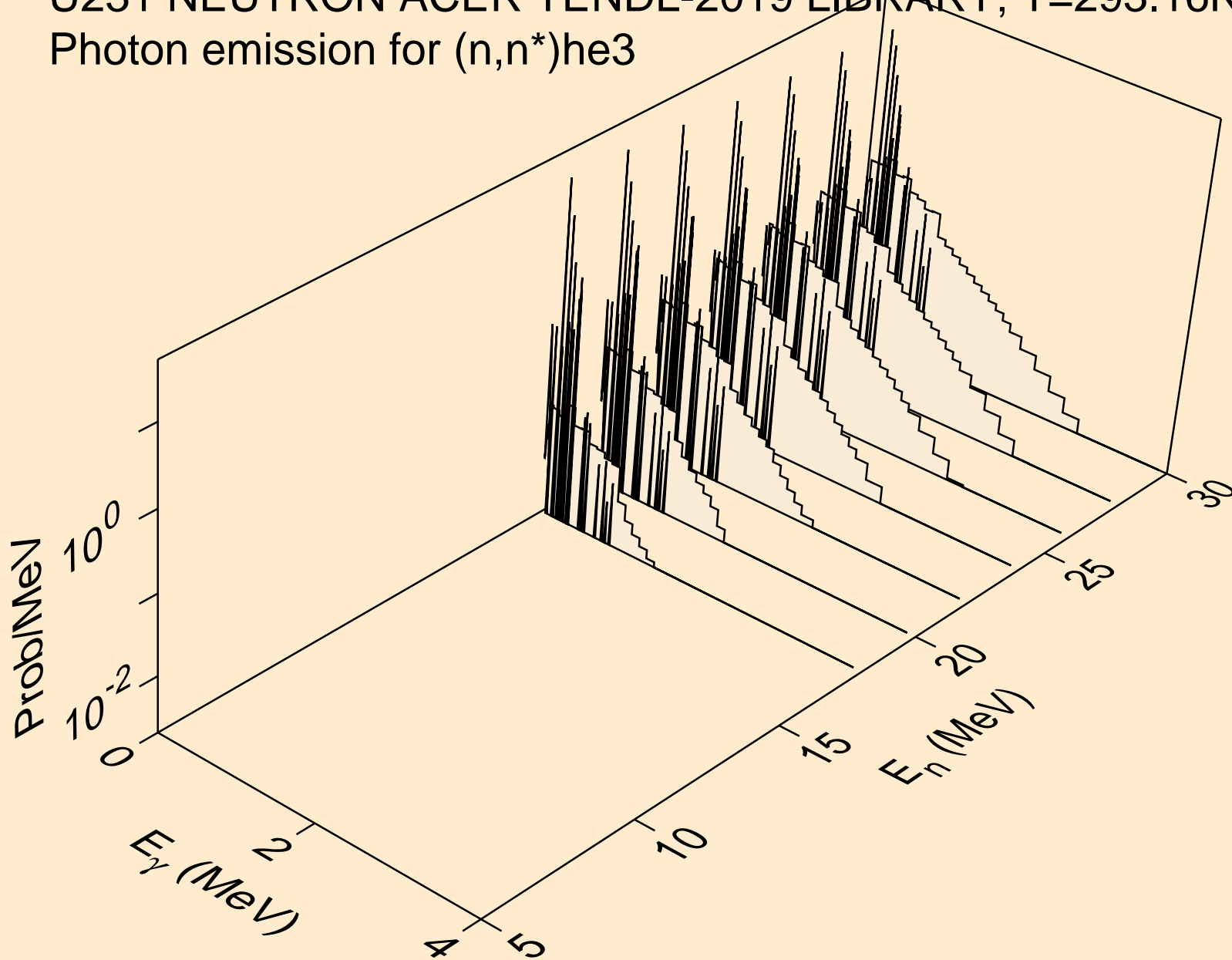

U231 NEUTRON ACER TENDL-2019 LIBRARY; T=293.16K  
Photon emission for (n,4n)

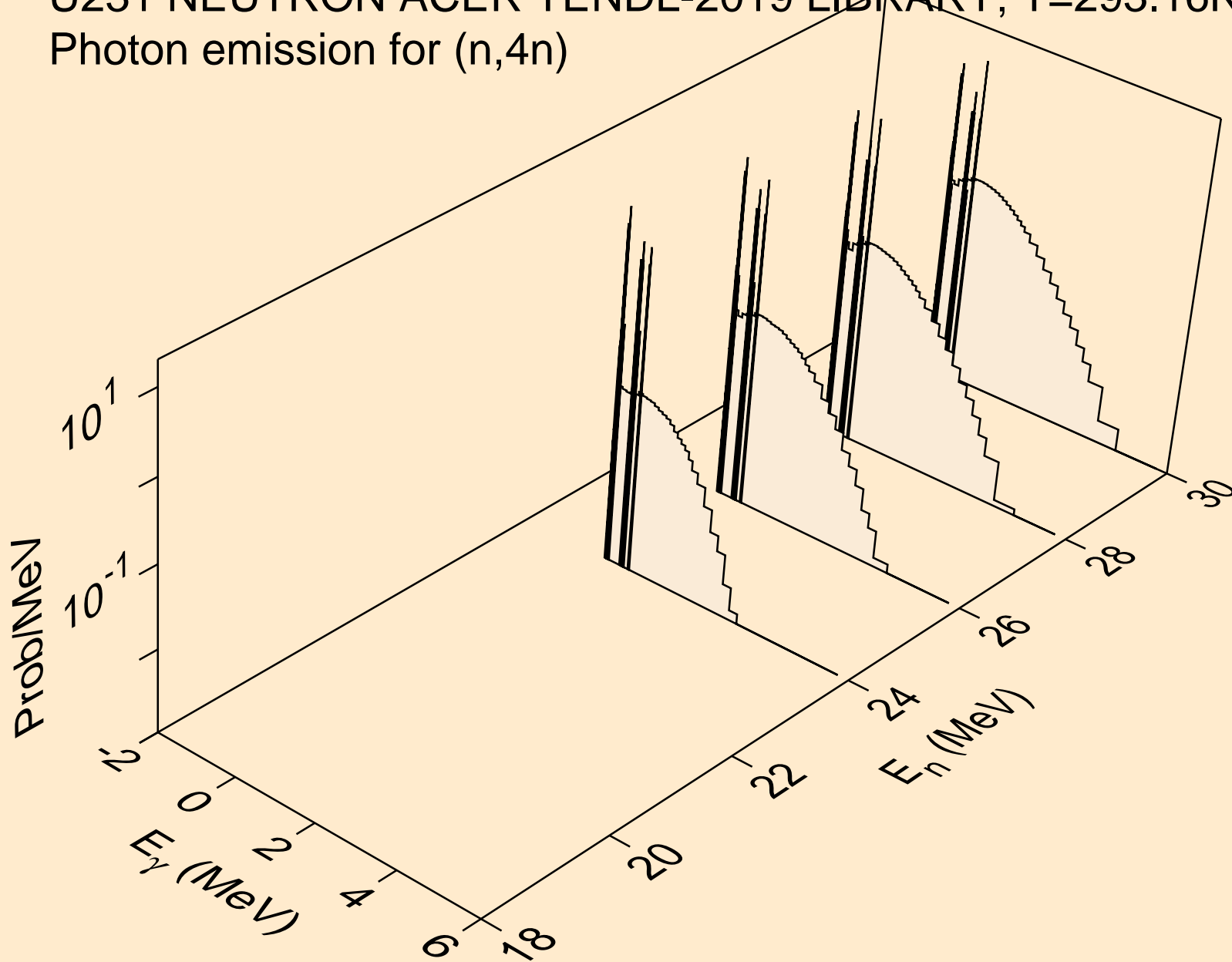

U231 NEUTRON ACER TENDL-2019 LIBRARY; T=293.16K  
Photon emission for (n,2np)

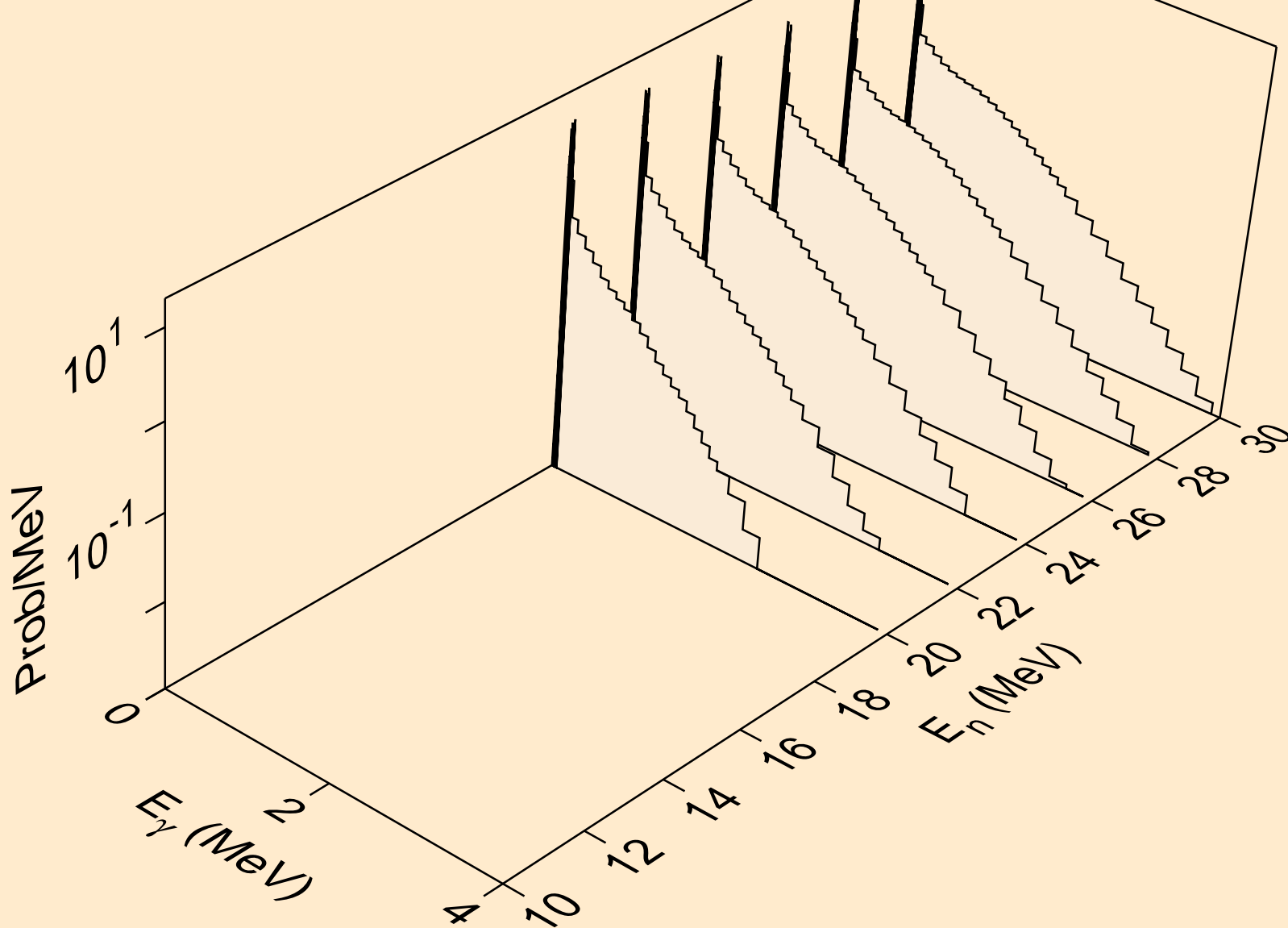

U231 NEUTRON ACER TENDL-2019 LIBRARY; T=293.16K  
Photon emission for (n,3np)

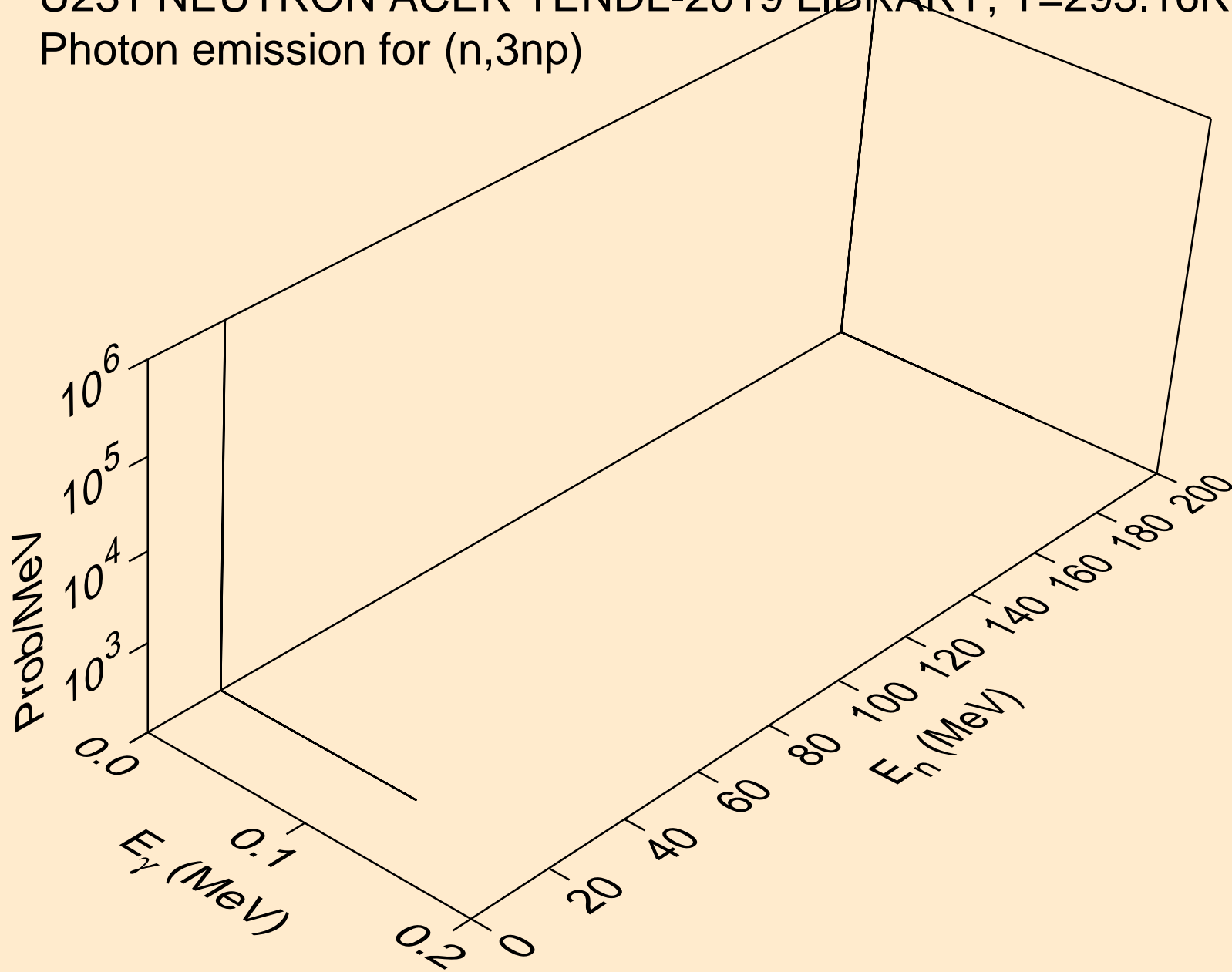

U231 NEUTRON ACER TENDL-2019 LIBRARY; T=293.16K  
Photon emission for (n,2np)

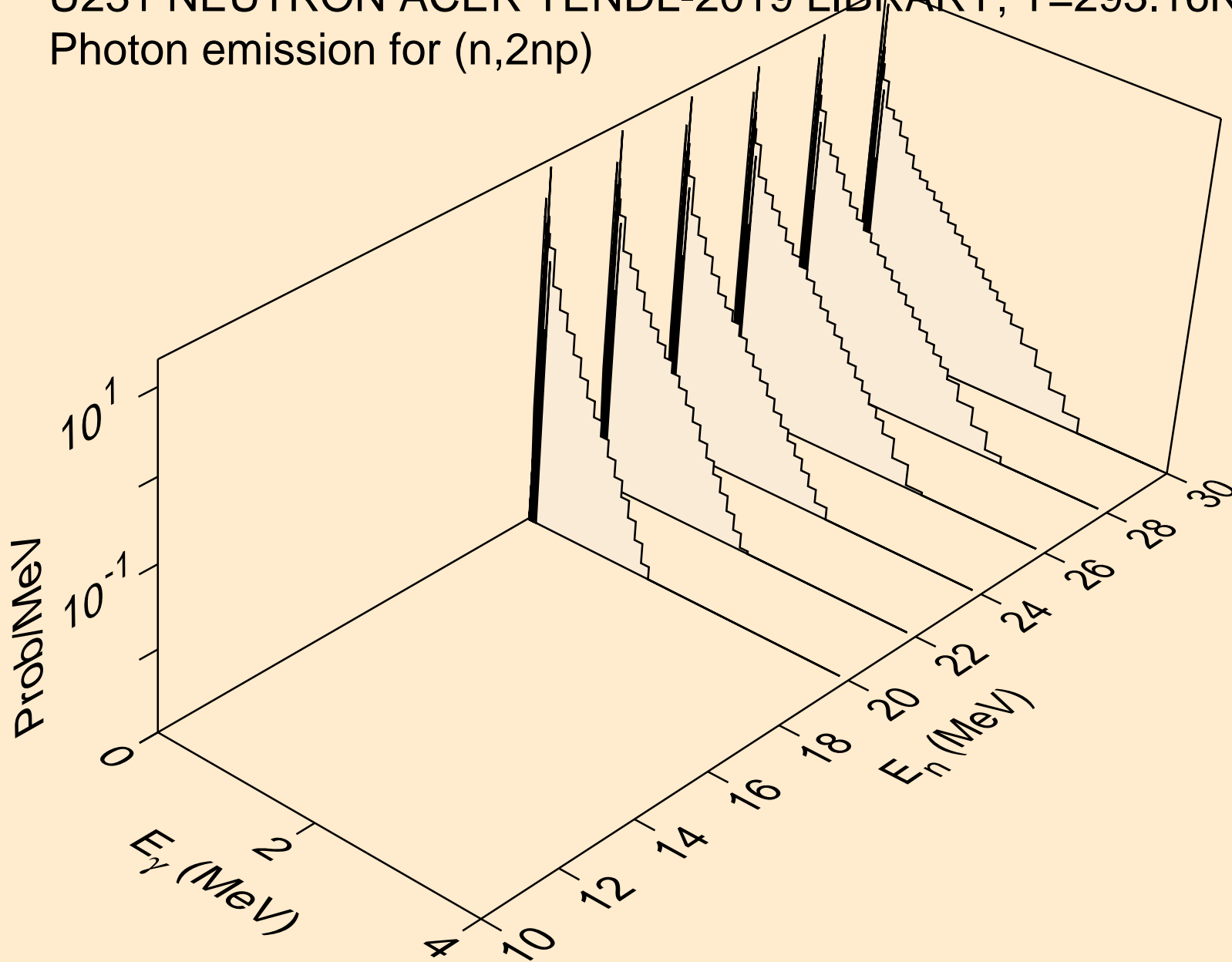

U231 NEUTRON ACER TENDL-2019 LIBRARY; T=293.16K  
Photon emission for (n,npa)

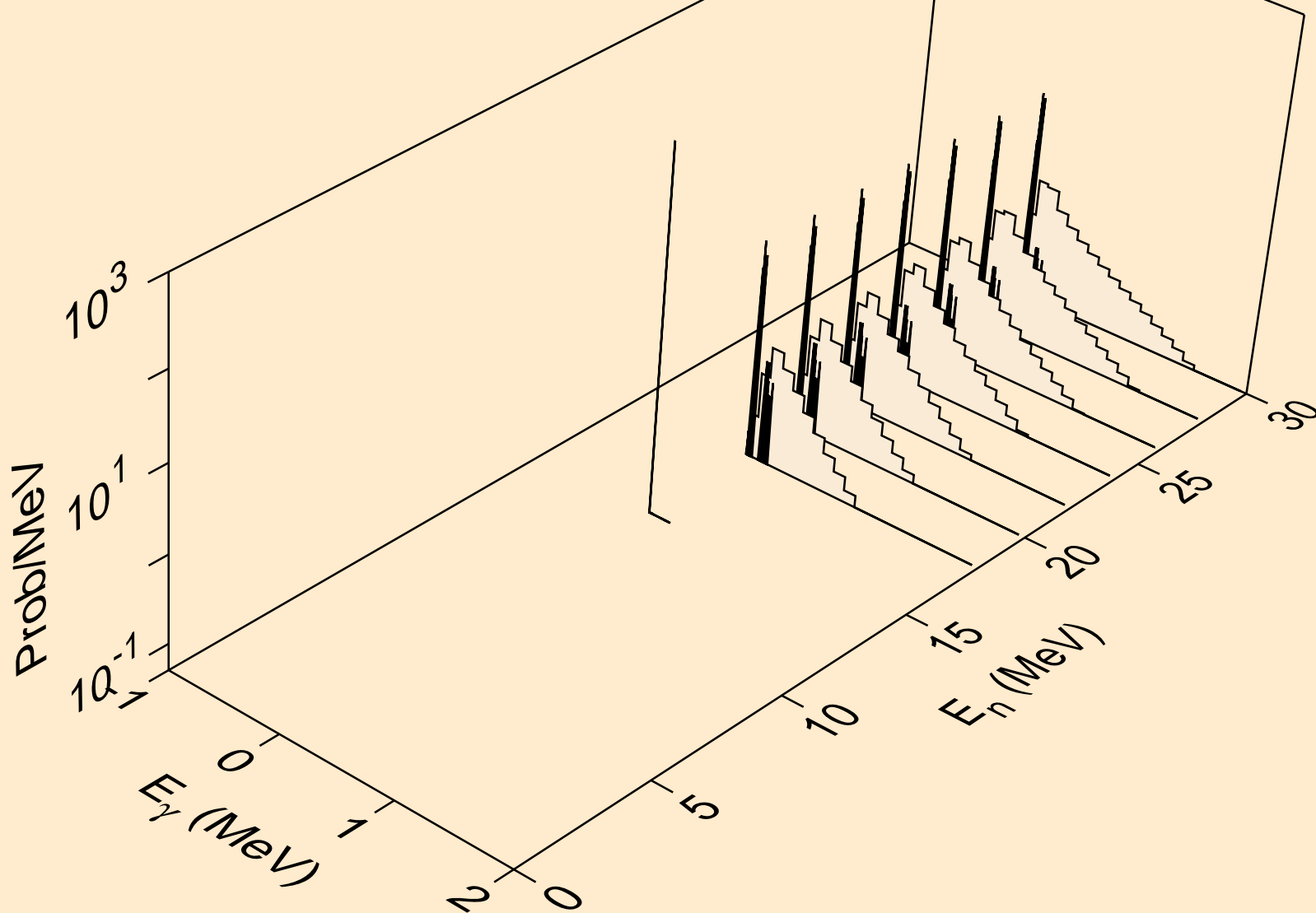

U231 NEUTRON ACER TENDL-2019 LIBRARY; T=293.16K  
Photon emission for (n,n\*c)

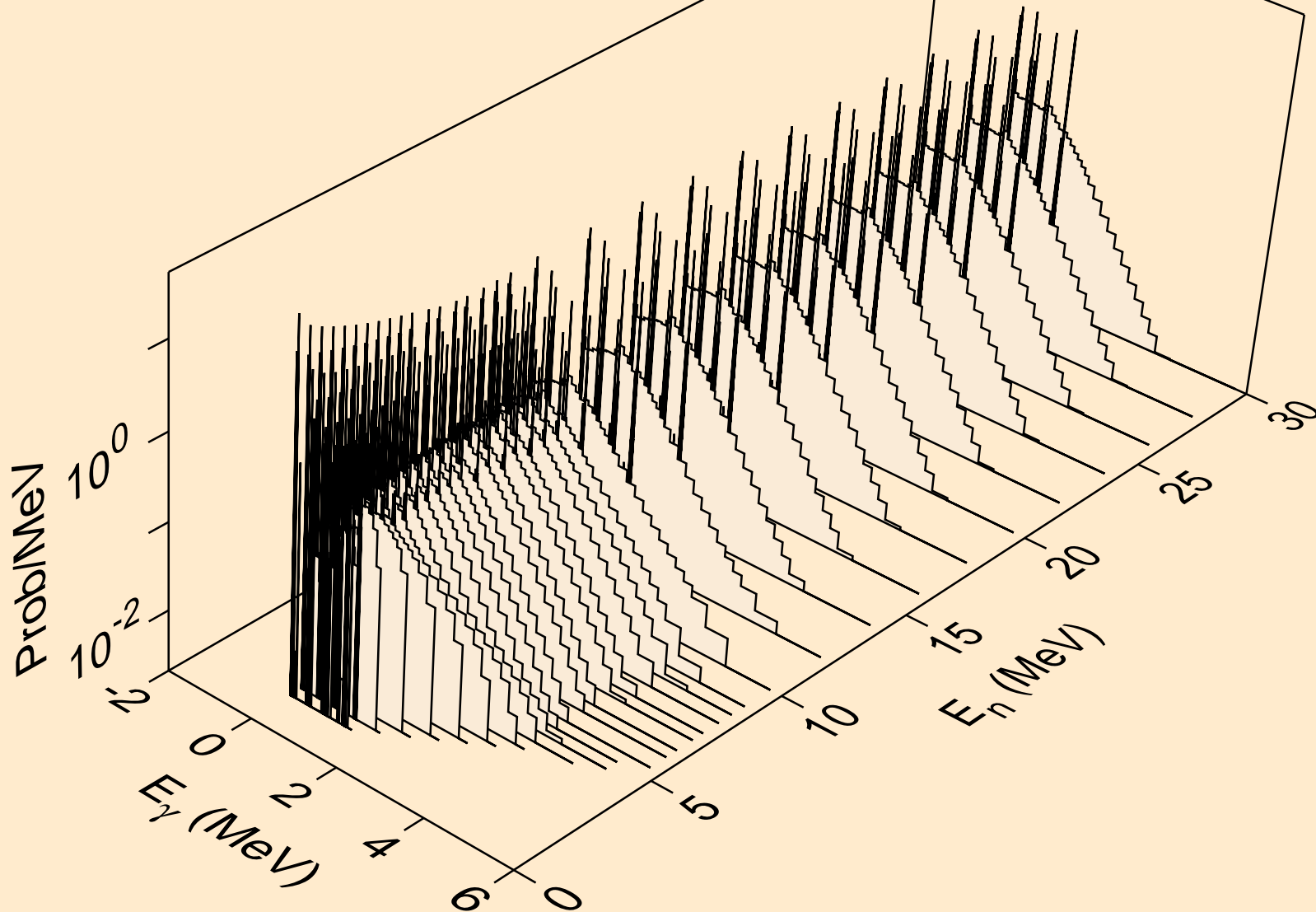

U231 NEUTRON ACER TENDL-2019 LIBRARY; T=293.16K  
Photon emission for (n,gma)

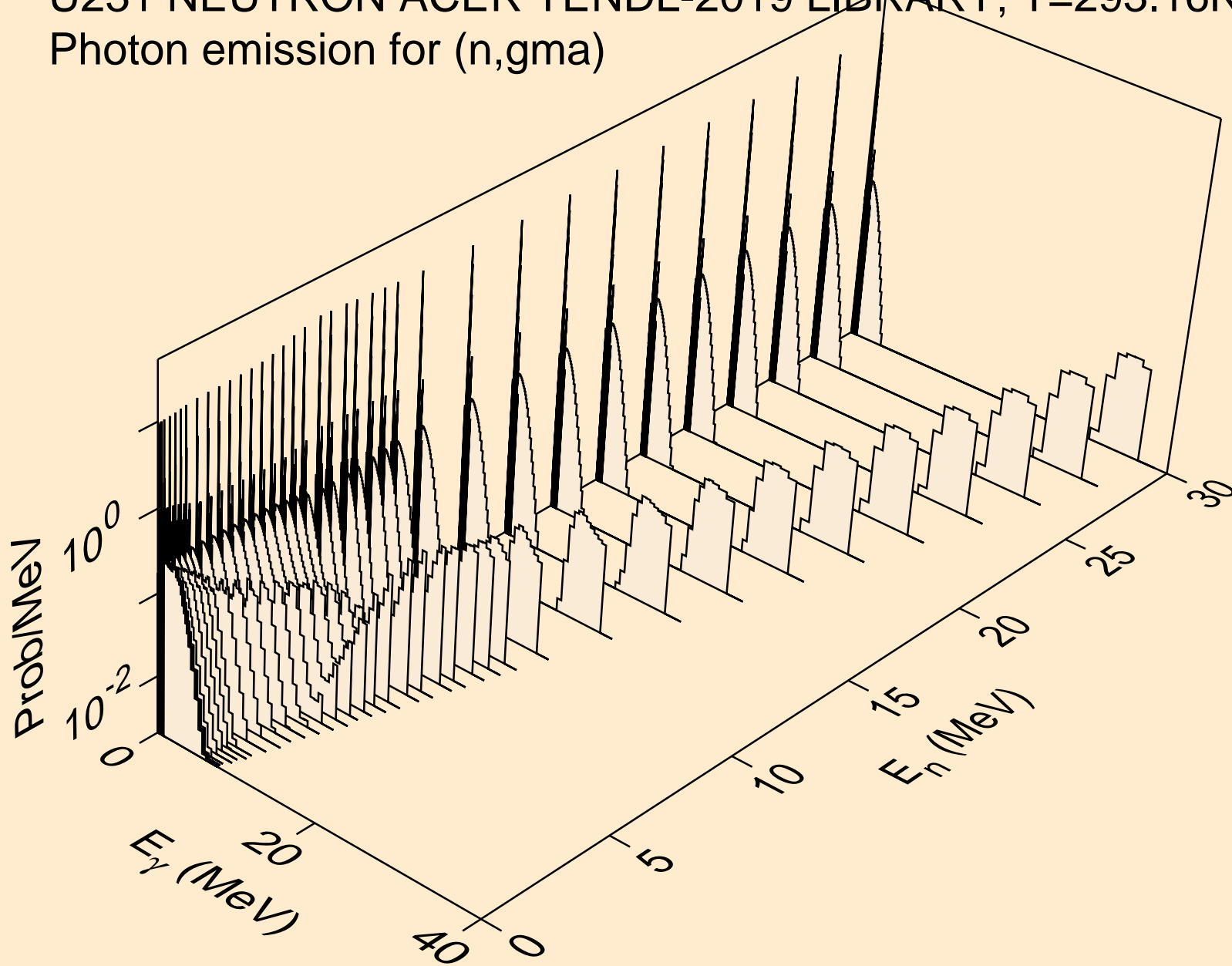

U231 NEUTRON ACER TENDL-2019 LIBRARY; T=293.16K  
Photon emission for (n,p)

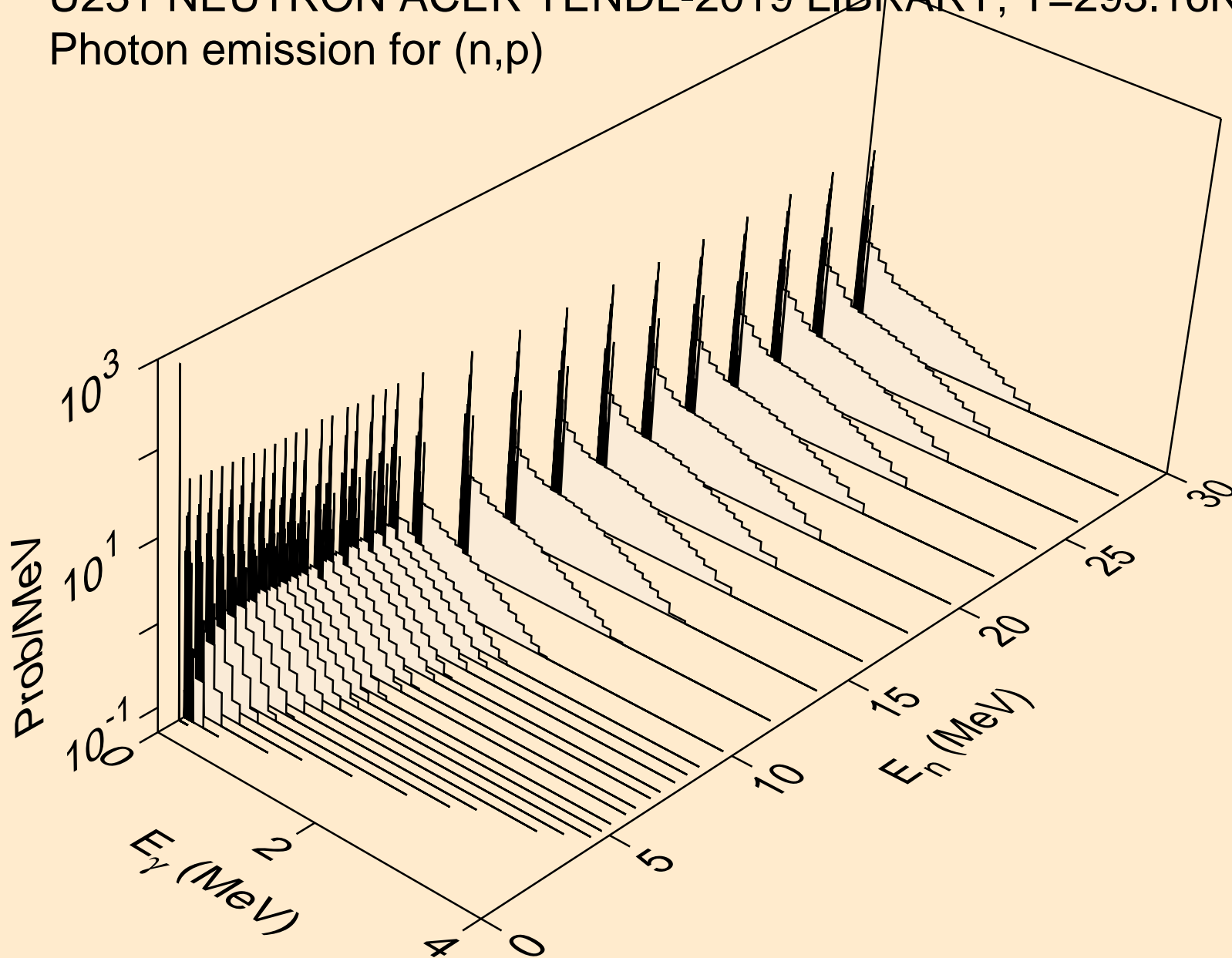

U231 NEUTRON ACER TENDL-2019 LIBRARY; T=293.16K  
Photon emission for (n,d)

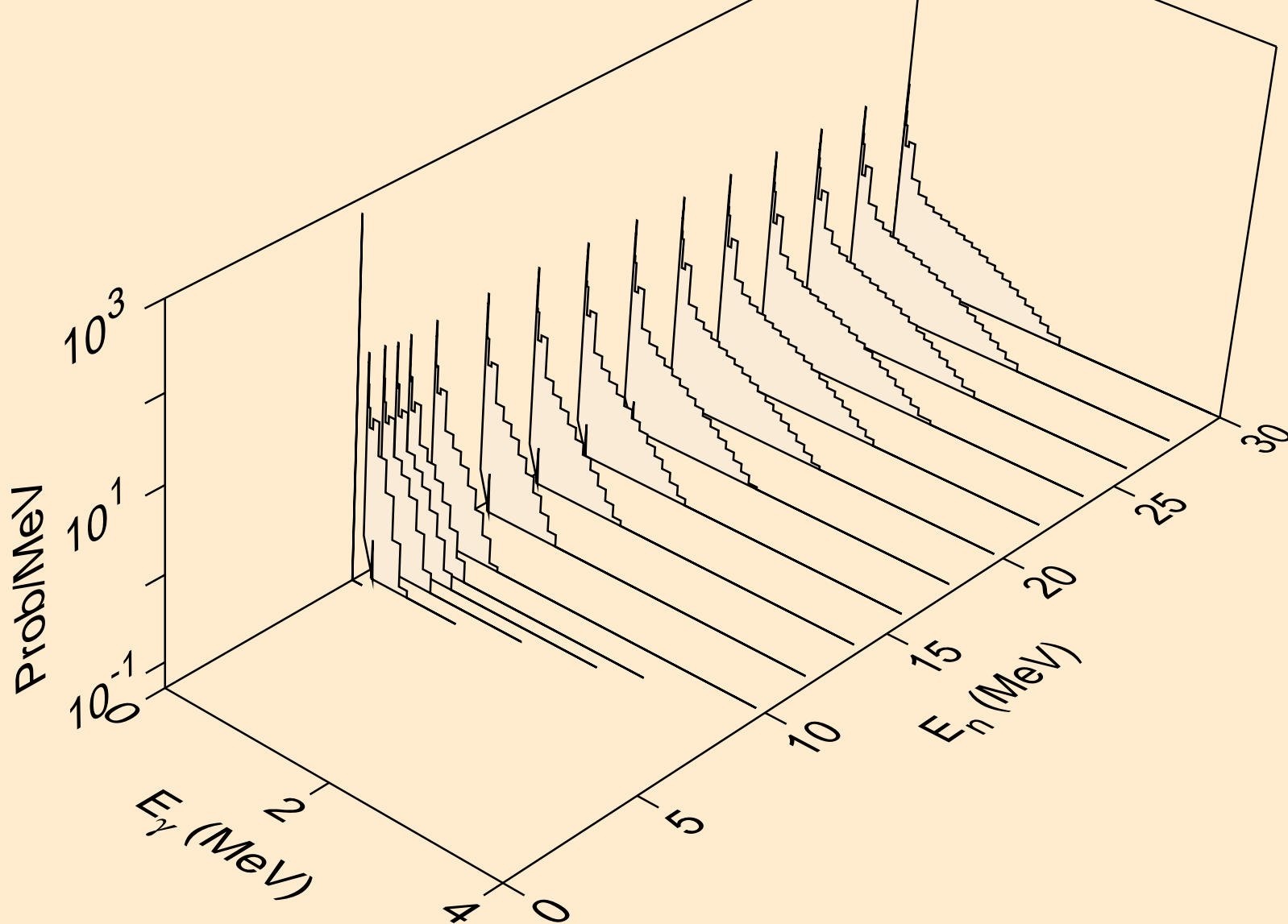

U231 NEUTRON ACER TENDL-2019 LIBRARY; T=293.16K  
Photon emission for (n,t)

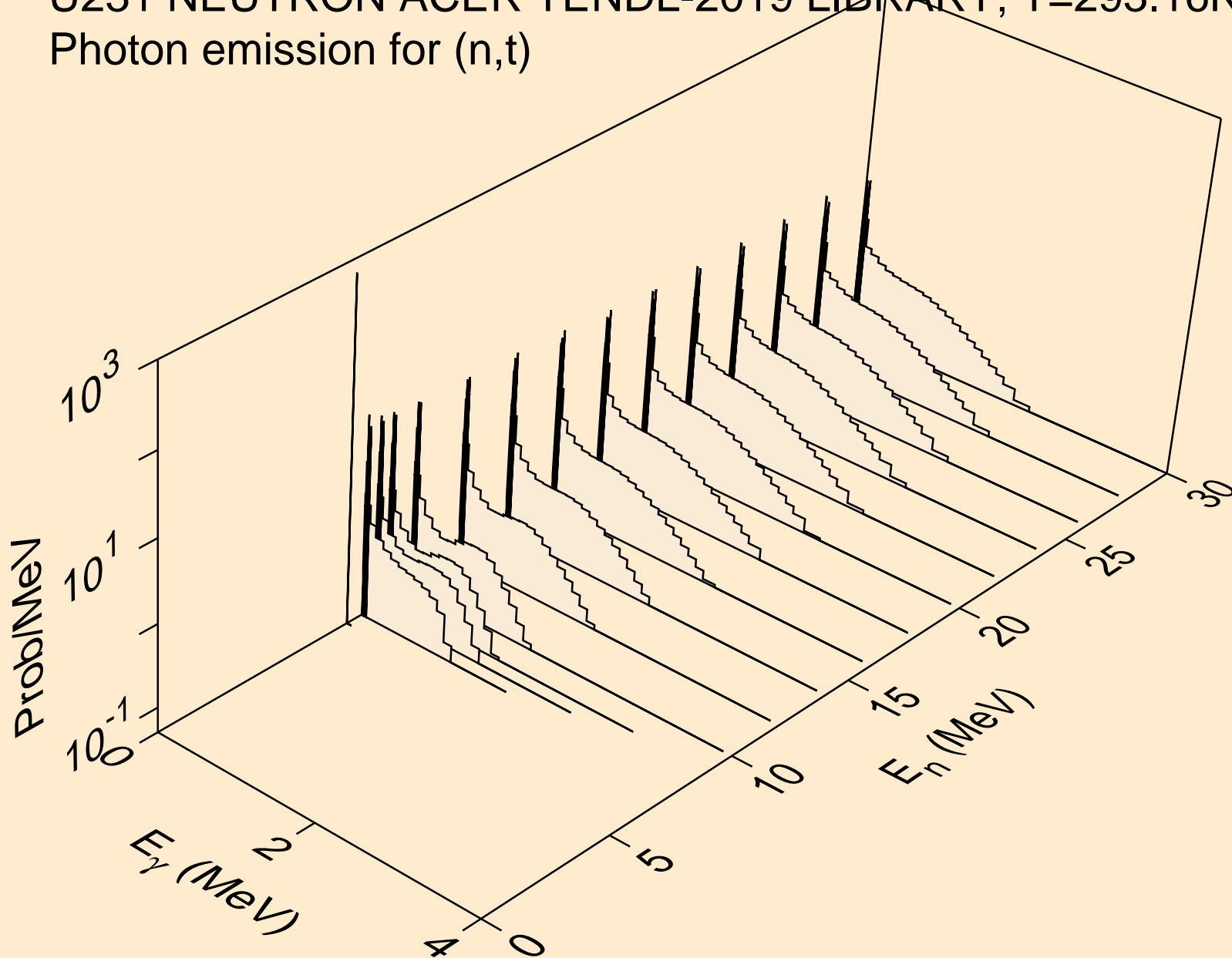

U231 NEUTRON ACER TENDL-2019 LIBRARY; T=293.16K  
Photon emission for (n,he3)

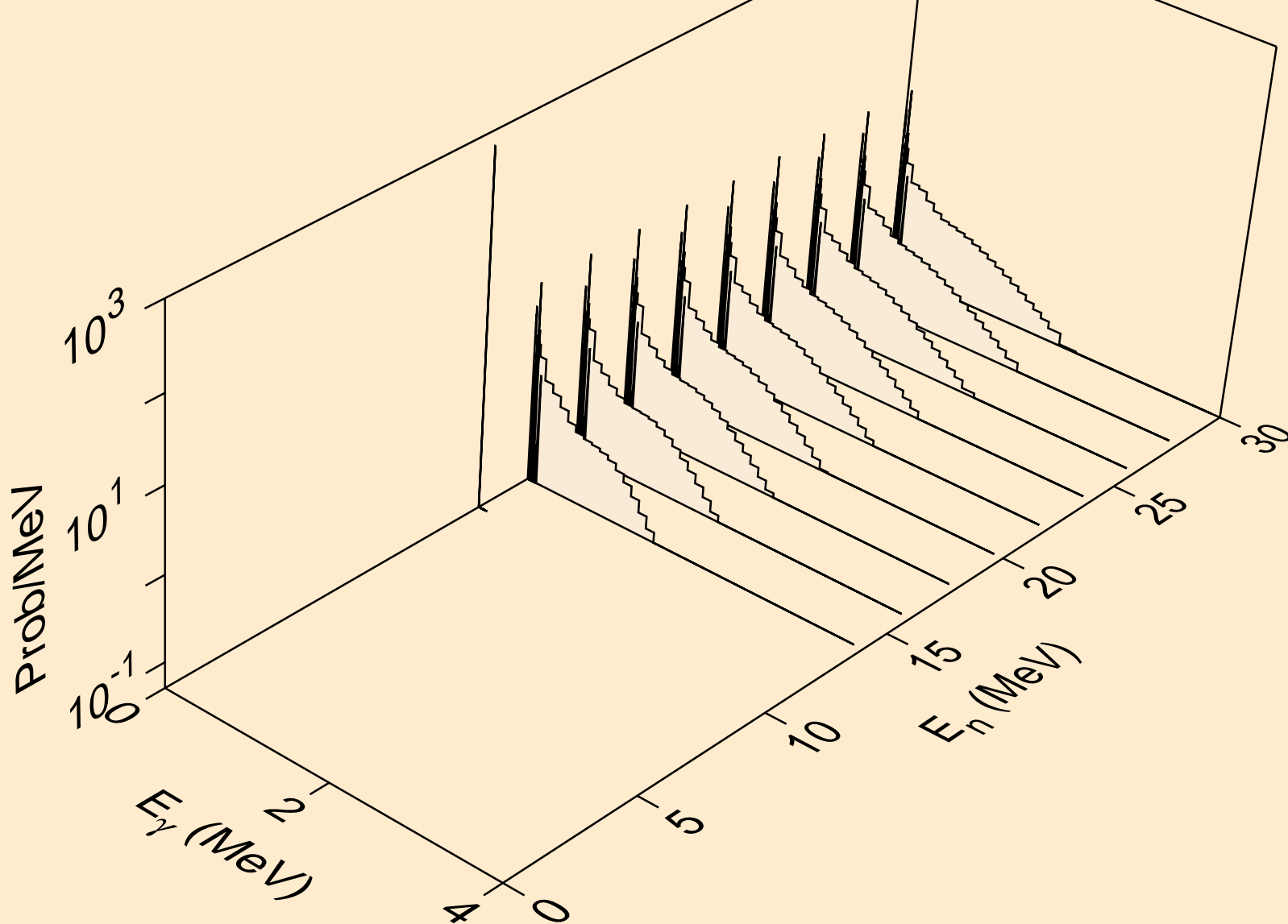

U231 NEUTRON ACER TENDL-2019 LIBRARY; T=293.16K  
Photon emission for (n,a)

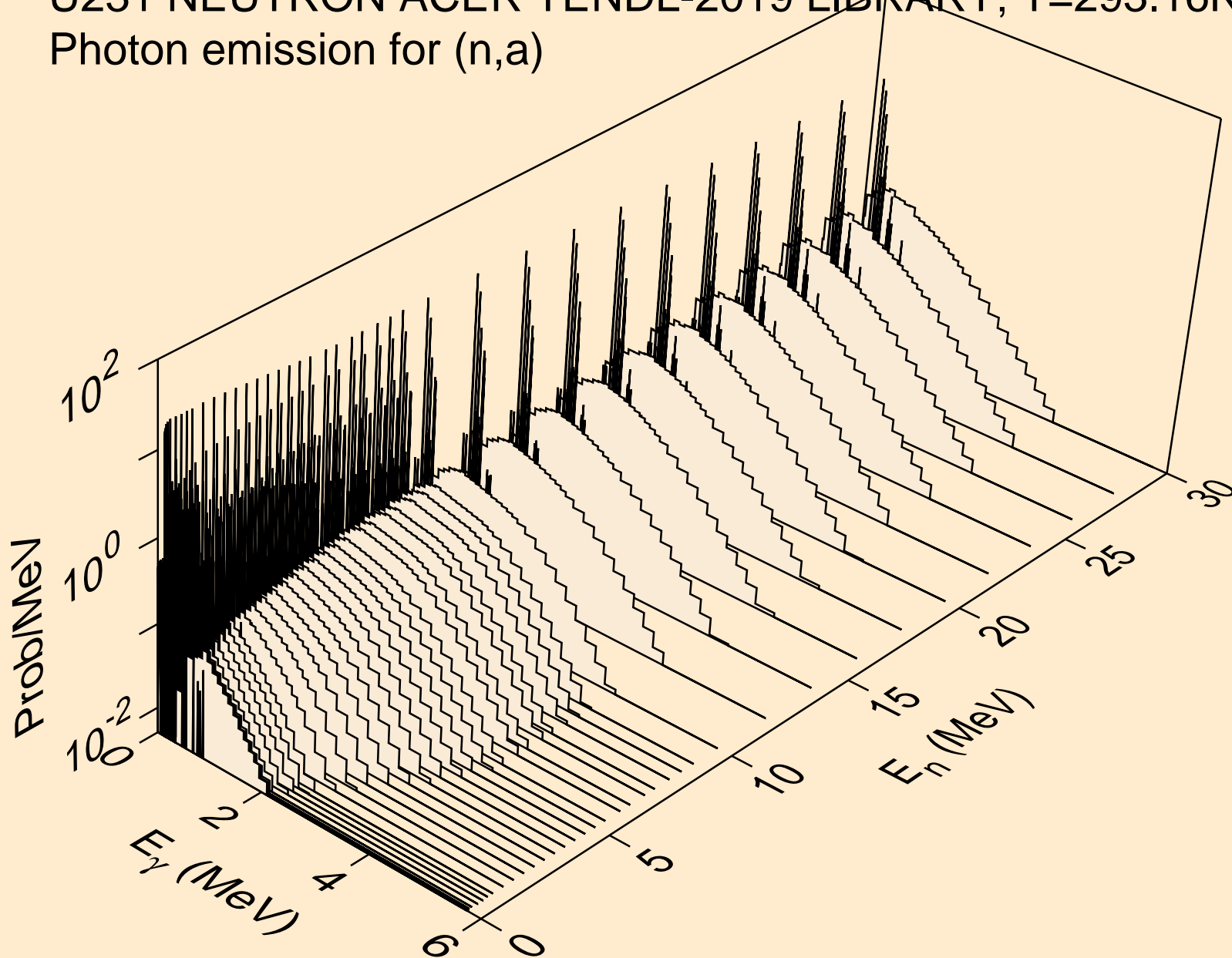

U231 NEUTRON ACER TENDL-2019 LIBRARY; T=293.16K  
Photon emission for (n,2a)

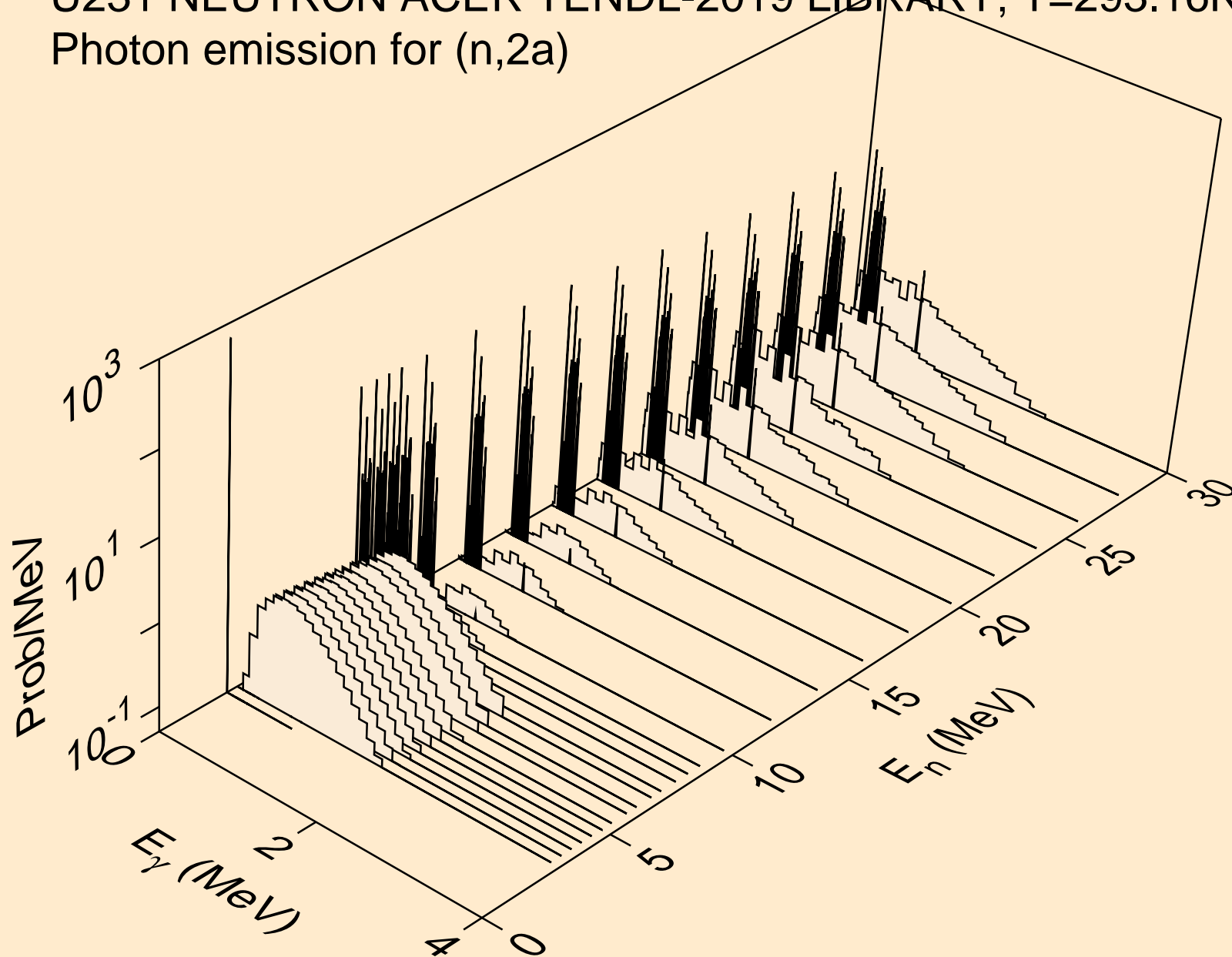

U231 NEUTRON ACER TENDL-2019 LIBRARY; T=293.16K  
Photon emission for (n,2p)

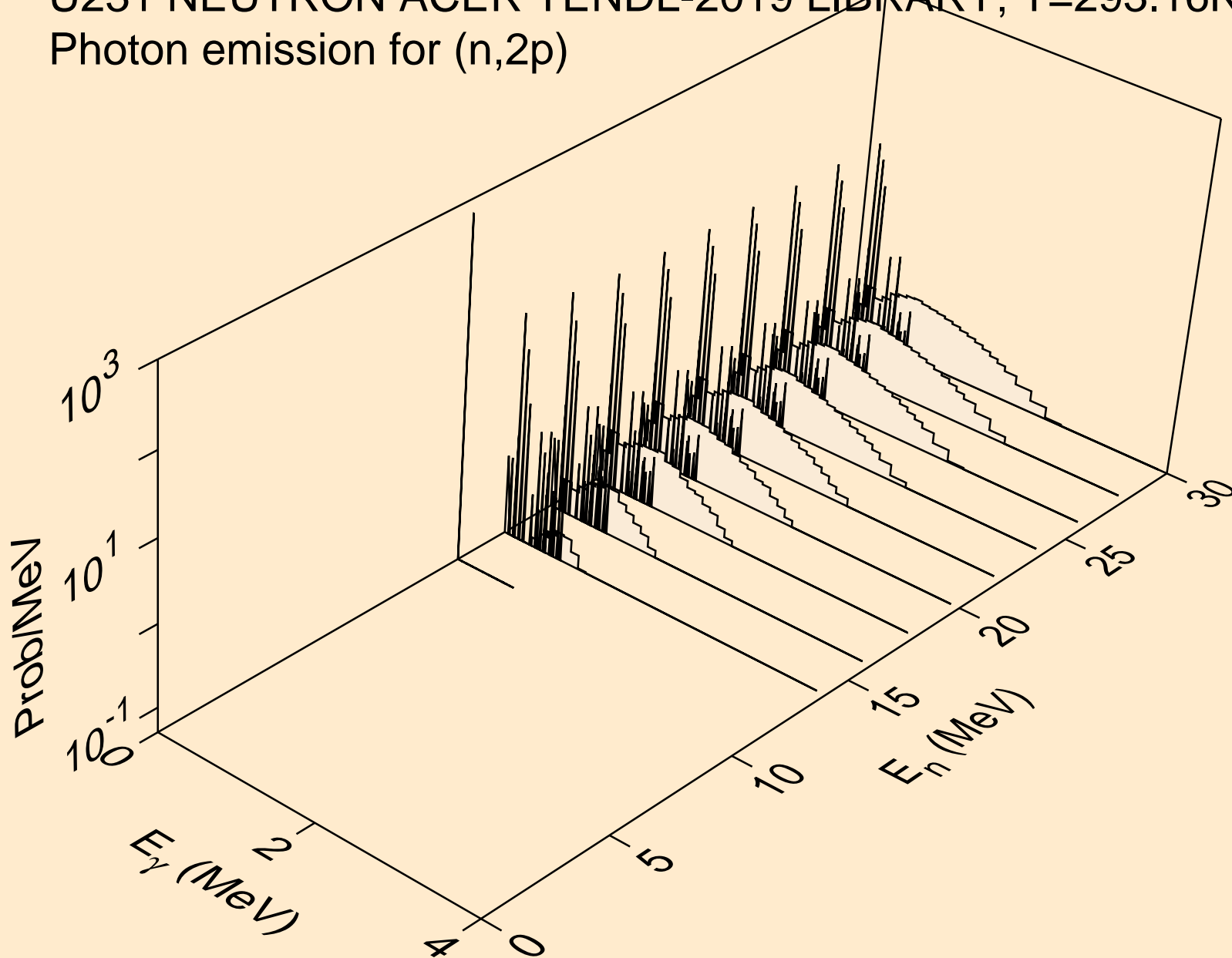

U231 NEUTRON ACER TENDL-2019 LIBRARY; T=293.16K  
Photon emission for (n,p $\alpha$ )

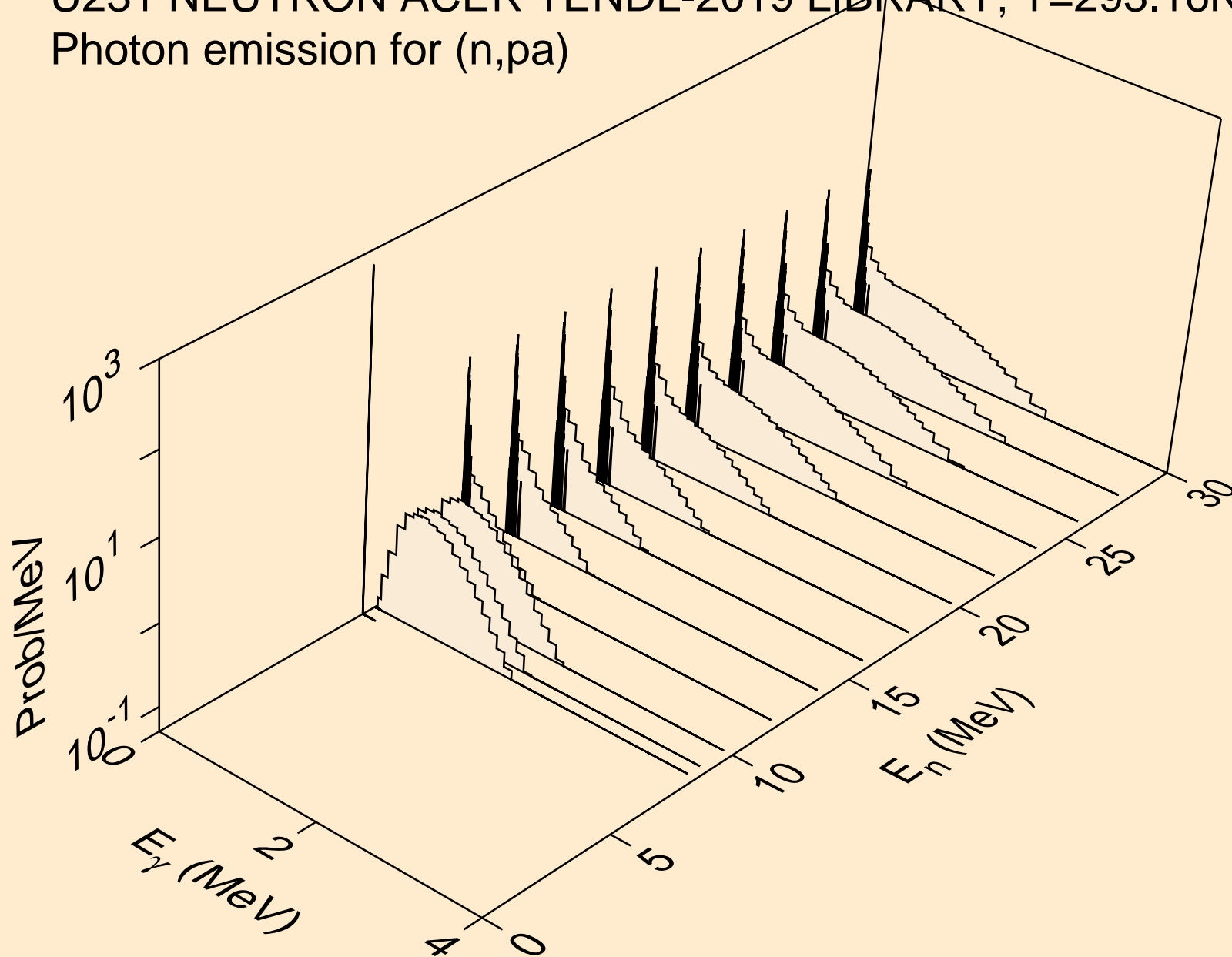

U231 NEUTRON ACER TENDL-2019 LIBRARY; T=293.16K  
Photon emission for (n,pd)

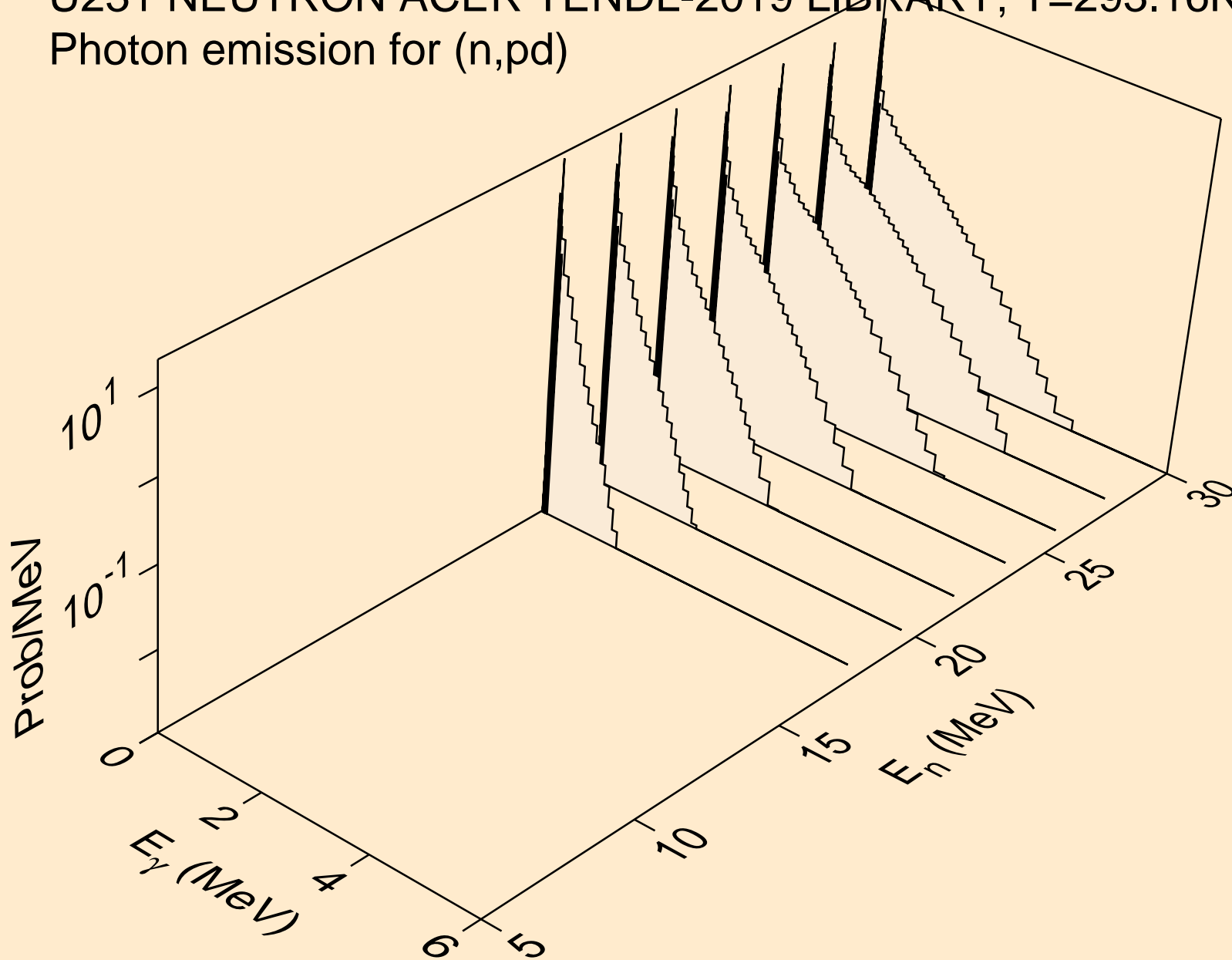

U231 NEUTRON ACER TENDL-2019 LIBRARY; T=293.16K  
thermal capture photon spectrum

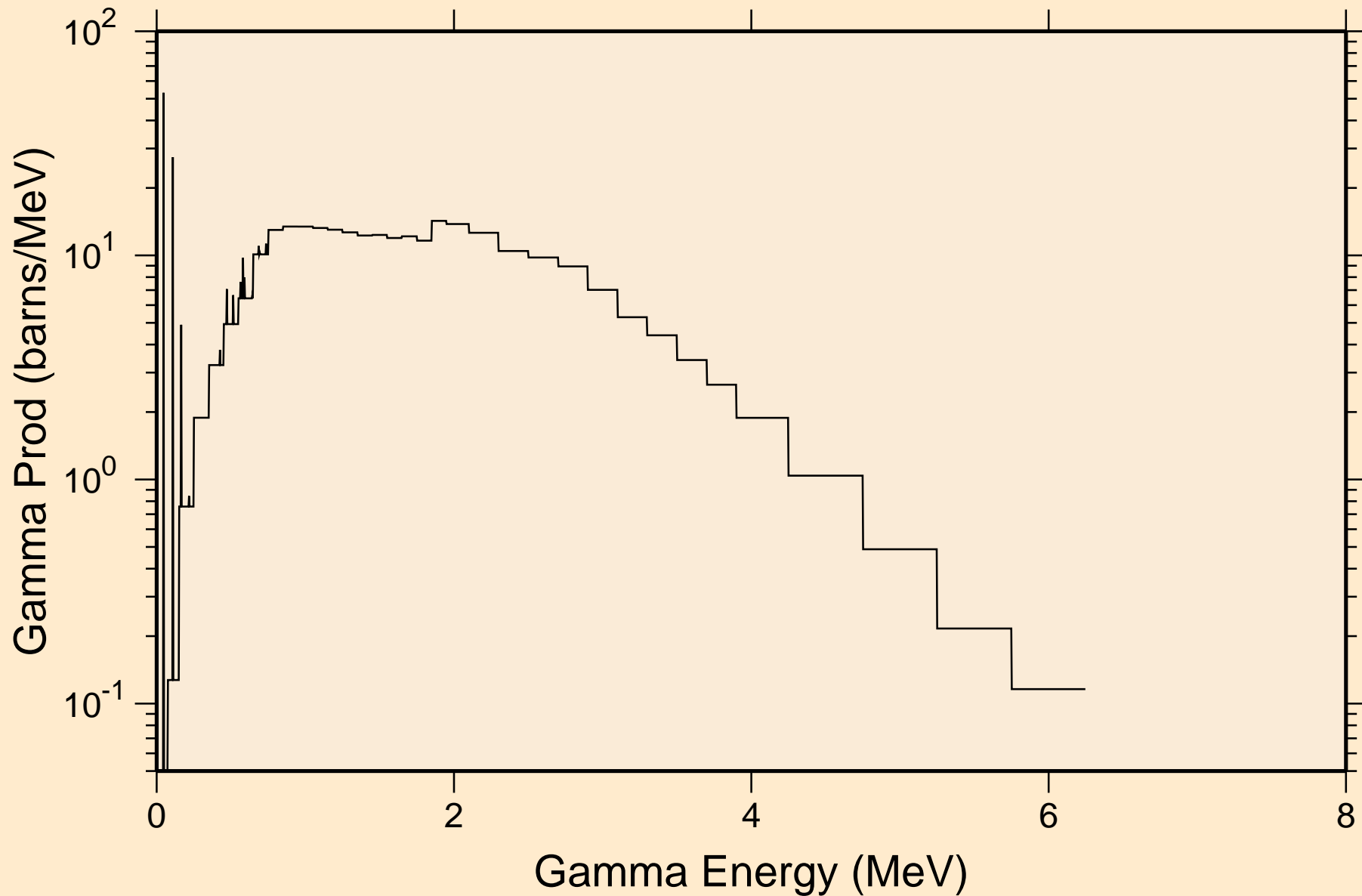

U231 NEUTRON ACER TENDL-2019 LIBRARY; T=293.16K  
14 MeV photon spectrum

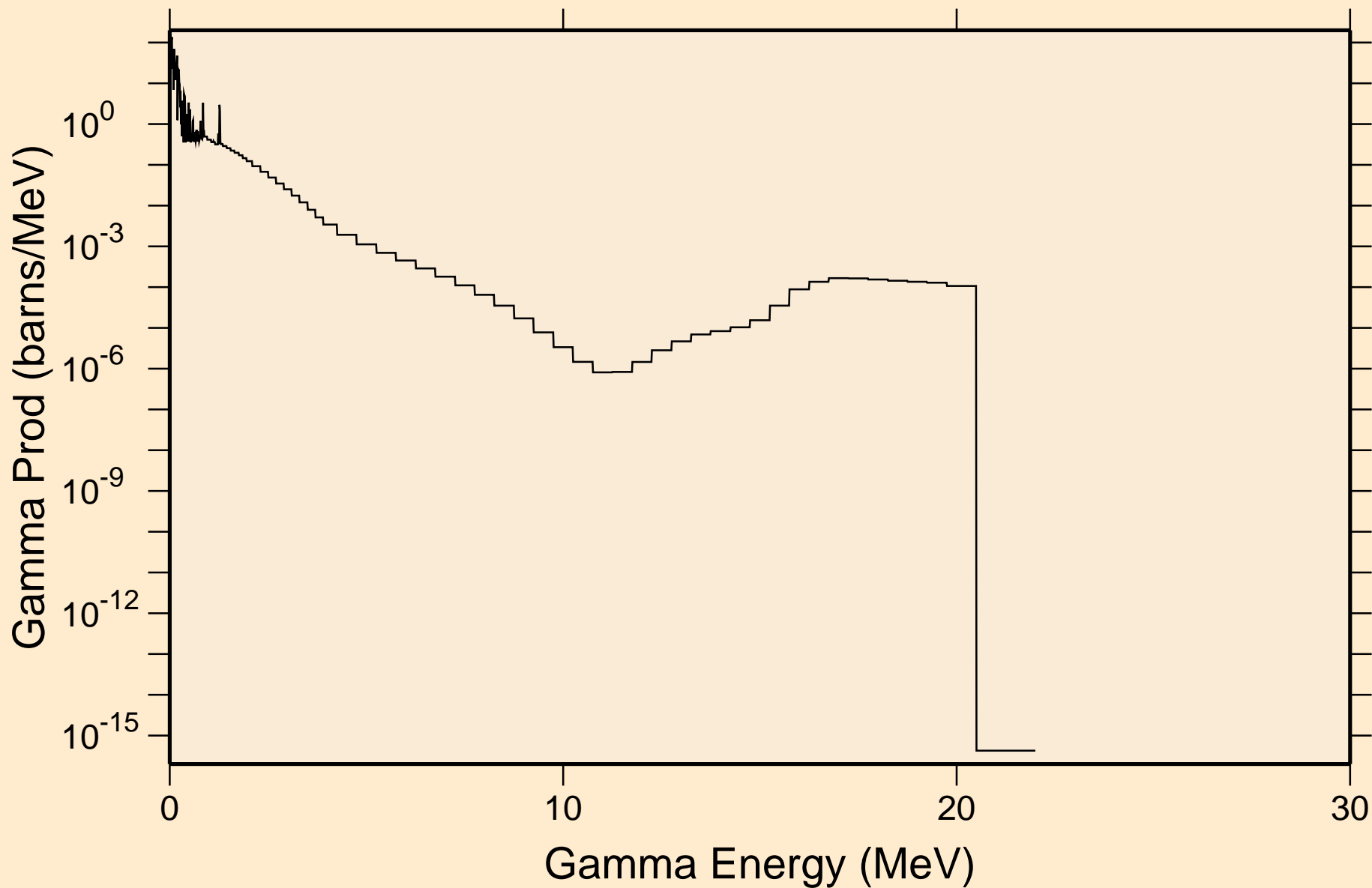

# U231 NEUTRON ACER TENDL-2019 LIBRARY; T=293.16K

## Particle heating contributions

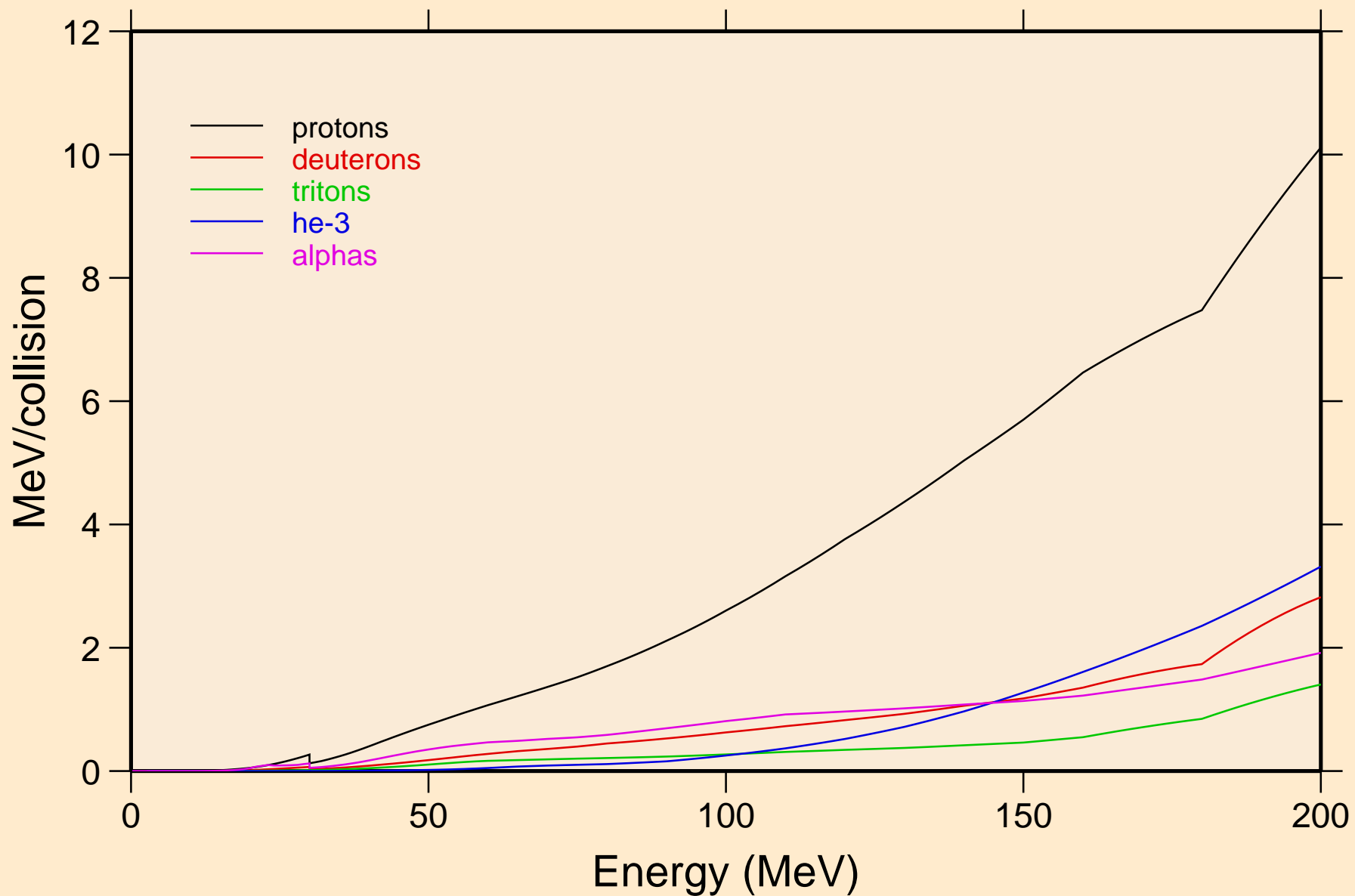

U231 NEUTRON ACER TENDL-2019 LIBRARY; T=293.16K  
Recoil Heating

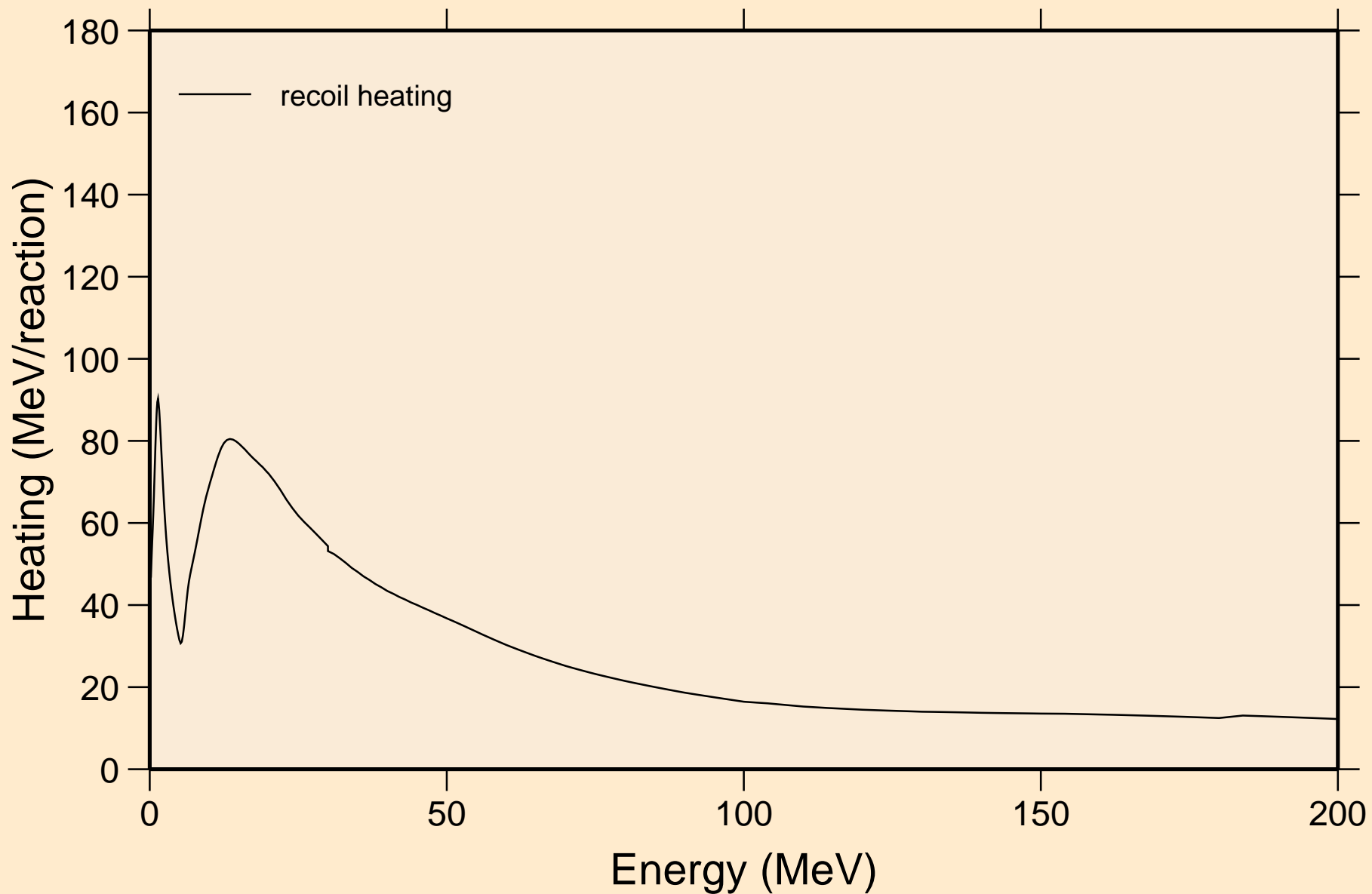

U231 NEUTRON ACER TENDL-2019 LIBRARY; T=293.16K  
Particle production cross sections

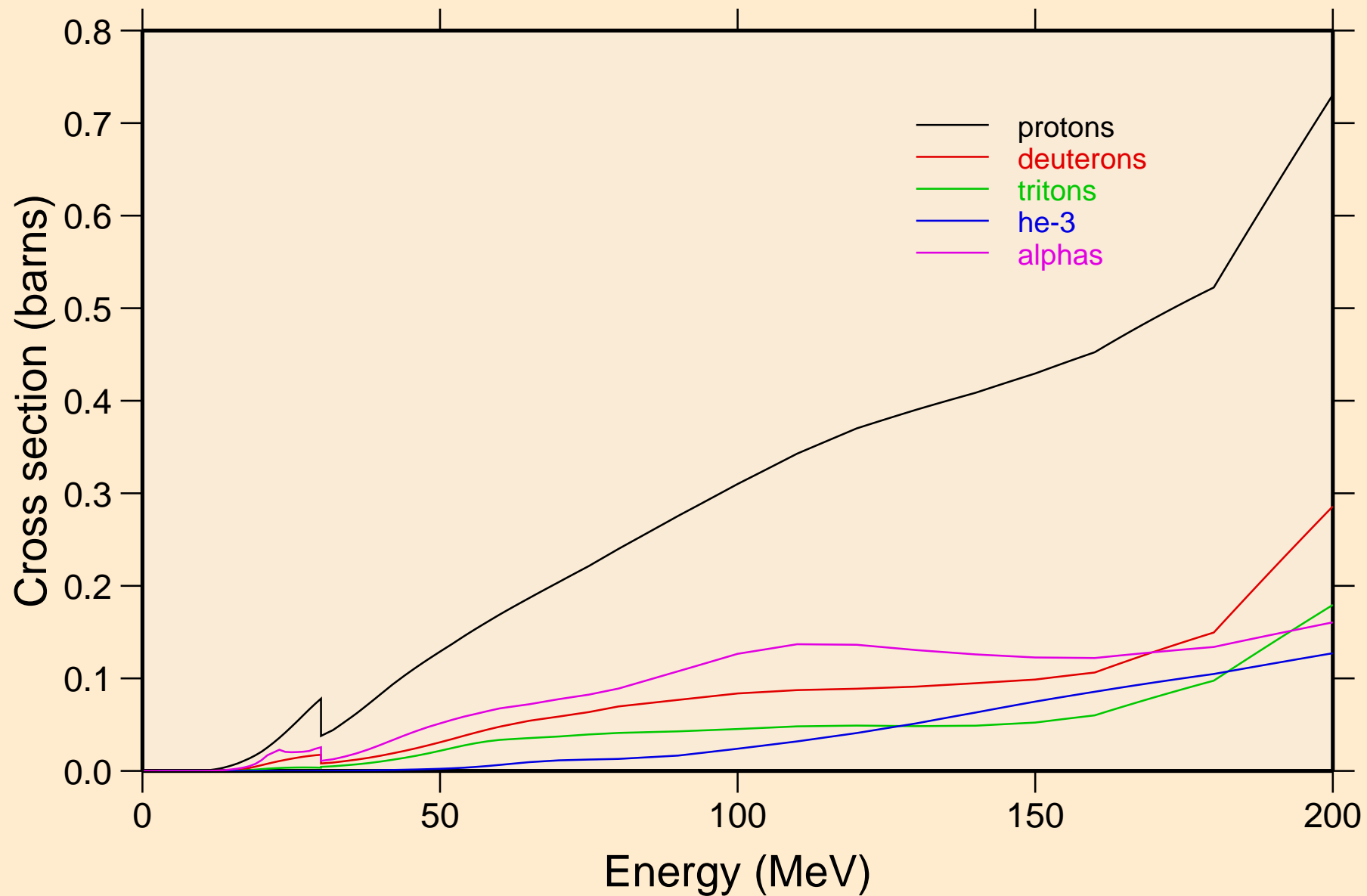

U231 NEUTRON ACER TENDL-2019 LIBRARY; T=293.16K  
protons from (n,x)

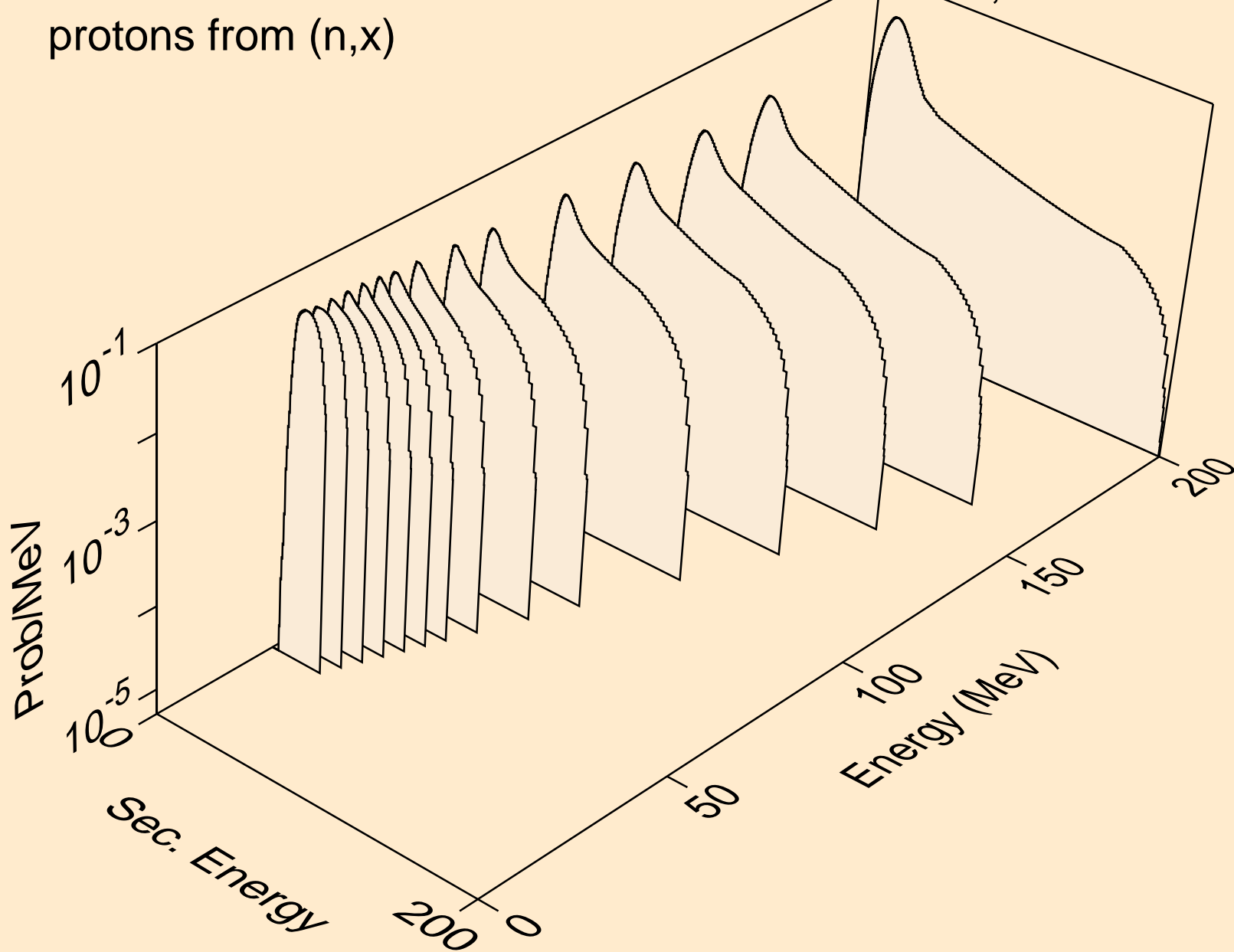

U231 NEUTRON ACER TENDL-2019 LIBRARY; T=293.16K  
protons from (n,n\*)p

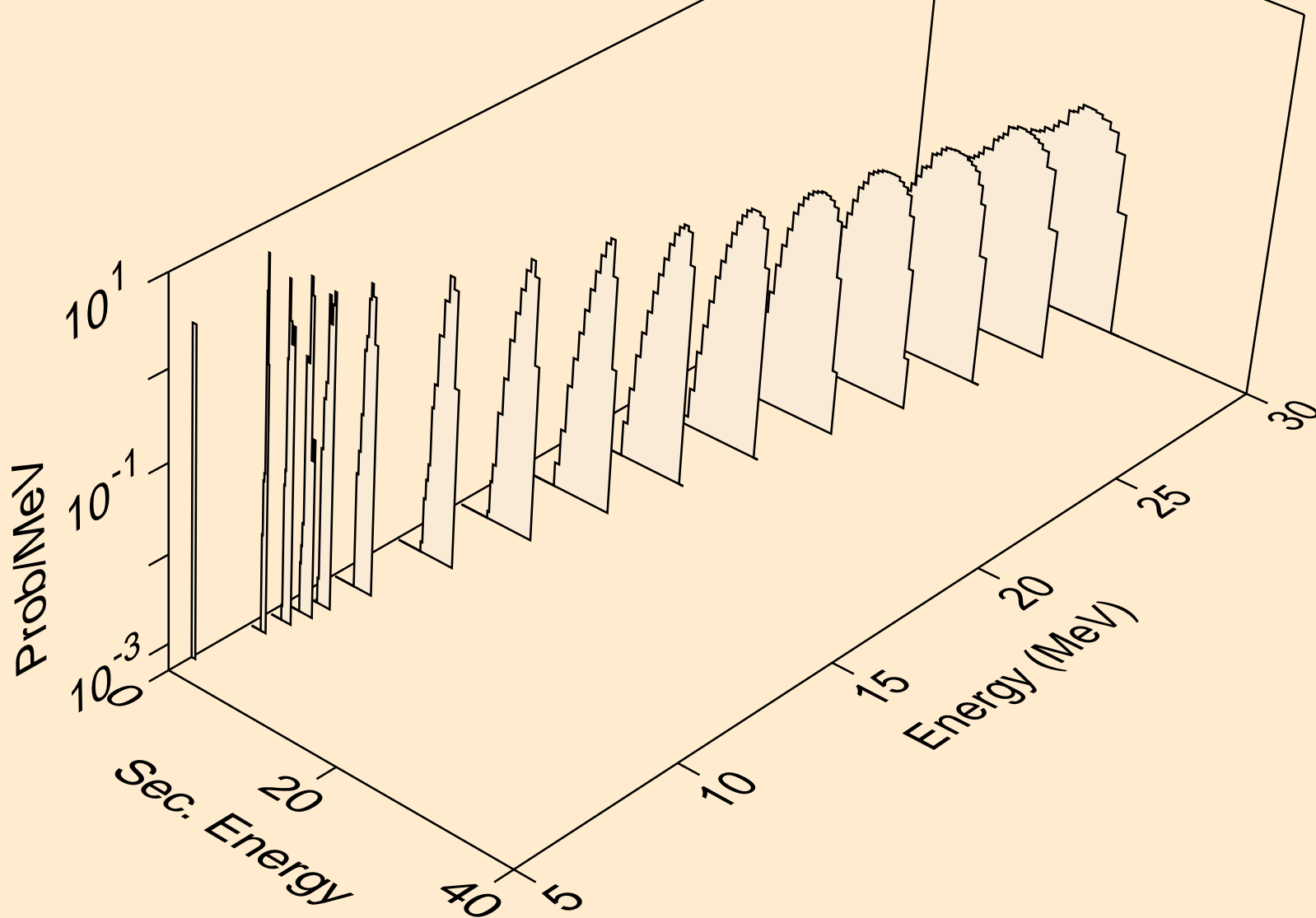

U231 NEUTRON ACER TENDL-2019 LIBRARY; T=293.16K  
protons from (n,2np)

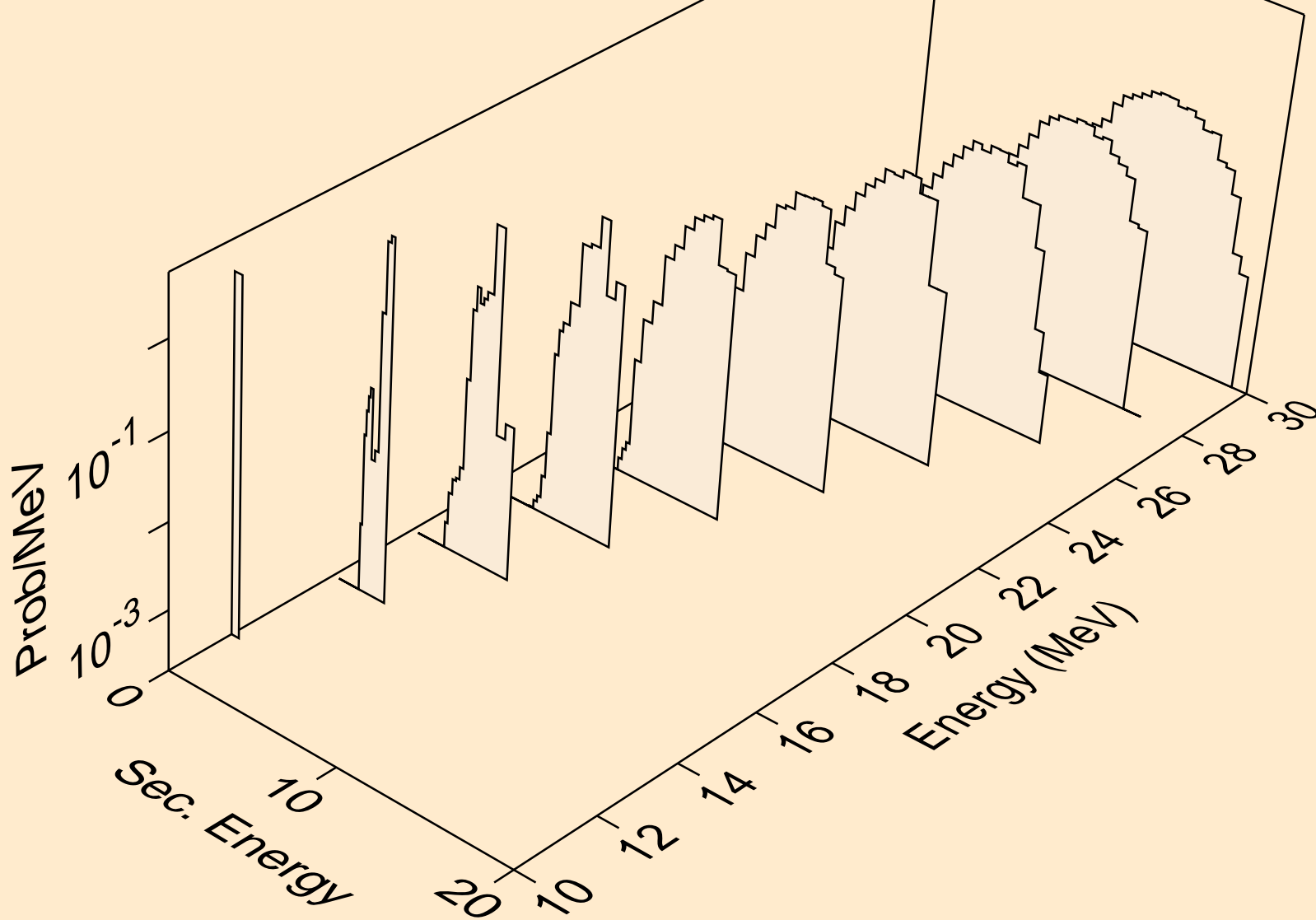

U231 NEUTRON ACER TENDL-2019 LIBRARY; T=293.16K  
protons from (n,3np)

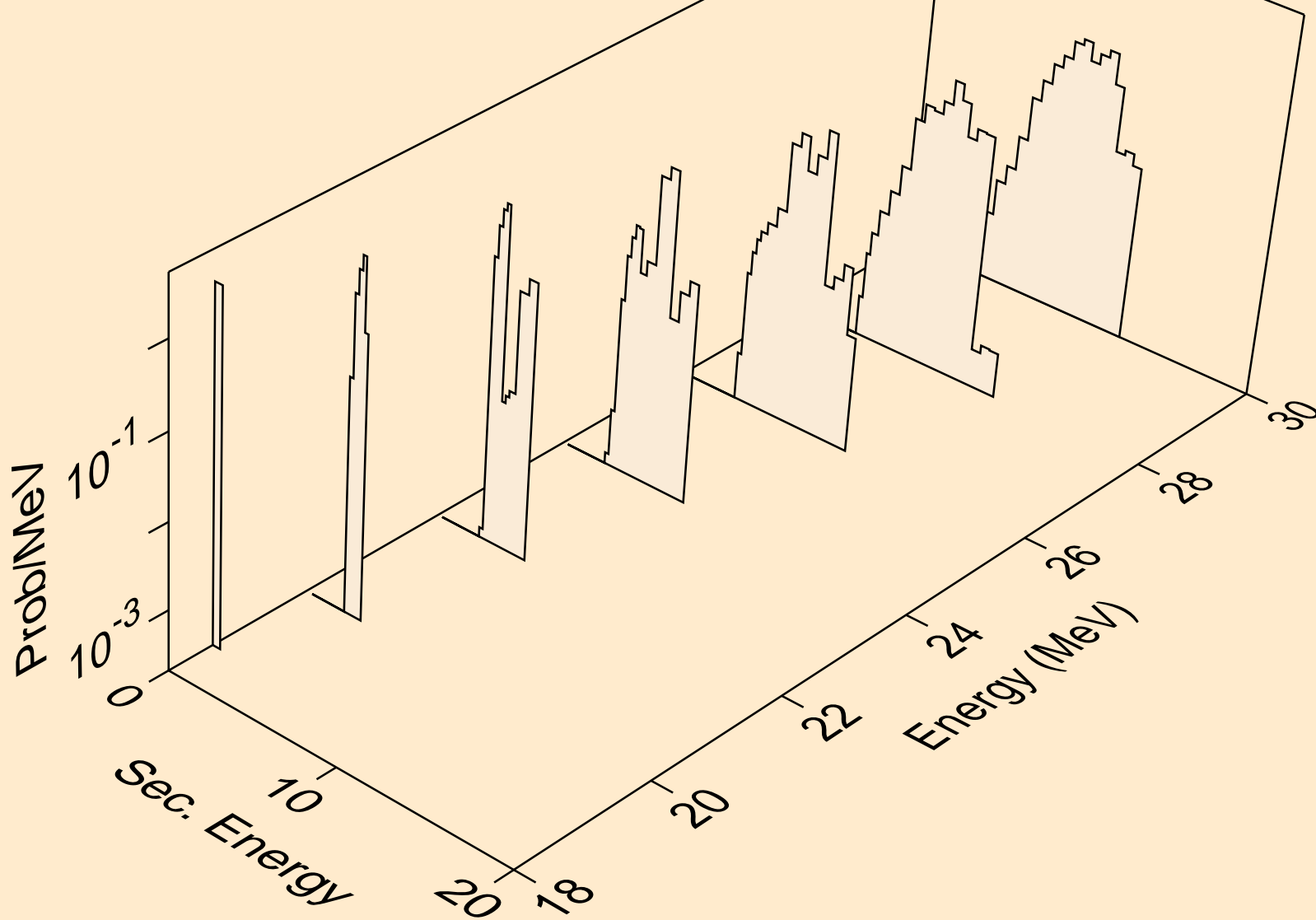

U231 NEUTRON ACER TENDL-2019 LIBRARY; T=293.16K  
protons from (n,2np)

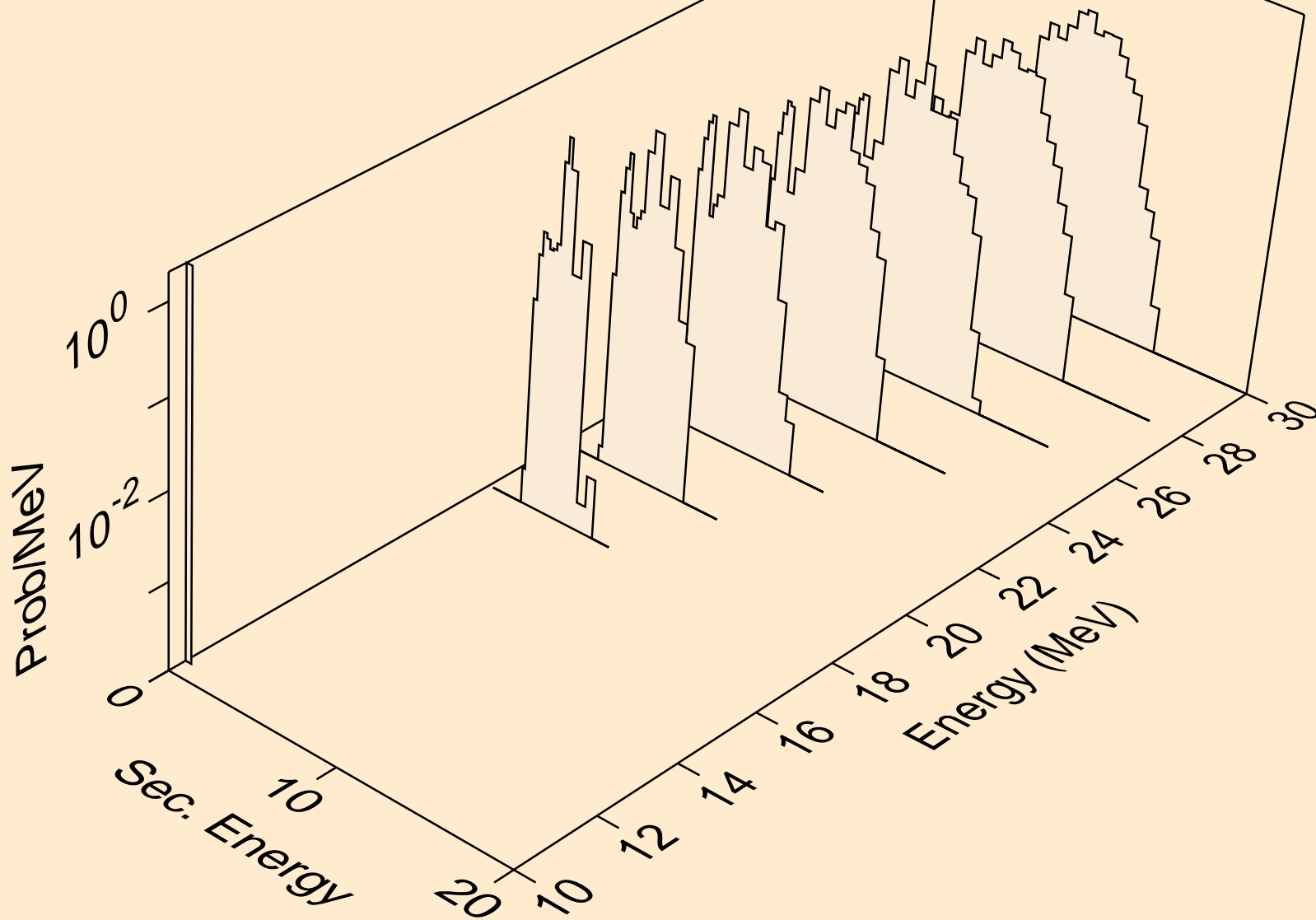

U231 NEUTRON ACER TENDL-2019 LIBRARY; T=293.16K  
protons from (n,npa)

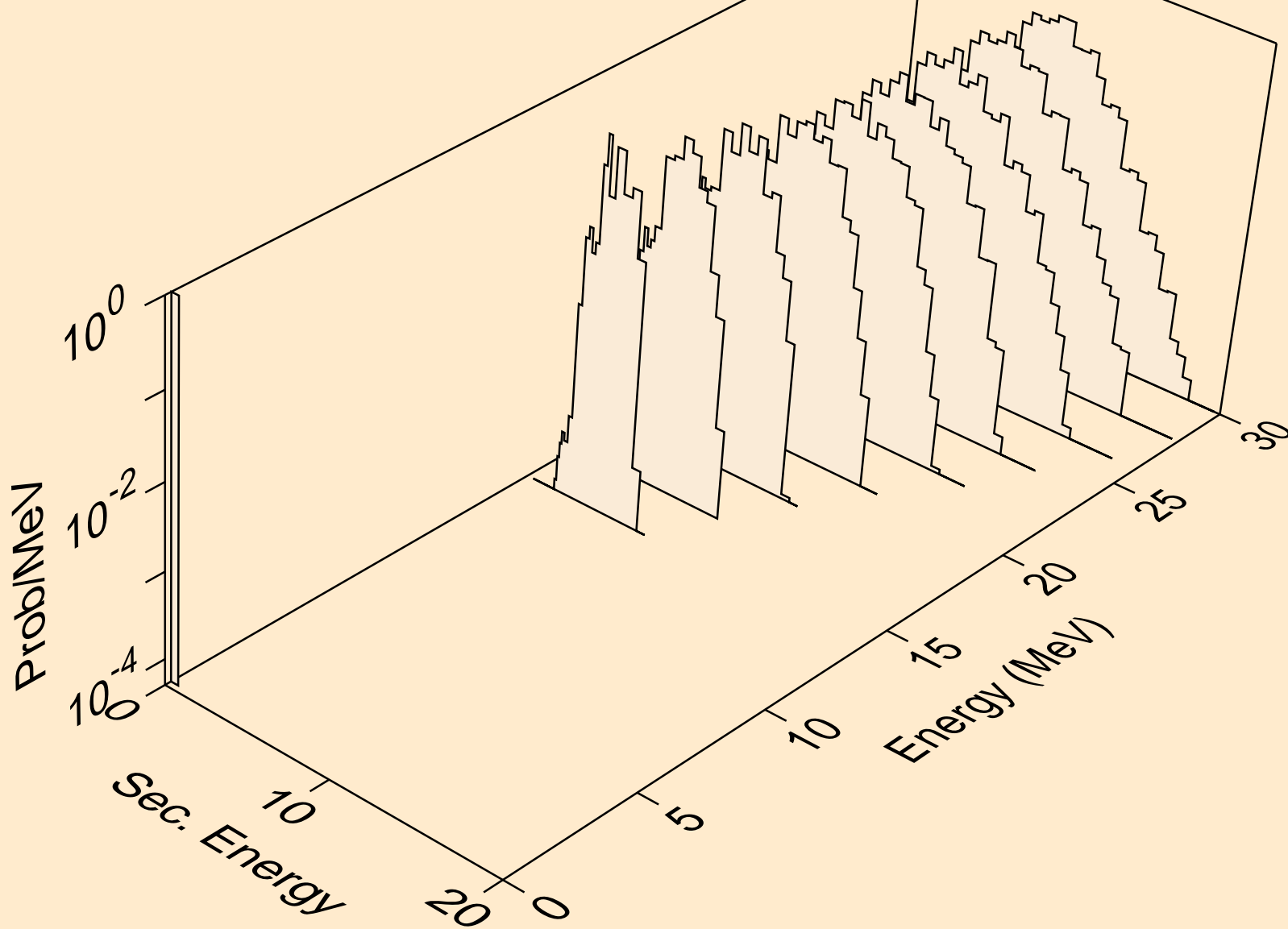

U231 NEUTRON ACER TENDL-2019 LIBRARY; T=293.16K  
protons from (n,p)

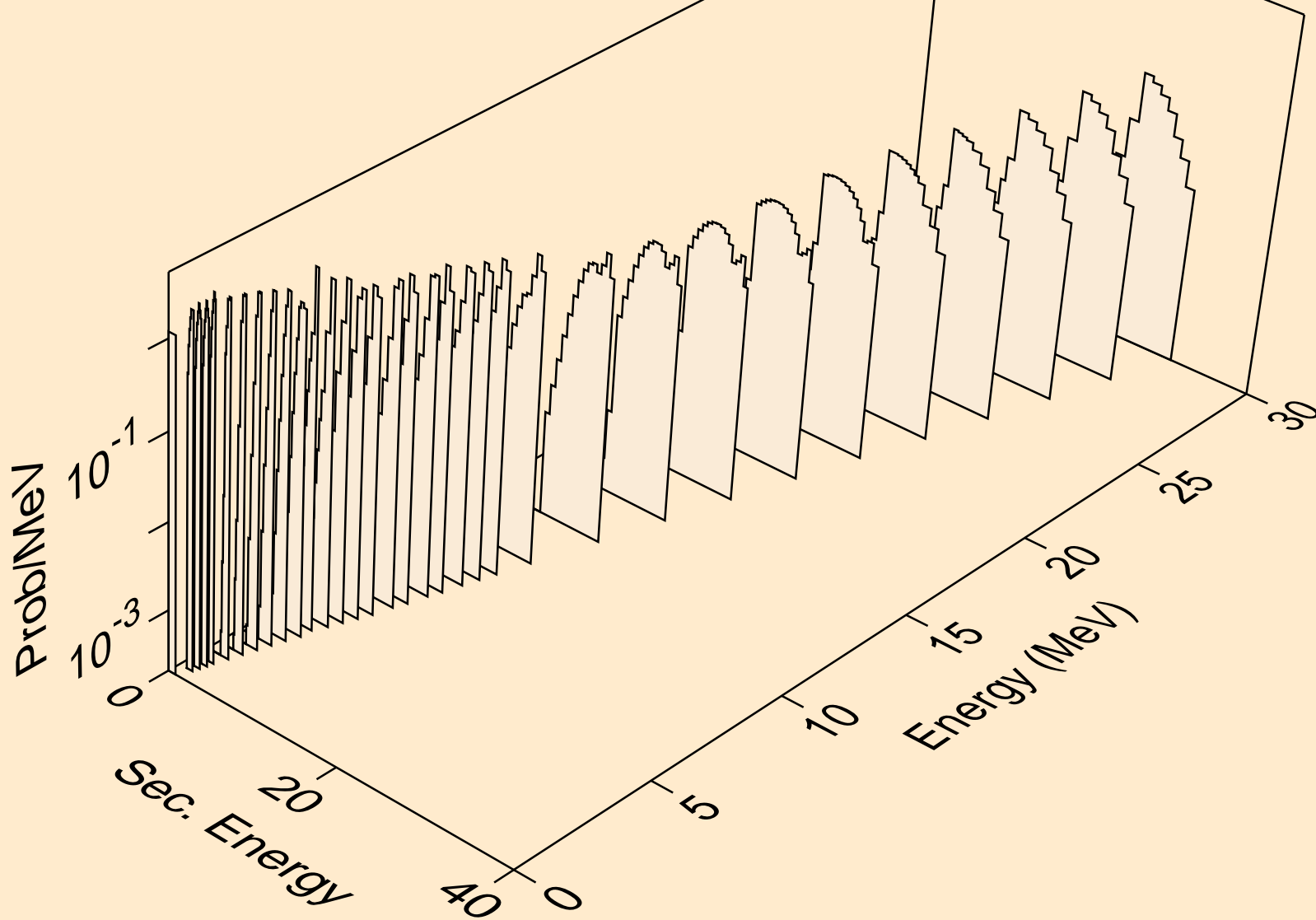

U231 NEUTRON ACER TENDL-2019 LIBRARY; T=293.16K  
protons from (n,2p)

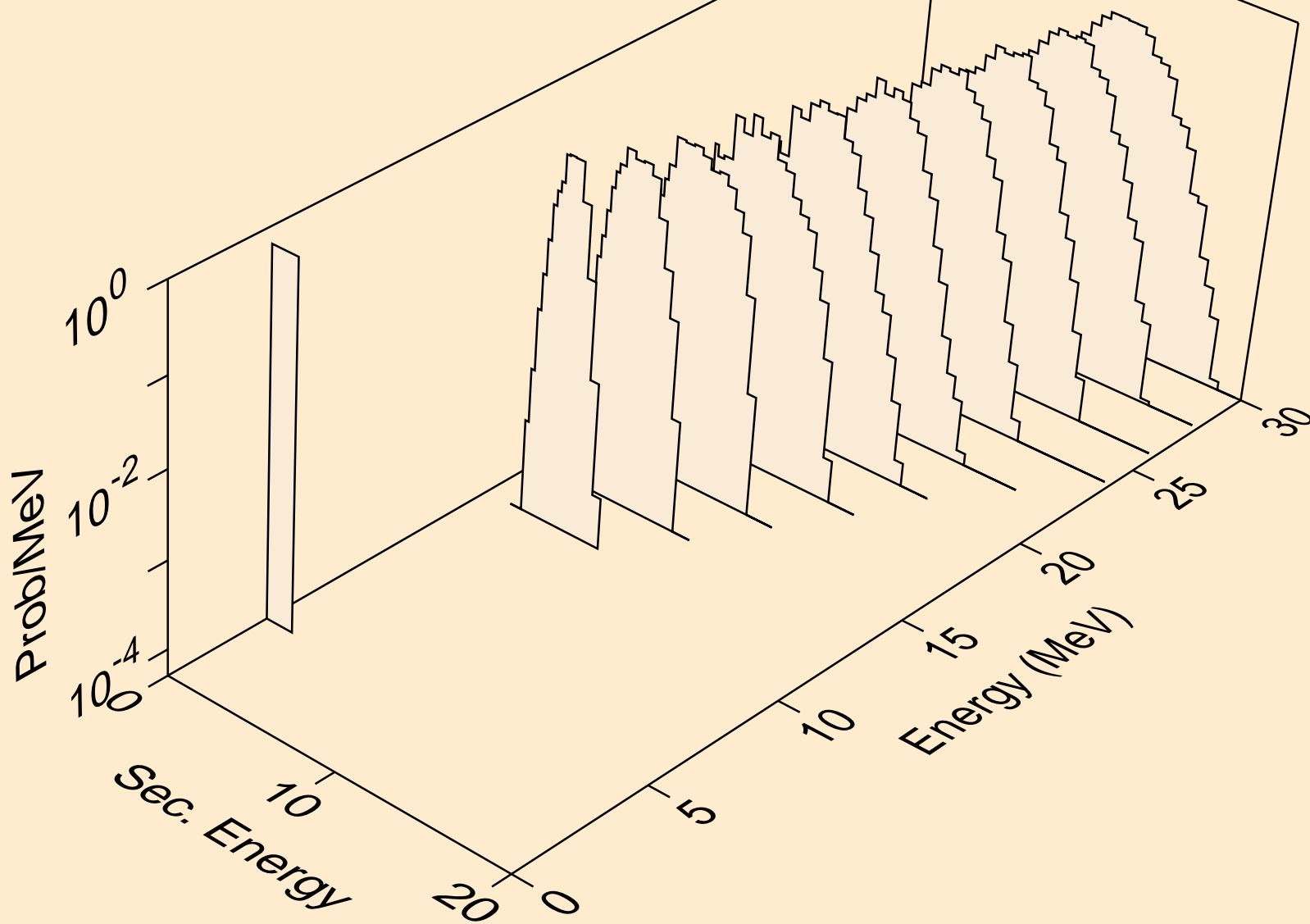

U231 NEUTRON ACER TENDL-2019 LIBRARY; T=293.16K  
protons from (n,p)

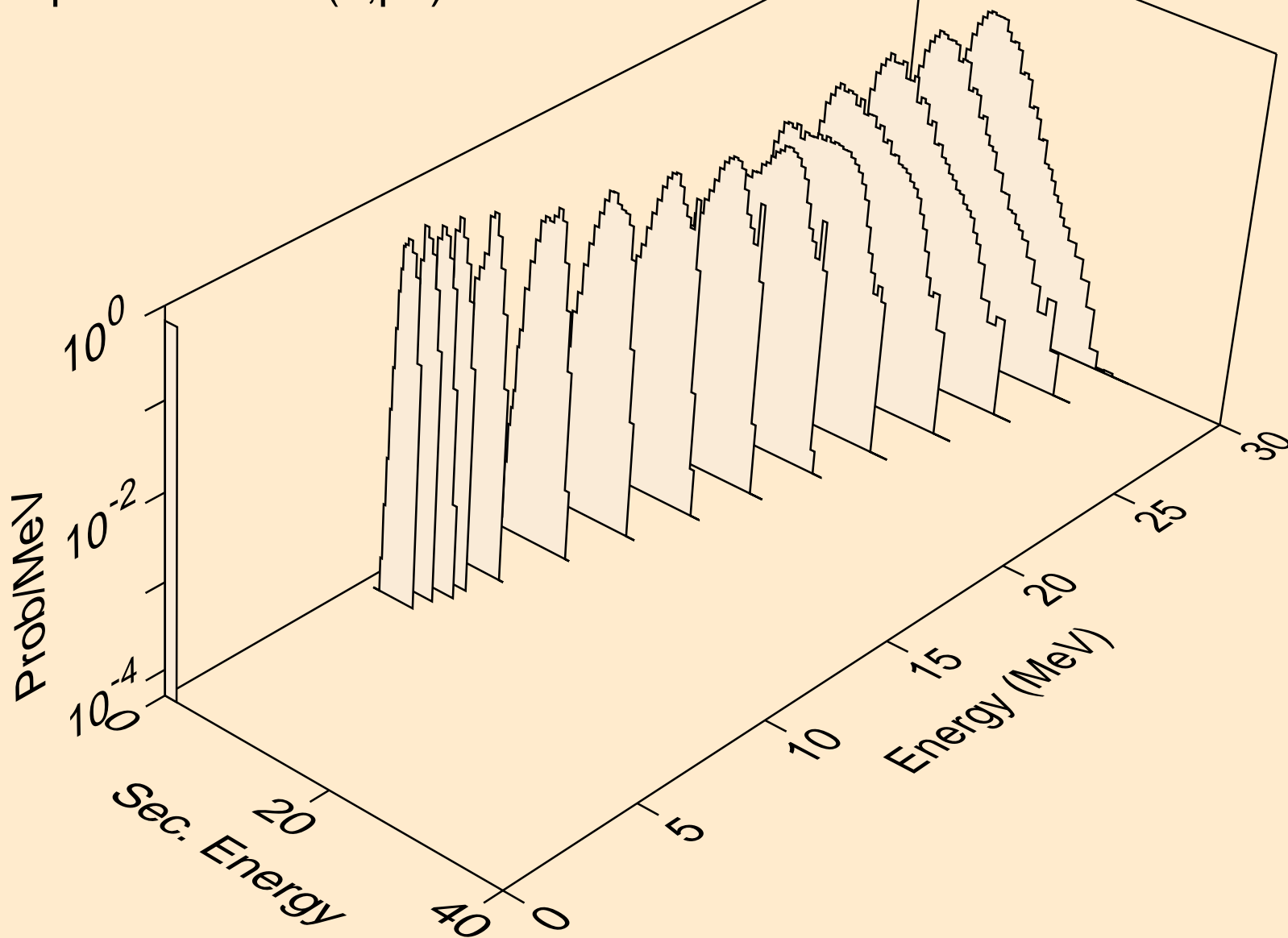

U231 NEUTRON ACER TENDL-2019 LIBRARY; T=293.16K  
protons from (n,pd)

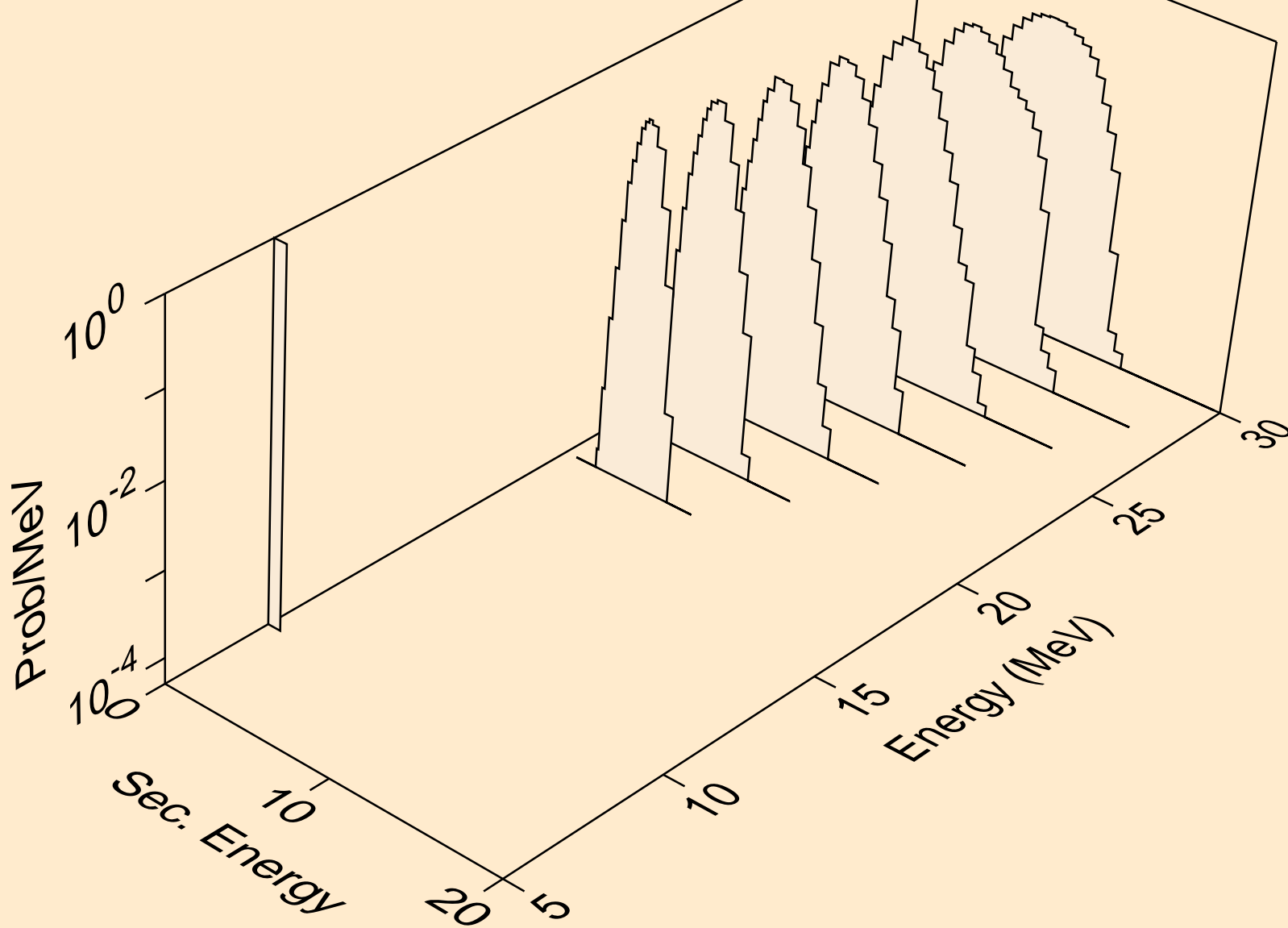

U231 NEUTRON ACER TENDL-2019 LIBRARY; T=293.16K  
deuterons from (n,x)

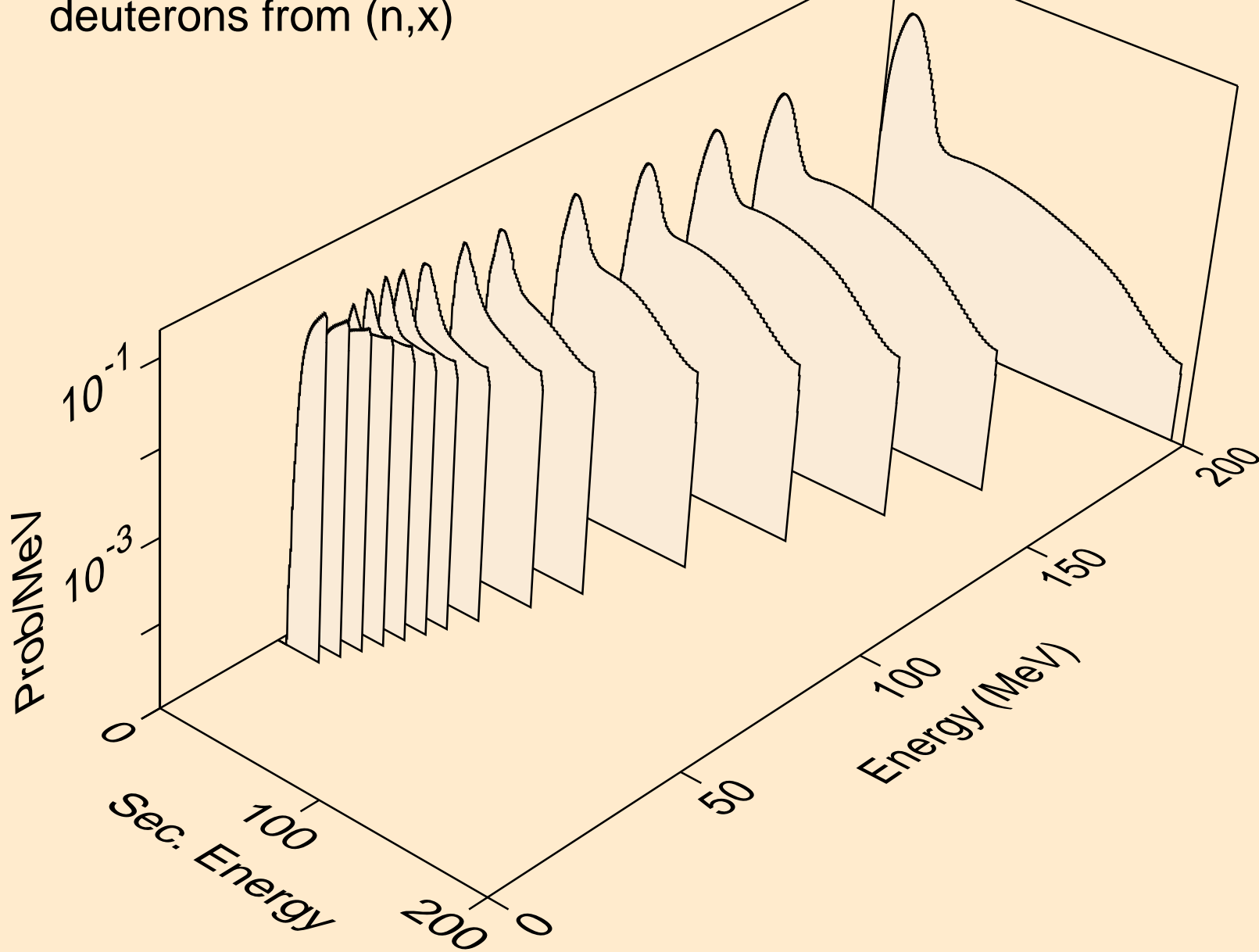

U231 NEUTRON ACER TENDL-2019 LIBRARY; T=293.16K  
deuterons from (n,2nd)

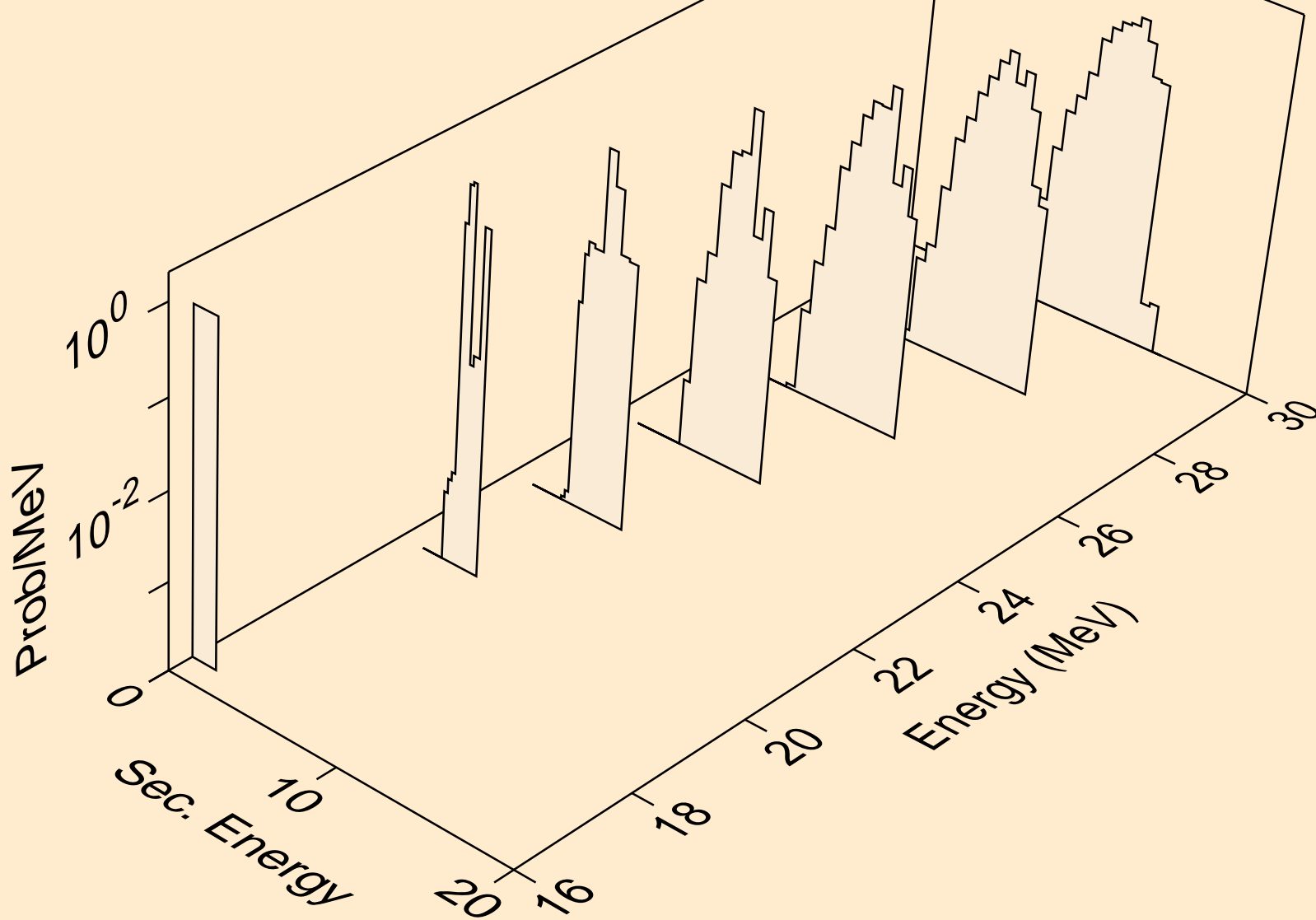

U231 NEUTRON ACER TENDL-2019 LIBRARY; T=293.16K  
deuterons from (n,n\*)d

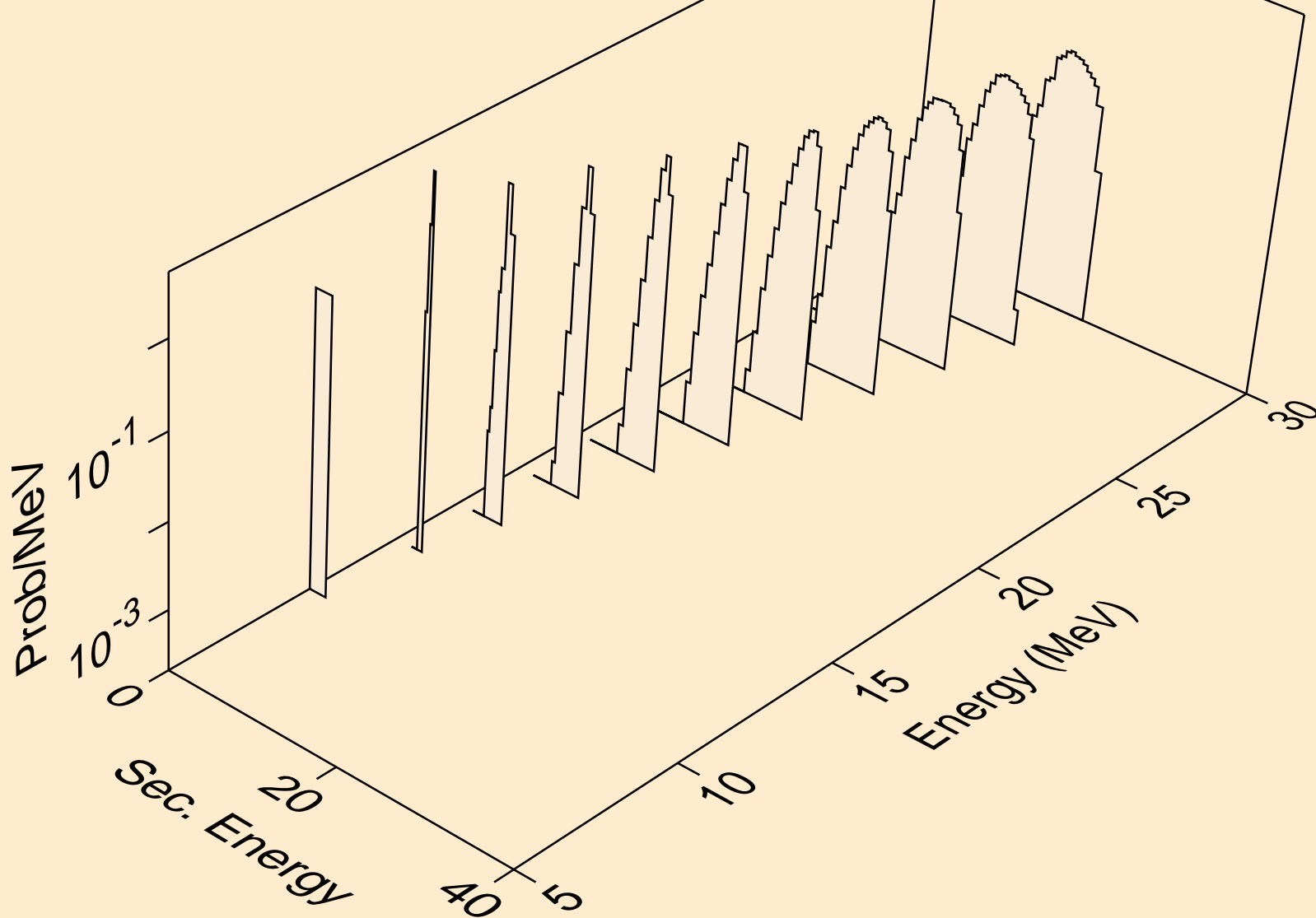

U231 NEUTRON ACER TENDL-2019 LIBRARY; T=293.16K  
deuterons from (n,d)

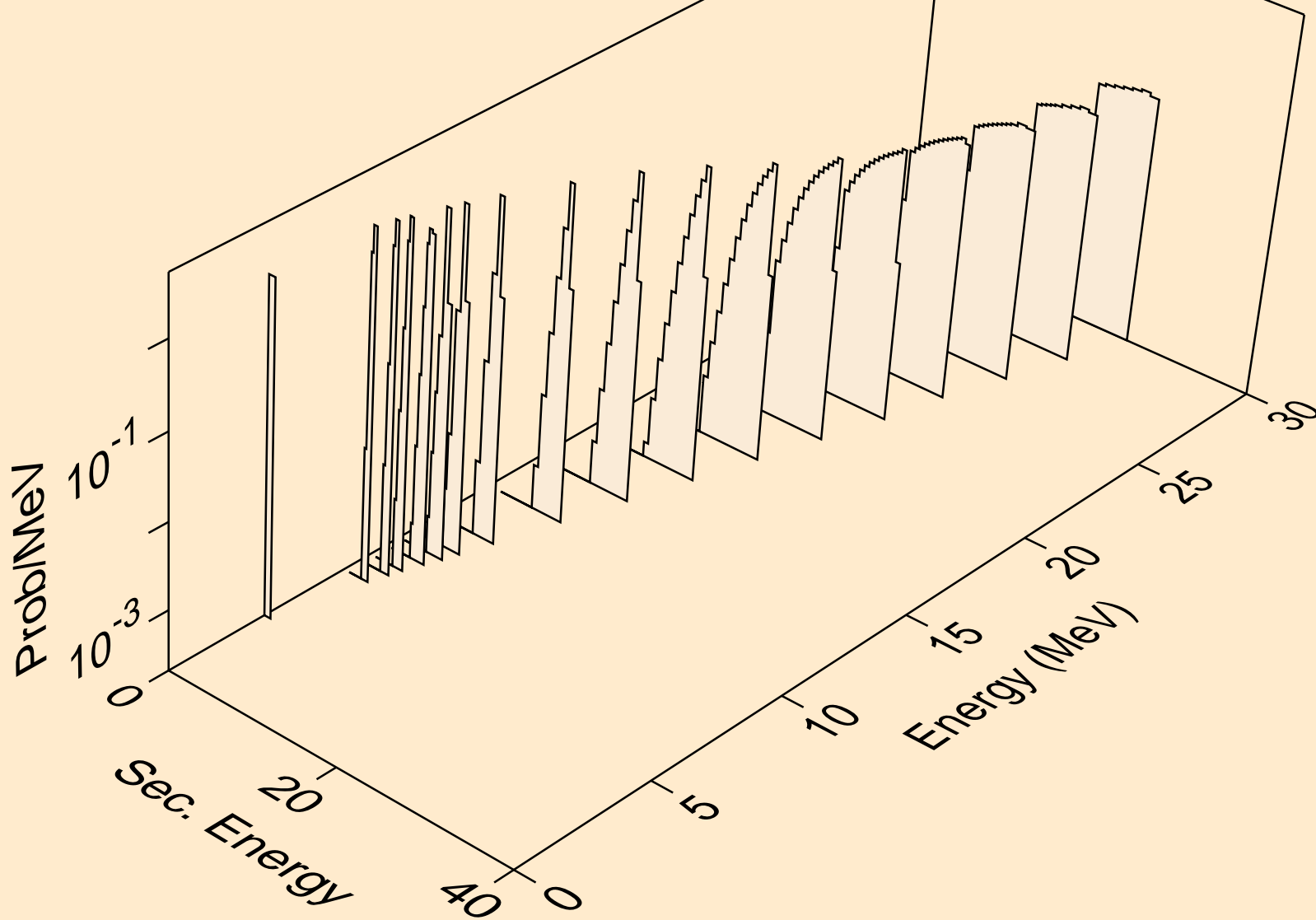

U231 NEUTRON ACER TENDL-2019 LIBRARY; T=293.16K  
deuterons from (n,pd)

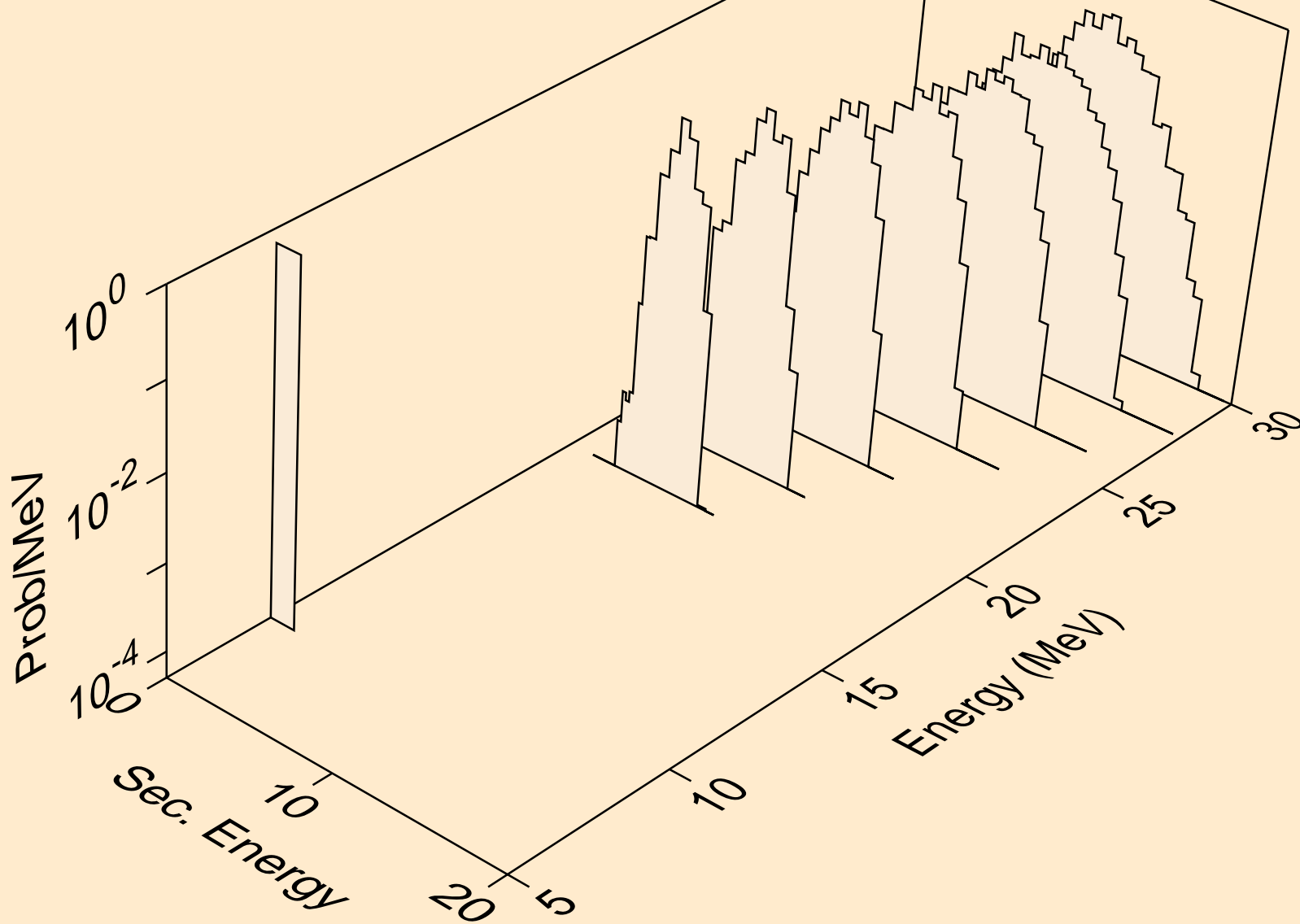

U231 NEUTRON ACER TENDL-2019 LIBRARY; T=293.16K  
tritons from (n,x)

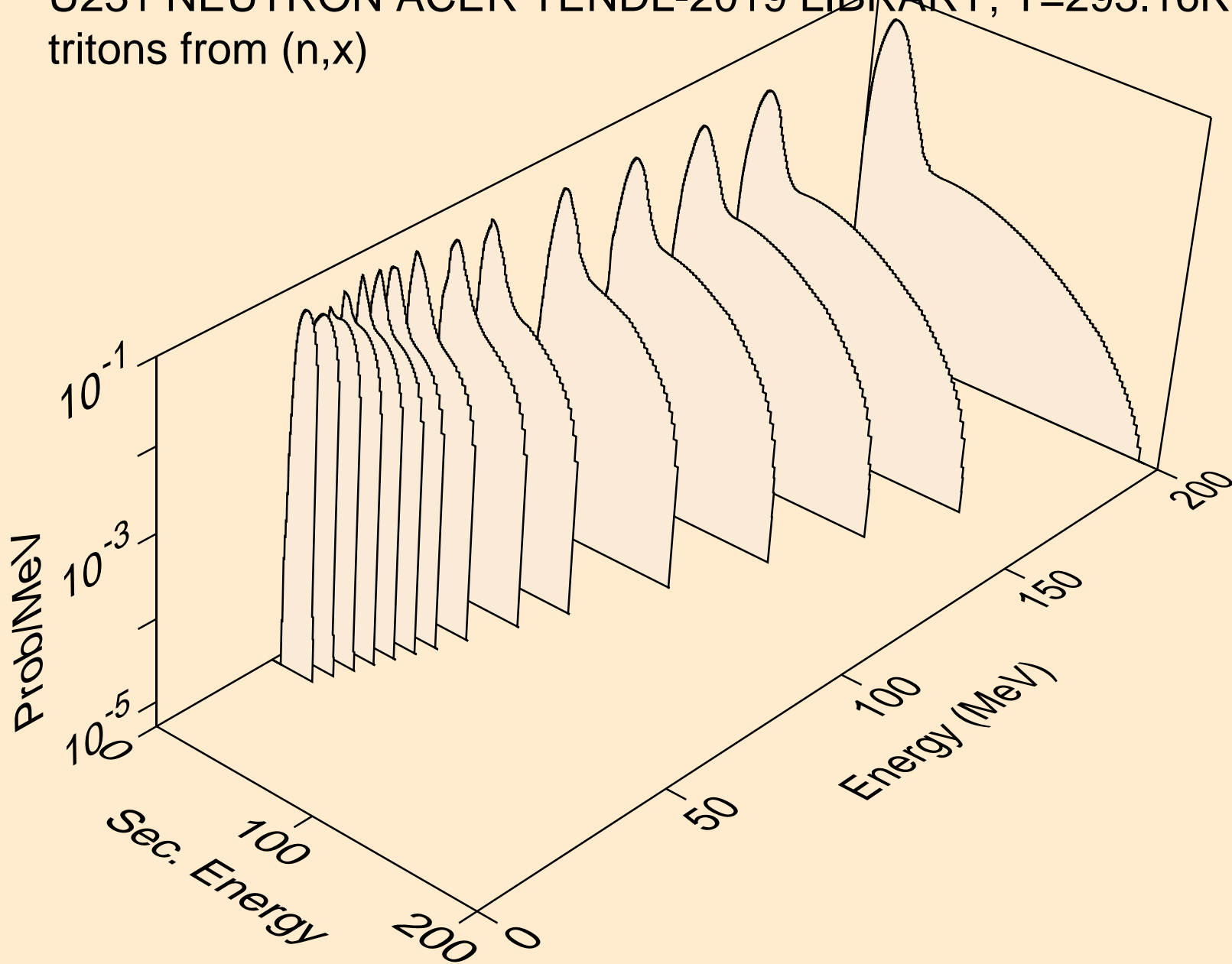

U231 NEUTRON ACER TENDL-2019 LIBRARY; T=293.16K  
tritons from (n,n\*)t

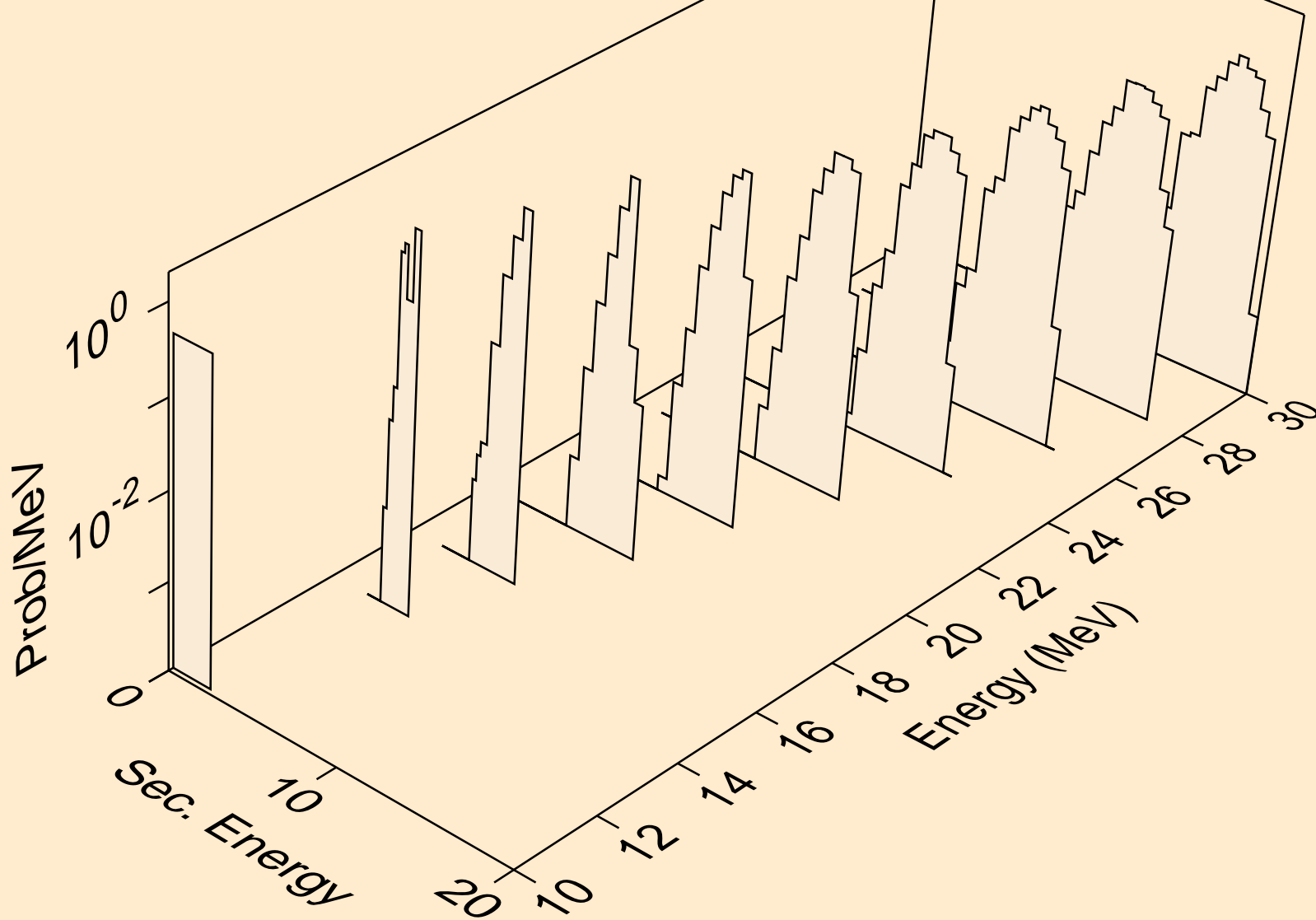

U231 NEUTRON ACER TENDL-2019 LIBRARY; T=293.16K  
tritons from (n,t)

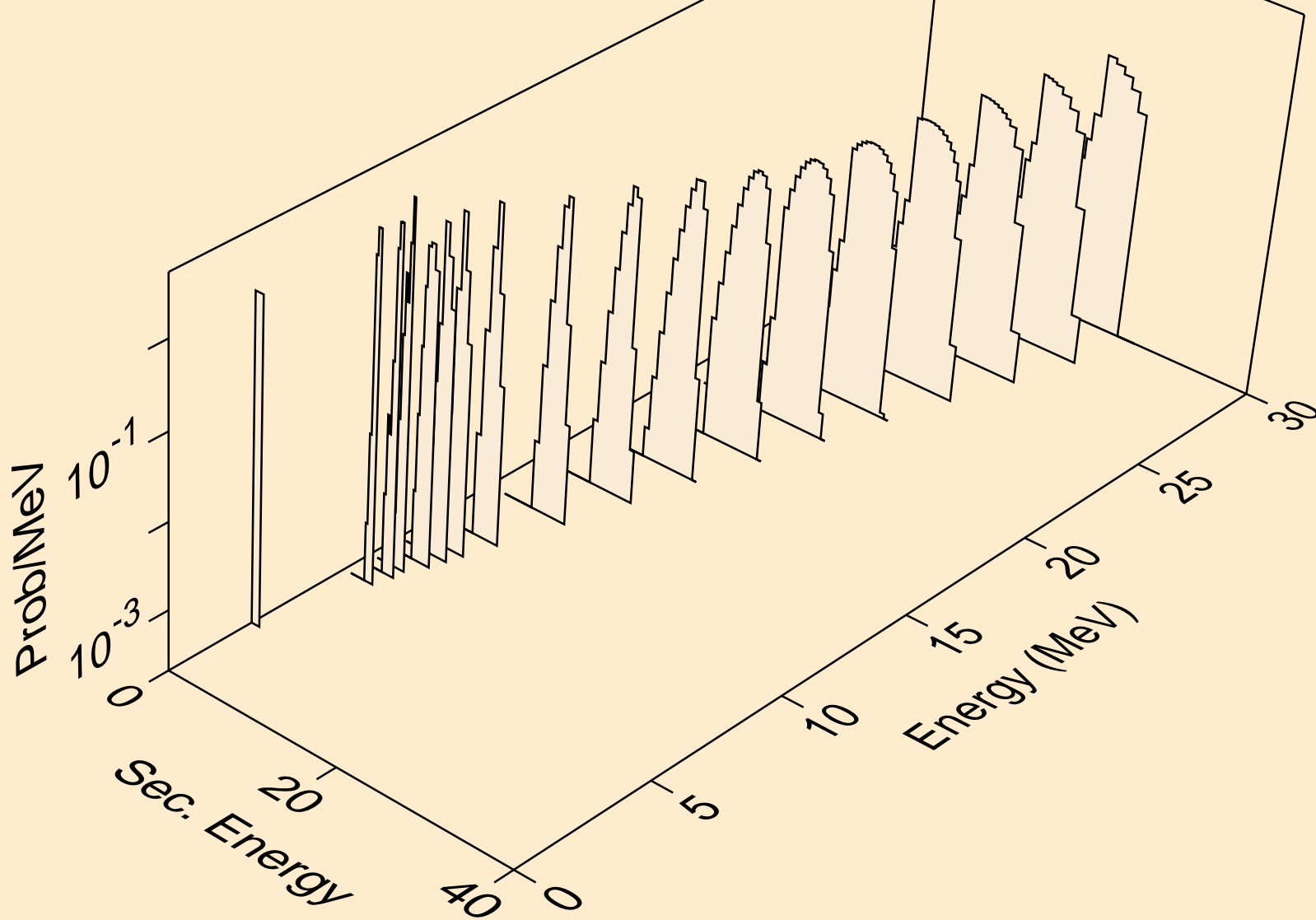

U231 NEUTRON ACER TENDL-2019 LIBRARY; T=293.16K  
he3s from (n,x)

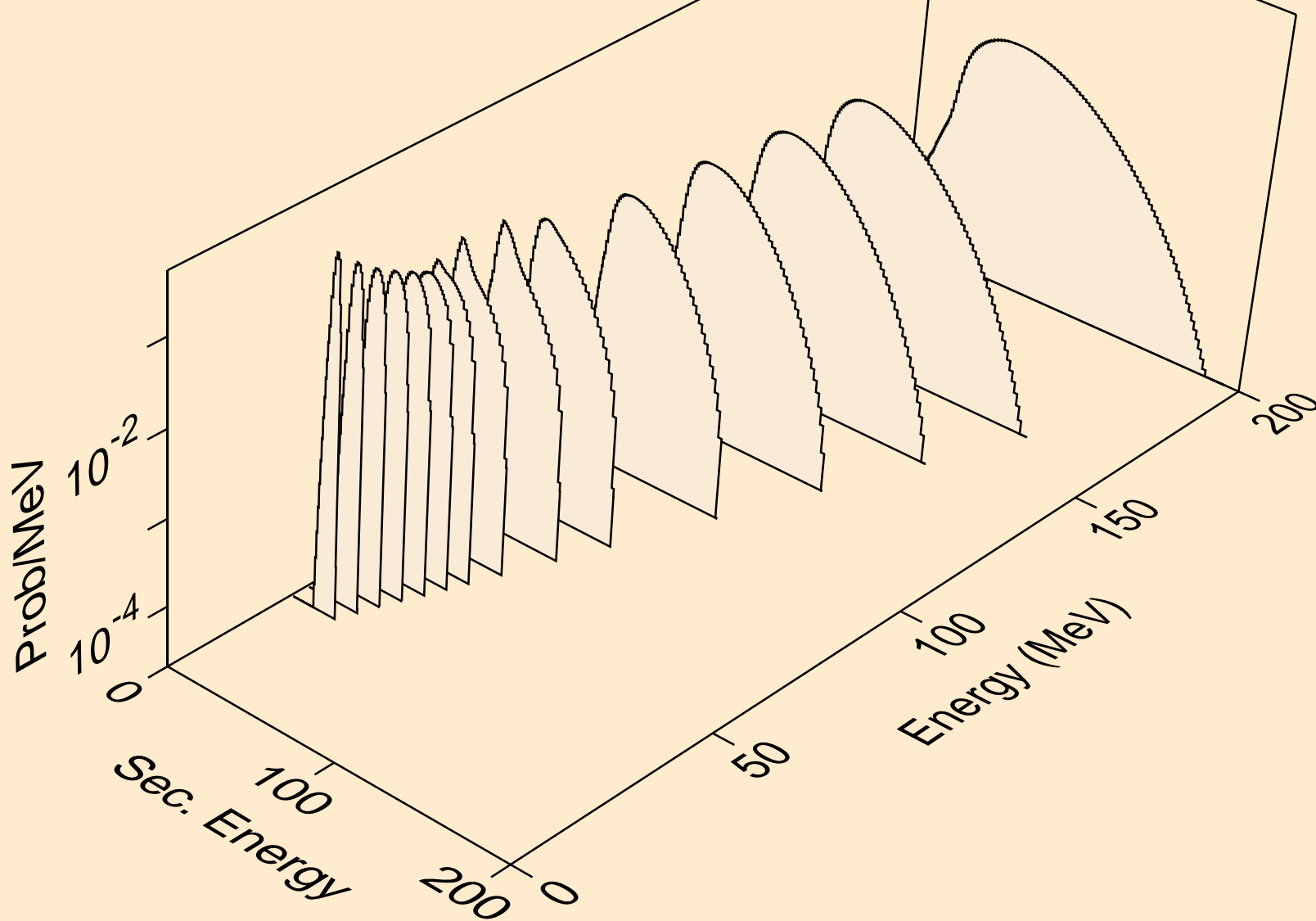

U231 NEUTRON ACER TENDL-2019 LIBRARY; T=293.16K  
he3s from (n,n\*)he3

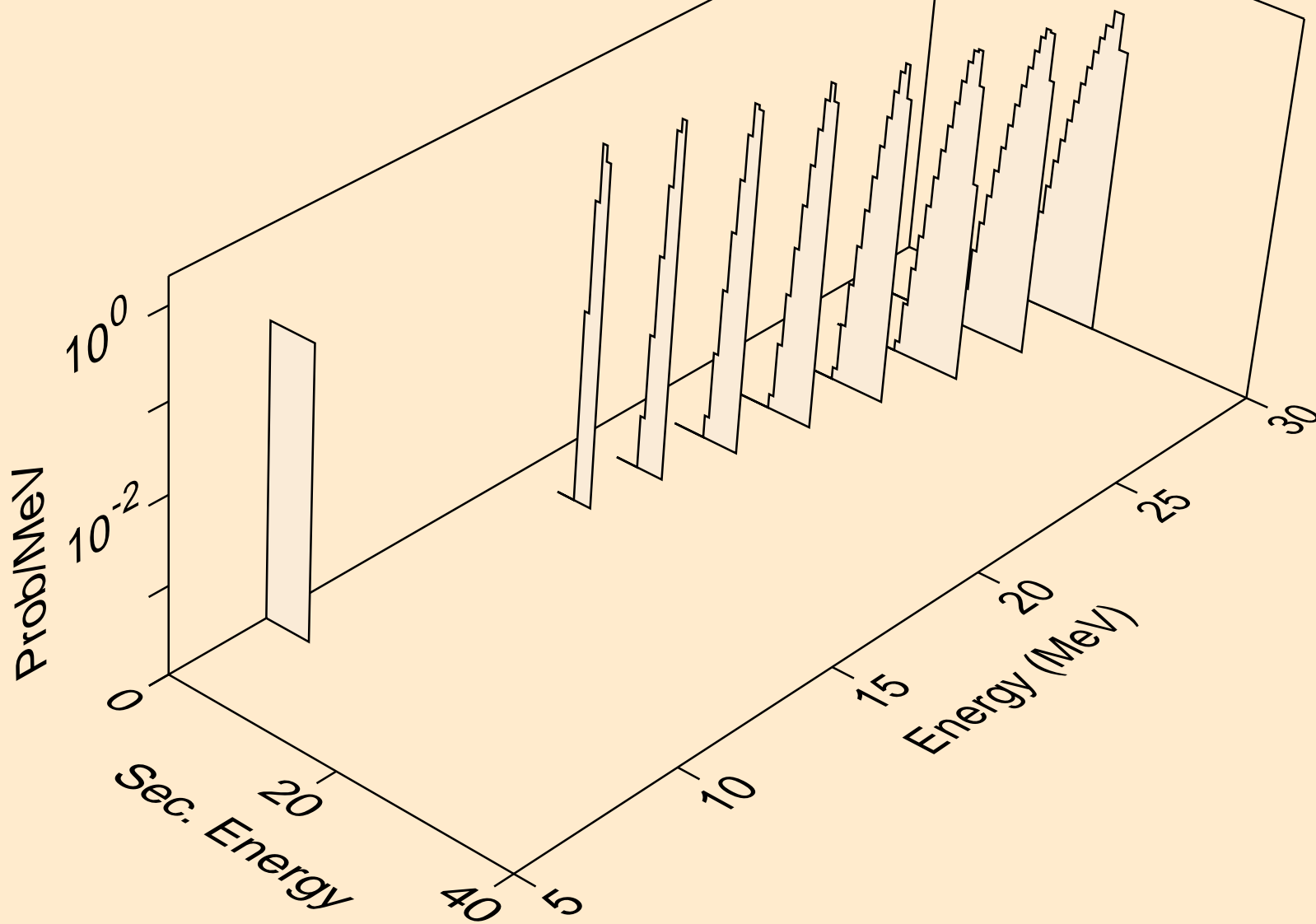

U231 NEUTRON ACER TENDL-2019 LIBRARY; T=293.16K  
he3s from (n,he3)

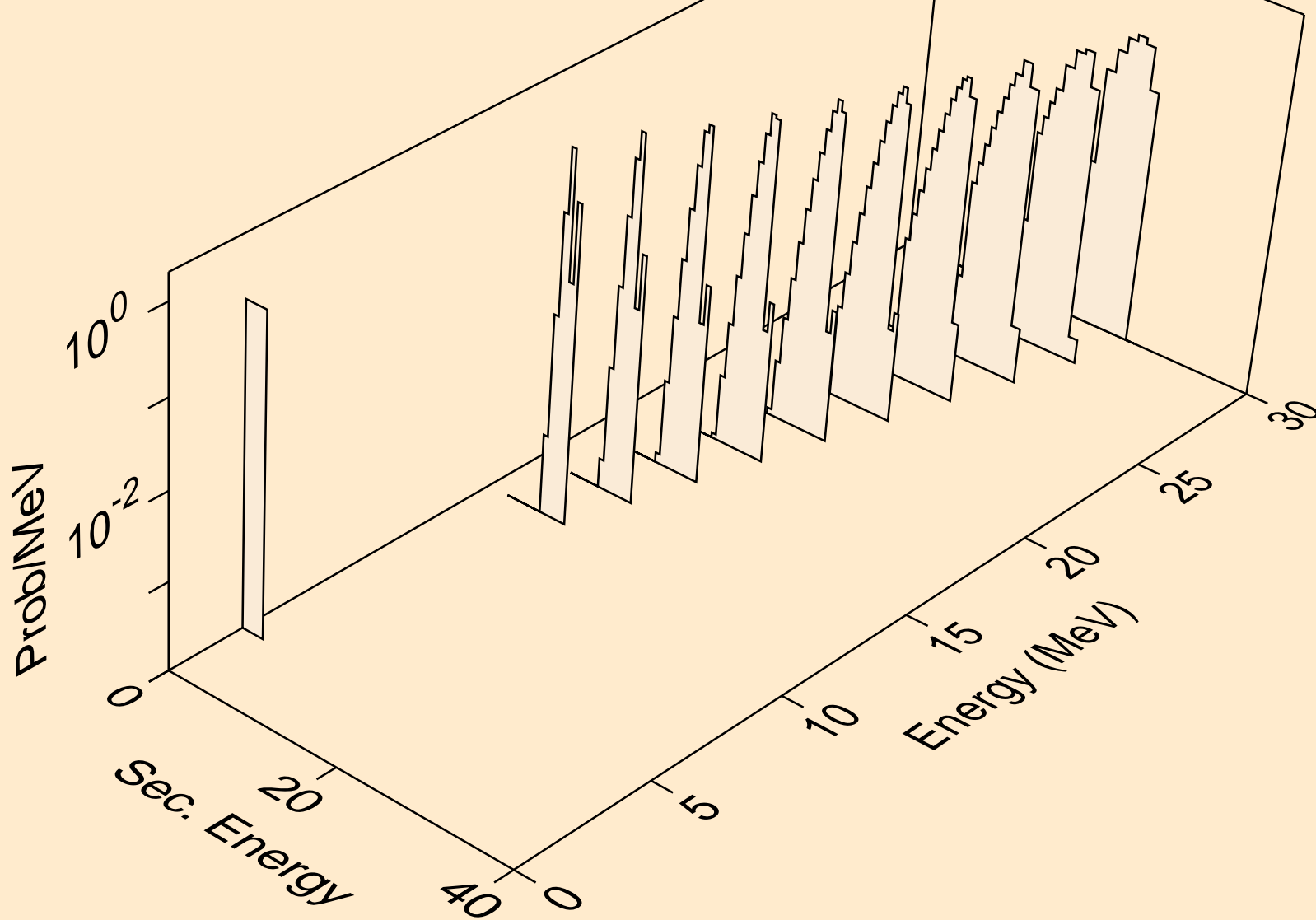

U231 NEUTRON ACER TENDL-2019 LIBRARY; T=293.16K  
alphas from (n,x)

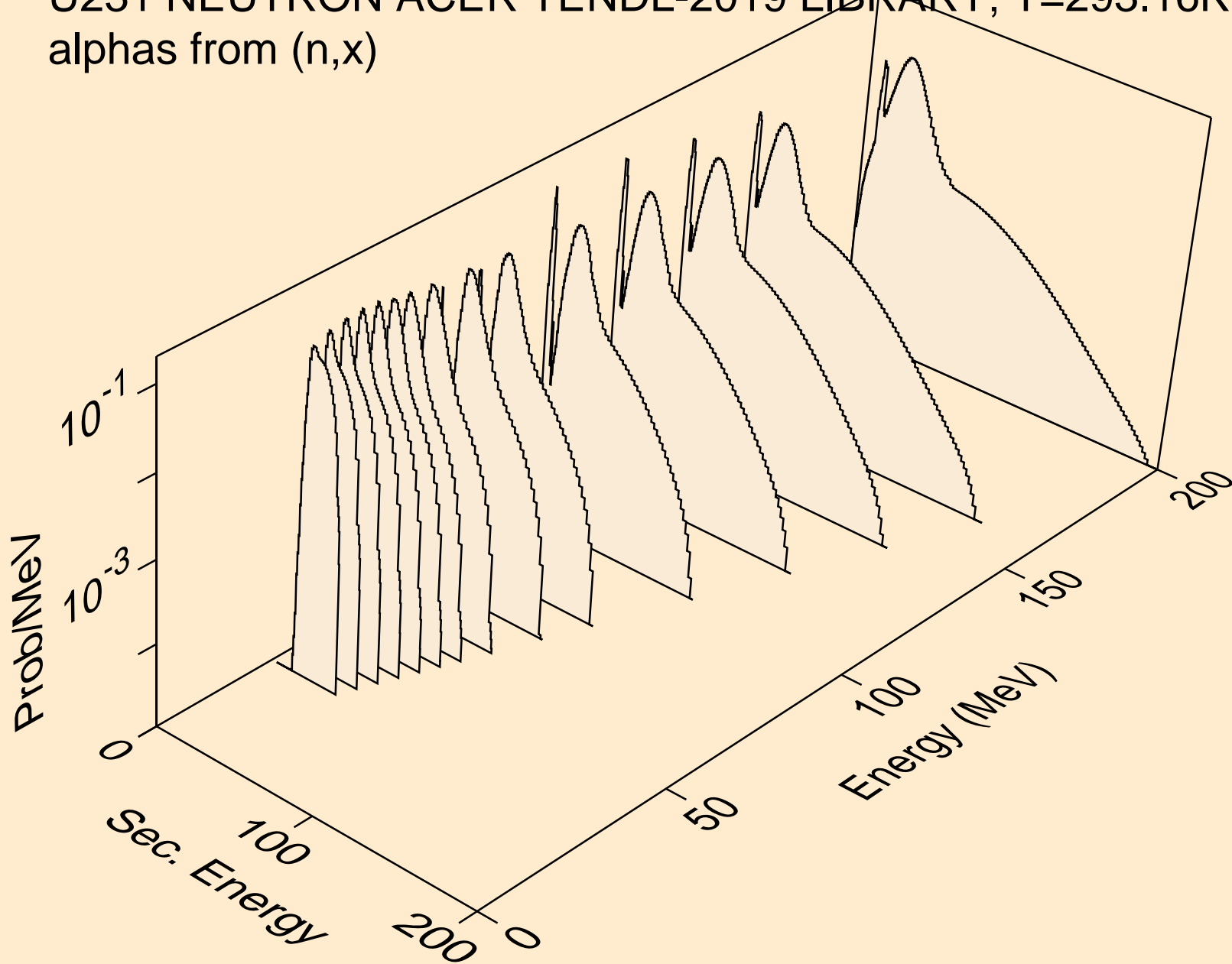

U231 NEUTRON ACER TENDL-2019 LIBRARY; T=293.16K  
alphas from (n,n\*)a

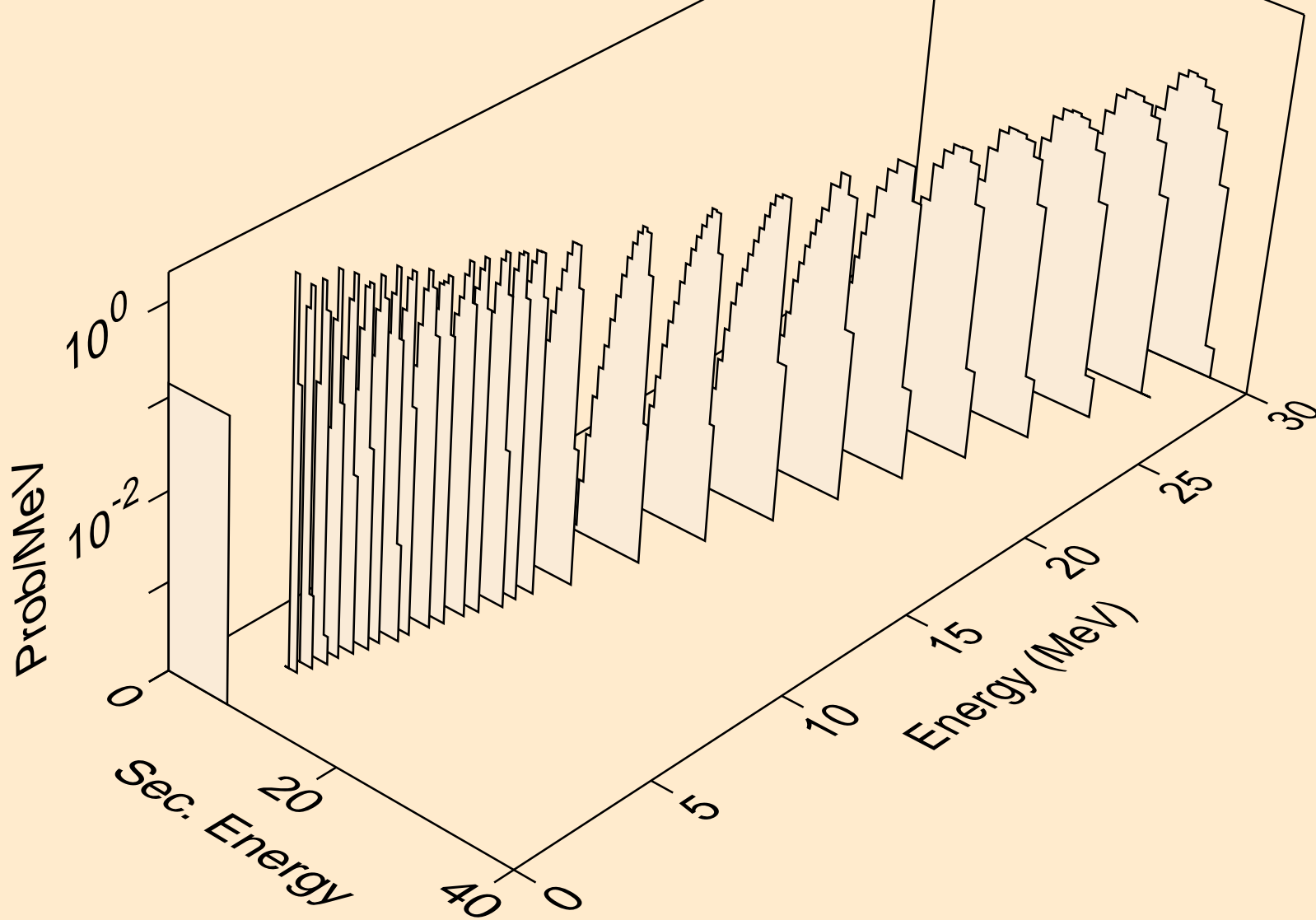

U231 NEUTRON ACER TENDL-2019 LIBRARY; T=293.16K  
alphas from (n,2n)a

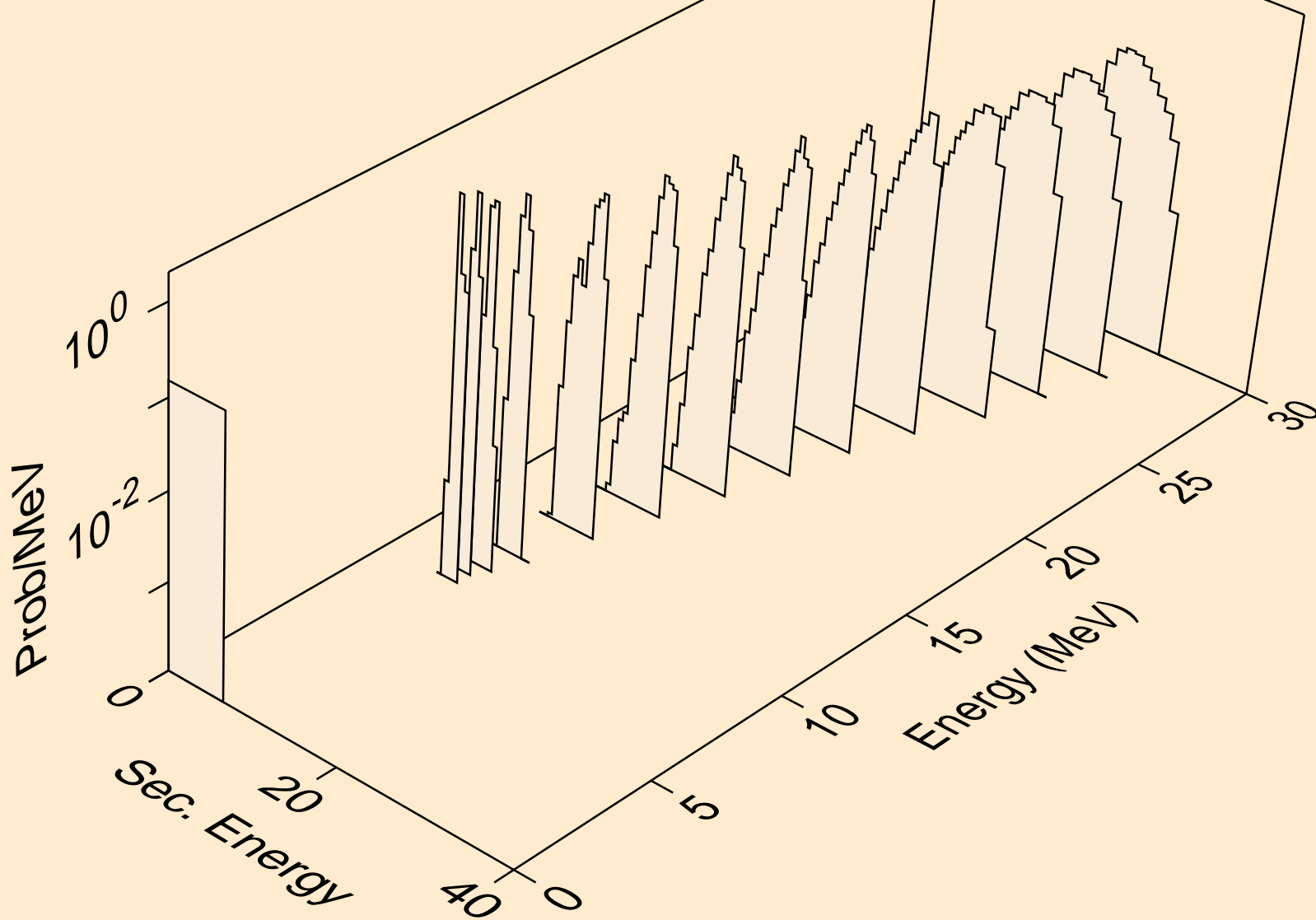

U231 NEUTRON ACER TENDL-2019 LIBRARY; T=293.16K  
alphas from (n,3n)a

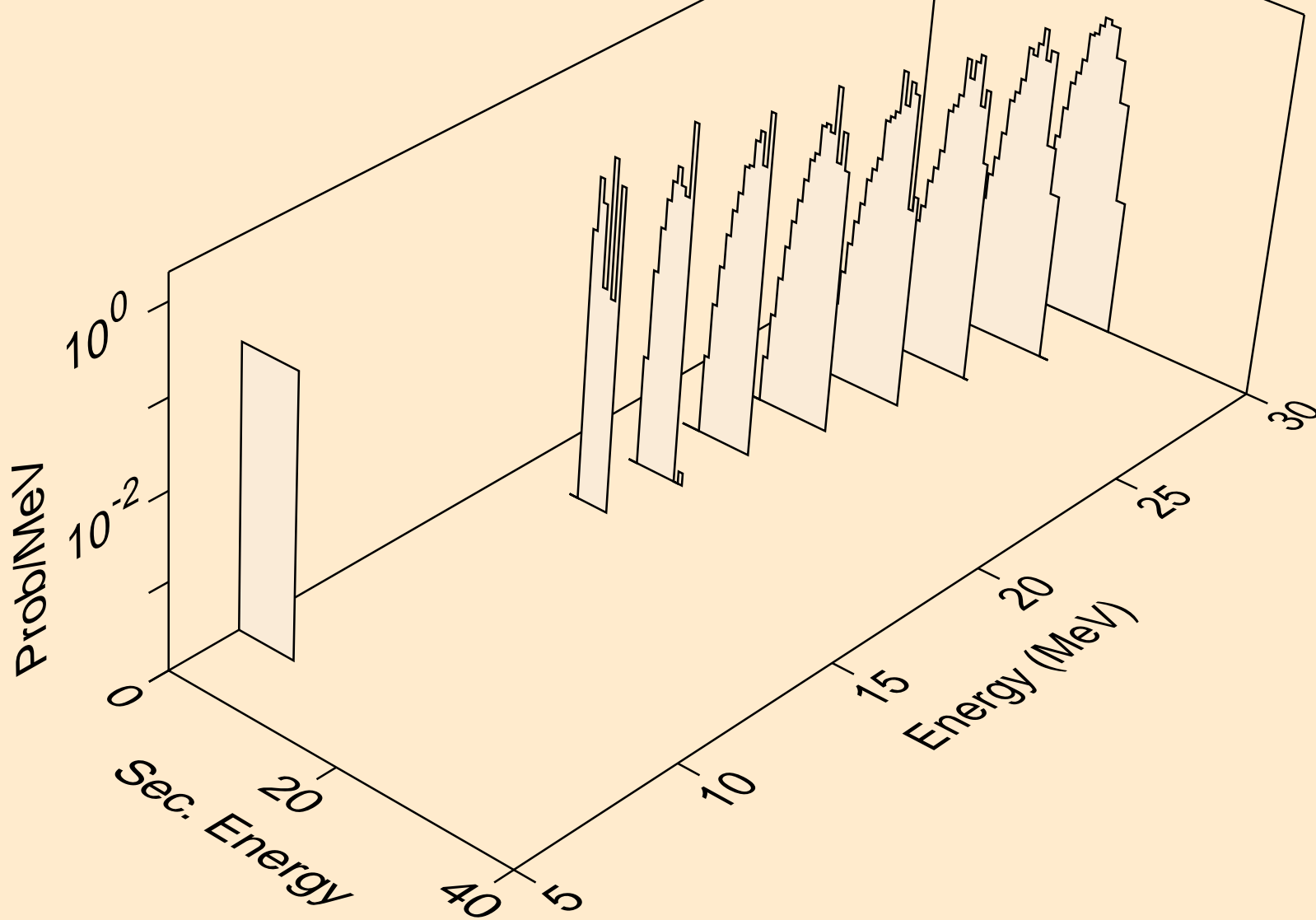

U231 NEUTRON ACER TENDL-2019 LIBRARY; T=293.16K  
alphas from (n,n\*)2a

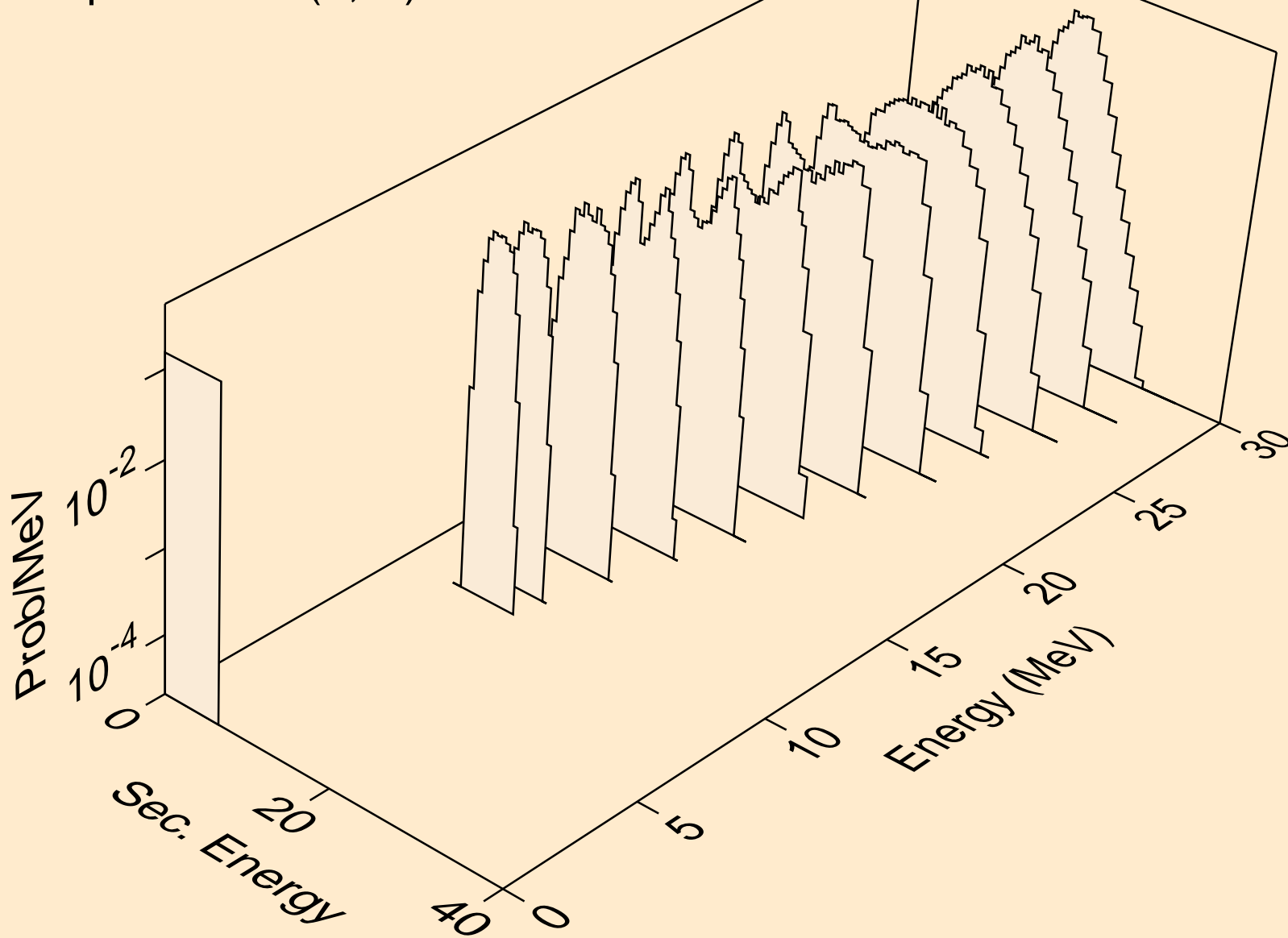

U231 NEUTRON ACER TENDL-2019 LIBRARY; T=293.16K  
alphas from (n,2n)2a

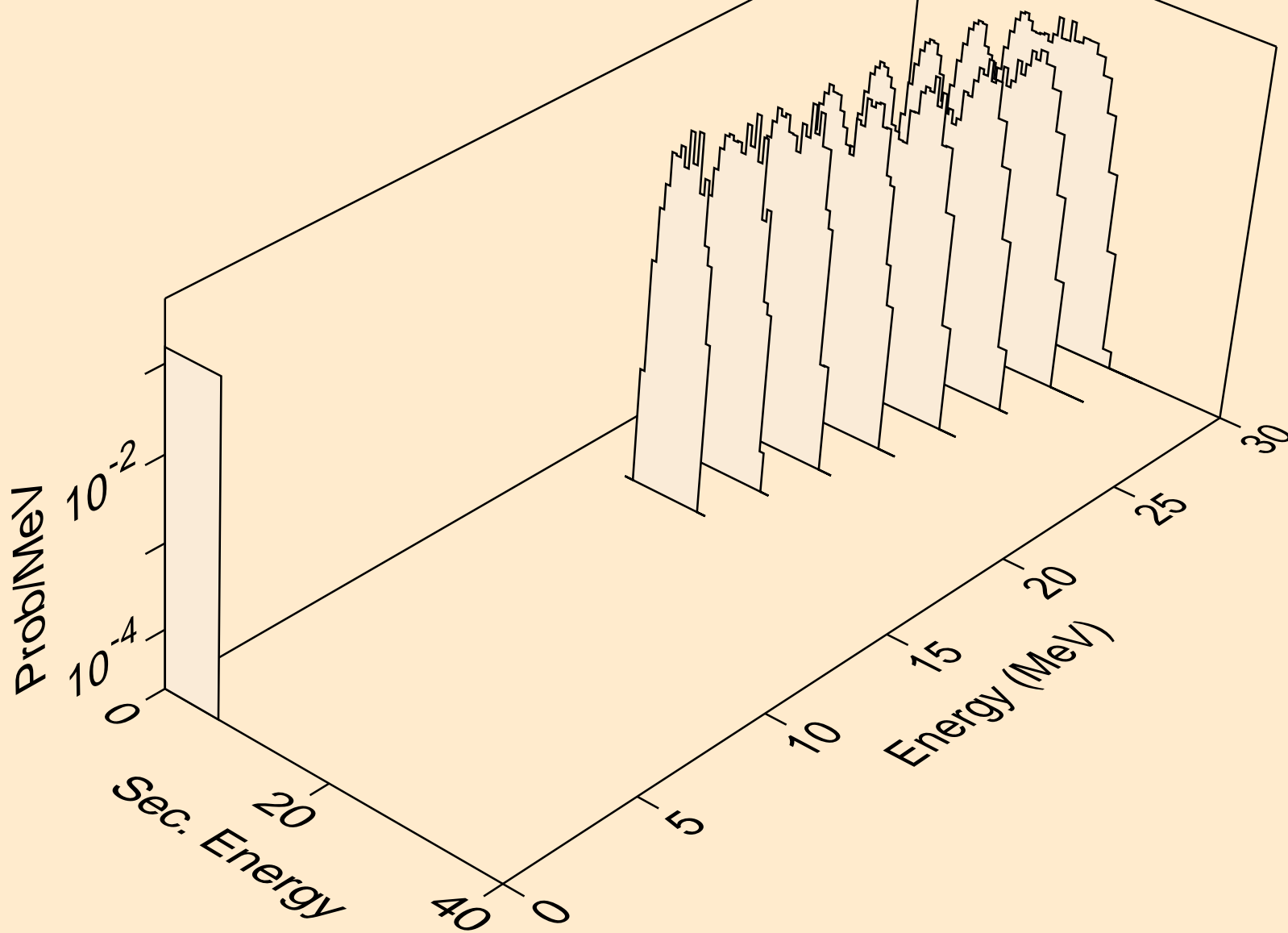

U231 NEUTRON ACER TENDL-2019 LIBRARY; T=293.16K  
alphas from (n,npa)

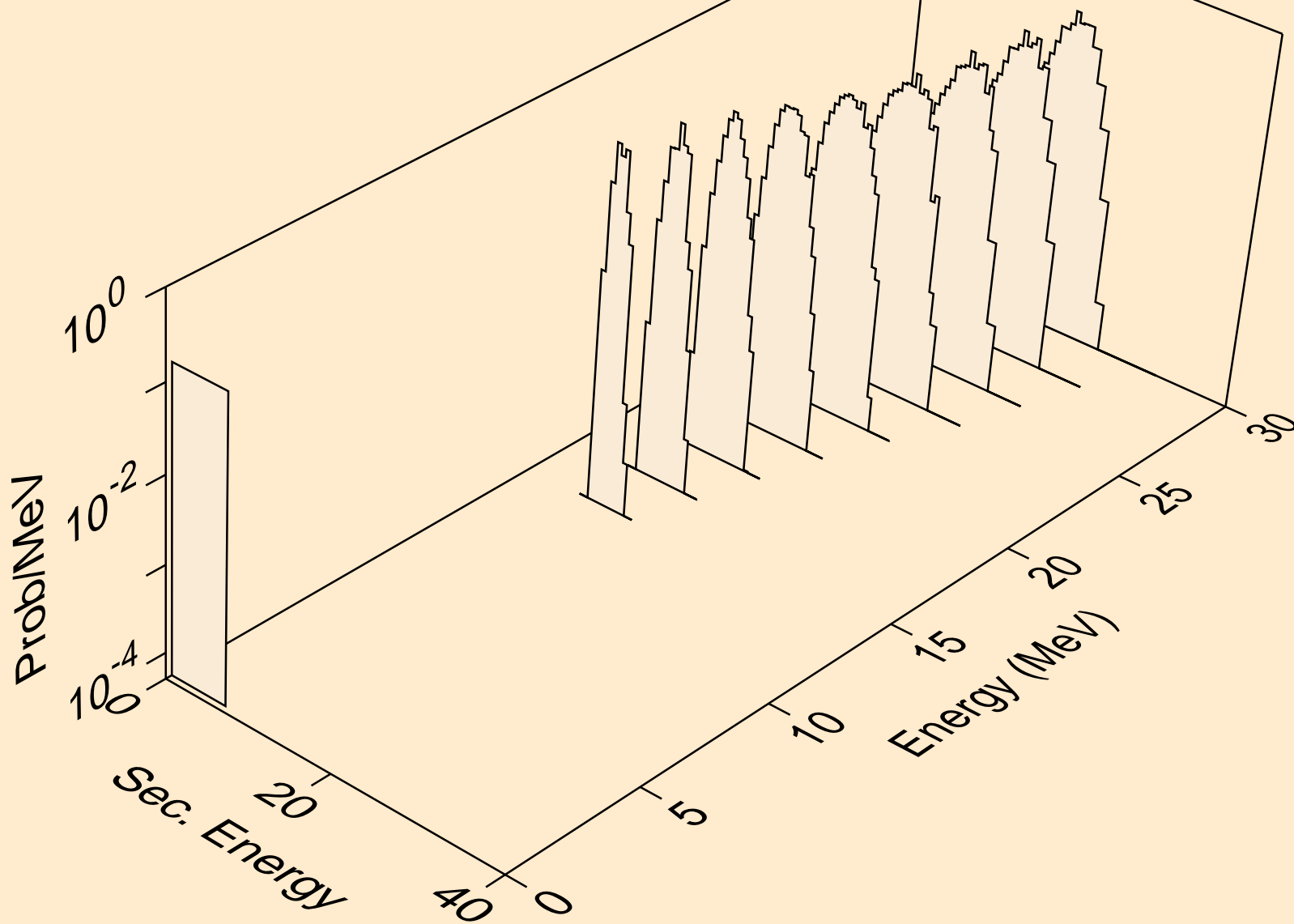

U231 NEUTRON ACER TENDL-2019 LIBRARY; T=293.16K  
alphas from (n,a)

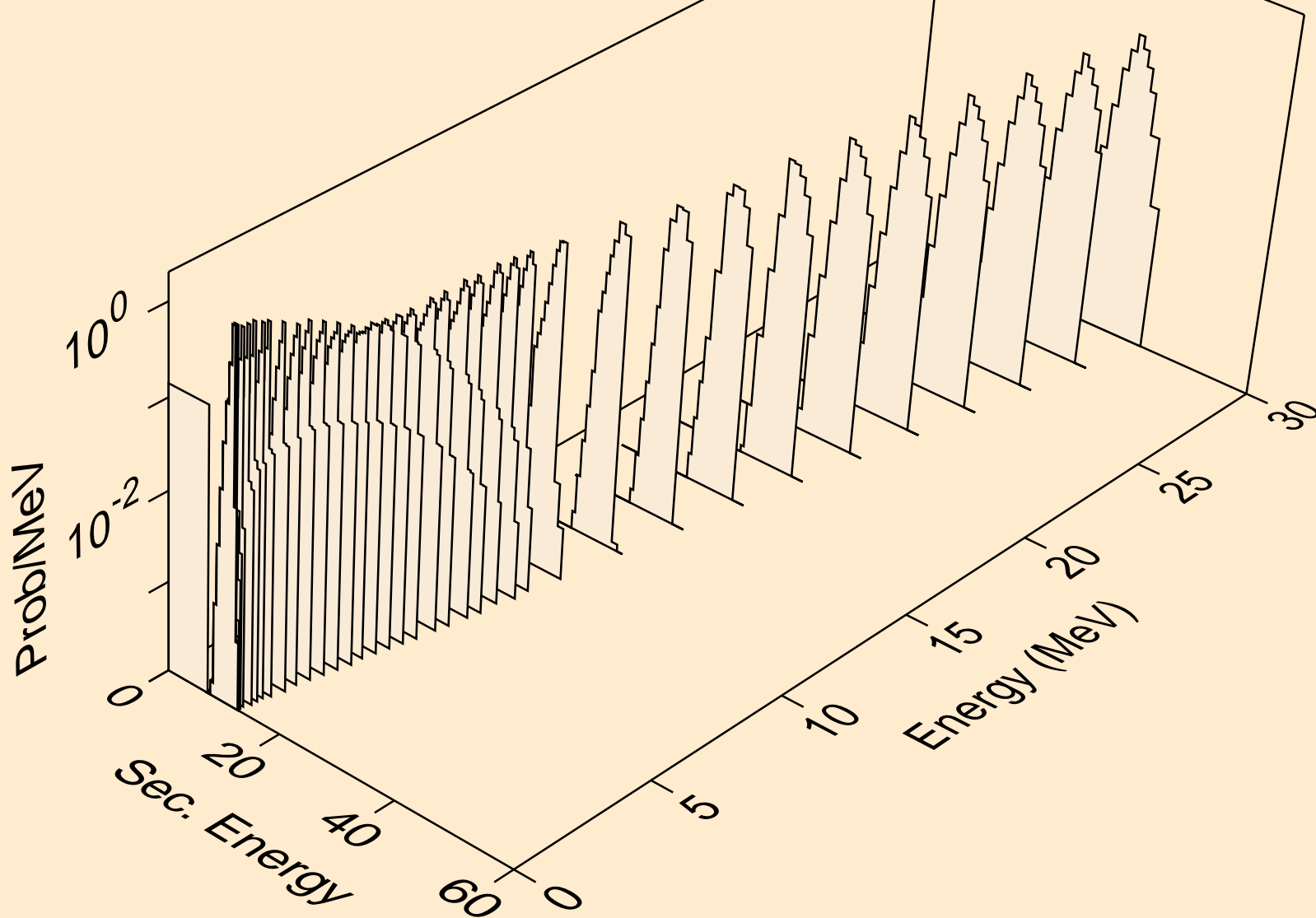

U231 NEUTRON ACER TENDL-2019 LIBRARY; T=293.16K  
alphas from (n,2a)

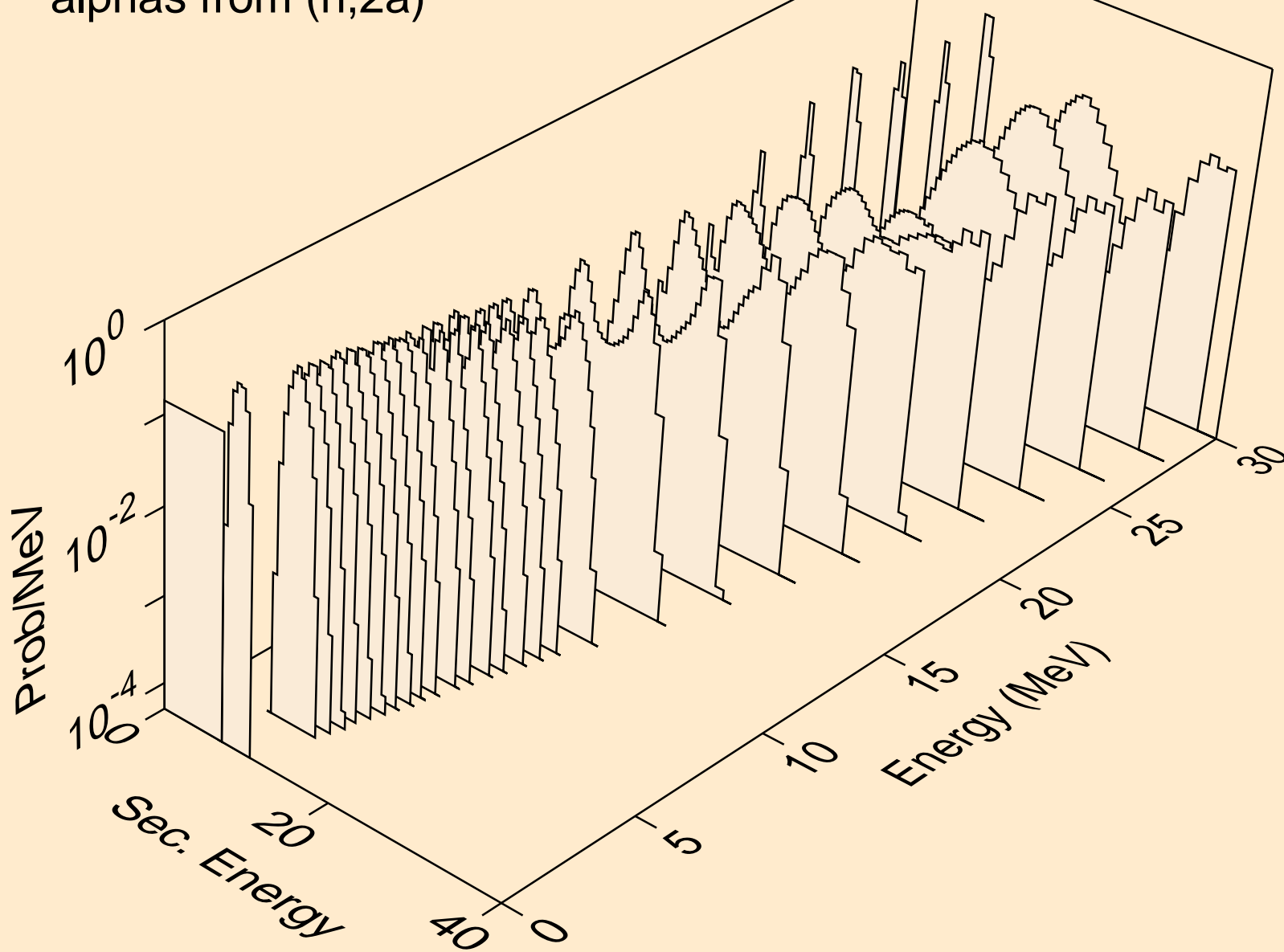

U231 NEUTRON ACER TENDL-2019 LIBRARY; T=293.16K  
alphas from (n,pa)

