

U243 NEUTRON ACER TENDL-2019 LIBRARY; T=293.16K
Principal cross sections

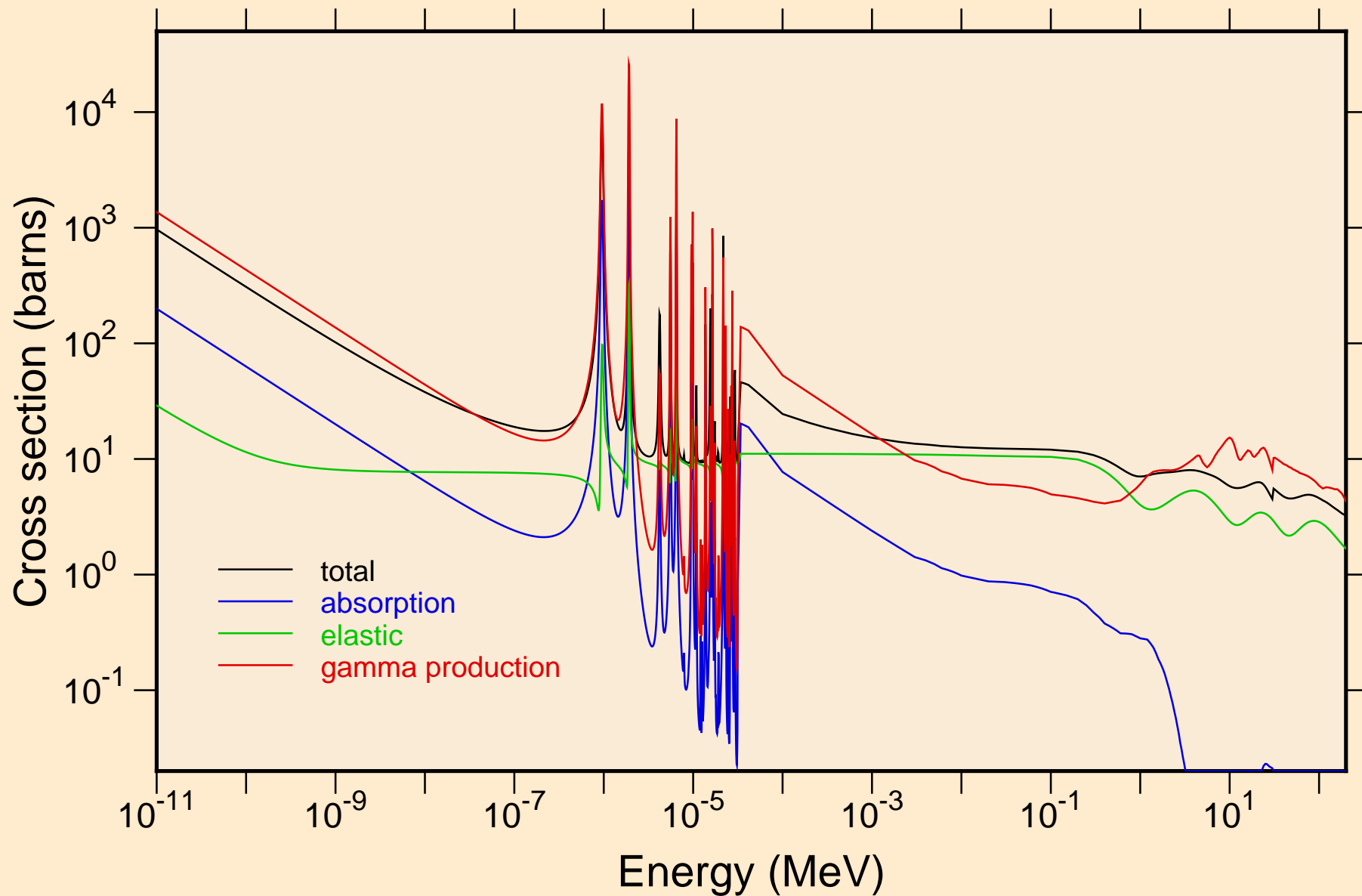

U243 NEUTRON ACER TENDL-2019 LIBRARY; T=293.16K
resonance total cross section

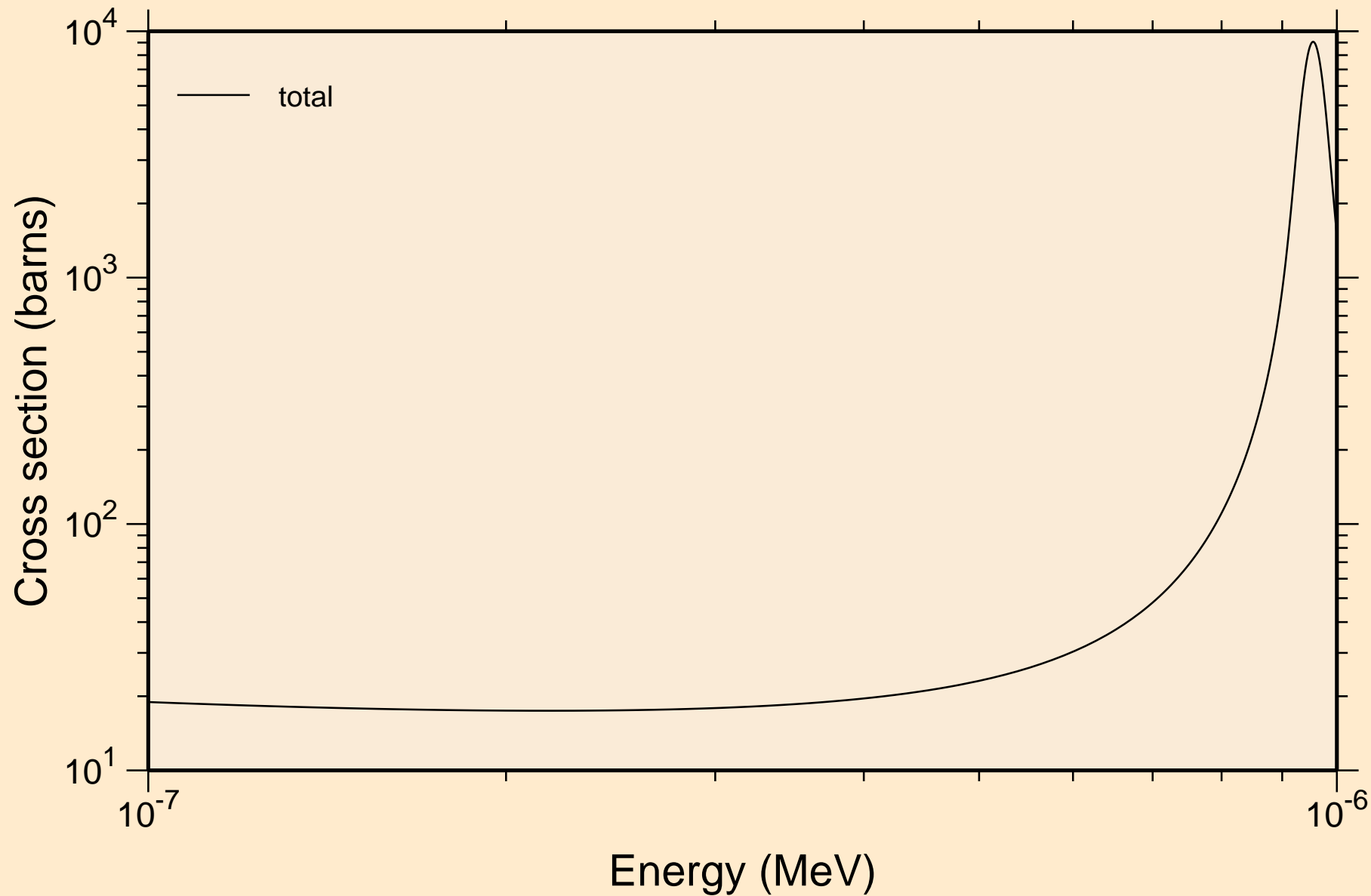

U243 NEUTRON ACER TENDL-2019 LIBRARY; T=293.16K
resonance total cross section

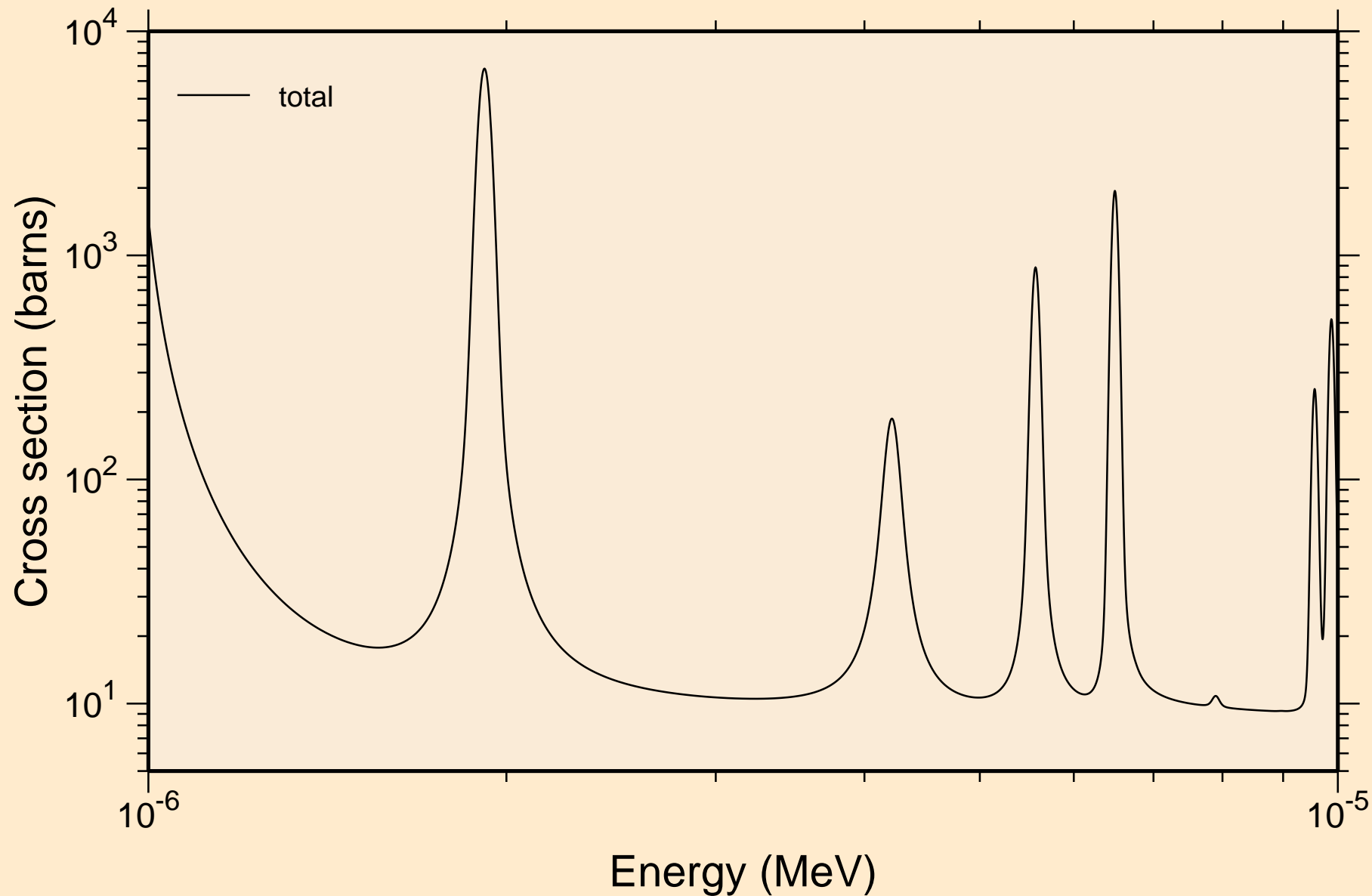

U243 NEUTRON ACER TENDL-2019 LIBRARY; T=293.16K
resonance total cross section

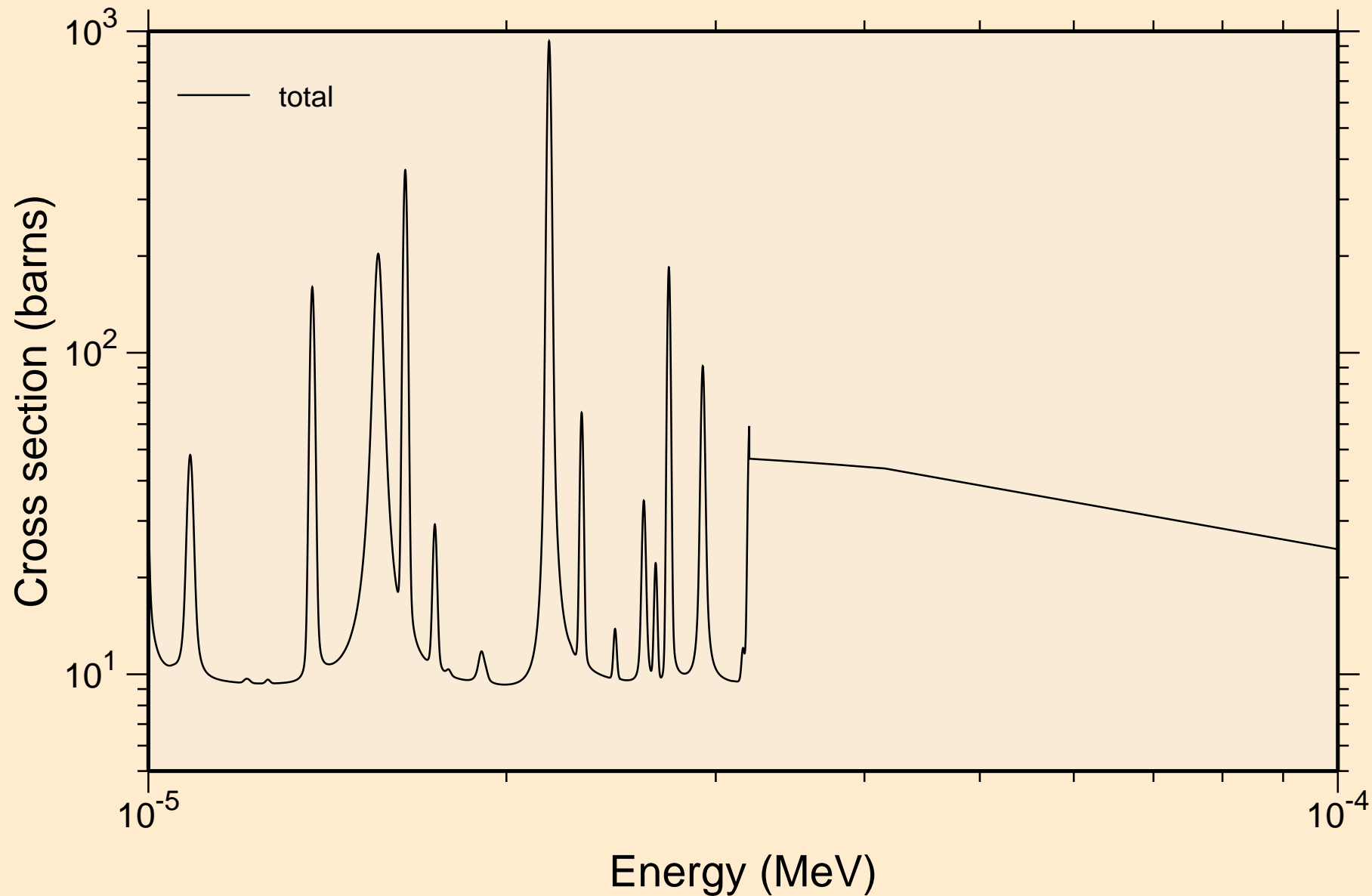

U243 NEUTRON ACER TENDL-2019 LIBRARY; T=293.16K
resonance total cross section

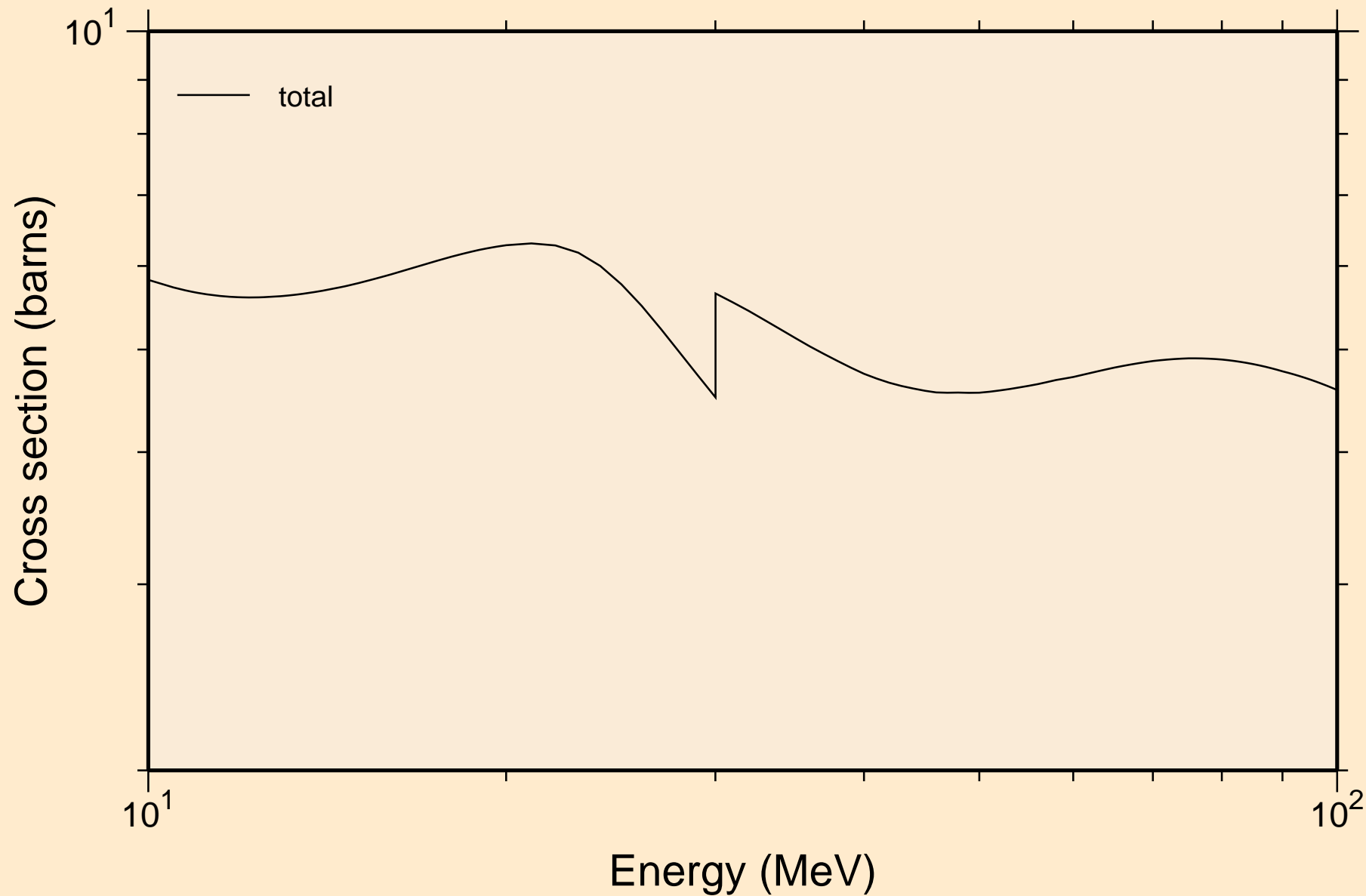

U243 NEUTRON ACER TENDL-2019 LIBRARY; T=293.16K
resonance absorption cross sections

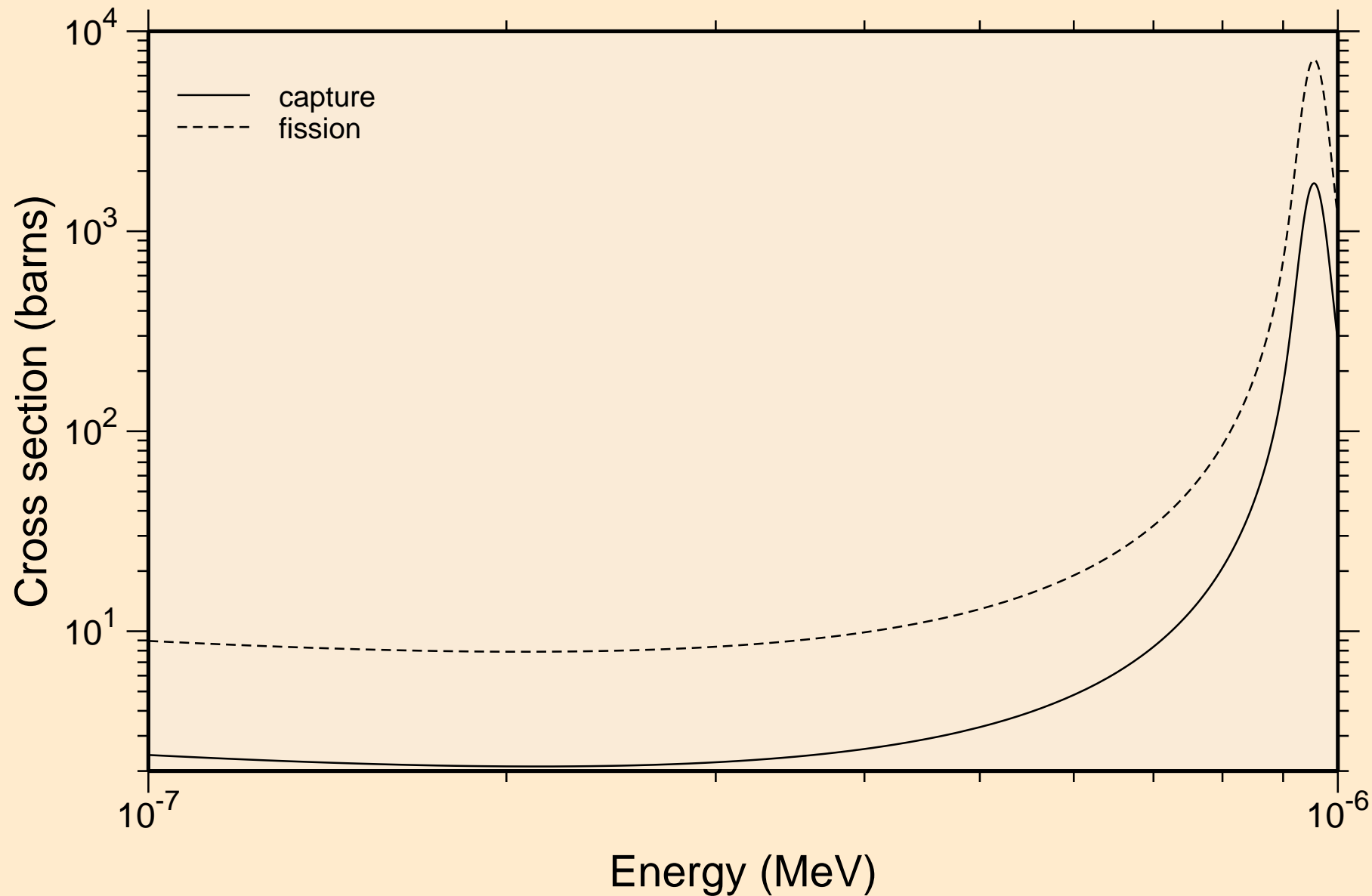

U243 NEUTRON ACER TENDL-2019 LIBRARY; T=293.16K
resonance absorption cross sections

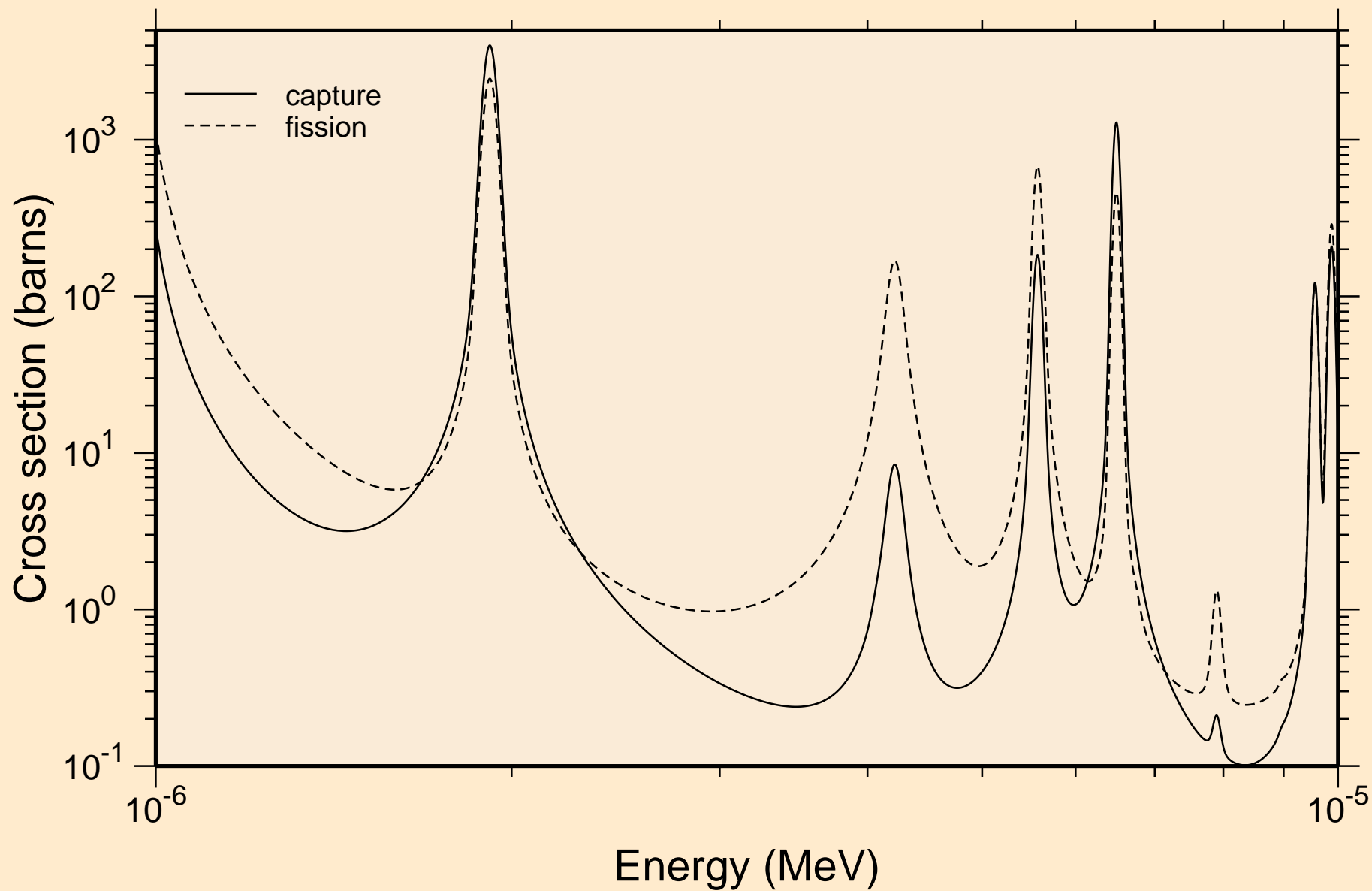

U243 NEUTRON ACER TENDL-2019 LIBRARY; T=293.16K
resonance absorption cross sections

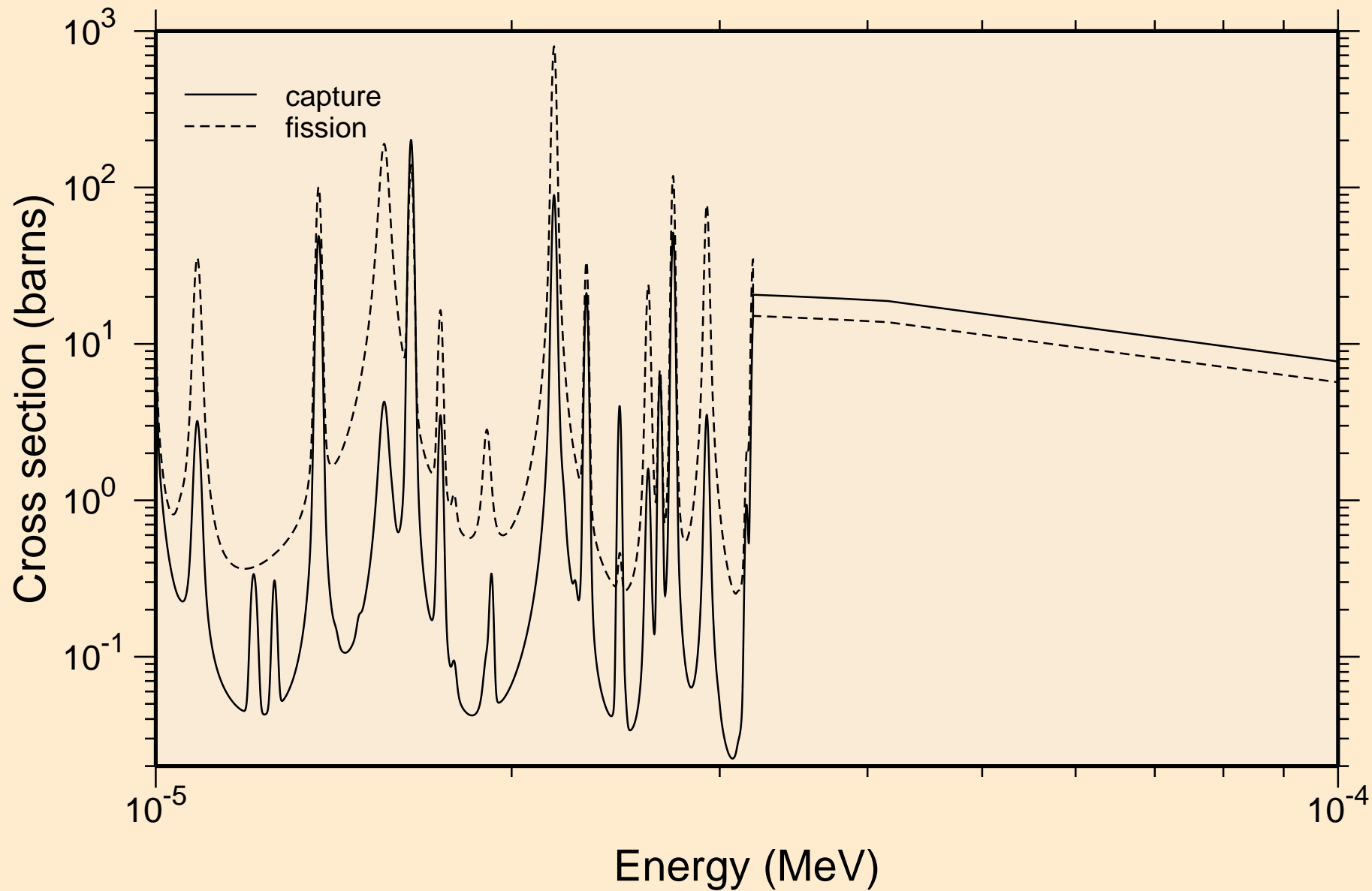

U243 NEUTRON ACER TENDL-2019 LIBRARY; T=293.16K
resonance absorption cross sections

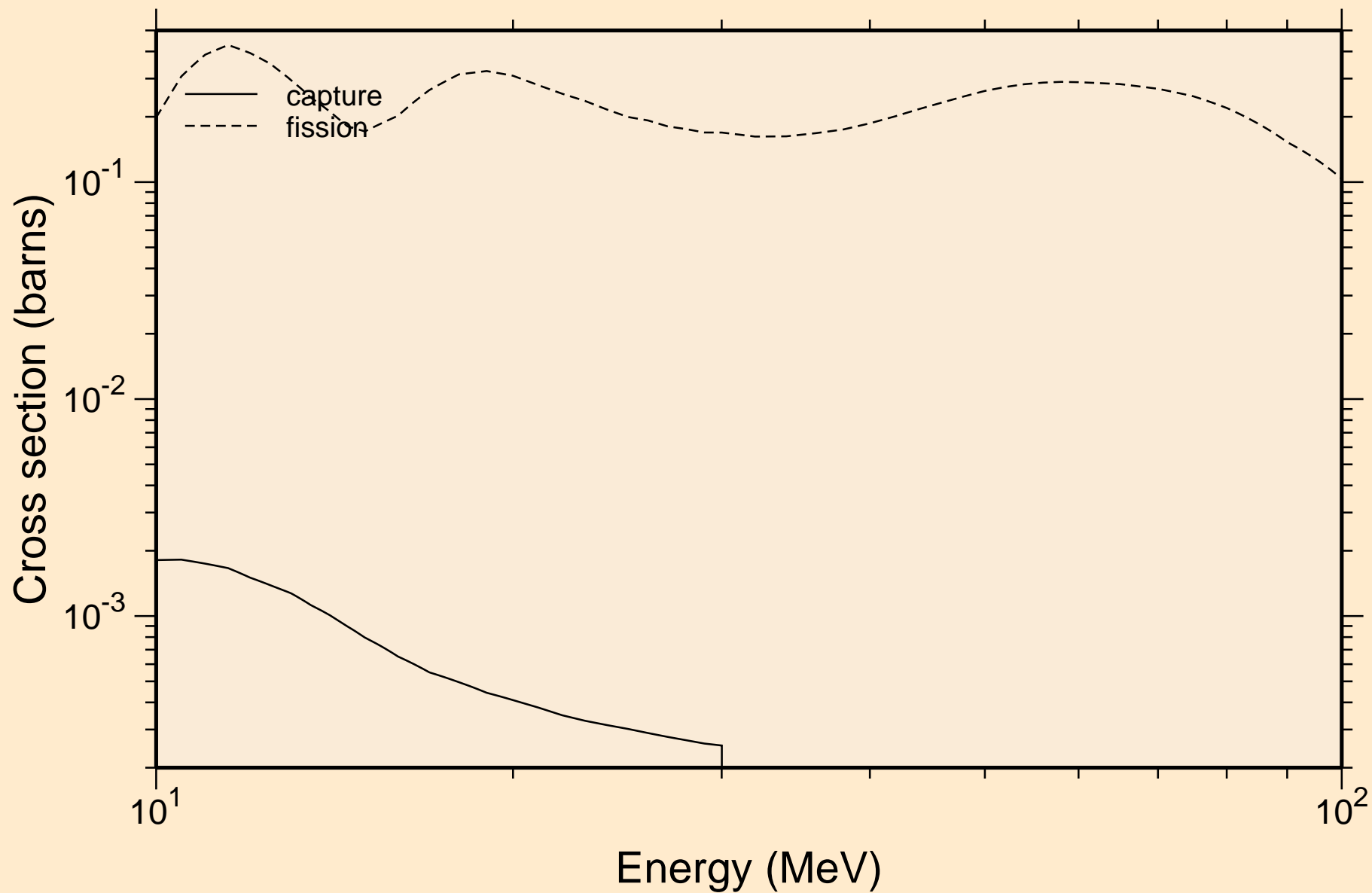

U243 NEUTRON ACER TENDL-2019 LIBRARY; T=293.16K
Heating

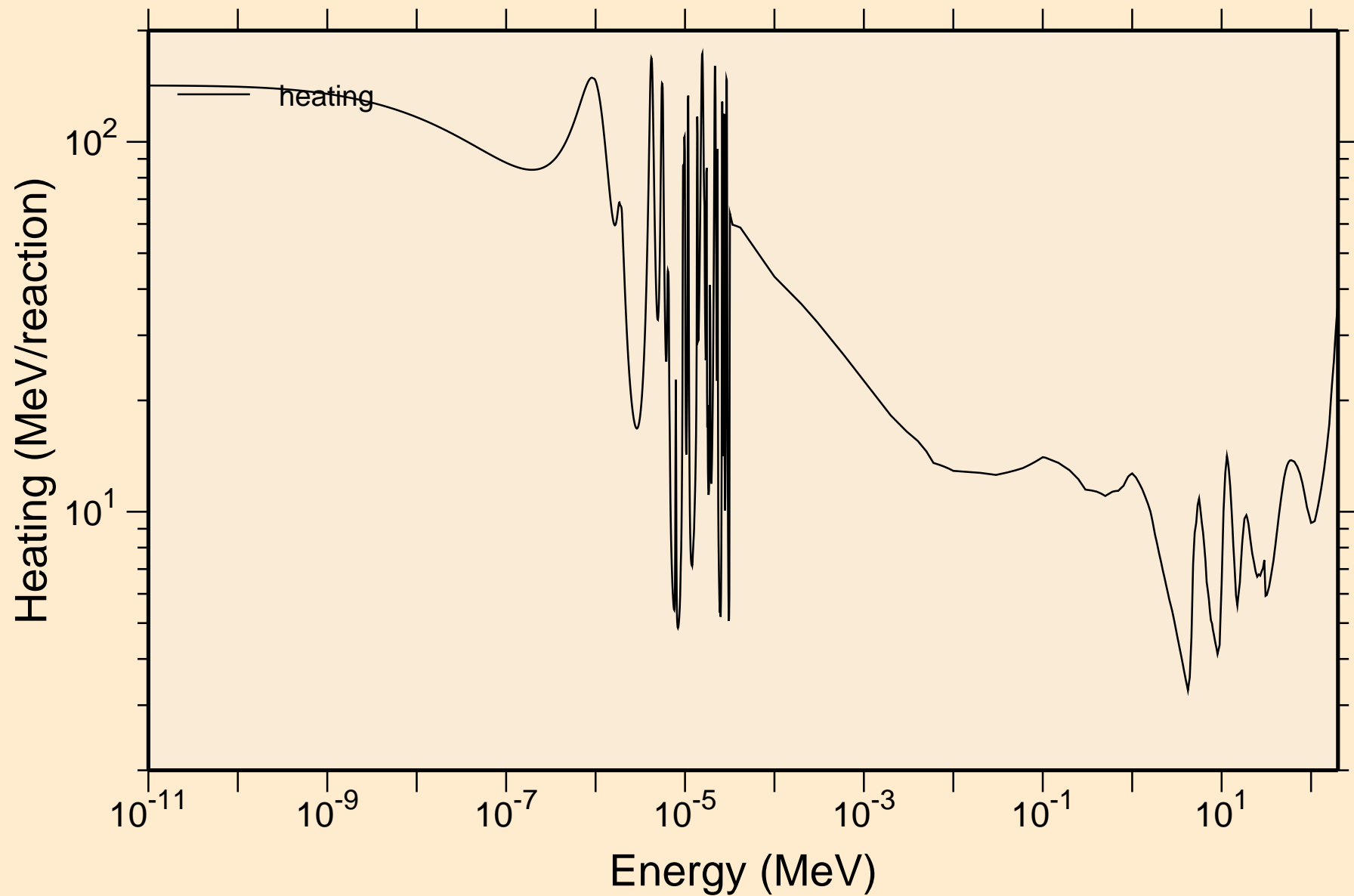

U243 NEUTRON ACER TENDL-2019 LIBRARY; T=293.16K

Damage

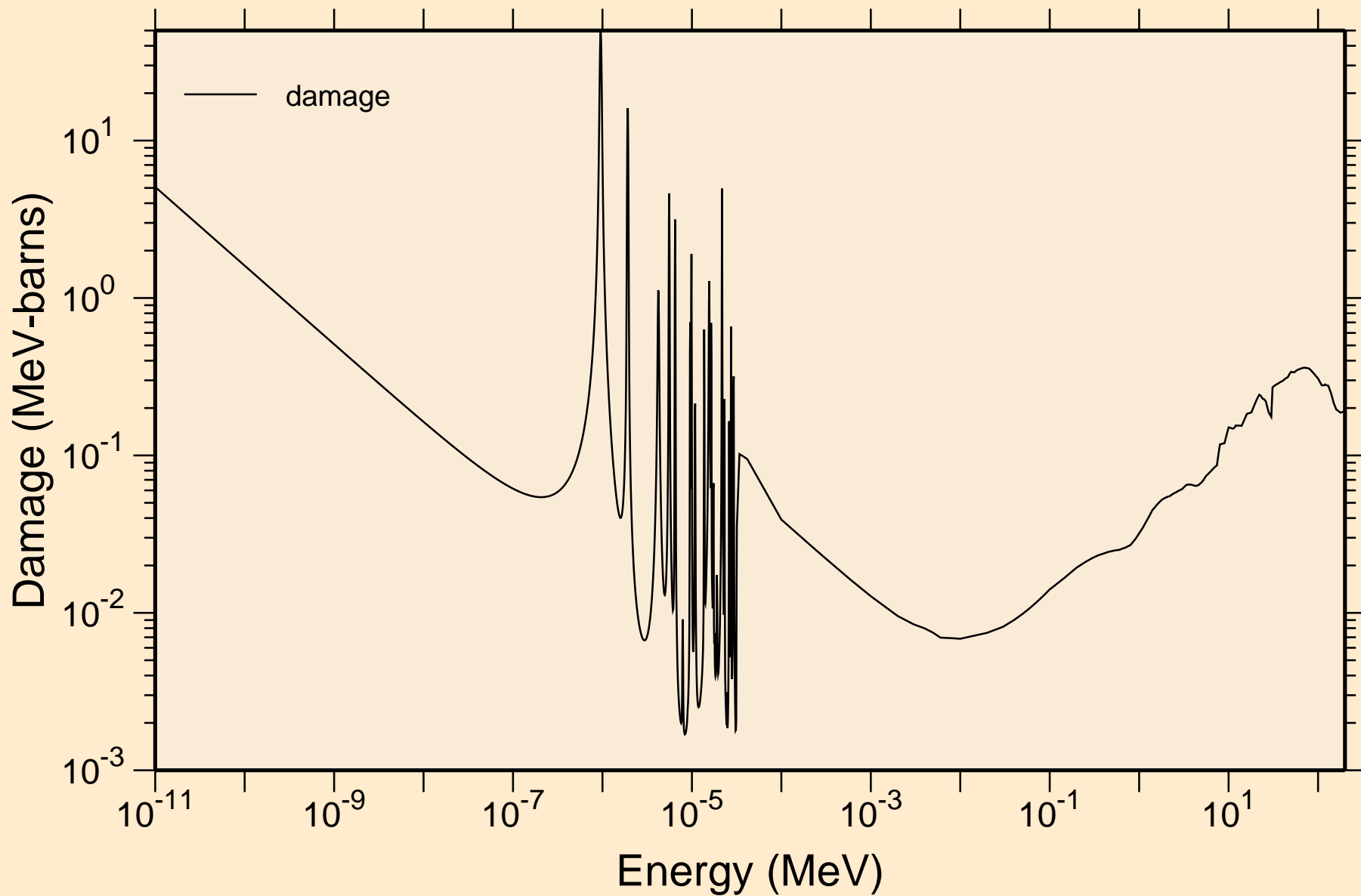

U243 NEUTRON ACER TENDL-2019 LIBRARY; T=293.16K

Non-threshold reactions

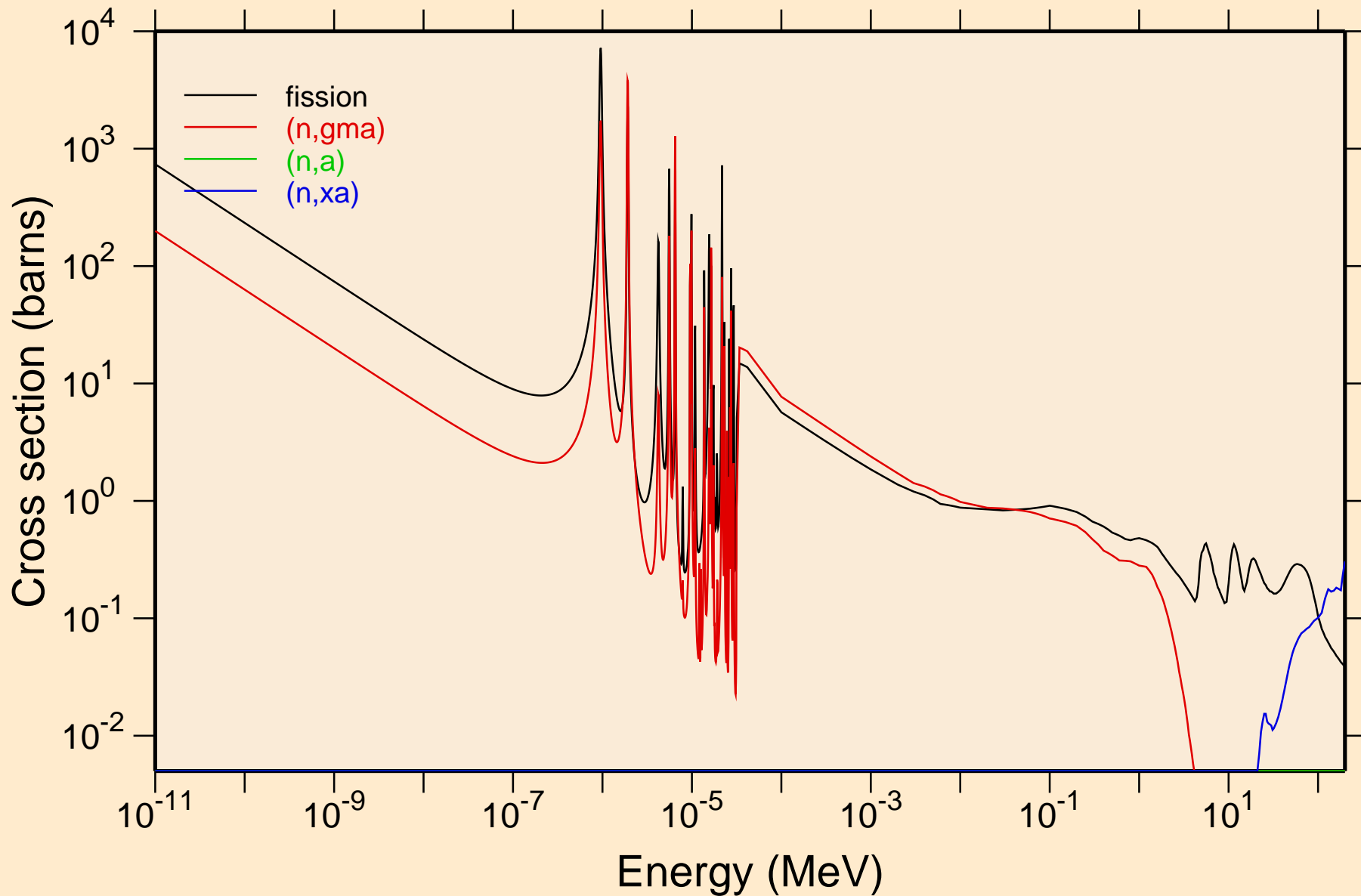

U243 NEUTRON ACER TENDL-2019 LIBRARY; T=293.16K
Principal cross sections

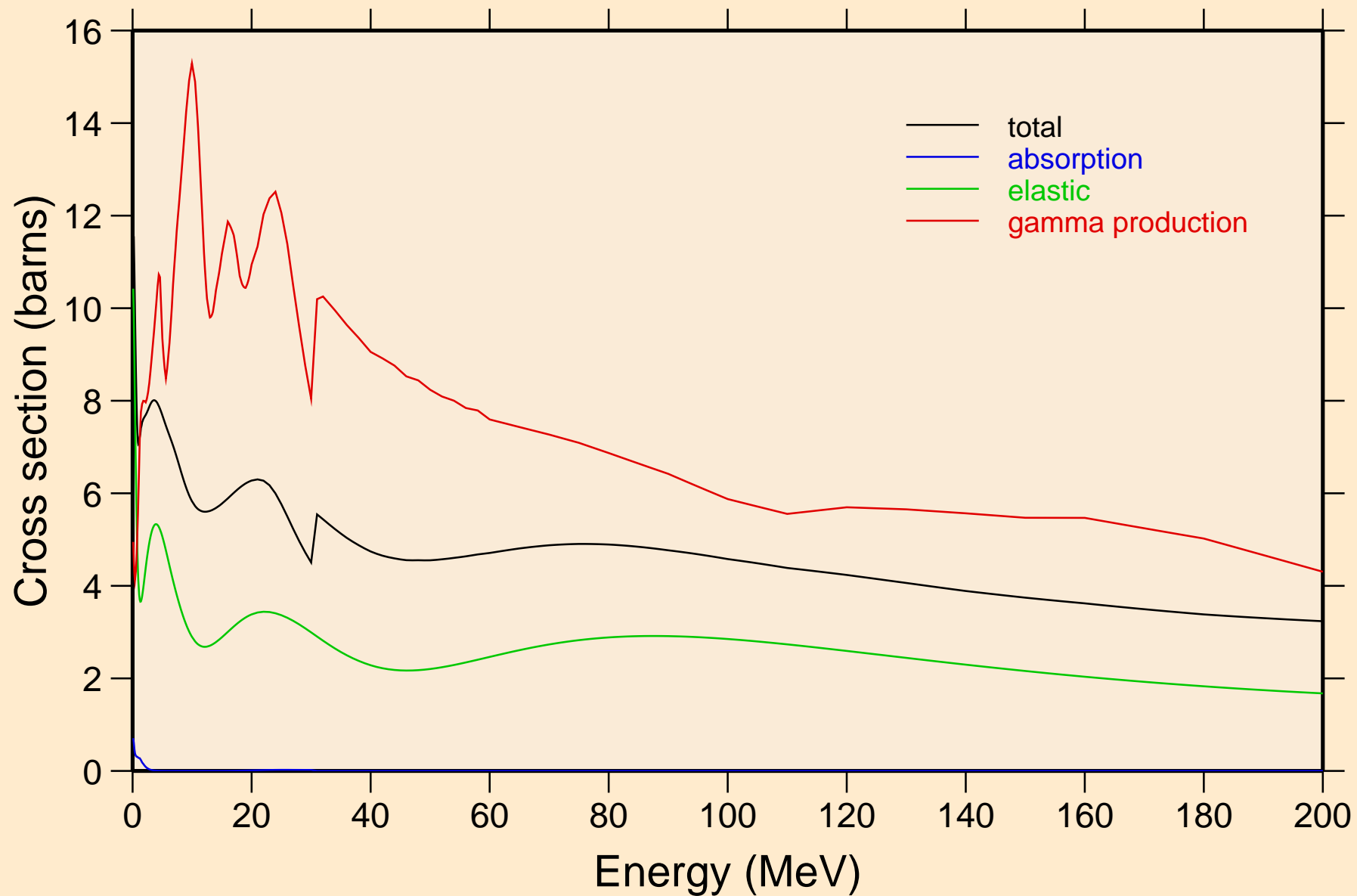

U243 NEUTRON ACER TENDL-2019 LIBRARY; T=293.16K
Heating

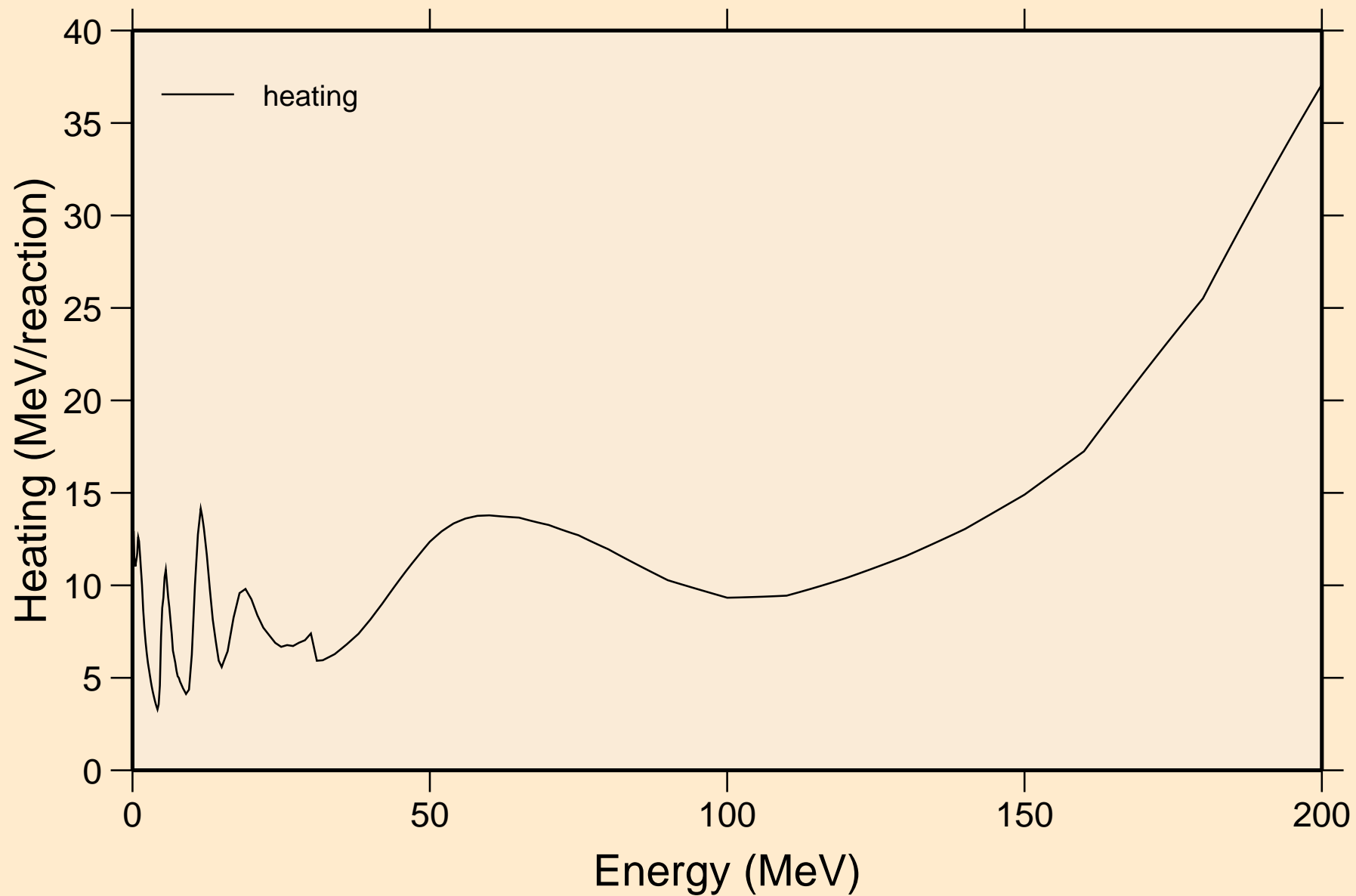

U243 NEUTRON ACER TENDL-2019 LIBRARY; T=293.16K
Damage

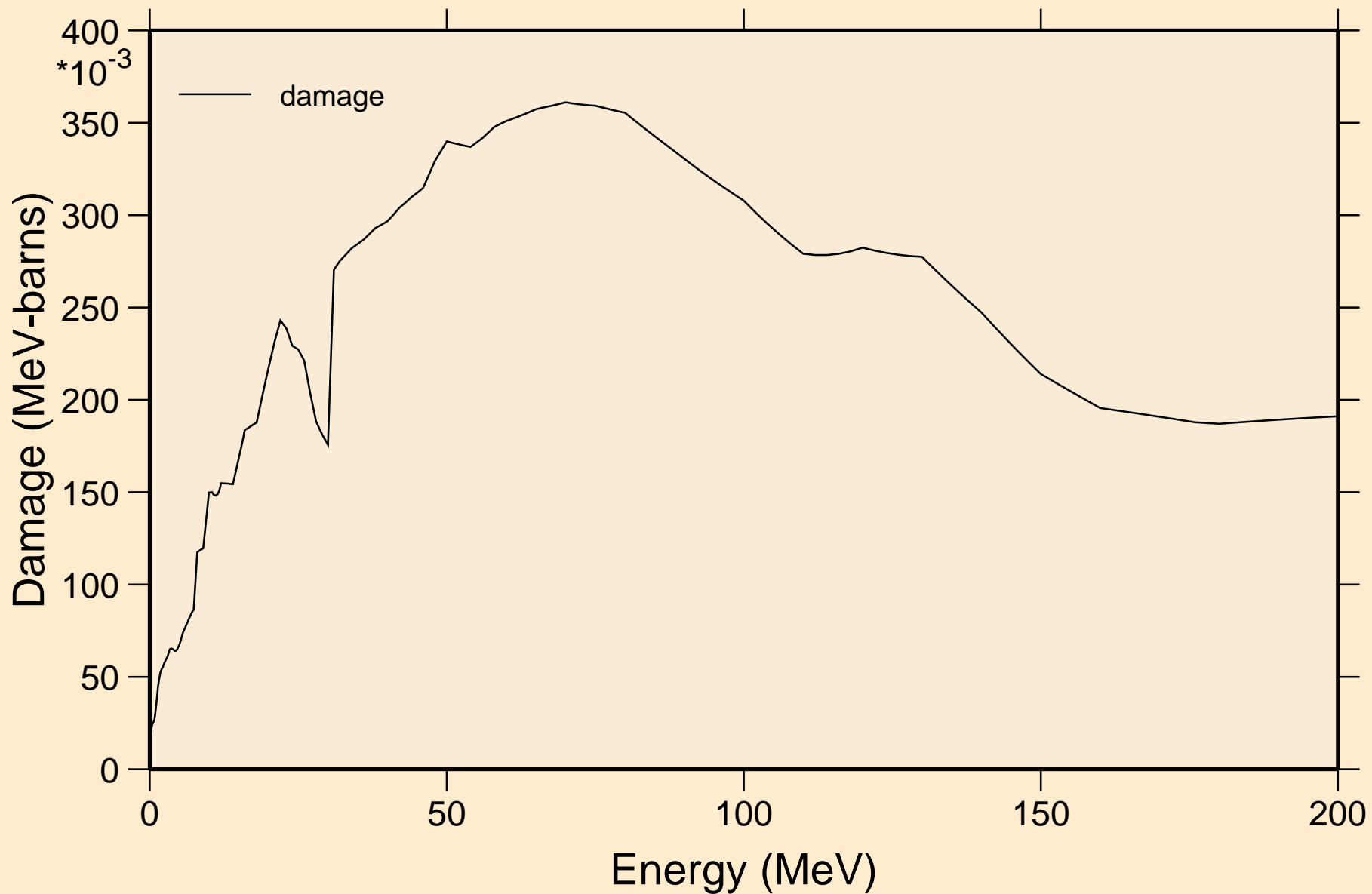

U243 NEUTRON ACER TENDL-2019 LIBRARY; T=293.16K
Non-threshold reactions

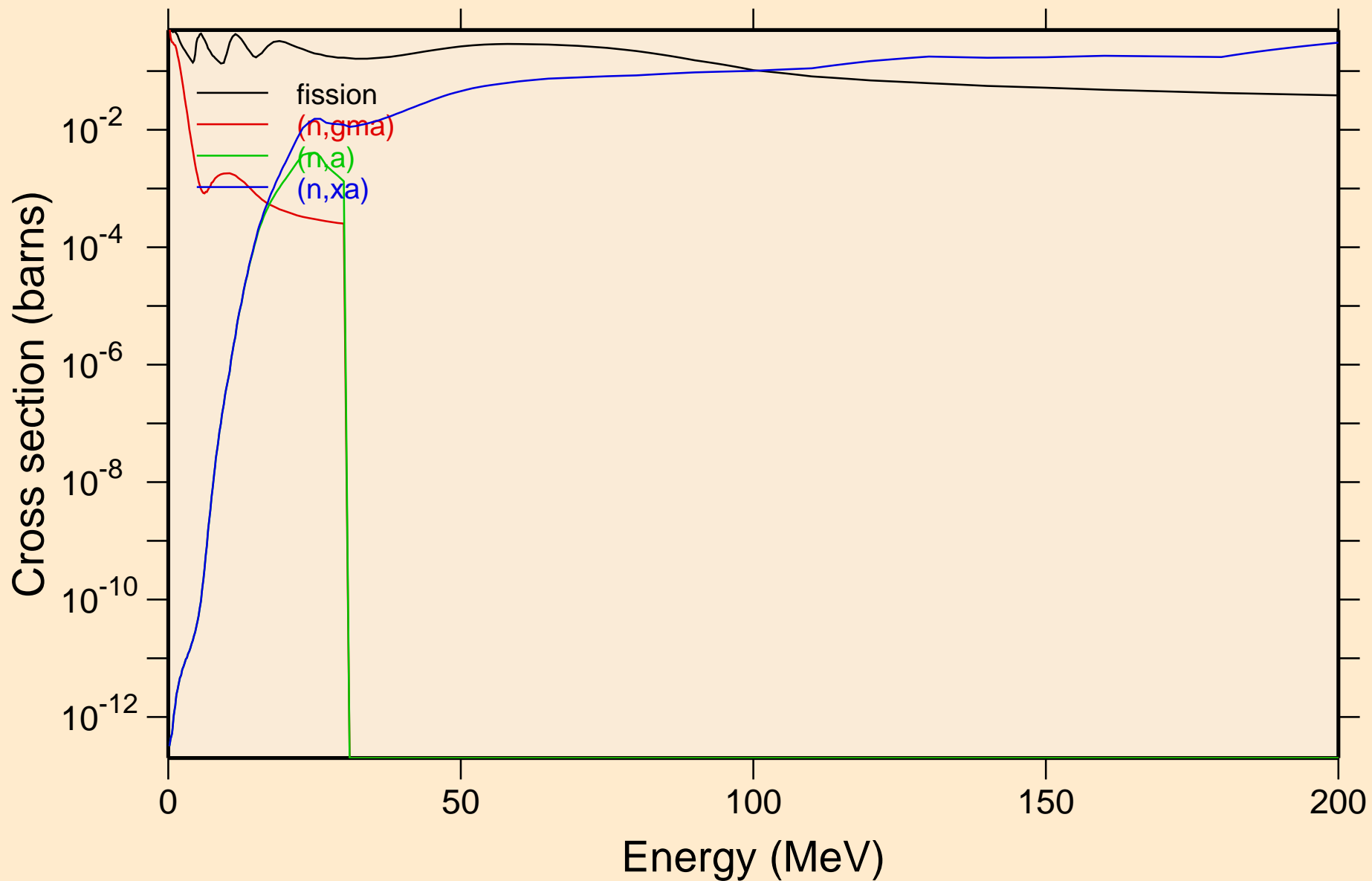

U243 NEUTRON ACER TENDL-2019 LIBRARY; T=293.16K
Inelastic levels

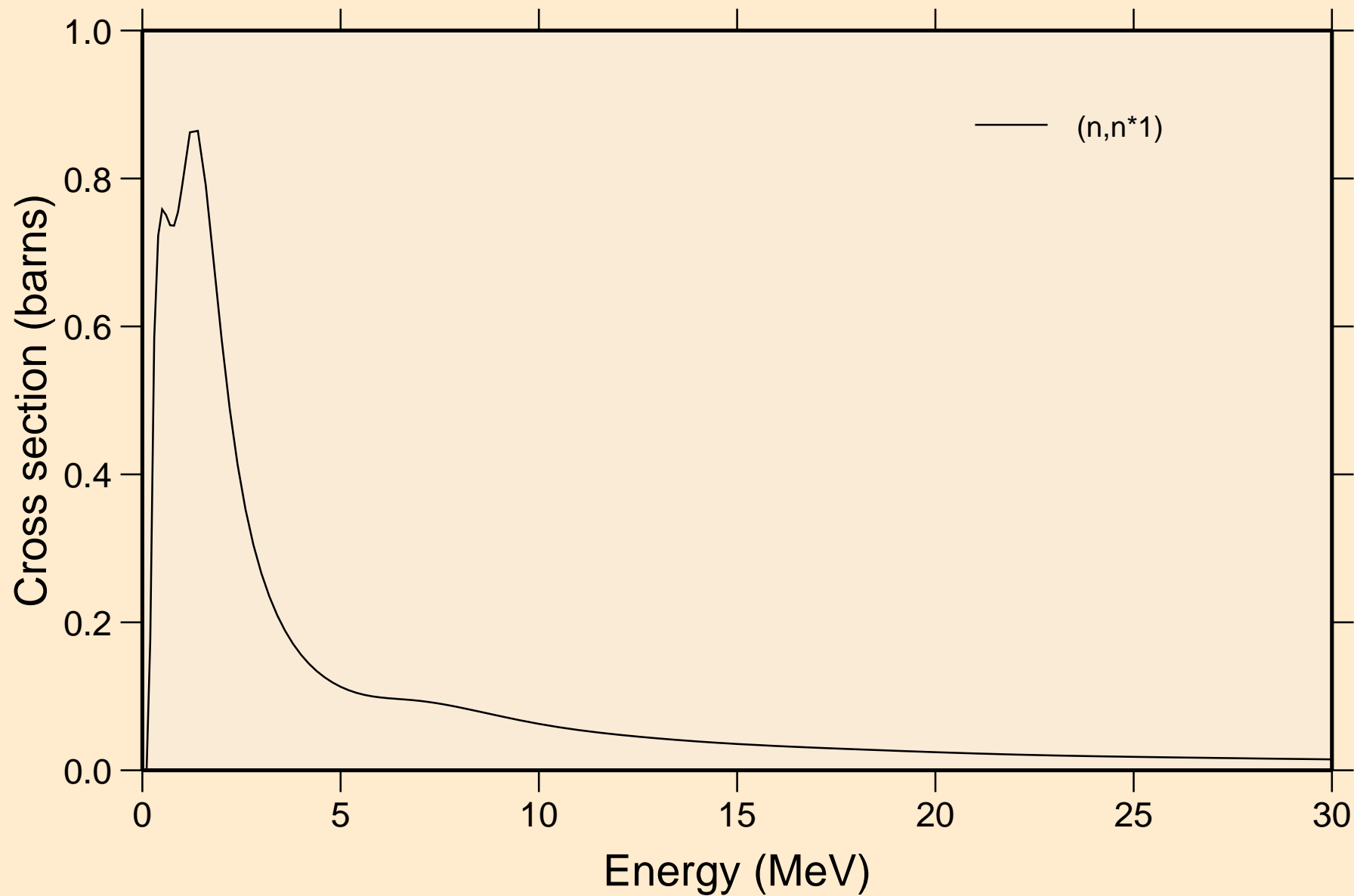

U243 NEUTRON ACER TENDL-2019 LIBRARY; T=293.16K

Threshold reactions

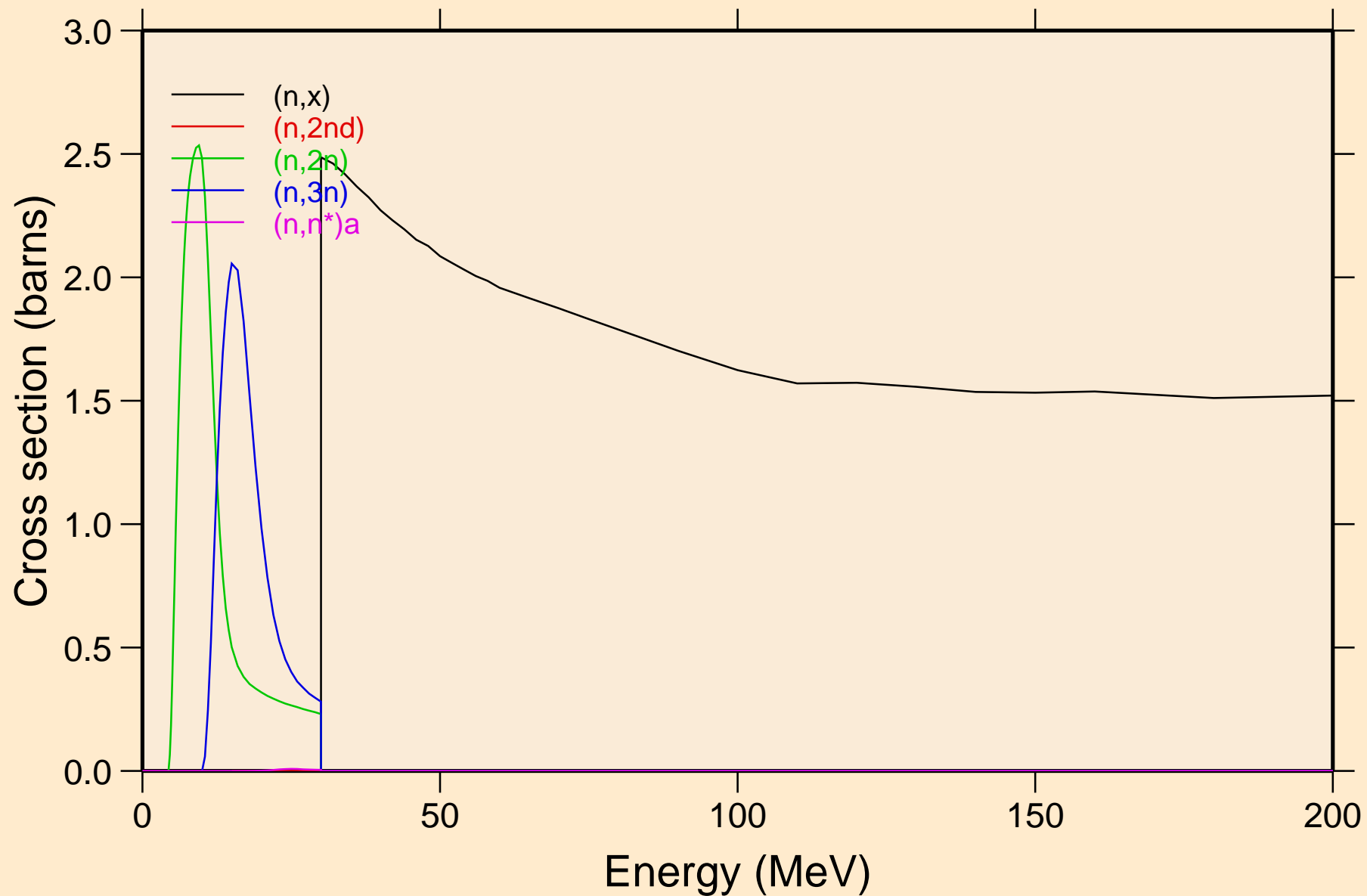

U243 NEUTRON ACER TENDL-2019 LIBRARY; T=293.16K
Threshold reactions

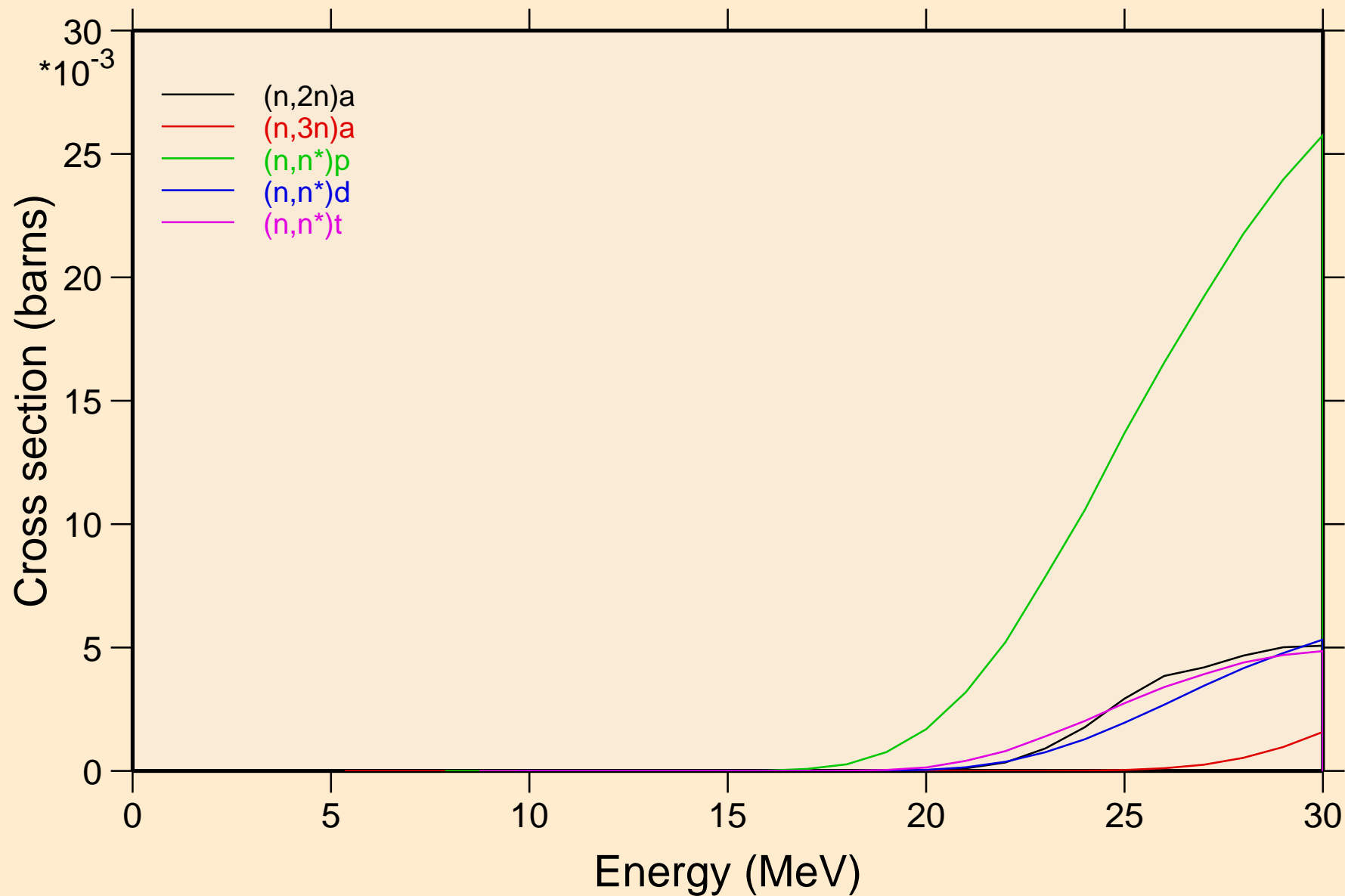

U243 NEUTRON ACER TENDL-2019 LIBRARY; T=293.16K
Threshold reactions

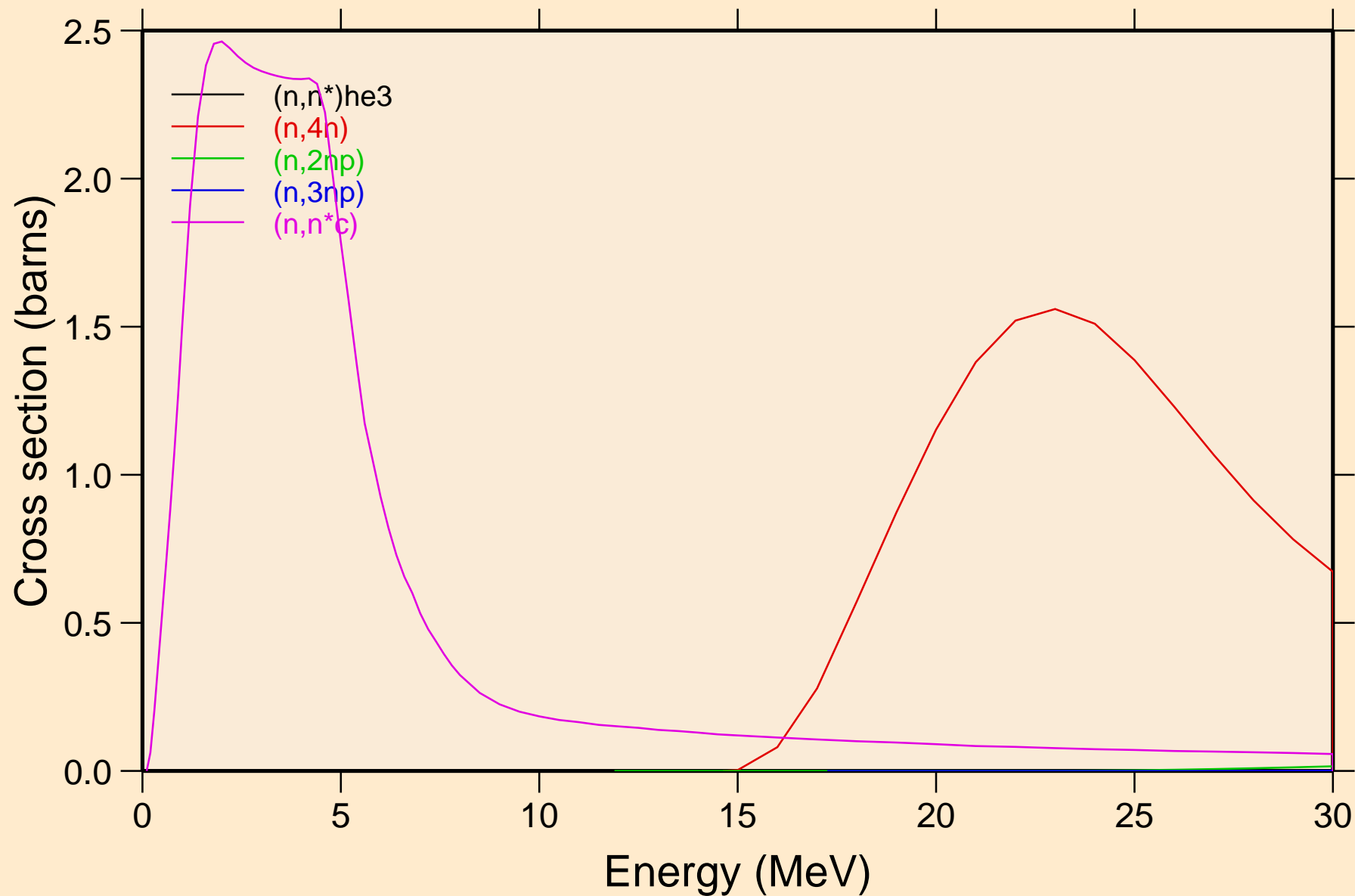

U243 NEUTRON ACER TENDL-2019 LIBRARY; T=293.16K
Threshold reactions

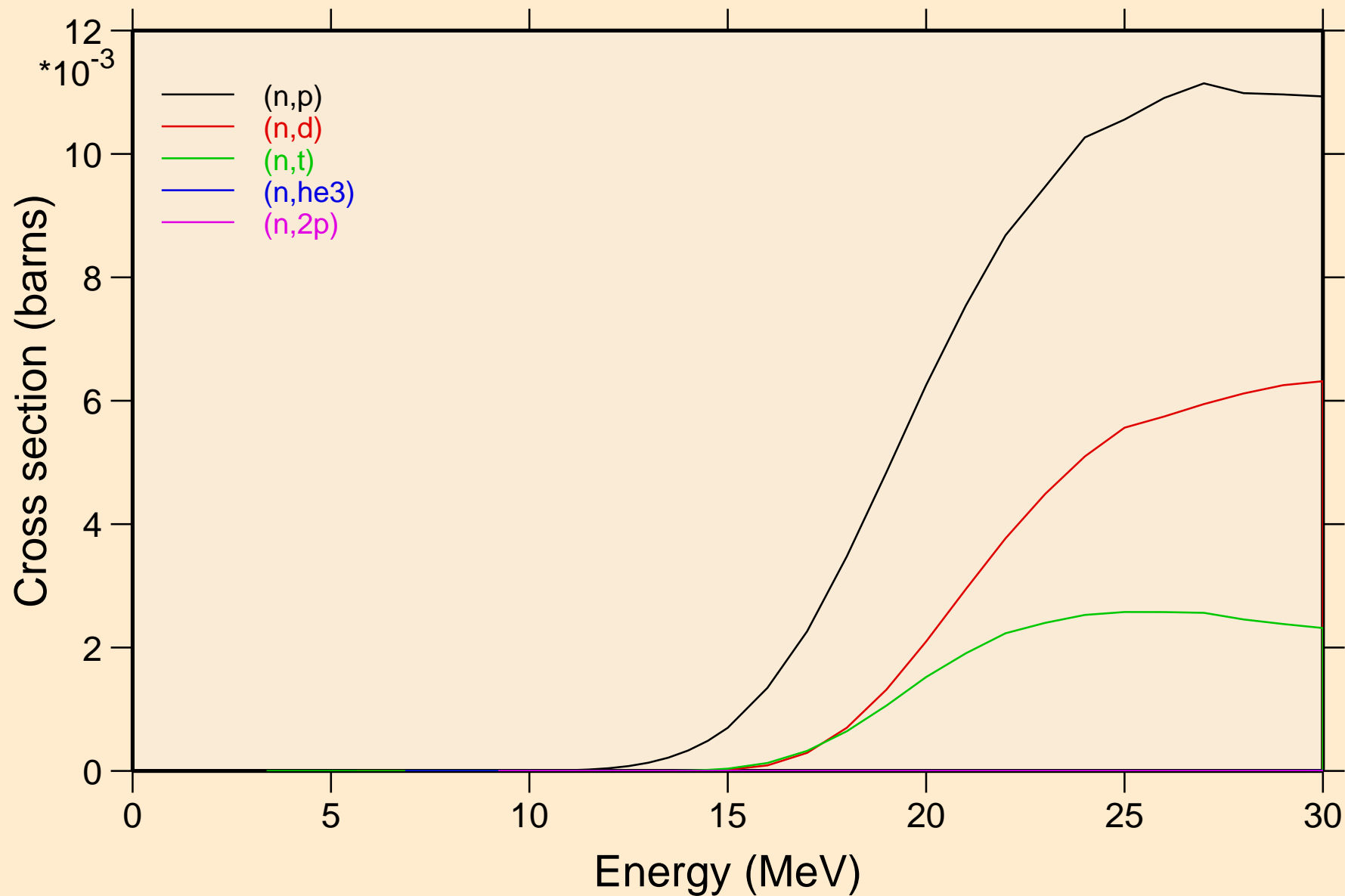

U243 NEUTRON ACER TENDL-2019 LIBRARY; T=293.16K
Threshold reactions

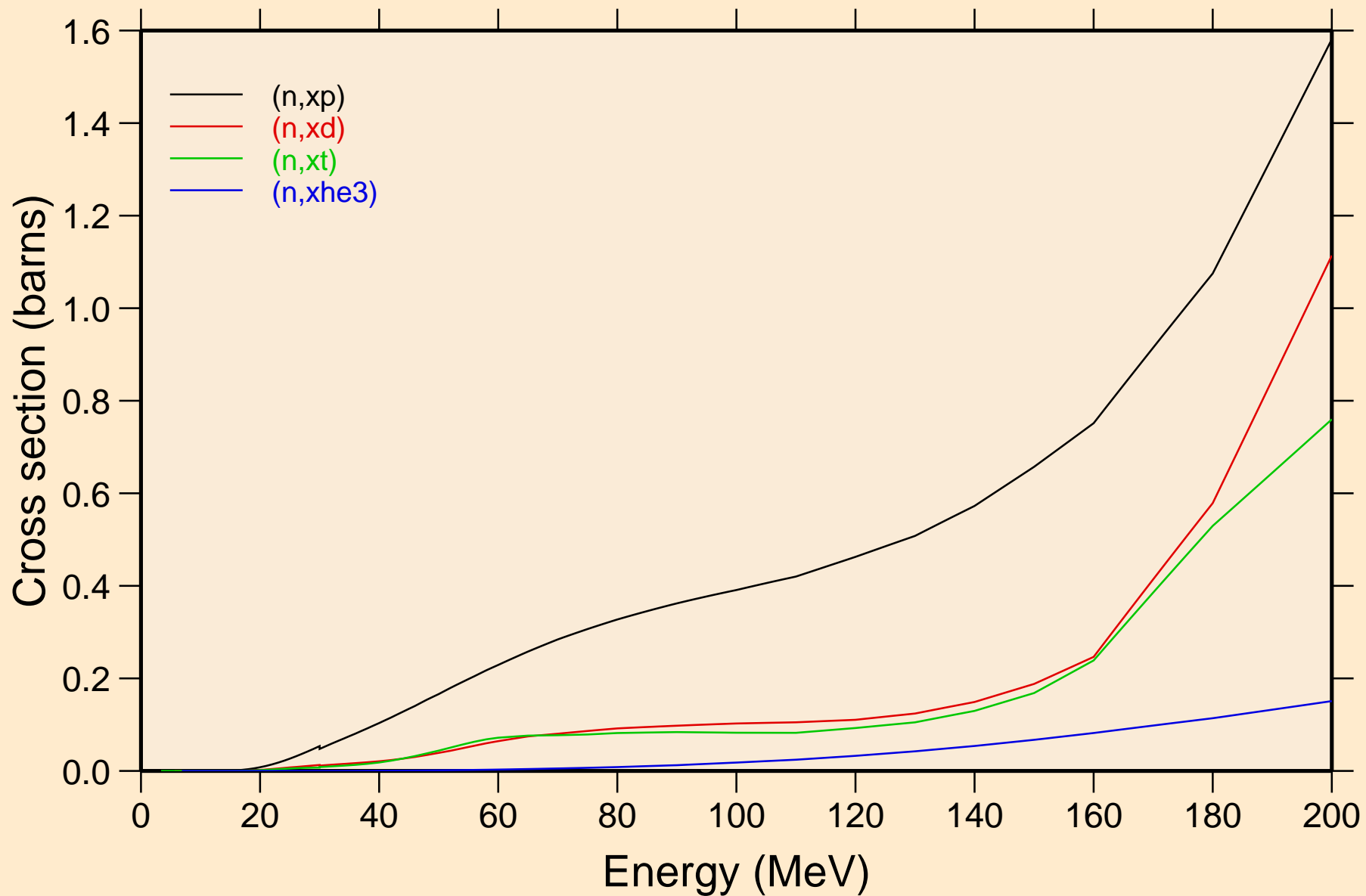

U243 NEUTRON ACER TENDL-2019 LIBRARY; T=293.16K
angular distribution for elastic

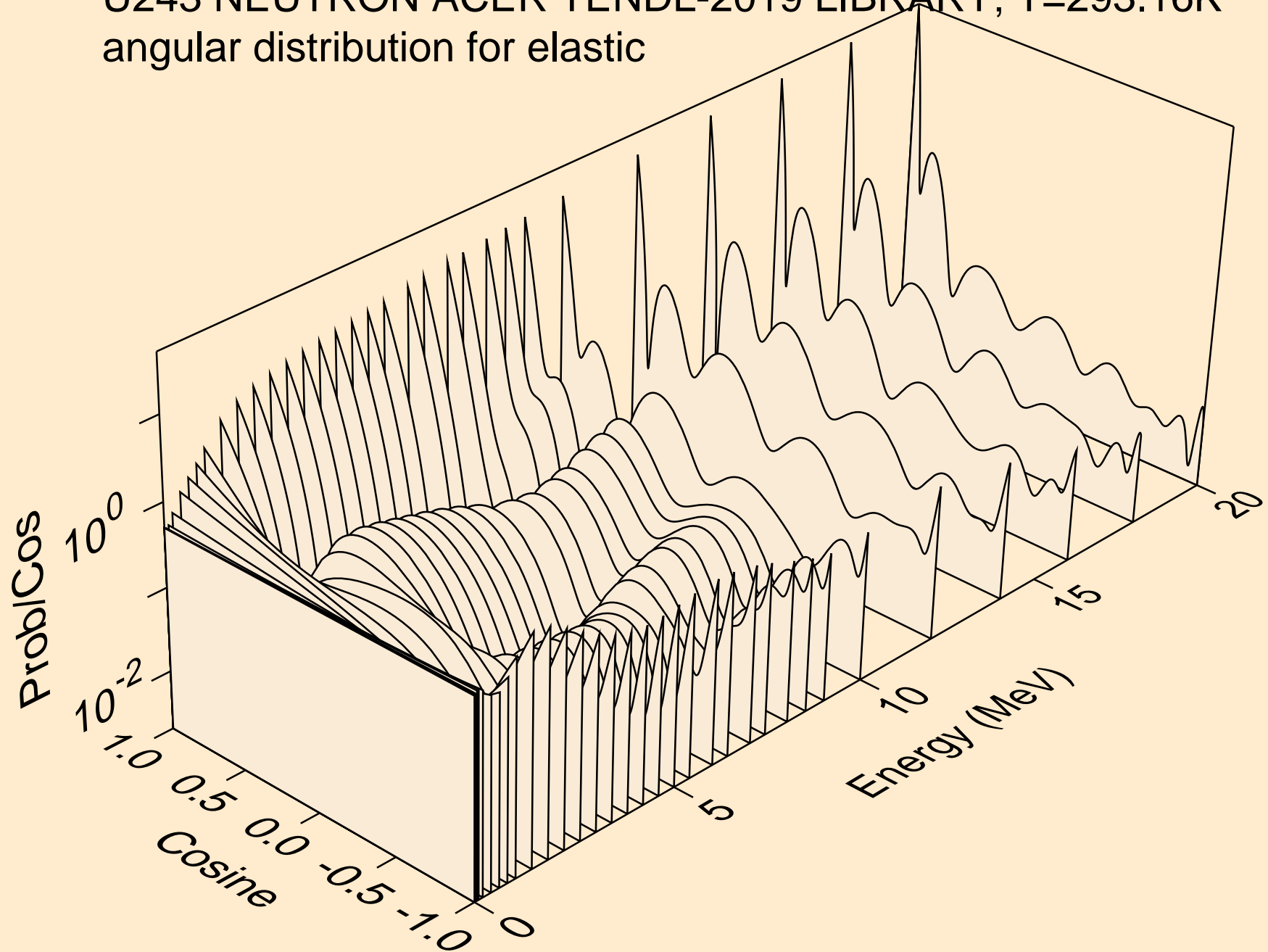

U243 NEUTRON ACER TENDL-2019 LIBRARY; T=293.16K
angular distribution for elastic

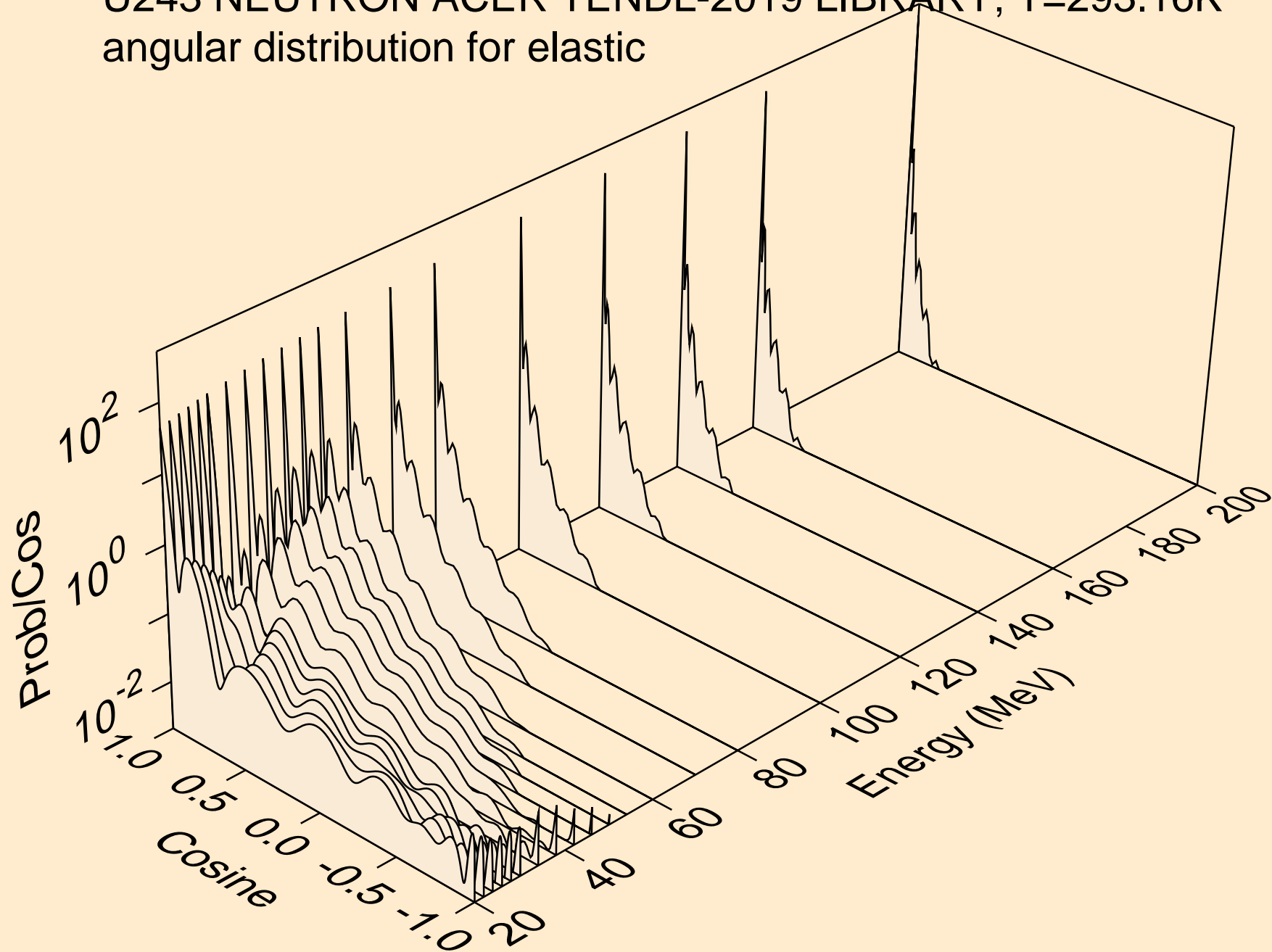

U243 NEUTRON ACER TENDL-2019 LIBRARY; T=293.16K
angular distribution for (n,n*1)

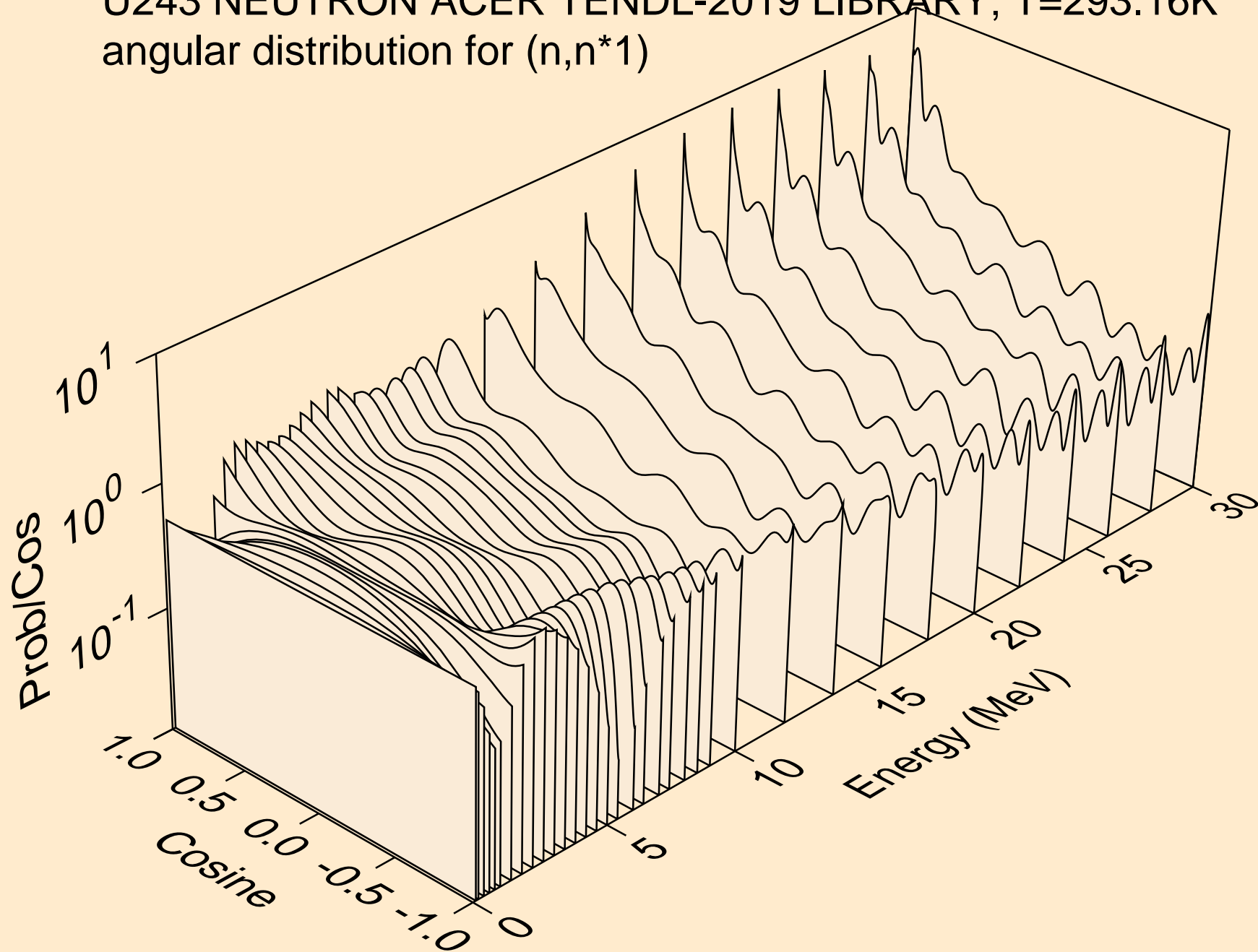

U243 NEUTRON ACER TENDL-2019 LIBRARY; T=293.16K
Total fission nubar

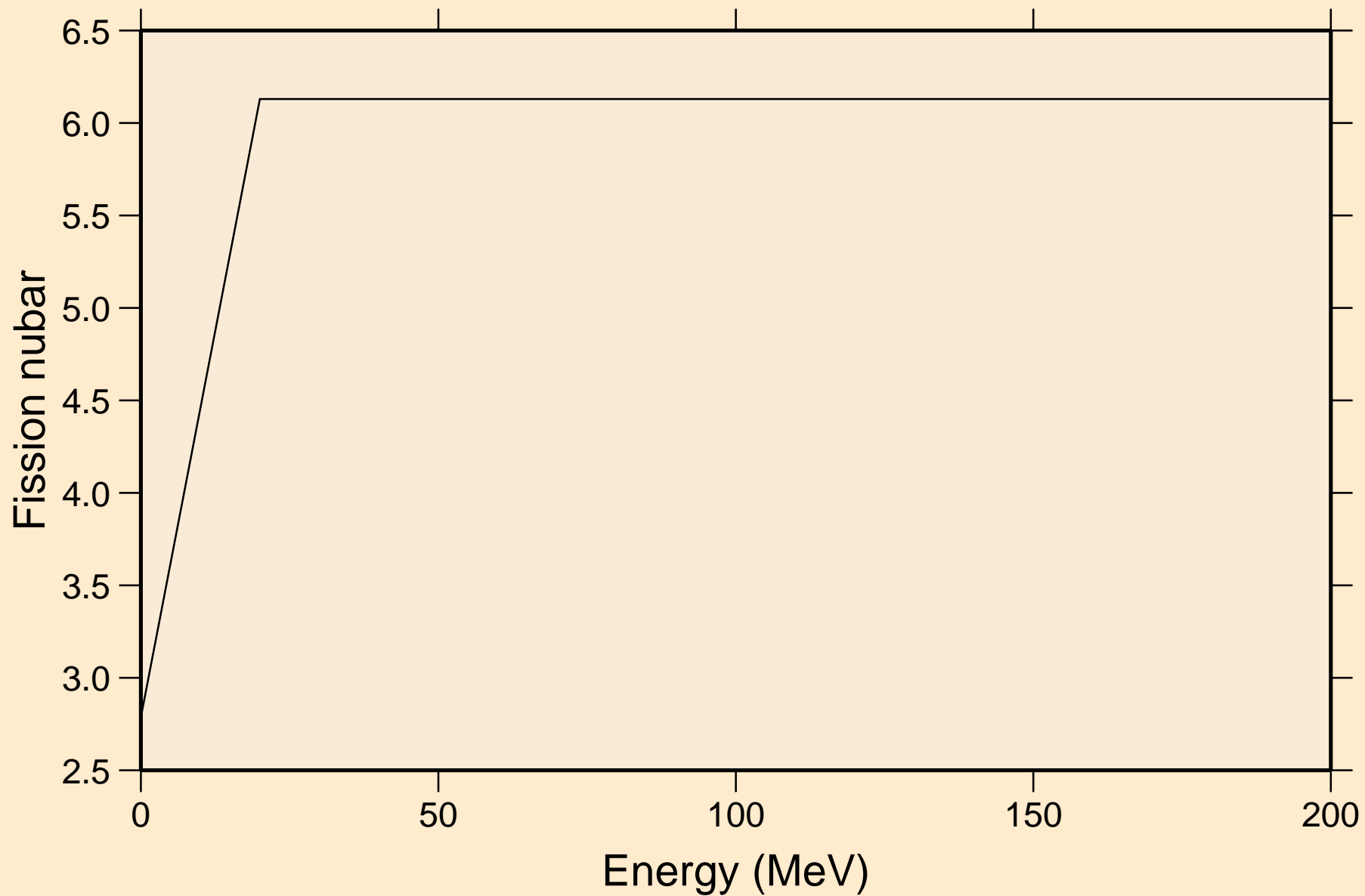

U243 NEUTRON ACER TENDL-2019 LIBRARY; T=293.16K
Neutron emission for (n,x)

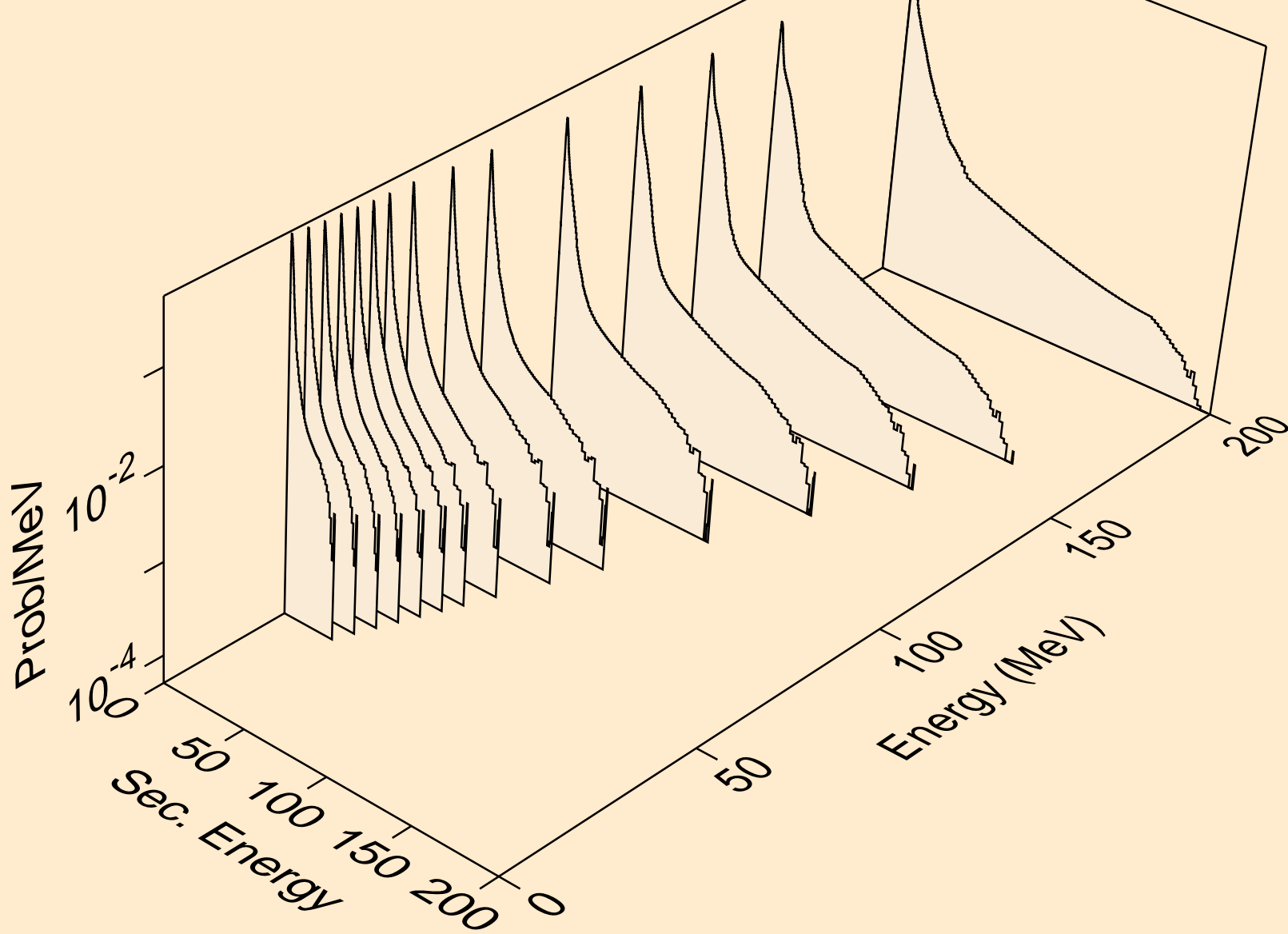

U243 NEUTRON ACER TENDL-2019 LIBRARY; T=293.16K
Neutron emission for (n,2nd)

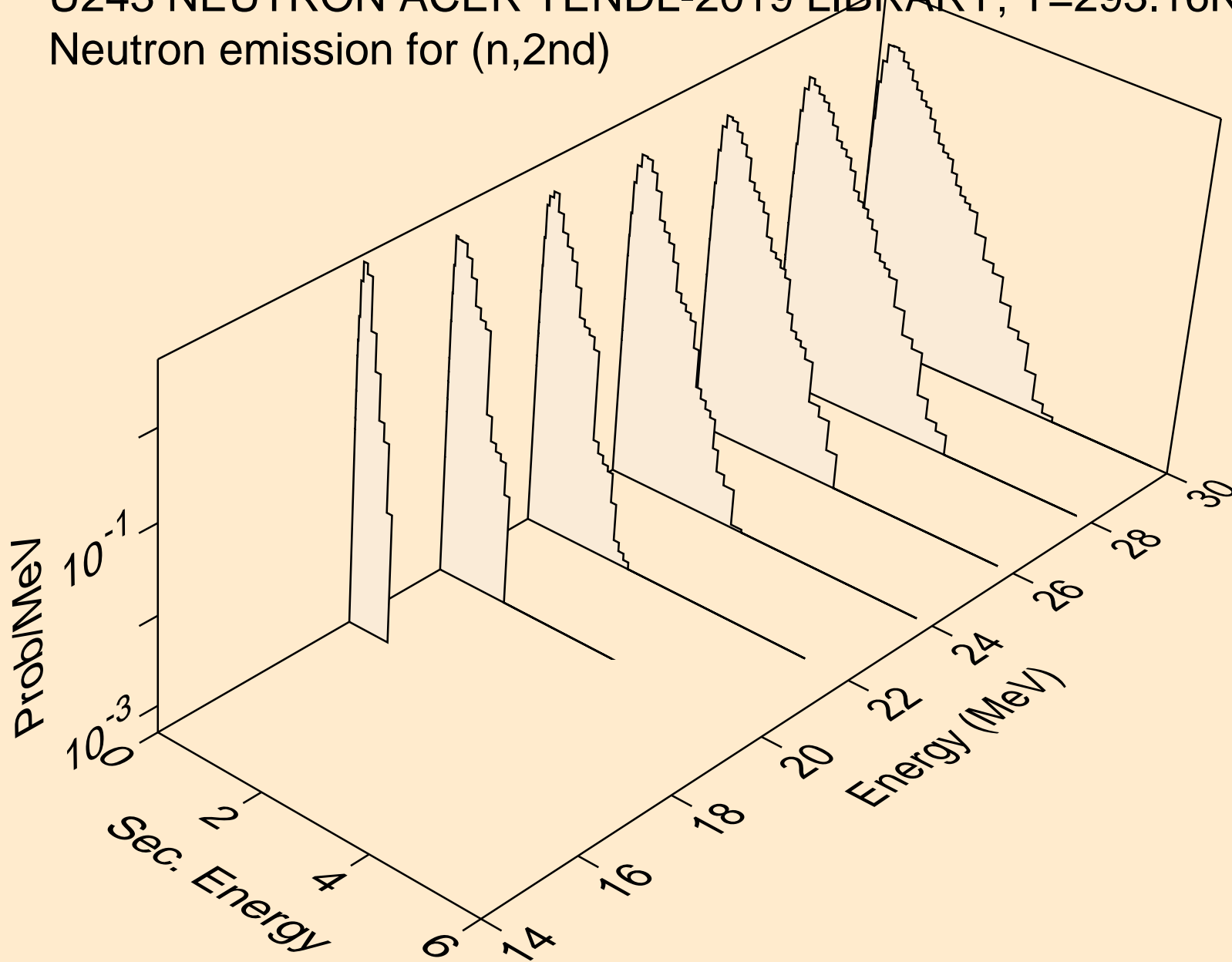

U243 NEUTRON ACER TENDL-2019 LIBRARY; T=293.16K
Neutron emission for (n,2n)

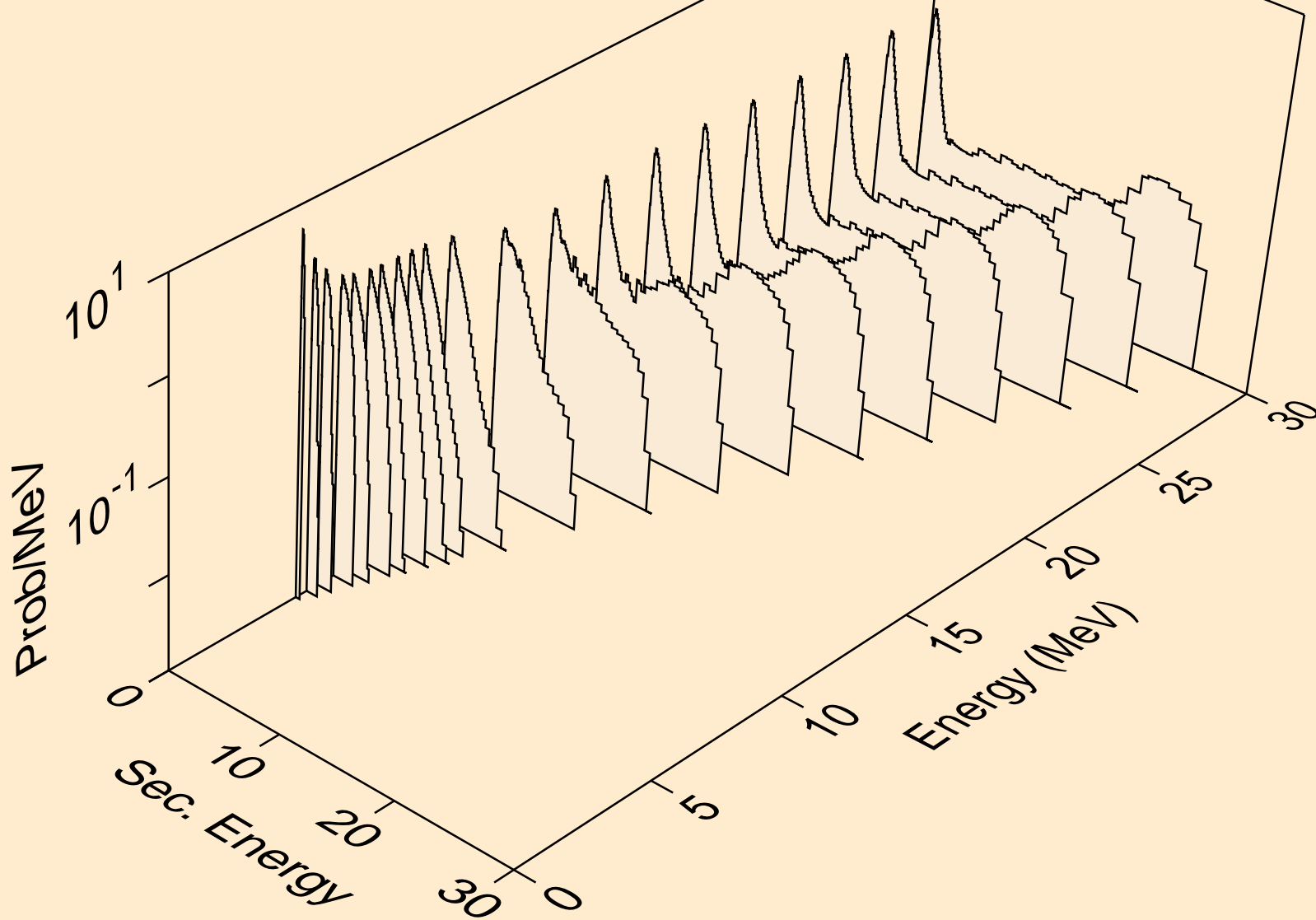

U243 NEUTRON ACER TENDL-2019 LIBRARY; T=293.16K
Neutron emission for (n,3n)

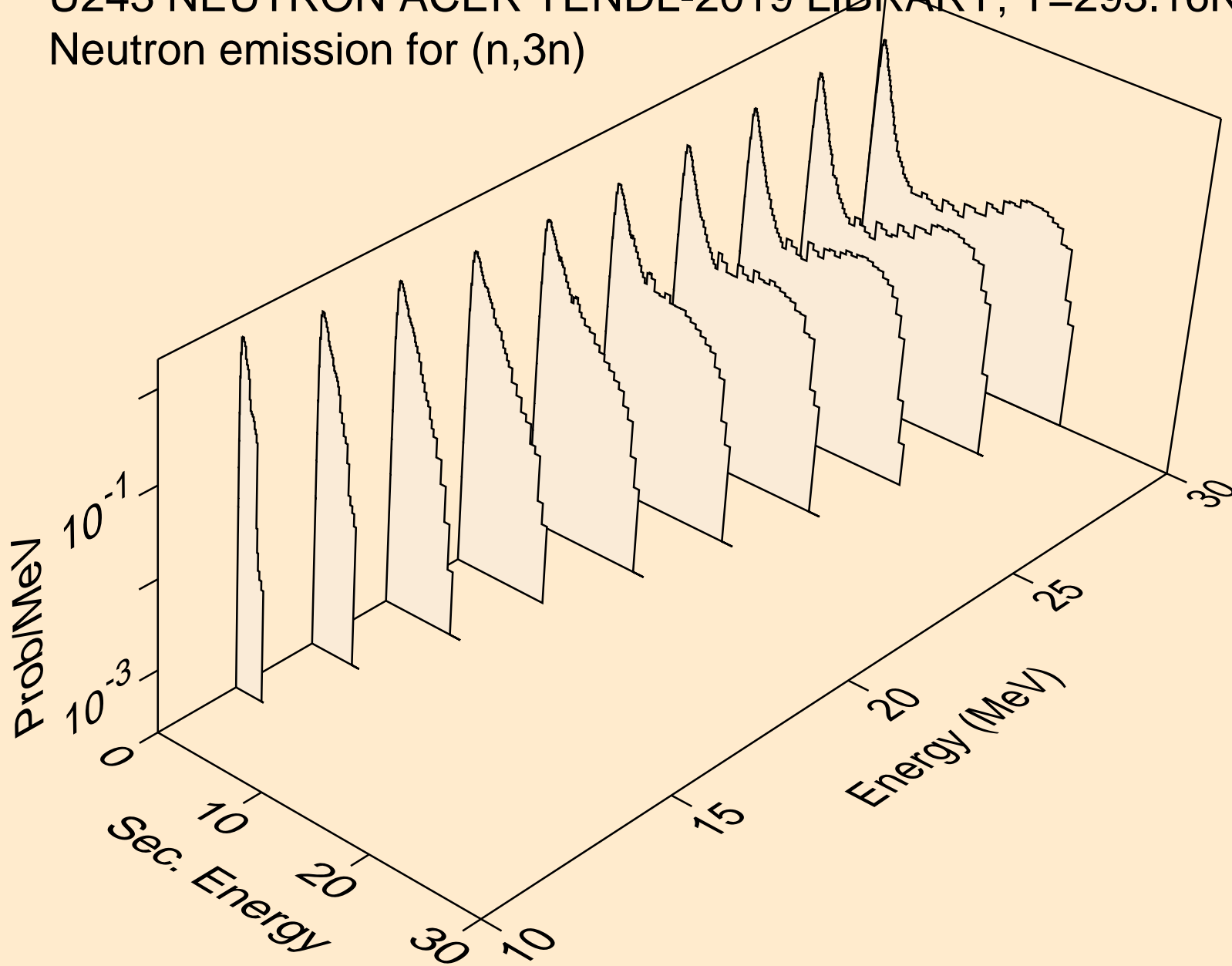

U243 NEUTRON ACER TENDL-2019 LIBRARY; T=293.16K
Neutron emission for fission

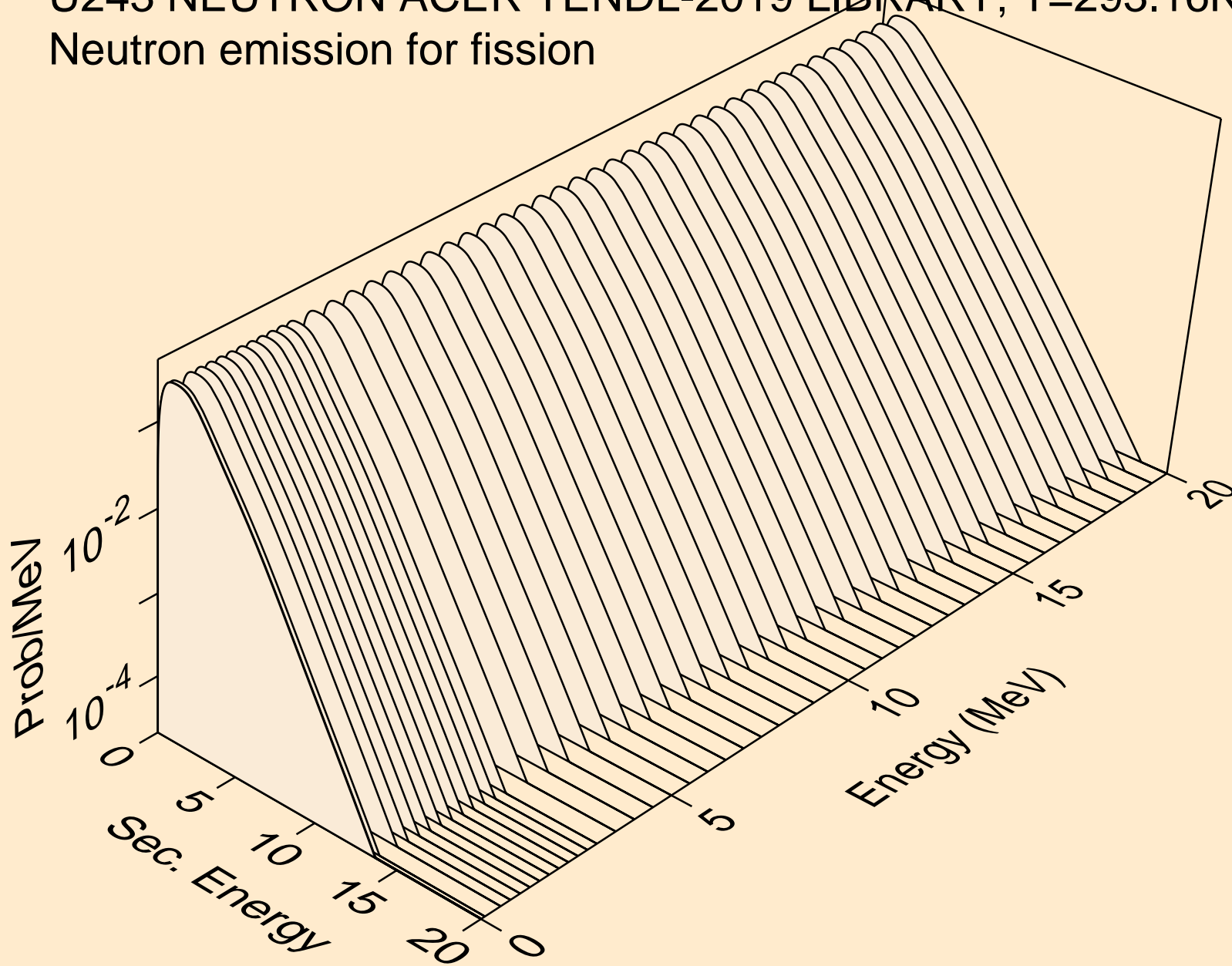

U243 NEUTRON ACER TENDL-2019 LIBRARY; T=293.16K
Neutron emission for (n,n*)a

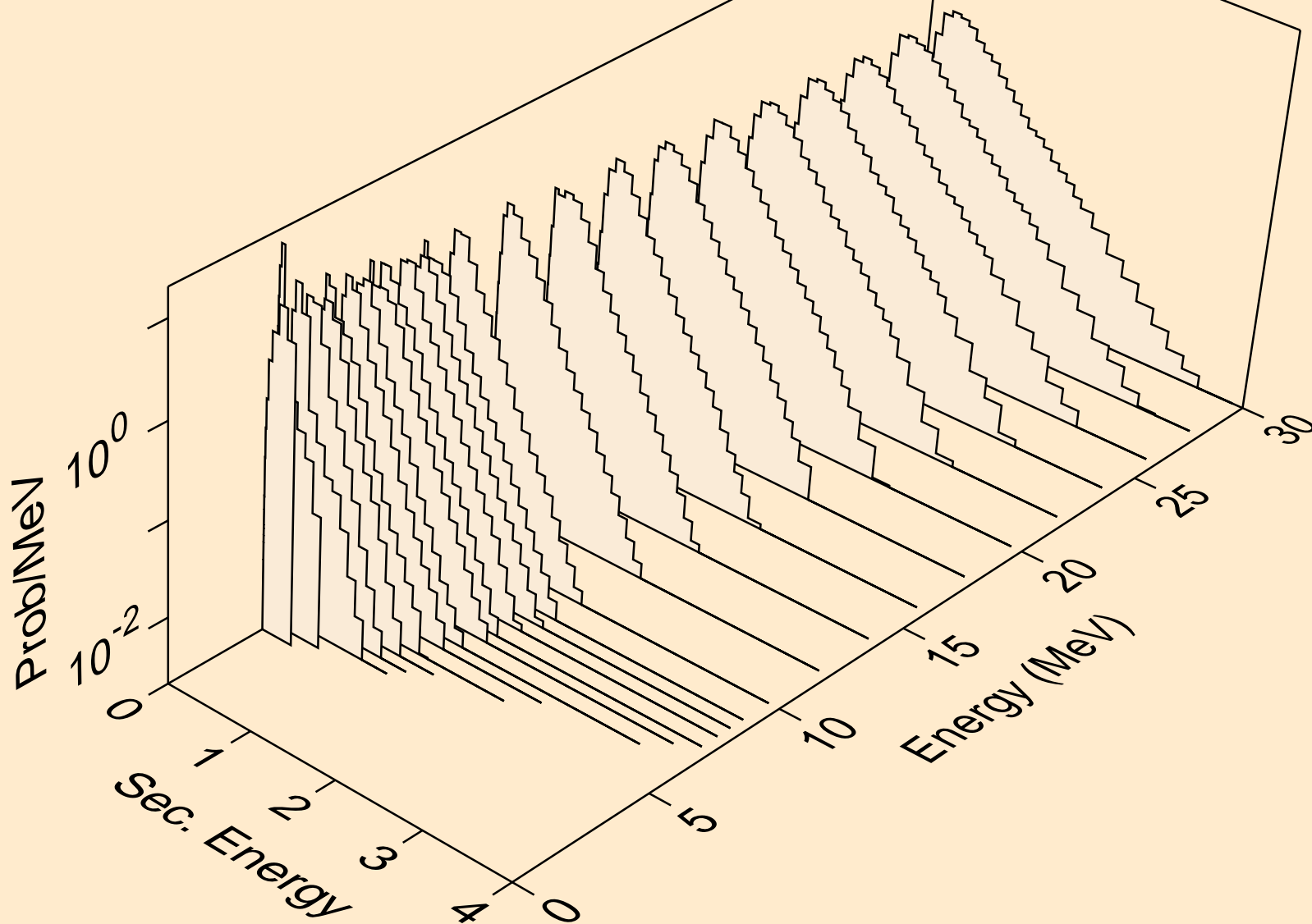

U243 NEUTRON ACER TENDL-2019 LIBRARY; T=293.16K
Neutron emission for (n,2n)a

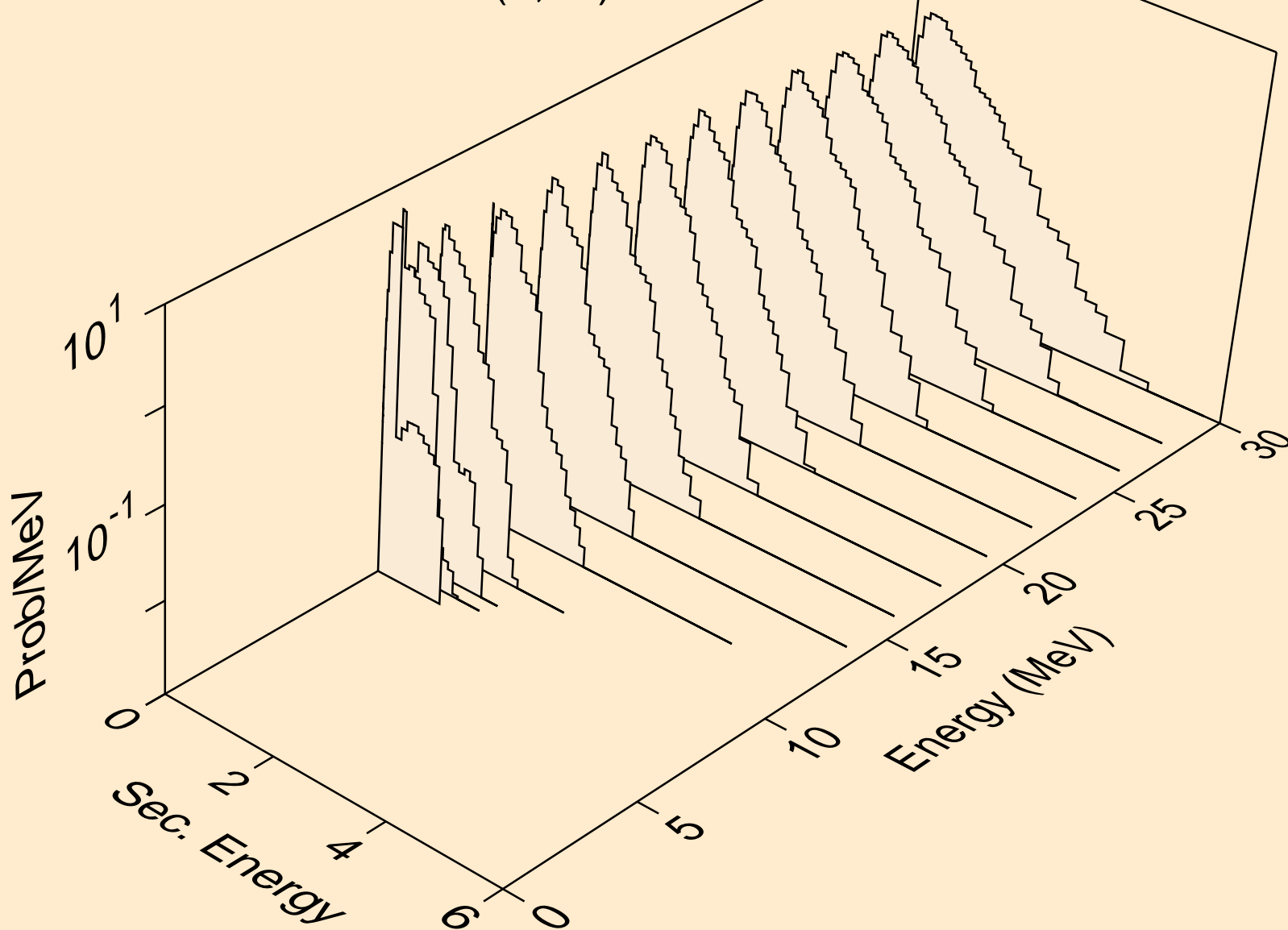

U243 NEUTRON ACER TENDL-2019 LIBRARY; T=293.16K
Neutron emission for (n,3n)a

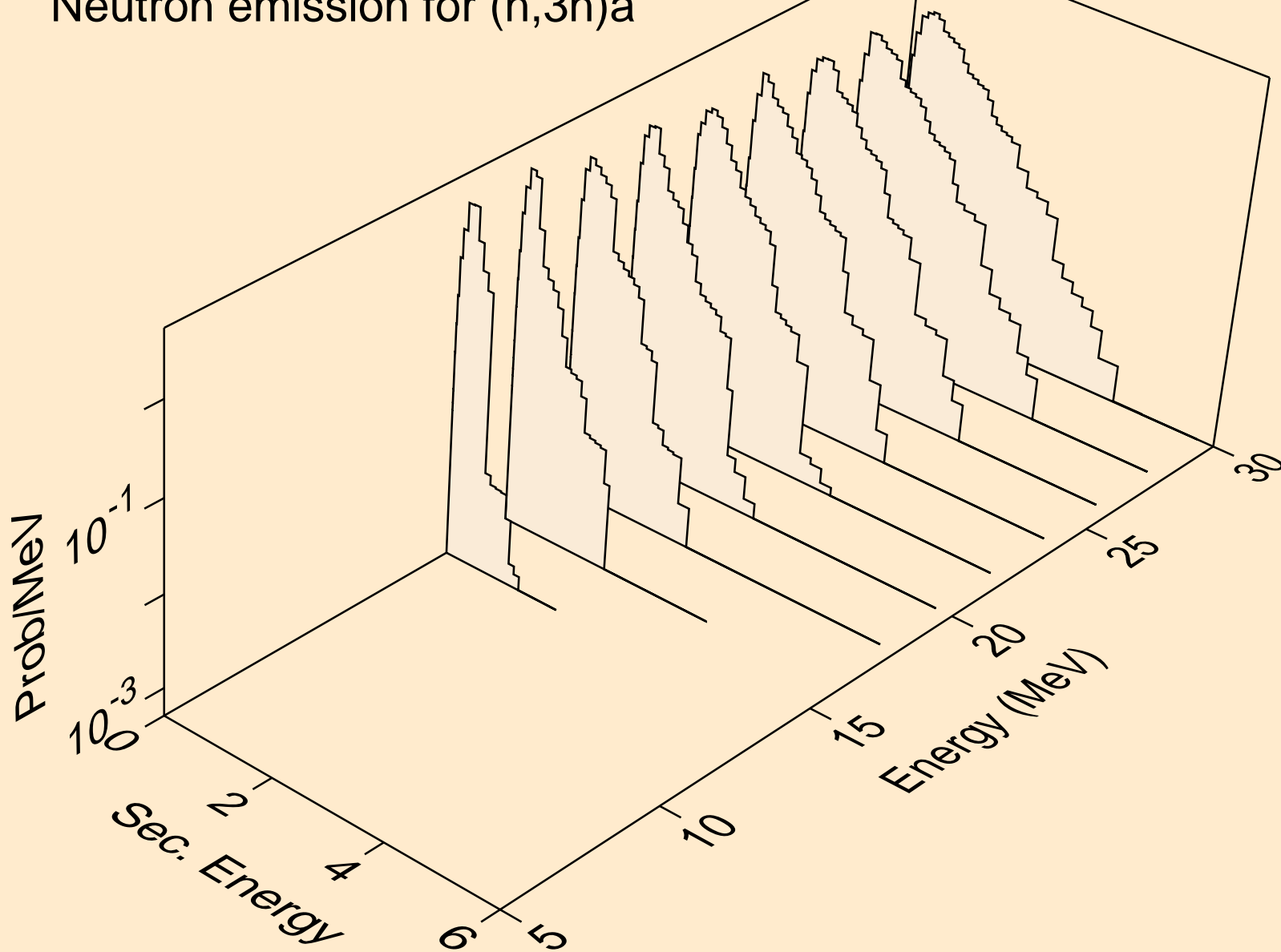

U243 NEUTRON ACER TENDL-2019 LIBRARY; T=293.16K
Neutron emission for (n,n*)p

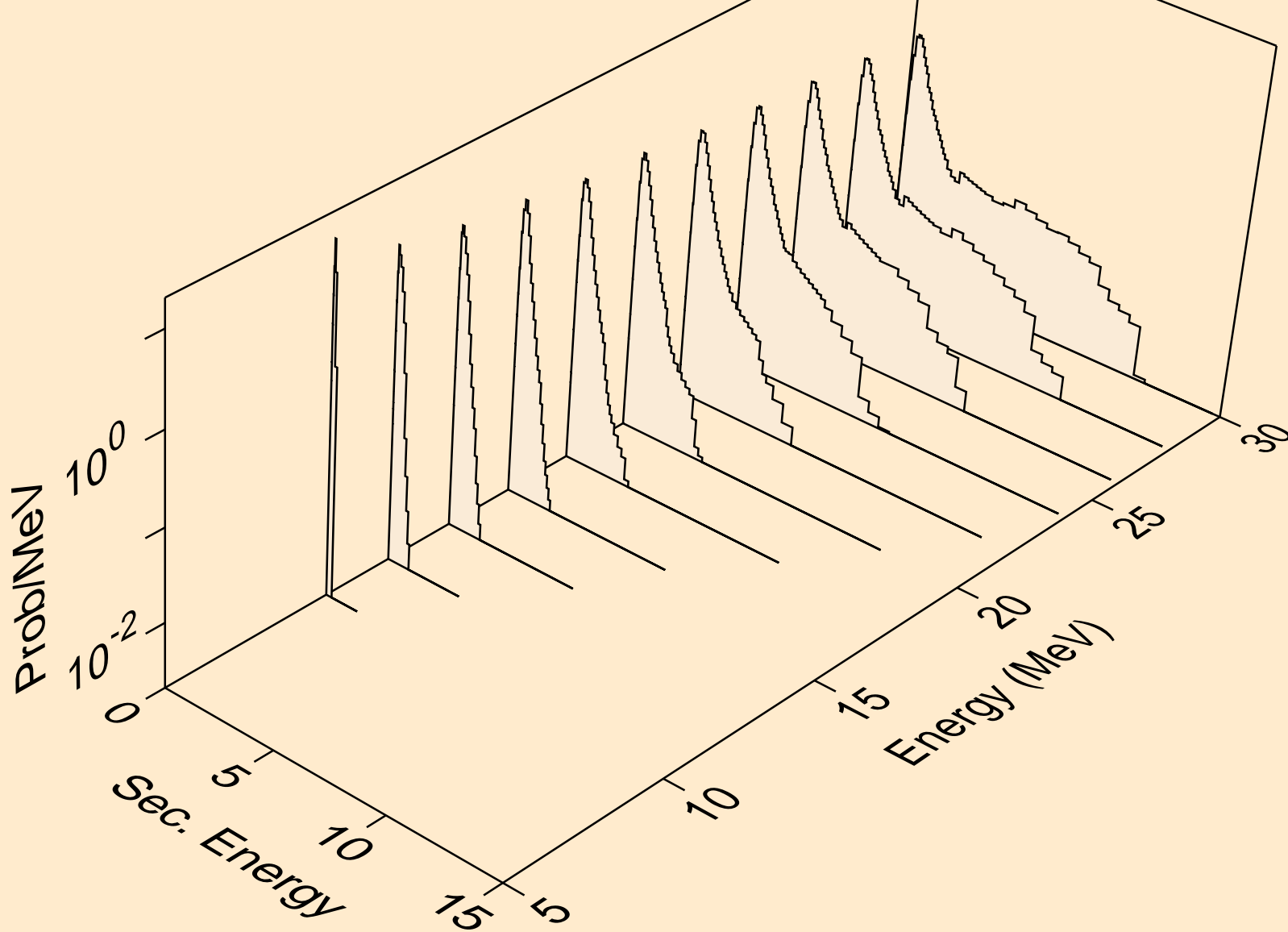

U243 NEUTRON ACER TENDL-2019 LIBRARY; T=293.16K
Neutron emission for (n,n*)d

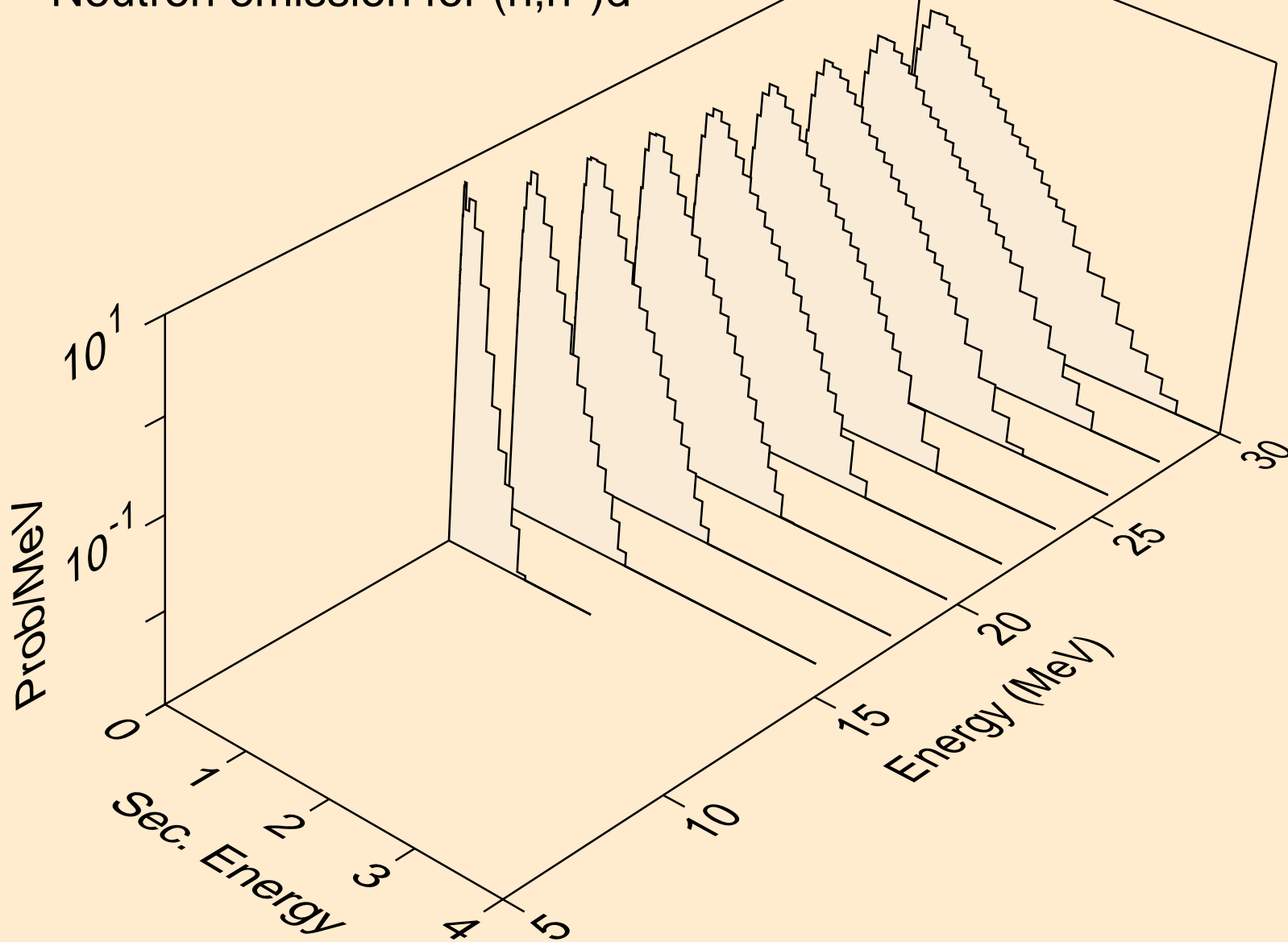

U243 NEUTRON ACER TENDL-2019 LIBRARY; T=293.16K
Neutron emission for (n,n*)t

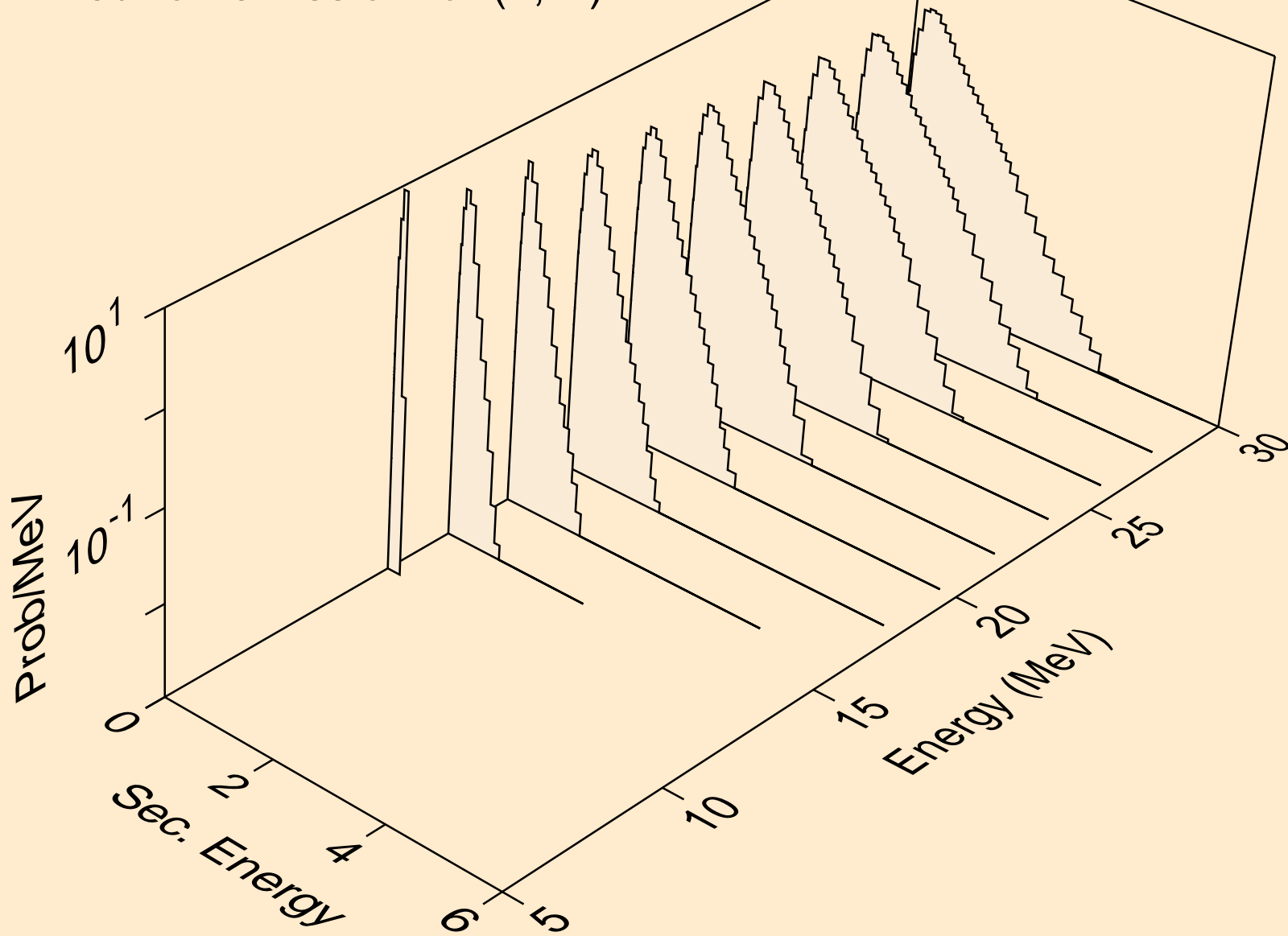

U243 NEUTRON ACER TENDL-2019 LIBRARY; T=293.16K
Neutron emission for (n,n*)he3

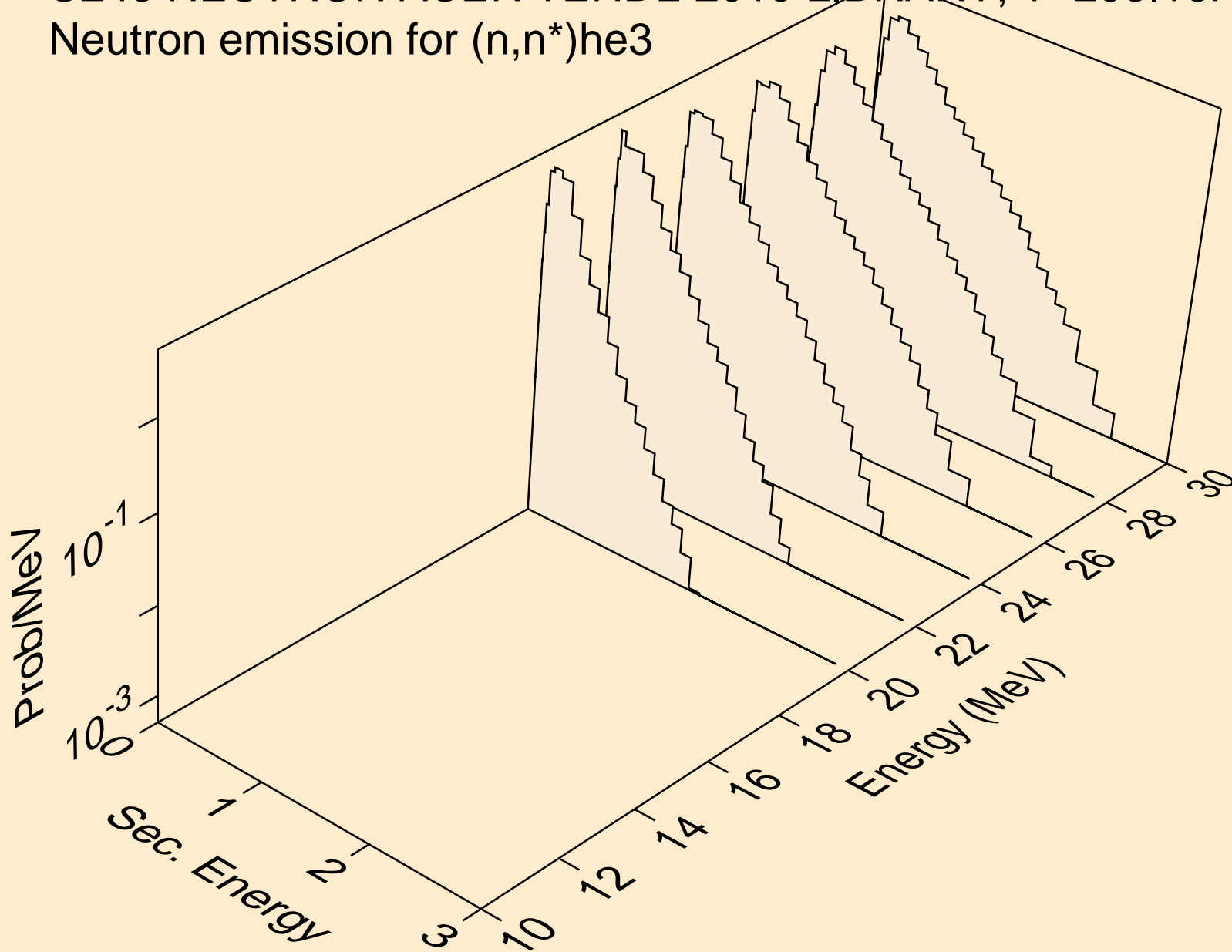

U243 NEUTRON ACER TENDL-2019 LIBRARY; T=293.16K
Neutron emission for (n,4n)

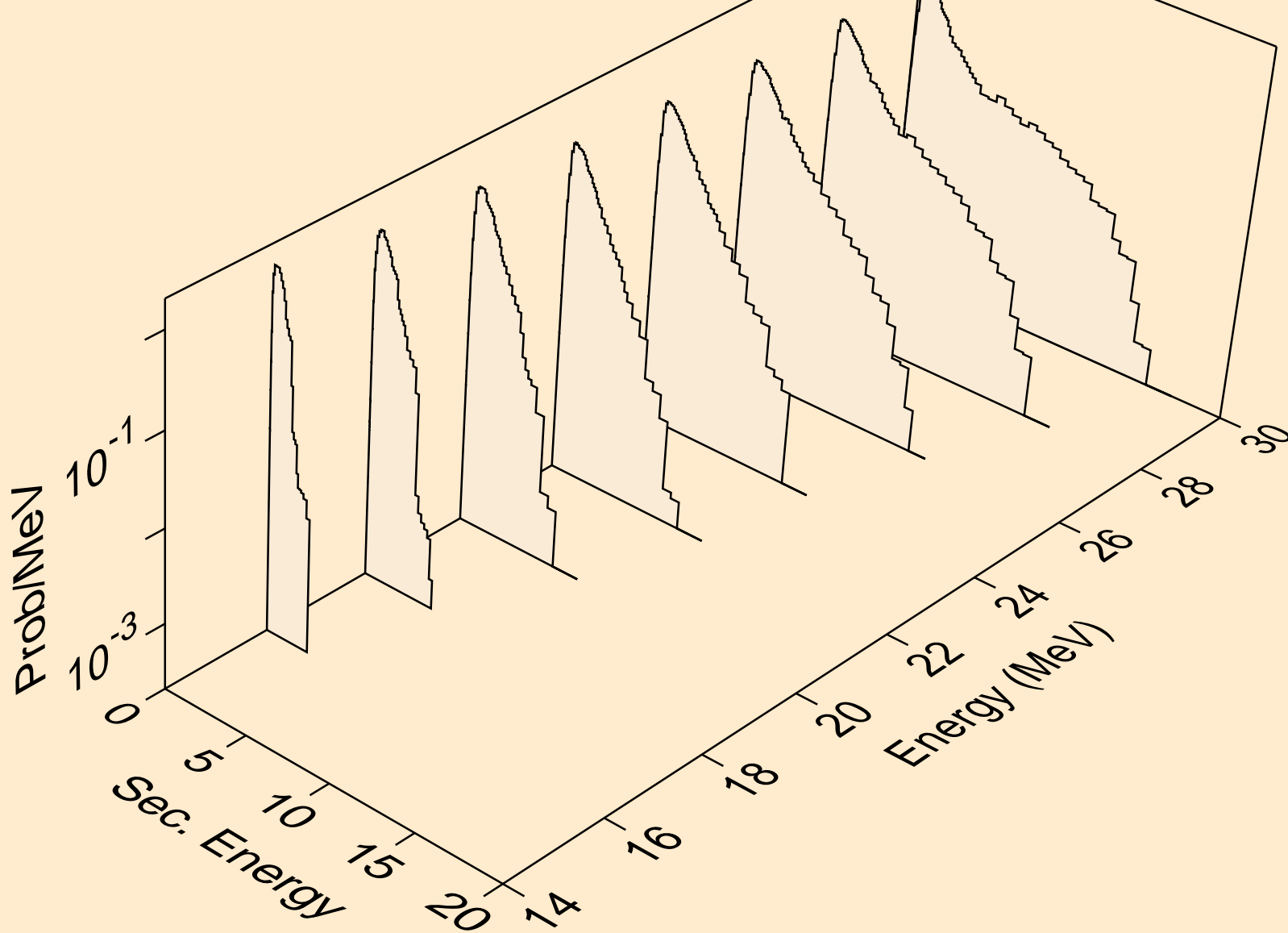

U243 NEUTRON ACER TENDL-2019 LIBRARY; T=293.16K
Neutron emission for (n,2np)

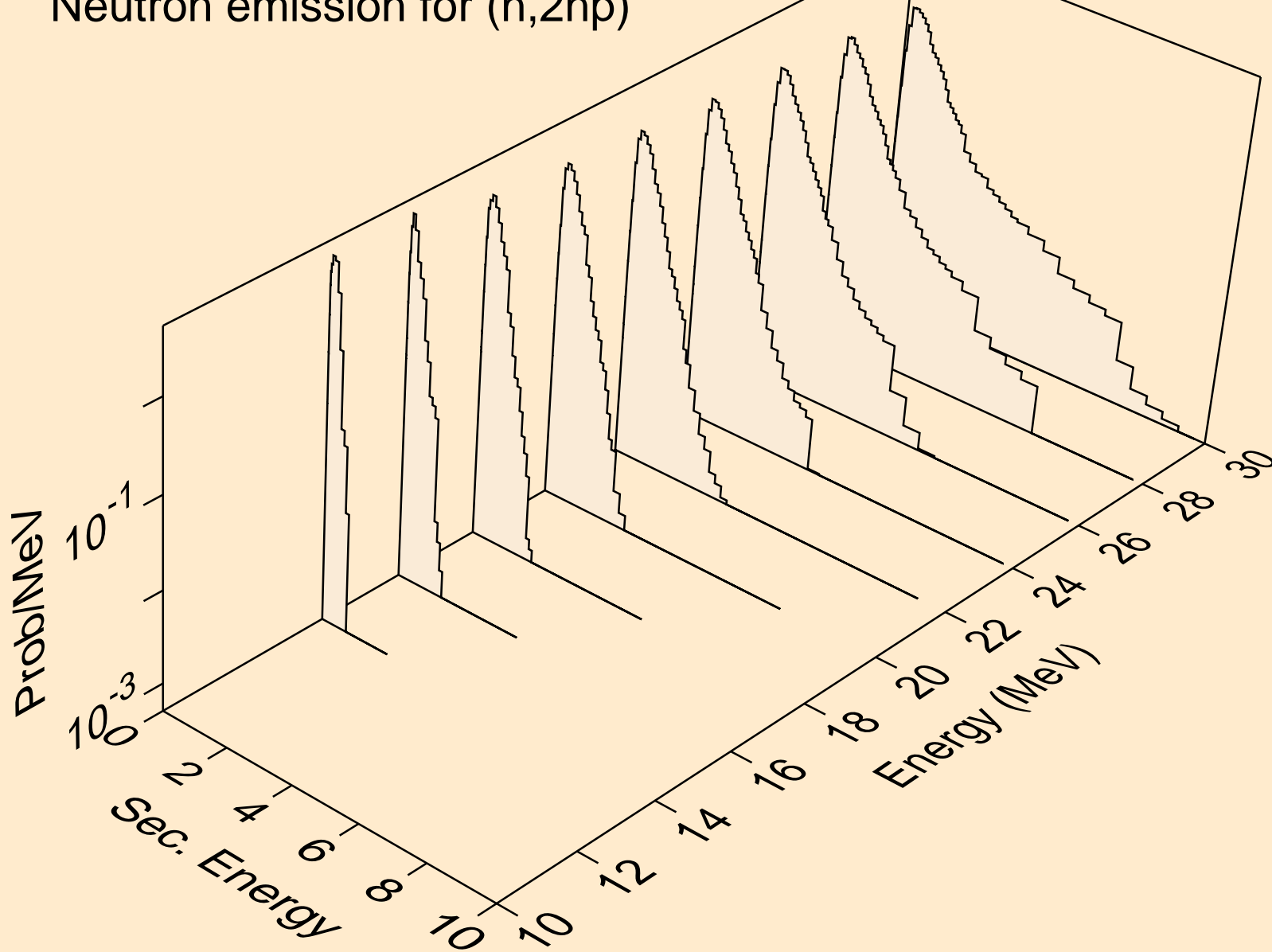

U243 NEUTRON ACER TENDL-2019 LIBRARY; T=293.16K
Neutron emission for (n,3np)

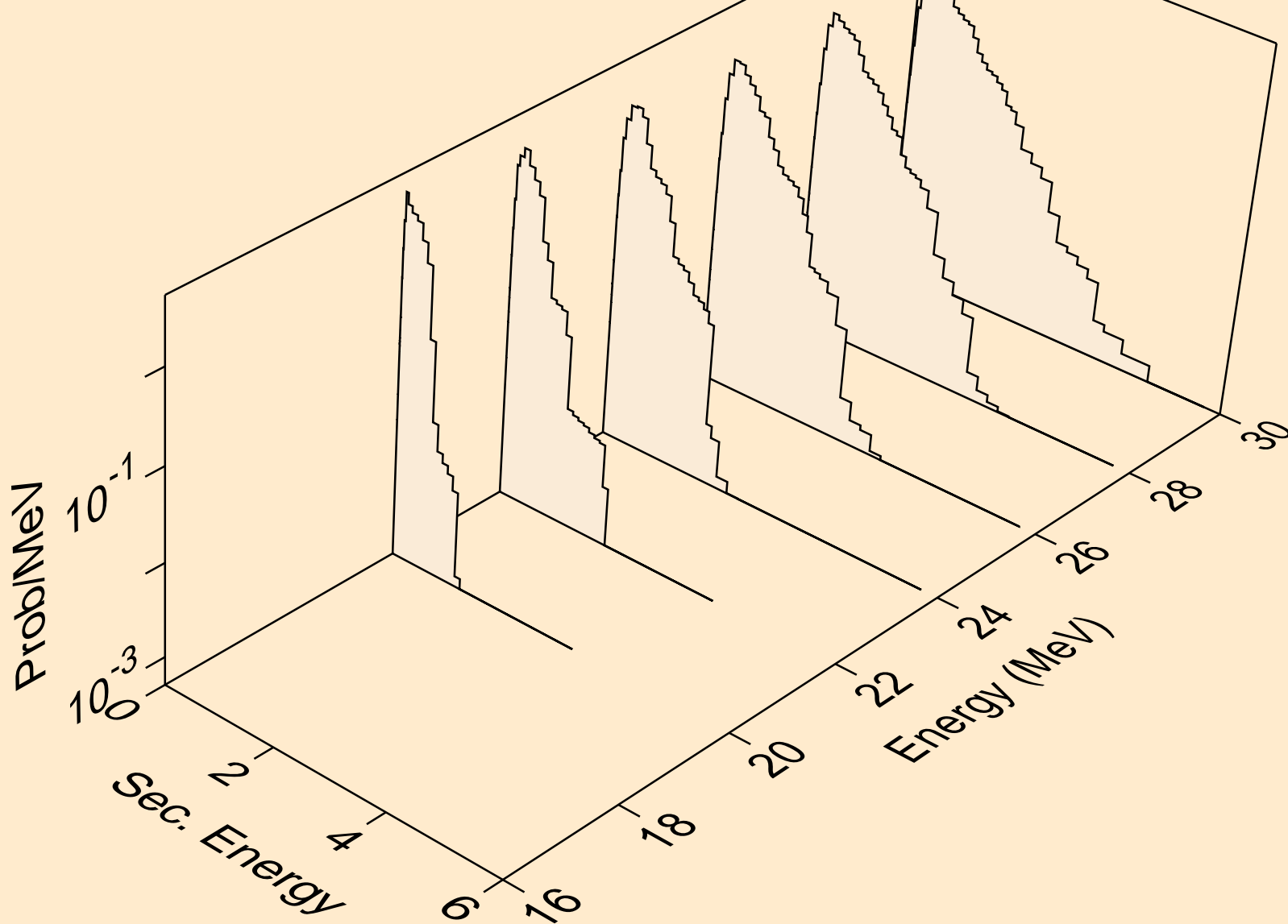

U243 NEUTRON ACER TENDL-2019 LIBRARY; T=293.16K
Neutron emission for (n,n*c)

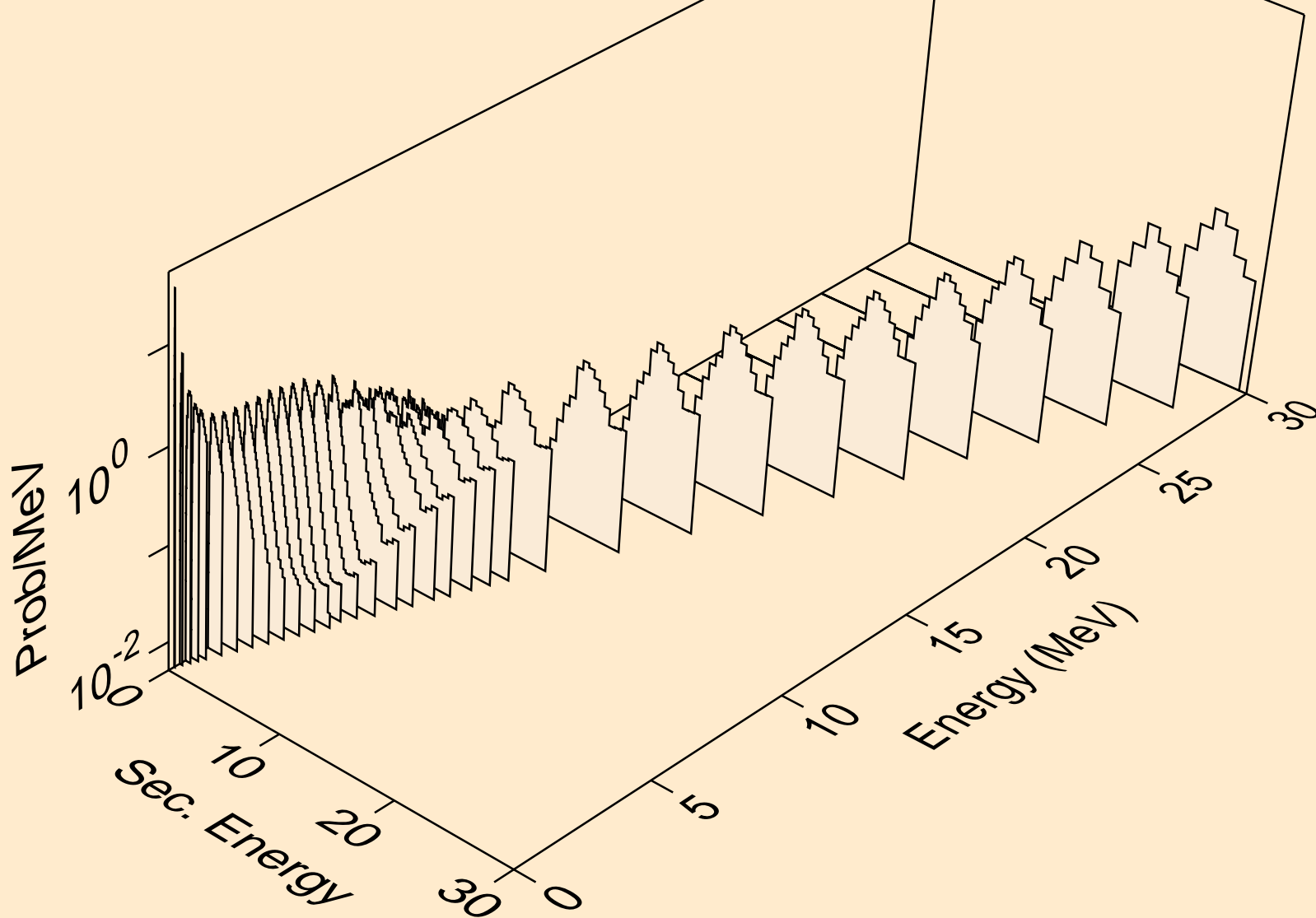

U243 NEUTRON ACER TENDL-2019 LIBRARY; T=293.16K
Delayed nubar

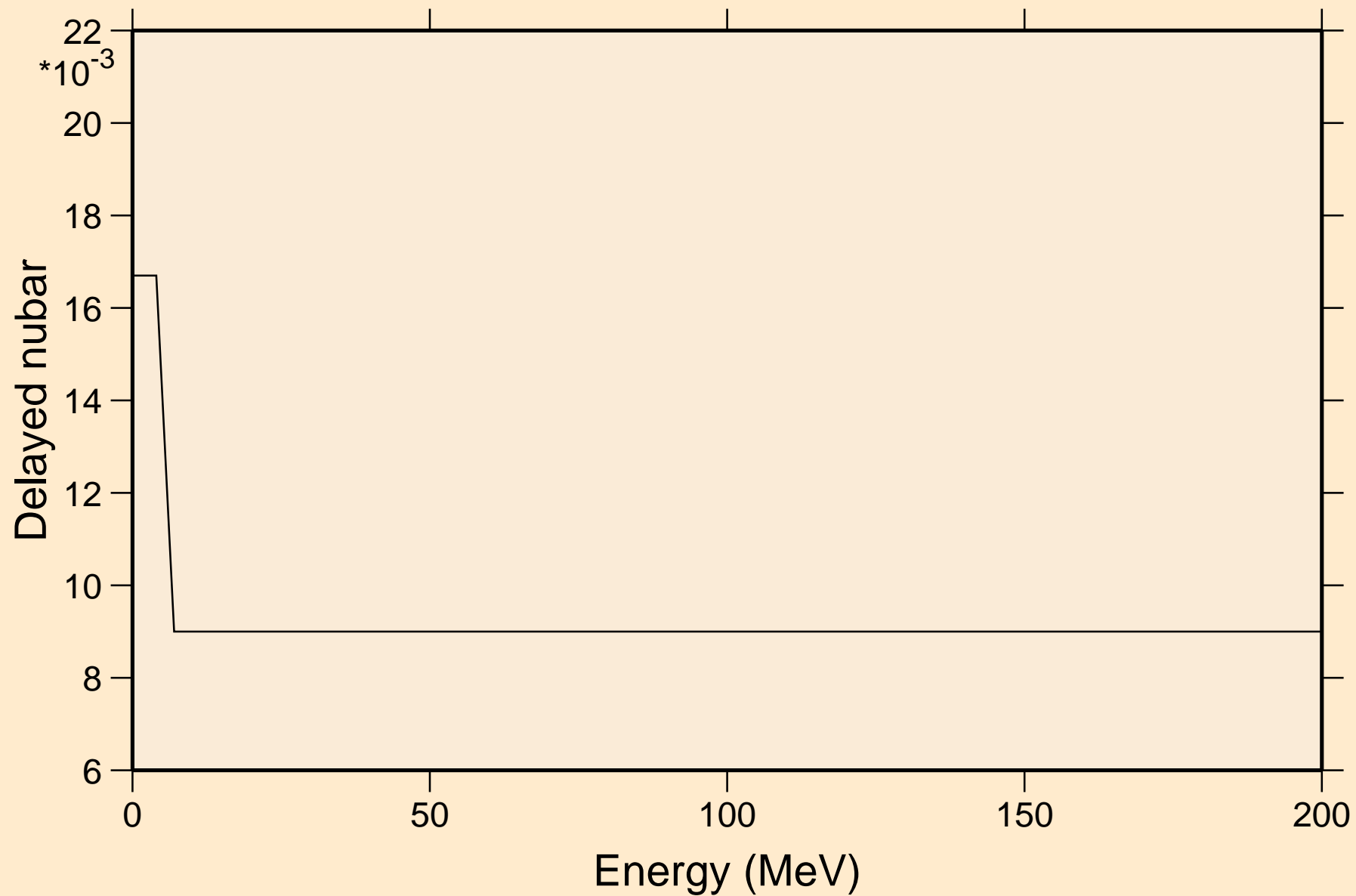

U243 NEUTRON ACER TENDL-2019 LIBRARY; T=293.16K

Delayed neutron spectra

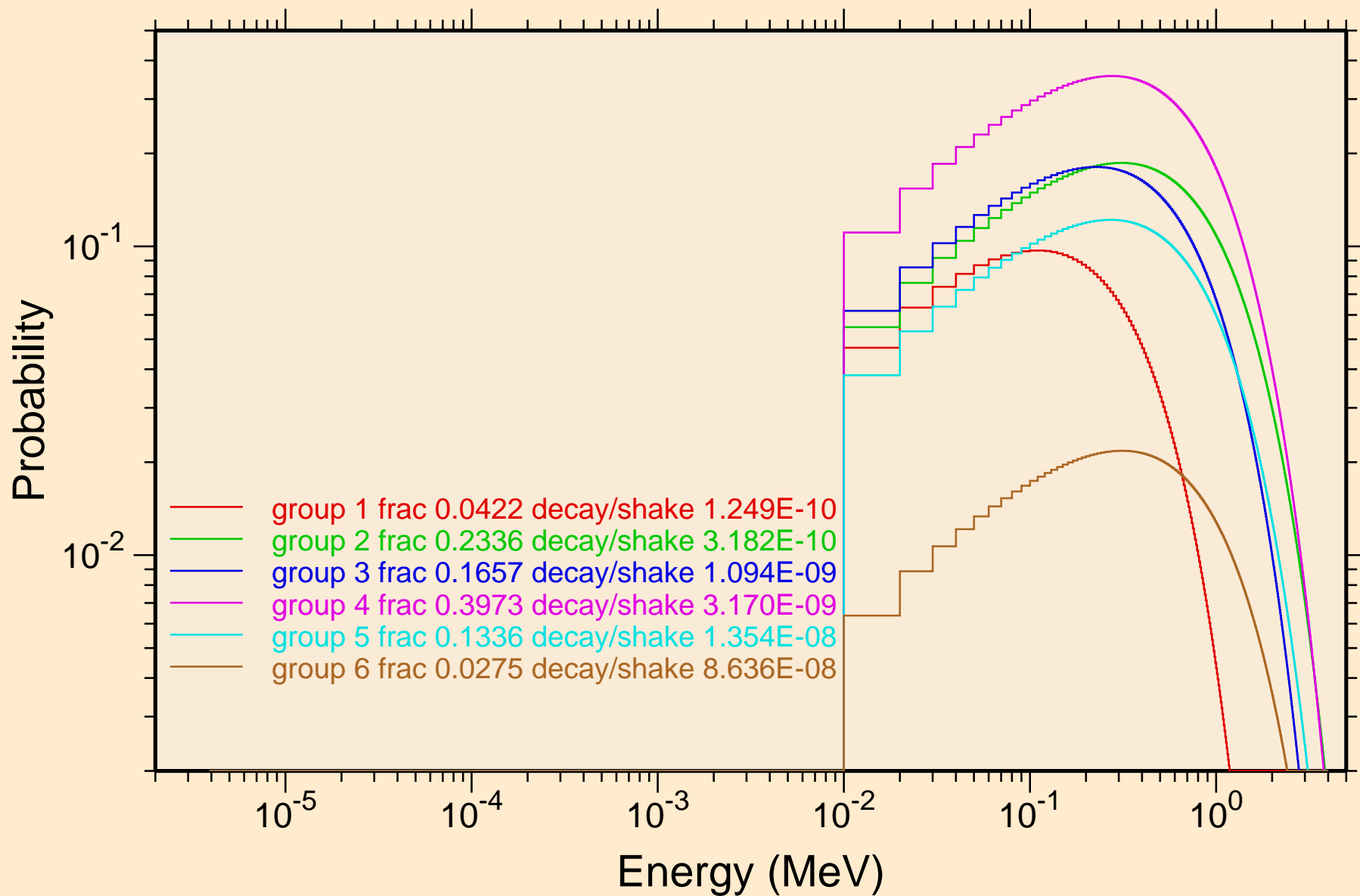

U243 NEUTRON ACER TENDL-2019 LIBRARY; T=293.16K
Photon emission for (n,x)

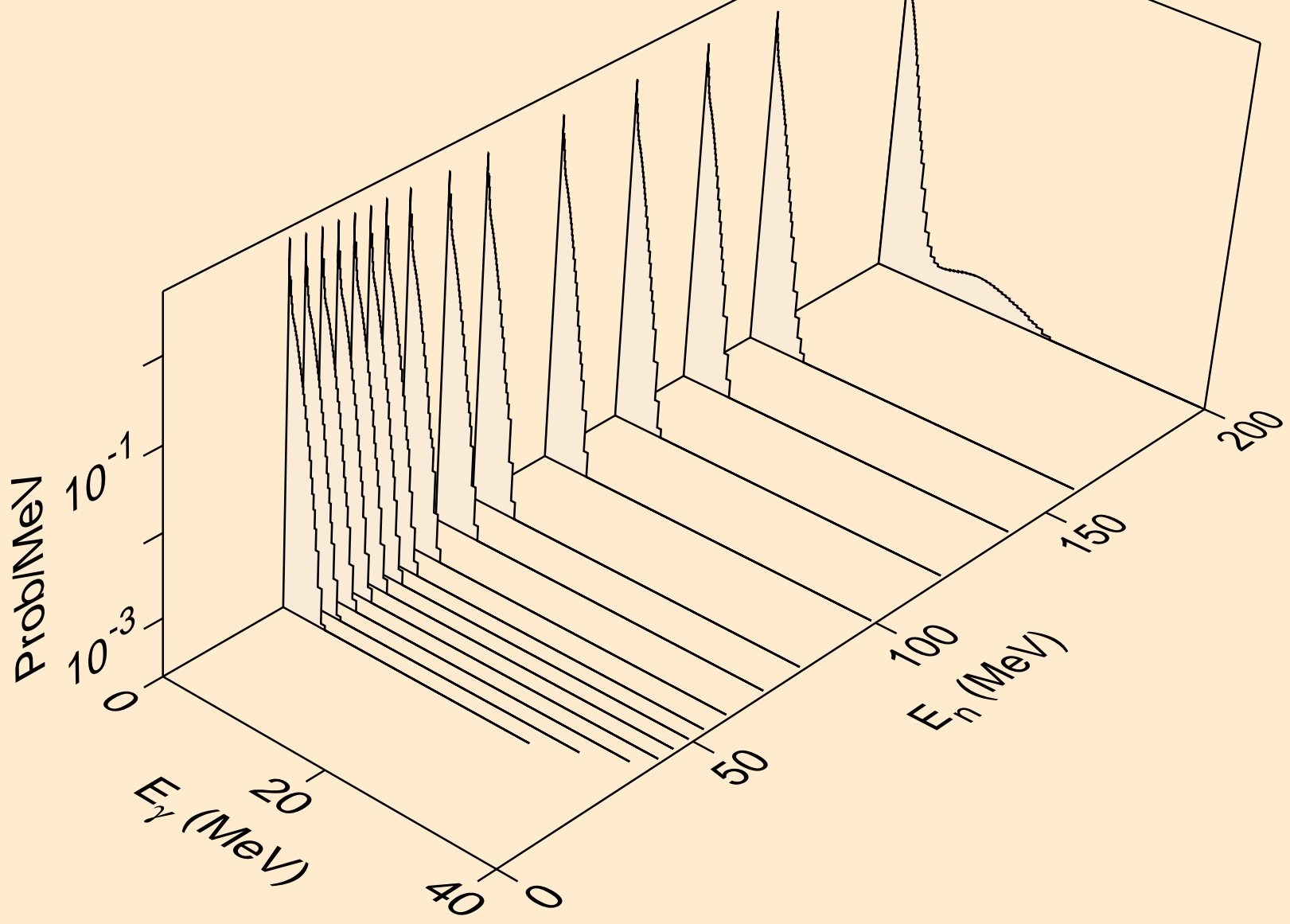

U243 NEUTRON ACER TENDL-2019 LIBRARY; T=293.16K
Photon emission for (n,2nd)

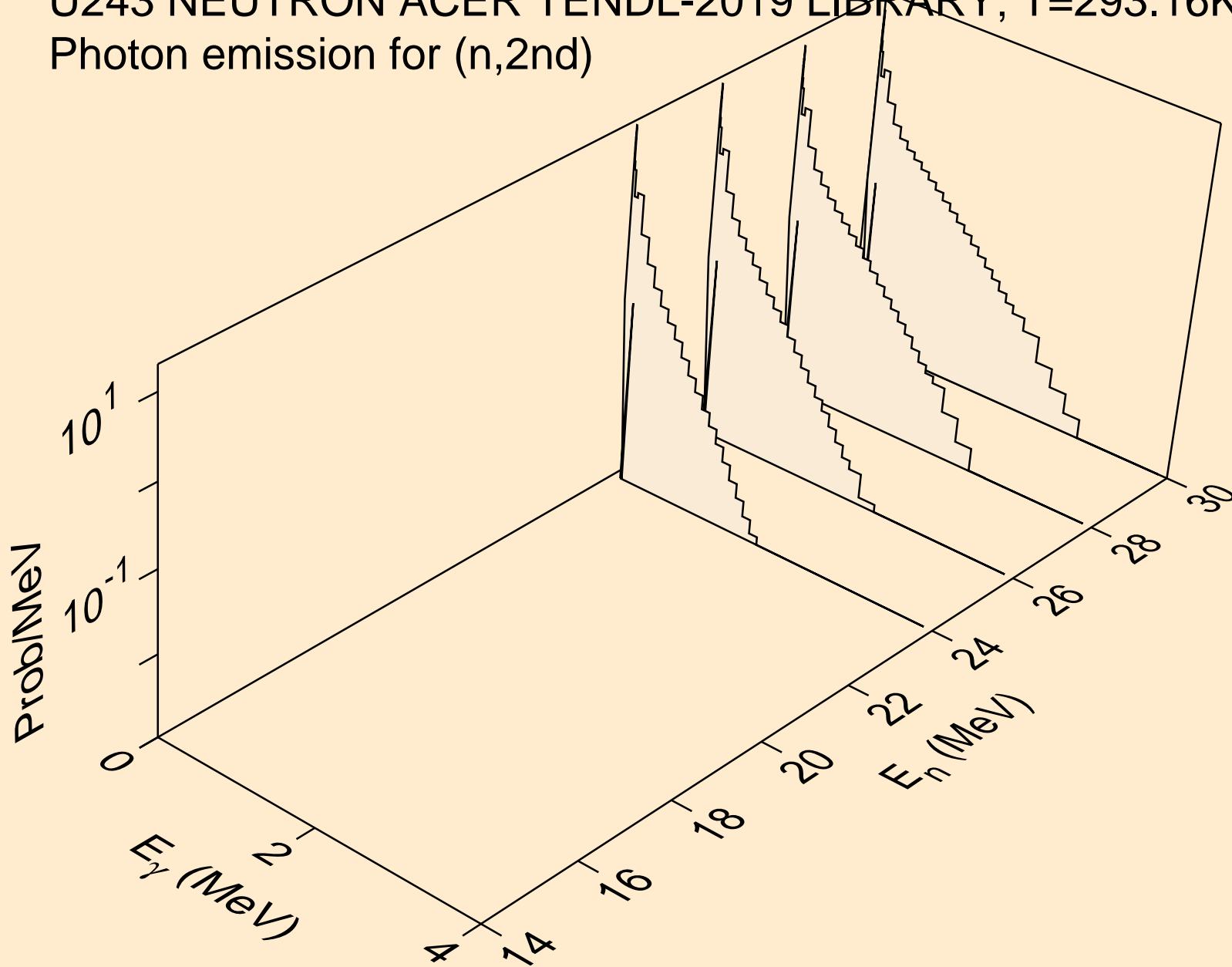

U243 NEUTRON ACER TENDL-2019 LIBRARY; T=293.16K
Photon emission for (n,2n)

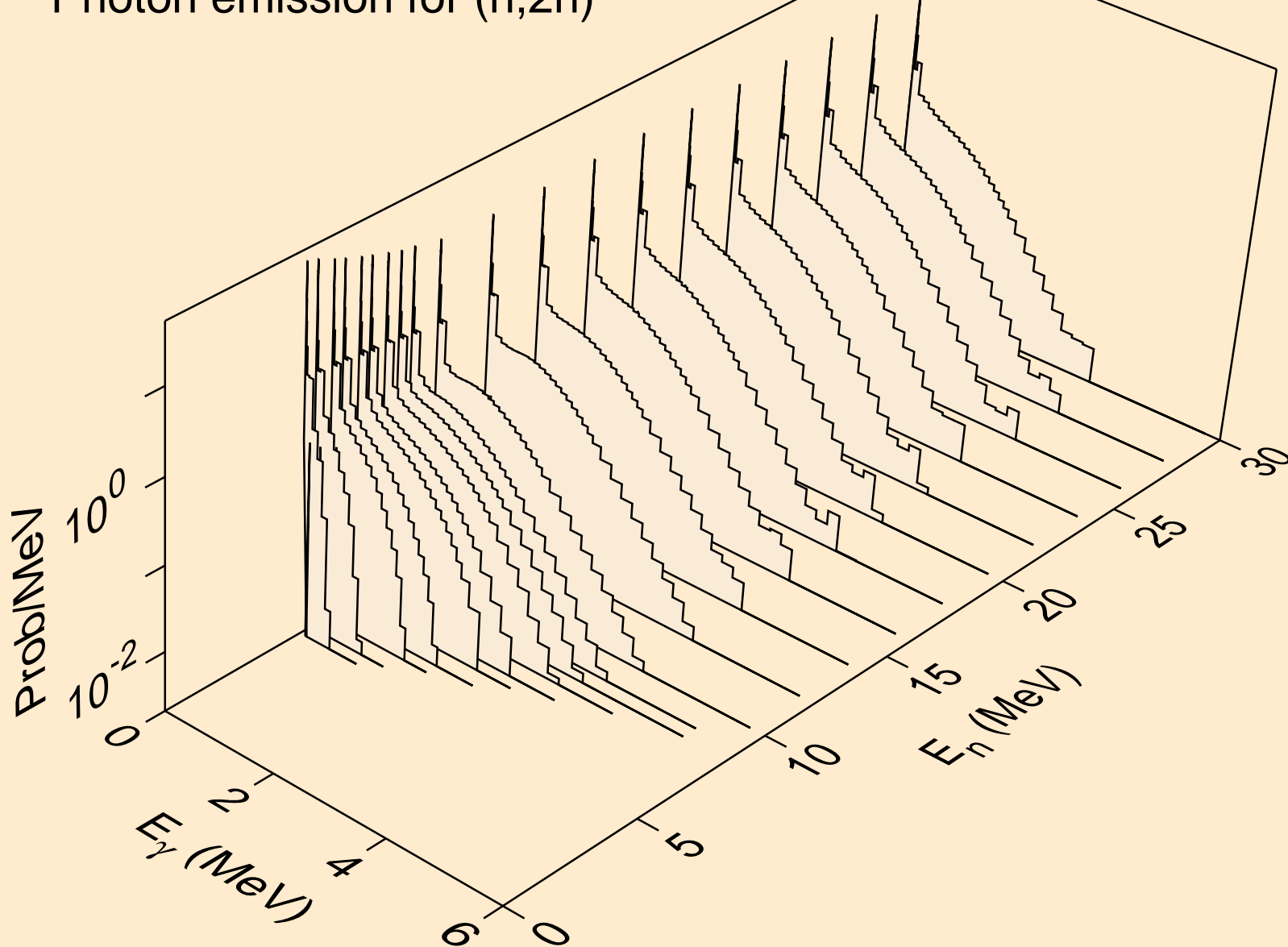

U243 NEUTRON ACER TENDL-2019 LIBRARY; T=293.16K
Photon emission for (n,3n)

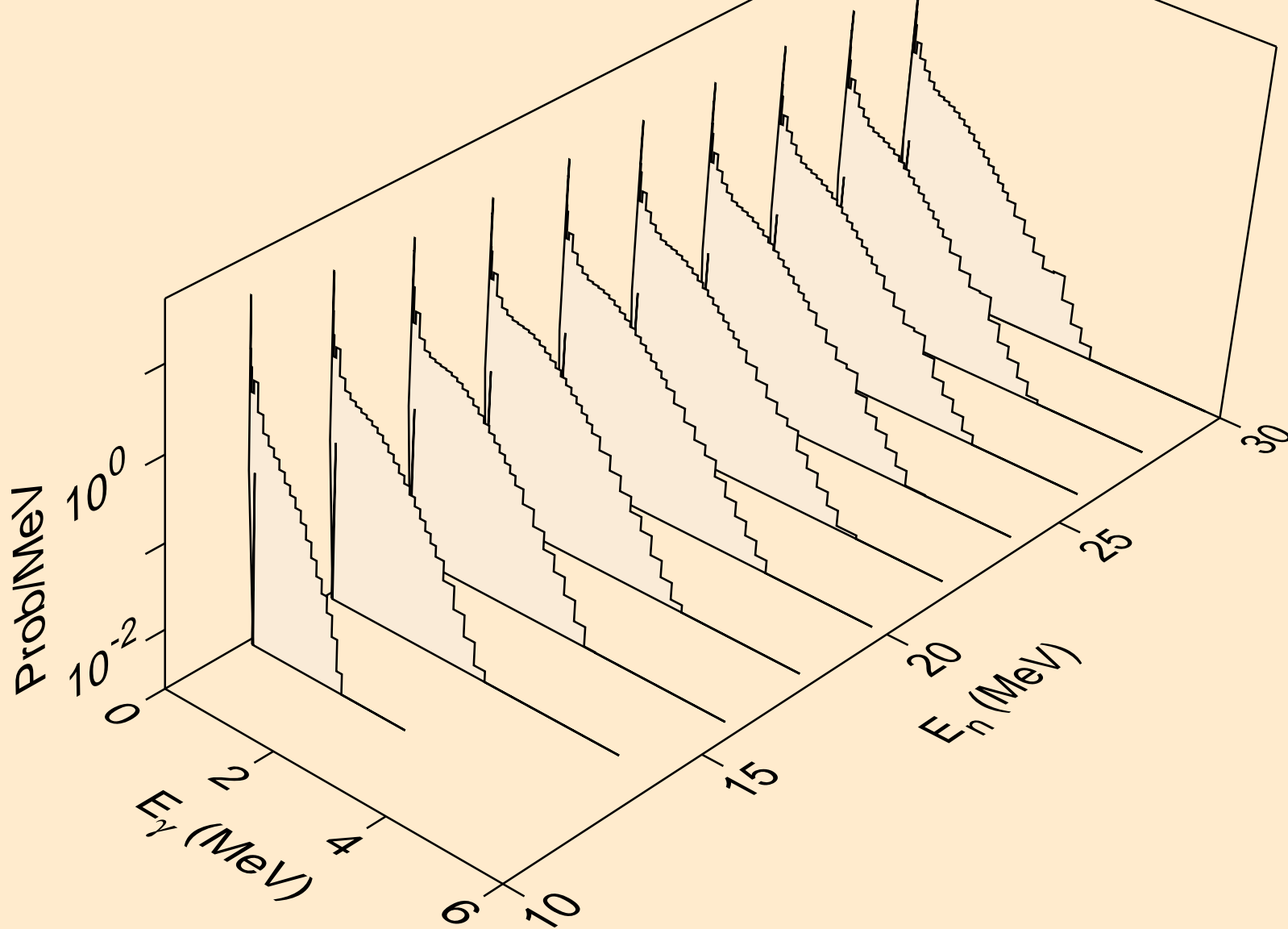

U243 NEUTRON ACER TENDL-2019 LIBRARY; T=293.16K
Photon emission for (n,n*)a

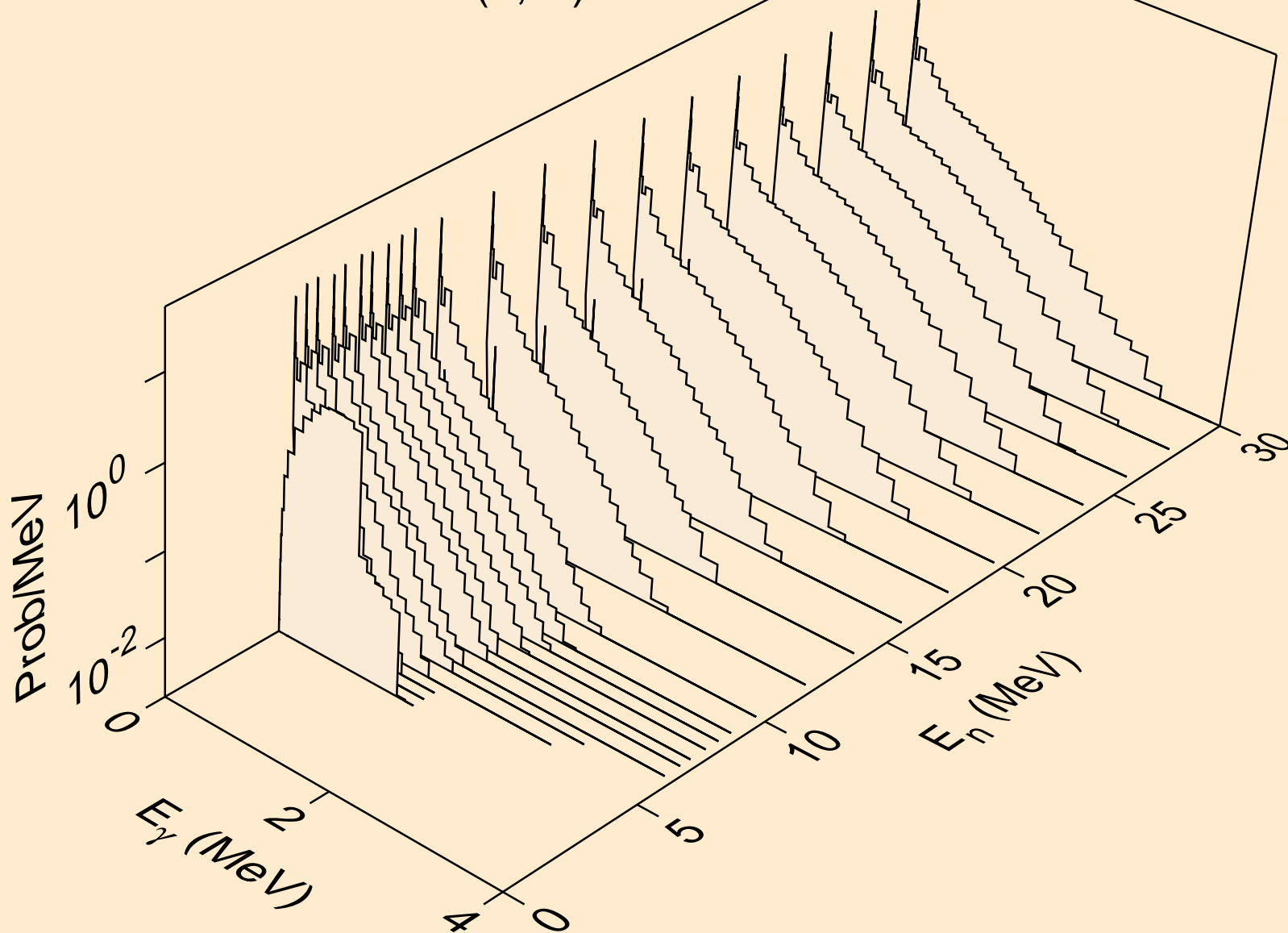

U243 NEUTRON ACER TENDL-2019 LIBRARY; T=293.16K
Photon emission for (n,2n)a

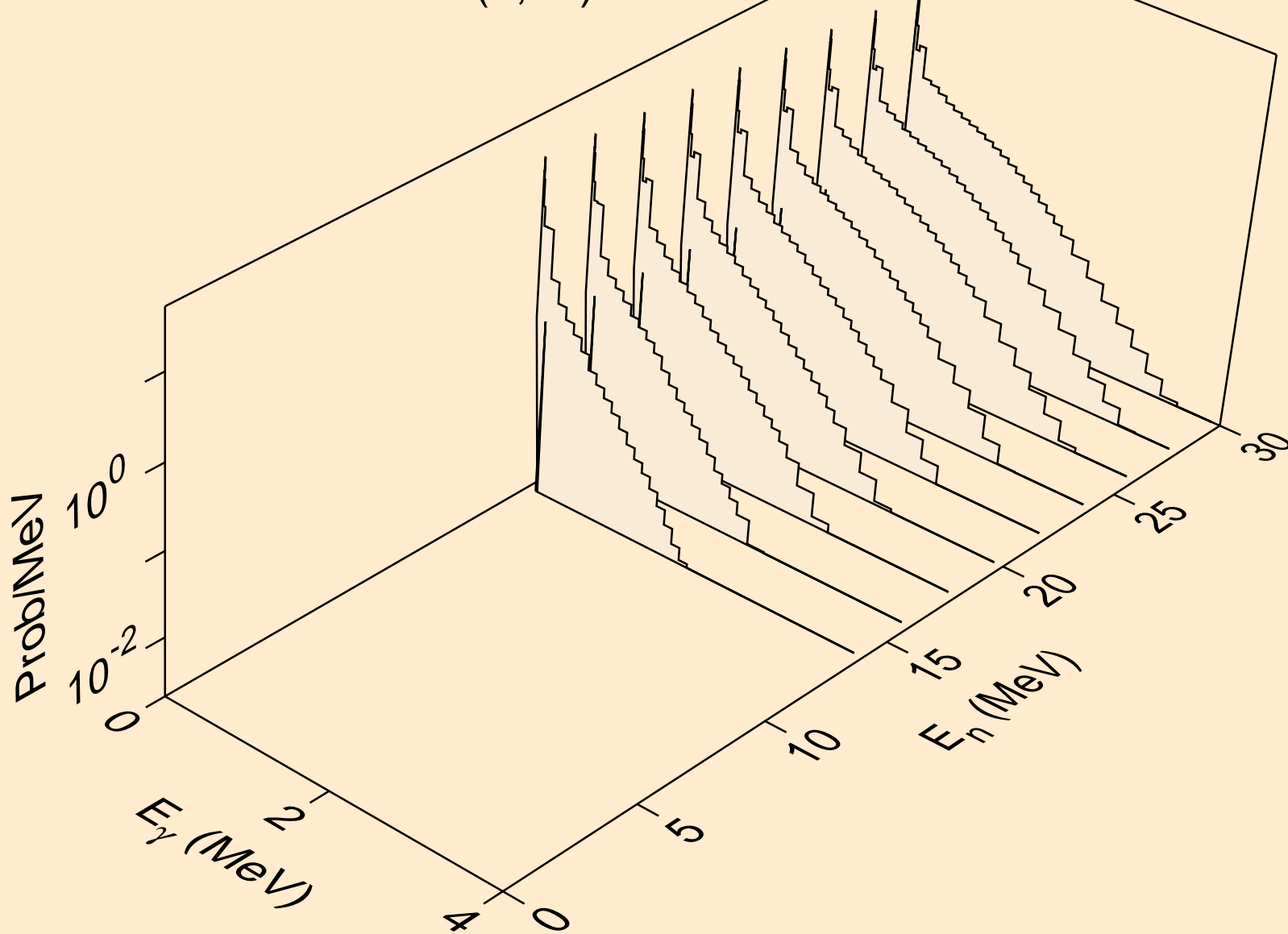

U243 NEUTRON ACER TENDL-2019 LIBRARY; T=293.16K
Photon emission for (n,3n)a

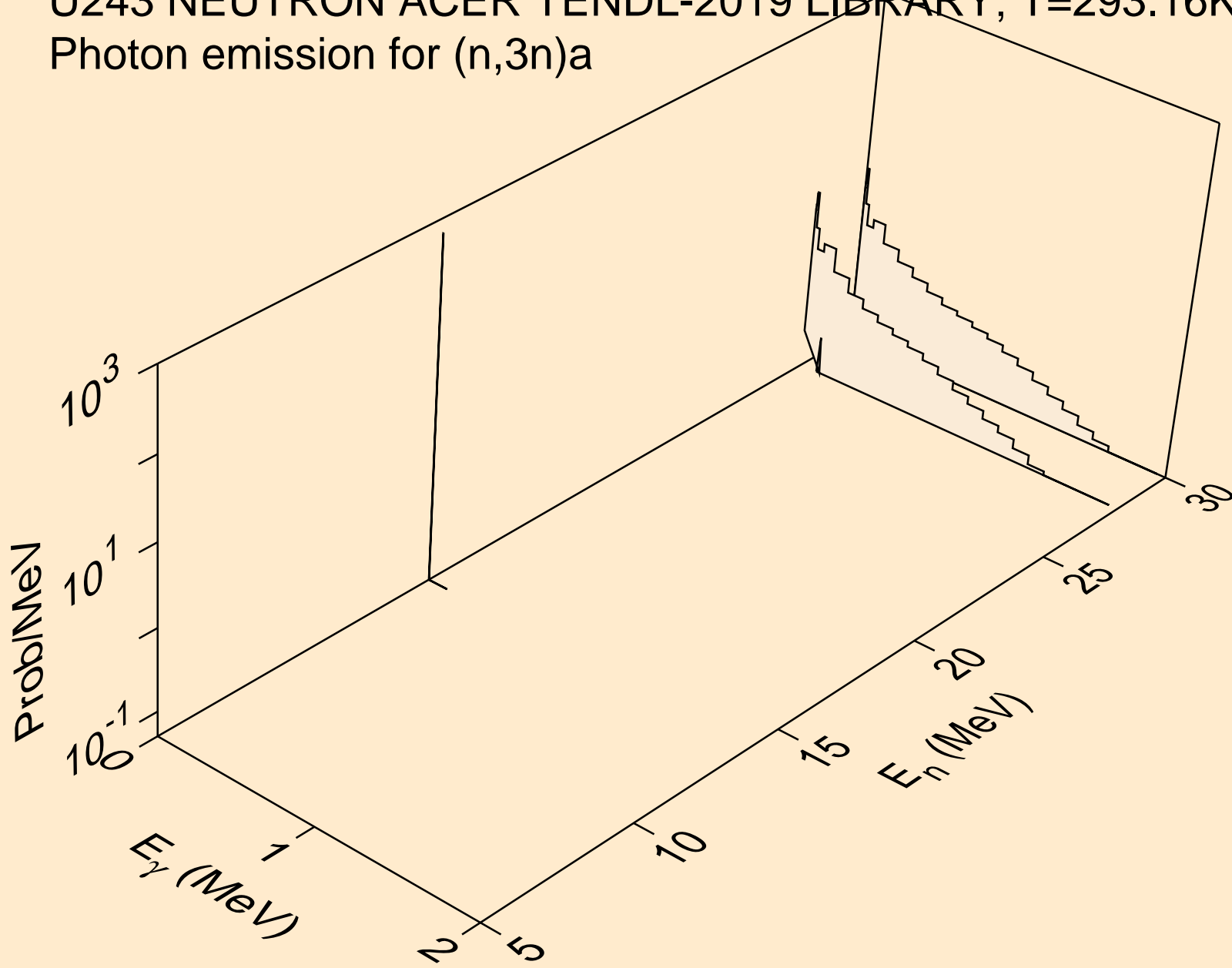

U243 NEUTRON ACER TENDL-2019 LIBRARY; T=293.16K
Photon emission for (n,n*)p

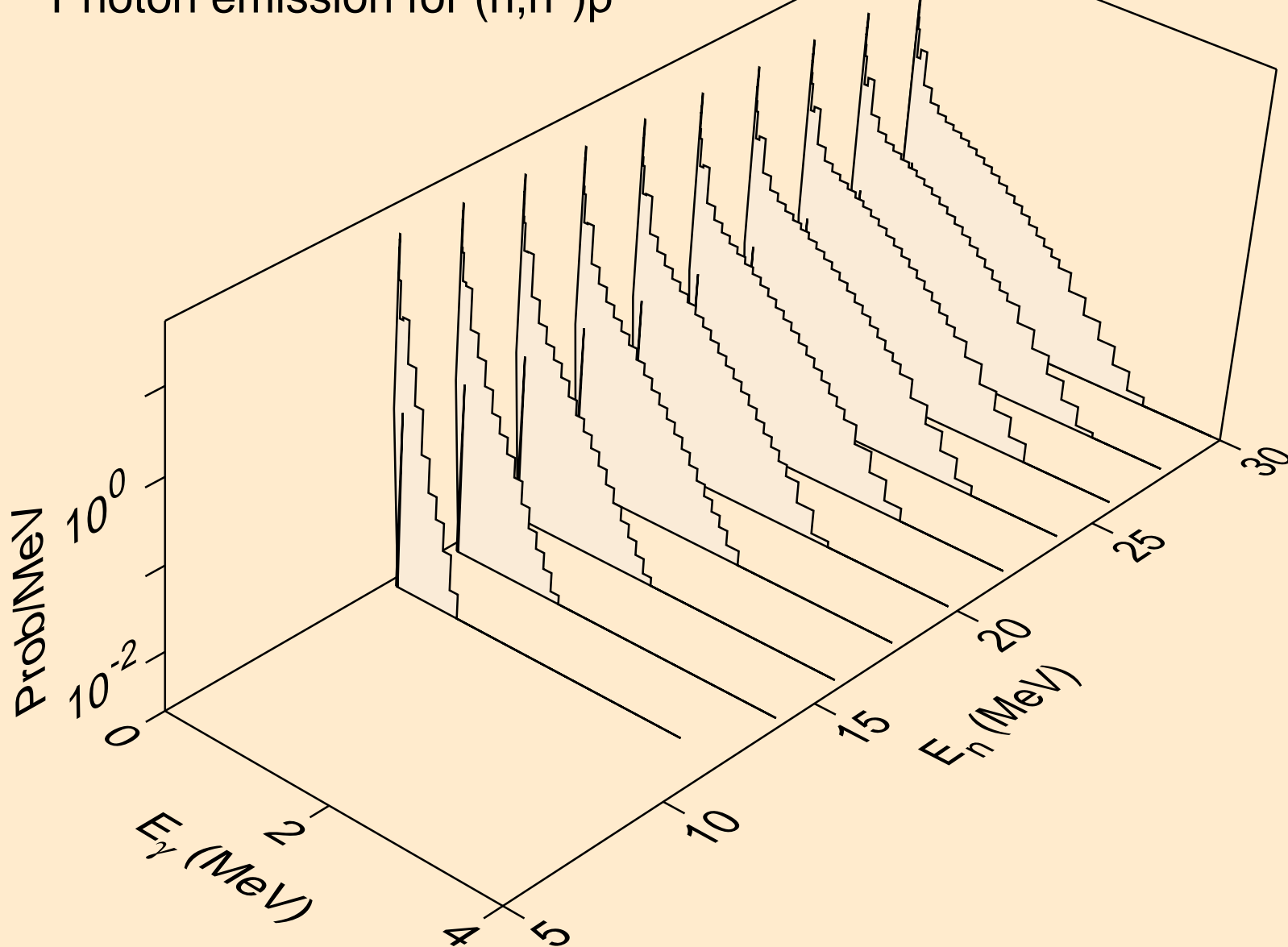

U243 NEUTRON ACER TENDL-2019 LIBRARY; T=293.16K
Photon emission for (n,n*)d

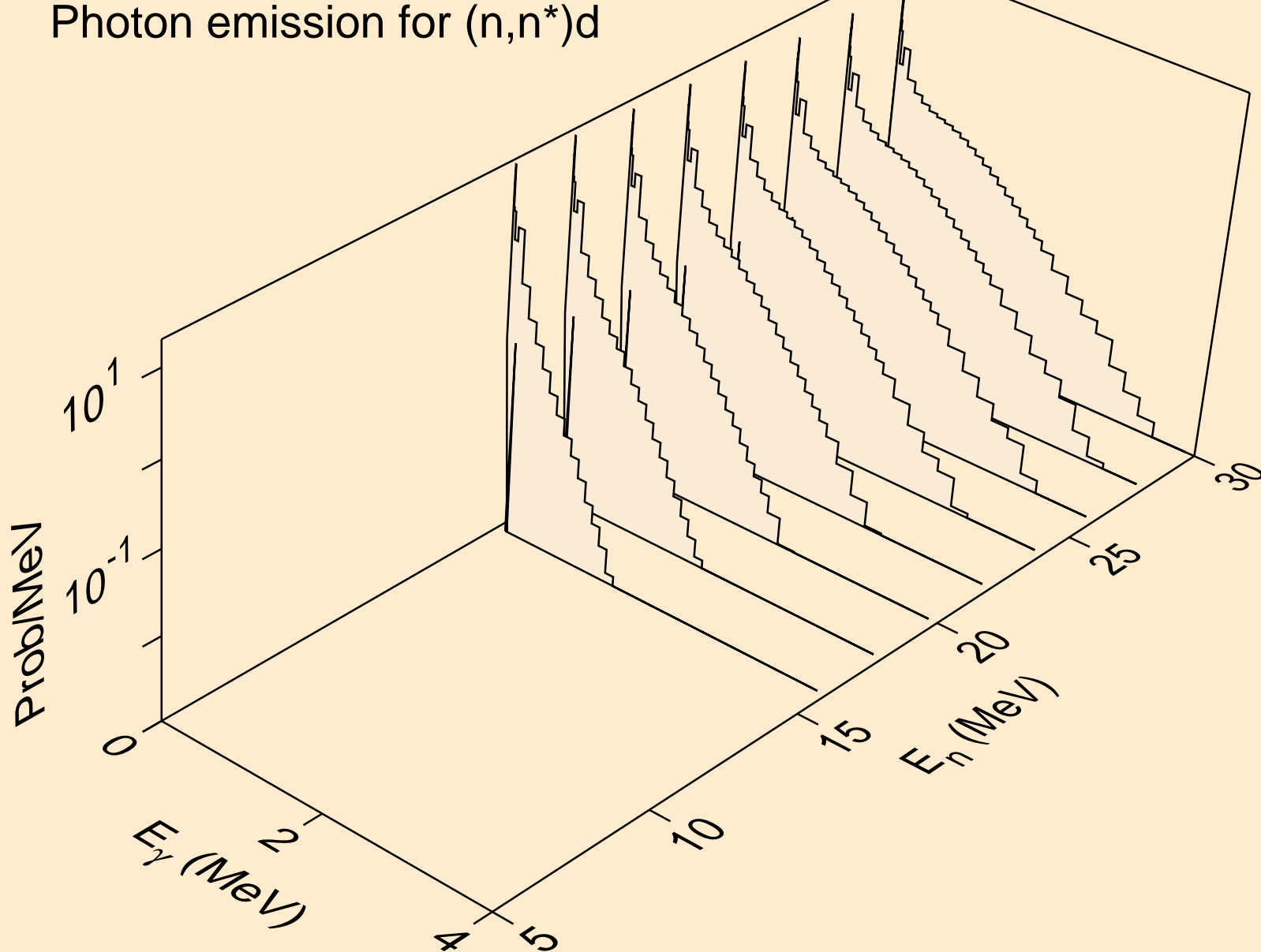

U243 NEUTRON ACER TENDL-2019 LIBRARY; T=293.16K
Photon emission for (n,n*)t

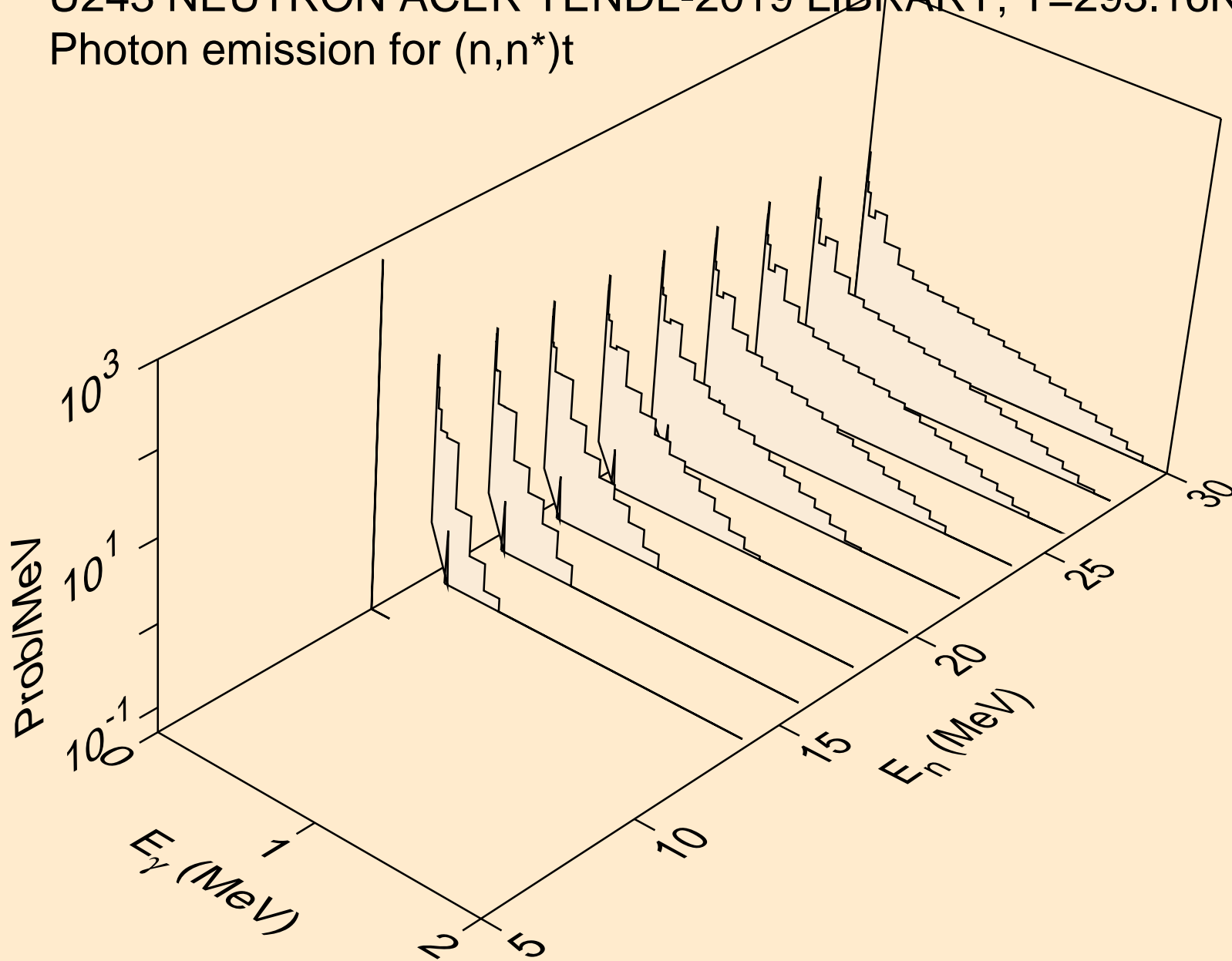

U243 NEUTRON ACER TENDL-2019 LIBRARY; T=293.16K
Photon emission for (n,n*)he3

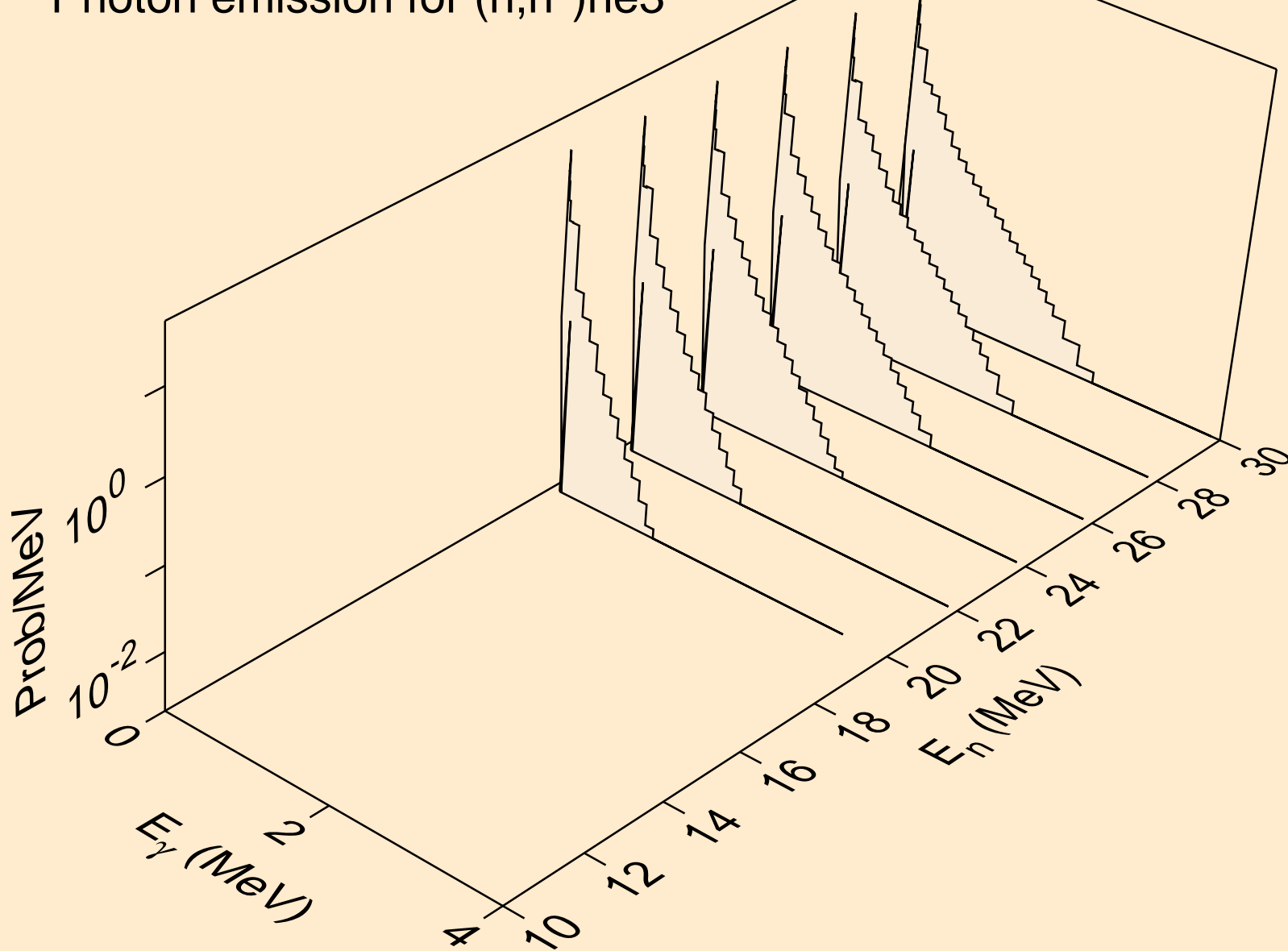

U243 NEUTRON ACER TENDL-2019 LIBRARY; T=293.16K
Photon emission for (n,4n)

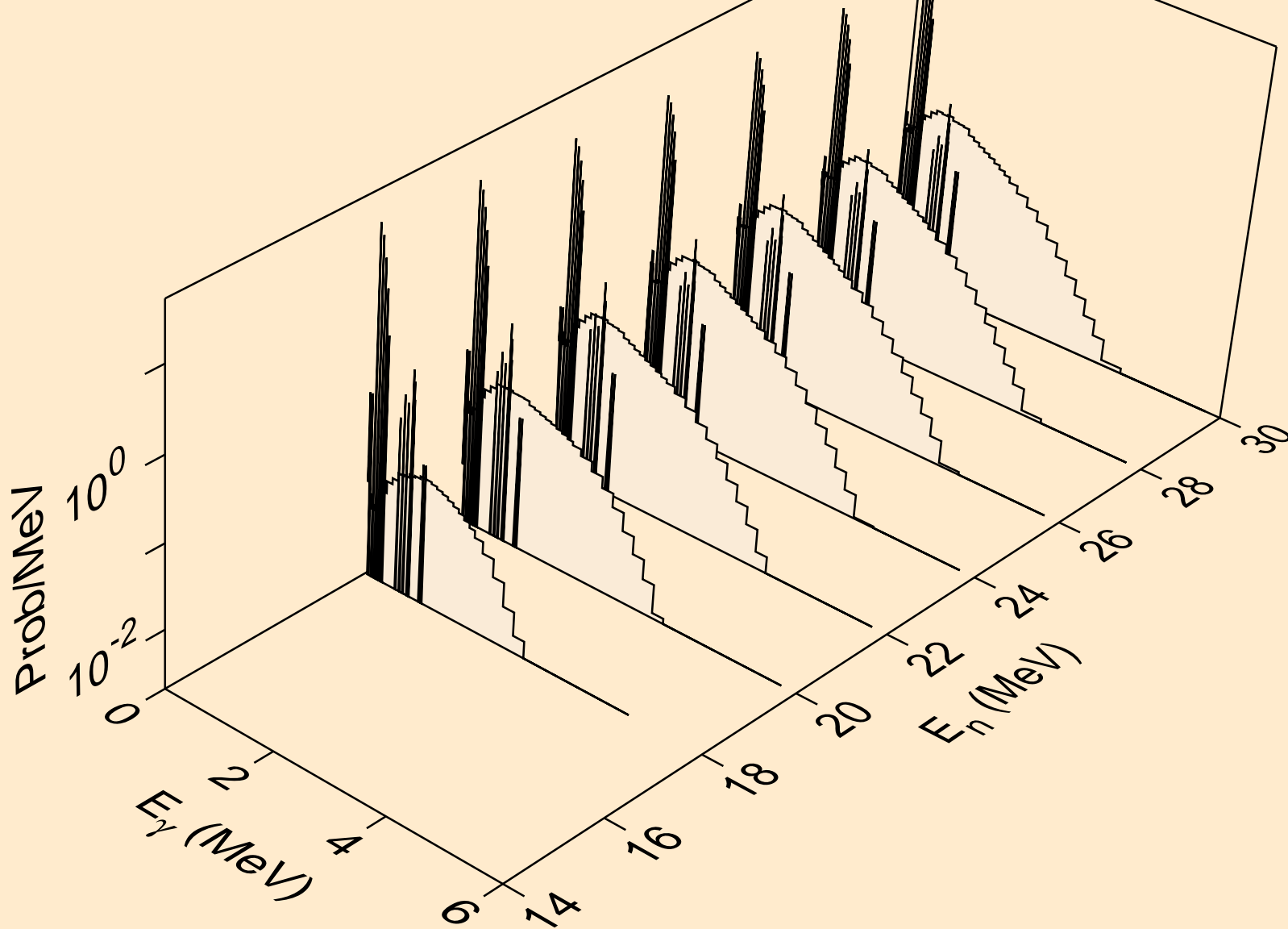

U243 NEUTRON ACER TENDL-2019 LIBRARY; T=293.16K
Photon emission for (n,2np)

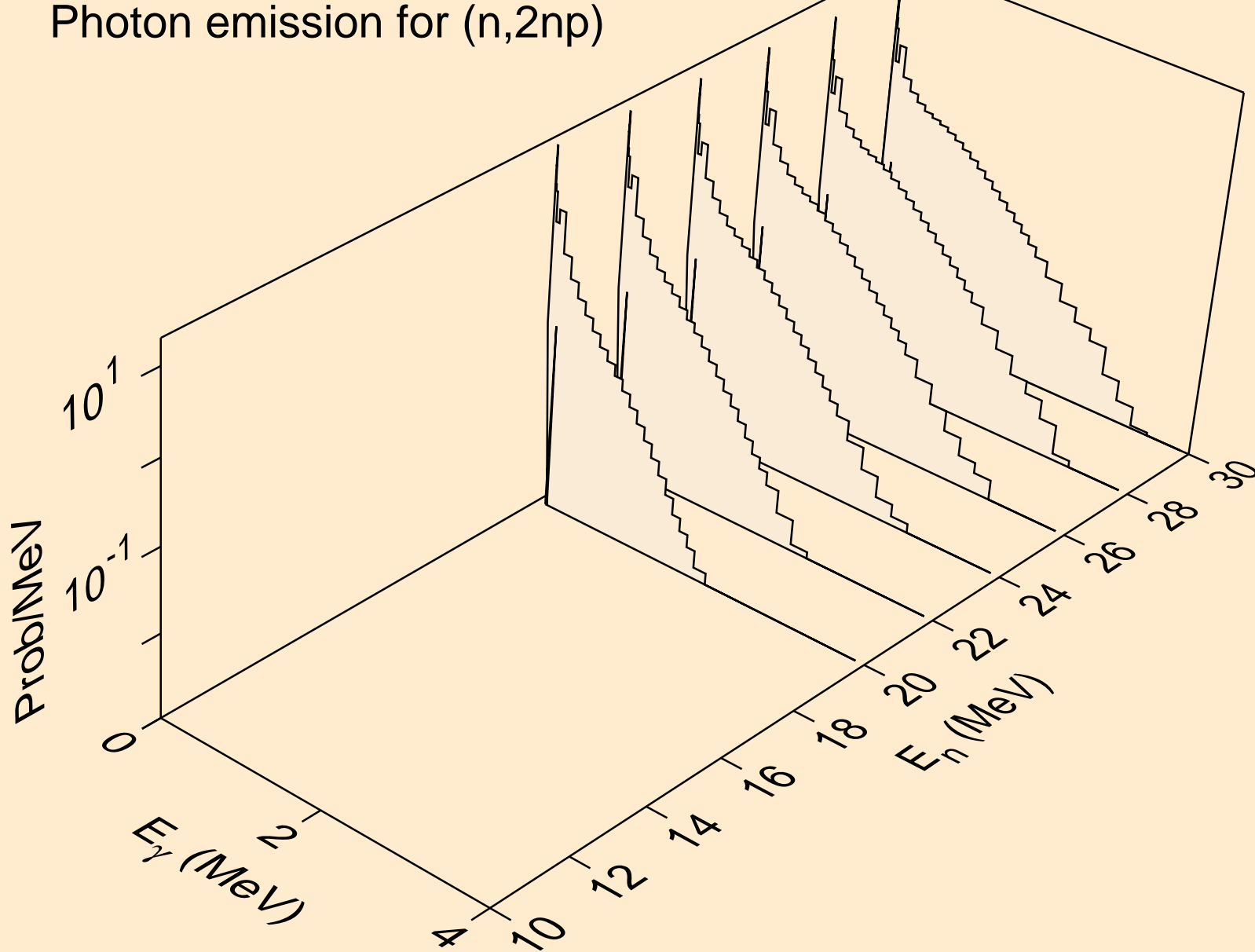

U243 NEUTRON ACER TENDL-2019 LIBRARY; T=293.16K
Photon emission for (n,3np)

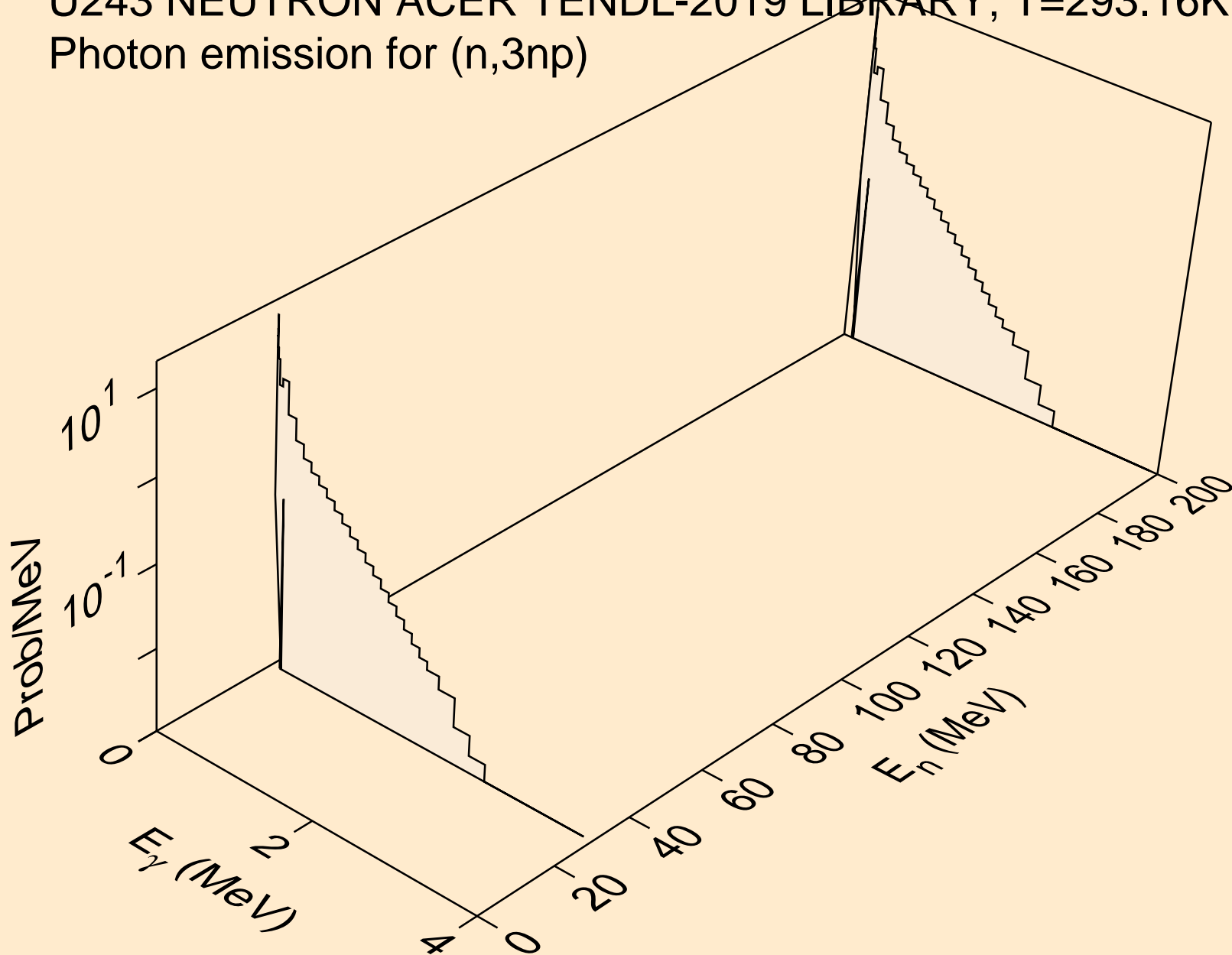

U243 NEUTRON ACER TENDL-2019 LIBRARY; T=293.16K
Photon emission for (n,n*c)

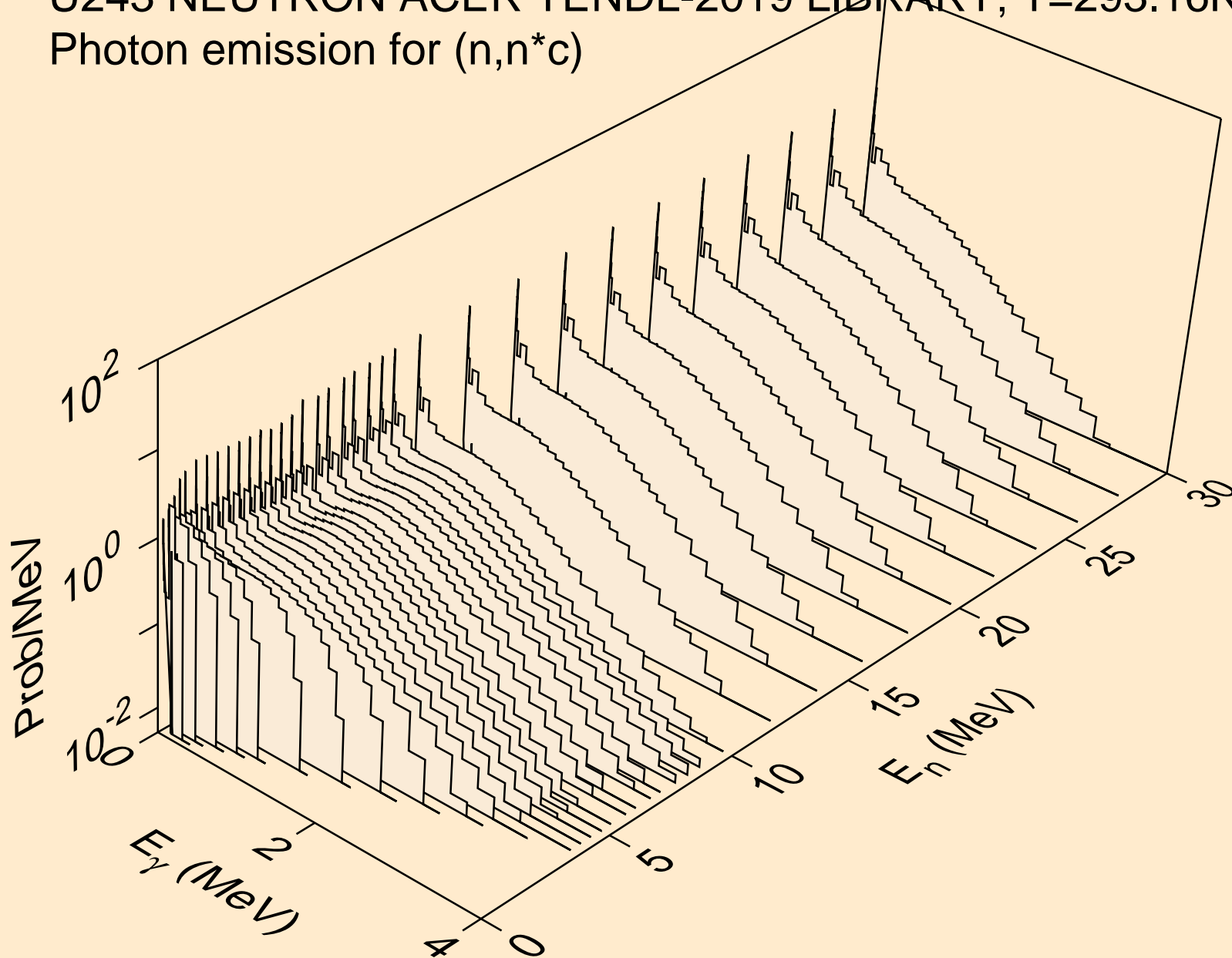

U243 NEUTRON ACER TENDL-2019 LIBRARY; T=293.16K
Photon emission for (n,gma)

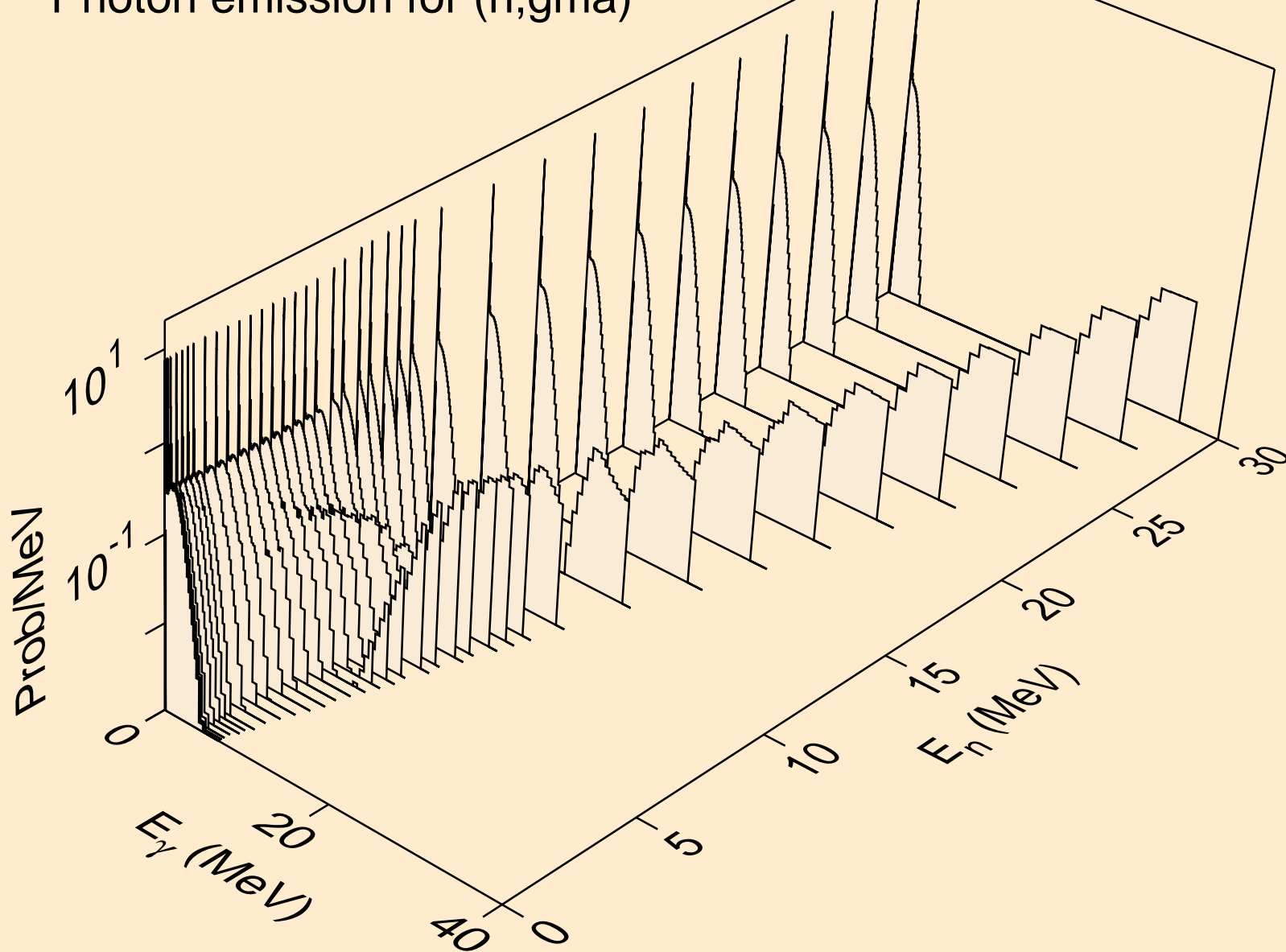

U243 NEUTRON ACER TENDL-2019 LIBRARY; T=293.16K
Photon emission for (n,p)

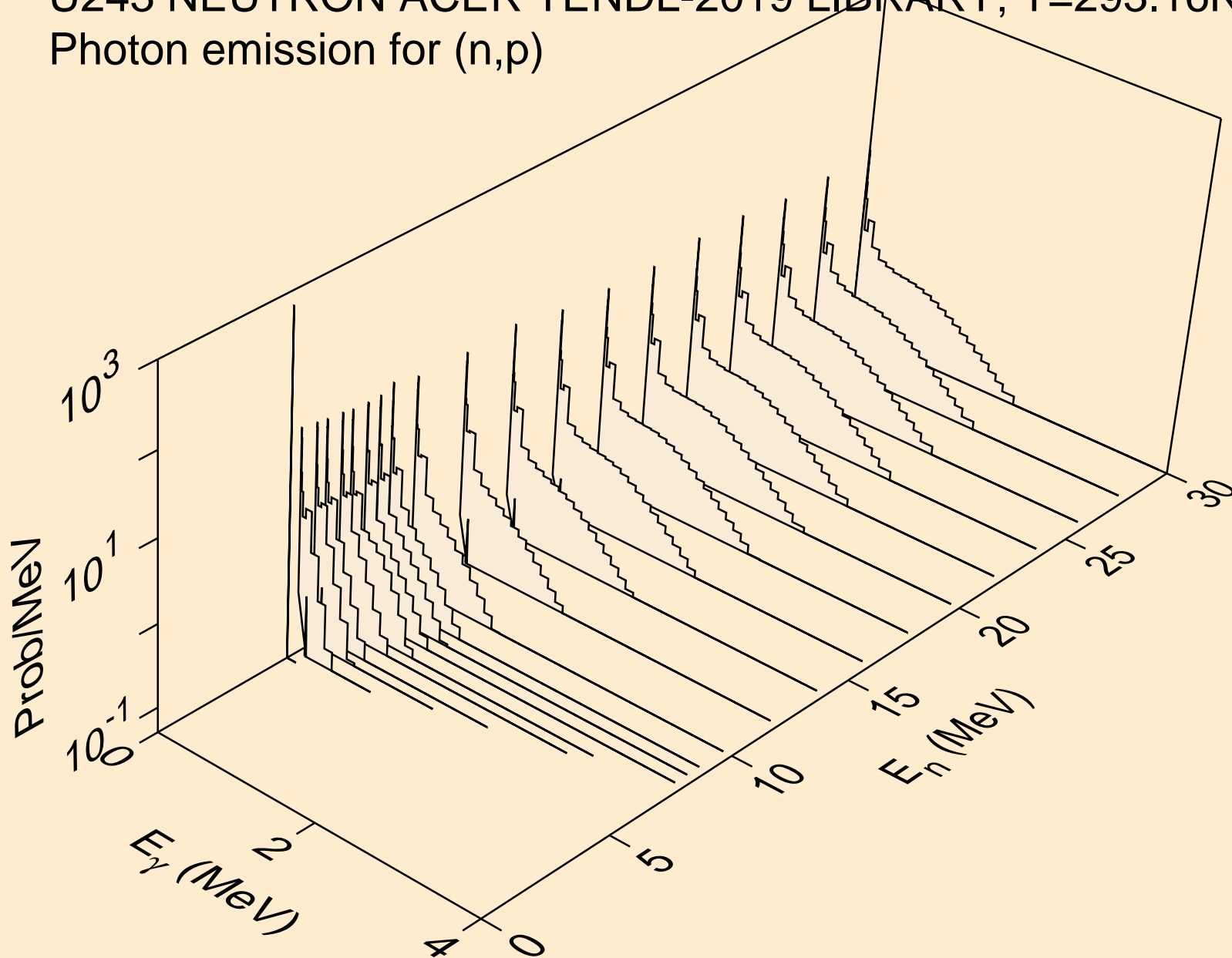

U243 NEUTRON ACER TENDL-2019 LIBRARY; T=293.16K
Photon emission for (n,d)

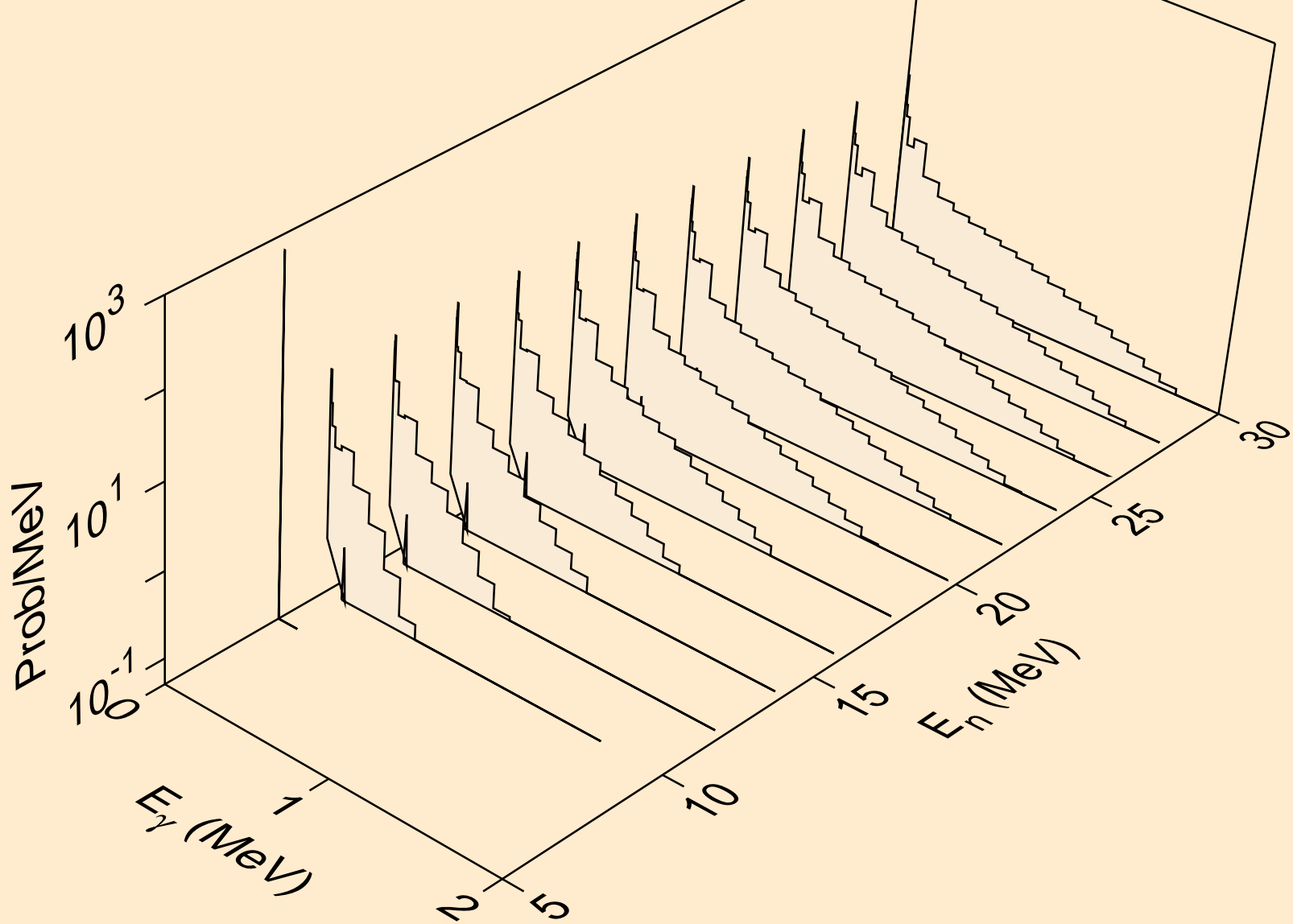

U243 NEUTRON ACER TENDL-2019 LIBRARY; T=293.16K
Photon emission for (n,t)

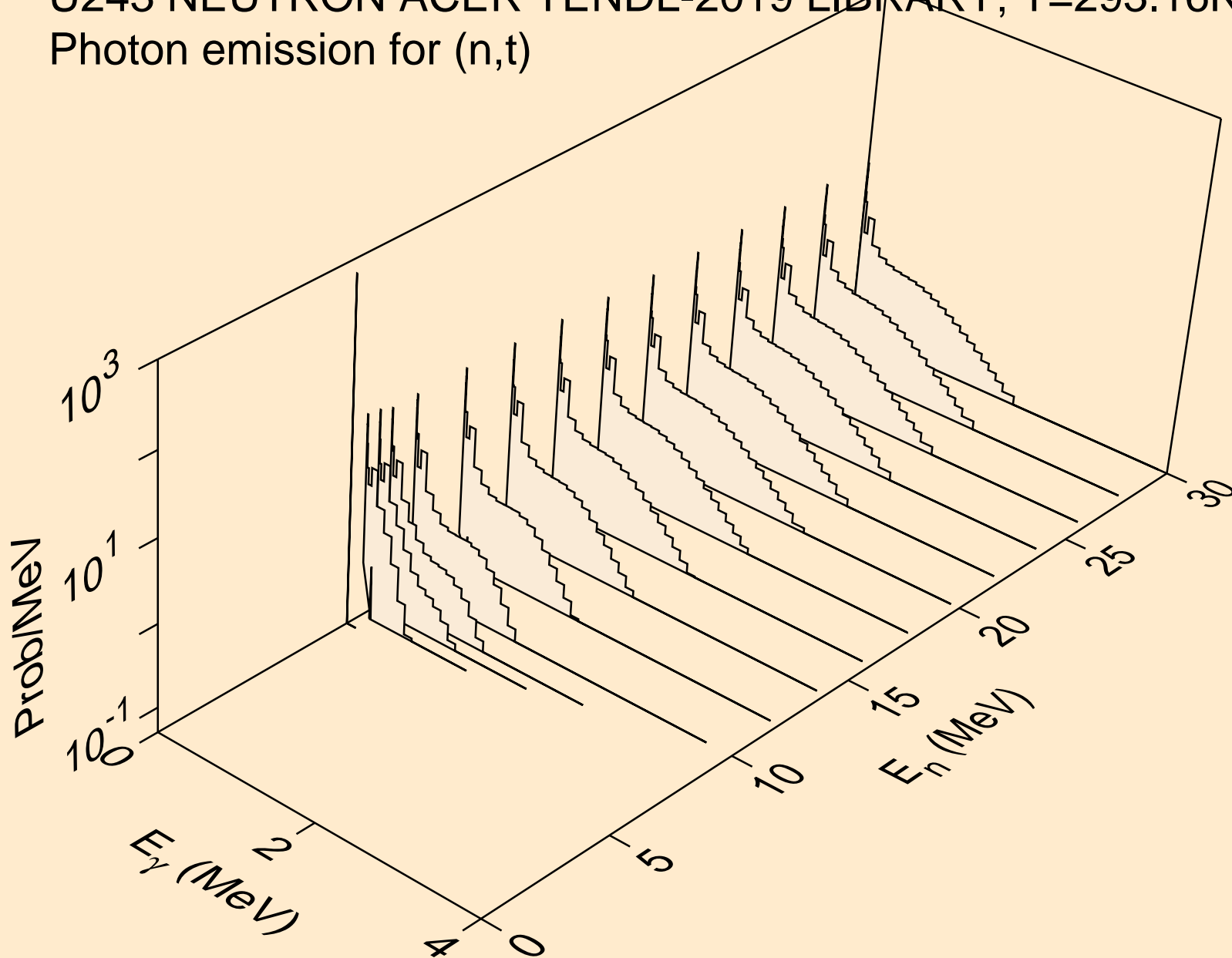

U243 NEUTRON ACER TENDL-2019 LIBRARY; T=293.16K
Photon emission for (n,he3)

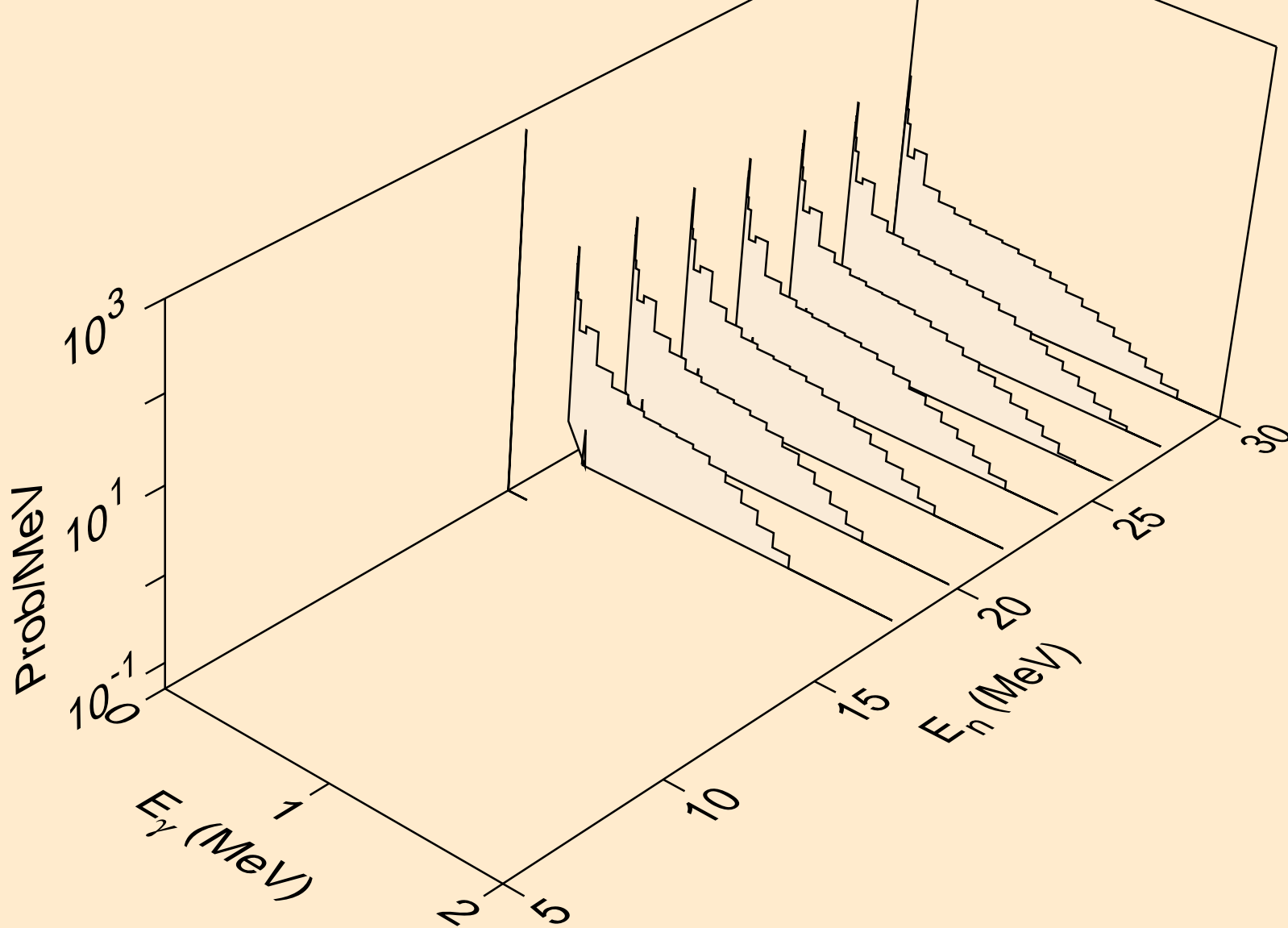

U243 NEUTRON ACER TENDL-2019 LIBRARY; T=293.16K
Photon emission for (n,a)

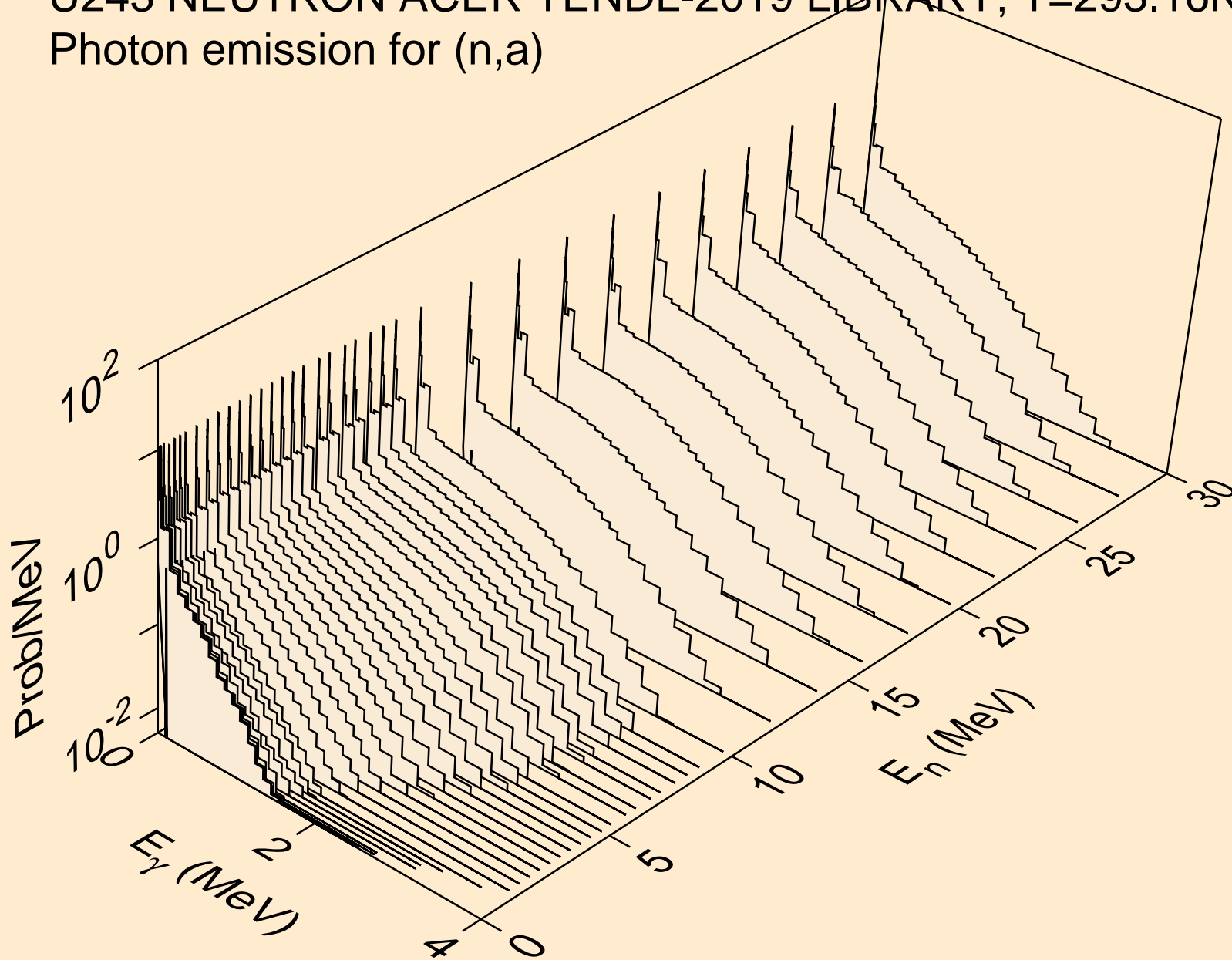

U243 NEUTRON ACER TENDL-2019 LIBRARY; T=293.16K
Photon emission for (n,2p)

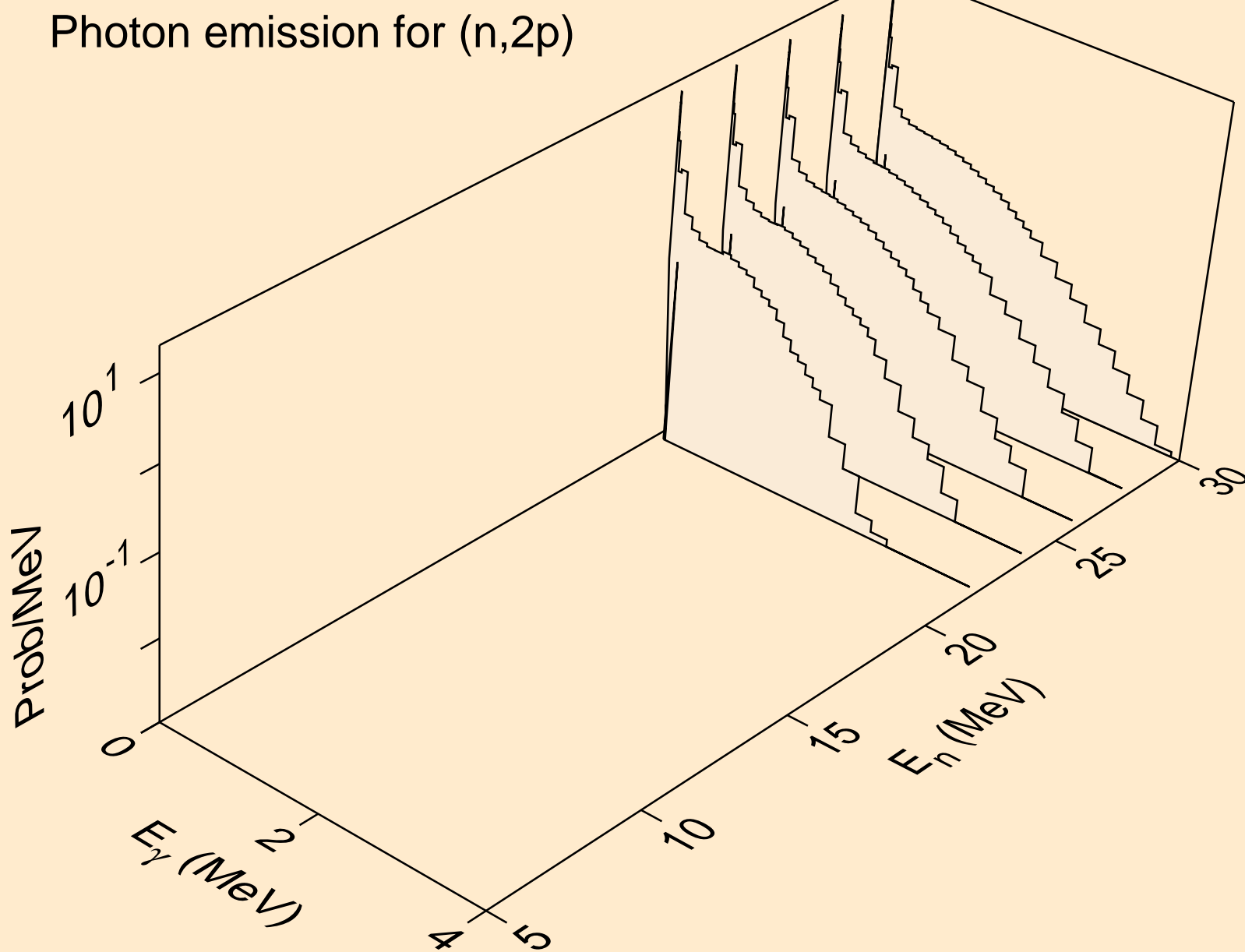

U243 NEUTRON ACER TENDL-2019 LIBRARY; T=293.16K
thermal capture photon spectrum

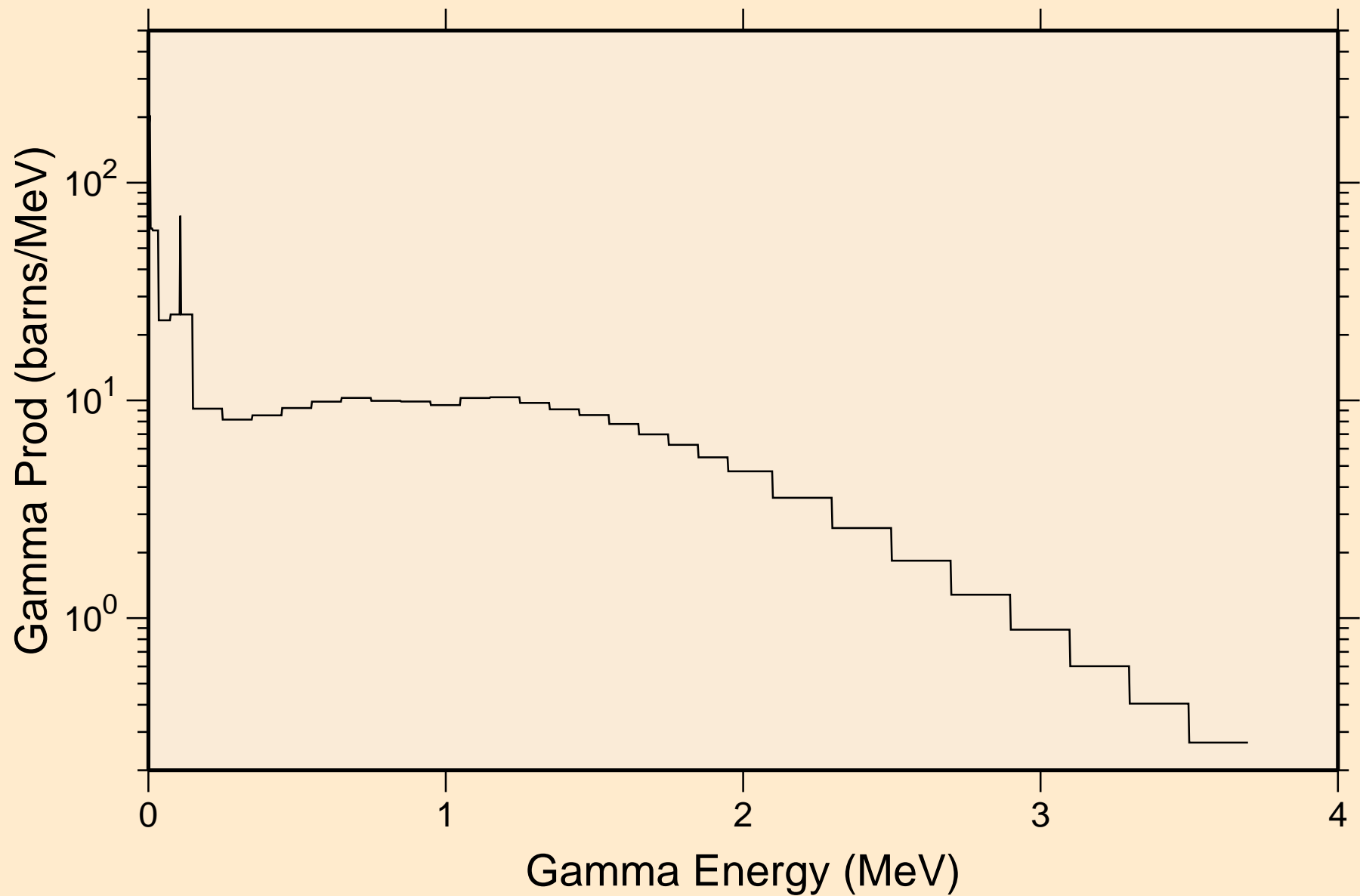

U243 NEUTRON ACER TENDL-2019 LIBRARY; T=293.16K
14 MeV photon spectrum

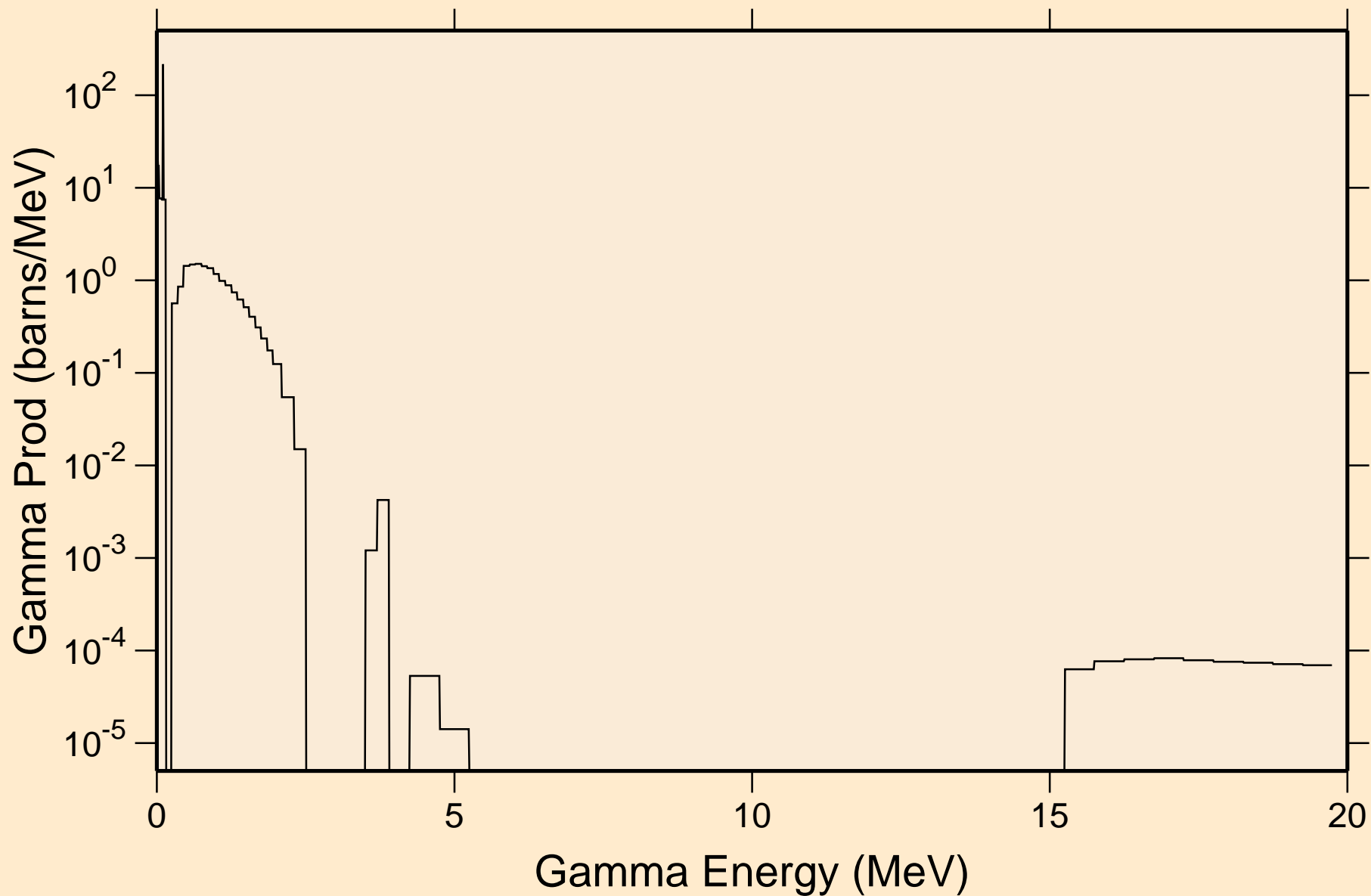

U243 NEUTRON ACER TENDL-2019 LIBRARY; T=293.16K

Particle heating contributions

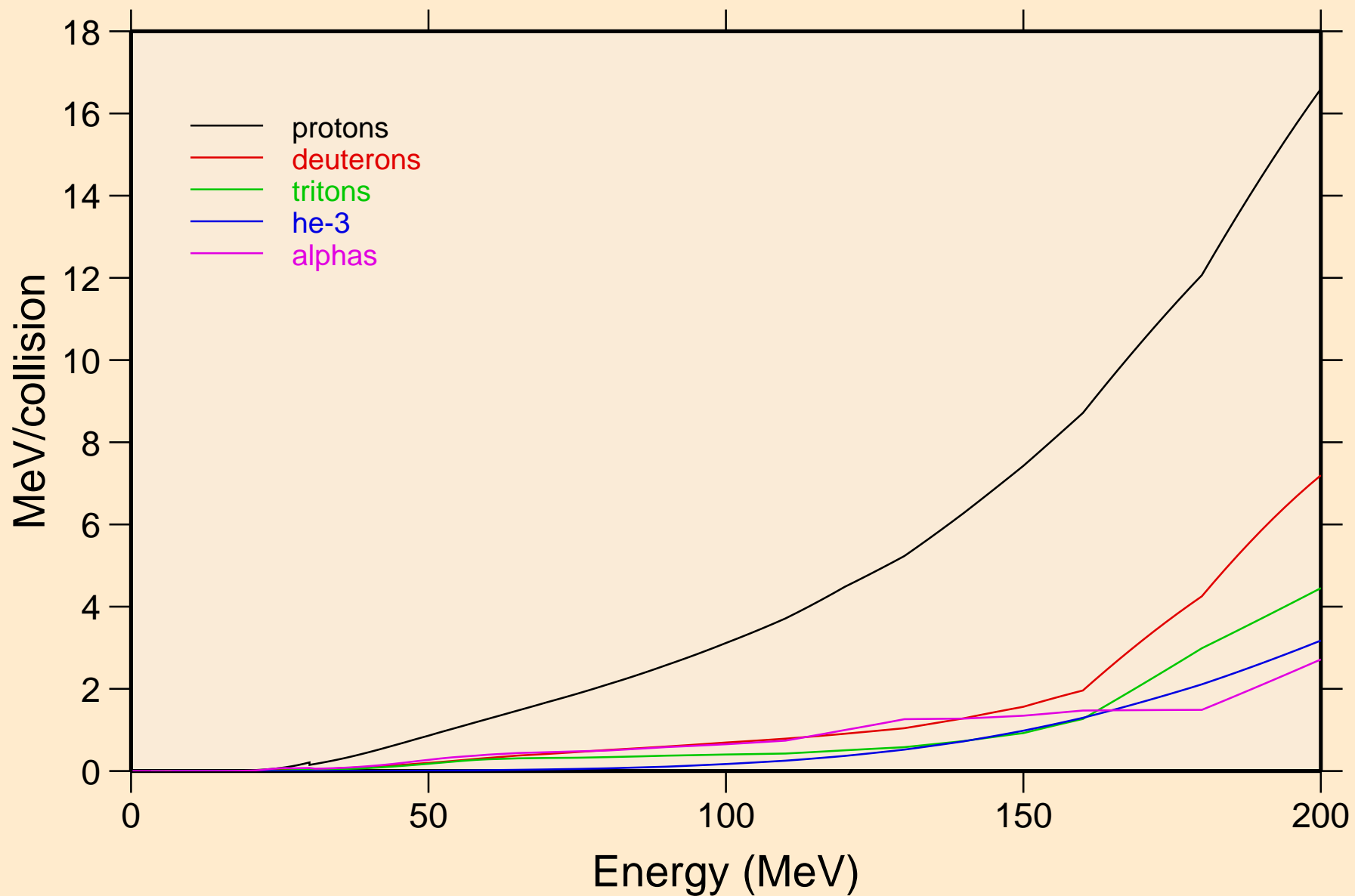

U243 NEUTRON ACER TENDL-2019 LIBRARY; T=293.16K
Recoil Heating

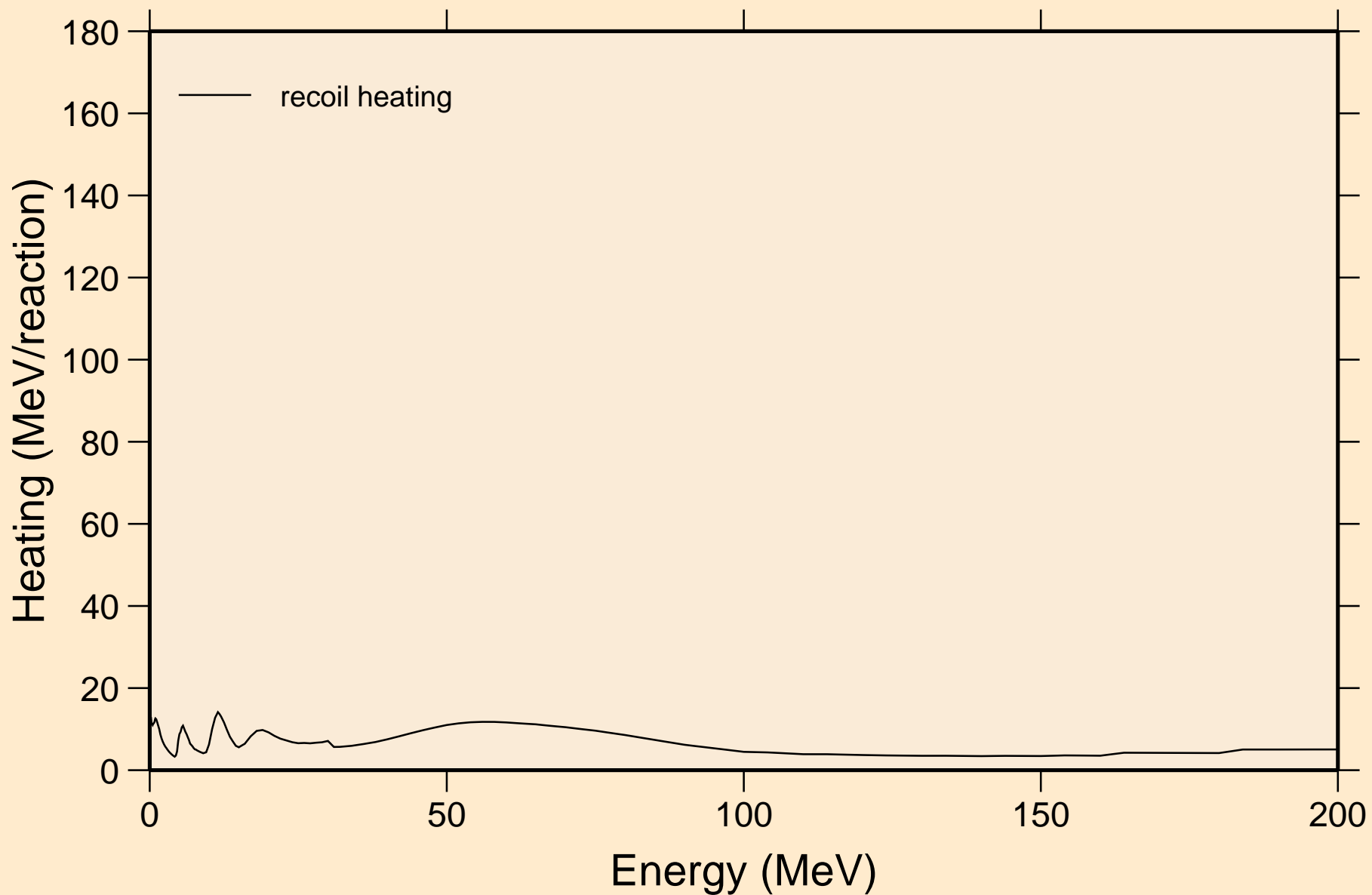

U243 NEUTRON ACER TENDL-2019 LIBRARY; T=293.16K
Particle production cross sections

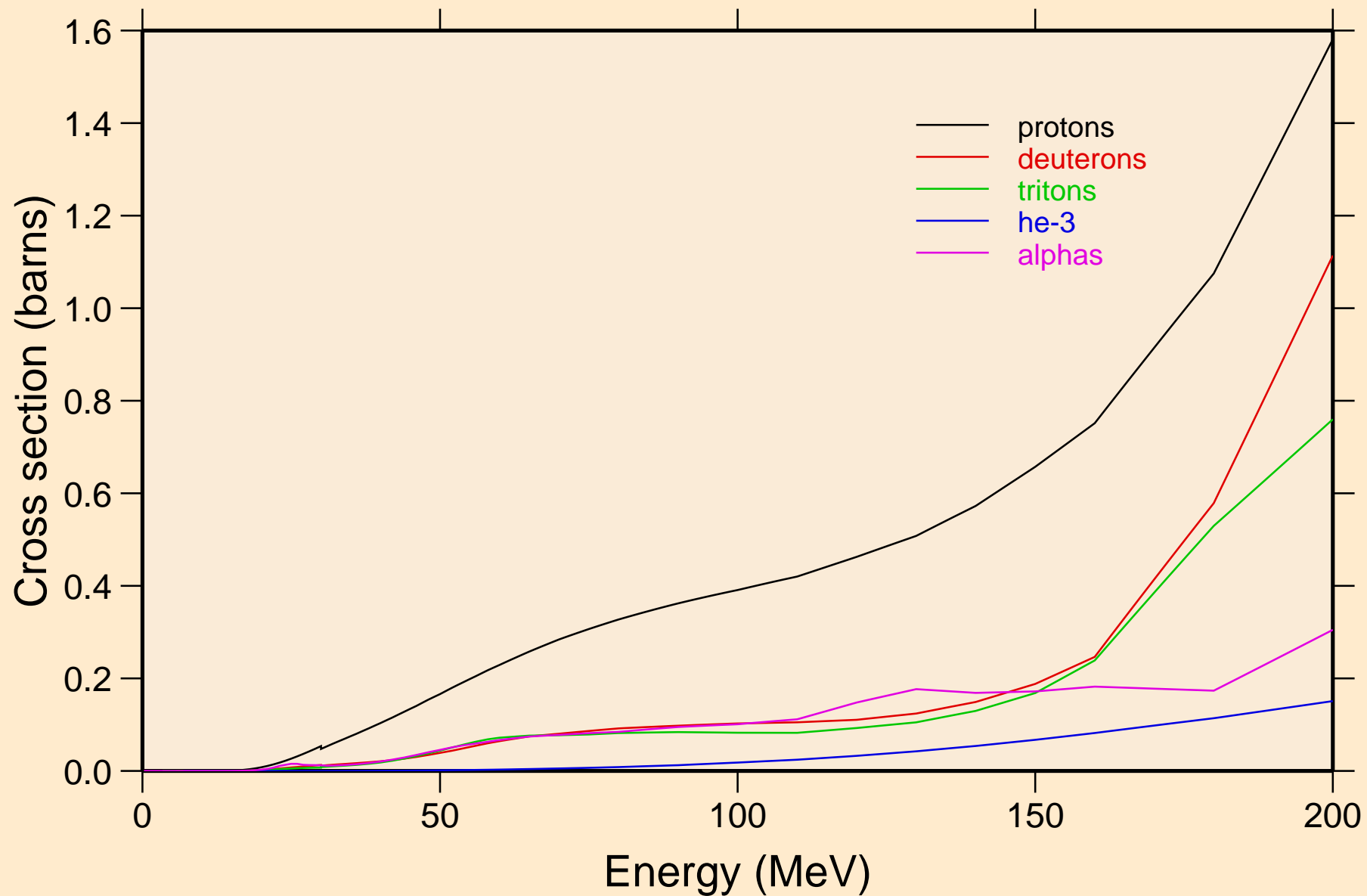

U243 NEUTRON ACER TENDL-2019 LIBRARY; T=293.16K
protons from (n,x)

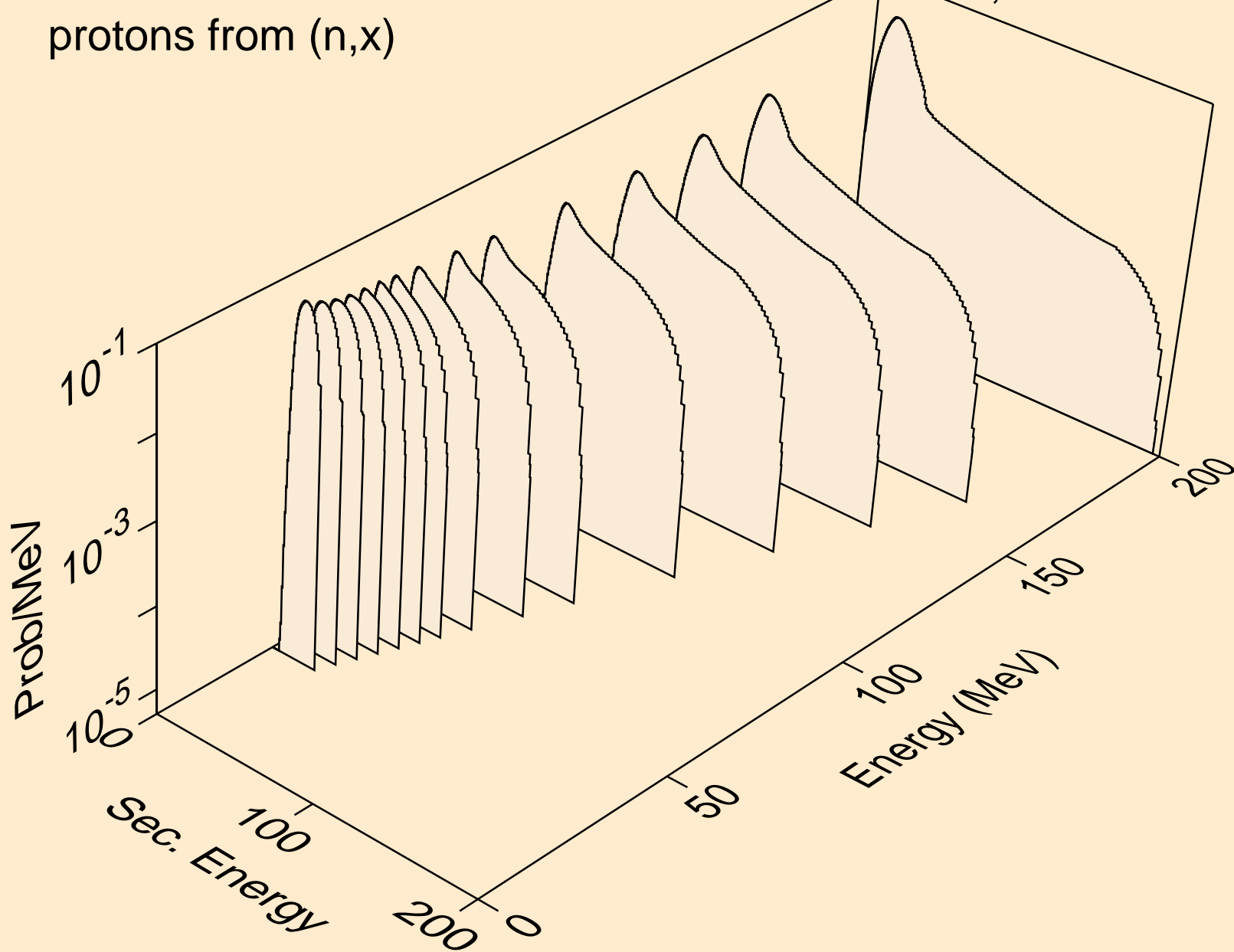

U243 NEUTRON ACER TENDL-2019 LIBRARY; T=293.16K
protons from (n,n*)p

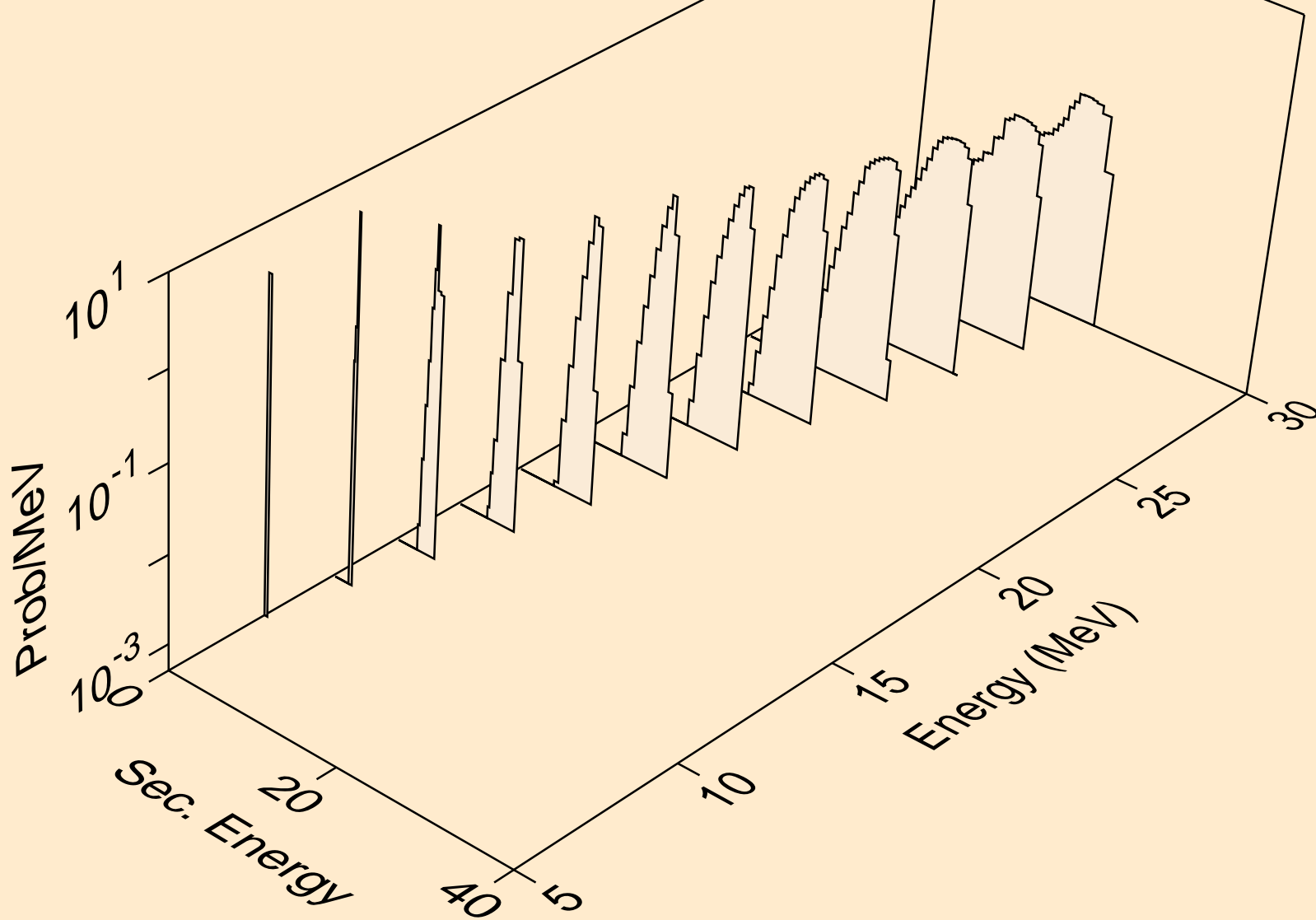

U243 NEUTRON ACER TENDL-2019 LIBRARY; T=293.16K
protons from (n,2np)

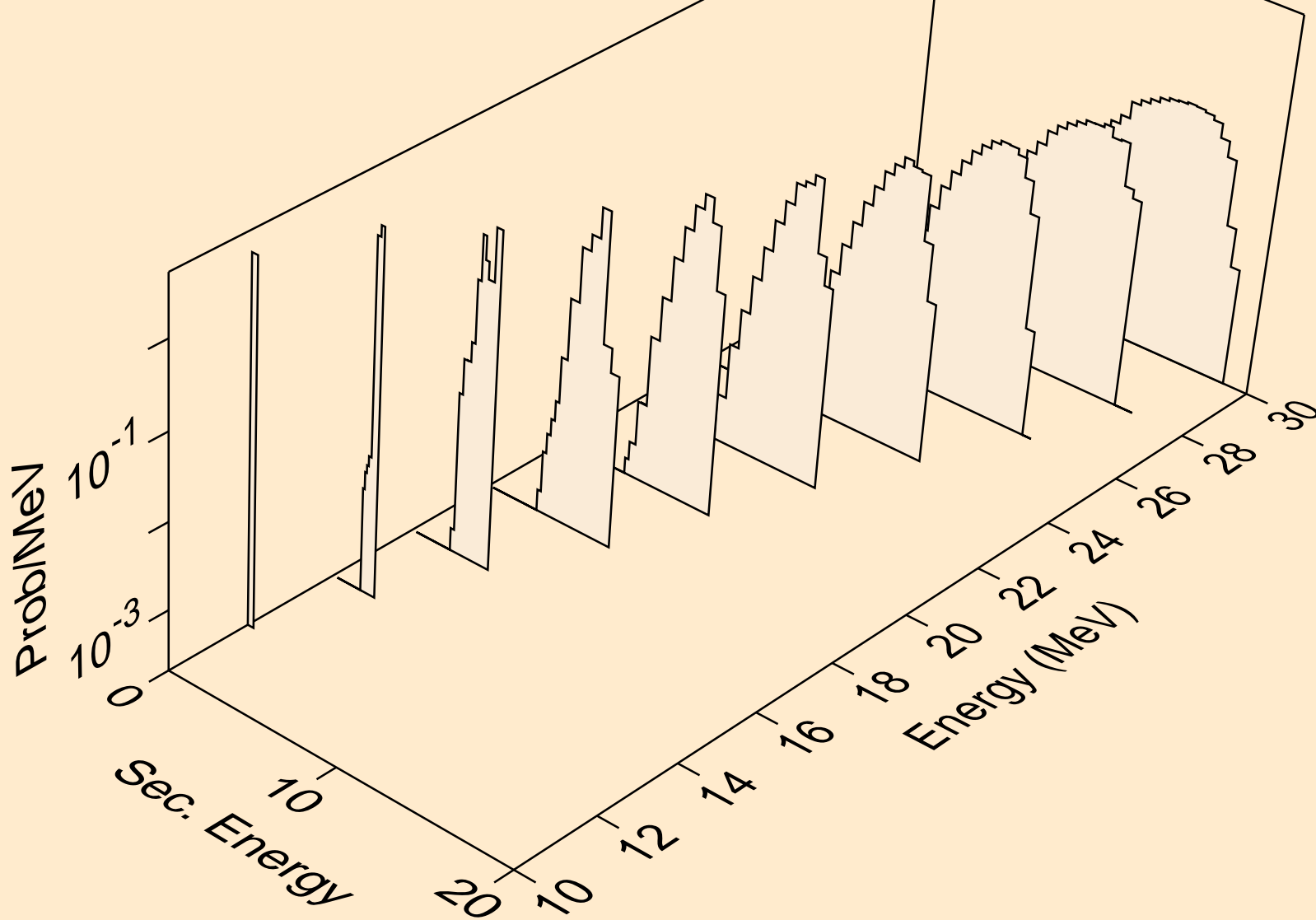

U243 NEUTRON ACER TENDL-2019 LIBRARY; T=293.16K
protons from (n,3np)

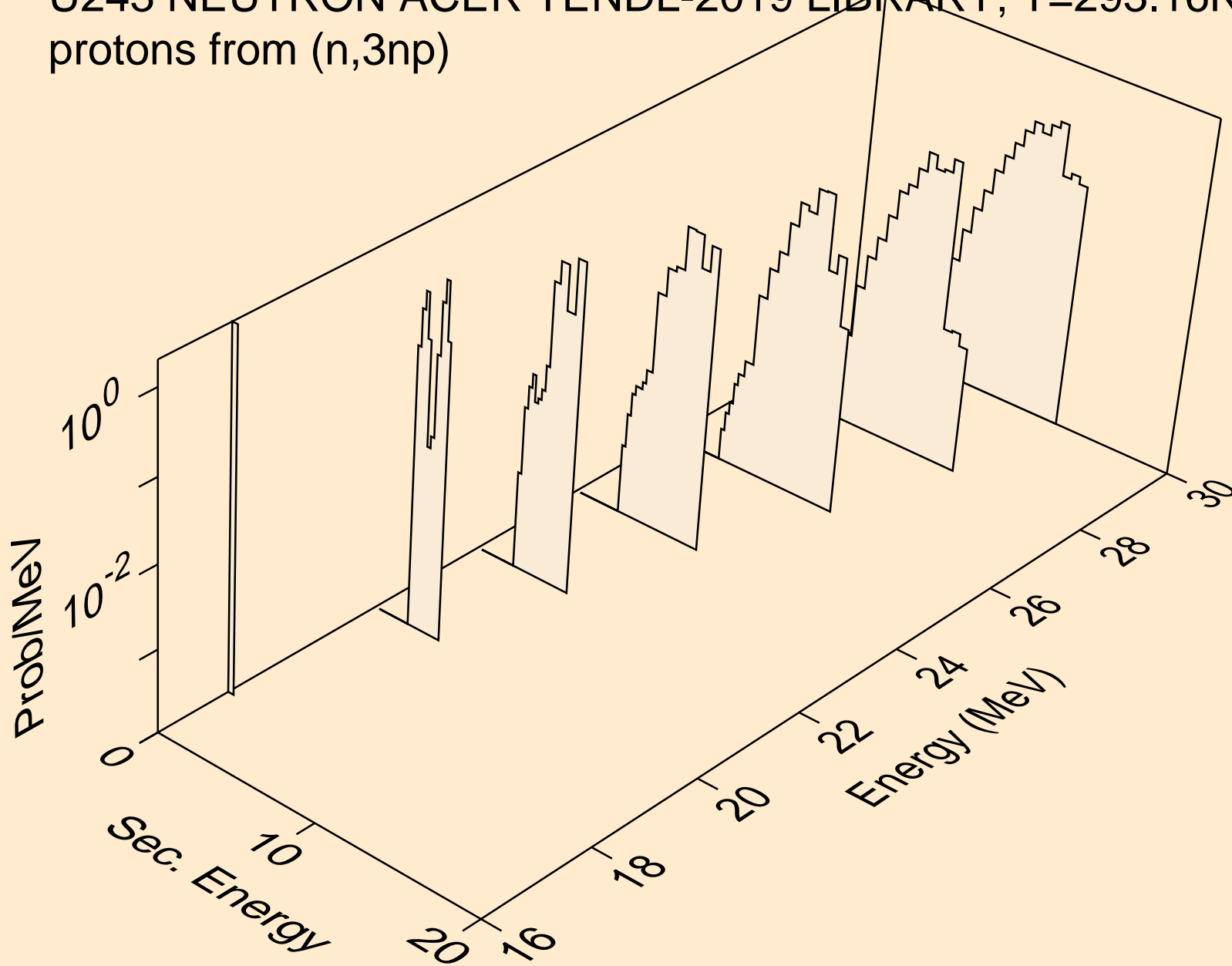

U243 NEUTRON ACER TENDL-2019 LIBRARY; T=293.16K
protons from (n,p)

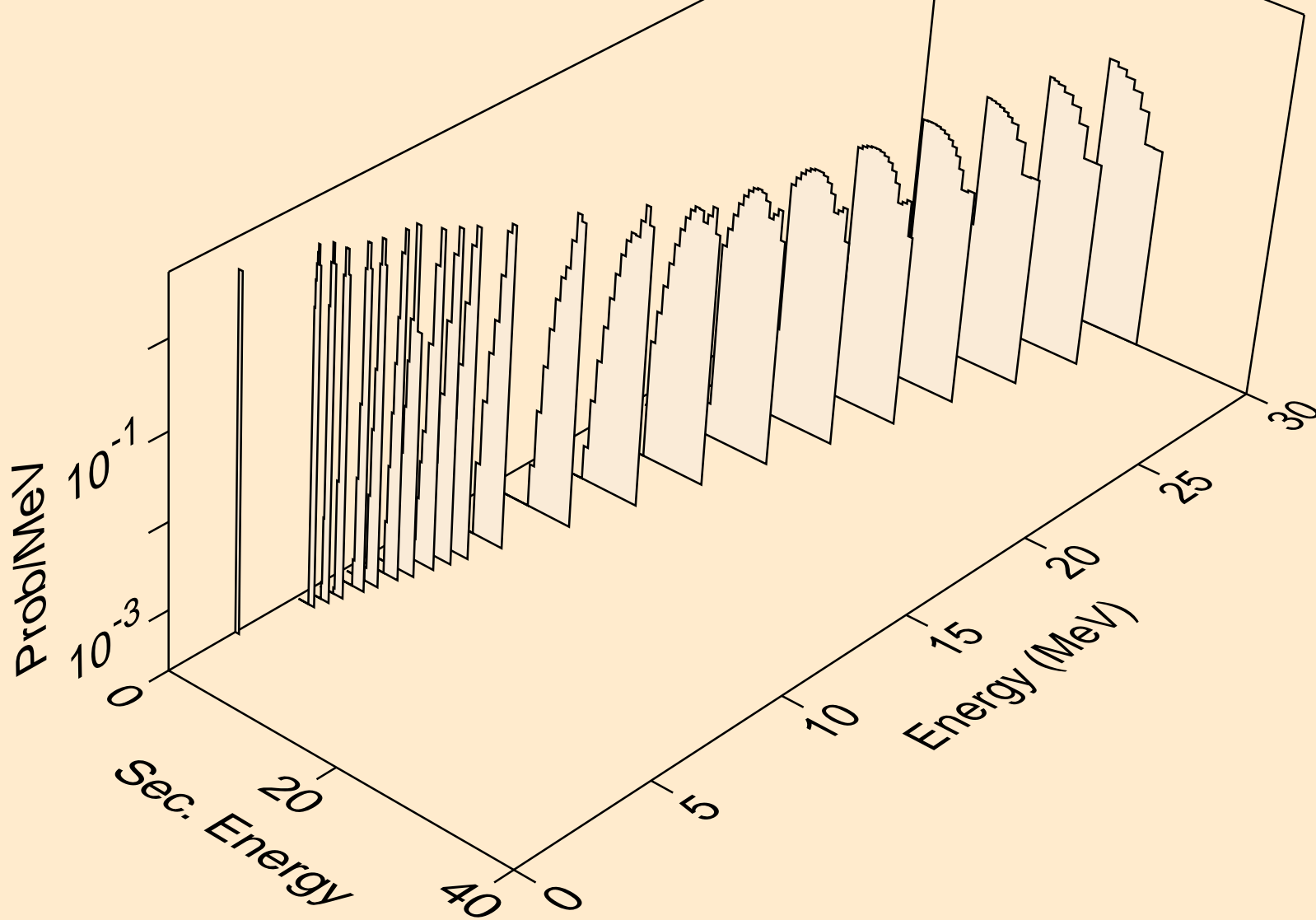

U243 NEUTRON ACER TENDL-2019 LIBRARY; T=293.16K
protons from (n,2p)

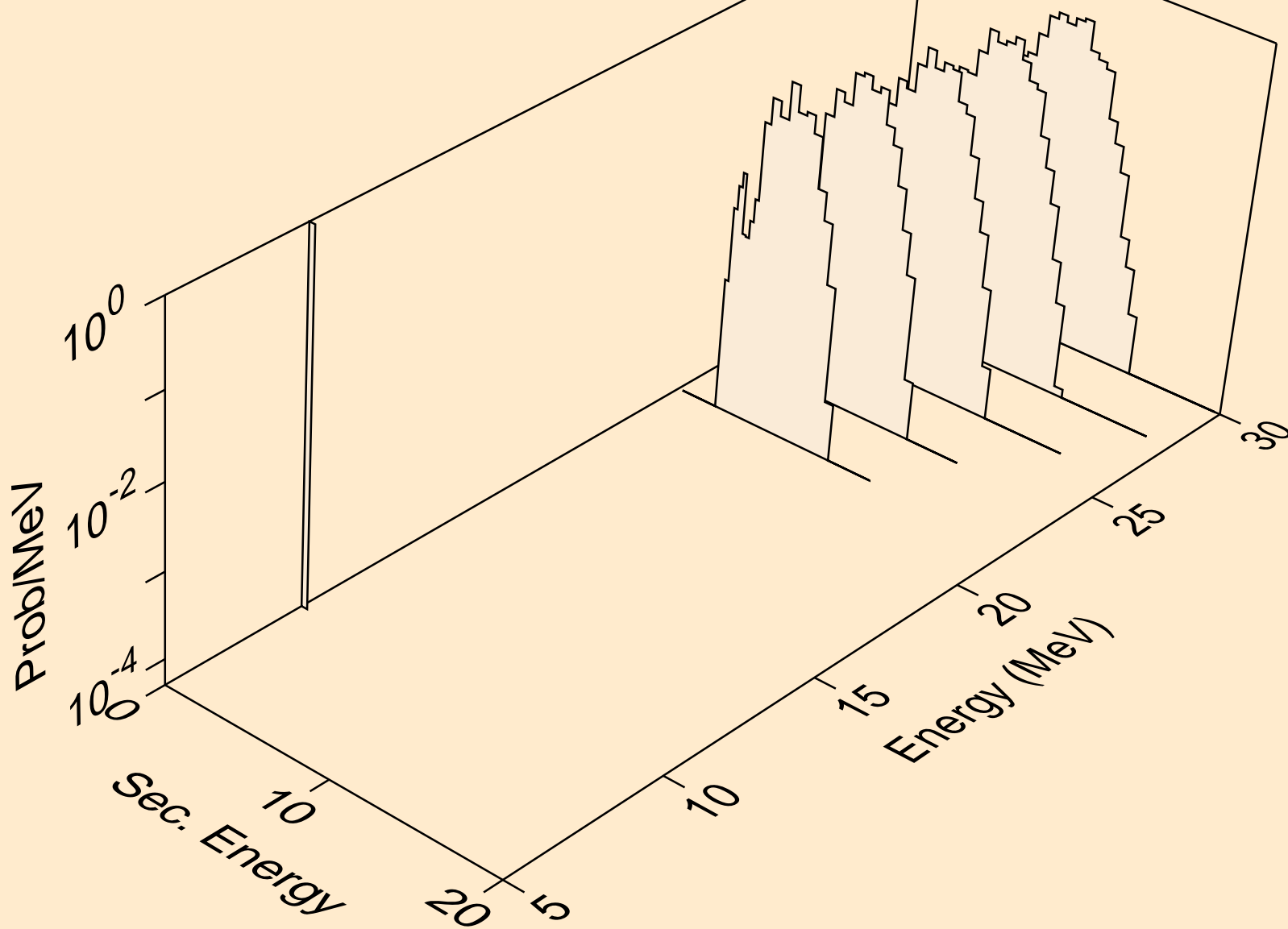

U243 NEUTRON ACER TENDL-2019 LIBRARY; T=293.16K
deuterons from (n,x)

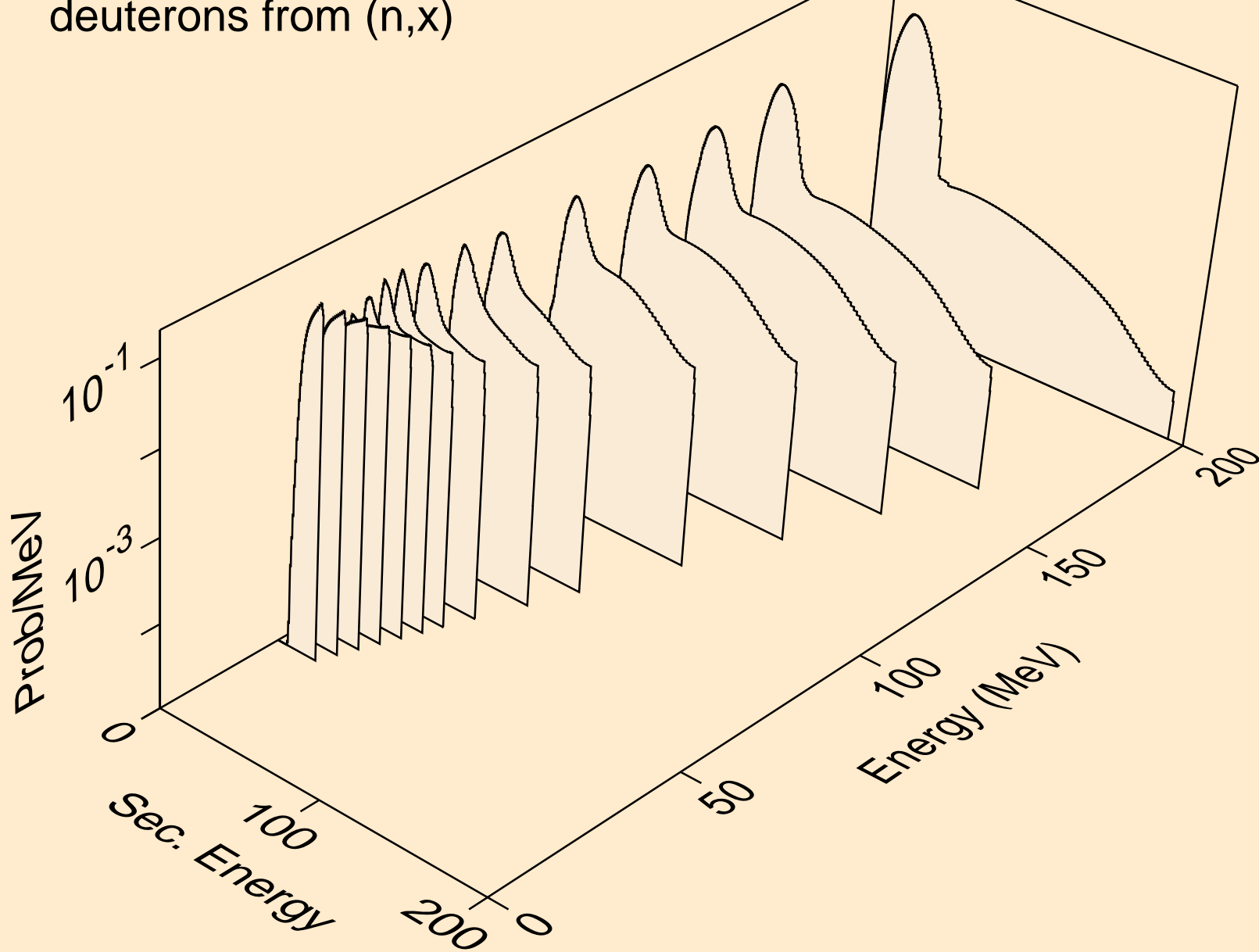

U243 NEUTRON ACER TENDL-2019 LIBRARY; T=293.16K
deuterons from (n,2nd)

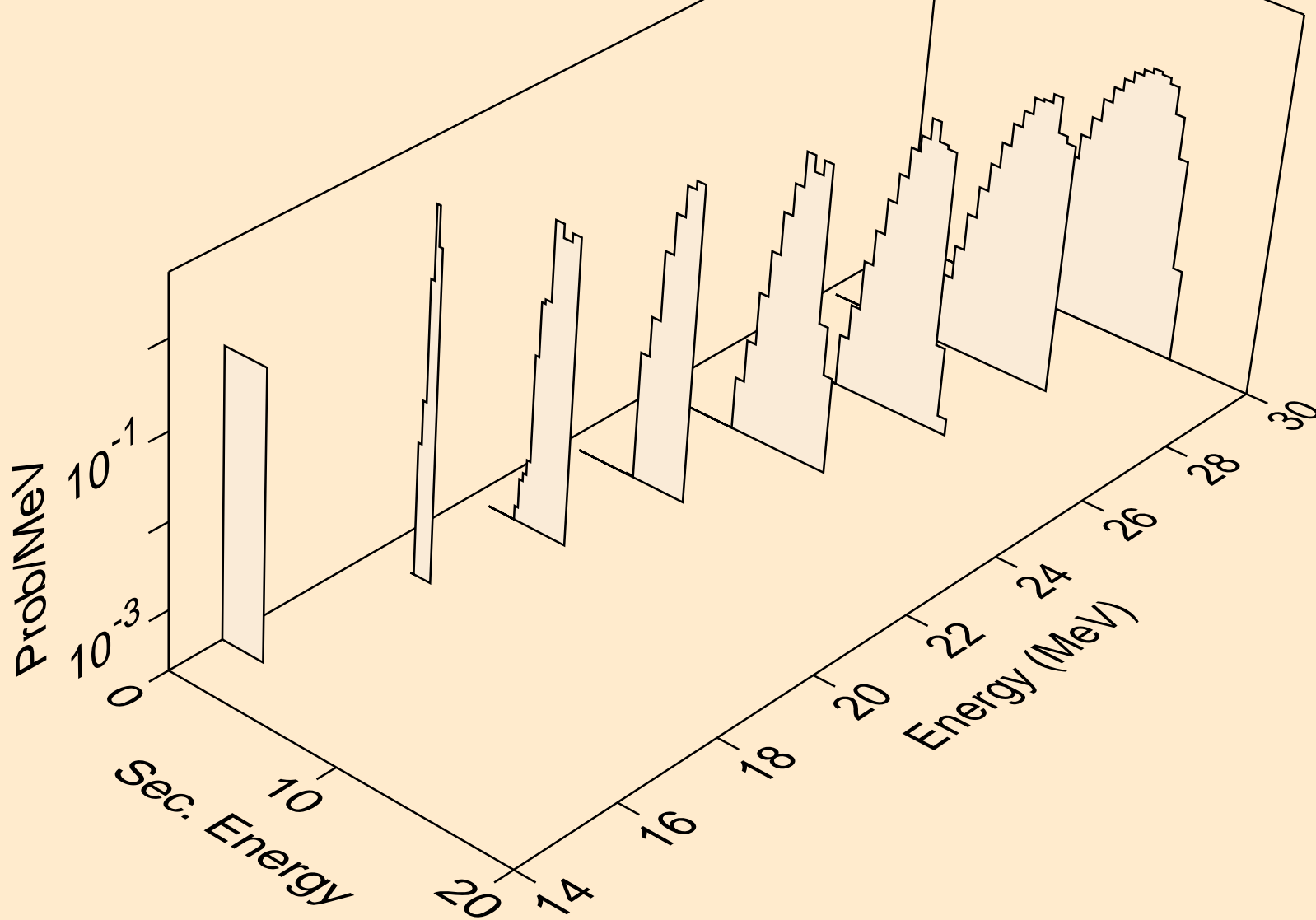

U243 NEUTRON ACER TENDL-2019 LIBRARY; T=293.16K
deuterons from (n,n*)d

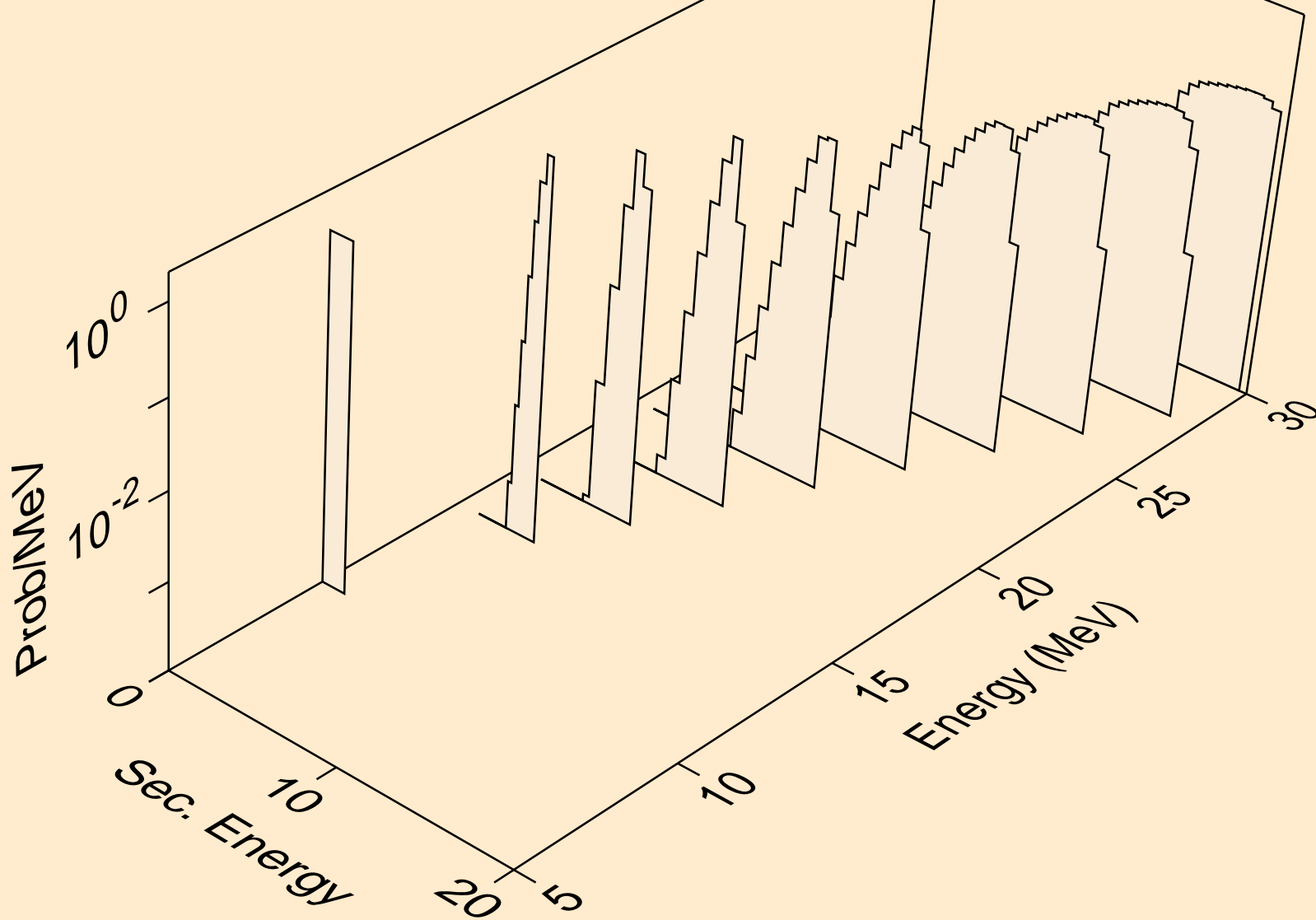

U243 NEUTRON ACER TENDL-2019 LIBRARY; T=293.16K
deuterons from (n,d)

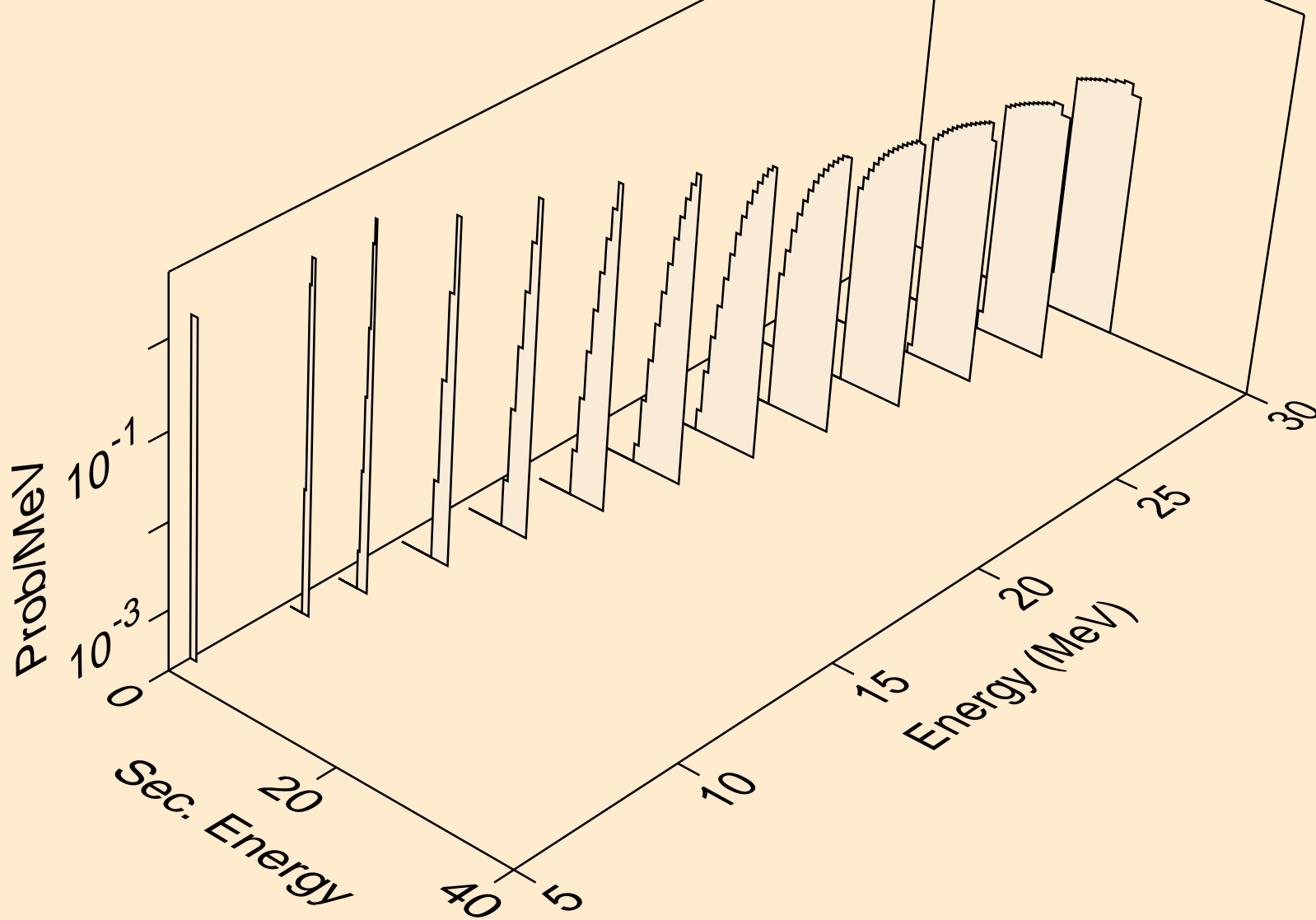

U243 NEUTRON ACER TENDL-2019 LIBRARY; T=293.16K
tritons from (n,x)

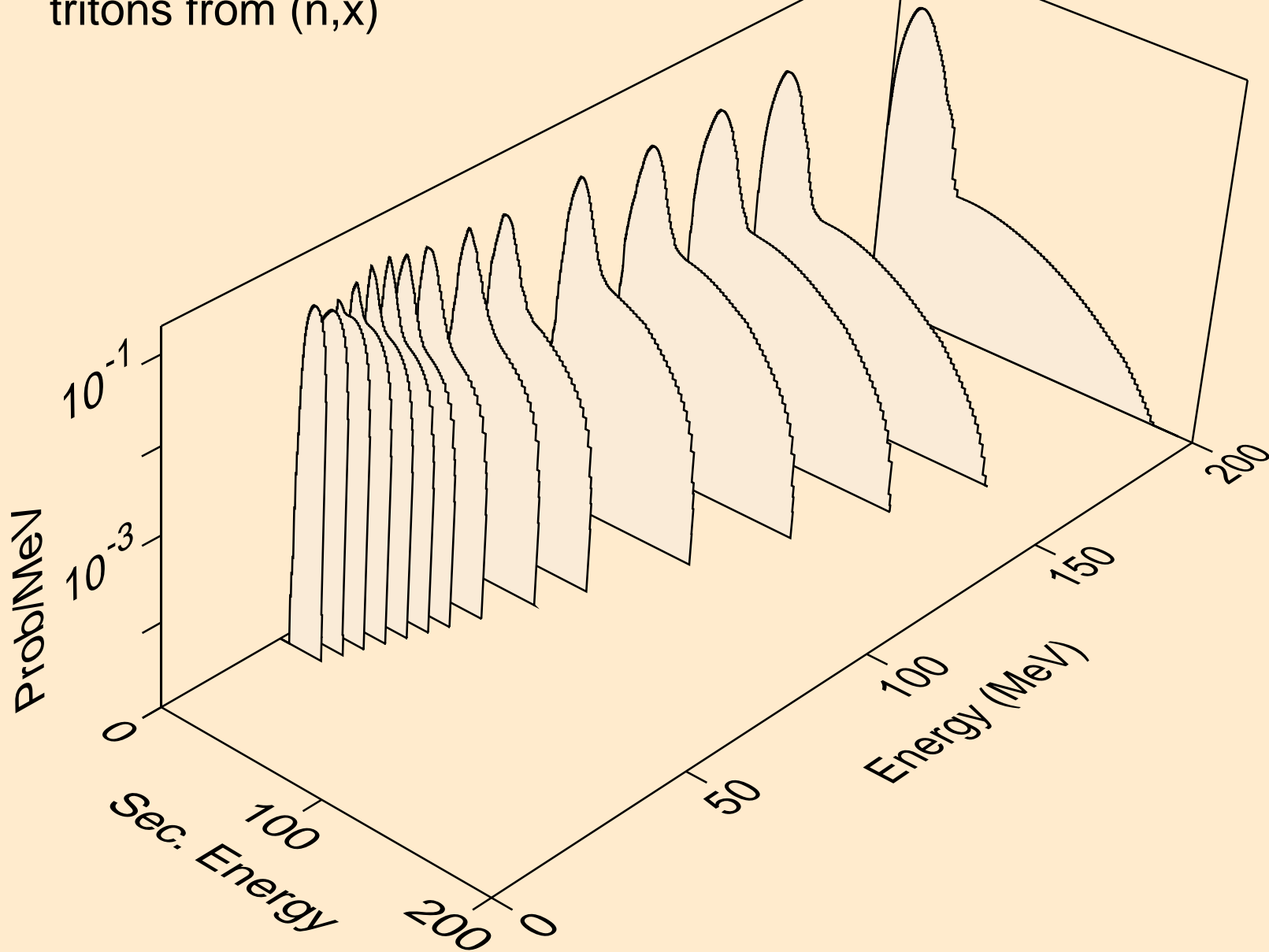

U243 NEUTRON ACER TENDL-2019 LIBRARY; T=293.16K
tritons from (n,n*)t

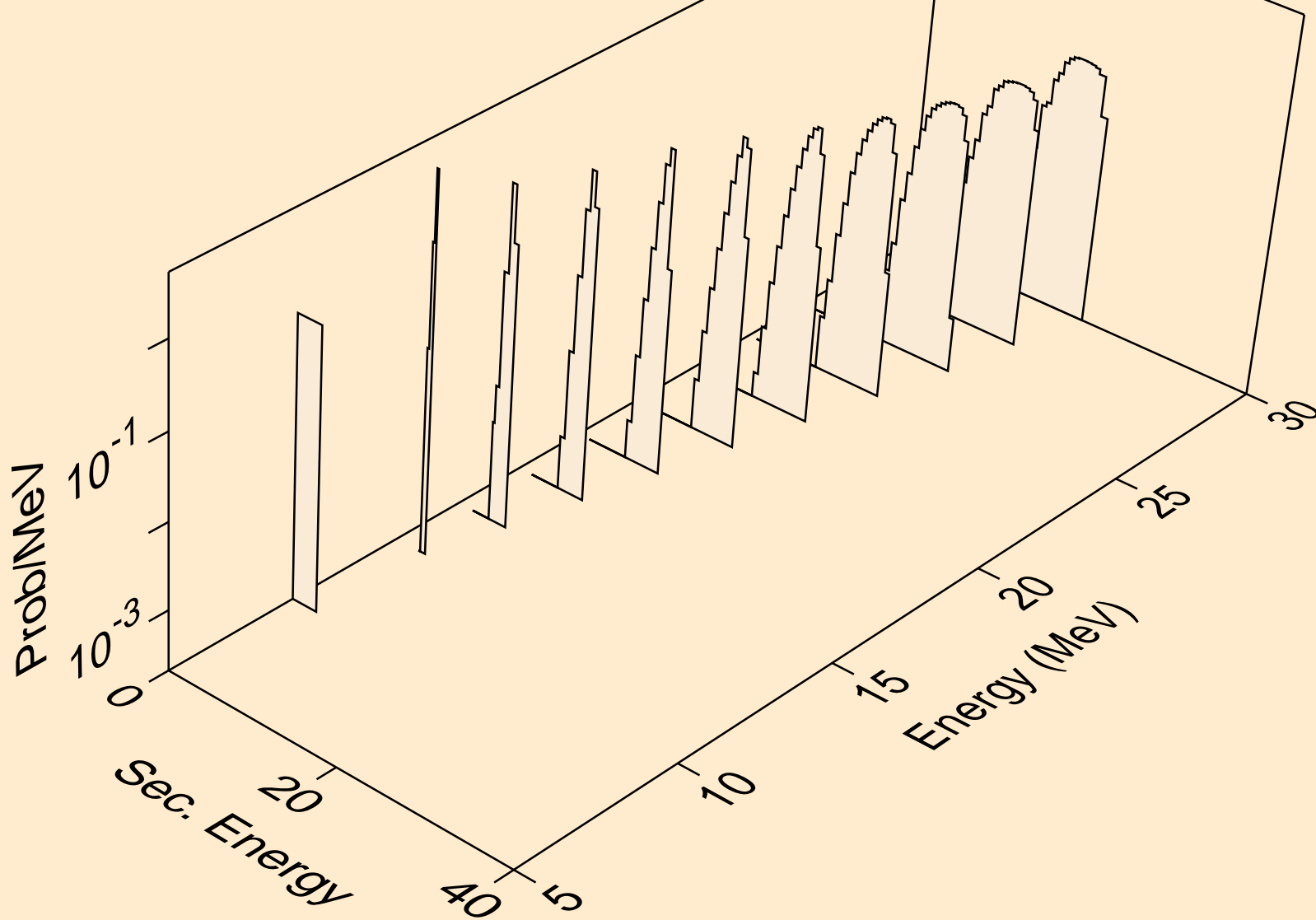

U243 NEUTRON ACER TENDL-2019 LIBRARY; T=293.16K
tritons from (n,t)

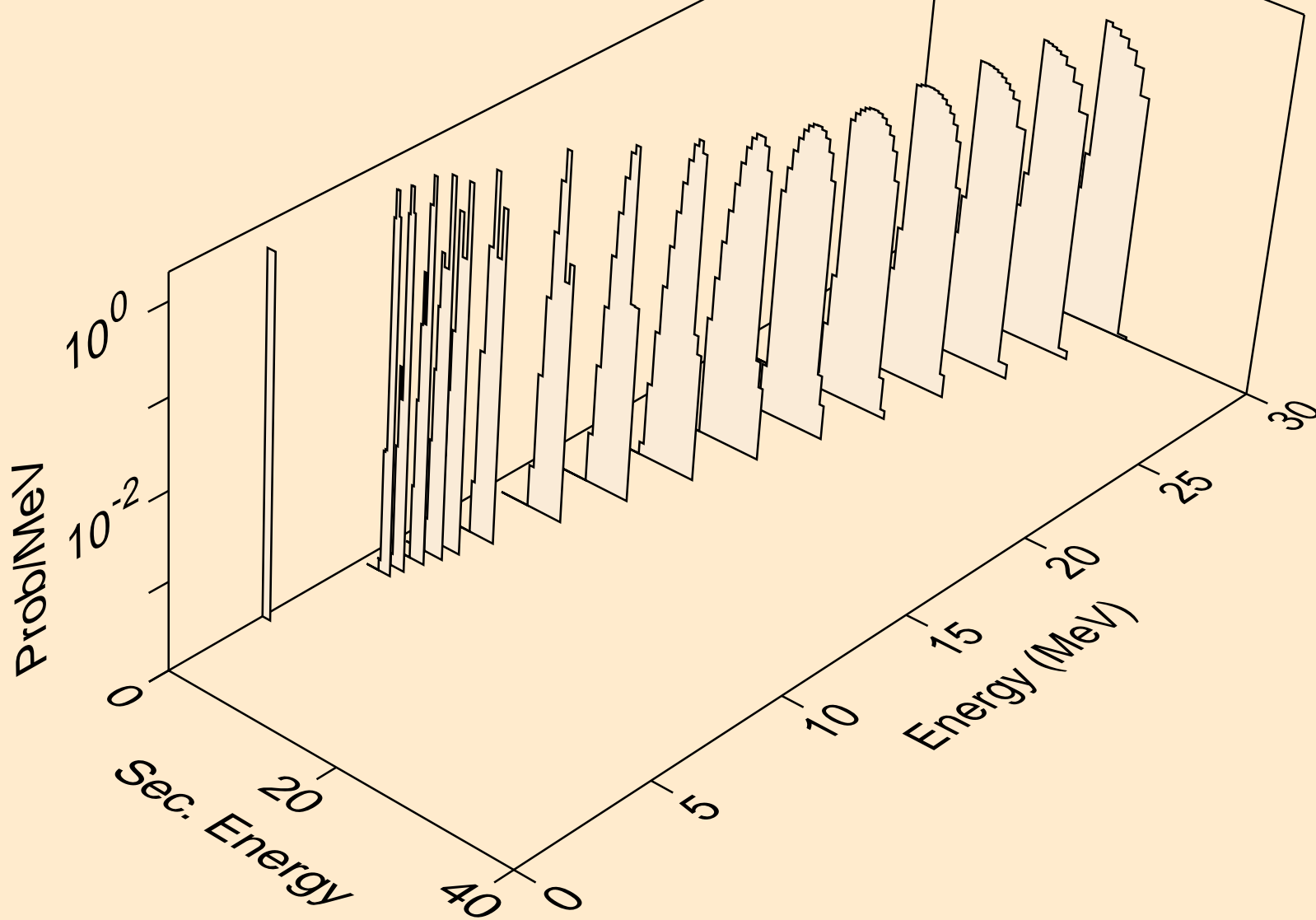

U243 NEUTRON ACER TENDL-2019 LIBRARY; T=293.16K
he3s from (n,x)

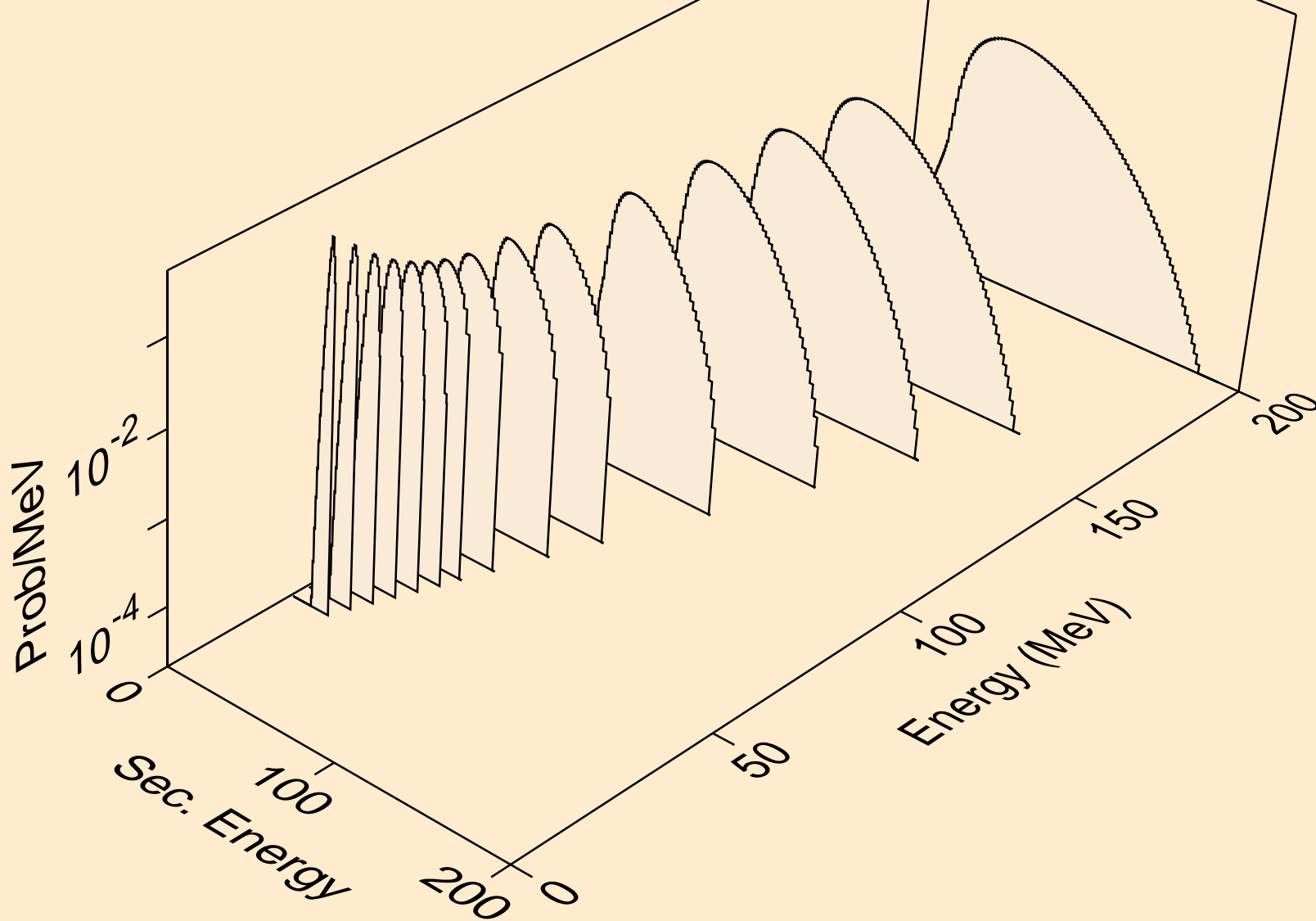

U243 NEUTRON ACER TENDL-2019 LIBRARY; T=293.16K
he3s from (n,n*)he3

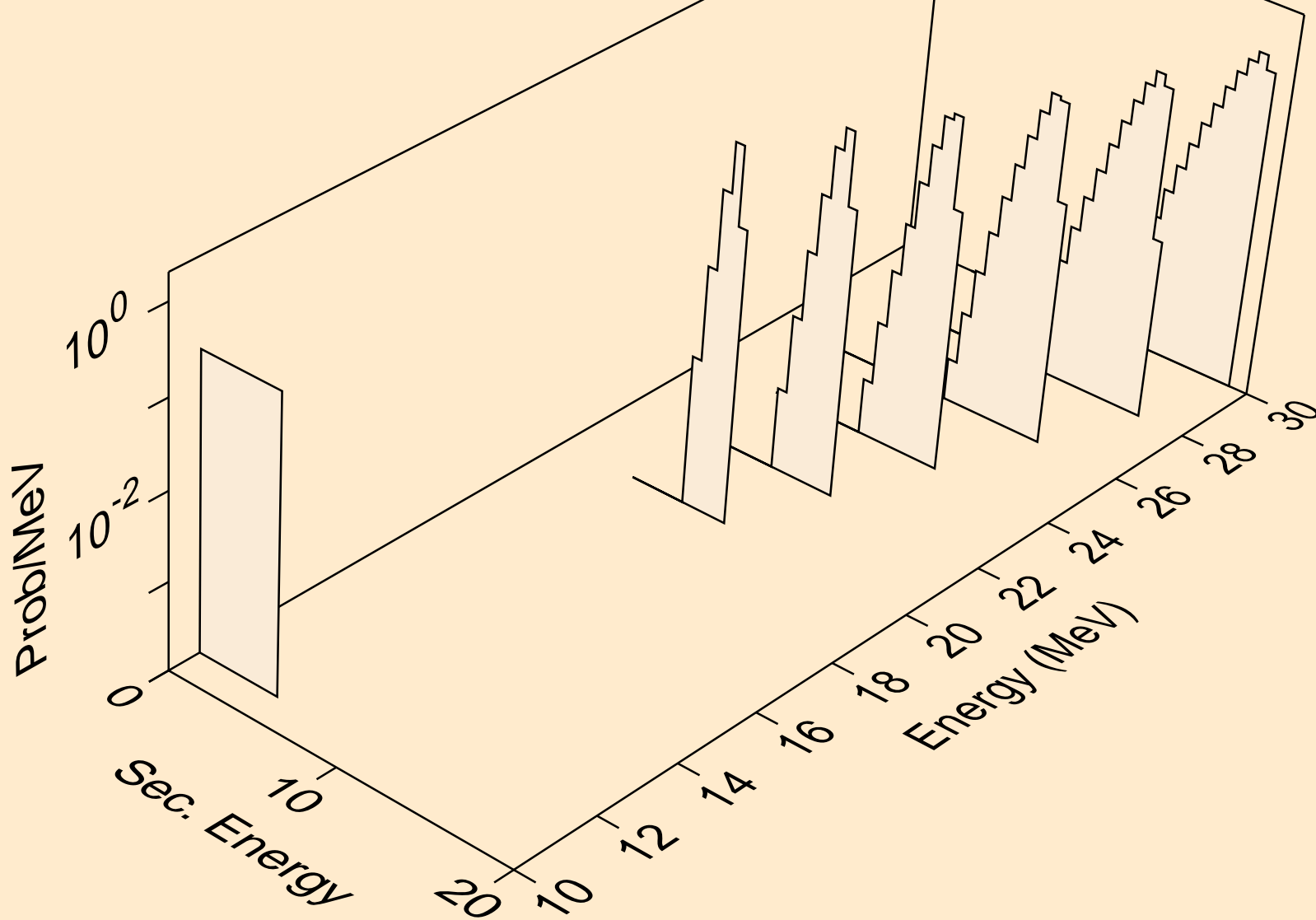

U243 NEUTRON ACER TENDL-2019 LIBRARY; T=293.16K
he3s from (n,he3)

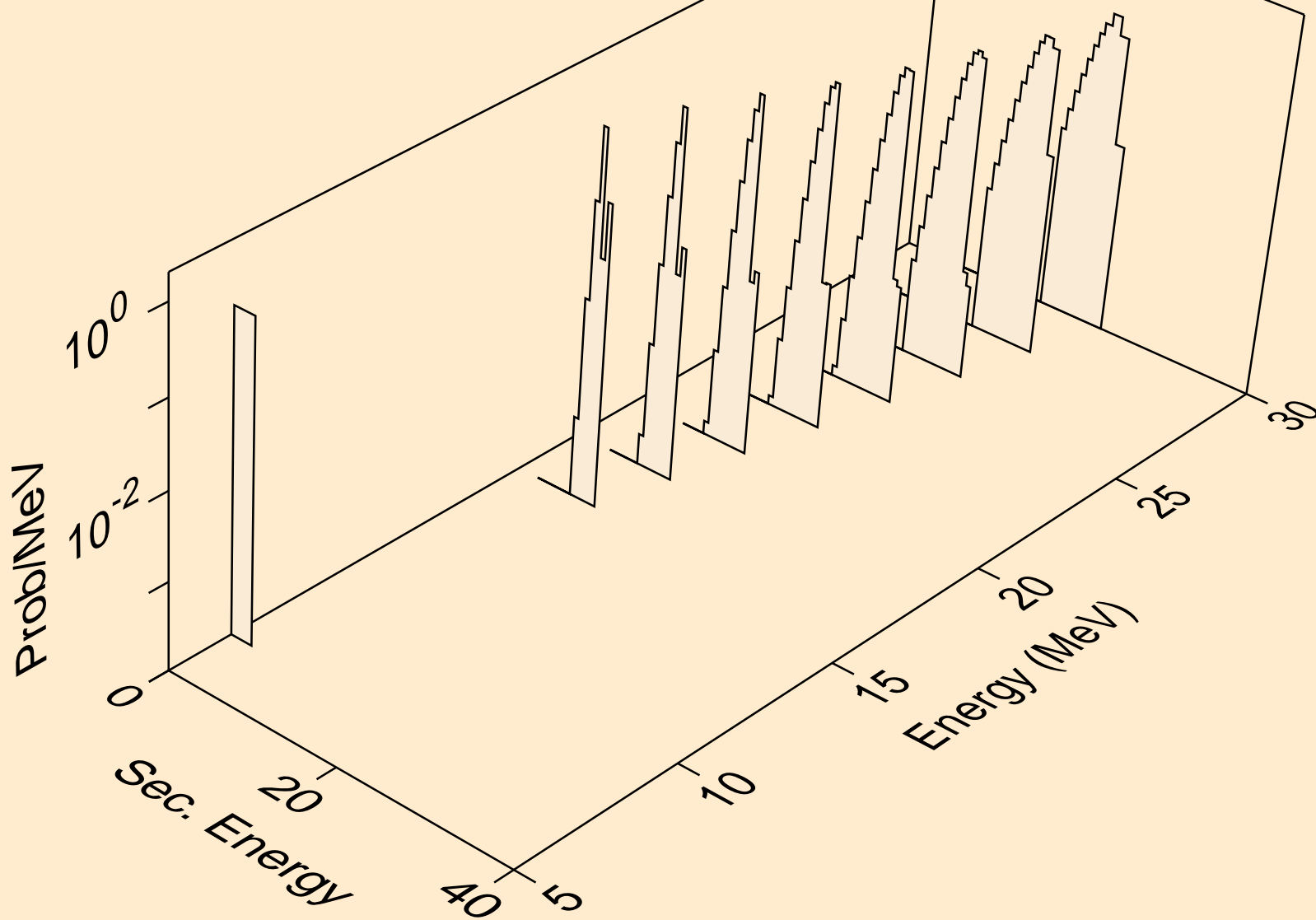

U243 NEUTRON ACER TENDL-2019 LIBRARY; T=293.16K
alphas from (n,x)

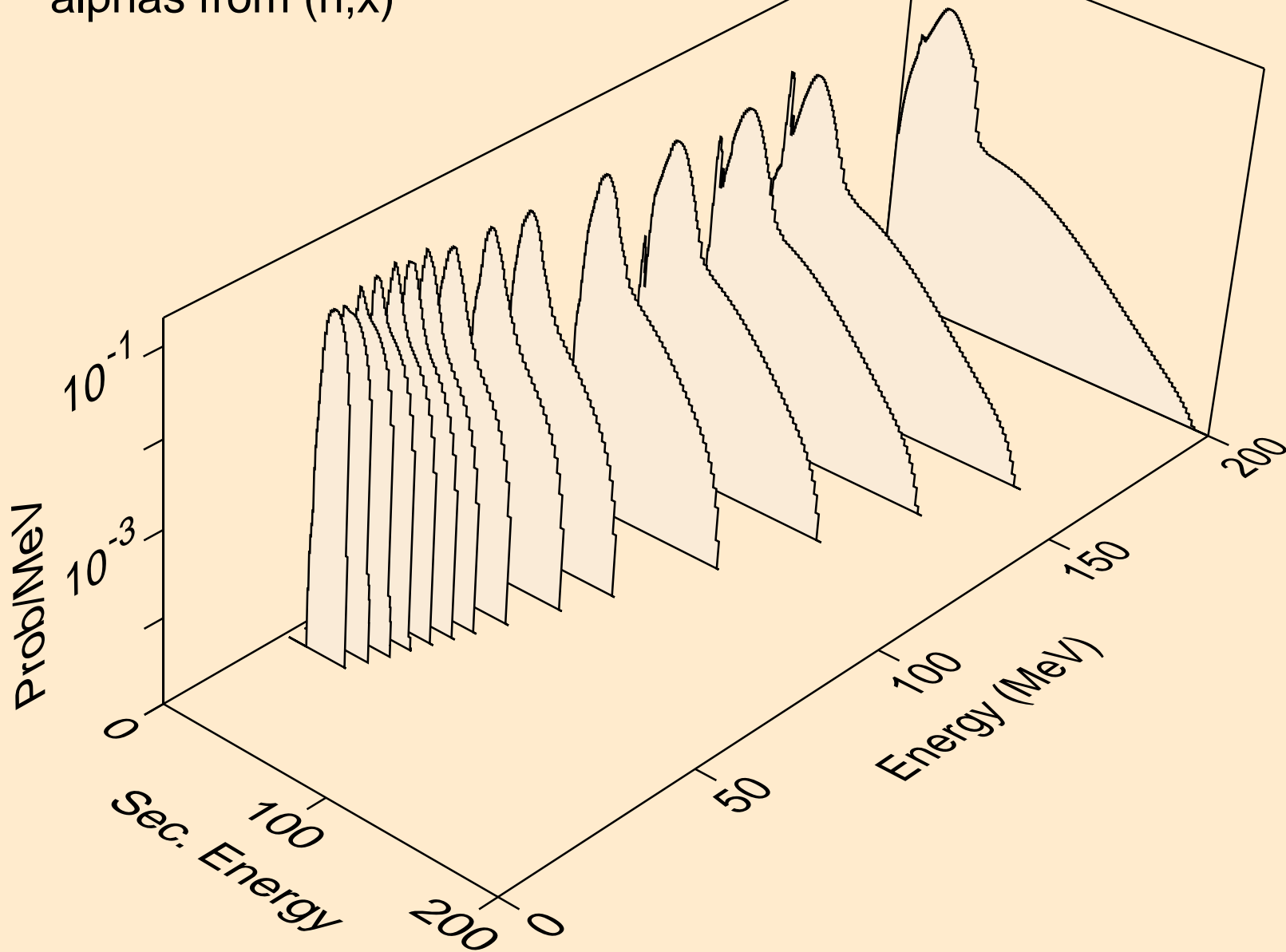

U243 NEUTRON ACER TENDL-2019 LIBRARY; T=293.16K
alphas from (n,n*)a

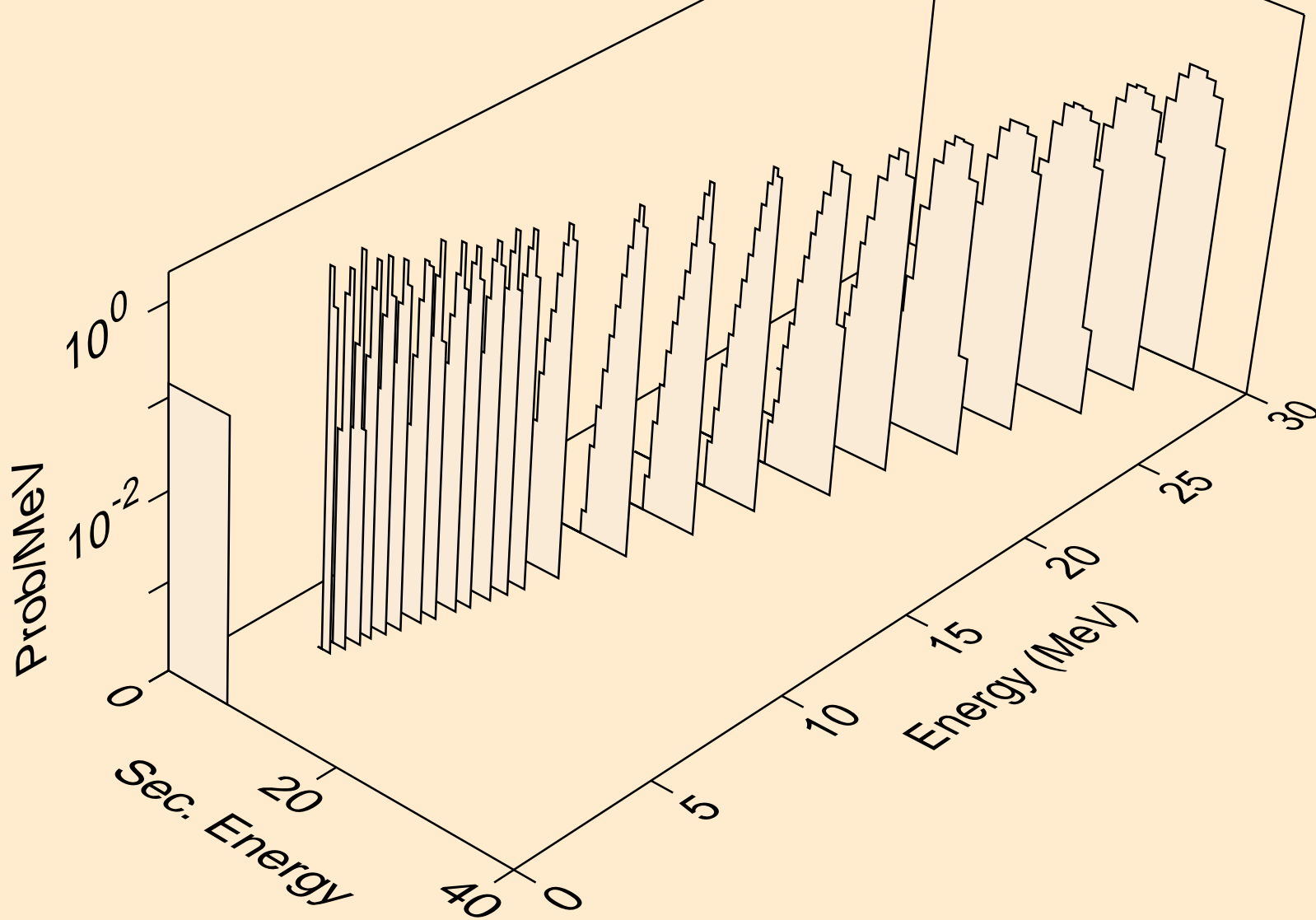

U243 NEUTRON ACER TENDL-2019 LIBRARY; T=293.16K
alphas from (n,2n)a

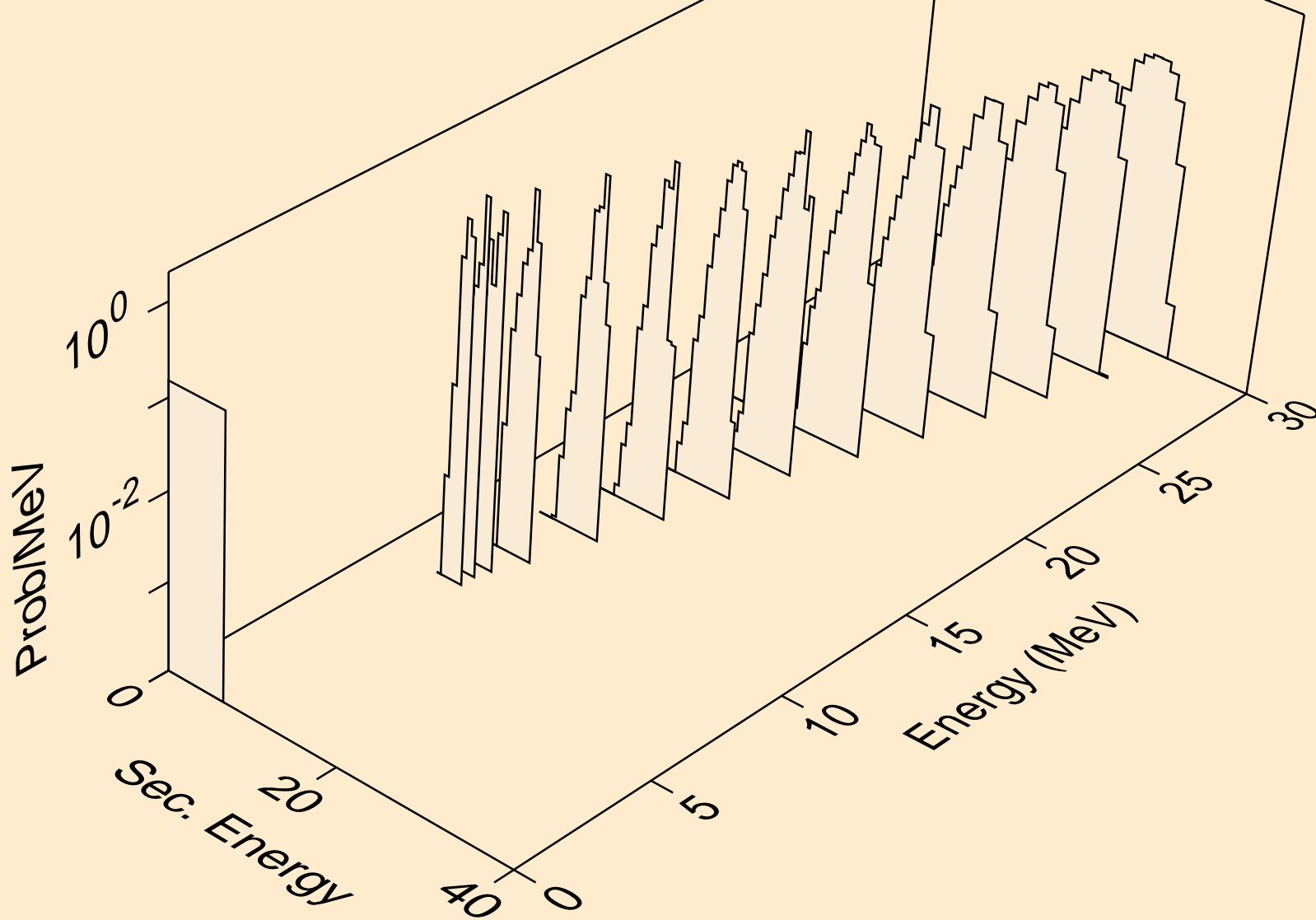

U243 NEUTRON ACER TENDL-2019 LIBRARY; T=293.16K
alphas from (n,3n)a

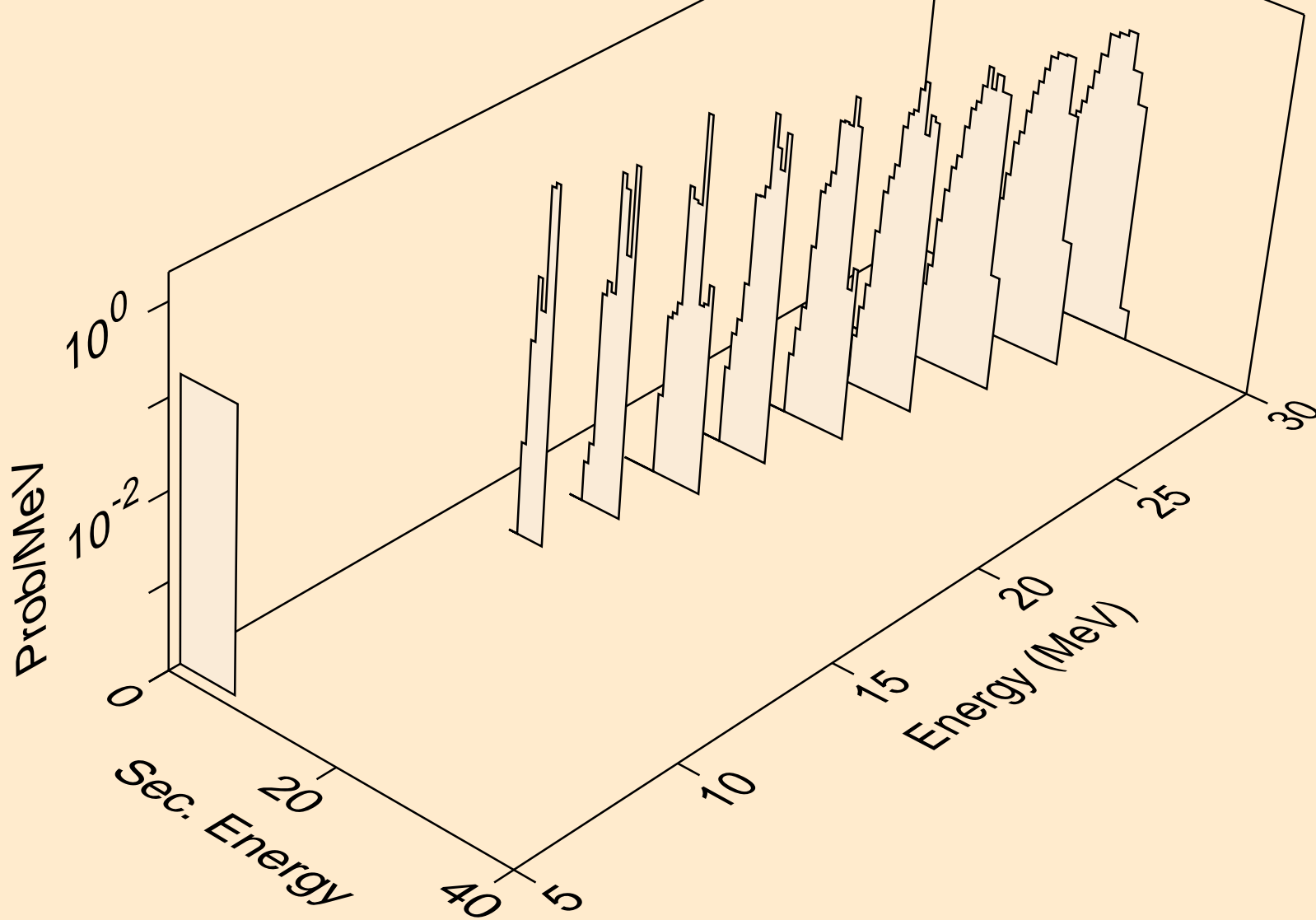

U243 NEUTRON ACER TENDL-2019 LIBRARY; T=293.16K
alphas from (n,a)

