

# YB153 ALPHA ACER TENDL-2021 LIBRARY; T=0.K

## Principal cross sections

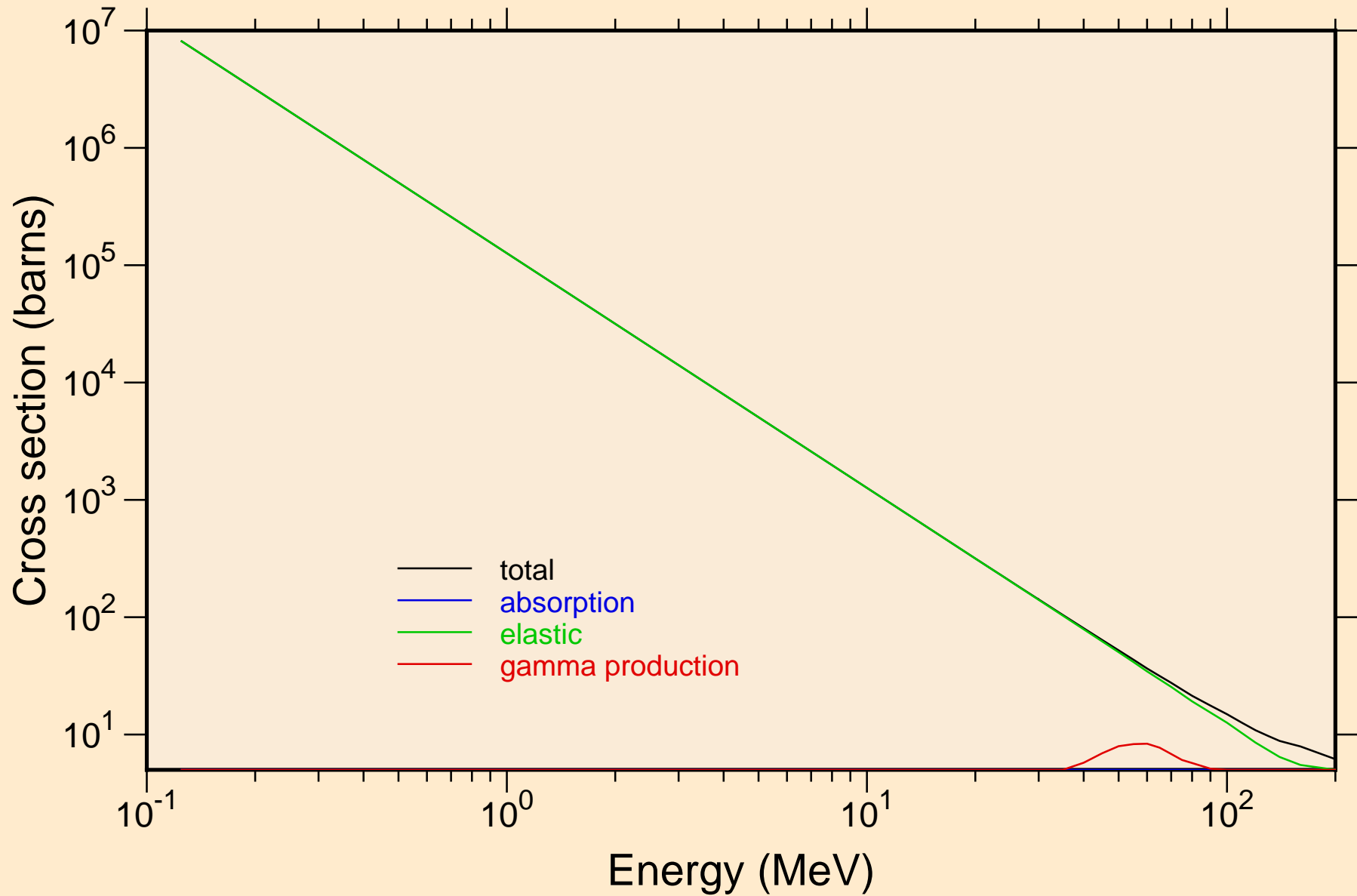

YB153 ALPHA ACER TENDL-2021 LIBRARY; T=0.K

Heating

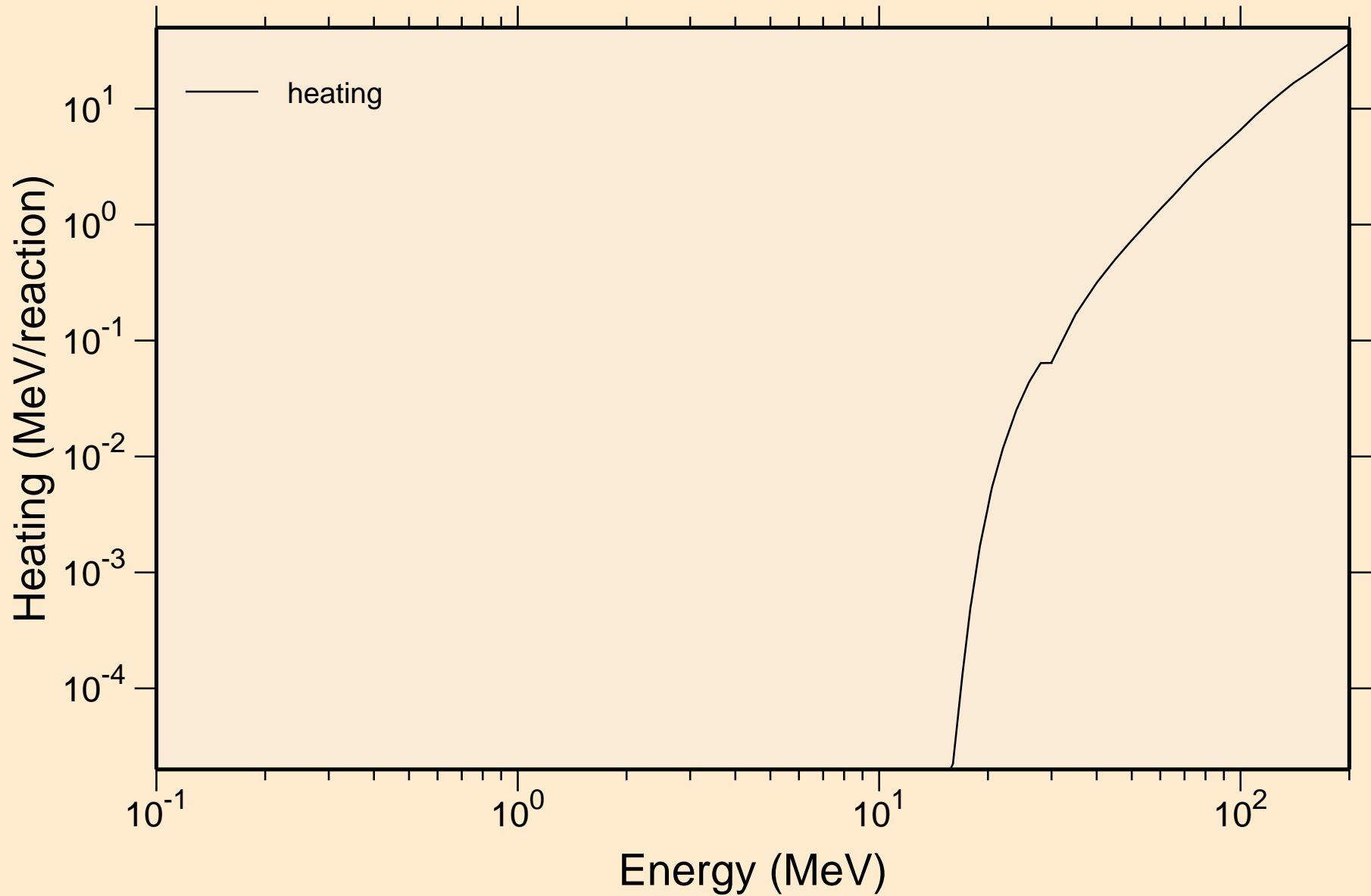

# YB153 ALPHA ACER TENDL-2021 LIBRARY; T=0.K

## Principal cross sections

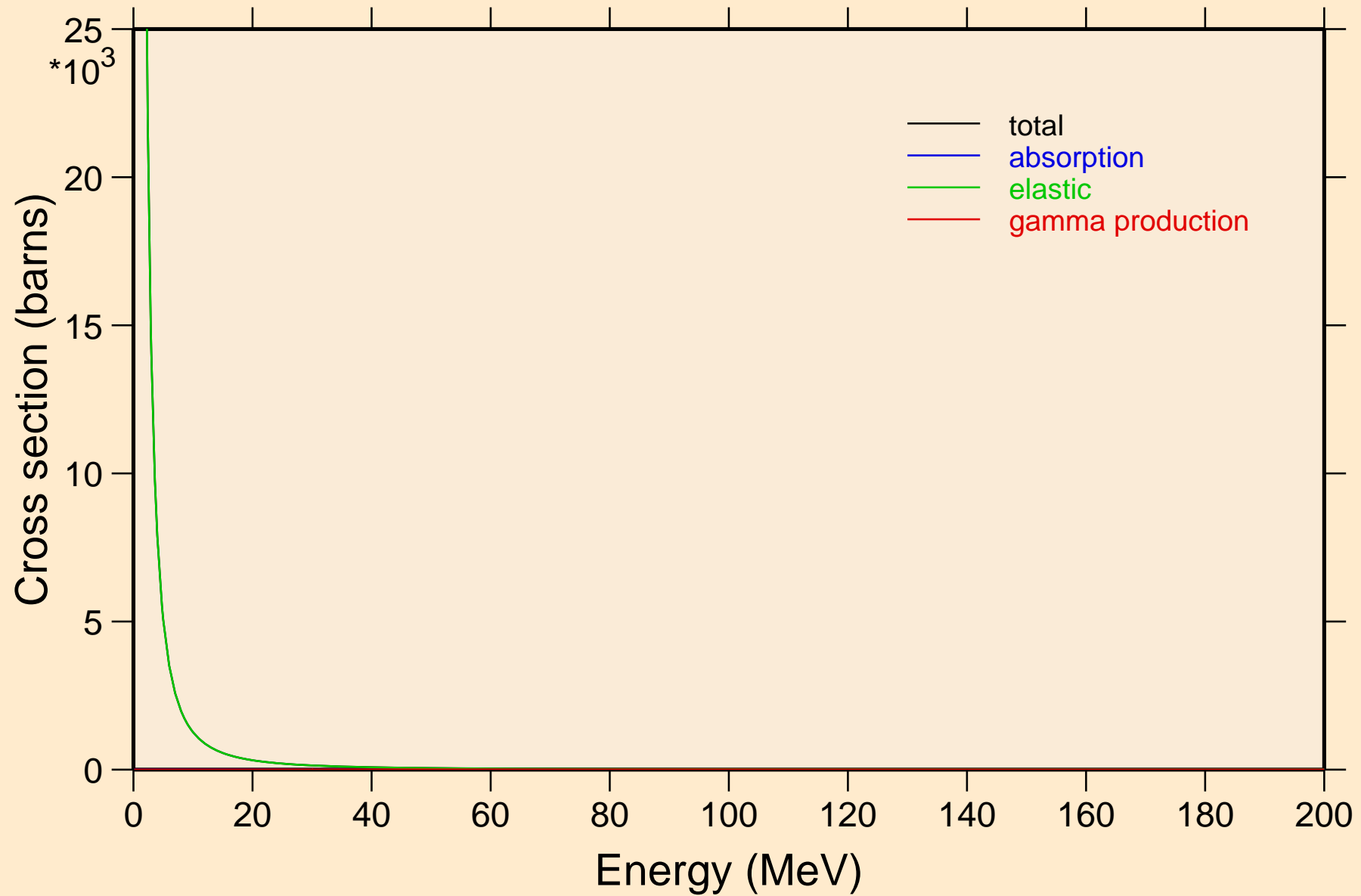

YB153 ALPHA ACER TENDL-2021 LIBRARY; T=0.K

Heating

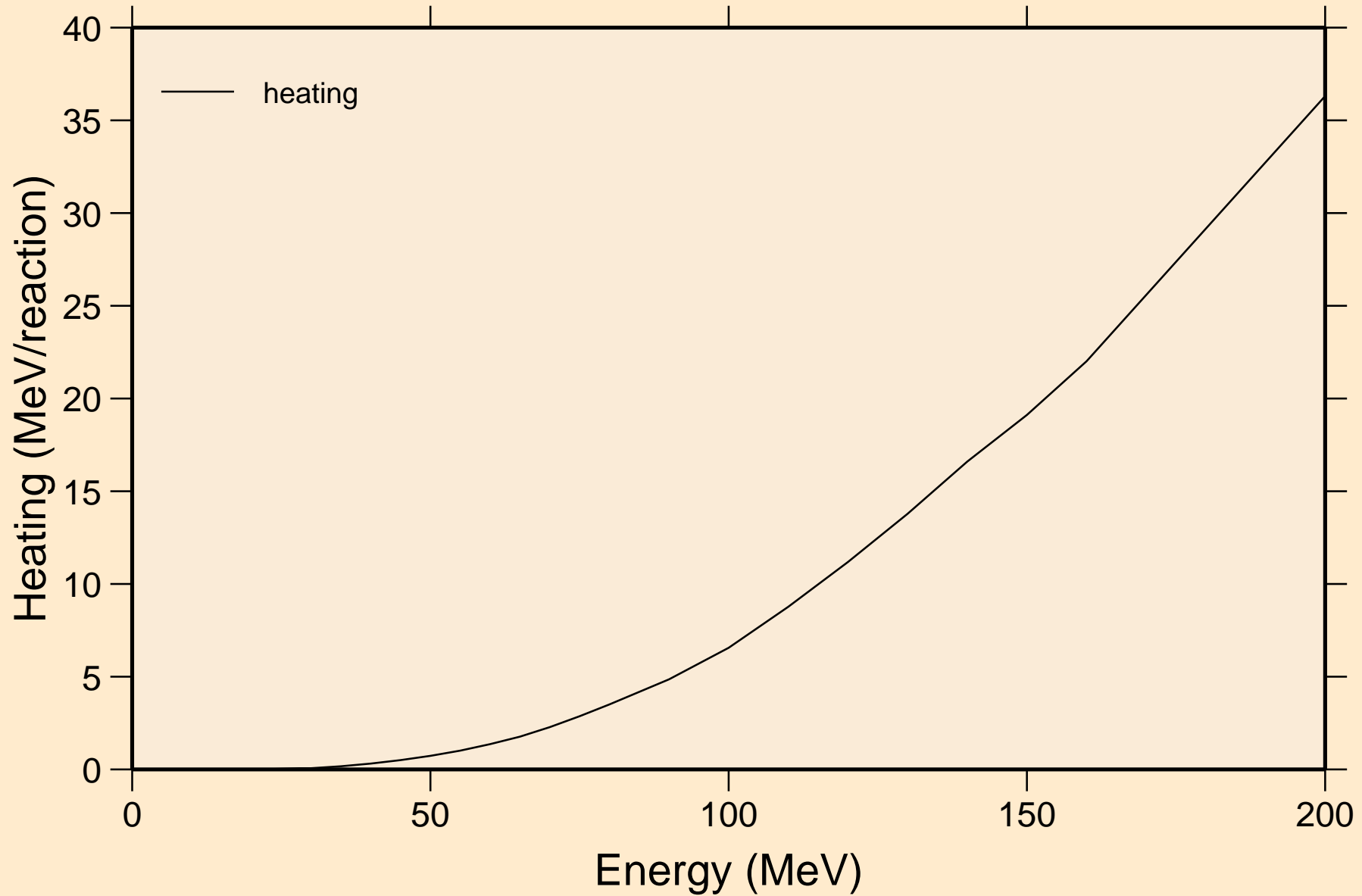

YB153 ALPHA ACER TENDL-2021 LIBRARY; T=0.K  
Threshold reactions

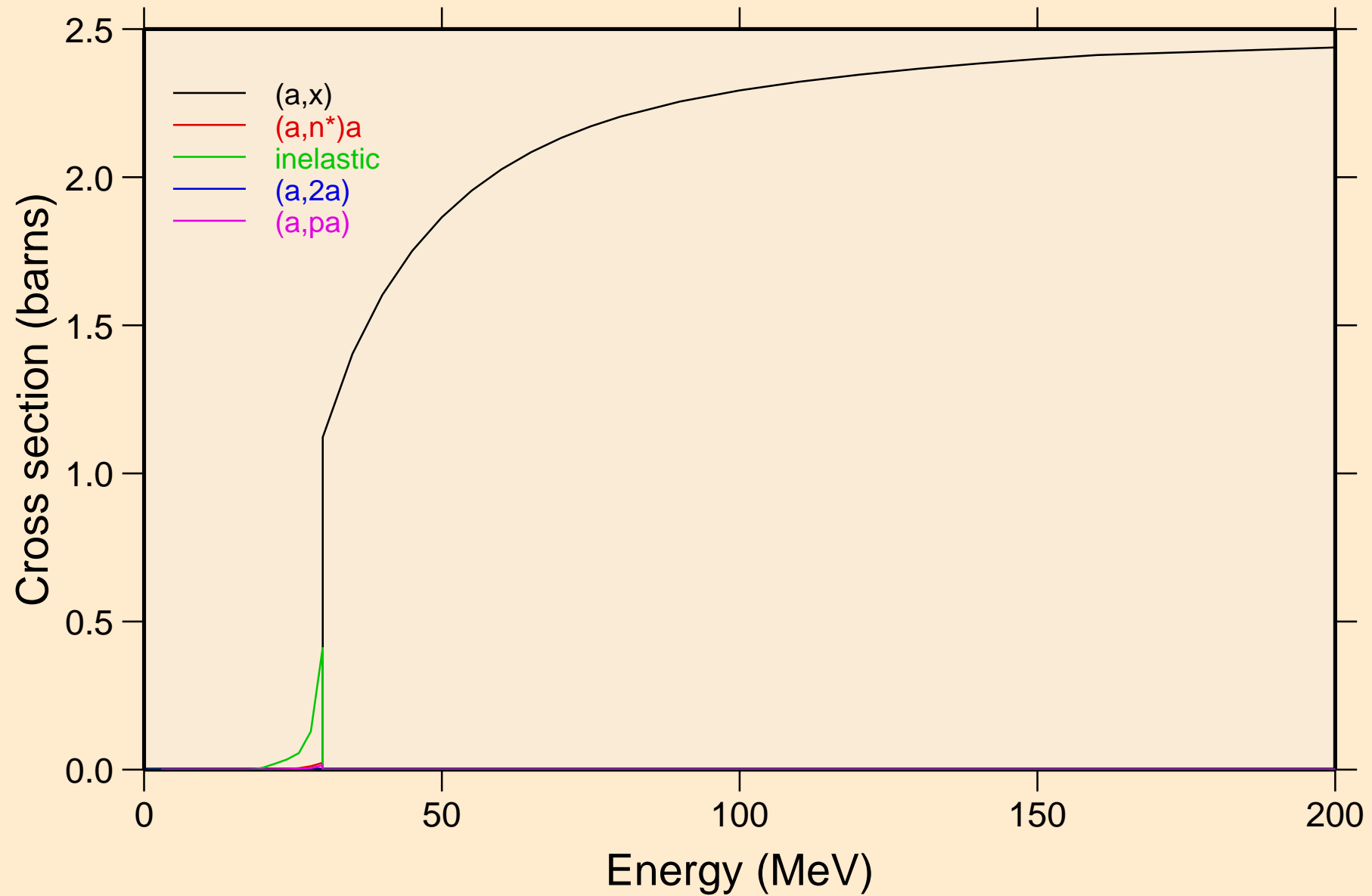

YB153 ALPHA ACER TENDL-2021 LIBRARY; T=0.K  
Threshold reactions

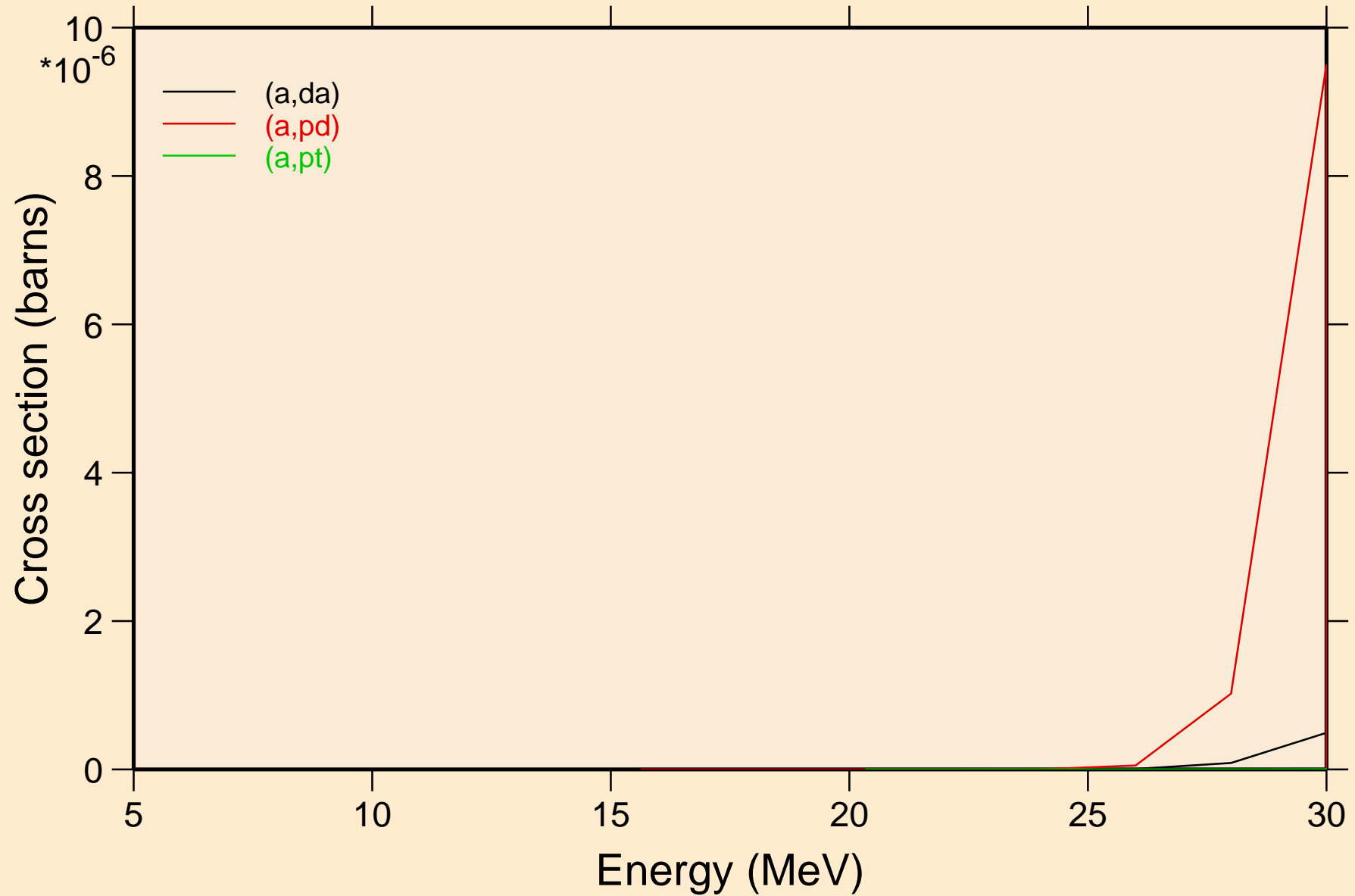

YB153 ALPHA ACER TENDL-2021 LIBRARY; T=0.K  
Threshold reactions

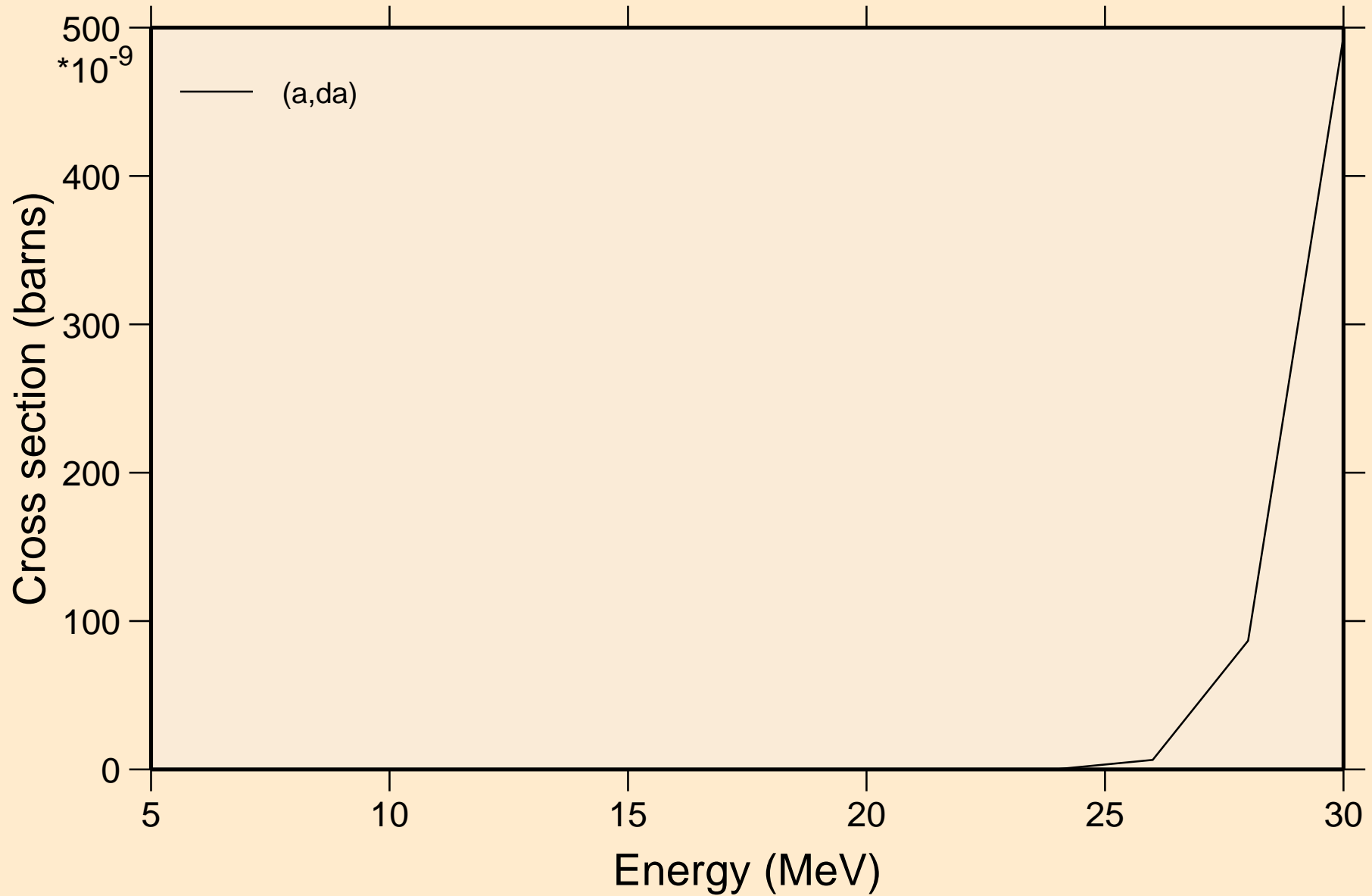

YB153 ALPHA ACER TENDL-2021 LIBRARY; T=0.K  
angular distribution for elastic

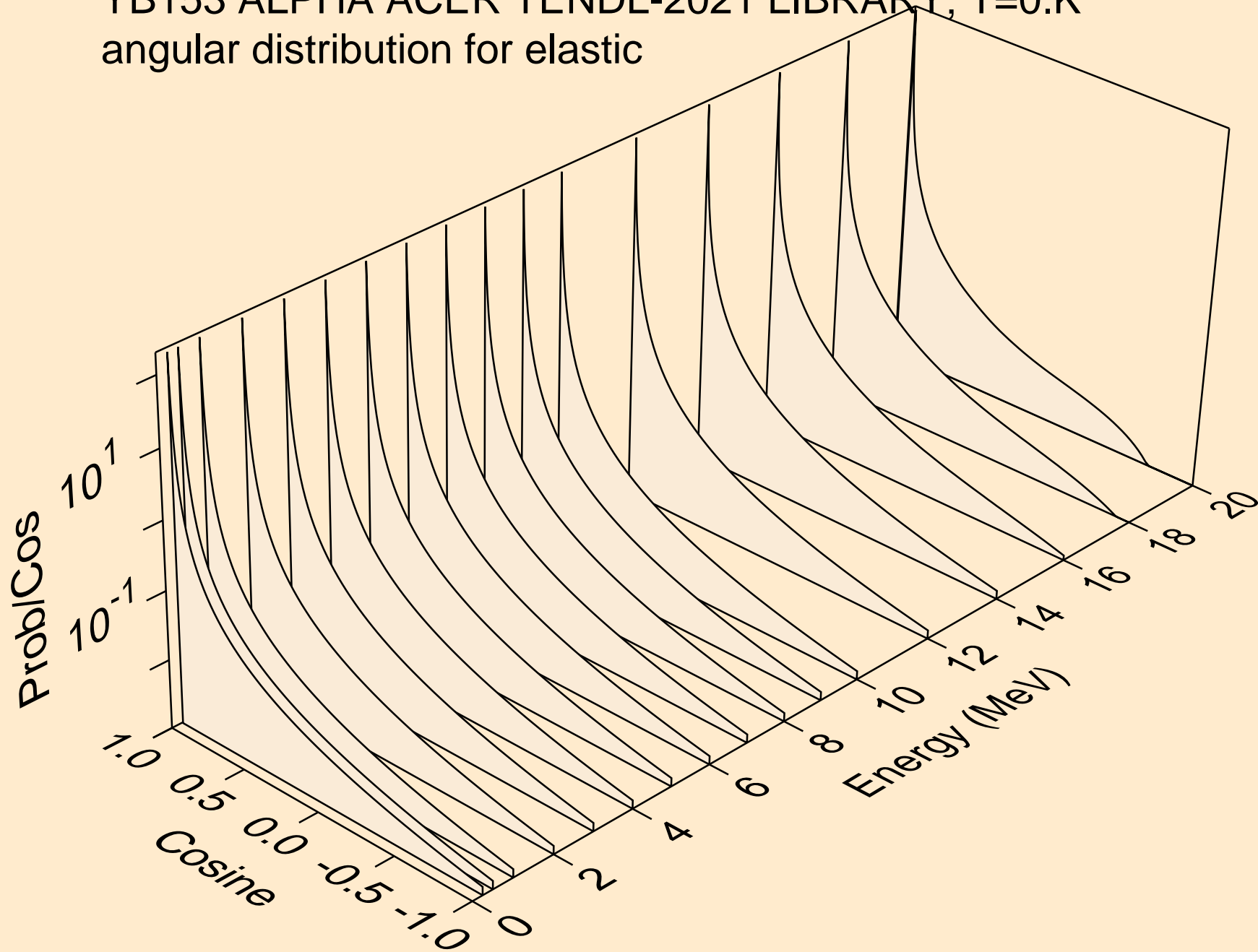

YB153 ALPHA ACER TENDL-2021 LIBRARY; T=0.K  
angular distribution for elastic

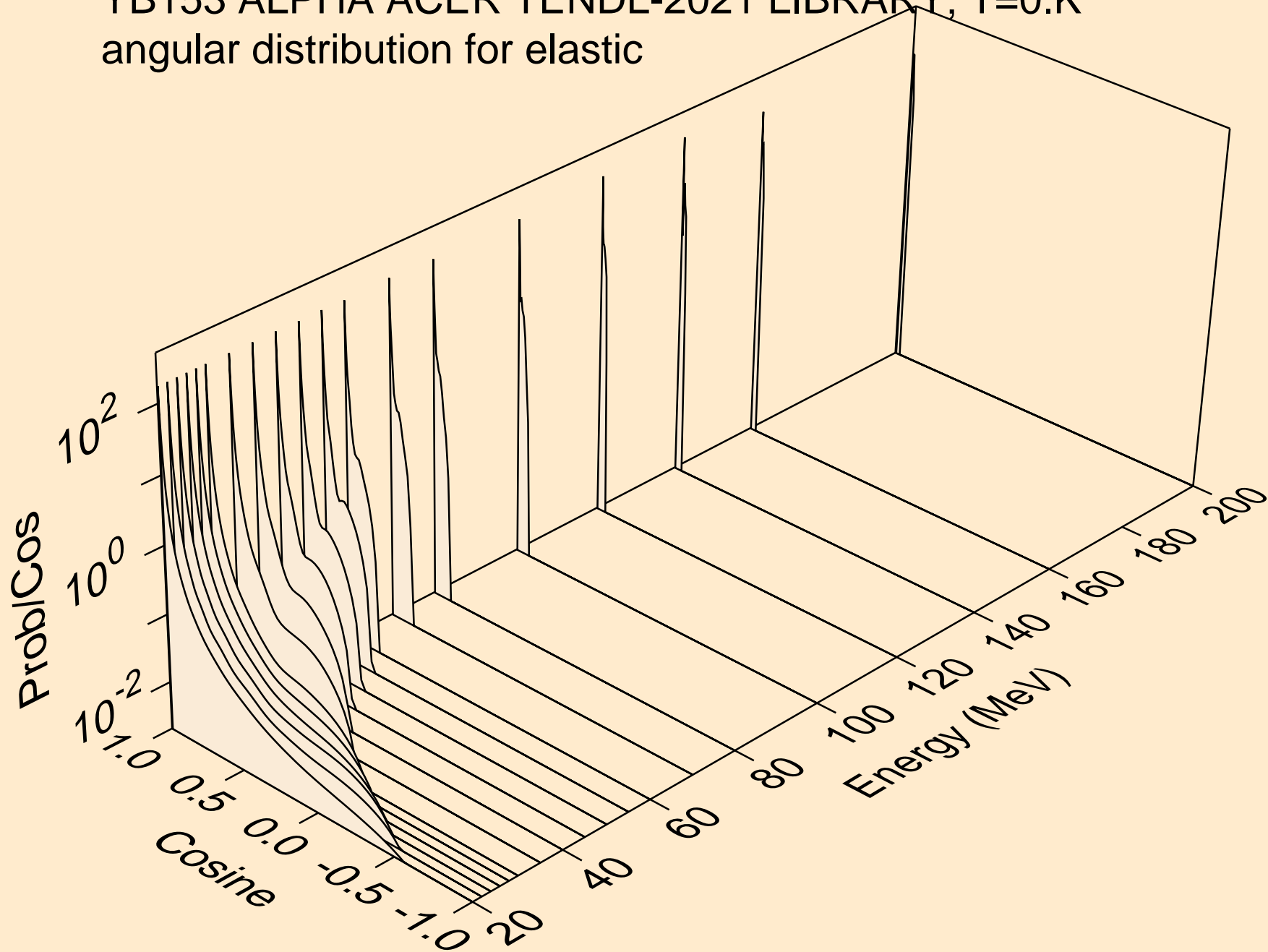

YB153 ALPHA ACER TENDL-2021 LIBRARY; T=0.K

Alpha emission for (a,x)

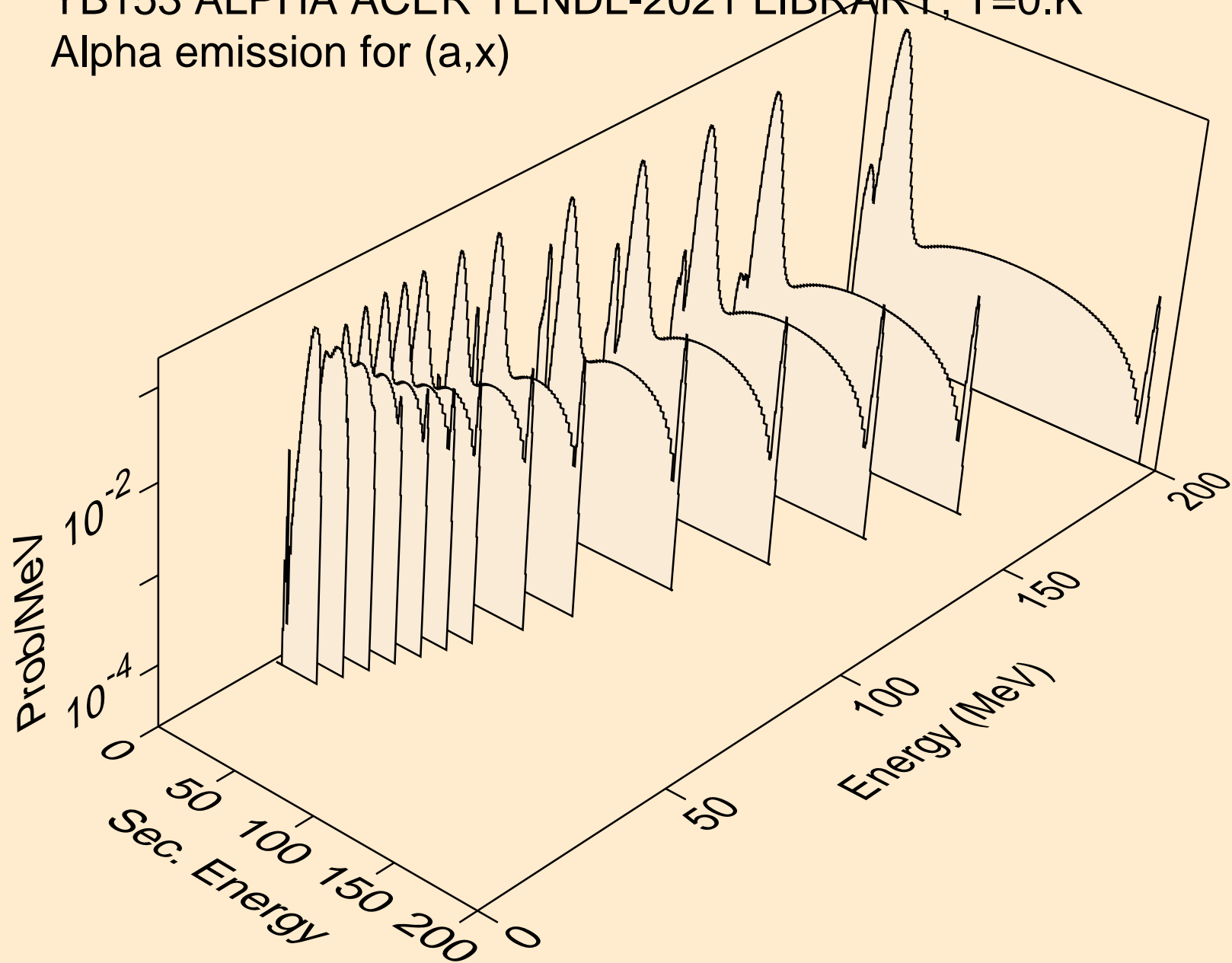

YB153 ALPHA ACER TENDL-2021 LIBRARY; T=0.K  
Alpha emission for (a,n\*)a

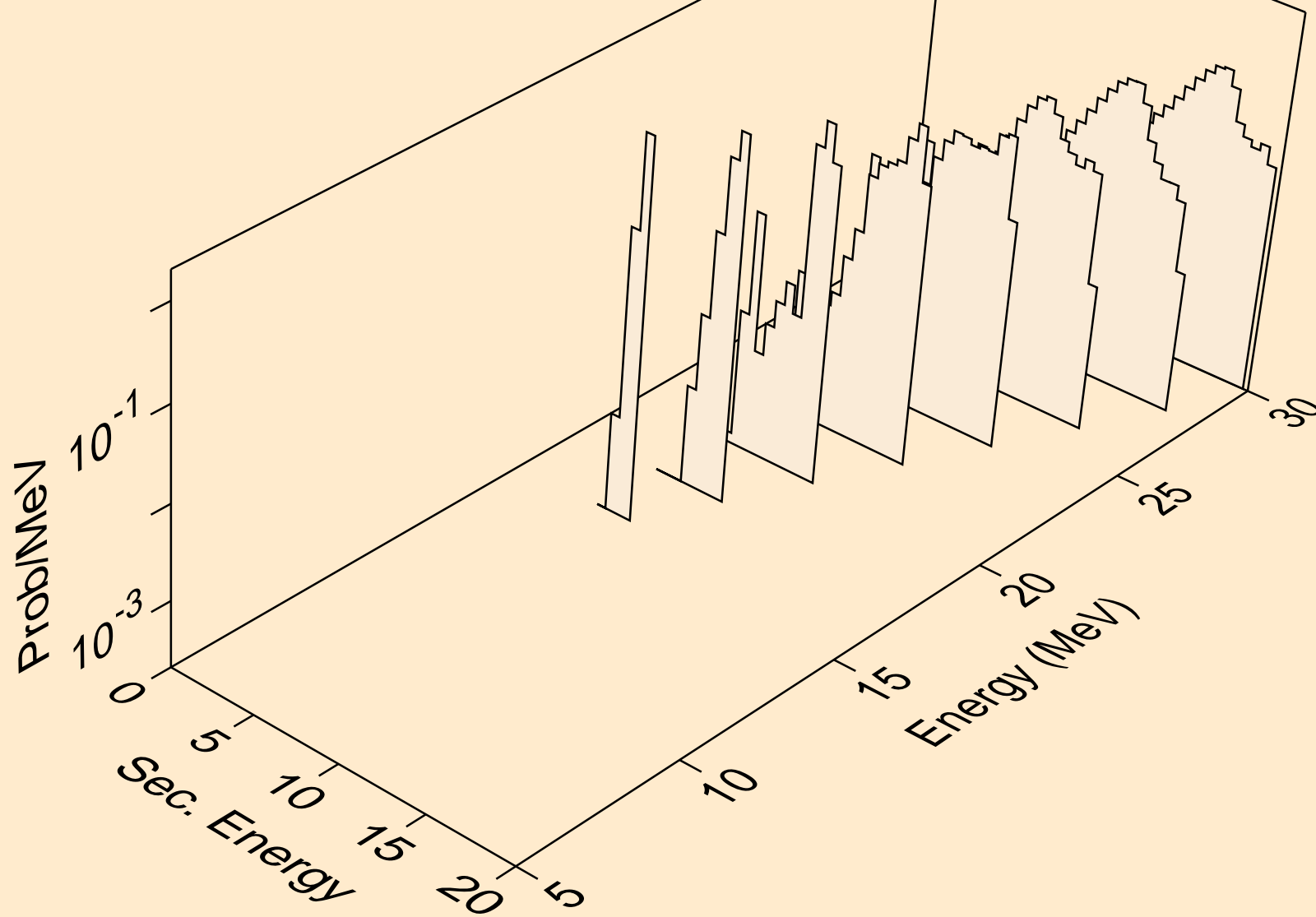

YB153 ALPHA ACER TENDL-2021 LIBRARY; T=0.K  
Alpha emission for inelastic

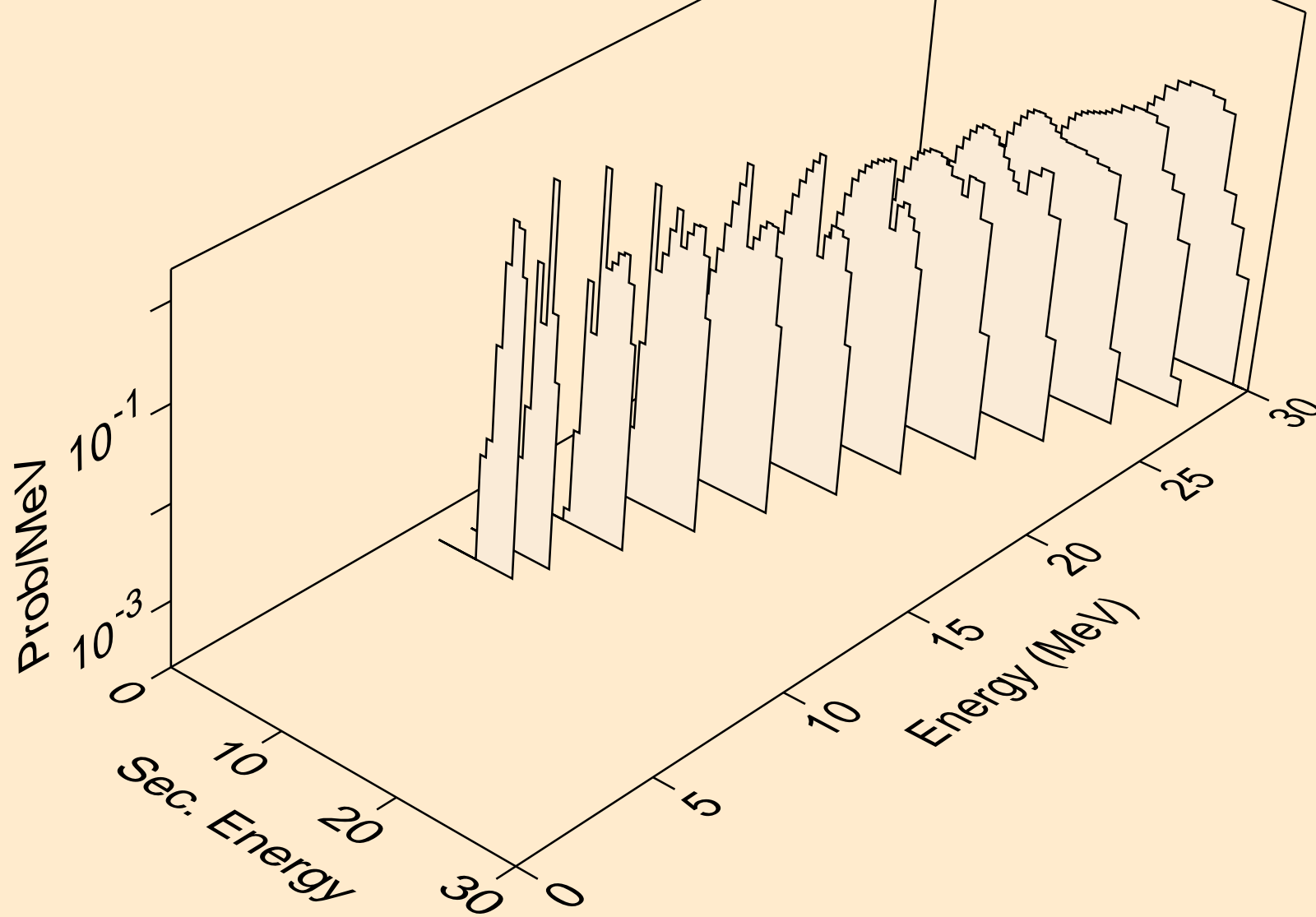

YB153 ALPHA ACER TENDL-2021 LIBRARY; T=0.K  
Alpha emission for (a,2a)

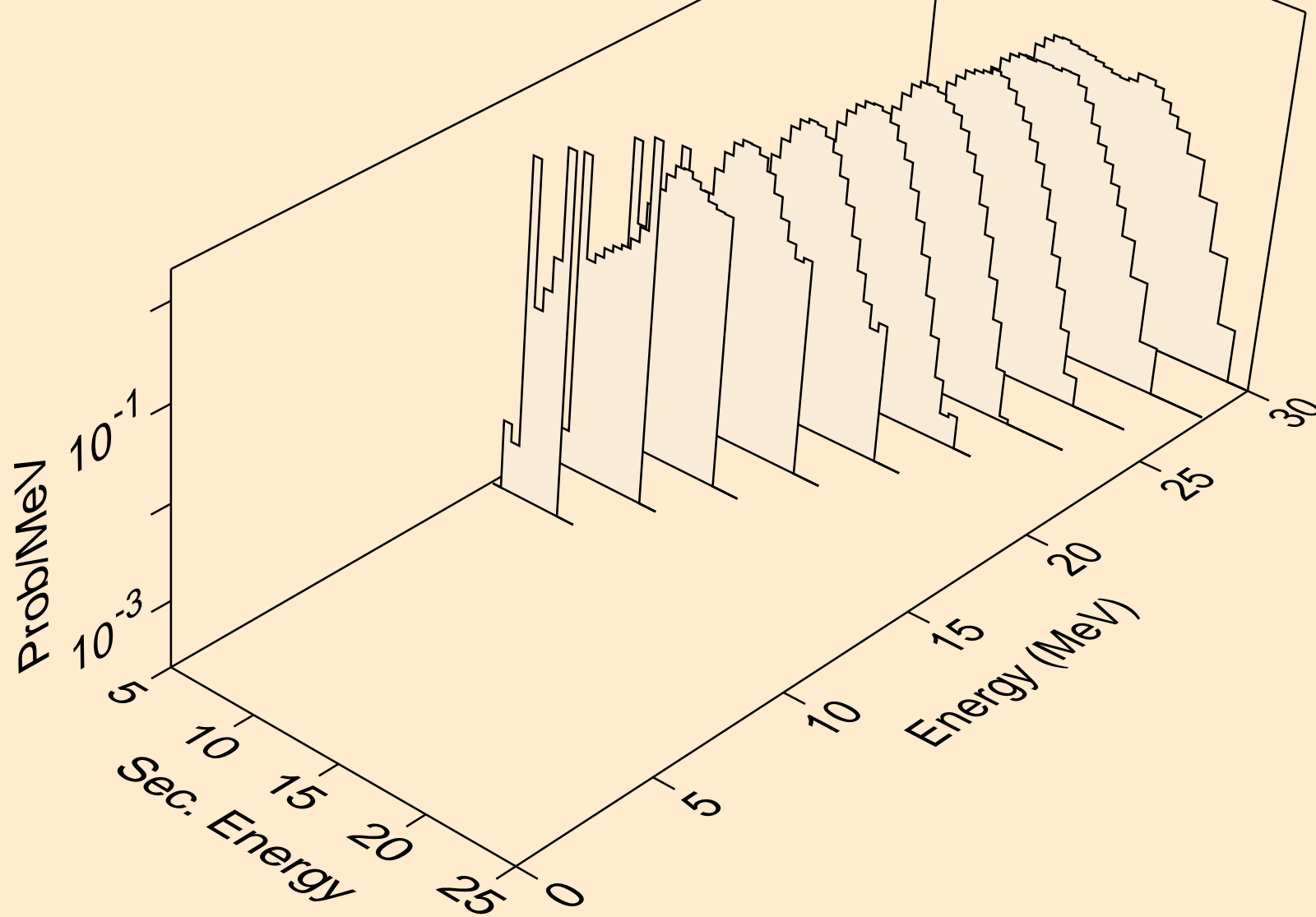

YB153 ALPHA ACER TENDL-2021 LIBRARY; T=0.K  
Alpha emission for (a,pa)

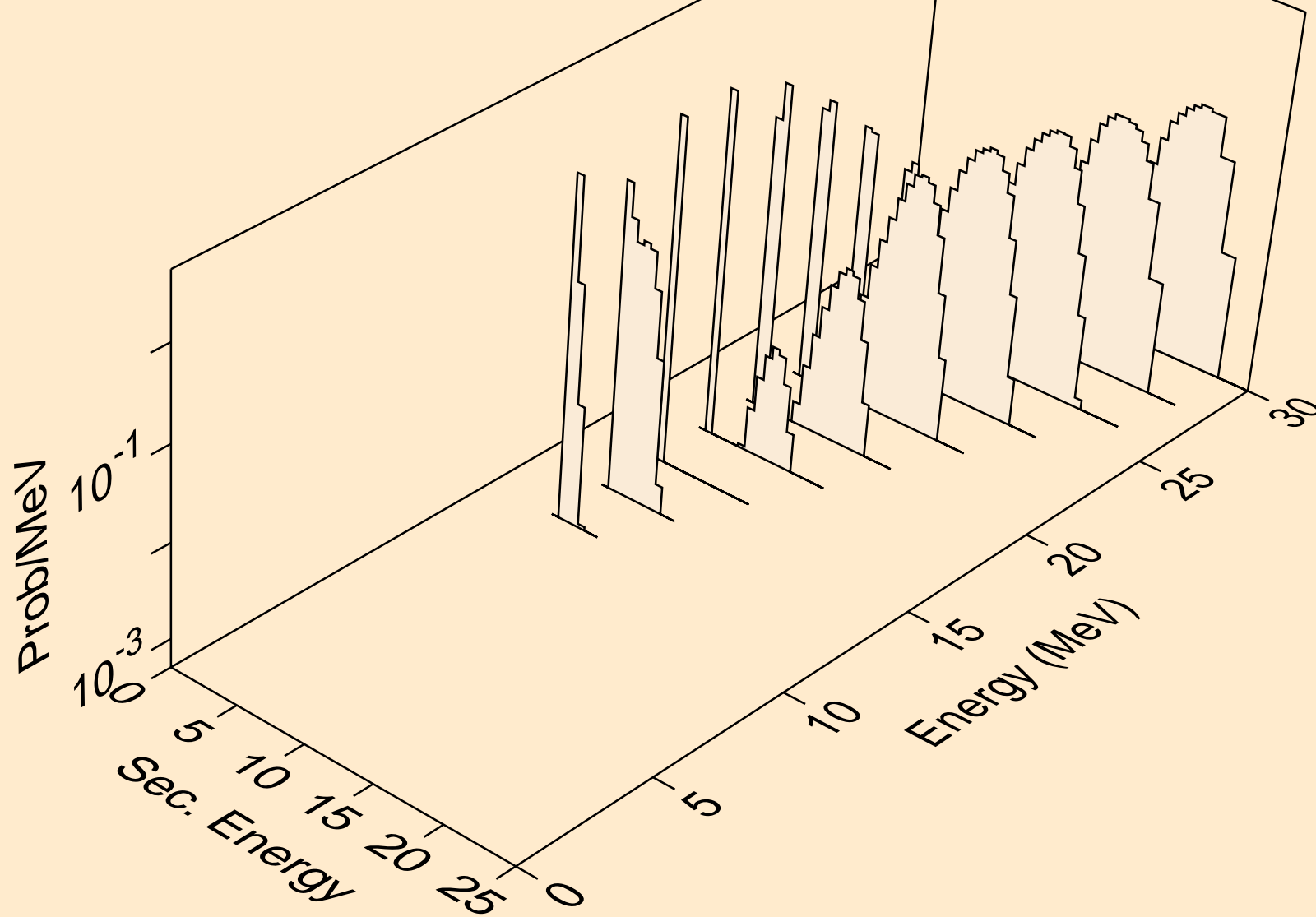

YB153 ALPHA ACER TENDL-2021 LIBRARY; T=0.K  
Alpha emission for (a,da)

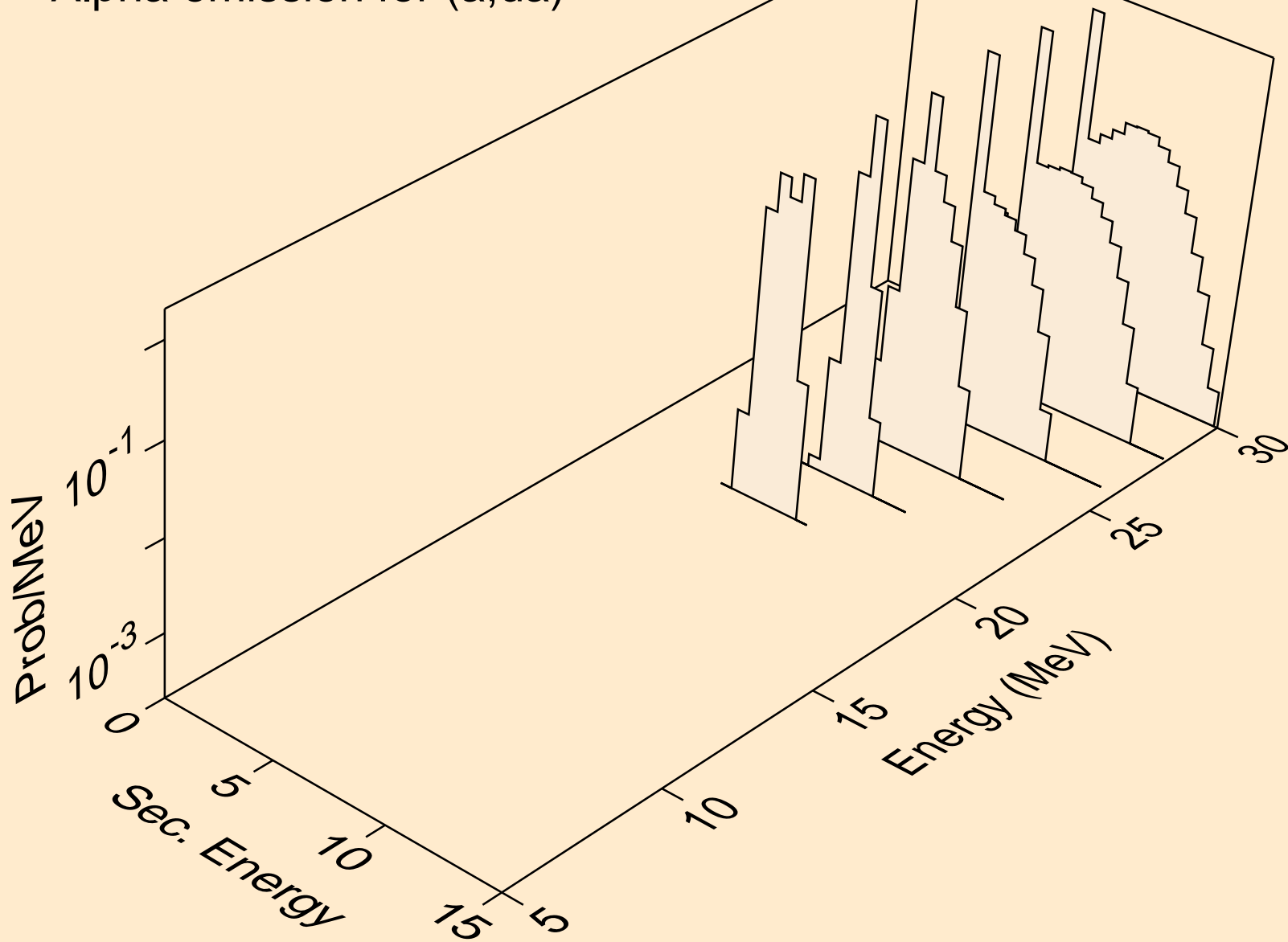

YB153 ALPHA ACER TENDL-2021 LIBRARY; T=0.K  
Photon emission for (z,n)

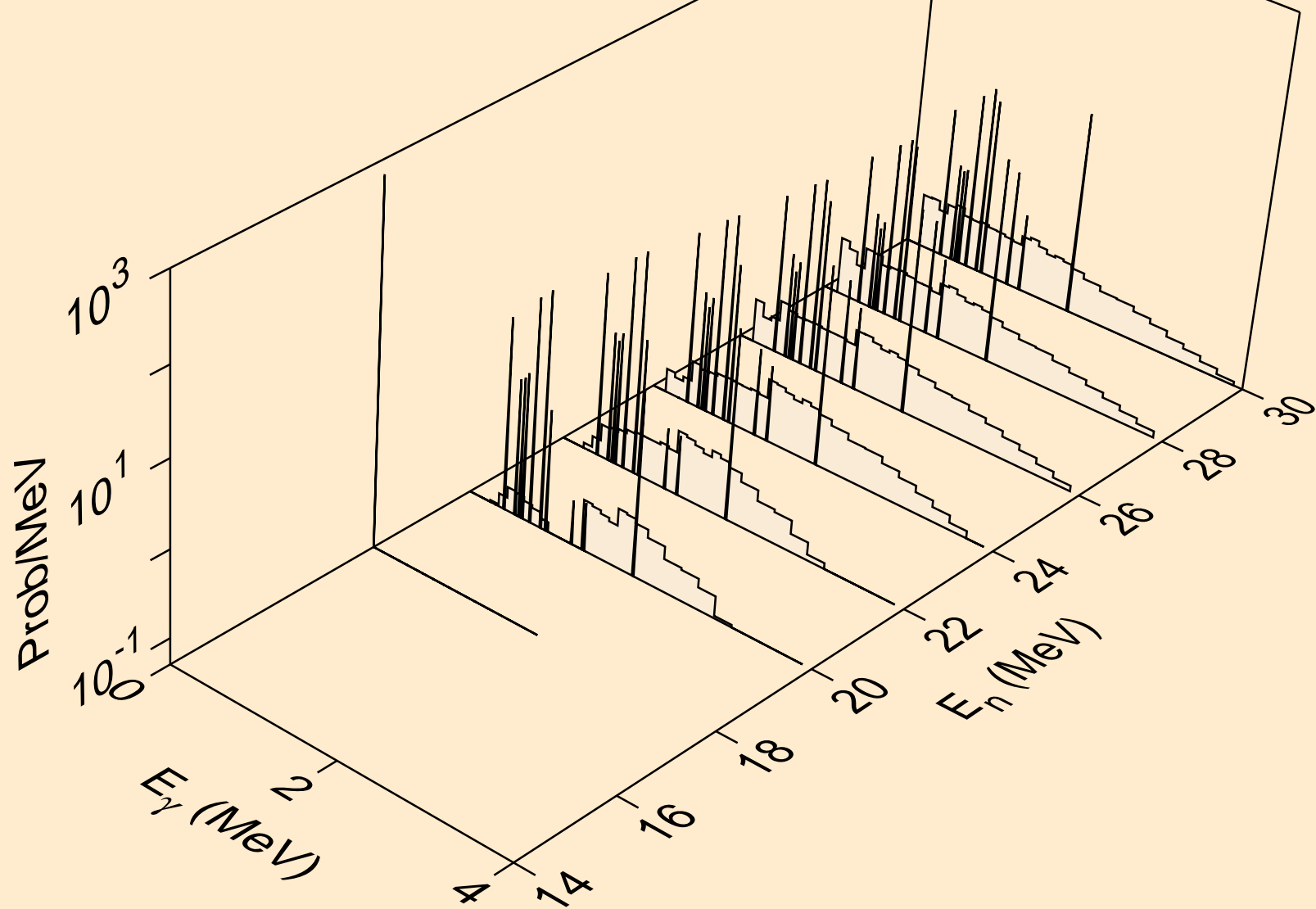

YB153 ALPHA ACER TENDL-2021 LIBRARY; T=0.K  
Photon emission for (n,x)

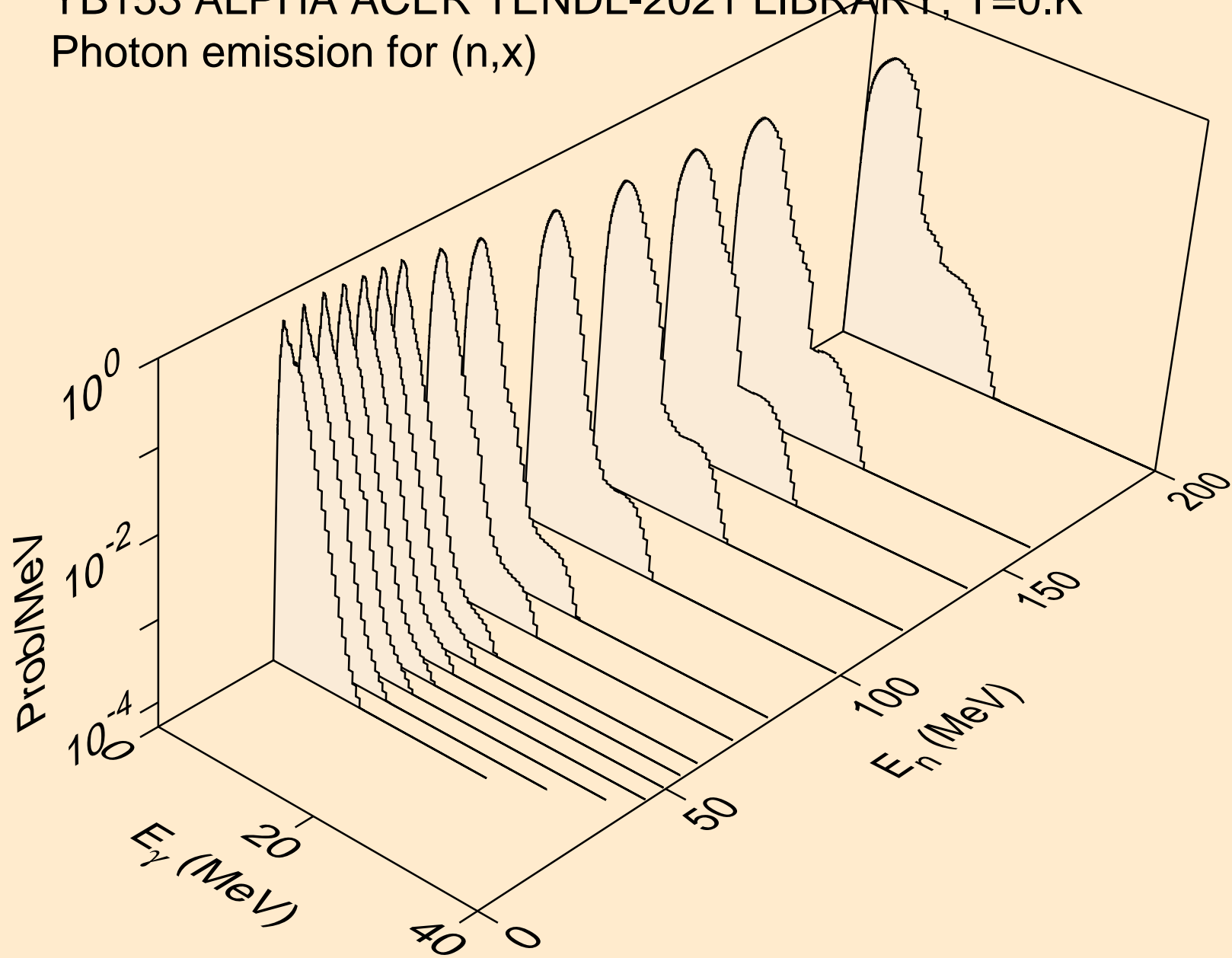

YB153 ALPHA ACER TENDL-2021 LIBRARY; T=0.K  
Photon emission for (n,2n)

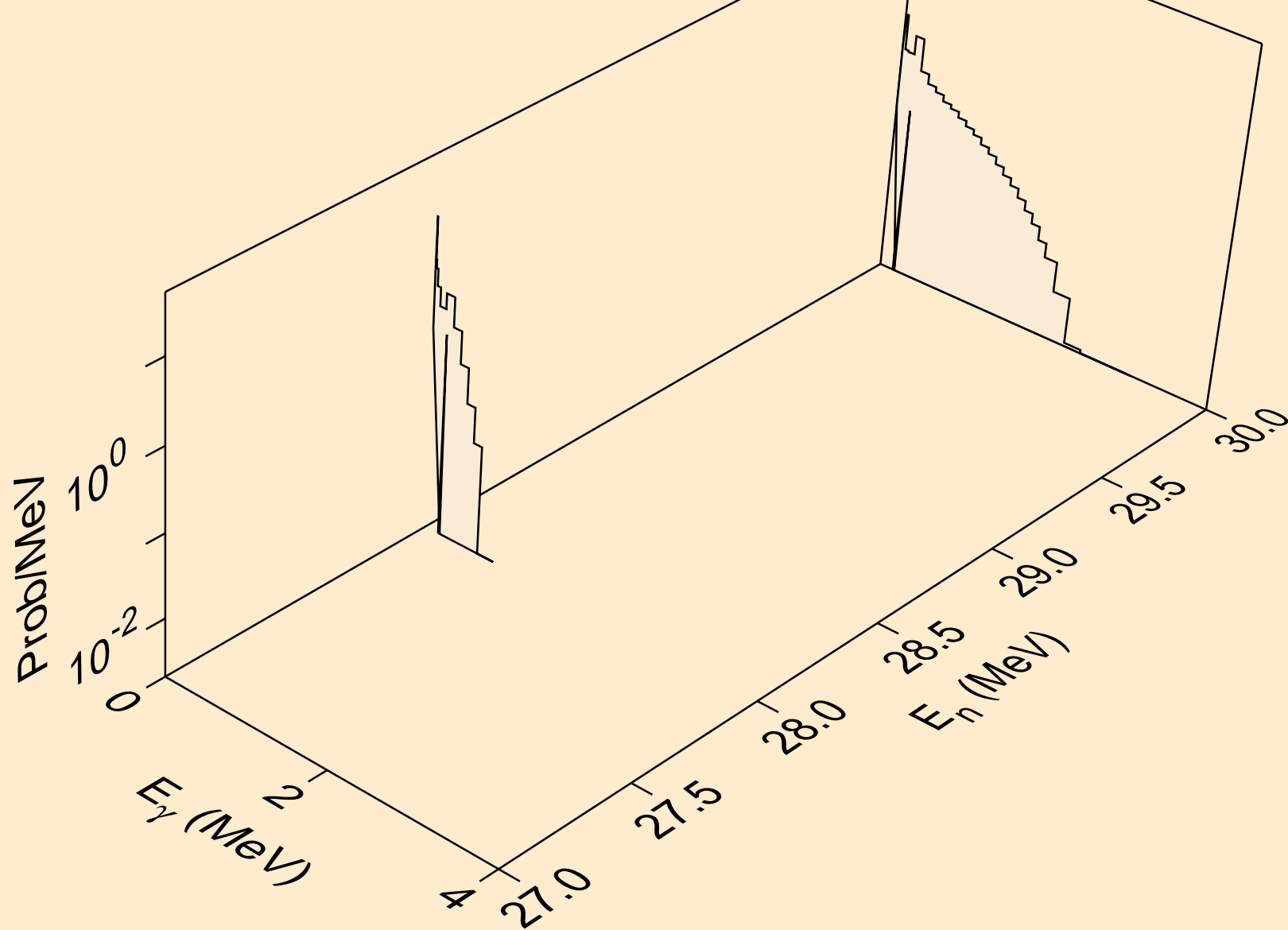

YB153 ALPHA ACER TENDL-2021 LIBRARY; T=0.K

Photon emission for (n,n\*)a

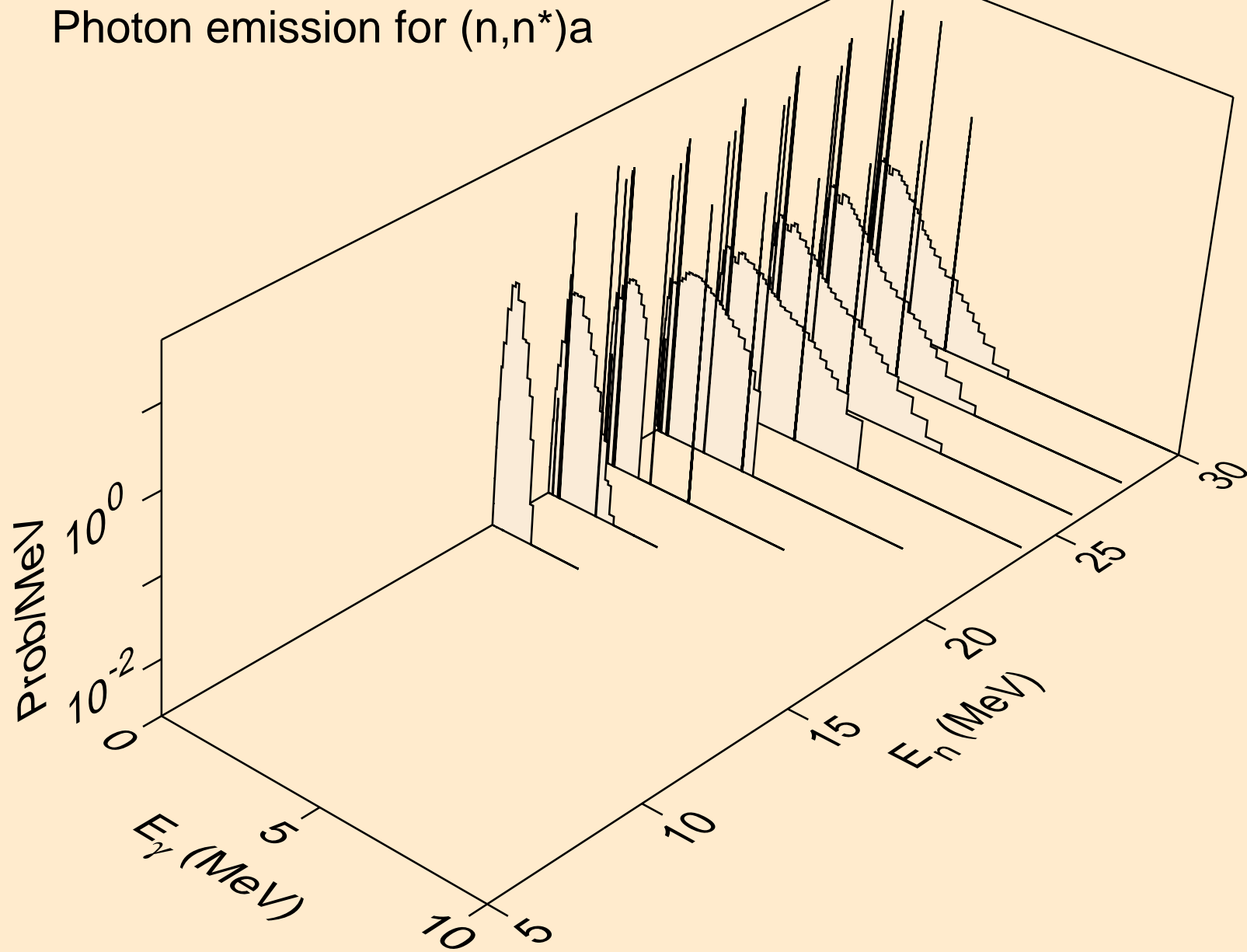

YB153 ALPHA ACER TENDL-2021 LIBRARY; T=0.K

Photon emission for (n,n\*)p

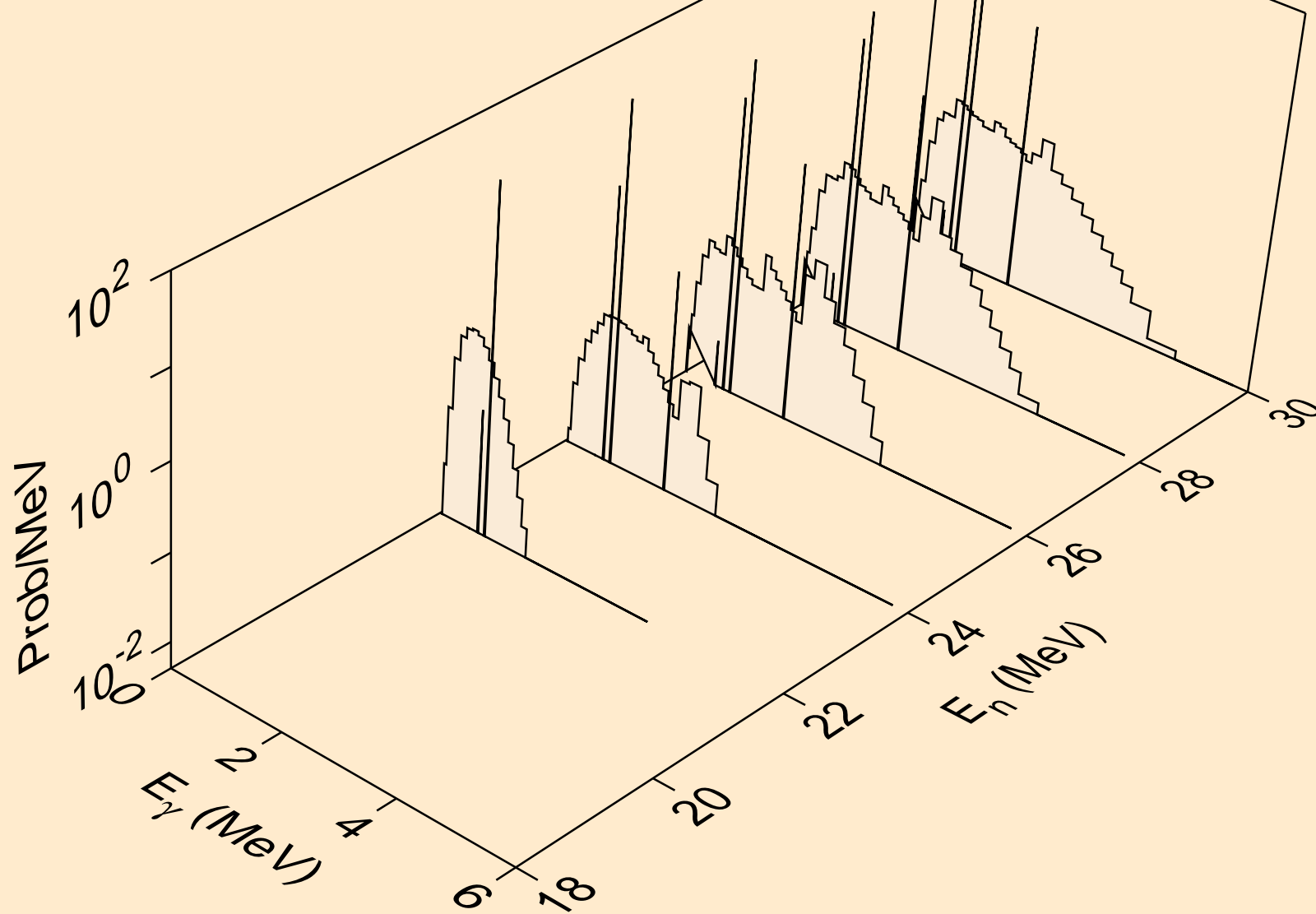

YB153 ALPHA ACER TENDL-2021 LIBRARY; T=0.K  
Photon emission for (n,2np)

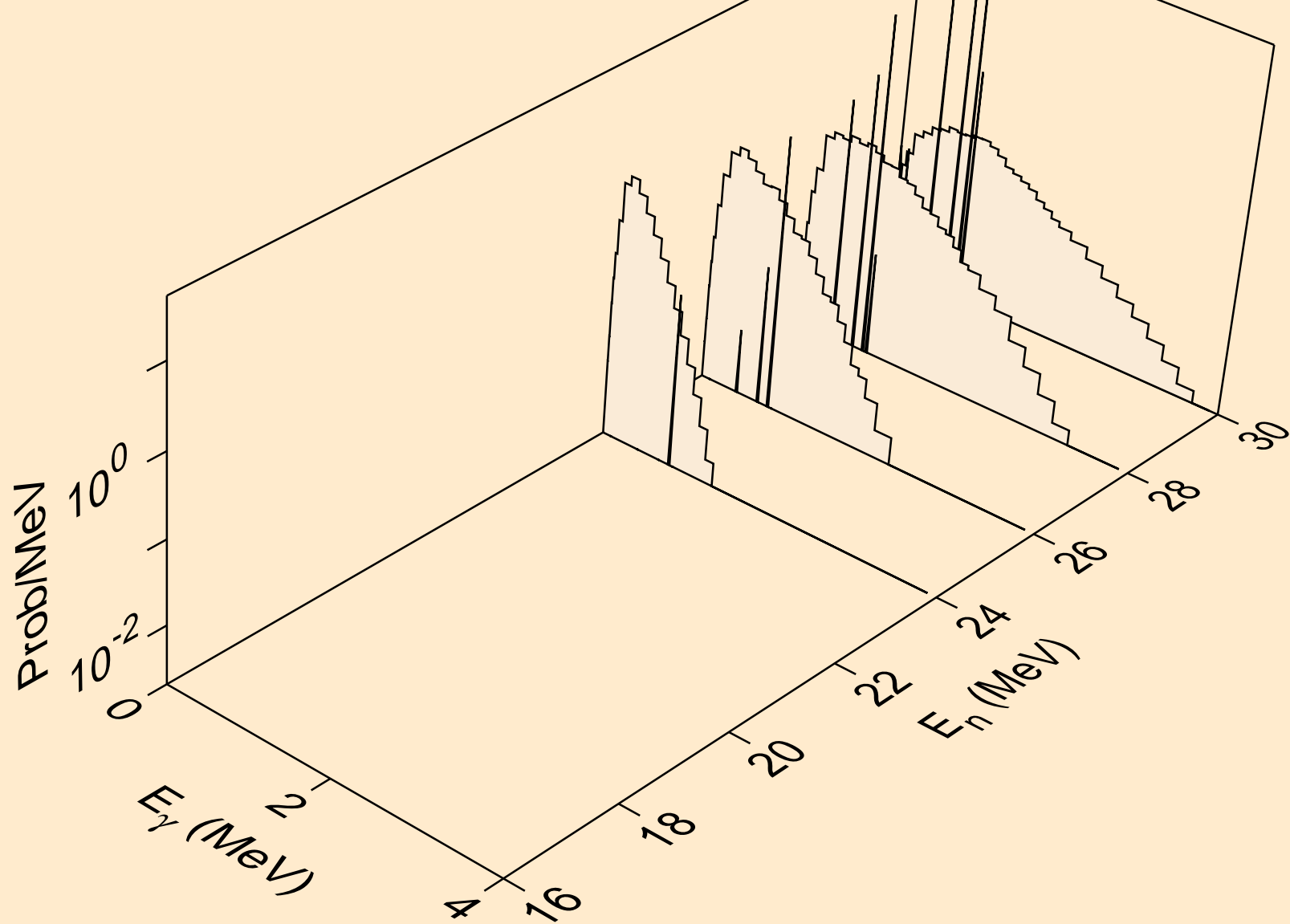

YB153 ALPHA ACER TENDL-2021 LIBRARY; T=0.K  
Photon emission for (n,npa)

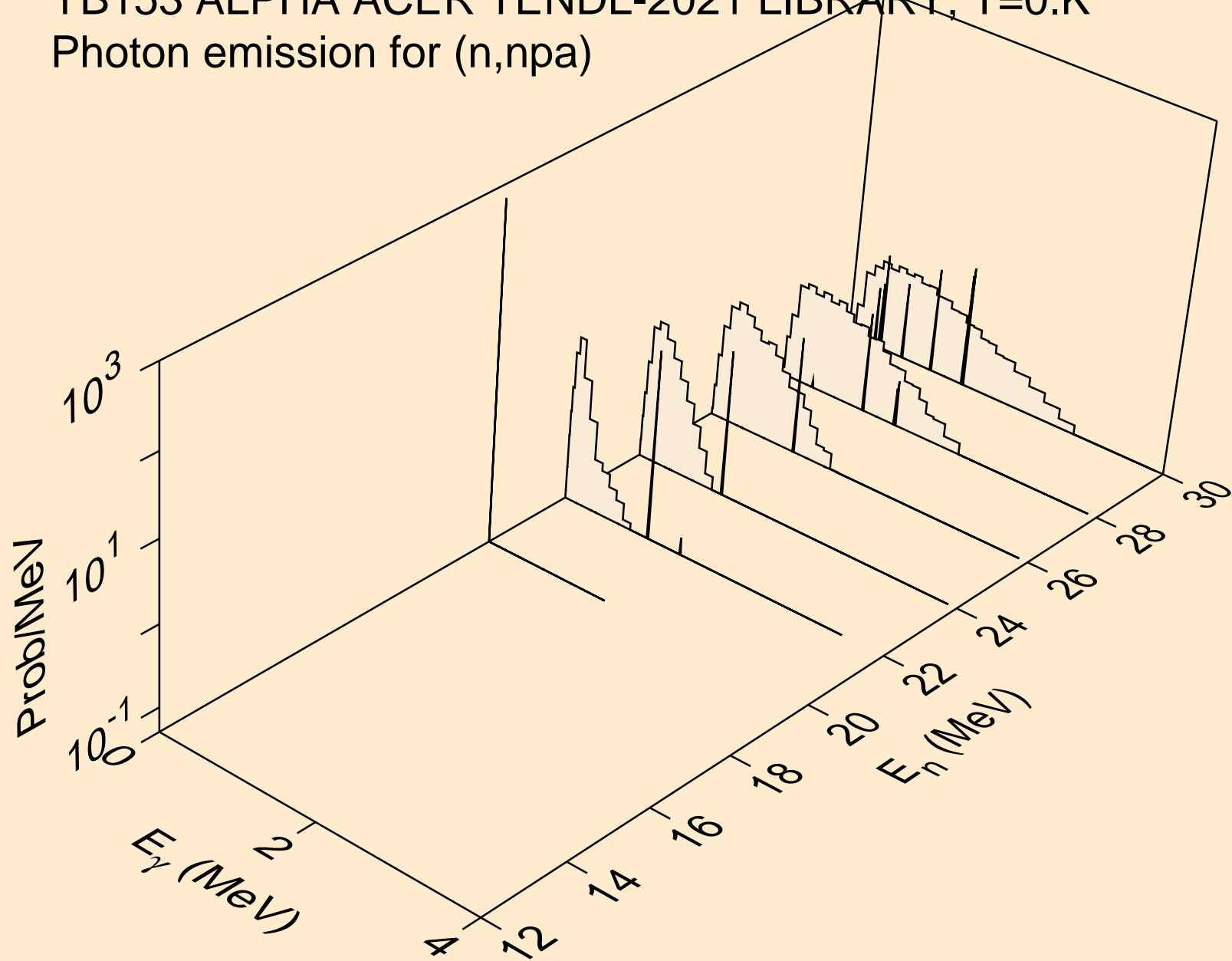

YB153 ALPHA ACER TENDL-2021 LIBRARY; T=0.K  
Photon emission for (n,gma)

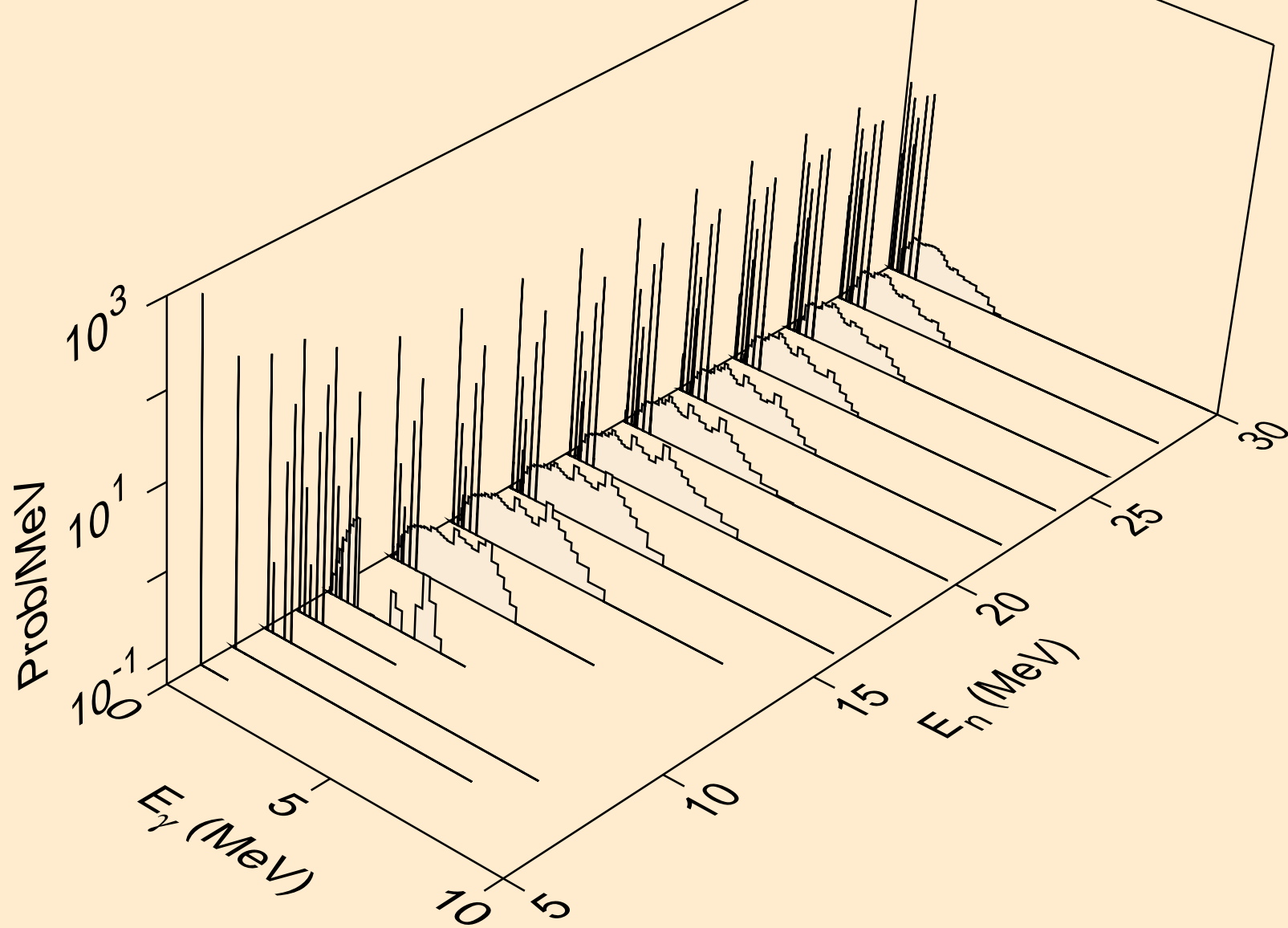

YB153 ALPHA ACER TENDL-2021 LIBRARY; T=0.K  
Photon emission for (n,p)

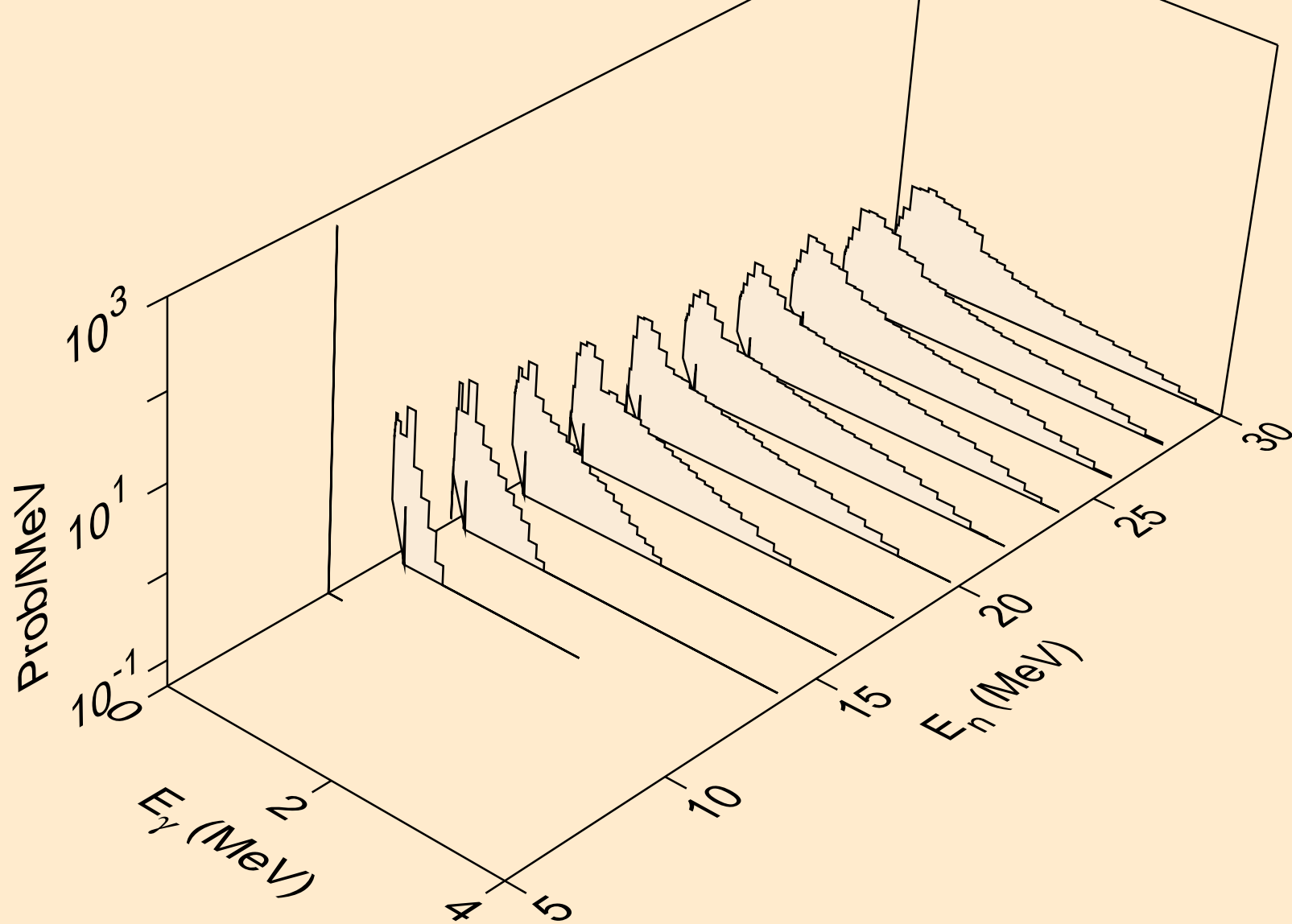

YB153 ALPHA ACER TENDL-2021 LIBRARY; T=0.K  
Photon emission for (n,d)

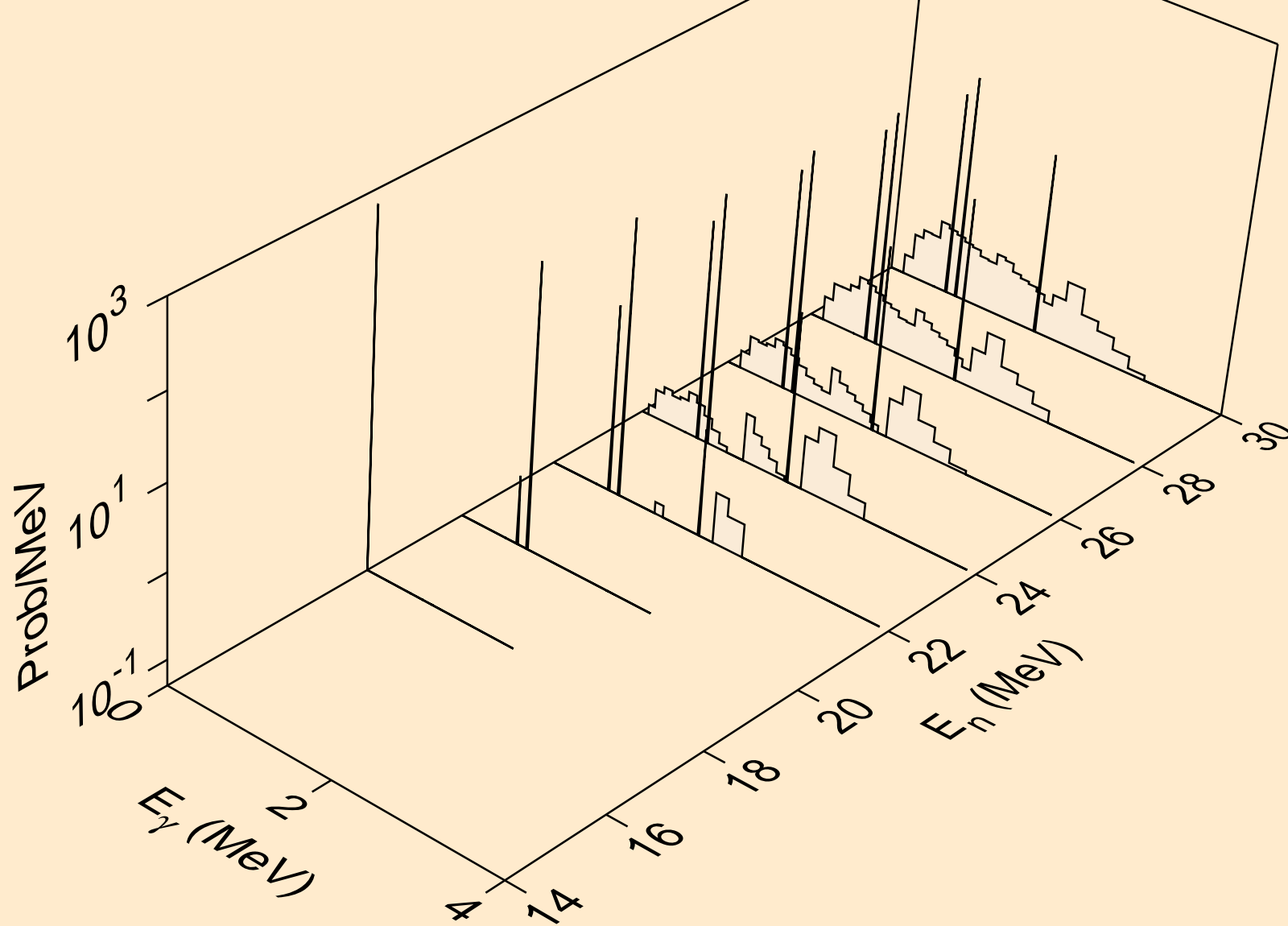

# YB153 ALPHA ACER TENDL-2021 LIBRARY; T=0.K

Photon emission for (n,t)

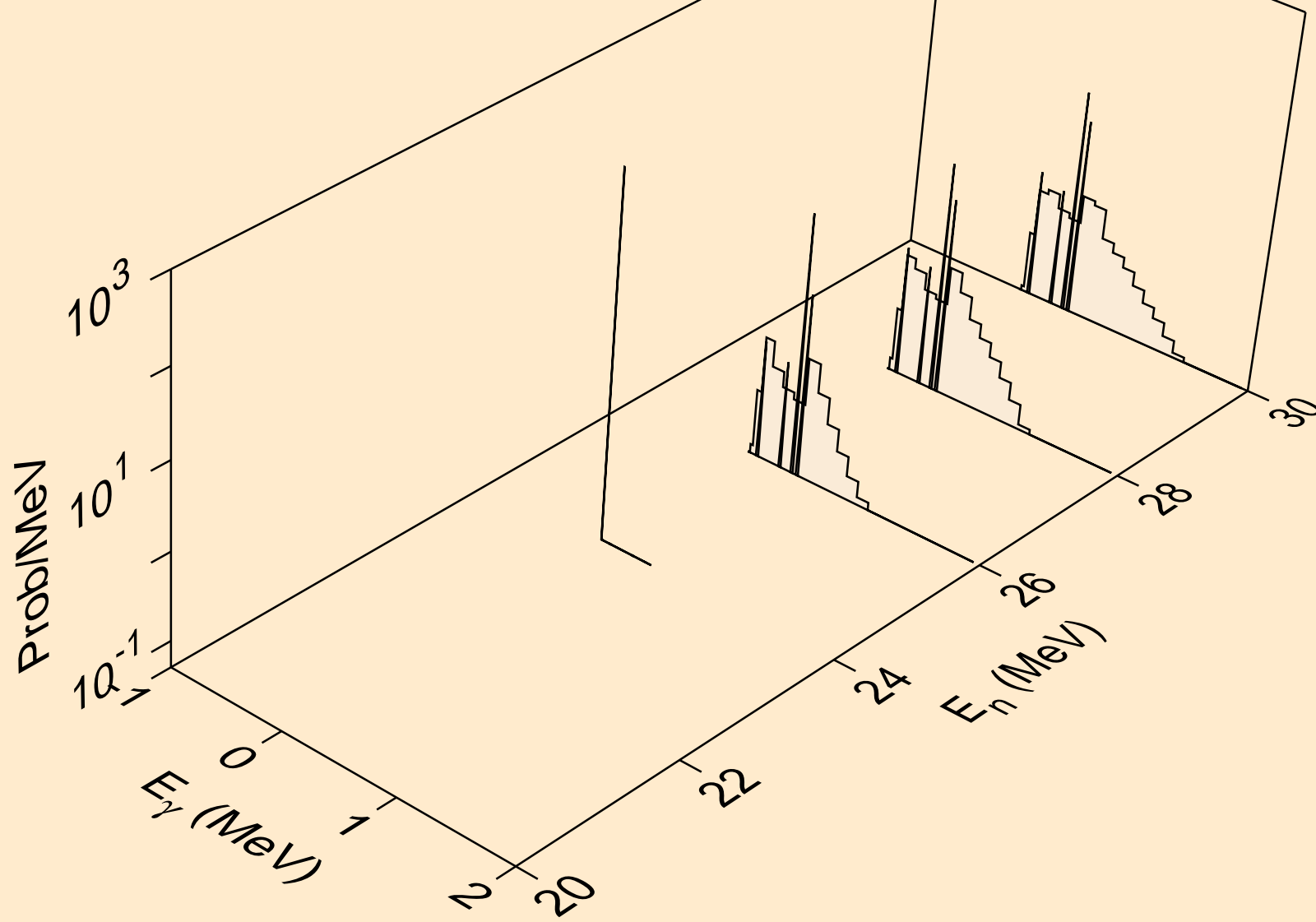

YB153 ALPHA ACER TENDL-2021 LIBRARY; T=0.K  
Photon emission for (n,he3)

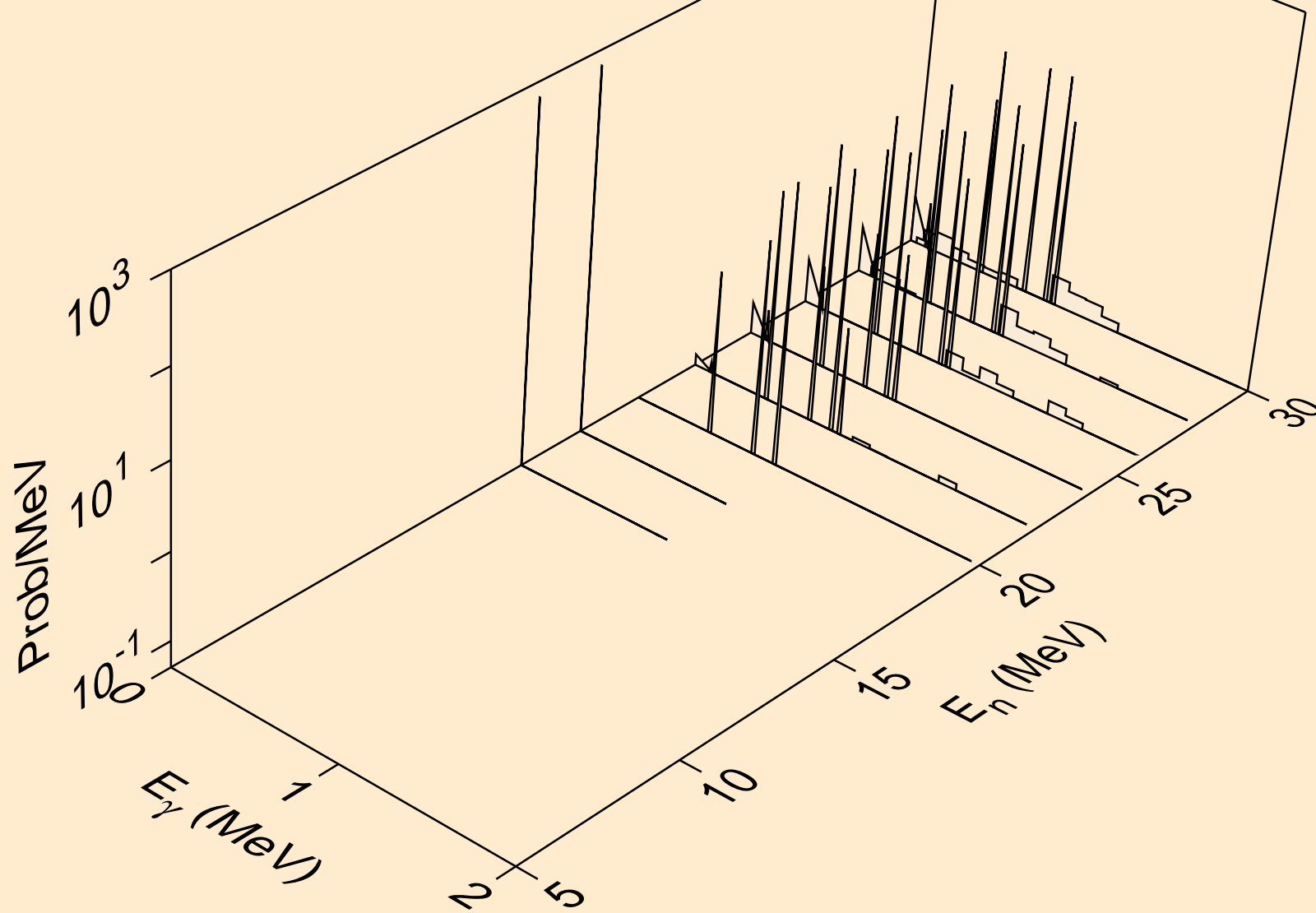

YB153 ALPHA ACER TENDL-2021 LIBRARY; T=0.K  
Photon emission for inelastic

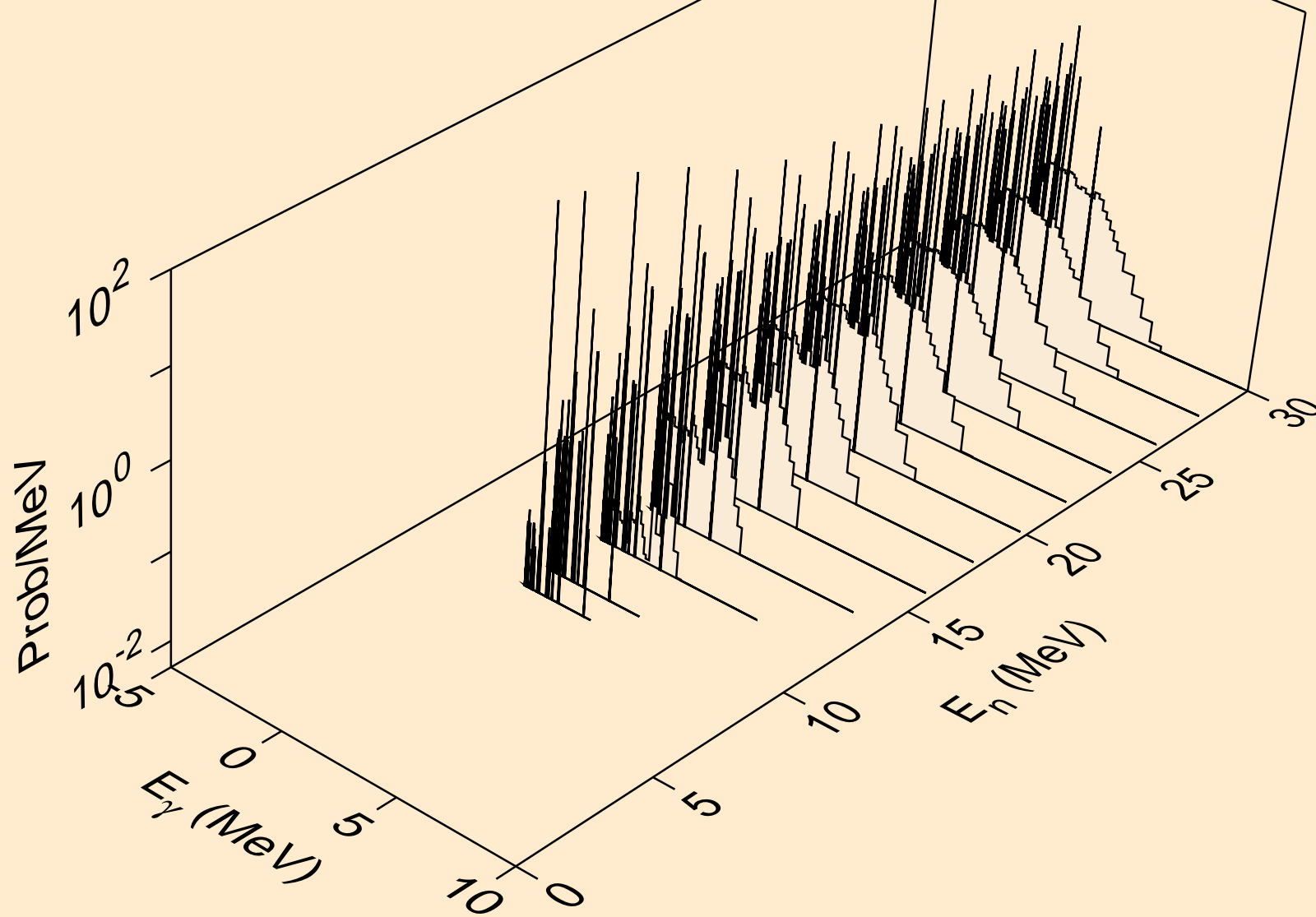

YB153 ALPHA ACER TENDL-2021 LIBRARY; T=0.K  
Photon emission for (n,2a)

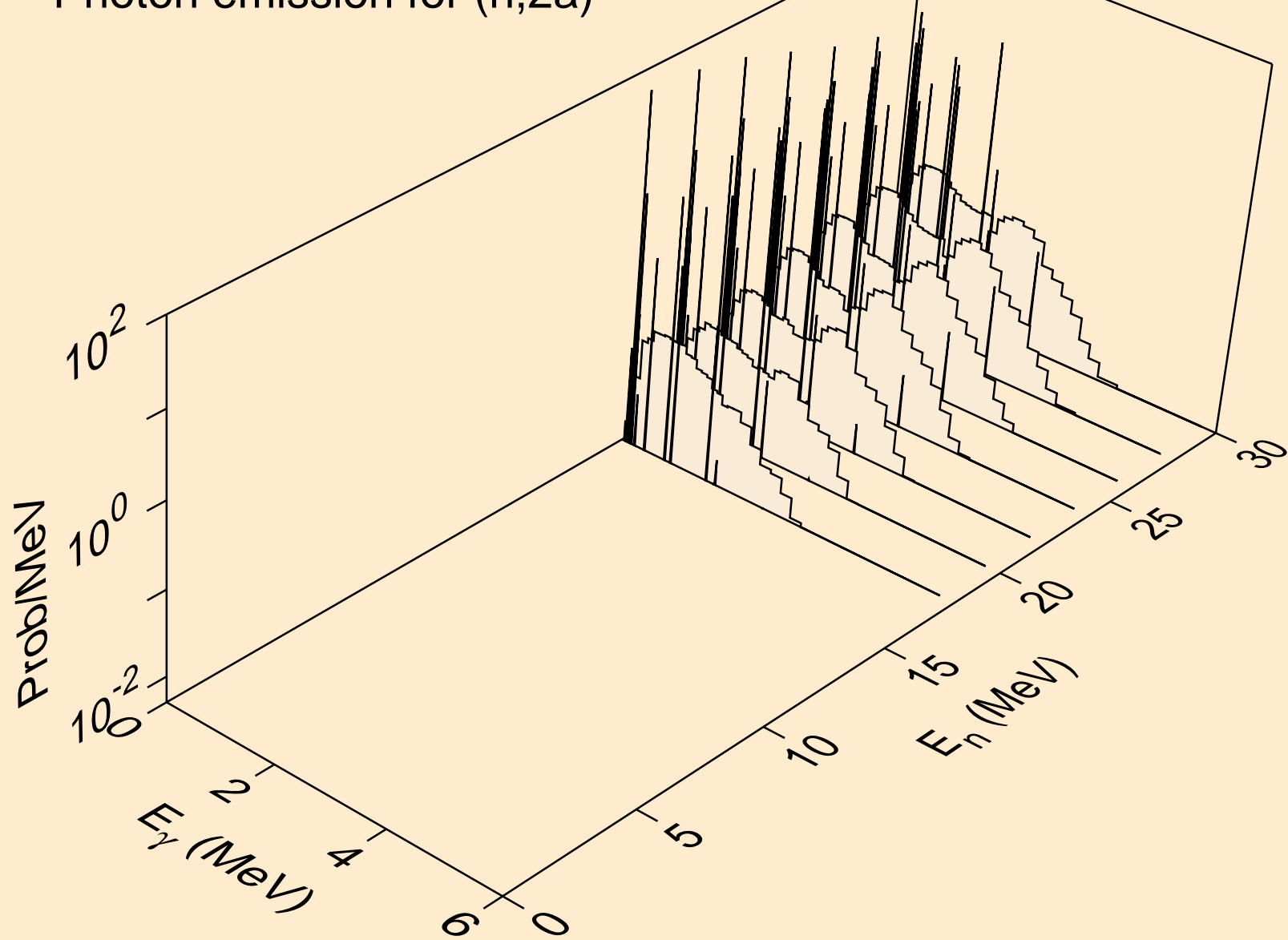

YB153 ALPHA ACER TENDL-2021 LIBRARY; T=0.K  
Photon emission for (n,2p)

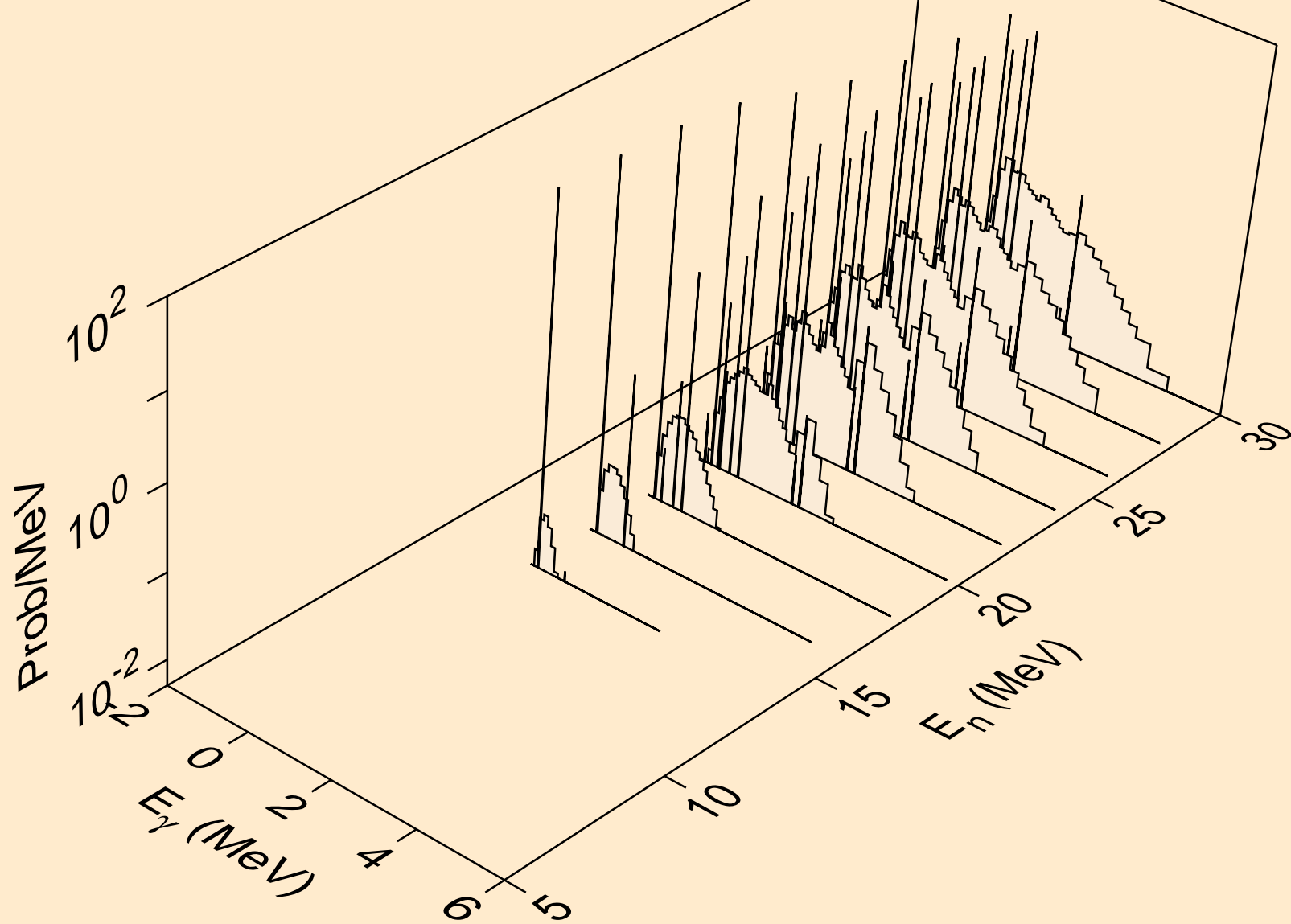

YB153 ALPHA ACER TENDL-2021 LIBRARY; T=0.K  
Photon emission for (n,pa)

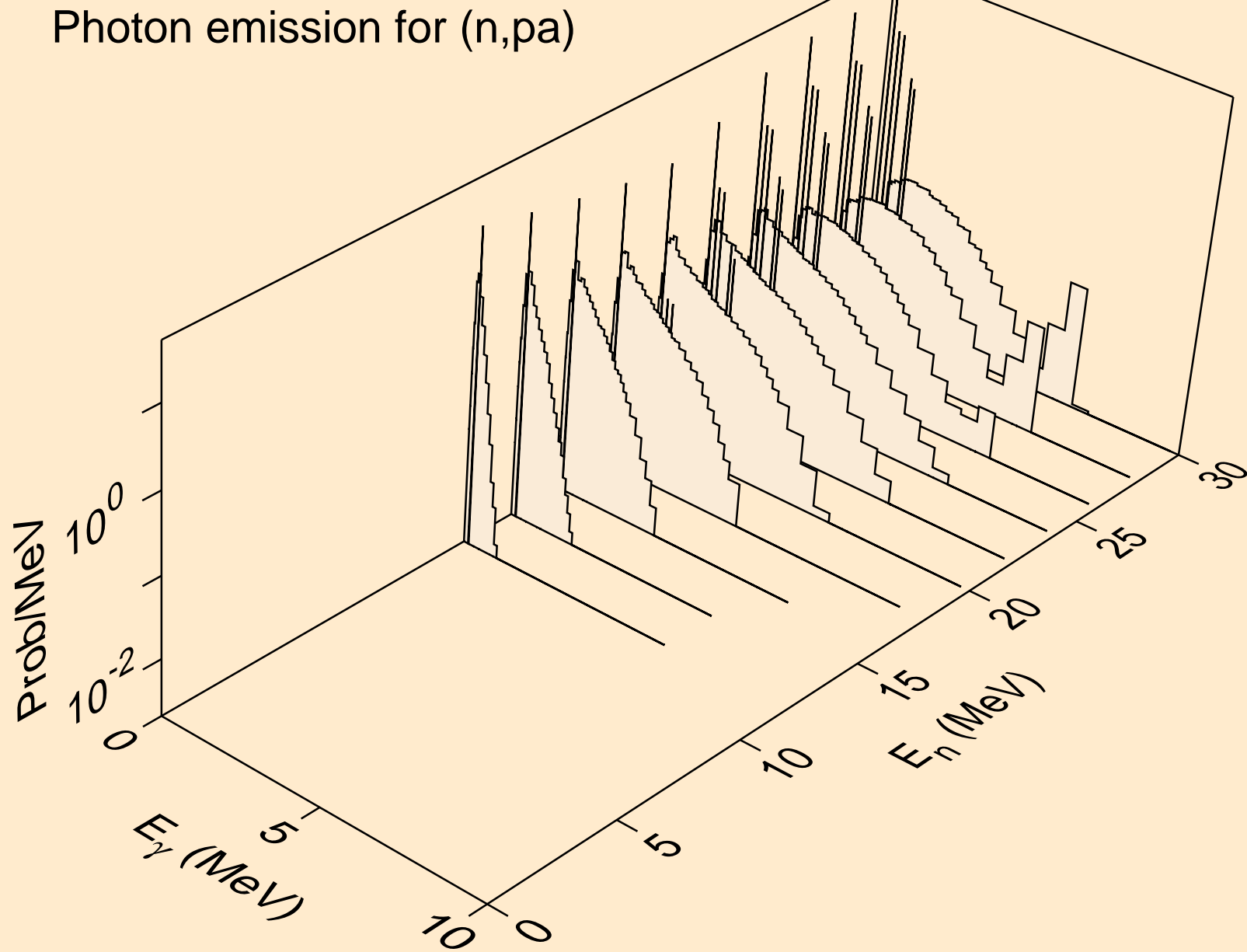

YB153 ALPHA ACER TENDL-2021 LIBRARY; T=0.K  
Photon emission for (n,pd)

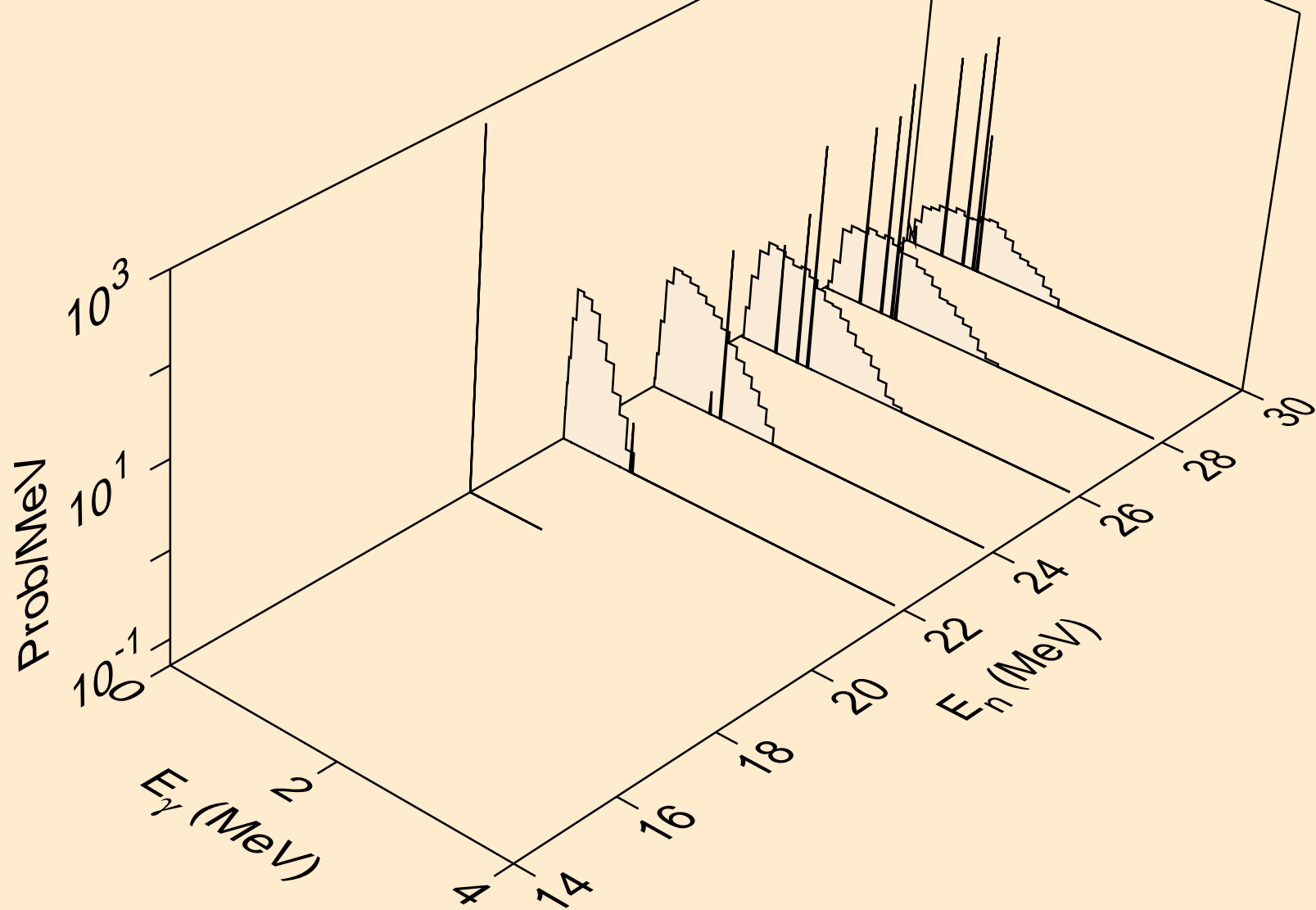

YB153 ALPHA ACER TENDL-2021 LIBRARY; T=0.K  
Photon emission for (n,pt)

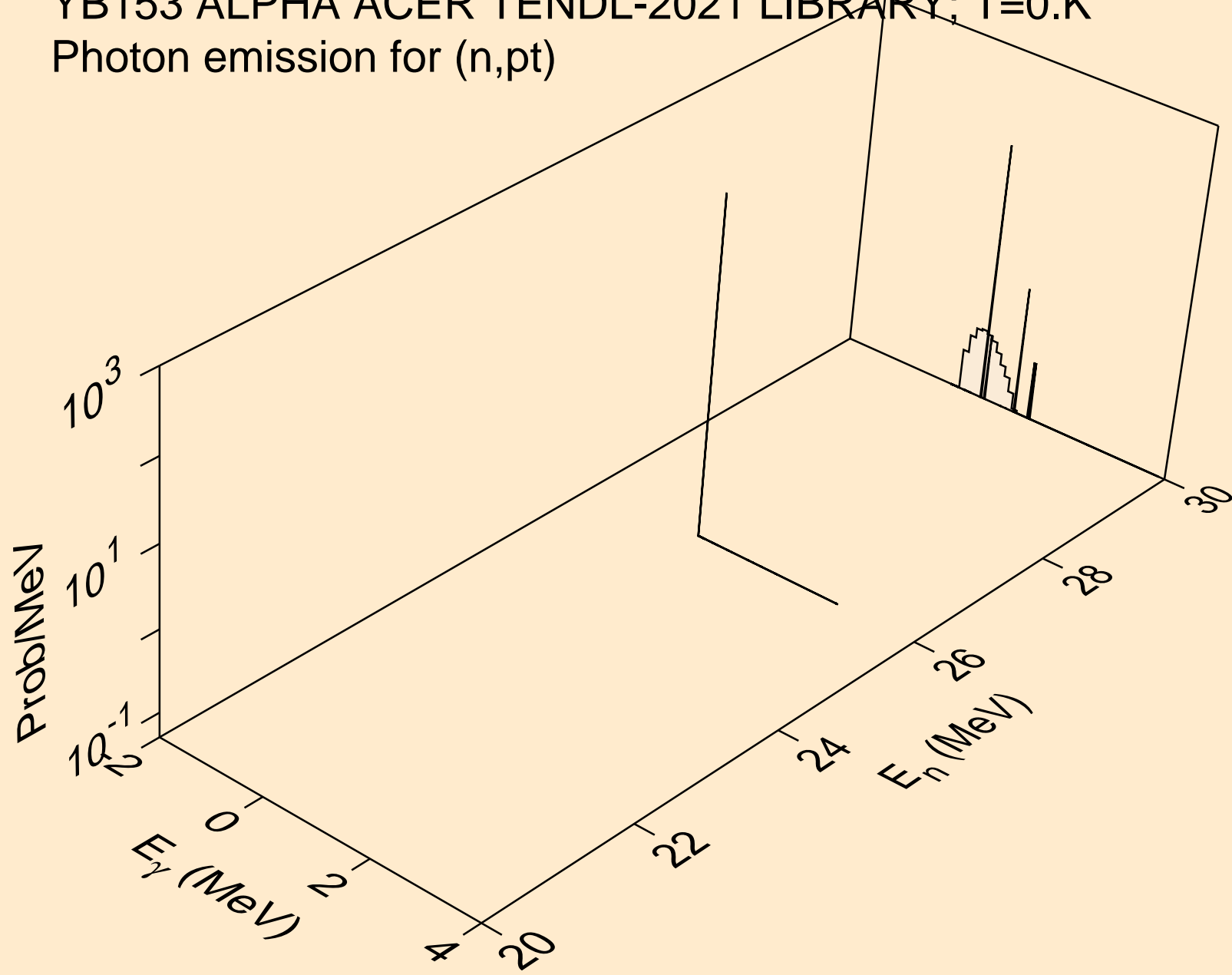

YB153 ALPHA ACER TENDL-2021 LIBRARY; T=0.K  
Photon emission for (n,da)

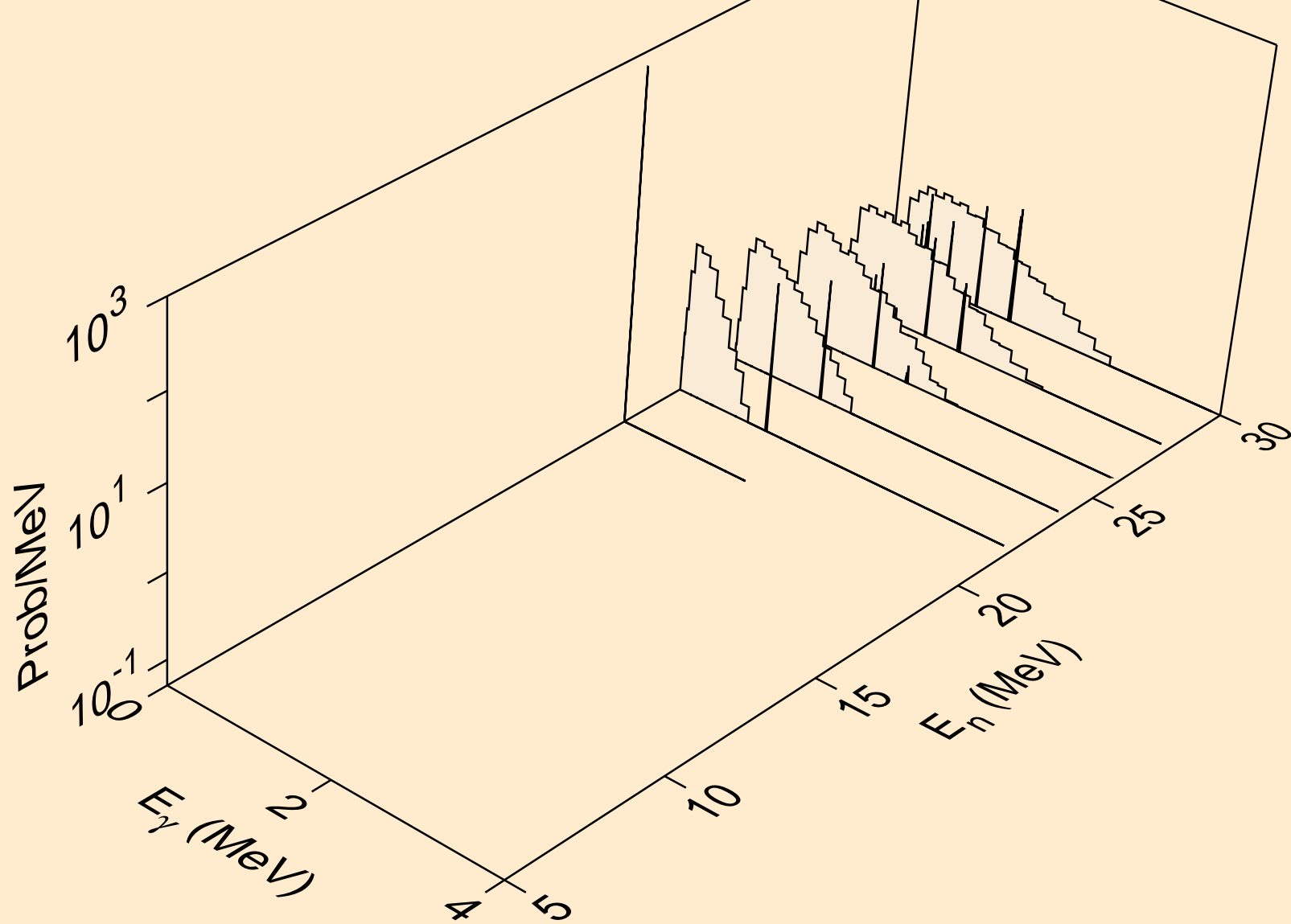

YB153 ALPHA ACER TENDL-2021 LIBRARY; T=0.K  
Particle heating contributions

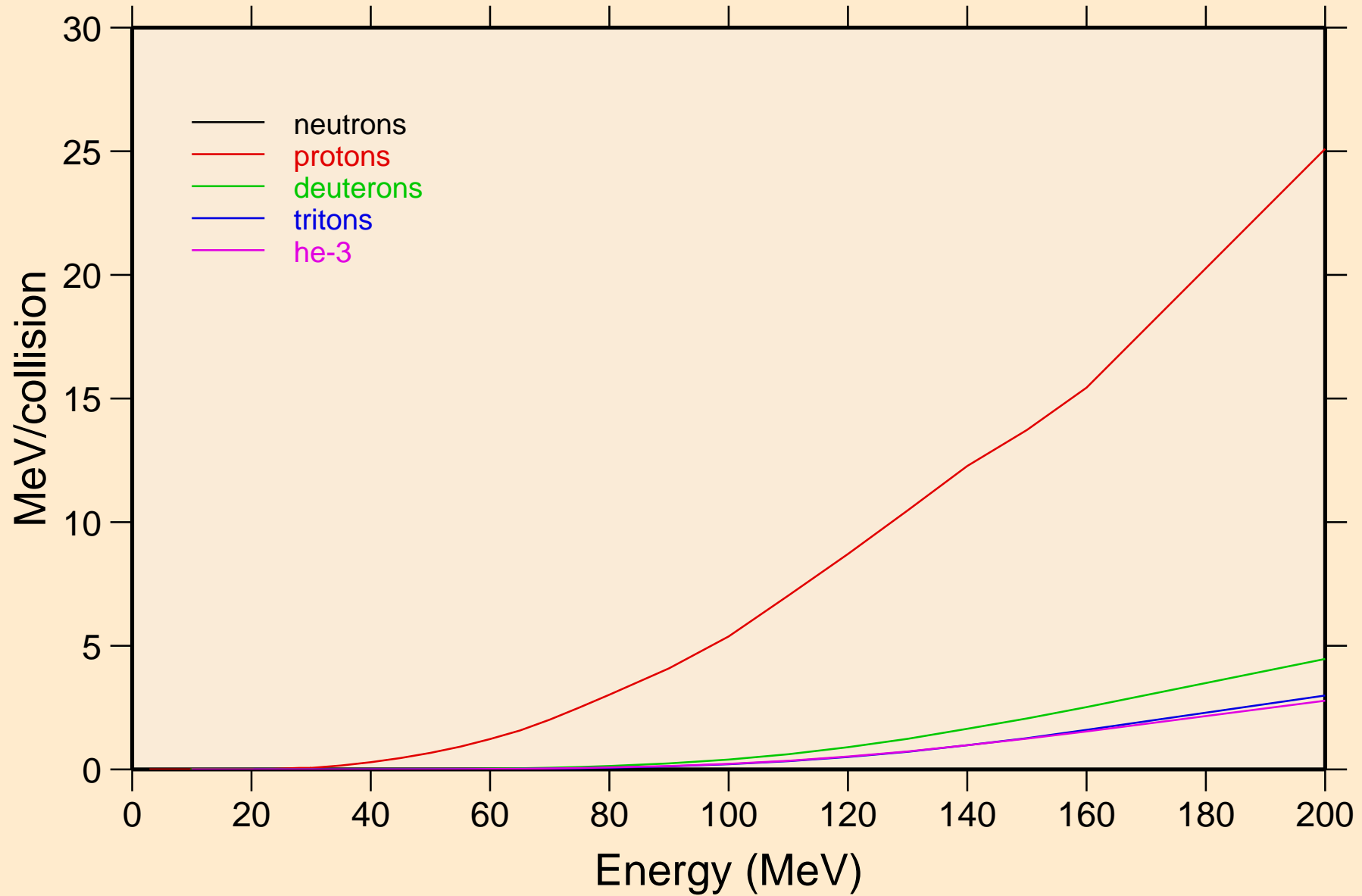

YB153 ALPHA ACER TENDL-2021 LIBRARY; T=0.K  
Recoil Heating

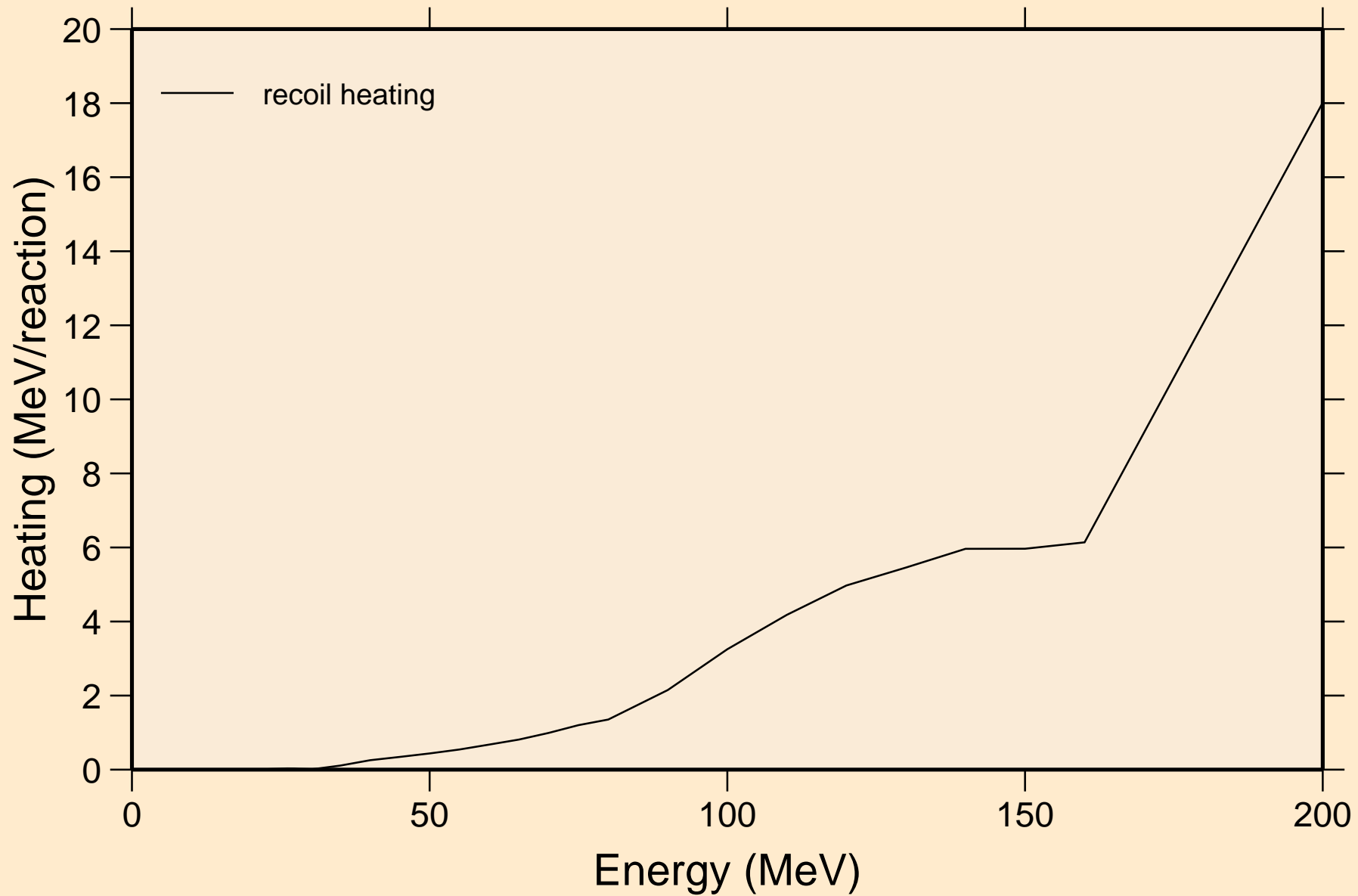

YB153 ALPHA ACER TENDL-2021 LIBRARY; T=0.K  
Particle production cross sections

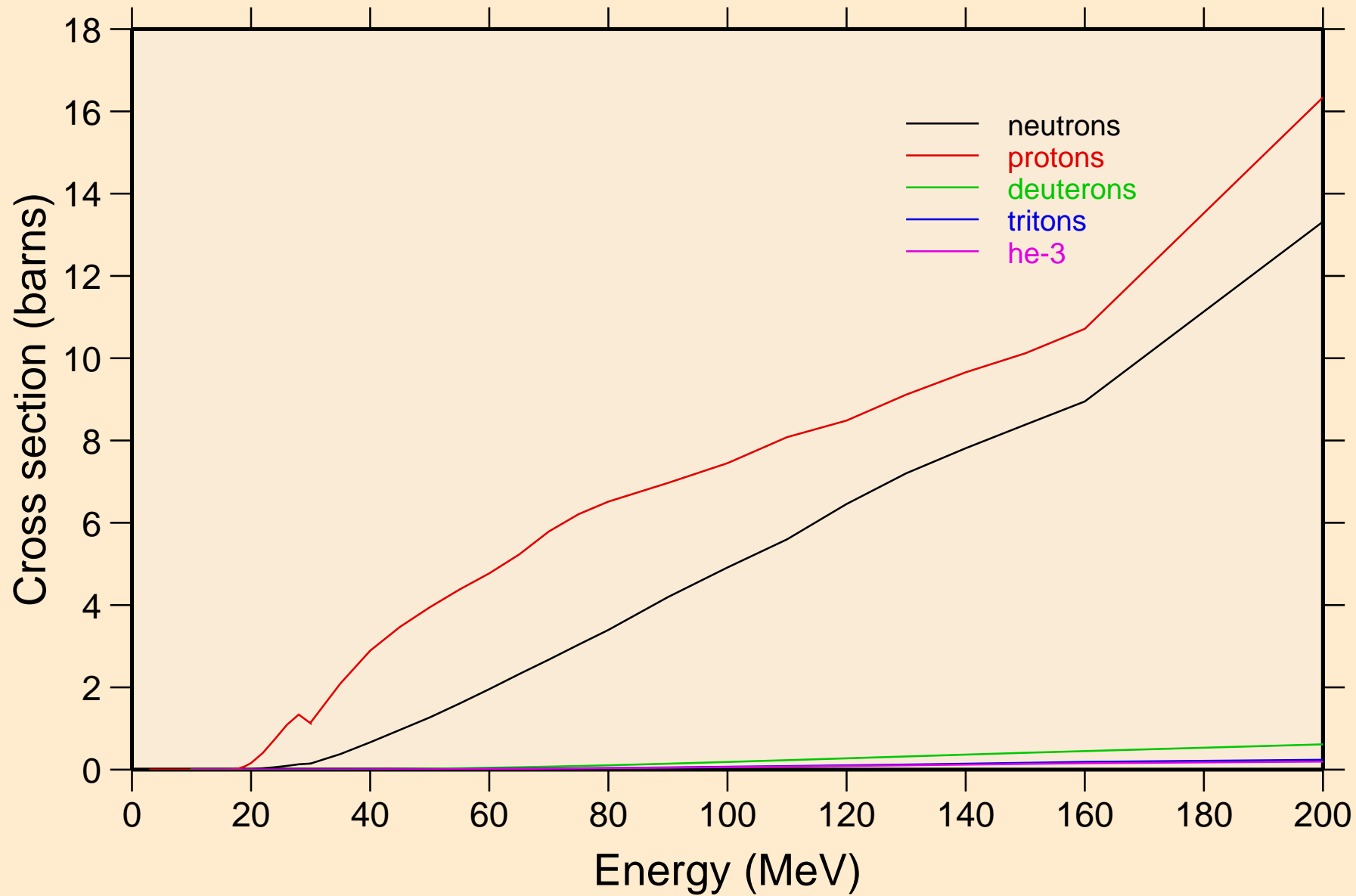

YB153 ALPHA ACER TENDL-2021 LIBRARY; T=0.K  
neutrons from (a,n)

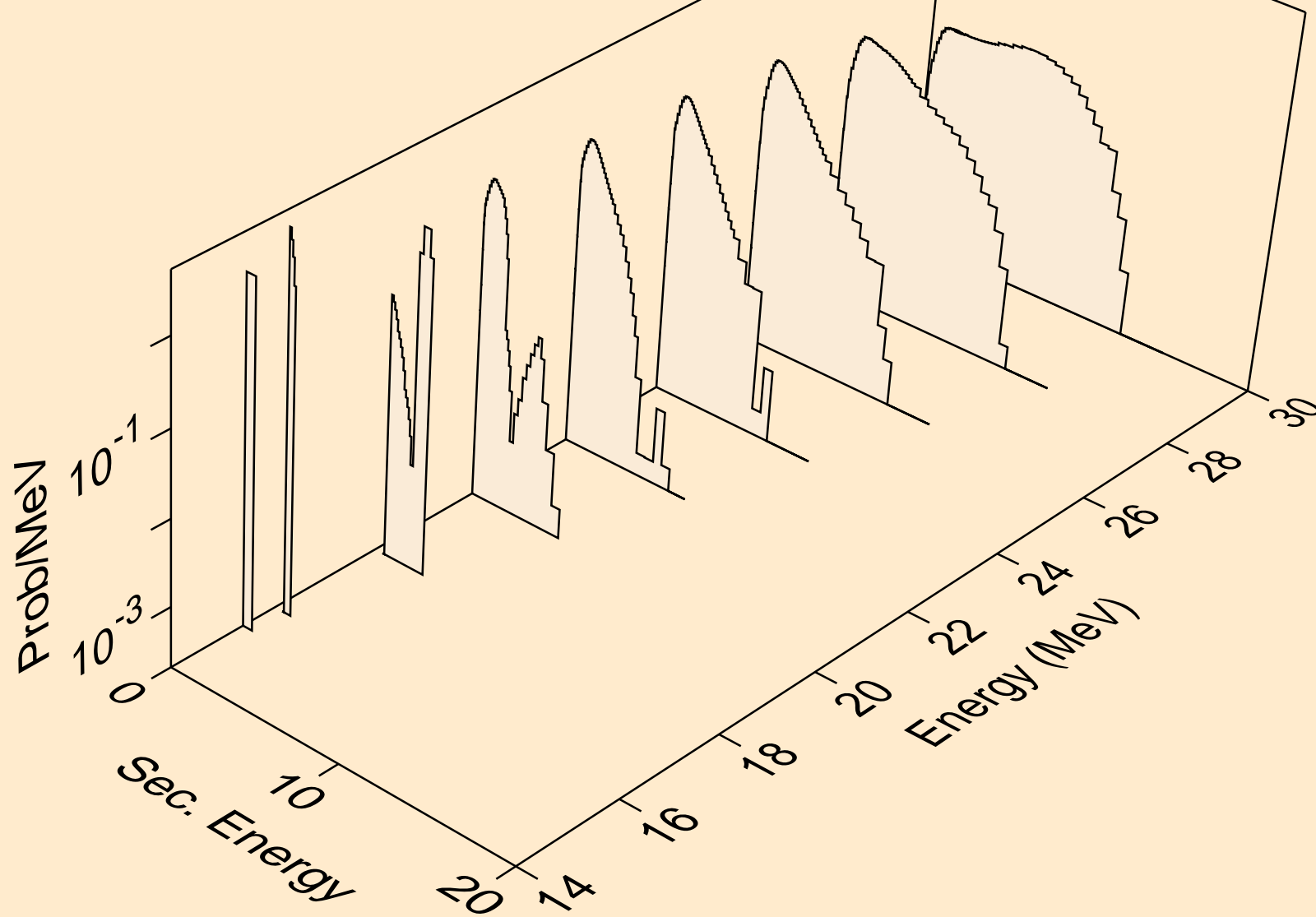

YB153 ALPHA ACER TENDL-2021 LIBRARY; T=0.K  
neutrons from (a,x)

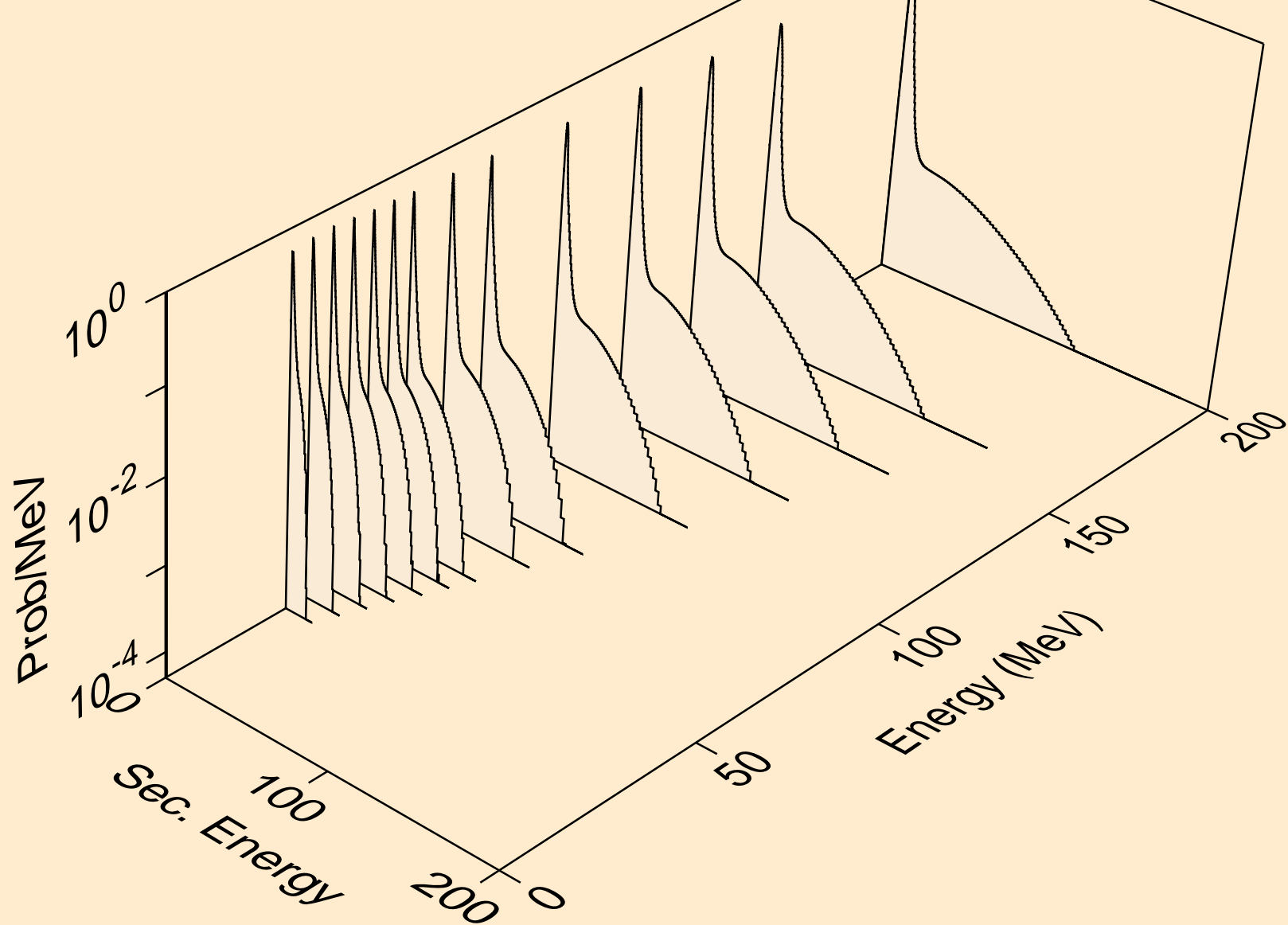

YB153 ALPHA ACER TENDL-2021 LIBRARY; T=0.K  
neutrons from (a,2n)

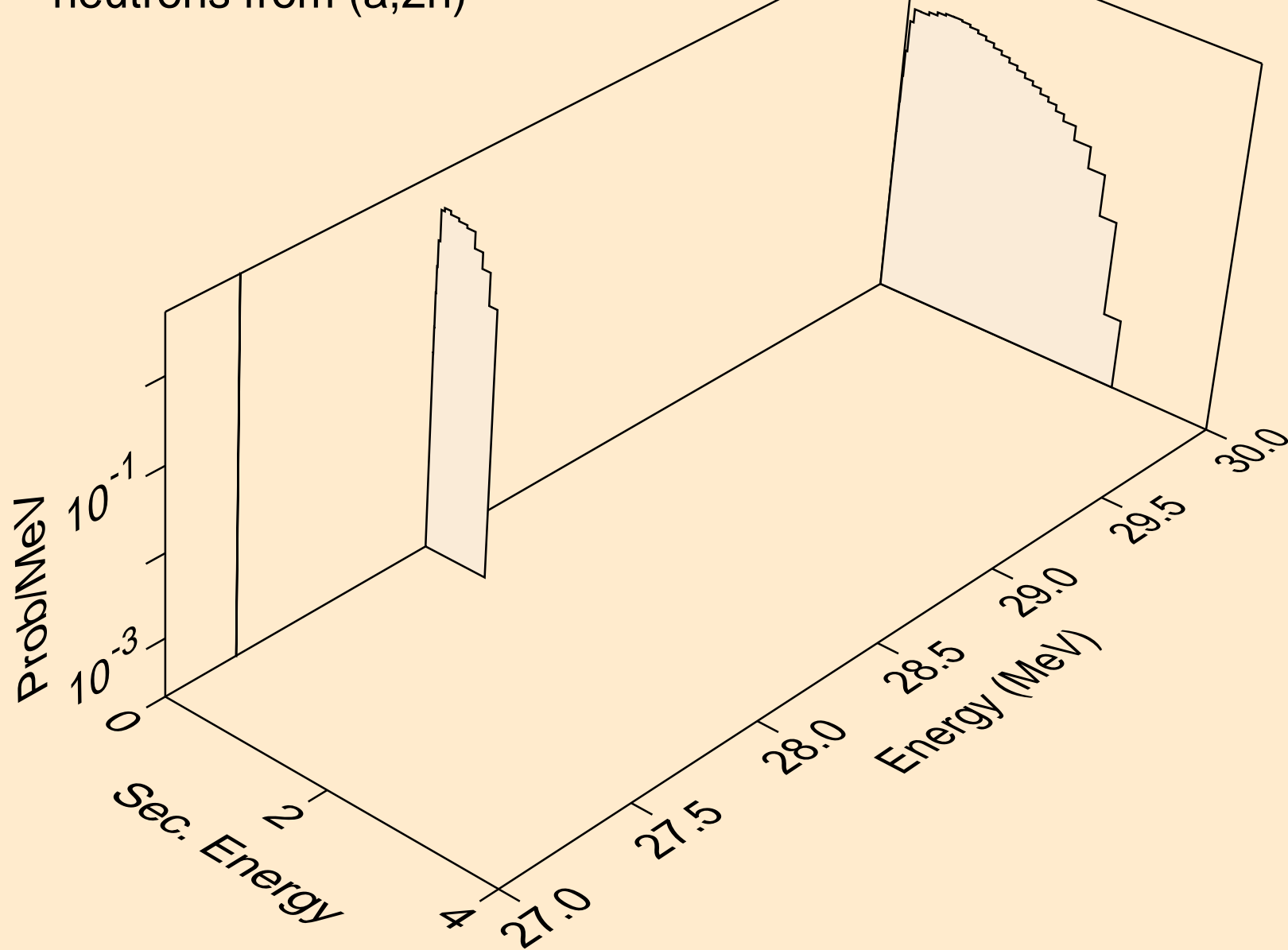

YB153 ALPHA ACER TENDL-2021 LIBRARY; T=0.K  
neutrons from (a,n\*)a

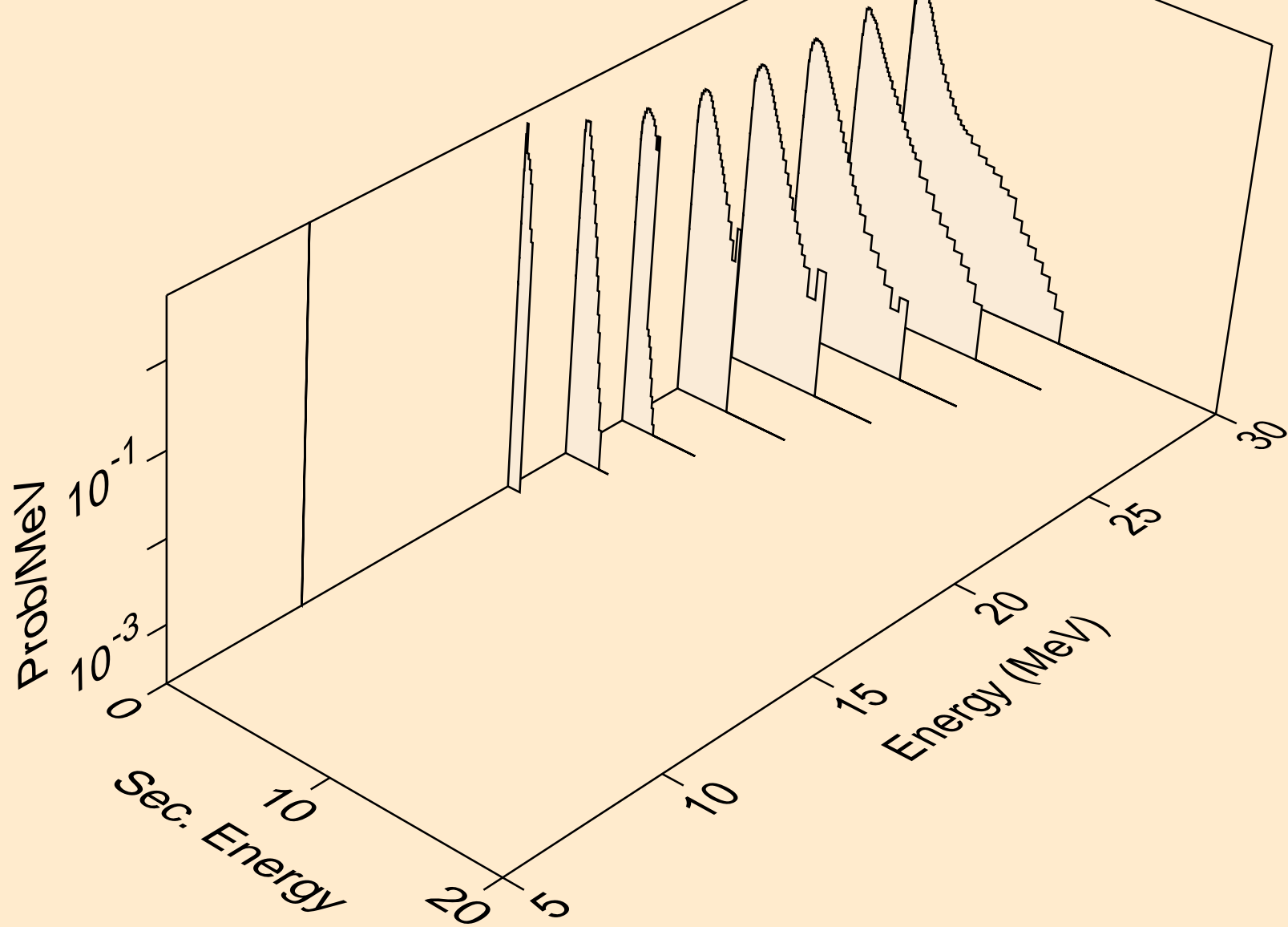

YB153 ALPHA ACER TENDL-2021 LIBRARY; T=0.K  
neutrons from (a,n\*)p

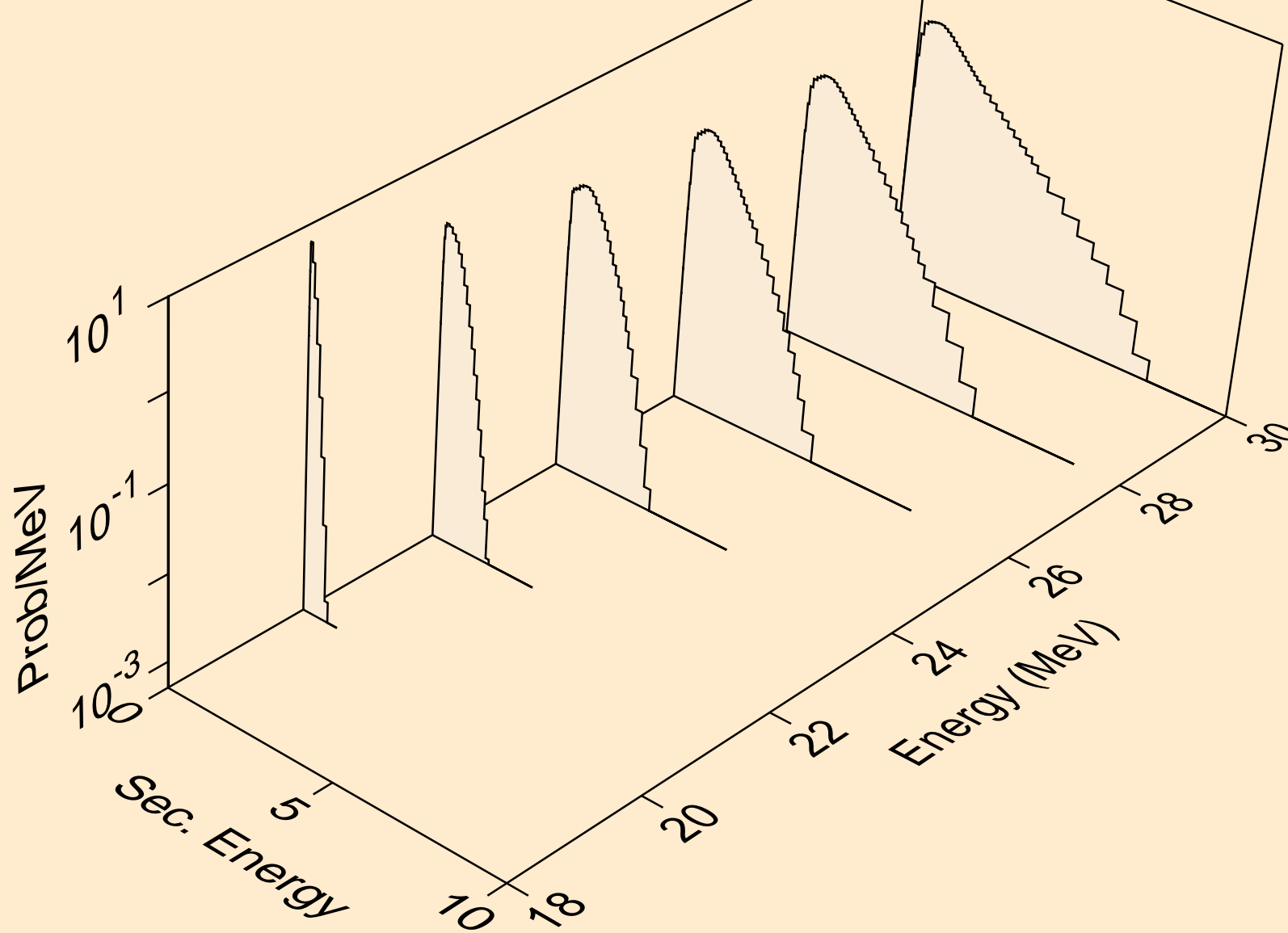

YB153 ALPHA ACER TENDL-2021 LIBRARY; T=0.K  
neutrons from (a,2np)

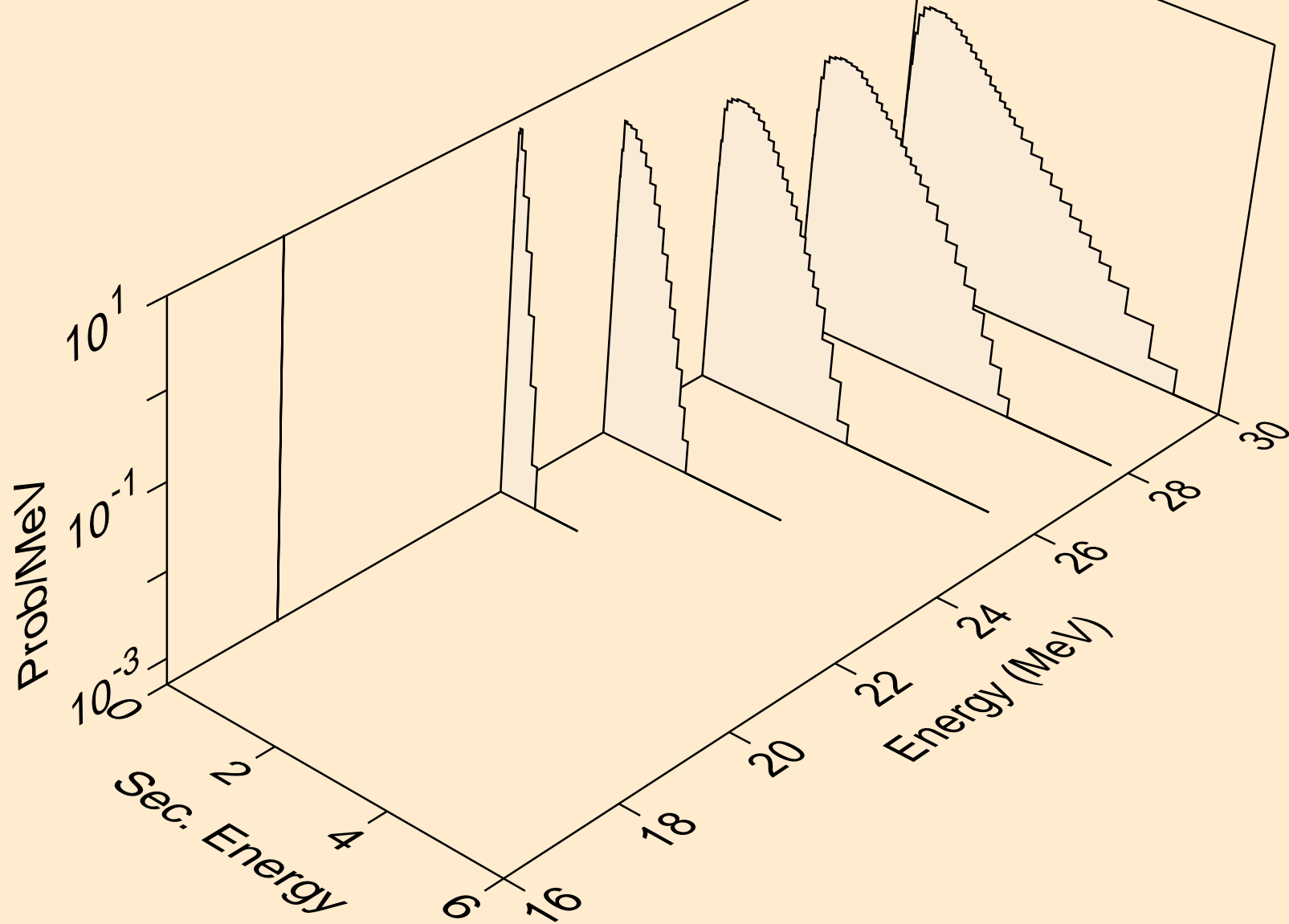

YB153 ALPHA ACER TENDL-2021 LIBRARY; T=0.K  
neutrons from (a,npa)

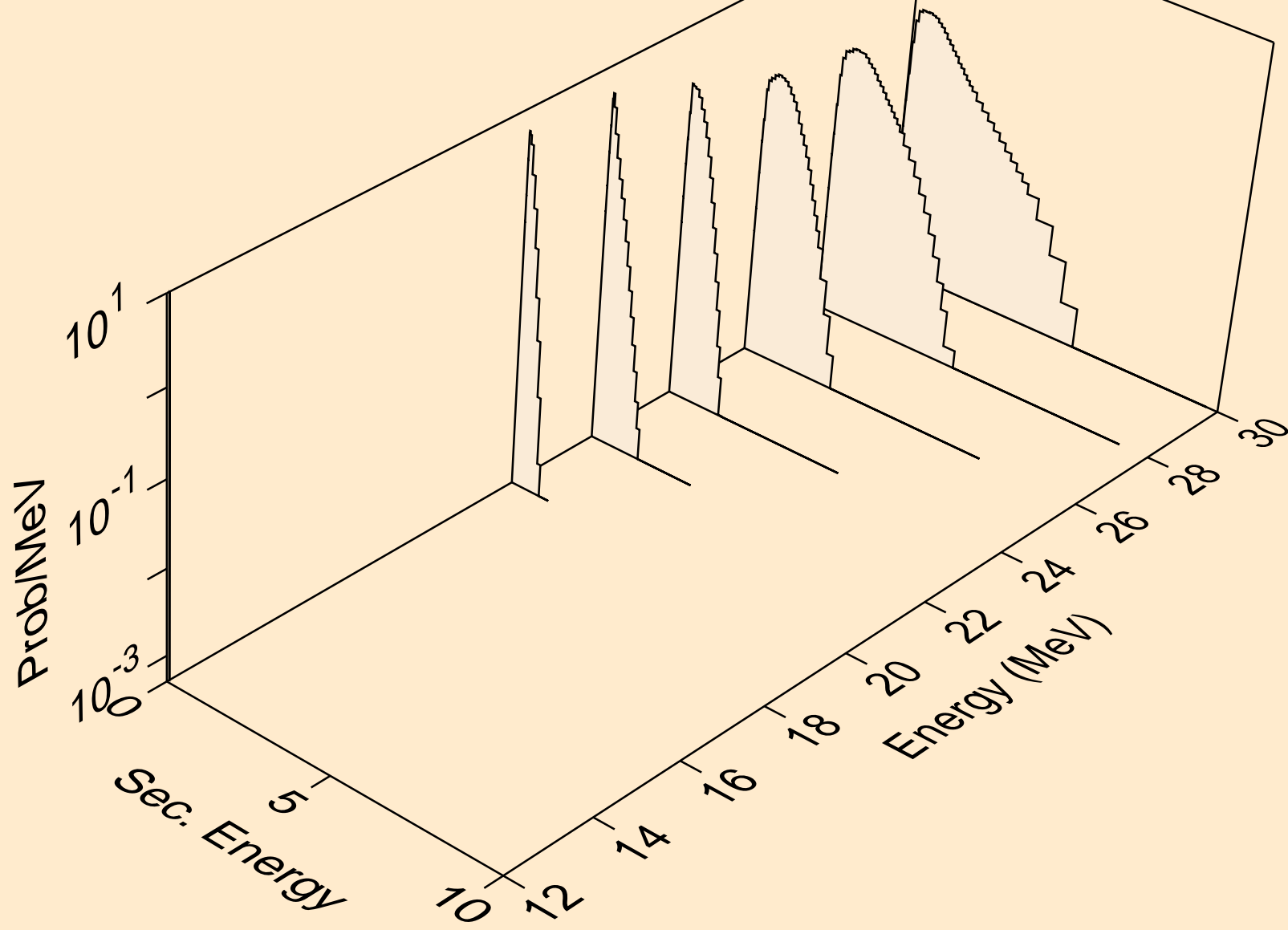

YB153 ALPHA ACER TENDL-2021 LIBRARY; T=0.K  
protons from (a,x)

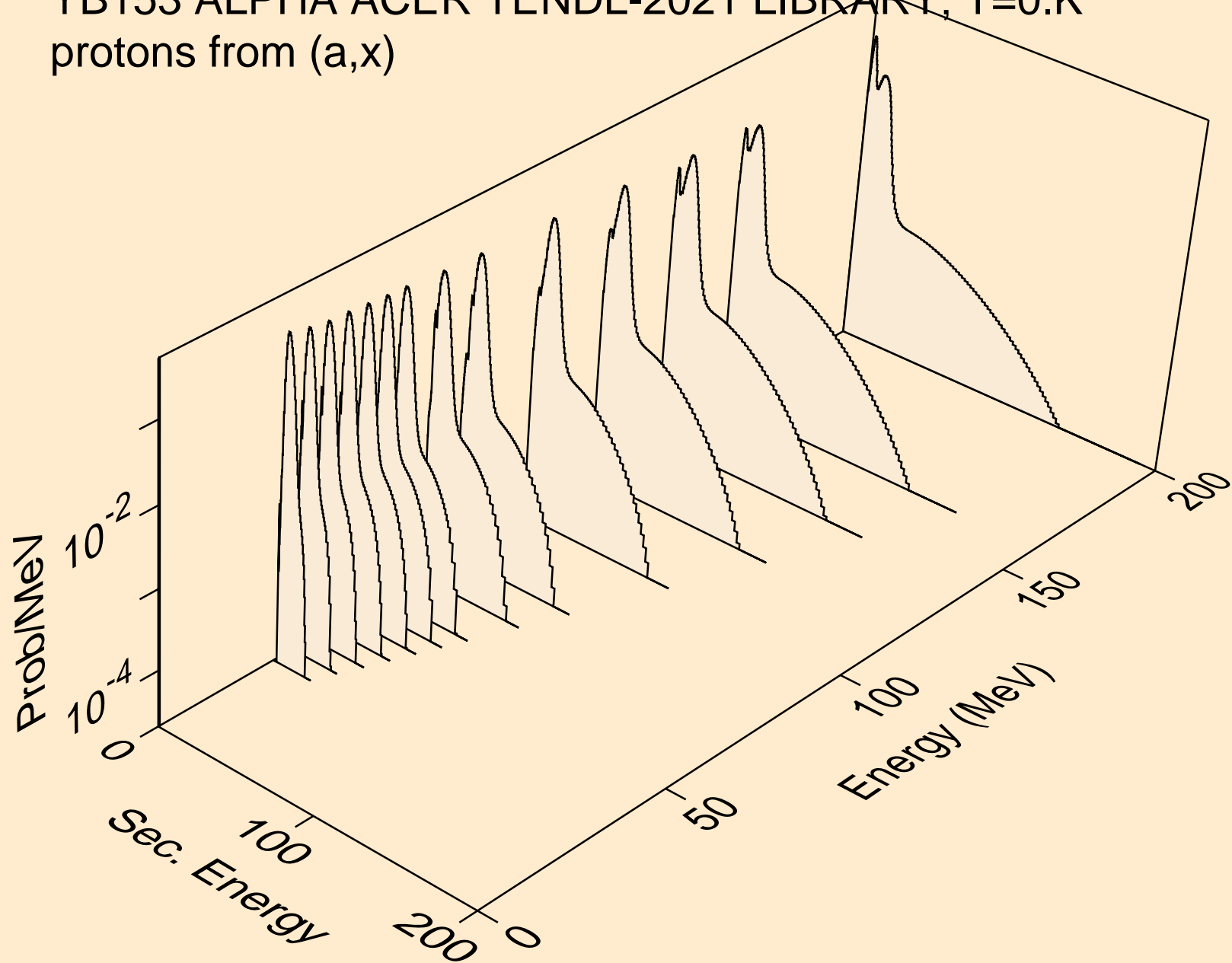

YB153 ALPHA ACER TENDL-2021 LIBRARY; T=0.K  
protons from (a,n\*)p

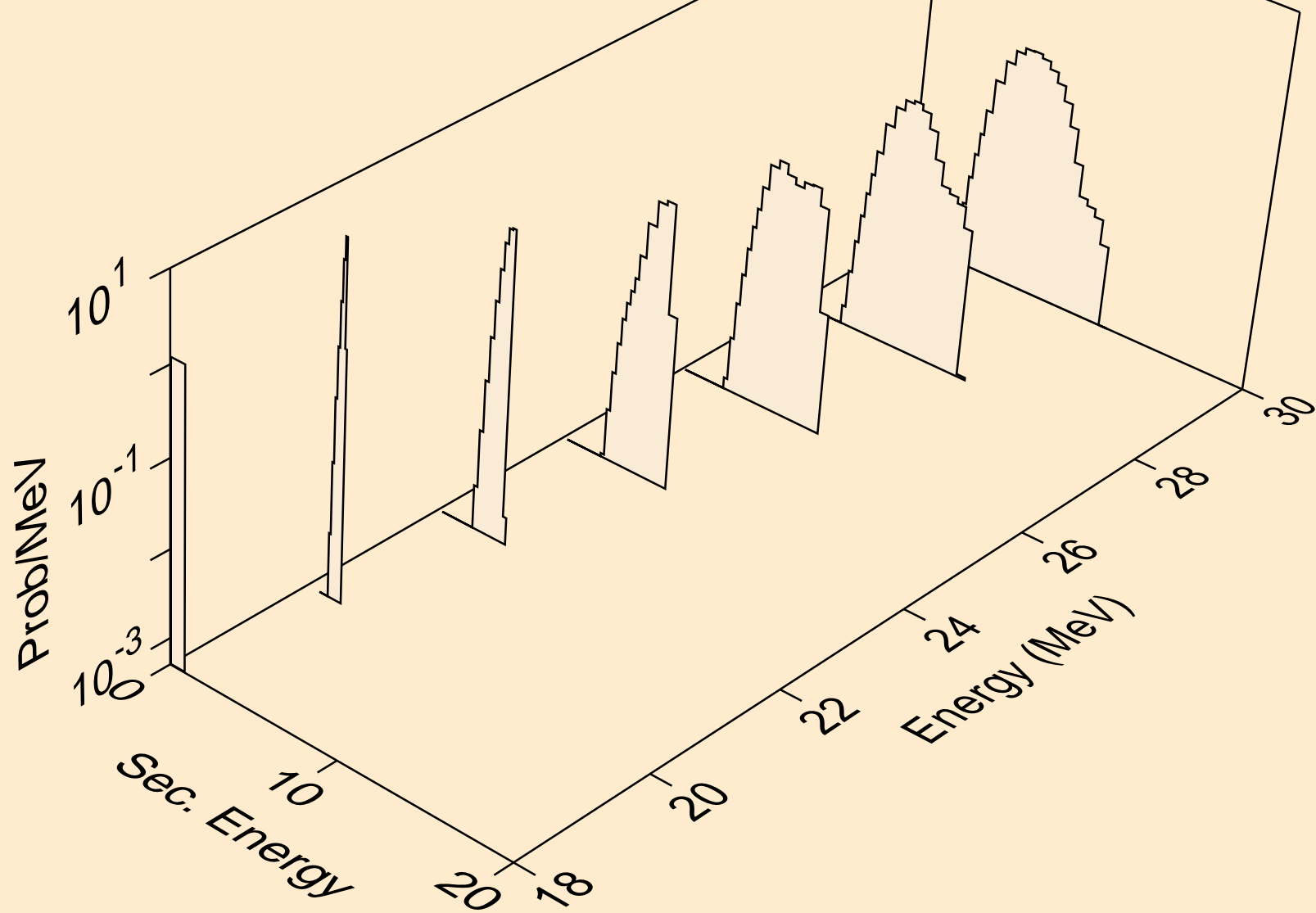

YB153 ALPHA ACER TENDL-2021 LIBRARY; T=0.K  
protons from (a,2np)

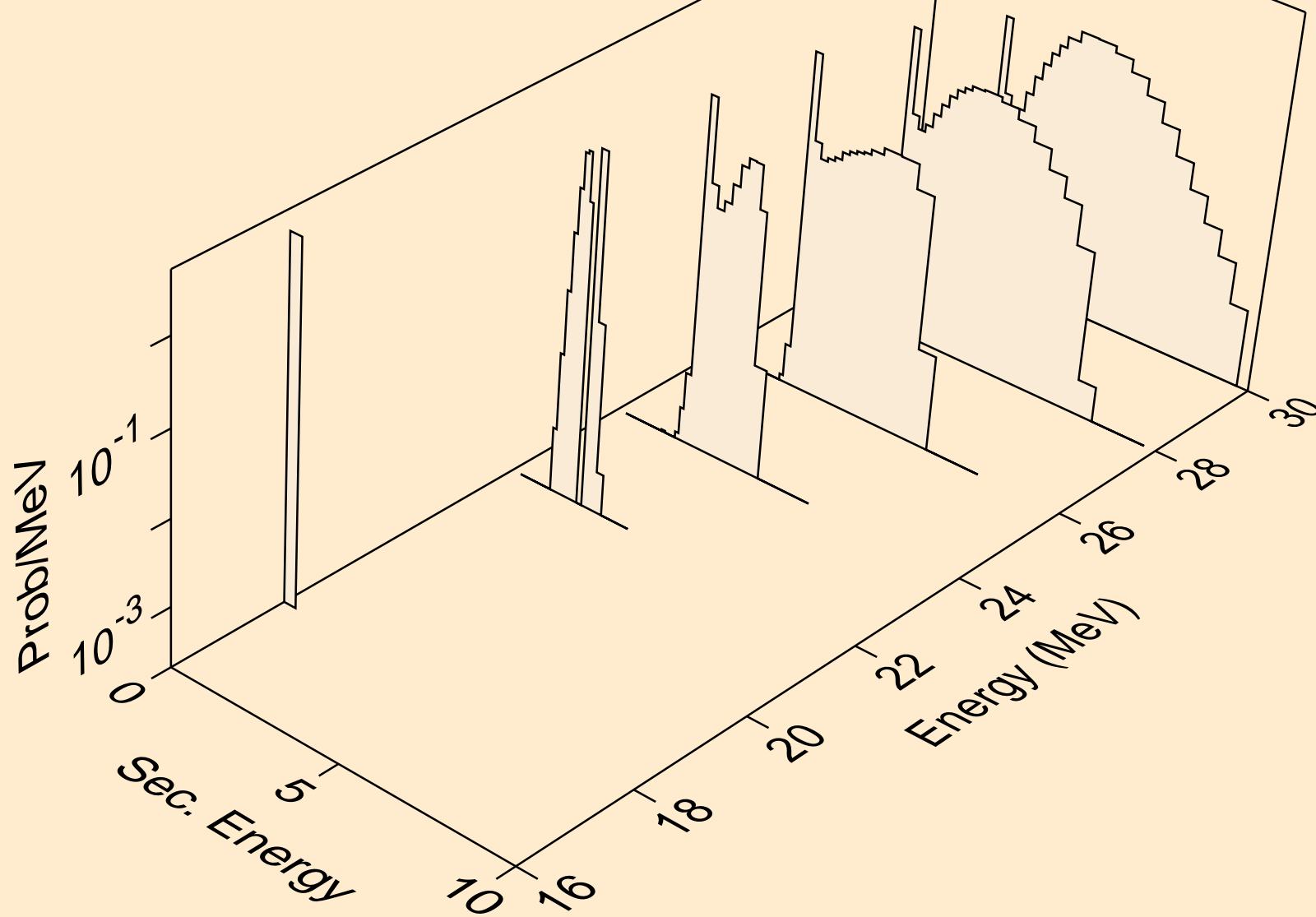

YB153 ALPHA ACER TENDL-2021 LIBRARY; T=0.K  
protons from (a,npa)

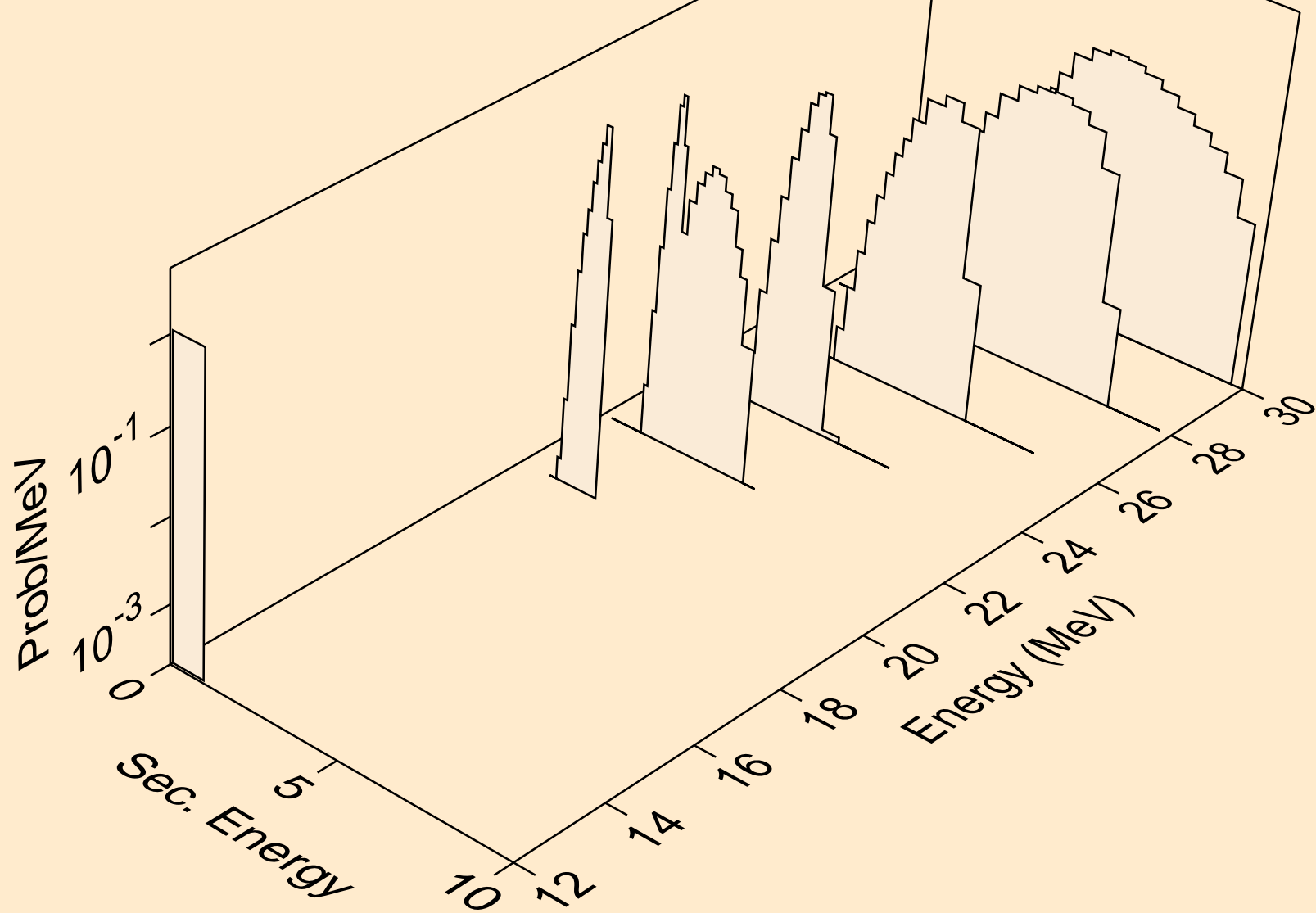

YB153 ALPHA ACER TENDL-2021 LIBRARY; T=0.K  
protons from (a,p)

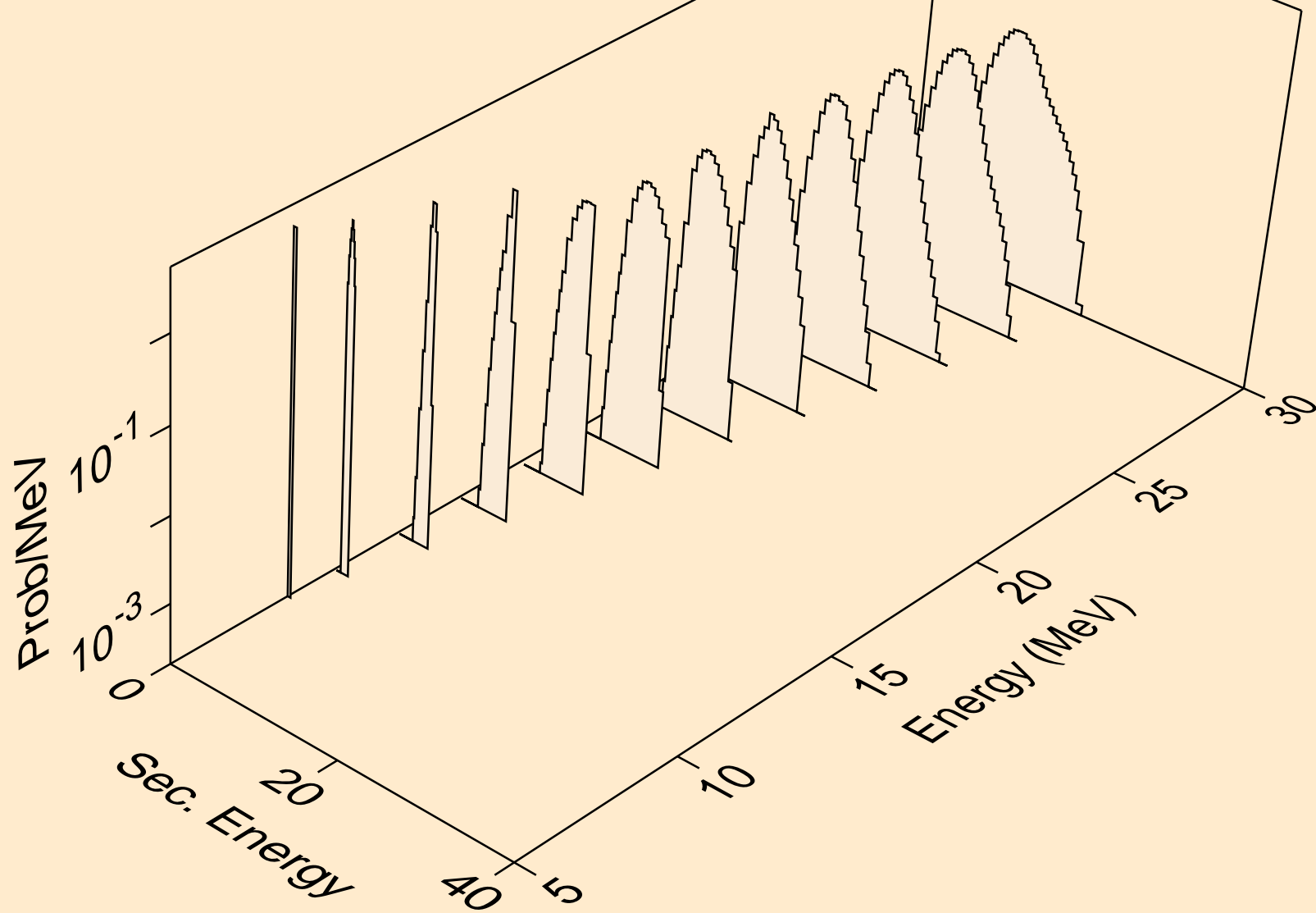

YB153 ALPHA ACER TENDL-2021 LIBRARY; T=0.K  
protons from (a,2p)

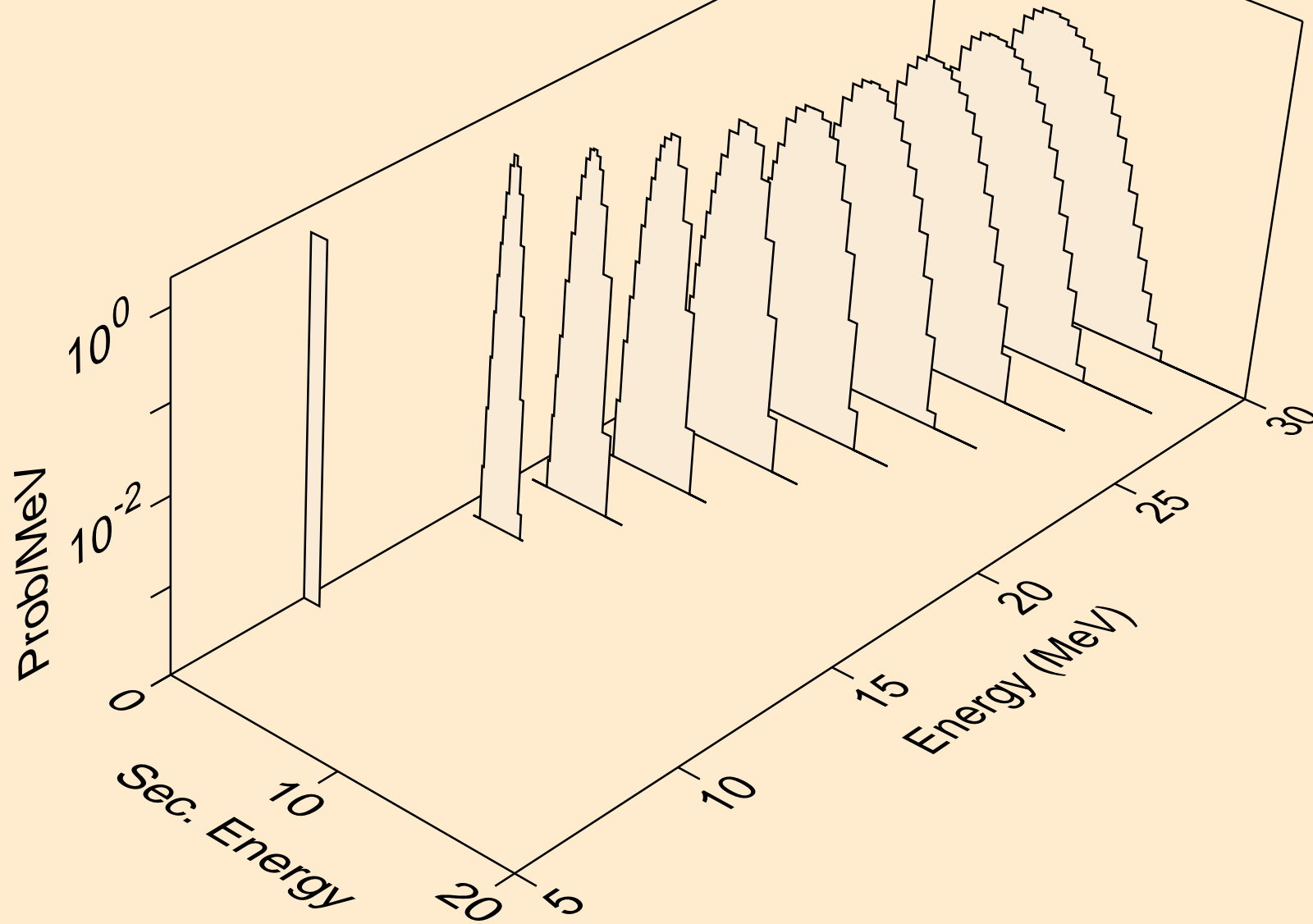

YB153 ALPHA ACER TENDL-2021 LIBRARY; T=0.K  
protons from (a,pa)

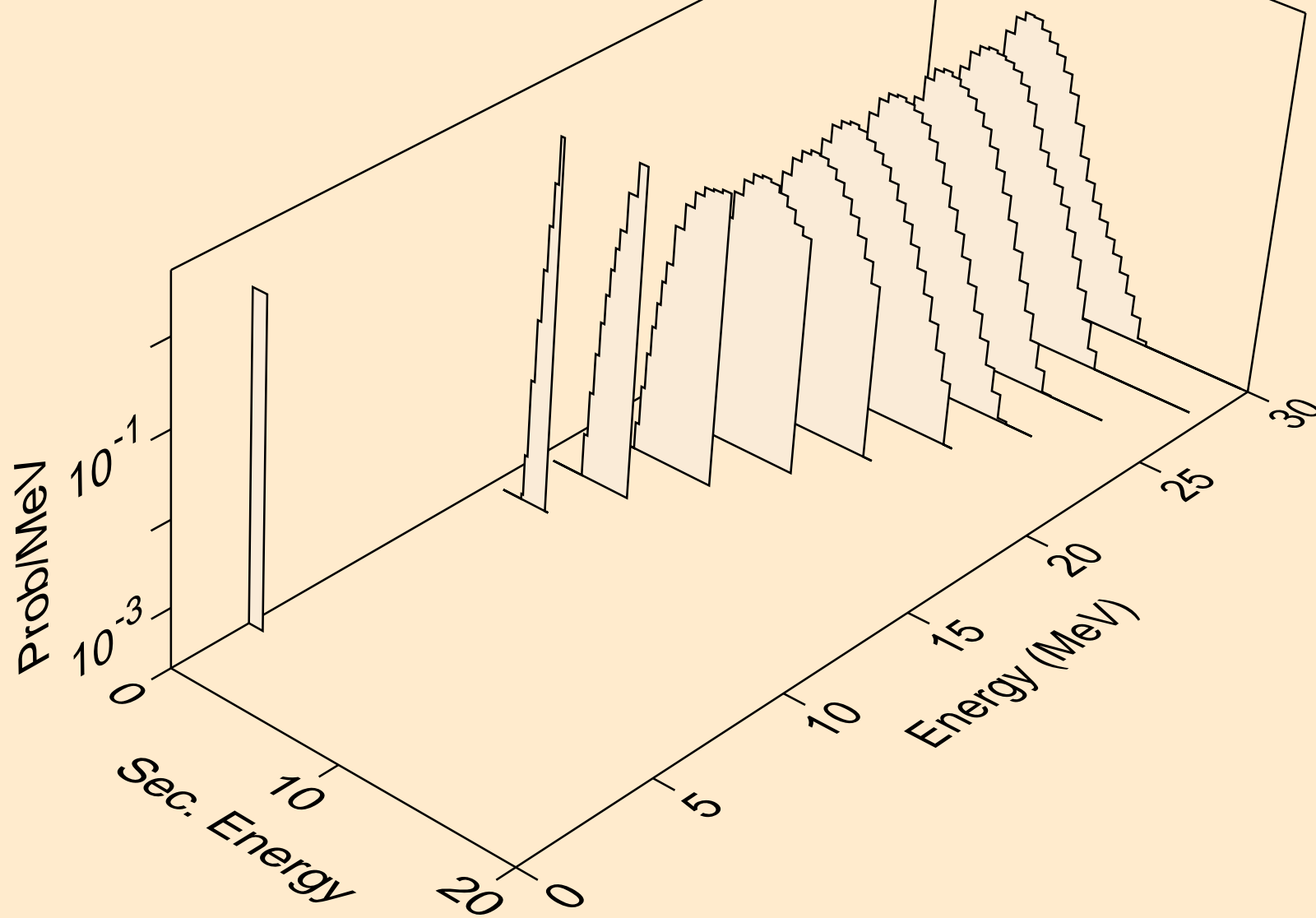

YB153 ALPHA ACER TENDL-2021 LIBRARY; T=0.K  
protons from (a,pd)

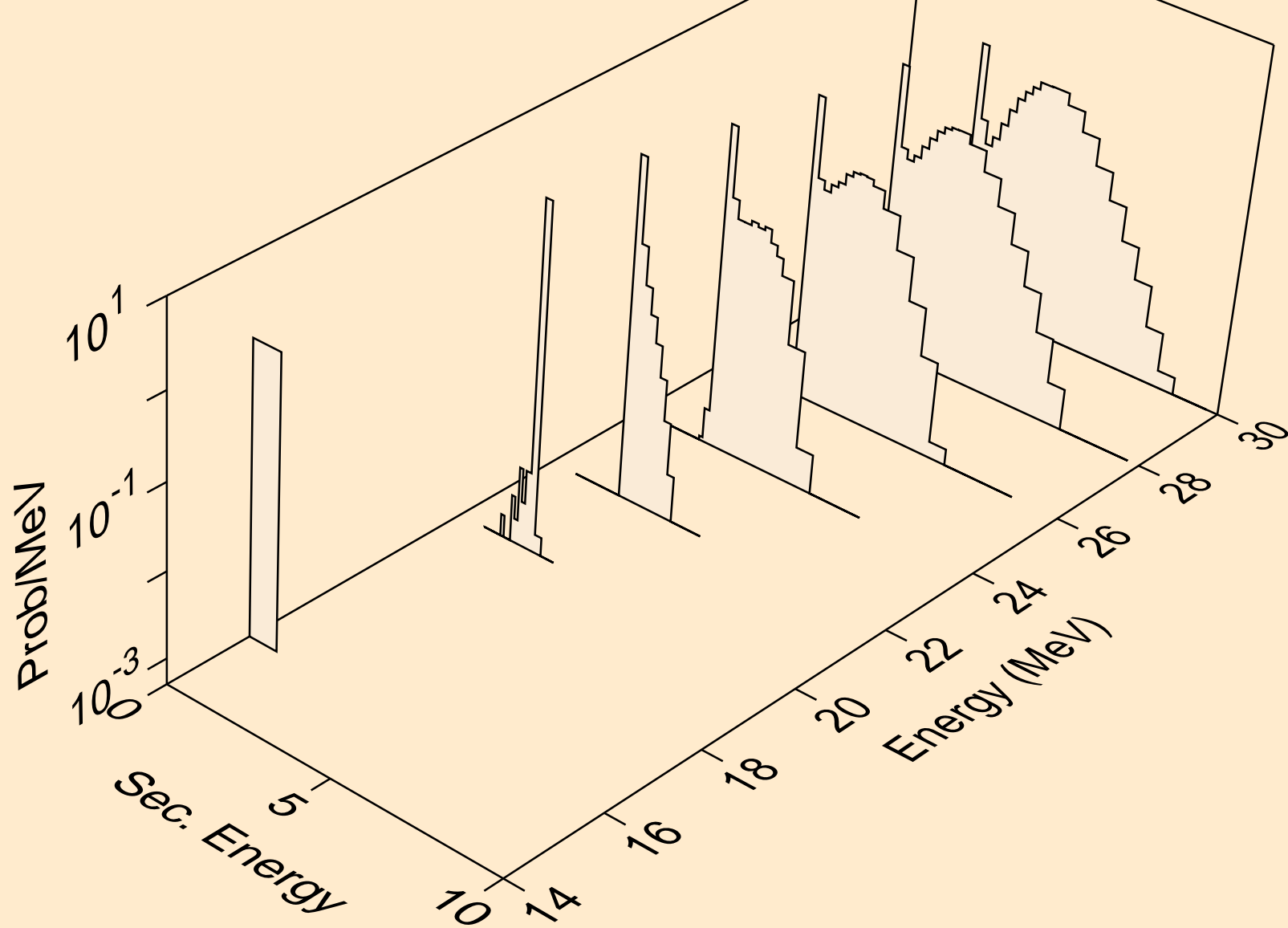

YB153 ALPHA ACER TENDL-2021 LIBRARY; T=0.K  
protons from (a,pt)

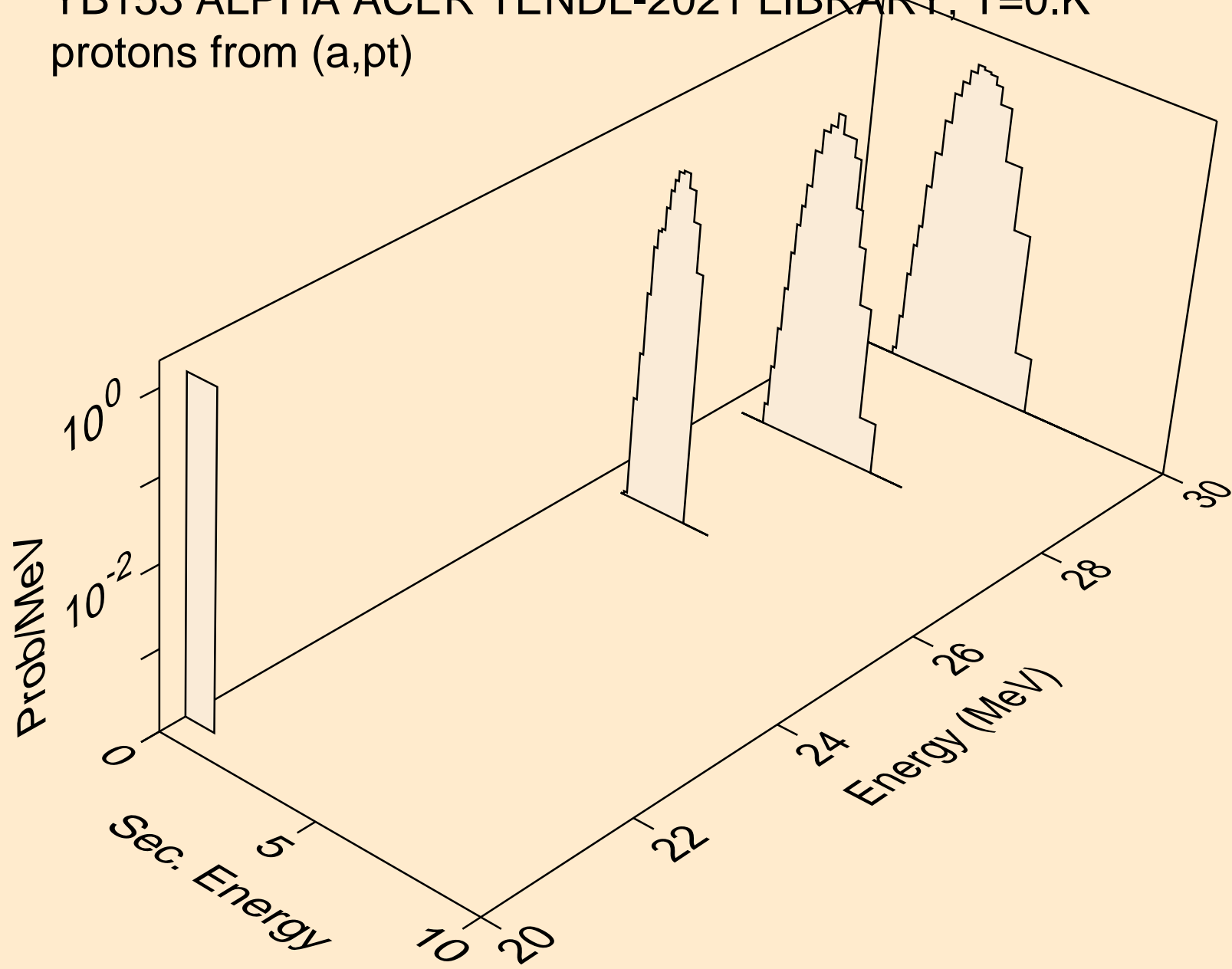

YB153 ALPHA ACER TENDL-2021 LIBRARY; T=0.K  
deuterons from (a,x)

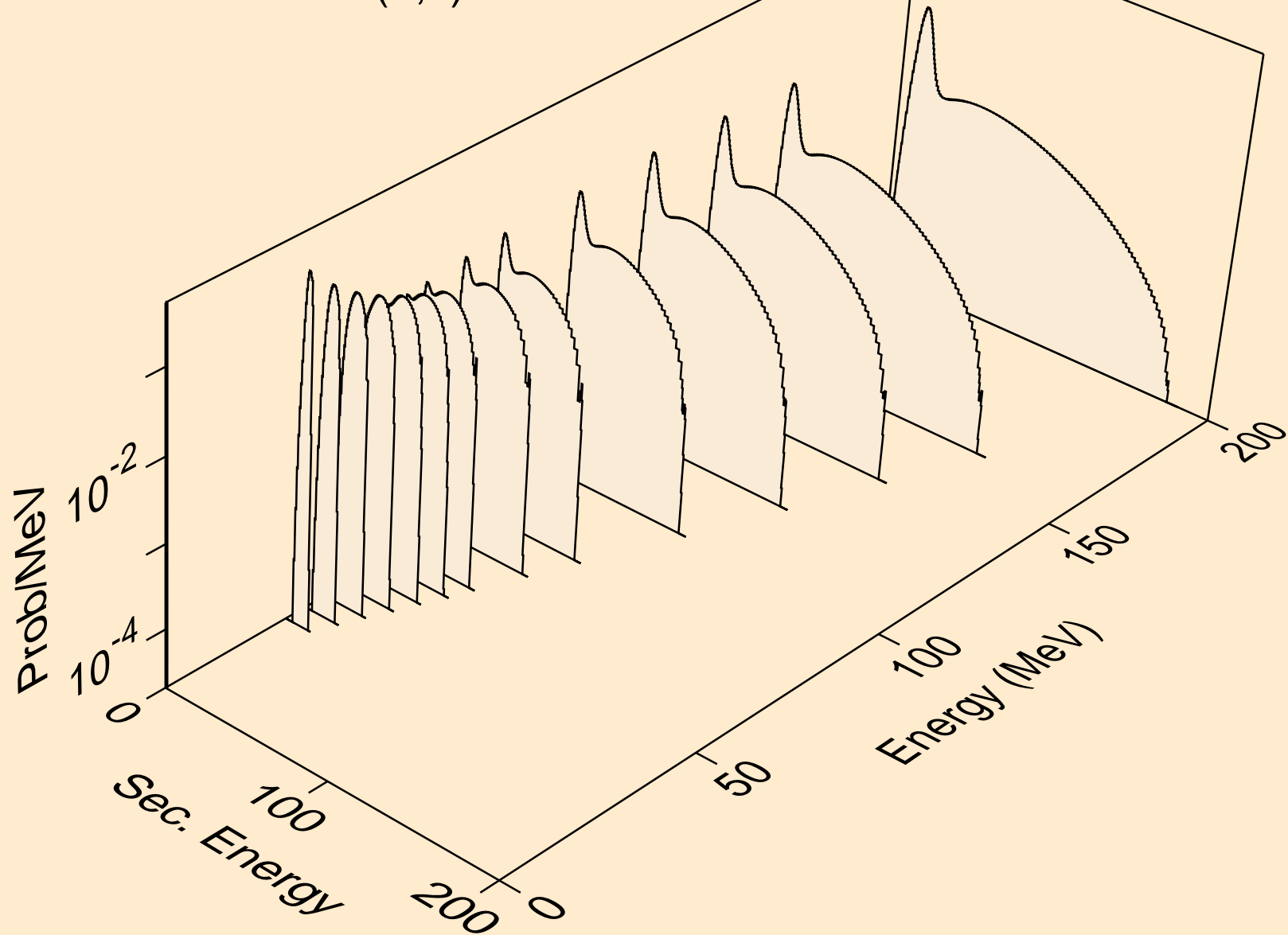

YB153 ALPHA ACER TENDL-2021 LIBRARY; T=0.K  
deuterons from (a,d)

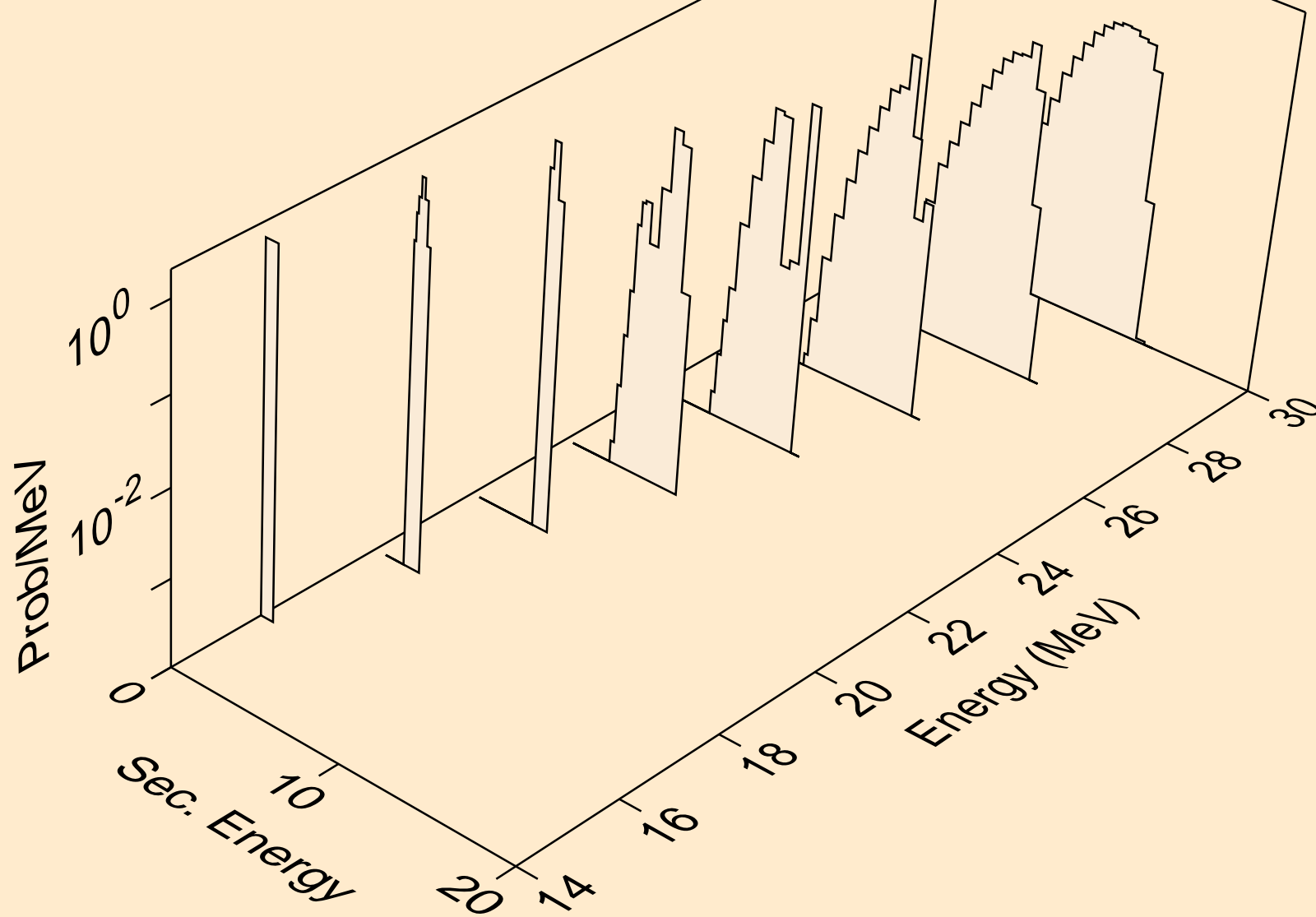

YB153 ALPHA ACER TENDL-2021 LIBRARY; T=0.K  
deuterons from (a,pd)

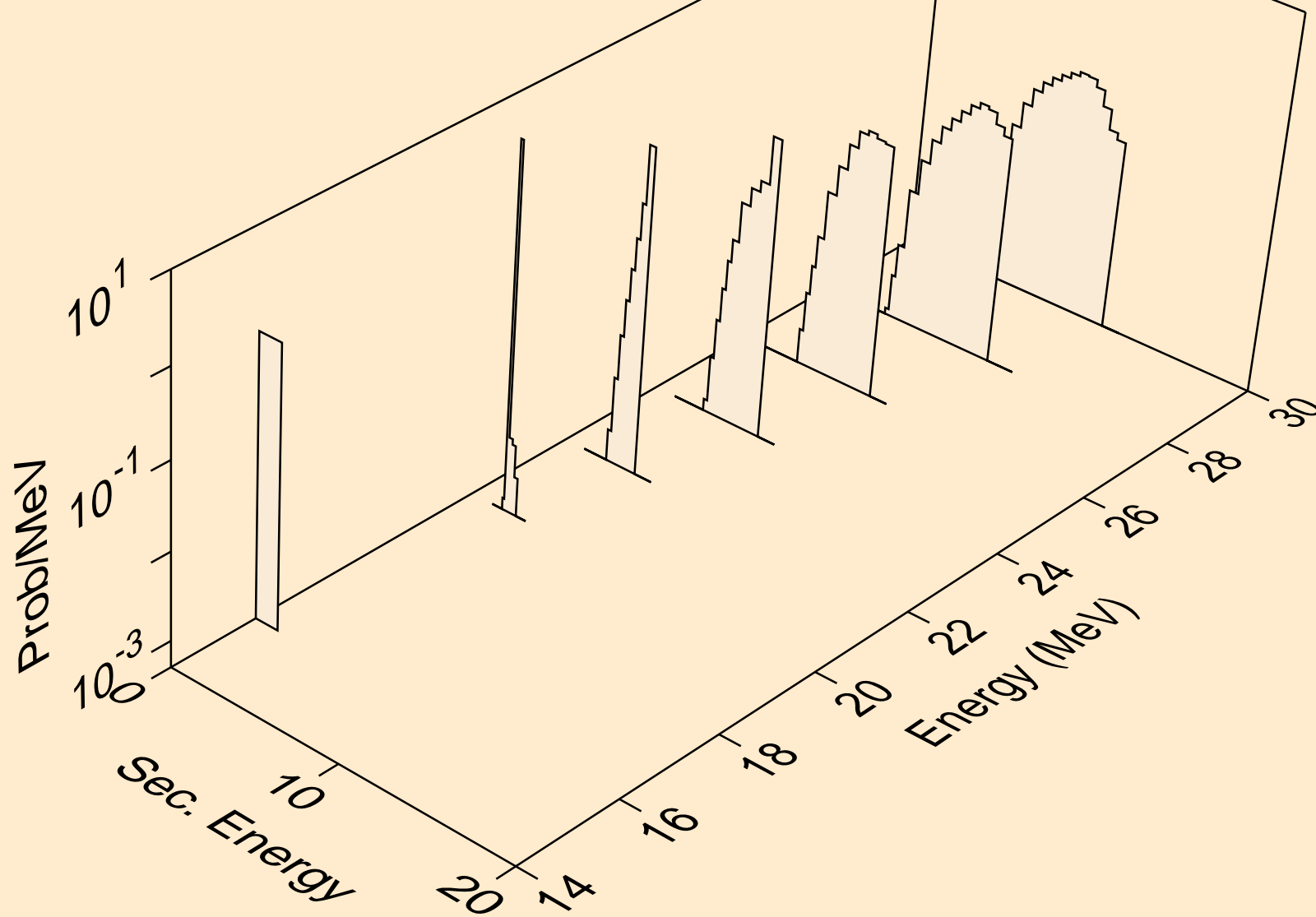

YB153 ALPHA ACER TENDL-2021 LIBRARY; T=0.K  
deuterons from (a,da)

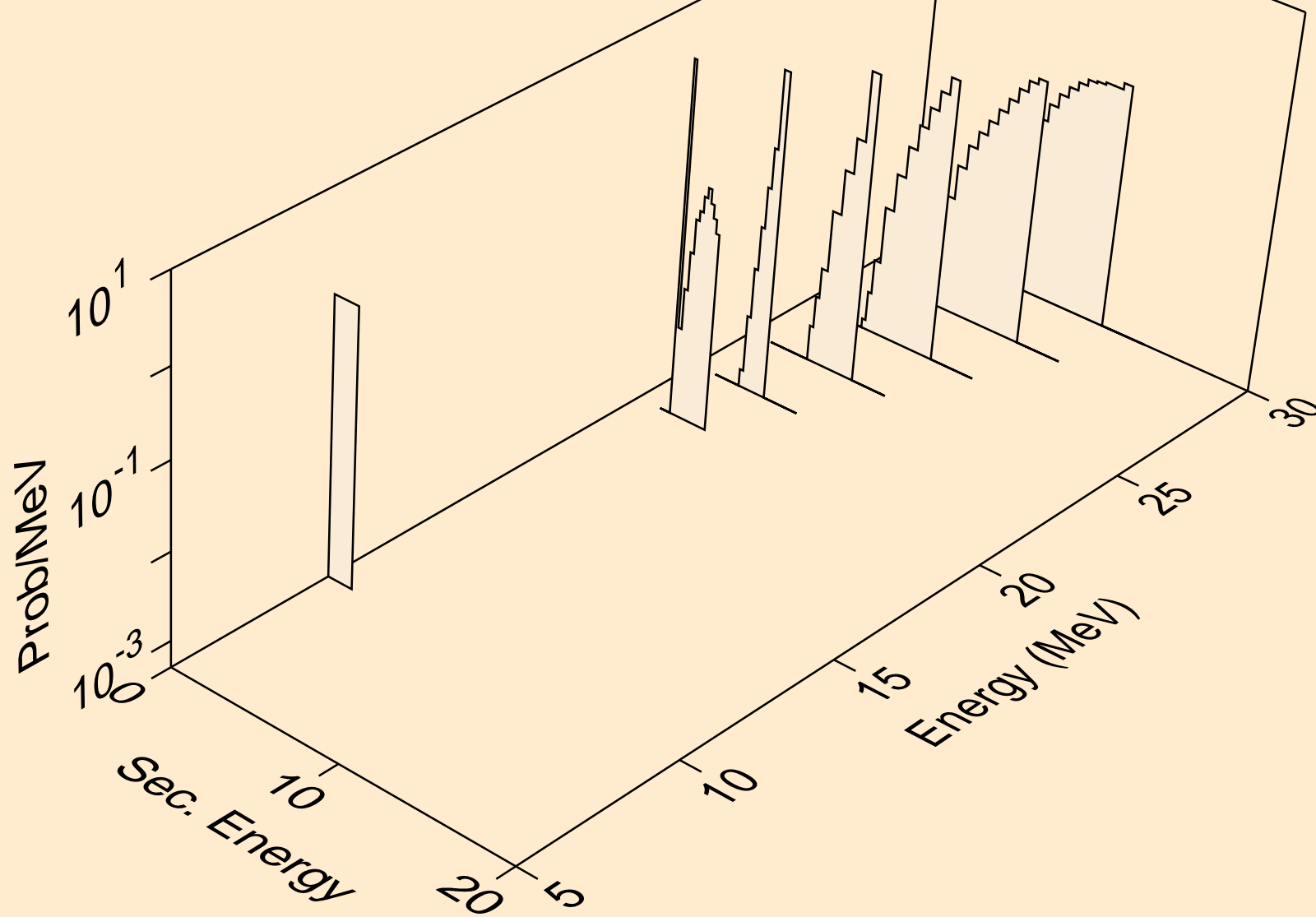

YB153 ALPHA ACER TENDL-2021 LIBRARY; T=0.K  
tritons from (a,x)

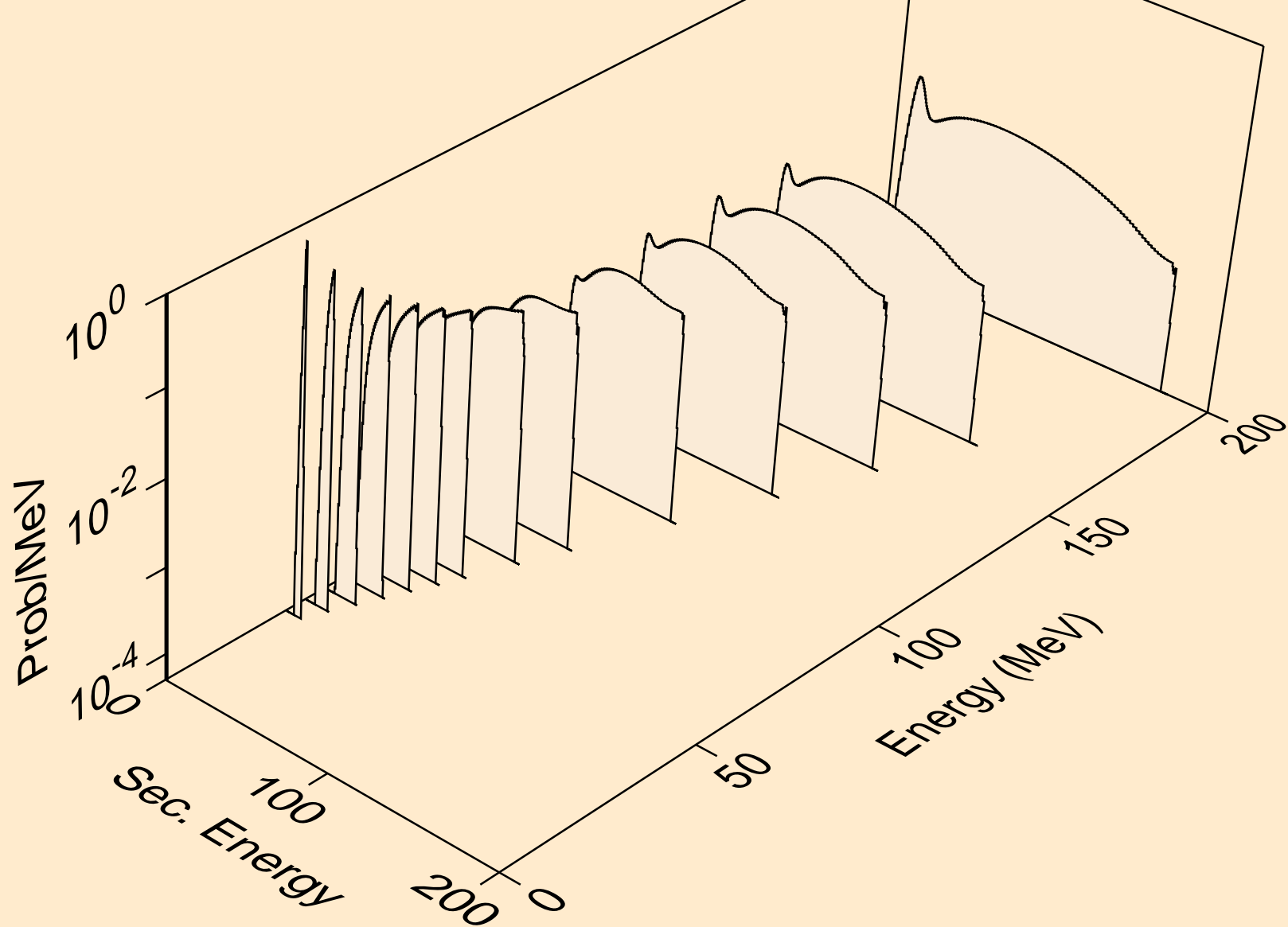

YB153 ALPHA ACER TENDL-2021 LIBRARY; T=0.K  
tritons from (a,t)

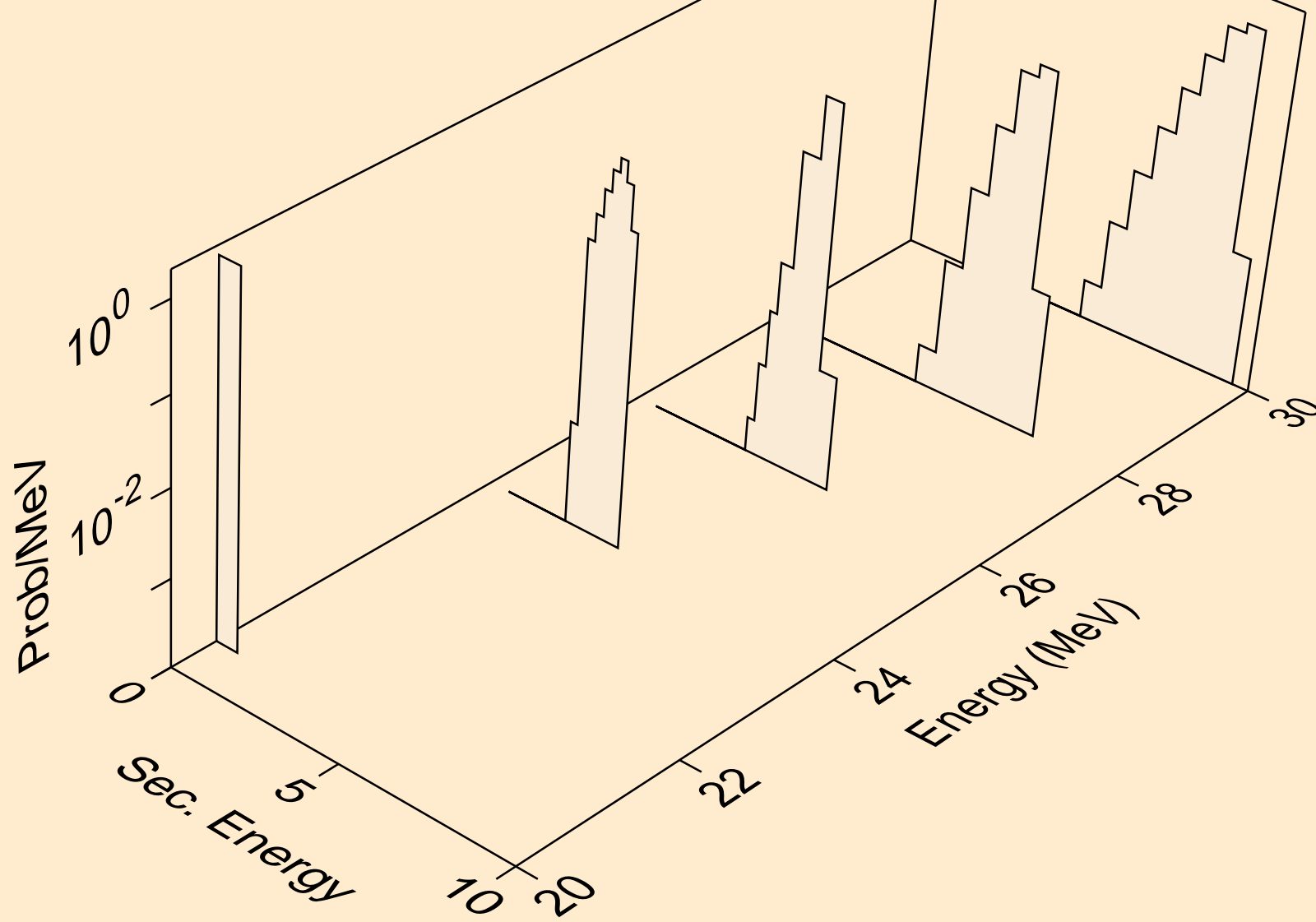

YB153 ALPHA ACER TENDL-2021 LIBRARY; T=0.K  
tritons from (a,pt)

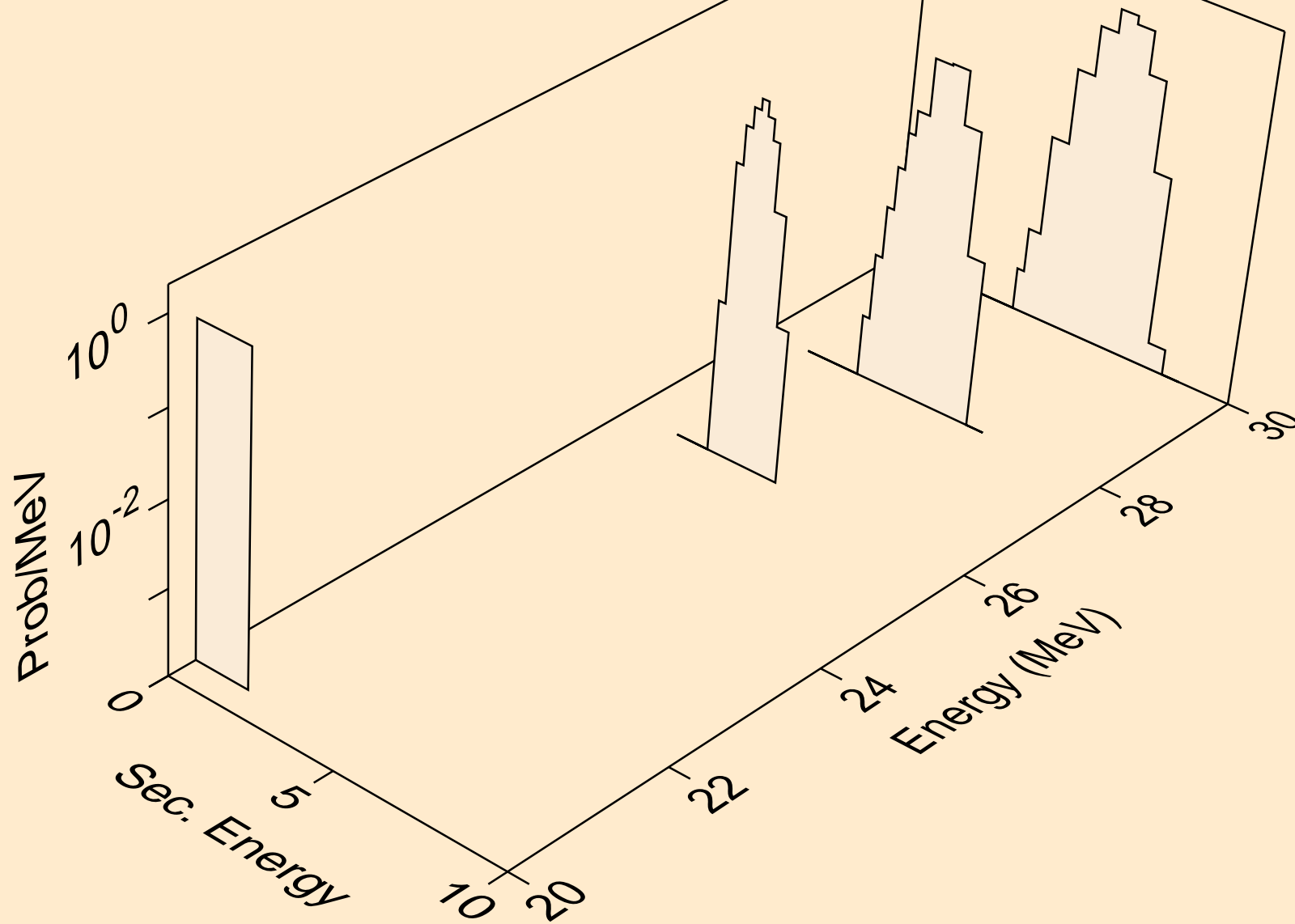

YB153 ALPHA ACER TENDL-2021 LIBRARY; T=0.K  
he3s from (a,x)

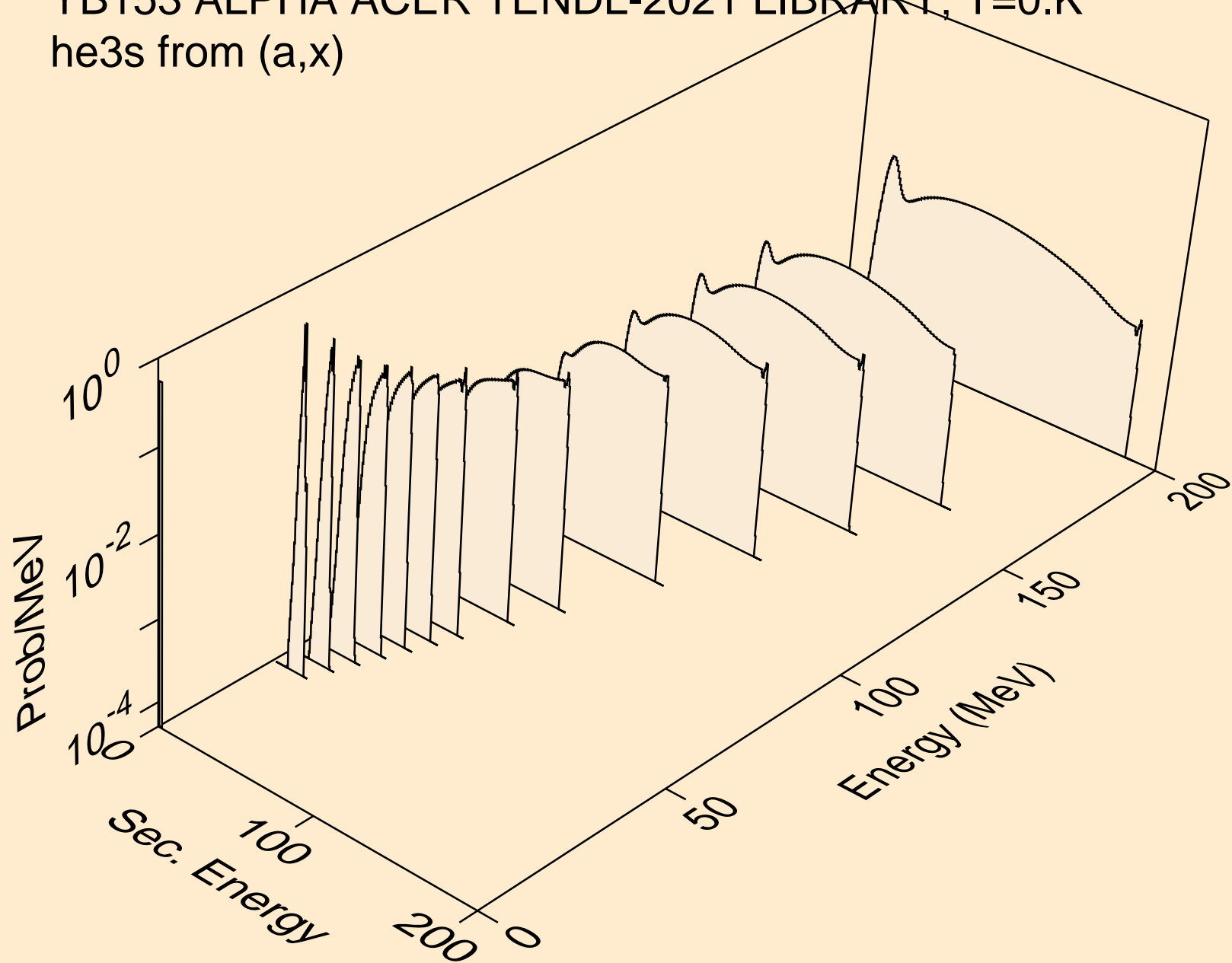

YB153 ALPHA ACER TENDL-2021 LIBRARY; T=0.K  
he3s from (a,he3)

