

# YB156 ALPHA ACER TENDL-2021 LIBRARY; T=0.K

## Principal cross sections

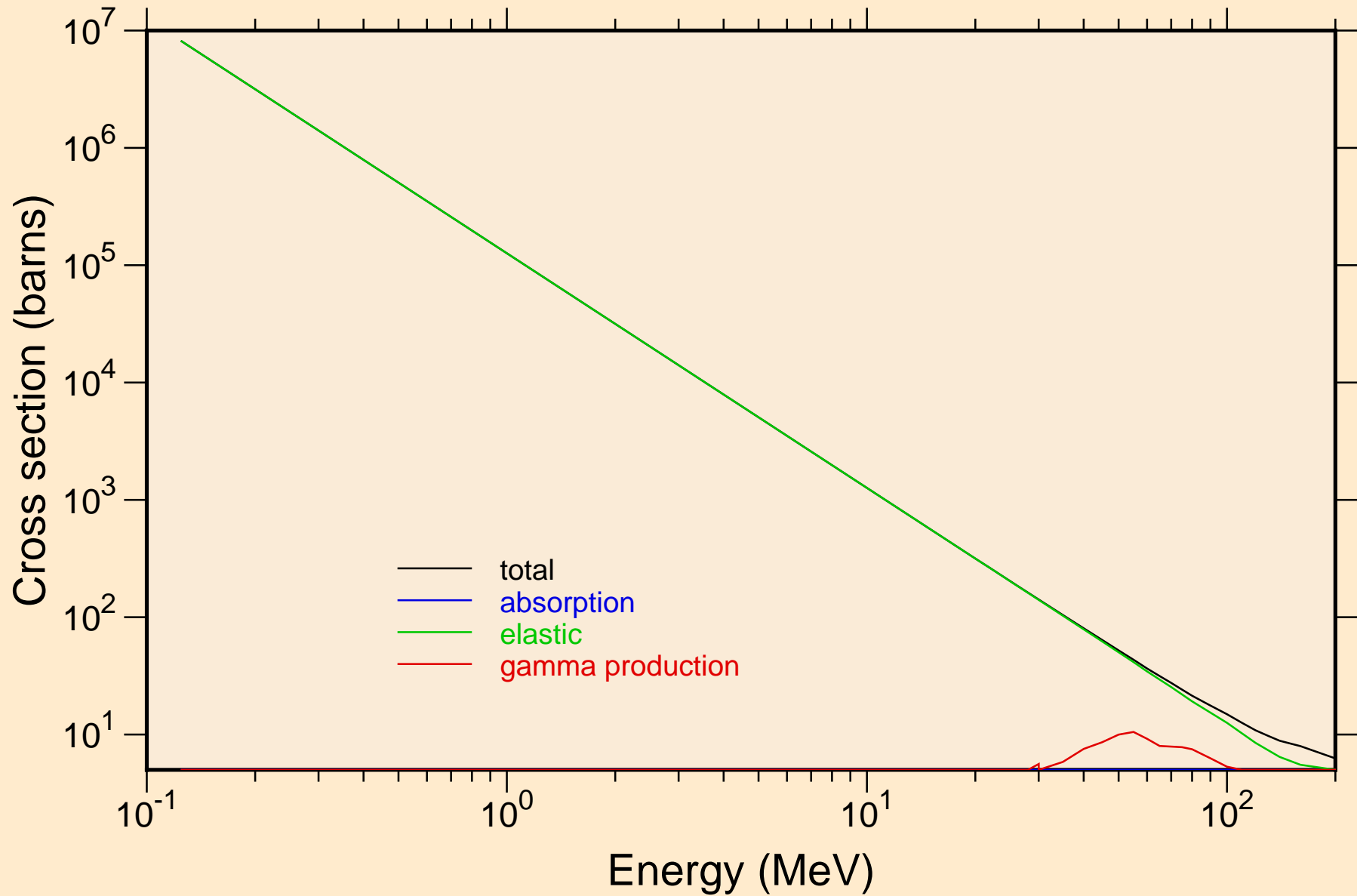

YB156 ALPHA ACER TENDL-2021 LIBRARY; T=0.K

Heating

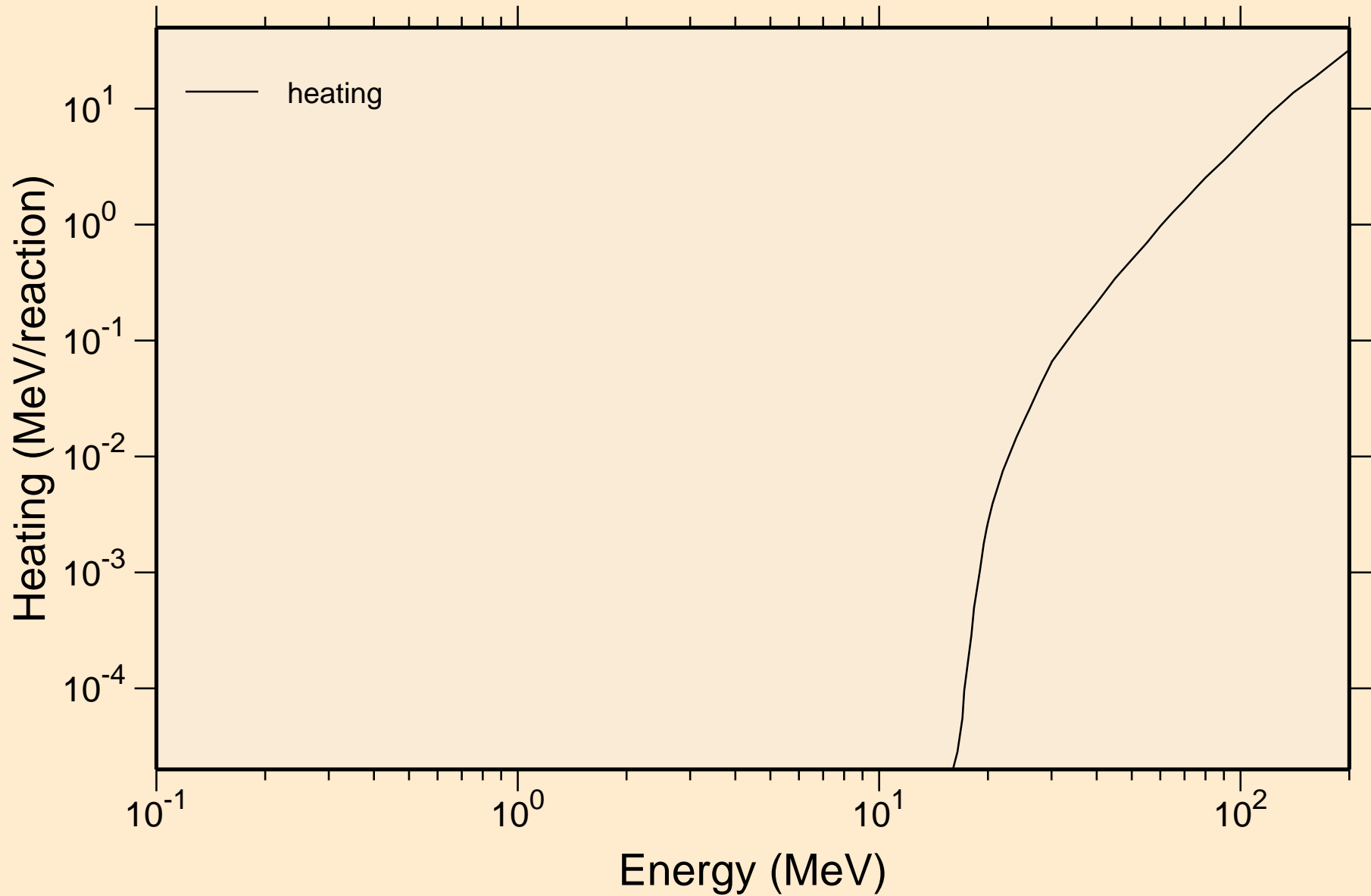

# YB156 ALPHA ACER TENDL-2021 LIBRARY; T=0.K

## Principal cross sections

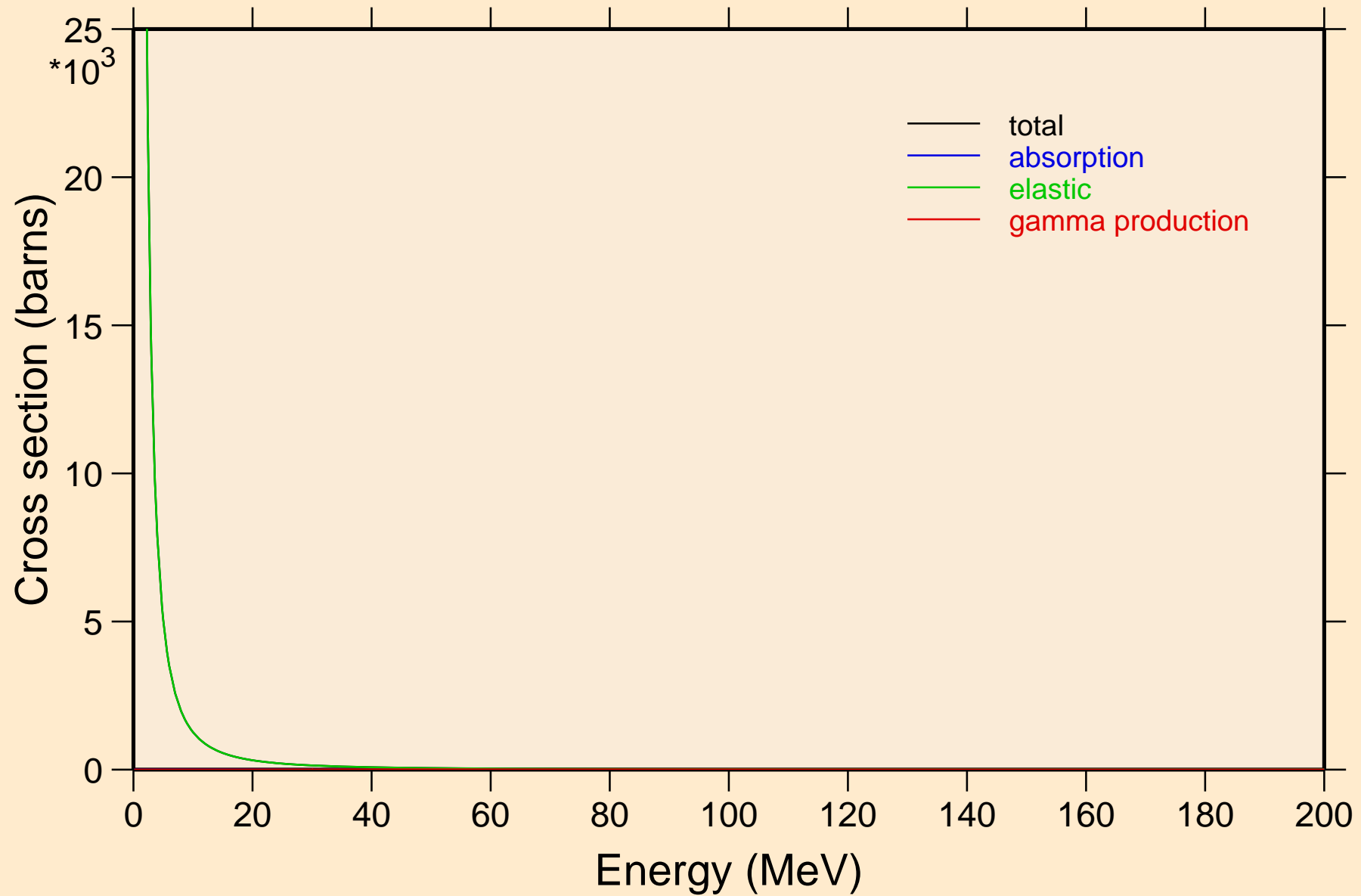

YB156 ALPHA ACER TENDL-2021 LIBRARY; T=0.K

Heating

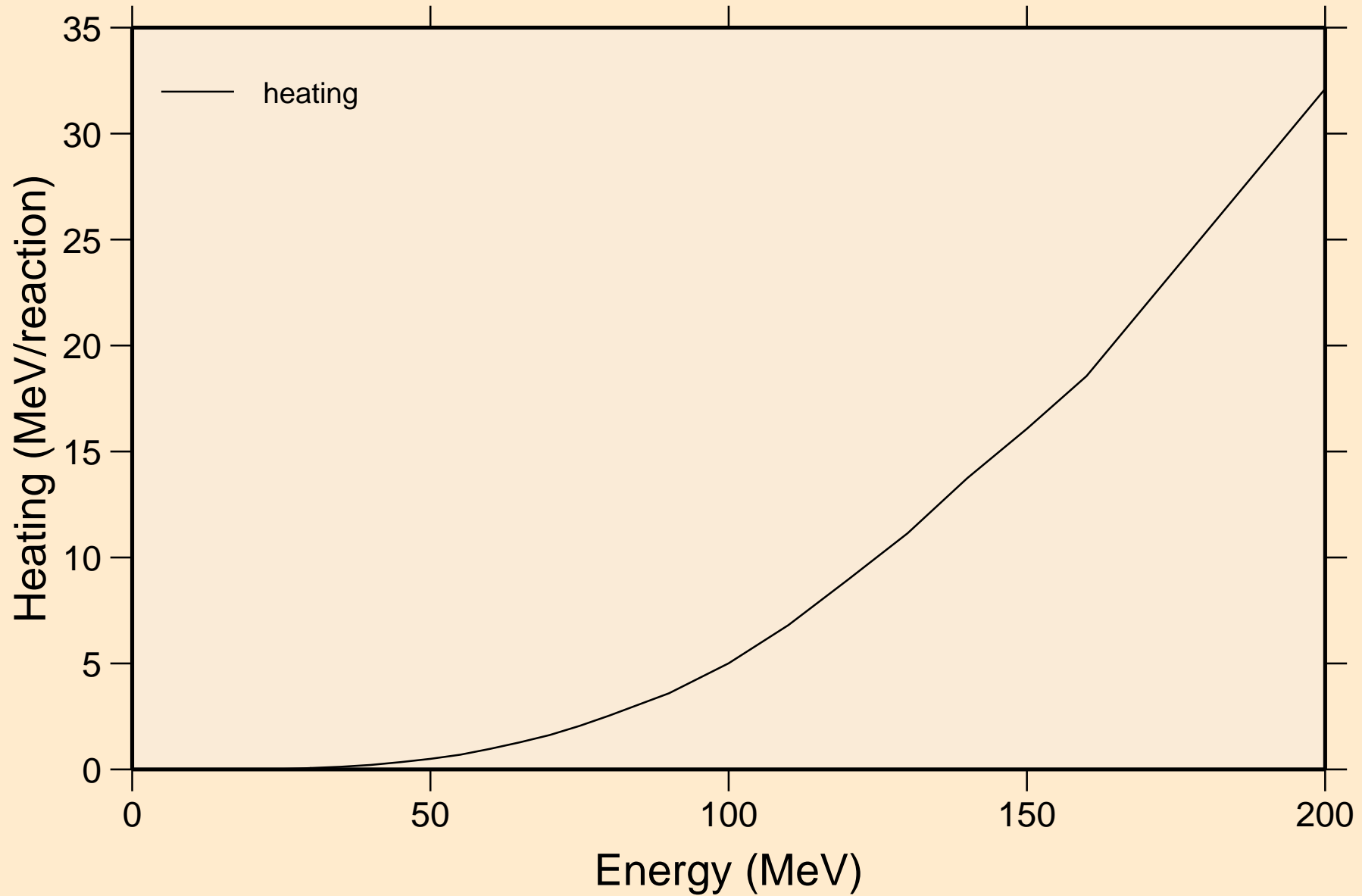

YB156 ALPHA ACER TENDL-2021 LIBRARY; T=0.K  
Threshold reactions

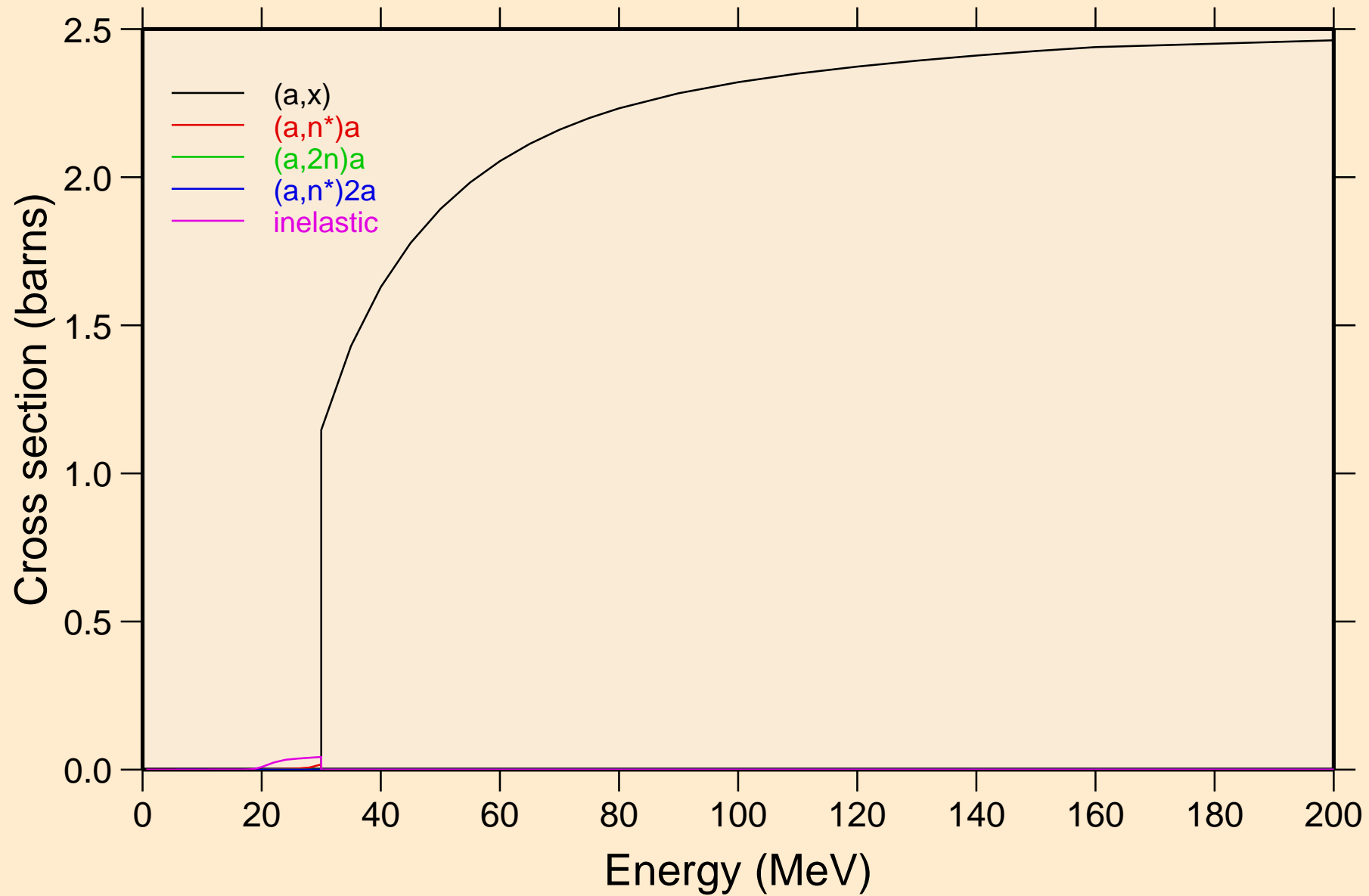

YB156 ALPHA ACER TENDL-2021 LIBRARY; T=0.K  
Threshold reactions

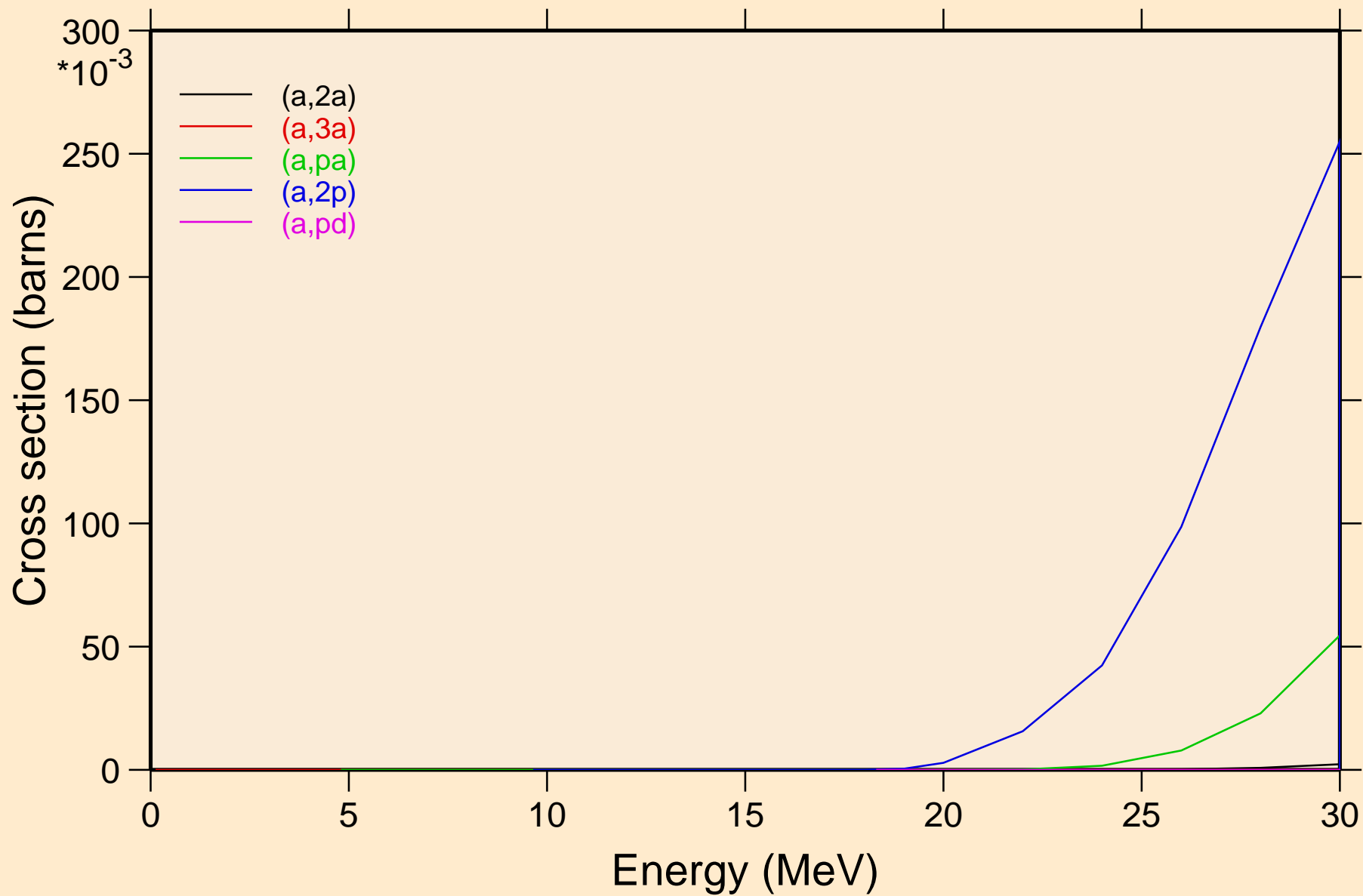

YB156 ALPHA ACER TENDL-2021 LIBRARY; T=0.K  
angular distribution for elastic

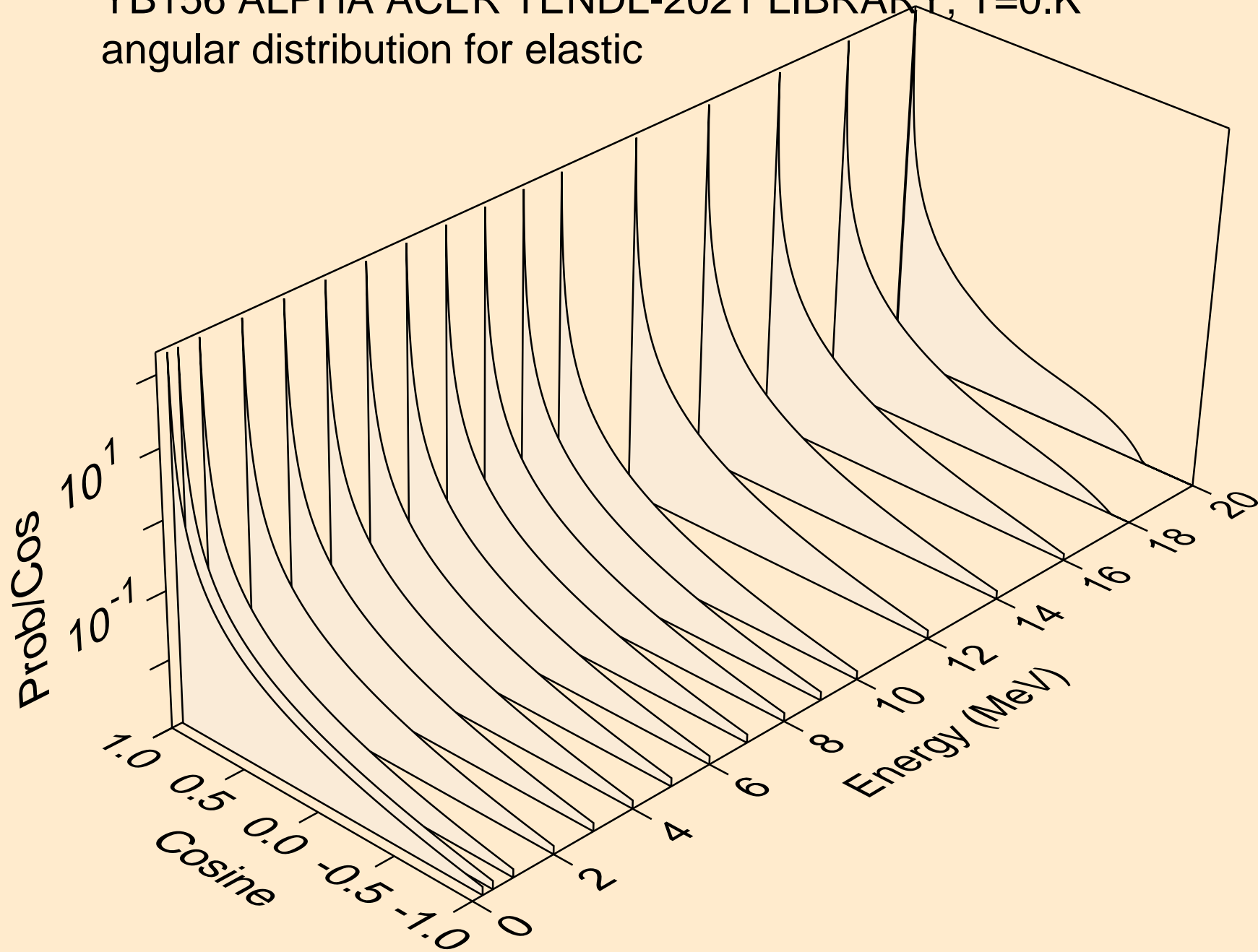

YB156 ALPHA ACER TENDL-2021 LIBRARY; T=0.K  
angular distribution for elastic

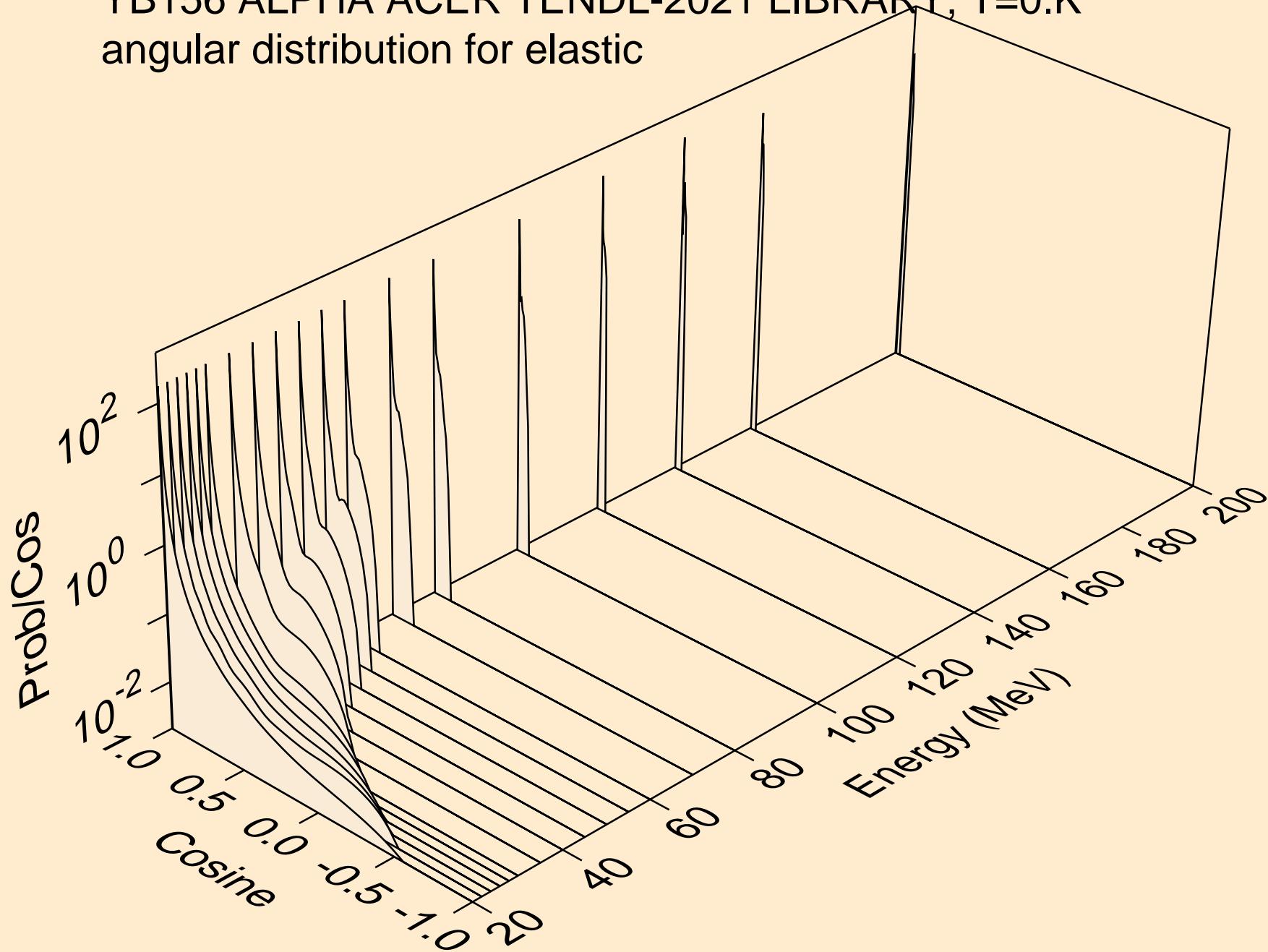

YB156 ALPHA ACER TENDL-2021 LIBRARY; T=0.K

Alpha emission for (a,x)

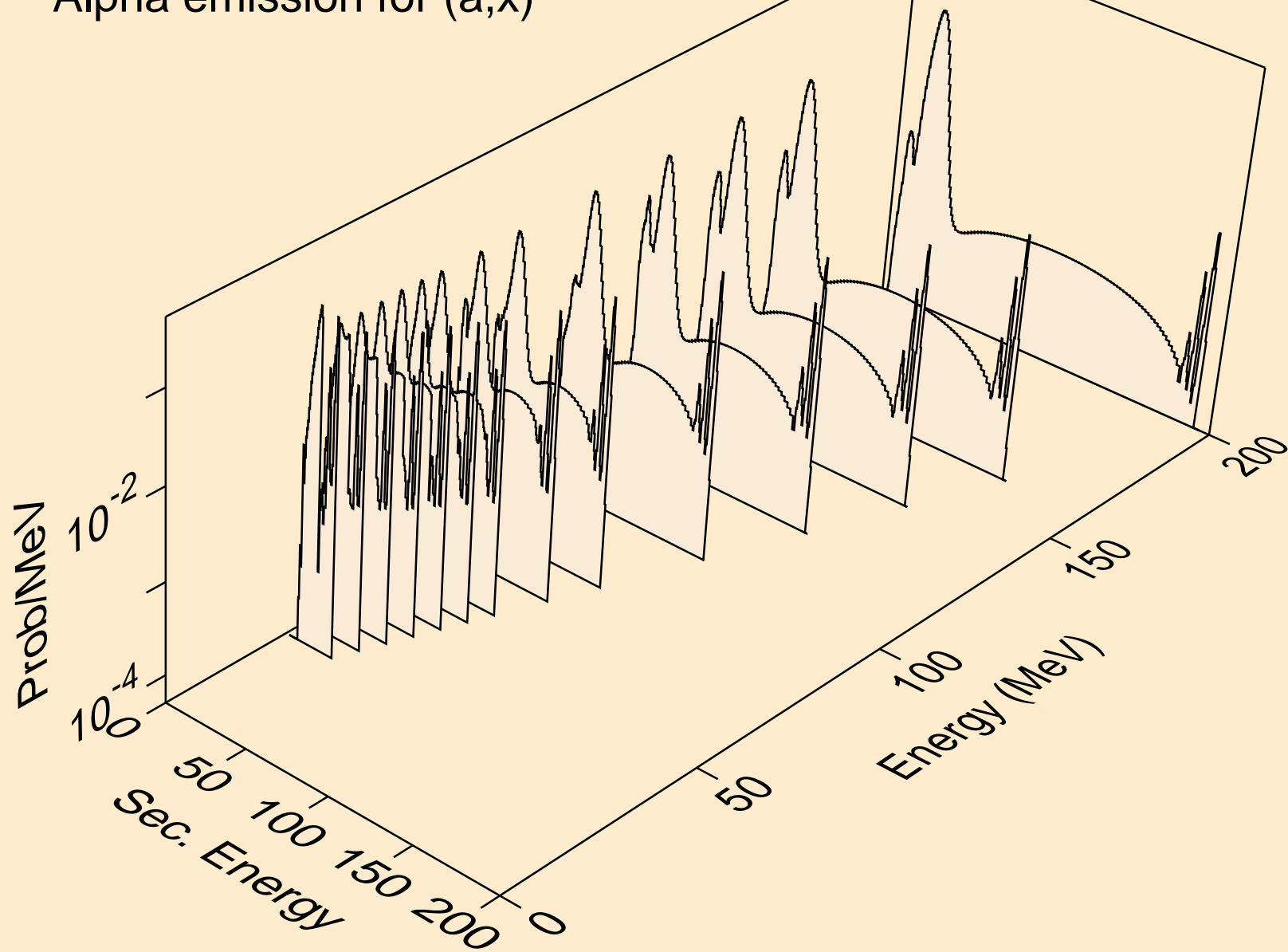

YB156 ALPHA ACER TENDL-2021 LIBRARY; T=0.K  
Alpha emission for (a,n\*)a

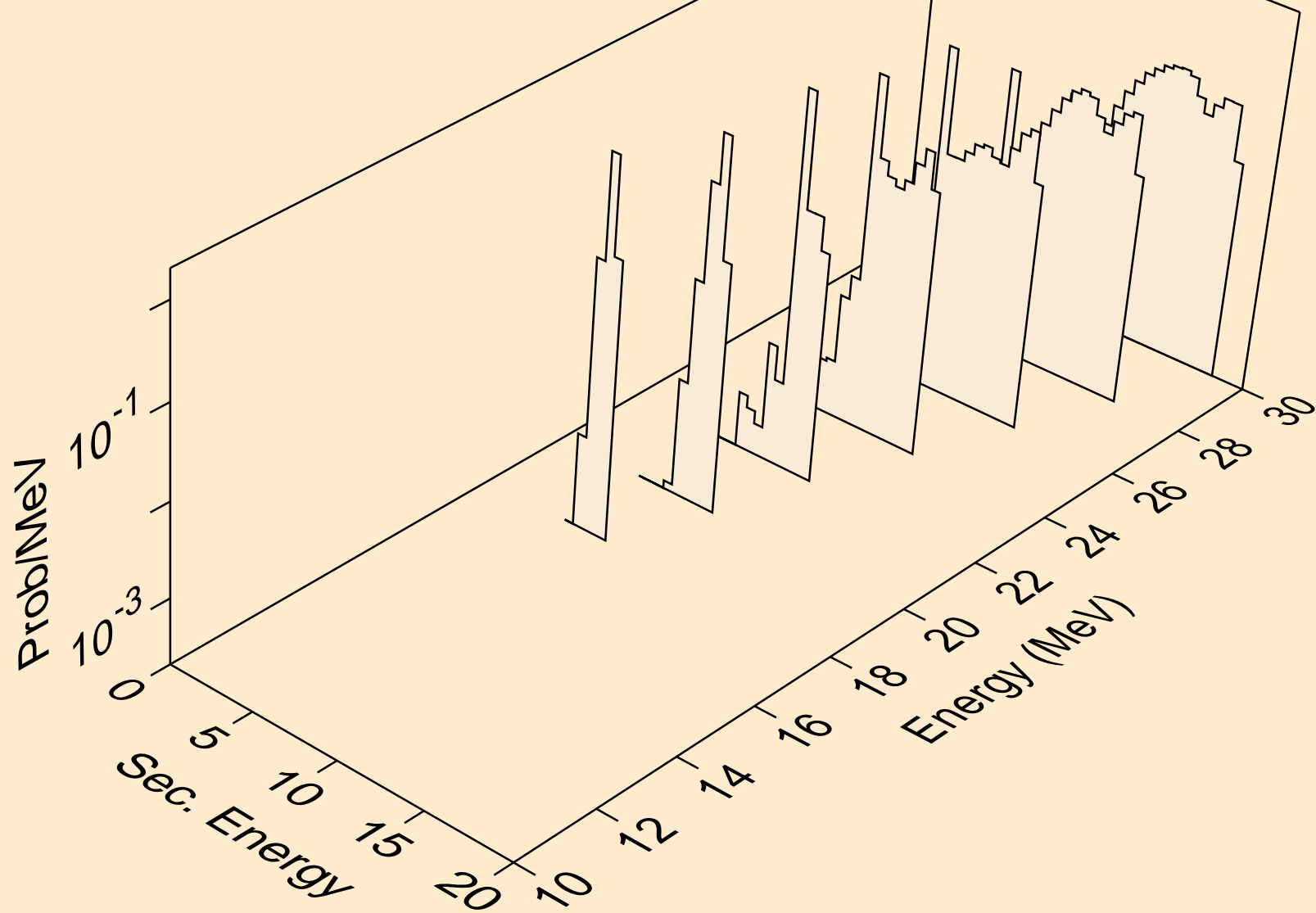

YB156 ALPHA ACER TENDL-2021 LIBRARY; T=0.K  
Alpha emission for (a,2n)a

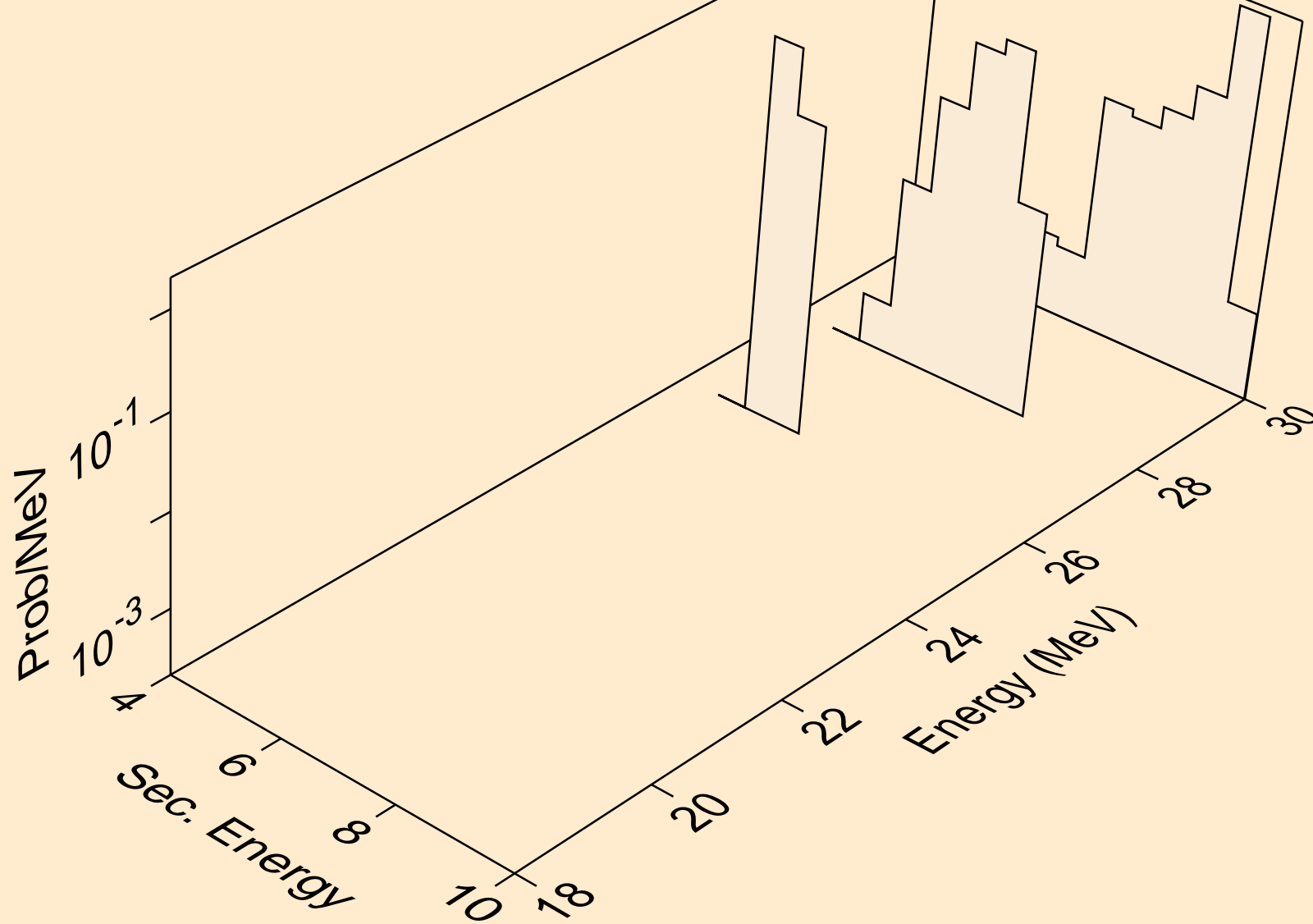

YB156 ALPHA ACER TENDL-2021 LIBRARY; T=0.K

Alpha emission for (a,n\*)2a

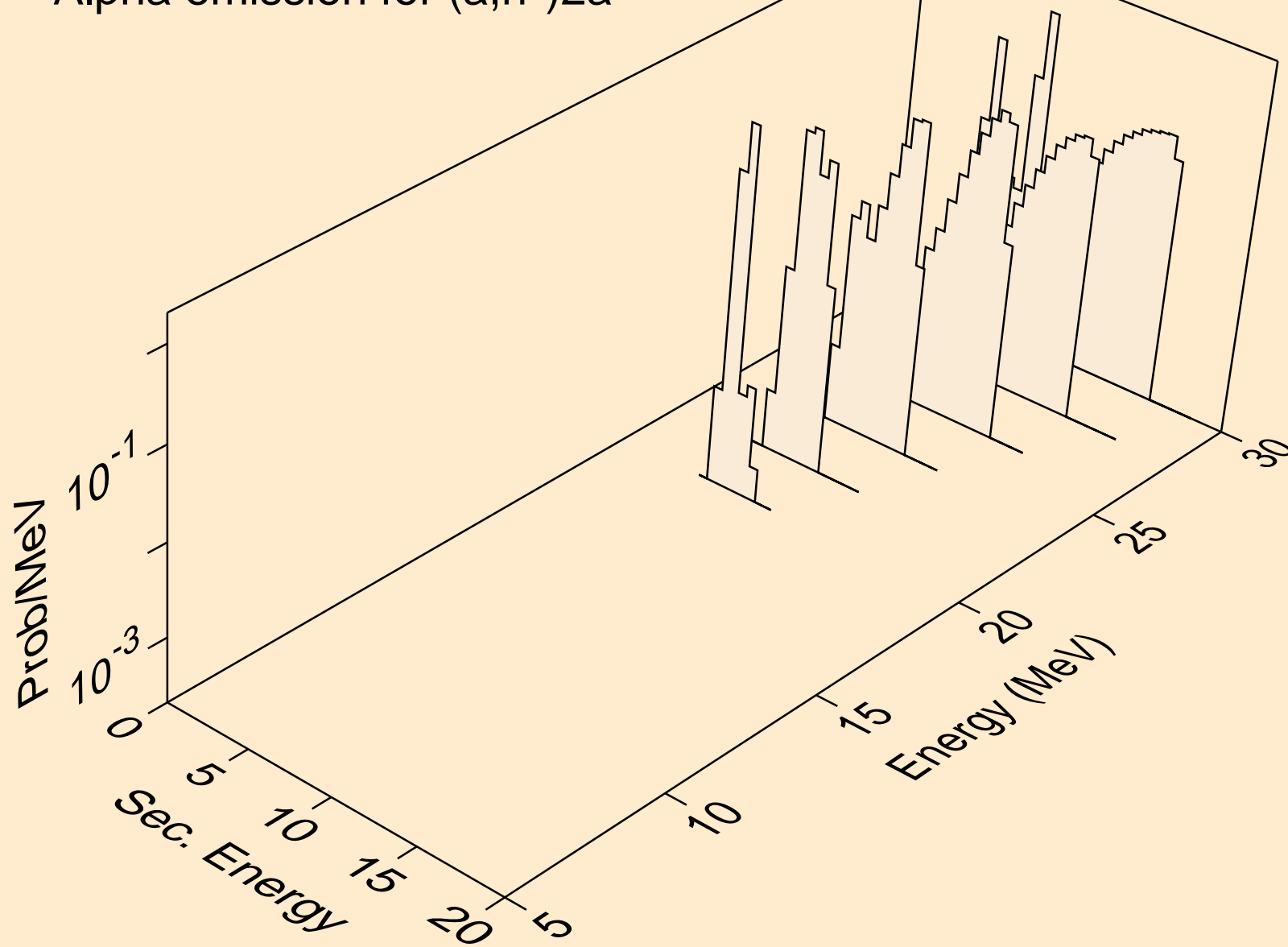

YB156 ALPHA ACER TENDL-2021 LIBRARY; T=0.K  
Alpha emission for inelastic

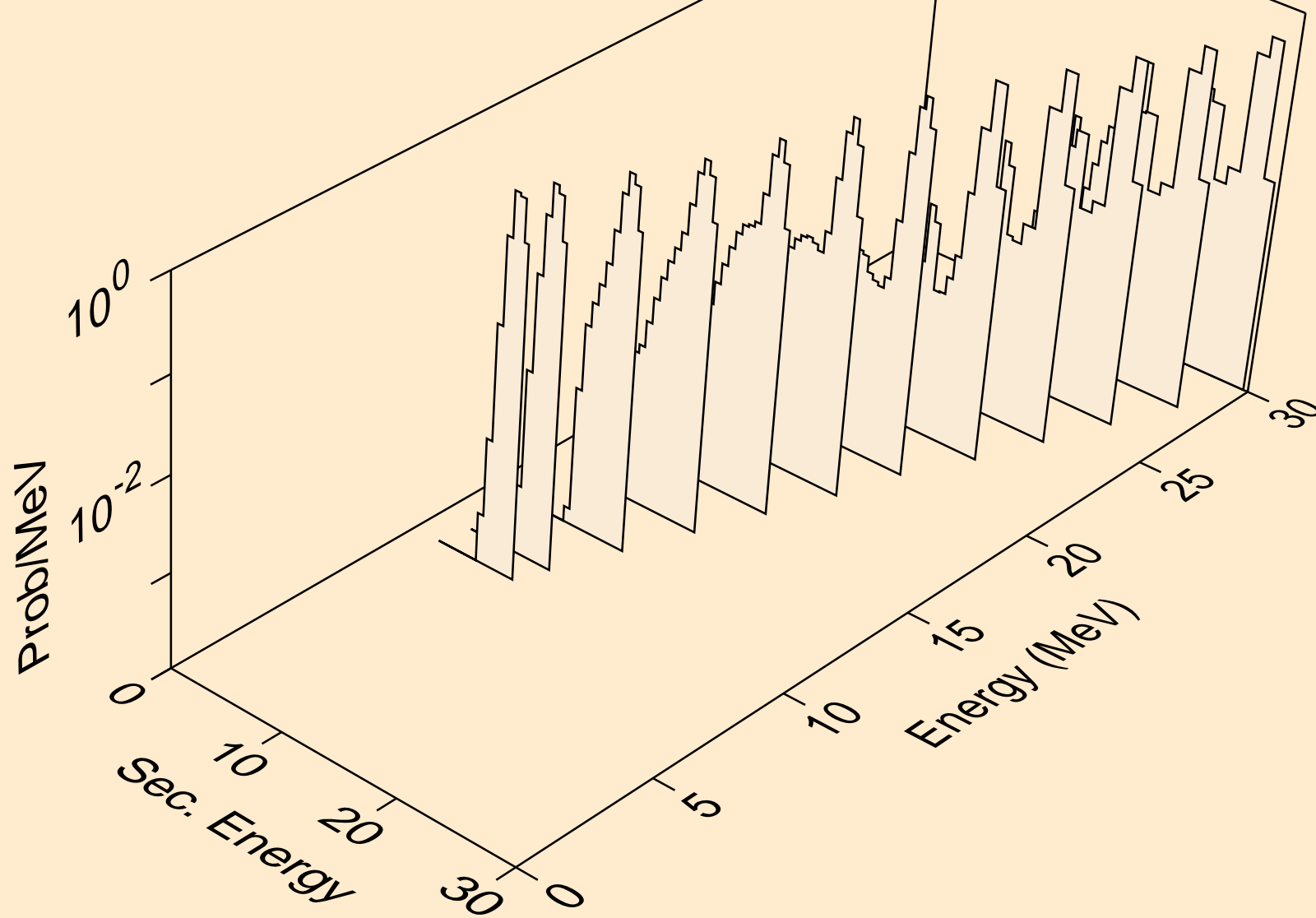

YB156 ALPHA ACER TENDL-2021 LIBRARY; T=0.K  
Alpha emission for (a,2a)

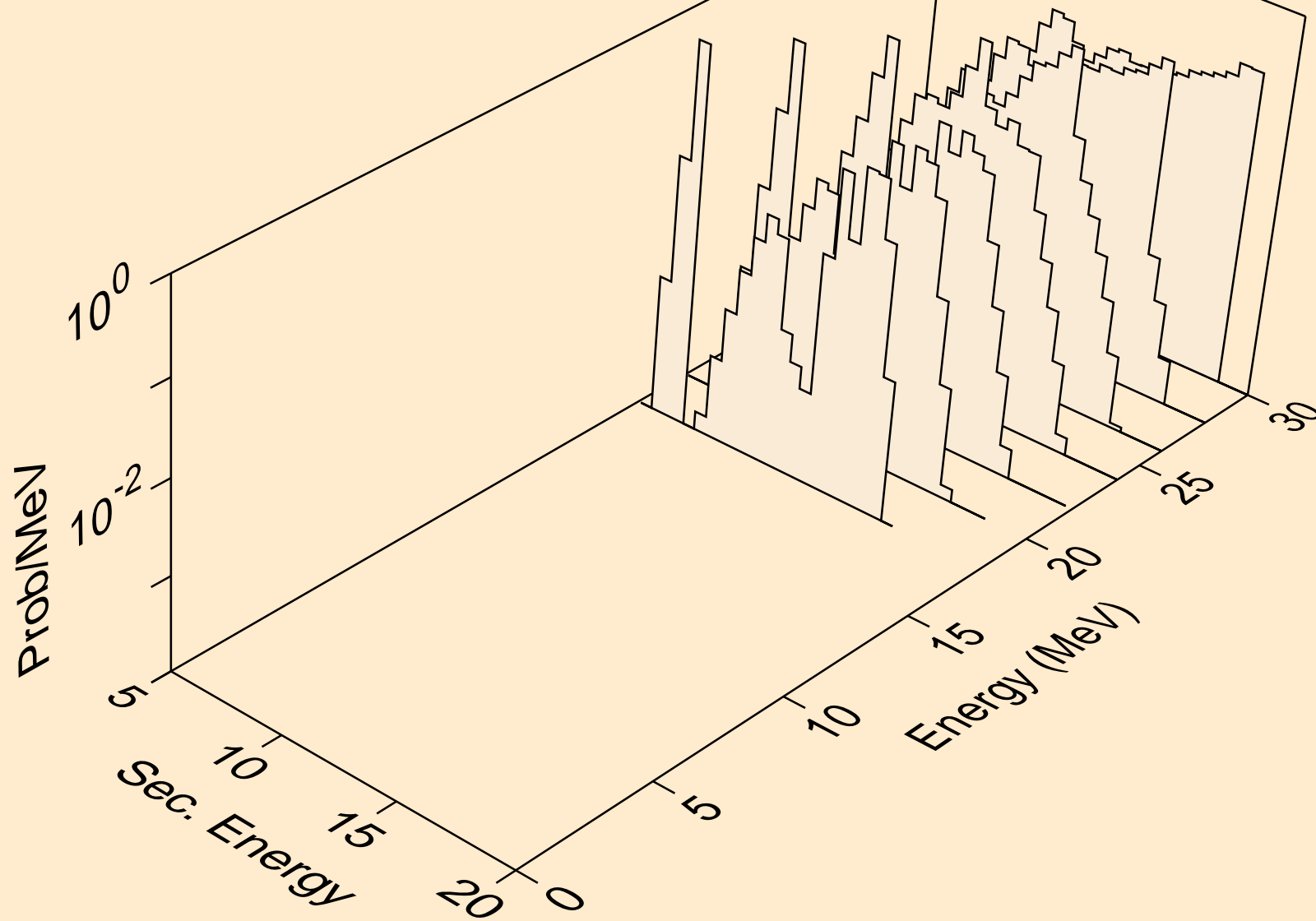

YB156 ALPHA ACER TENDL-2021 LIBRARY; T=0.K

Alpha emission for (a,3a)

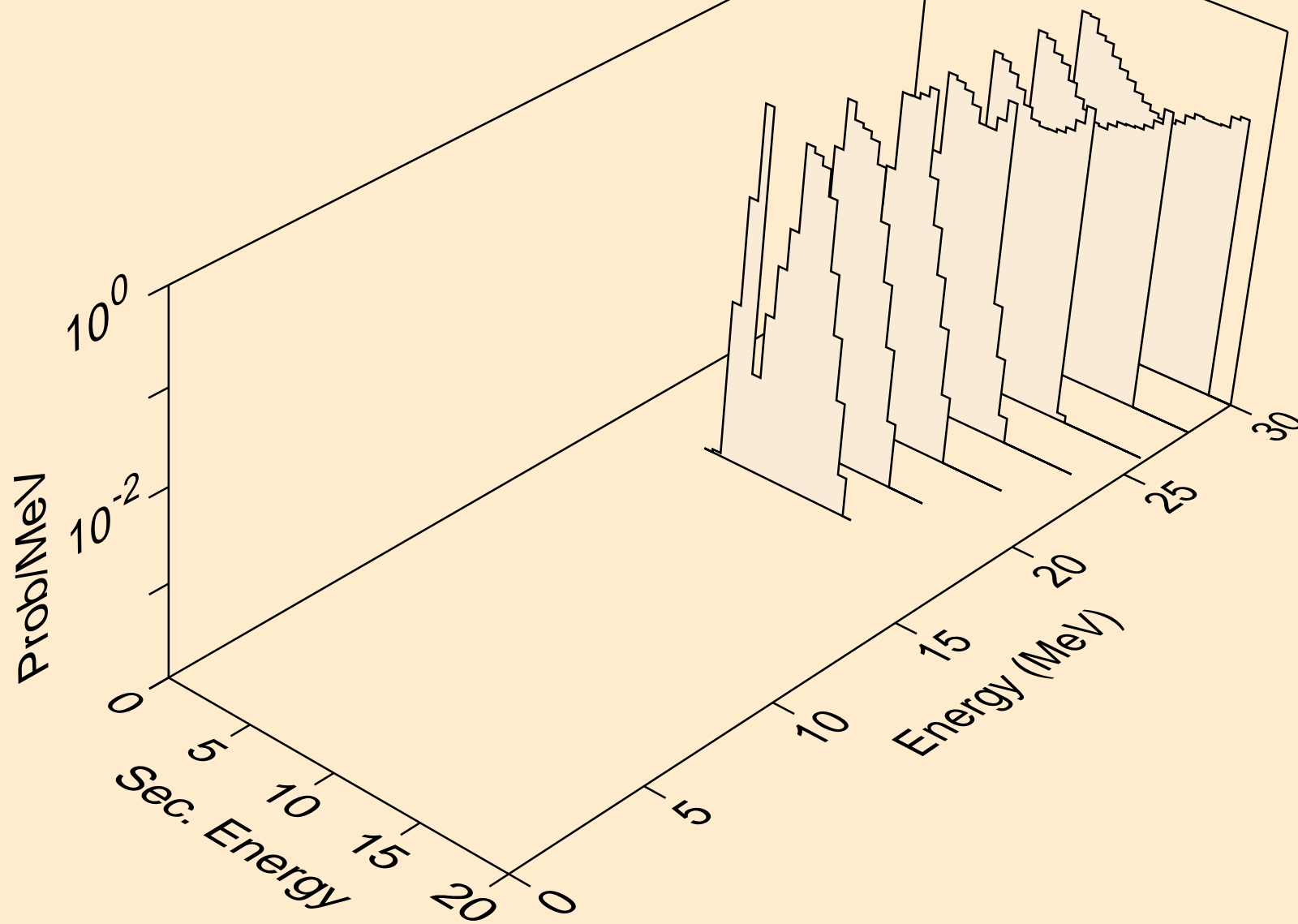

YB156 ALPHA ACER TENDL-2021 LIBRARY; T=0.K  
Alpha emission for (a,pa)

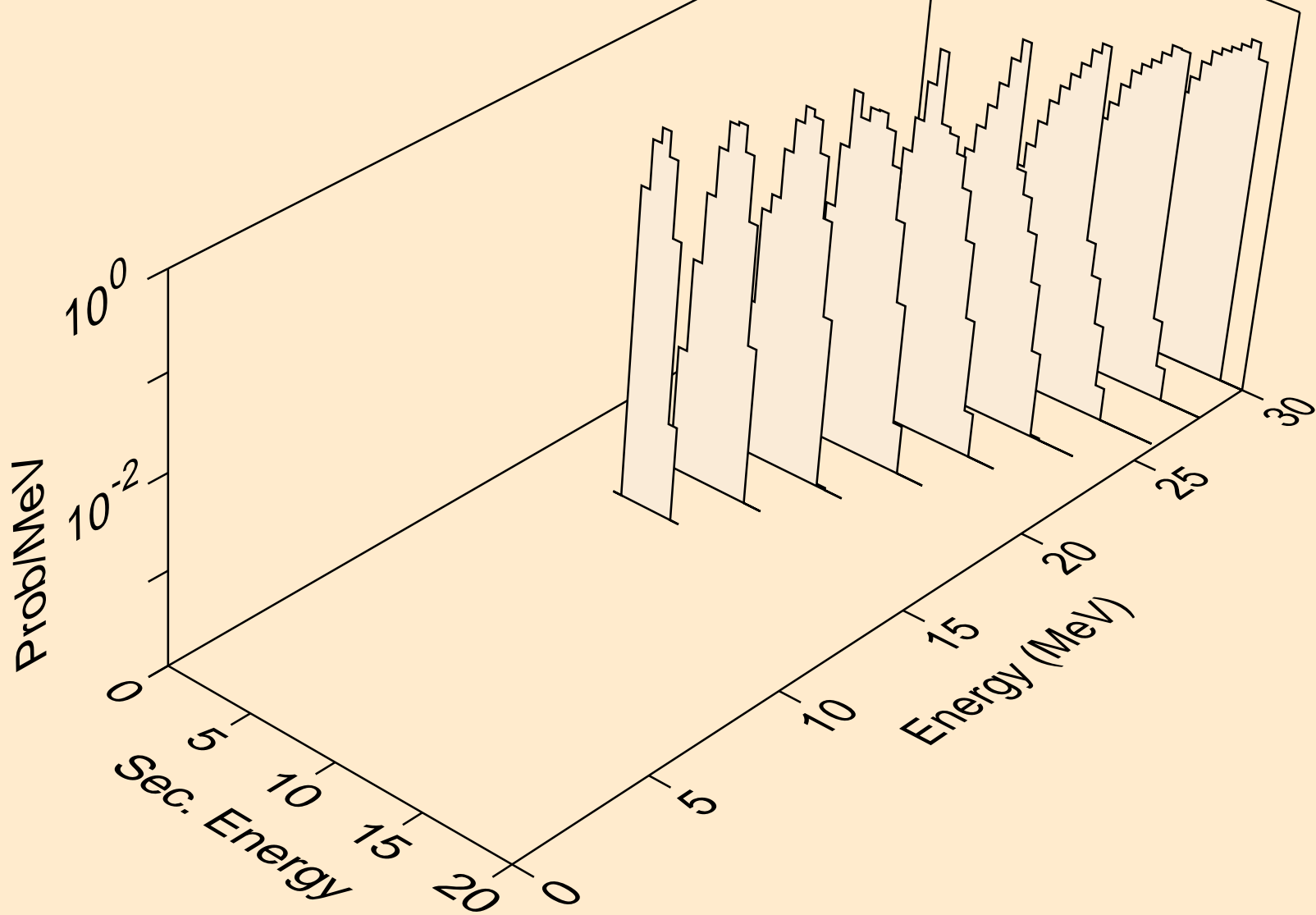

YB156 ALPHA ACER TENDL-2021 LIBRARY; T=0.K  
Photon emission for (z,n)

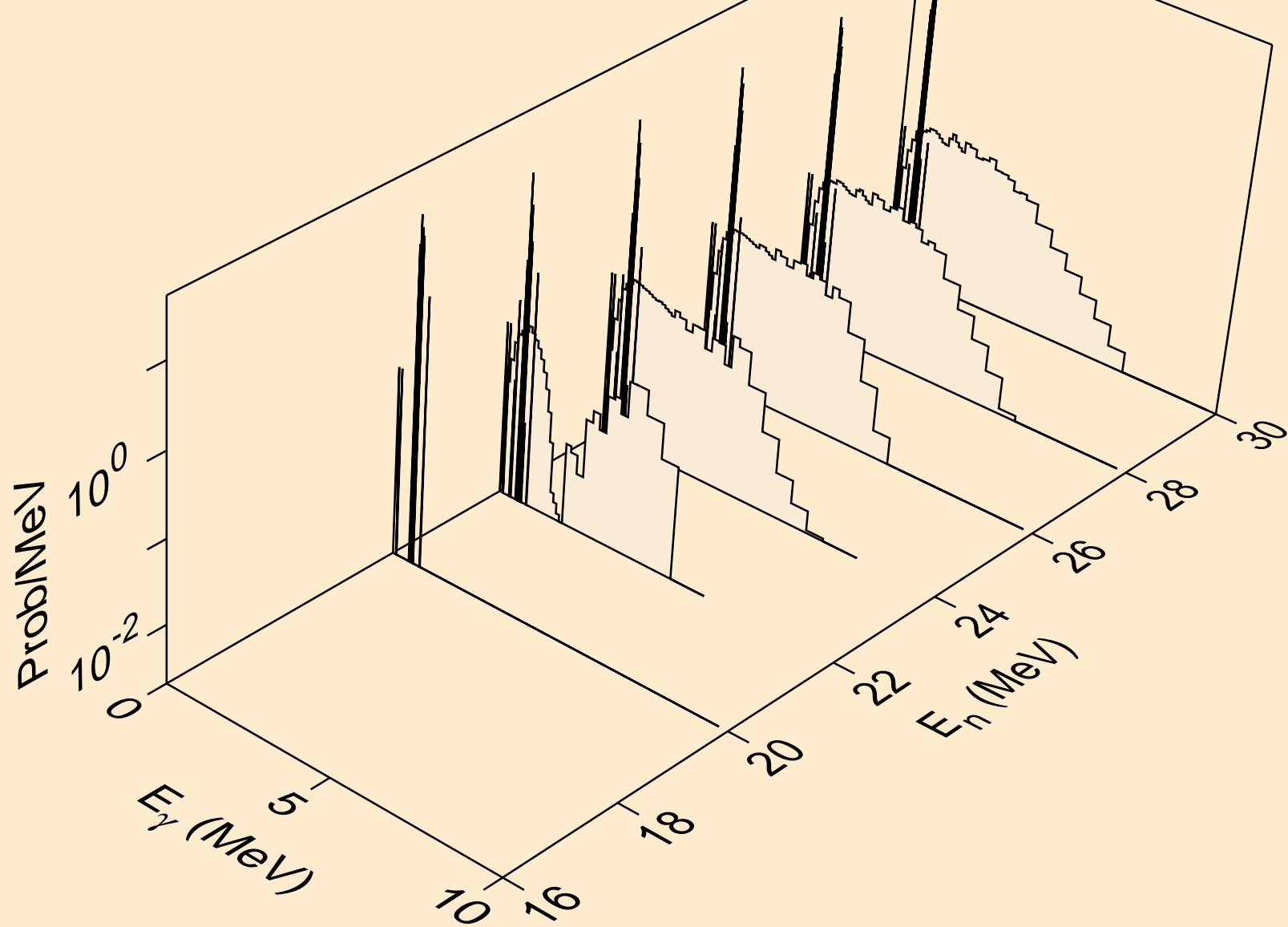

YB156 ALPHA ACER TENDL-2021 LIBRARY; T=0.K  
Photon emission for (n,x)

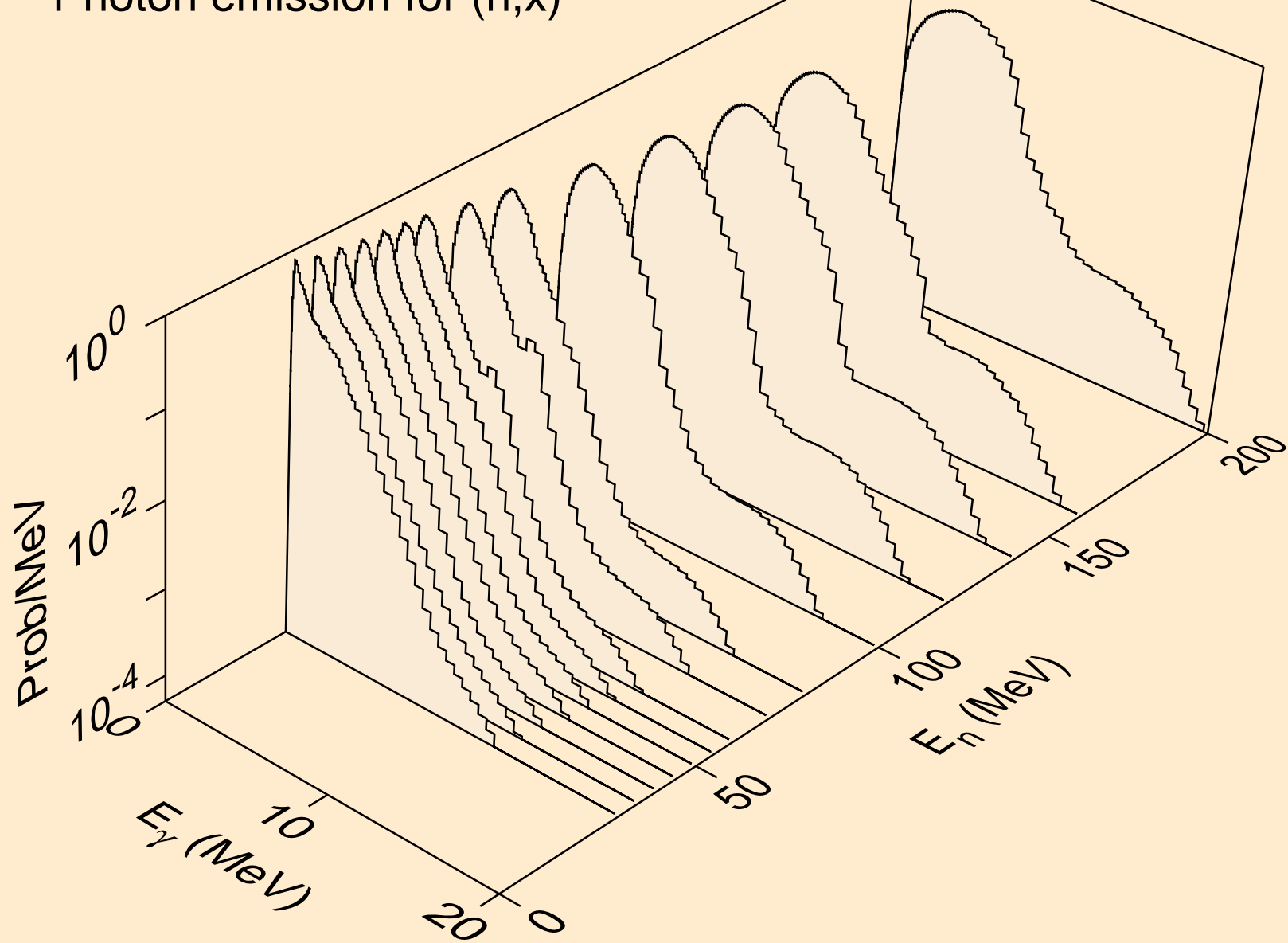

YB156 ALPHA ACER TENDL-2021 LIBRARY; T=0.K  
Photon emission for (n,2n)

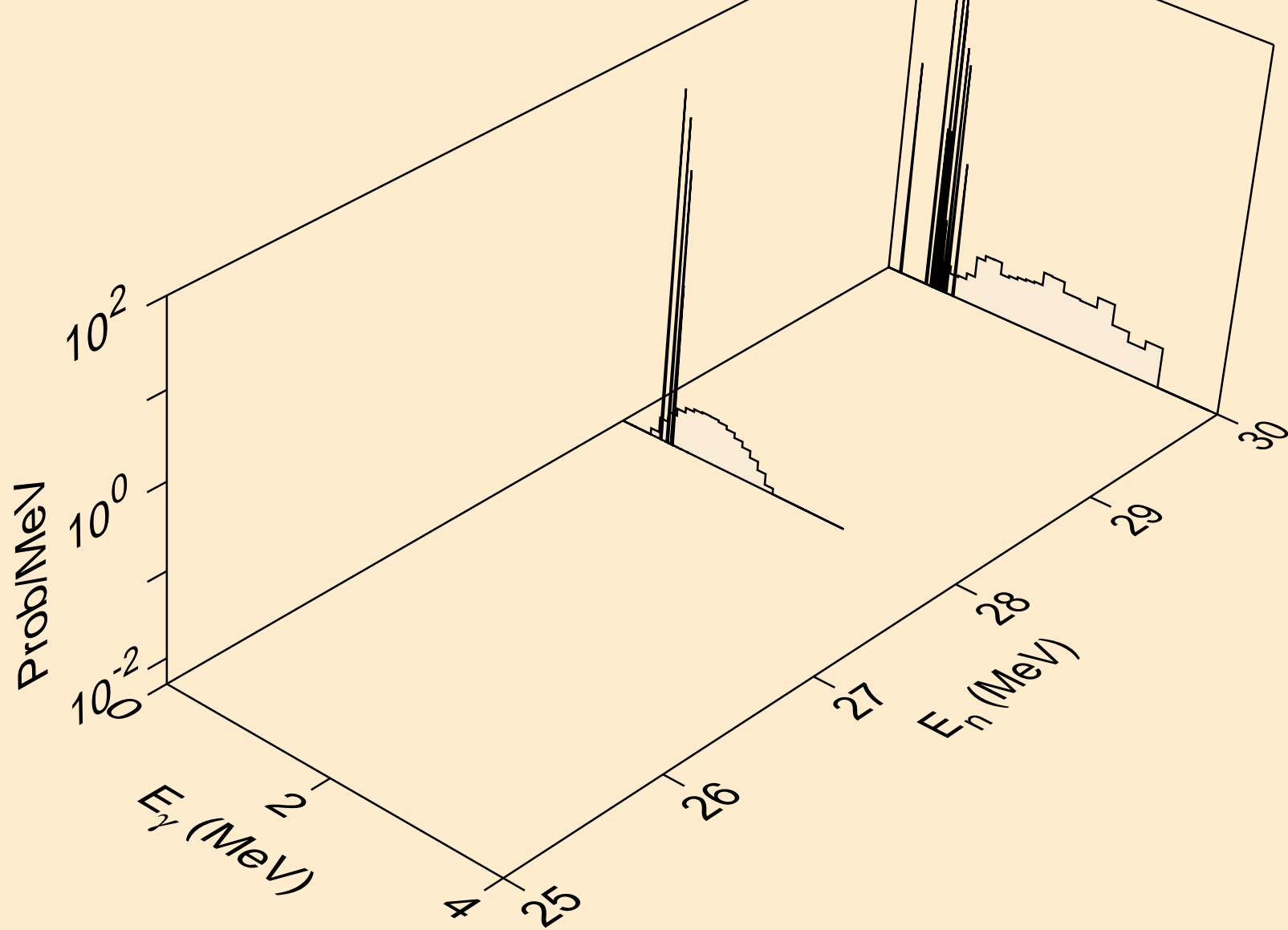

YB156 ALPHA ACER TENDL-2021 LIBRARY; T=0.K  
Photon emission for (n,n\*)a

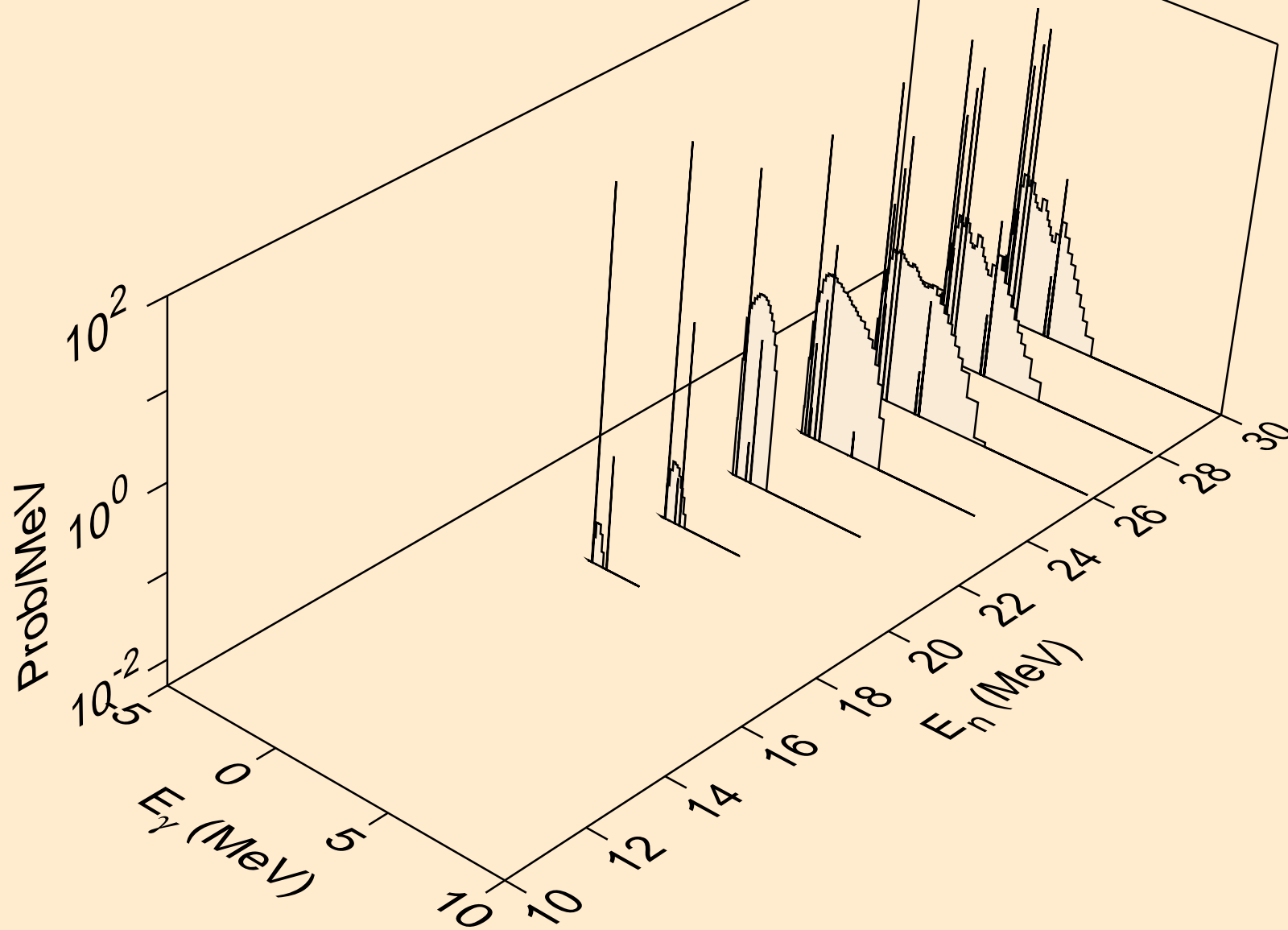

YB156 ALPHA ACER TENDL-2021 LIBRARY; T=0.K  
Photon emission for (n,2n)a

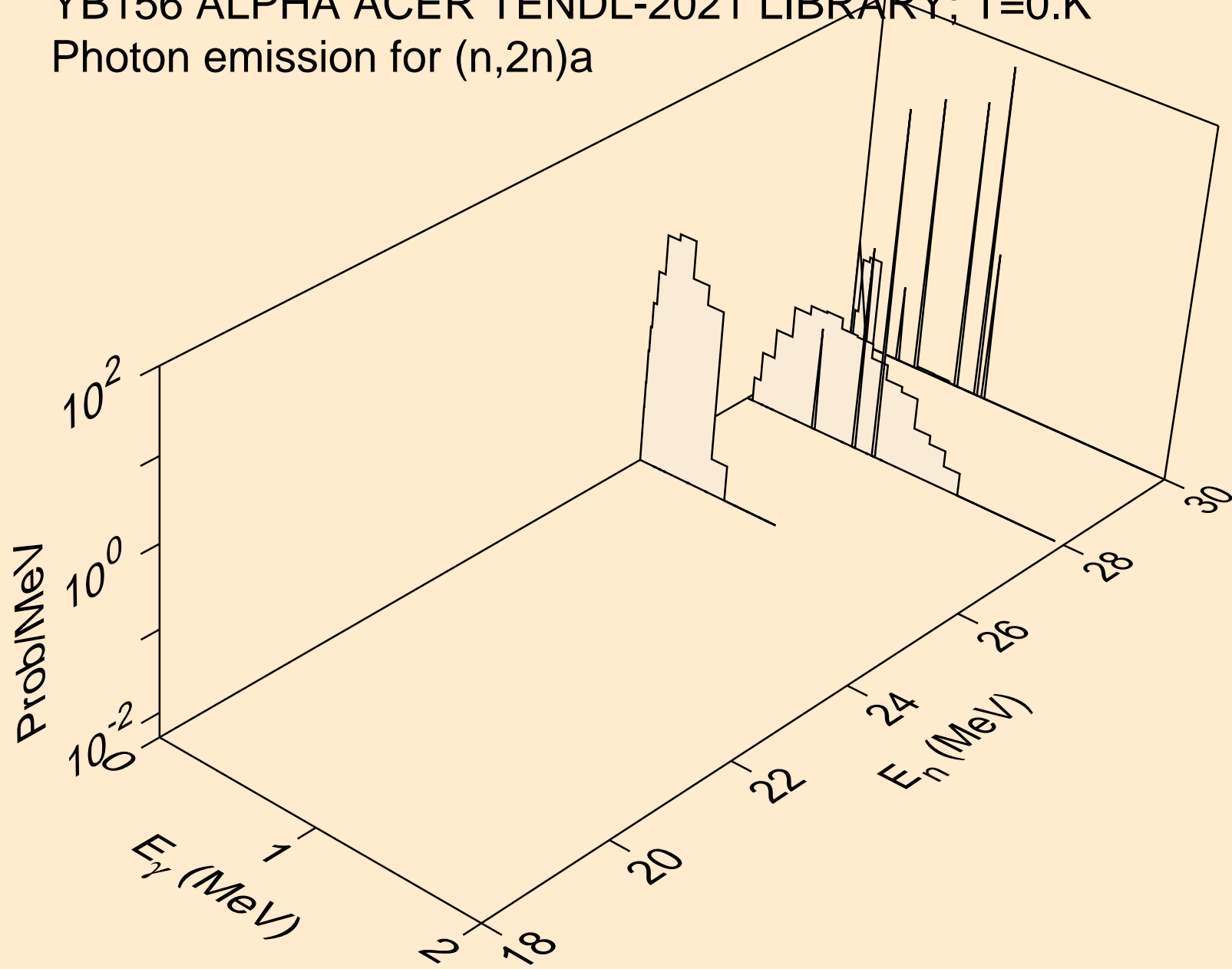

YB156 ALPHA ACER TENDL-2021 LIBRARY; T=0.K  
Photon emission for (n,n\*)p

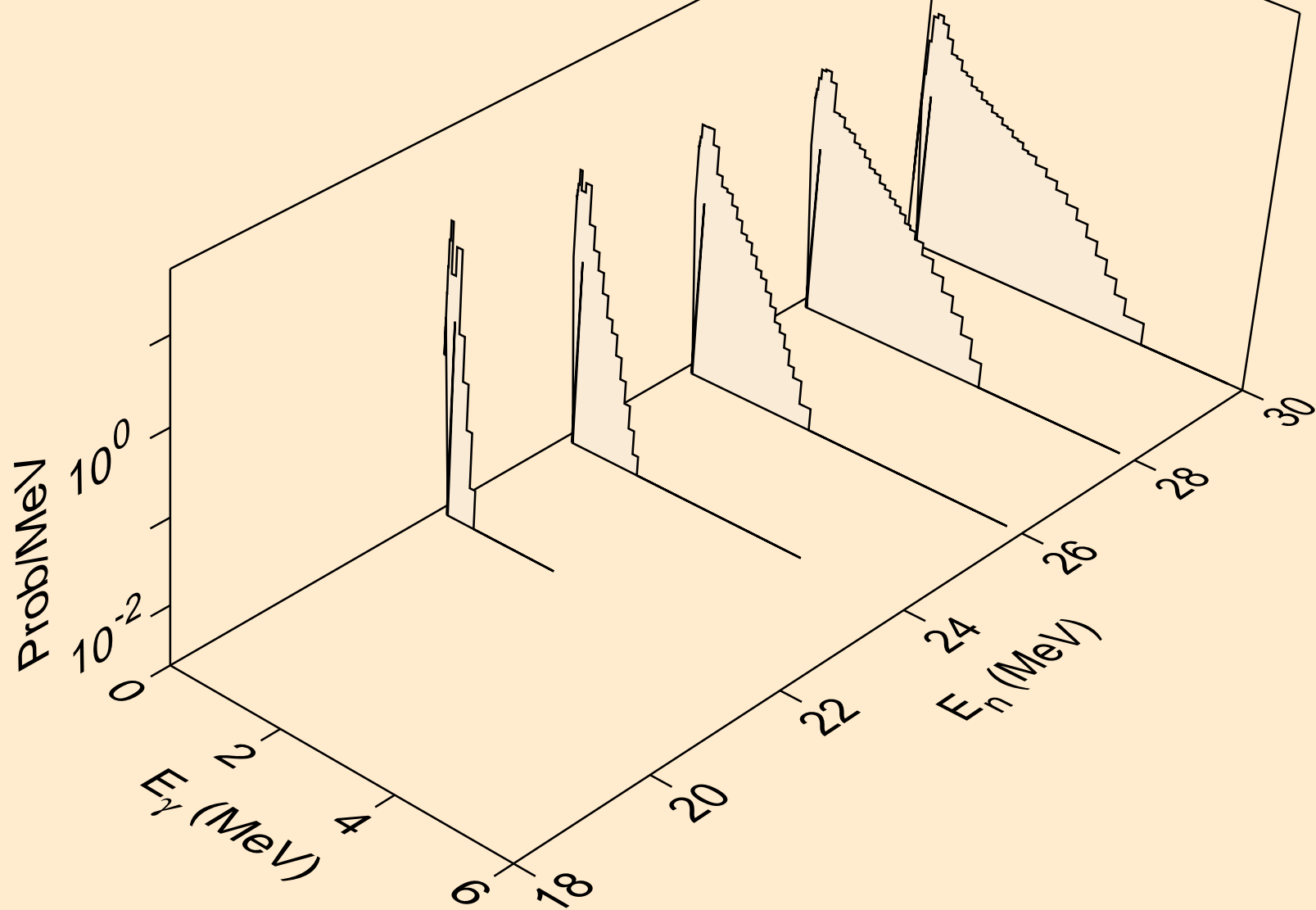

YB156 ALPHA ACER TENDL-2021 LIBRARY; T=0.K  
Photon emission for (n,n\*)2a

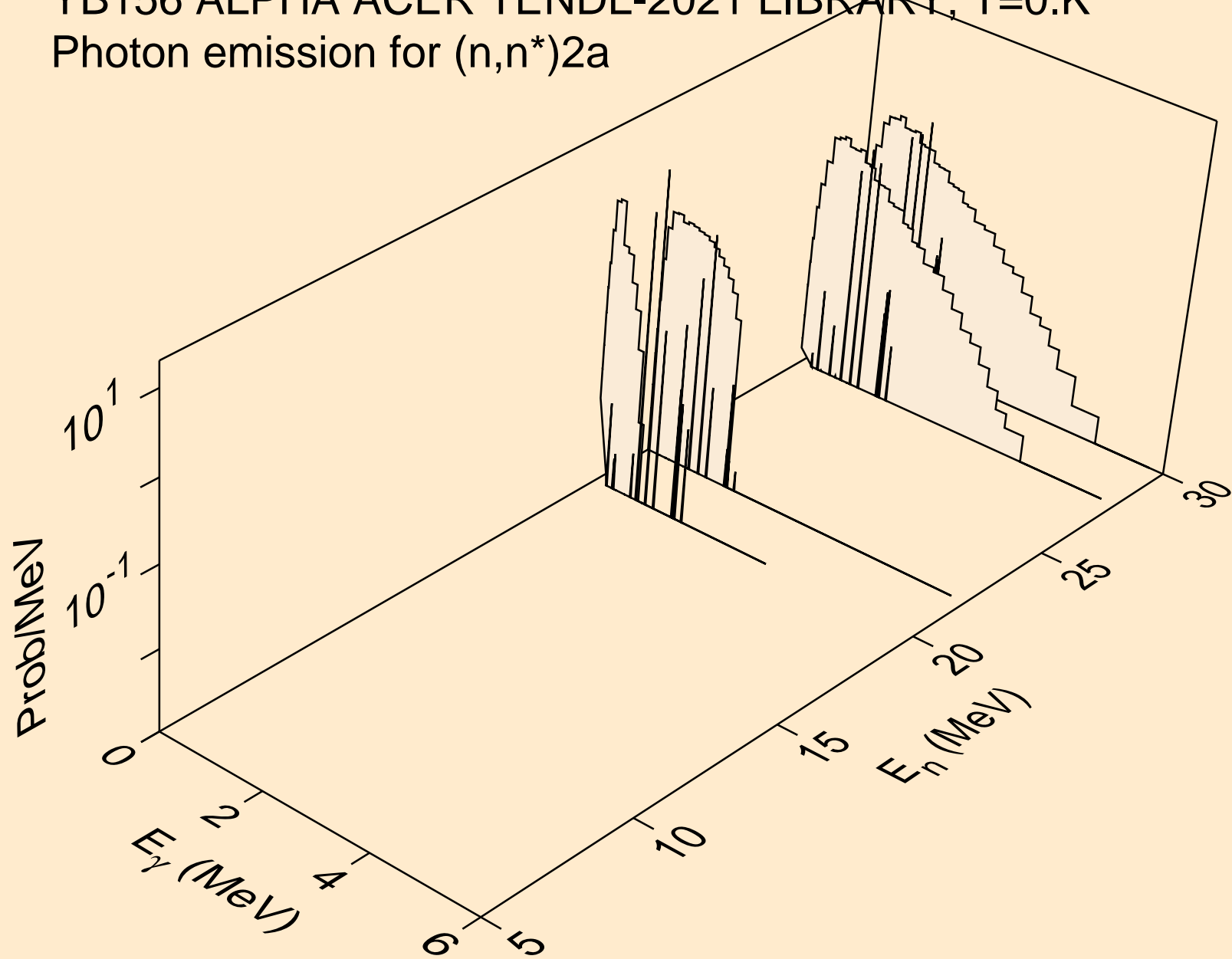

YB156 ALPHA ACER TENDL-2021 LIBRARY; T=0.K  
Photon emission for (n,2np)

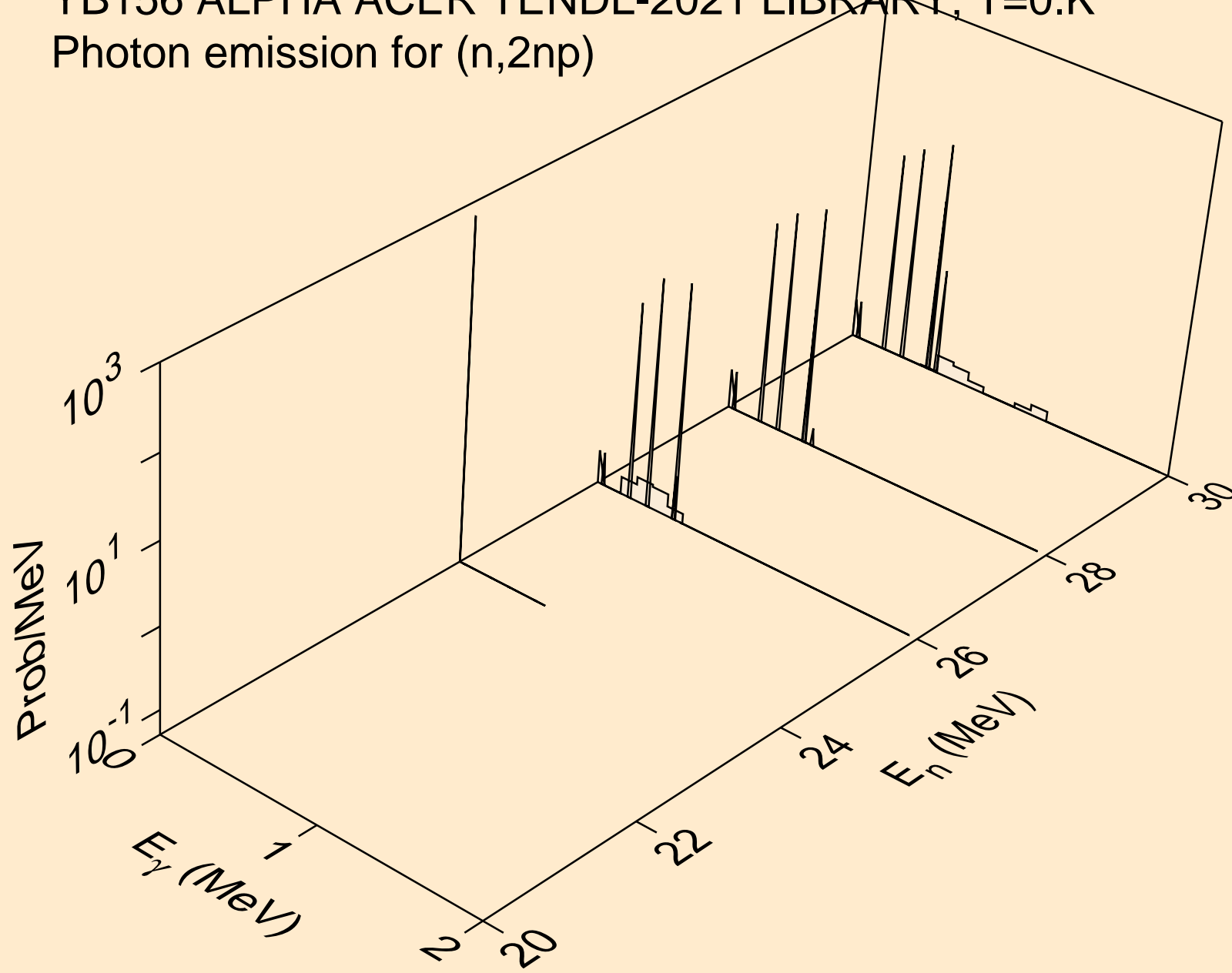

YB156 ALPHA ACER TENDL-2021 LIBRARY; T=0.K  
Photon emission for (n,npa)

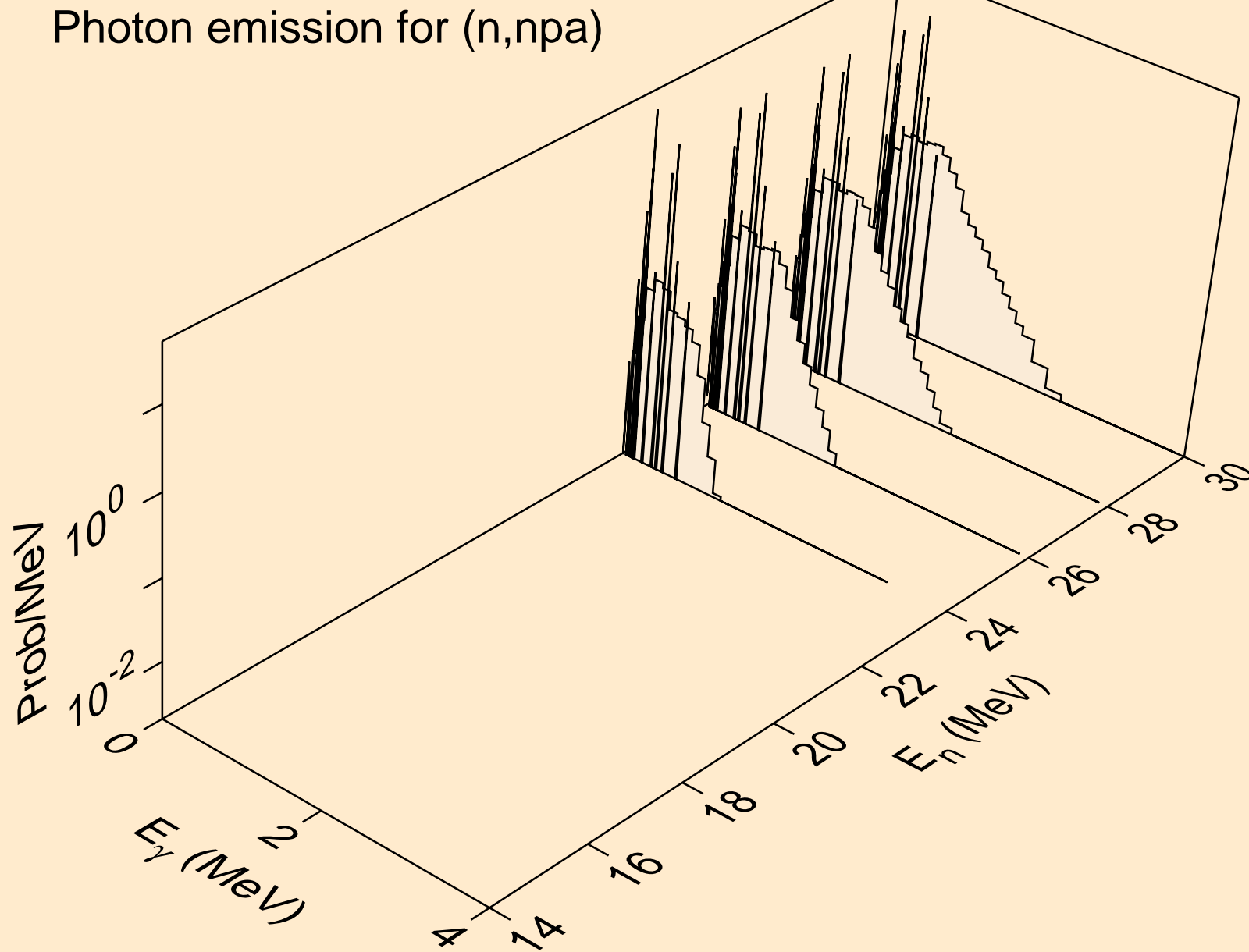

YB156 ALPHA ACER TENDL-2021 LIBRARY; T=0.K  
Photon emission for (n,gma)

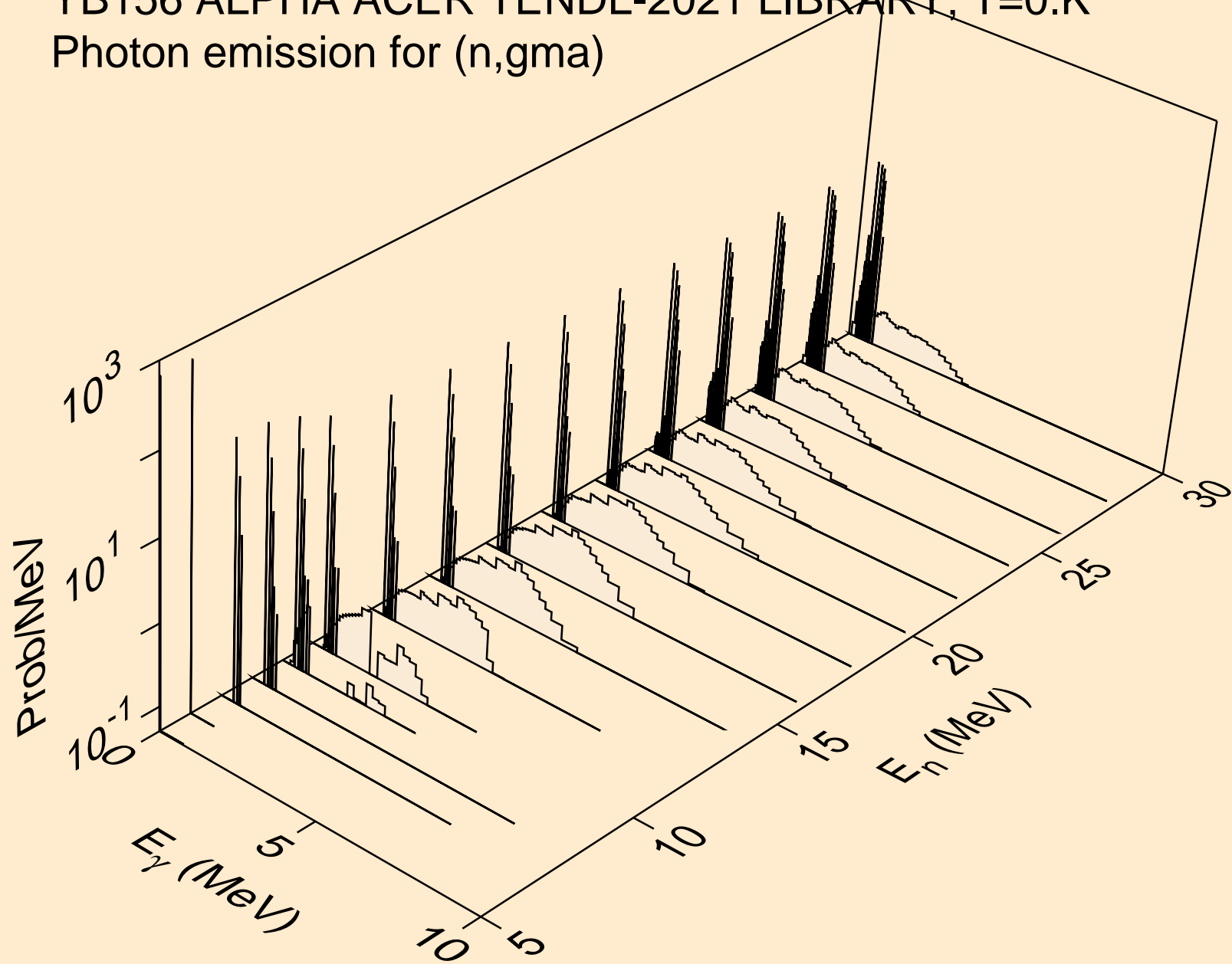

YB156 ALPHA ACER TENDL-2021 LIBRARY; T=0.K  
Photon emission for (n,p)

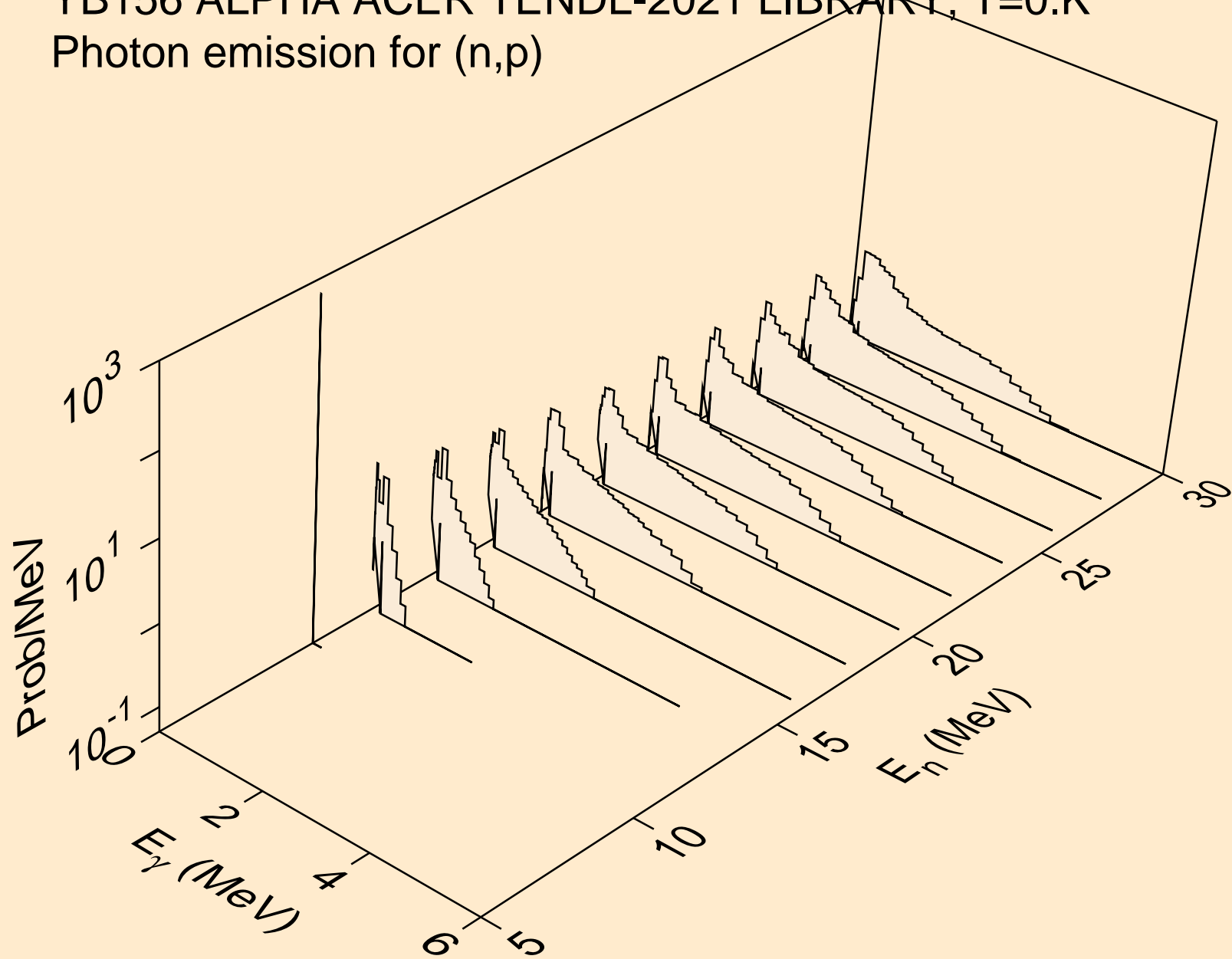

YB156 ALPHA ACER TENDL-2021 LIBRARY; T=0.K  
Photon emission for (n,d)

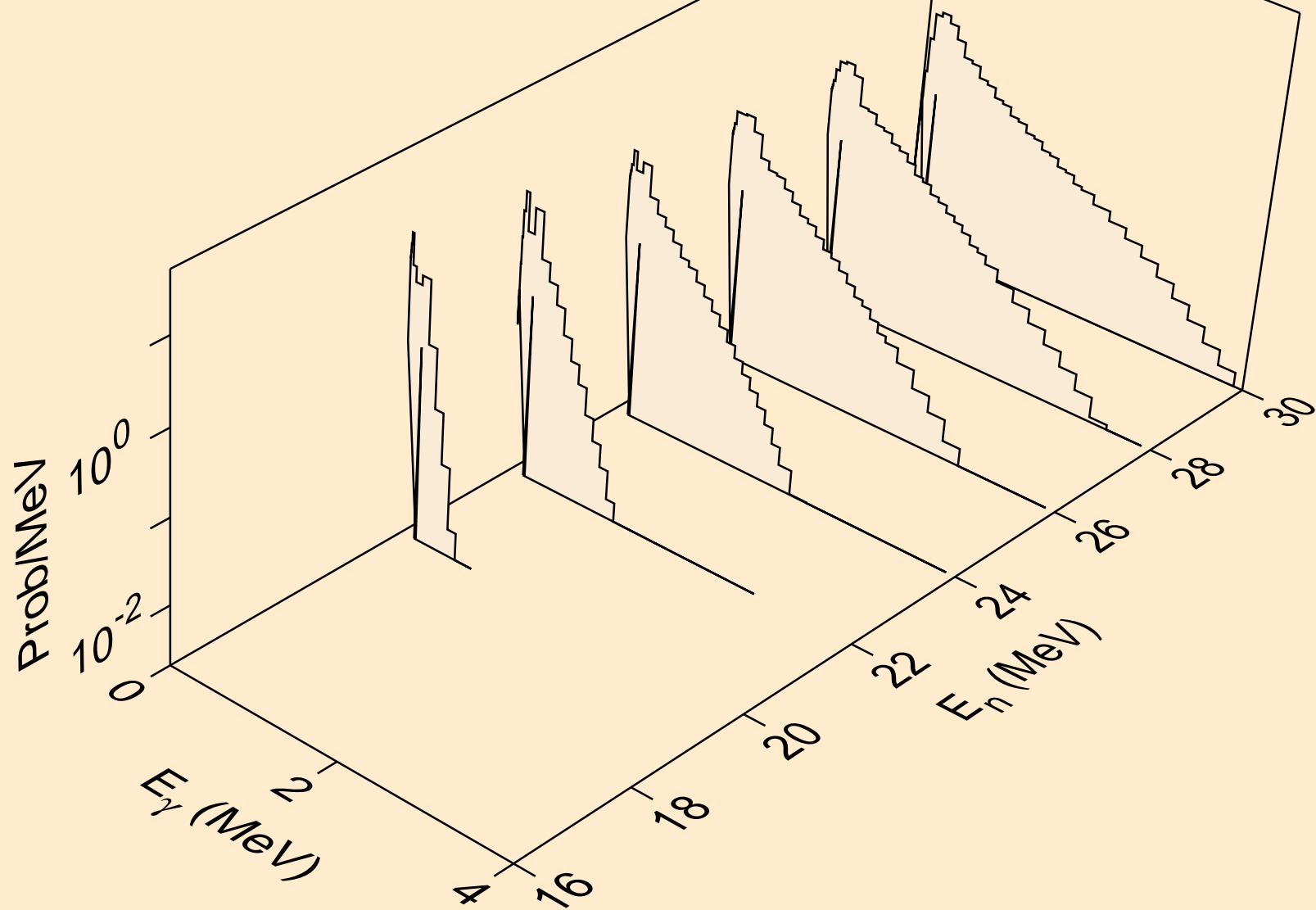

YB156 ALPHA ACER TENDL-2021 LIBRARY; T=0.K  
Photon emission for (n,t)

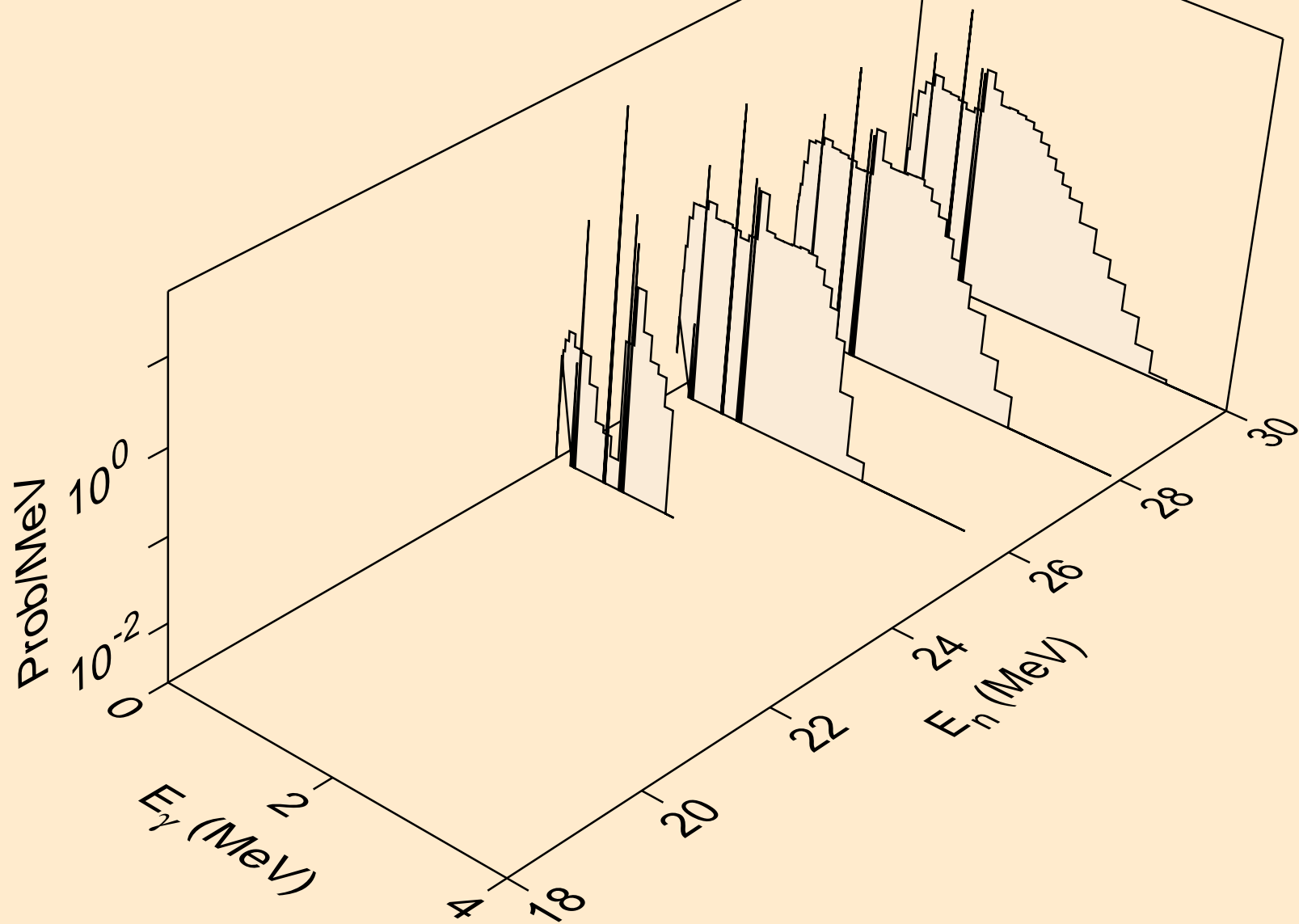

YB156 ALPHA ACER TENDL-2021 LIBRARY; T=0.K  
Photon emission for (n,he3)

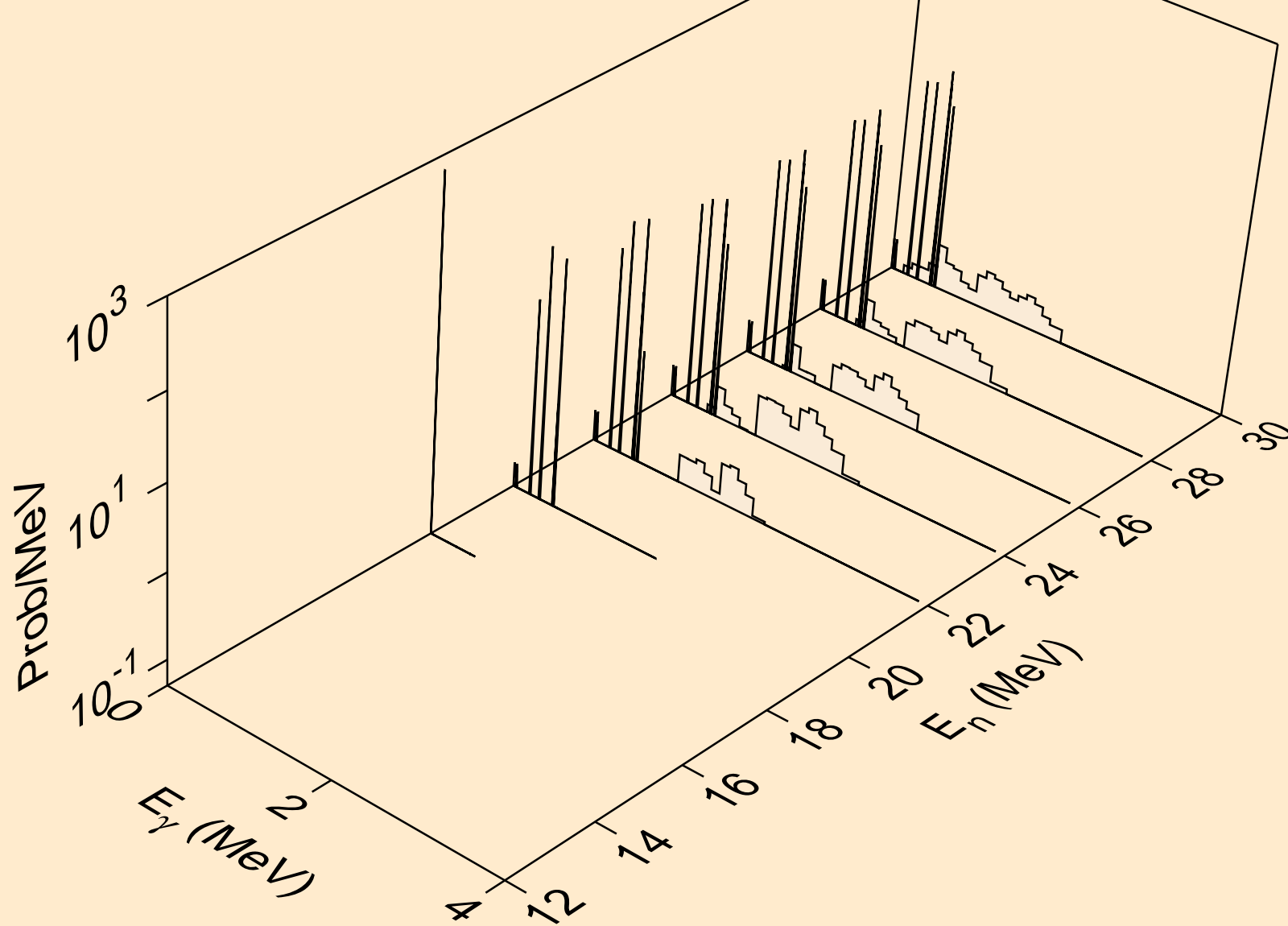

YB156 ALPHA ACER TENDL-2021 LIBRARY; T=0.K  
Photon emission for inelastic

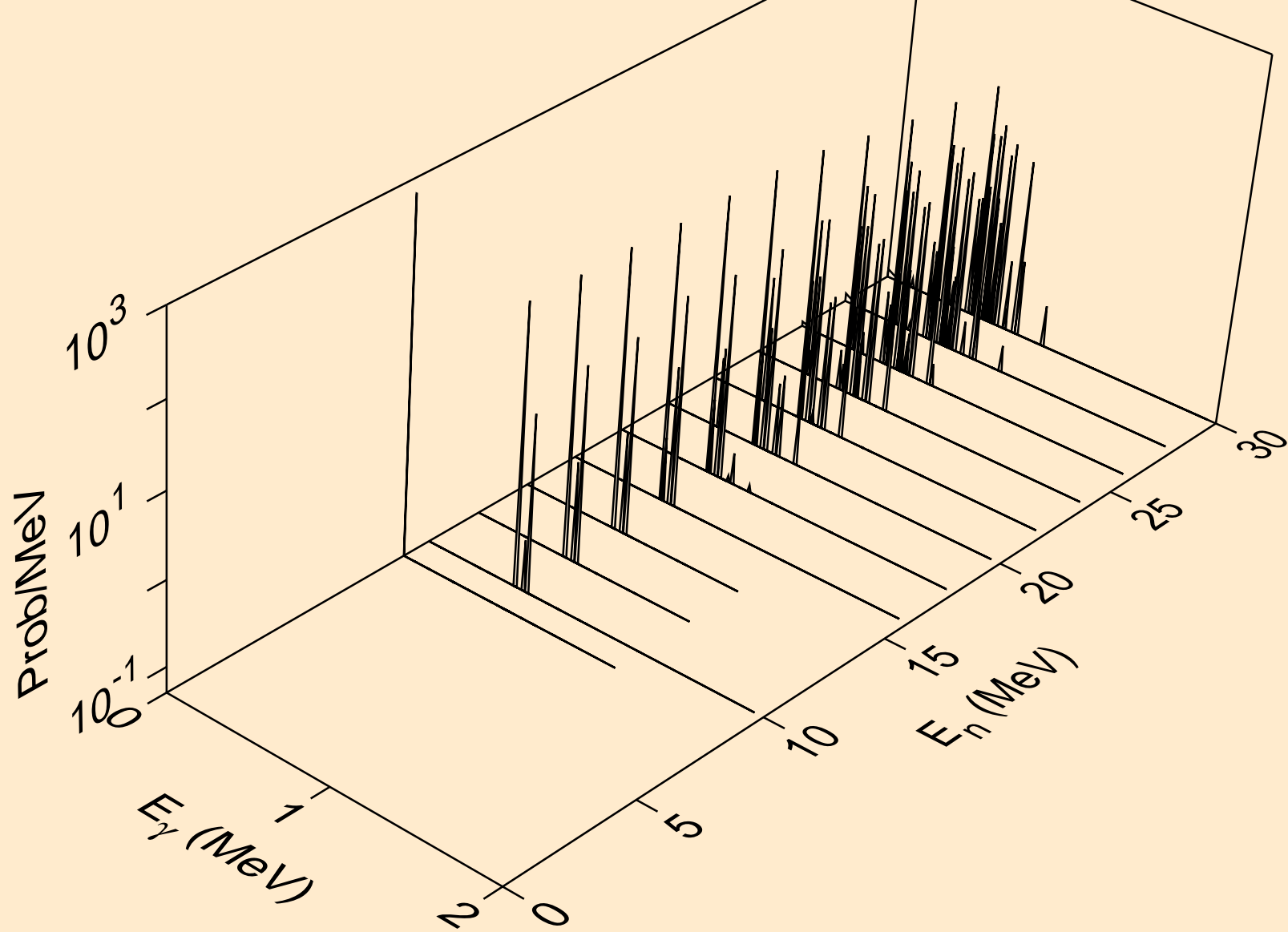

YB156 ALPHA ACER TENDL-2021 LIBRARY; T=0.K  
Photon emission for (n,2a)

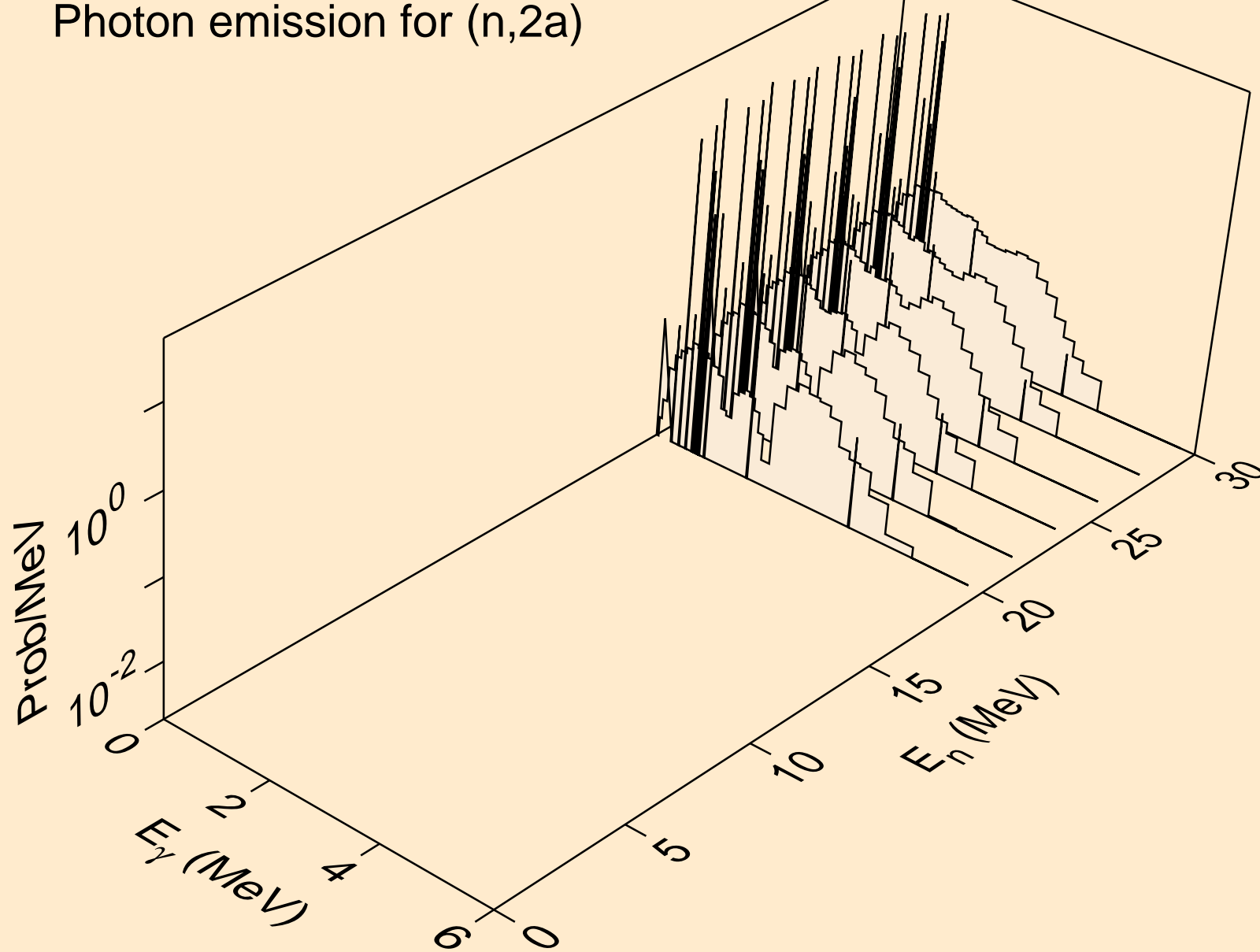

YB156 ALPHA ACER TENDL-2021 LIBRARY; T=0.K  
Photon emission for (n,3a)

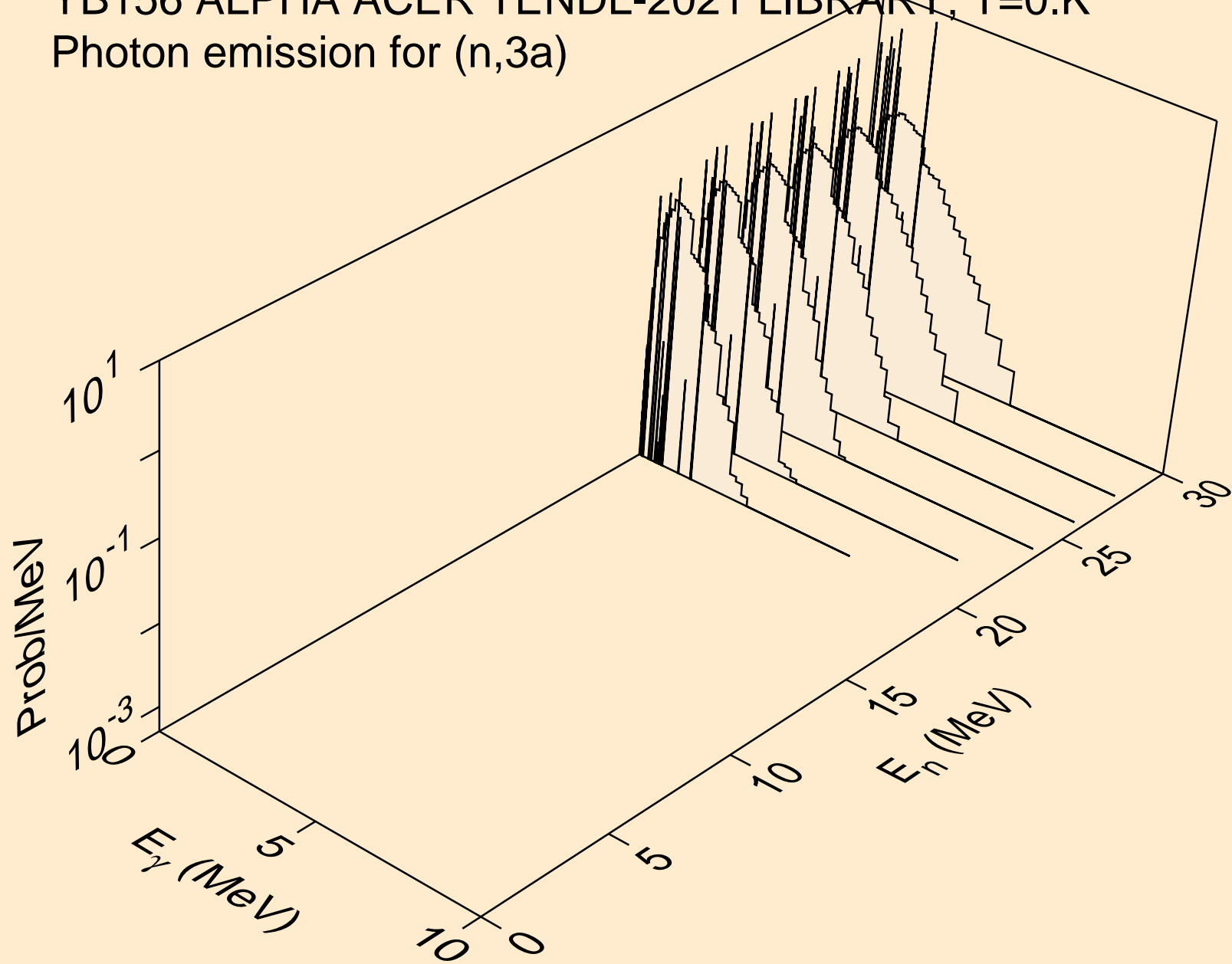

YB156 ALPHA ACER TENDL-2021 LIBRARY; T=0.K  
Photon emission for (n,2p)

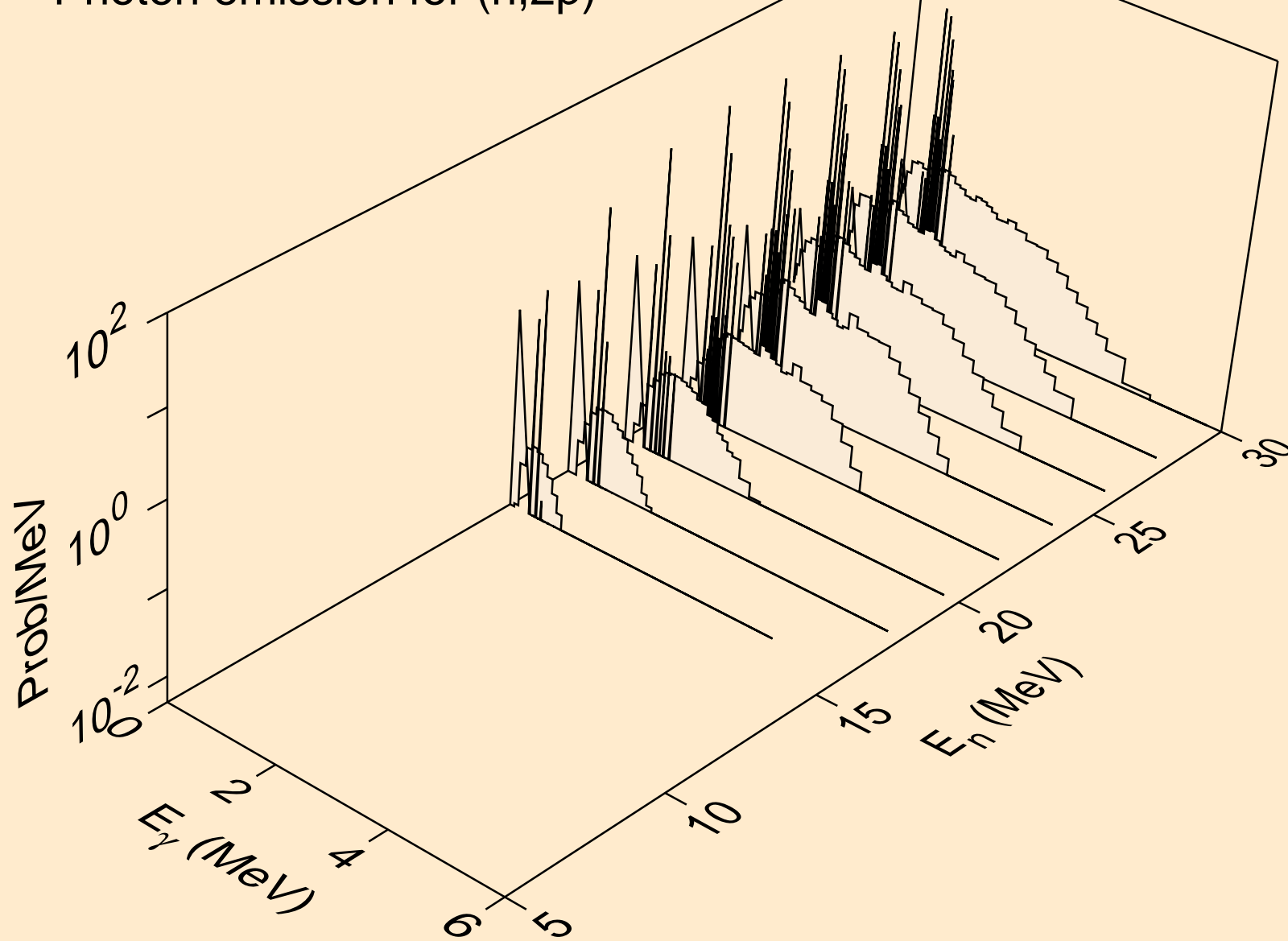

YB156 ALPHA ACER TENDL-2021 LIBRARY; T=0.K  
Photon emission for (n,pa)

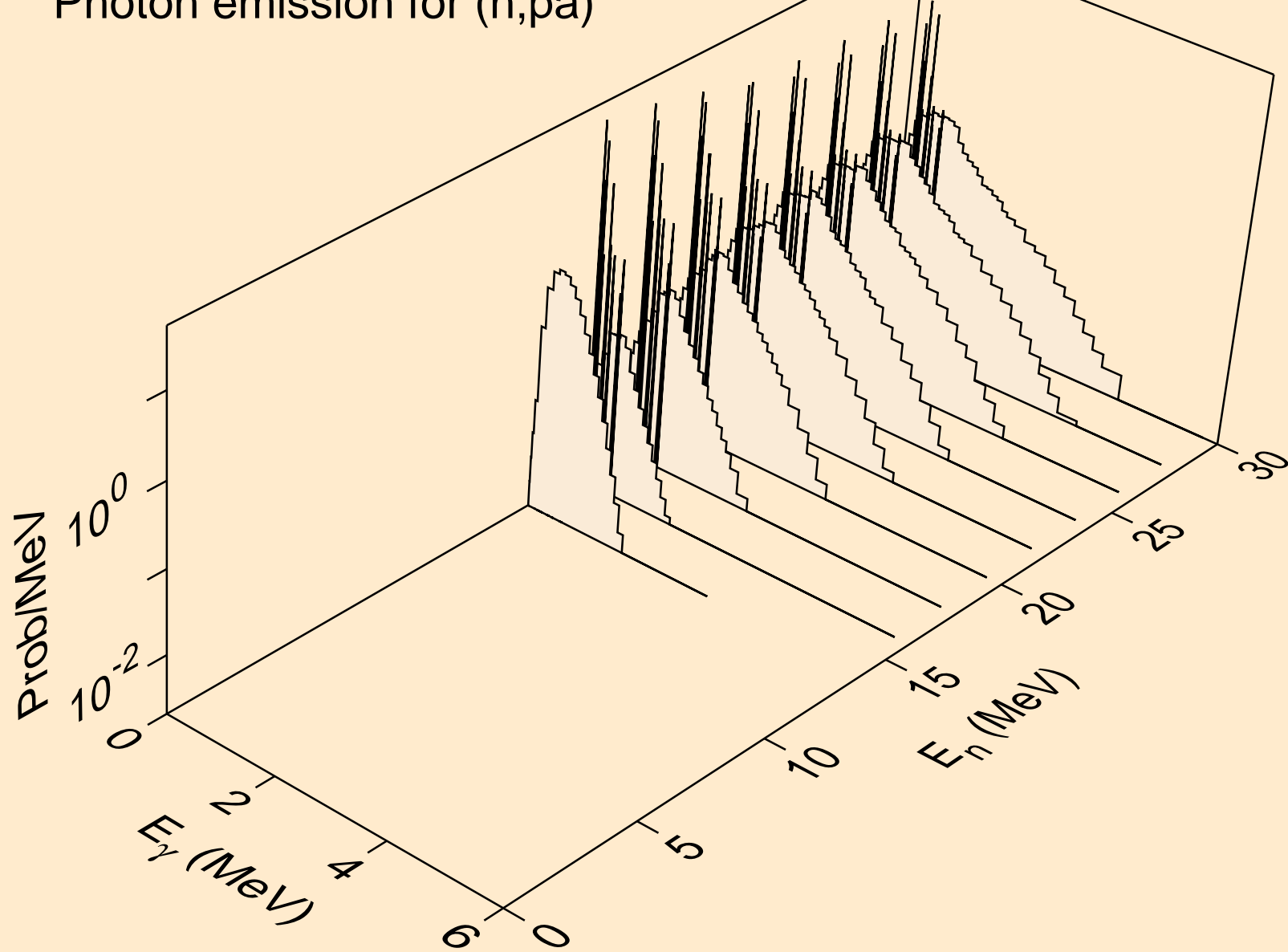

YB156 ALPHA ACER TENDL-2021 LIBRARY; T=0.K  
Photon emission for (n,pd)

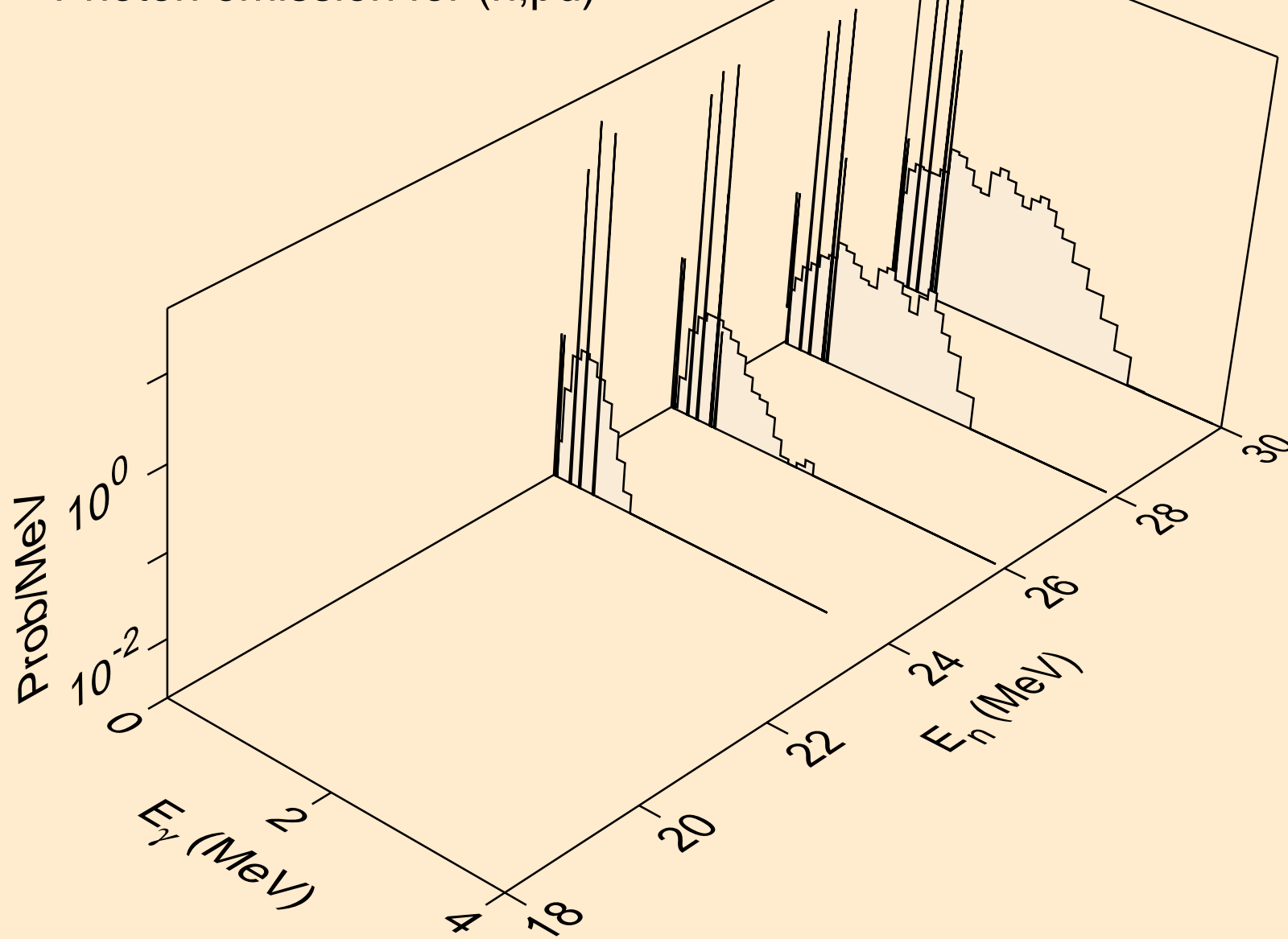

YB156 ALPHA ACER TENDL-2021 LIBRARY; T=0.K  
Particle heating contributions

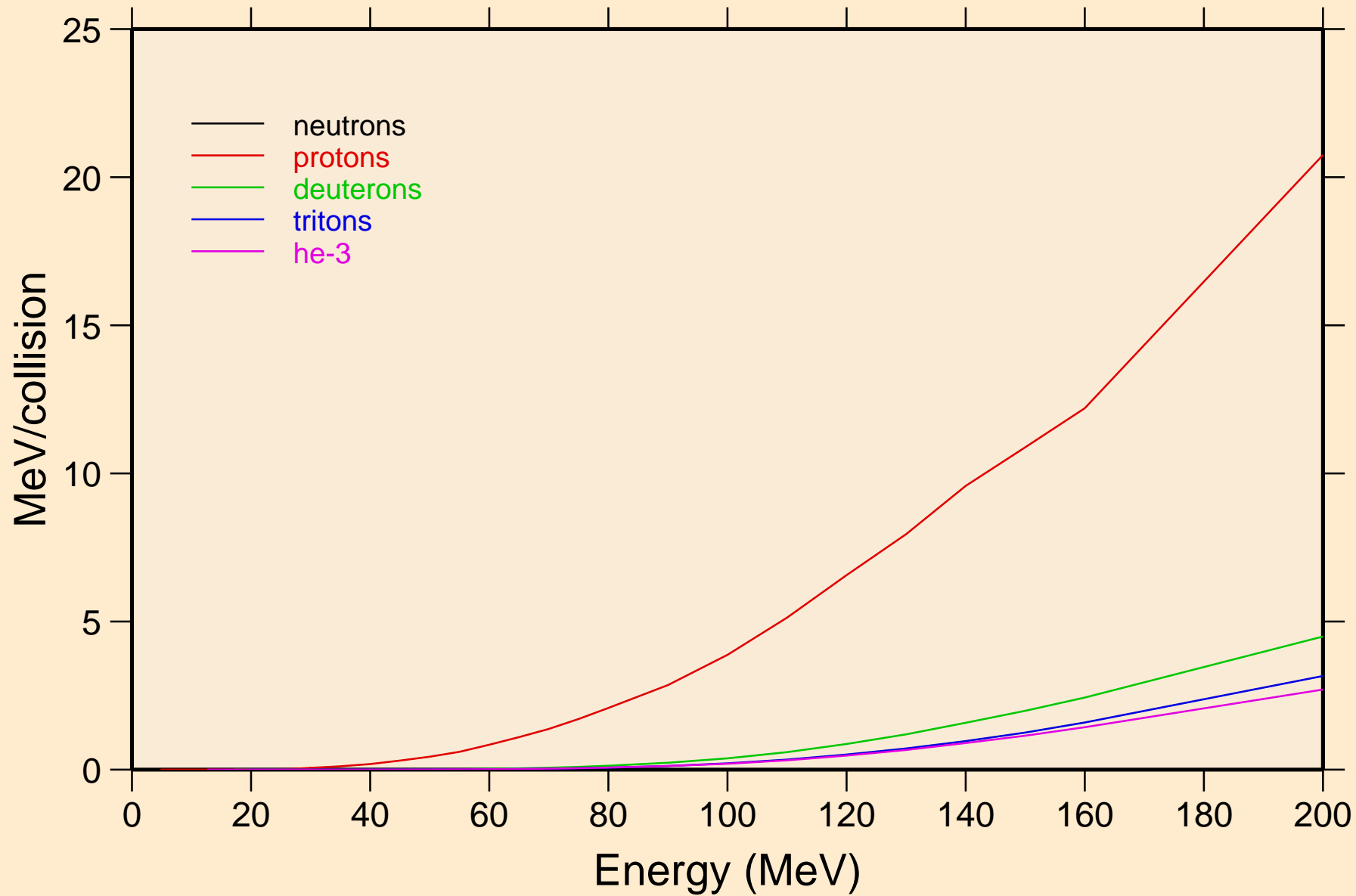

YB156 ALPHA ACER TENDL-2021 LIBRARY; T=0.K  
Recoil Heating

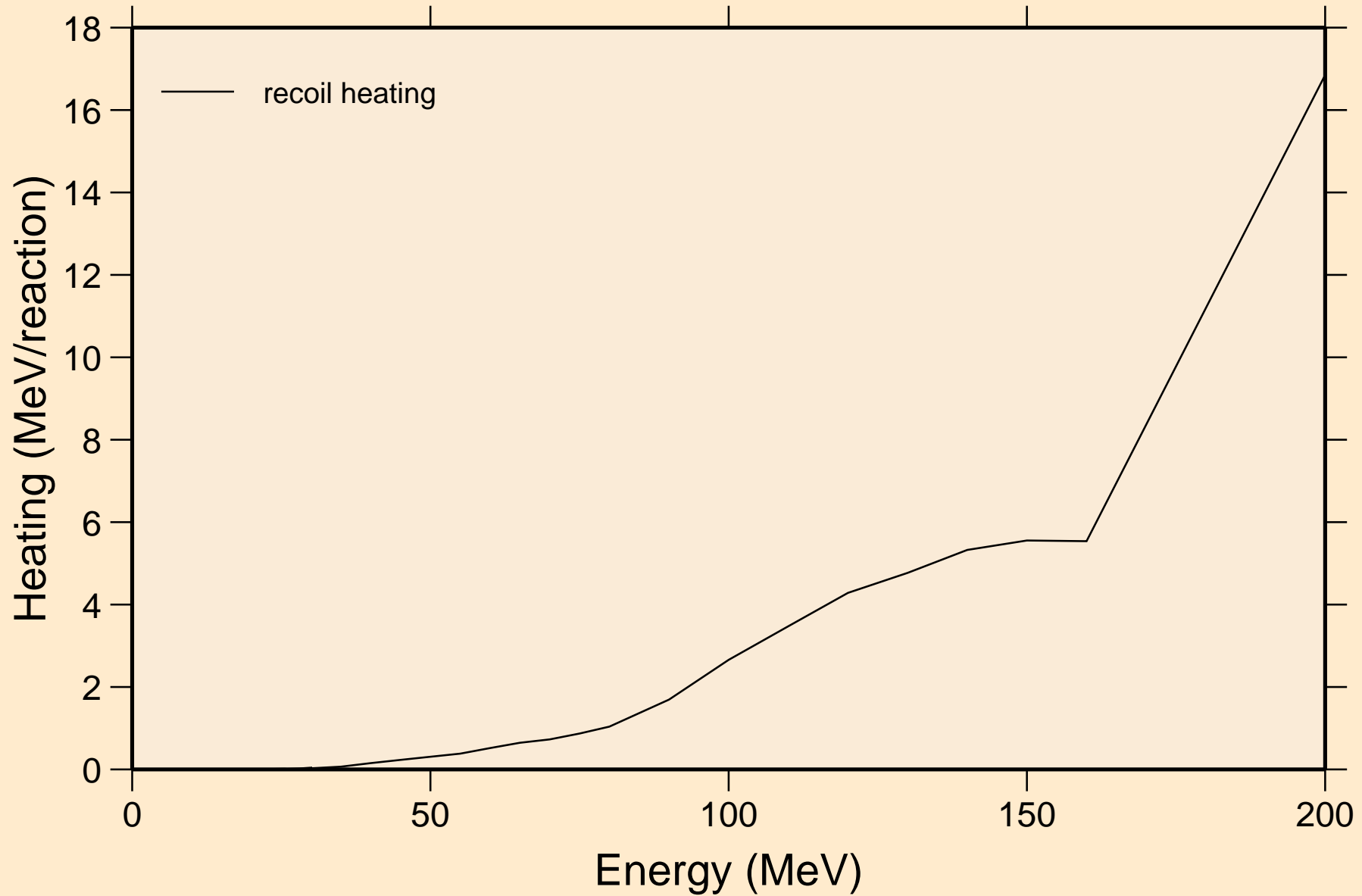

YB156 ALPHA ACER TENDL-2021 LIBRARY; T=0.K  
Particle production cross sections

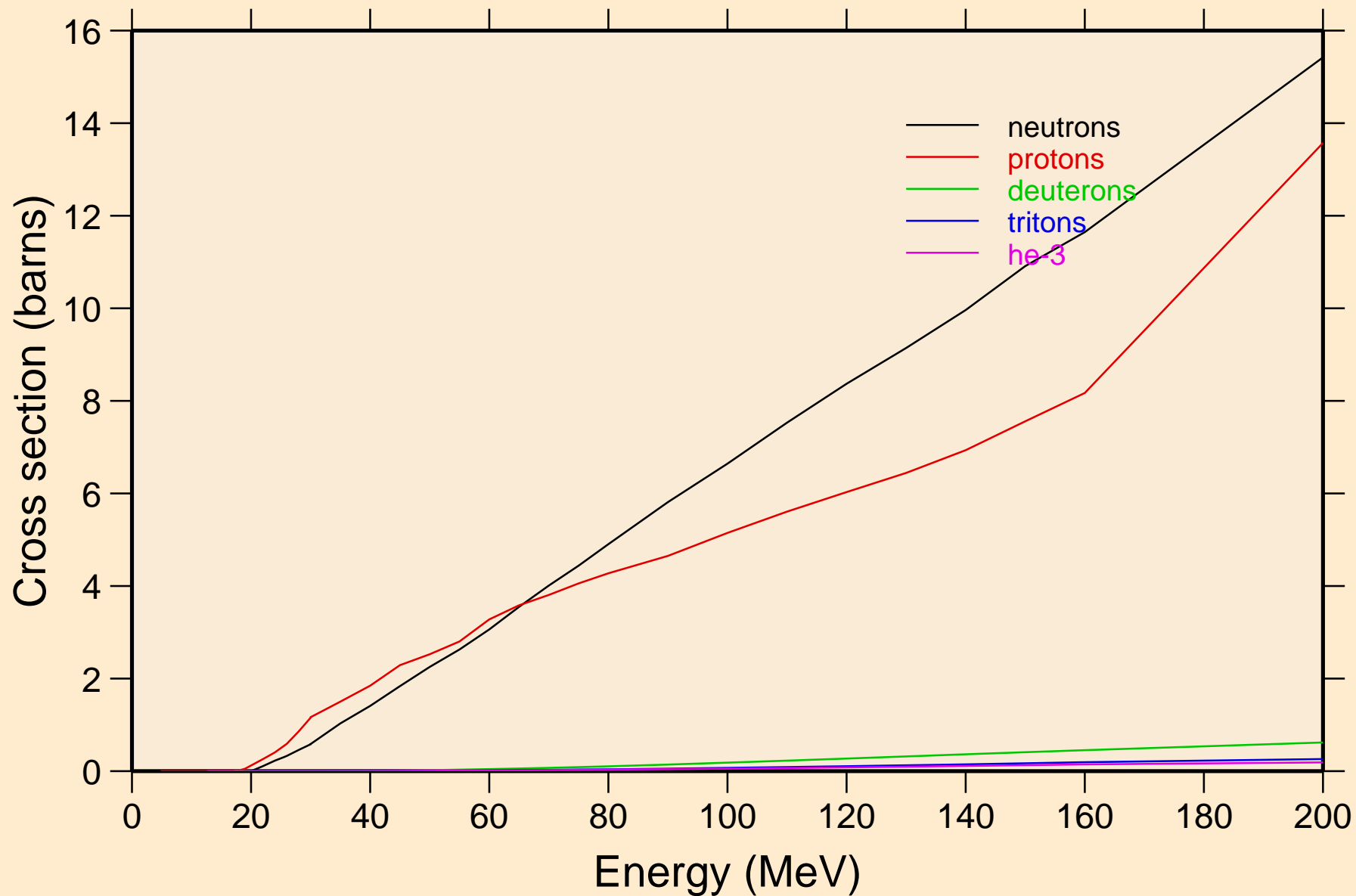

YB156 ALPHA ACER TENDL-2021 LIBRARY; T=0.K  
neutrons from (a,n)

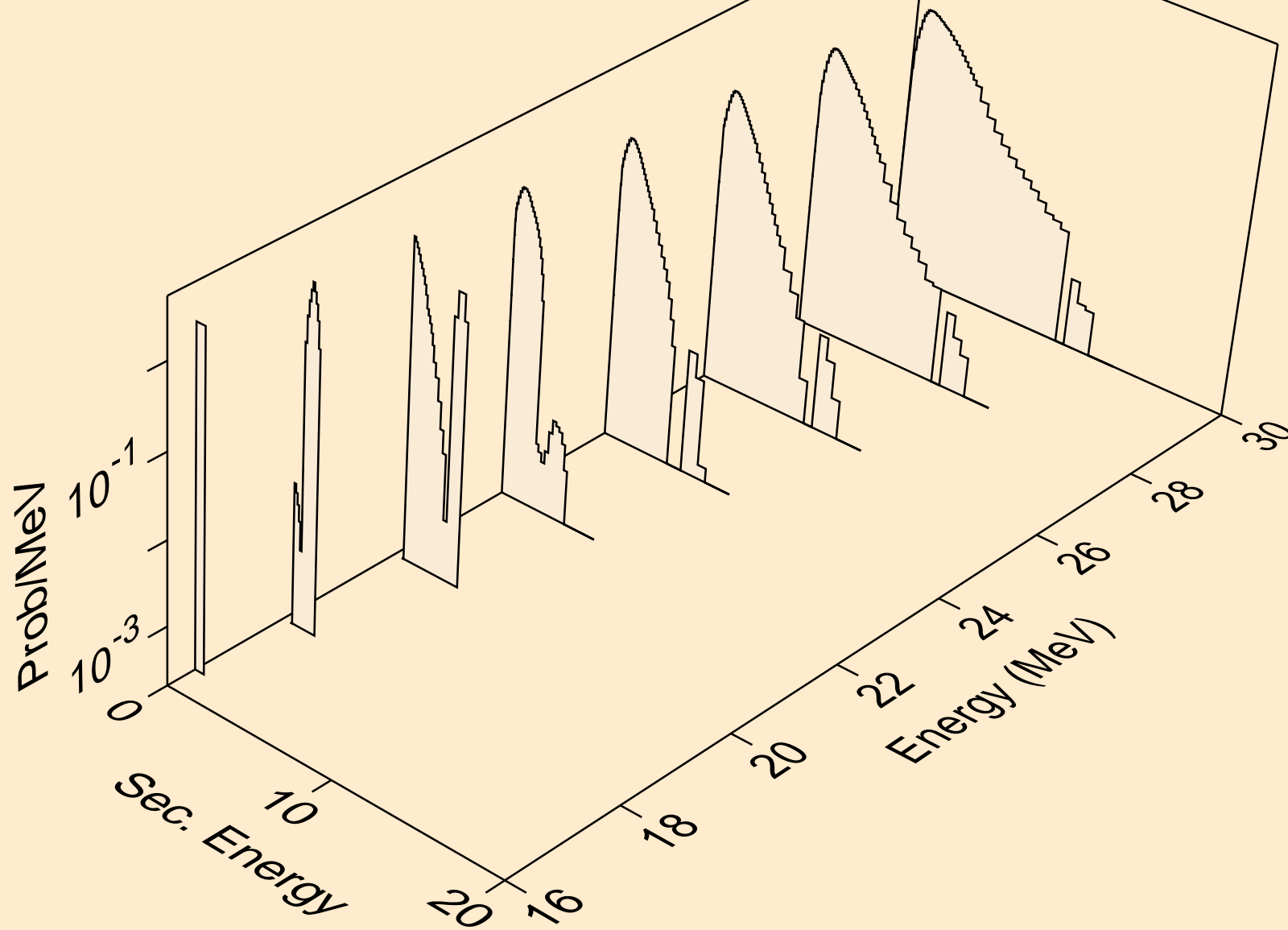

YB156 ALPHA ACER TENDL-2021 LIBRARY; T=0.K  
neutrons from (a,x)

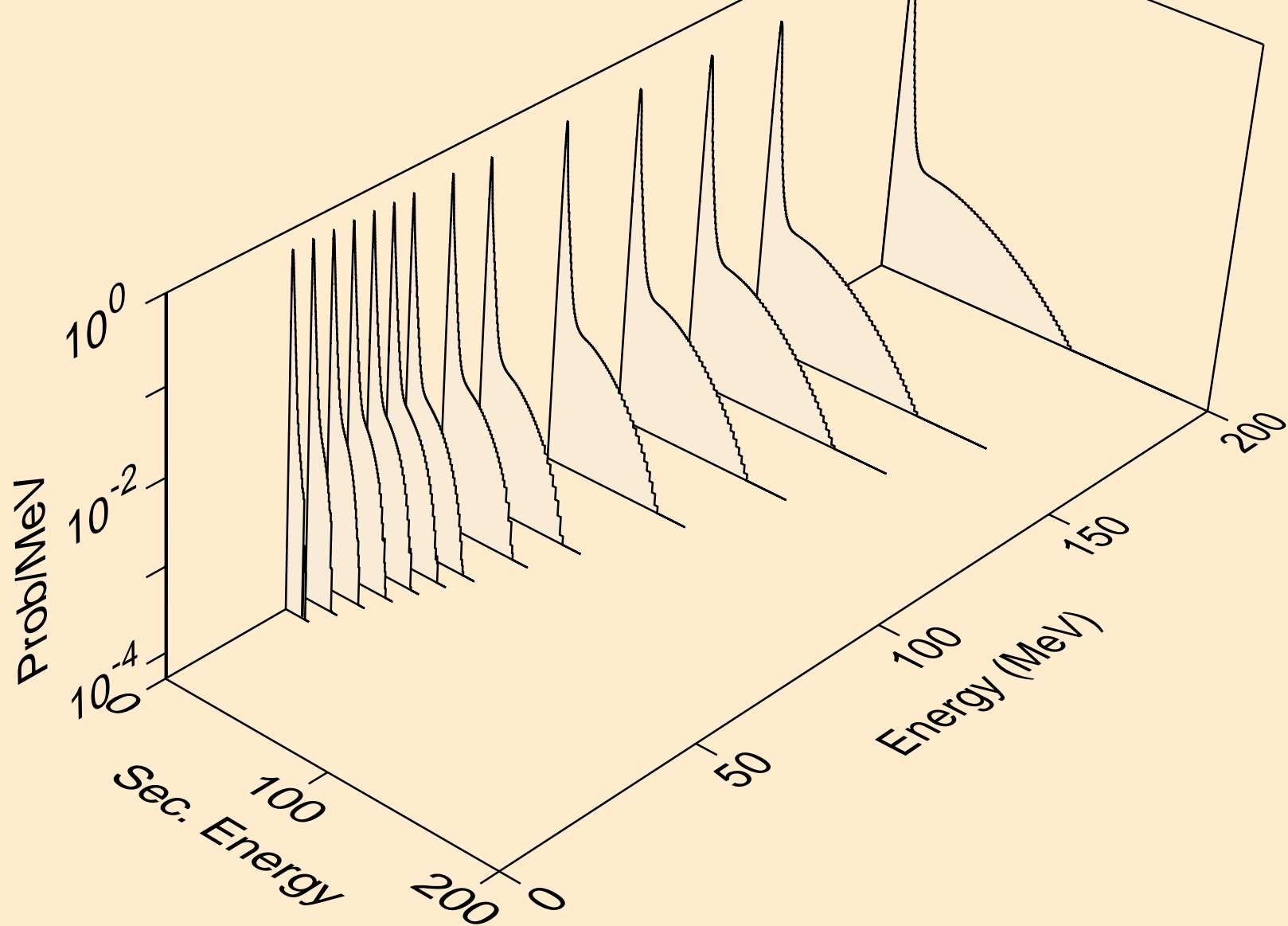

YB156 ALPHA ACER TENDL-2021 LIBRARY; T=0.K  
neutrons from (a,2n)

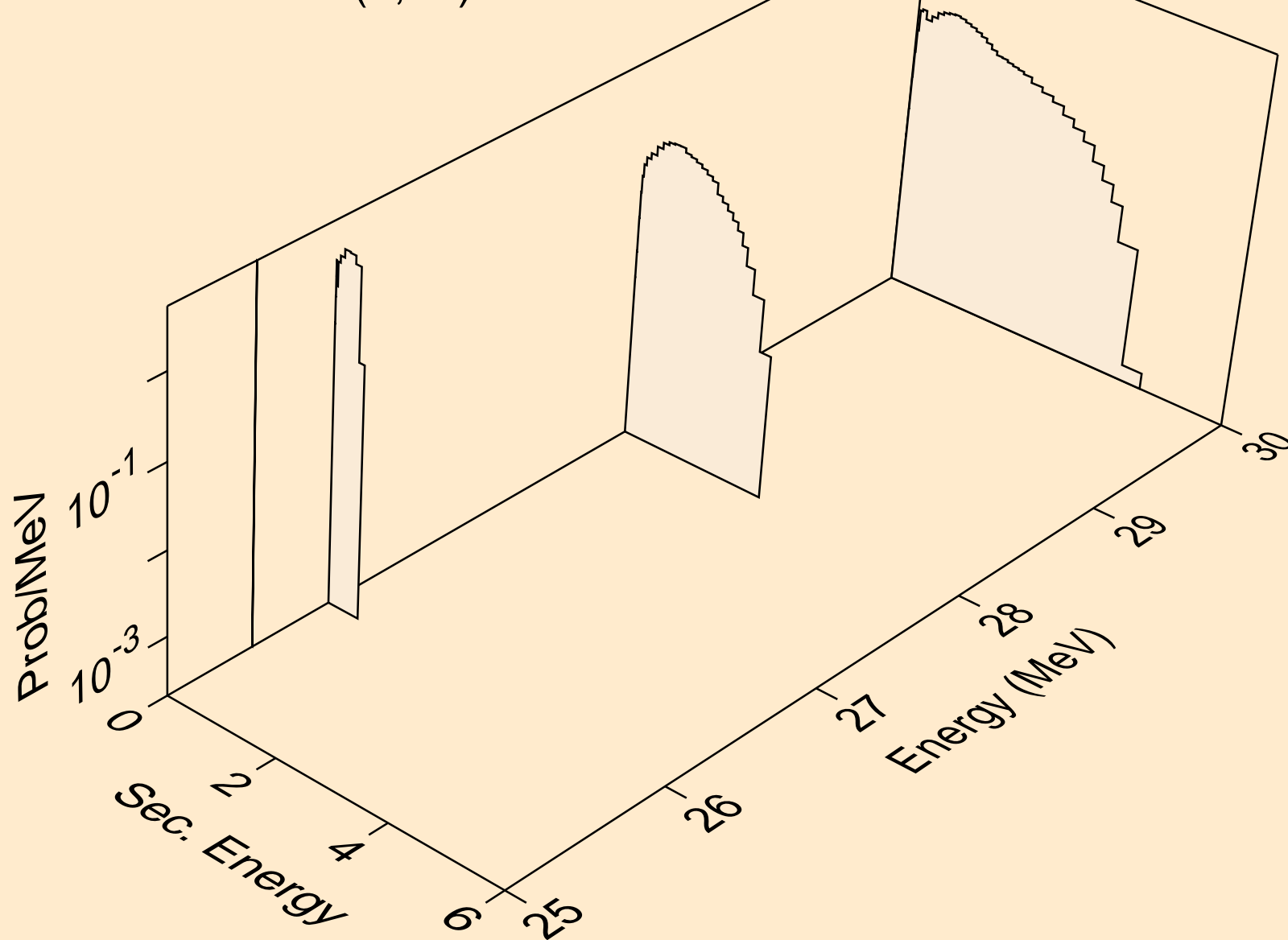

YB156 ALPHA ACER TENDL-2021 LIBRARY; T=0.K  
neutrons from (a,n\*)a

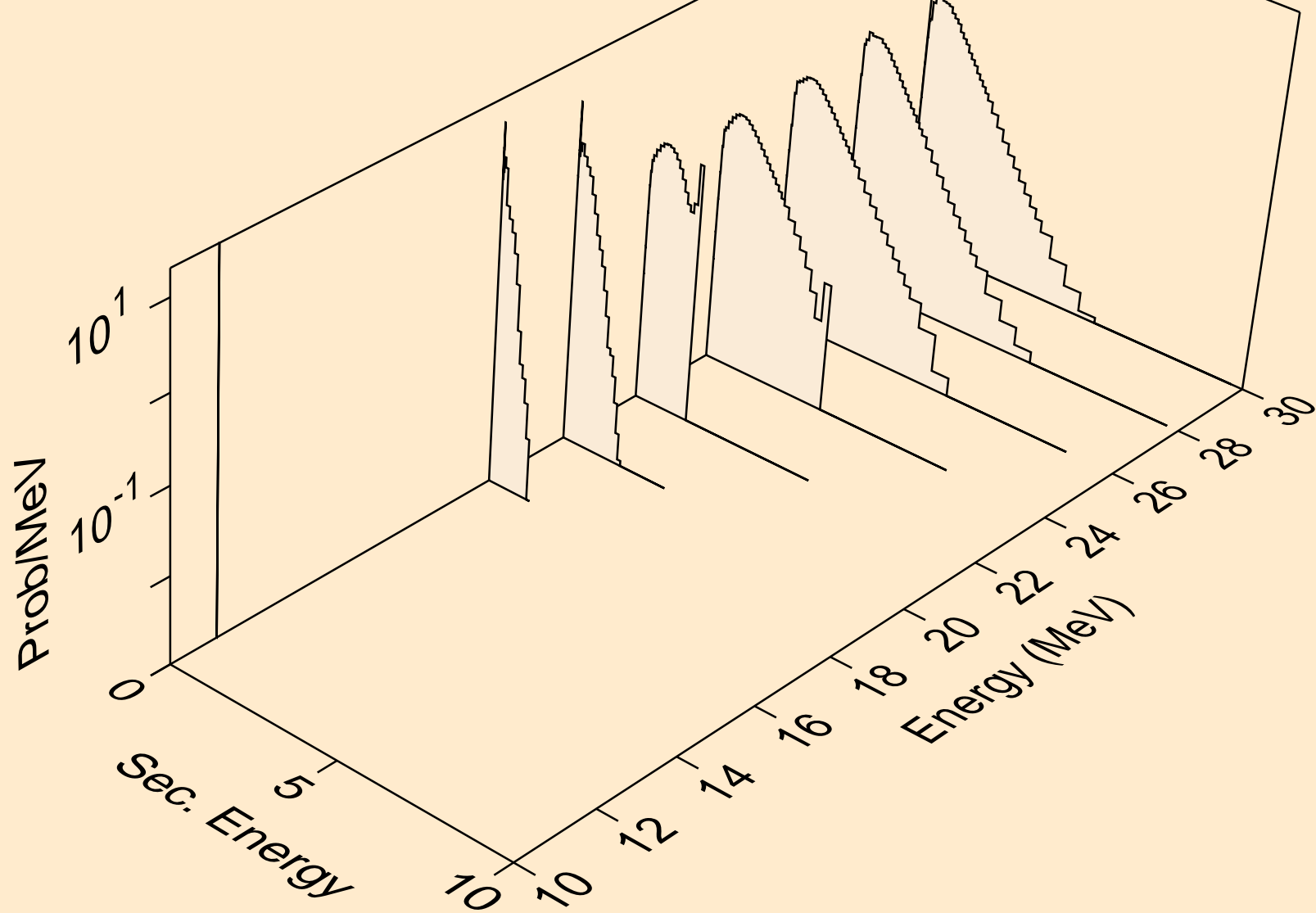

YB156 ALPHA ACER TENDL-2021 LIBRARY; T=0.K  
neutrons from (a,2n)a

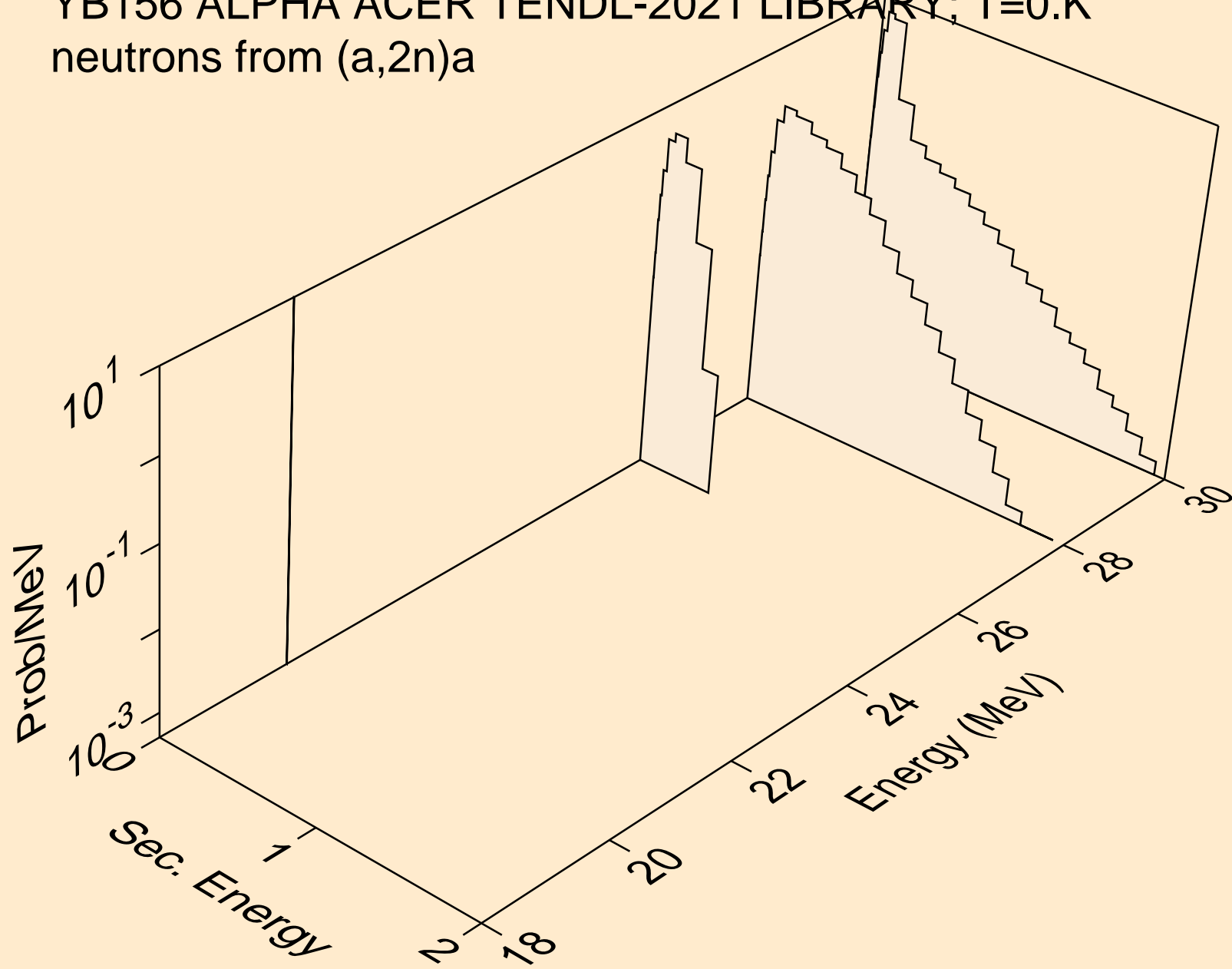

YB156 ALPHA ACER TENDL-2021 LIBRARY; T=0.K  
neutrons from (a,n\*)p

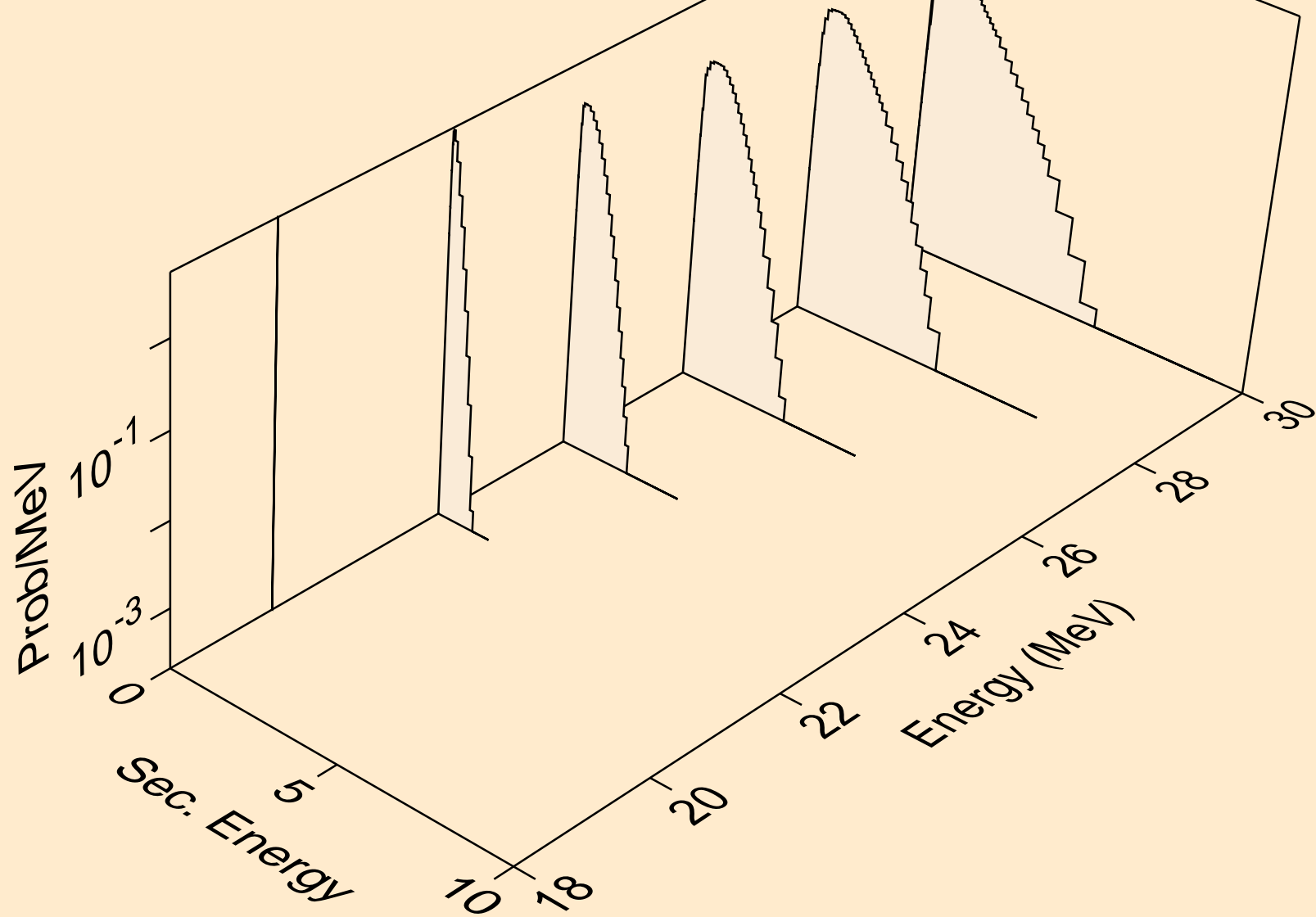

YB156 ALPHA ACER TENDL-2021 LIBRARY; T=0.K  
neutrons from (a,n\*)2a

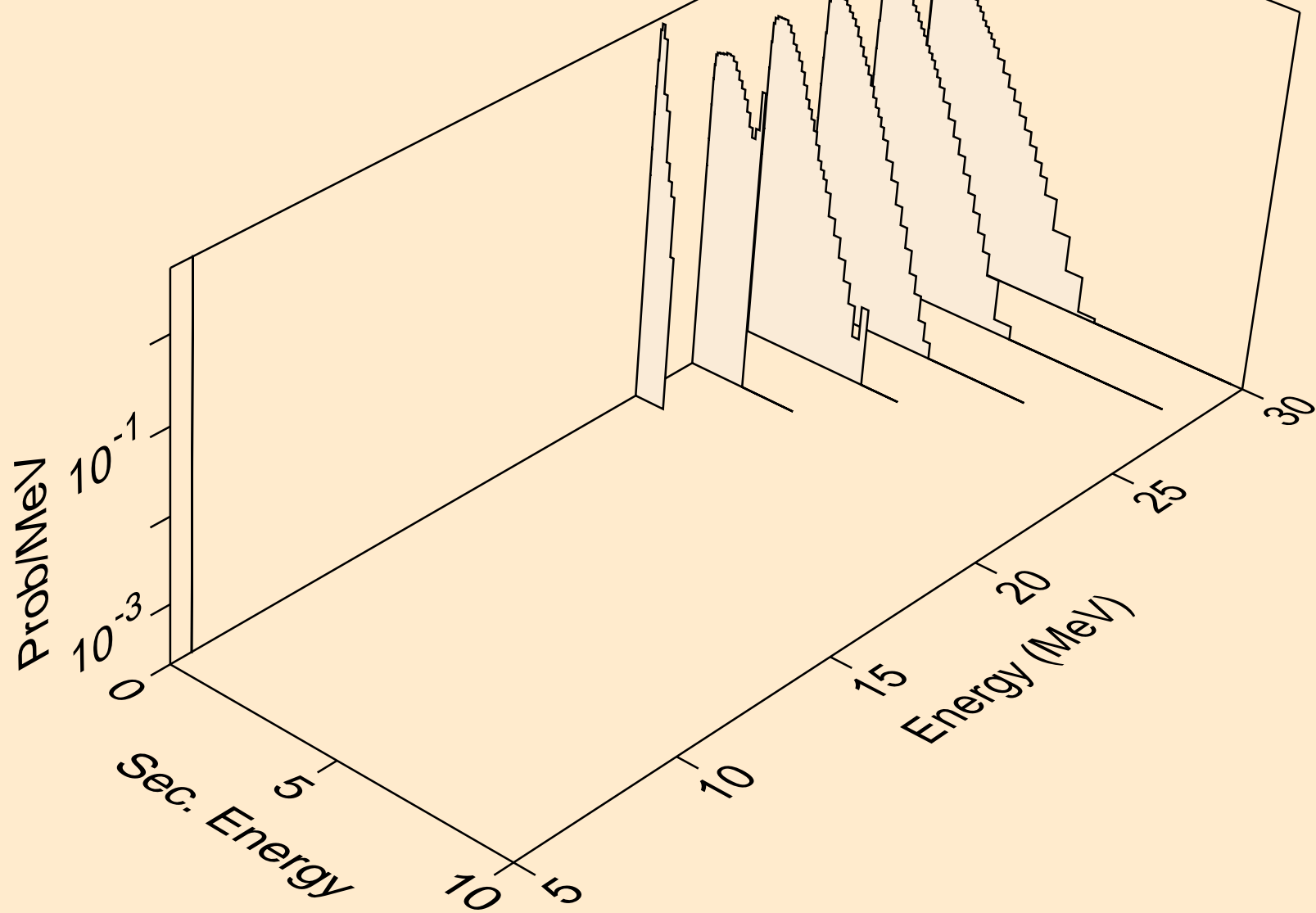

YB156 ALPHA ACER TENDL-2021 LIBRARY; T=0.K  
neutrons from (a,2np)

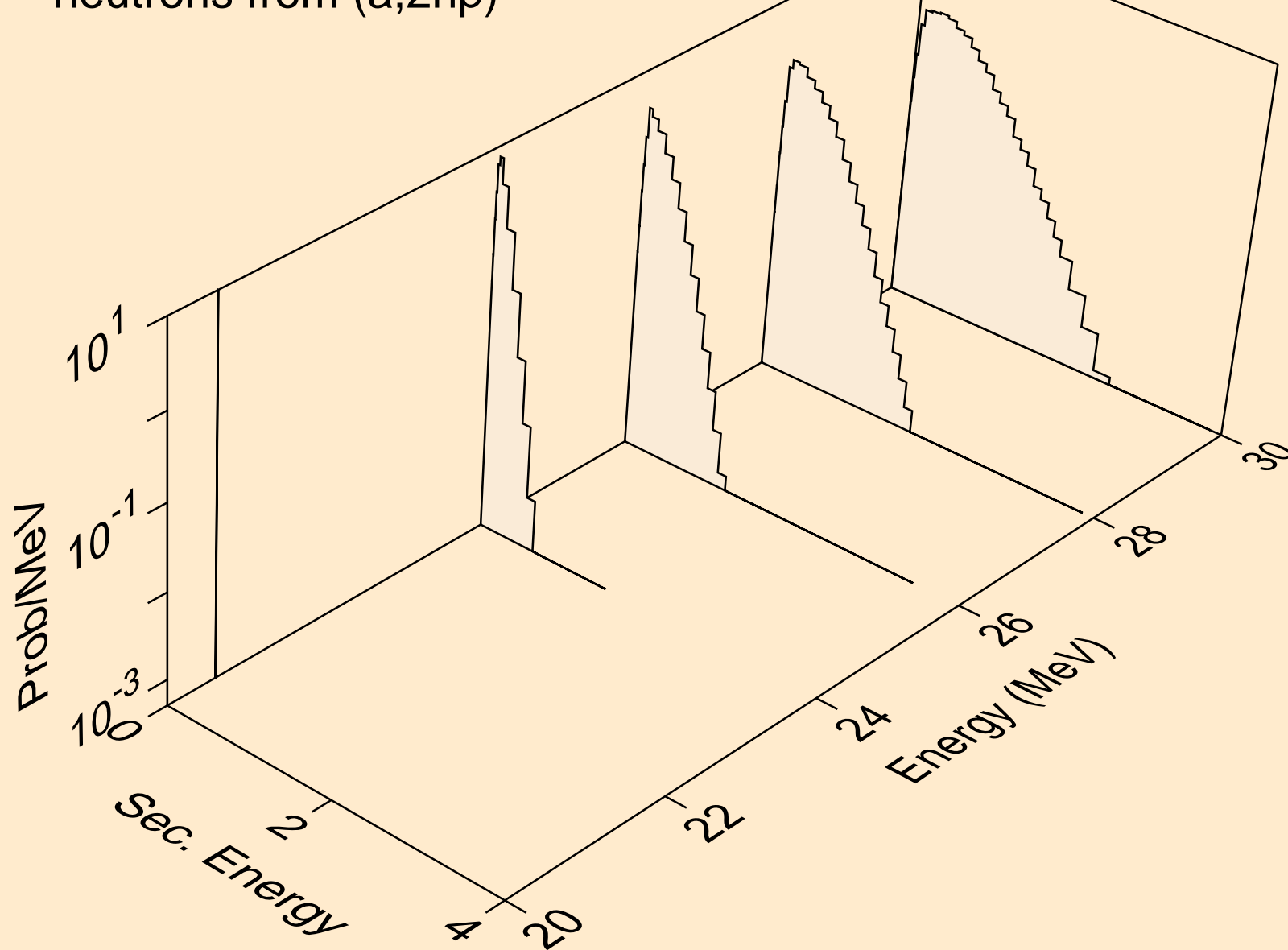

YB156 ALPHA ACER TENDL-2021 LIBRARY; T=0.K  
neutrons from (a,npa)

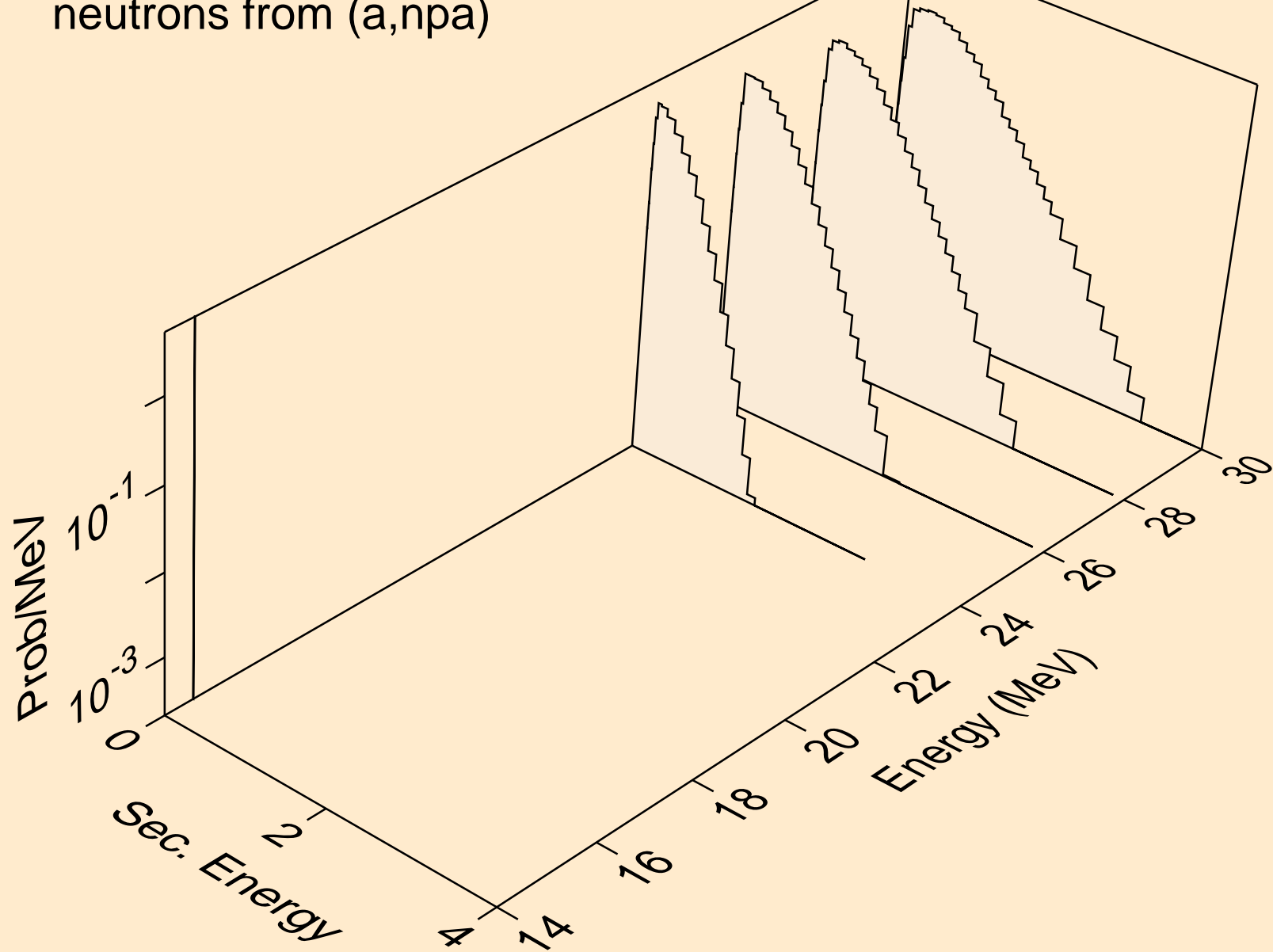

YB156 ALPHA ACER TENDL-2021 LIBRARY; T=0.K  
protons from (a,x)

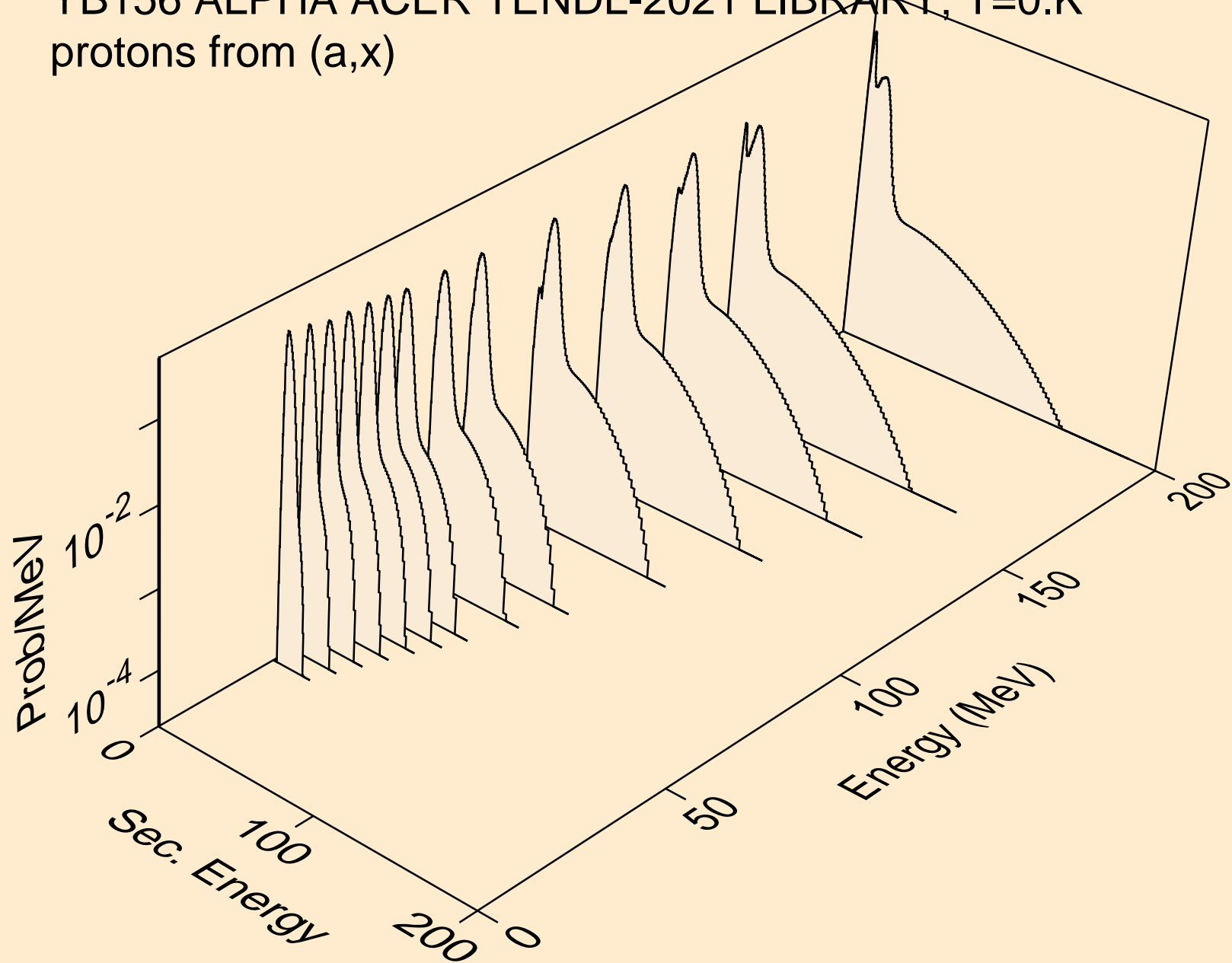

YB156 ALPHA ACER TENDL-2021 LIBRARY; T=0.K  
protons from (a,n\*)p

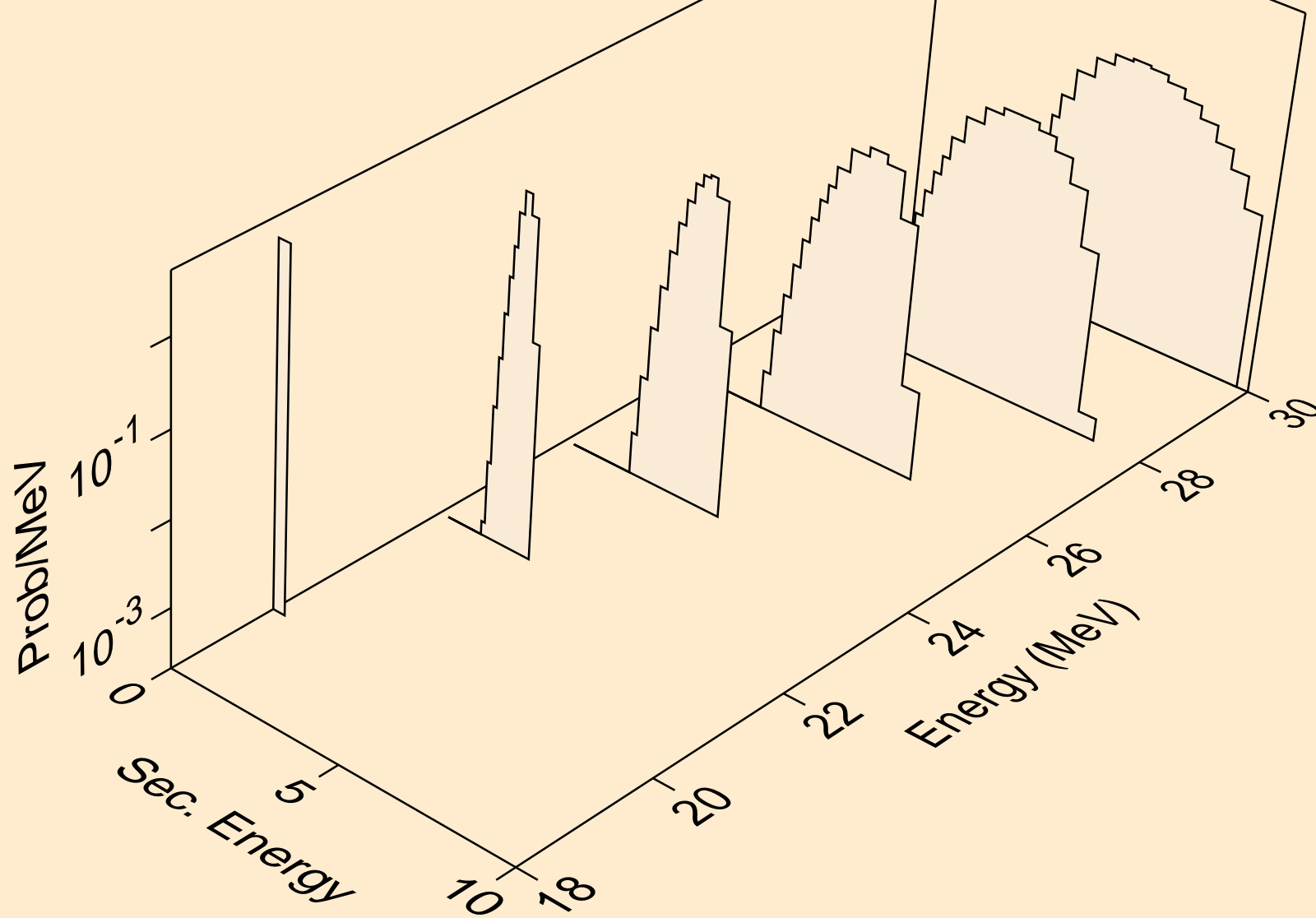

YB156 ALPHA ACER TENDL-2021 LIBRARY; T=0.K  
protons from (a,2np)

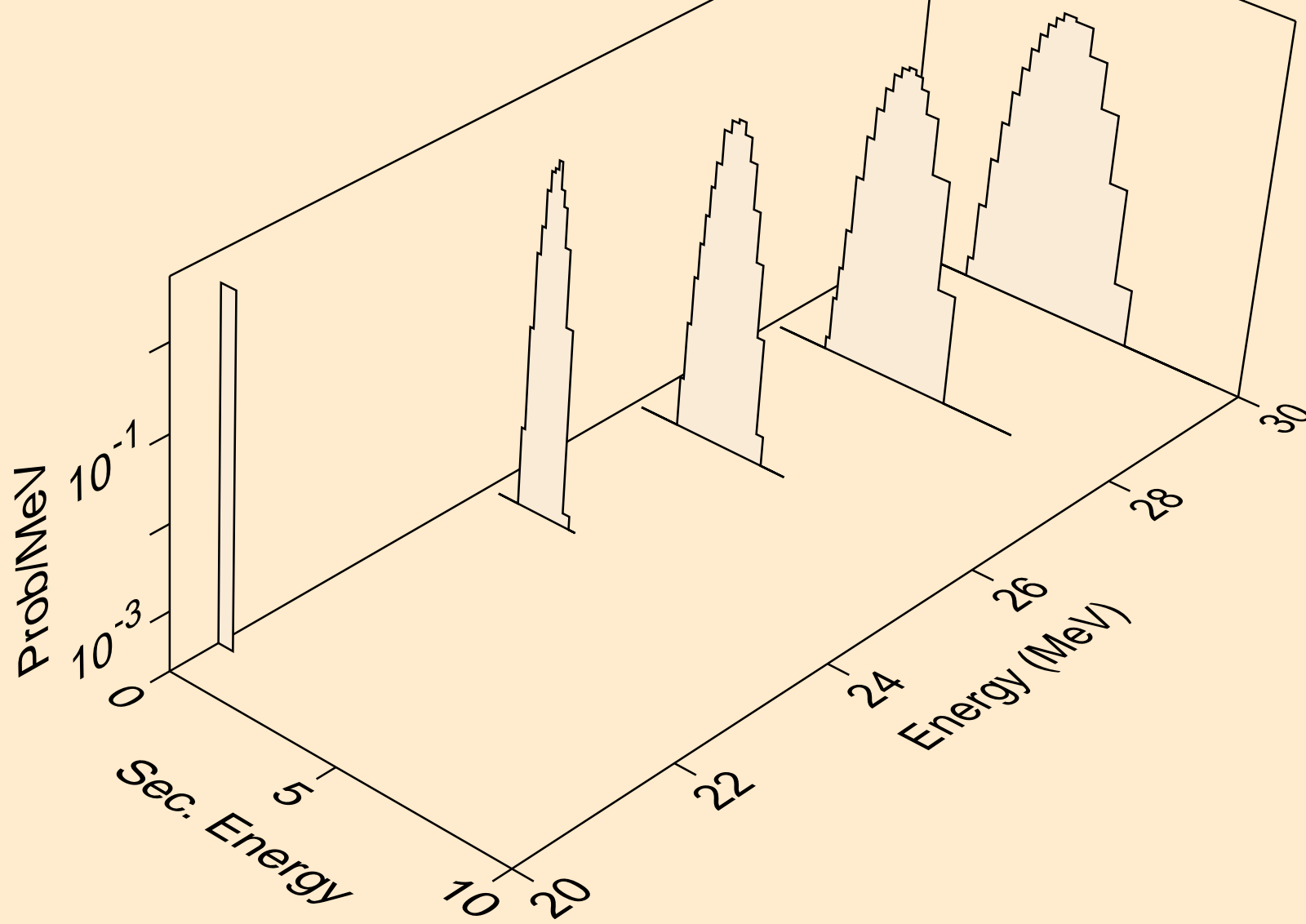

YB156 ALPHA ACER TENDL-2021 LIBRARY; T=0.K  
protons from (a,npa)

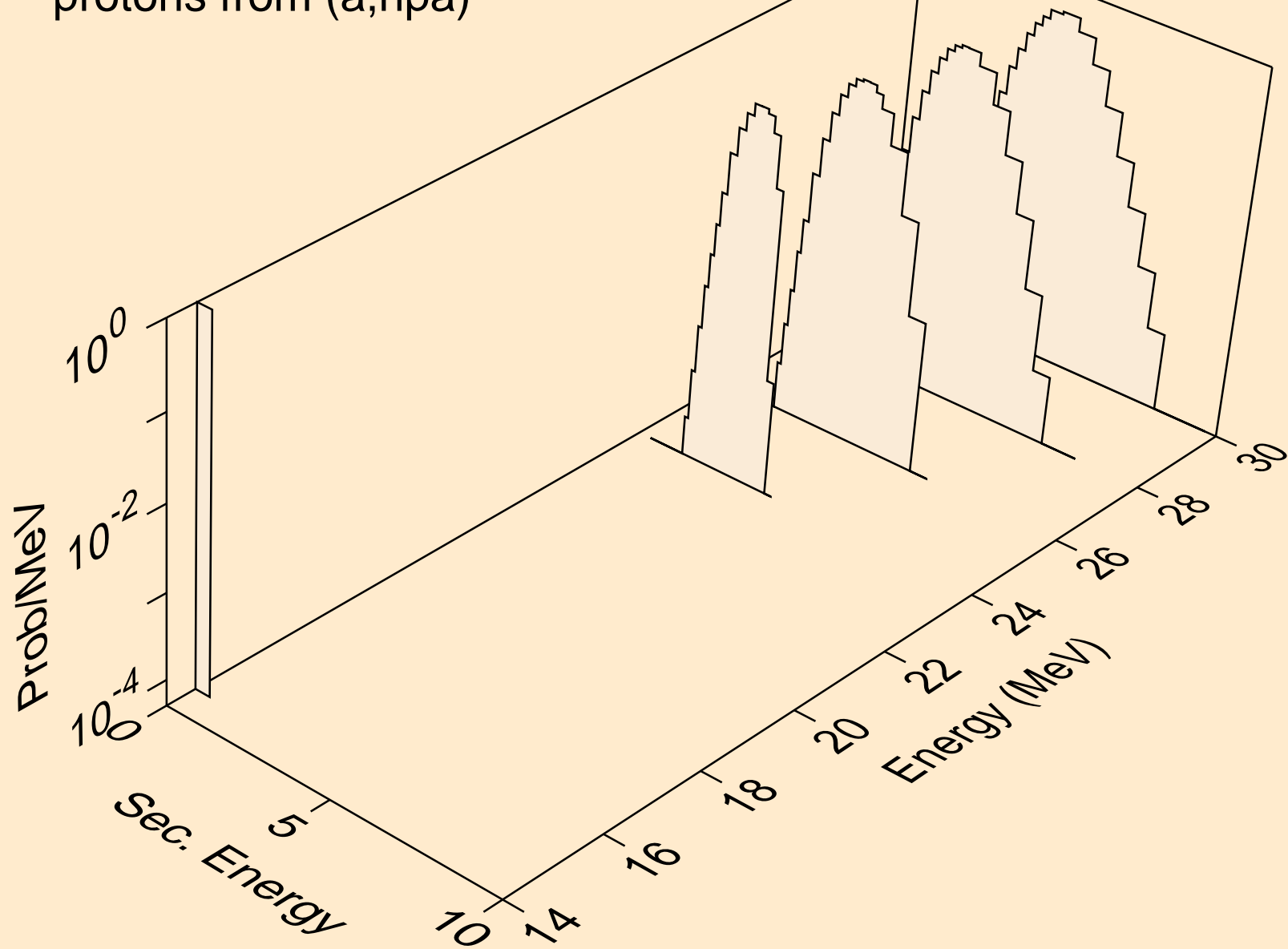

YB156 ALPHA ACER TENDL-2021 LIBRARY; T=0.K  
protons from (a,p)

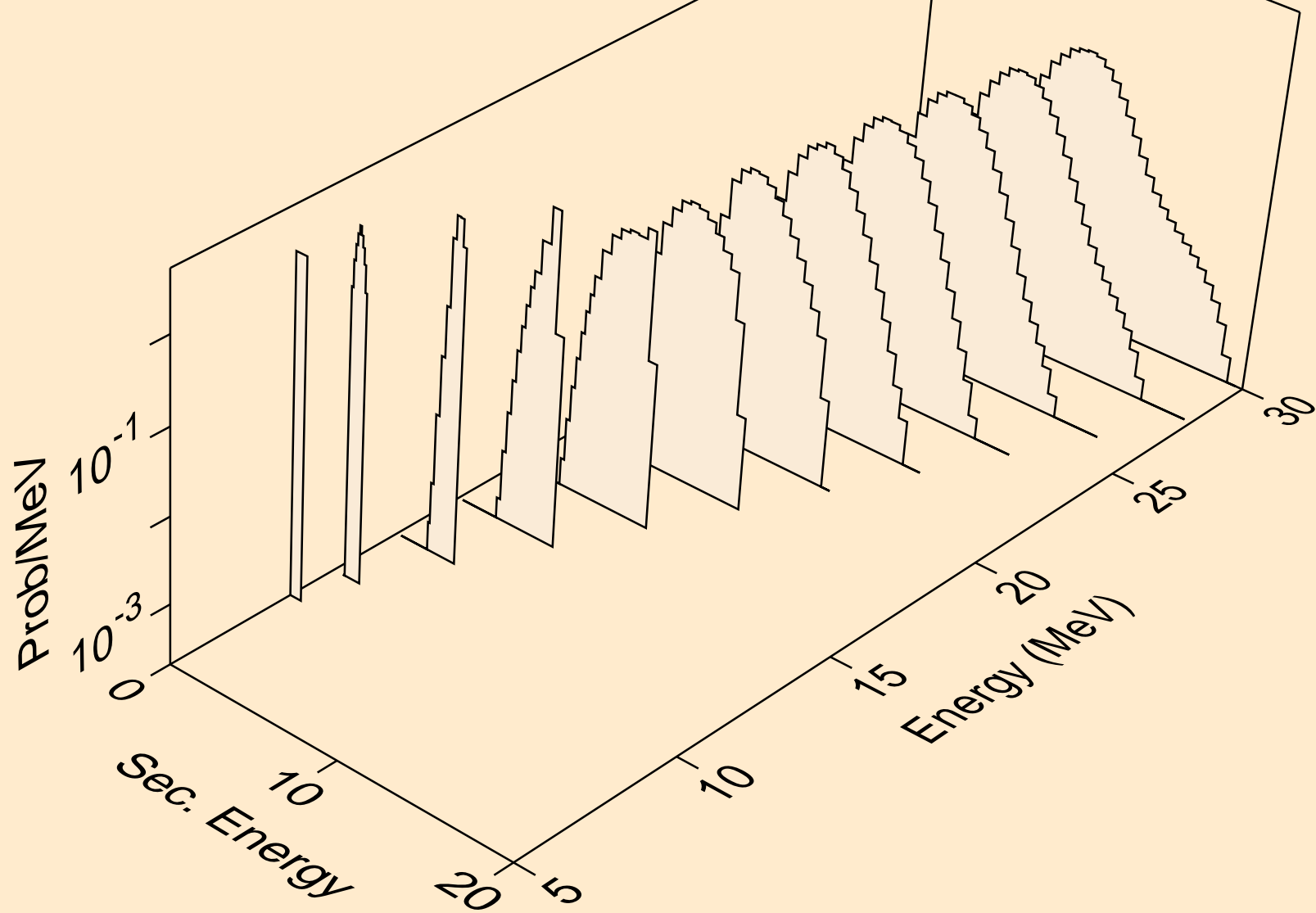

YB156 ALPHA ACER TENDL-2021 LIBRARY; T=0.K  
protons from (a,2p)

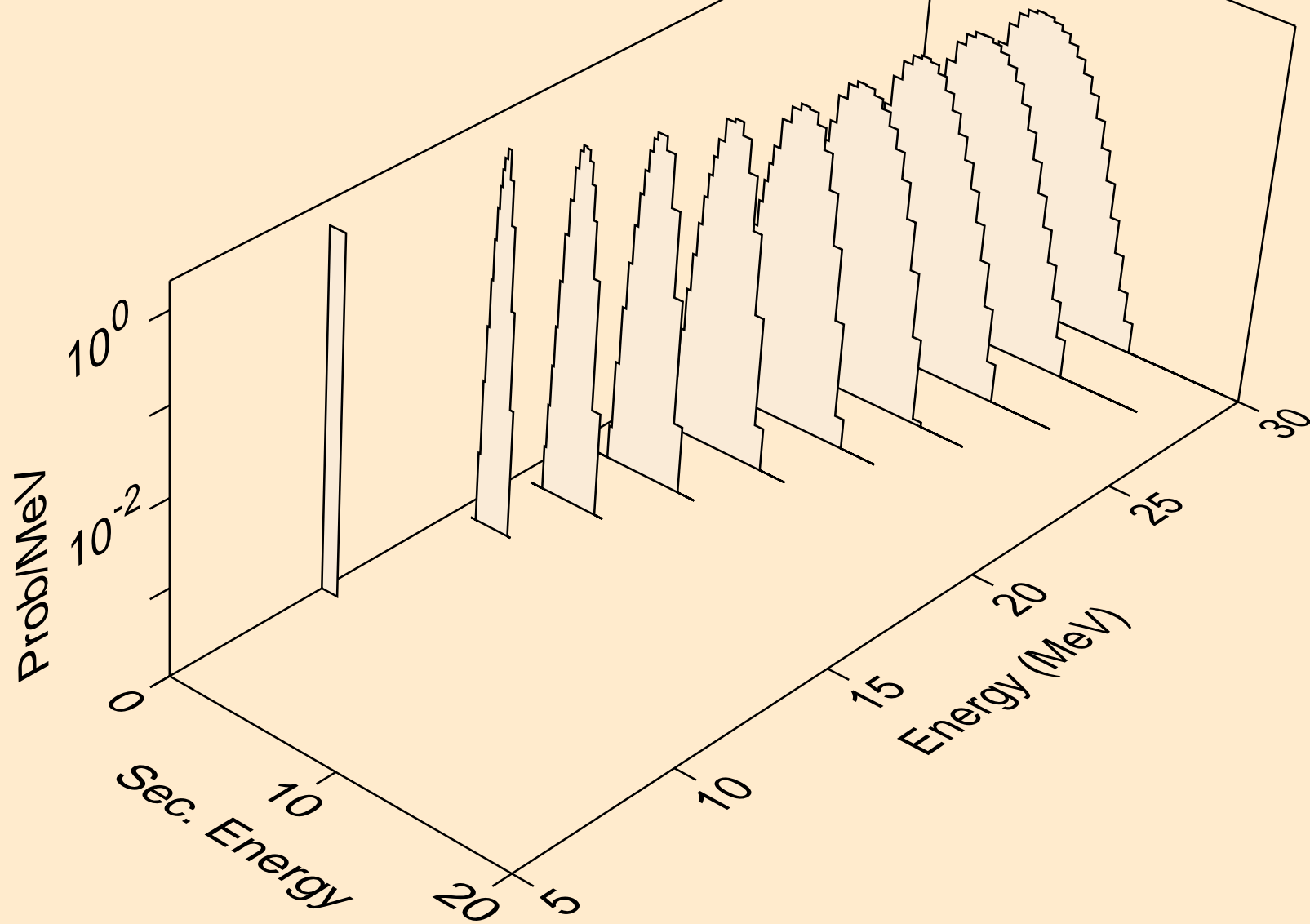

YB156 ALPHA ACER TENDL-2021 LIBRARY; T=0.K  
protons from (a,pa)

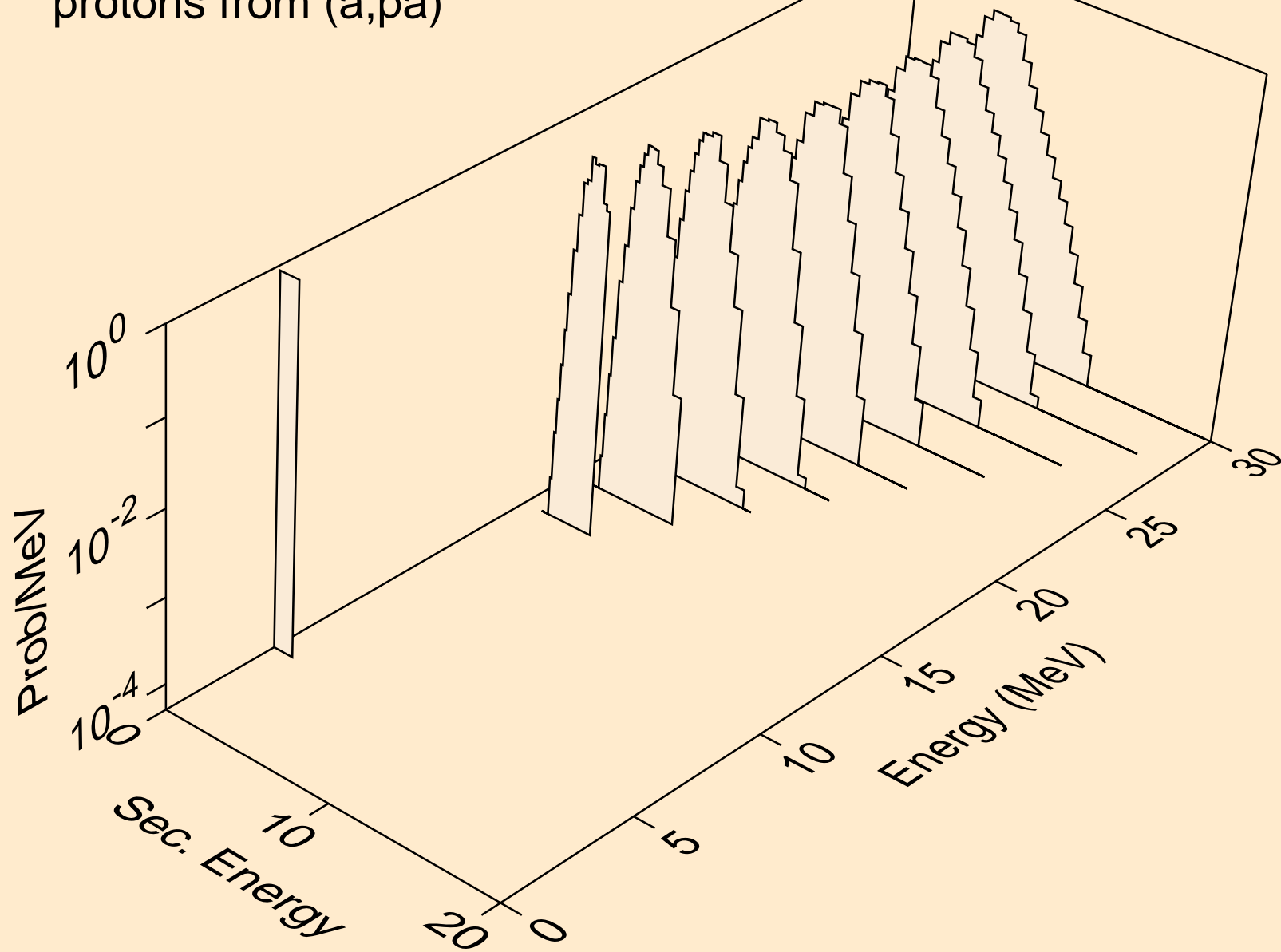

YB156 ALPHA ACER TENDL-2021 LIBRARY; T=0.K  
protons from (a,pd)

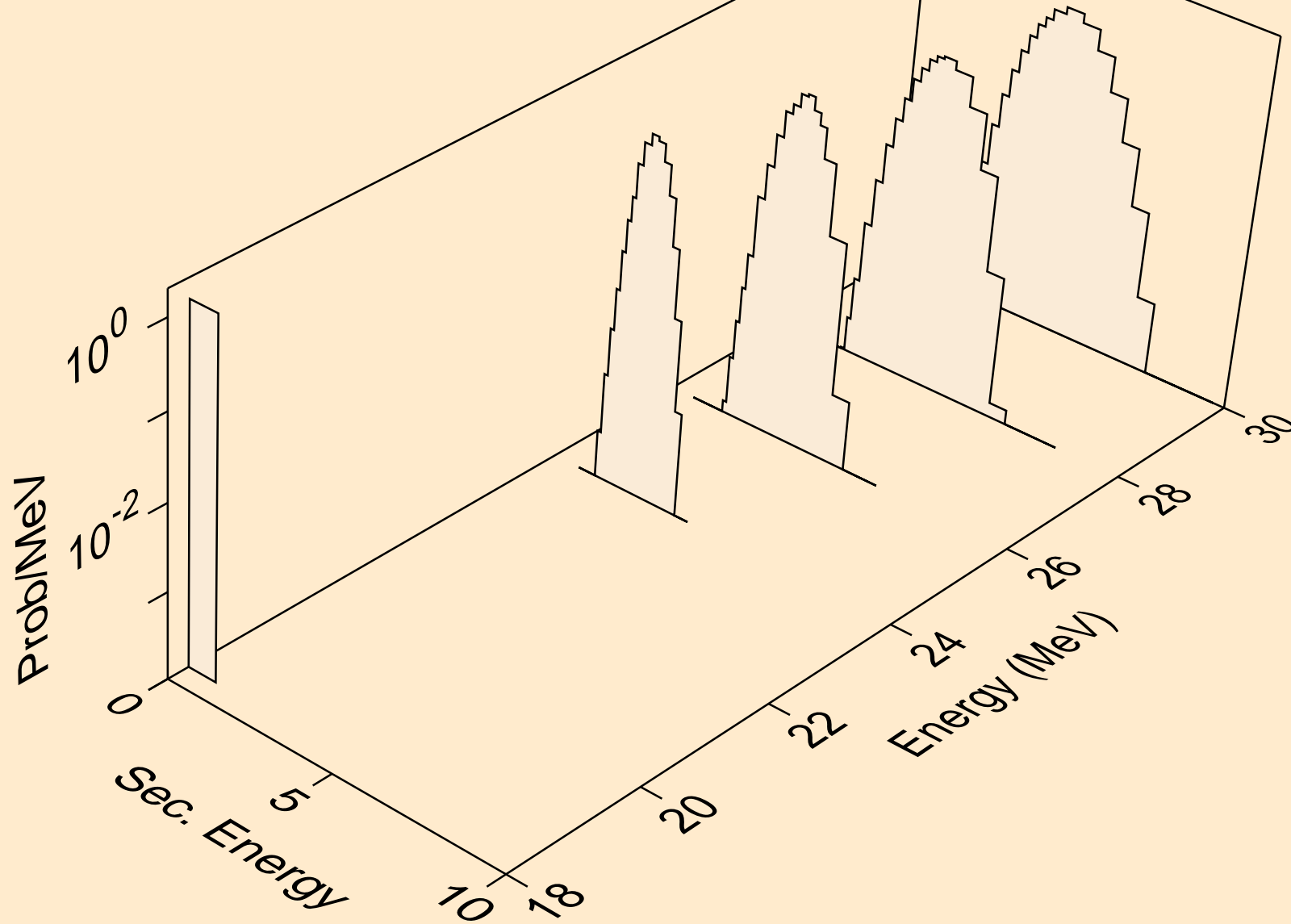

YB156 ALPHA ACER TENDL-2021 LIBRARY; T=0.K  
deuterons from (a,x)

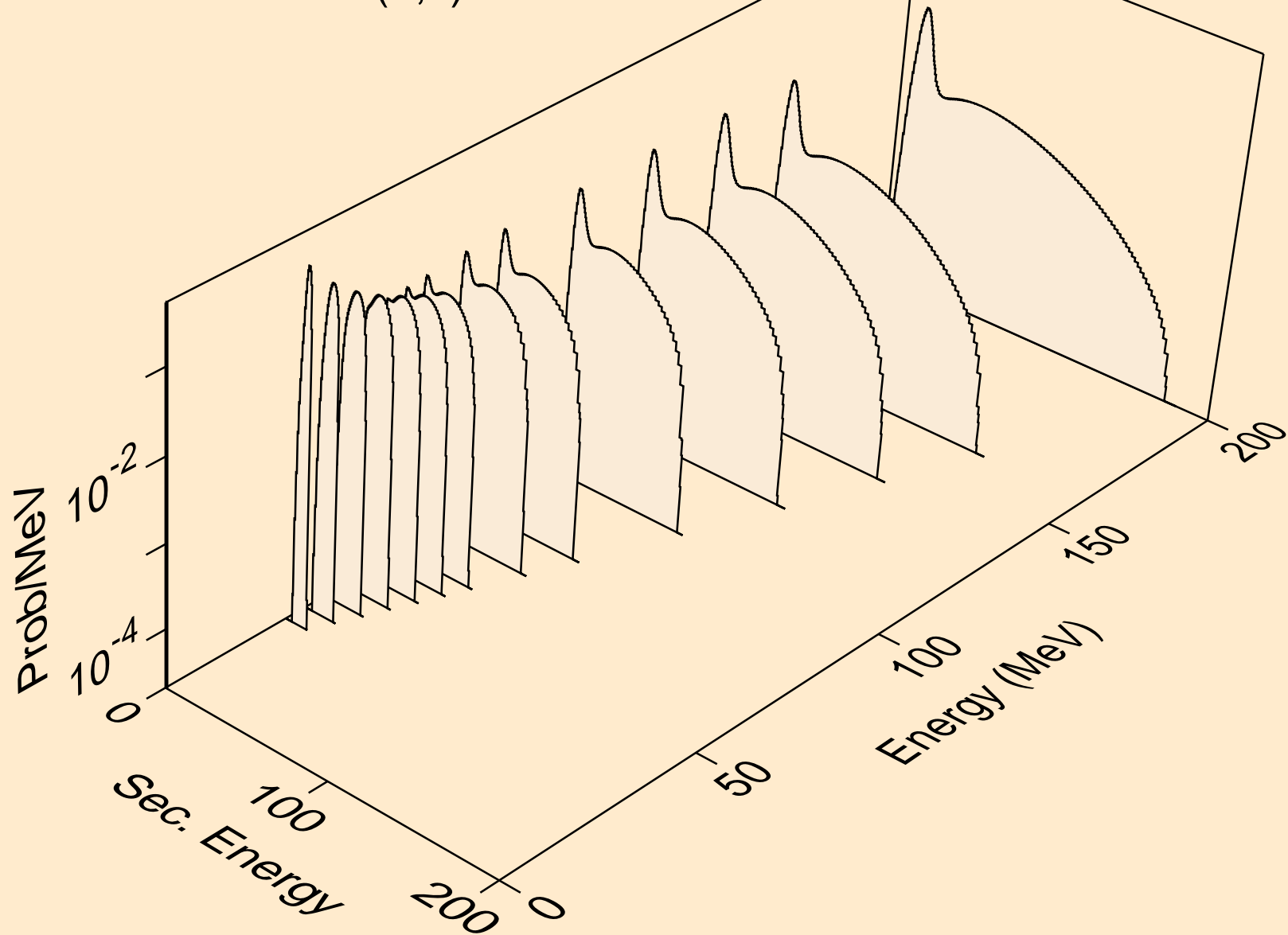

YB156 ALPHA ACER TENDL-2021 LIBRARY; T=0.K  
deuterons from (a,d)

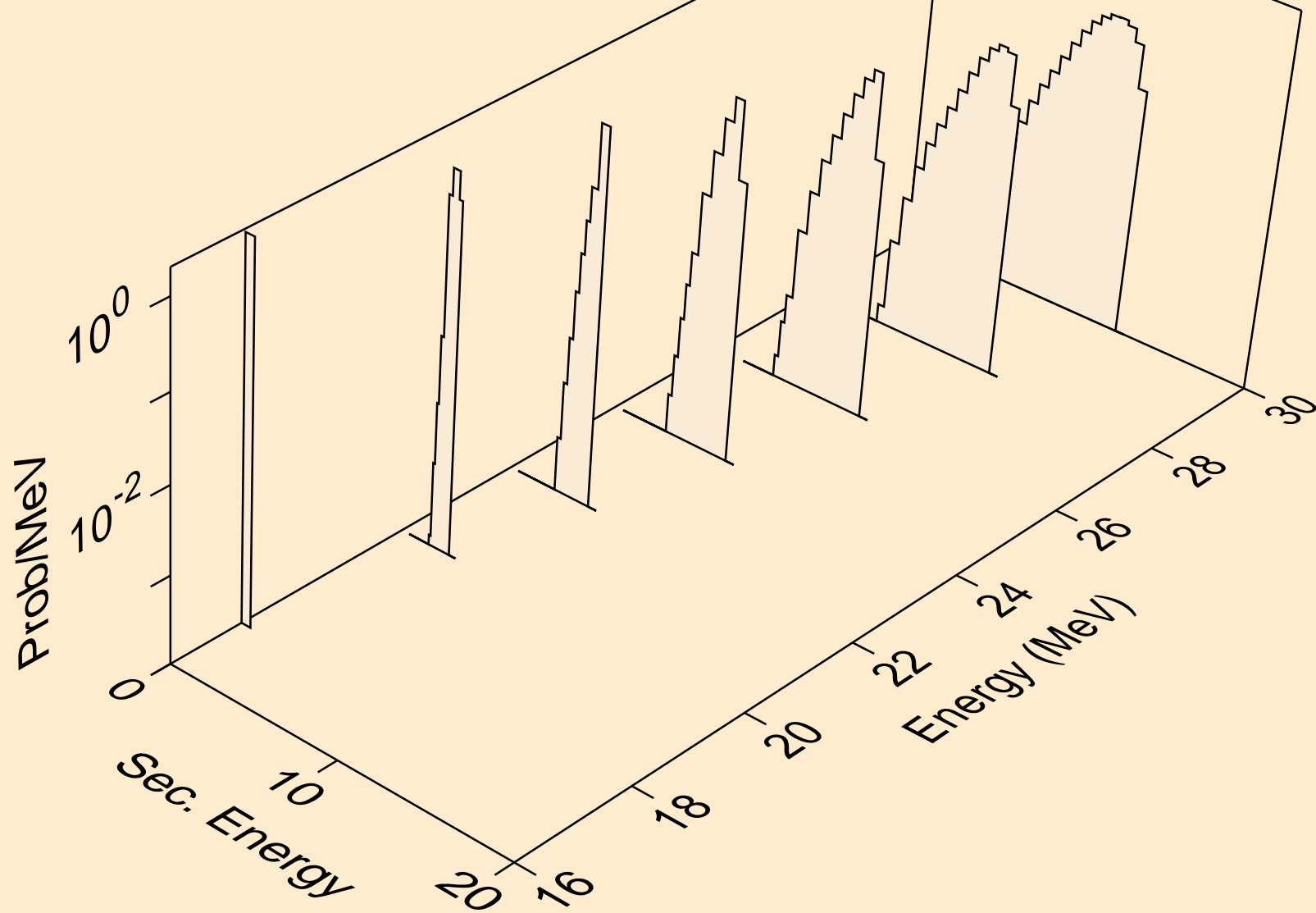

YB156 ALPHA ACER TENDL-2021 LIBRARY; T=0.K  
deuterons from (a,pd)

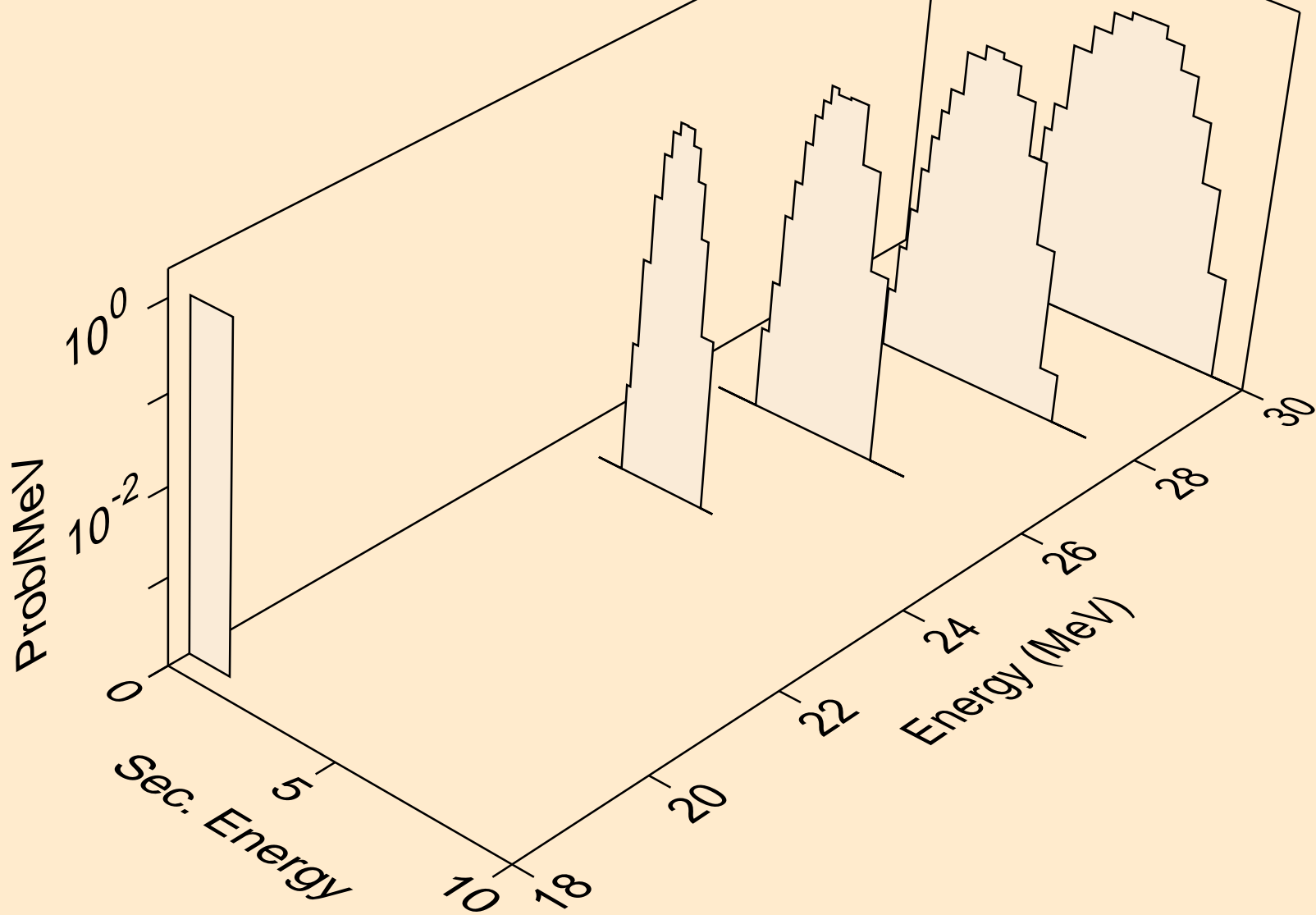

YB156 ALPHA ACER TENDL-2021 LIBRARY; T=0.K  
tritons from (a,x)

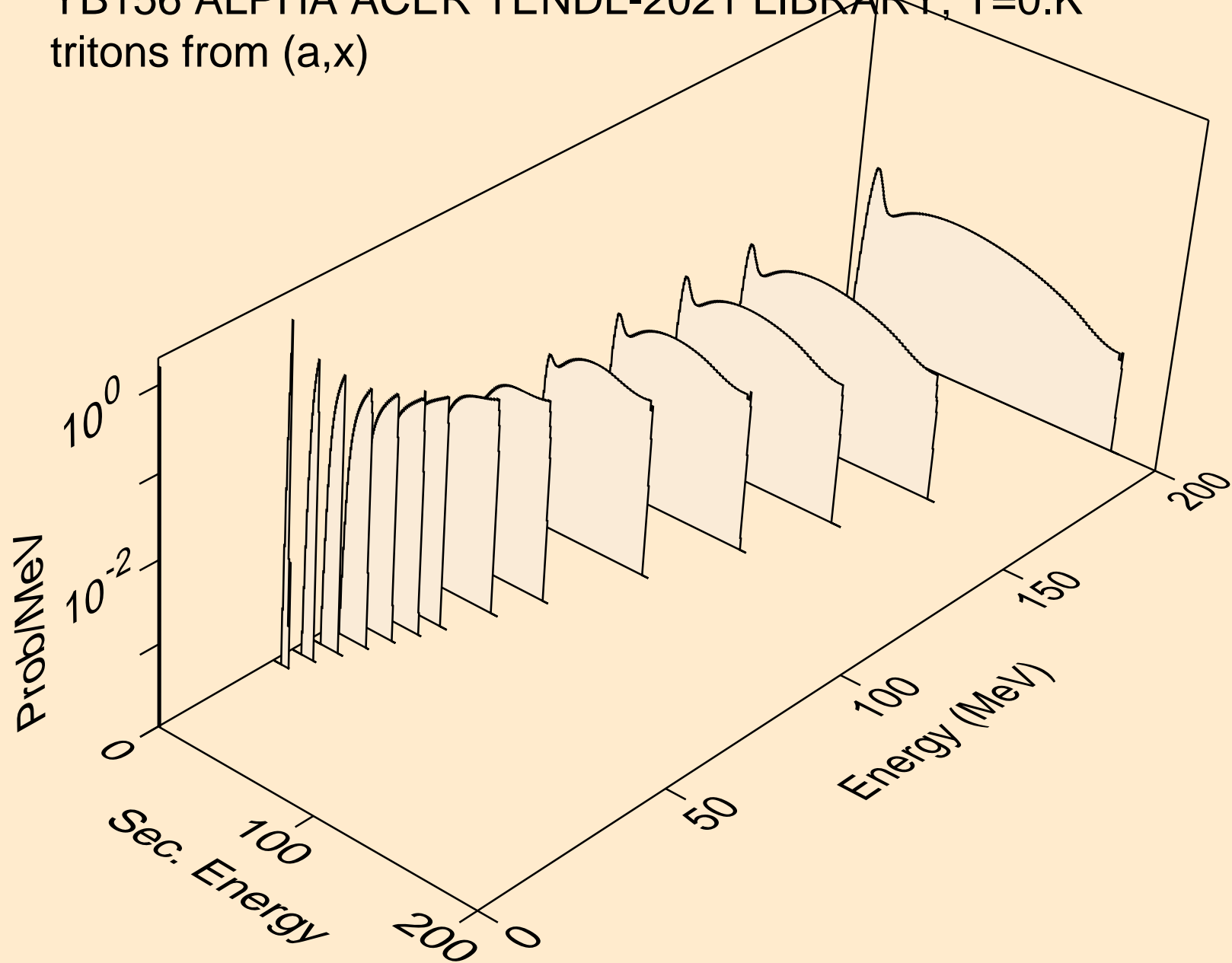

YB156 ALPHA ACER TENDL-2021 LIBRARY; T=0.K  
tritons from (a,t)

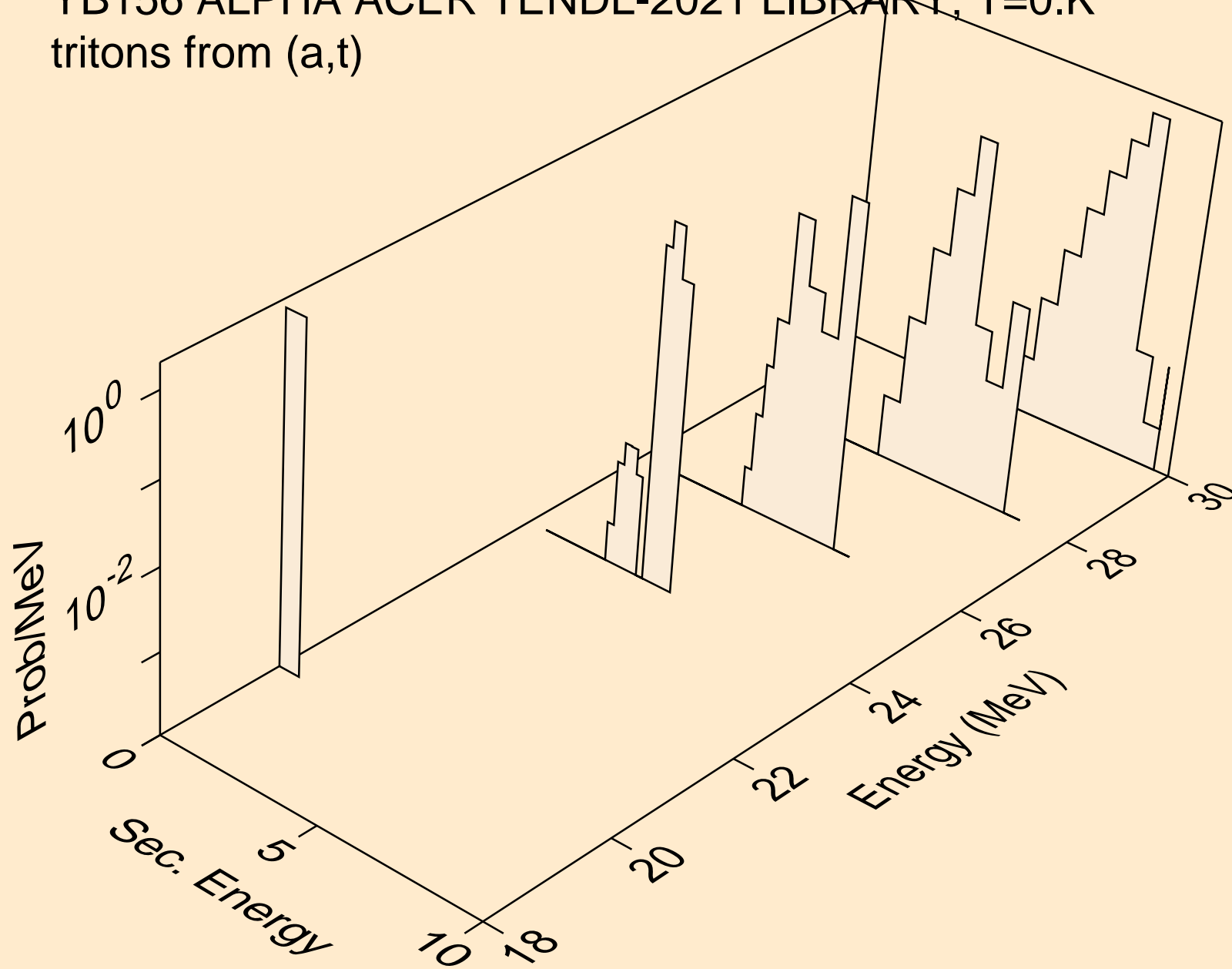

YB156 ALPHA ACER TENDL-2021 LIBRARY; T=0.K  
he3s from (a,x)

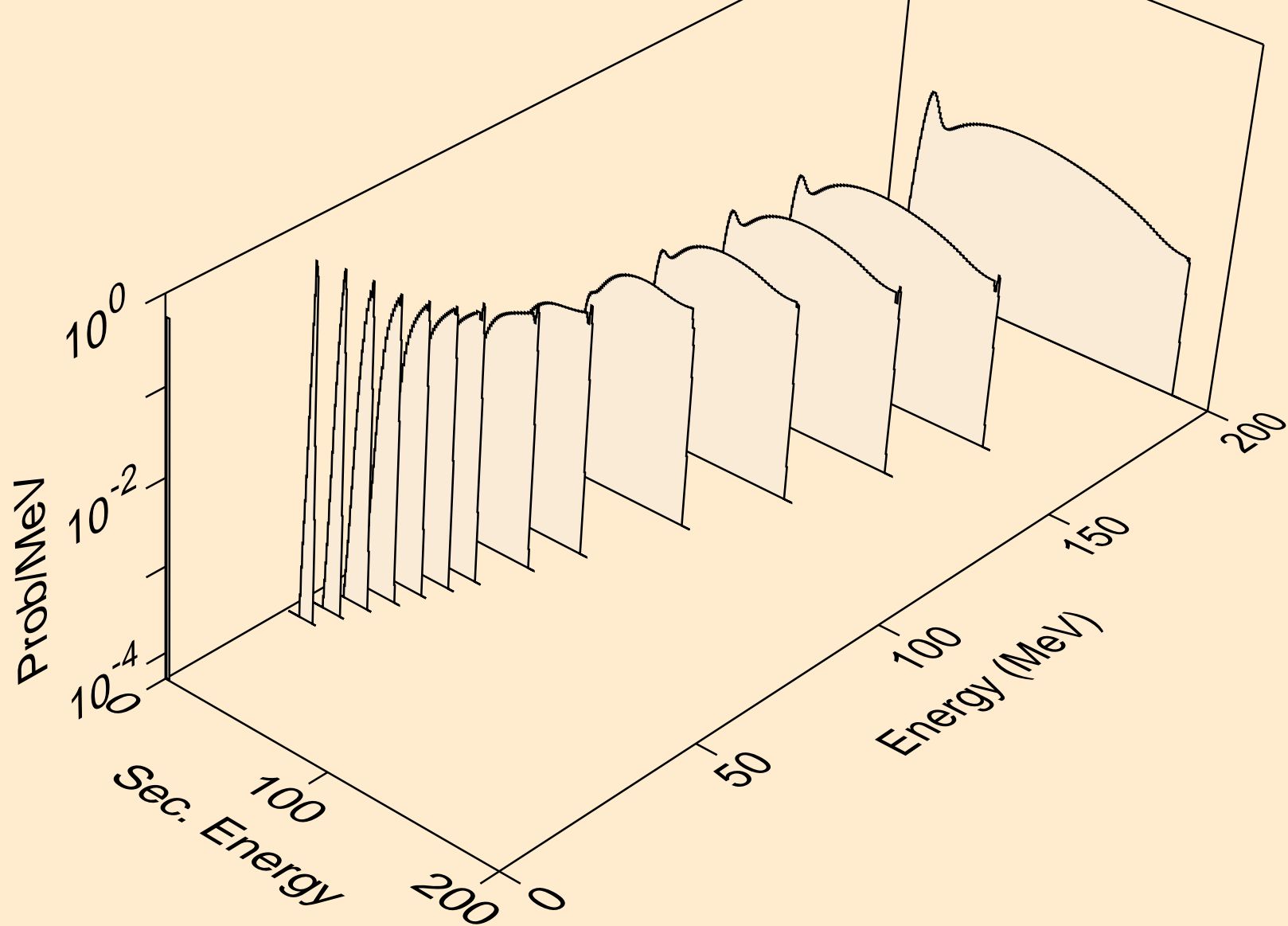

YB156 ALPHA ACER TENDL-2021 LIBRARY; T=0.K  
he3s from (a,he3)

