

BH269 DEUTERON ACER TENDL-2021 LIBRARY; T=0.K
Principal cross sections

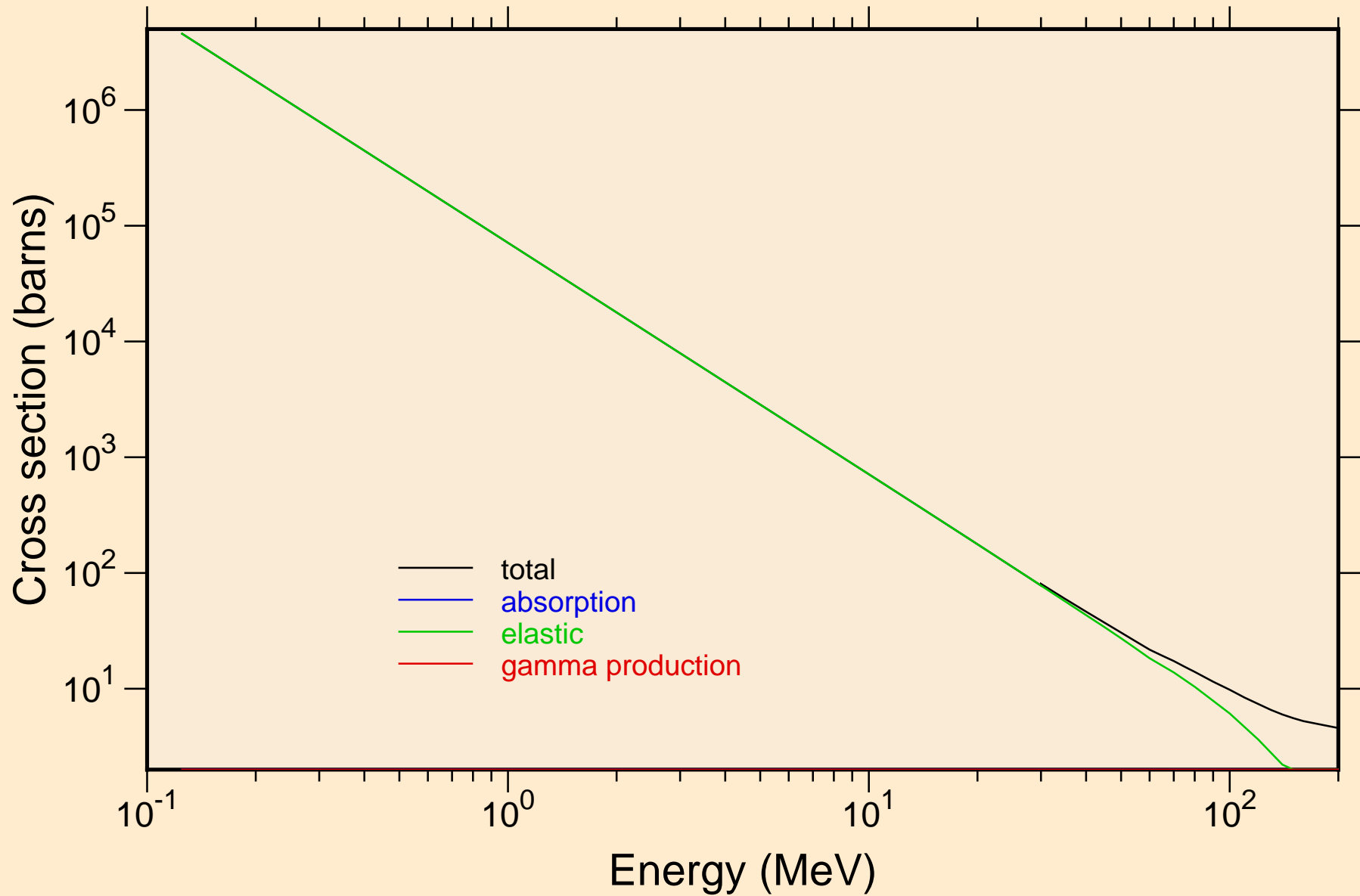

BH269 DEUTERON ACER TENDL-2021 LIBRARY; T=0.K
Heating

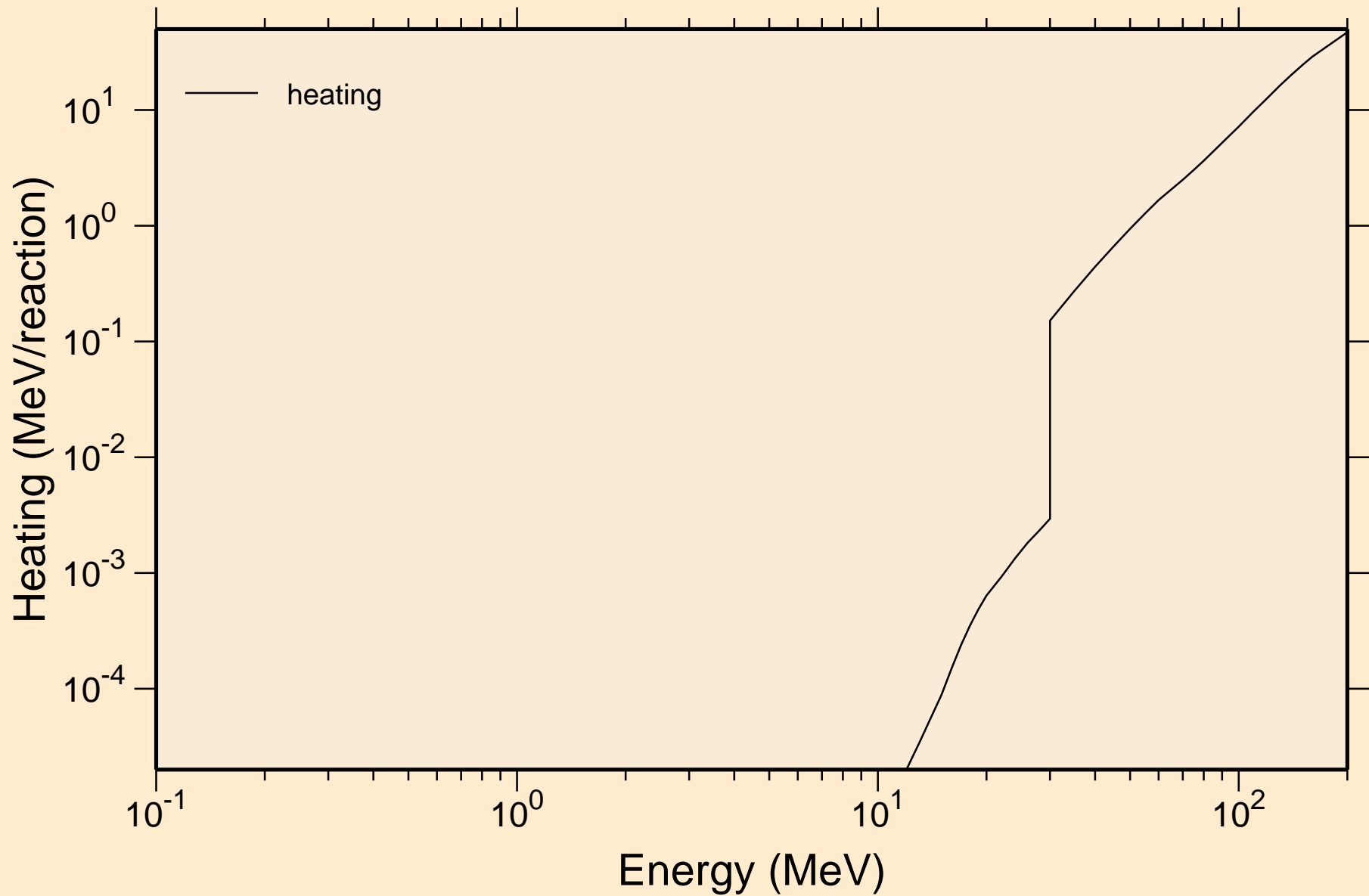

BH269 DEUTERON ACER TENDL-2021 LIBRARY; T=0.K
Principal cross sections

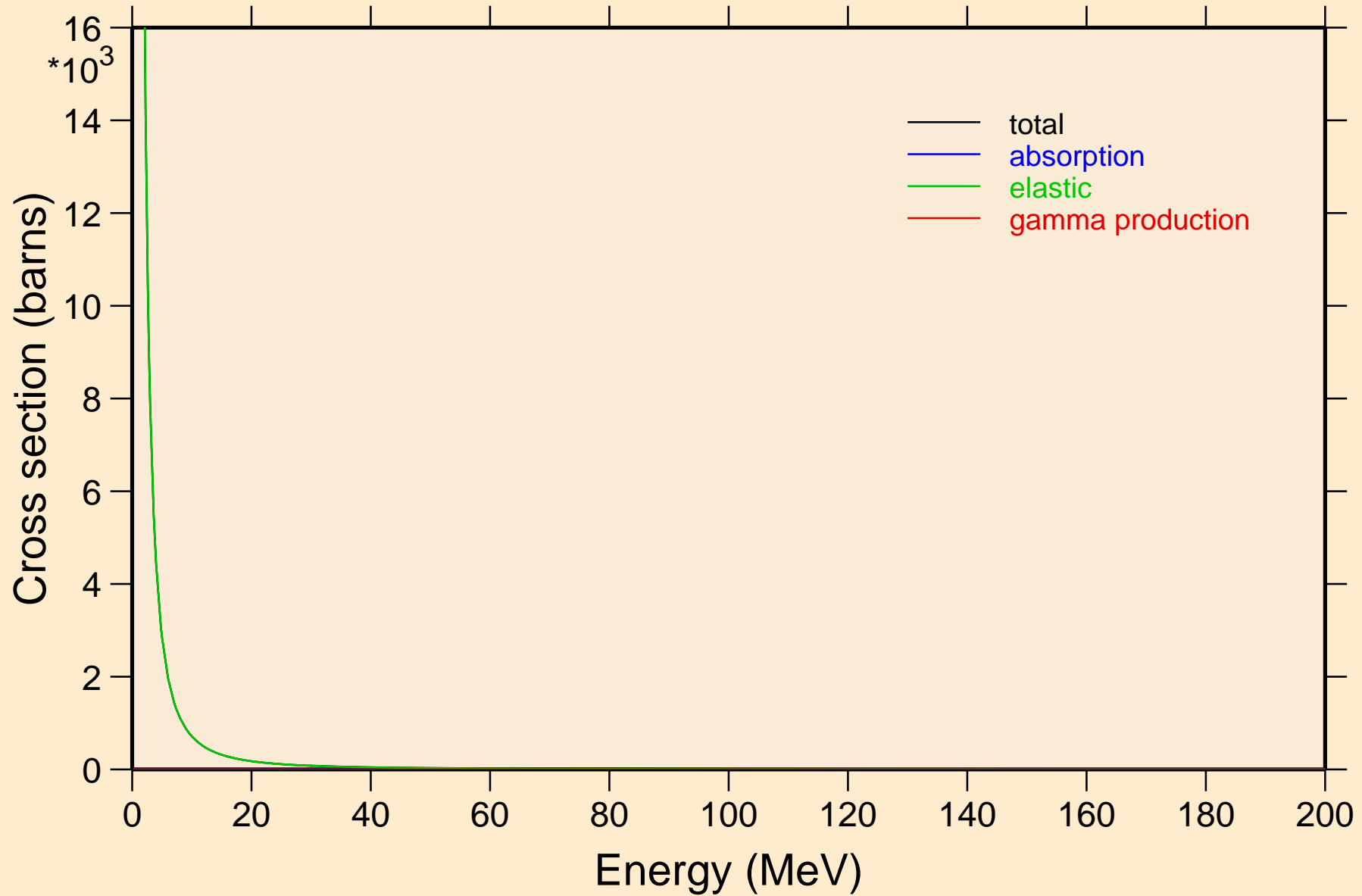

BH269 DEUTERON ACER TENDL-2021 LIBRARY; T=0.K

Heating

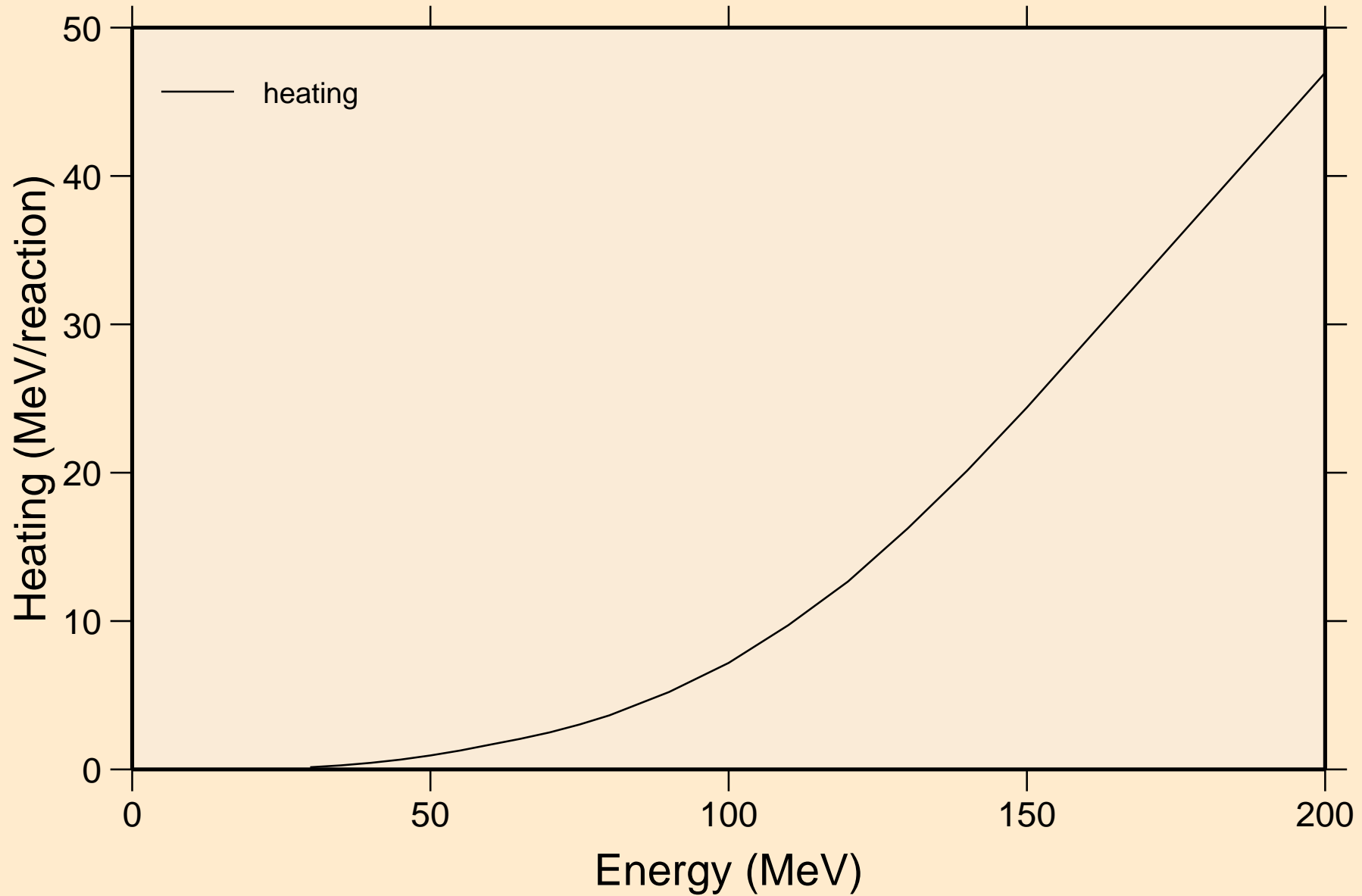

BH269 DEUTERON ACER TENDL-2021 LIBRARY; T=0.K
Threshold reactions

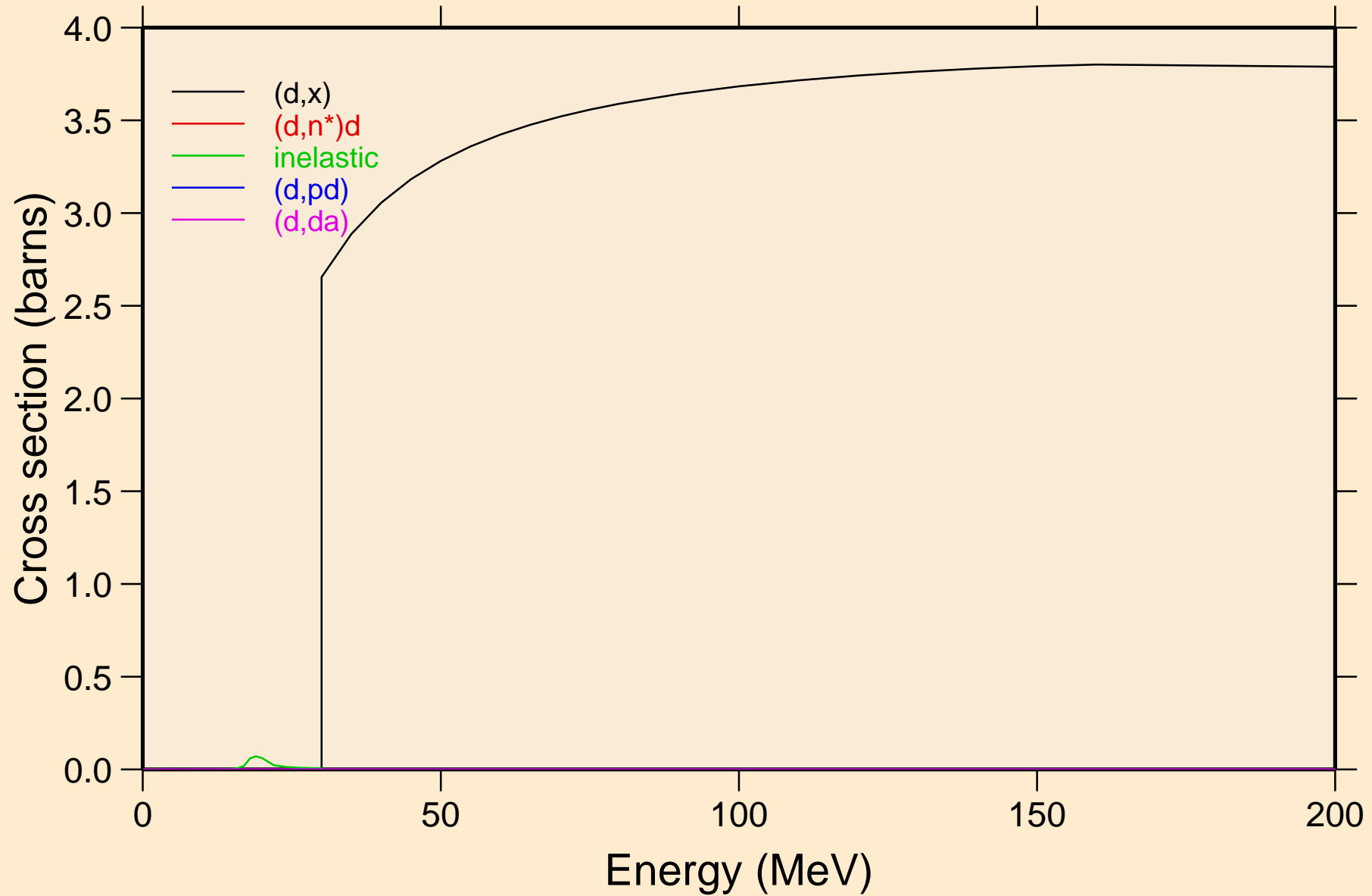

BH269 DEUTERON ACER TENDL-2021 LIBRARY; T=0.K
angular distribution for elastic

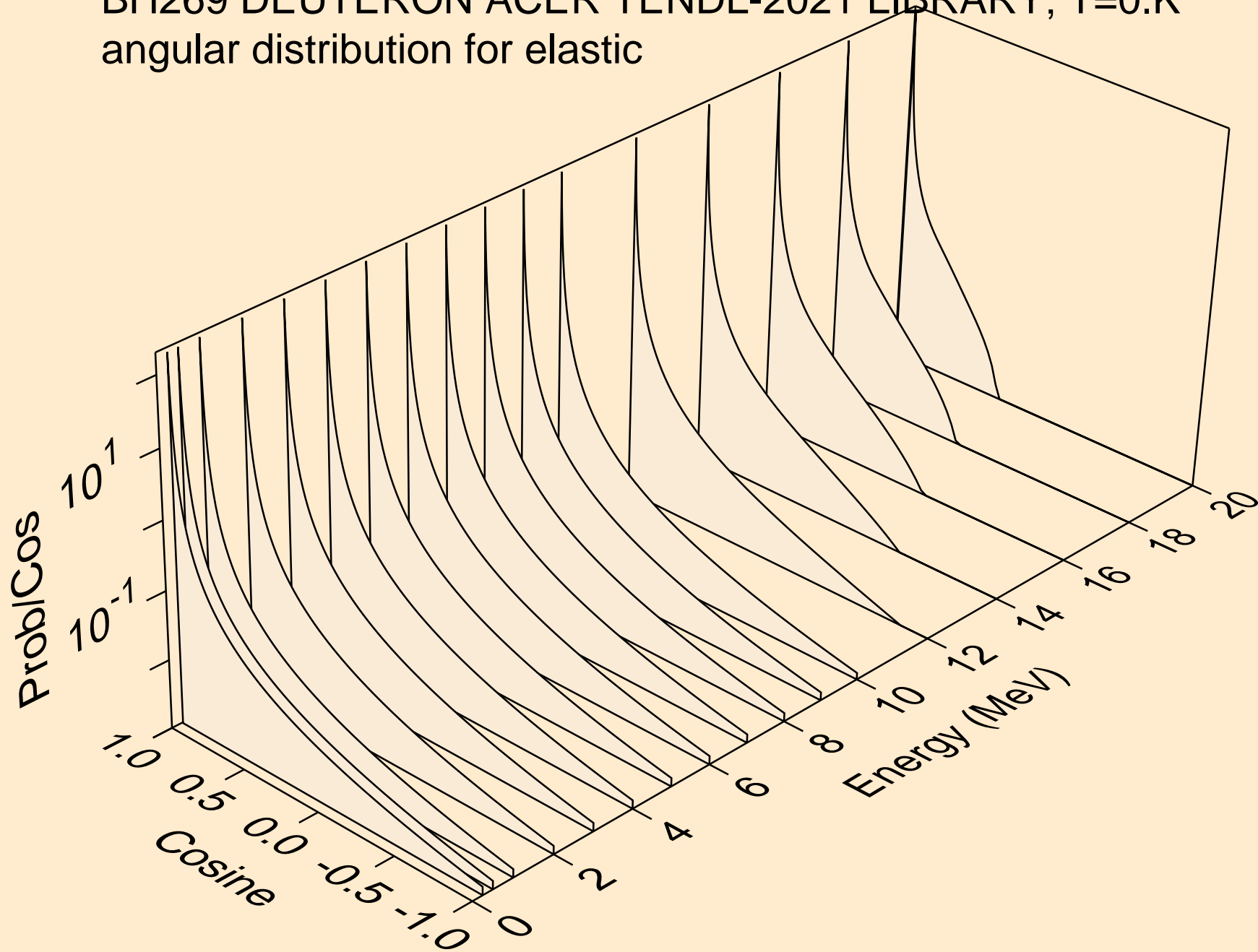

BH269 DEUTERON ACER TENDL-2021 LIBRARY; T=0.K
angular distribution for elastic

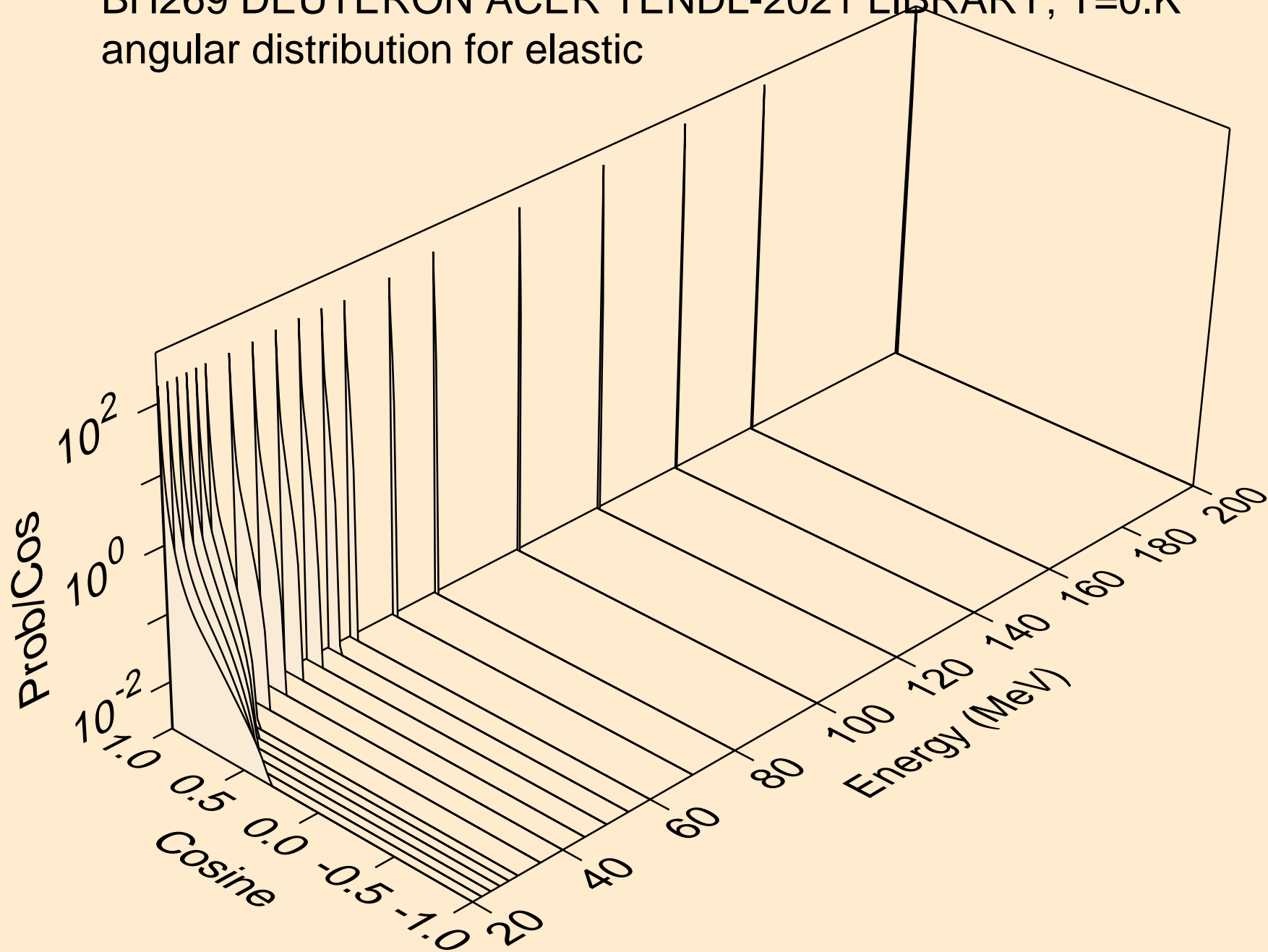

BH269 DEUTERON ACER TENDL-2021 LIBRARY; T=0.K
Deuteron emission for (d,x)

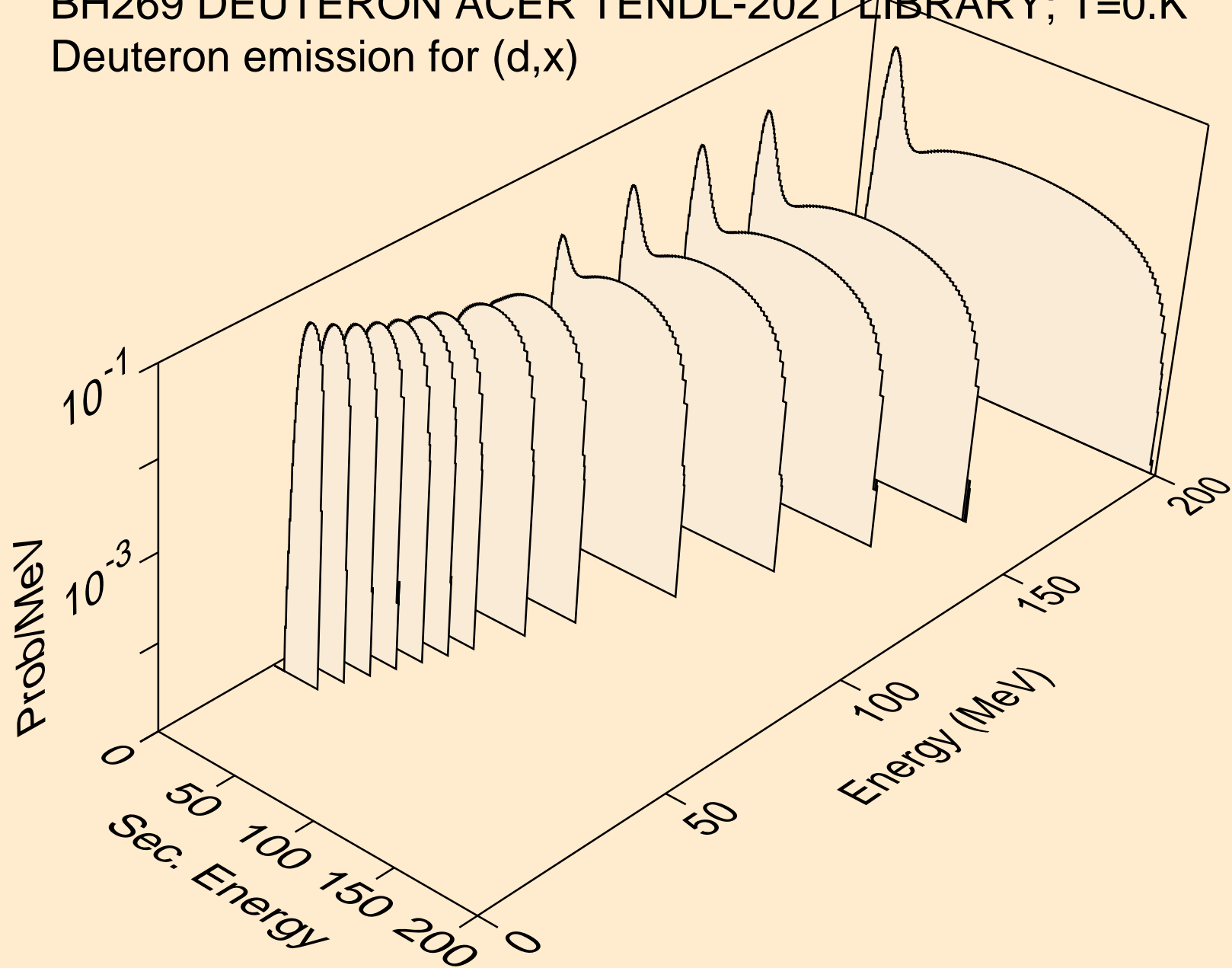

BH269 DEUTERON ACER TENDL-2021 LIBRARY; T=0.K
Deuteron emission for (d,n*)d

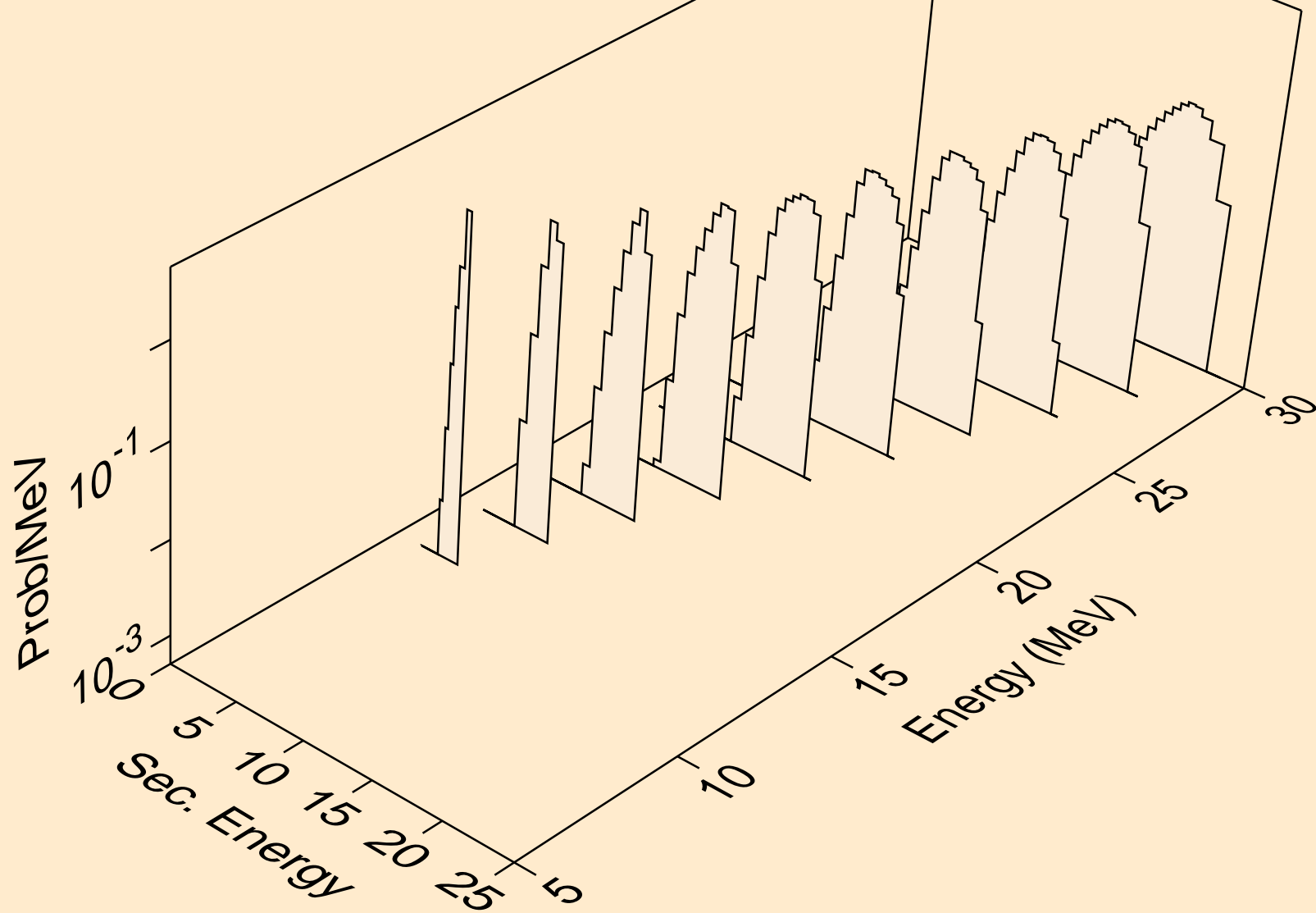

BH269 DEUTERON ACER TENDL-2021 LIBRARY; T=0.K
Deuteron emission for inelastic

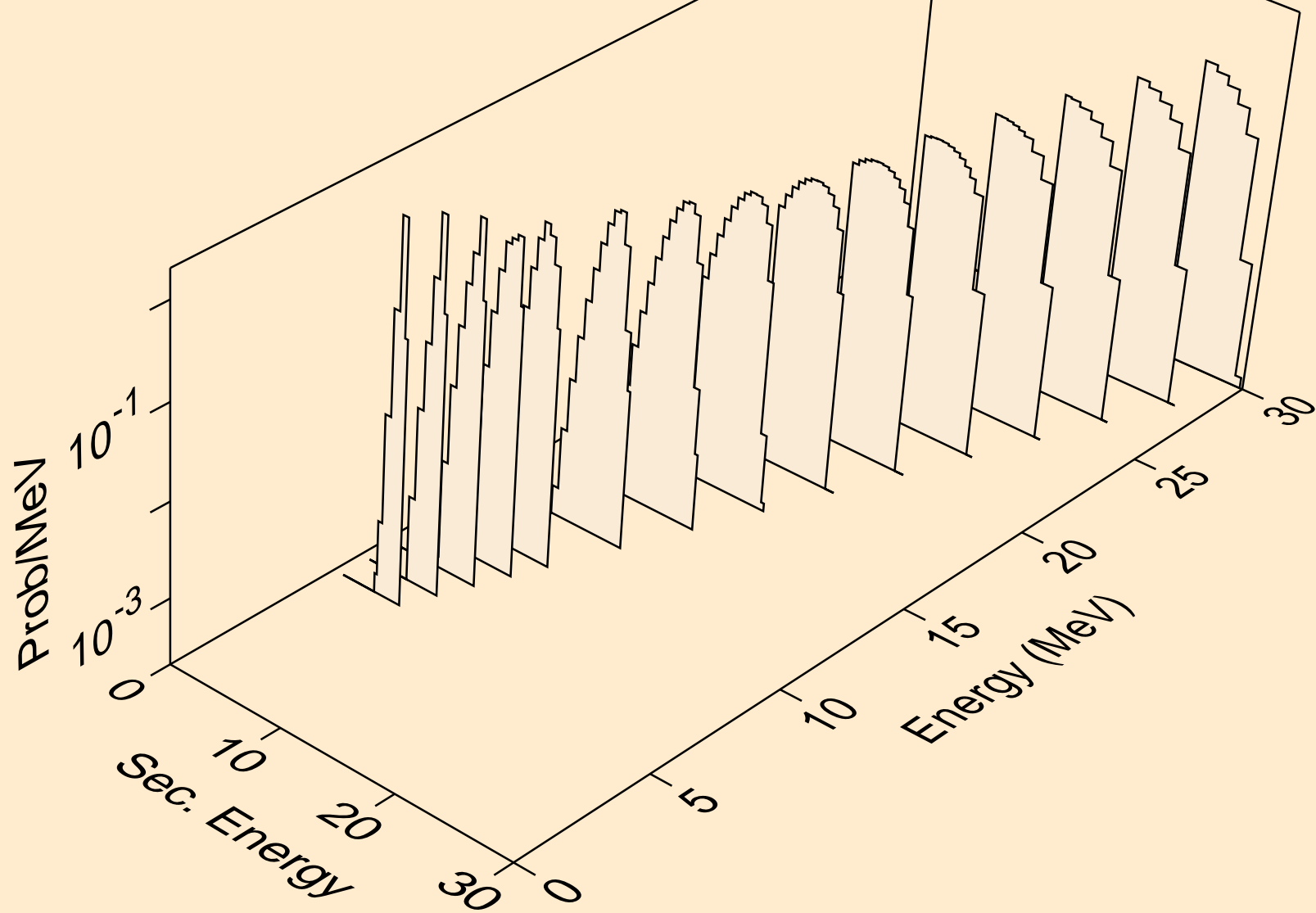

BH269 DEUTERON ACER TENDL-2021 LIBRARY; T=0.K
Deuteron emission for (d,pd)

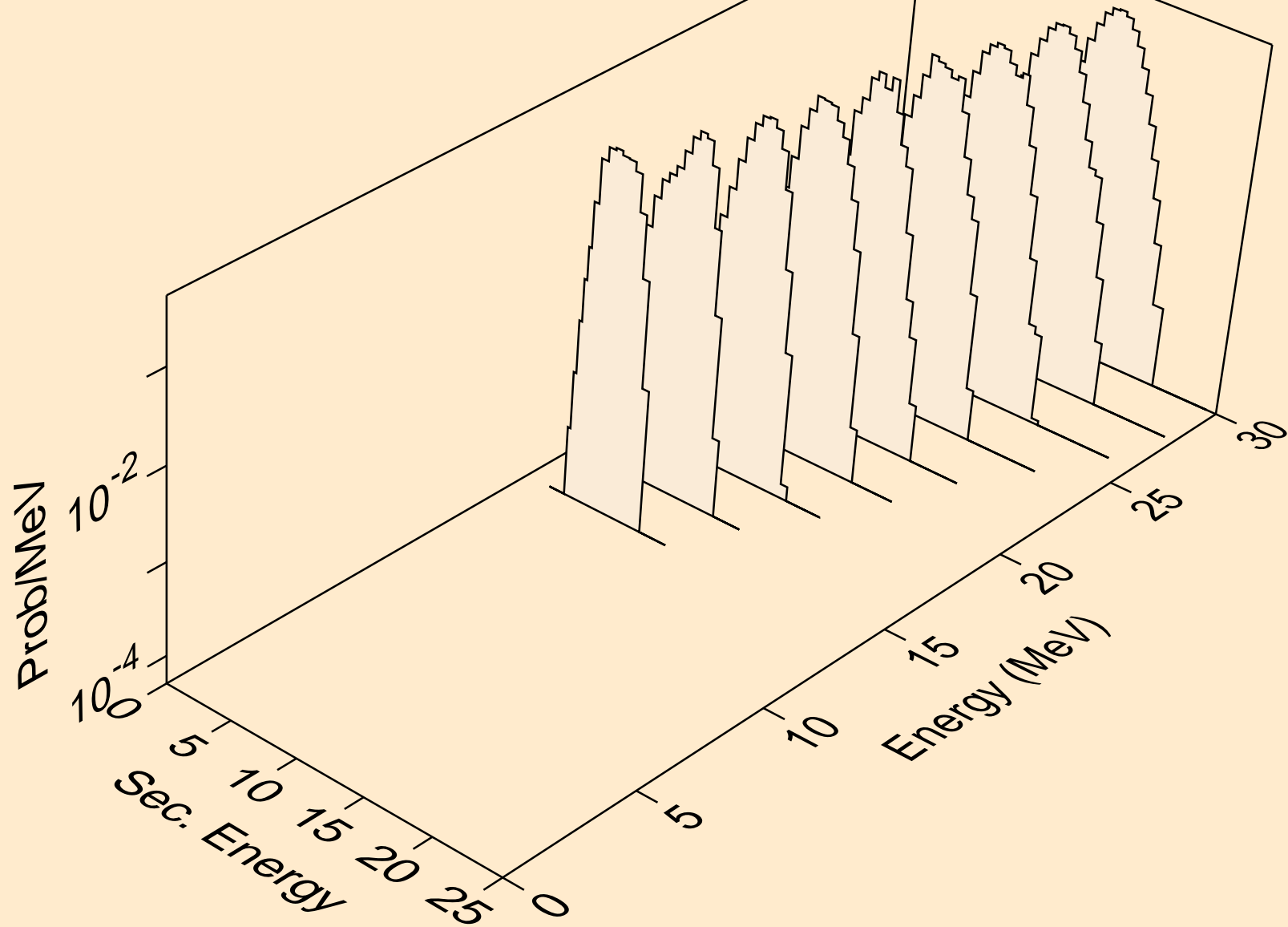

BH269 DEUTERON ACER TENDL-2021 LIBRARY; T=0.K
Deuteron emission for (d,da)

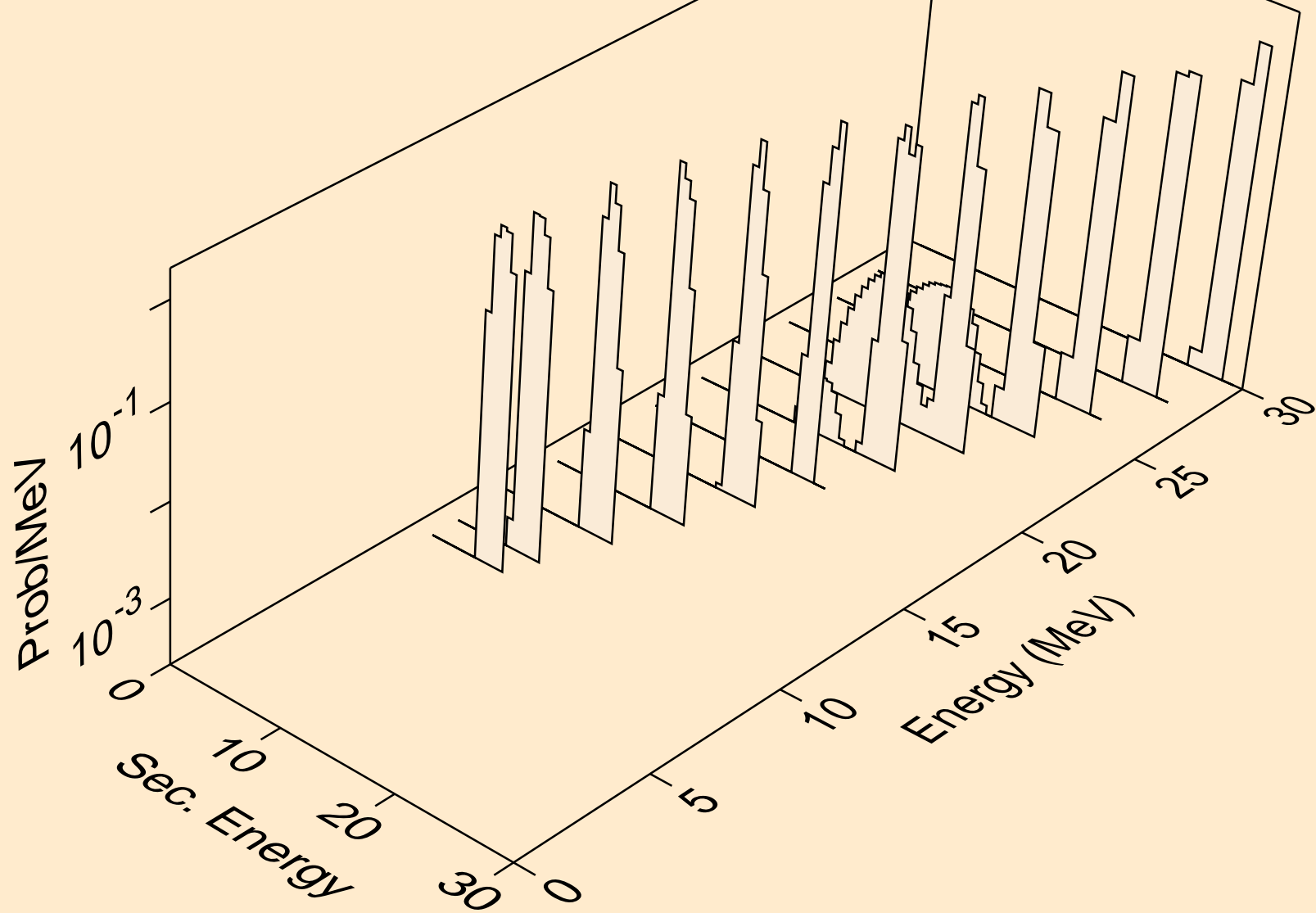

BH269 DEUTERON ACER TENDL-2021 LIBRARY; T=0.K
Photon emission for (z,n)

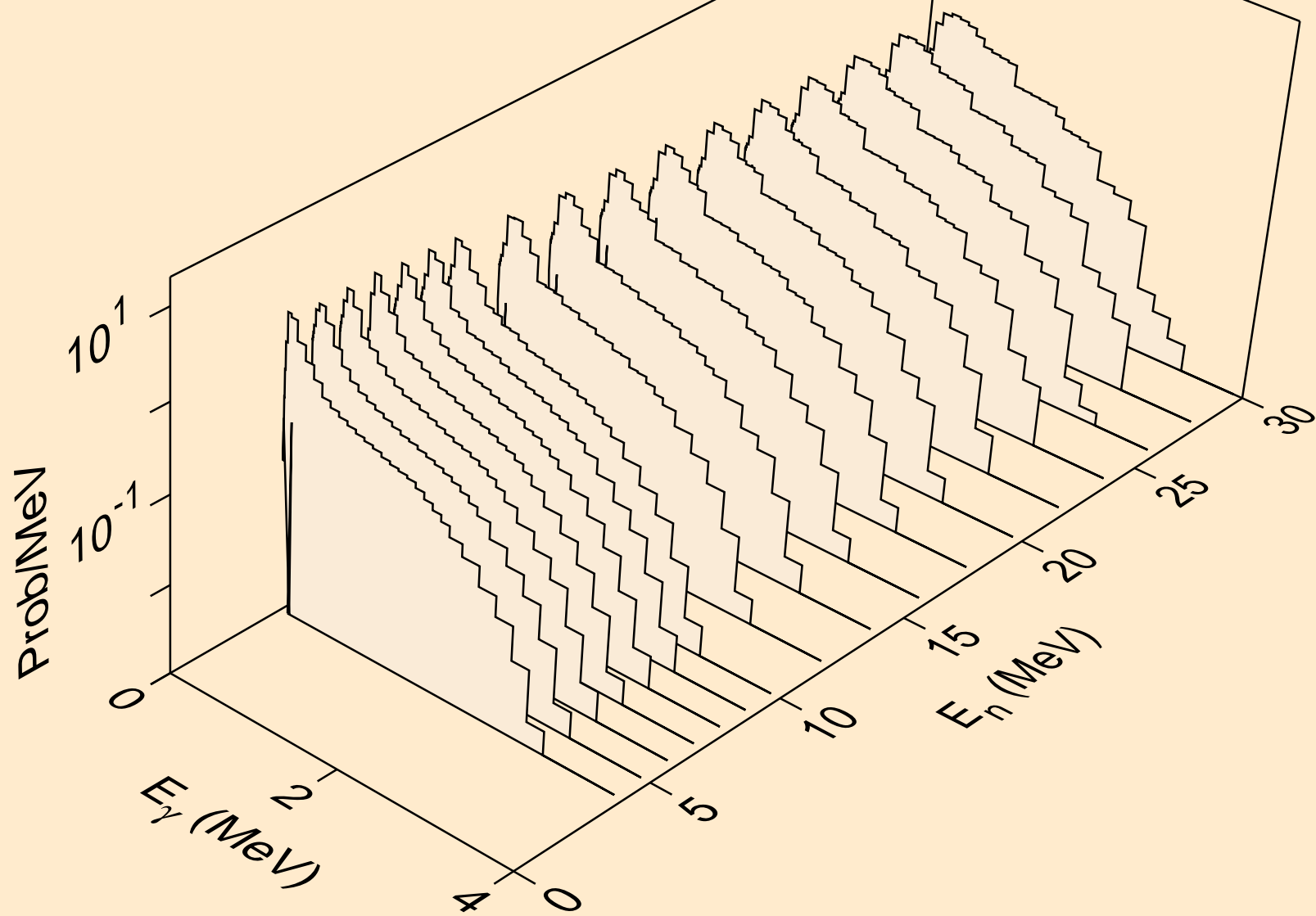

BH269 DEUTERON ACER TENDL-2021 LIBRARY; T=0.K
Photon emission for (n,x)

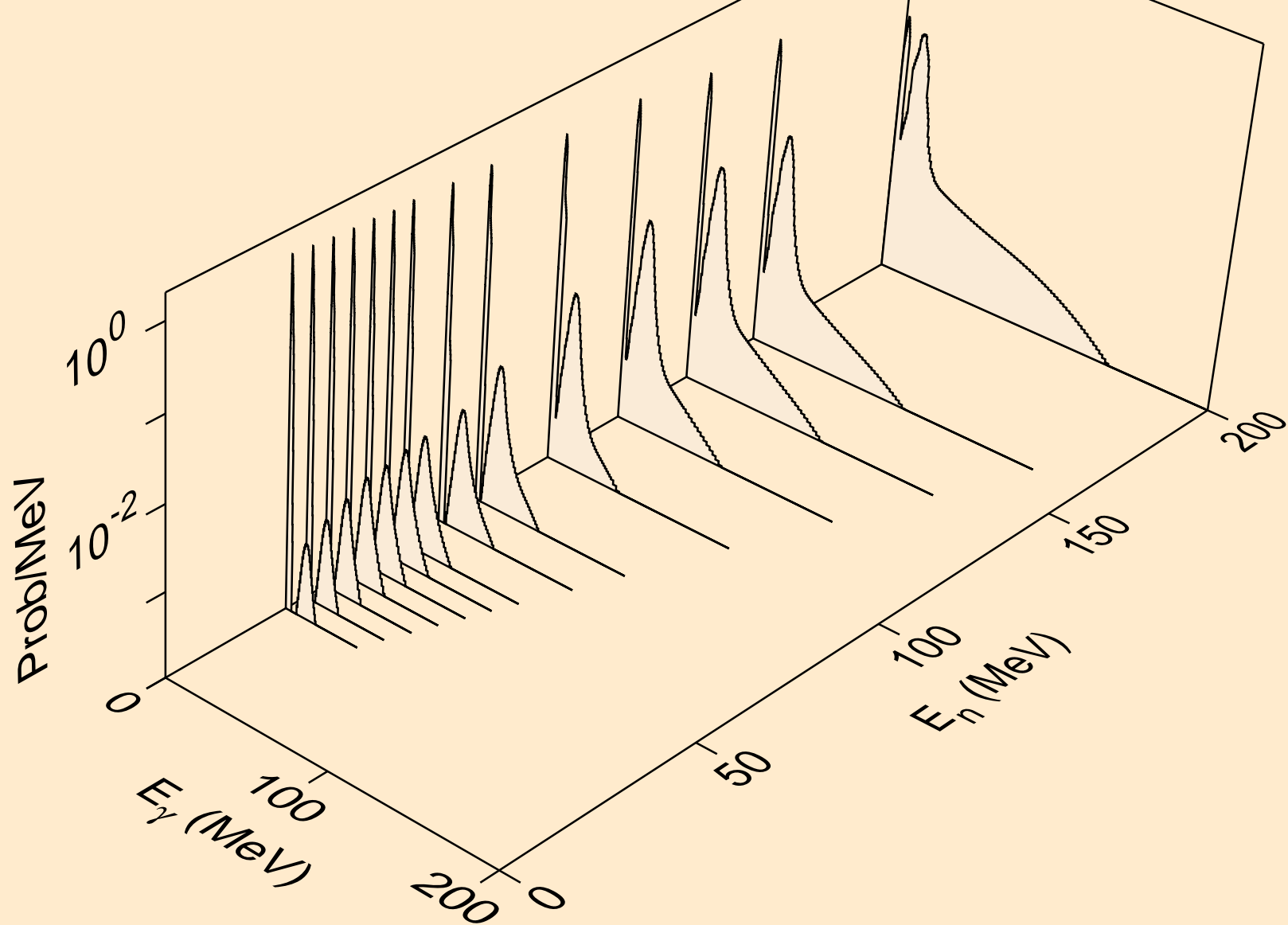

BH269 DEUTERON ACER TENDL-2021 LIBRARY; T=0.K
Photon emission for (n,2n)

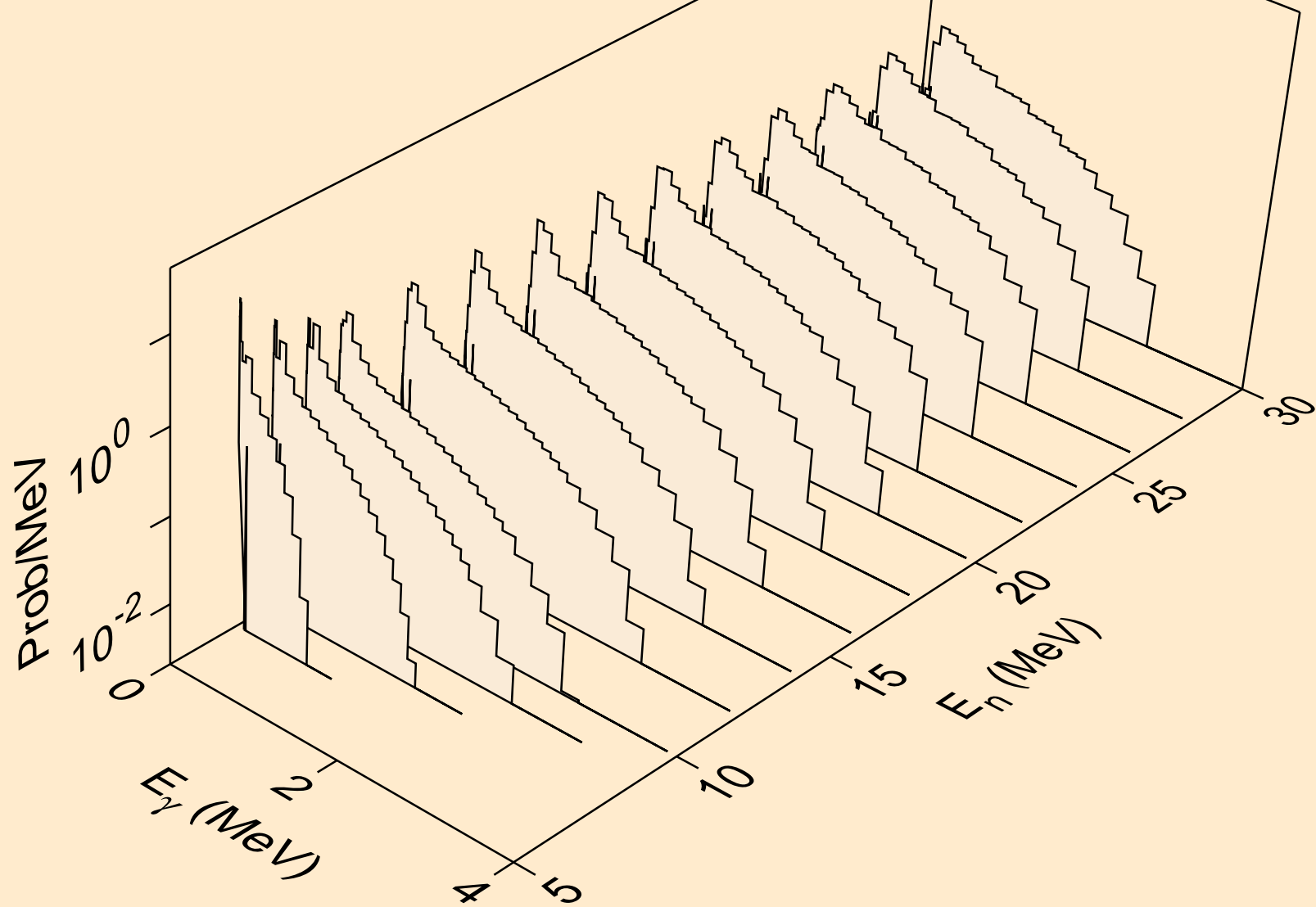

BH269 DEUTERON ACER TENDL-2021 LIBRARY; T=0.K
Photon emission for (n,3n)

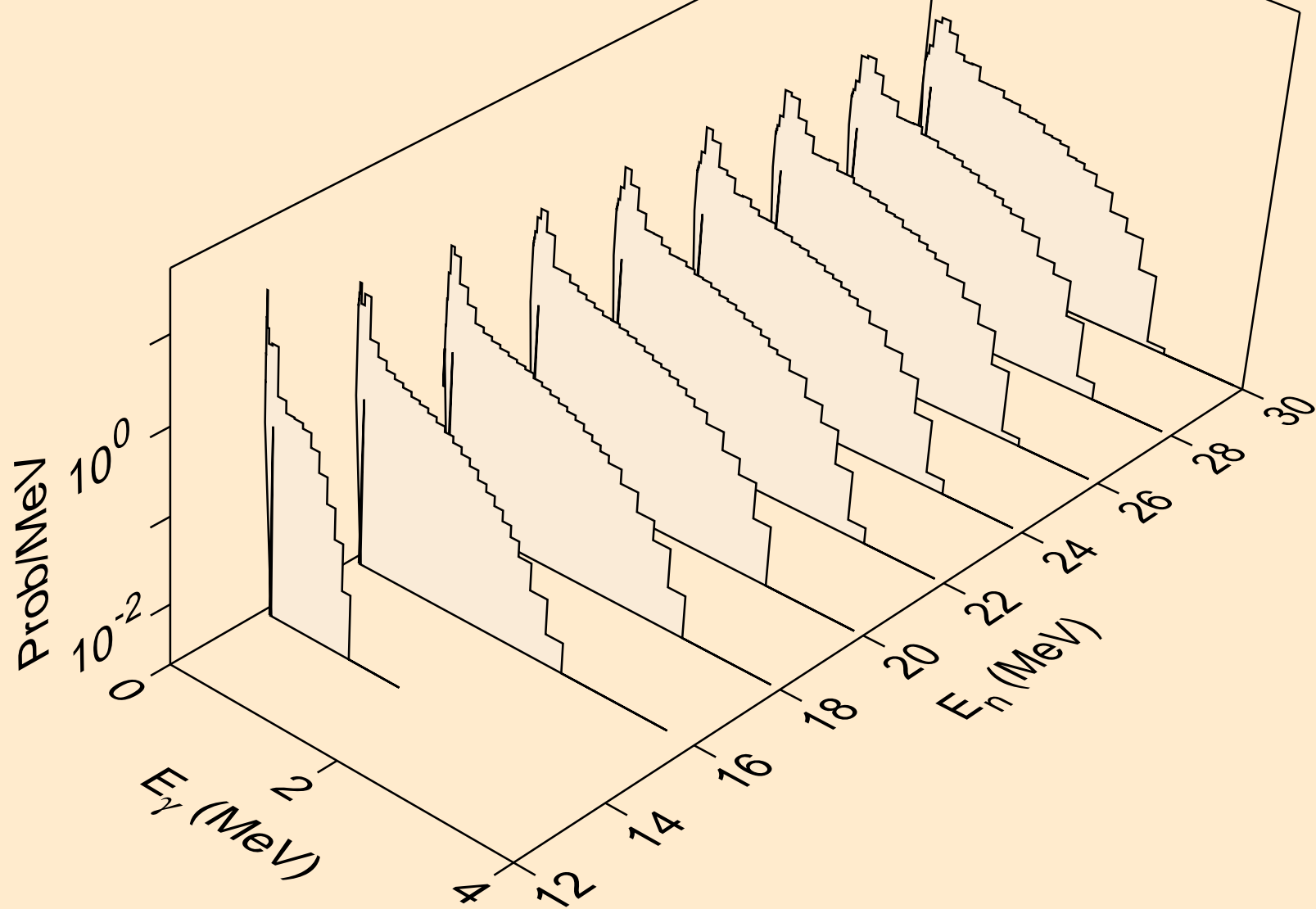

BH269 DEUTERON ACER TENDL-2021 LIBRARY; T=0.K
Photon emission for (n,n*)a

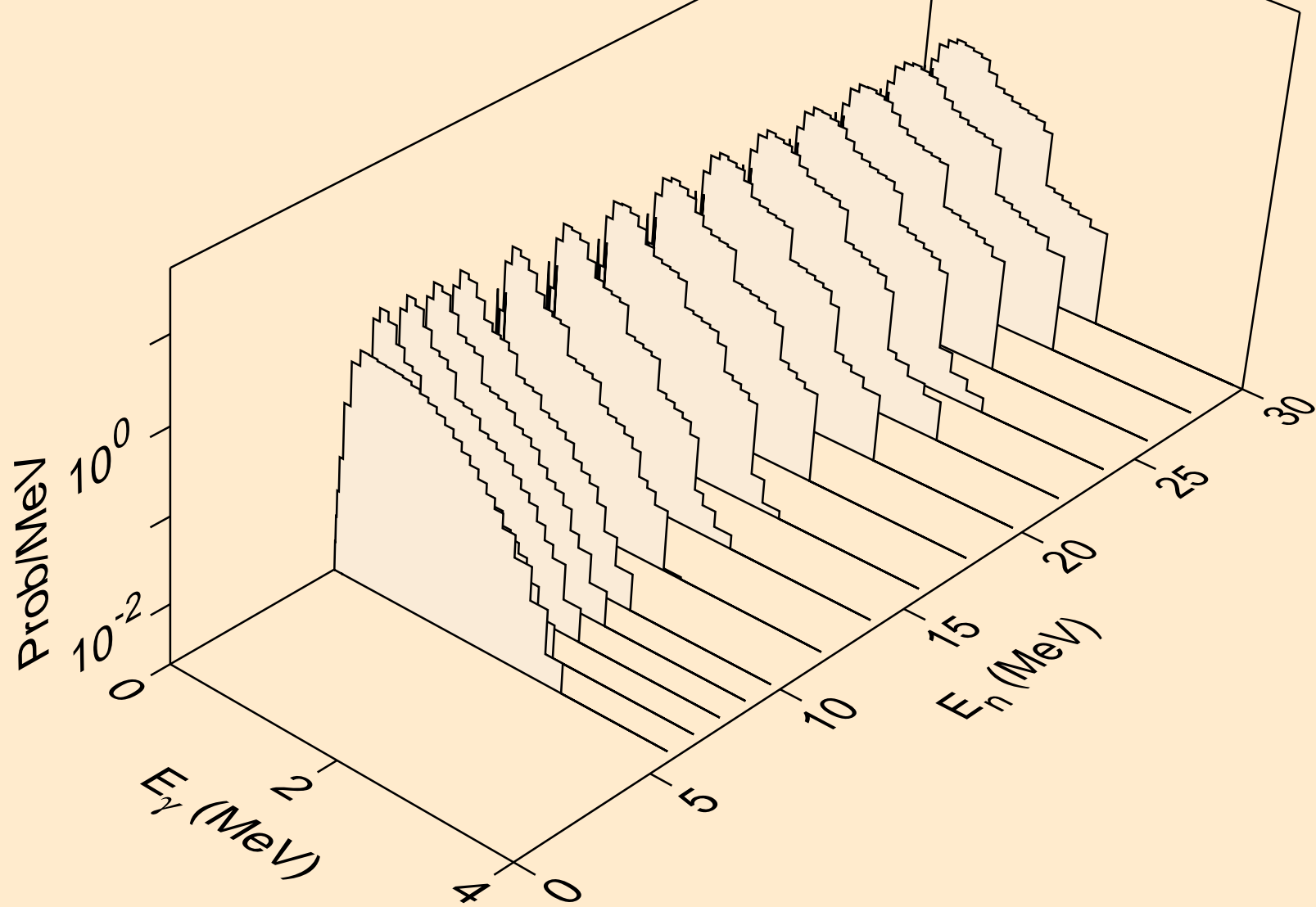

BH269 DEUTERON ACER TENDL-2021 LIBRARY; T=0.K
Photon emission for (n,2n)a

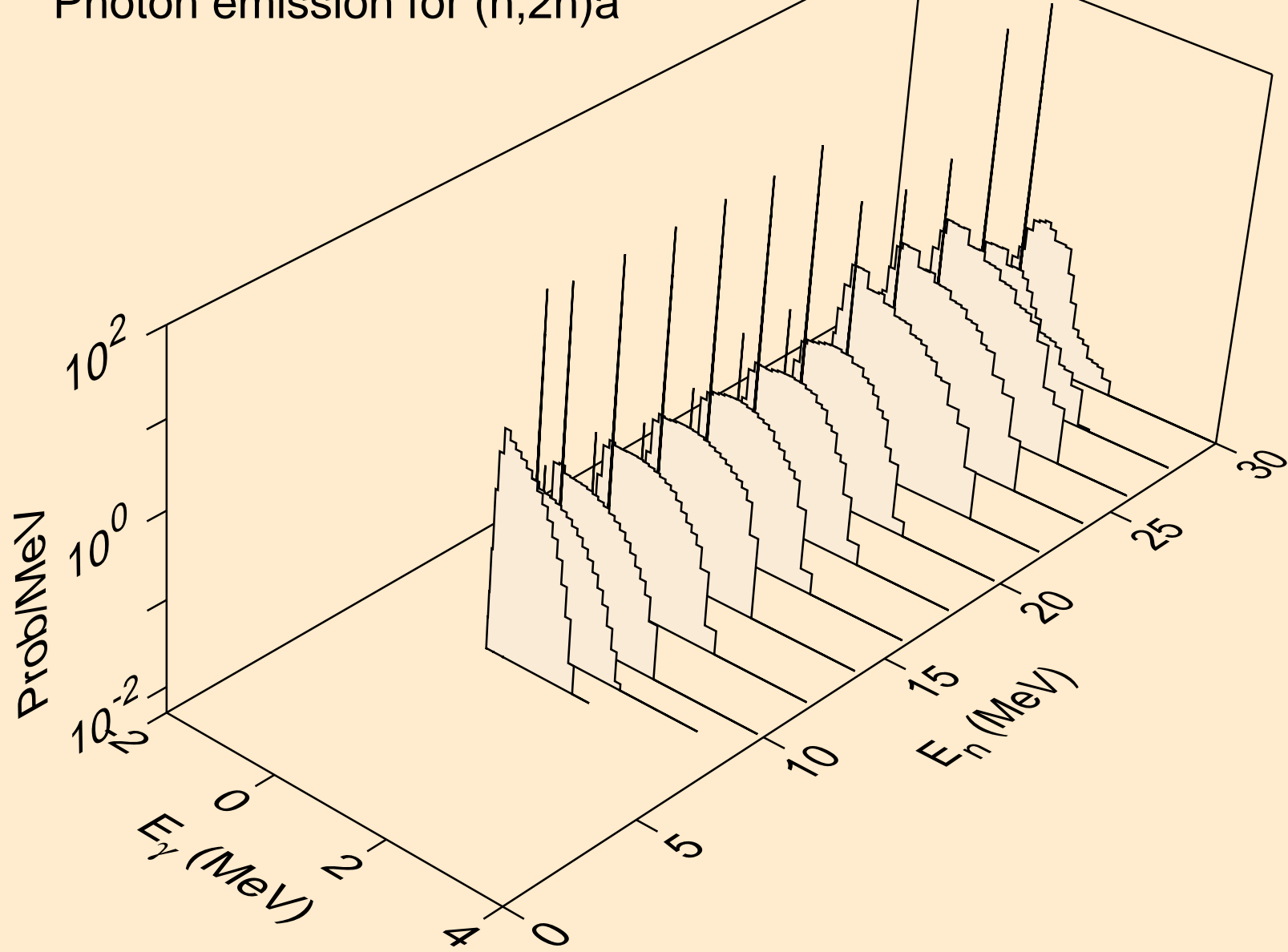

BH269 DEUTERON ACER TENDL-2021 LIBRARY; T=0.K
Photon emission for (n,3n)a

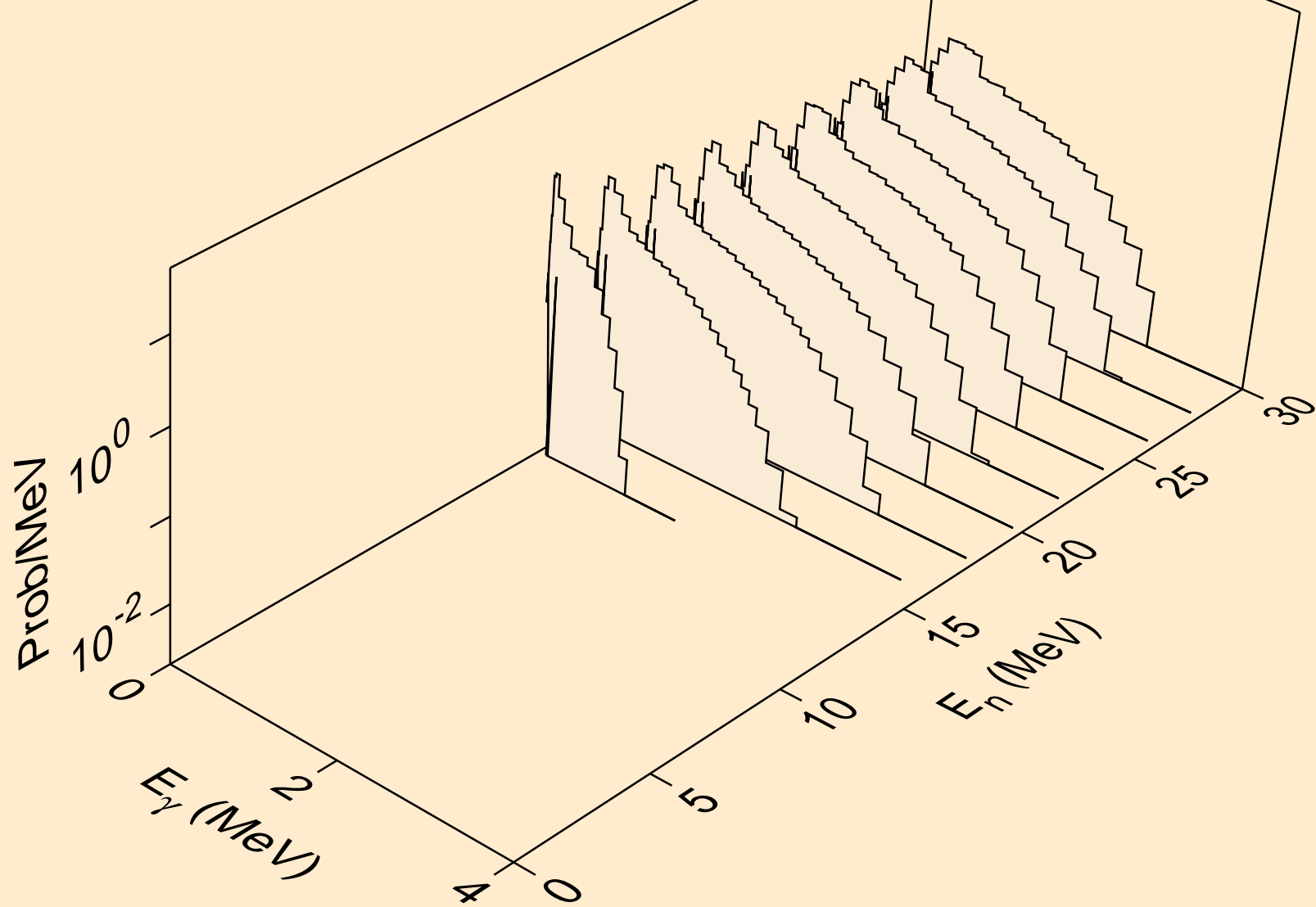

BH269 DEUTERON ACER TENDL-2021 LIBRARY; T=0.K
Photon emission for (n,n*)p

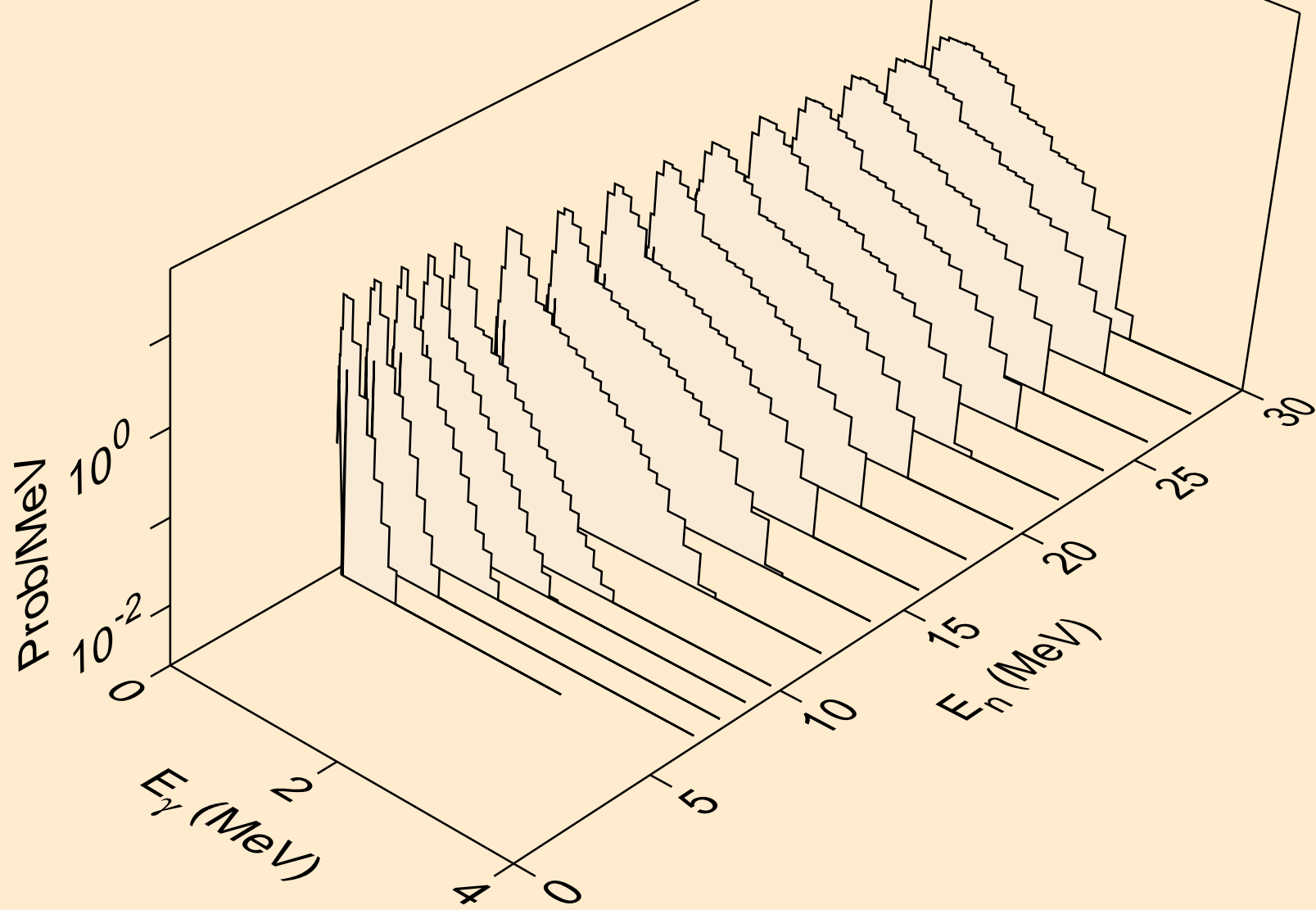

BH269 DEUTERON ACER TENDL-2021 LIBRARY; T=0.K
Photon emission for (n,n*)d

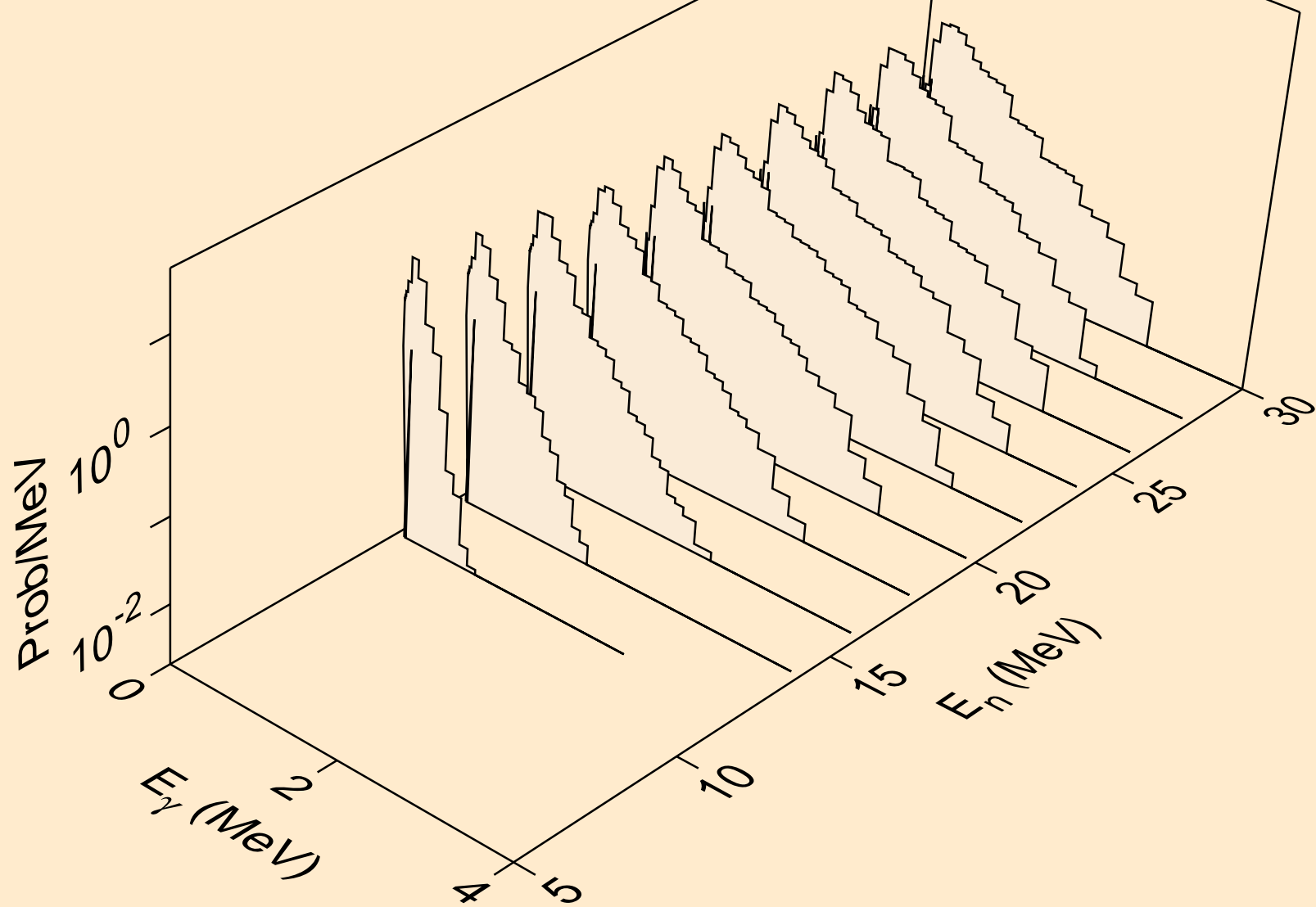

BH269 DEUTERON ACER TENDL-2021 LIBRARY; T=0.K
Photon emission for (n,n*)t

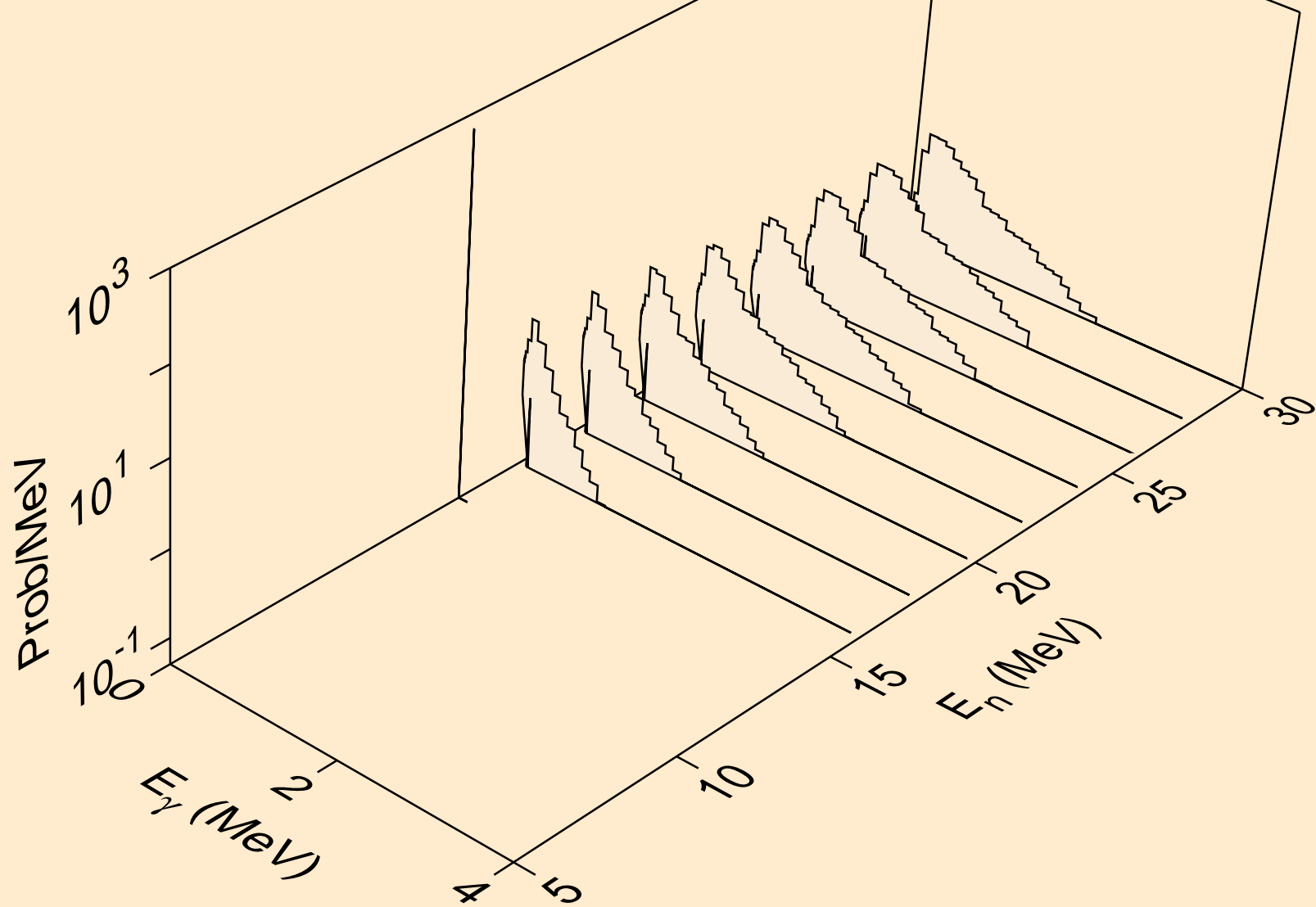

BH269 DEUTERON ACER TENDL-2021 LIBRARY; T=0.K
Photon emission for (n,4n)

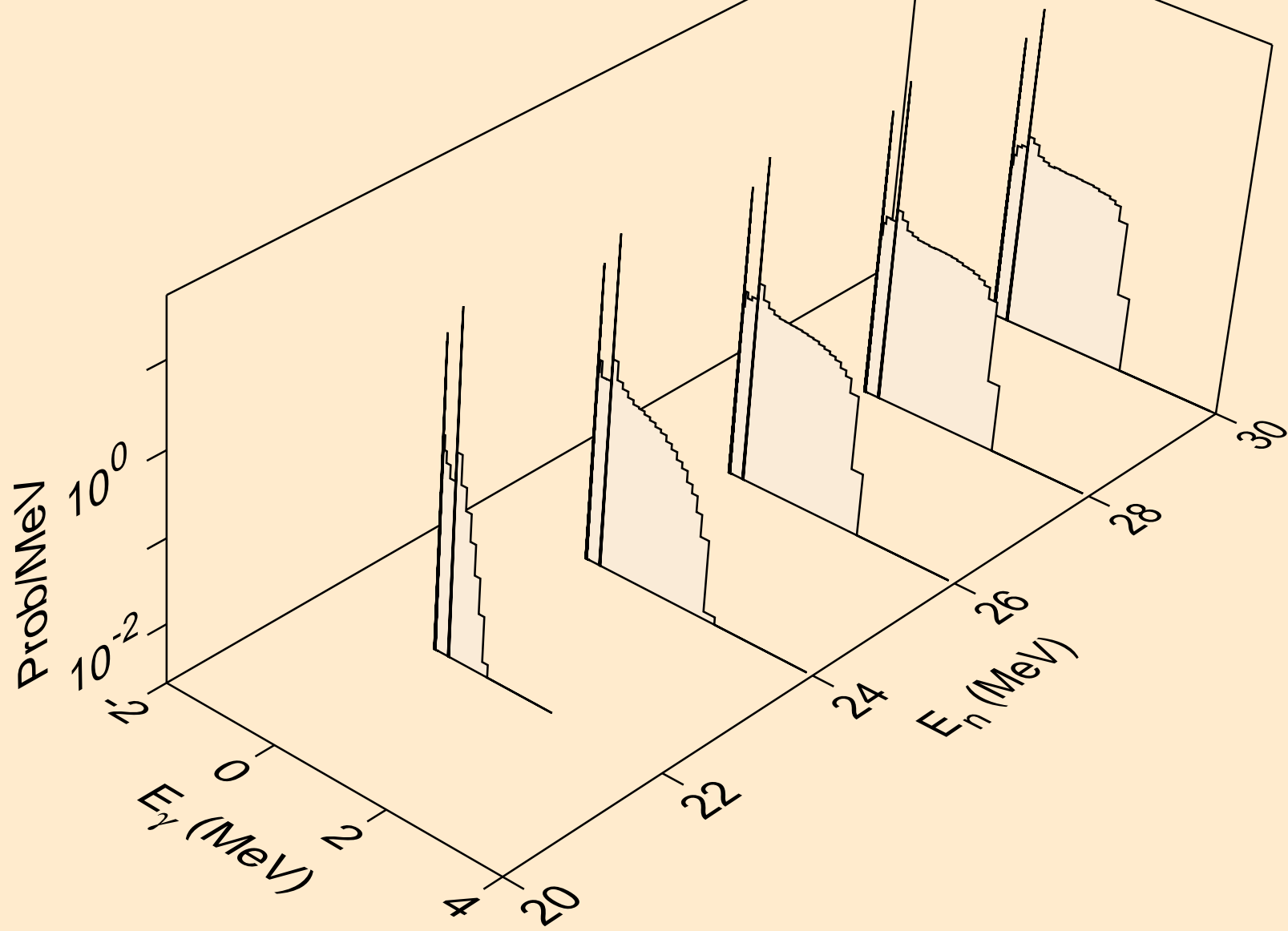

BH269 DEUTERON ACER TENDL-2021 LIBRARY; T=0.K
Photon emission for (n,2np)

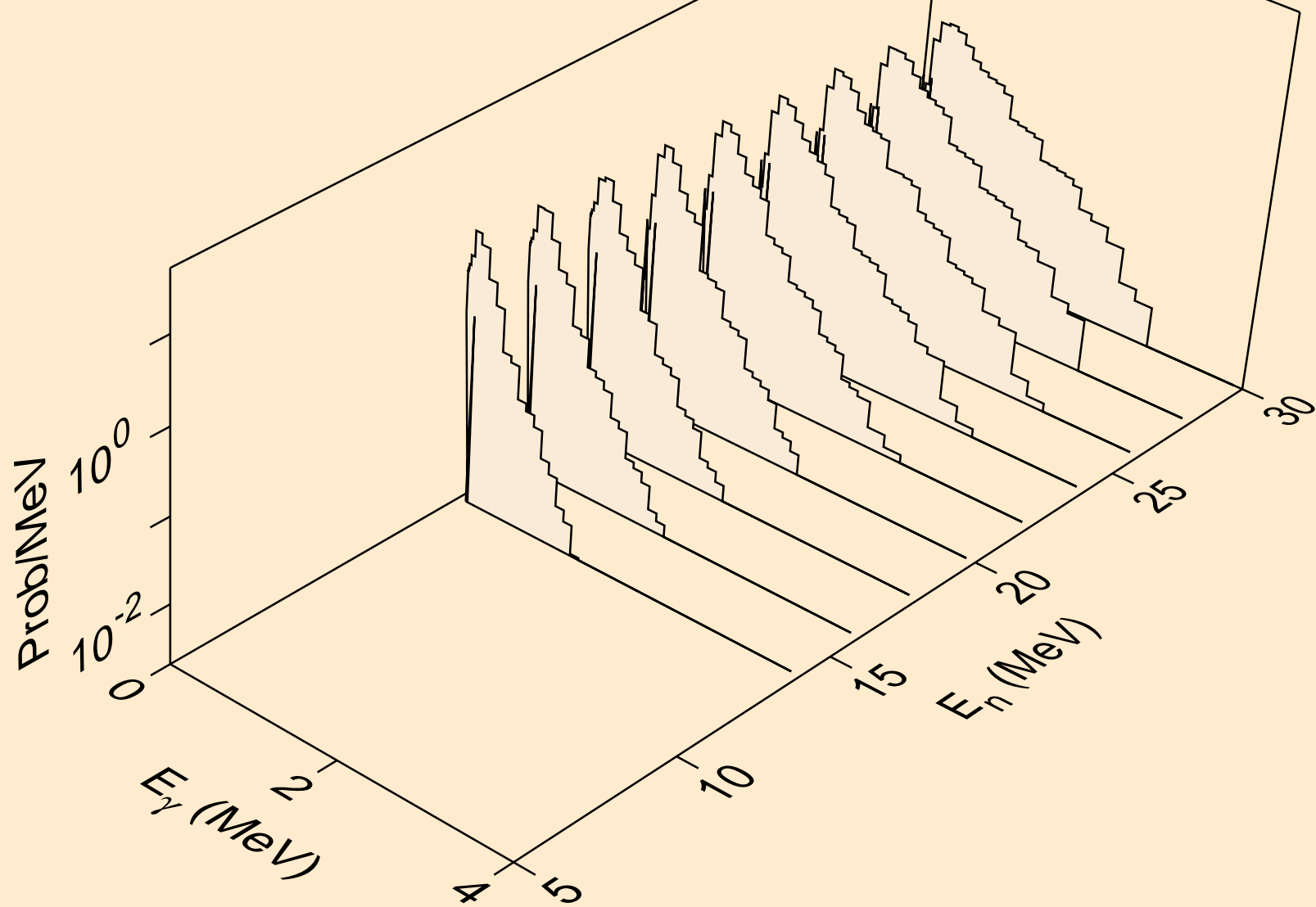

BH269 DEUTERON ACER TENDL-2021 LIBRARY; T=0.K
Photon emission for (n,2np)

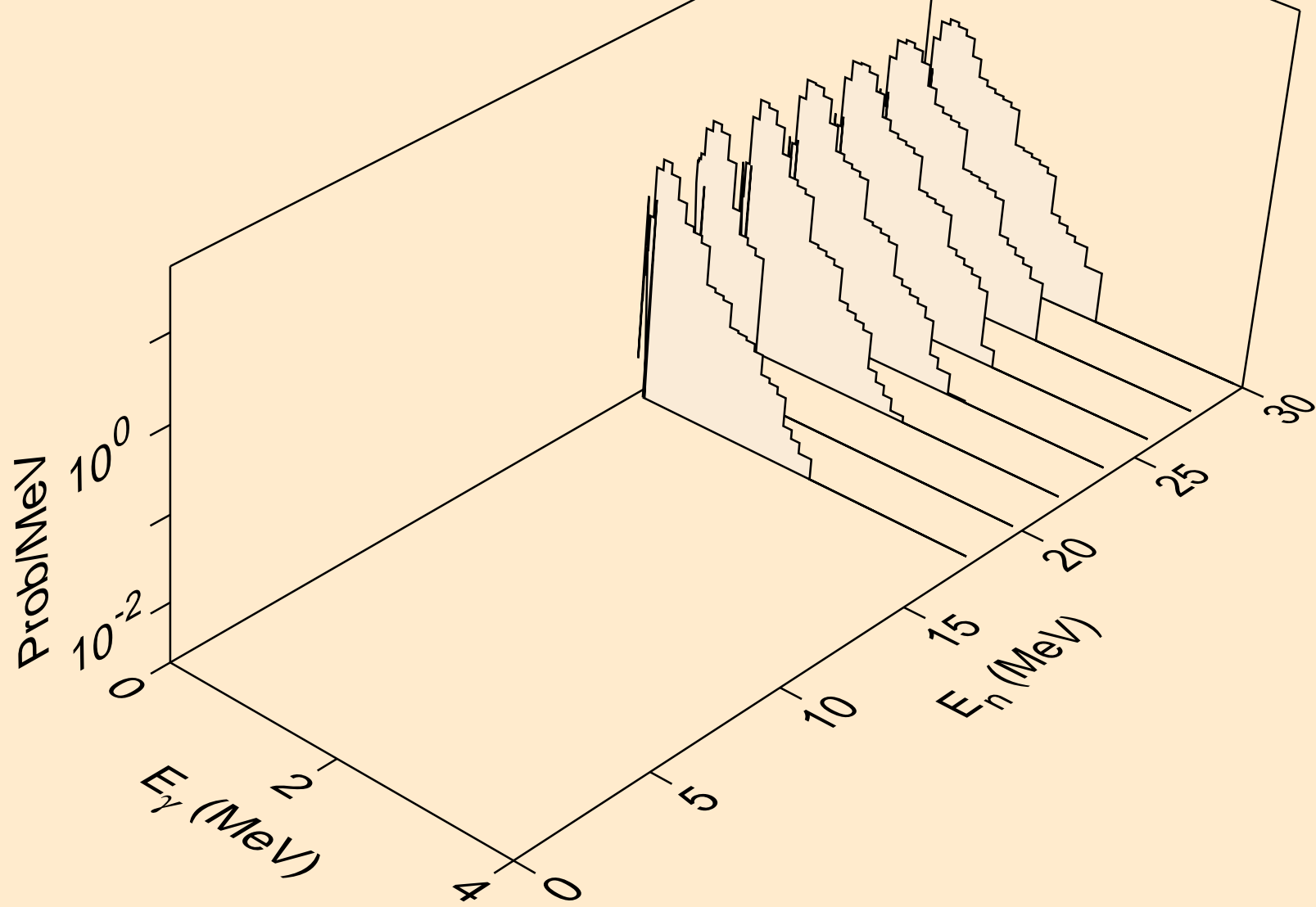

BH269 DEUTERON ACER TENDL-2021 LIBRARY; T=0.K
Photon emission for (n,npa)

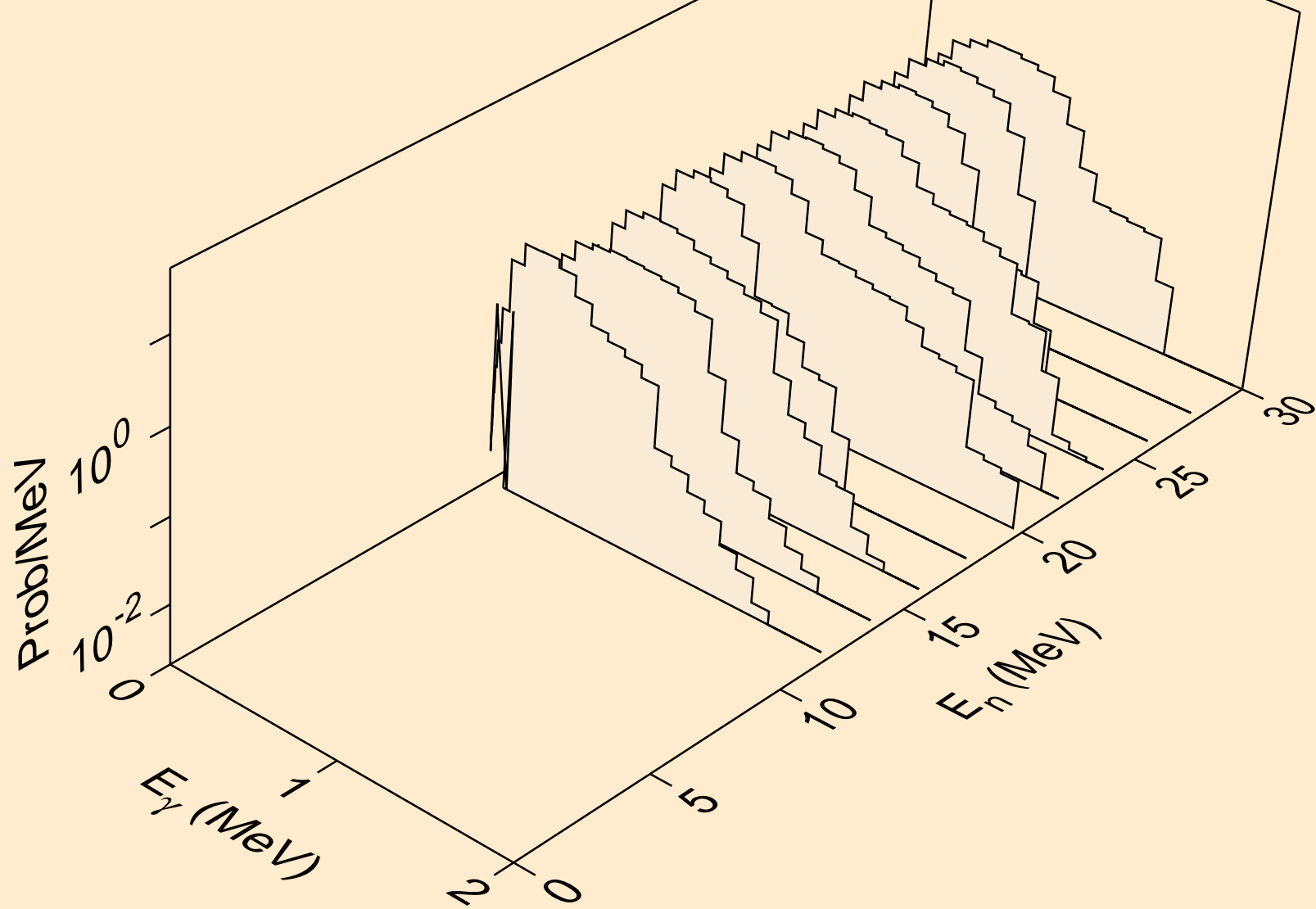

BH269 DEUTERON ACER TENDL-2021 LIBRARY; T=0.K
Photon emission for (n,p)

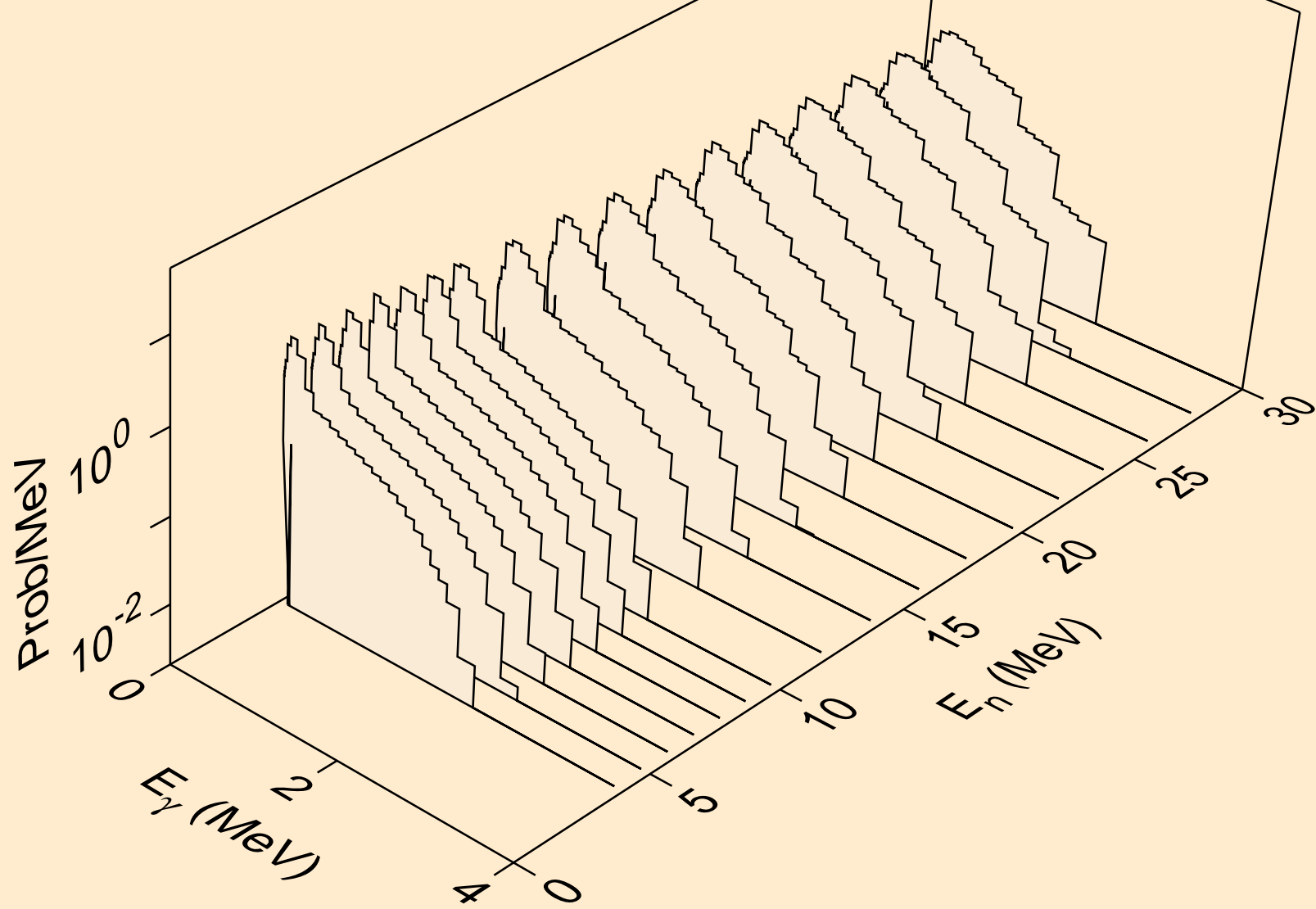

BH269 DEUTERON ACER TENDL-2021 LIBRARY; T=0.K
Photon emission for inelastic

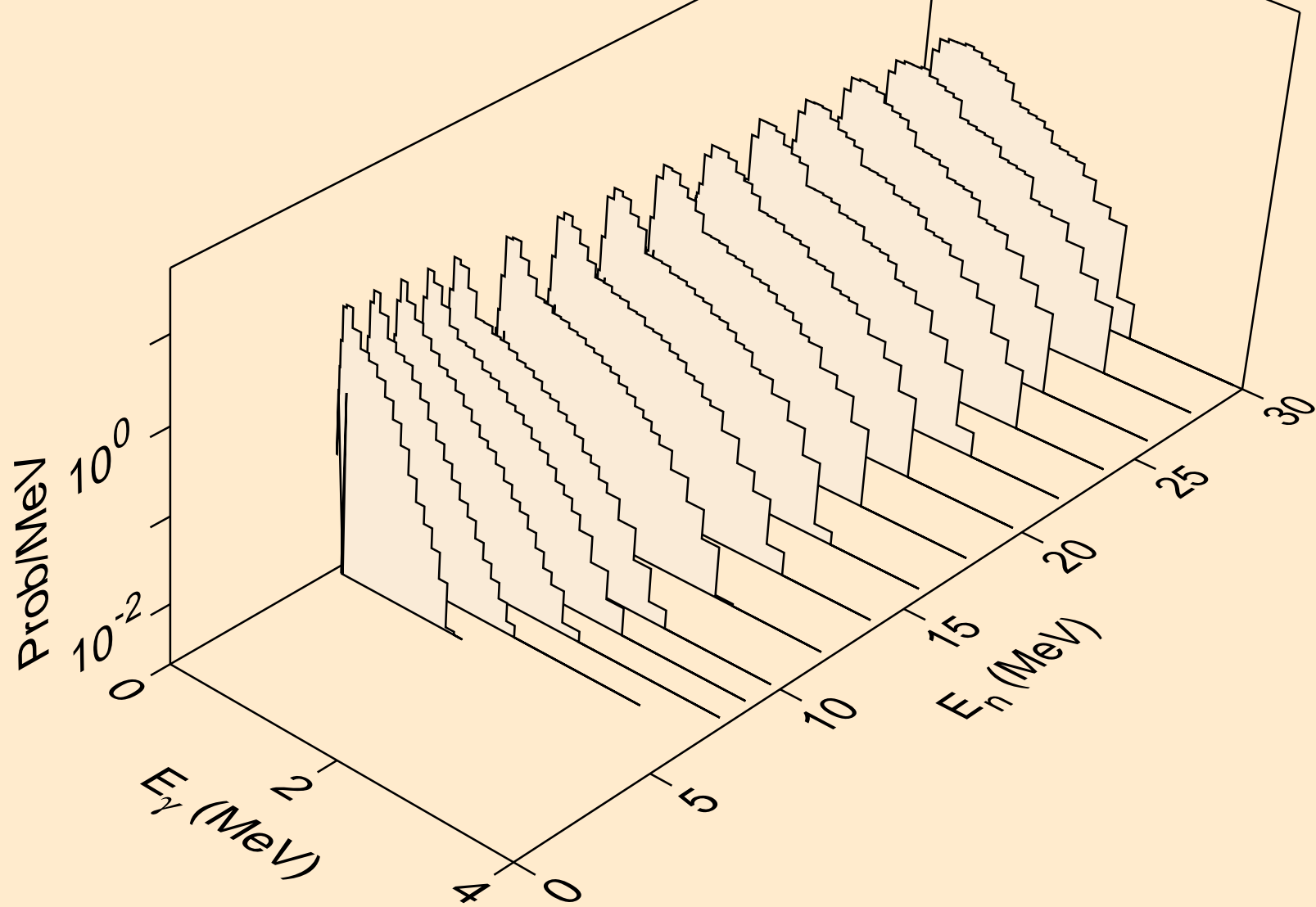

BH269 DEUTERON ACER TENDL-2021 LIBRARY; T=0.K
Photon emission for (n,t)

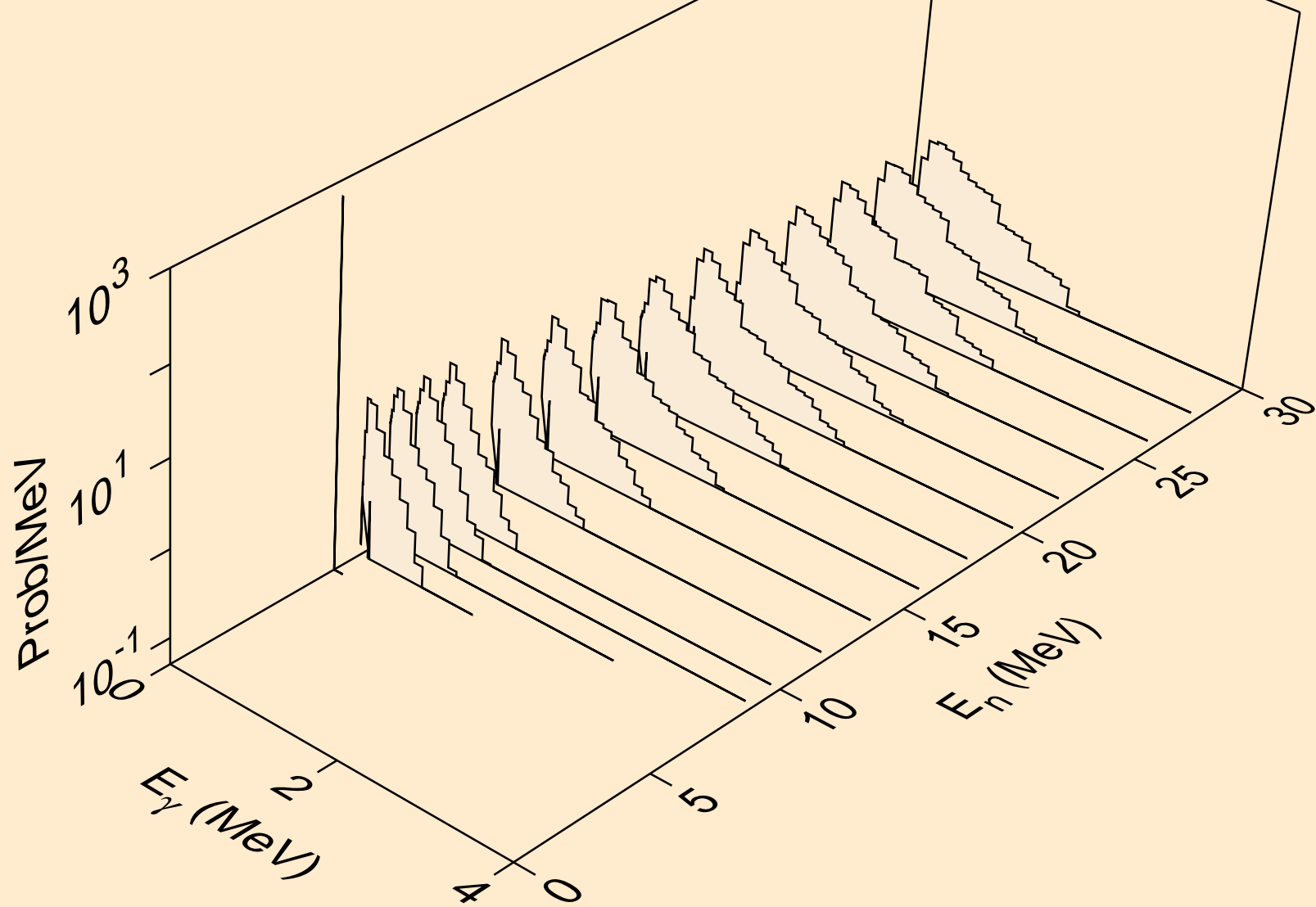

BH269 DEUTERON ACER TENDL-2021 LIBRARY; T=0.K
Photon emission for (n,he3)

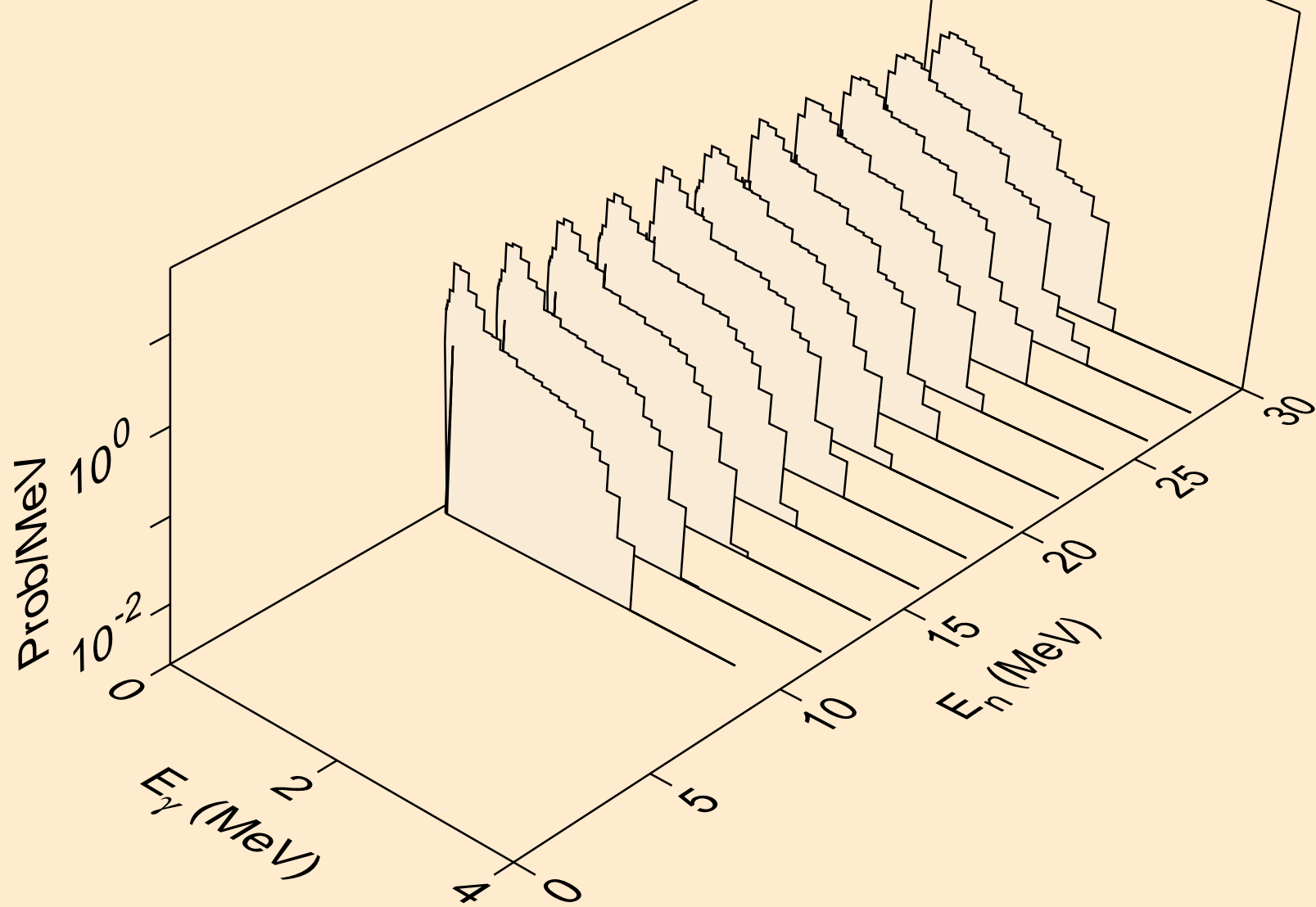

BH269 DEUTERON ACER TENDL-2021 LIBRARY; T=0.K
Photon emission for (n,a)

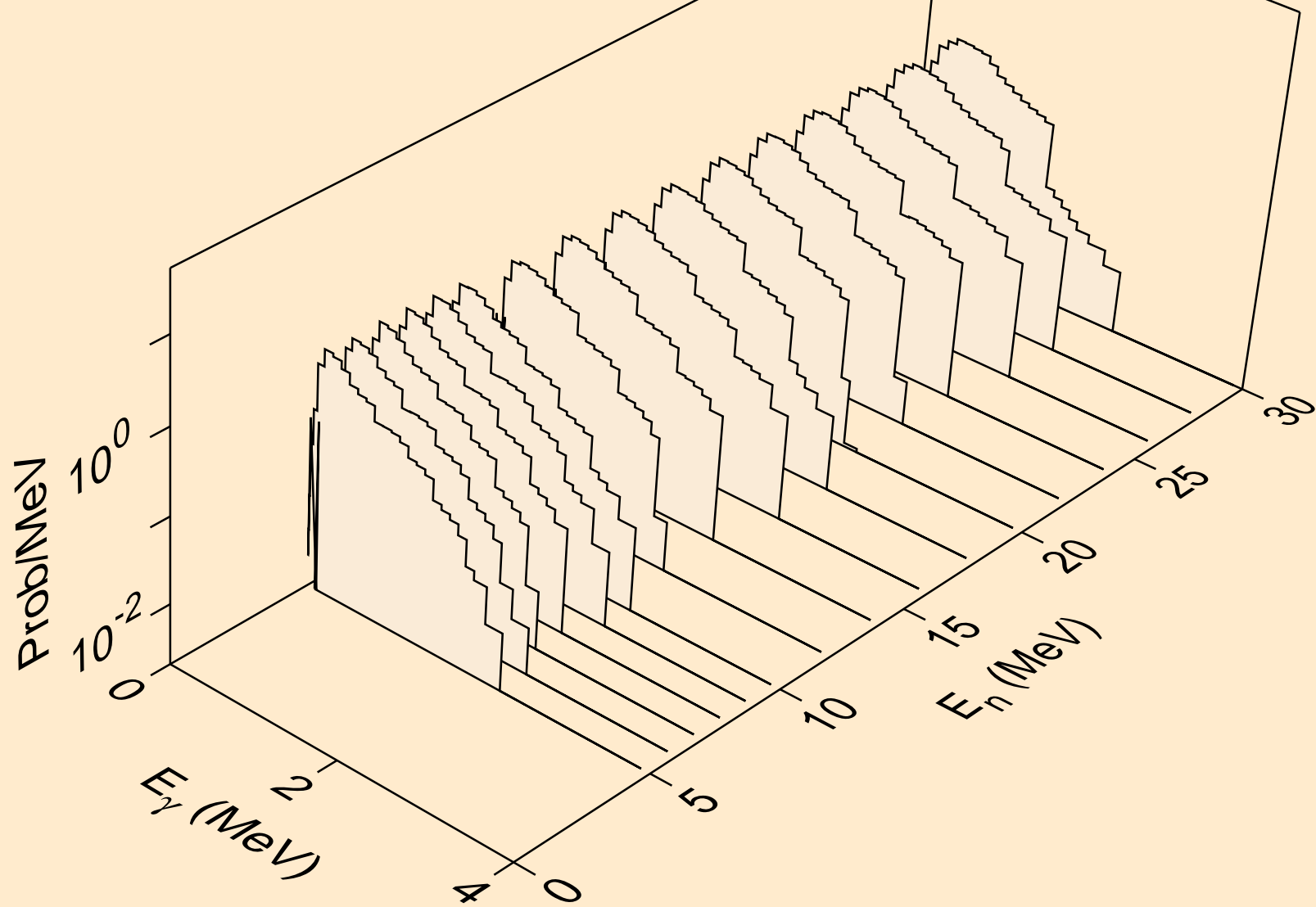

BH269 DEUTERON ACER TENDL-2021 LIBRARY; T=0.K
Photon emission for (n,2p)

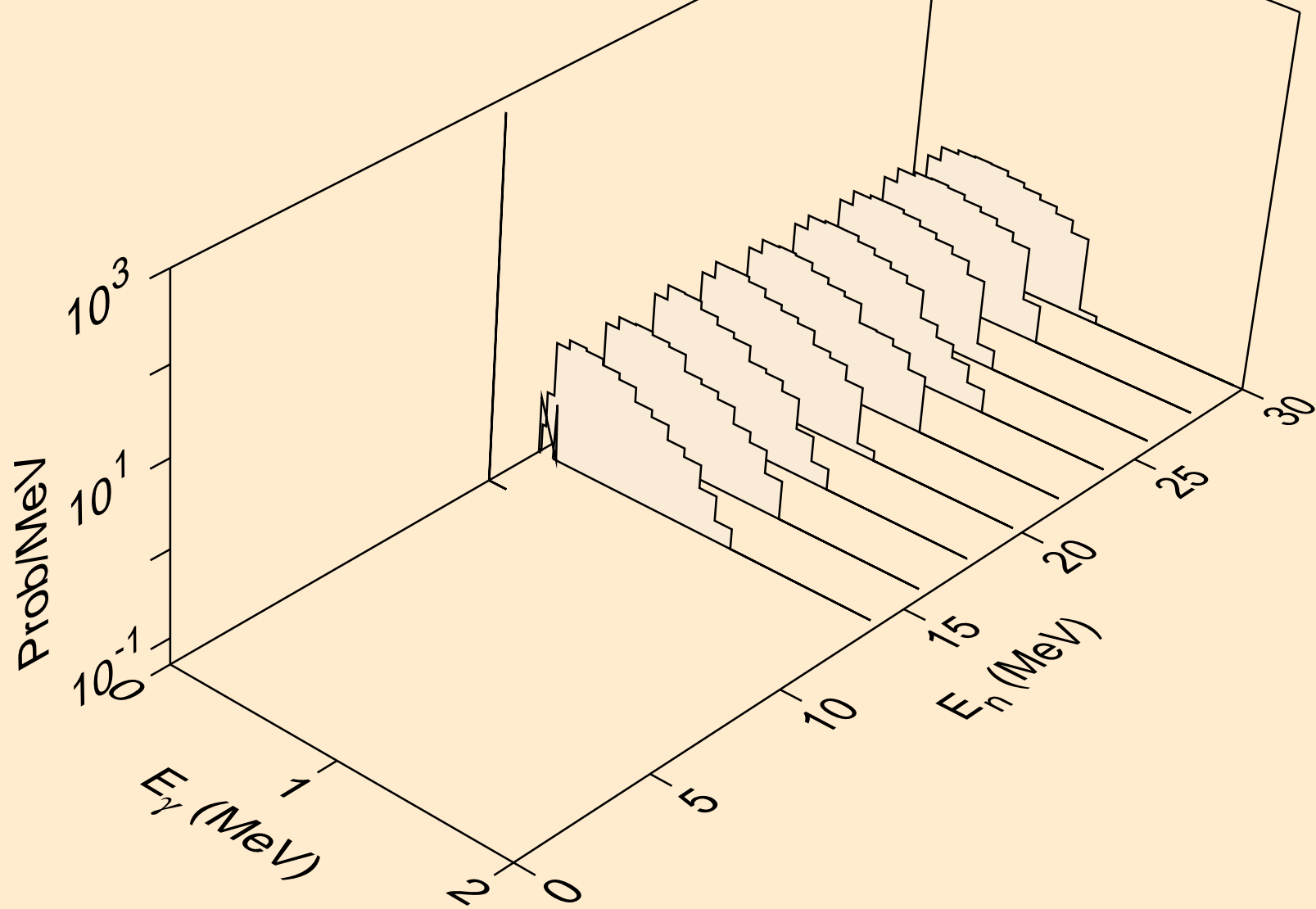

BH269 DEUTERON ACER TENDL-2021 LIBRARY; T=0.K
Photon emission for (n,p)

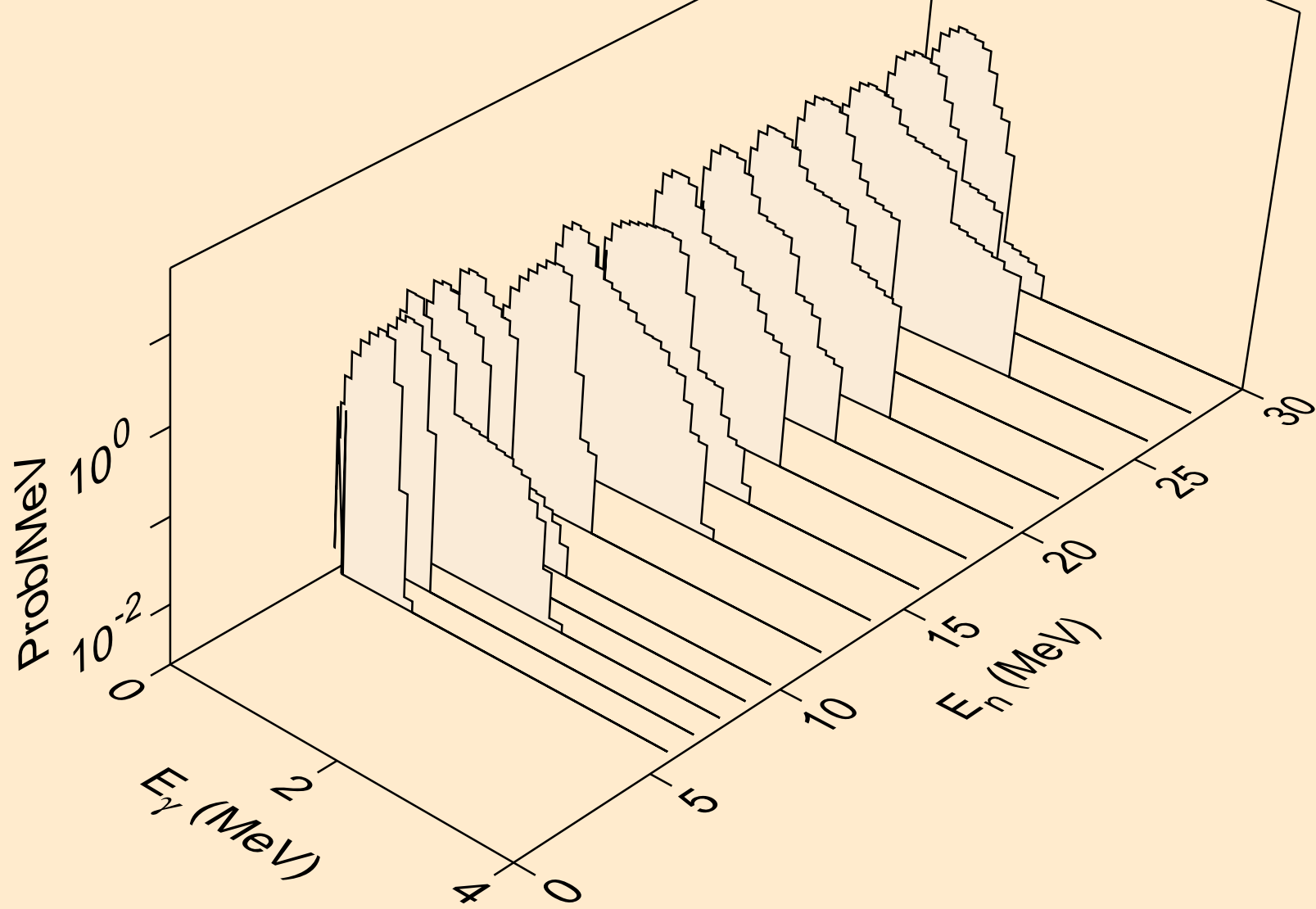

BH269 DEUTERON ACER TENDL-2021 LIBRARY; T=0.K
Photon emission for (n,pd)

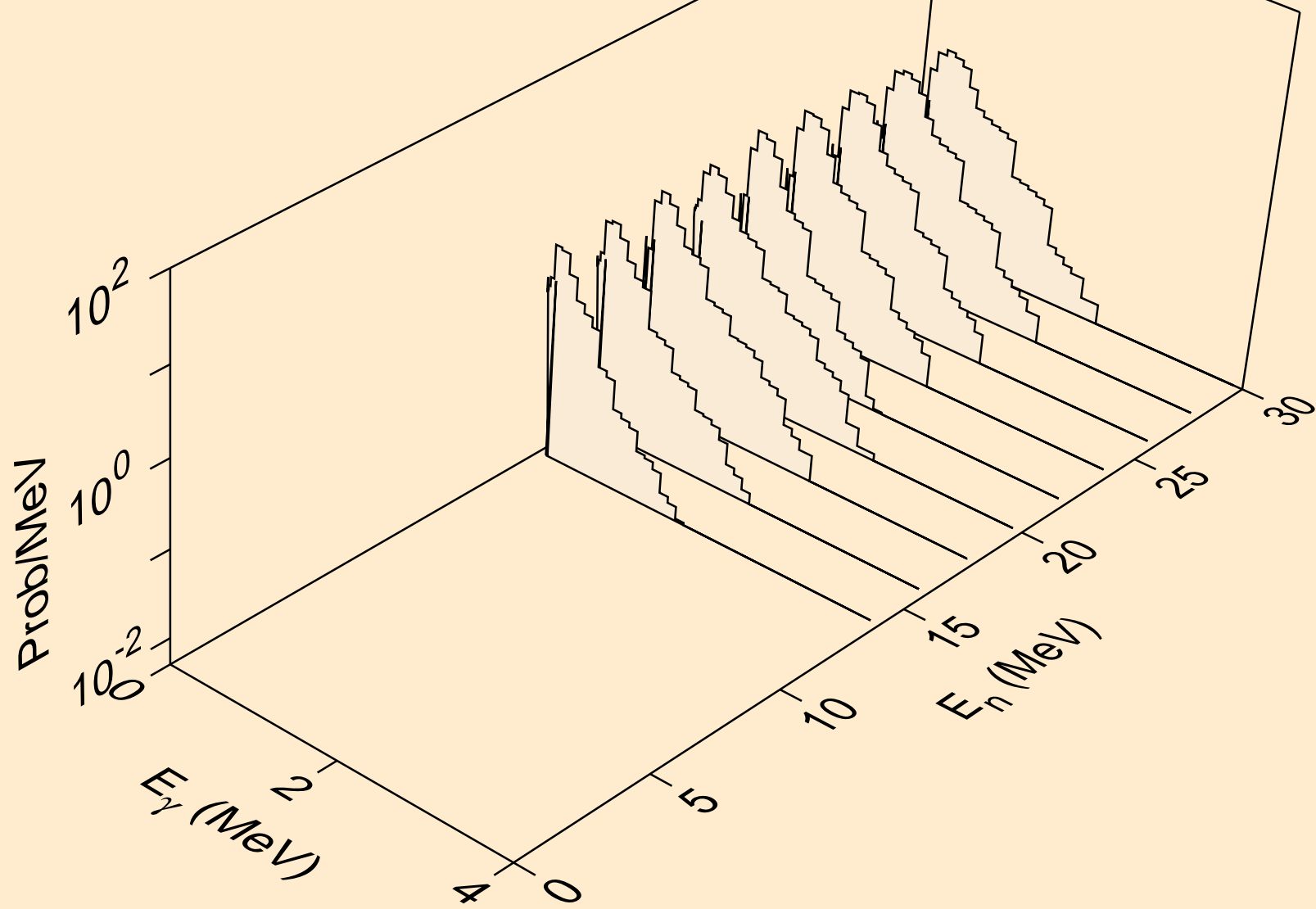

BH269 DEUTERON ACER TENDL-2021 LIBRARY; T=0.K
Photon emission for (n,da)

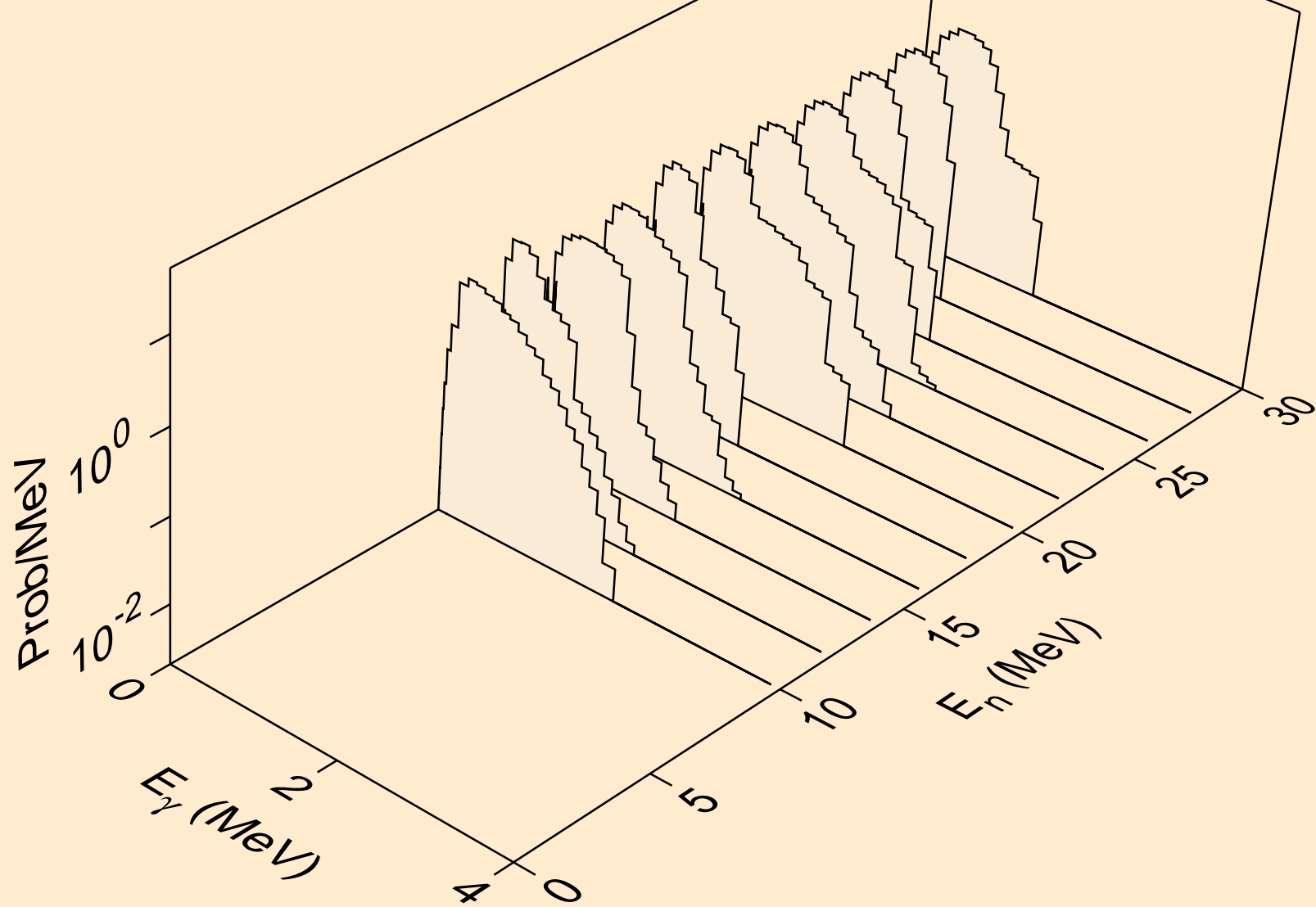

BH269 DEUTERON ACER TENDL-2021 LIBRARY; T=0.K
Particle heating contributions

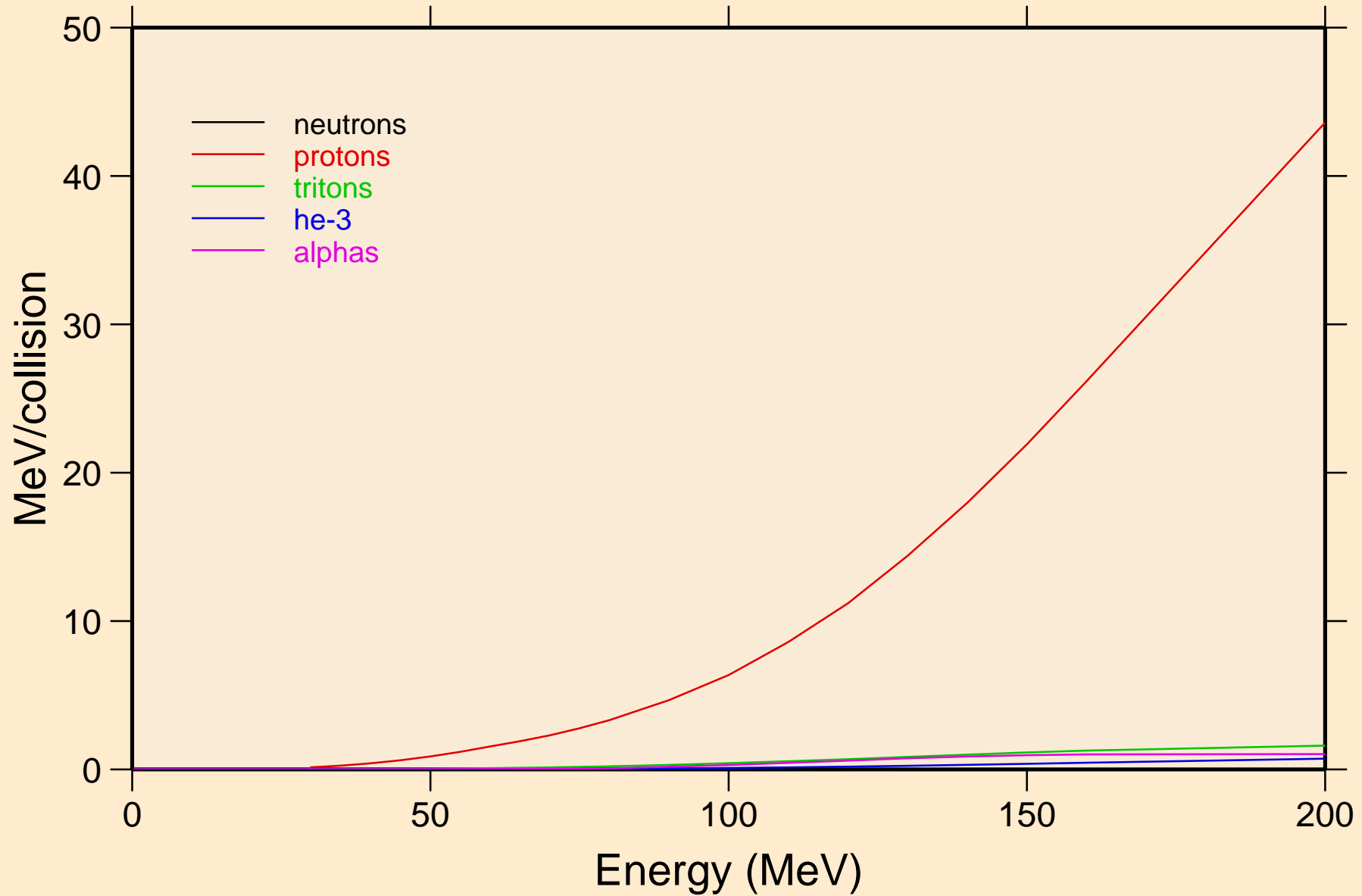

BH269 DEUTERON ACER TENDL-2021 LIBRARY; T=0.K
Recoil Heating

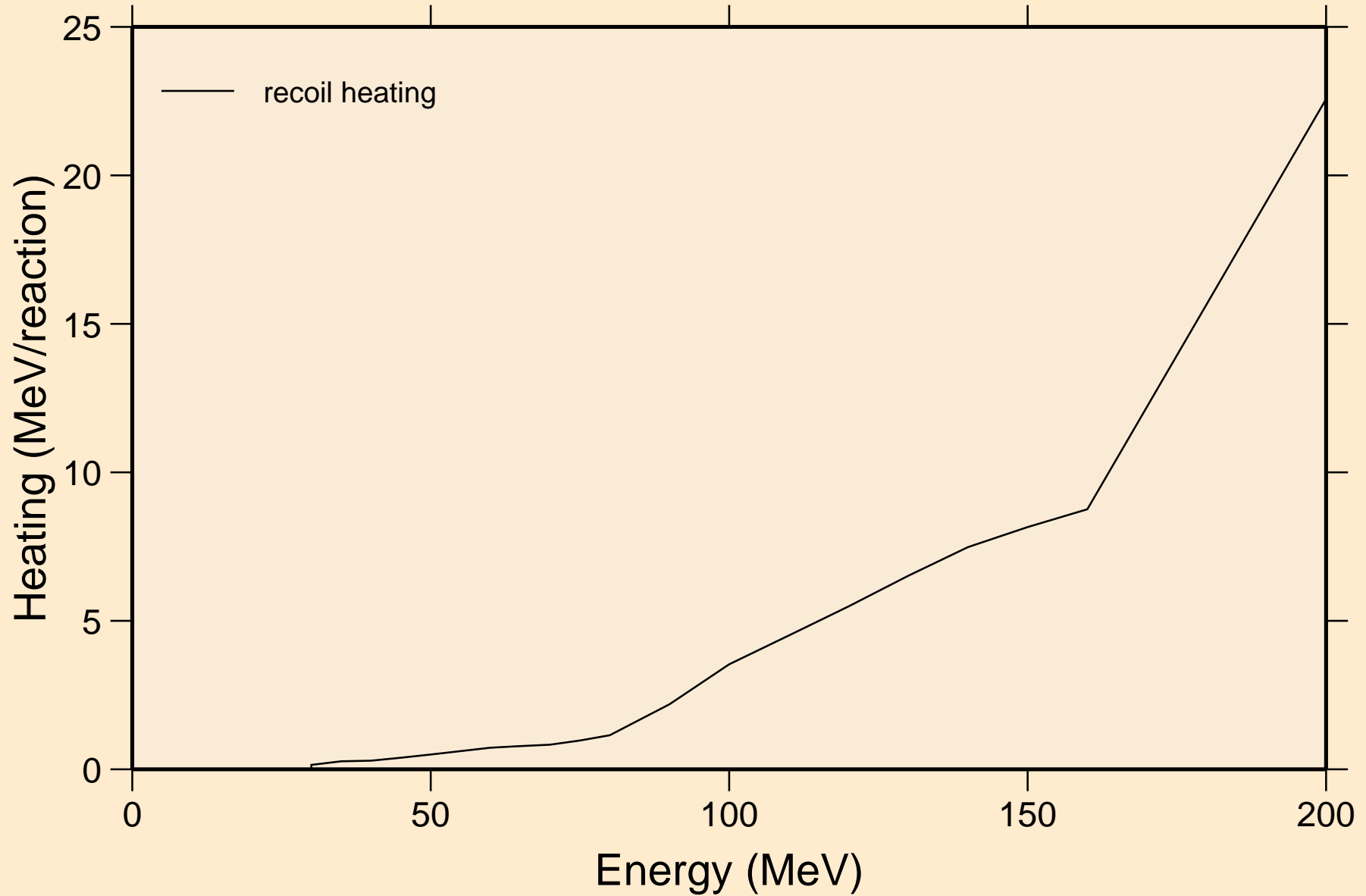

BH269 DEUTERON ACER TENDL-2021 LIBRARY; T=0.K
Particle production cross sections

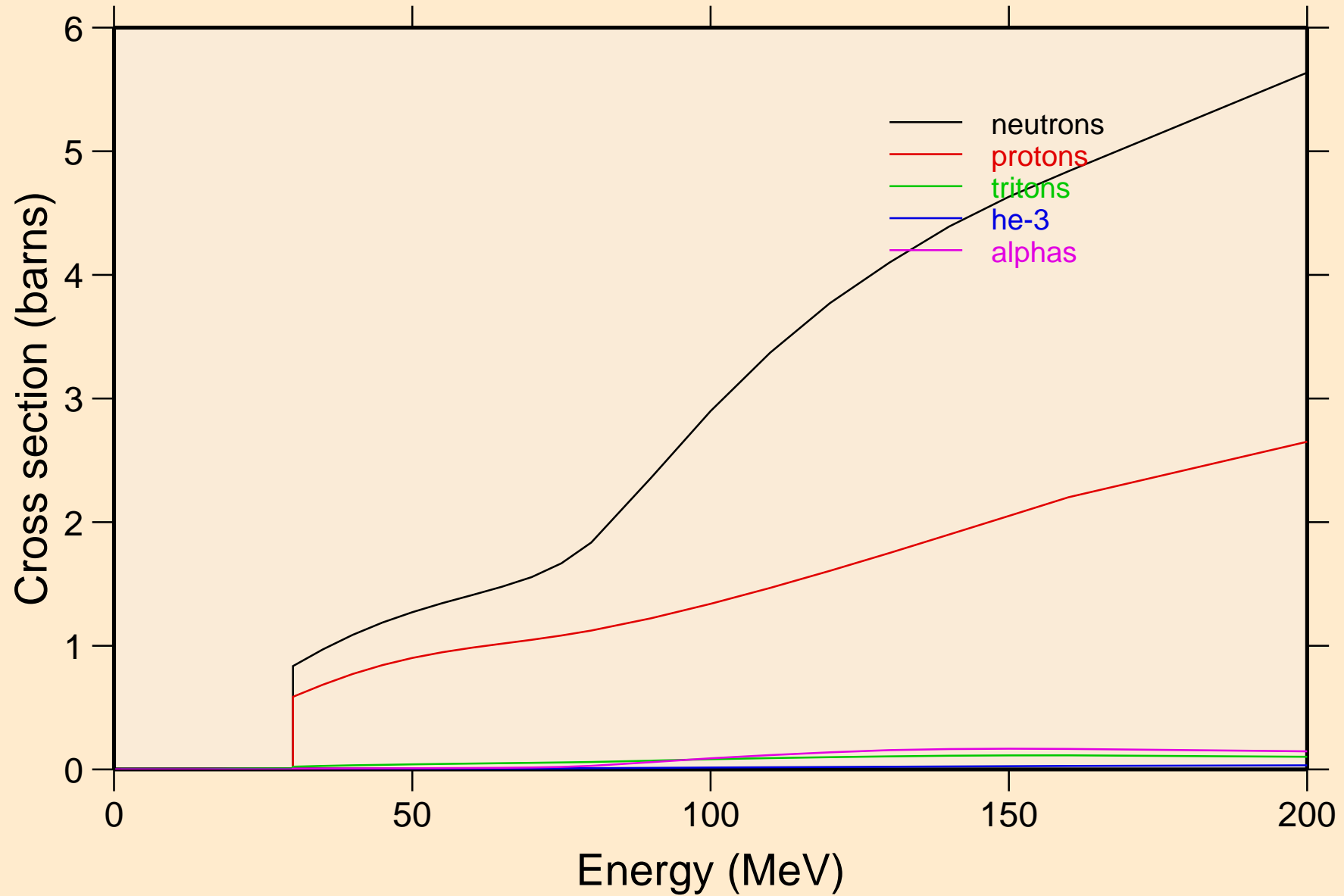

BH269 DEUTERON ACER TENDL-2021 LIBRARY; T=0.K
neutrons from (d,n)

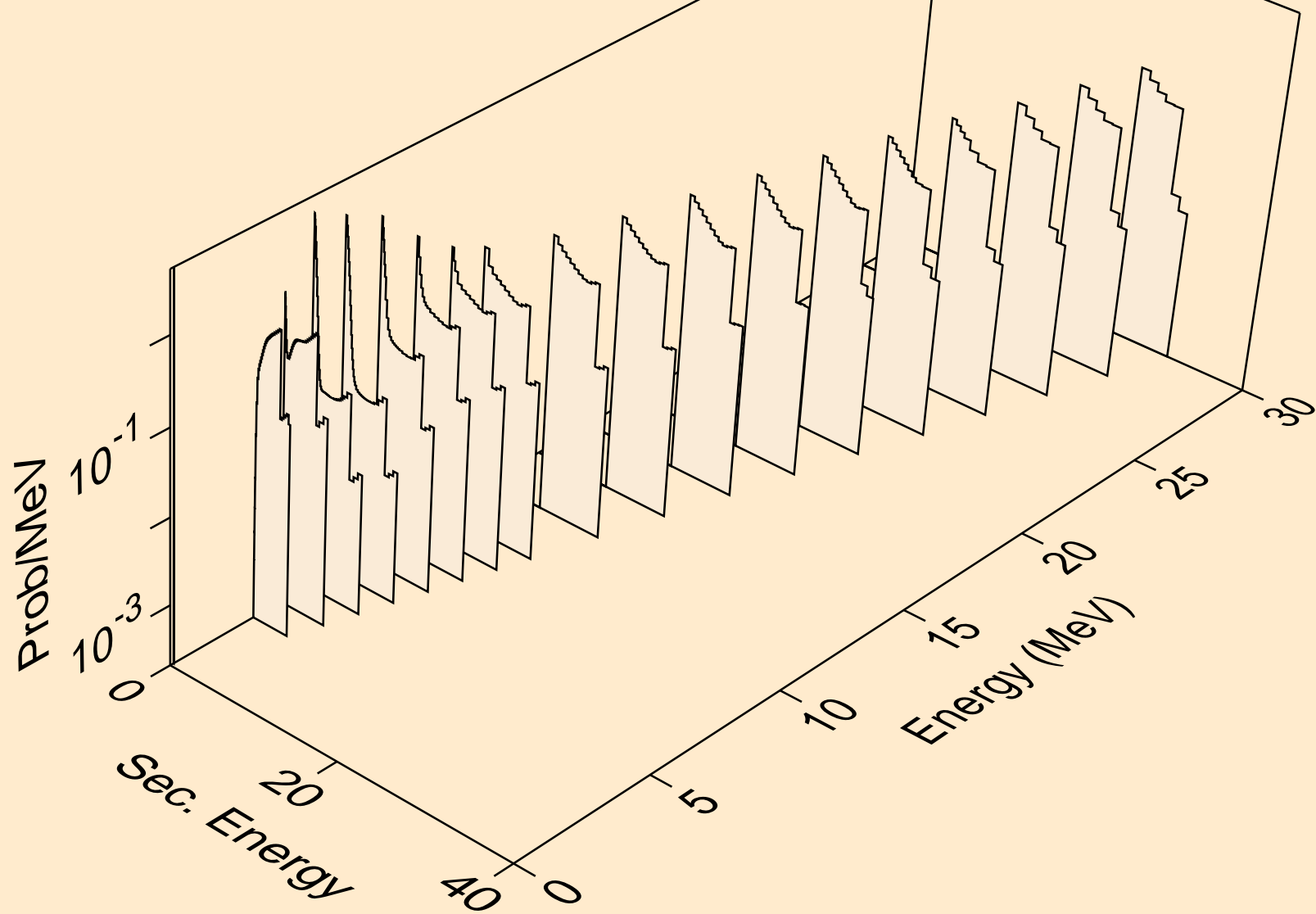

BH269 DEUTERON ACER TENDL-2021 LIBRARY; T=0.K
neutrons from (d,x)

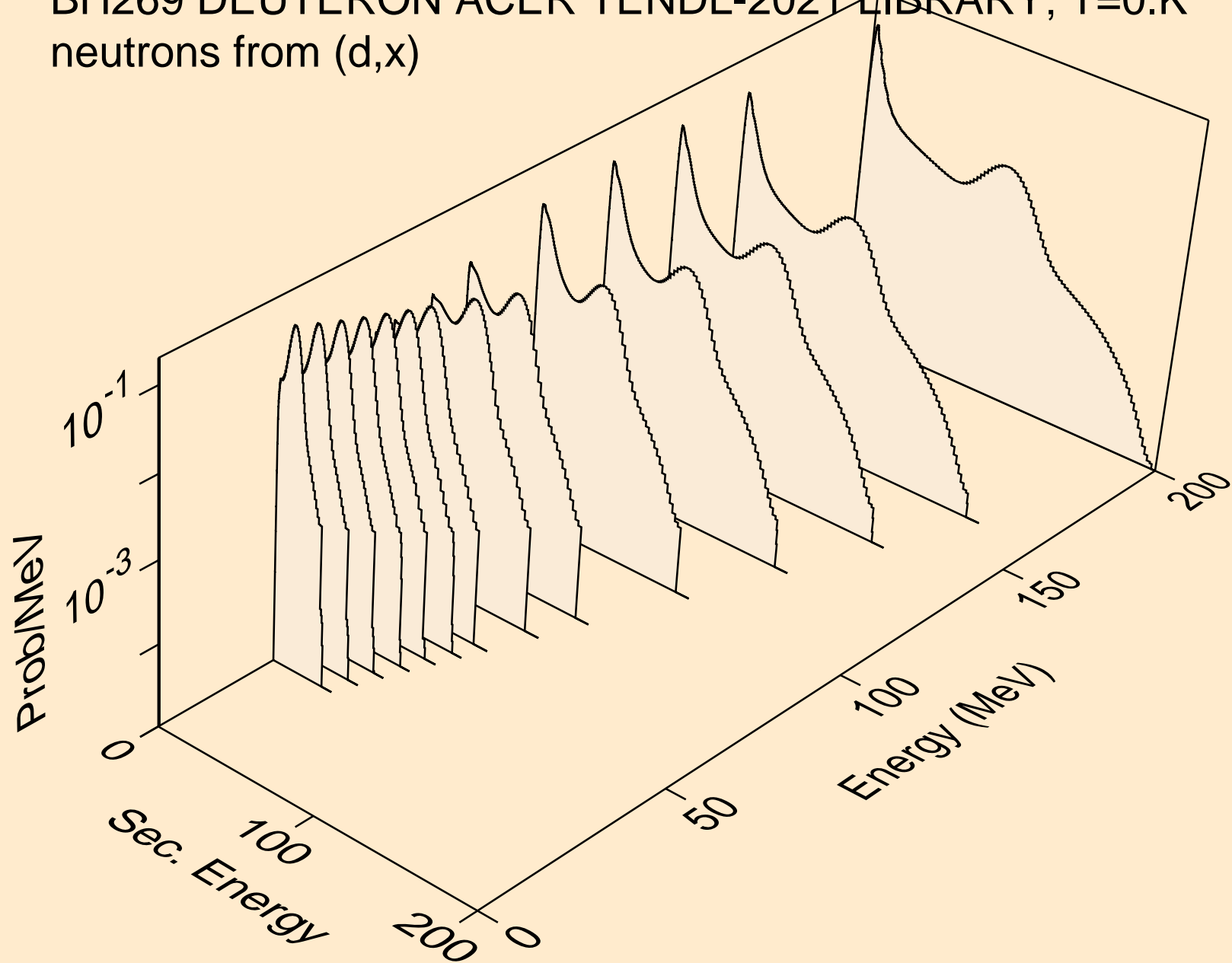

BH269 DEUTERON ACER TENDL-2021 LIBRARY; T=0.K
neutrons from (d,2n)

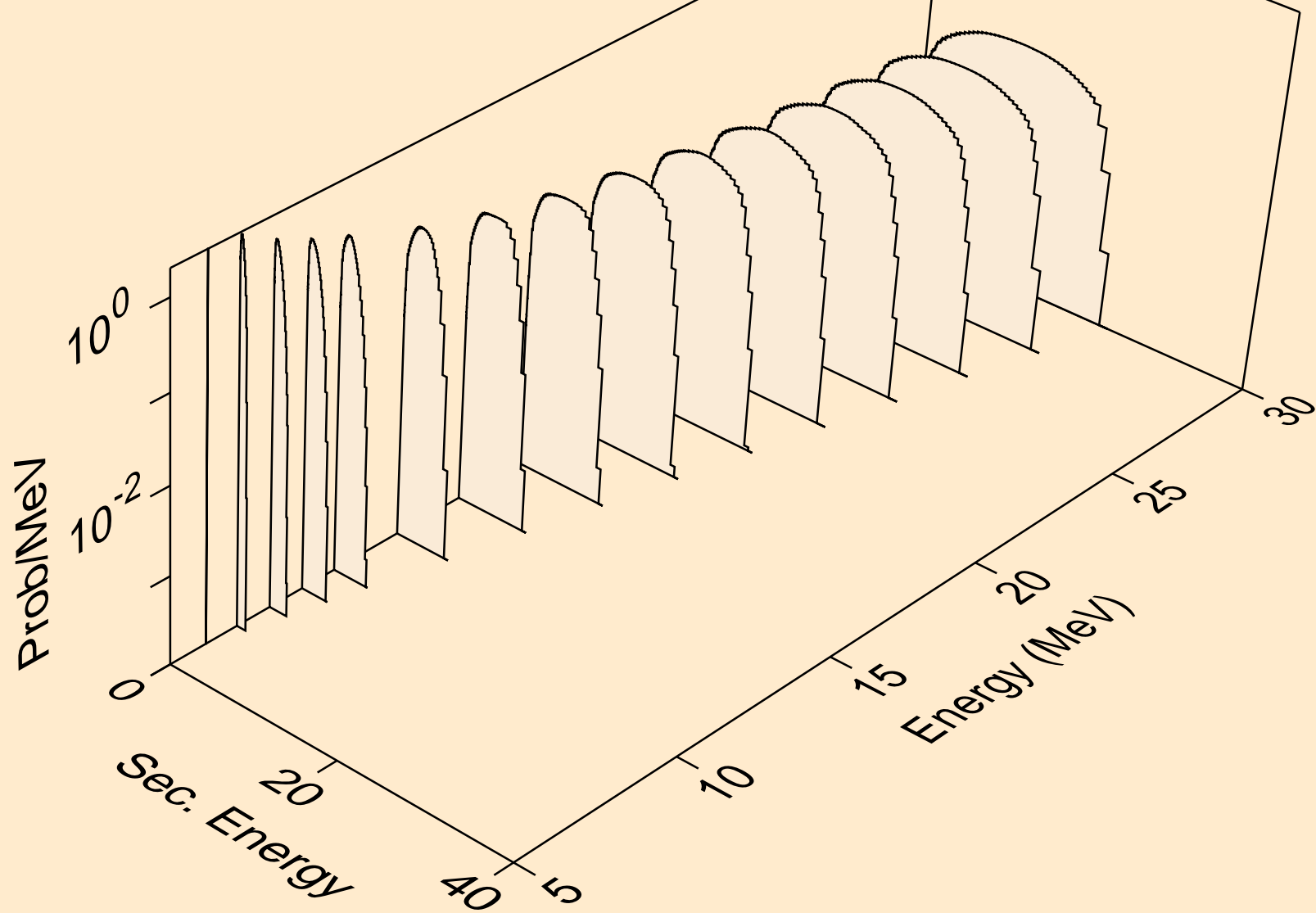

BH269 DEUTERON ACER TENDL-2021 LIBRARY; T=0.K
neutrons from (d,3n)

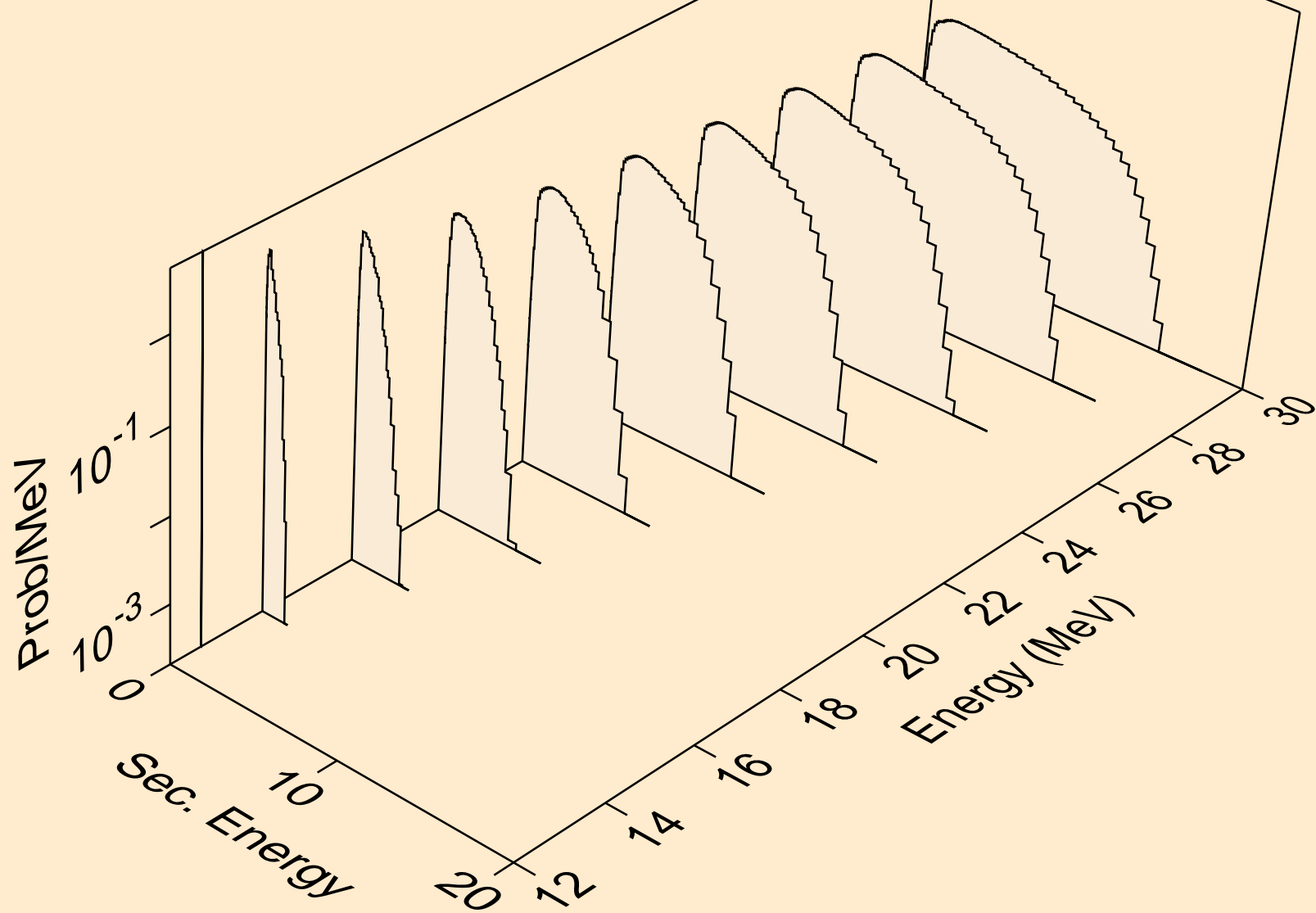

BH269 DEUTERON ACER TENDL-2021 LIBRARY; T=0.K
neutrons from (d,n*)a

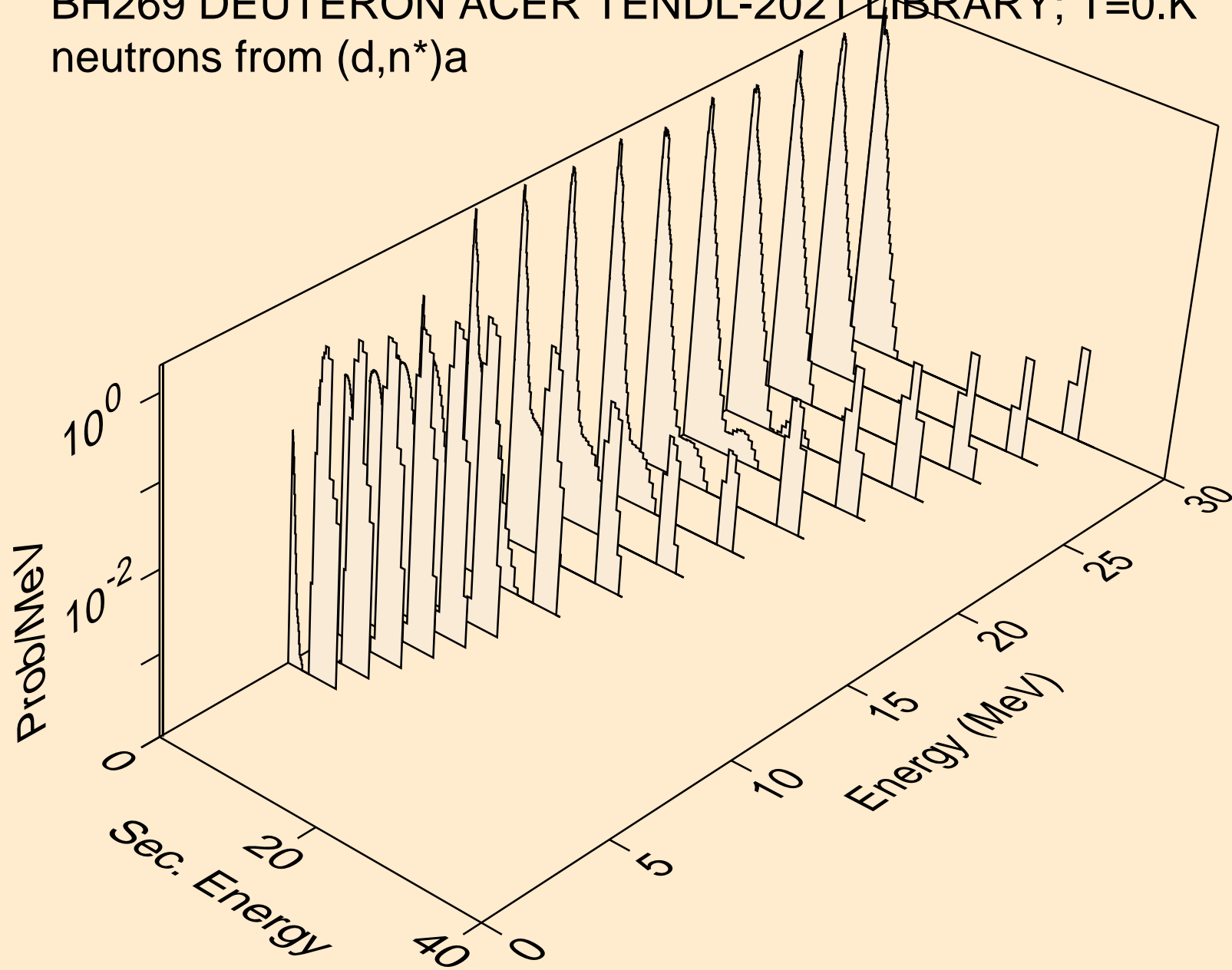

BH269 DEUTERON ACER TENDL-2021 LIBRARY; T=0.K
neutrons from (d,2n)a

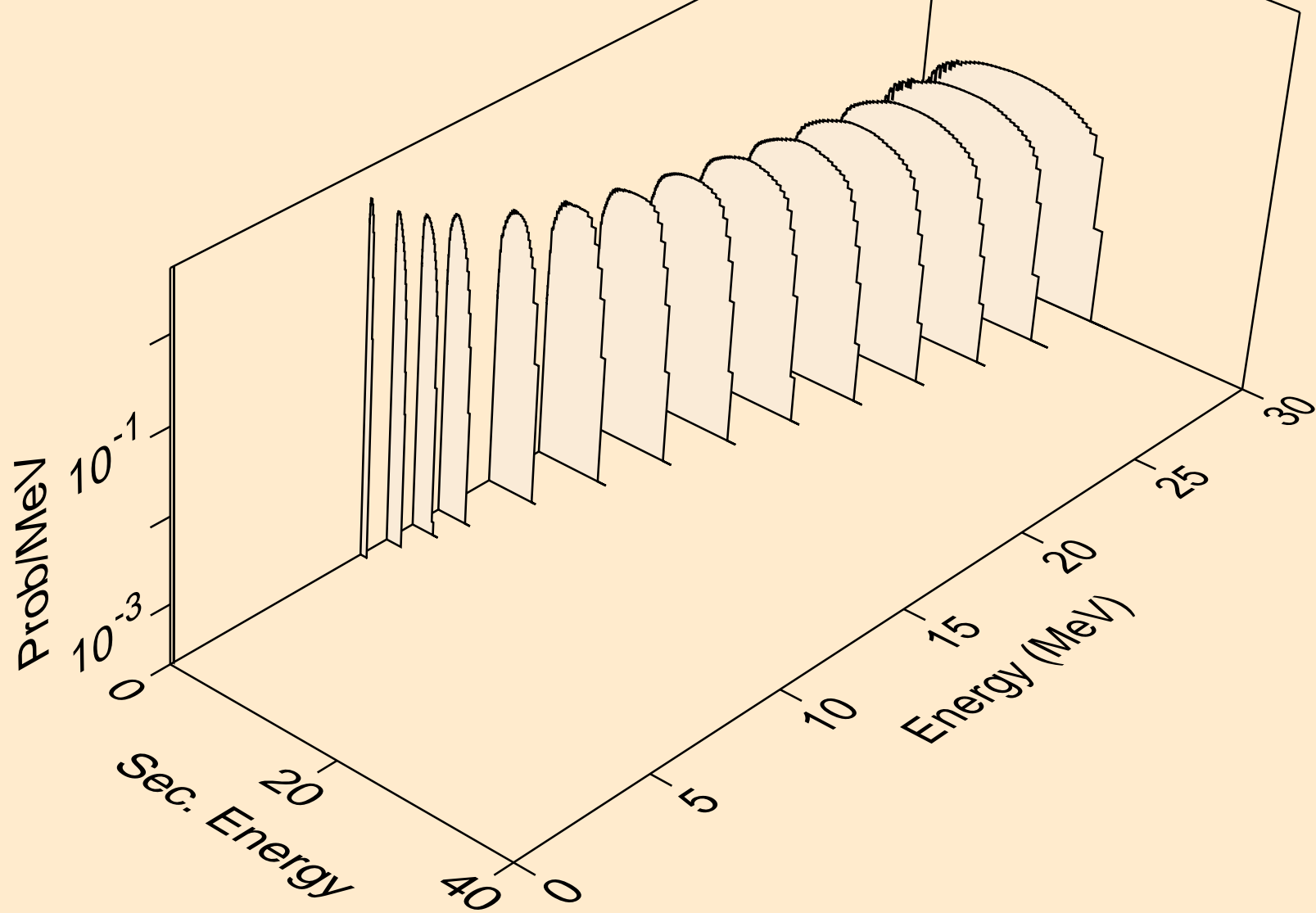

BH269 DEUTERON ACER TENDL-2021 LIBRARY; T=0.K
neutrons from (d,3n)a

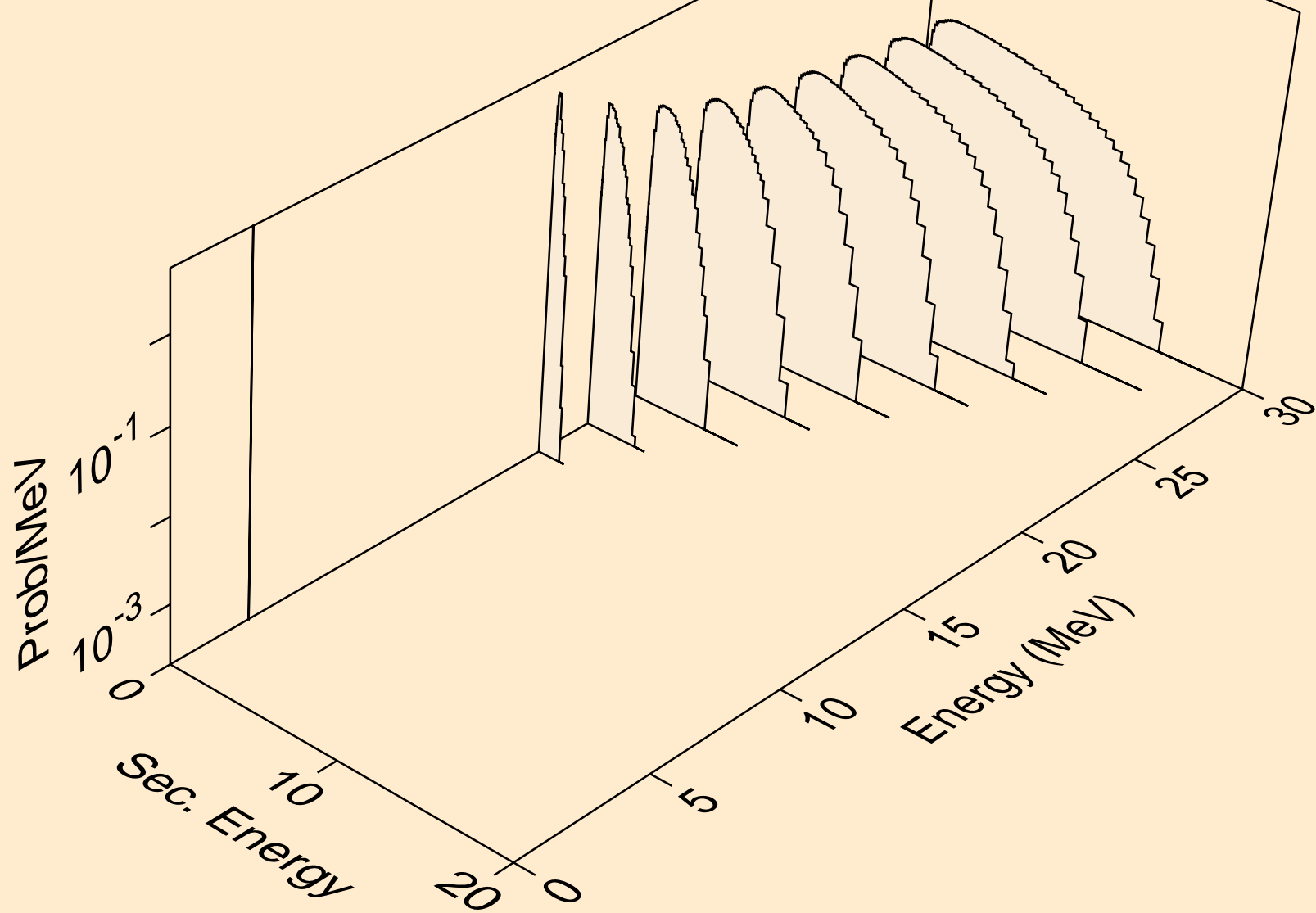

BH269 DEUTERON ACER TENDL-2021 LIBRARY; T=0.K
neutrons from (d,n*)p

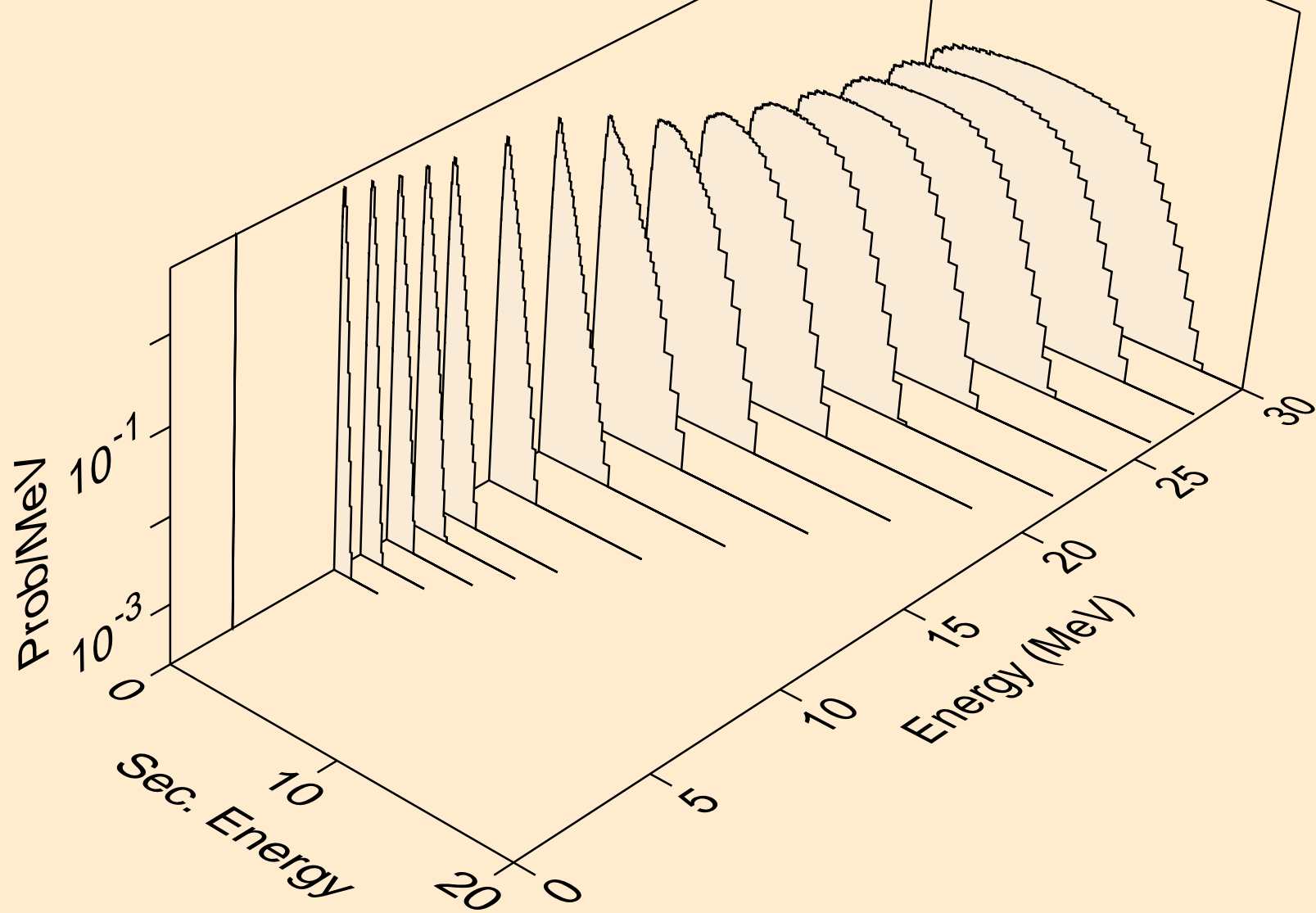

BH269 DEUTERON ACER TENDL-2021 LIBRARY; T=0.K
neutrons from (d,n*)d

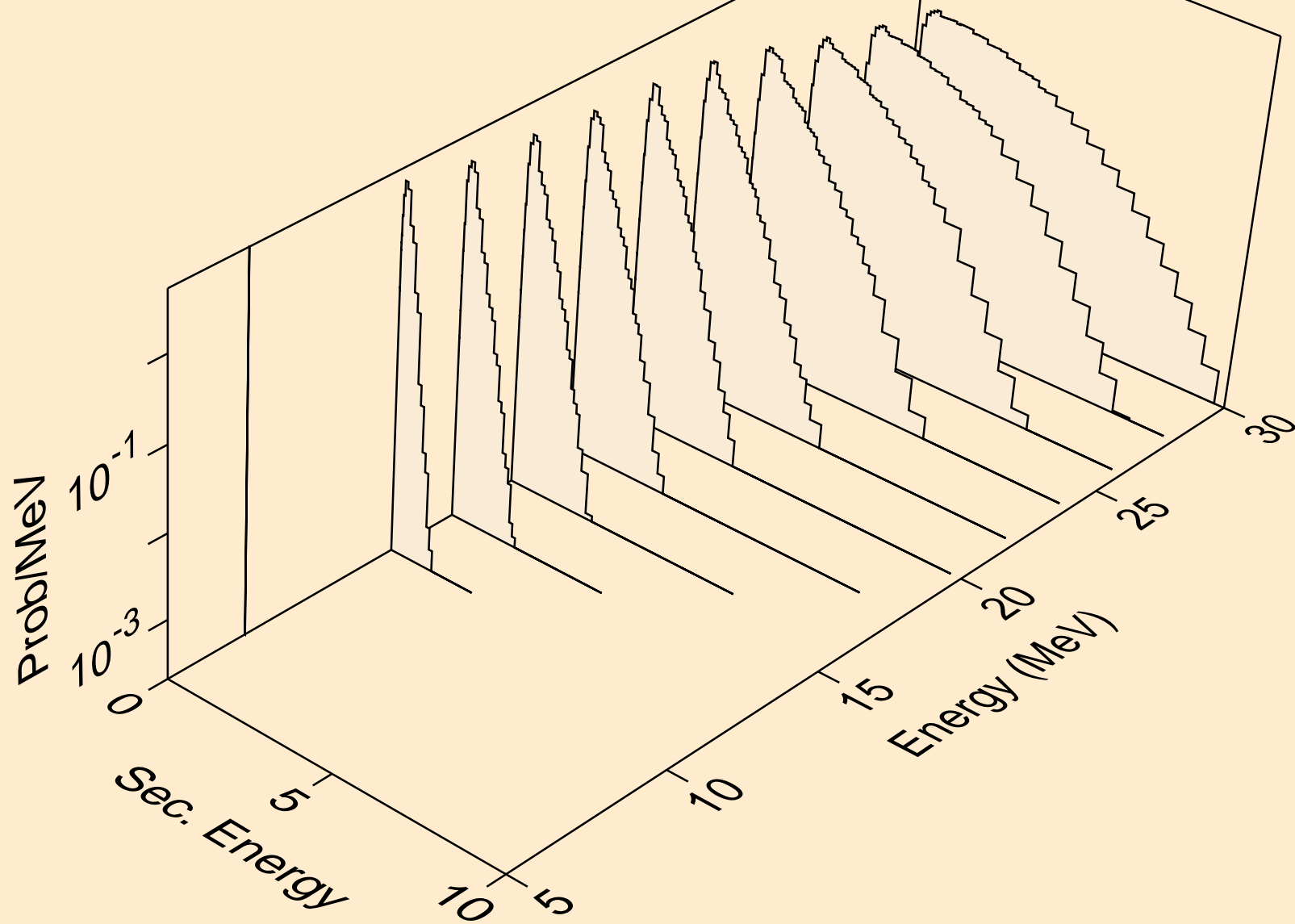

BH269 DEUTERON ACER TENDL-2021 LIBRARY; T=0.K
neutrons from (d,n*)t

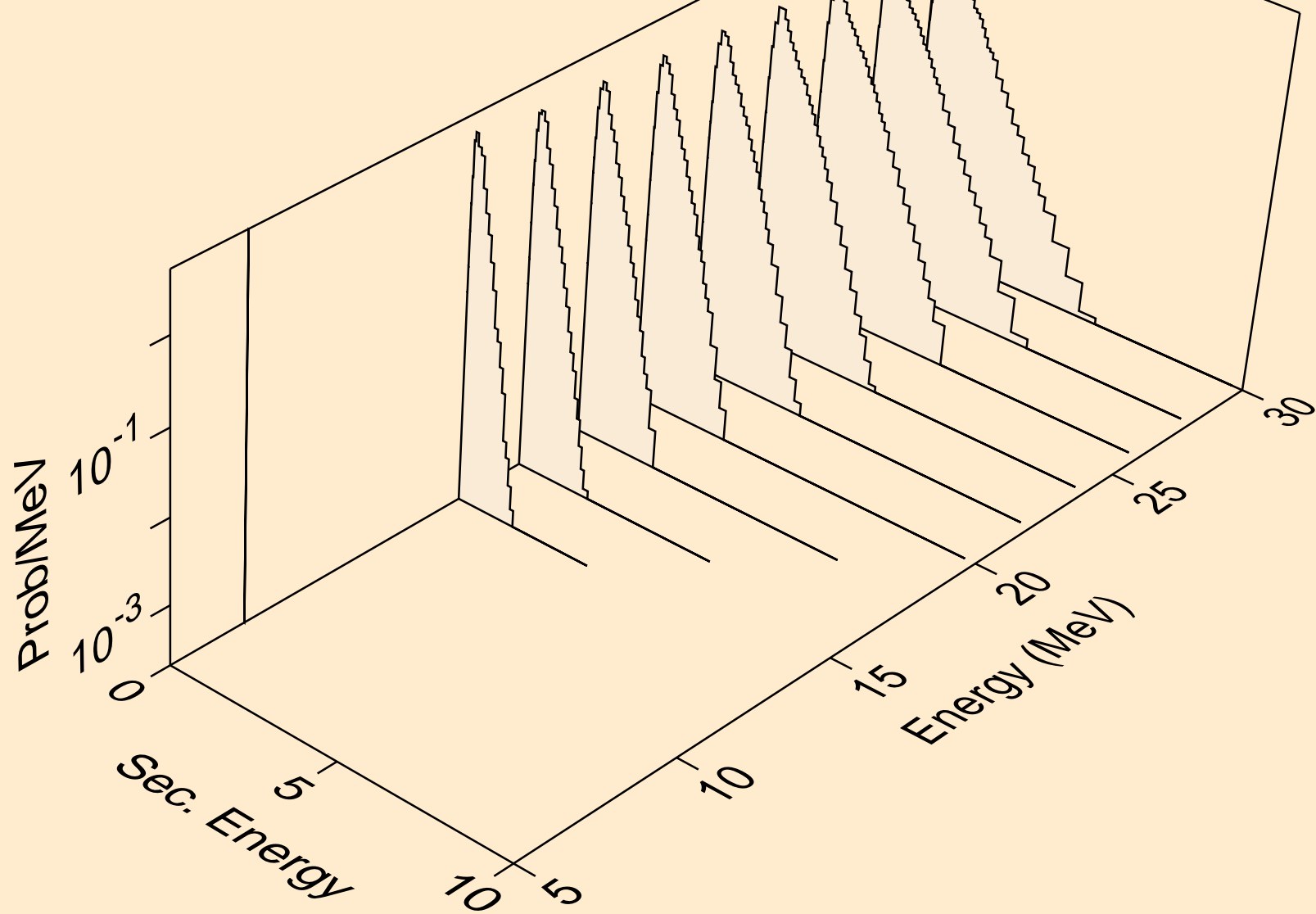

BH269 DEUTERON ACER TENDL-2021 LIBRARY; T=0.K
neutrons from (d,4n)

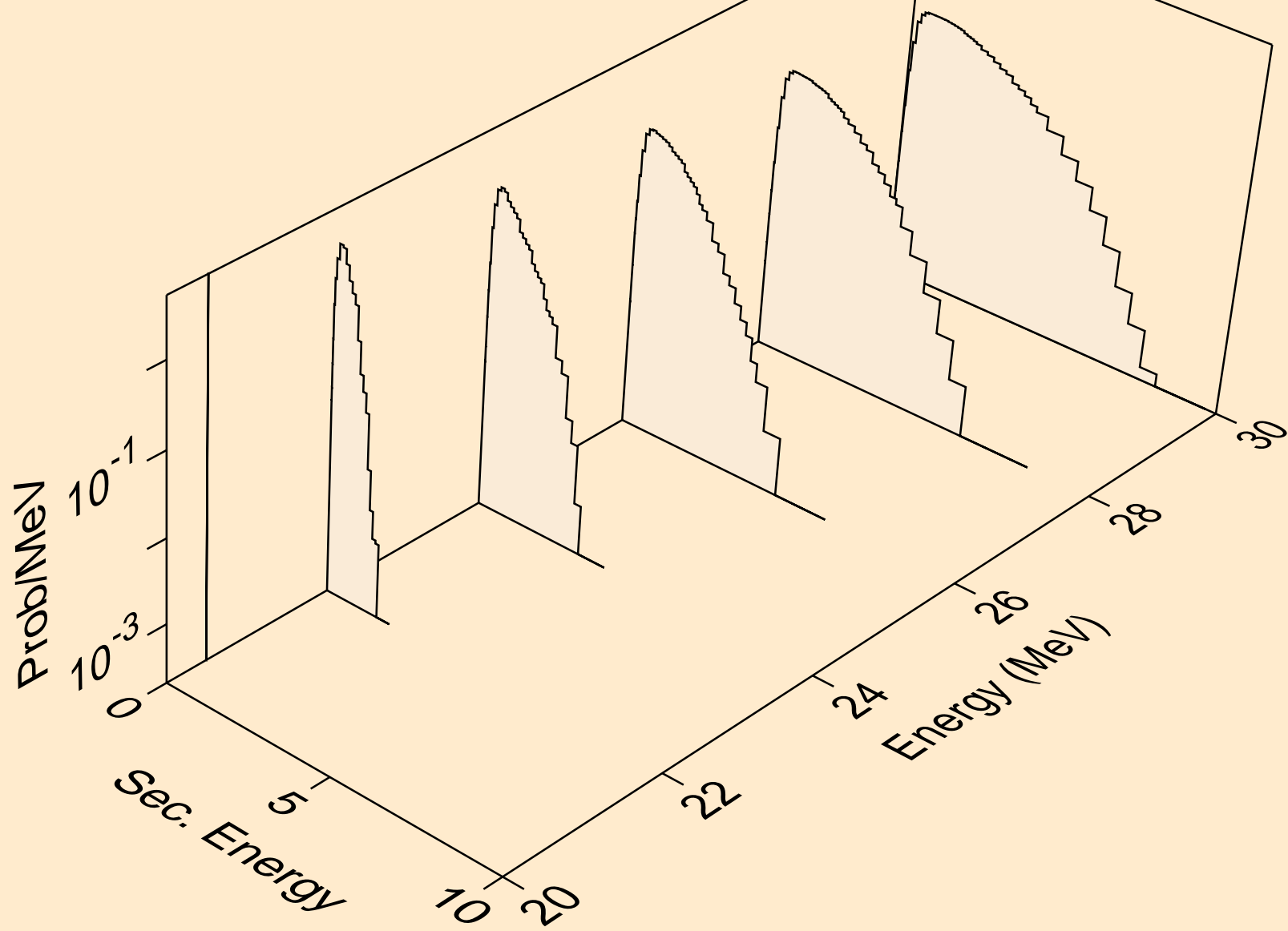

BH269 DEUTERON ACER TENDL-2021 LIBRARY; T=0.K
neutrons from (d,2np)

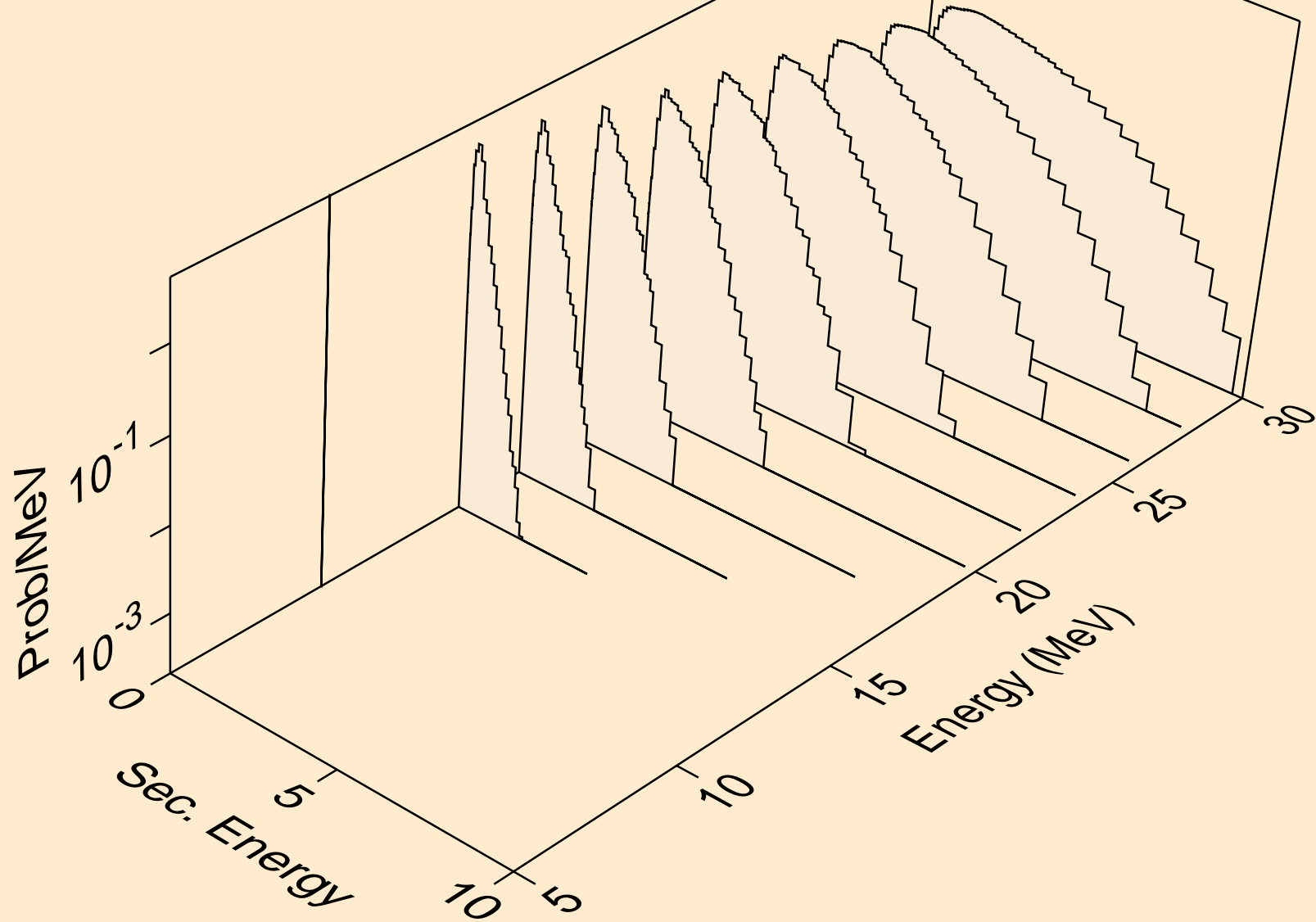

BH269 DEUTERON ACER TENDL-2021 LIBRARY; T=0.K
neutrons from (d,2np)

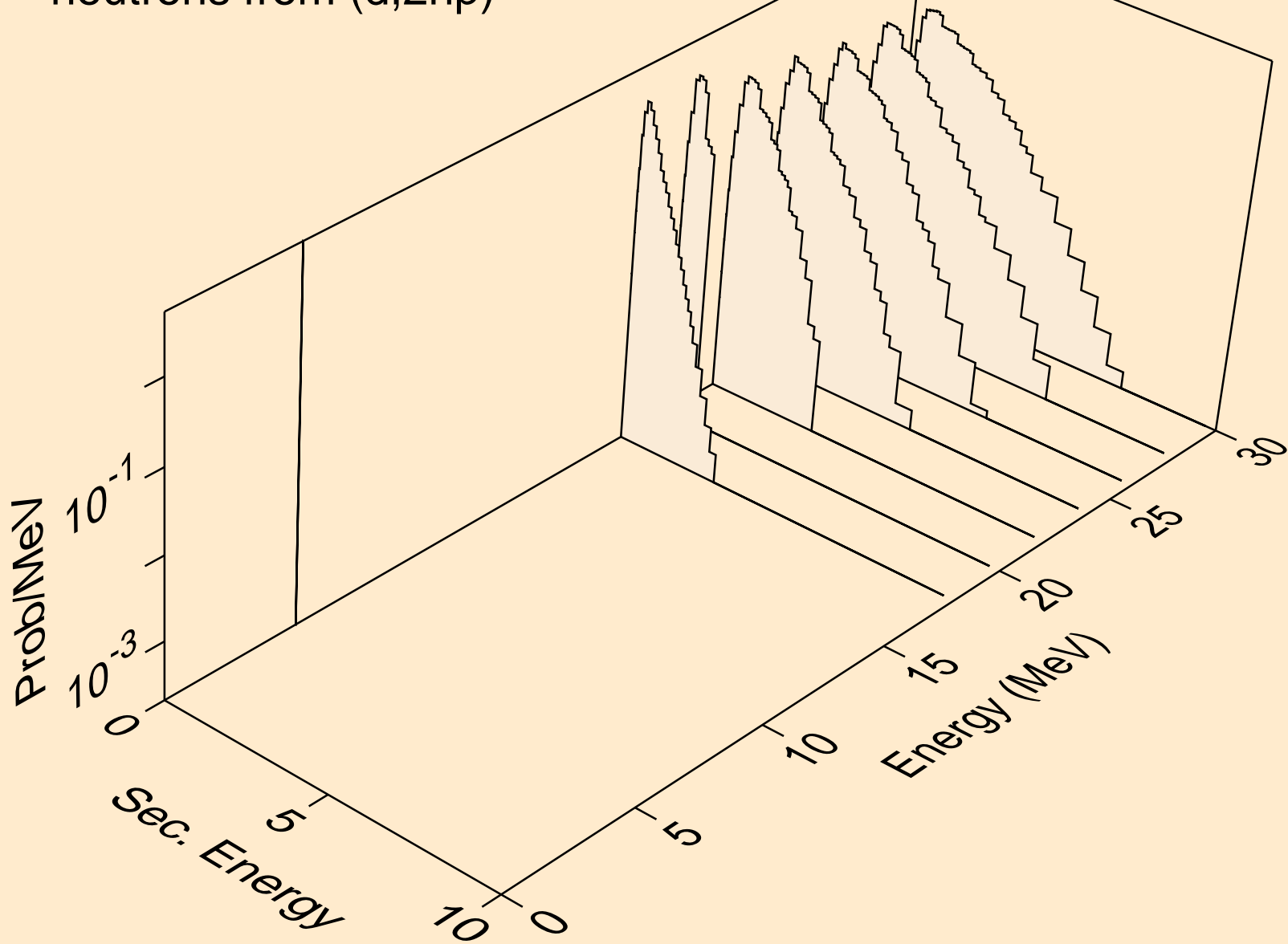

BH269 DEUTERON ACER TENDL-2021 LIBRARY; T=0.K
neutrons from (d,npa)

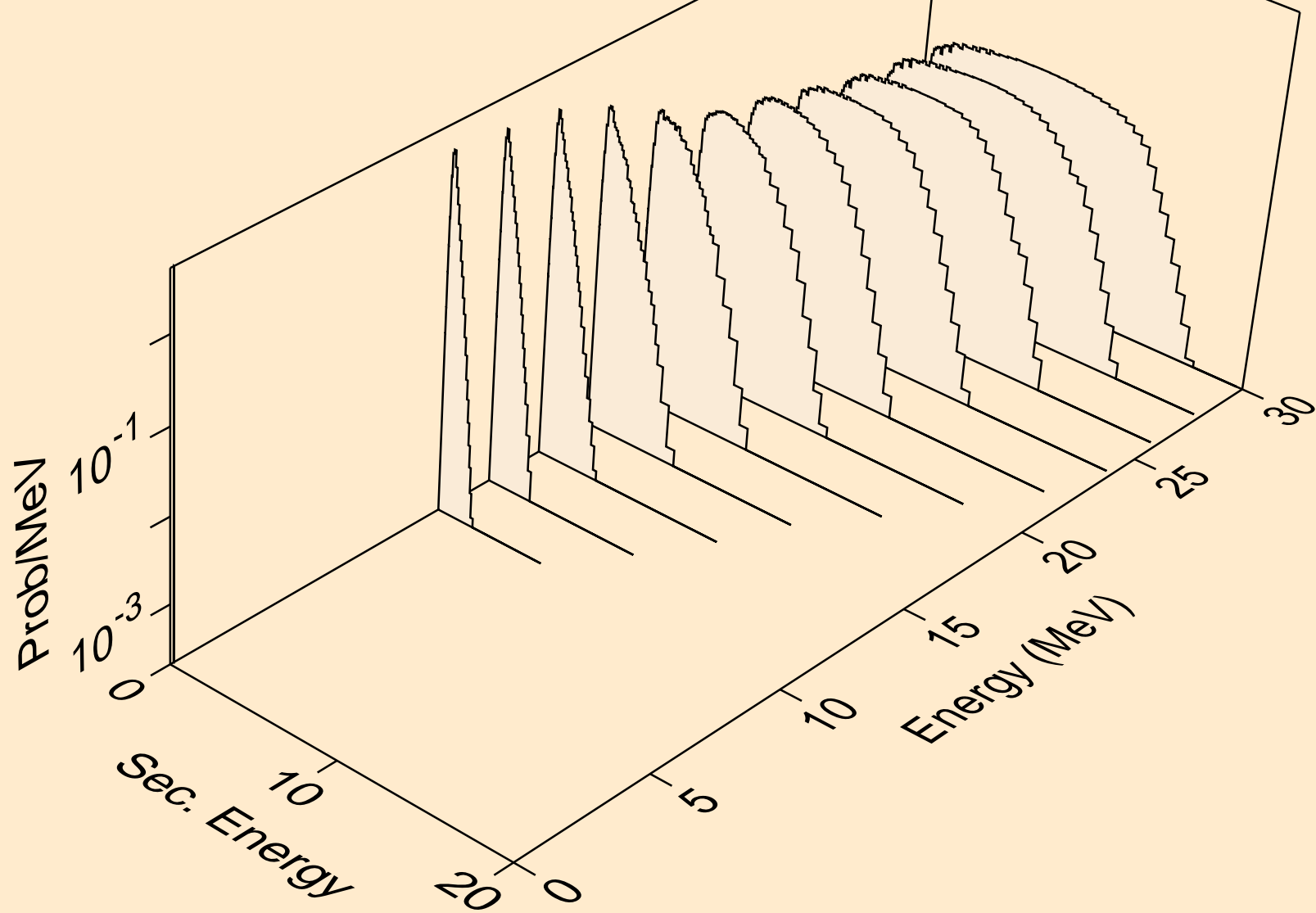

BH269 DEUTERON ACER TENDL-2021 LIBRARY; T=0.K
protons from (d,x)

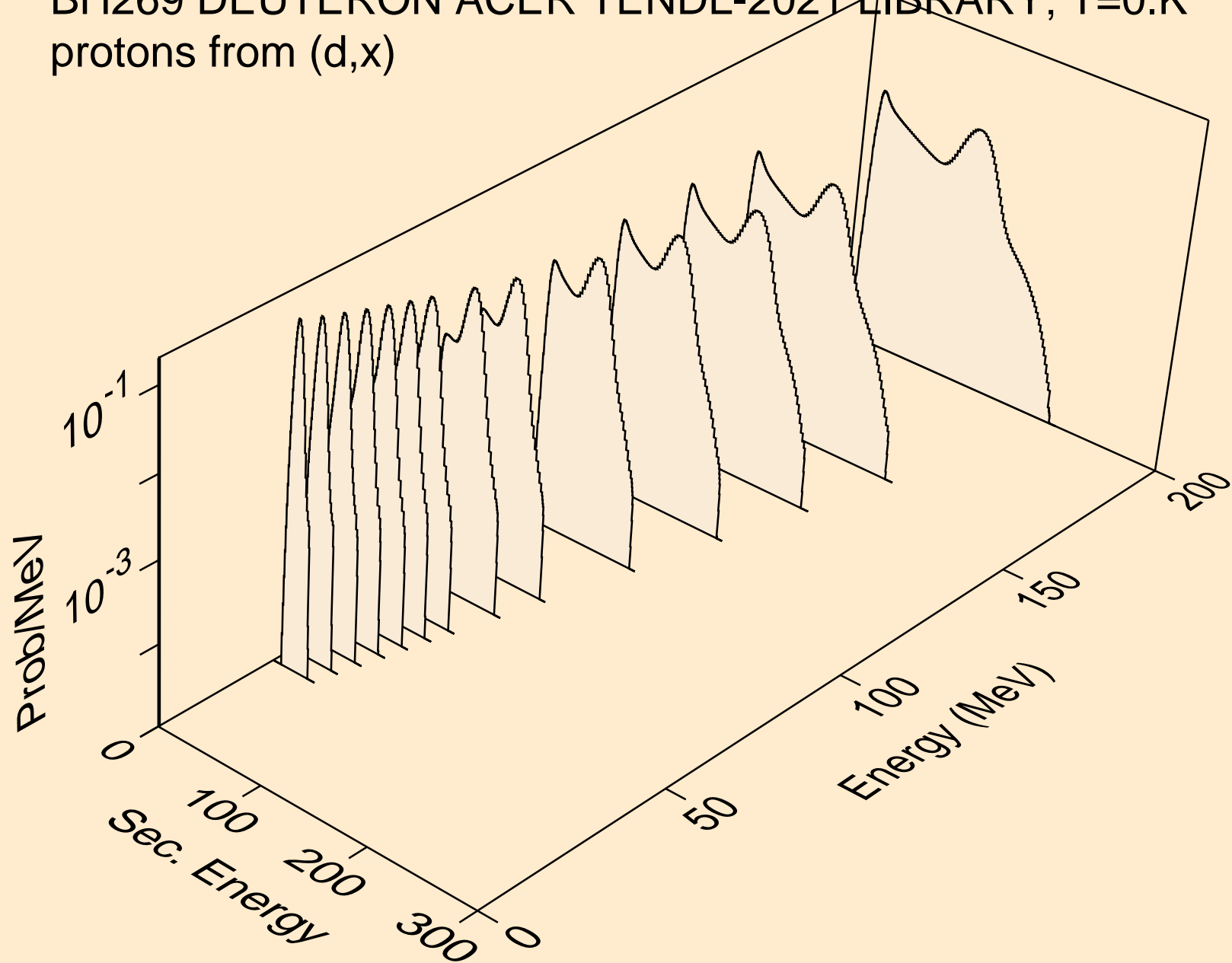

BH269 DEUTERON ACER TENDL-2021 LIBRARY; T=0.K
protons from (d,n*)p

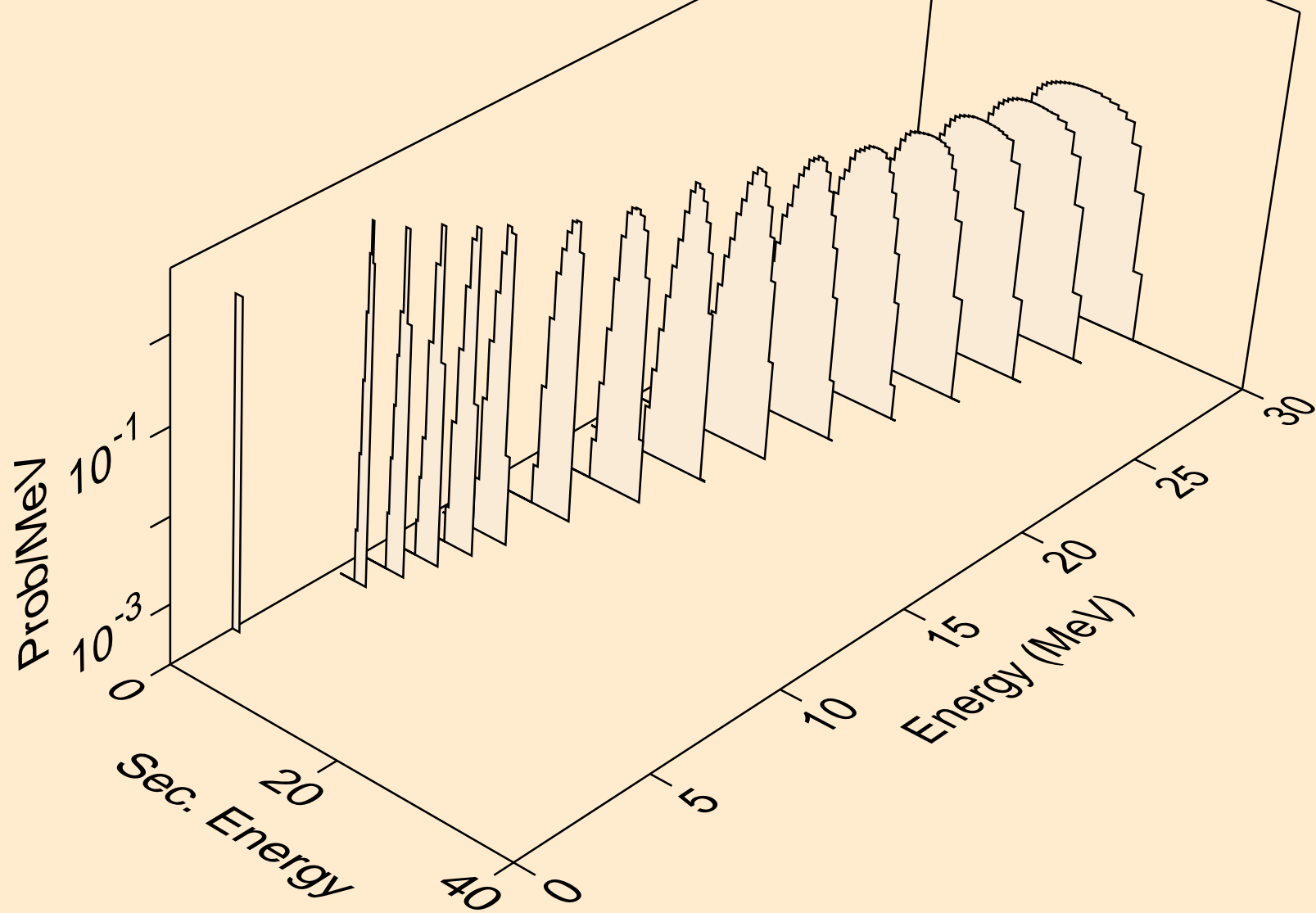

BH269 DEUTERON ACER TENDL-2021 LIBRARY; T=0.K
protons from (d,2np)

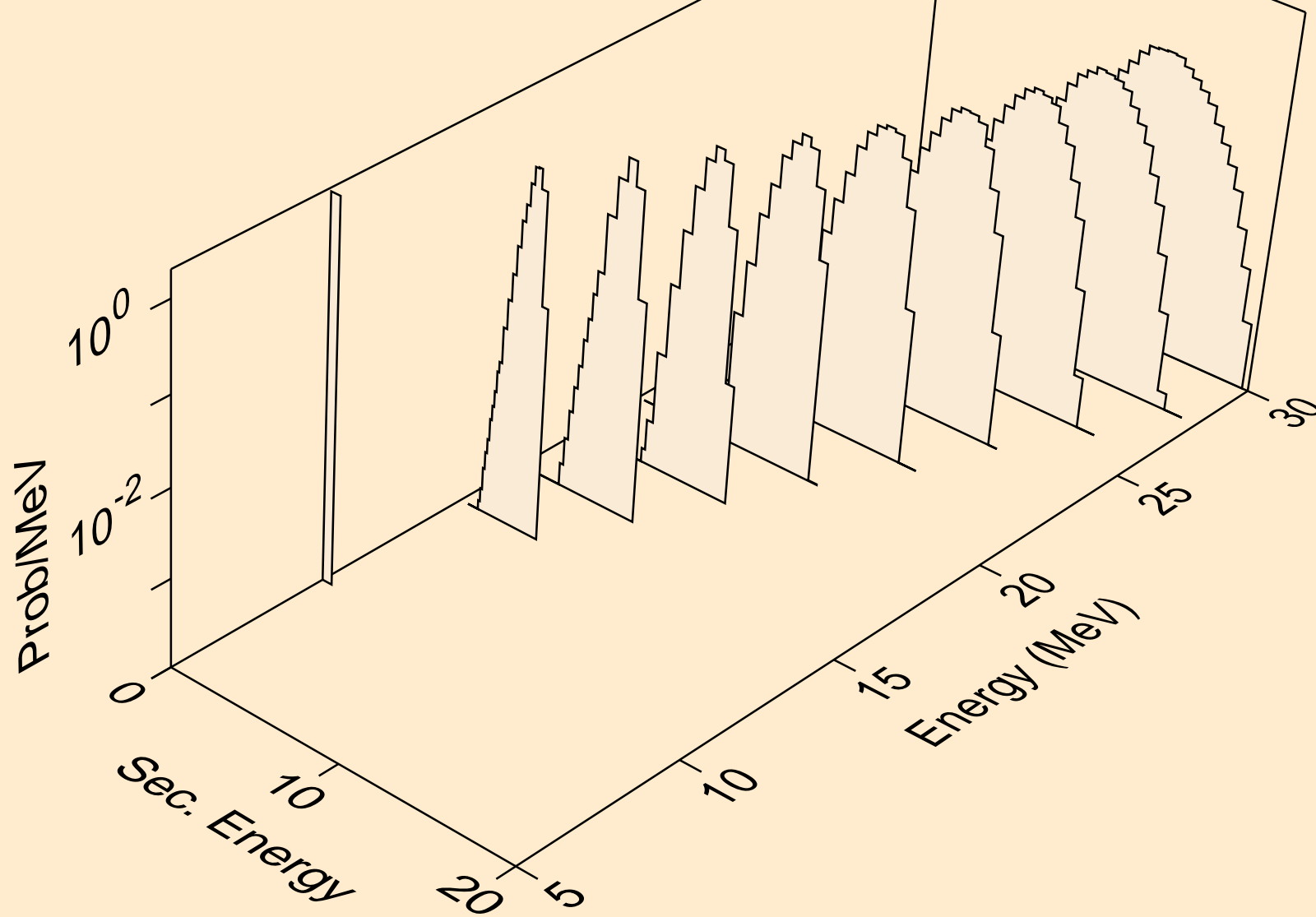

BH269 DEUTERON ACER TENDL-2021 LIBRARY; T=0.K
protons from (d,2np)

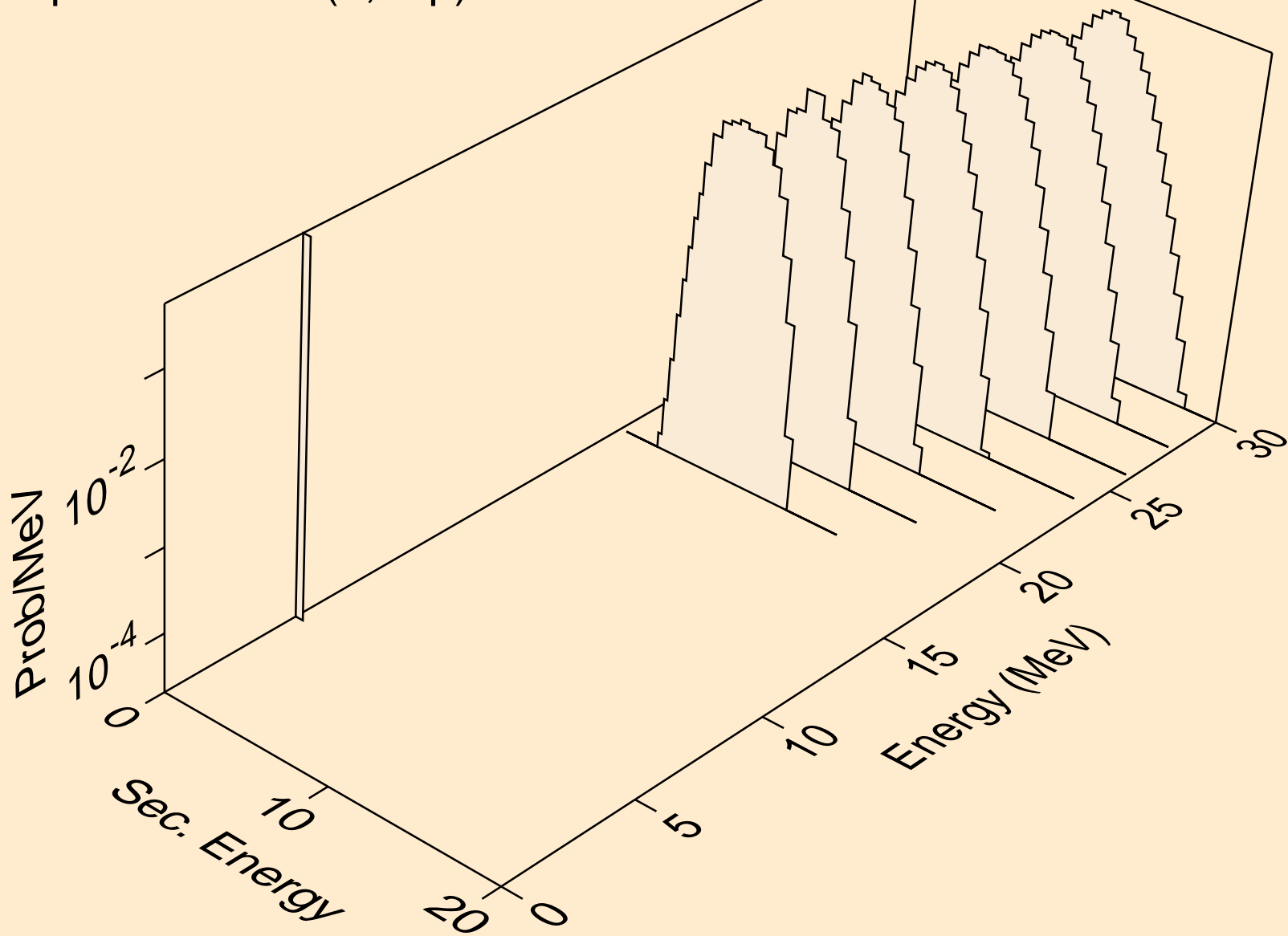

BH269 DEUTERON ACER TENDL-2021 LIBRARY; T=0.K
protons from (d,npa)

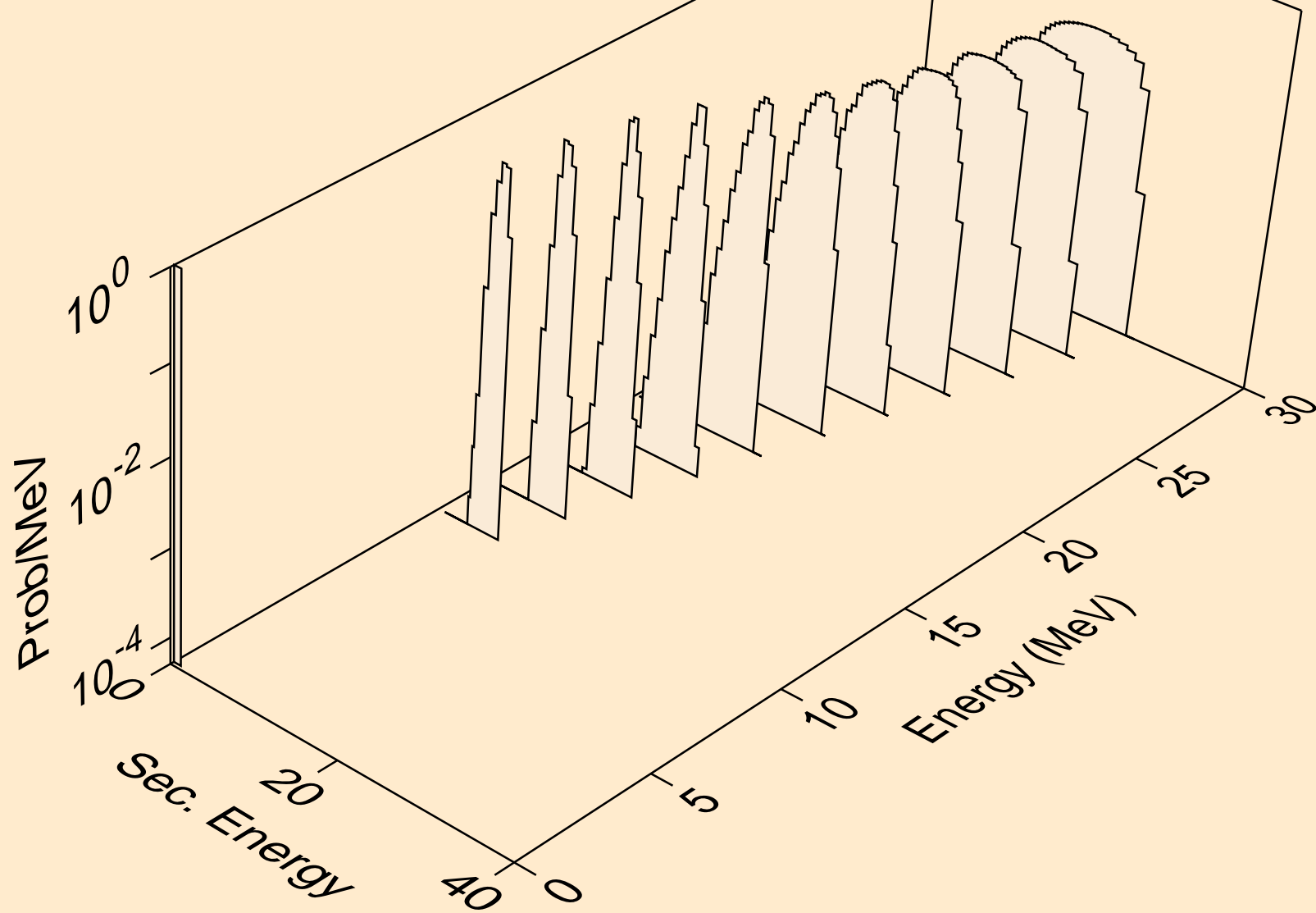

BH269 DEUTERON ACER TENDL-2021 LIBRARY; T=0.K
protons from (d,p)

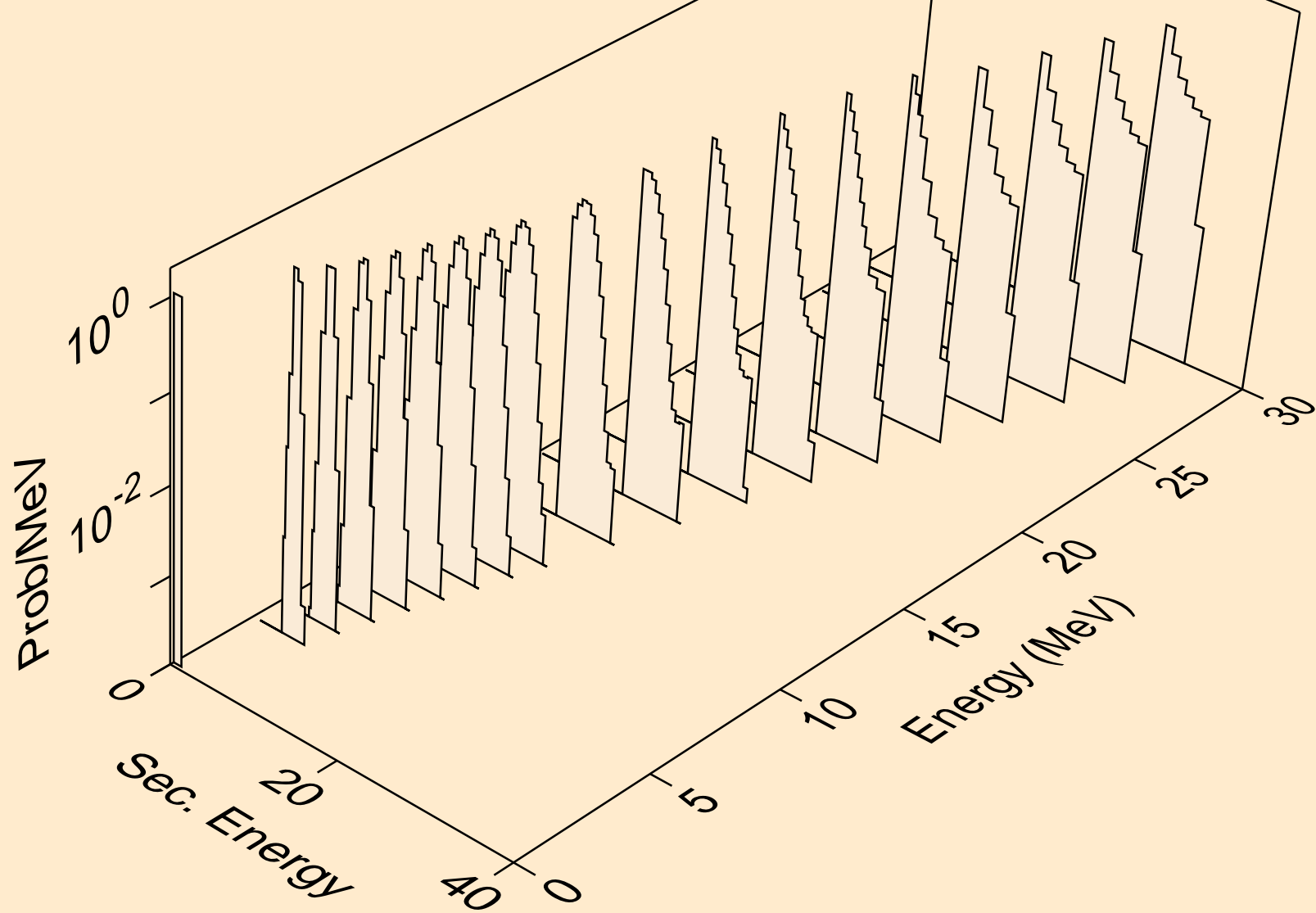

BH269 DEUTERON ACER TENDL-2021 LIBRARY; T=0.K
protons from (d,2p)

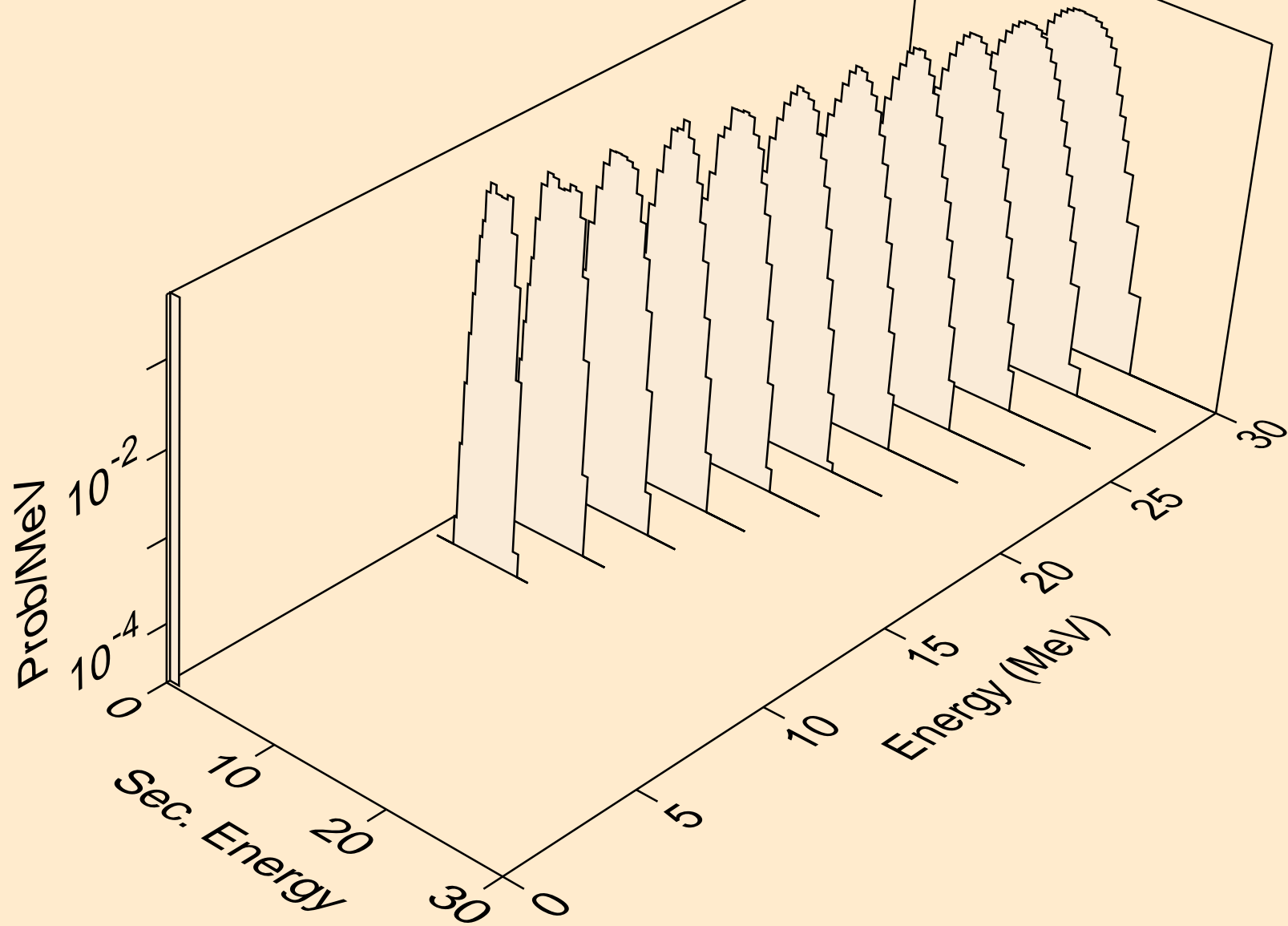

BH269 DEUTERON ACER TENDL-2021 LIBRARY; T=0.K
protons from (d,pa)

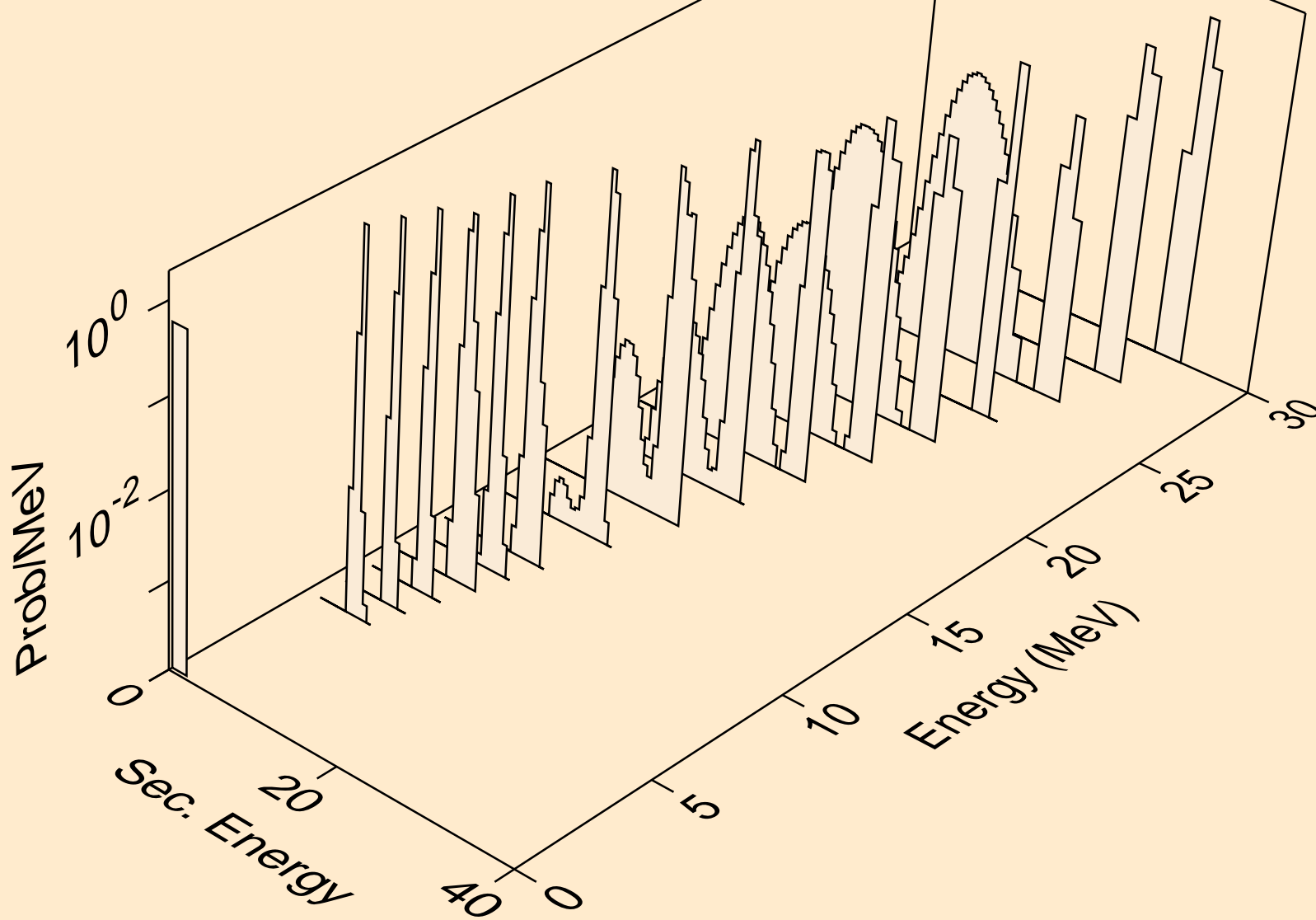

BH269 DEUTERON ACER TENDL-2021 LIBRARY; T=0.K
protons from (d,pd)

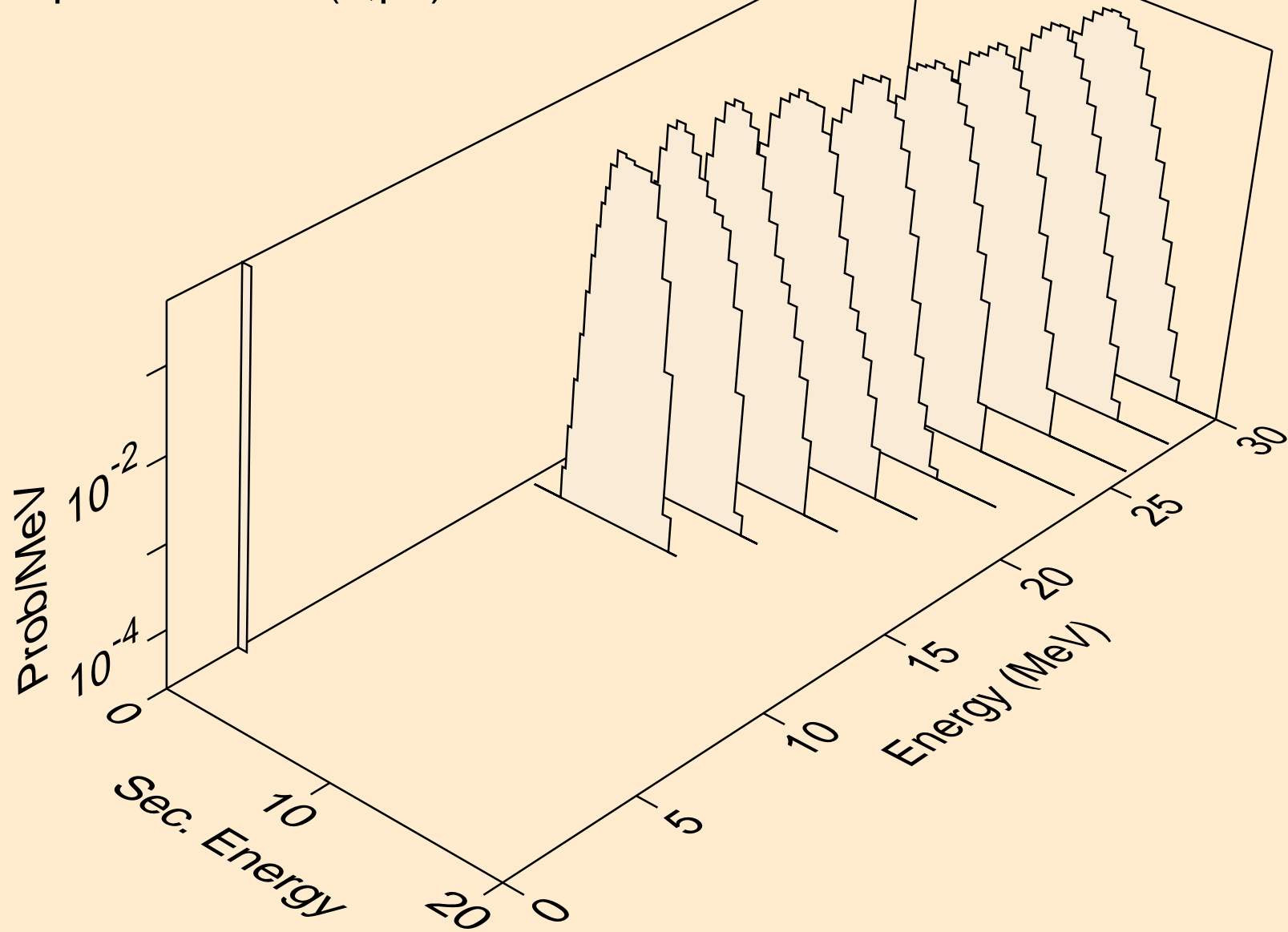

BH269 DEUTERON ACER TENDL-2021 LIBRARY; T=0.K
tritons from (d,x)

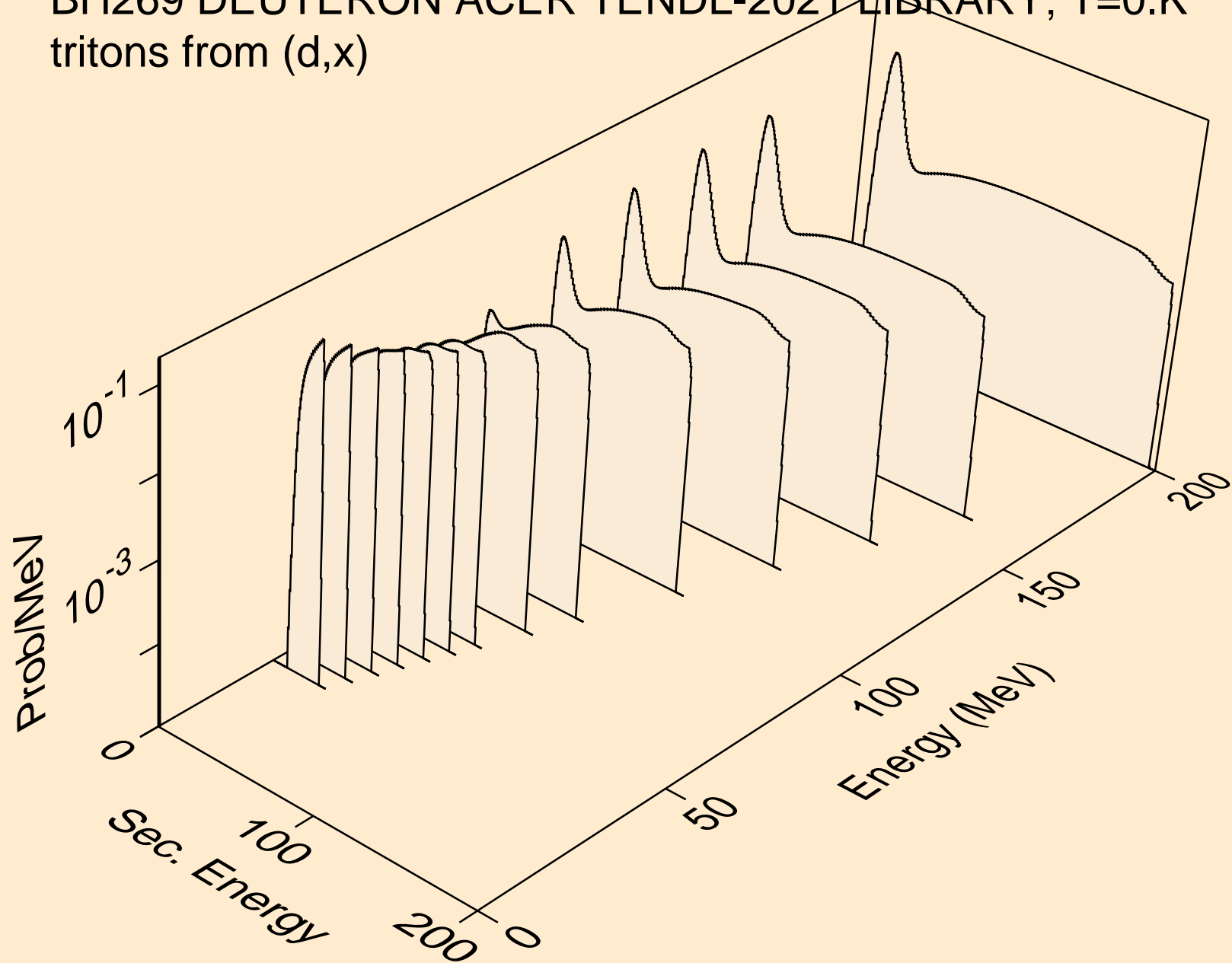

BH269 DEUTERON ACER TENDL-2021 LIBRARY; T=0.K
tritons from (d,n*)t

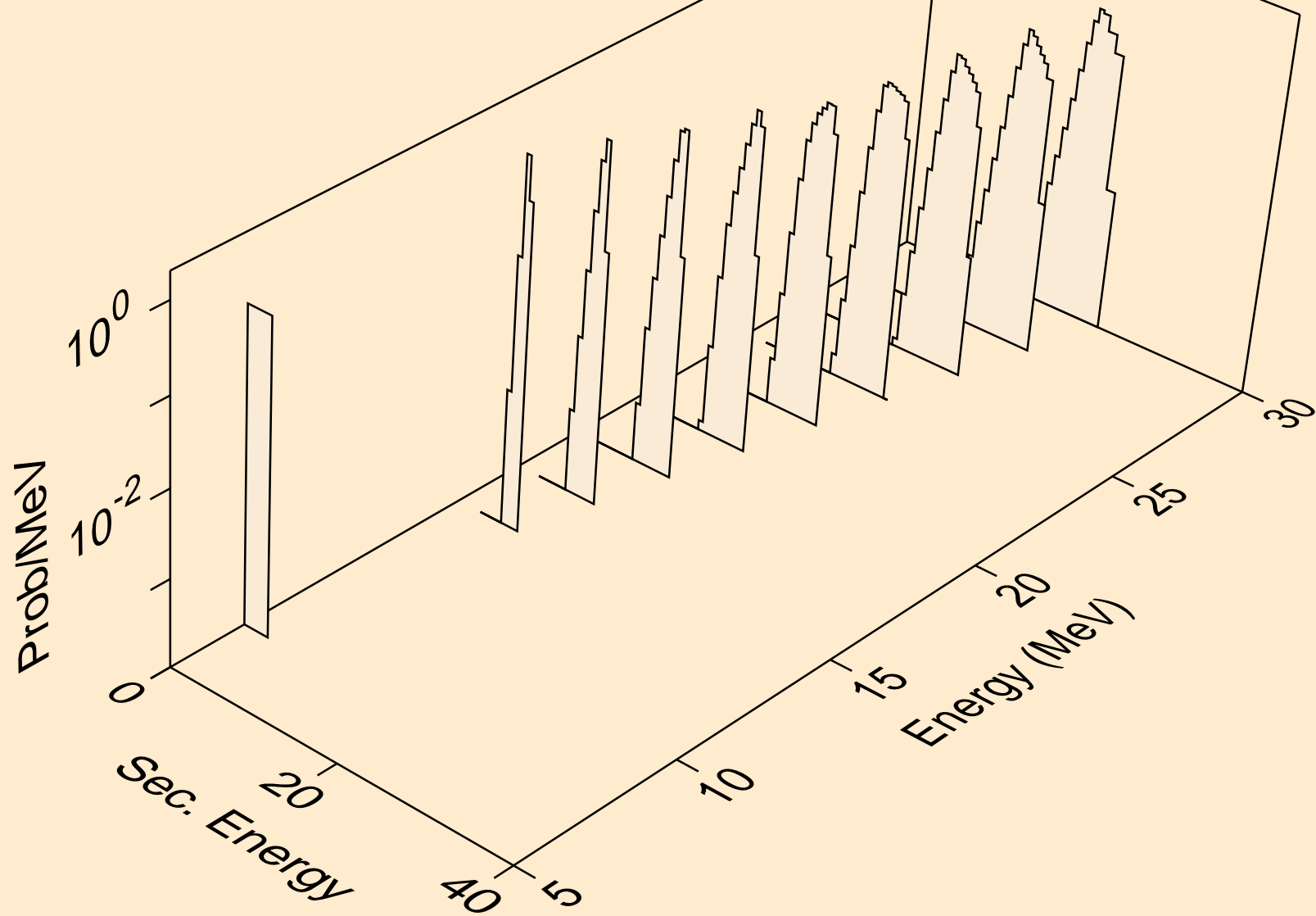

BH269 DEUTERON ACER TENDL-2021 LIBRARY; T=0.K
tritons from (d,t)

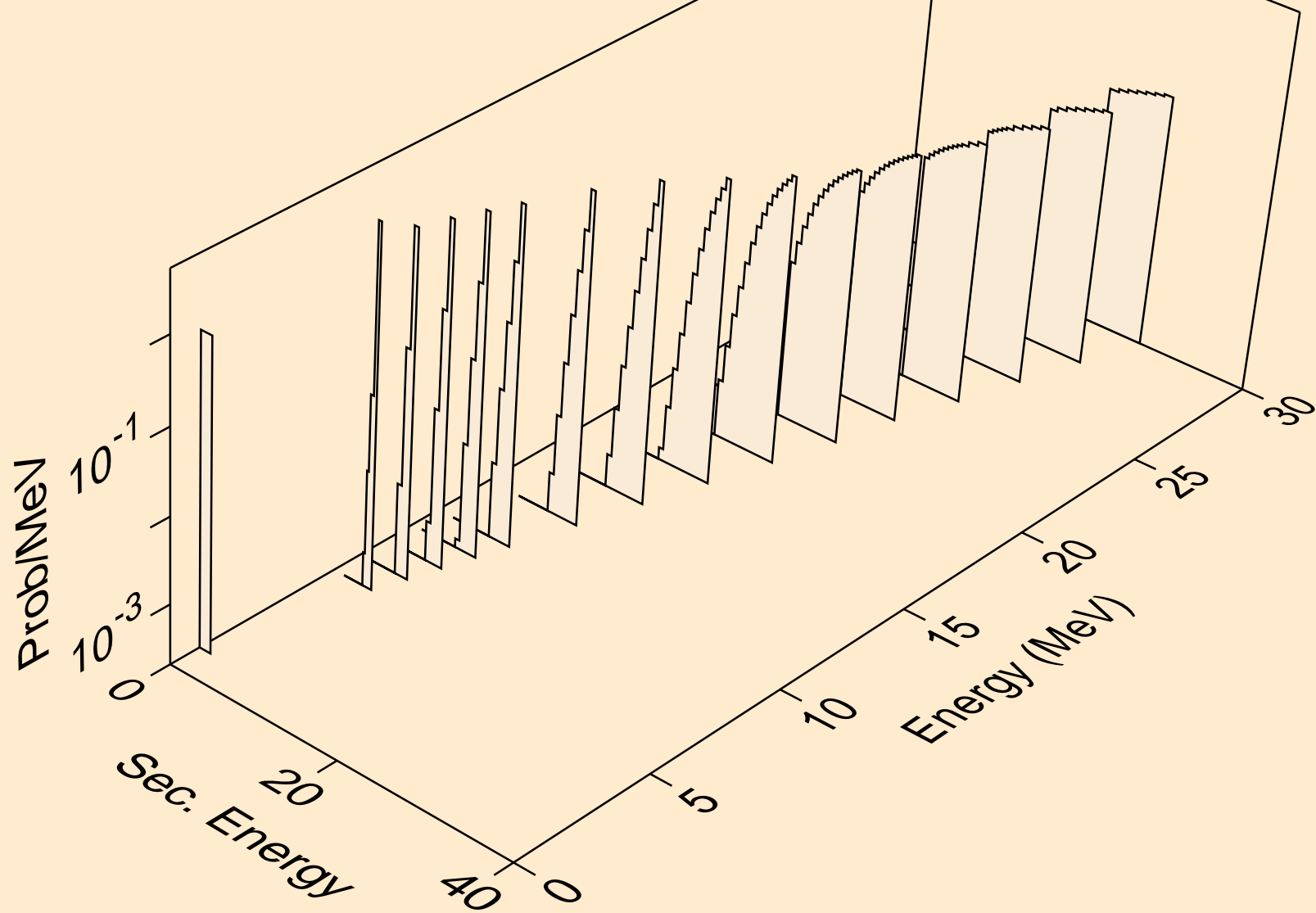

BH269 DEUTERON ACER TENDL-2021 LIBRARY; T=0.K
he3s from (d,x)

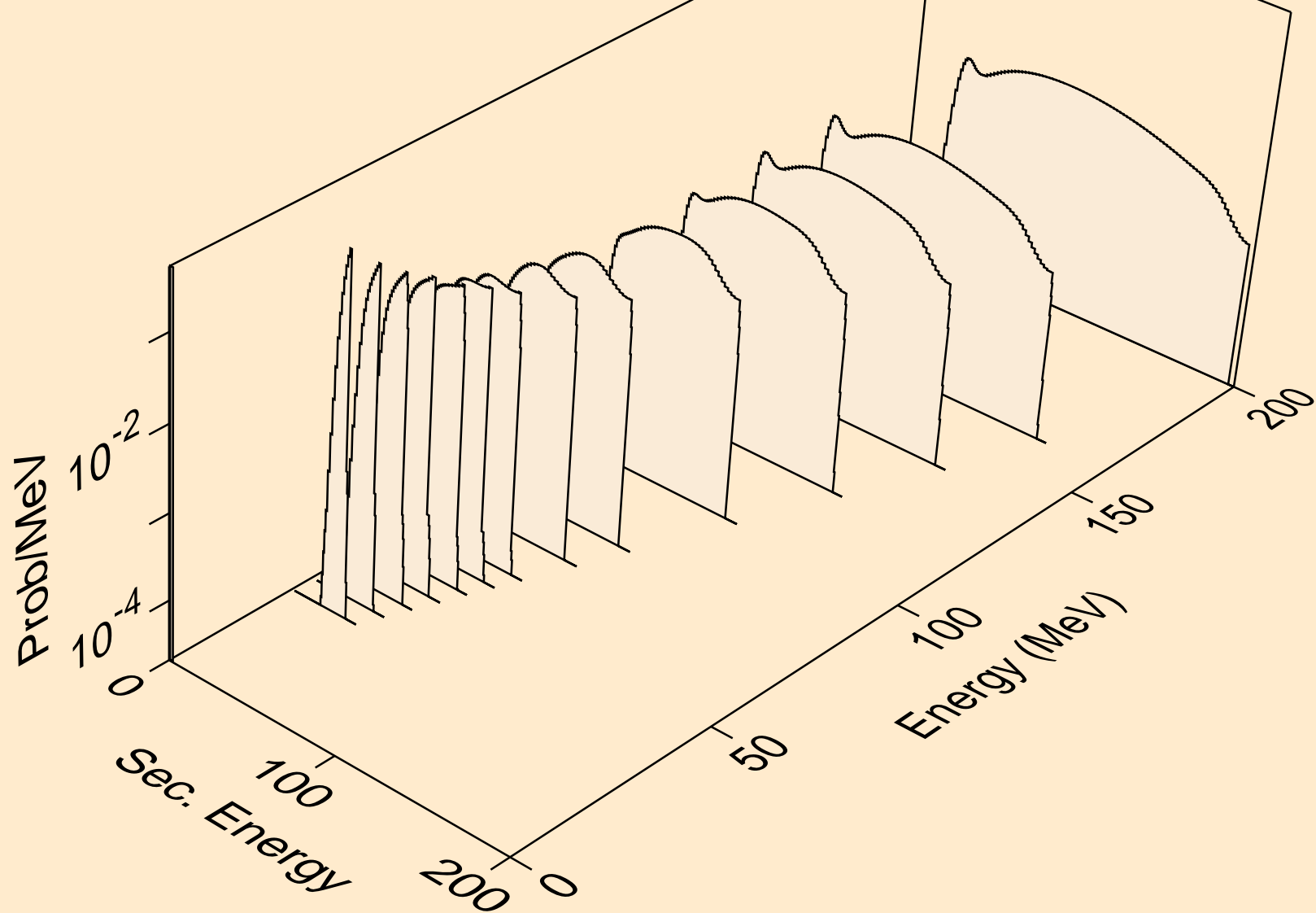

BH269 DEUTERON ACER TENDL-2021 LIBRARY; T=0.K
he3s from (d,he3)

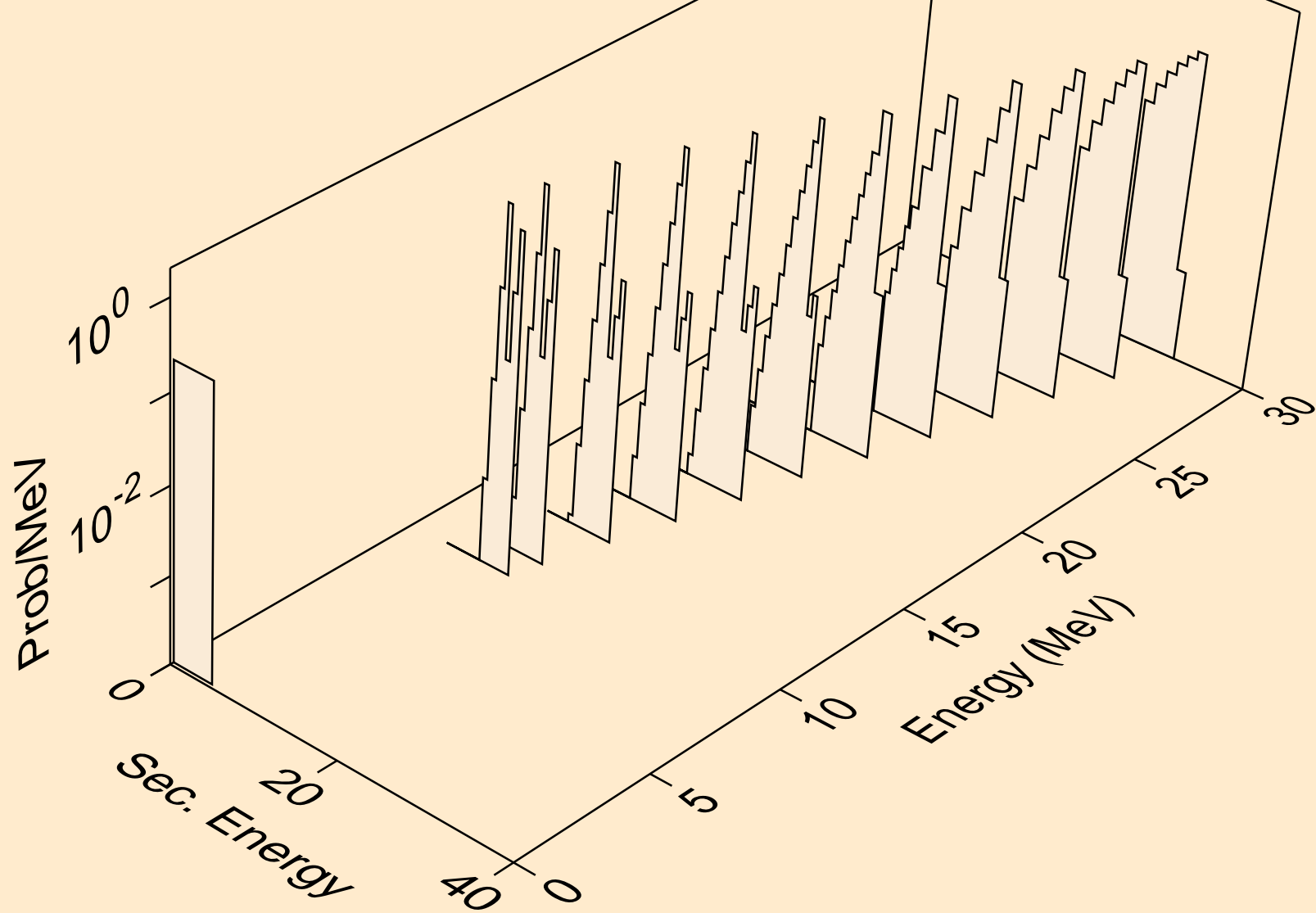

BH269 DEUTERON ACER TENDL-2021 LIBRARY; T=0.K
alphas from (d,x)

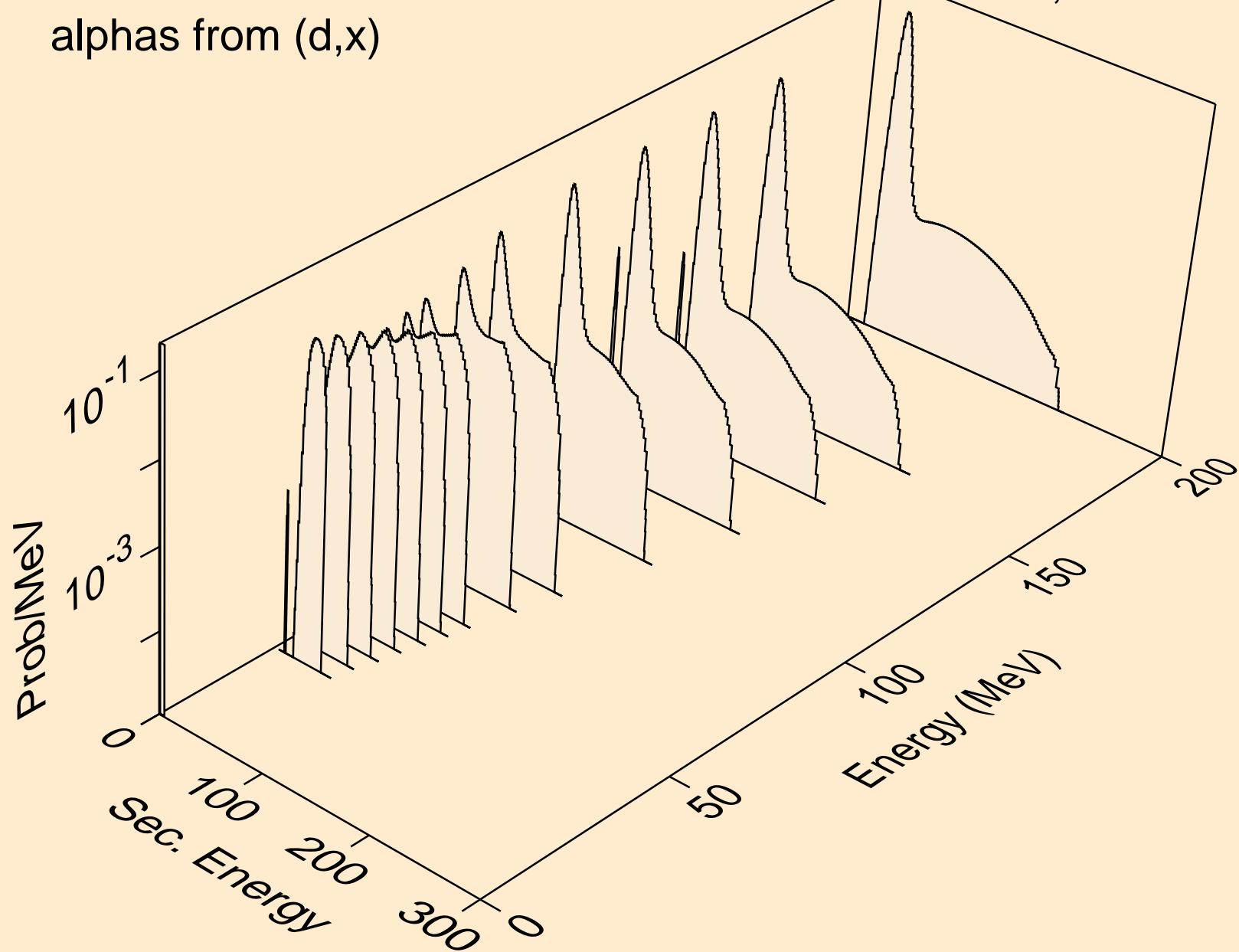

BH269 DEUTERON ACER TENDL-2021 LIBRARY; T=0.K
alphas from (d,n*)a

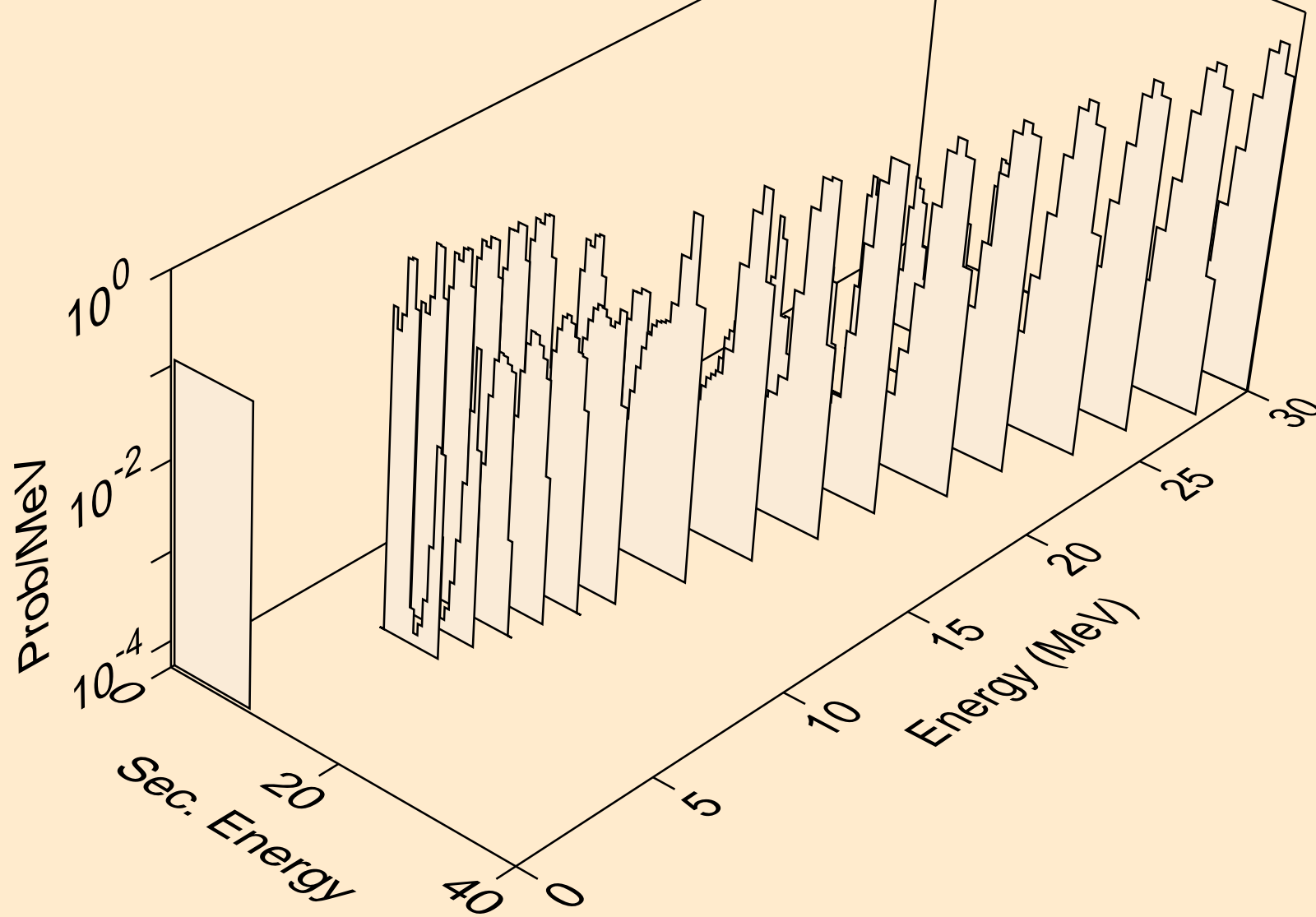

BH269 DEUTERON ACER TENDL-2021 LIBRARY; T=0.K
alphas from (d,2n)a

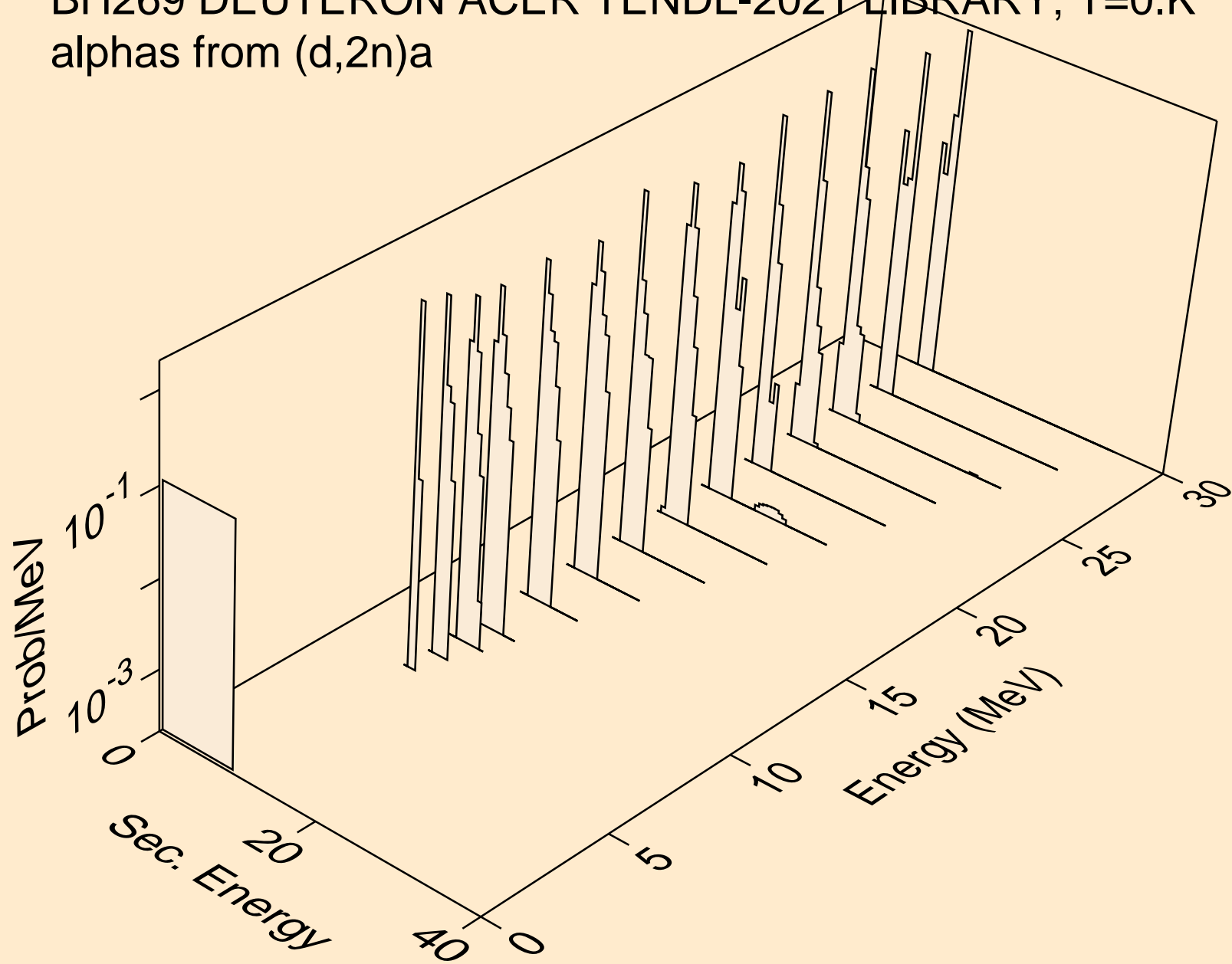

BH269 DEUTERON ACER TENDL-2021 LIBRARY; T=0.K
alphas from (d,3n)a

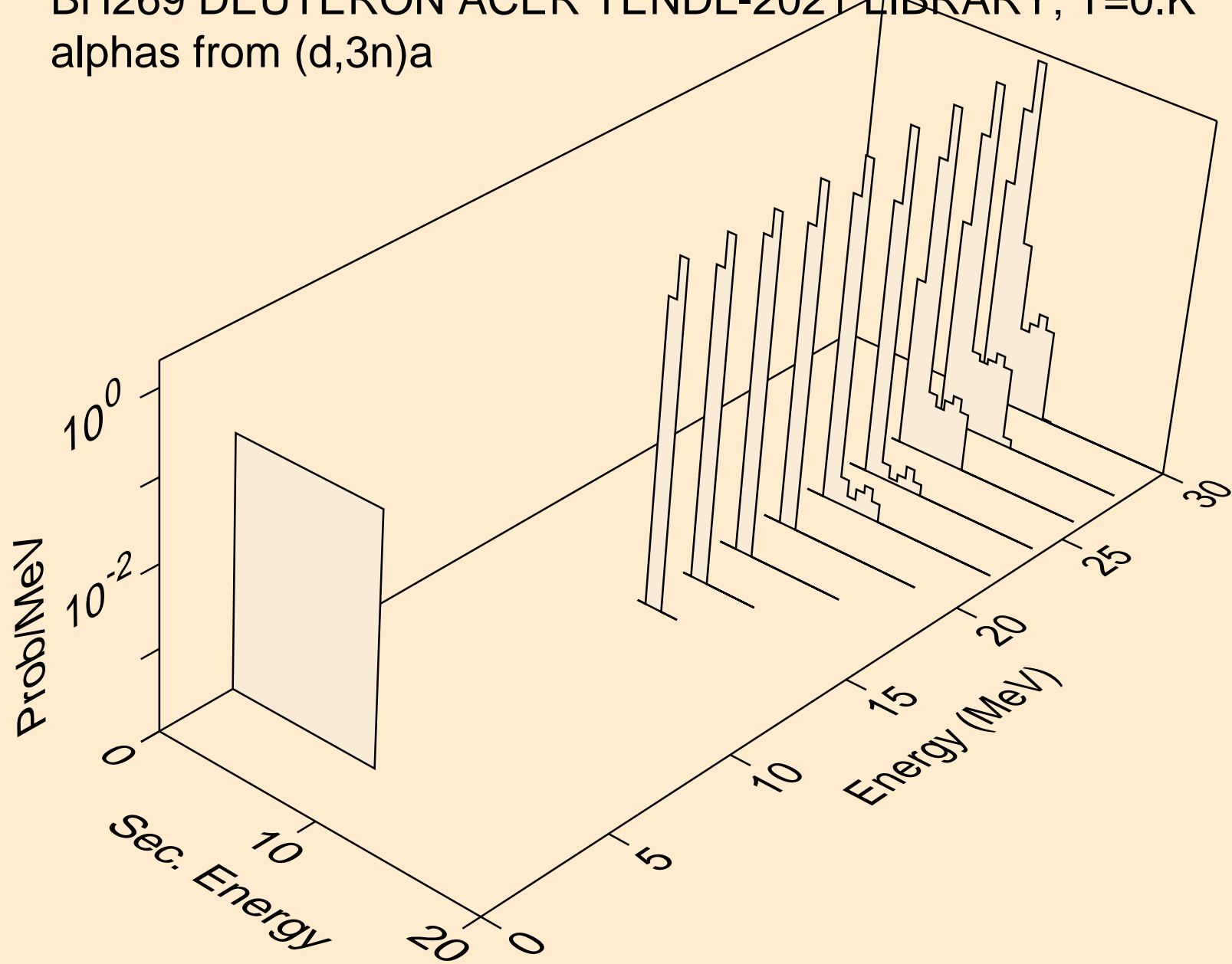

BH269 DEUTERON ACER TENDL-2021 LIBRARY; T=0.K
alphas from (d,npa)

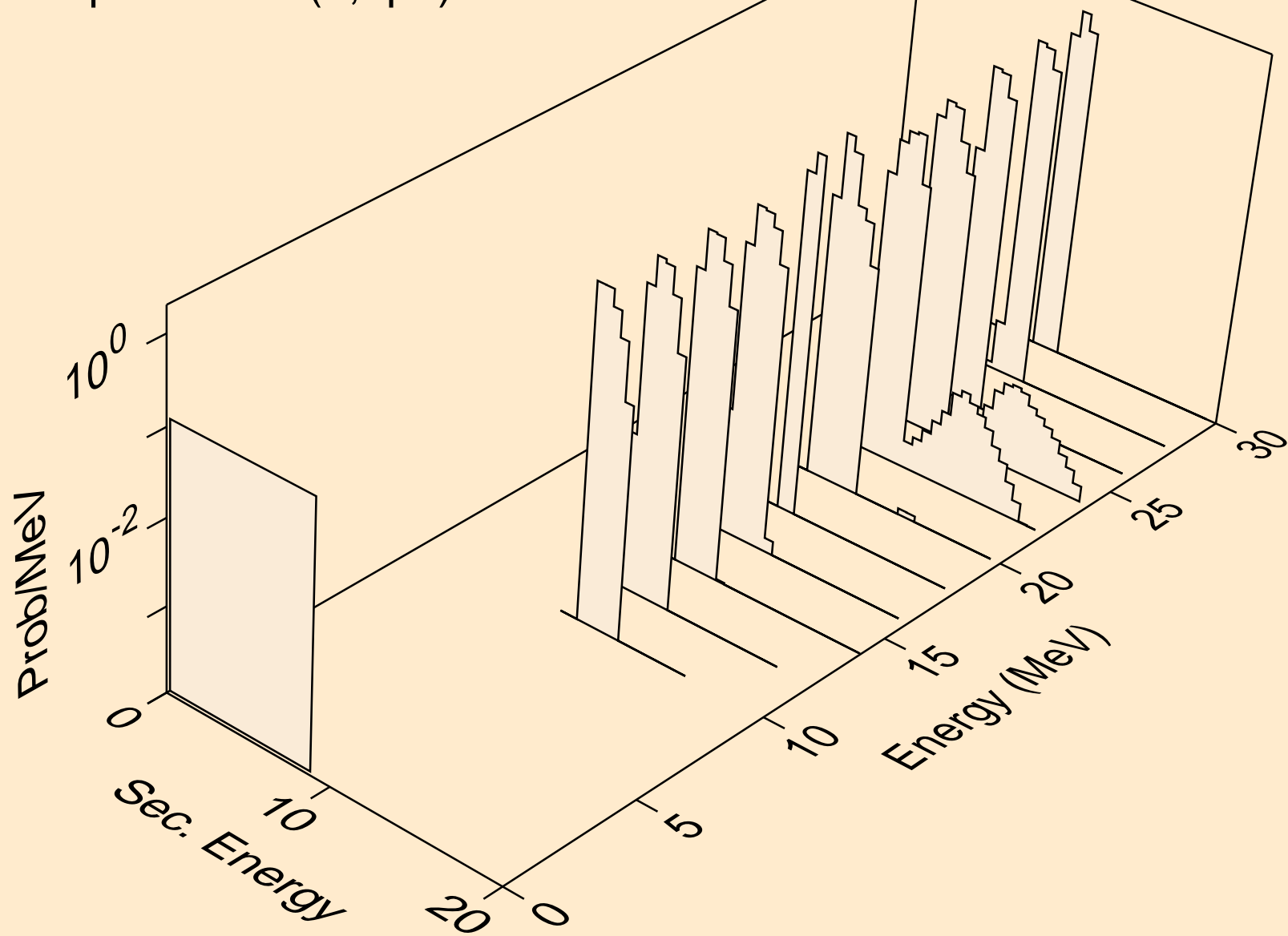

BH269 DEUTERON ACER TENDL-2021 LIBRARY; T=0.K
alphas from (d,a)

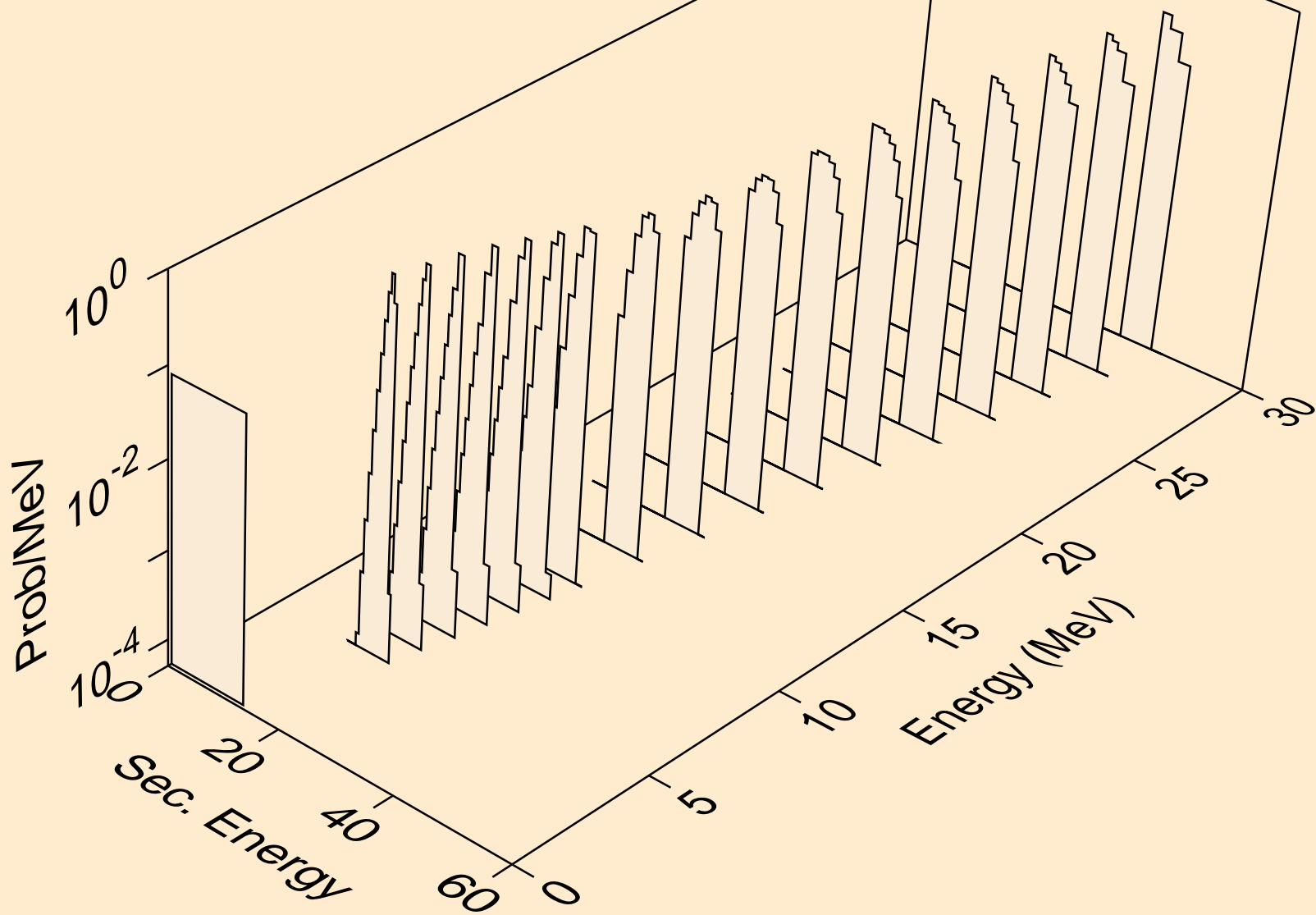

BH269 DEUTERON ACER TENDL-2021 LIBRARY; T=0.K
alphas from (d,pa)

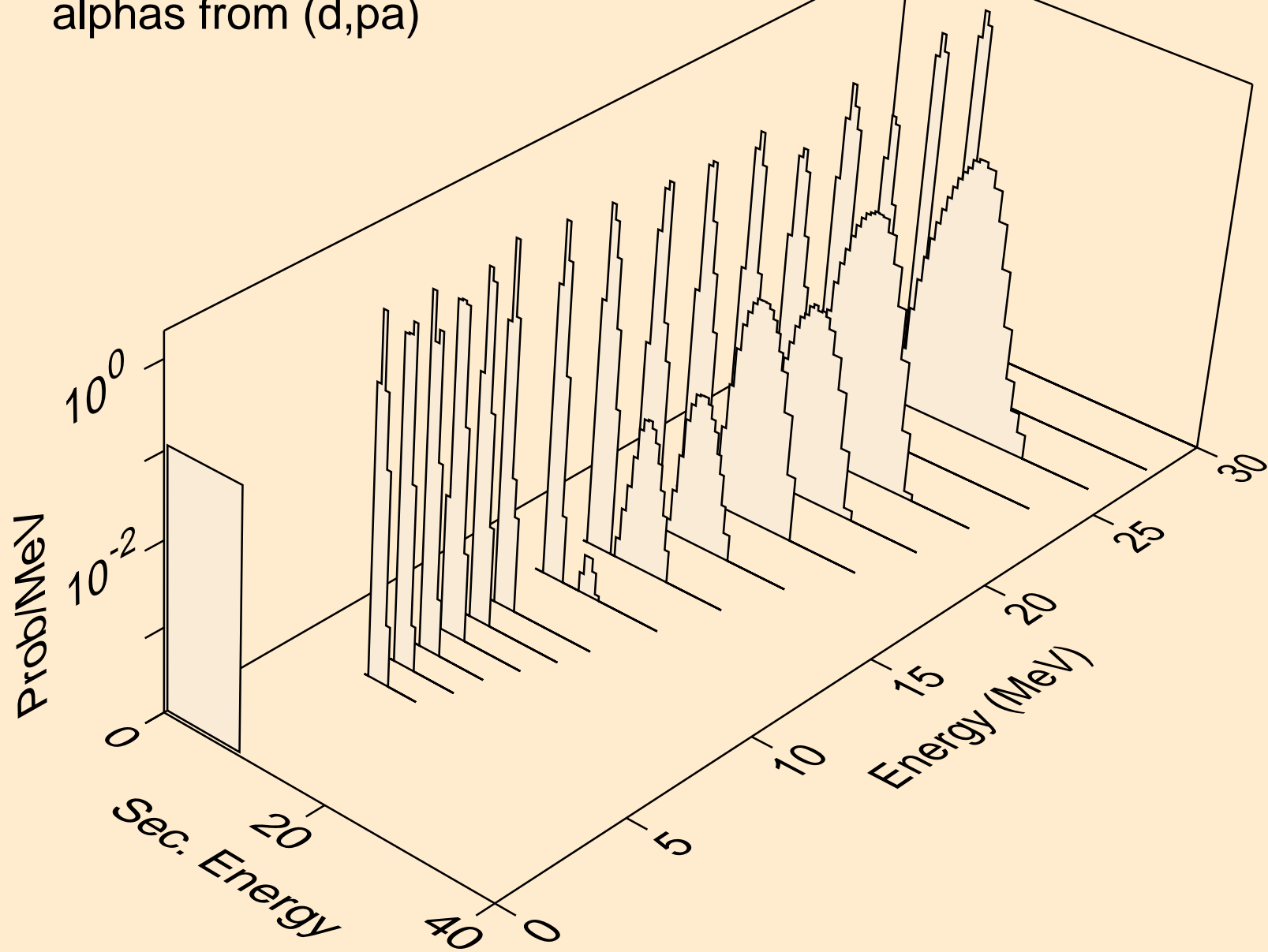

BH269 DEUTERON ACER TENDL-2021 LIBRARY; T=0.K
alphas from (d,da)

