

BK239 DEUTERON ACER TENDL-2021 LIBRARY; T=0.K
Principal cross sections

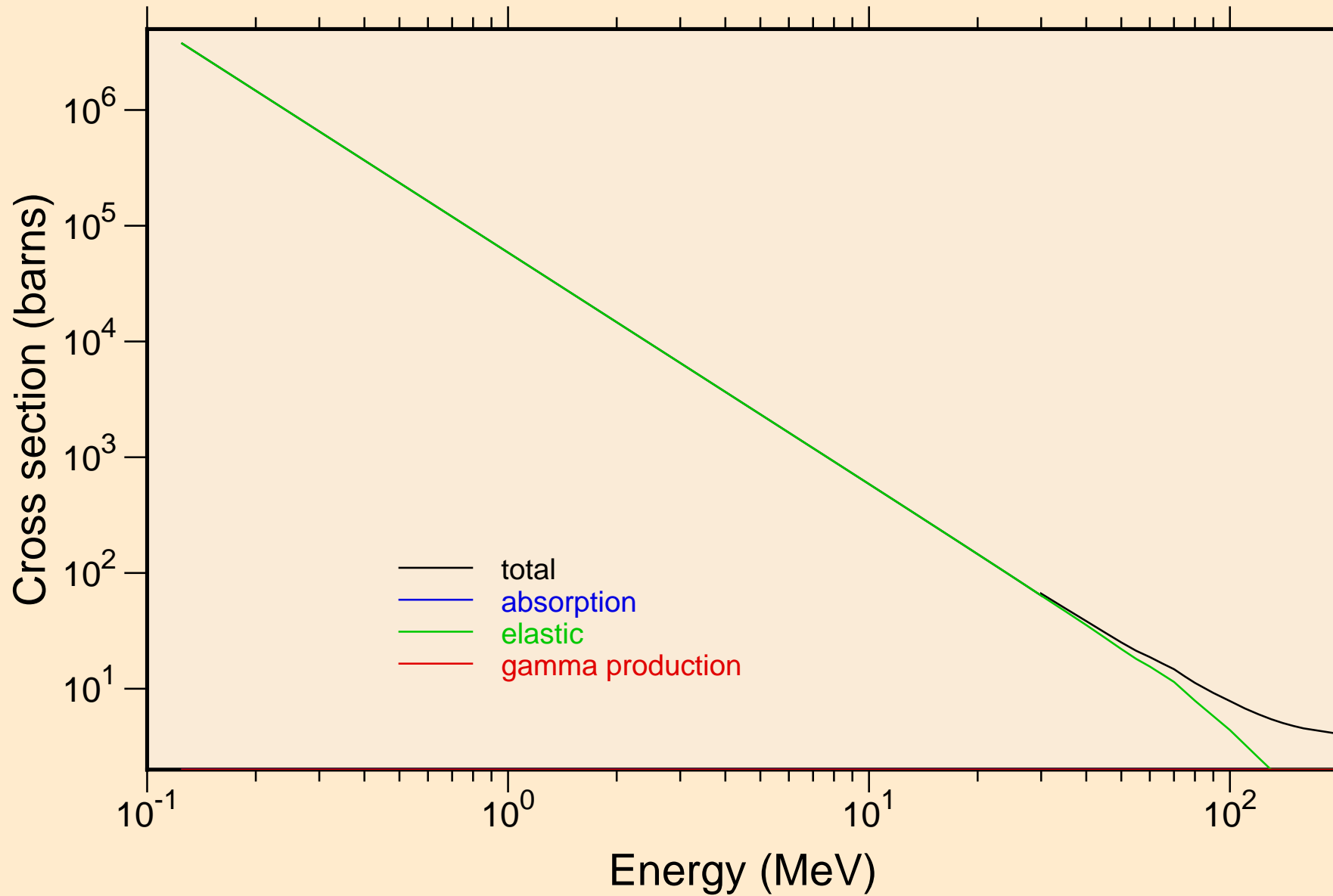

BK239 DEUTERON ACER TENDL-2021 LIBRARY; T=0.K
Heating

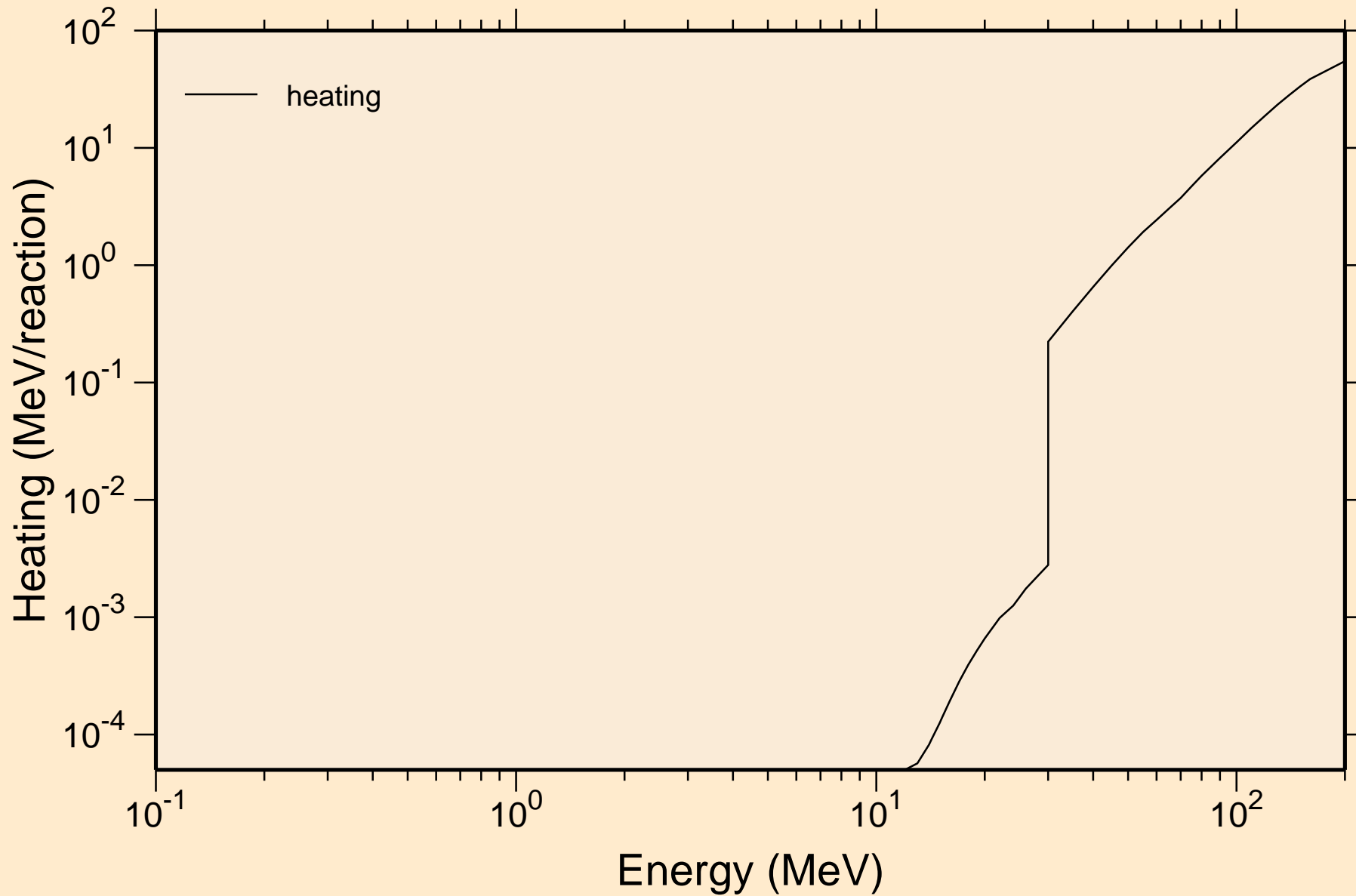

BK239 DEUTERON ACER TENDL-2021 LIBRARY; T=0.K
Principal cross sections

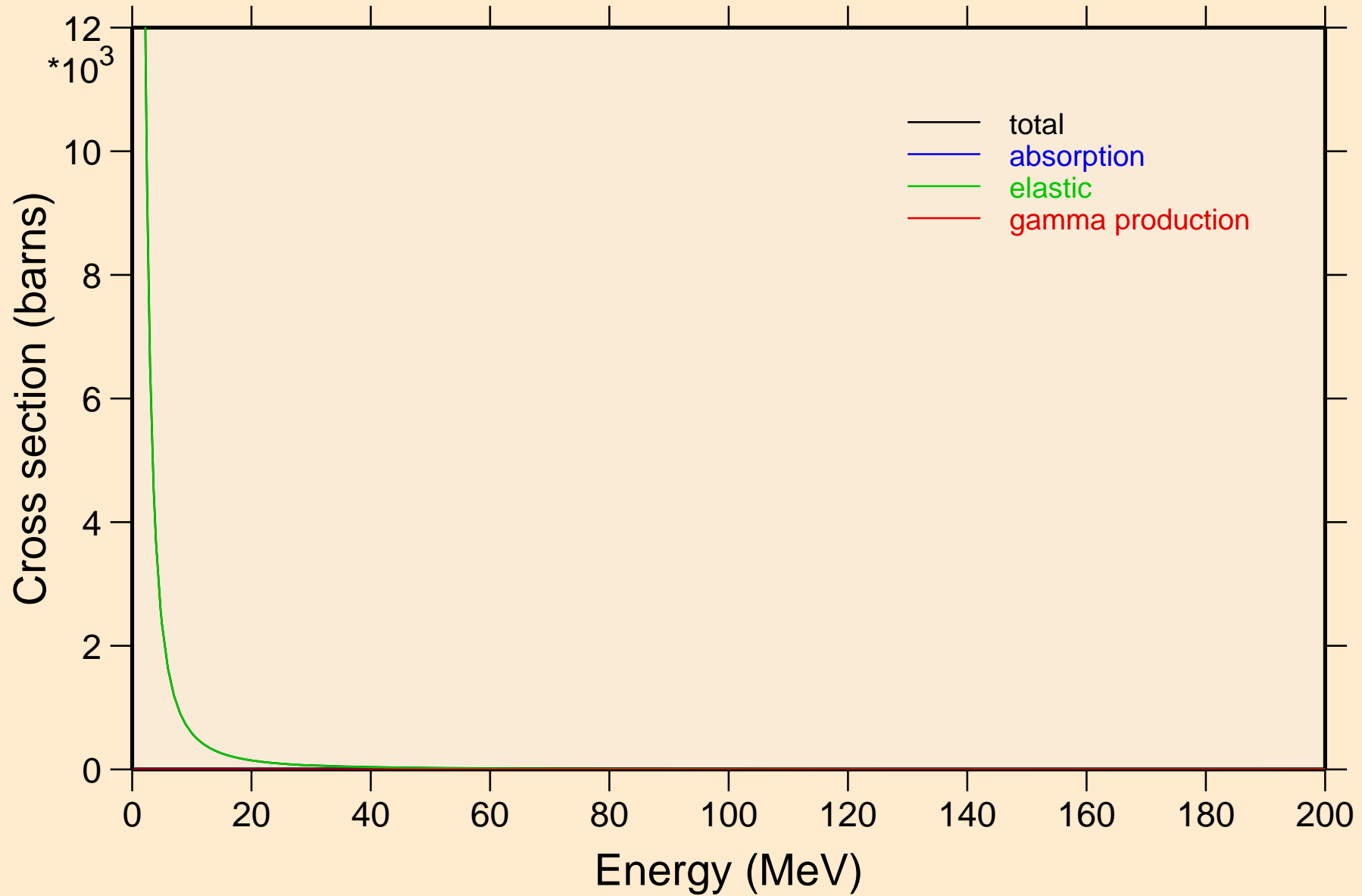

BK239 DEUTERON ACER TENDL-2021 LIBRARY; T=0.K

Heating

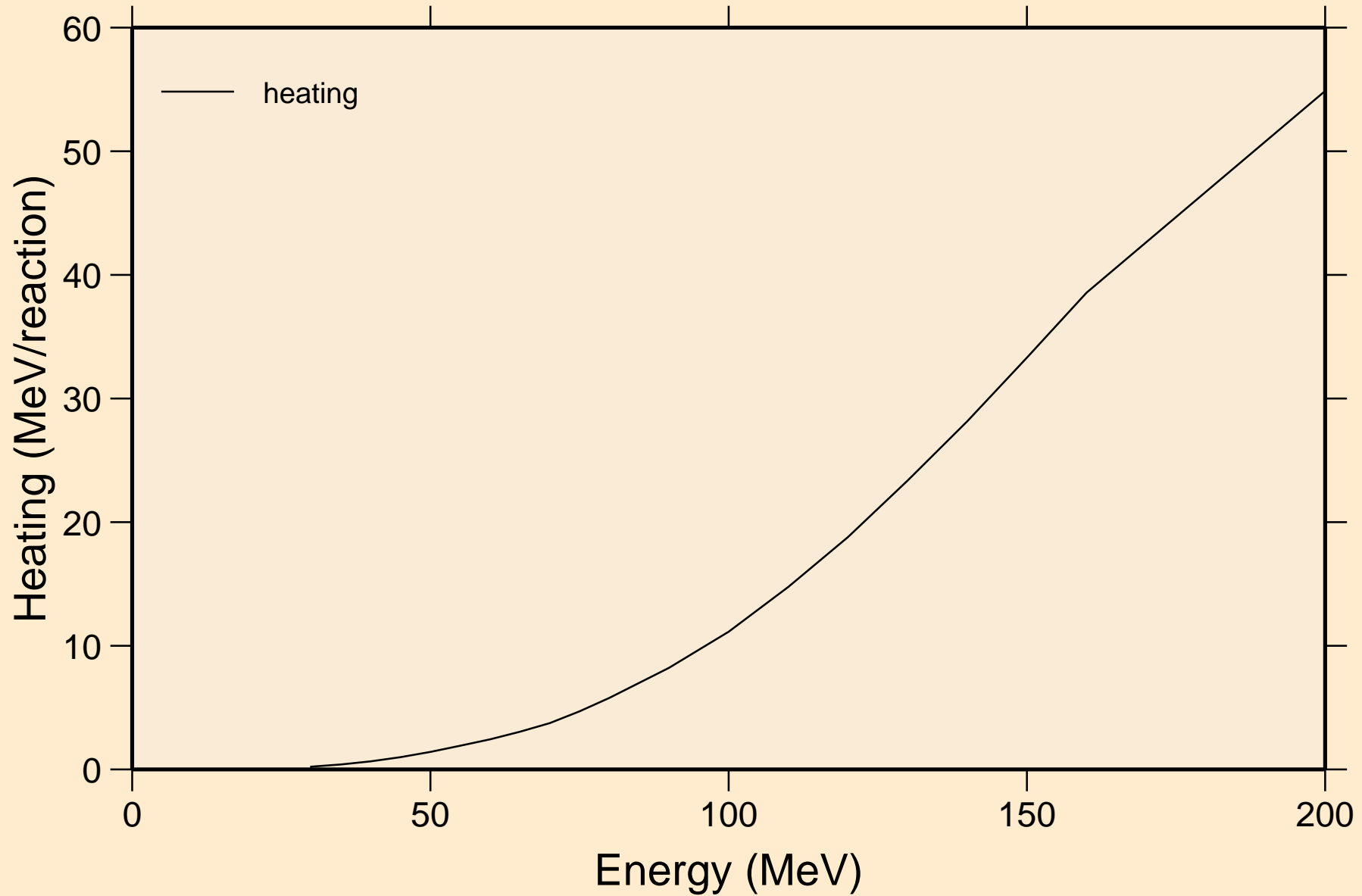

BK239 DEUTERON ACER TENDL-2021 LIBRARY; T=0.K

Threshold reactions

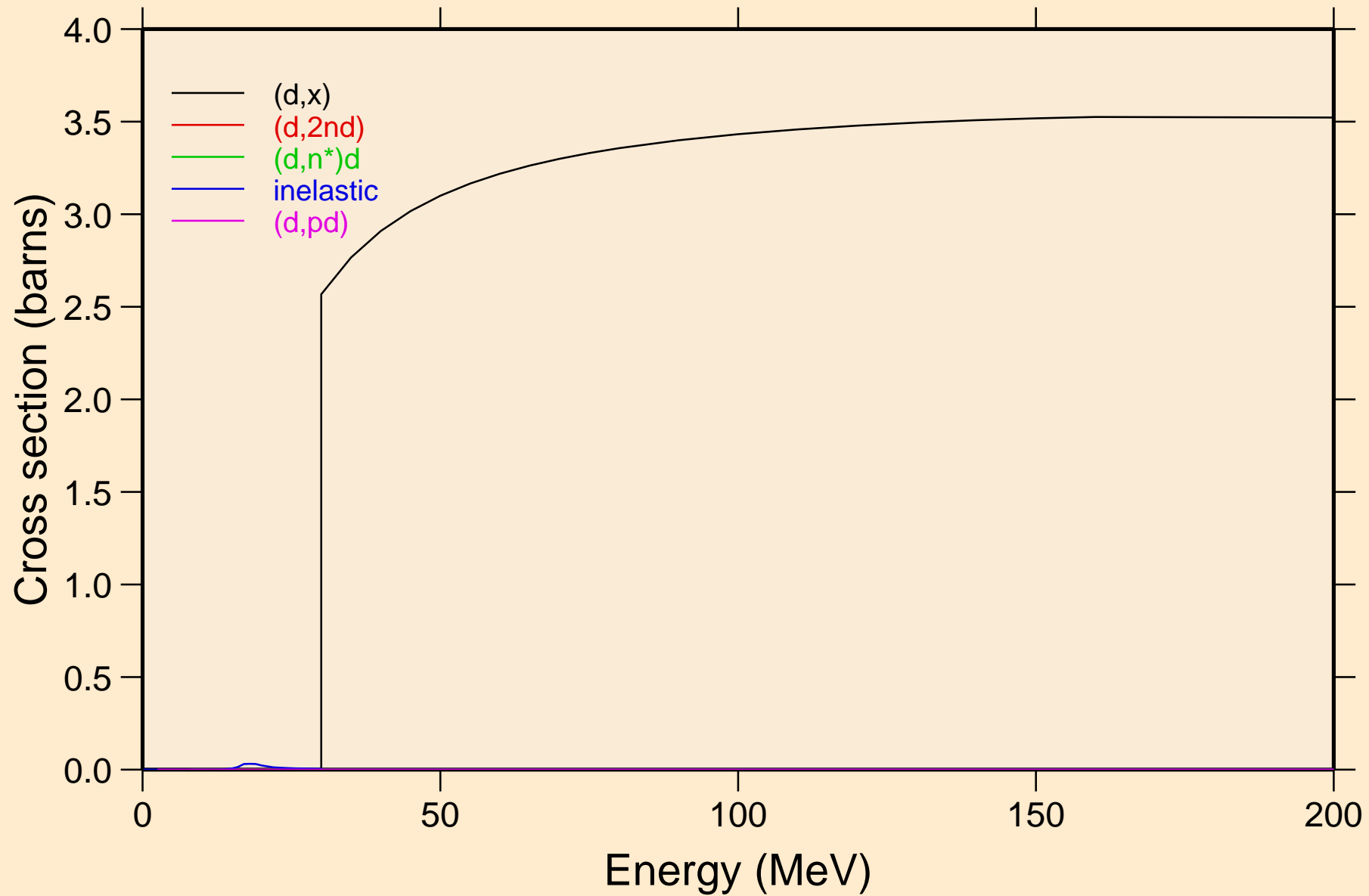

BK239 DEUTERON ACER TENDL-2021 LIBRARY; T=0.K
angular distribution for elastic

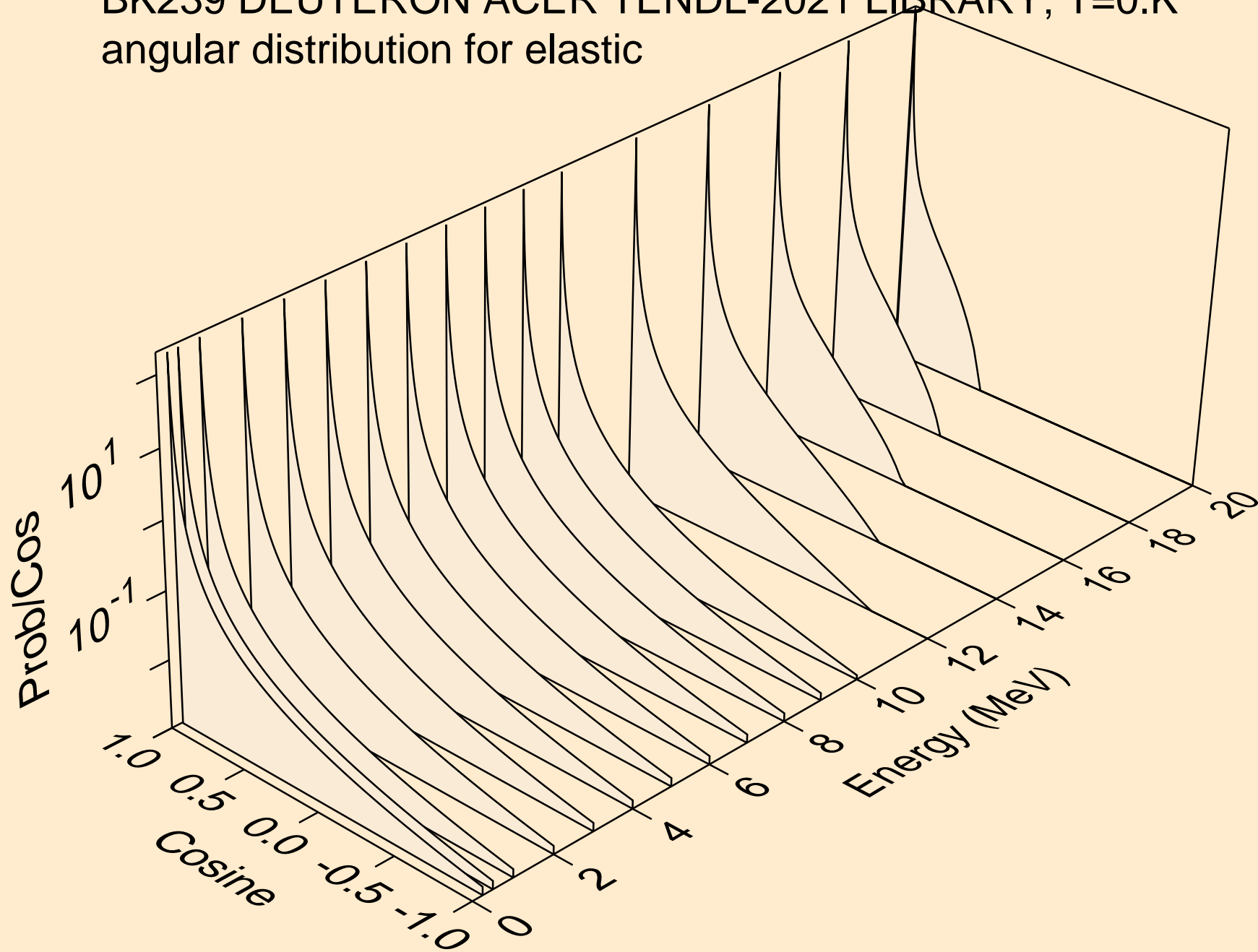

BK239 DEUTERON ACER TENDL-2021 LIBRARY; T=0.K
angular distribution for elastic

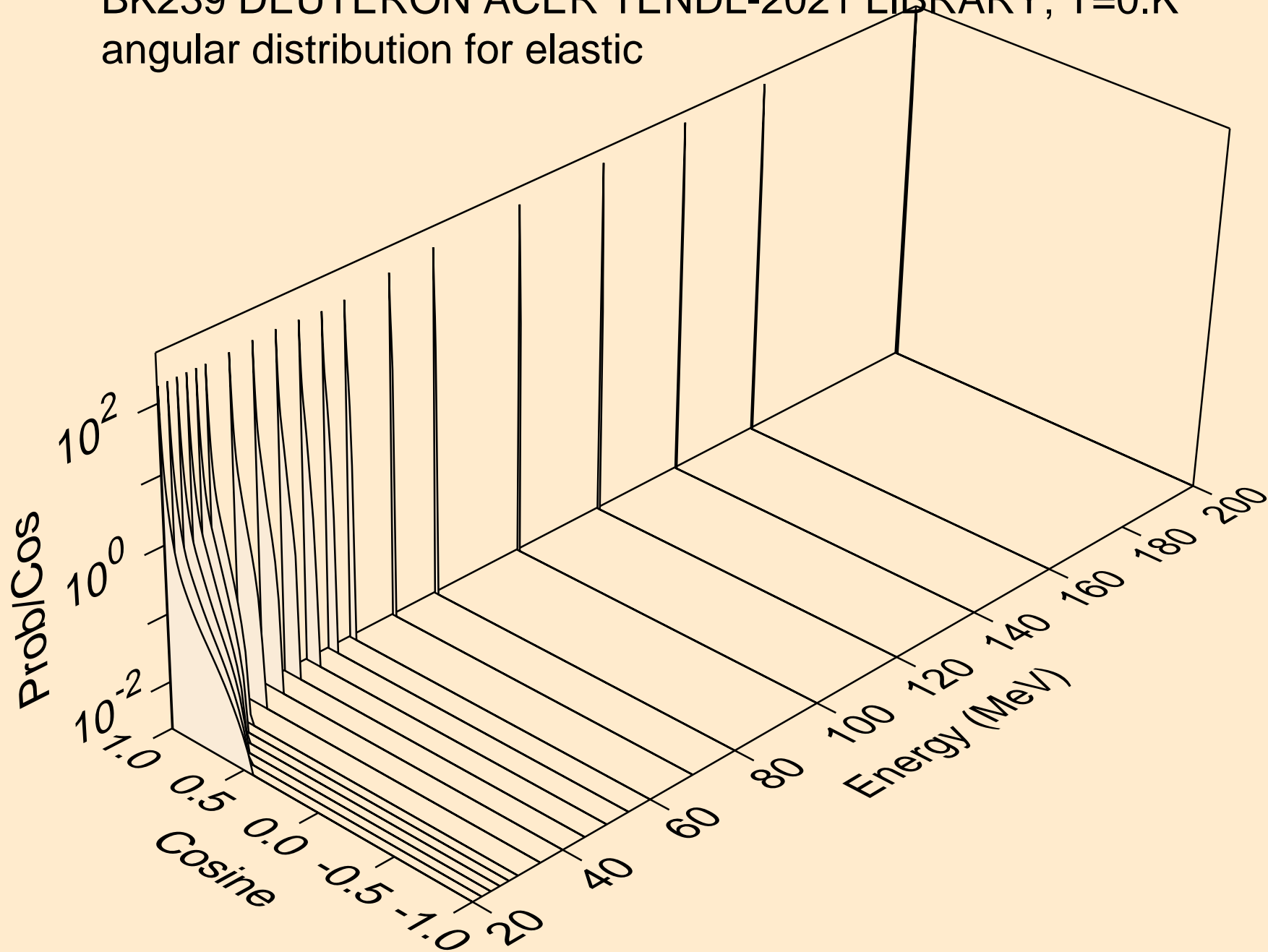

BK239 DEUTERON ACER TENDL-2021 LIBRARY; T=0.K
Deuteron emission for (d,x)

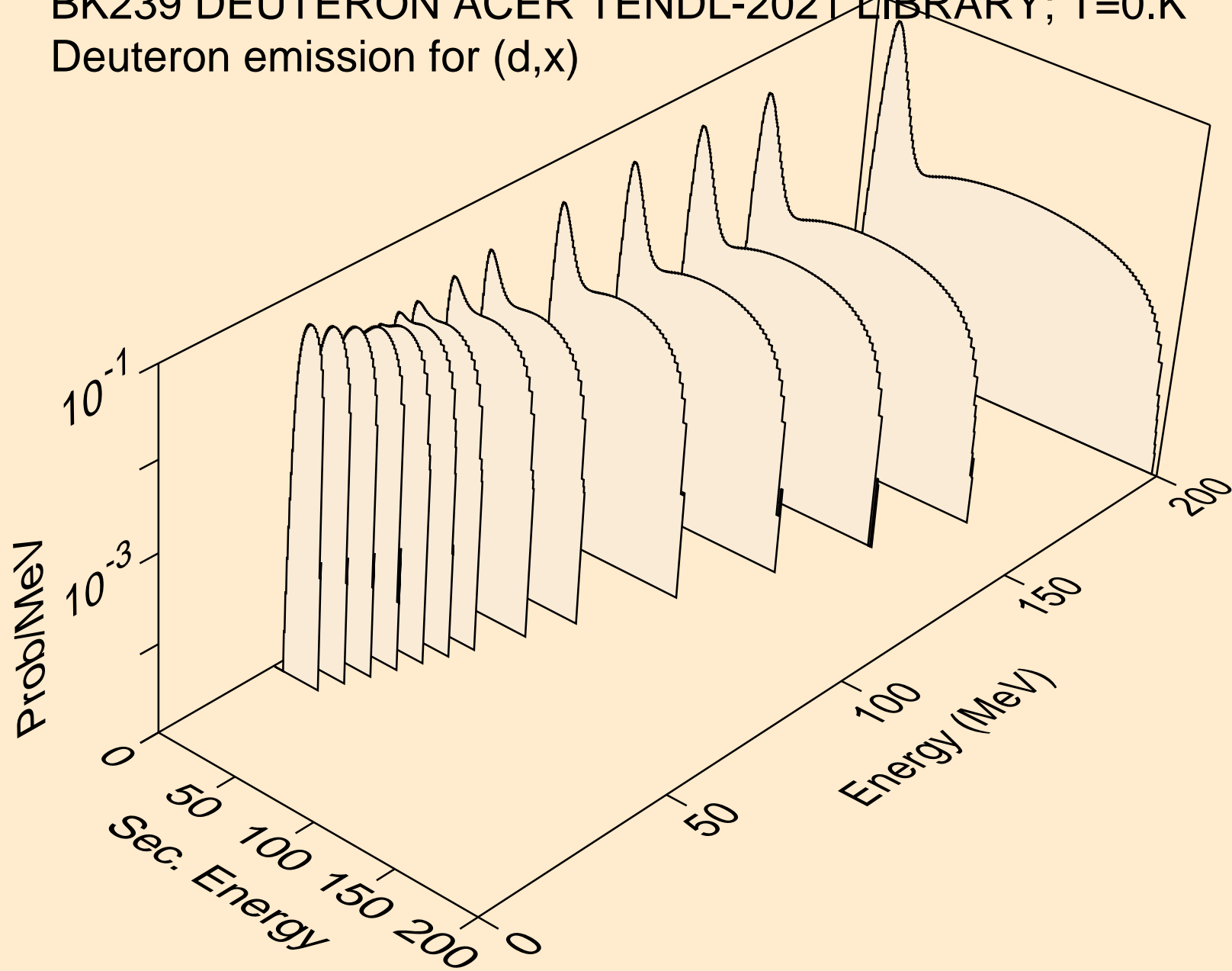

BK239 DEUTERON ACER TENDL-2021 LIBRARY; T=0.K
Deuteron emission for (d,2nd)

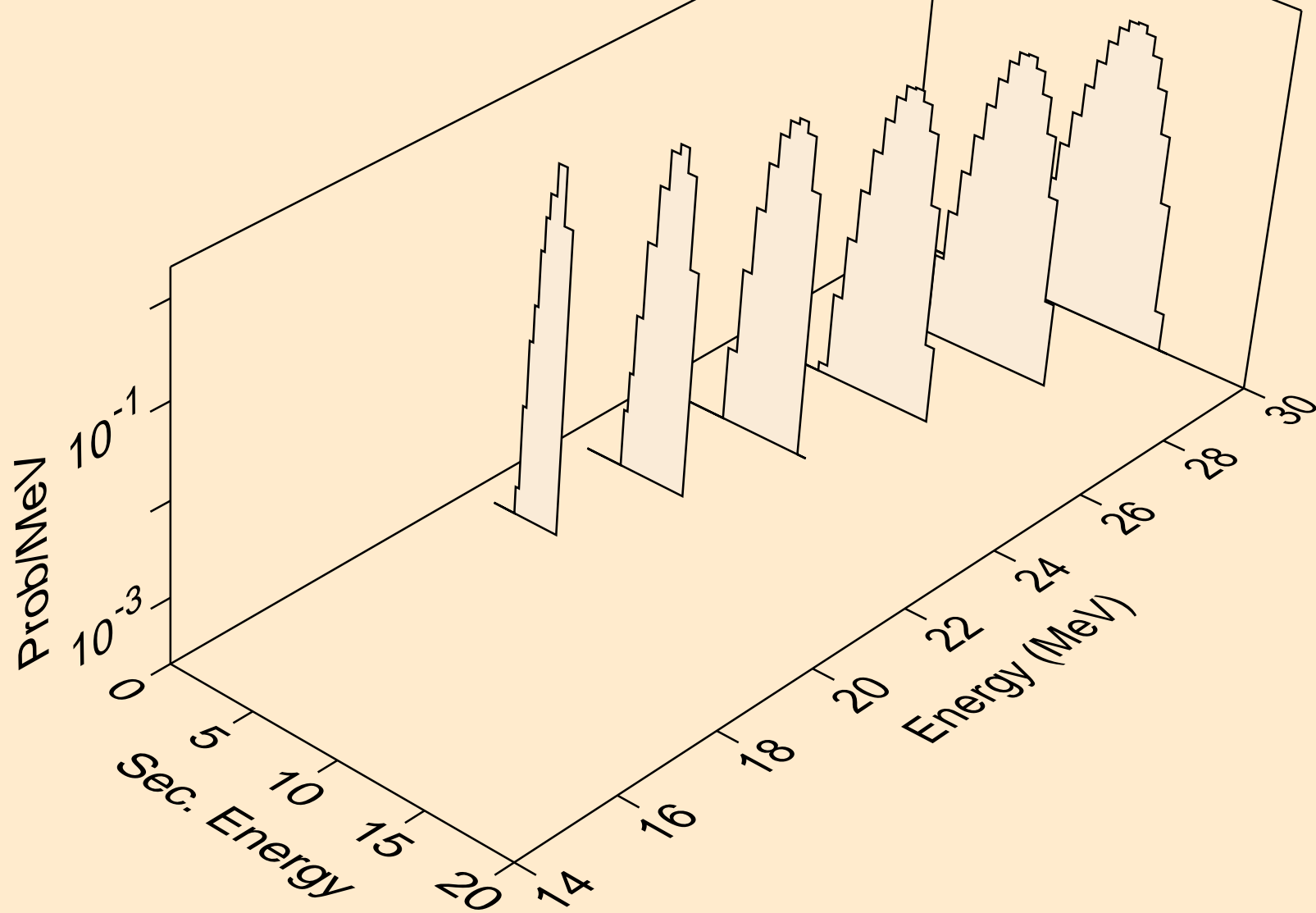

BK239 DEUTERON ACER TENDL-2021 LIBRARY; T=0.K
Deuteron emission for (d,n*)d

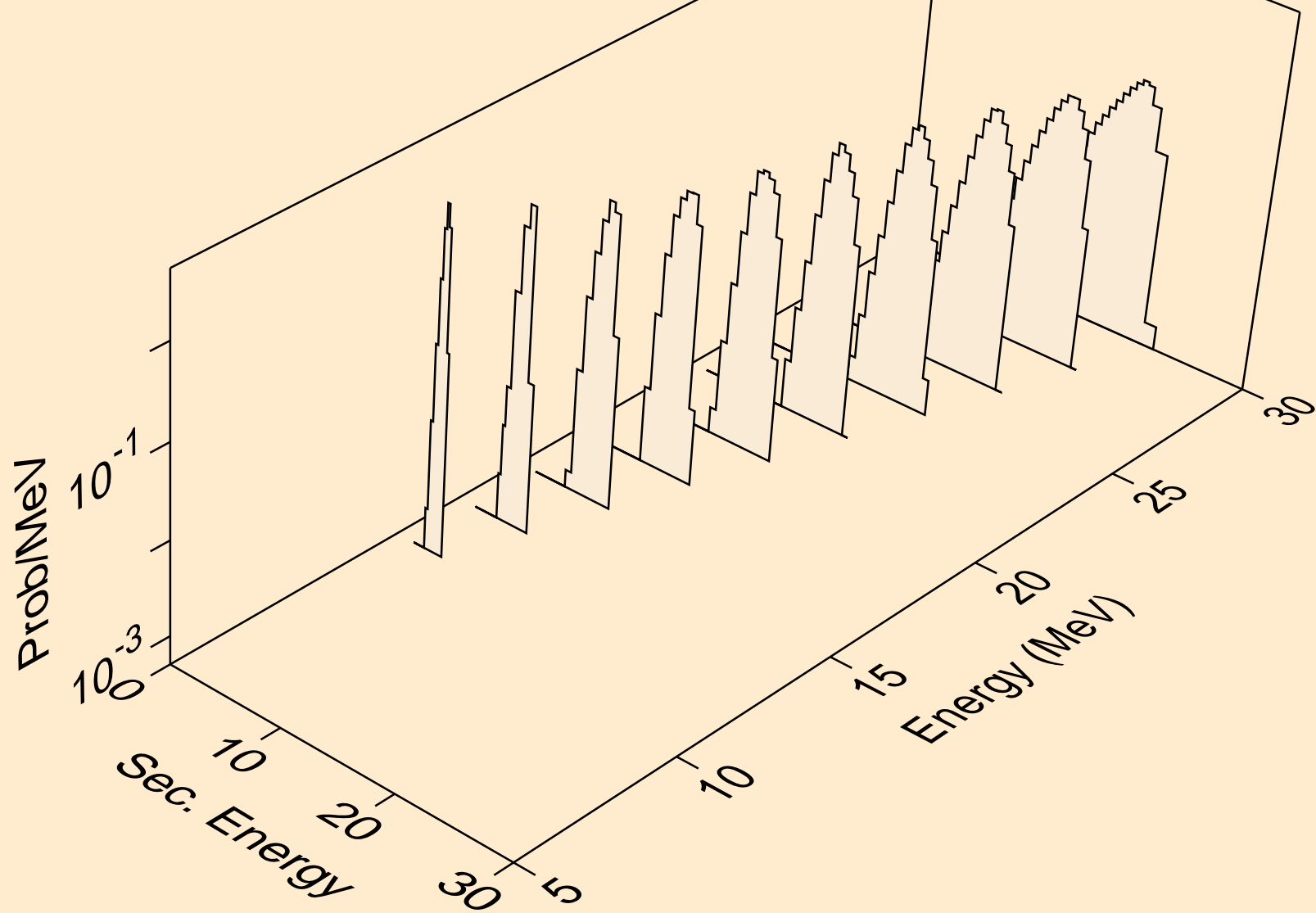

BK239 DEUTERON ACER TENDL-2021 LIBRARY; T=0.K
Deuteron emission for inelastic

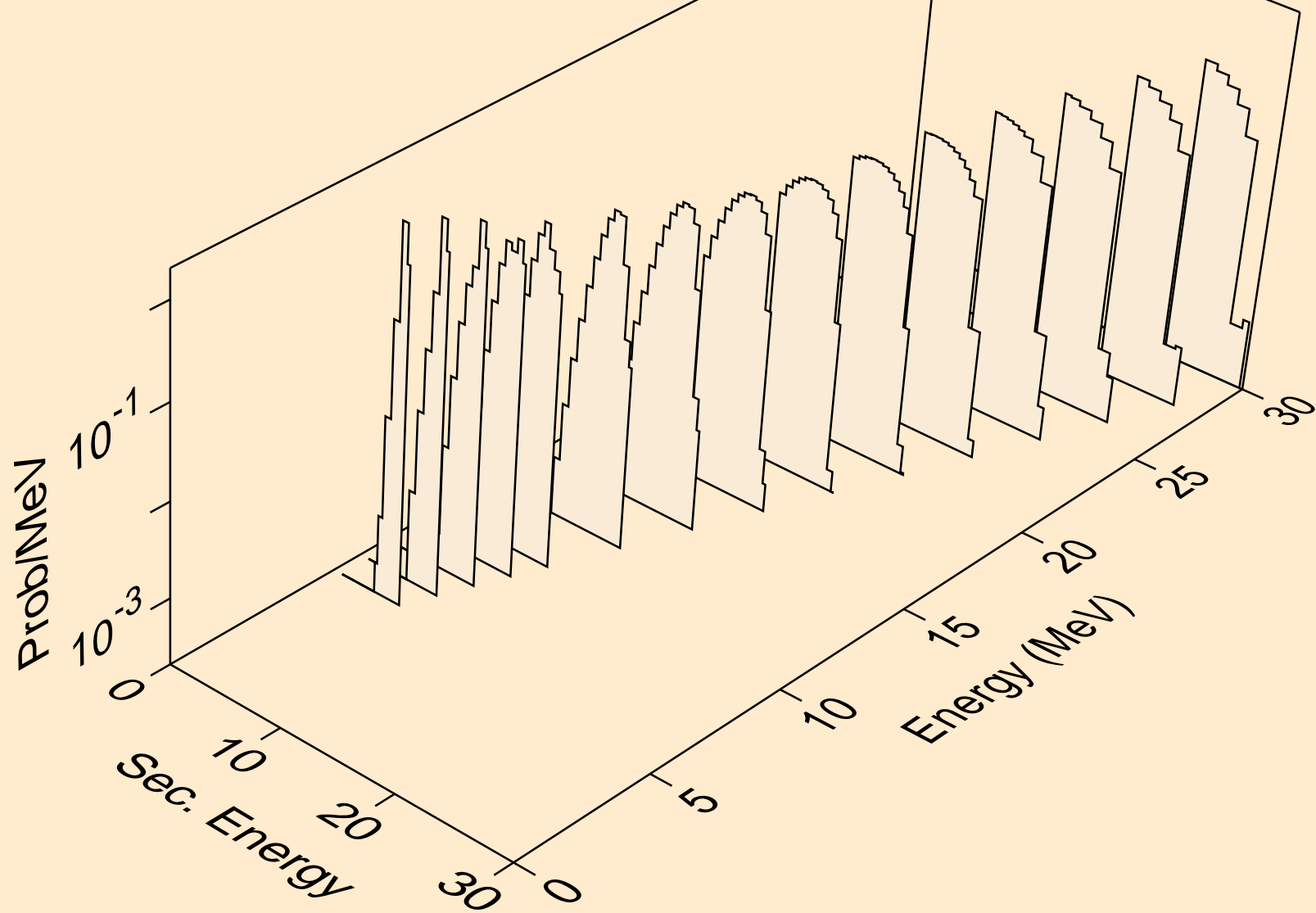

BK239 DEUTERON ACER TENDL-2021 LIBRARY; T=0.K
Deuteron emission for (d,pd)

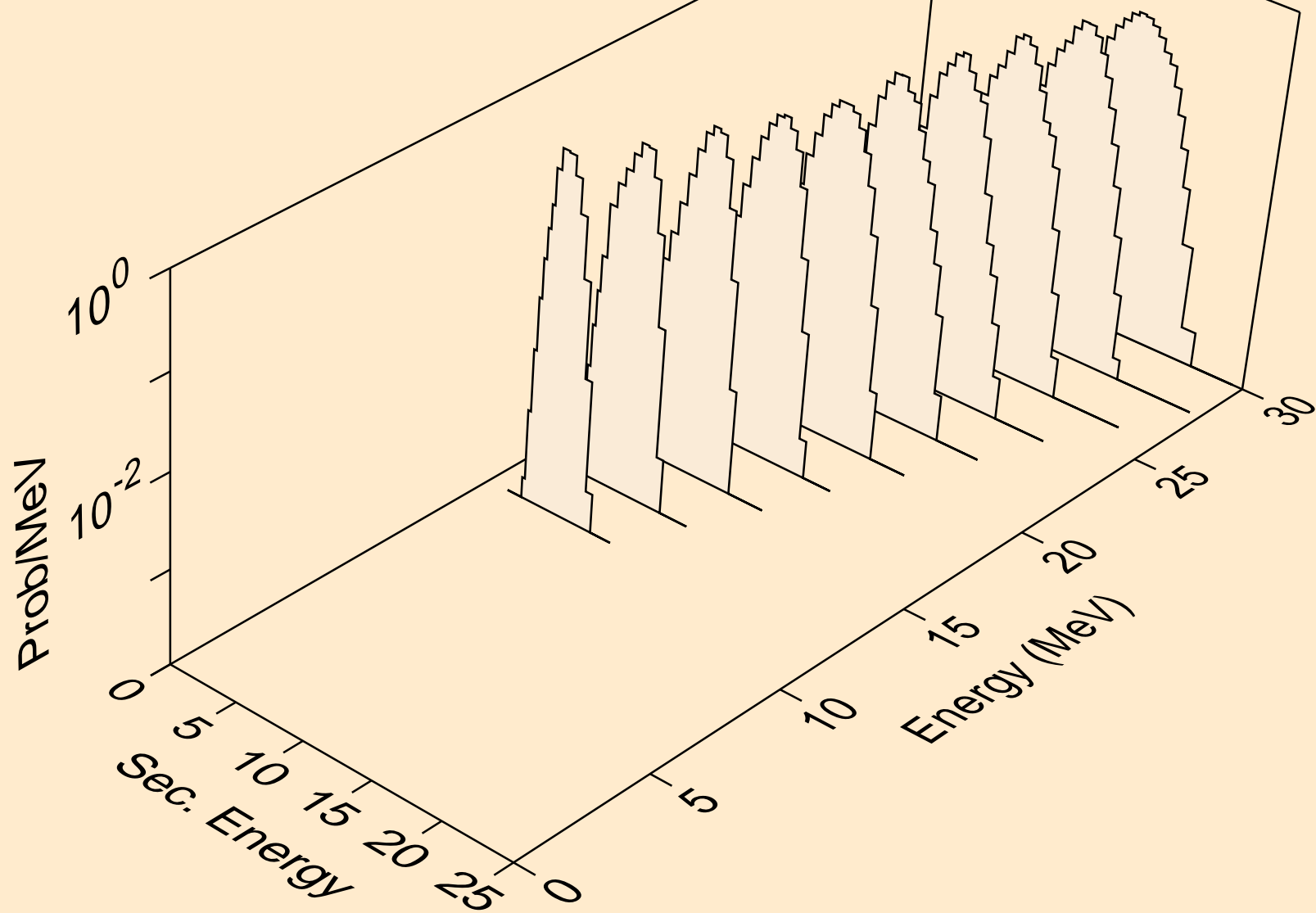

BK239 DEUTERON ACER TENDL-2021 LIBRARY; T=0.K
Photon emission for (z,n)

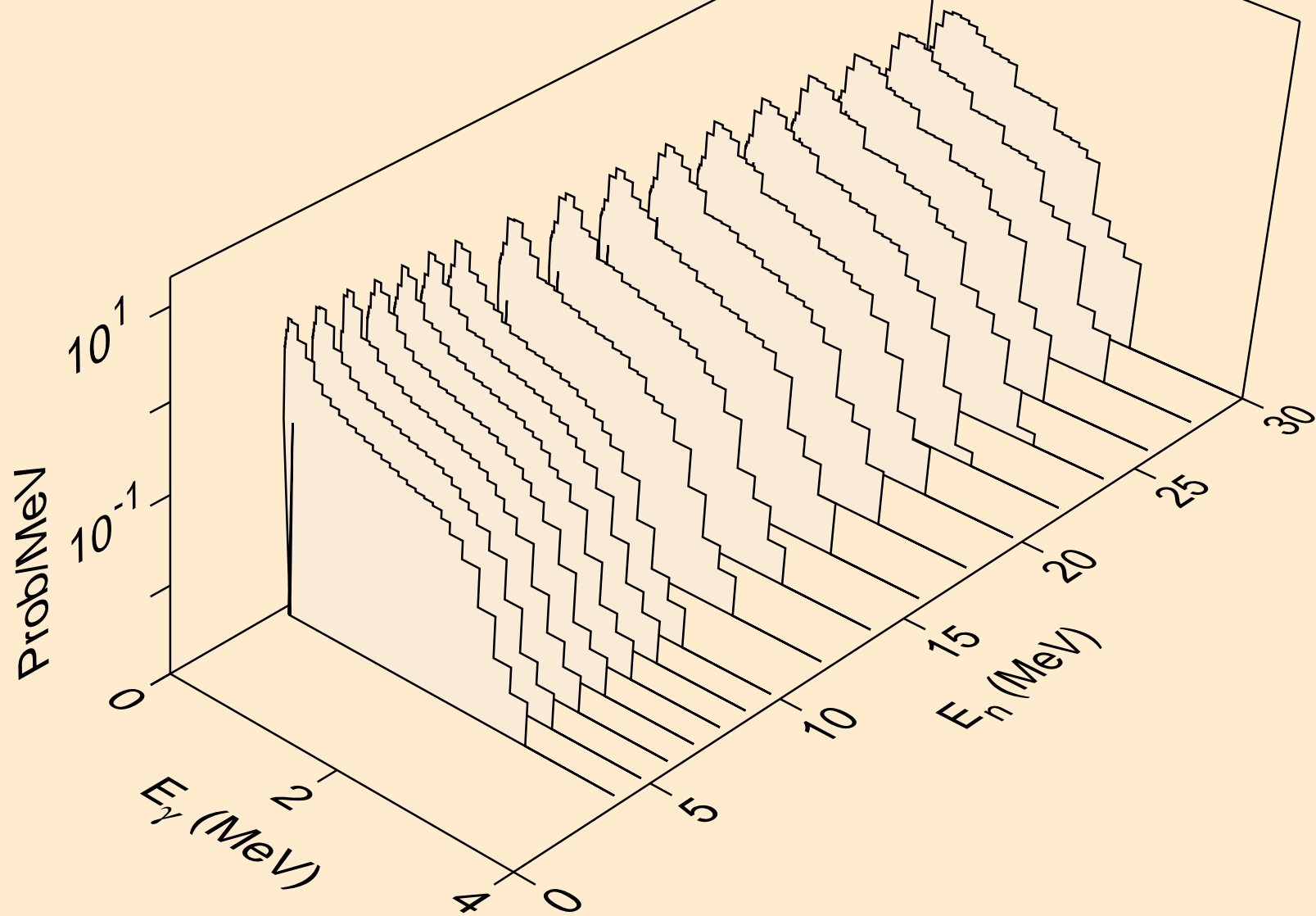

BK239 DEUTERON ACER TENDL-2021 LIBRARY; T=0.K
Photon emission for (n,x)

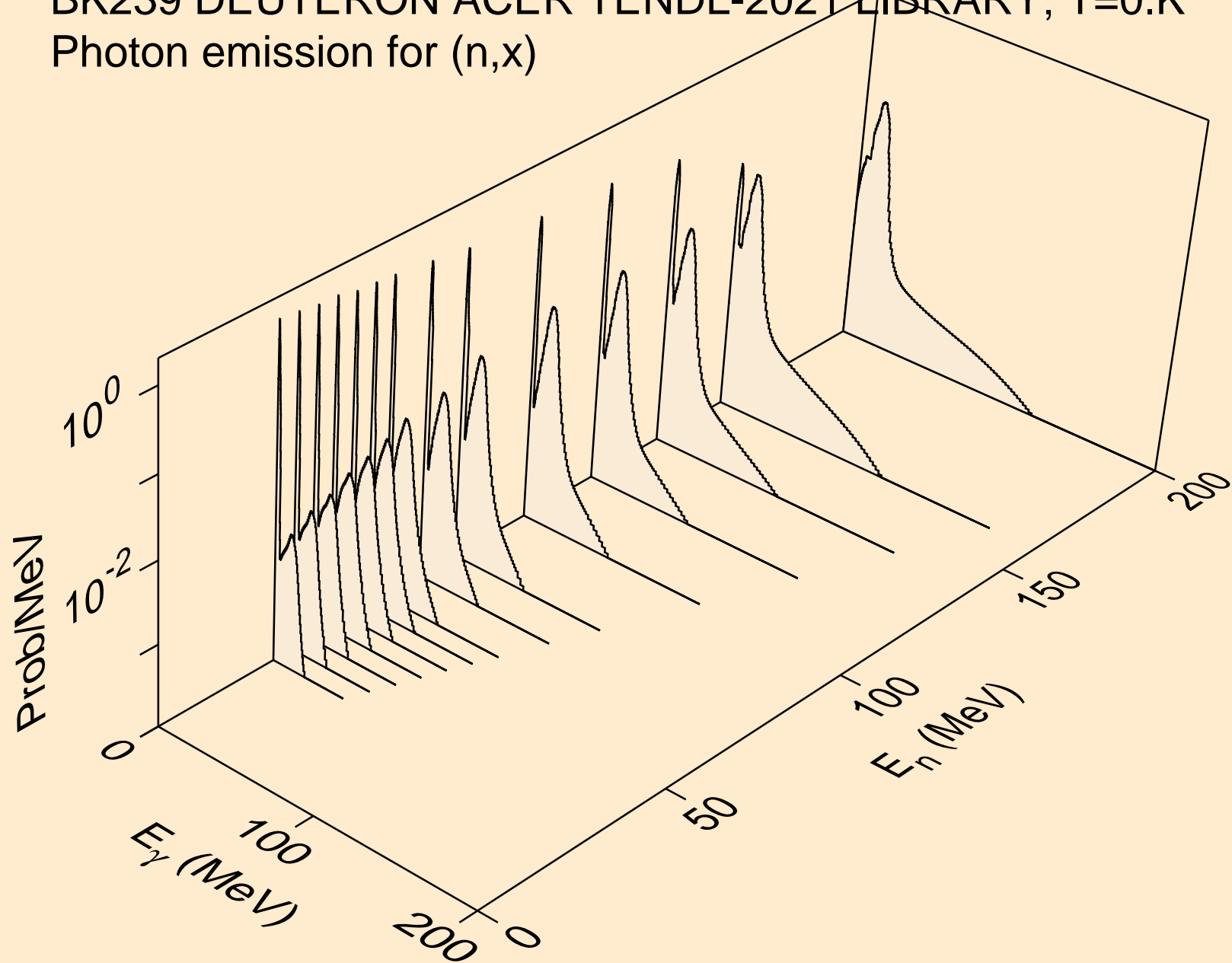

BK239 DEUTERON ACER TENDL-2021 LIBRARY; T=0.K
Photon emission for (n,2nd)

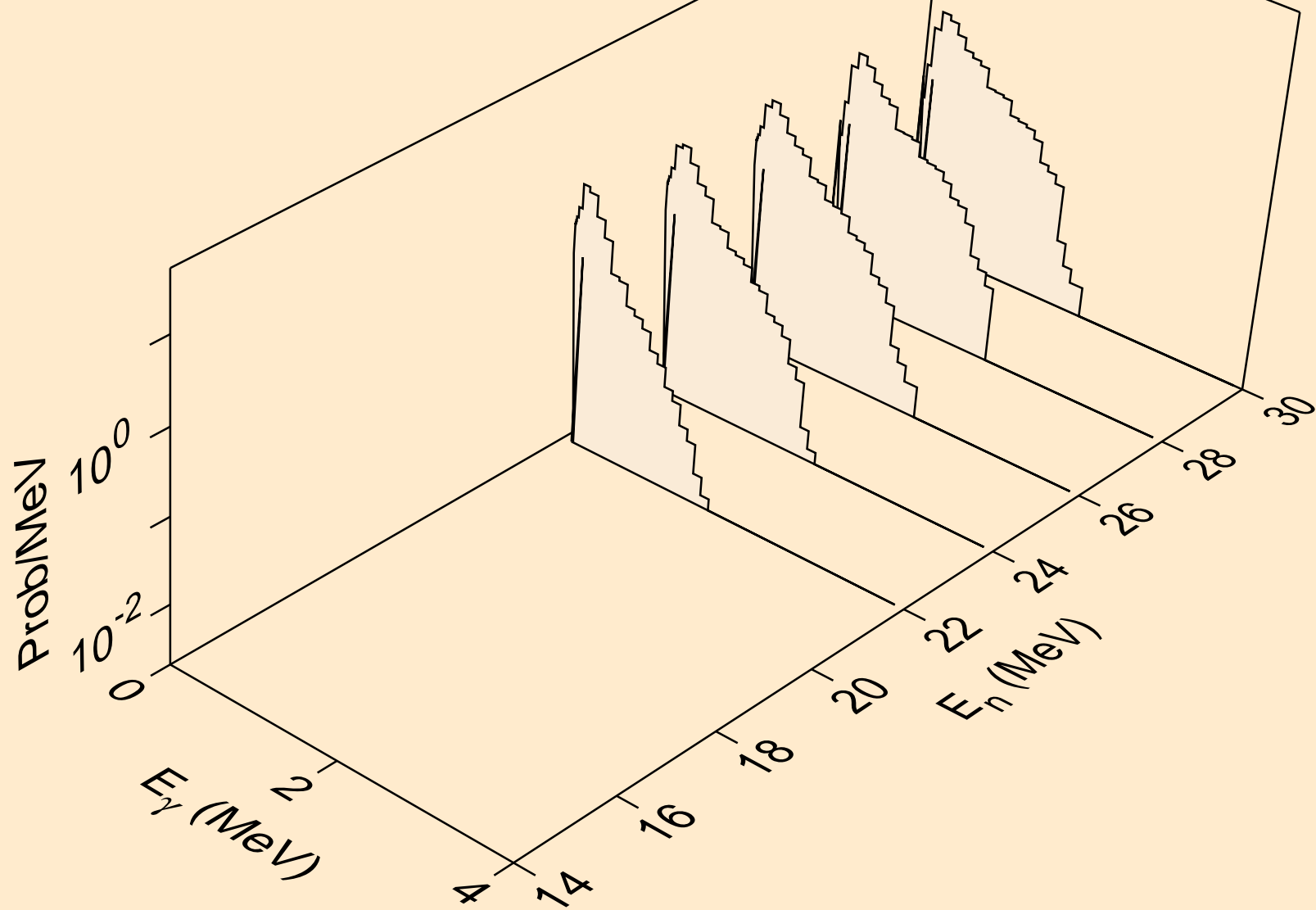

BK239 DEUTERON ACER TENDL-2021 LIBRARY; T=0.K
Photon emission for (n,2n)

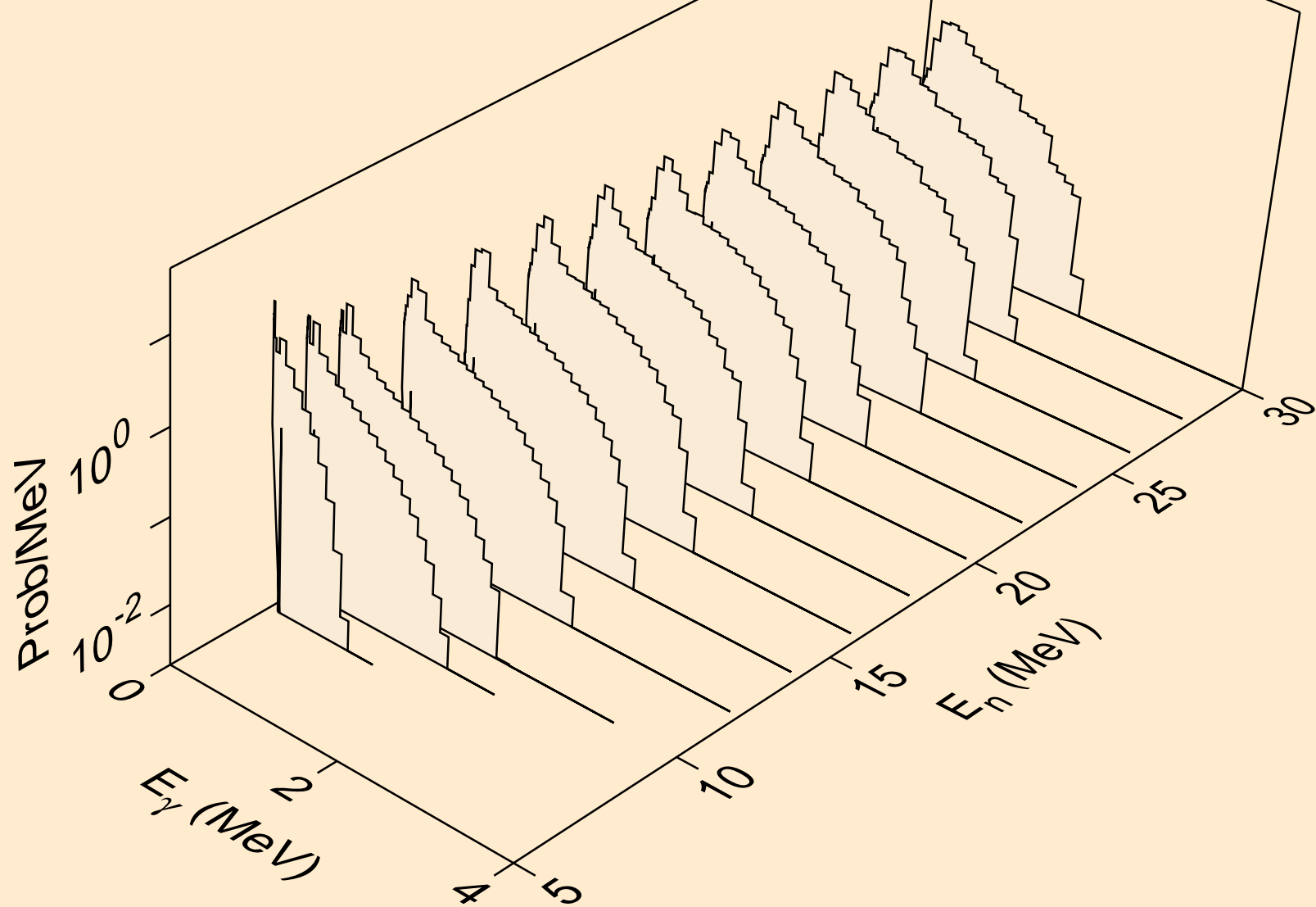

BK239 DEUTERON ACER TENDL-2021 LIBRARY; T=0.K
Photon emission for (n,3n)

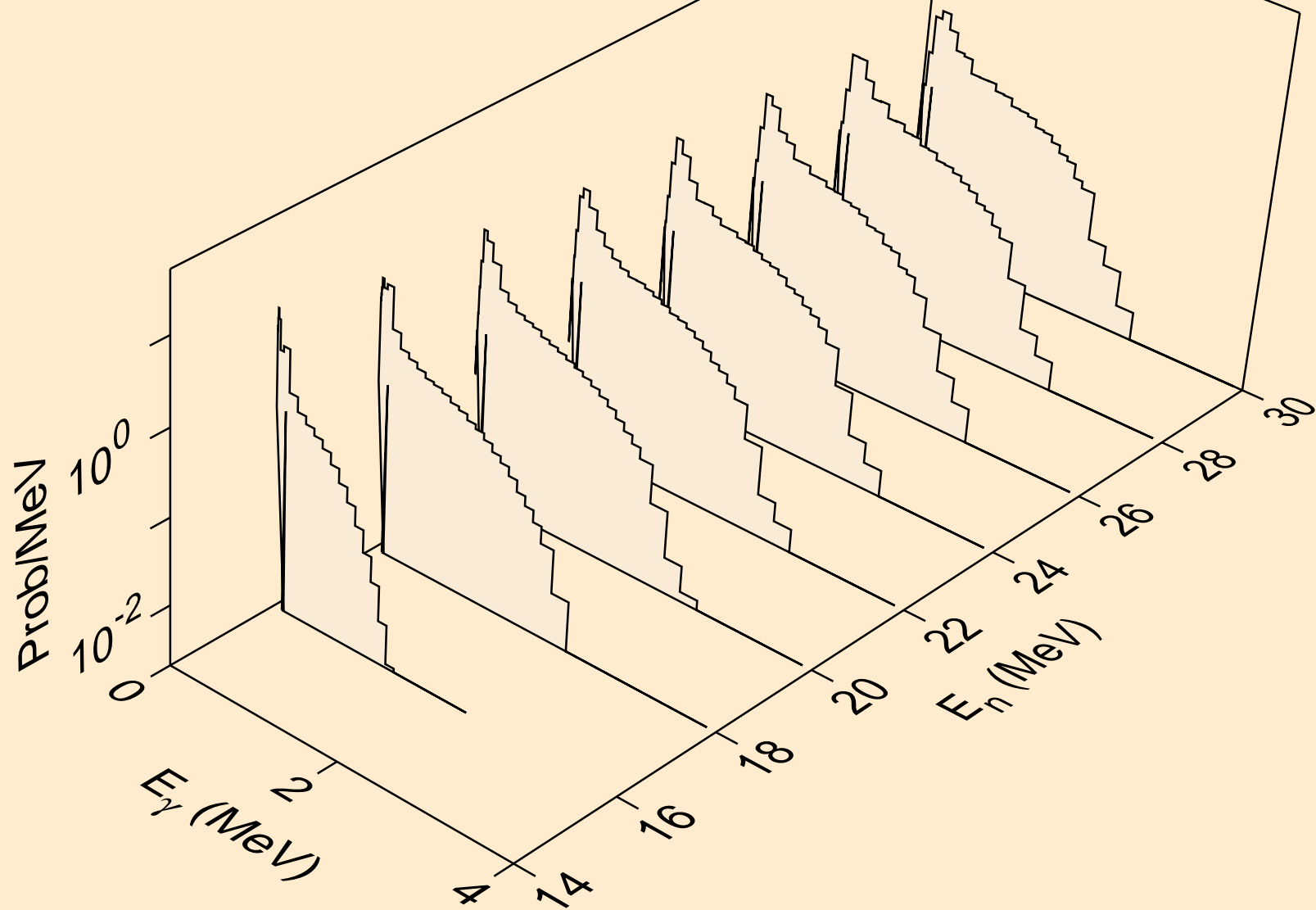

BK239 DEUTERON ACER TENDL-2021 LIBRARY; T=0.K
Photon emission for (n,n*)a

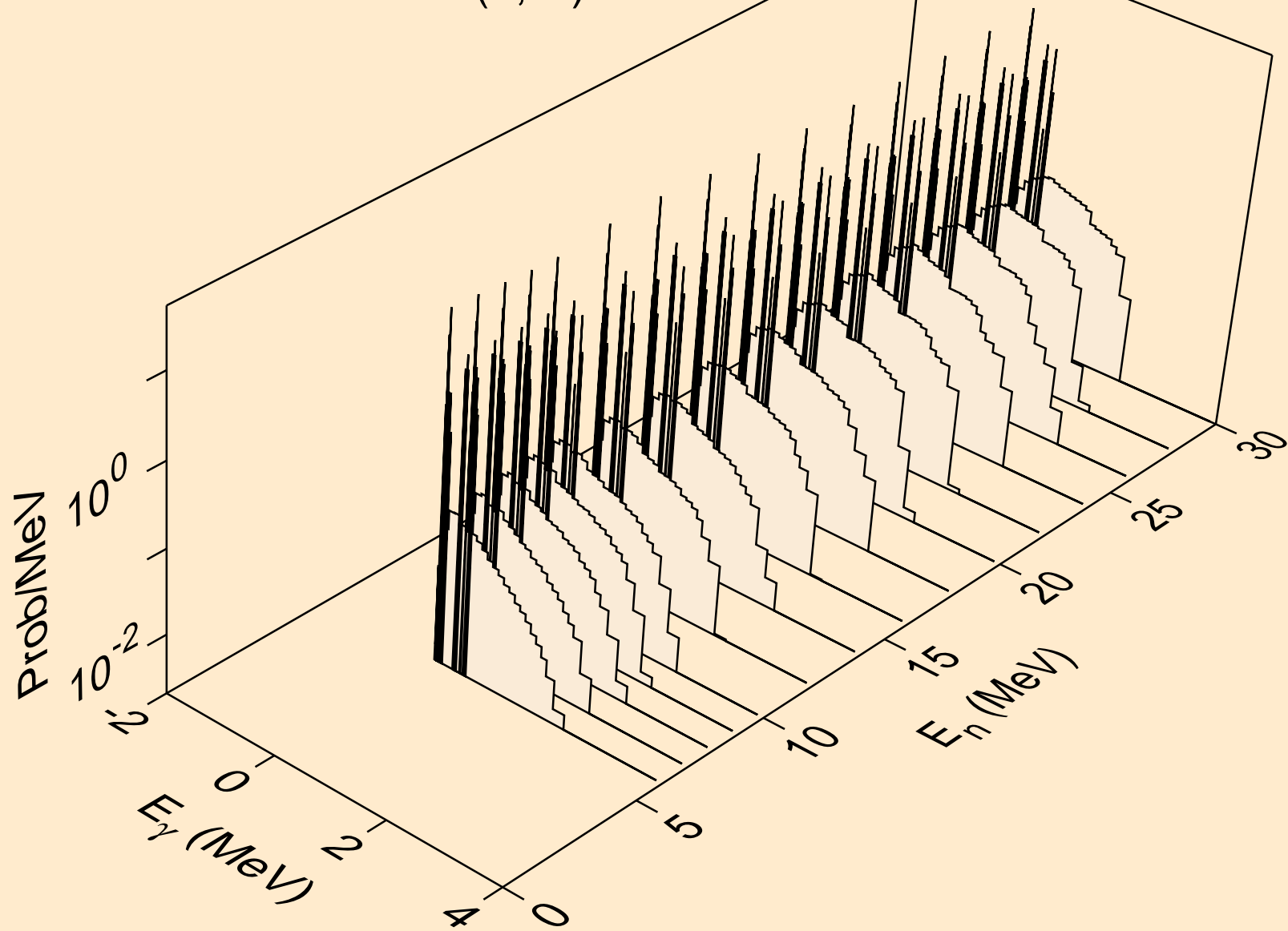

BK239 DEUTERON ACER TENDL-2021 LIBRARY; T=0.K
Photon emission for (n,2n) α

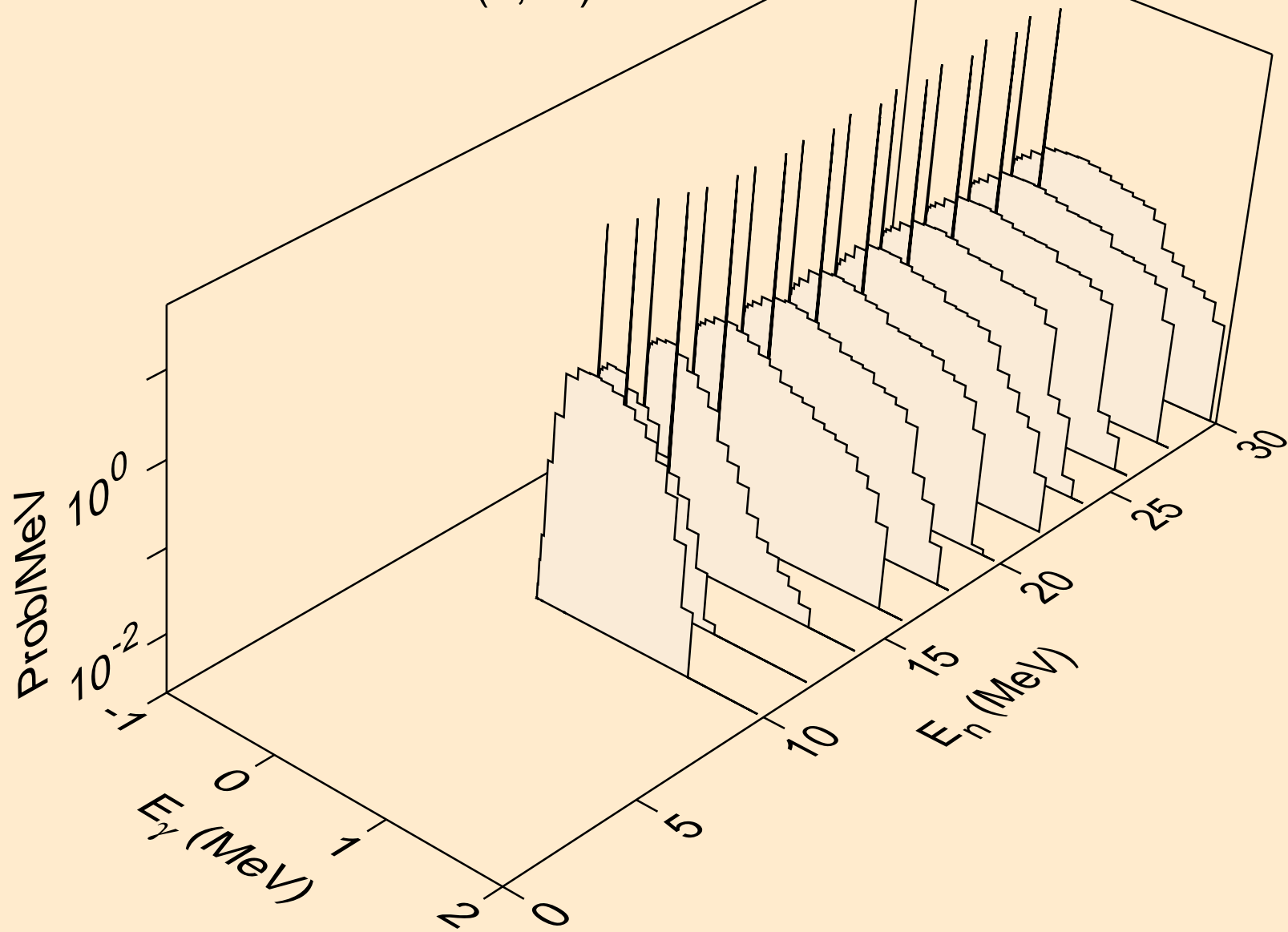

BK239 DEUTERON ACER TENDL-2021 LIBRARY; T=0.K
Photon emission for (n,n*)p

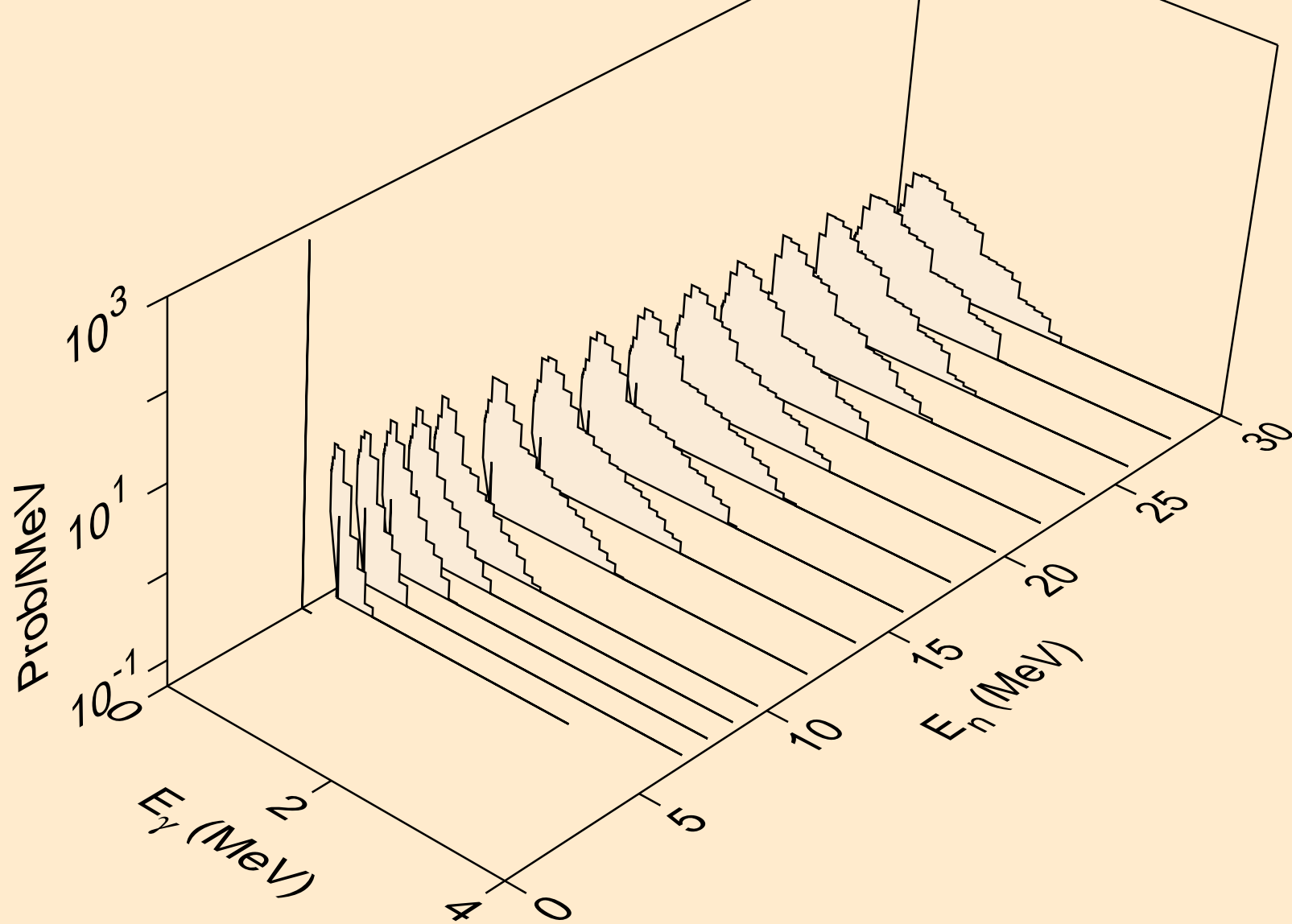

BK239 DEUTERON ACER TENDL-2021 LIBRARY; T=0.K
Photon emission for (n,n*)d

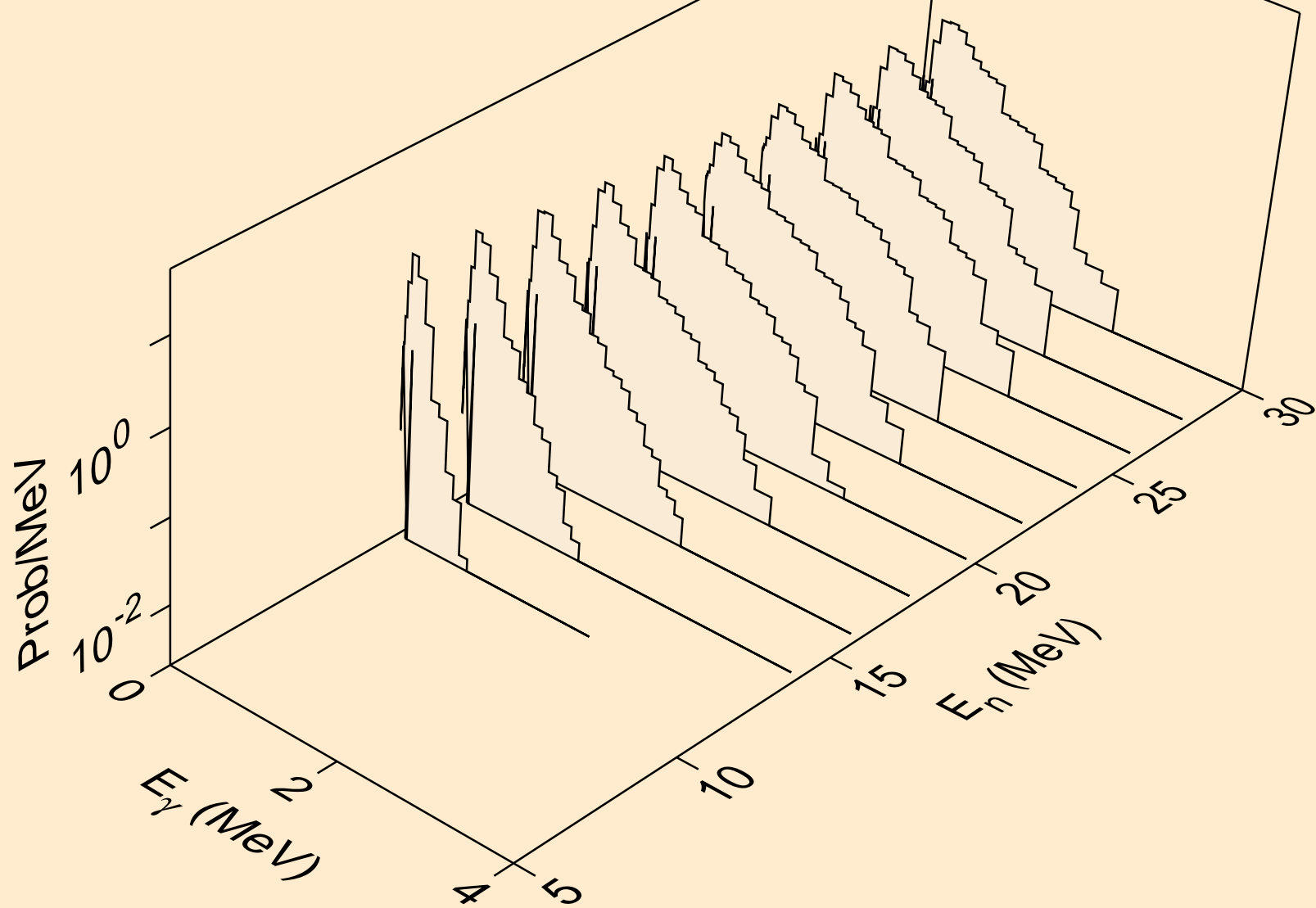

BK239 DEUTERON ACER TENDL-2021 LIBRARY; T=0.K
Photon emission for (n,n*)t

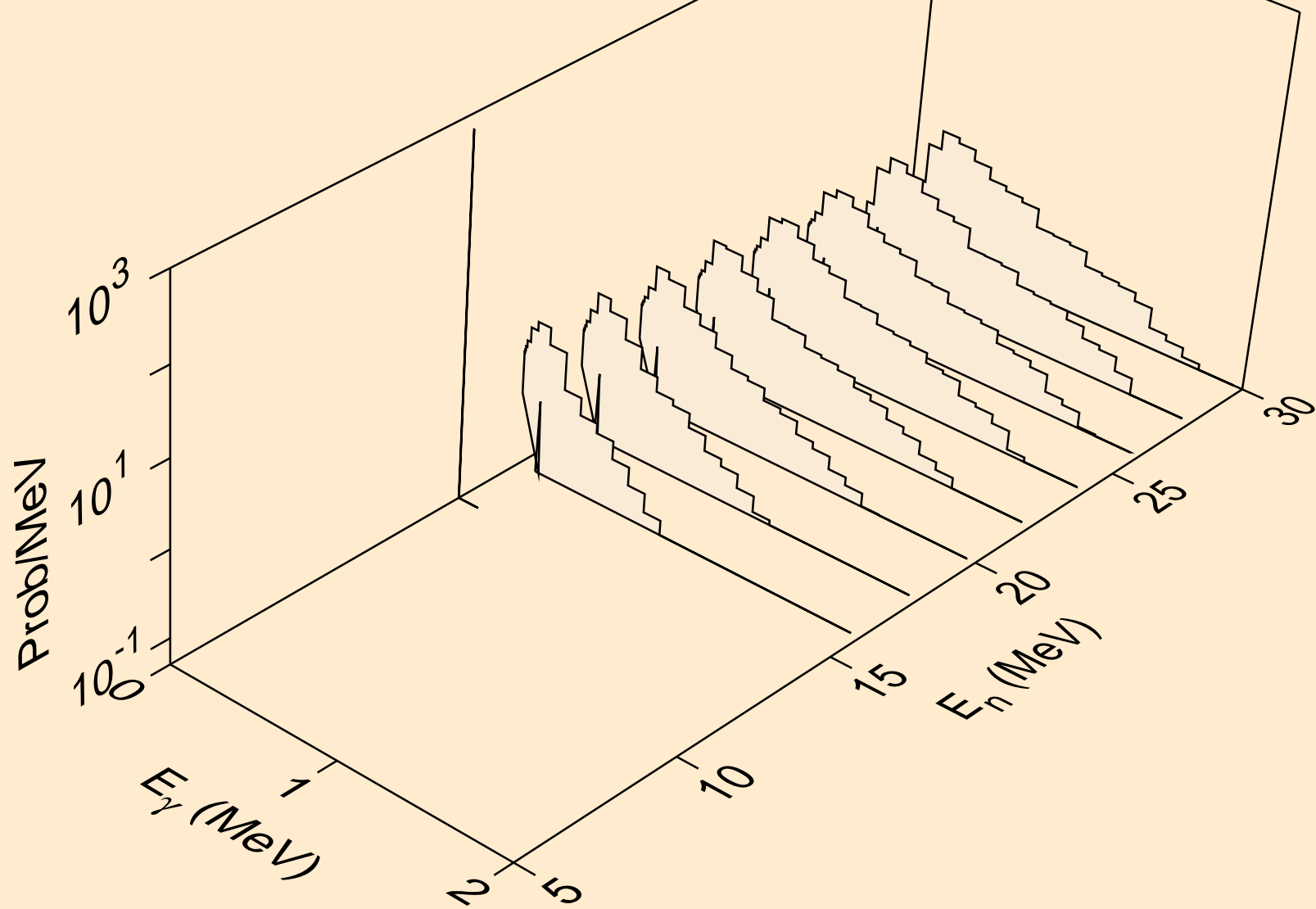

BK239 DEUTERON ACER TENDL-2021 LIBRARY; T=0.K
Photon emission for (n,n*)he3

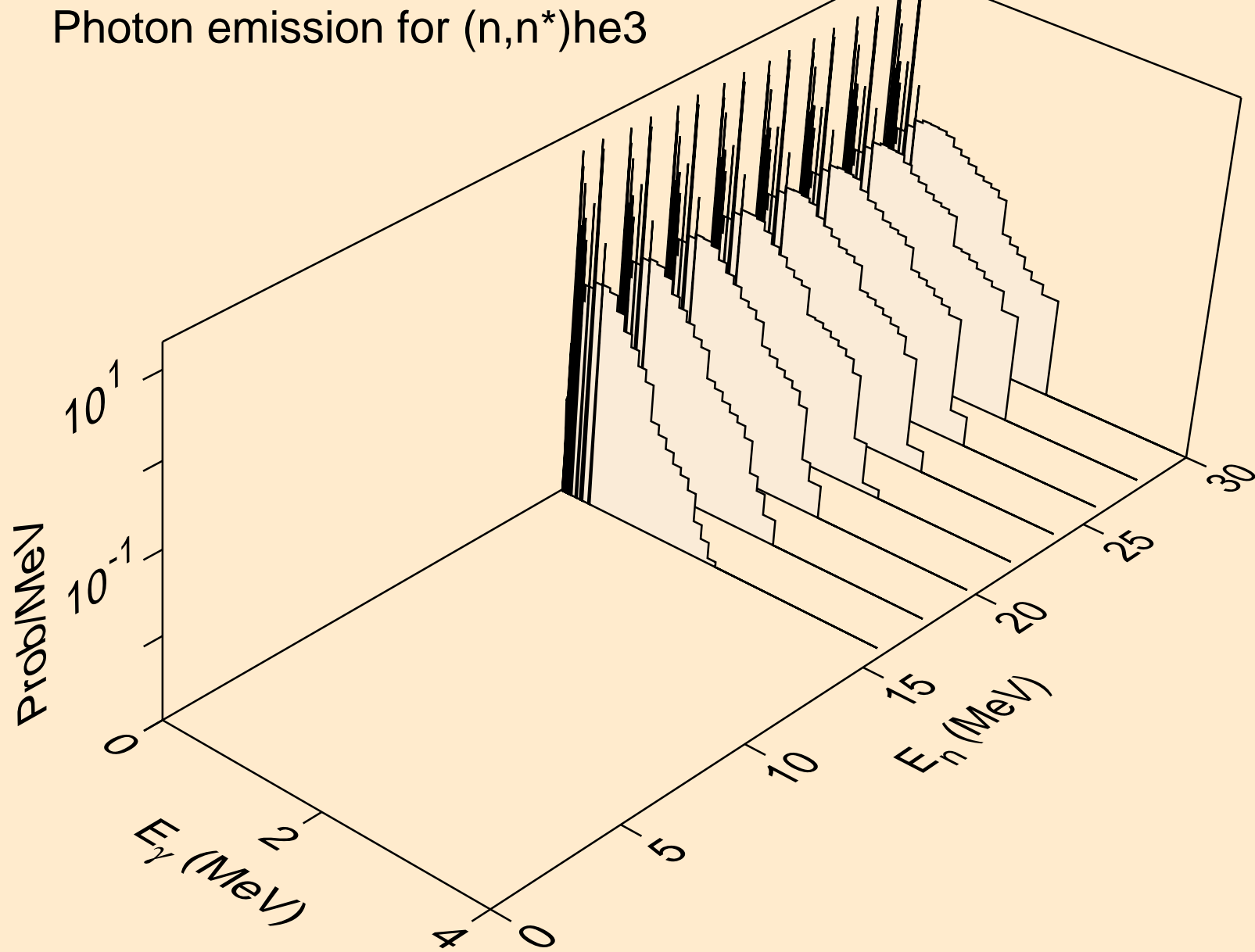

BK239 DEUTERON ACER TENDL-2021 LIBRARY; T=0.K
Photon emission for (n,4n)

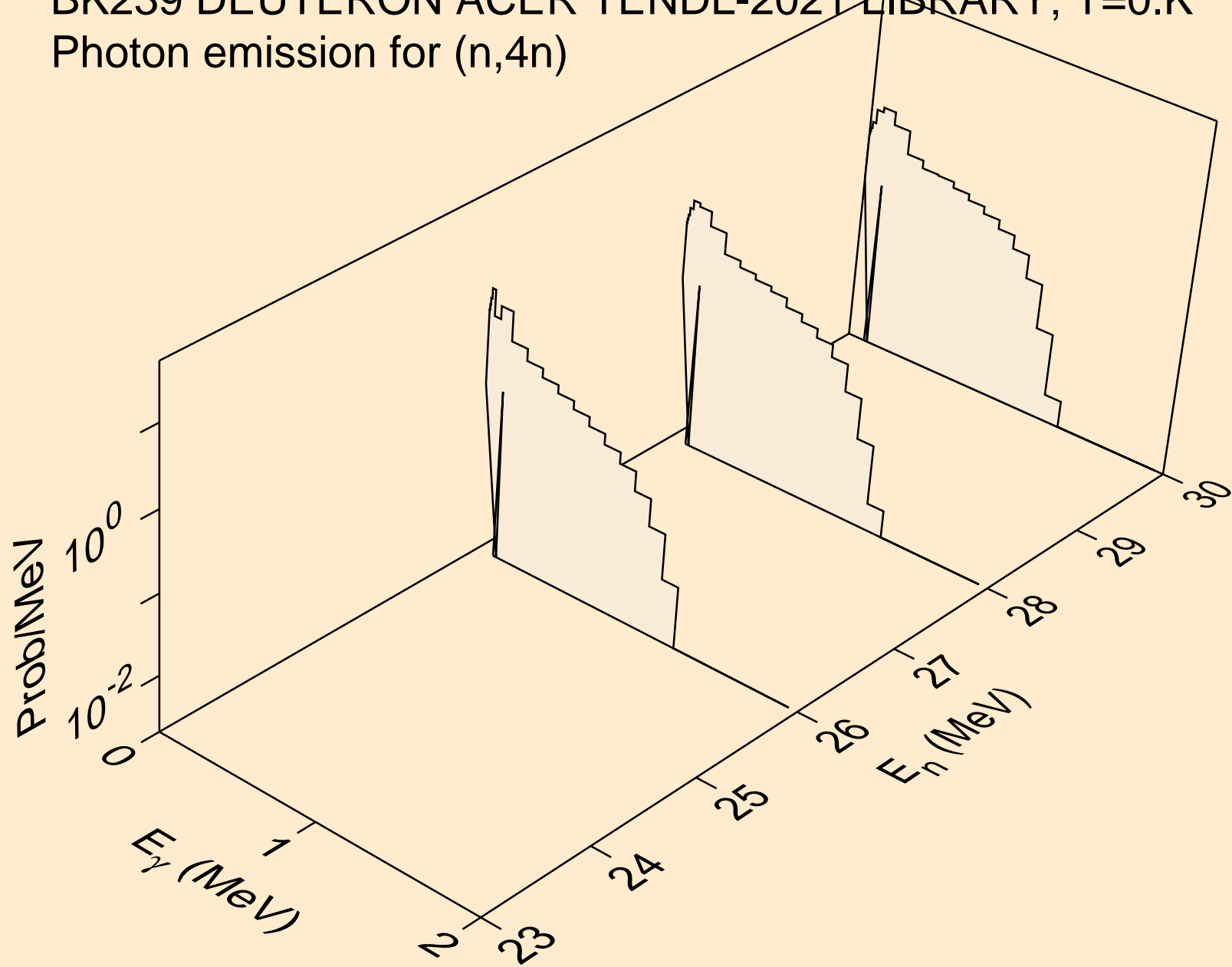

BK239 DEUTERON ACER TENDL-2021 LIBRARY; T=0.K
Photon emission for (n,2np)

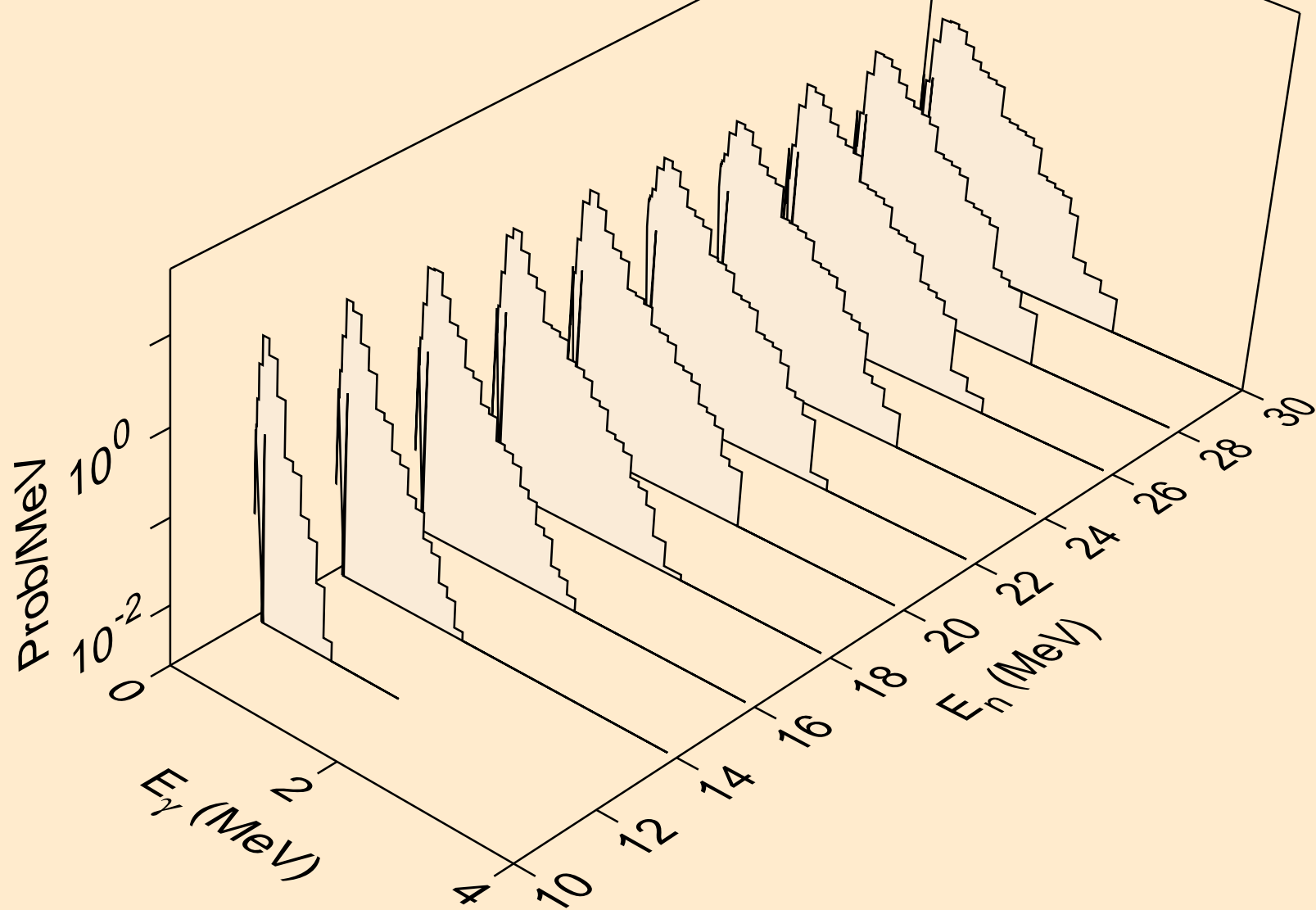

BK239 DEUTERON ACER TENDL-2021 LIBRARY; T=0.K
Photon emission for (n,2np)

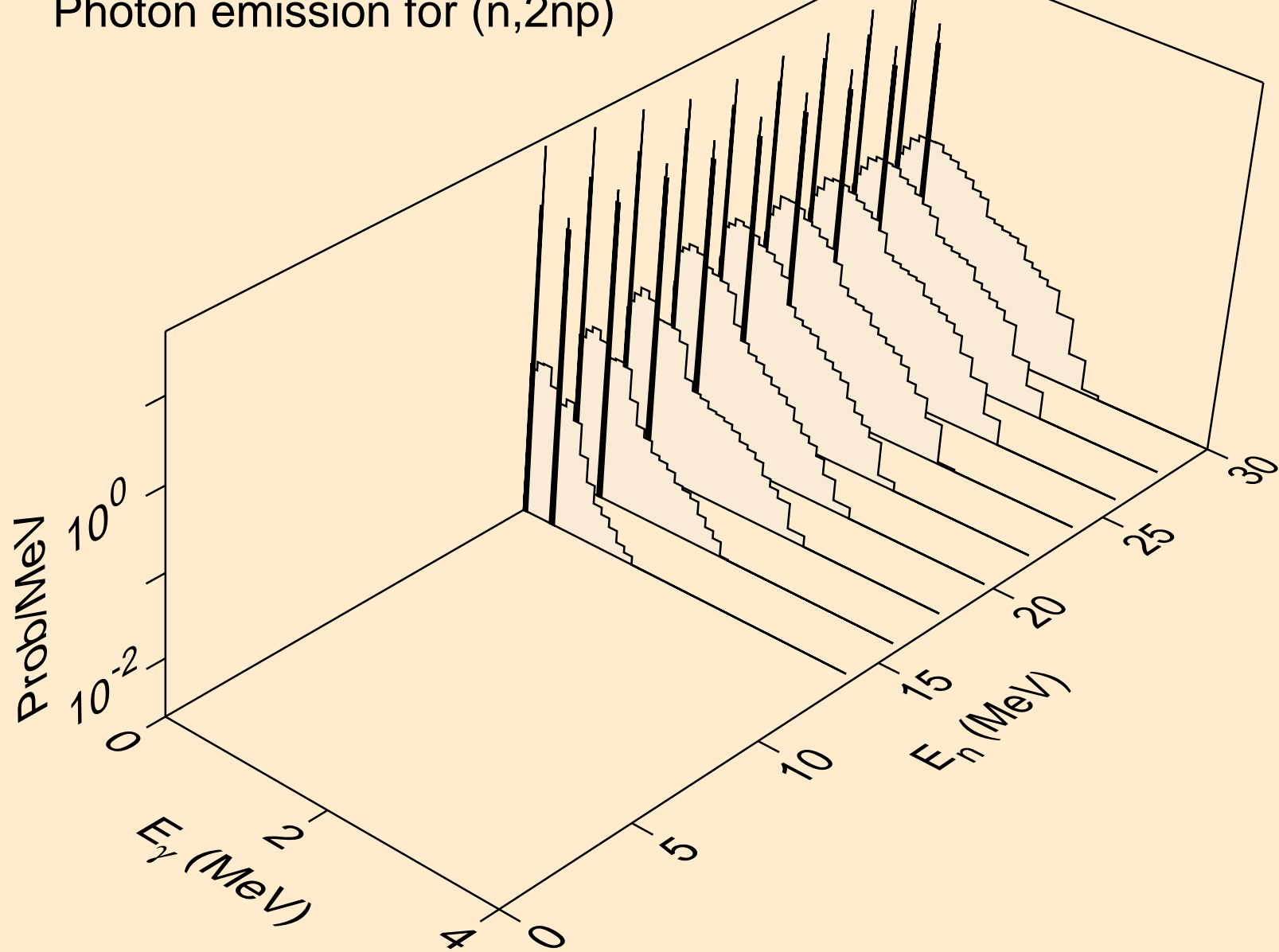

BK239 DEUTERON ACER TENDL-2021 LIBRARY; T=0.K
Photon emission for (n,p)

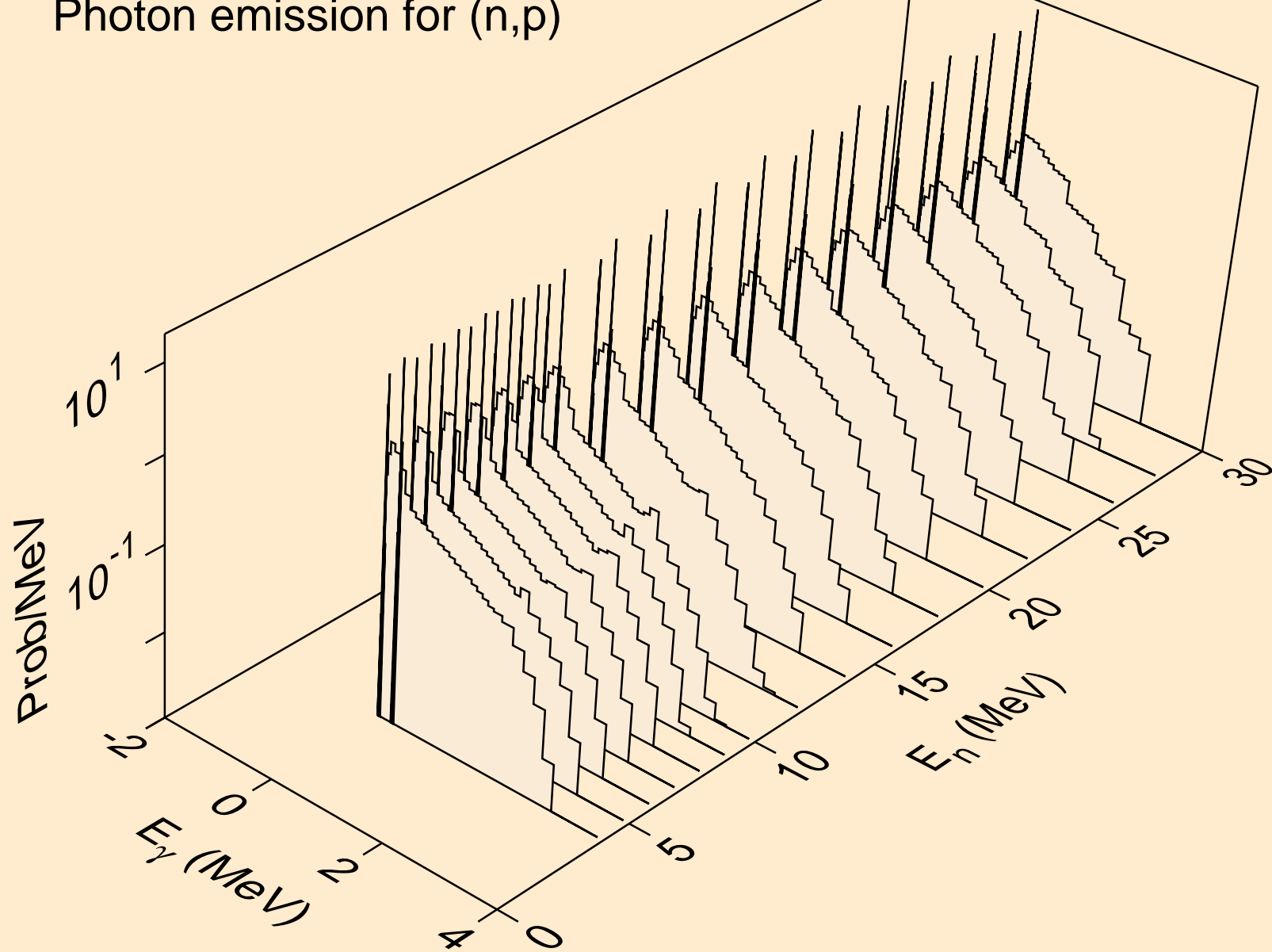

BK239 DEUTERON ACER TENDL-2021 LIBRARY; T=0.K
Photon emission for inelastic

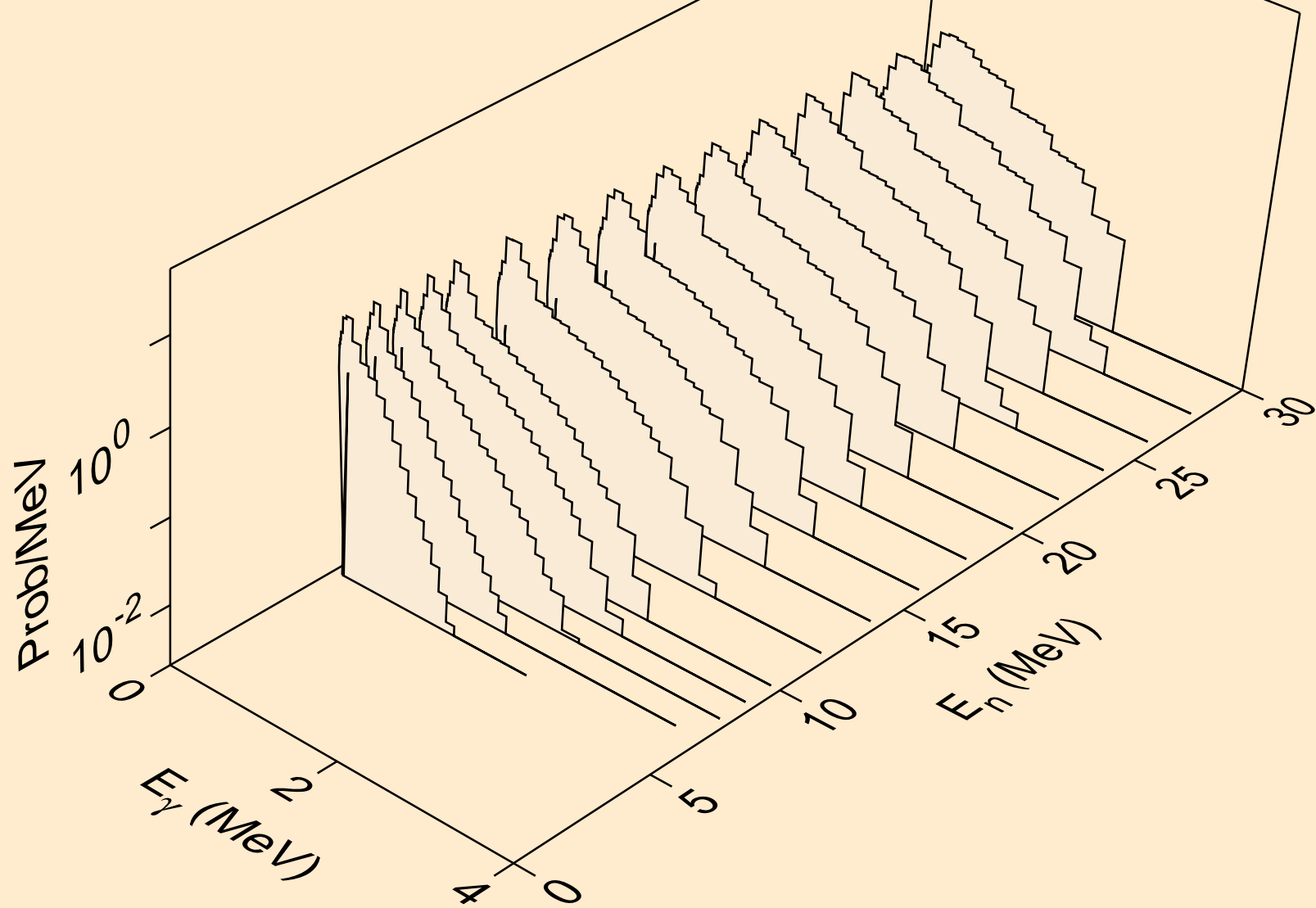

BK239 DEUTERON ACER TENDL-2021 LIBRARY; T=0.K
Photon emission for (n,t)

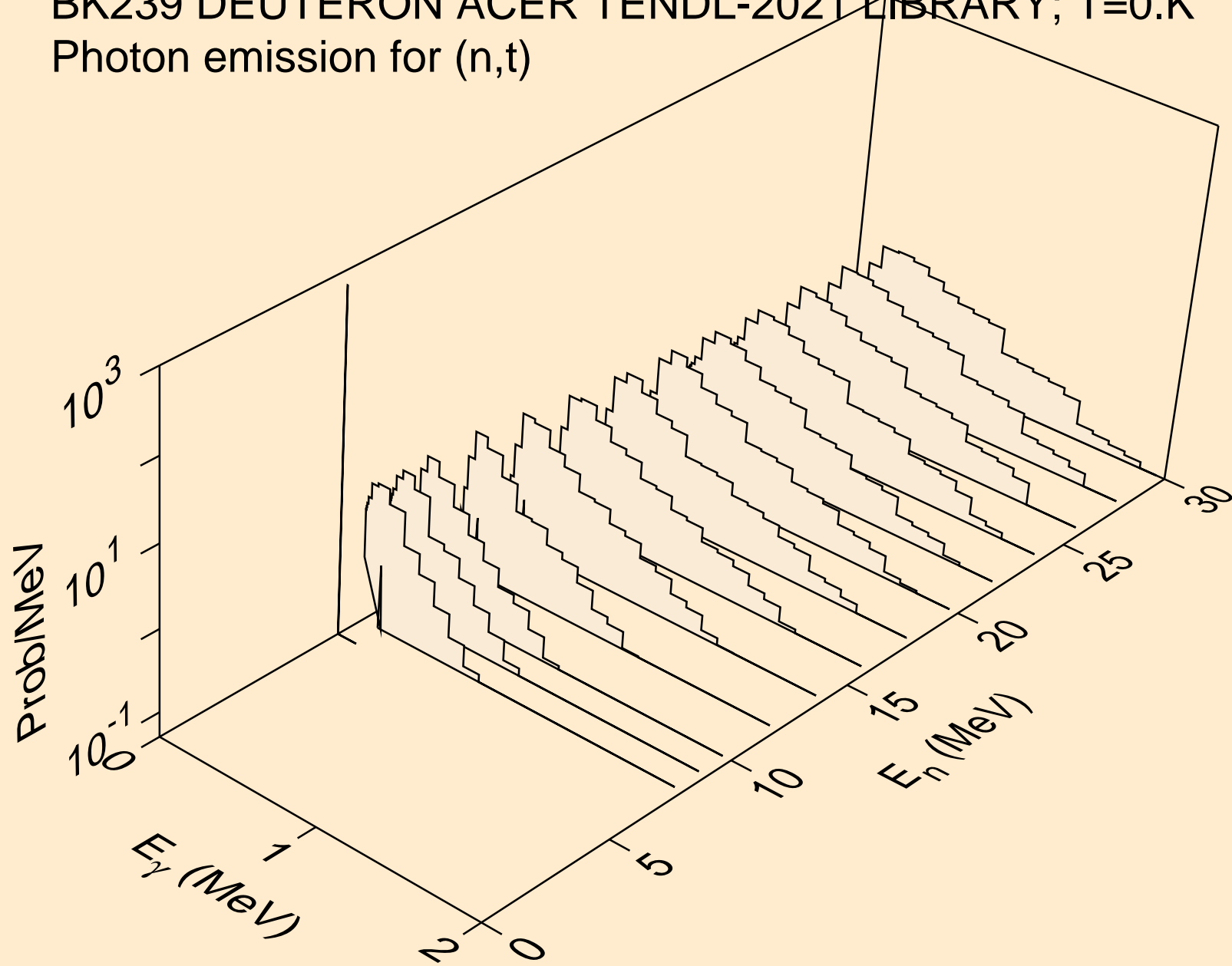

BK239 DEUTERON ACER TENDL-2021 LIBRARY; T=0.K
Photon emission for (n,he3)

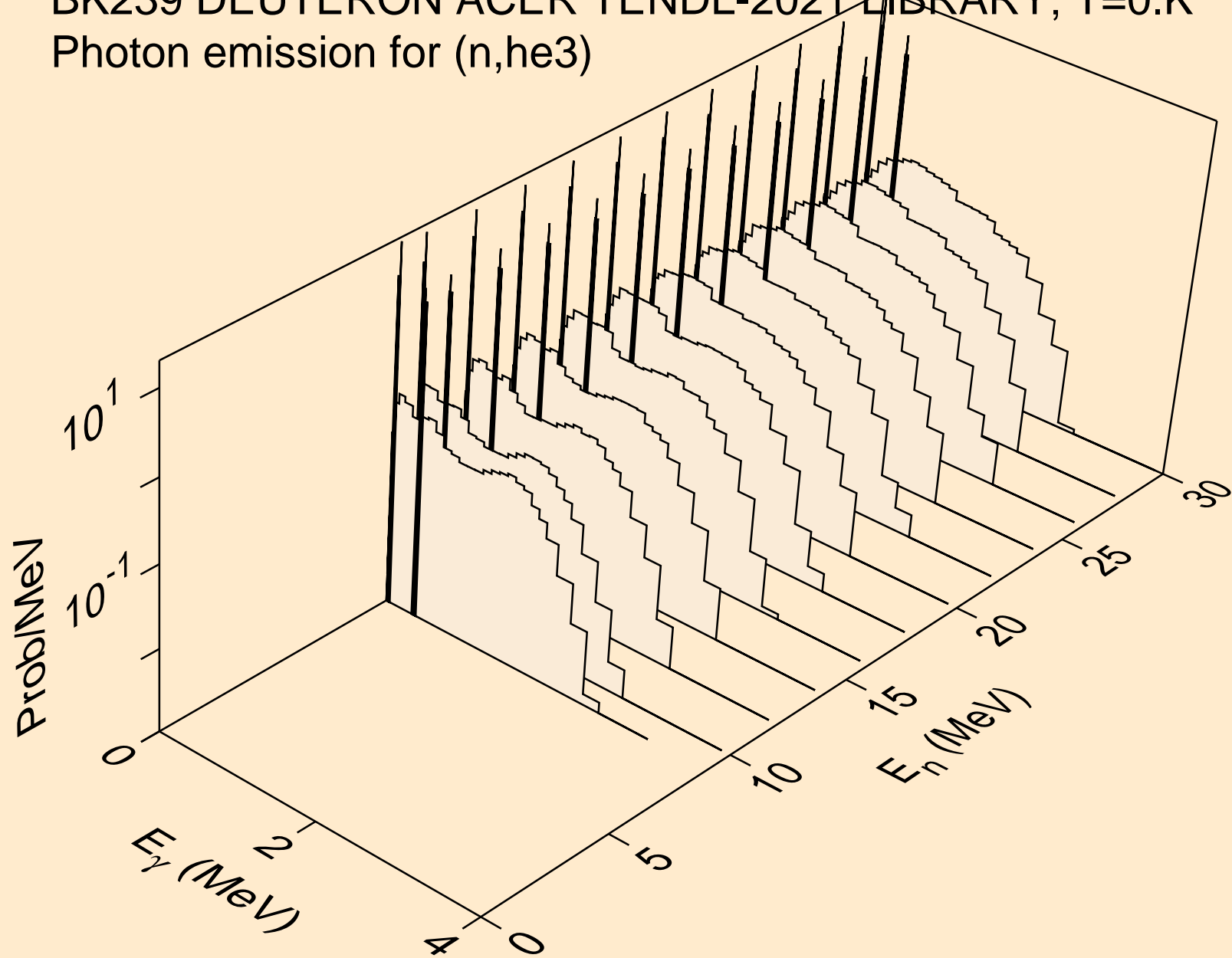

BK239 DEUTERON ACER TENDL-2021 LIBRARY; T=0.K
Photon emission for (n,a)

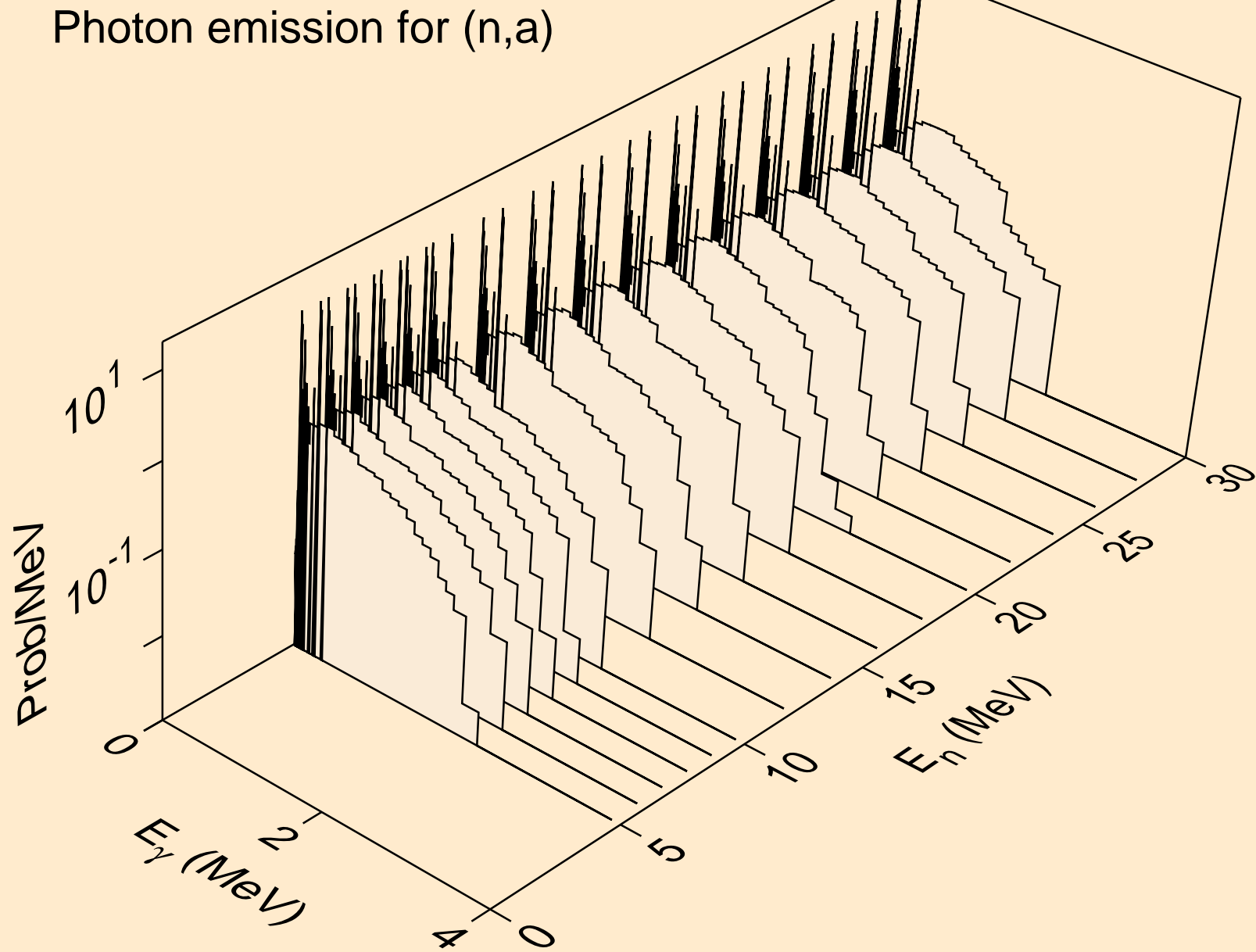

BK239 DEUTERON ACER TENDL-2021 LIBRARY; T=0.K
Photon emission for (n,2p)

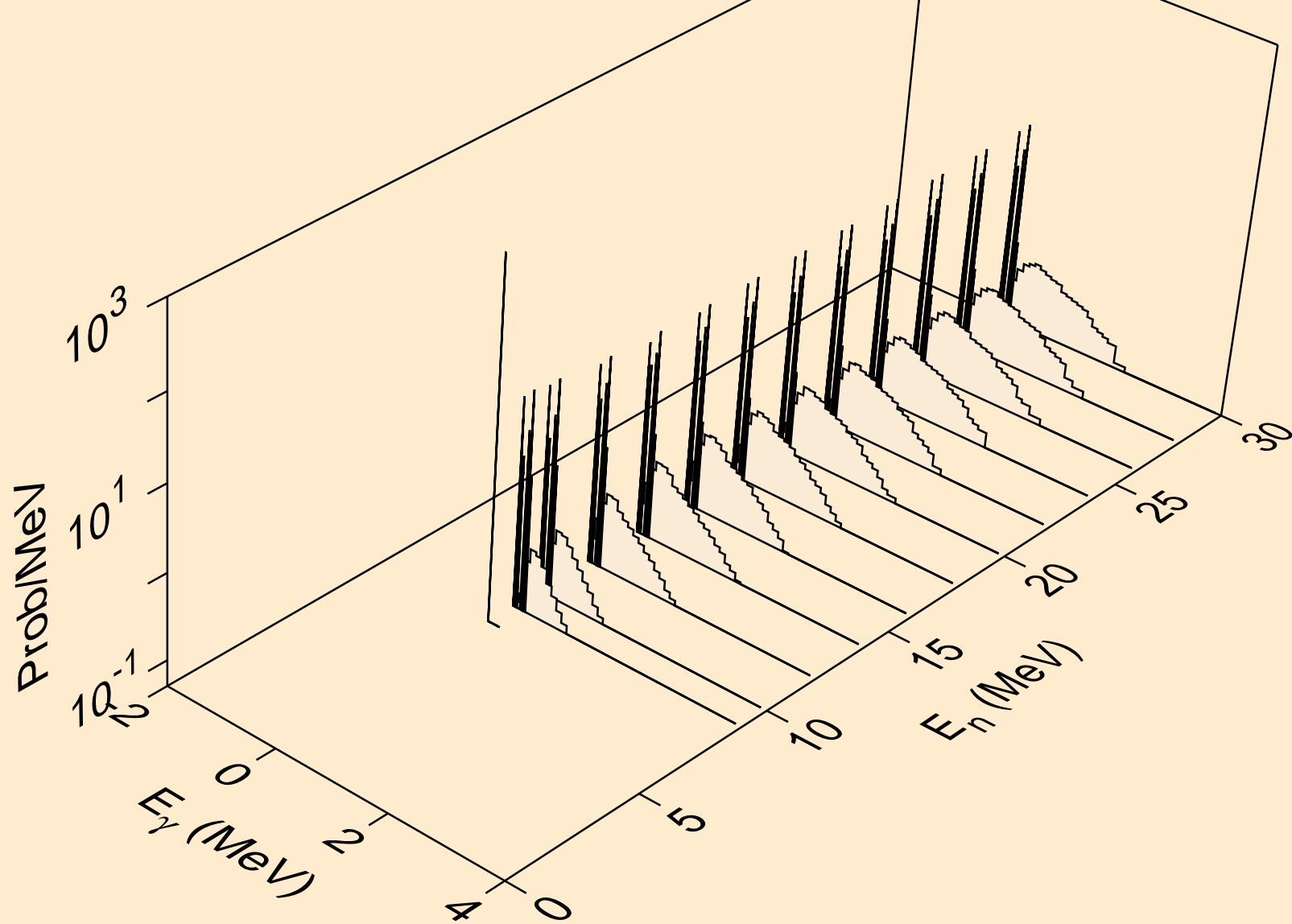

BK239 DEUTERON ACER TENDL-2021 LIBRARY; T=0.K
Photon emission for (n,p)

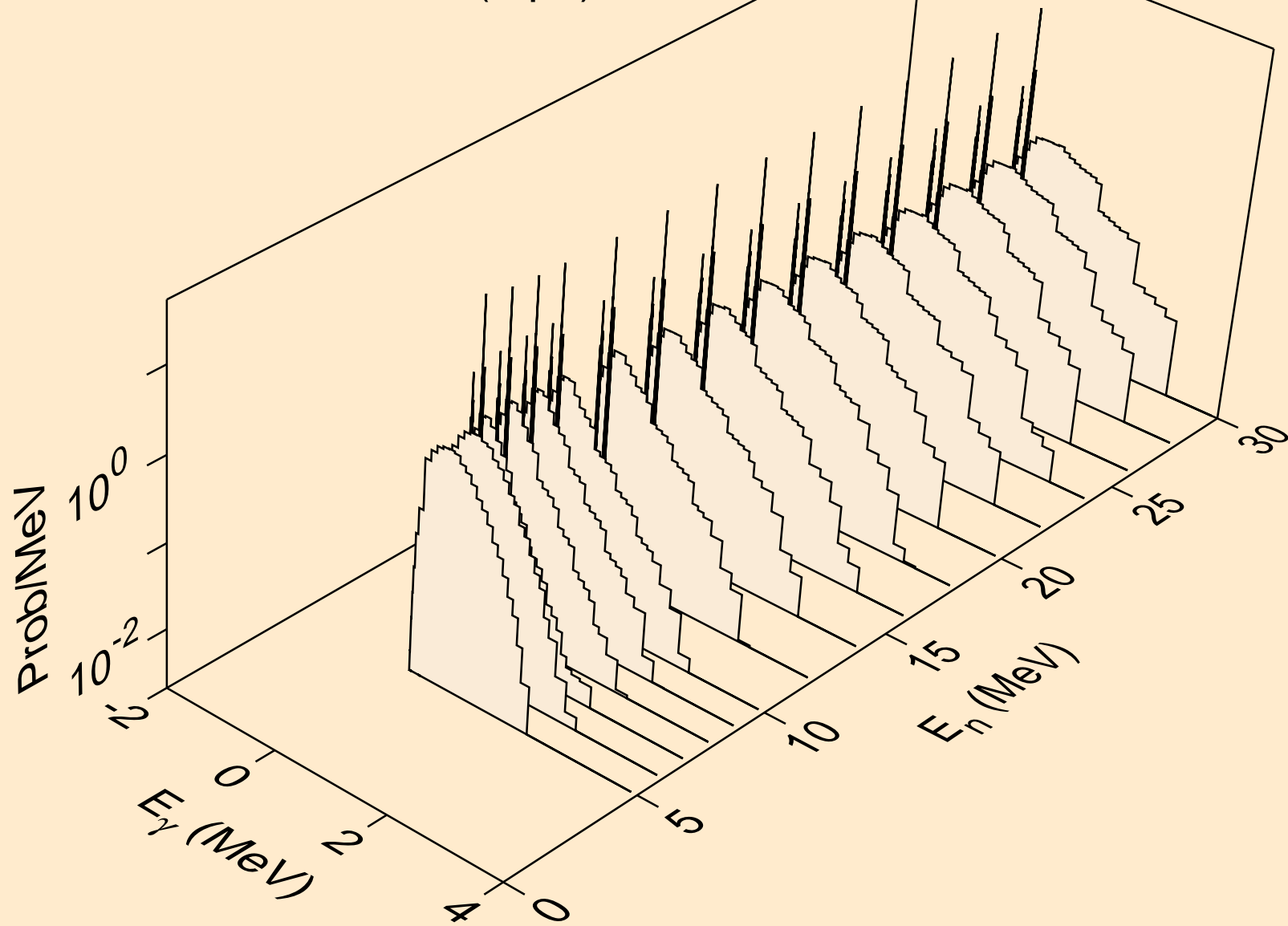

BK239 DEUTERON ACER TENDL-2021 LIBRARY; T=0.K
Photon emission for (n,pd)

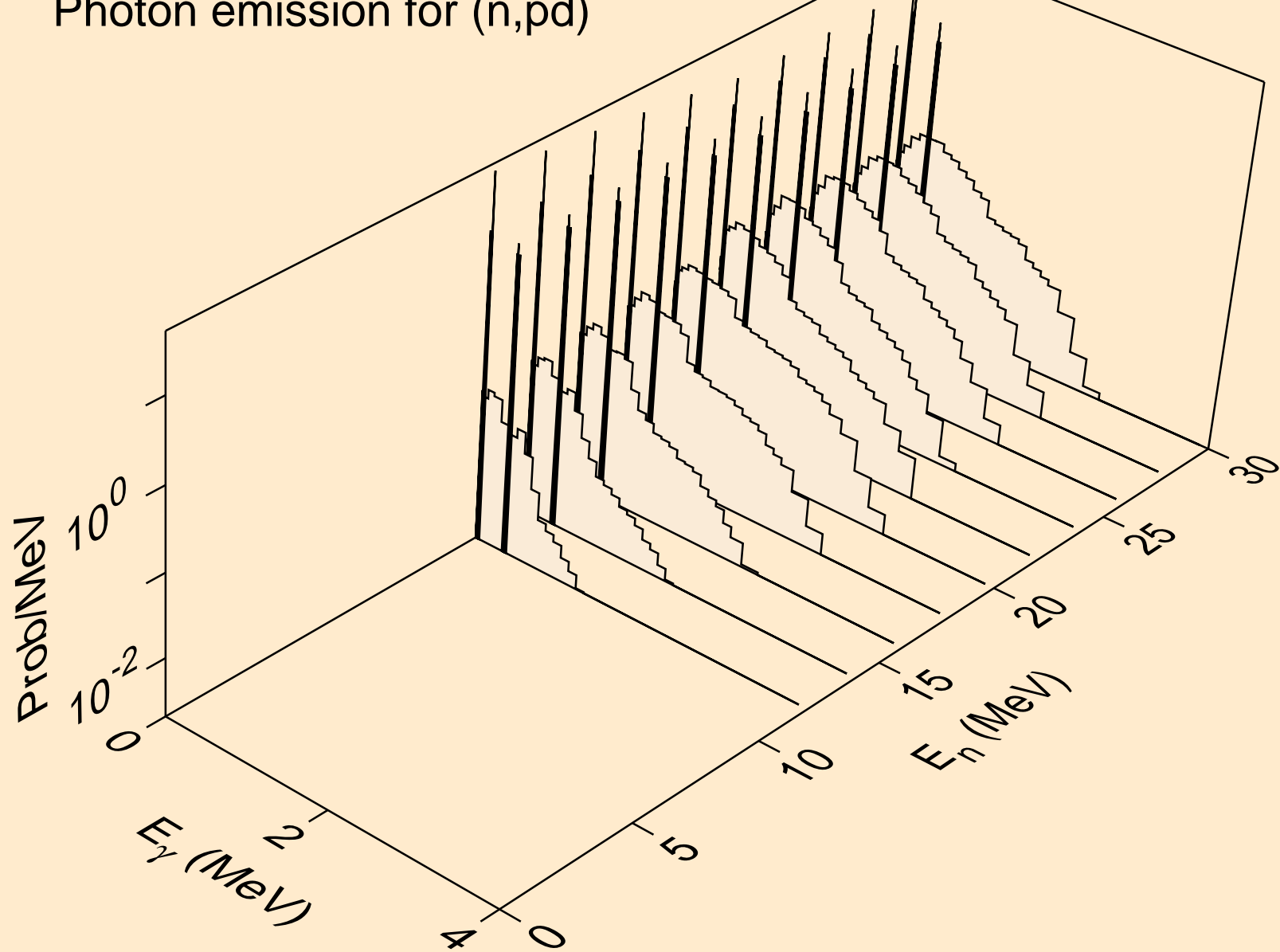

BK239 DEUTERON ACER TENDL-2021 LIBRARY; T=0.K
Particle heating contributions

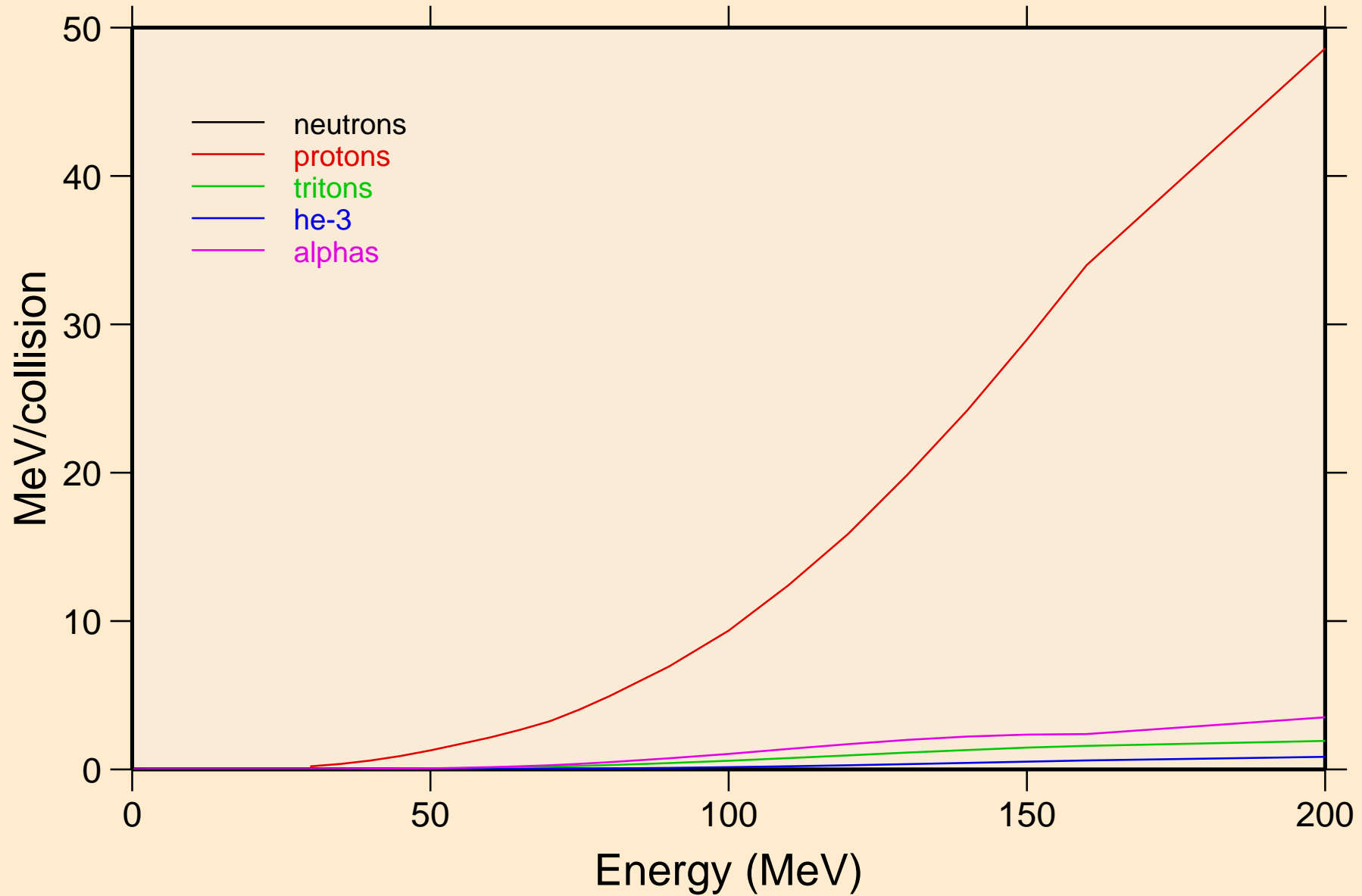

BK239 DEUTERON ACER TENDL-2021 LIBRARY; T=0.K
Recoil Heating

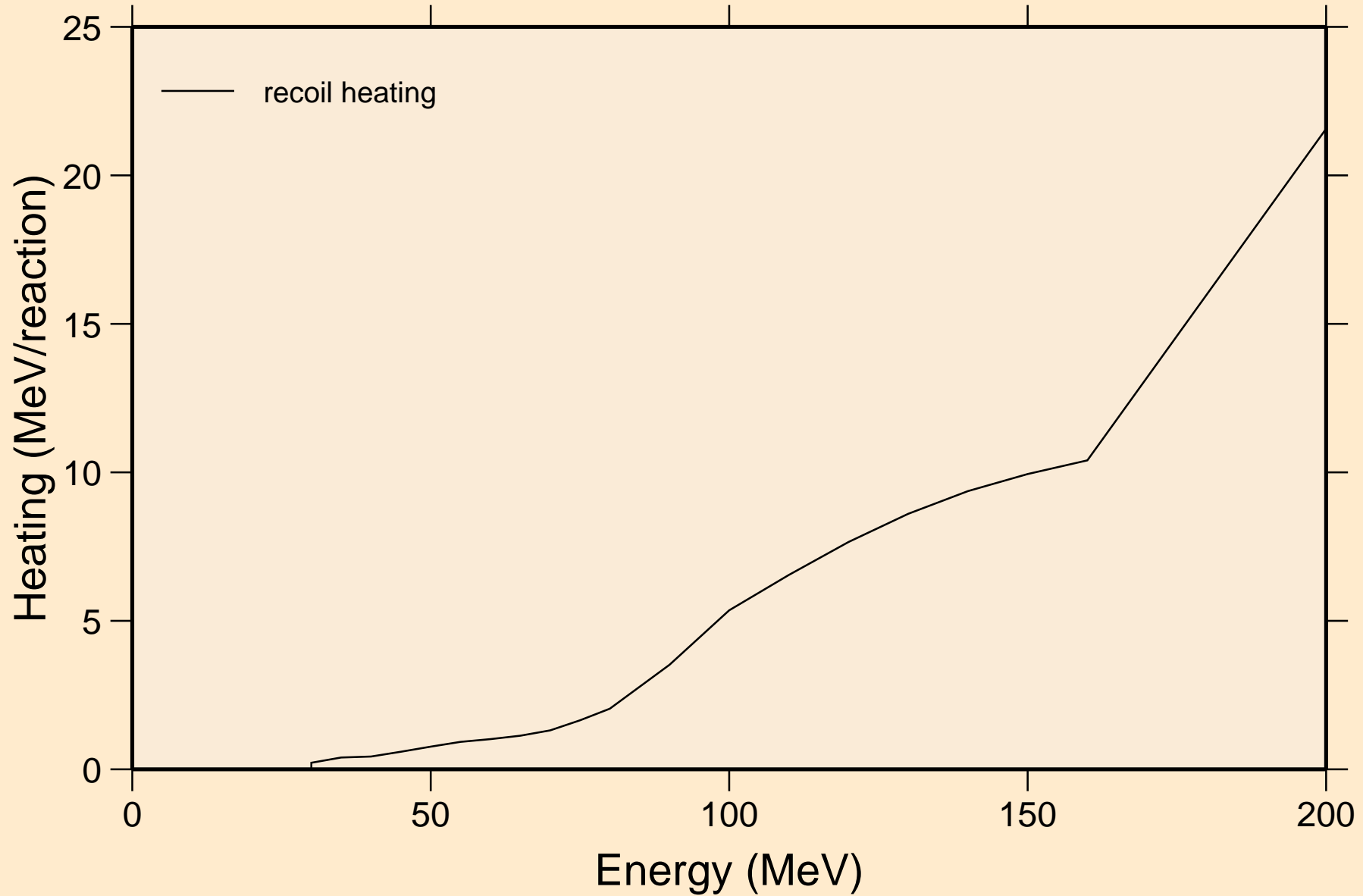

BK239 DEUTERON ACER TENDL-2021 LIBRARY; T=0.K
Particle production cross sections

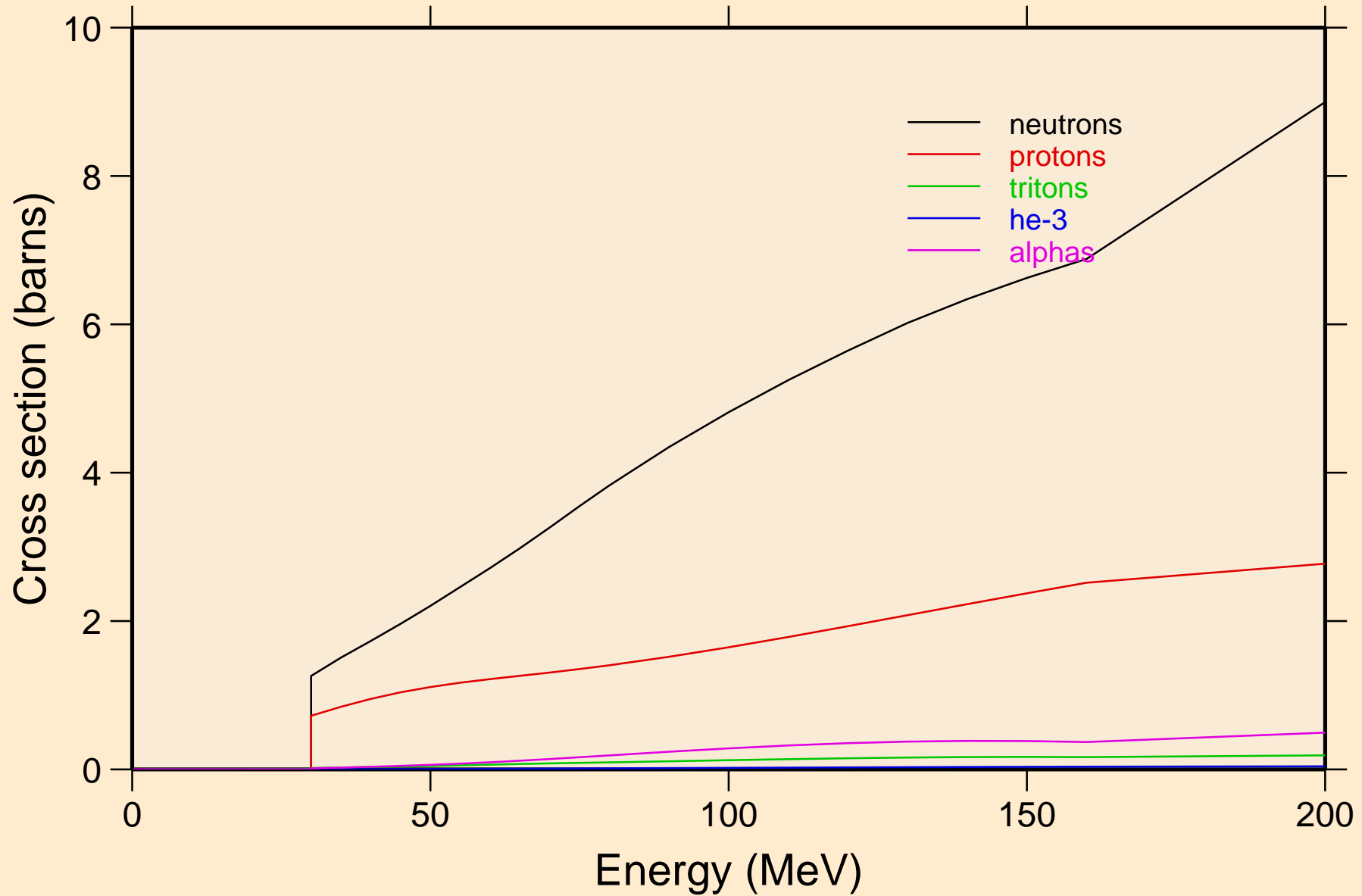

BK239 DEUTERON ACER TENDL-2021 LIBRARY; T=0.K
neutrons from (d,n)

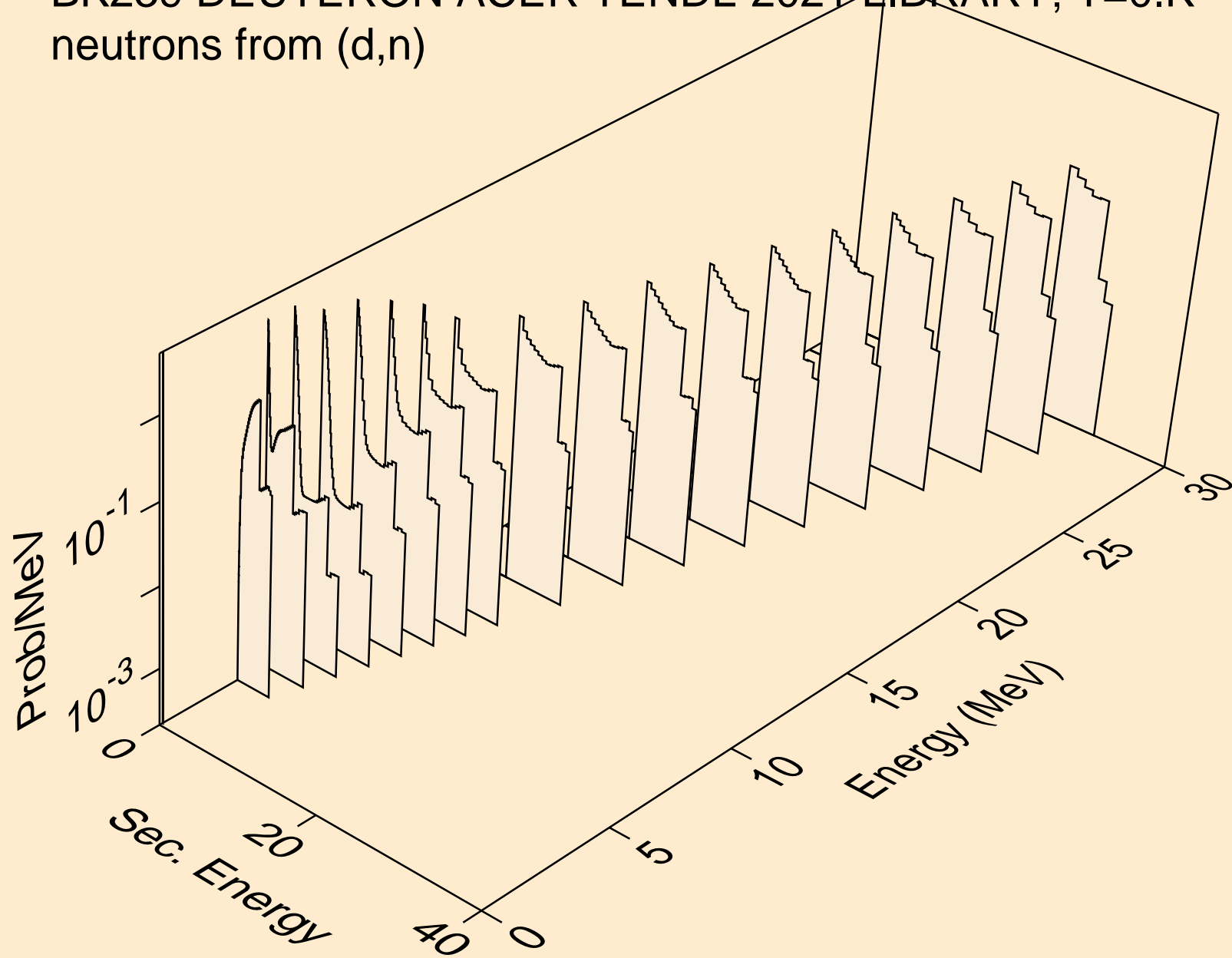

BK239 DEUTERON ACER TENDL-2021 LIBRARY; T=0.K
neutrons from (d,x)

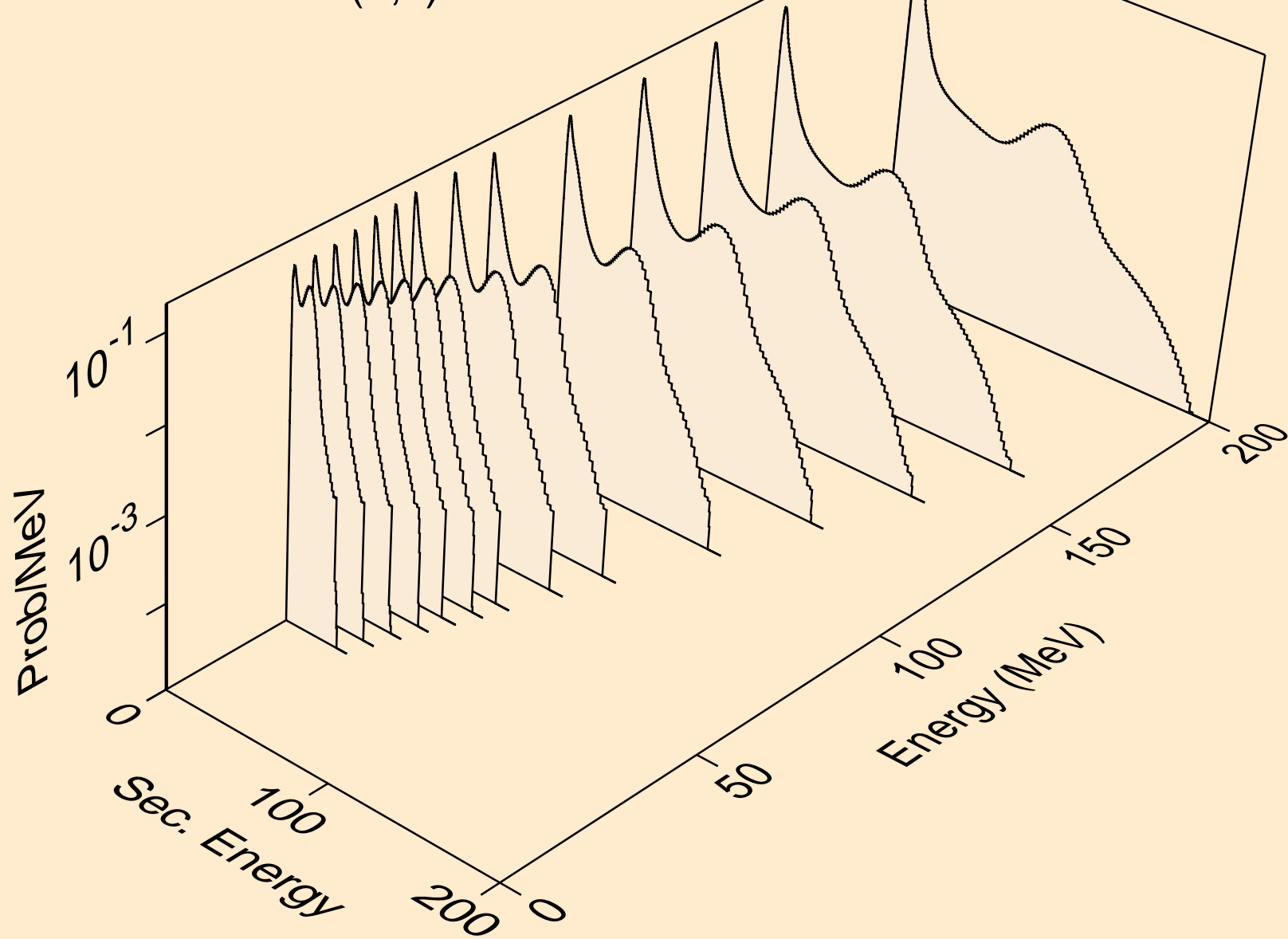

BK239 DEUTERON ACER TENDL-2021 LIBRARY; T=0.K
neutrons from (d,2nd)

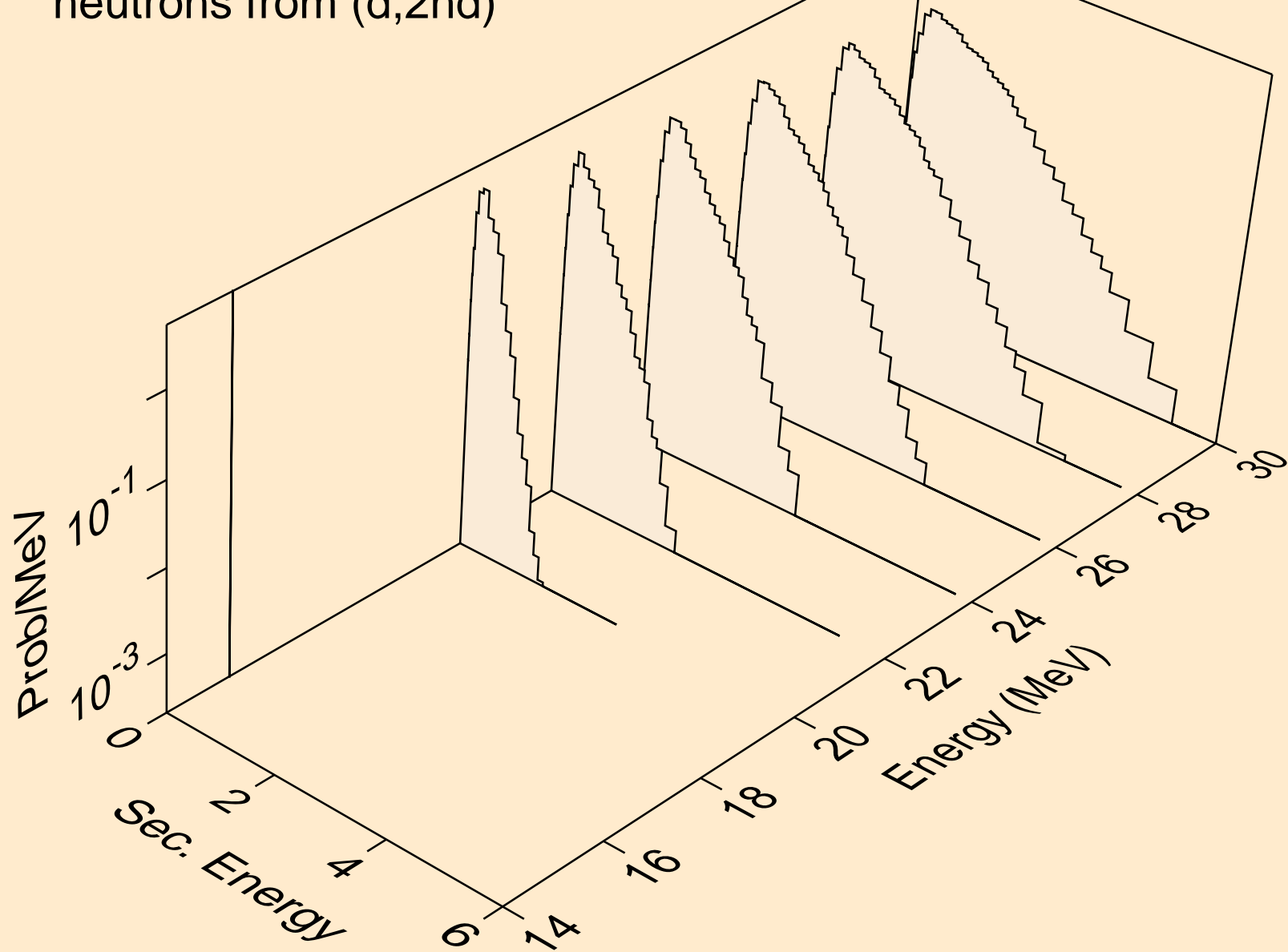

BK239 DEUTERON ACER TENDL-2021 LIBRARY; T=0.K
neutrons from (d,2n)

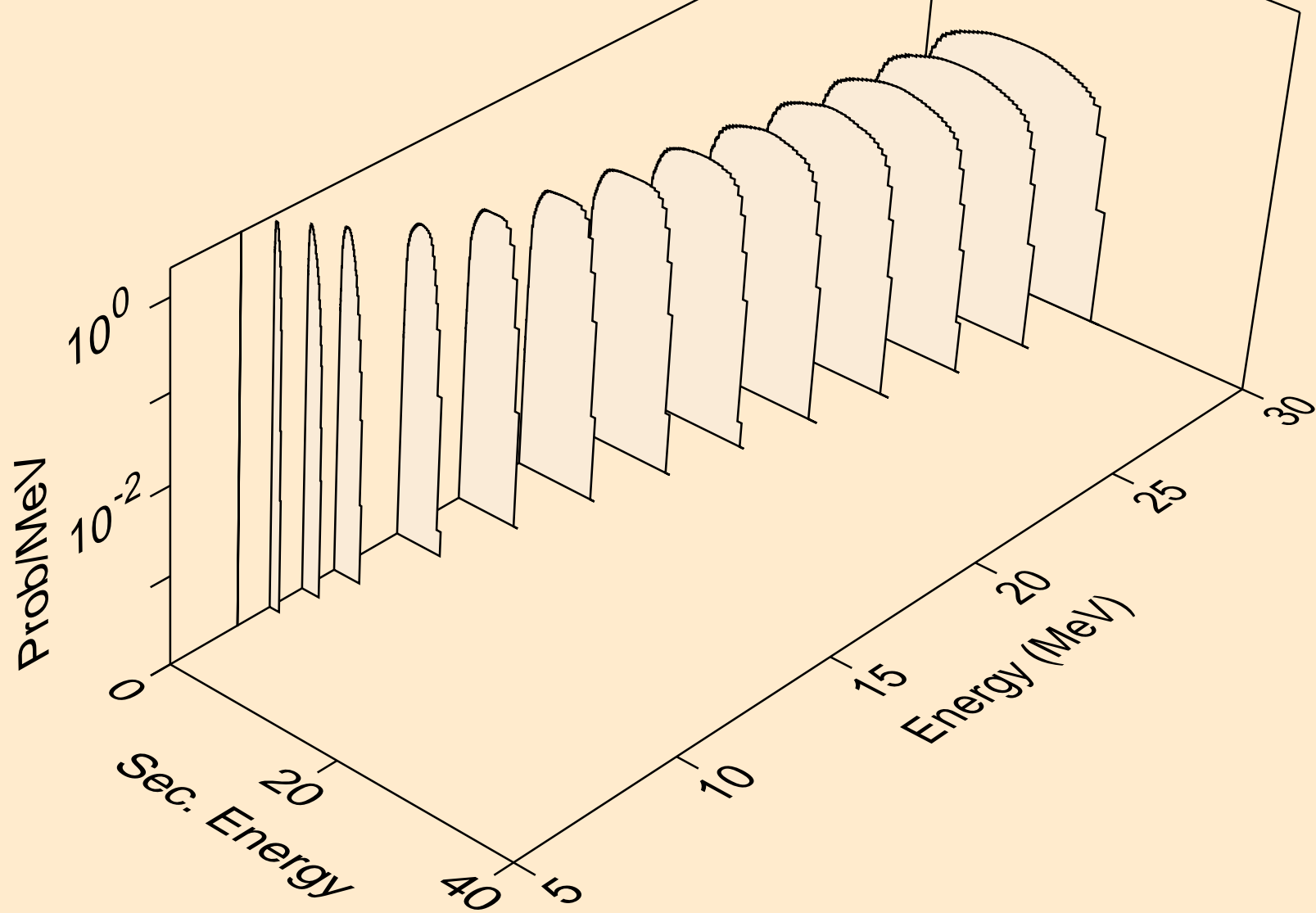

BK239 DEUTERON ACER TENDL-2021 LIBRARY; T=0.K
neutrons from (d,3n)

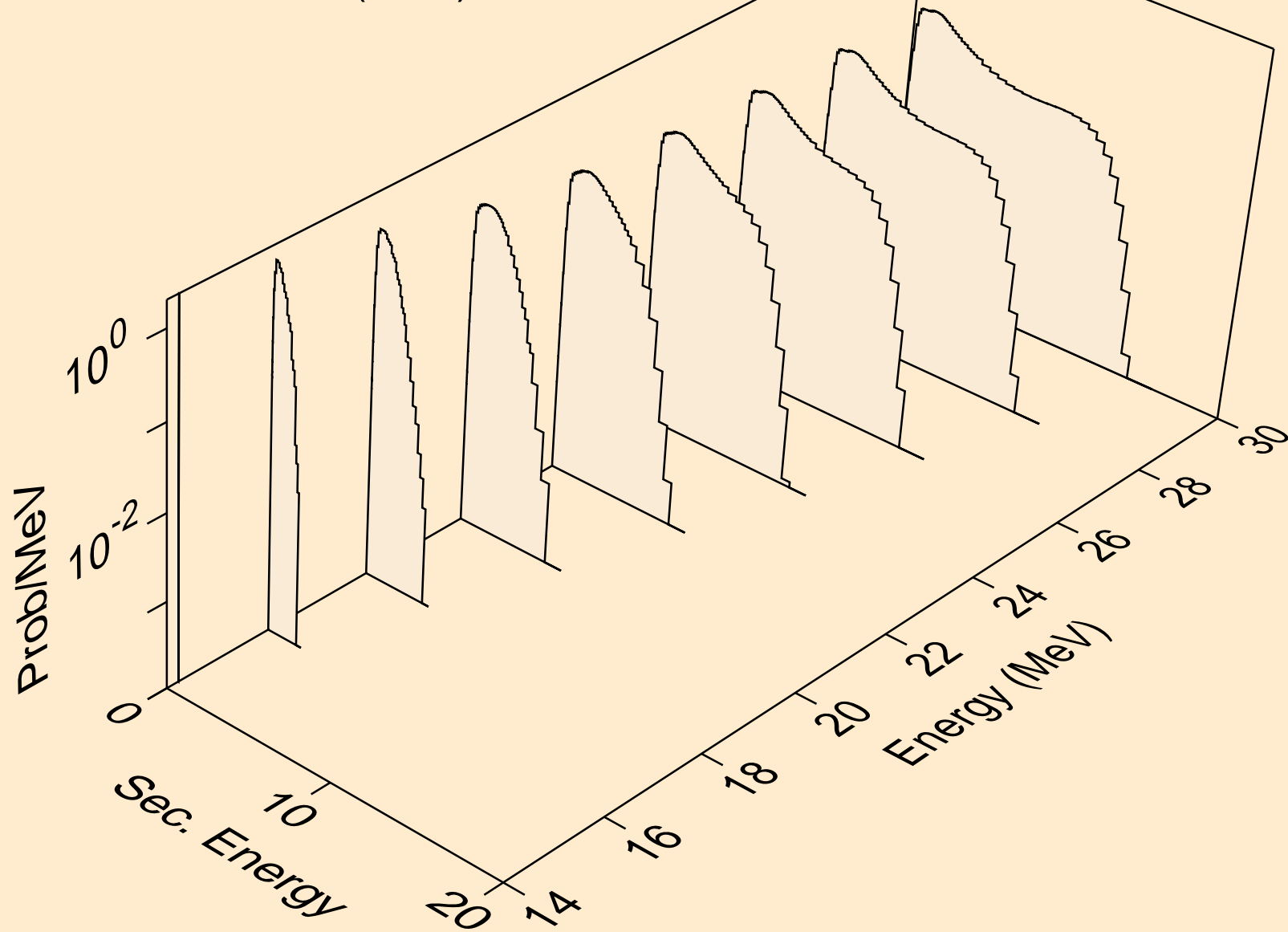

BK239 DEUTERON ACER TENDL-2021 LIBRARY; T=0.K
neutrons from (d,n*)a

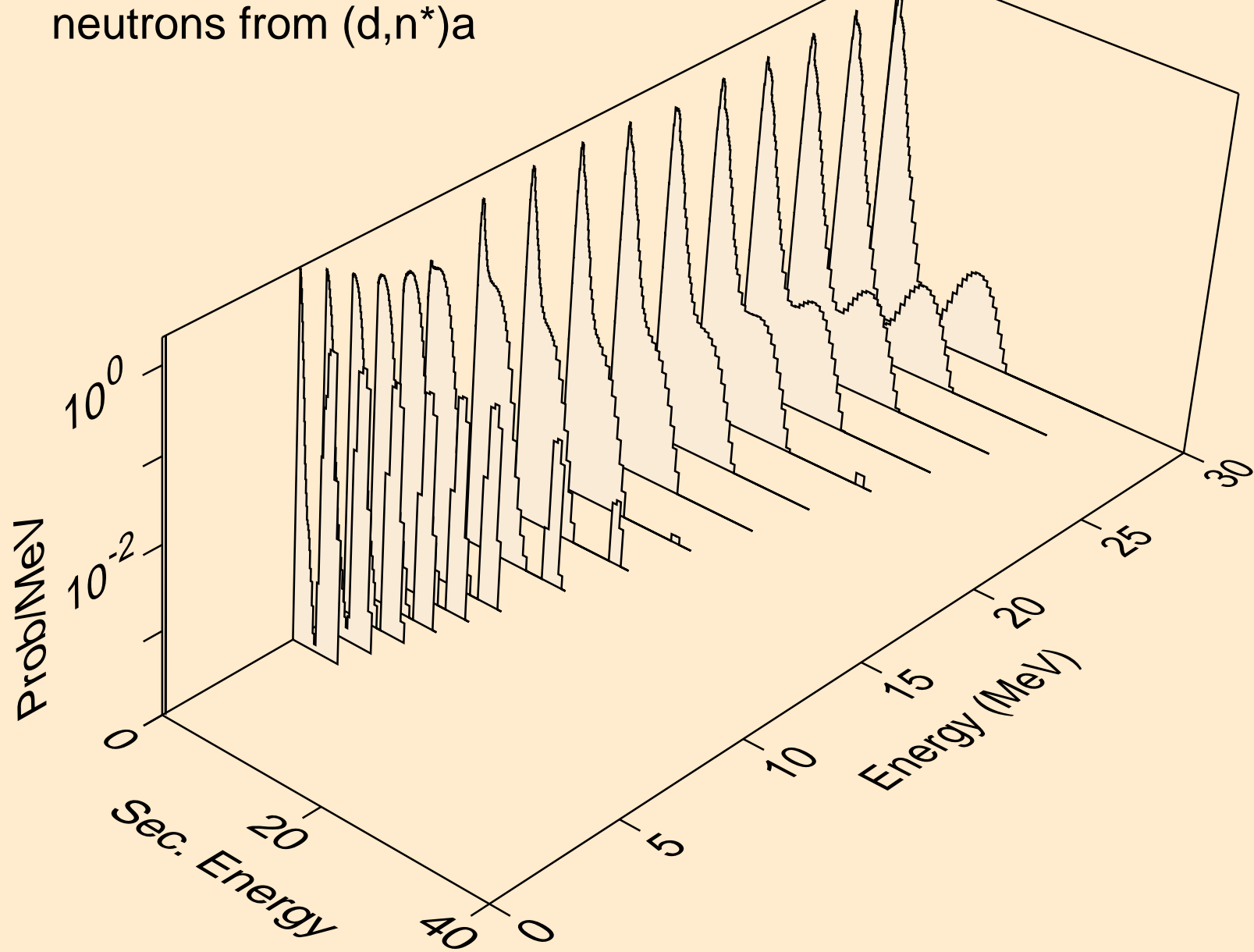

BK239 DEUTERON ACER TENDL-2021 LIBRARY; T=0.K
neutrons from (d,2n)a

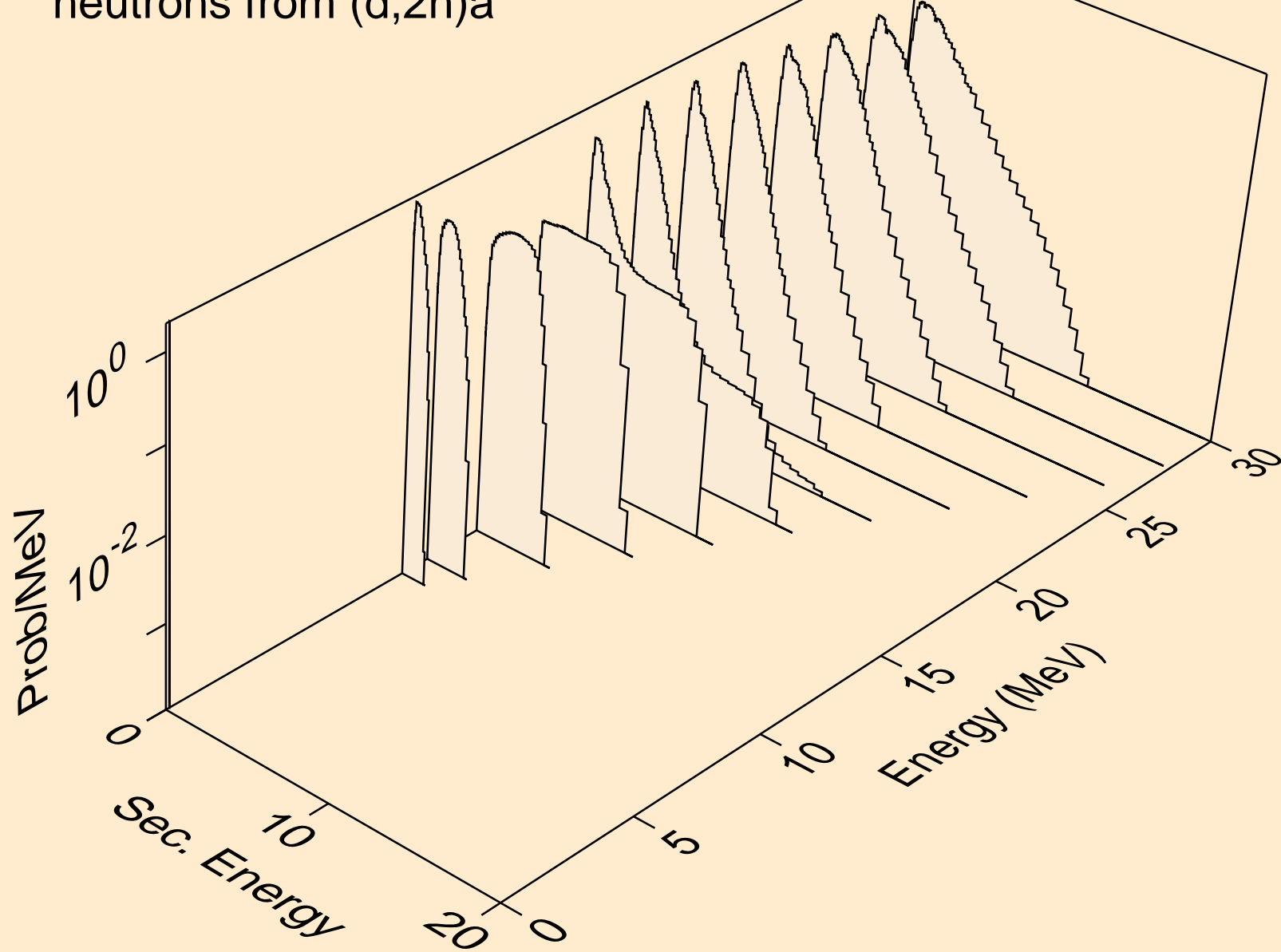

BK239 DEUTERON ACER TENDL-2021 LIBRARY; T=0.K
neutrons from (d,n*)p

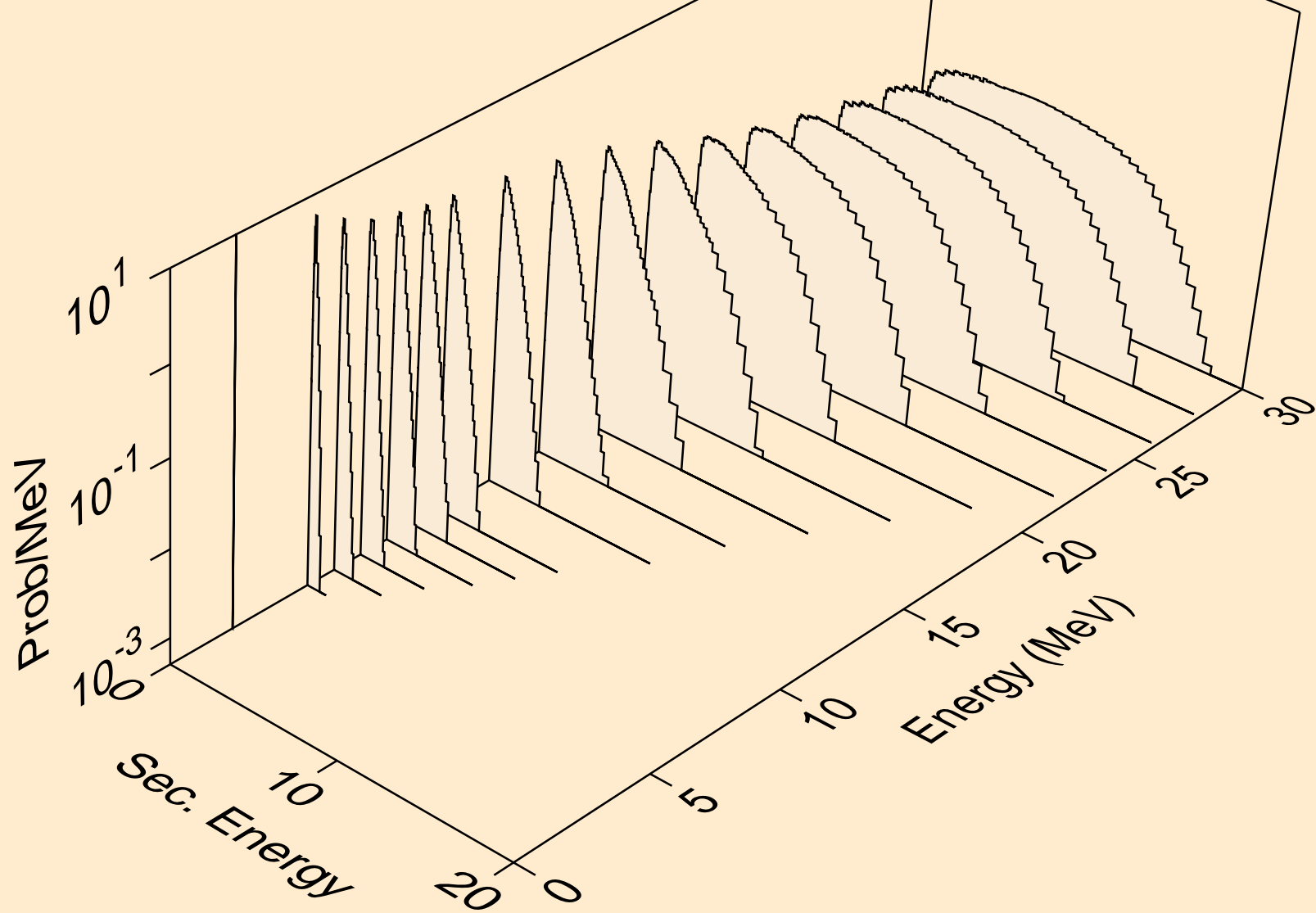

BK239 DEUTERON ACER TENDL-2021 LIBRARY; T=0.K
neutrons from (d,n*)d

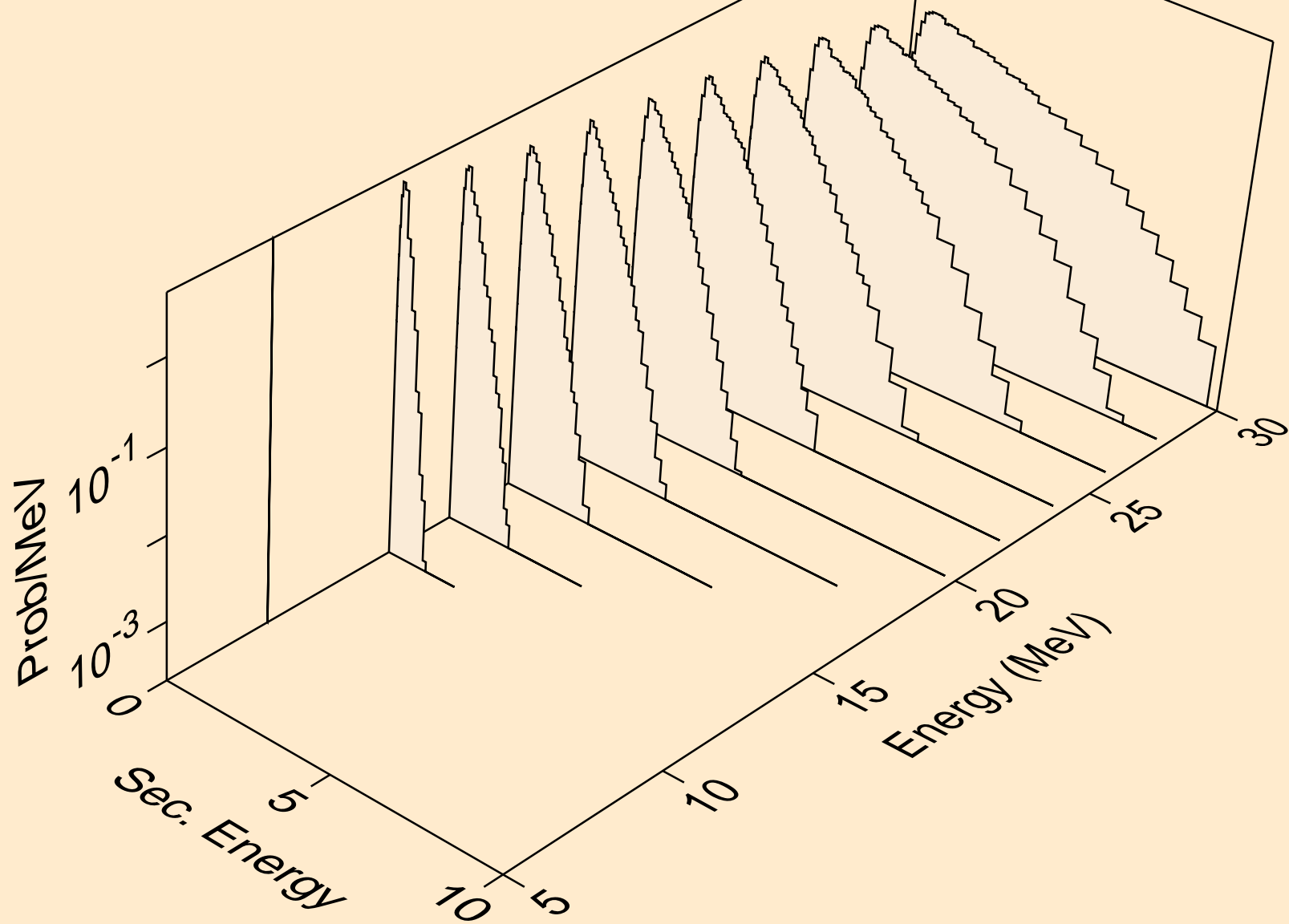

BK239 DEUTERON ACER TENDL-2021 LIBRARY; T=0.K
neutrons from (d,n*)t

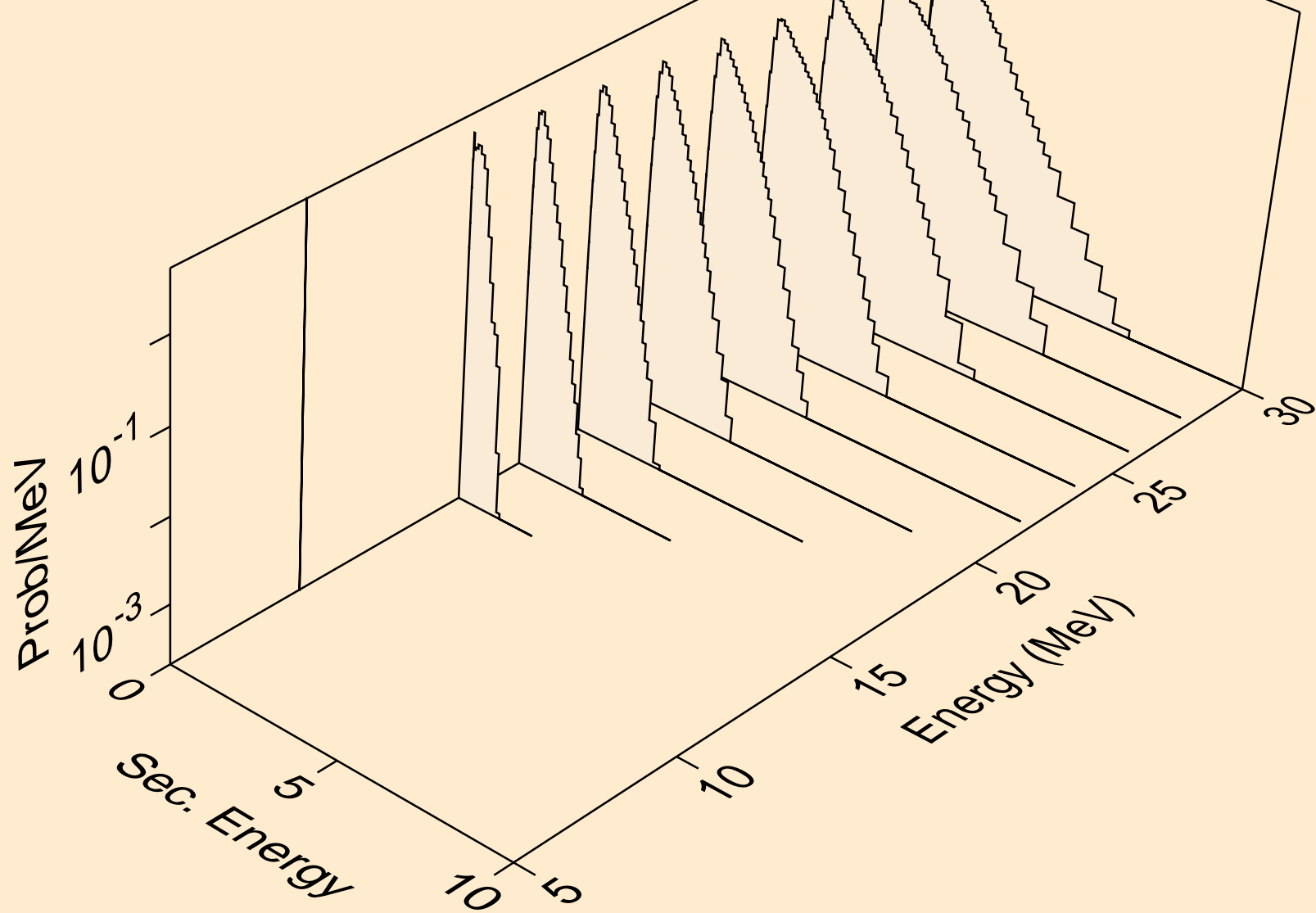

BK239 DEUTERON ACER TENDL-2021 LIBRARY; T=0.K
neutrons from (d,n*)he3

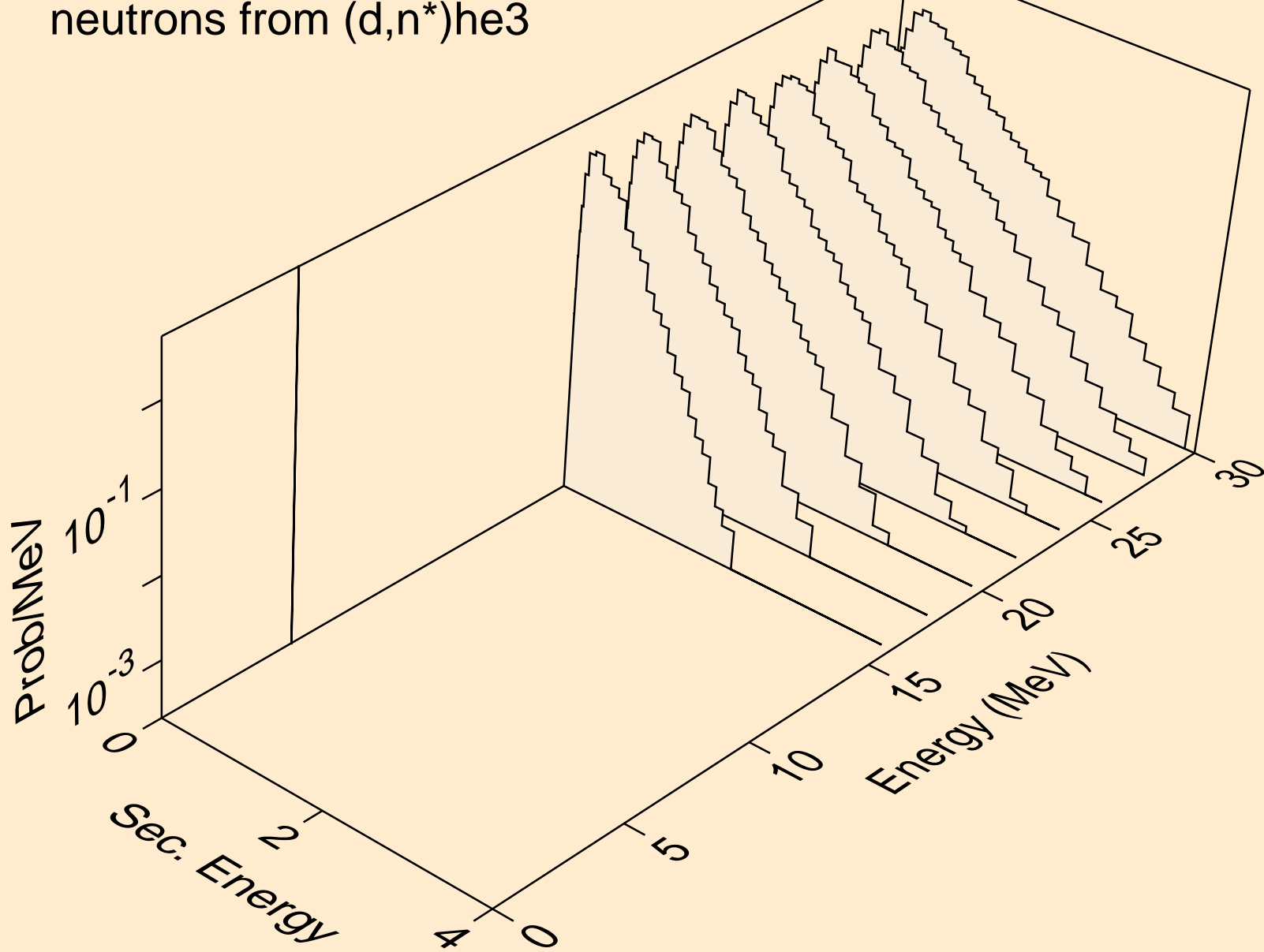

BK239 DEUTERON ACER TENDL-2021 LIBRARY; T=0.K
neutrons from (d,4n)

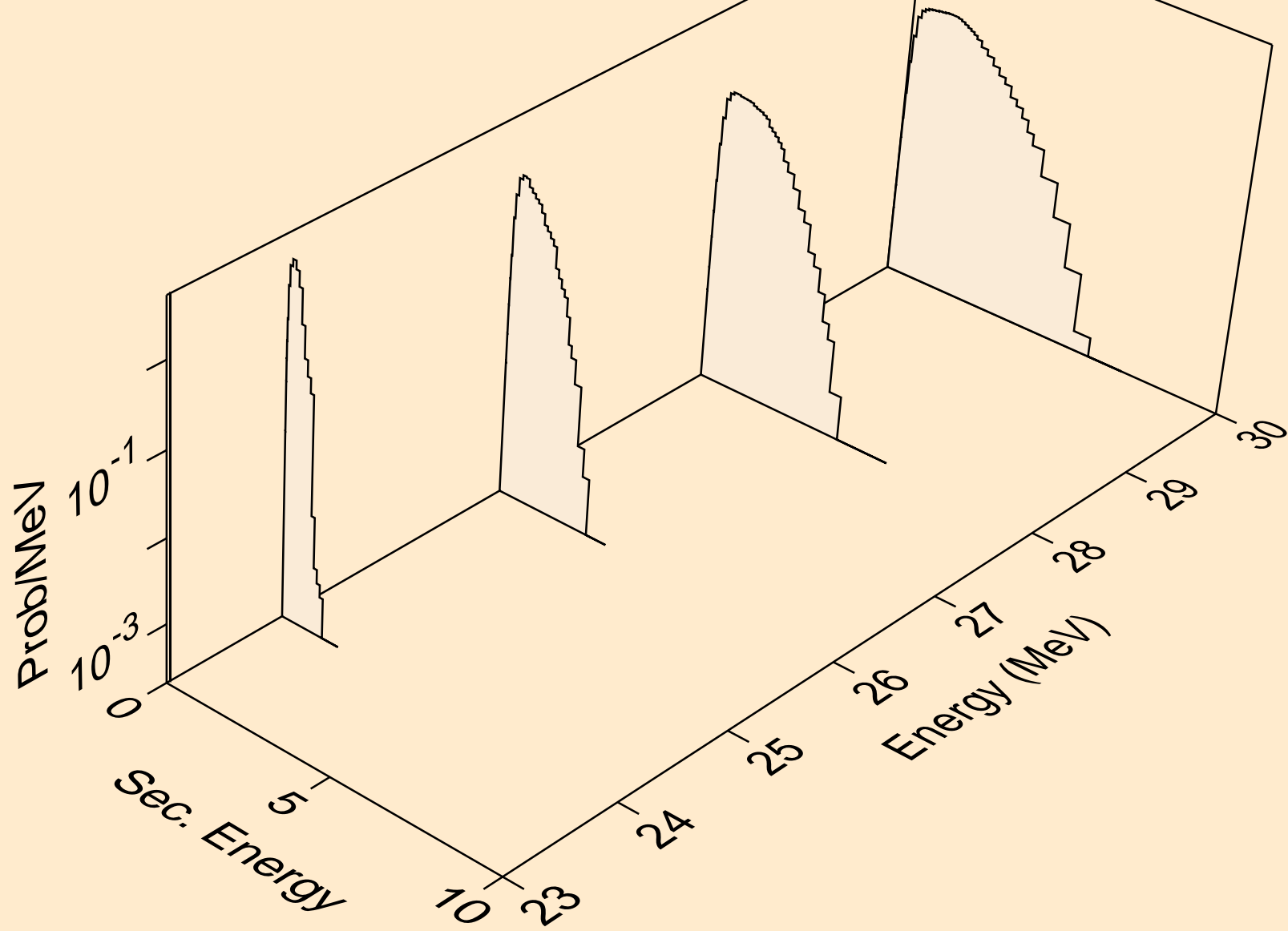

BK239 DEUTERON ACER TENDL-2021 LIBRARY; T=0.K
neutrons from (d,2np)

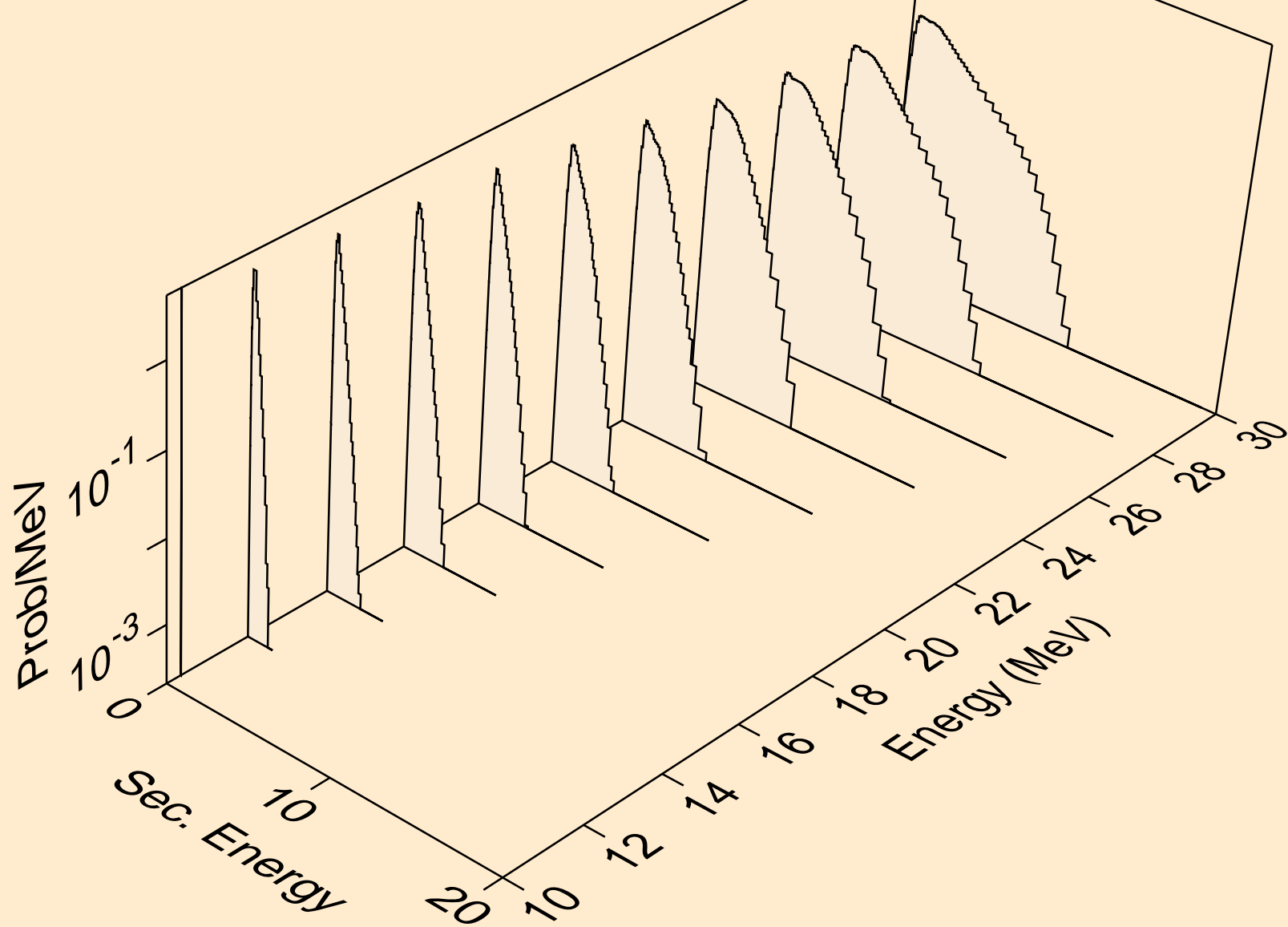

BK239 DEUTERON ACER TENDL-2021 LIBRARY; T=0.K
neutrons from (d,2np)

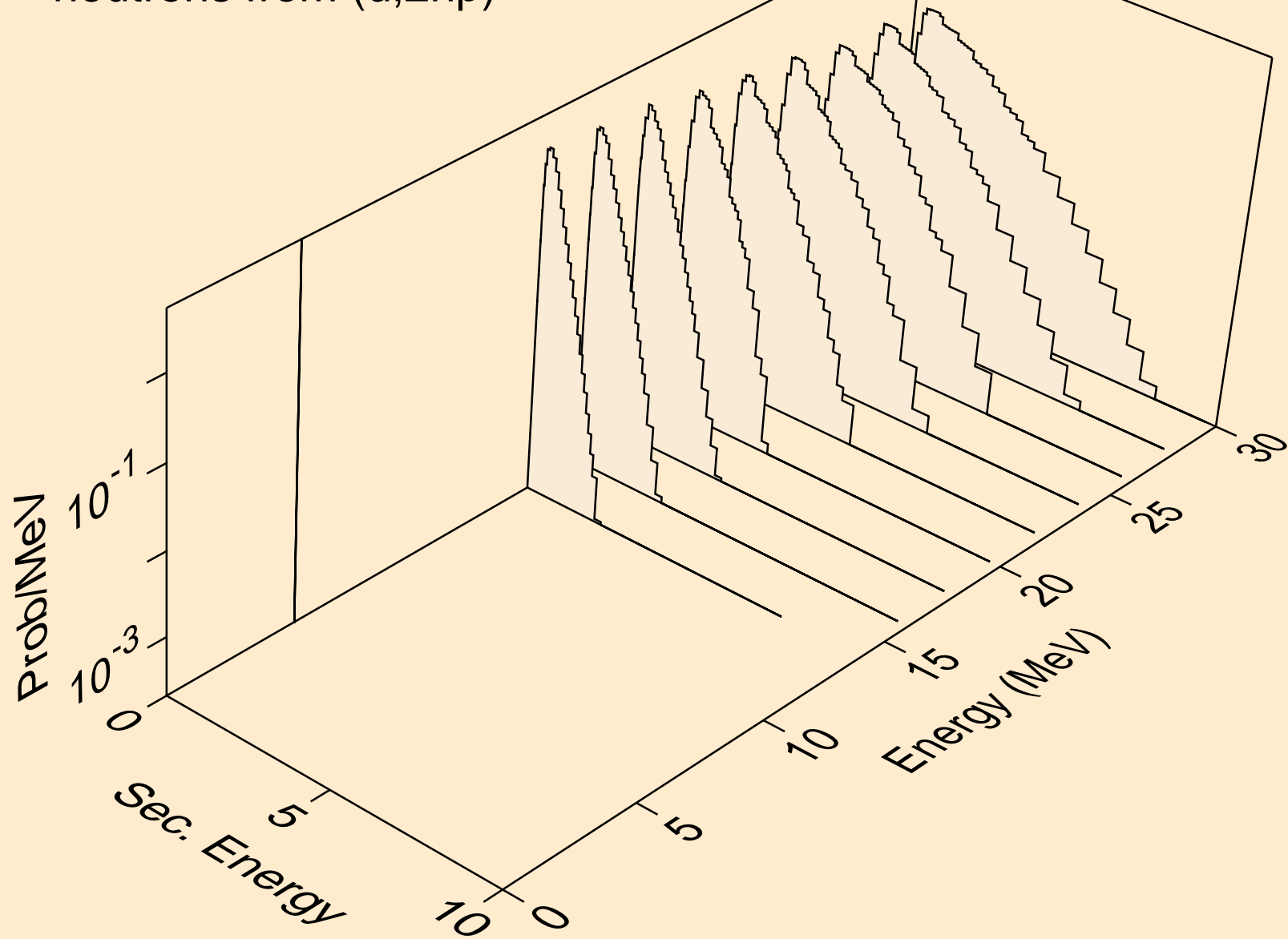

BK239 DEUTERON ACER TENDL-2021 LIBRARY; T=0.K
protons from (d,x)

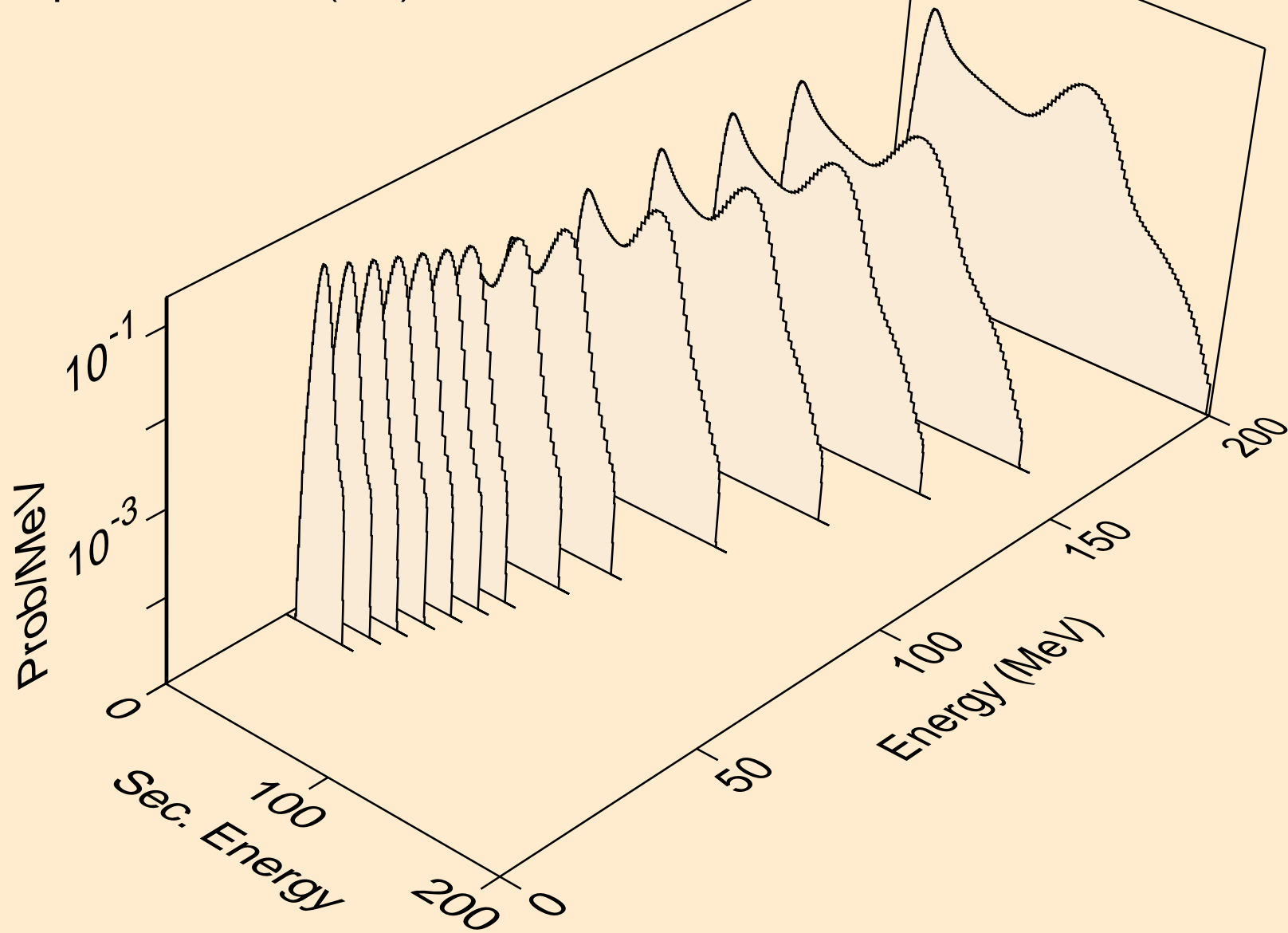

BK239 DEUTERON ACER TENDL-2021 LIBRARY; T=0.K
protons from (d,n*)p

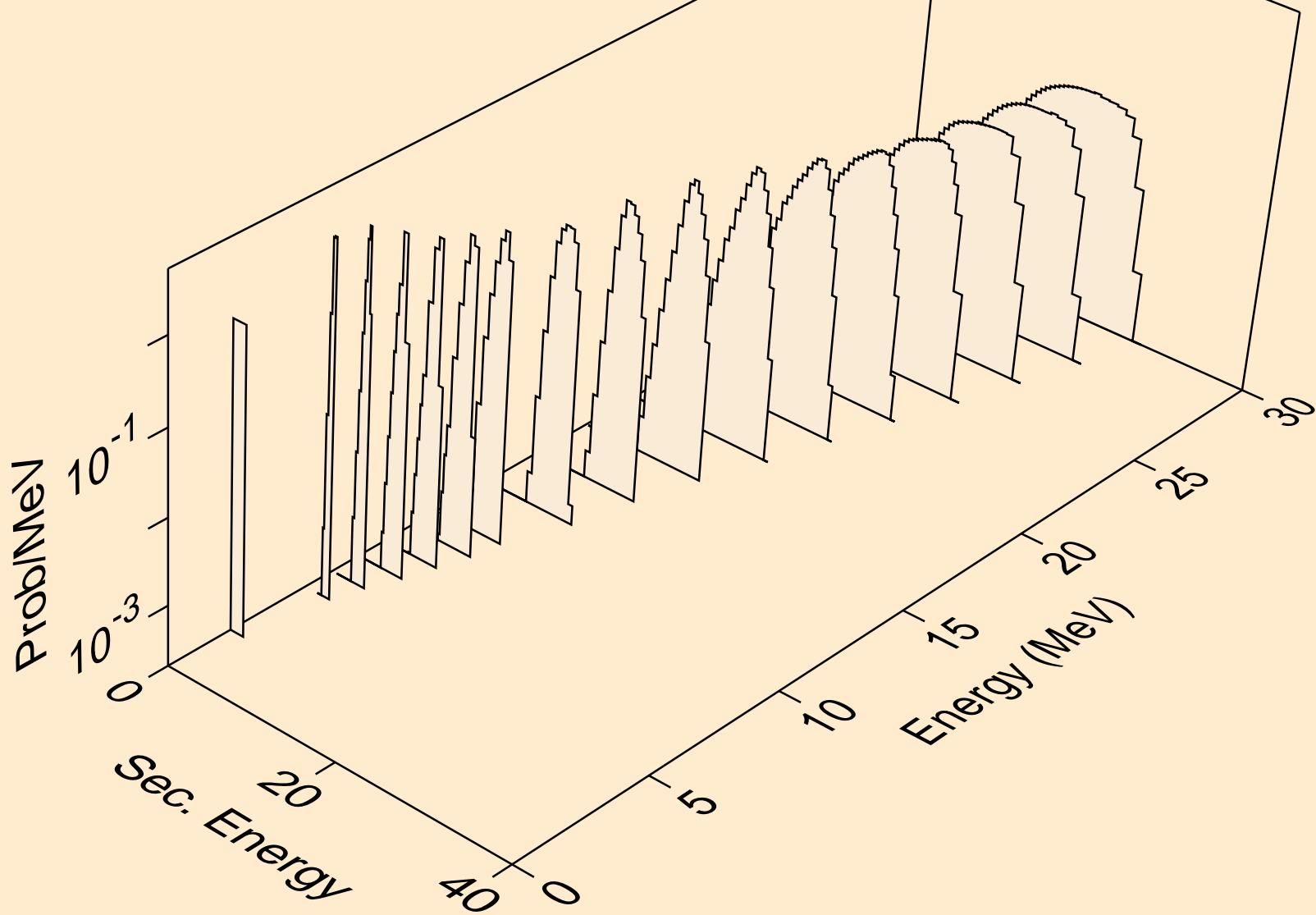

BK239 DEUTERON ACER TENDL-2021 LIBRARY; T=0.K
protons from (d,2np)

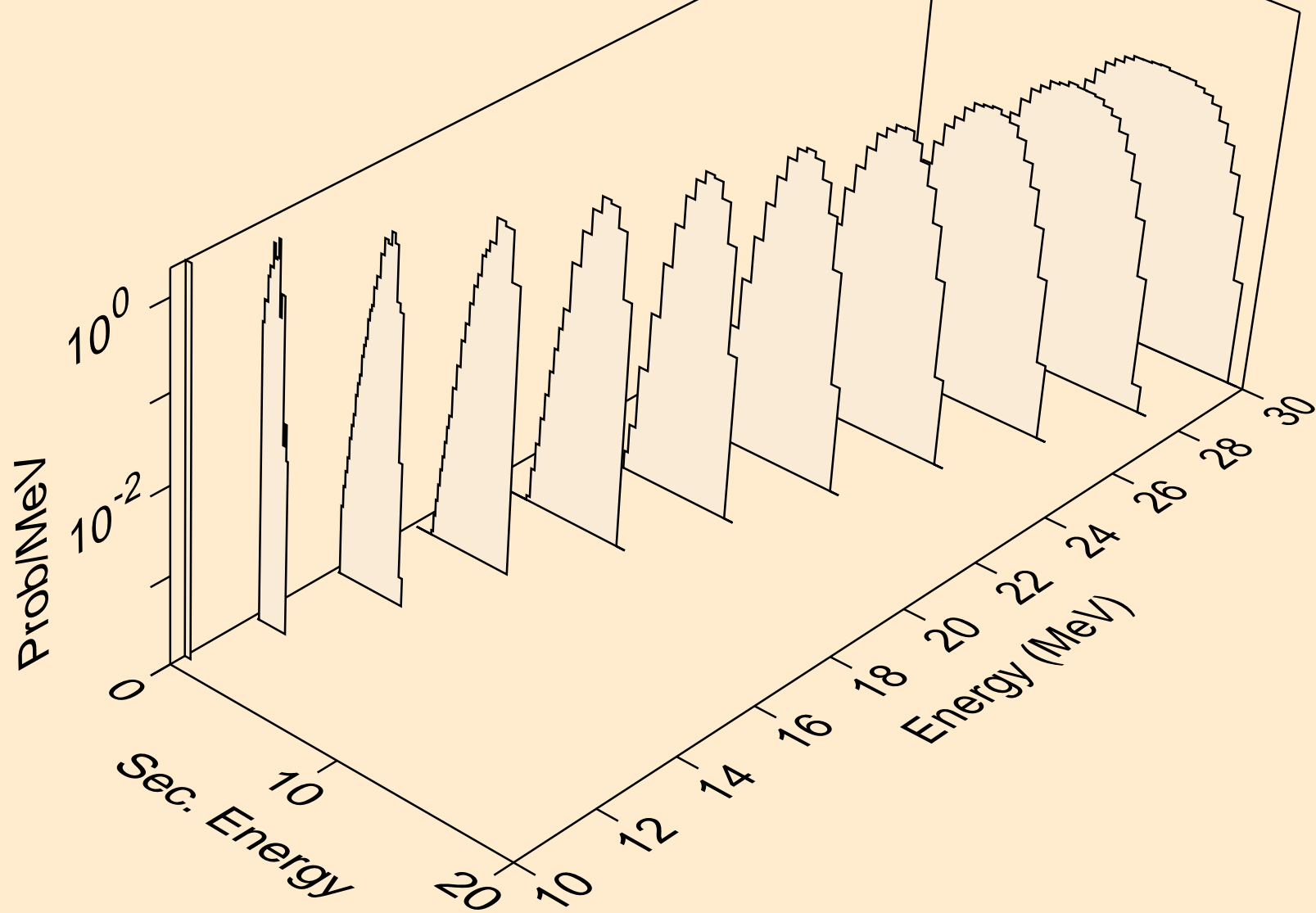

BK239 DEUTERON ACER TENDL-2021 LIBRARY; T=0.K
protons from (d,2np)

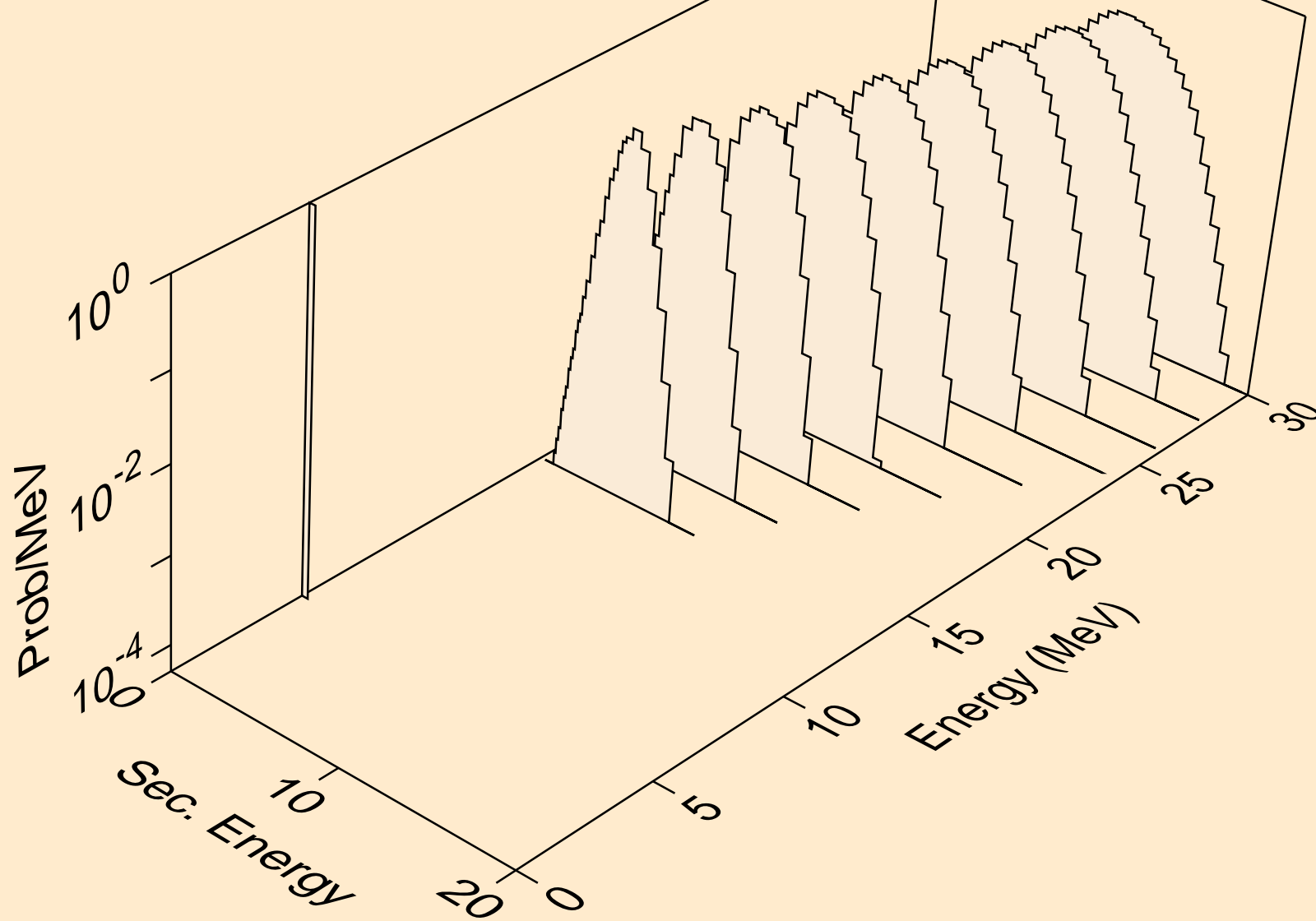

BK239 DEUTERON ACER TENDL-2021 LIBRARY; T=0.K
protons from (d,p)

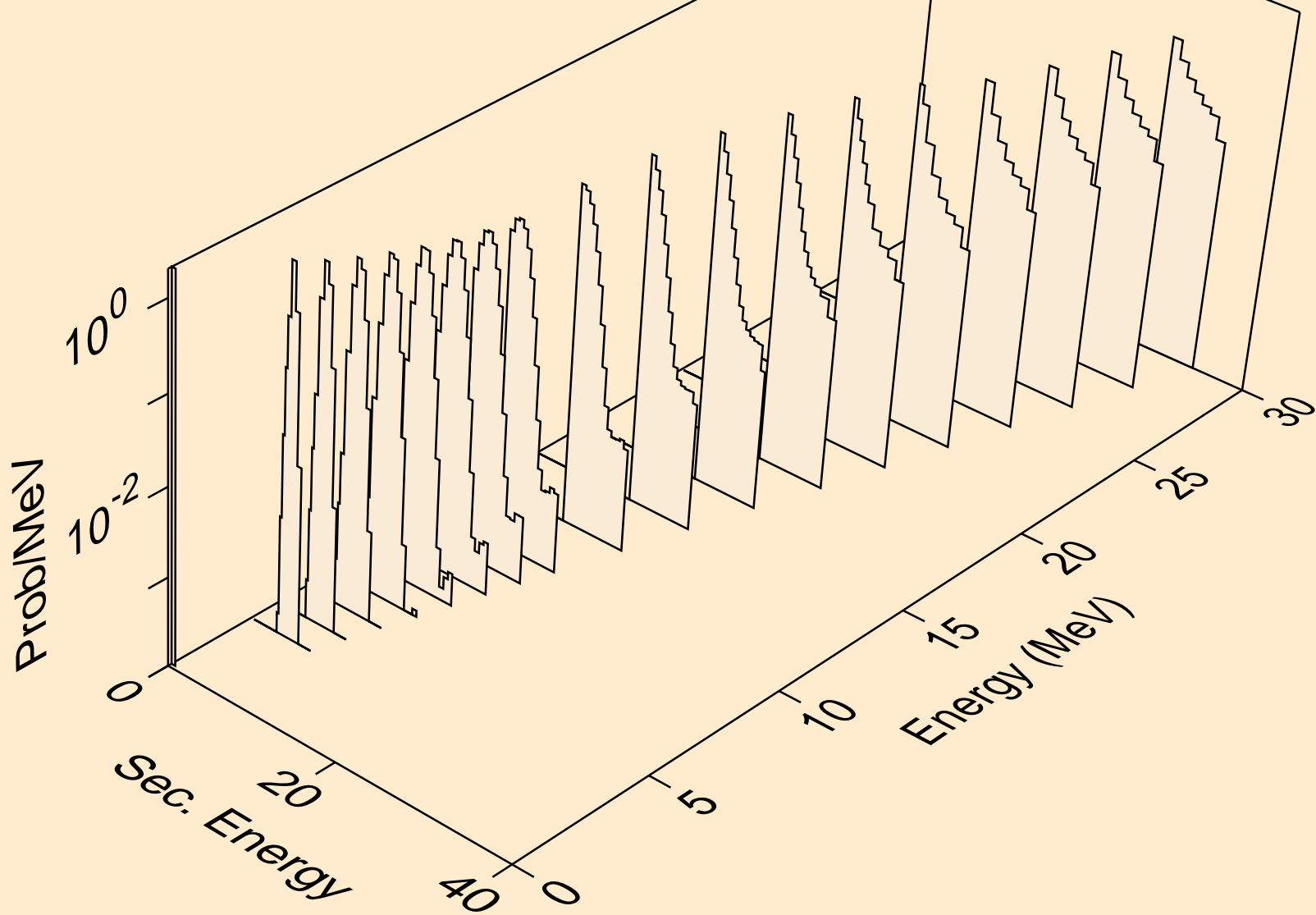

BK239 DEUTERON ACER TENDL-2021 LIBRARY; T=0.K
protons from (d,2p)

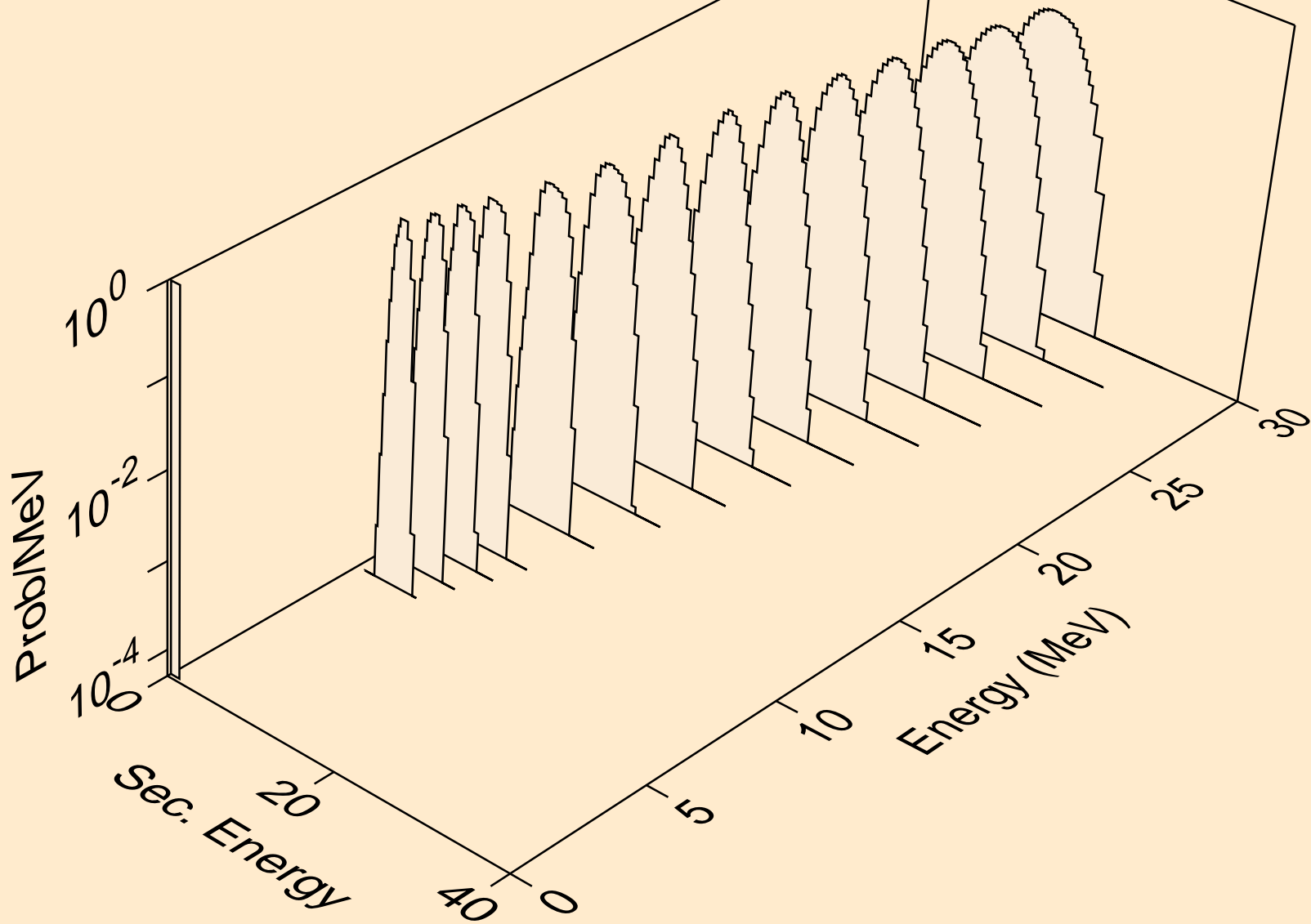

BK239 DEUTERON ACER TENDL-2021 LIBRARY; T=0.K
protons from (d,pa)

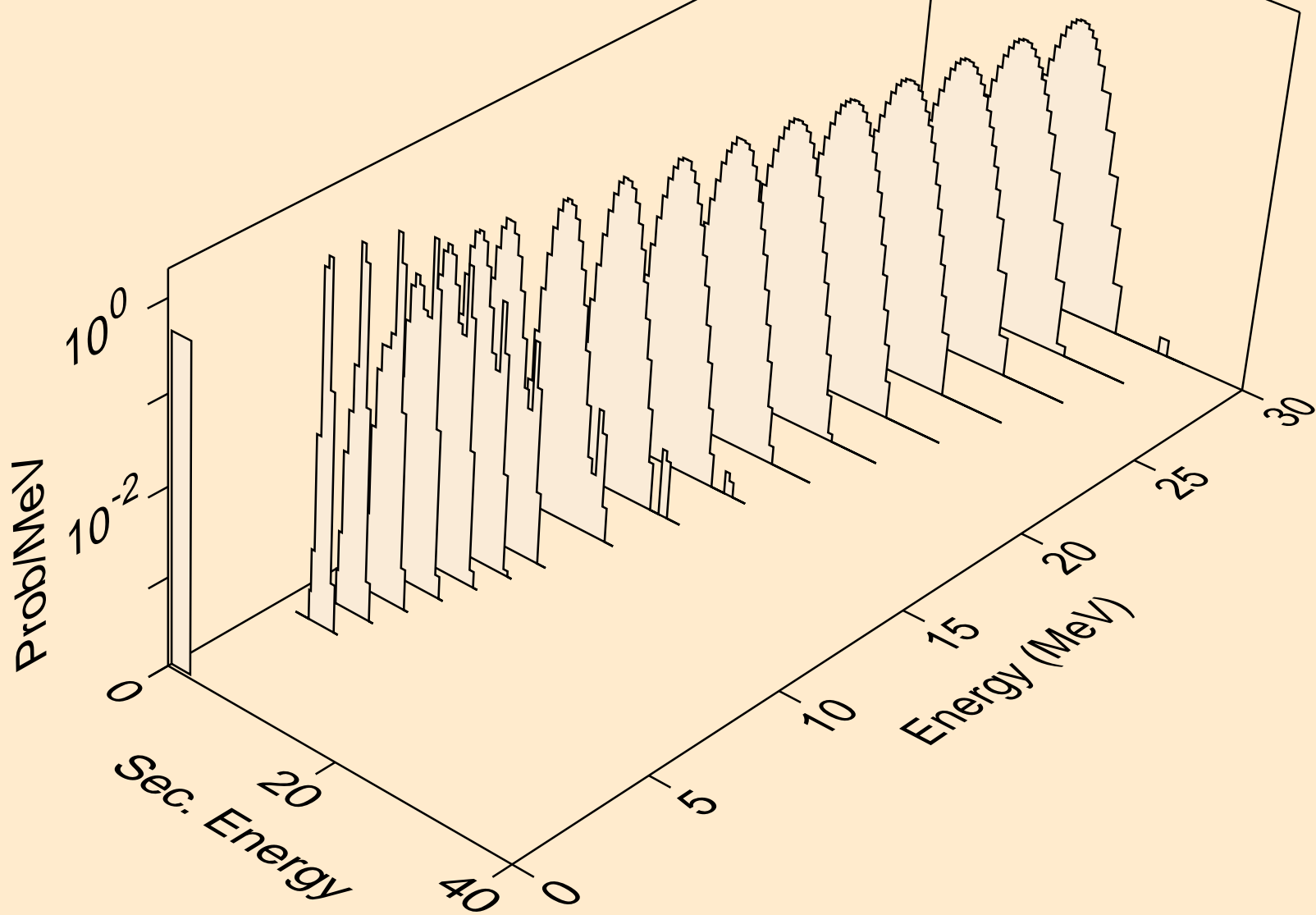

BK239 DEUTERON ACER TENDL-2021 LIBRARY; T=0.K
protons from (d,pd)

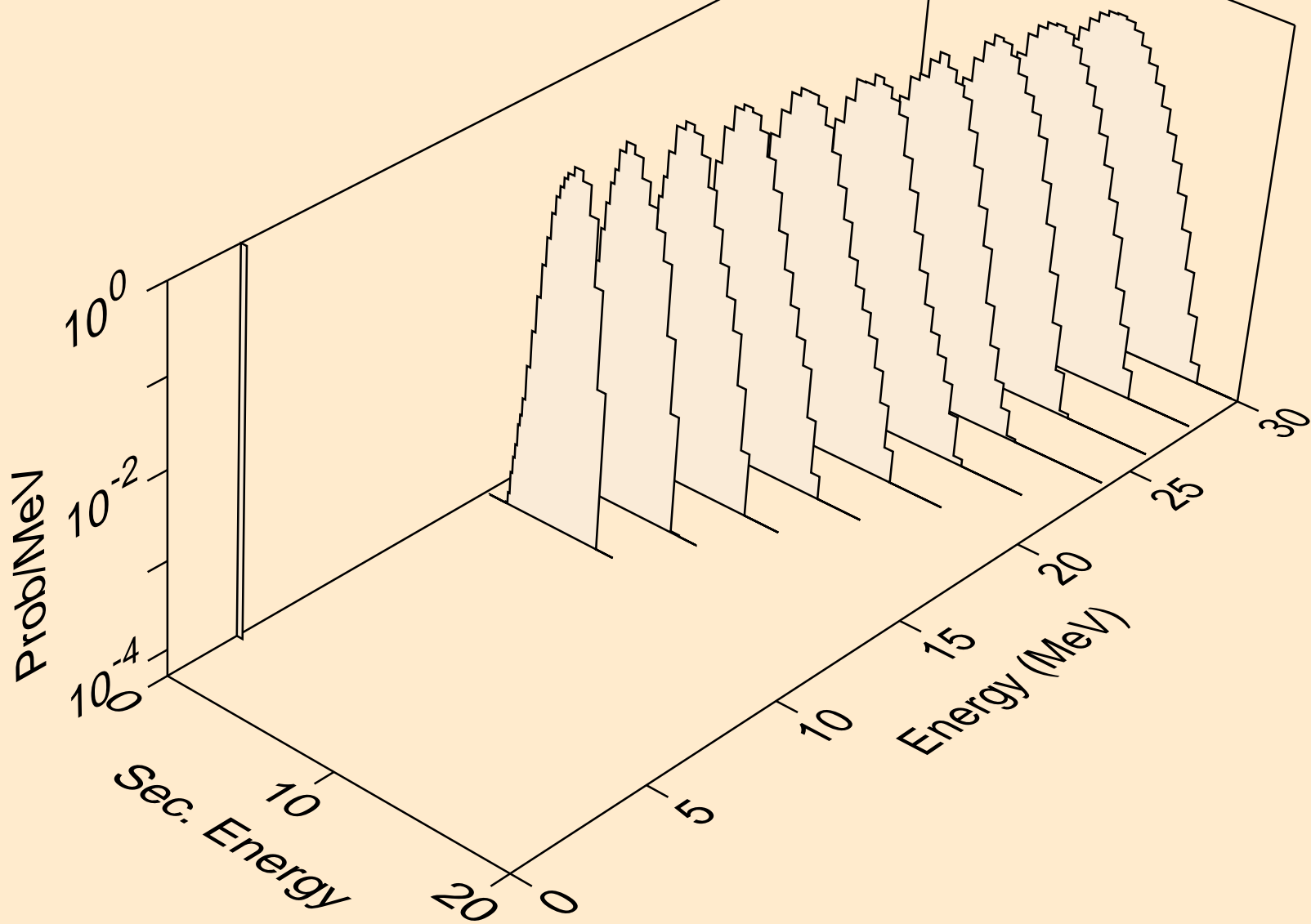

BK239 DEUTERON ACER TENDL-2021 LIBRARY; T=0.K
tritons from (d,x)

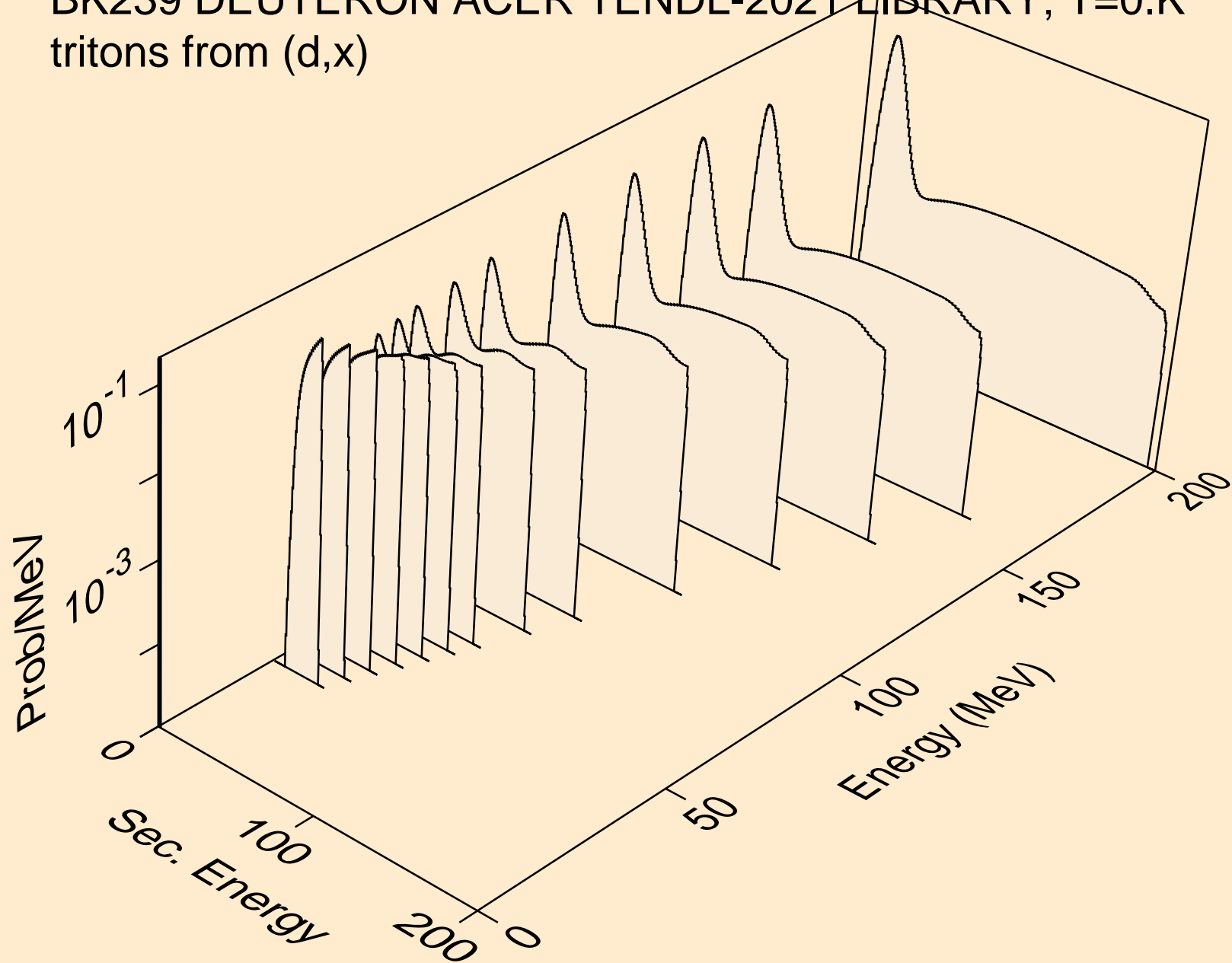

BK239 DEUTERON ACER TENDL-2021 LIBRARY; T=0.K
tritons from (d,n*)t

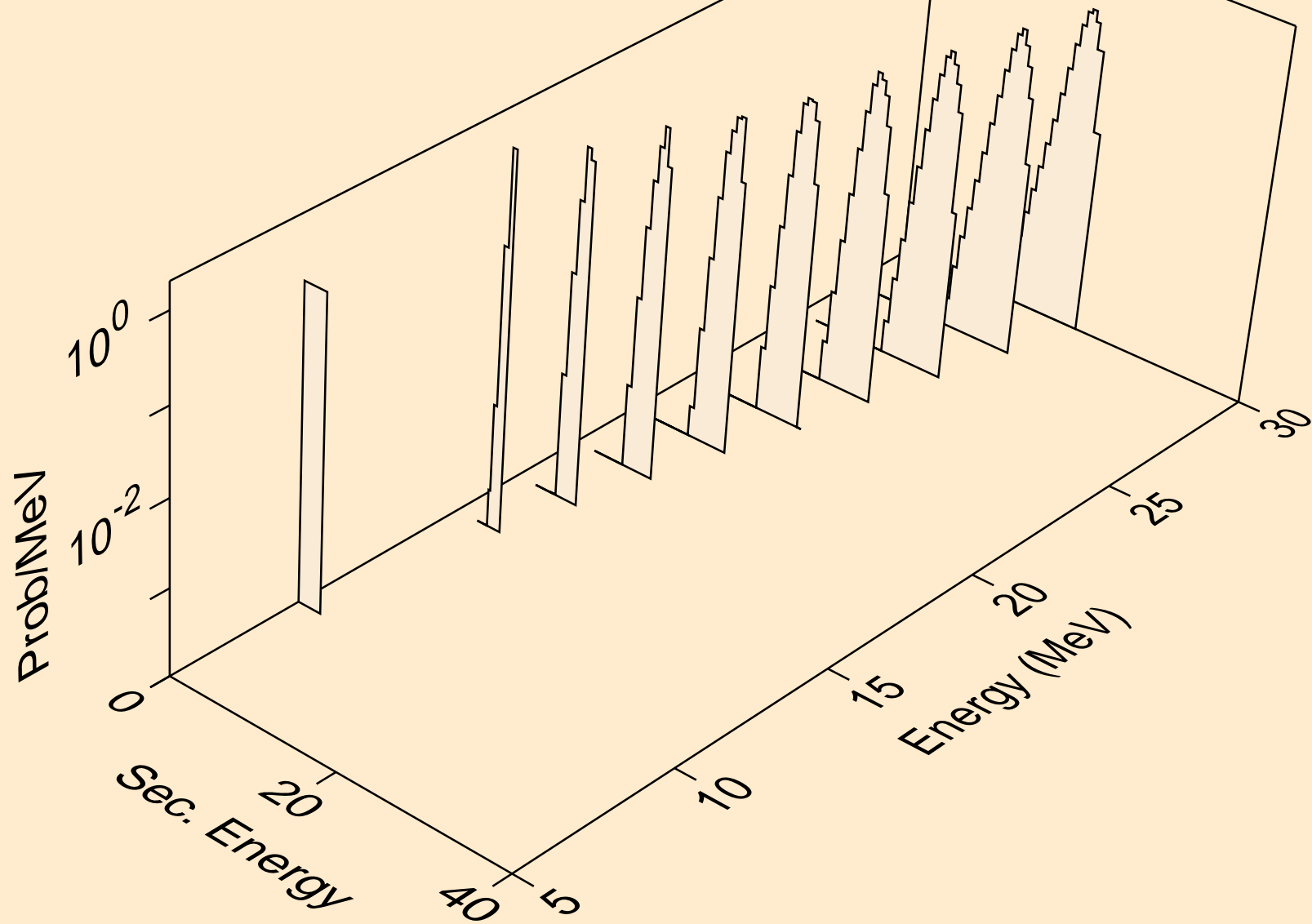

BK239 DEUTERON ACER TENDL-2021 LIBRARY; T=0.K
tritons from (d,t)

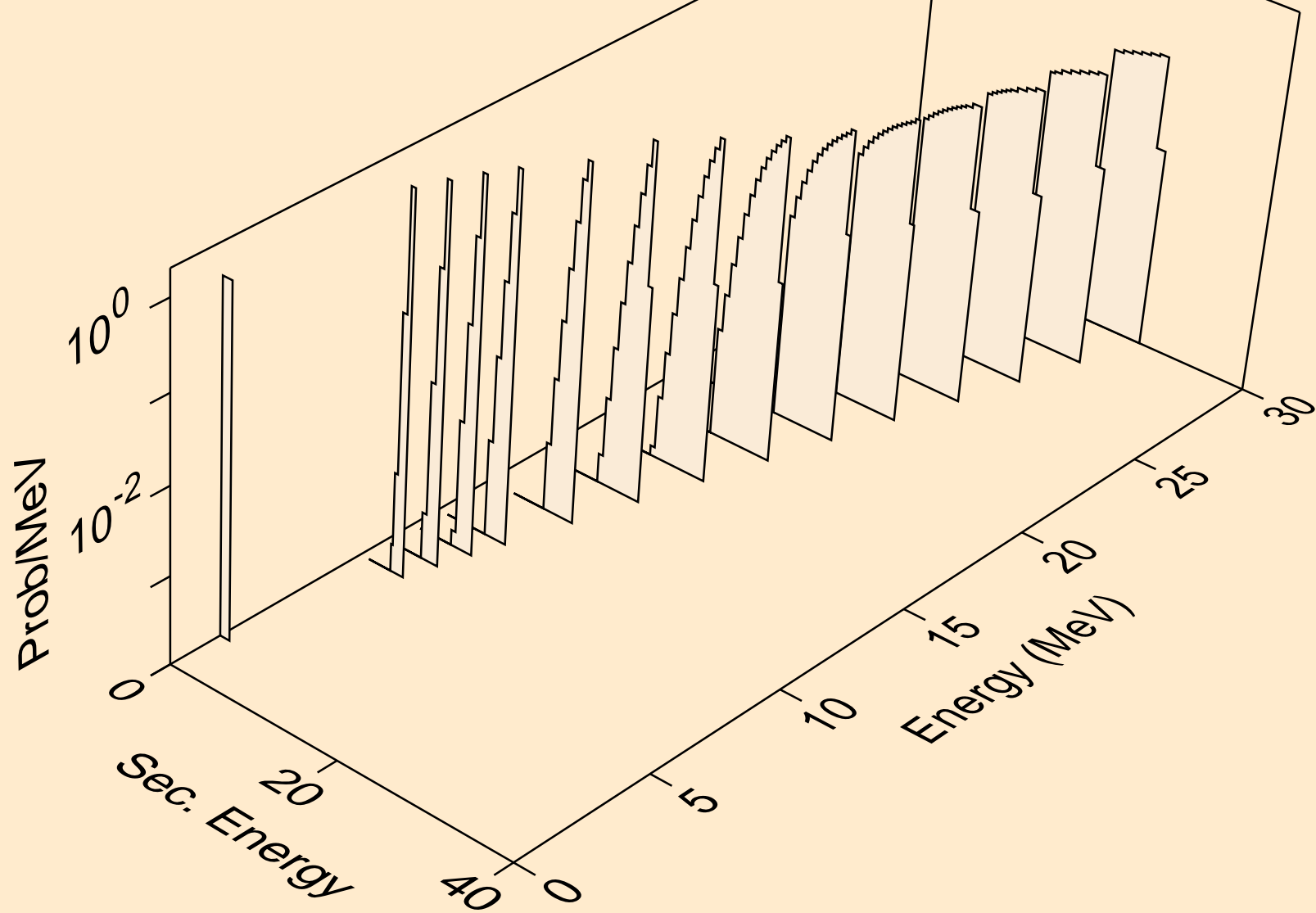

BK239 DEUTERON ACER TENDL-2021 LIBRARY; T=0.K
he3s from (d,x)

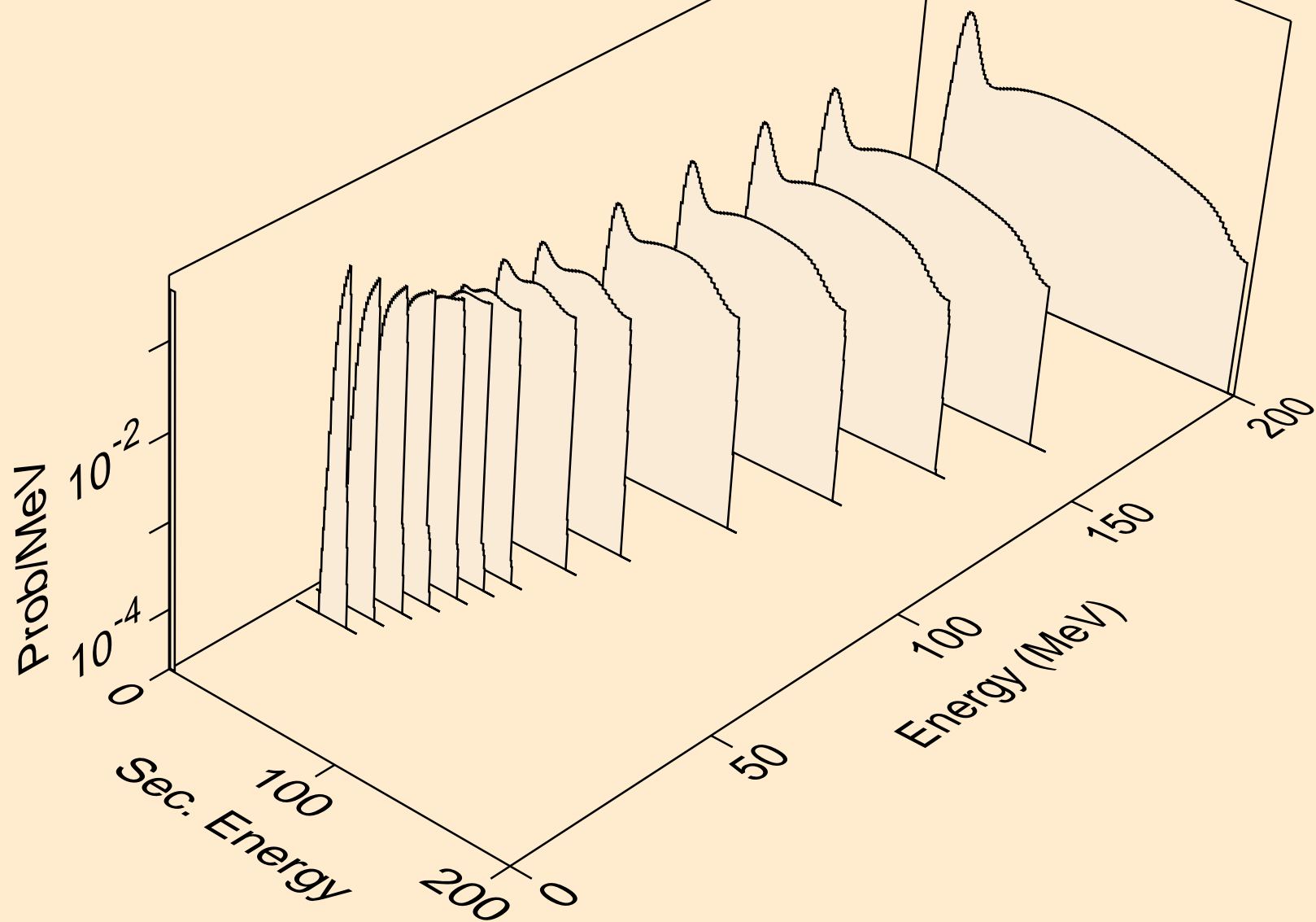

BK239 DEUTERON ACER TENDL-2021 LIBRARY; T=0.K
he3s from (d,n*)he3

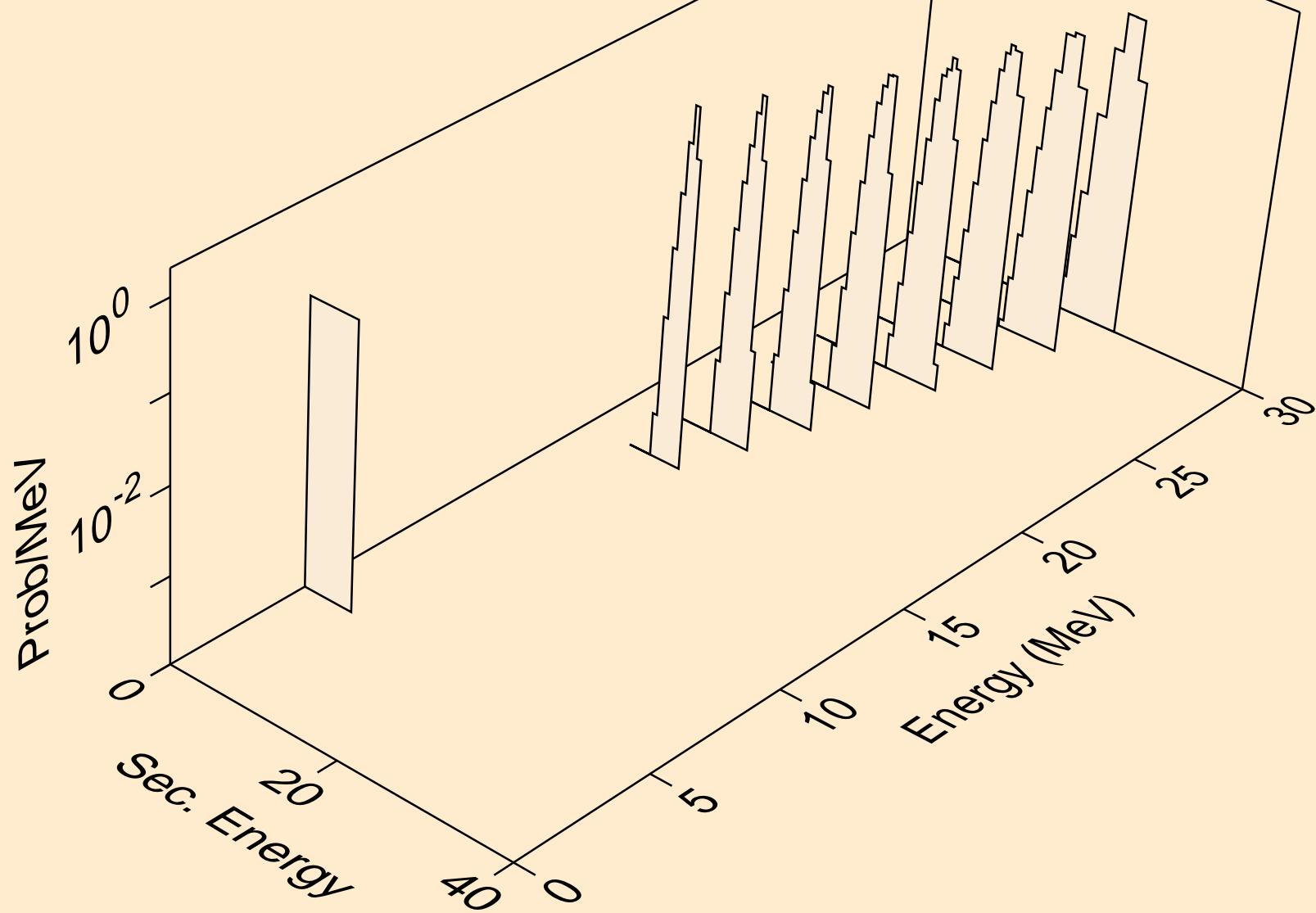

BK239 DEUTERON ACER TENDL-2021 LIBRARY; T=0.K
he3s from (d,he3)

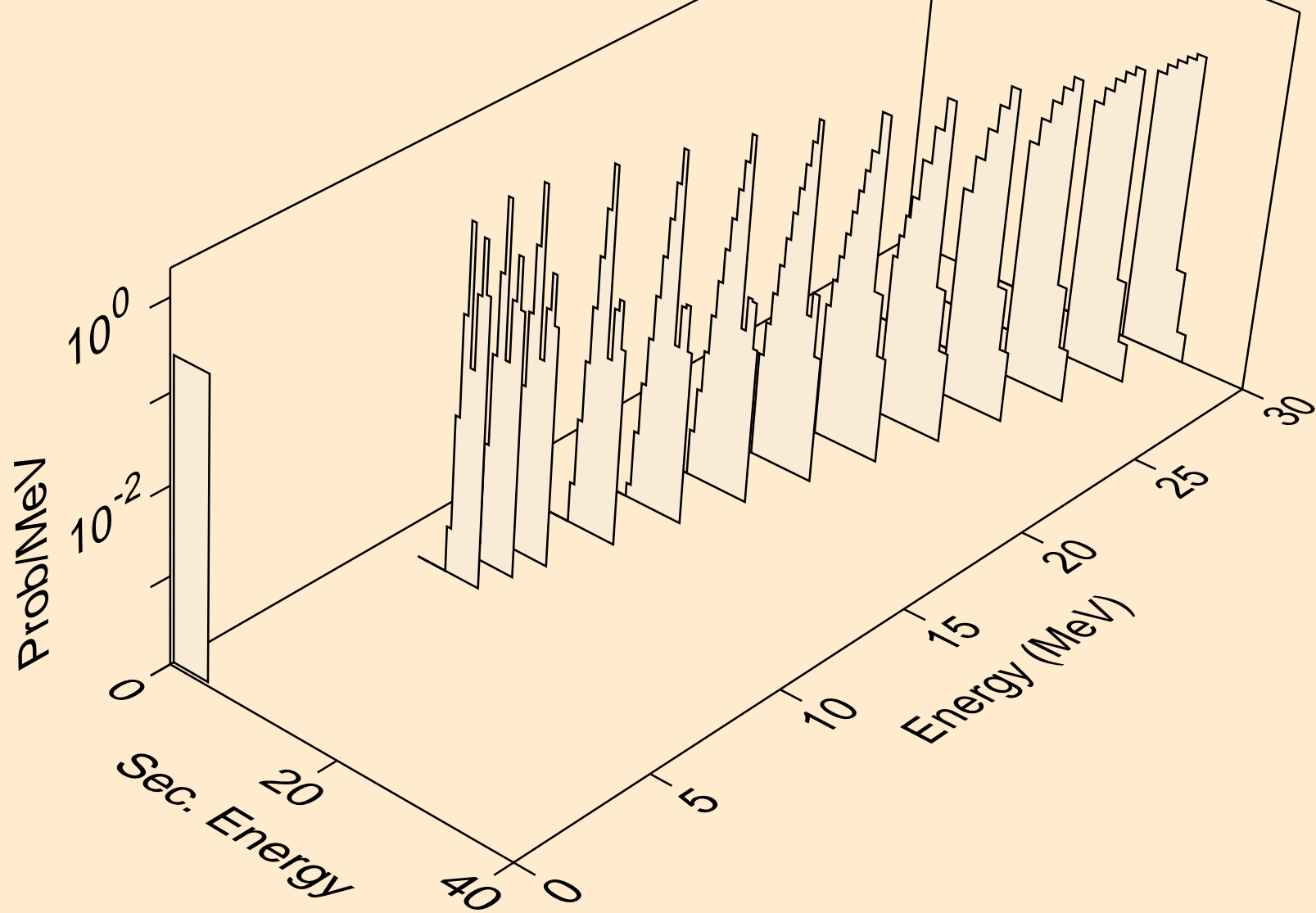

BK239 DEUTERON ACER TENDL-2021 LIBRARY; T=0.K
alphas from (d,x)

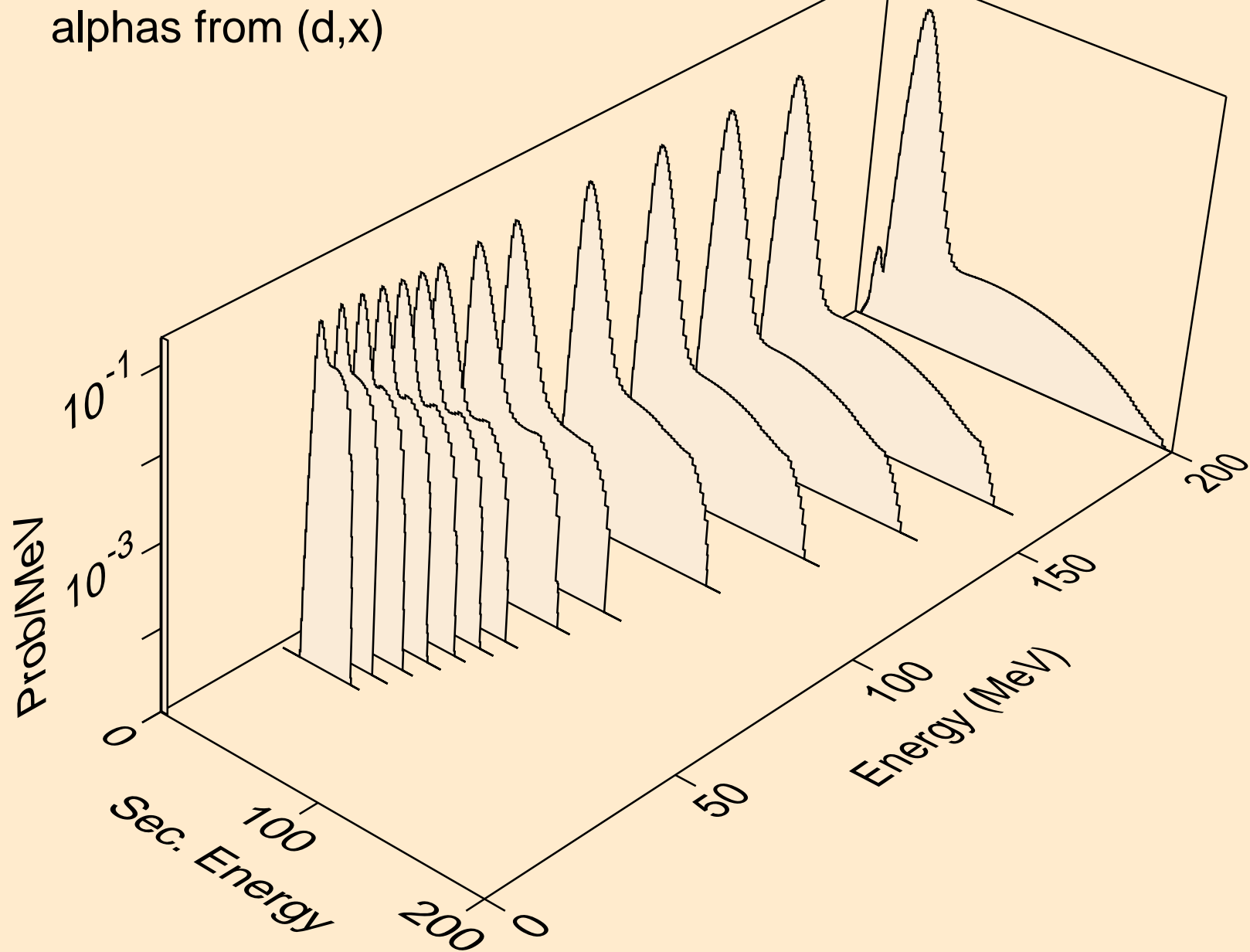

BK239 DEUTERON ACER TENDL-2021 LIBRARY; T=0.K
alphas from (d,n*)a

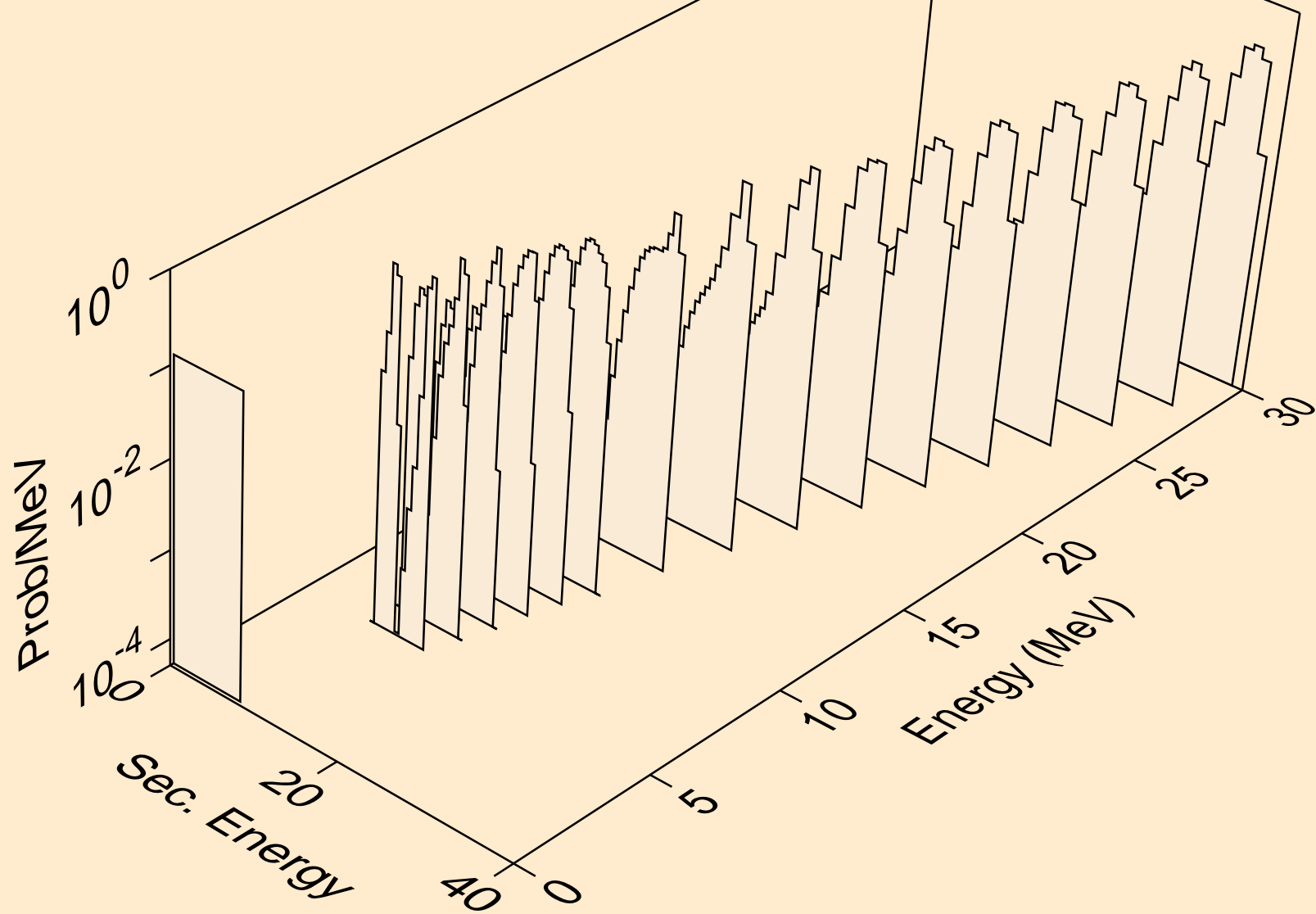

BK239 DEUTERON ACER TENDL-2021 LIBRARY; T=0.K
alphas from (d,2n)a

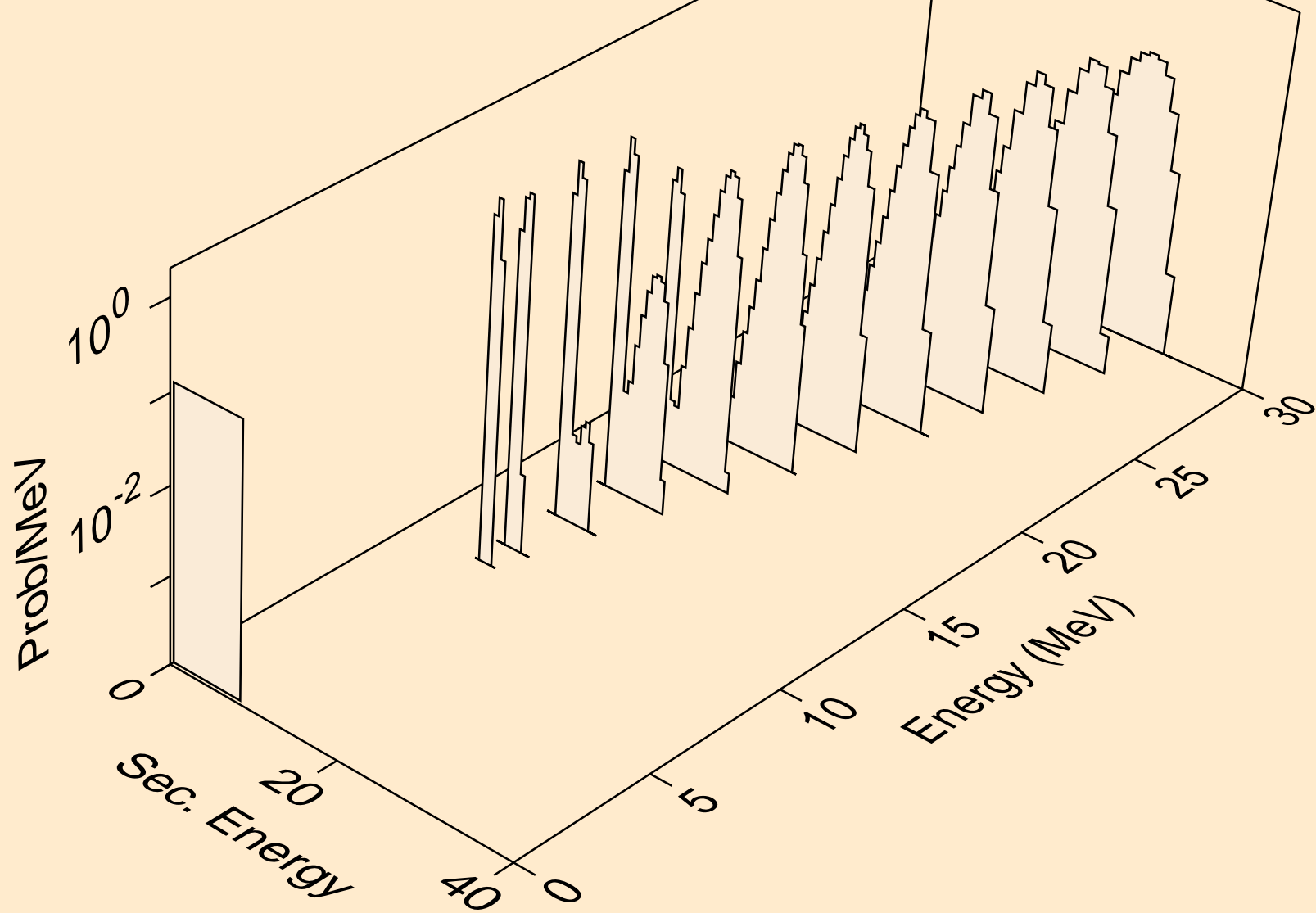

BK239 DEUTERON ACER TENDL-2021 LIBRARY; T=0.K
alphas from (d,a)

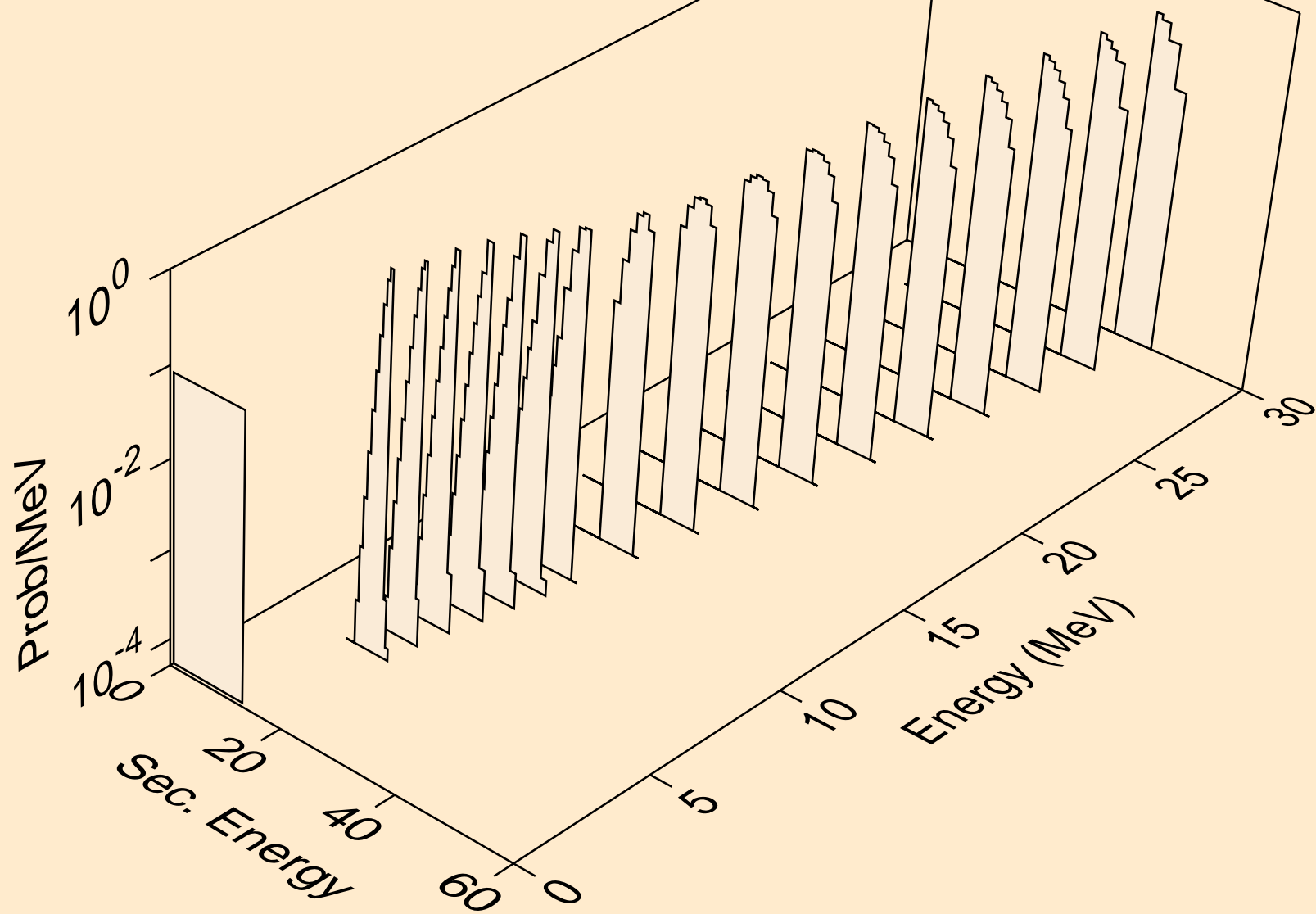

BK239 DEUTERON ACER TENDL-2021 LIBRARY; T=0.K
alphas from (d,pa)

