

NO257 DEUTERON ACER TENDL-2021 LIBRARY; T=0.K
Principal cross sections

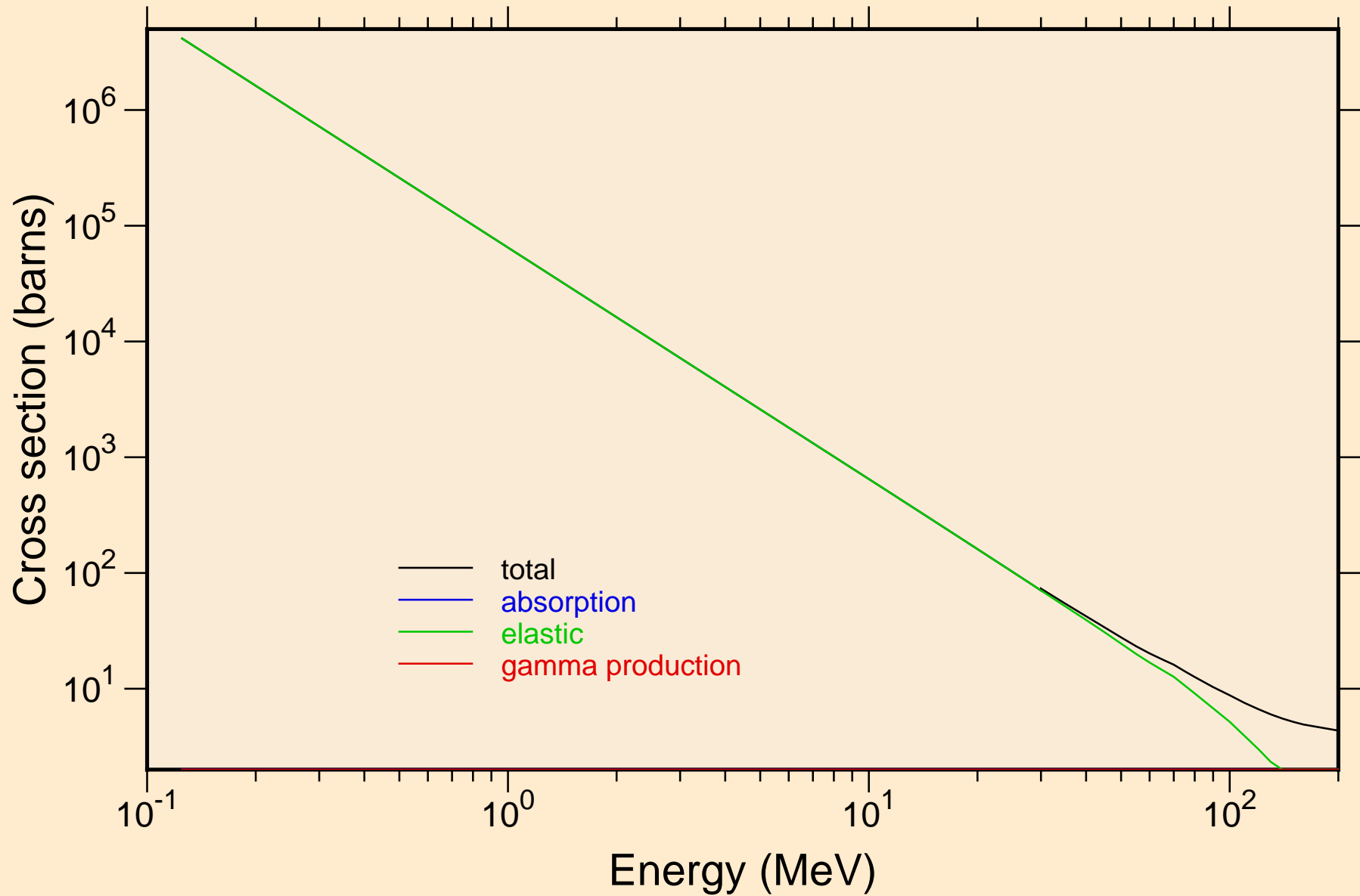

NO257 DEUTERON ACER TENDL-2021 LIBRARY; T=0.K
Heating

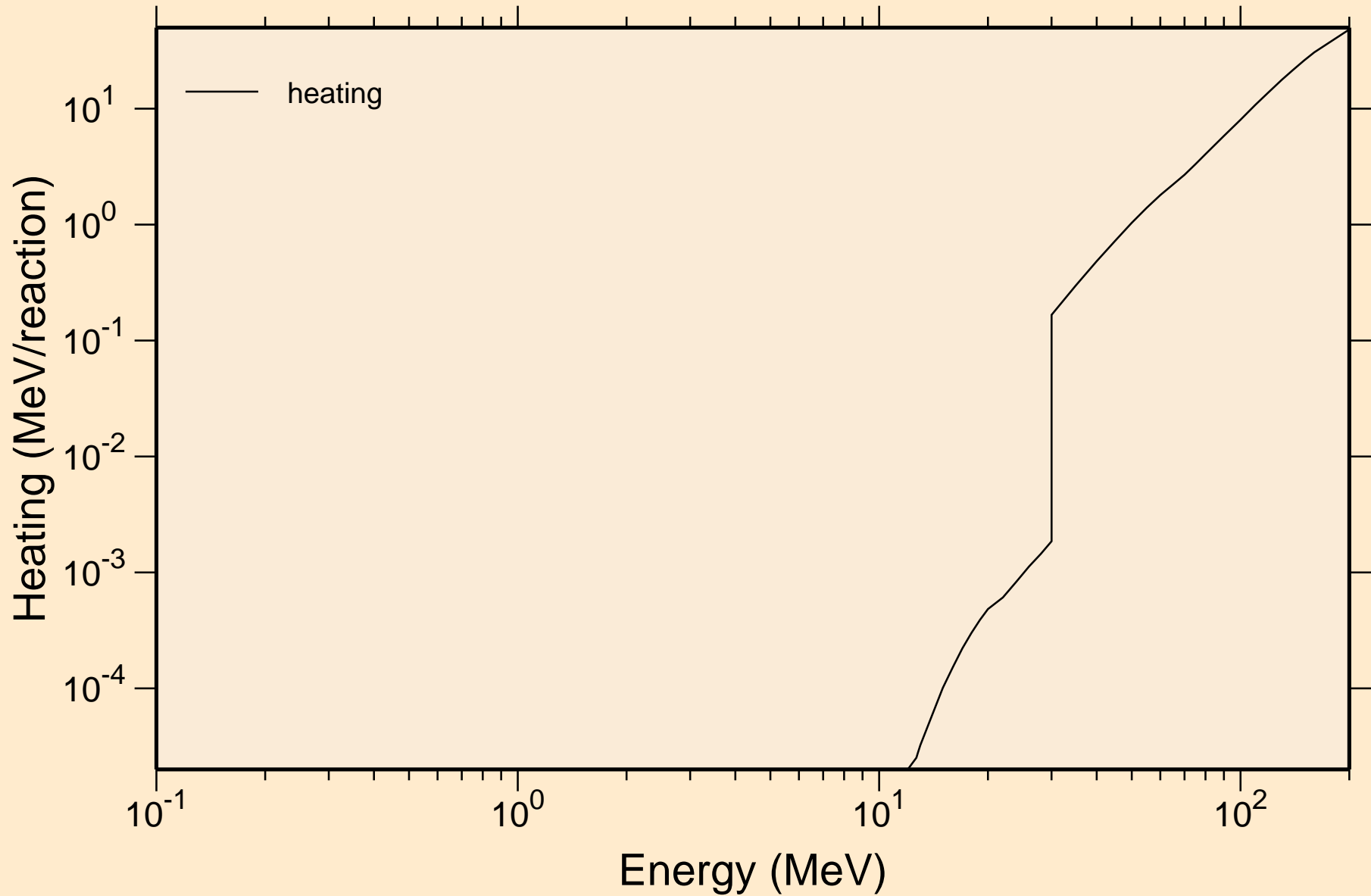

NO257 DEUTERON ACER TENDL-2021 LIBRARY; T=0.K
Principal cross sections

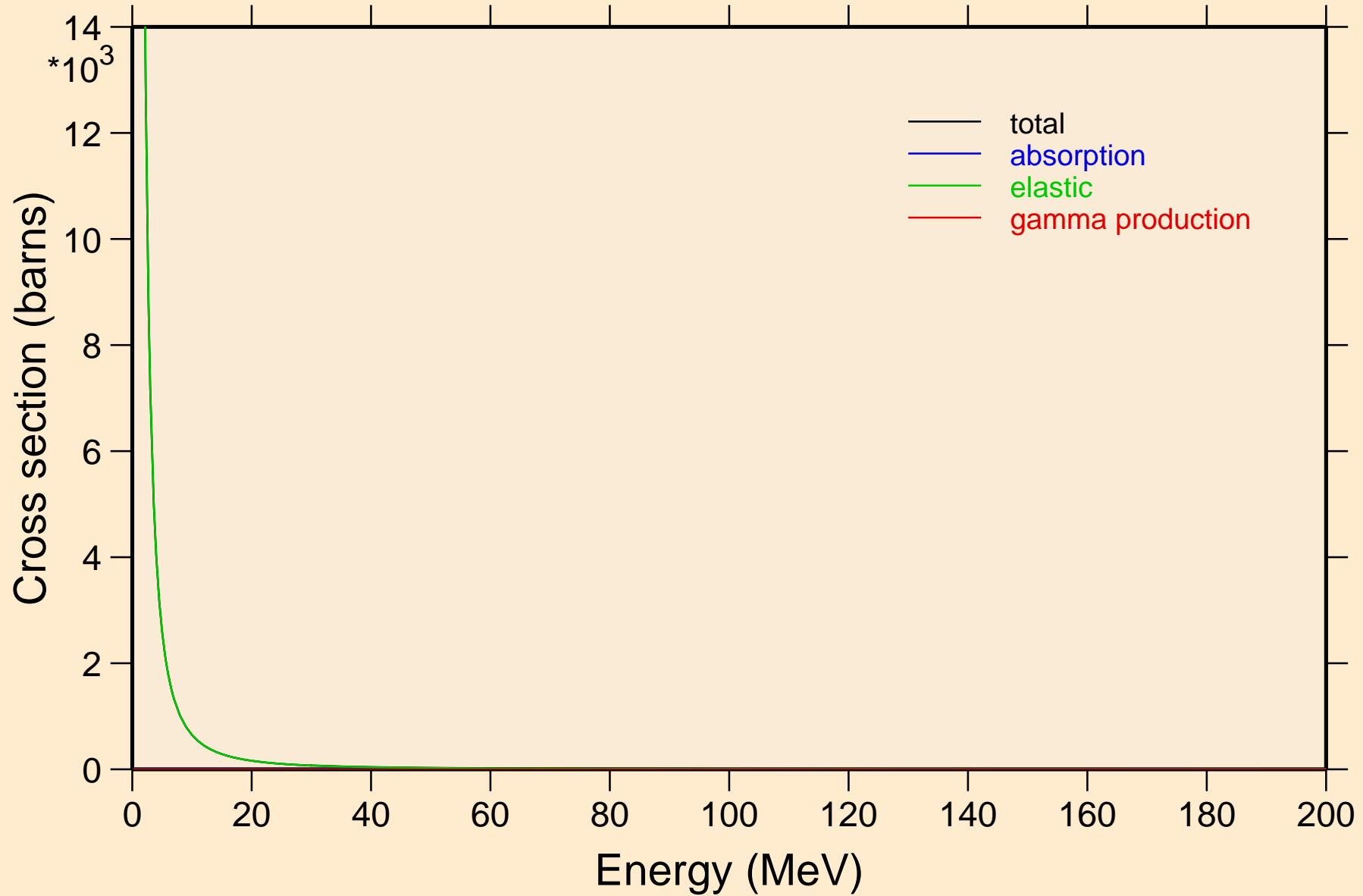

NO257 DEUTERON ACER TENDL-2021 LIBRARY; T=0.K

Heating

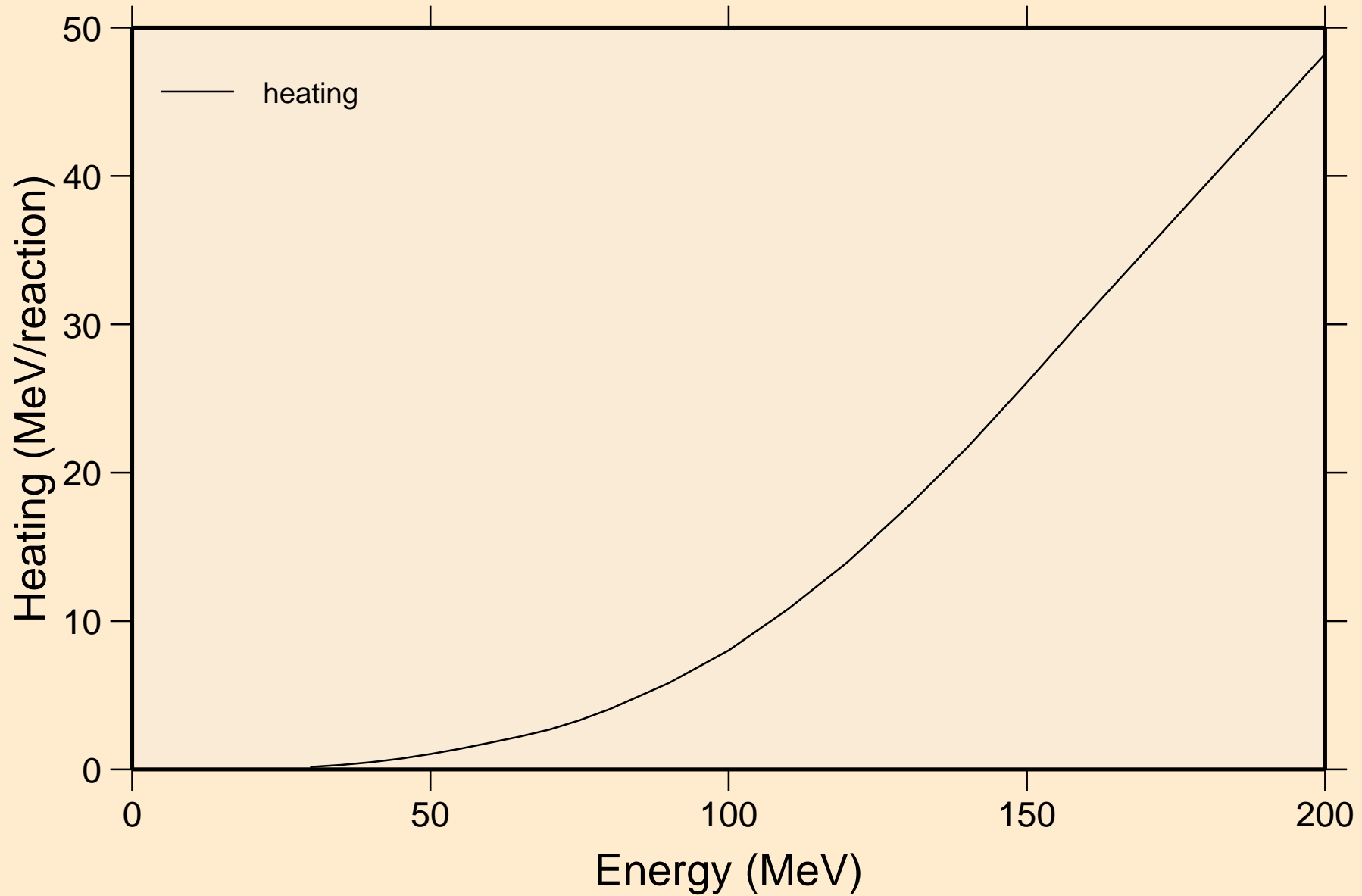

NO257 DEUTERON ACER TENDL-2021 LIBRARY; T=0.K

Threshold reactions

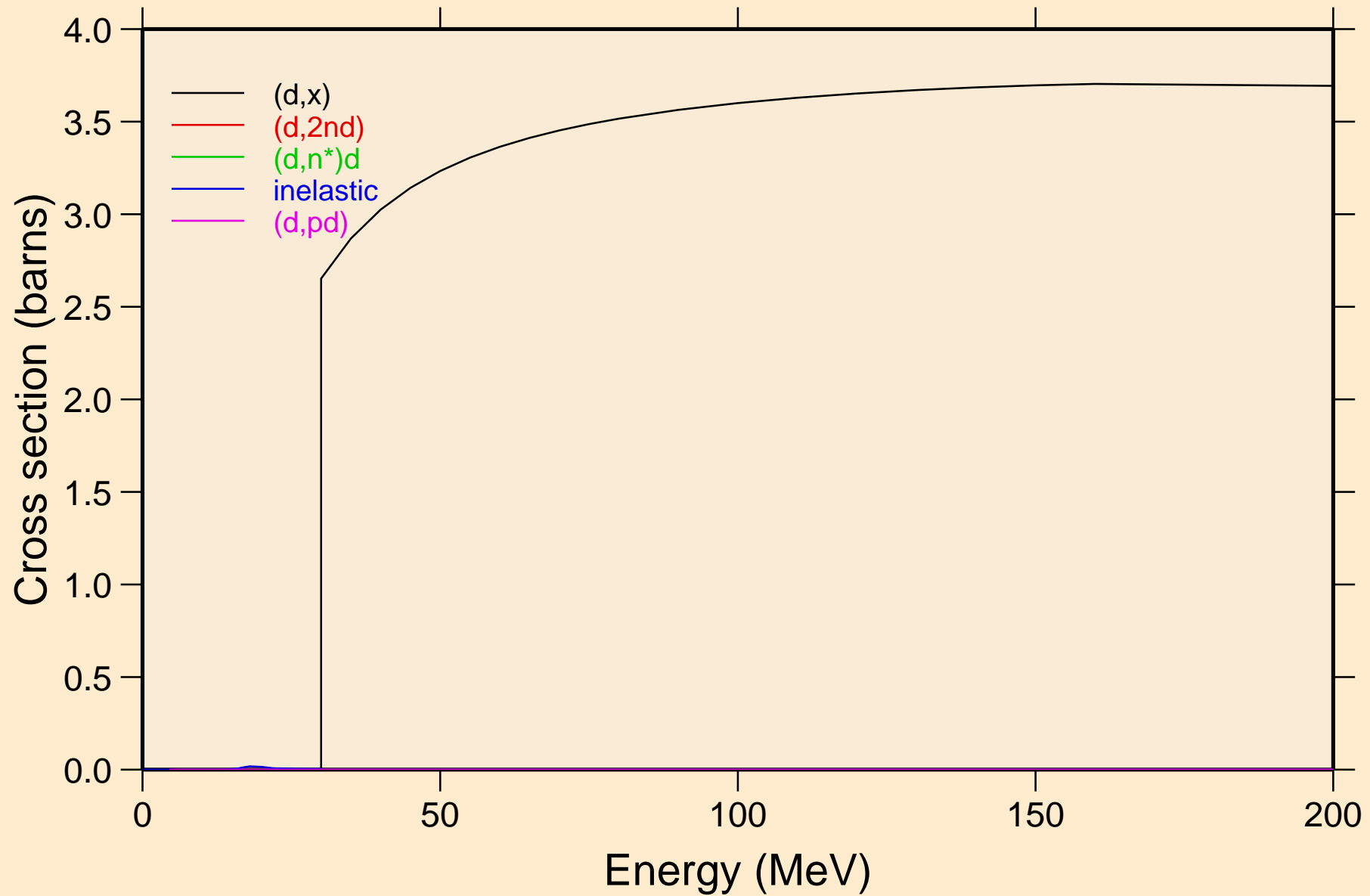

NO257 DEUTERON ACER TENDL-2021 LIBRARY; T=0.K
Threshold reactions

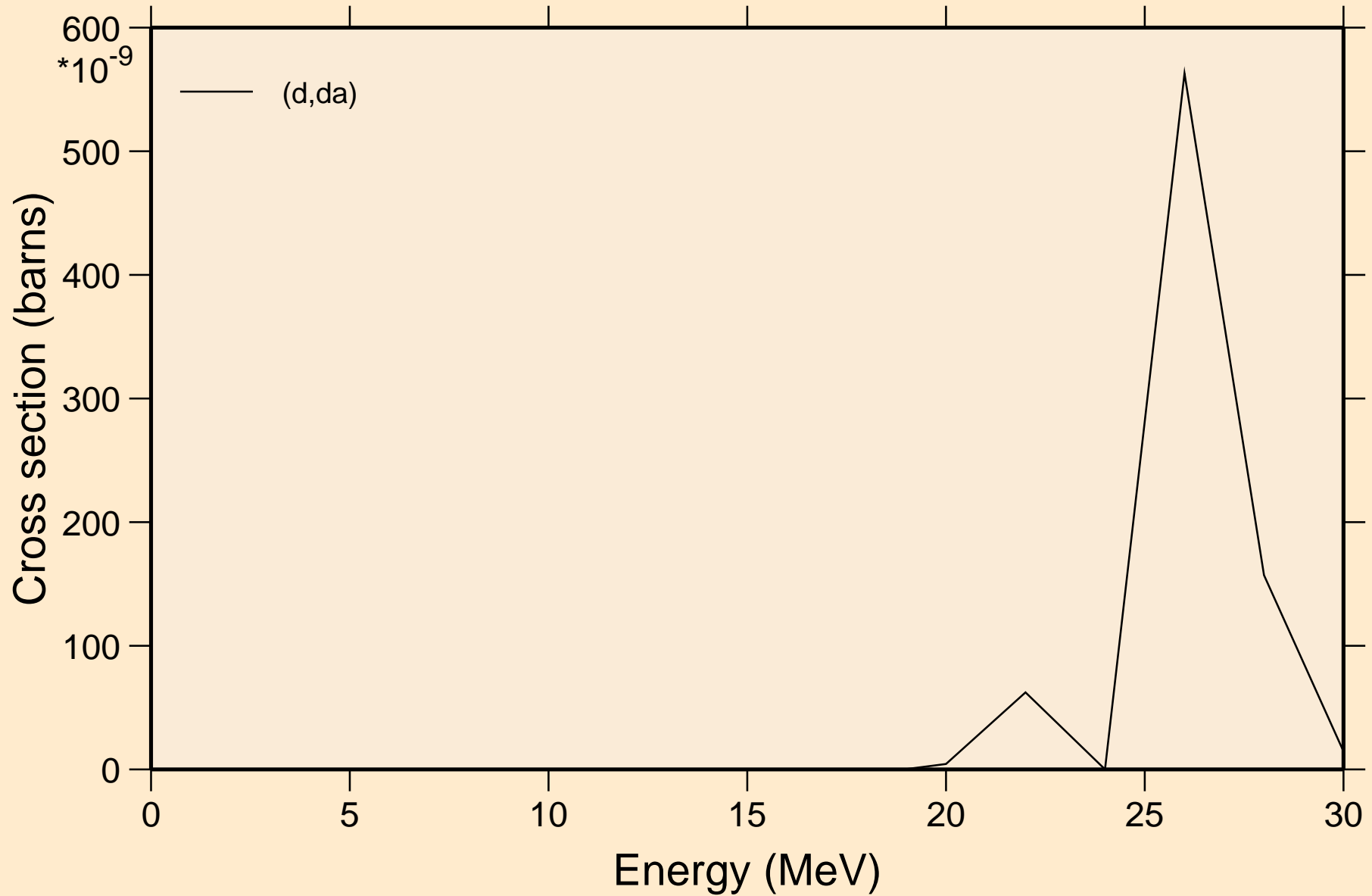

NO257 DEUTERON ACER TENDL-2021 LIBRARY; T=0.K
angular distribution for elastic

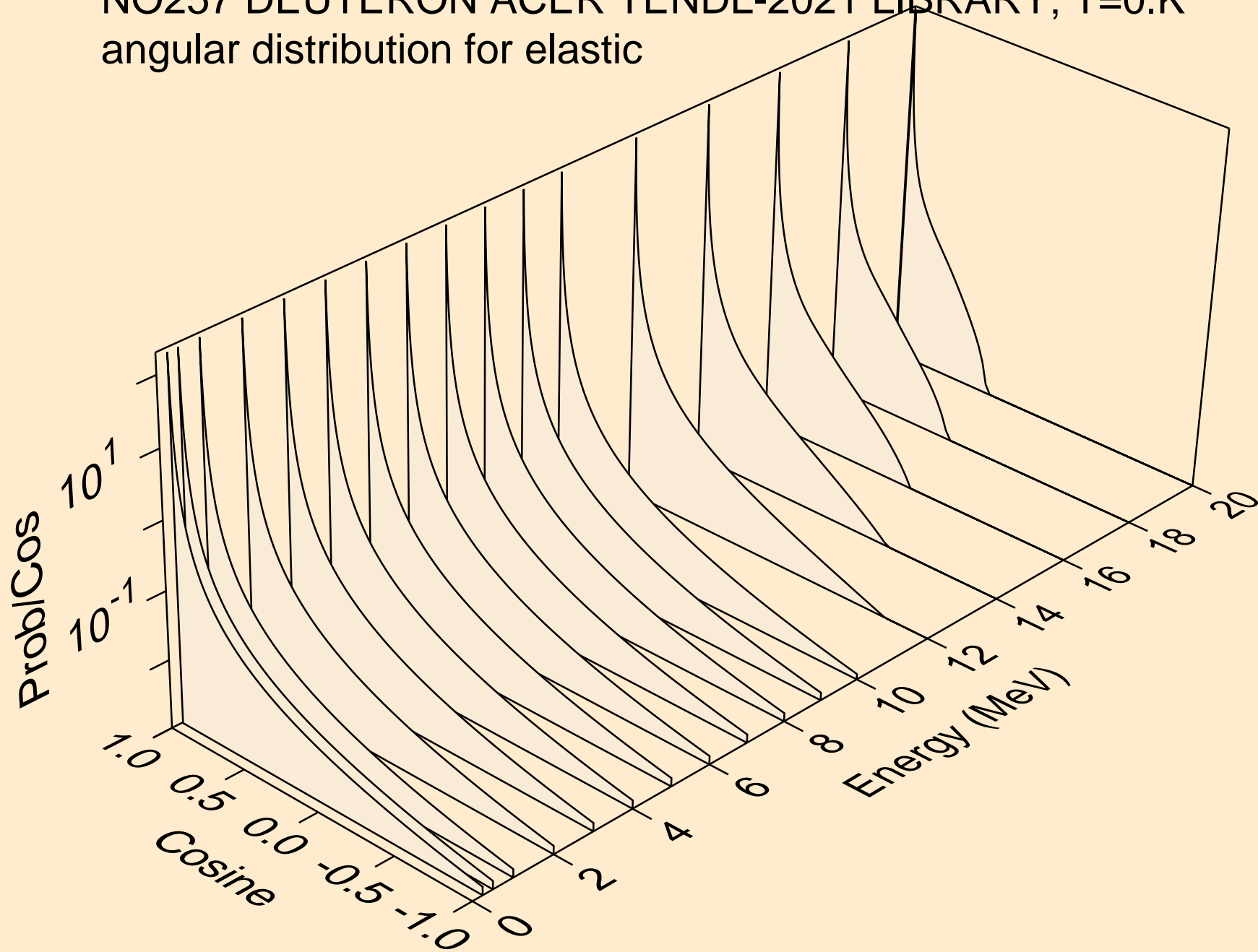

NO257 DEUTERON ACER TENDL-2021 LIBRARY; T=0.K
angular distribution for elastic

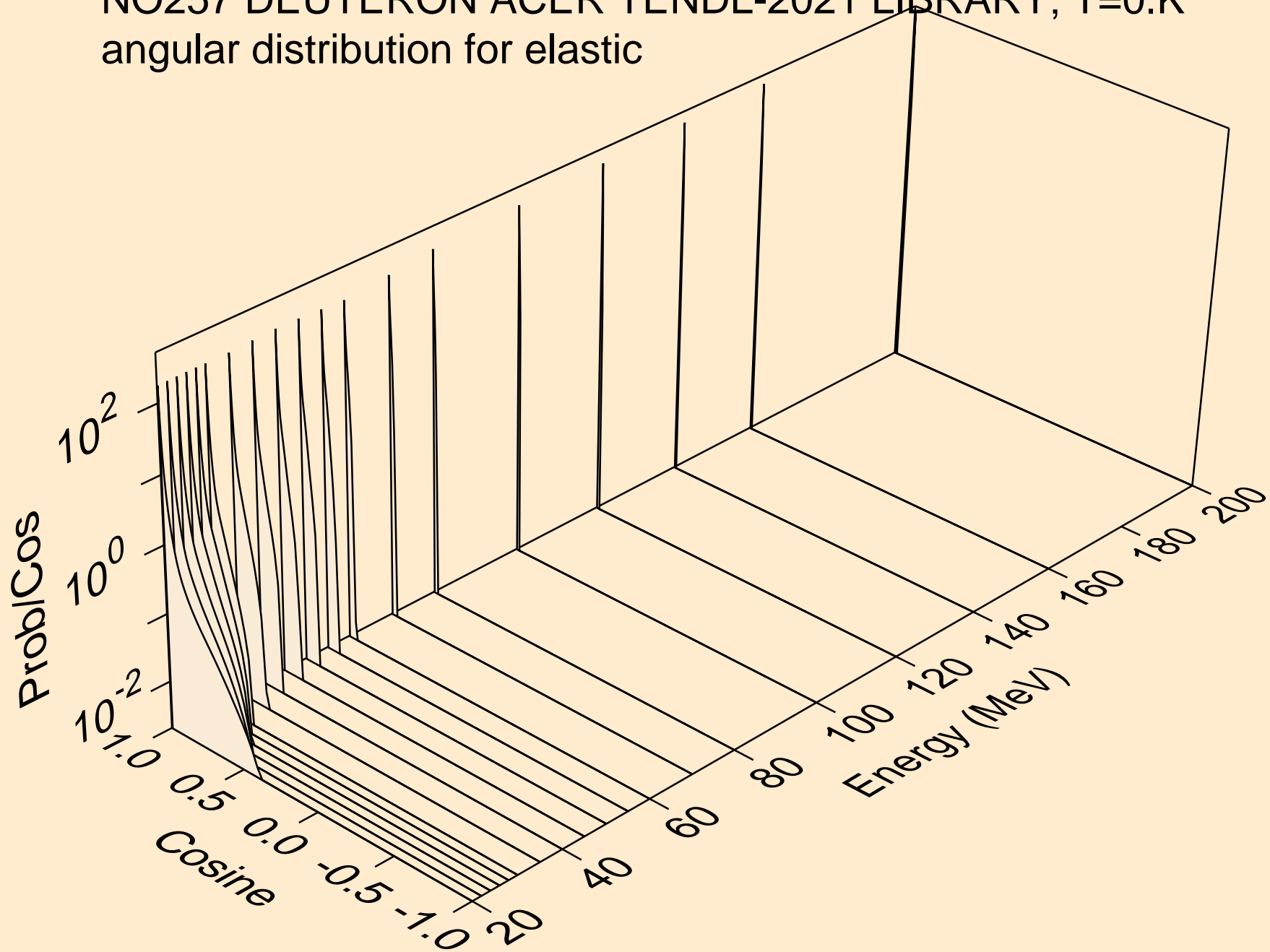

NO257 DEUTERON ACER TENDL-2021 LIBRARY; T=0.K
Deuteron emission for (d,x)

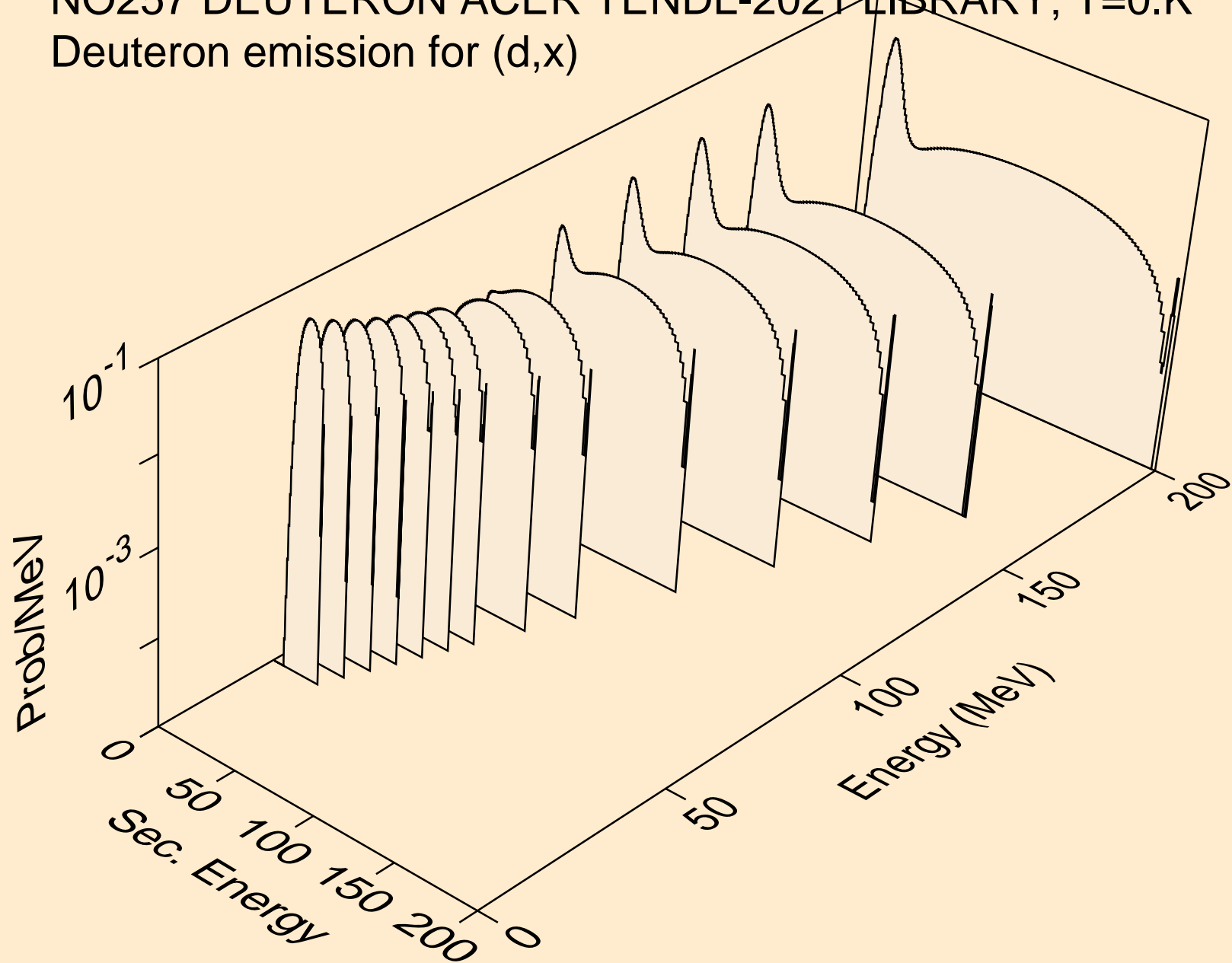

NO257 DEUTERON ACER TENDL-2021 LIBRARY; T=0.K
Deuteron emission for (d,2nd)

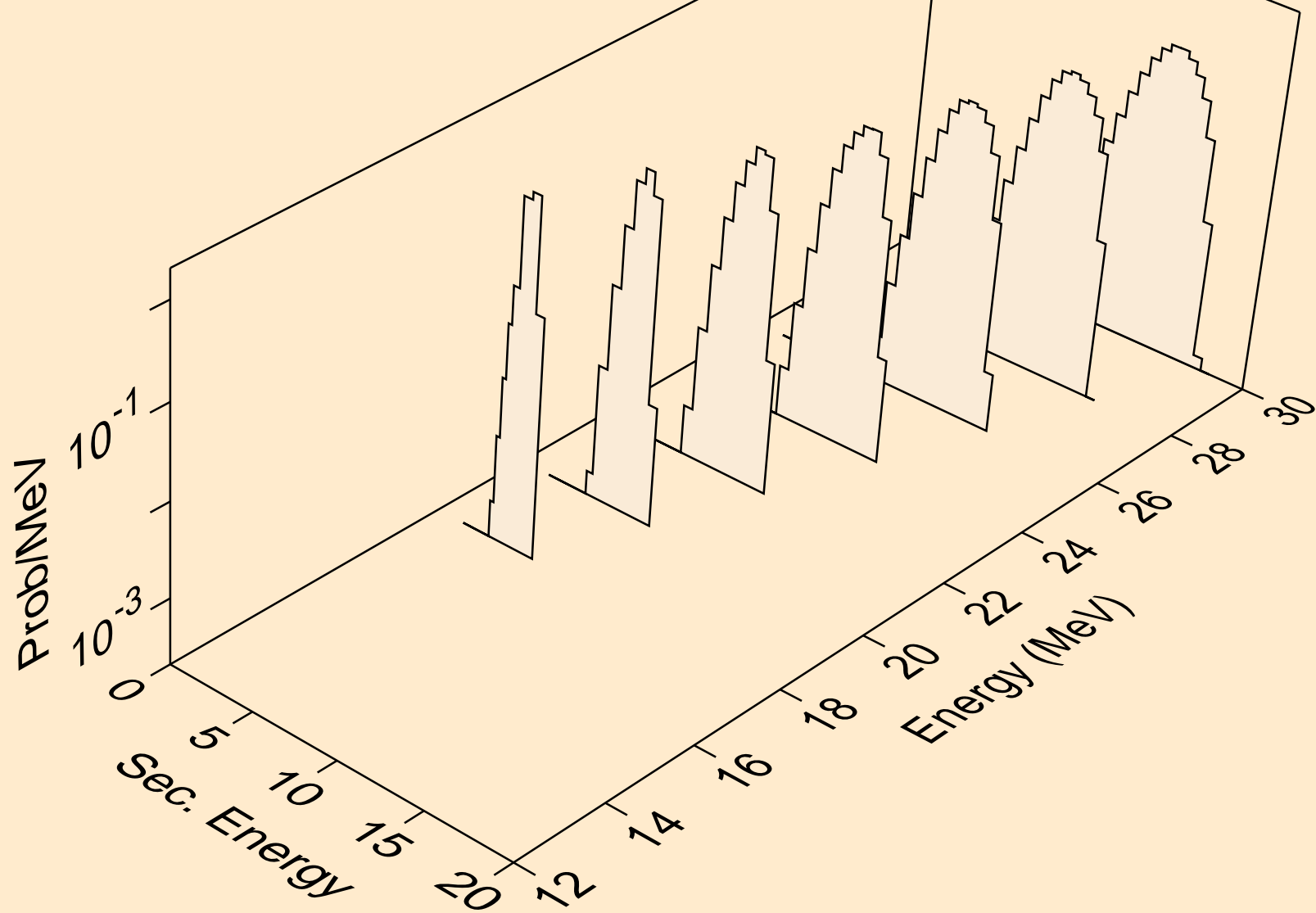

NO257 DEUTERON ACER TENDL-2021 LIBRARY; T=0.K
Deuteron emission for (d,n*)d

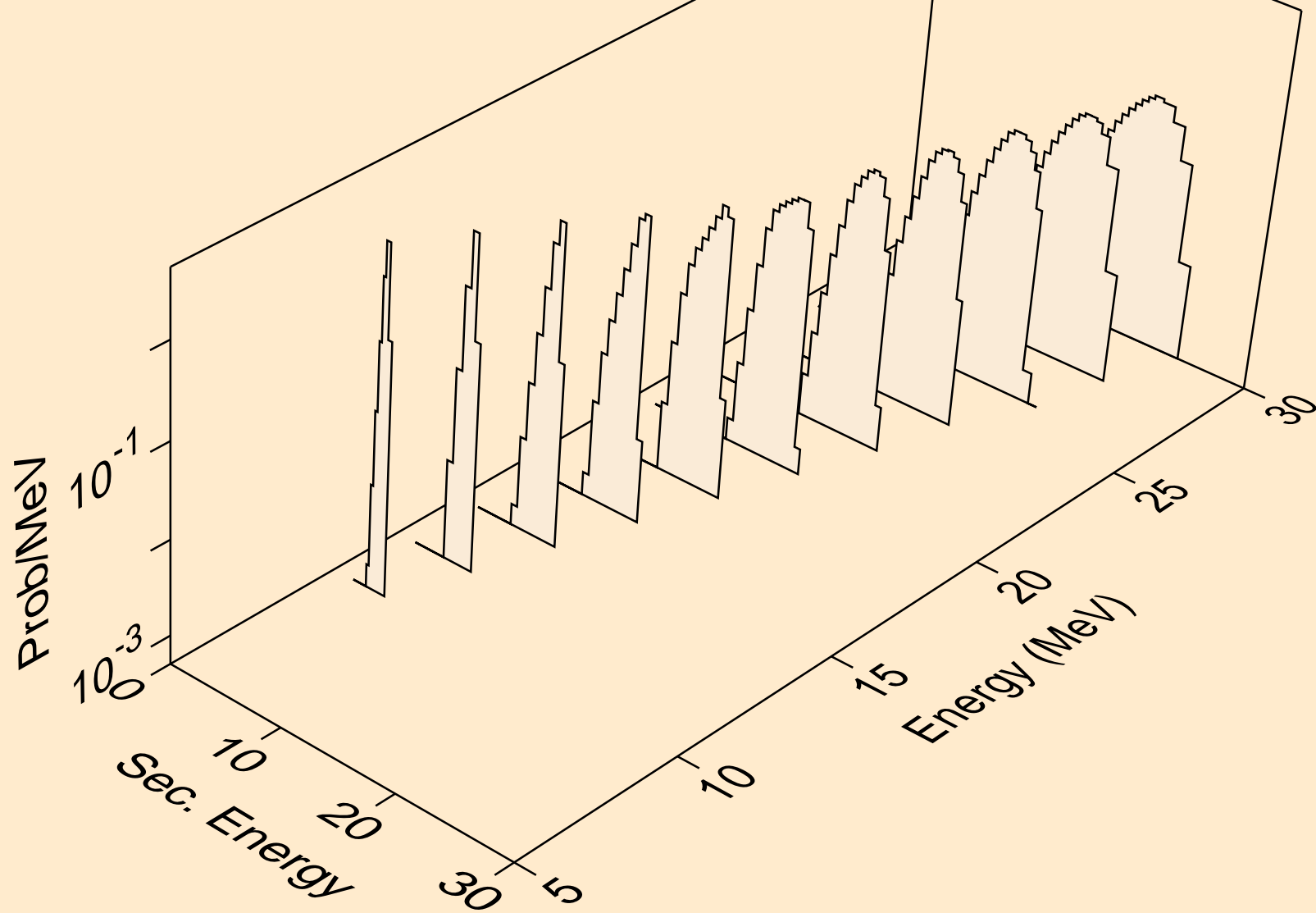

NO257 DEUTERON ACER TENDL-2021 LIBRARY; T=0.K
Deuteron emission for inelastic

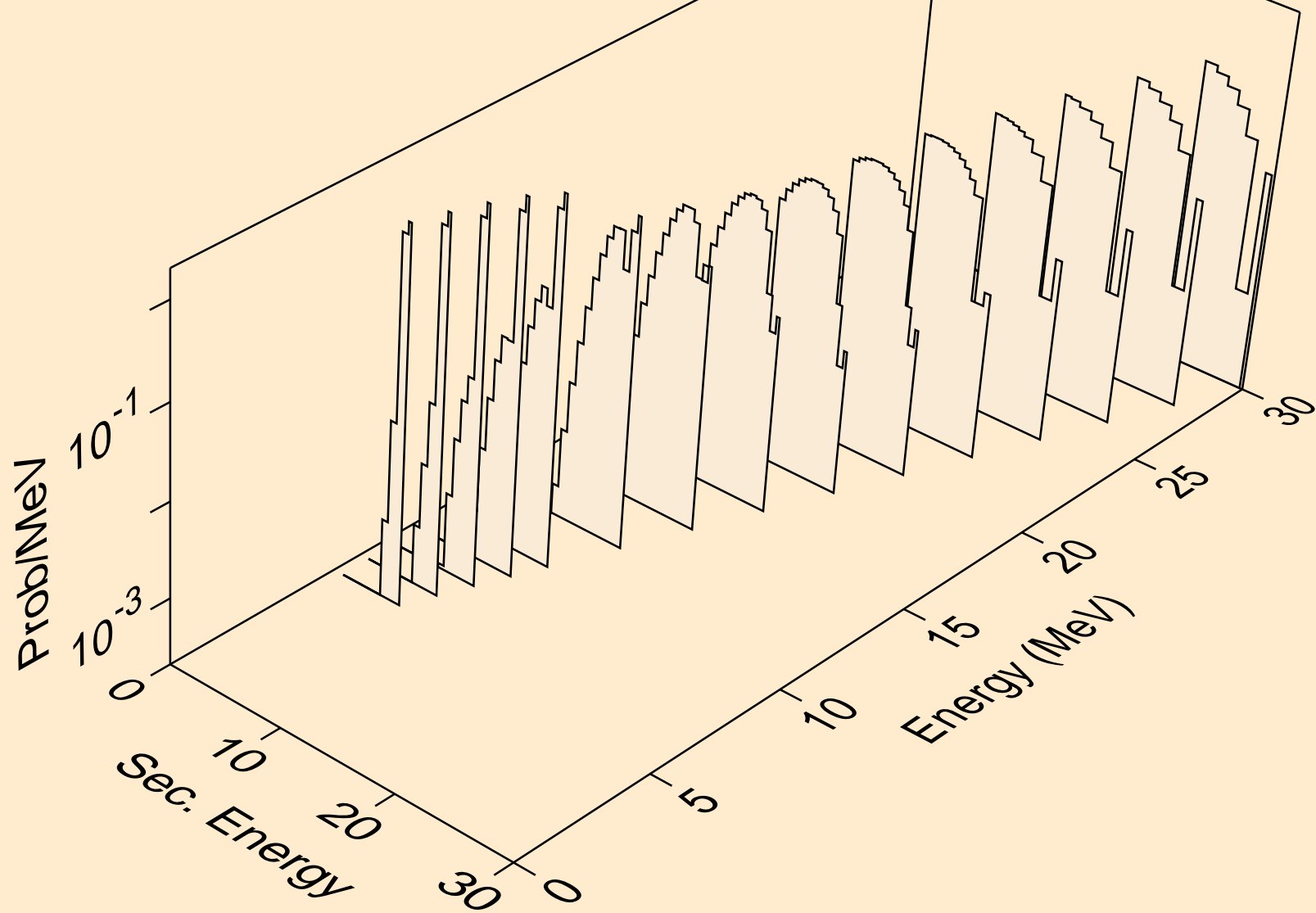

NO257 DEUTERON ACER TENDL-2021 LIBRARY; T=0.K
Deuteron emission for (d,pd)

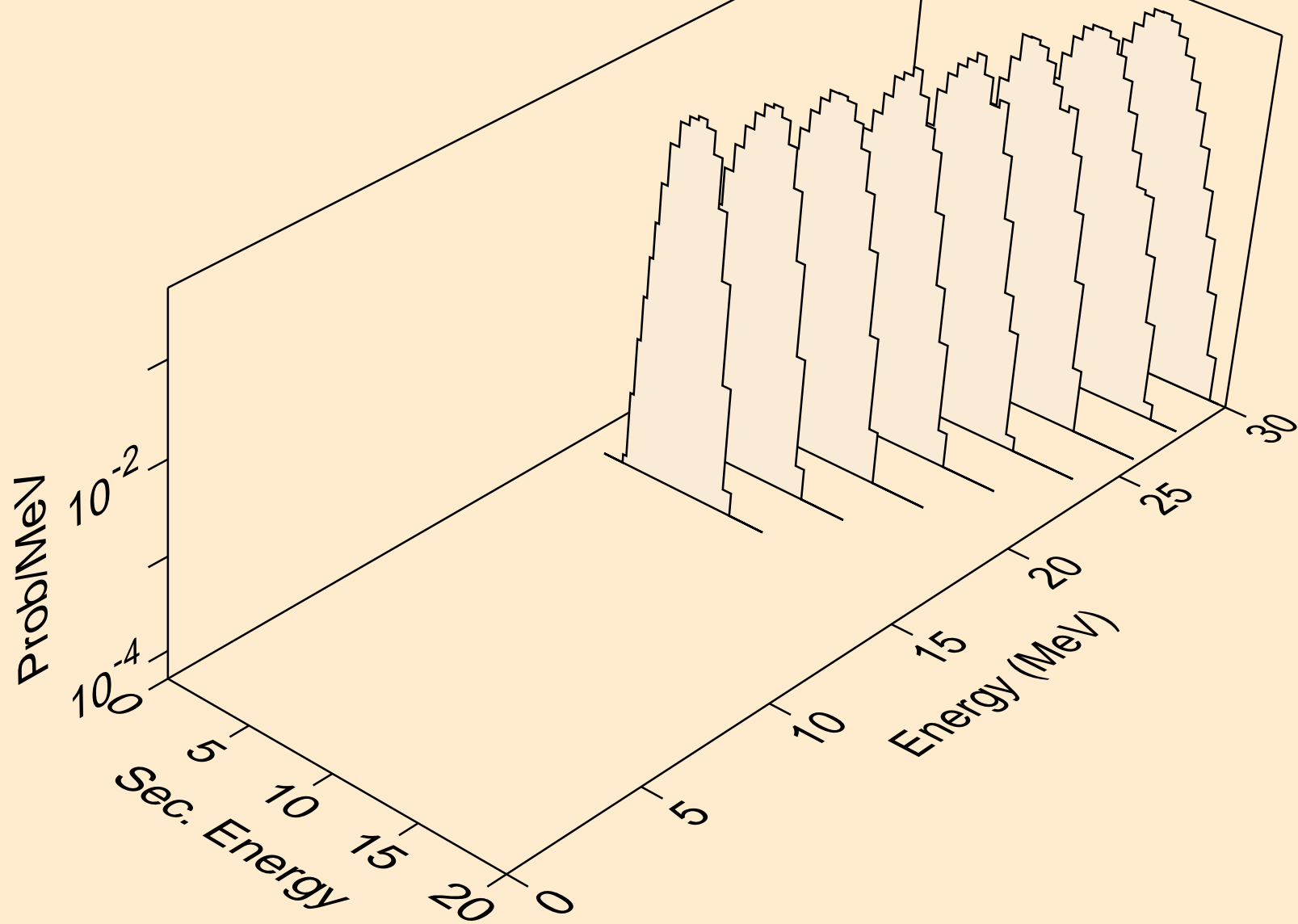

NO257 DEUTERON ACER TENDL-2021 LIBRARY; T=0.K
Deuteron emission for (d,da)

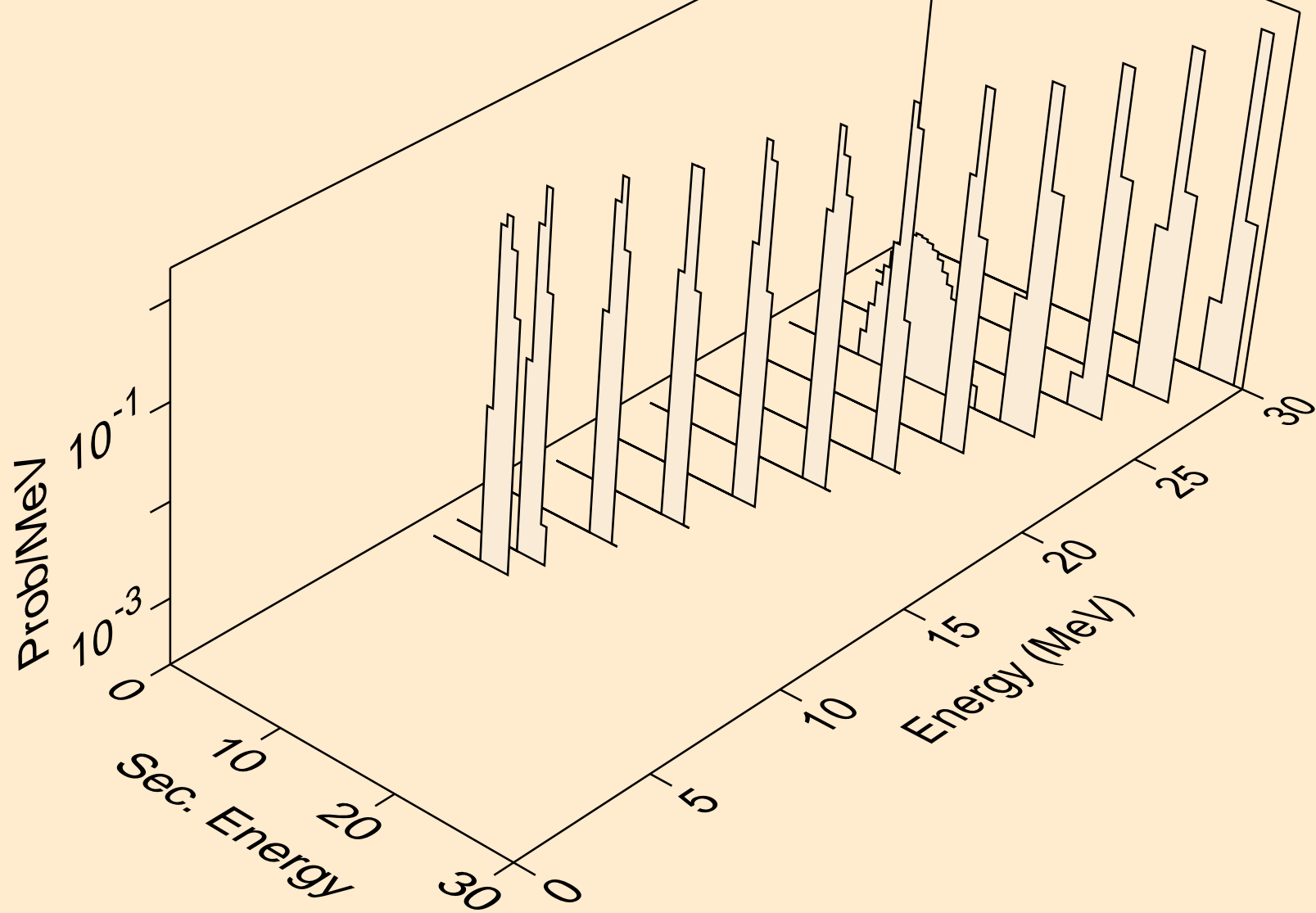

NO257 DEUTERON ACER TENDL-2021 LIBRARY; T=0.K
Photon emission for (z,n)

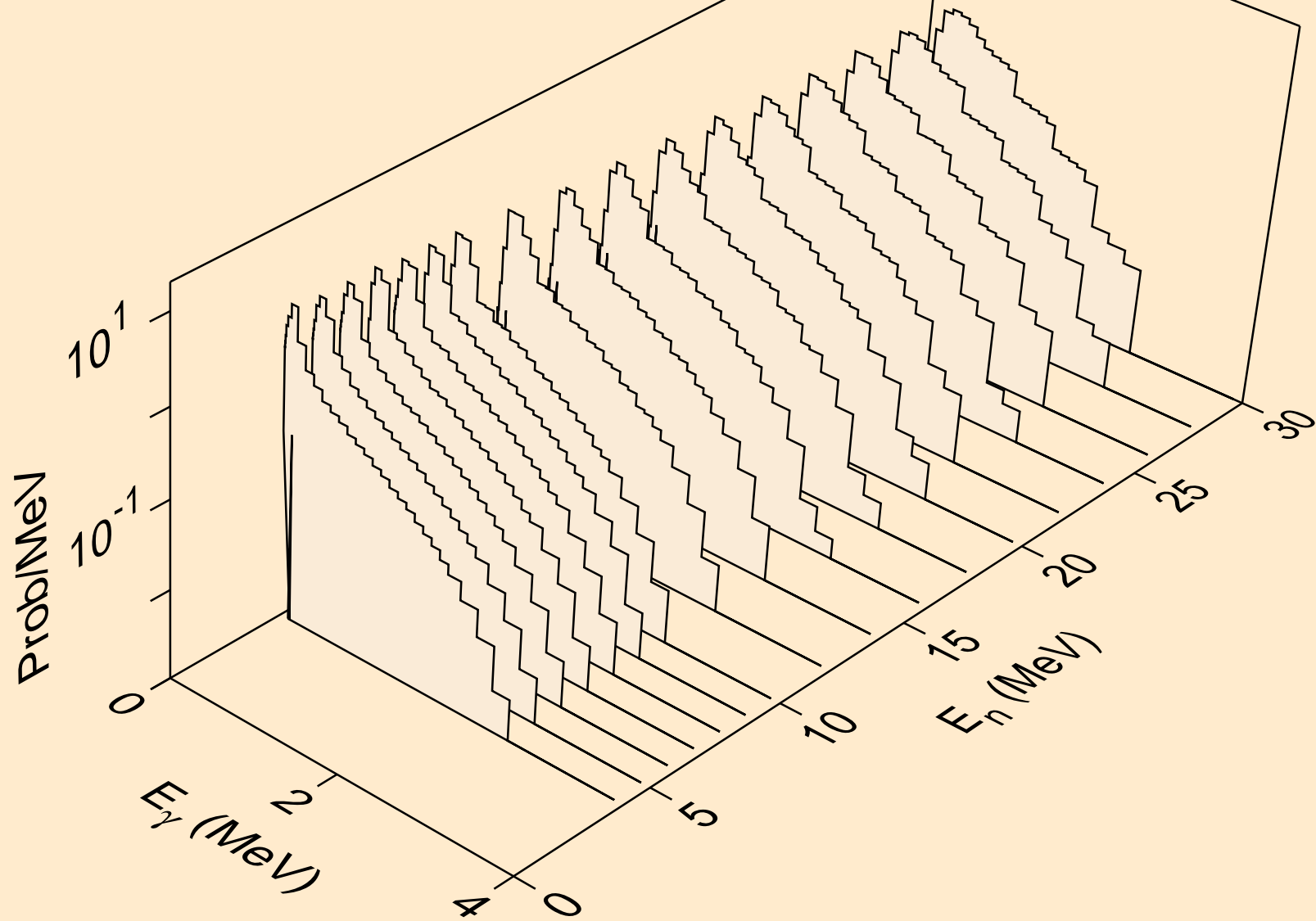

NO257 DEUTERON ACER TENDL-2021 LIBRARY; T=0.K
Photon emission for (n,x)

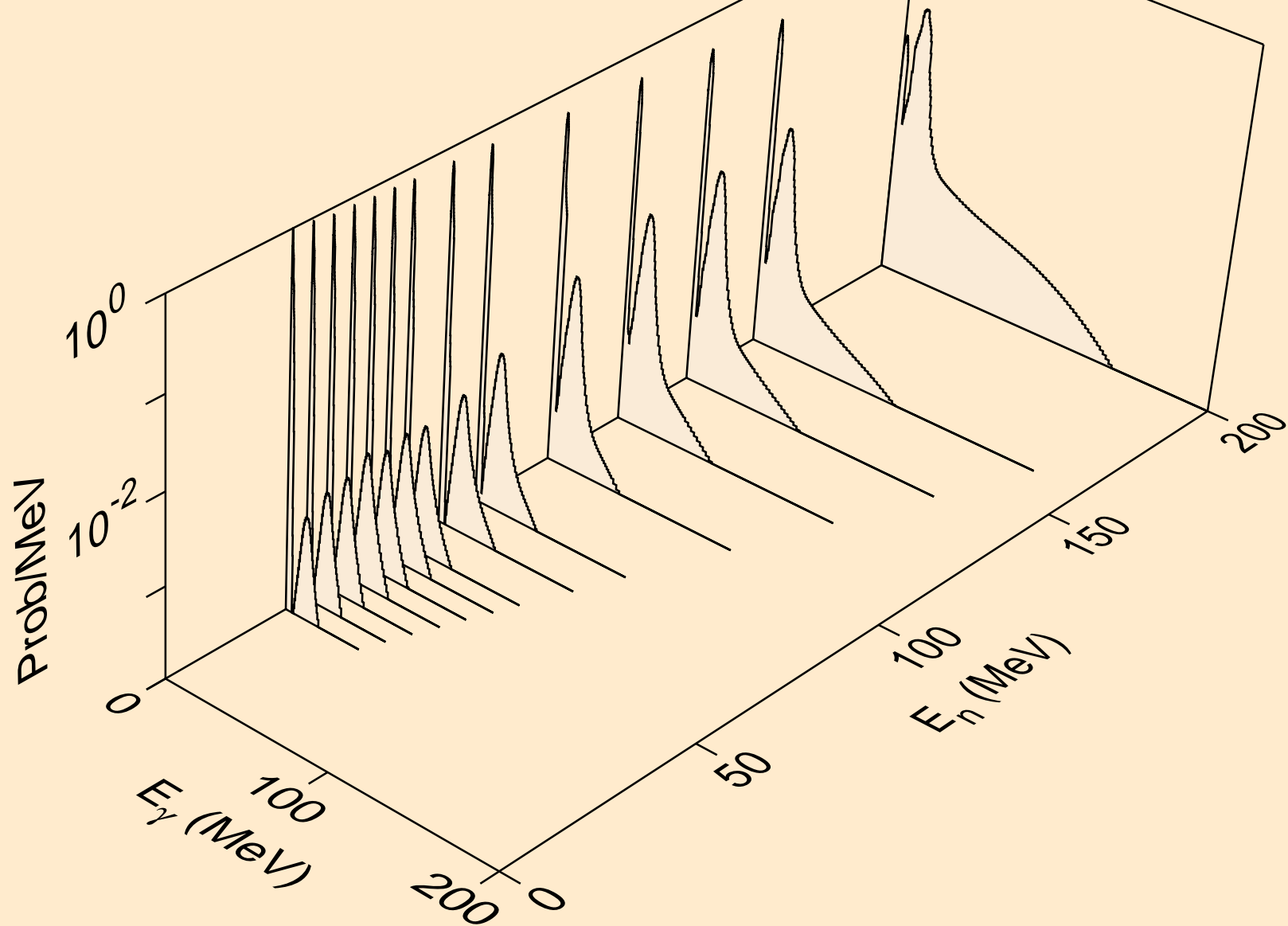

NO257 DEUTERON ACER TENDL-2021 LIBRARY; T=0.K
Photon emission for (n,2nd)

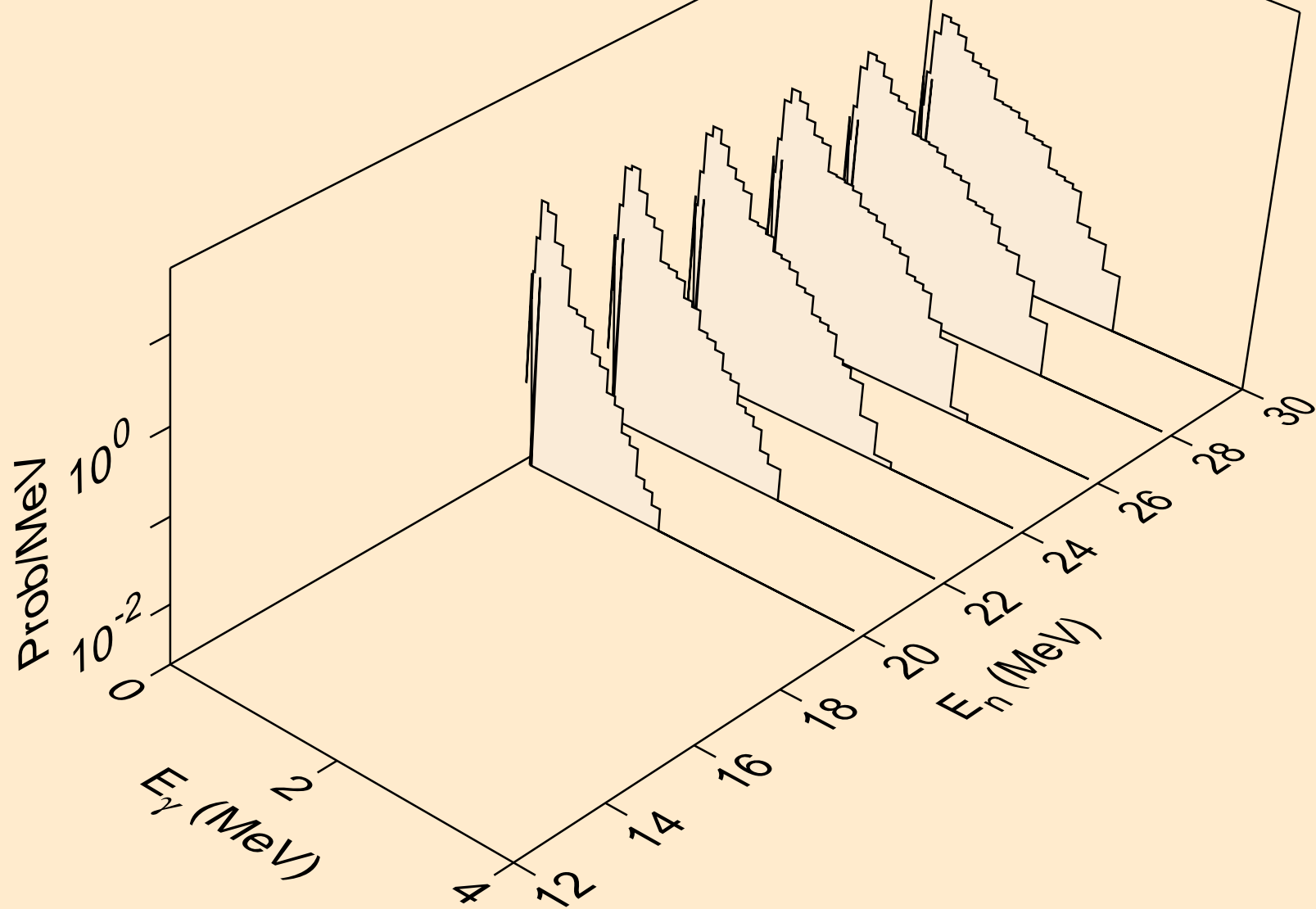

NO257 DEUTERON ACER TENDL-2021 LIBRARY; T=0.K
Photon emission for (n,2n)

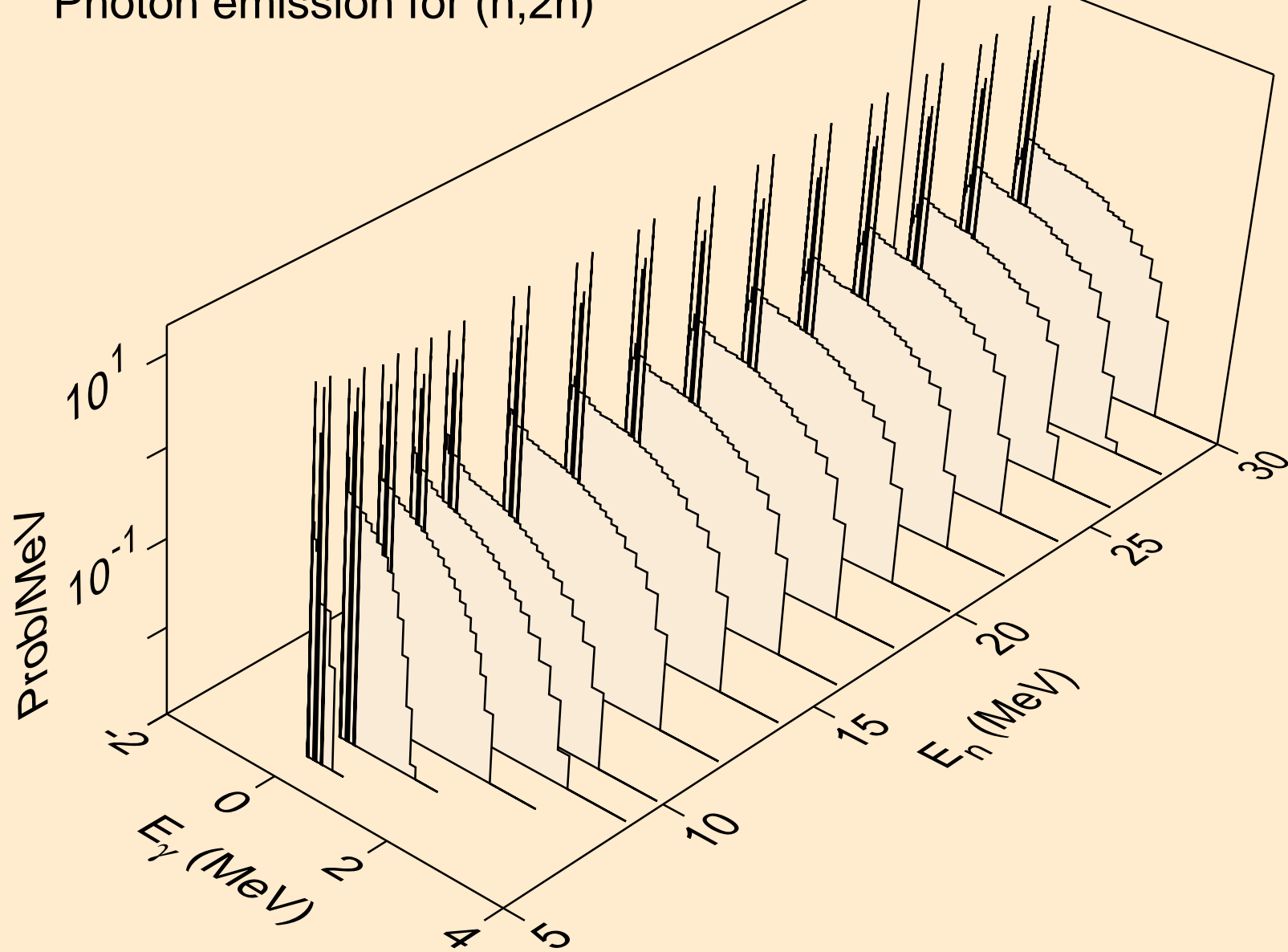

NO257 DEUTERON ACER TENDL-2021 LIBRARY; T=0.K
Photon emission for (n,3n)

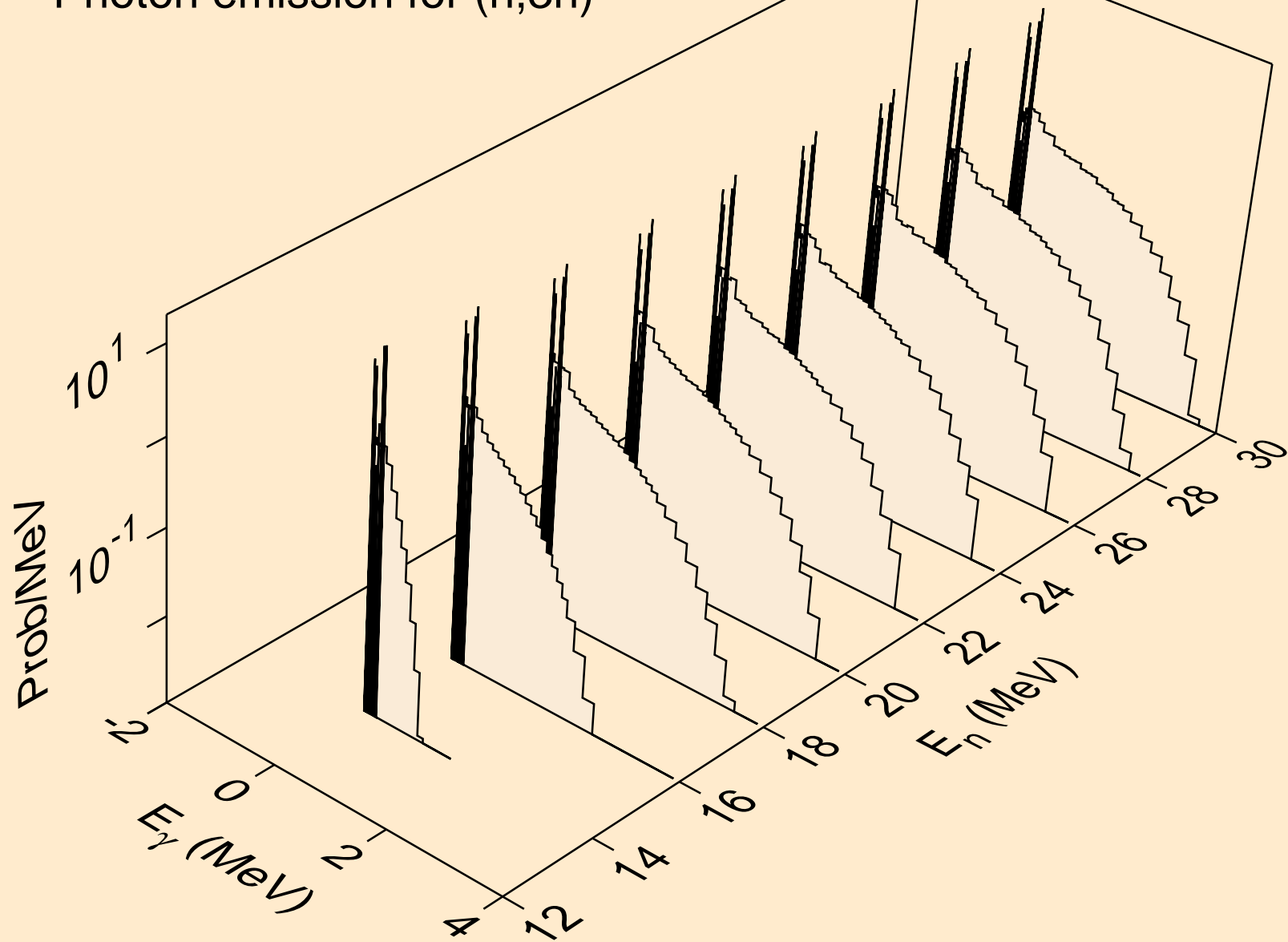

NO257 DEUTERON ACER TENDL-2021 LIBRARY; T=0.K
Photon emission for (n,n*)a

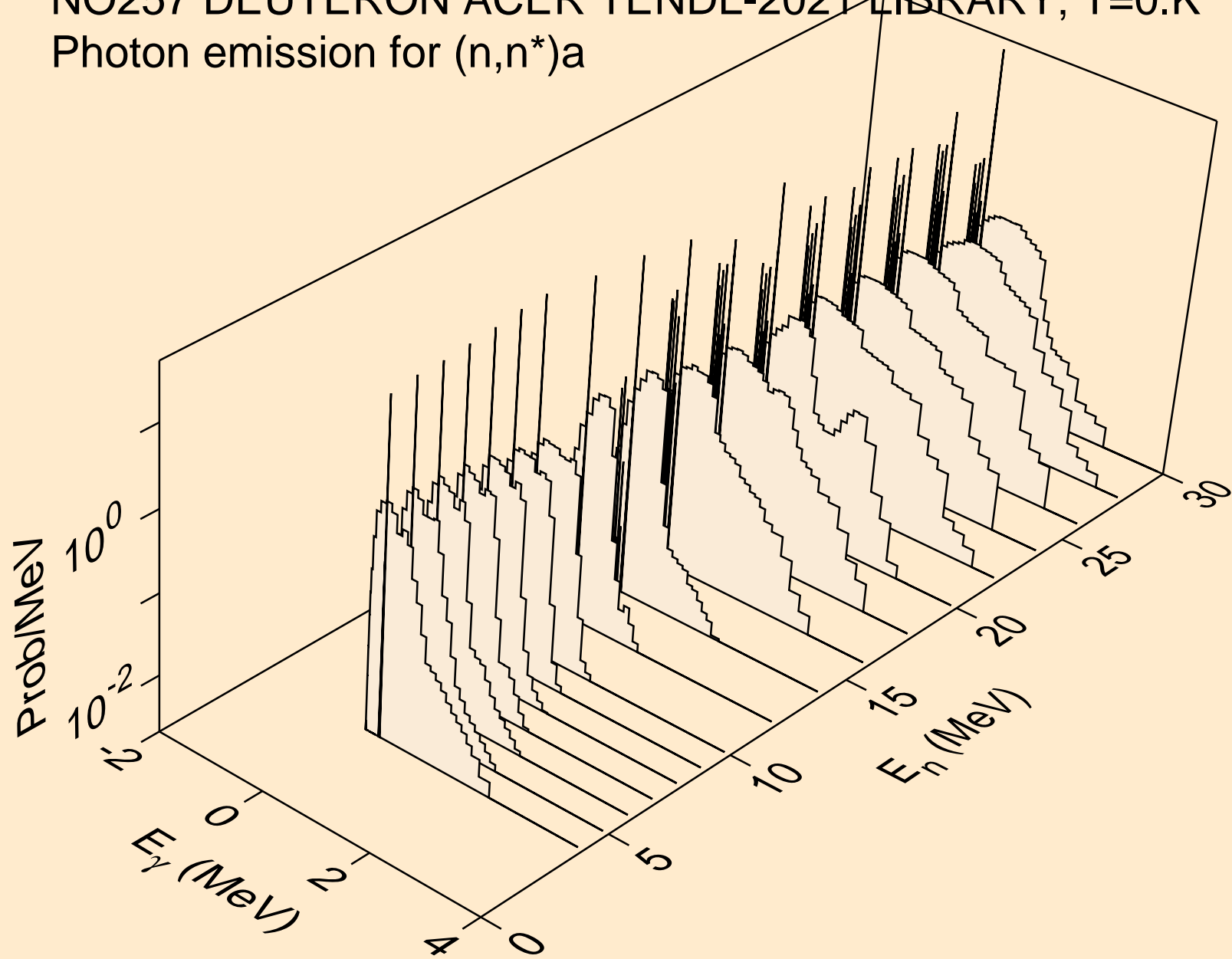

NO257 DEUTERON ACER TENDL-2021 LIBRARY; T=0.K
Photon emission for (n,2n)a

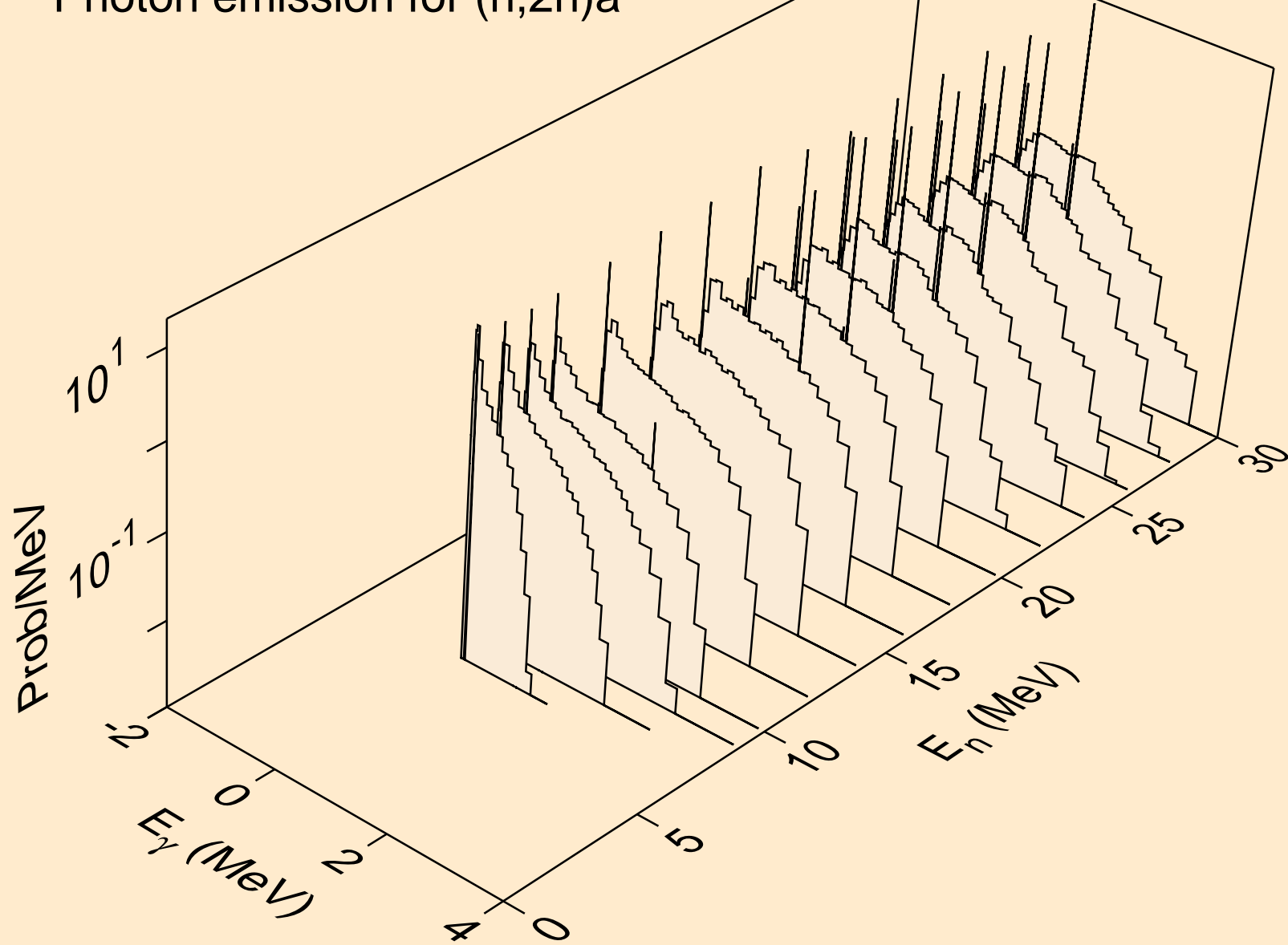

NO257 DEUTERON ACER TENDL-2021 LIBRARY; T=0.K
Photon emission for (n,n*)p

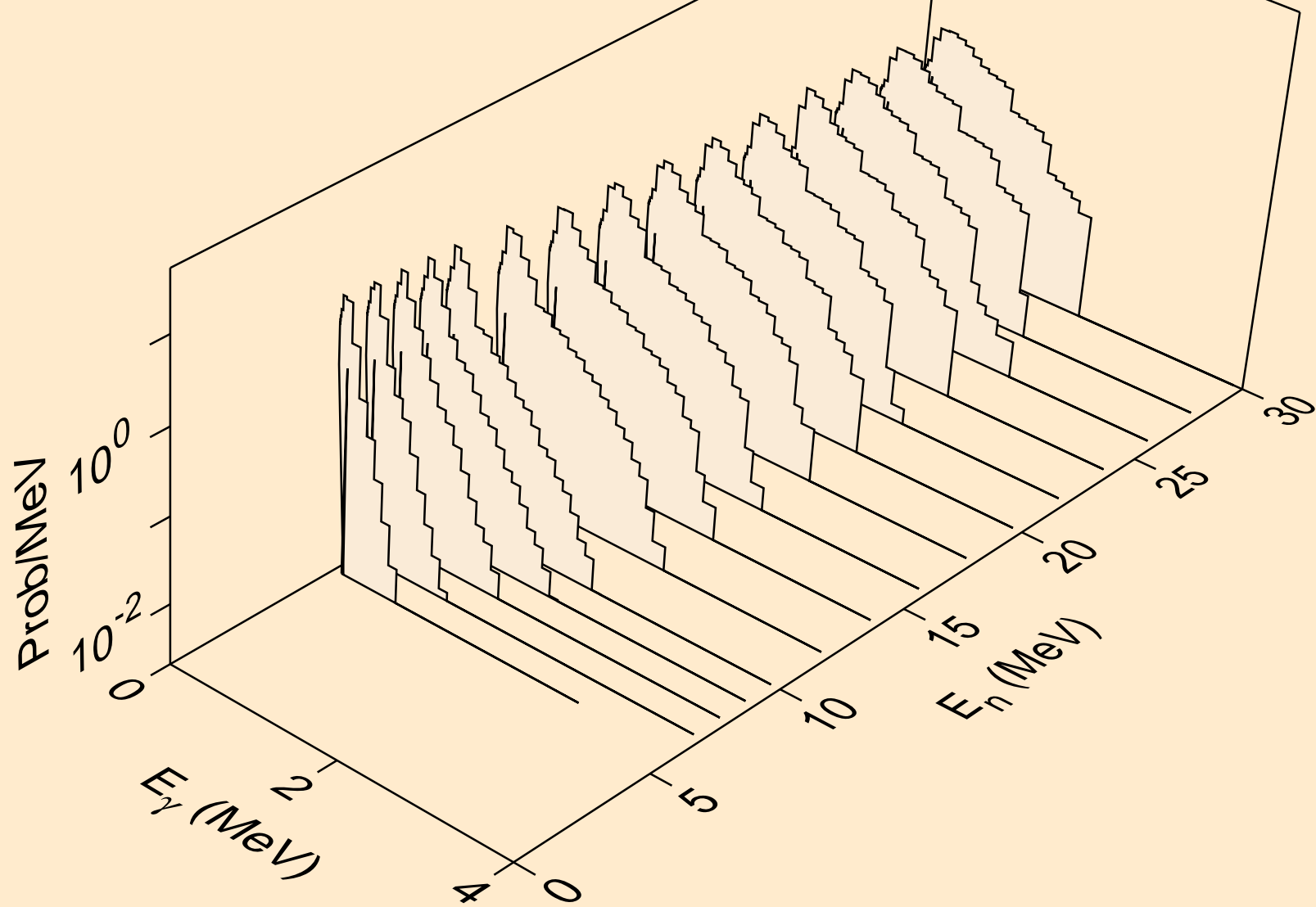

NO257 DEUTERON ACER TENDL-2021 LIBRARY; T=0.K
Photon emission for (n,n*)d

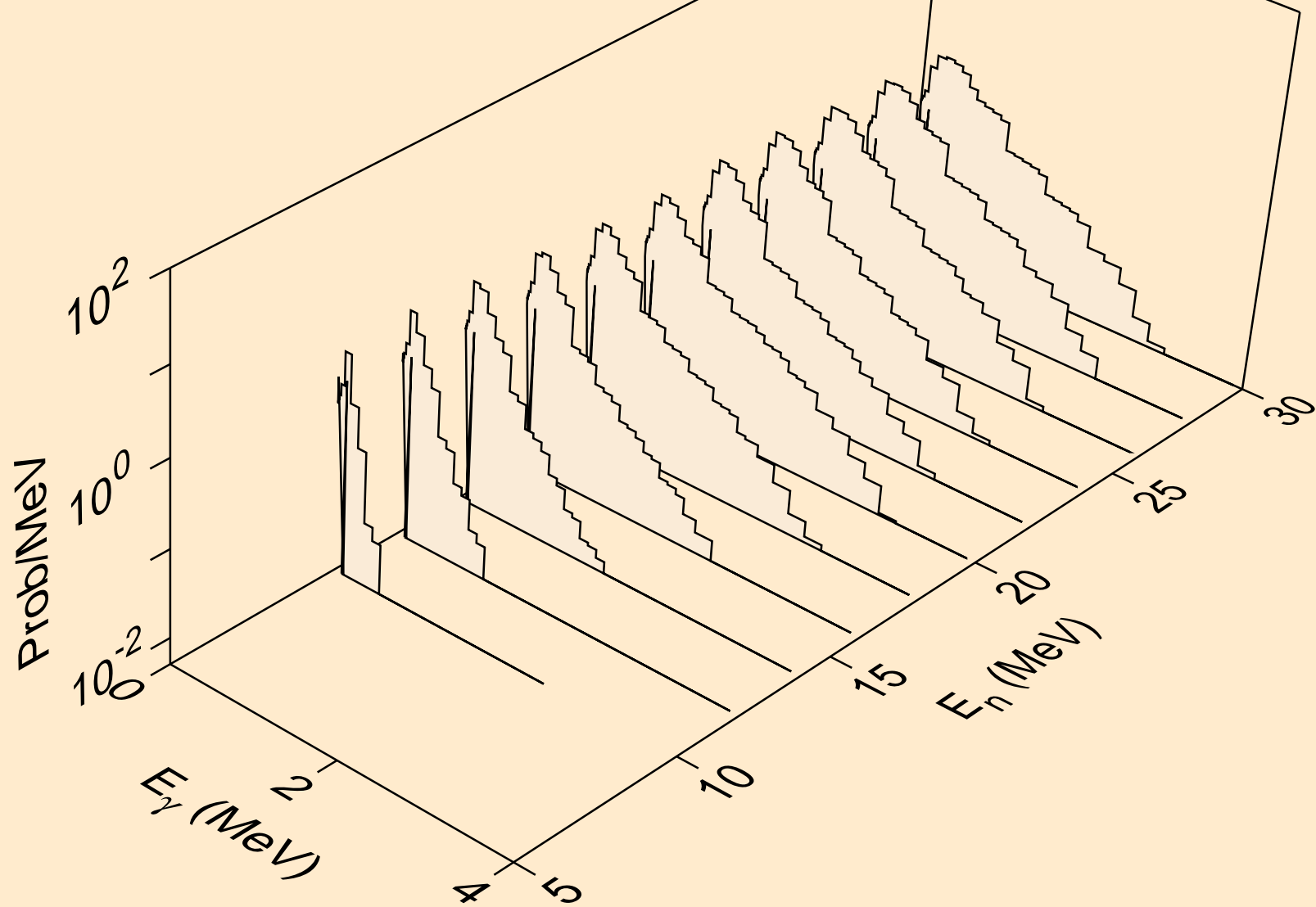

NO257 DEUTERON ACER TENDL-2021 LIBRARY; T=0.K
Photon emission for (n,n*)t

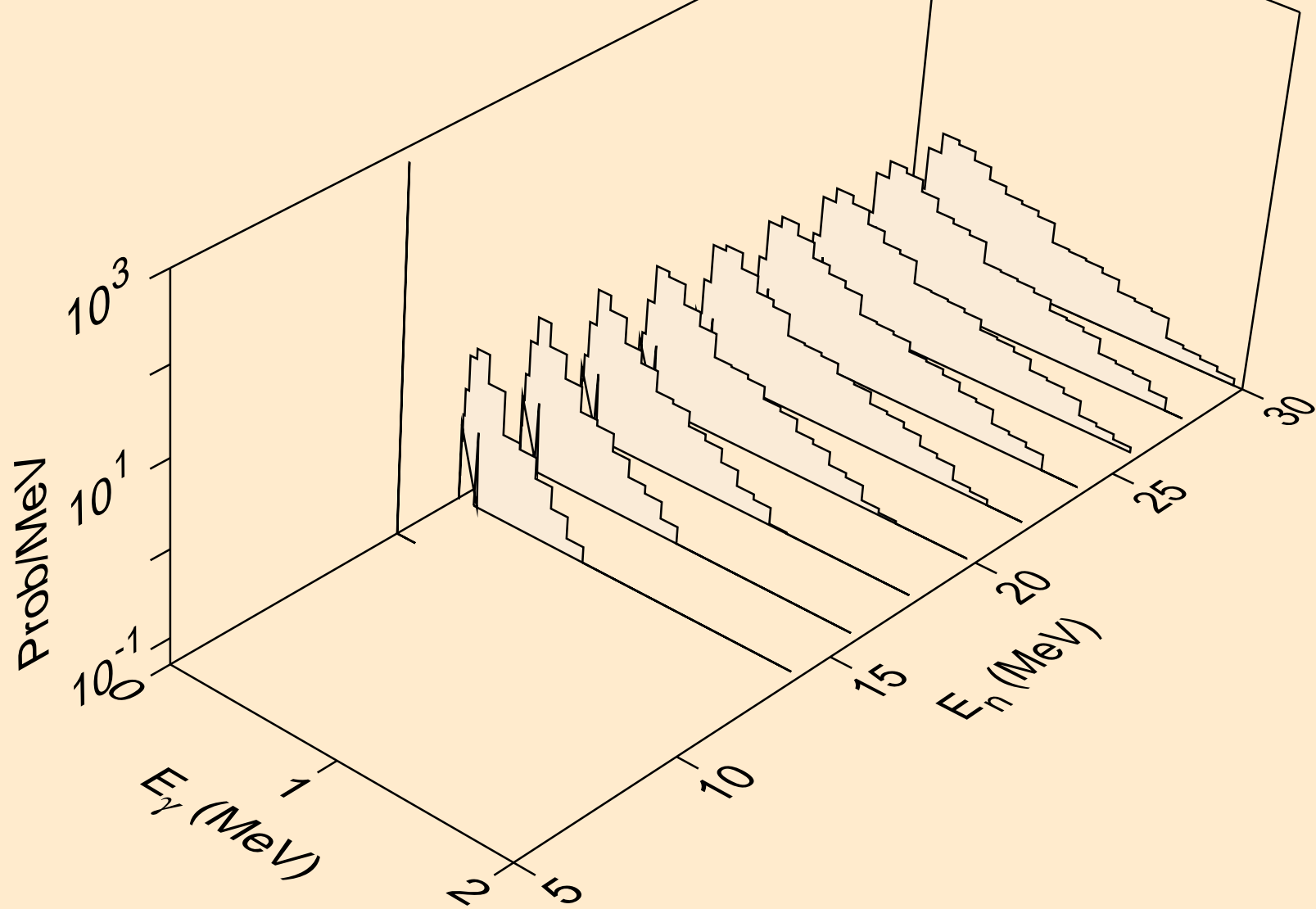

NO257 DEUTERON ACER TENDL-2021 LIBRARY; T=0.K
Photon emission for (n,n*)he3

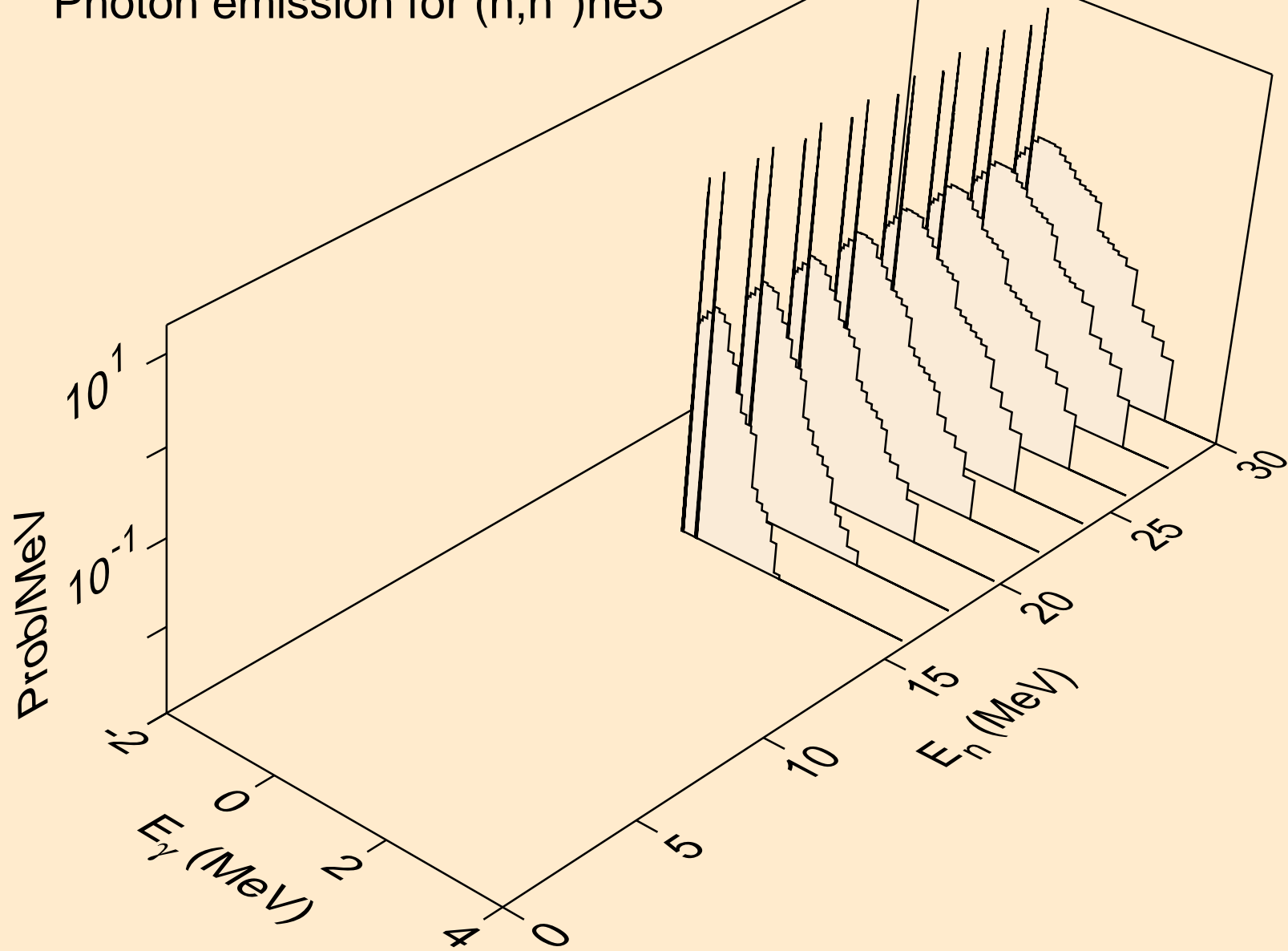

NO257 DEUTERON ACER TENDL-2021 LIBRARY; T=0.K
Photon emission for (n,4n)

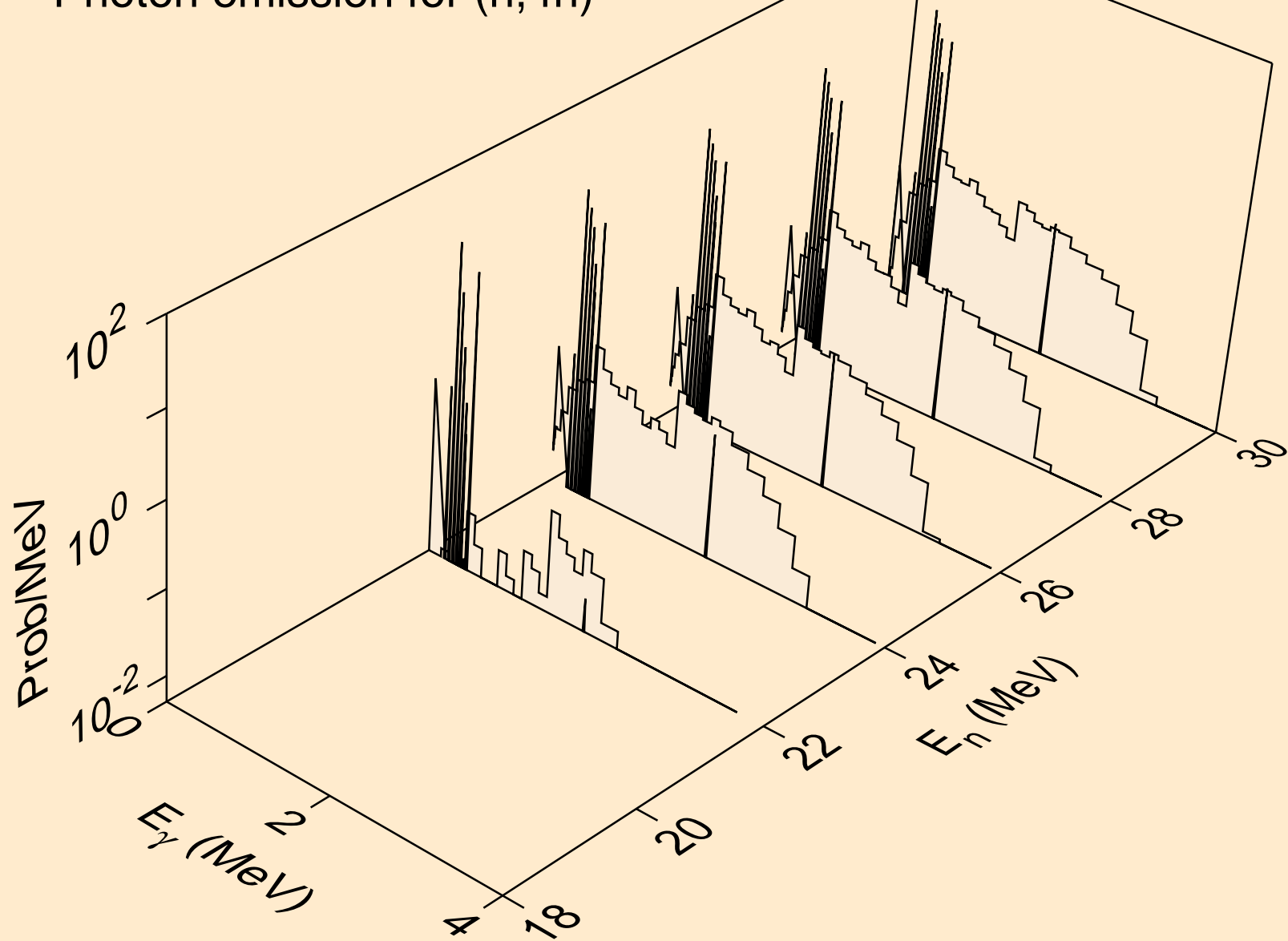

NO257 DEUTERON ACER TENDL-2021 LIBRARY; T=0.K
Photon emission for (n,2np)

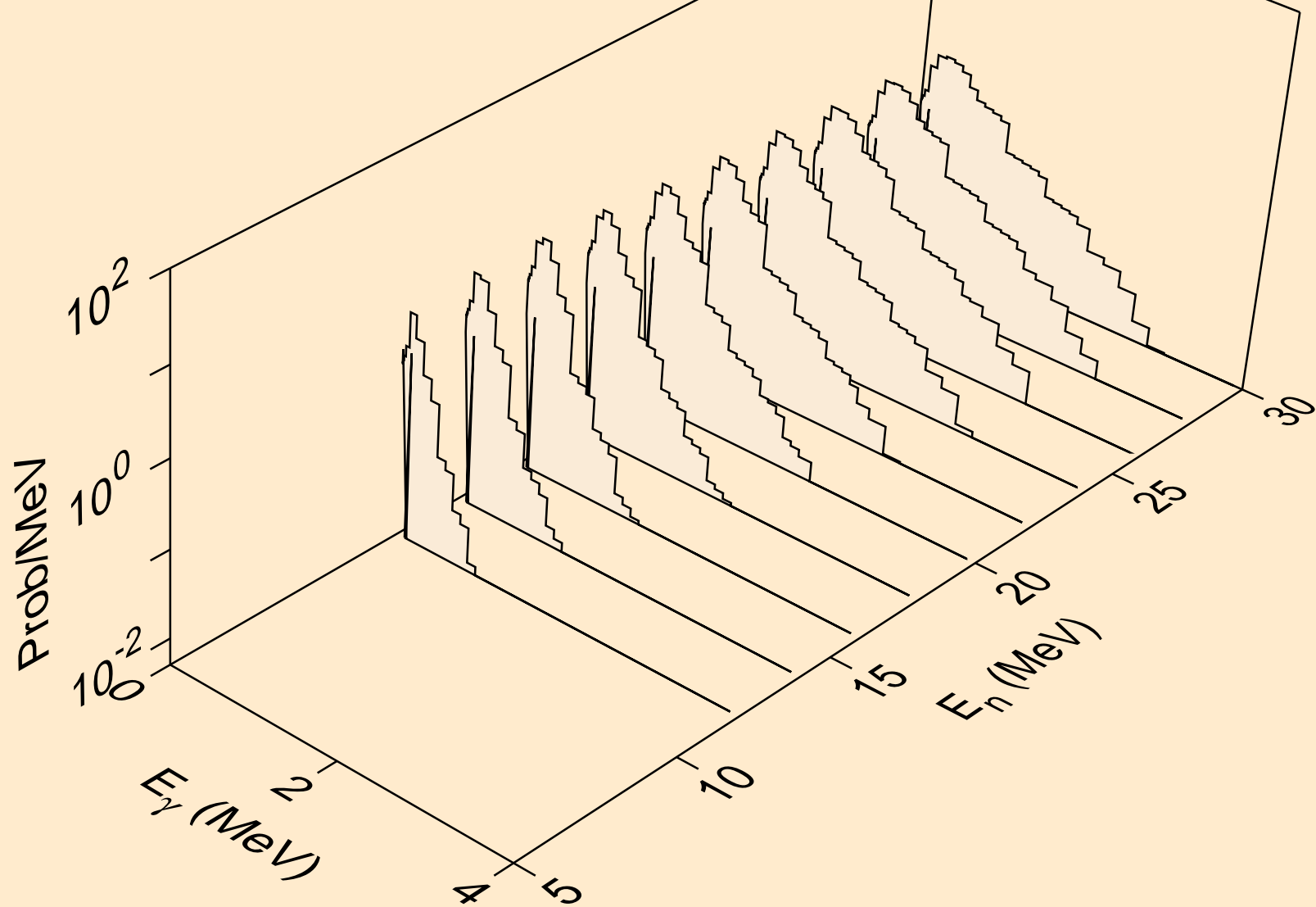

NO257 DEUTERON ACER TENDL-2021 LIBRARY; T=0.K
Photon emission for (n,3np)

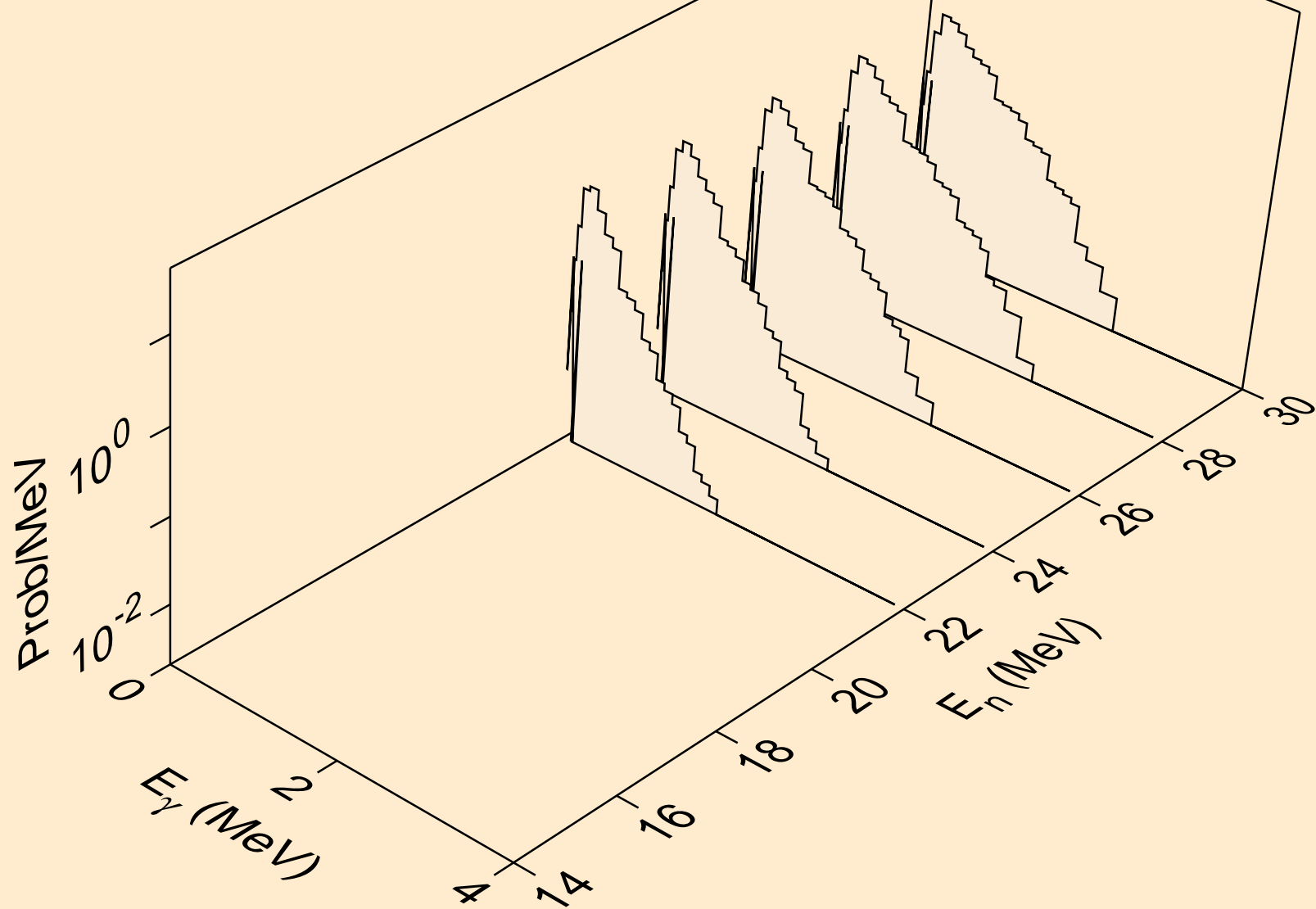

NO257 DEUTERON ACER TENDL-2021 LIBRARY; T=0.K
Photon emission for (n,2np)

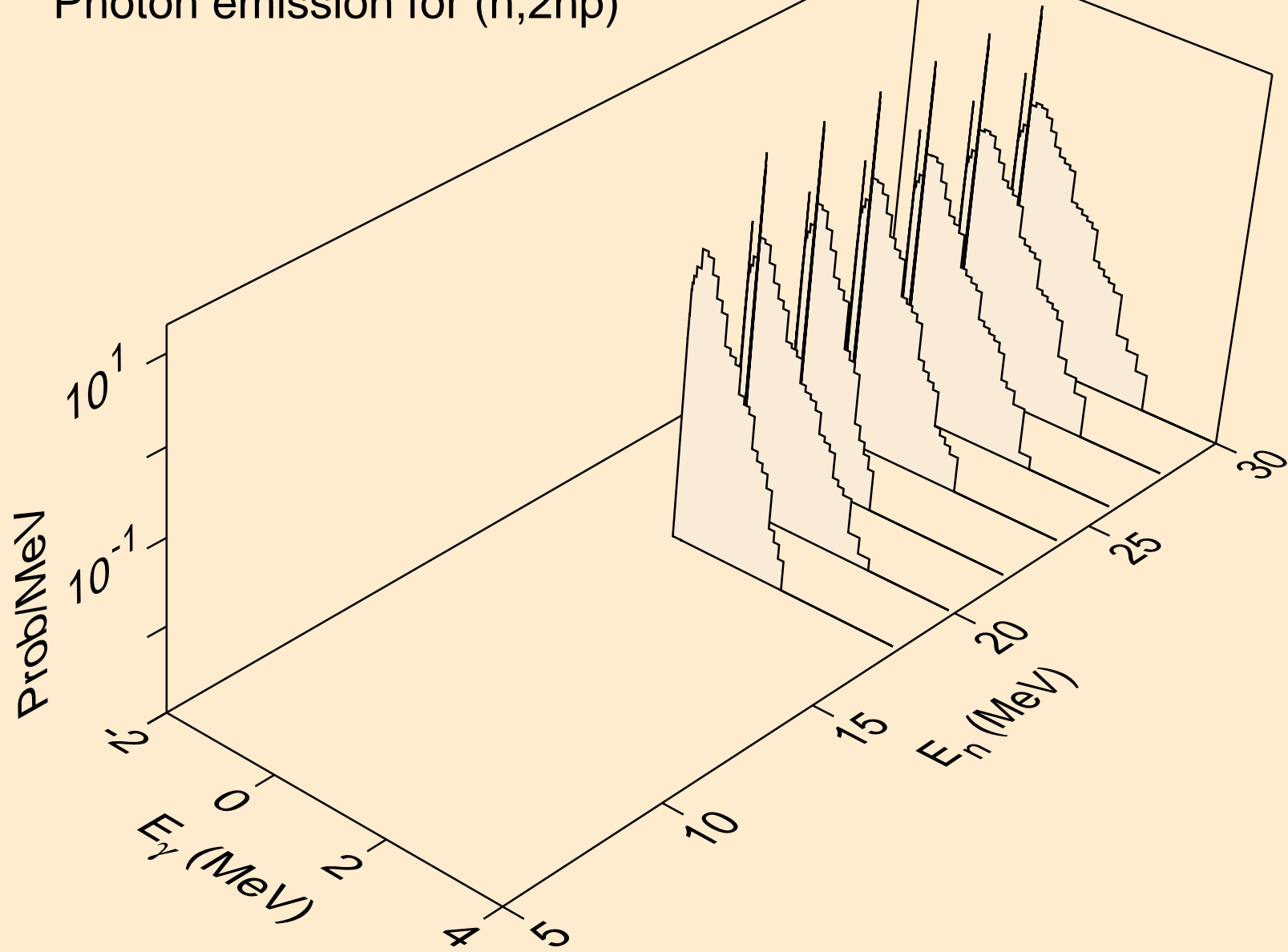

NO257 DEUTERON ACER TENDL-2021 LIBRARY; T=0.K
Photon emission for (n,npa)

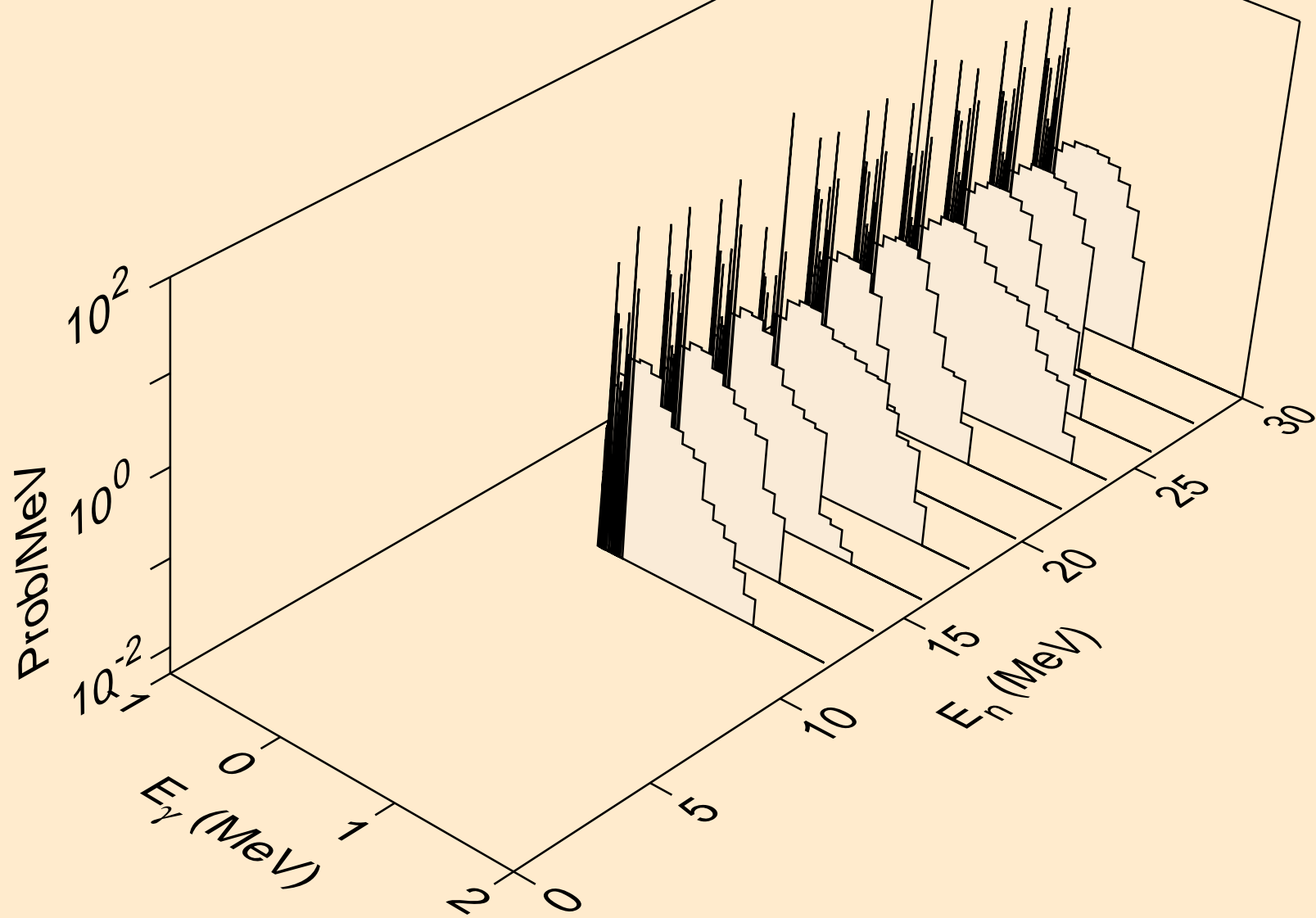

NO257 DEUTERON ACER TENDL-2021 LIBRARY; T=0.K
Photon emission for (n,gma)

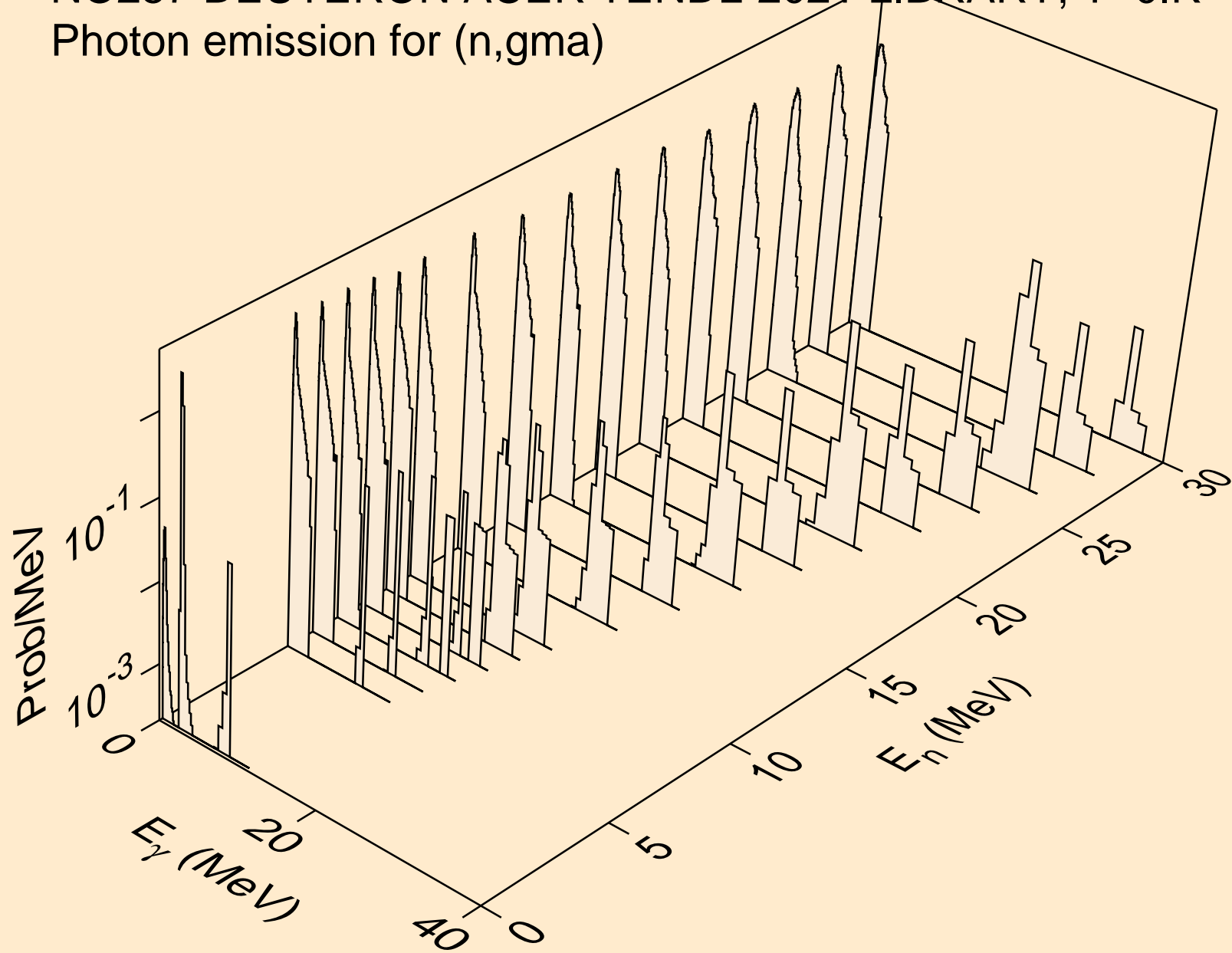

NO257 DEUTERON ACER TENDL-2021 LIBRARY; T=0.K
Photon emission for (n,p)

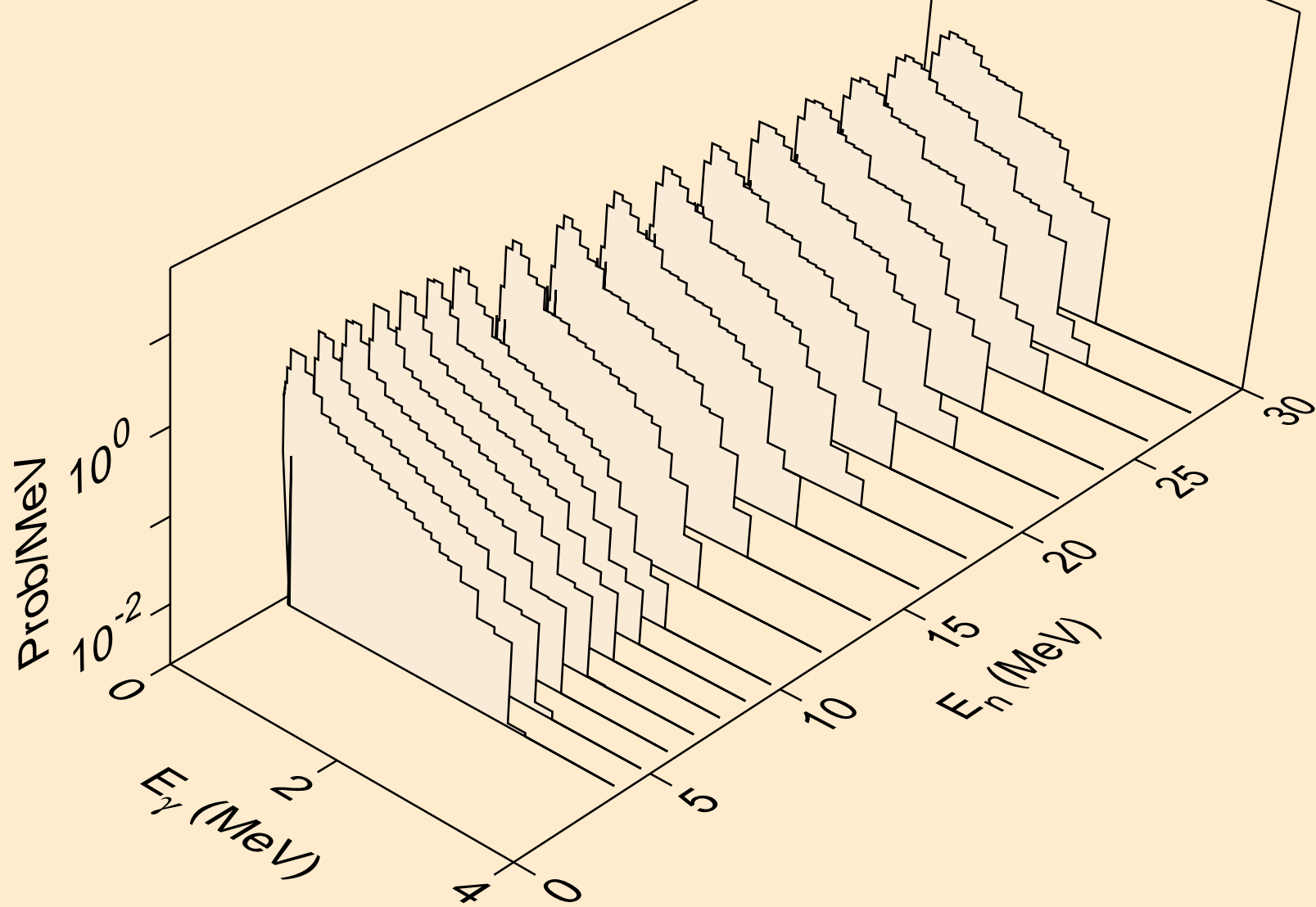

NO257 DEUTERON ACER TENDL-2021 LIBRARY; T=0.K
Photon emission for inelastic

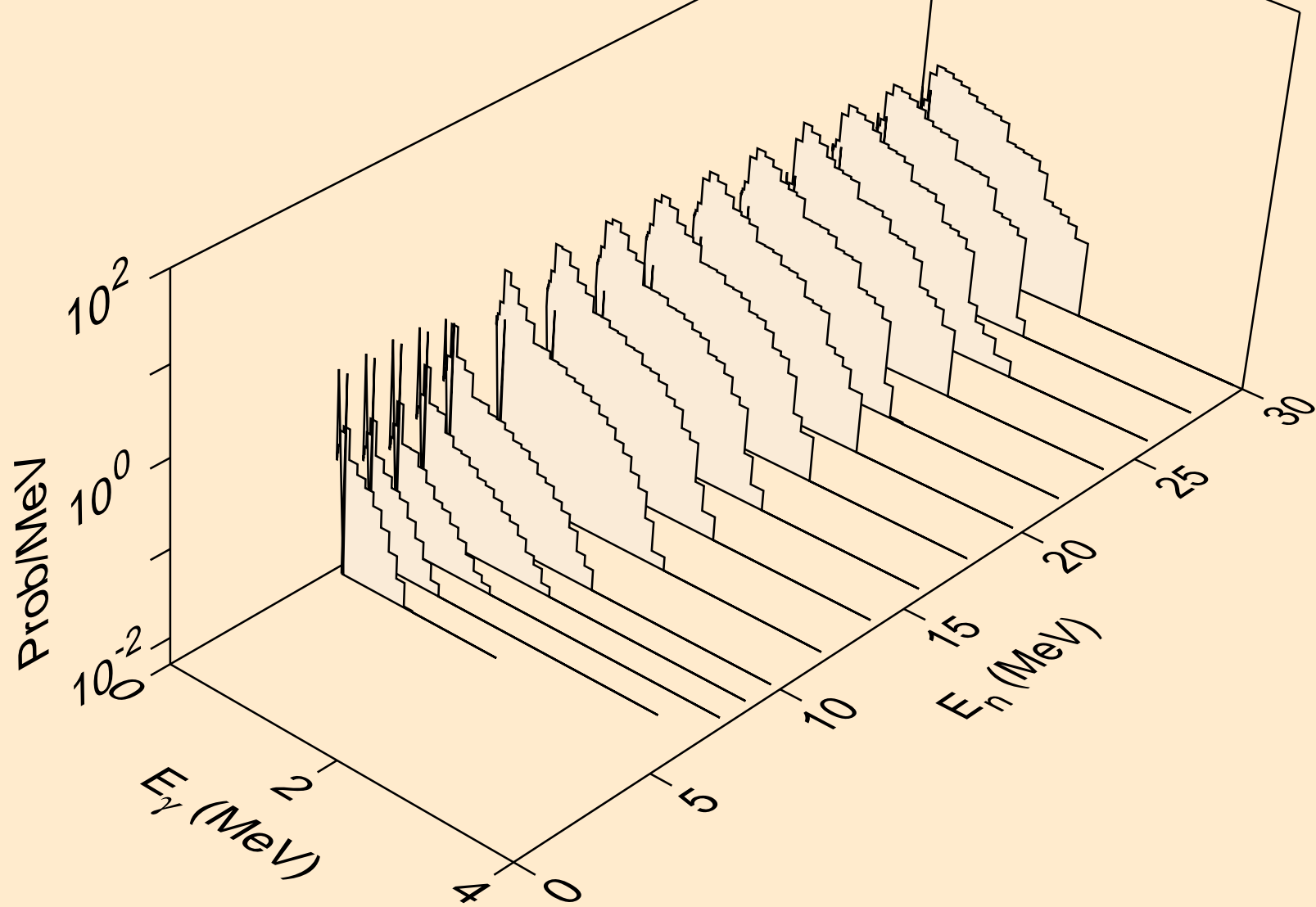

NO257 DEUTERON ACER TENDL-2021 LIBRARY; T=0.K
Photon emission for (n,t)

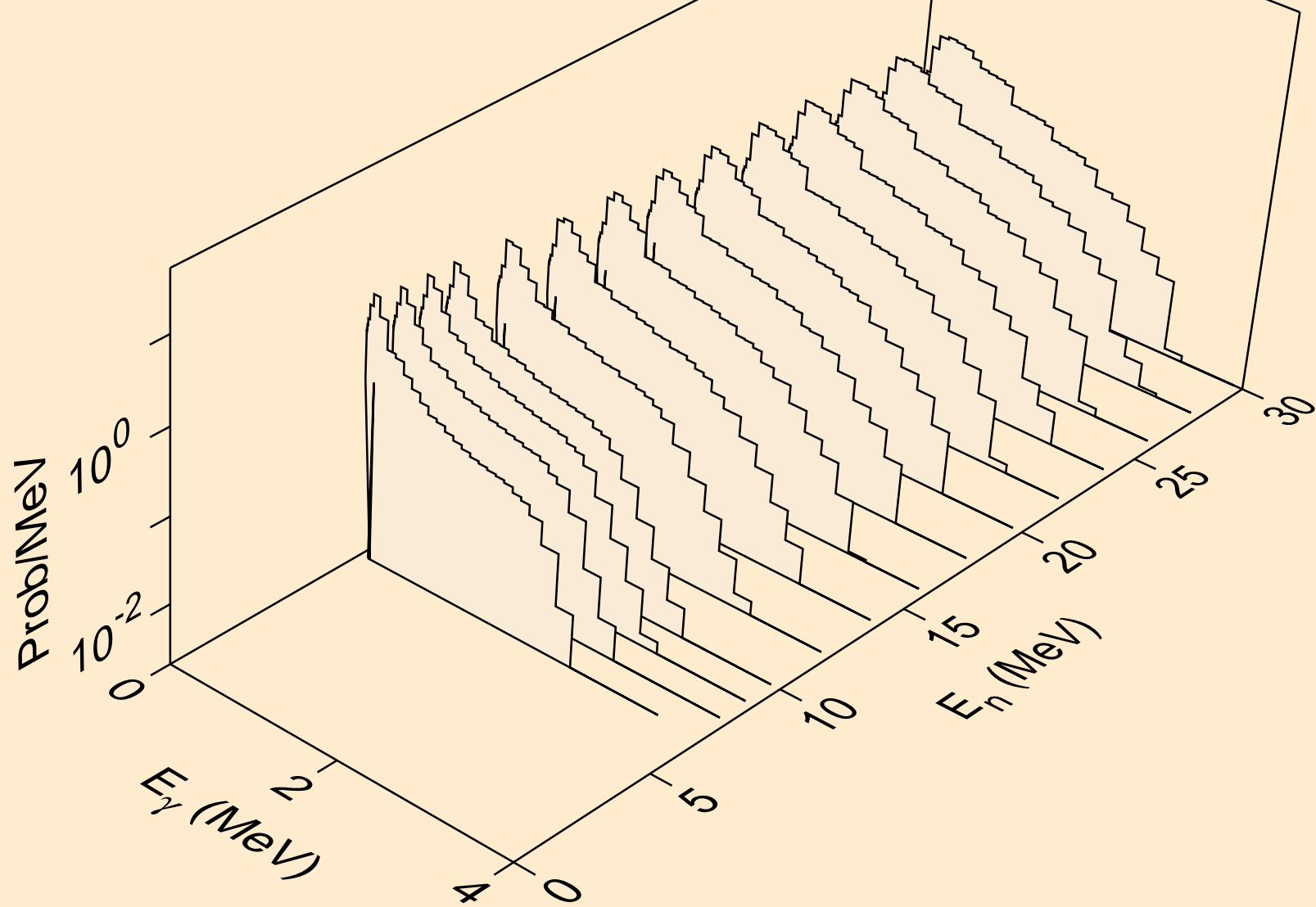

NO257 DEUTERON ACER TENDL-2021 LIBRARY; T=0.K
Photon emission for (n,he3)

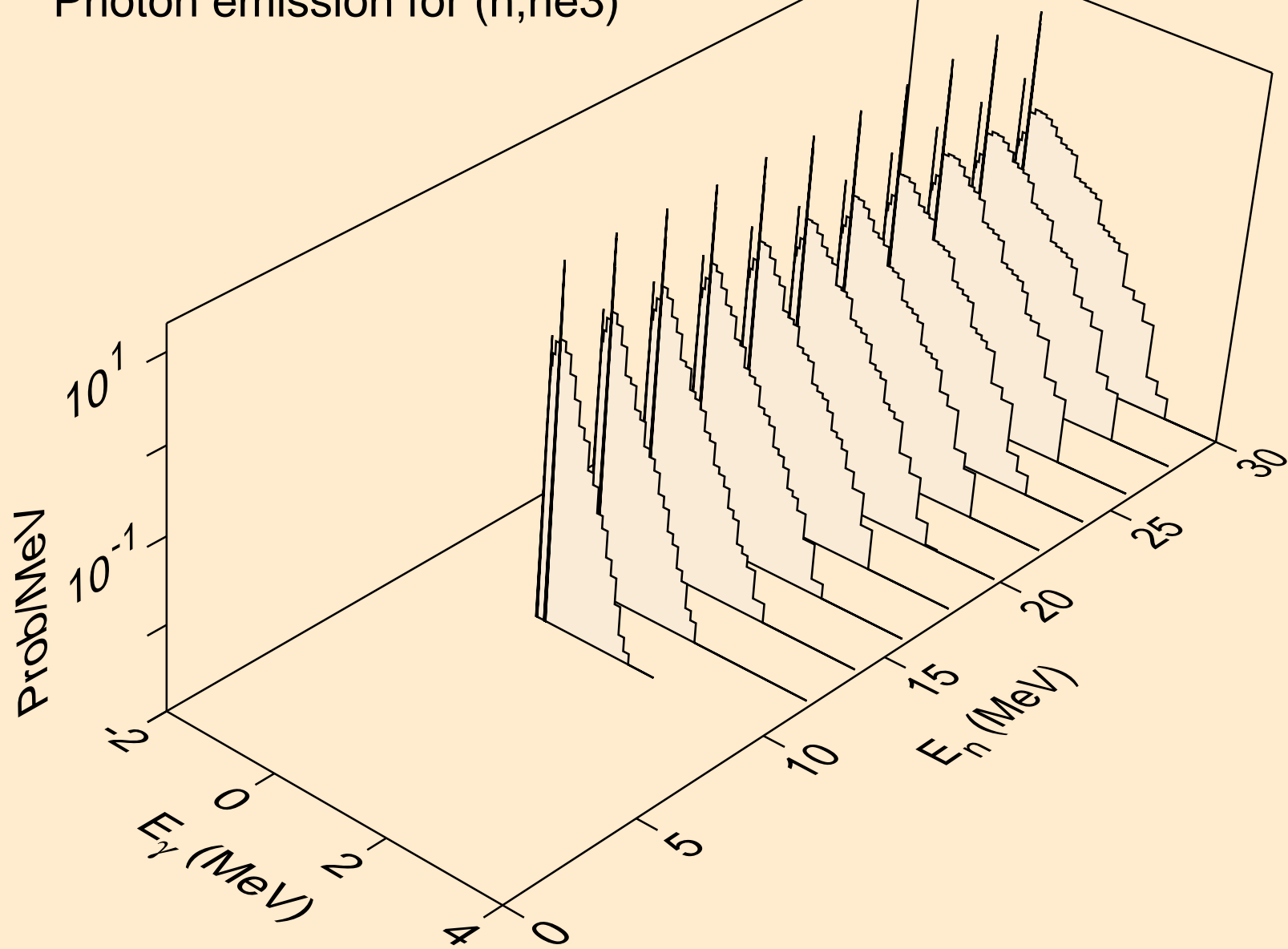

NO257 DEUTERON ACER TENDL-2021 LIBRARY; T=0.K
Photon emission for (n,a)

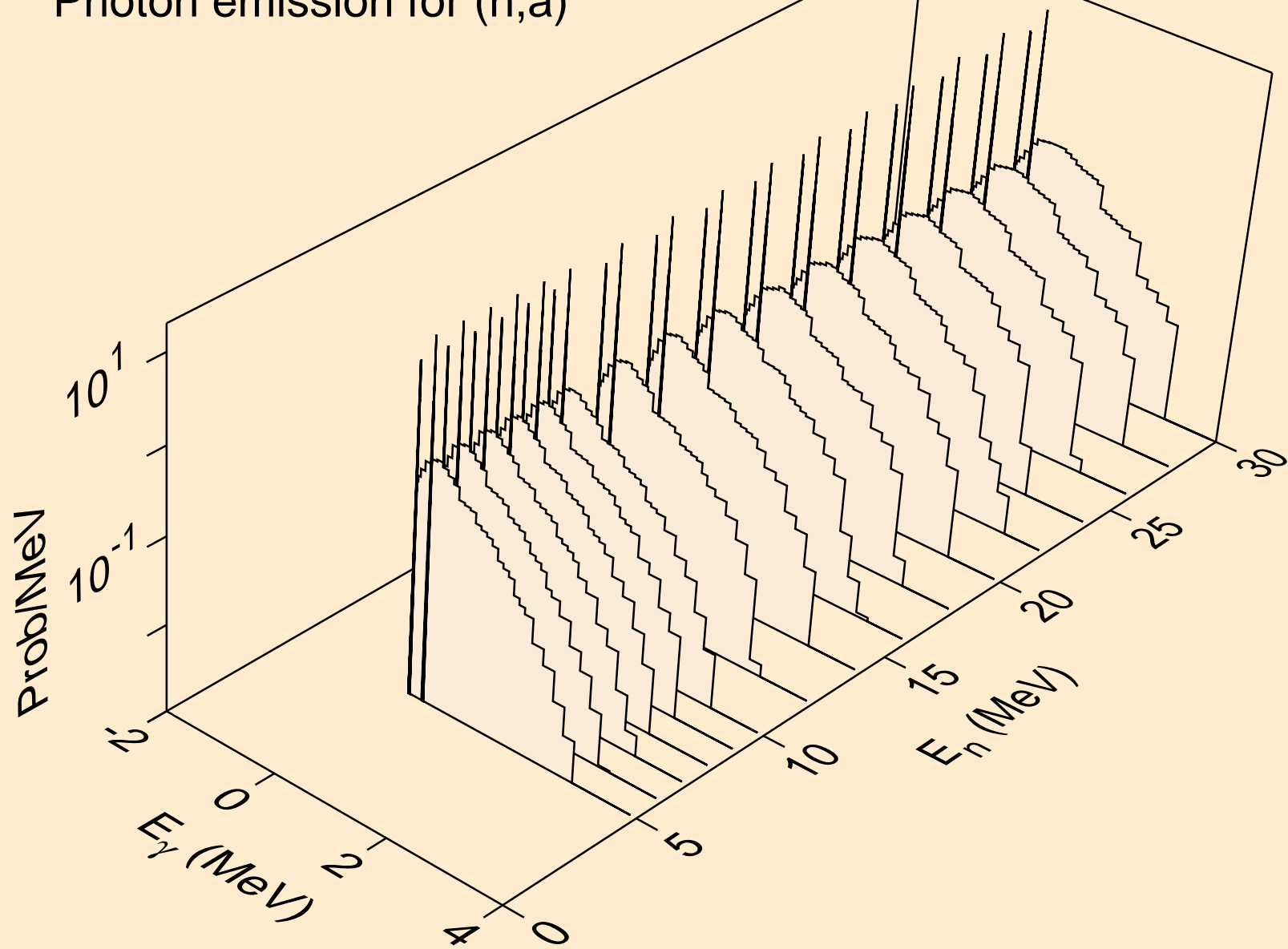

NO257 DEUTERON ACER TENDL-2021 LIBRARY; T=0.K
Photon emission for (n,2p)

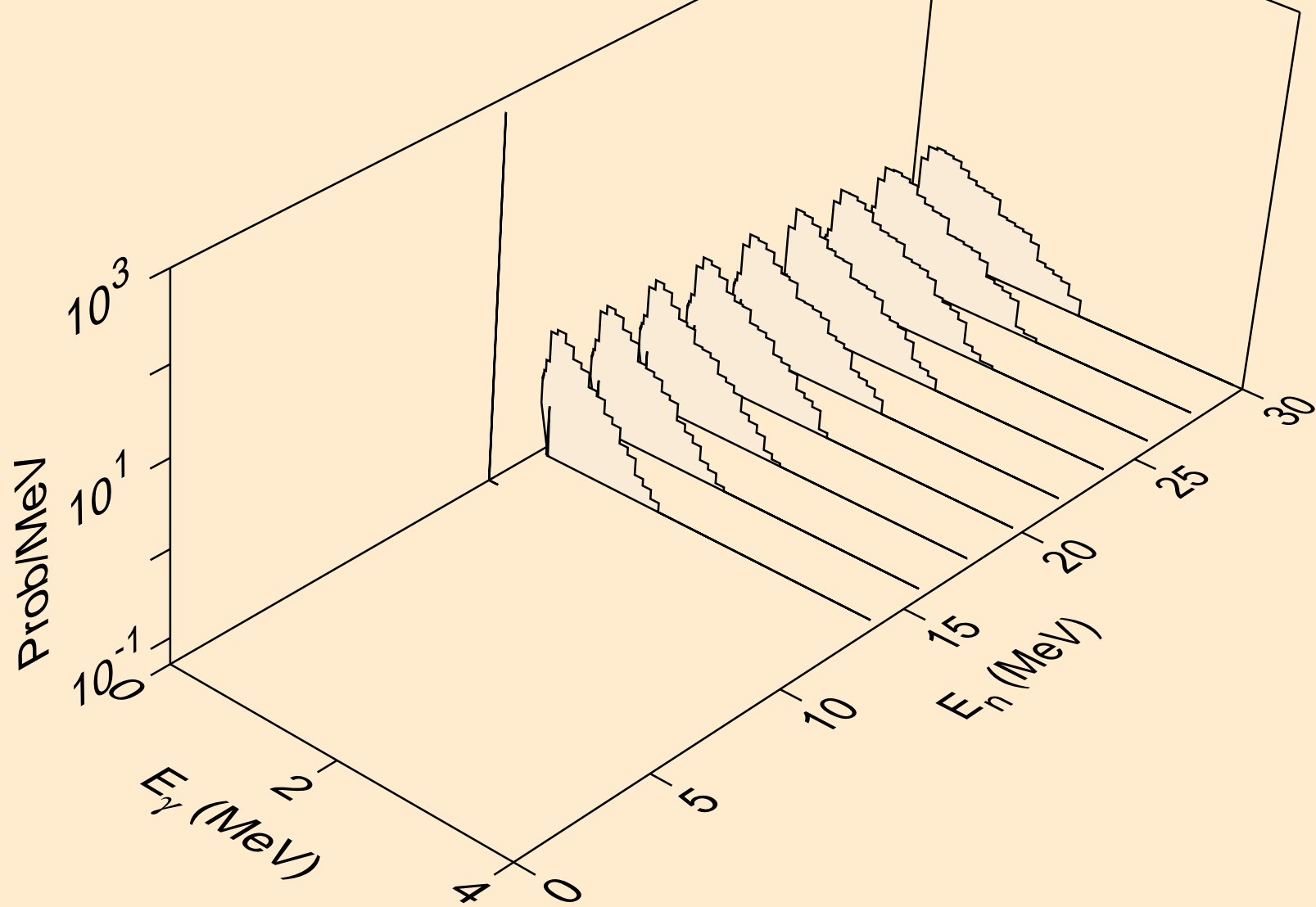

NO257 DEUTERON ACER TENDL-2021 LIBRARY; T=0.K
Photon emission for (n,pd)

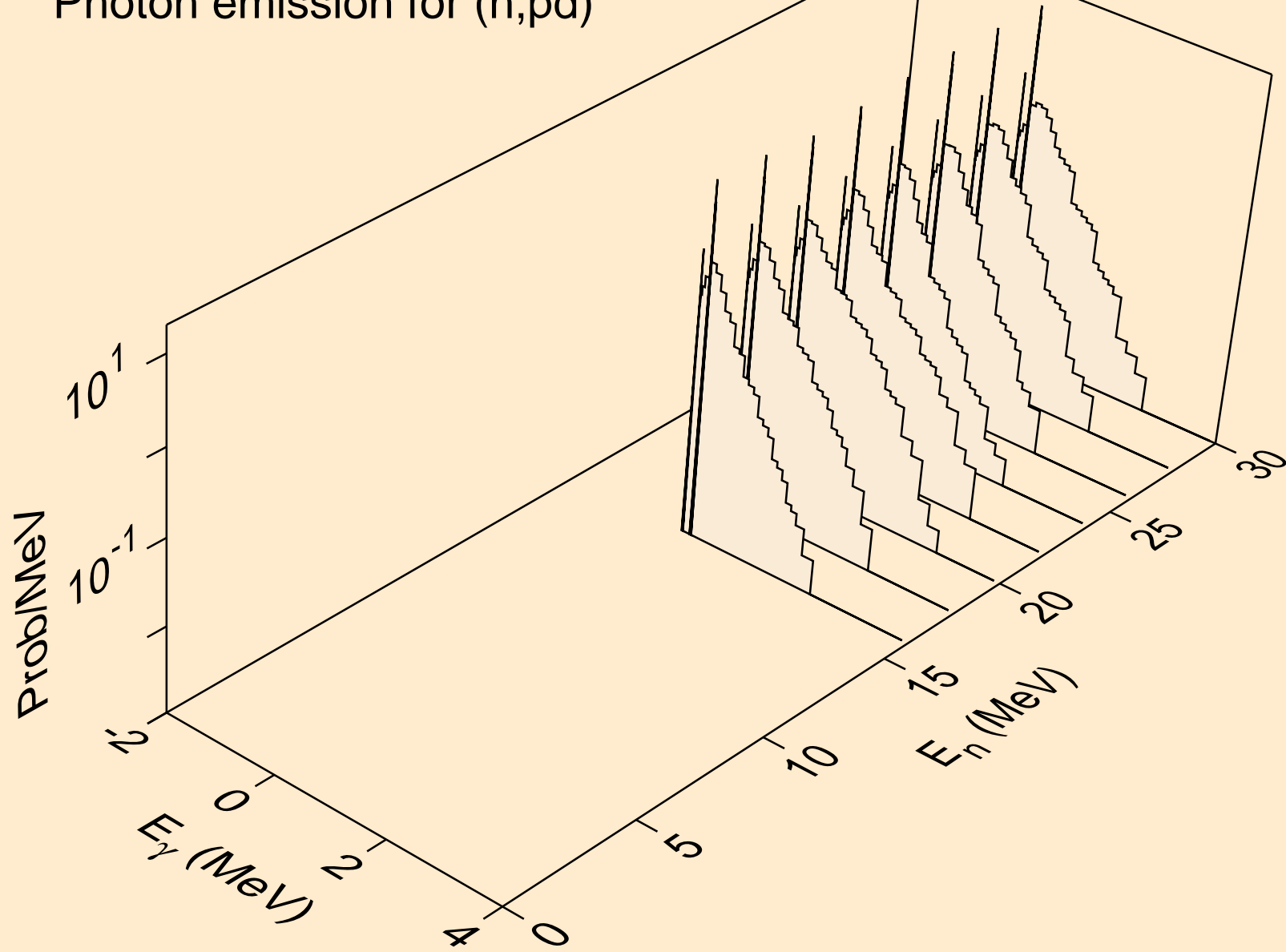

NO257 DEUTERON ACER TENDL-2021 LIBRARY; T=0.K
Photon emission for (n,da)

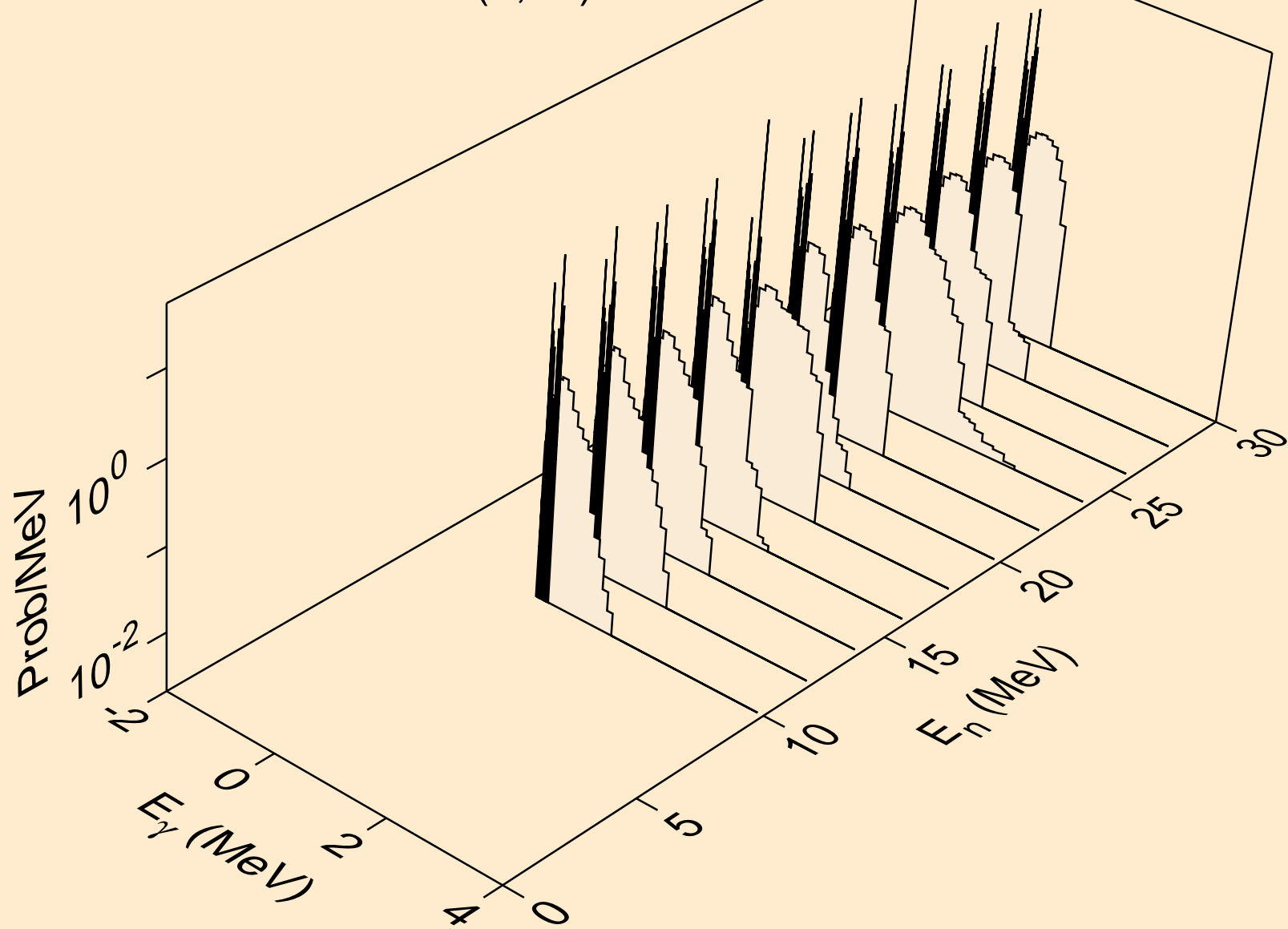

NO257 DEUTERON ACER TENDL-2021 LIBRARY; T=0.K

Particle heating contributions

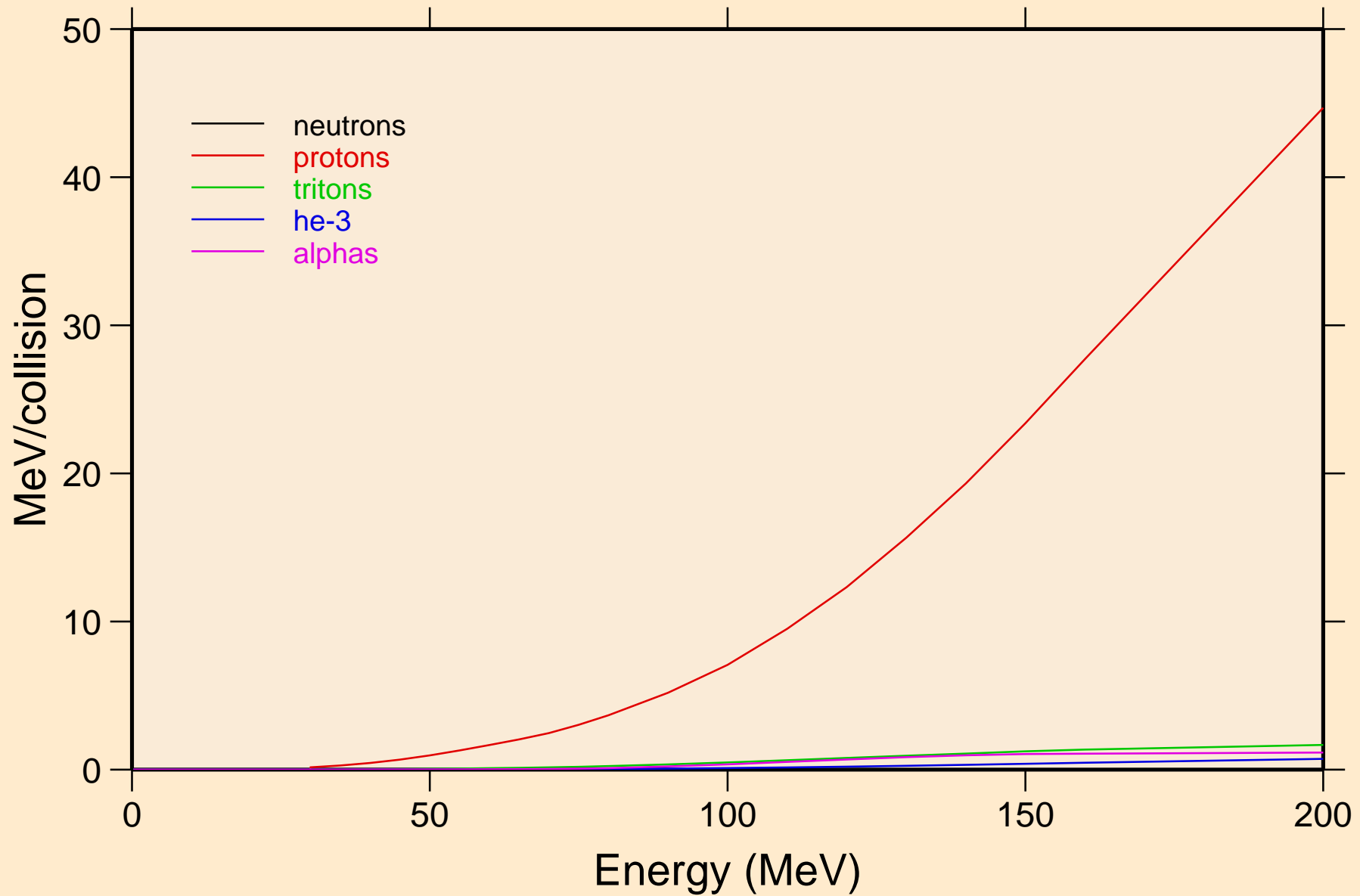

NO257 DEUTERON ACER TENDL-2021 LIBRARY; T=0.K
Recoil Heating

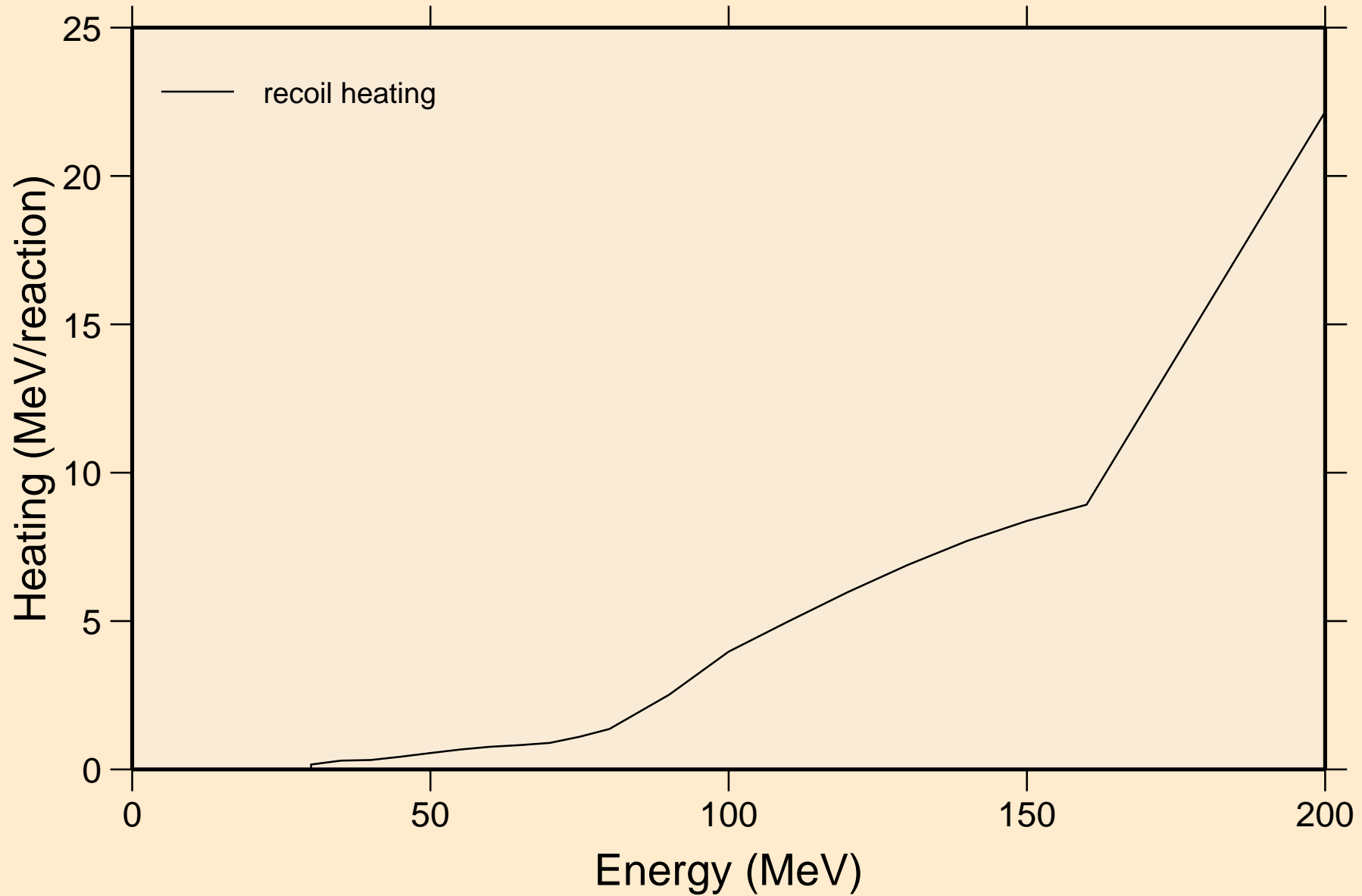

NO257 DEUTERON ACER TENDL-2021 LIBRARY; T=0.K
Particle production cross sections

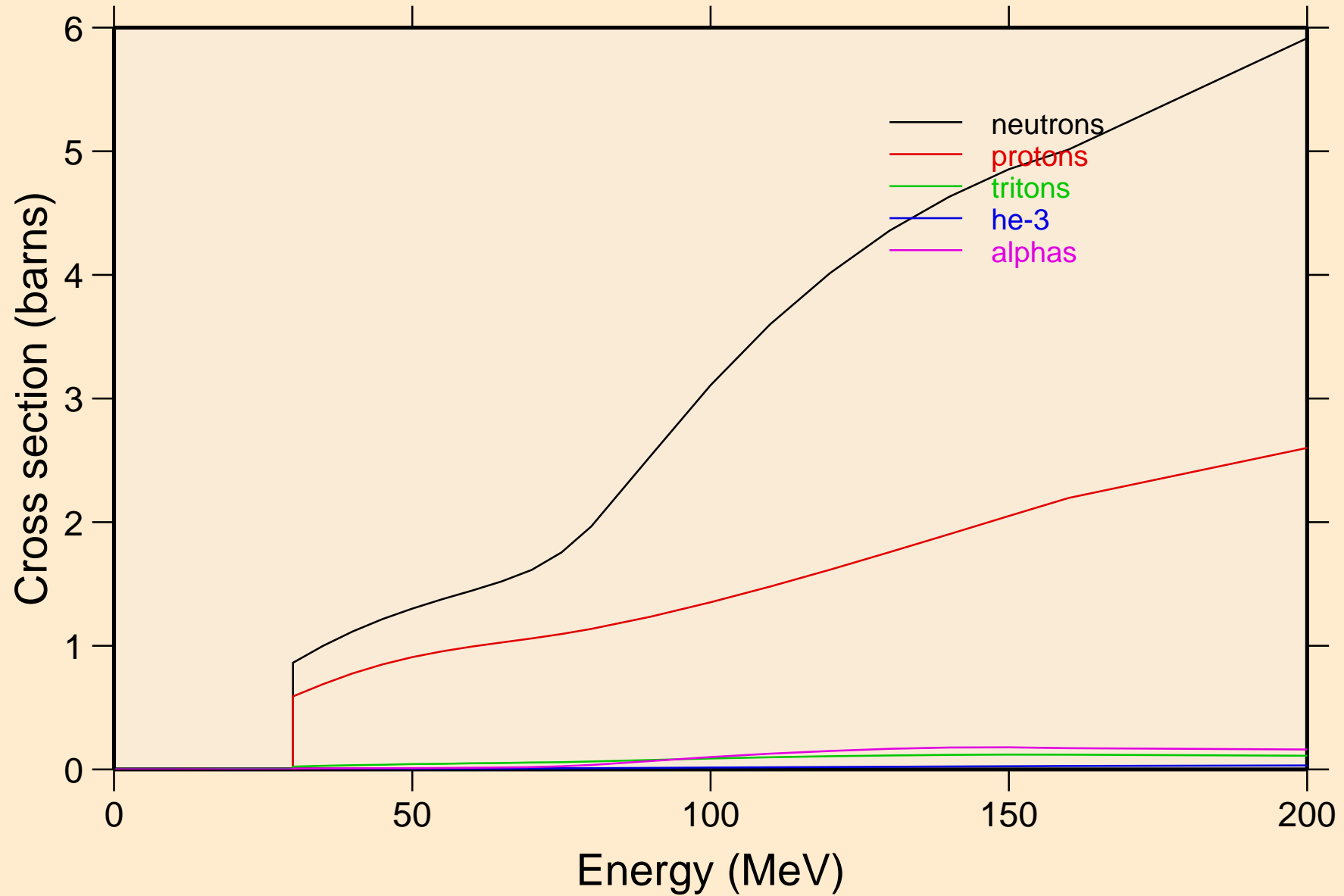

NO257 DEUTERON ACER TENDL-2021 LIBRARY; T=0.K
neutrons from (d,n)

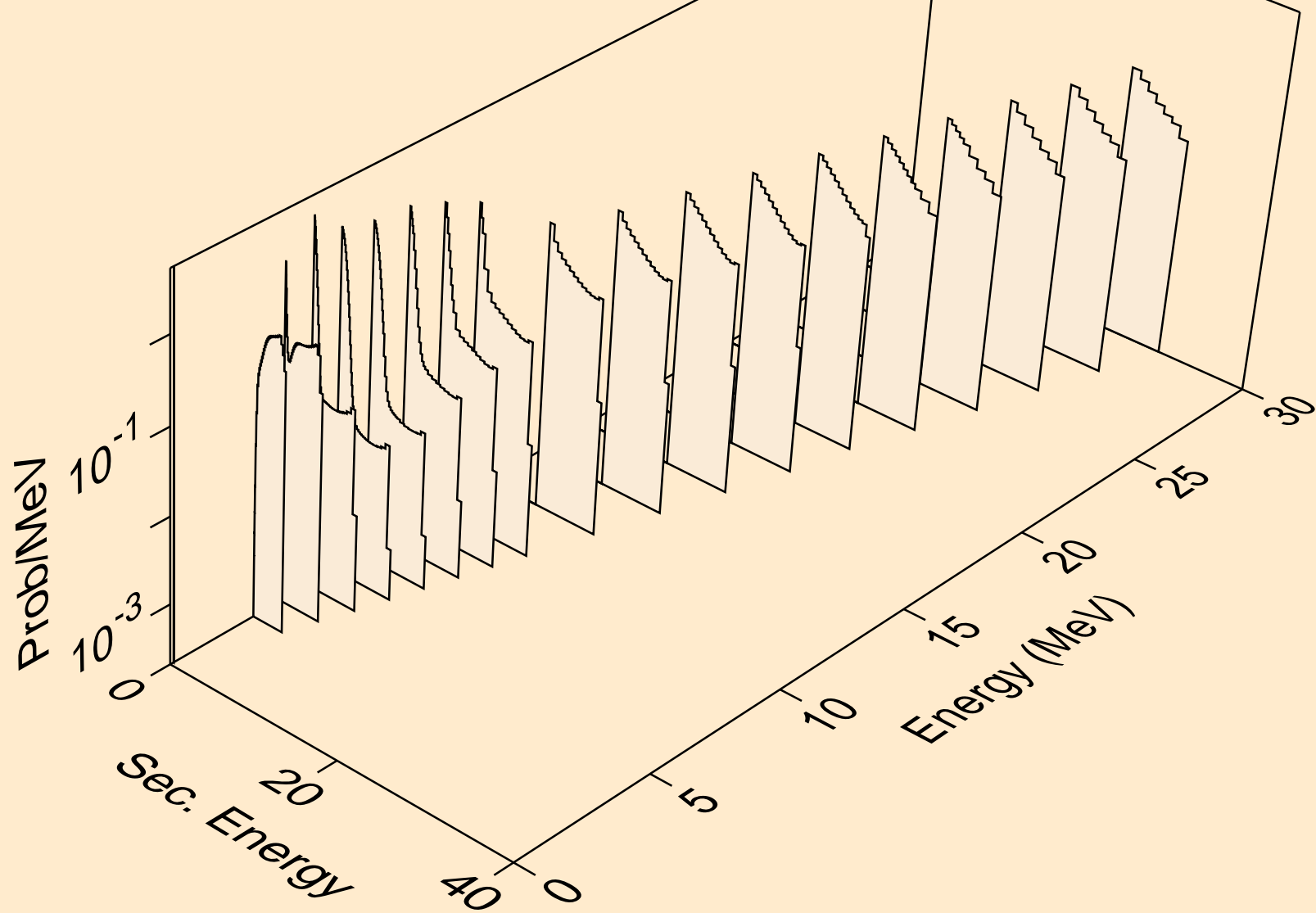

NO257 DEUTERON ACER TENDL-2021 LIBRARY; T=0.K
neutrons from (d,x)

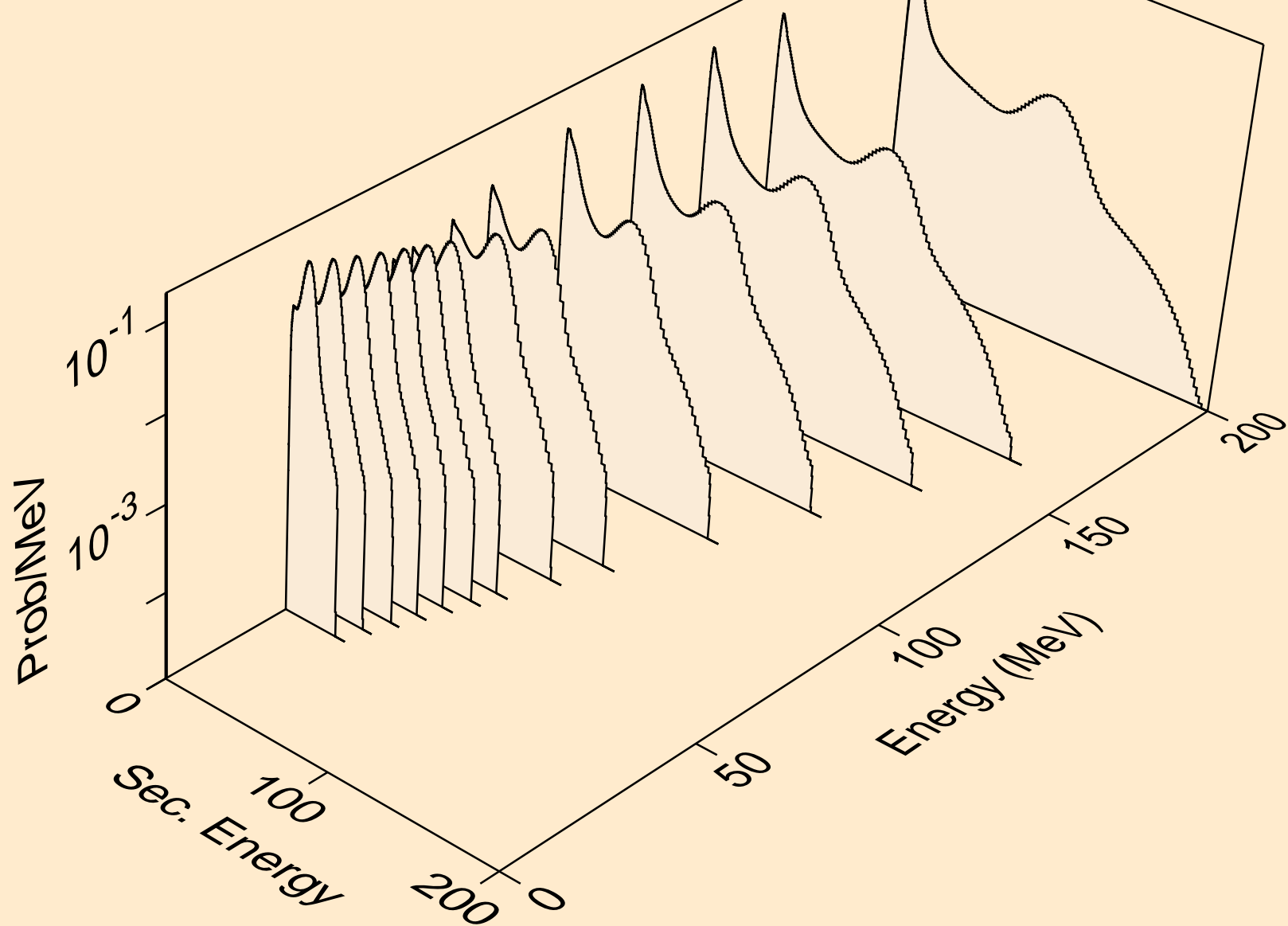

NO257 DEUTERON ACER TENDL-2021 LIBRARY; T=0.K
neutrons from (d,2nd)

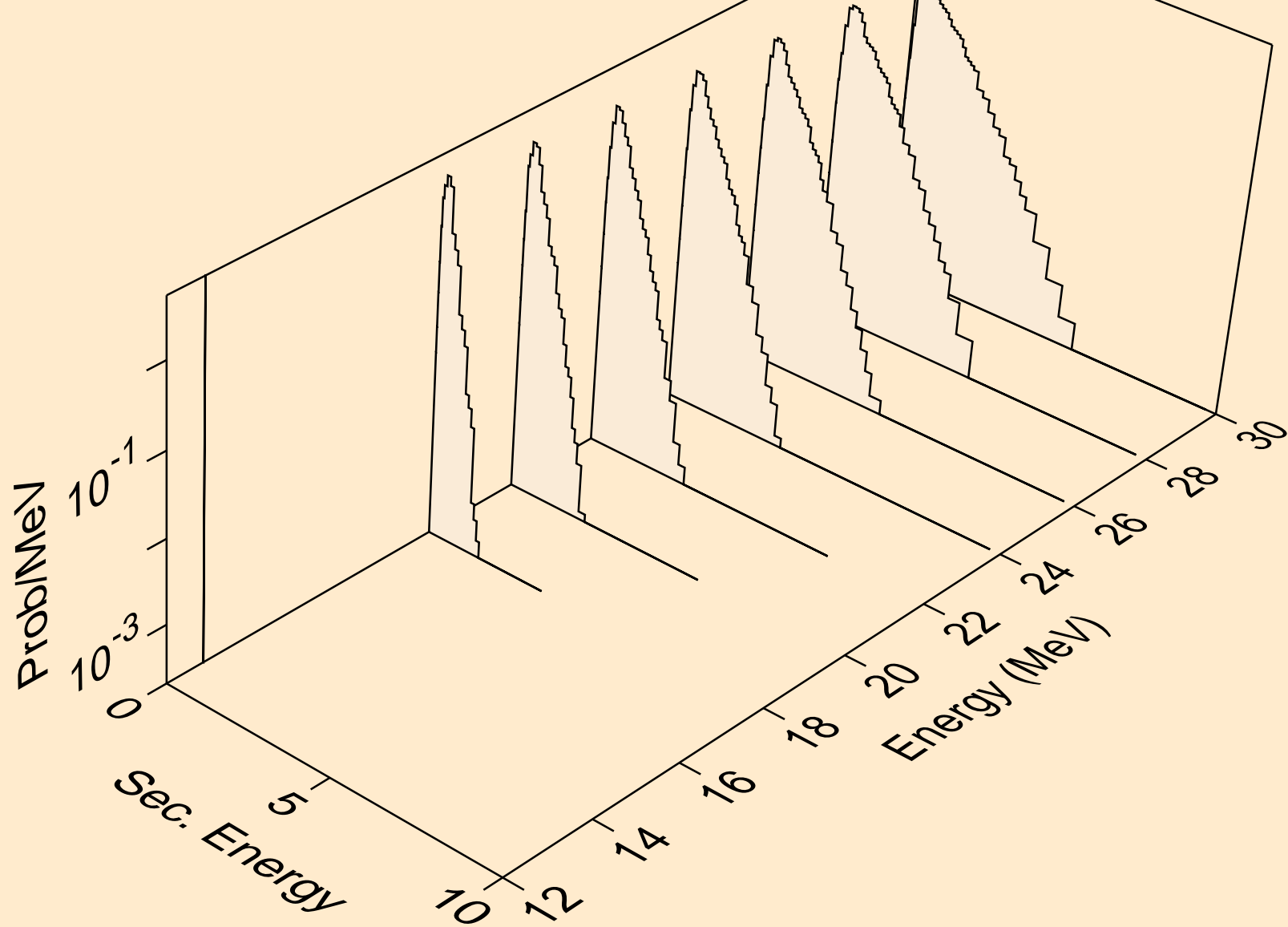

NO257 DEUTERON ACER TENDL-2021 LIBRARY; T=0.K
neutrons from (d,2n)

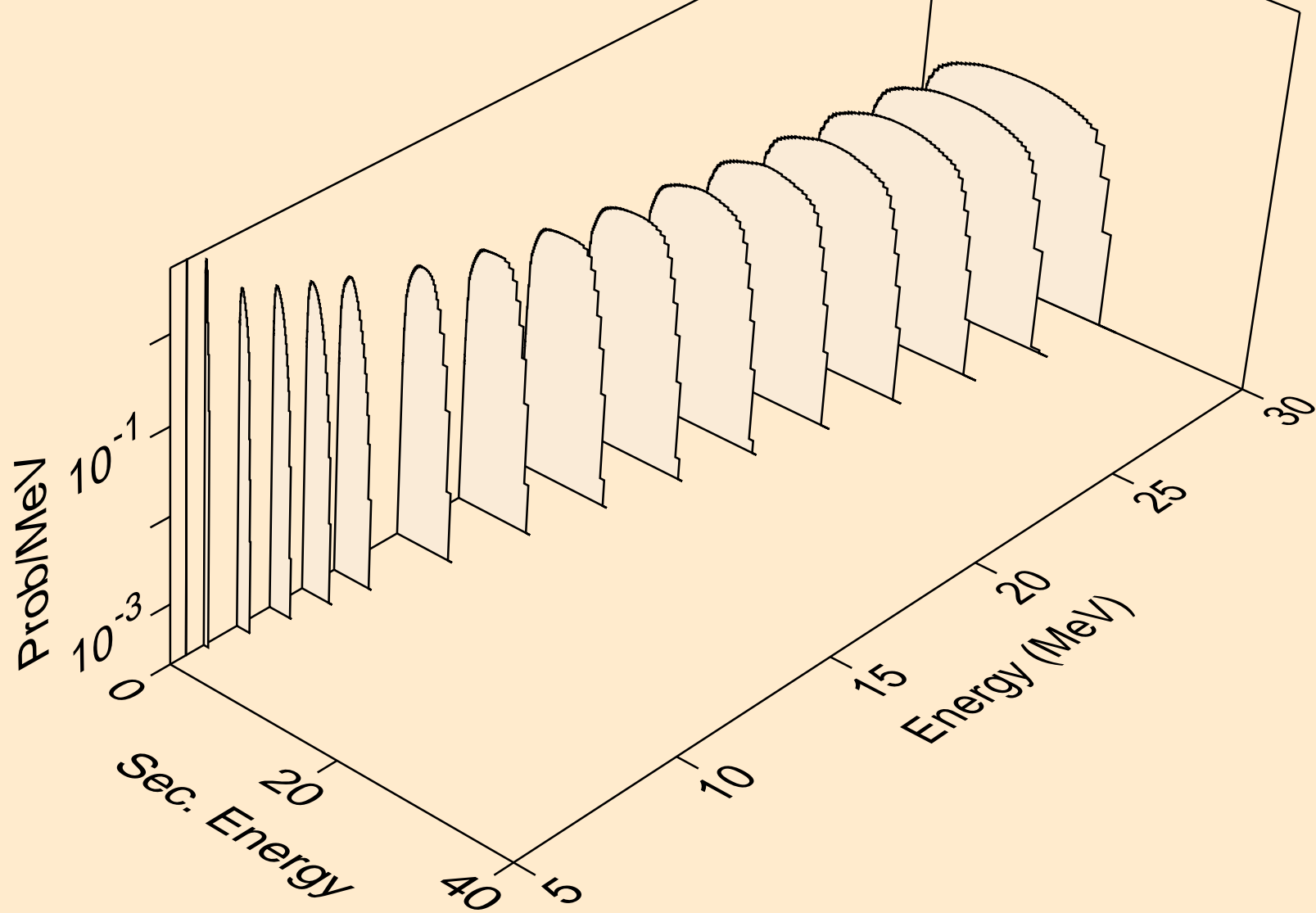

NO257 DEUTERON ACER TENDL-2021 LIBRARY; T=0.K
neutrons from (d,3n)

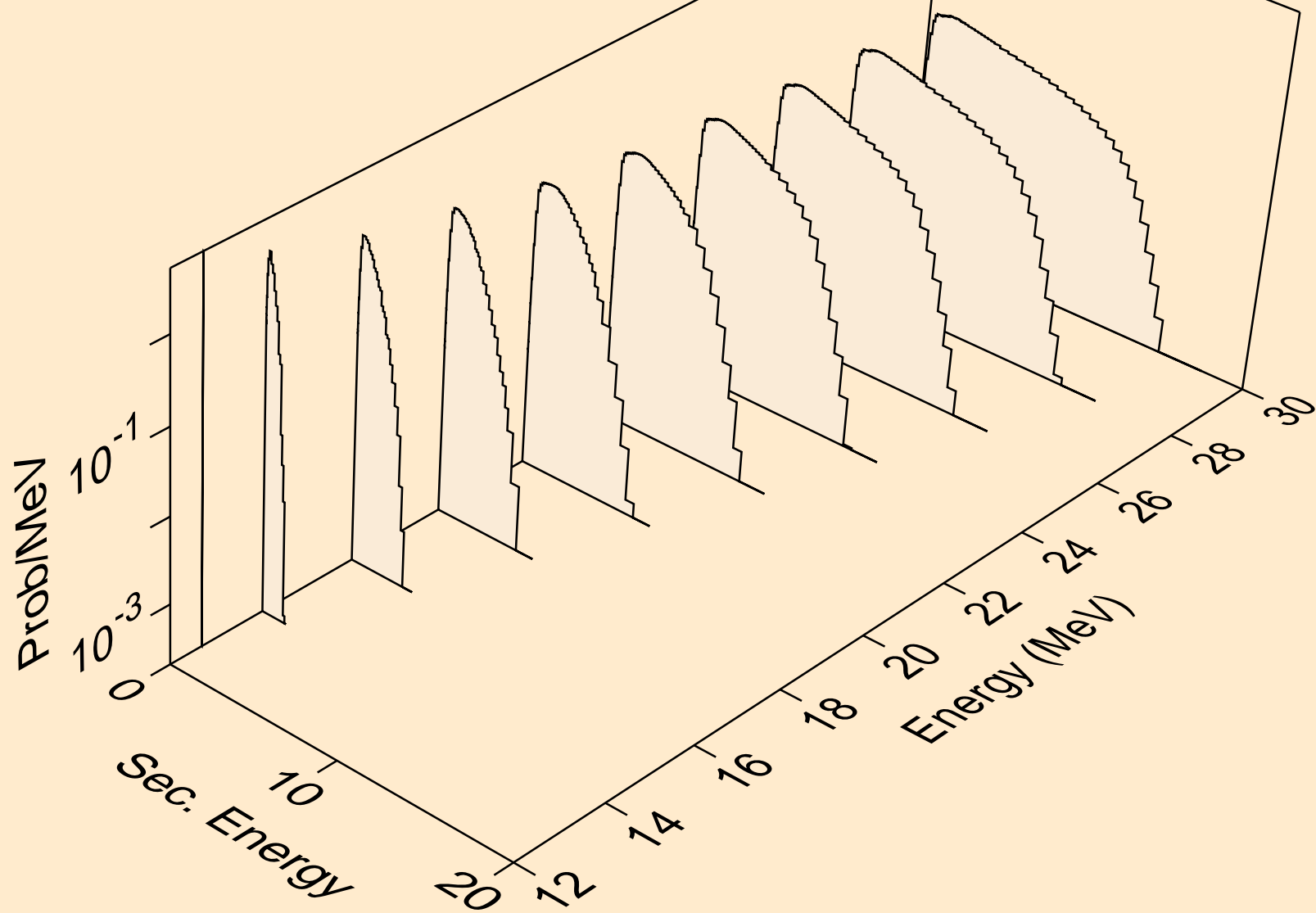

NO257 DEUTERON ACER TENDL-2021 LIBRARY; T=0.K
neutrons from (d,n*)a

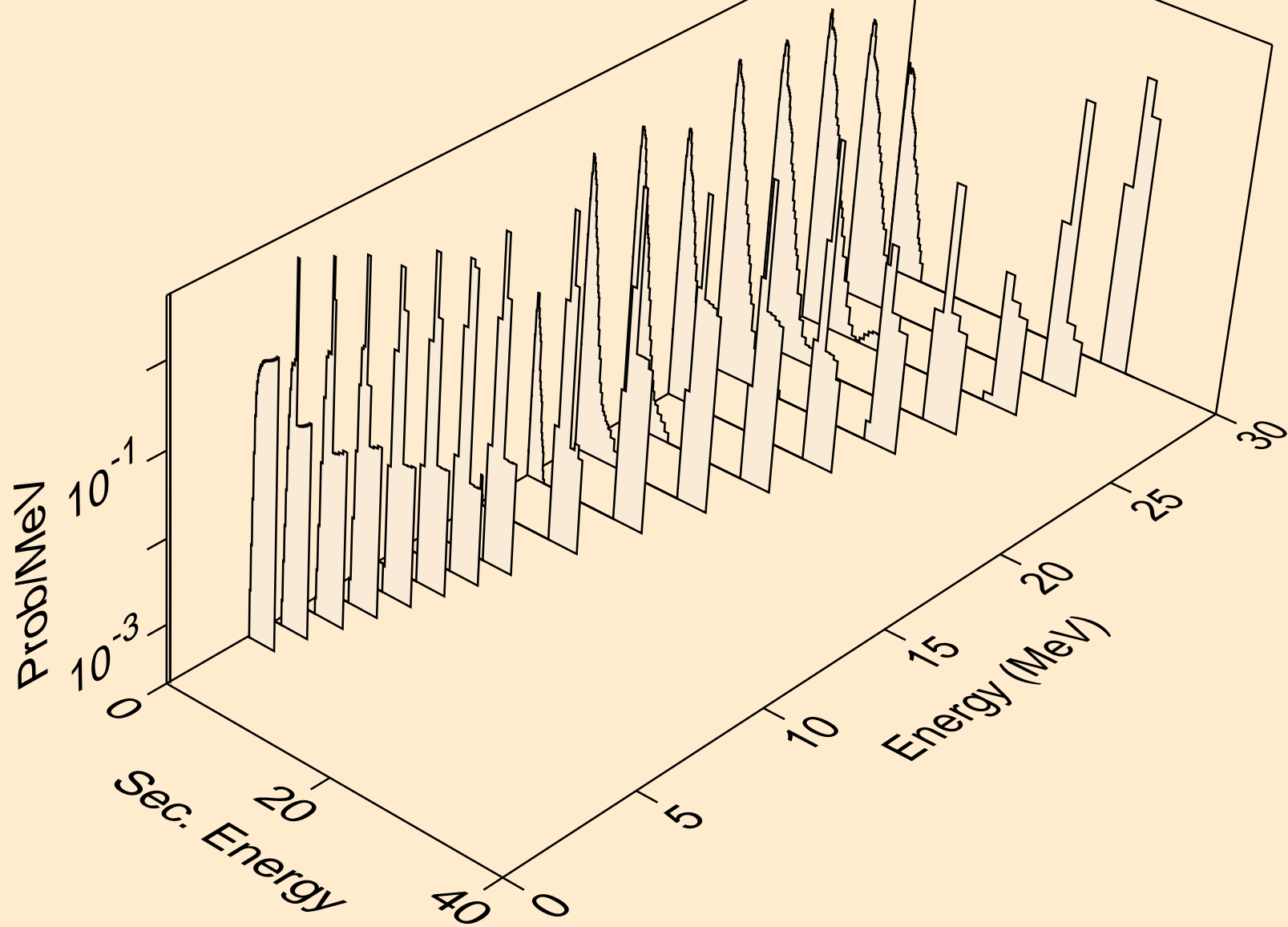

NO257 DEUTERON ACER TENDL-2021 LIBRARY; T=0.K
neutrons from (d,2n)a

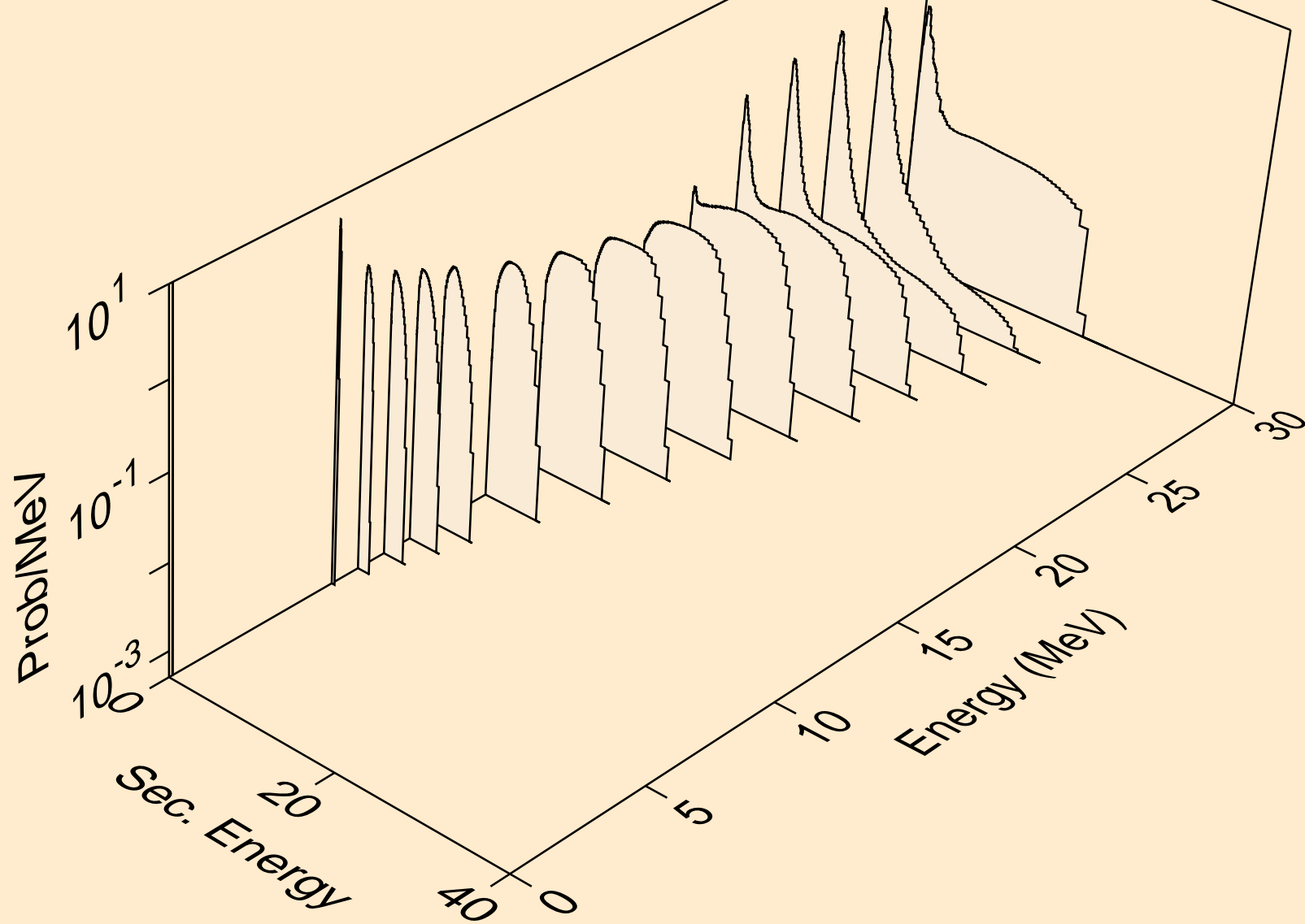

NO257 DEUTERON ACER TENDL-2021 LIBRARY; T=0.K
neutrons from (d,n*)p

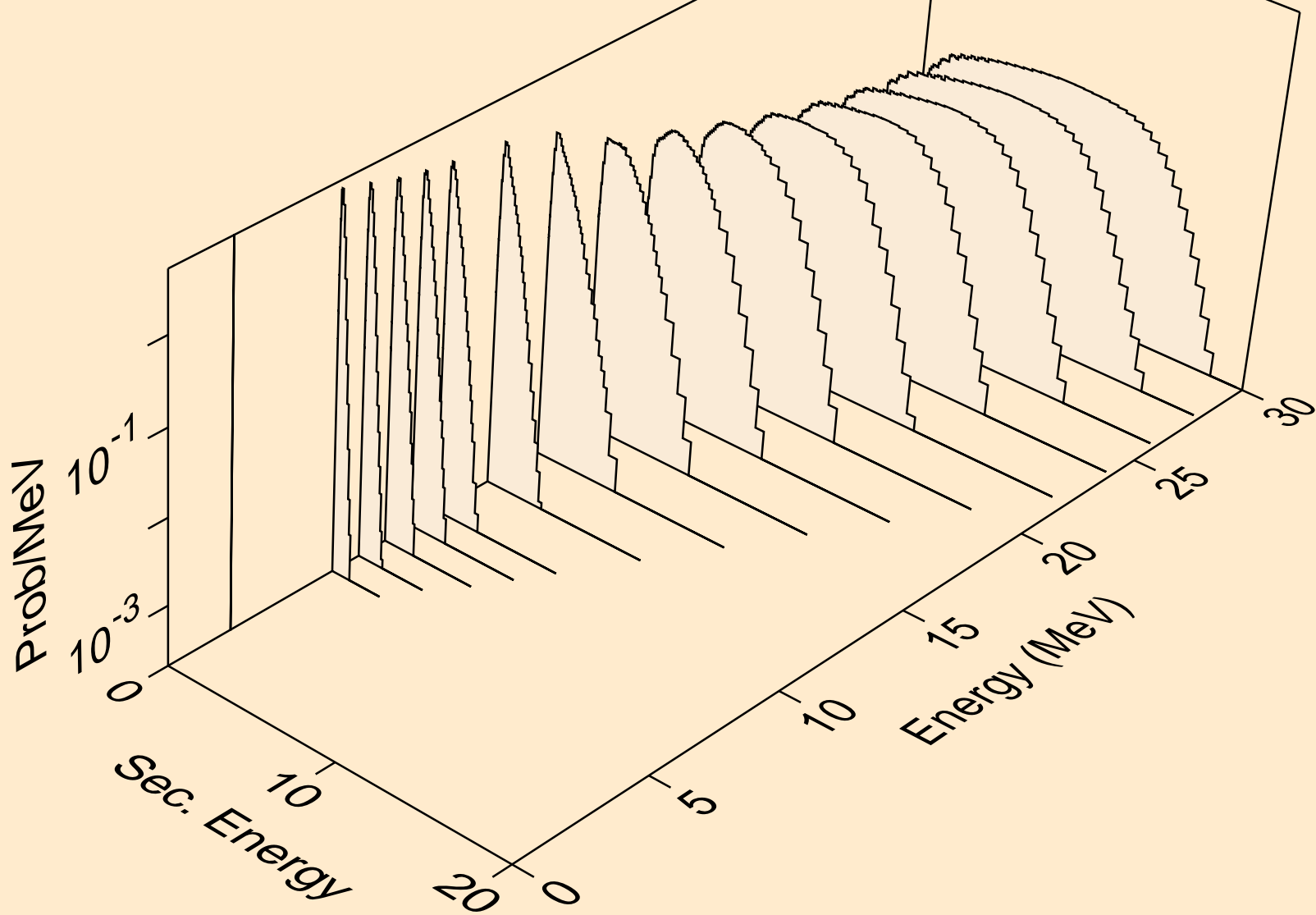

NO257 DEUTERON ACER TENDL-2021 LIBRARY; T=0.K
neutrons from (d,n*)d

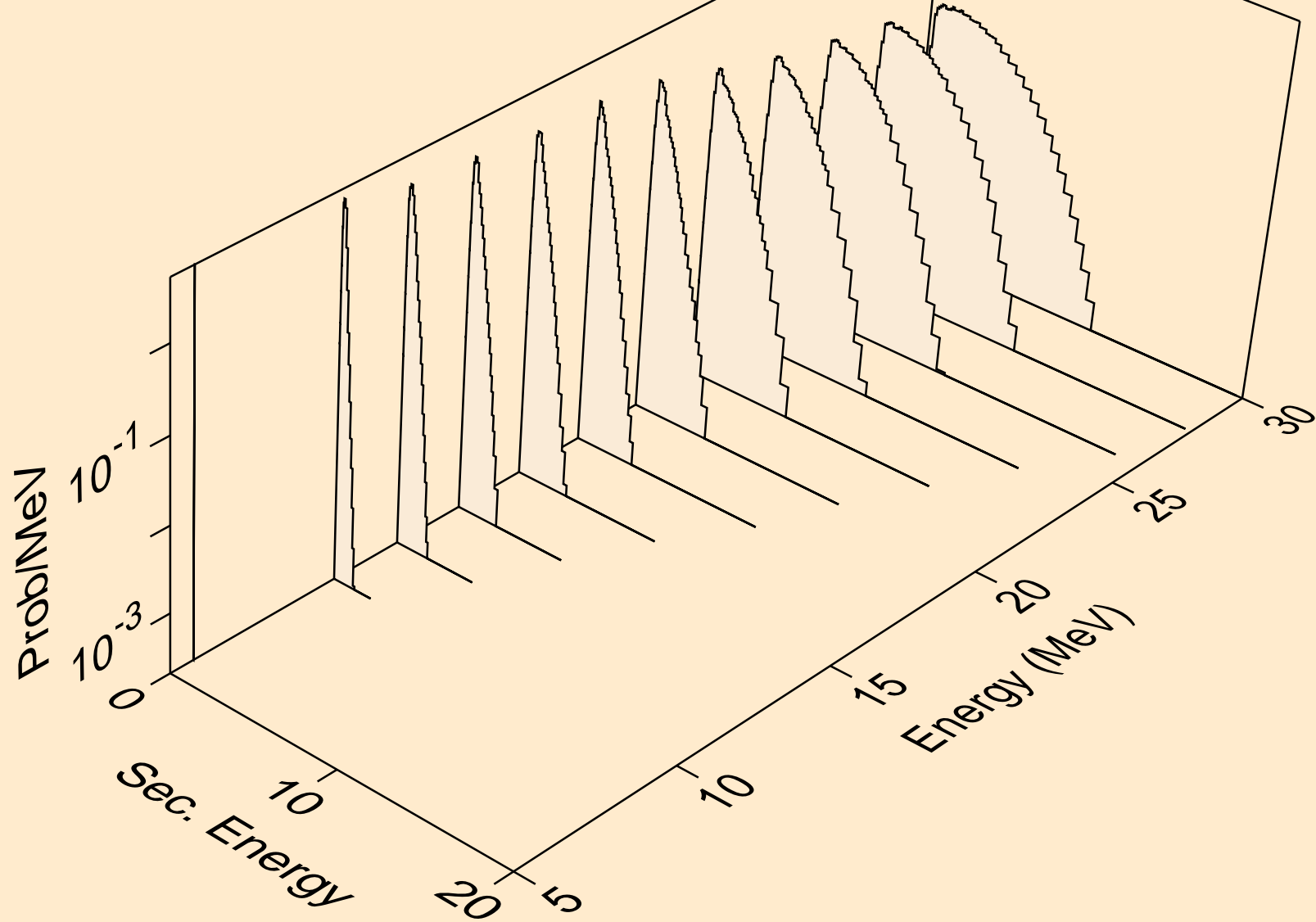

NO257 DEUTERON ACER TENDL-2021 LIBRARY; T=0.K
neutrons from (d,n*)t

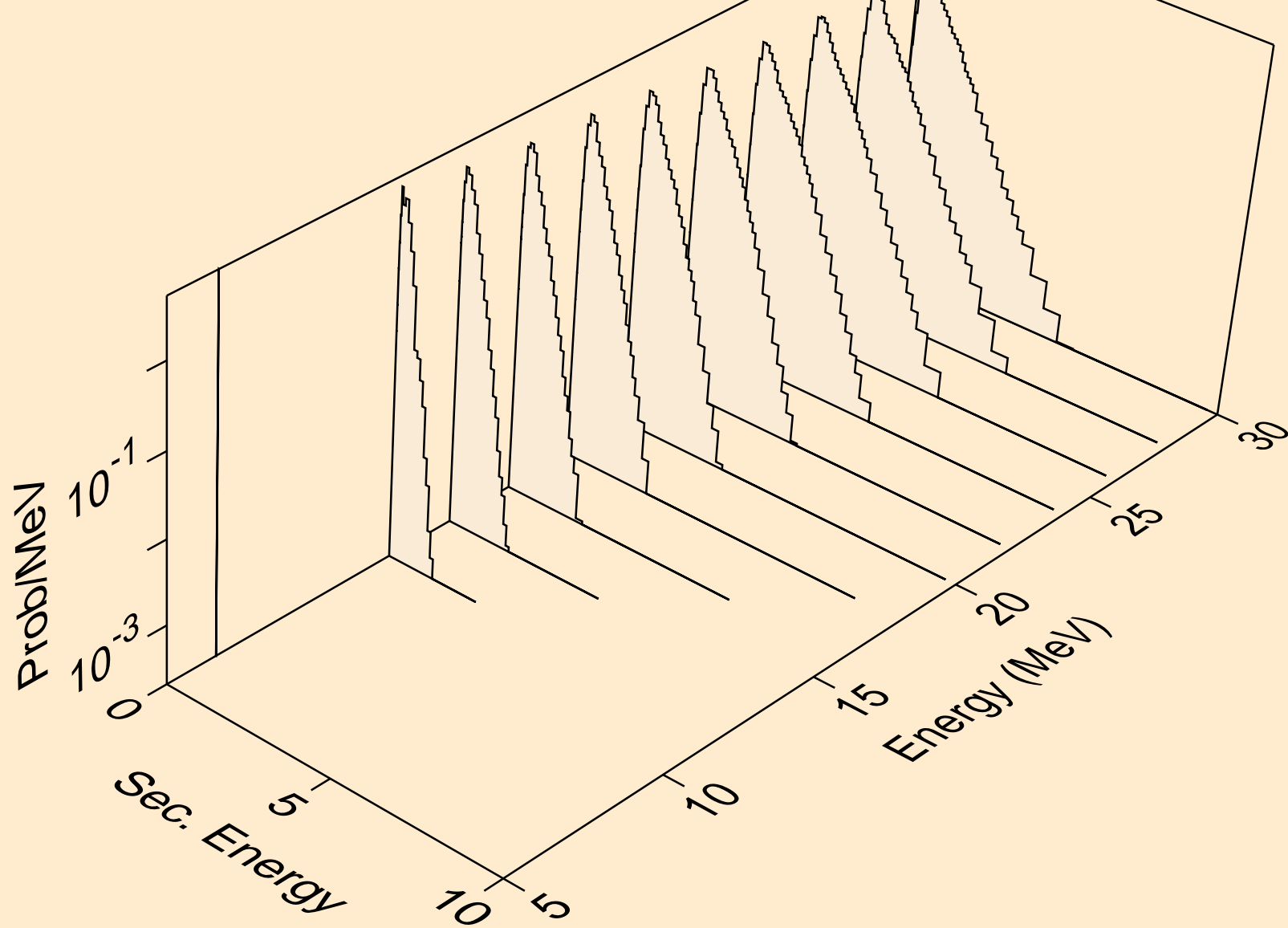

NO257 DEUTERON ACER TENDL-2021 LIBRARY; T=0.K
neutrons from (d,n*)he3

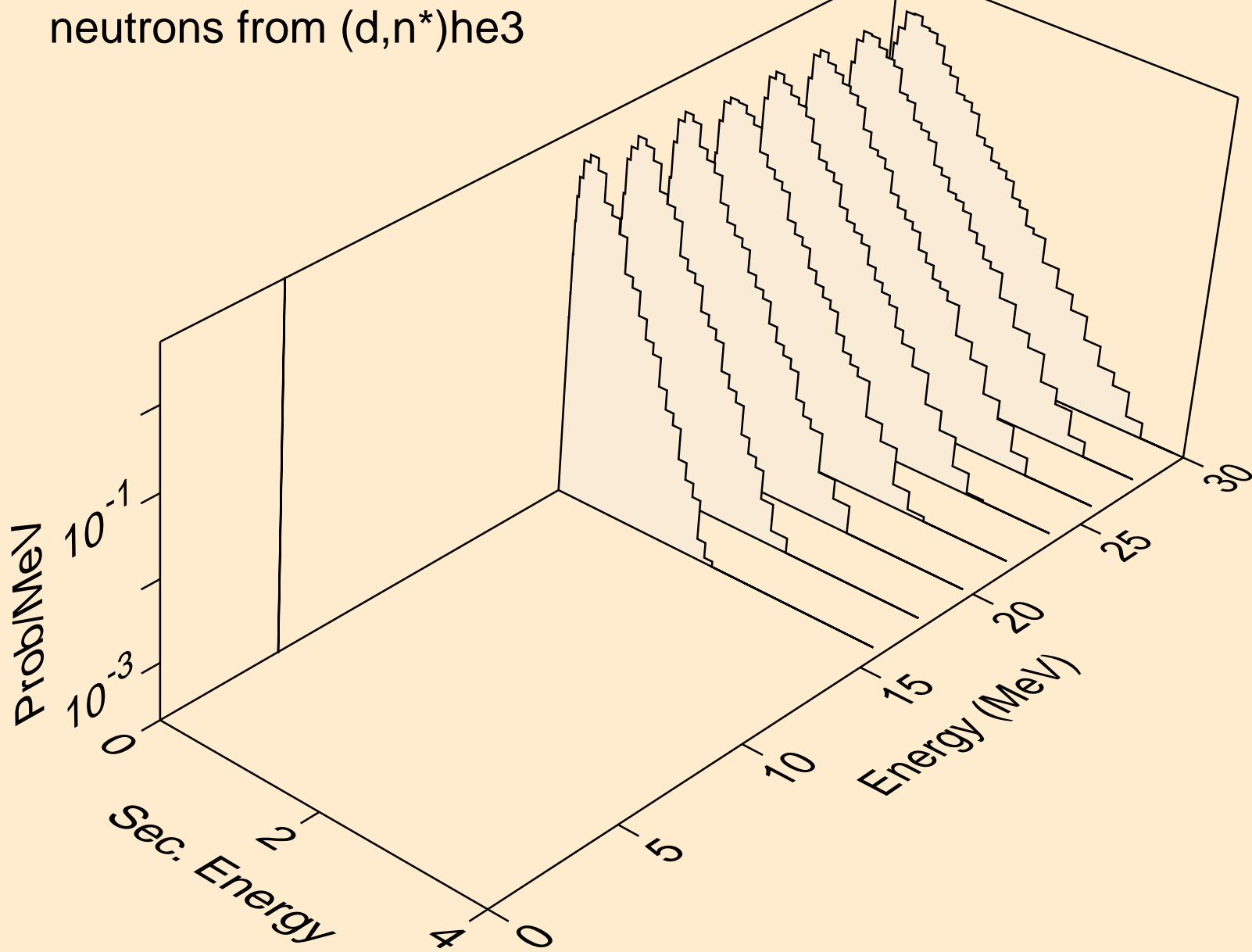

NO257 DEUTERON ACER TENDL-2021 LIBRARY; T=0.K
neutrons from (d,4n)

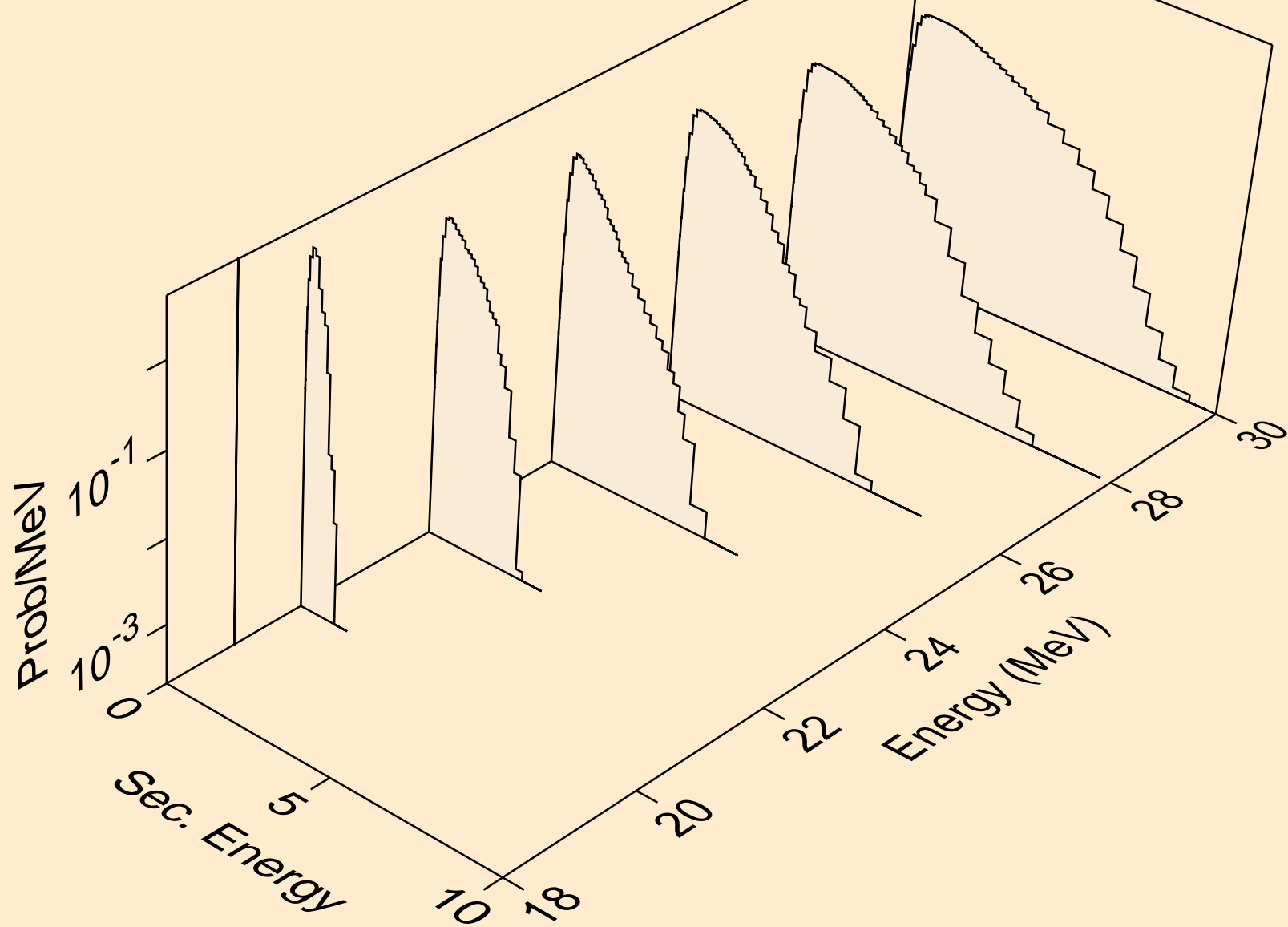

NO257 DEUTERON ACER TENDL-2021 LIBRARY; T=0.K
neutrons from (d,2np)

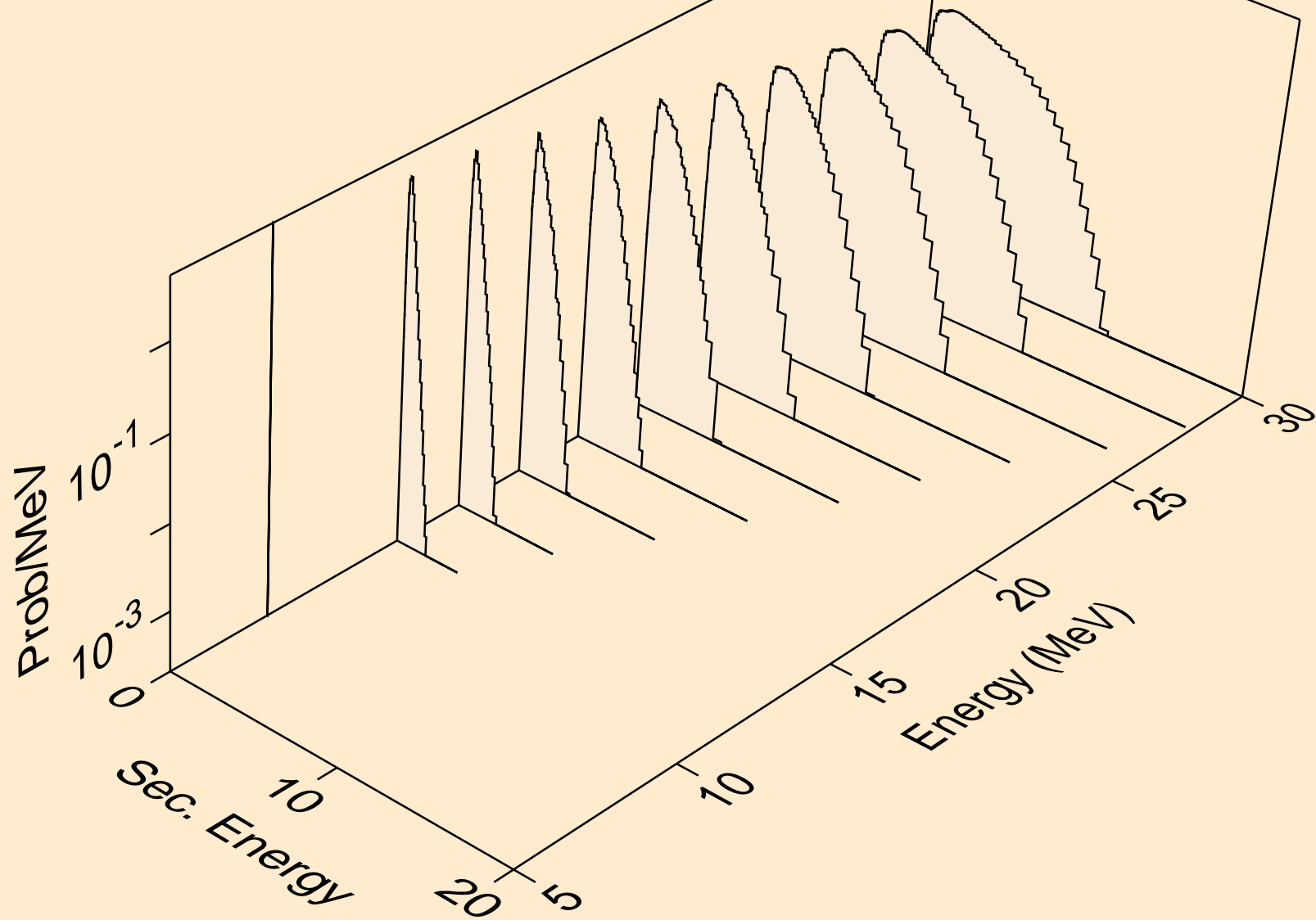

NO257 DEUTERON ACER TENDL-2021 LIBRARY; T=0.K
neutrons from (d,3np)

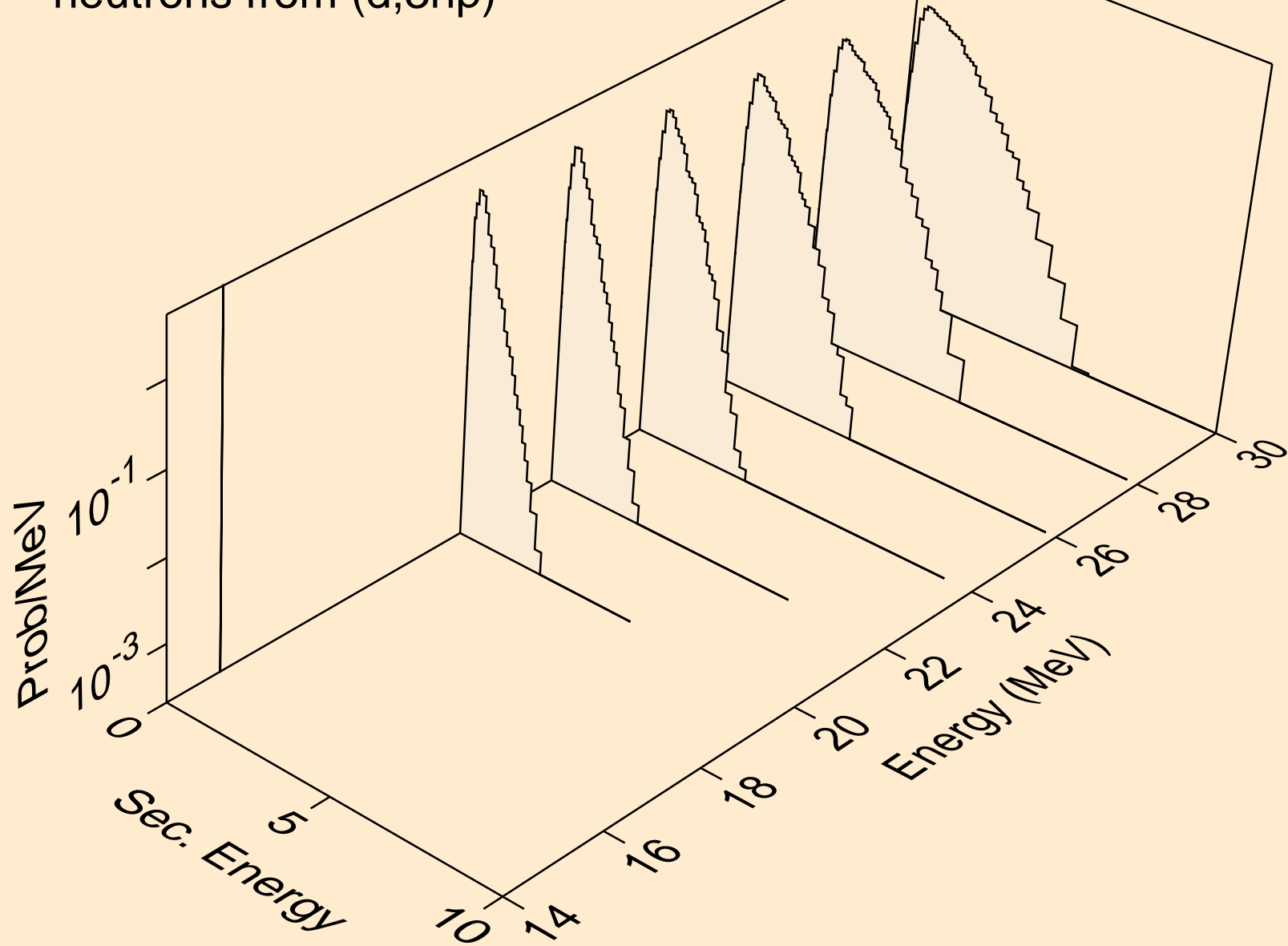

NO257 DEUTERON ACER TENDL-2021 LIBRARY; T=0.K
neutrons from (d,2np)

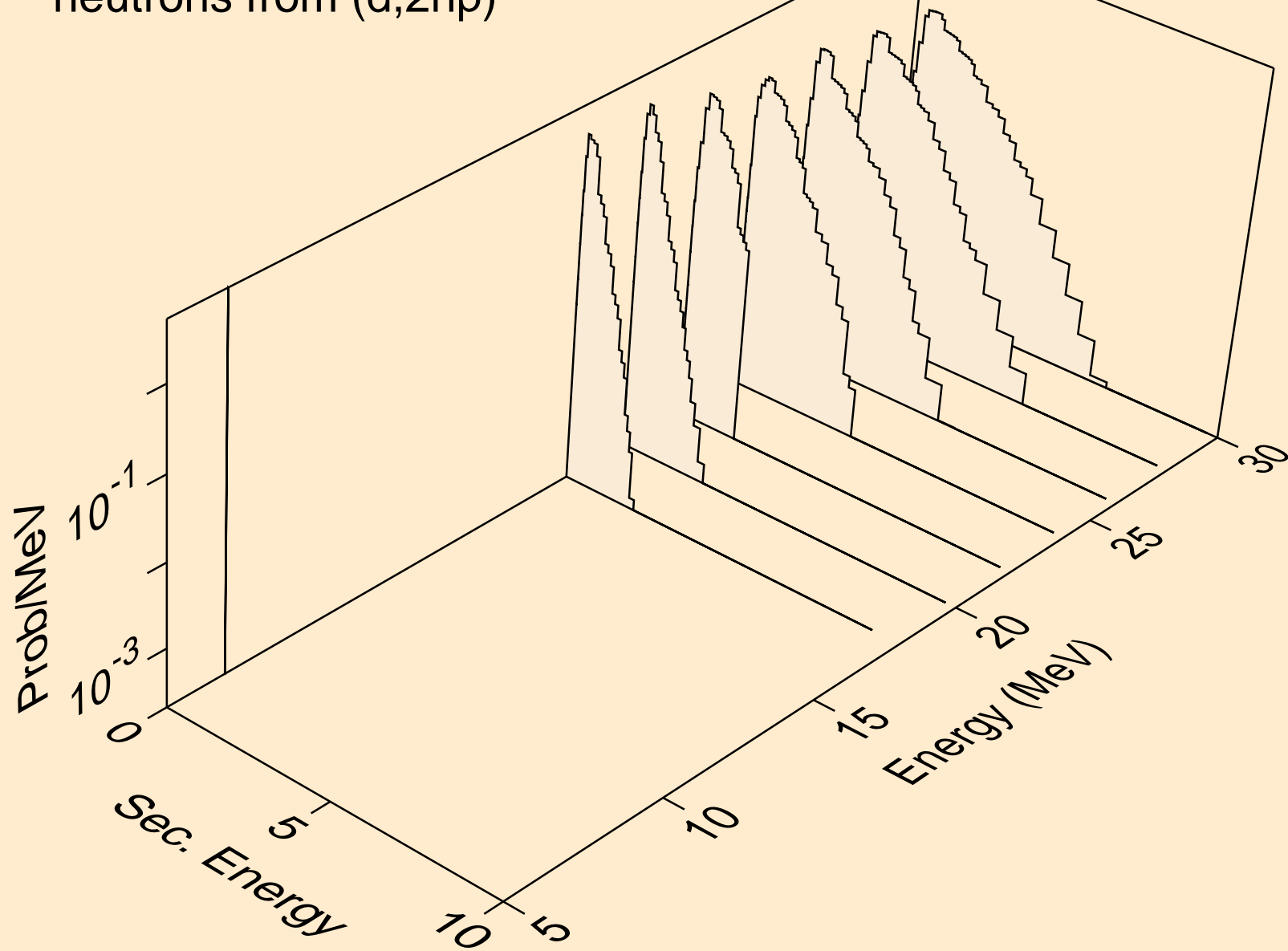

NO257 DEUTERON ACER TENDL-2021 LIBRARY; T=0.K
neutrons from (d,npa)

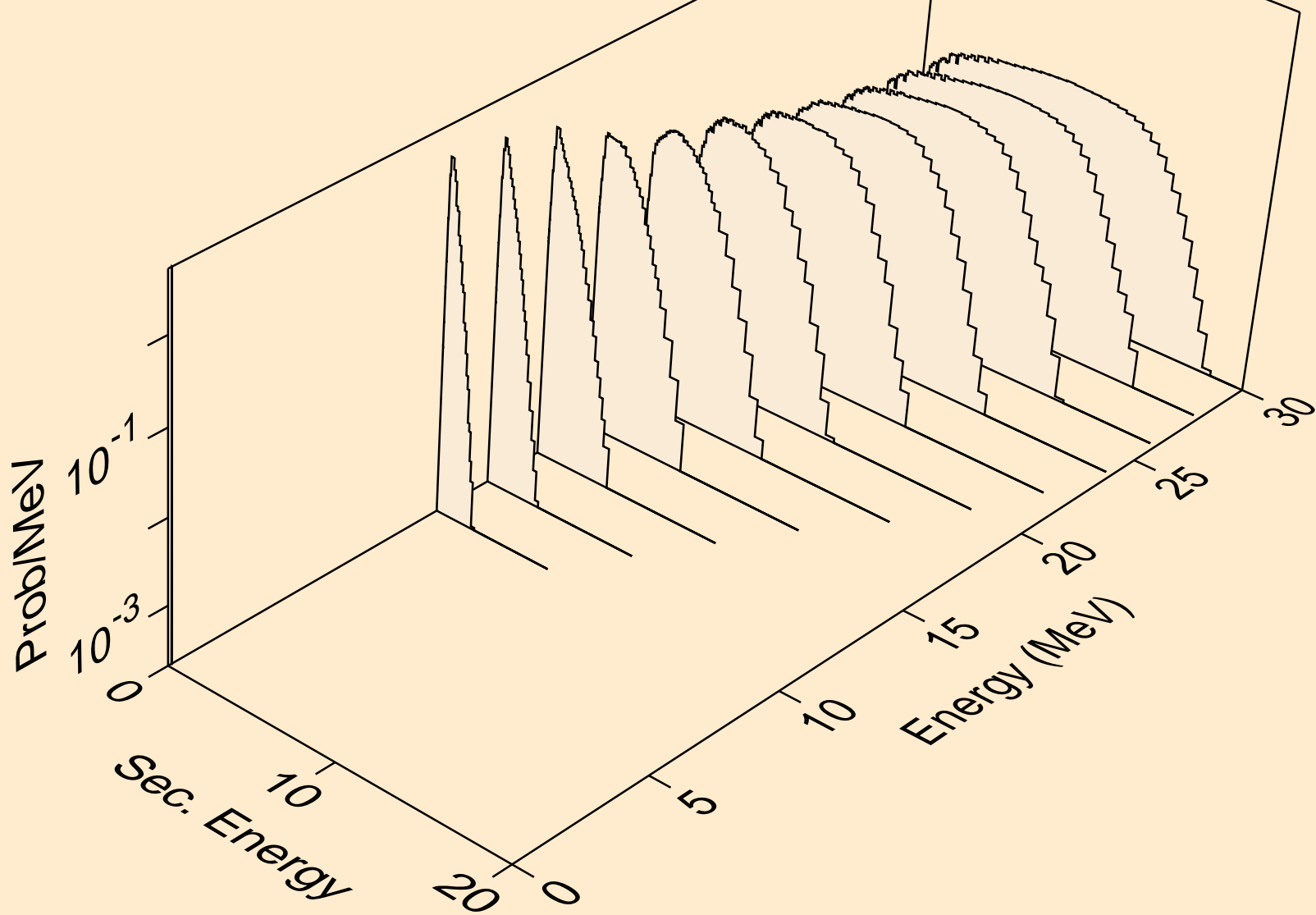

NO257 DEUTERON ACER TENDL-2021 LIBRARY; T=0.K
protons from (d,x)

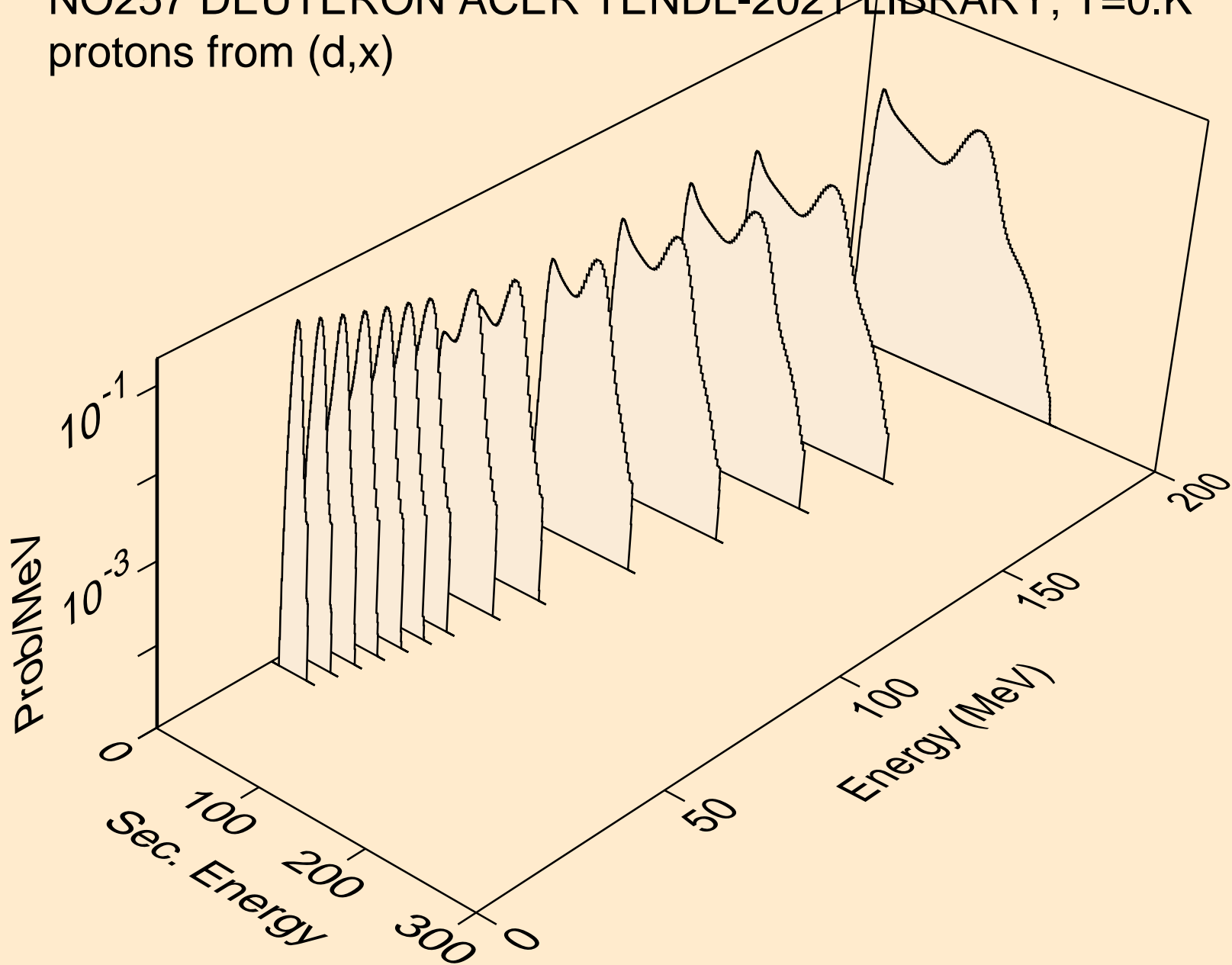

NO257 DEUTERON ACER TENDL-2021 LIBRARY; T=0.K
protons from (d,n*)p

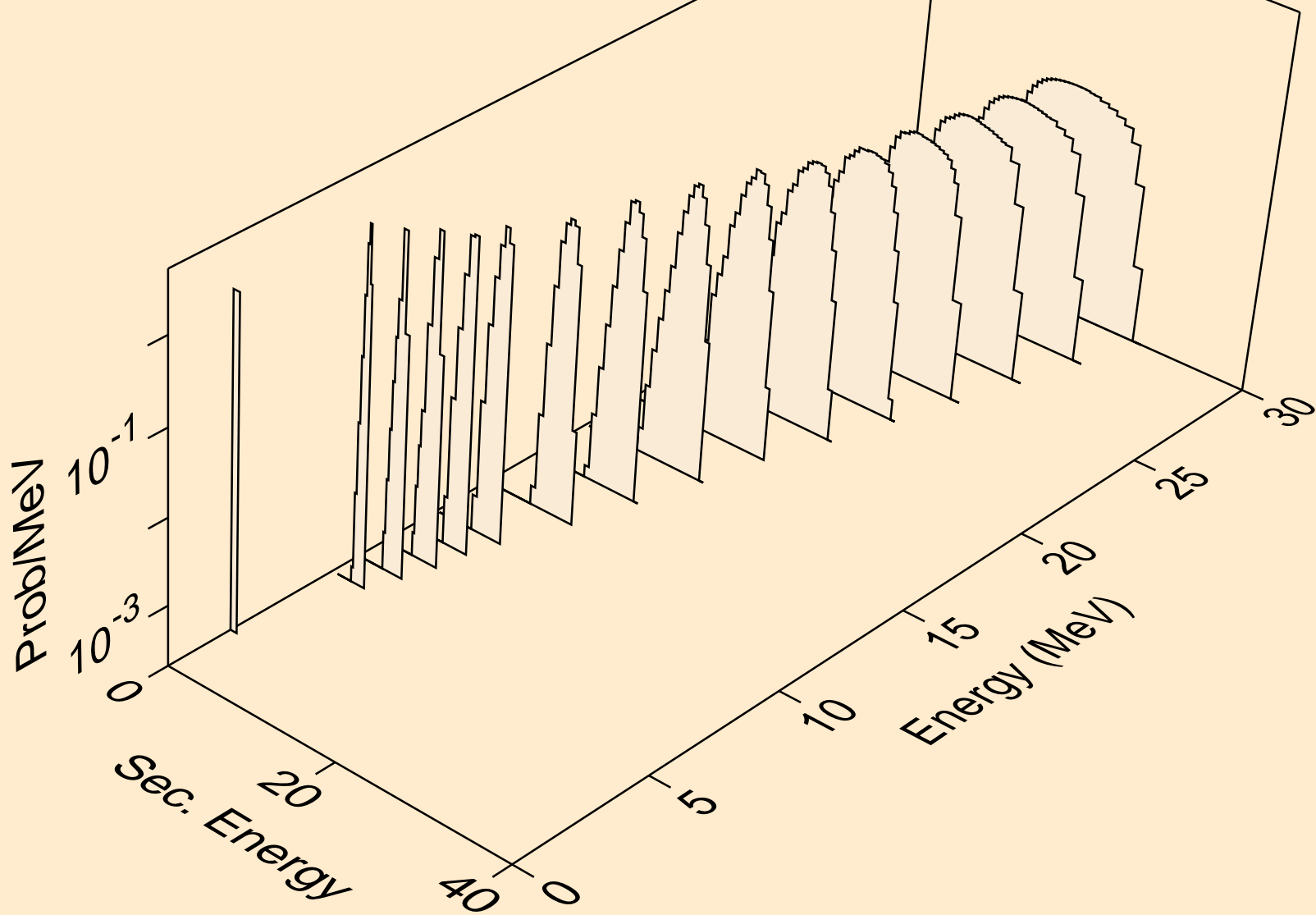

NO257 DEUTERON ACER TENDL-2021 LIBRARY; T=0.K
protons from (d,2np)

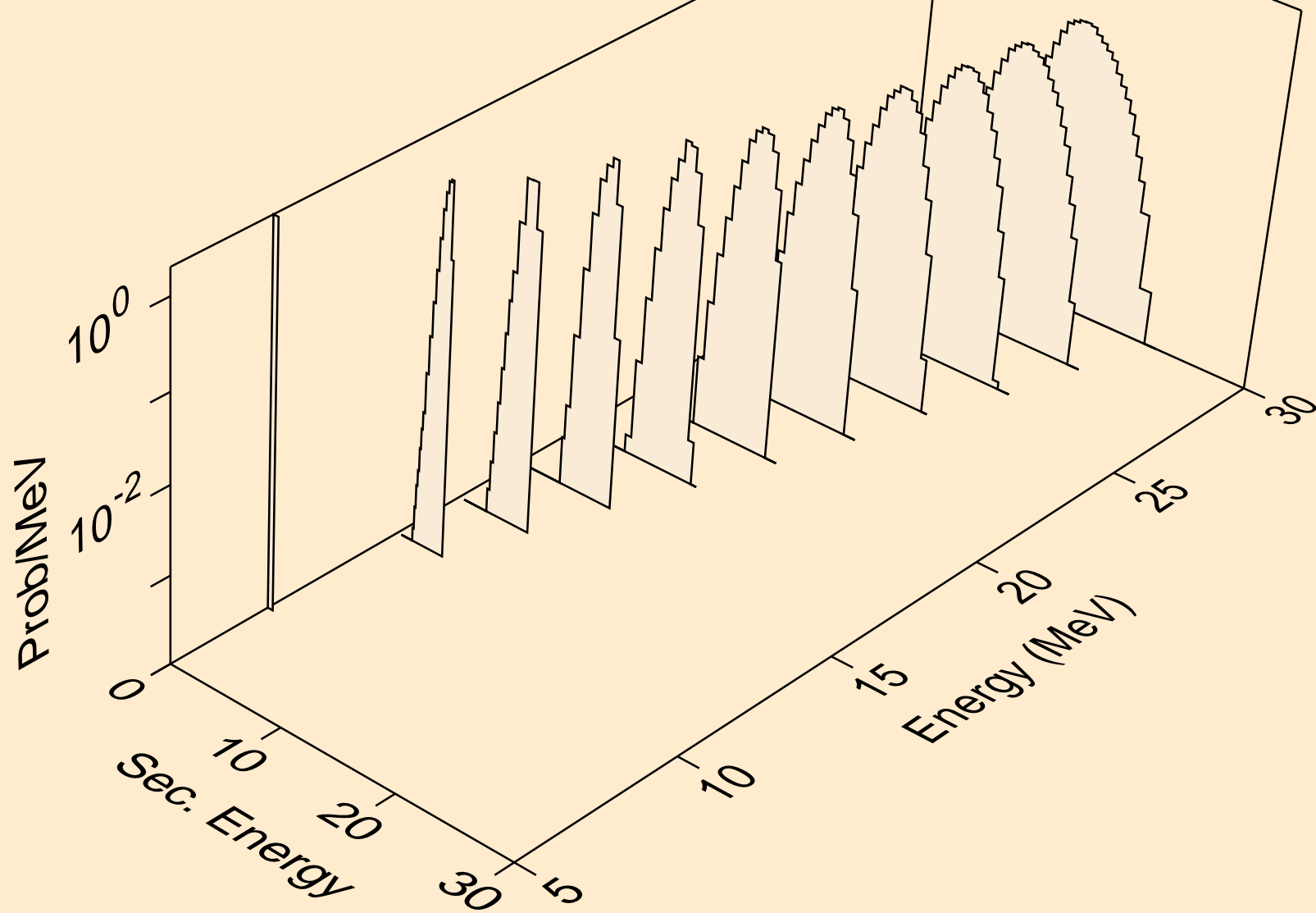

NO257 DEUTERON ACER TENDL-2021 LIBRARY; T=0.K
protons from (d,3np)

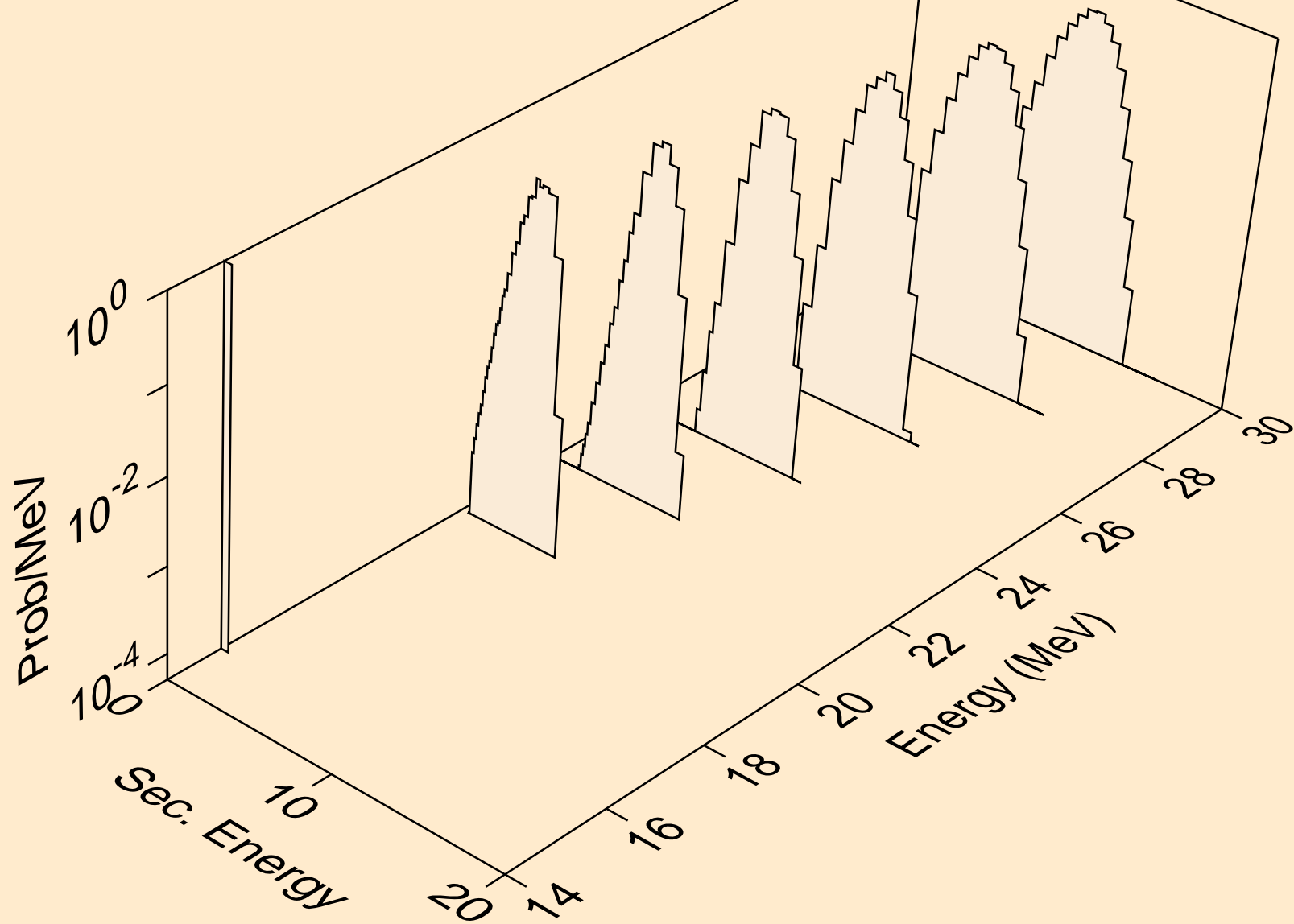

NO257 DEUTERON ACER TENDL-2021 LIBRARY; T=0.K
protons from (d,2np)

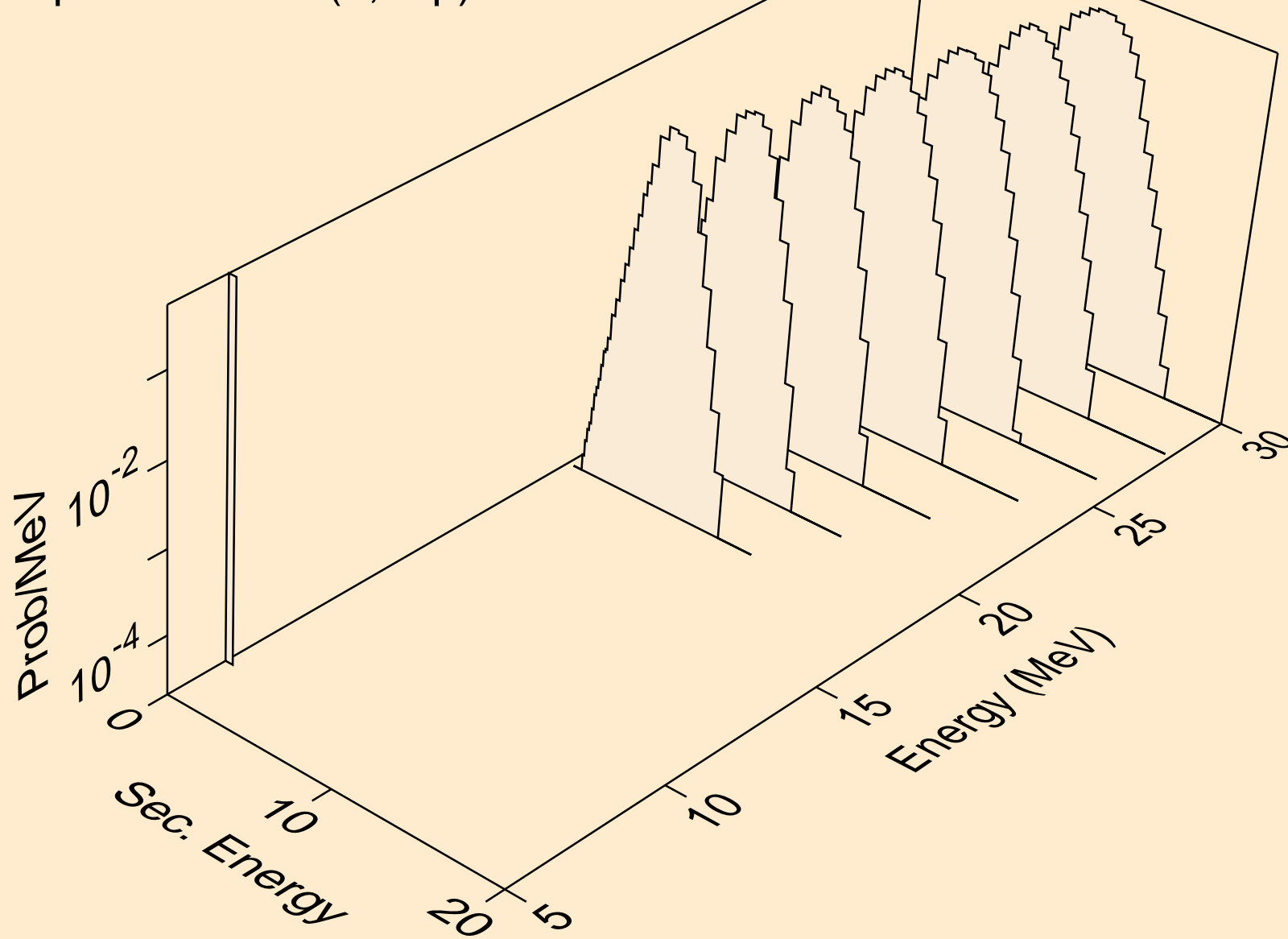

NO257 DEUTERON ACER TENDL-2021 LIBRARY; T=0.K
protons from (d,npa)

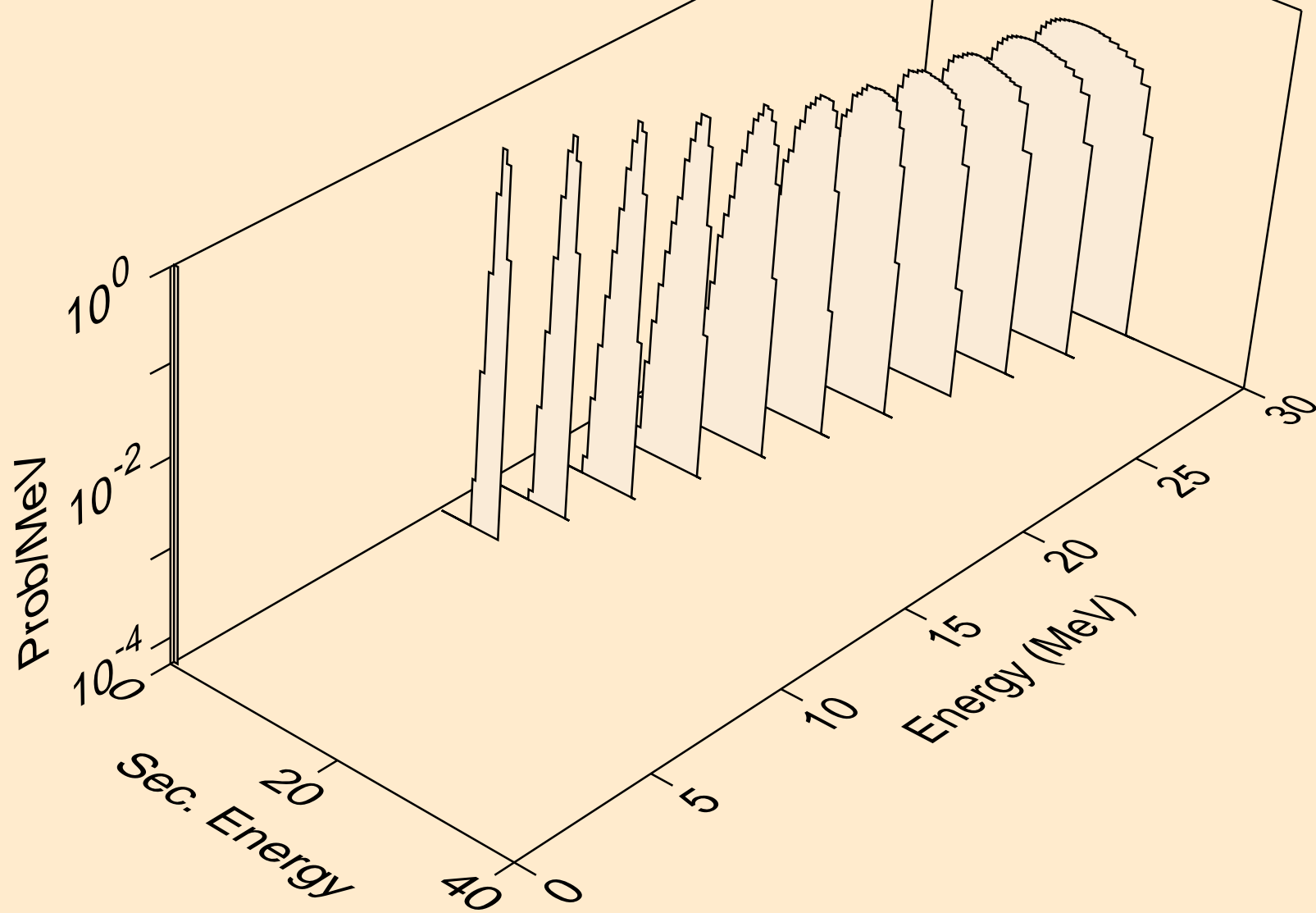

NO257 DEUTERON ACER TENDL-2021 LIBRARY; T=0.K
protons from (d,p)

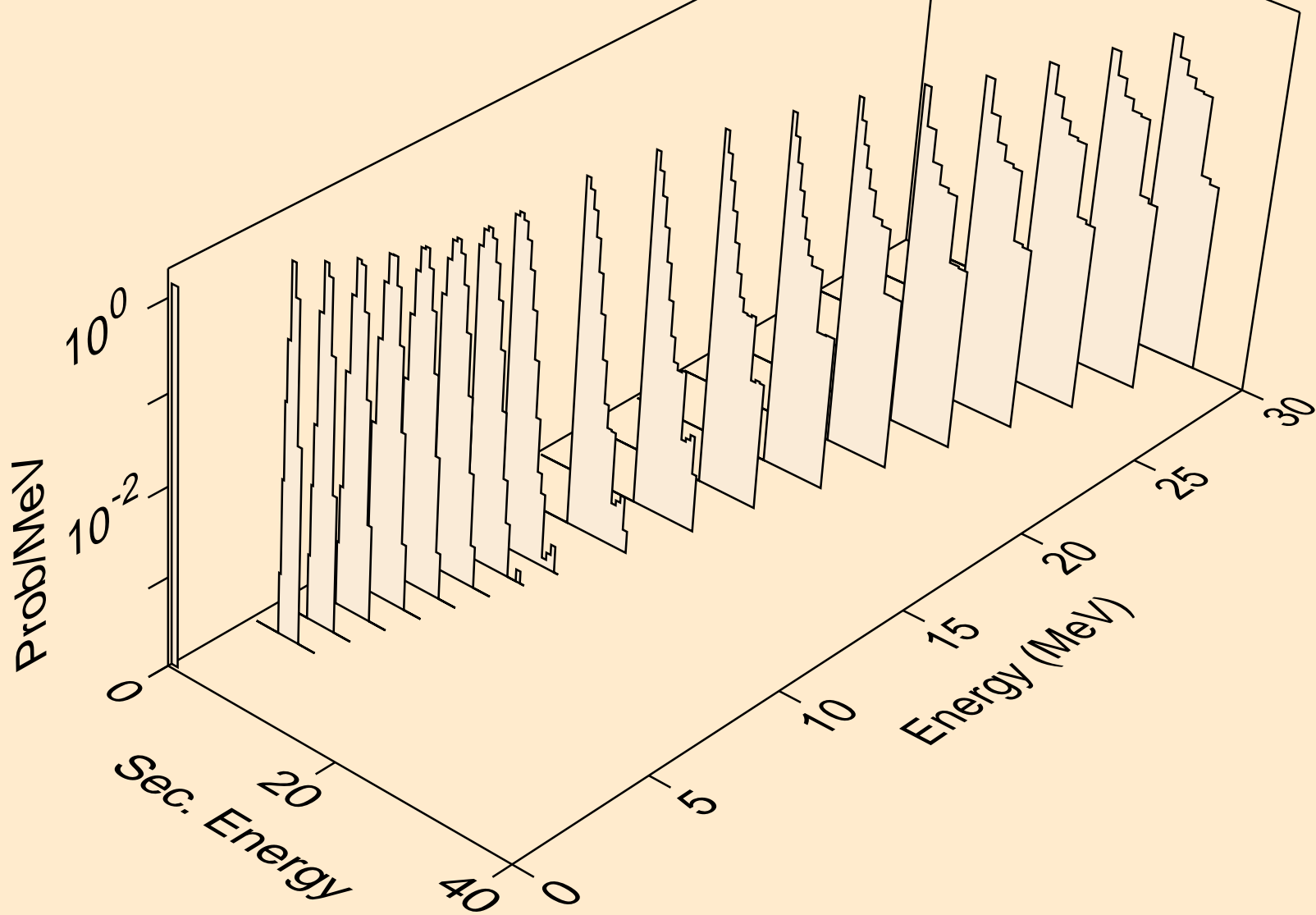

NO257 DEUTERON ACER TENDL-2021 LIBRARY; T=0.K
protons from (d,2p)

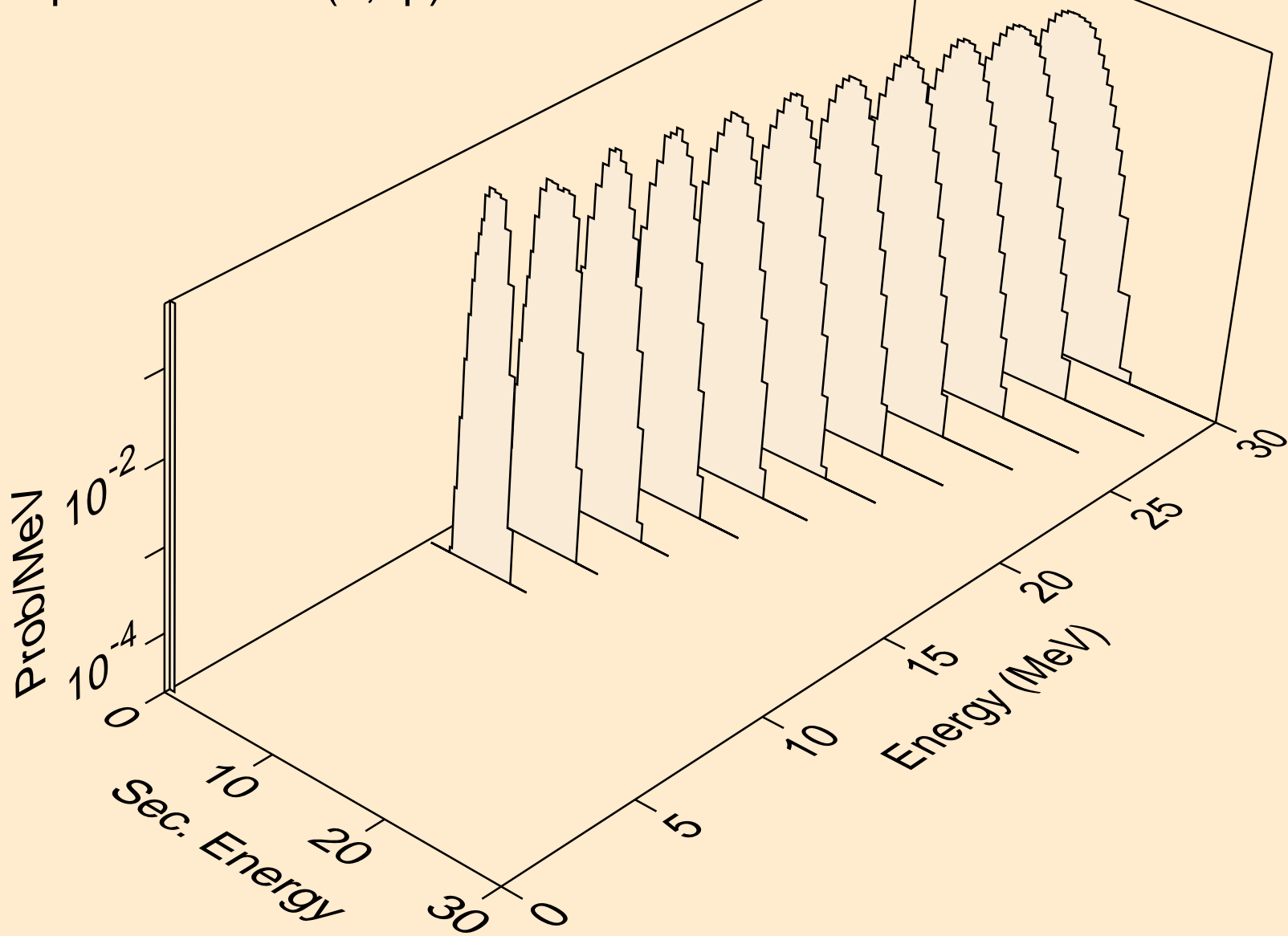

NO257 DEUTERON ACER TENDL-2021 LIBRARY; T=0.K
protons from (d,pd)

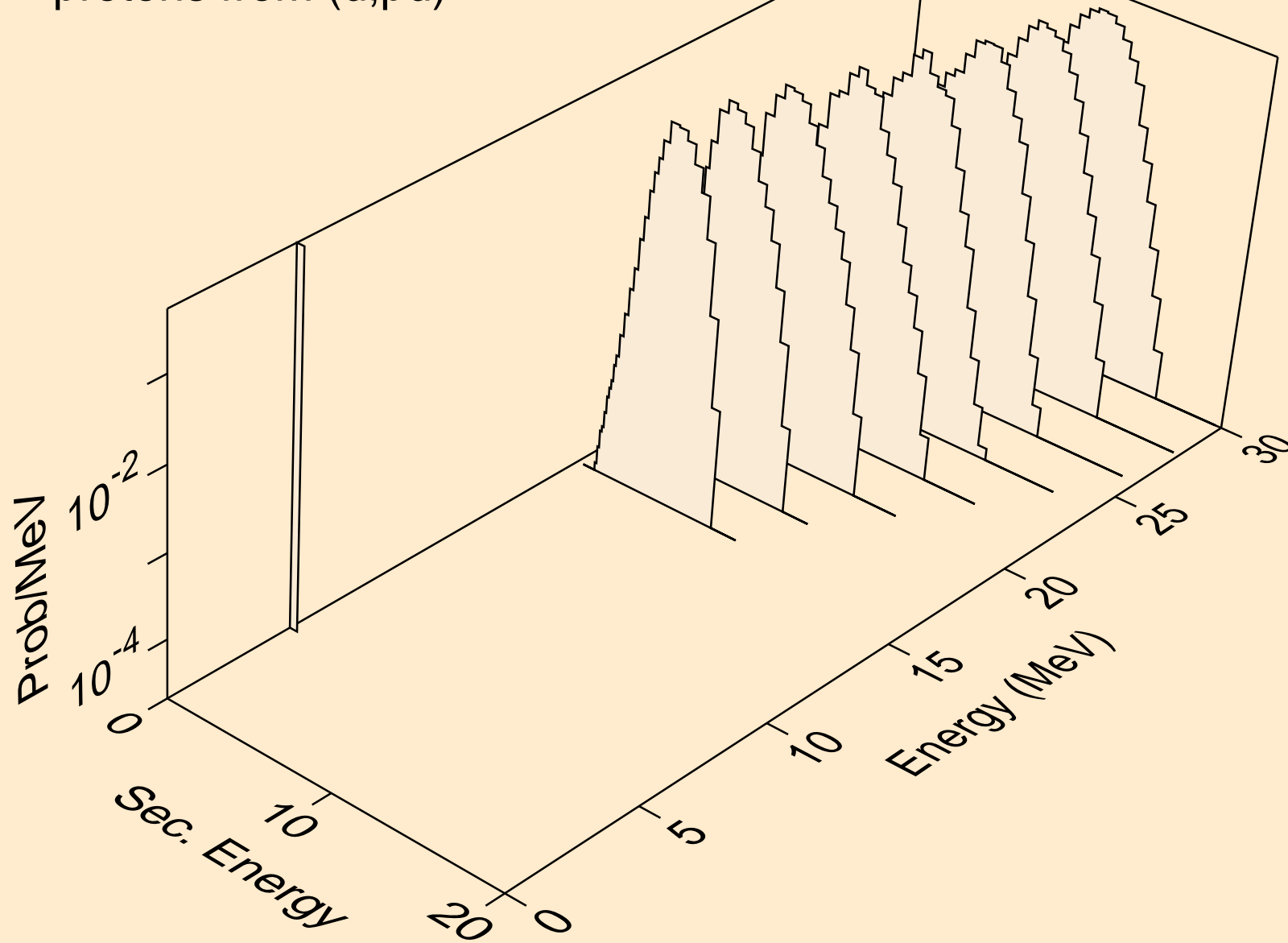

NO257 DEUTERON ACER TENDL-2021 LIBRARY; T=0.K
tritons from (d,x)

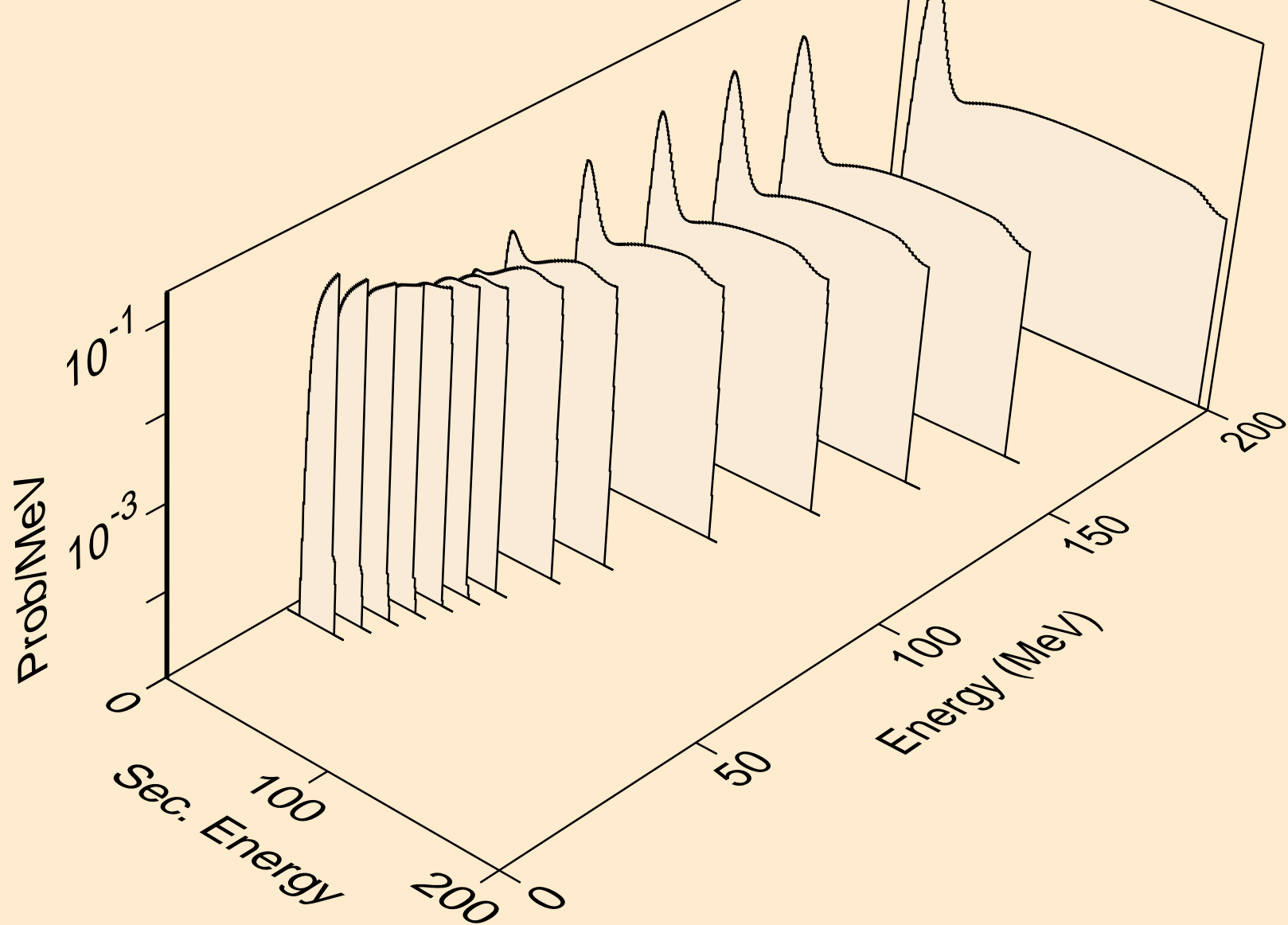

NO257 DEUTERON ACER TENDL-2021 LIBRARY; T=0.K
tritons from (d,n*)t

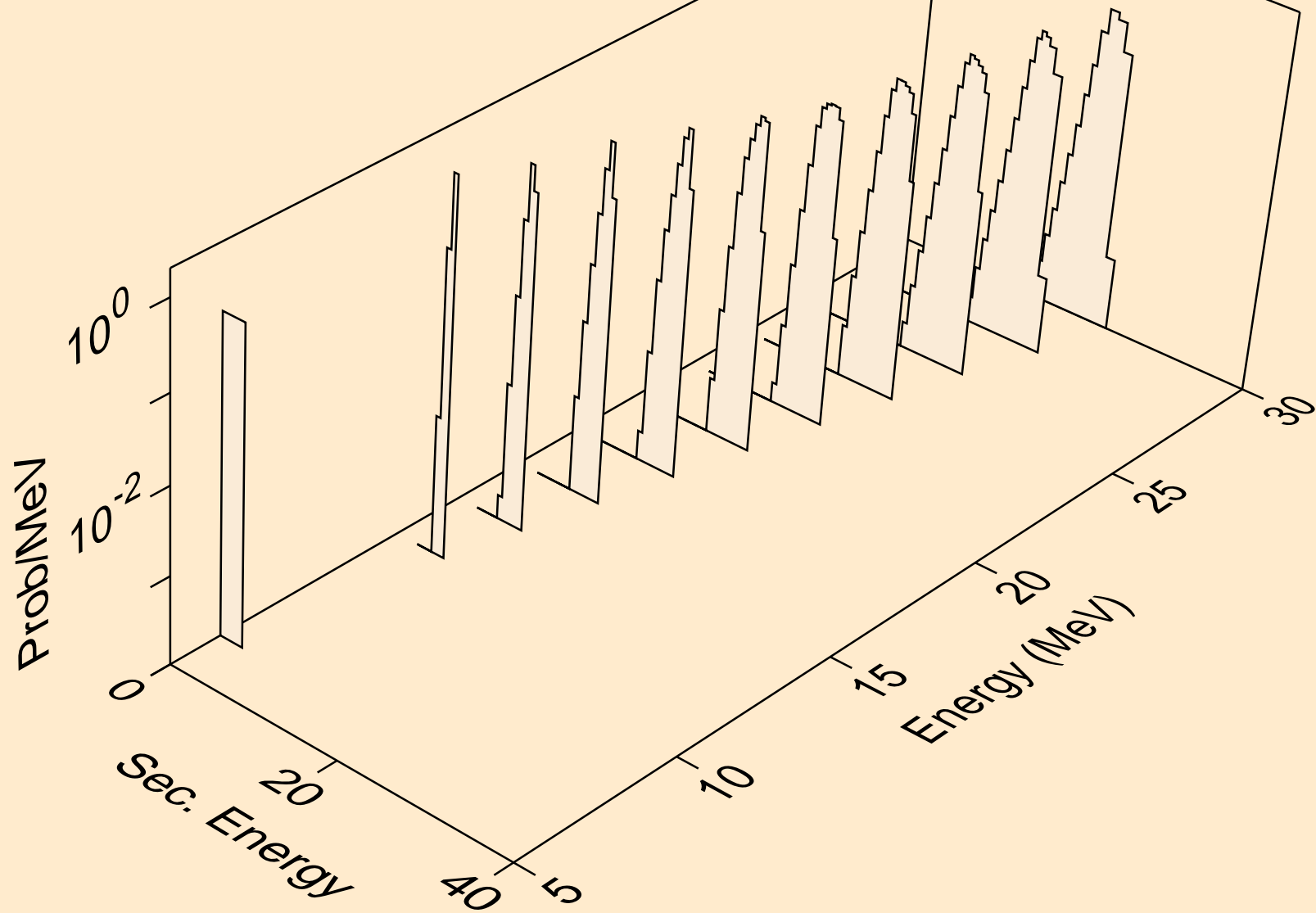

NO257 DEUTERON ACER TENDL-2021 LIBRARY; T=0.K
tritons from (d,t)

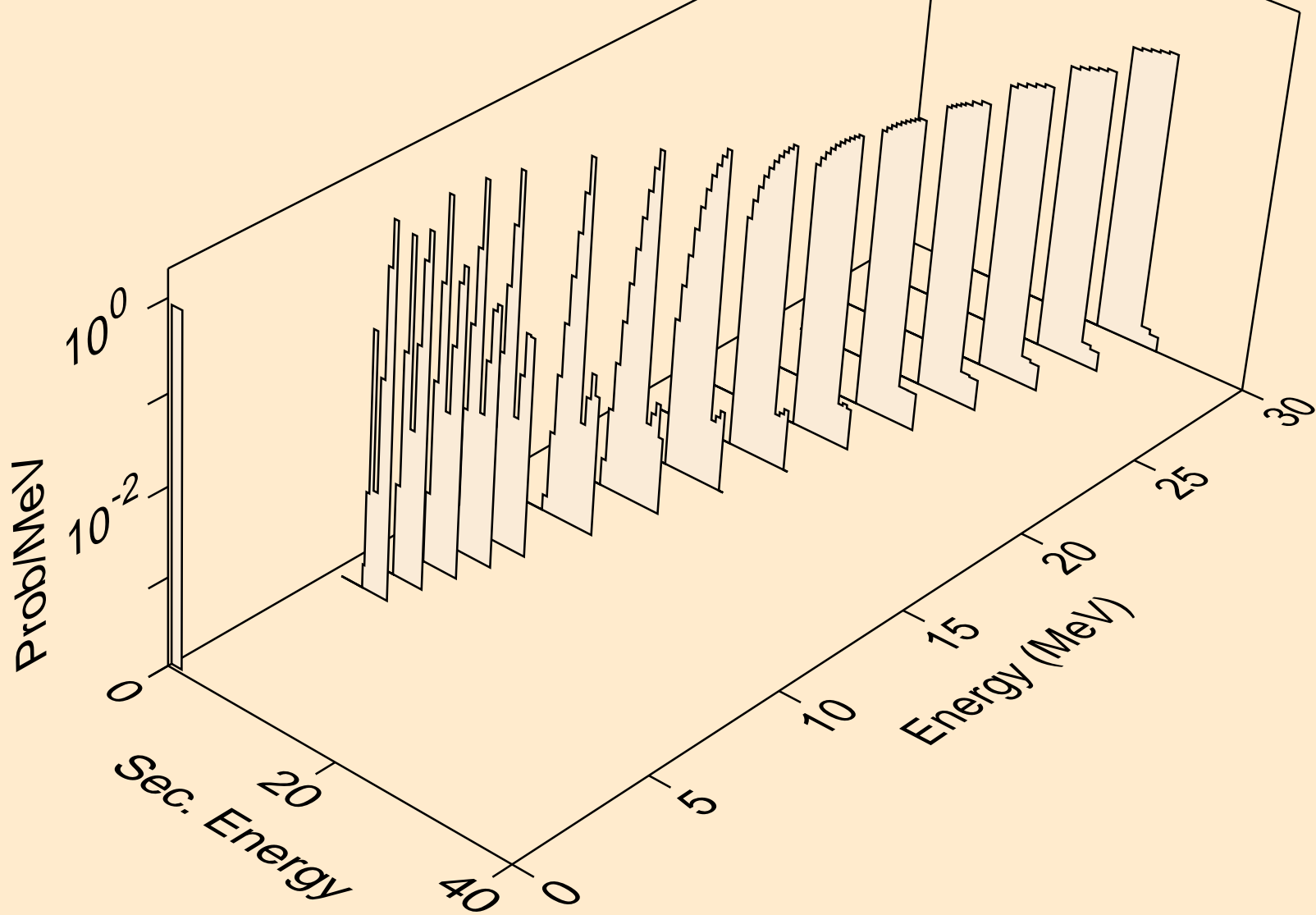

NO257 DEUTERON ACER TENDL-2021 LIBRARY; T=0.K
he3s from (d,x)

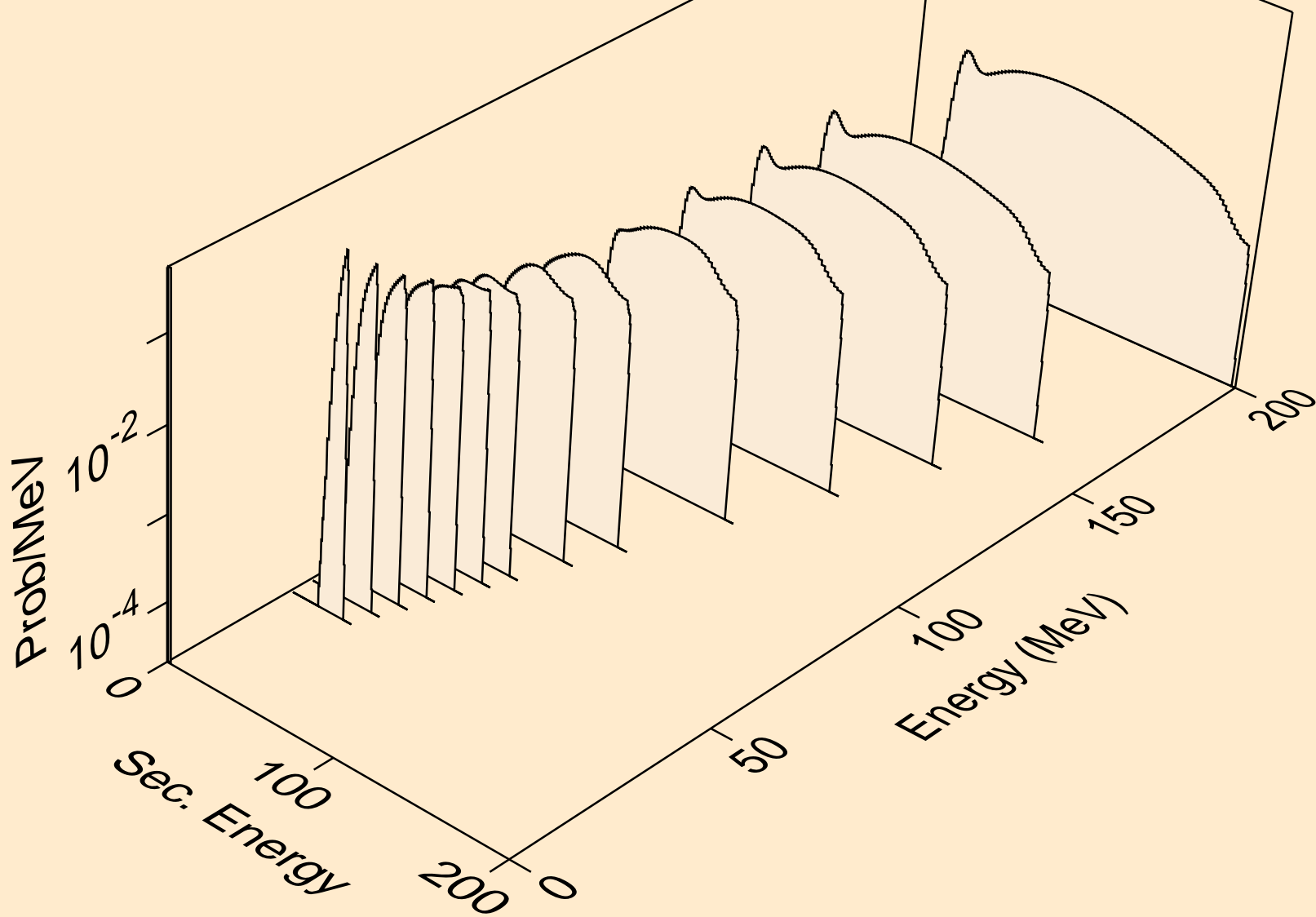

NO257 DEUTERON ACER TENDL-2021 LIBRARY; T=0.K
he3s from (d,n*)he3

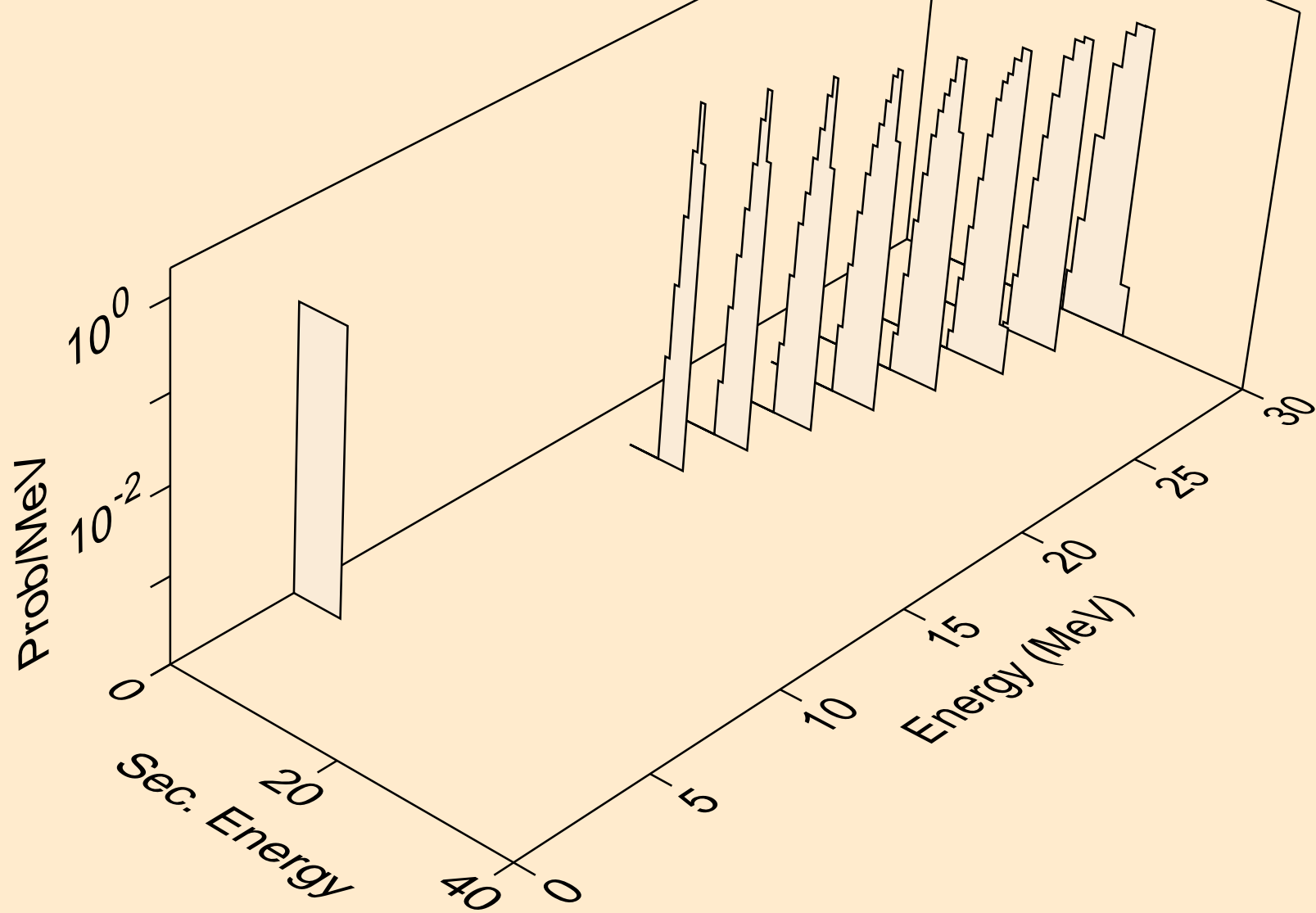

NO257 DEUTERON ACER TENDL-2021 LIBRARY; T=0.K
he3s from (d,he3)

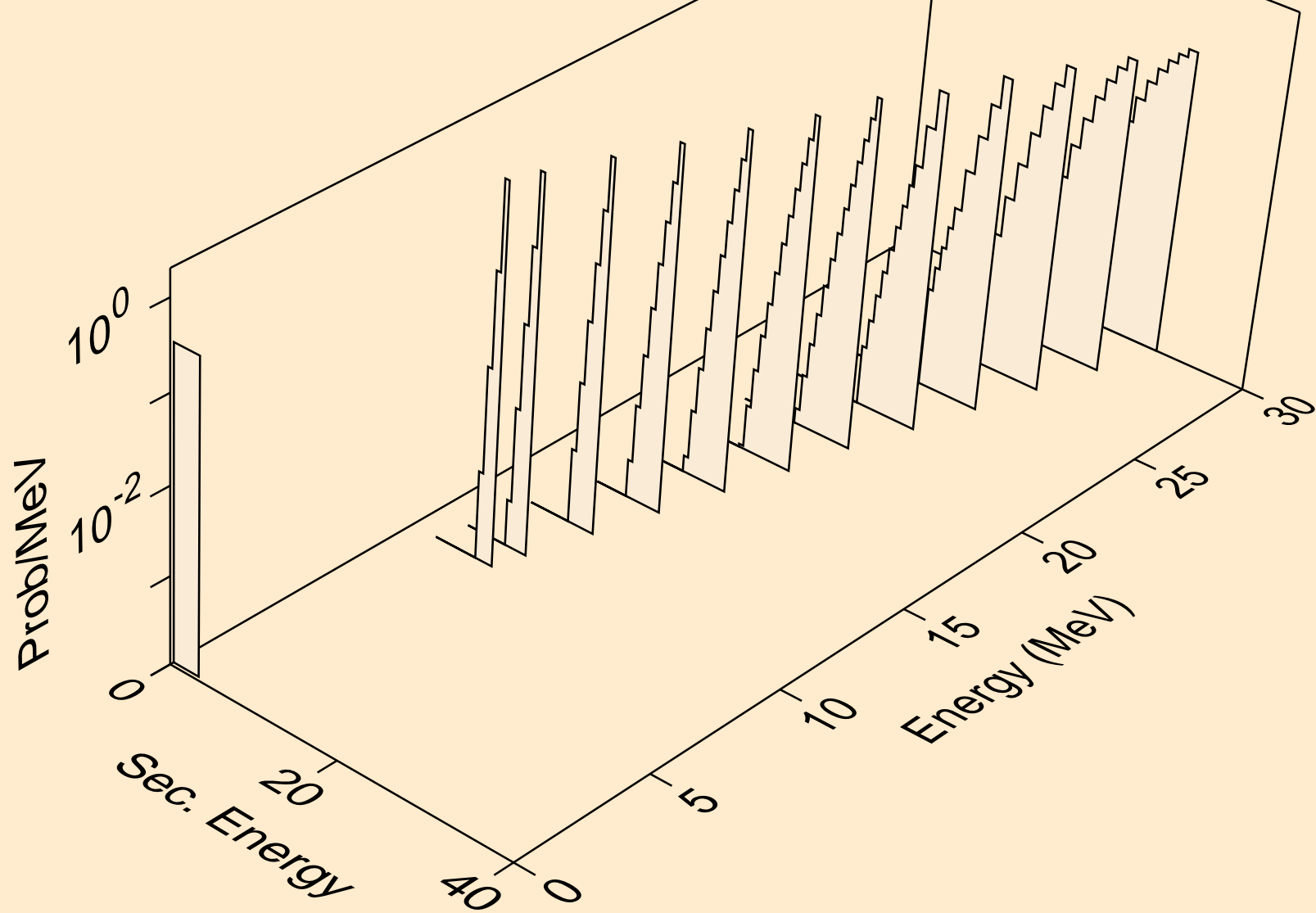

NO257 DEUTERON ACER TENDL-2021 LIBRARY; T=0.K
alphas from (d,x)

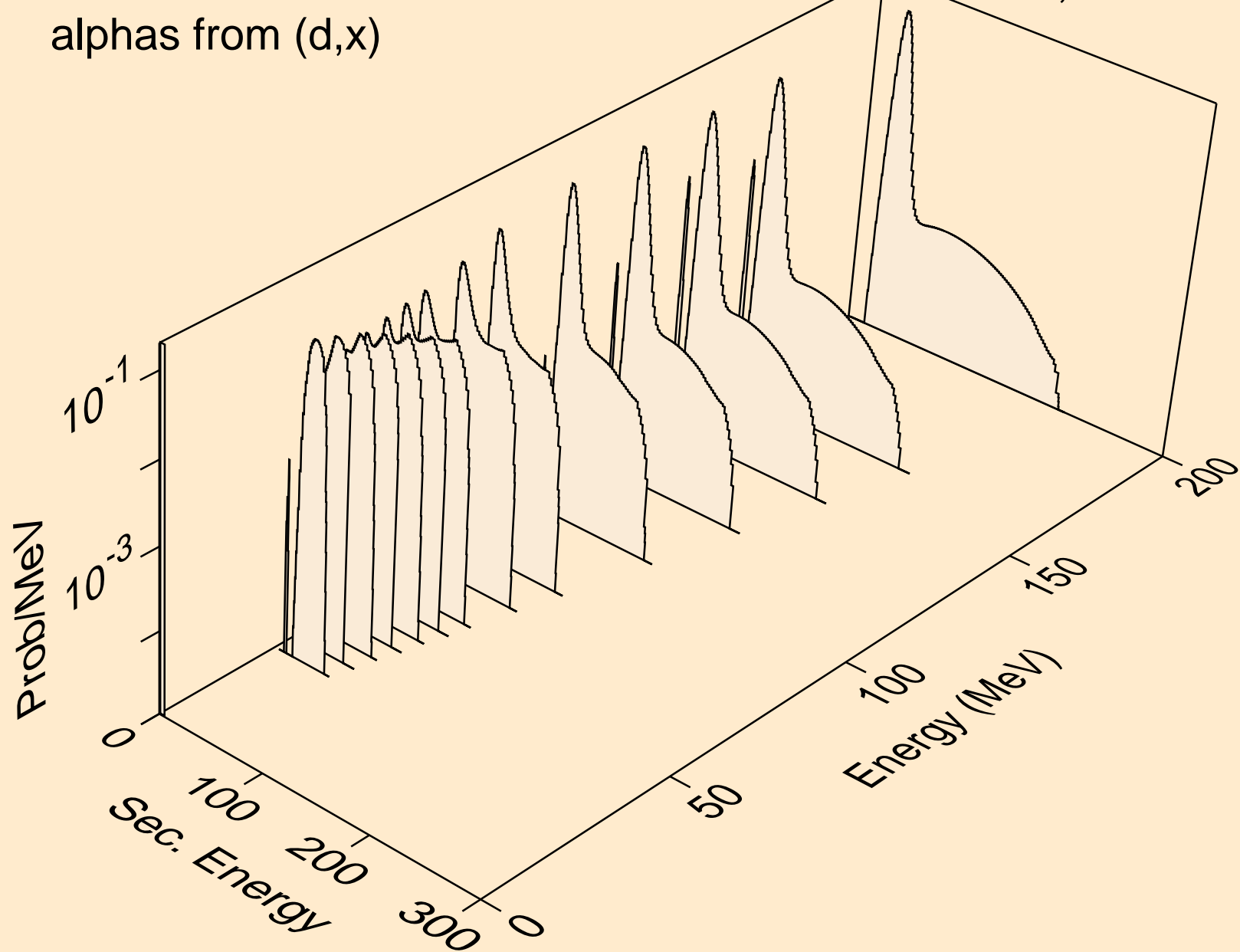

NO257 DEUTERON ACER TENDL-2021 LIBRARY; T=0.K
alphas from (d,n*)a

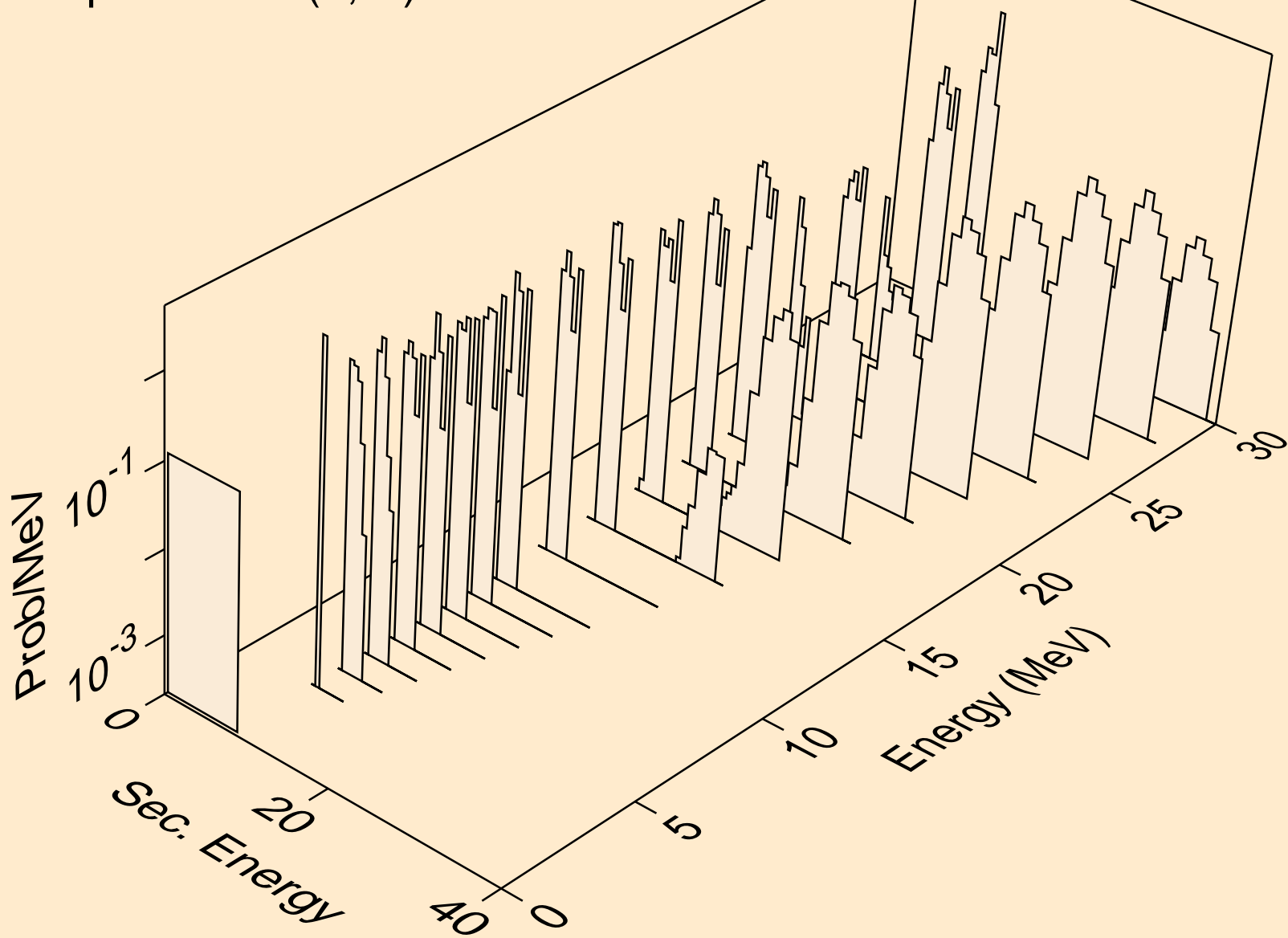

NO257 DEUTERON ACER TENDL-2021 LIBRARY; T=0.K
alphas from (d,2n)a

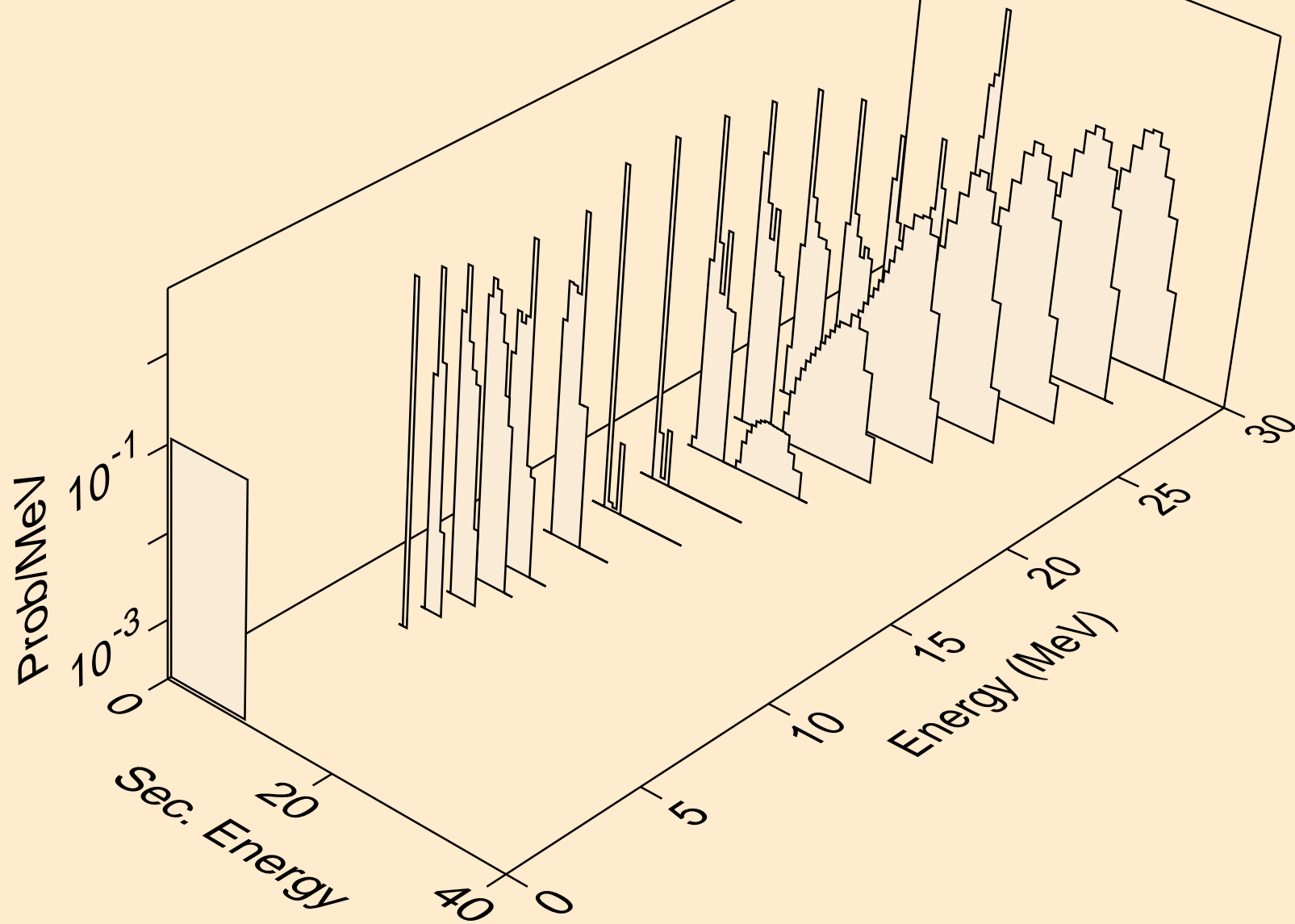

NO257 DEUTERON ACER TENDL-2021 LIBRARY; T=0.K
alphas from (d,npa)

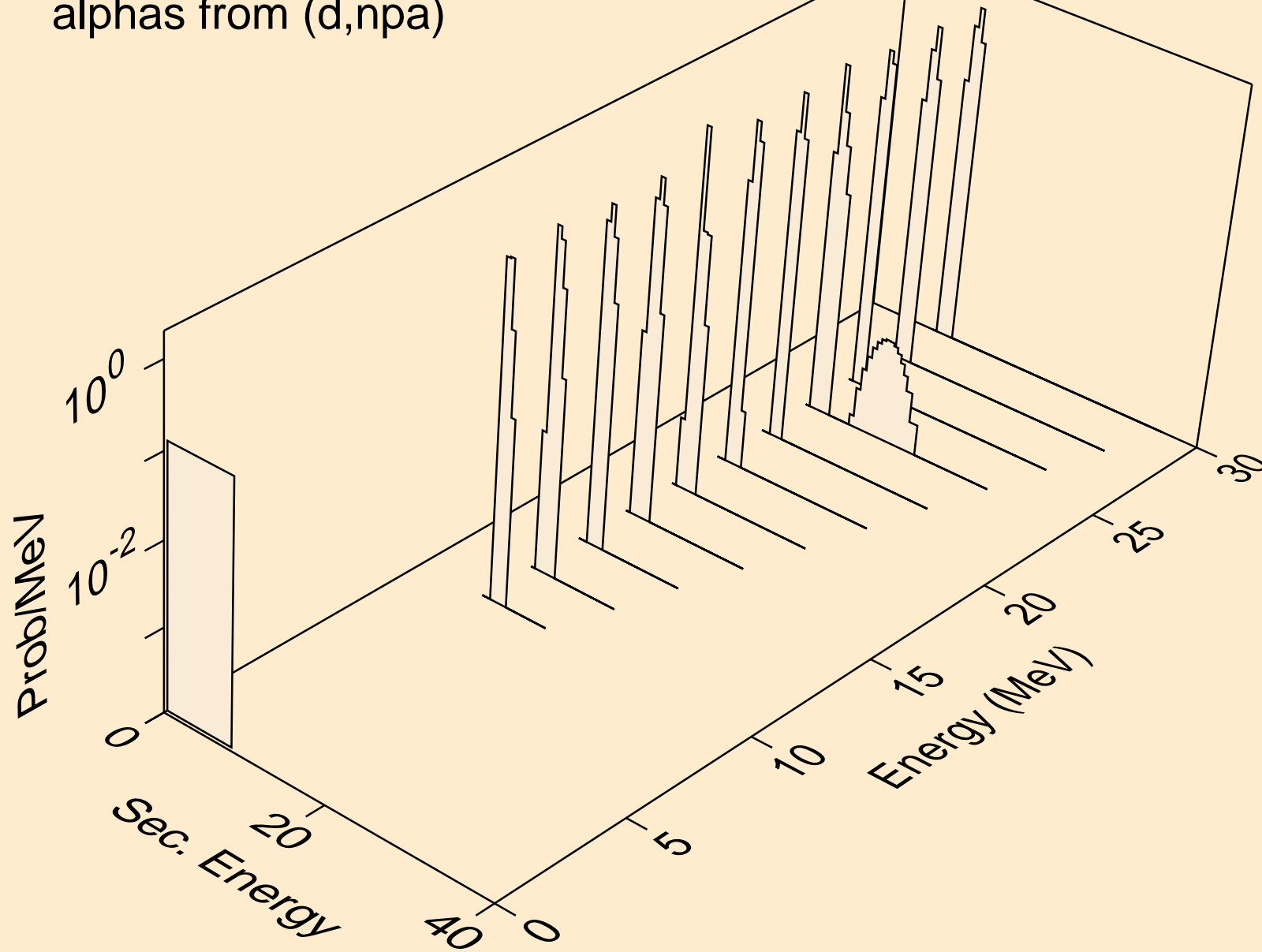

NO257 DEUTERON ACER TENDL-2021 LIBRARY; T=0.K
alphas from (d,a)

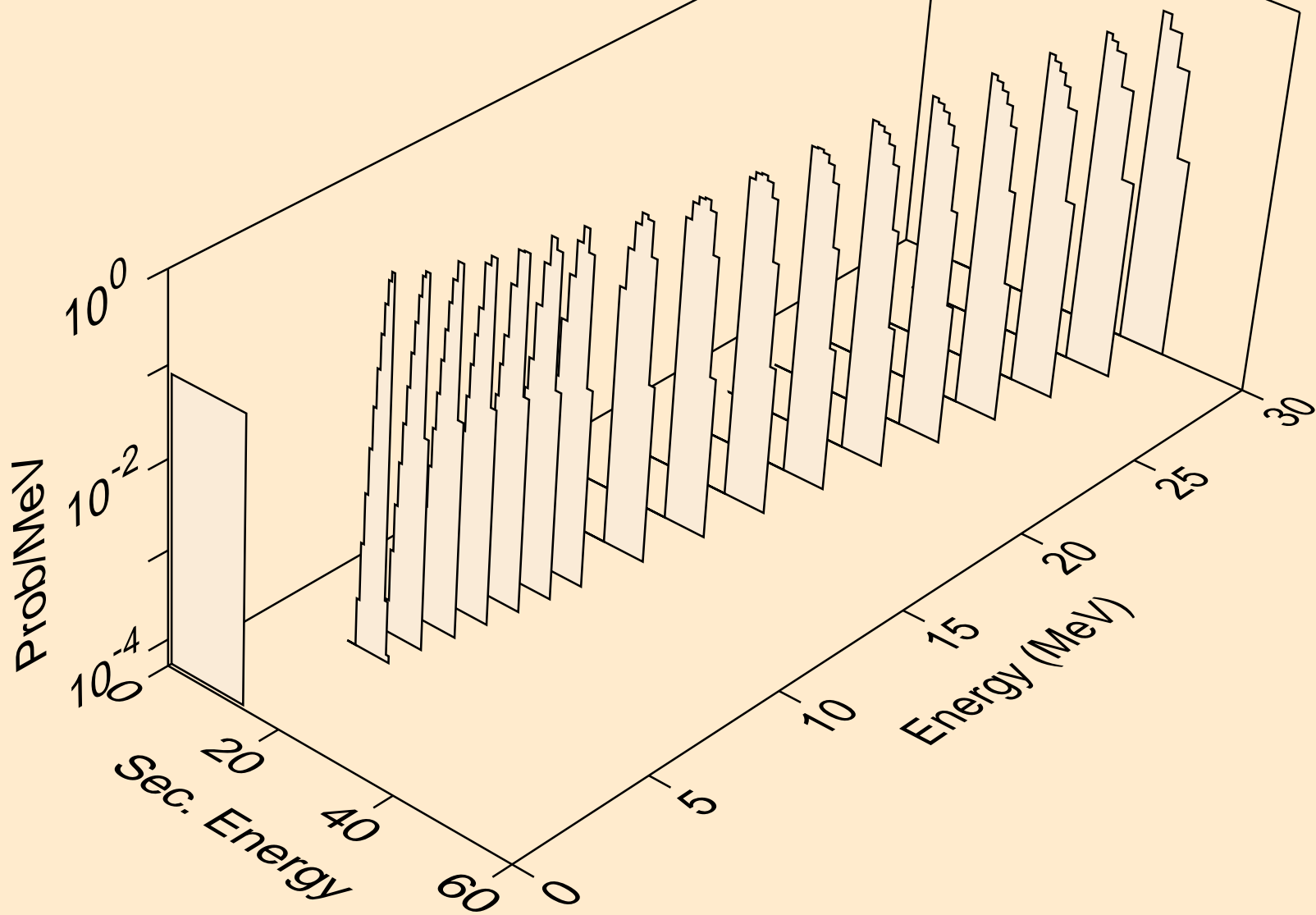

NO257 DEUTERON ACER TENDL-2021 LIBRARY; T=0.K
alphas from (d,da)

