

ER149M HELION ACER TENDL-2021 LIBRARY; T=0.K  
Principal cross sections

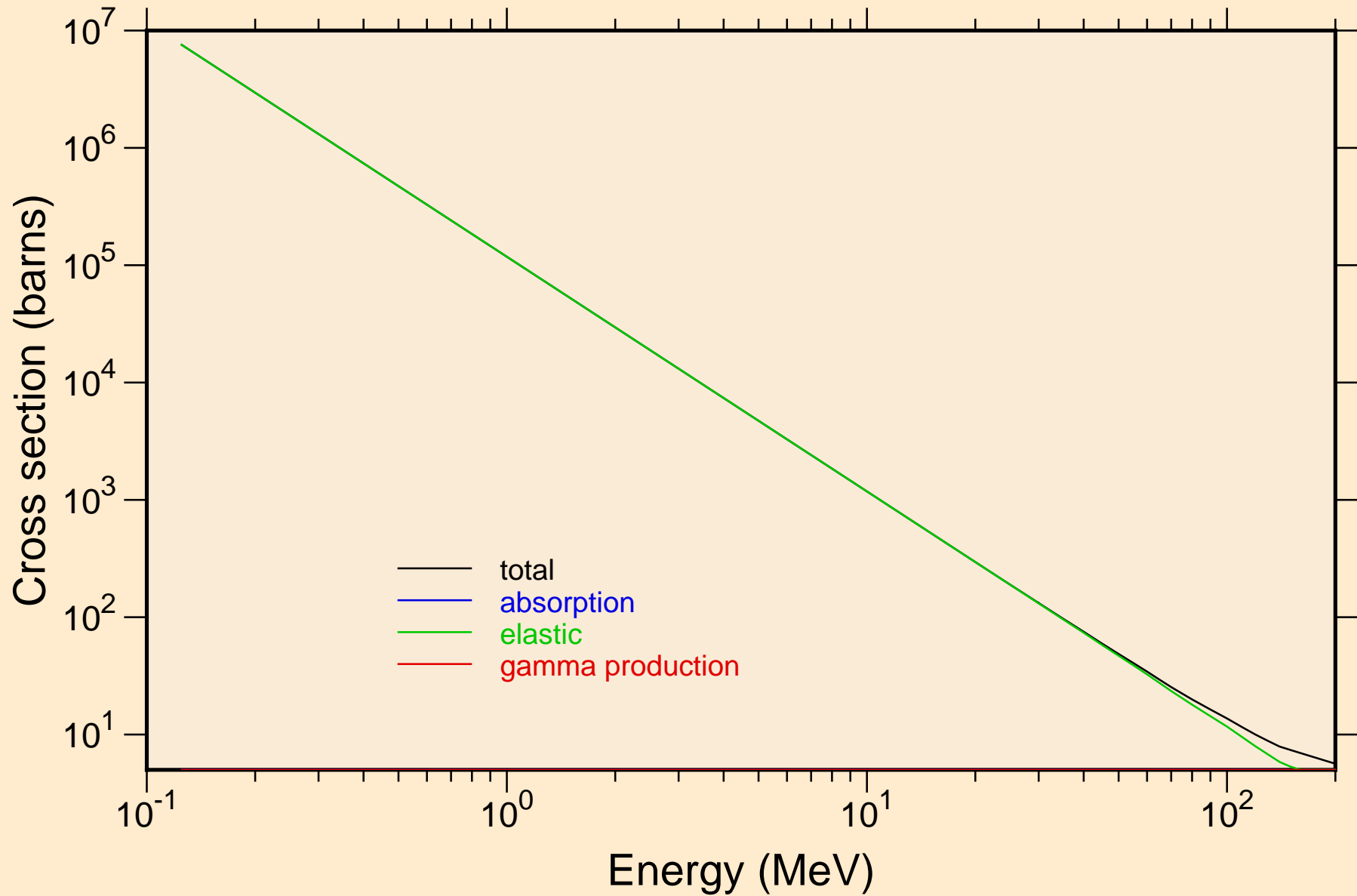

ER149M HELION ACER TENDL-2021 LIBRARY; T=0.K

Heating

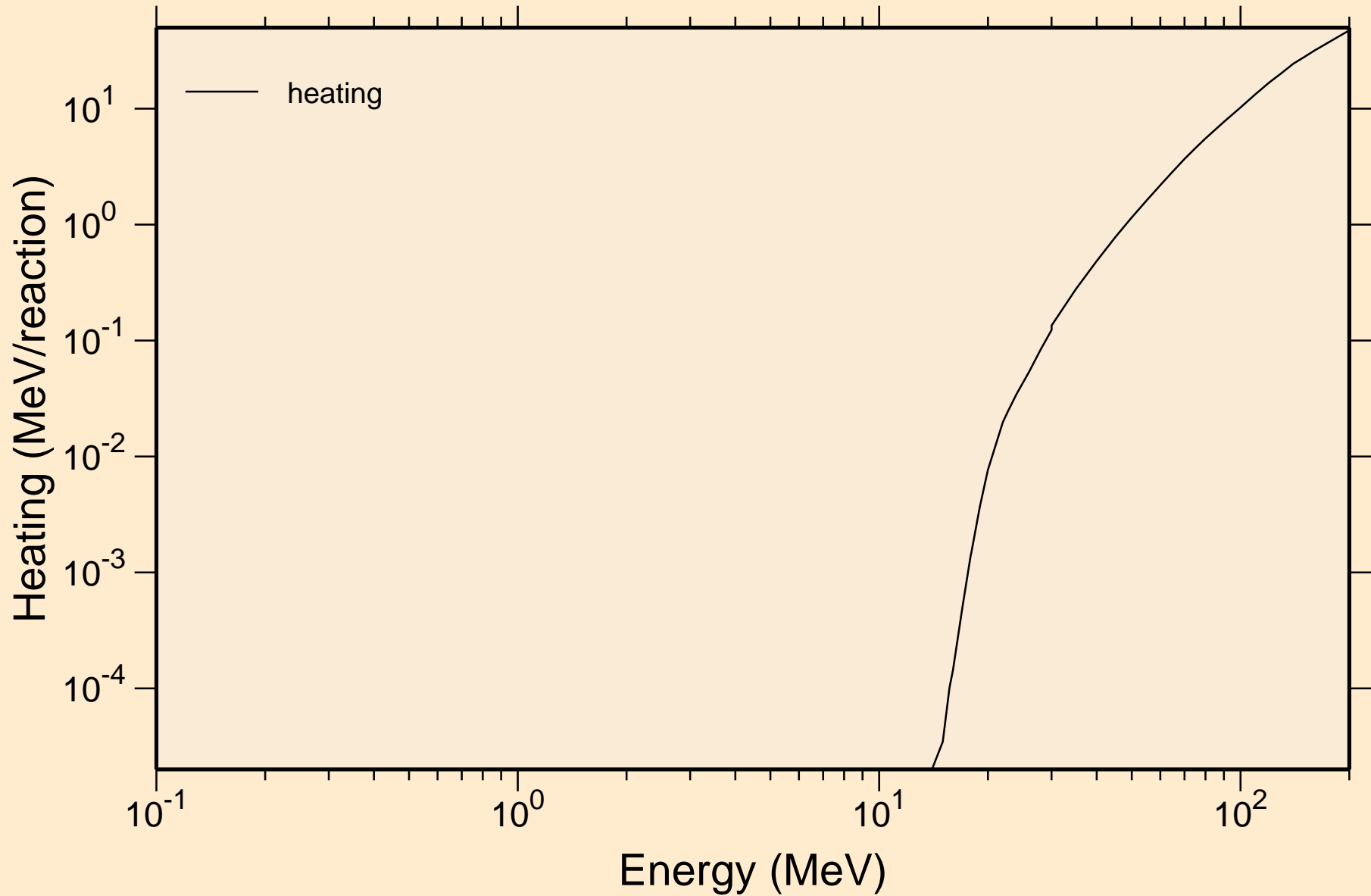

# ER149M HELION ACER TENDL-2021 LIBRARY; T=0.K

## Principal cross sections

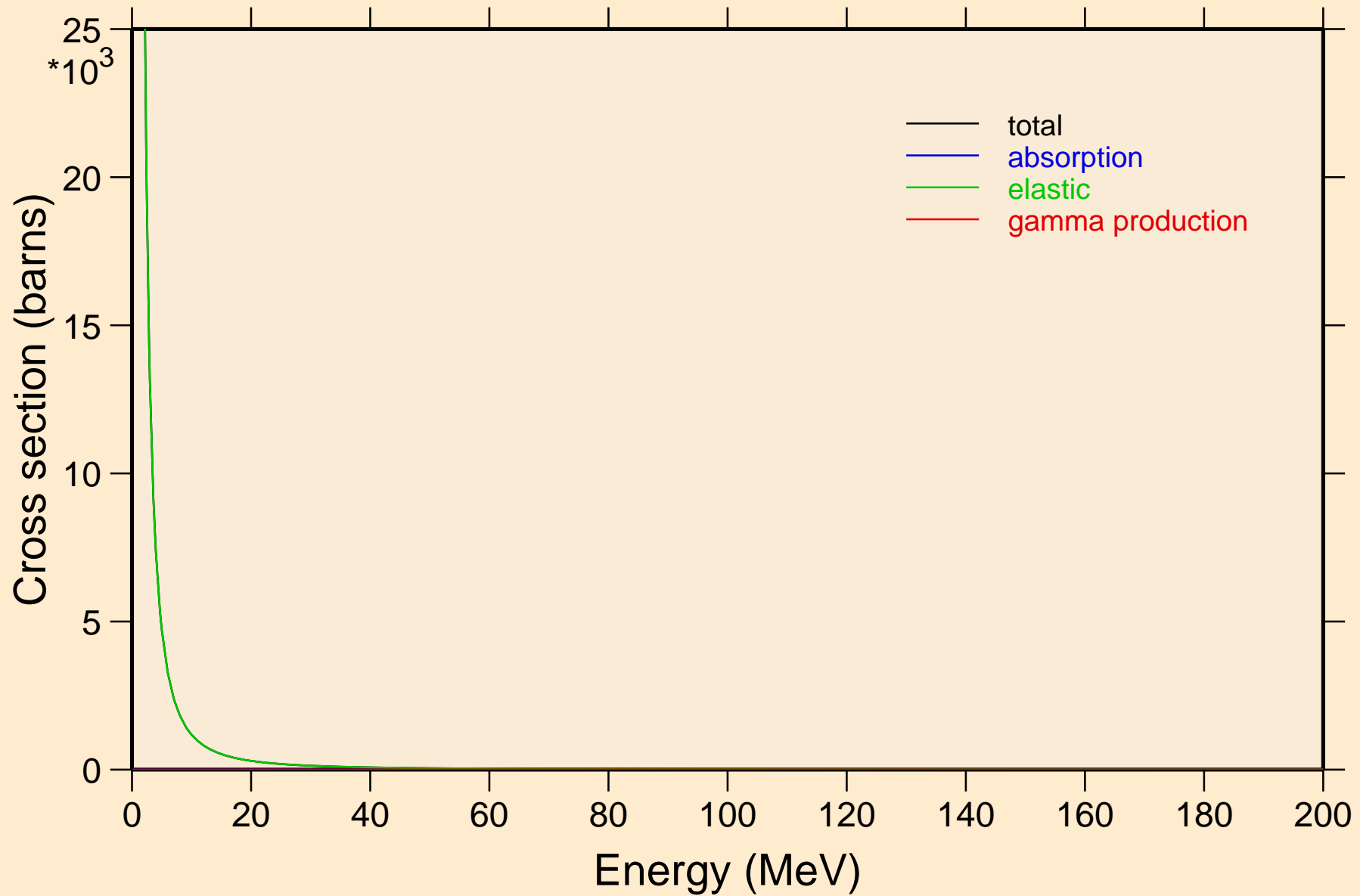

ER149M HELION ACER TENDL-2021 LIBRARY; T=0.K

Heating

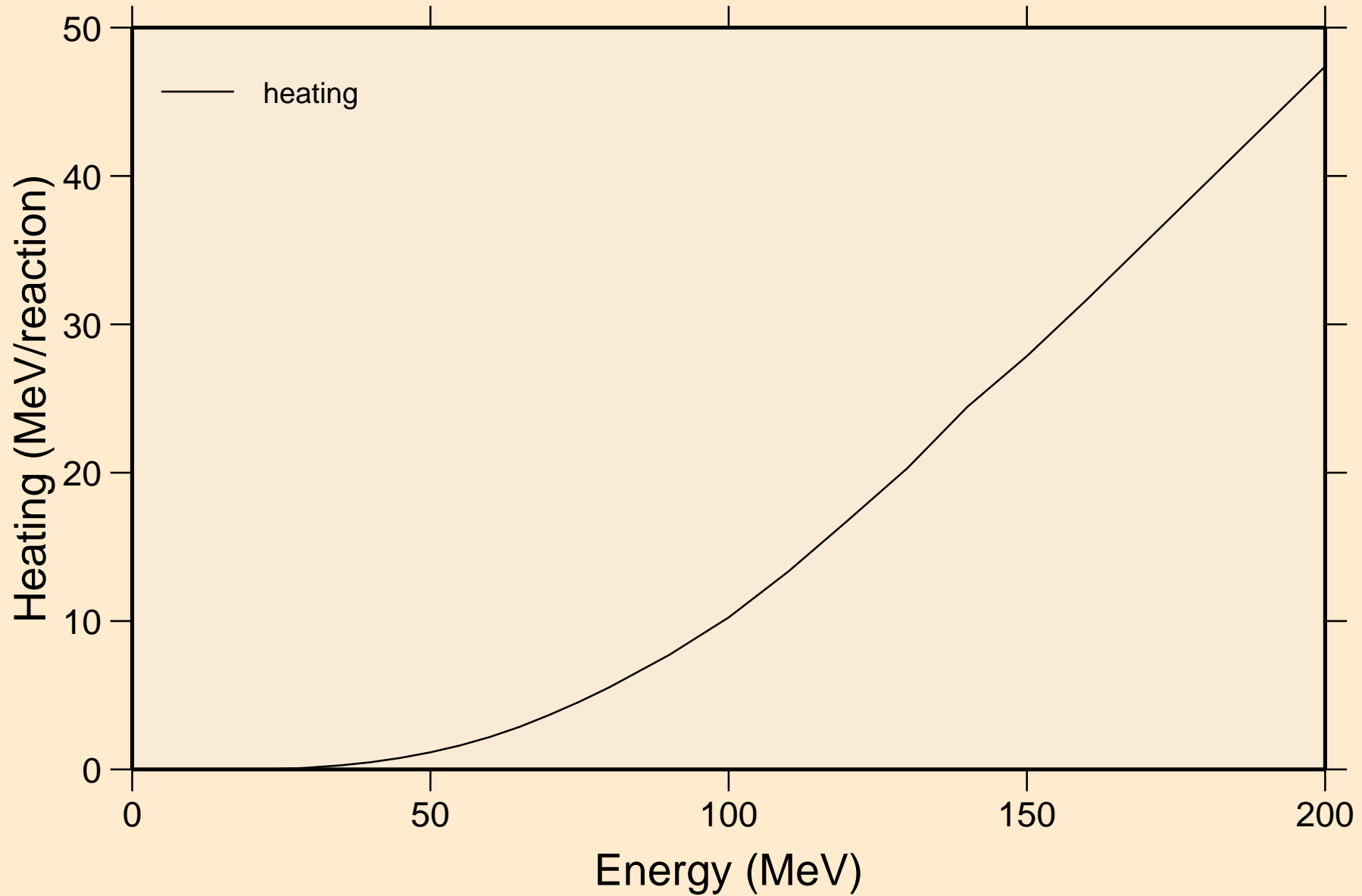

ER149M HELION ACER TENDL-2021 LIBRARY; T=0.K  
Threshold reactions

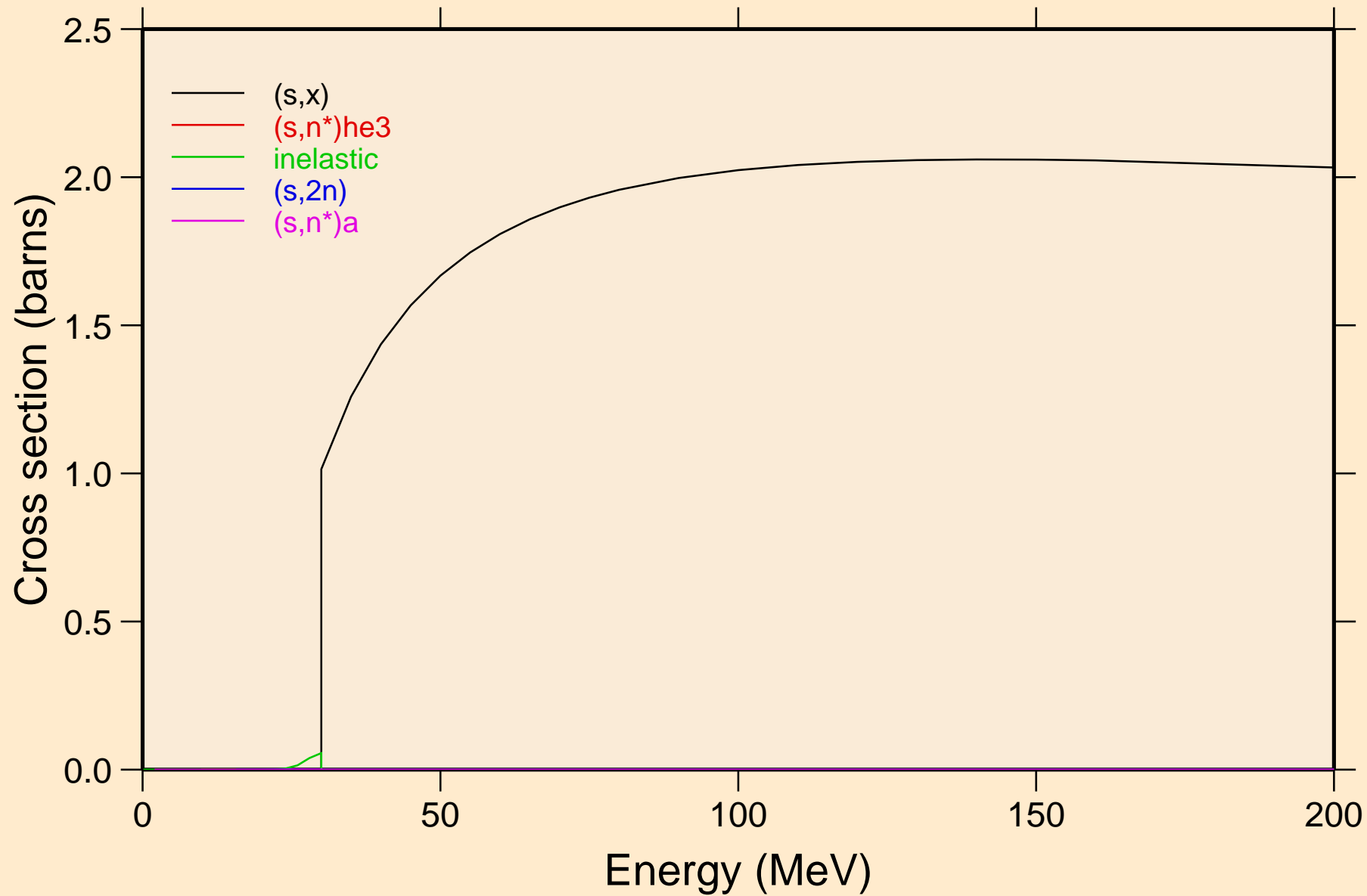

ER149M HELION ACER TENDL-2021 LIBRARY; T=0.K  
Threshold reactions

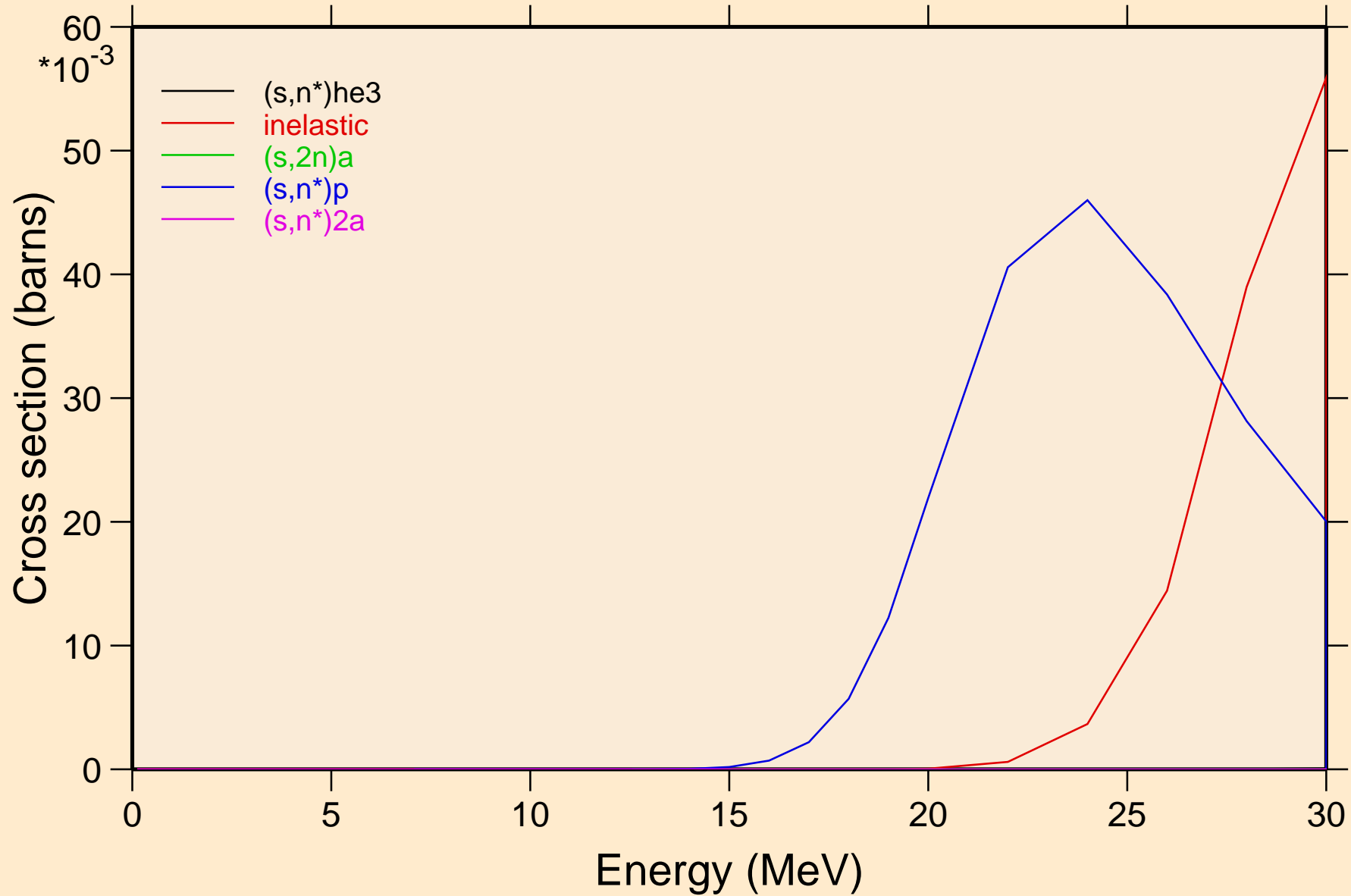

ER149M HELION ACER TENDL-2021 LIBRARY; T=0.K  
Threshold reactions

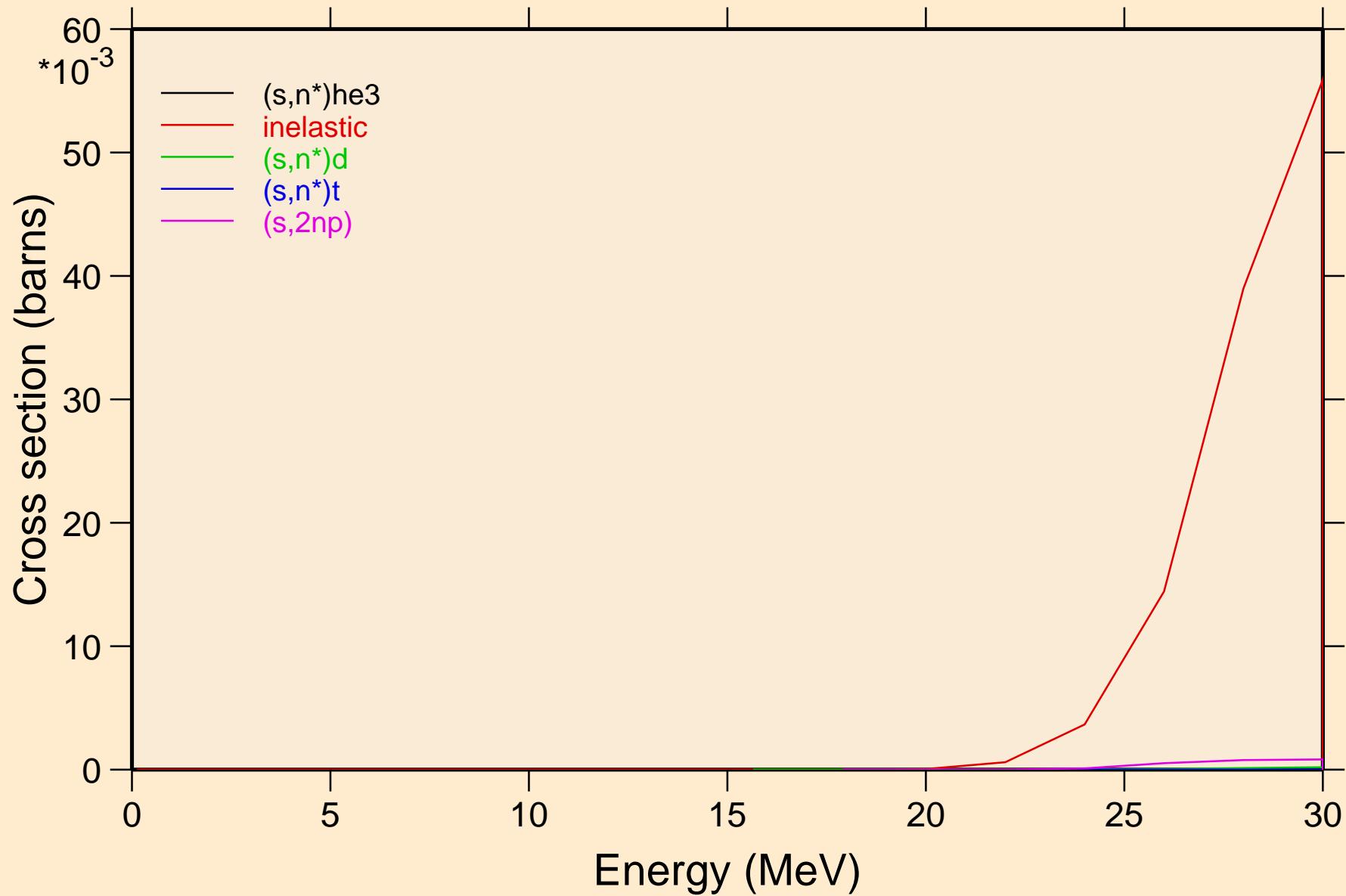

ER149M HELION ACER TENDL-2021 LIBRARY; T=0.K  
Threshold reactions

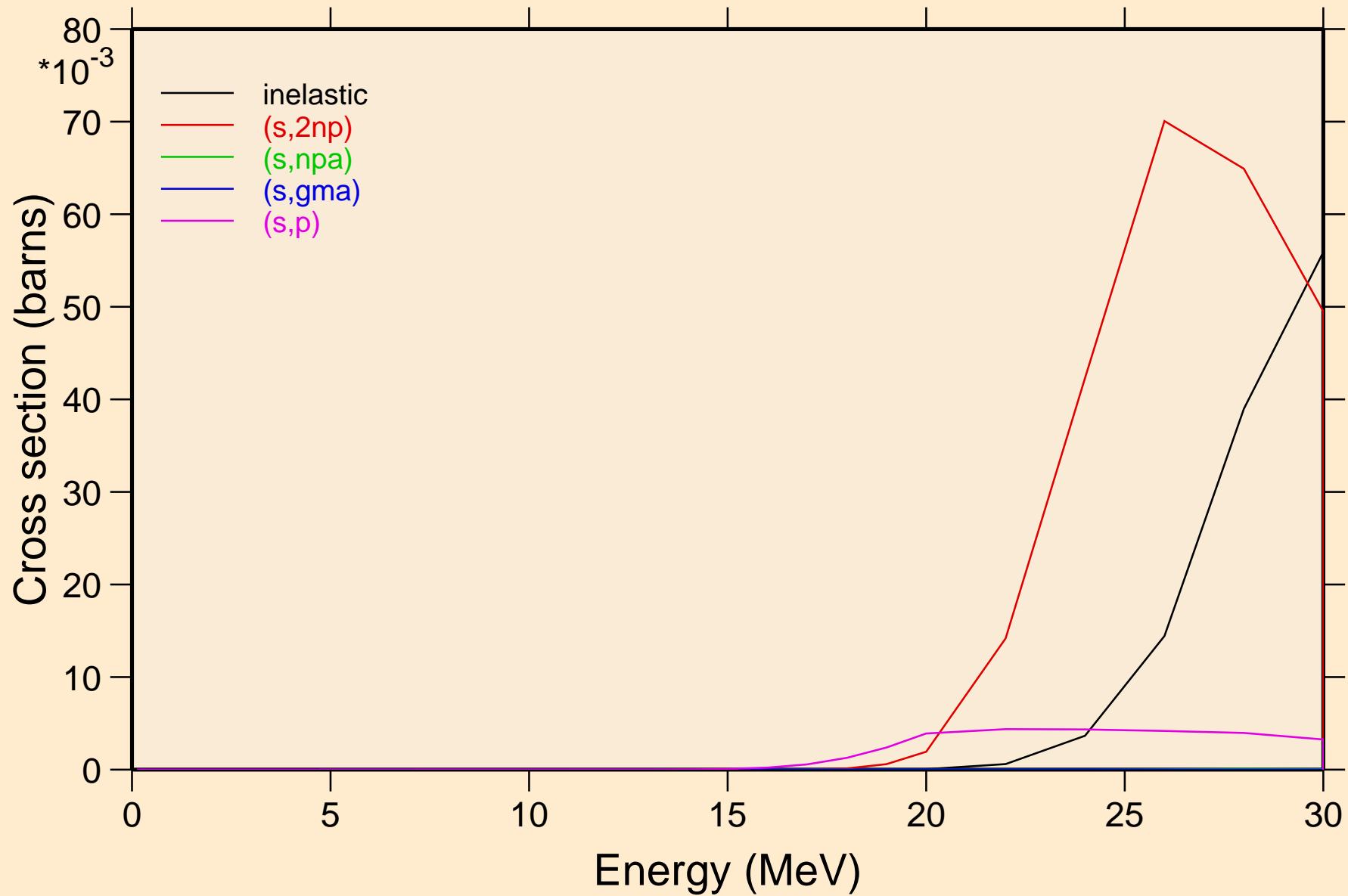

ER149M HELION ACER TENDL-2021 LIBRARY; T=0.K  
Threshold reactions

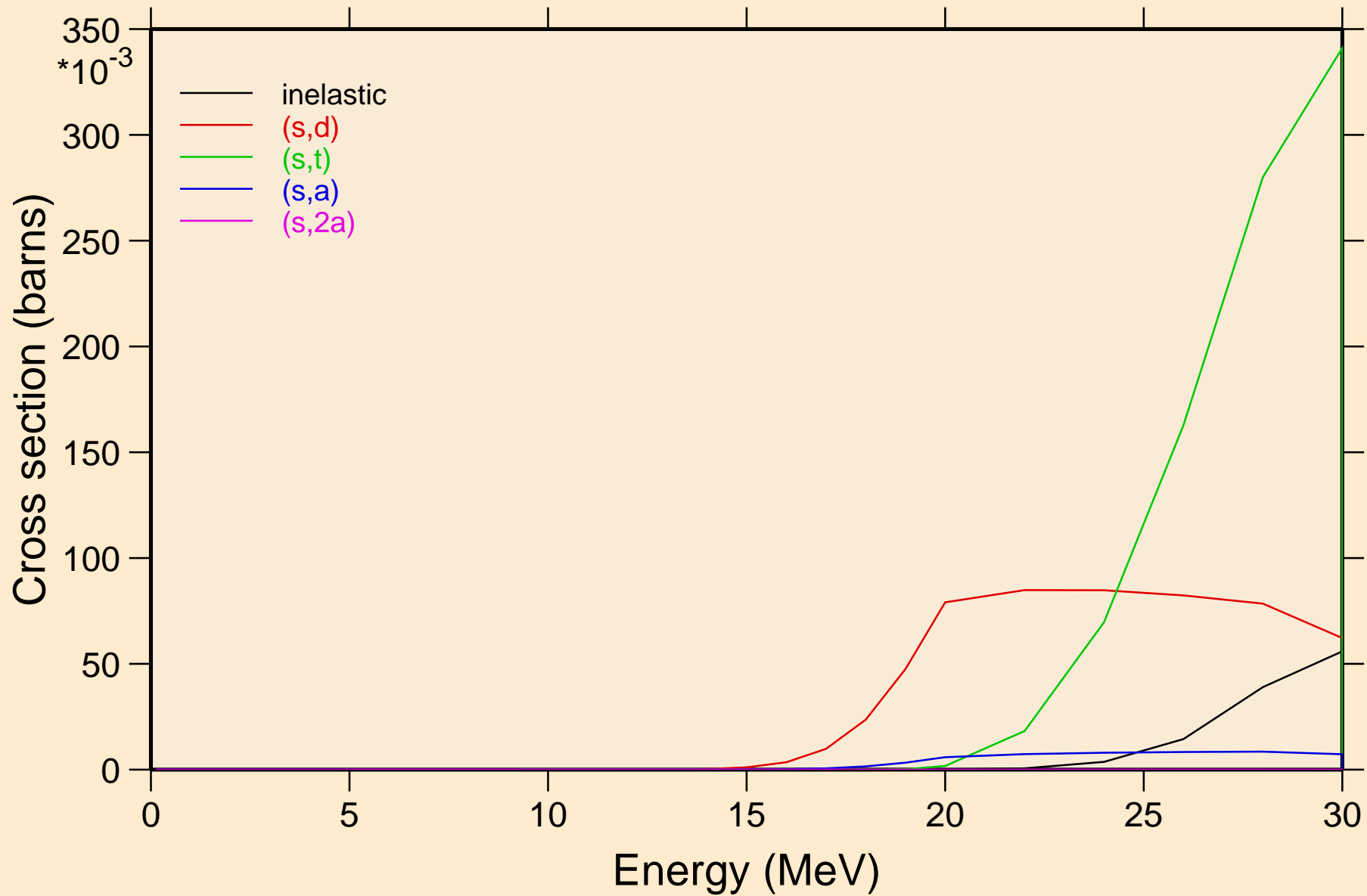

ER149M HELION ACER TENDL-2021 LIBRARY; T=0.K  
Threshold reactions

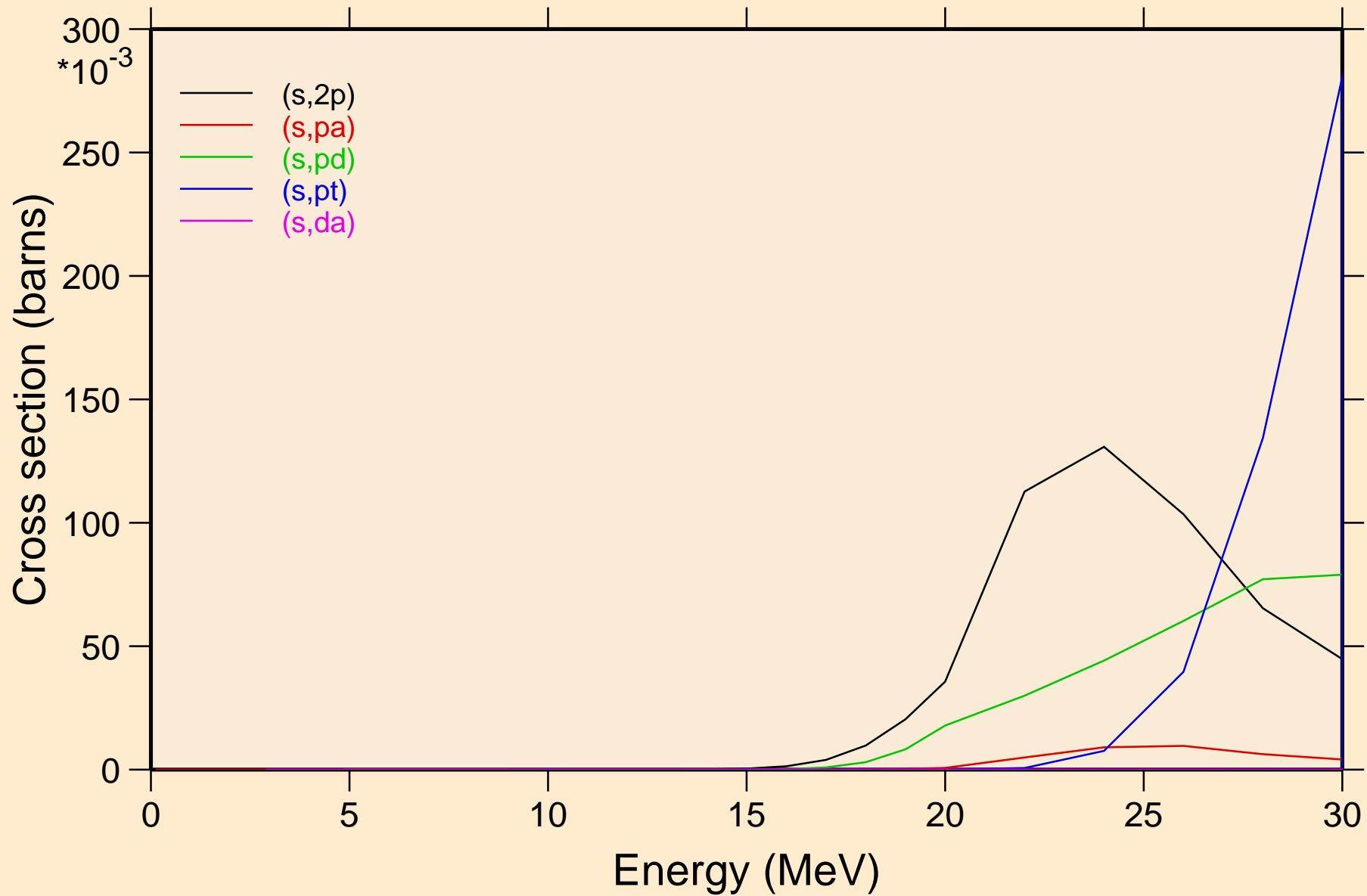

ER149M HELION ACER TENDL-2021 LIBRARY; T=0.K  
angular distribution for elastic

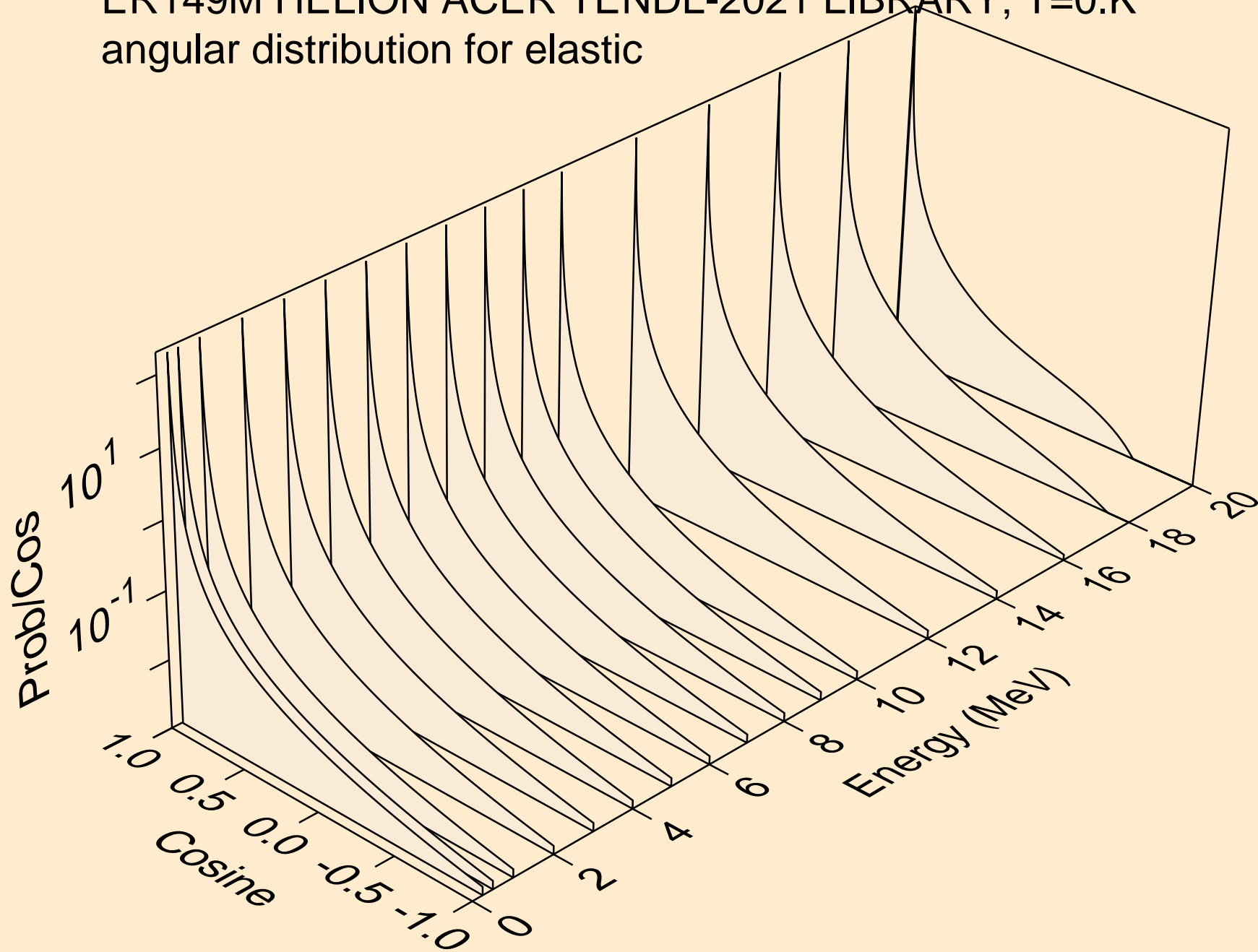

ER149M HELION ACER TENDL-2021 LIBRARY; T=0.K  
angular distribution for elastic

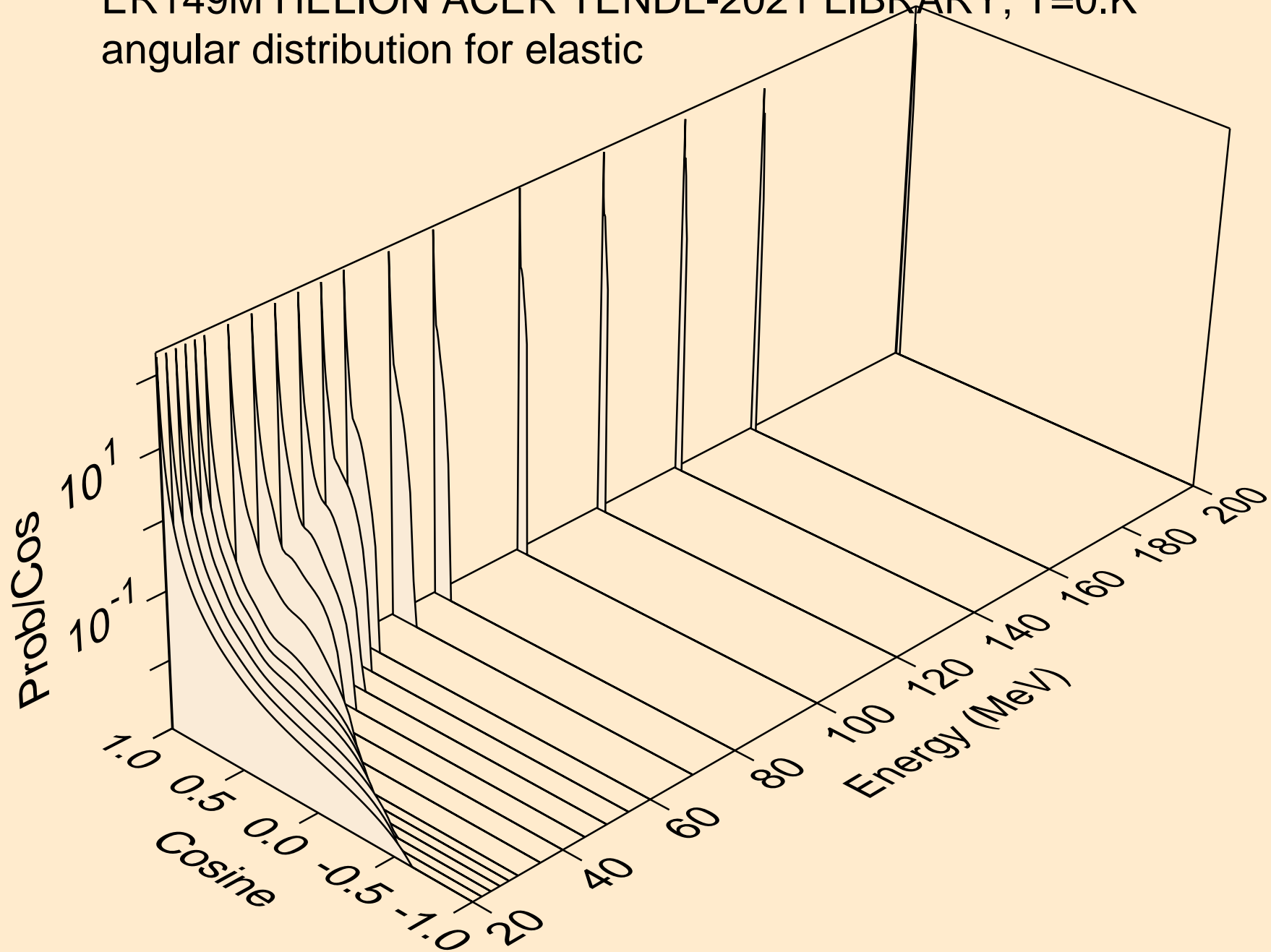

ER149M HELION ACER TENDL-2021 LIBRARY; T=0.K  
He-3 emission for (s,x)

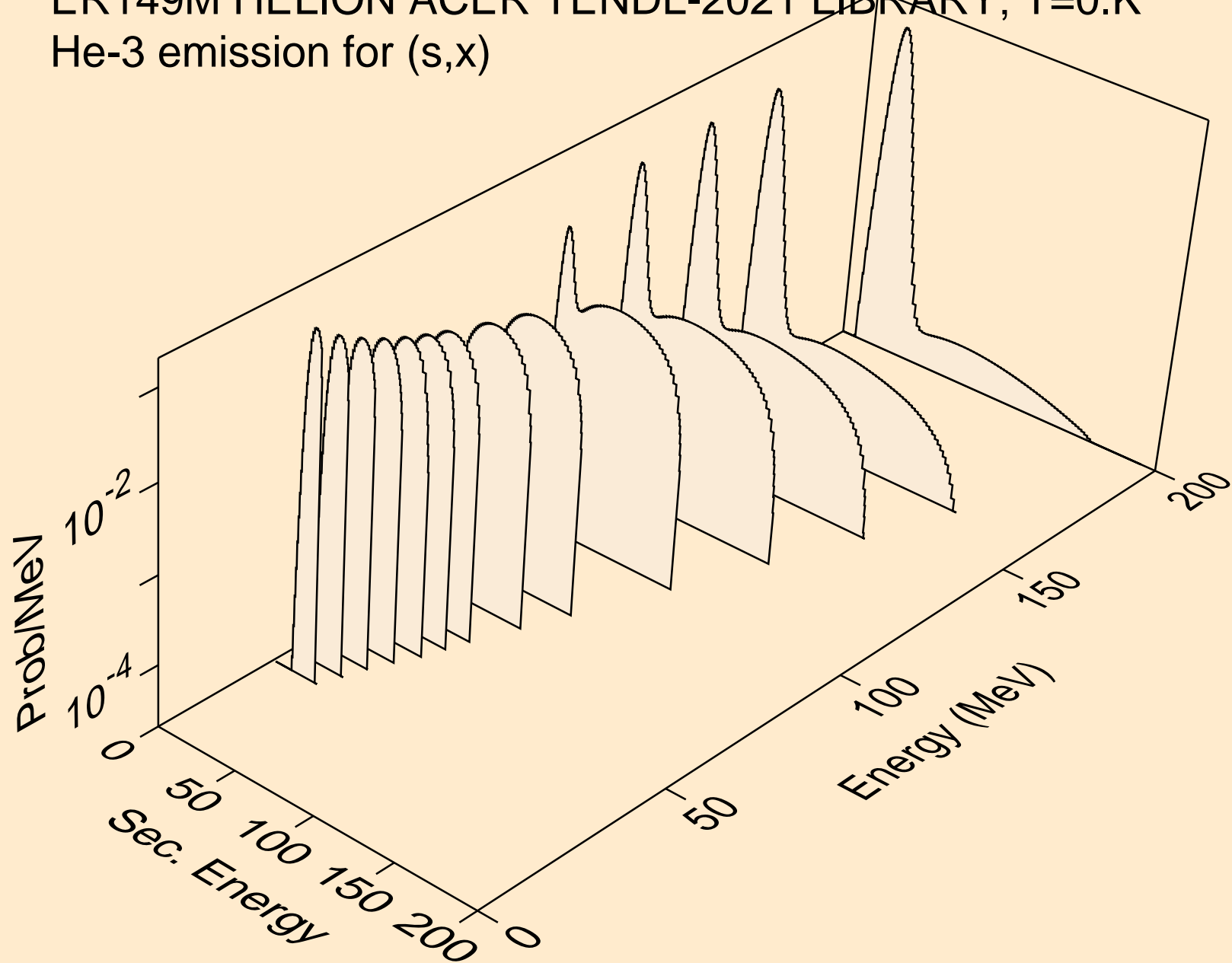

ER149M HELION ACER TENDL-2021 LIBRARY; T=0.K  
He-3 emission for (s,n\*)he3

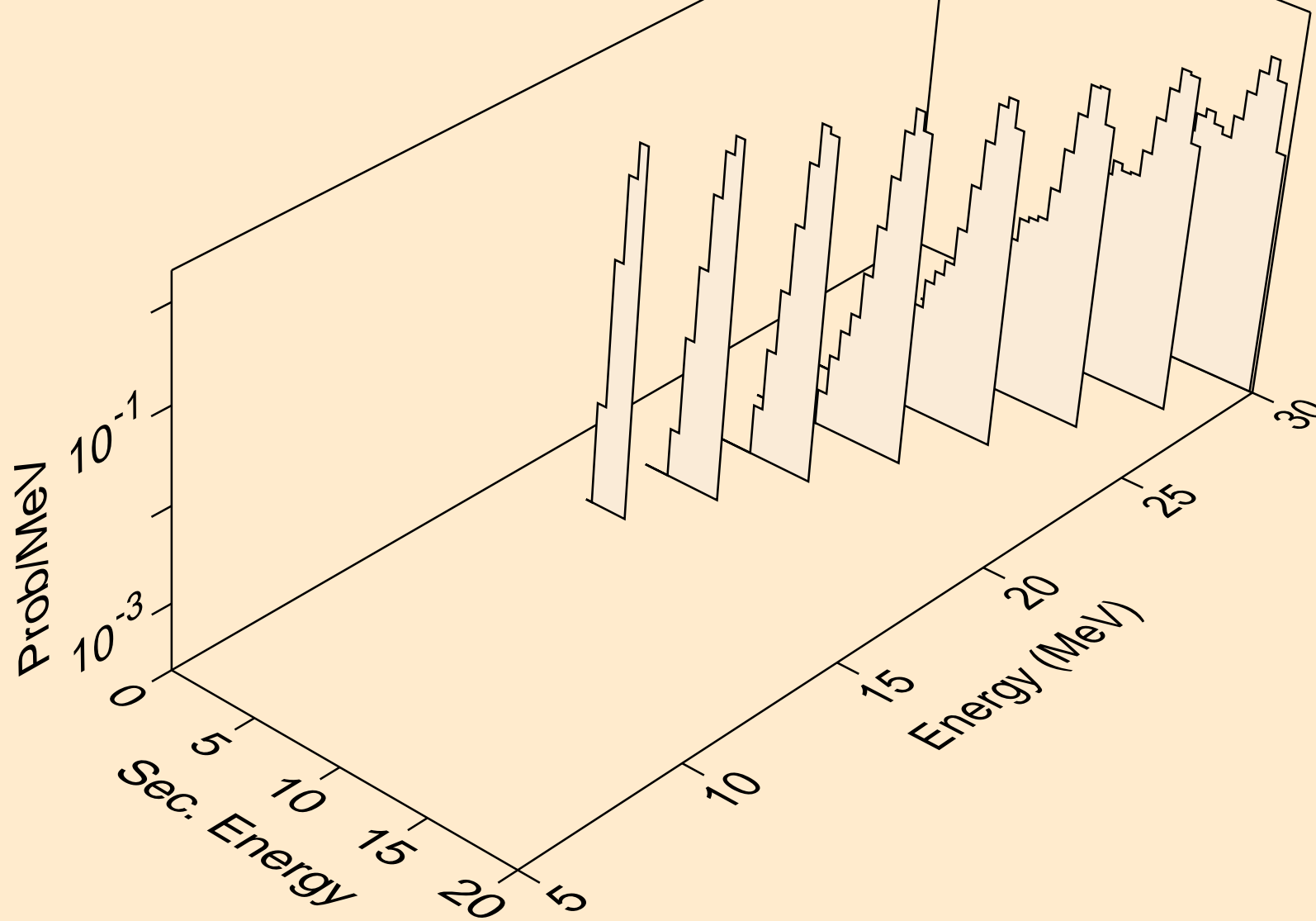

ER149M HELION ACER TENDL-2021 LIBRARY; T=0.K  
He-3 emission for inelastic

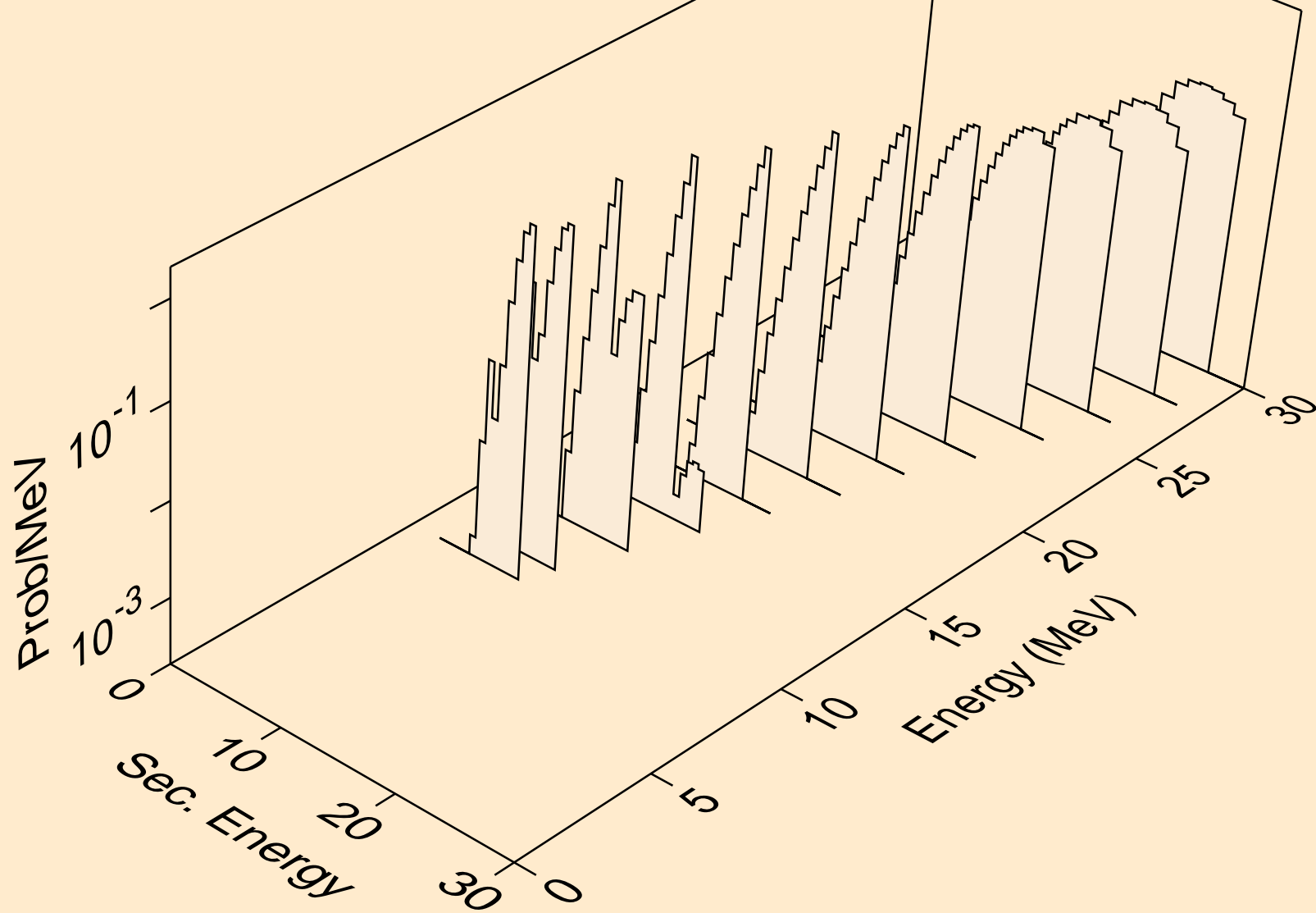

ER149M HELION ACER TENDL-2021 LIBRARY; T=0.K  
Photon emission for (z,n)

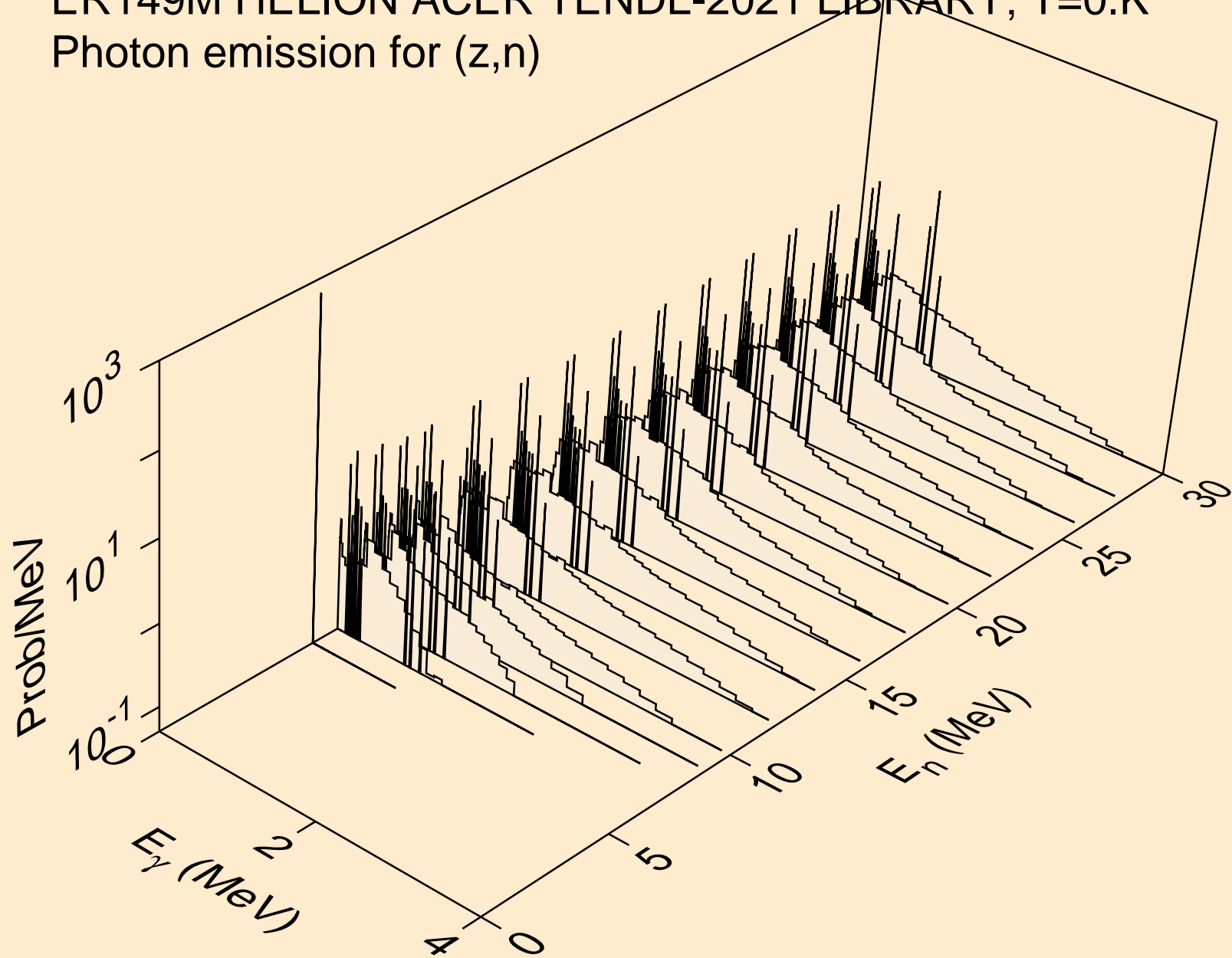

ER149M HELION ACER TENDL-2021 LIBRARY; T=0.K  
Photon emission for (n,x)

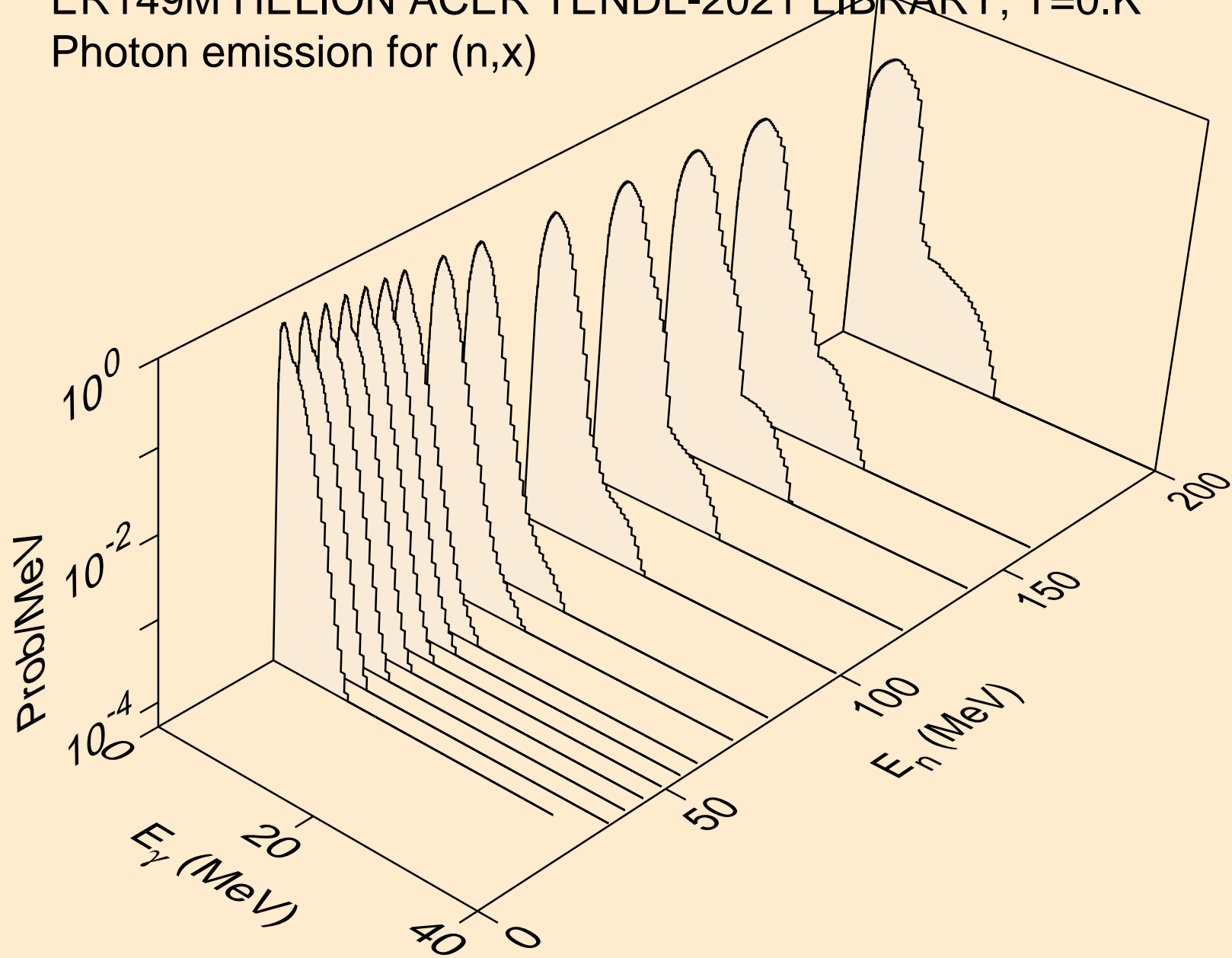

ER149M HELION ACER TENDL-2021 LIBRARY; T=0.K  
Photon emission for (n,2n)

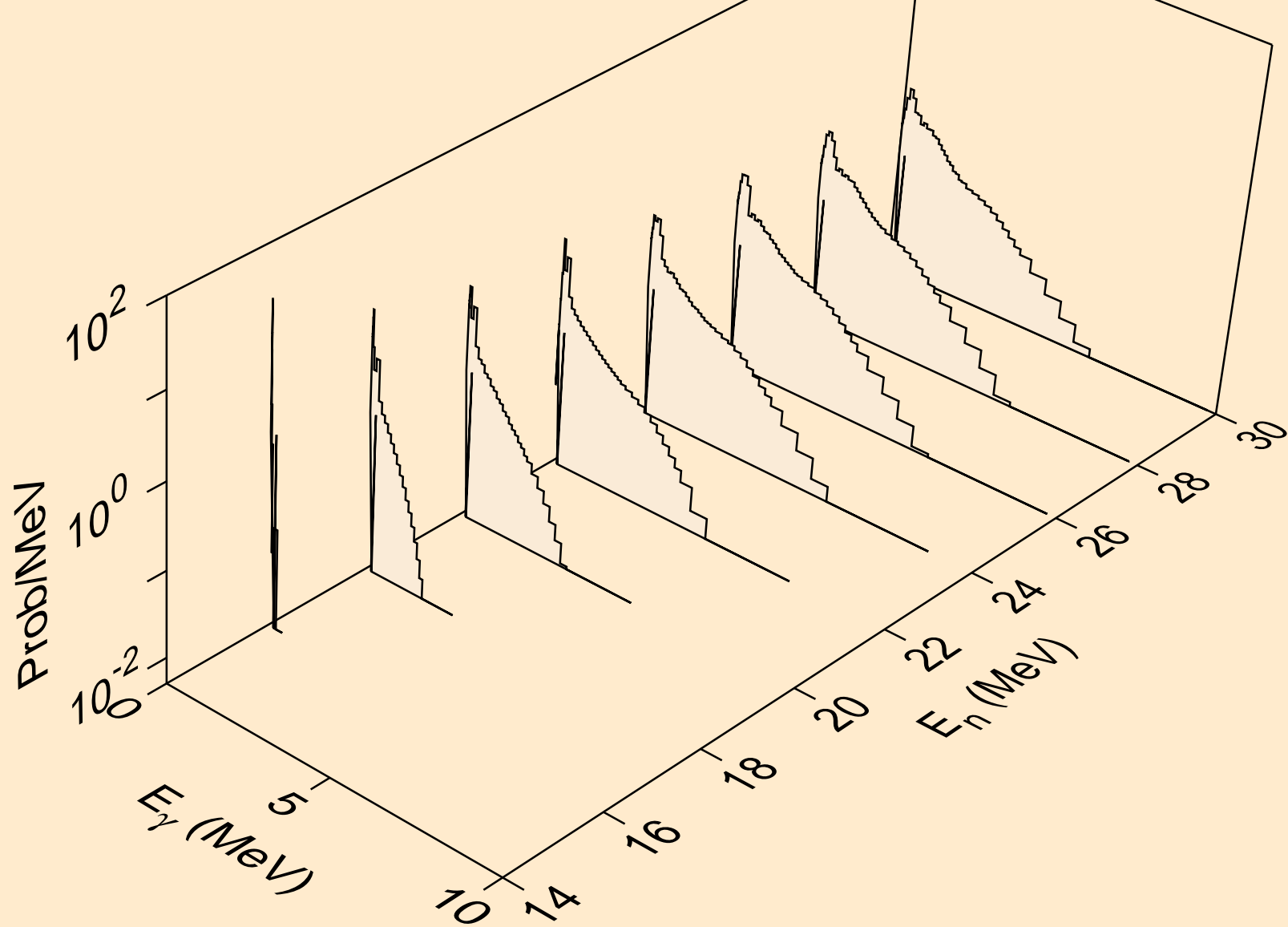

ER149M HELION ACER TENDL-2021 LIBRARY; T=0.K  
Photon emission for (n,n\*)a

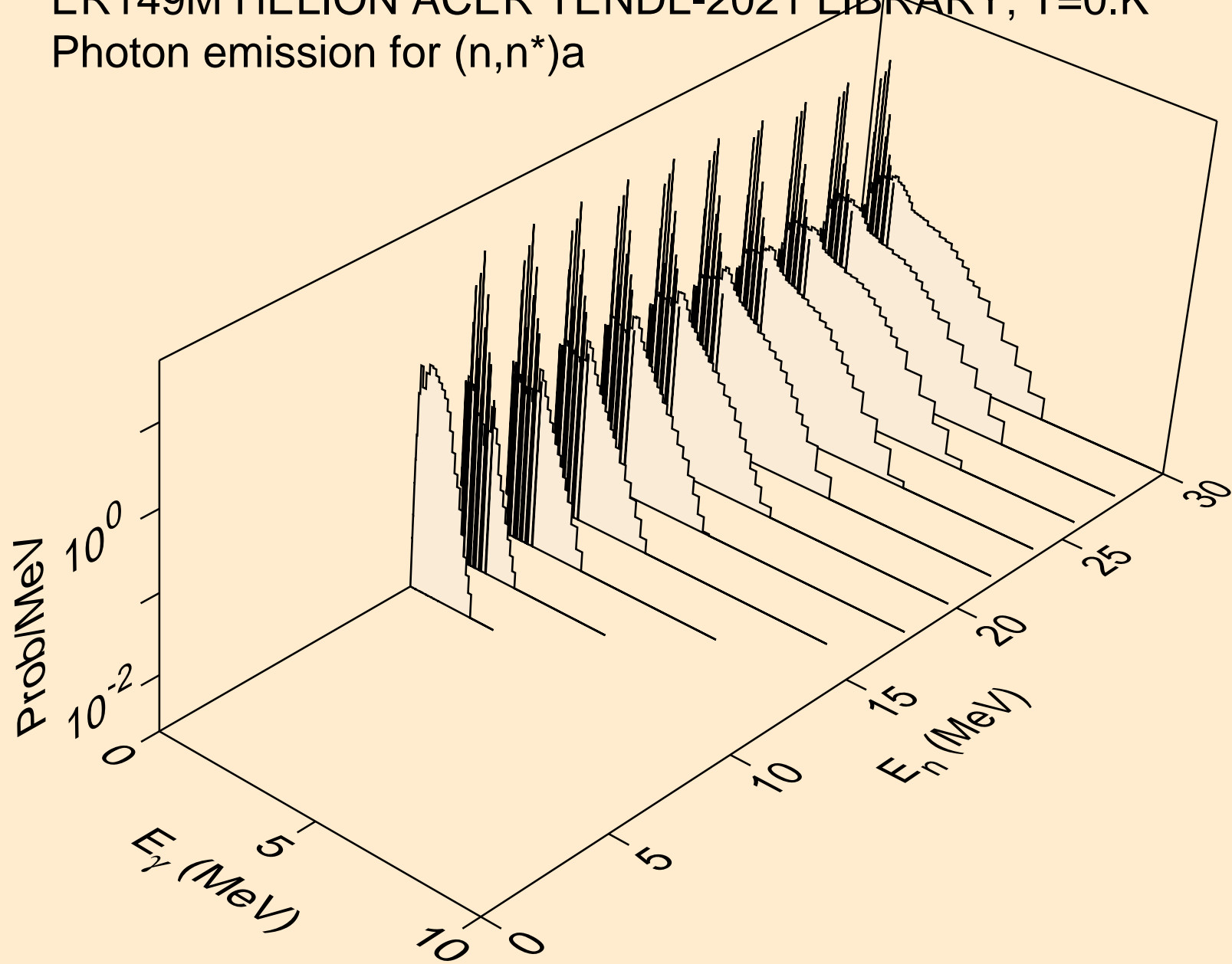

ER149M HELION ACER TENDL-2021 LIBRARY; T=0.K  
Photon emission for (n,2n)a

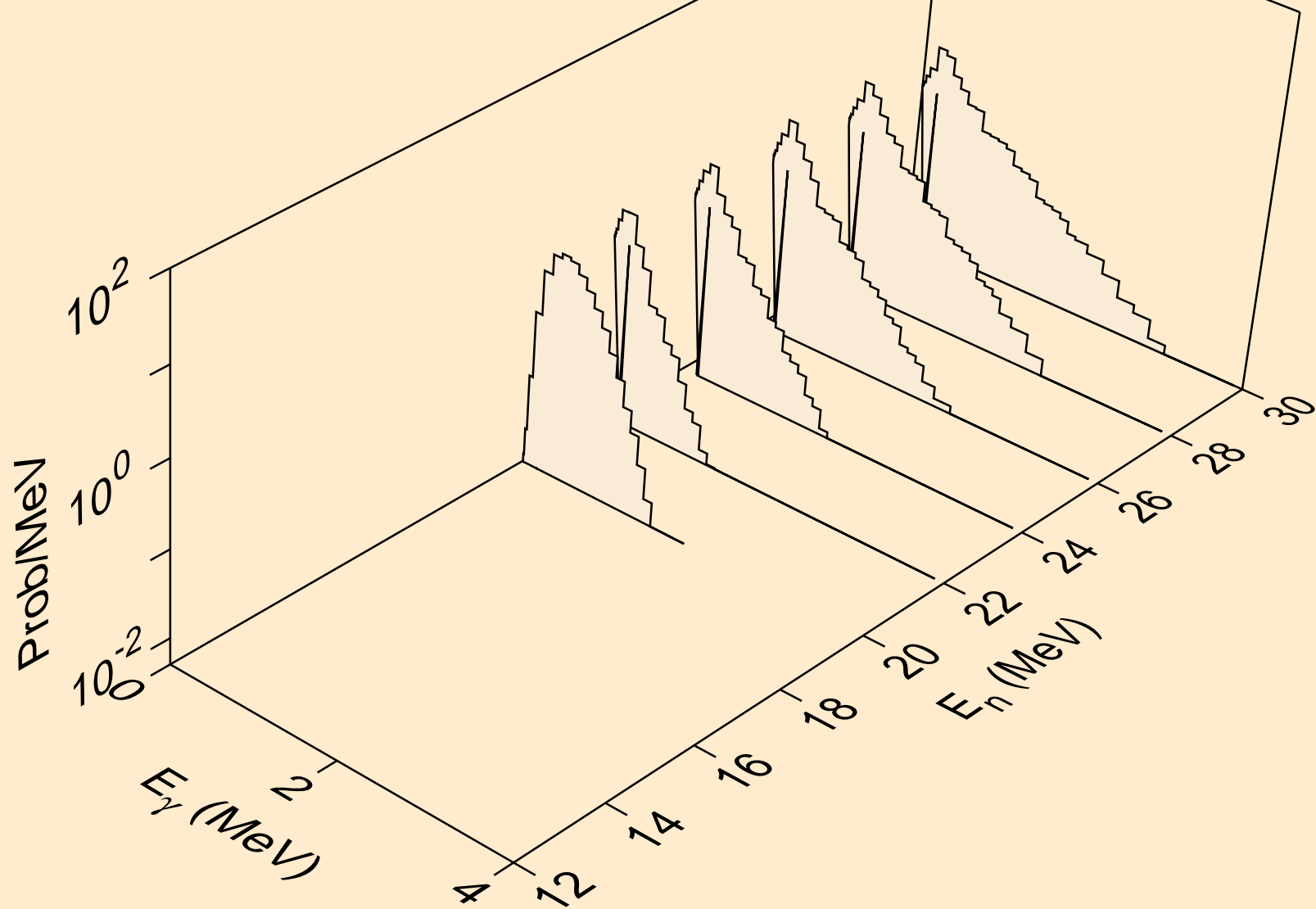

ER149M HELION ACER TENDL-2021 LIBRARY; T=0.K  
Photon emission for (n,n\*)p

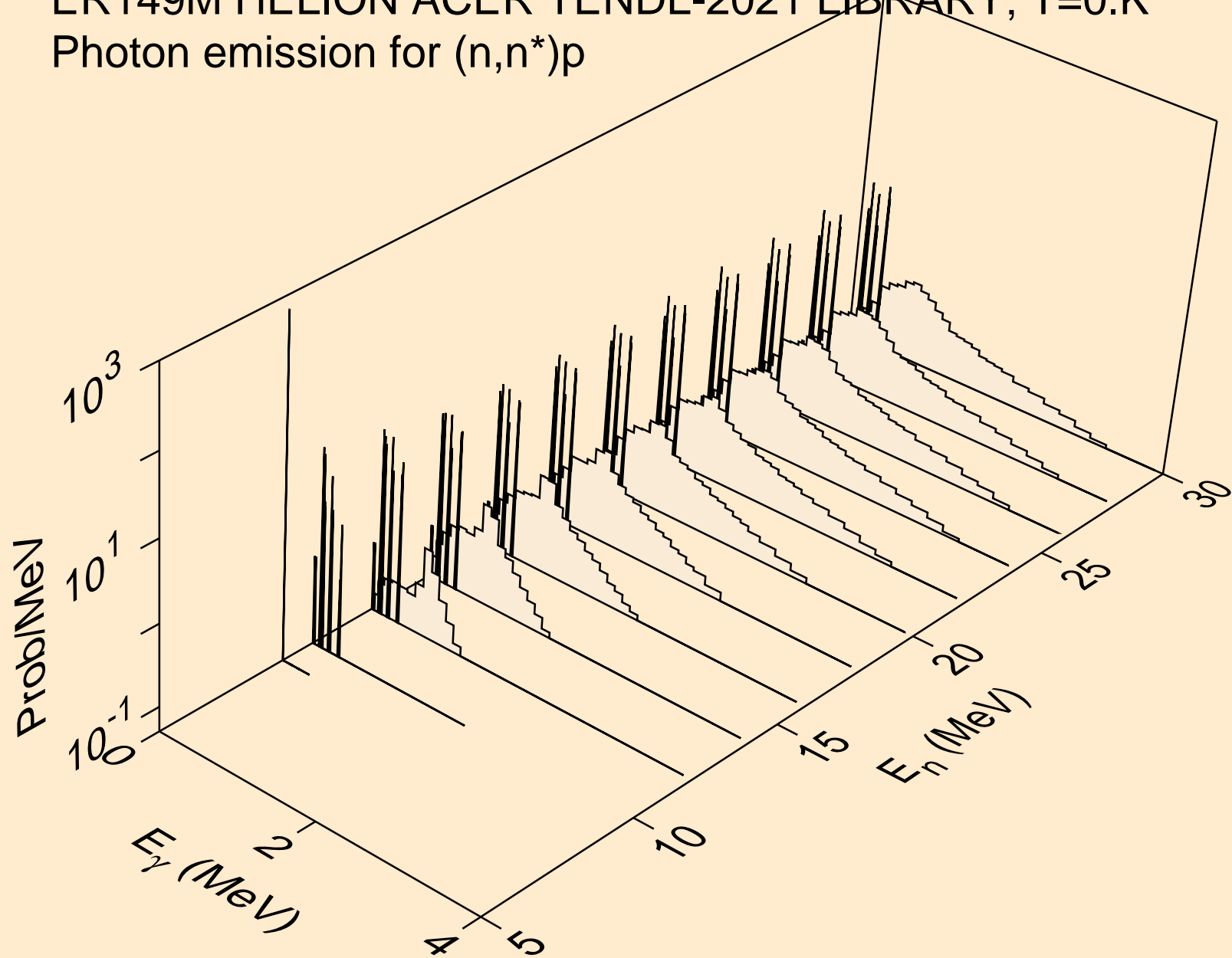

ER149M HELION ACER TENDL-2021 LIBRARY; T=0.K  
Photon emission for (n,n\*)2a

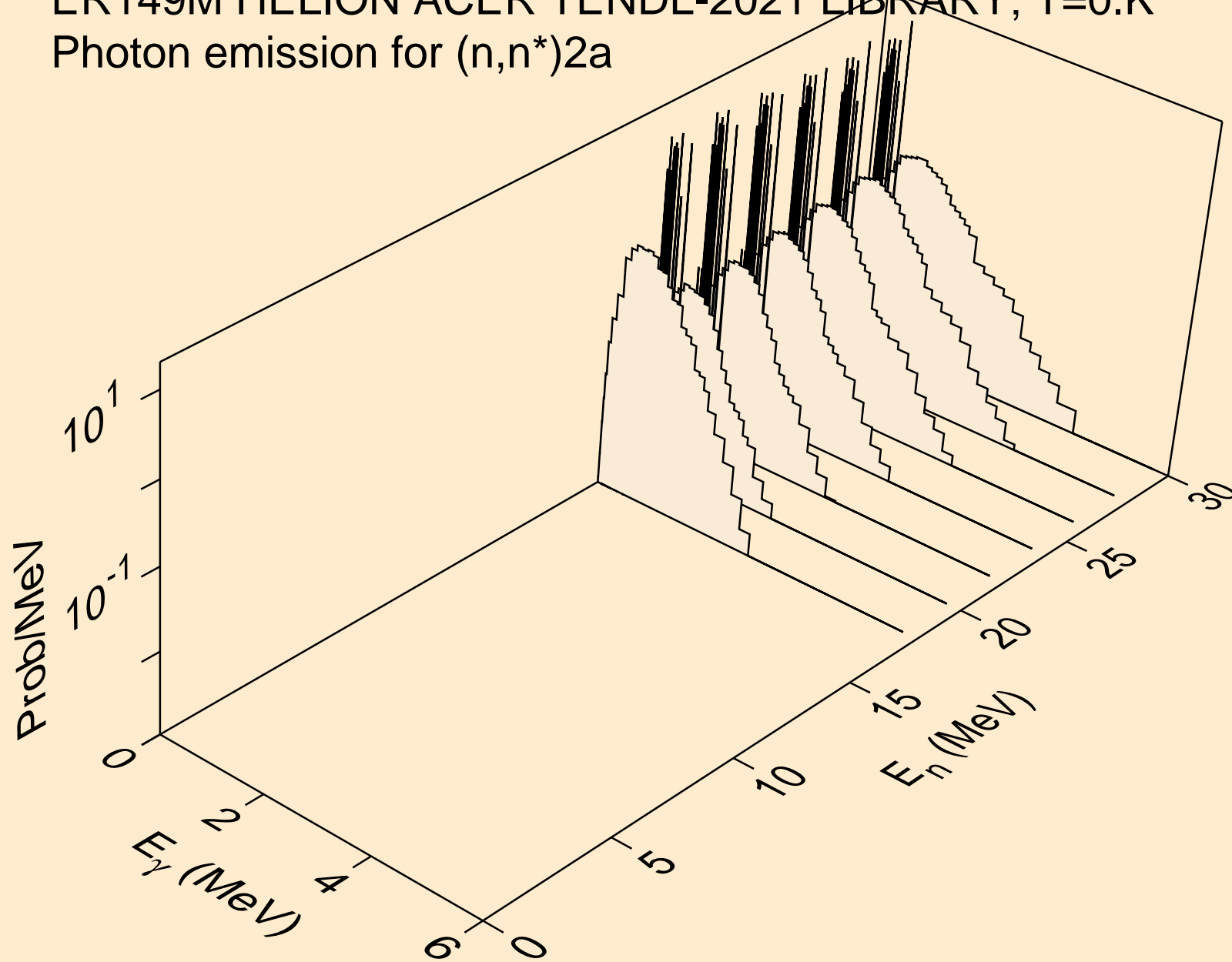

ER149M HELION ACER TENDL-2021 LIBRARY; T=0.K  
Photon emission for (n,n\*)d

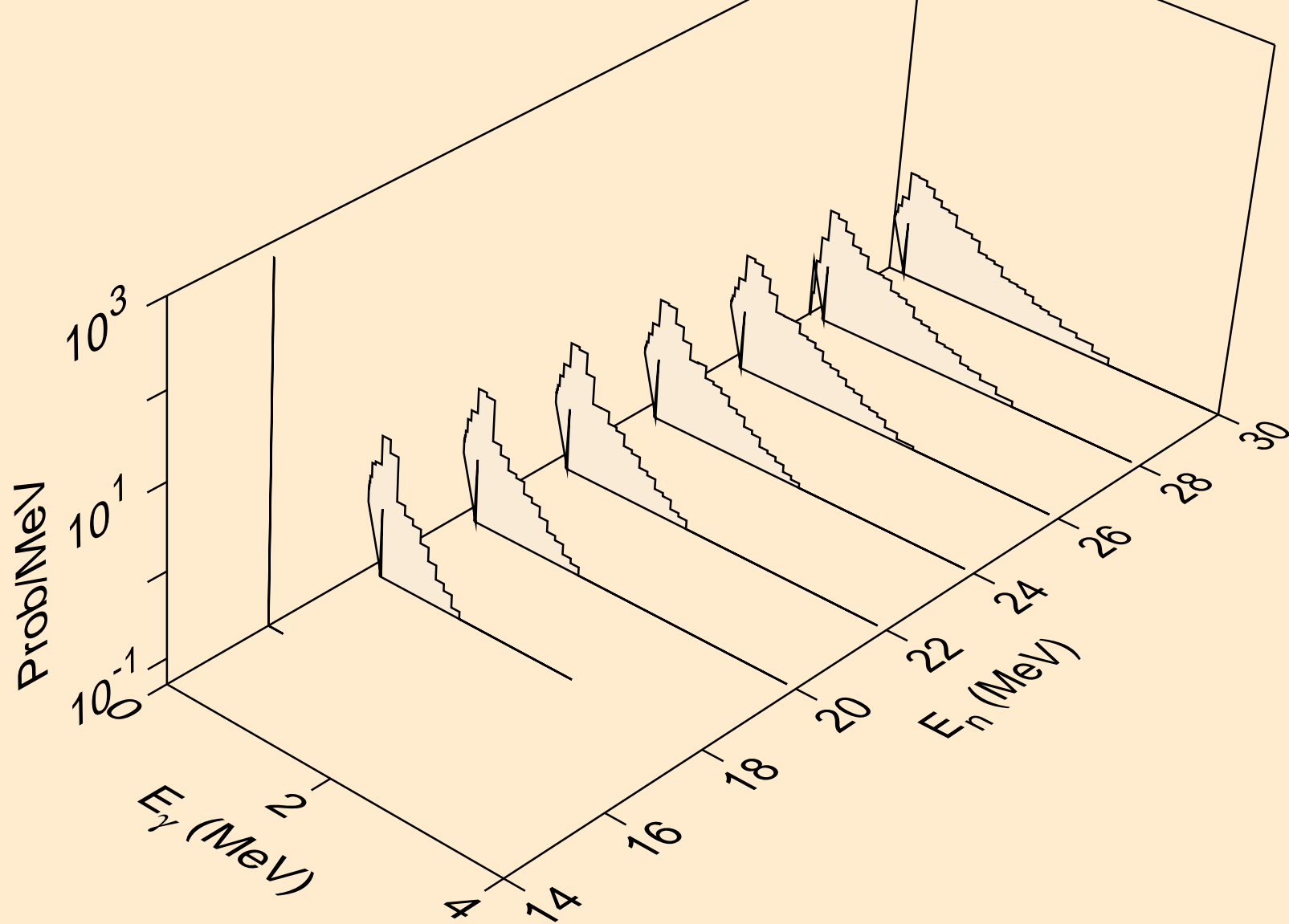

ER149M HELION ACER TENDL-2021 LIBRARY; T=0.K  
Photon emission for (n,n\*)t

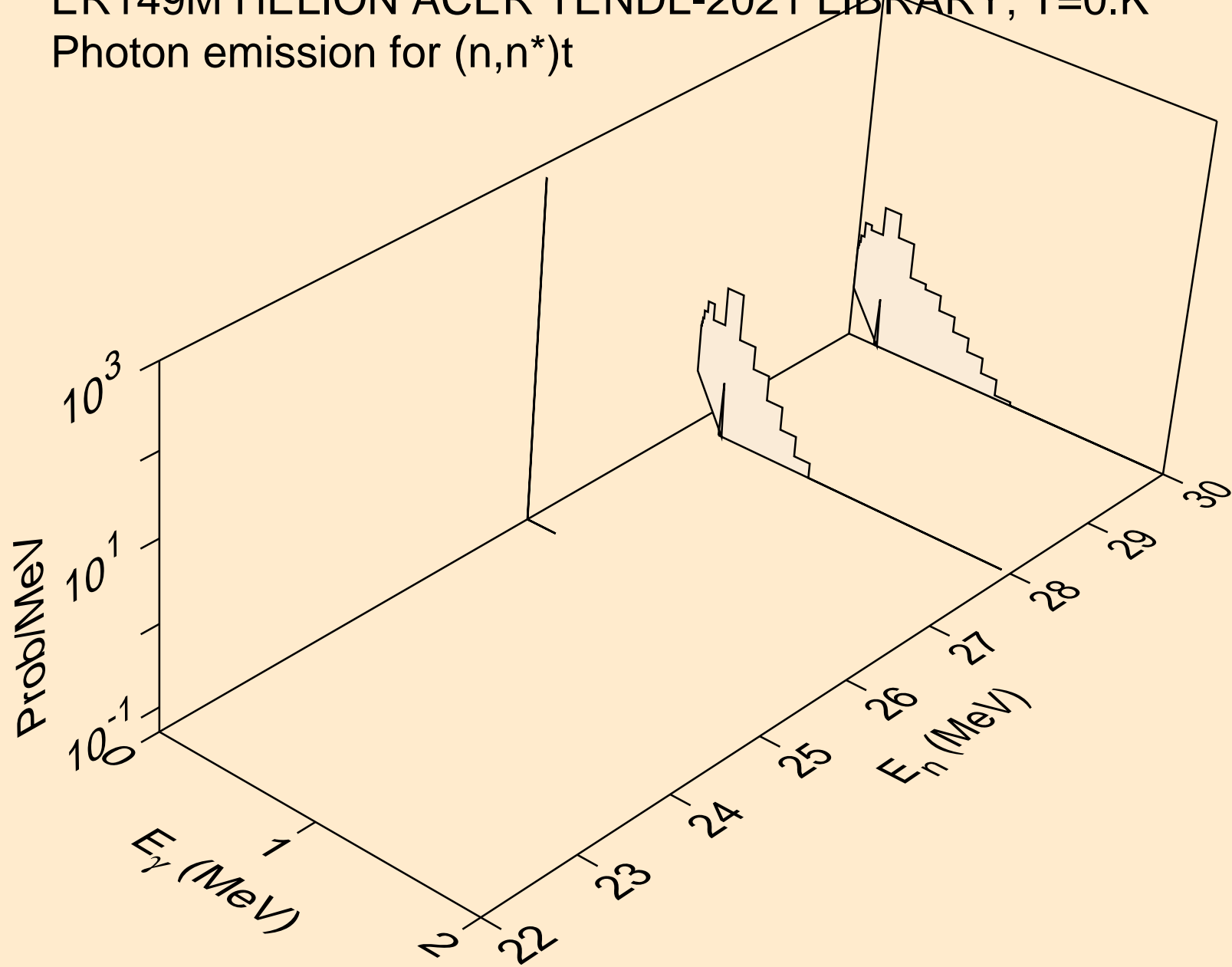

ER149M HELION ACER TENDL-2021 LIBRARY; T=0.K  
Photon emission for (n,n\*)he3

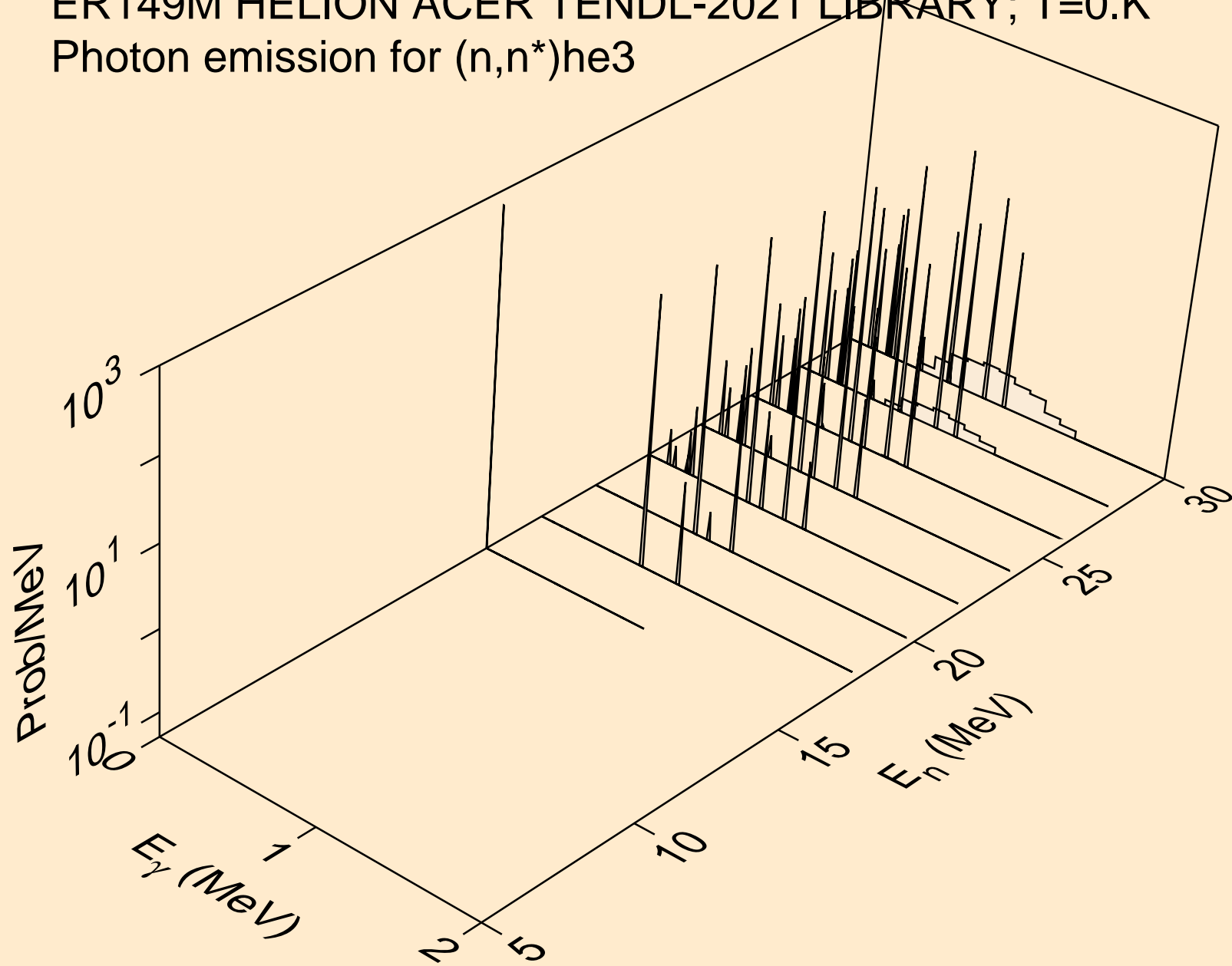

ER149M HELION ACER TENDL-2021 LIBRARY; T=0.K  
Photon emission for (n,2np)

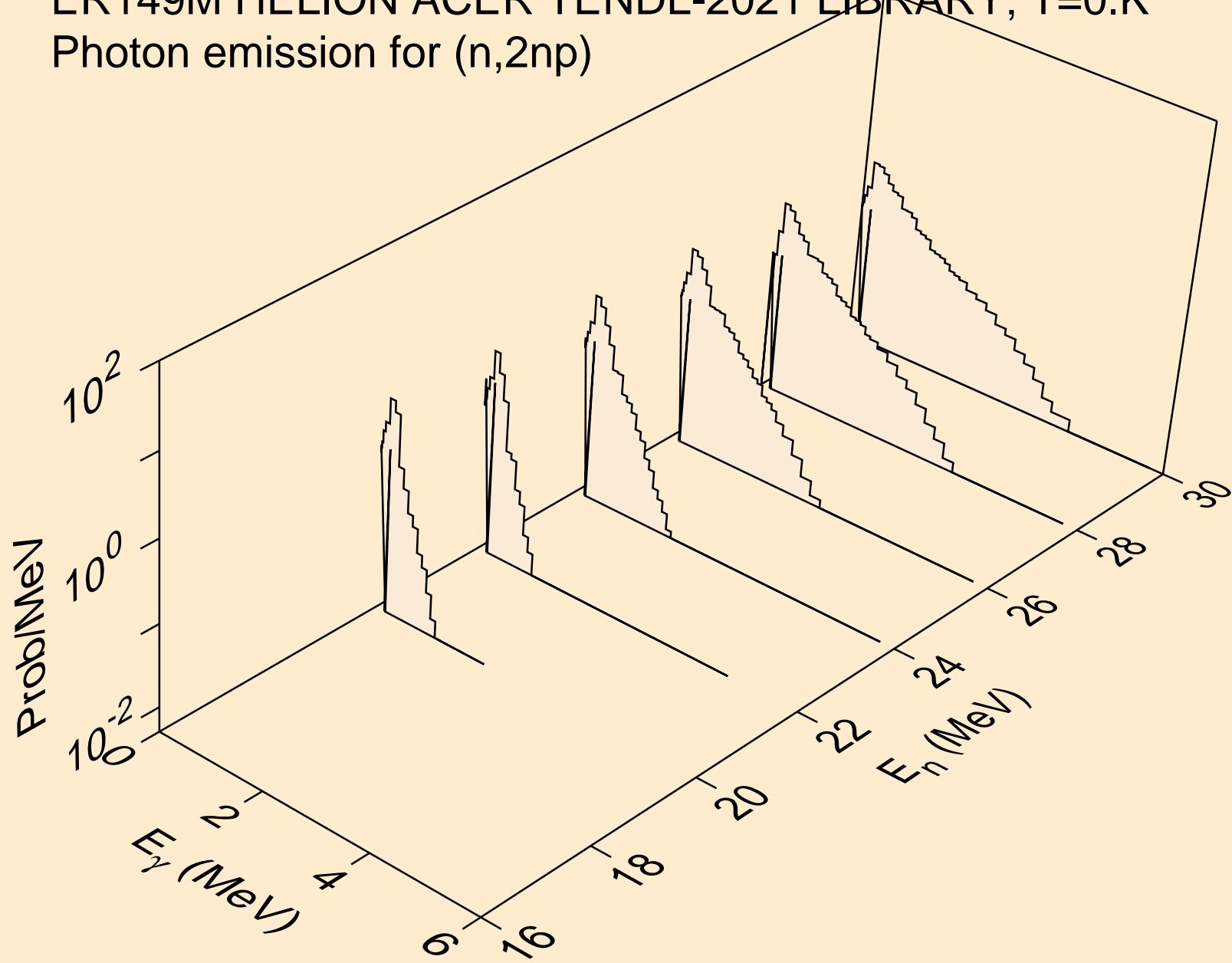

ER149M HELION ACER TENDL-2021 LIBRARY; T=0.K  
Photon emission for (n,2np)

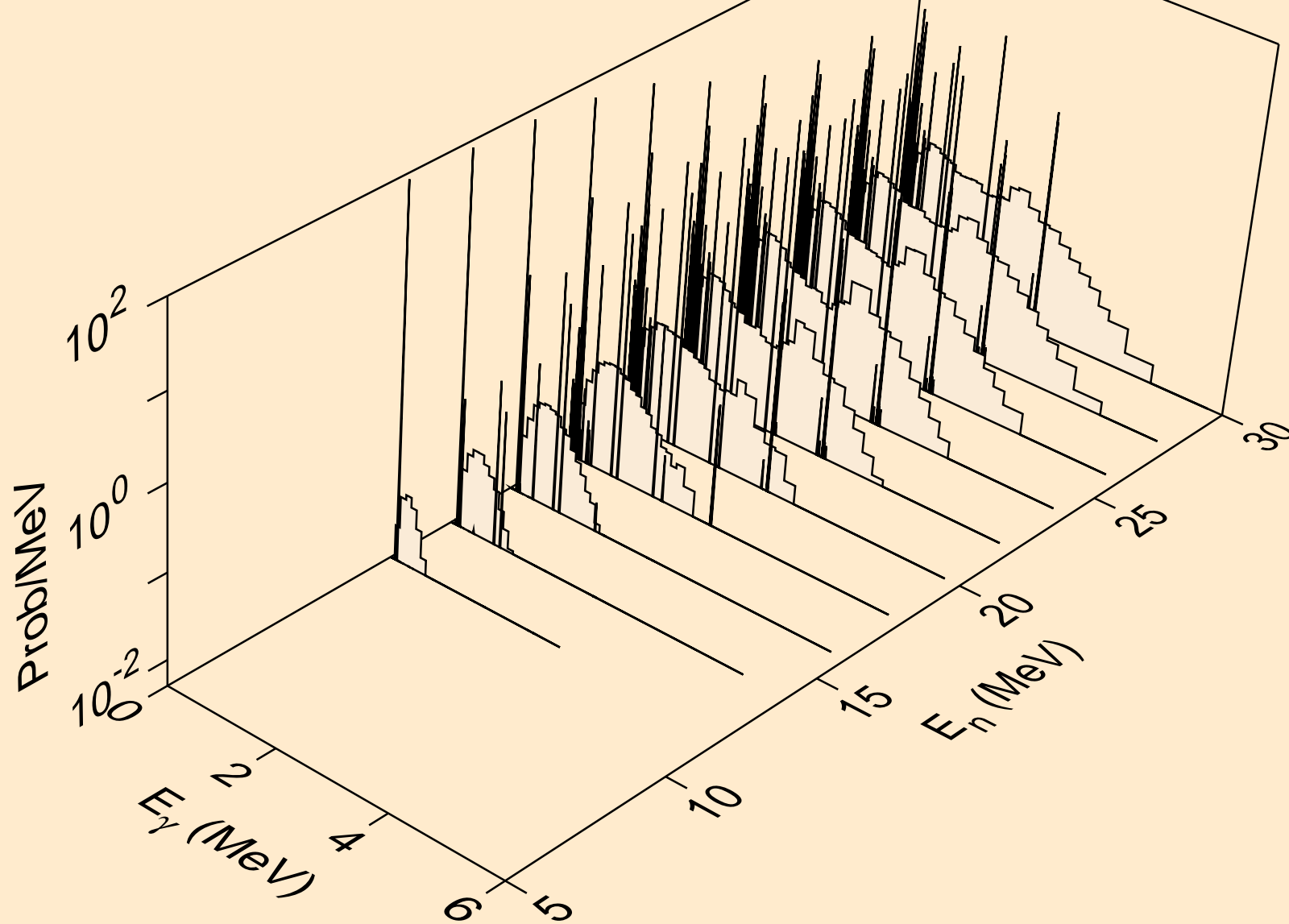

ER149M HELION ACER TENDL-2021 LIBRARY; T=0.K  
Photon emission for (n,npa)

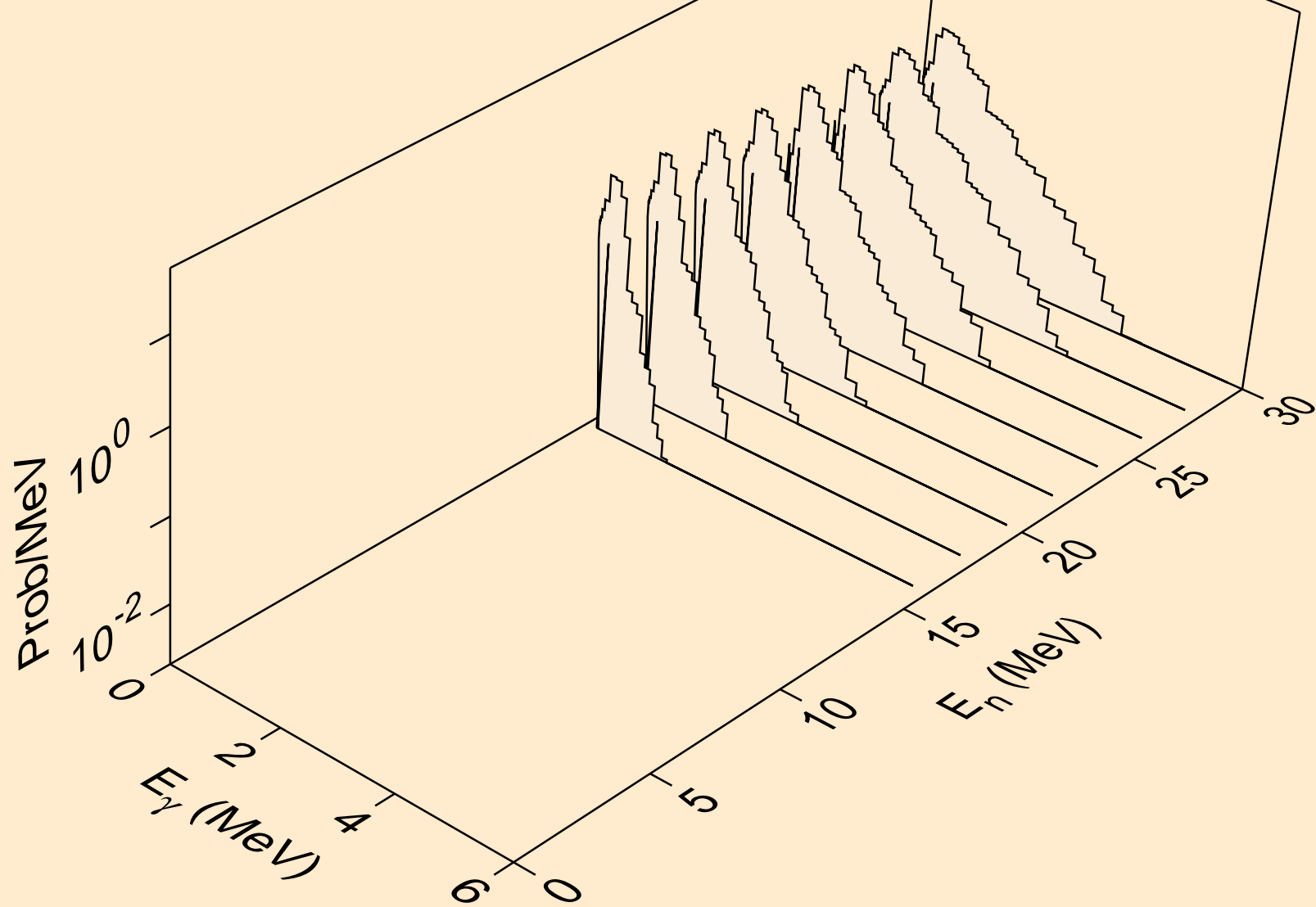

ER149M HELION ACER TENDL-2021 LIBRARY; T=0.K  
Photon emission for (n,gma)

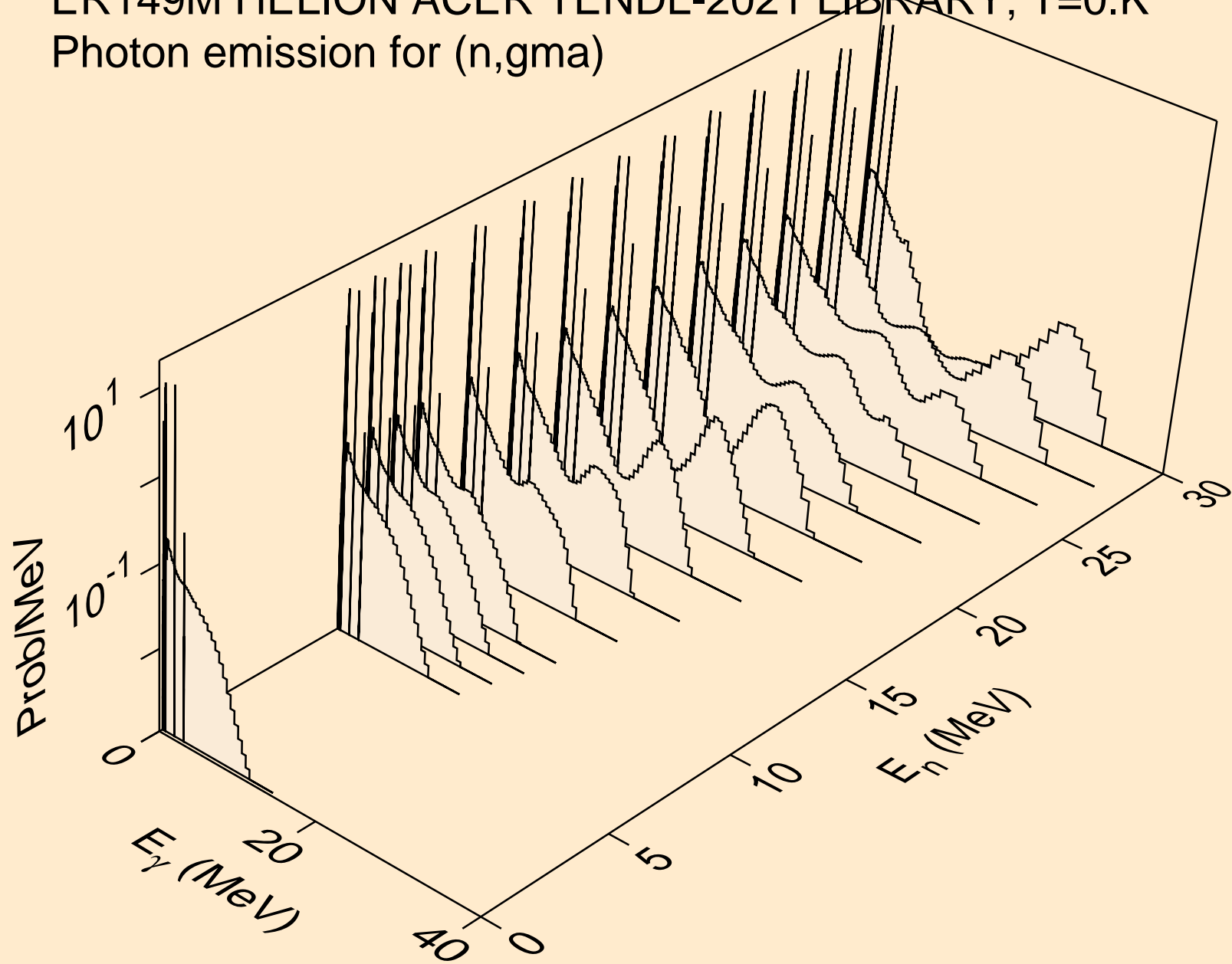

ER149M HELION ACER TENDL-2021 LIBRARY; T=0.K  
Photon emission for (n,p)

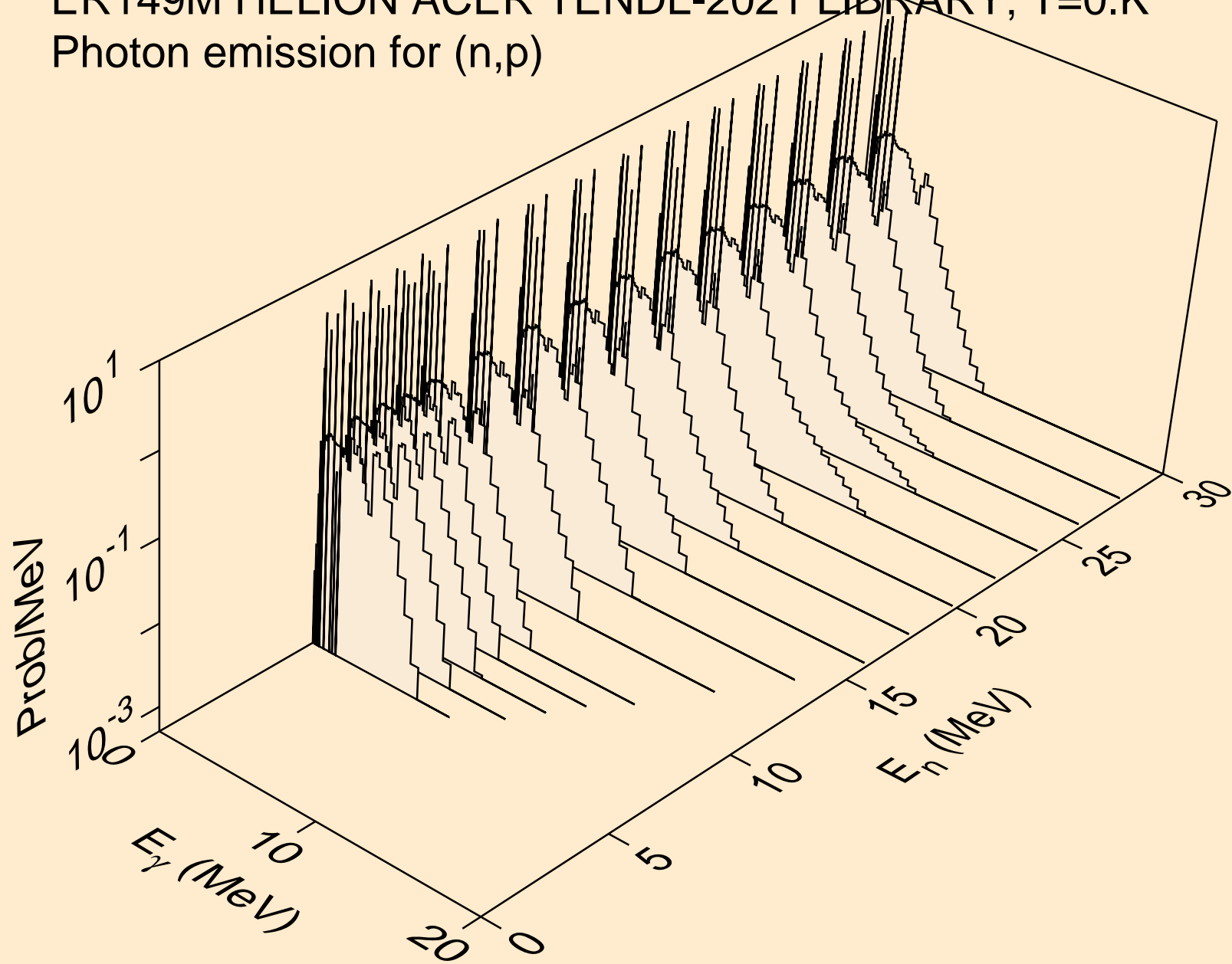

ER149M HELION ACER TENDL-2021 LIBRARY; T=0.K  
Photon emission for (n,d)

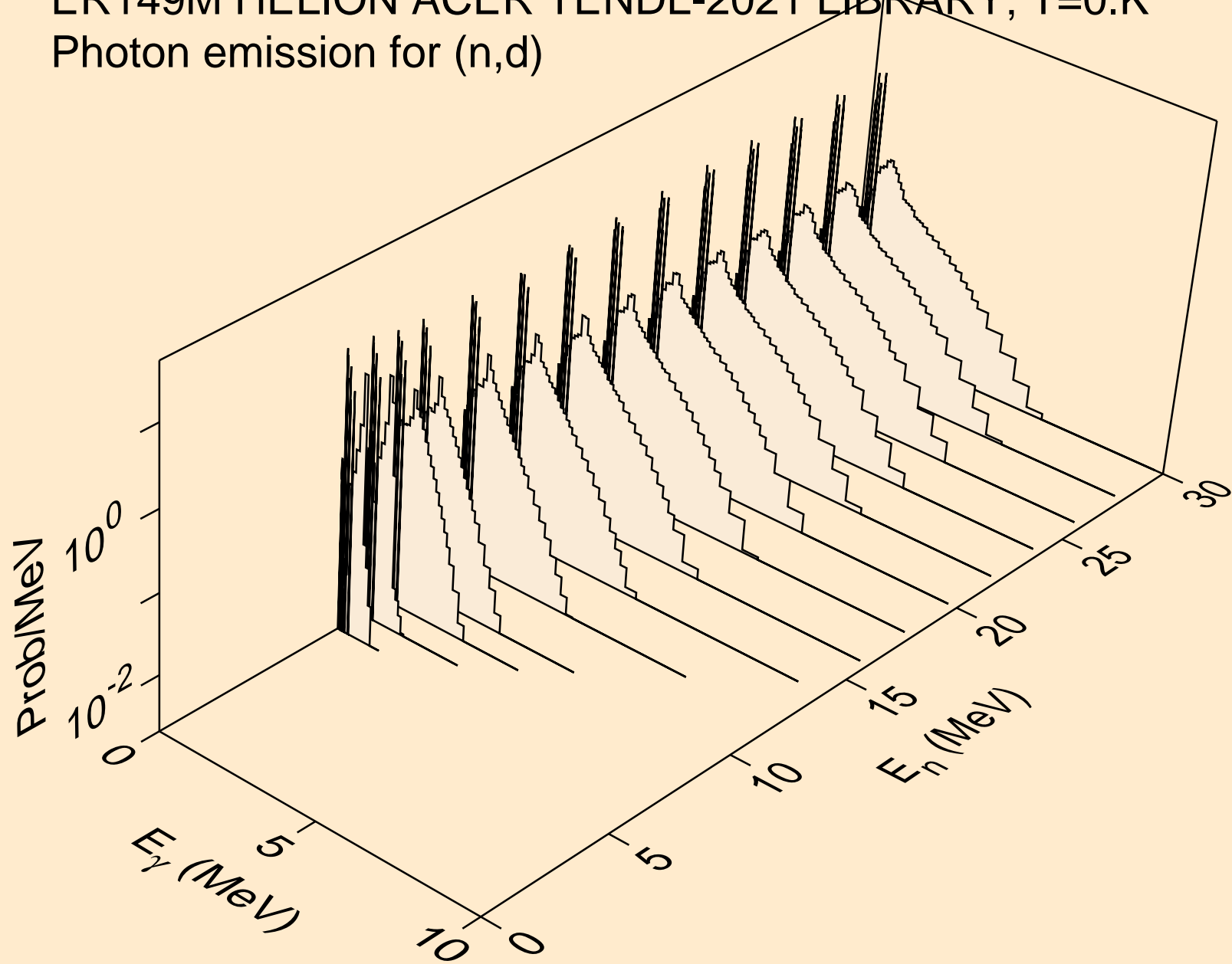

ER149M HELION ACER TENDL-2021 LIBRARY; T=0.K  
Photon emission for (n,t)

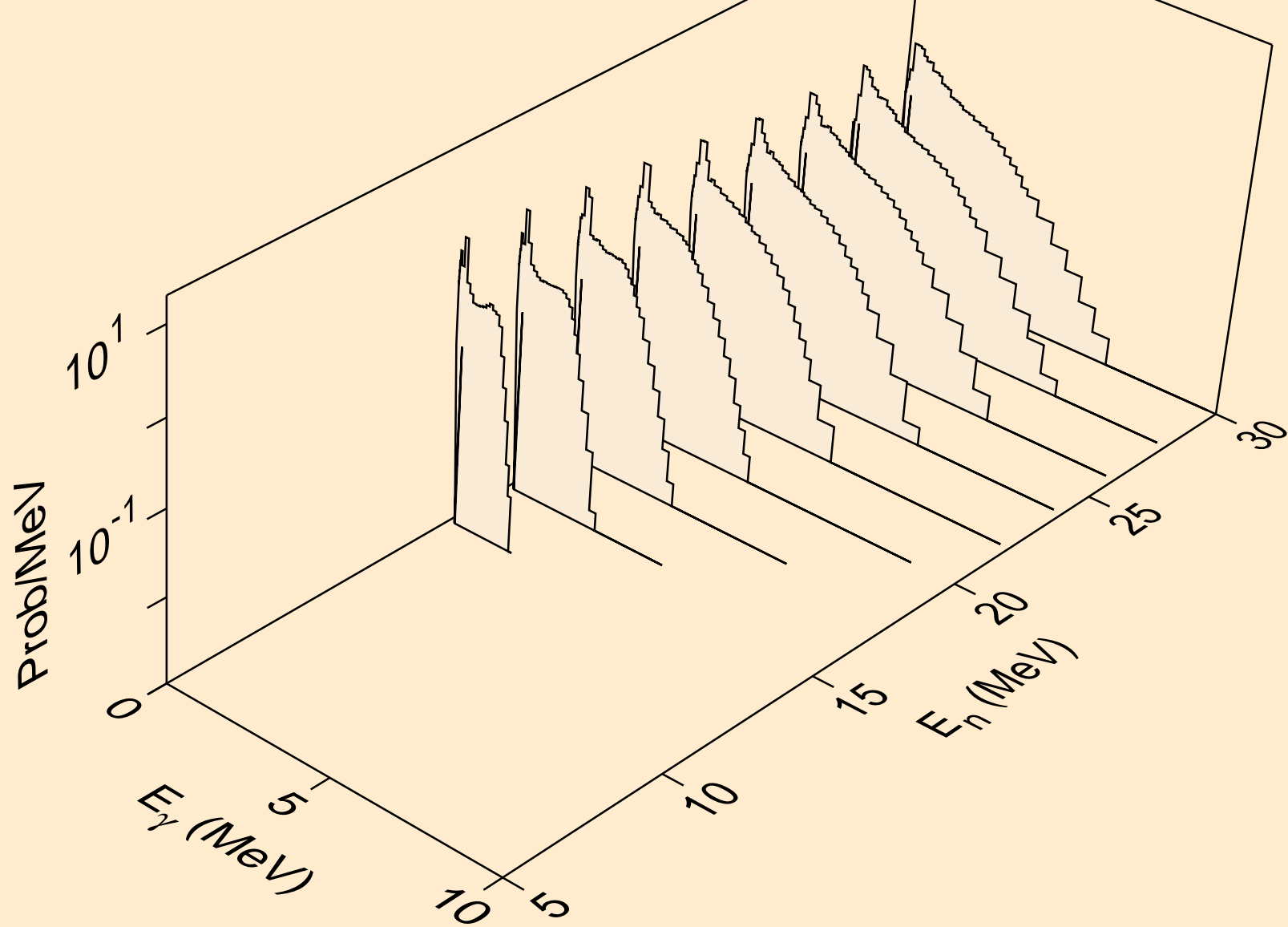

ER149M HELION ACER TENDL-2021 LIBRARY; T=0.K  
Photon emission for inelastic

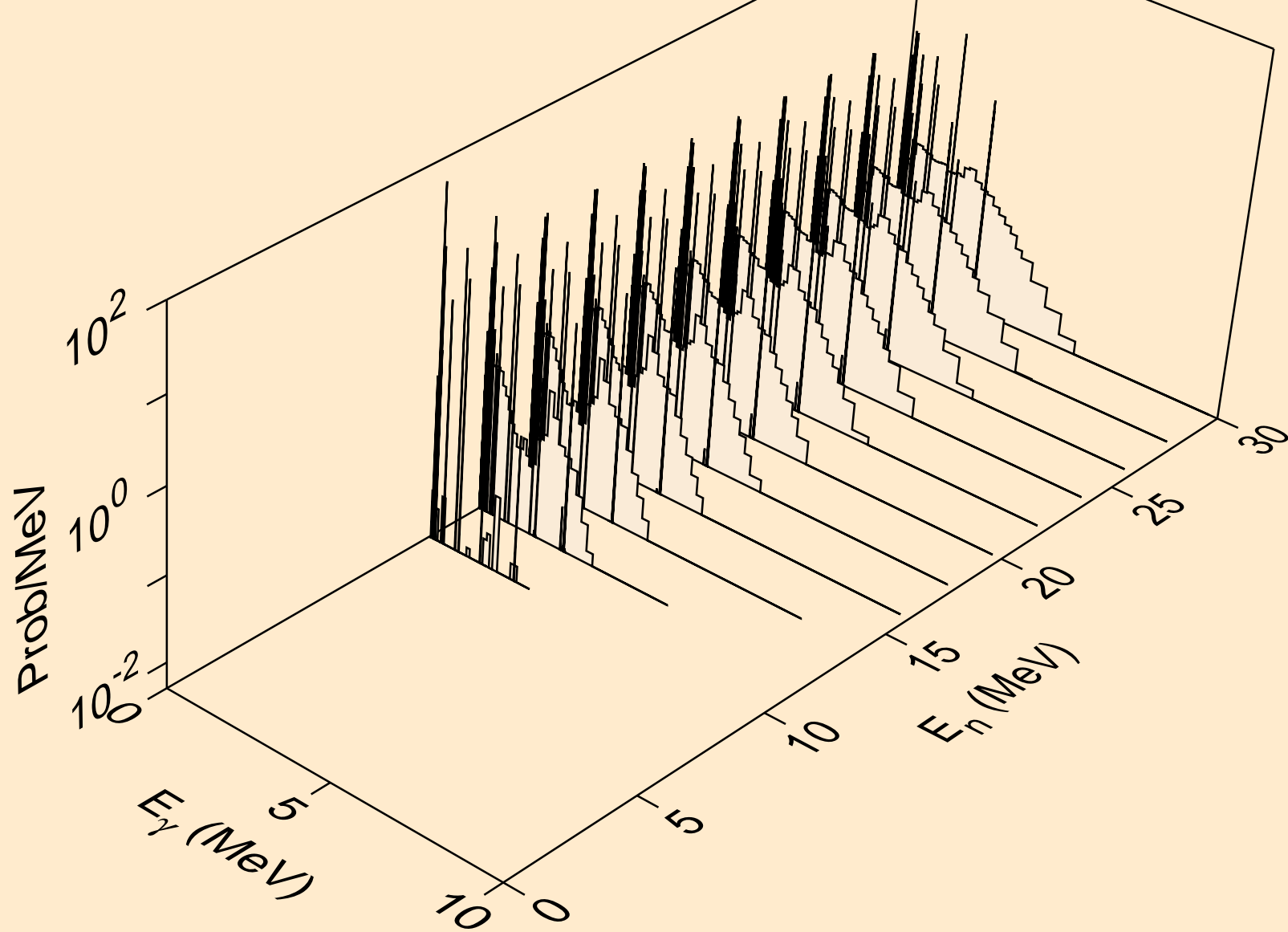

ER149M HELION ACER TENDL-2021 LIBRARY; T=0.K  
Photon emission for (n,a)

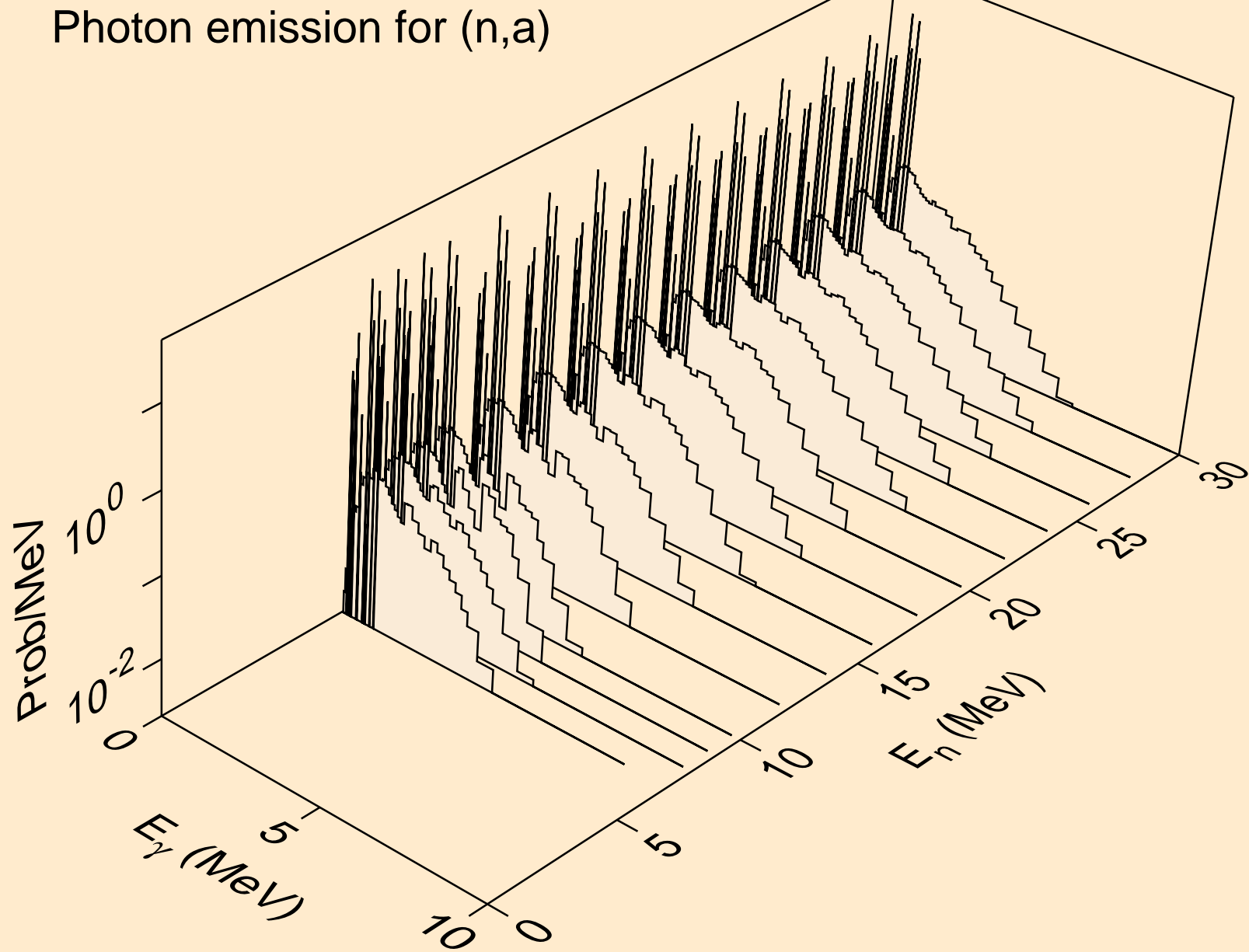

ER149M HELION ACER TENDL-2021 LIBRARY; T=0.K  
Photon emission for (n,2a)

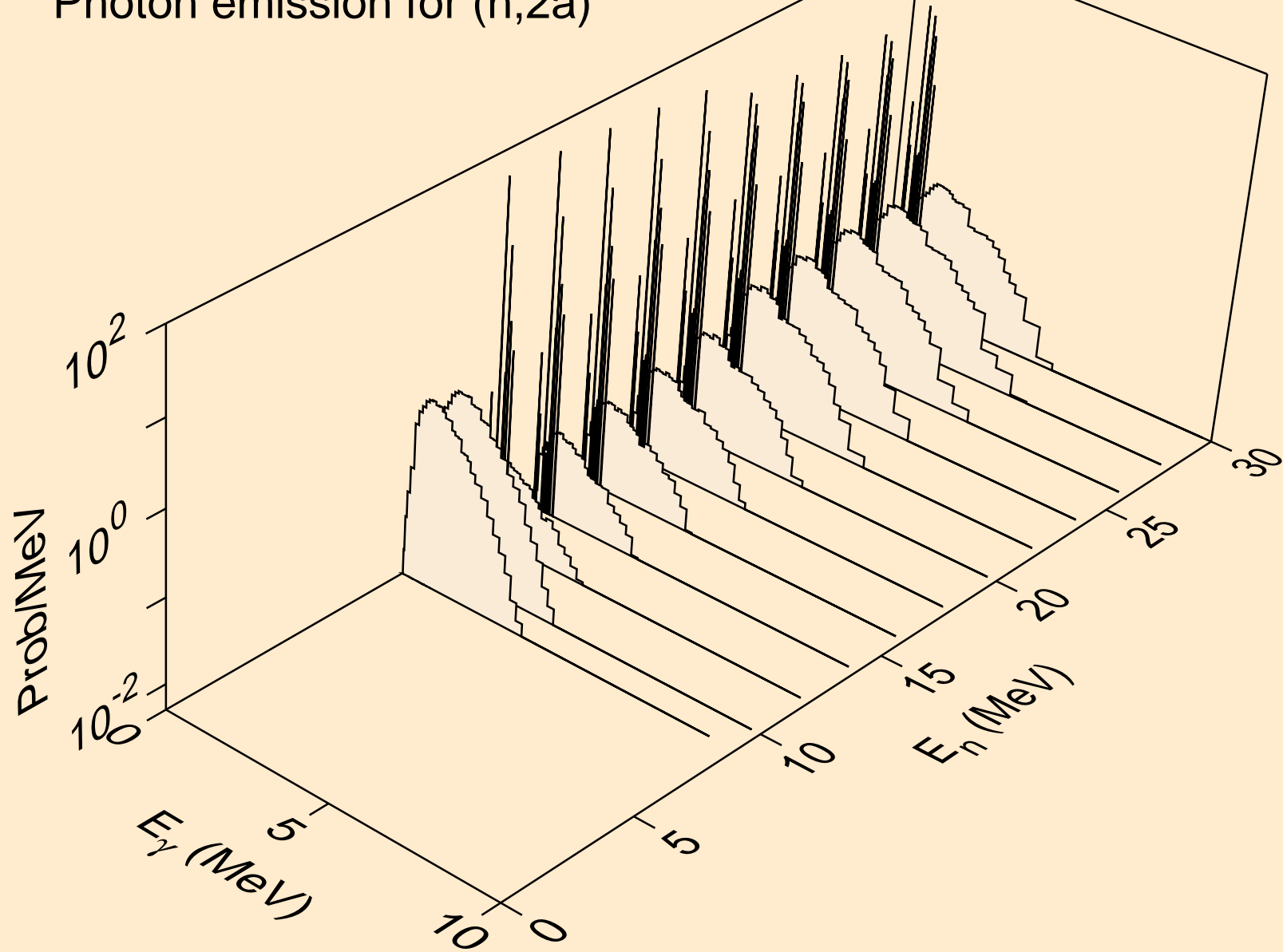

ER149M HELION ACER TENDL-2021 LIBRARY; T=0.K  
Photon emission for (n,2p)

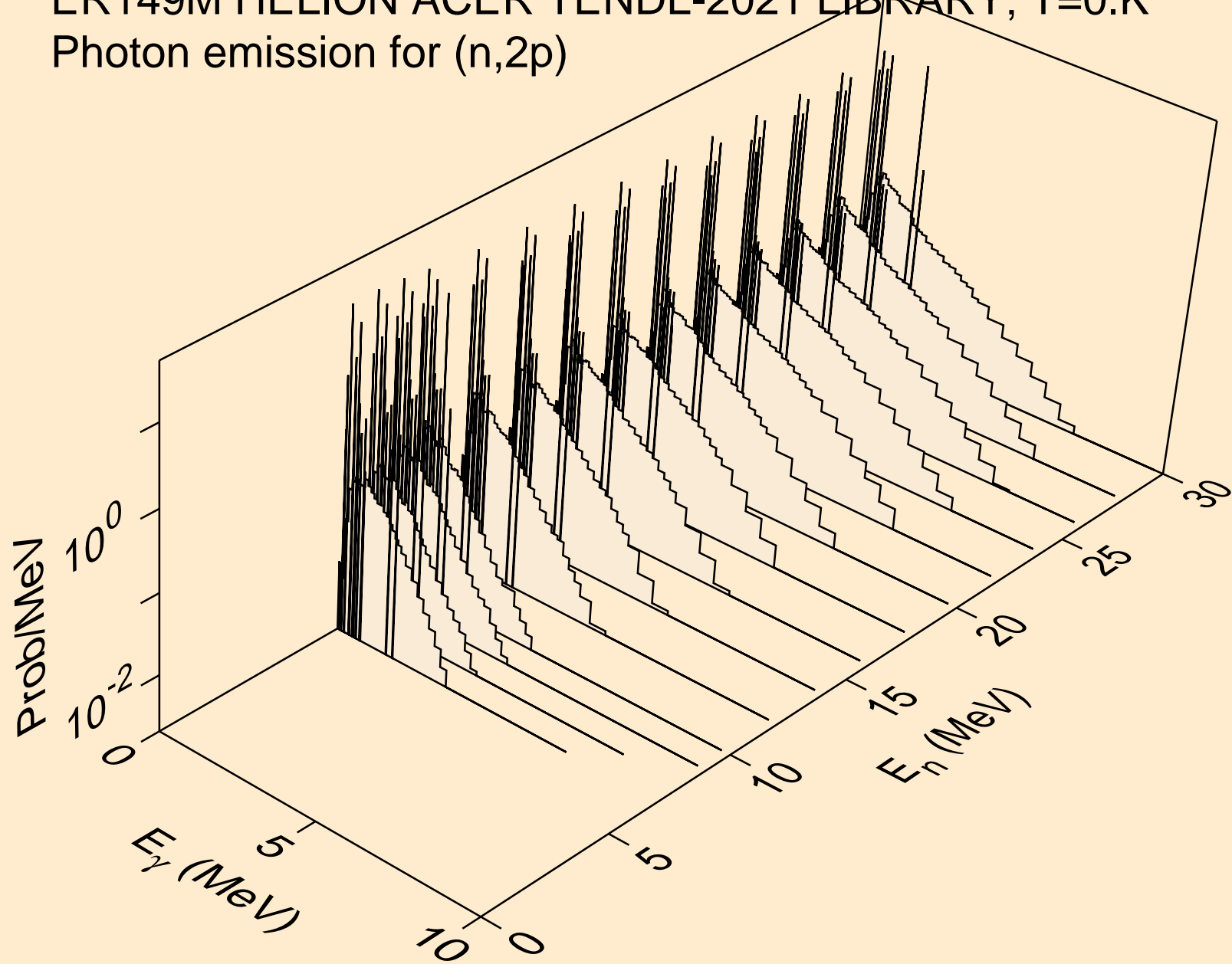

ER149M HELION ACER TENDL-2021 LIBRARY; T=0.K  
Photon emission for (n,pa)

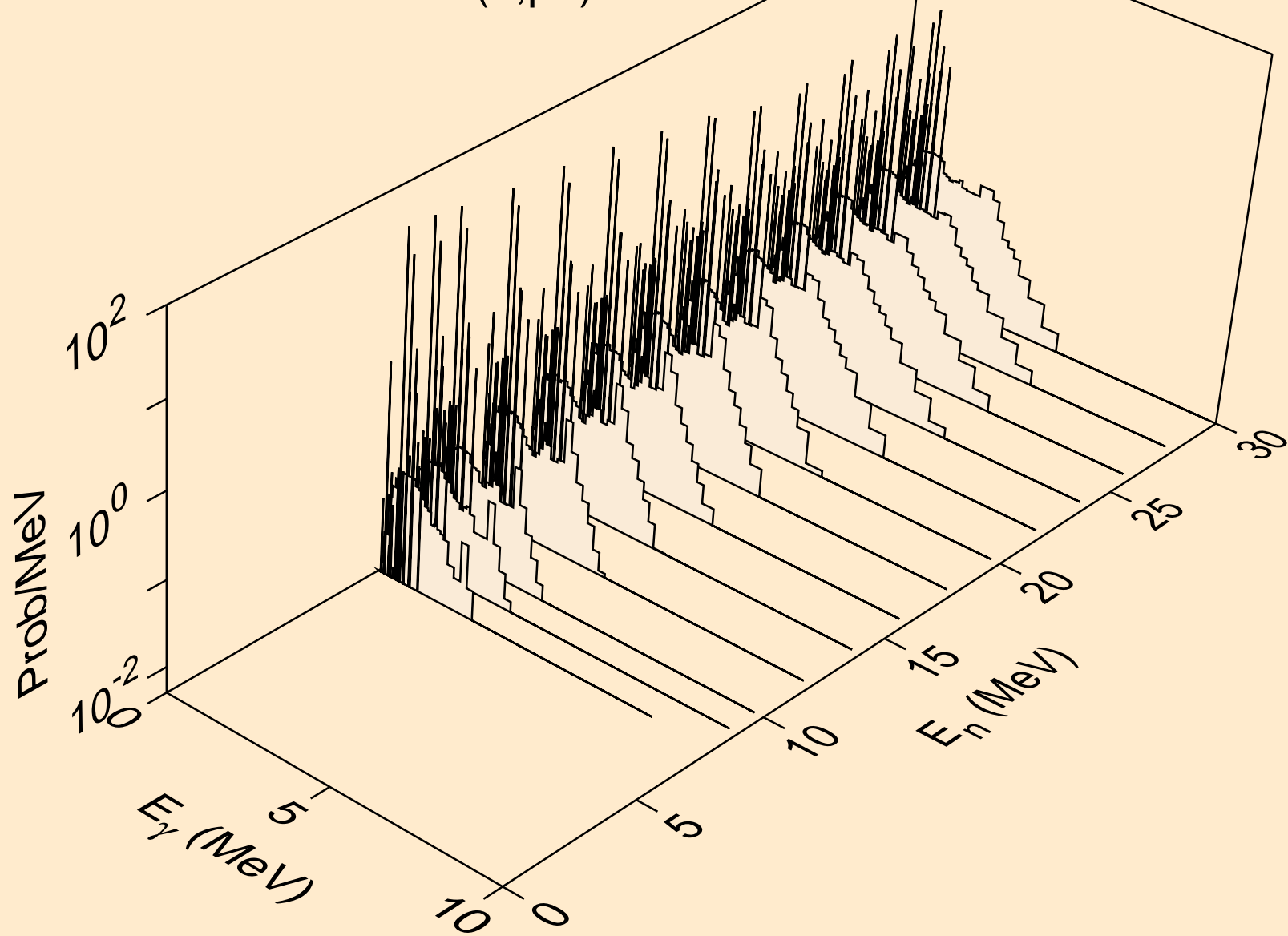

ER149M HELION ACER TENDL-2021 LIBRARY; T=0.K  
Photon emission for (n,pd)

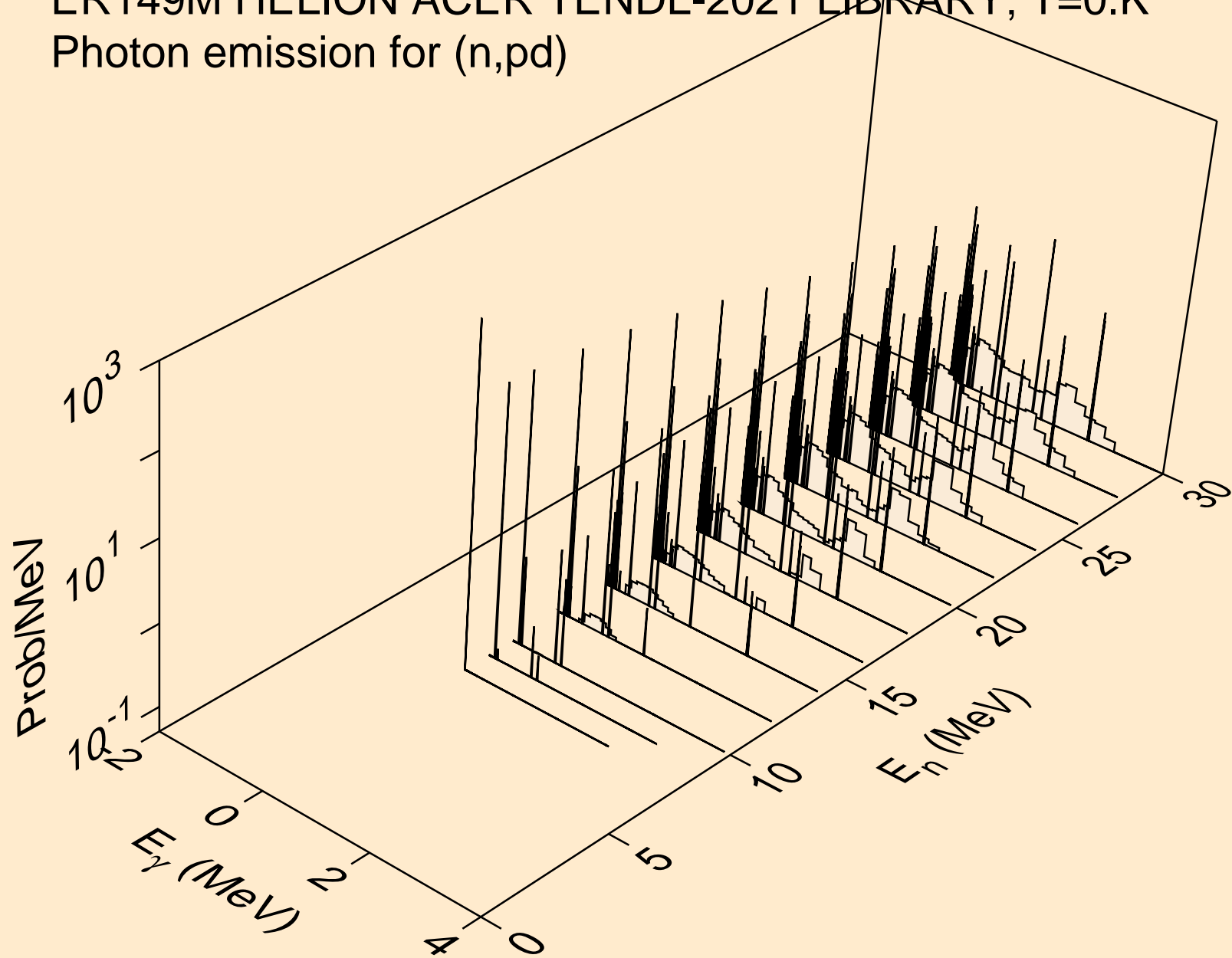

ER149M HELION ACER TENDL-2021 LIBRARY; T=0.K  
Photon emission for (n,pt)

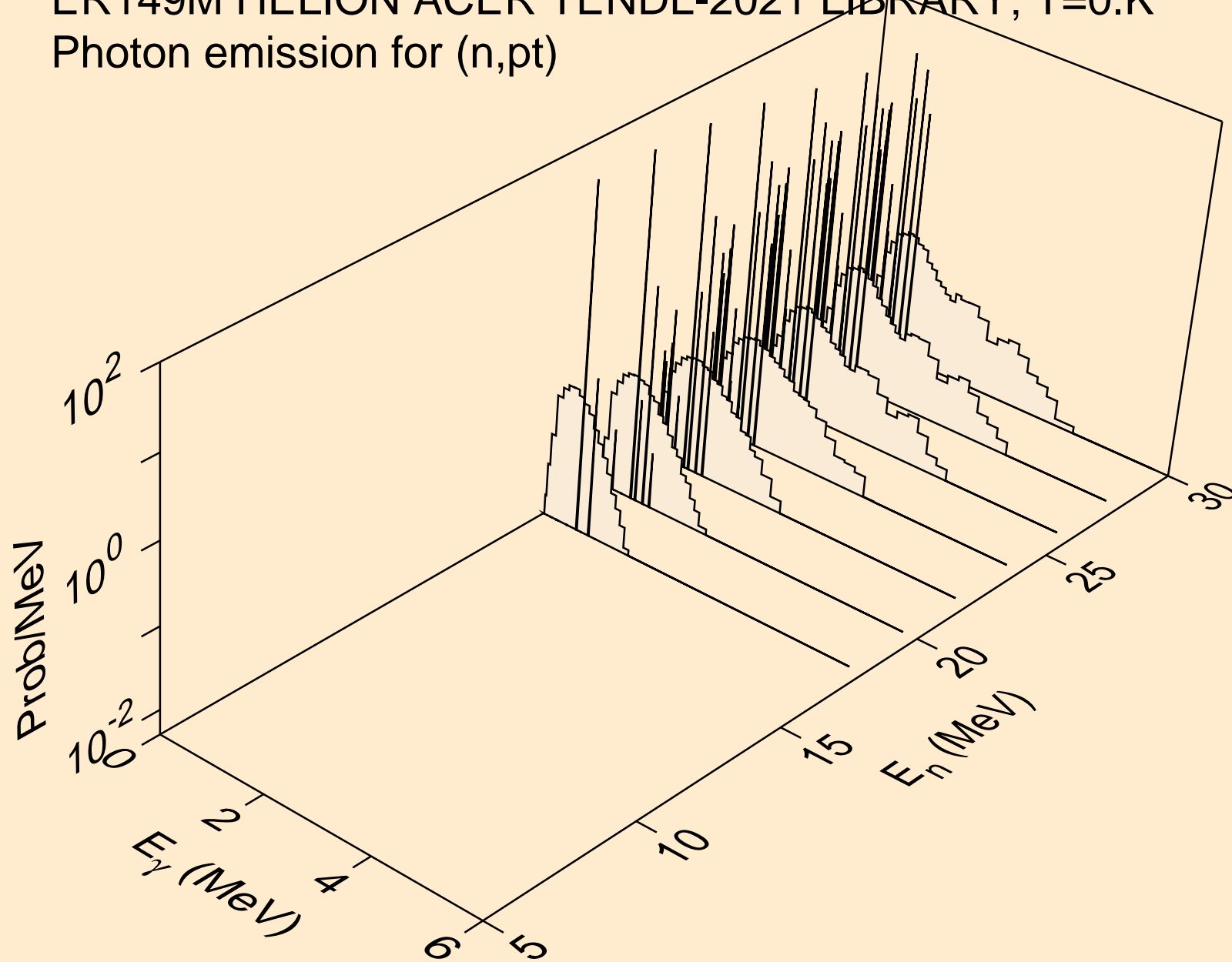

ER149M HELION ACER TENDL-2021 LIBRARY; T=0.K  
Photon emission for (n,da)

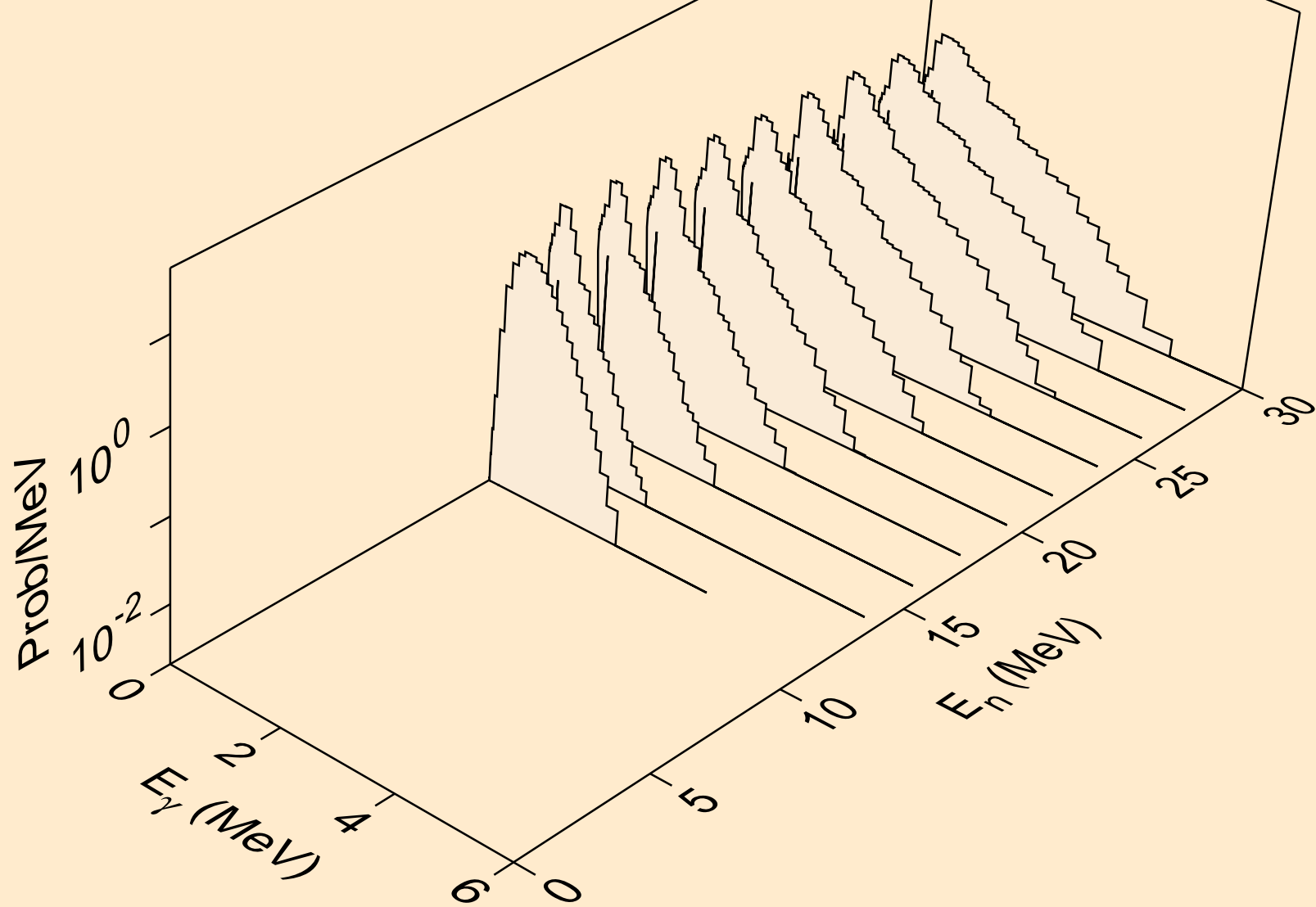

ER149M HELION ACER TENDL-2021 LIBRARY; T=0.K  
Particle heating contributions

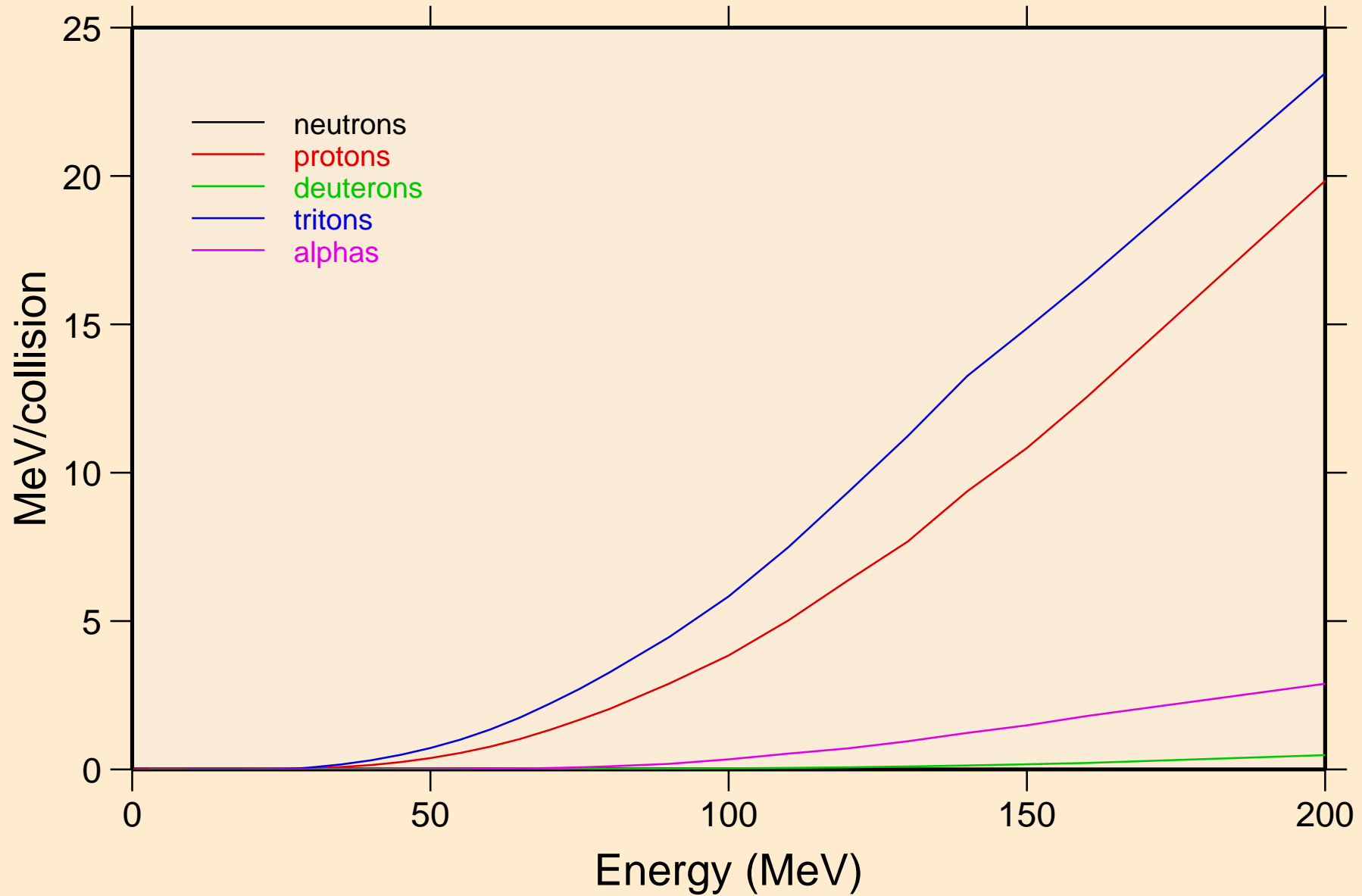

ER149M HELION ACER TENDL-2021 LIBRARY; T=0.K  
Recoil Heating

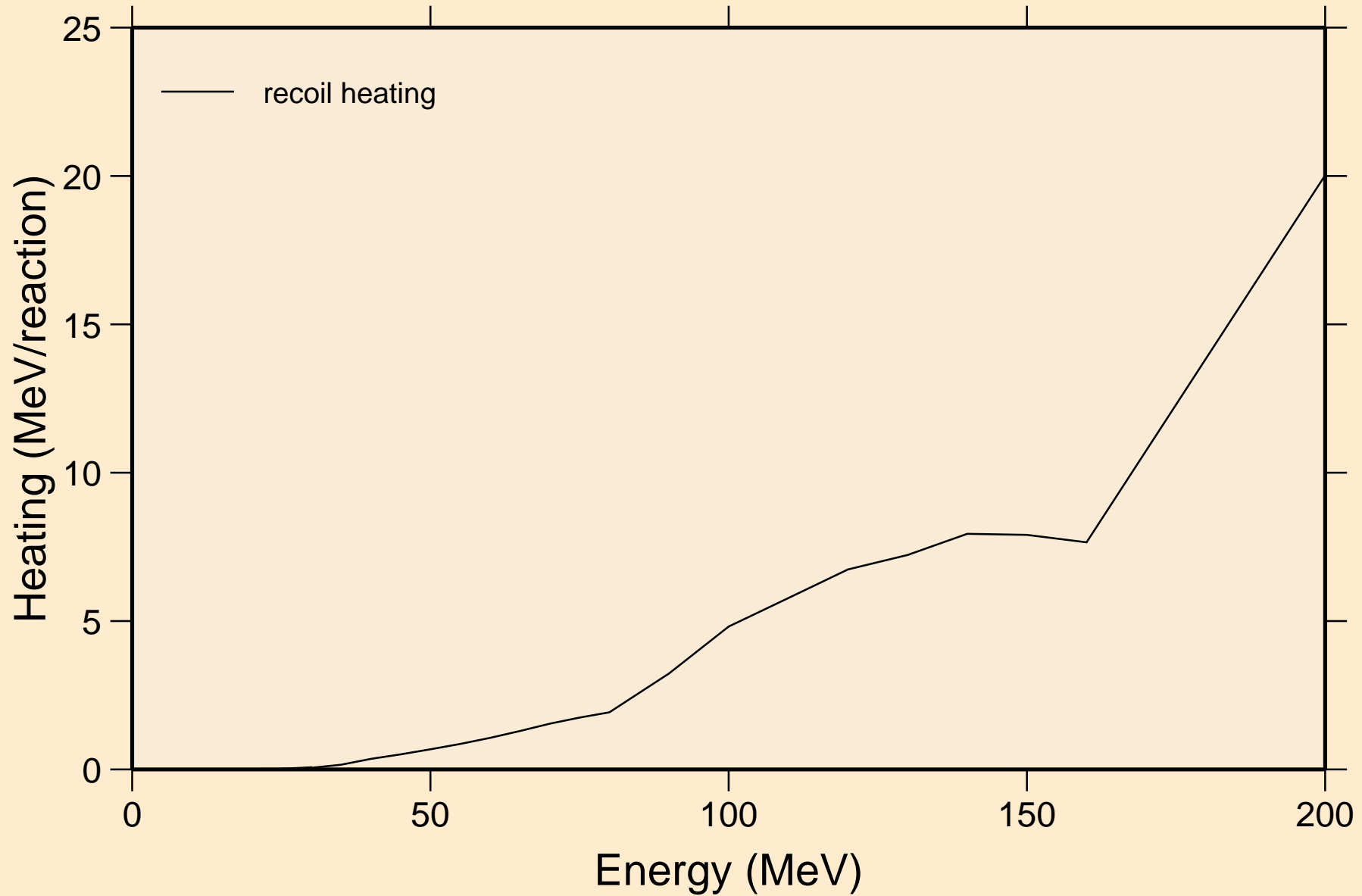

ER149M HELION ACER TENDL-2021 LIBRARY; T=0.K  
Particle production cross sections

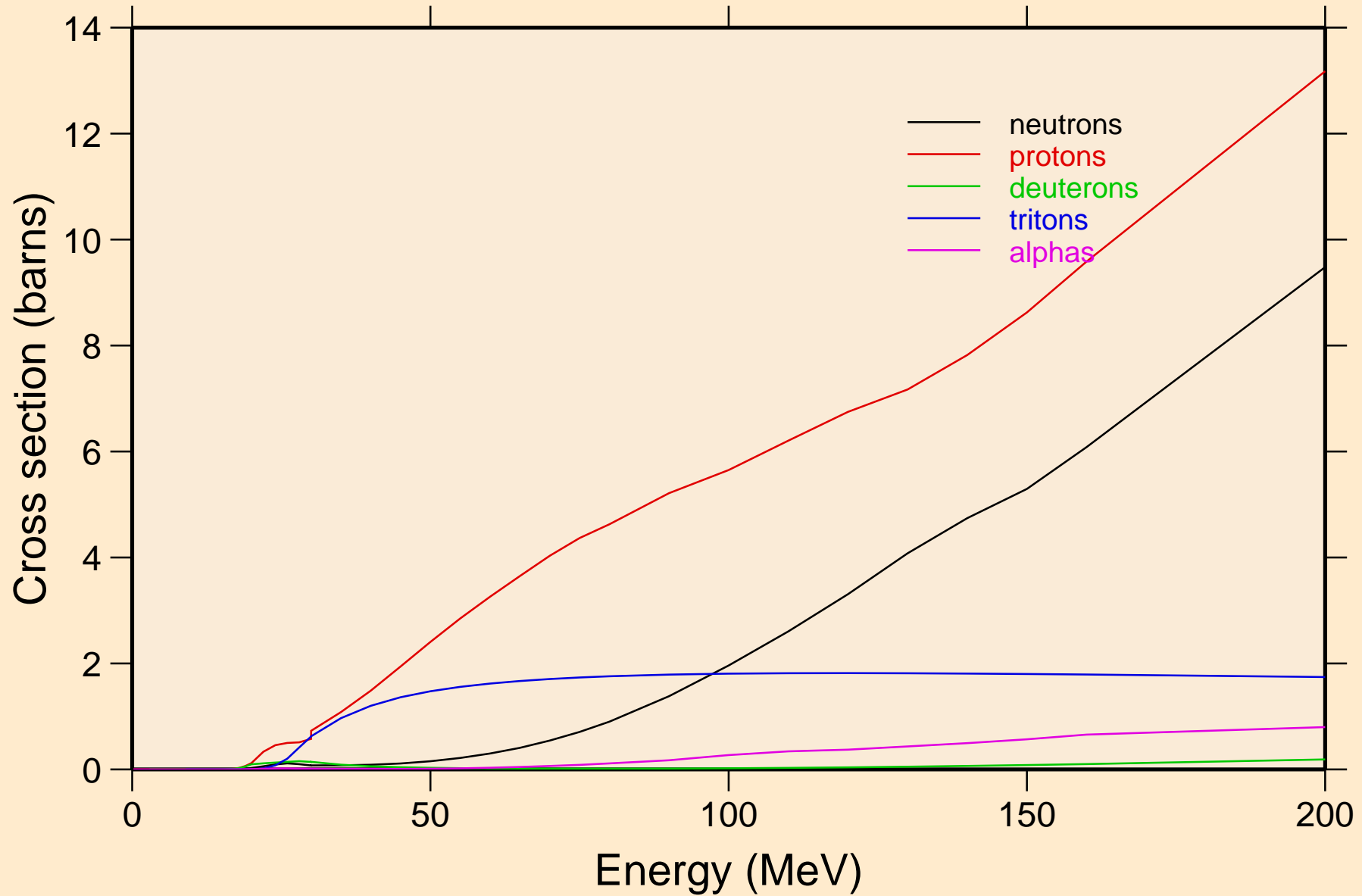

ER149M HELION ACER TENDL-2021 LIBRARY; T=0.K  
neutrons from (s,n)

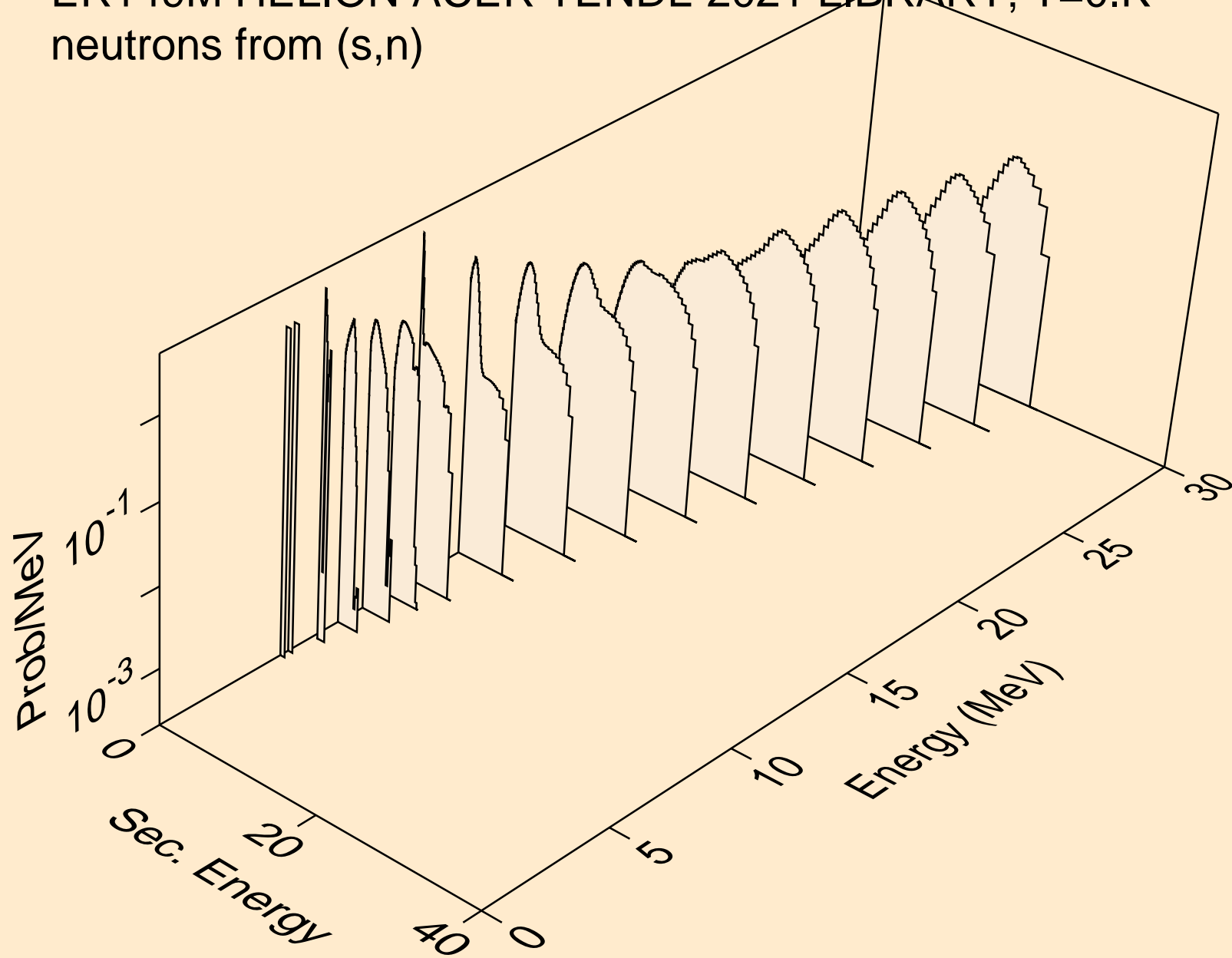

ER149M HELION ACER TENDL-2021 LIBRARY; T=0.K  
neutrons from (s,x)

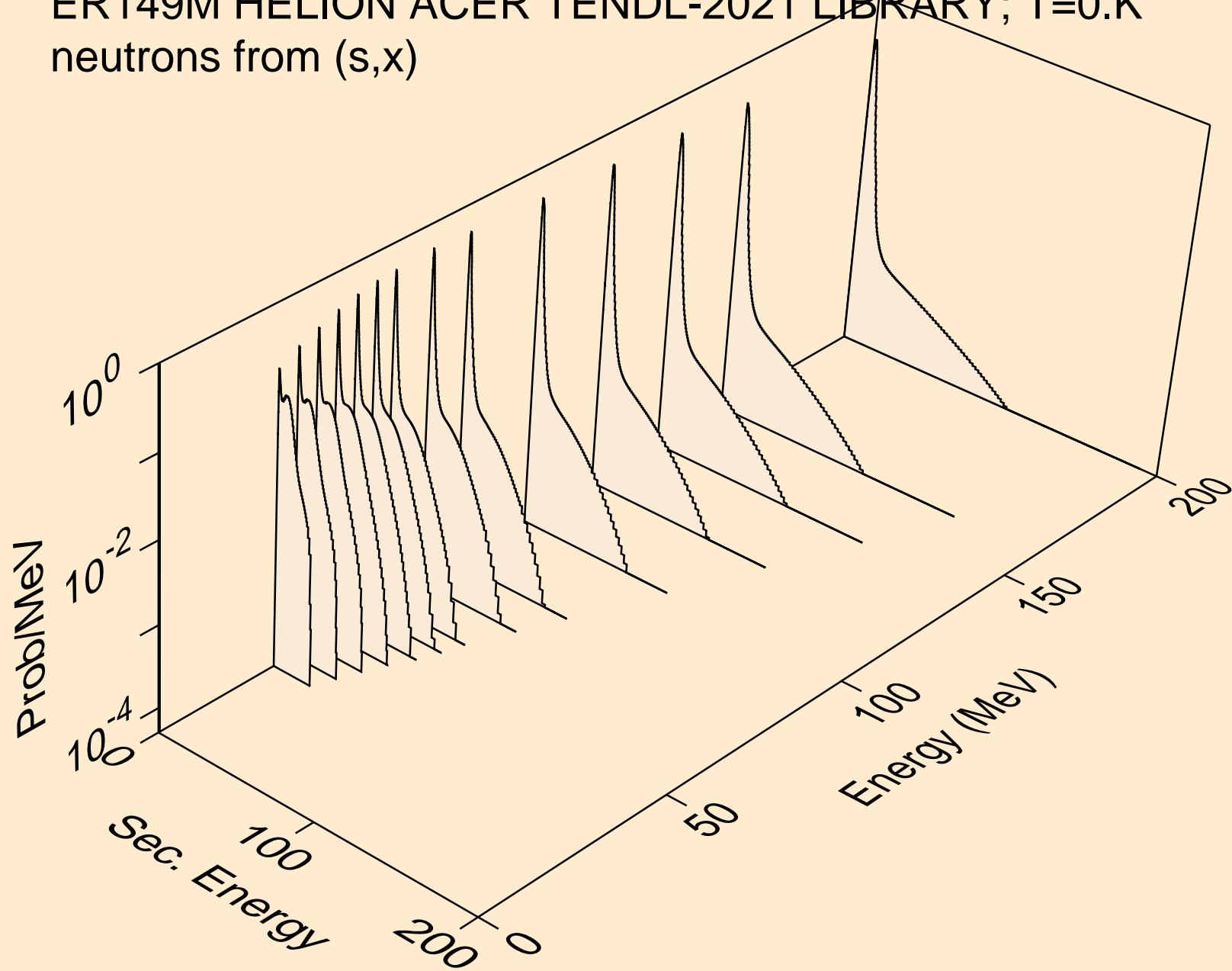

ER149M HELION ACER TENDL-2021 LIBRARY; T=0.K  
neutrons from (s,2n)

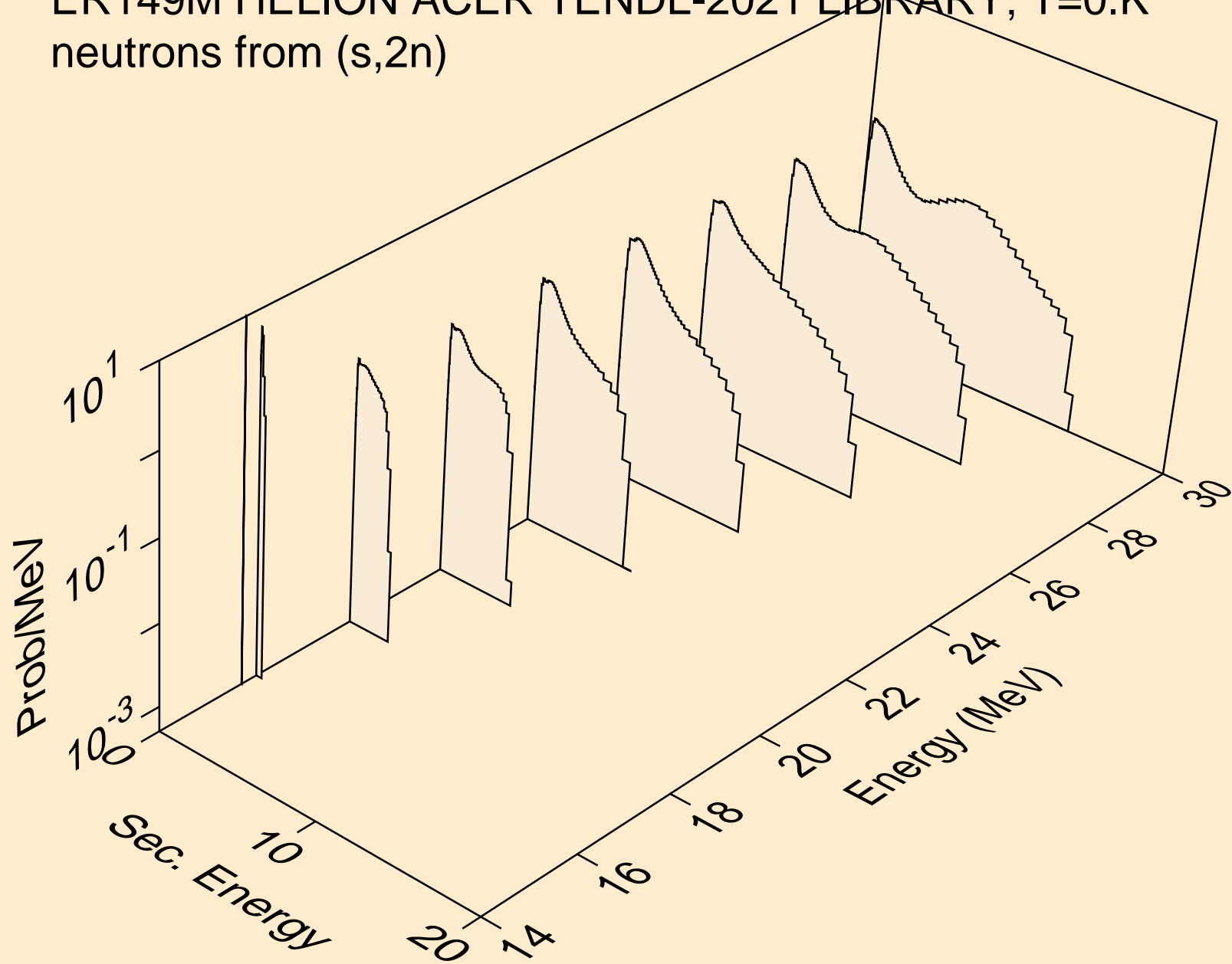

ER149M HELION ACER TENDL-2021 LIBRARY; T=0.K  
neutrons from (s,n\*)a

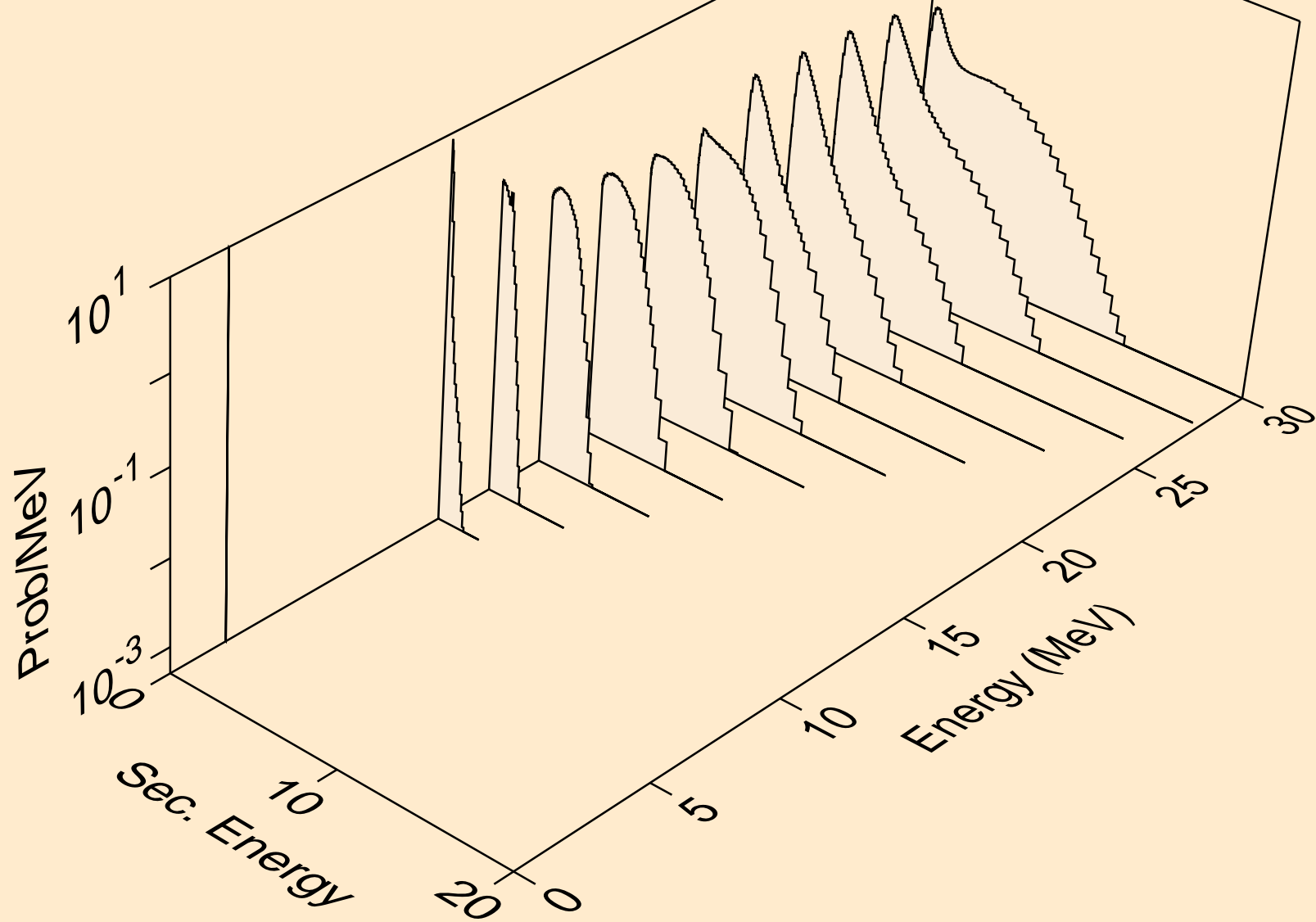

ER149M HELION ACER TENDL-2021 LIBRARY; T=0.K  
neutrons from (s,2n)a

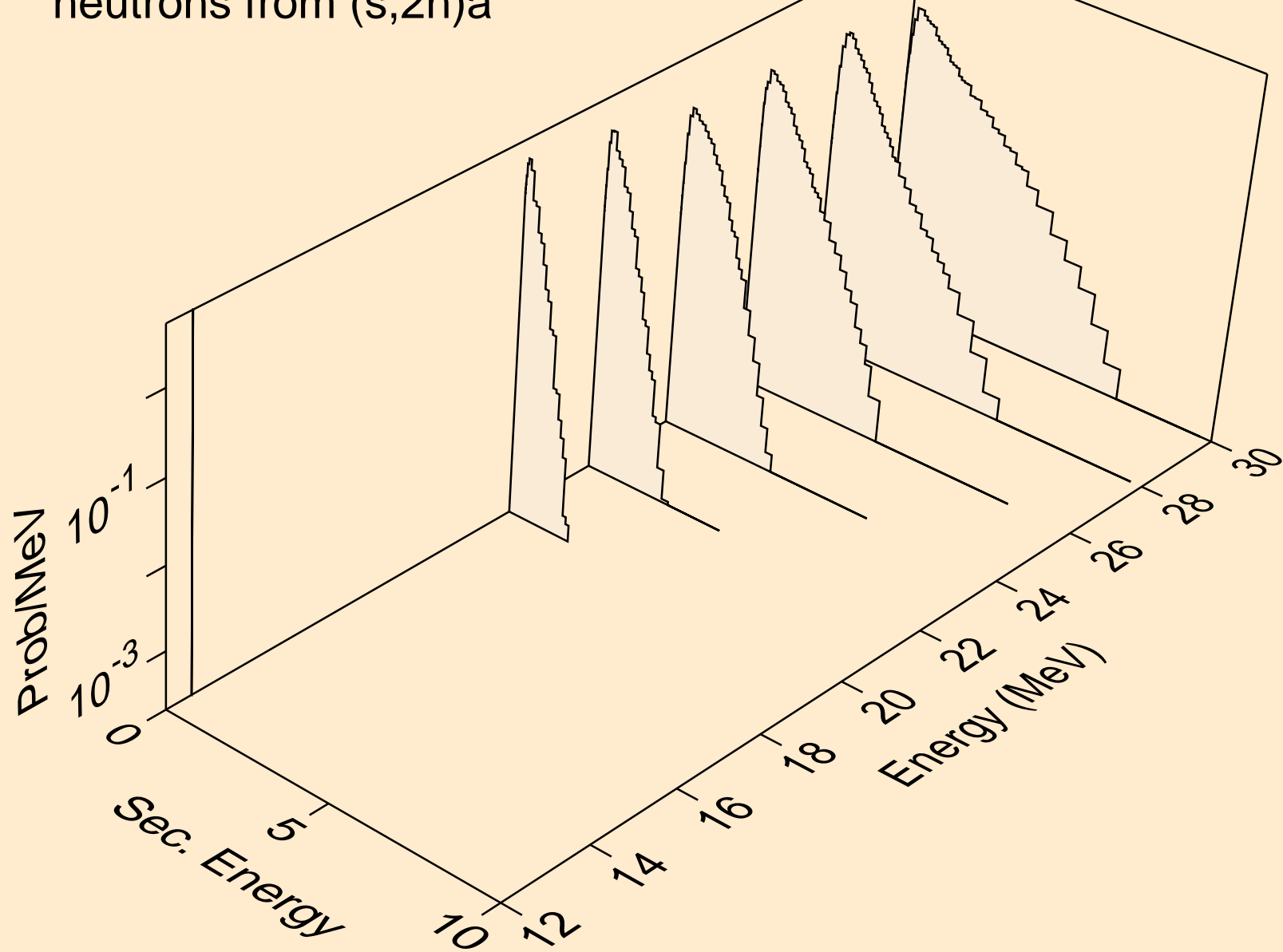

ER149M HELION ACER TENDL-2021 LIBRARY; T=0.K  
neutrons from (s,n\*)p

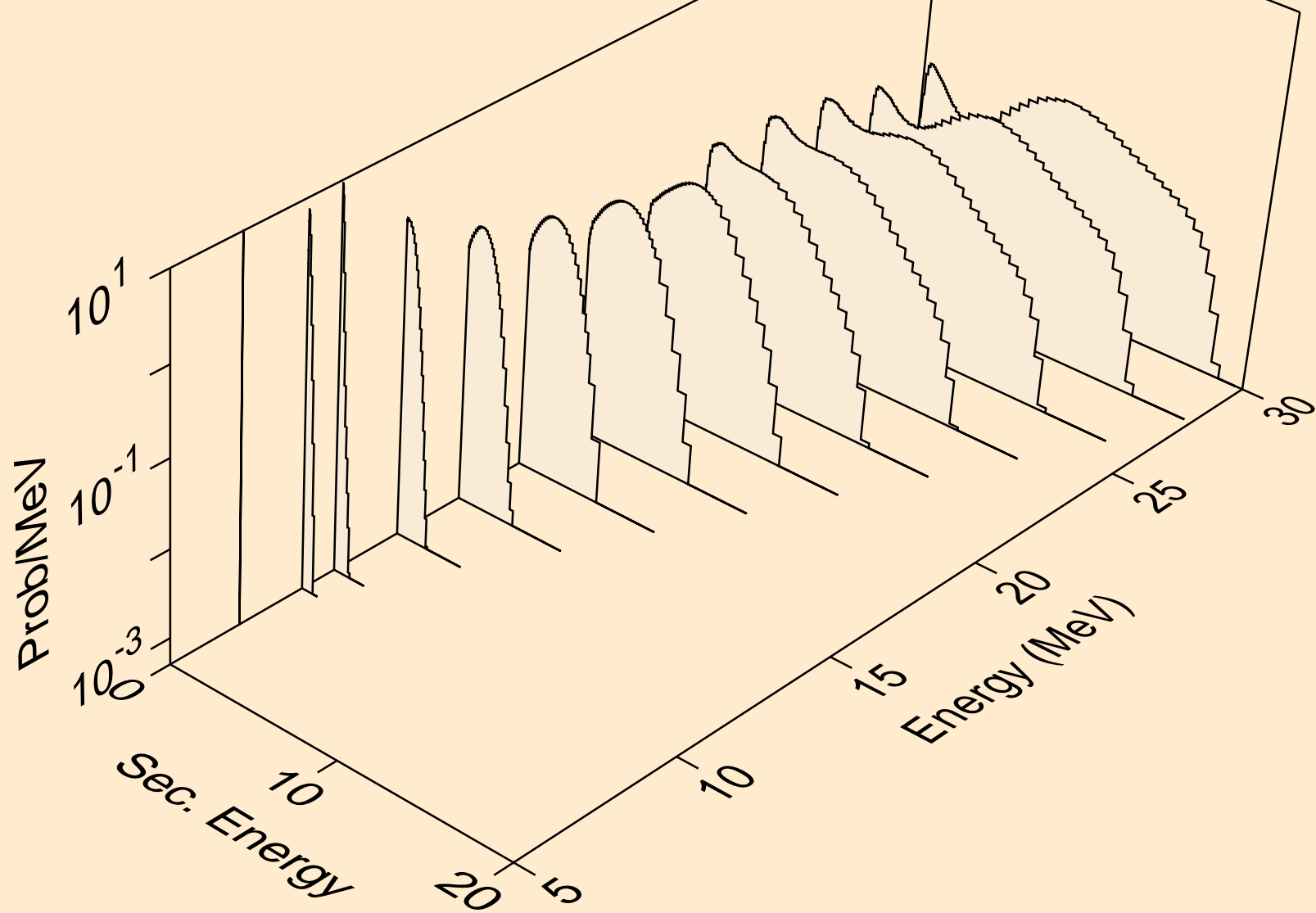

ER149M HELION ACER TENDL-2021 LIBRARY; T=0.K  
neutrons from (s,n\*)2a

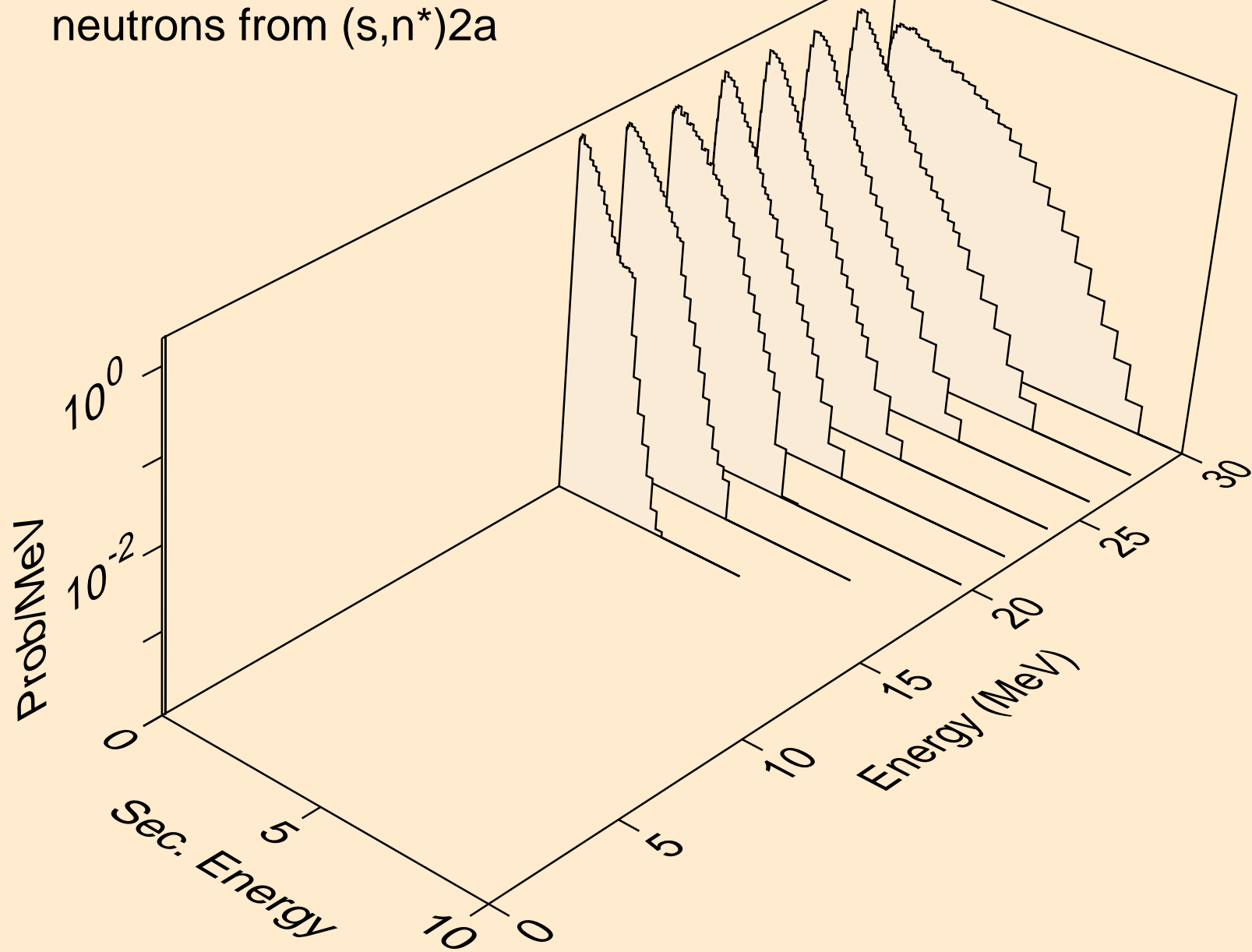

ER149M HELION ACER TENDL-2021 LIBRARY; T=0.K  
neutrons from (s,n\*)d

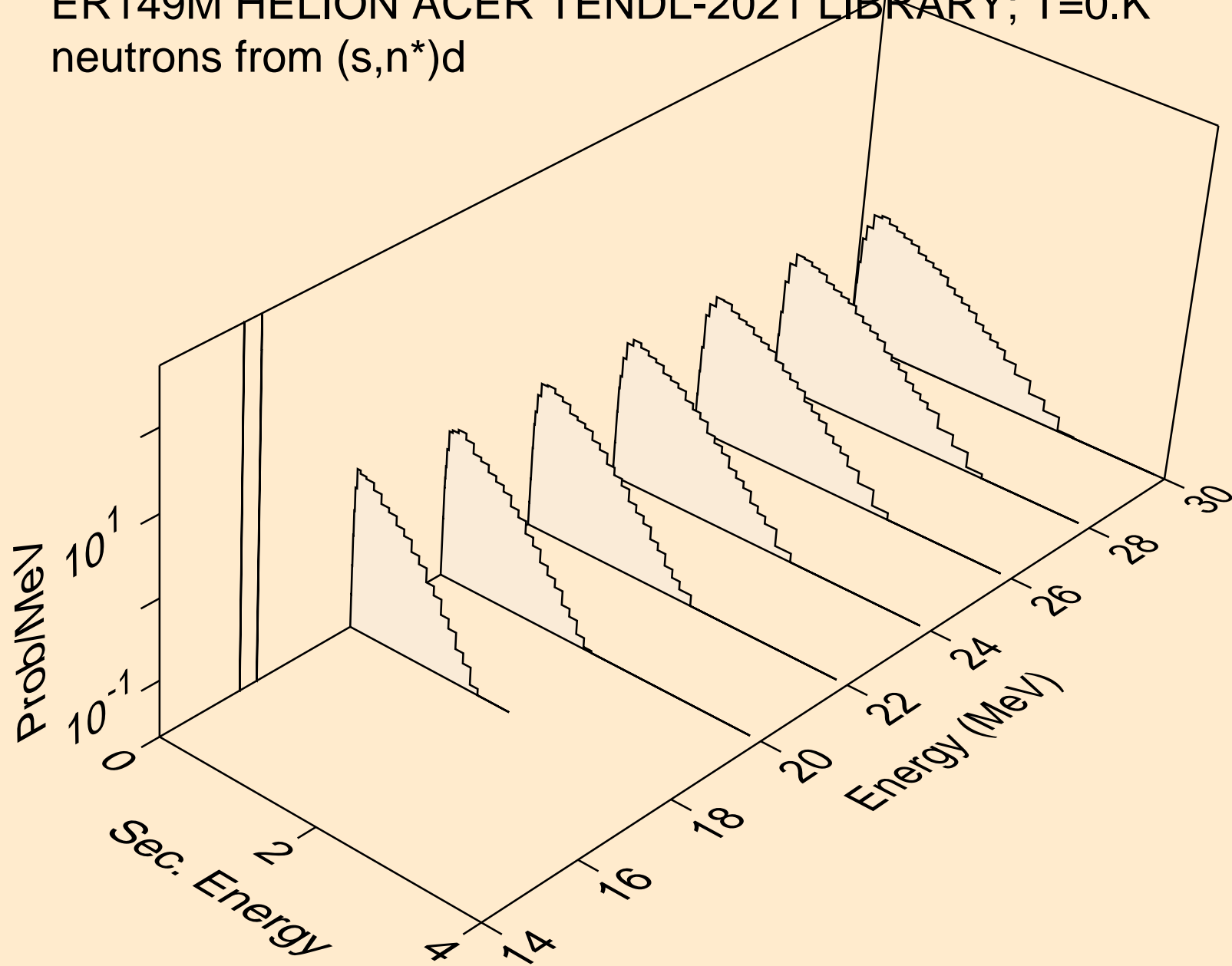

ER149M HELION ACER TENDL-2021 LIBRARY; T=0.K  
neutrons from (s,n\*)t

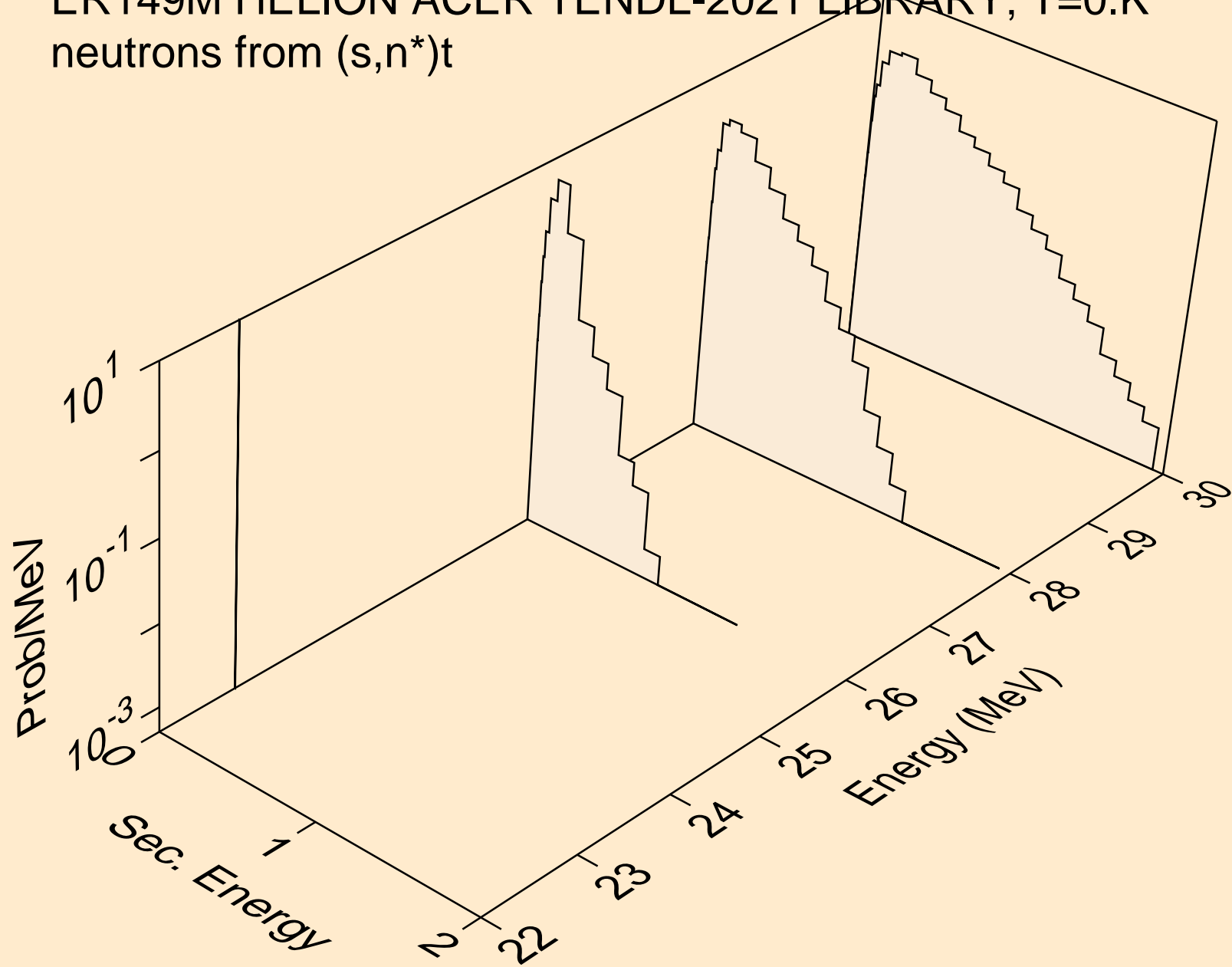

ER149M HELION ACER TENDL-2021 LIBRARY; T=0.K  
neutrons from (s,n\*)he3

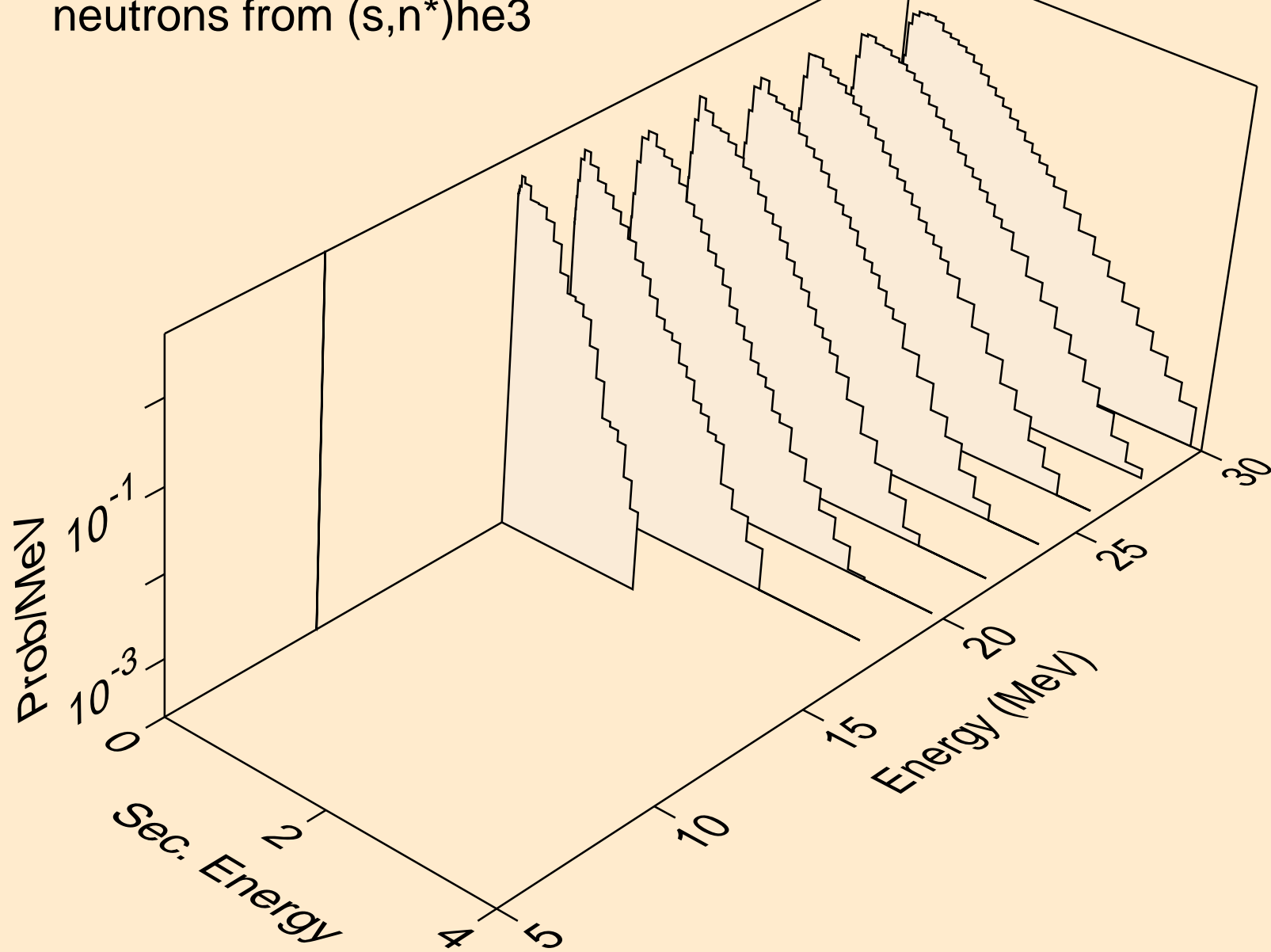

ER149M HELION ACER TENDL-2021 LIBRARY; T=0.K  
neutrons from (s,2np)

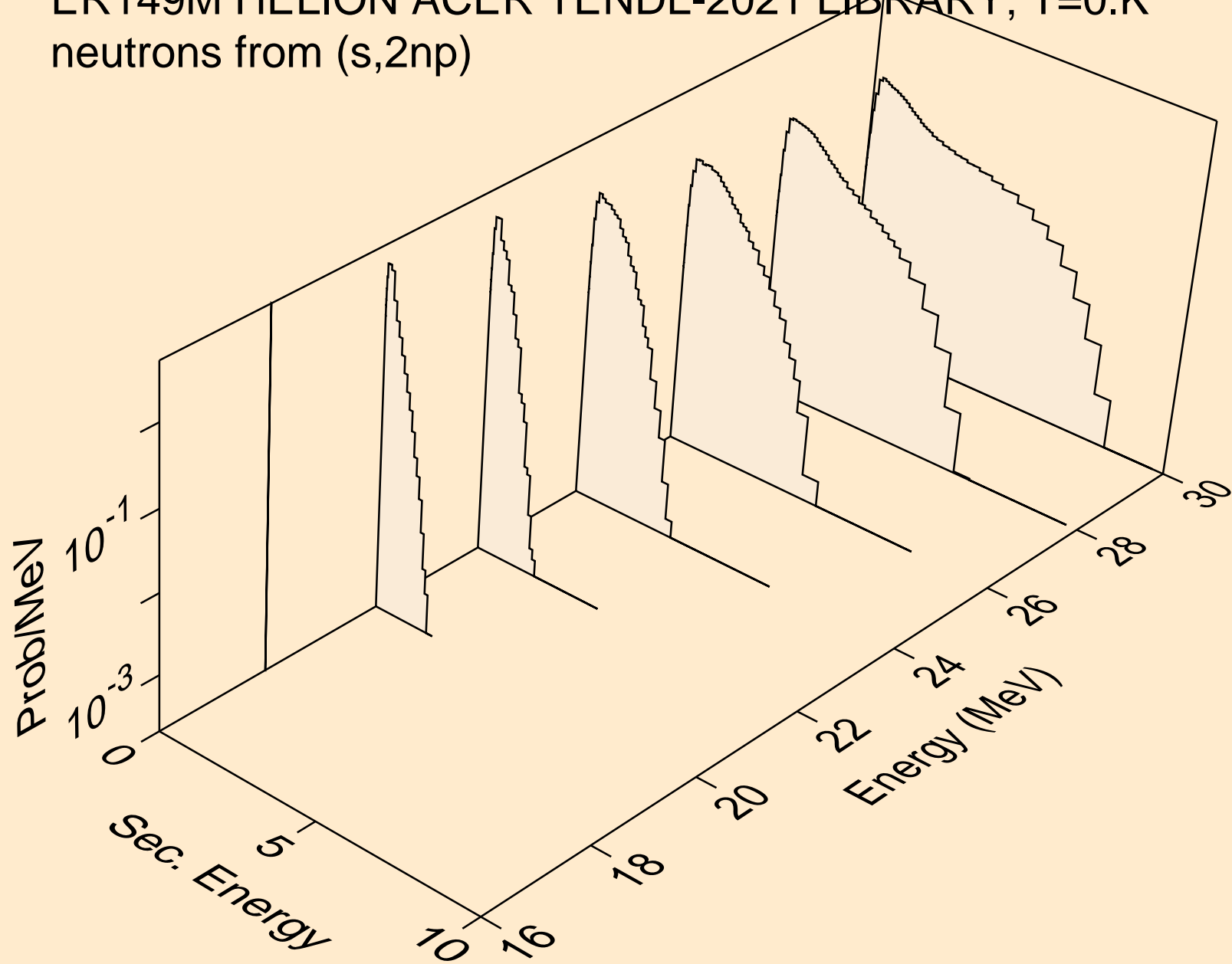

ER149M HELION ACER TENDL-2021 LIBRARY; T=0.K  
neutrons from (s,2np)

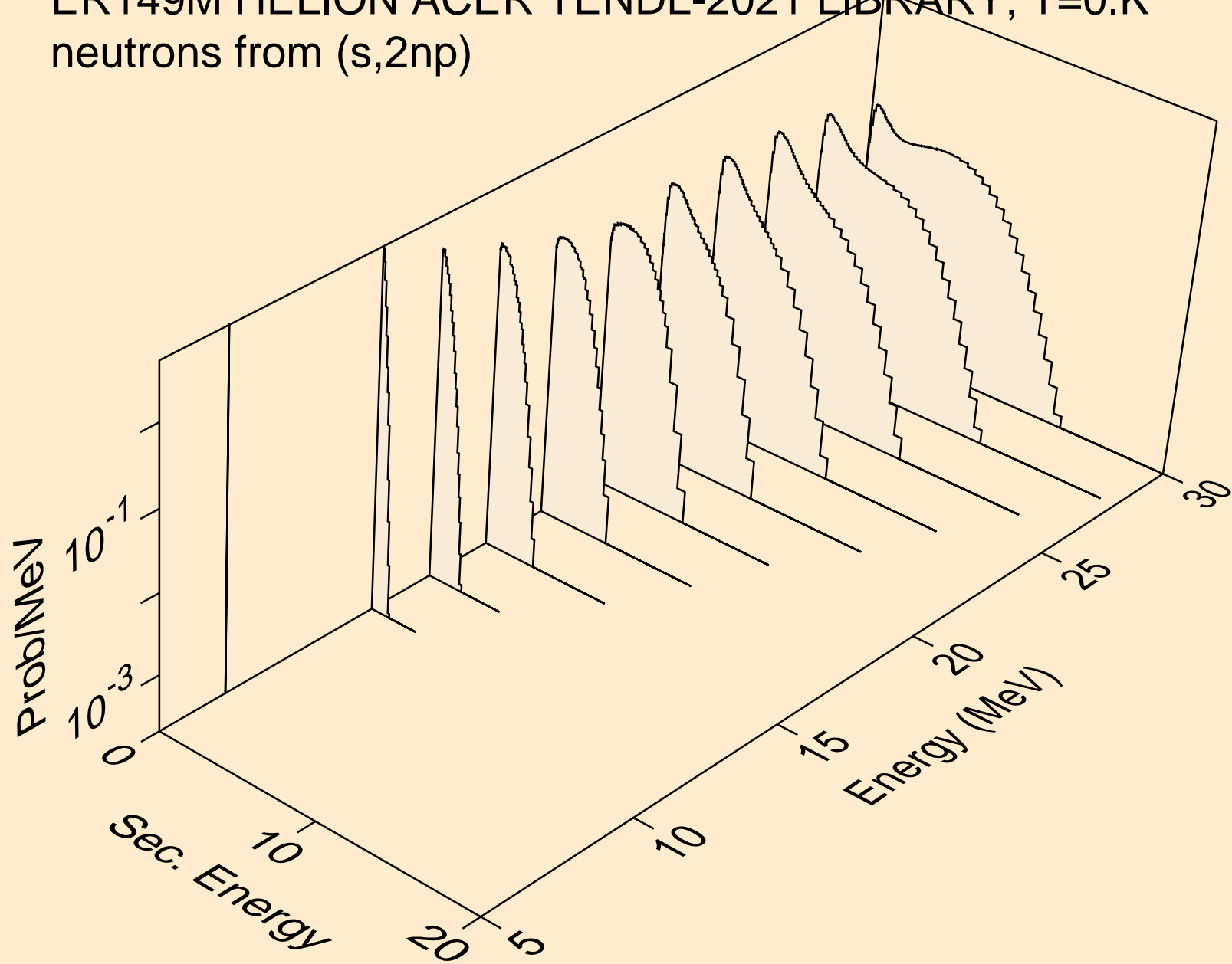

ER149M HELION ACER TENDL-2021 LIBRARY; T=0.K  
neutrons from (s,npa)

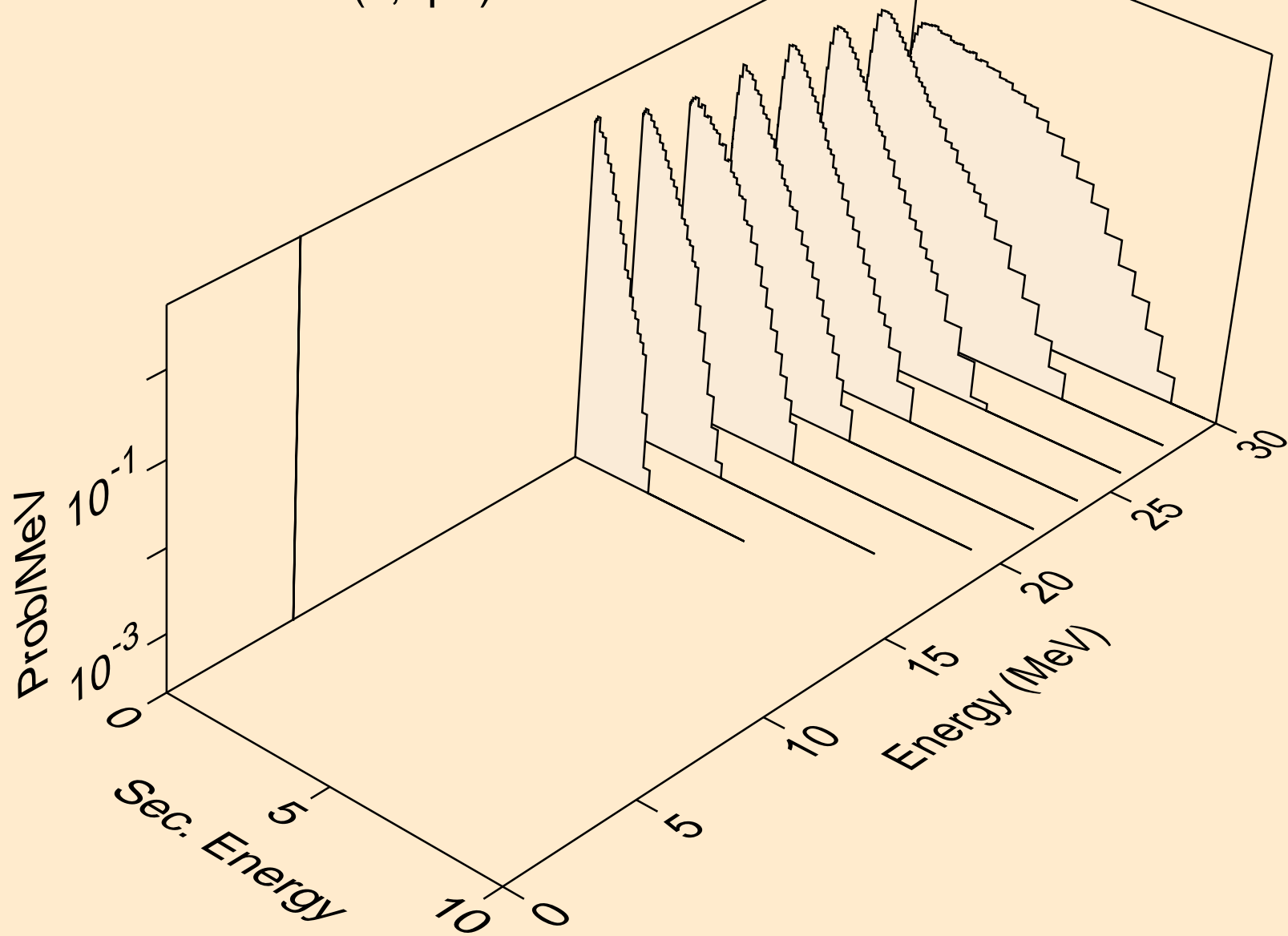

ER149M HELION ACER TENDL-2021 LIBRARY; T=0.K  
protons from (s,x)

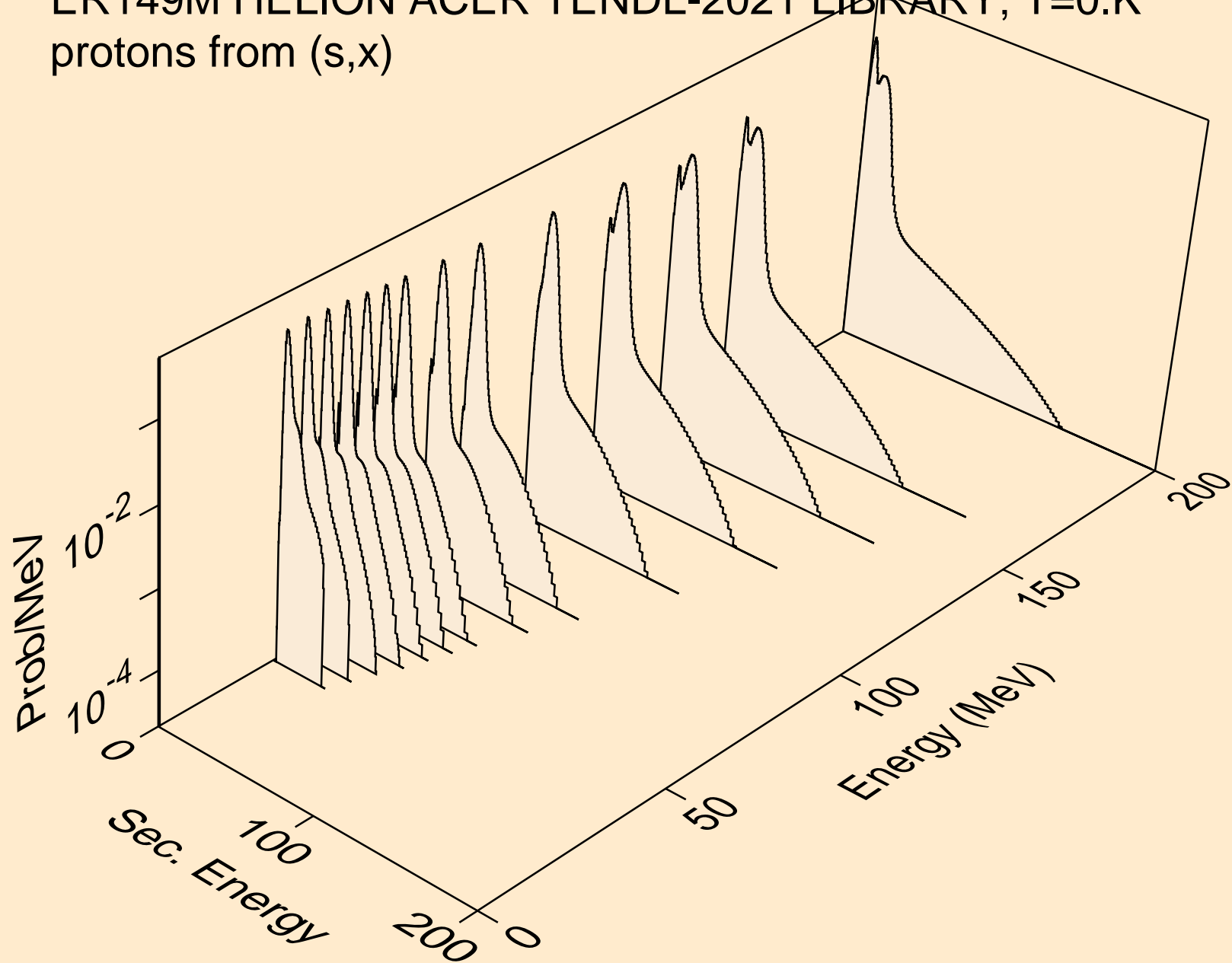

ER149M HELION ACER TENDL-2021 LIBRARY; T=0.K  
protons from (s,n\*)p

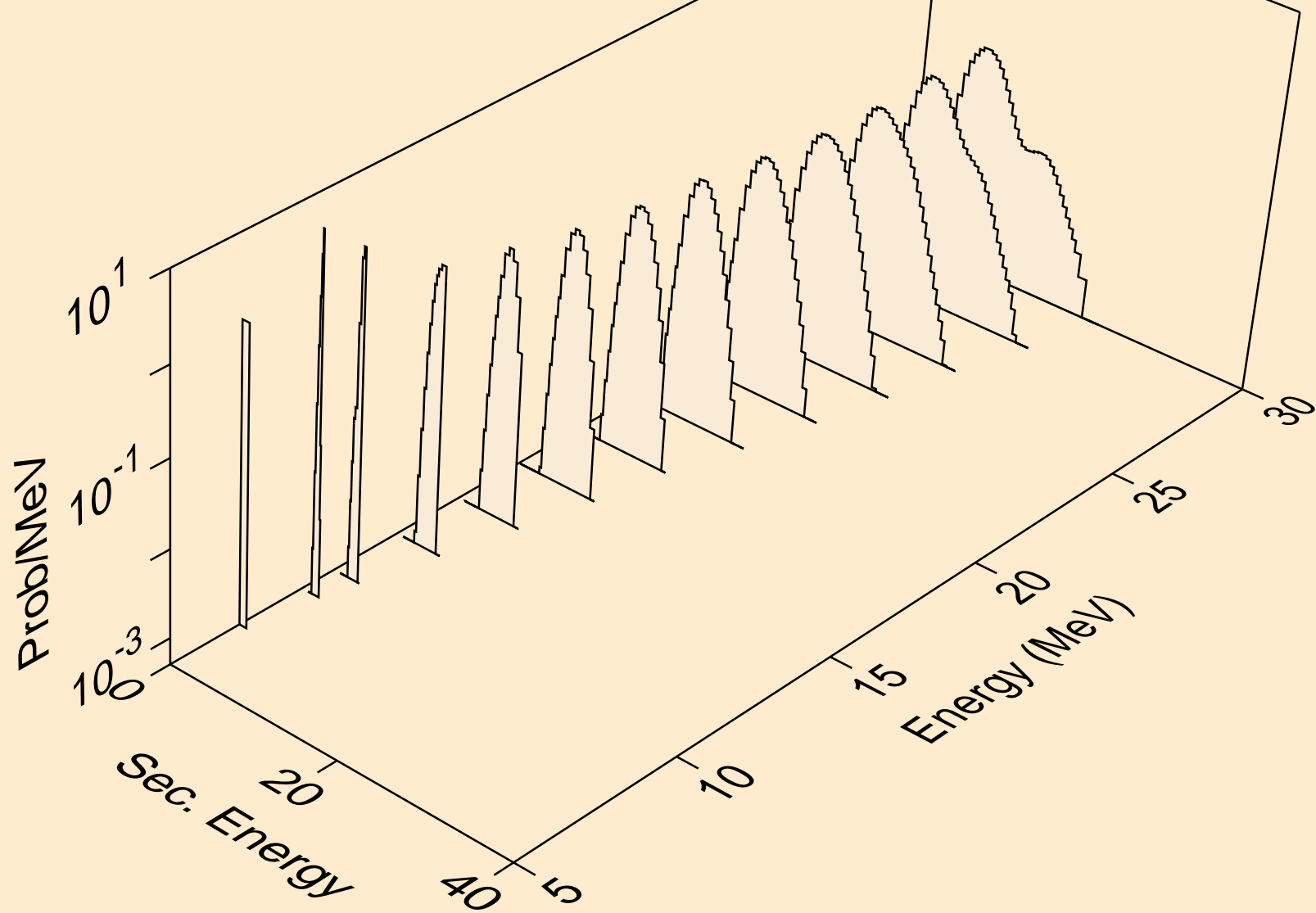

ER149M HELION ACER TENDL-2021 LIBRARY; T=0.K  
protons from (s,2np)

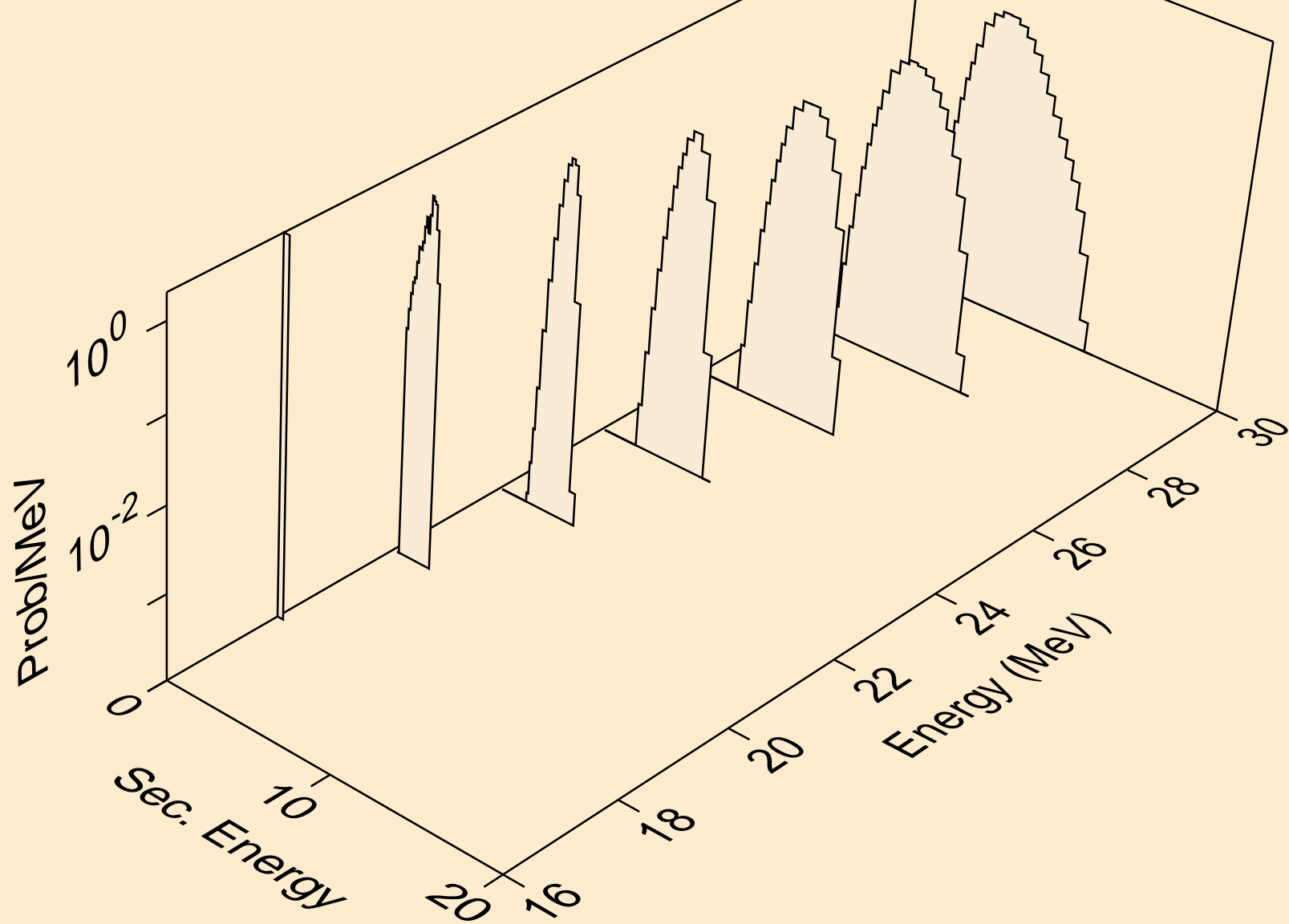

ER149M HELION ACER TENDL-2021 LIBRARY; T=0.K  
protons from (s,2np)

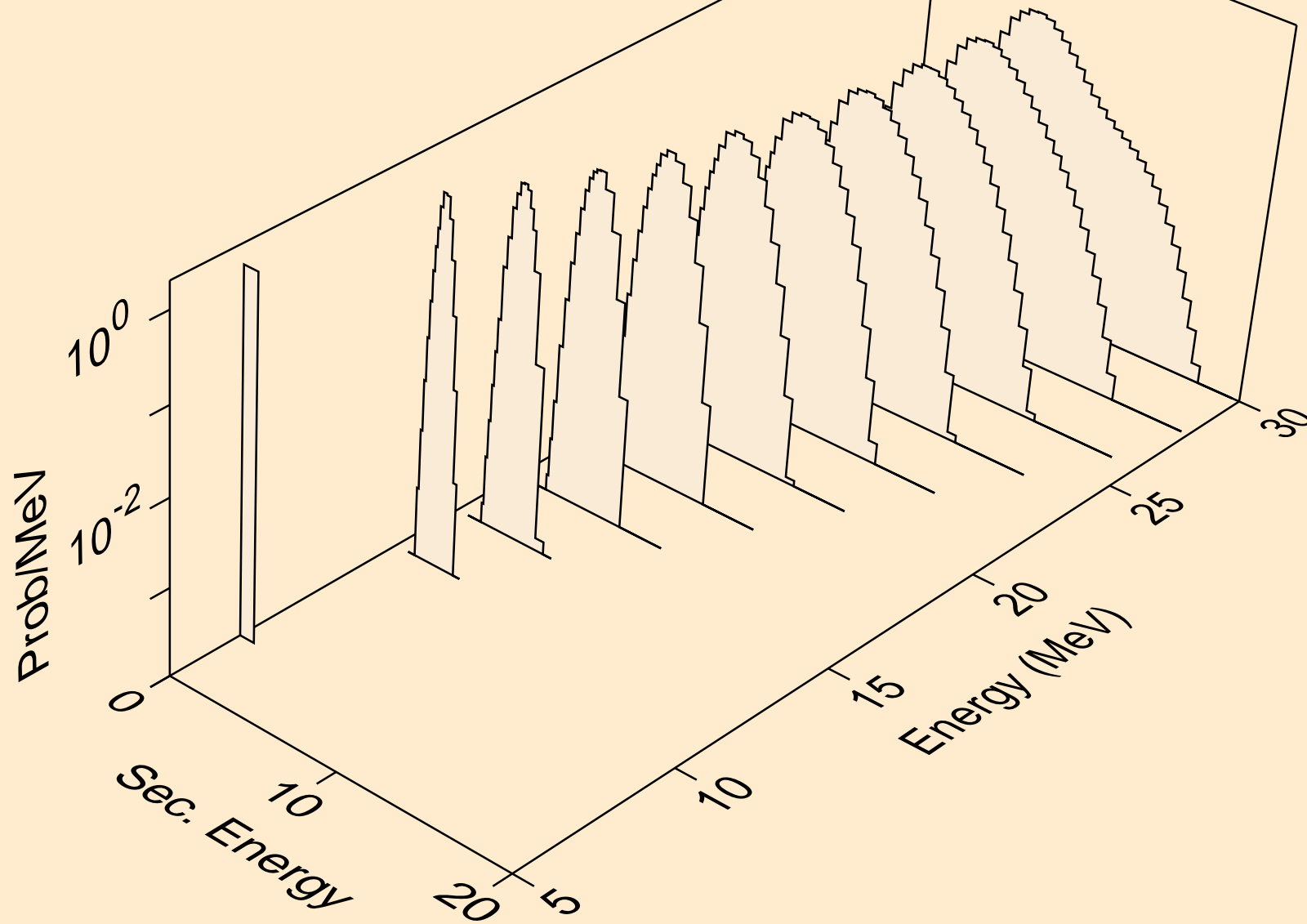

ER149M HELION ACER TENDL-2021 LIBRARY; T=0.K  
protons from (s,npa)

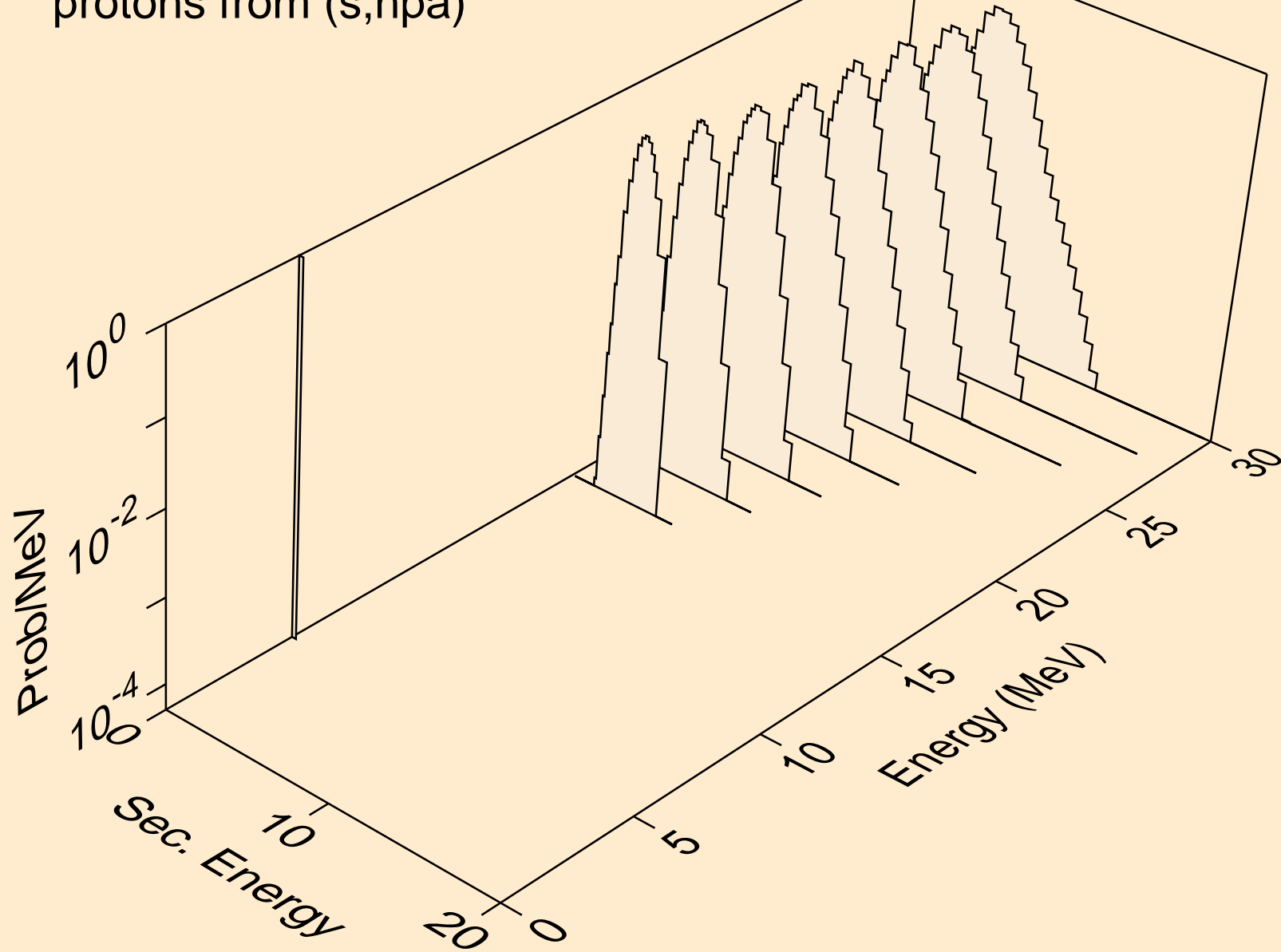

ER149M HELION ACER TENDL-2021 LIBRARY; T=0.K  
protons from (s,p)

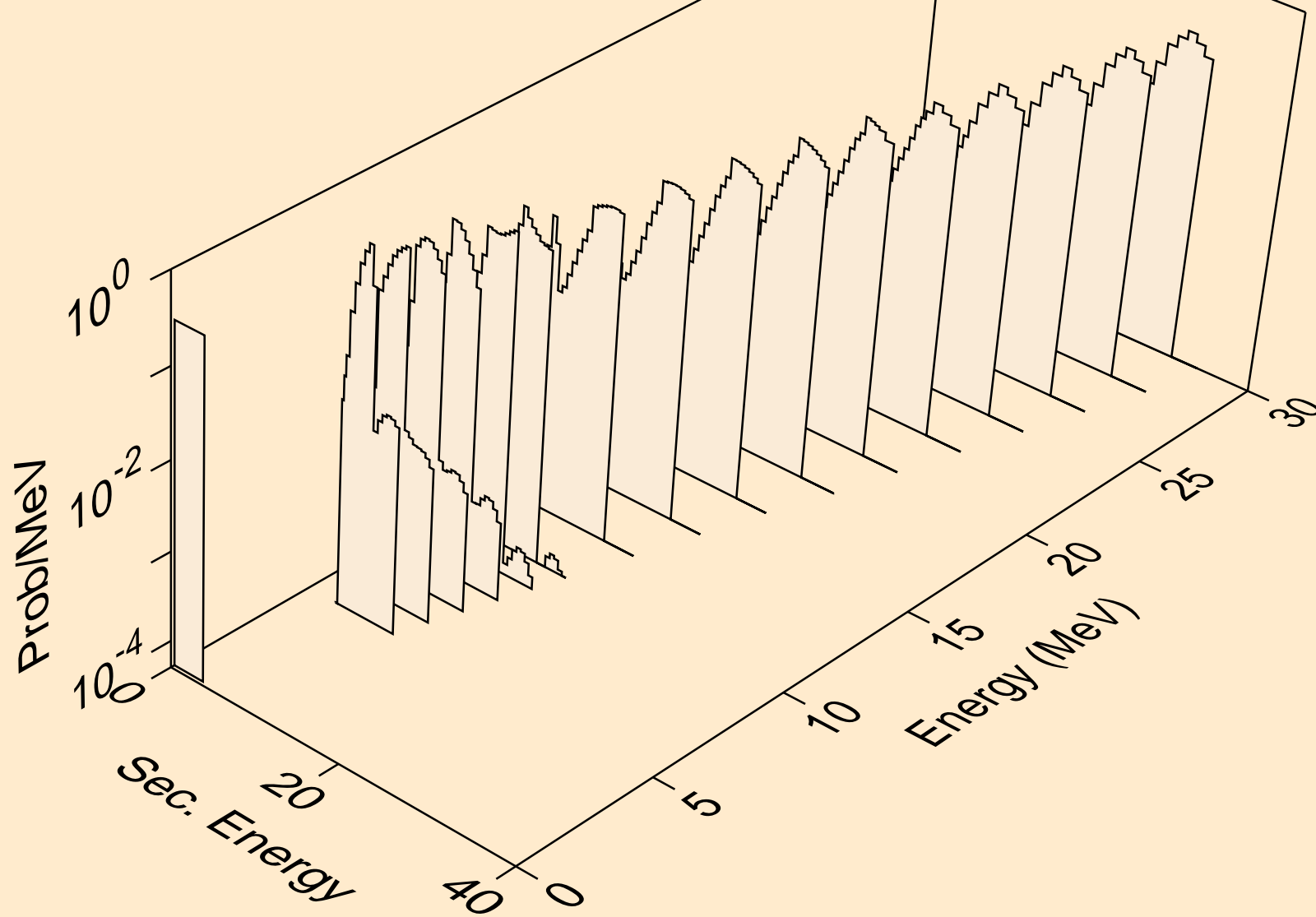

ER149M HELION ACER TENDL-2021 LIBRARY; T=0.K  
protons from (s,2p)

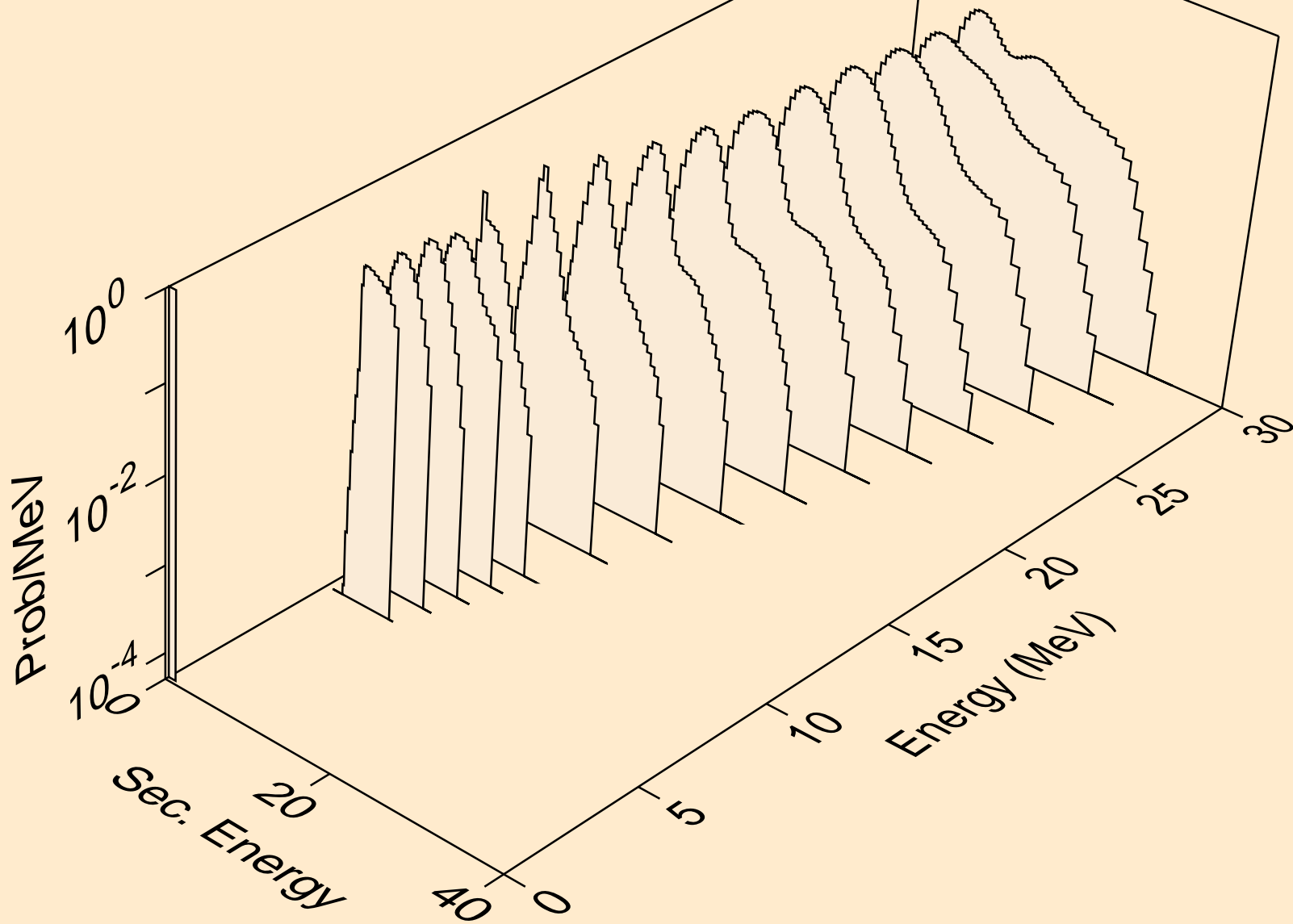

ER149M HELION ACER TENDL-2021 LIBRARY; T=0.K  
protons from (s,pa)

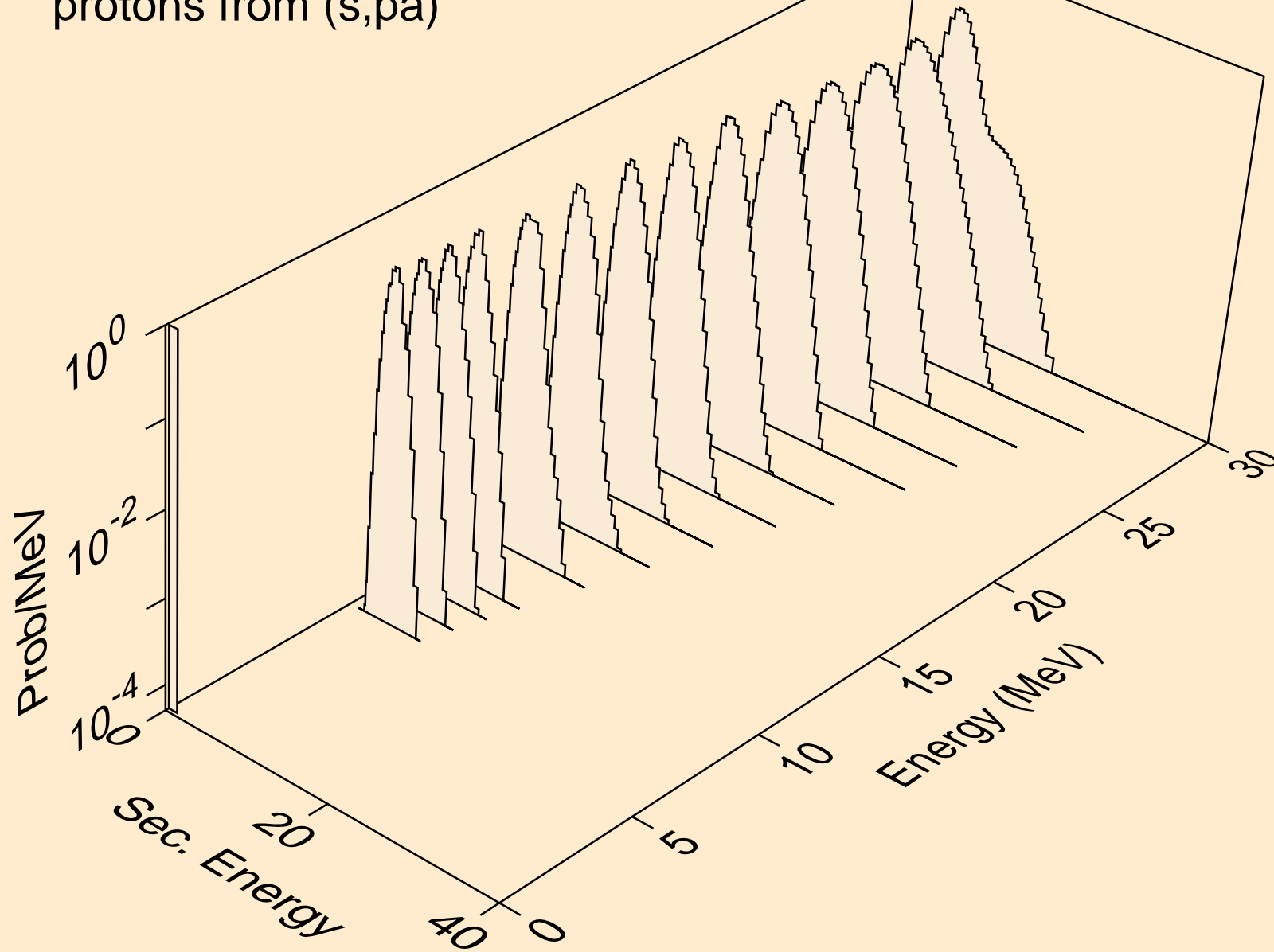

ER149M HELION ACER TENDL-2021 LIBRARY; T=0.K  
protons from (s,pd)

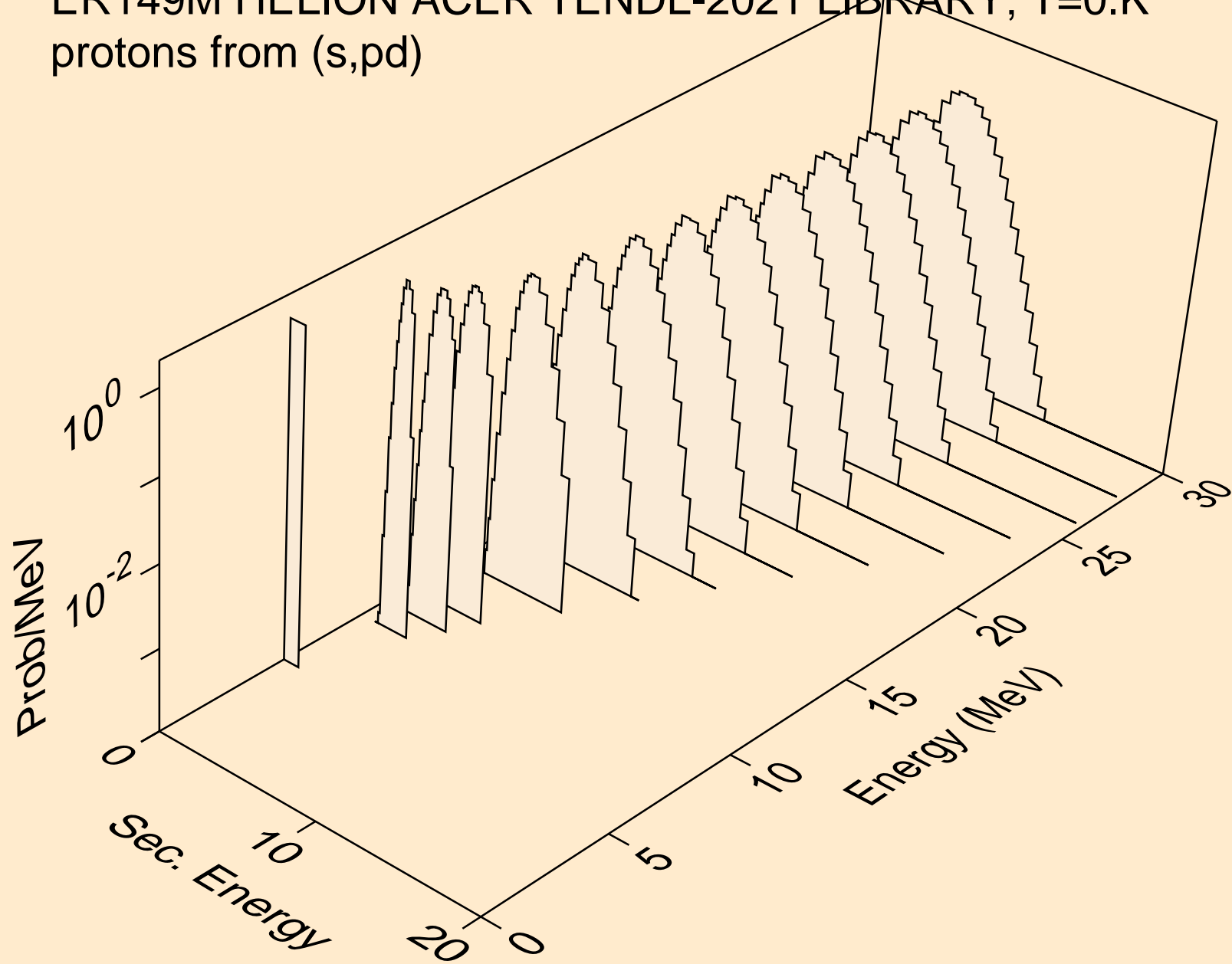

ER149M HELION ACER TENDL-2021 LIBRARY; T=0.K  
protons from (s,pt)

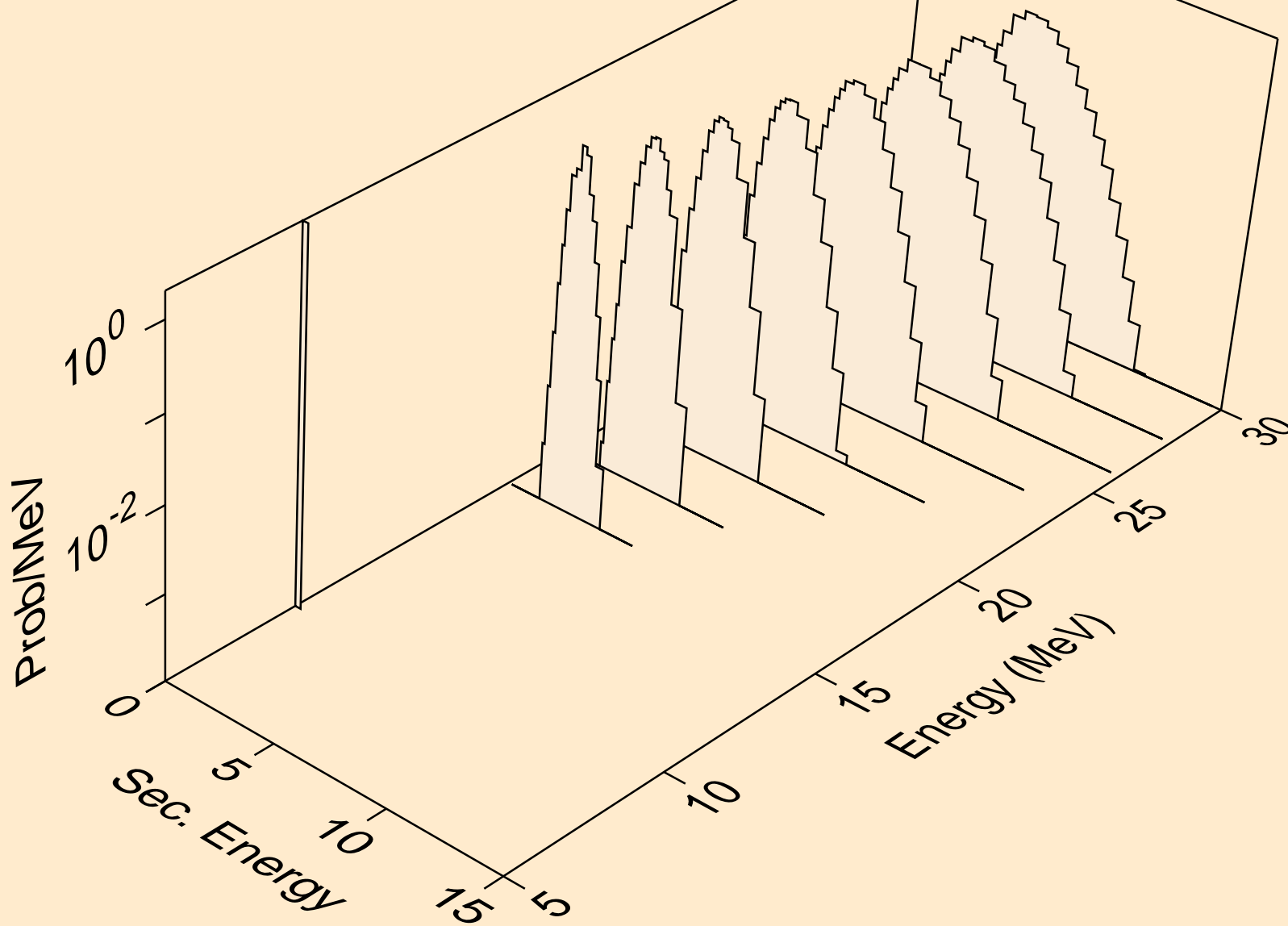

ER149M HELION ACER TENDL-2021 LIBRARY; T=0.K  
deuterons from (s,x)

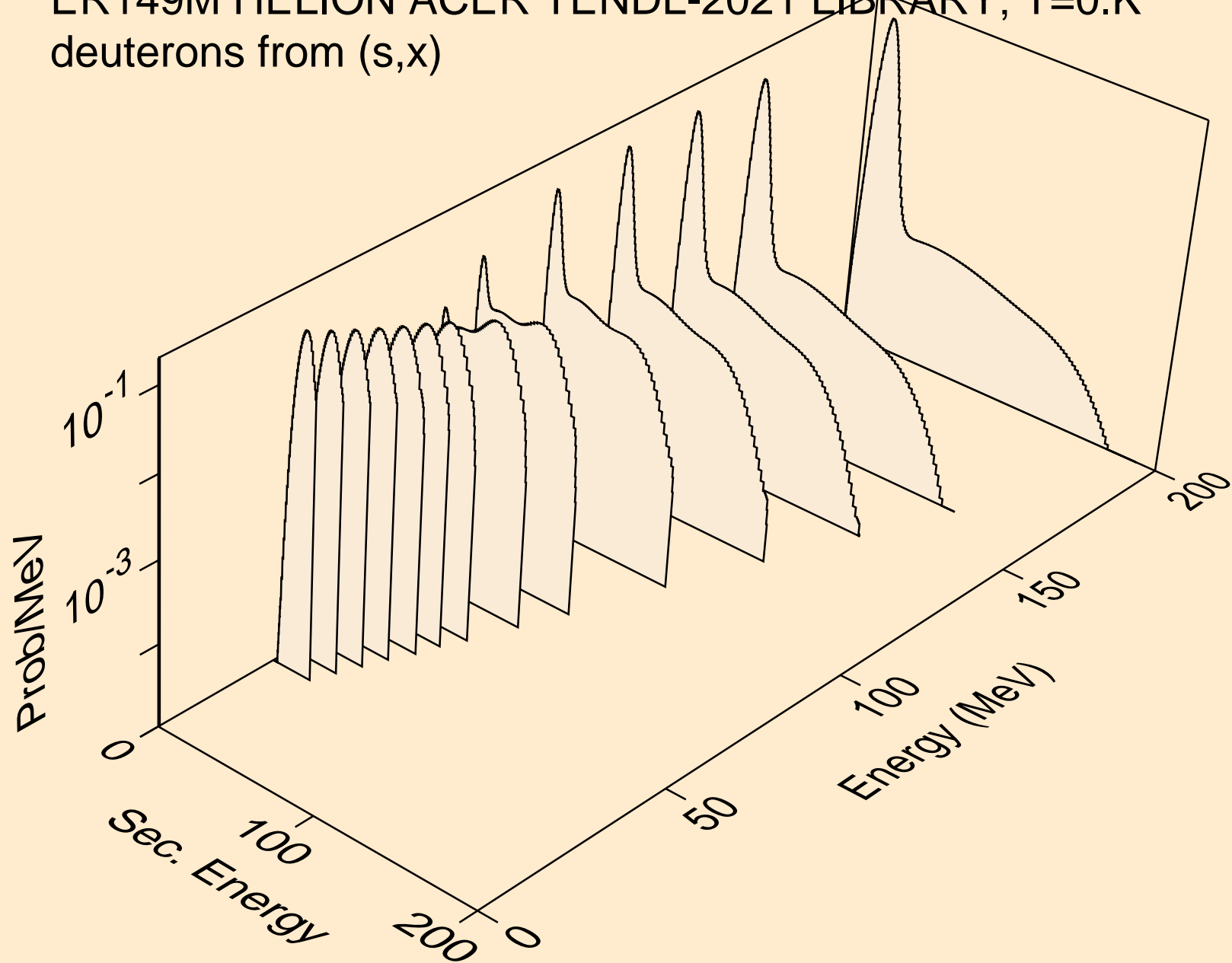

ER149M HELION ACER TENDL-2021 LIBRARY; T=0.K  
deuterons from (s,n\*)d

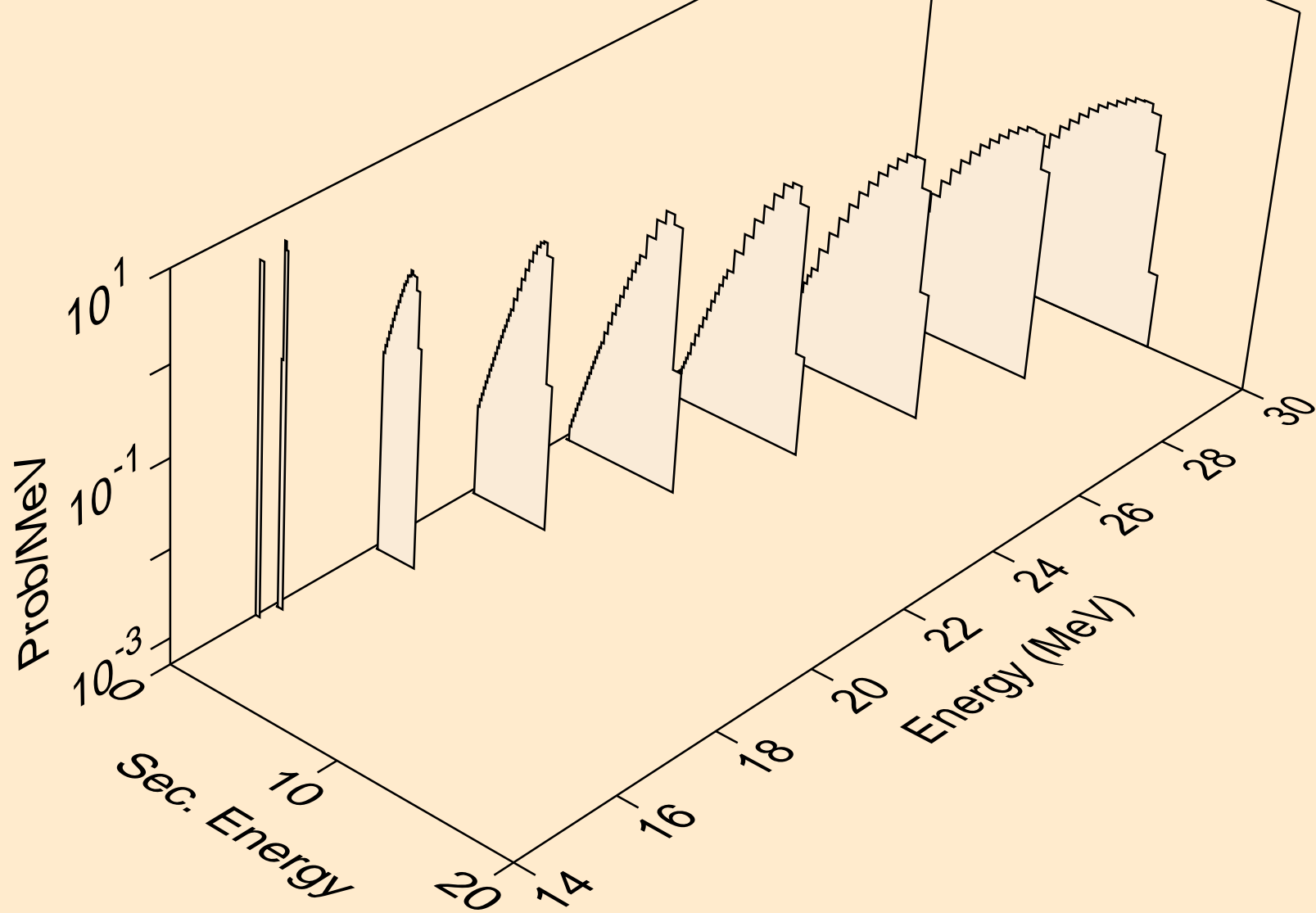

ER149M HELION ACER TENDL-2021 LIBRARY; T=0.K  
deuterons from (s,d)

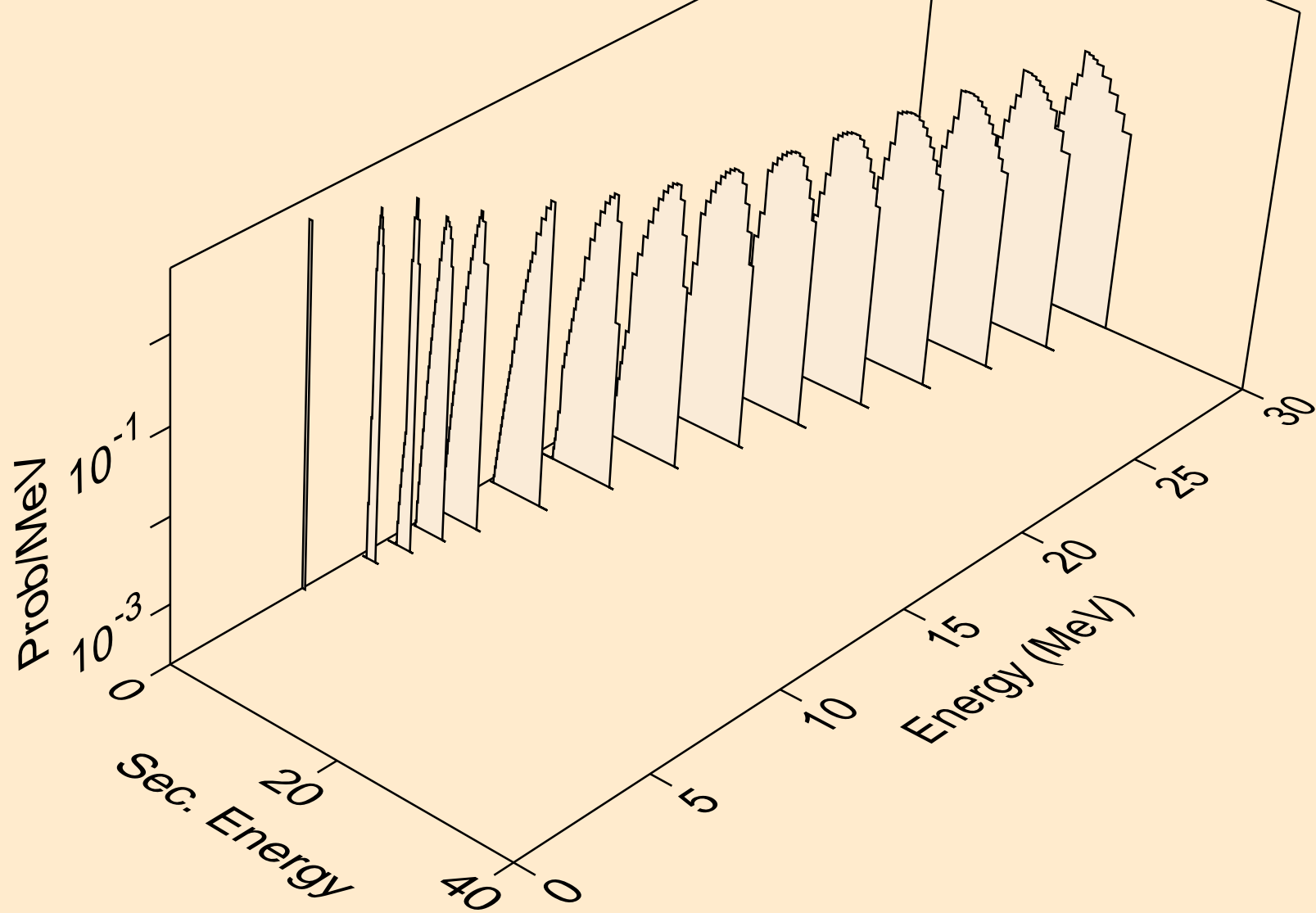

ER149M HELION ACER TENDL-2021 LIBRARY; T=0.K  
deuterons from (s,pd)

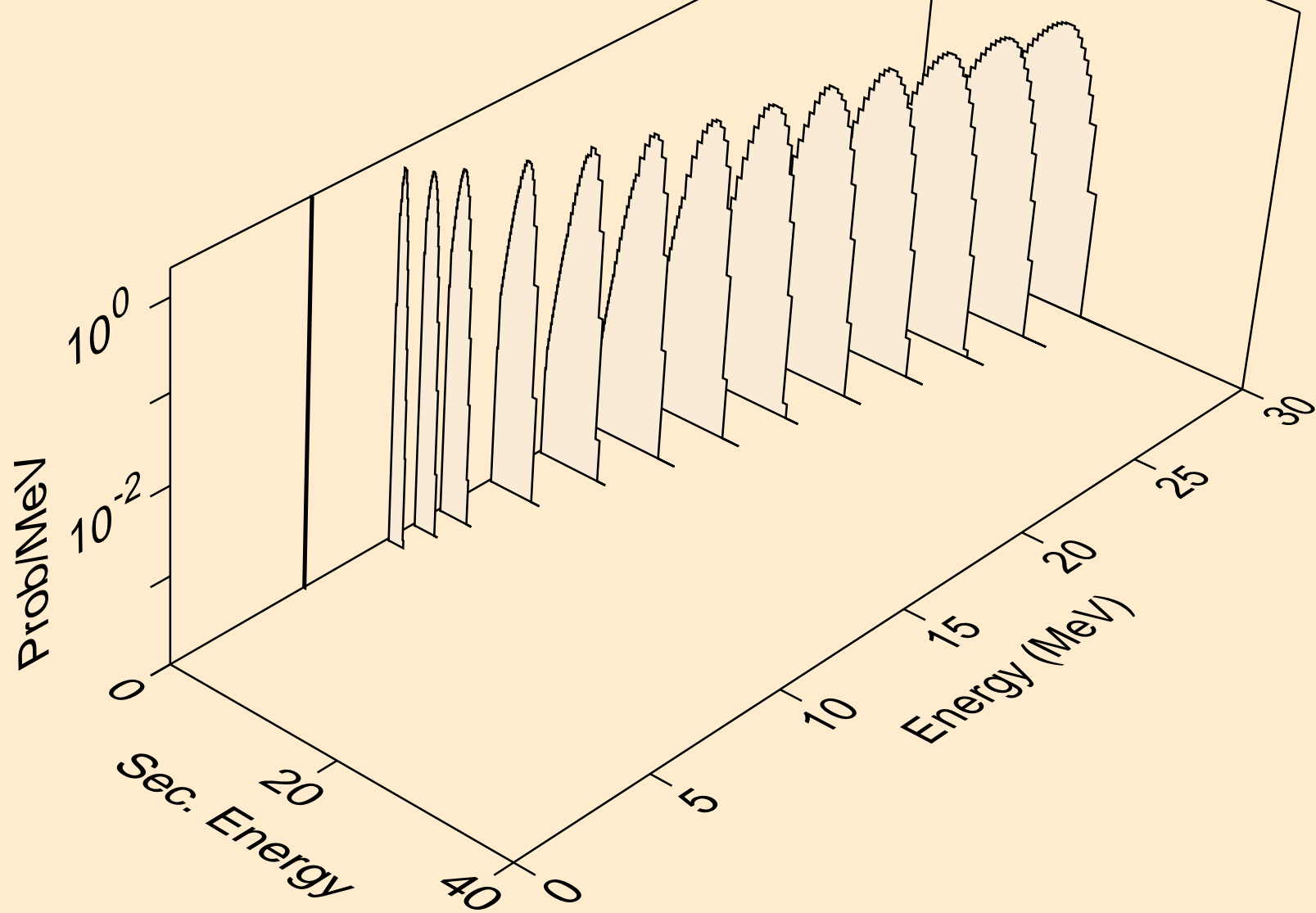

ER149M HELION ACER TENDL-2021 LIBRARY; T=0.K  
deuterons from (s,da)

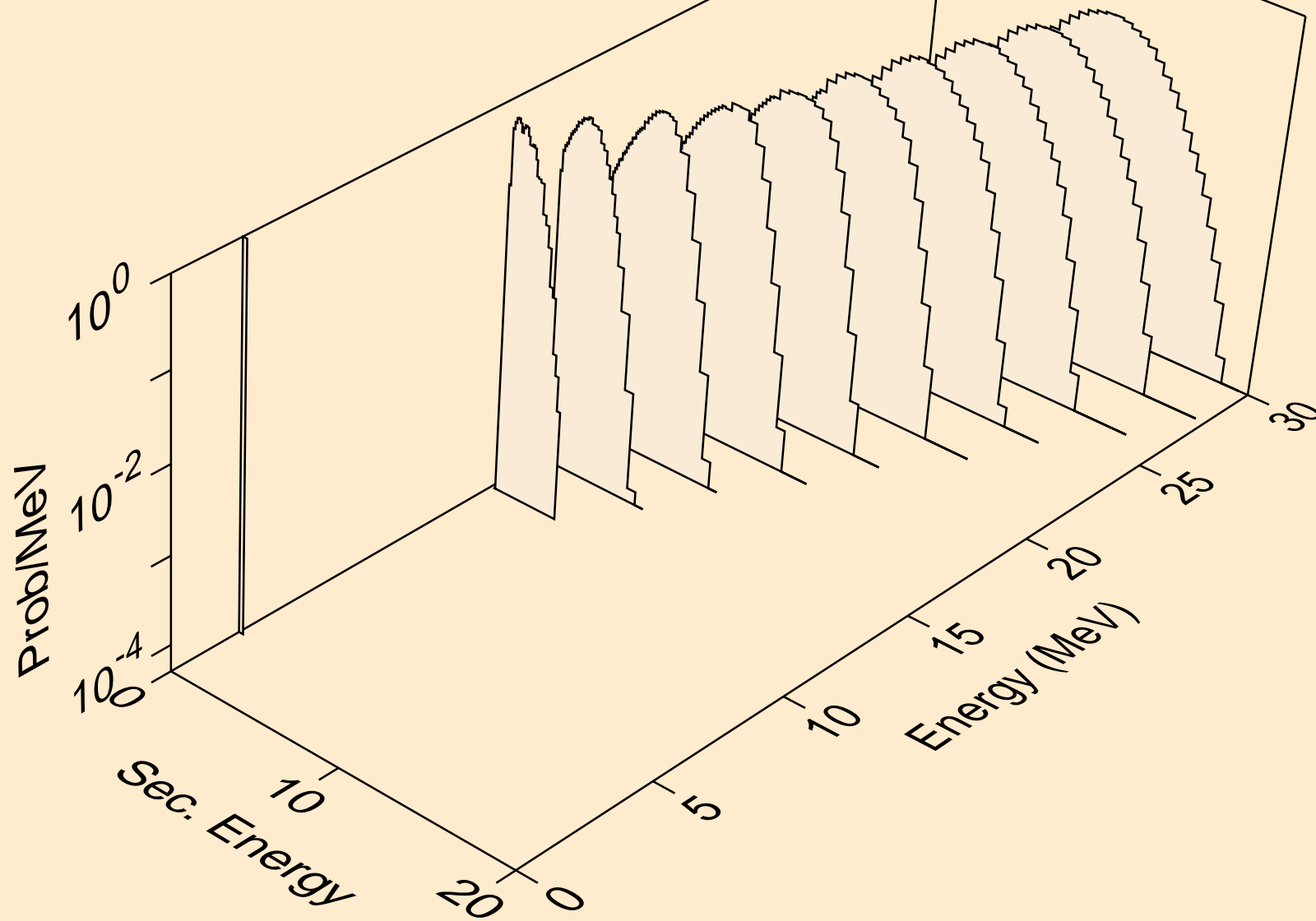

ER149M HELION ACER TENDL-2021 LIBRARY; T=0.K  
tritons from (s,x)

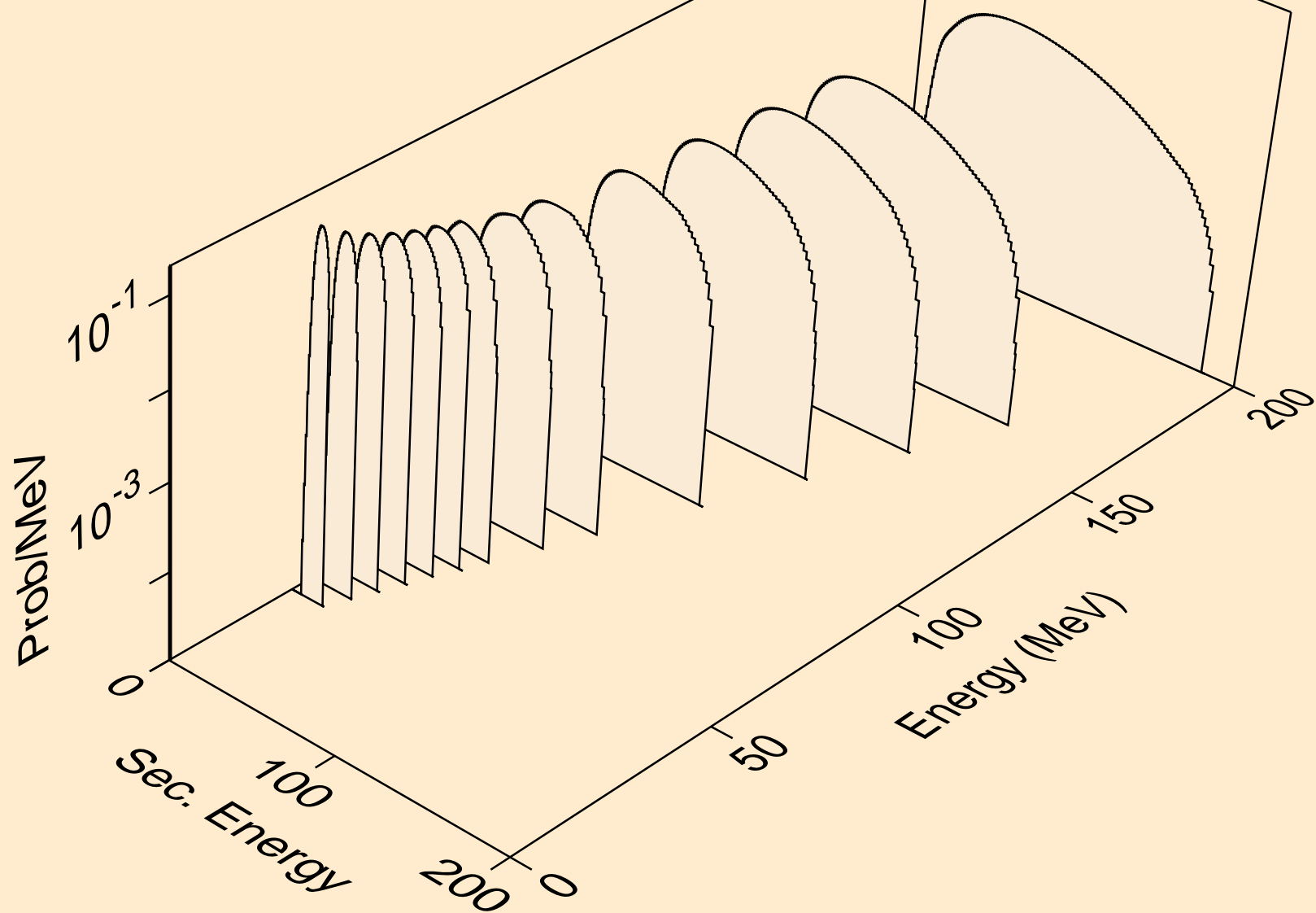

ER149M HELION ACER TENDL-2021 LIBRARY; T=0.K  
tritons from (s,n\*)t

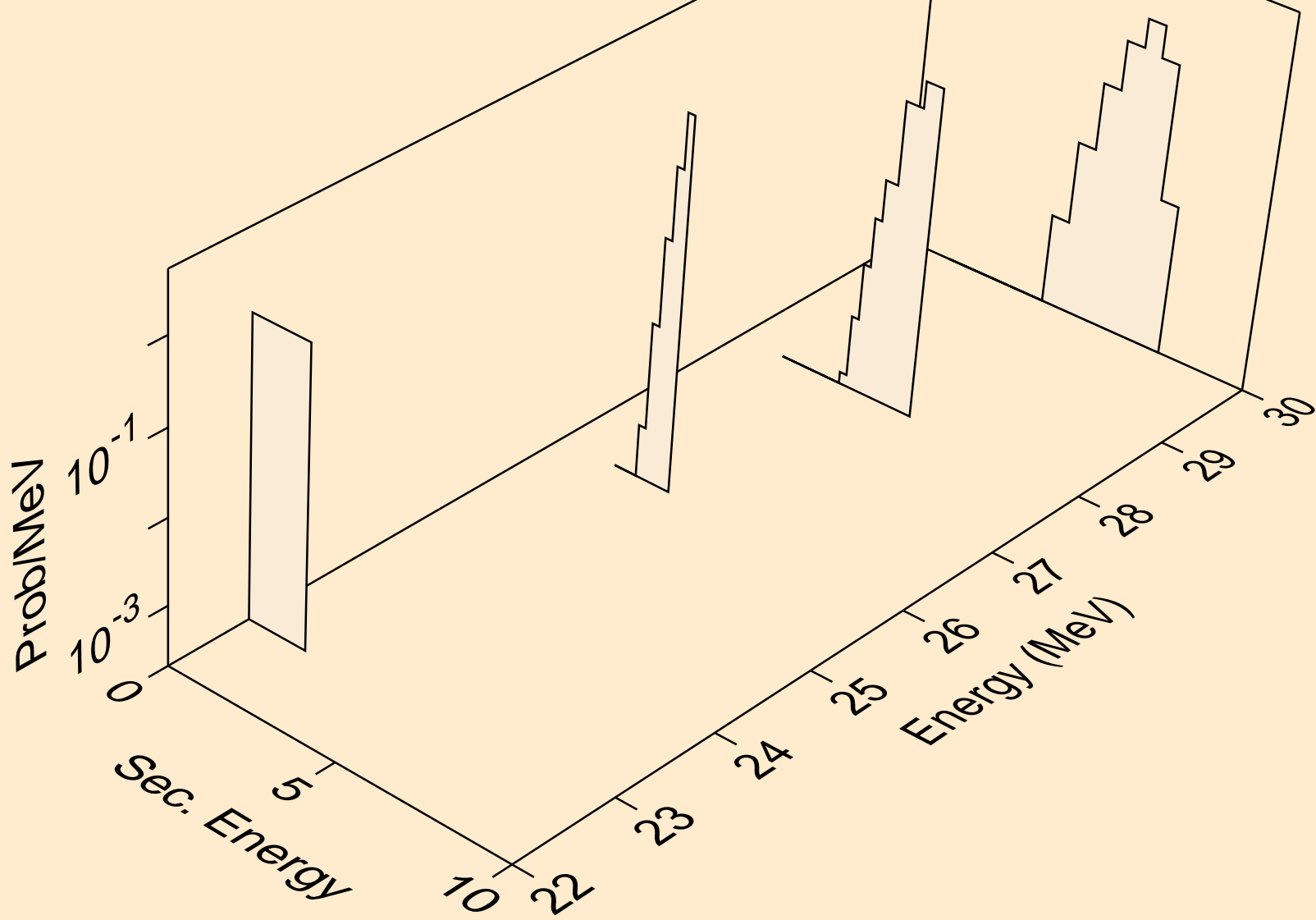

ER149M HELION ACER TENDL-2021 LIBRARY; T=0.K  
tritons from (s,t)

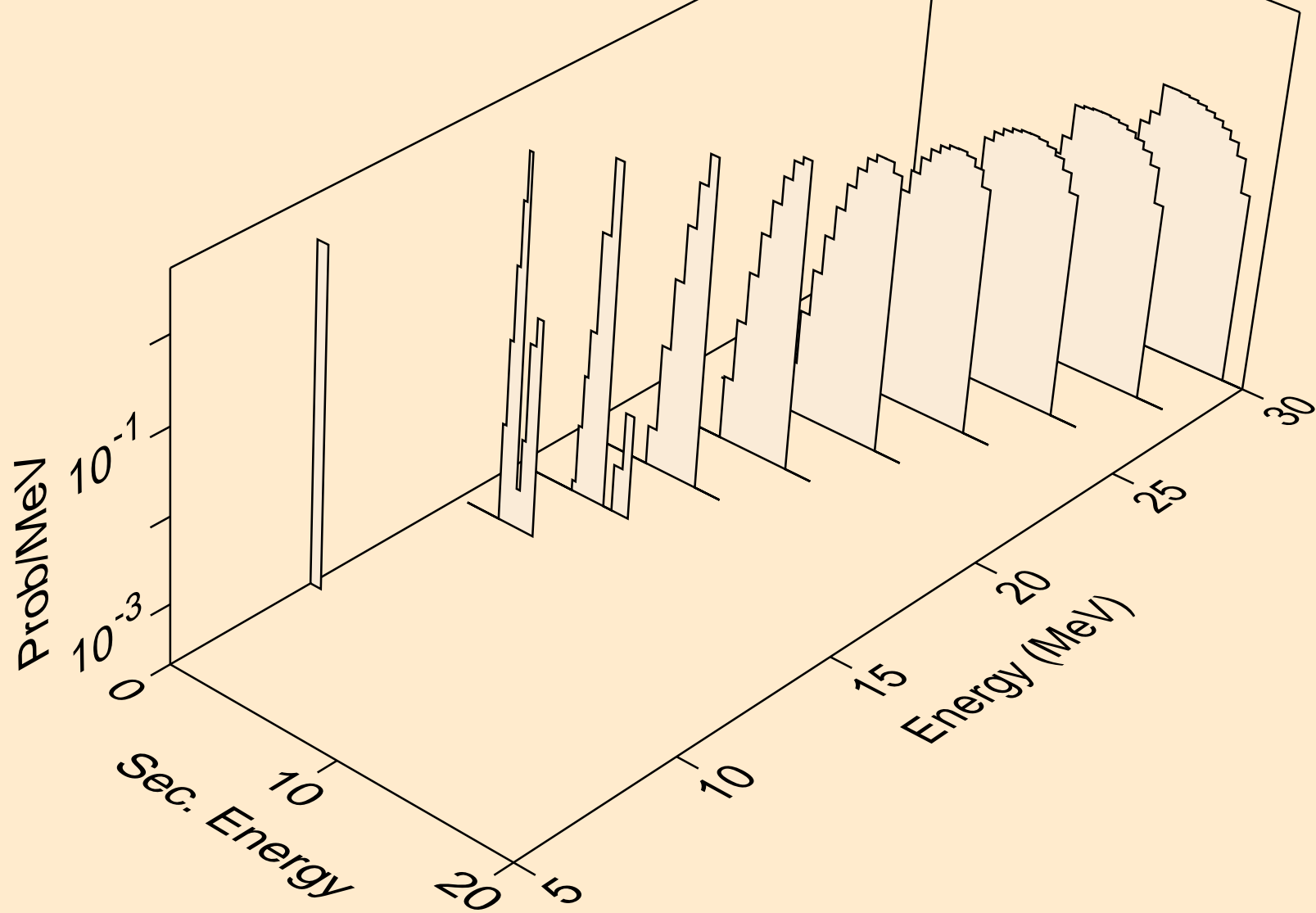

ER149M HELION ACER TENDL-2021 LIBRARY; T=0.K  
tritons from (s,pt)

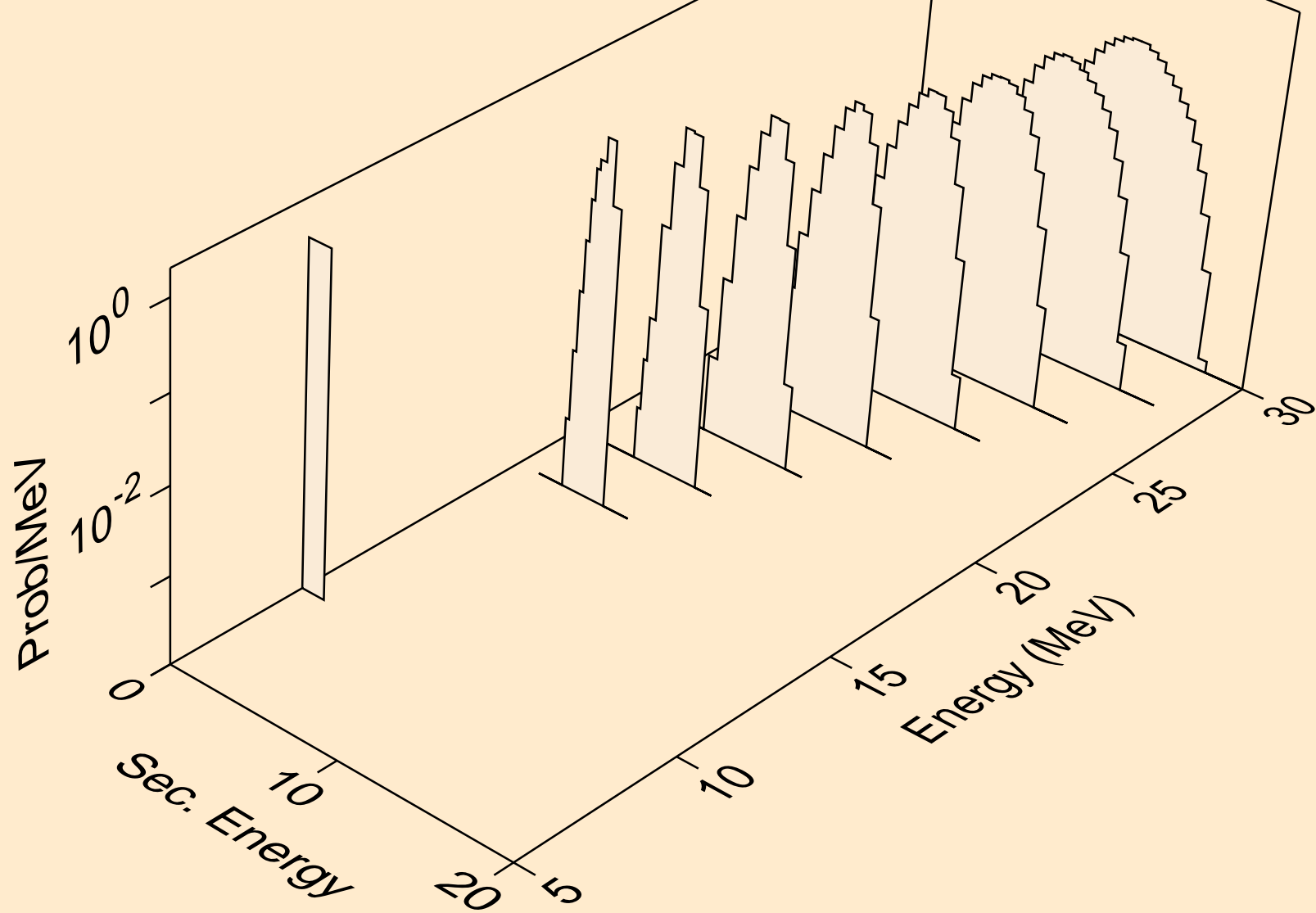

ER149M HELION ACER TENDL-2021 LIBRARY; T=0.K  
alphas from (s,x)

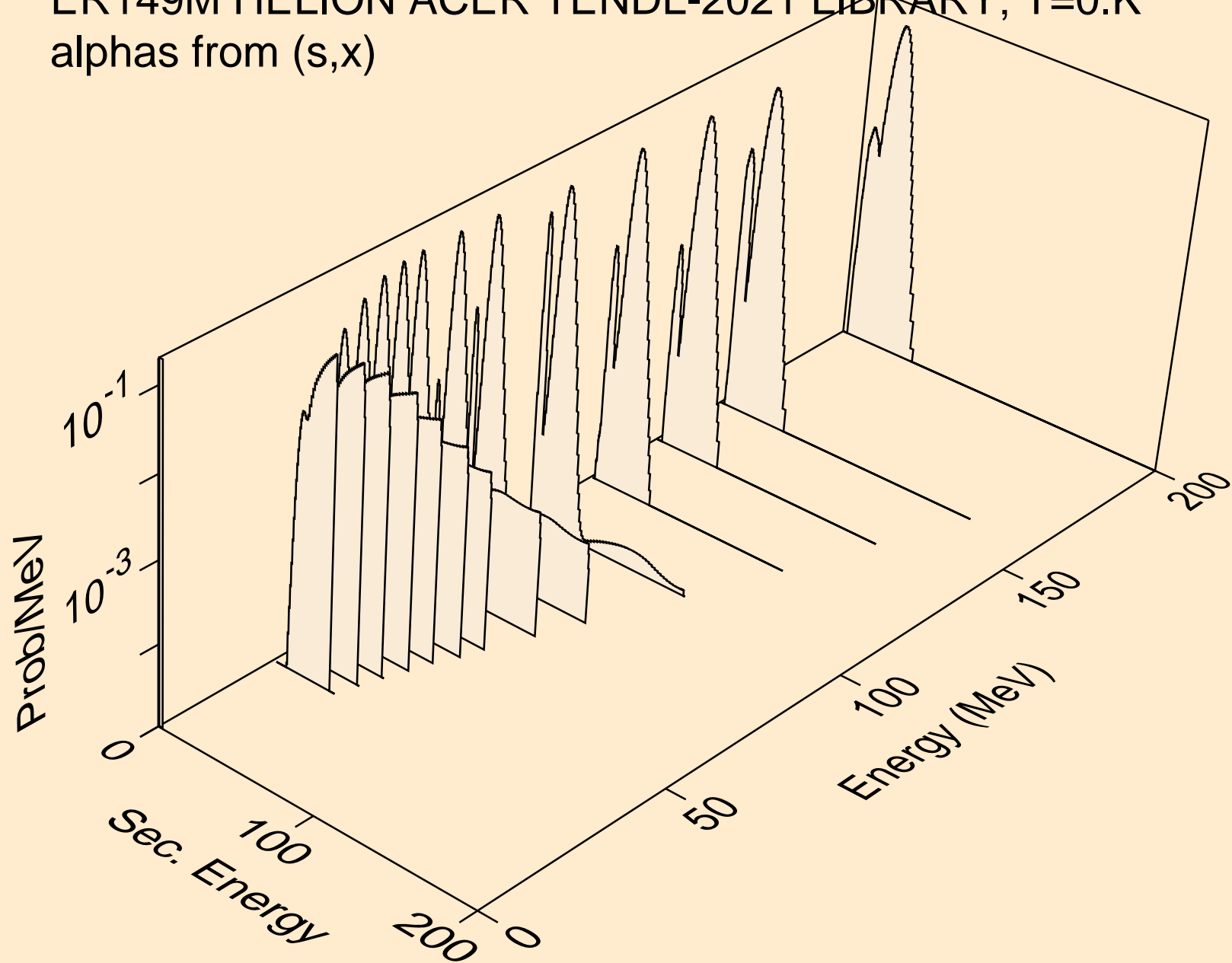

ER149M HELION ACER TENDL-2021 LIBRARY; T=0.K  
alphas from (s,n\*)a

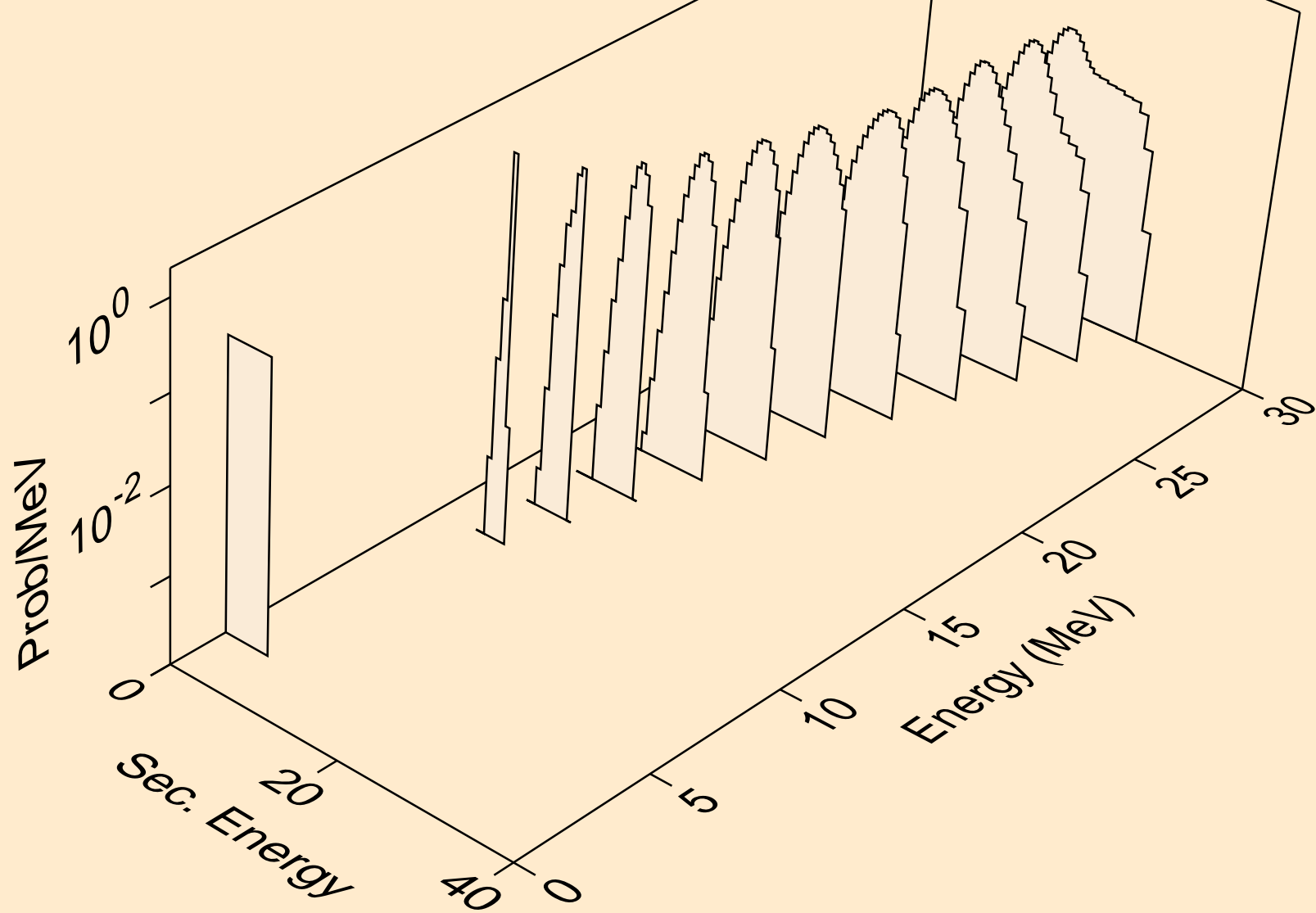

ER149M HELION ACER TENDL-2021 LIBRARY; T=0.K  
alphas from (s,2n)a

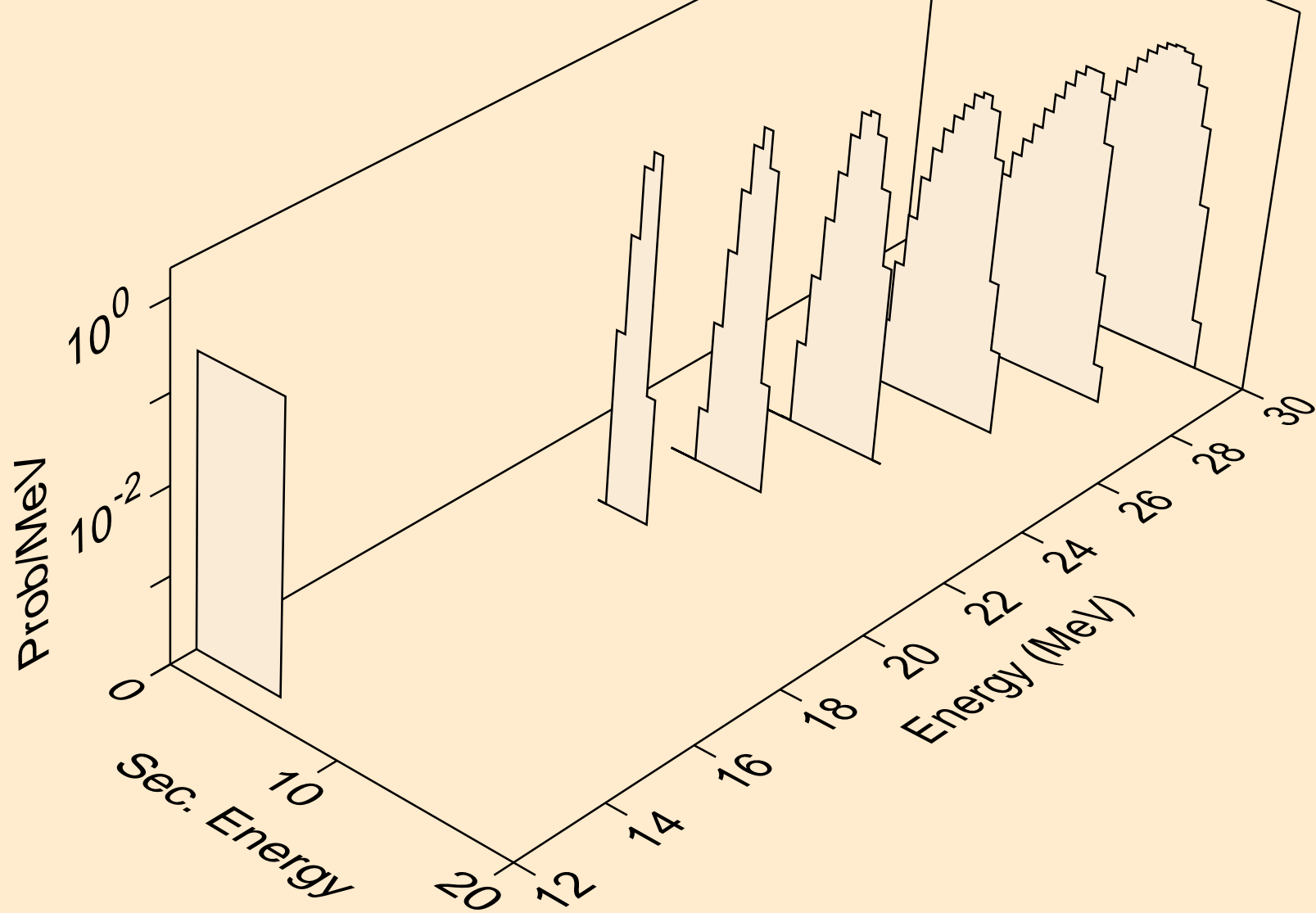

ER149M HELION ACER TENDL-2021 LIBRARY; T=0.K  
alphas from (s,n\*)2a

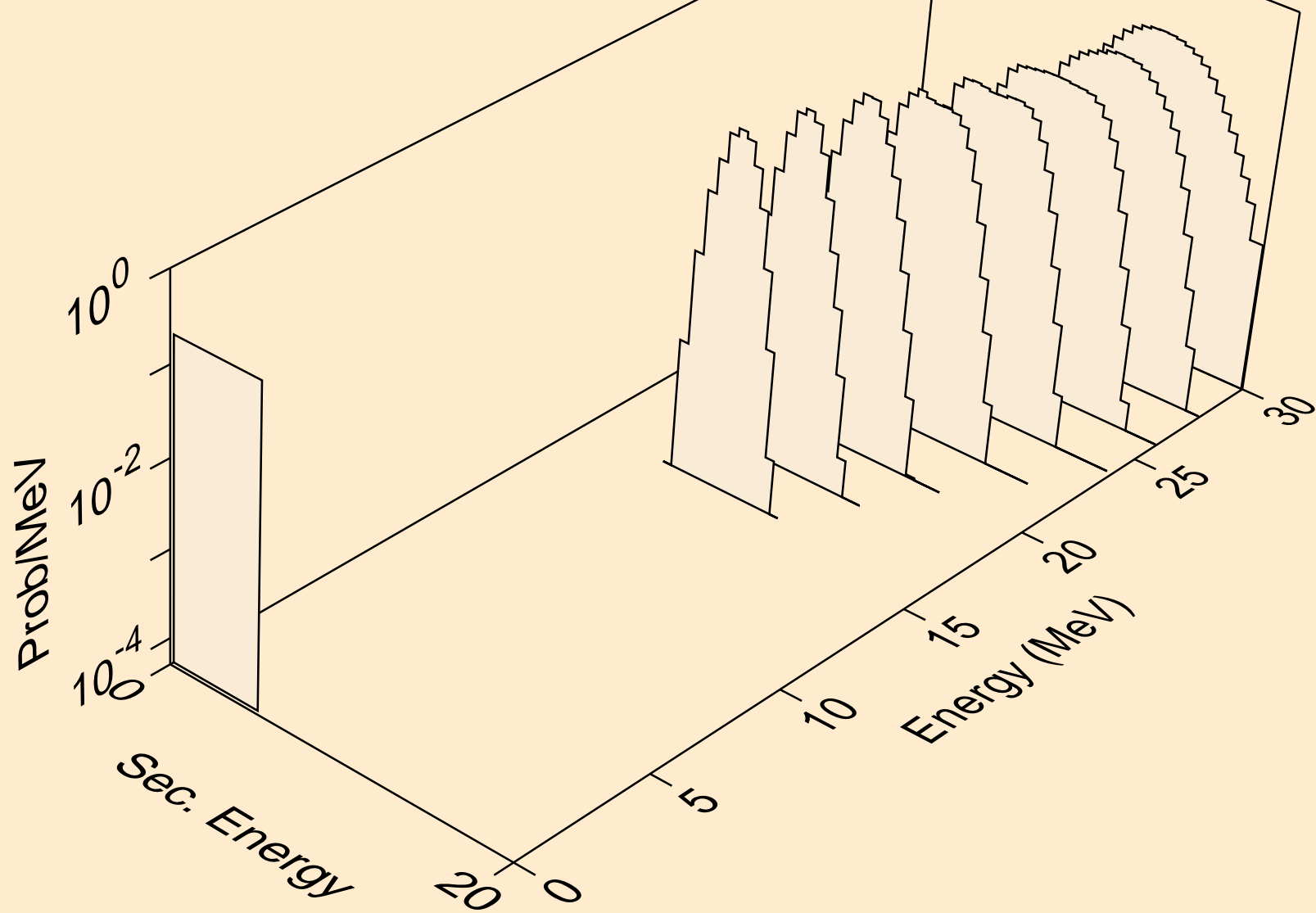

ER149M HELION ACER TENDL-2021 LIBRARY; T=0.K  
alphas from (s,npa)

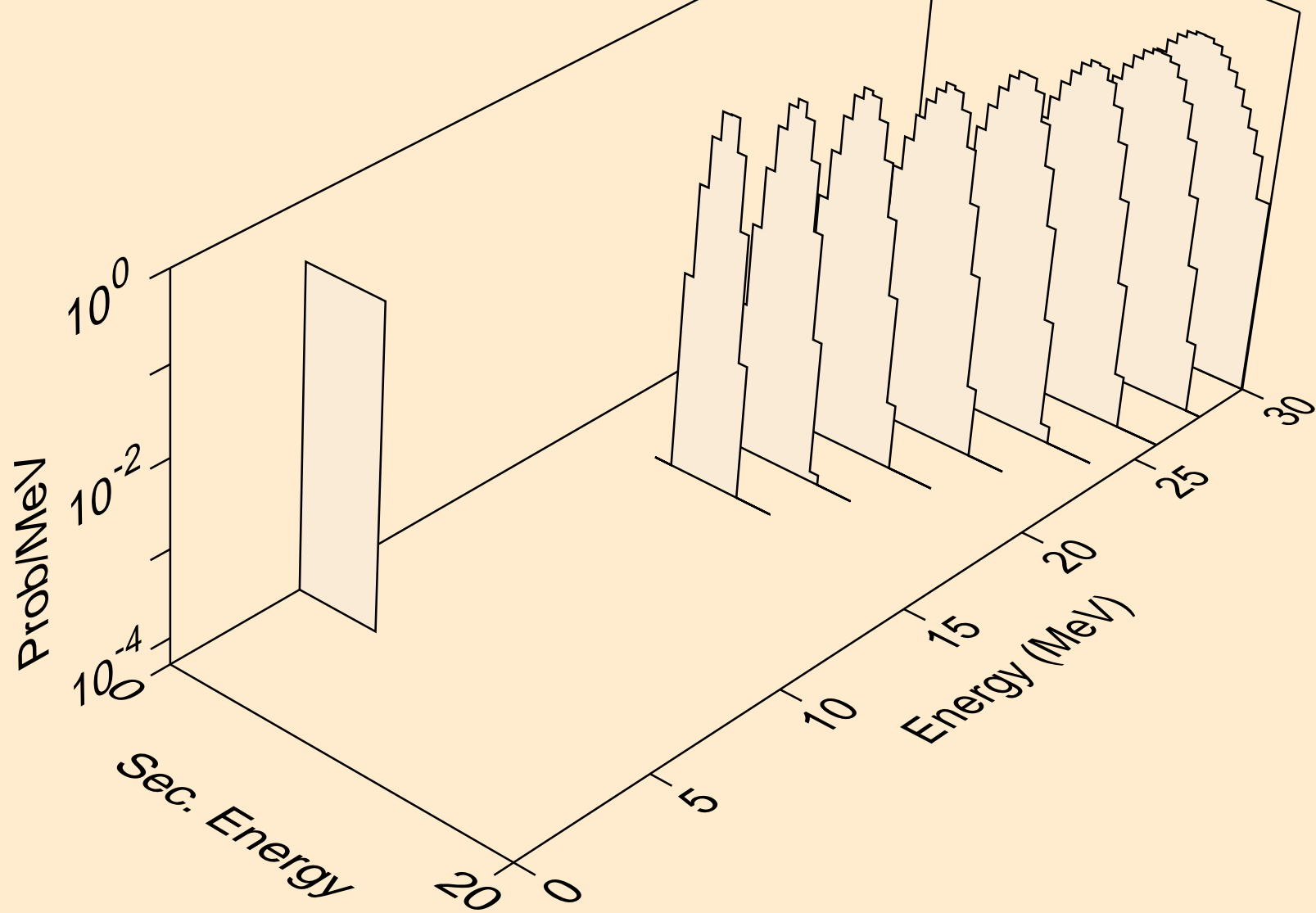

ER149M HELION ACER TENDL-2021 LIBRARY; T=0.K  
alphas from (s,a)

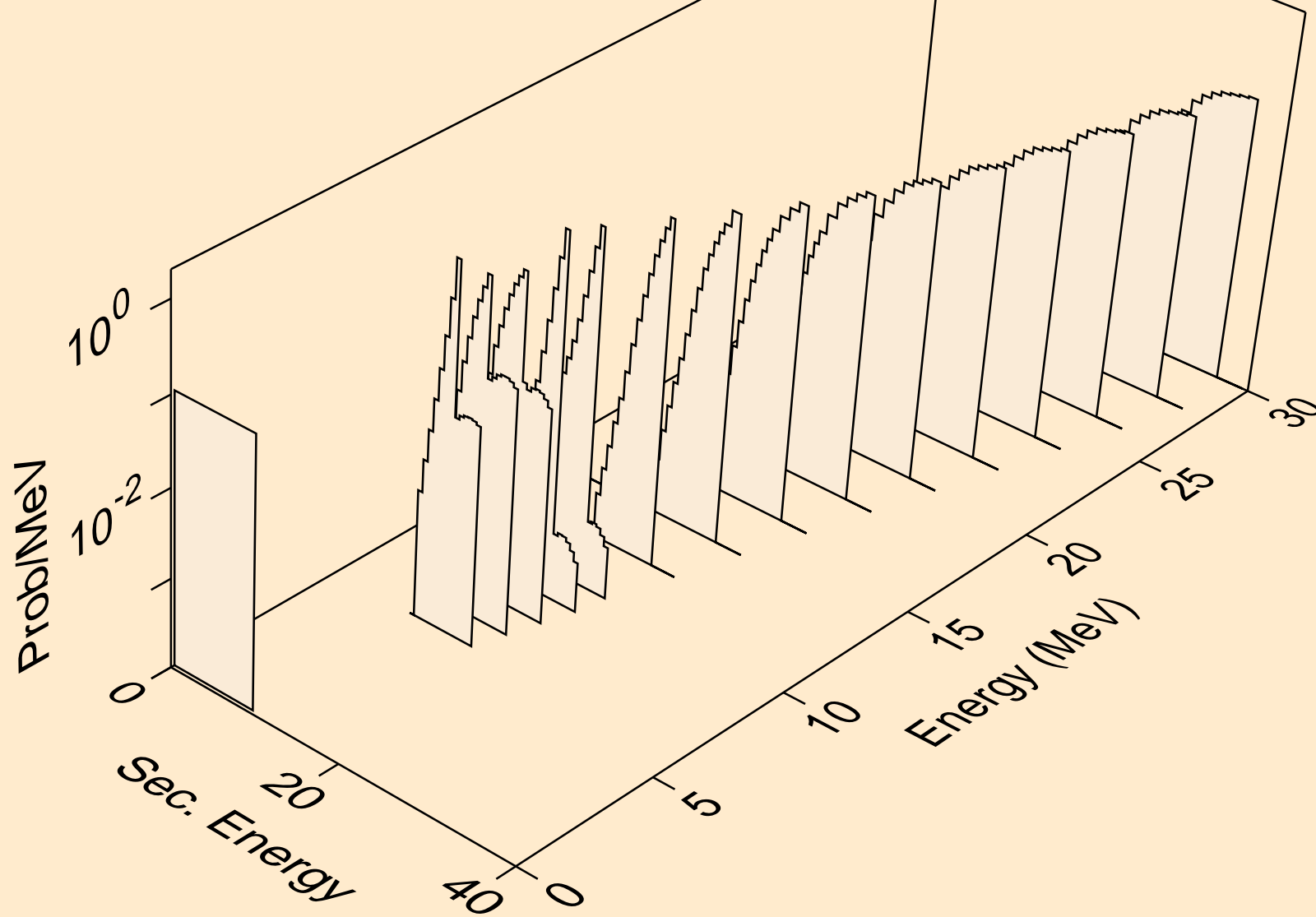

ER149M HELION ACER TENDL-2021 LIBRARY; T=0.K  
alphas from (s,2a)

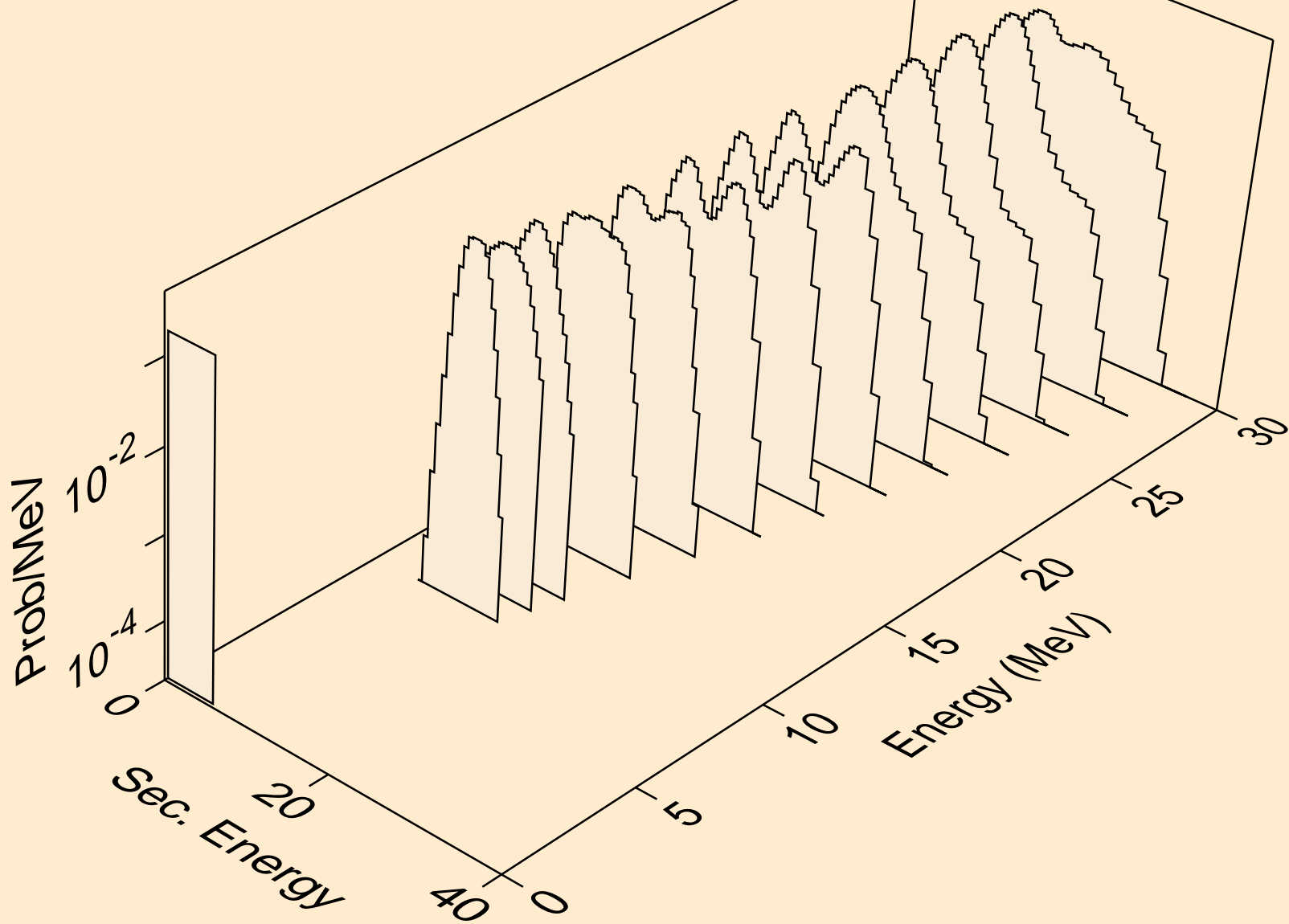

ER149M HELION ACER TENDL-2021 LIBRARY; T=0.K  
alphas from (s,pa)

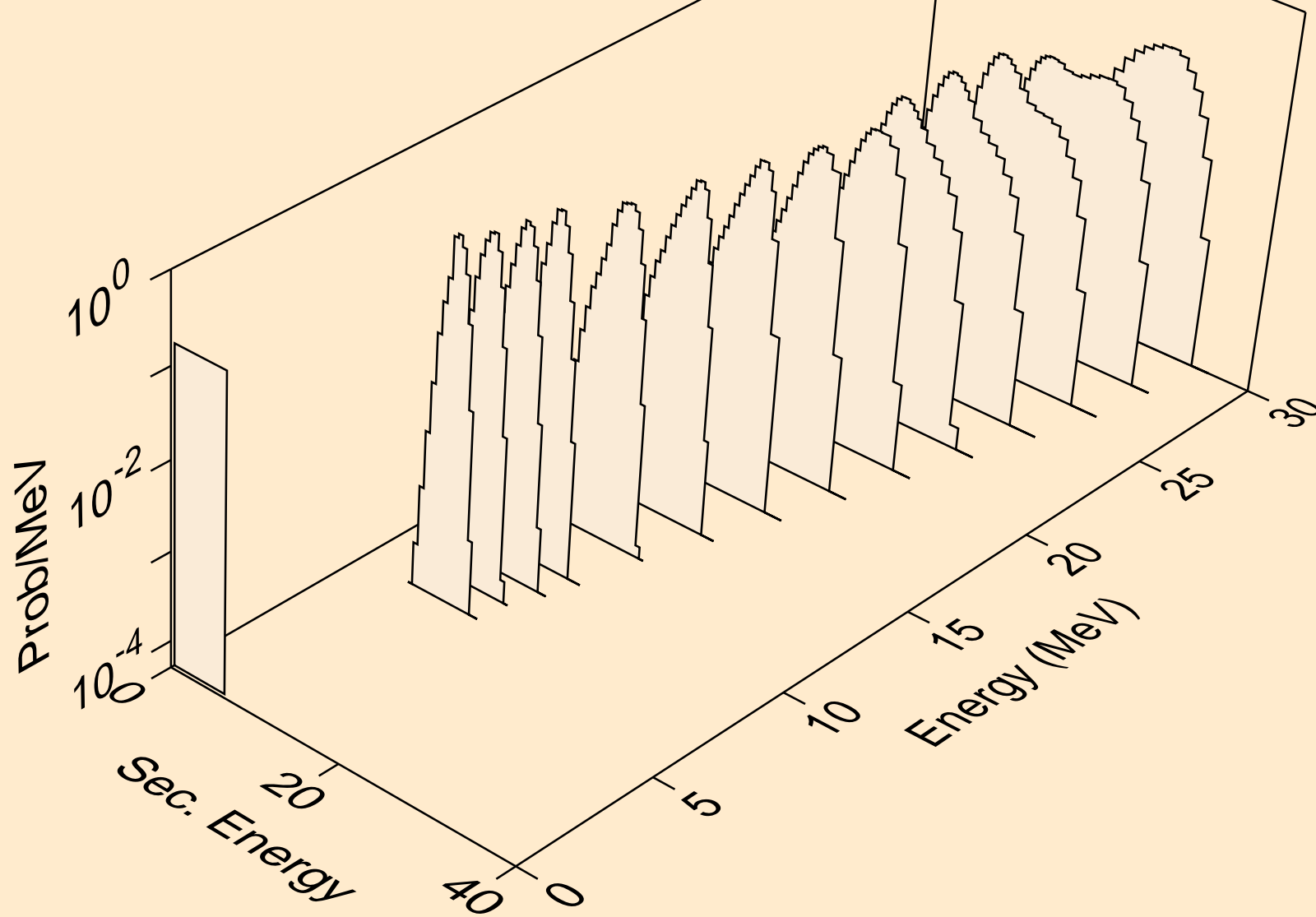

ER149M HELION ACER TENDL-2021 LIBRARY; T=0.K  
alphas from (s,da)

