

CE125 NEUTRON ACER TENDL-2021 LIBRARY; T=293.6K

Principal cross sections

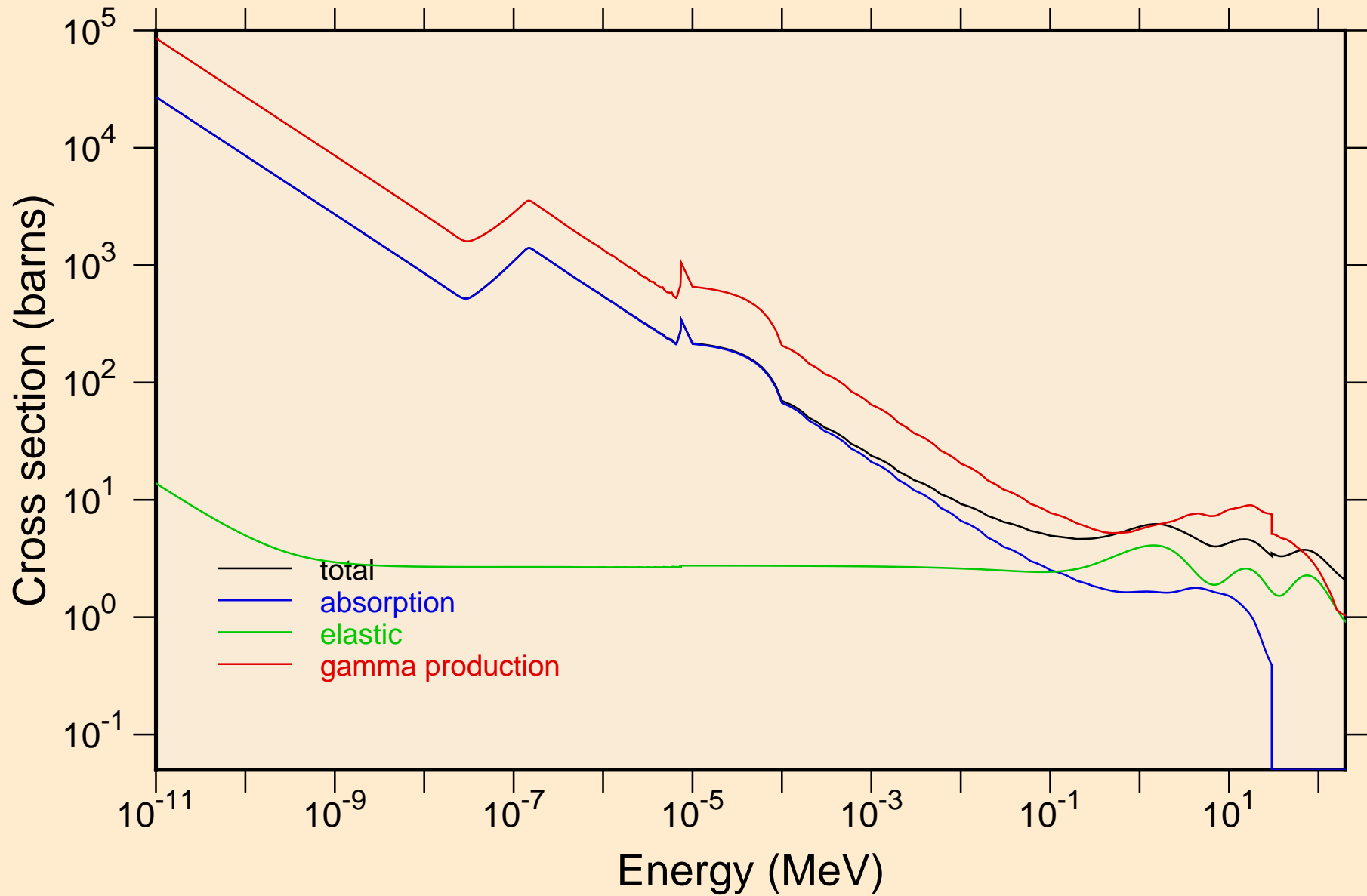

CE125 NEUTRON ACER TENDL-2021 LIBRARY; T=293.6K
resonance total cross section

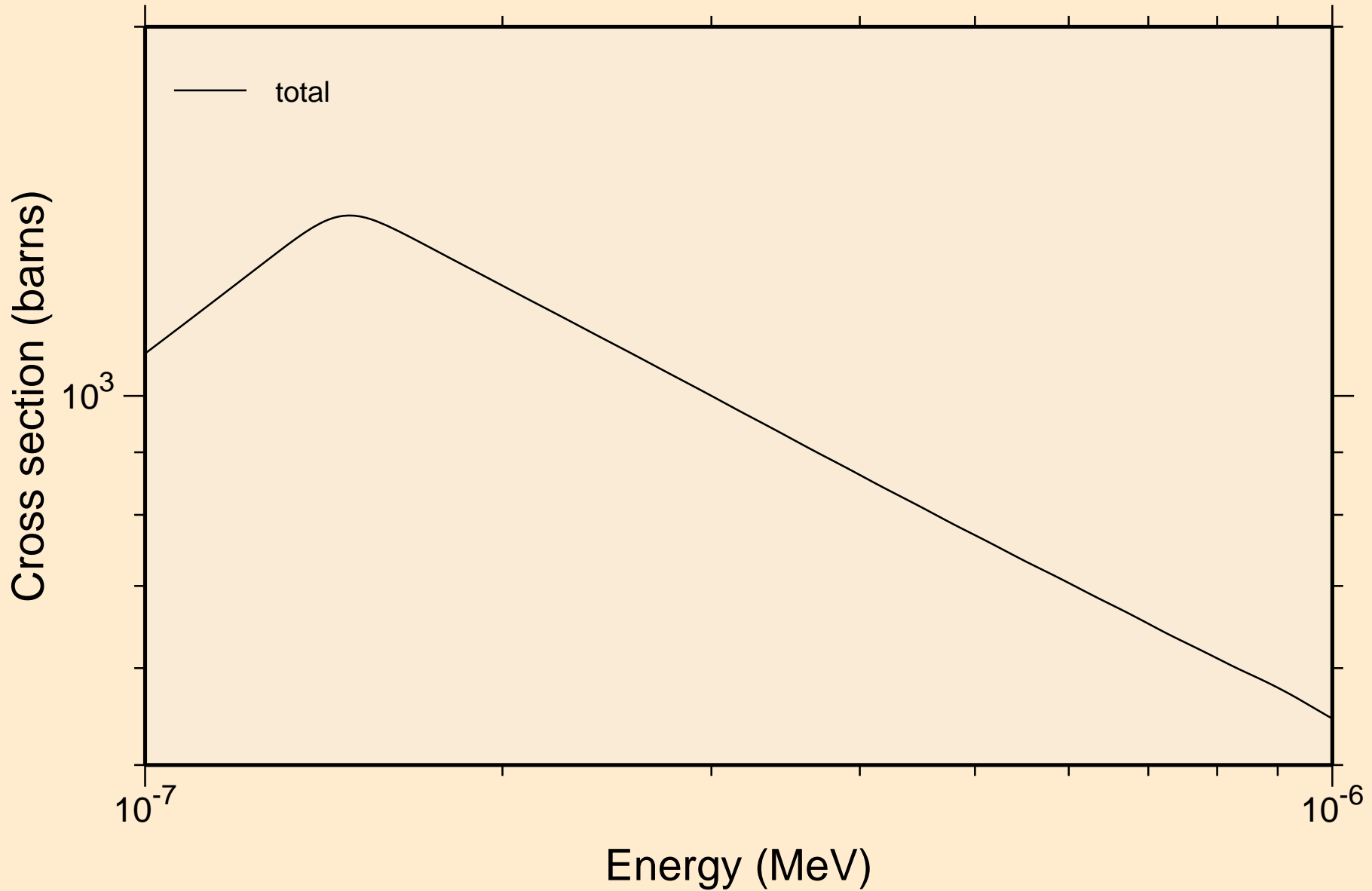

CE125 NEUTRON ACER TENDL-2021 LIBRARY; T=293.6K
resonance total cross section

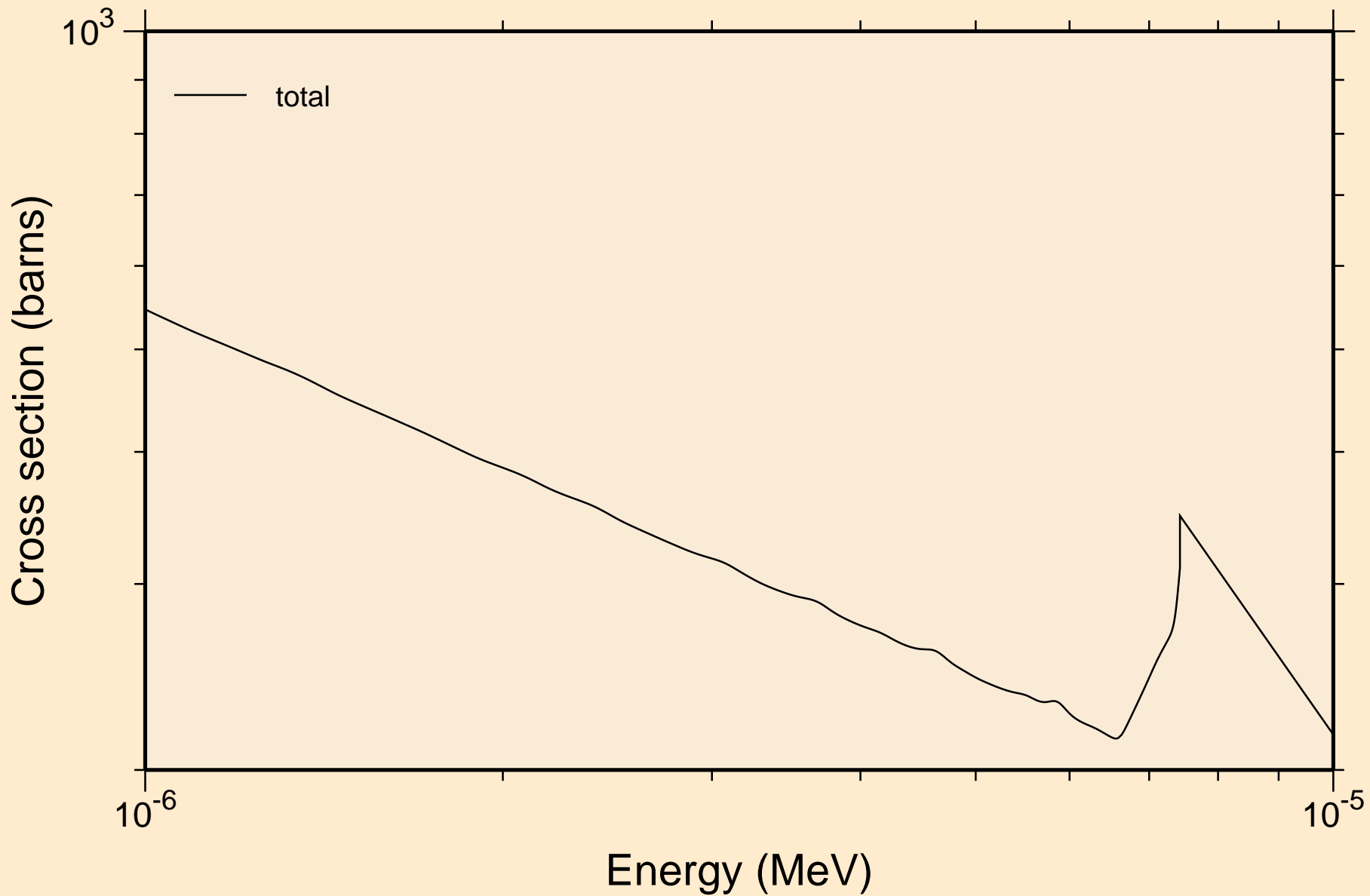

C¹²⁵ NEUTRON ACER TENDL-2021 LIBRARY; T=293.6K
resonance total cross section

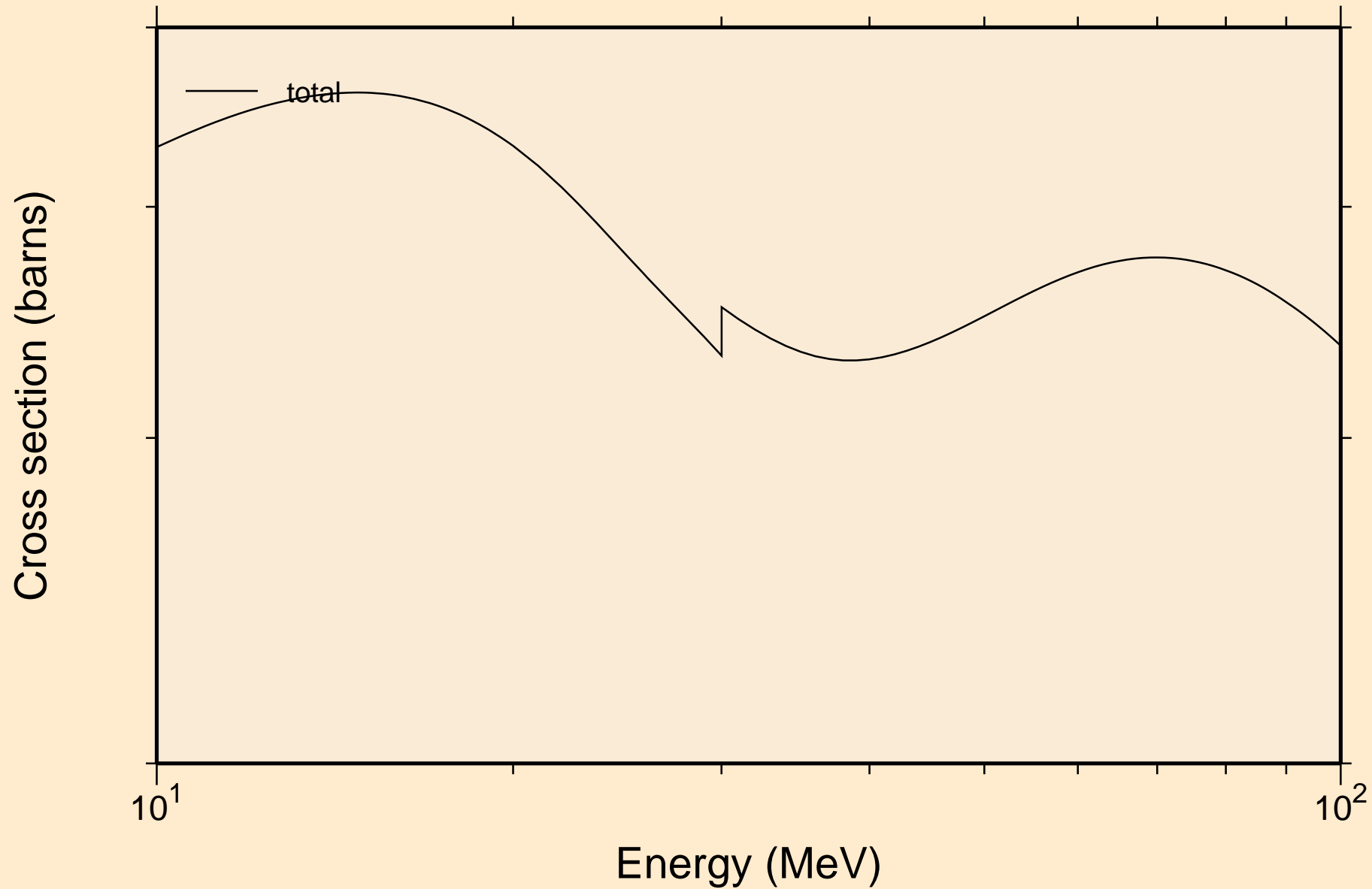

CE125 NEUTRON ACER TENDL-2021 LIBRARY; T=293.6K
resonance absorption cross sections

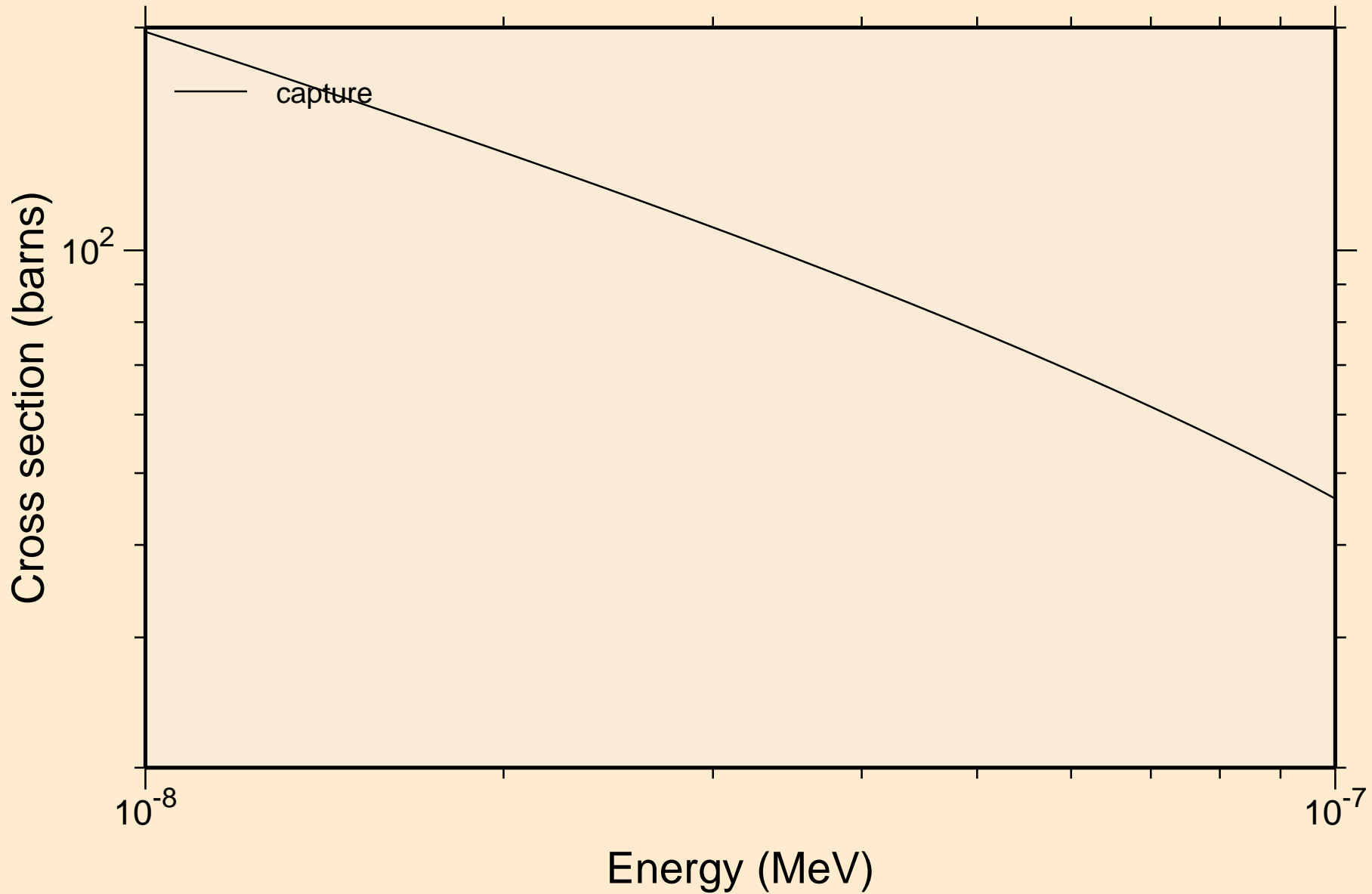

CE125 NEUTRON ACER TENDL-2021 LIBRARY; T=293.6K
resonance absorption cross sections

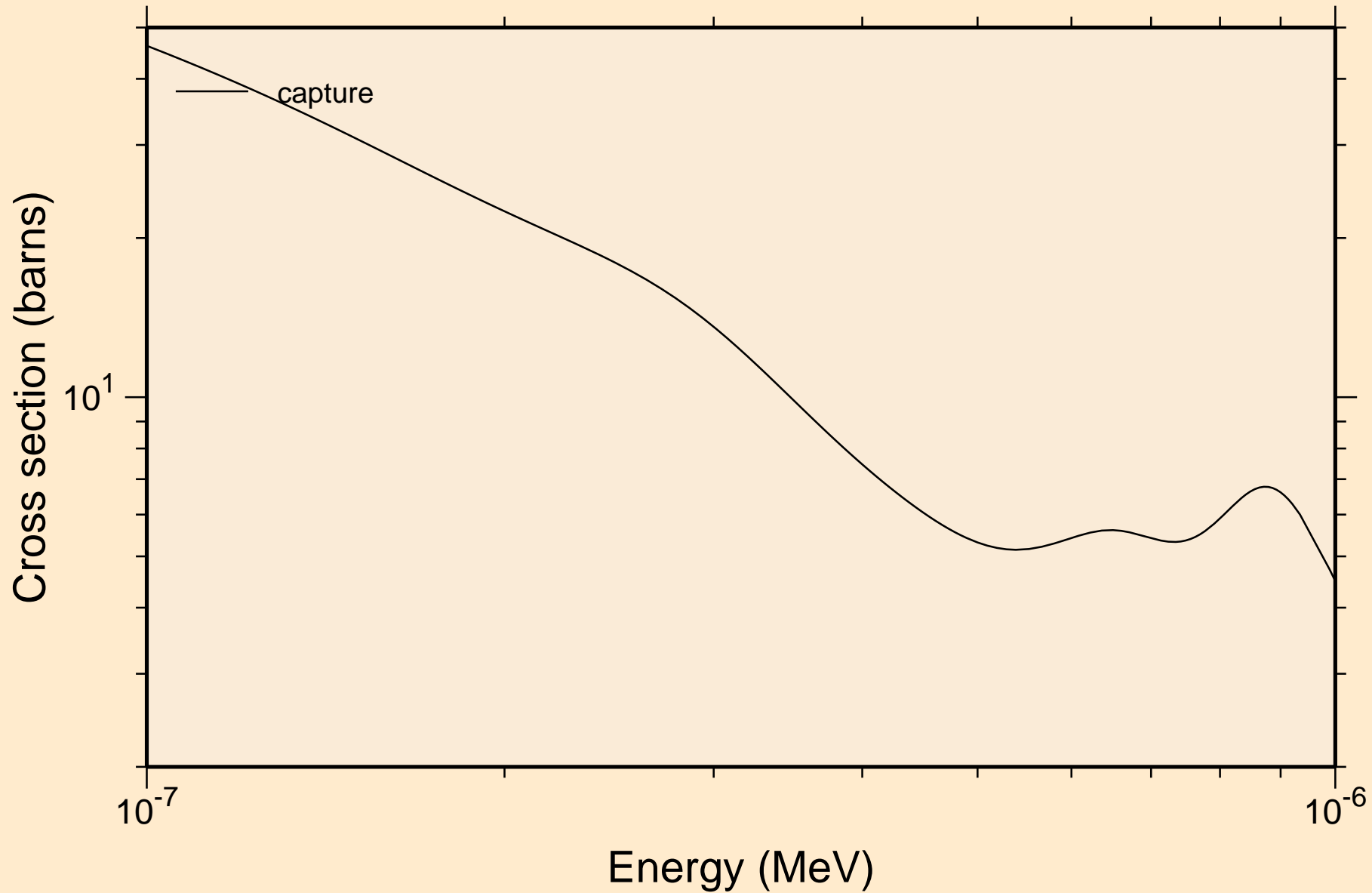

CE125 NEUTRON ACER TENDL-2021 LIBRARY; T=293.6K
resonance absorption cross sections

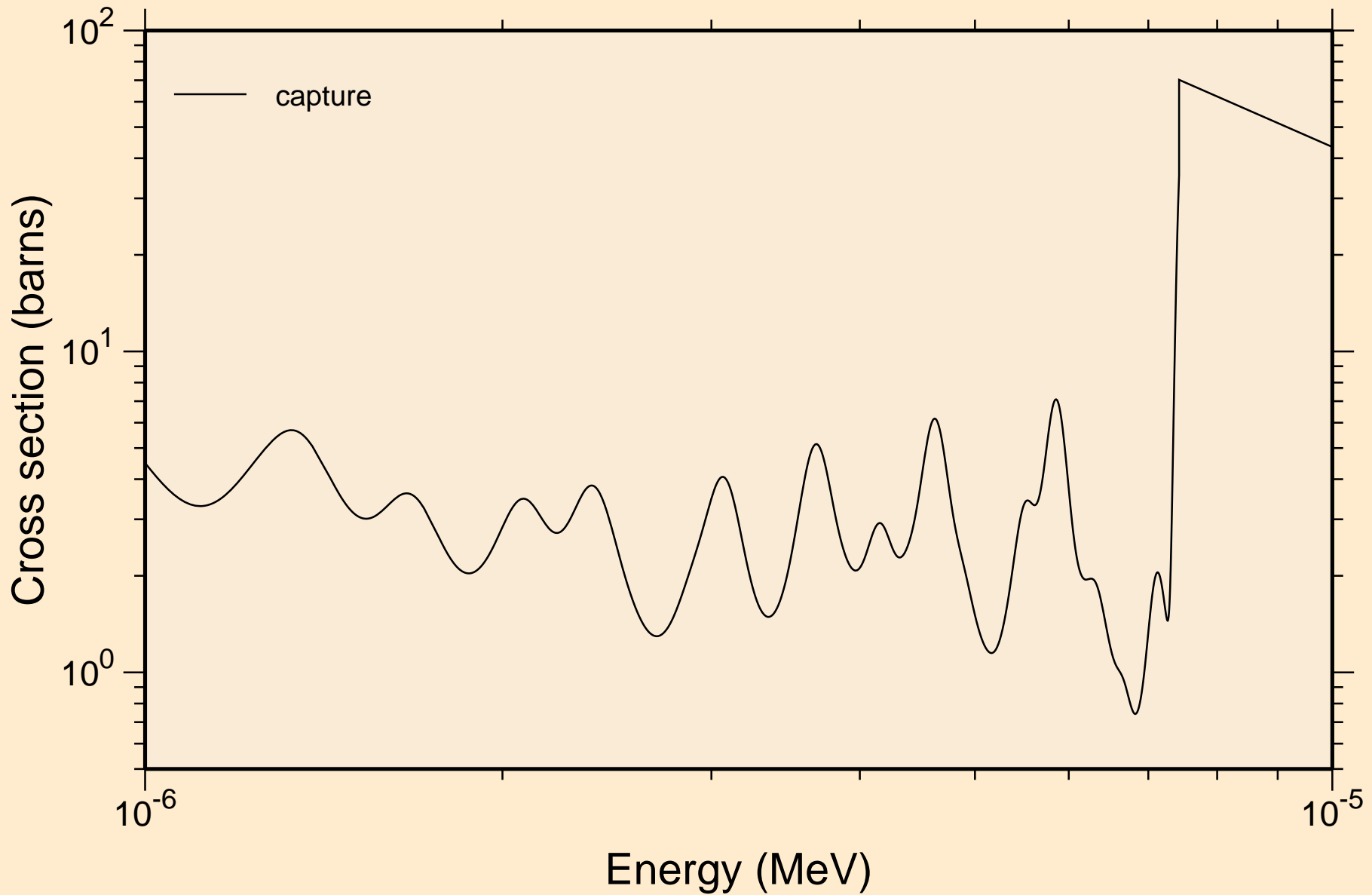

CE125 NEUTRON ACER TENDL-2021 LIBRARY; T=293.6K
resonance absorption cross sections

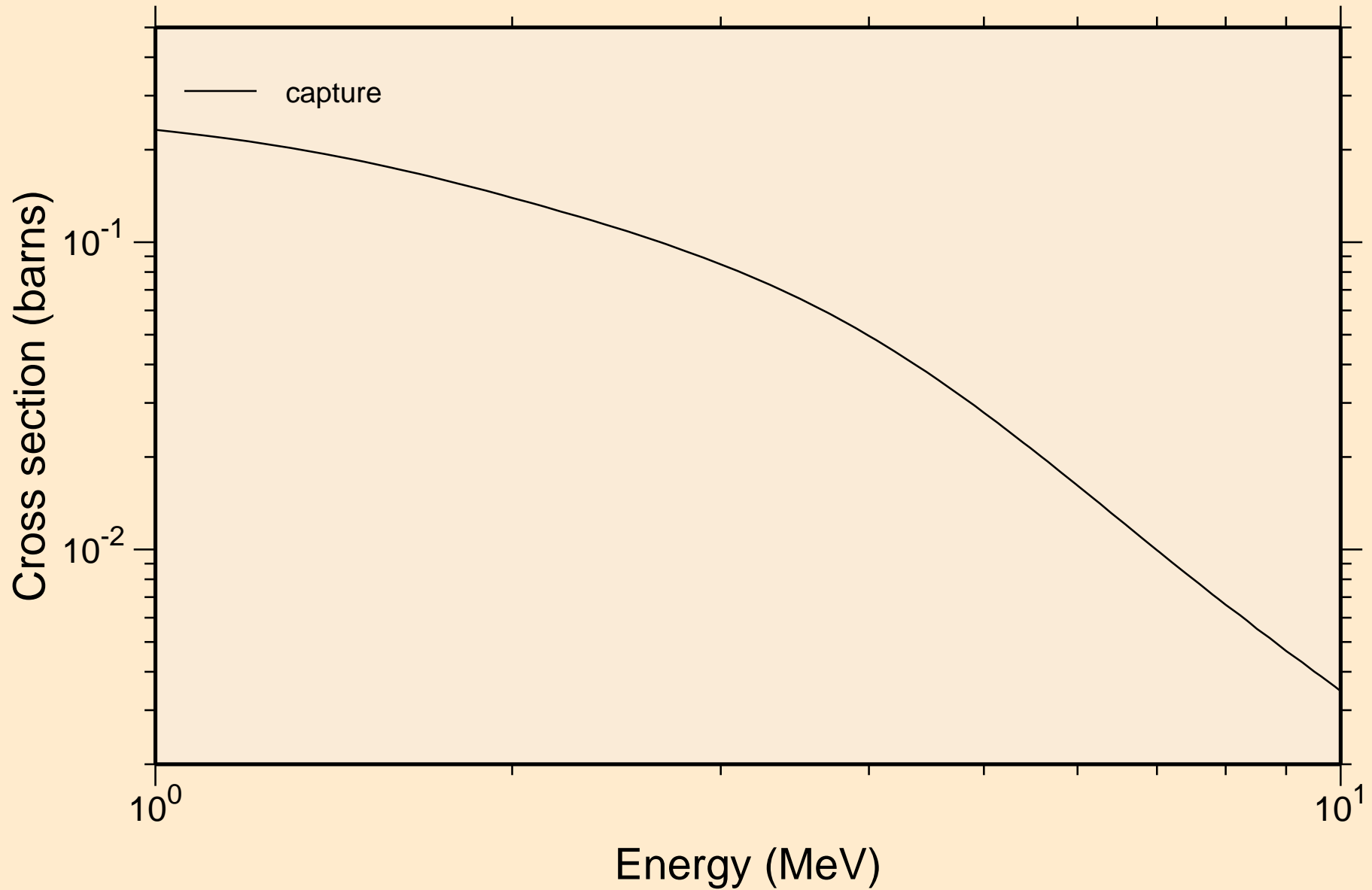

CE125 NEUTRON ACER TENDL-2021 LIBRARY; T=293.6K
Heating

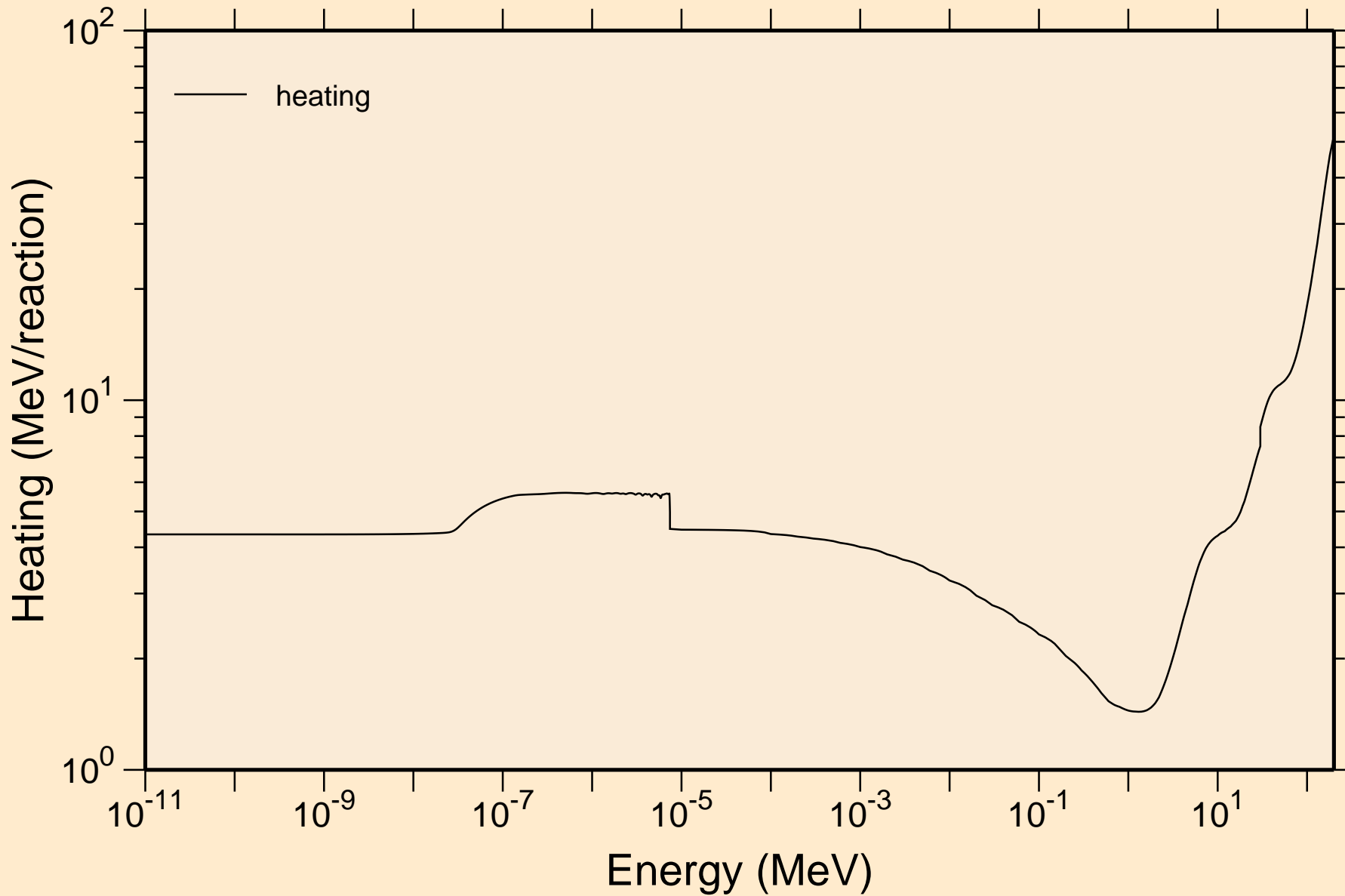

CE125 NEUTRON ACER TENDL-2021 LIBRARY; T=293.6K
Damage

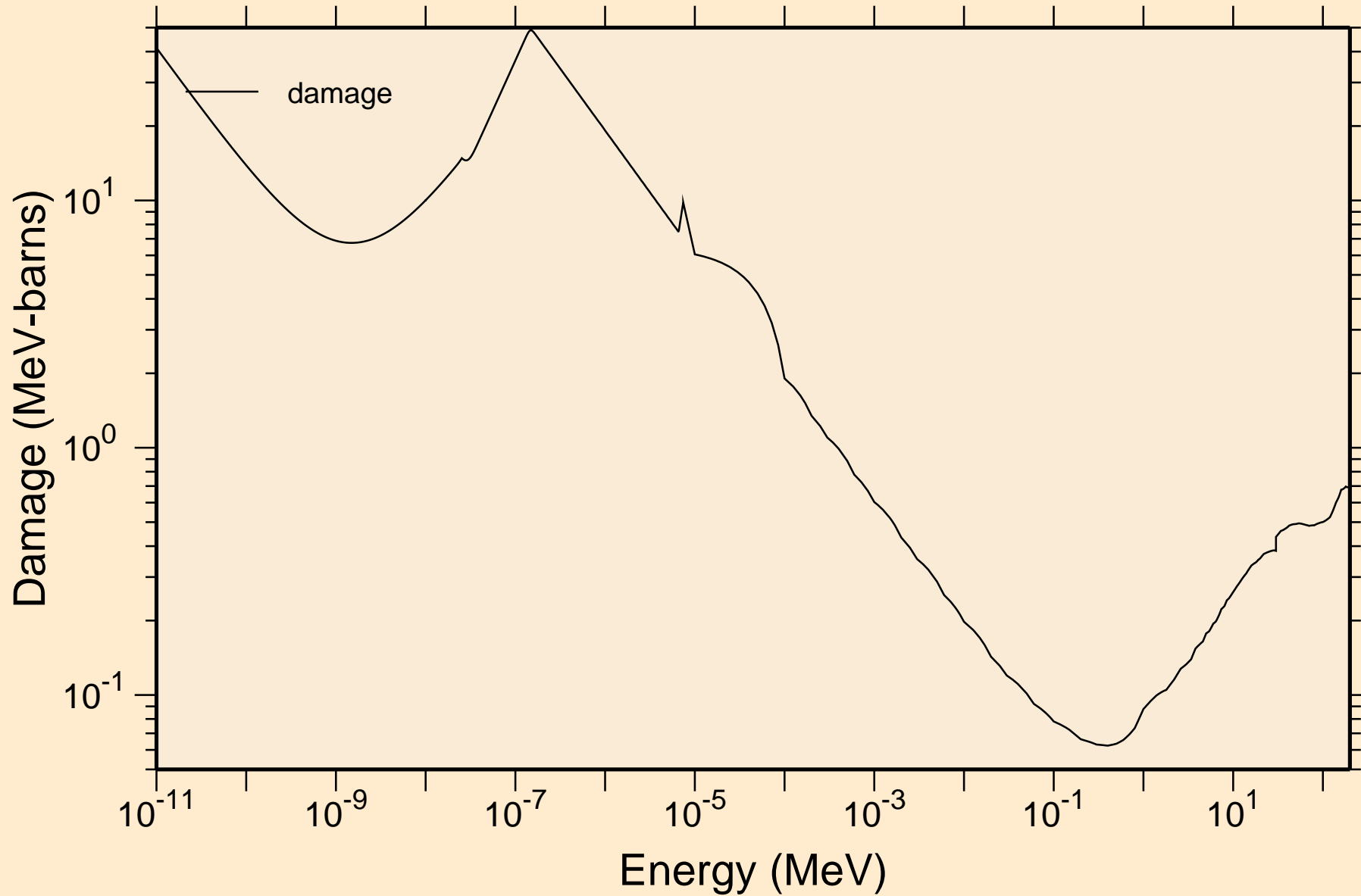

CE125 NEUTRON ACER TENDL-2021 LIBRARY; T=293.6K

Non-threshold reactions

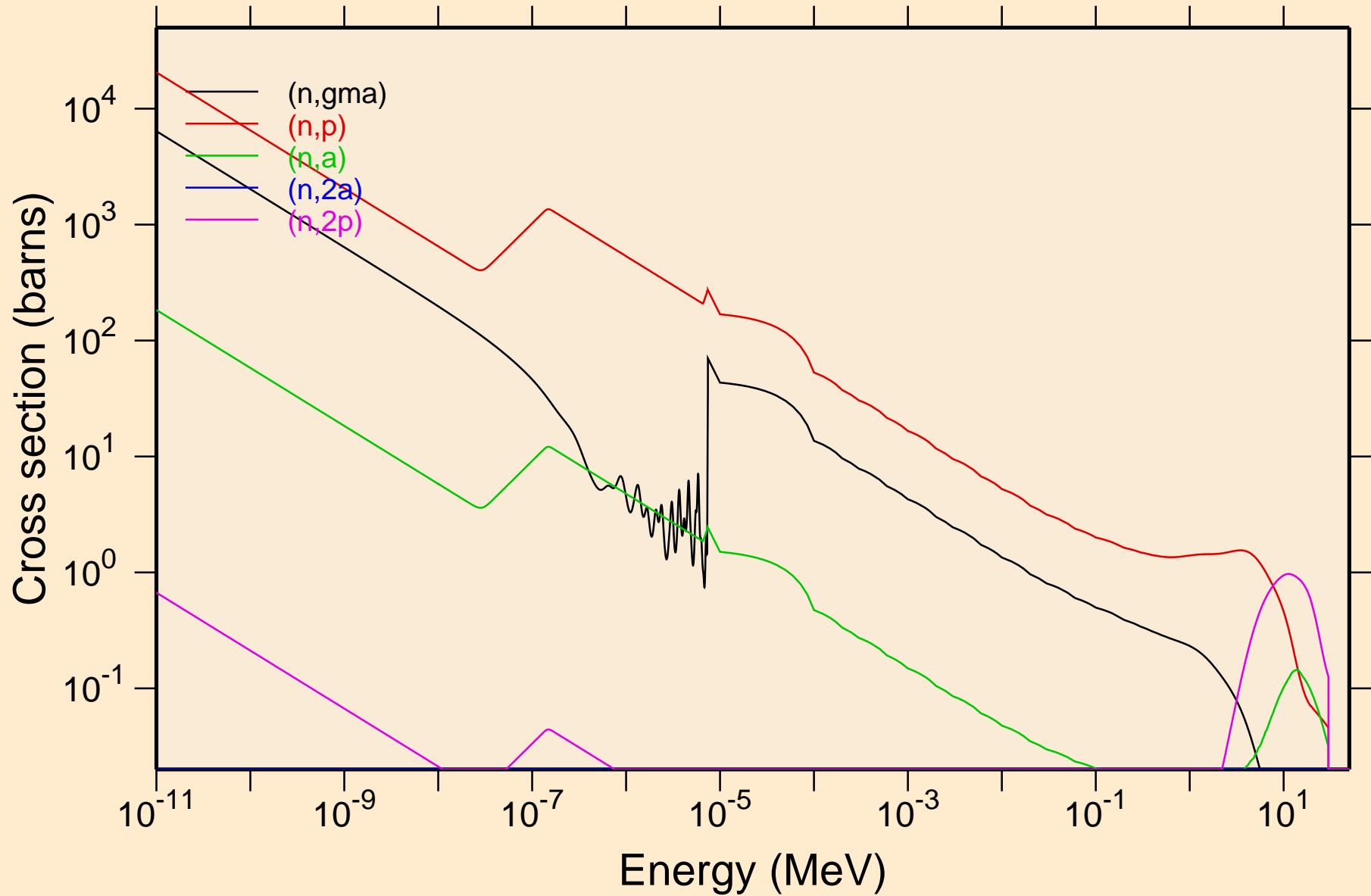

CE125 NEUTRON ACER TENDL-2021 LIBRARY; T=293.6K
Non-threshold reactions

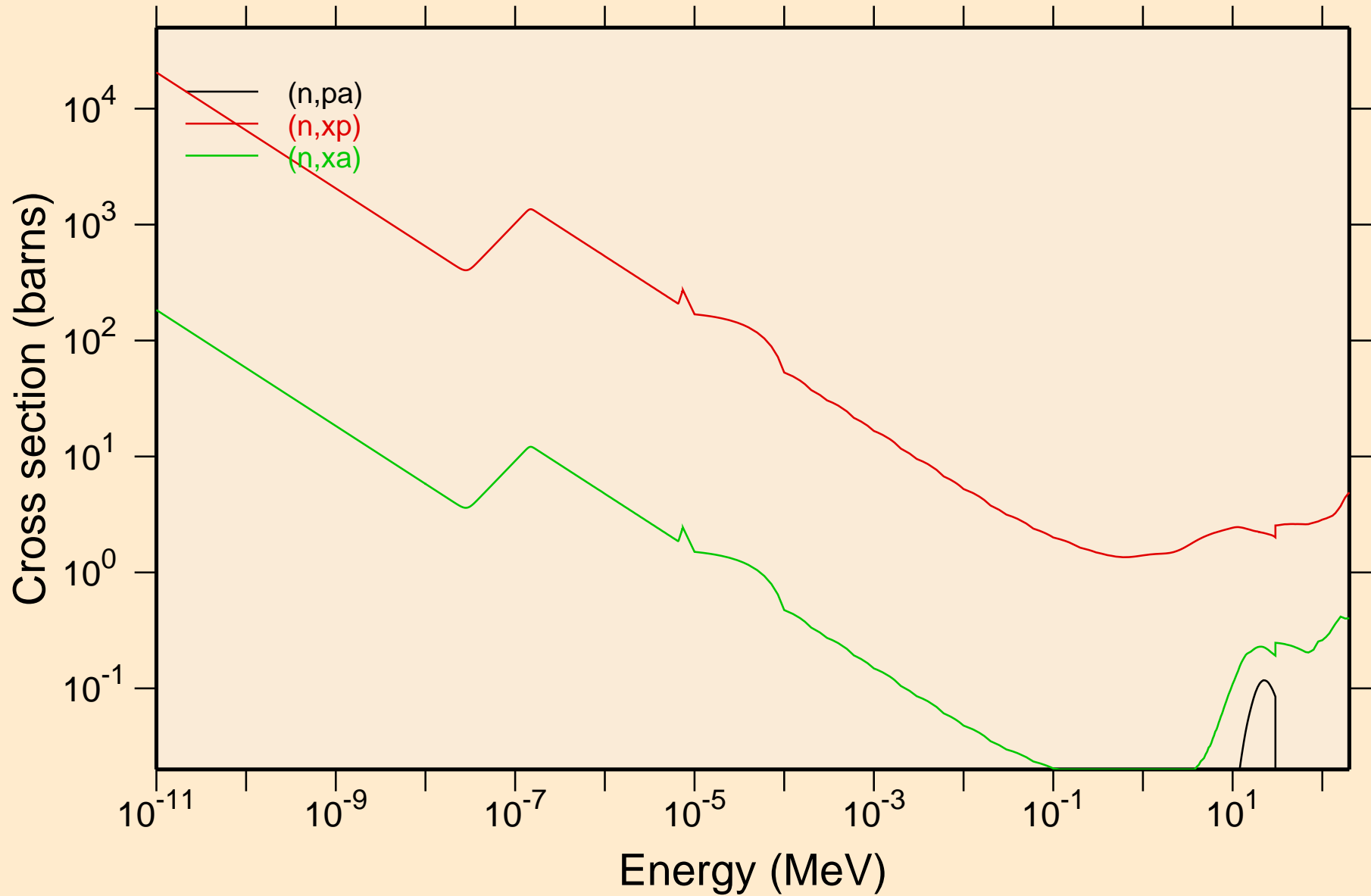

CE125 NEUTRON ACER TENDL-2021 LIBRARY; T=293.6K
Principal cross sections

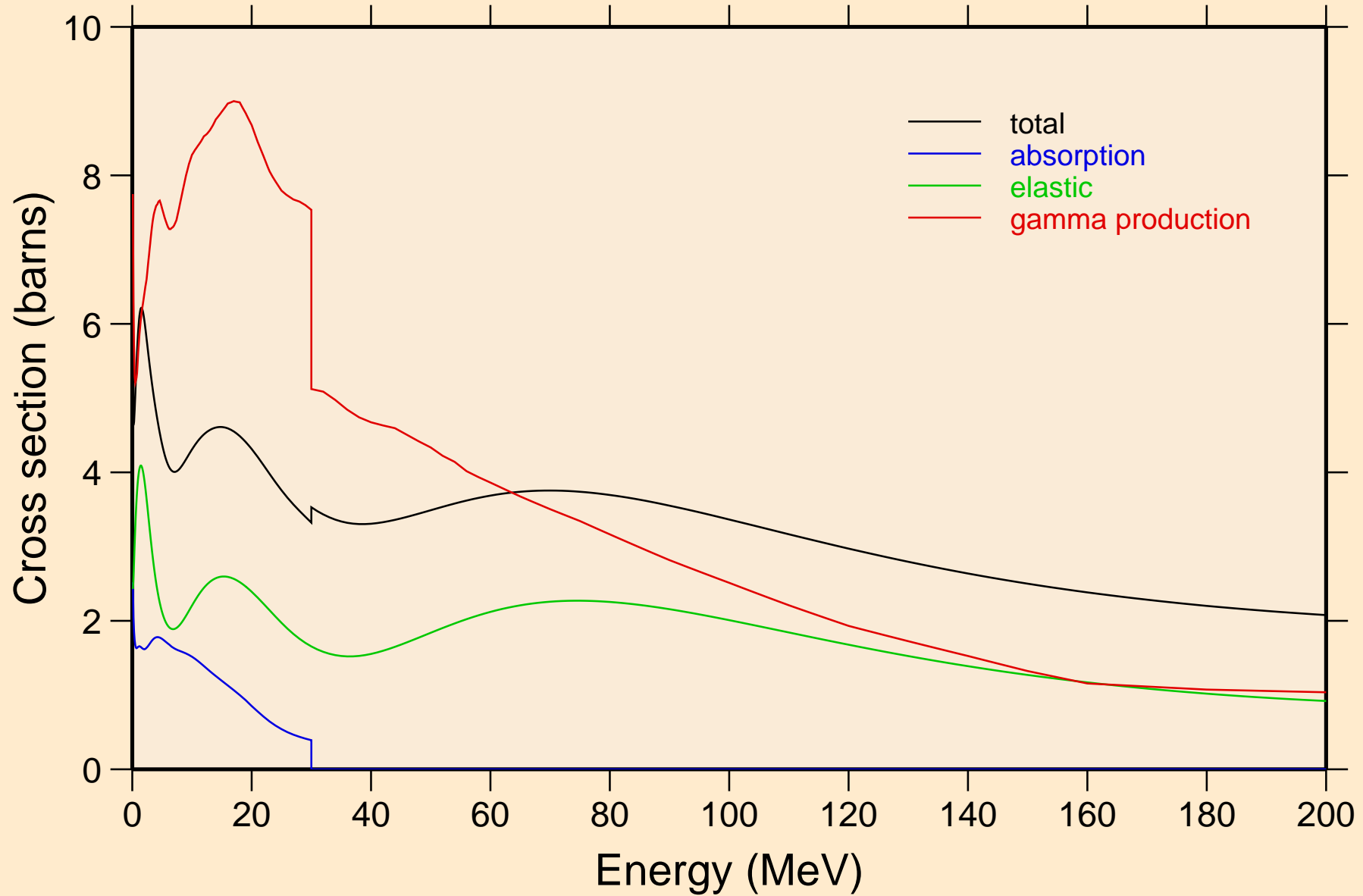

CE125 NEUTRON ACER TENDL-2021 LIBRARY; T=293.6K
Heating

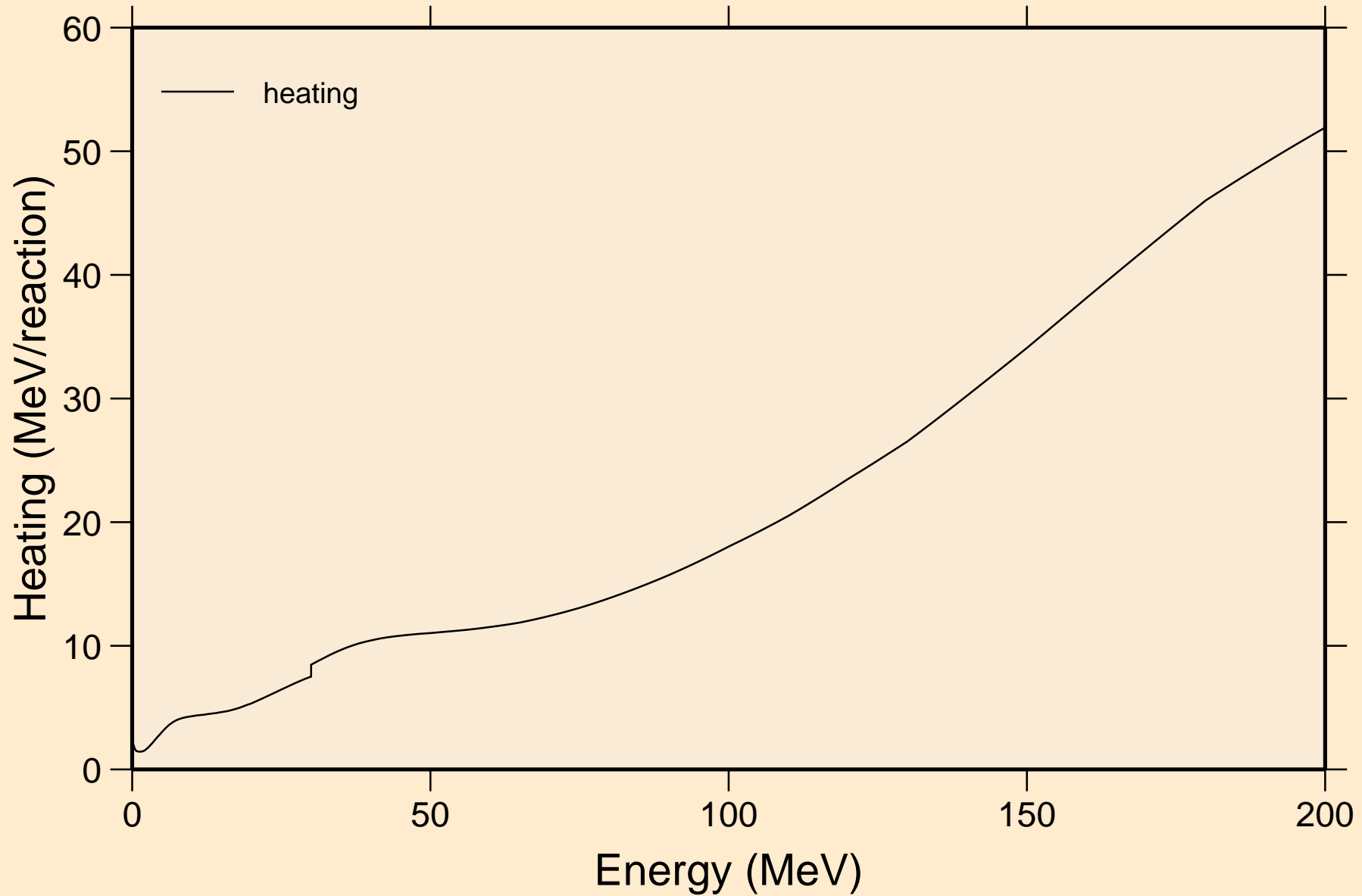

CE125 NEUTRON ACER TENDL-2021 LIBRARY; T=293.6K
Damage

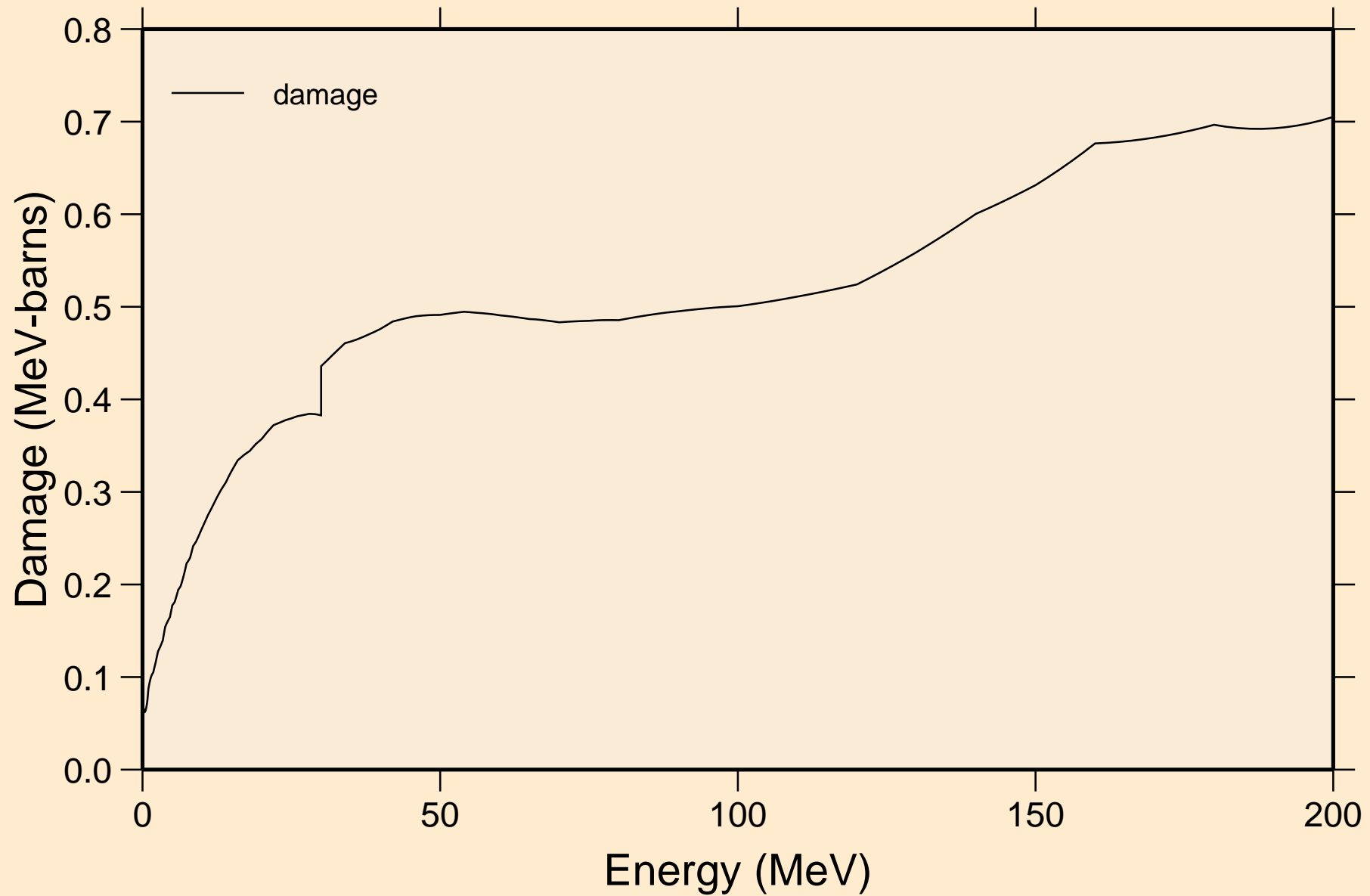

CE125 NEUTRON ACER TENDL-2021 LIBRARY; T=293.6K
Non-threshold reactions

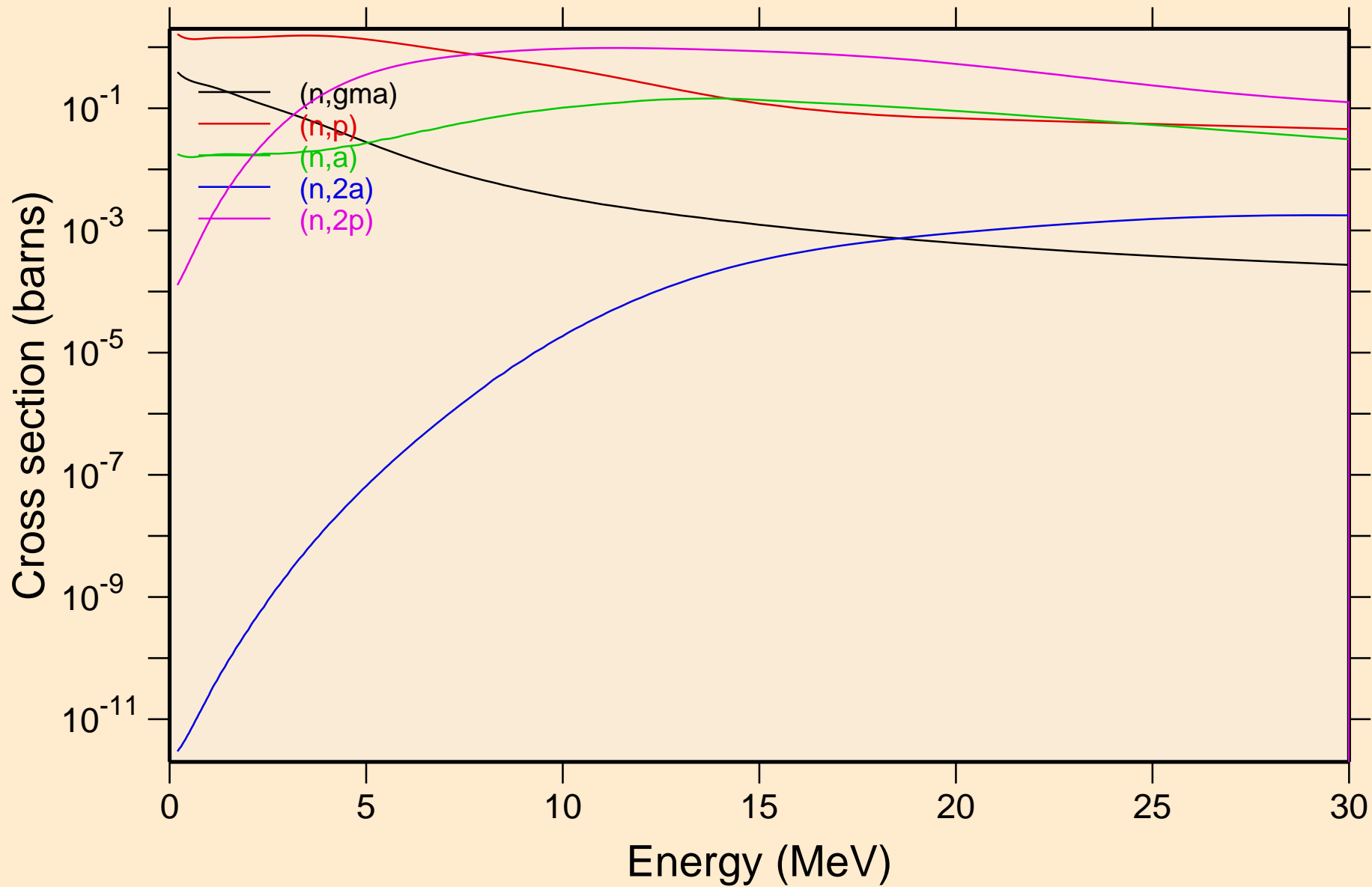

CE125 NEUTRON ACER TENDL-2021 LIBRARY; T=293.6K
Non-threshold reactions

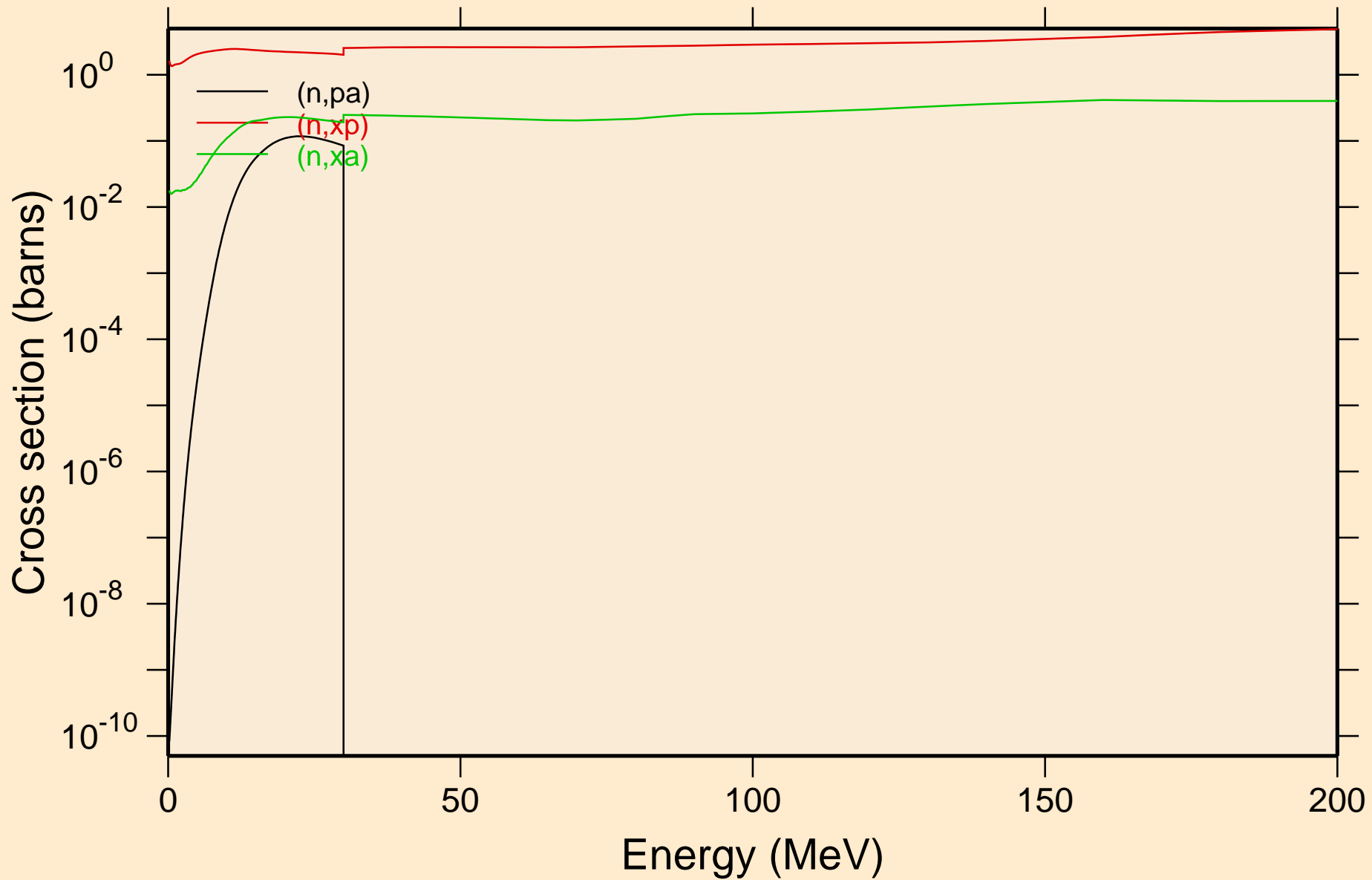

CE125 NEUTRON ACER TENDL-2021 LIBRARY; T=293.6K
Inelastic levels

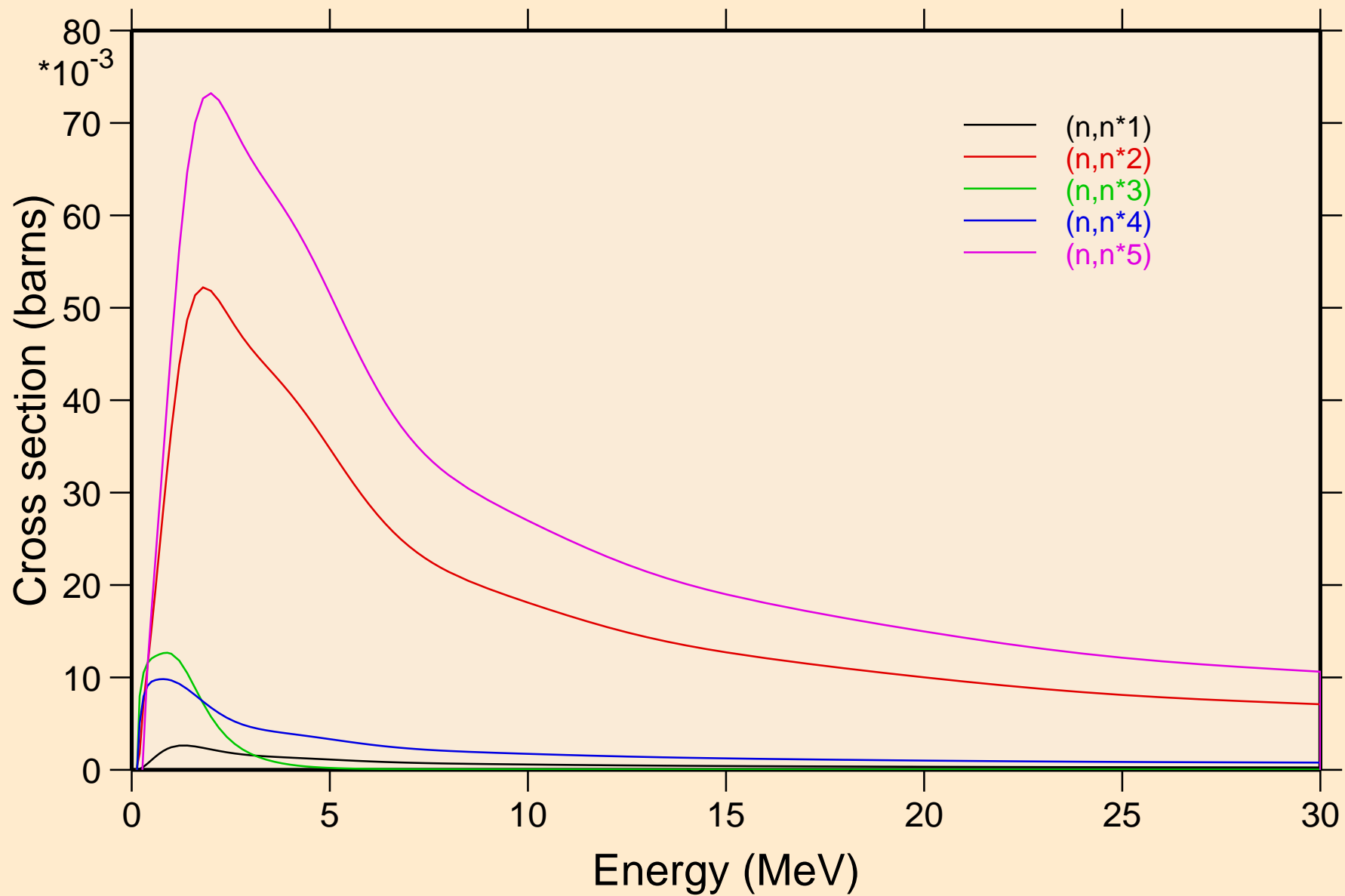

CE125 NEUTRON ACER TENDL-2021 LIBRARY; T=293.6K
Inelastic levels

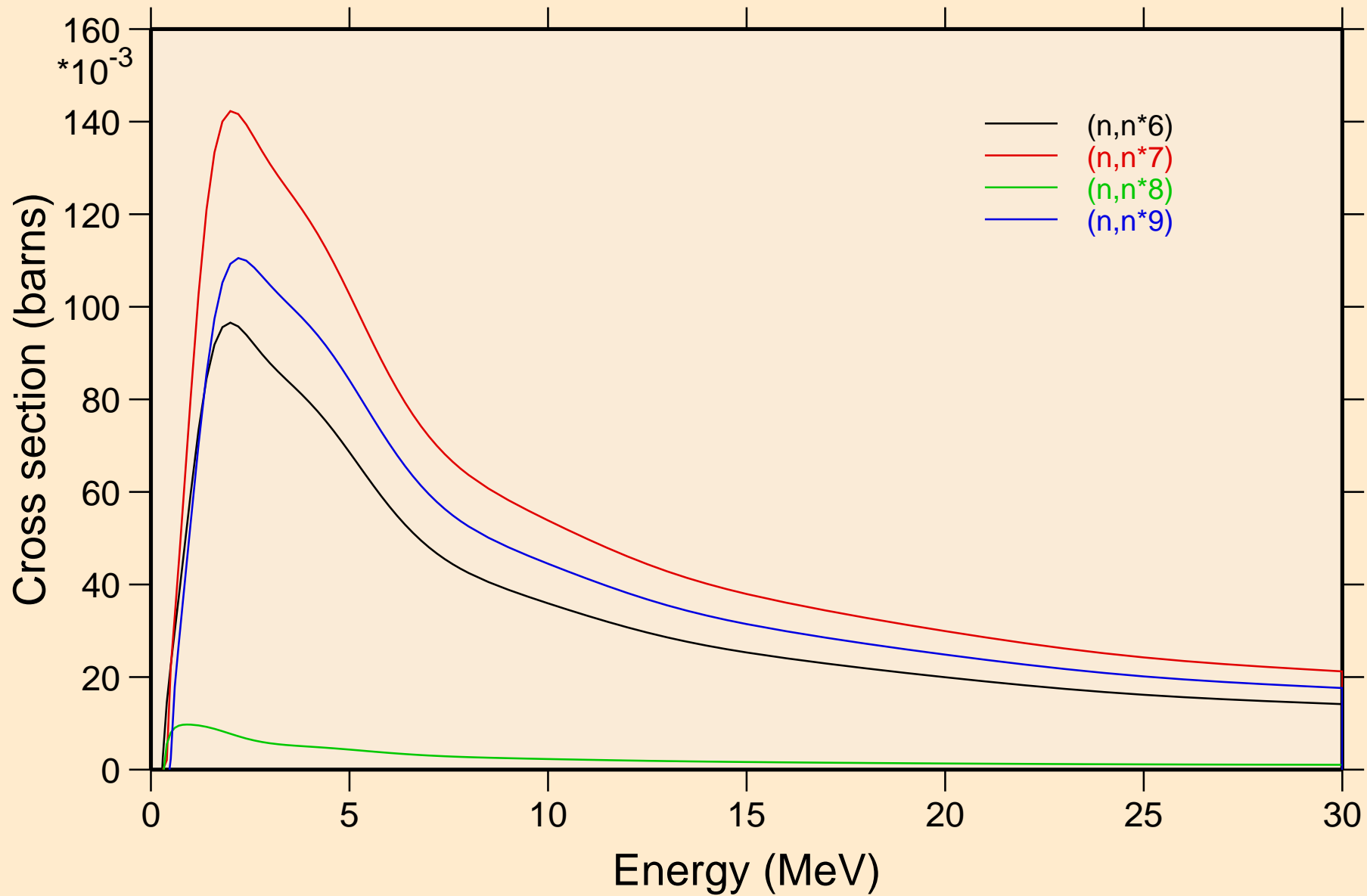

CE125 NEUTRON ACER TENDL-2021 LIBRARY; T=293.6K
Threshold reactions

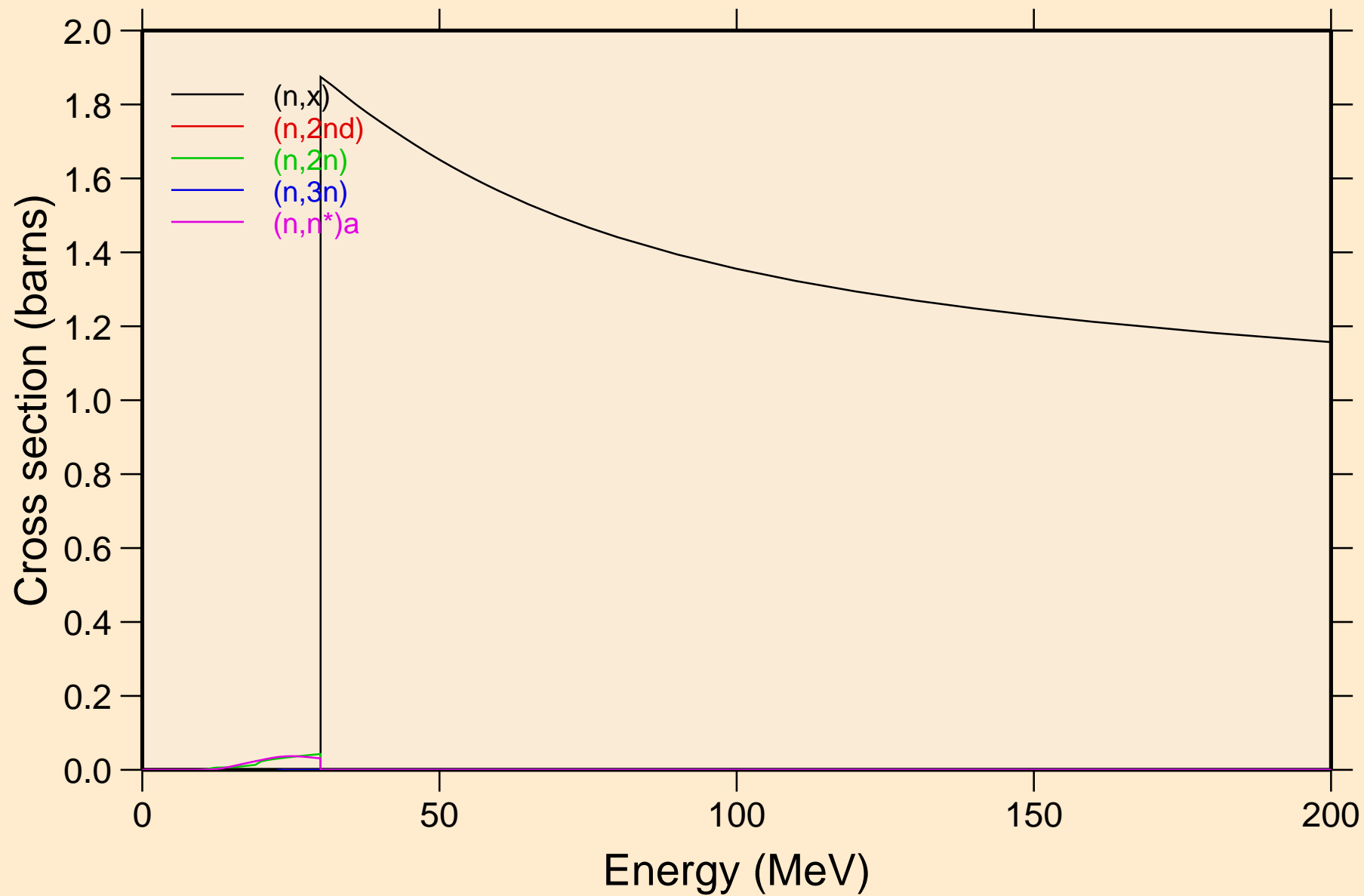

CE125 NEUTRON ACER TENDL-2021 LIBRARY; T=293.6K
Threshold reactions

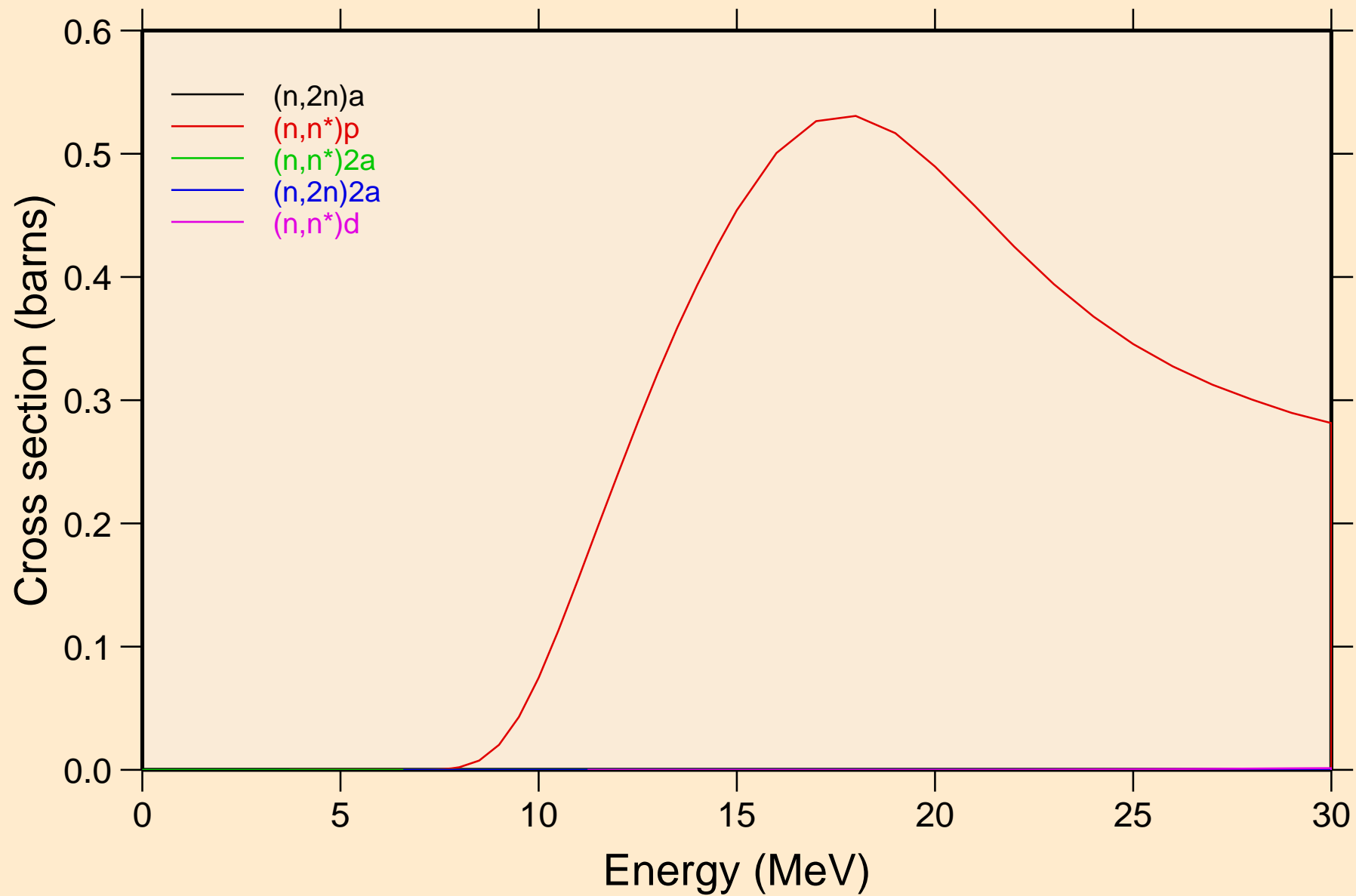

CE125 NEUTRON ACER TENDL-2021 LIBRARY; T=293.6K
Threshold reactions

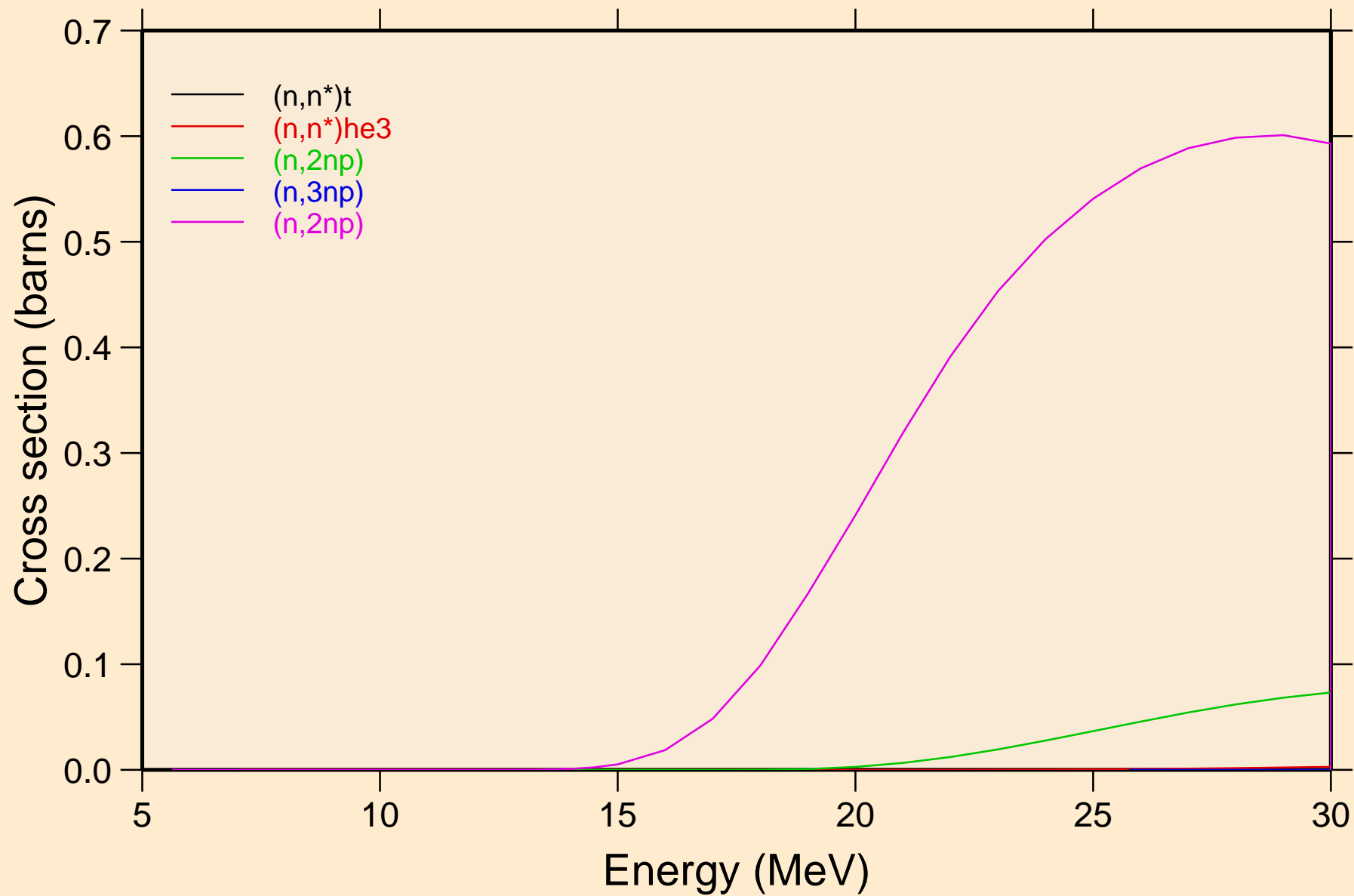

CE125 NEUTRON ACER TENDL-2021 LIBRARY; T=293.6K
Threshold reactions

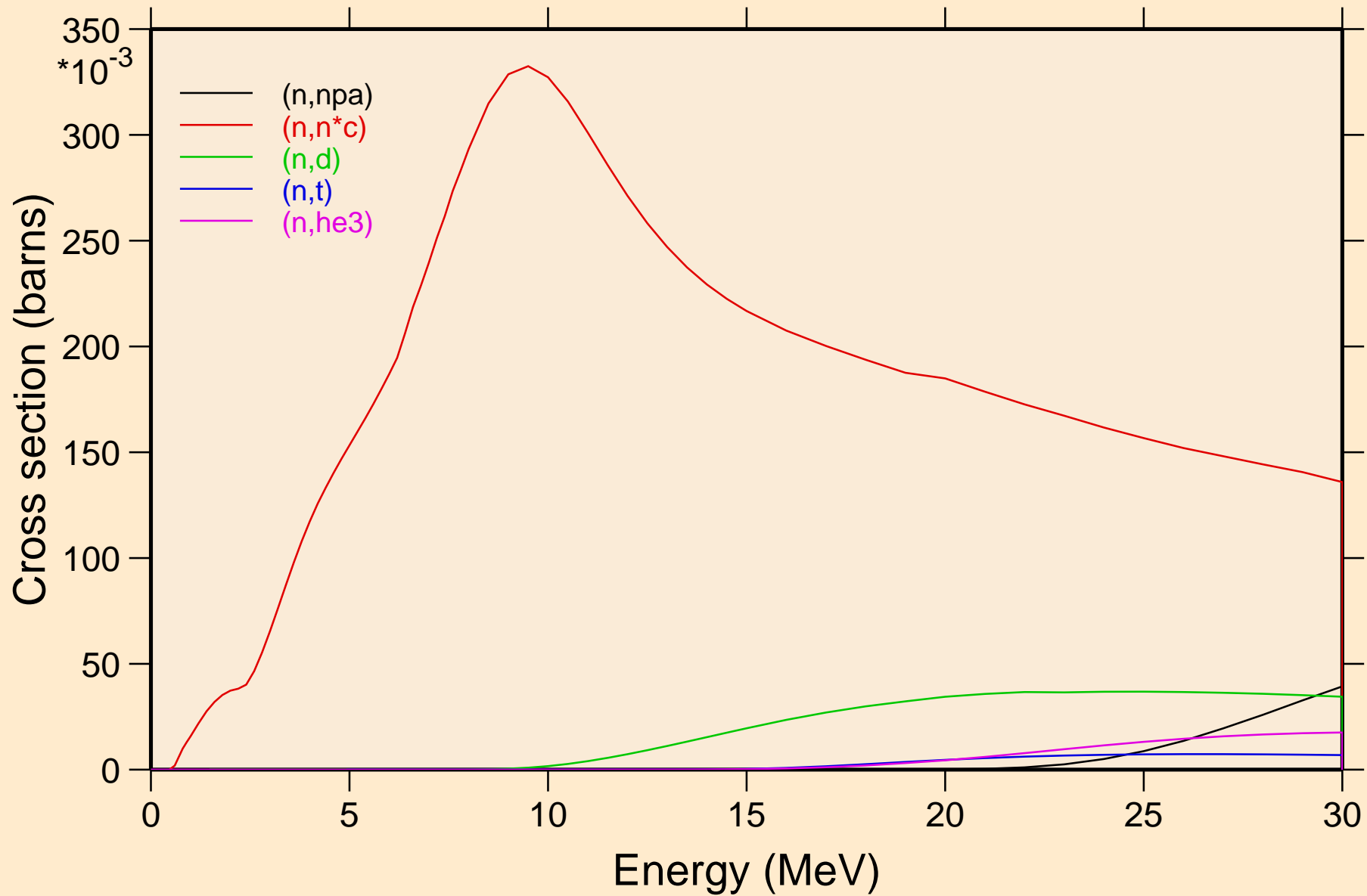

CE125 NEUTRON ACER TENDL-2021 LIBRARY; T=293.6K

Threshold reactions

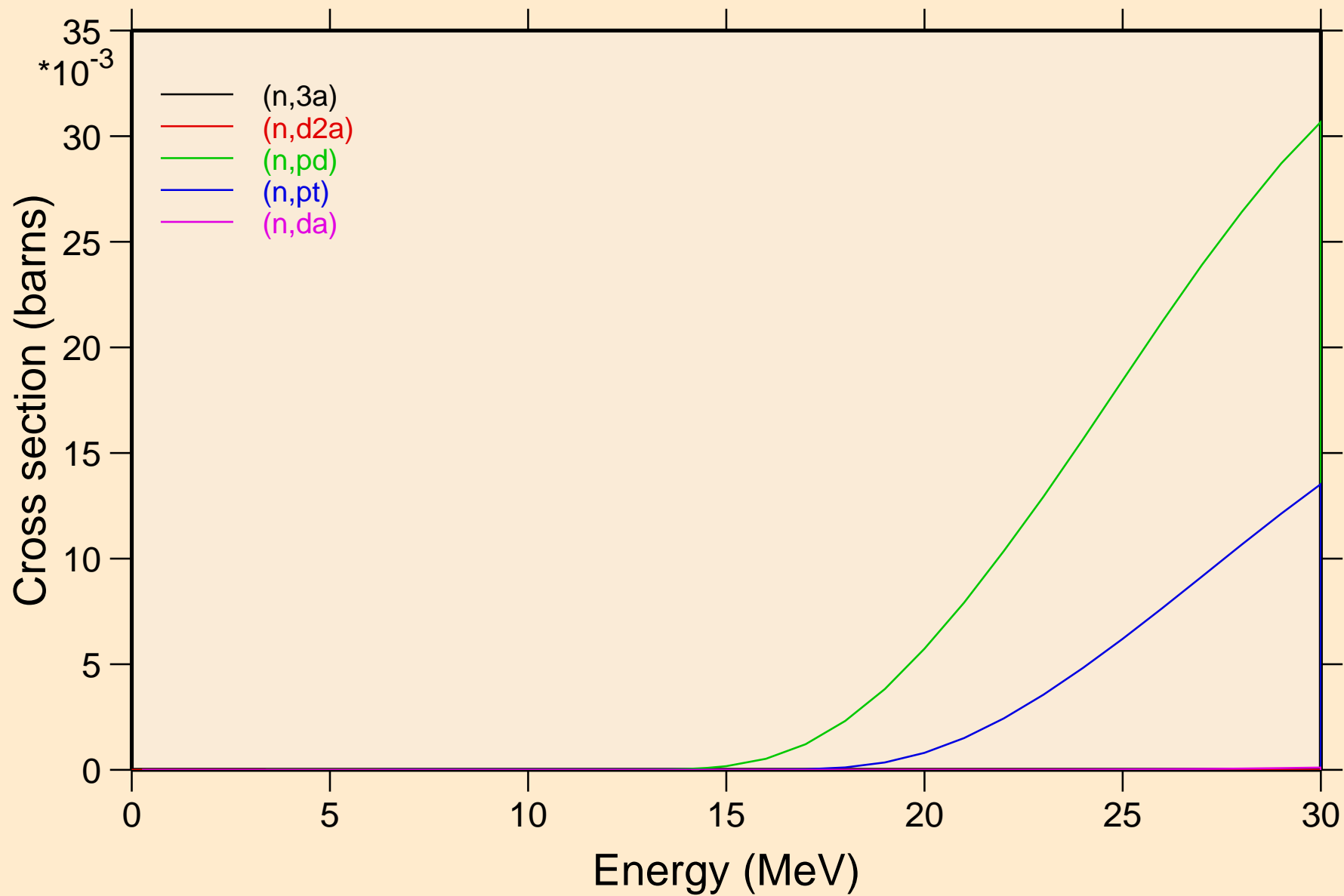

CE125 NEUTRON ACER TENDL-2021 LIBRARY; T=293.6K
Threshold reactions

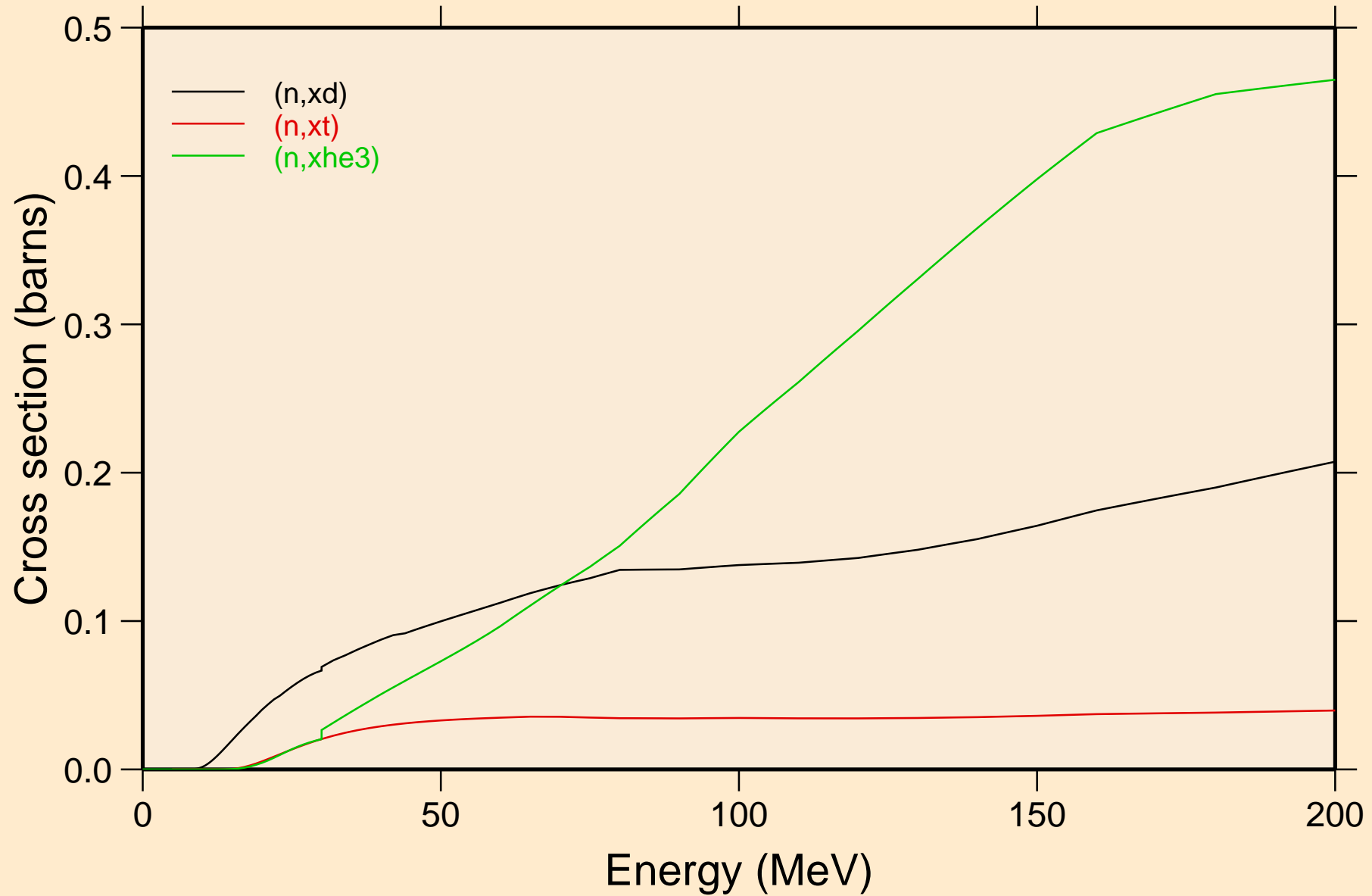

CE125 NEUTRON ACER TENDL-2021 LIBRARY; T=293.6K
angular distribution for elastic

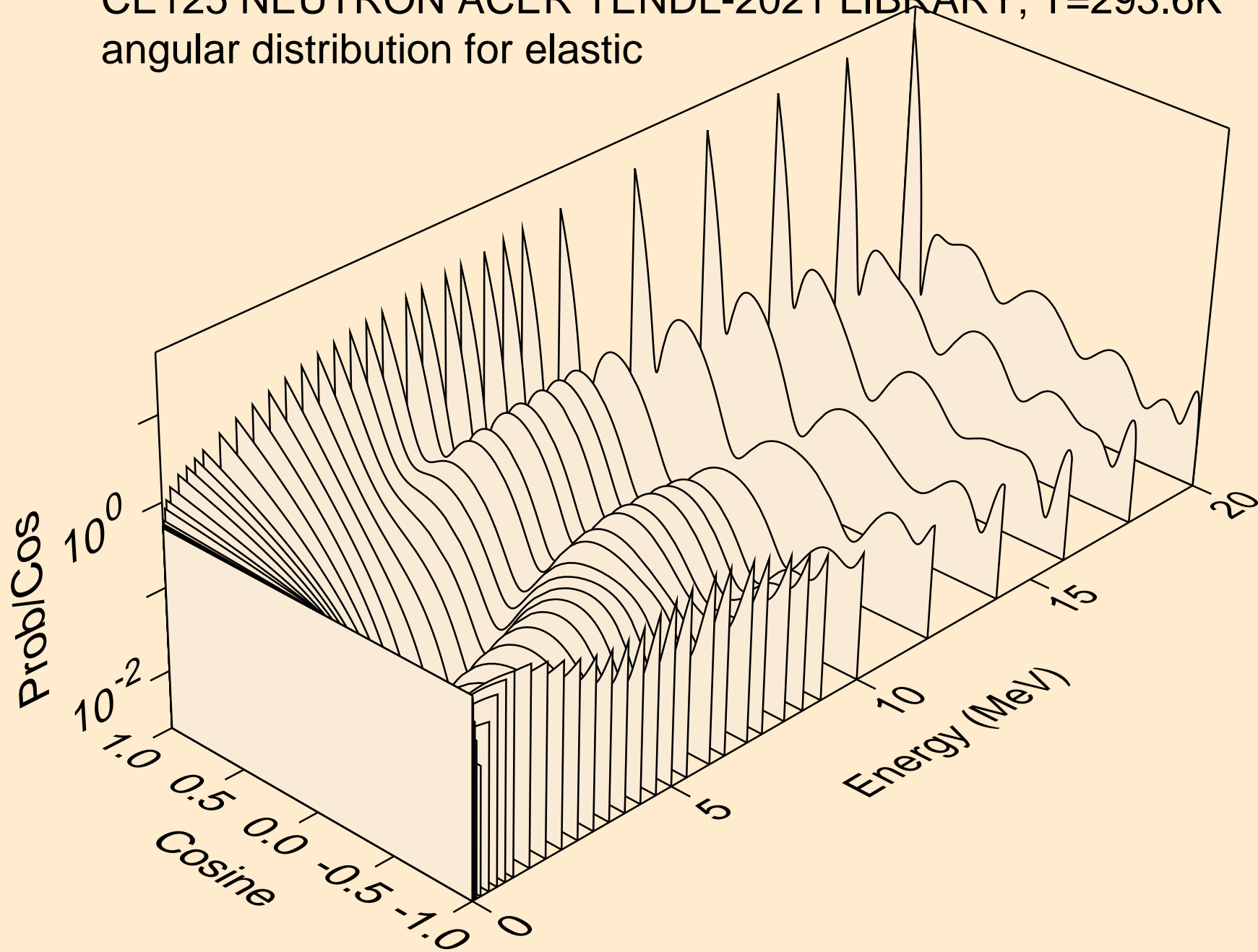

CE125 NEUTRON ACER TENDL-2021 LIBRARY; T=293.6K
angular distribution for elastic

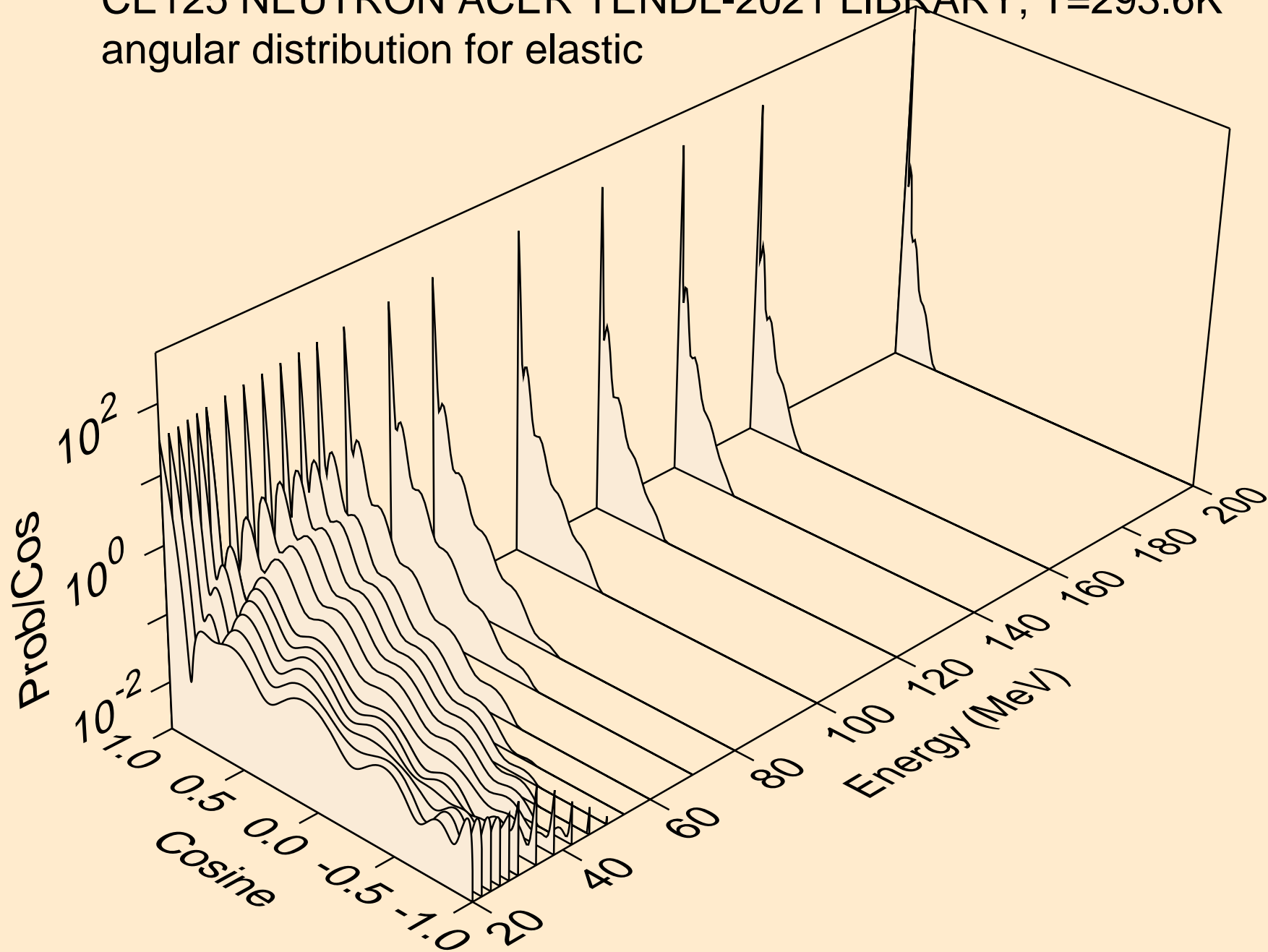

CE125 NEUTRON ACER TENDL-2021 LIBRARY; T=293.6K
angular distribution for (n,n*1)

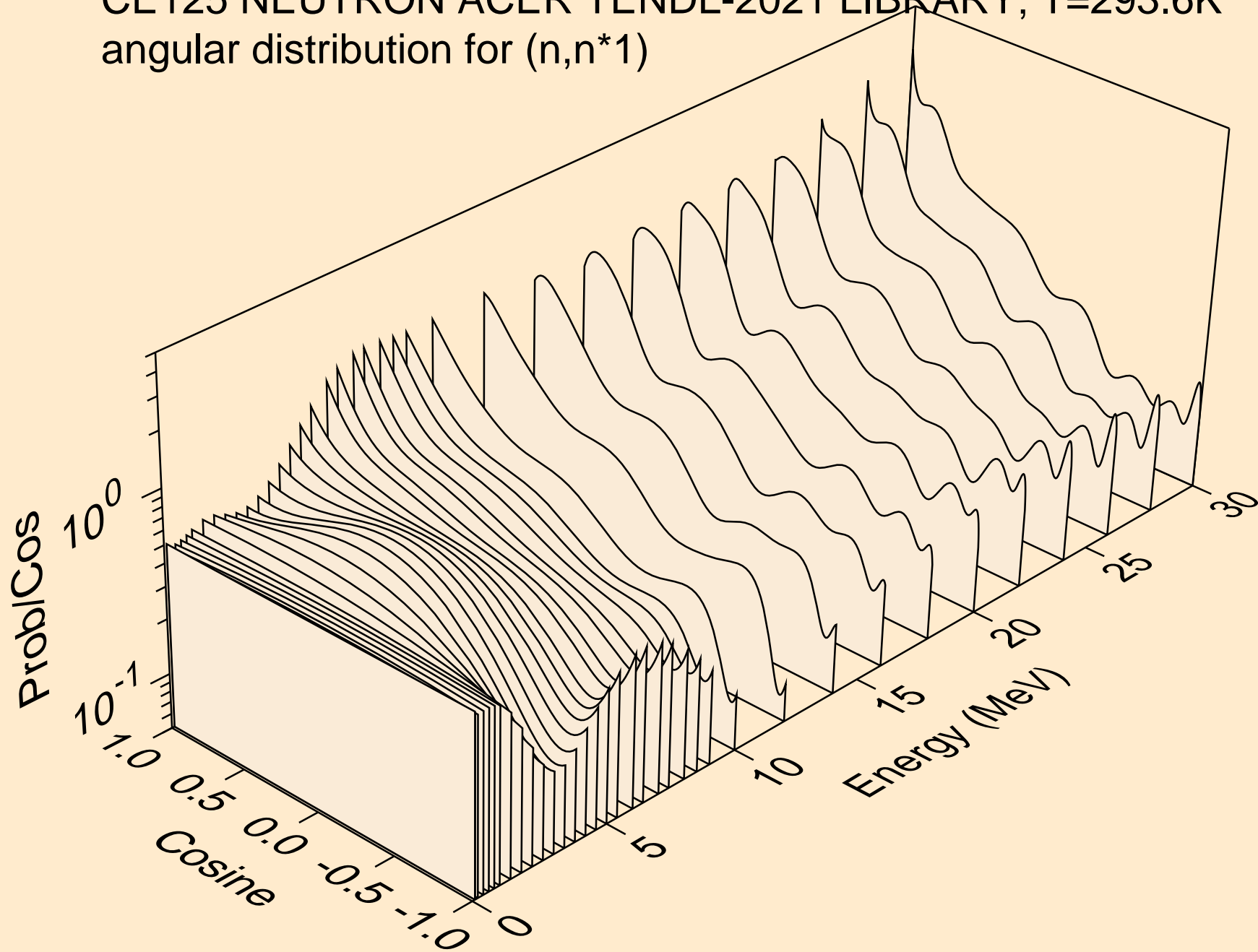

CE125 NEUTRON ACER TENDL-2021 LIBRARY; T=293.6K
angular distribution for (n,n*2)

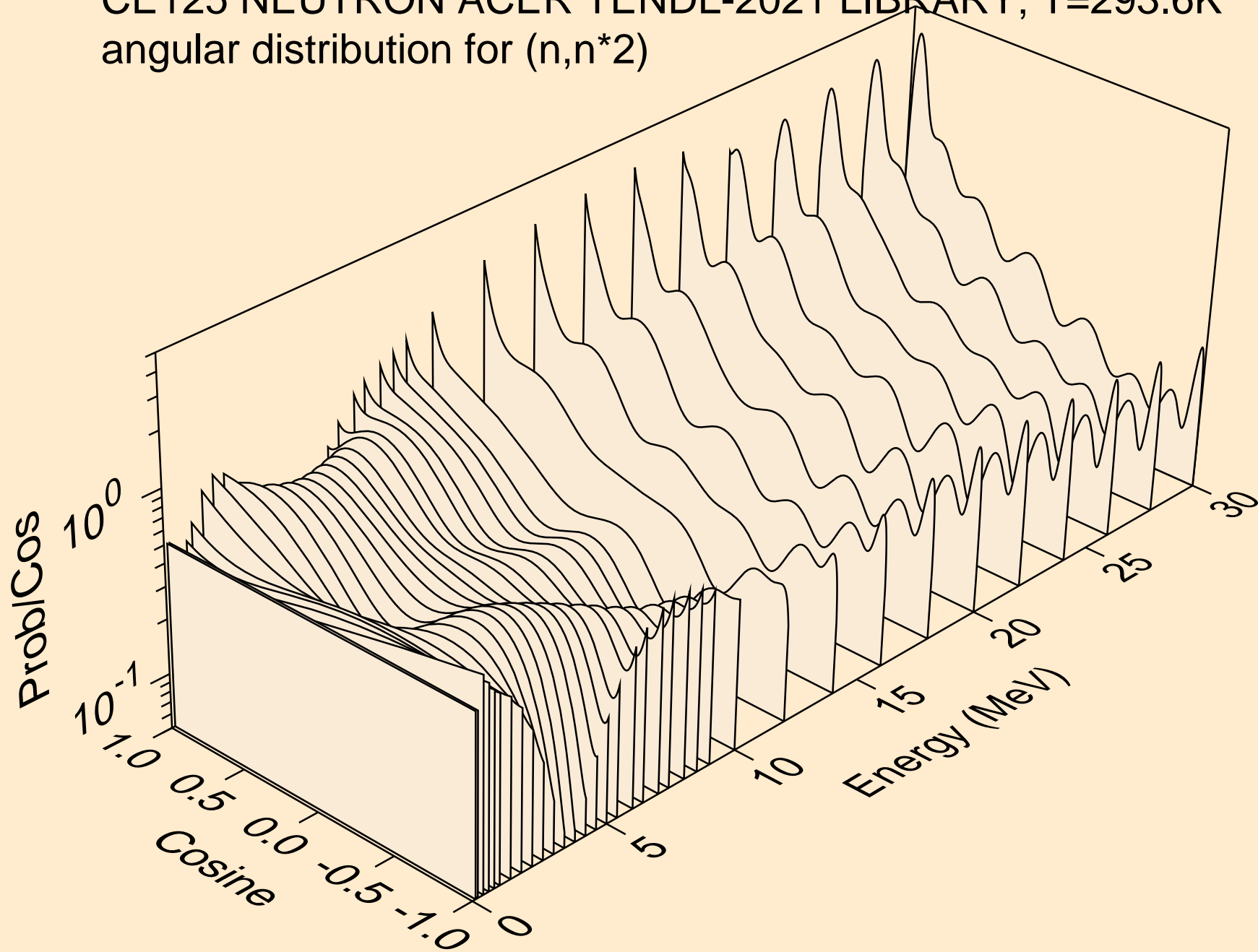

CE125 NEUTRON ACER TENDL-2021 LIBRARY; T=293.6K
angular distribution for (n,n*3)

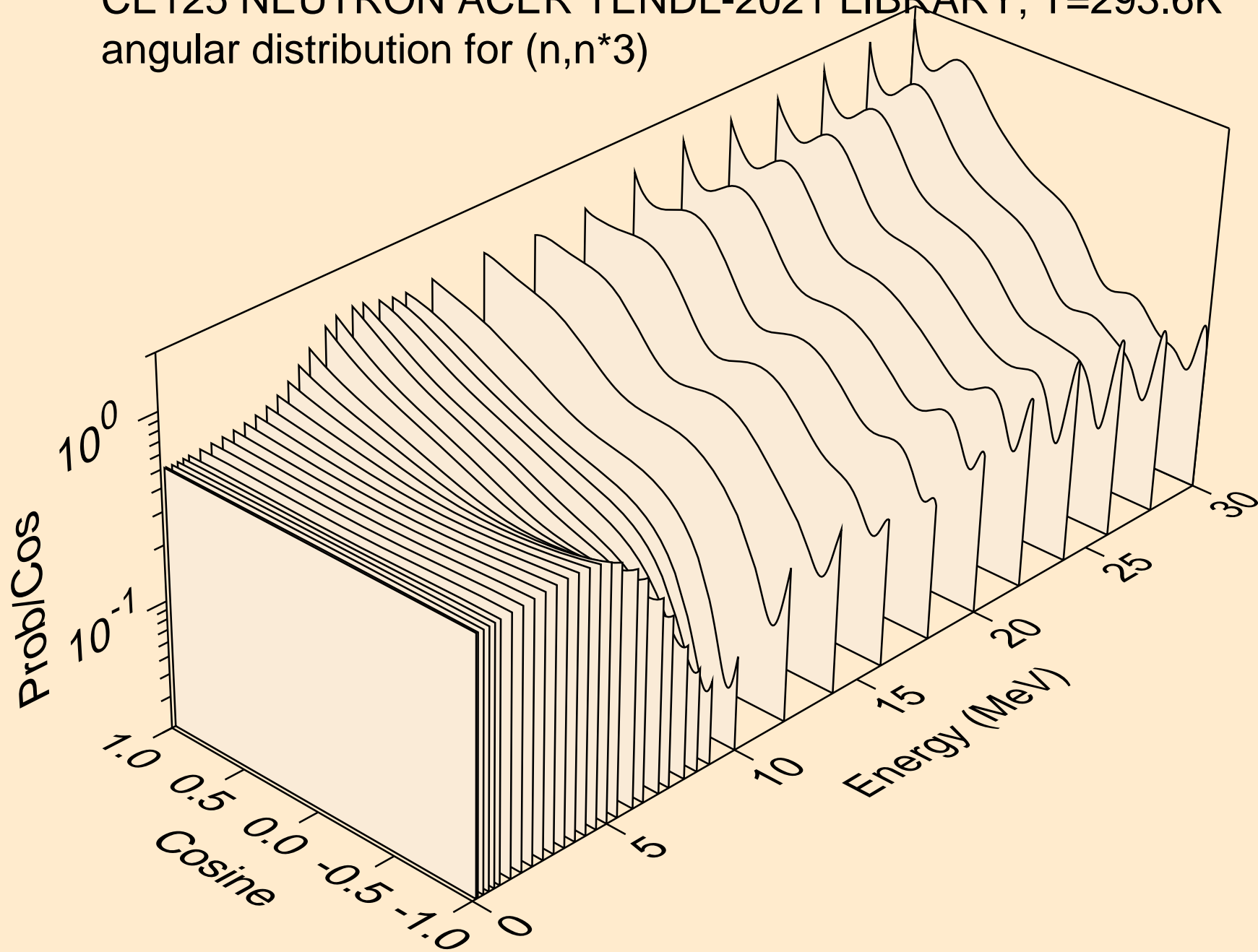

CE125 NEUTRON ACER TENDL-2021 LIBRARY; T=293.6K
angular distribution for (n,n*4)

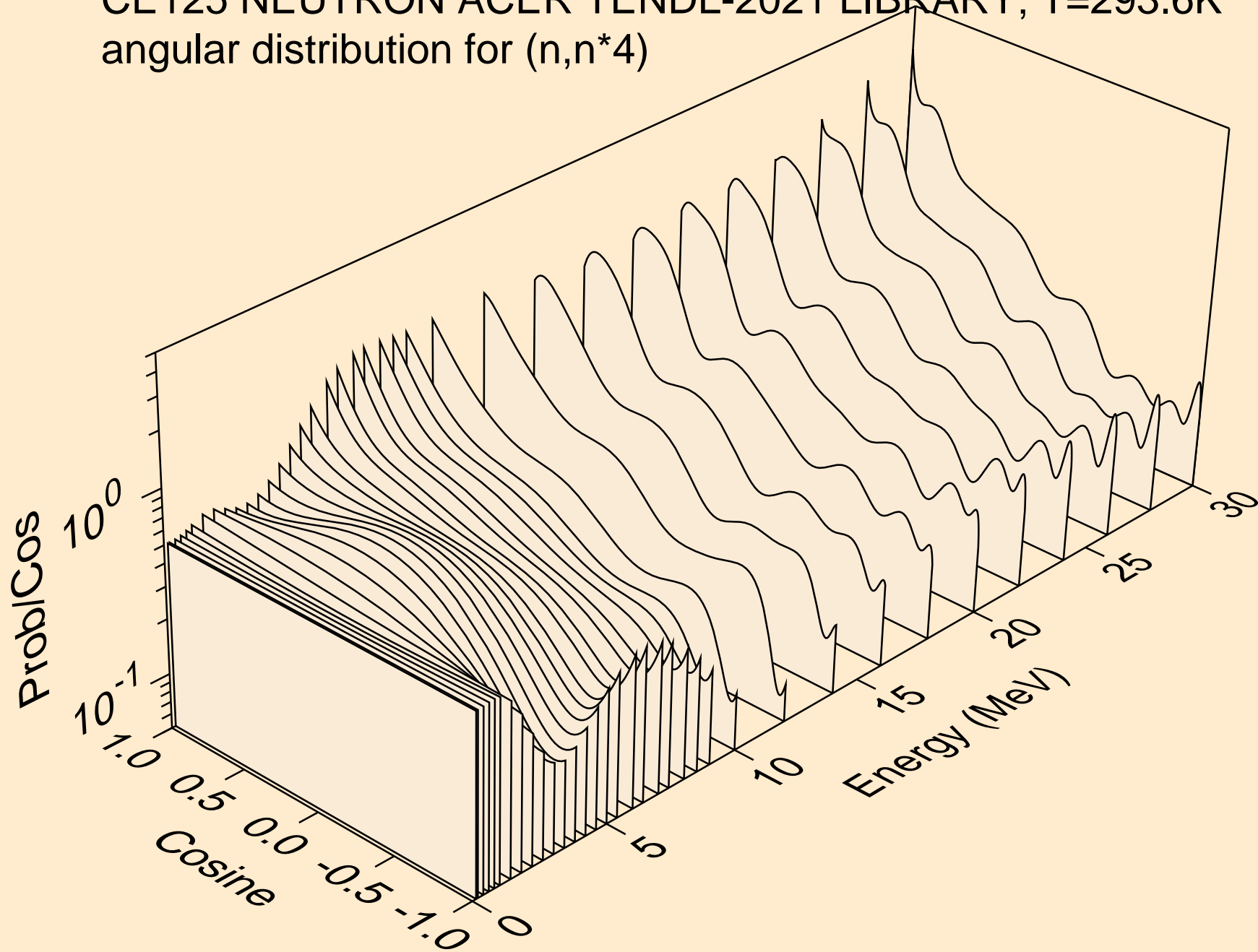

CE125 NEUTRON ACER TENDL-2021 LIBRARY; T=293.6K
angular distribution for (n,n*5)

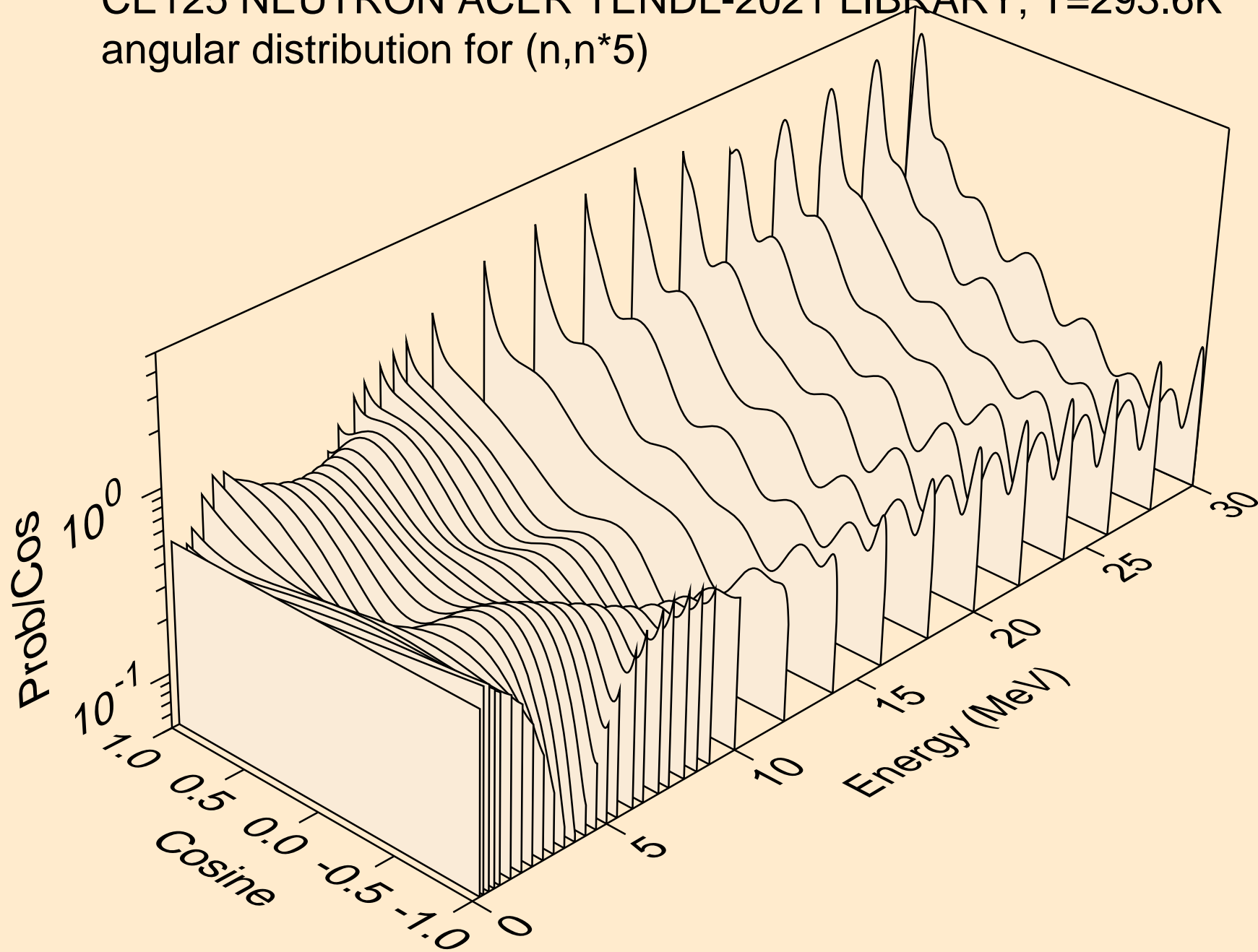

CE125 NEUTRON ACER TENDL-2021 LIBRARY; T=293.6K
angular distribution for (n,n*6)

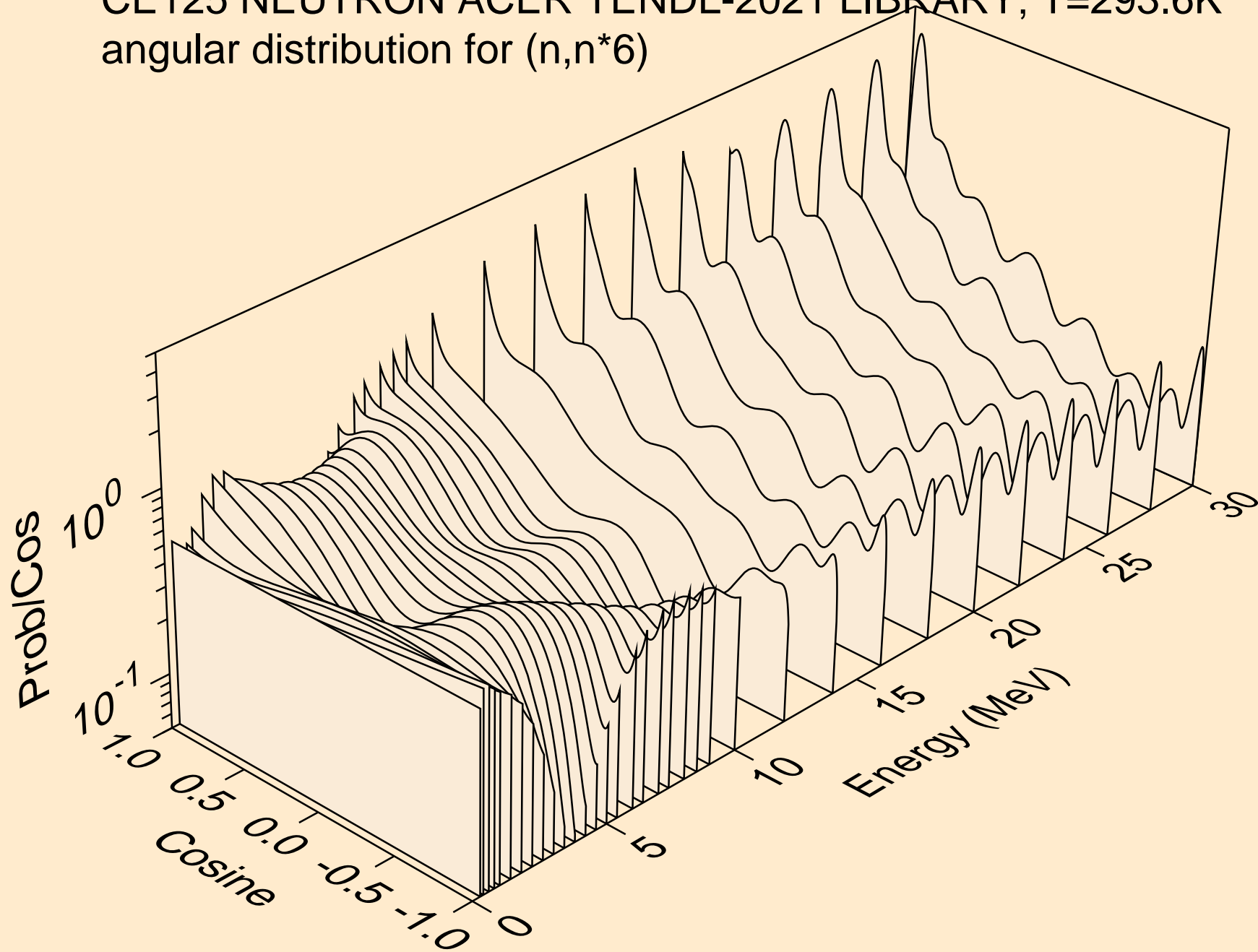

CE125 NEUTRON ACER TENDL-2021 LIBRARY; T=293.6K
angular distribution for (n,n*7)

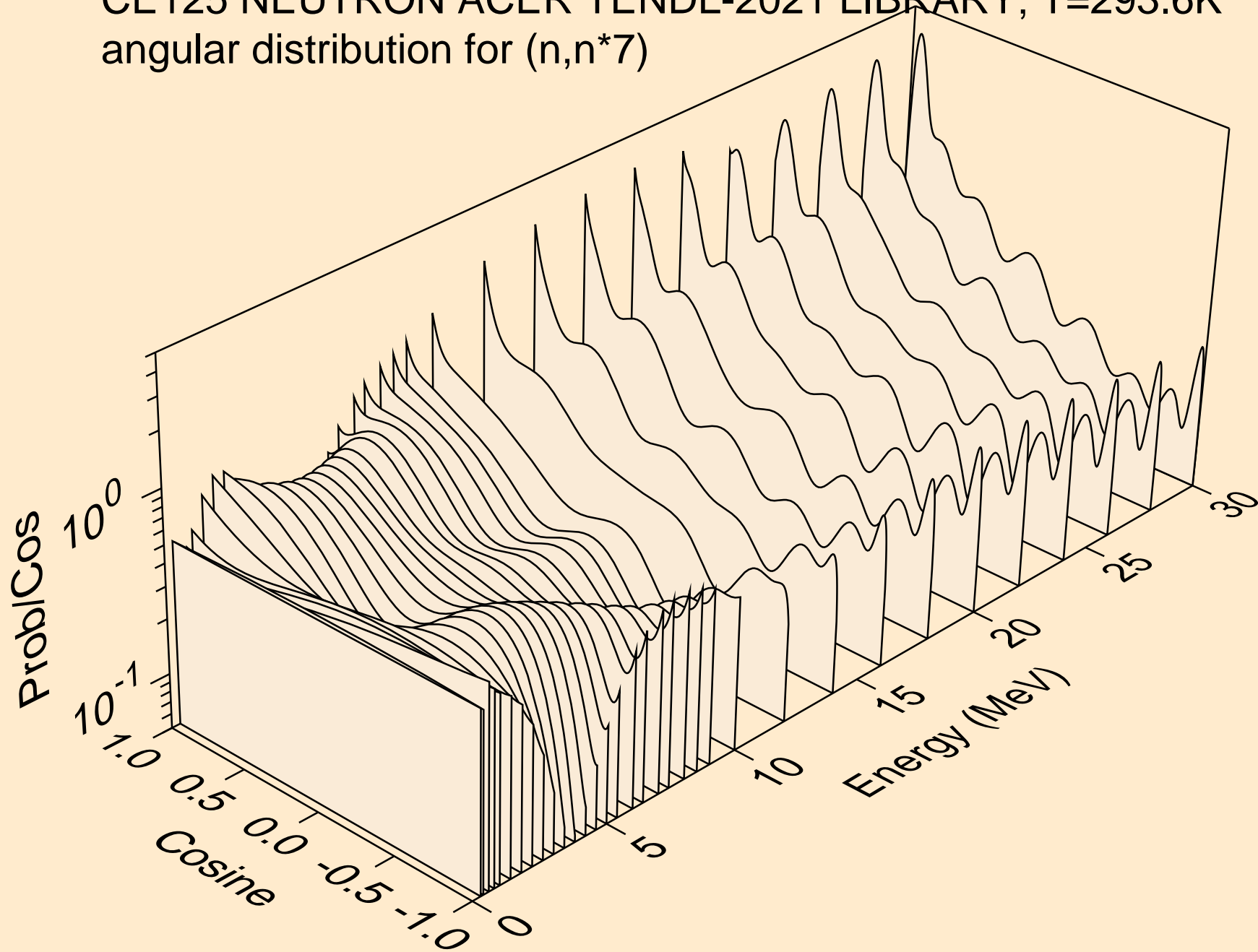

CE125 NEUTRON ACER TENDL-2021 LIBRARY; T=293.6K
angular distribution for (n,n*8)

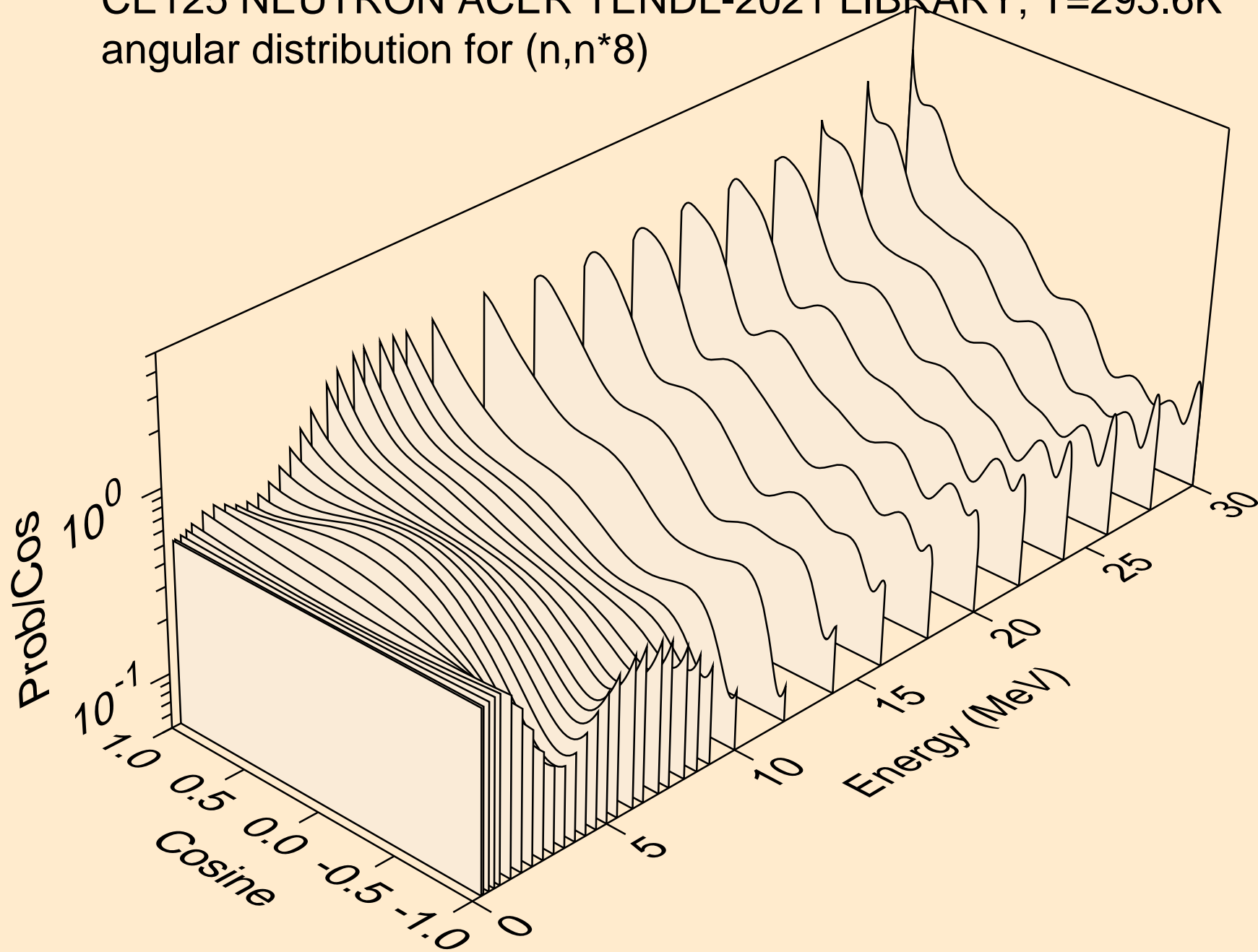

CE125 NEUTRON ACER TENDL-2021 LIBRARY; T=293.6K
angular distribution for (n,n*9)

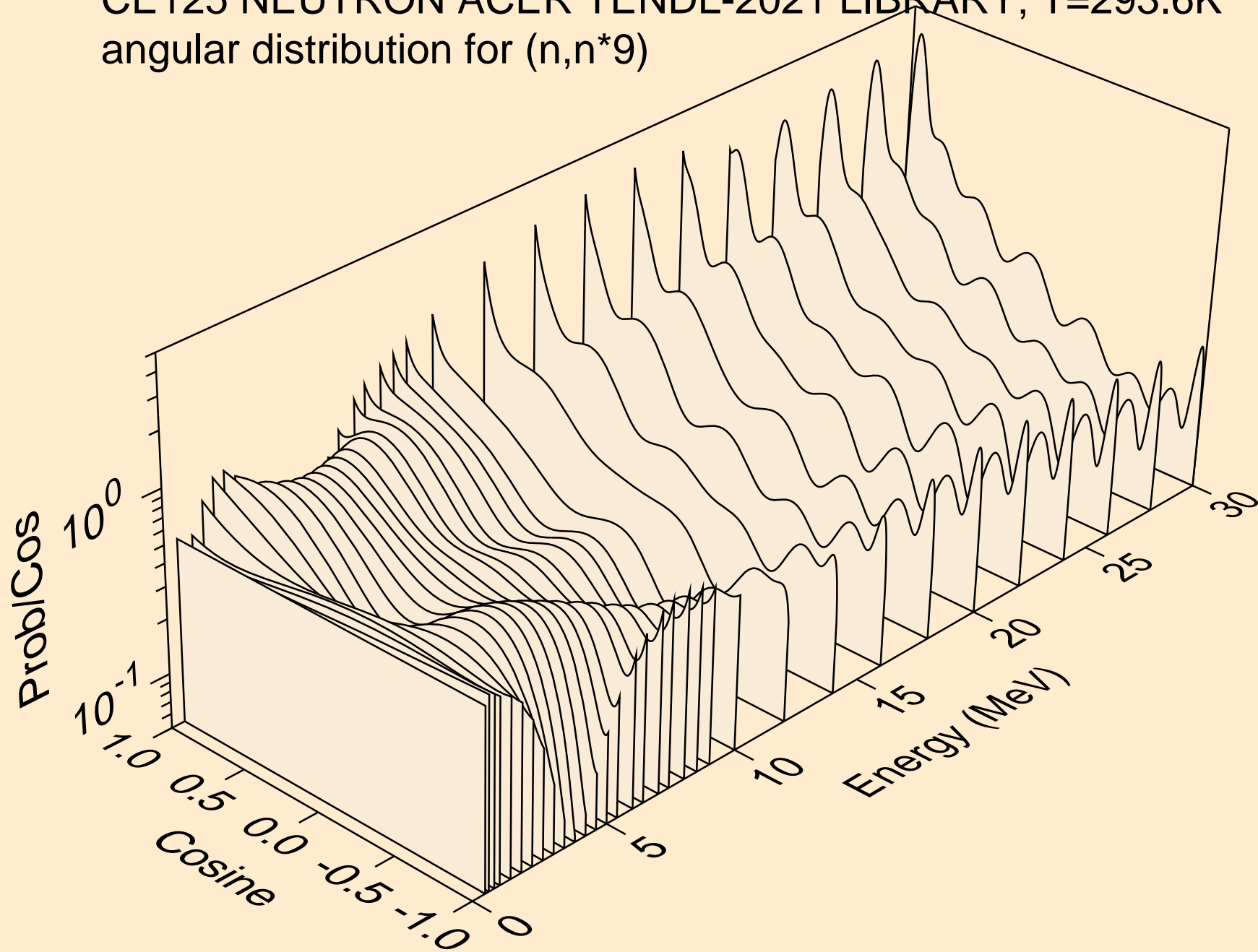

CE125 NEUTRON ACER TENDL-2021 LIBRARY; T=293.6K
Neutron emission for (n,x)

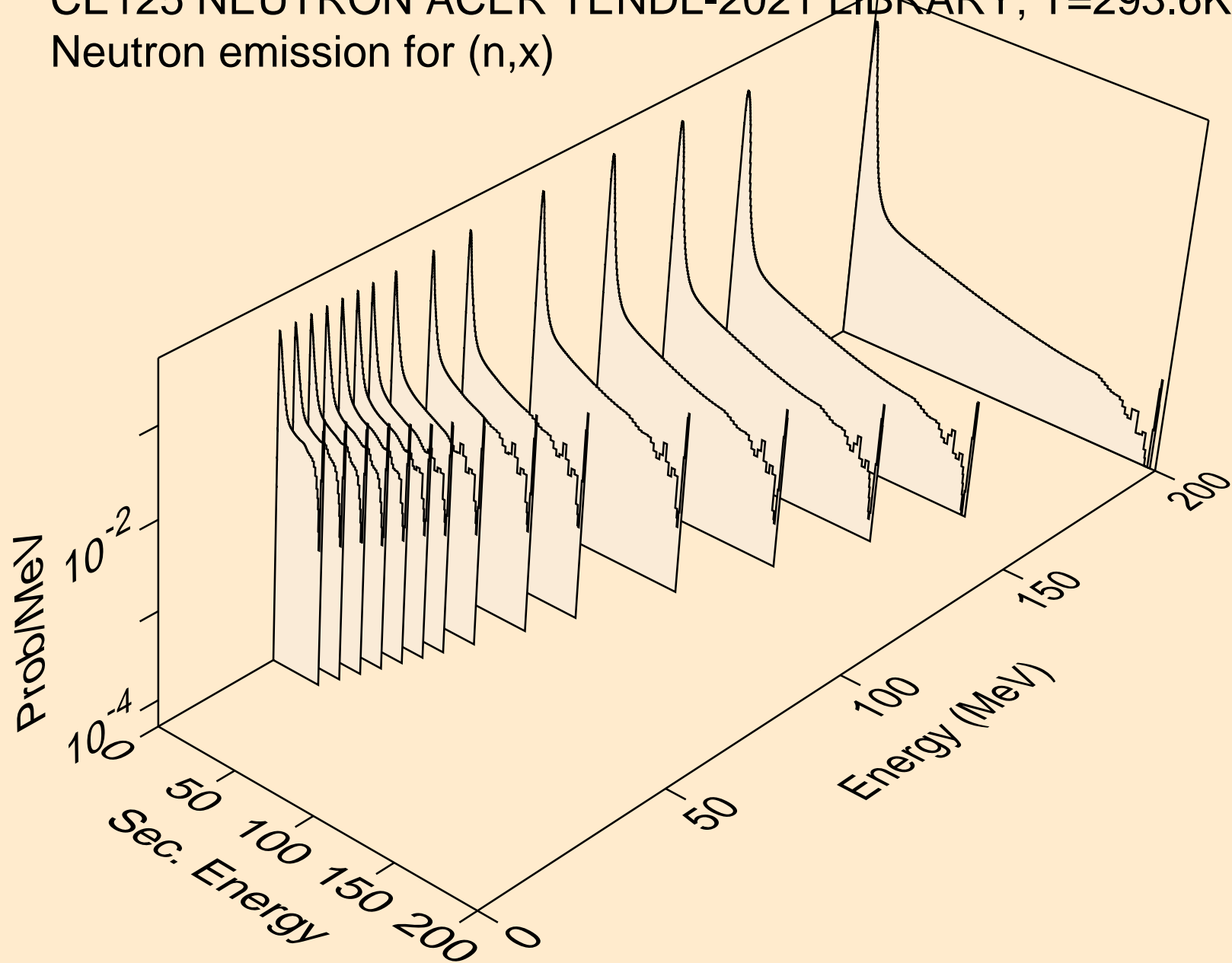

CE125 NEUTRON ACER TENDL-2021 LIBRARY; T=293.6K
Neutron emission for (n,2nd)

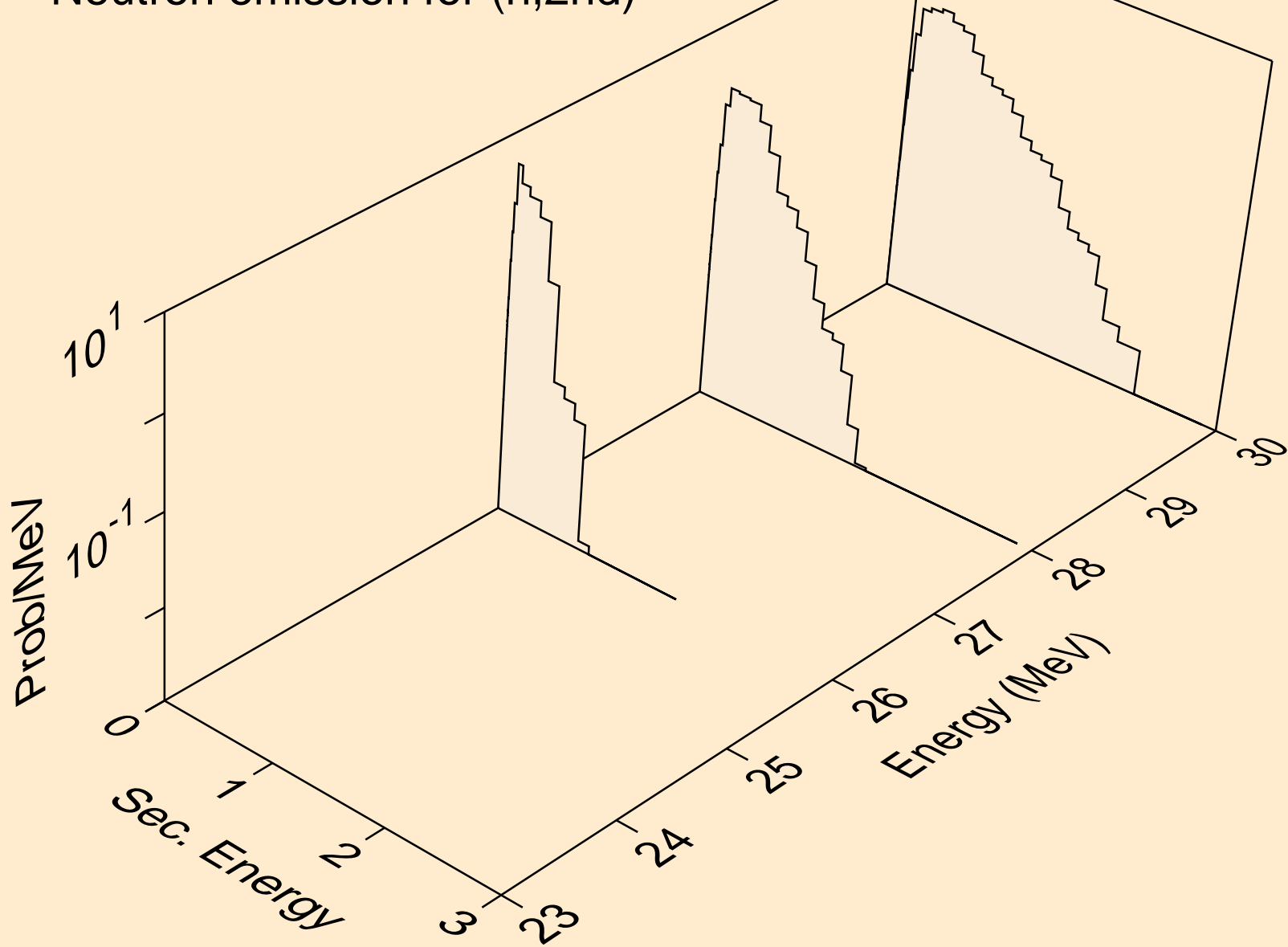

CE125 NEUTRON ACER TENDL-2021 LIBRARY; T=293.6K
Neutron emission for (n,2n)

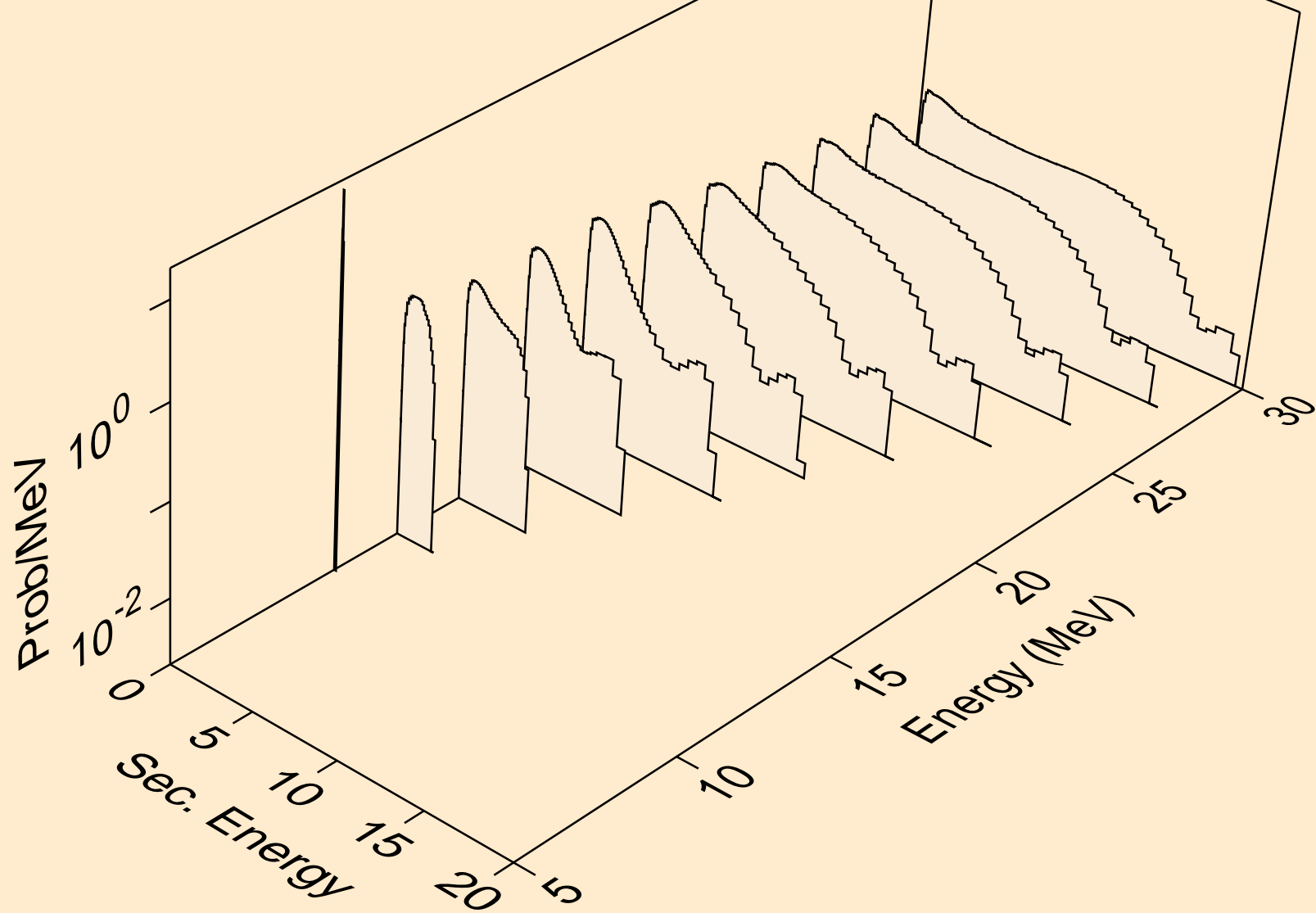

CE125 NEUTRON ACER TENDL-2021 LIBRARY; T=293.6K
Neutron emission for (n,3n)

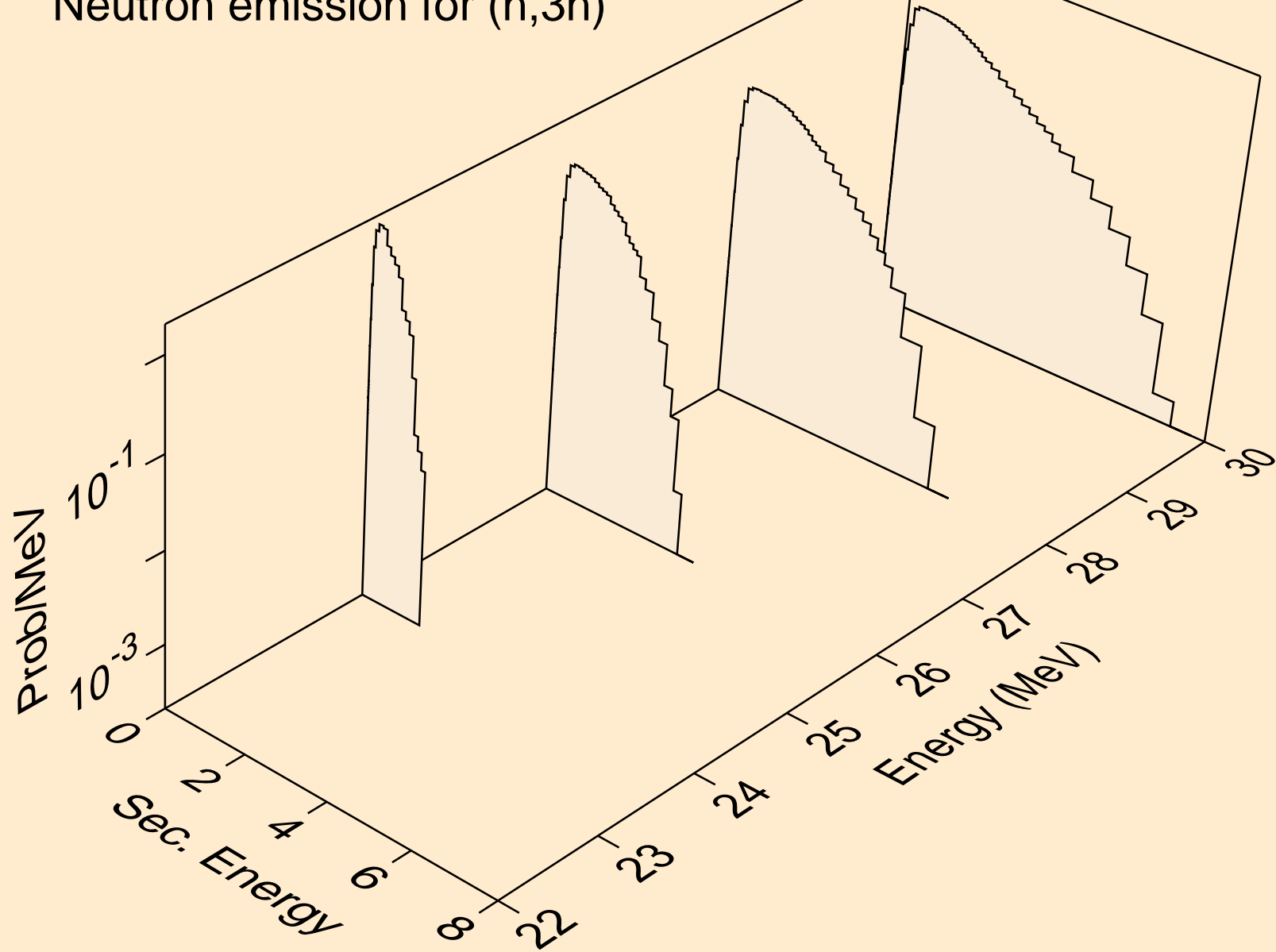

CE125 NEUTRON ACER TENDL-2021 LIBRARY; T=293.6K
Neutron emission for (n,n*)a

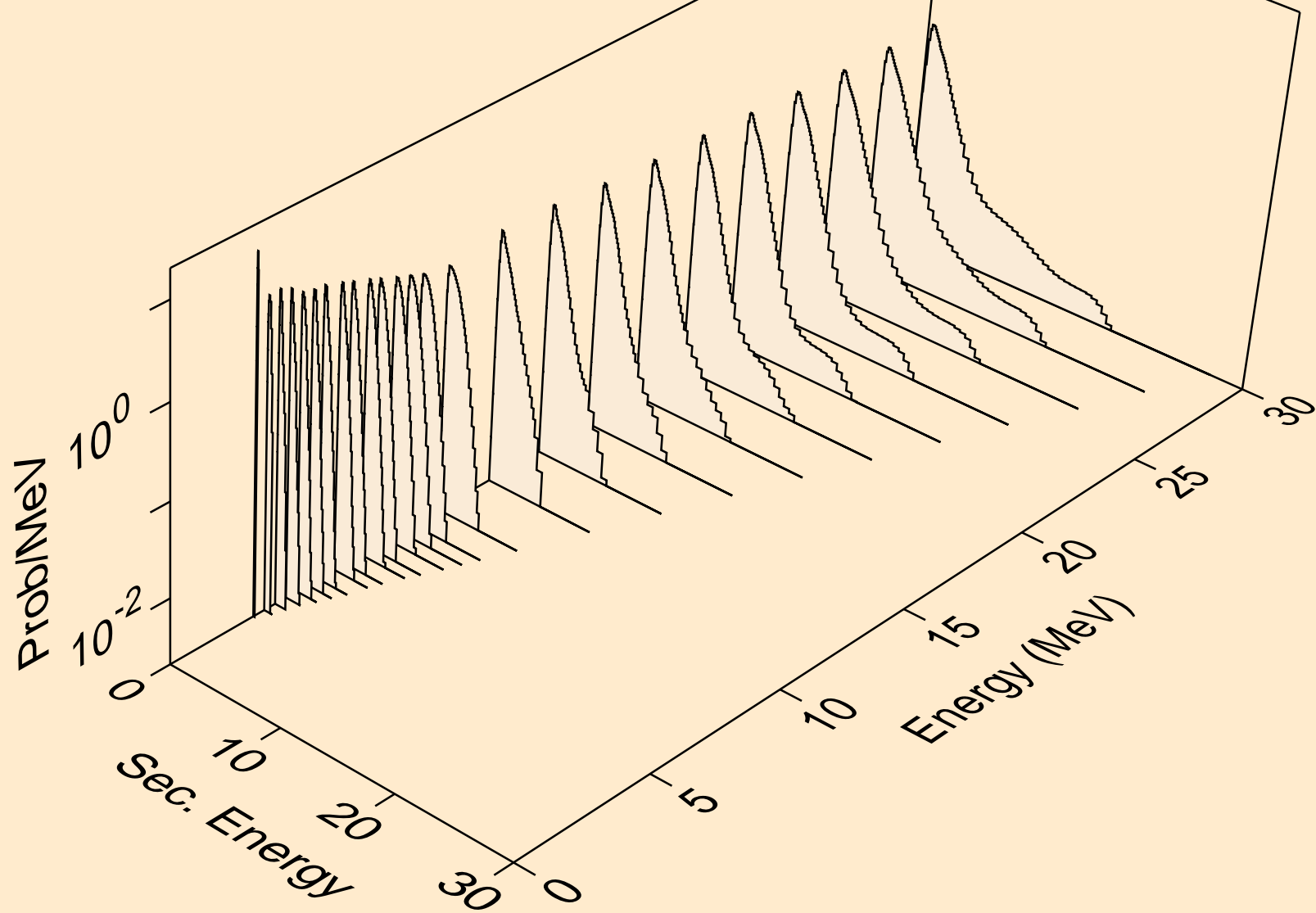

CE125 NEUTRON ACER TENDL-2021 LIBRARY; T=293.6K
Neutron emission for (n,2n)_a

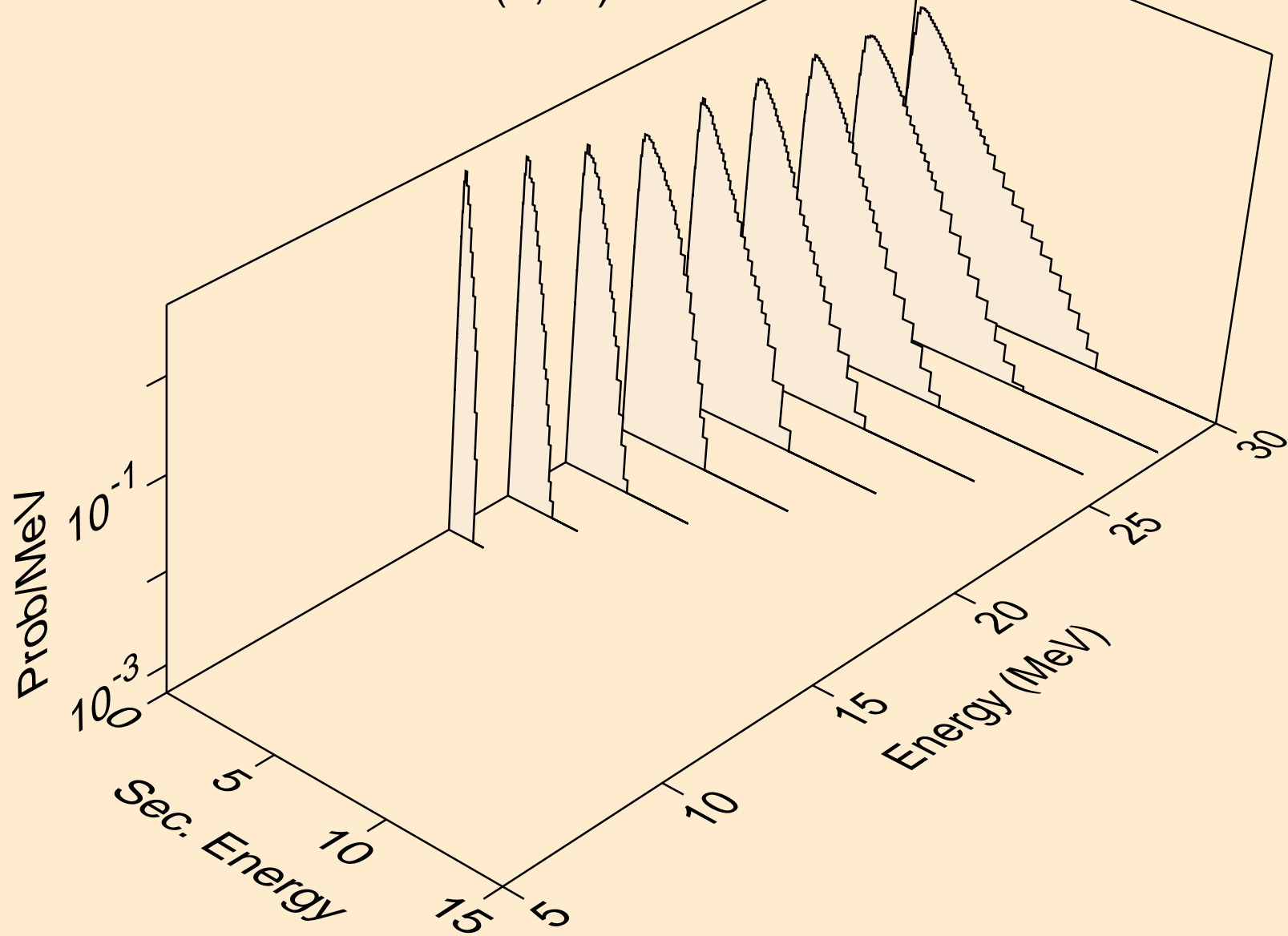

CE125 NEUTRON ACER TENDL-2021 LIBRARY; T=293.6K
Neutron emission for (n,n*)p

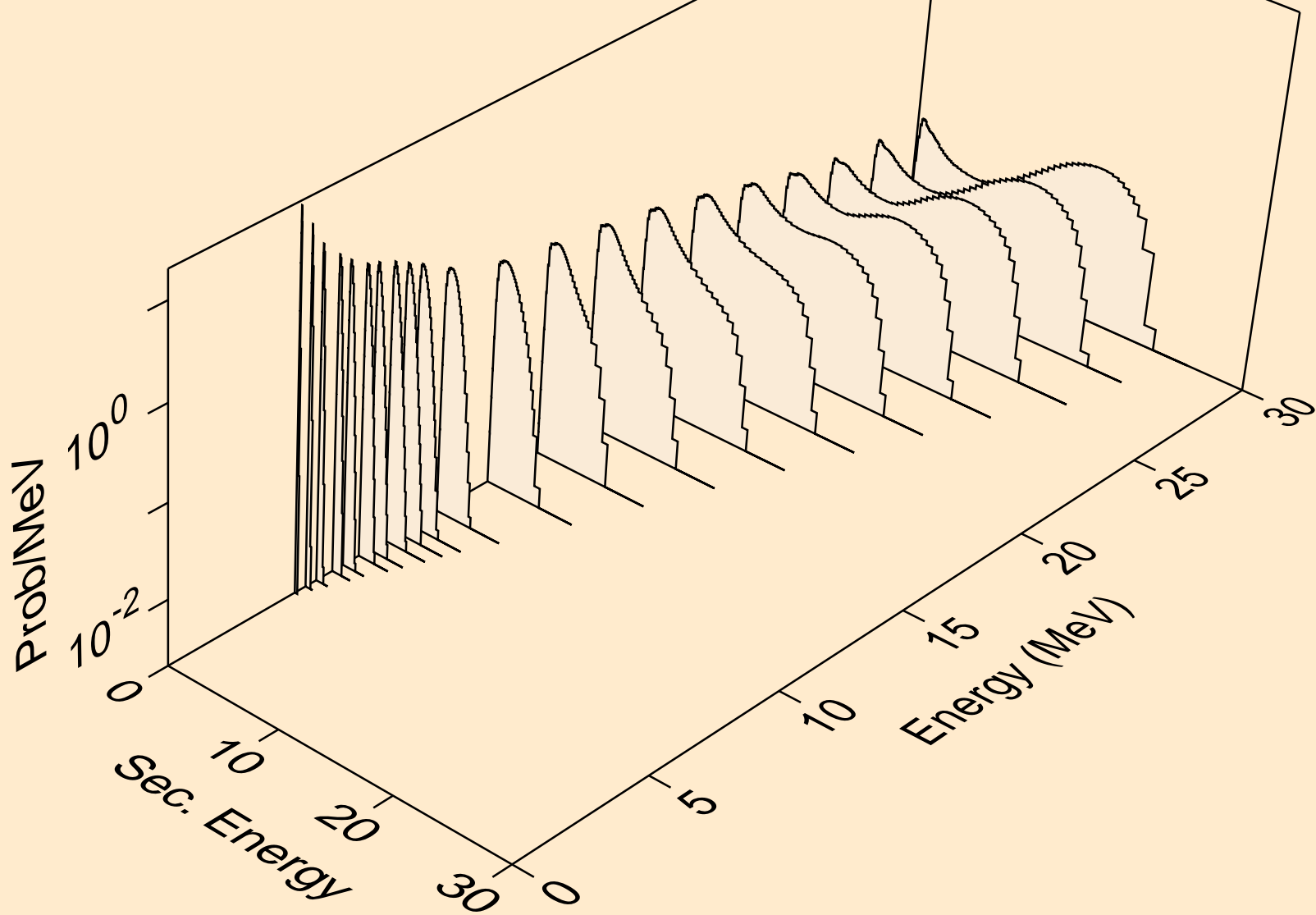

CE125 NEUTRON ACER TENDL-2021 LIBRARY; T=293.6K
Neutron emission for (n,n*)2a

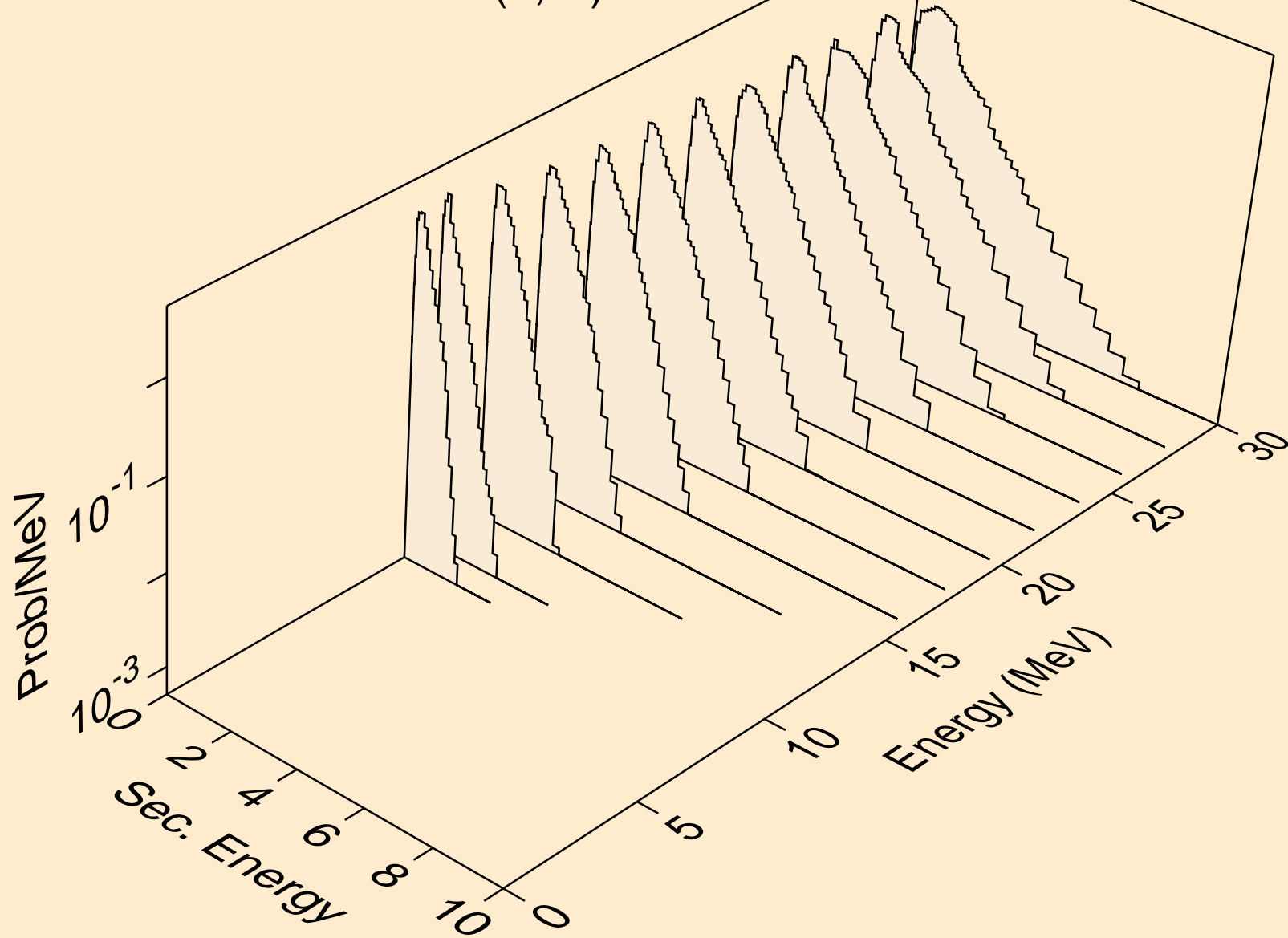

CE125 NEUTRON ACER TENDL-2021 LIBRARY; T=293.6K
Neutron emission for (n,2n)2a

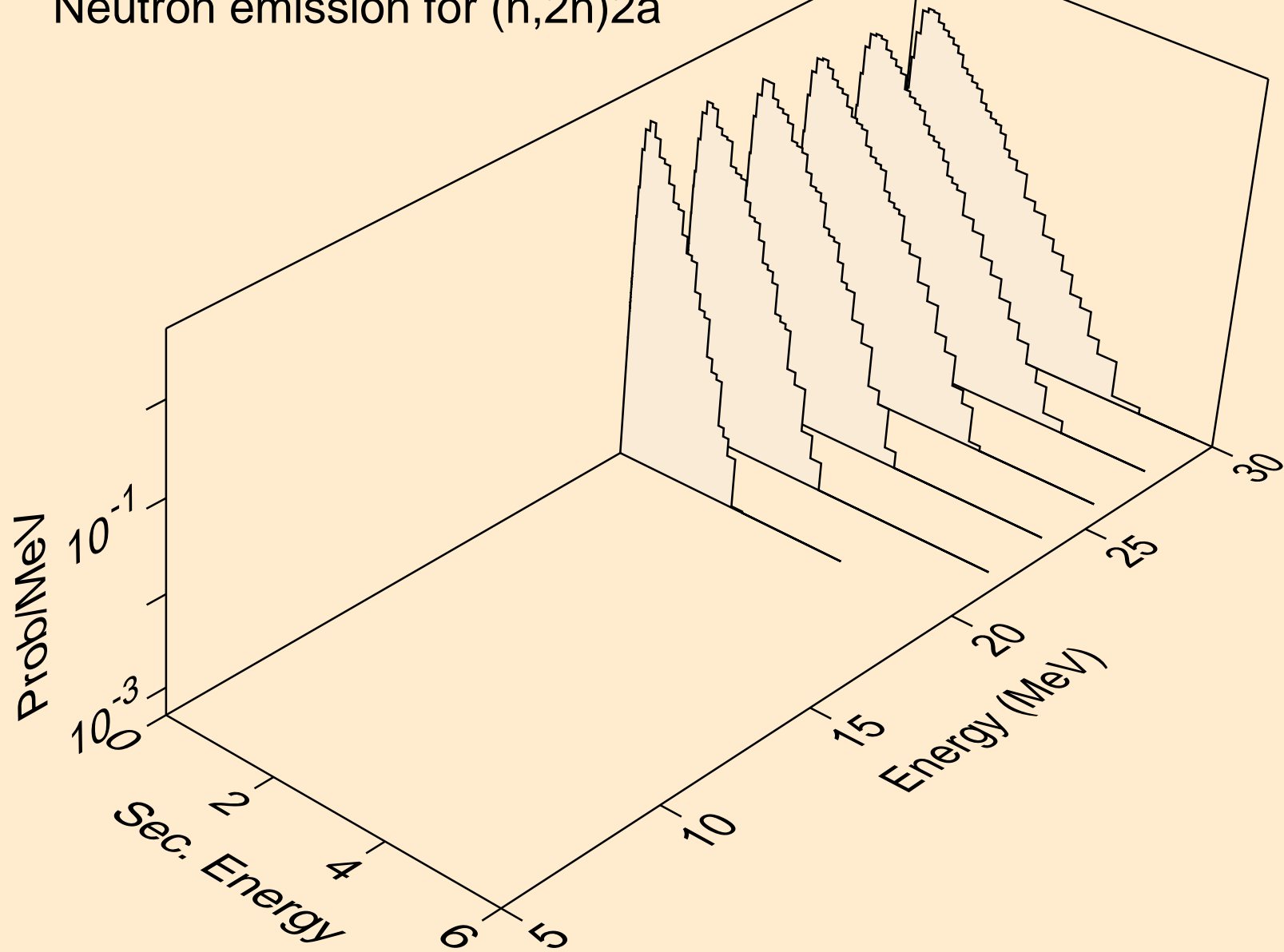

CE125 NEUTRON ACER TENDL-2021 LIBRARY; T=293.6K
Neutron emission for (n,n*)d

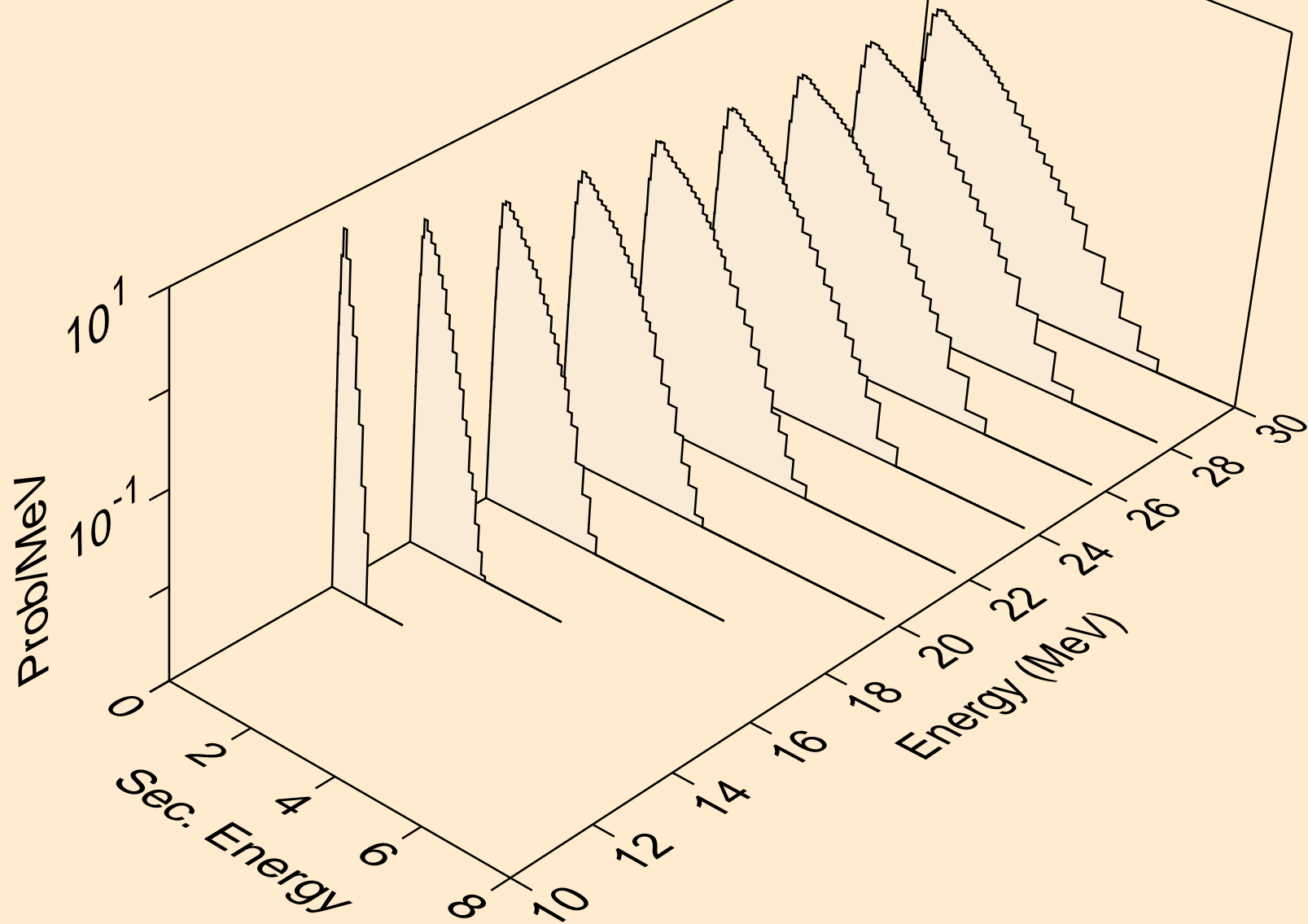

CE125 NEUTRON ACER TENDL-2021 LIBRARY; T=293.6K
Neutron emission for (n,n*)t

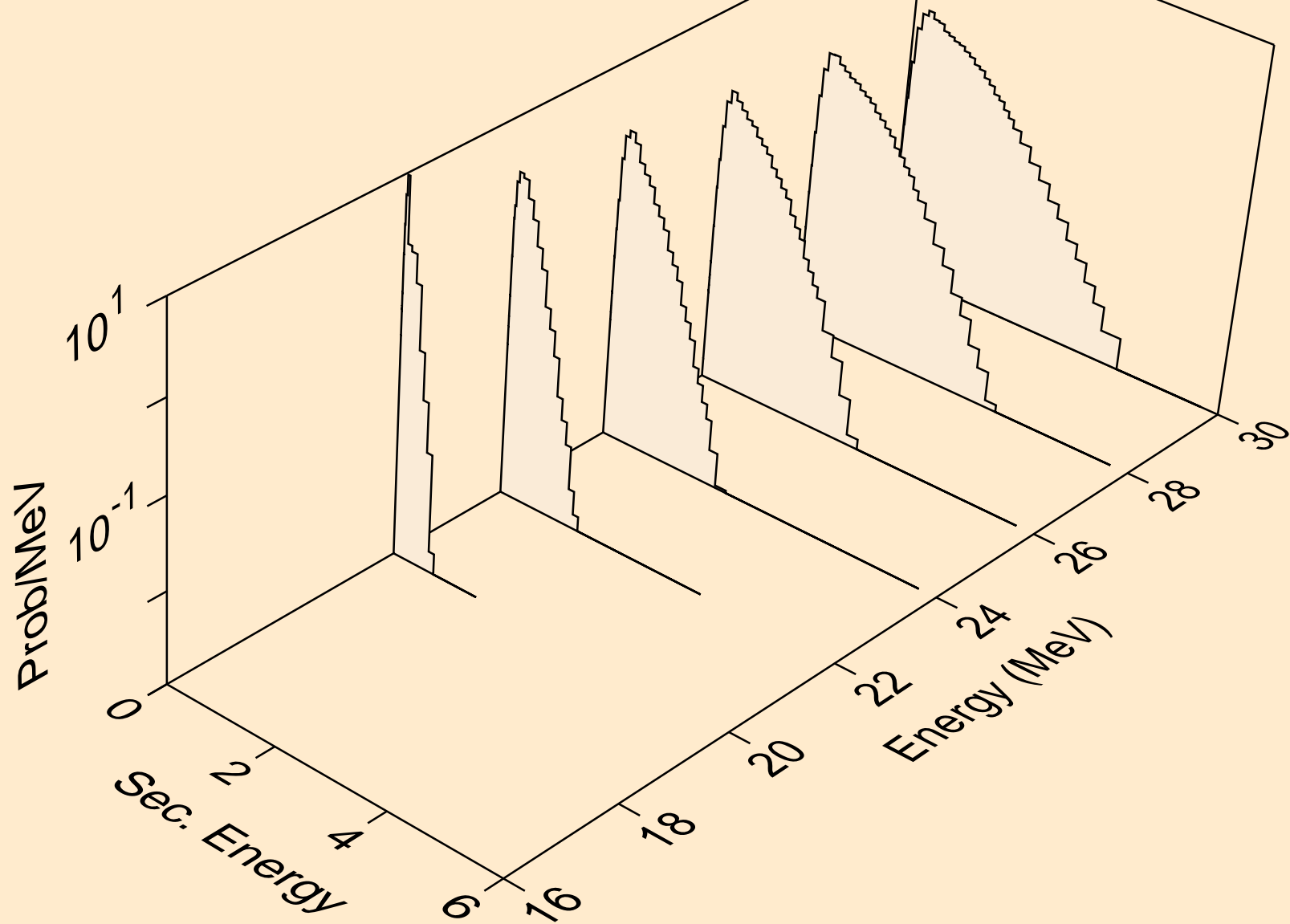

CE125 NEUTRON ACER TENDL-2021 LIBRARY; T=293.6K
Neutron emission for (n,n*)he3

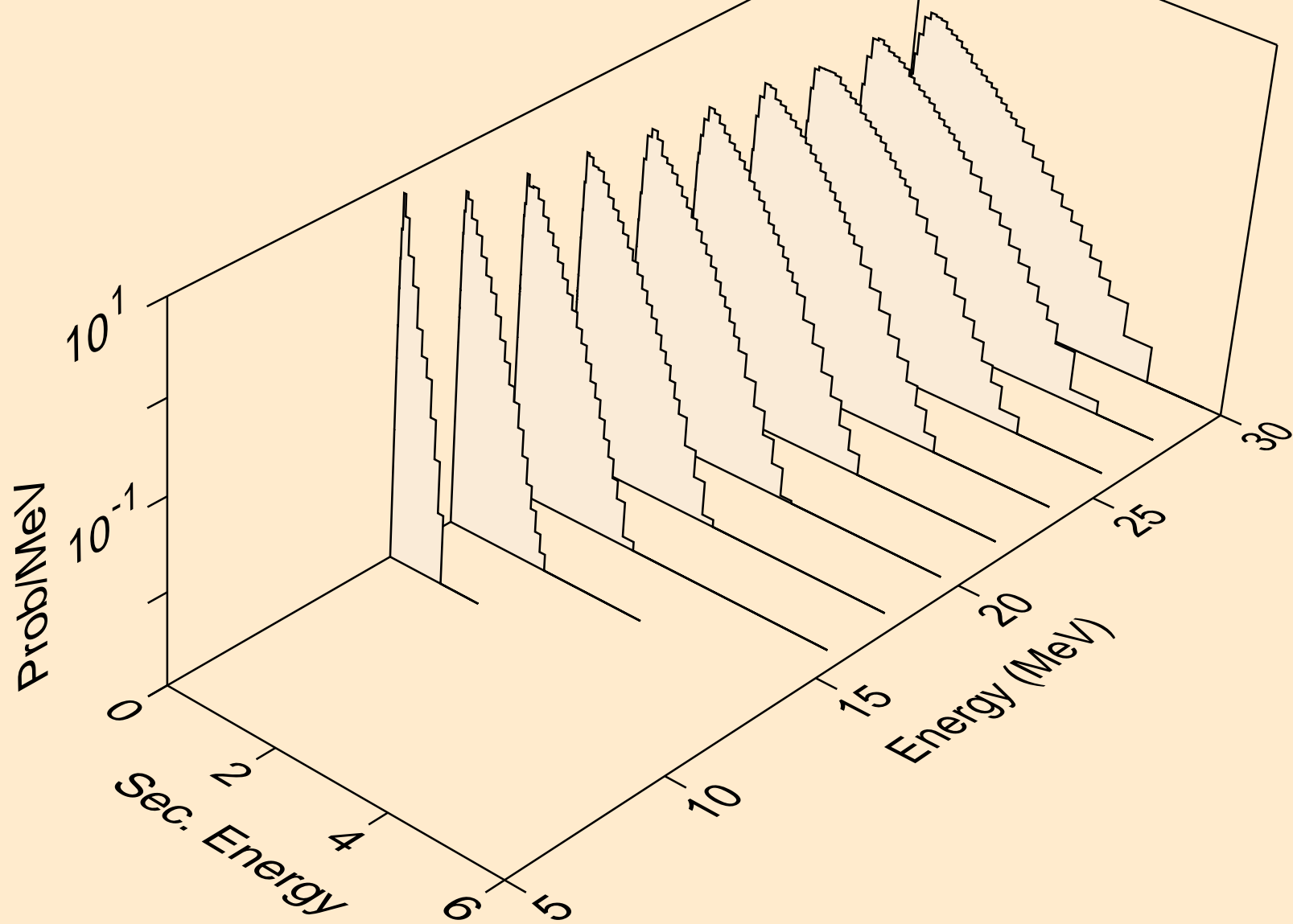

CE125 NEUTRON ACER TENDL-2021 LIBRARY; T=293.6K
Neutron emission for (n,2np)

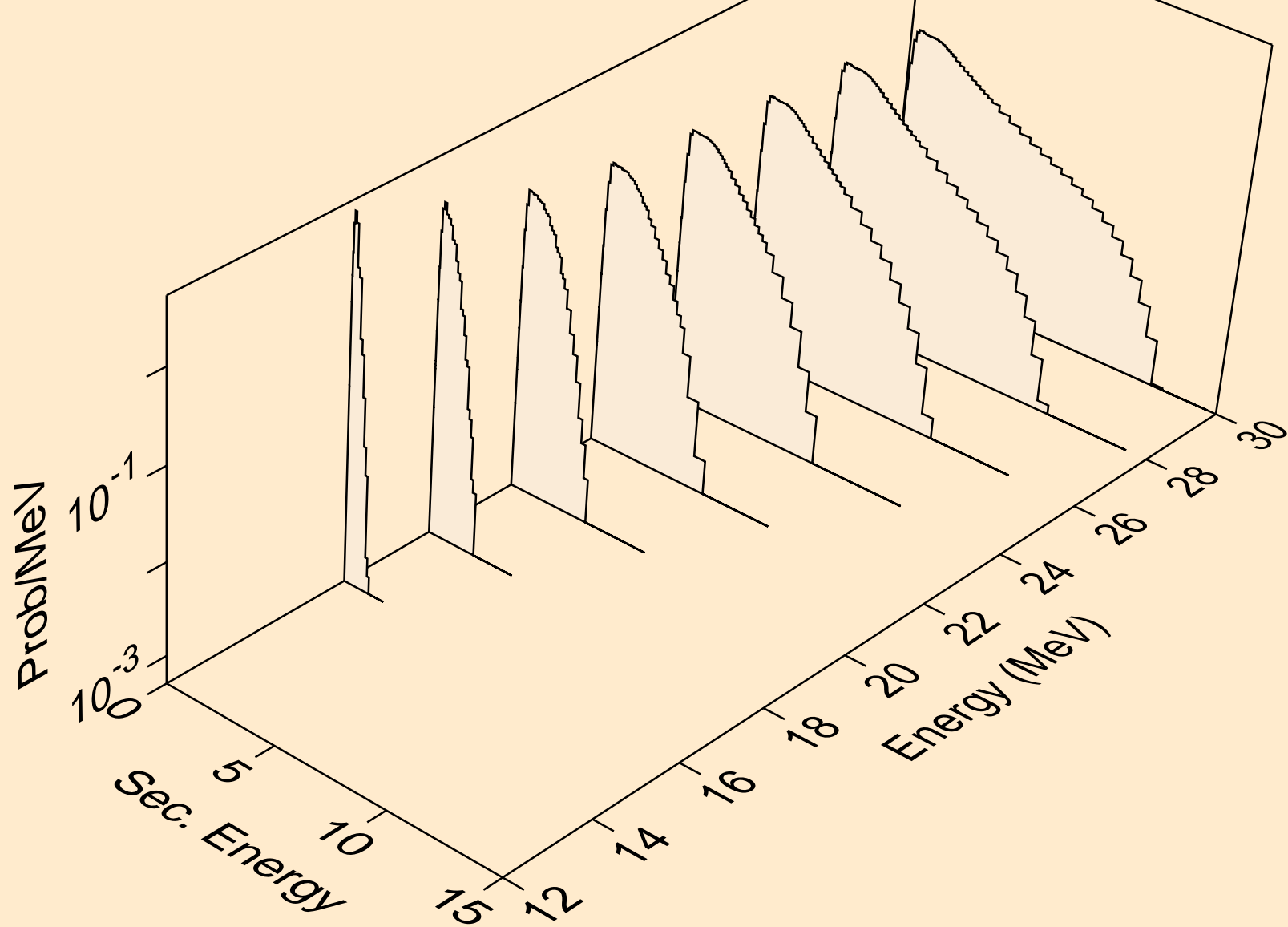

CE125 NEUTRON ACER TENDL-2021 LIBRARY; T=293.6K
Neutron emission for (n,3np)

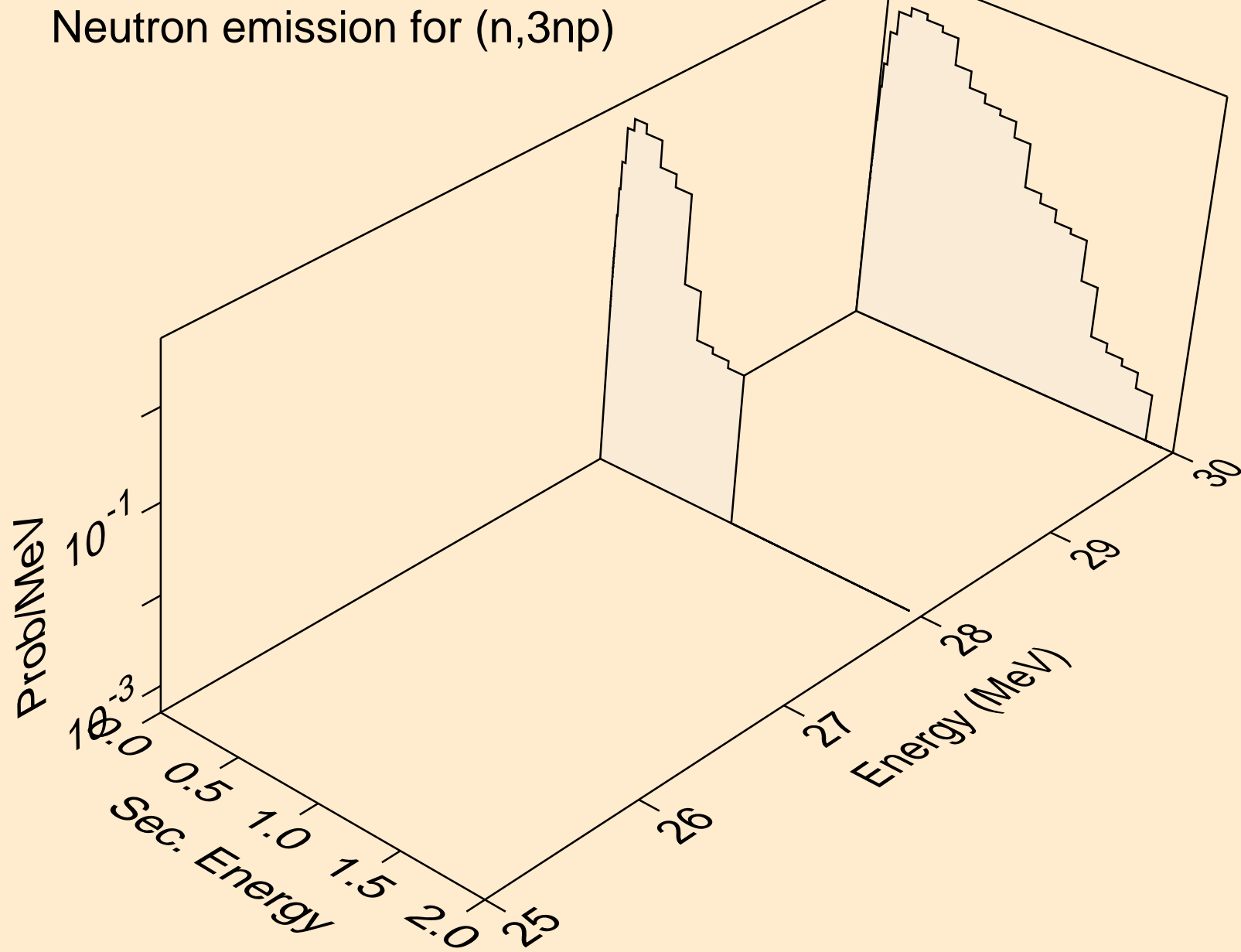

CE125 NEUTRON ACER TENDL-2021 LIBRARY; T=293.6K
Neutron emission for (n,2np)

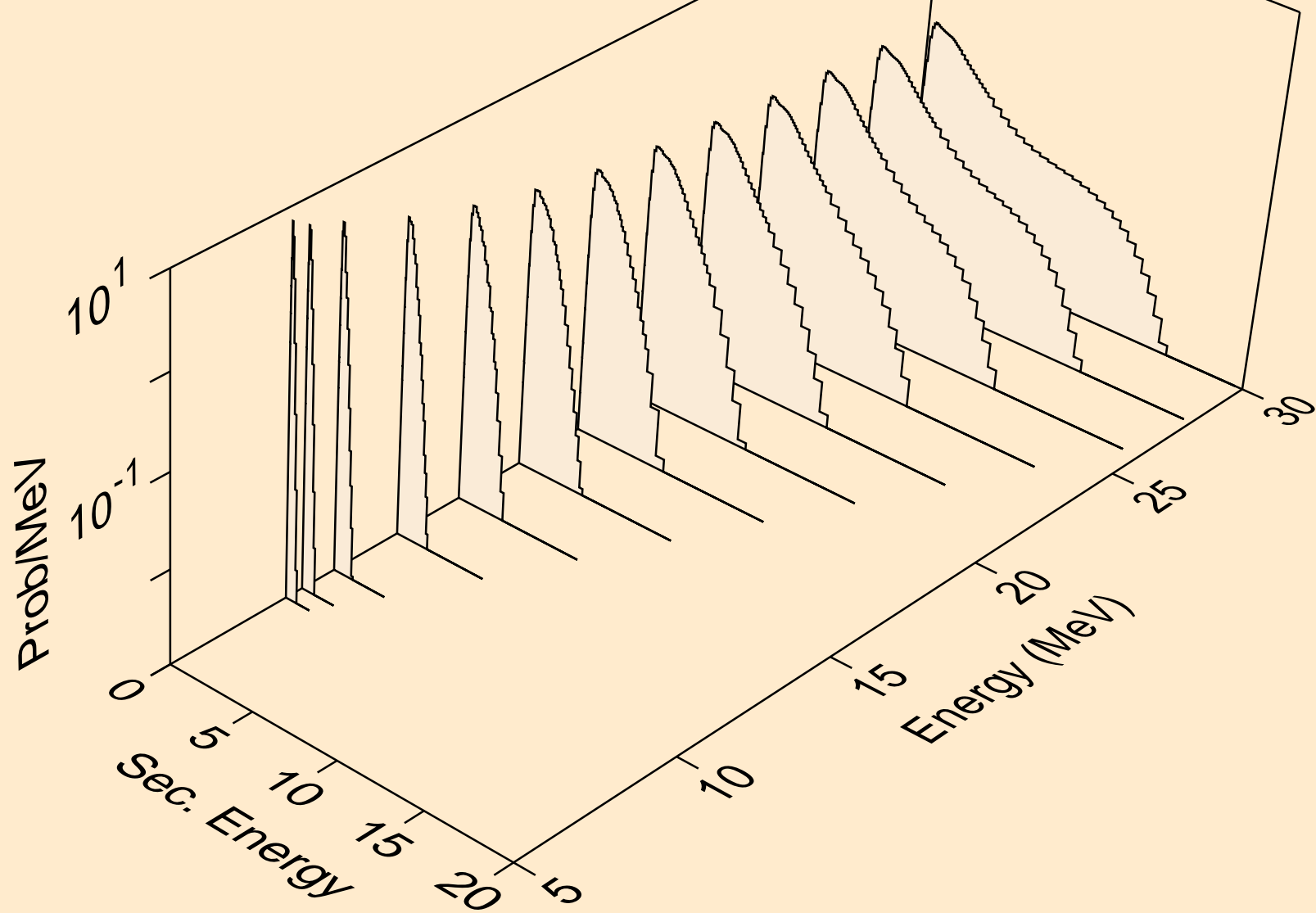

CE125 NEUTRON ACER TENDL-2021 LIBRARY; T=293.6K
Neutron emission for (n,npa)

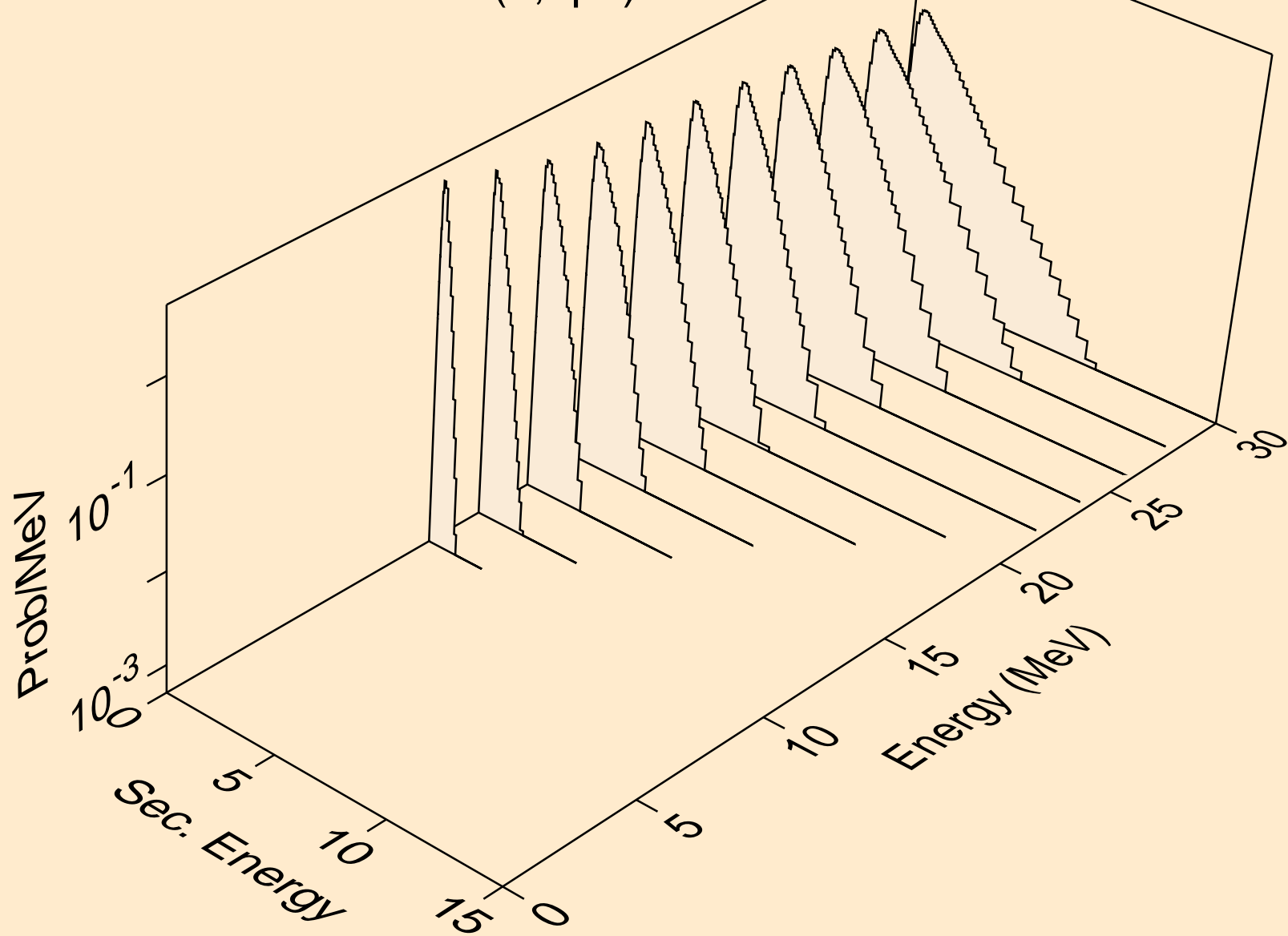

CE125 NEUTRON ACER TENDL-2021 LIBRARY; T=293.6K
Neutron emission for (n,n*c)

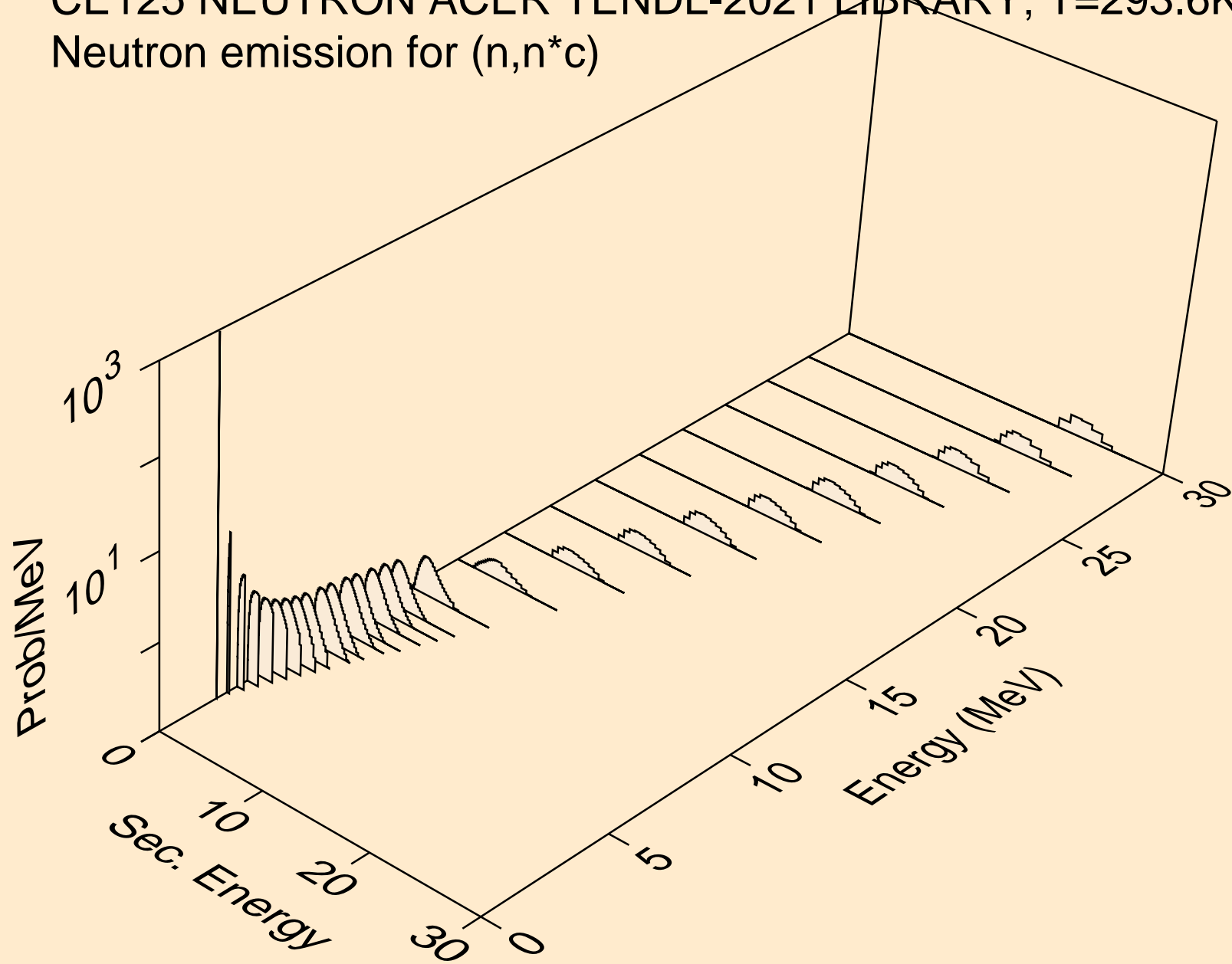

CE125 NEUTRON ACER TENDL-2021 LIBRARY; T=293.6K
Photon emission for (n,x)

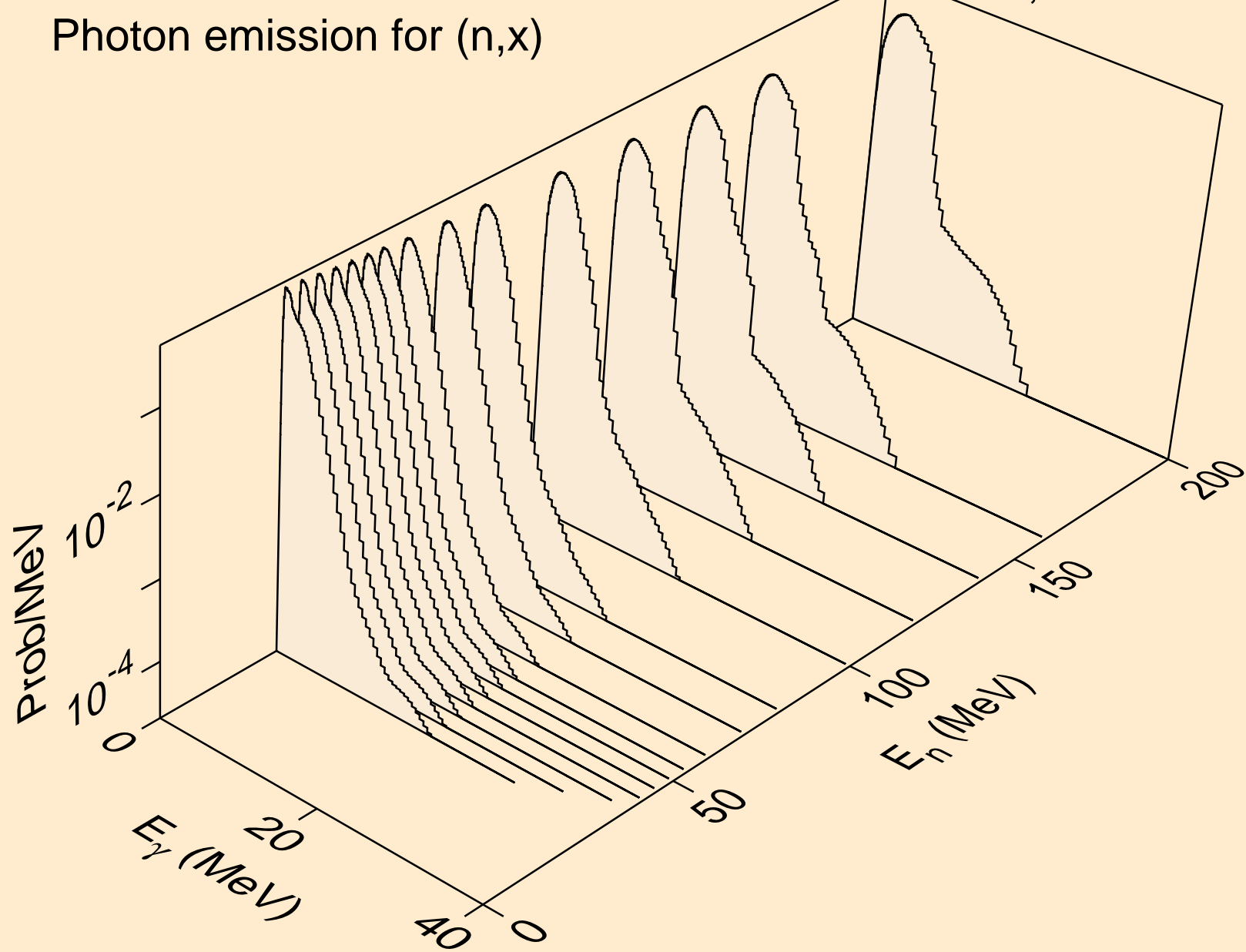

CE125 NEUTRON ACER TENDL-2021 LIBRARY; T=293.6K
Photon emission for (n,2nd)

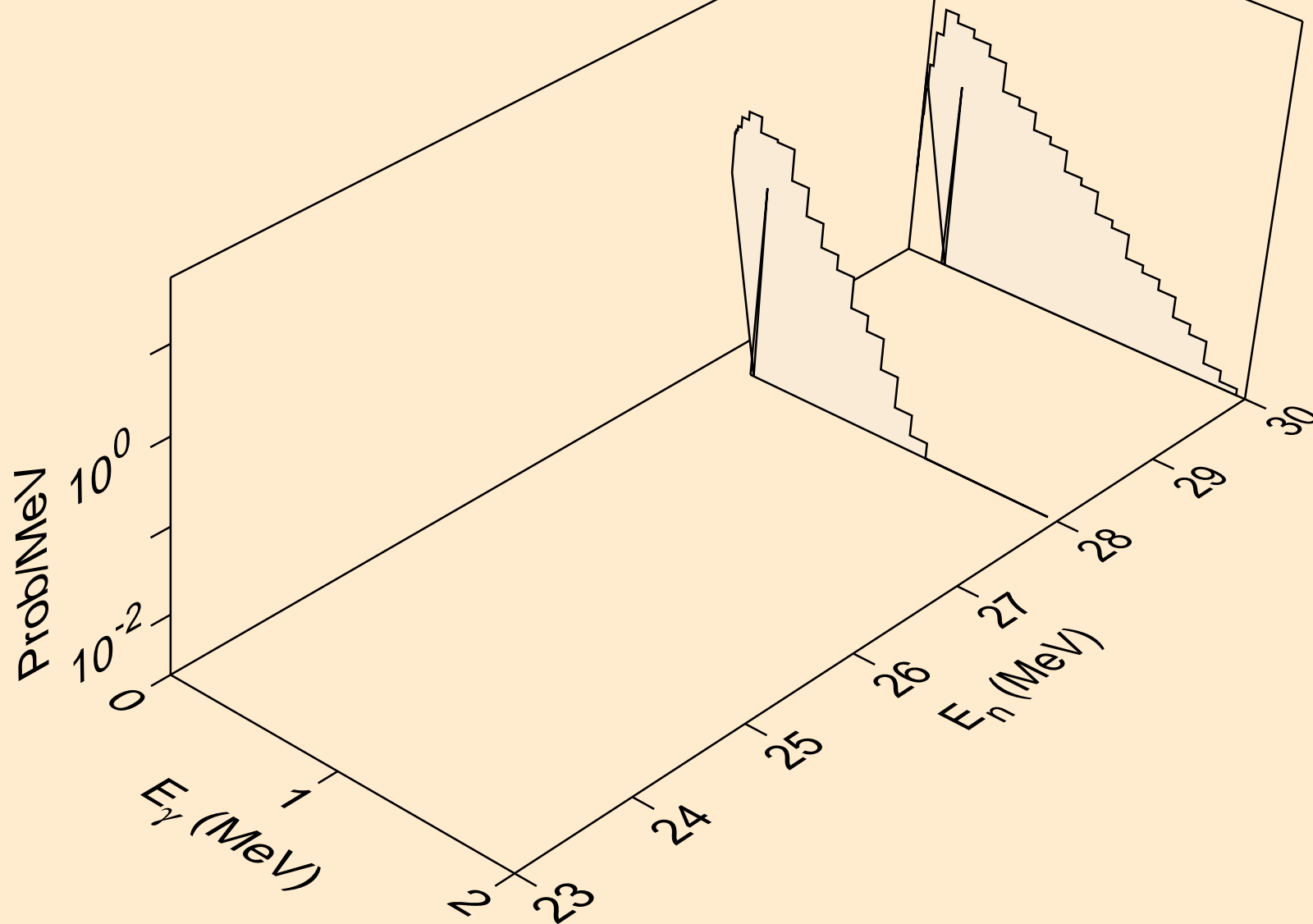

CE125 NEUTRON ACER TENDL-2021 LIBRARY; T=293.6K
Photon emission for (n,2n)

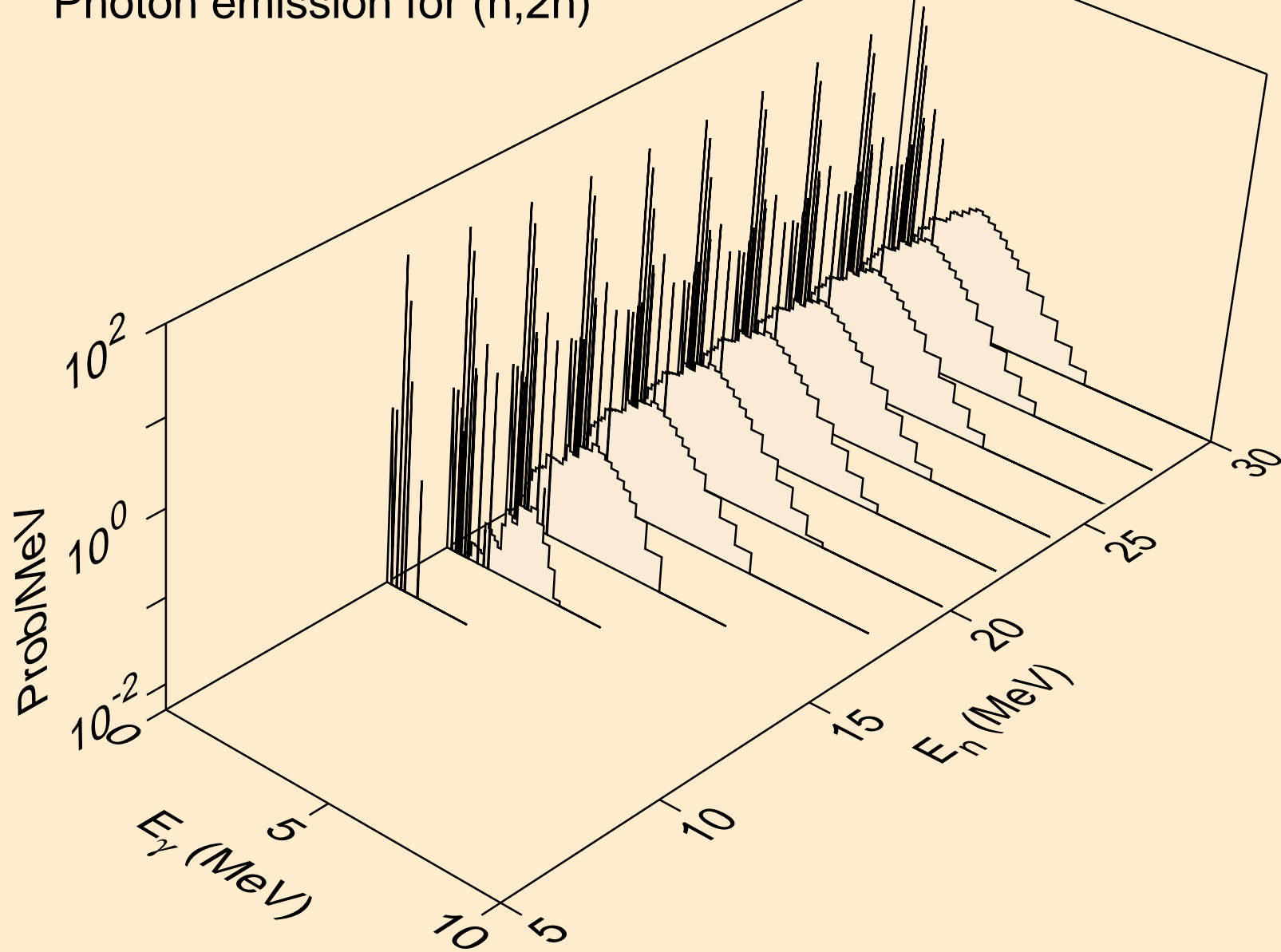

CE125 NEUTRON ACER TENDL-2021 LIBRARY; T=293.6K
Photon emission for (n,3n)

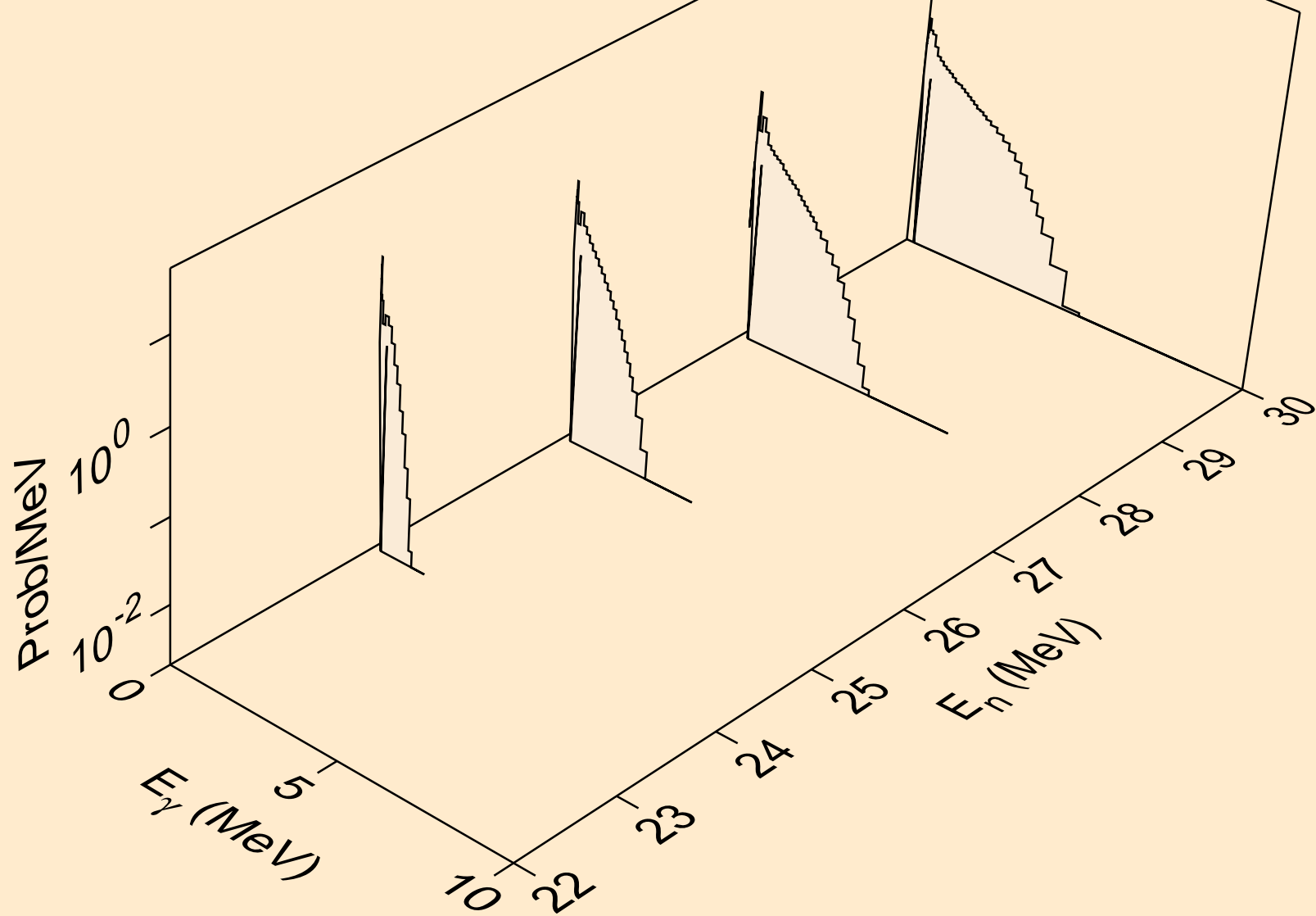

CE125 NEUTRON ACER TENDL-2021 LIBRARY; T=293.6K
Photon emission for (n,n*)a

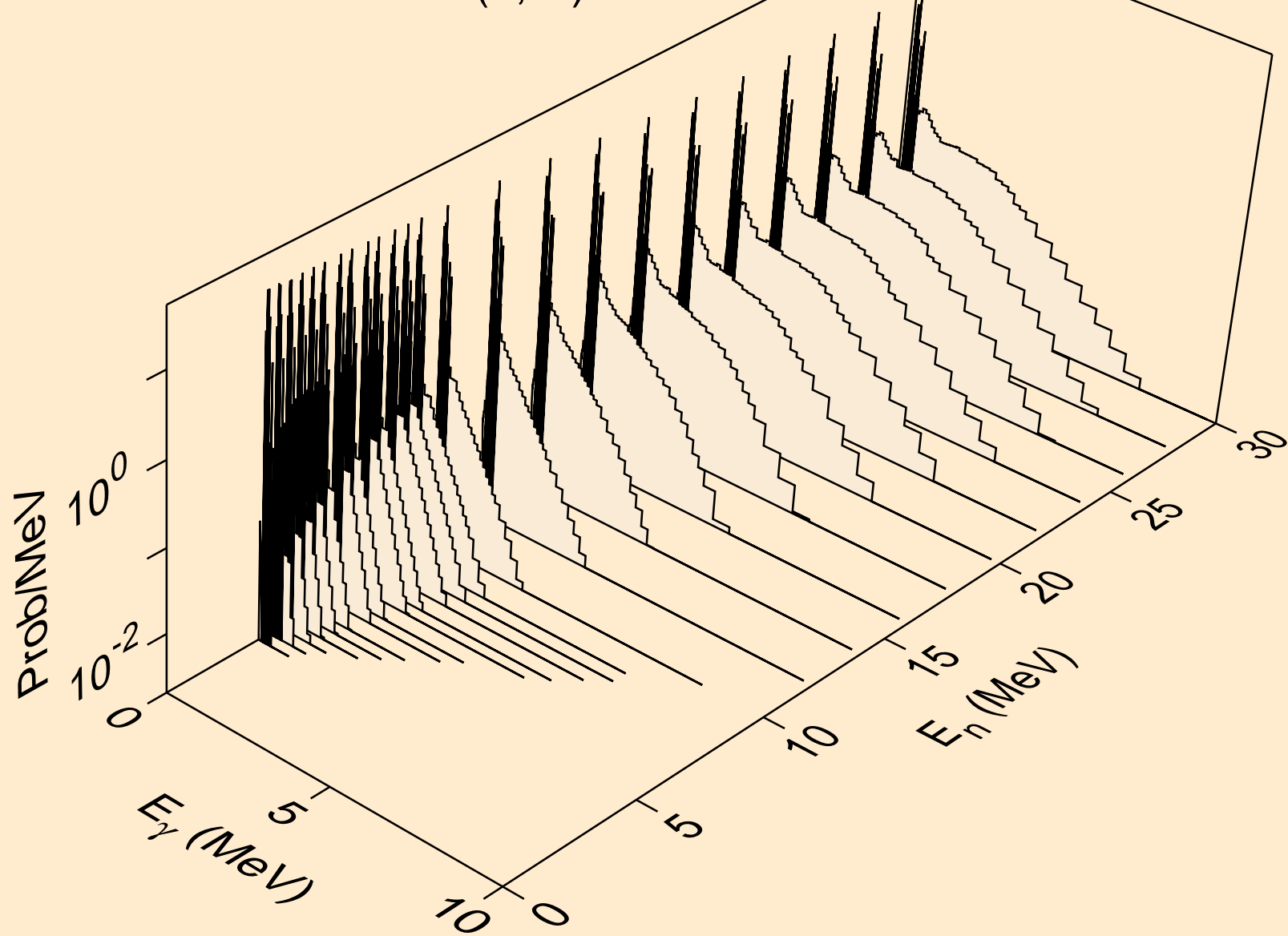

CE125 NEUTRON ACER TENDL-2021 LIBRARY; T=293.6K
Photon emission for (n,2n)a

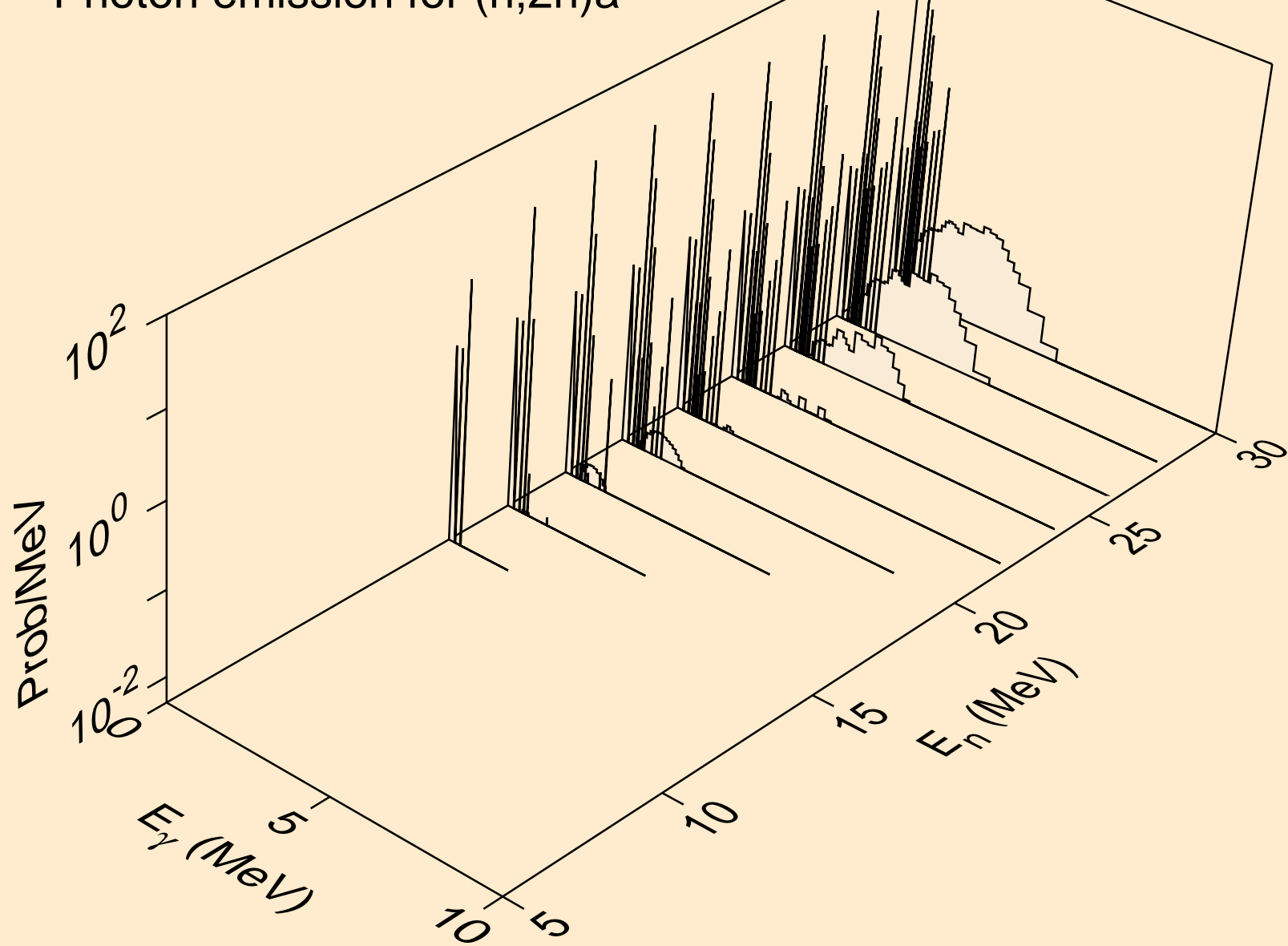

CE125 NEUTRON ACER TENDL-2021 LIBRARY; T=293.6K
Photon emission for (n,n*)p

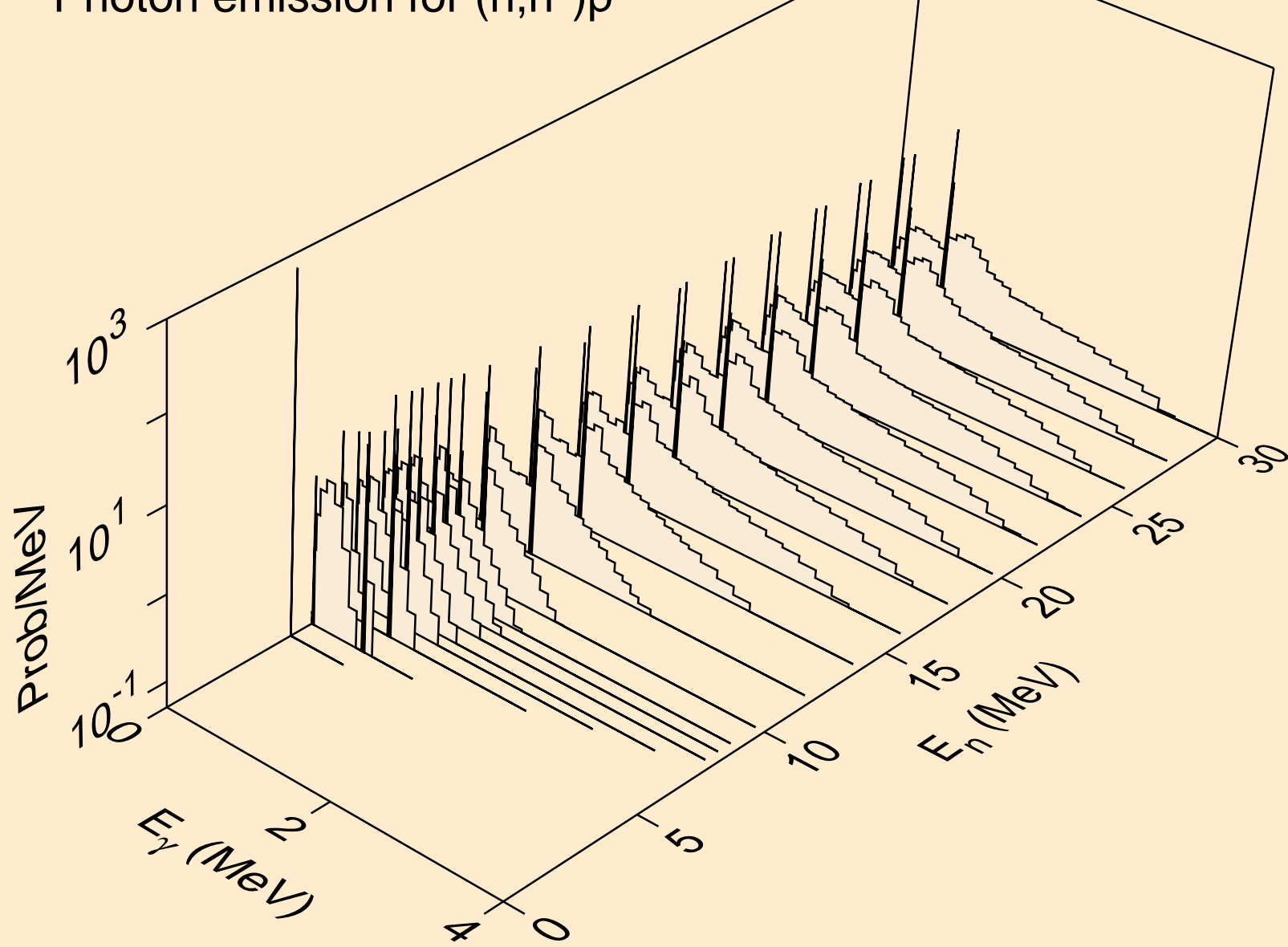

CE125 NEUTRON ACER TENDL-2021 LIBRARY; T=293.6K
Photon emission for (n,n*)2a

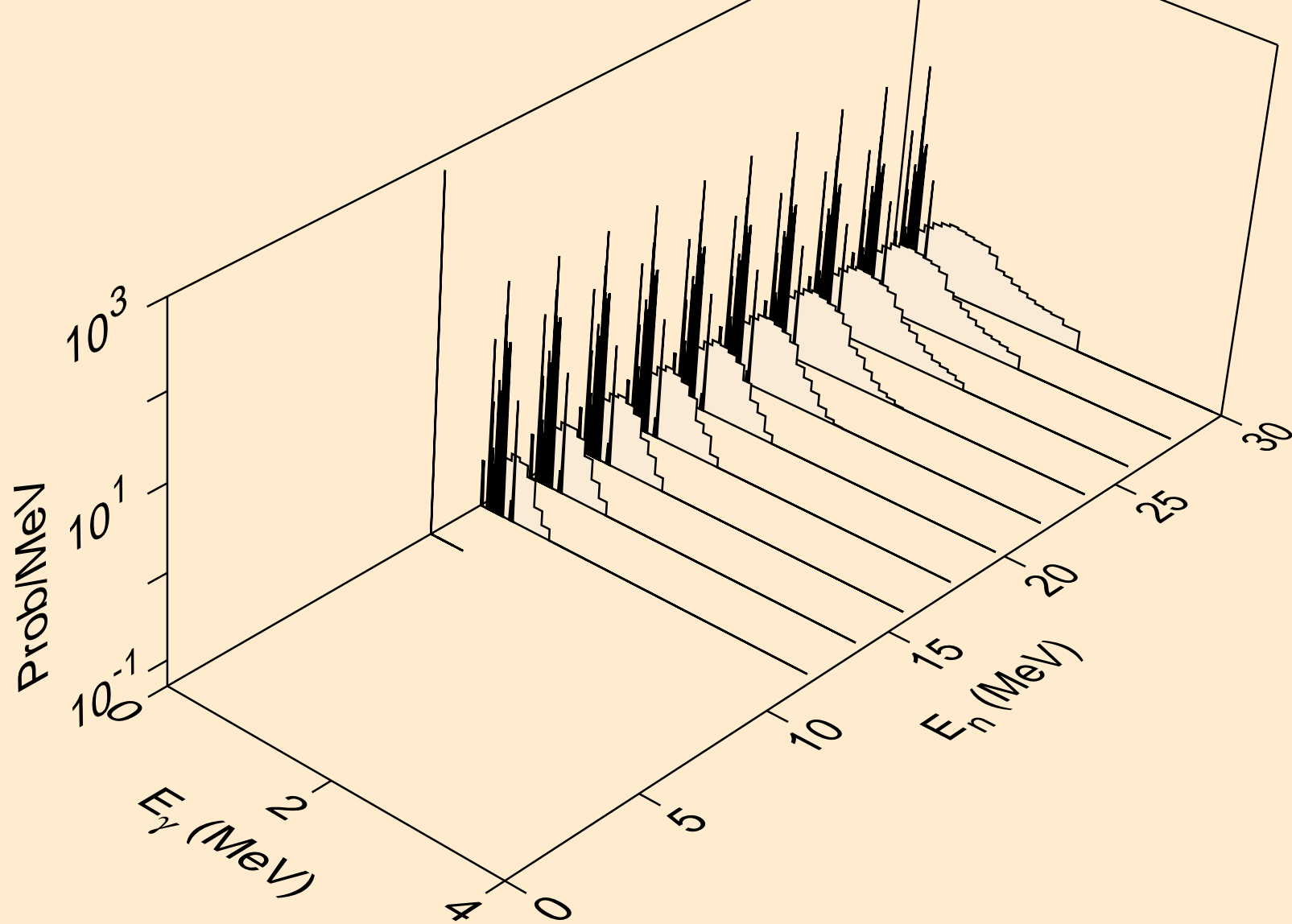

CE125 NEUTRON ACER TENDL-2021 LIBRARY; T=293.6K
Photon emission for (n,2n)2a

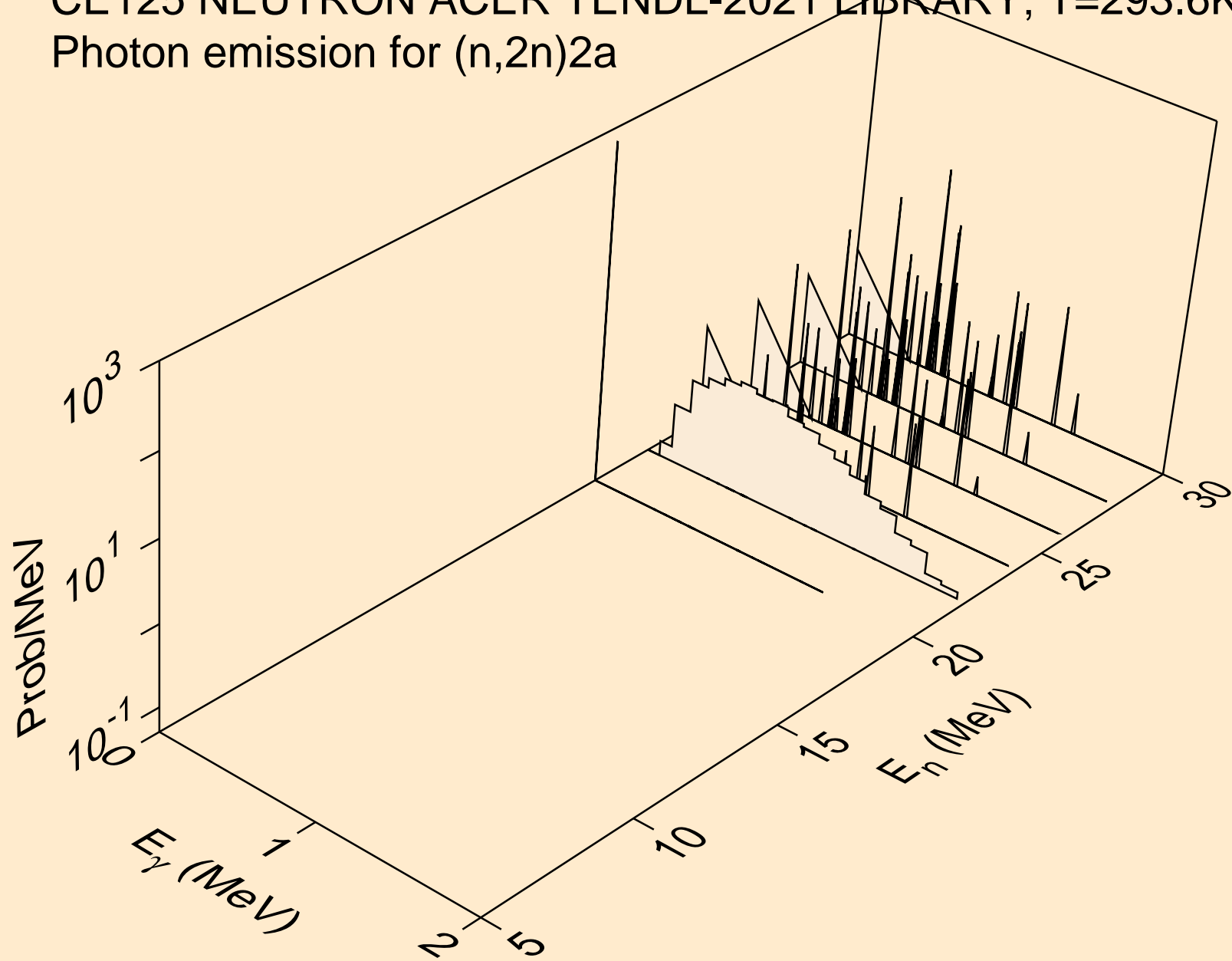

CE125 NEUTRON ACER TENDL-2021 LIBRARY; T=293.6K
Photon emission for (n,n*)d

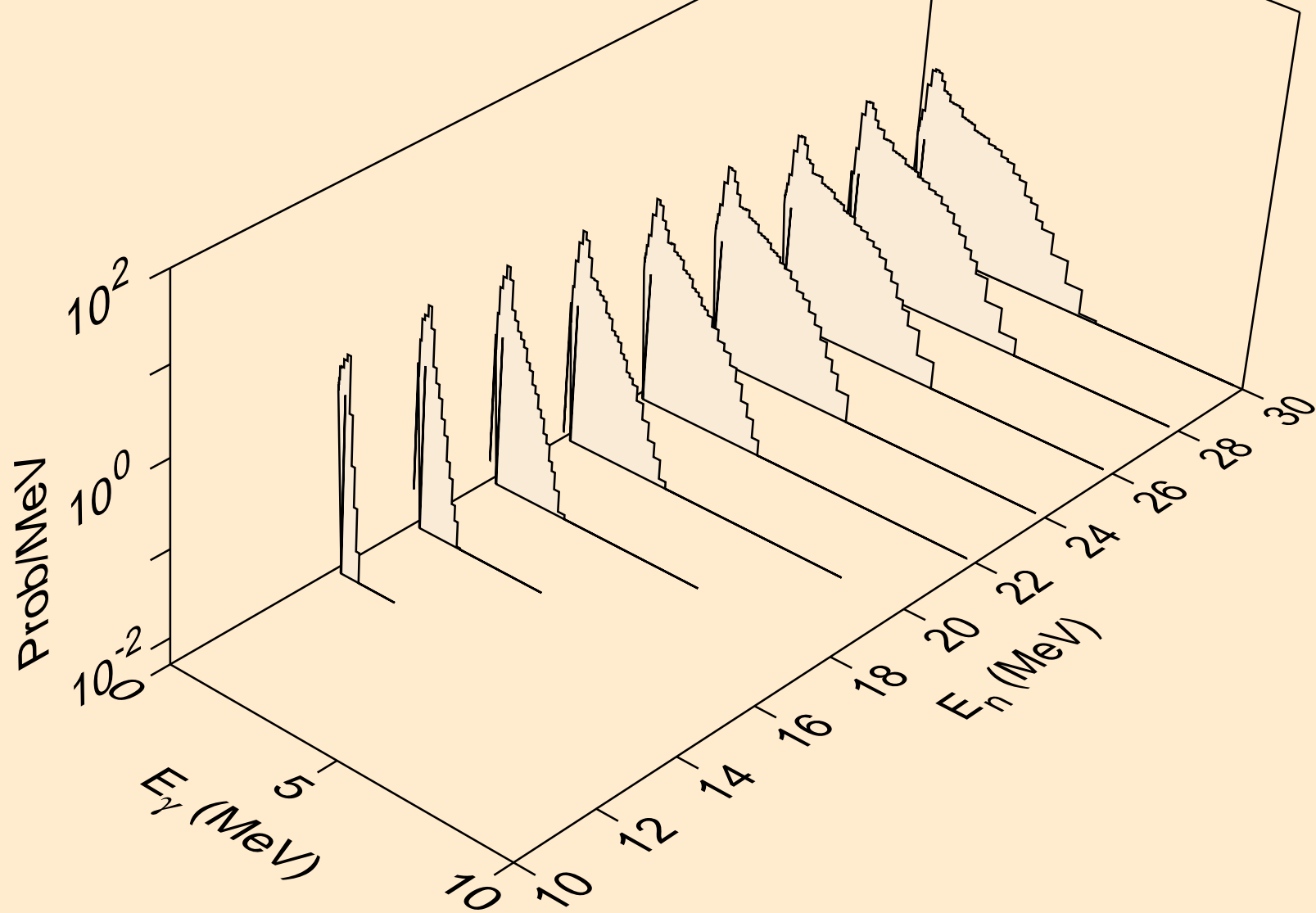

CE125 NEUTRON ACER TENDL-2021 LIBRARY; T=293.6K
Photon emission for (n,n*)t

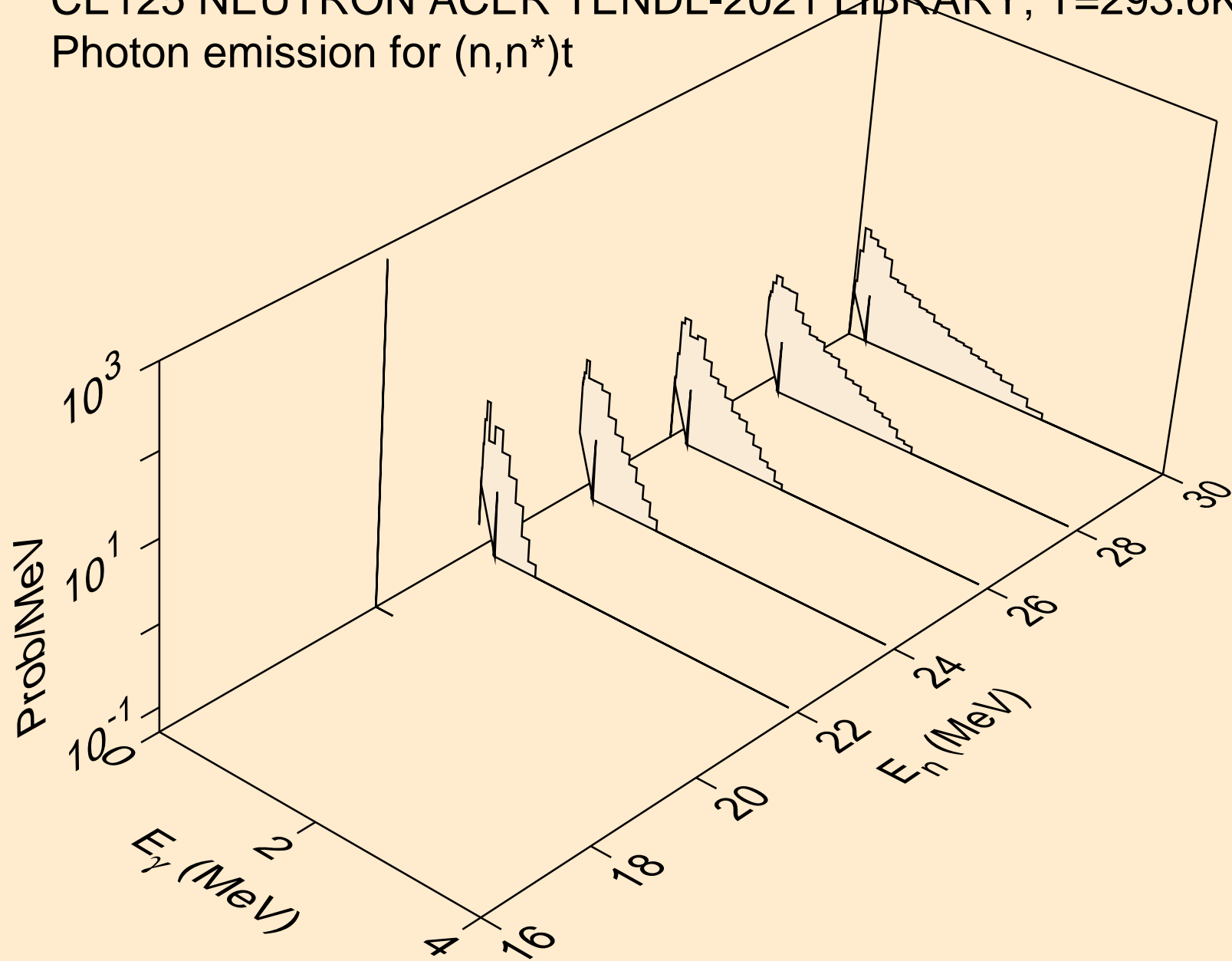

CE125 NEUTRON ACER TENDL-2021 LIBRARY; T=293.6K
Photon emission for (n,n*)he3

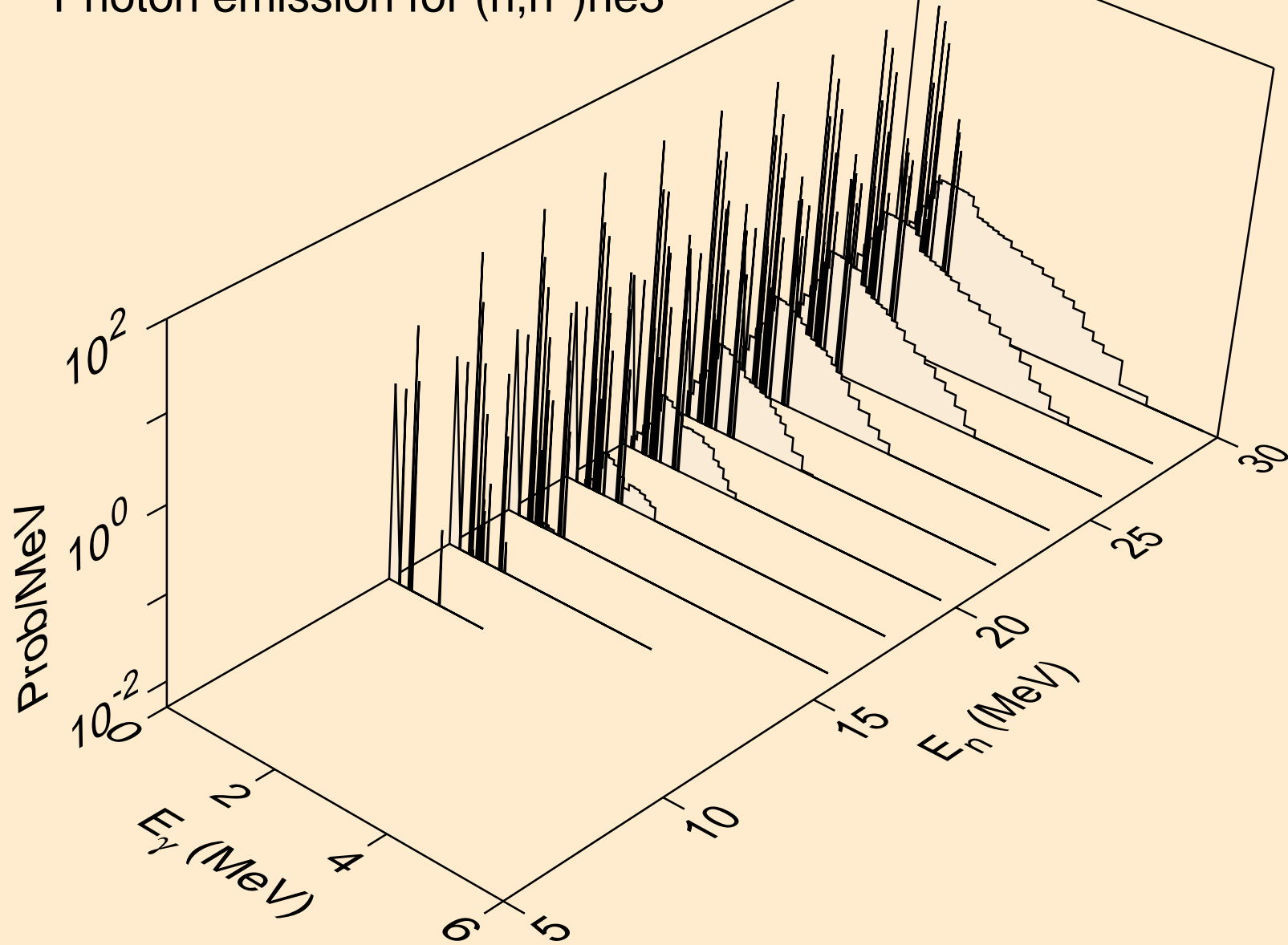

CE125 NEUTRON ACER TENDL-2021 LIBRARY; T=293.6K
Photon emission for (n,2np)

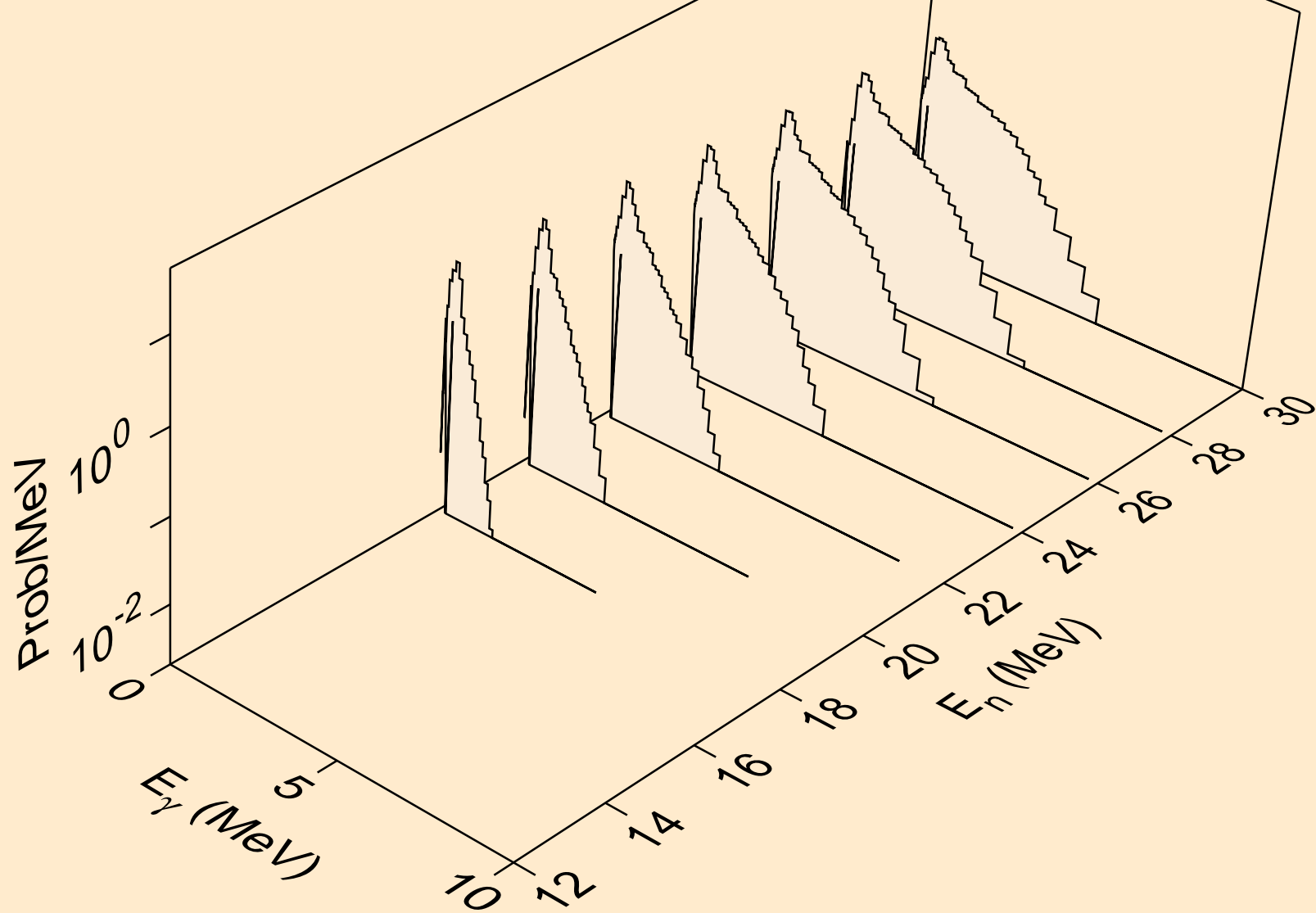

CE125 NEUTRON ACER TENDL-2021 LIBRARY; T=293.6K
Photon emission for (n,3np)

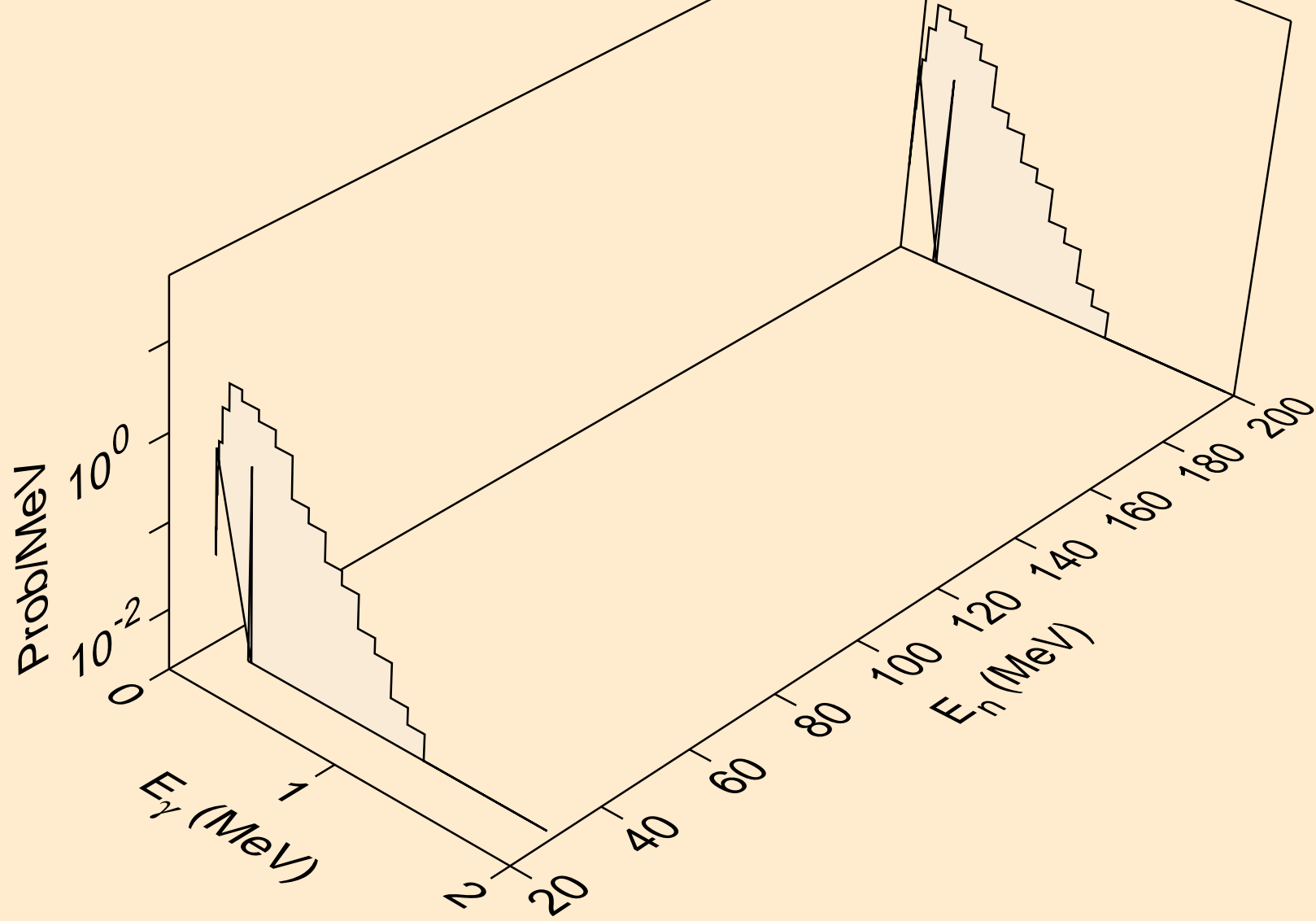

CE125 NEUTRON ACER TENDL-2021 LIBRARY; T=293.6K
Photon emission for (n,2np)

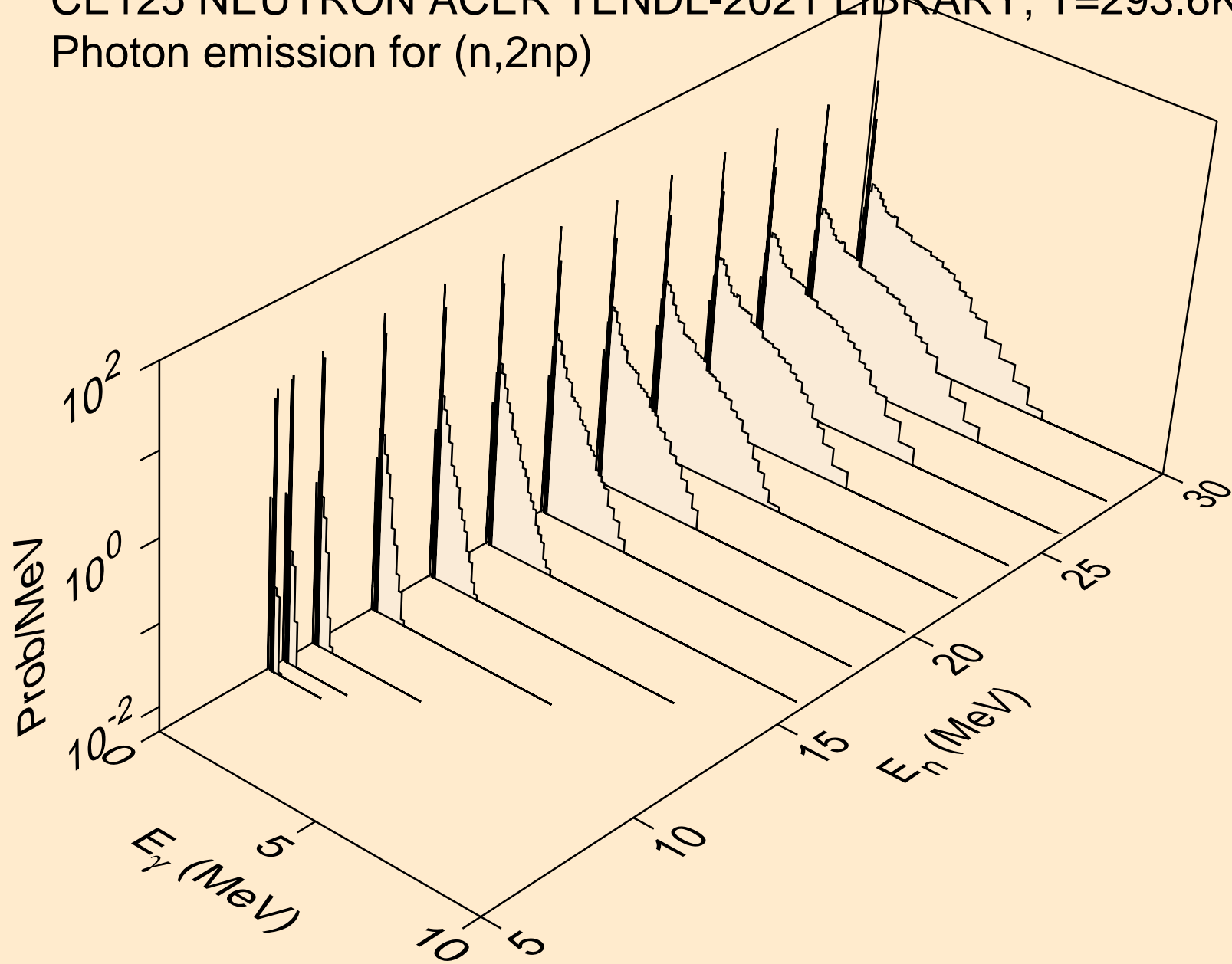

CE125 NEUTRON ACER TENDL-2021 LIBRARY; T=293.6K
Photon emission for (n,npa)

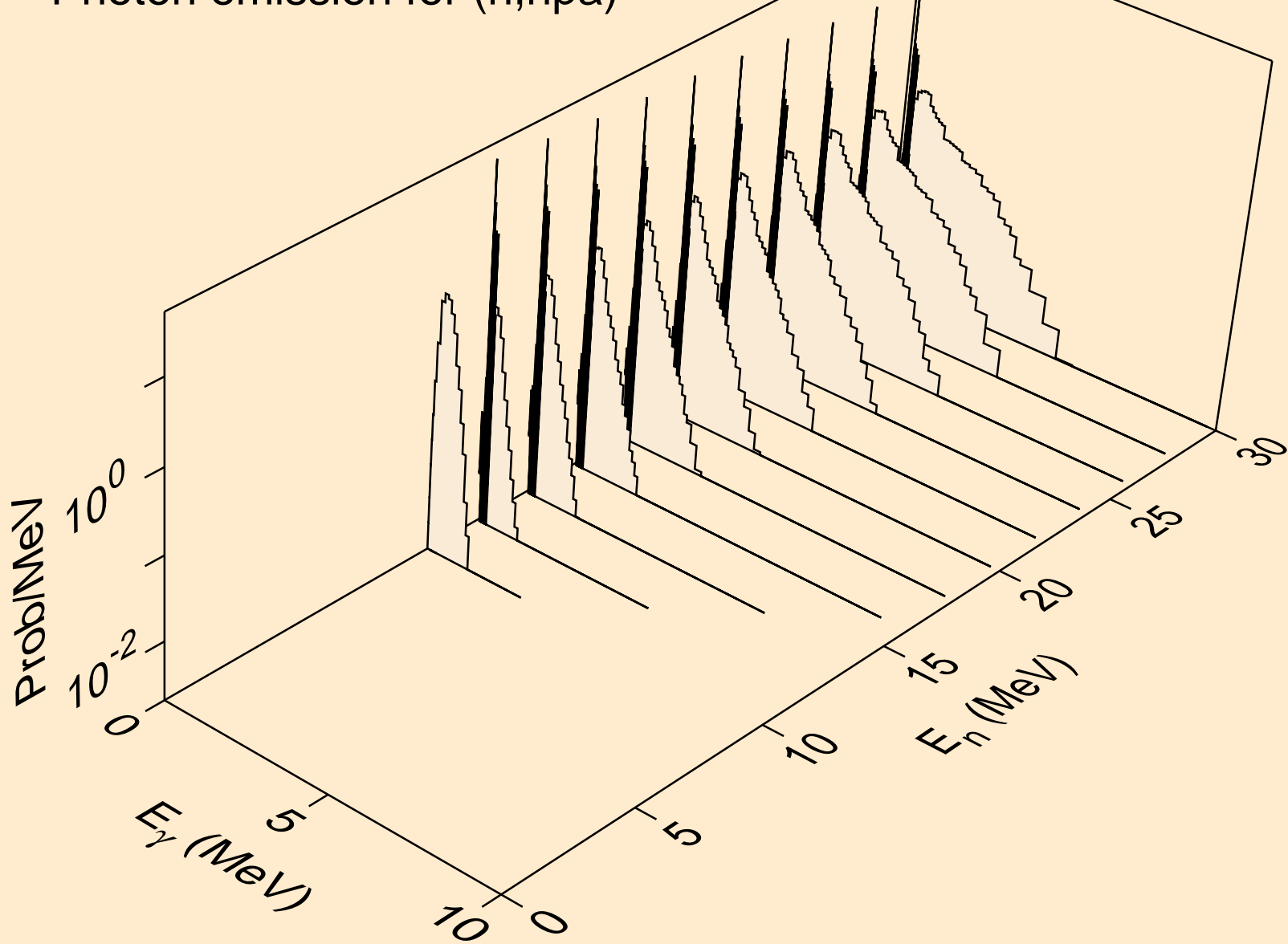

CE125 NEUTRON ACER TENDL-2021 LIBRARY; T=293.6K
Photon emission for (n,n*c)

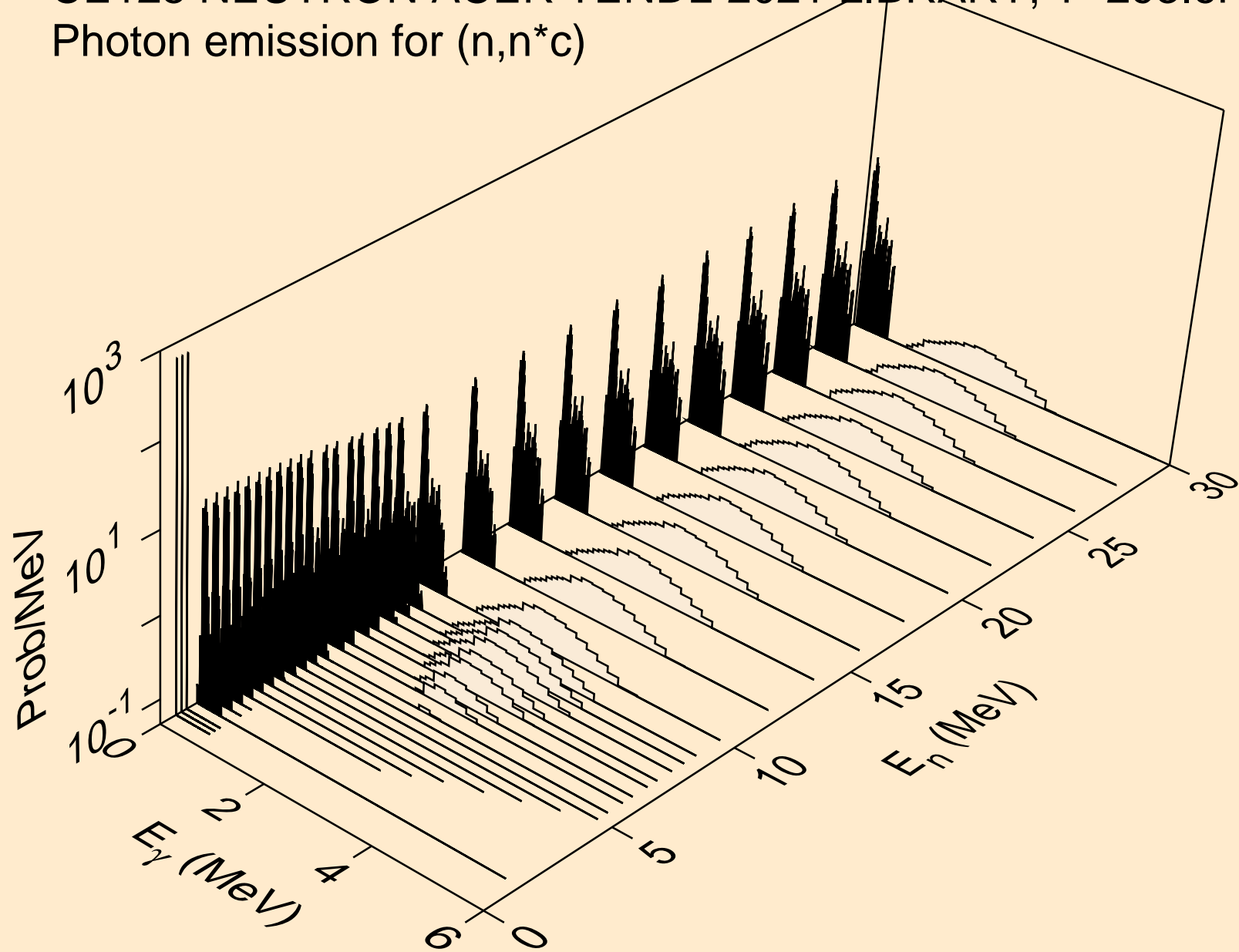

CE125 NEUTRON ACER TENDL-2021 LIBRARY; T=293.6K
Photon emission for (n,gma)

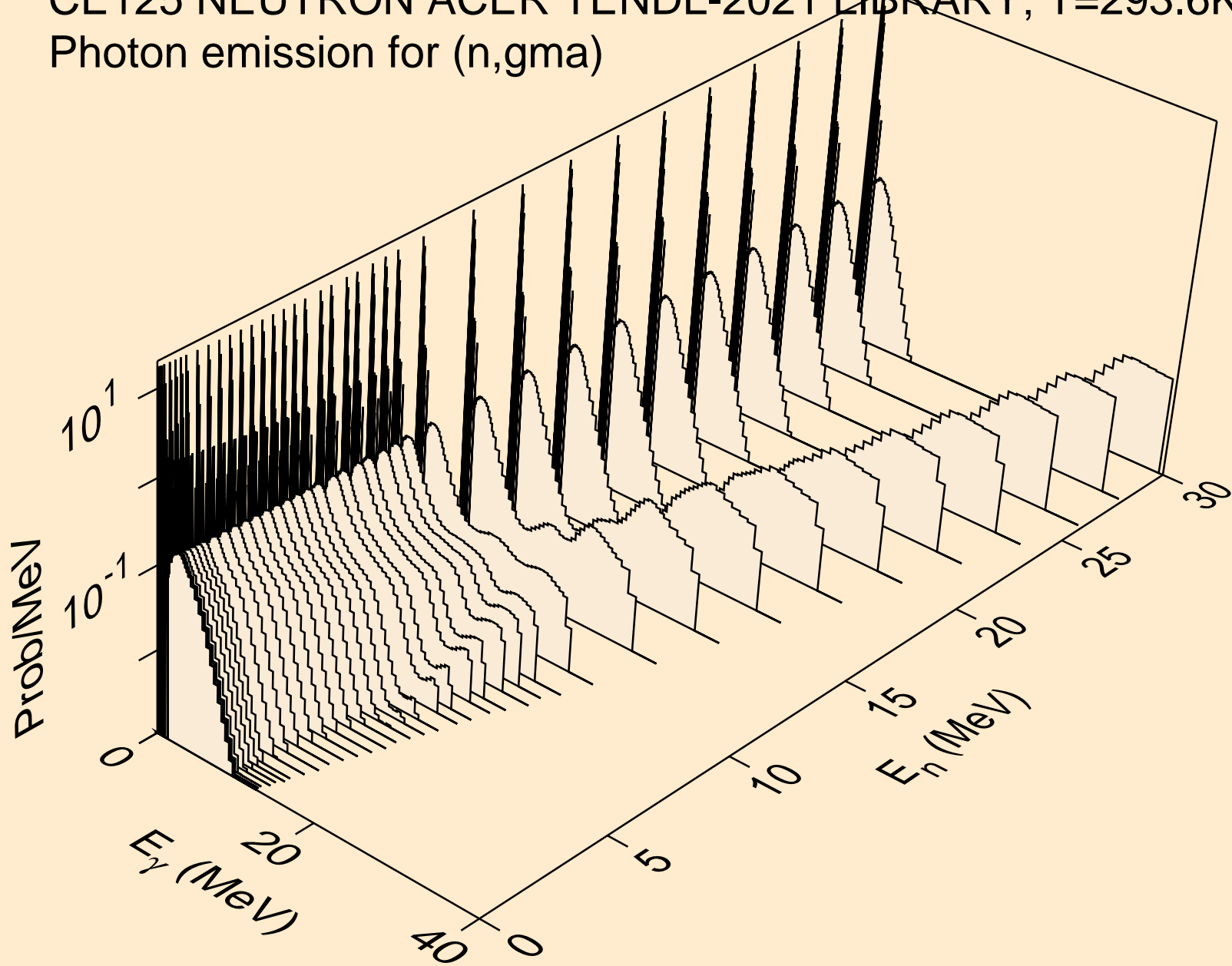

CE125 NEUTRON ACER TENDL-2021 LIBRARY; T=293.6K
Photon emission for (n,p)

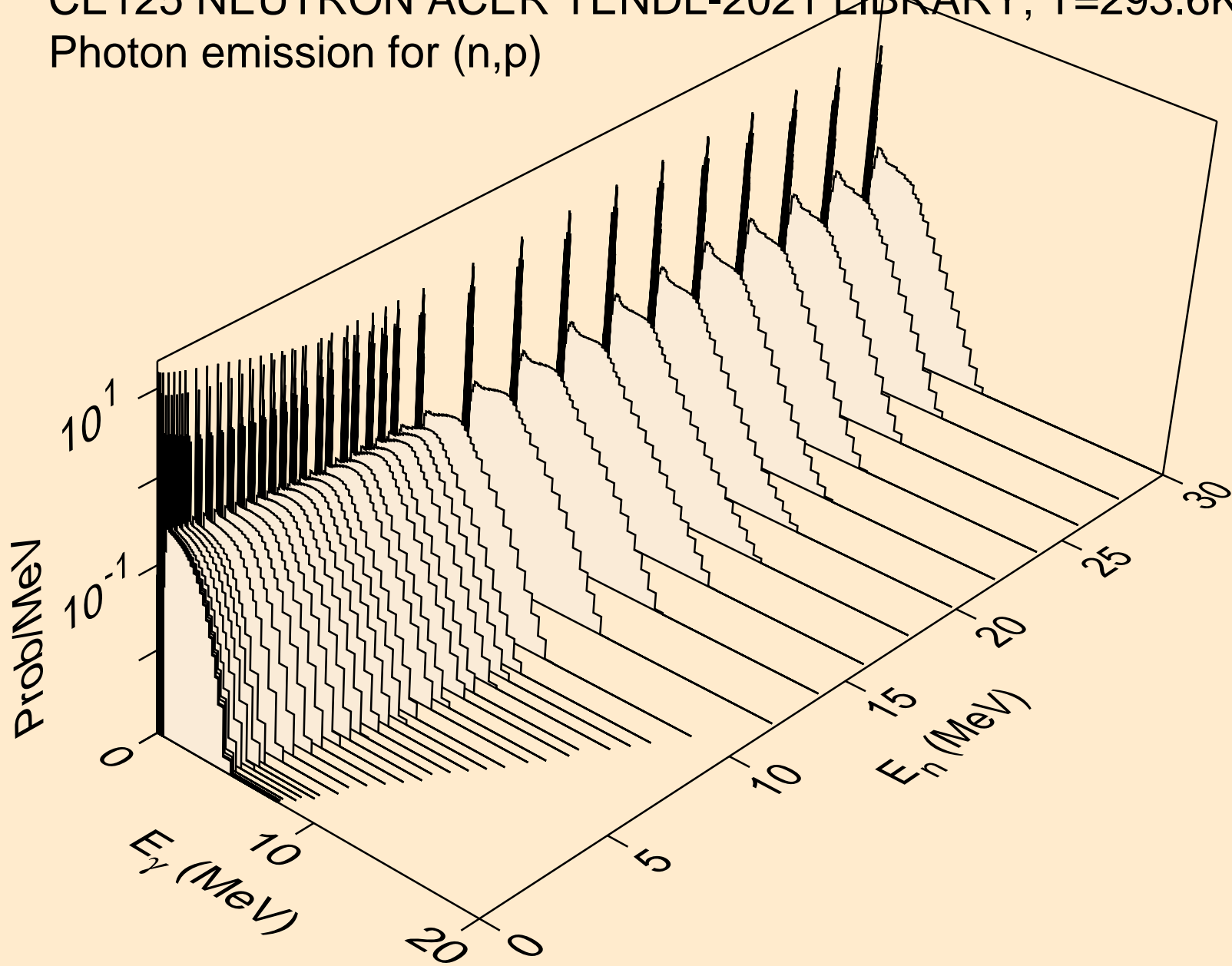

CE125 NEUTRON ACER TENDL-2021 LIBRARY; T=293.6K
Photon emission for (n,d)

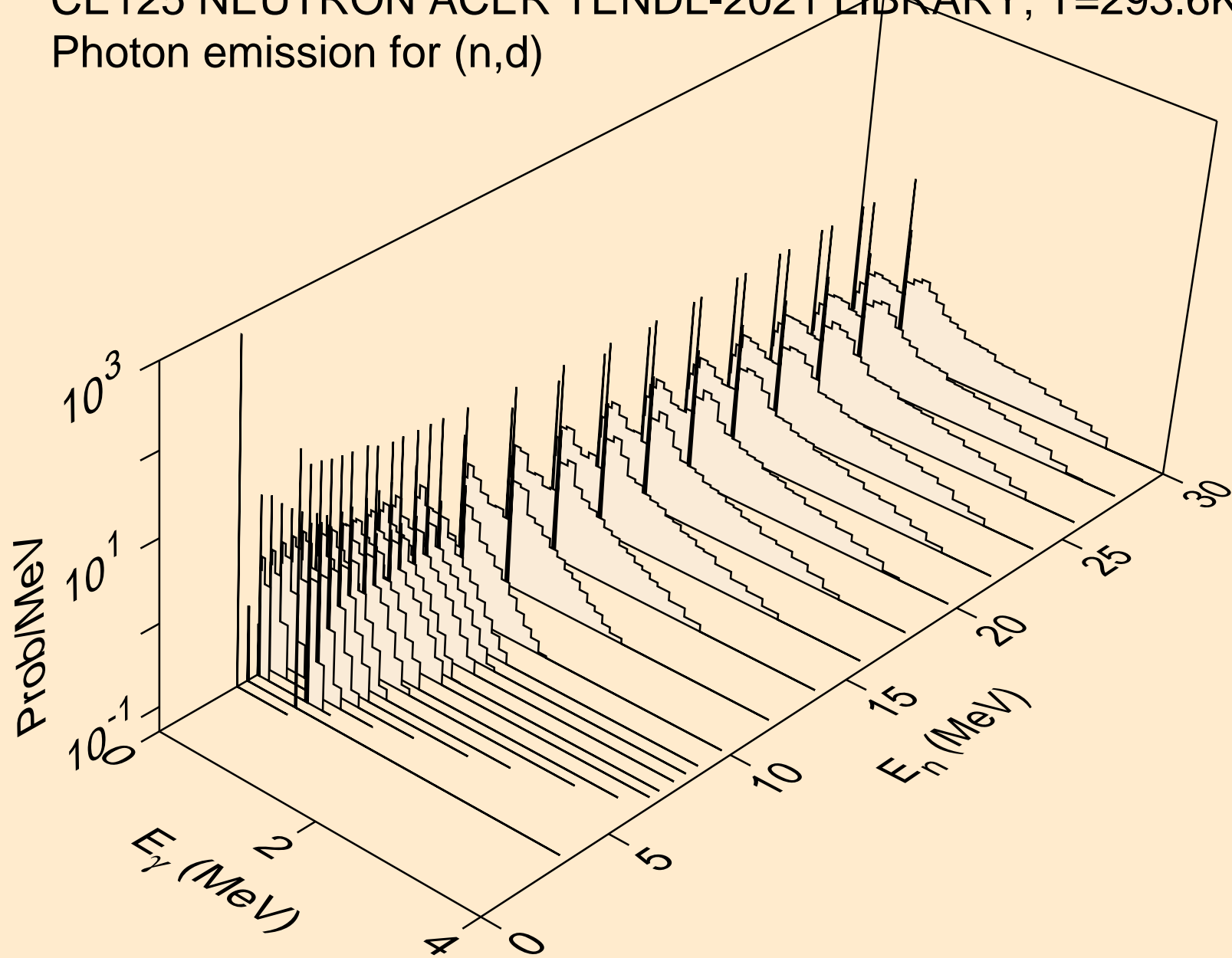

CE125 NEUTRON ACER TENDL-2021 LIBRARY; T=293.6K
Photon emission for (n,t)

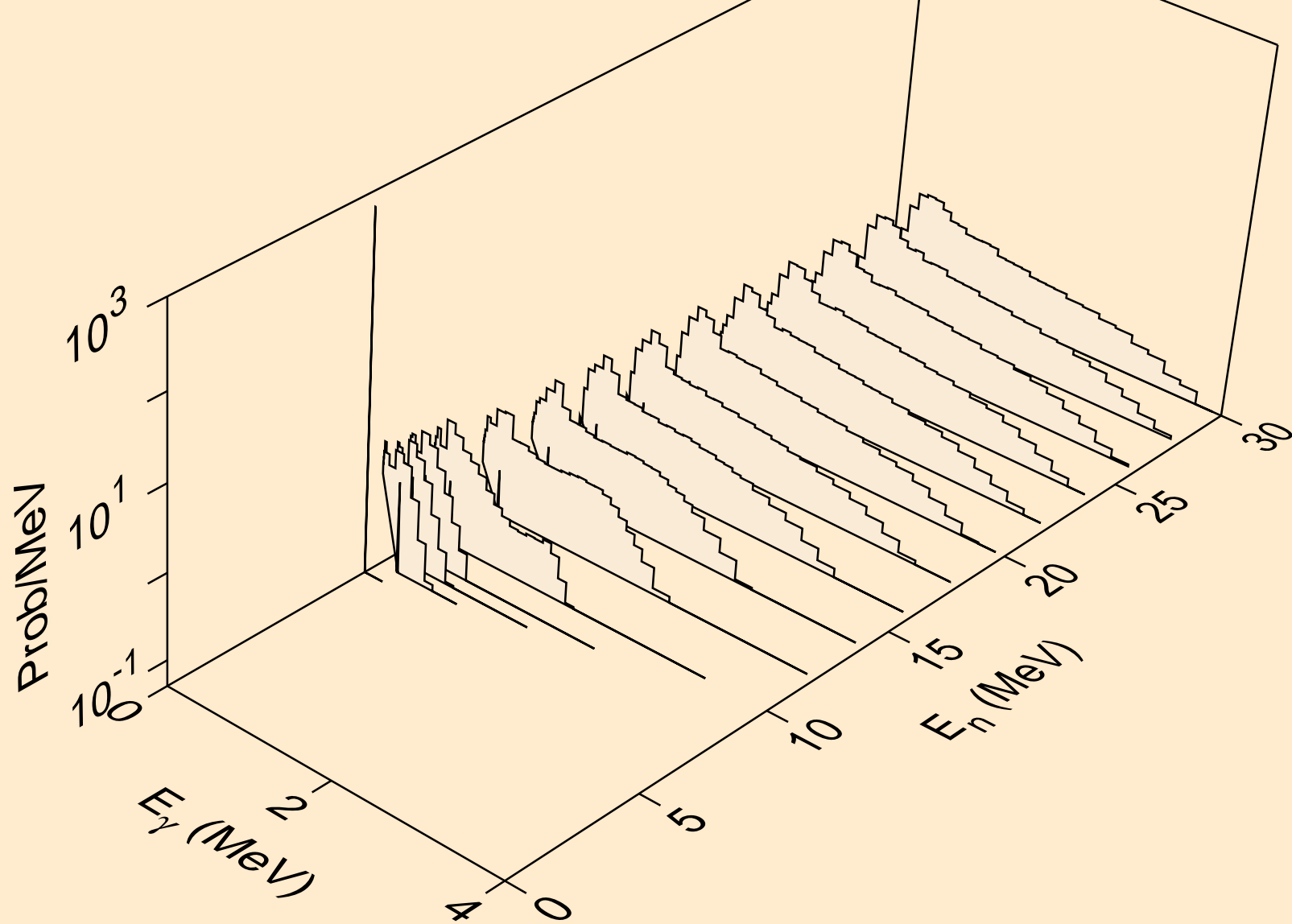

CE125 NEUTRON ACER TENDL-2021 LIBRARY; T=293.6K
Photon emission for (n,he3)

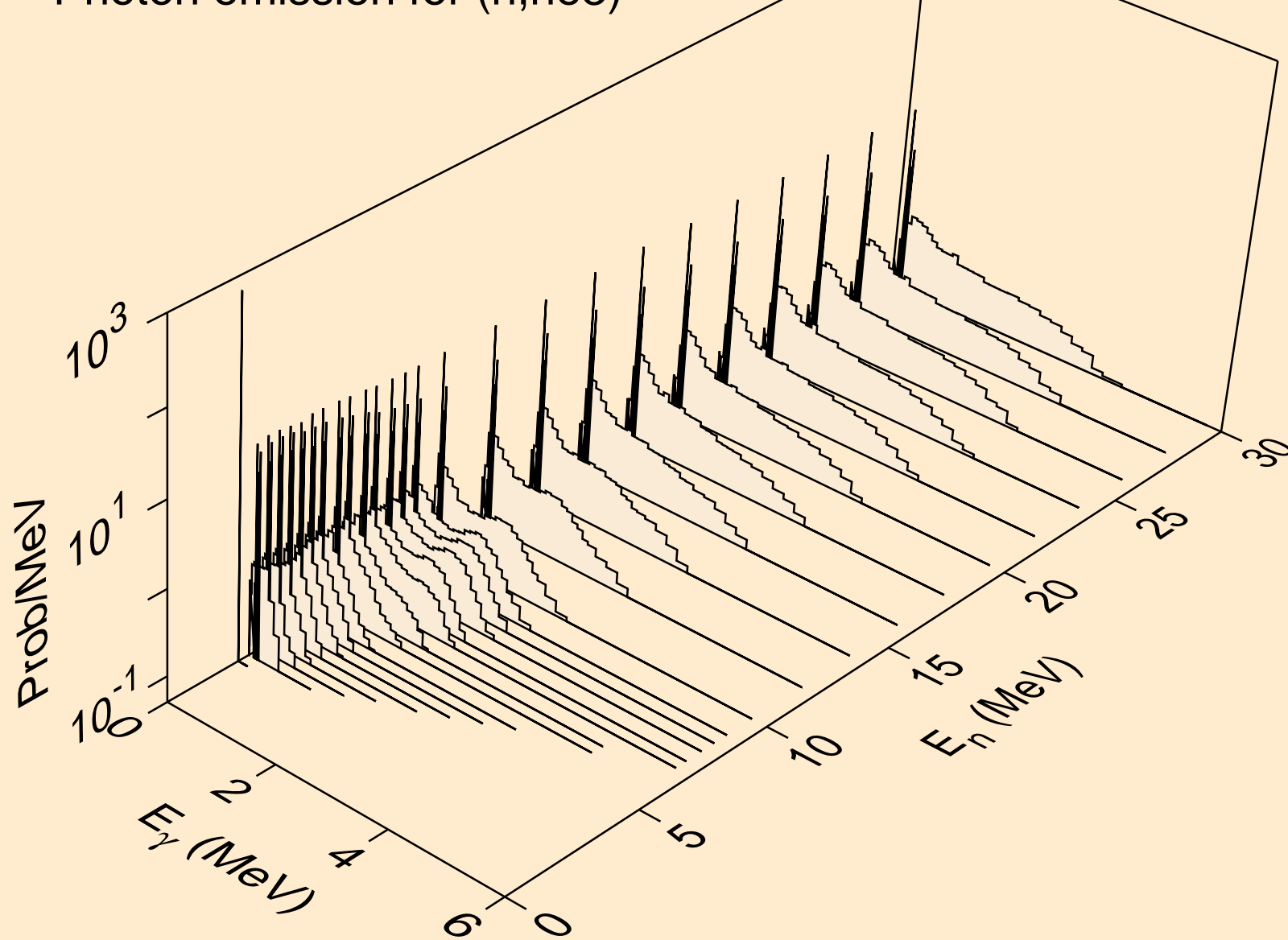

CE125 NEUTRON ACER TENDL-2021 LIBRARY; T=293.6K
Photon emission for (n,a)

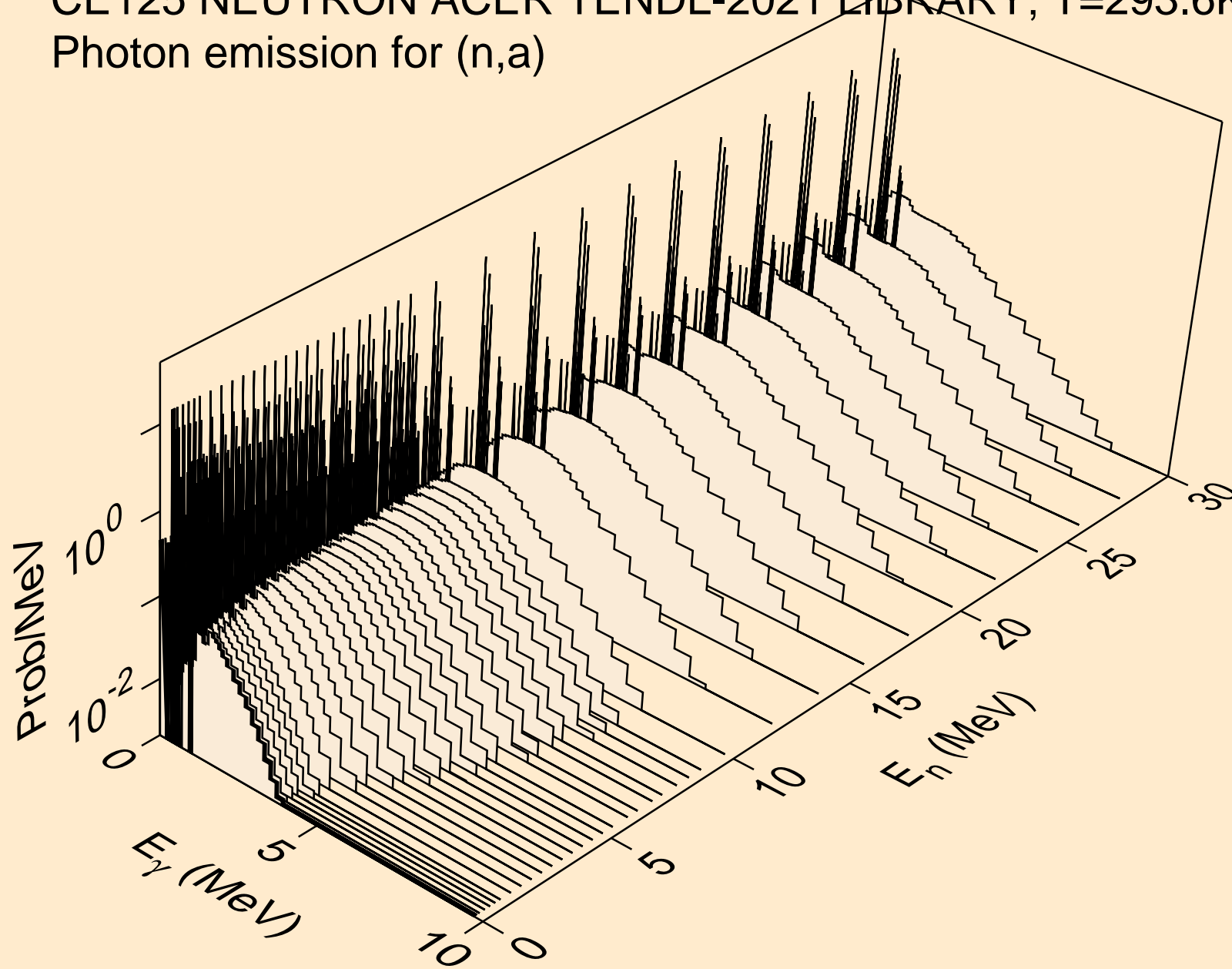

CE125 NEUTRON ACER TENDL-2021 LIBRARY; T=293.6K
Photon emission for (n,2a)

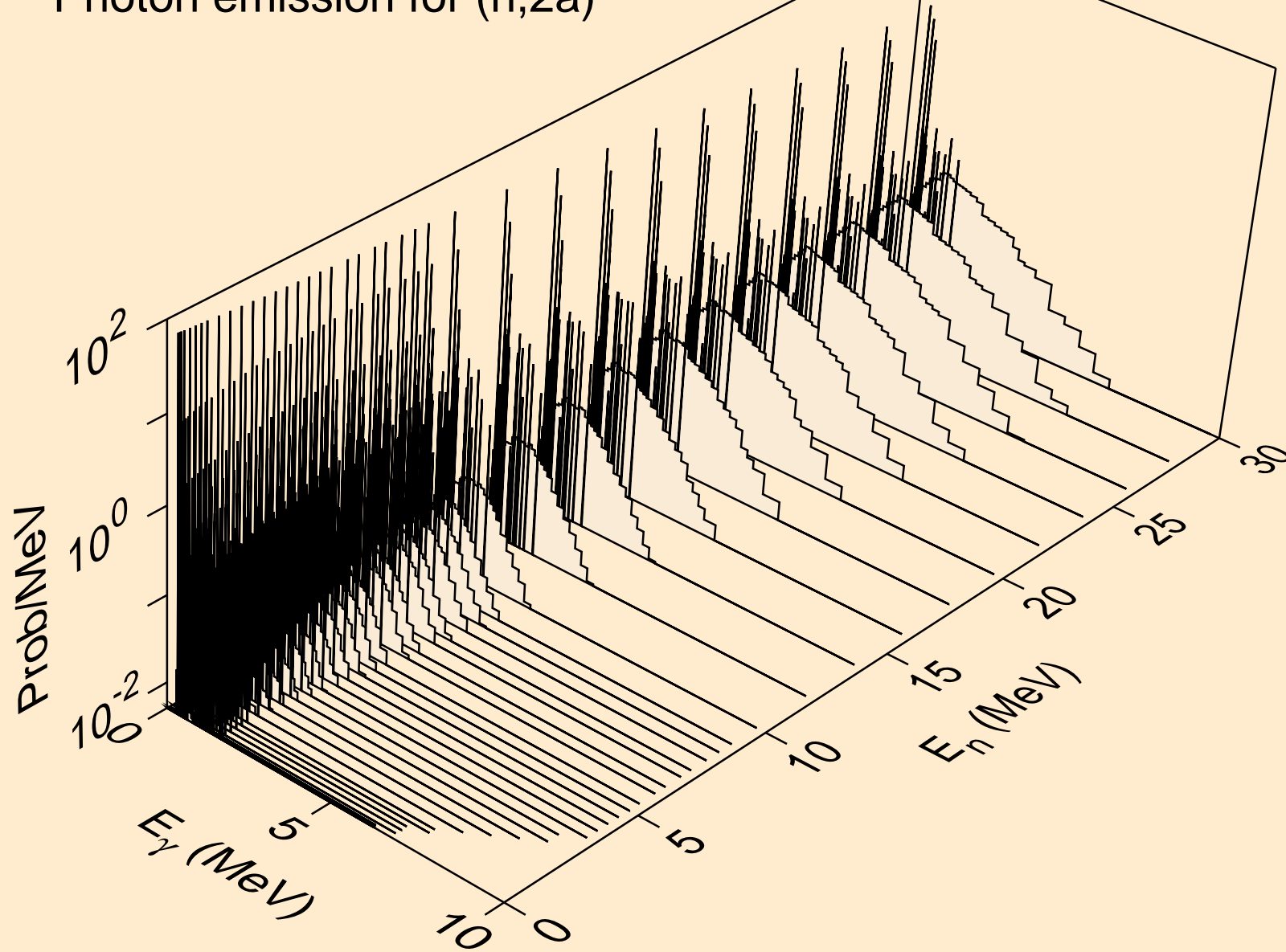

CE125 NEUTRON ACER TENDL-2021 LIBRARY; T=293.6K
Photon emission for (n,3a)

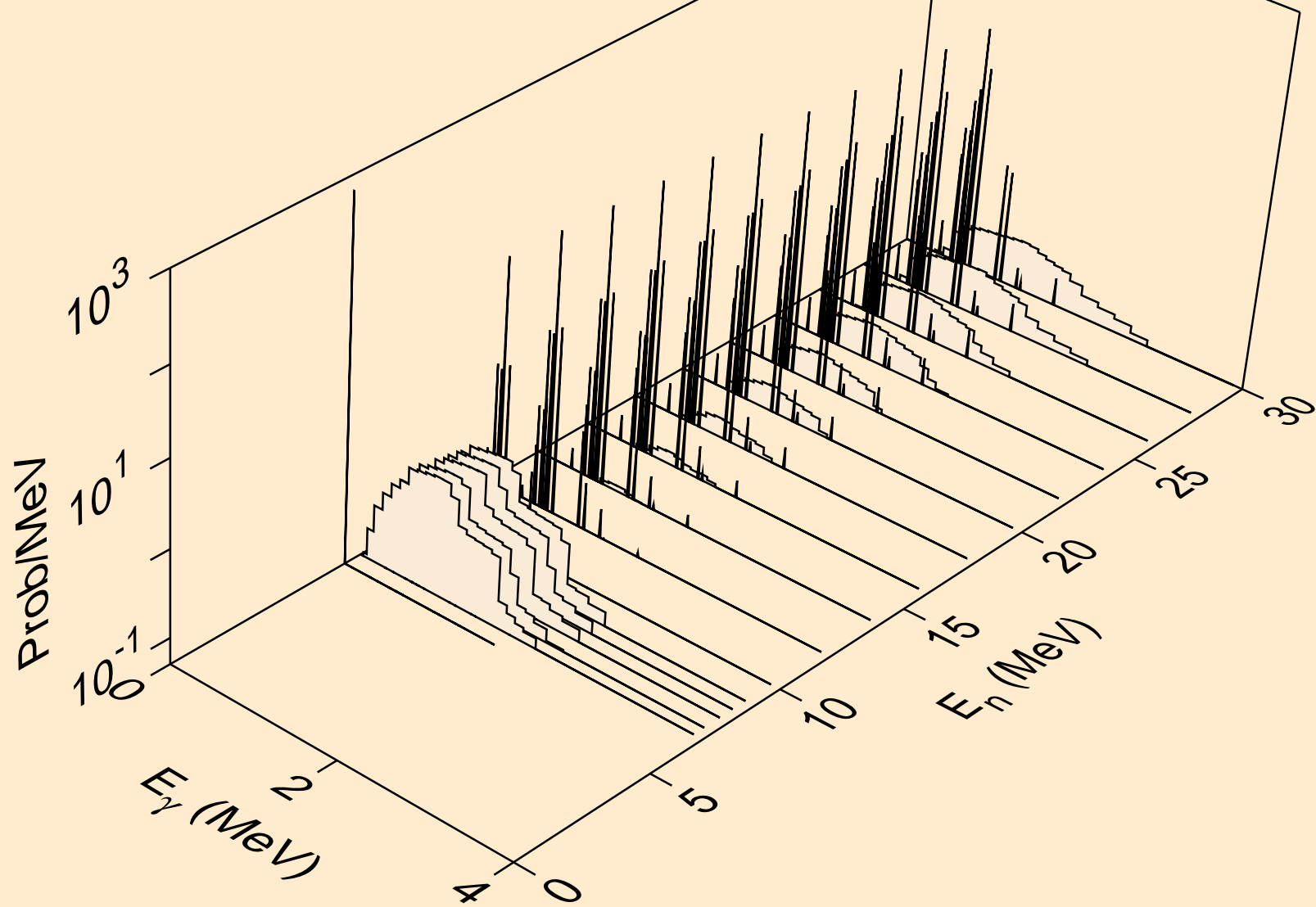

CE125 NEUTRON ACER TENDL-2021 LIBRARY; T=293.6K
Photon emission for (n,2p)

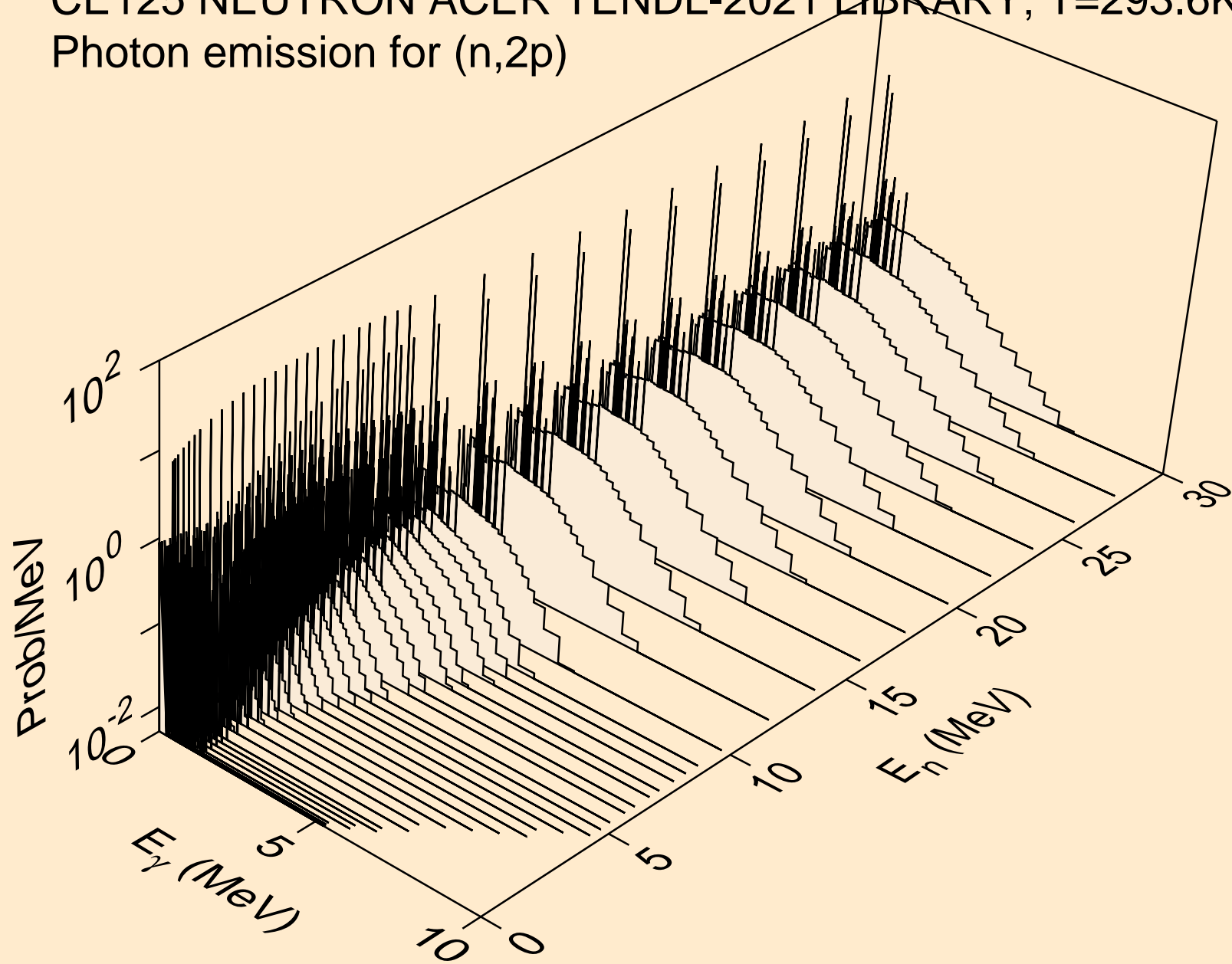

CE125 NEUTRON ACER TENDL-2021 LIBRARY; T=293.6K
Photon emission for (n,p α)

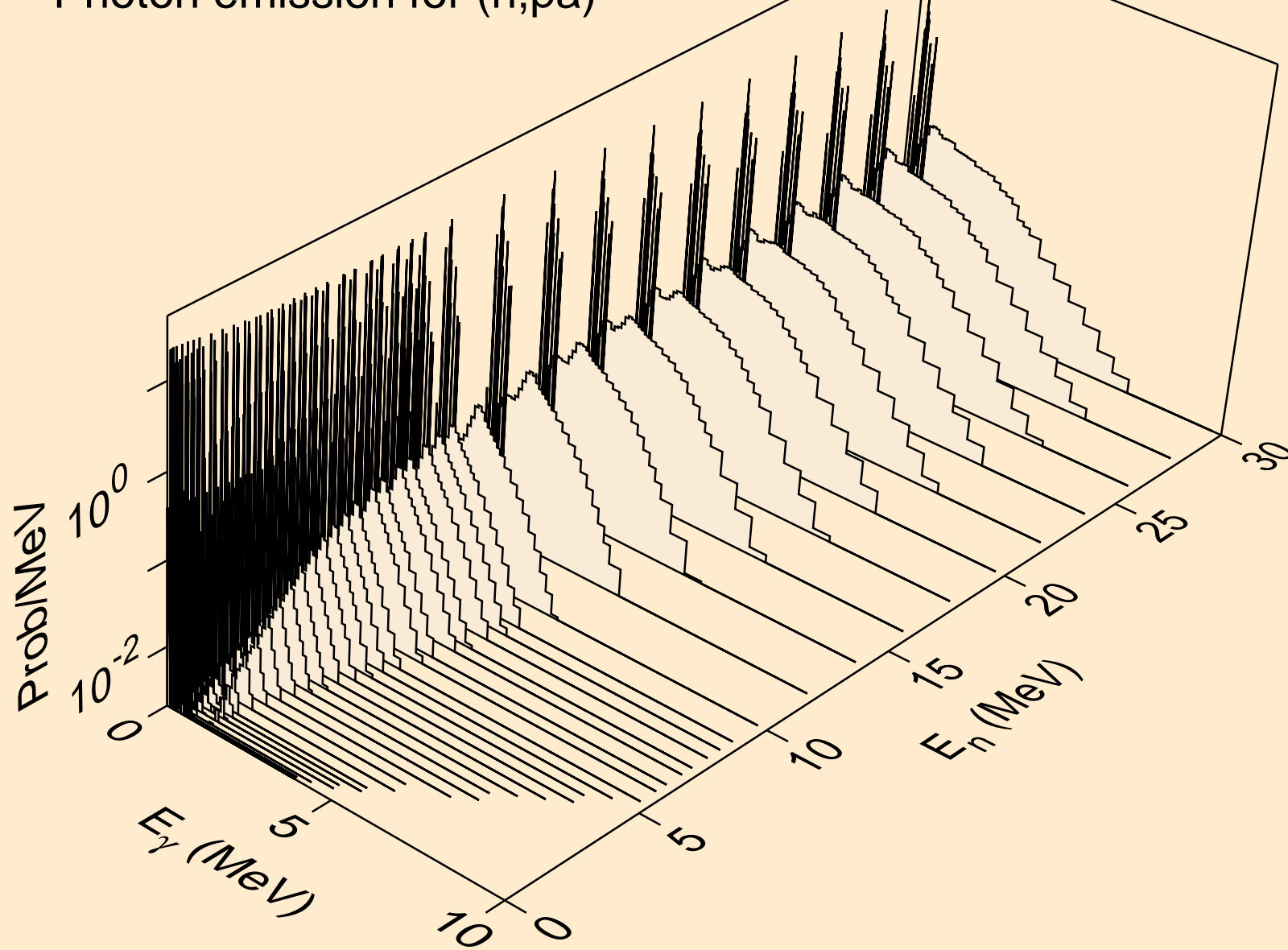

CE125 NEUTRON ACER TENDL-2021 LIBRARY; T=293.6K
Photon emission for (n,d2a)

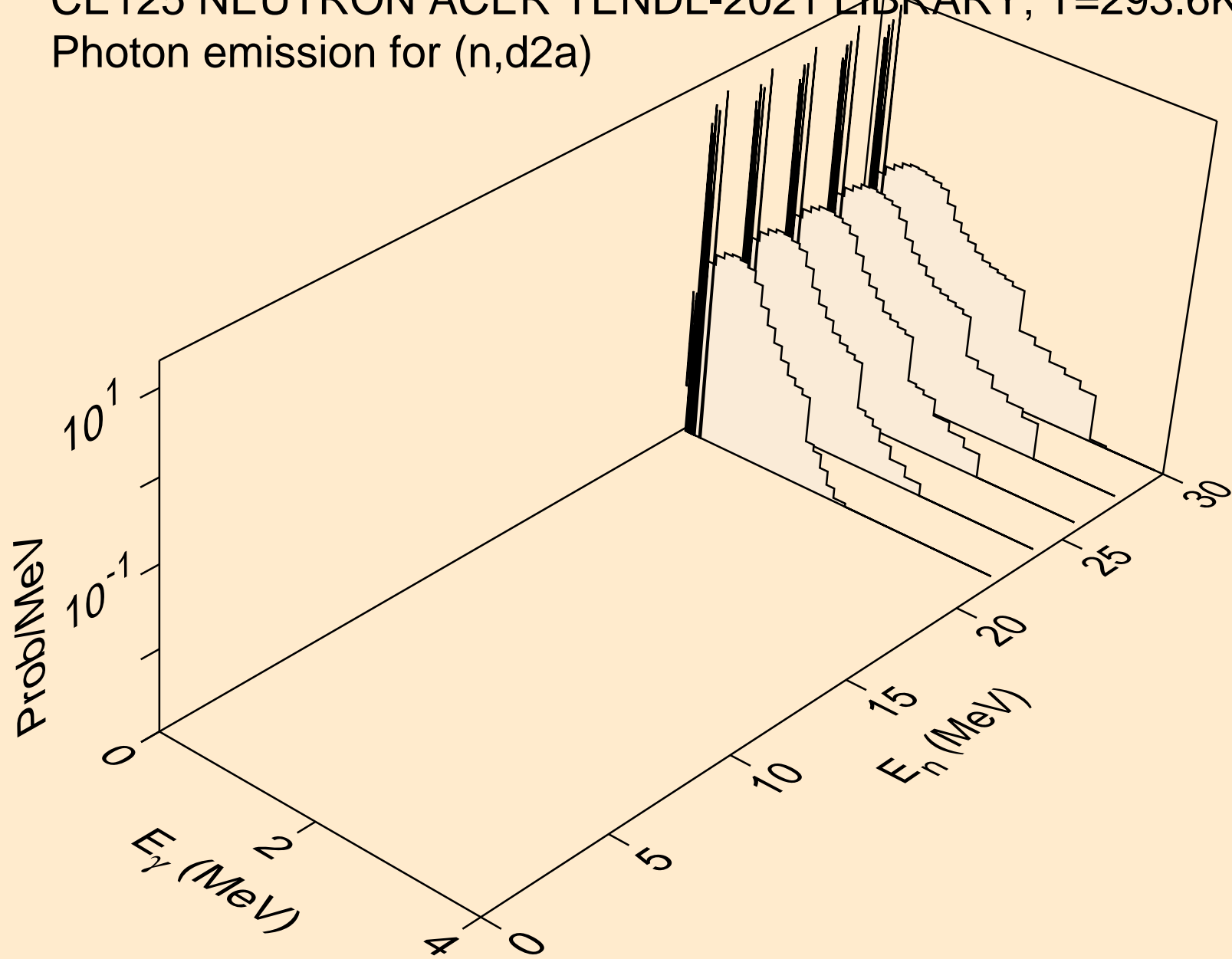

CE125 NEUTRON ACER TENDL-2021 LIBRARY; T=293.6K
Photon emission for (n,pd)

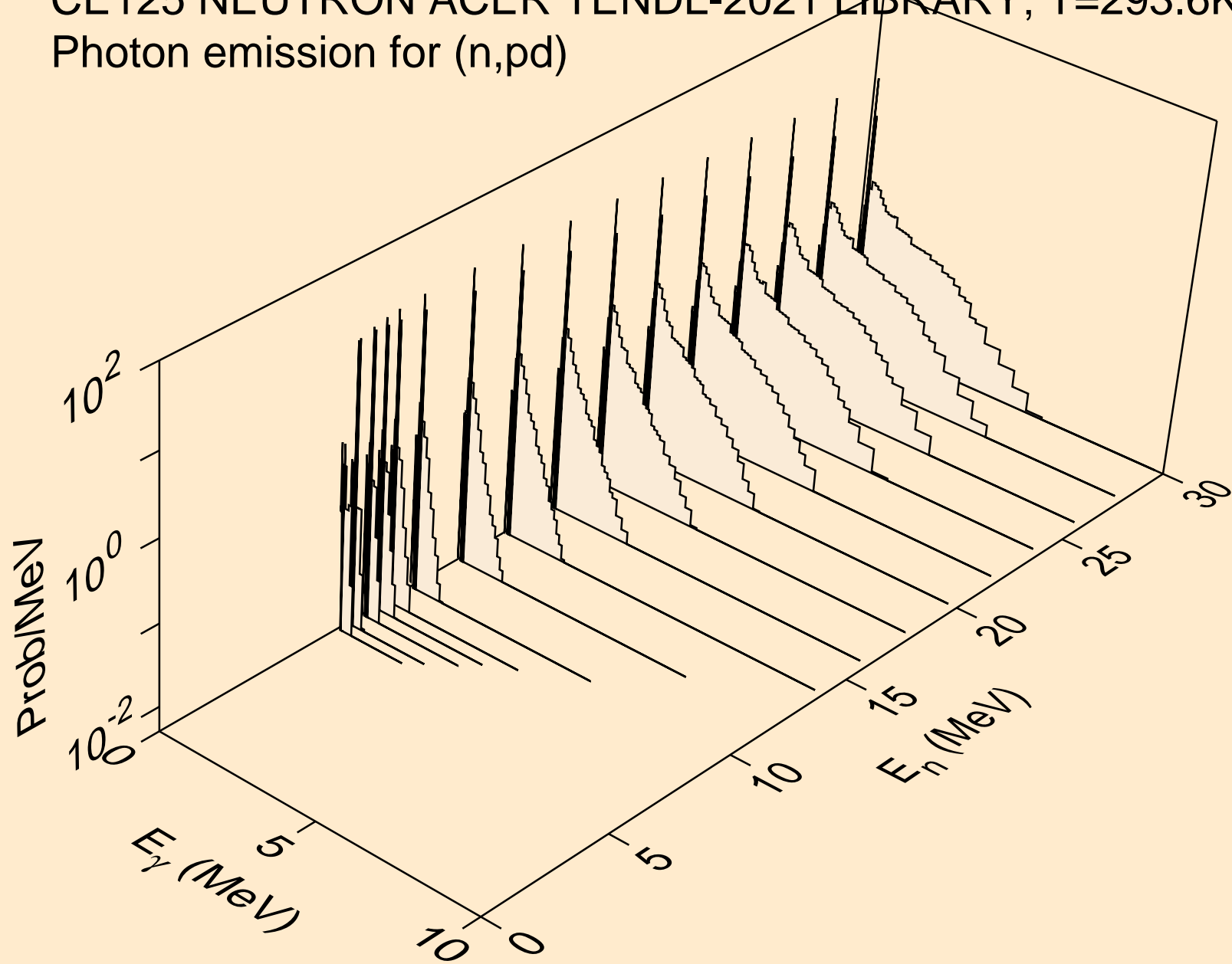

CE125 NEUTRON ACER TENDL-2021 LIBRARY; T=293.6K
Photon emission for (n,pt)

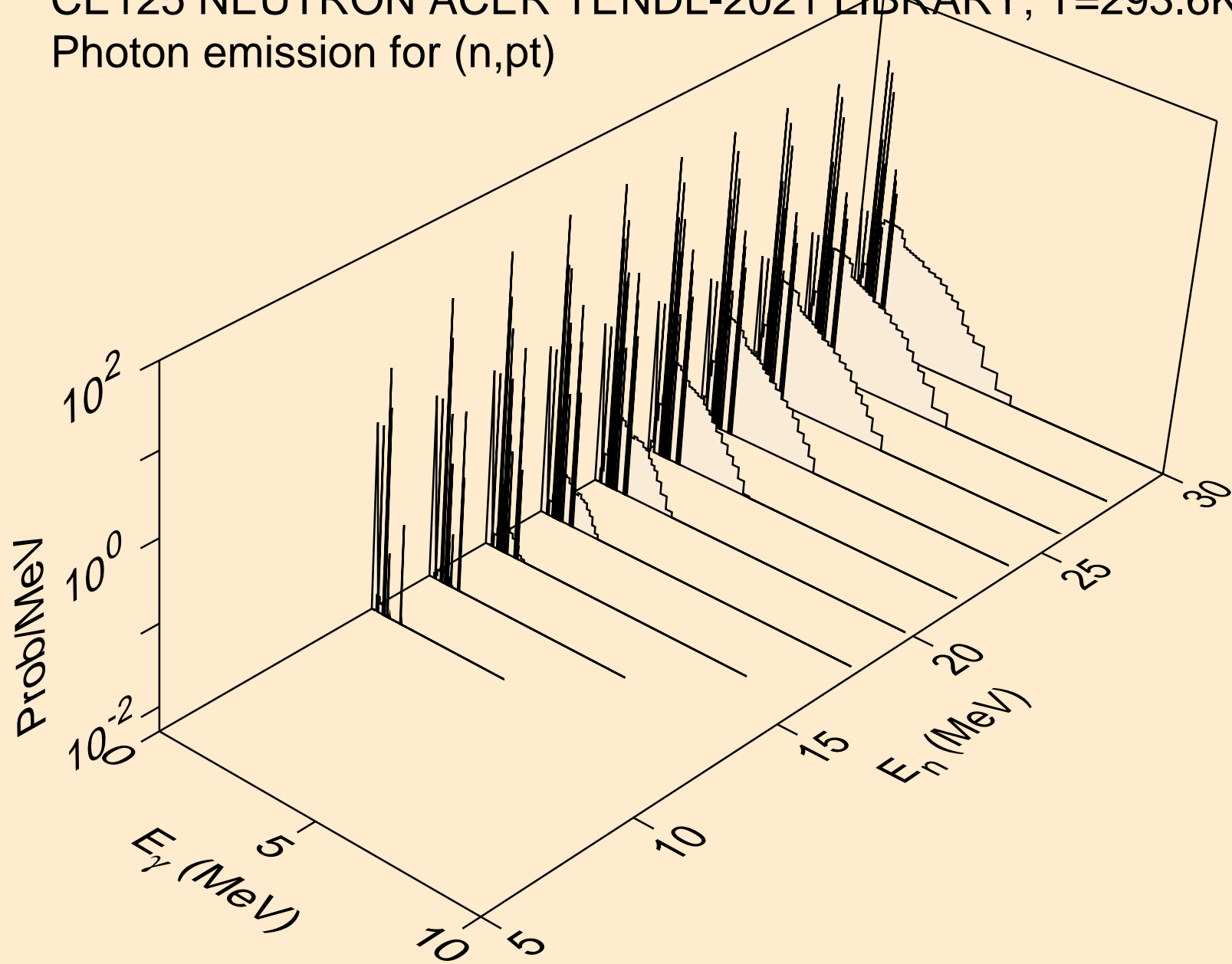

CE125 NEUTRON ACER TENDL-2021 LIBRARY; T=293.6K
Photon emission for (n,da)

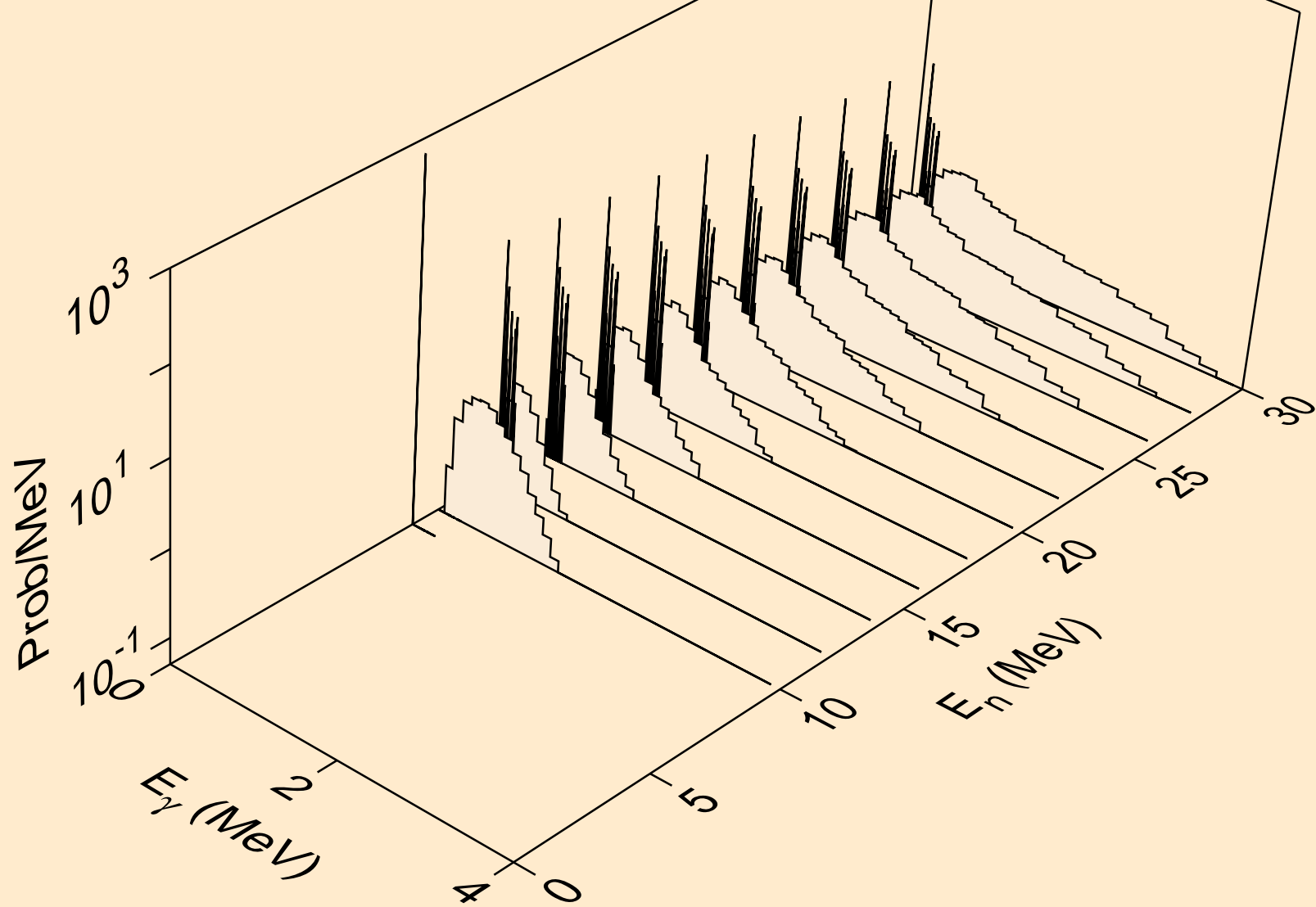

CE125 NEUTRON ACER TENDL-2021 LIBRARY; T=293.6K
thermal capture photon spectrum

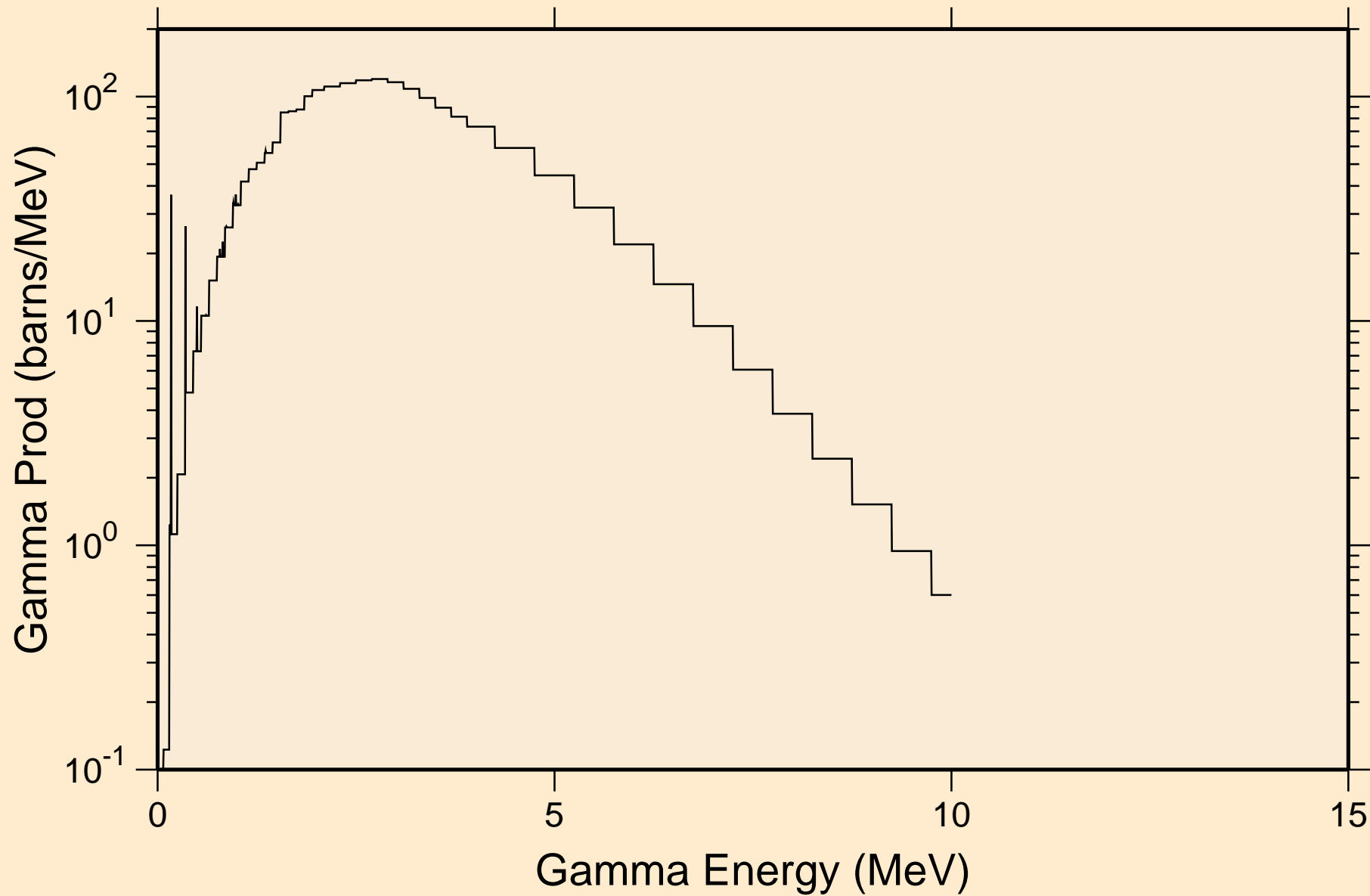

CE125 NEUTRON ACER TENDL-2021 LIBRARY; T=293.6K
14 MeV photon spectrum

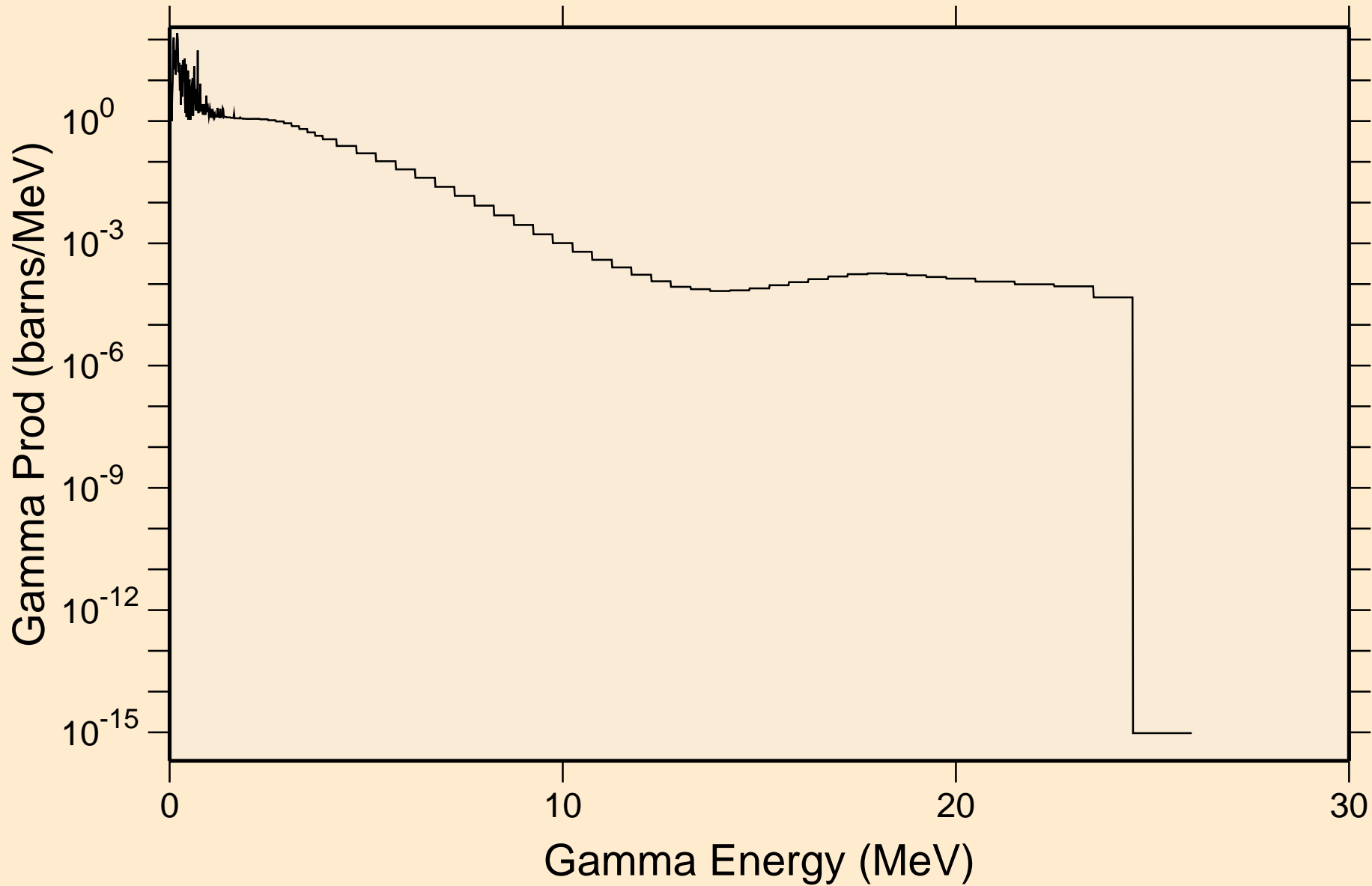

CE125 NEUTRON ACER TENDL-2021 LIBRARY; T=293.6K

Particle heating contributions

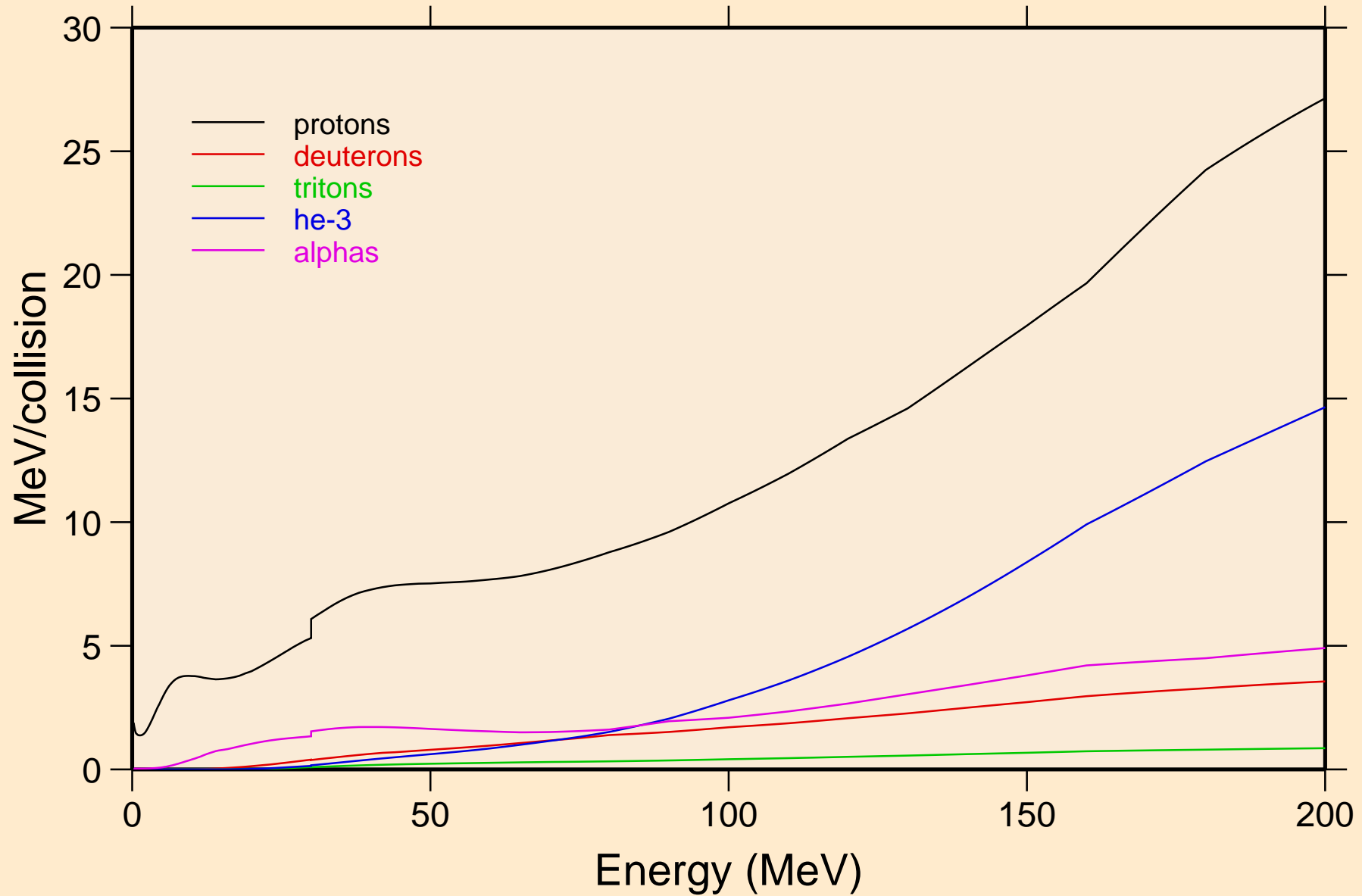

CE125 NEUTRON ACER TENDL-2021 LIBRARY; T=293.6K
Recoil Heating

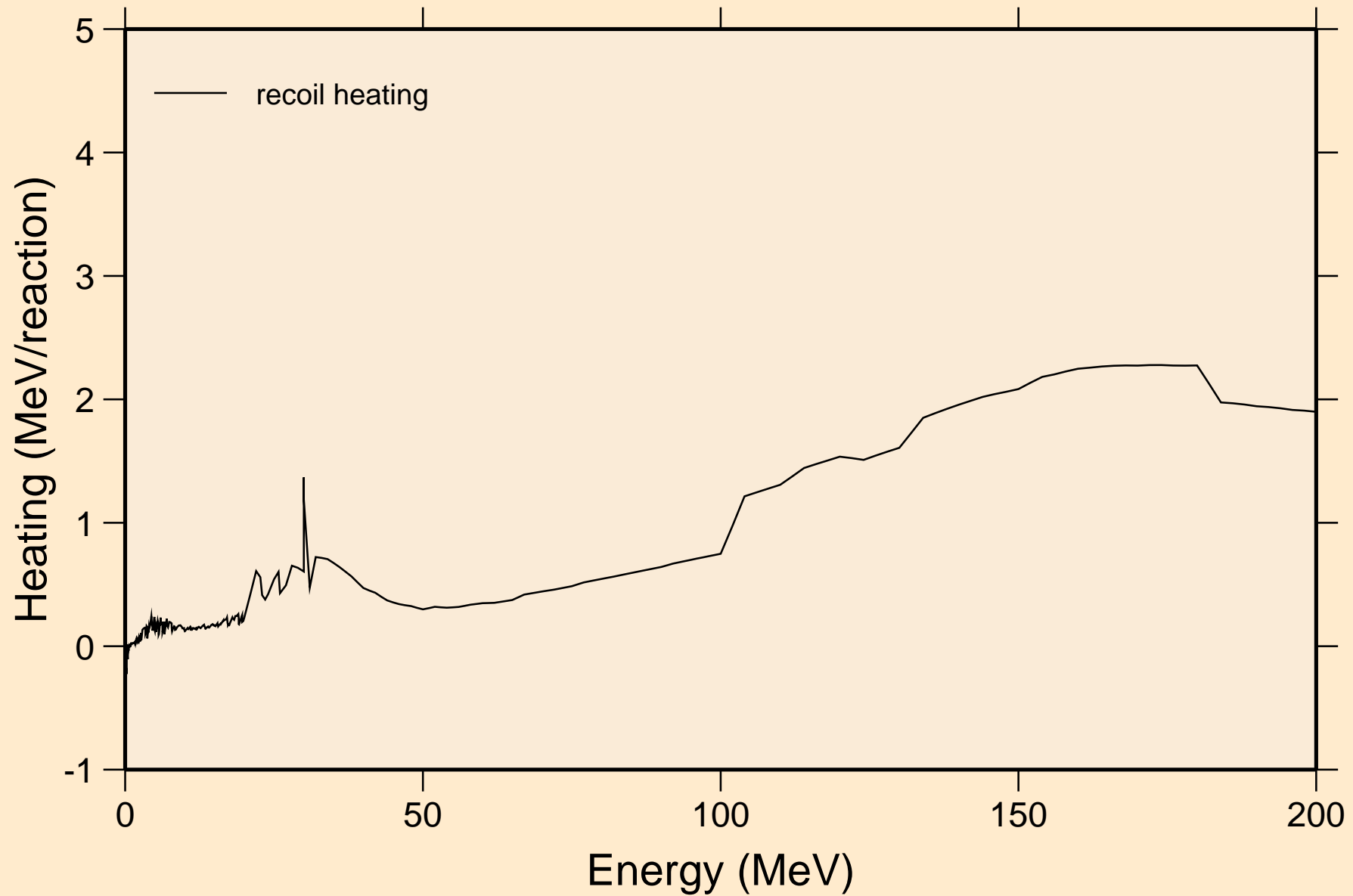

CE125 NEUTRON ACER TENDL-2021 LIBRARY; T=293.6K
Particle production cross sections

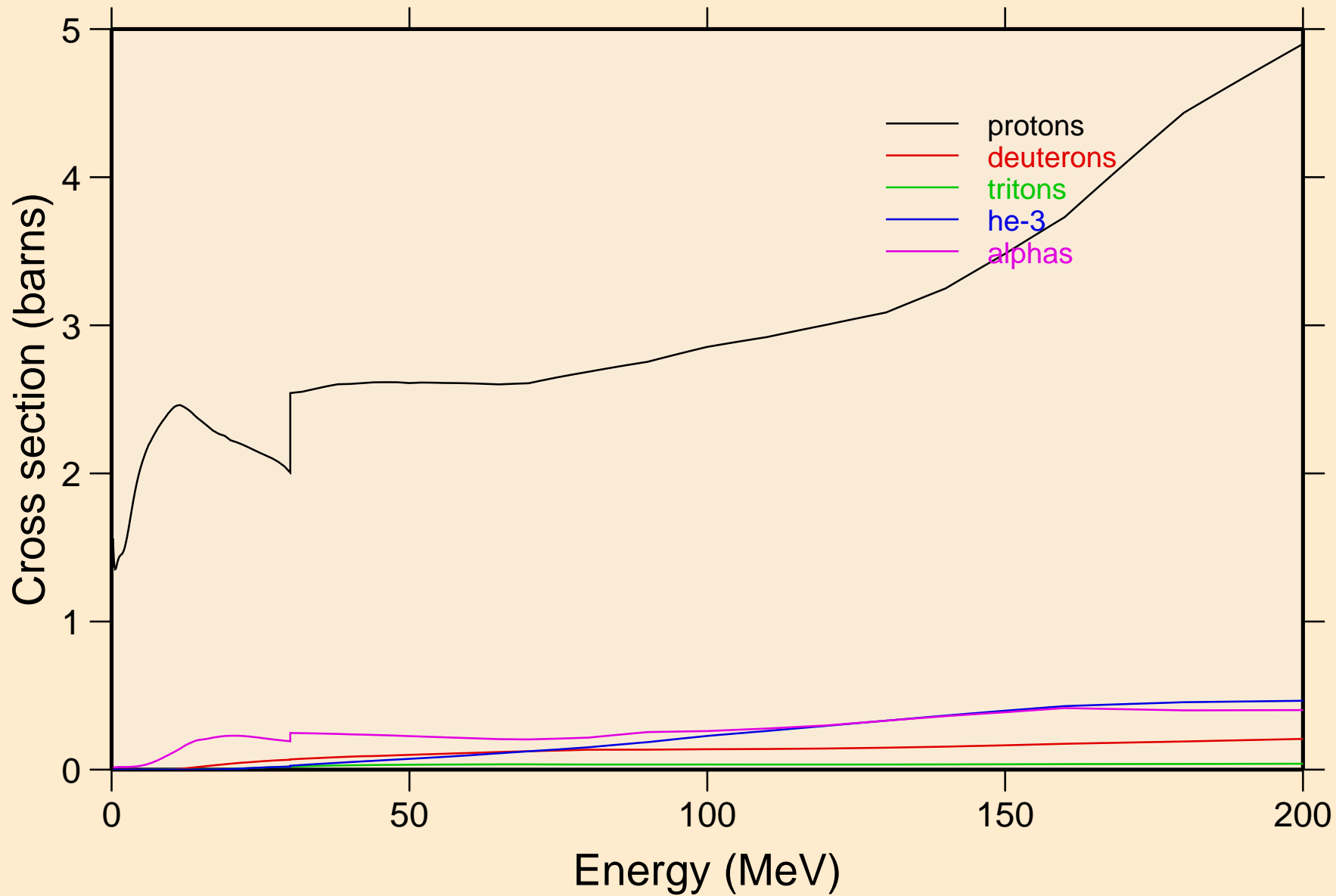

CE125 NEUTRON ACER TENDL-2021 LIBRARY; T=293.6K
protons from (n,x)

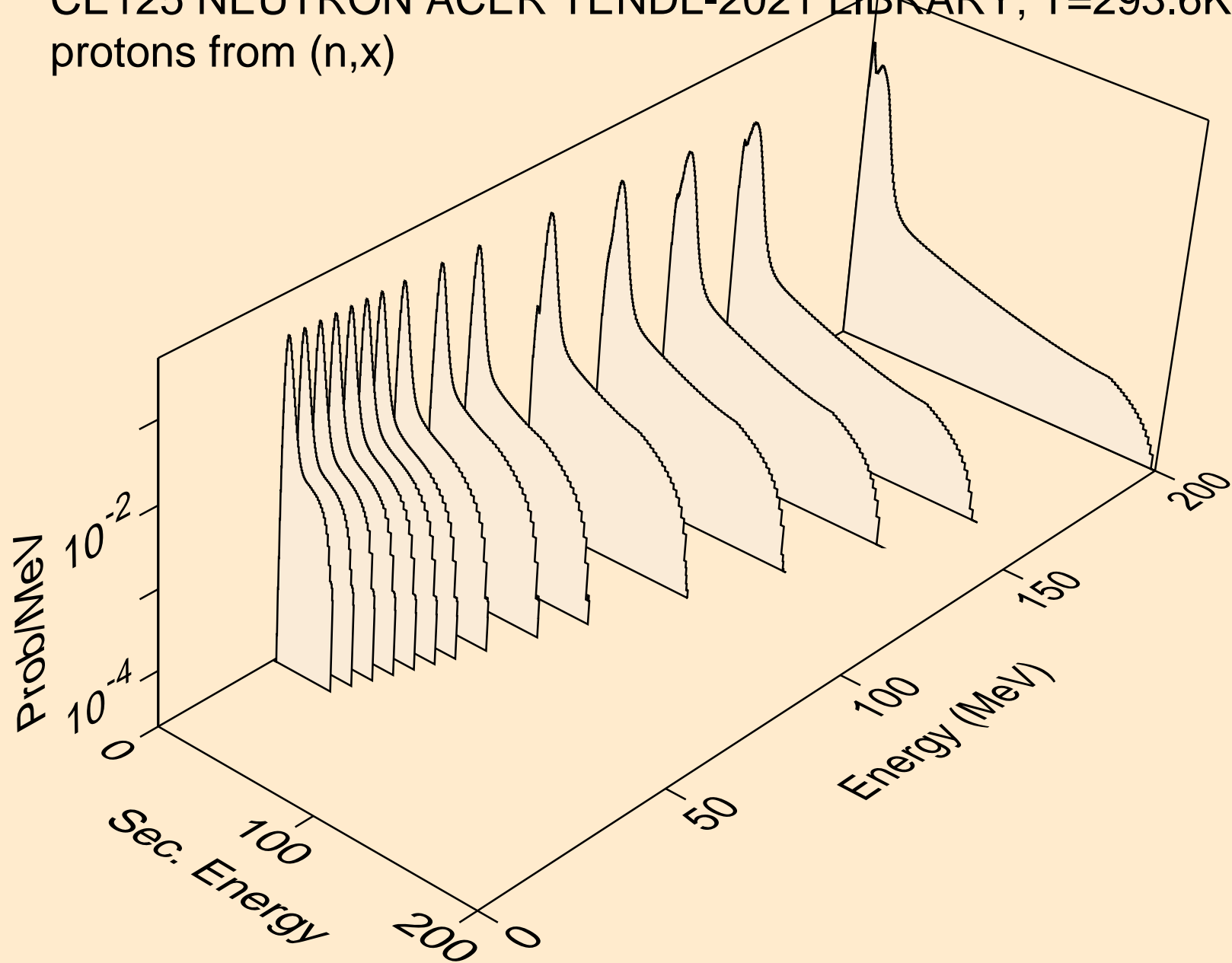

CE125 NEUTRON ACER TENDL-2021 LIBRARY; T=293.6K
protons from (n,n*)p

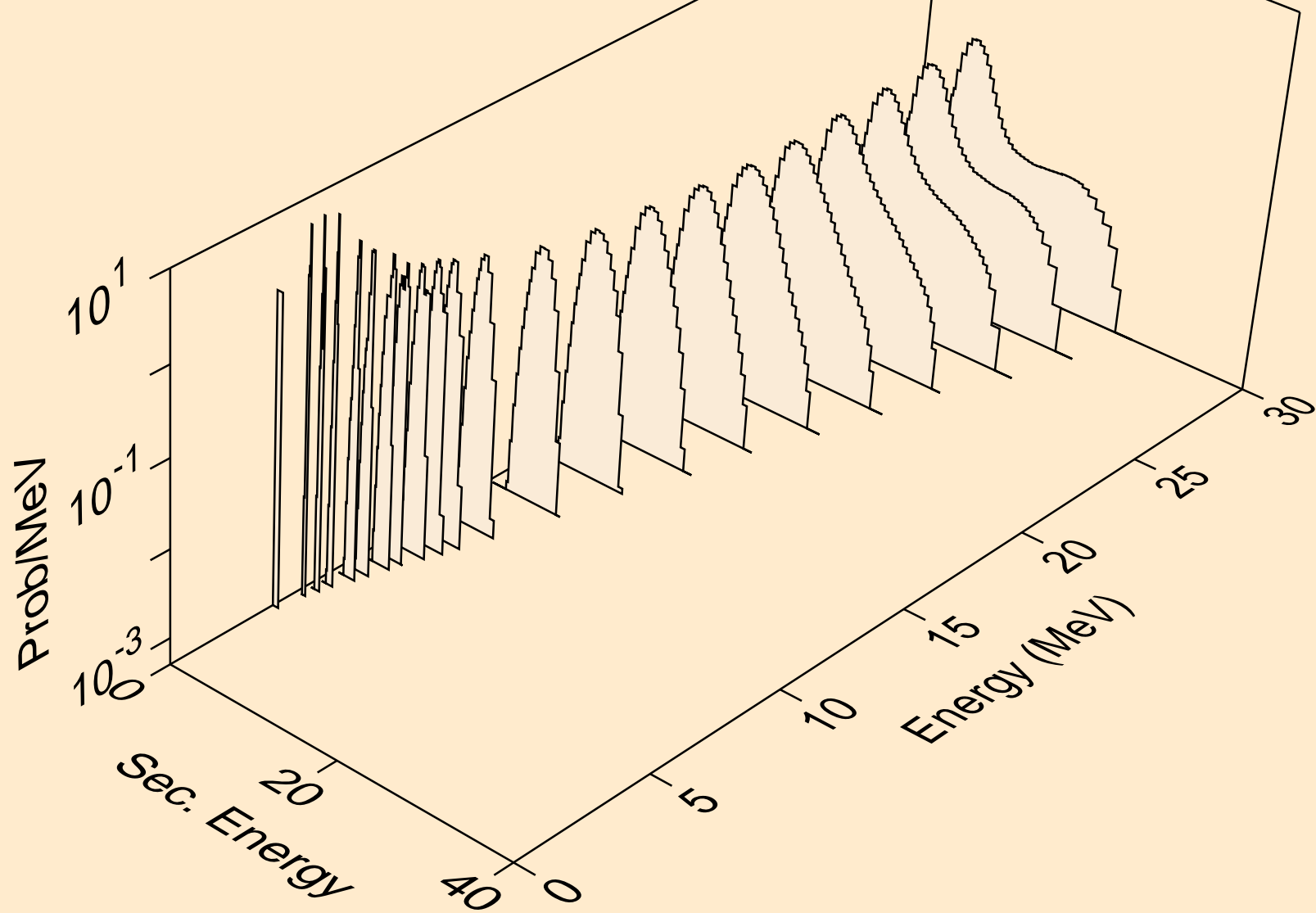

CE125 NEUTRON ACER TENDL-2021 LIBRARY; T=293.6K
protons from (n,2np)

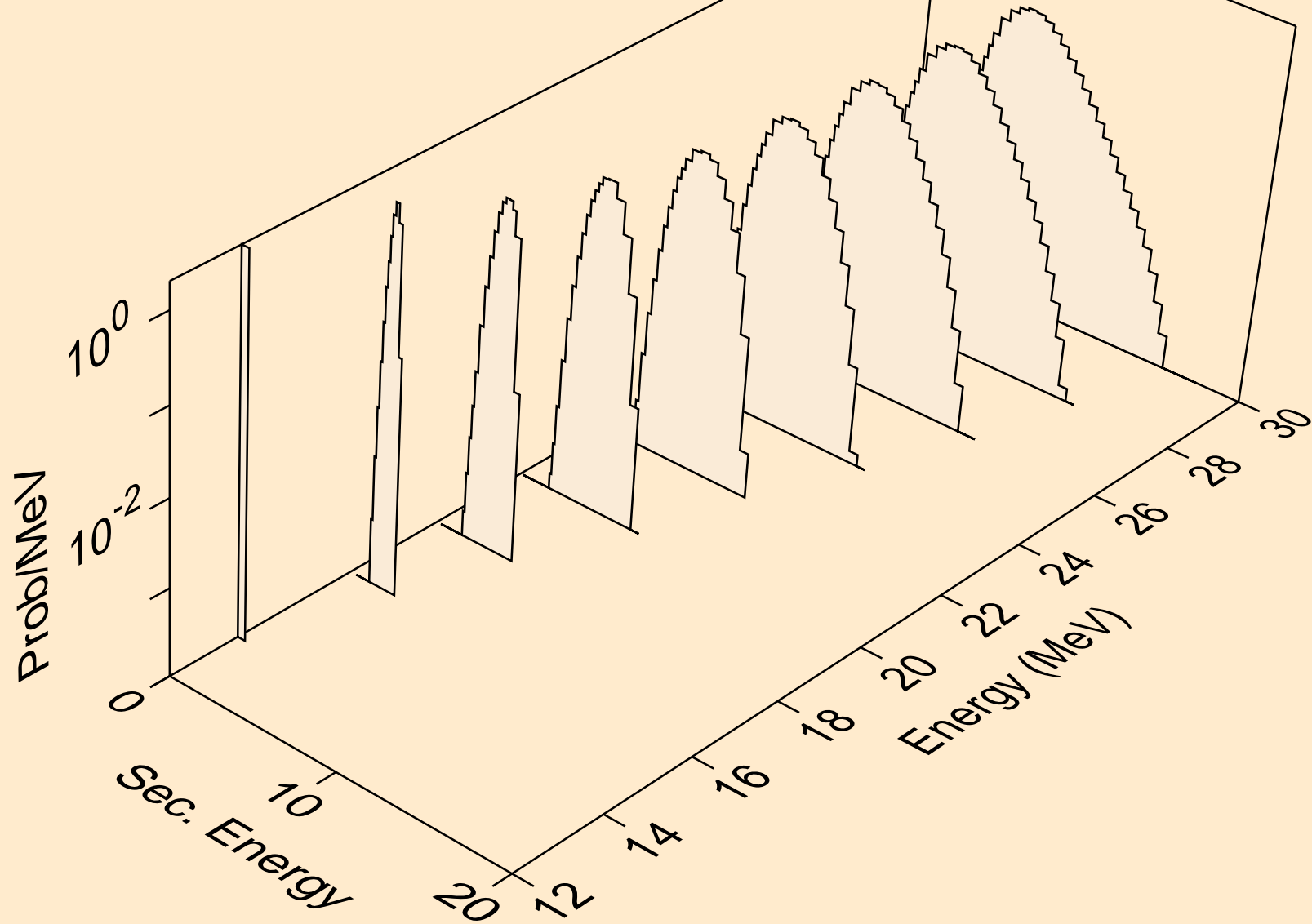

CE125 NEUTRON ACER TENDL-2021 LIBRARY; T=293.6K
protons from (n,3np)

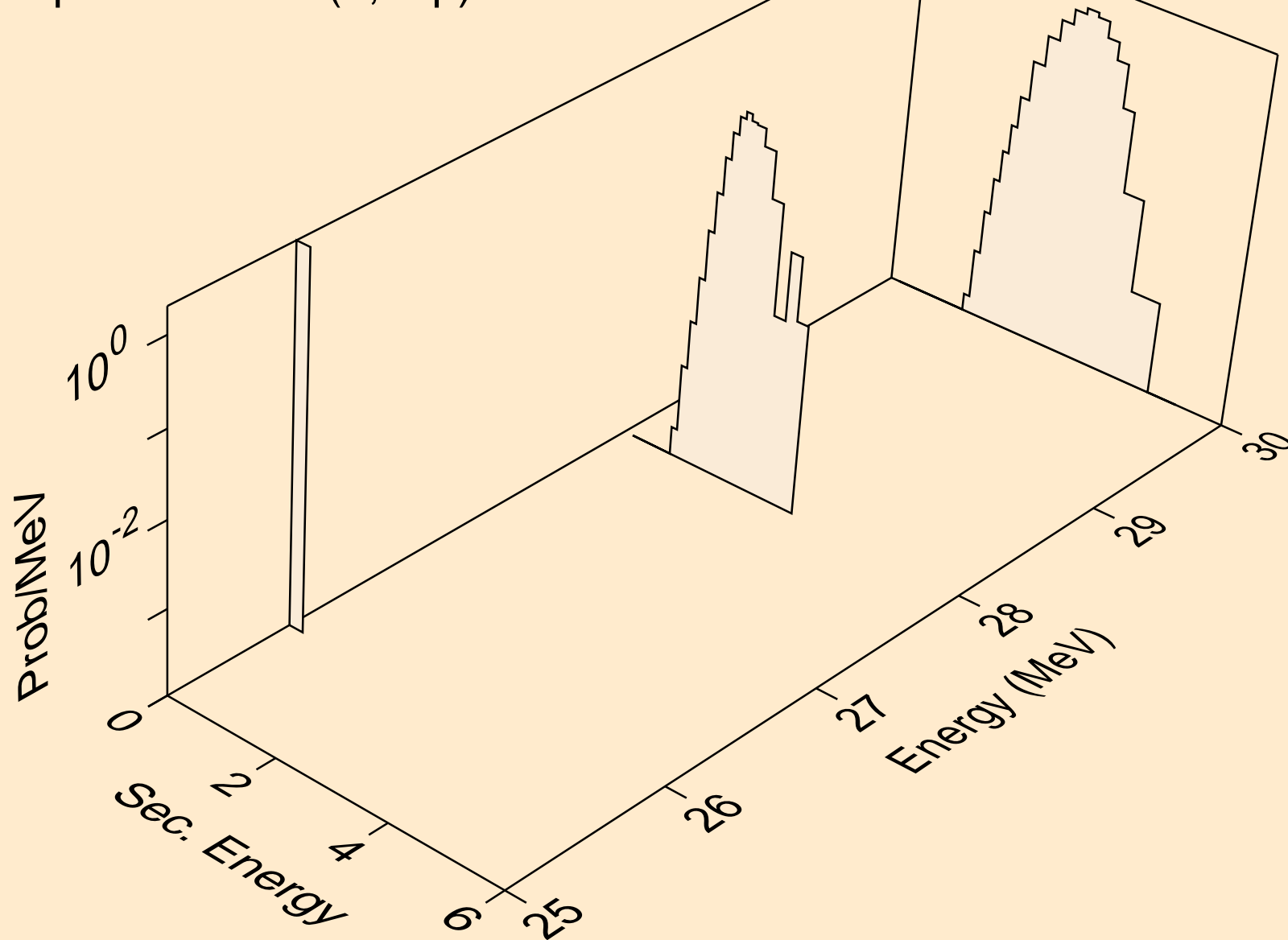

CE125 NEUTRON ACER TENDL-2021 LIBRARY; T=293.6K
protons from (n,2np)

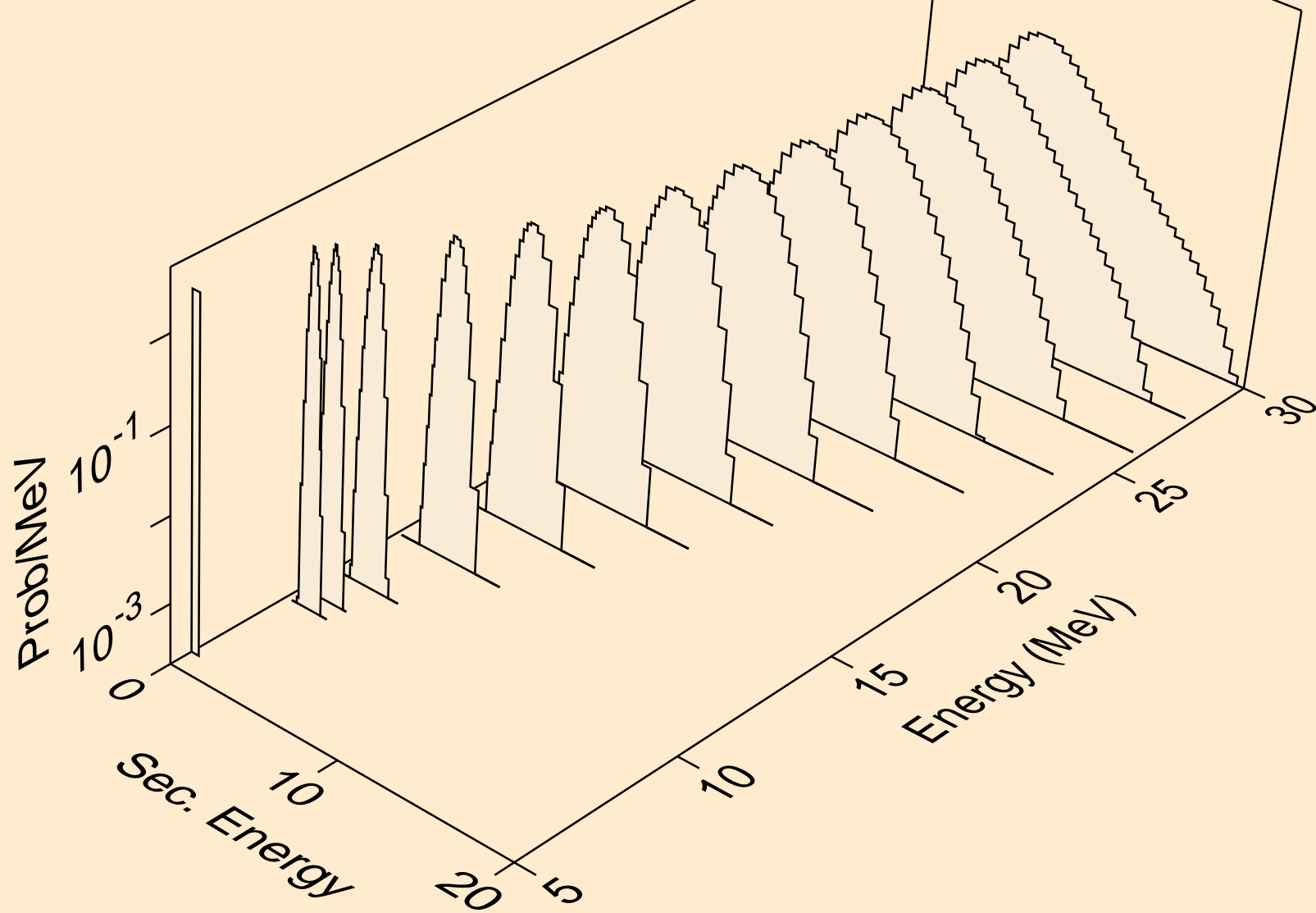

CE125 NEUTRON ACER TENDL-2021 LIBRARY; T=293.6K
protons from (n,npa)

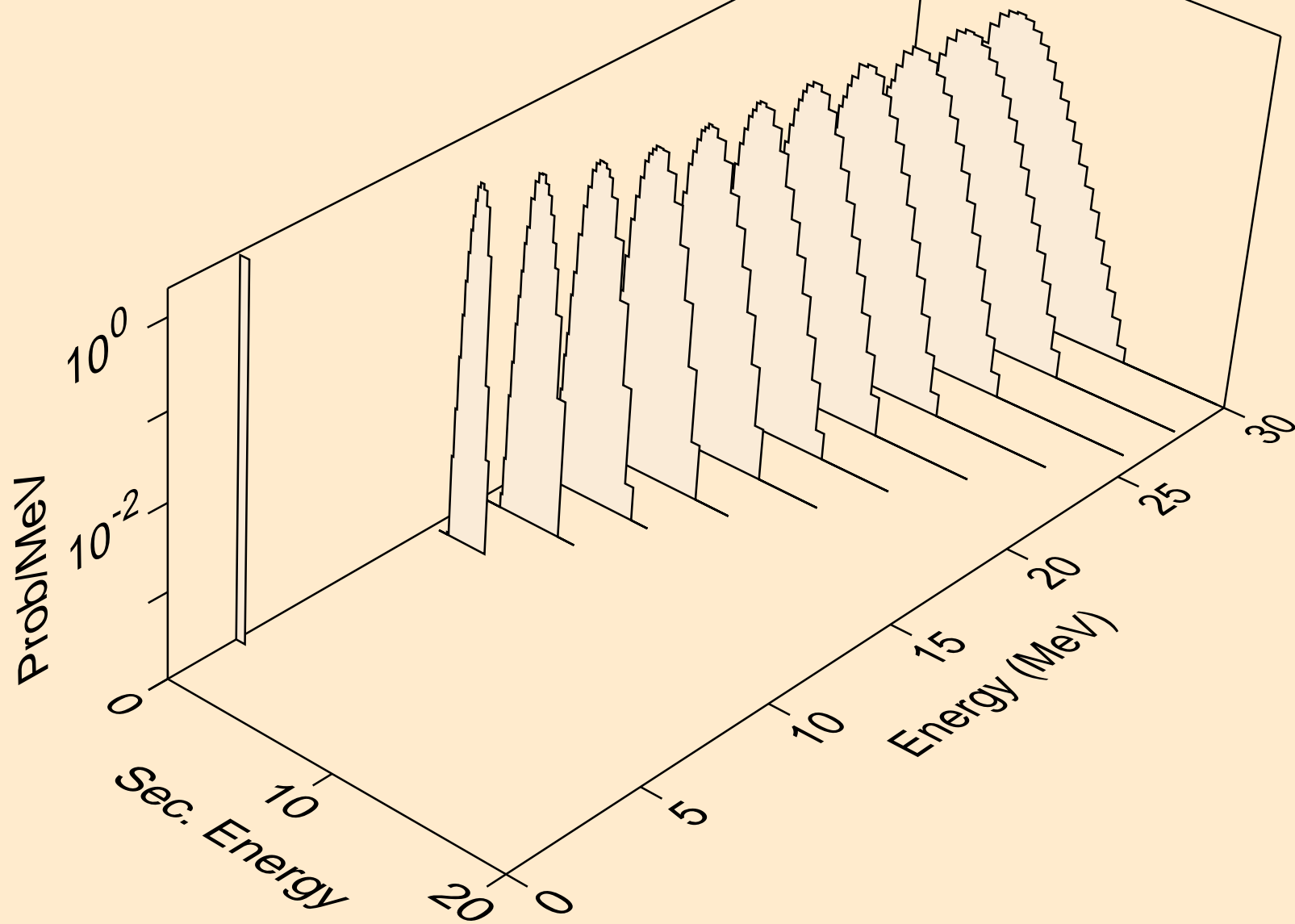

CE125 NEUTRON ACER TENDL-2021 LIBRARY; T=293.6K
protons from (n,p)

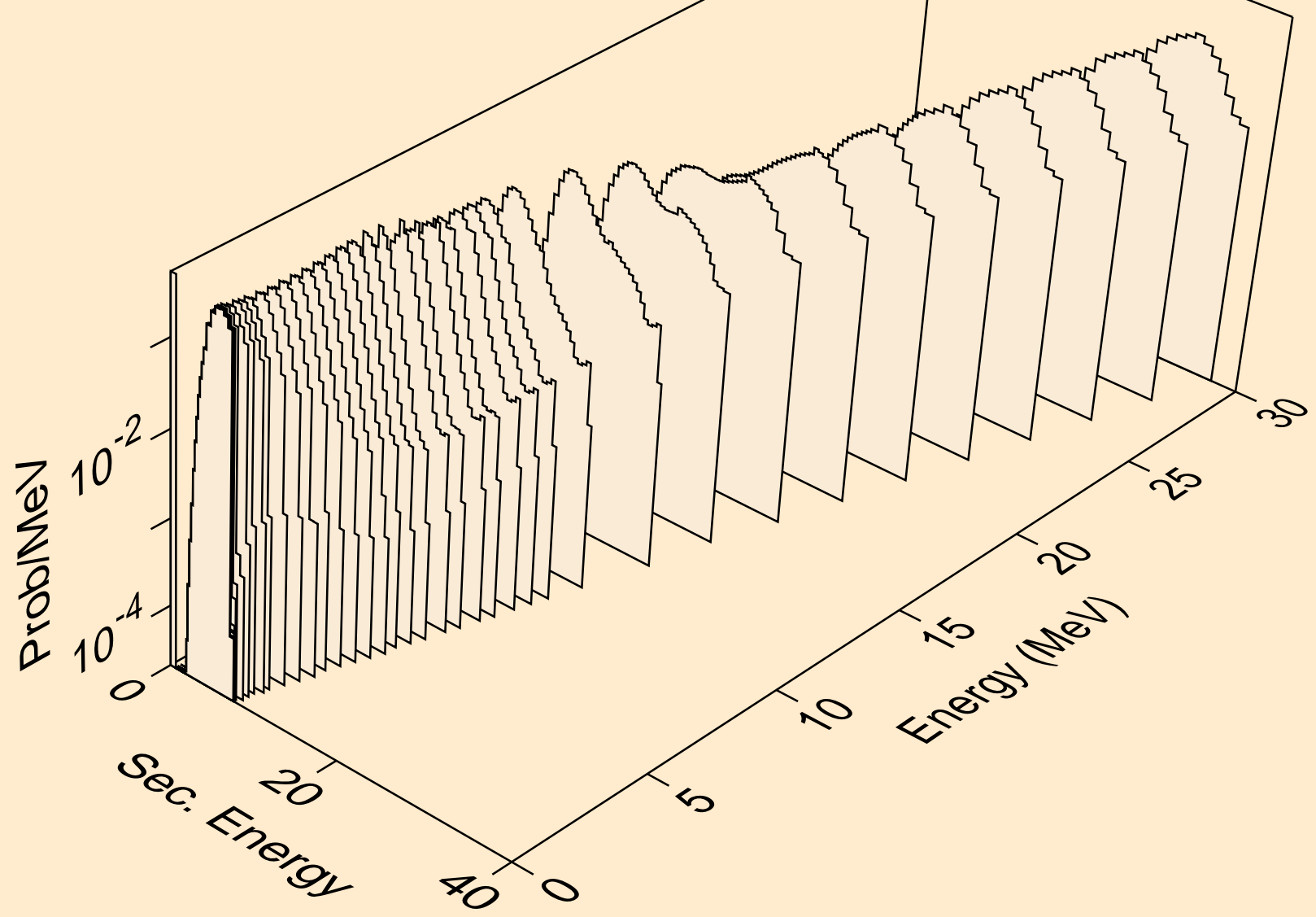

CE125 NEUTRON ACER TENDL-2021 LIBRARY; T=293.6K
protons from (n,2p)

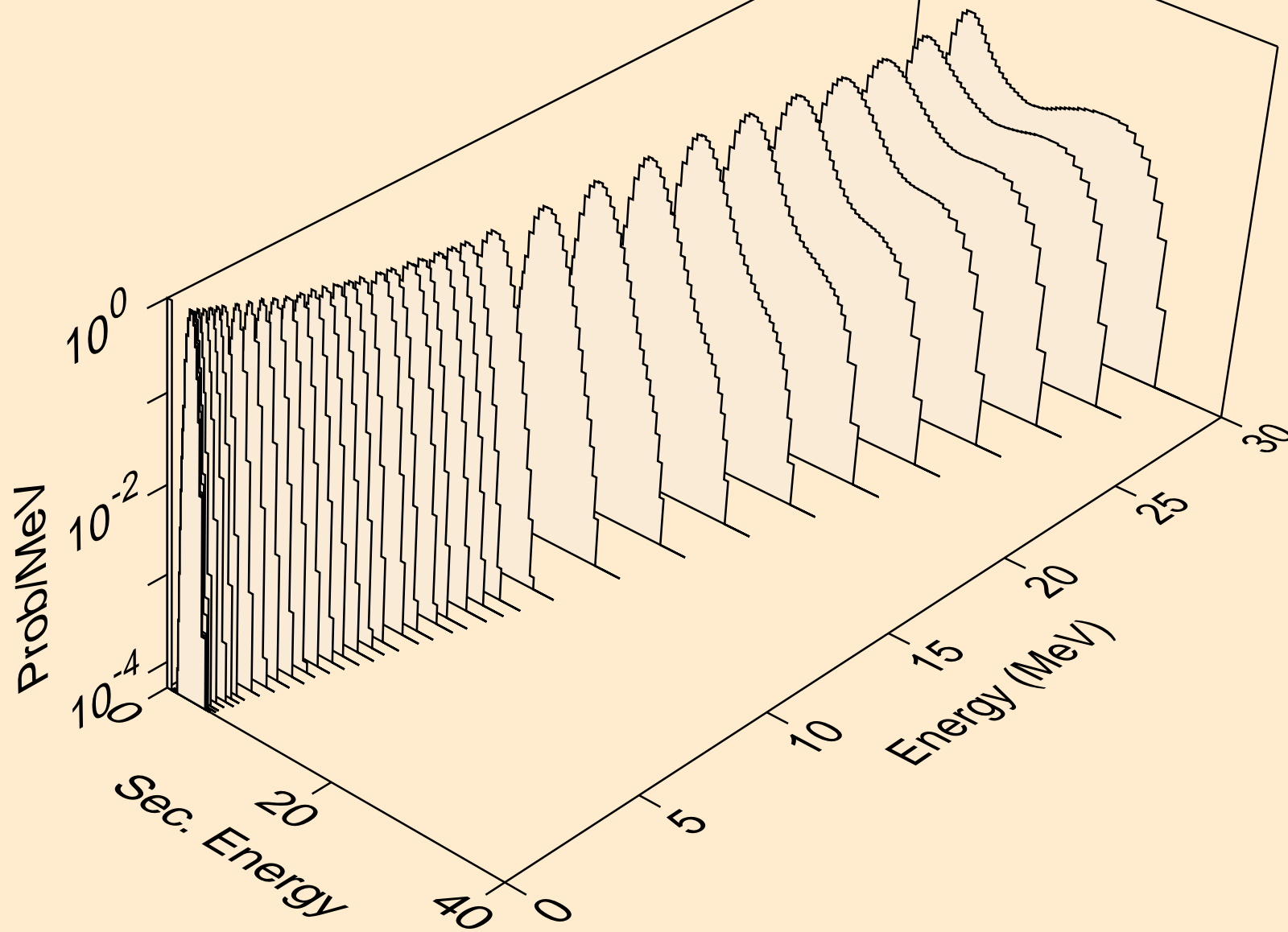

CE125 NEUTRON ACER TENDL-2021 LIBRARY; T=293.6K
protons from (n,p)

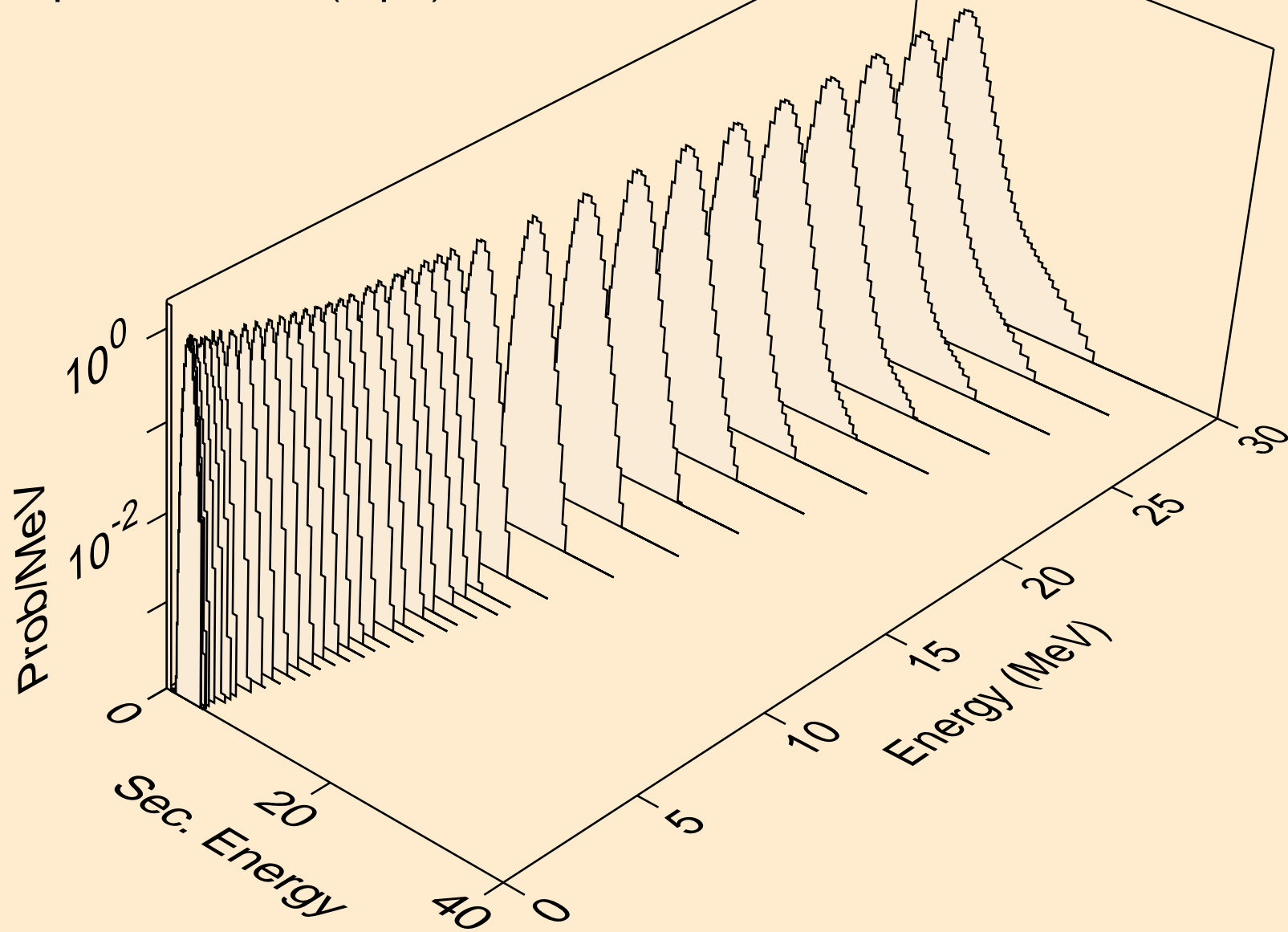

CE125 NEUTRON ACER TENDL-2021 LIBRARY; T=293.6K
protons from (n,pd)

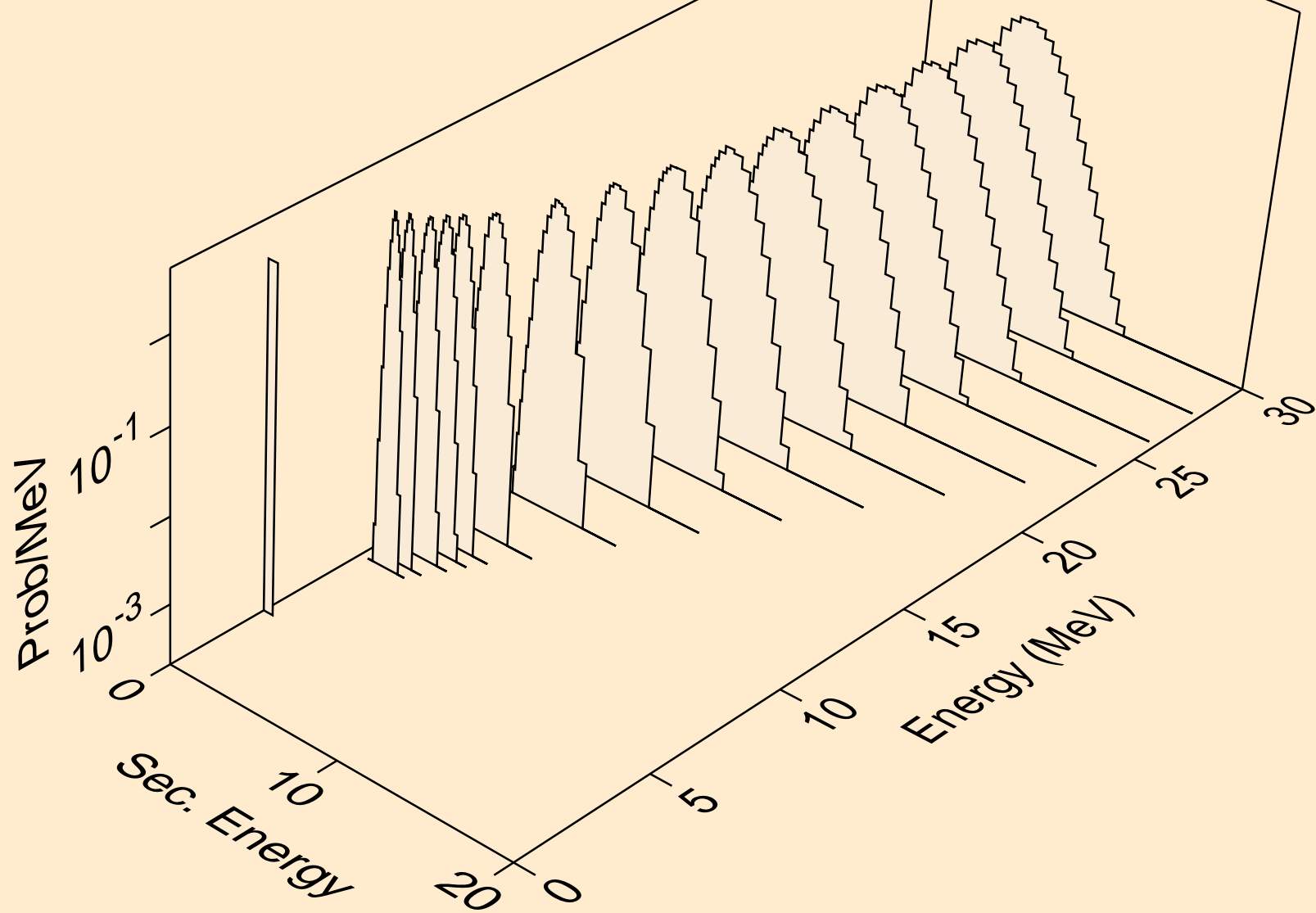

CE125 NEUTRON ACER TENDL-2021 LIBRARY; T=293.6K
protons from (n,pt)

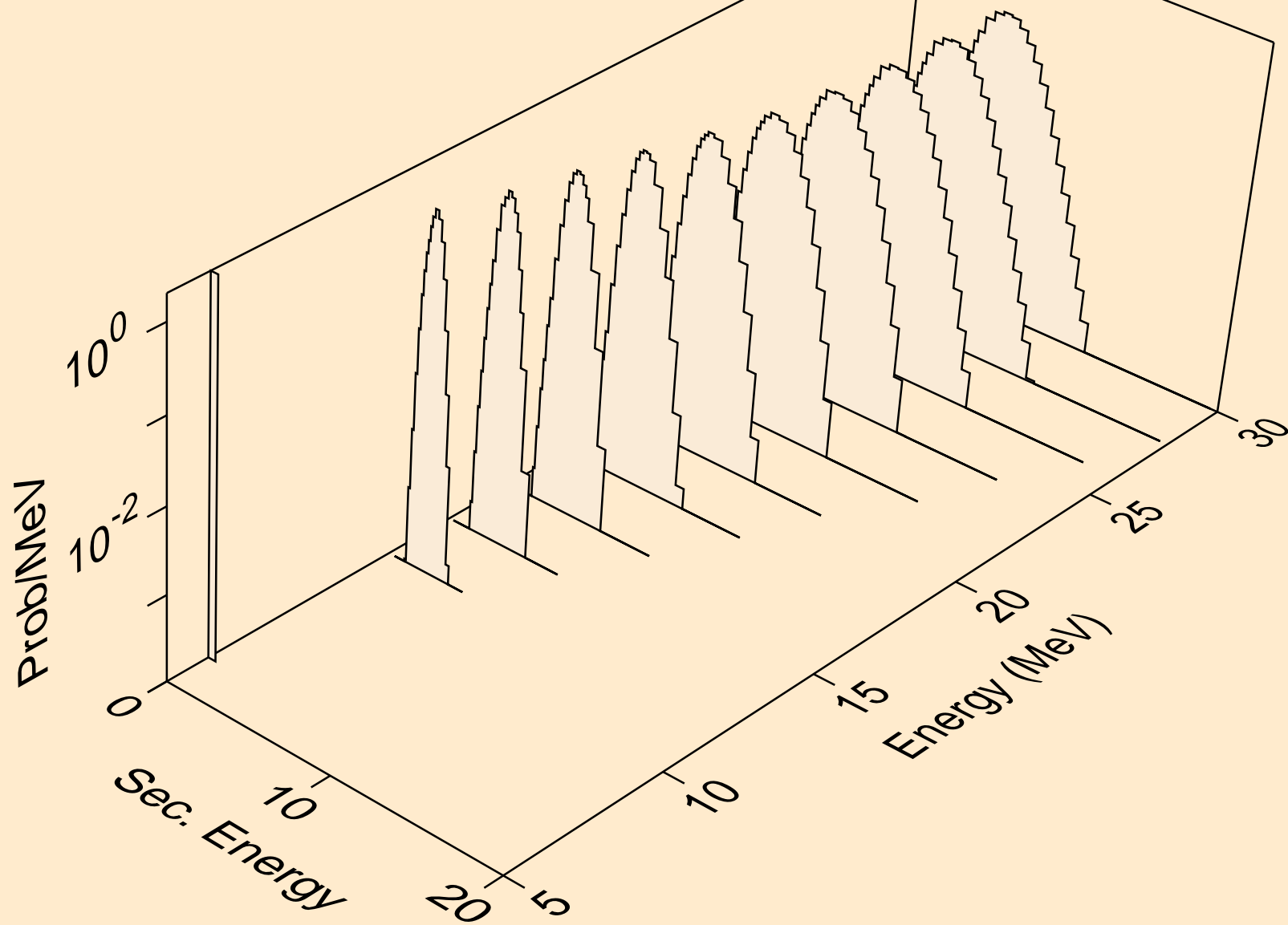

CE125 NEUTRON ACER TENDL-2021 LIBRARY; T=293.6K
deuterons from (n,x)

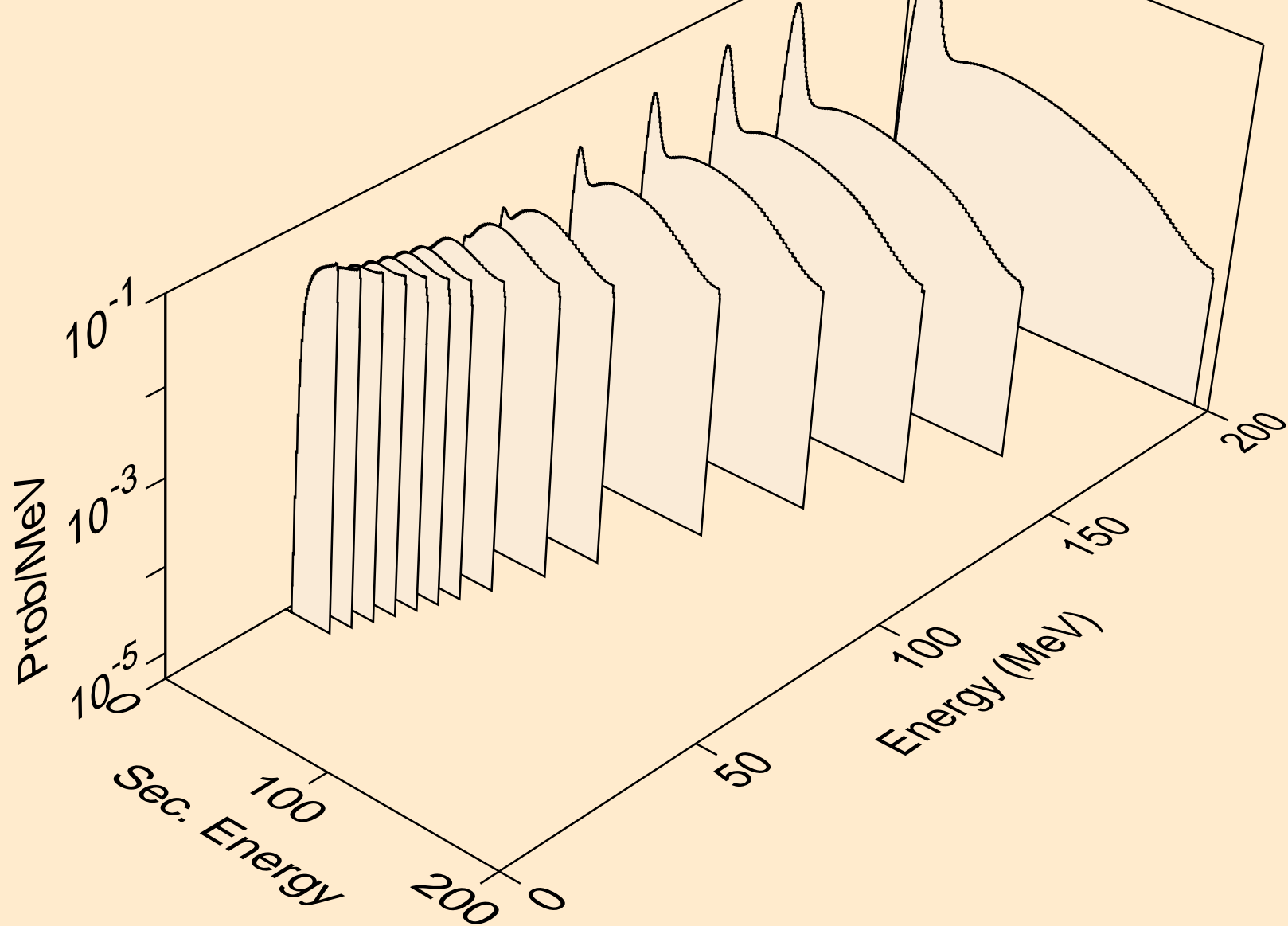

CE125 NEUTRON ACER TENDL-2021 LIBRARY; T=293.6K
deuterons from (n,2nd)

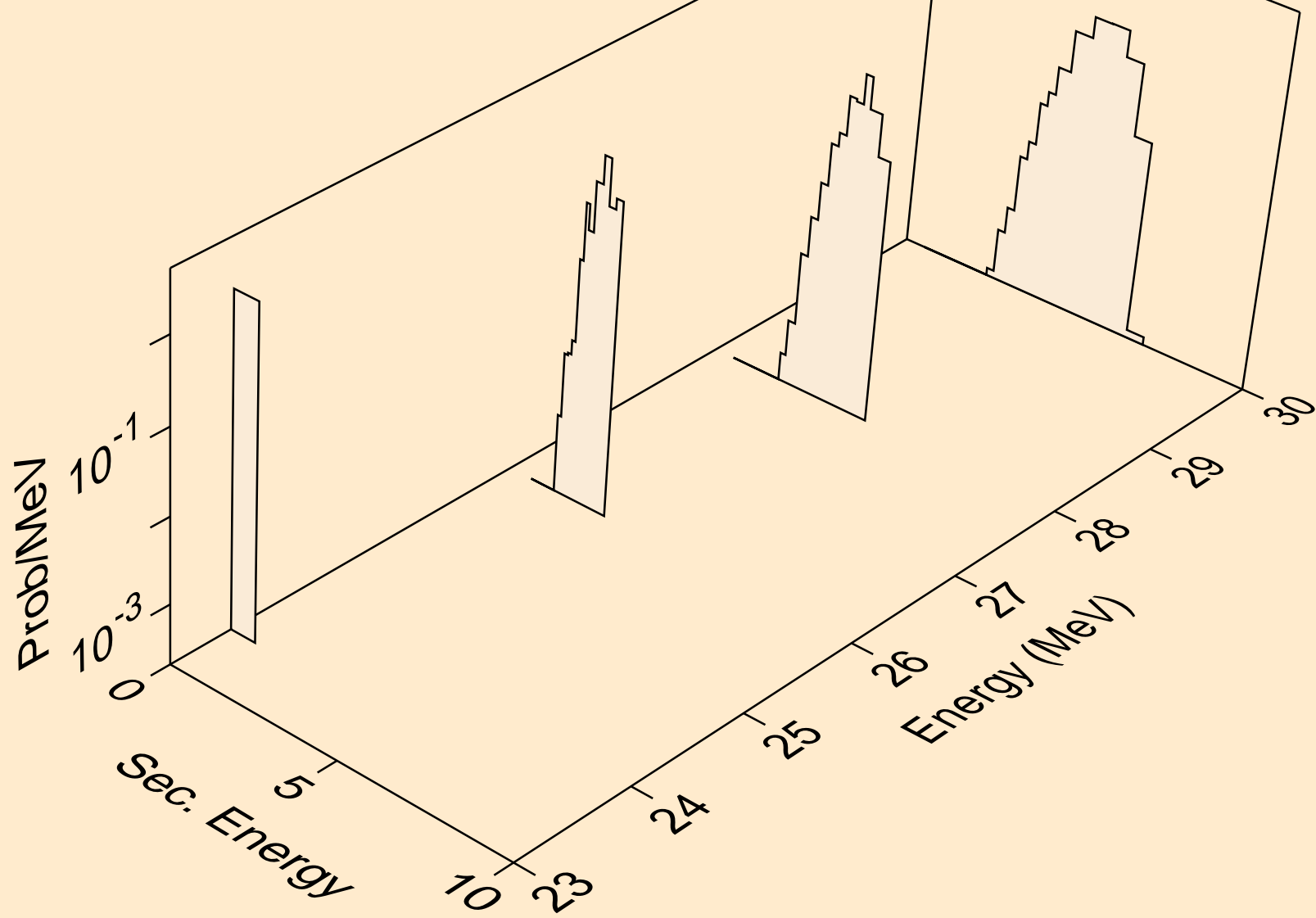

CE125 NEUTRON ACER TENDL-2021 LIBRARY; T=293.6K
deuterons from (n,n*)d

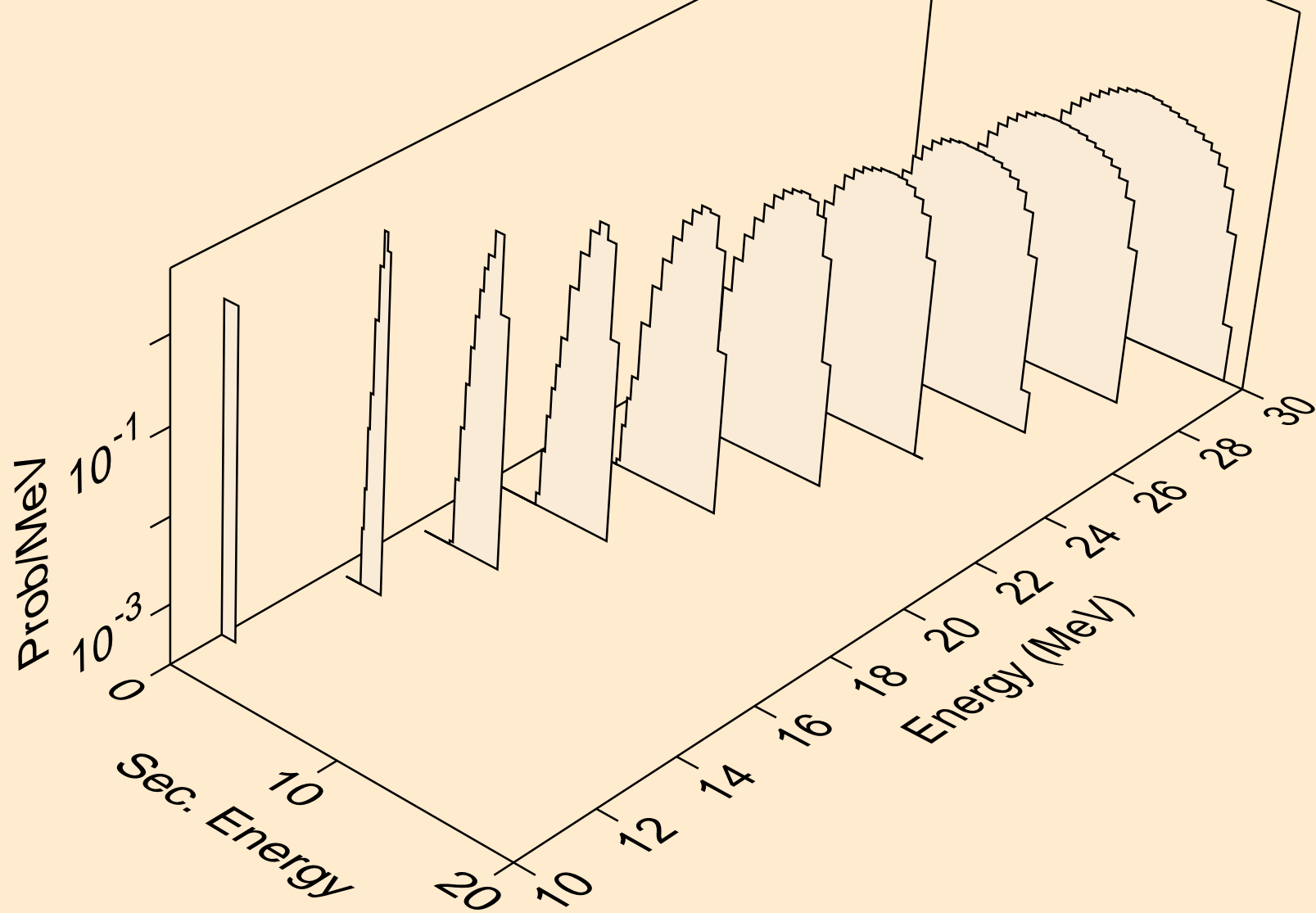

CE125 NEUTRON ACER TENDL-2021 LIBRARY; T=293.6K
deuterons from (n,d)

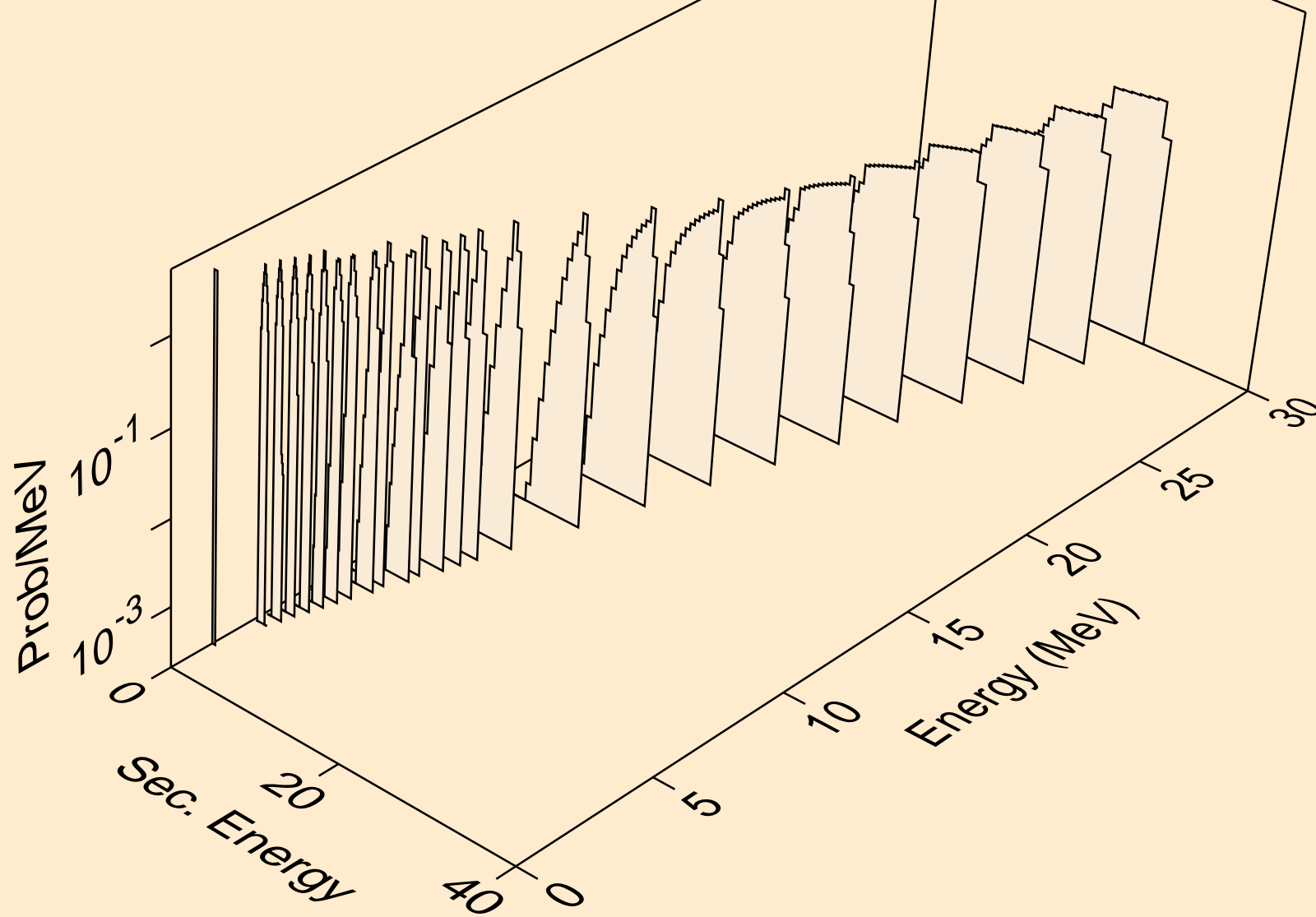

CE125 NEUTRON ACER TENDL-2021 LIBRARY; T=293.6K
deuterons from (n,d2a)

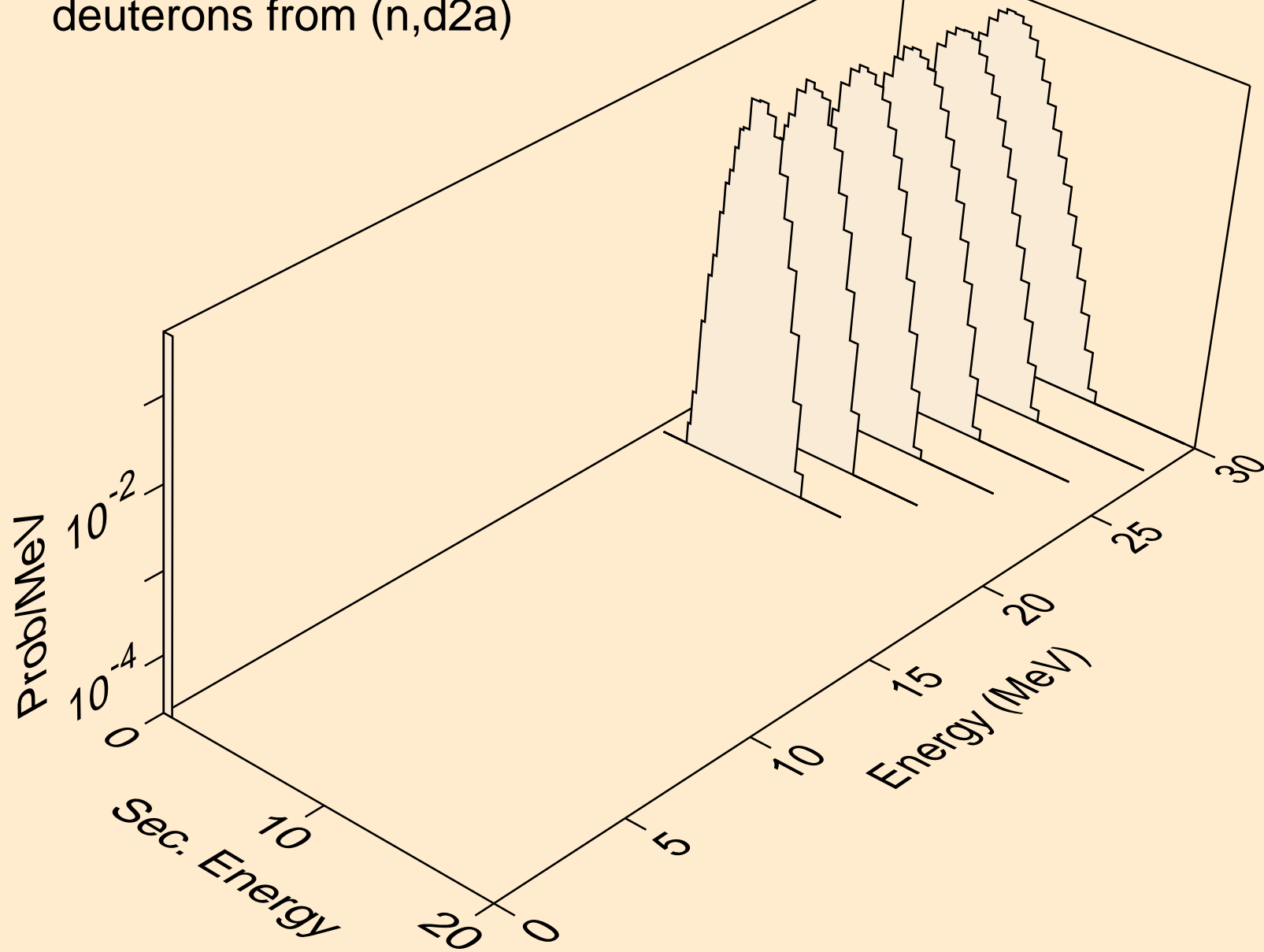

CE125 NEUTRON ACER TENDL-2021 LIBRARY; T=293.6K
deuterons from (n,pd)

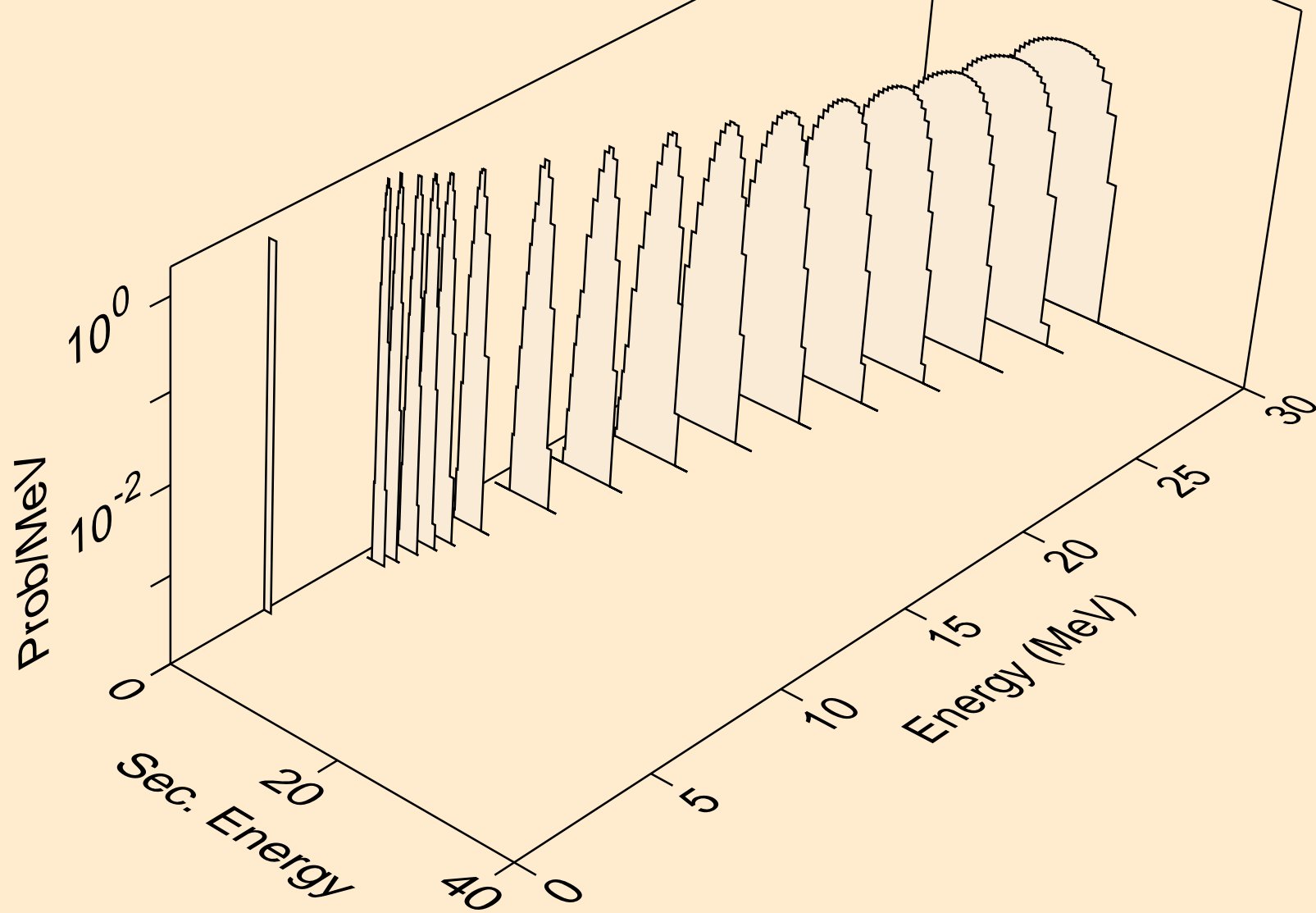

CE125 NEUTRON ACER TENDL-2021 LIBRARY; T=293.6K
deuterons from (n,da)

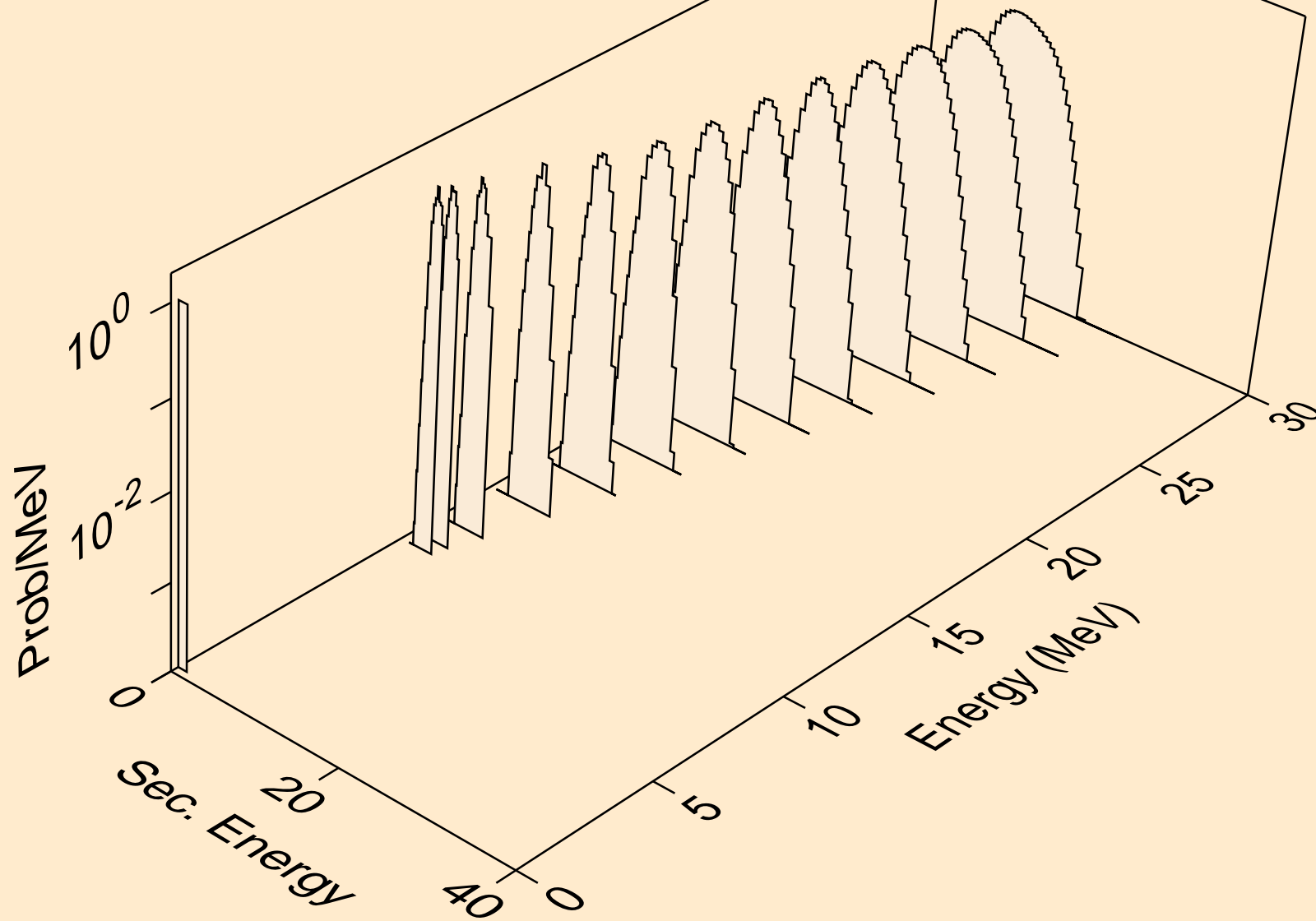

CE125 NEUTRON ACER TENDL-2021 LIBRARY; T=293.6K
tritons from (n,x)

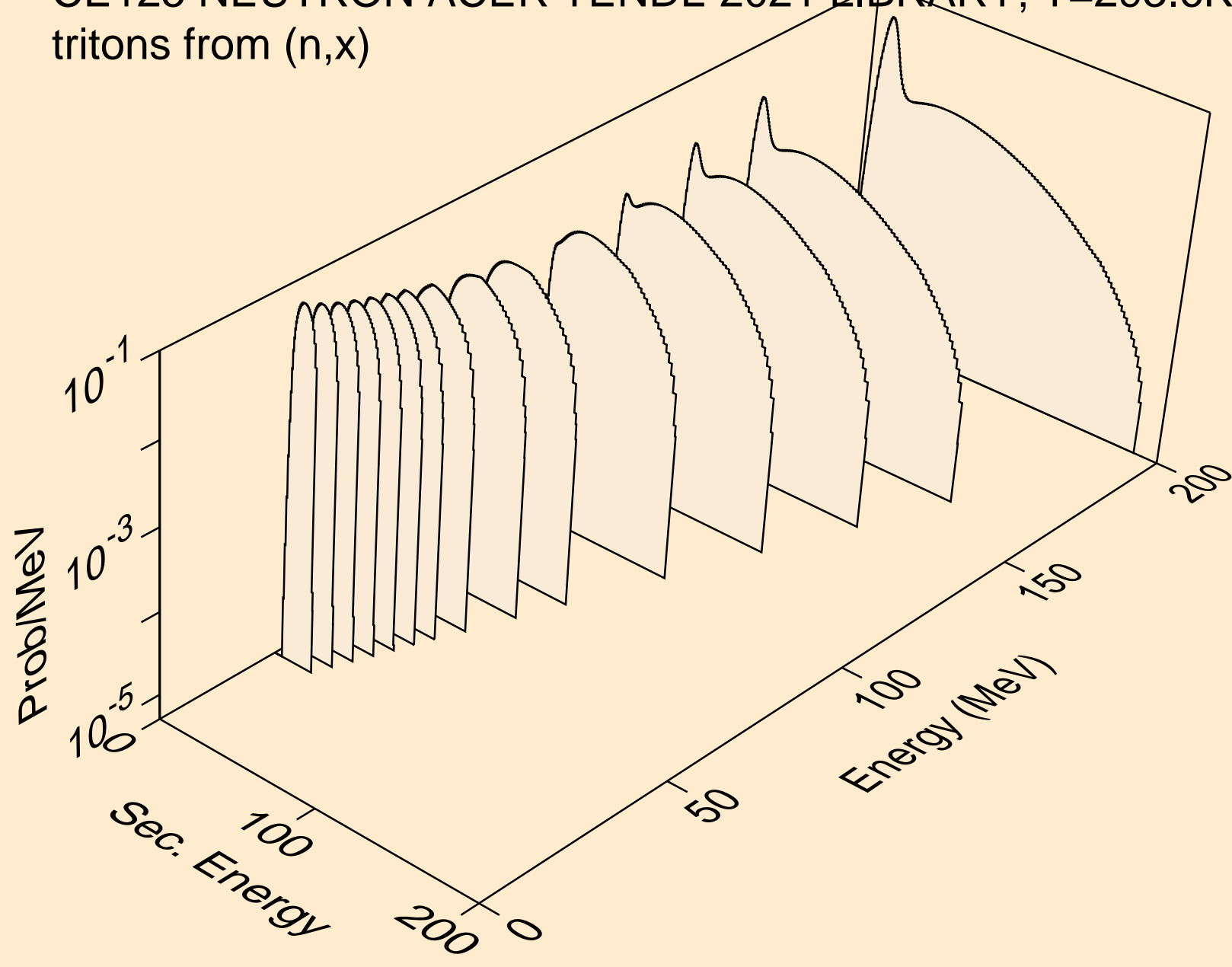

CE125 NEUTRON ACER TENDL-2021 LIBRARY; T=293.6K
tritons from (n,n*)t

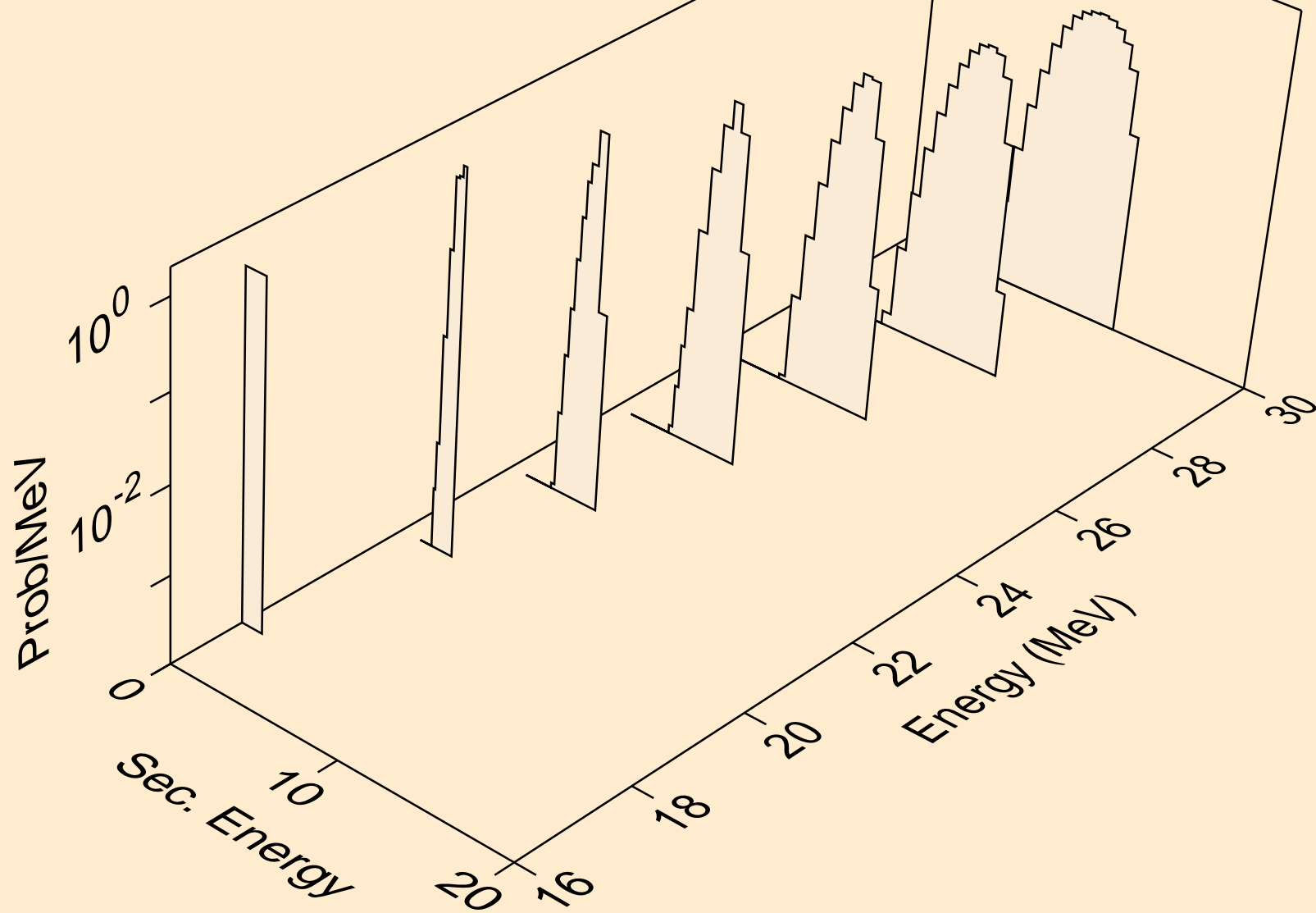

CE125 NEUTRON ACER TENDL-2021 LIBRARY; T=293.6K
tritons from (n,t)

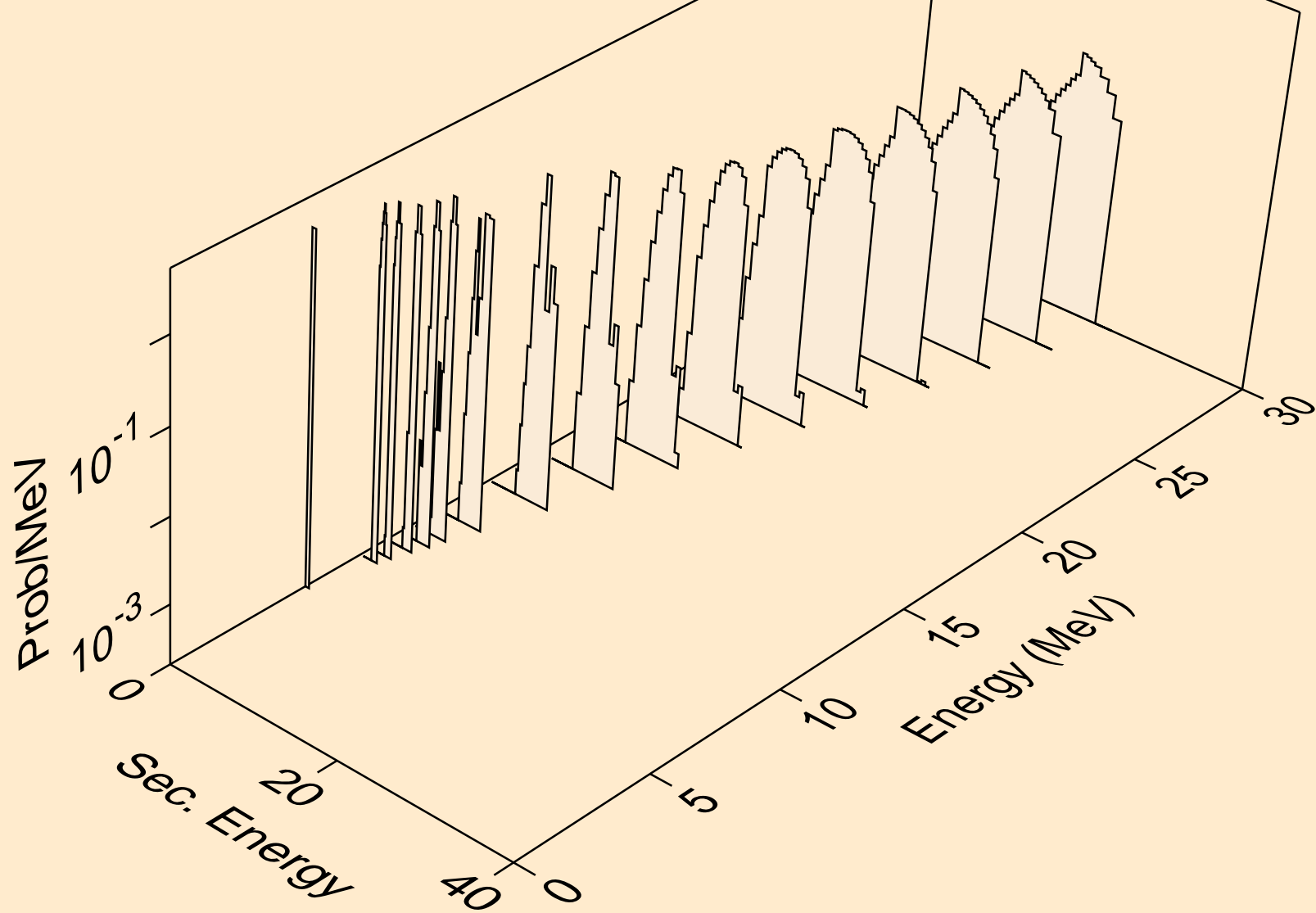

CE125 NEUTRON ACER TENDL-2021 LIBRARY; T=293.6K
tritons from (n,pt)

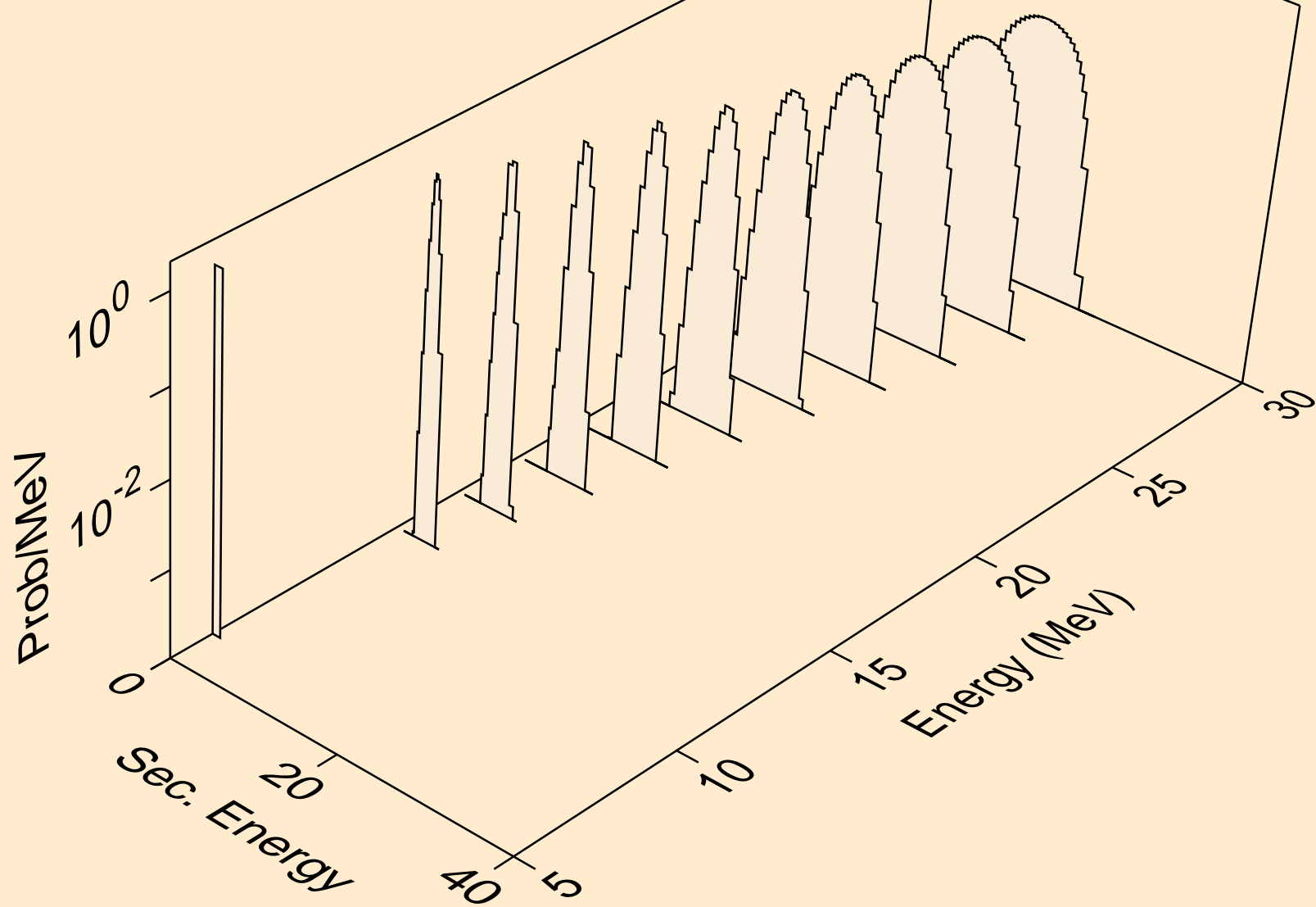

CE125 NEUTRON ACER TENDL-2021 LIBRARY; T=293.6K
he3s from (n,x)

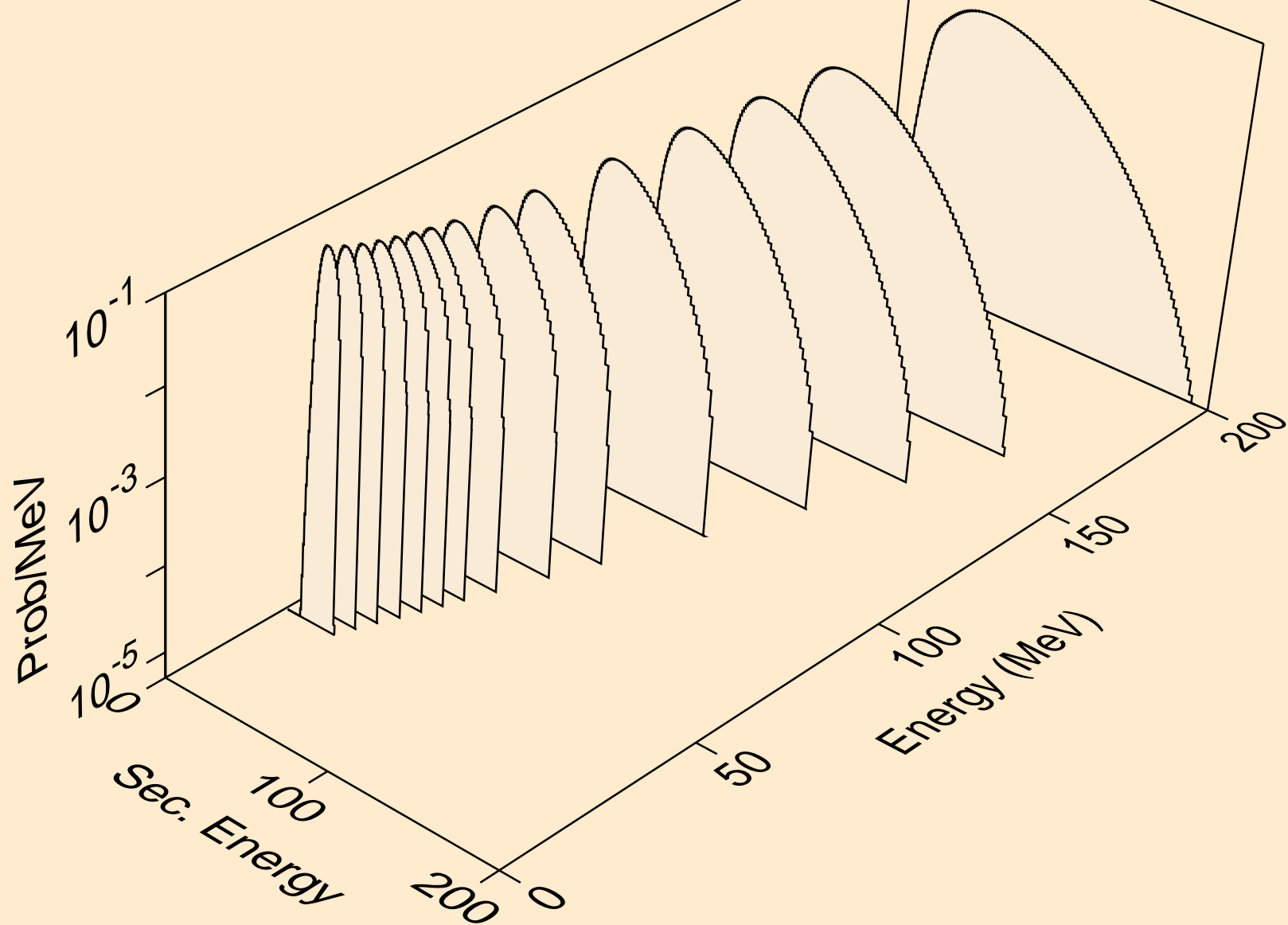

CE125 NEUTRON ACER TENDL-2021 LIBRARY; T=293.6K
he3s from (n,n*)he3

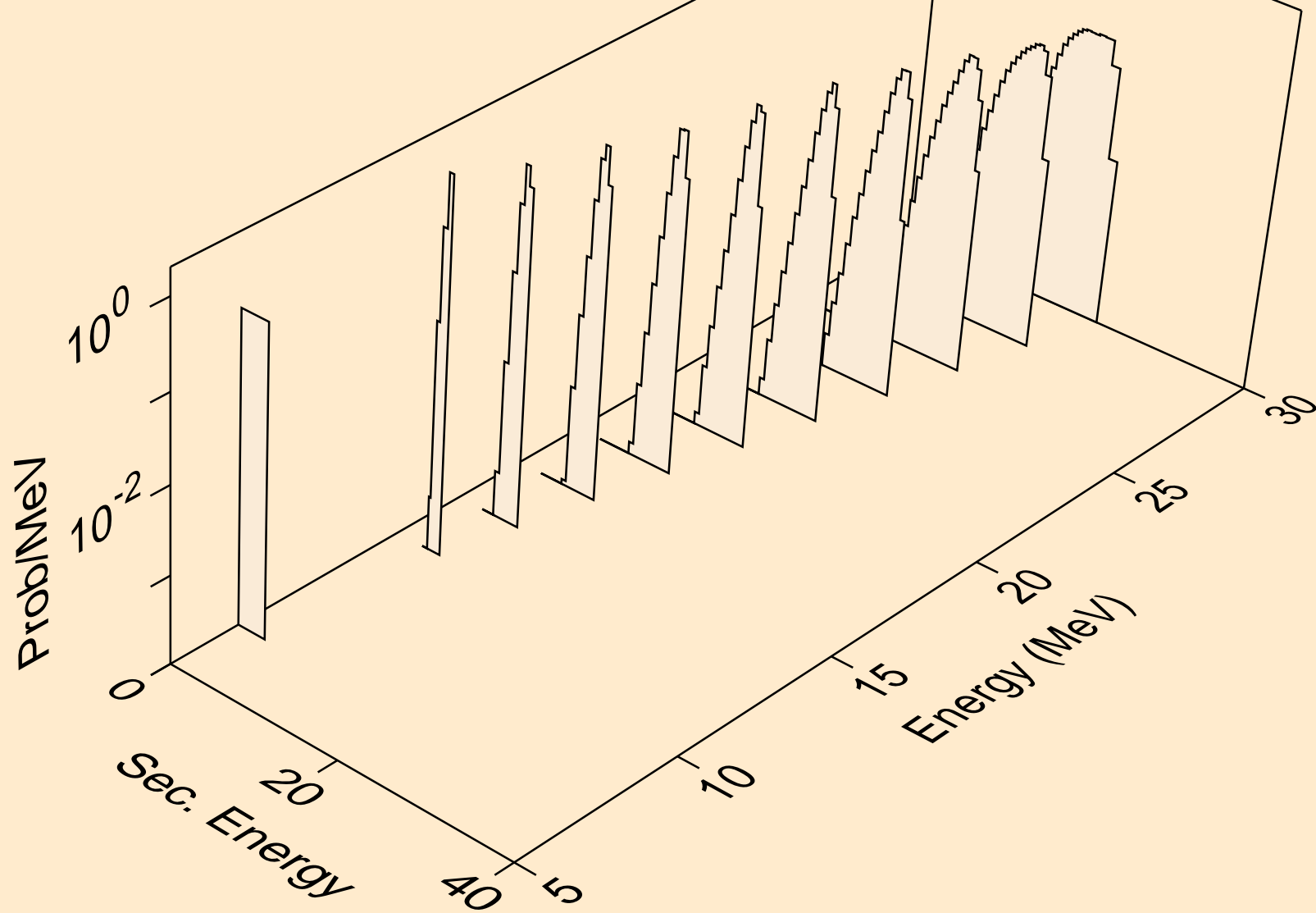

CE125 NEUTRON ACER TENDL-2021 LIBRARY; T=293.6K
he3s from (n,he3)

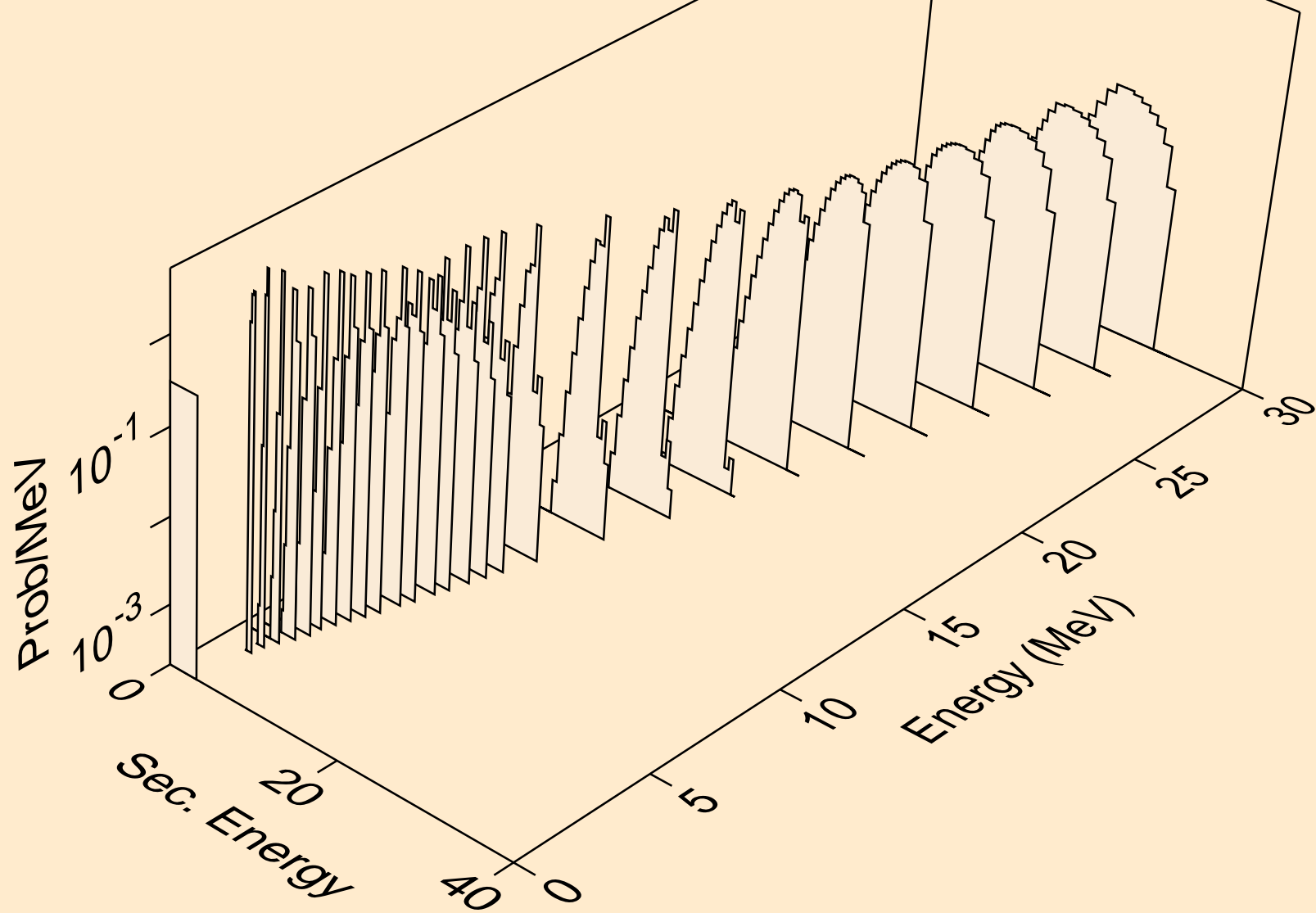

CE125 NEUTRON ACER TENDL-2021 LIBRARY; T=293.6K
alphas from (n,x)

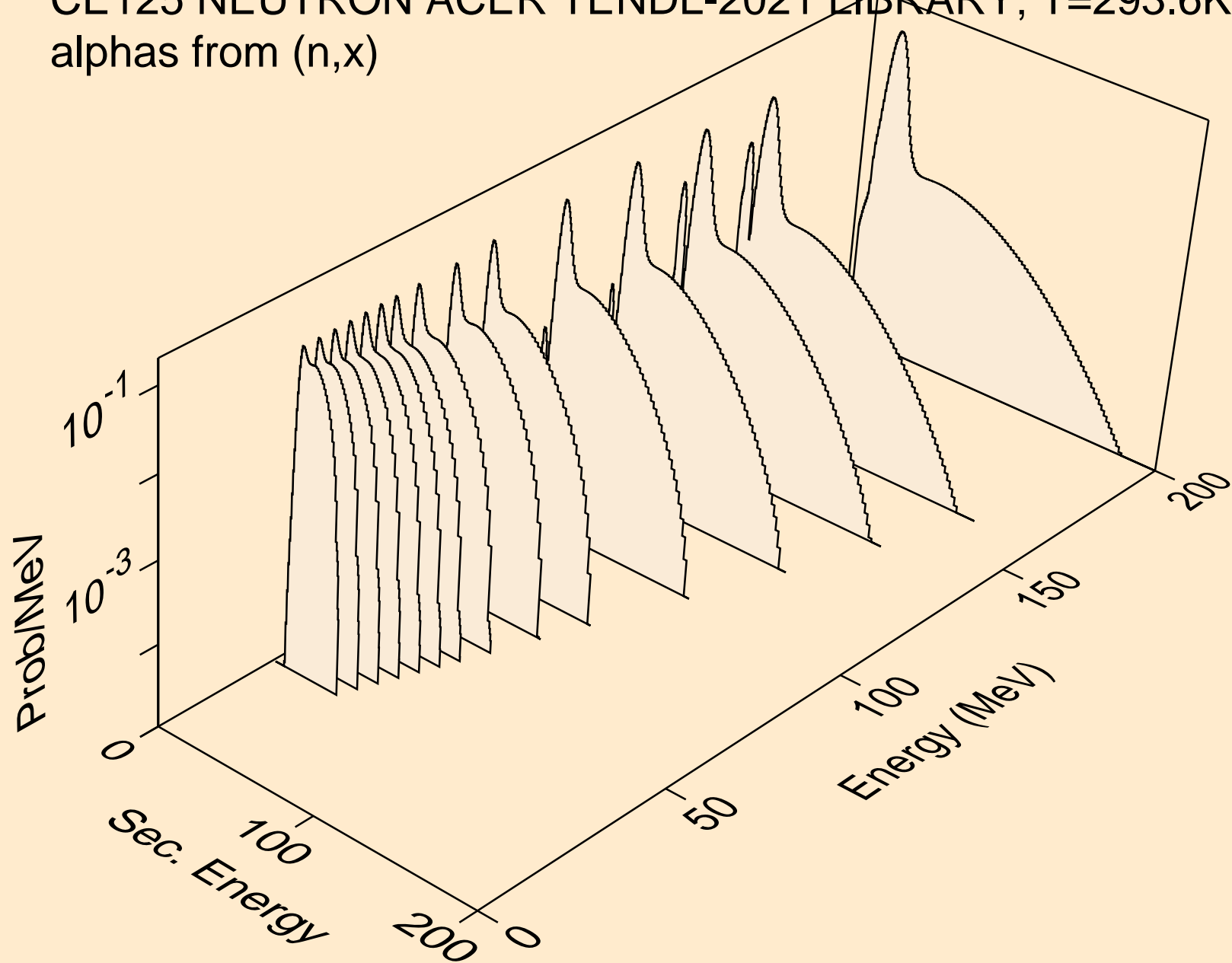

CE125 NEUTRON ACER TENDL-2021 LIBRARY; T=293.6K
alphas from (n,n*)a

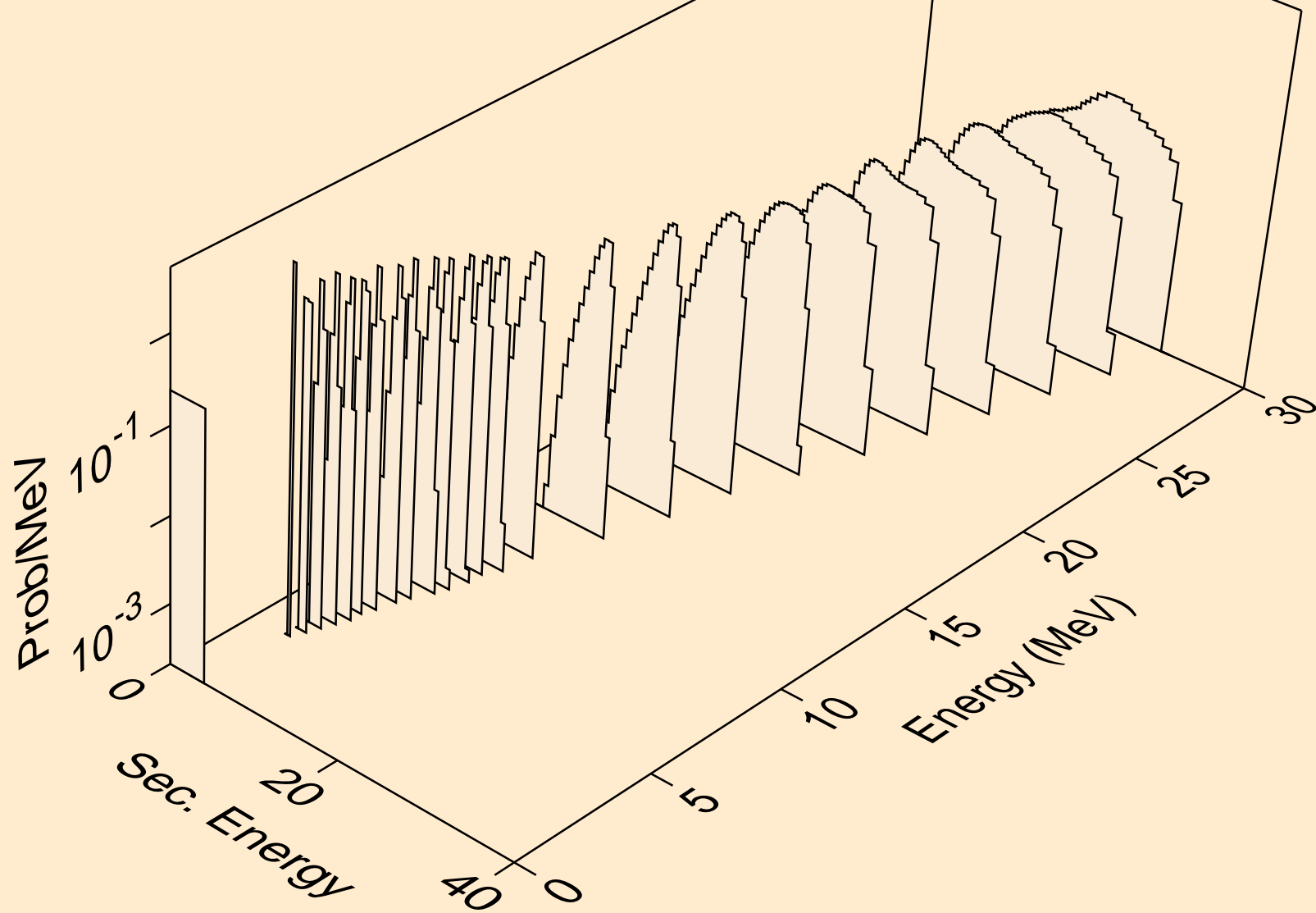

CE125 NEUTRON ACER TENDL-2021 LIBRARY; T=293.6K
alphas from (n,2n)a

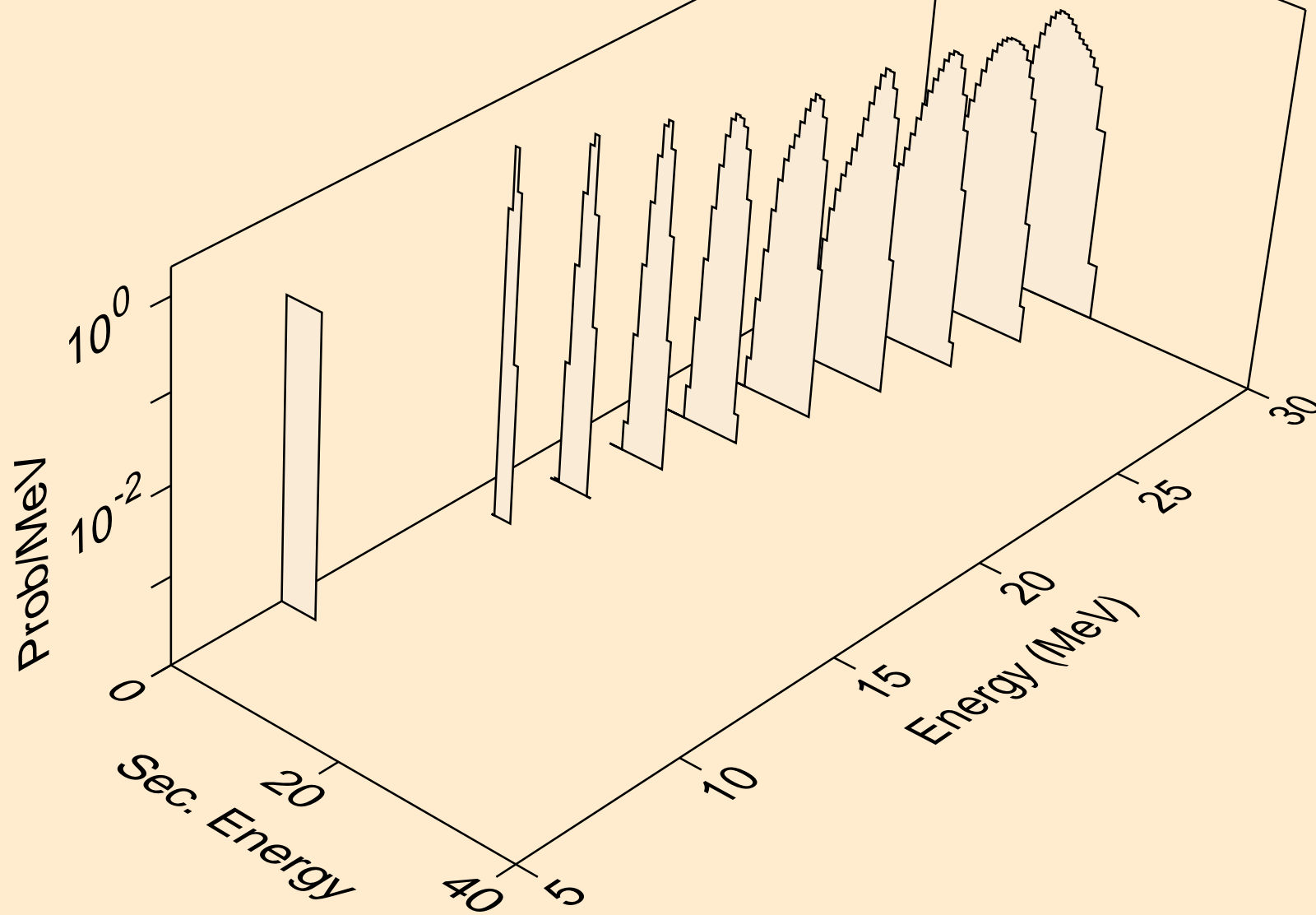

CE125 NEUTRON ACER TENDL-2021 LIBRARY; T=293.6K
alphas from (n,n*)2a

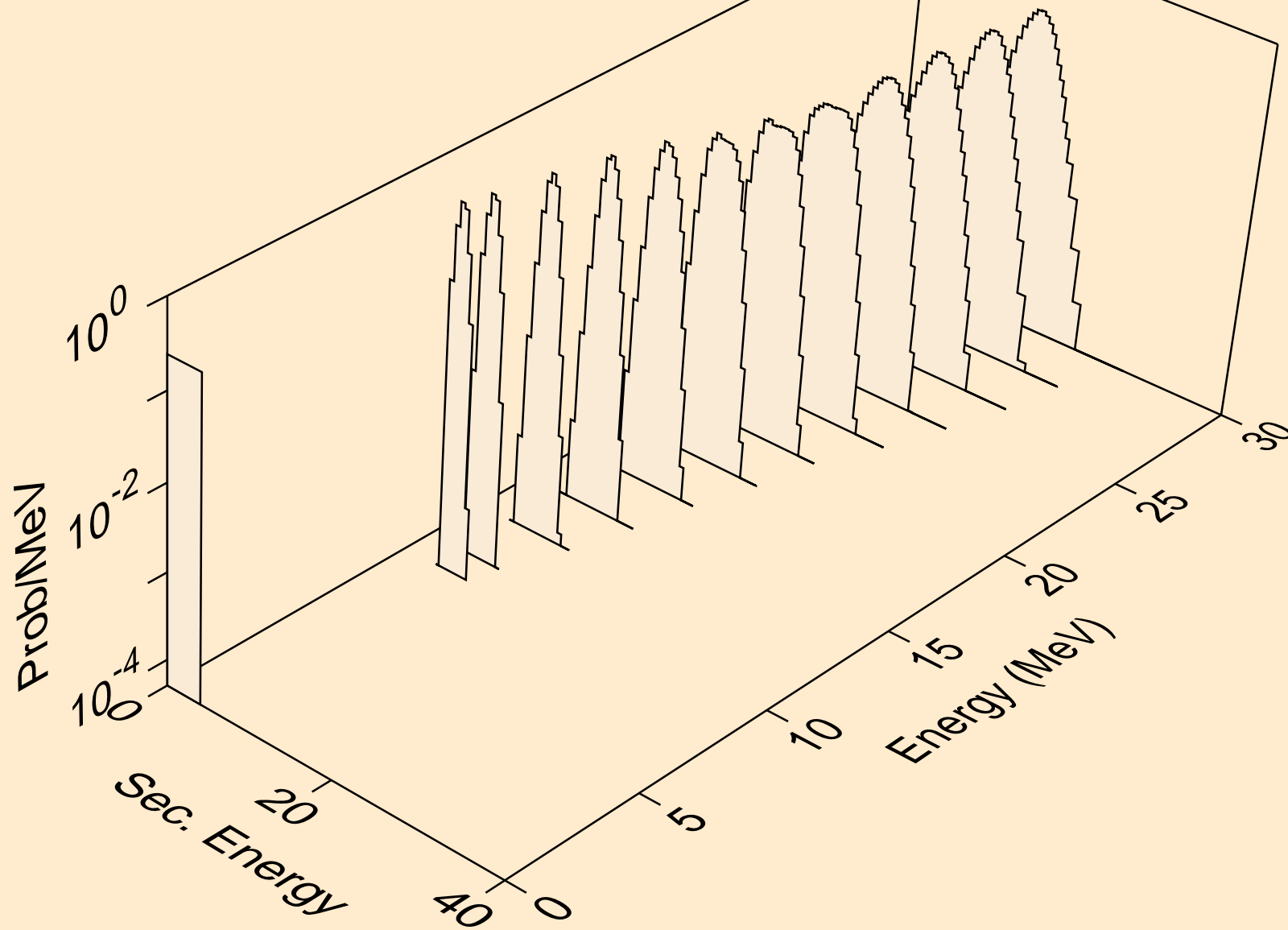

CE125 NEUTRON ACER TENDL-2021 LIBRARY; T=293.6K
alphas from (n,2n)2a

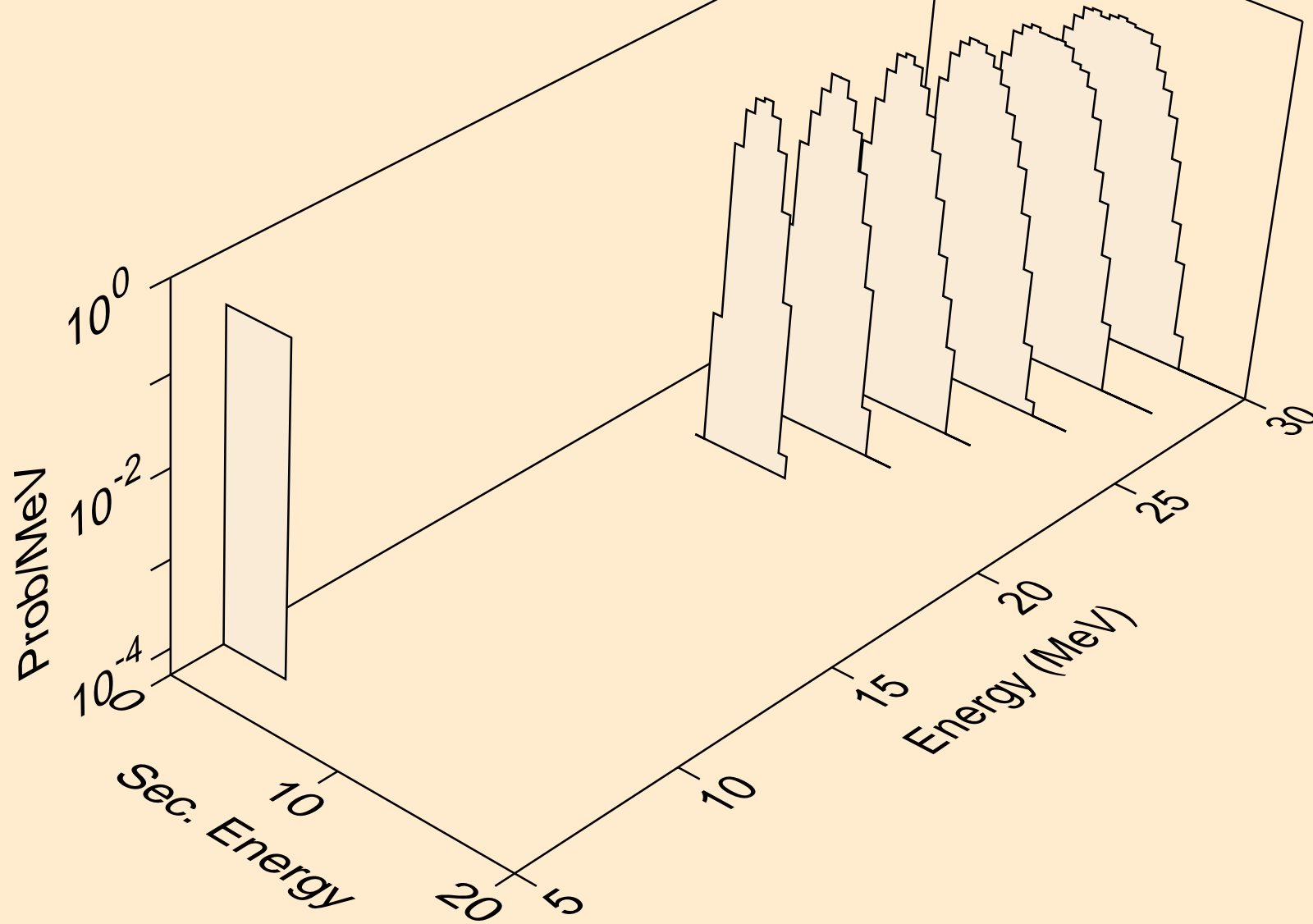

CE125 NEUTRON ACER TENDL-2021 LIBRARY; T=293.6K
alphas from (n,npa)

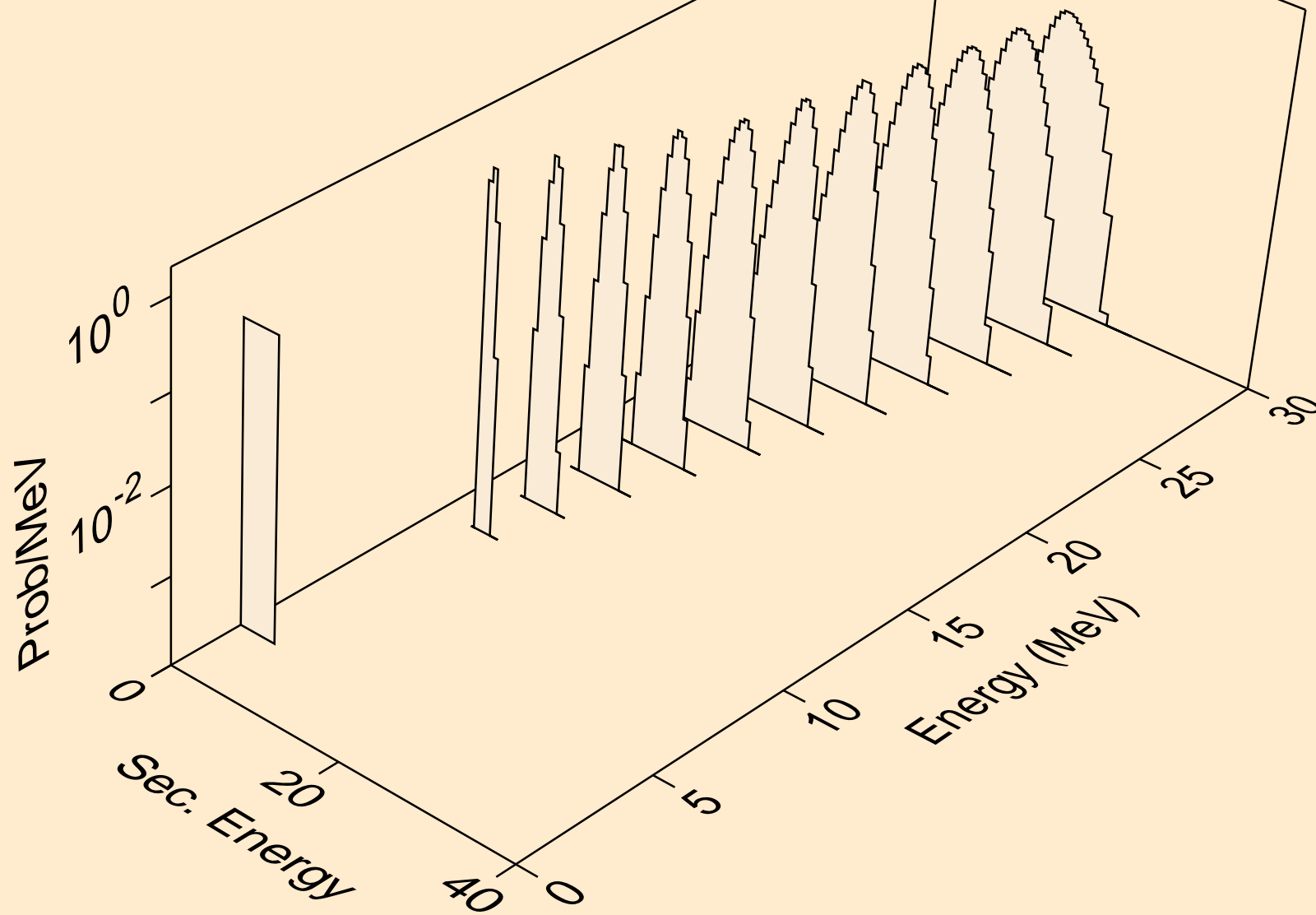

CE125 NEUTRON ACER TENDL-2021 LIBRARY; T=293.6K
alphas from (n,a)

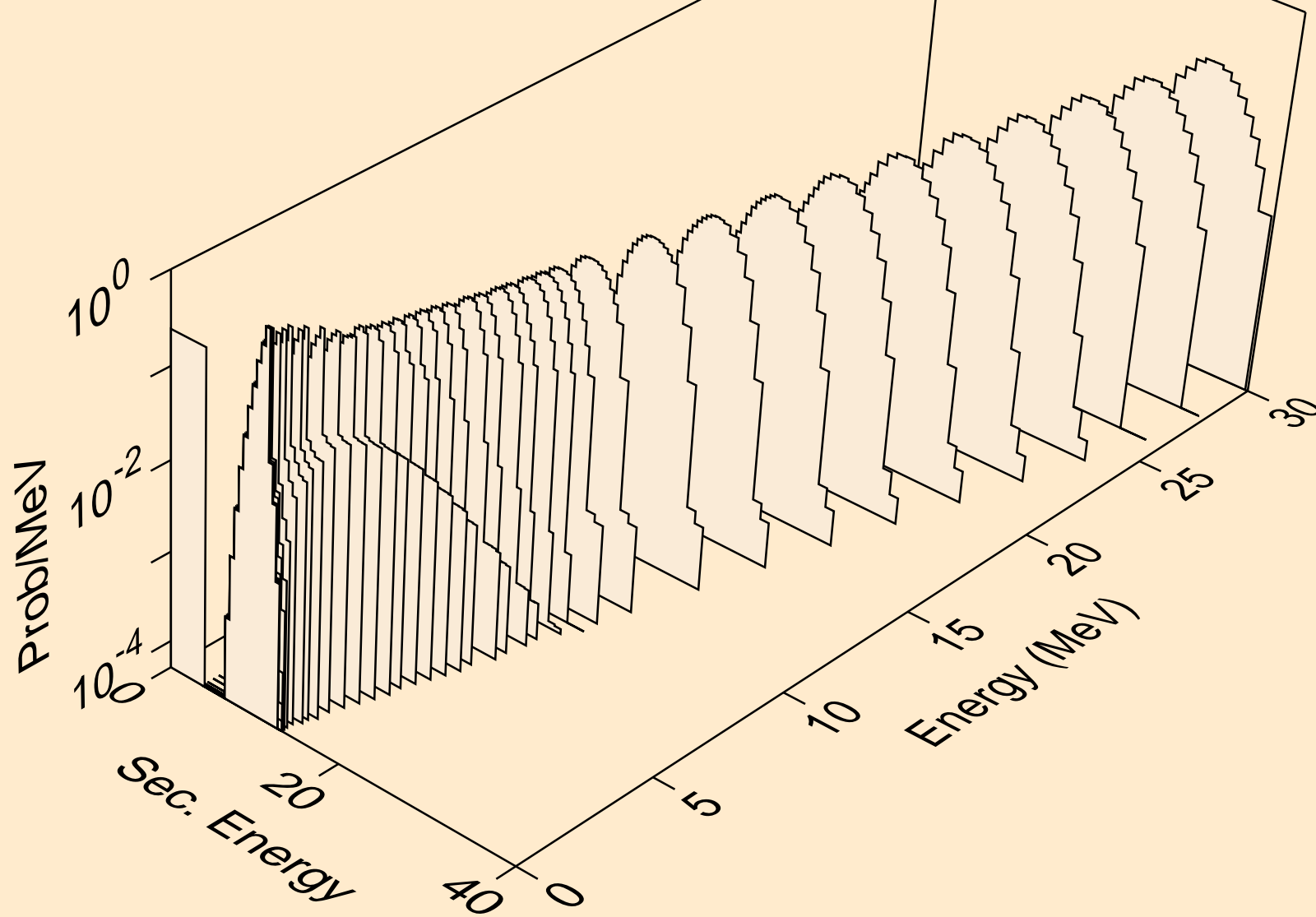

CE125 NEUTRON ACER TENDL-2021 LIBRARY; T=293.6K
alphas from (n,2a)

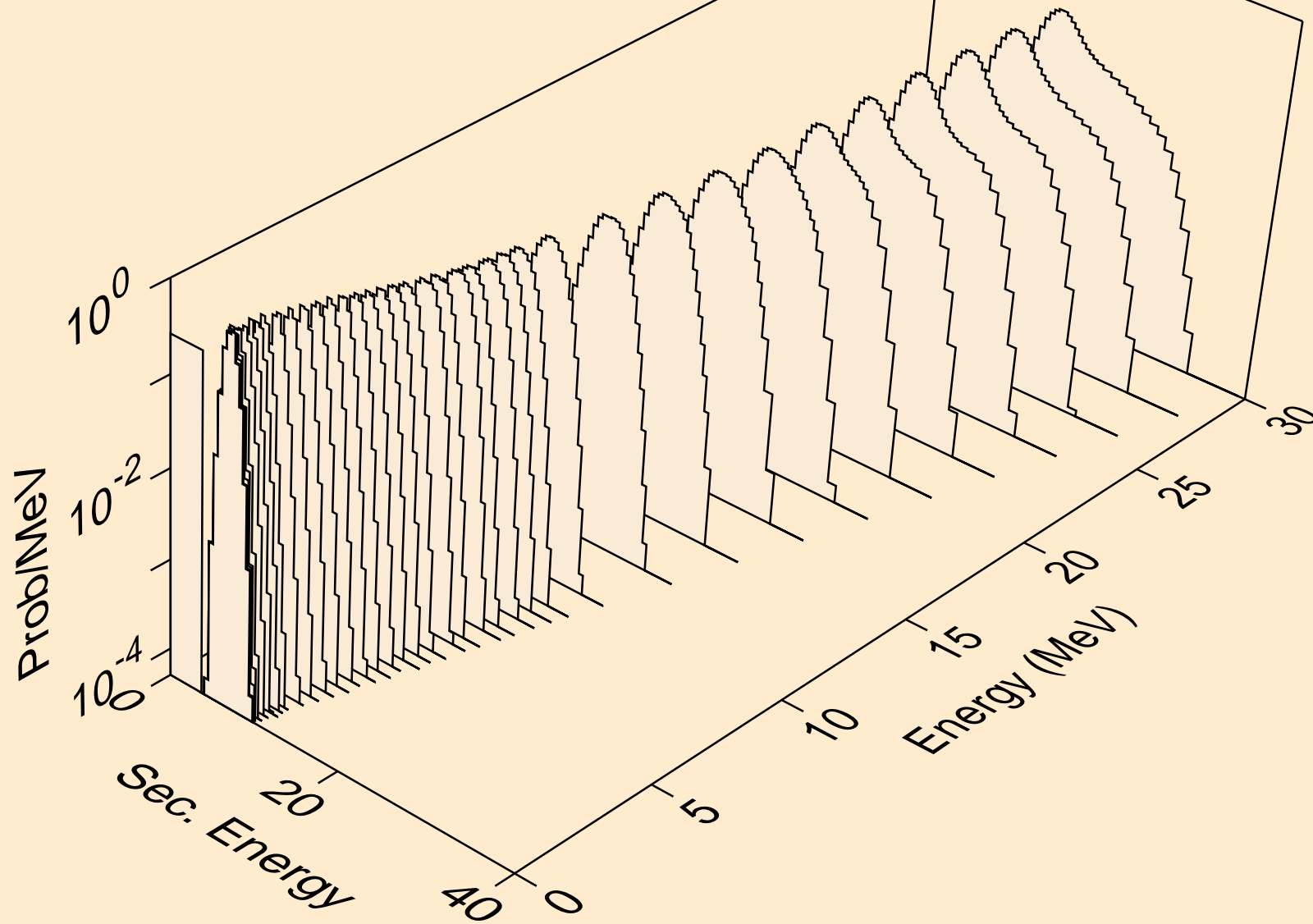

CE125 NEUTRON ACER TENDL-2021 LIBRARY; T=293.6K
alphas from (n,3a)

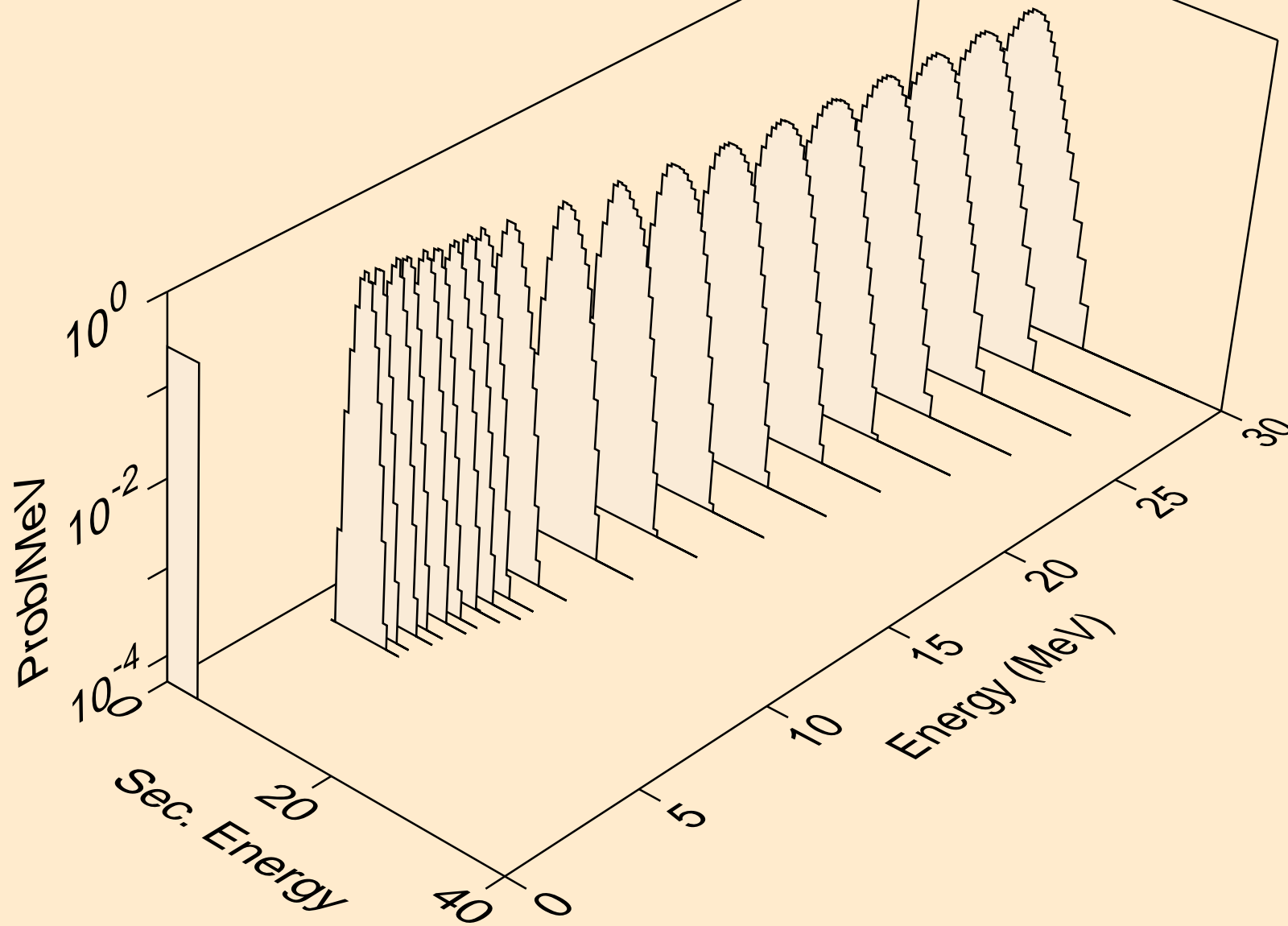

CE125 NEUTRON ACER TENDL-2021 LIBRARY; T=293.6K
alphas from (n,pa)

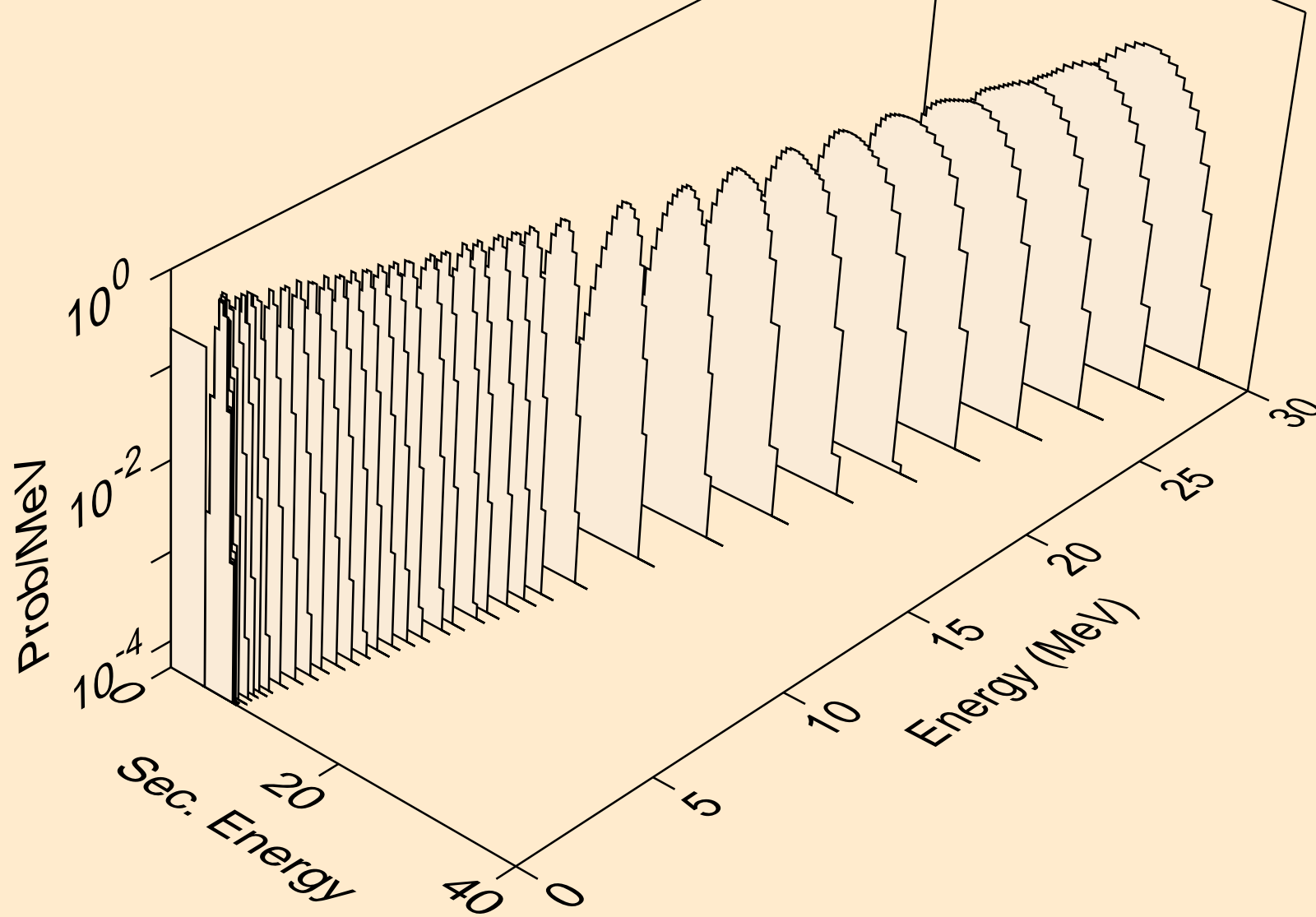

CE125 NEUTRON ACER TENDL-2021 LIBRARY; T=293.6K
alphas from (n,d2a)

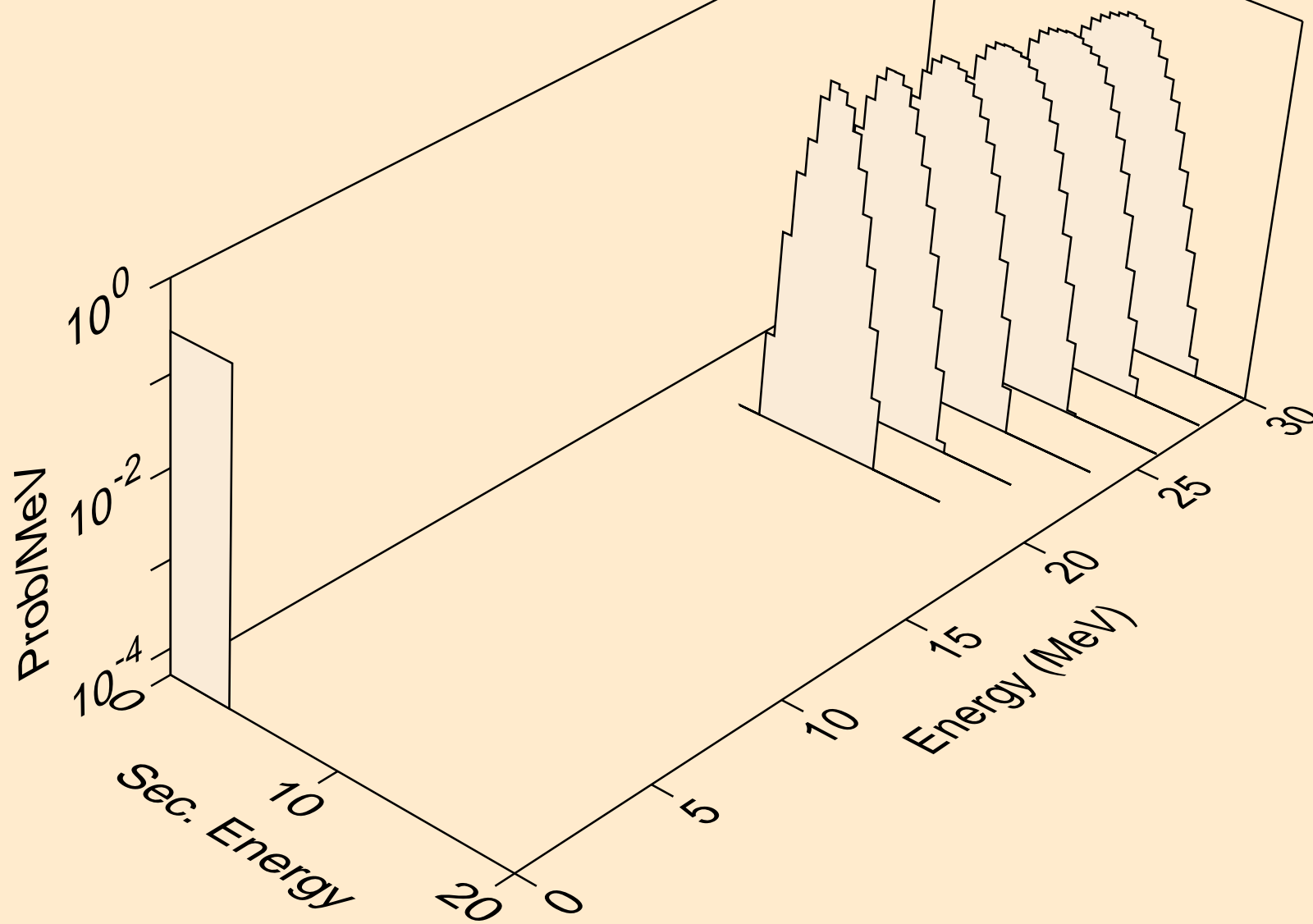

CE125 NEUTRON ACER TENDL-2021 LIBRARY; T=293.6K
alphas from (n,da)

