

ES257 NEUTRON ACER TENDL-2021 LIBRARY; T=293.6K

Principal cross sections

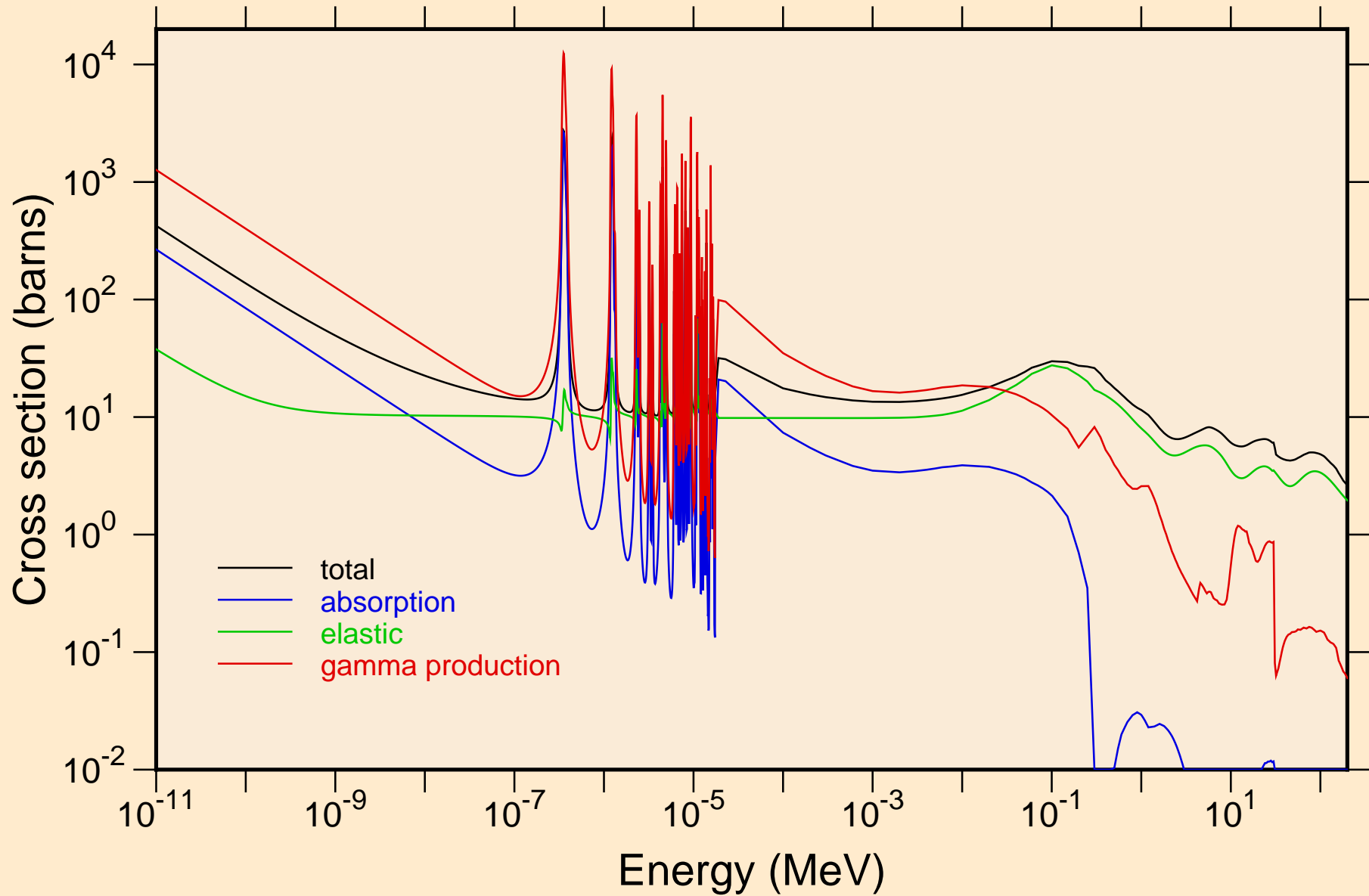

ES257 NEUTRON ACER TENDL-2021 LIBRARY; T=293.6K
resonance total cross section

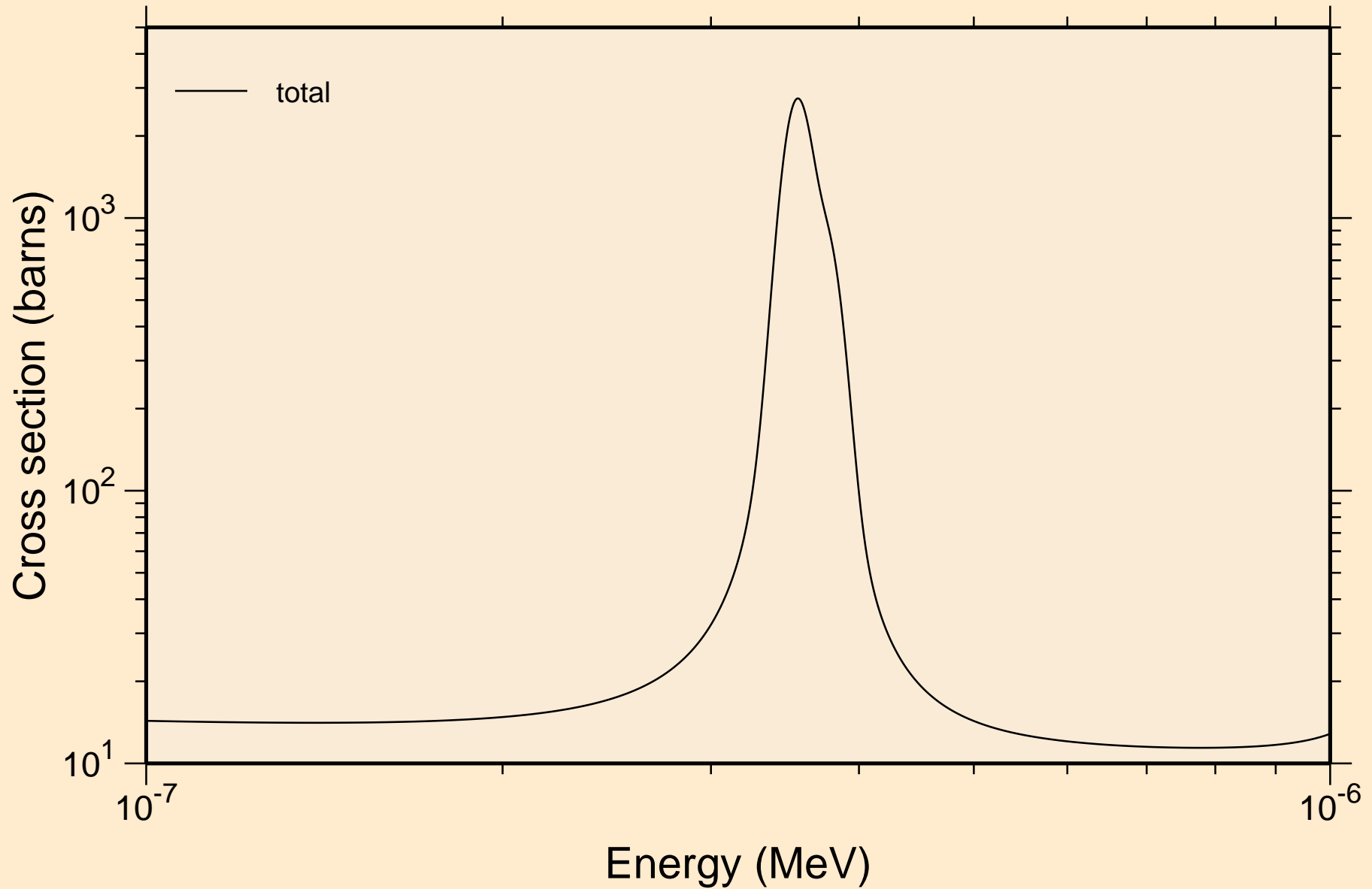

ES257 NEUTRON ACER TENDL-2021 LIBRARY; T=293.6K
resonance total cross section

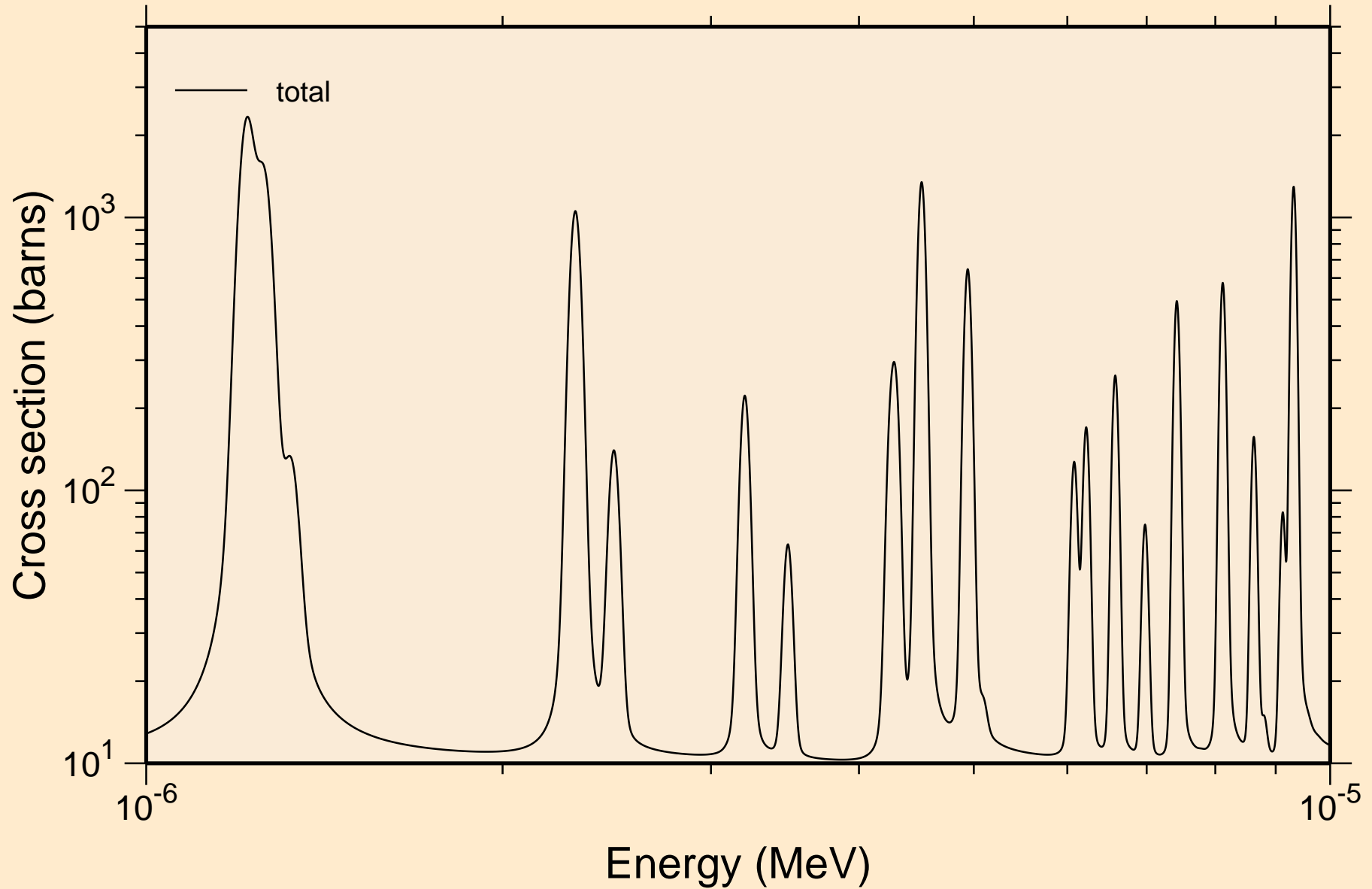

ES257 NEUTRON ACER TENDL-2021 LIBRARY; T=293.6K
resonance total cross section

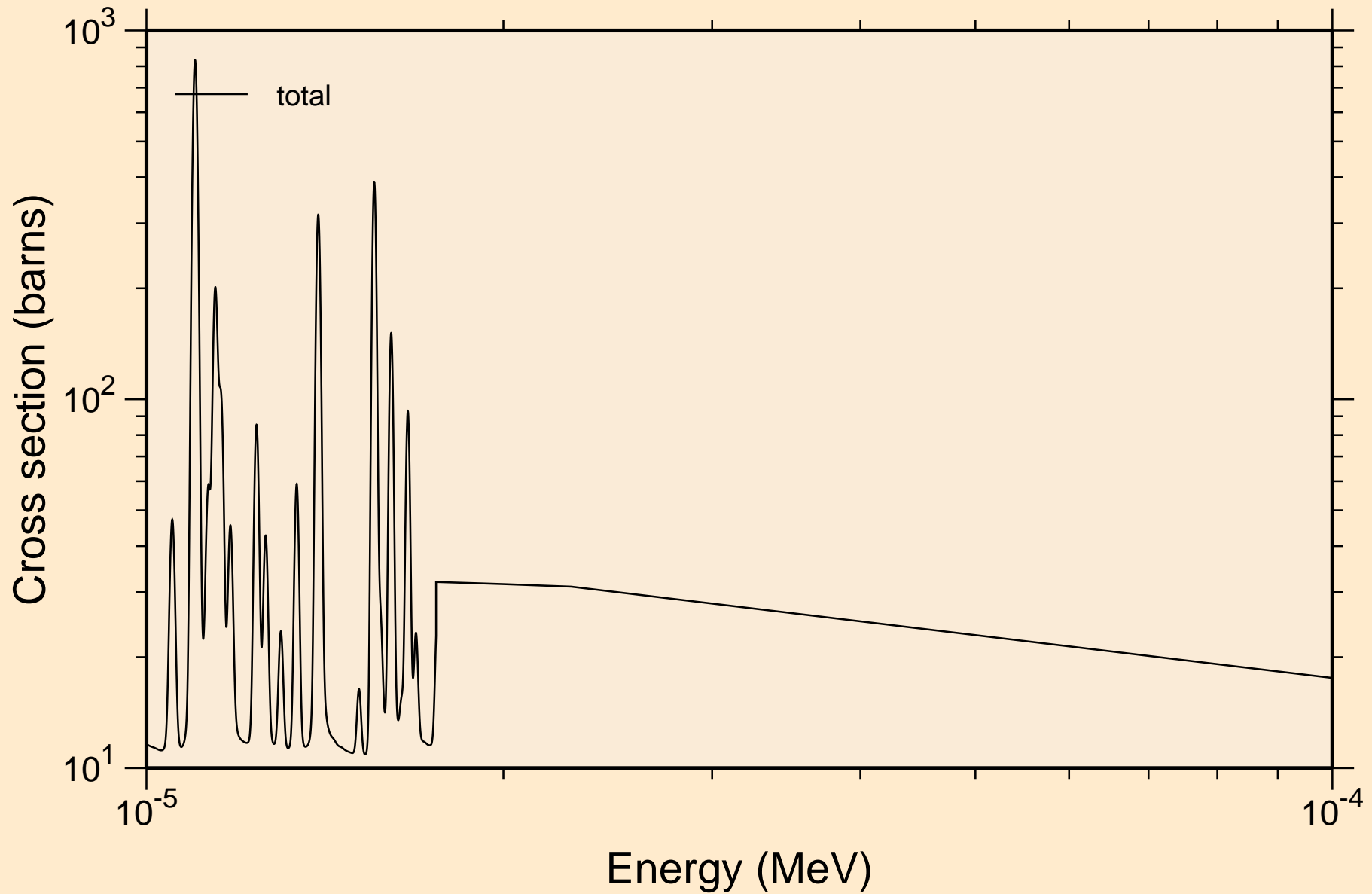

ES257 NEUTRON ACER TENDL-2021 LIBRARY; T=293.6K
resonance total cross section

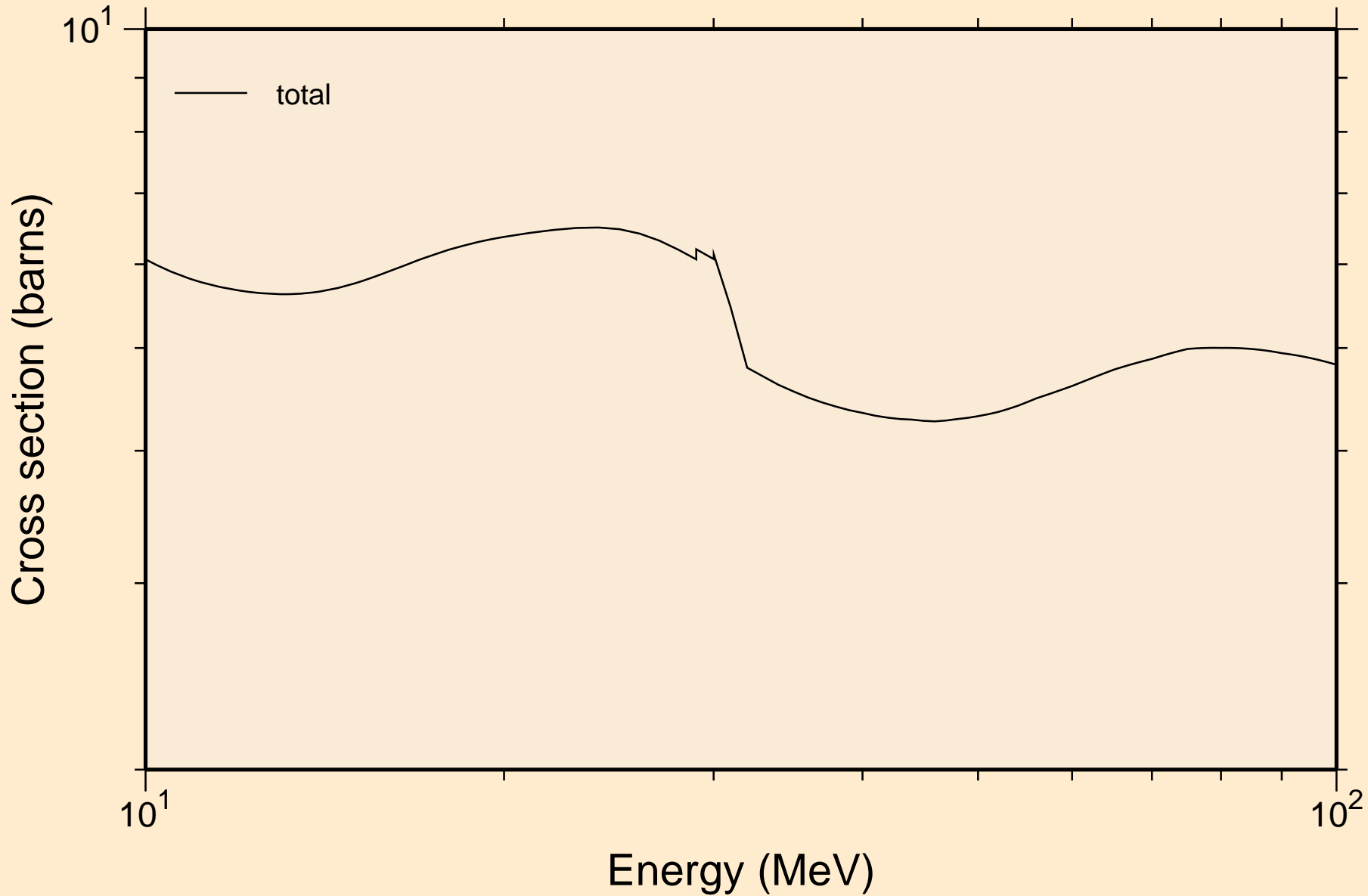

ES257 NEUTRON ACER TENDL-2021 LIBRARY; T=293.6K
resonance absorption cross sections

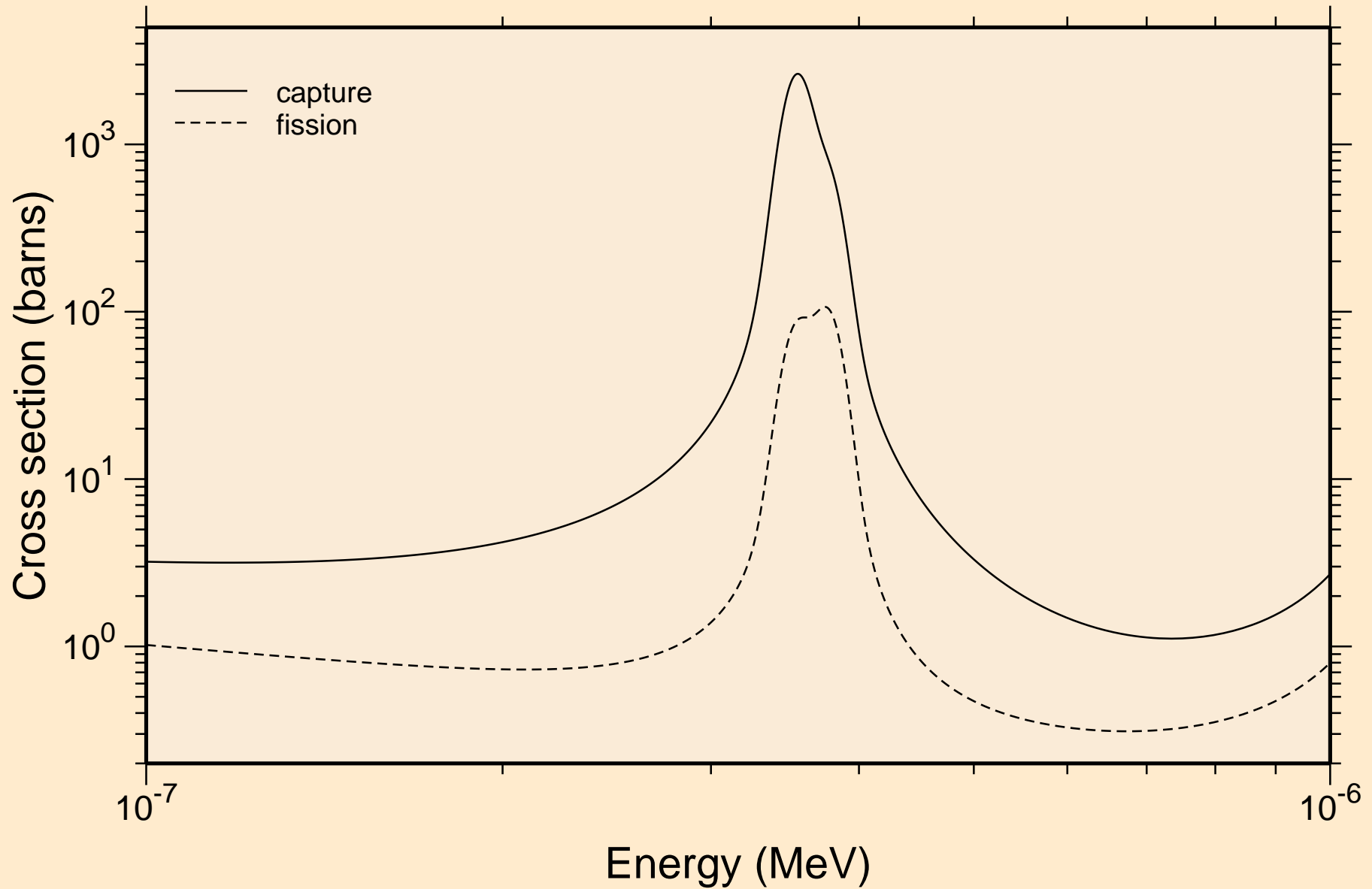

ES257 NEUTRON ACER TENDL-2021 LIBRARY; T=293.6K
resonance absorption cross sections

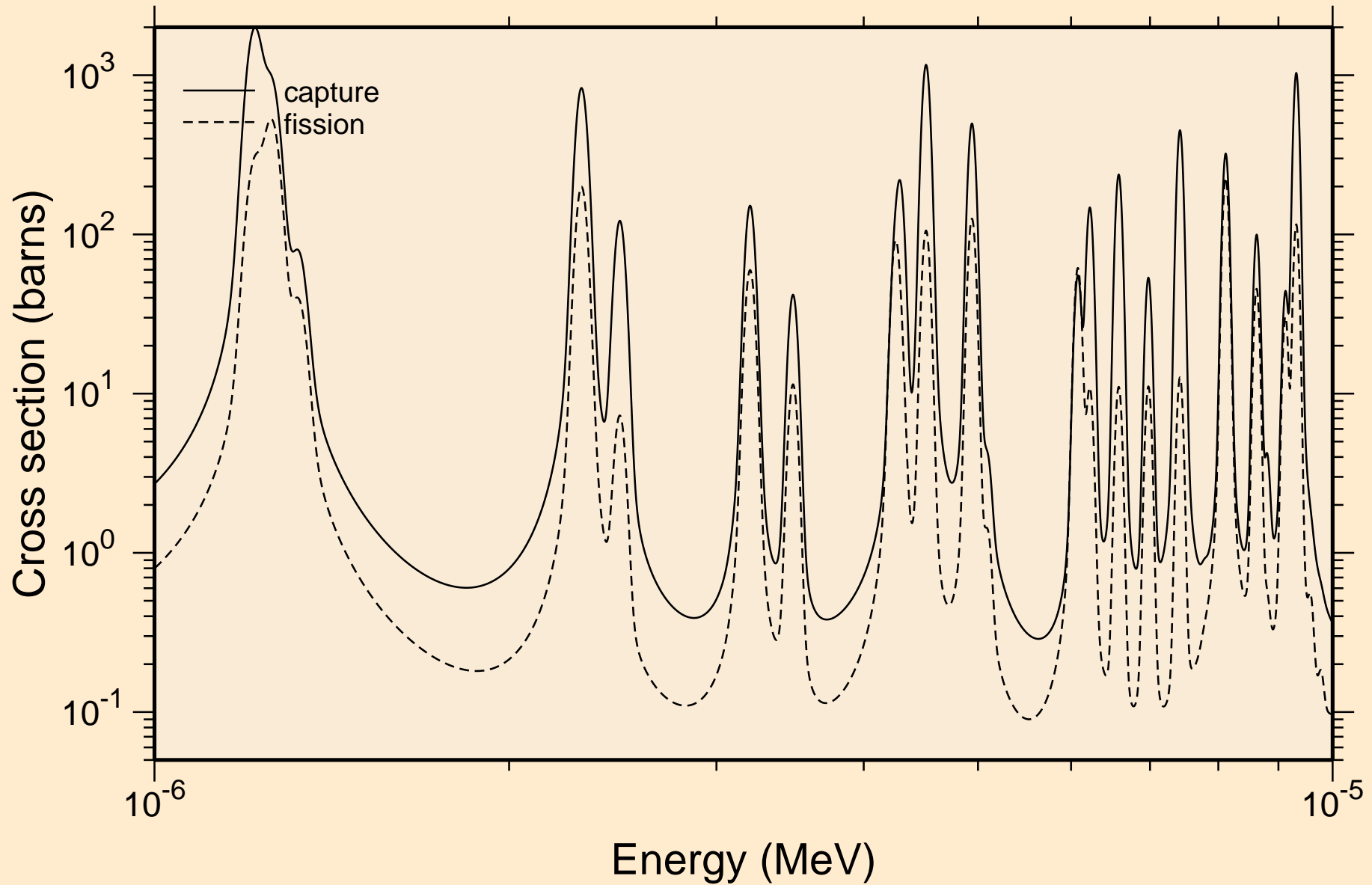

ES257 NEUTRON ACER TENDL-2021 LIBRARY; T=293.6K
resonance absorption cross sections

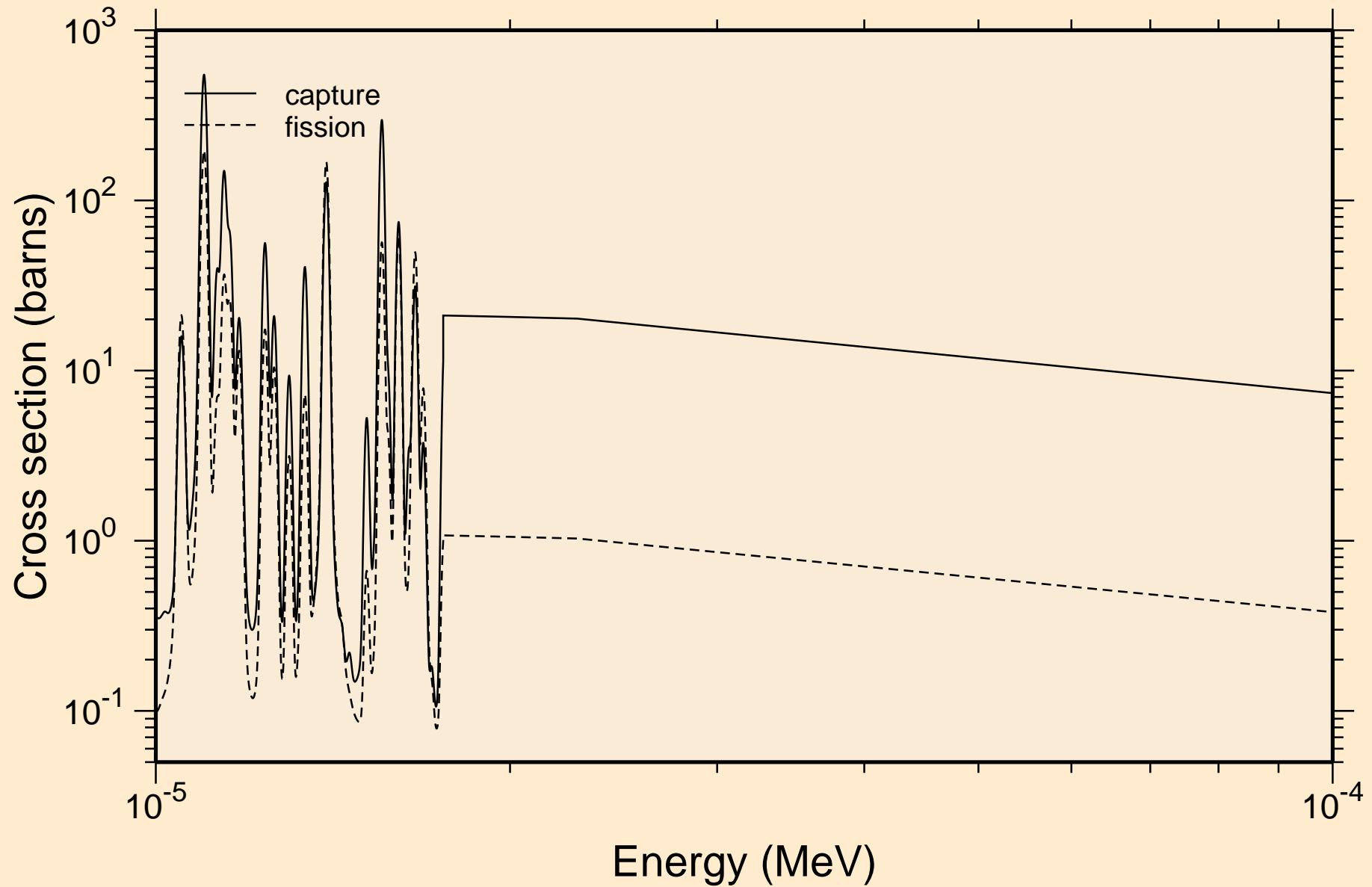

ES257 NEUTRON ACER TENDL-2021 LIBRARY; T=293.6K
resonance absorption cross sections

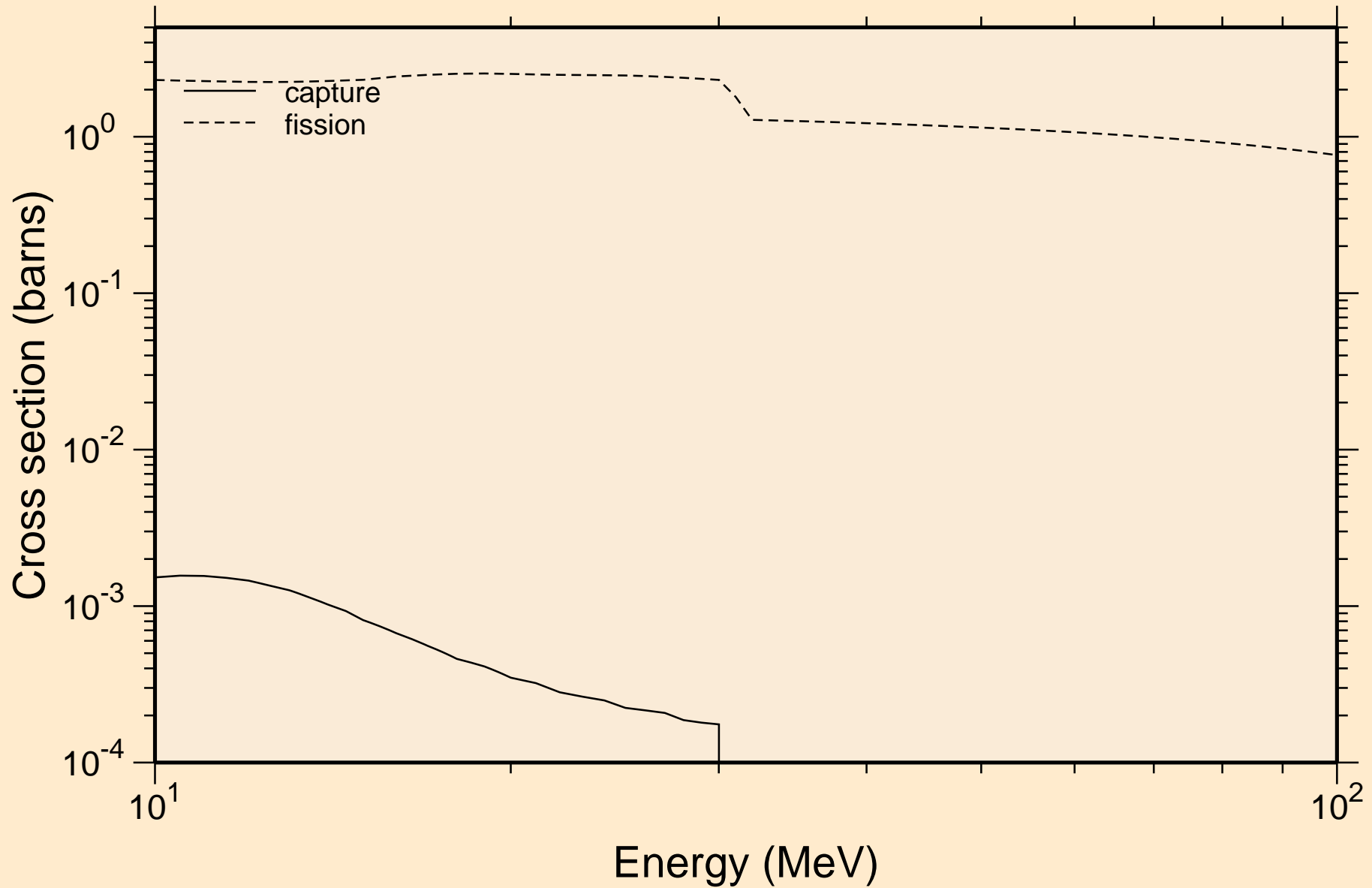

ES257 NEUTRON ACER TENDL-2021 LIBRARY; T=293.6K
Heating

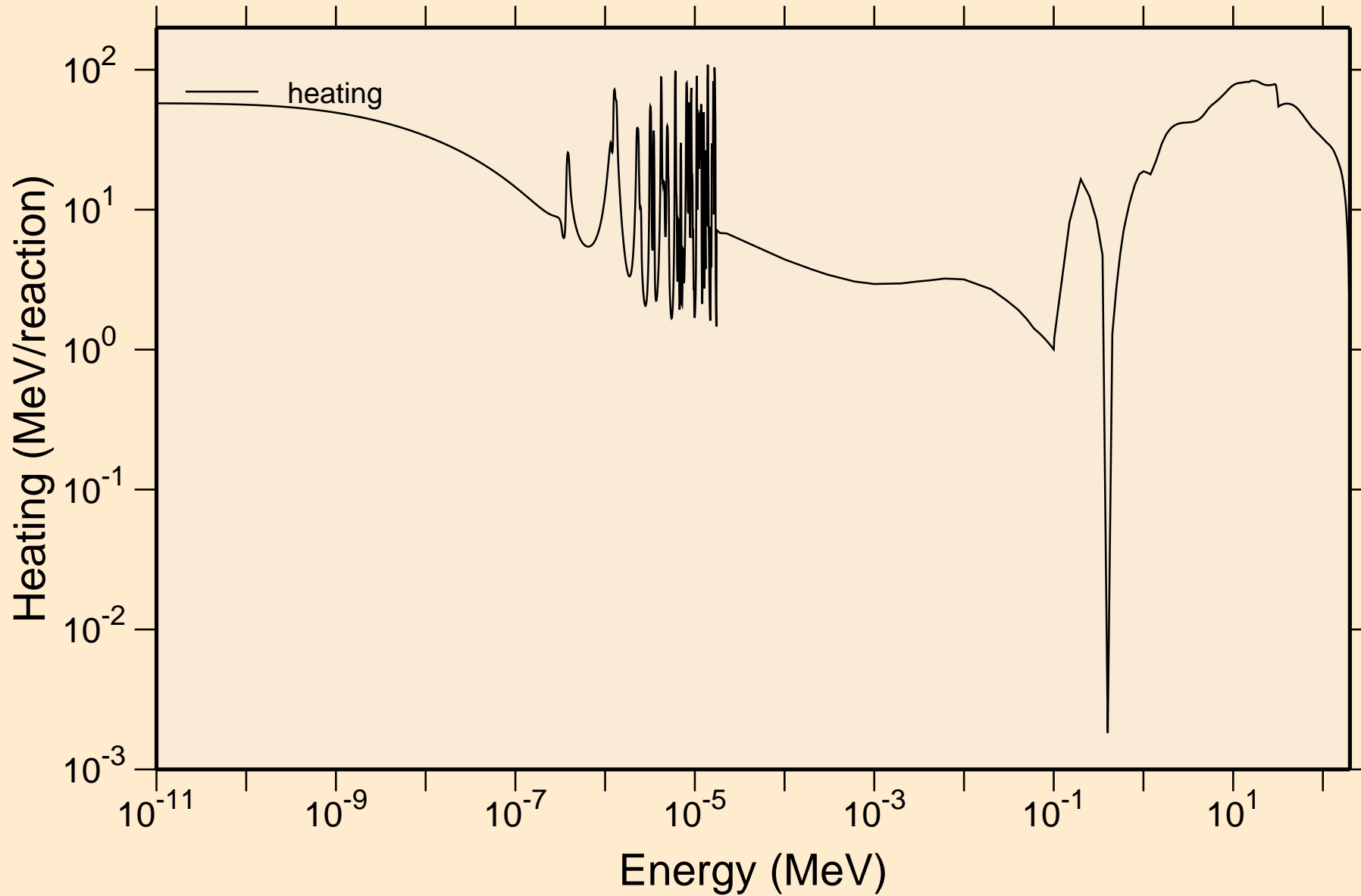

ES257 NEUTRON ACER TENDL-2021 LIBRARY; T=293.6K

Damage

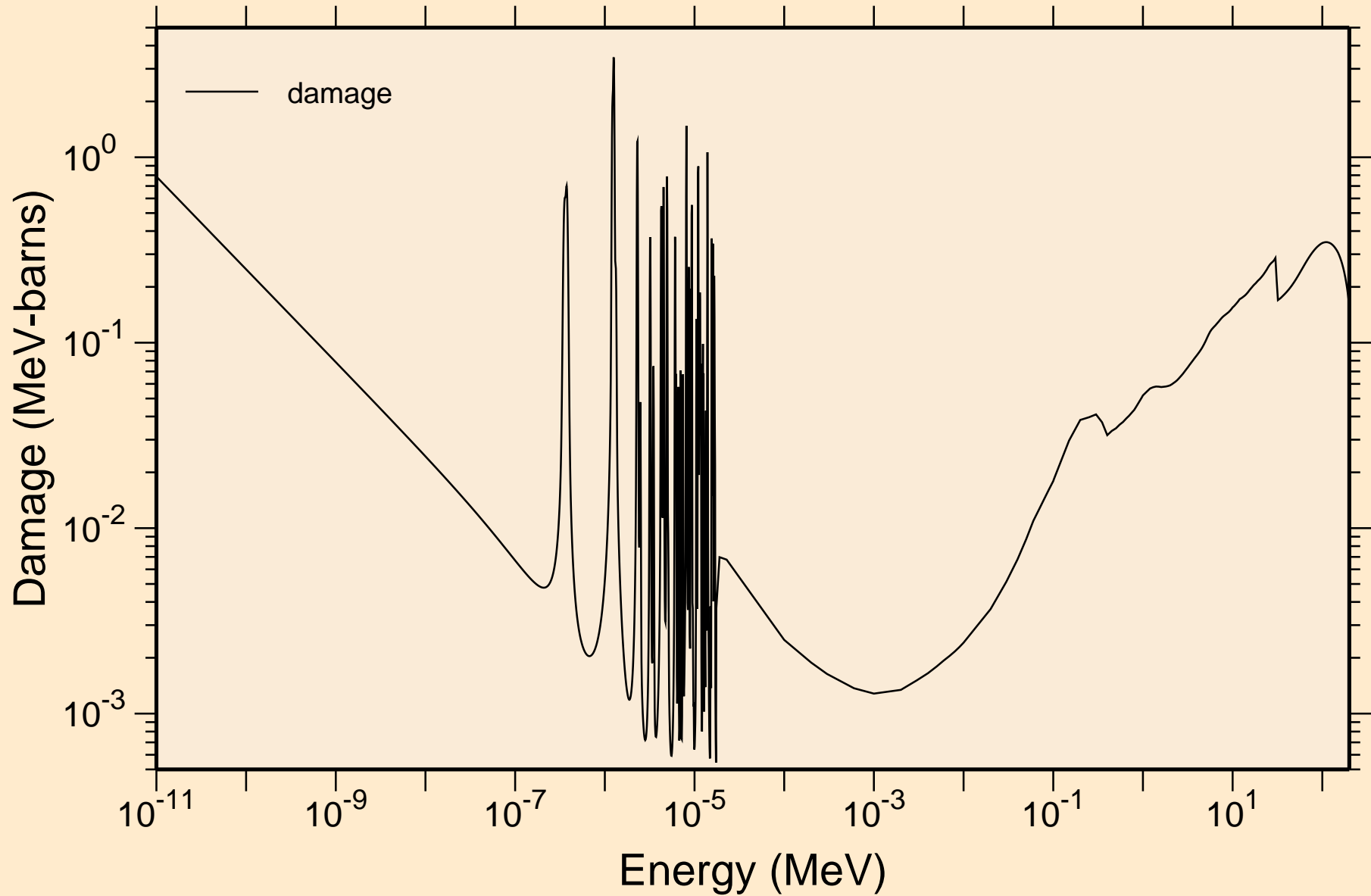

ES257 NEUTRON ACER TENDL-2021 LIBRARY; T=293.6K

Non-threshold reactions

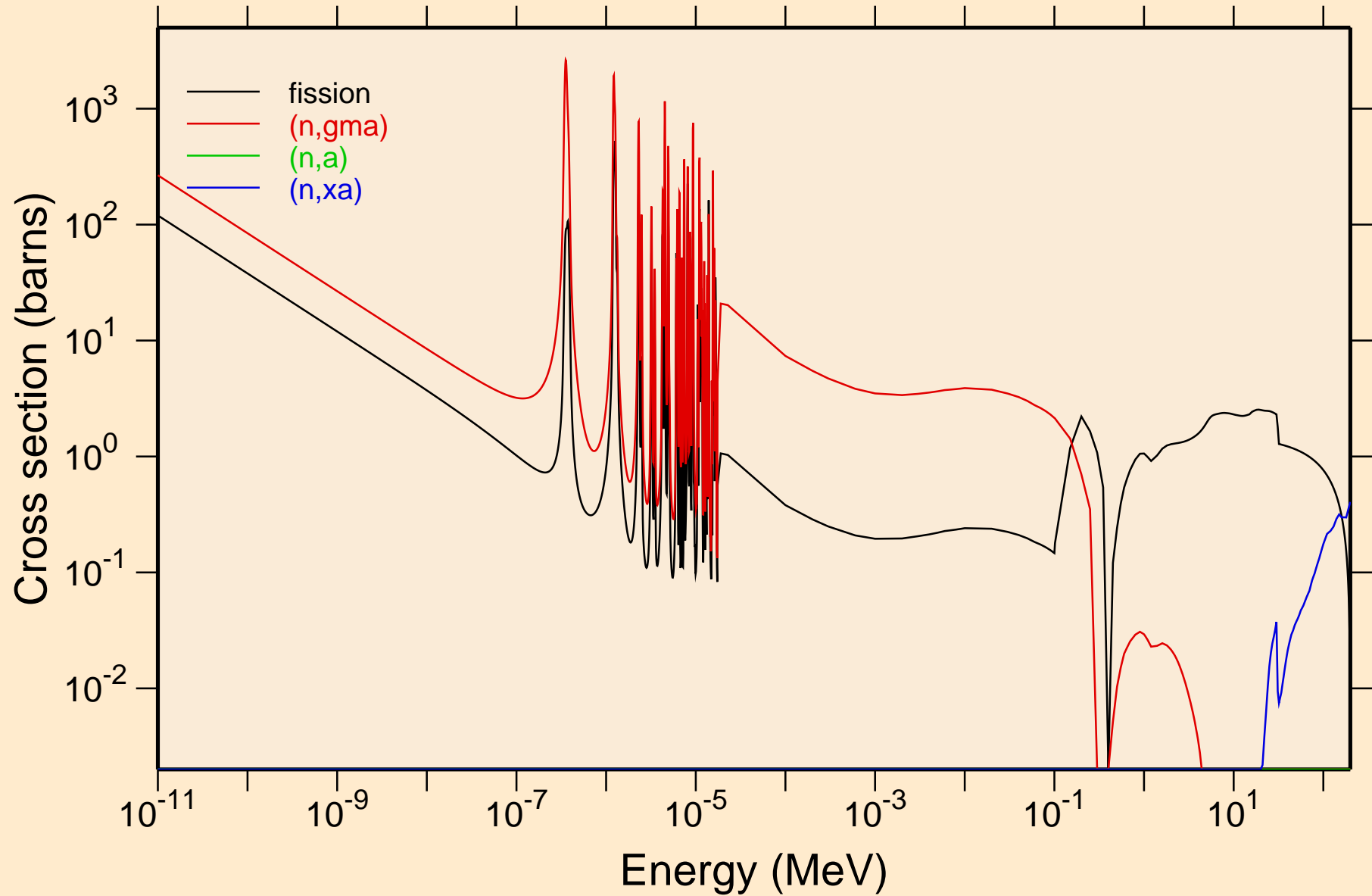

ES257 NEUTRON ACER TENDL-2021 LIBRARY; T=293.6K

Principal cross sections

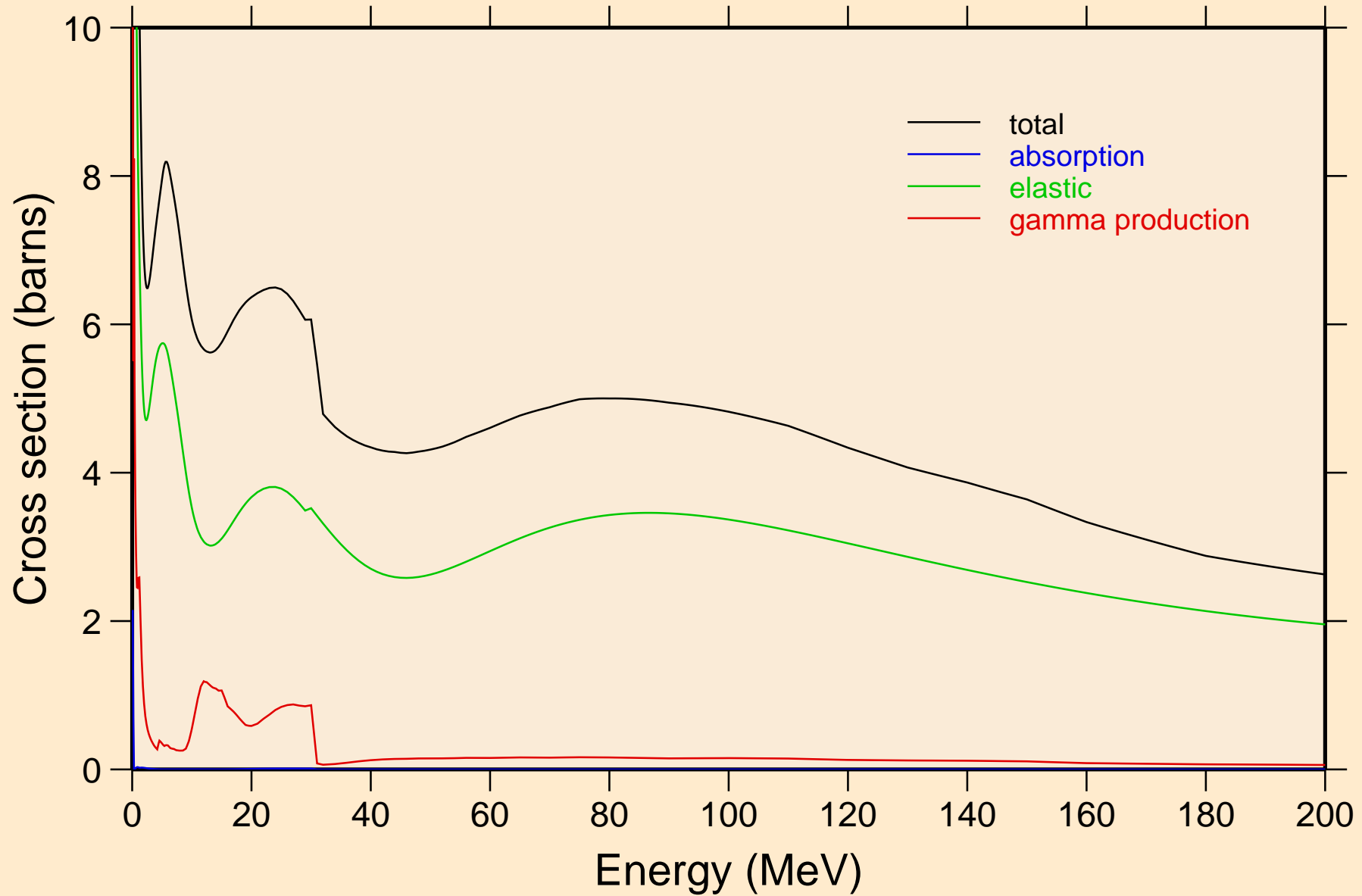

ES257 NEUTRON ACER TENDL-2021 LIBRARY; T=293.6K
Heating

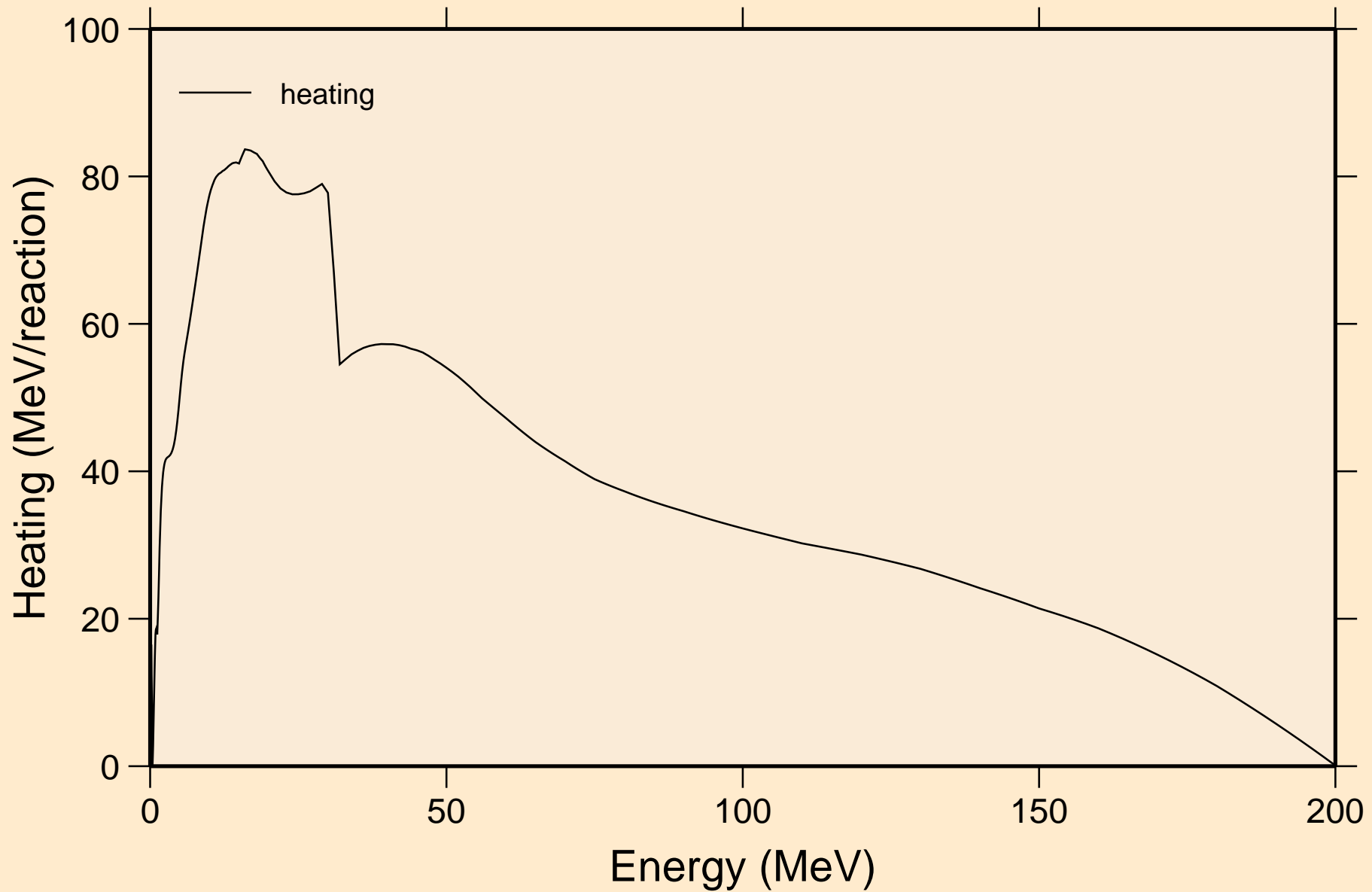

ES257 NEUTRON ACER TENDL-2021 LIBRARY; T=293.6K
Damage

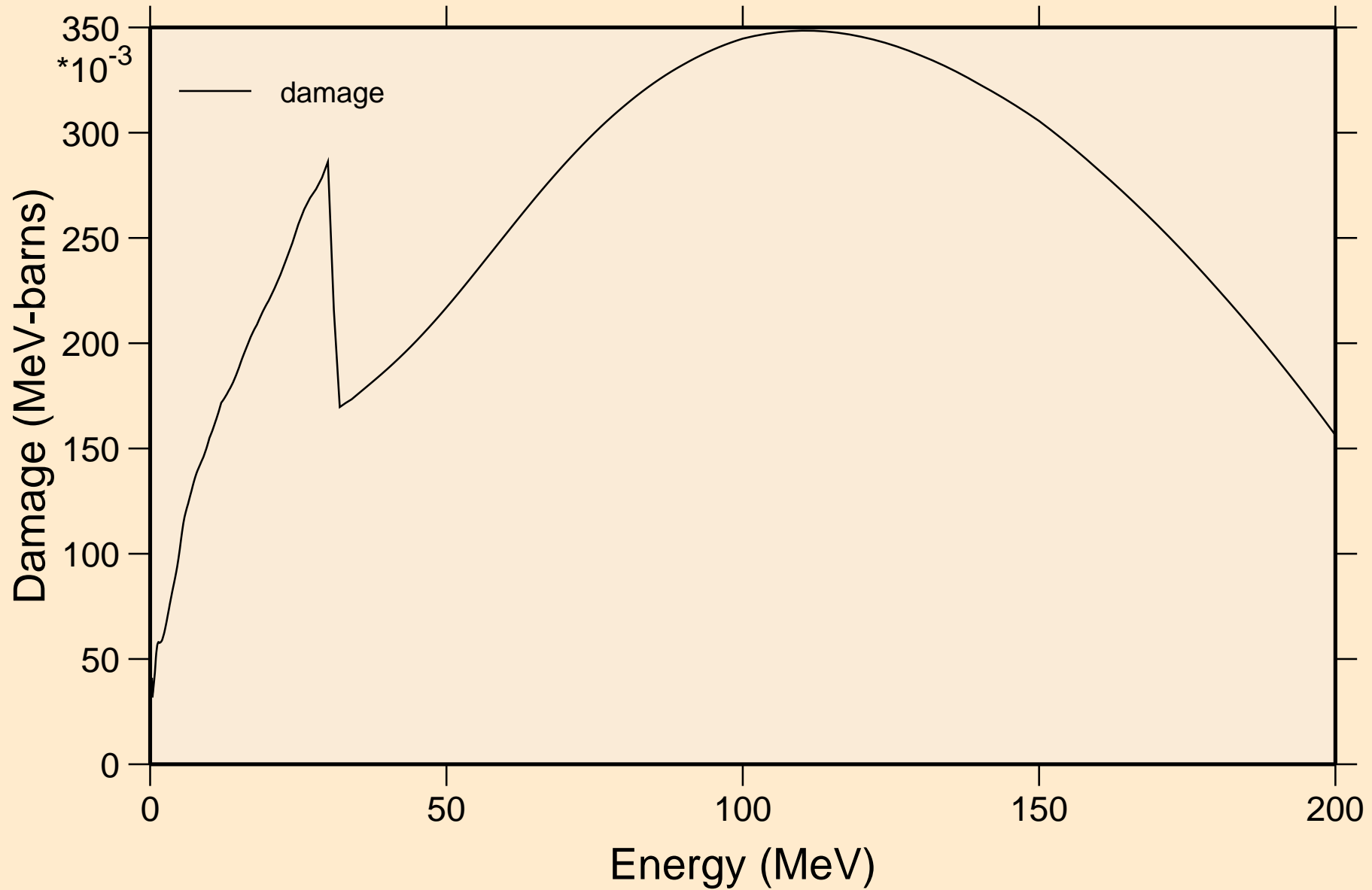

ES257 NEUTRON ACER TENDL-2021 LIBRARY; T=293.6K

Non-threshold reactions

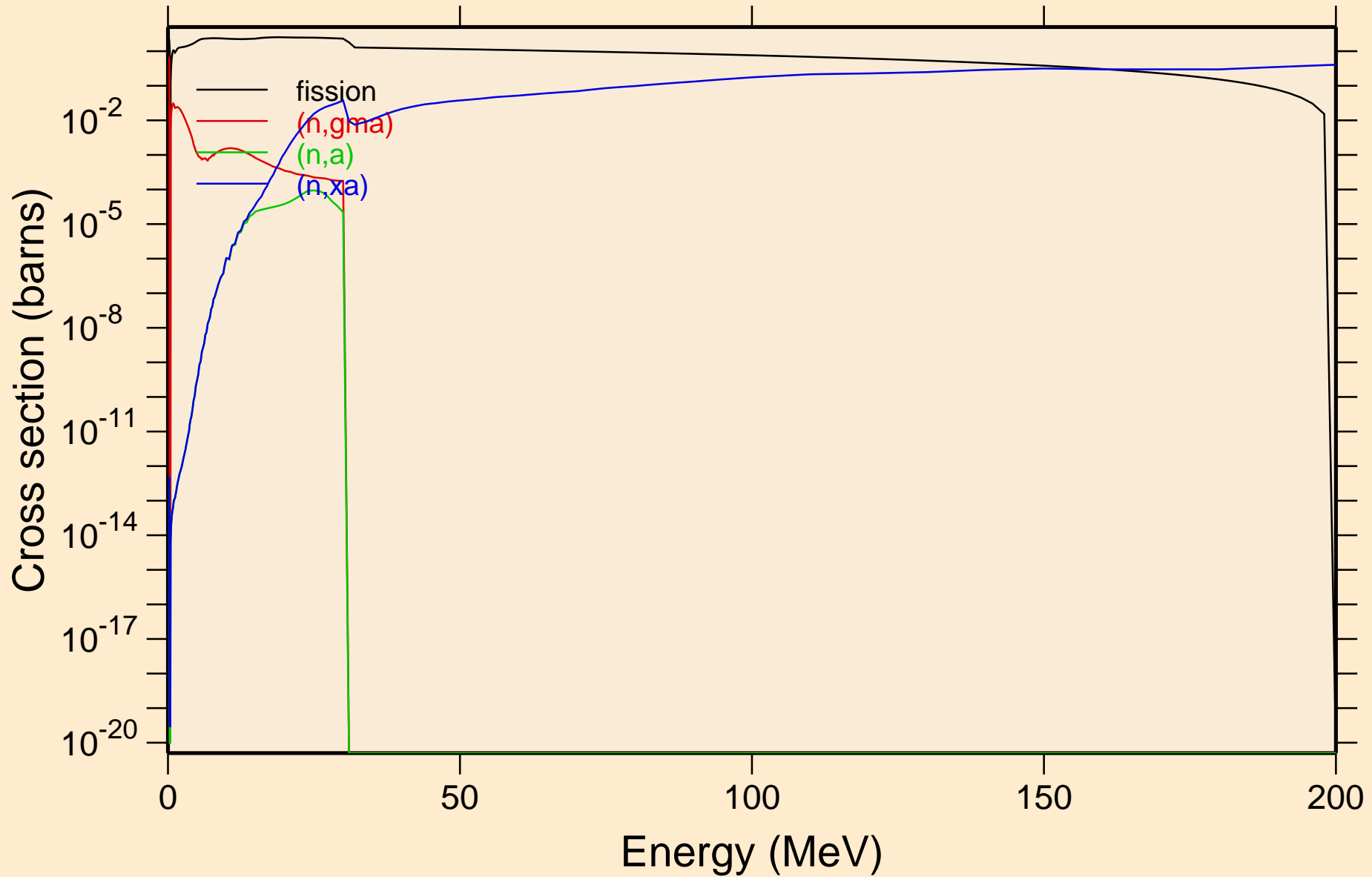

ES257 NEUTRON ACER TENDL-2021 LIBRARY; T=293.6K
Inelastic levels

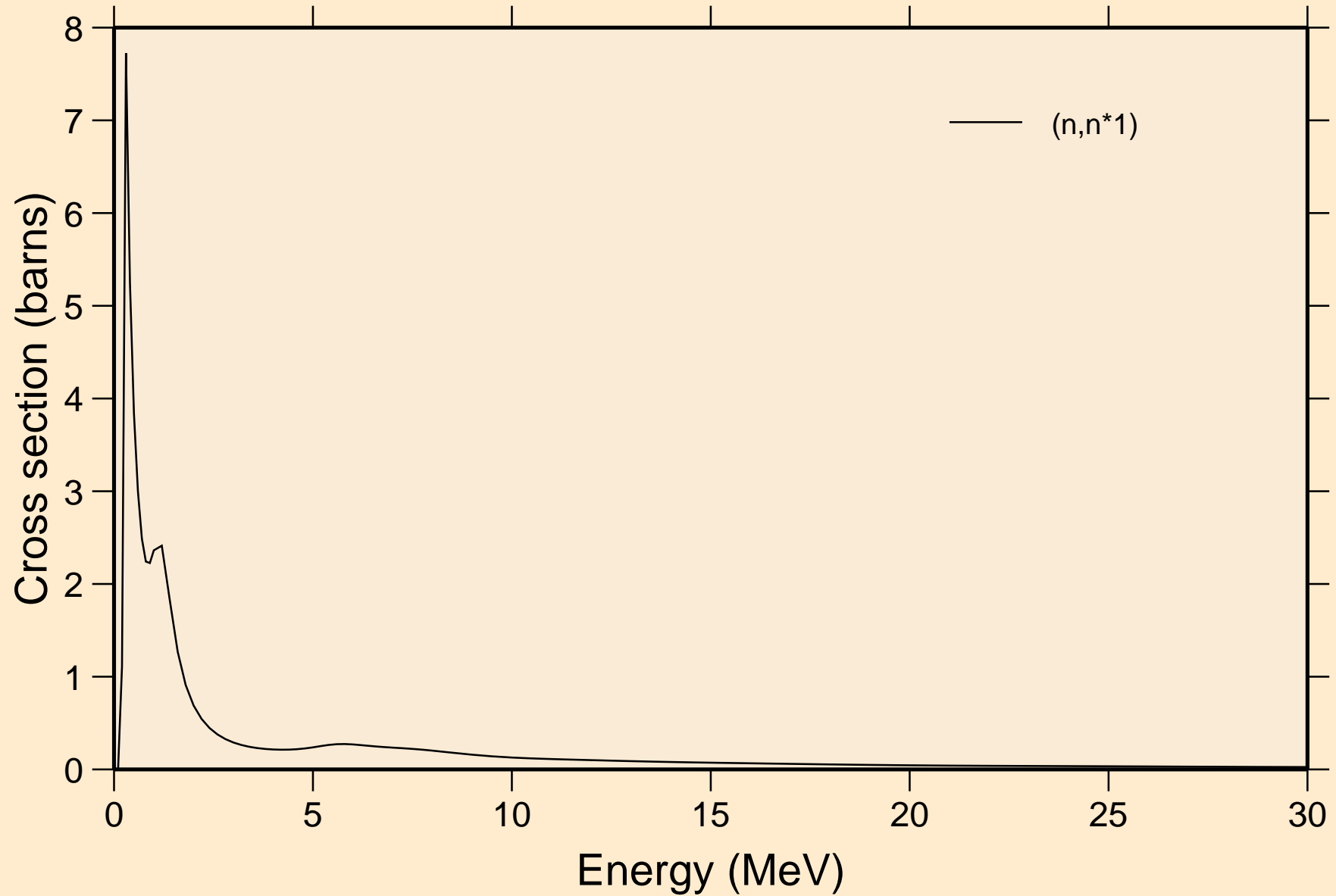

ES257 NEUTRON ACER TENDL-2021 LIBRARY; T=293.6K

Threshold reactions

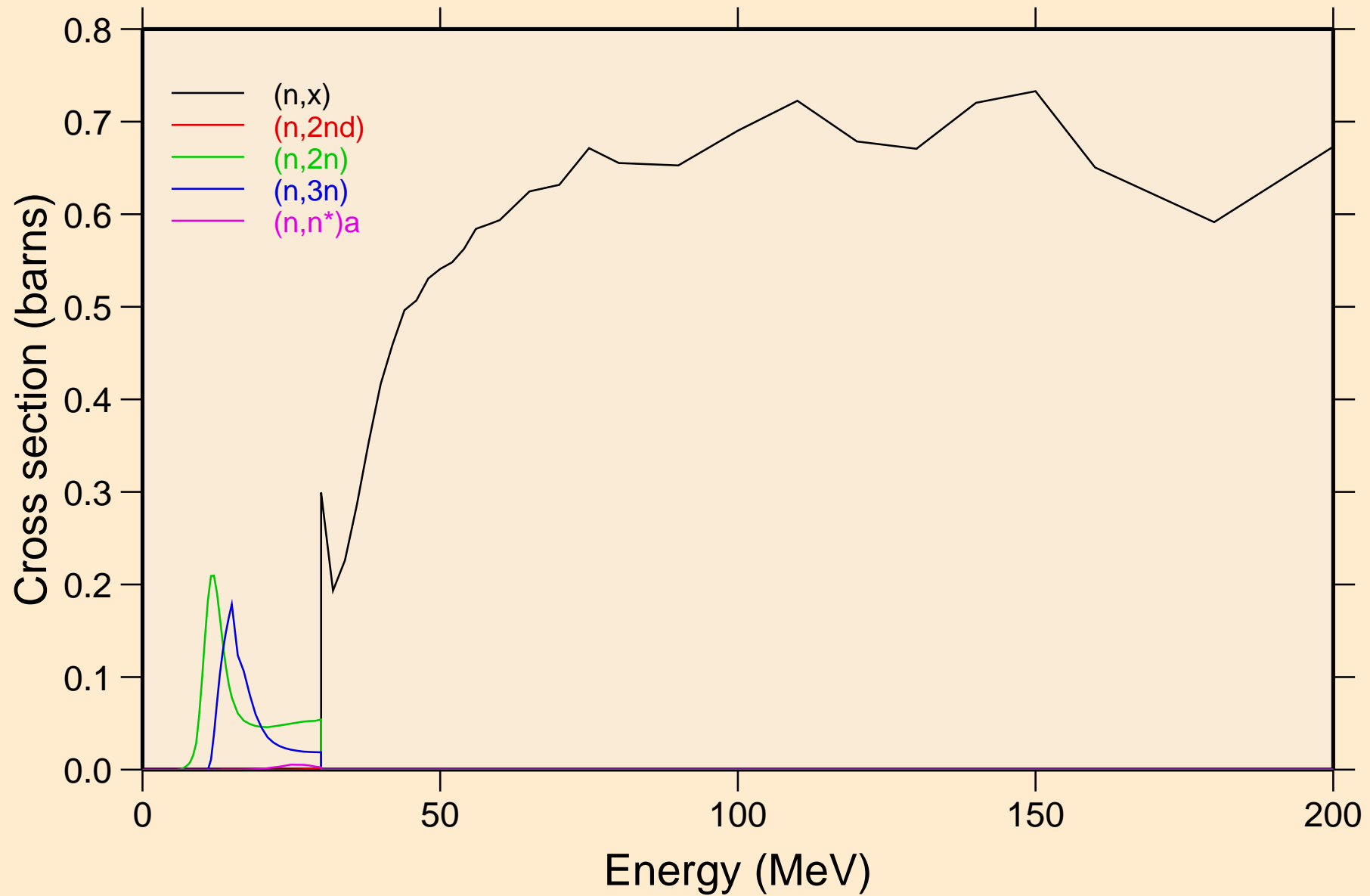

ES257 NEUTRON ACER TENDL-2021 LIBRARY; T=293.6K

Threshold reactions

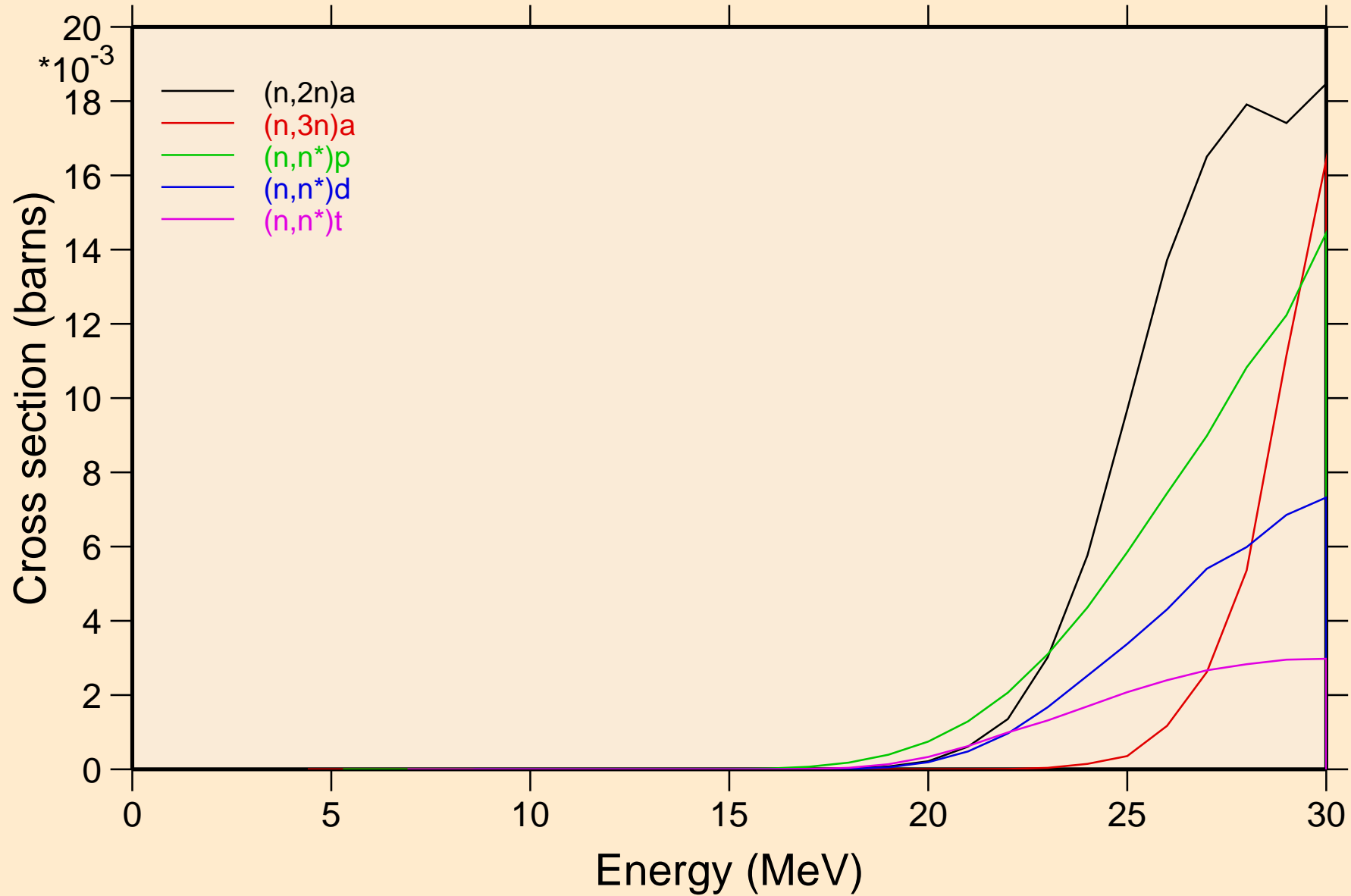

ES257 NEUTRON ACER TENDL-2021 LIBRARY; T=293.6K

Threshold reactions

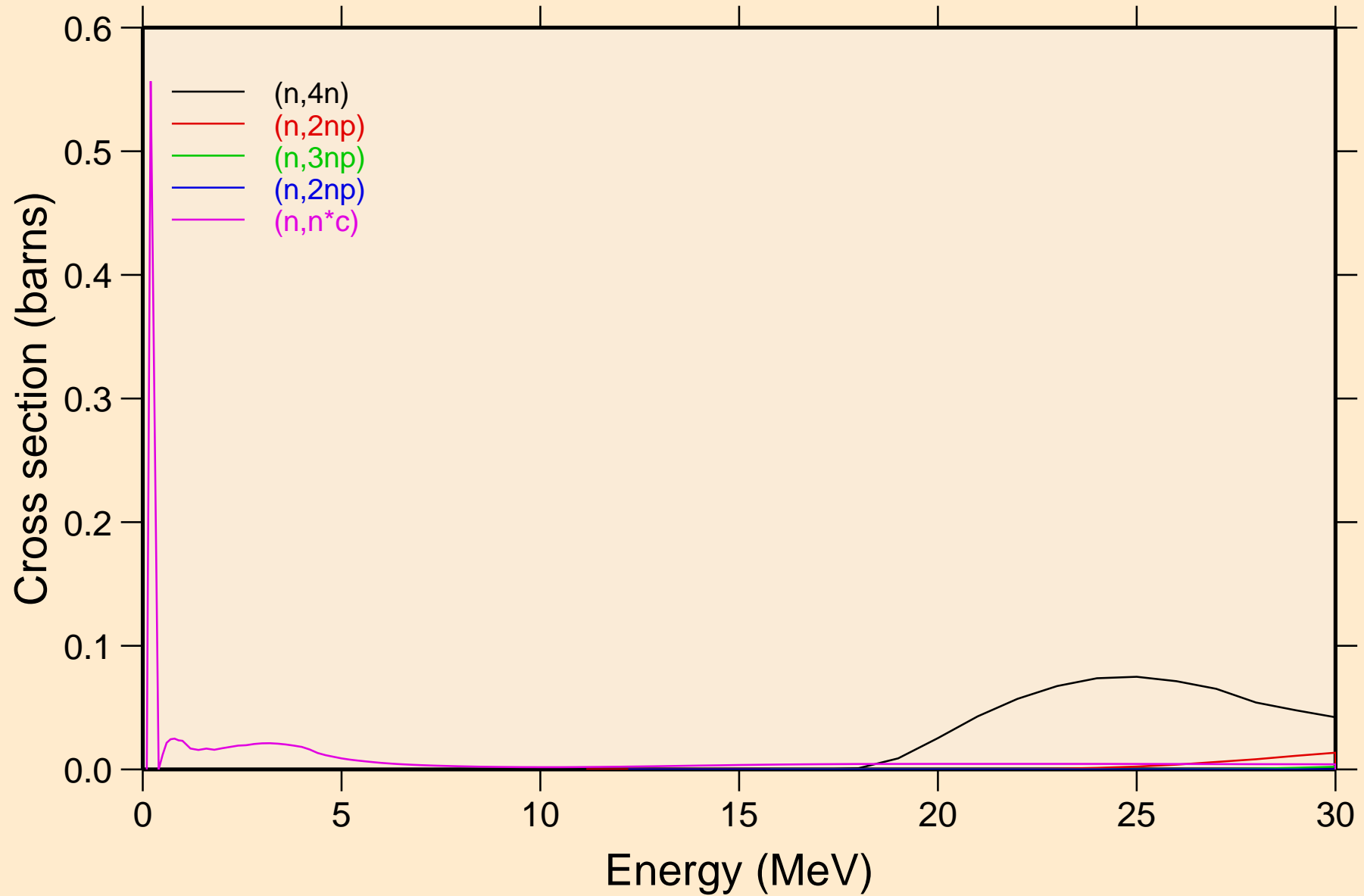

ES257 NEUTRON ACER TENDL-2021 LIBRARY; T=293.6K
Threshold reactions

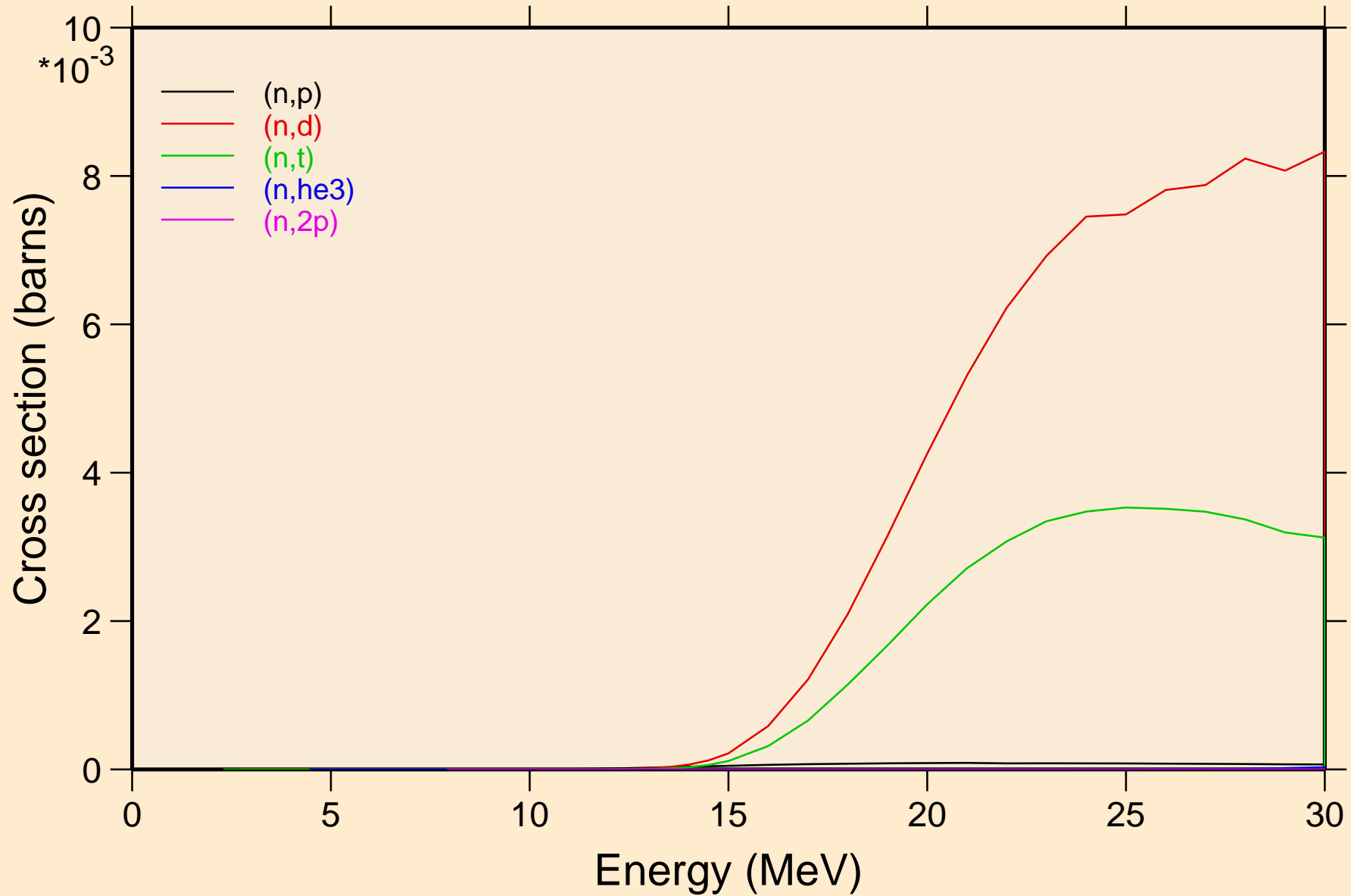

ES257 NEUTRON ACER TENDL-2021 LIBRARY; T=293.6K
Threshold reactions

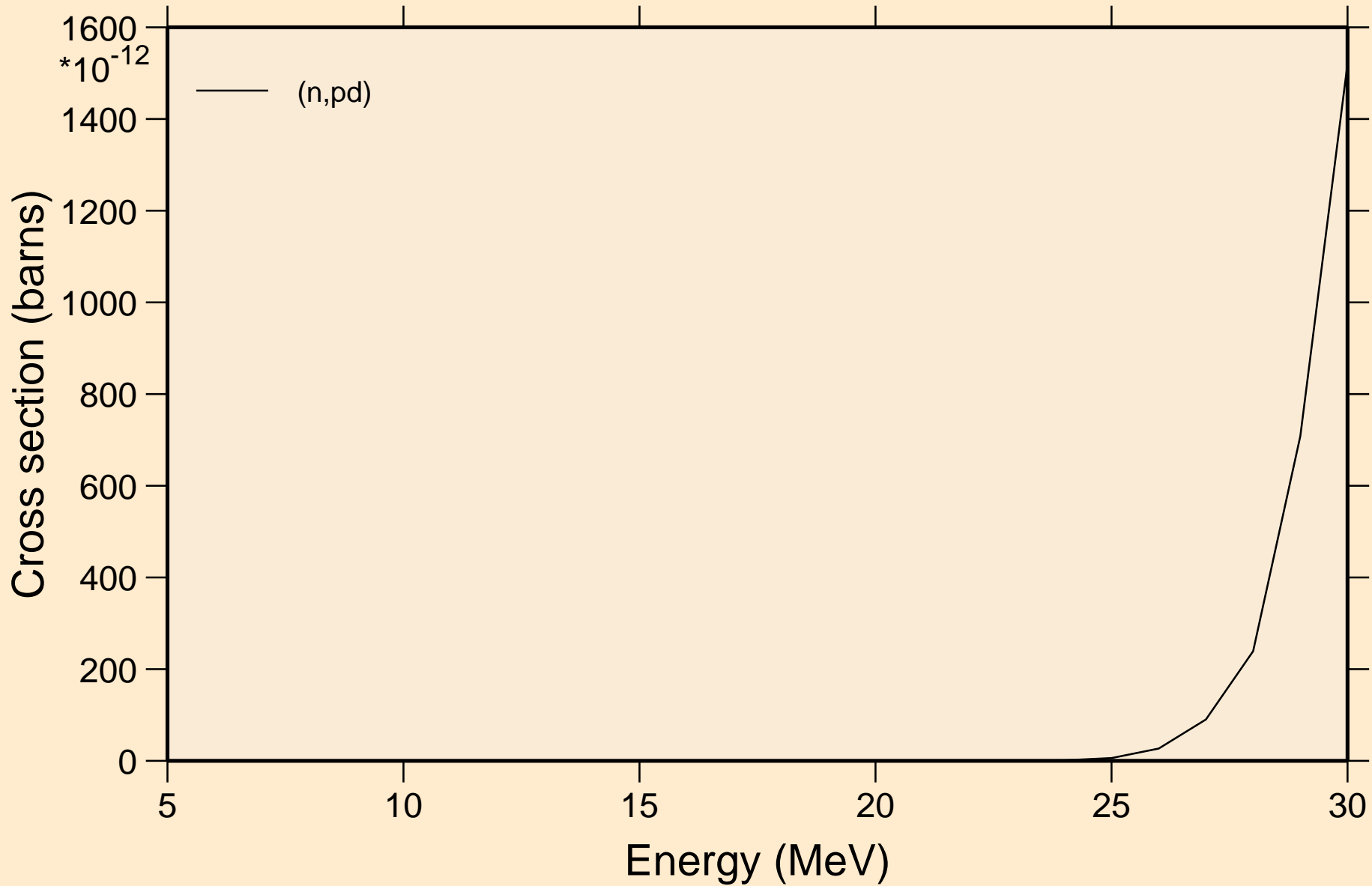

ES257 NEUTRON ACER TENDL-2021 LIBRARY; T=293.6K

Threshold reactions

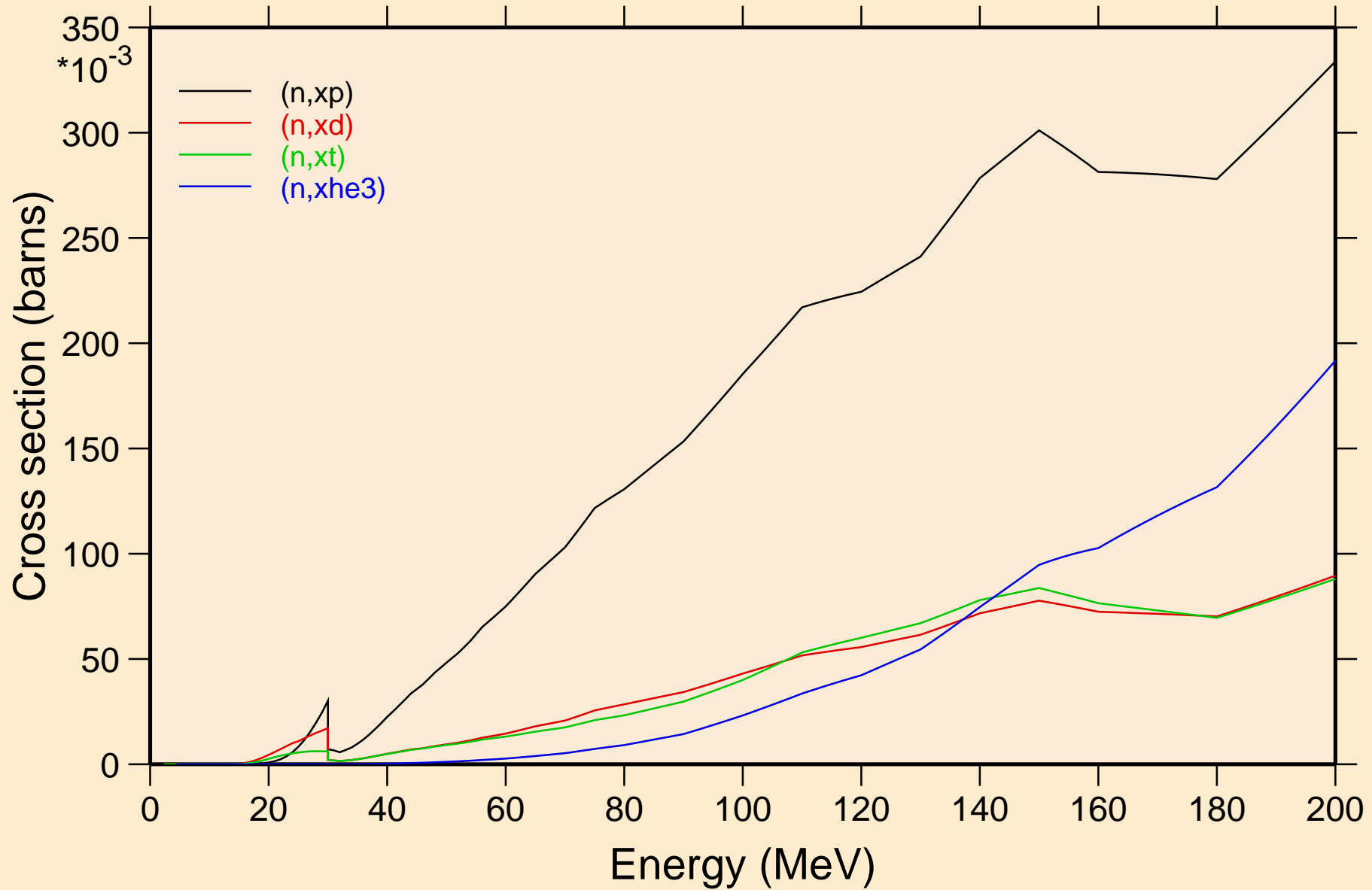

ES257 NEUTRON ACER TENDL-2021 LIBRARY; T=293.6K
angular distribution for elastic

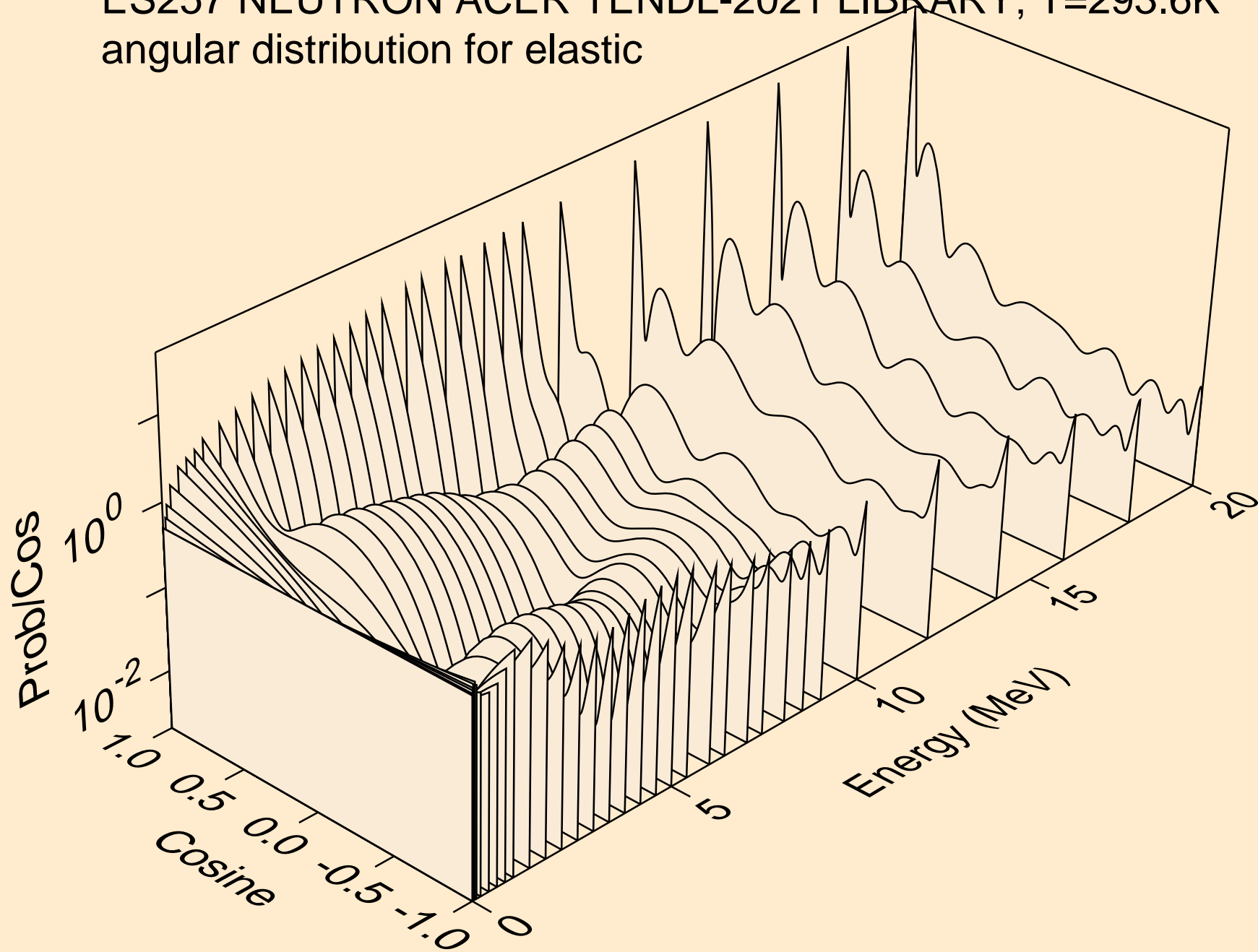

ES257 NEUTRON ACER TENDL-2021 LIBRARY; T=293.6K
angular distribution for elastic

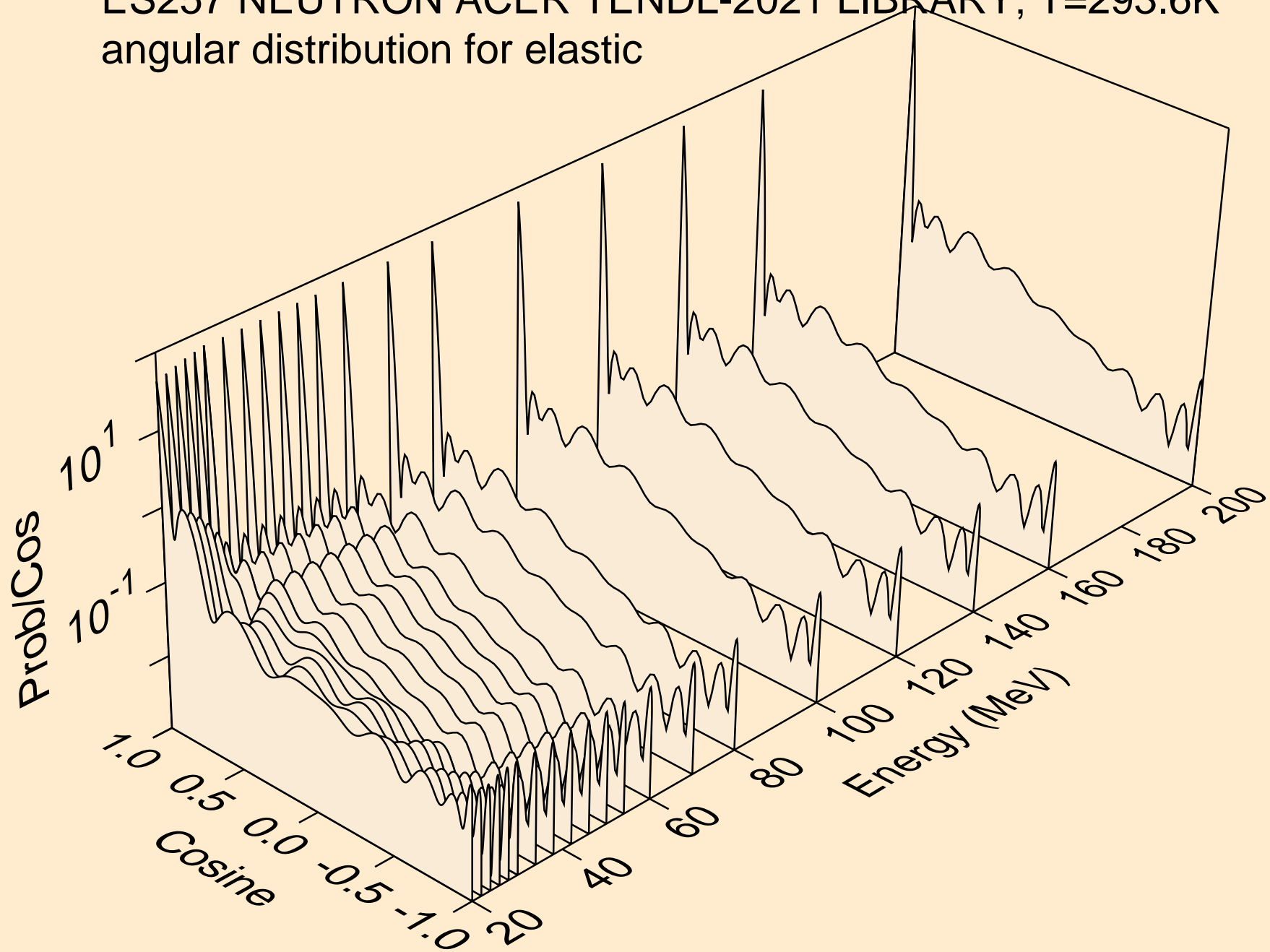

ES257 NEUTRON ACER TENDL-2021 LIBRARY; T=293.6K
angular distribution for (n,n*1)

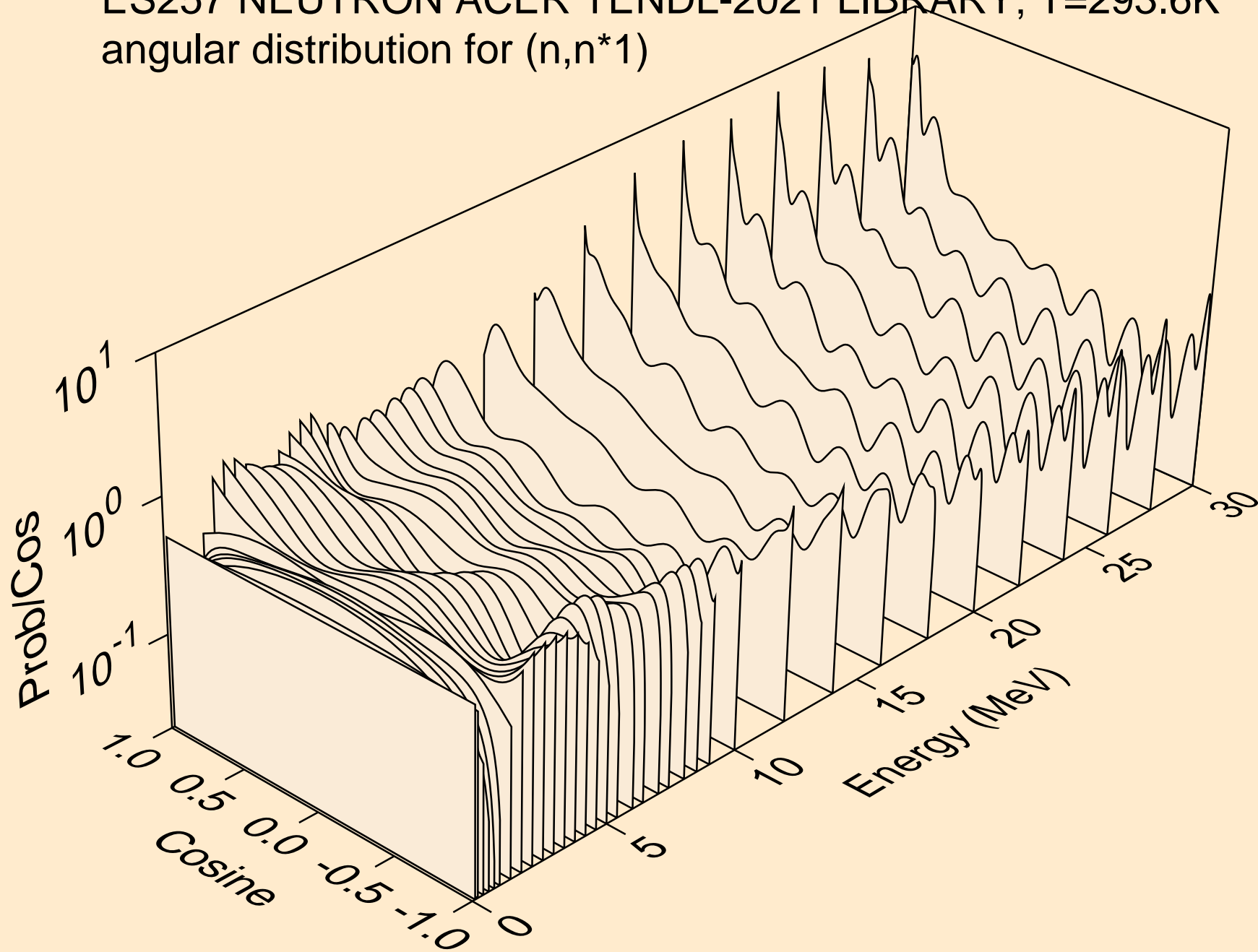

ES257 NEUTRON ACER TENDL-2021 LIBRARY; T=293.6K
Total fission nubar

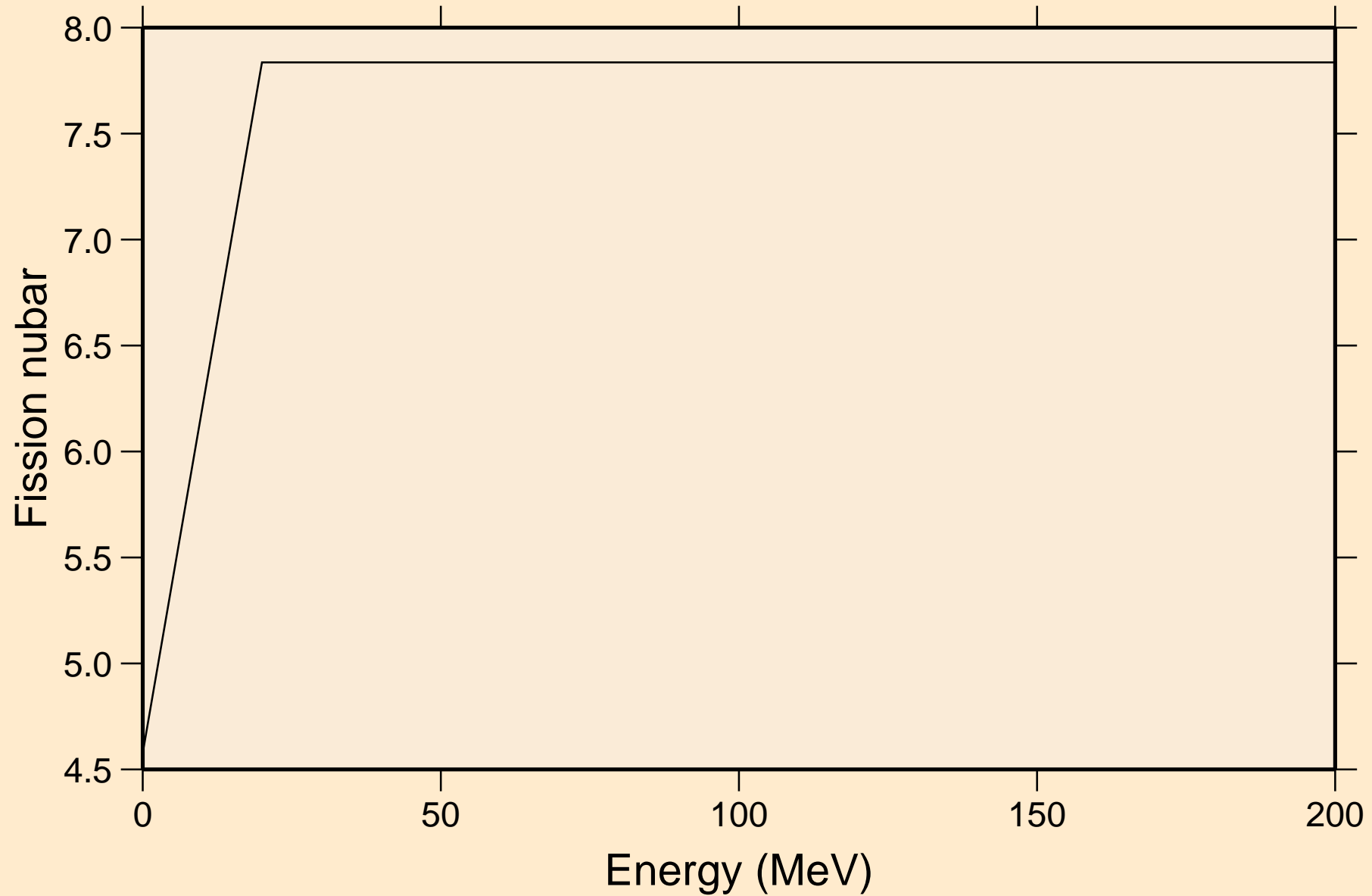

ES257 NEUTRON ACER TENDL-2021 LIBRARY; T=293.6K
Neutron emission for (n,x)

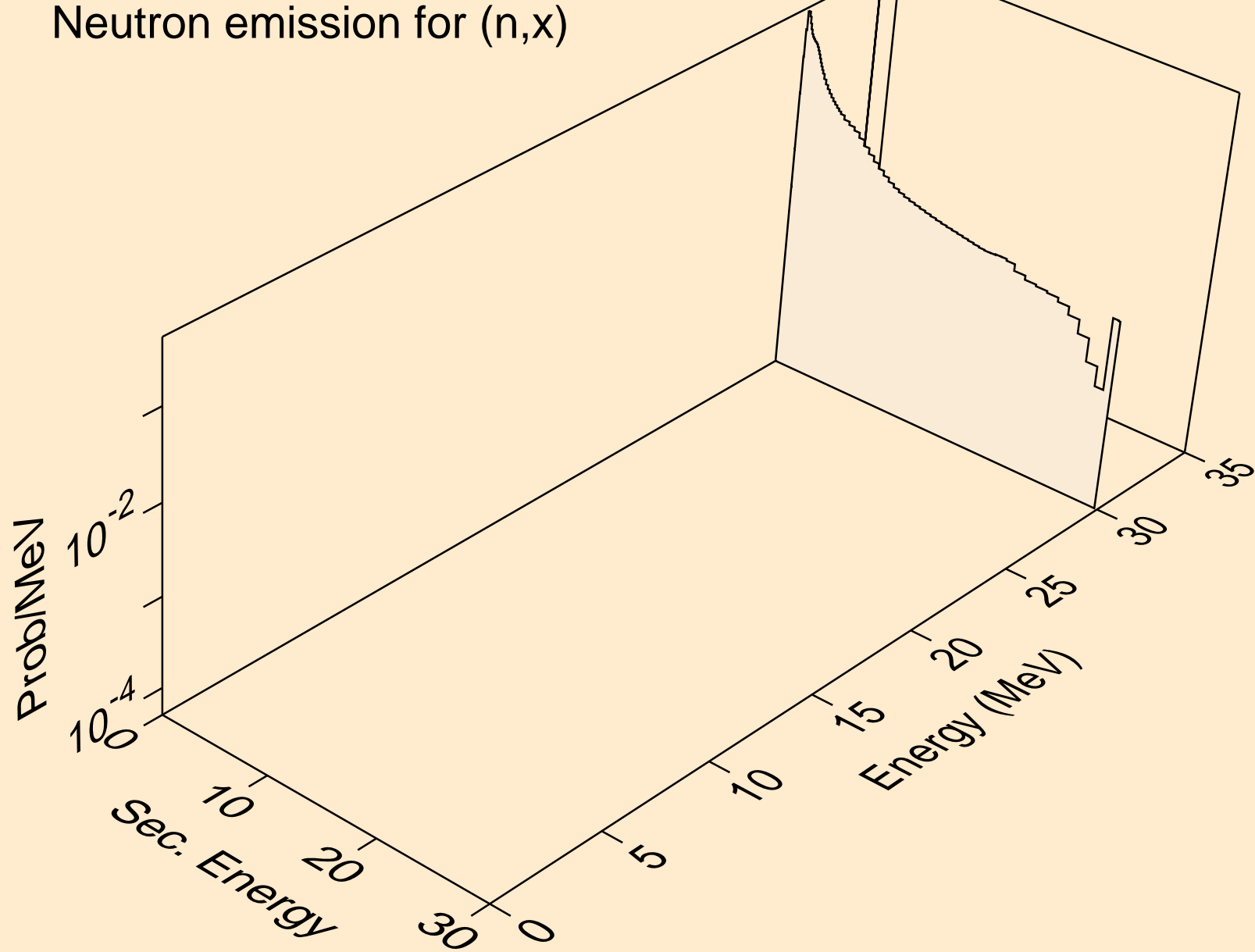

ES257 NEUTRON ACER TENDL-2021 LIBRARY; T=293.6K
Neutron emission for (n,2nd)

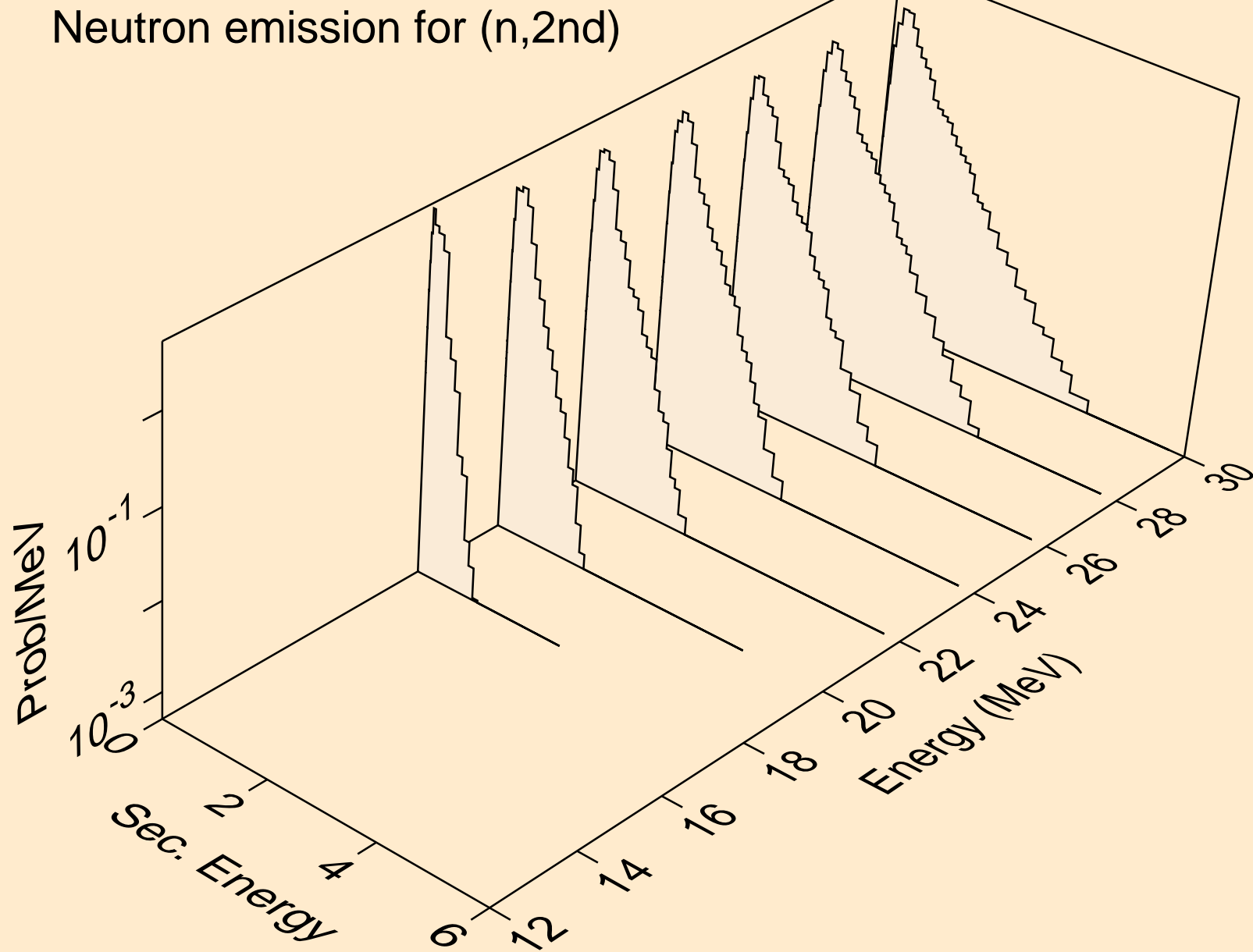

ES257 NEUTRON ACER TENDL-2021 LIBRARY; T=293.6K
Neutron emission for (n,2n)

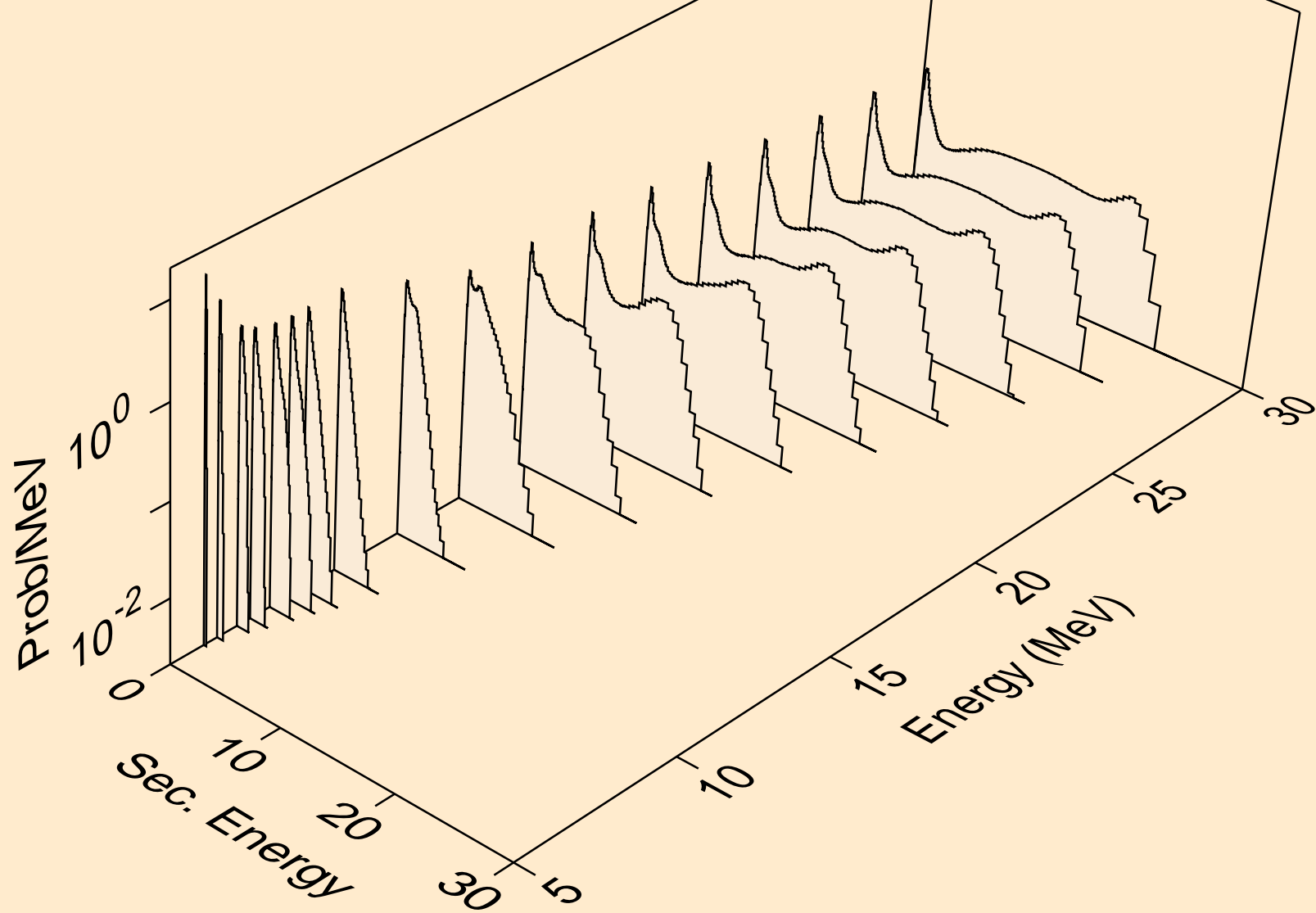

ES257 NEUTRON ACER TENDL-2021 LIBRARY; T=293.6K
Neutron emission for (n,3n)

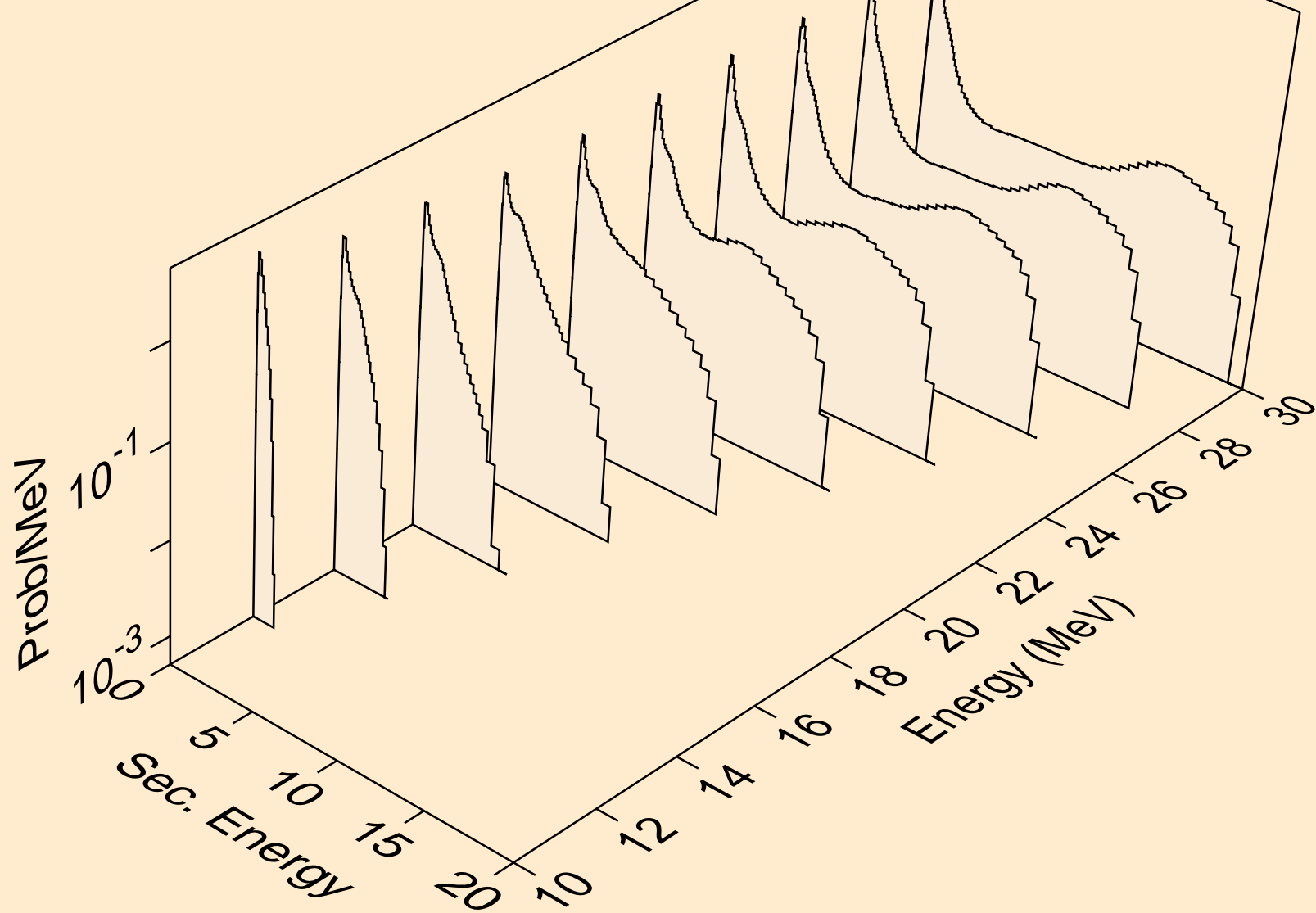

ES257 NEUTRON ACER TENDL-2021 LIBRARY; T=293.6K
Neutron emission for fission

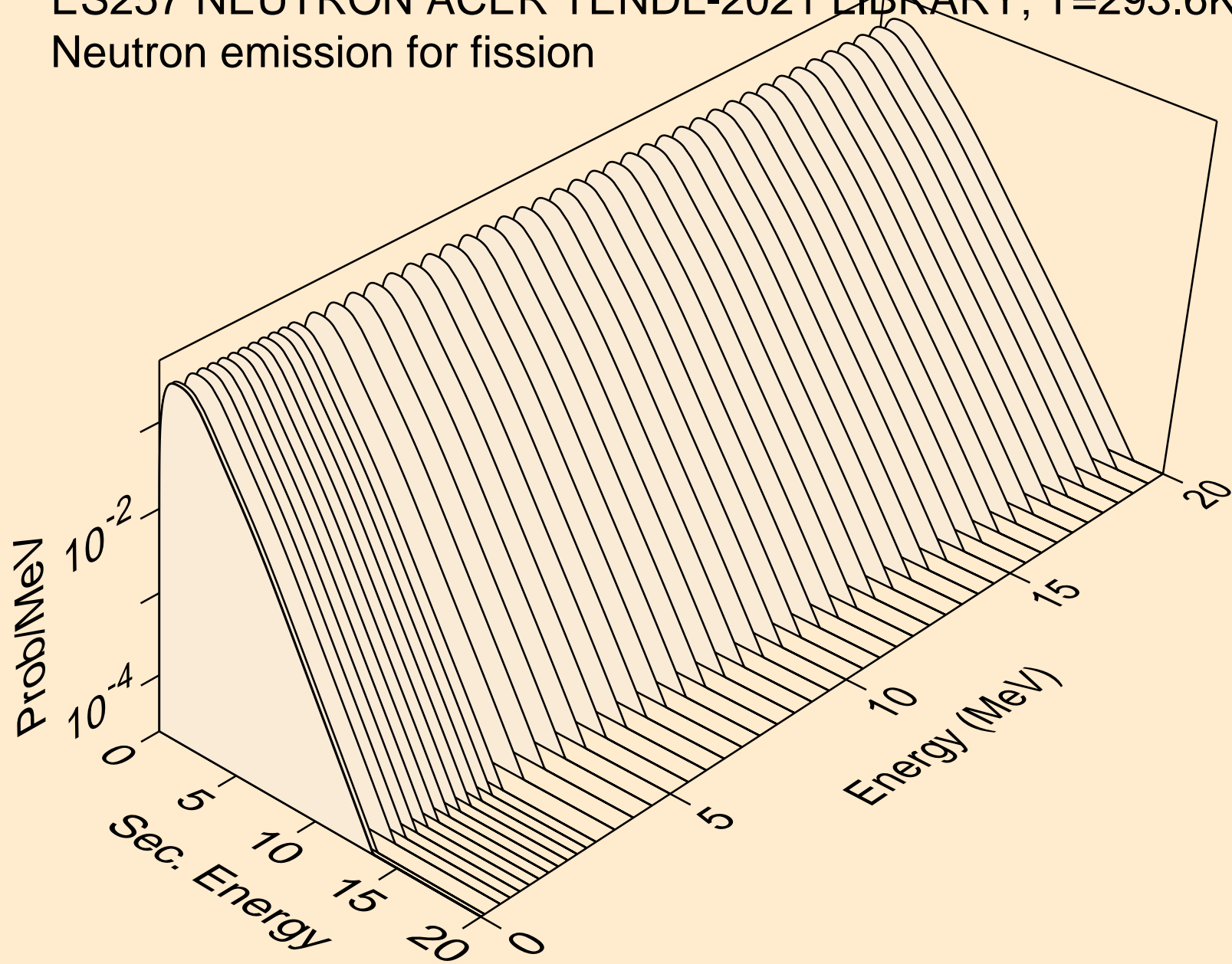

ES257 NEUTRON ACER TENDL-2021 LIBRARY; T=293.6K
Neutron emission for (n,n*)a

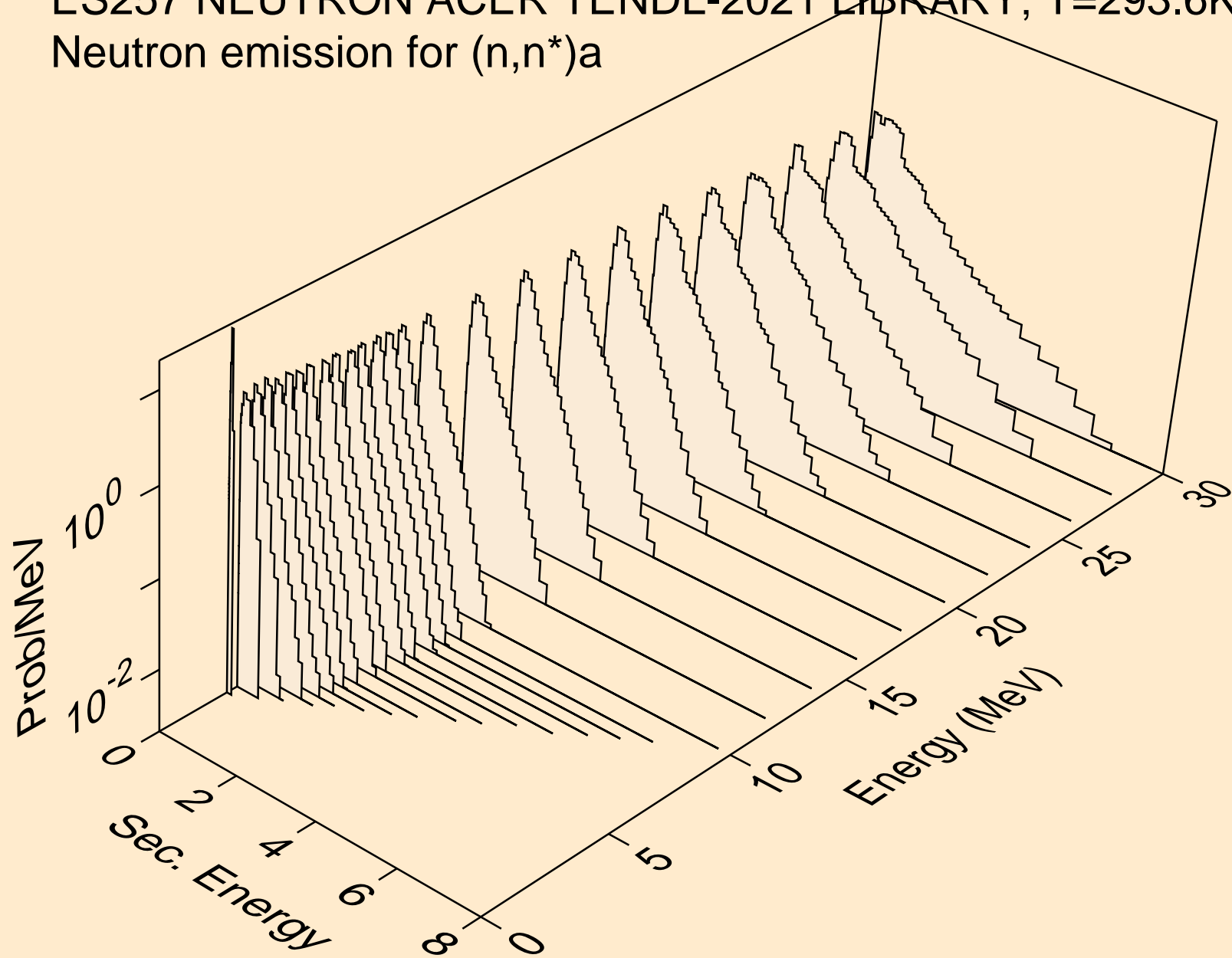

ES257 NEUTRON ACER TENDL-2021 LIBRARY; T=293.6K
Neutron emission for (n,2n)a

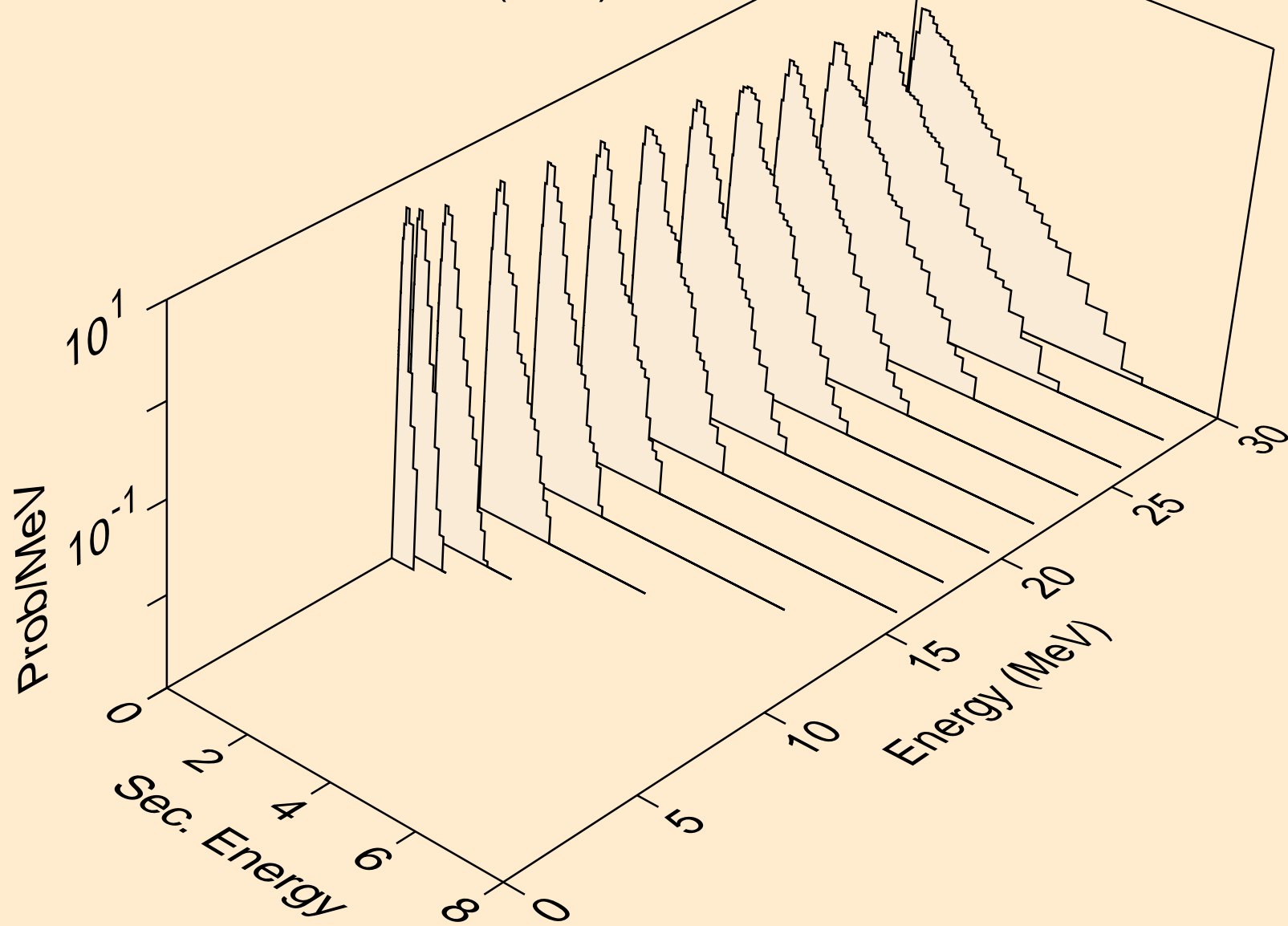

ES257 NEUTRON ACER TENDL-2021 LIBRARY; T=293.6K
Neutron emission for (n,3n)a

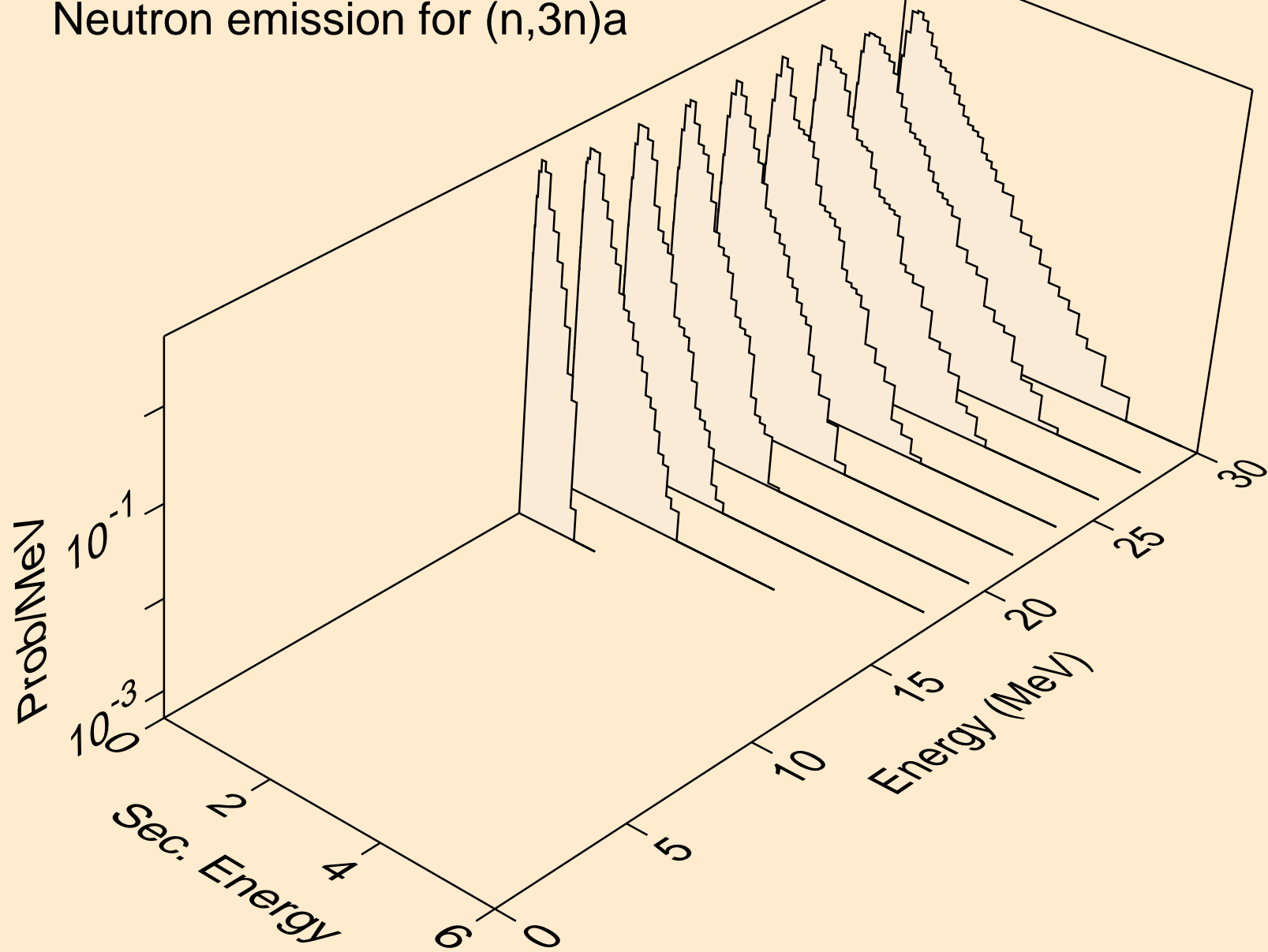

ES257 NEUTRON ACER TENDL-2021 LIBRARY; T=293.6K
Neutron emission for (n,n*)p

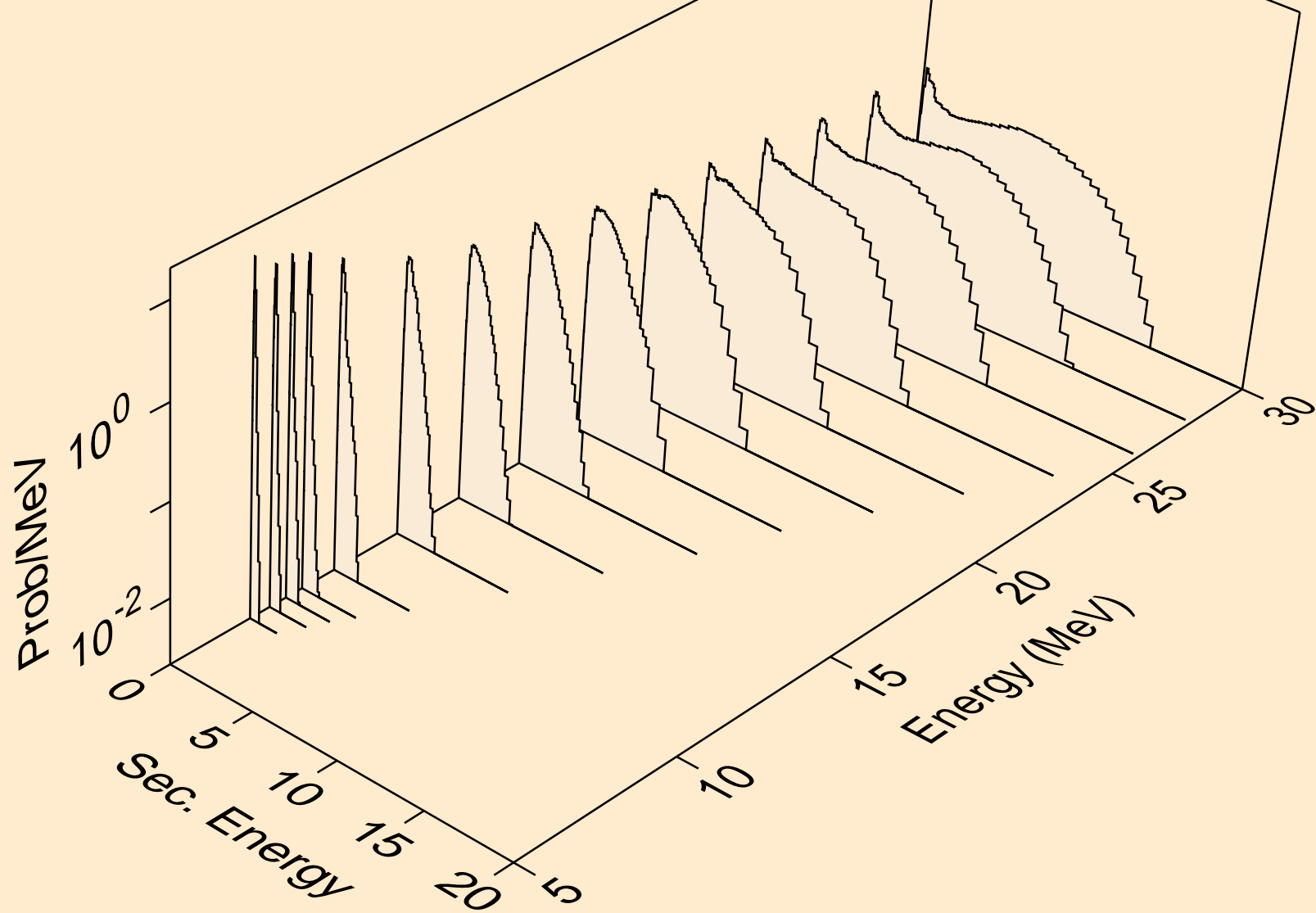

ES257 NEUTRON ACER TENDL-2021 LIBRARY; T=293.6K
Neutron emission for (n,n*)d

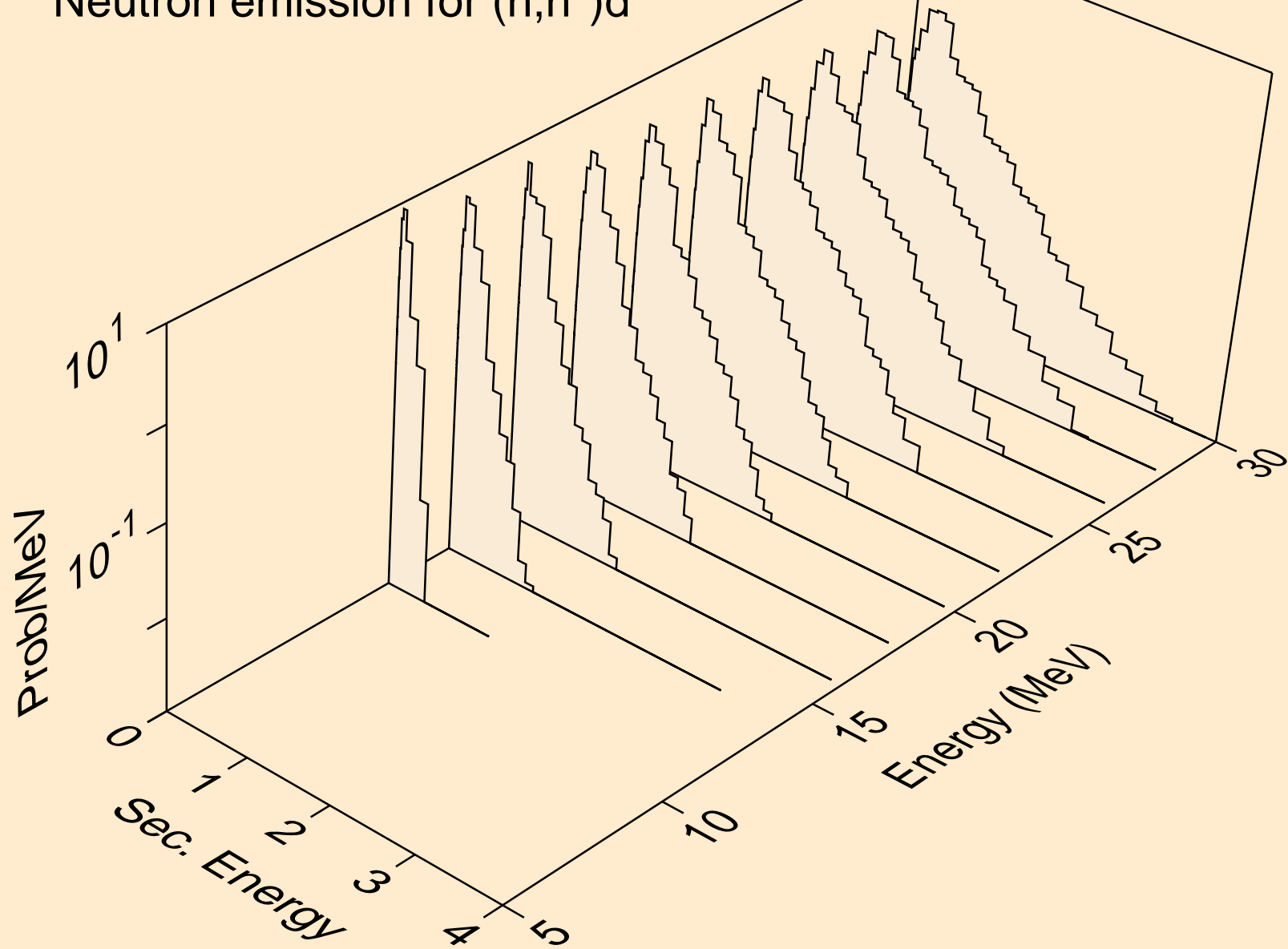

ES257 NEUTRON ACER TENDL-2021 LIBRARY; T=293.6K
Neutron emission for (n,n*)t

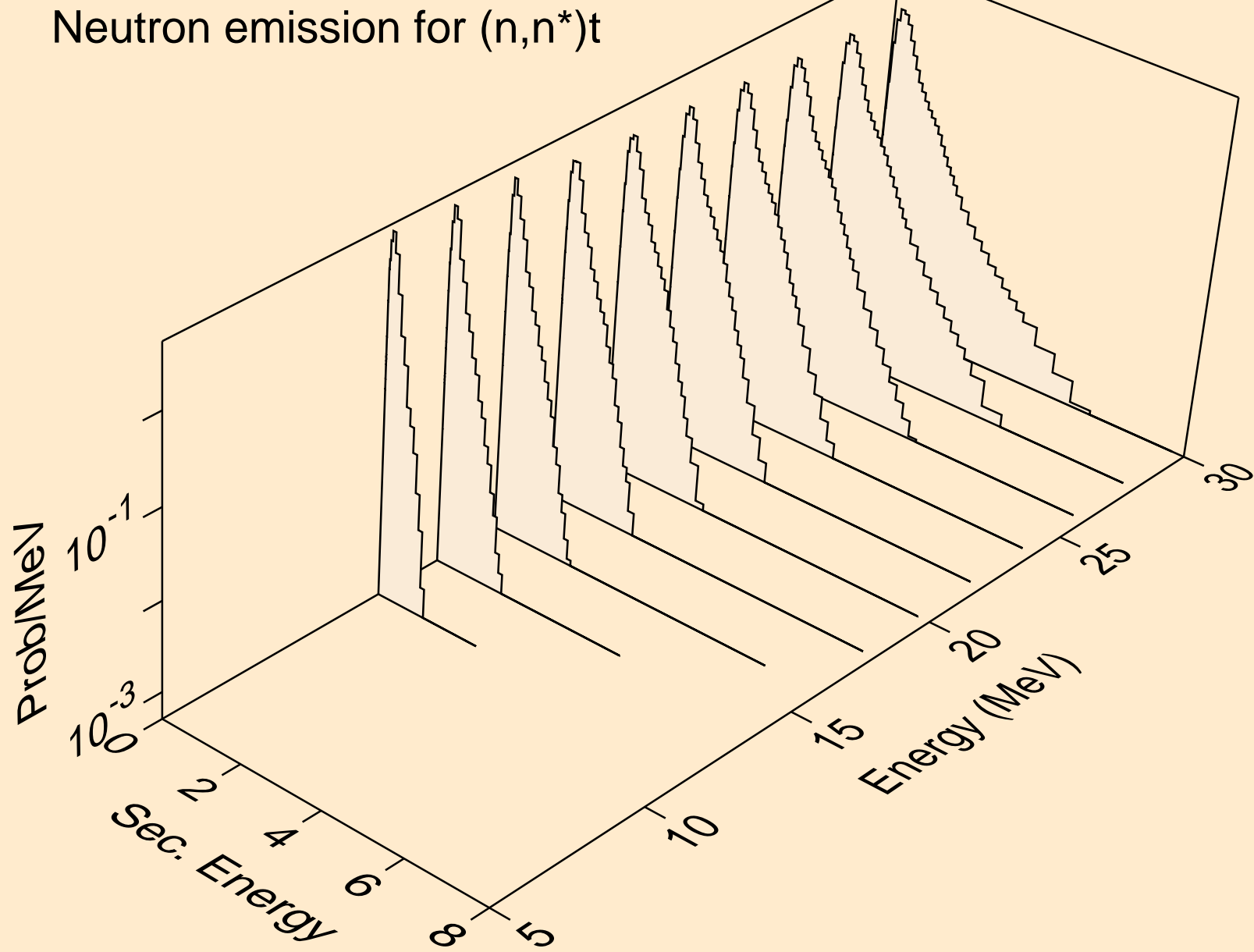

ES257 NEUTRON ACER TENDL-2021 LIBRARY; T=293.6K
Neutron emission for (n,4n)

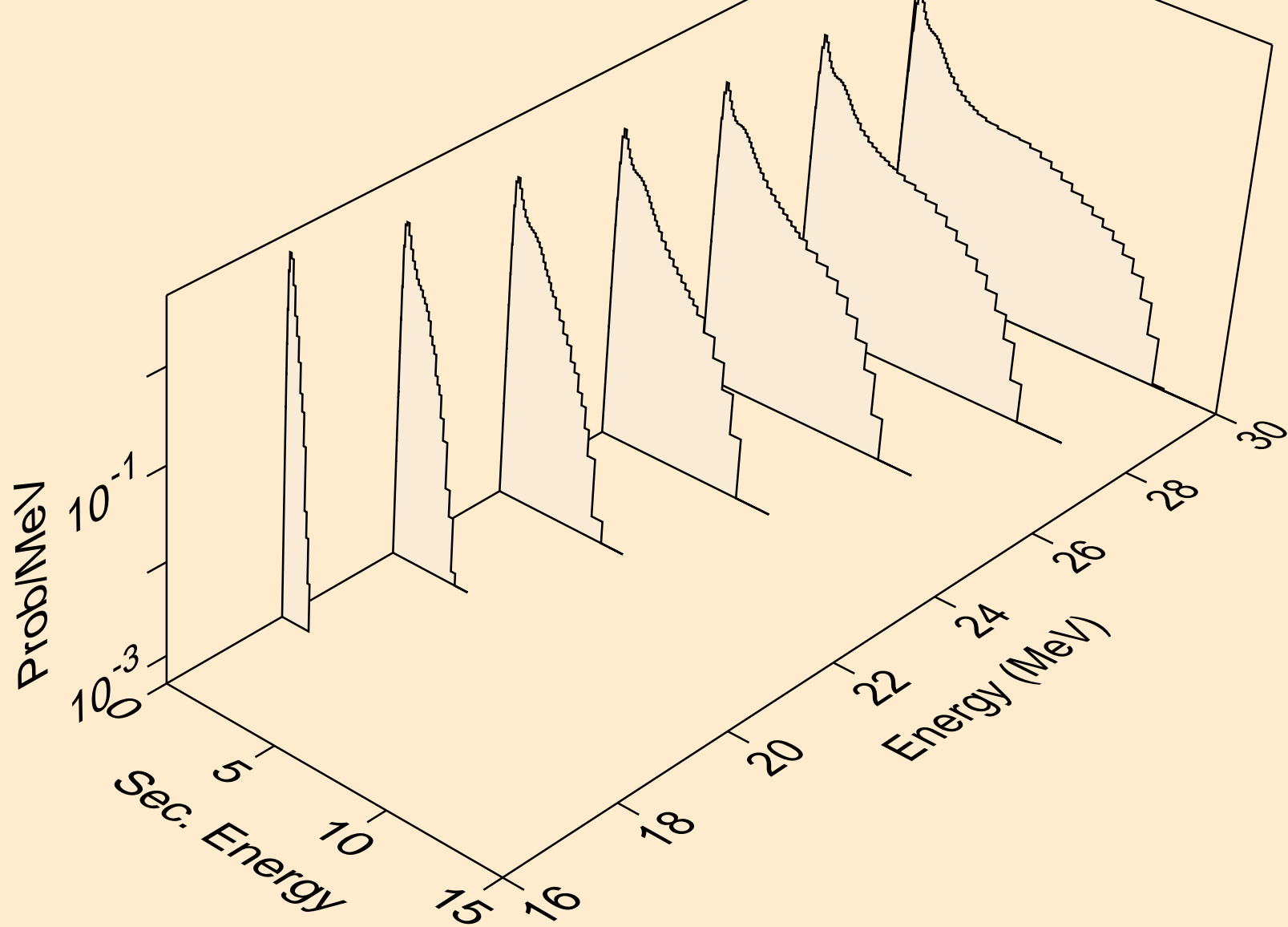

ES257 NEUTRON ACER TENDL-2021 LIBRARY; T=293.6K
Neutron emission for (n,2np)

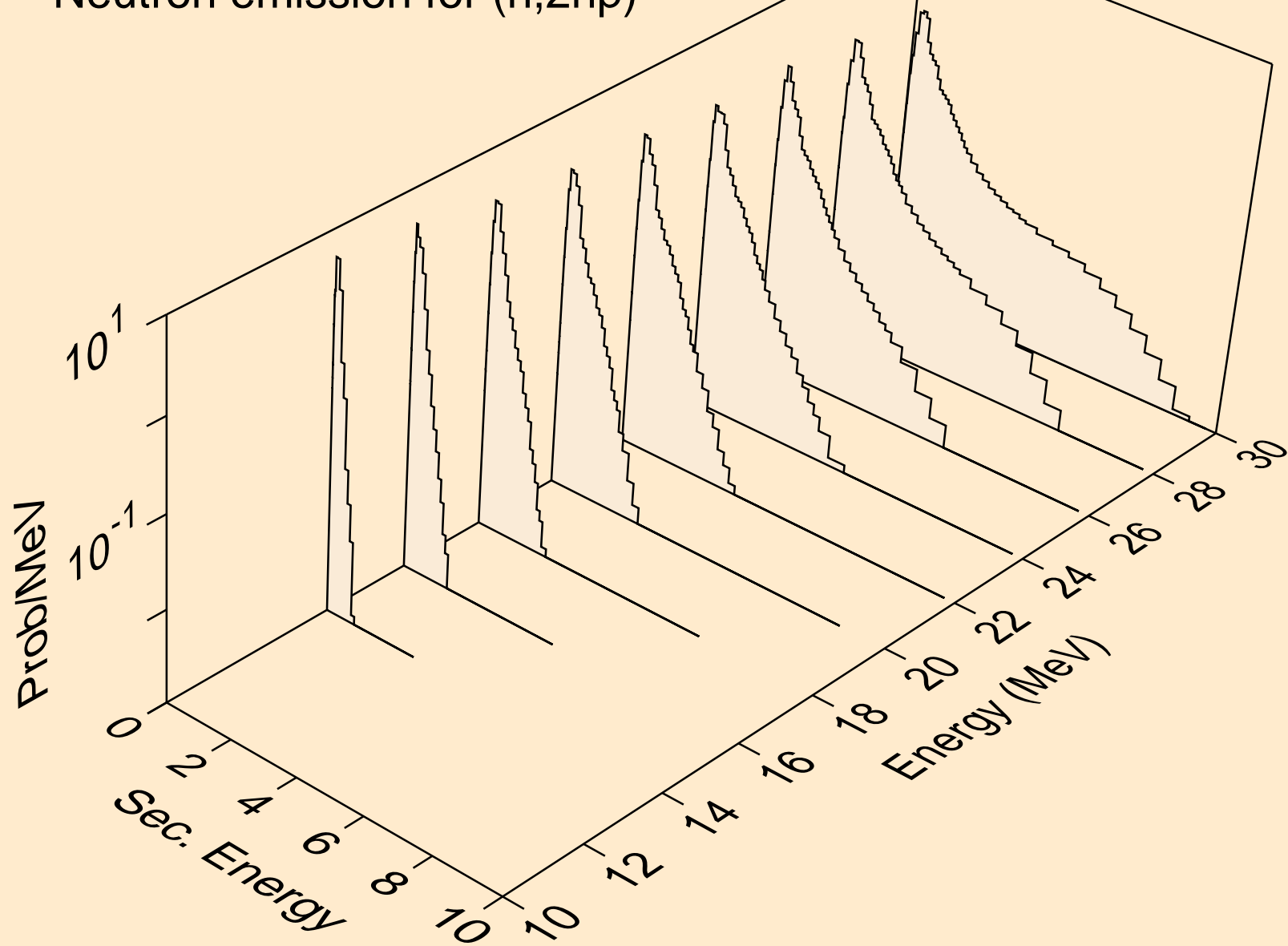

ES257 NEUTRON ACER TENDL-2021 LIBRARY; T=293.6K
Neutron emission for (n,3np)

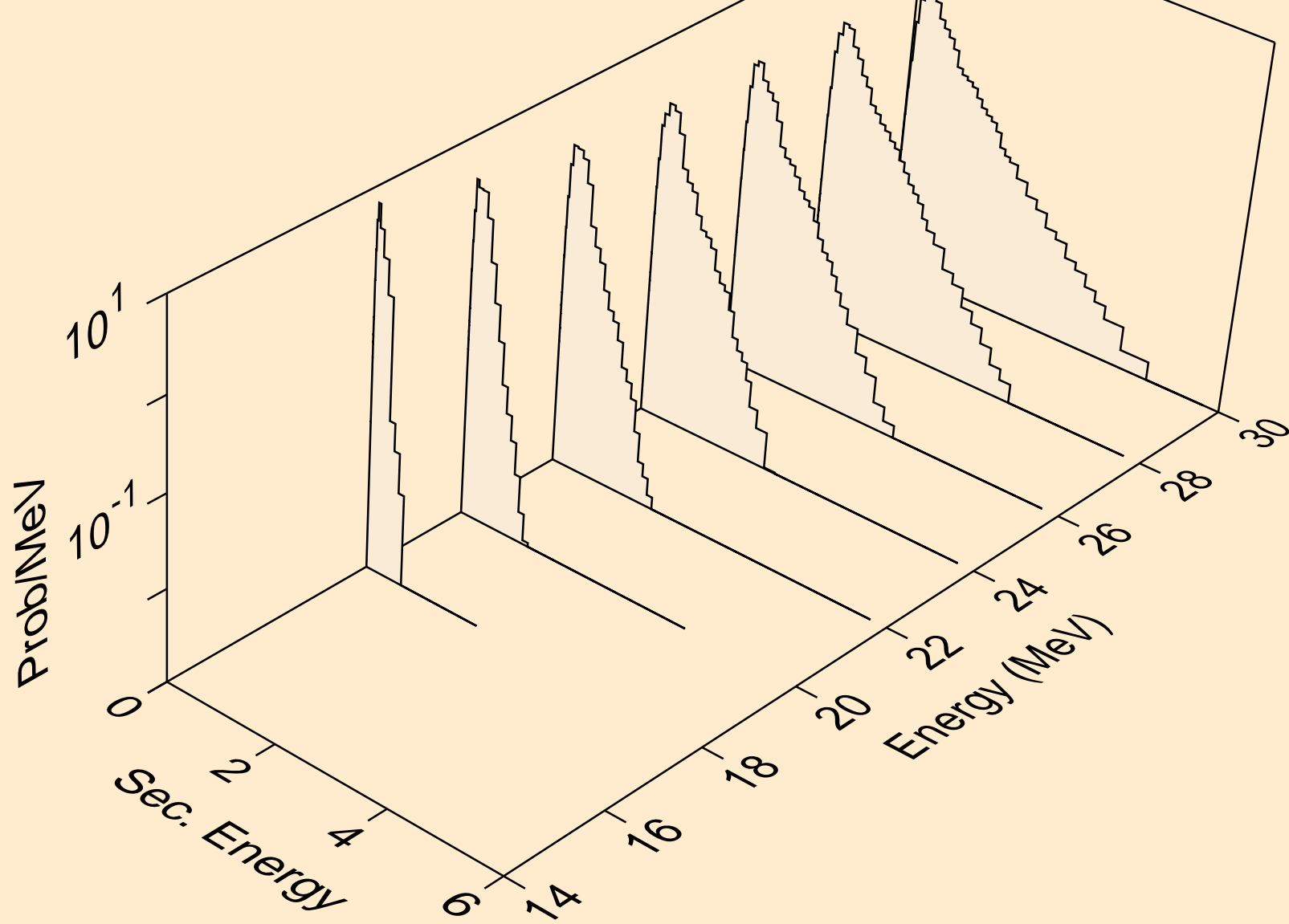

ES257 NEUTRON ACER TENDL-2021 LIBRARY; T=293.6K
Neutron emission for (n,2np)

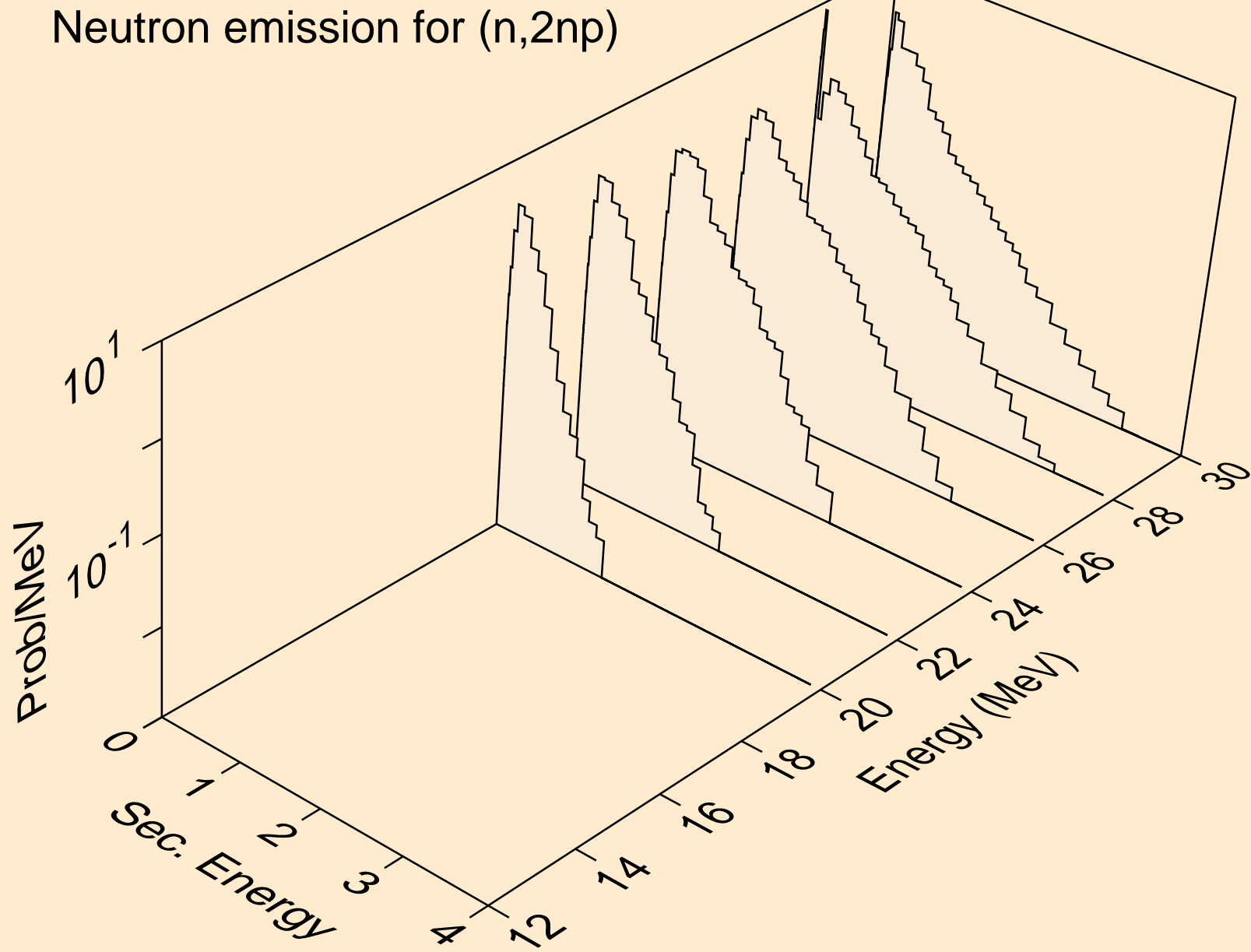

ES257 NEUTRON ACER TENDL-2021 LIBRARY; T=293.6K
Neutron emission for (n,n*c)

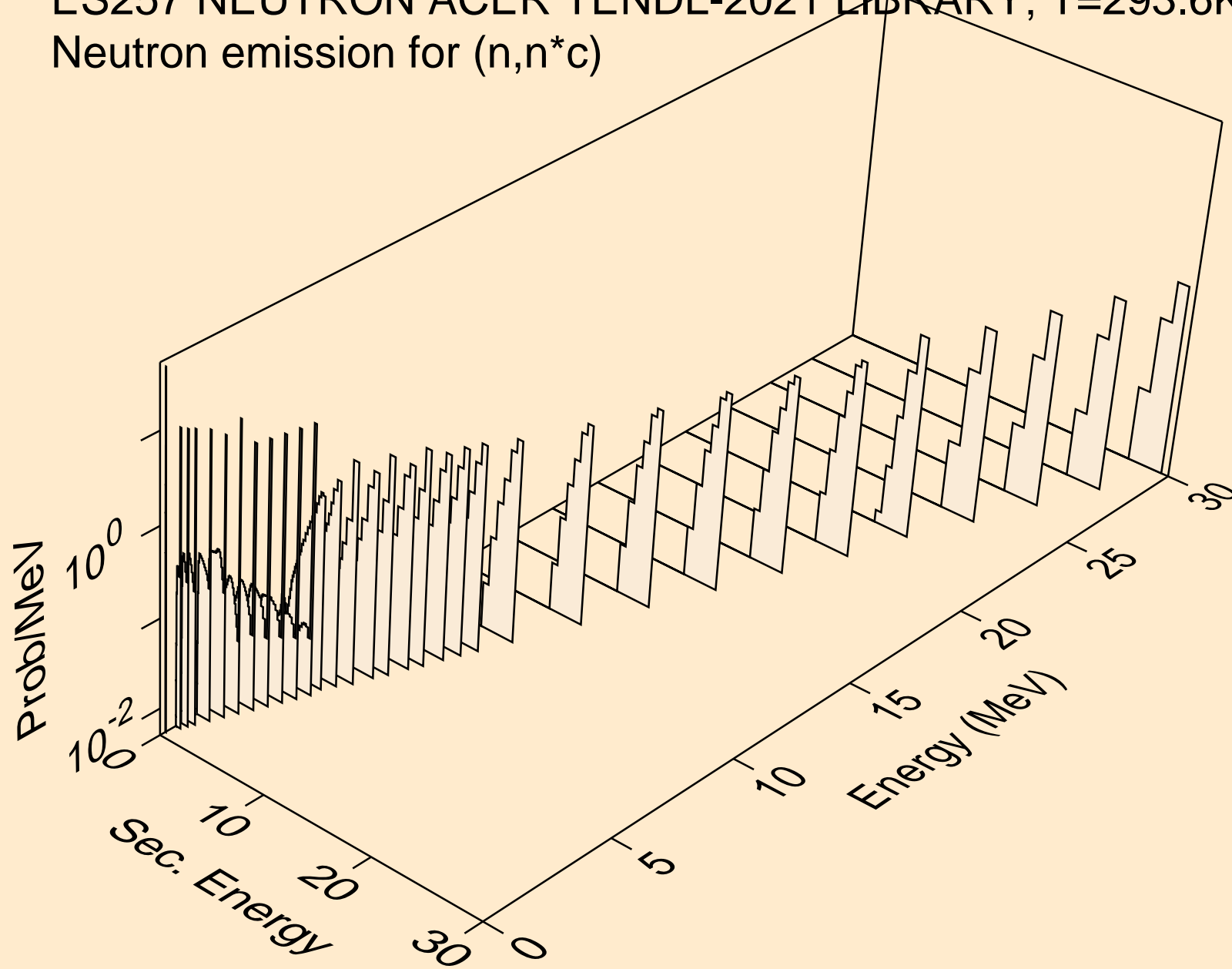

ES257 NEUTRON ACER TENDL-2021 LIBRARY; T=293.6K

Delayed nubar

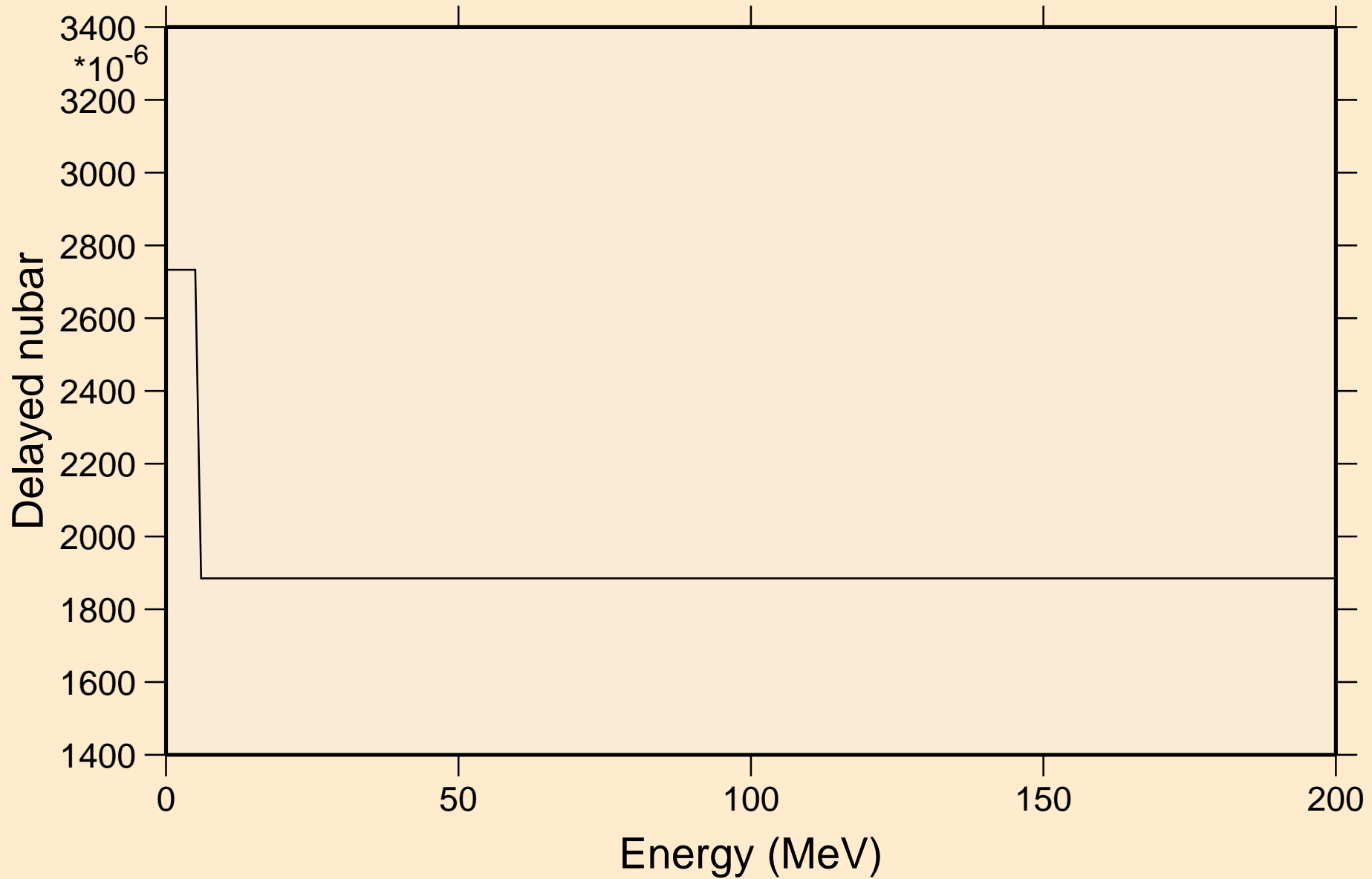

ES257 NEUTRON ACER TENDL-2021 LIBRARY; T=293.6K

Delayed neutron spectra

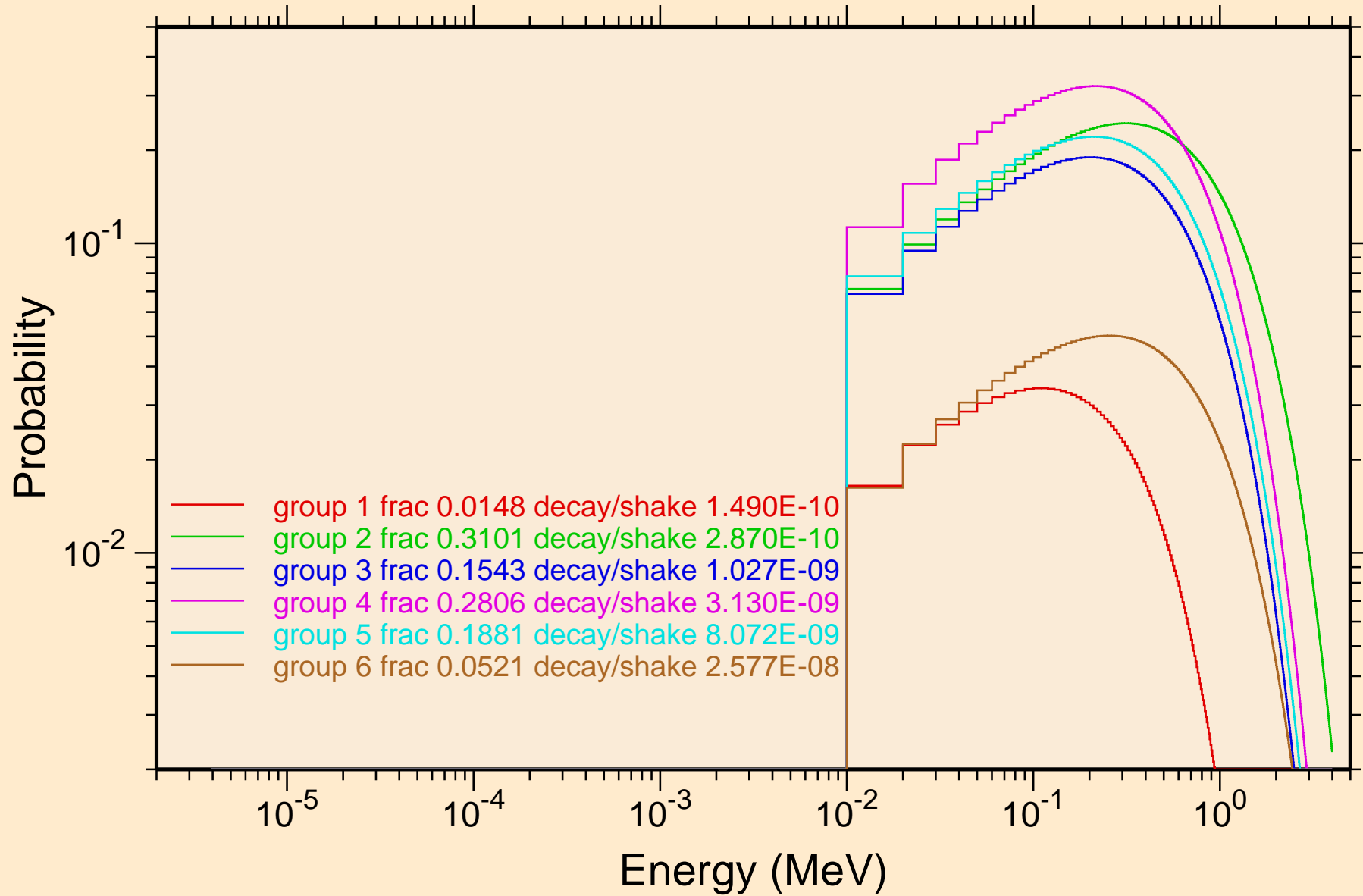

ES257 NEUTRON ACER TENDL-2021 LIBRARY; T=293.6K
Photon emission for (n,x)

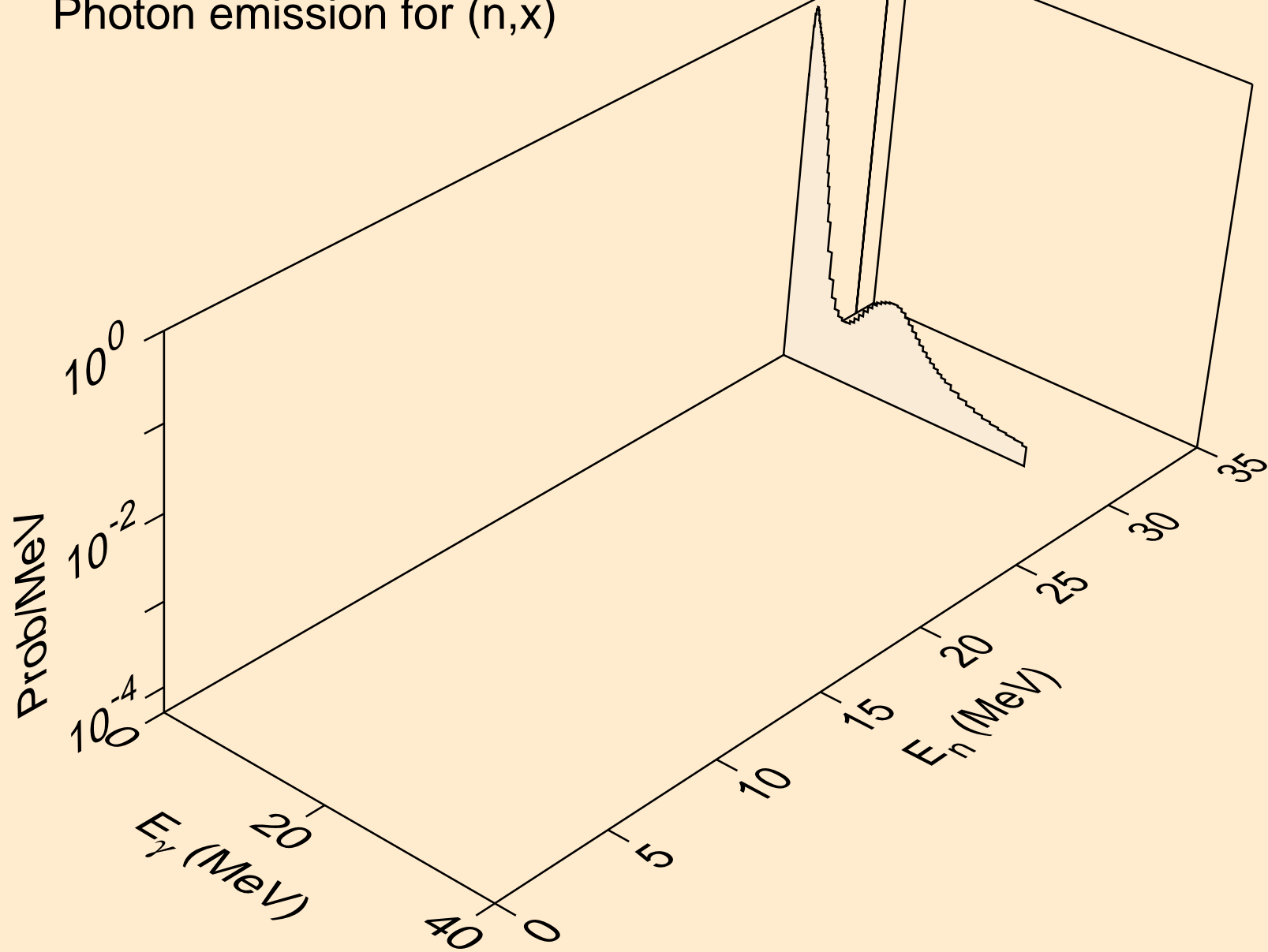

ES257 NEUTRON ACER TENDL-2021 LIBRARY; T=293.6K
Photon emission for (n,2nd)

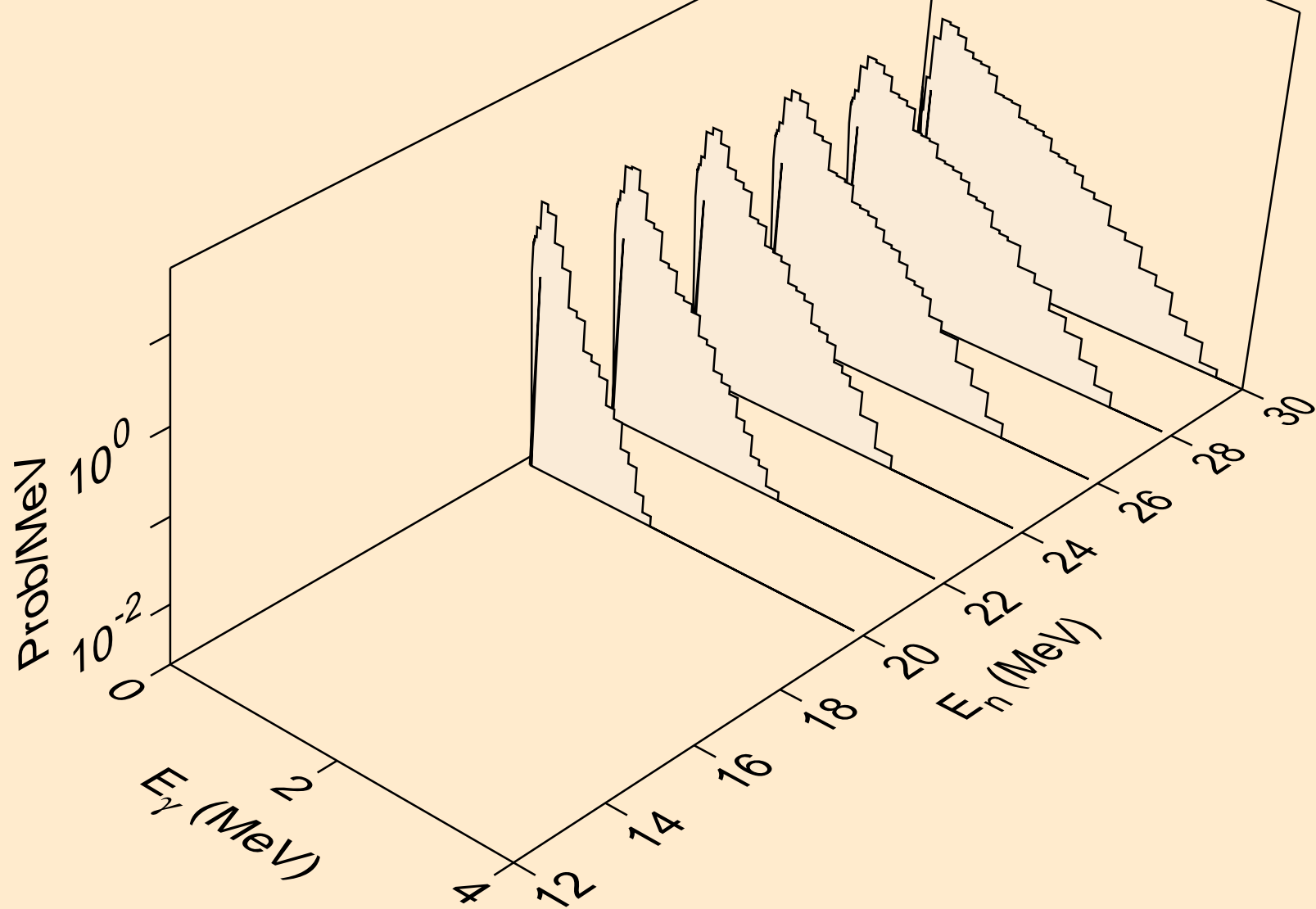

ES257 NEUTRON ACER TENDL-2021 LIBRARY; T=293.6K
Photon emission for (n,2n)

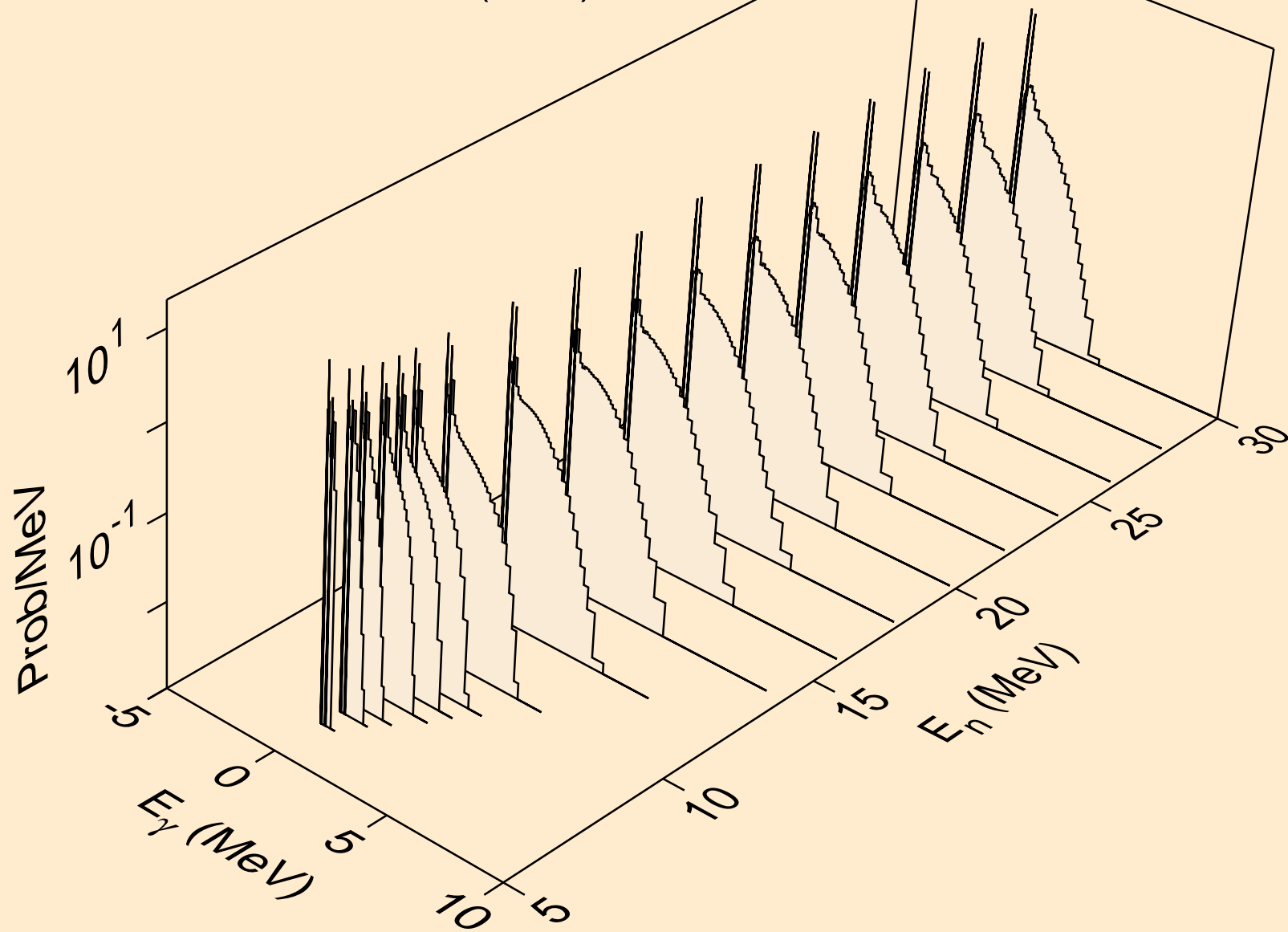

ES257 NEUTRON ACER TENDL-2021 LIBRARY; T=293.6K
Photon emission for (n,3n)

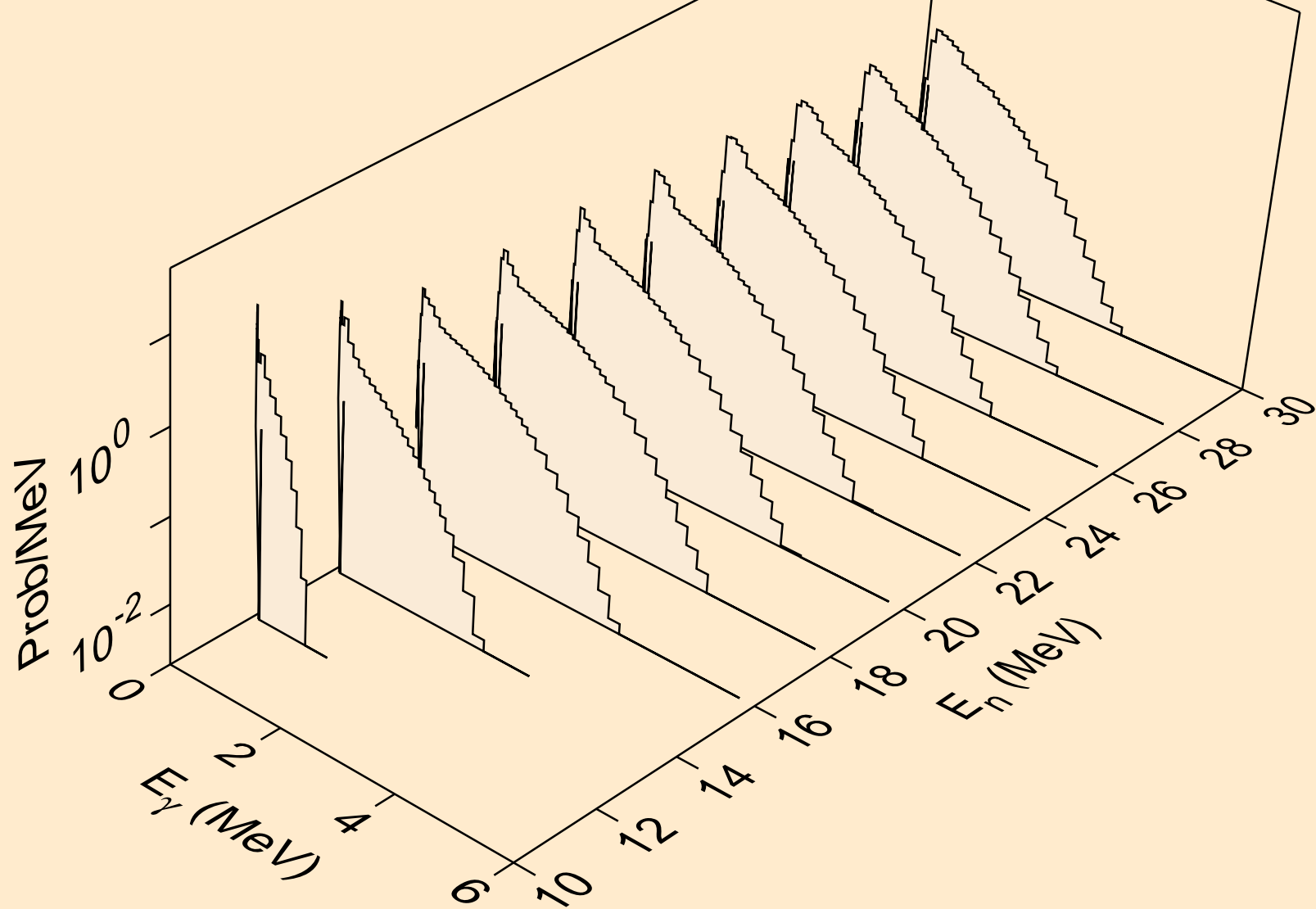

ES257 NEUTRON ACER TENDL-2021 LIBRARY; T=293.6K
Photon emission for (n,n*)a

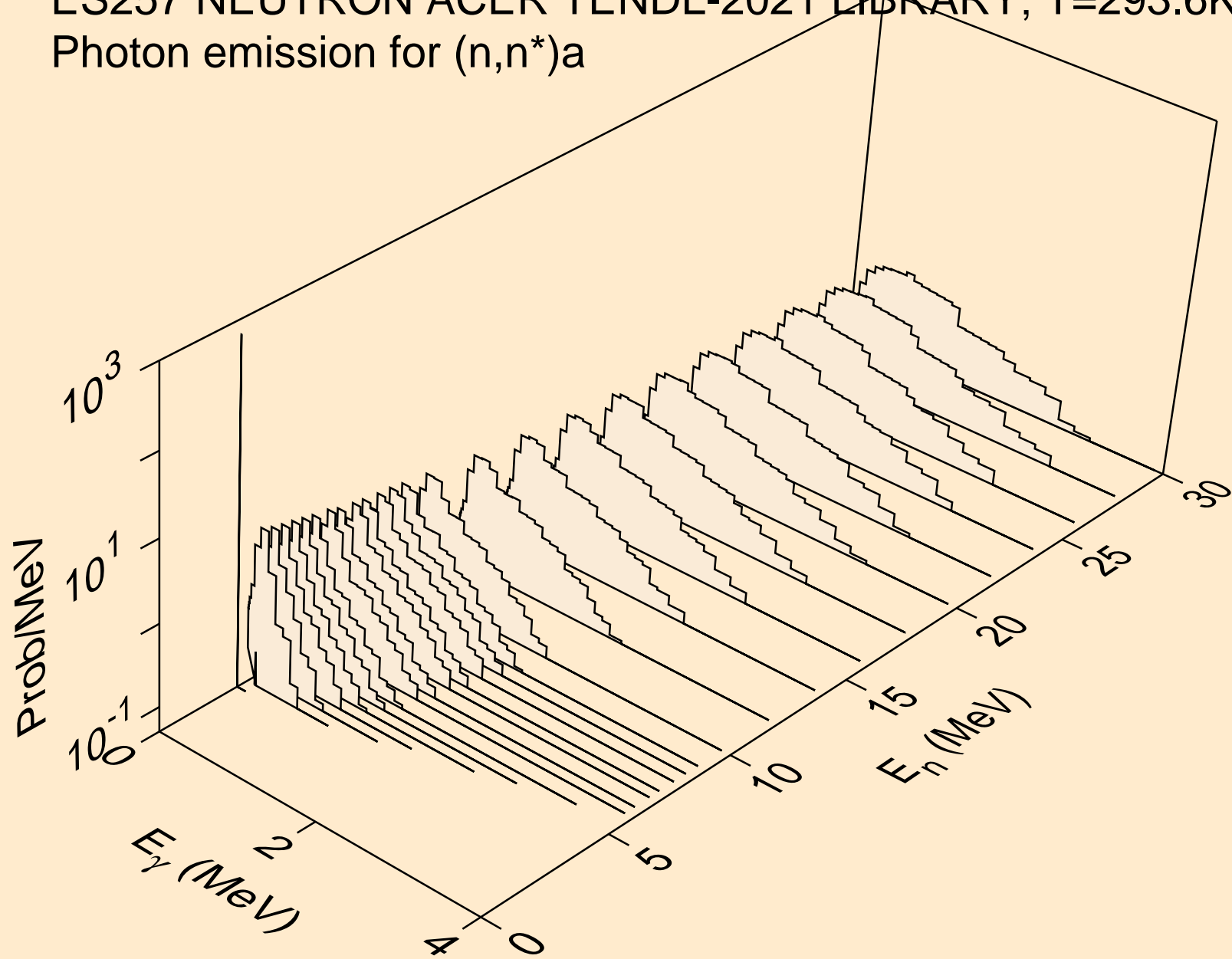

ES257 NEUTRON ACER TENDL-2021 LIBRARY; T=293.6K
Photon emission for (n,2n)a

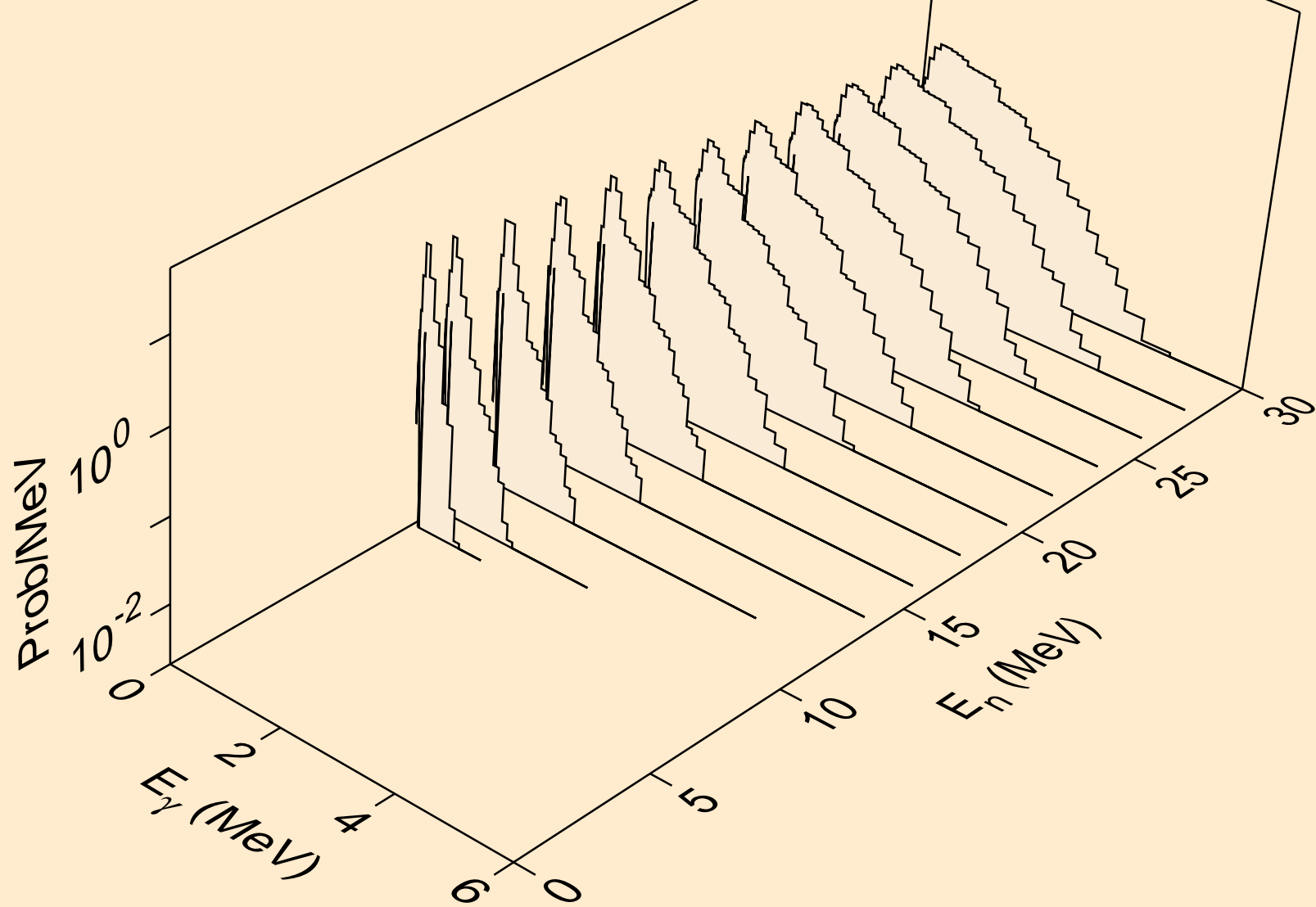

ES257 NEUTRON ACER TENDL-2021 LIBRARY; T=293.6K
Photon emission for (n,3n)a

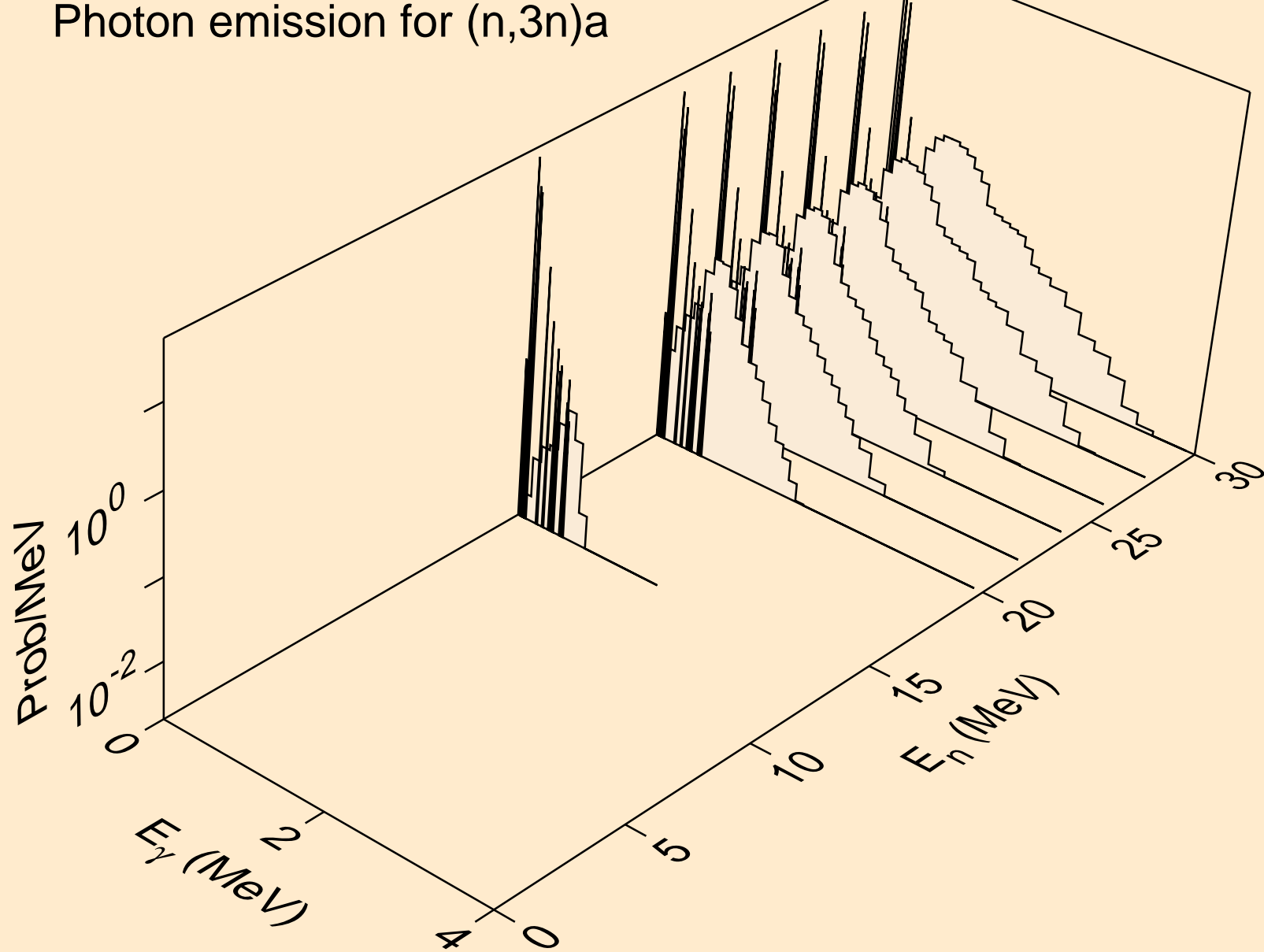

ES257 NEUTRON ACER TENDL-2021 LIBRARY; T=293.6K
Photon emission for (n,n*)p

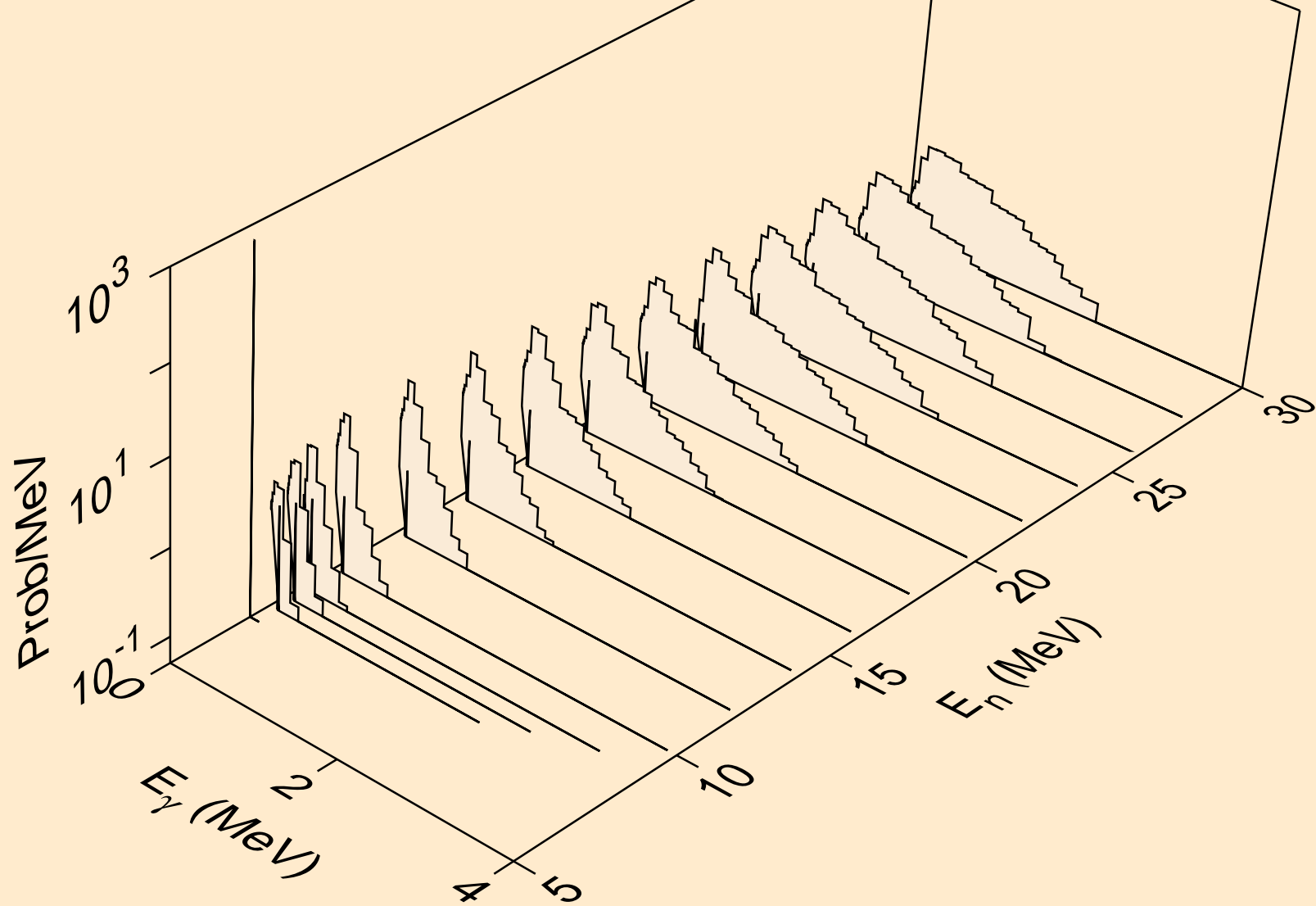

ES257 NEUTRON ACER TENDL-2021 LIBRARY; T=293.6K
Photon emission for (n,n*)d

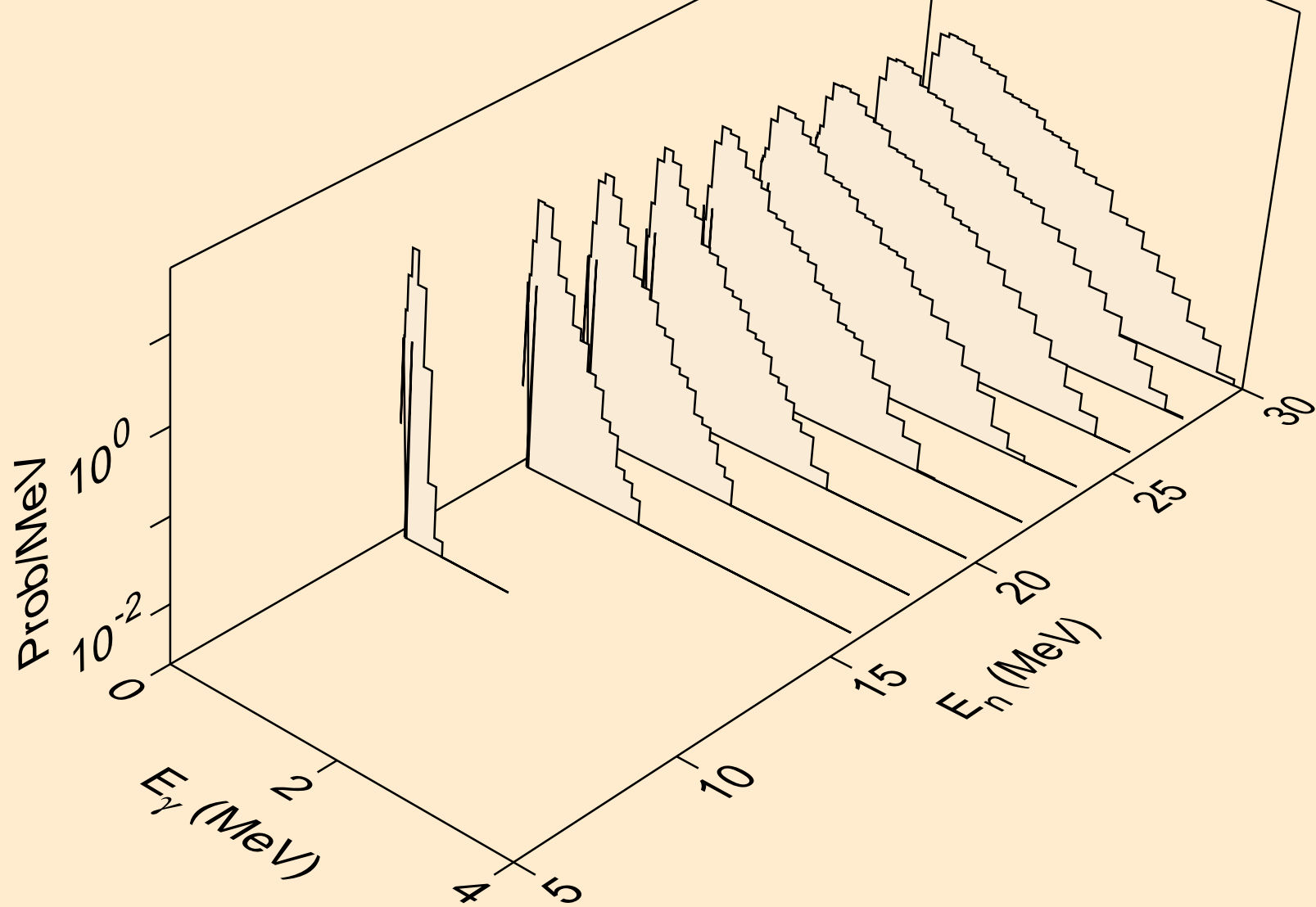

ES257 NEUTRON ACER TENDL-2021 LIBRARY; T=293.6K
Photon emission for (n,n*)t

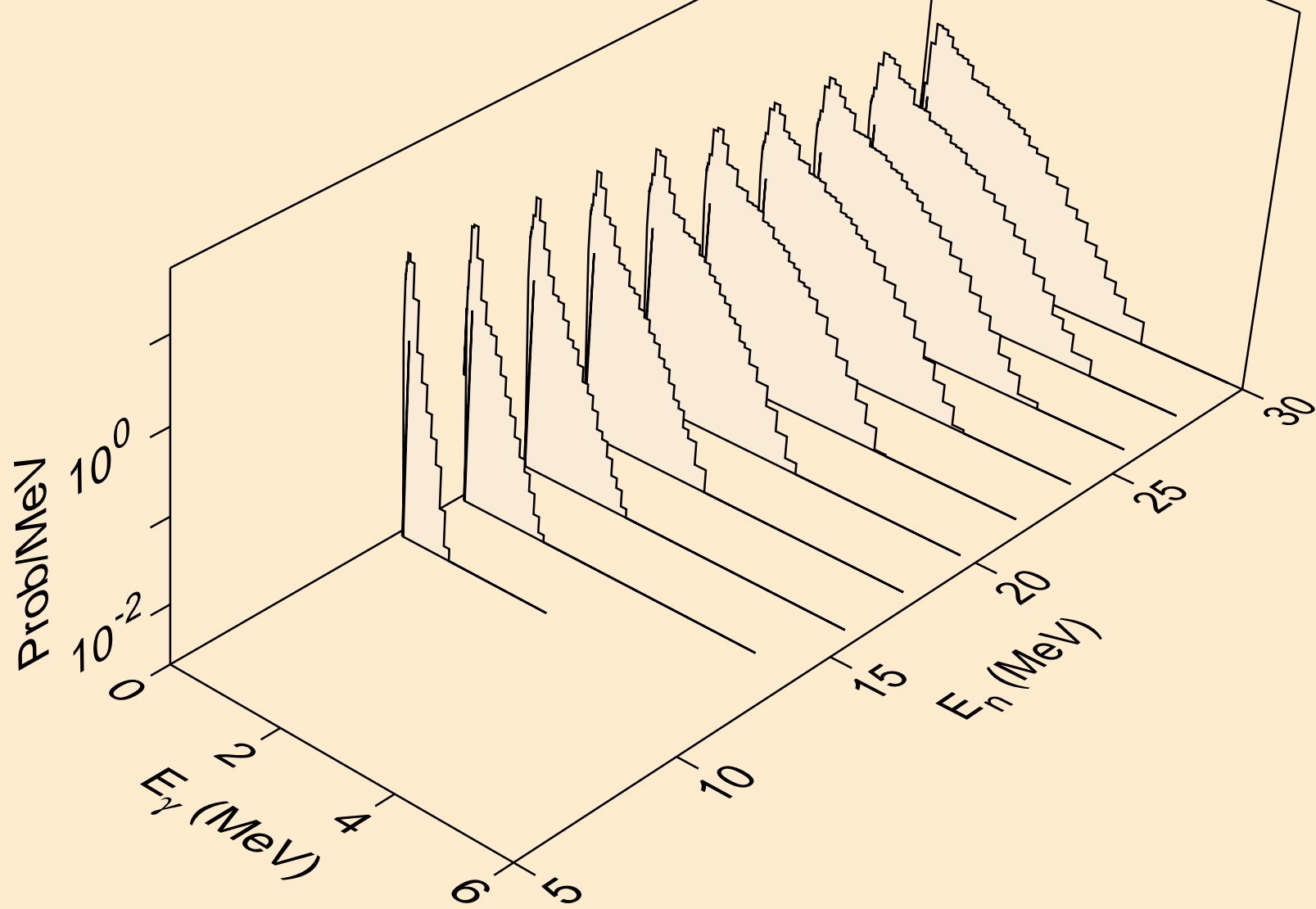

ES257 NEUTRON ACER TENDL-2021 LIBRARY; T=293.6K
Photon emission for (n,4n)

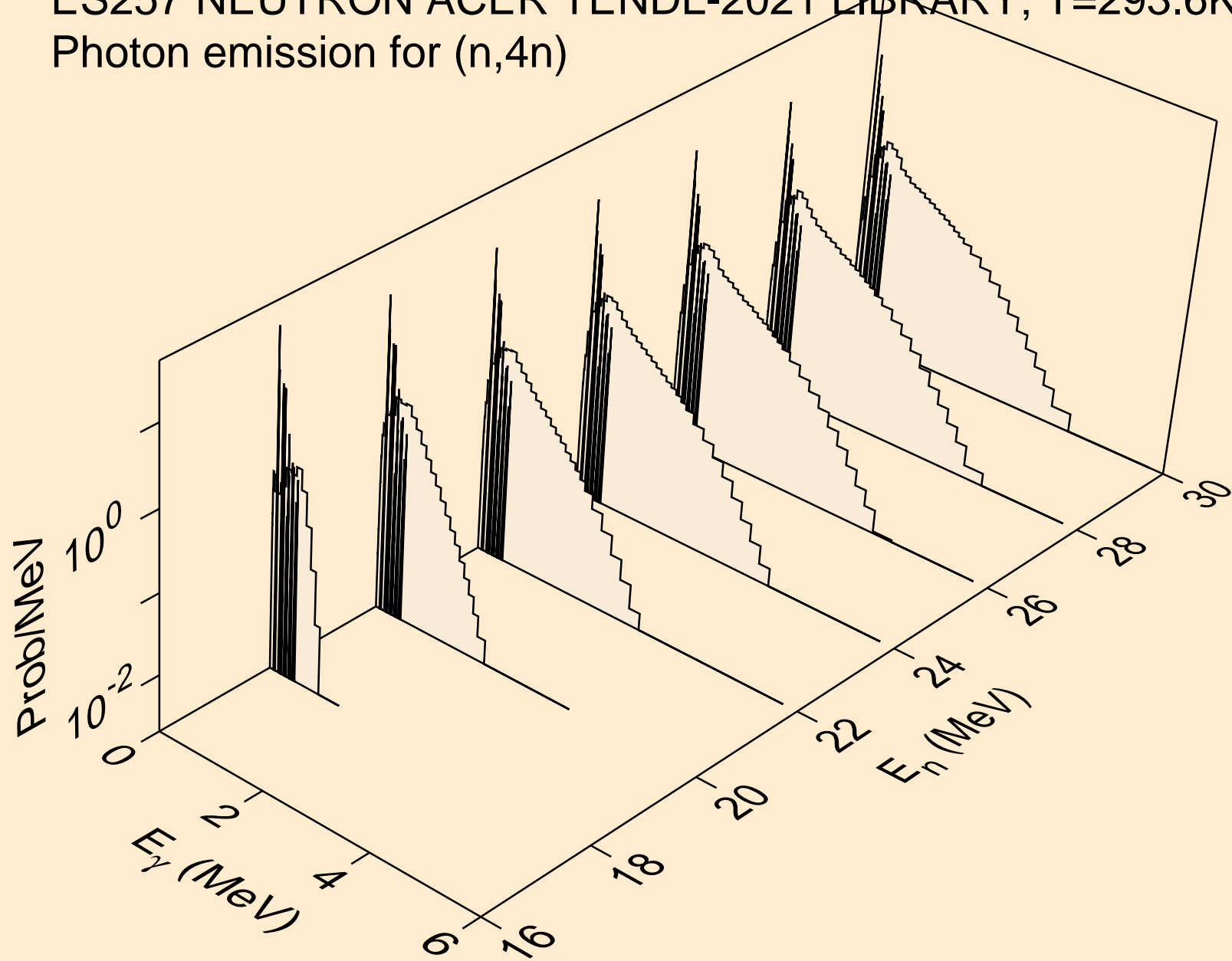

ES257 NEUTRON ACER TENDL-2021 LIBRARY; T=293.6K
Photon emission for (n,2np)

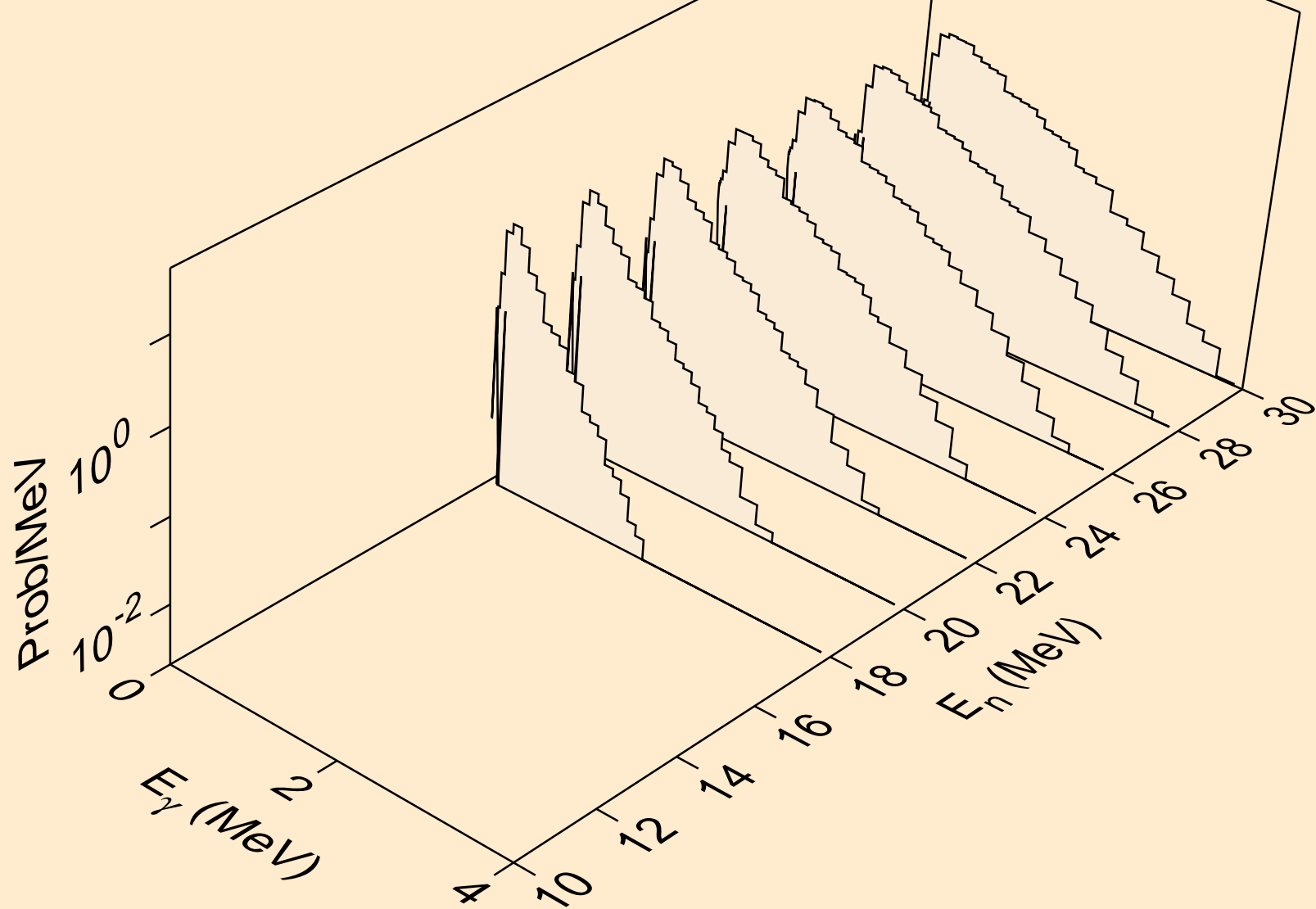

ES257 NEUTRON ACER TENDL-2021 LIBRARY; T=293.6K
Photon emission for (n,3np)

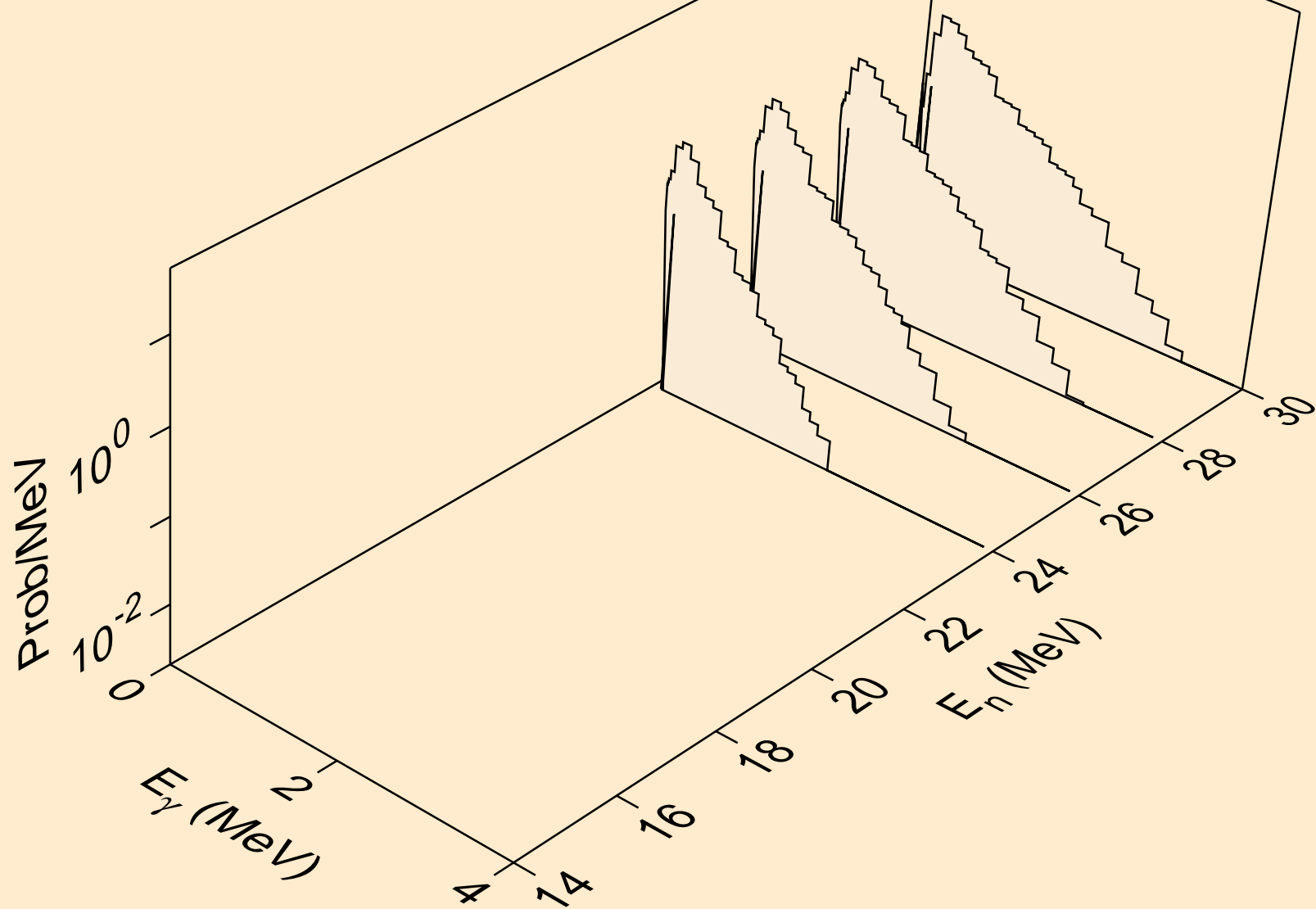

ES257 NEUTRON ACER TENDL-2021 LIBRARY; T=293.6K
Photon emission for (n,2np)

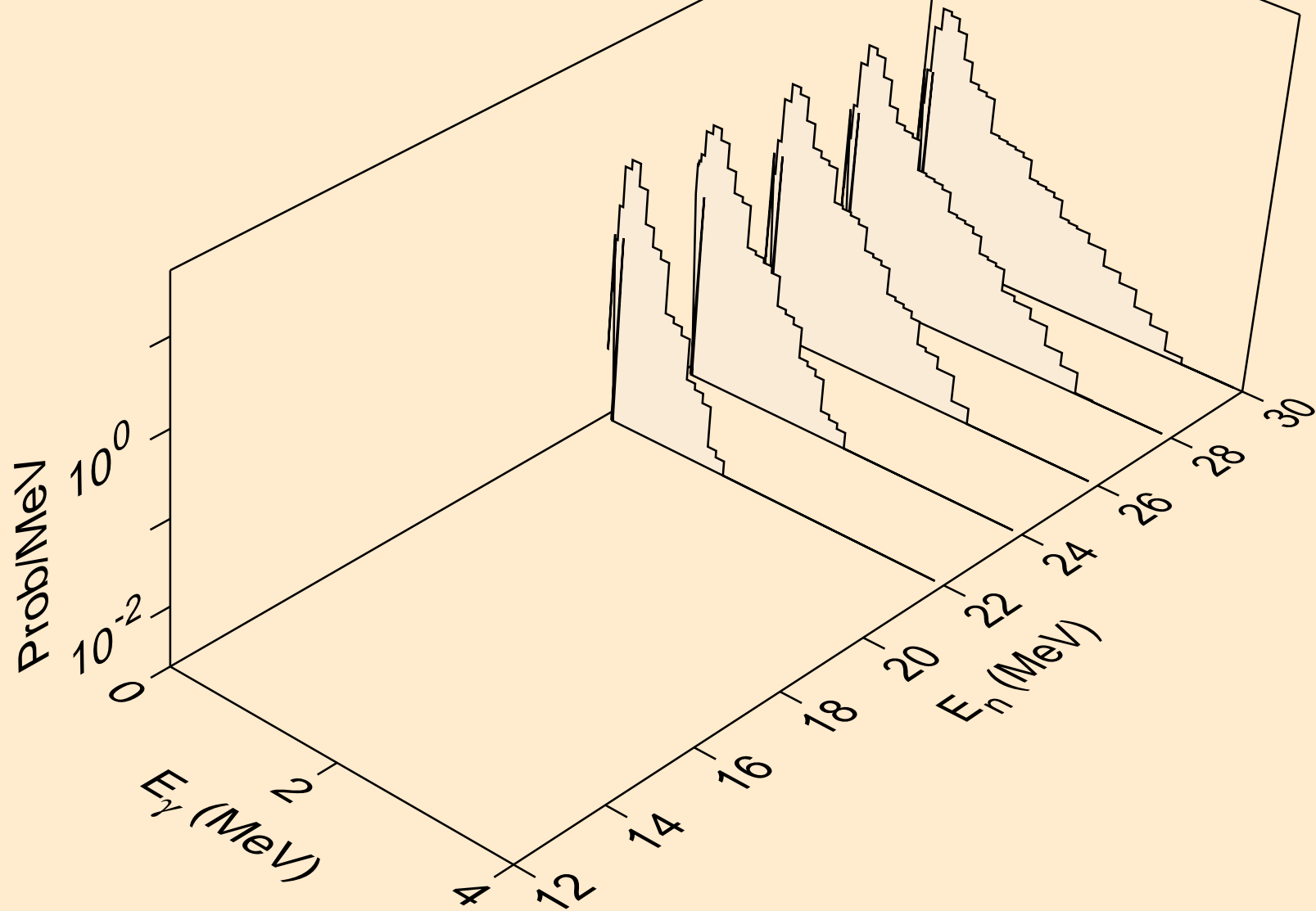

ES257 NEUTRON ACER TENDL-2021 LIBRARY; T=293.6K
Photon emission for (n,n*c)

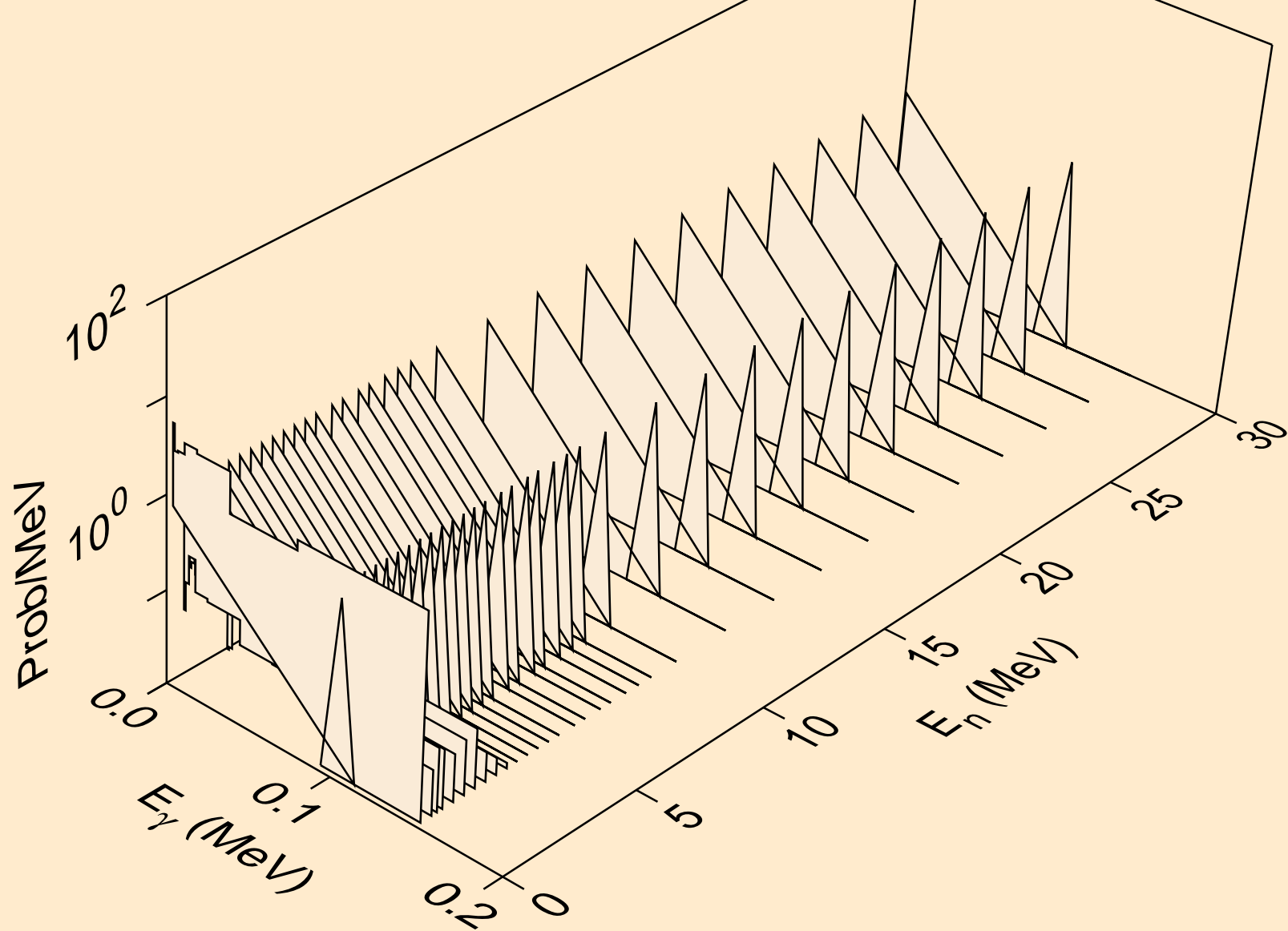

ES257 NEUTRON ACER TENDL-2021 LIBRARY; T=293.6K
Photon emission for (n,gma)

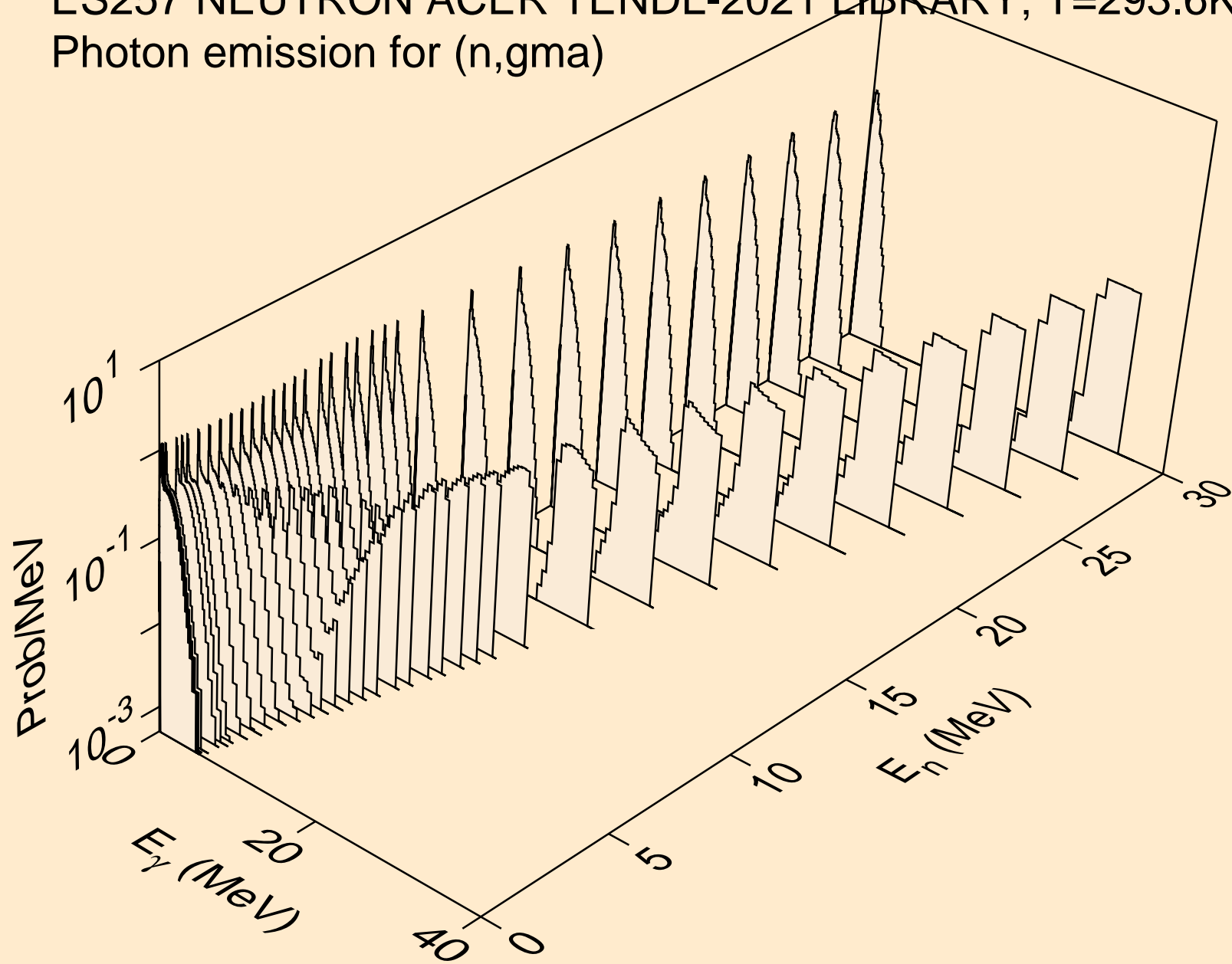

ES257 NEUTRON ACER TENDL-2021 LIBRARY; T=293.6K
Photon emission for (n,p)

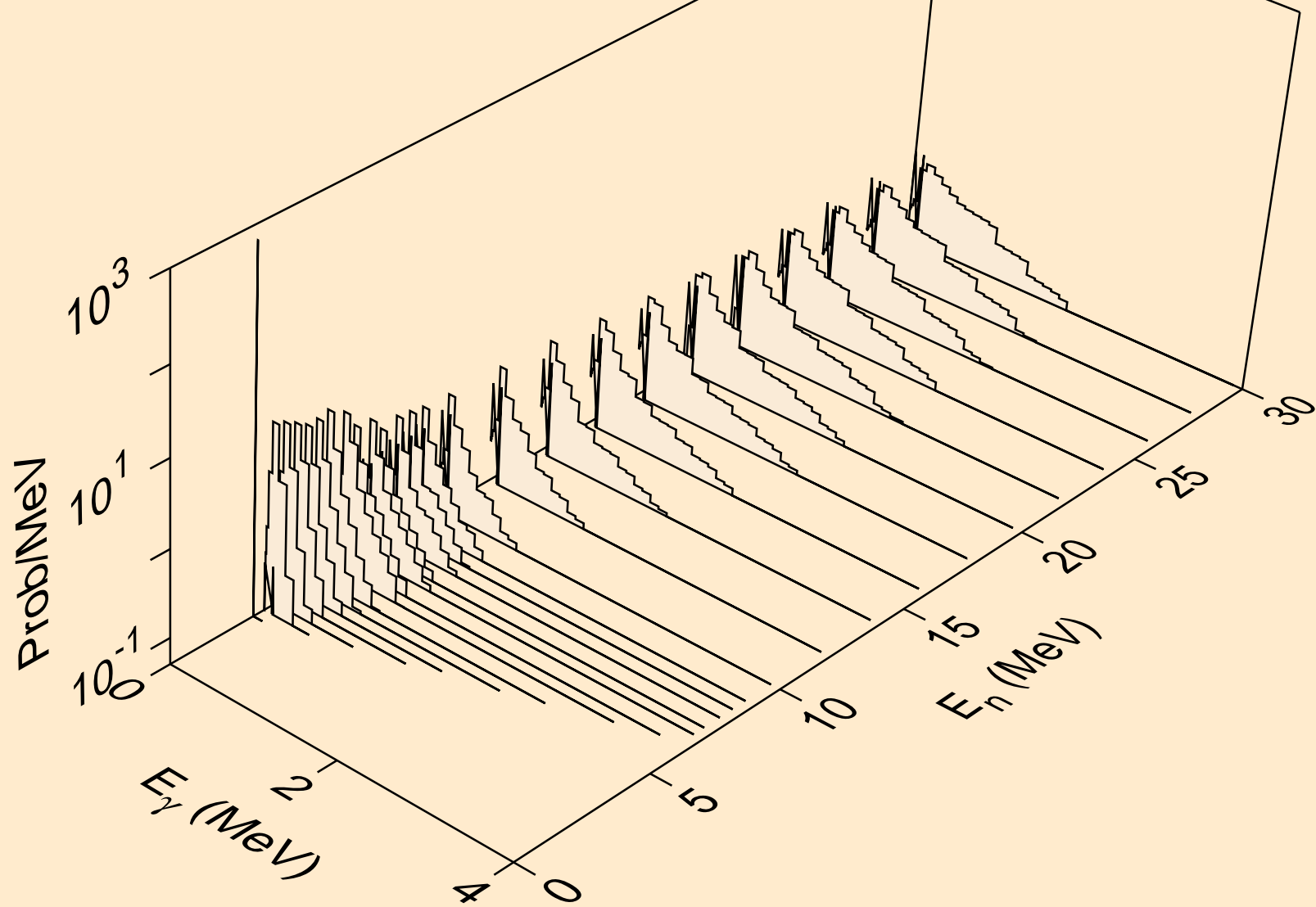

ES257 NEUTRON ACER TENDL-2021 LIBRARY; T=293.6K
Photon emission for (n,d)

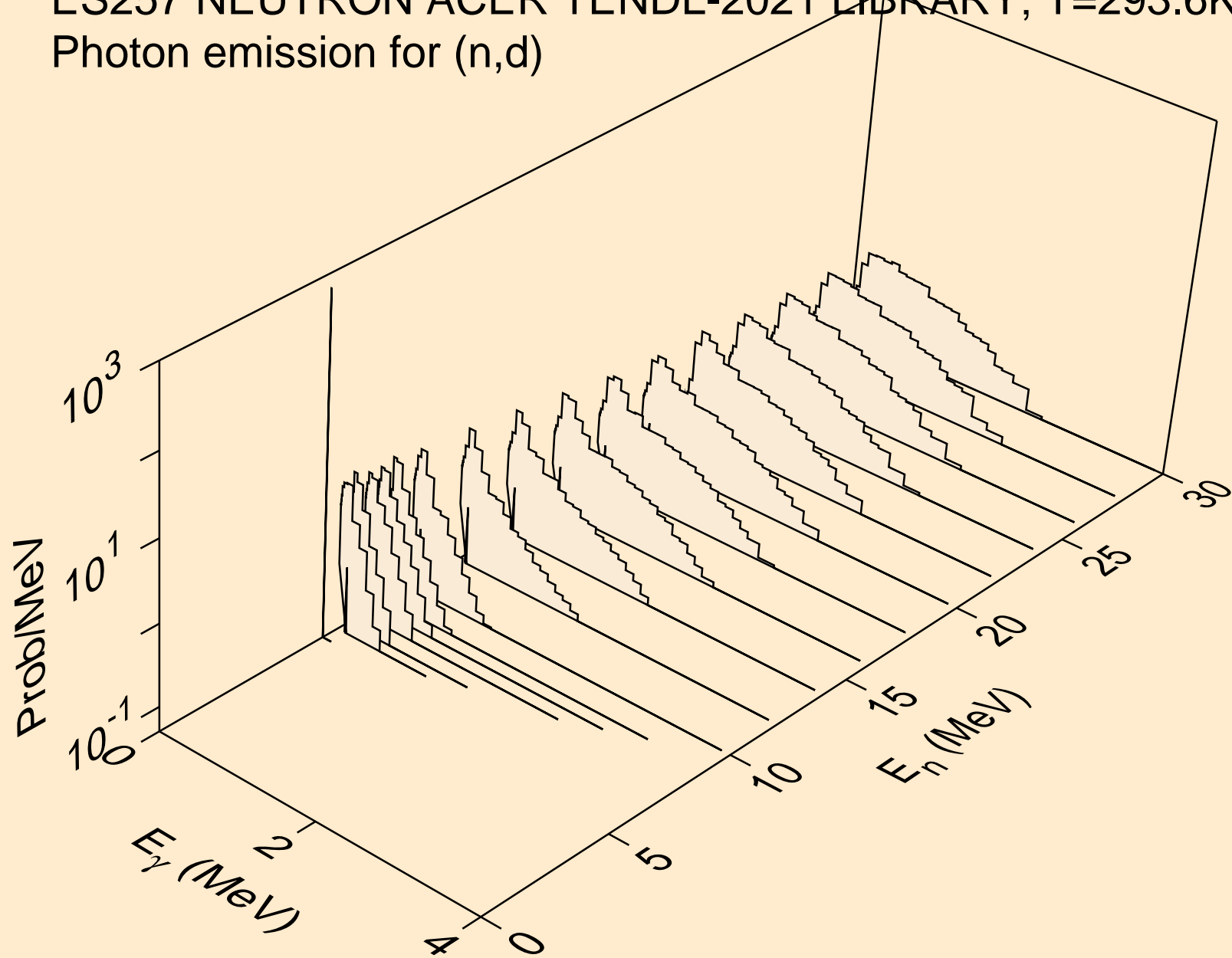

ES257 NEUTRON ACER TENDL-2021 LIBRARY; T=293.6K
Photon emission for (n,t)

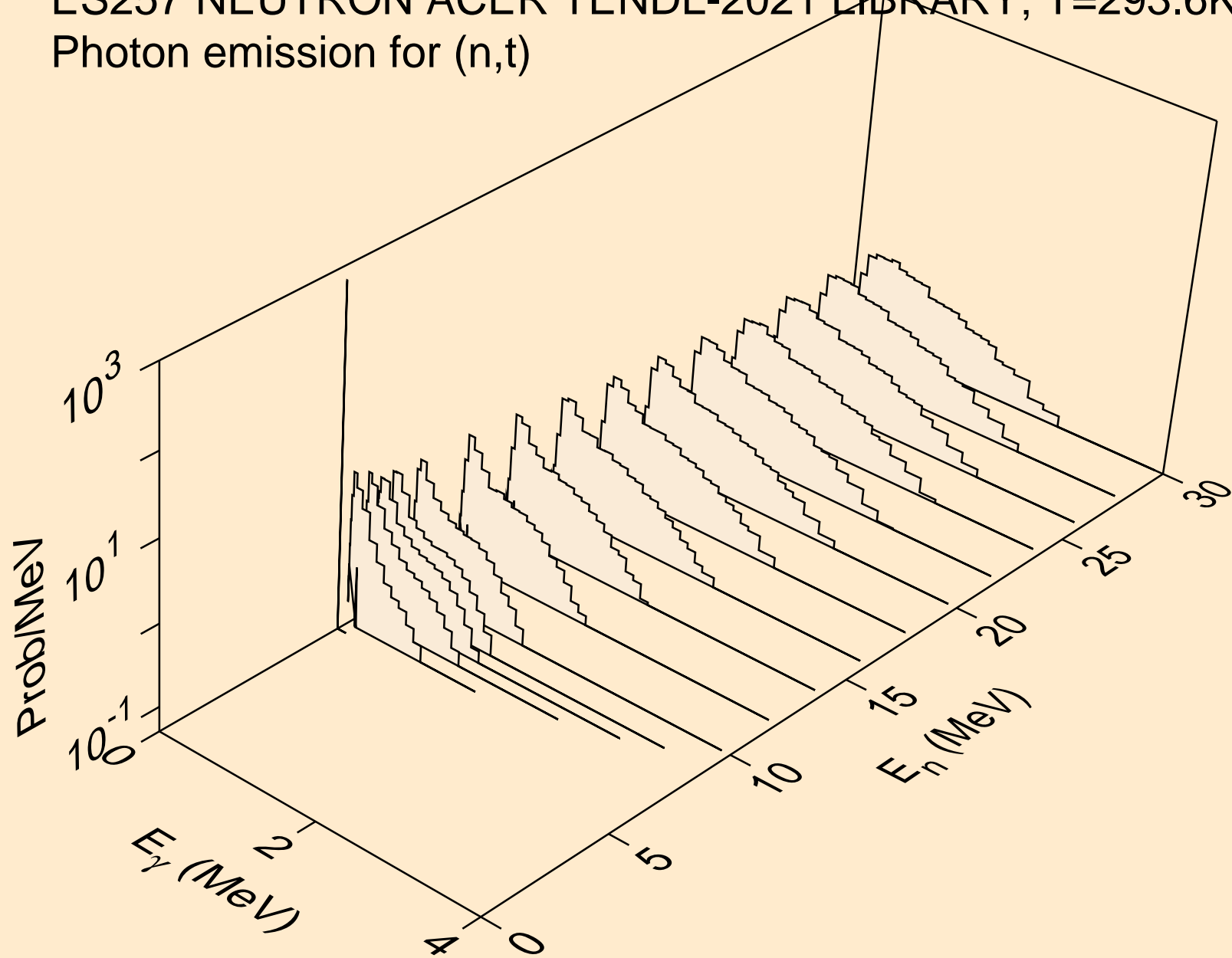

ES257 NEUTRON ACER TENDL-2021 LIBRARY; T=293.6K
Photon emission for (n,he3)

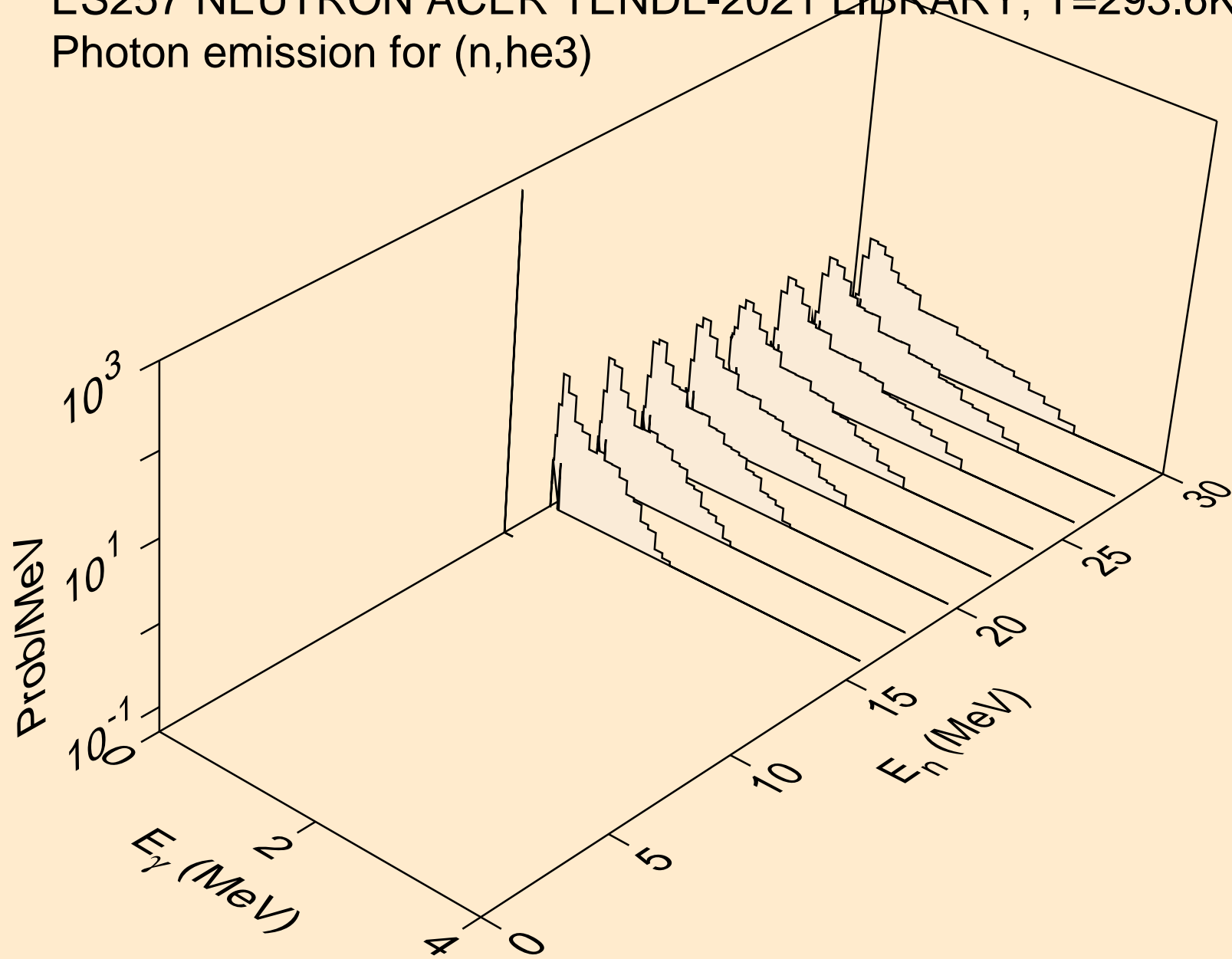

ES257 NEUTRON ACER TENDL-2021 LIBRARY; T=293.6K
Photon emission for (n,a)

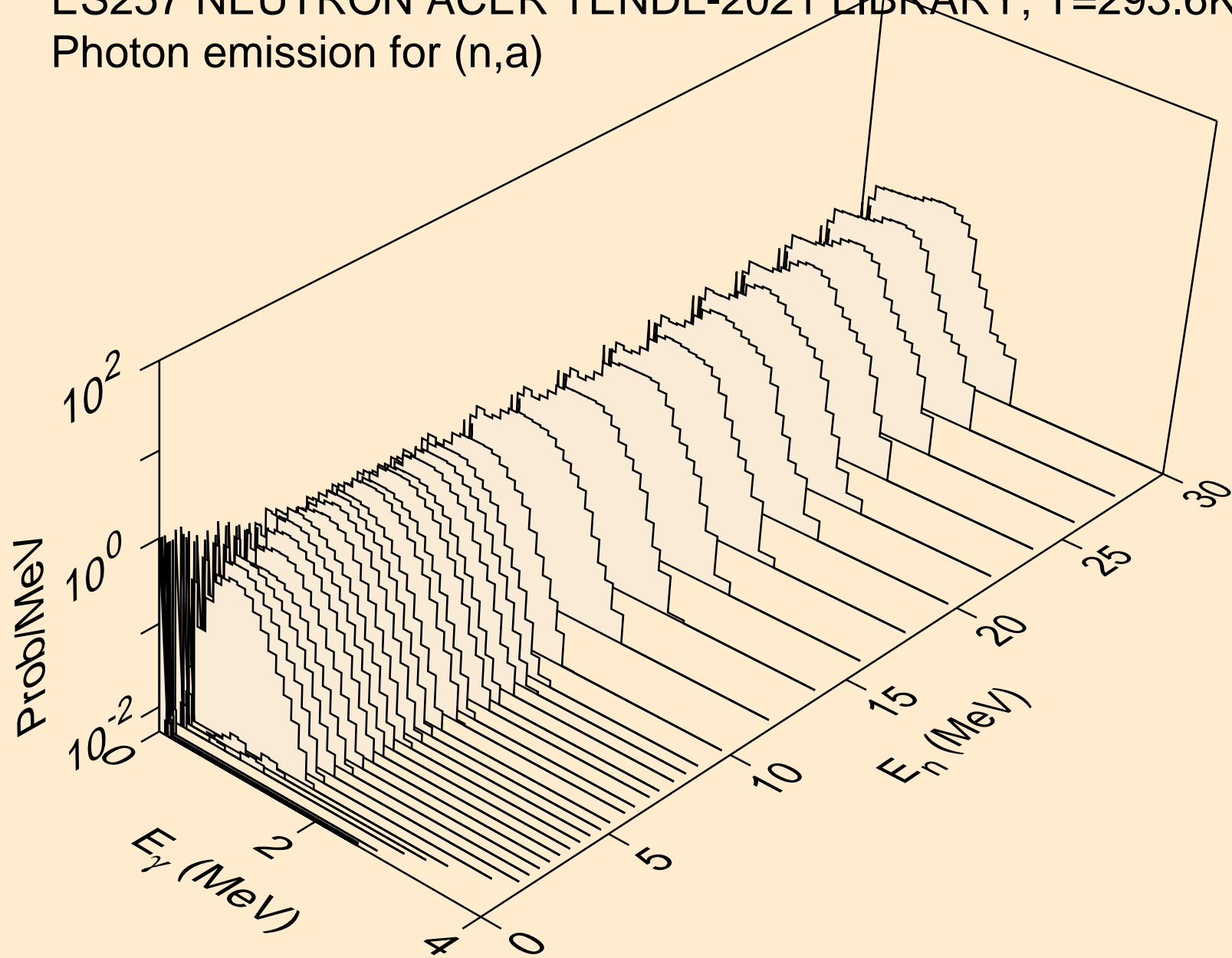

ES257 NEUTRON ACER TENDL-2021 LIBRARY; T=293.6K
Photon emission for (n,2p)

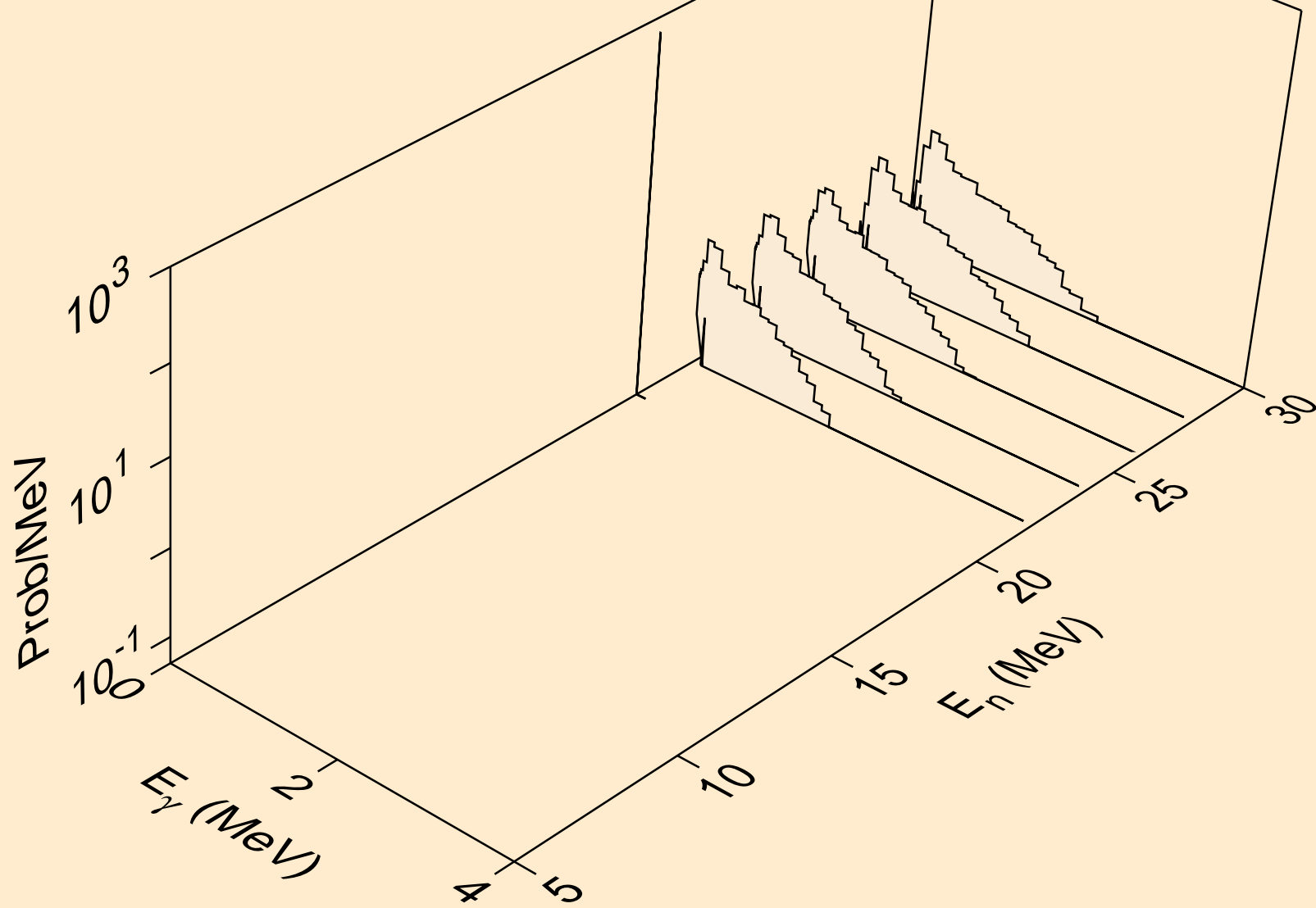

ES257 NEUTRON ACER TENDL-2021 LIBRARY; T=293.6K
Photon emission for (n,pd)

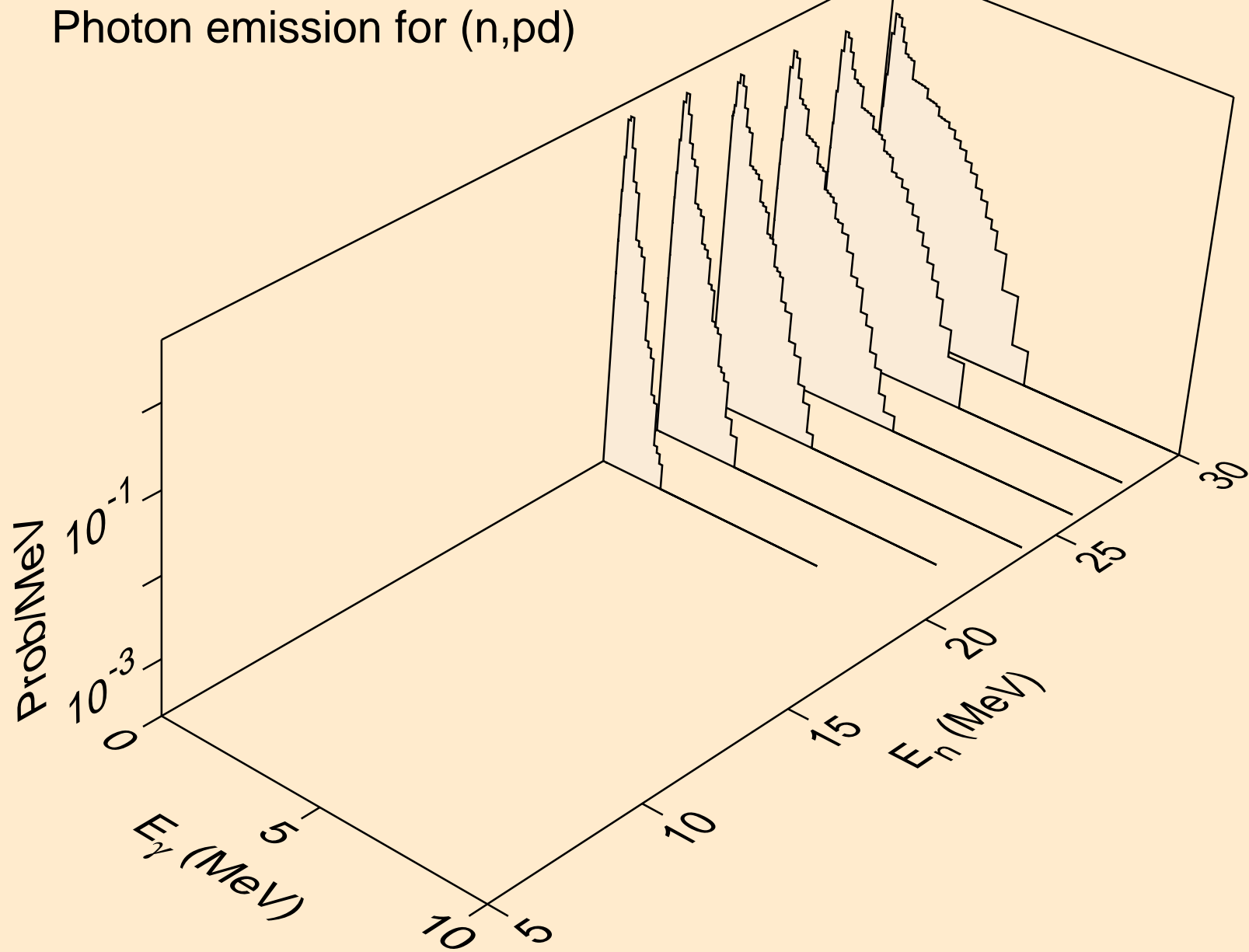

ES257 NEUTRON ACER TENDL-2021 LIBRARY; T=293.6K
thermal capture photon spectrum

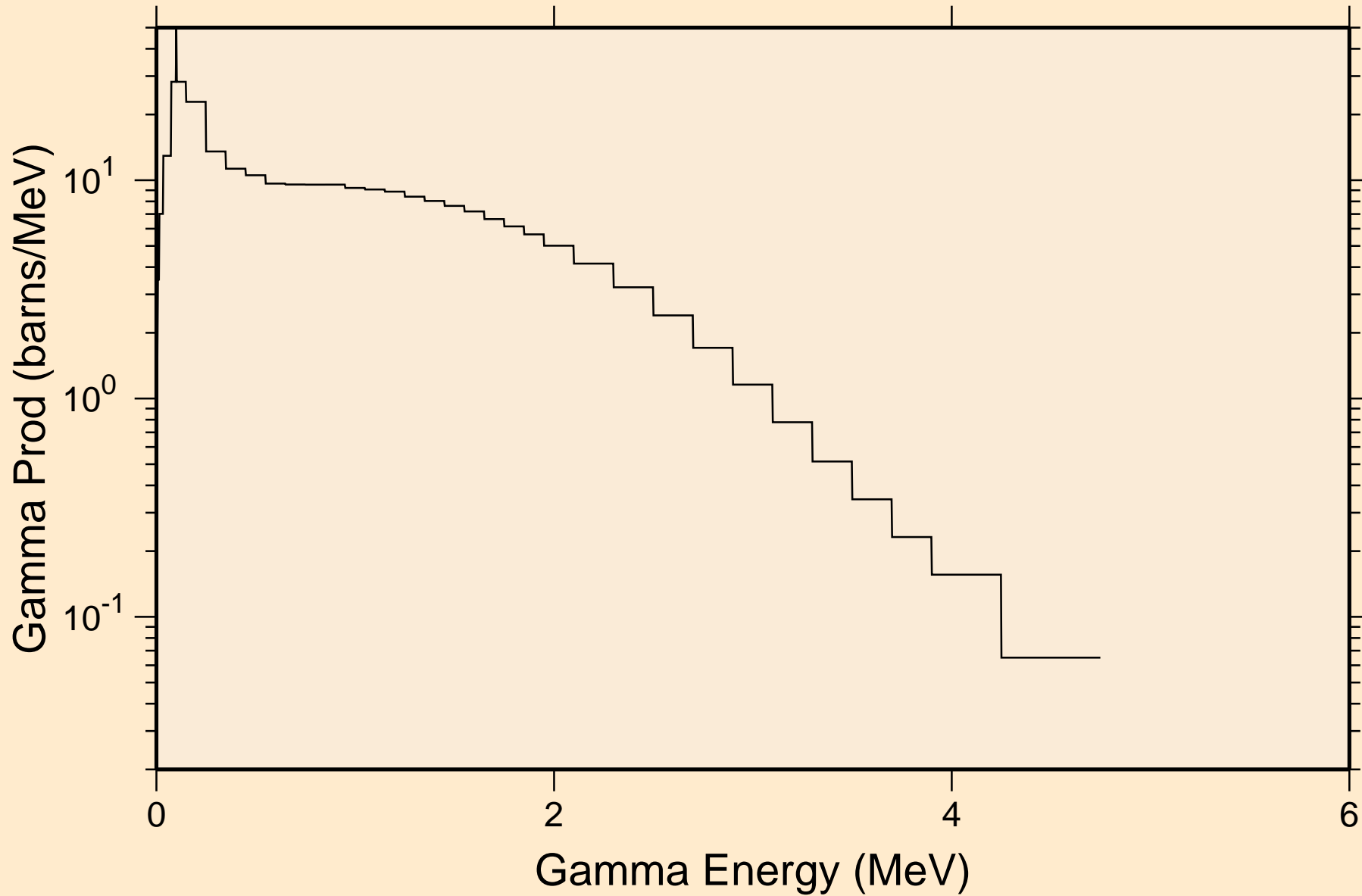

ES257 NEUTRON ACER TENDL-2021 LIBRARY; T=293.6K
14 MeV photon spectrum

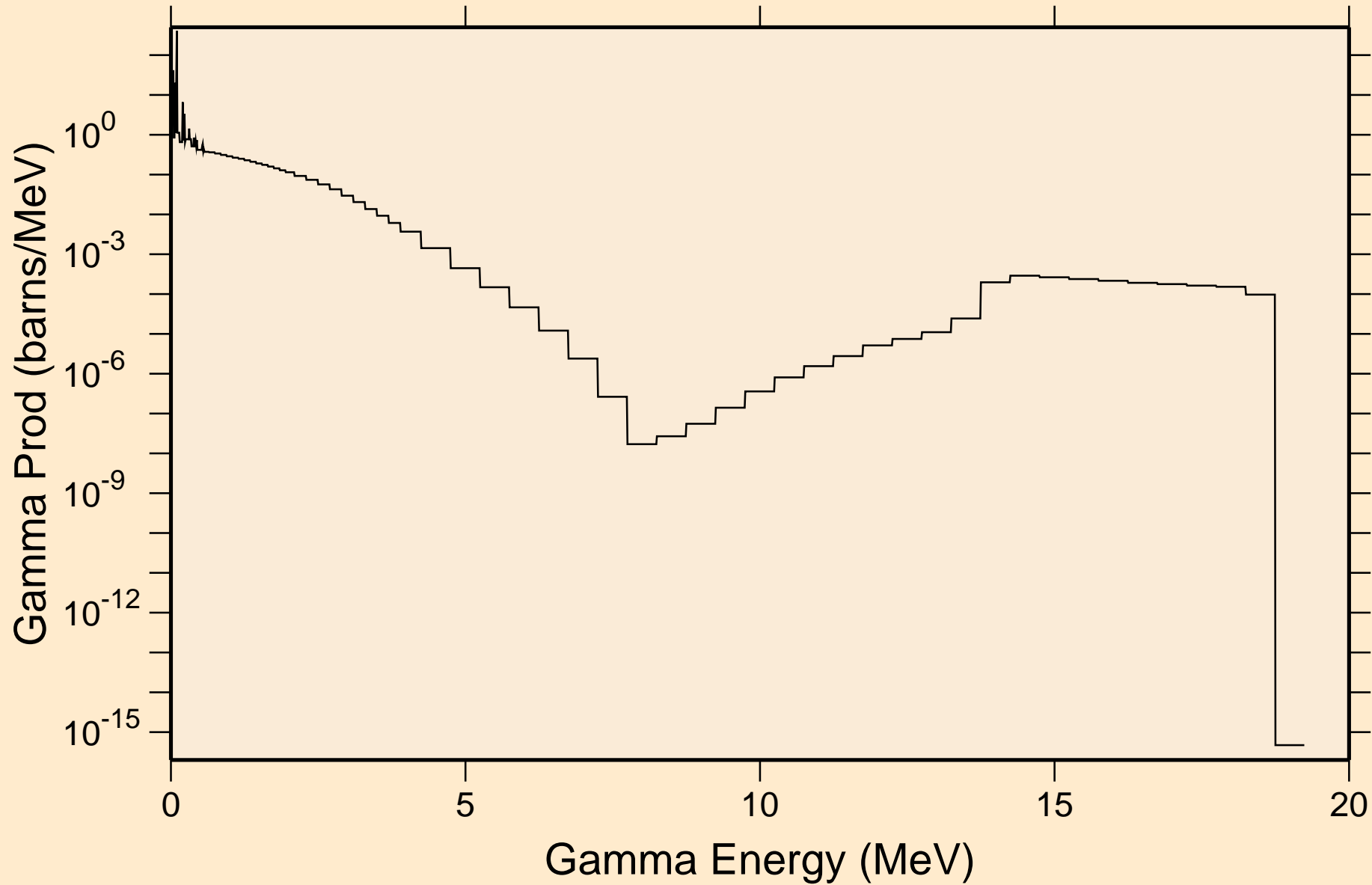

ES257 NEUTRON ACER TENDL-2021 LIBRARY; T=293.6K

Particle heating contributions

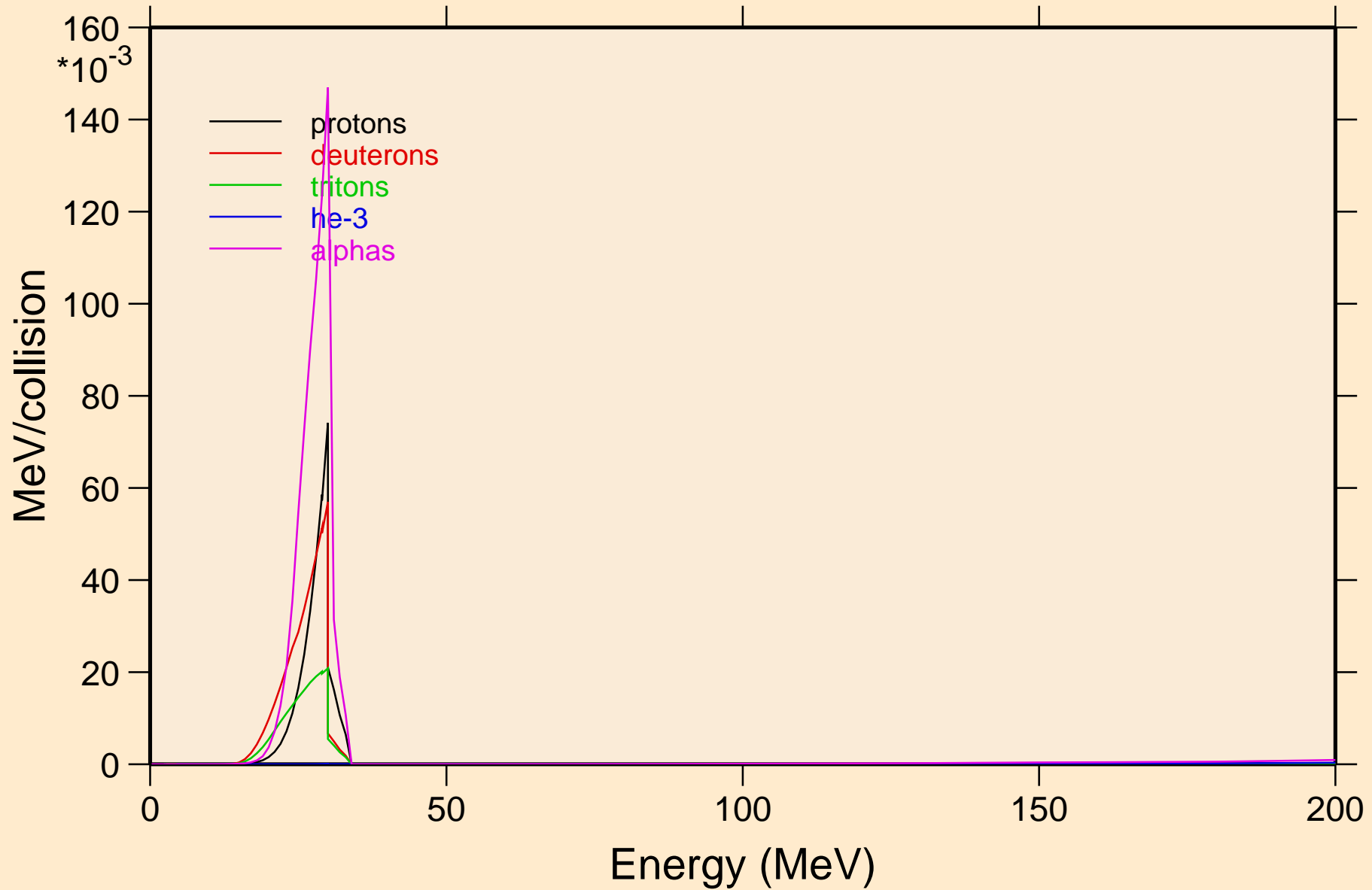

ES257 NEUTRON ACER TENDL-2021 LIBRARY; T=293.6K
Recoil Heating

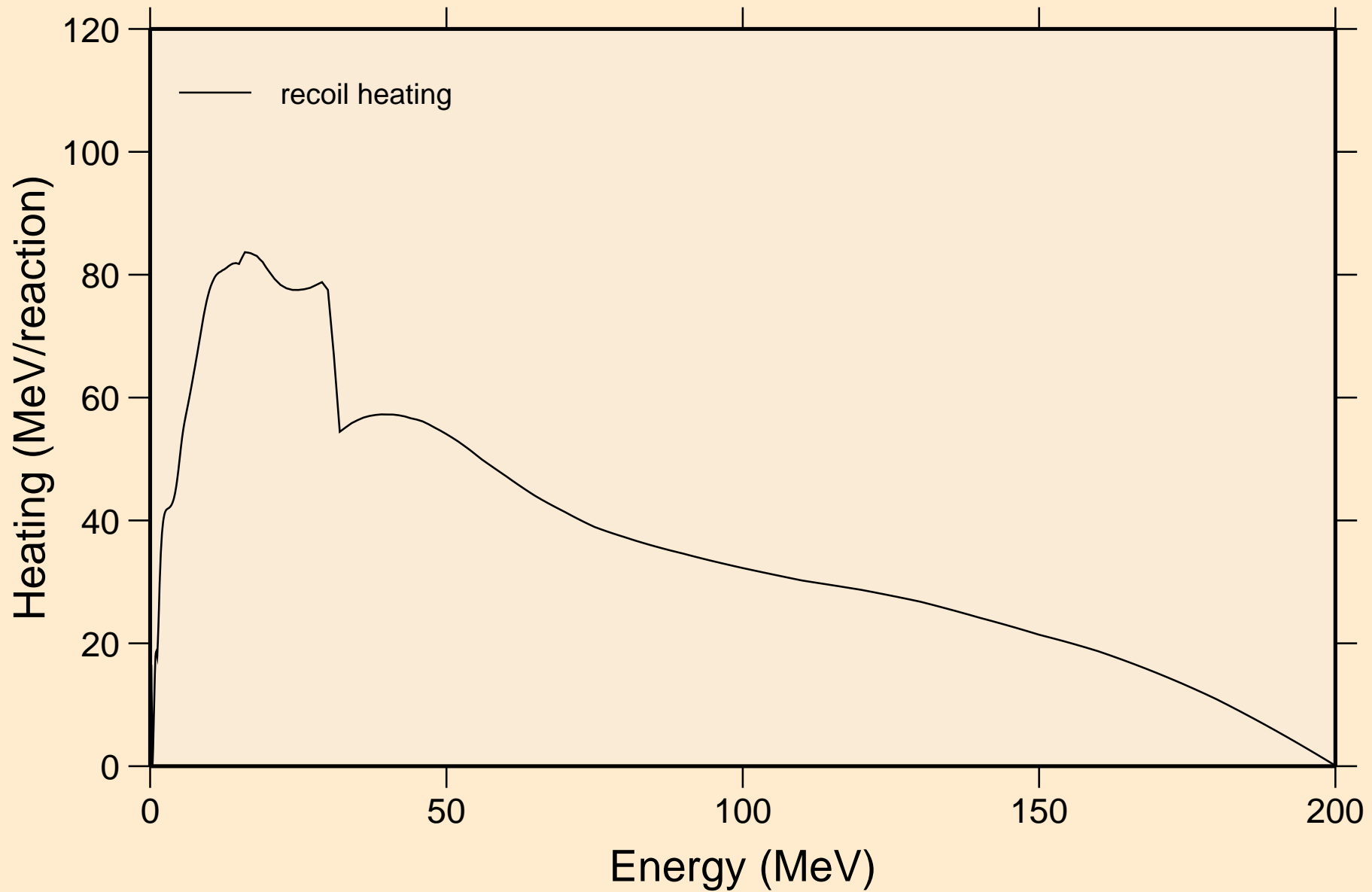

ES257 NEUTRON ACER TENDL-2021 LIBRARY; T=293.6K
Particle production cross sections

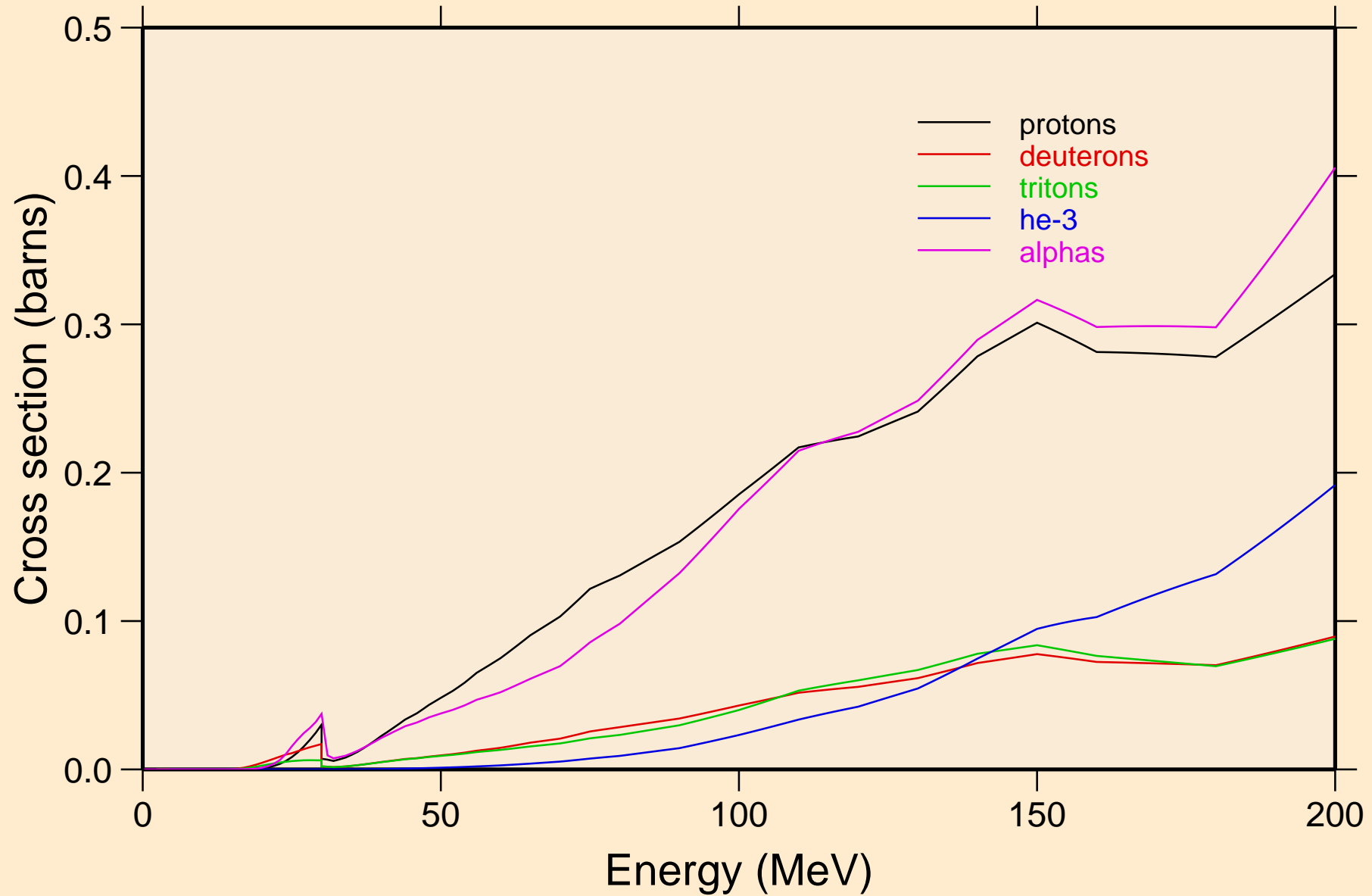

ES257 NEUTRON ACER TENDL-2021 LIBRARY; T=293.6K
protons from (n,x)

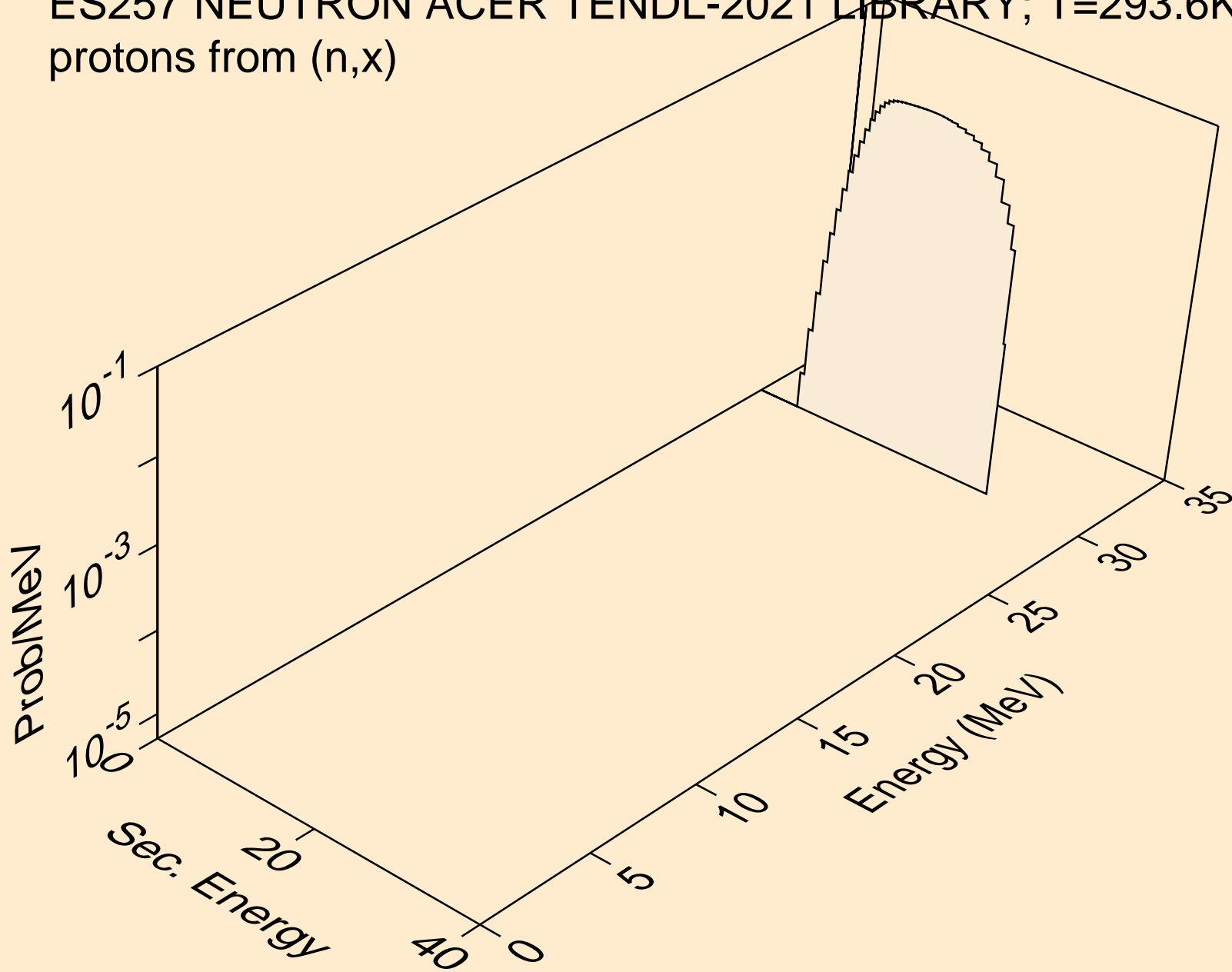

ES257 NEUTRON ACER TENDL-2021 LIBRARY; T=293.6K
protons from (n,n*)p

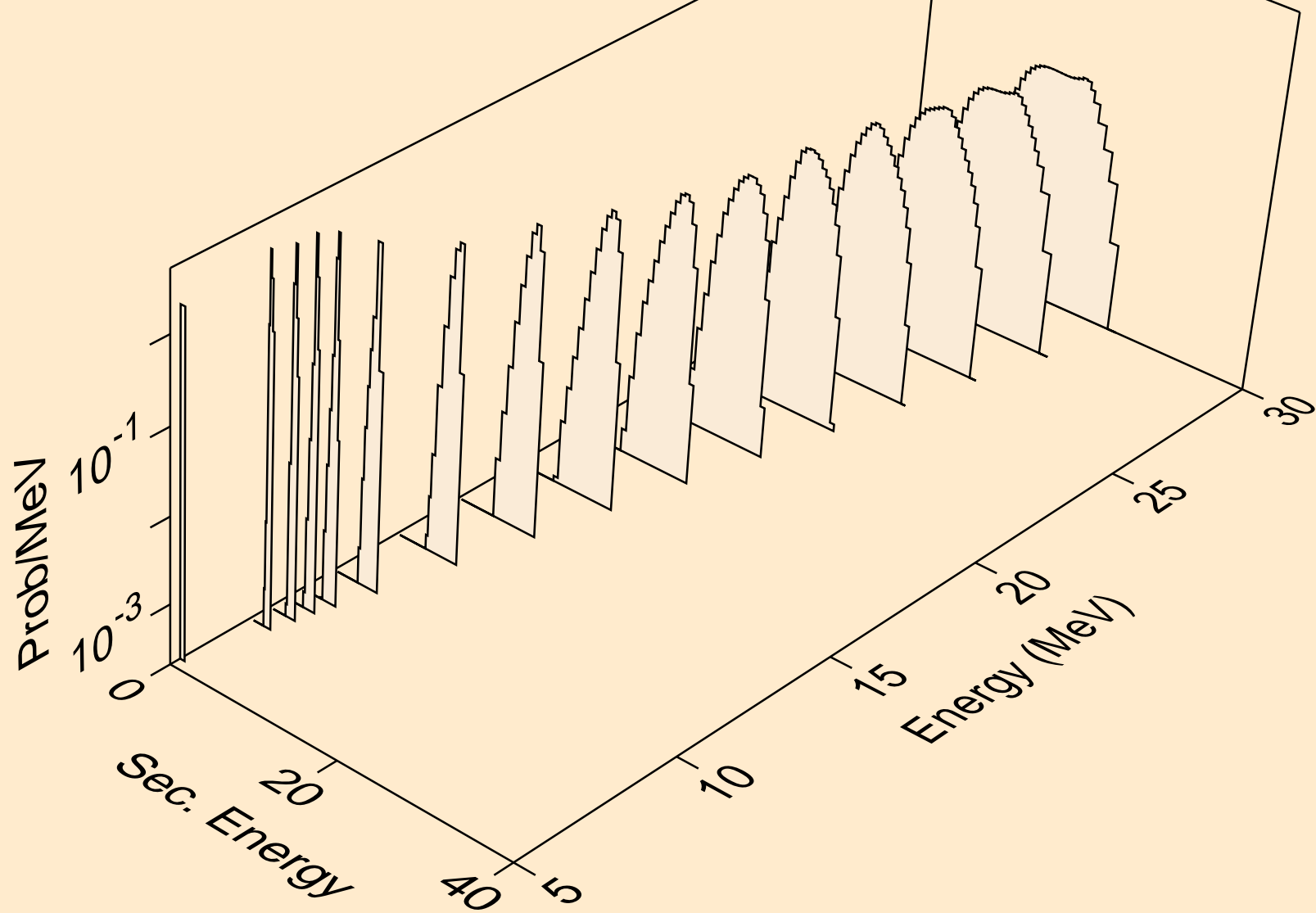

ES257 NEUTRON ACER TENDL-2021 LIBRARY; T=293.6K
protons from (n,2np)

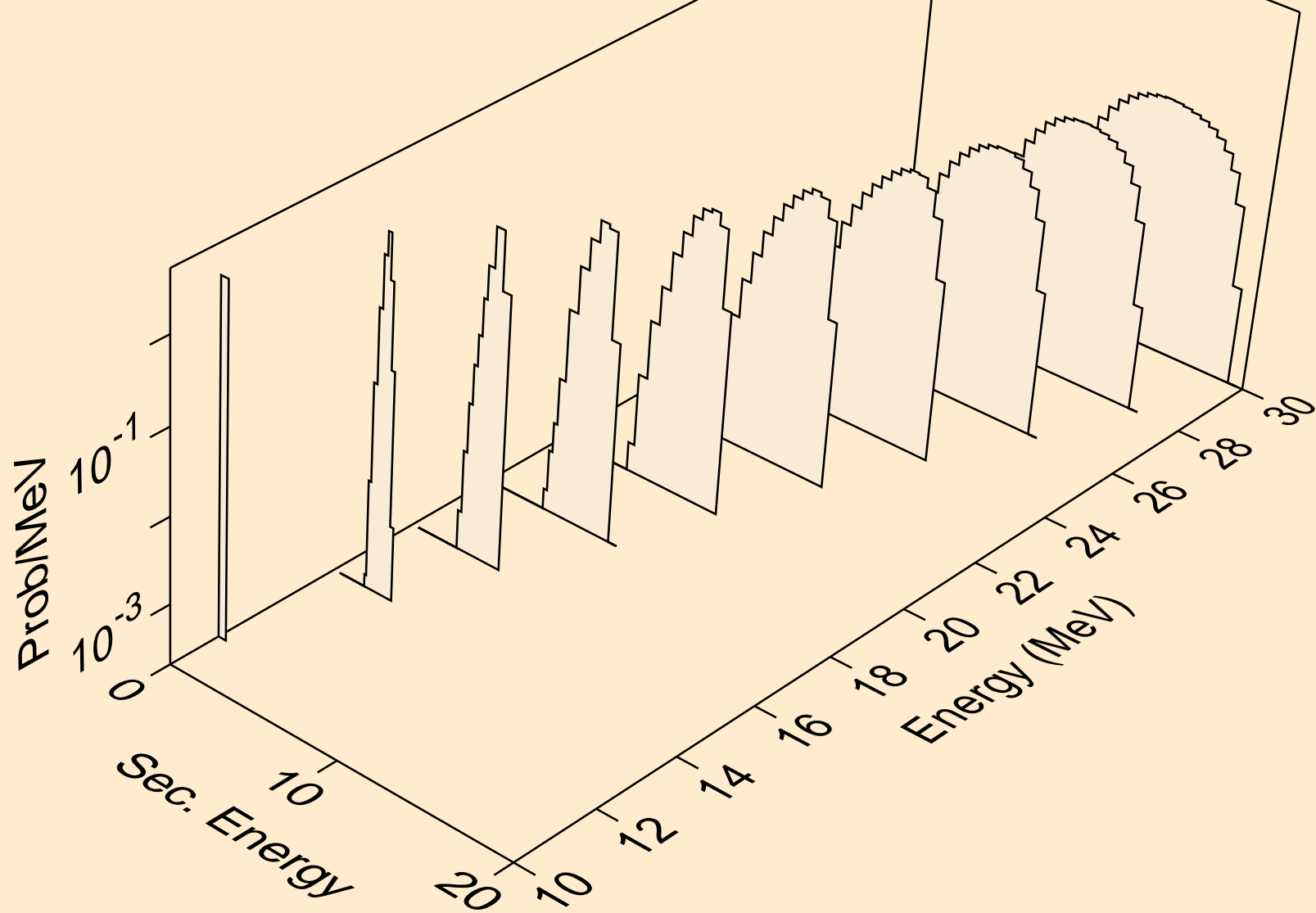

ES257 NEUTRON ACER TENDL-2021 LIBRARY; T=293.6K
protons from (n,3np)

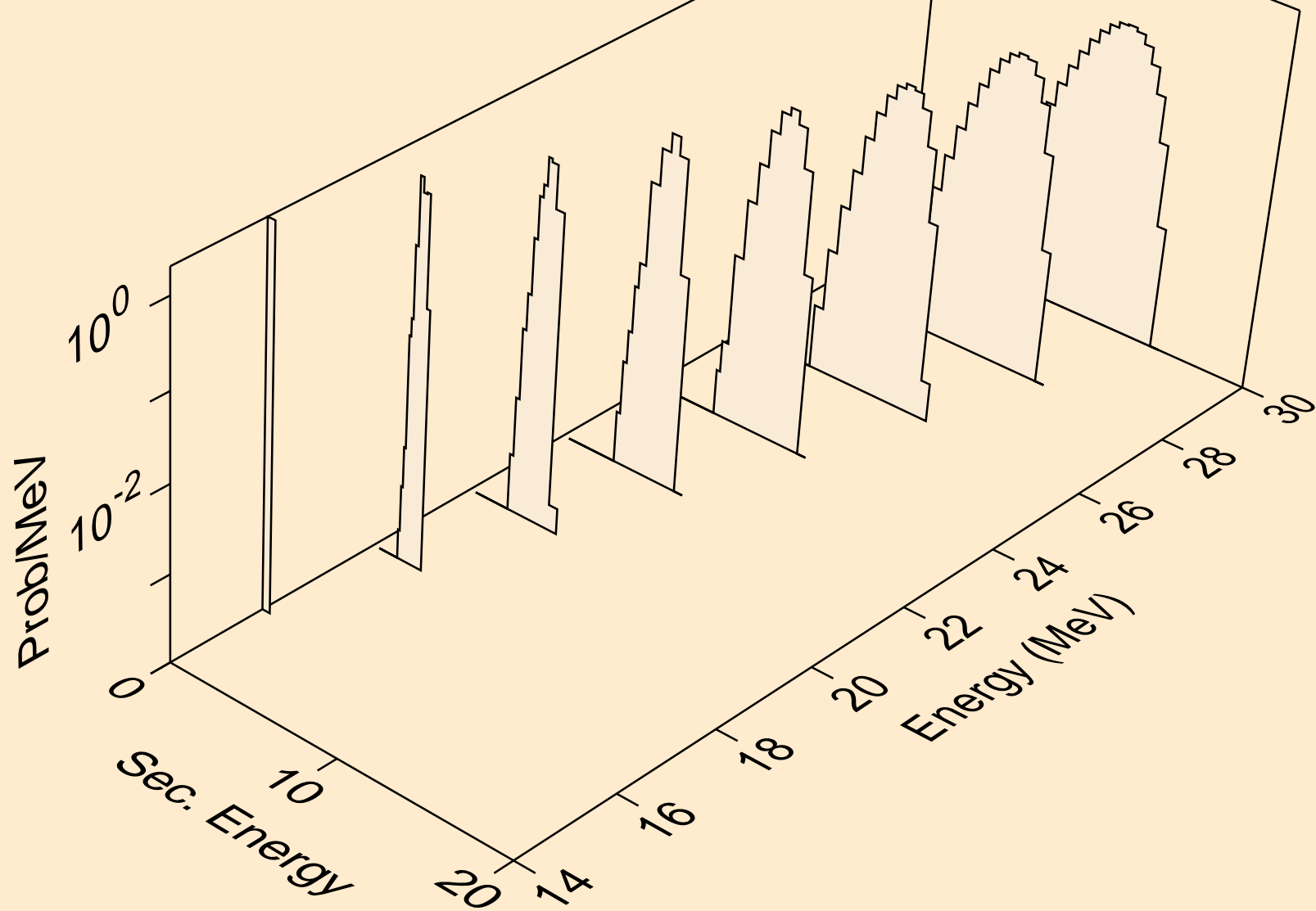

ES257 NEUTRON ACER TENDL-2021 LIBRARY; T=293.6K
protons from (n,2np)

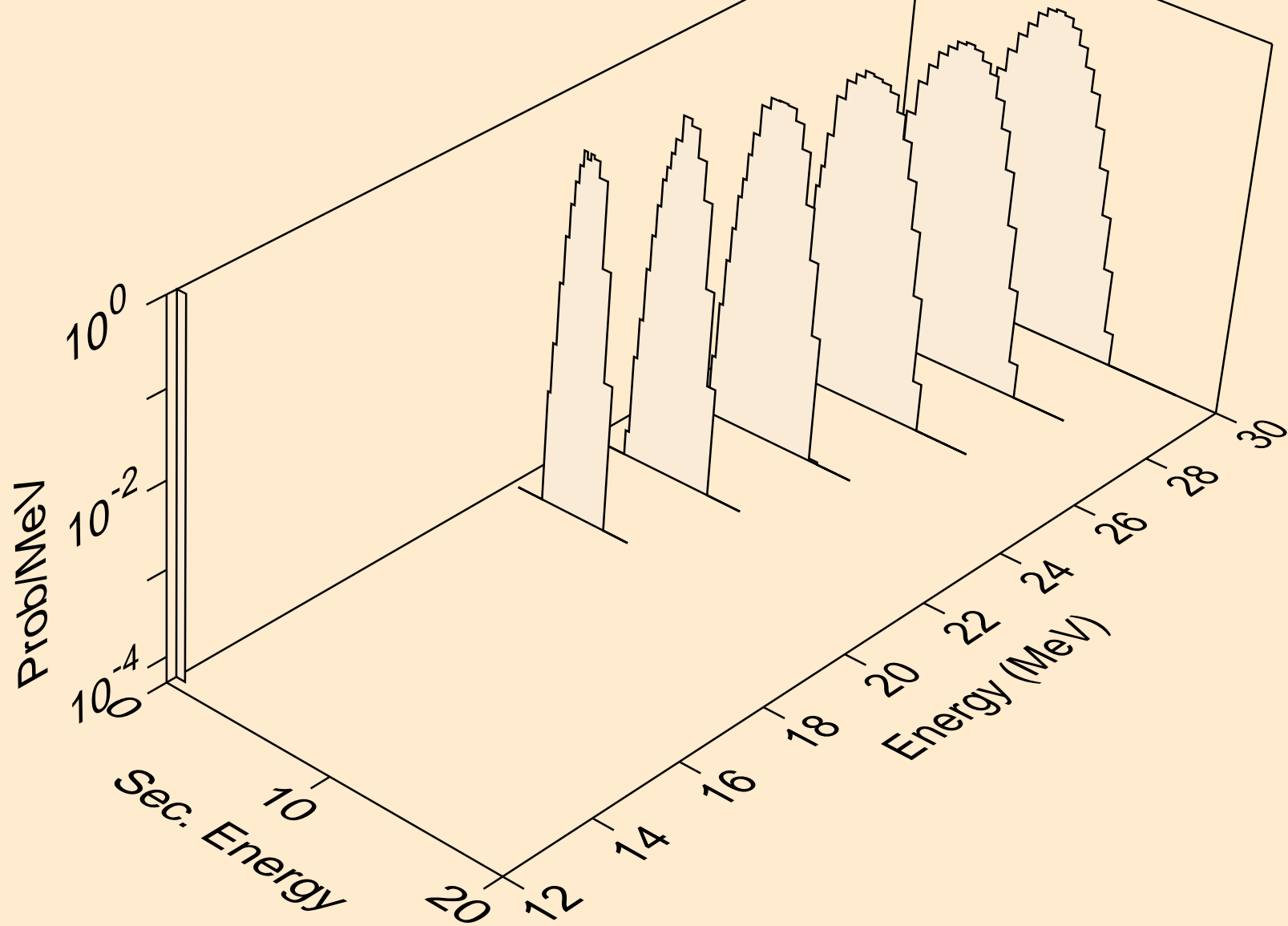

ES257 NEUTRON ACER TENDL-2021 LIBRARY; T=293.6K
protons from (n,p)

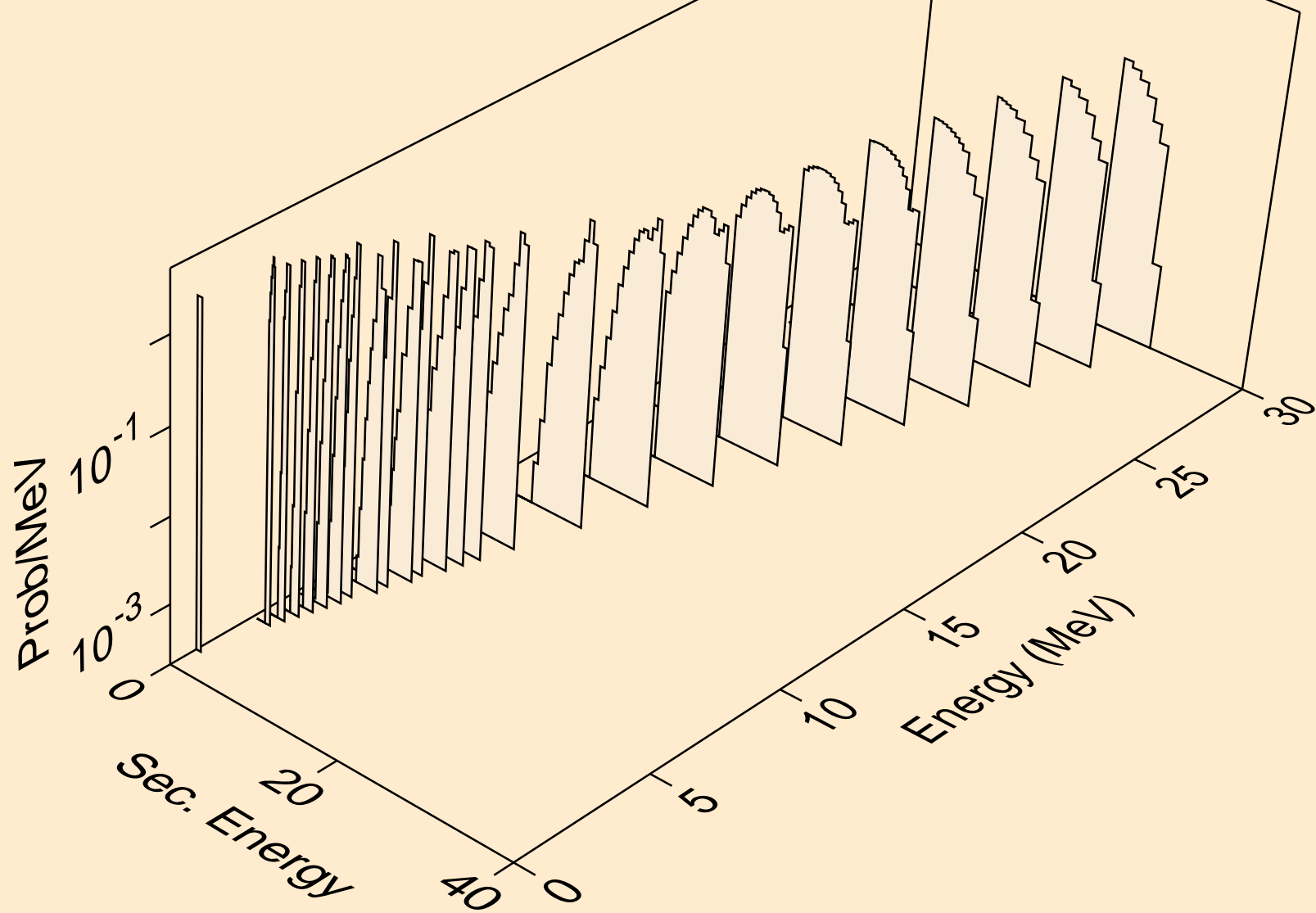

ES257 NEUTRON ACER TENDL-2021 LIBRARY; T=293.6K
protons from (n,2p)

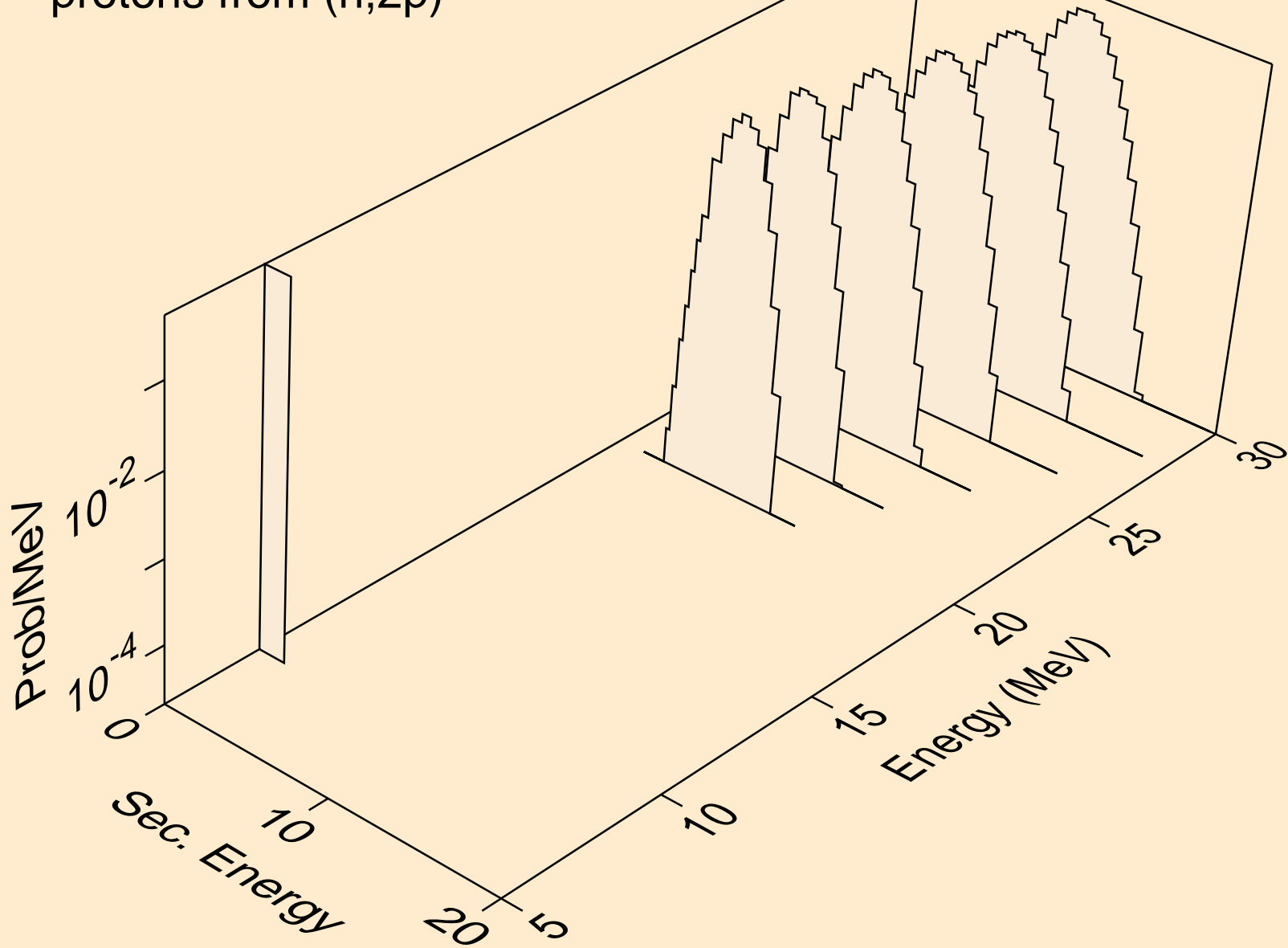

ES257 NEUTRON ACER TENDL-2021 LIBRARY; T=293.6K
protons from (n,pd)

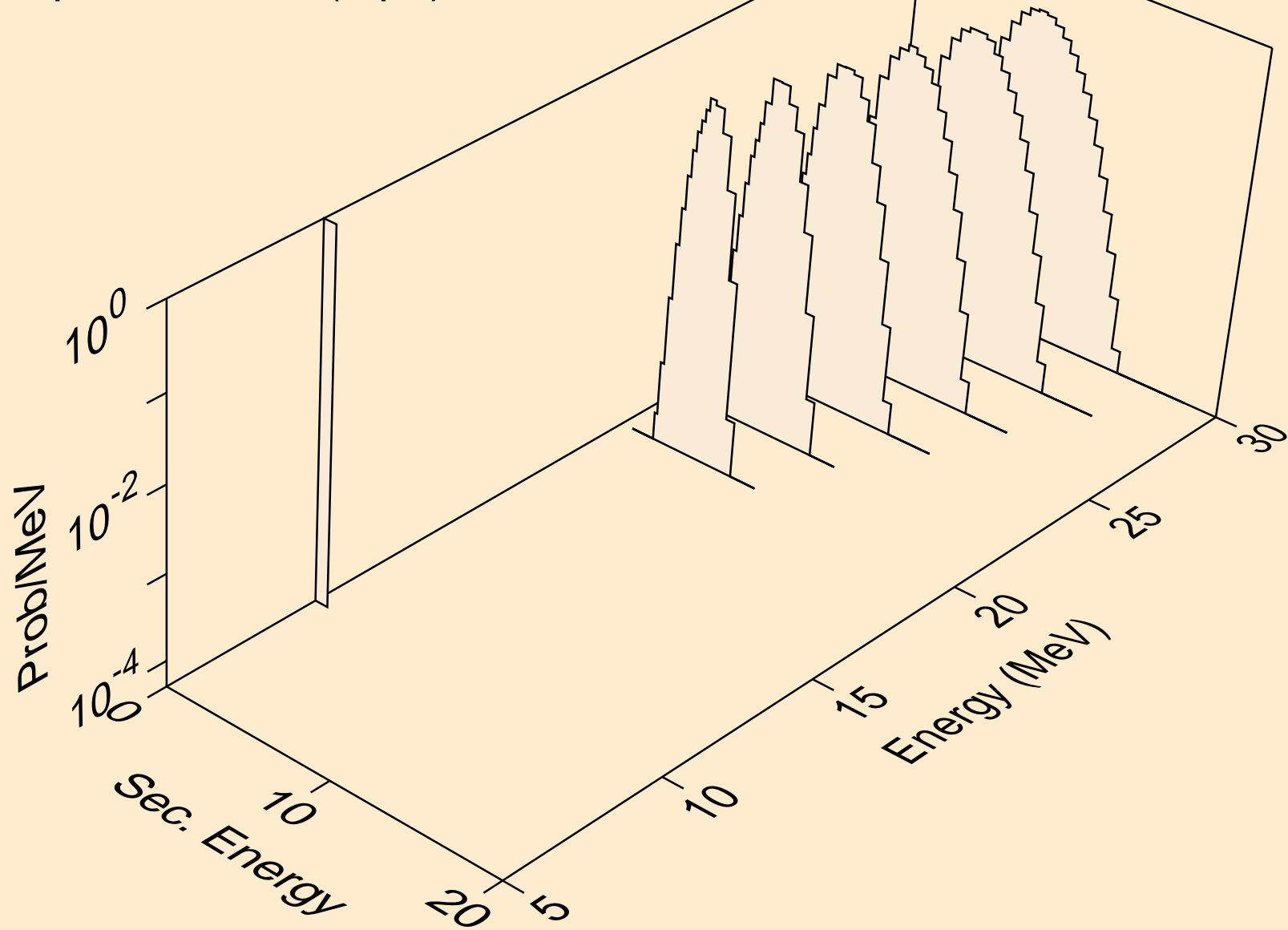

ES257 NEUTRON ACER TENDL-2021 LIBRARY; T=293.6K
deuterons from (n,x)

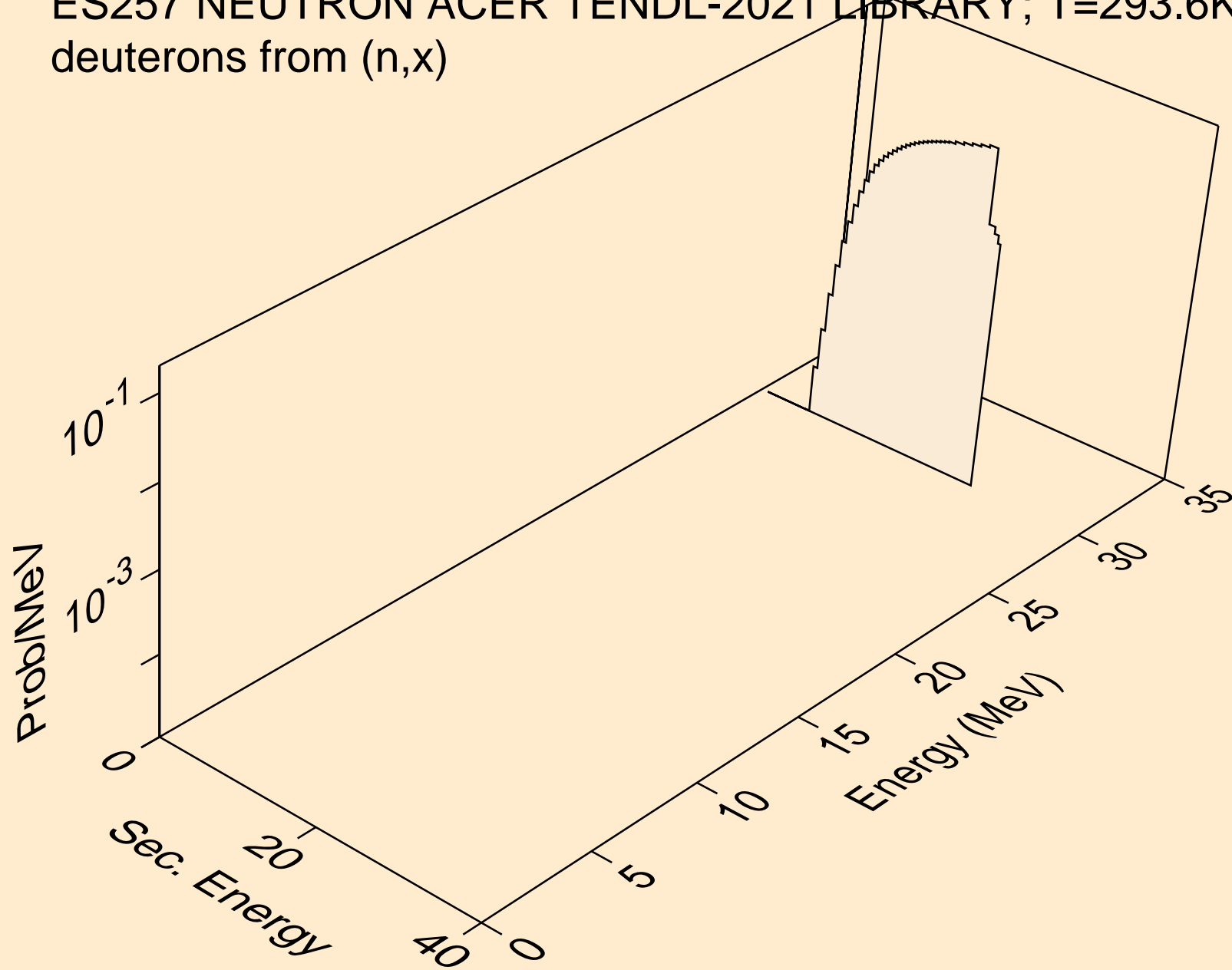

ES257 NEUTRON ACER TENDL-2021 LIBRARY; T=293.6K
deuterons from (n,2nd)

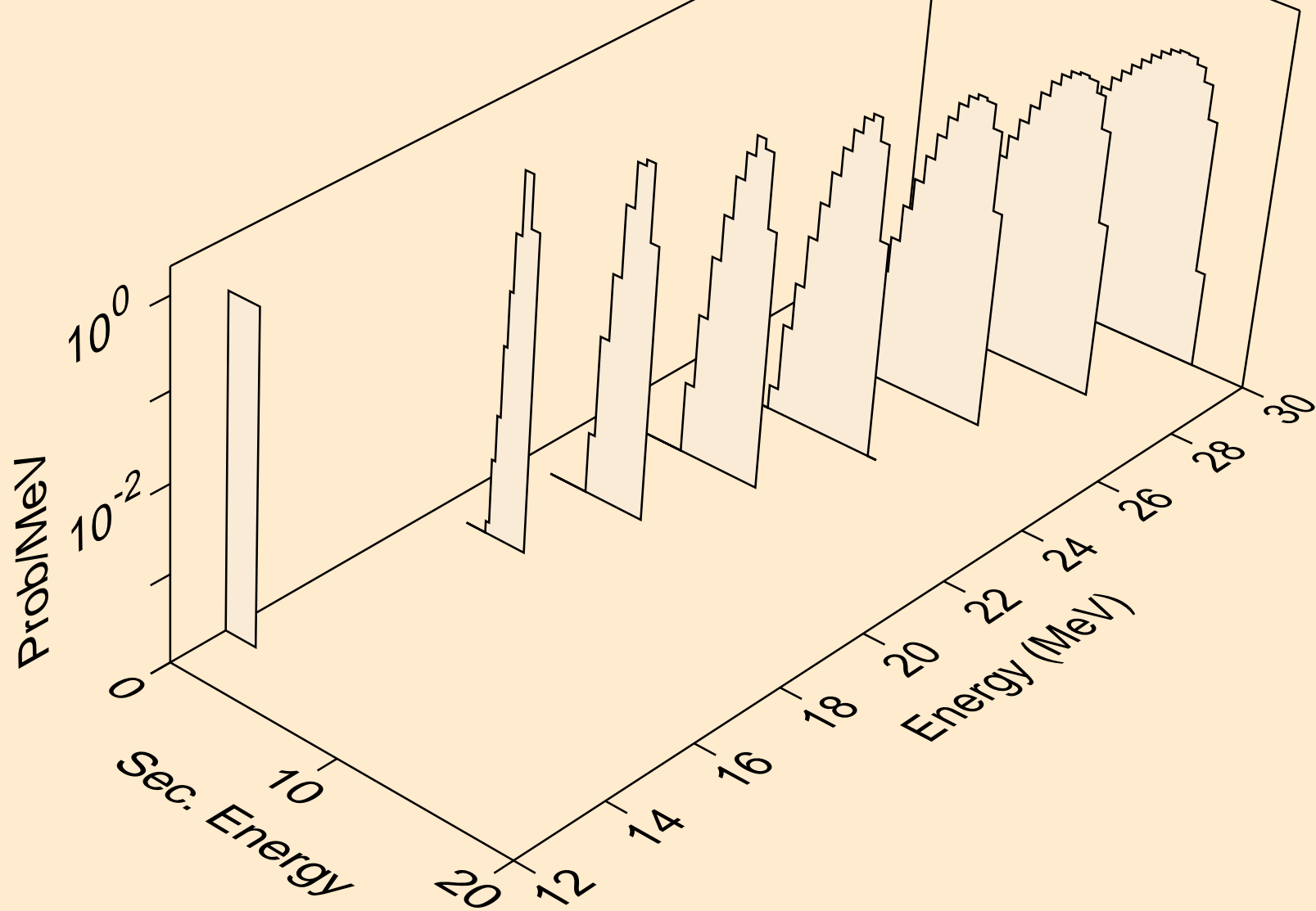

ES257 NEUTRON ACER TENDL-2021 LIBRARY; T=293.6K
deuterons from (n,n*)d

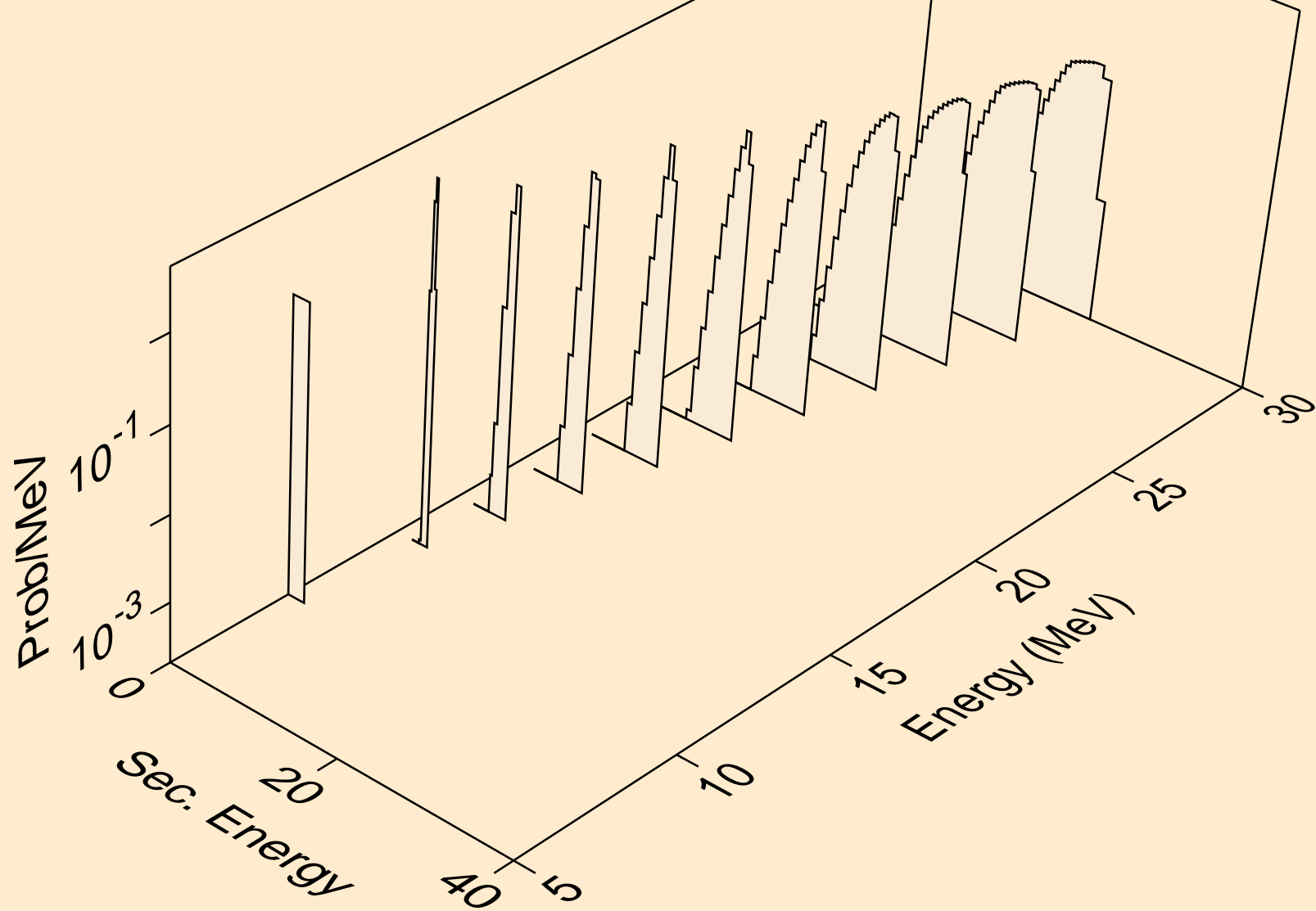

ES257 NEUTRON ACER TENDL-2021 LIBRARY; T=293.6K
deuterons from (n,d)

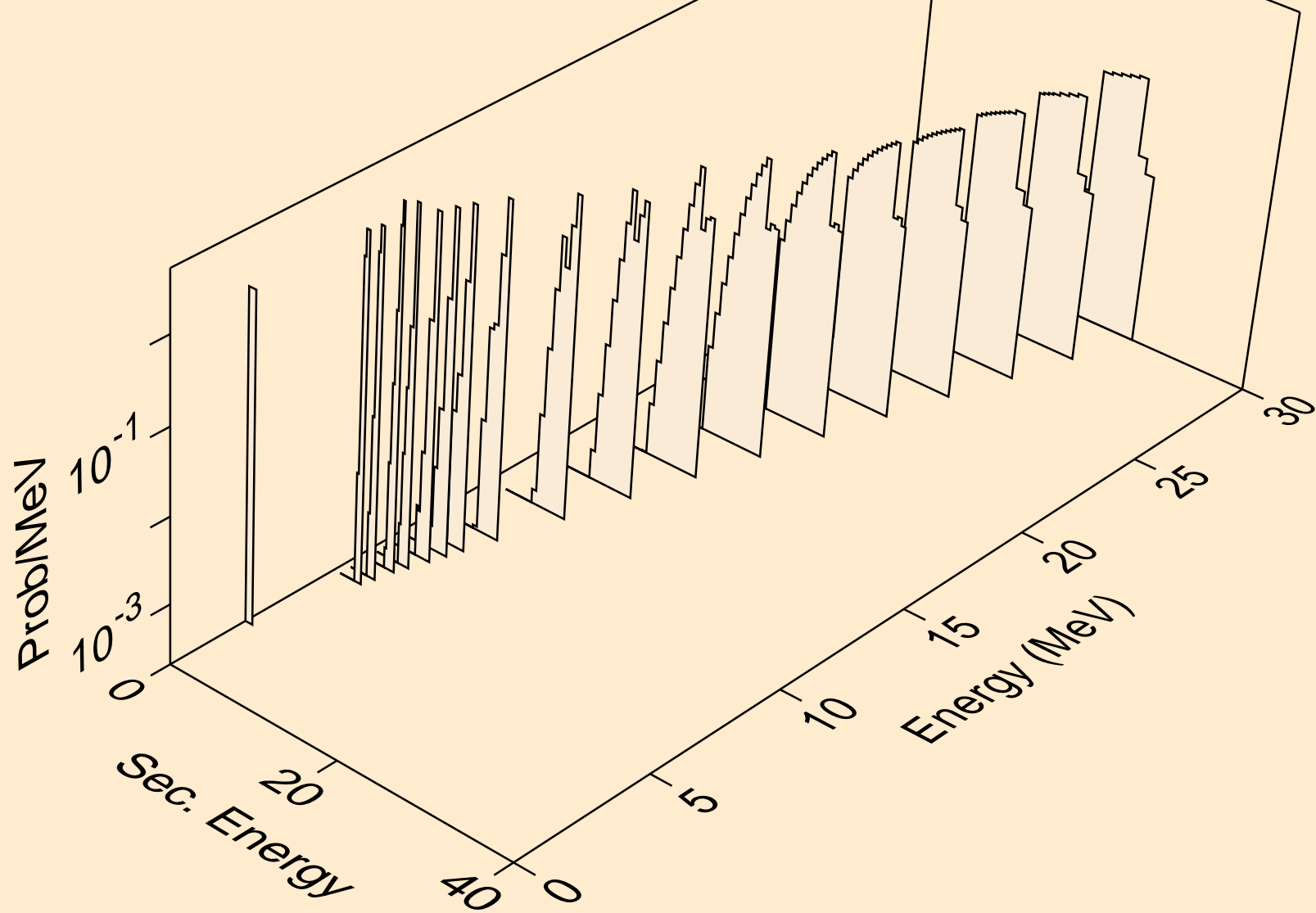

ES257 NEUTRON ACER TENDL-2021 LIBRARY; T=293.6K
deuterons from (n,pd)

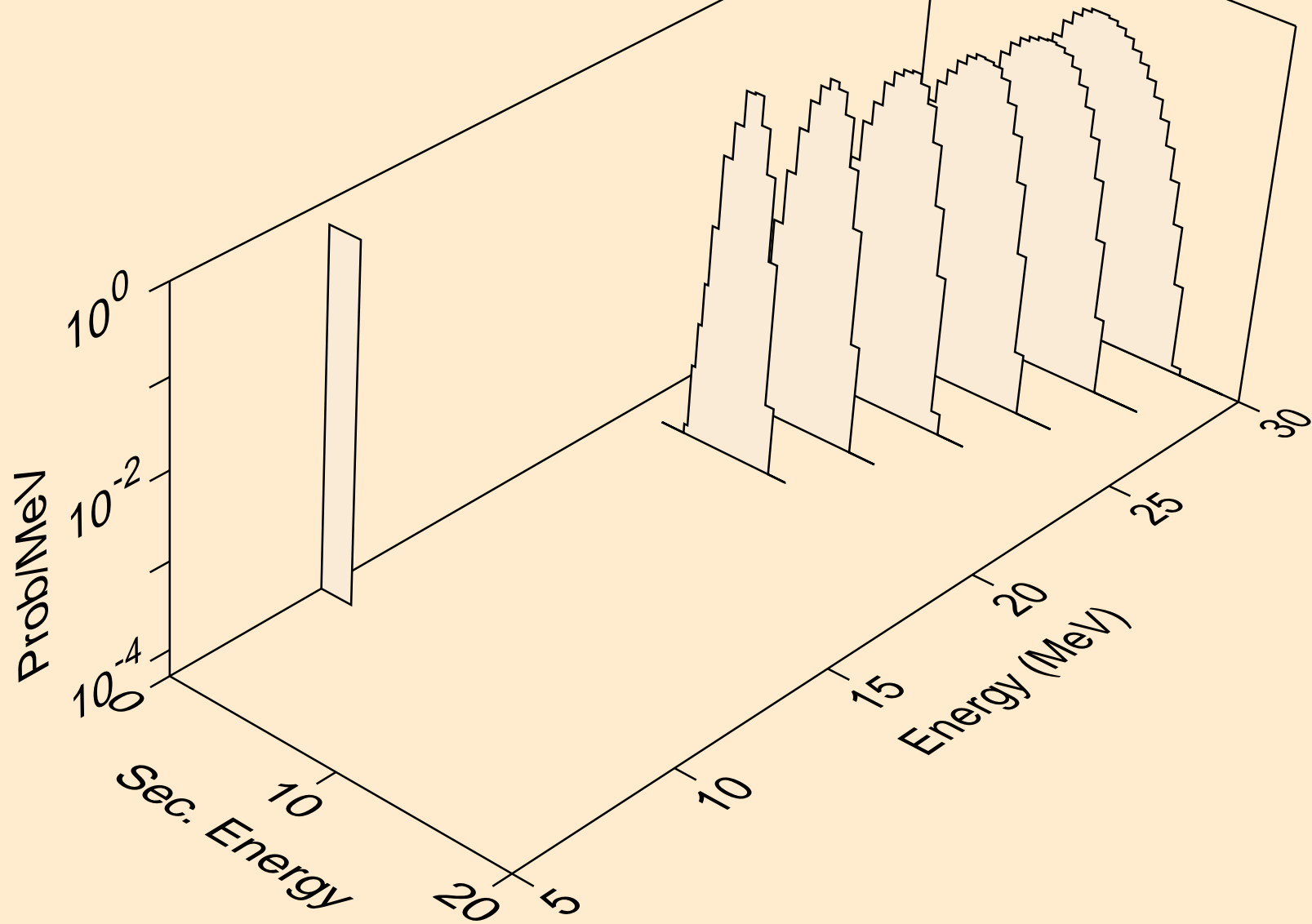

ES257 NEUTRON ACER TENDL-2021 LIBRARY; T=293.6K
tritons from (n,x)

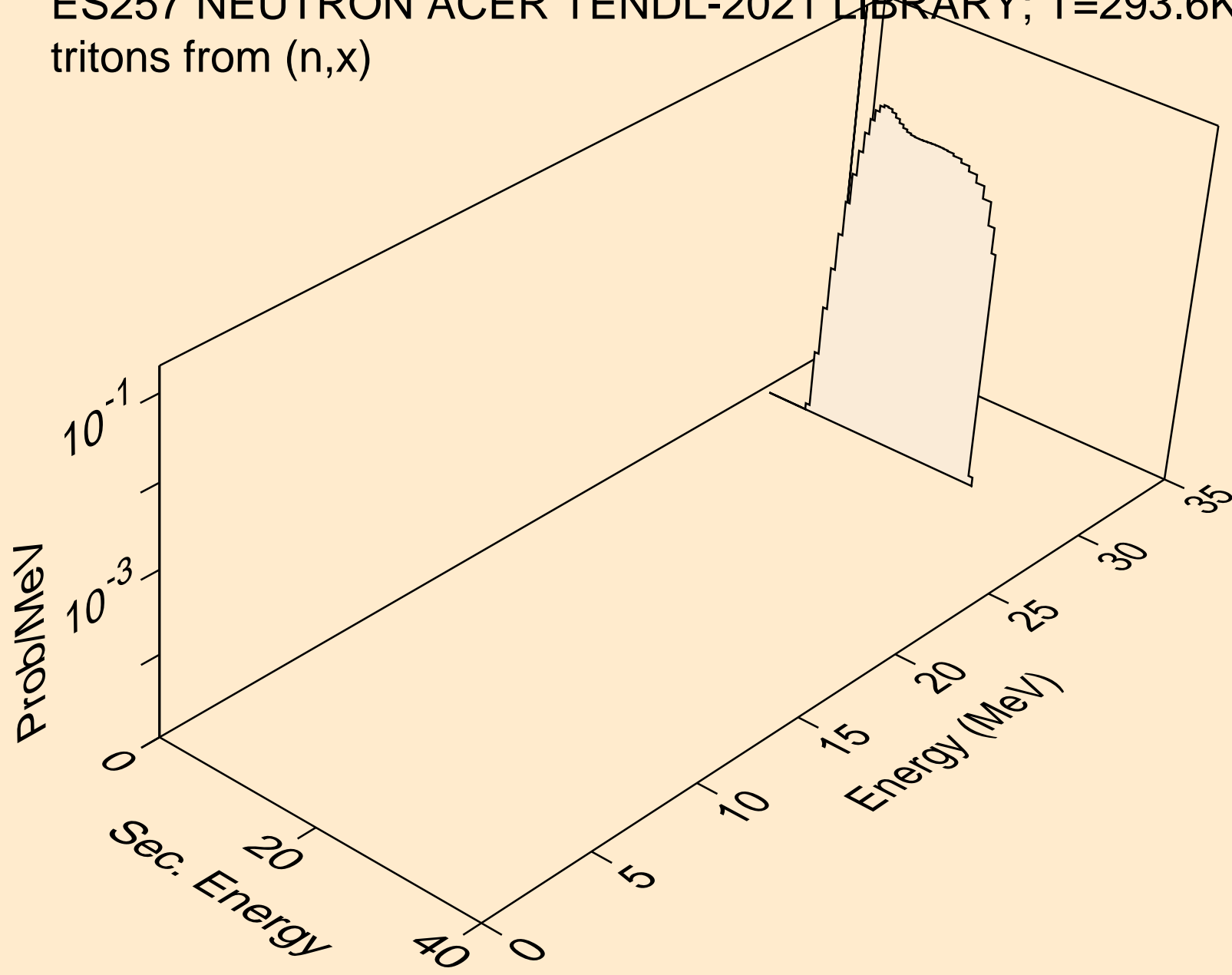

ES257 NEUTRON ACER TENDL-2021 LIBRARY; T=293.6K
tritons from (n,n*)t

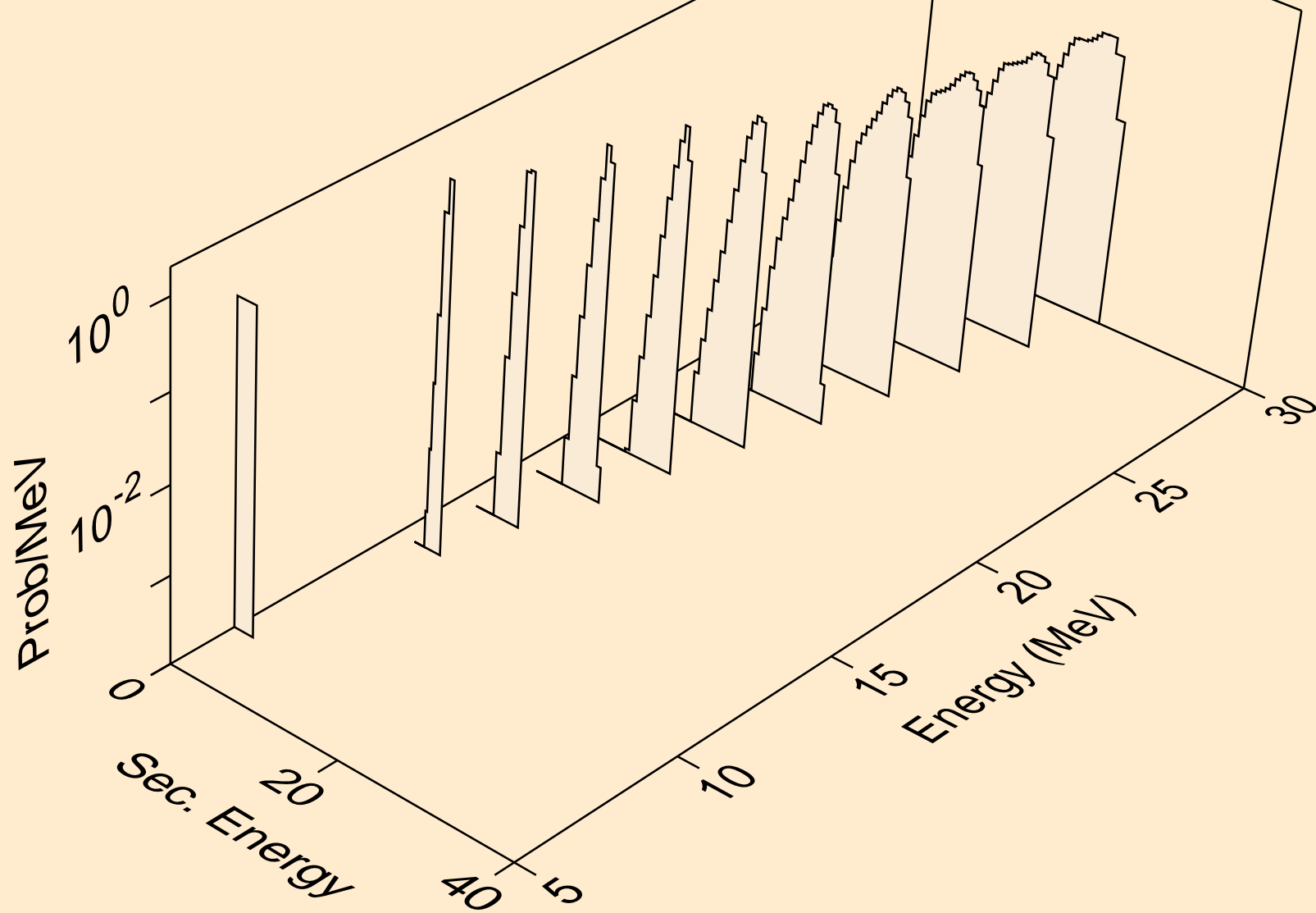

ES257 NEUTRON ACER TENDL-2021 LIBRARY; T=293.6K
tritons from (n,t)

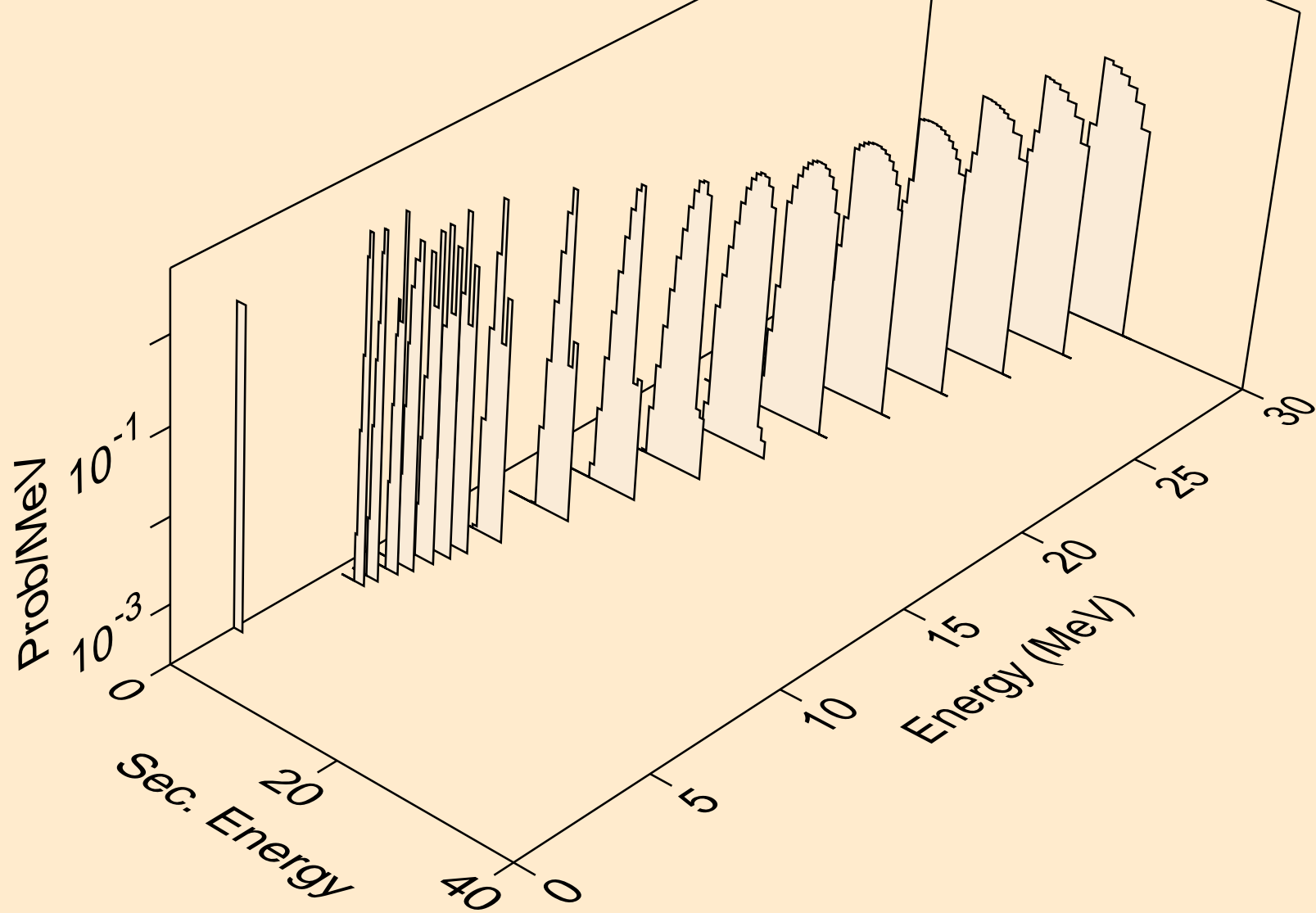

ES257 NEUTRON ACER TENDL-2021 LIBRARY; T=293.6K
he3s from (n,x)

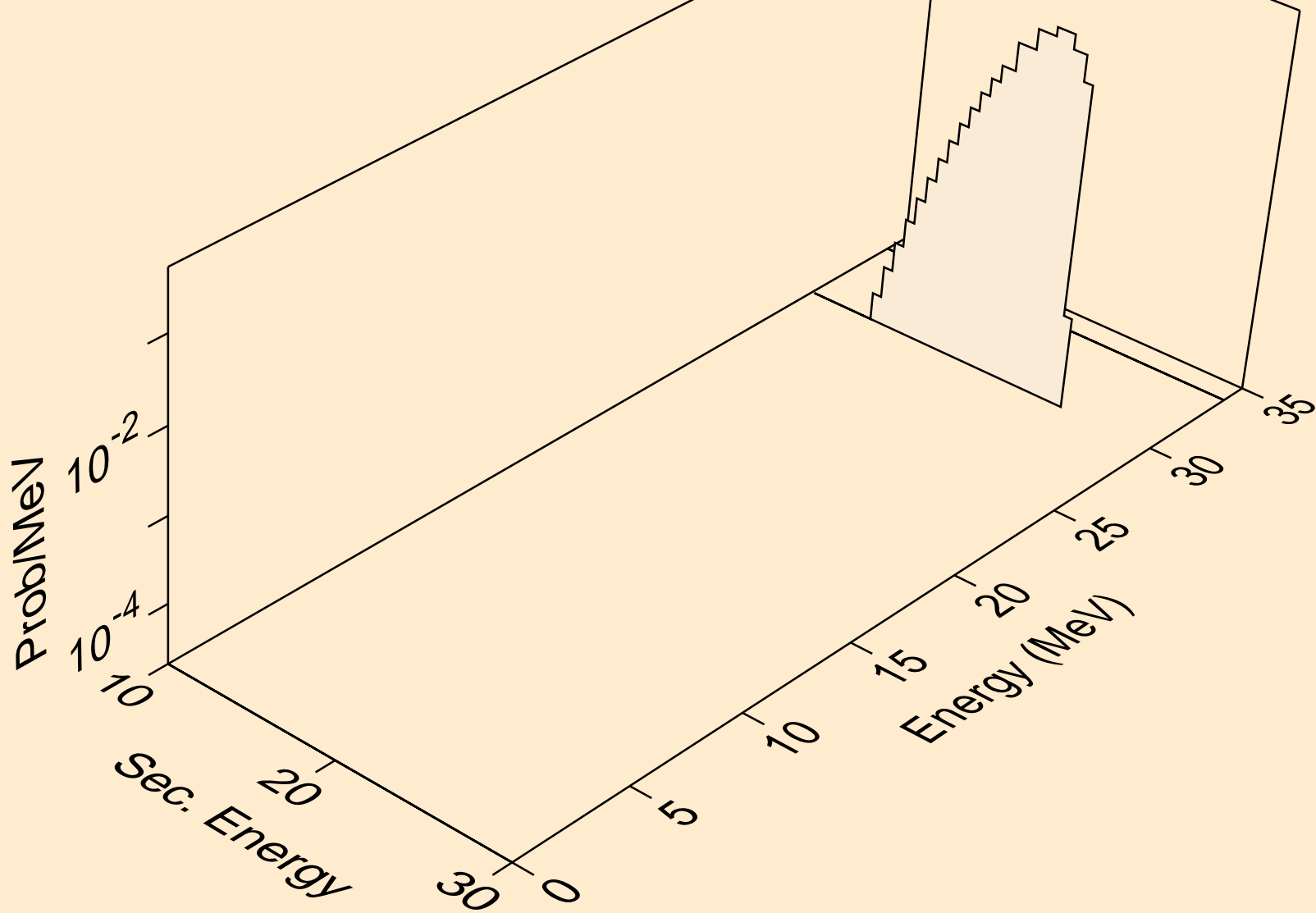

ES257 NEUTRON ACER TENDL-2021 LIBRARY; T=293.6K
he3s from (n,he3)

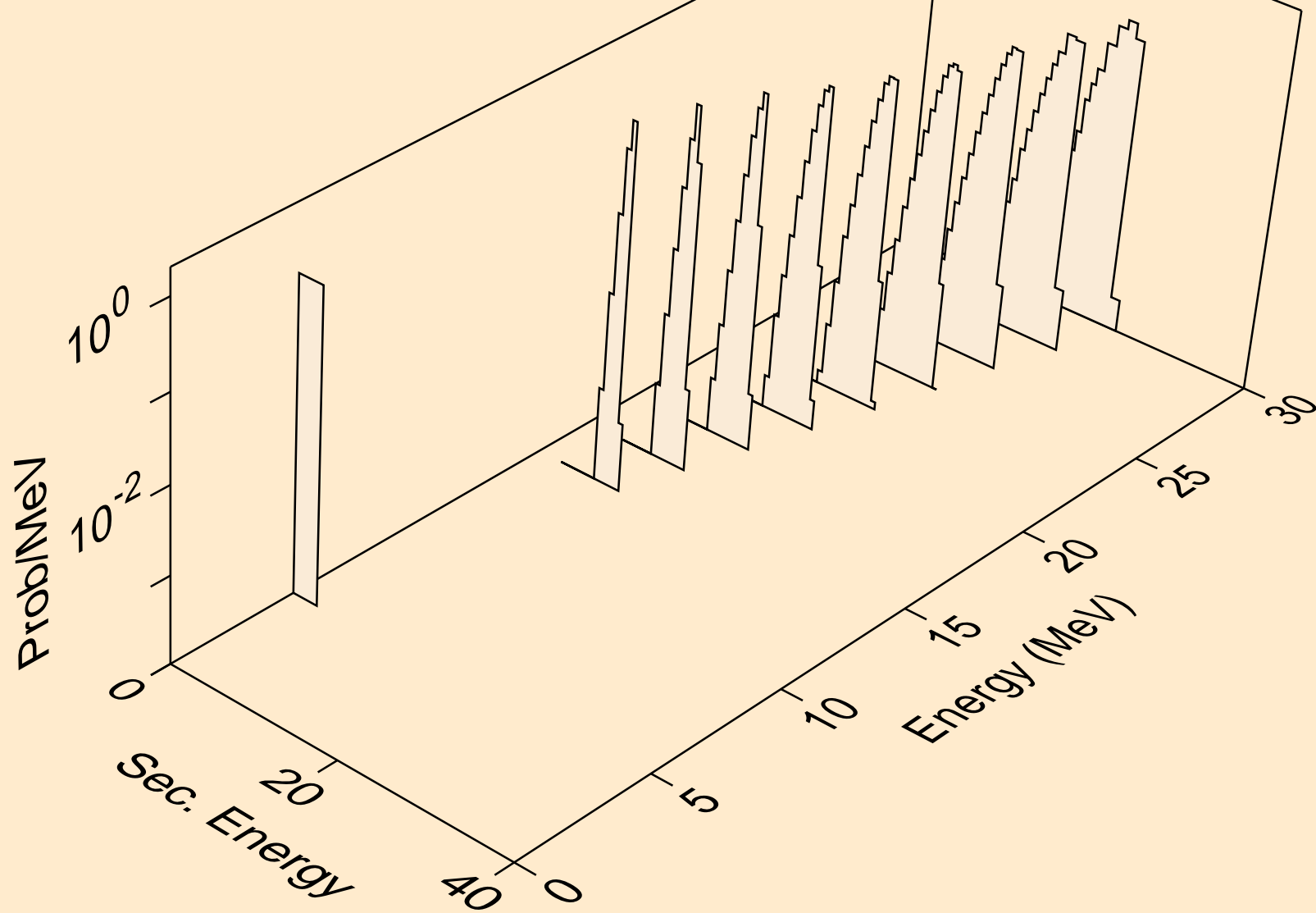

ES257 NEUTRON ACER TENDL-2021 LIBRARY; T=293.6K
alphas from (n,x)

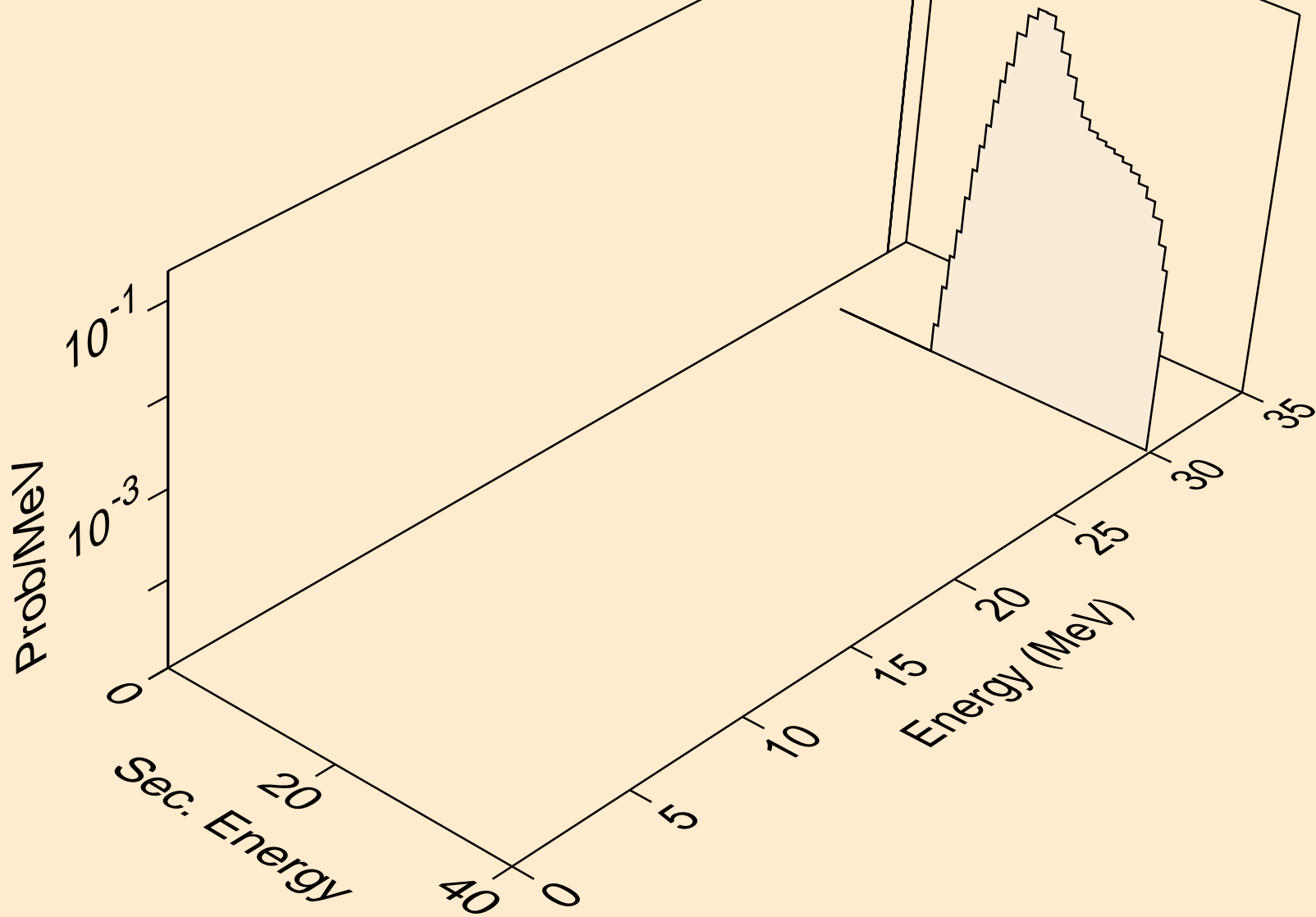

ES257 NEUTRON ACER TENDL-2021 LIBRARY; T=293.6K
alphas from (n,n*)a

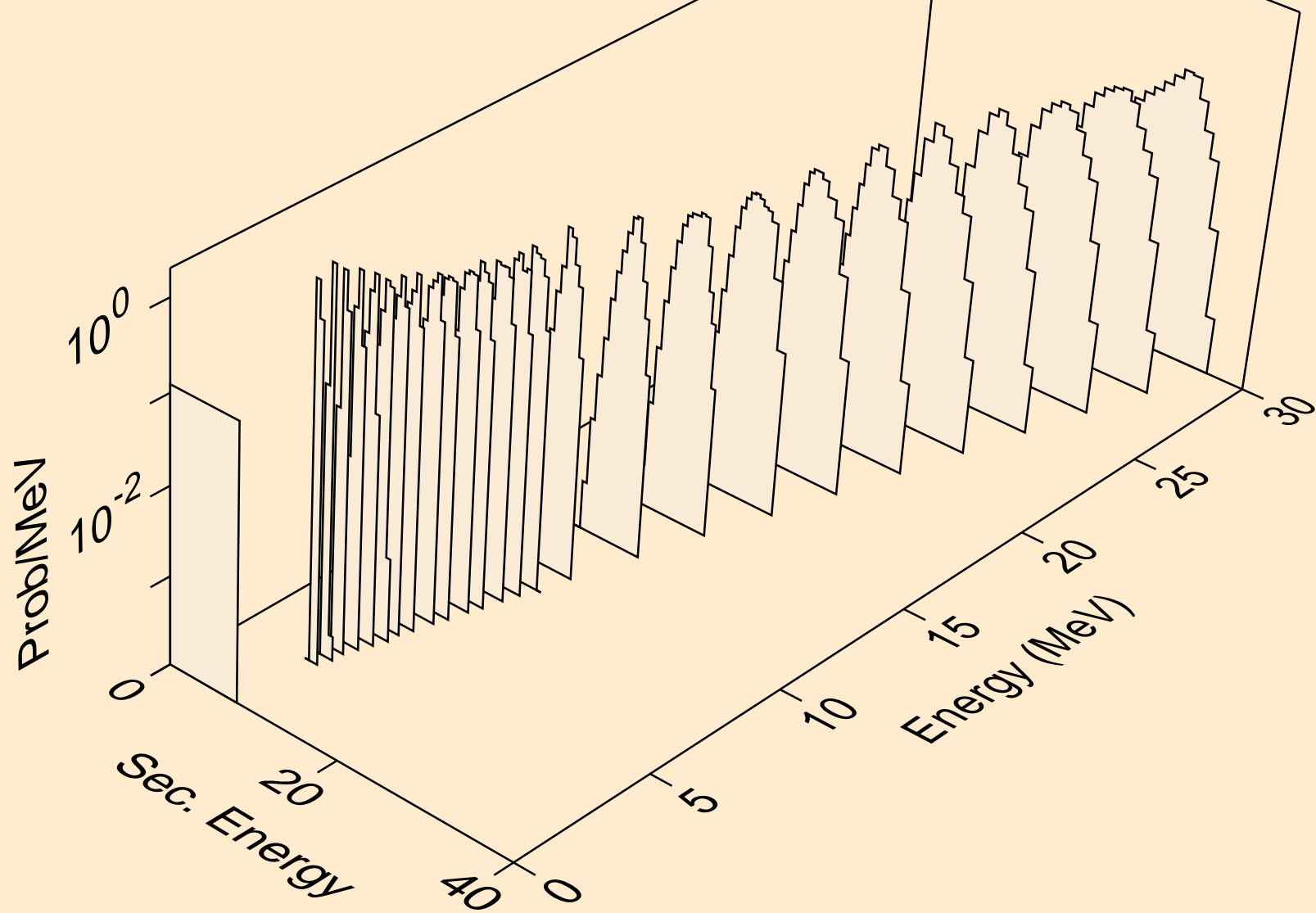

ES257 NEUTRON ACER TENDL-2021 LIBRARY; T=293.6K
alphas from (n,2n)a

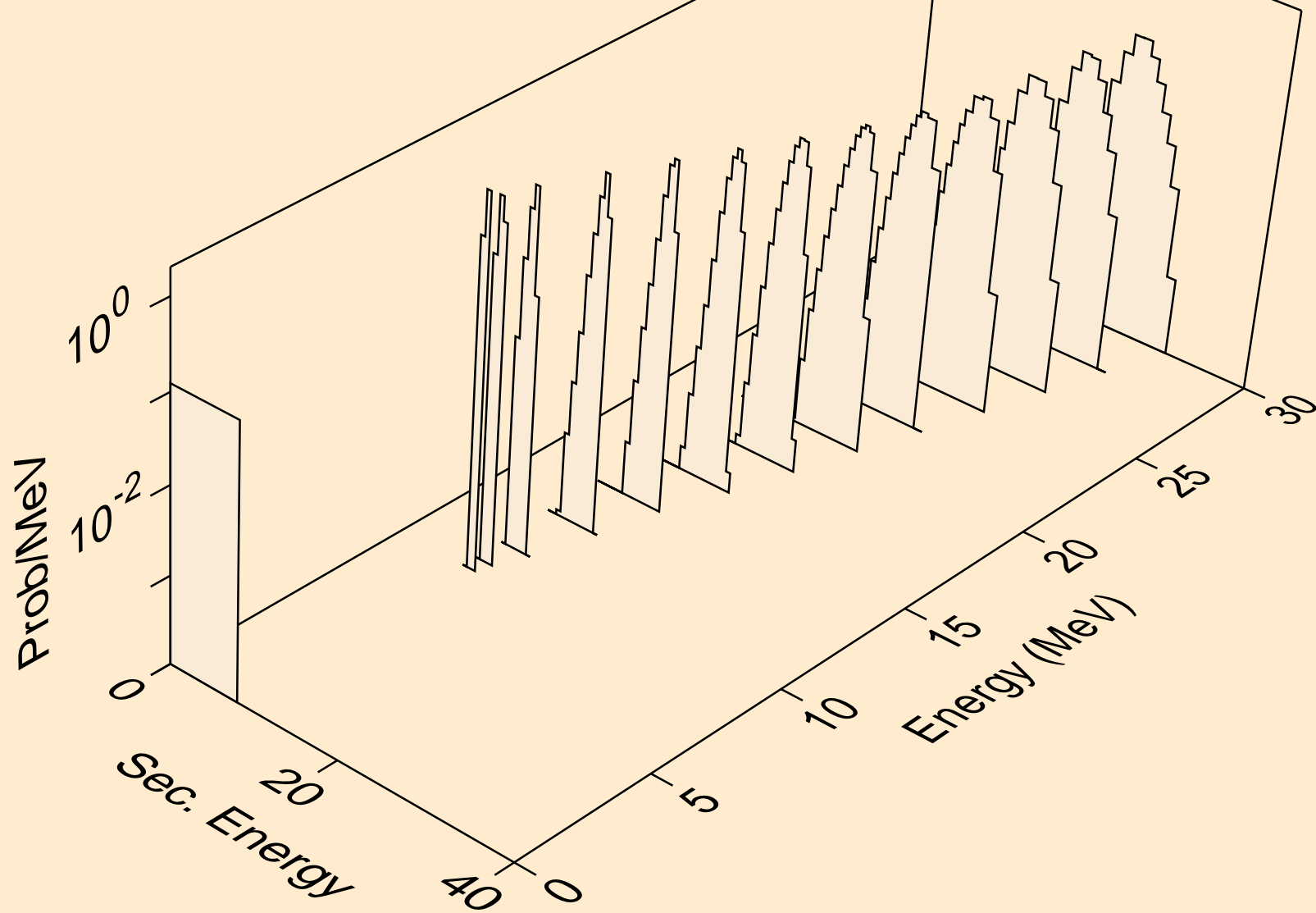

ES257 NEUTRON ACER TENDL-2021 LIBRARY; T=293.6K
alphas from (n,3n)a

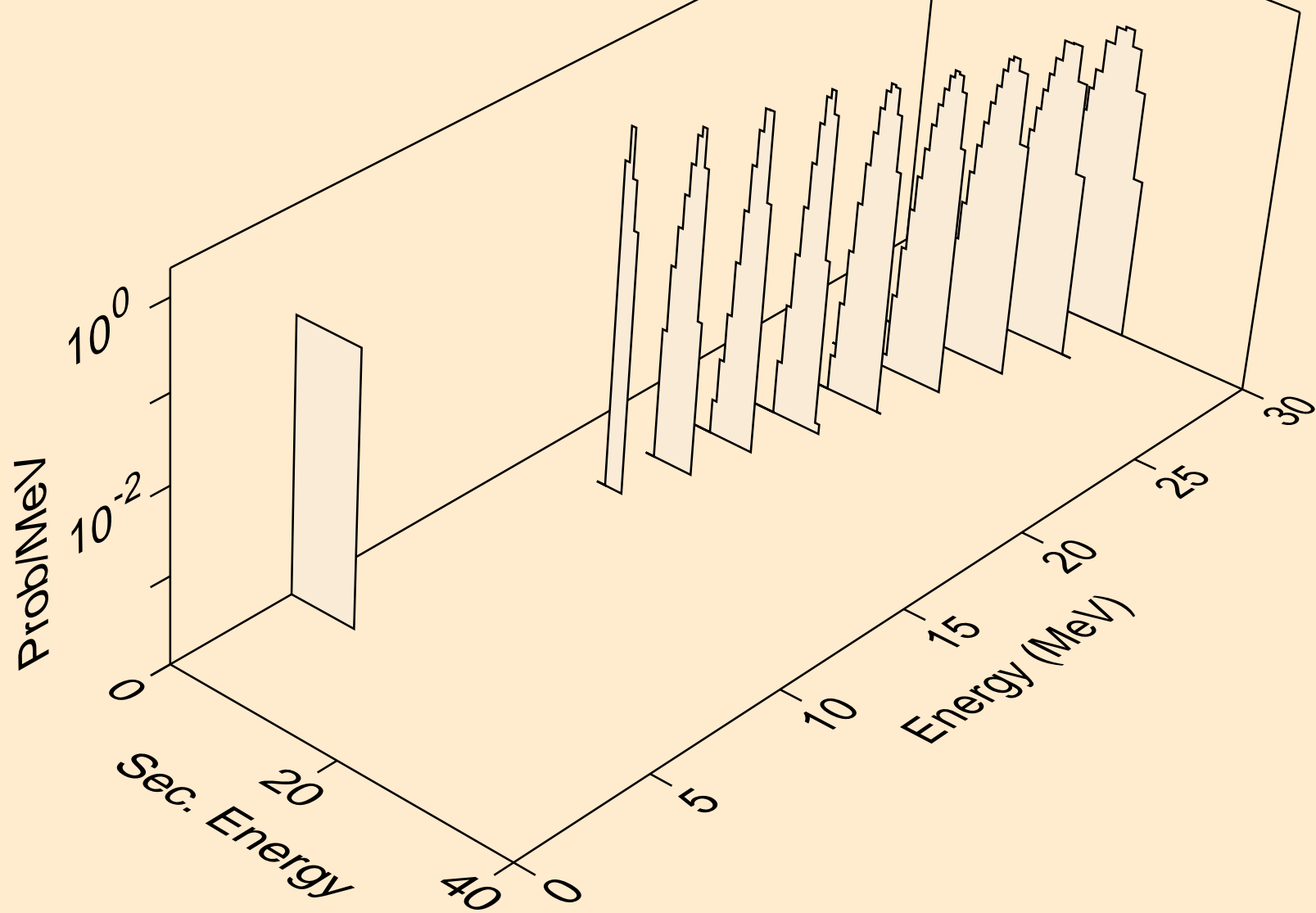

ES257 NEUTRON ACER TENDL-2021 LIBRARY; T=293.6K
alphas from (n,a)

