

FM259 NEUTRON ACER TENDL-2021 LIBRARY; T=293.6K

Principal cross sections

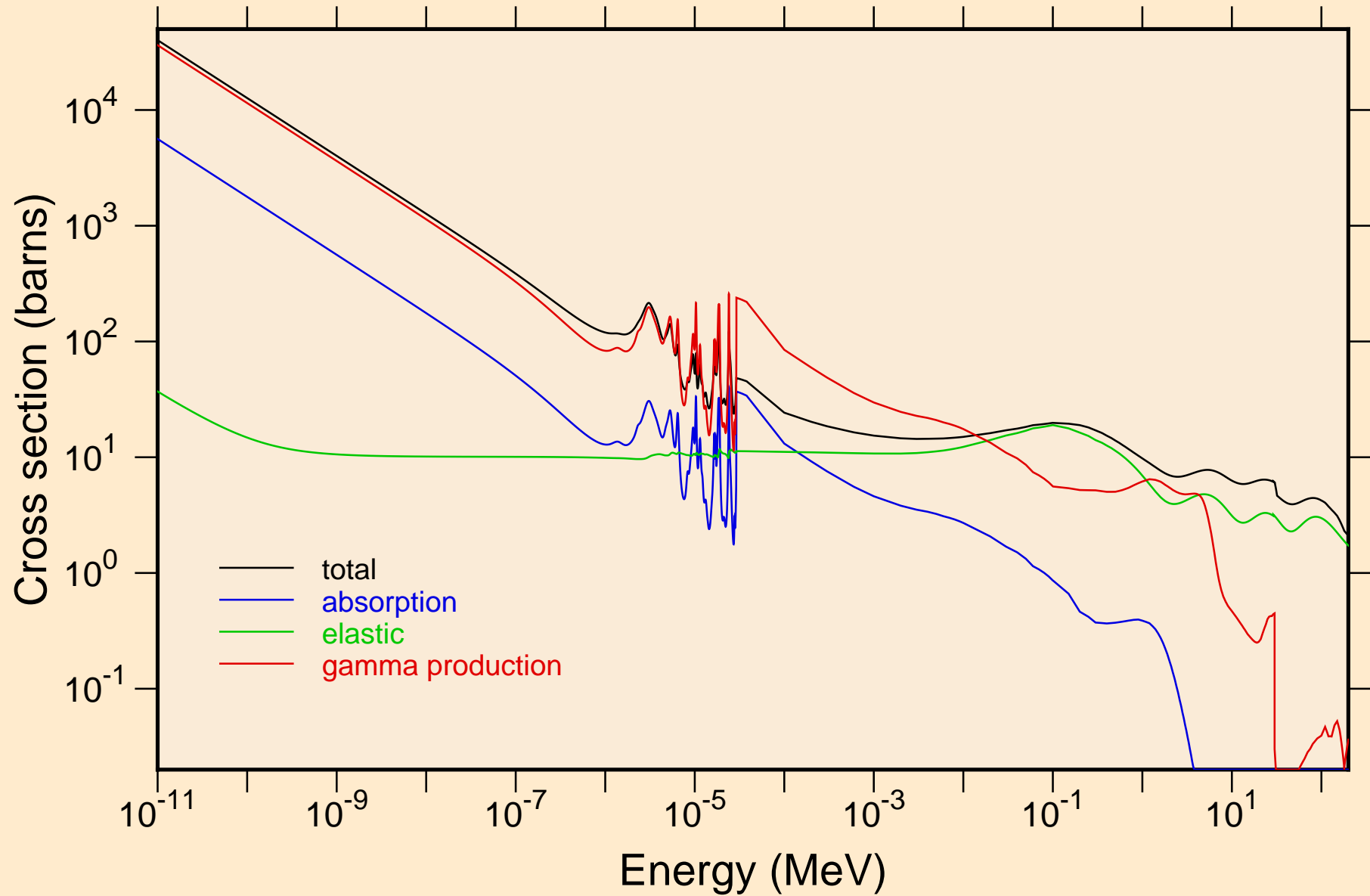

FM259 NEUTRON ACER TENDL-2021 LIBRARY; T=293.6K
resonance total cross section

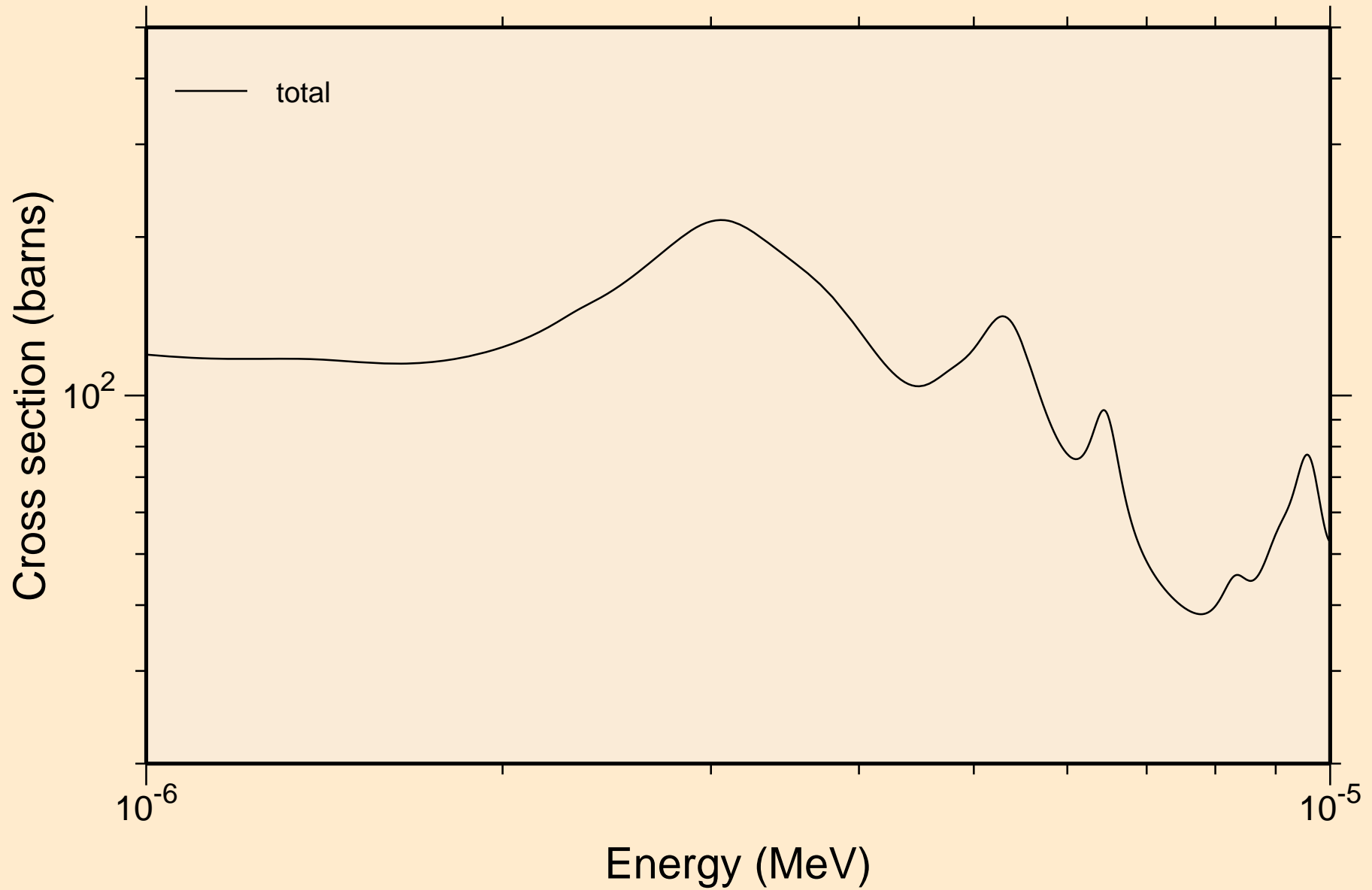

FM259 NEUTRON ACER TENDL-2021 LIBRARY; T=293.6K
resonance total cross section

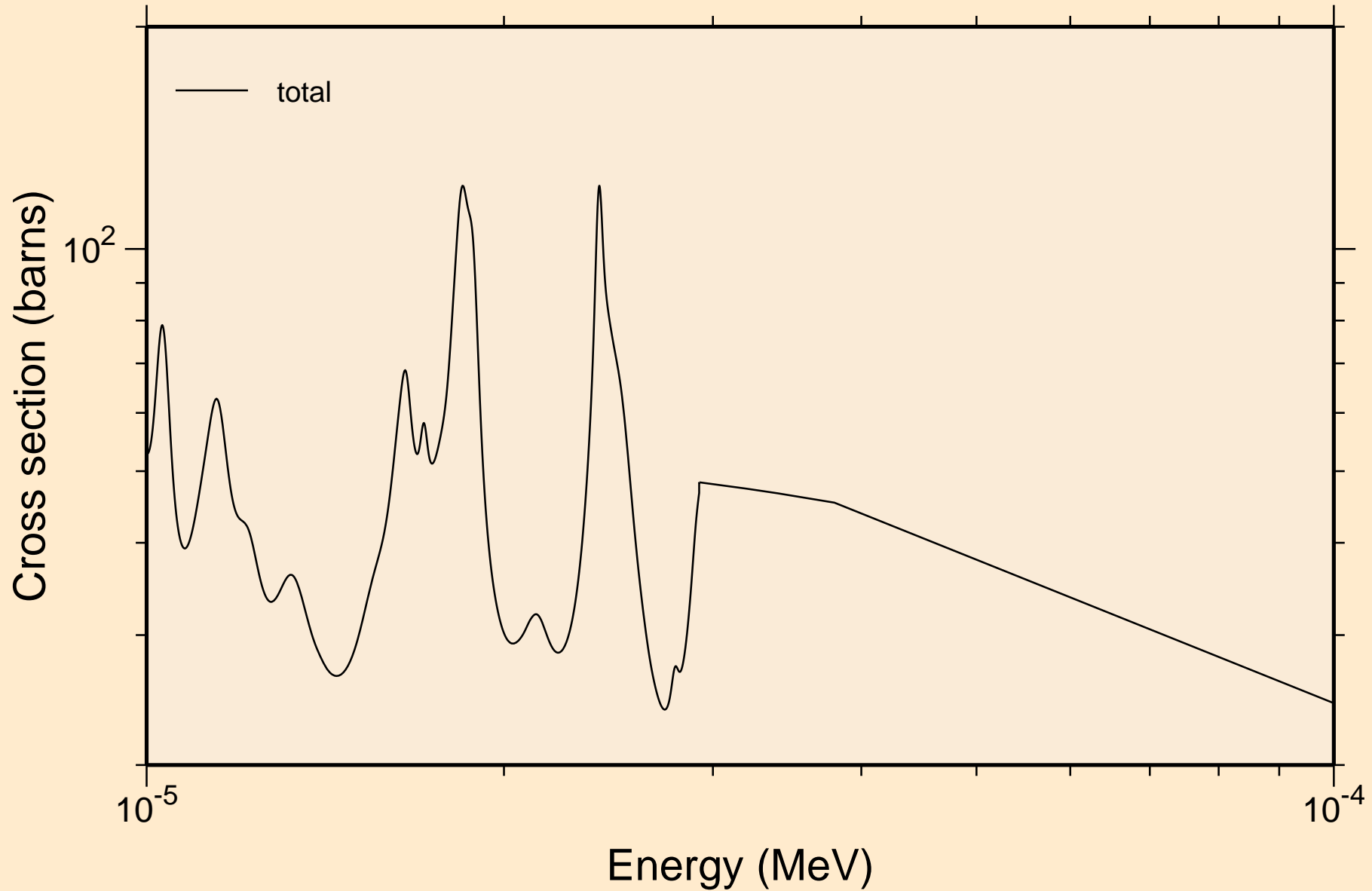

FM259 NEUTRON ACER TENDL-2021 LIBRARY; T=293.6K
resonance total cross section

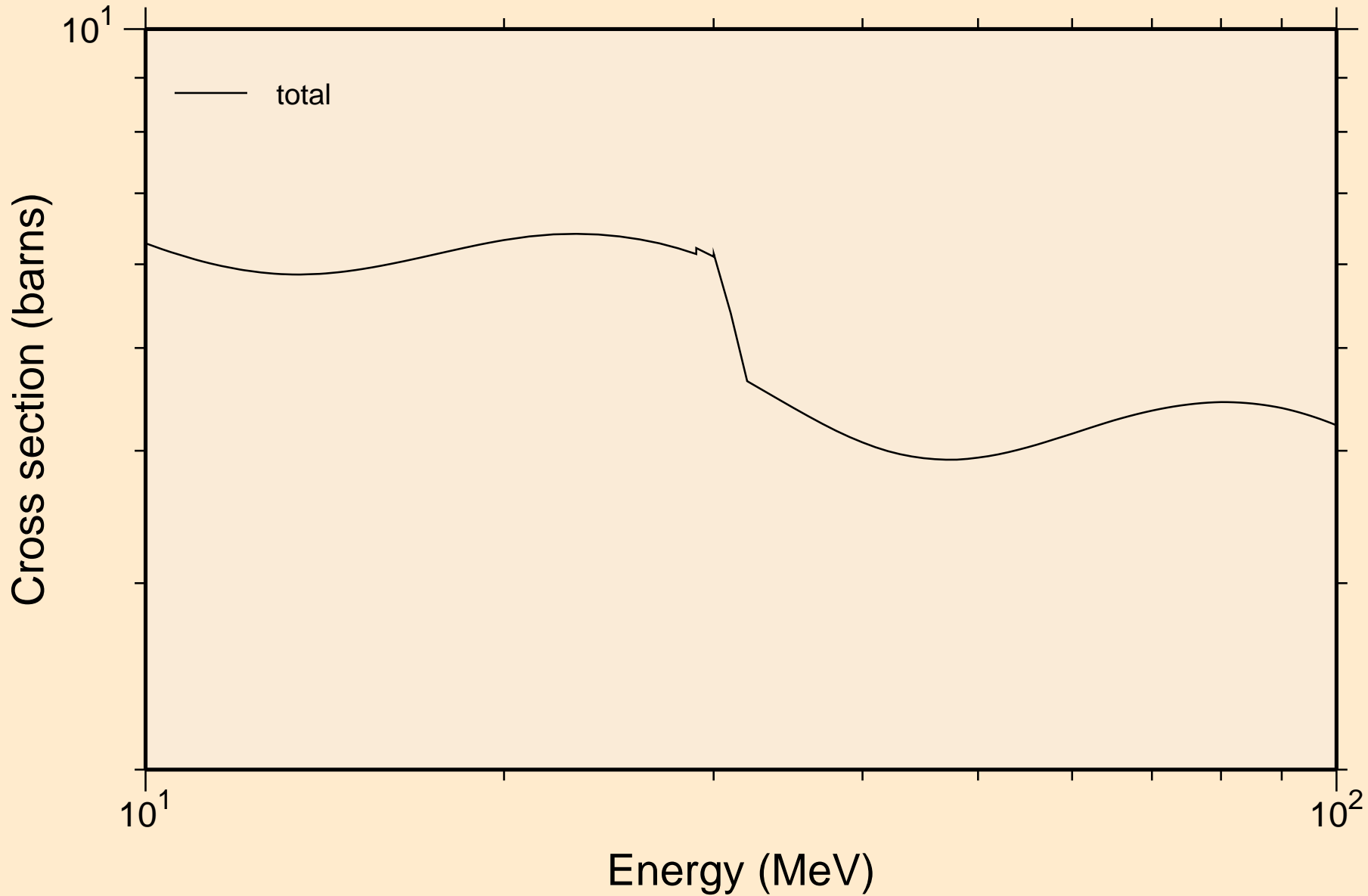

FM259 NEUTRON ACER TENDL-2021 LIBRARY; T=293.6K
resonance absorption cross sections

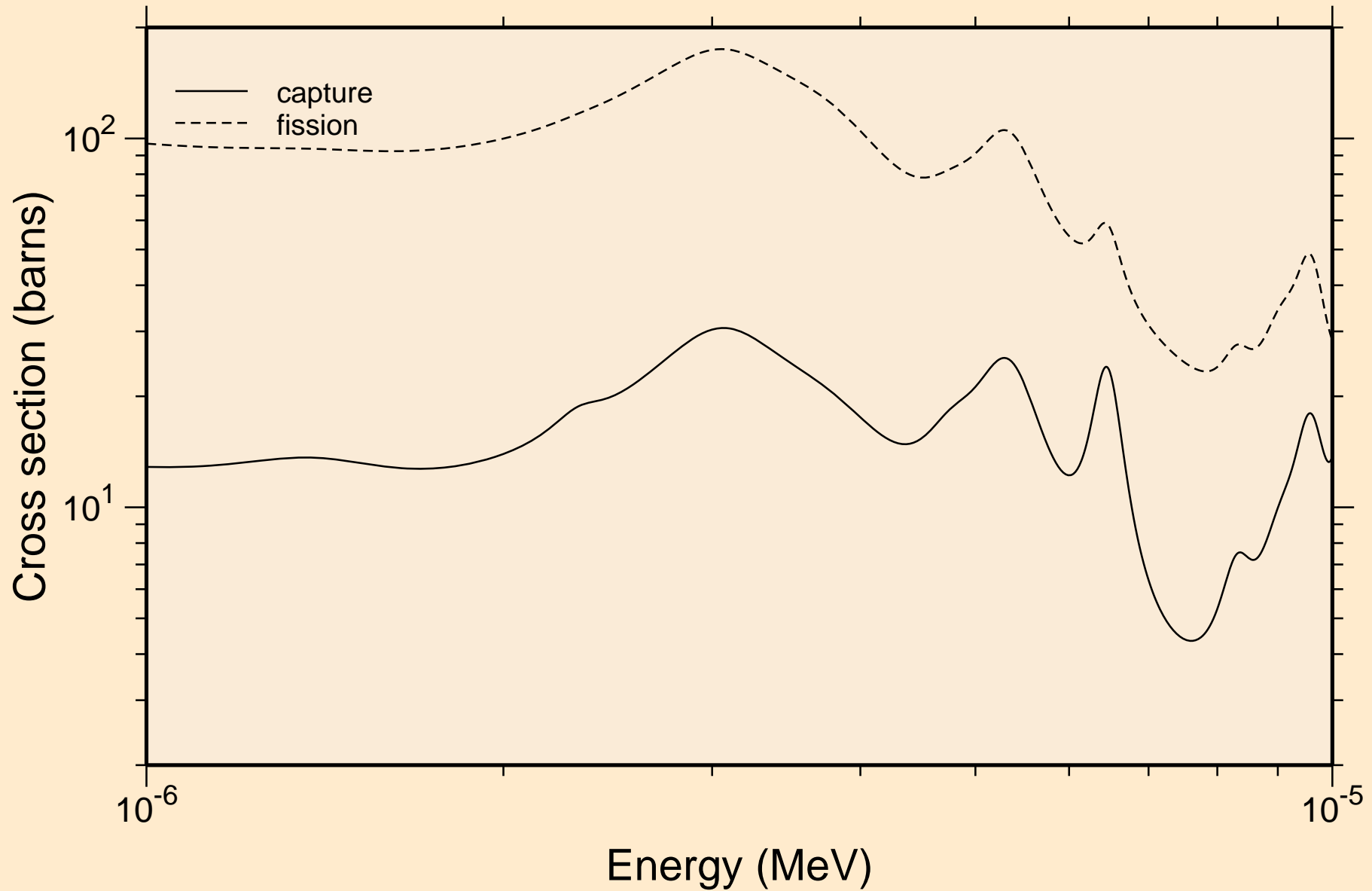

FM259 NEUTRON ACER TENDL-2021 LIBRARY; T=293.6K
resonance absorption cross sections

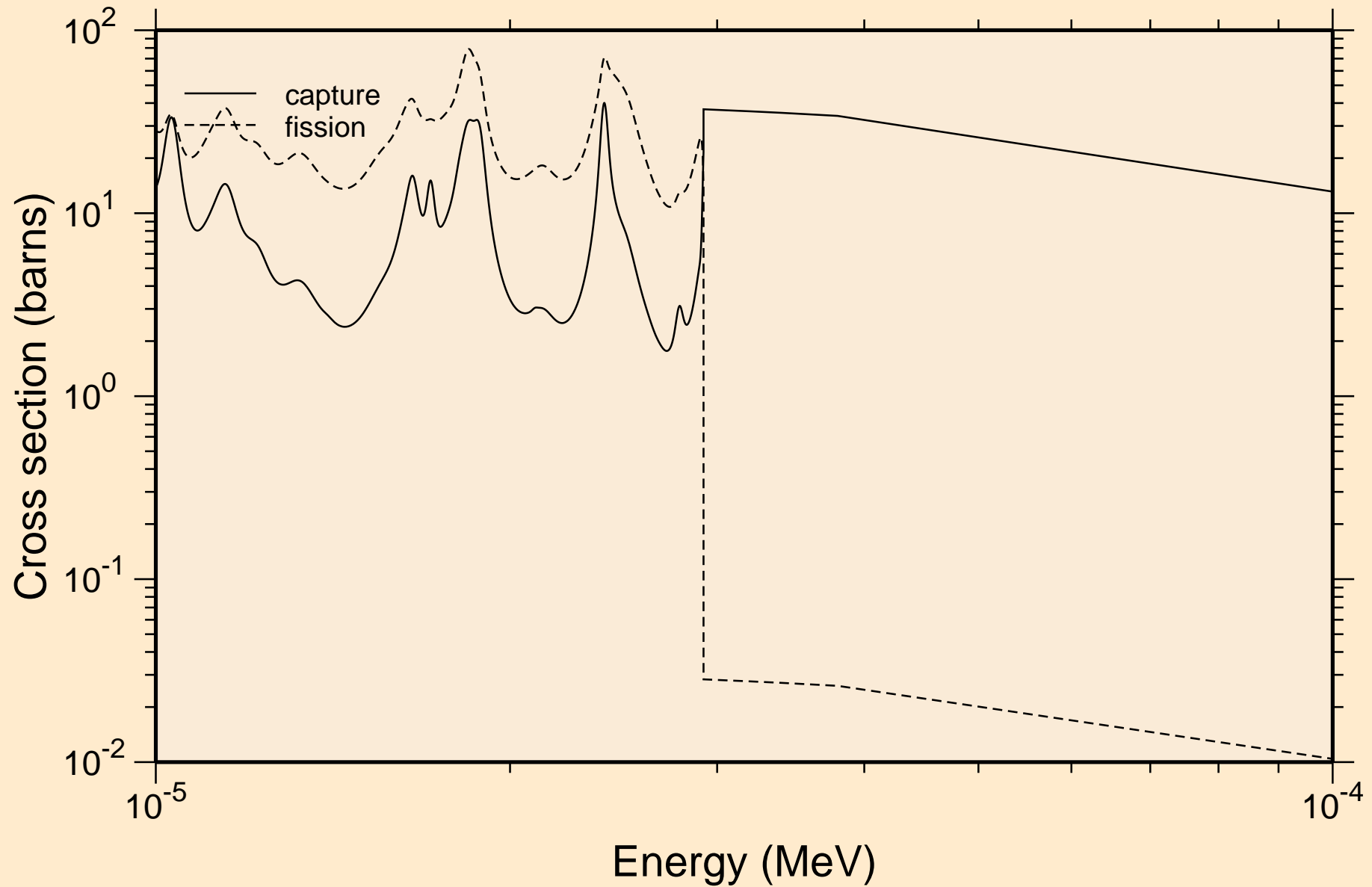

FM259 NEUTRON ACER TENDL-2021 LIBRARY; T=293.6K
resonance absorption cross sections

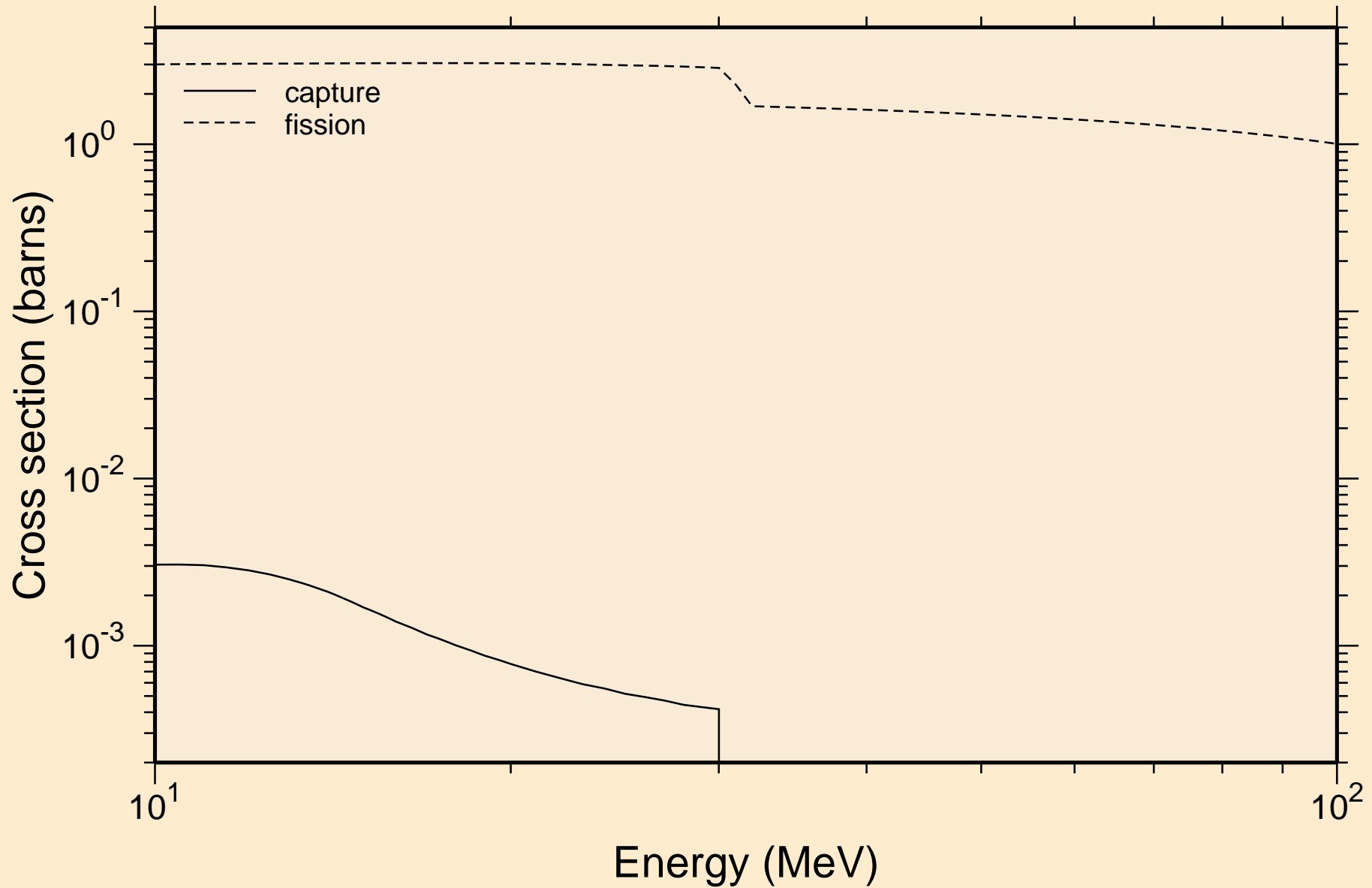

FM259 NEUTRON ACER TENDL-2021 LIBRARY; T=293.6K
Heating

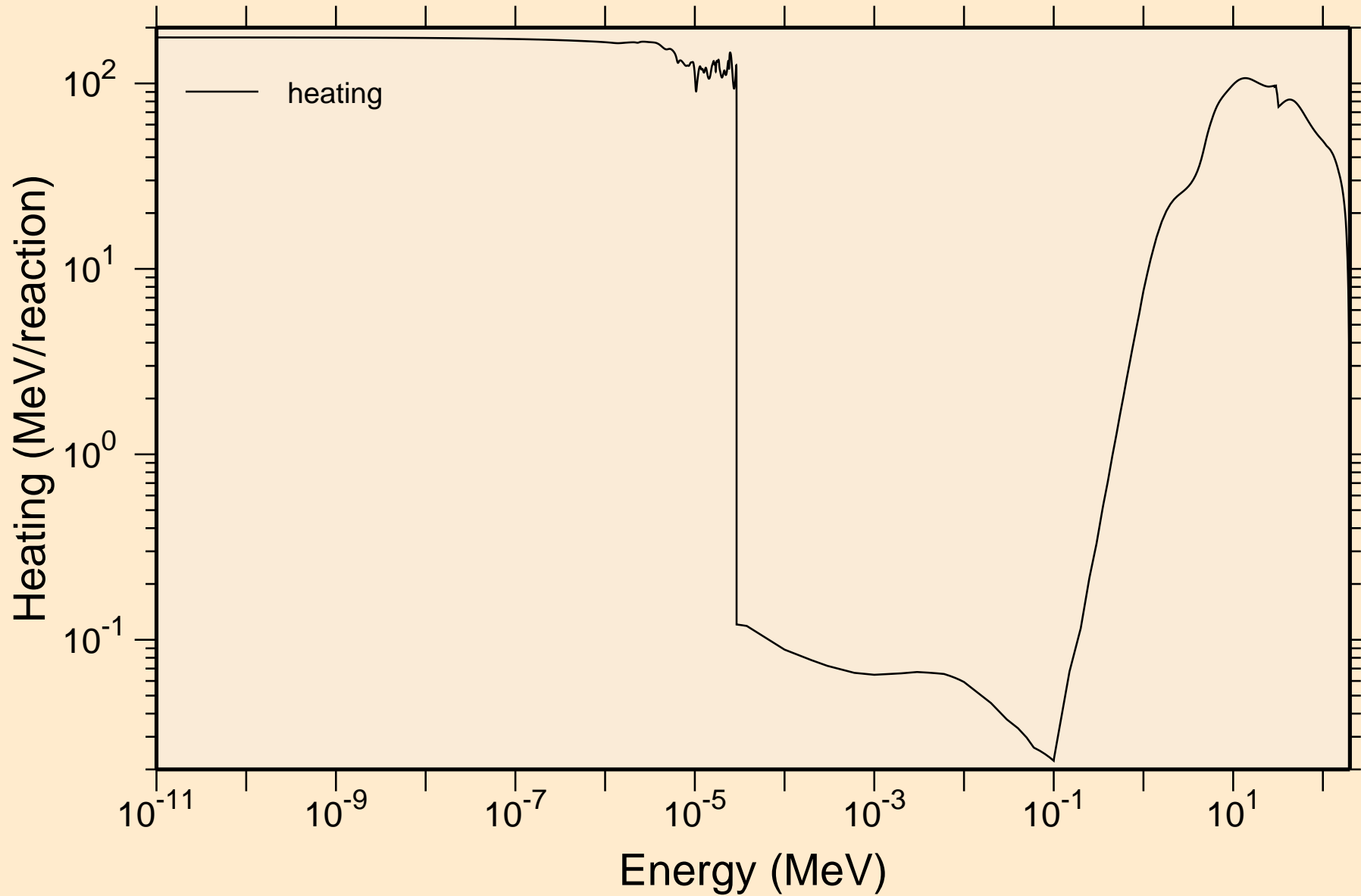

FM259 NEUTRON ACER TENDL-2021 LIBRARY; T=293.6K
Damage

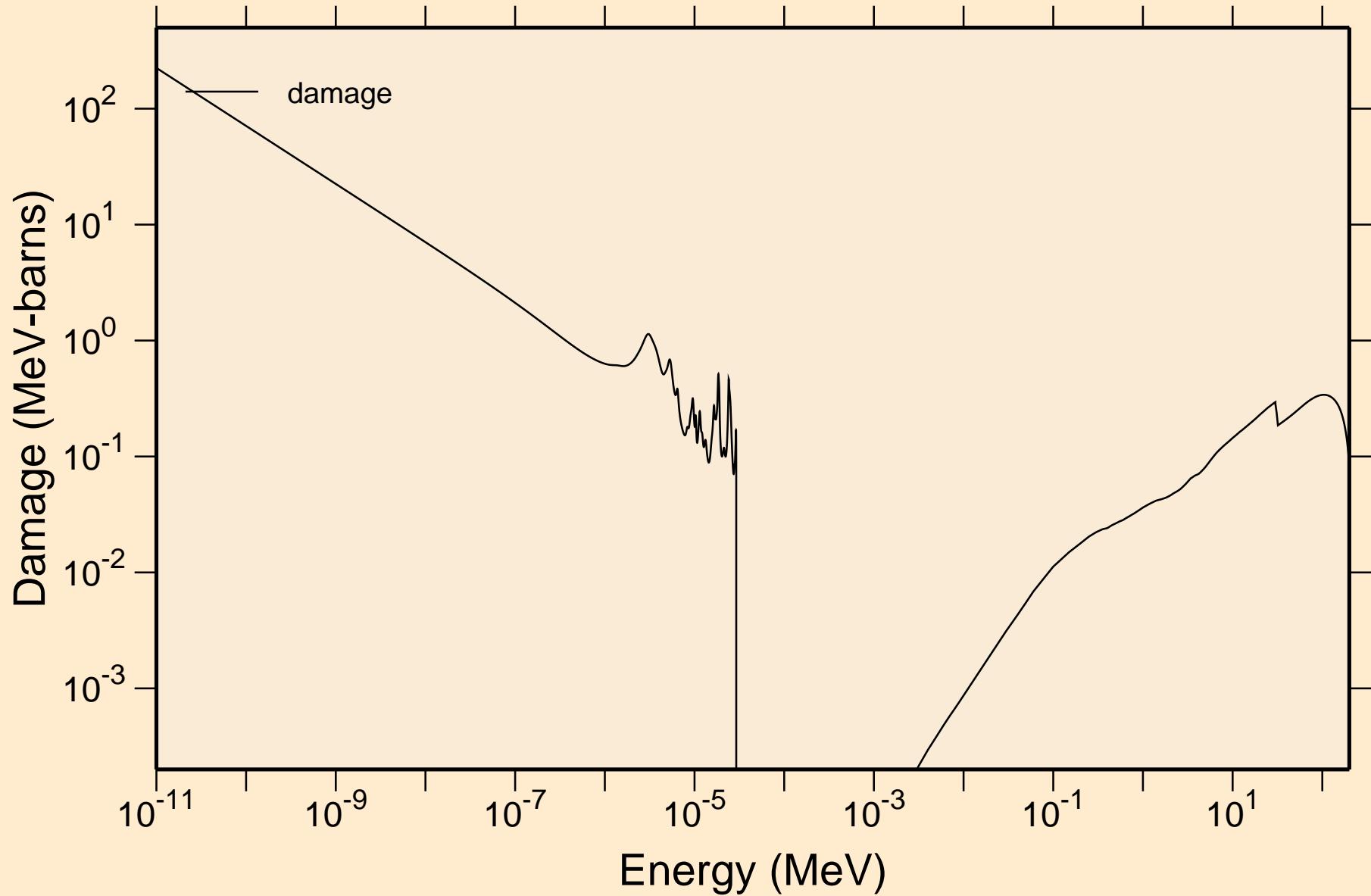

FM259 NEUTRON ACER TENDL-2021 LIBRARY; T=293.6K

Non-threshold reactions

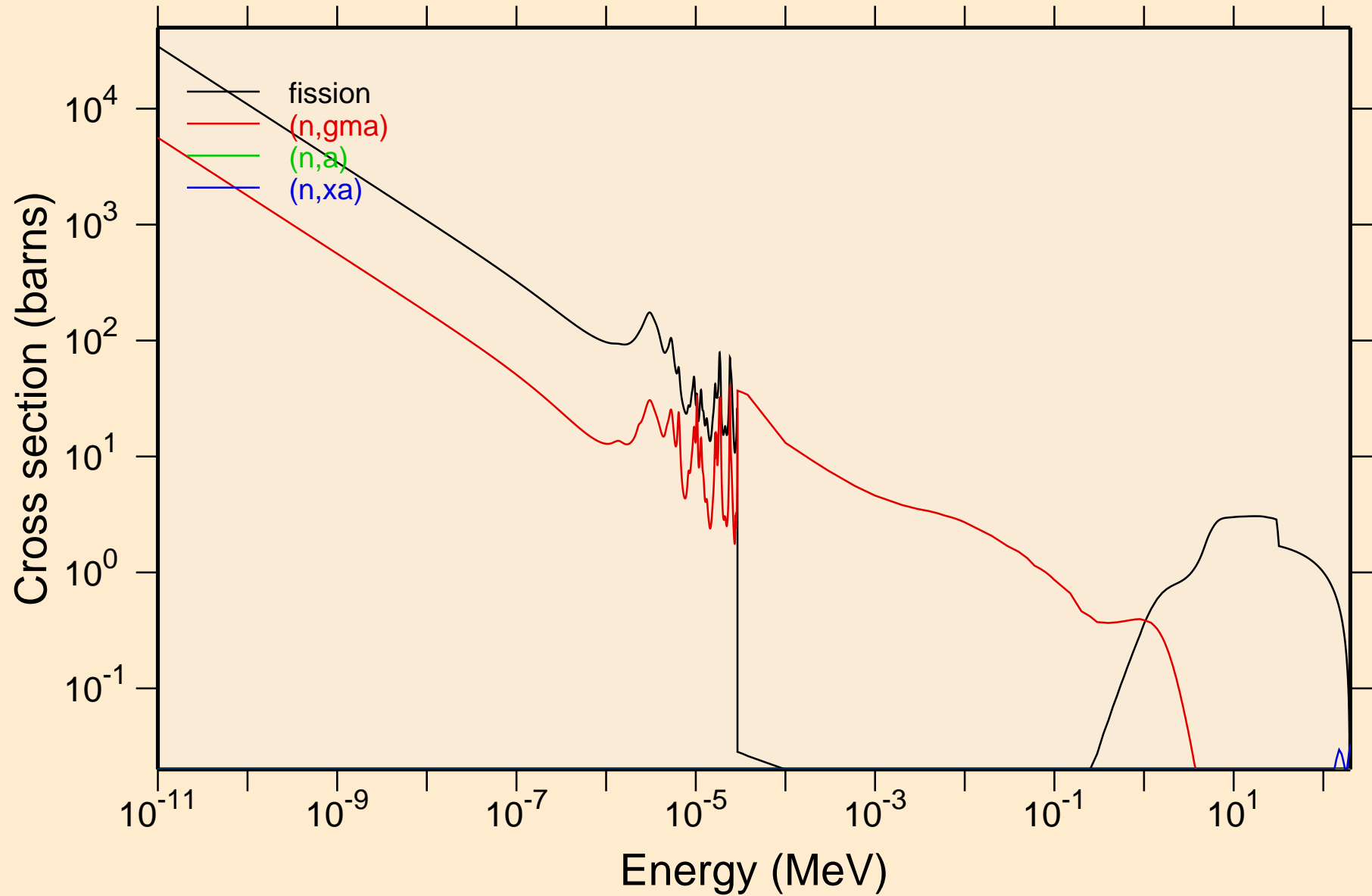

FM259 NEUTRON ACER TENDL-2021 LIBRARY; T=293.6K
Principal cross sections

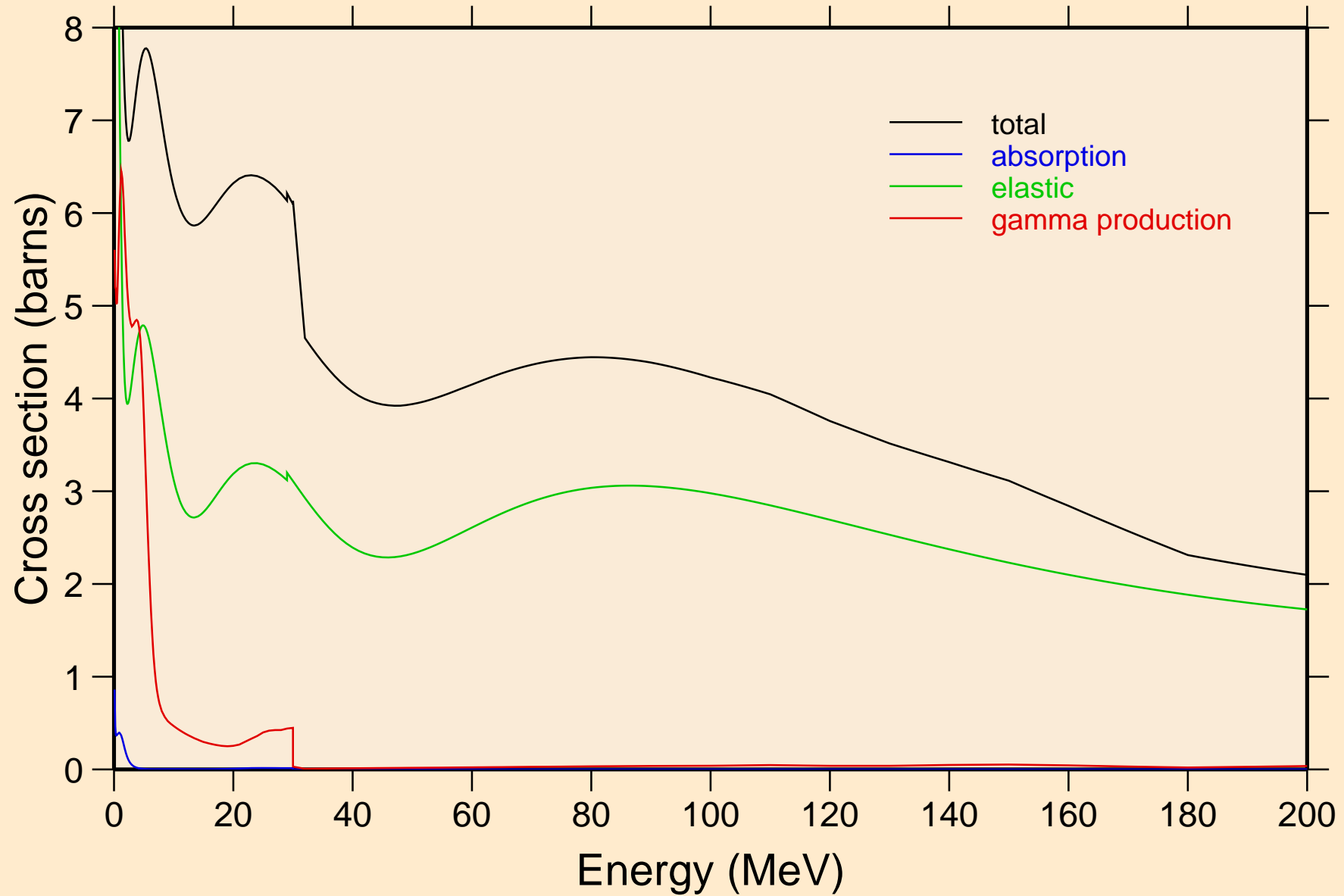

FM259 NEUTRON ACER TENDL-2021 LIBRARY; T=293.6K
Heating

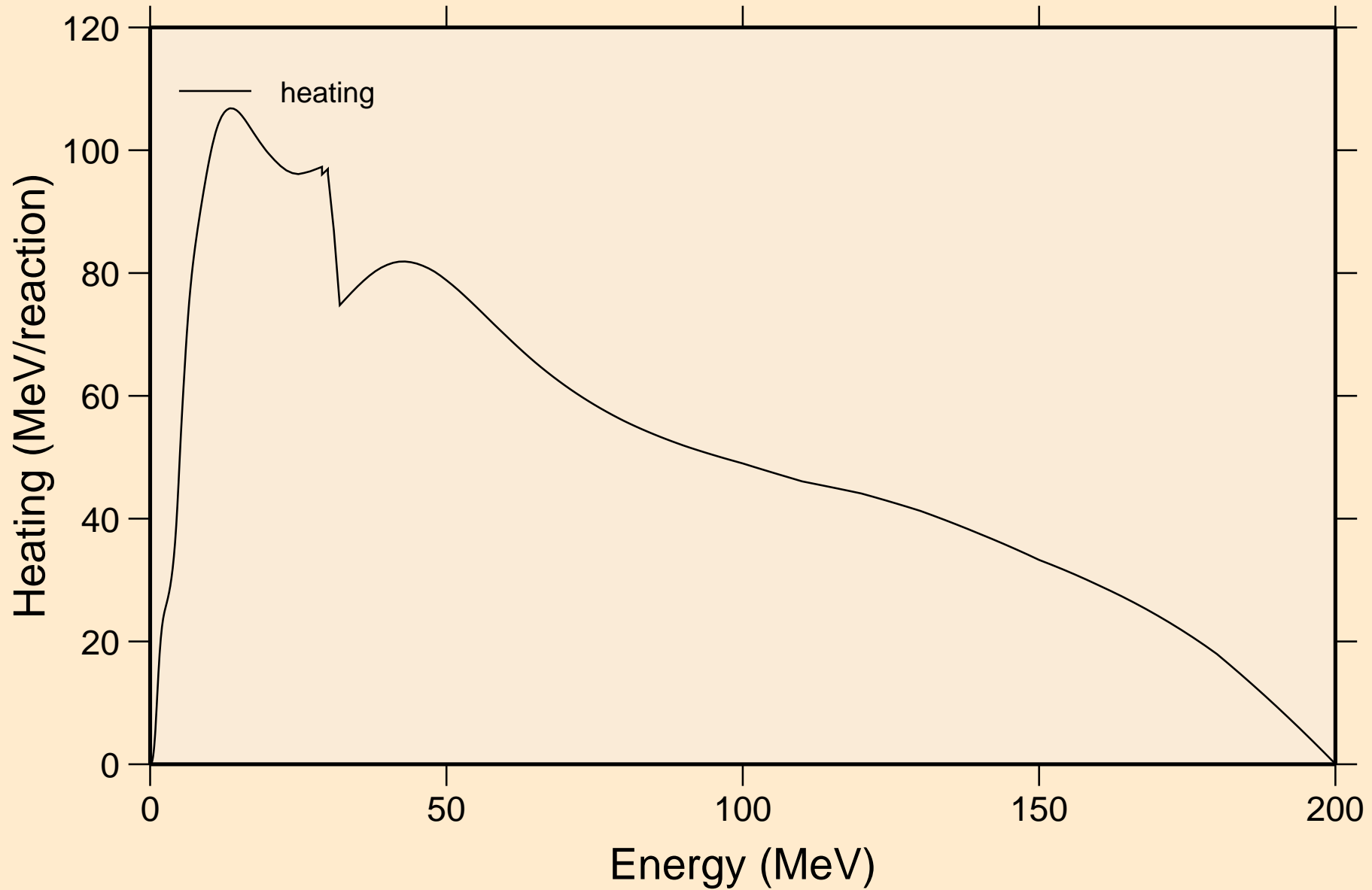

FM259 NEUTRON ACER TENDL-2021 LIBRARY; T=293.6K
Damage

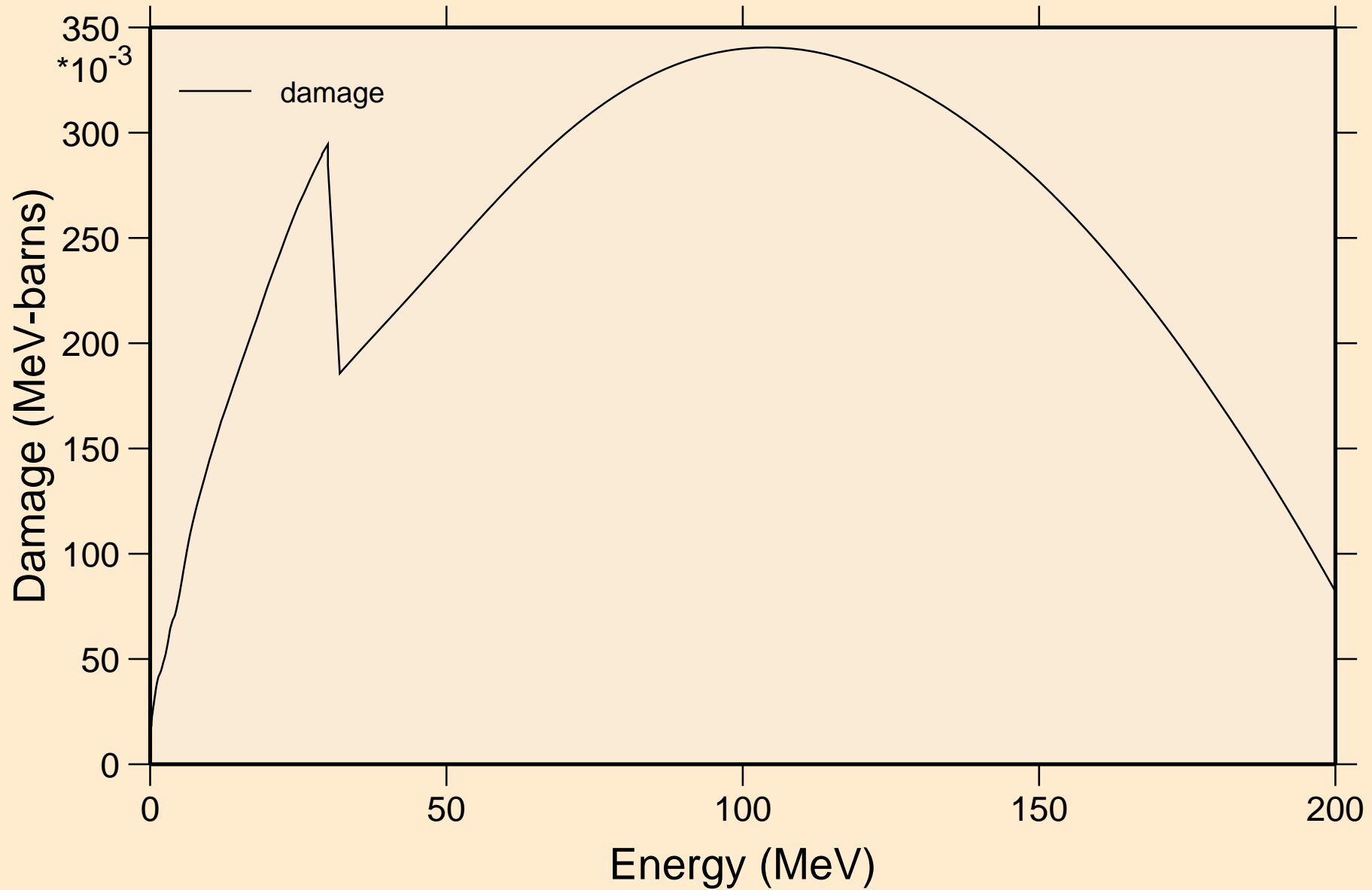

FM259 NEUTRON ACER TENDL-2021 LIBRARY; T=293.6K

Non-threshold reactions

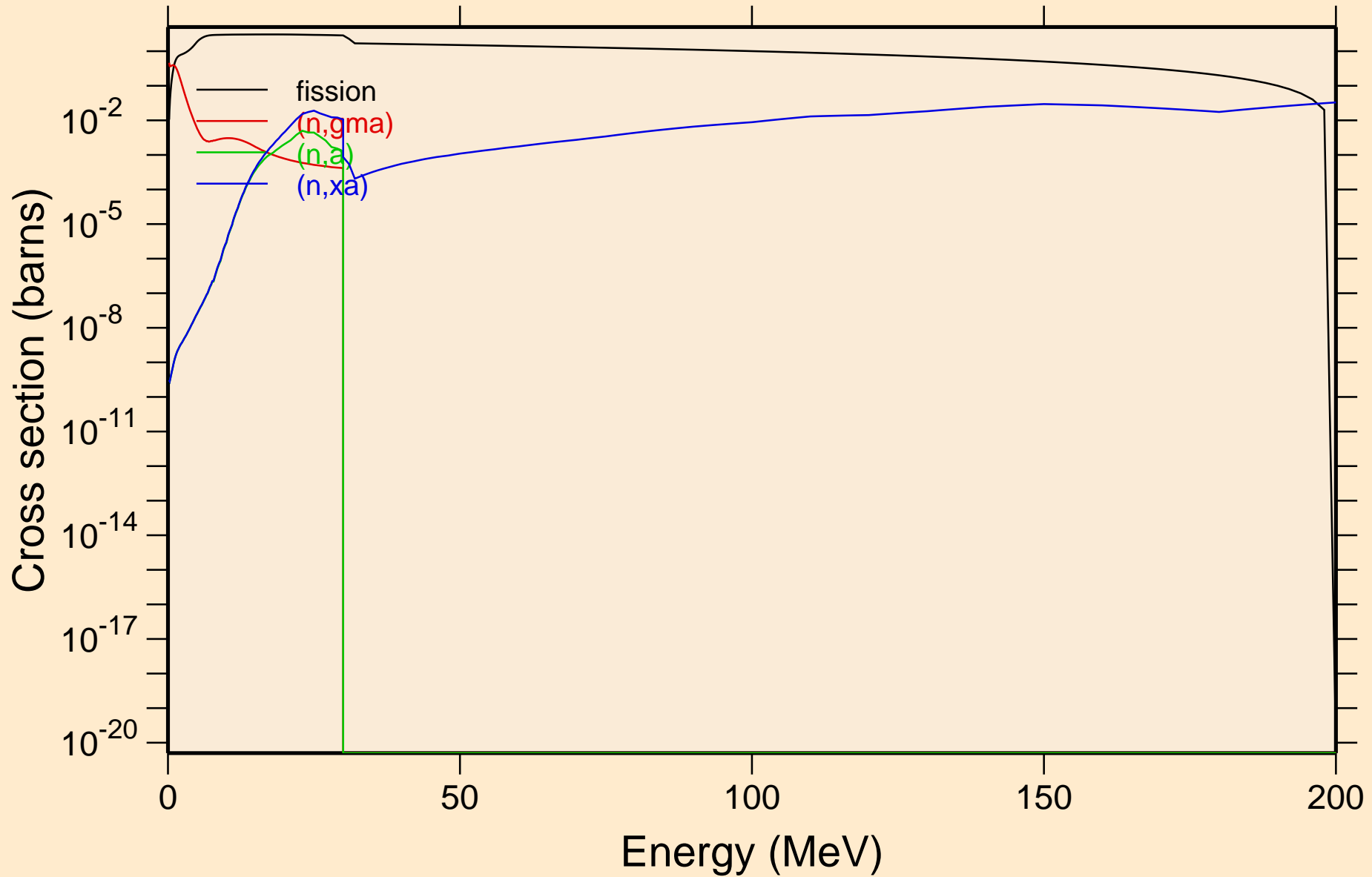

FM259 NEUTRON ACER TENDL-2021 LIBRARY; T=293.6K
Inelastic levels

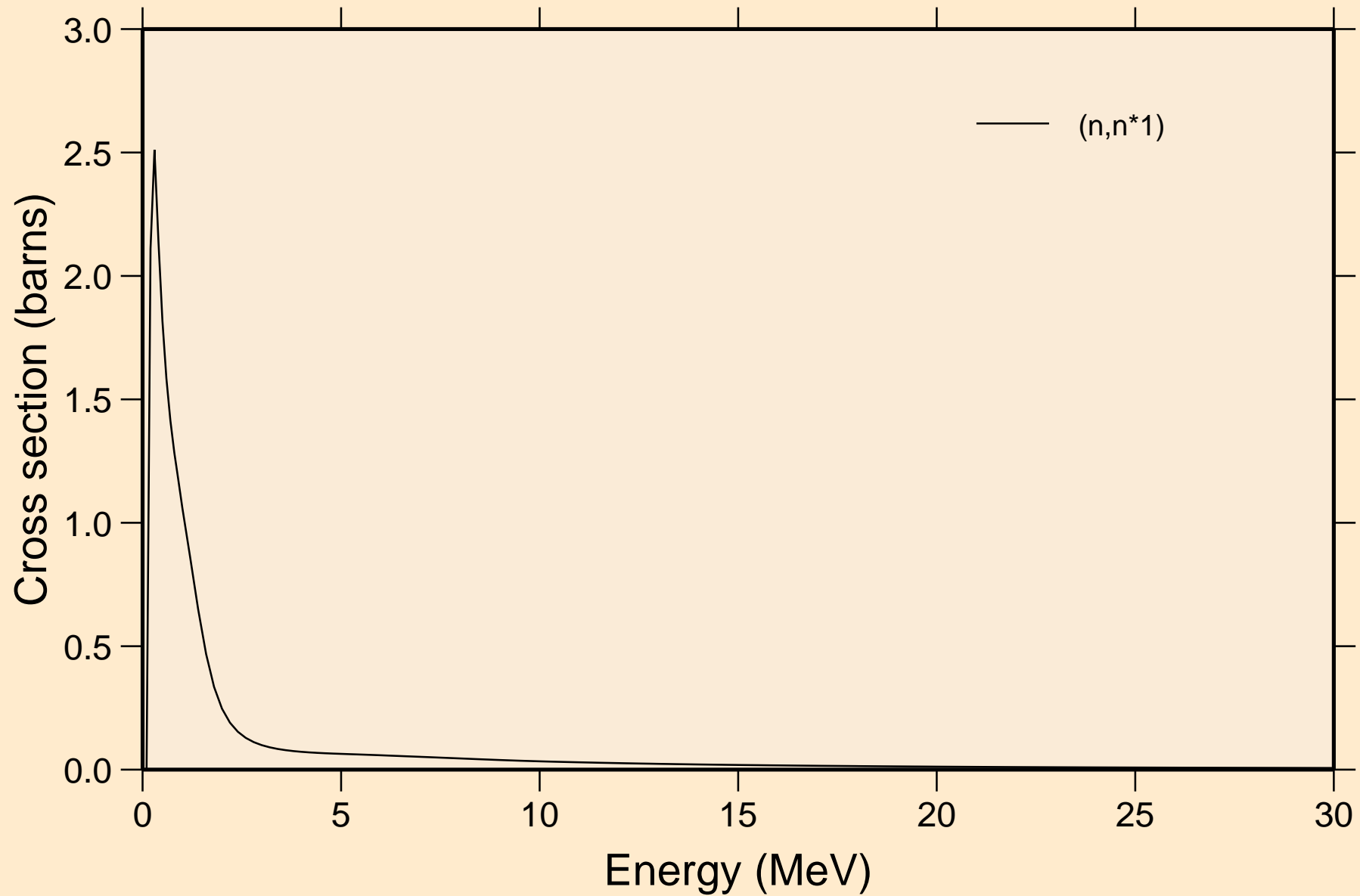

FM259 NEUTRON ACER TENDL-2021 LIBRARY; T=293.6K
Threshold reactions

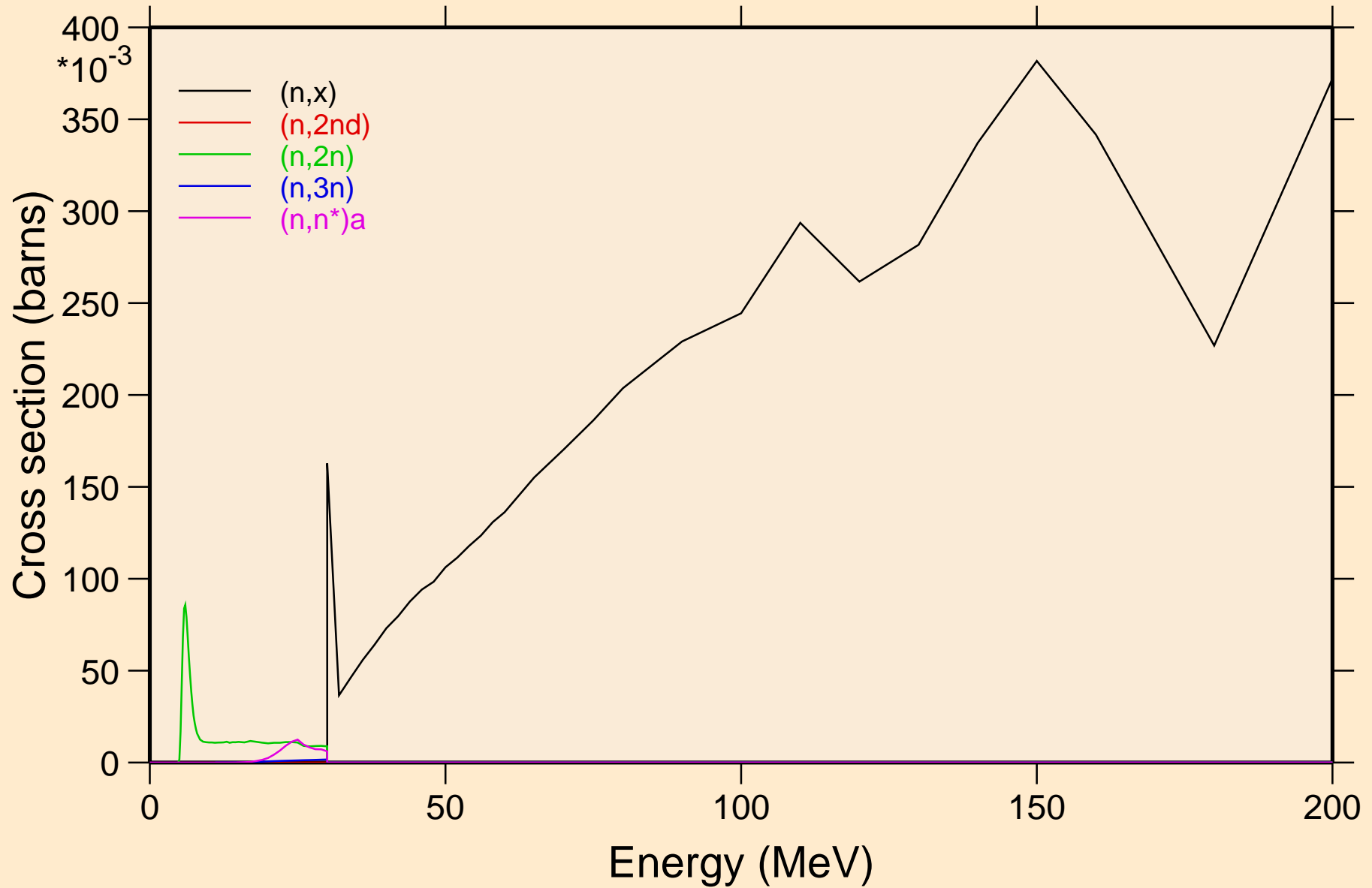

FM259 NEUTRON ACER TENDL-2021 LIBRARY; T=293.6K
Threshold reactions

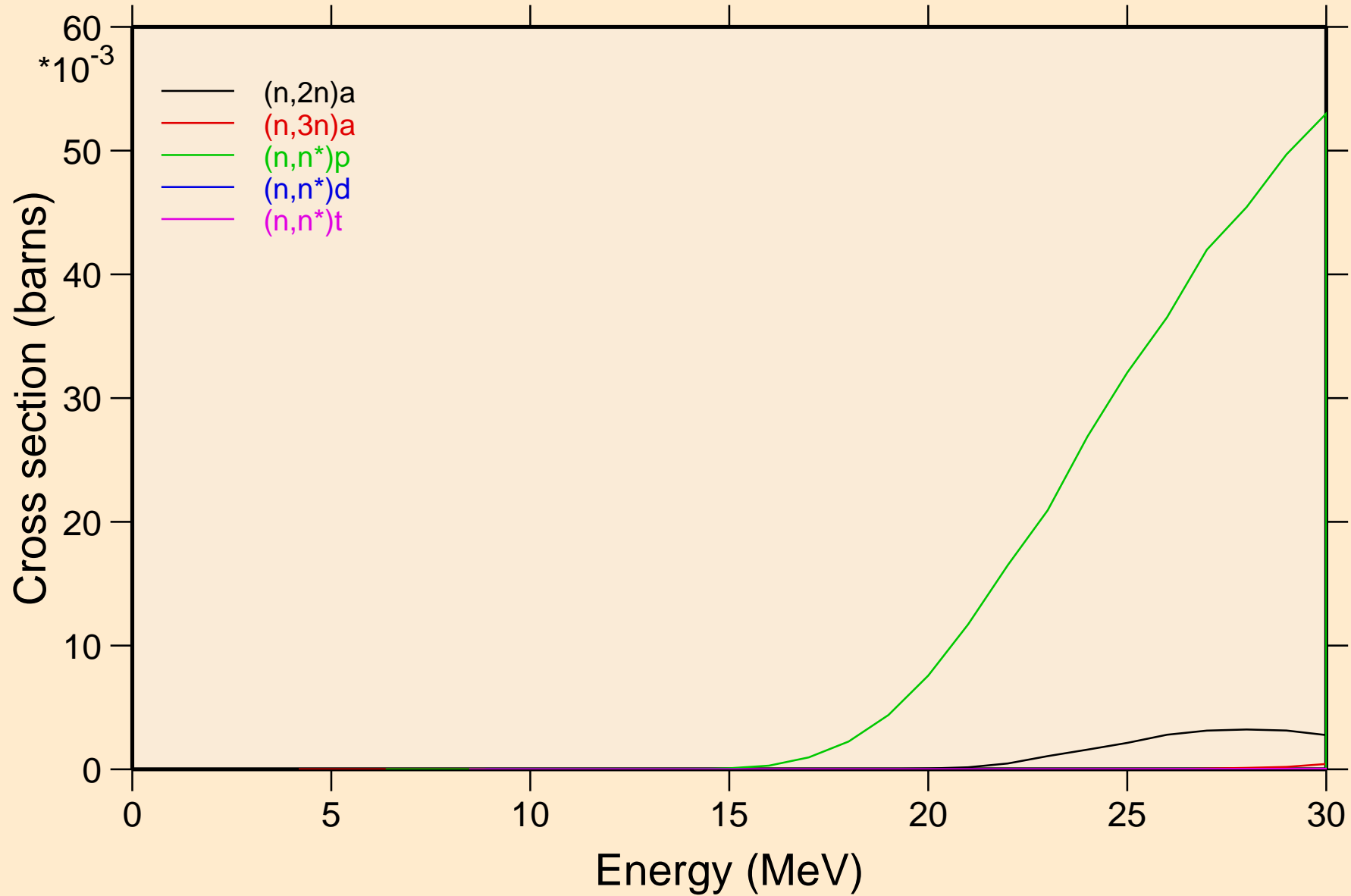

FM259 NEUTRON ACER TENDL-2021 LIBRARY; T=293.6K
Threshold reactions

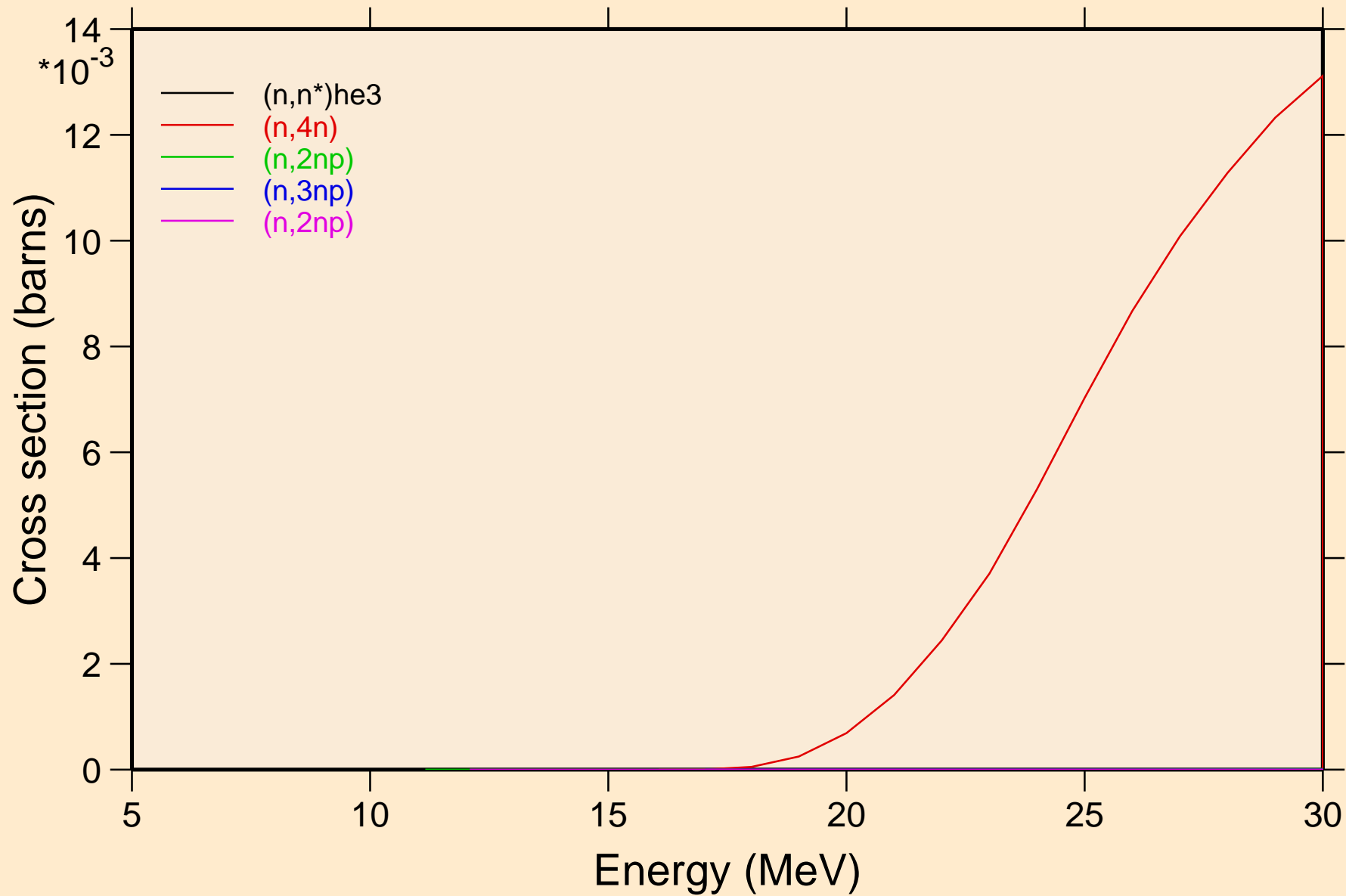

FM259 NEUTRON ACER TENDL-2021 LIBRARY; T=293.6K
Threshold reactions

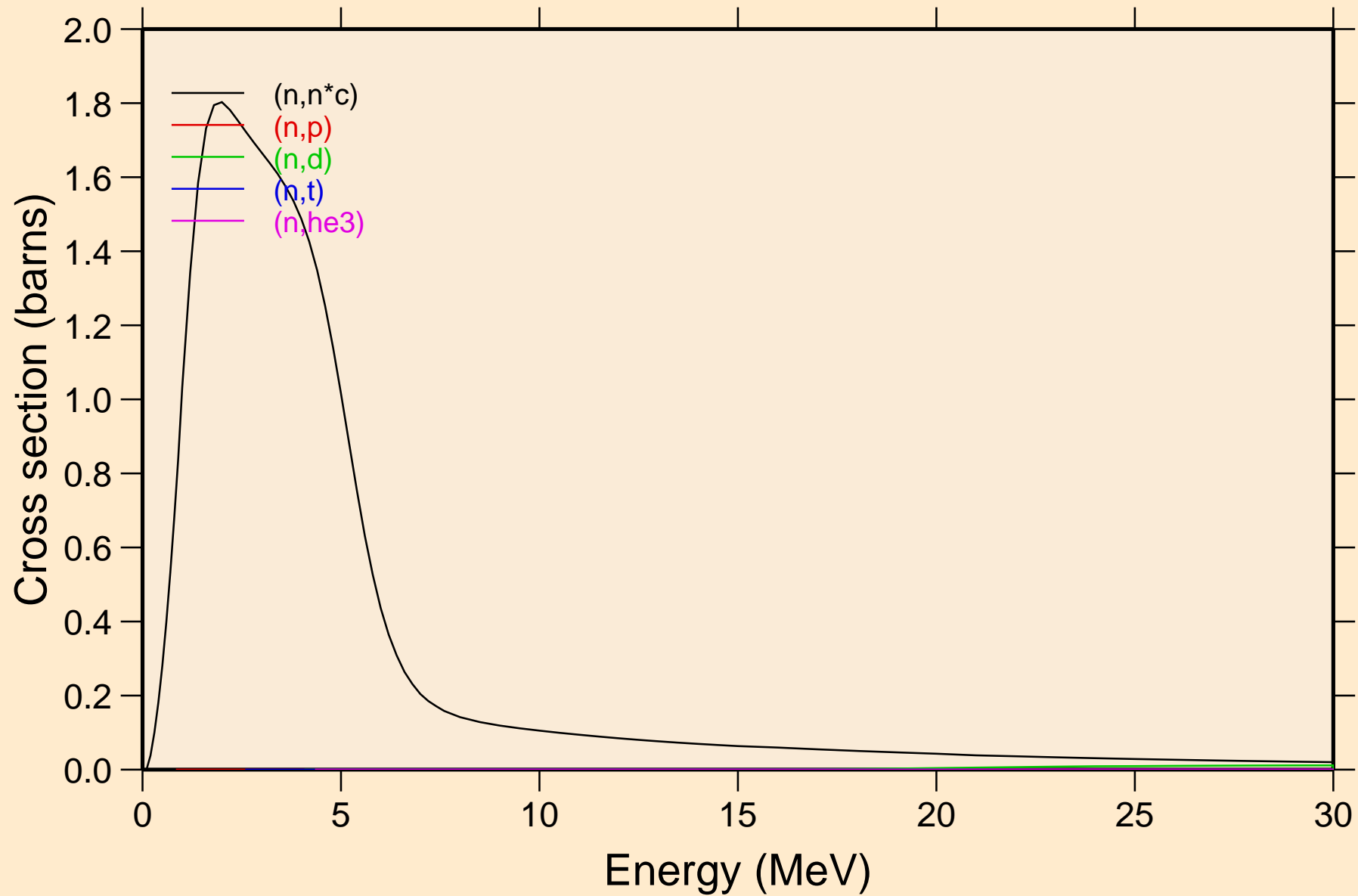

FM259 NEUTRON ACER TENDL-2021 LIBRARY; T=293.6K
Threshold reactions

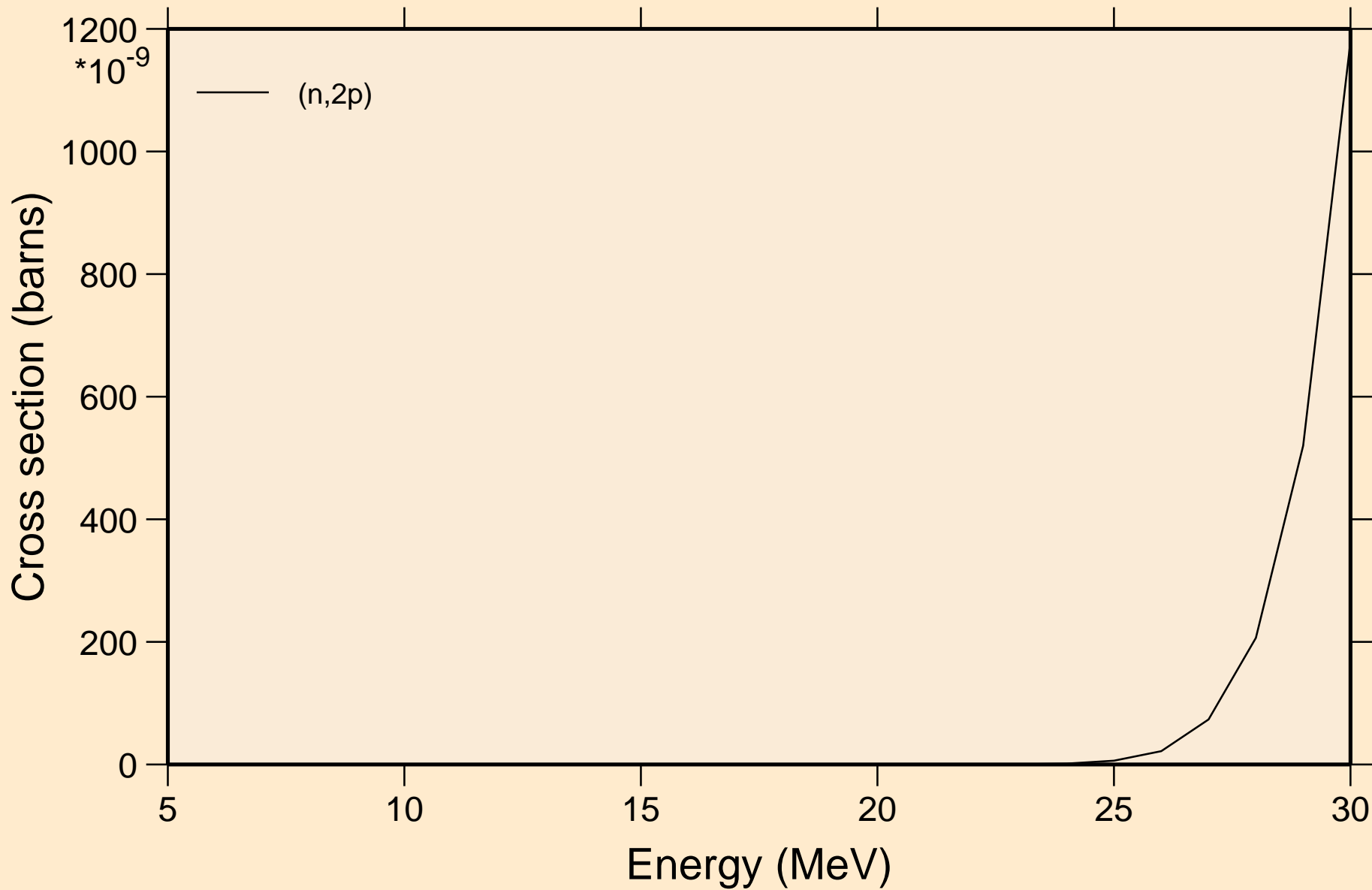

FM259 NEUTRON ACER TENDL-2021 LIBRARY; T=293.6K

Threshold reactions

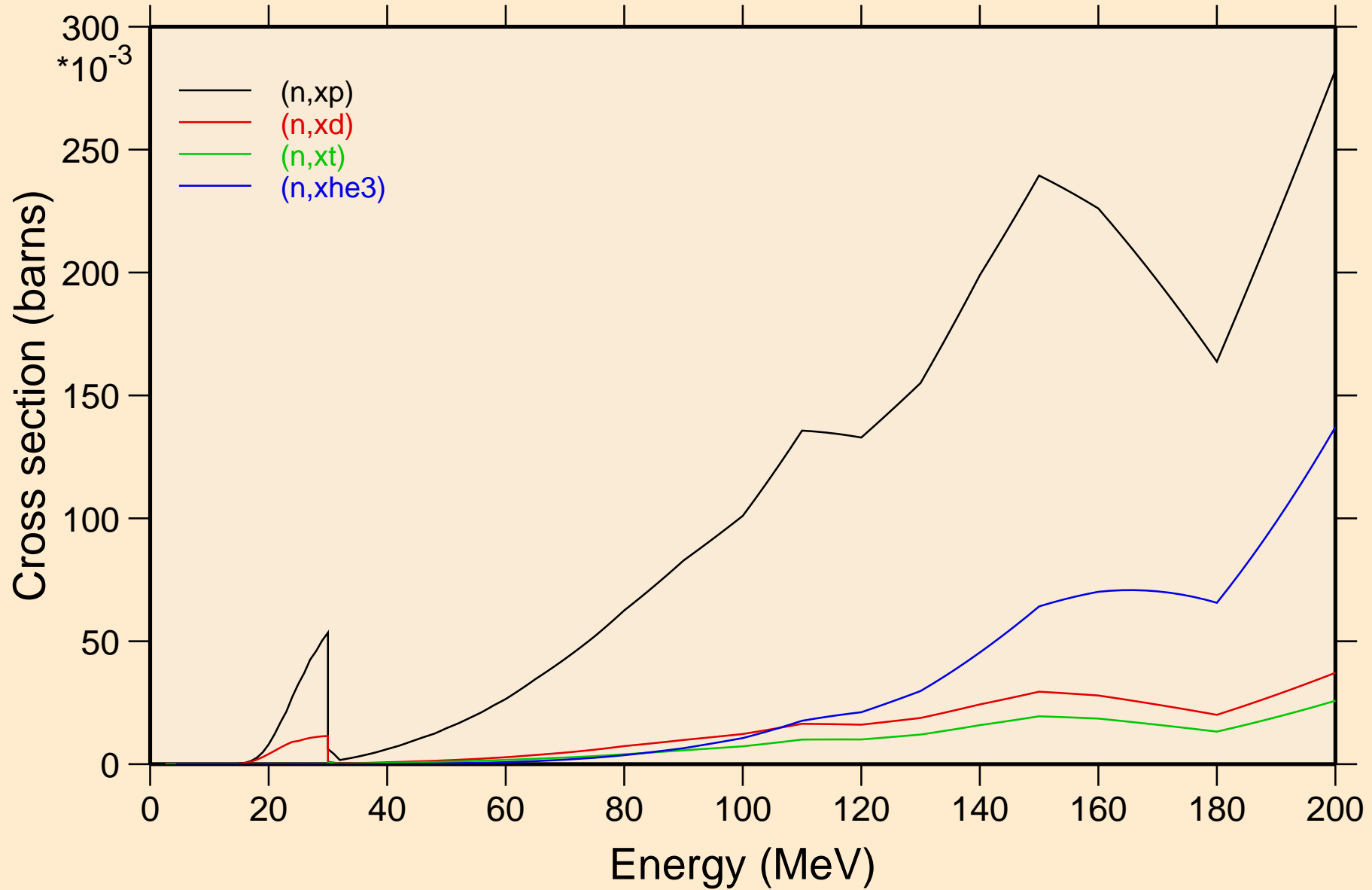

FM259 NEUTRON ACER TENDL-2021 LIBRARY; T=293.6K
angular distribution for elastic

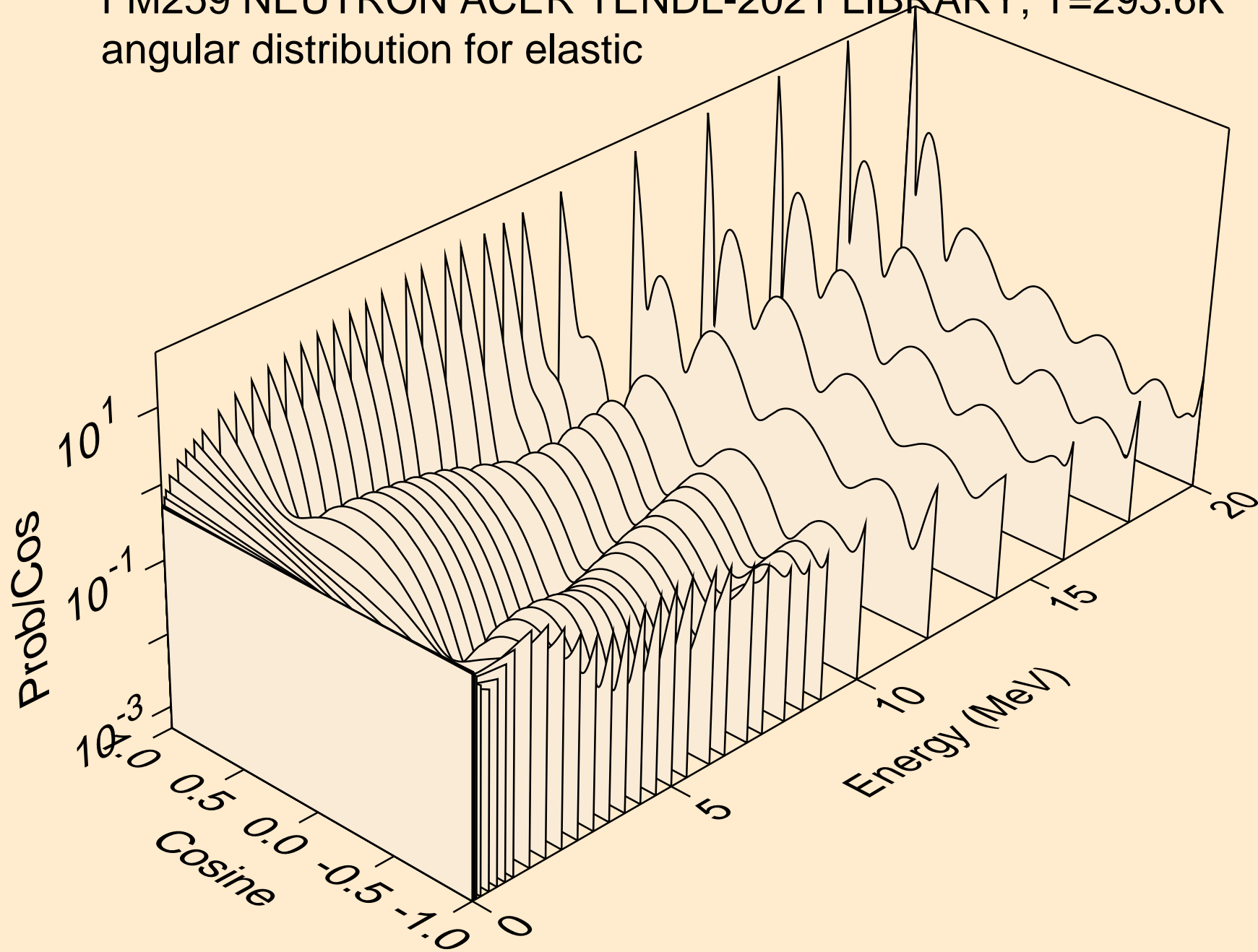

FM259 NEUTRON ACER TENDL-2021 LIBRARY; T=293.6K
angular distribution for elastic

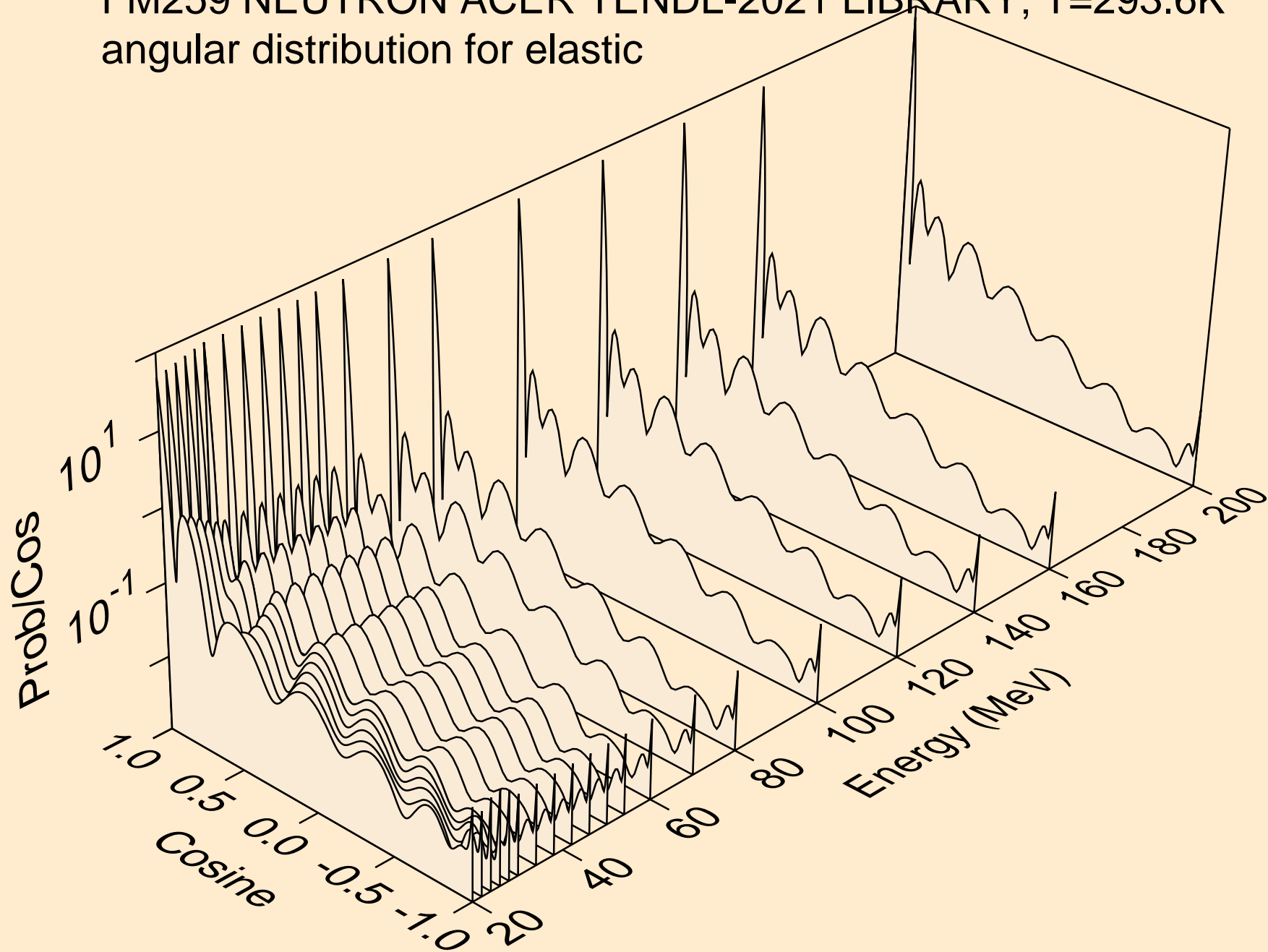

FM259 NEUTRON ACER TENDL-2021 LIBRARY; T=293.6K
angular distribution for (n,n*1)

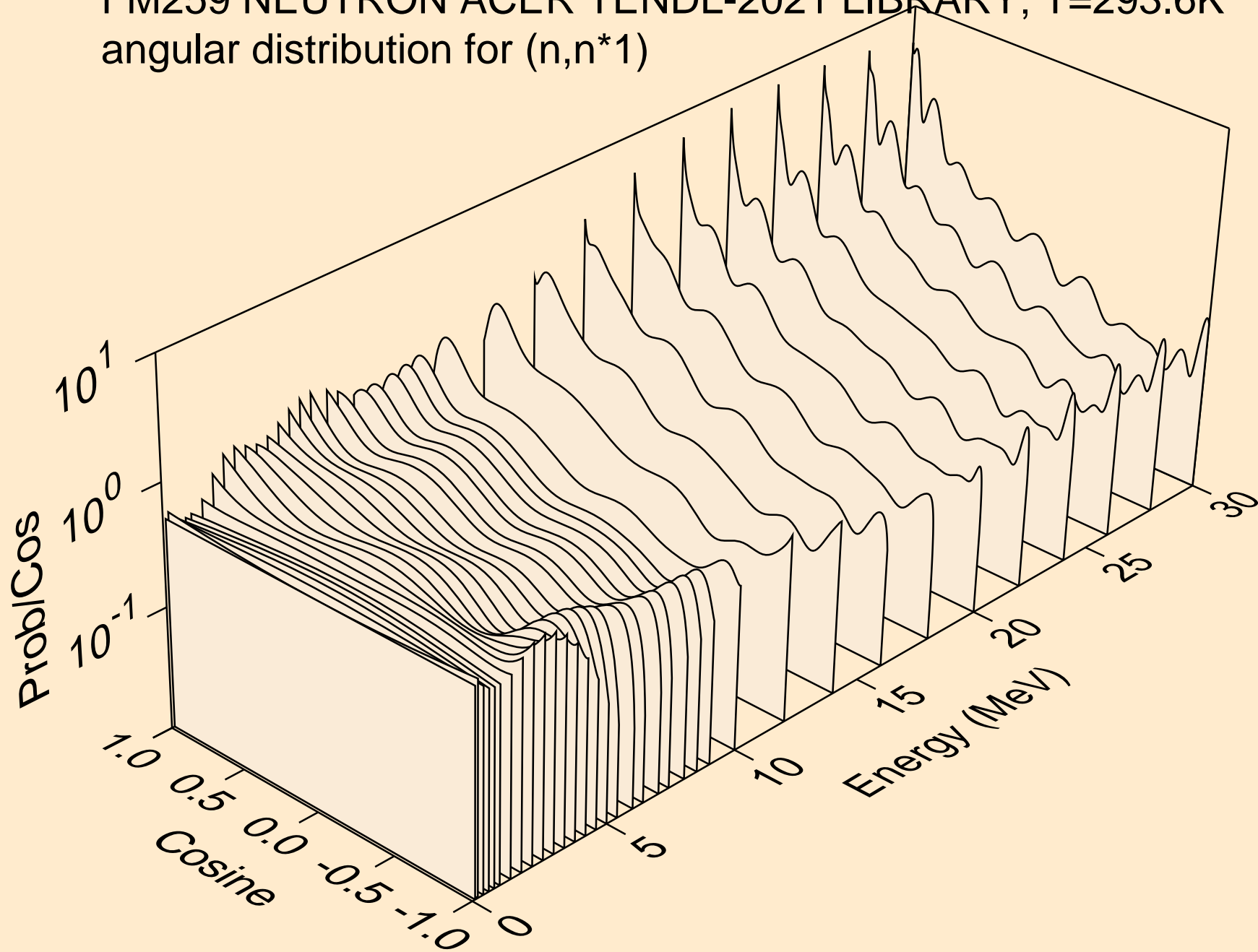

FM259 NEUTRON ACER TENDL-2021 LIBRARY; T=293.6K
Total fission nubar

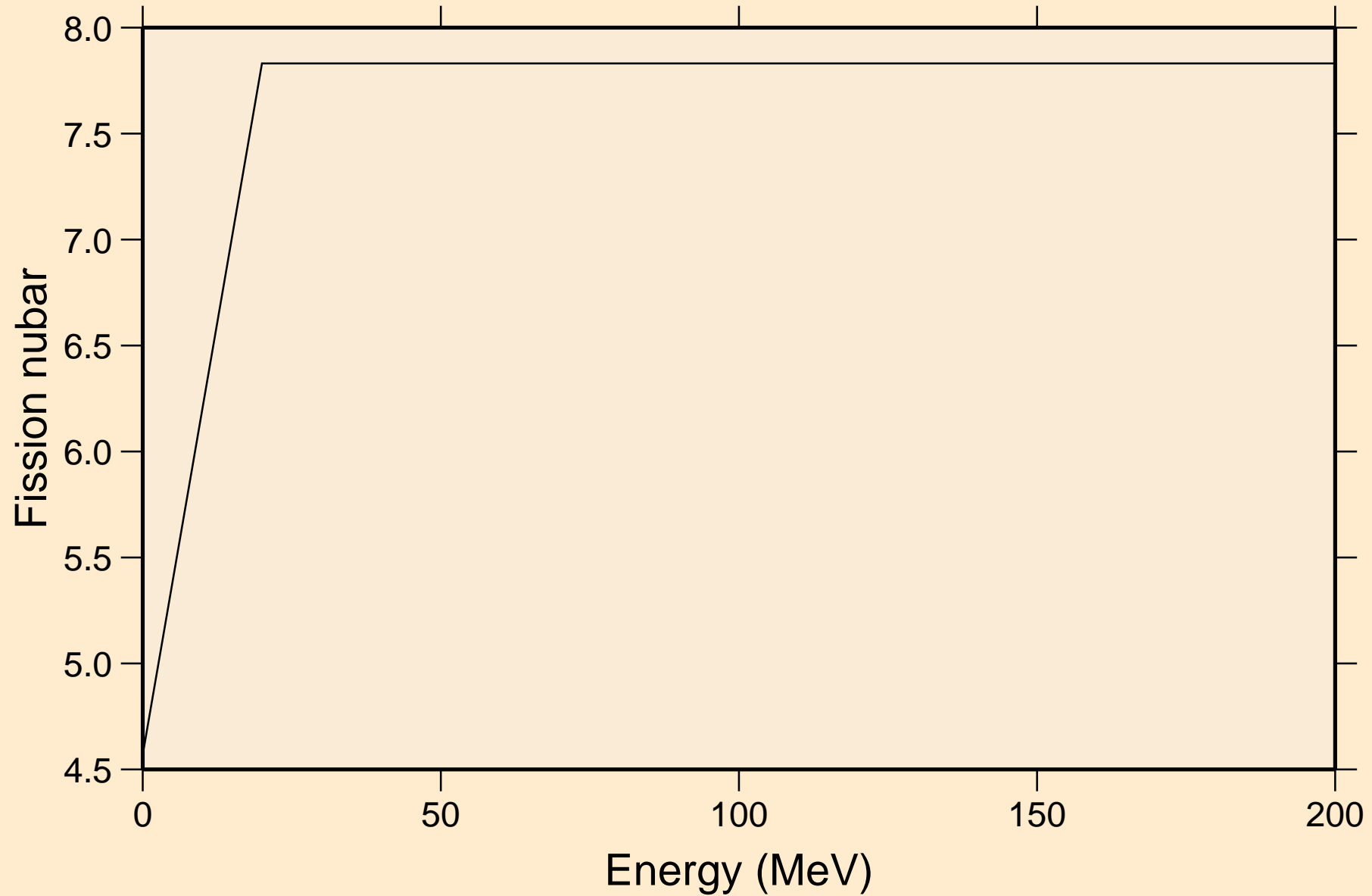

FM259 NEUTRON ACER TENDL-2021 LIBRARY; T=293.6K
Neutron emission for (n,x)

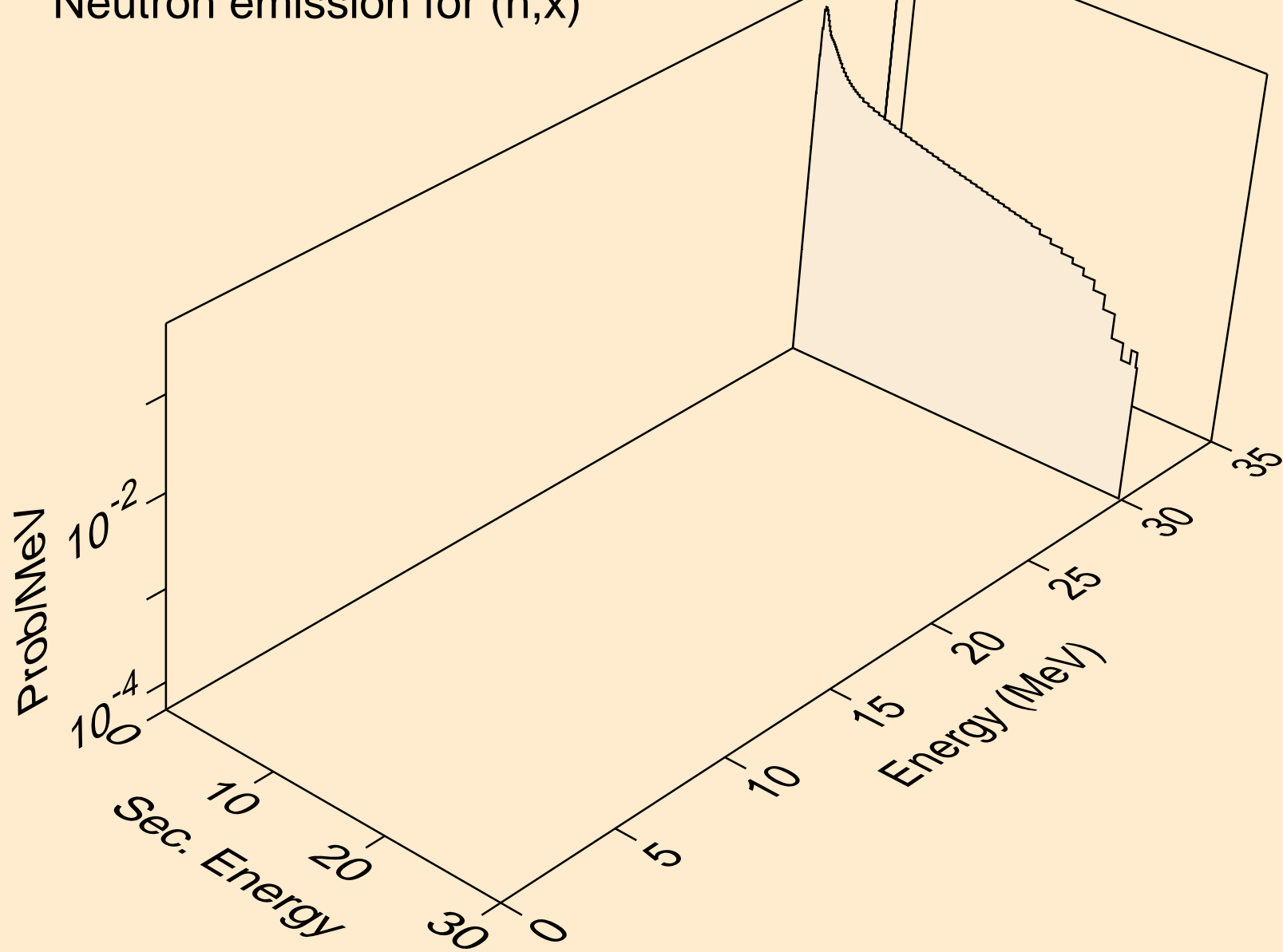

FM259 NEUTRON ACER TENDL-2021 LIBRARY; T=293.6K
Neutron emission for (n,2nd)

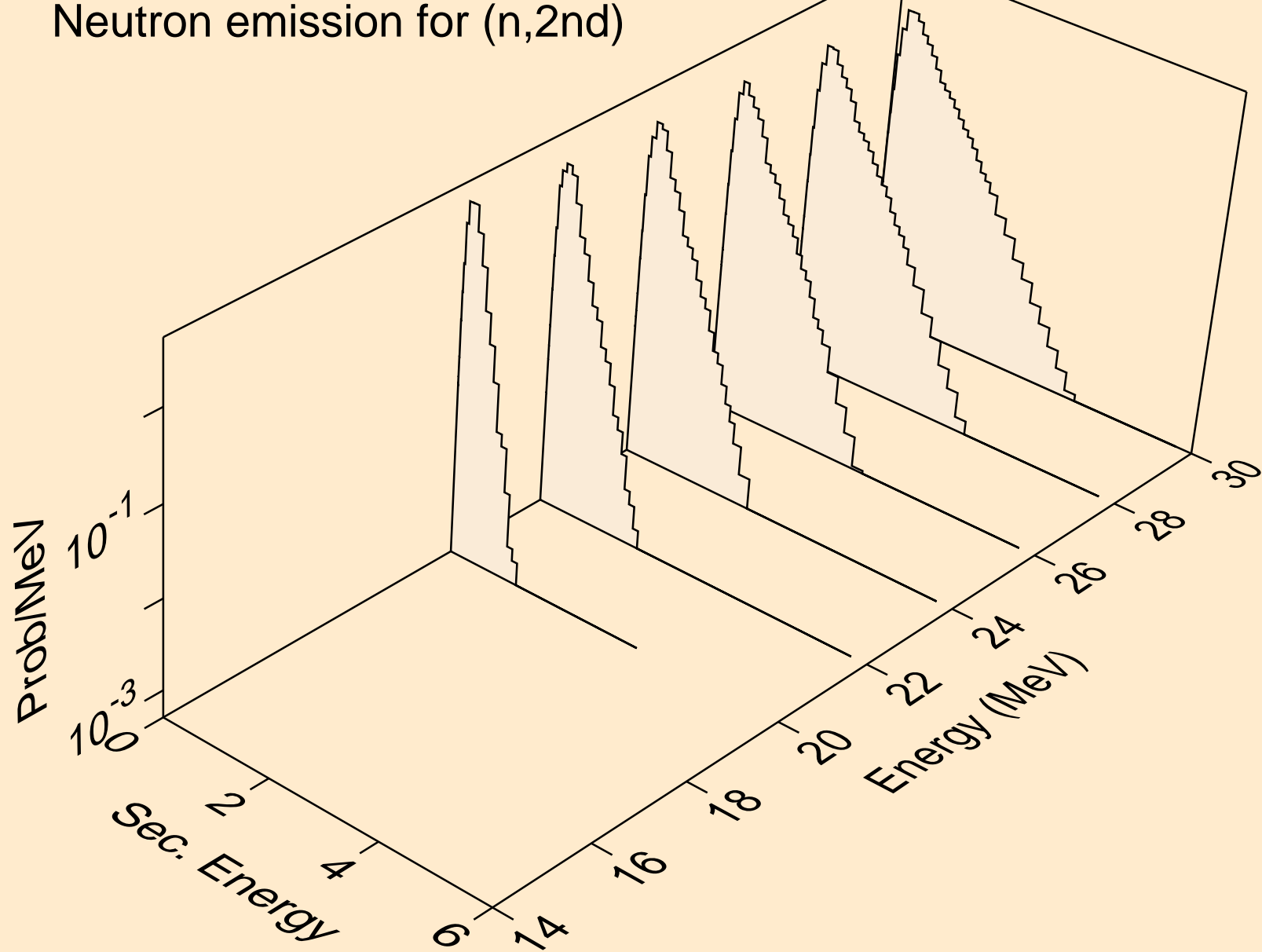

FM259 NEUTRON ACER TENDL-2021 LIBRARY; T=293.6K
Neutron emission for (n,2n)

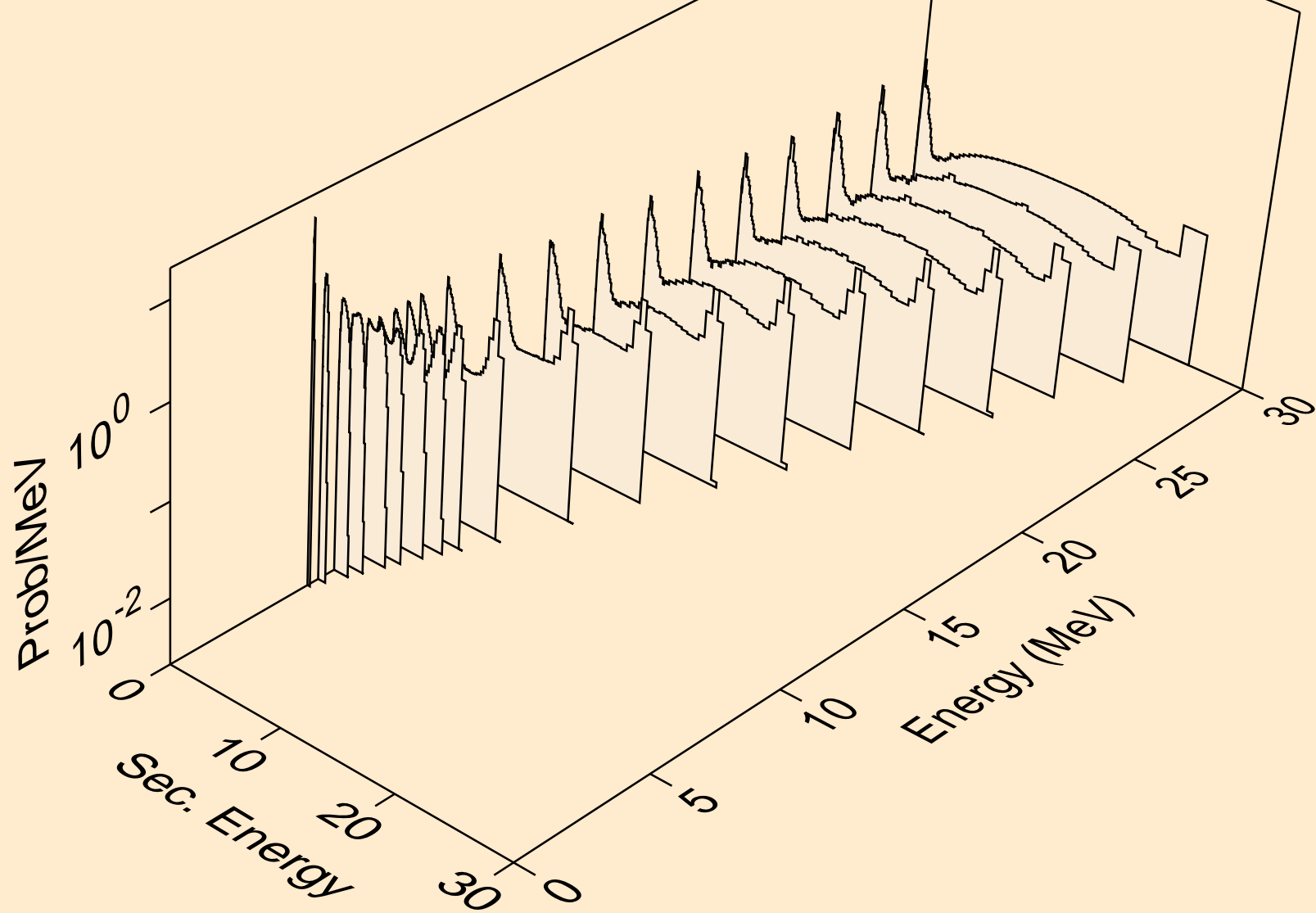

FM259 NEUTRON ACER TENDL-2021 LIBRARY; T=293.6K
Neutron emission for (n,3n)

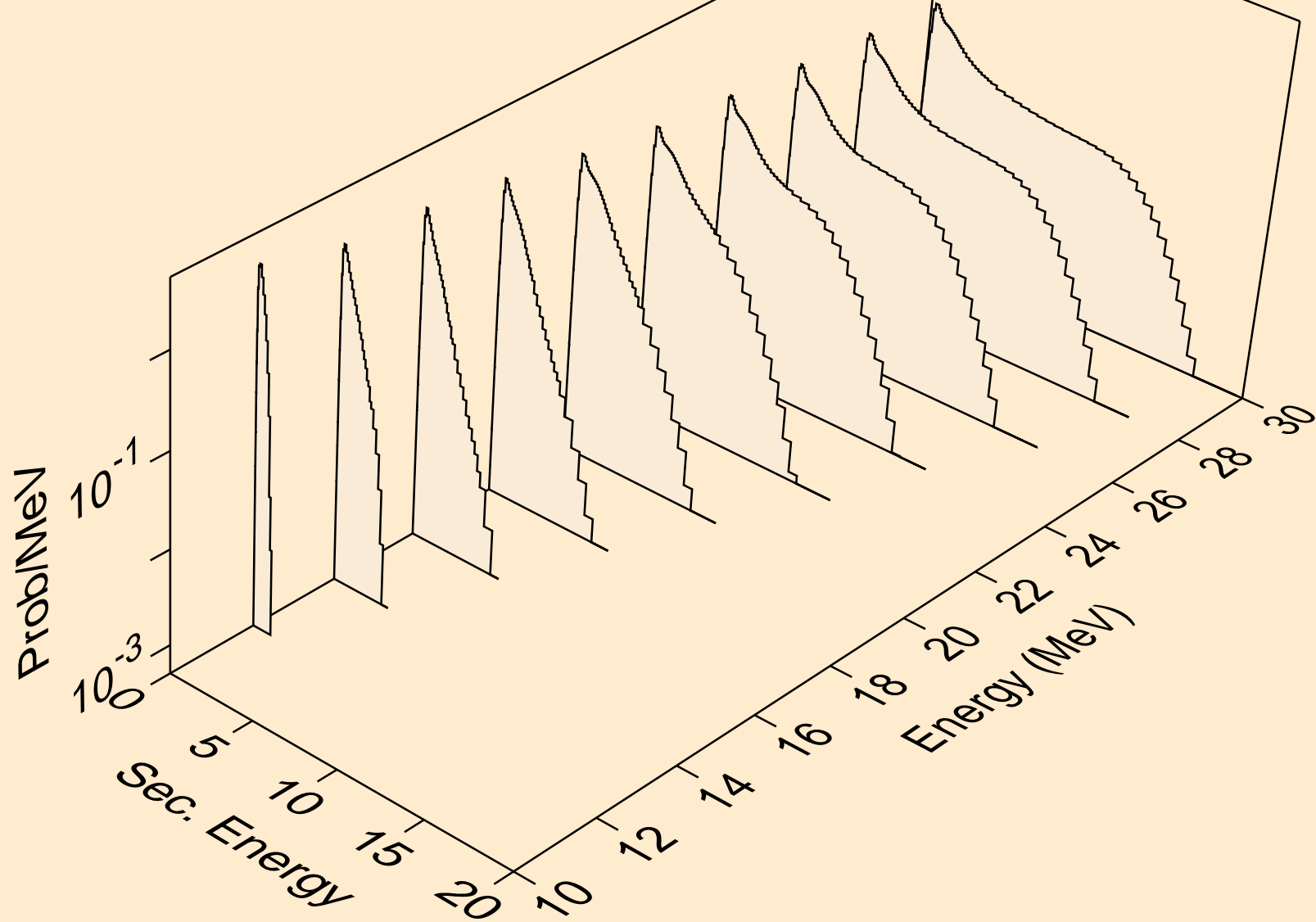

FM259 NEUTRON ACER TENDL-2021 LIBRARY; T=293.6K
Neutron emission for fission

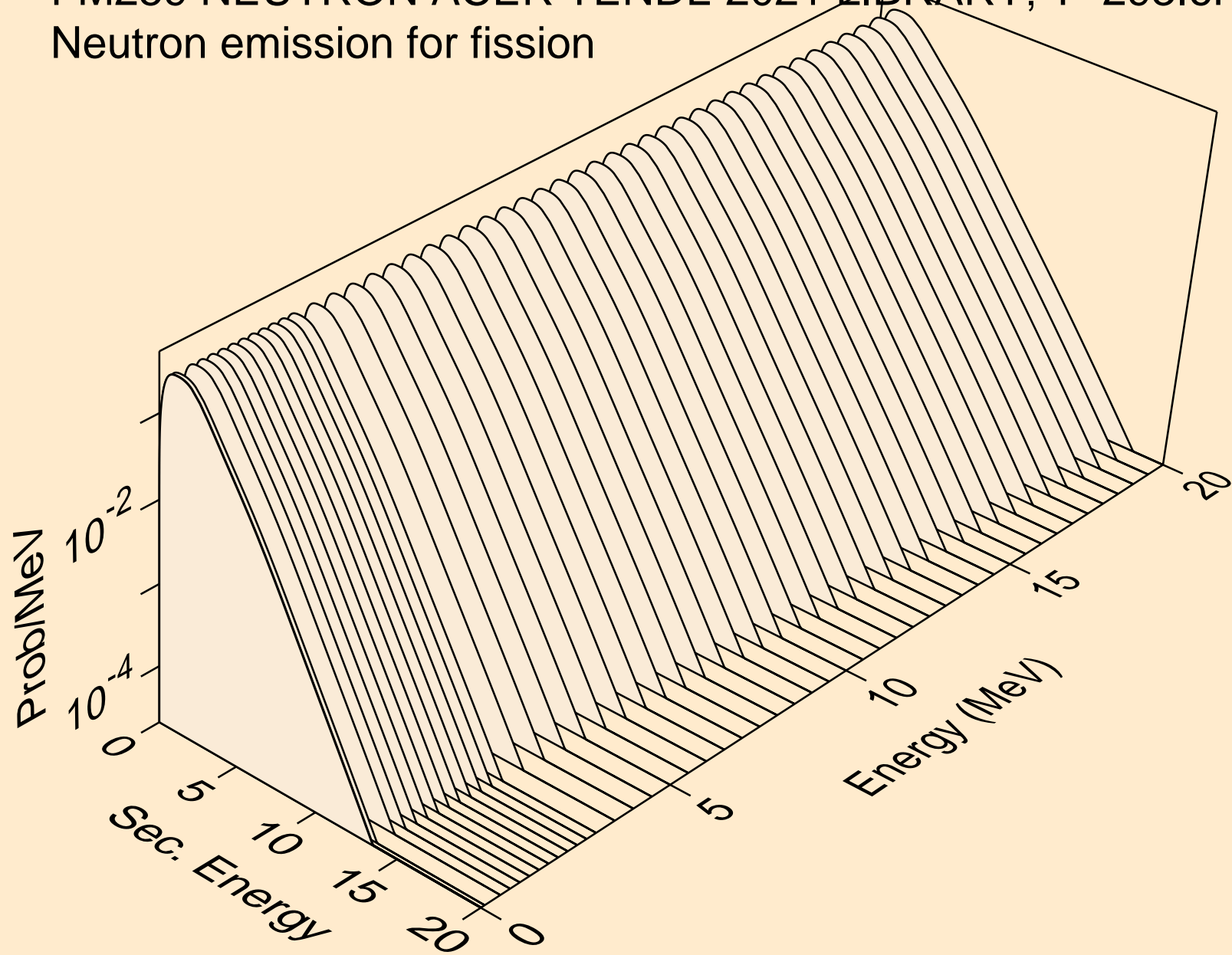

FM259 NEUTRON ACER TENDL-2021 LIBRARY; T=293.6K
Neutron emission for (n,n*)a

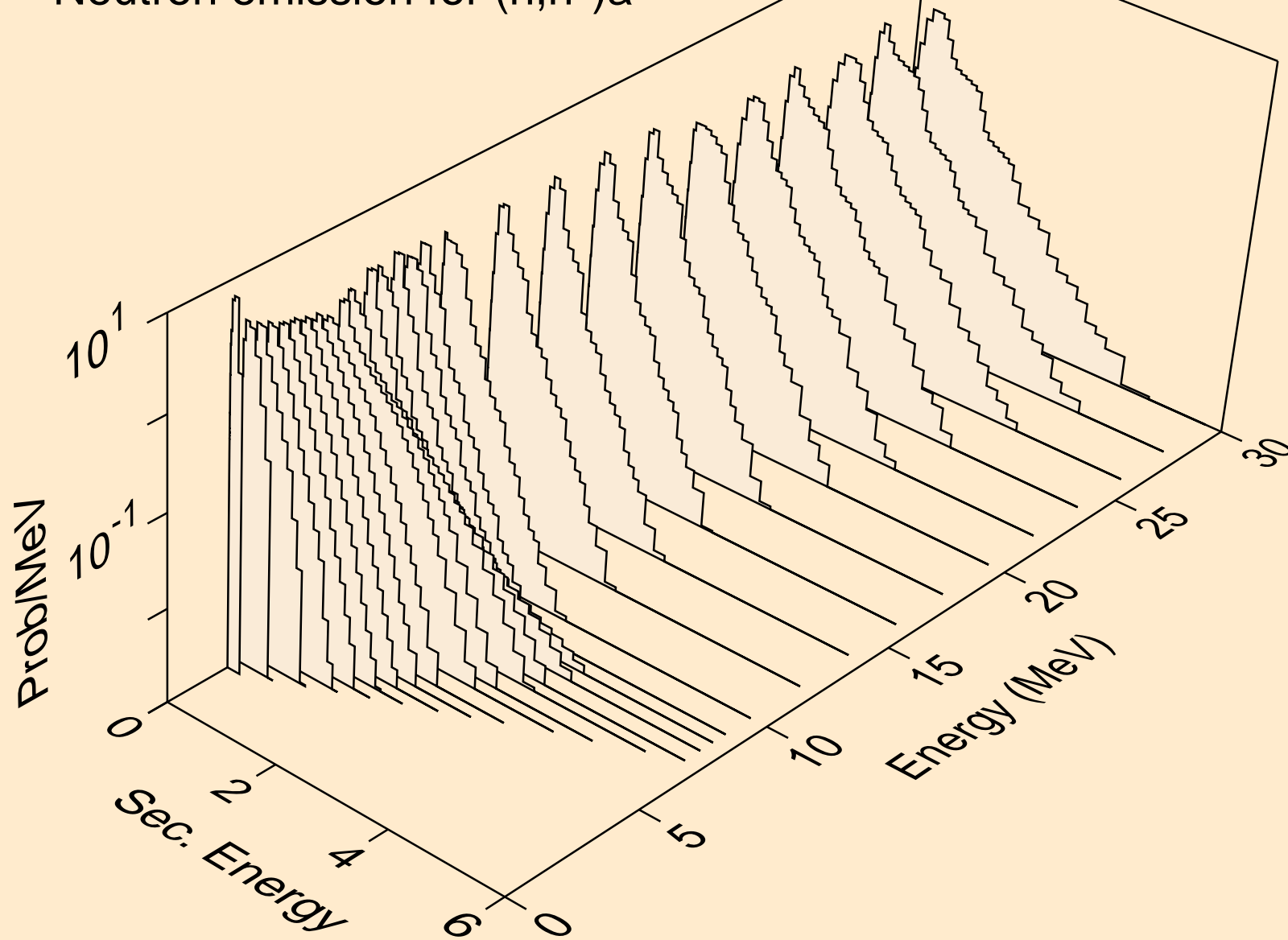

FM259 NEUTRON ACER TENDL-2021 LIBRARY; T=293.6K
Neutron emission for (n,2n)a

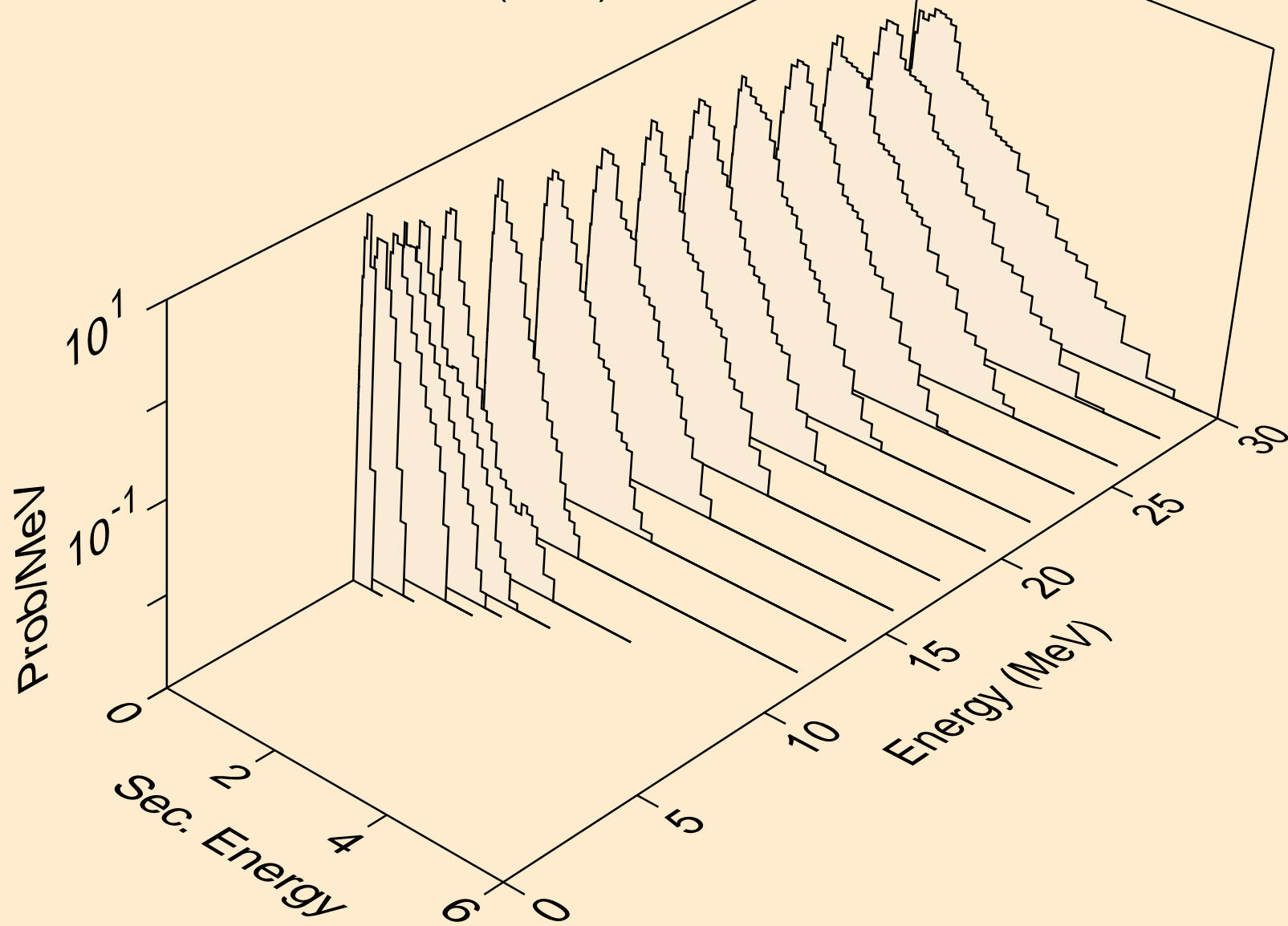

FM259 NEUTRON ACER TENDL-2021 LIBRARY; T=293.6K
Neutron emission for (n,3n)a

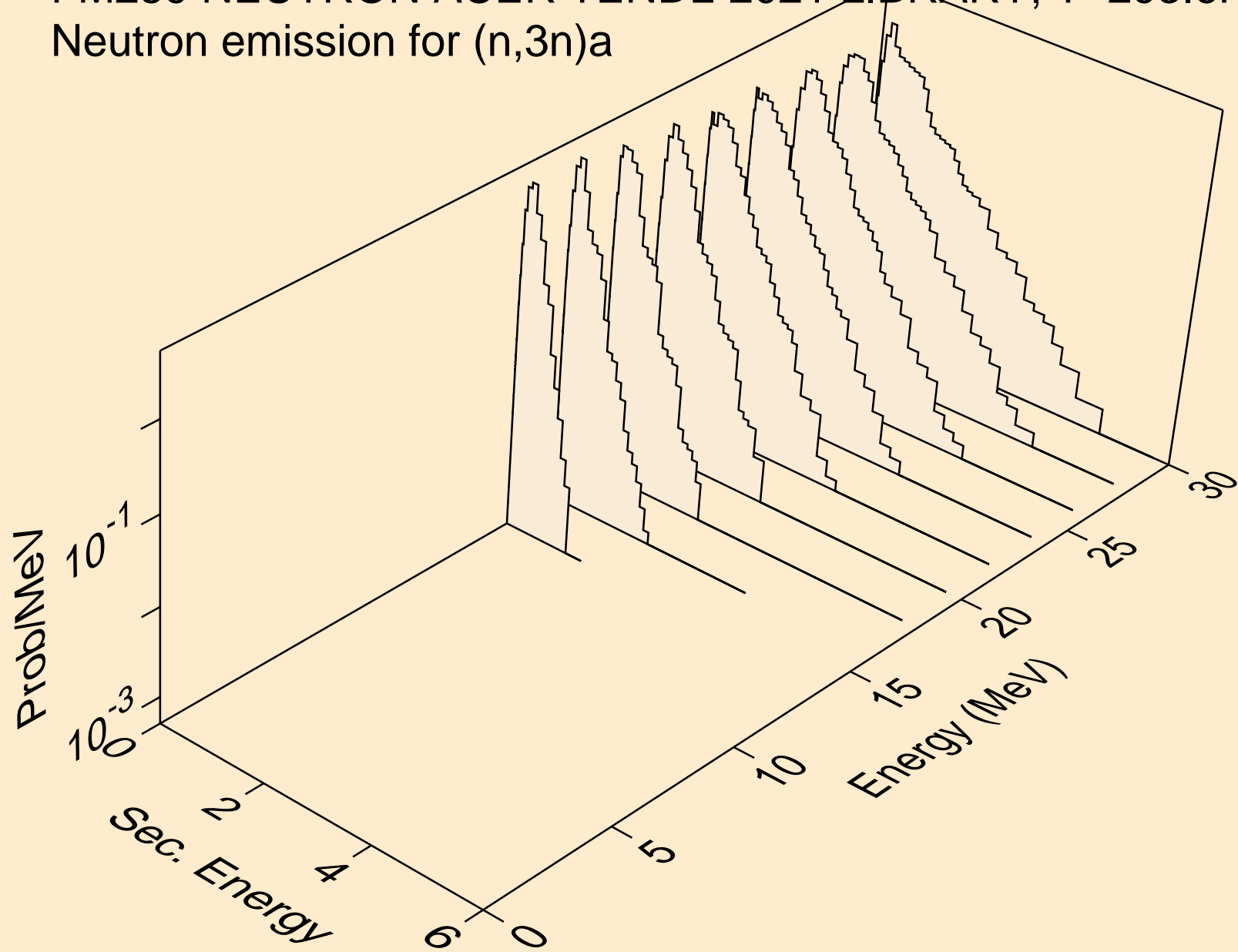

FM259 NEUTRON ACER TENDL-2021 LIBRARY; T=293.6K
Neutron emission for (n,n*)p

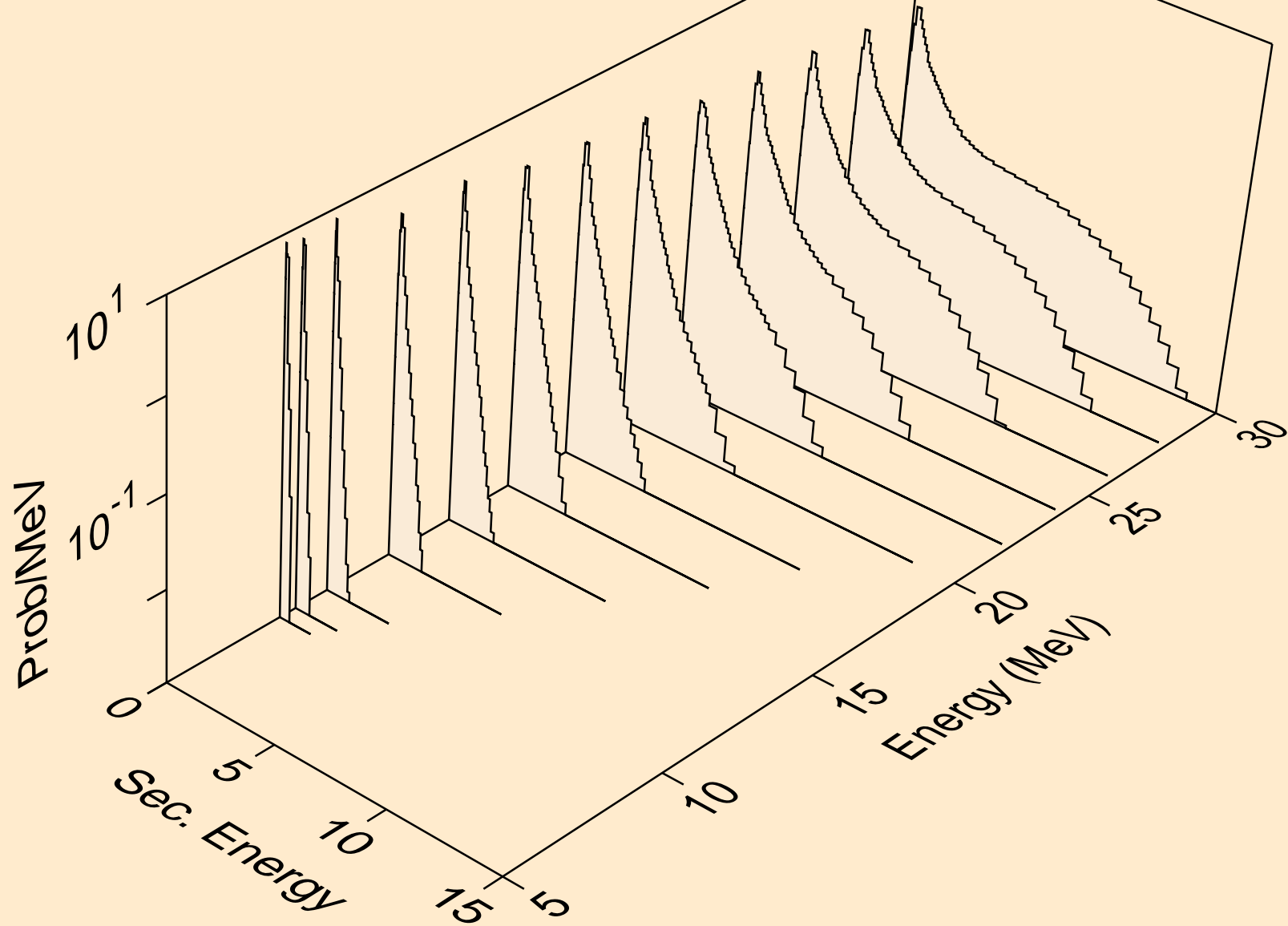

FM259 NEUTRON ACER TENDL-2021 LIBRARY; T=293.6K
Neutron emission for (n,n*)d

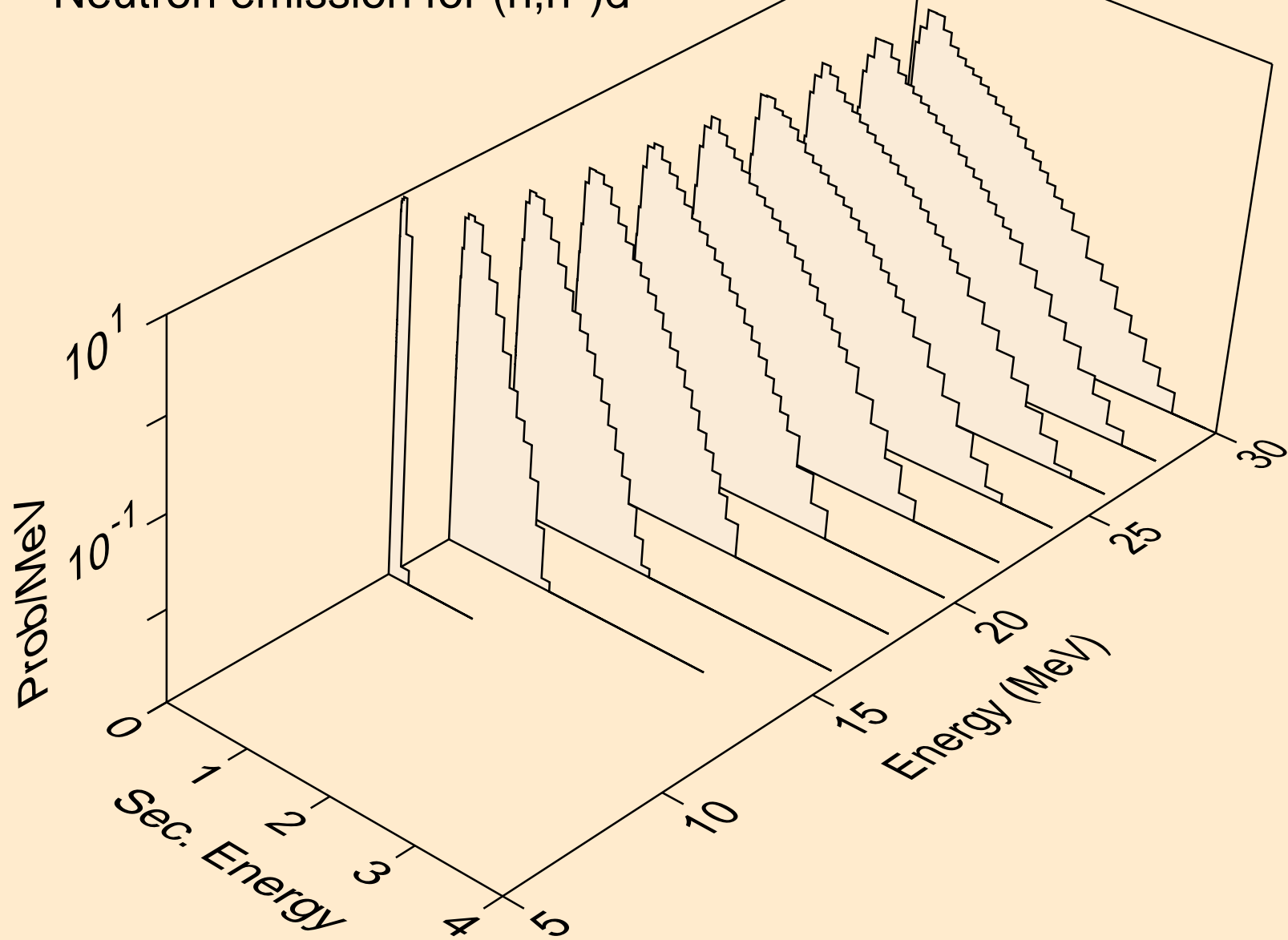

FM259 NEUTRON ACER TENDL-2021 LIBRARY; T=293.6K
Neutron emission for (n,n*)t

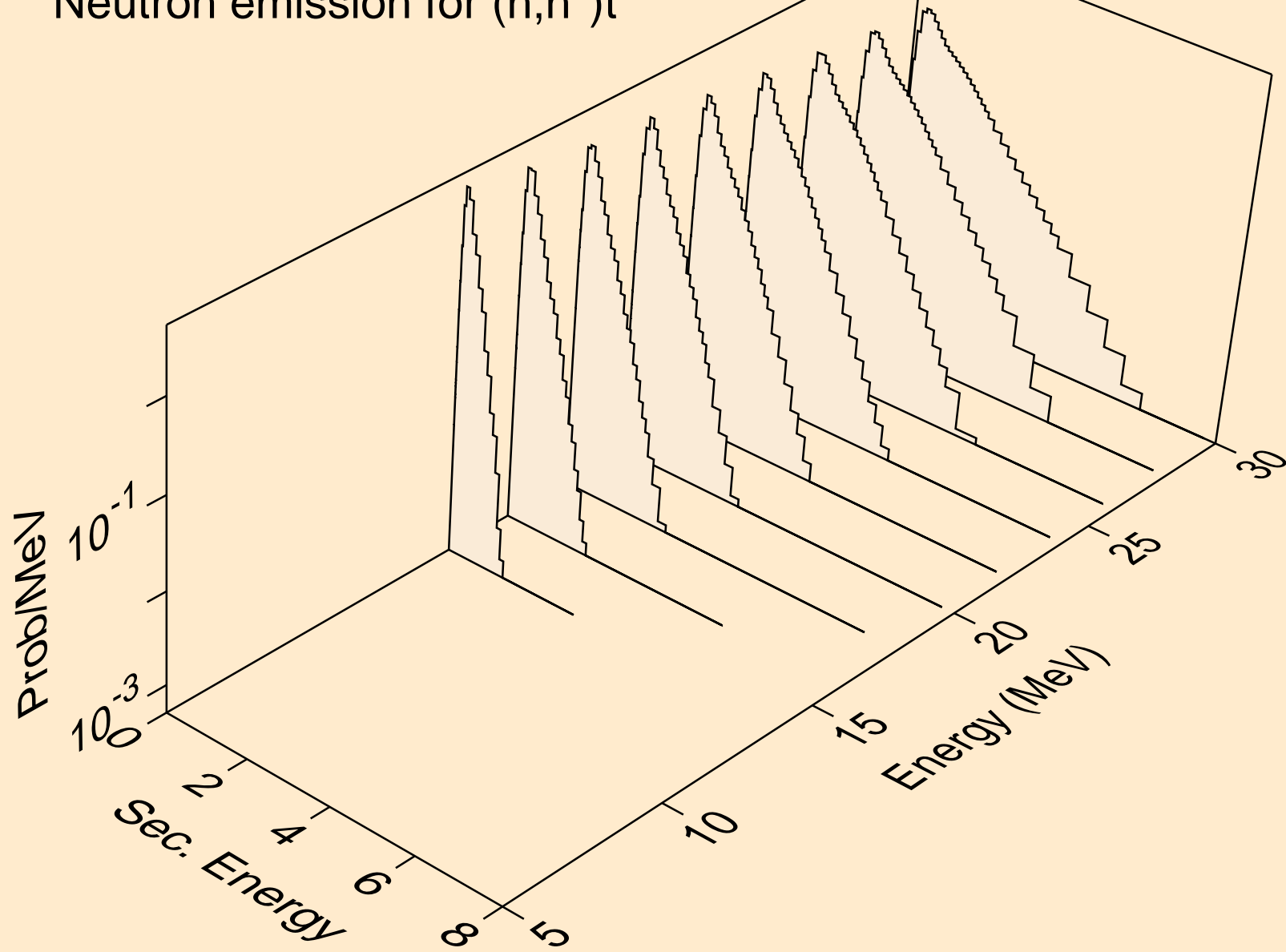

FM259 NEUTRON ACER TENDL-2021 LIBRARY; T=293.6K
Neutron emission for (n,n*)he3

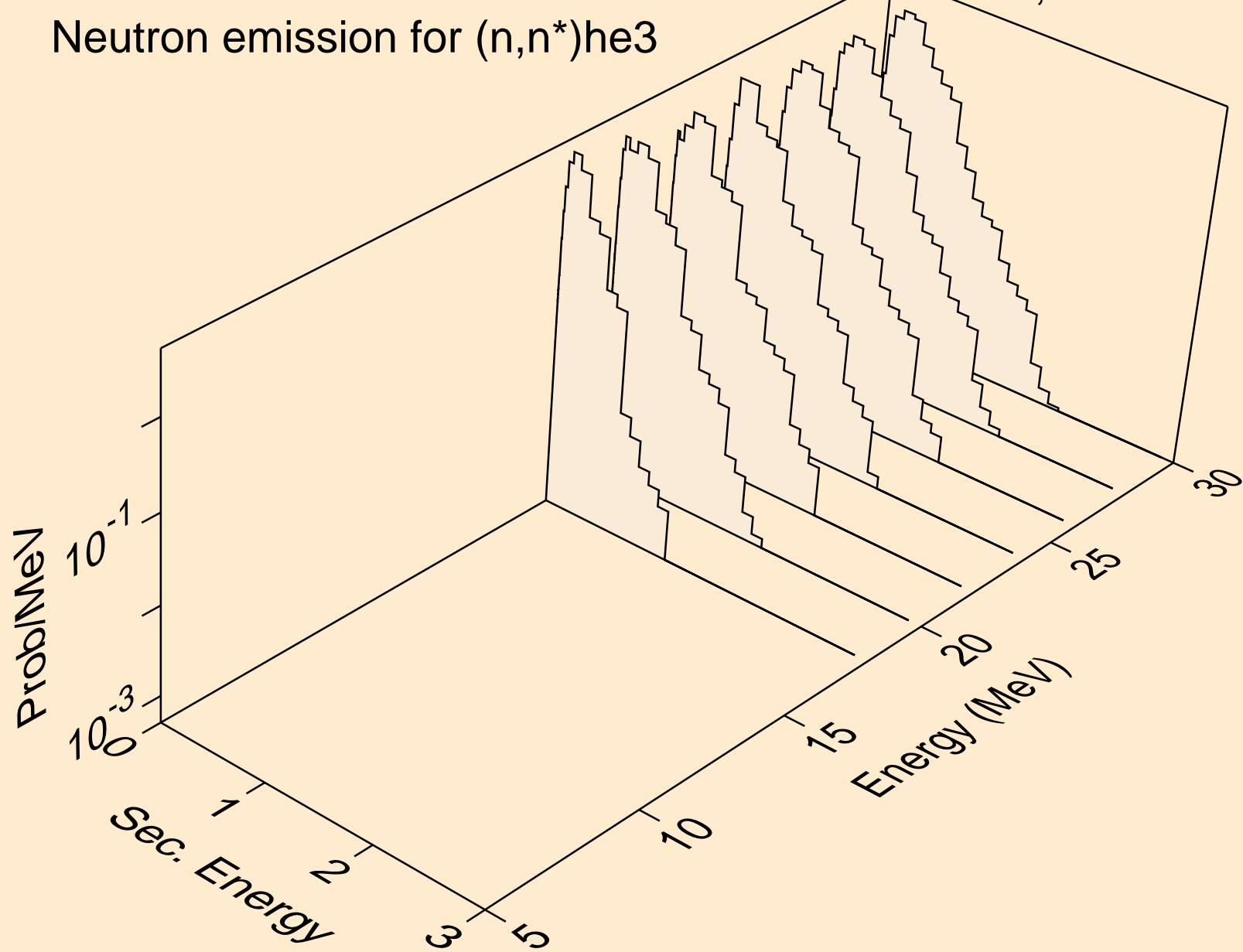

FM259 NEUTRON ACER TENDL-2021 LIBRARY; T=293.6K
Neutron emission for (n,4n)

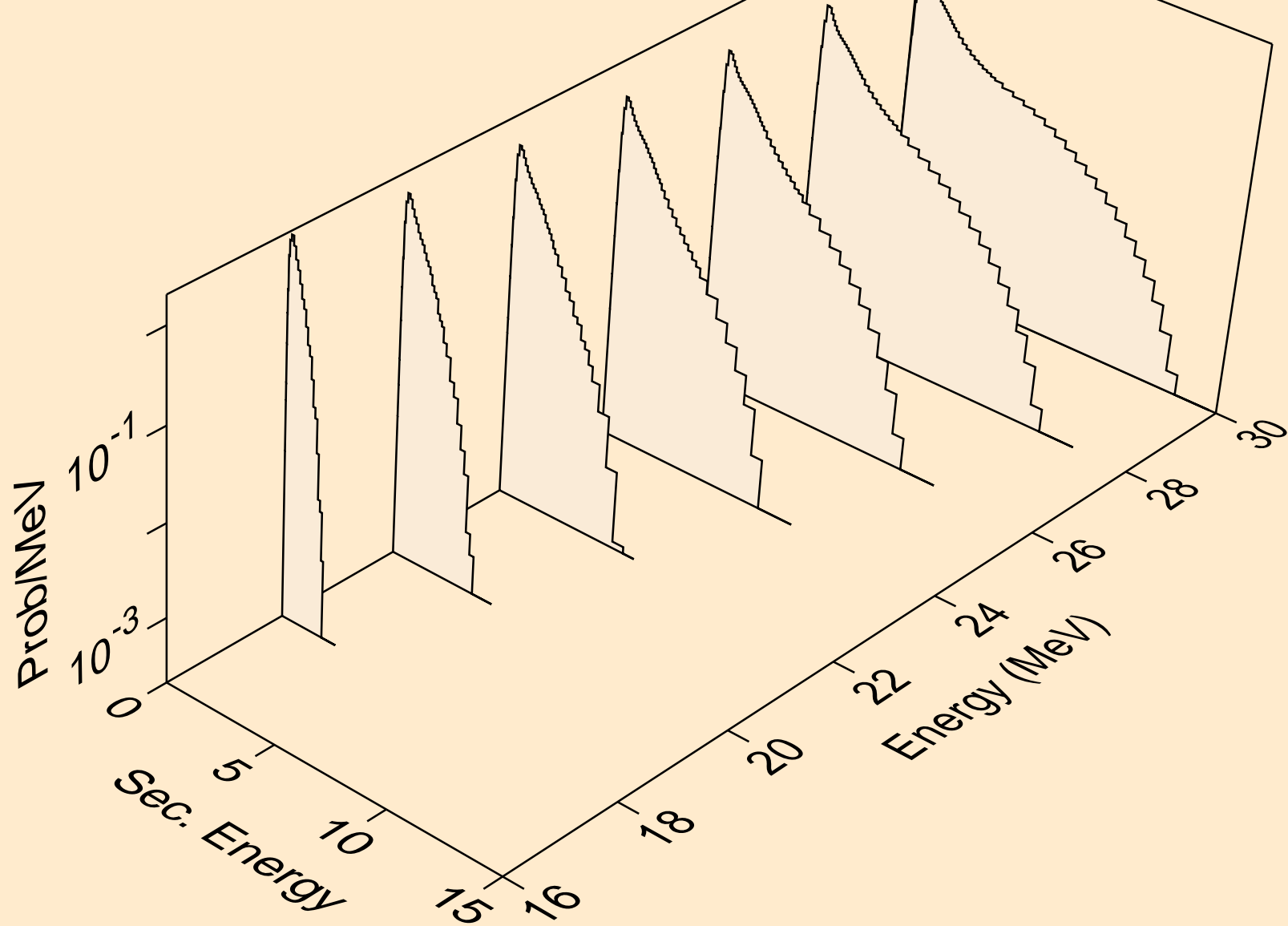

FM259 NEUTRON ACER TENDL-2021 LIBRARY; T=293.6K
Neutron emission for (n,2np)

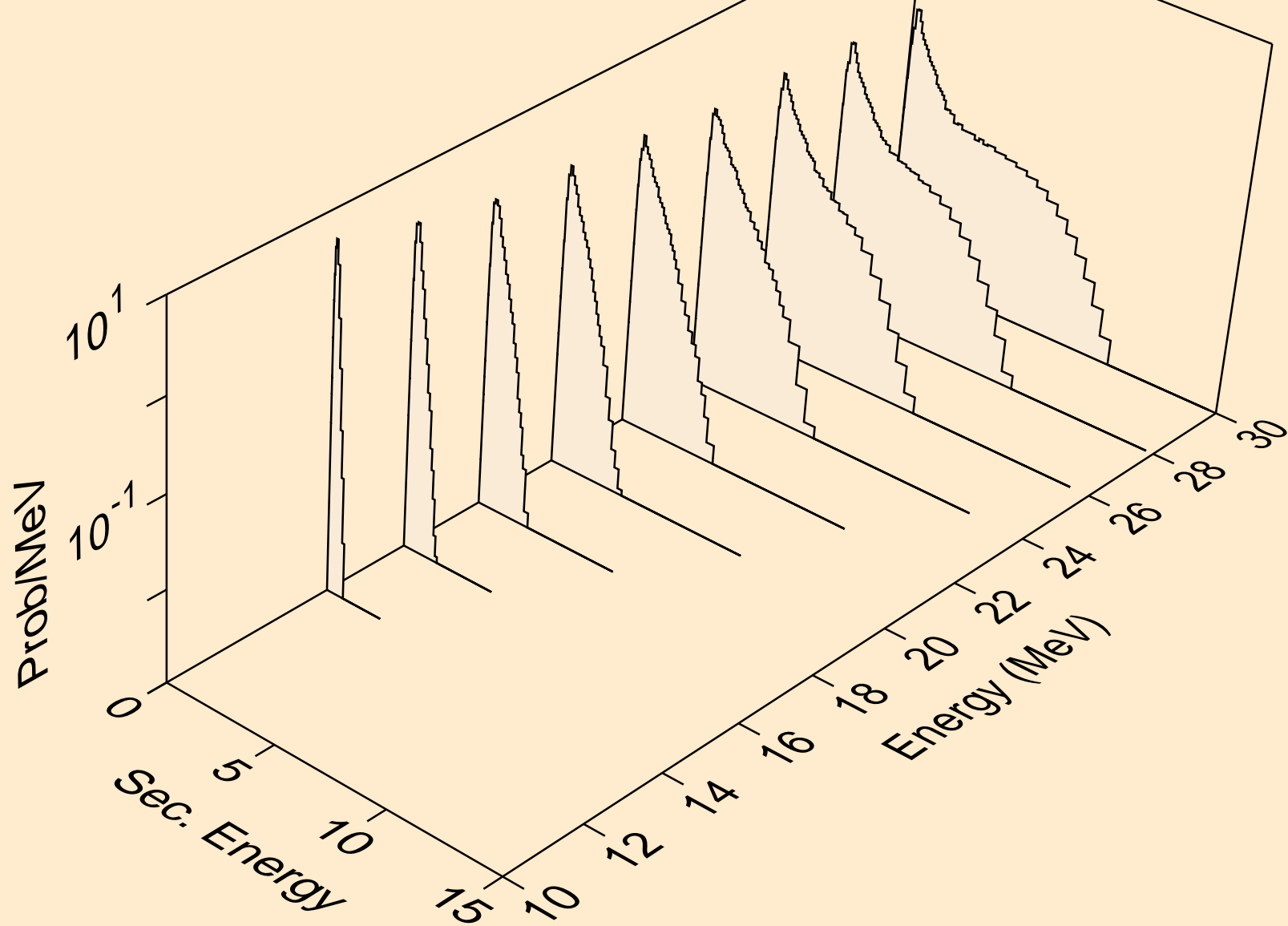

FM259 NEUTRON ACER TENDL-2021 LIBRARY; T=293.6K
Neutron emission for (n,3np)

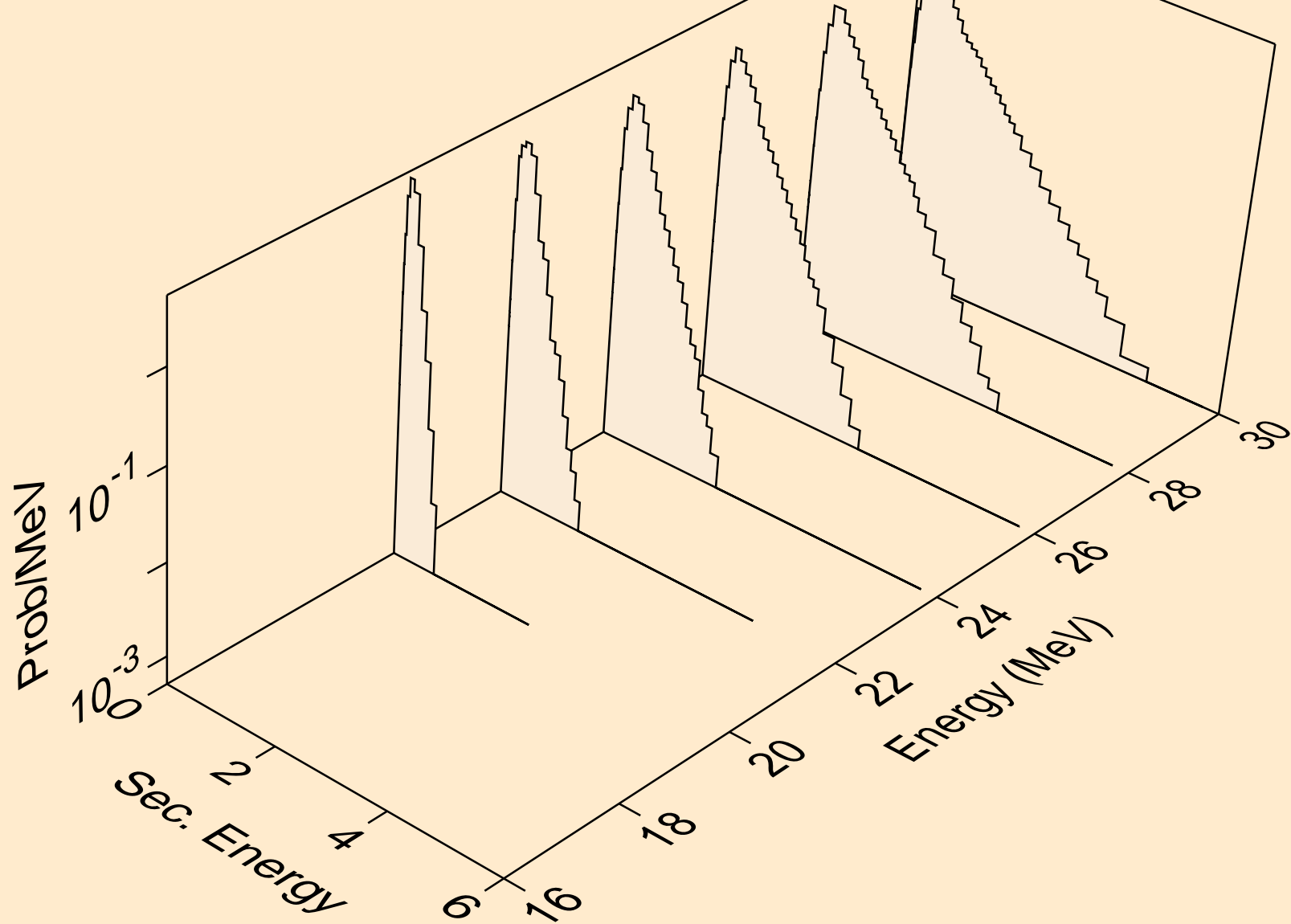

FM259 NEUTRON ACER TENDL-2021 LIBRARY; T=293.6K
Neutron emission for (n,2np)

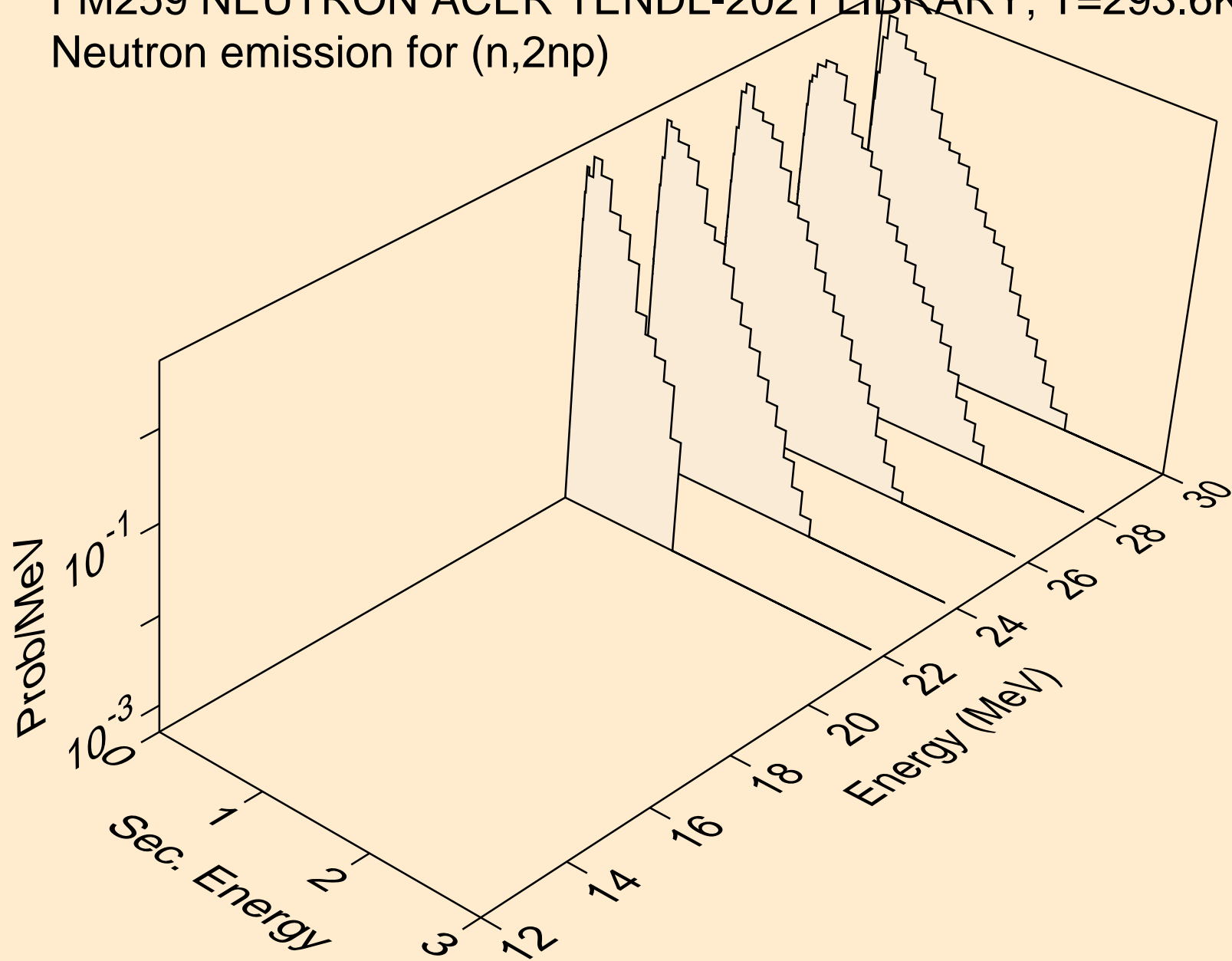

FM259 NEUTRON ACER TENDL-2021 LIBRARY; T=293.6K
Neutron emission for (n,n*c)

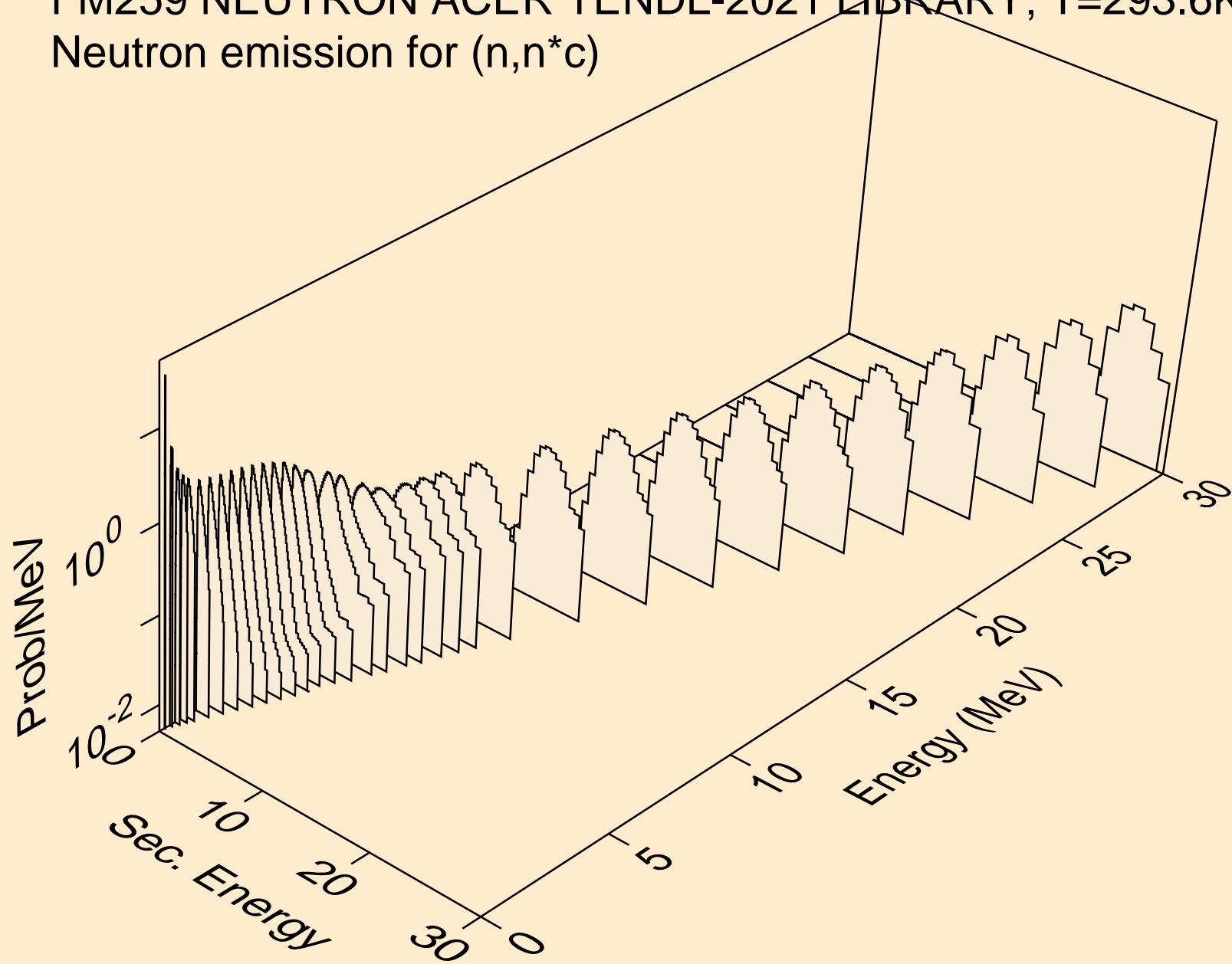

FM259 NEUTRON ACER TENDL-2021 LIBRARY; T=293.6K
Delayed nubar

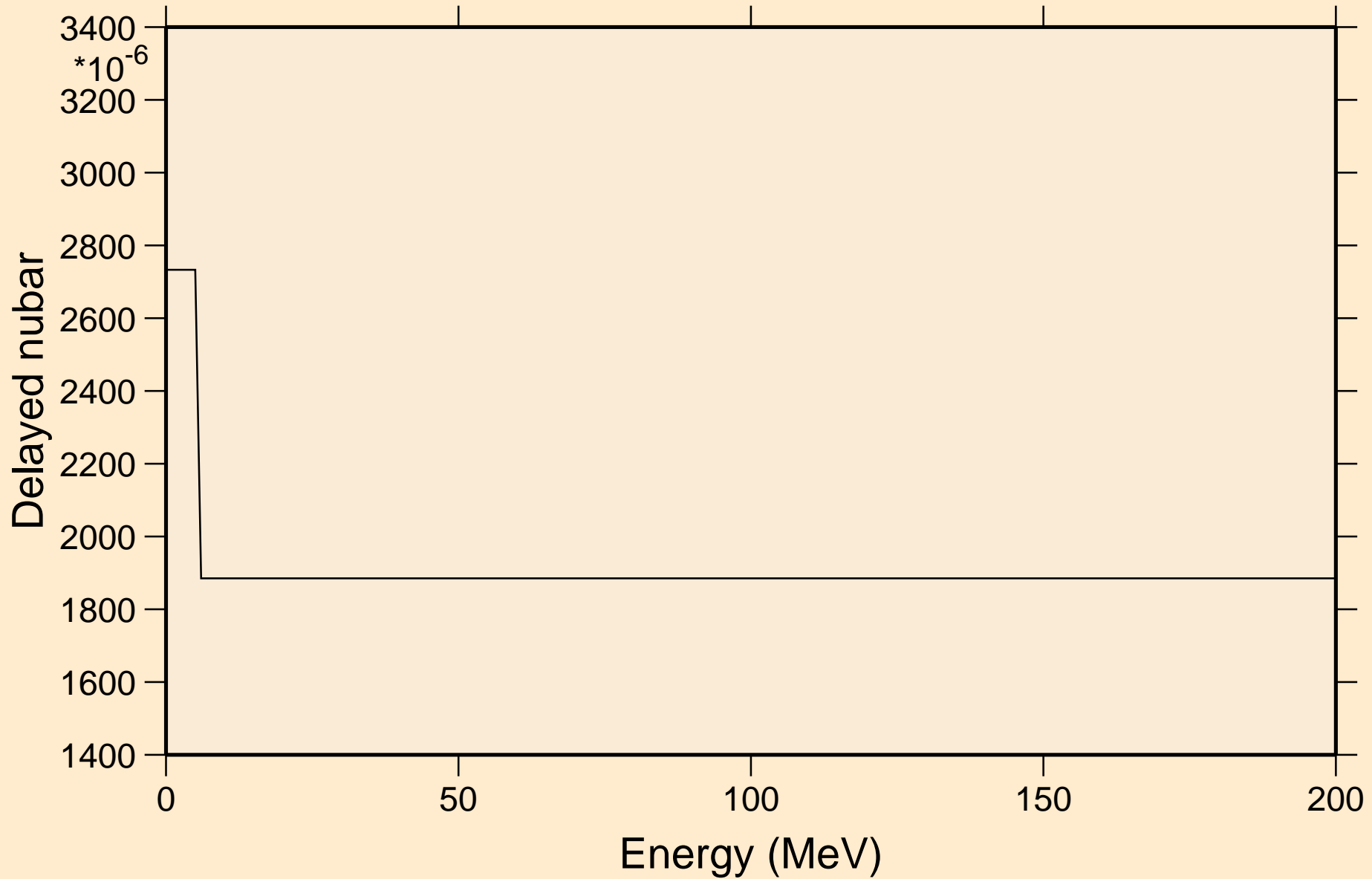

FM259 NEUTRON ACER TENDL-2021 LIBRARY; T=293.6K

Delayed neutron spectra

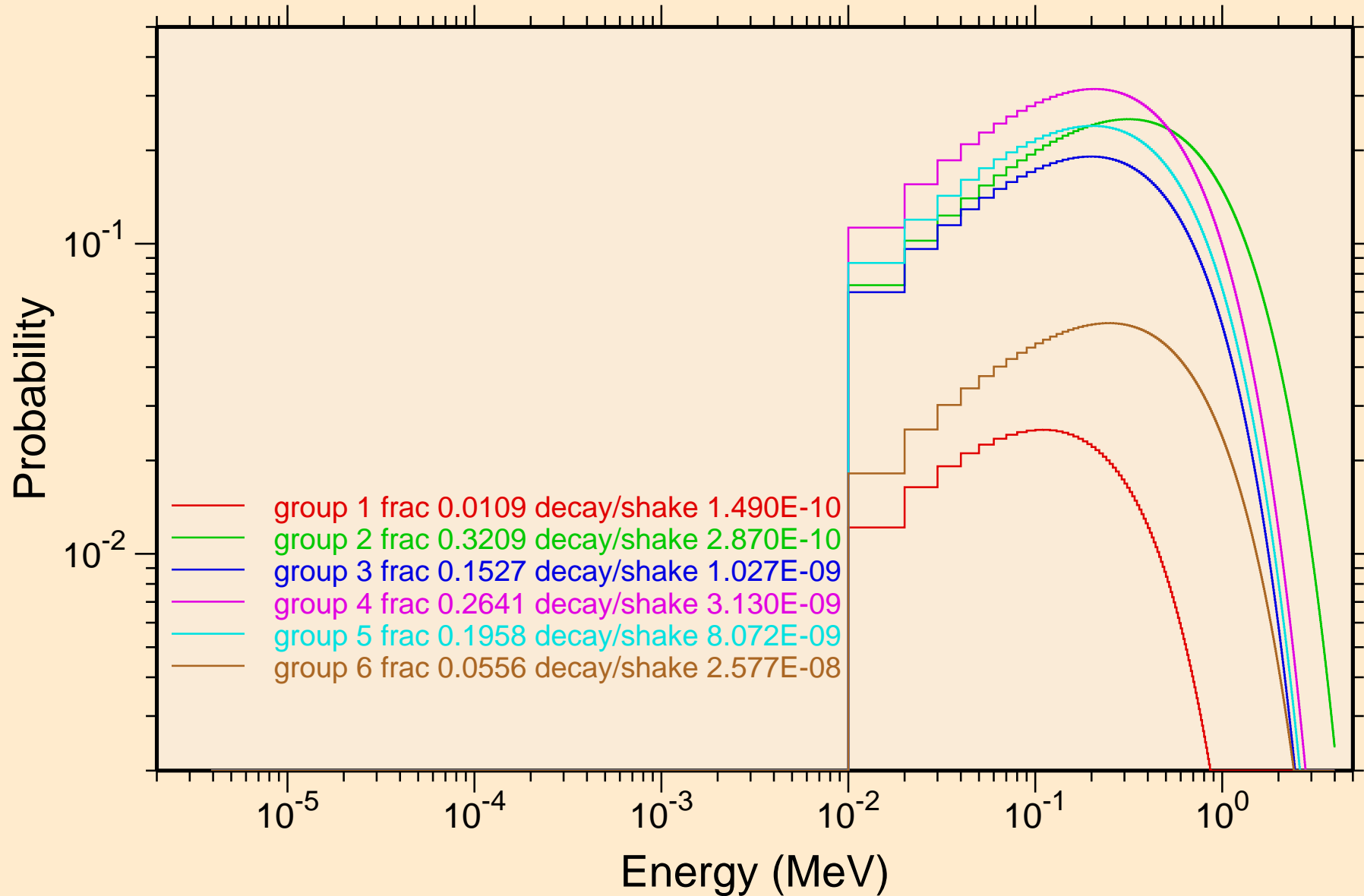

FM259 NEUTRON ACER TENDL-2021 LIBRARY; T=293.6K
Photon emission for (n,x)

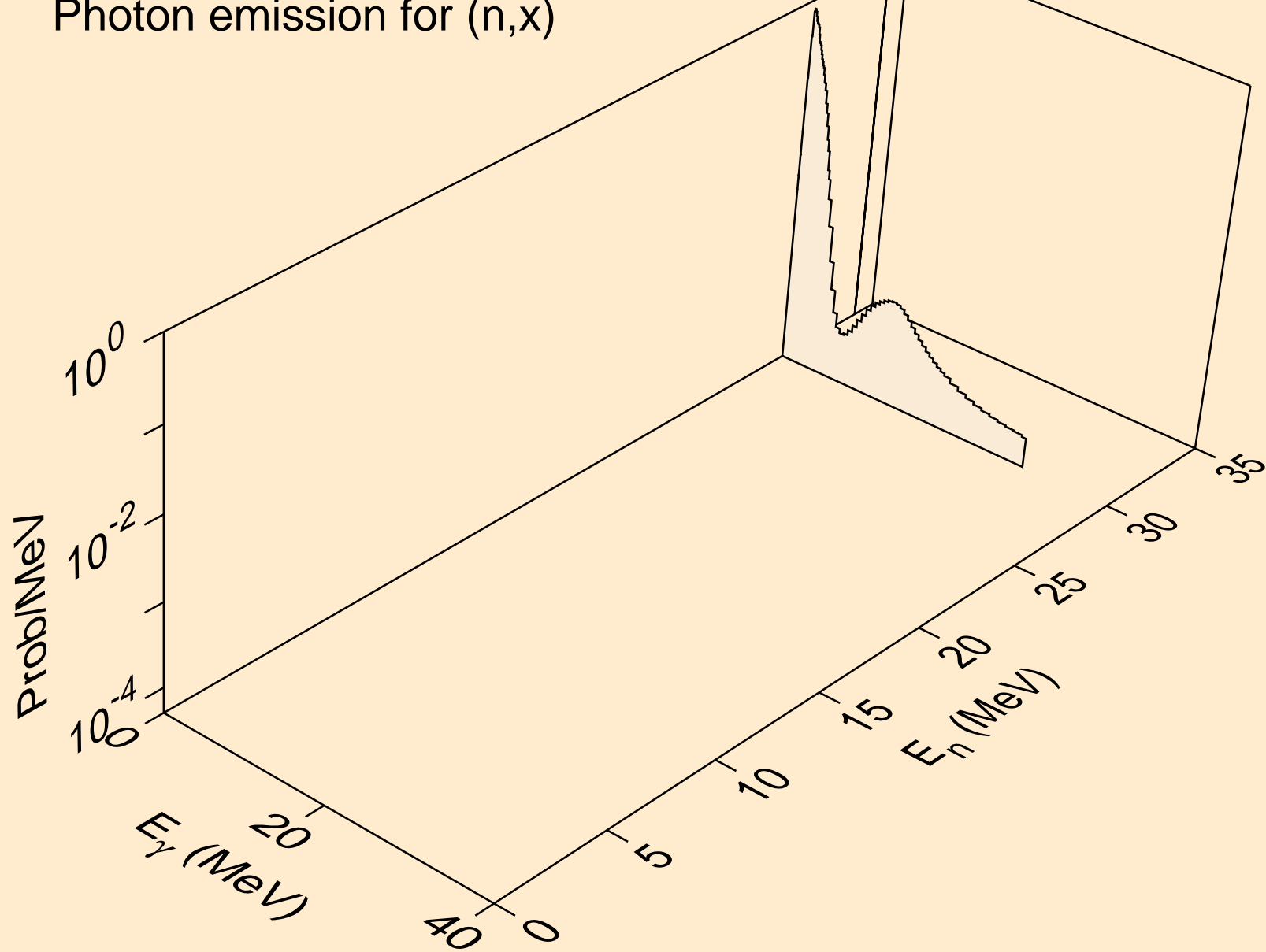

FM259 NEUTRON ACER TENDL-2021 LIBRARY; T=293.6K
Photon emission for (n,2nd)

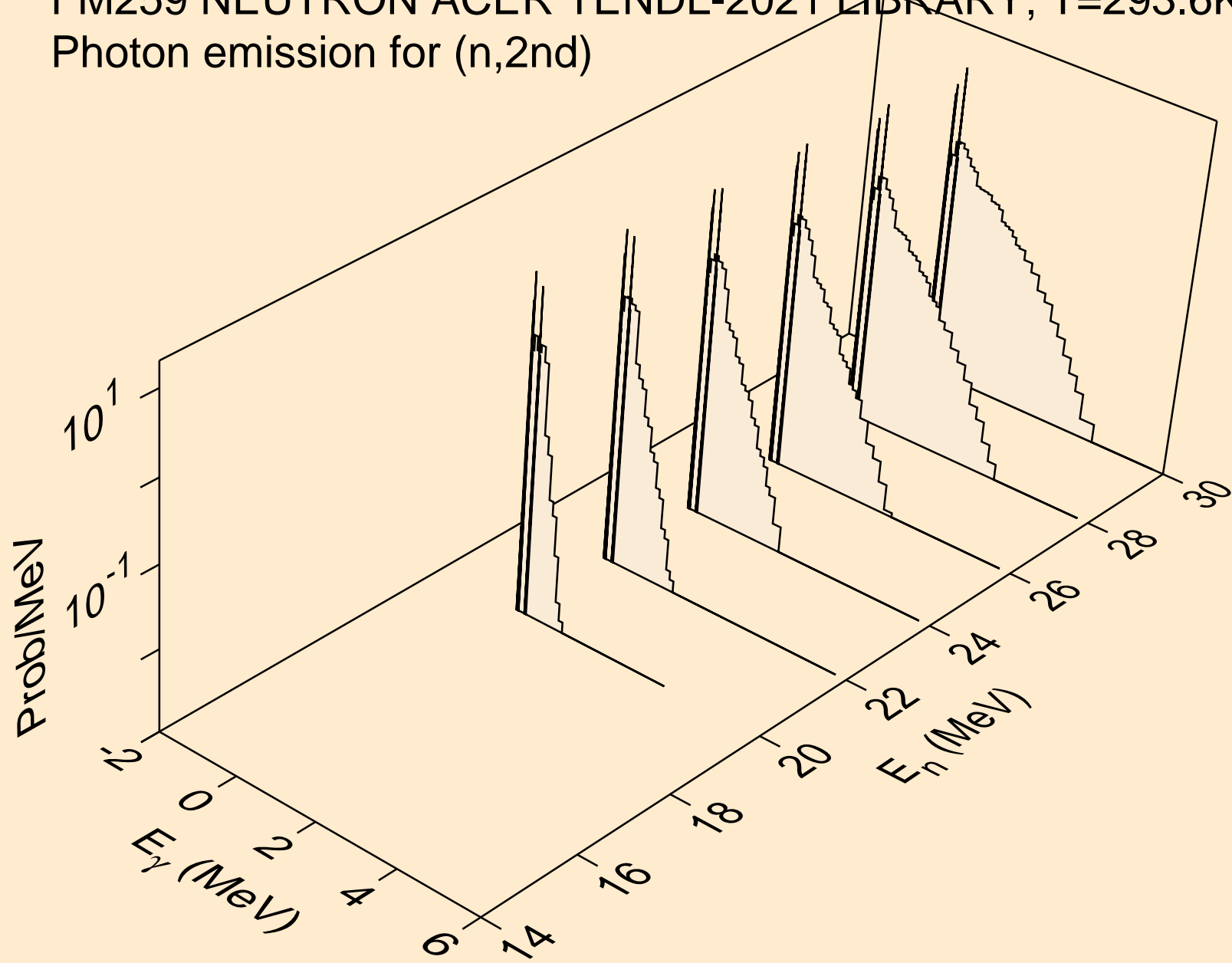

FM259 NEUTRON ACER TENDL-2021 LIBRARY; T=293.6K
Photon emission for (n,2n)

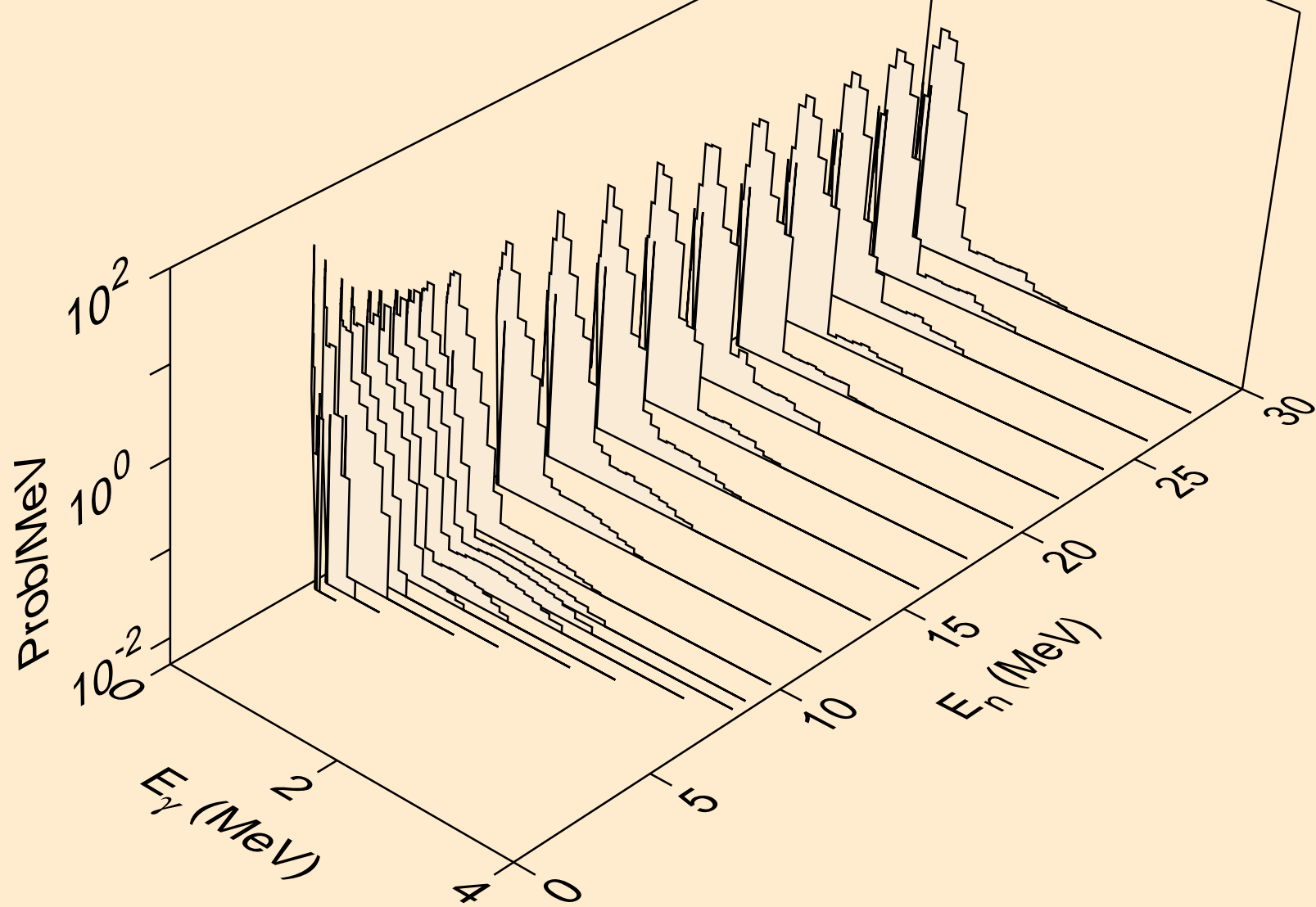

FM259 NEUTRON ACER TENDL-2021 LIBRARY; T=293.6K
Photon emission for (n,3n)

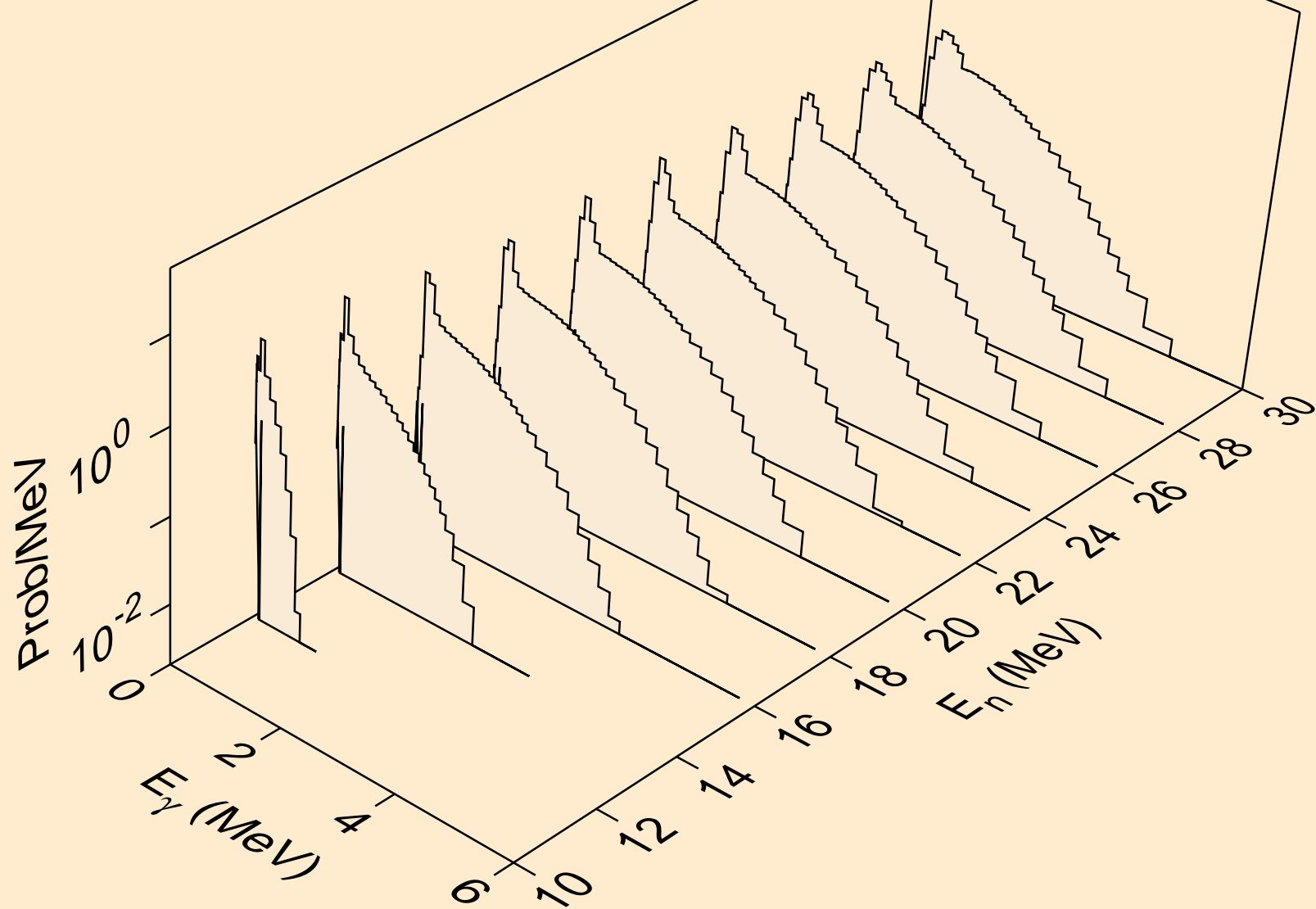

FM259 NEUTRON ACER TENDL-2021 LIBRARY; T=293.6K
Photon emission for (n,n*)a

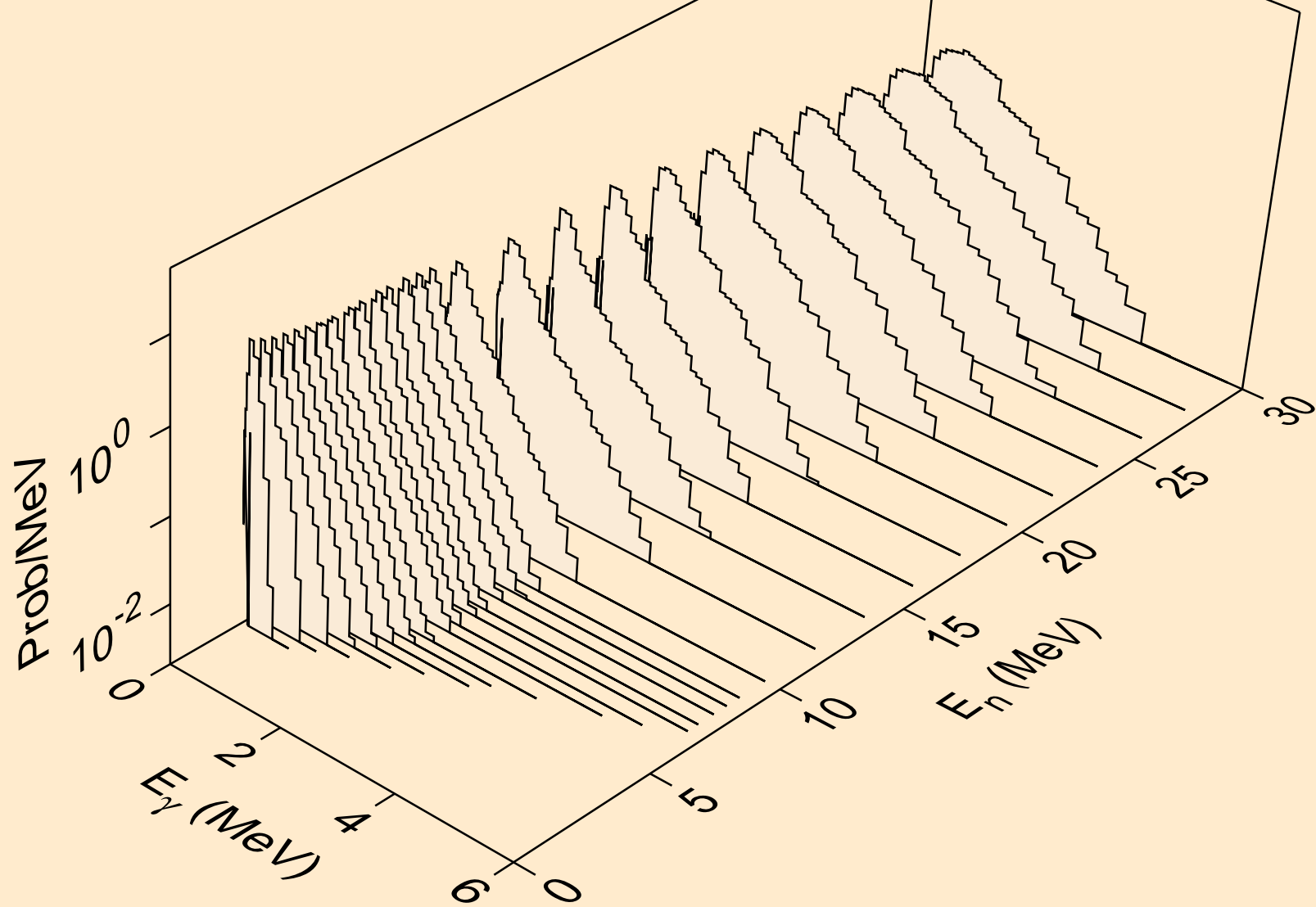

FM259 NEUTRON ACER TENDL-2021 LIBRARY; T=293.6K
Photon emission for (n,2n)a

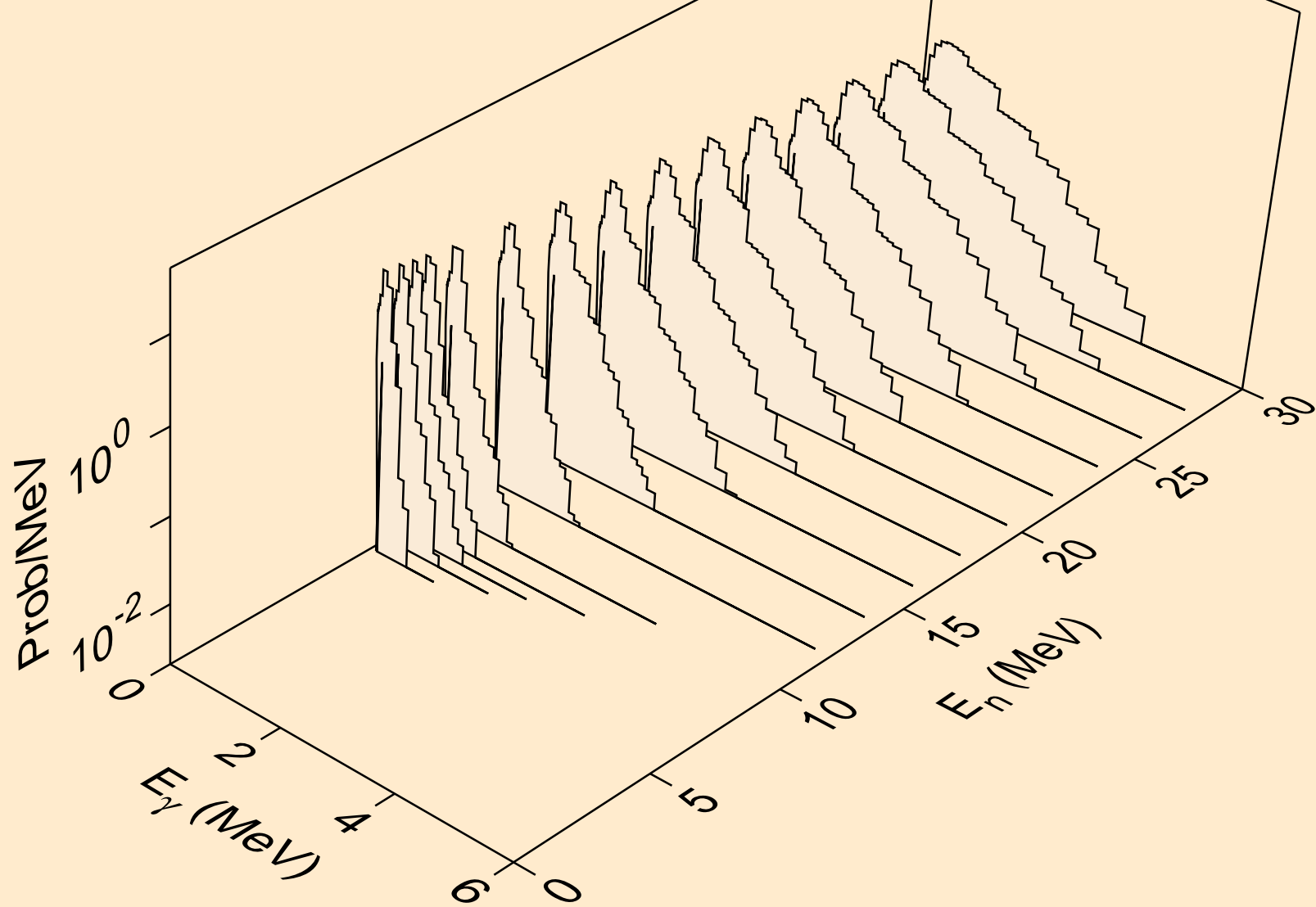

FM259 NEUTRON ACER TENDL-2021 LIBRARY; T=293.6K
Photon emission for (n,3n)a

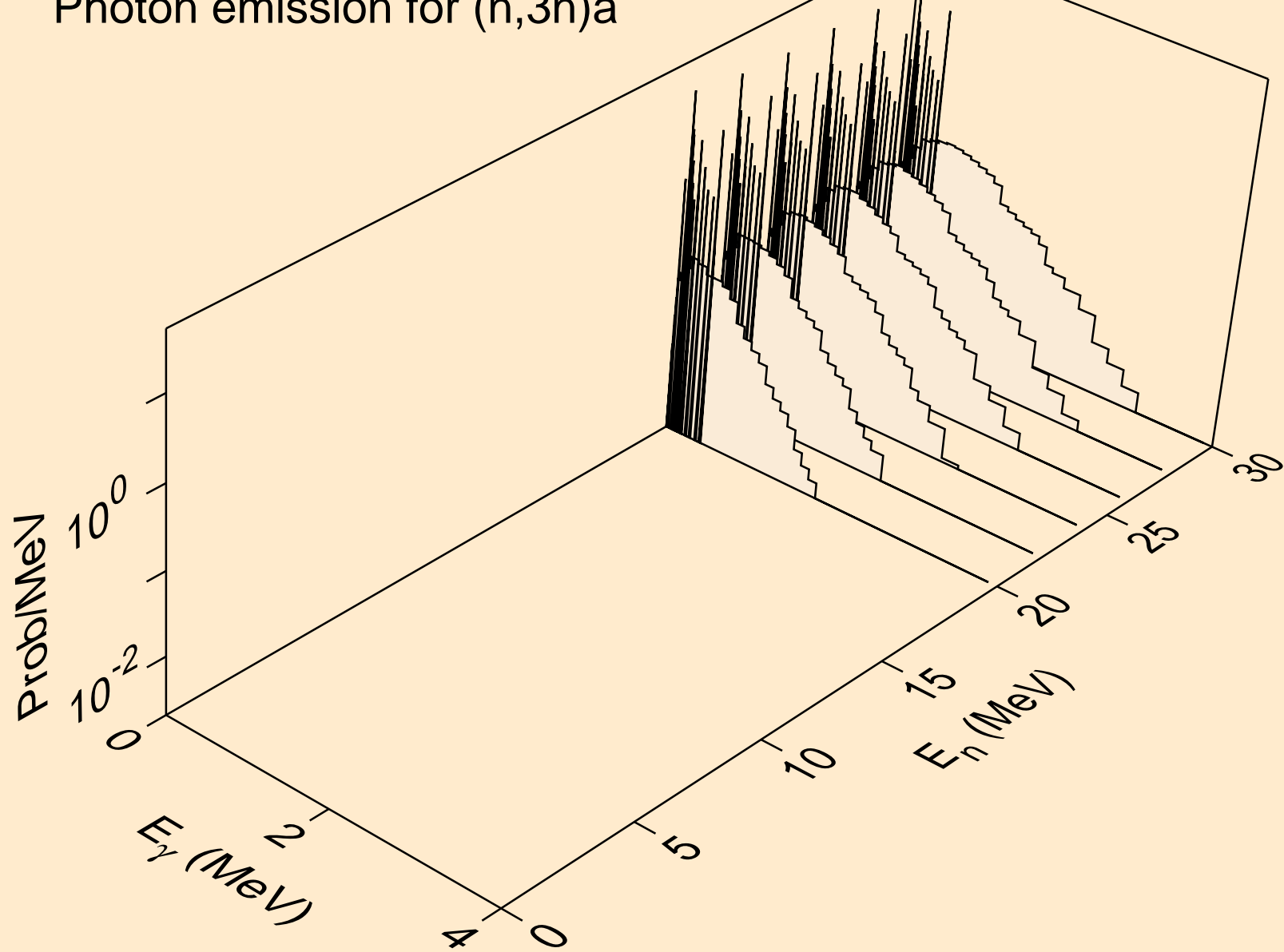

FM259 NEUTRON ACER TENDL-2021 LIBRARY; T=293.6K
Photon emission for (n,n*)p

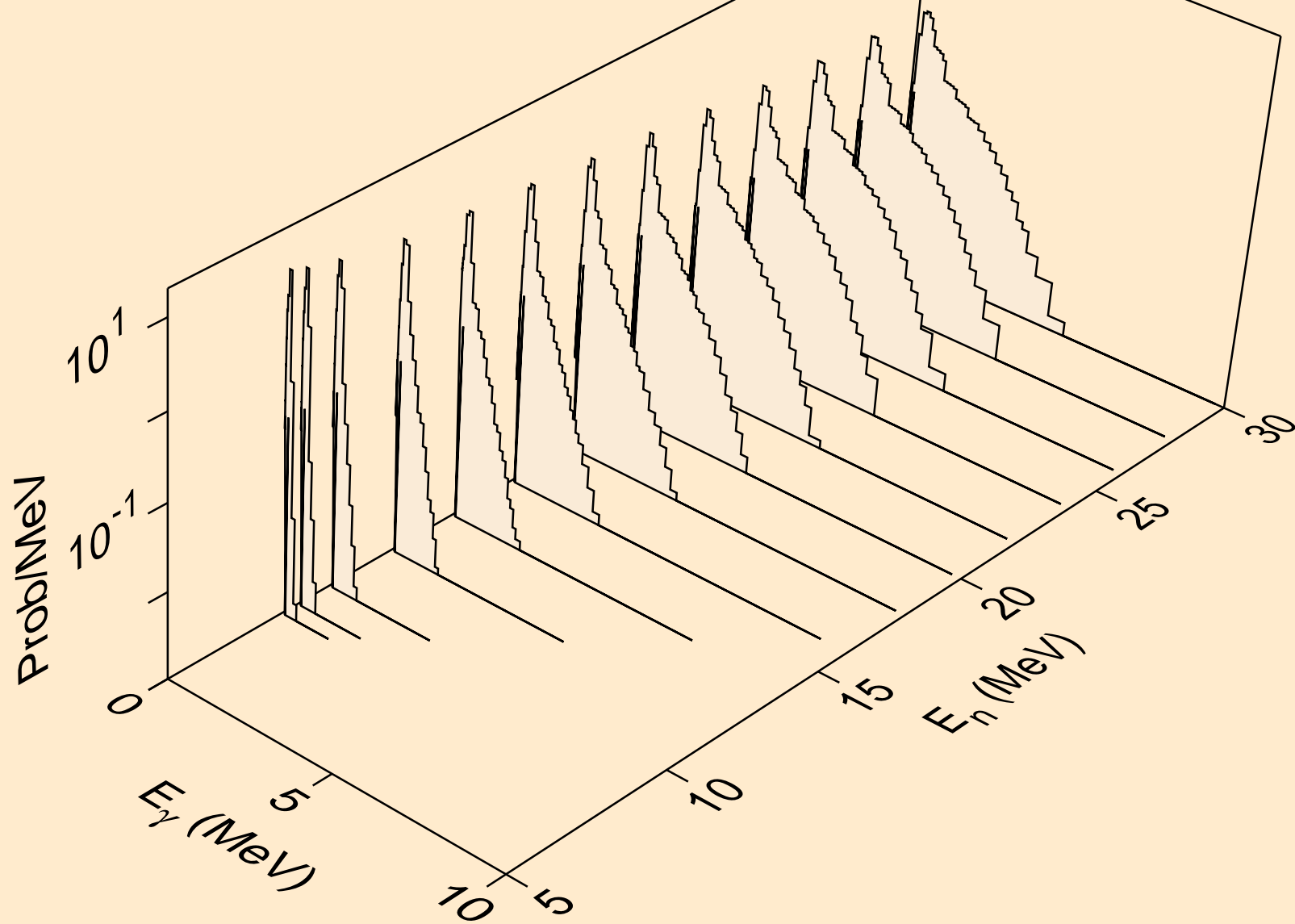

FM259 NEUTRON ACER TENDL-2021 LIBRARY; T=293.6K
Photon emission for (n,n*)d

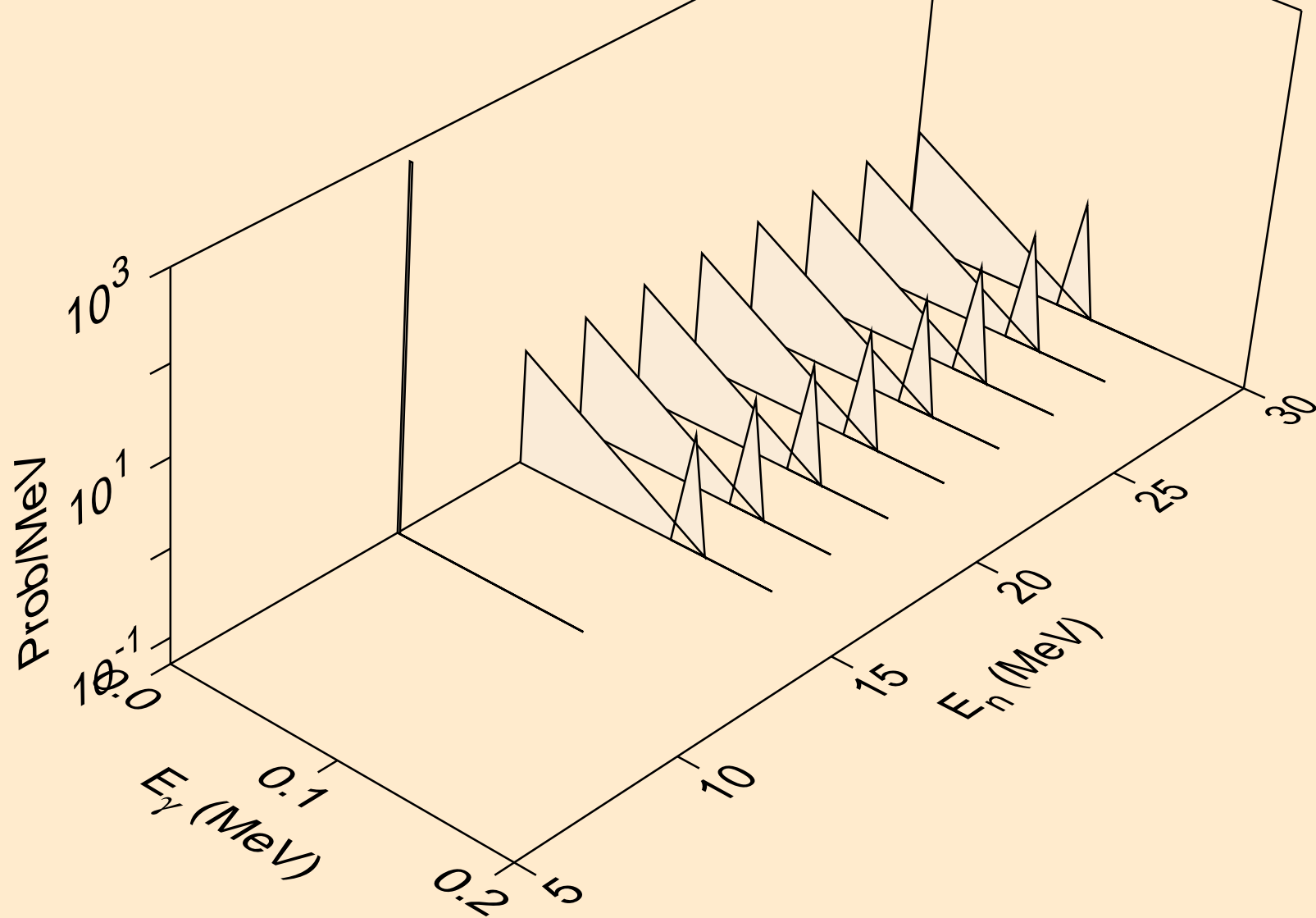

FM259 NEUTRON ACER TENDL-2021 LIBRARY; T=293.6K
Photon emission for (n,n*)t

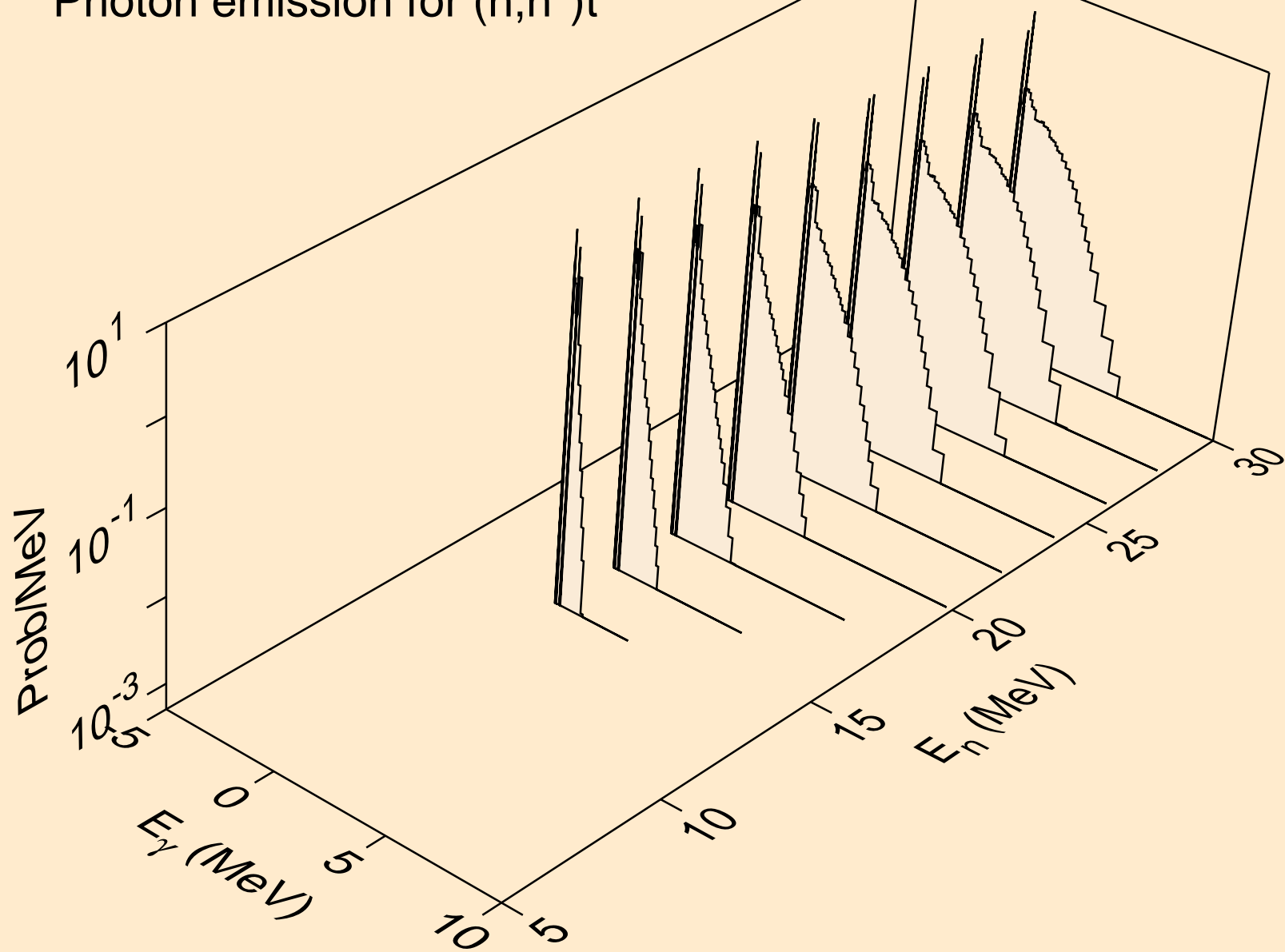

FM259 NEUTRON ACER TENDL-2021 LIBRARY; T=293.6K
Photon emission for (n,n*)he3

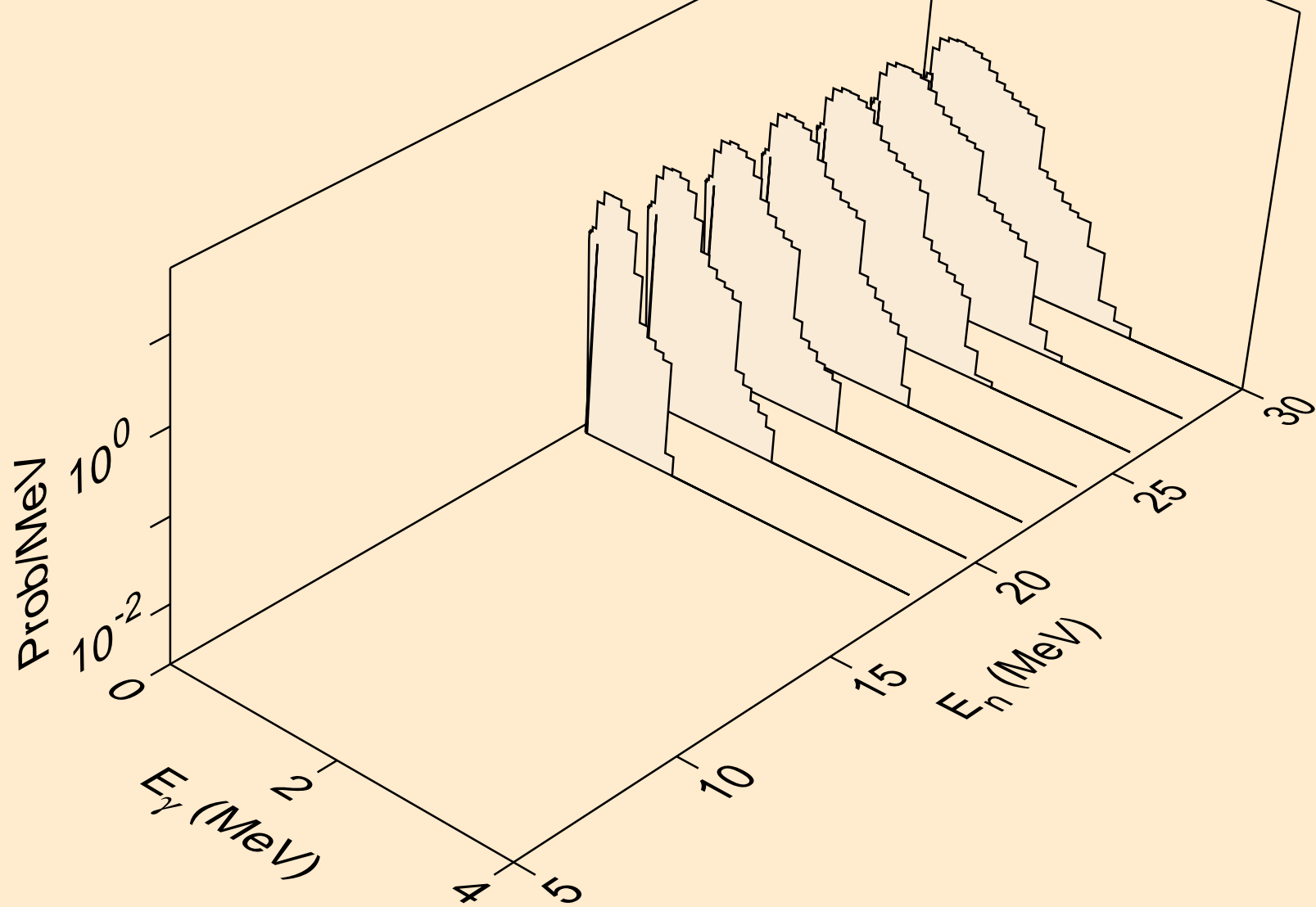

FM259 NEUTRON ACER TENDL-2021 LIBRARY; T=293.6K
Photon emission for (n,4n)

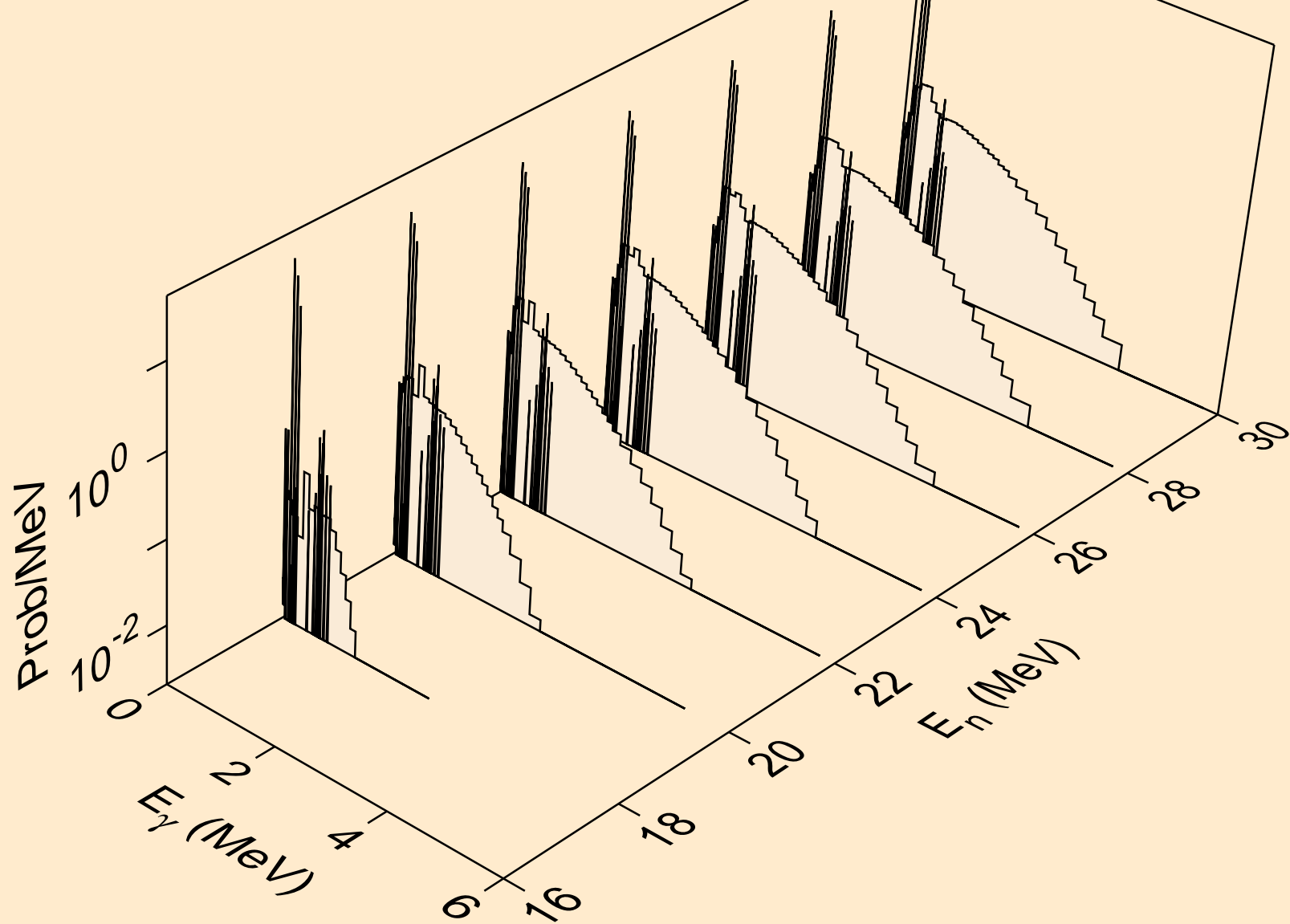

FM259 NEUTRON ACER TENDL-2021 LIBRARY; T=293.6K
Photon emission for (n,2np)

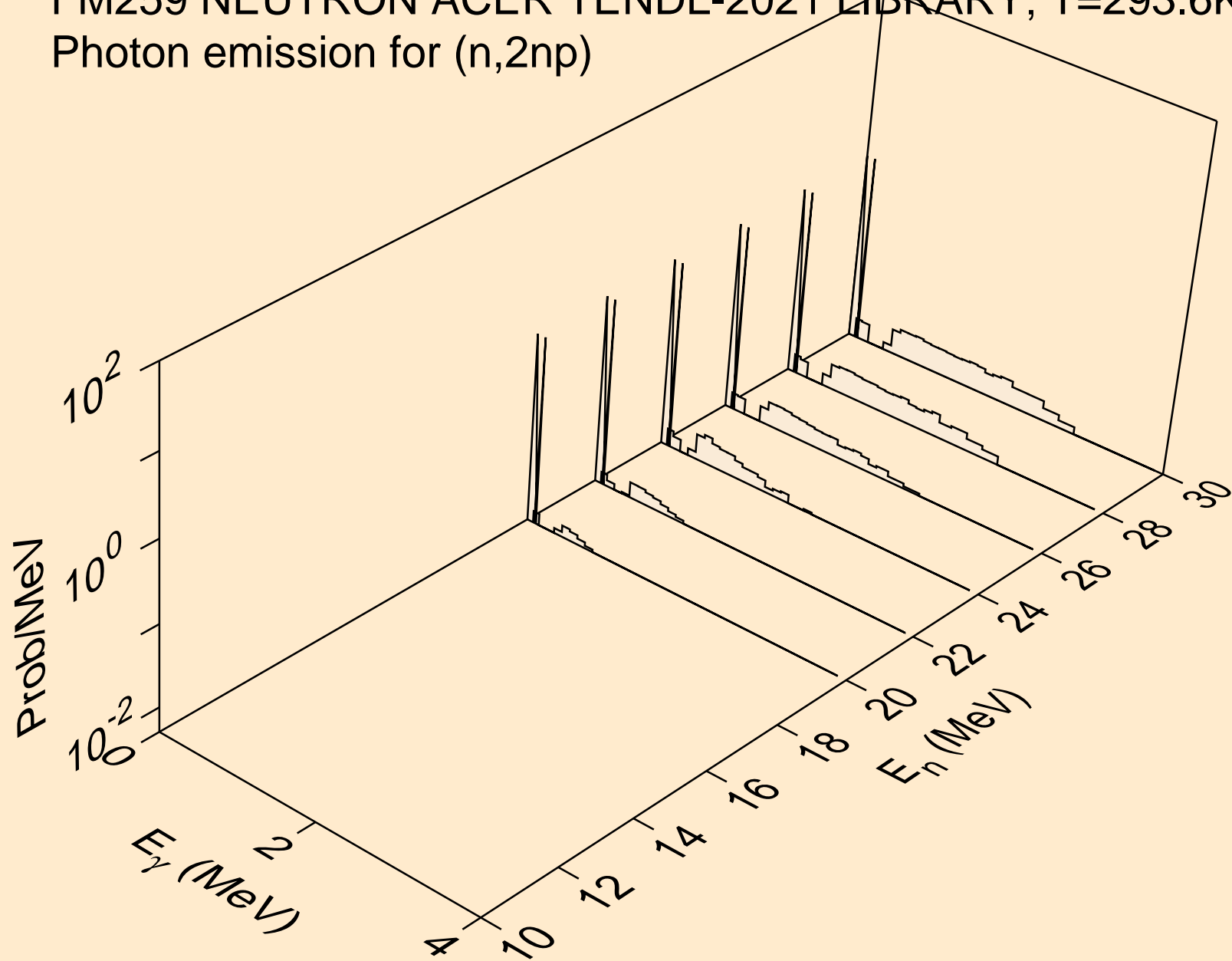

FM259 NEUTRON ACER TENDL-2021 LIBRARY; T=293.6K
Photon emission for (n,3np)

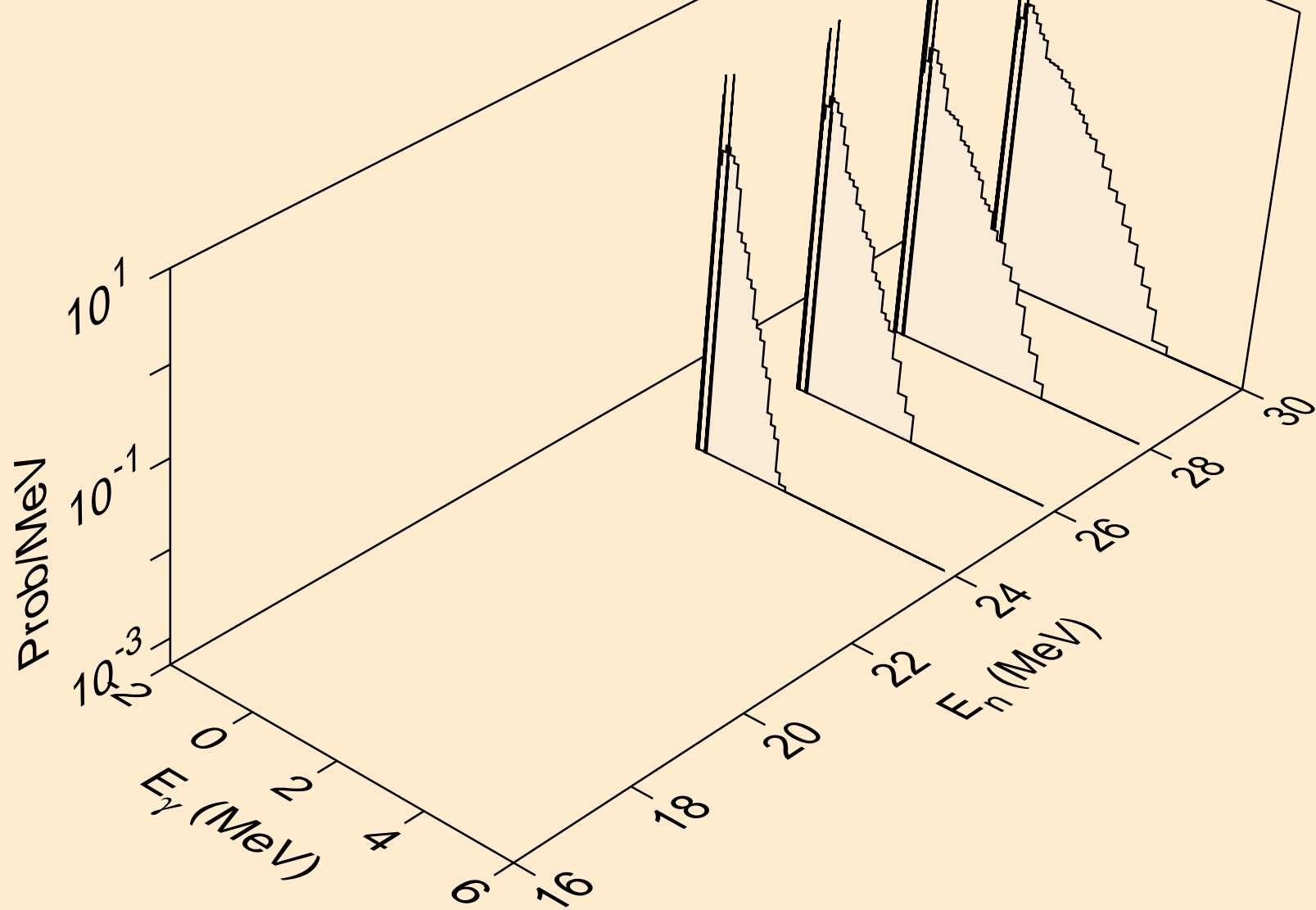

FM259 NEUTRON ACER TENDL-2021 LIBRARY; T=293.6K
Photon emission for (n,2np)

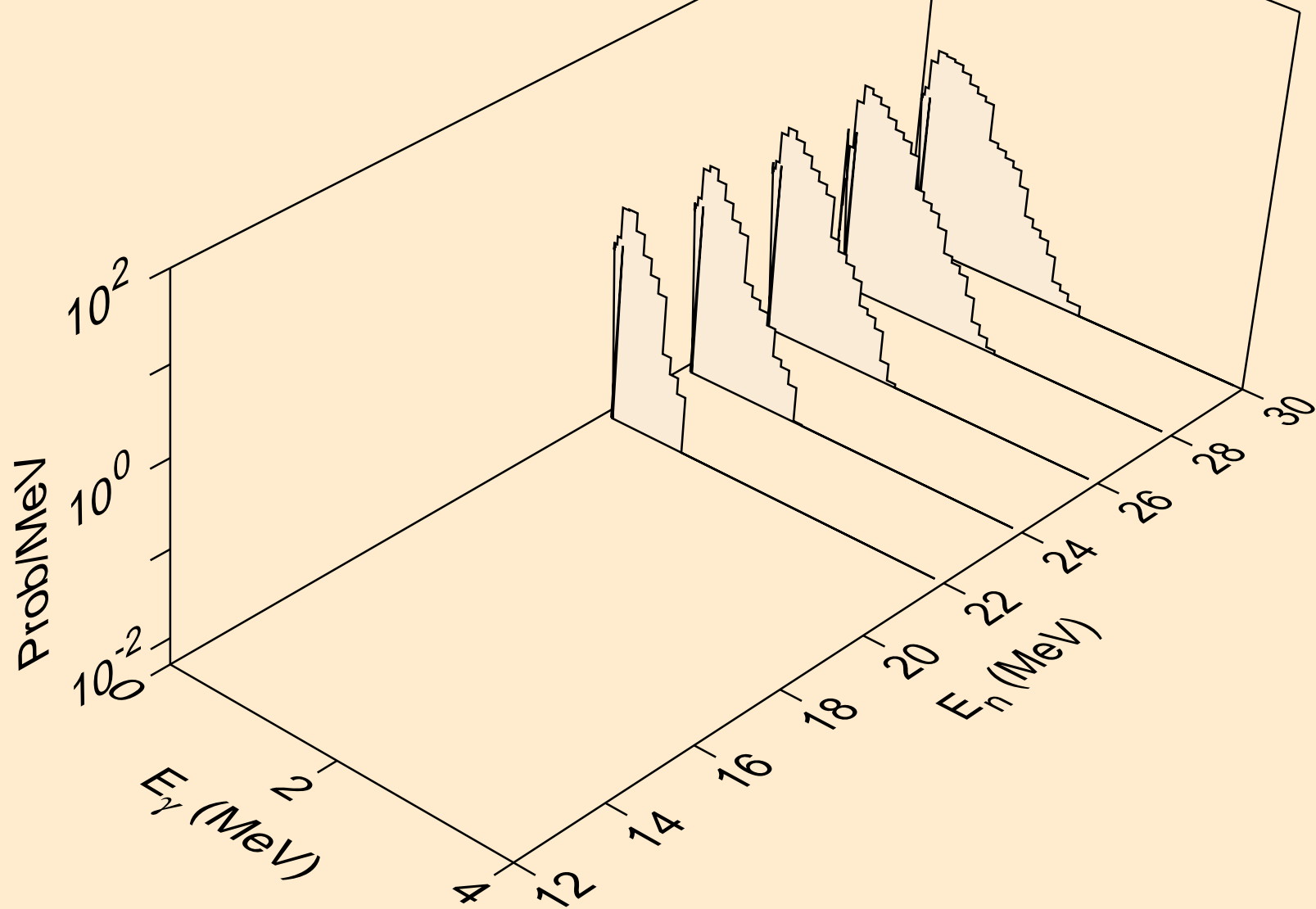

FM259 NEUTRON ACER TENDL-2021 LIBRARY; T=293.6K
Photon emission for (n,n*c)

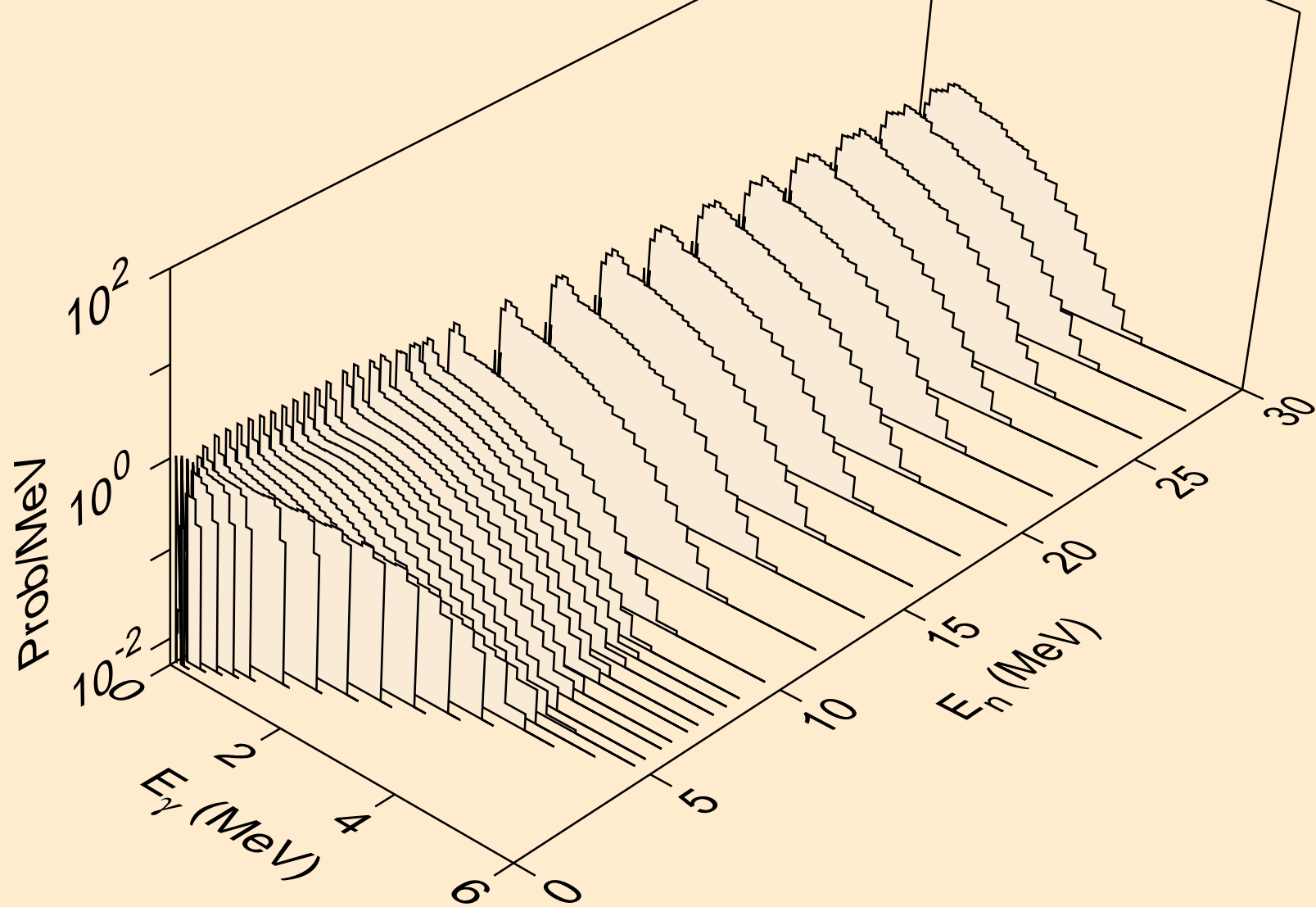

FM259 NEUTRON ACER TENDL-2021 LIBRARY; T=293.6K
Photon emission for (n,gma)

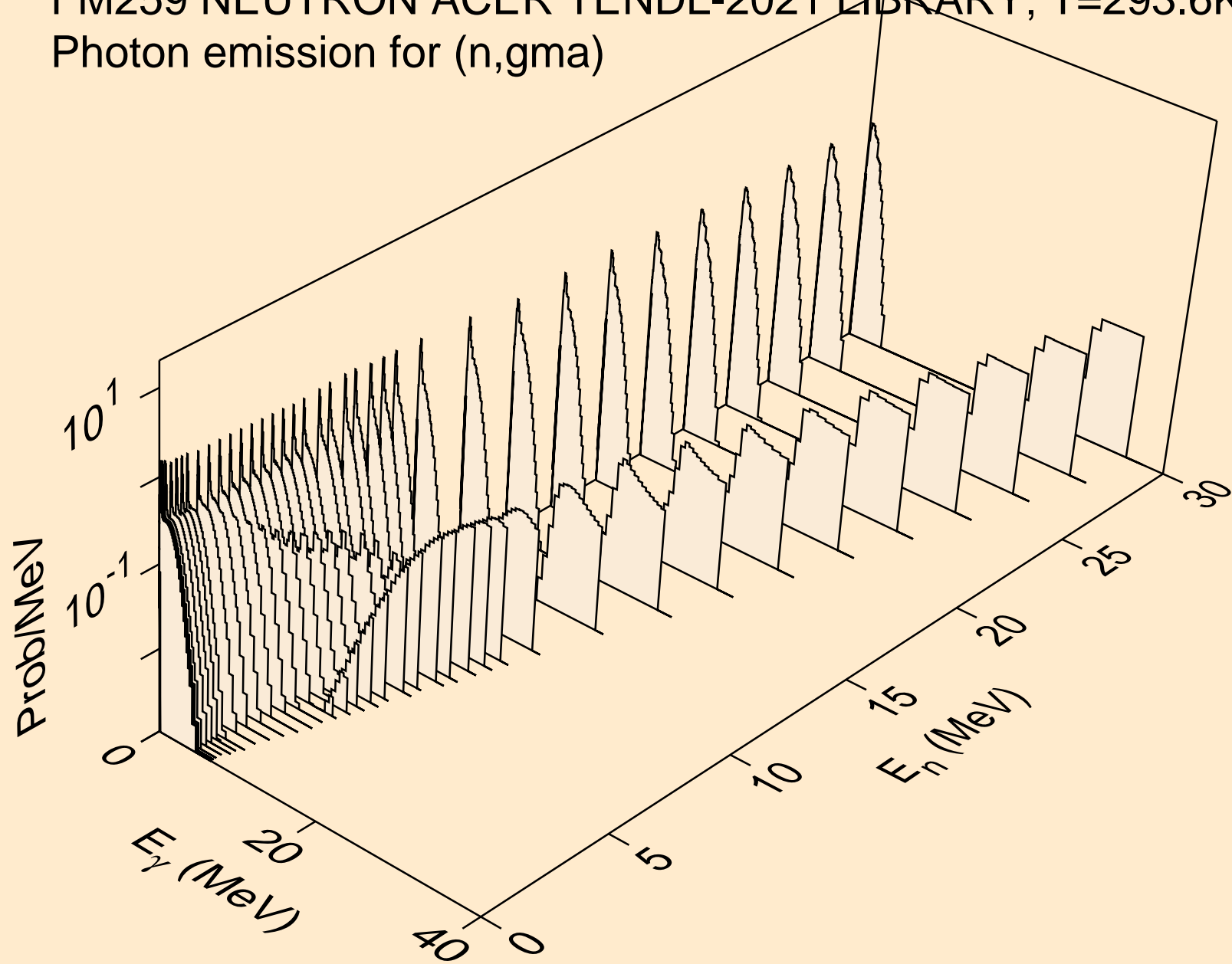

FM259 NEUTRON ACER TENDL-2021 LIBRARY; T=293.6K
Photon emission for (n,p)

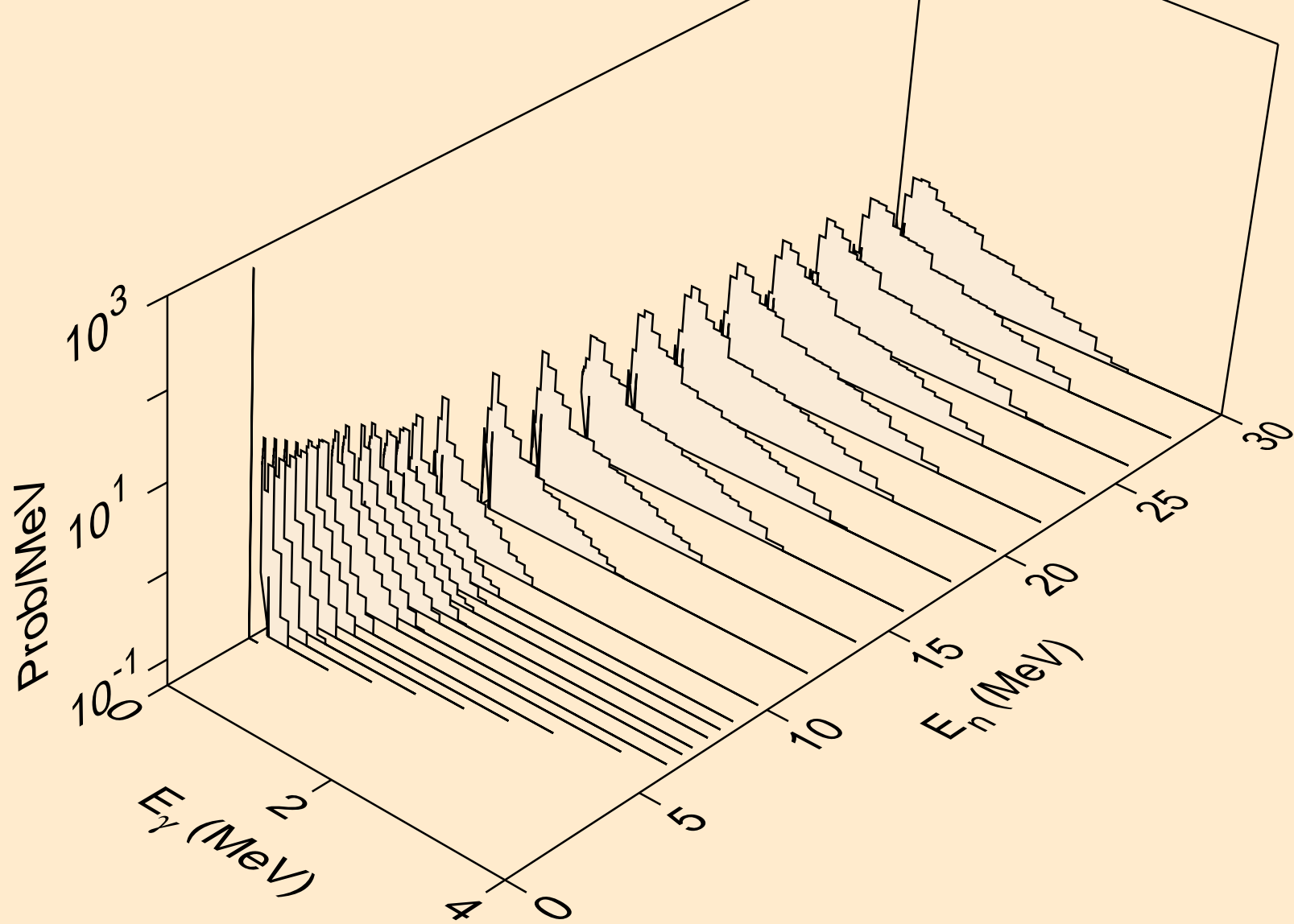

FM259 NEUTRON ACER TENDL-2021 LIBRARY; T=293.6K
Photon emission for (n,d)

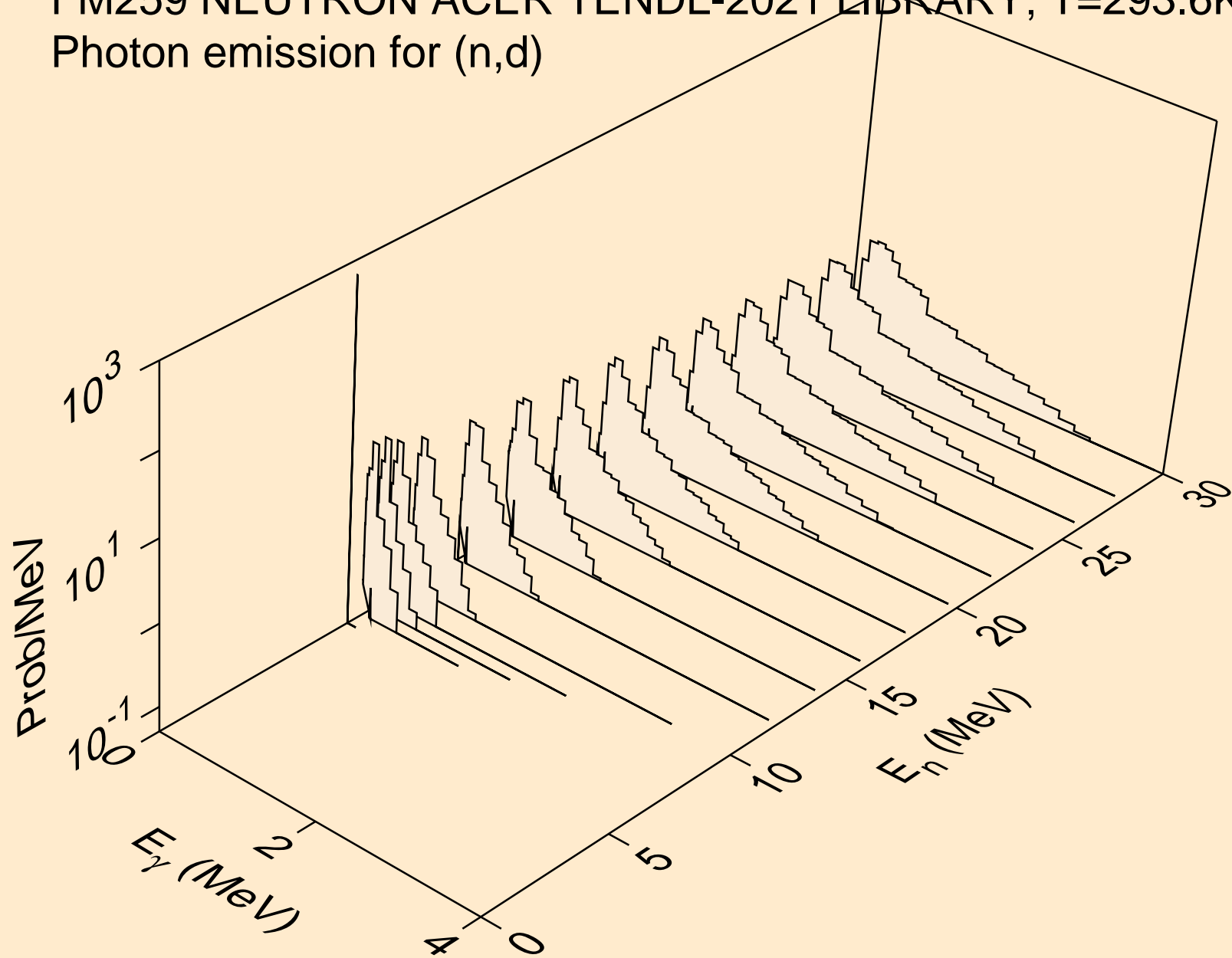

FM259 NEUTRON ACER TENDL-2021 LIBRARY; T=293.6K
Photon emission for (n,t)

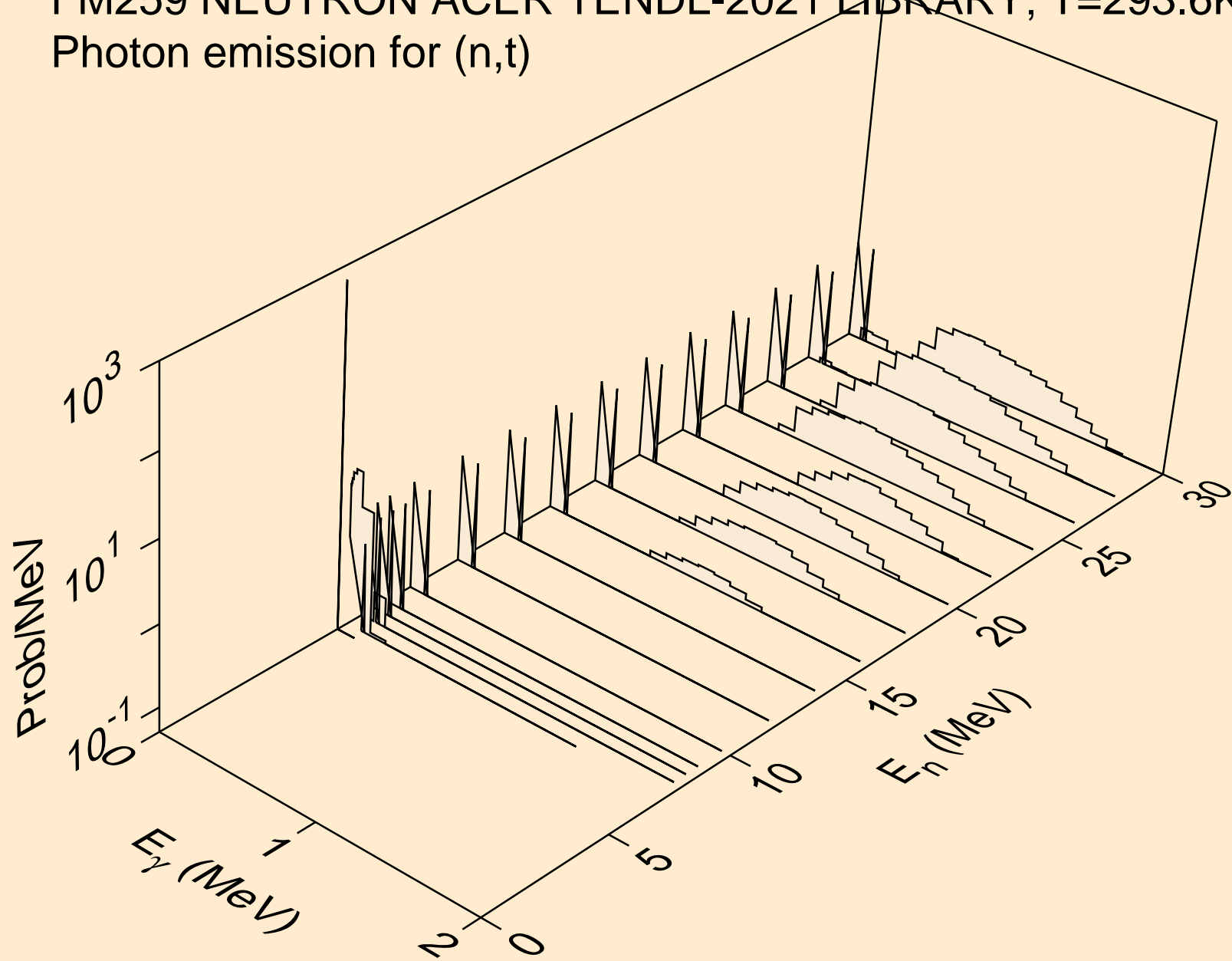

FM259 NEUTRON ACER TENDL-2021 LIBRARY; T=293.6K
Photon emission for (n,he3)

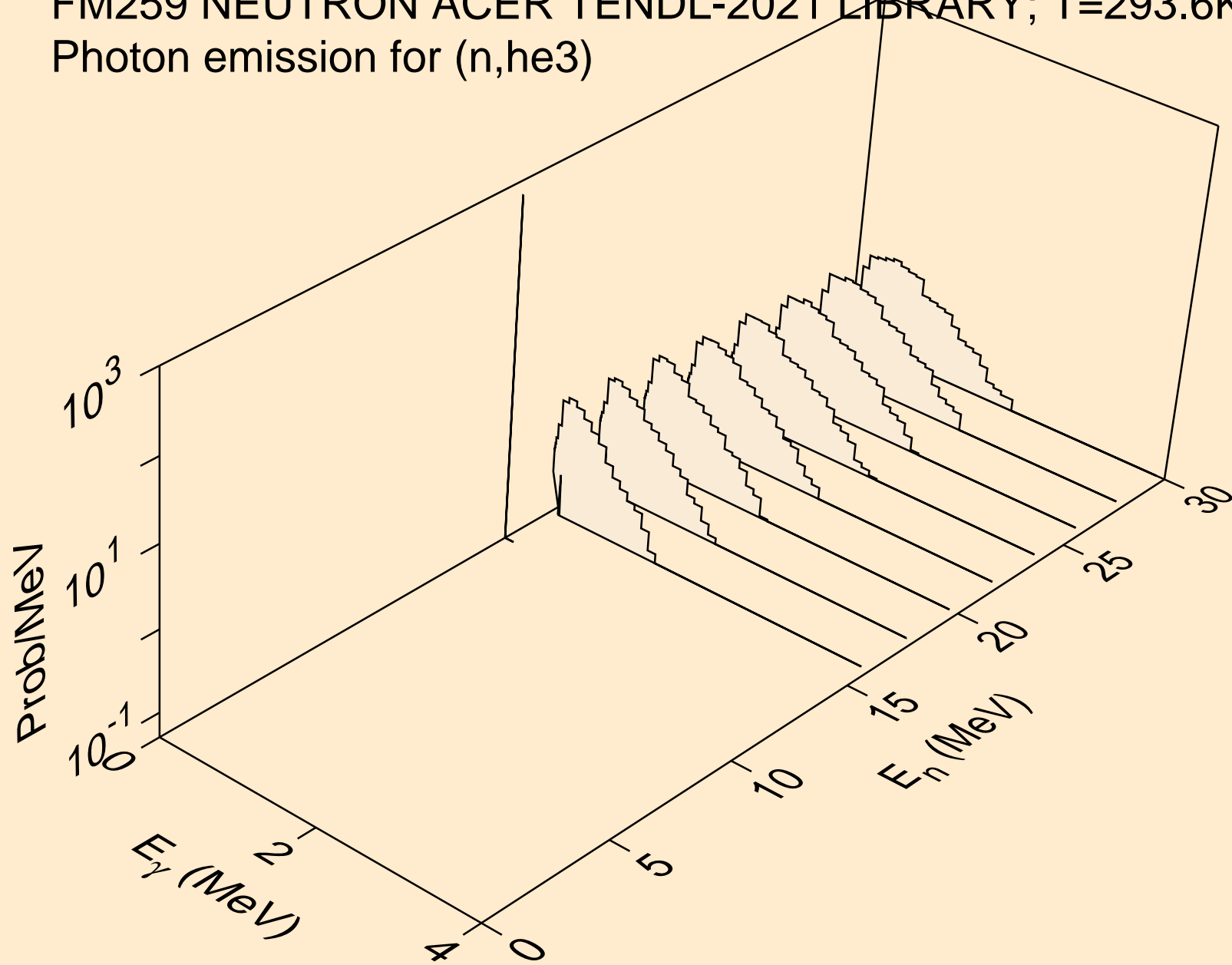

FM259 NEUTRON ACER TENDL-2021 LIBRARY; T=293.6K
Photon emission for (n,a)

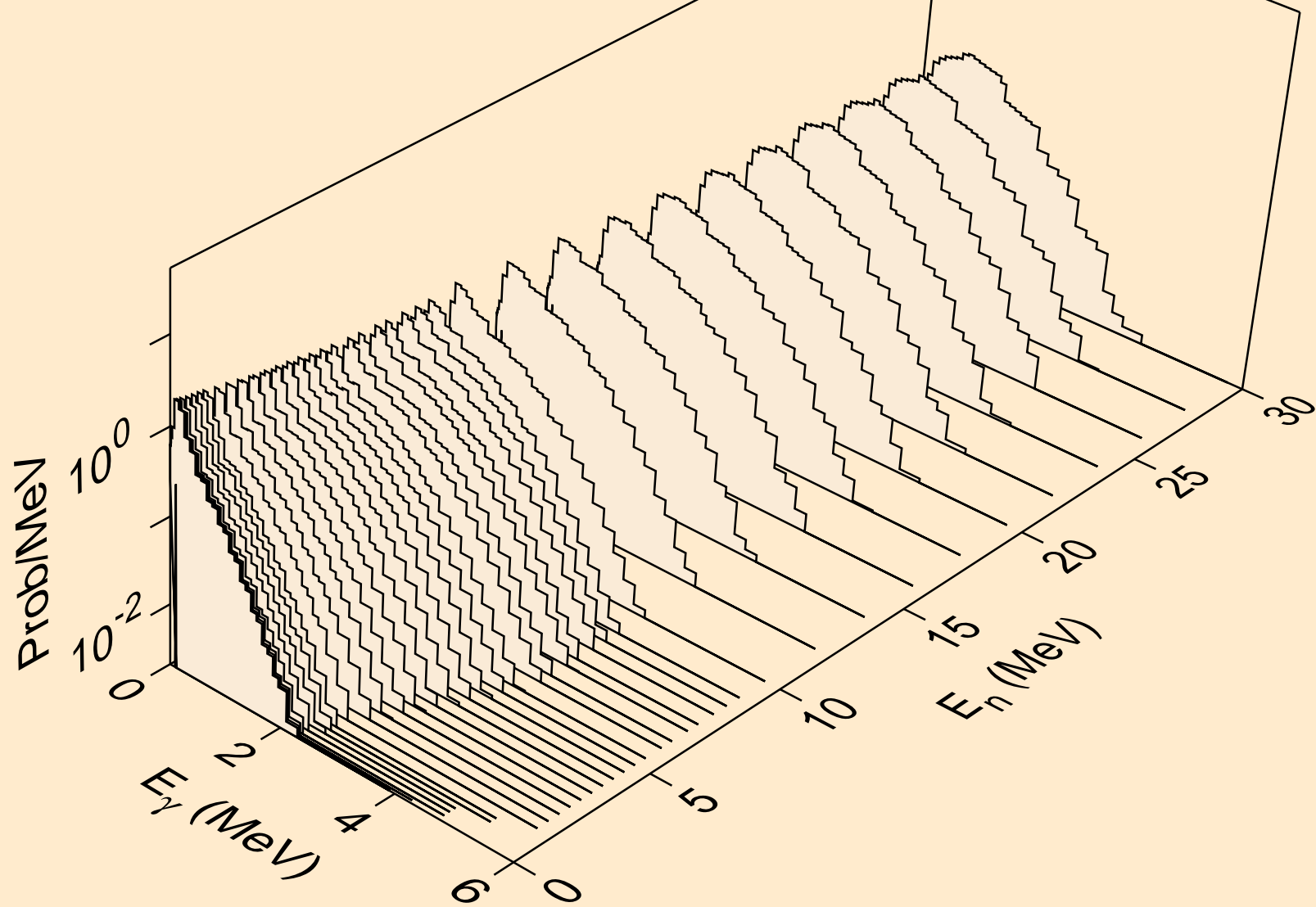

FM259 NEUTRON ACER TENDL-2021 LIBRARY; T=293.6K
Photon emission for (n,2p)

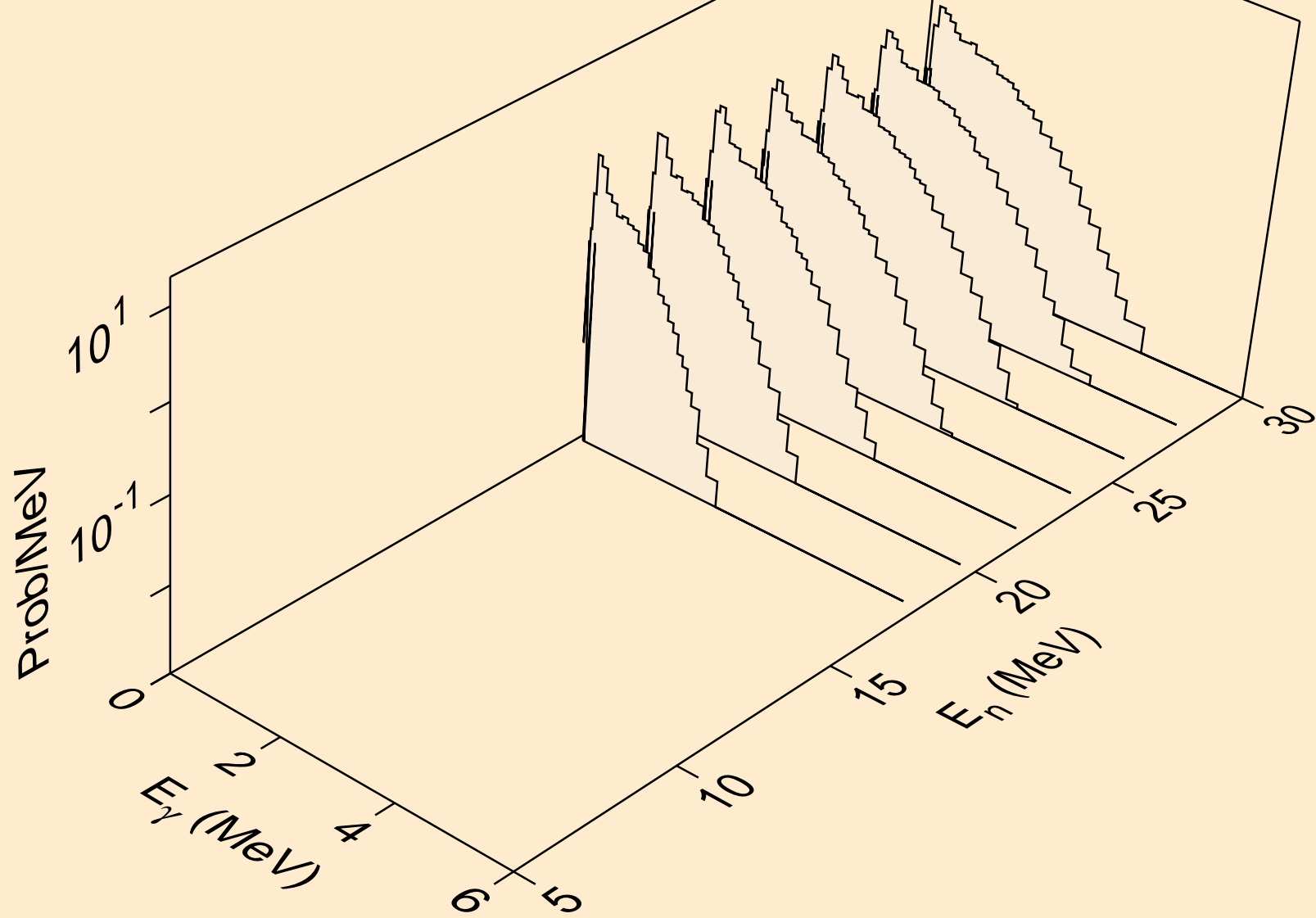

FM259 NEUTRON ACER TENDL-2021 LIBRARY; T=293.6K
thermal capture photon spectrum

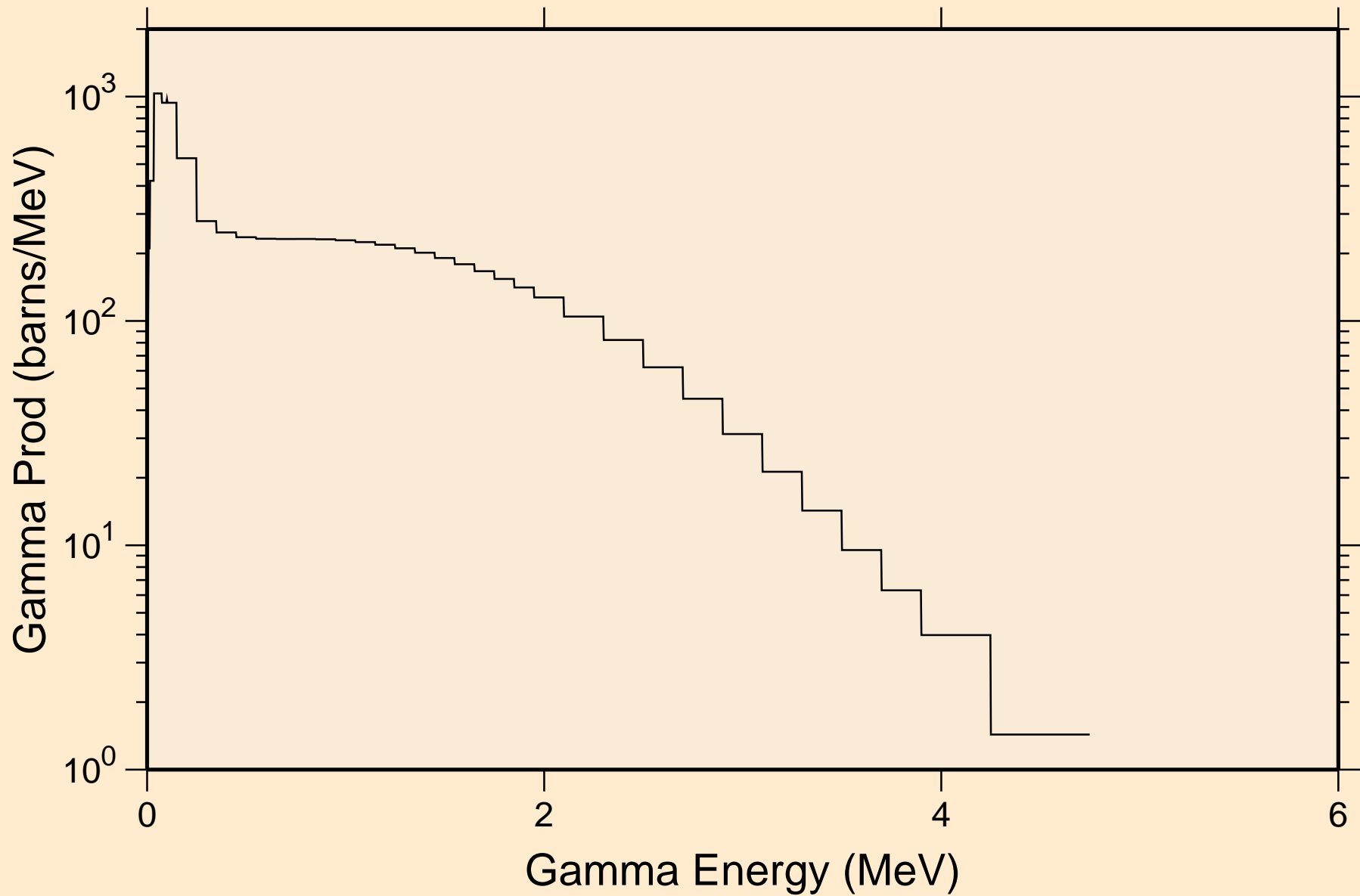

FM259 NEUTRON ACER TENDL-2021 LIBRARY; T=293.6K
14 MeV photon spectrum

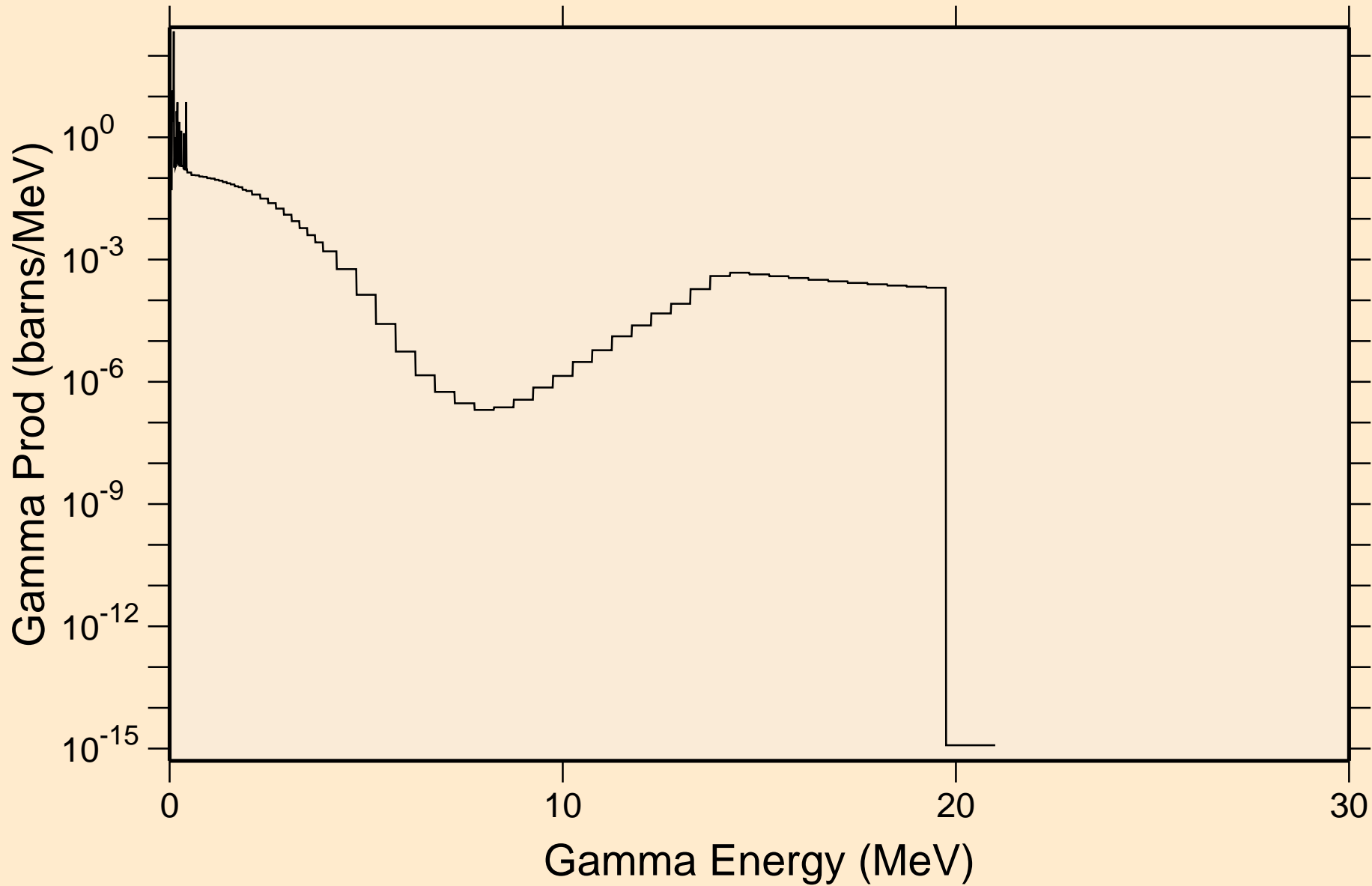

FM259 NEUTRON ACER TENDL-2021 LIBRARY; T=293.6K

Particle heating contributions

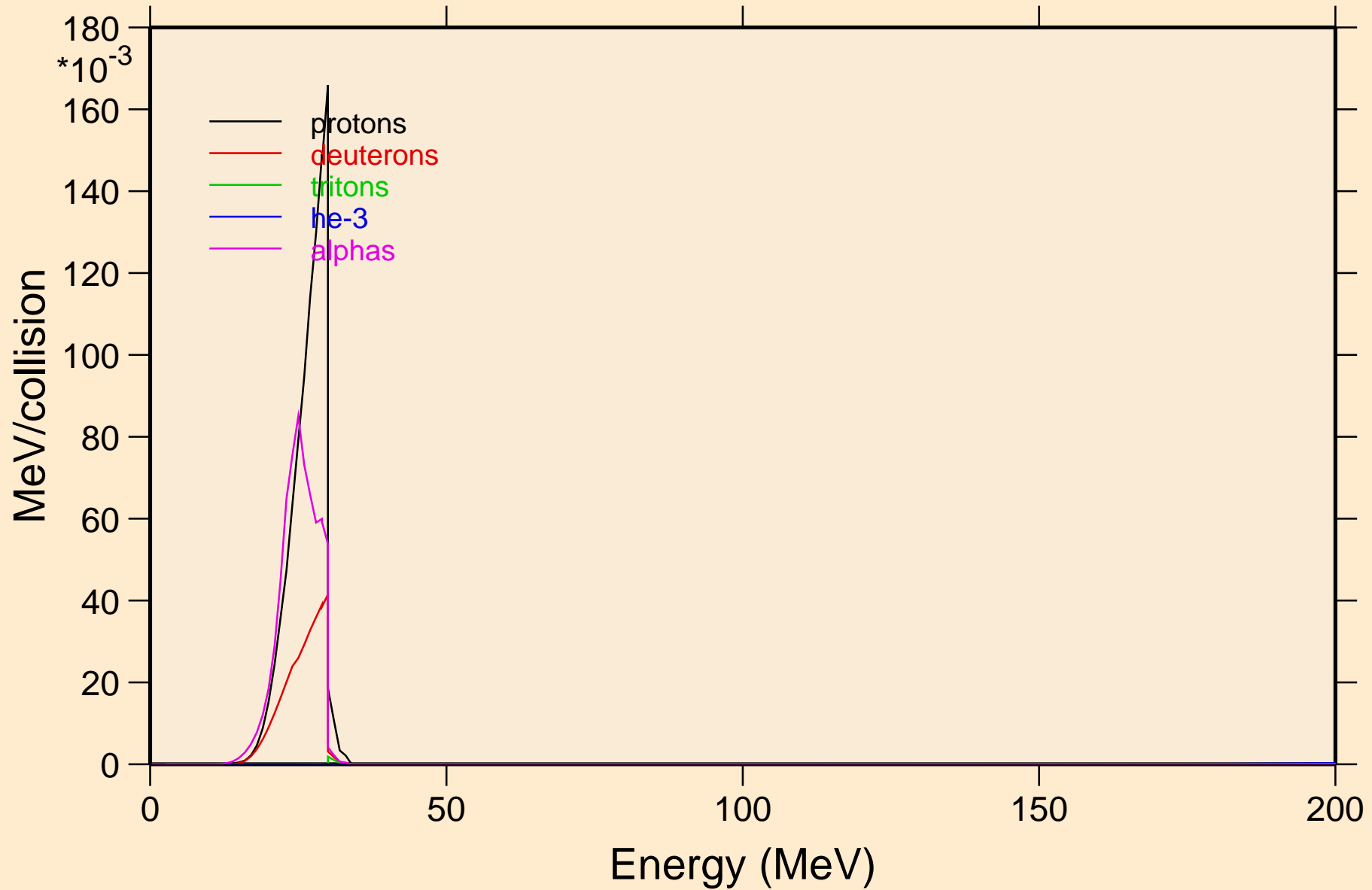

FM259 NEUTRON ACER TENDL-2021 LIBRARY; T=293.6K
Recoil Heating

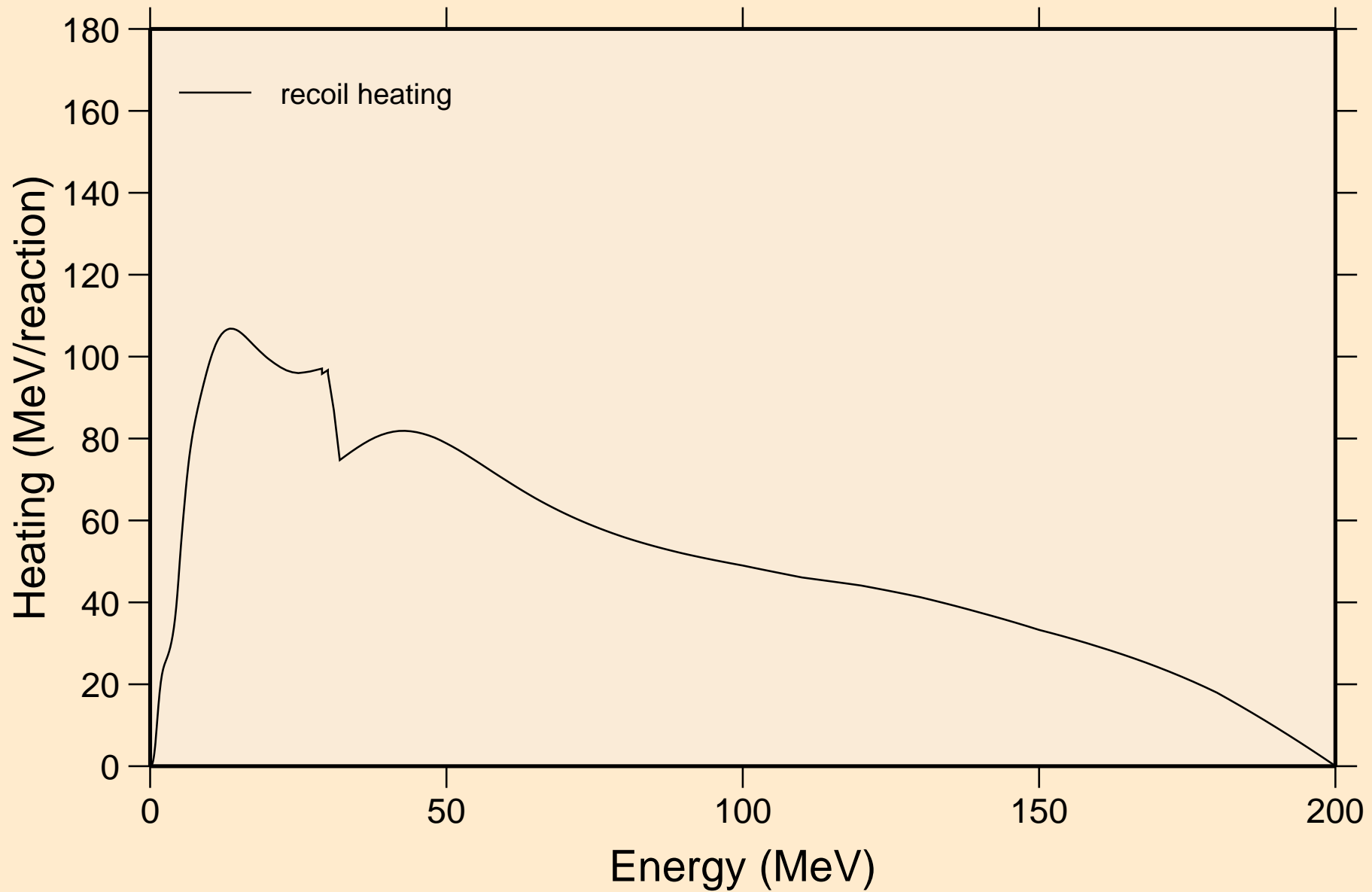

FM259 NEUTRON ACER TENDL-2021 LIBRARY; T=293.6K

Particle production cross sections

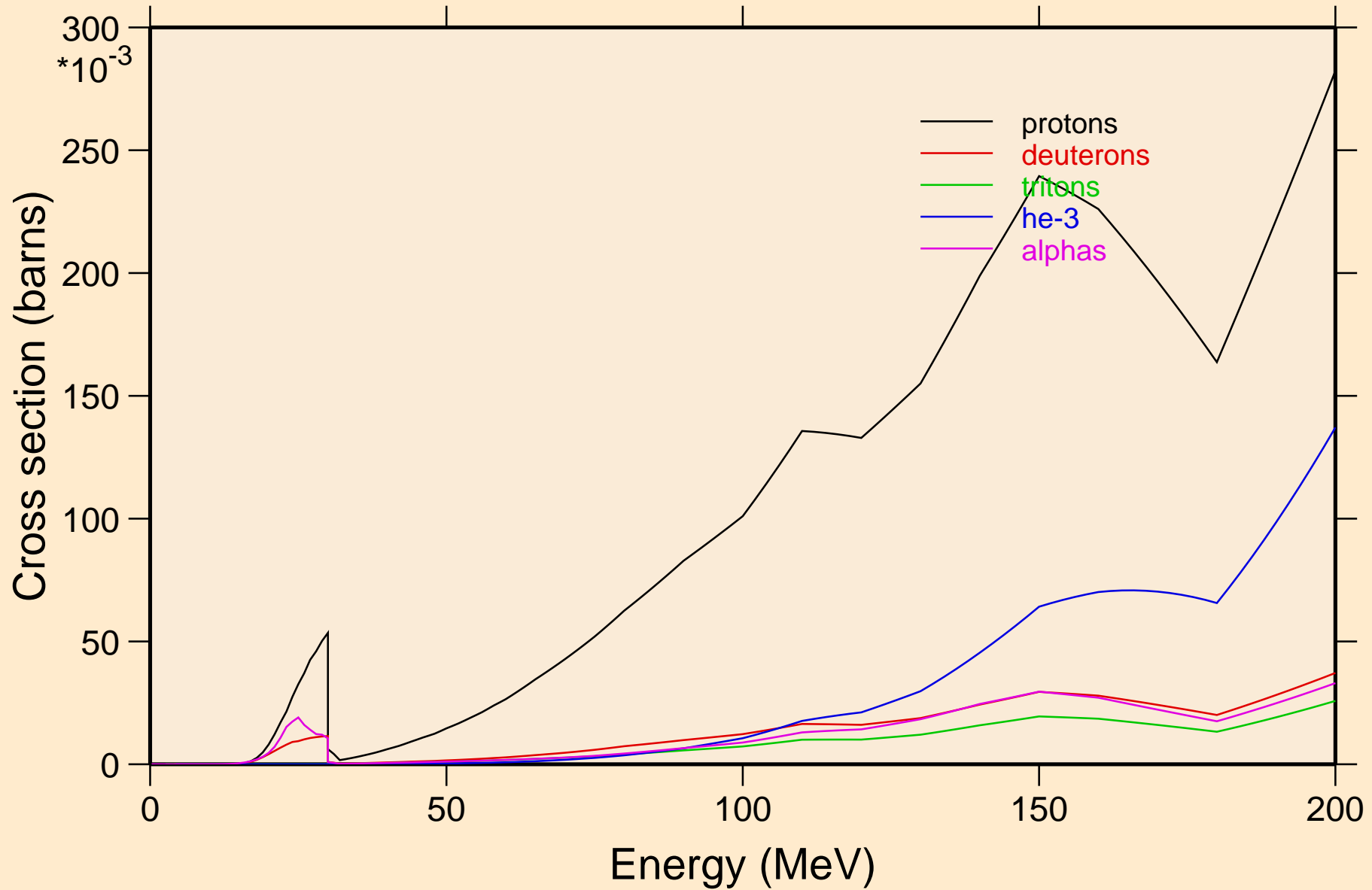

FM259 NEUTRON ACER TENDL-2021 LIBRARY; T=293.6K
protons from (n,x)

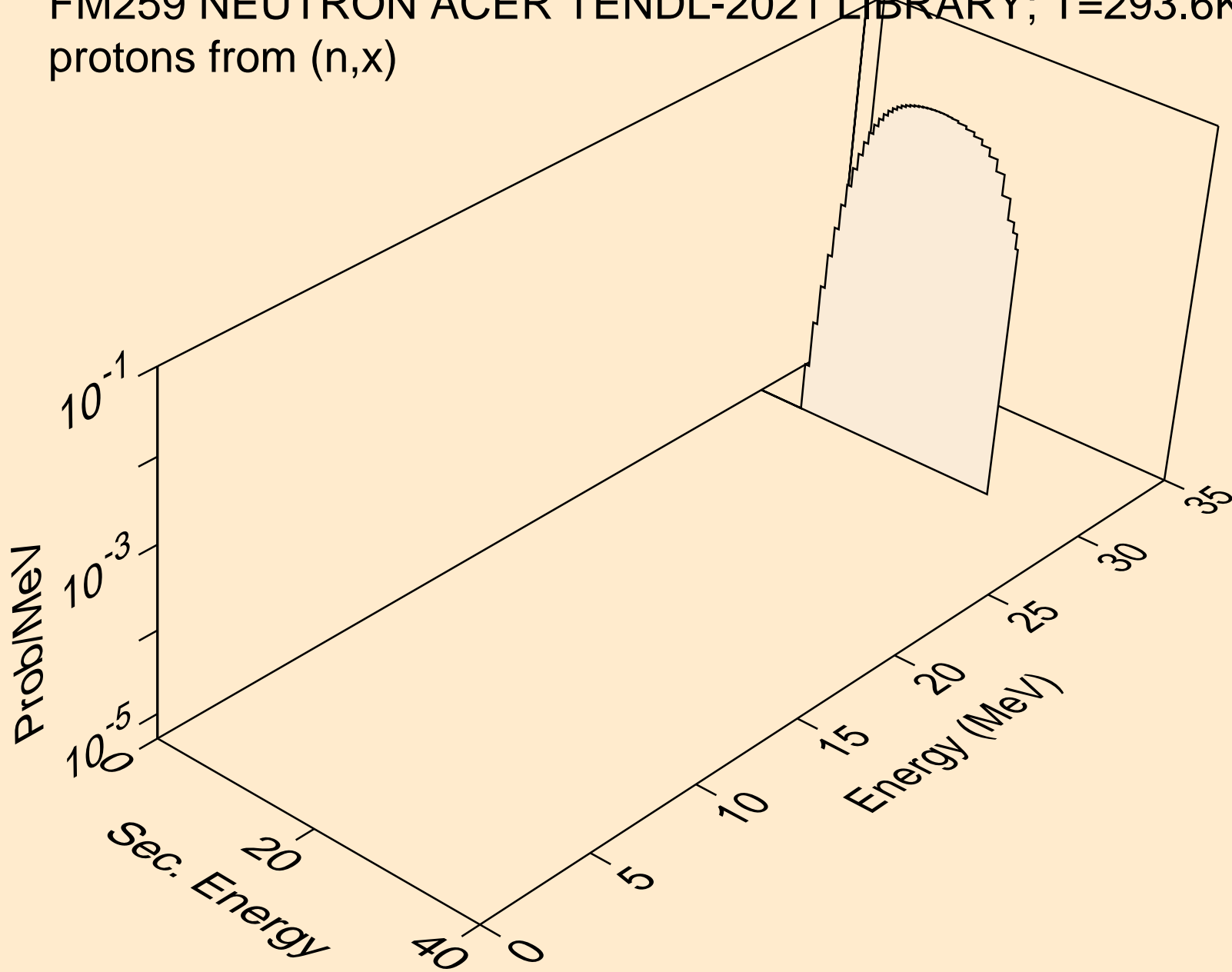

FM259 NEUTRON ACER TENDL-2021 LIBRARY; T=293.6K
protons from (n,n*)p

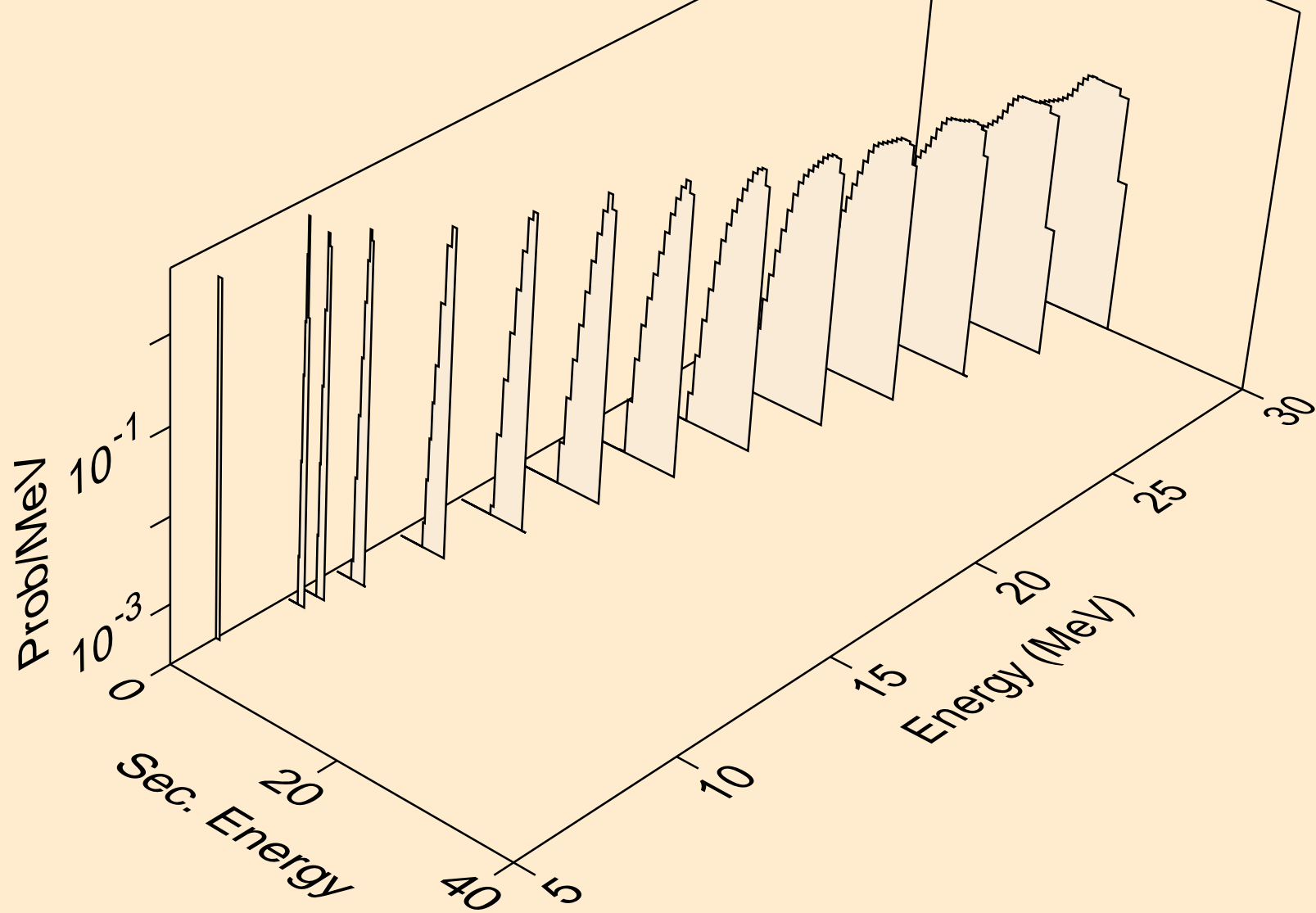

FM259 NEUTRON ACER TENDL-2021 LIBRARY; T=293.6K
protons from (n,2np)

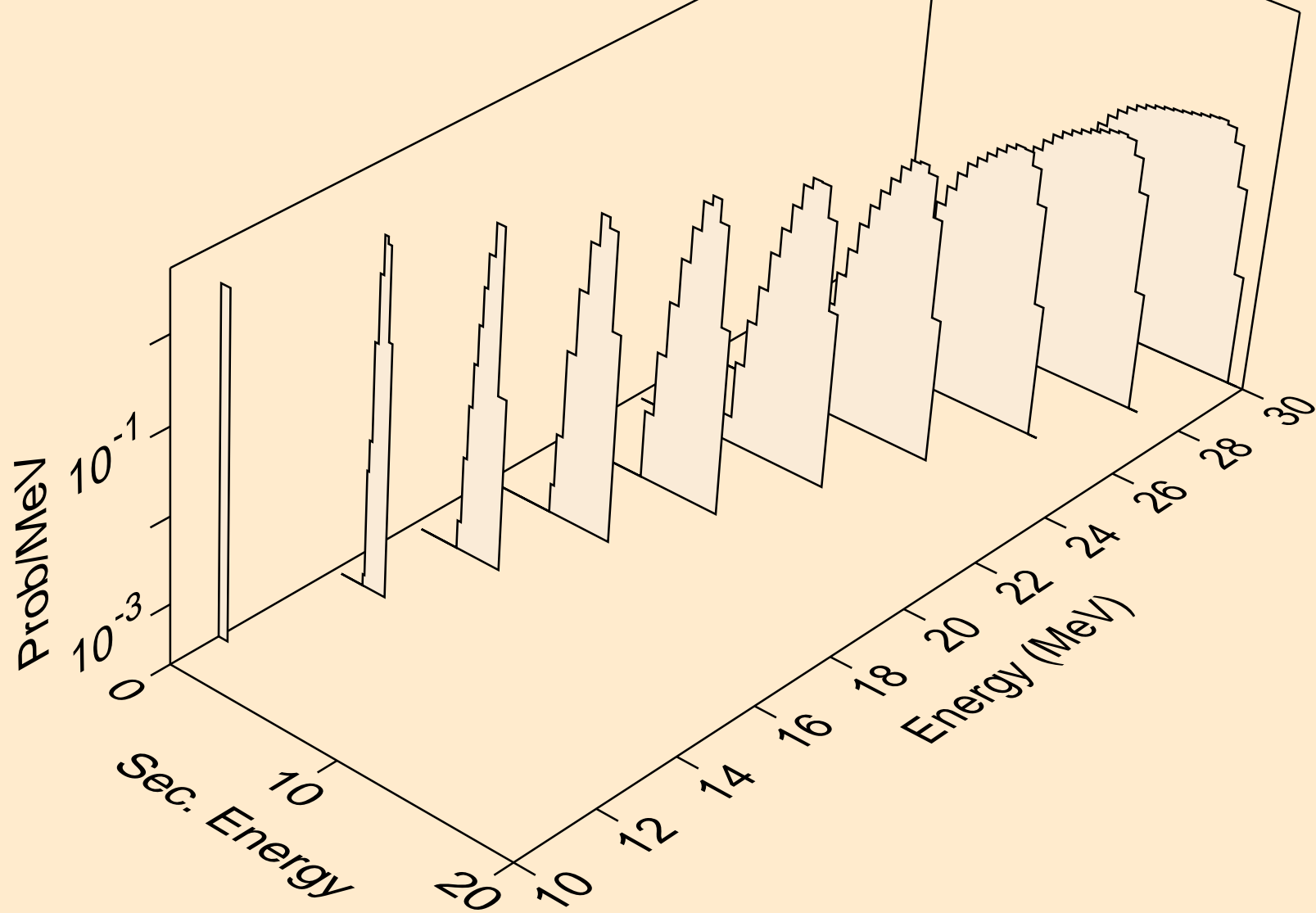

FM259 NEUTRON ACER TENDL-2021 LIBRARY; T=293.6K
protons from (n,3np)

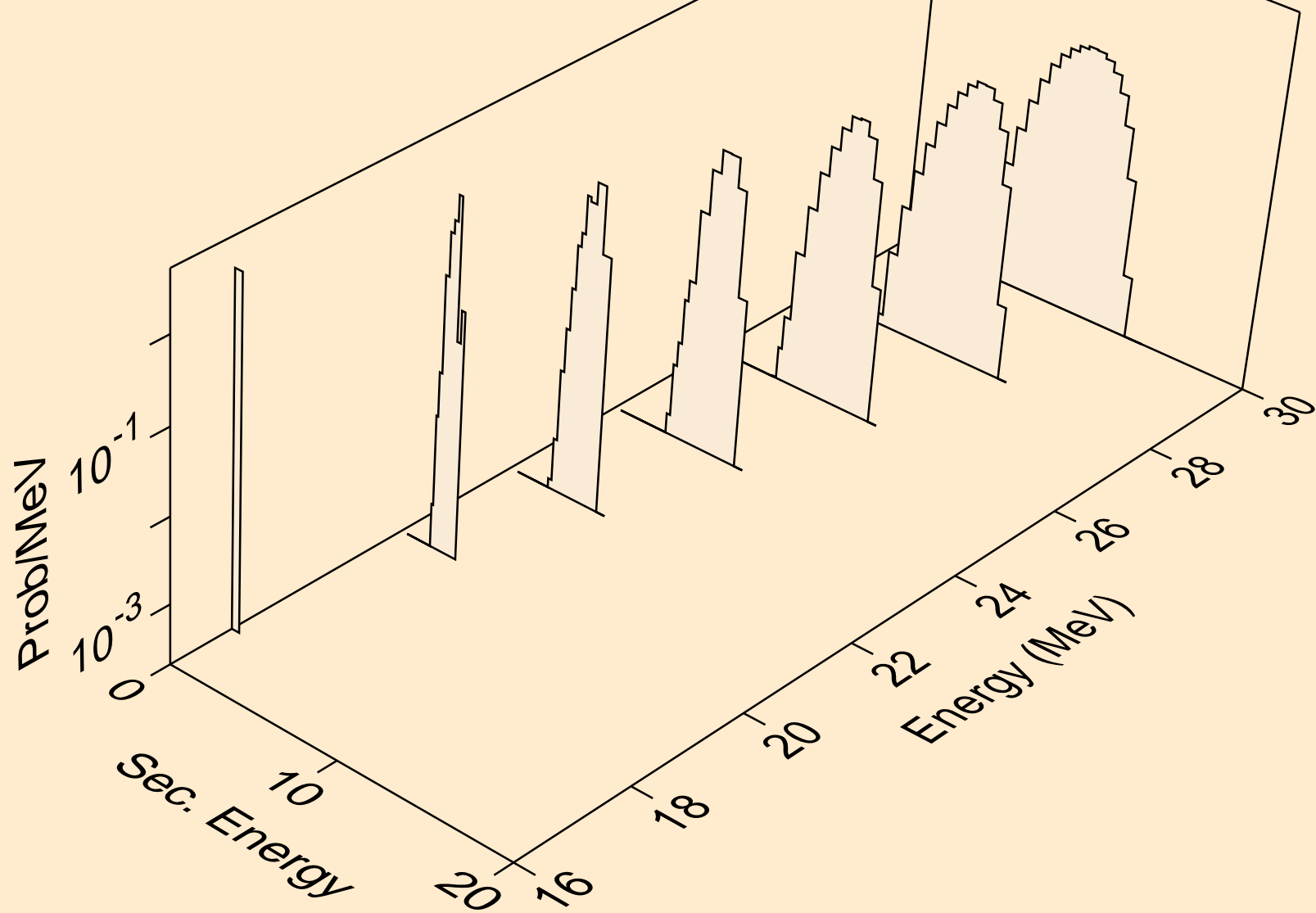

FM259 NEUTRON ACER TENDL-2021 LIBRARY; T=293.6K
protons from (n,2np)

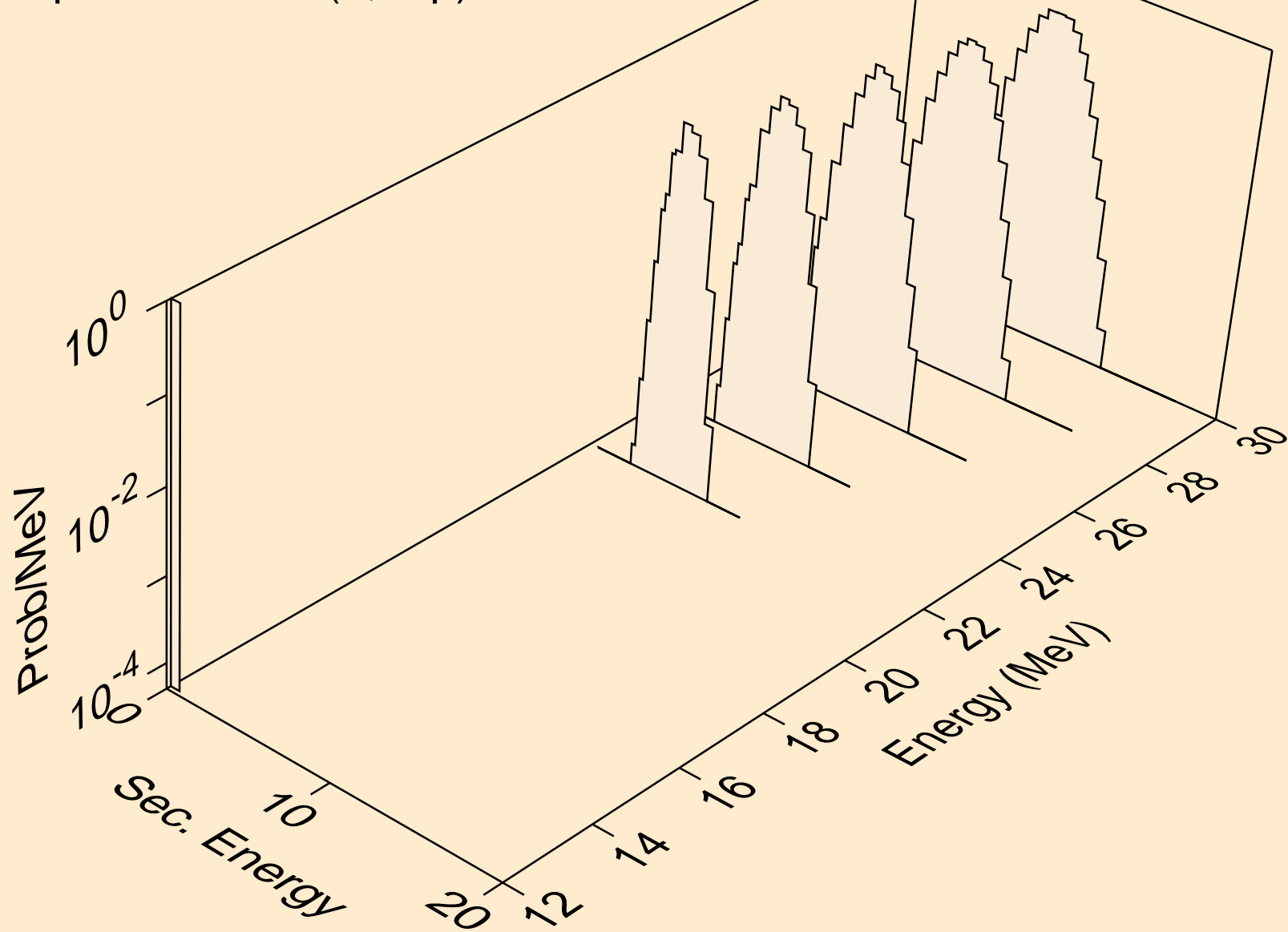

FM259 NEUTRON ACER TENDL-2021 LIBRARY; T=293.6K
protons from (n,p)

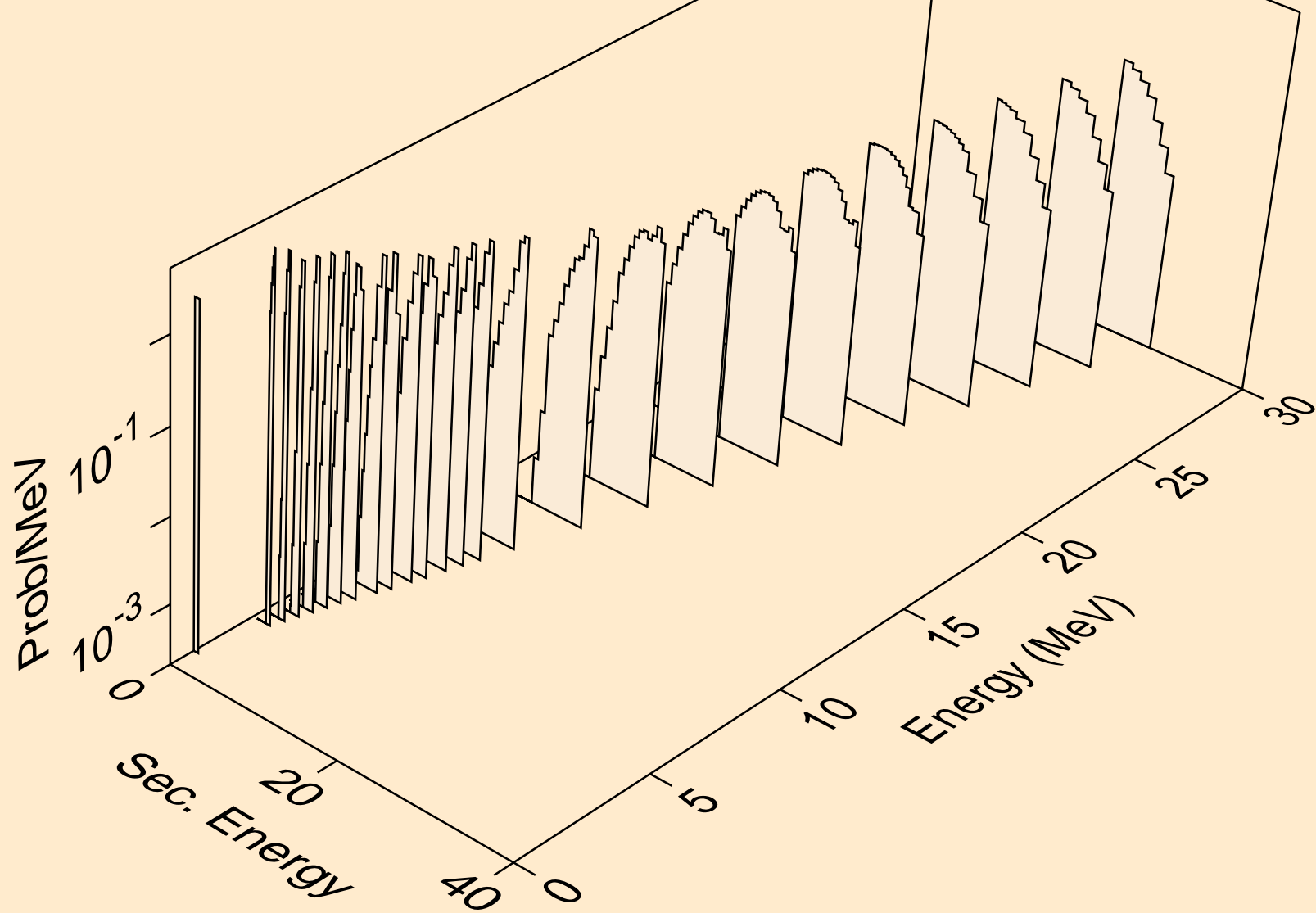

FM259 NEUTRON ACER TENDL-2021 LIBRARY; T=293.6K
protons from (n,2p)

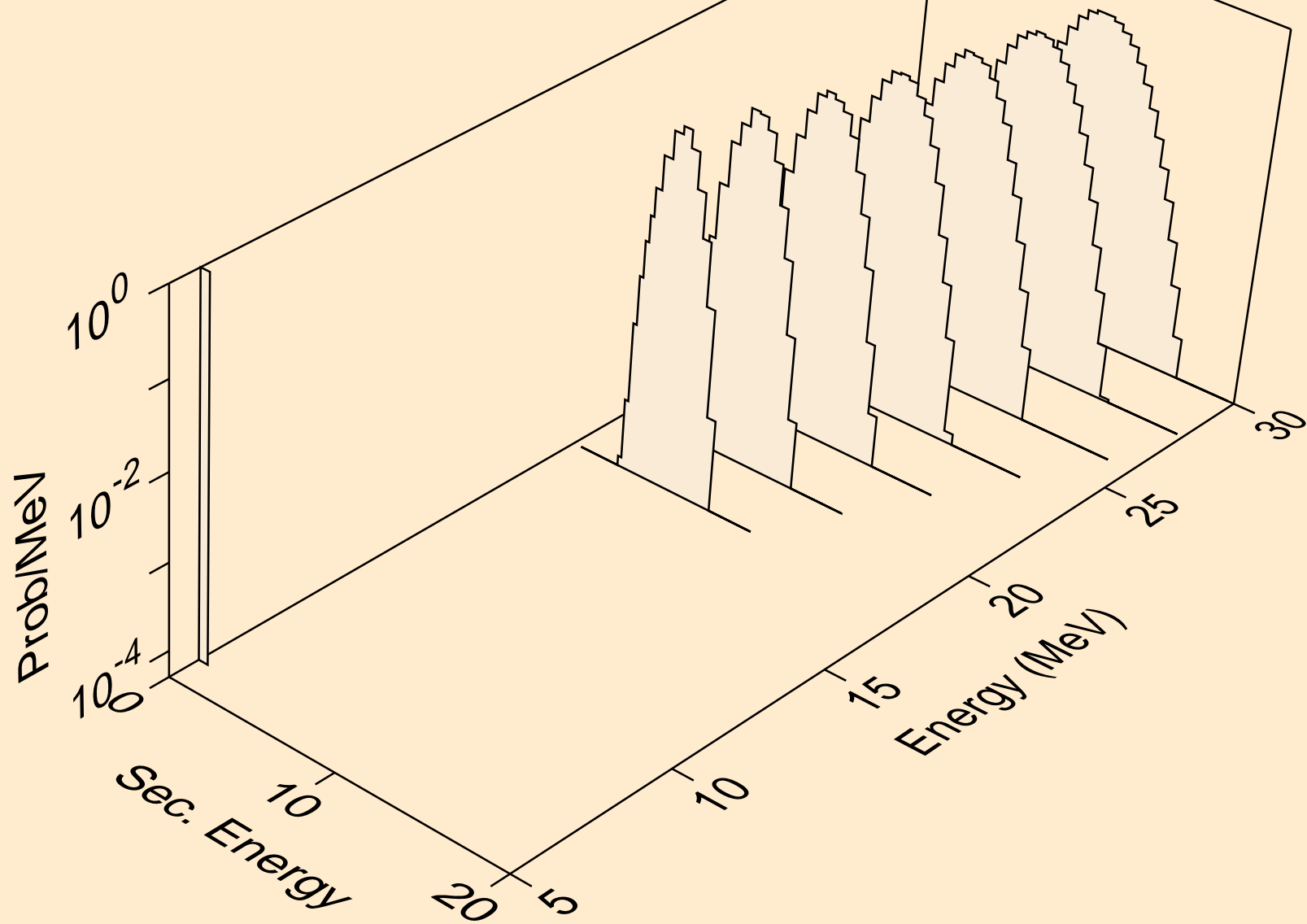

FM259 NEUTRON ACER TENDL-2021 LIBRARY; T=293.6K
deuterons from (n,x)

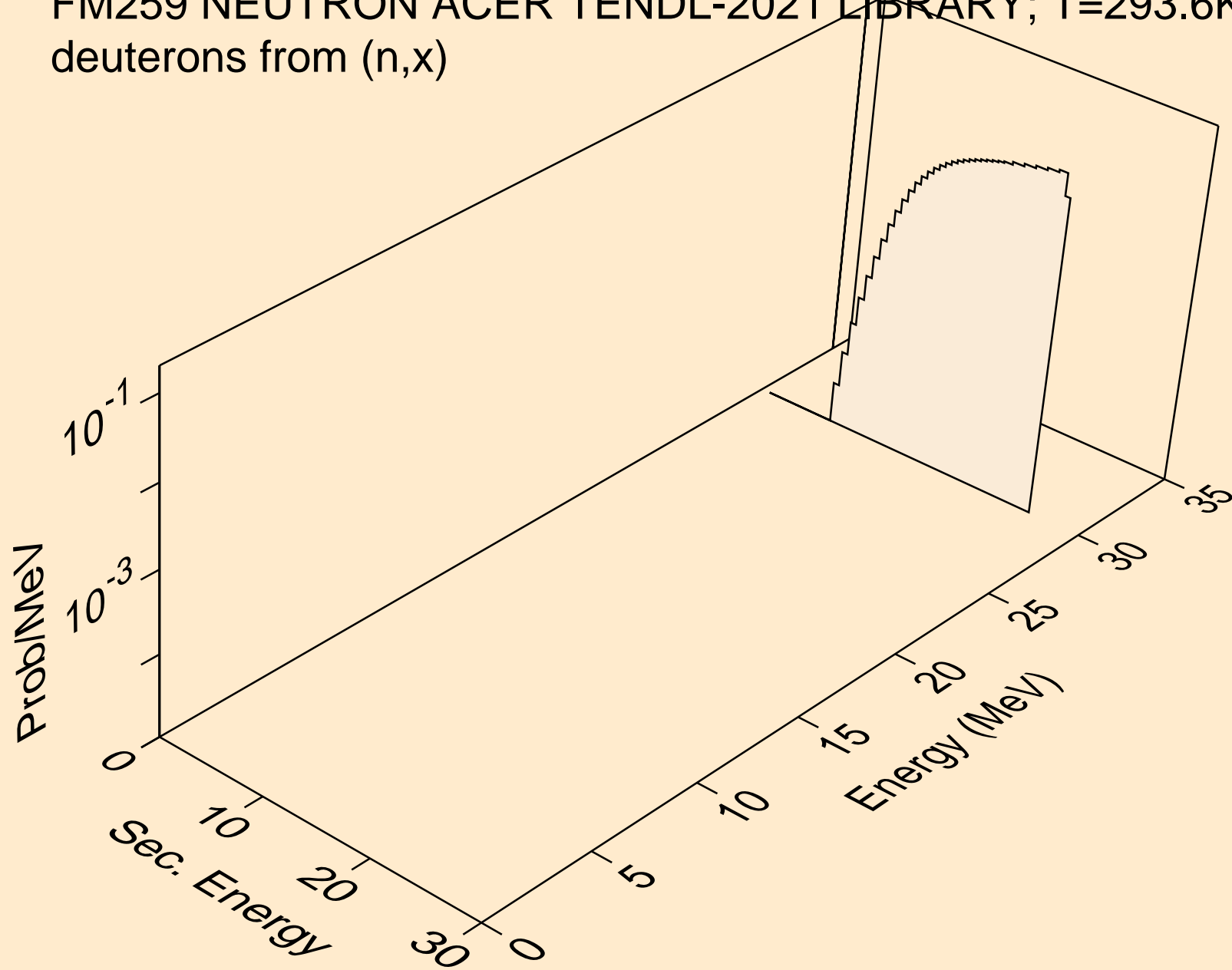

FM259 NEUTRON ACER TENDL-2021 LIBRARY; T=293.6K
deuterons from (n,2nd)

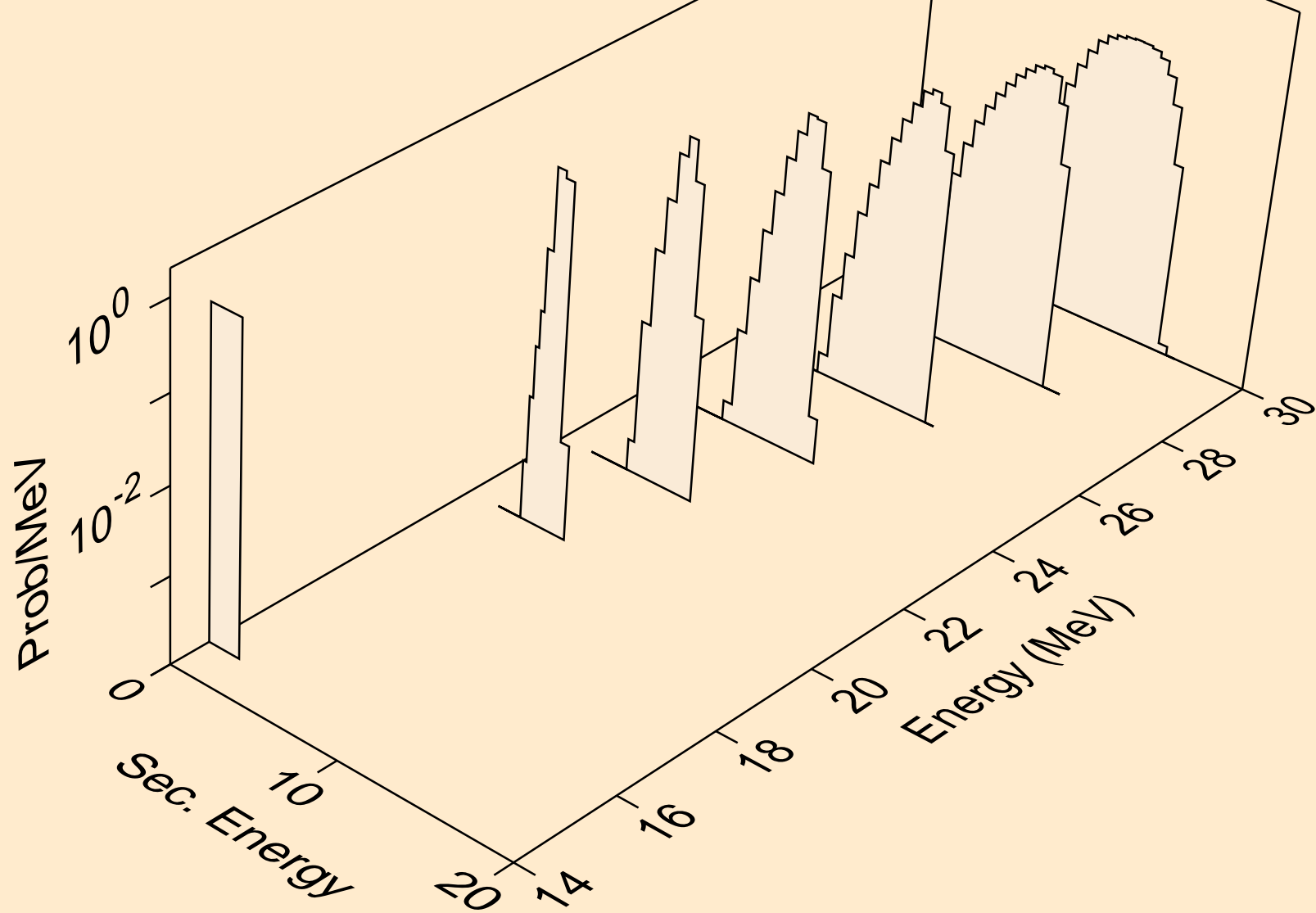

FM259 NEUTRON ACER TENDL-2021 LIBRARY; T=293.6K
deuterons from (n,n*)d

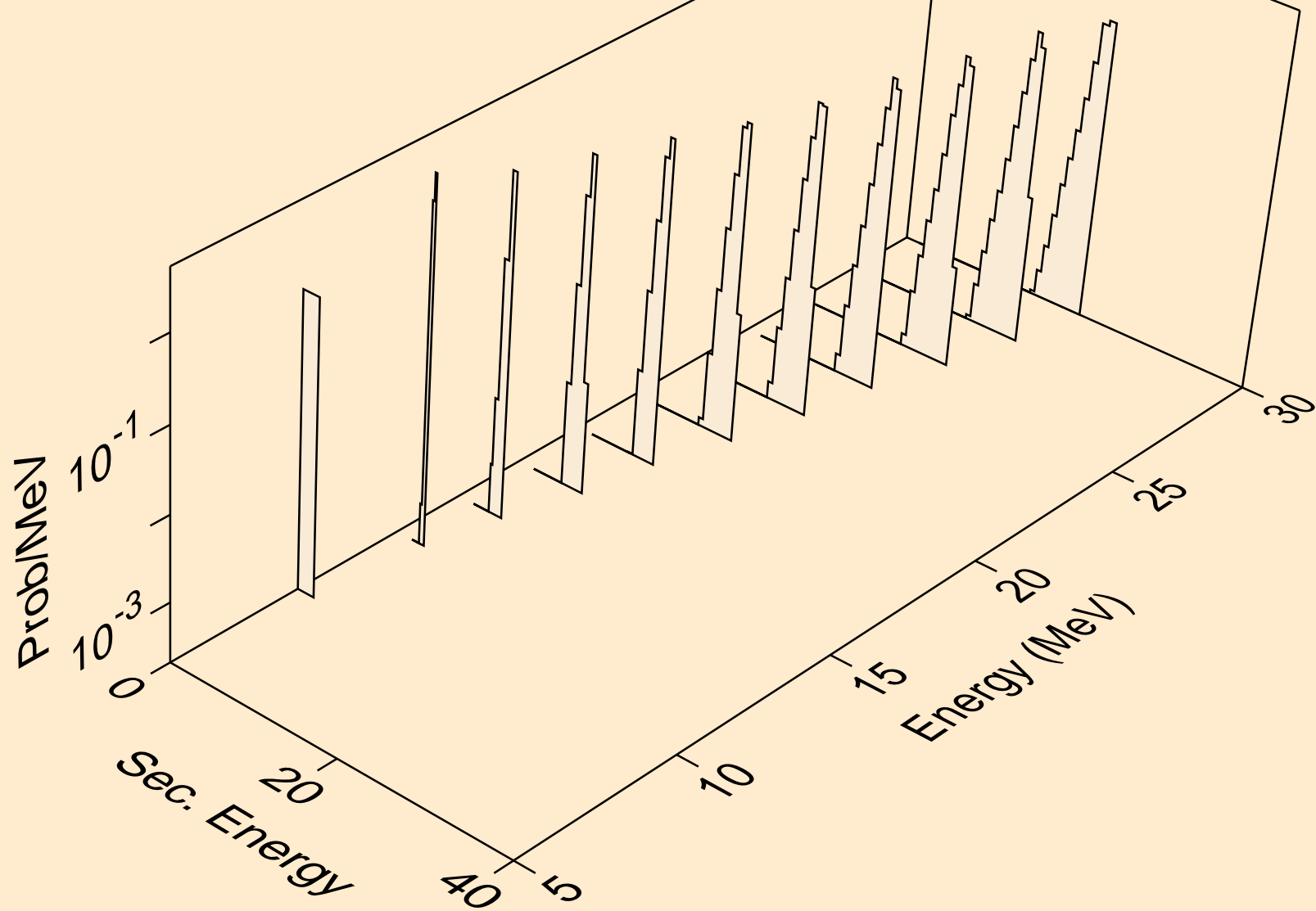

FM259 NEUTRON ACER TENDL-2021 LIBRARY; T=293.6K
deuterons from (n,d)

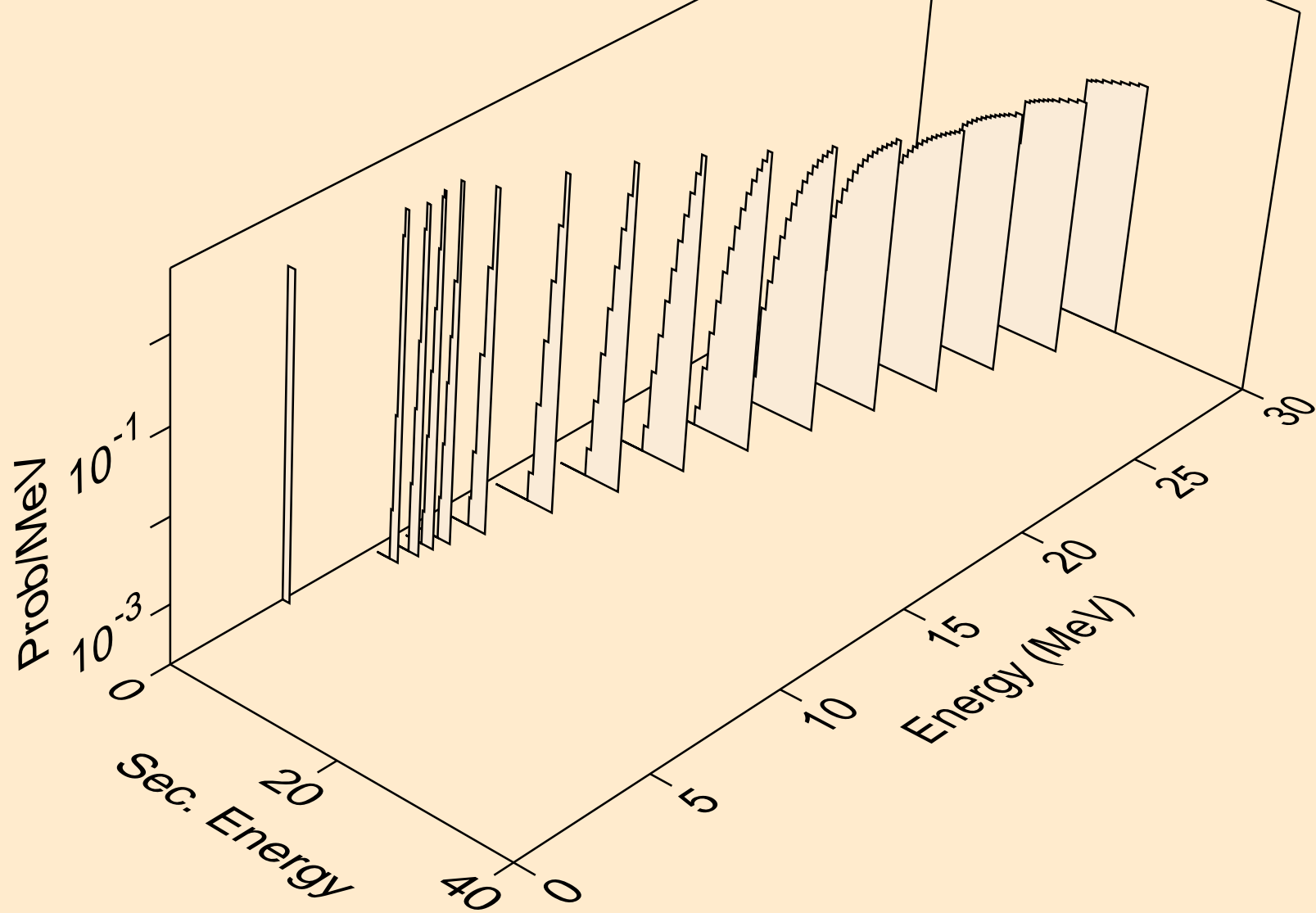

FM259 NEUTRON ACER TENDL-2021 LIBRARY; T=293.6K
tritons from (n,x)

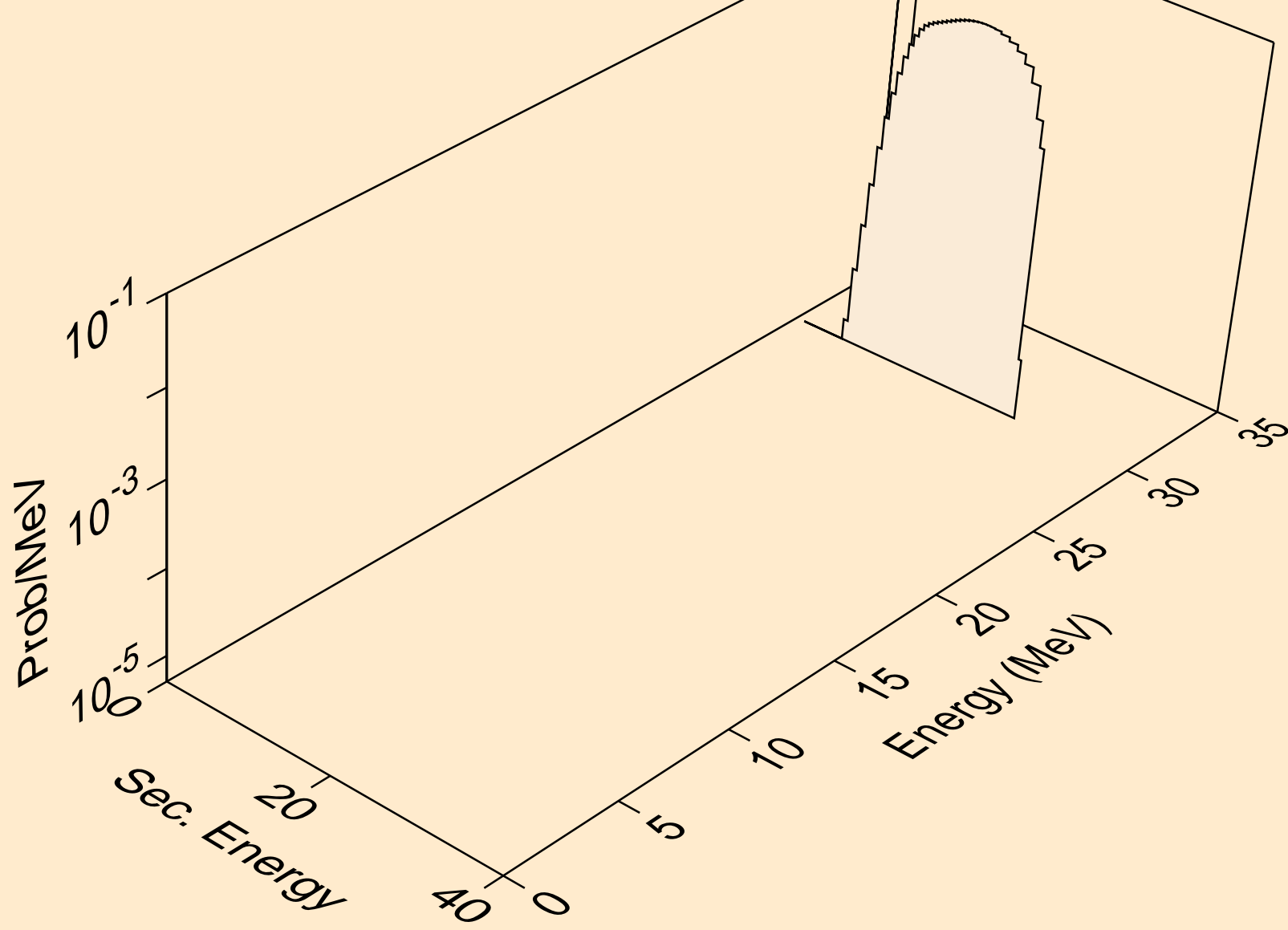

FM259 NEUTRON ACER TENDL-2021 LIBRARY; T=293.6K
tritons from (n,n*)t

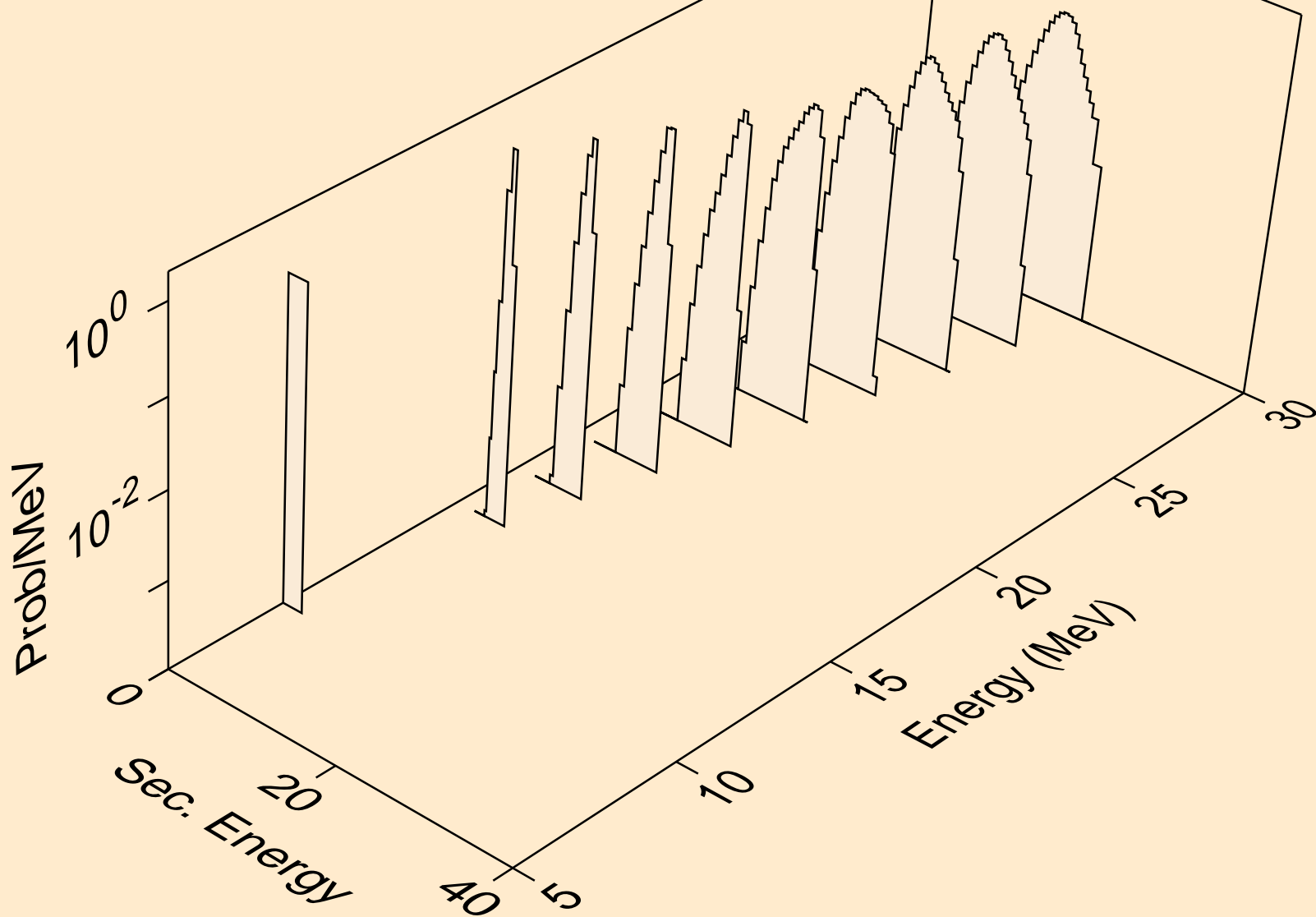

FM259 NEUTRON ACER TENDL-2021 LIBRARY; T=293.6K
tritons from (n,t)

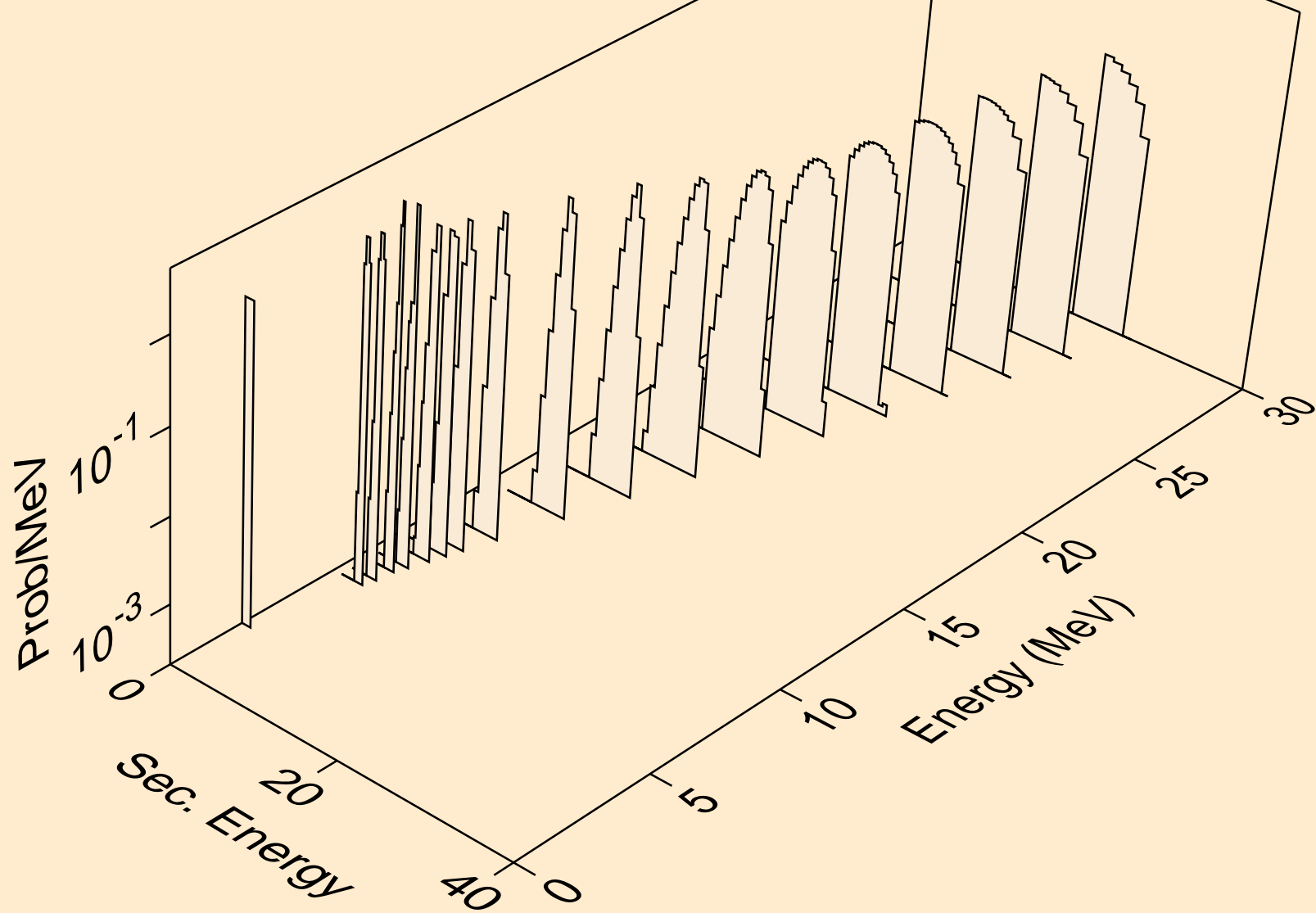

FM259 NEUTRON ACER TENDL-2021 LIBRARY; T=293.6K
he3s from (n,x)

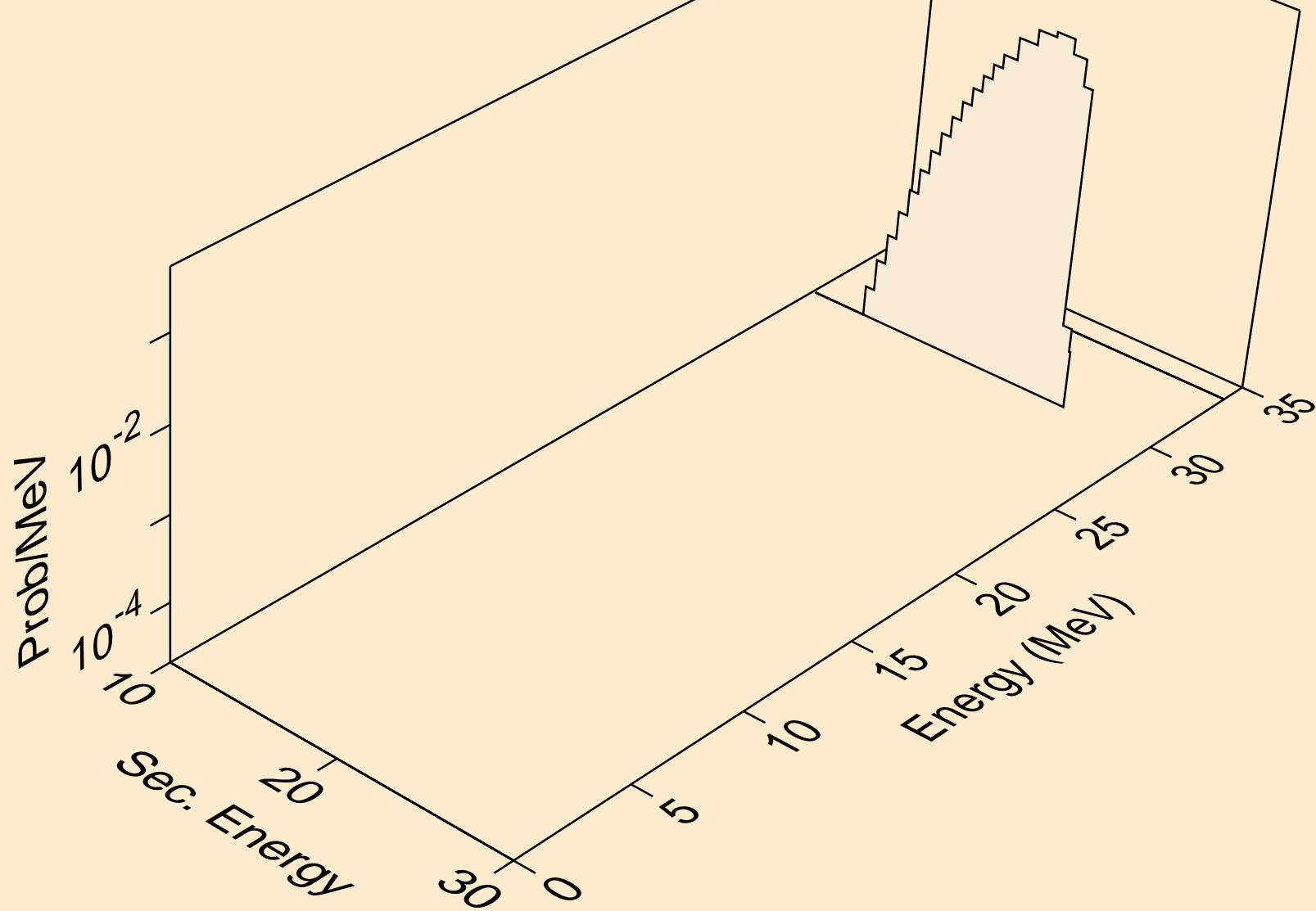

FM259 NEUTRON ACER TENDL-2021 LIBRARY; T=293.6K
he3s from (n,n*)he3

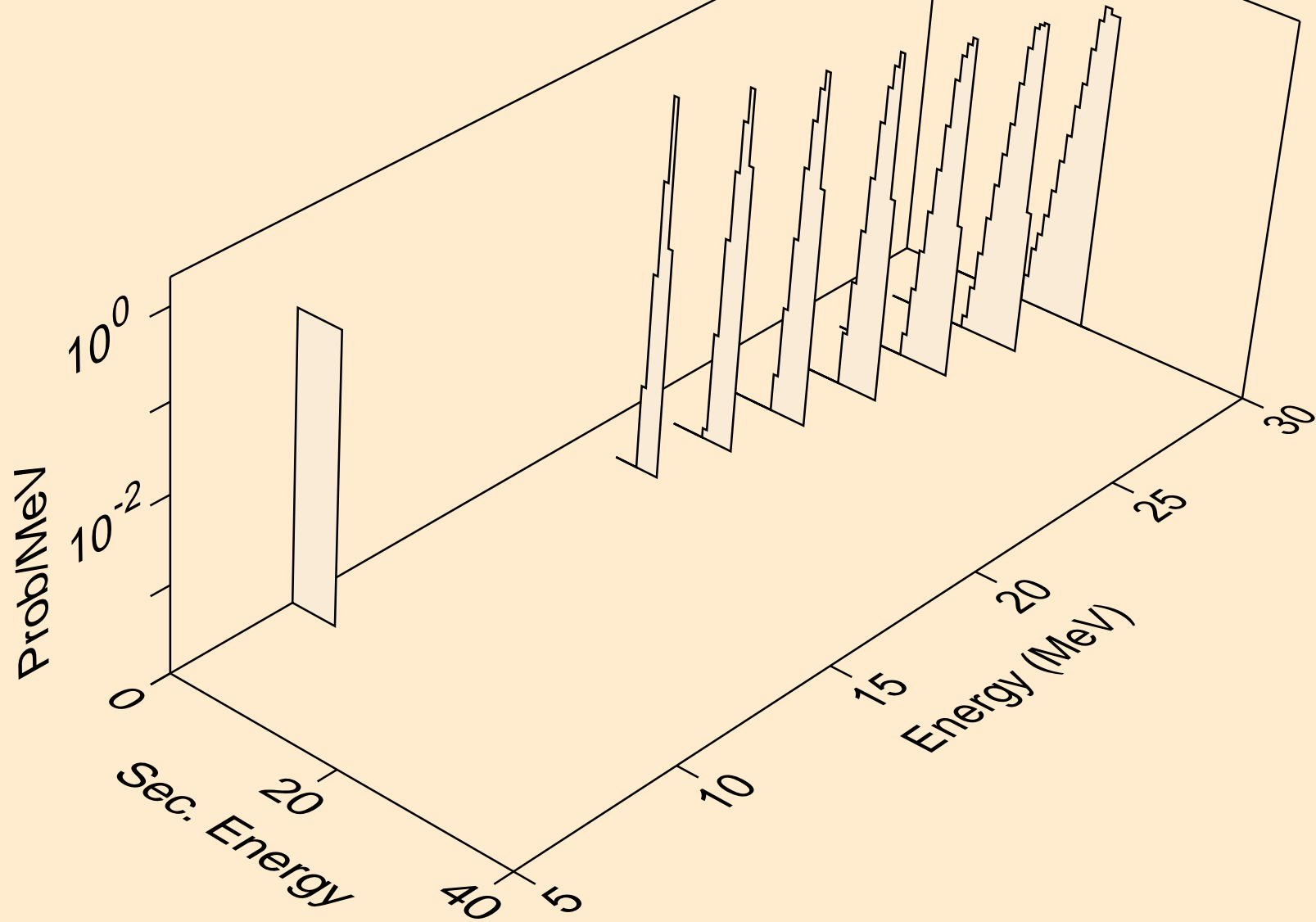

FM259 NEUTRON ACER TENDL-2021 LIBRARY; T=293.6K
he3s from (n,he3)

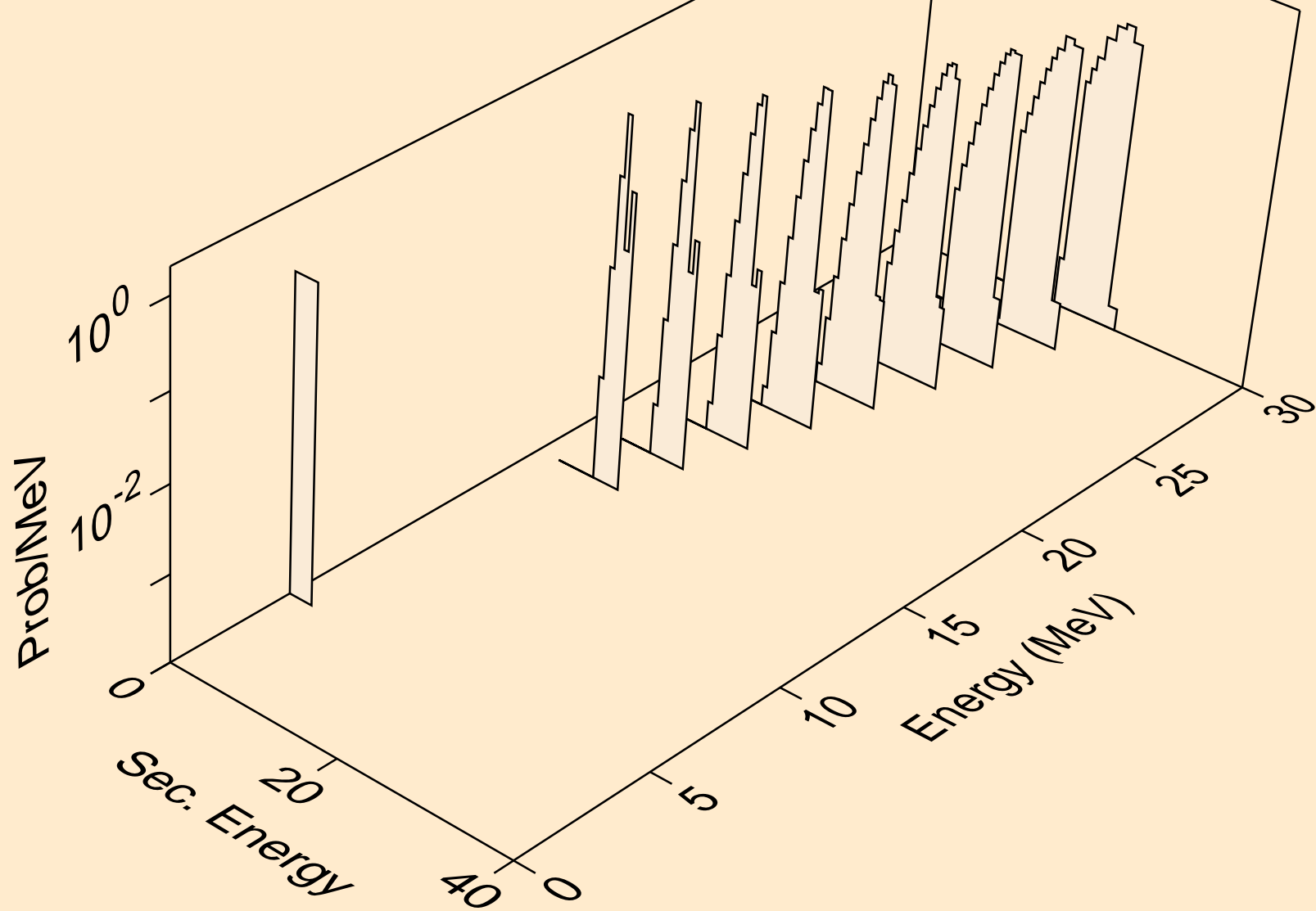

FM259 NEUTRON ACER TENDL-2021 LIBRARY; T=293.6K
alphas from (n,x)

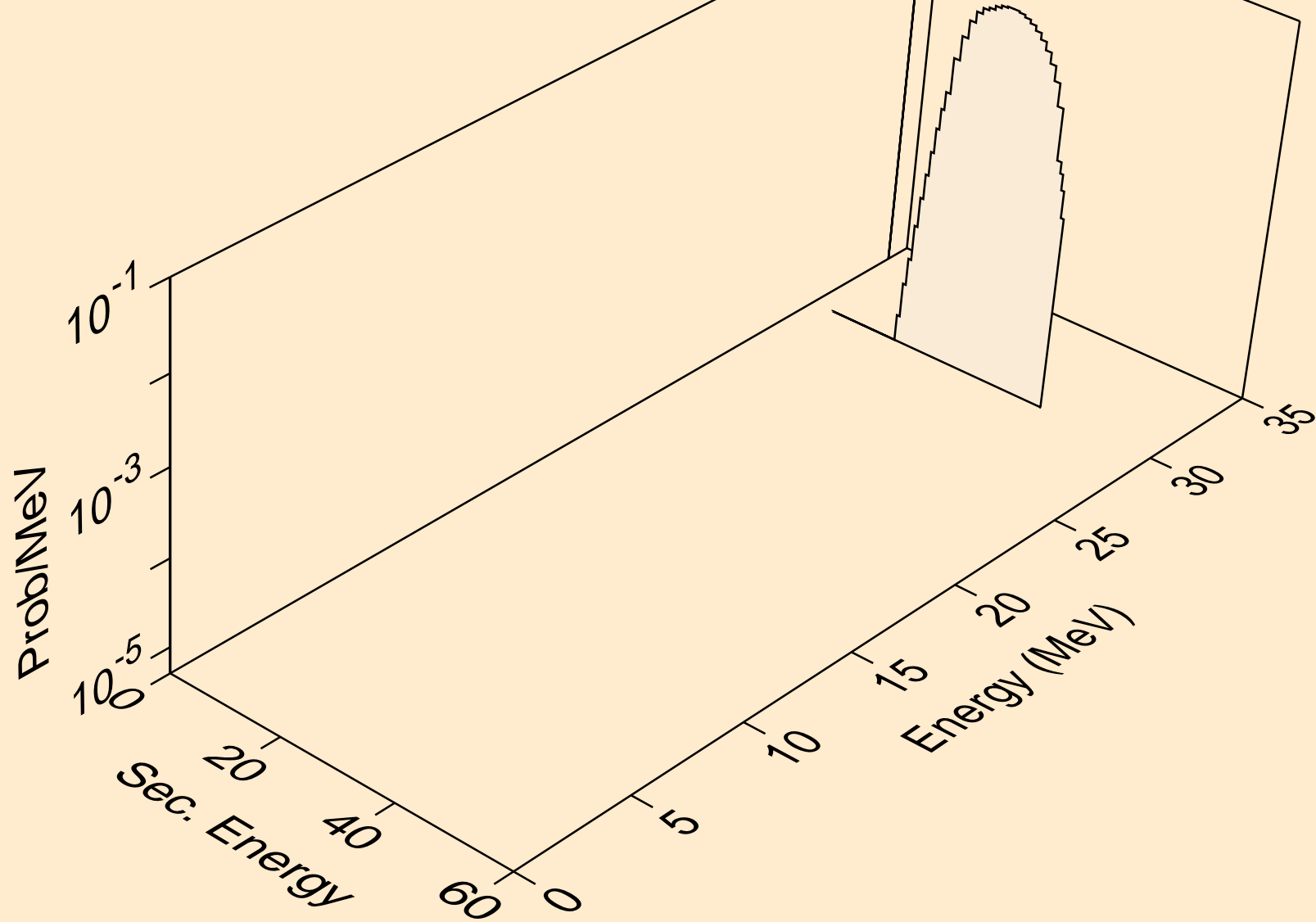

FM259 NEUTRON ACER TENDL-2021 LIBRARY; T=293.6K
alphas from (n,n*)a

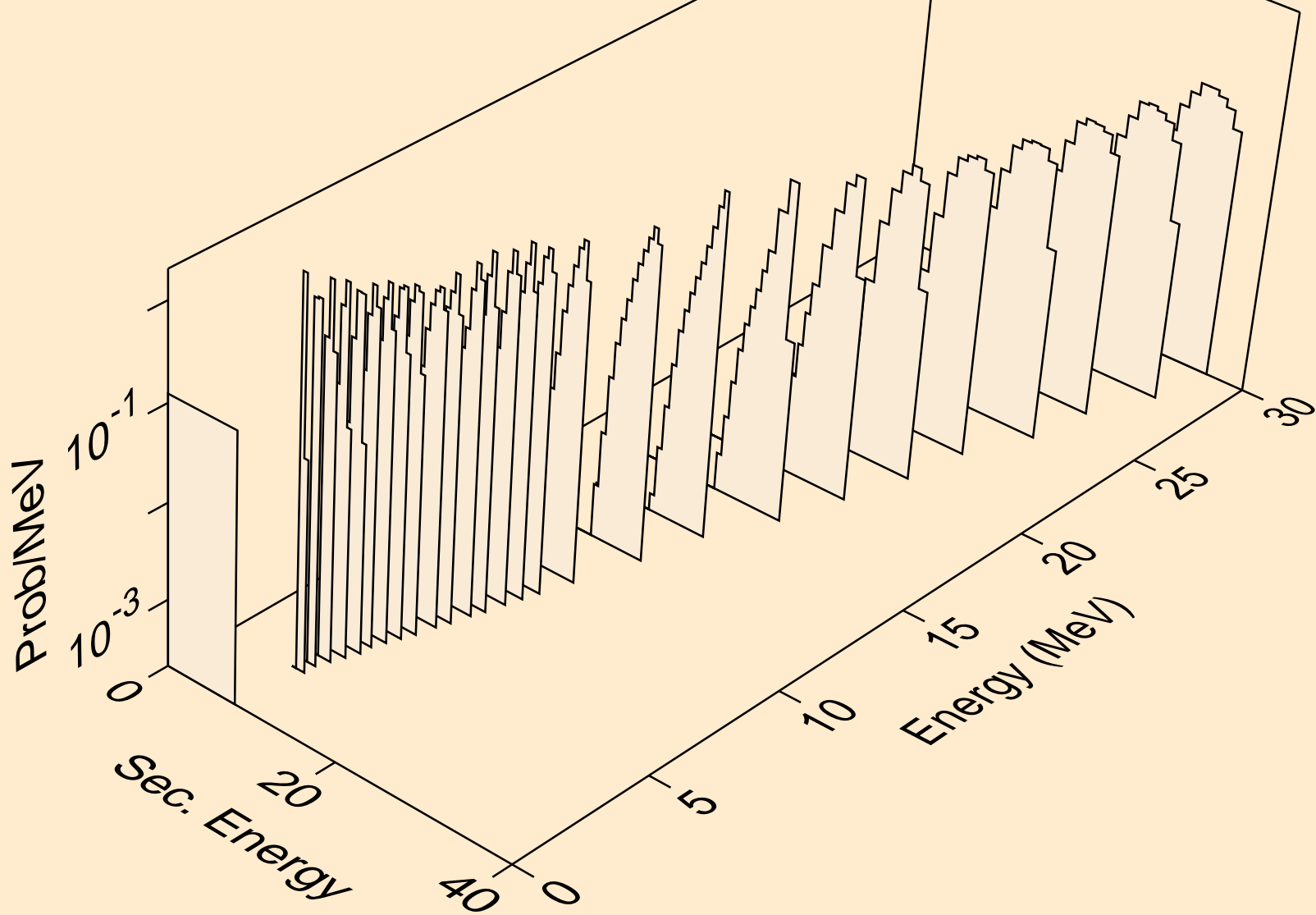

FM259 NEUTRON ACER TENDL-2021 LIBRARY; T=293.6K
alphas from (n,2n)a

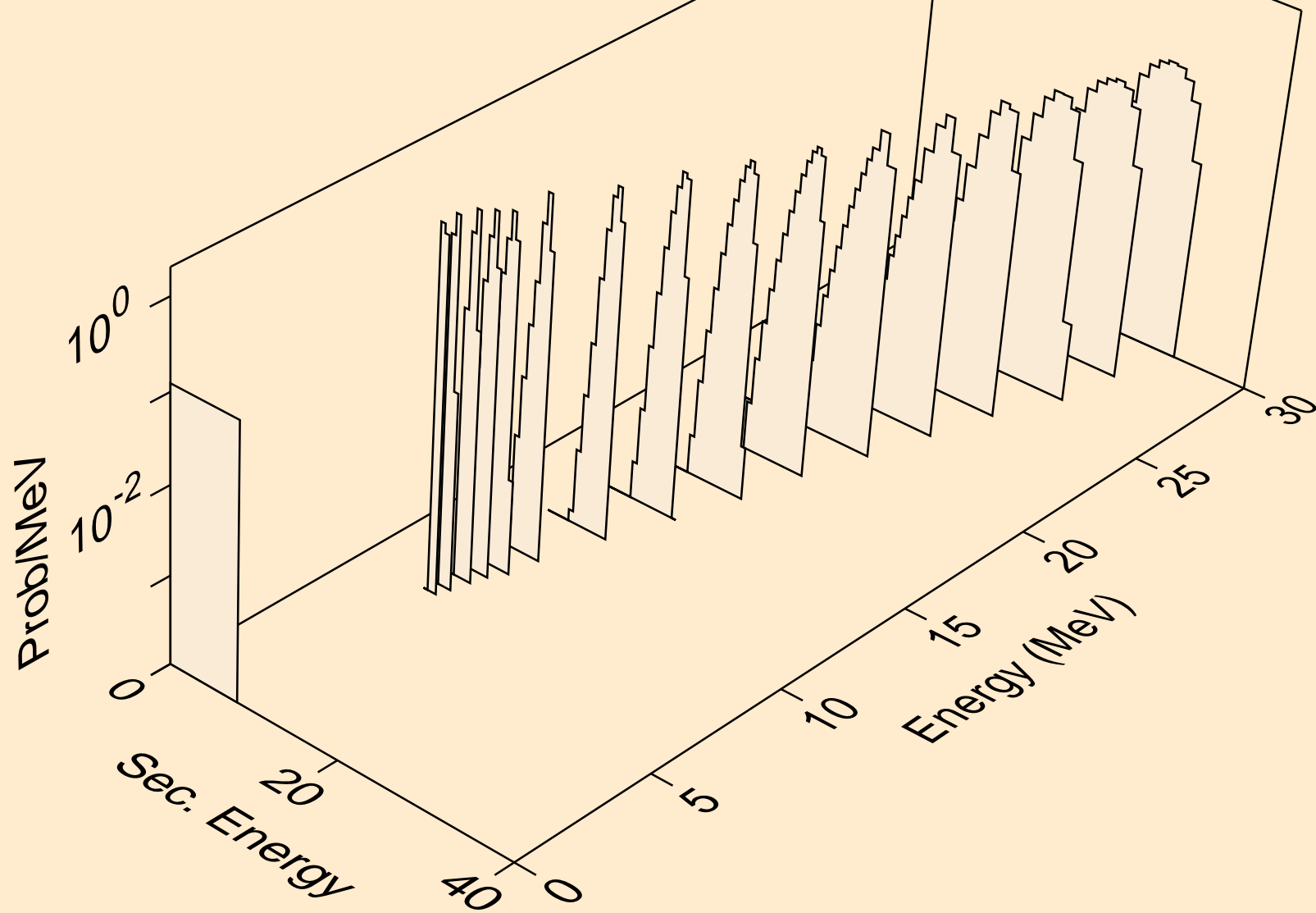

FM259 NEUTRON ACER TENDL-2021 LIBRARY; T=293.6K
alphas from (n,3n)a

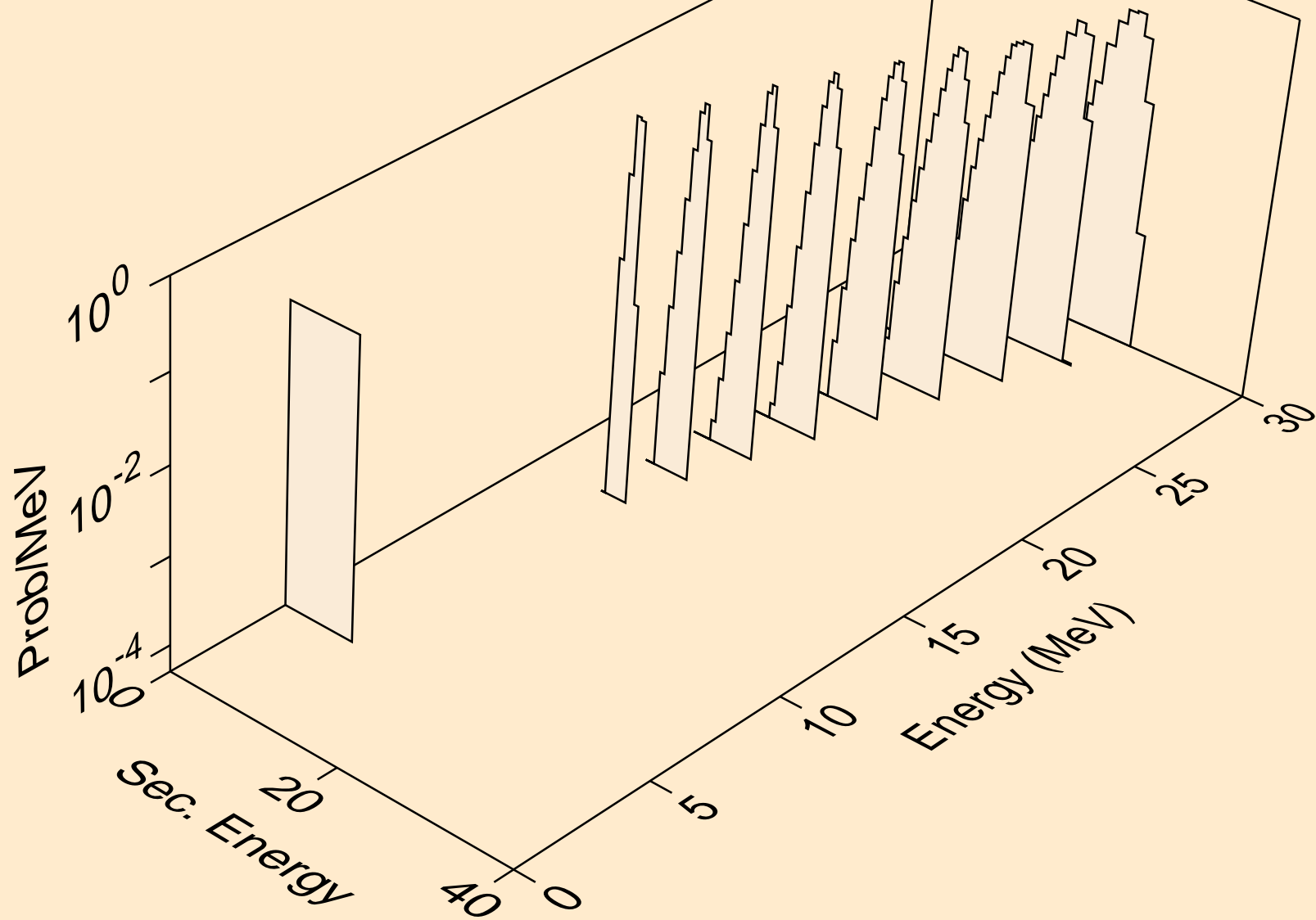

FM259 NEUTRON ACER TENDL-2021 LIBRARY; T=293.6K
alphas from (n,a)

