

FR212 NEUTRON ACER TENDL-2021 LIBRARY; T=293.6K
Principal cross sections

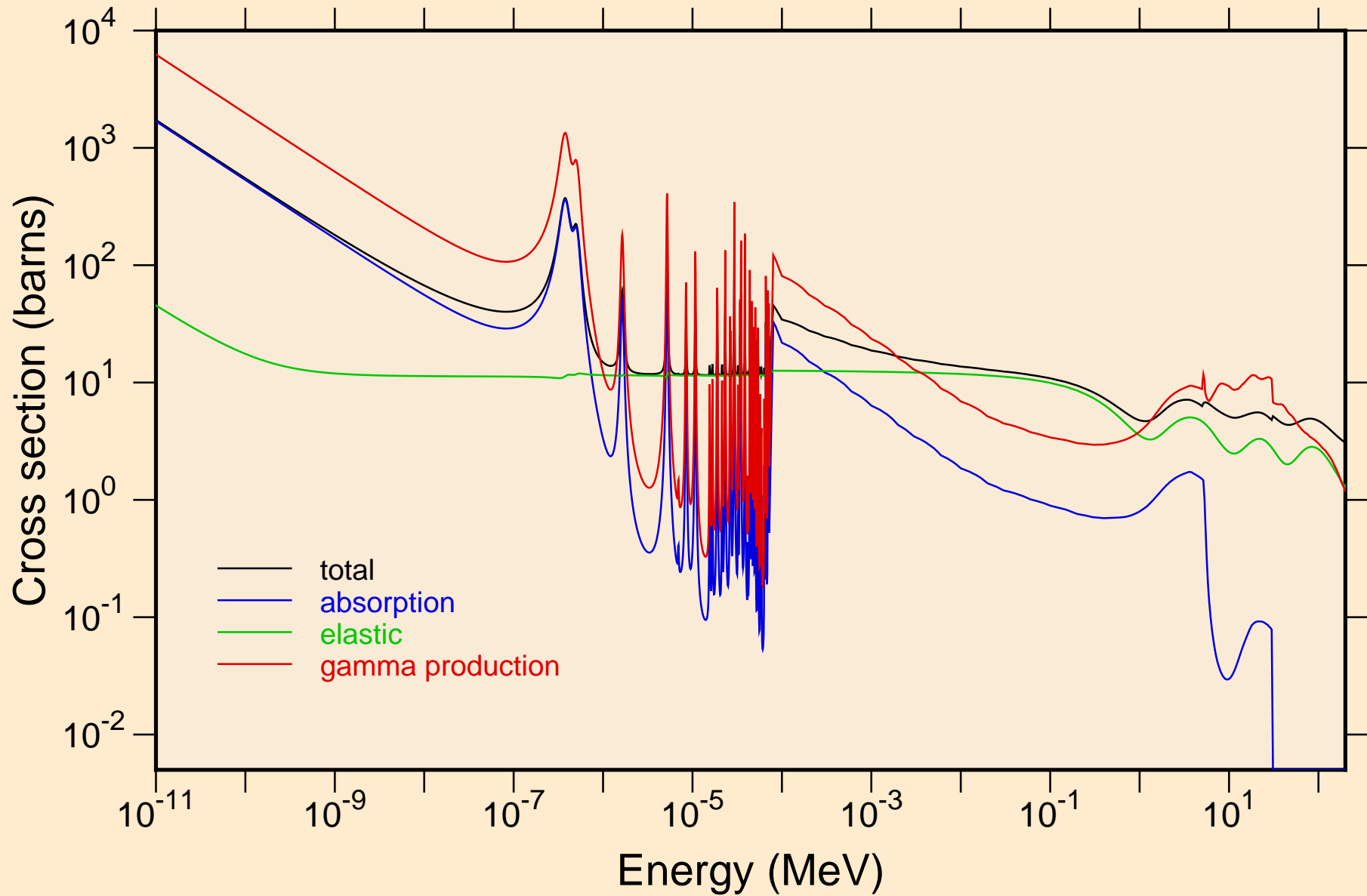

FR212 NEUTRON ACER TENDL-2021 LIBRARY; T=293.6K
resonance total cross section

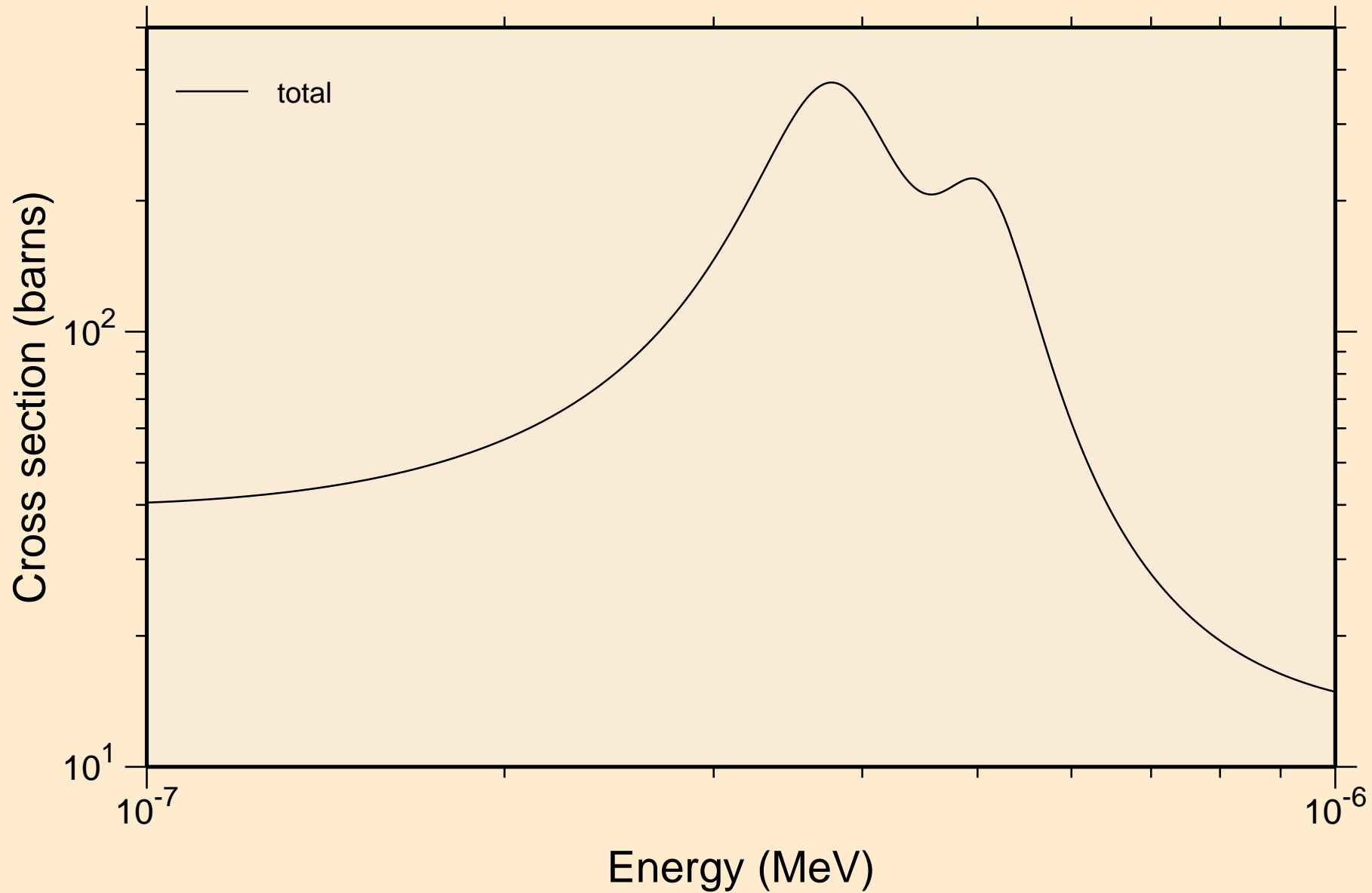

FR212 NEUTRON ACER TENDL-2021 LIBRARY; T=293.6K
resonance total cross section

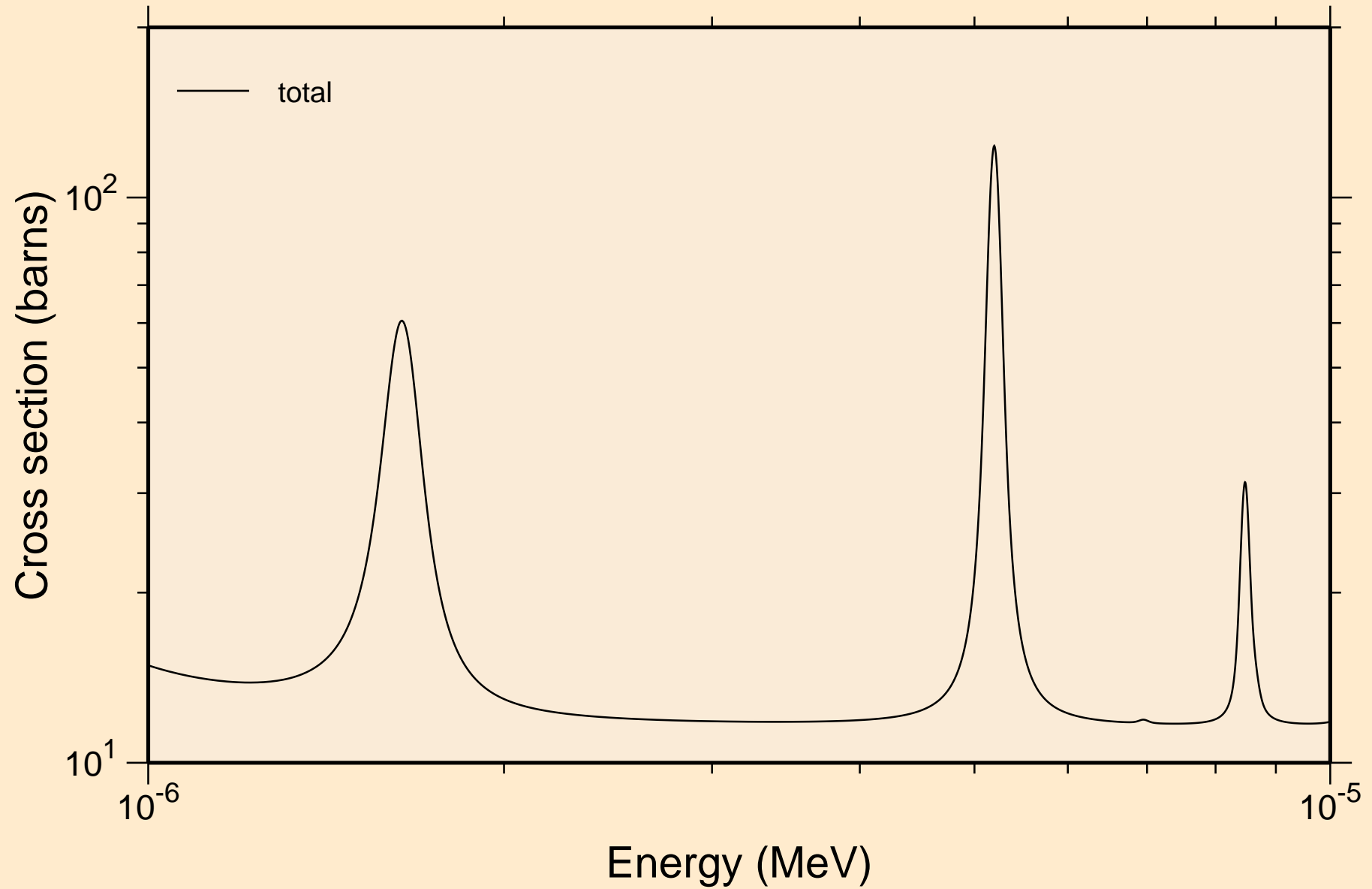

FR212 NEUTRON ACER TENDL-2021 LIBRARY; T=293.6K
resonance total cross section

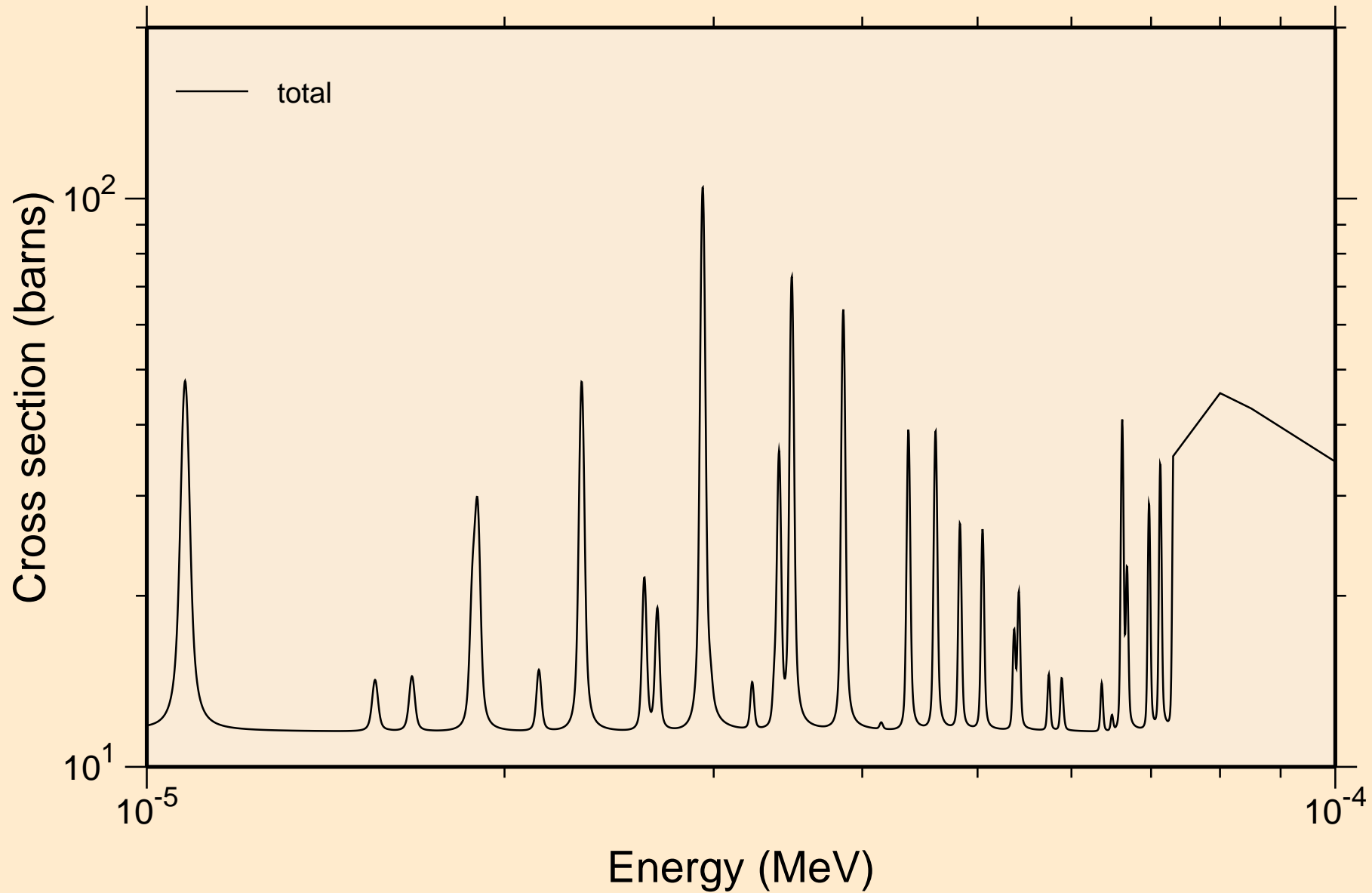

FR212 NEUTRON ACER TENDL-2021 LIBRARY; T=293.6K
resonance total cross section

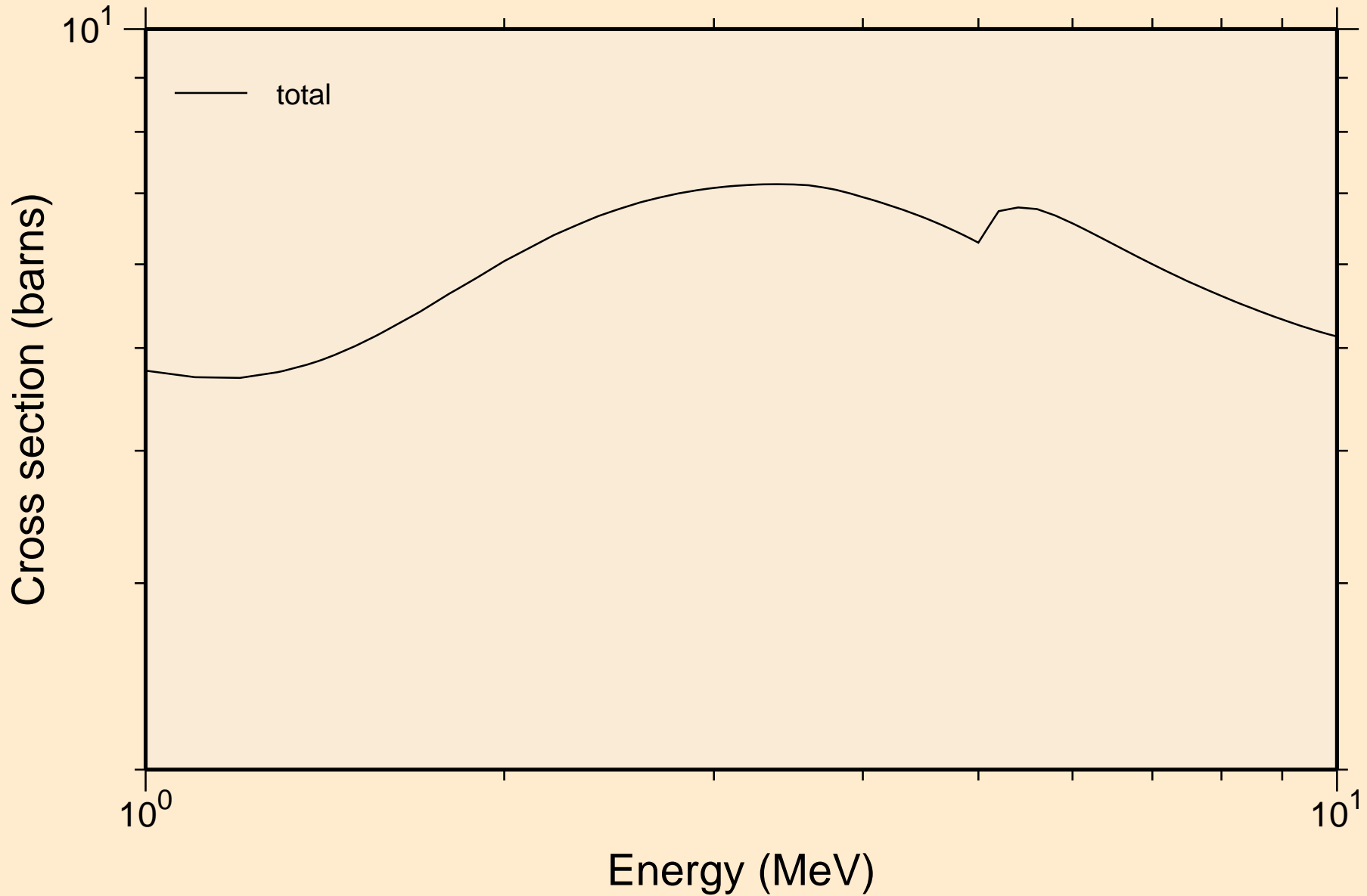

FR212 NEUTRON ACER TENDL-2021 LIBRARY; T=293.6K
resonance absorption cross sections

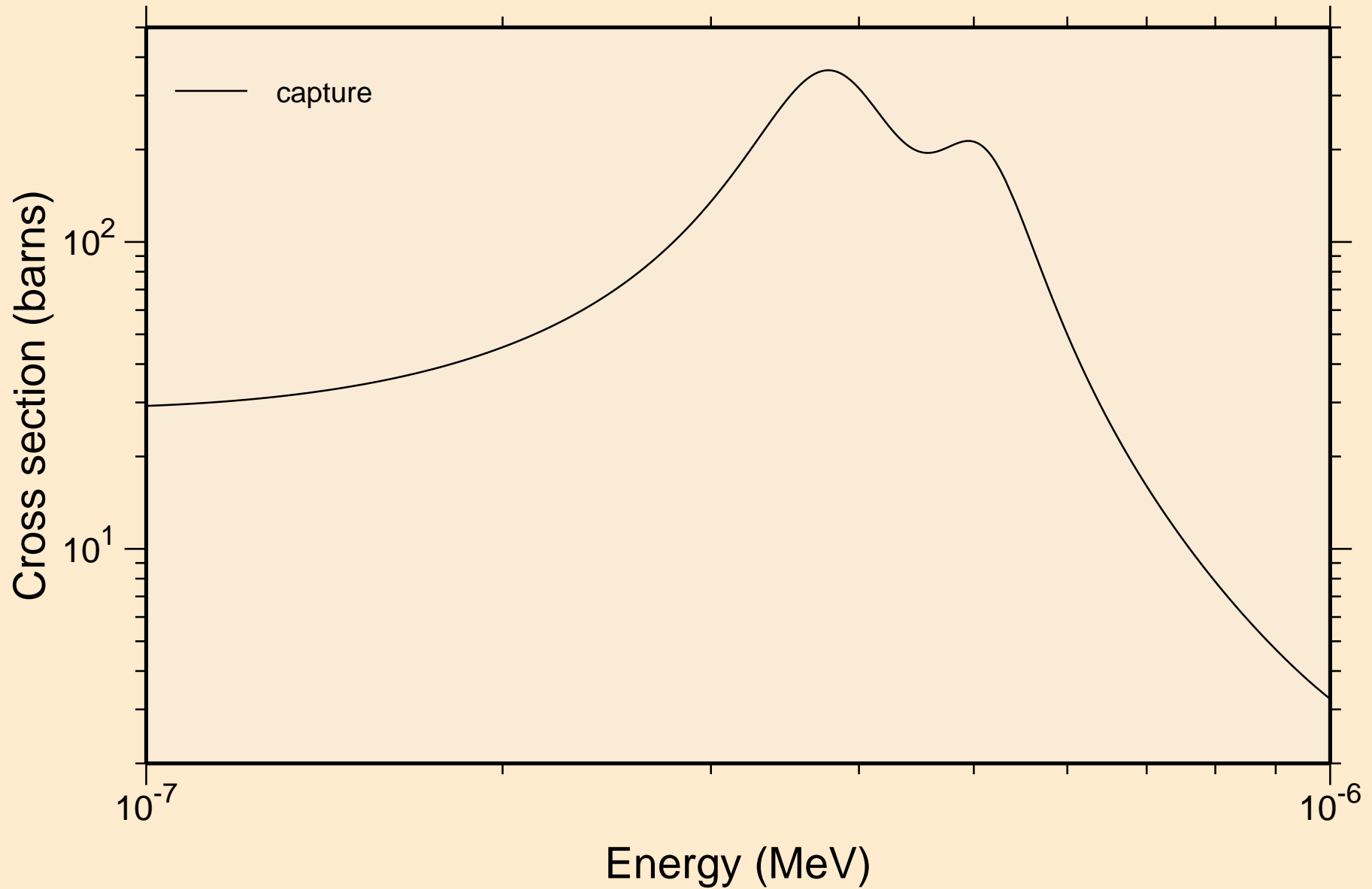

FR212 NEUTRON ACER TENDL-2021 LIBRARY; T=293.6K
resonance absorption cross sections

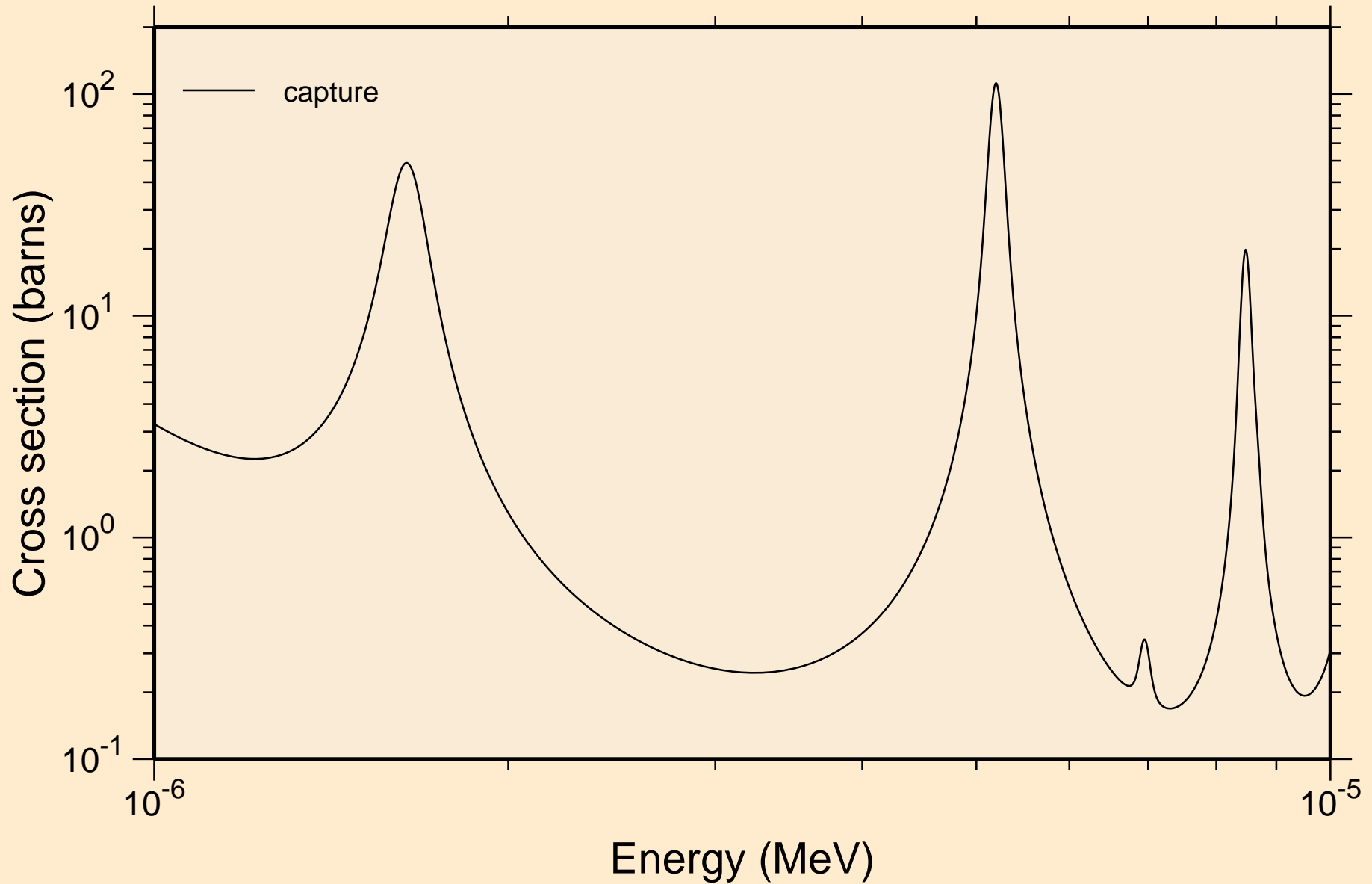

FR212 NEUTRON ACER TENDL-2021 LIBRARY; T=293.6K
resonance absorption cross sections

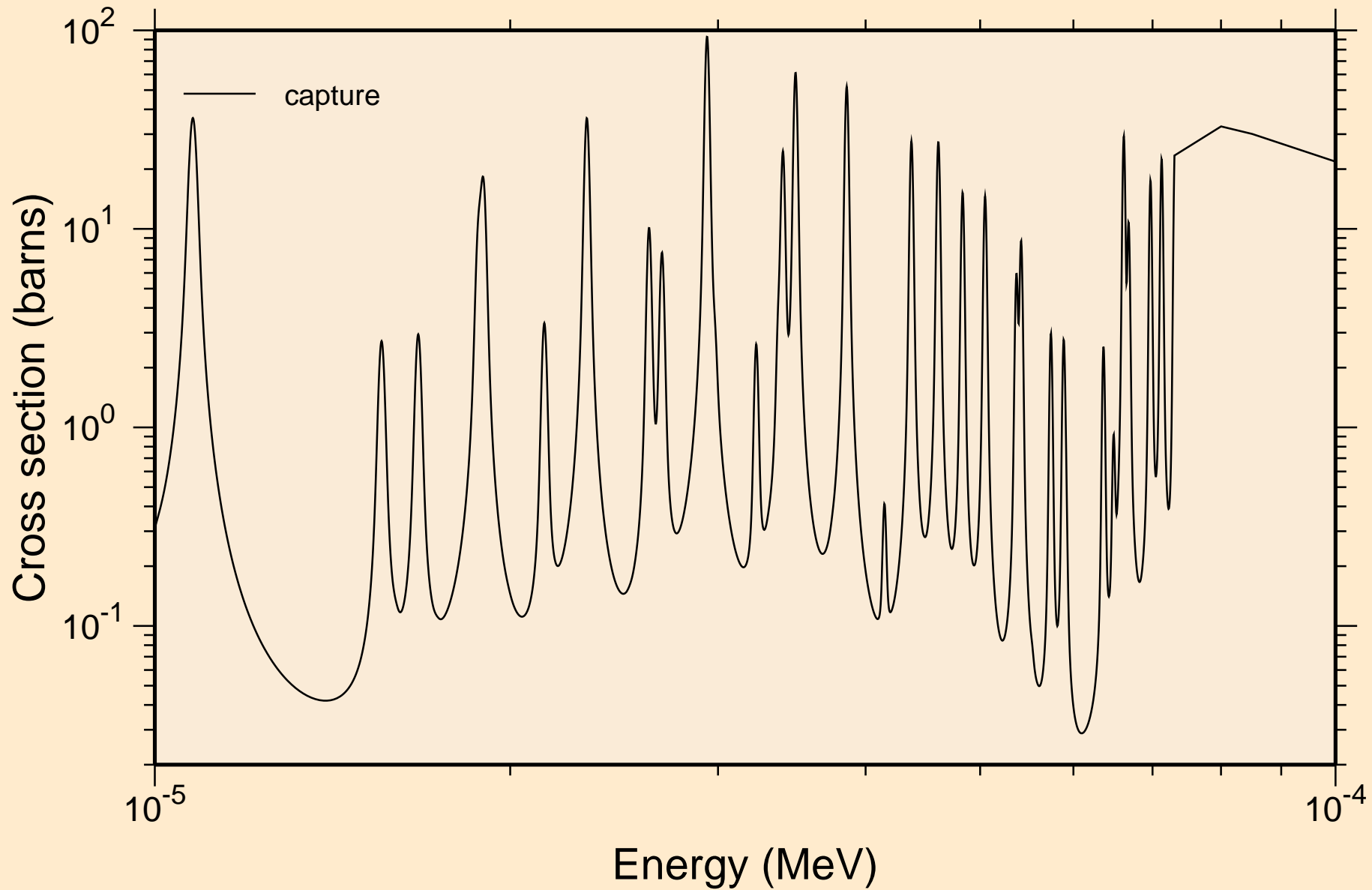

FR212 NEUTRON ACER TENDL-2021 LIBRARY; T=293.6K
resonance absorption cross sections

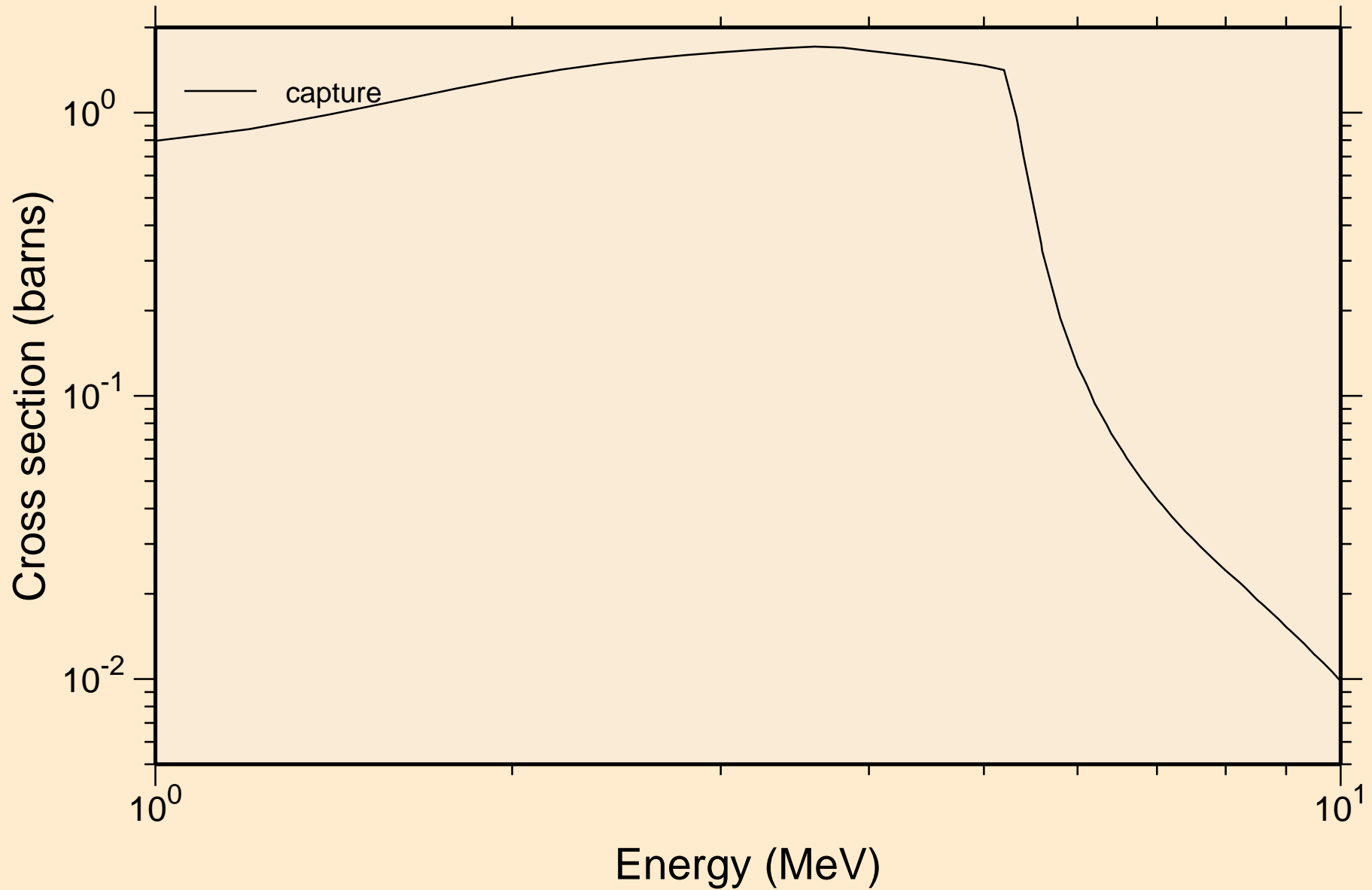

FR212 NEUTRON ACER TENDL-2021 LIBRARY; T=293.6K
Heating

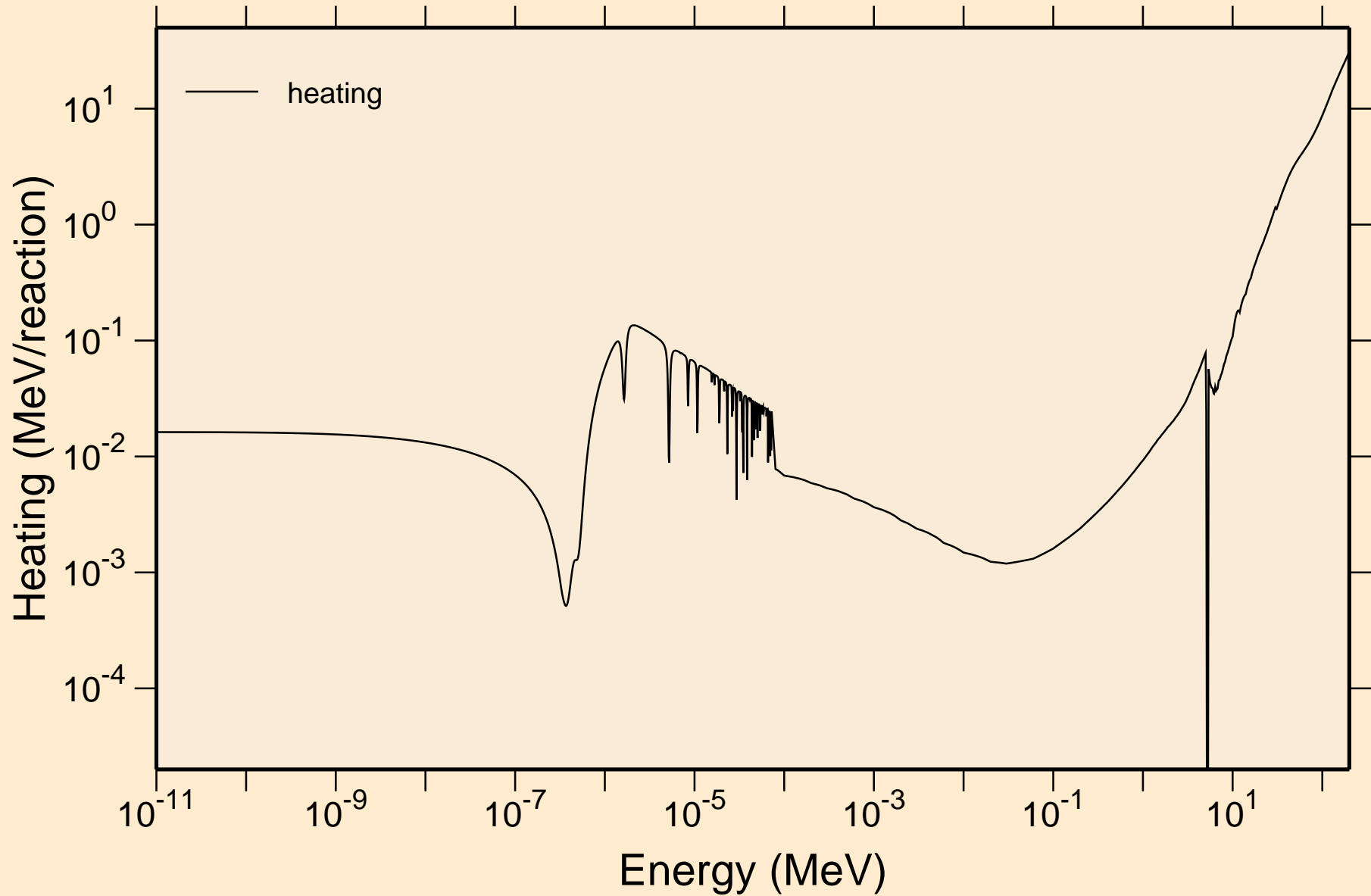

FR212 NEUTRON ACER TENDL-2021 LIBRARY; T=293.6K
Damage

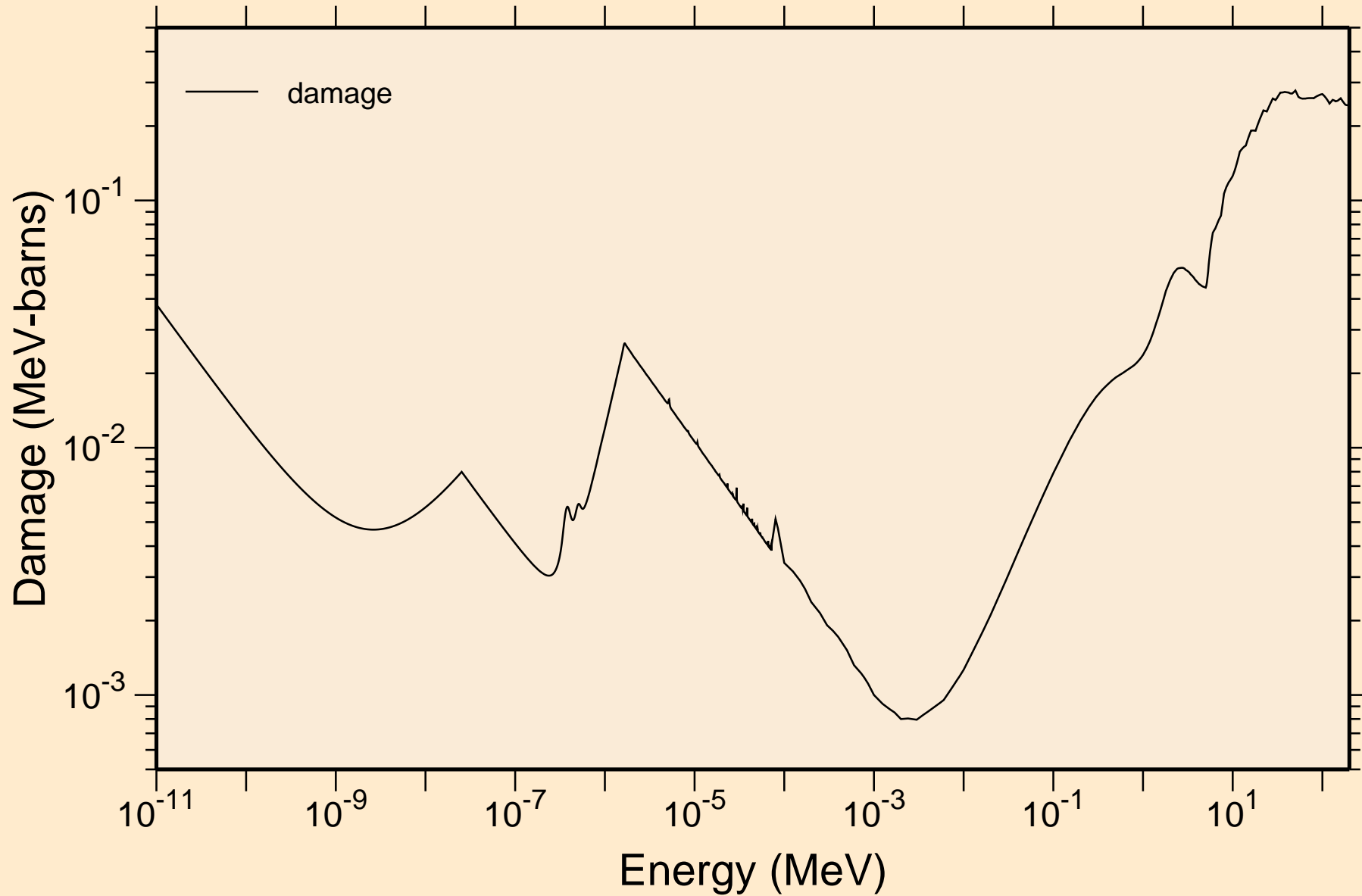

FR212 NEUTRON ACER TENDL-2021 LIBRARY; T=293.6K
Non-threshold reactions

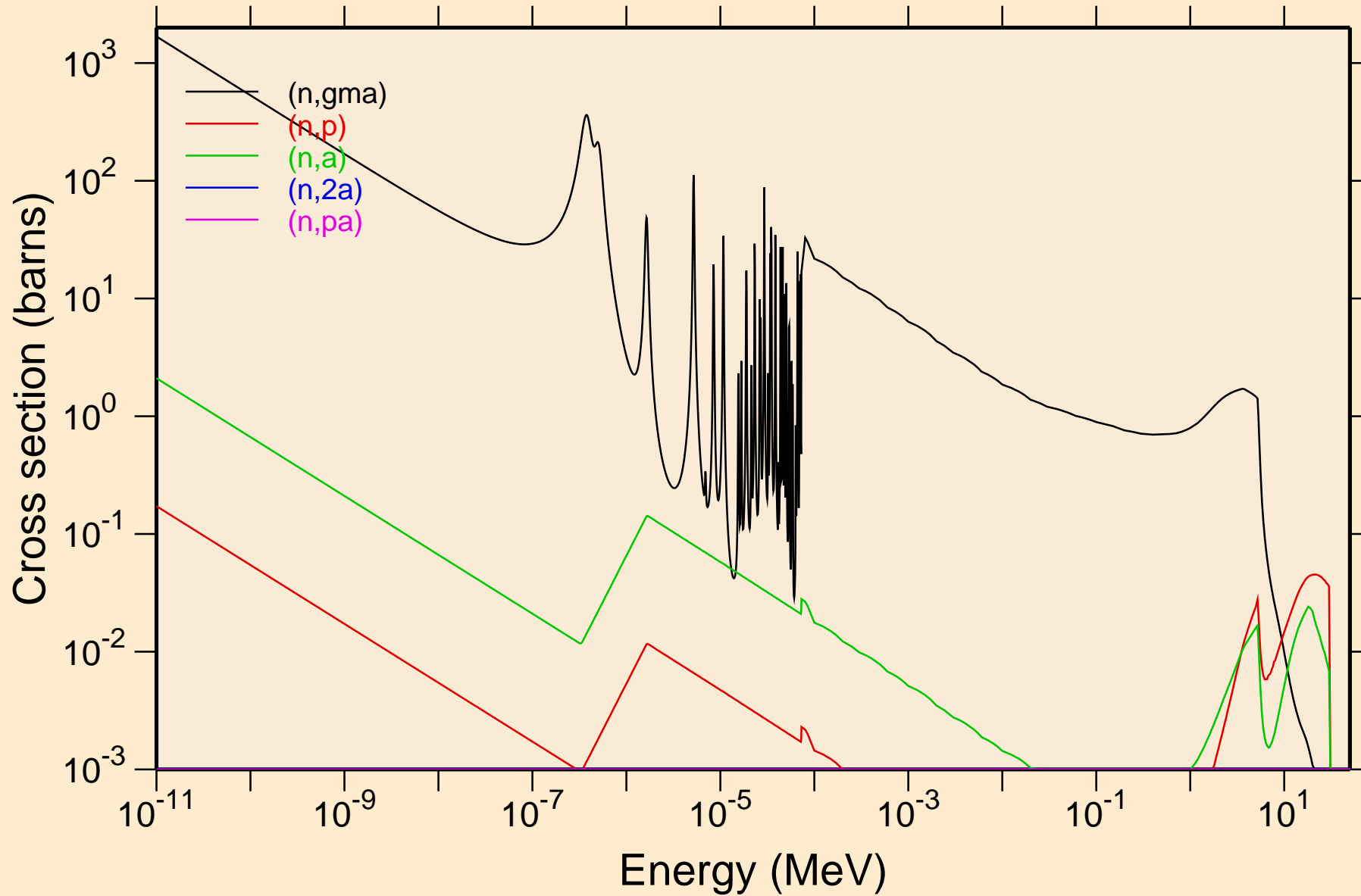

FR212 NEUTRON ACER TENDL-2021 LIBRARY; T=293.6K
Non-threshold reactions

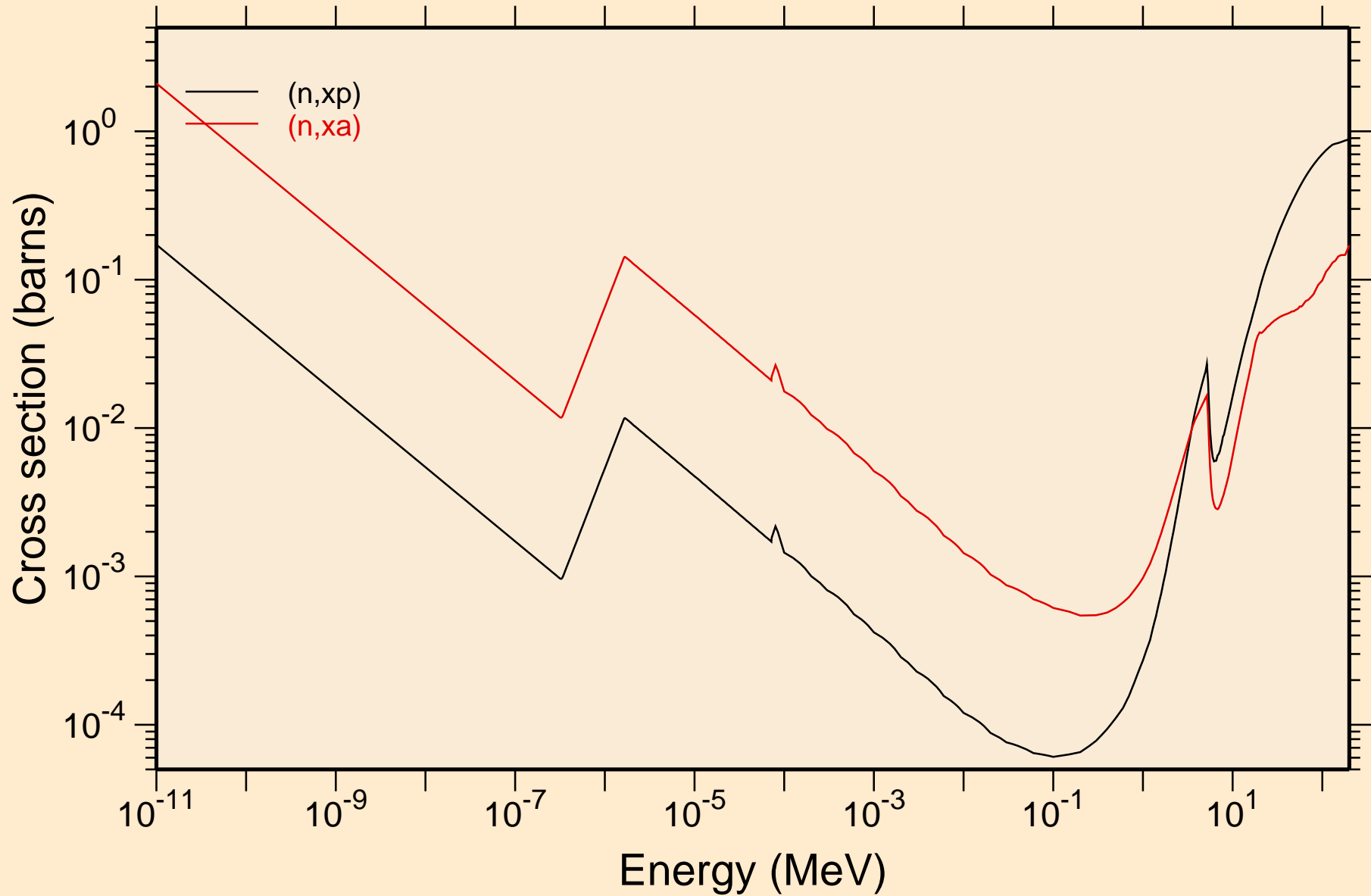

FR212 NEUTRON ACER TENDL-2021 LIBRARY; T=293.6K
Principal cross sections

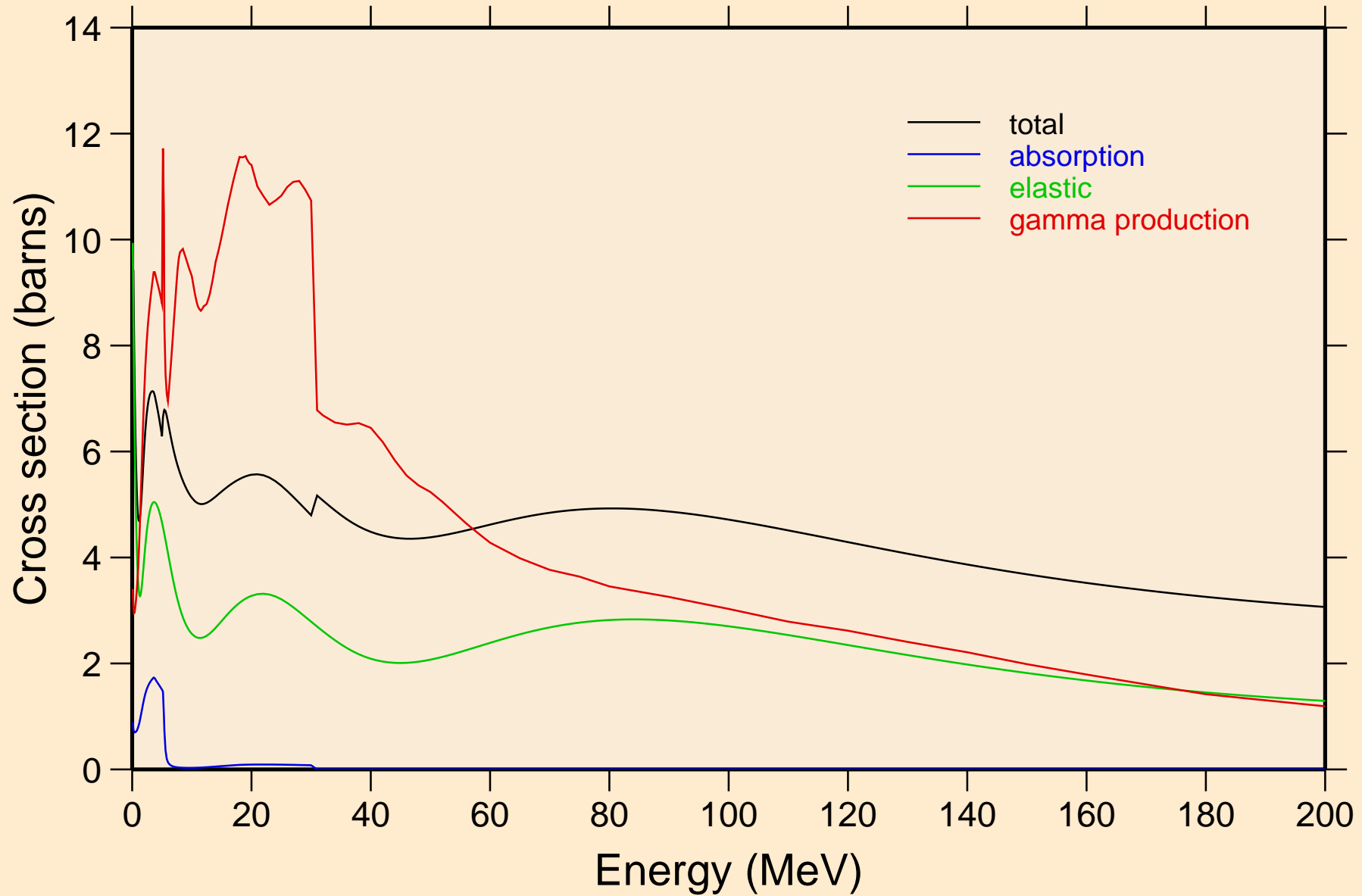

FR212 NEUTRON ACER TENDL-2021 LIBRARY; T=293.6K
Heating

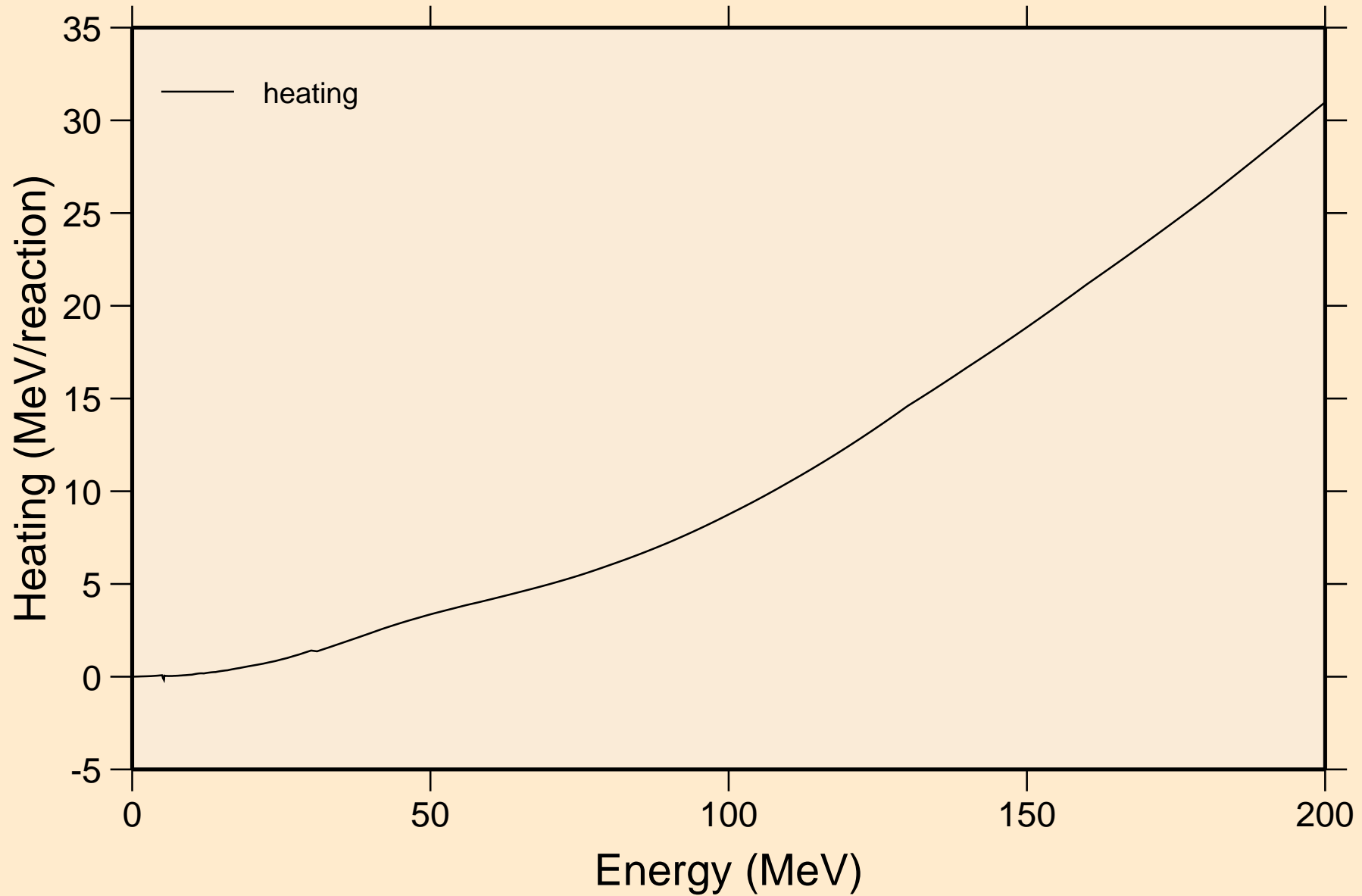

FR212 NEUTRON ACER TENDL-2021 LIBRARY; T=293.6K
Damage

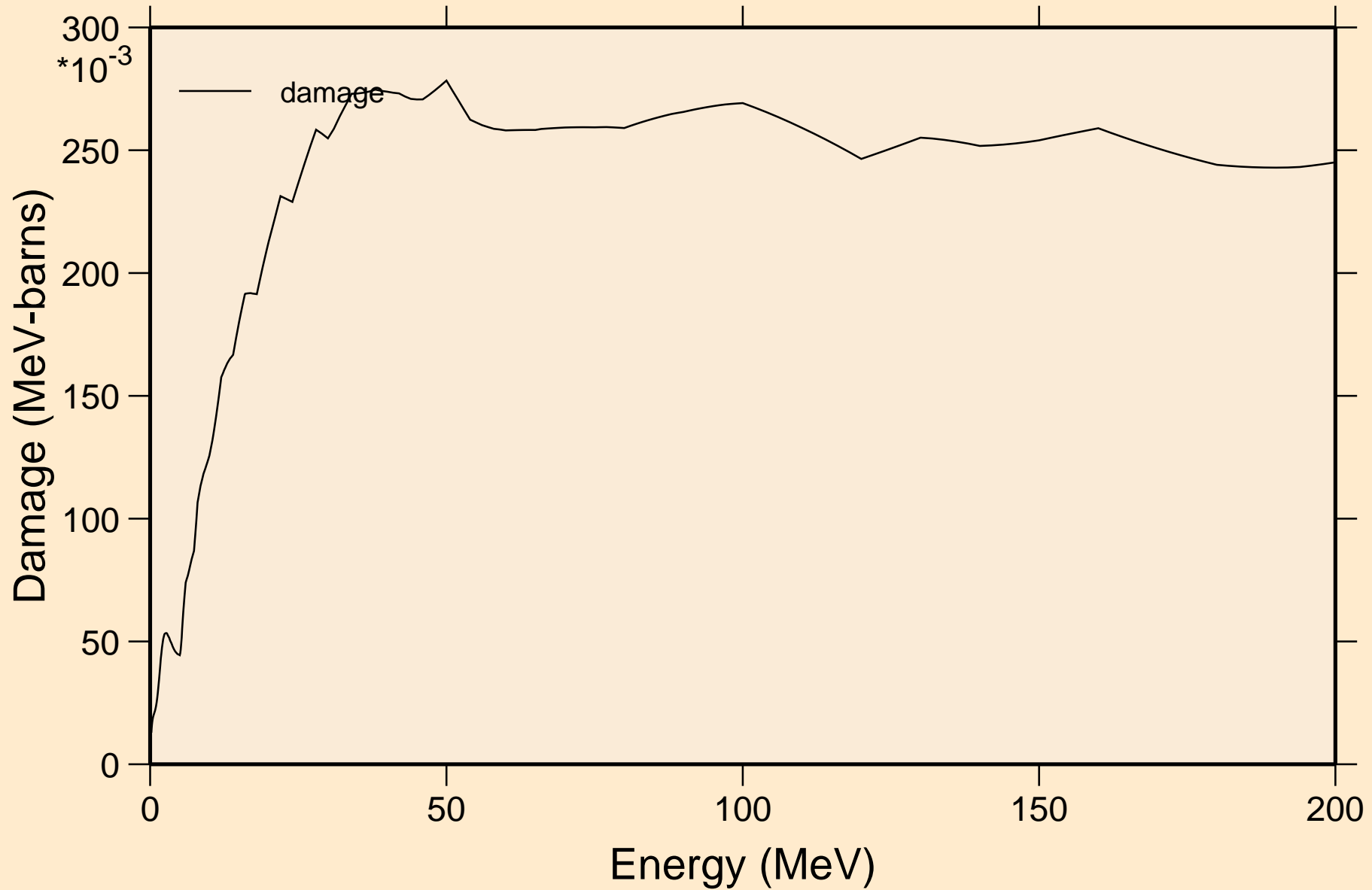

FR212 NEUTRON ACER TENDL-2021 LIBRARY; T=293.6K
Non-threshold reactions

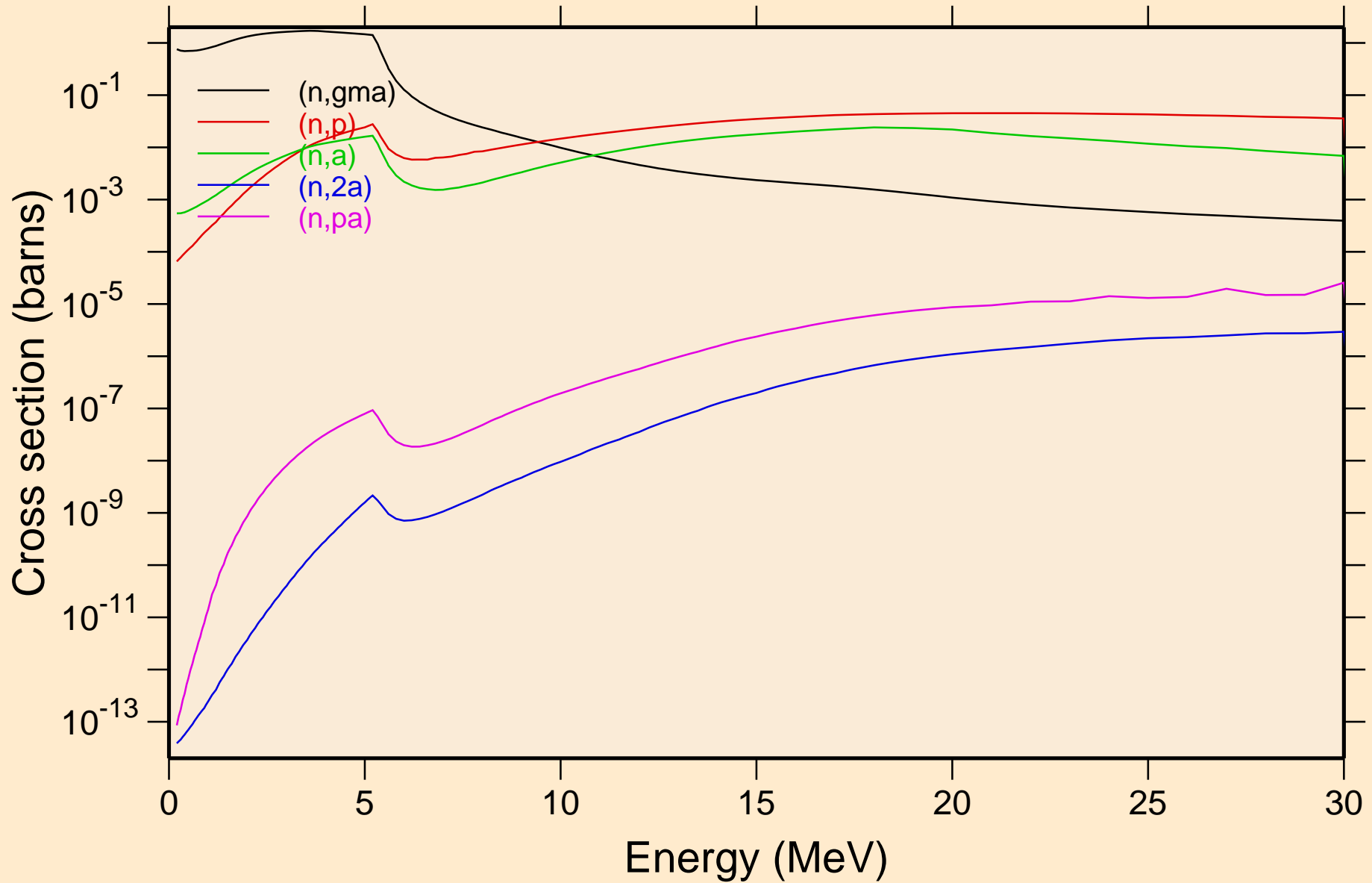

FR212 NEUTRON ACER TENDL-2021 LIBRARY; T=293.6K
Non-threshold reactions

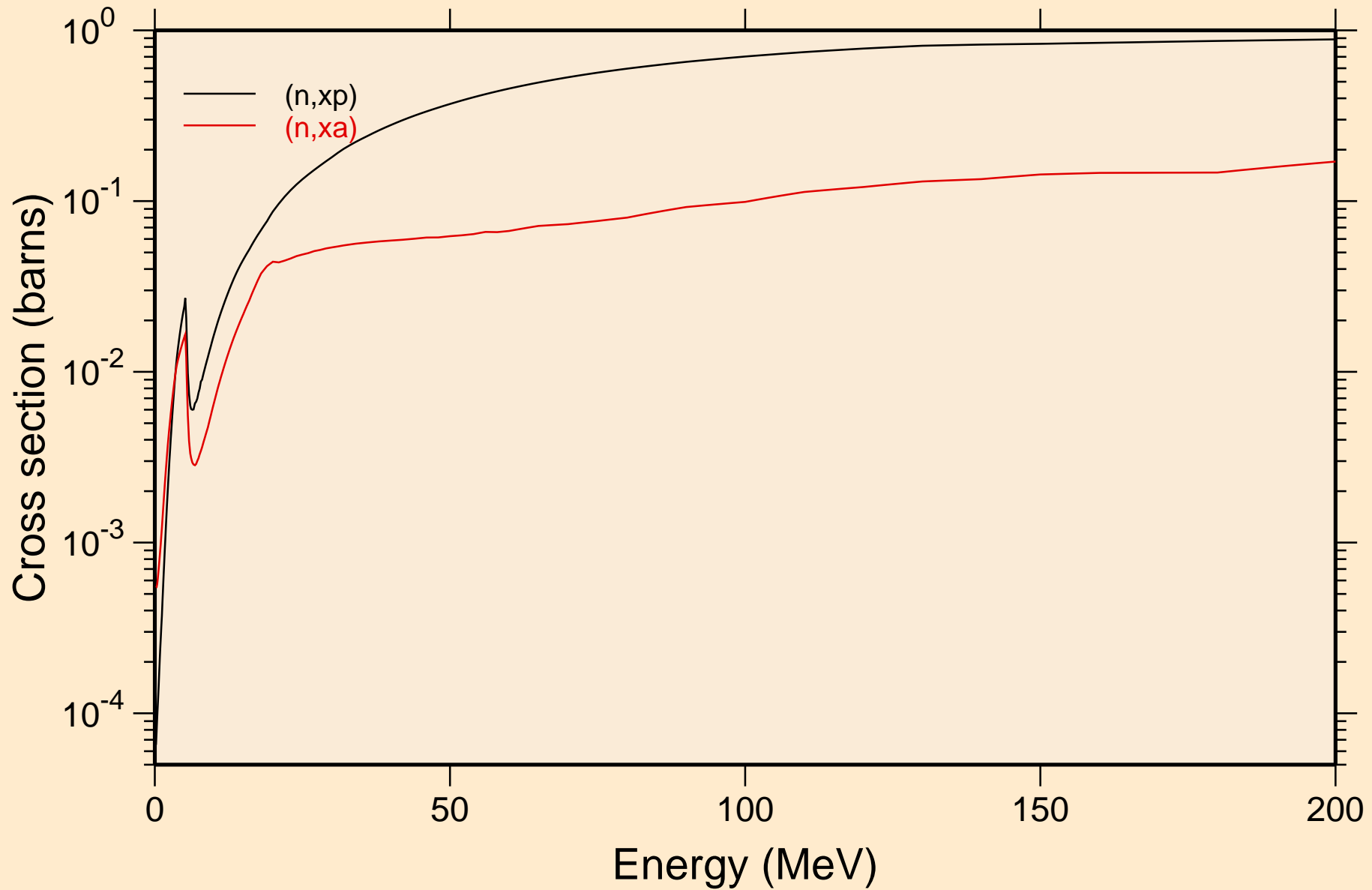

FR212 NEUTRON ACER TENDL-2021 LIBRARY; T=293.6K
Inelastic levels

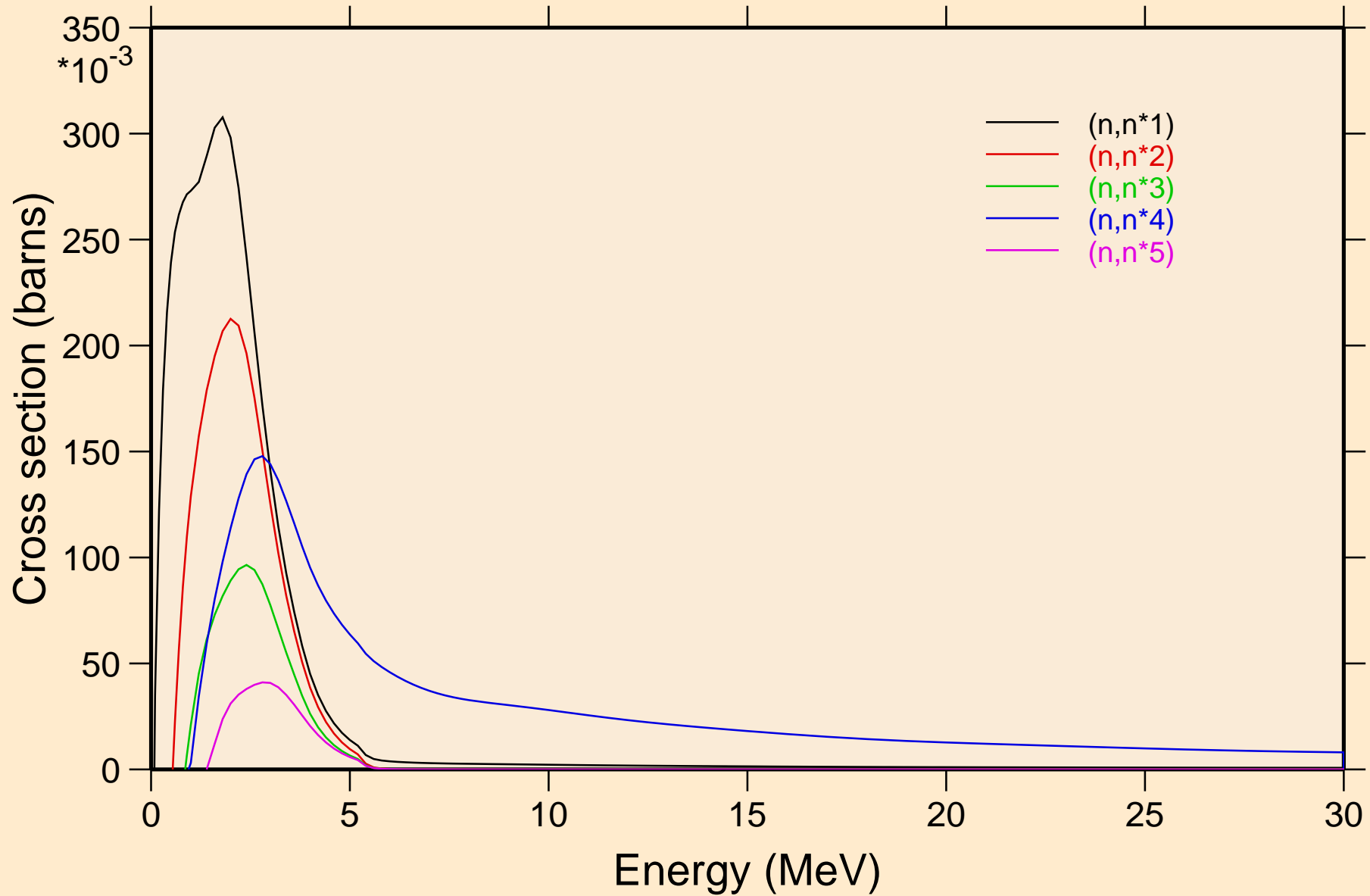

FR212 NEUTRON ACER TENDL-2021 LIBRARY; T=293.6K
Inelastic levels

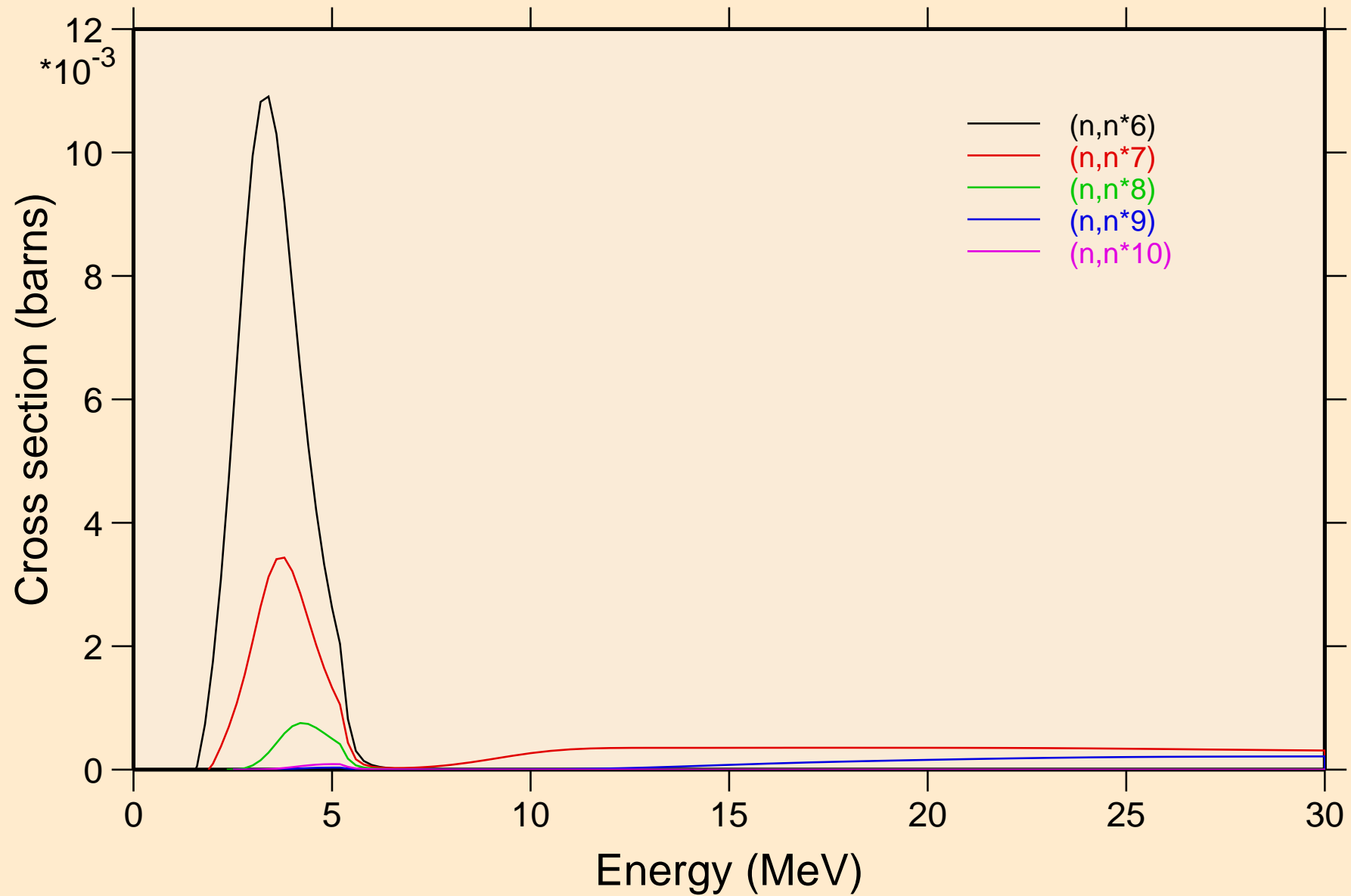

FR212 NEUTRON ACER TENDL-2021 LIBRARY; T=293.6K
Inelastic levels

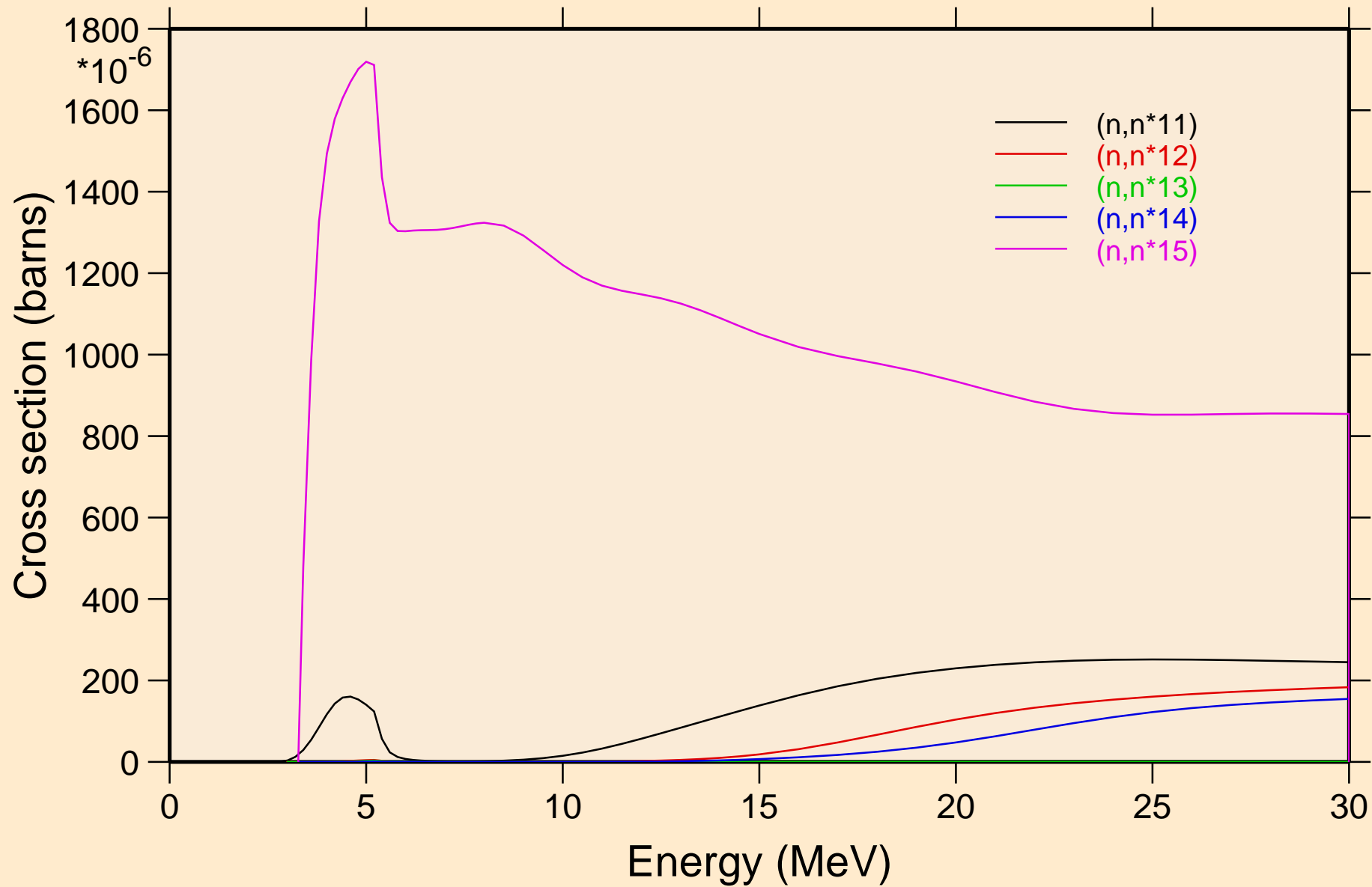

FR212 NEUTRON ACER TENDL-2021 LIBRARY; T=293.6K
Inelastic levels

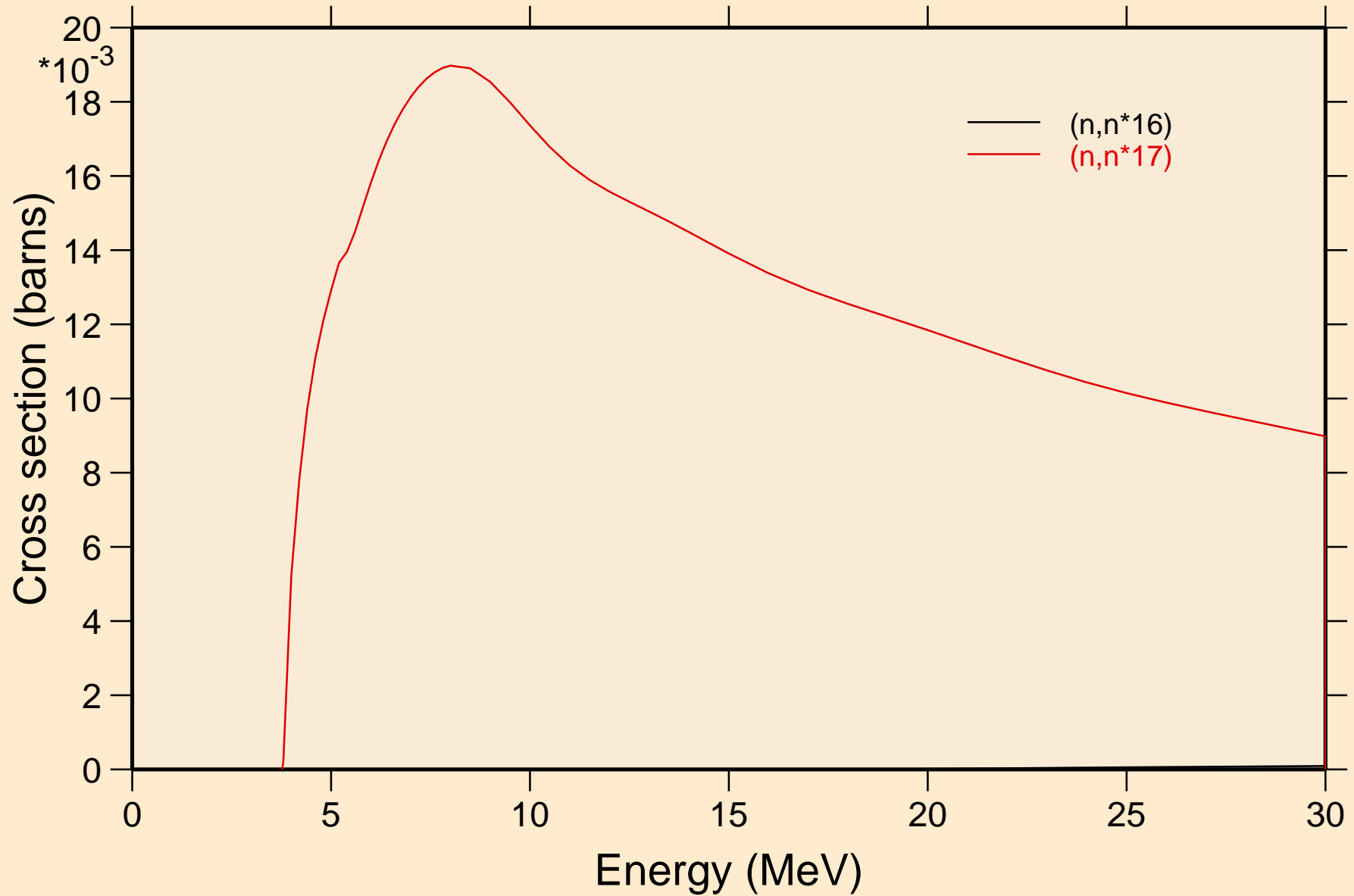

FR212 NEUTRON ACER TENDL-2021 LIBRARY; T=293.6K
Threshold reactions

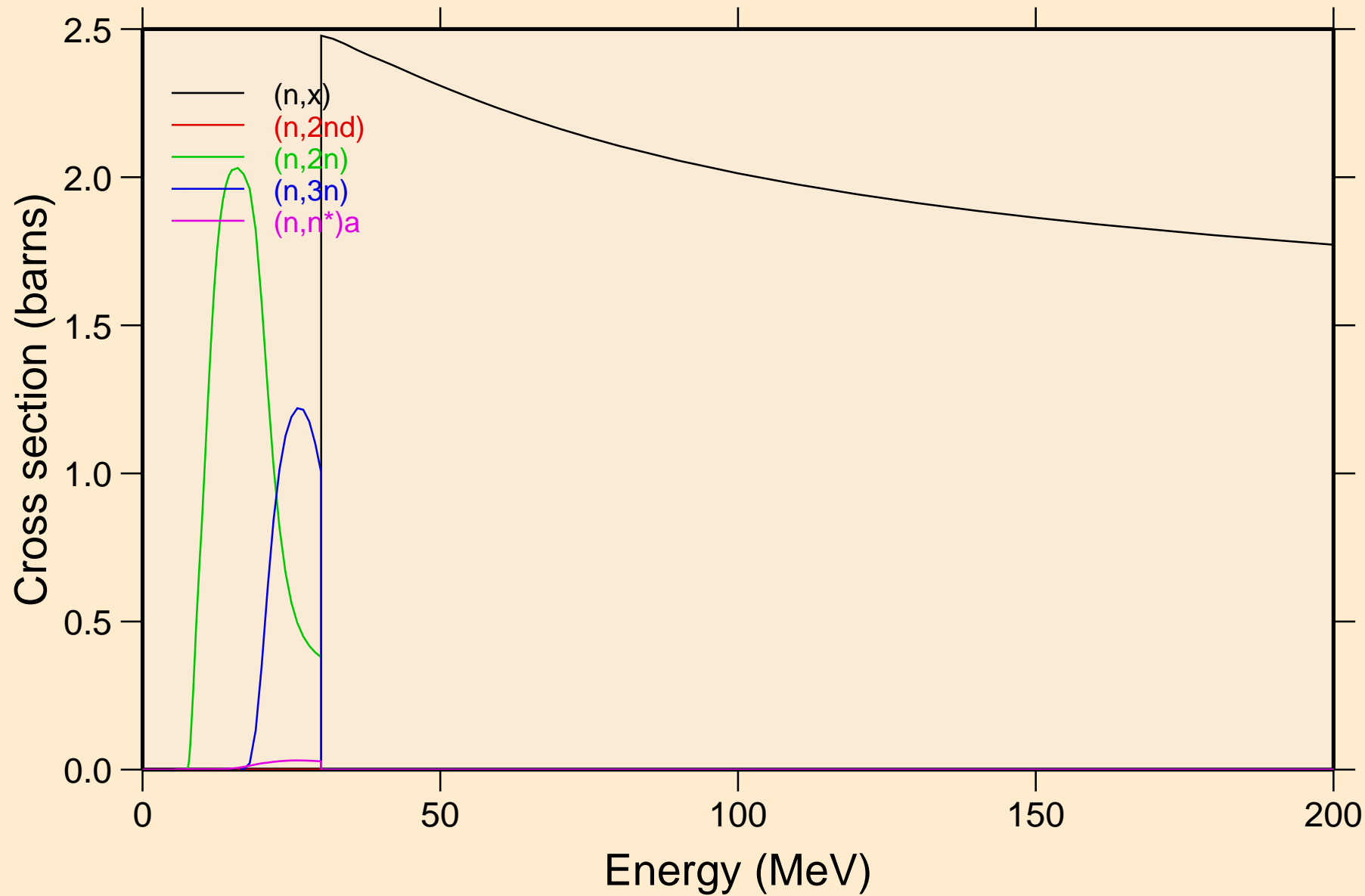

FR212 NEUTRON ACER TENDL-2021 LIBRARY; T=293.6K
Threshold reactions

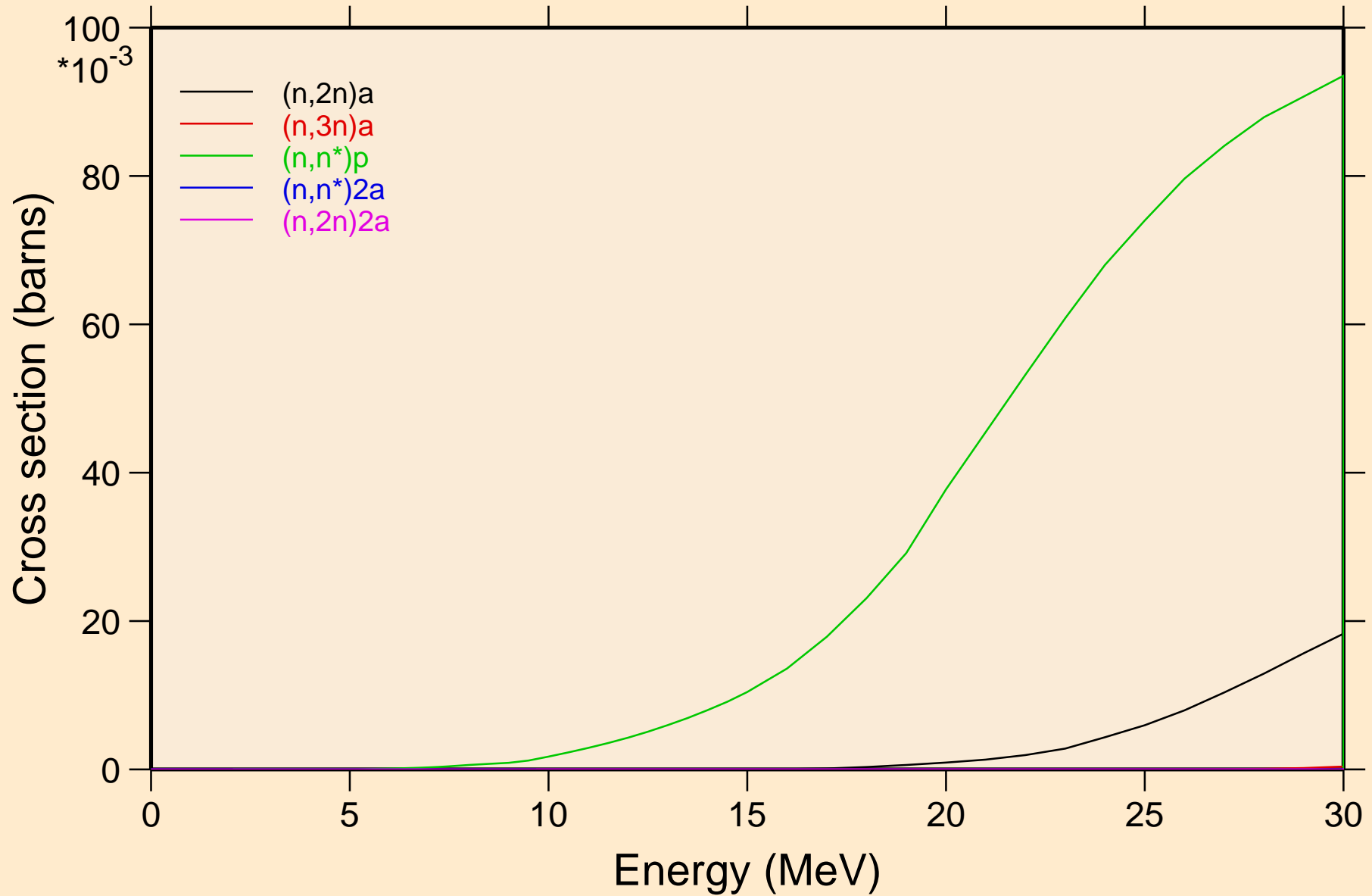

FR212 NEUTRON ACER TENDL-2021 LIBRARY; T=293.6K

Threshold reactions

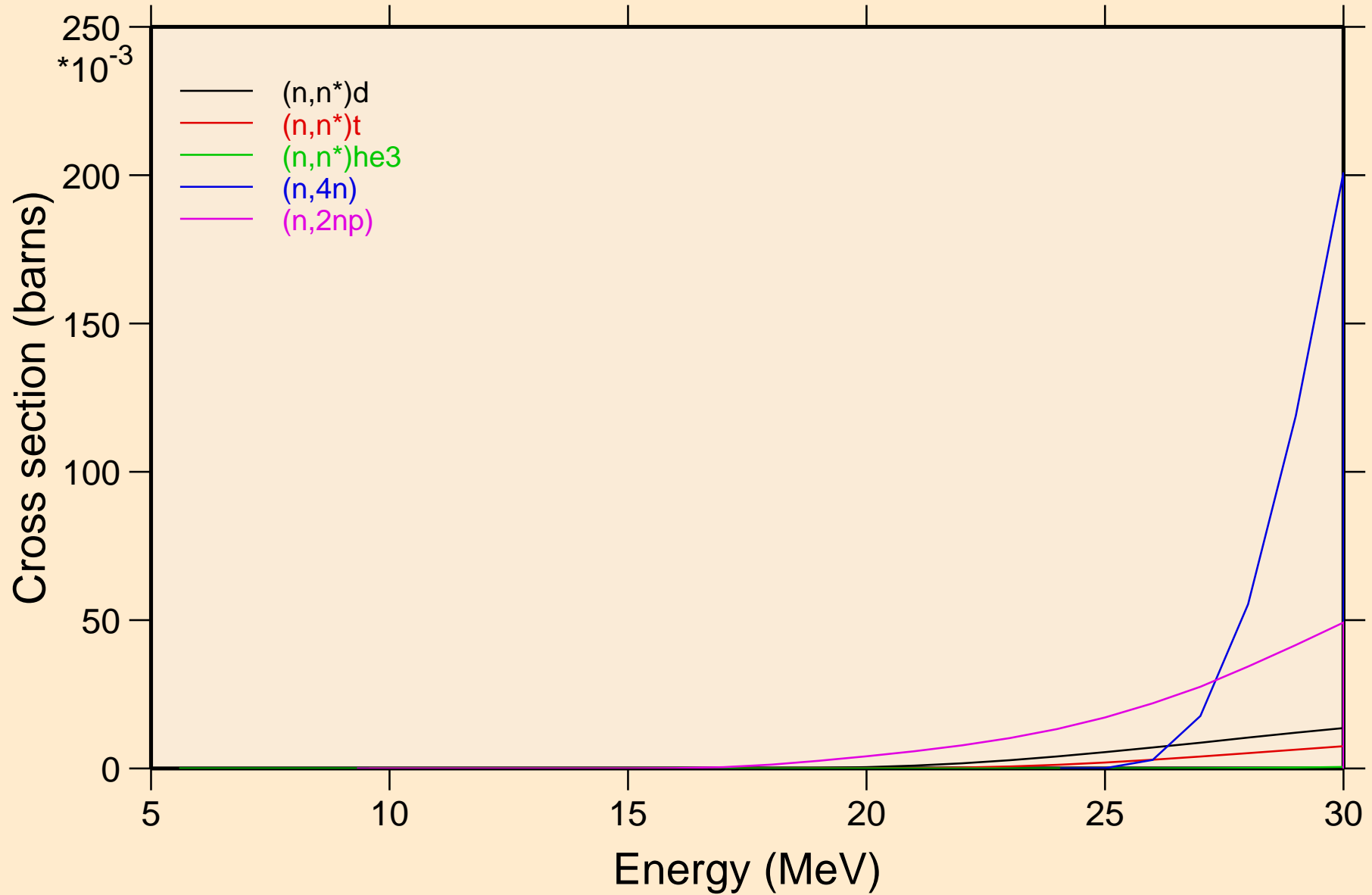

FR212 NEUTRON ACER TENDL-2021 LIBRARY; T=293.6K
Threshold reactions

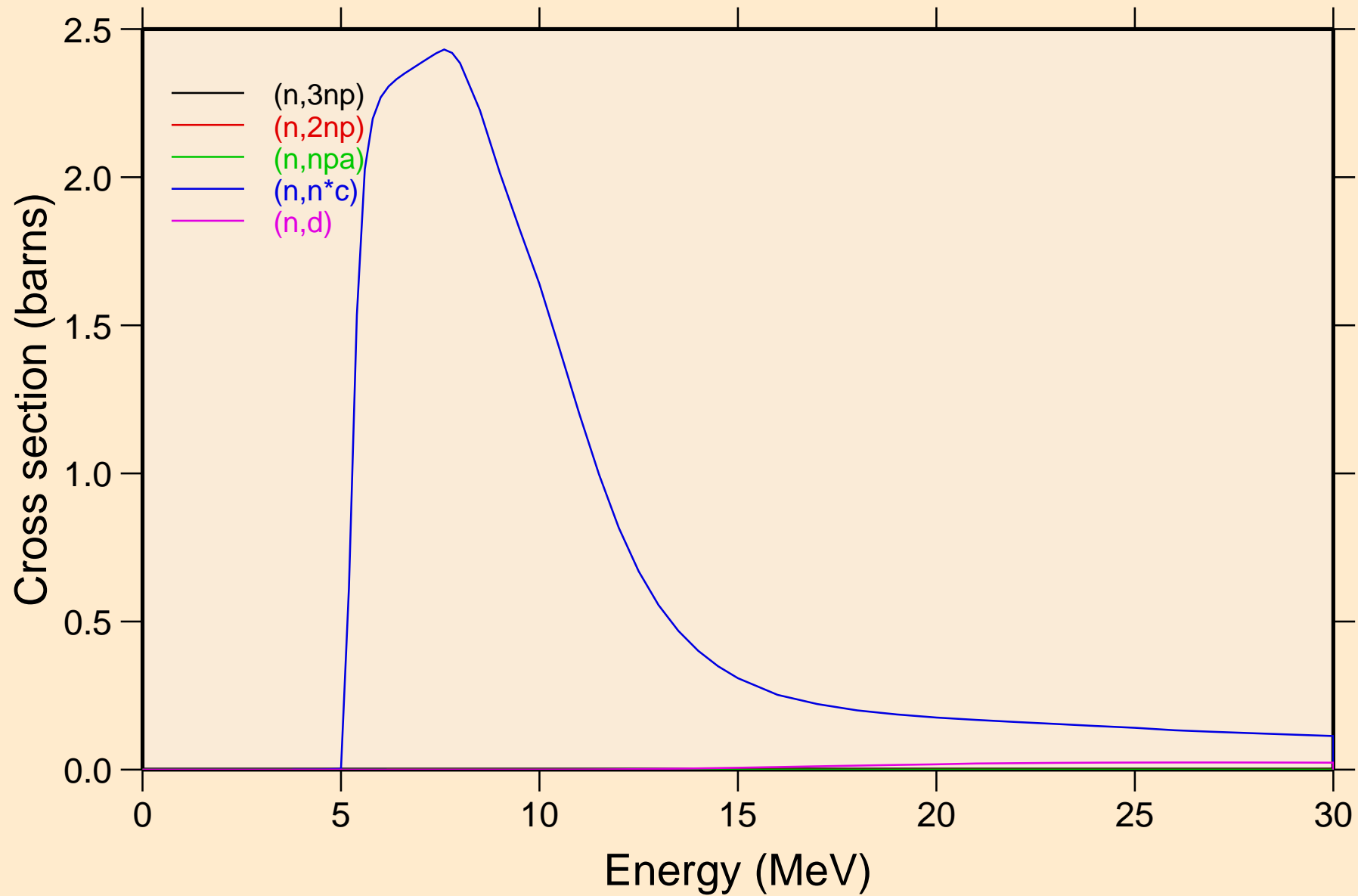

FR212 NEUTRON ACER TENDL-2021 LIBRARY; T=293.6K
Threshold reactions

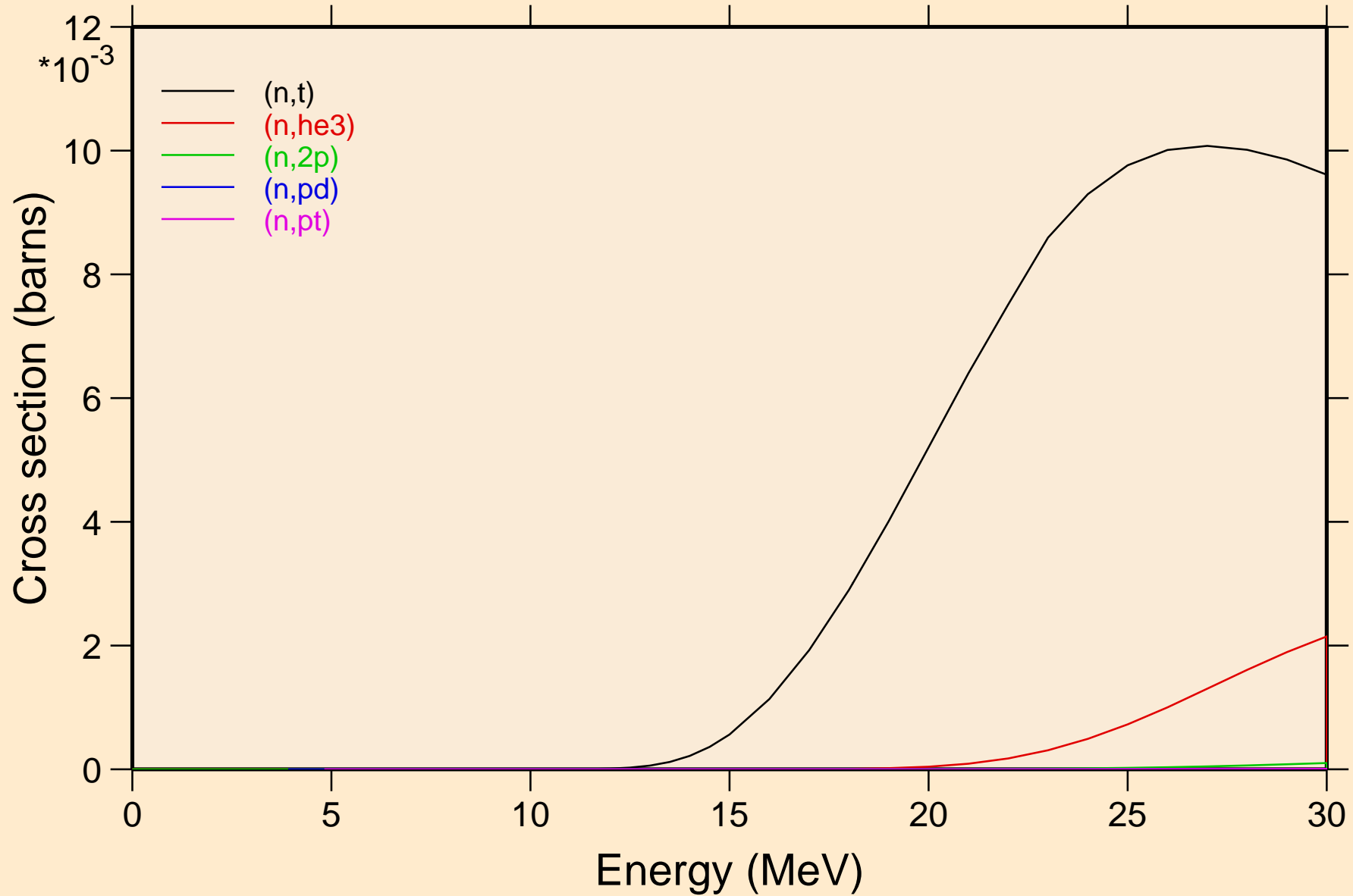

FR212 NEUTRON ACER TENDL-2021 LIBRARY; T=293.6K
Threshold reactions

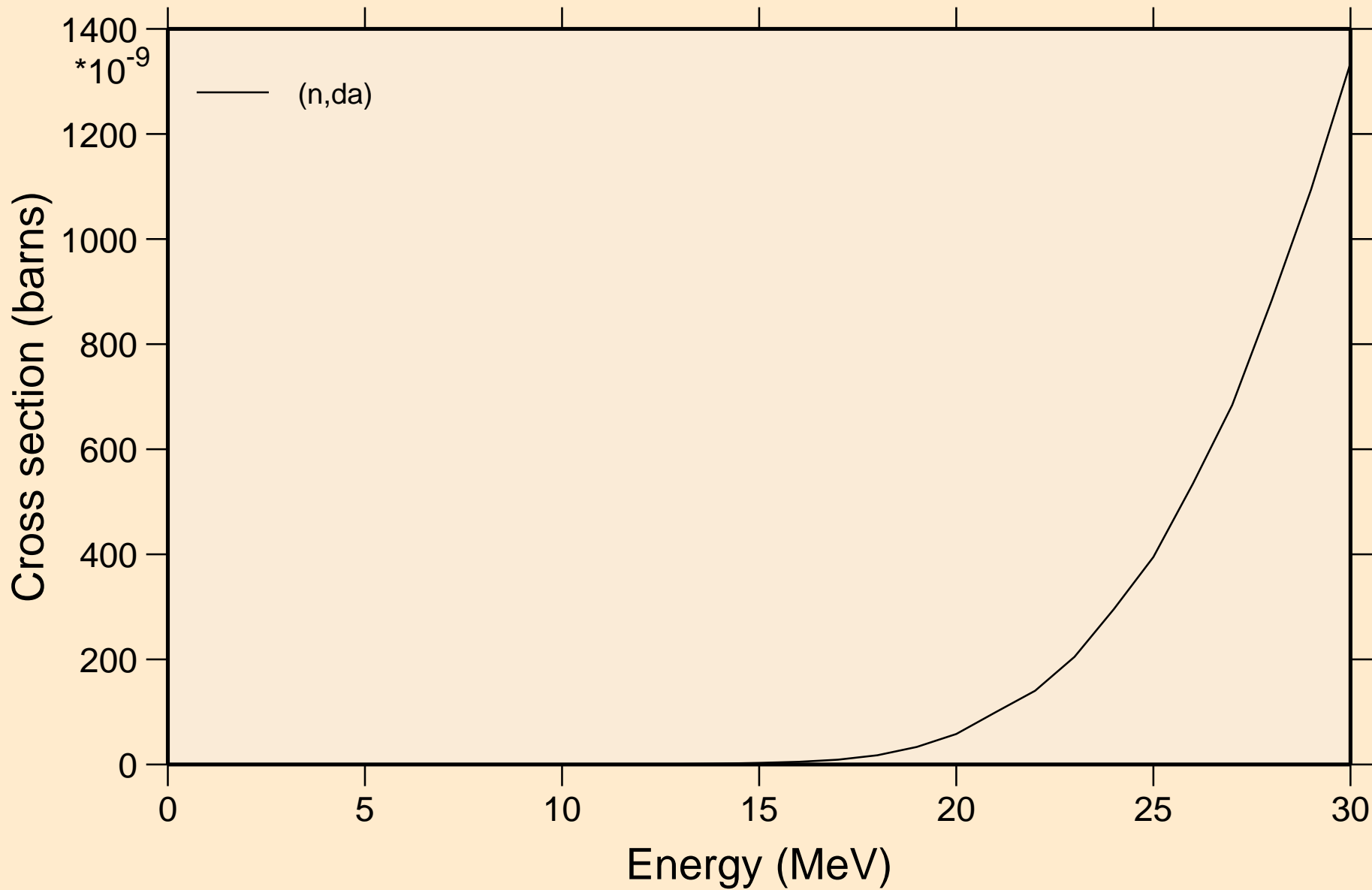

FR212 NEUTRON ACER TENDL-2021 LIBRARY; T=293.6K
Threshold reactions

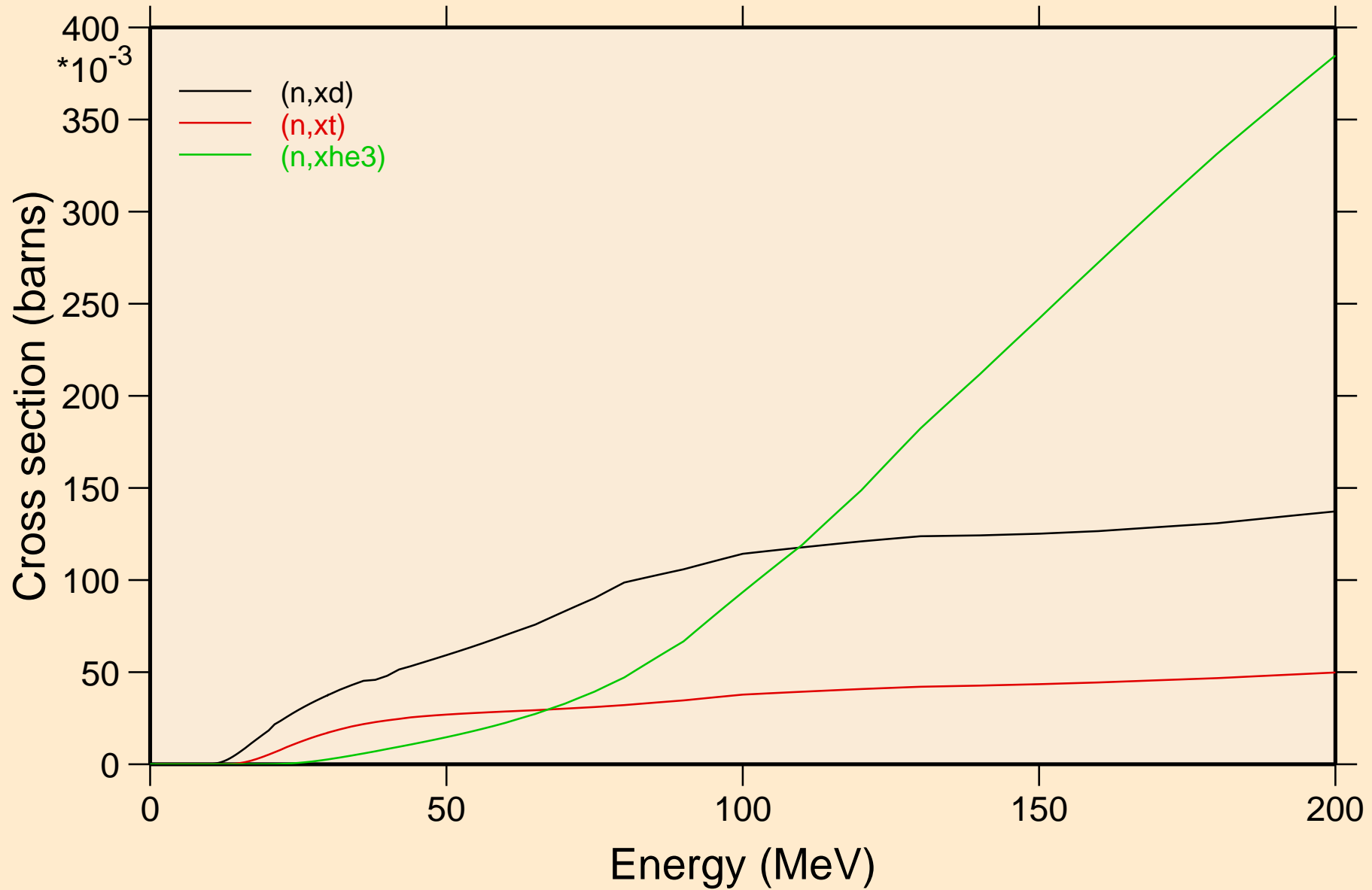

FR212 NEUTRON ACER TENDL-2021 LIBRARY; T=293.6K
angular distribution for elastic

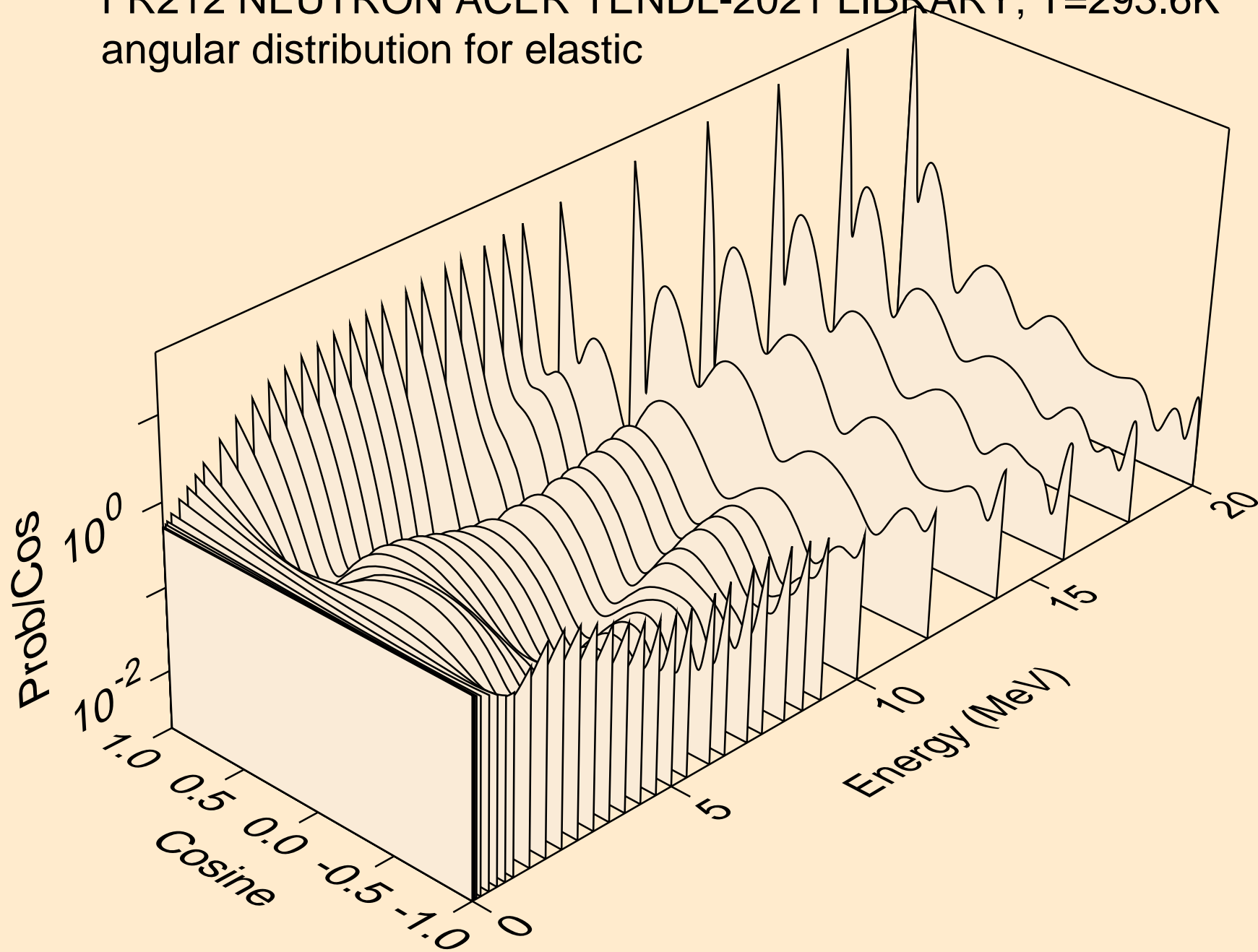

FR212 NEUTRON ACER TENDL-2021 LIBRARY; T=293.6K
angular distribution for elastic

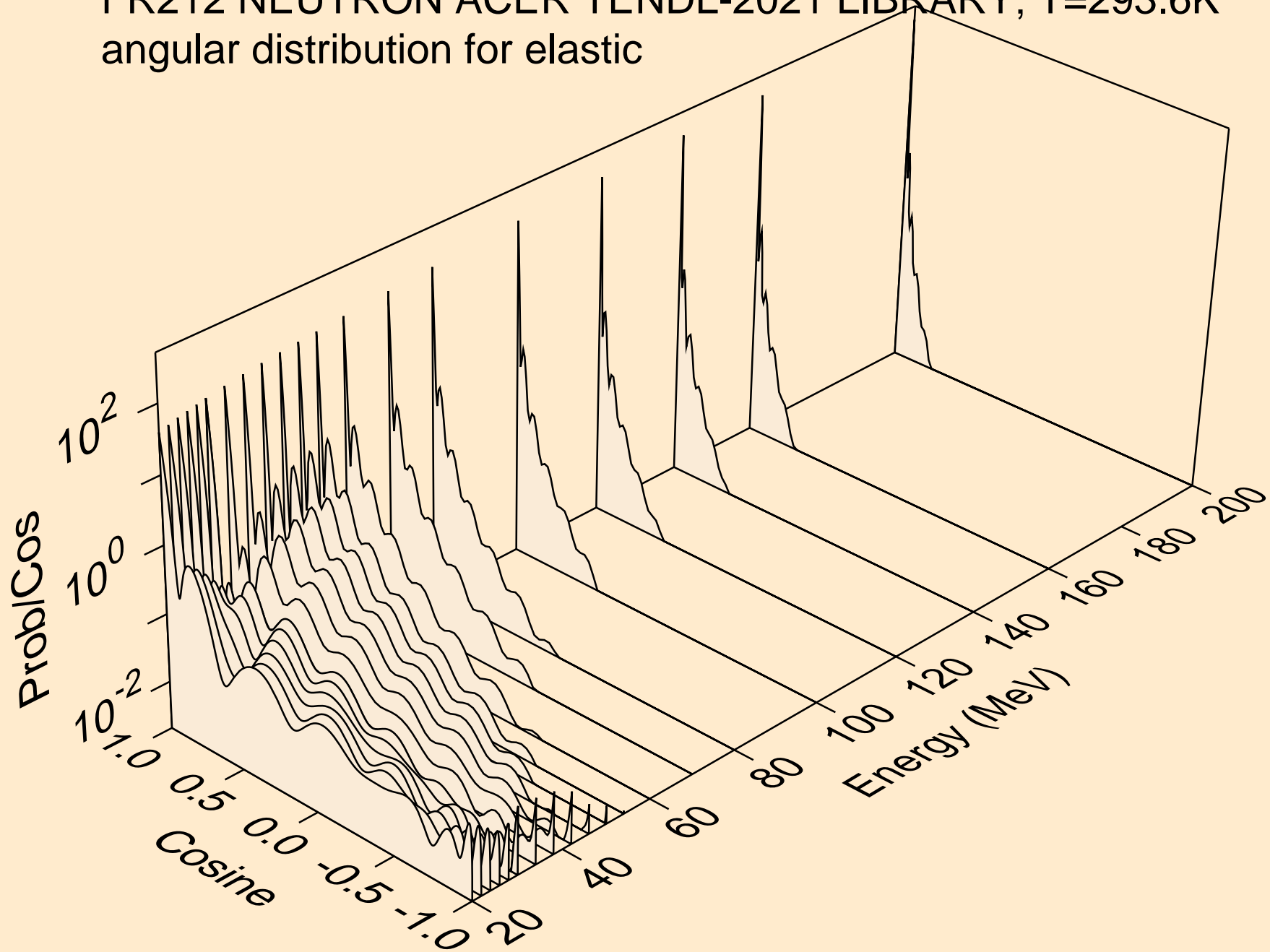

FR212 NEUTRON ACER TENDL-2021 LIBRARY; T=293.6K
angular distribution for (n,n*1)

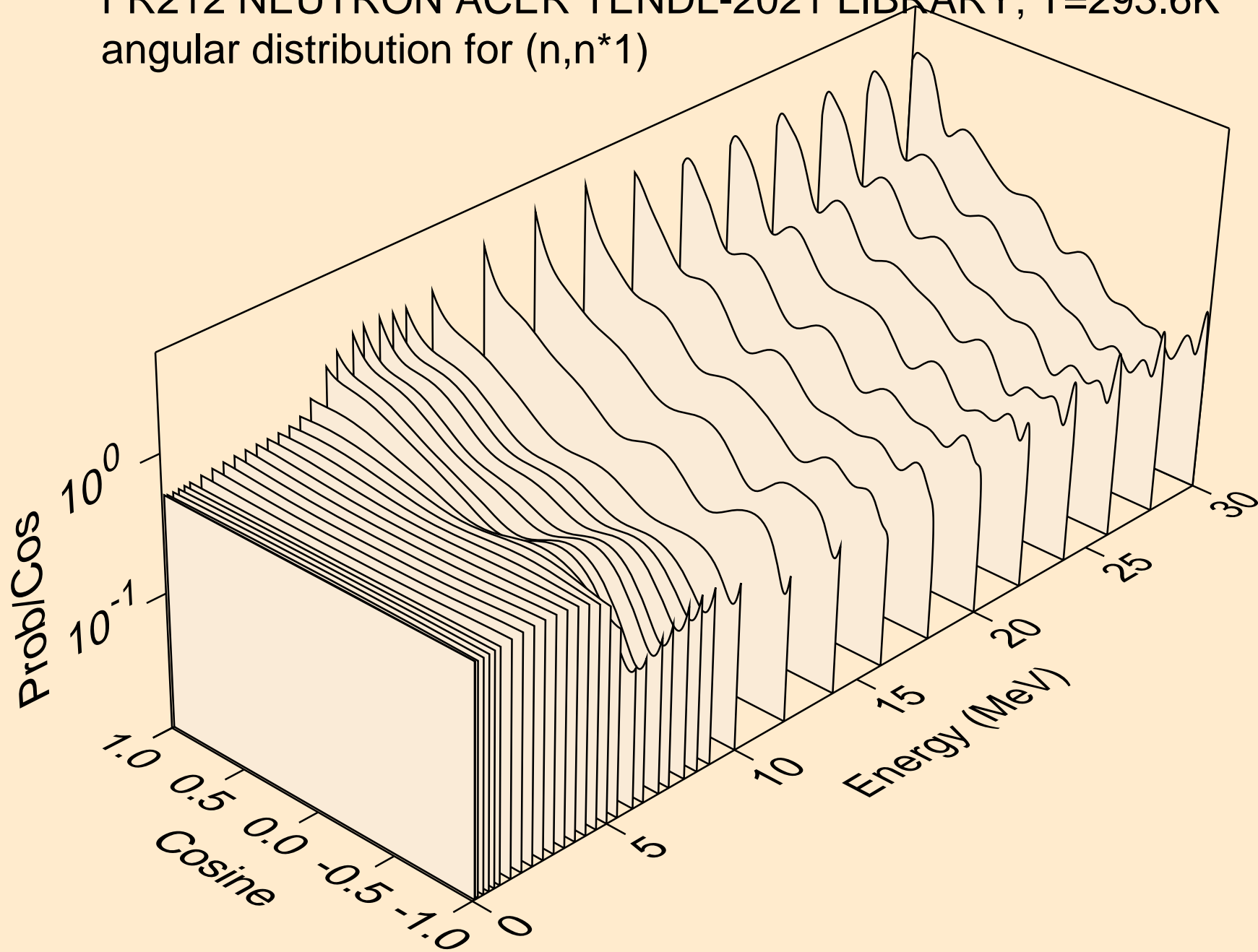

FR212 NEUTRON ACER TENDL-2021 LIBRARY; T=293.6K
angular distribution for (n,n*2)

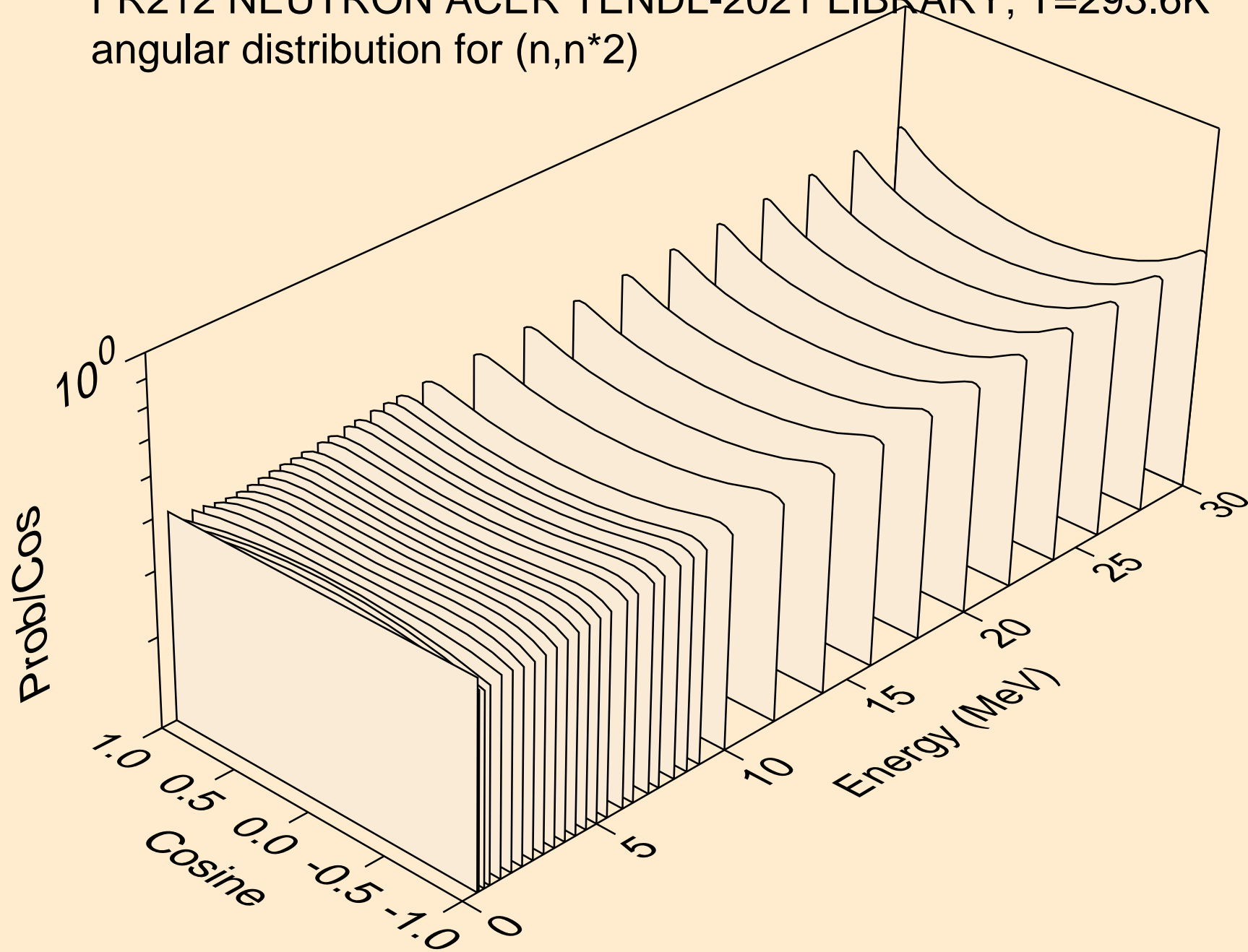

FR212 NEUTRON ACER TENDL-2021 LIBRARY; T=293.6K
angular distribution for (n,n*3)

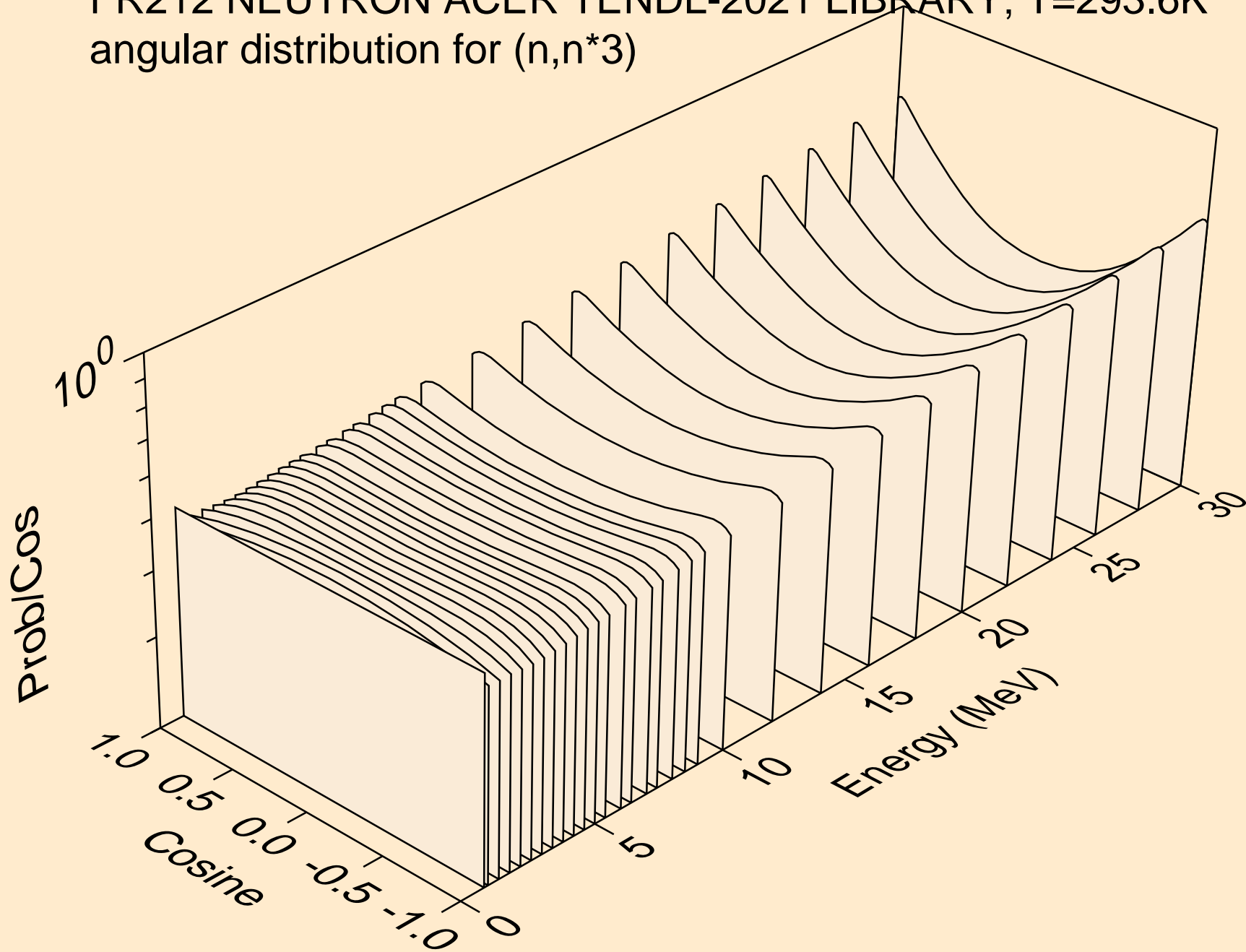

FR212 NEUTRON ACER TENDL-2021 LIBRARY; T=293.6K
angular distribution for (n,n*4)

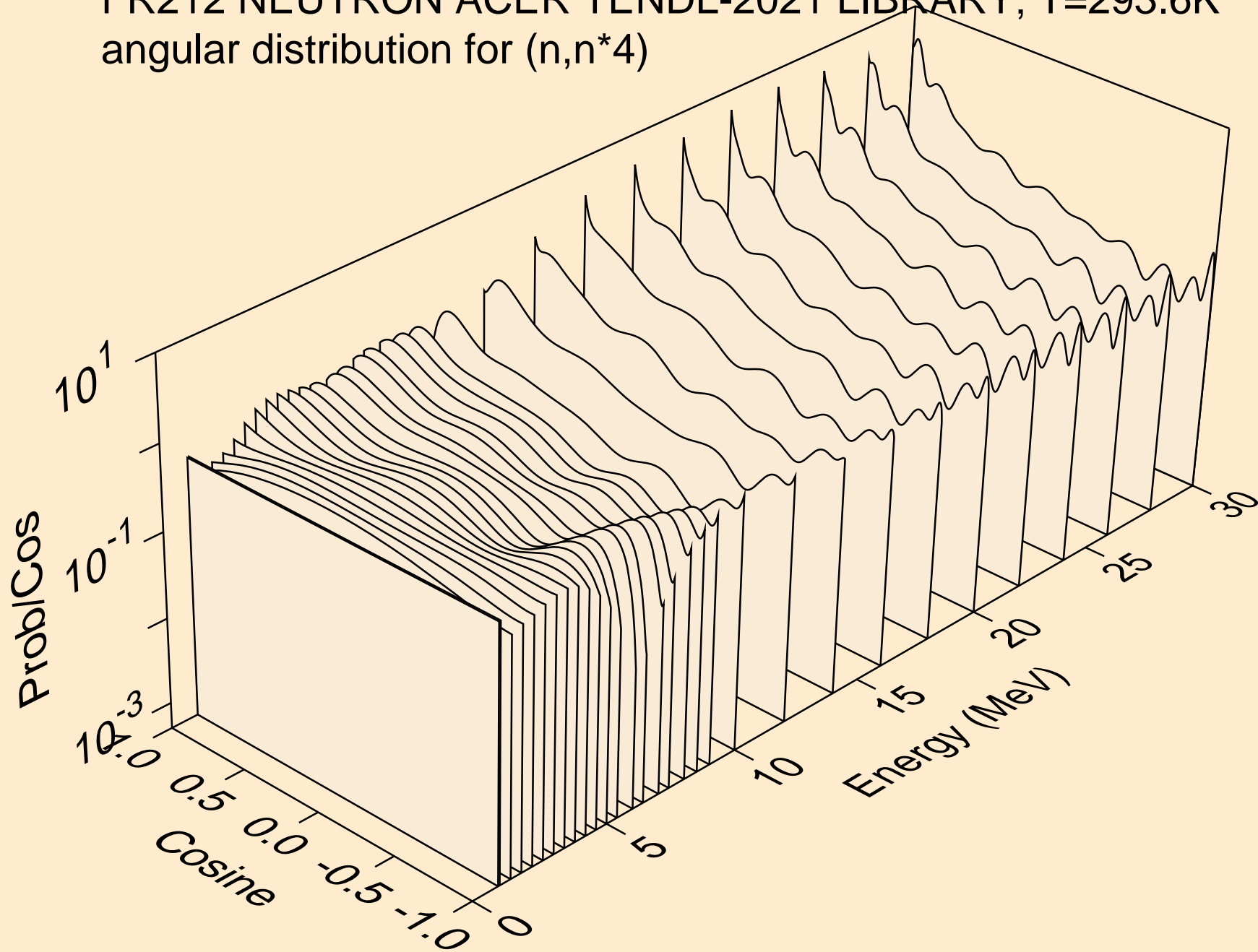

FR212 NEUTRON ACER TENDL-2021 LIBRARY; T=293.6K
angular distribution for (n,n*5)

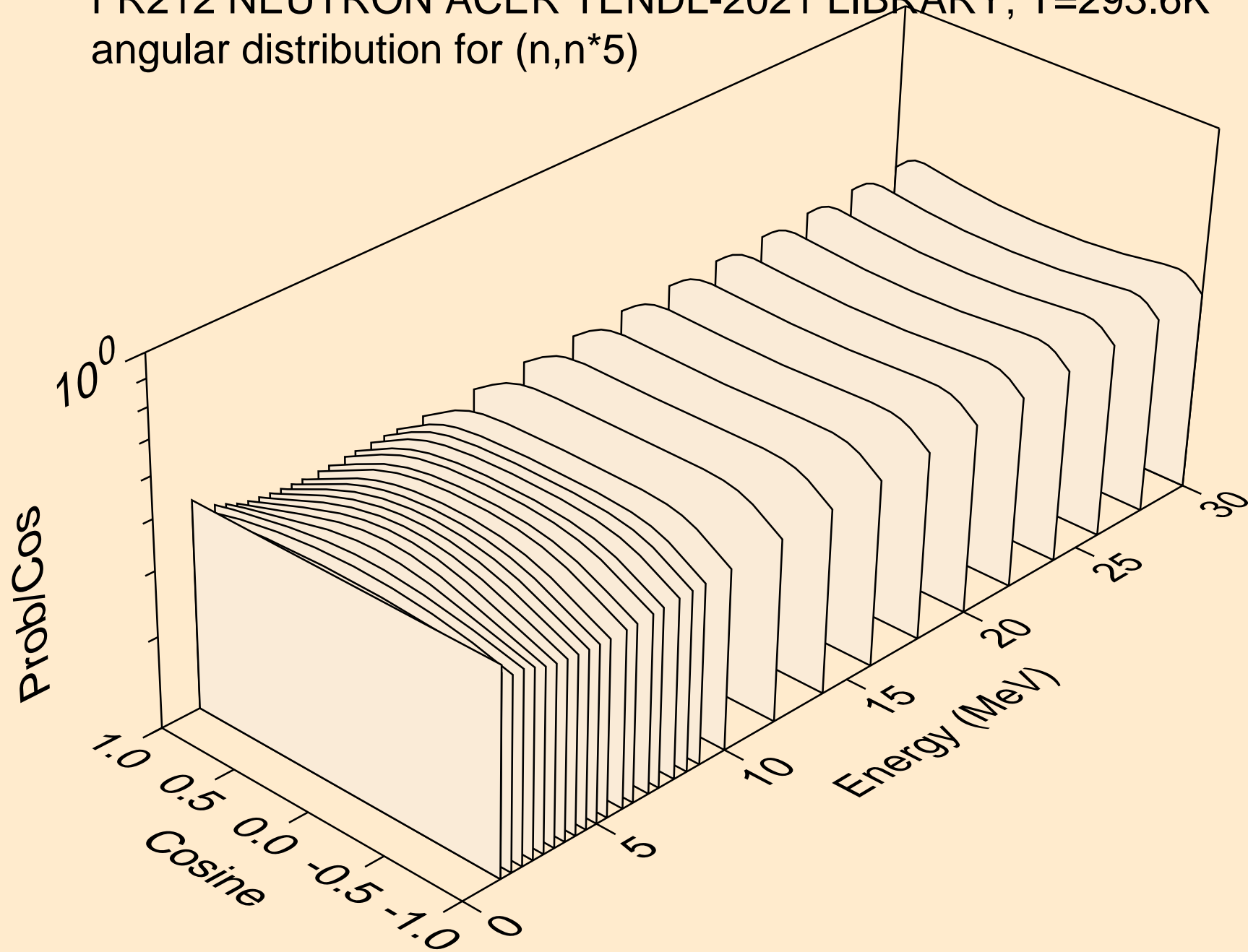

FR212 NEUTRON ACER TENDL-2021 LIBRARY; T=293.6K
angular distribution for (n,n*6)

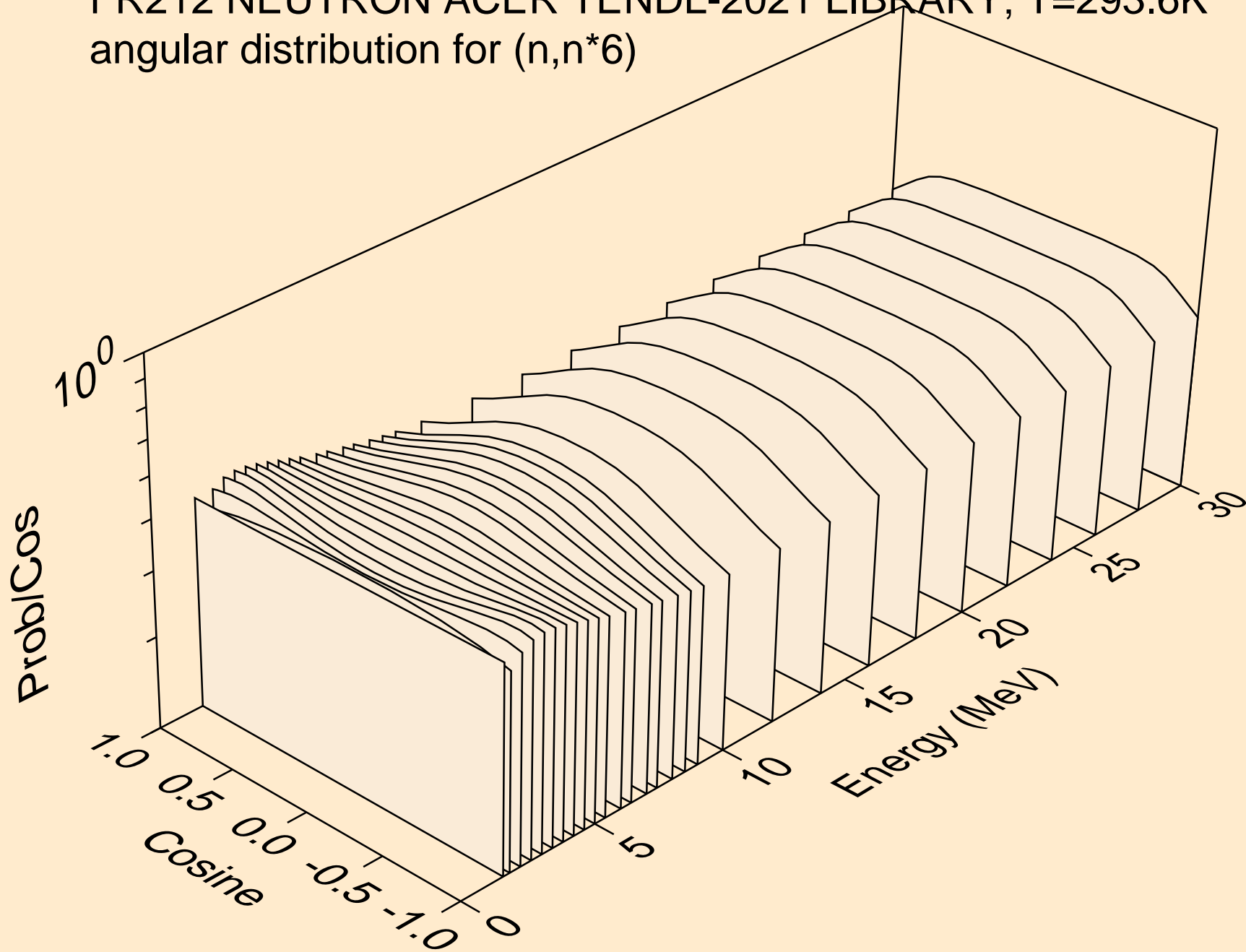

FR212 NEUTRON ACER TENDL-2021 LIBRARY; T=293.6K
angular distribution for (n,n*7)

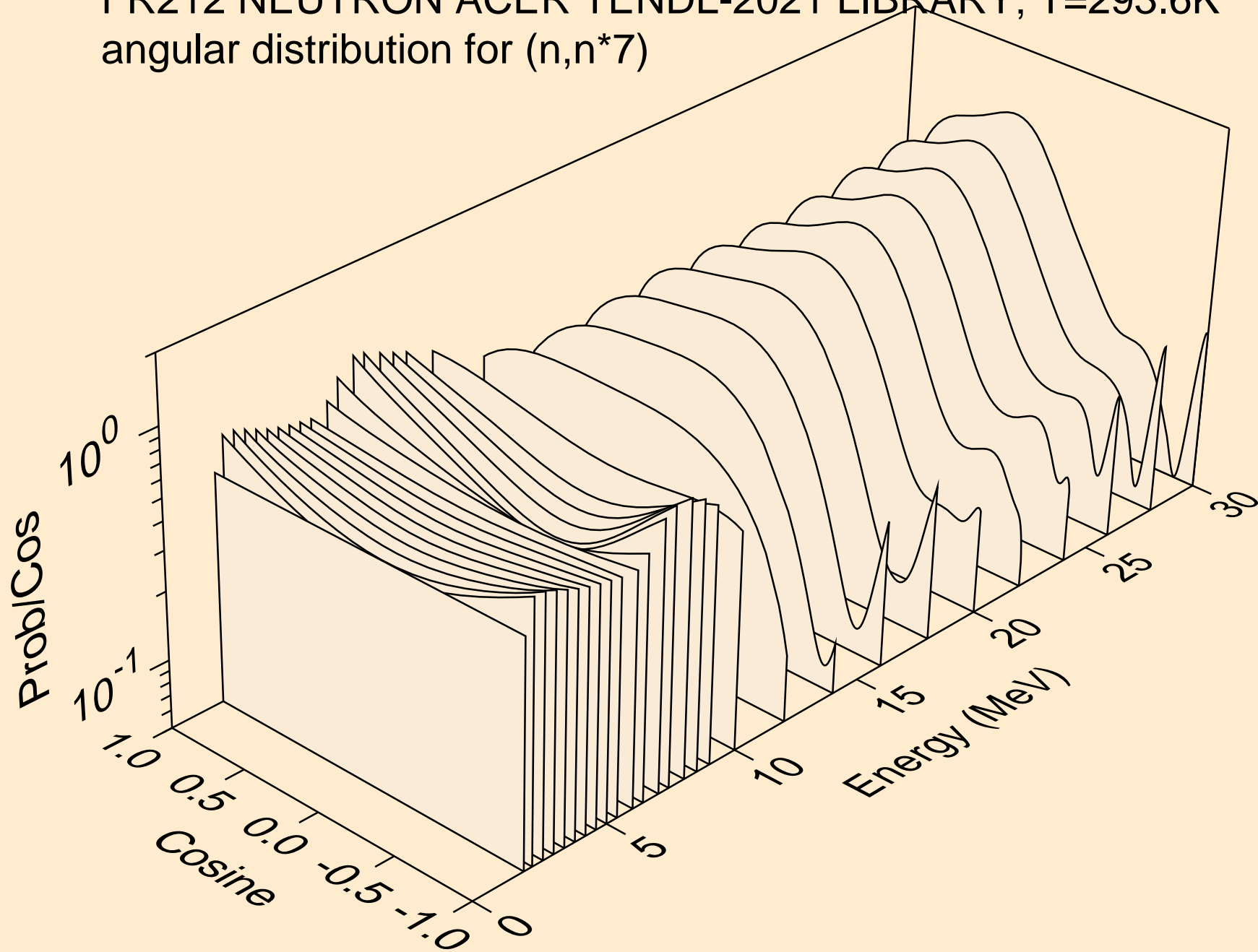

FR212 NEUTRON ACER TENDL-2021 LIBRARY; T=293.6K
angular distribution for (n,n*8)

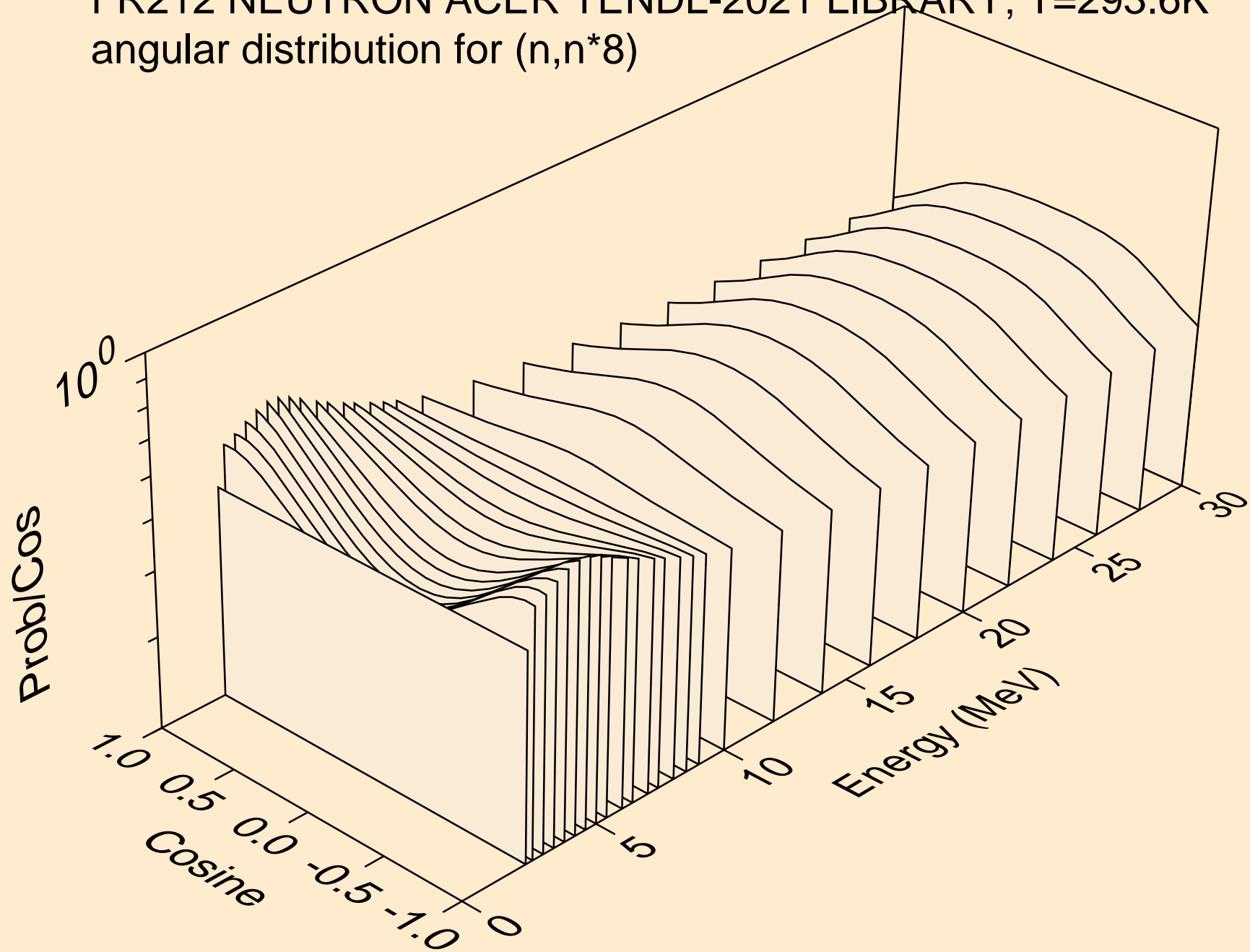

FR212 NEUTRON ACER TENDL-2021 LIBRARY; T=293.6K
angular distribution for (n,n*9)

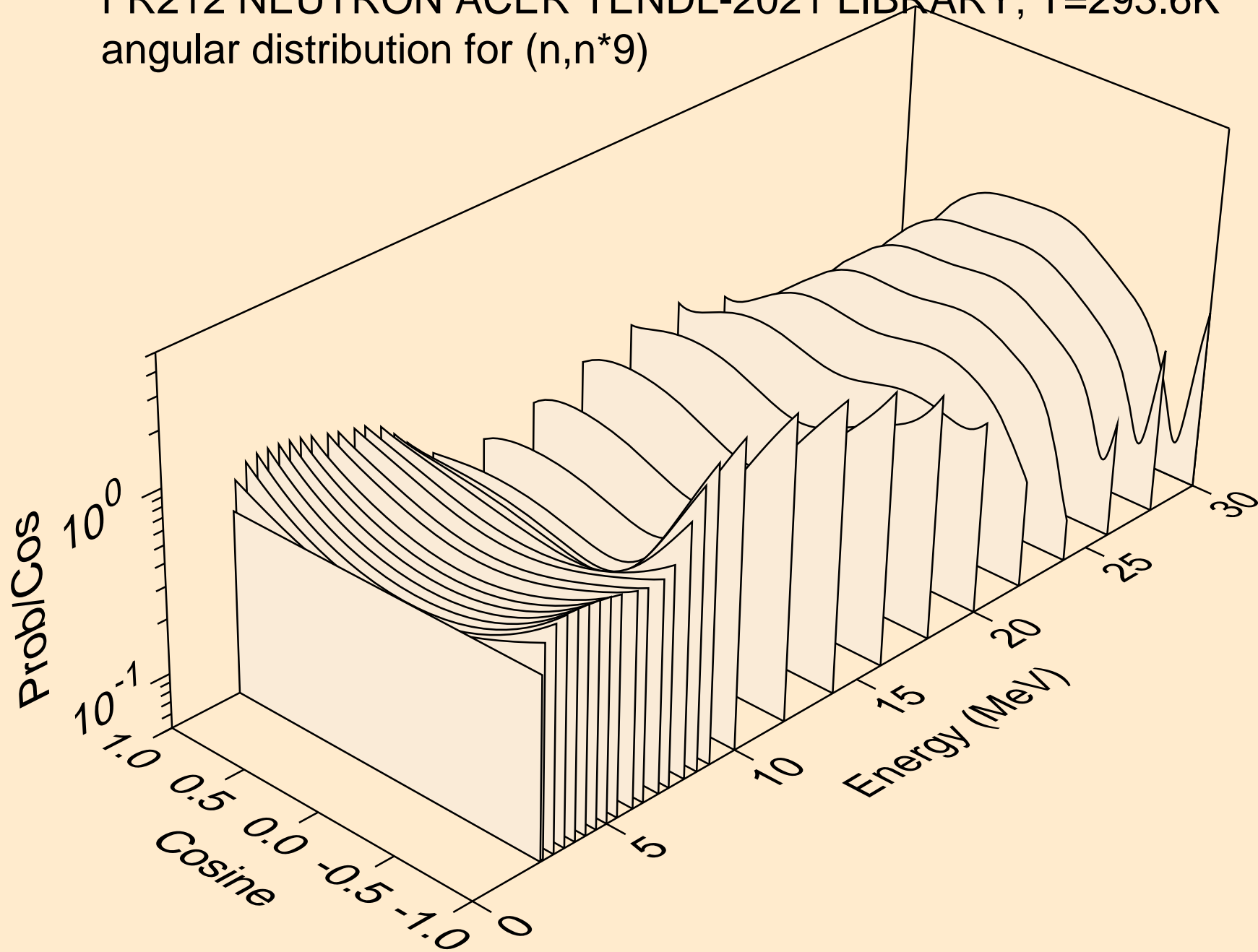

FR212 NEUTRON ACER TENDL-2021 LIBRARY; T=293.6K
angular distribution for (n,n*10)

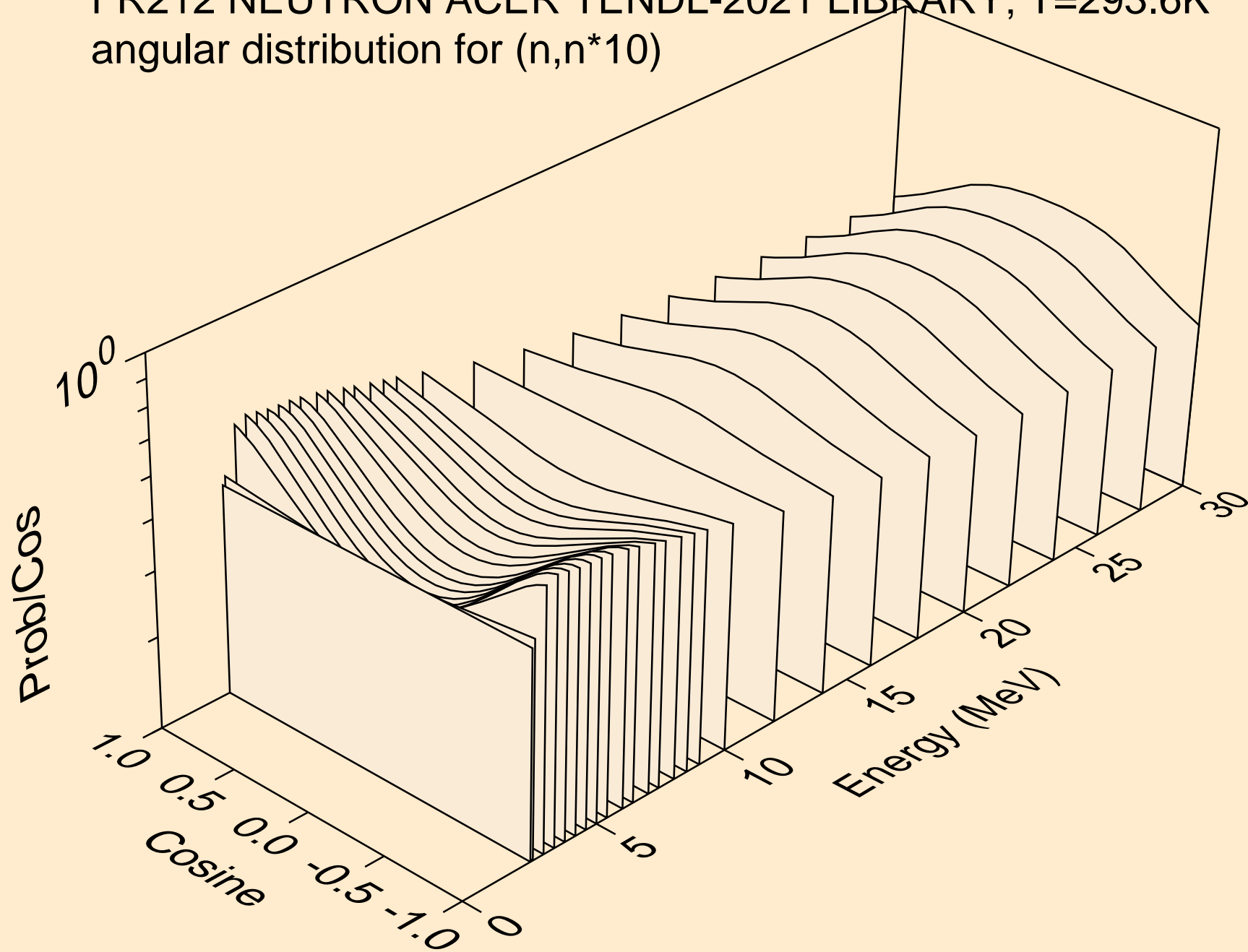

FR212 NEUTRON ACER TENDL-2021 LIBRARY; T=293.6K
angular distribution for (n,n*11)

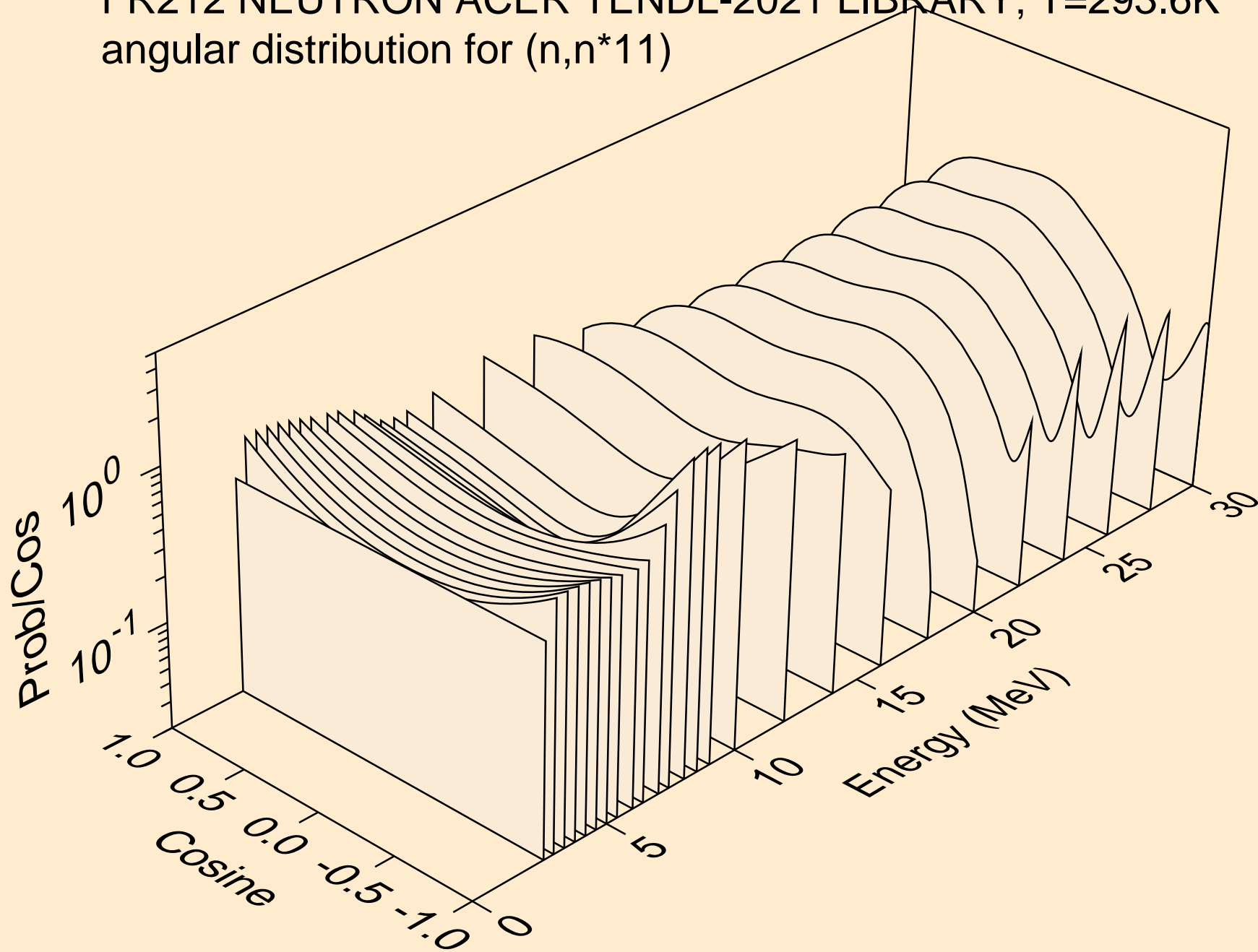

FR212 NEUTRON ACER TENDL-2021 LIBRARY; T=293.6K
angular distribution for (n,n*12)

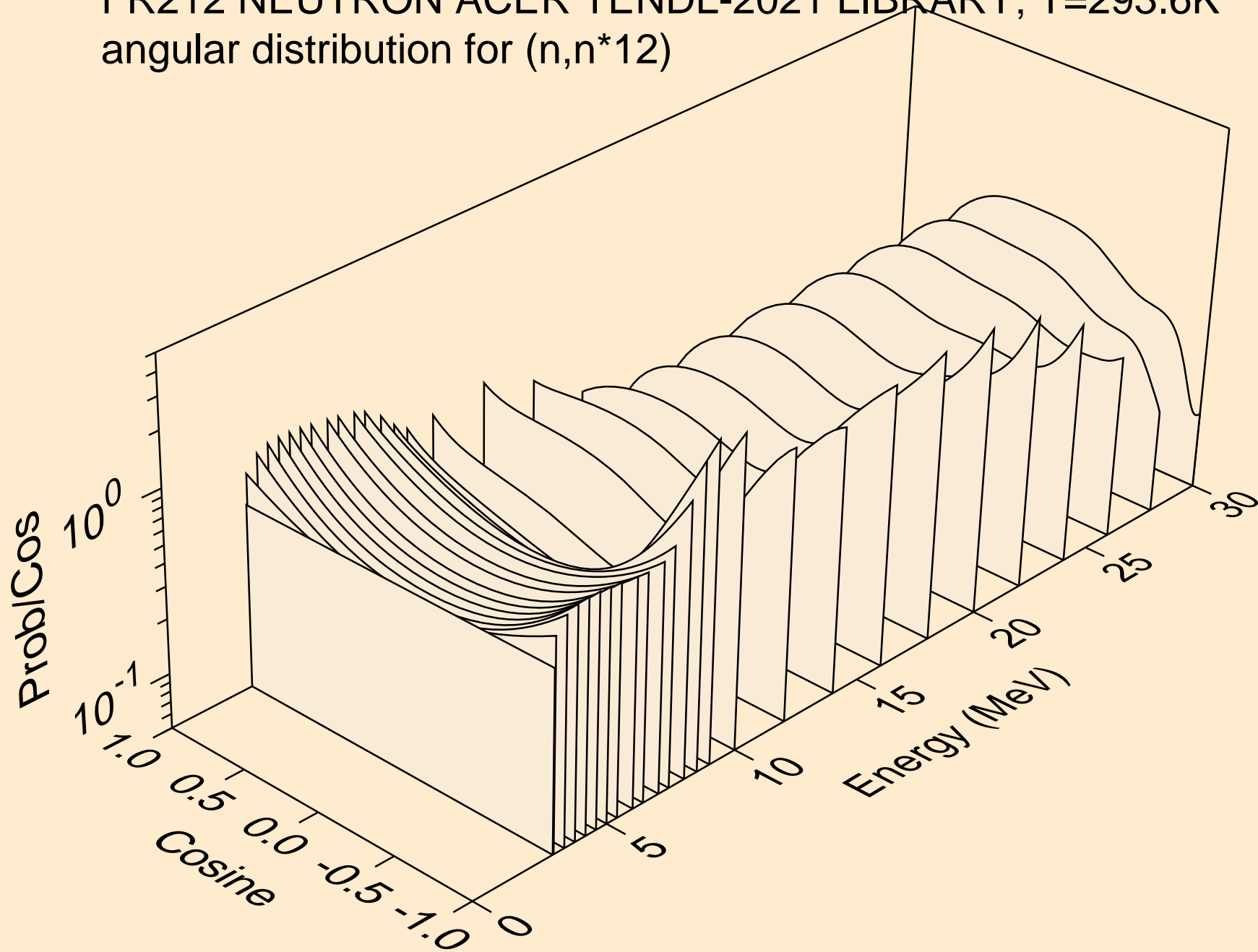

FR212 NEUTRON ACER TENDL-2021 LIBRARY; T=293.6K
angular distribution for (n,n*13)

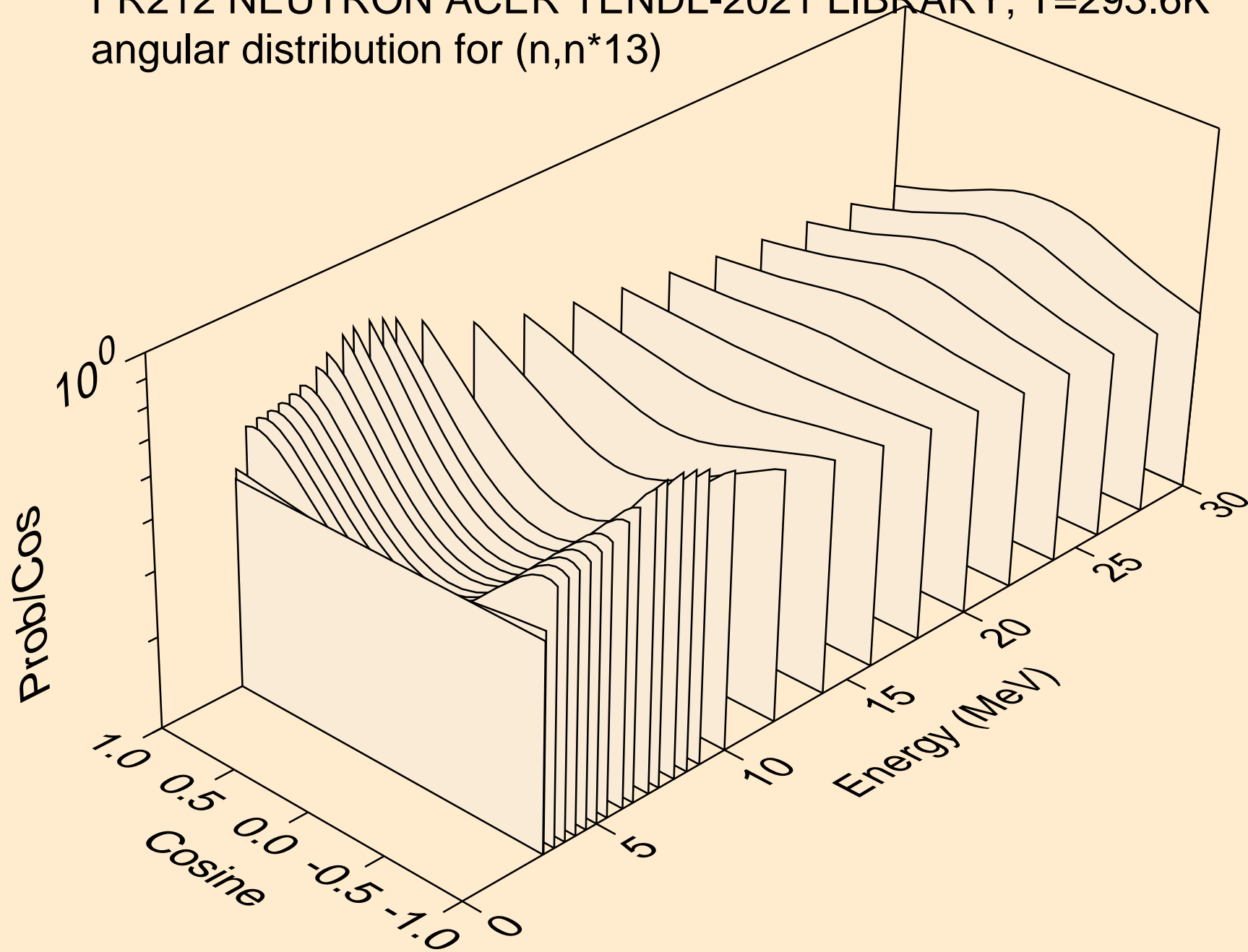

FR212 NEUTRON ACER TENDL-2021 LIBRARY; T=293.6K
angular distribution for (n,n*14)

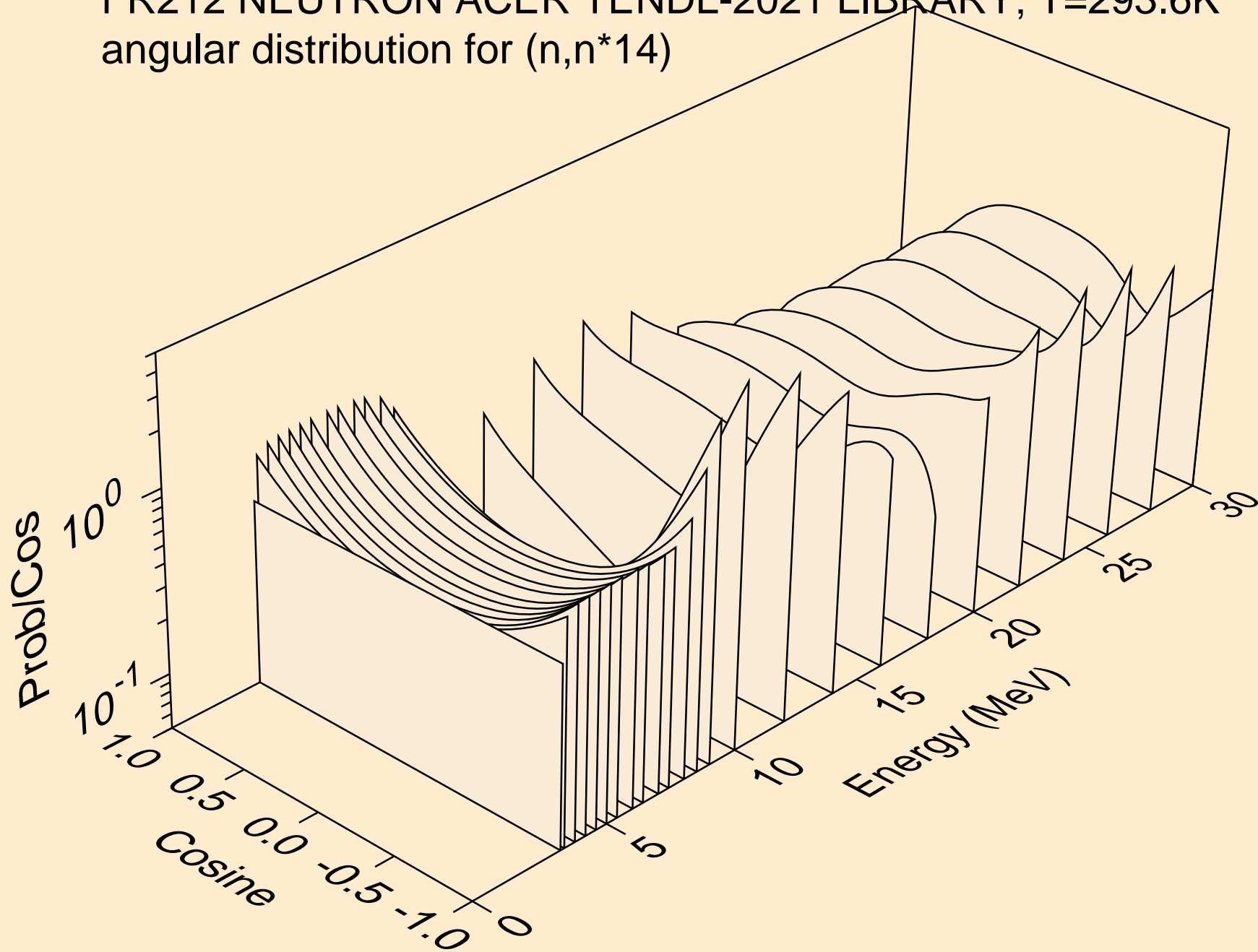

FR212 NEUTRON ACER TENDL-2021 LIBRARY; T=293.6K
angular distribution for (n,n*15)

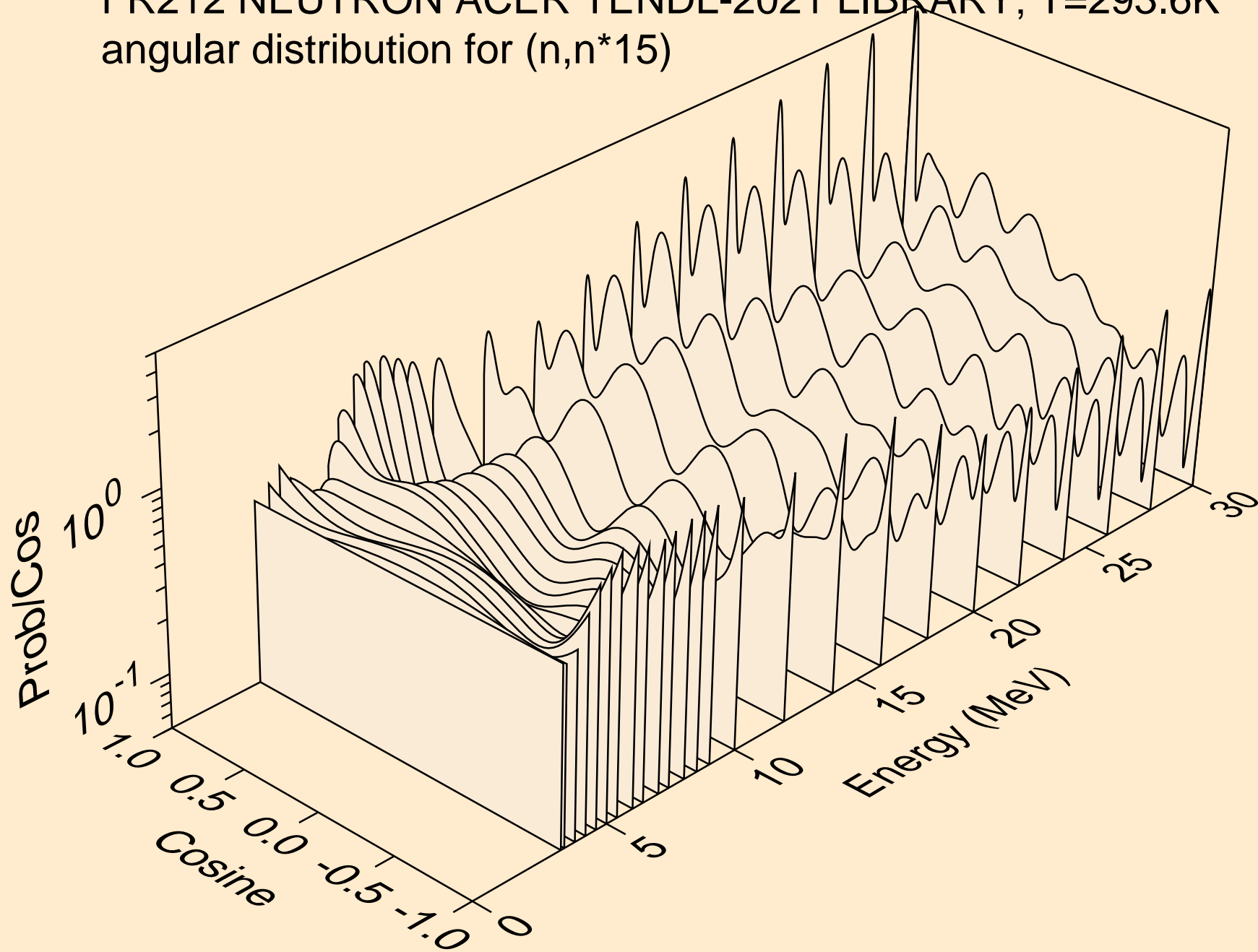

FR212 NEUTRON ACER TENDL-2021 LIBRARY; T=293.6K
angular distribution for (n,n*16)

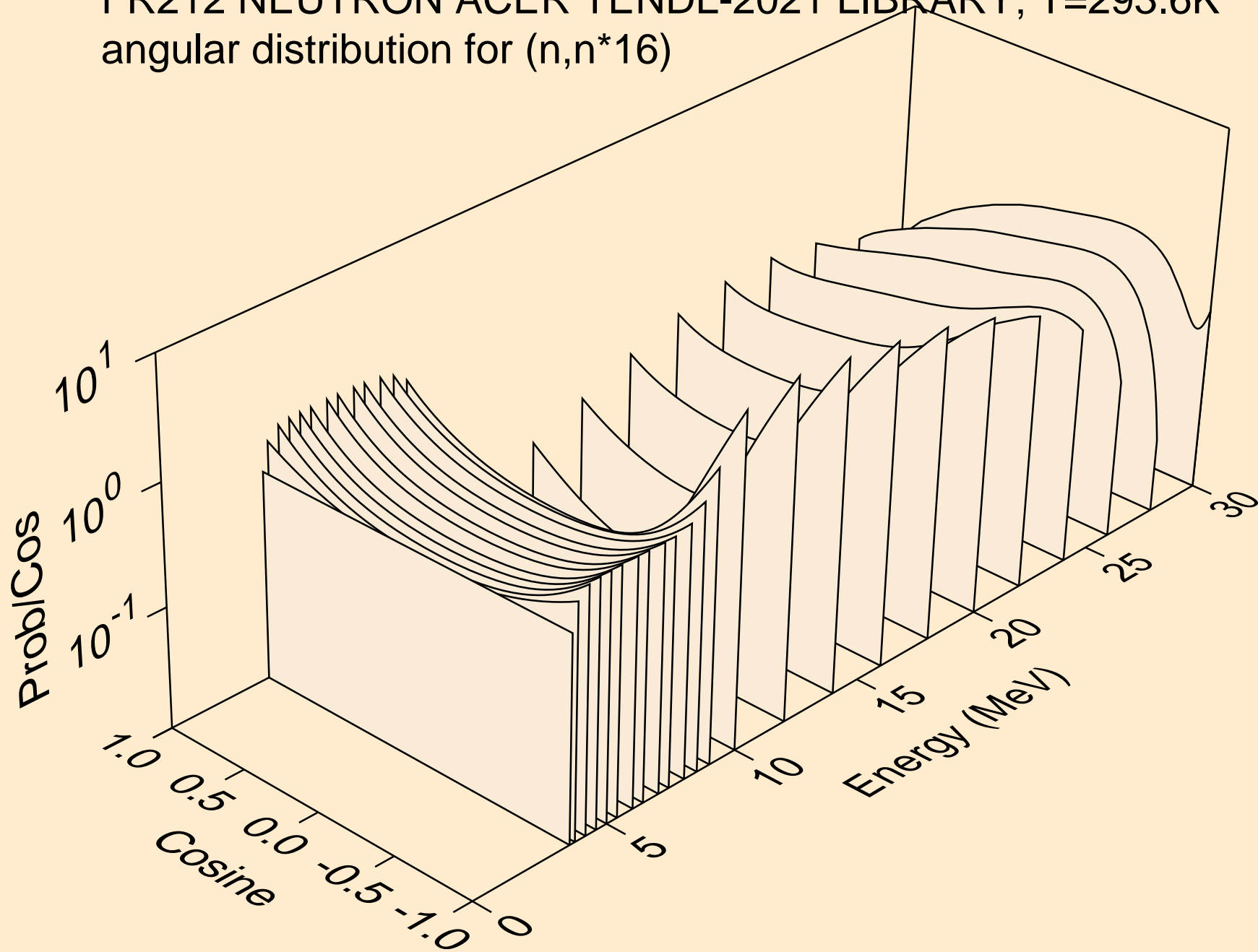

FR212 NEUTRON ACER TENDL-2021 LIBRARY; T=293.6K
angular distribution for (n,n*17)

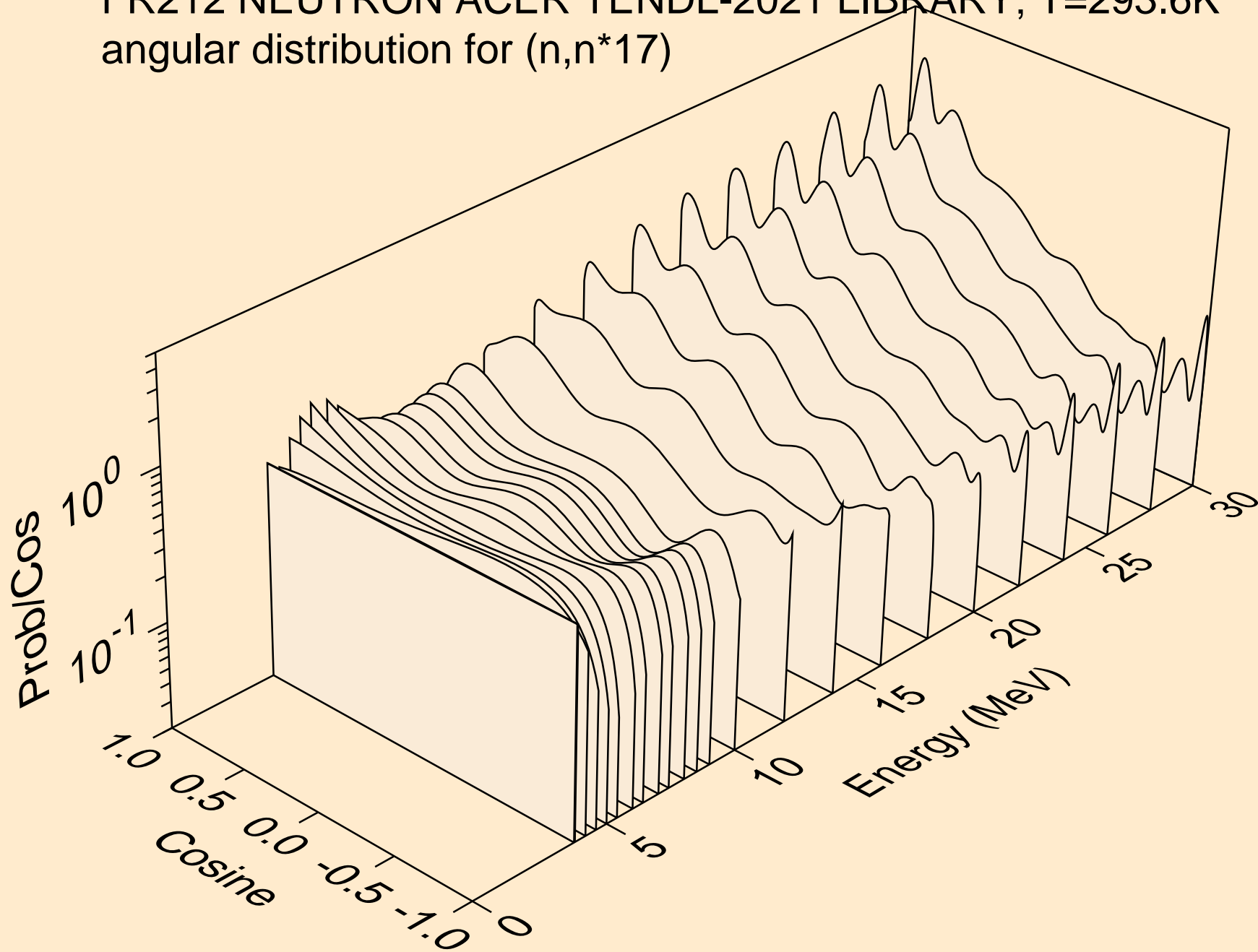

FR212 NEUTRON ACER TENDL-2021 LIBRARY; T=293.6K
Neutron emission for (n,x)

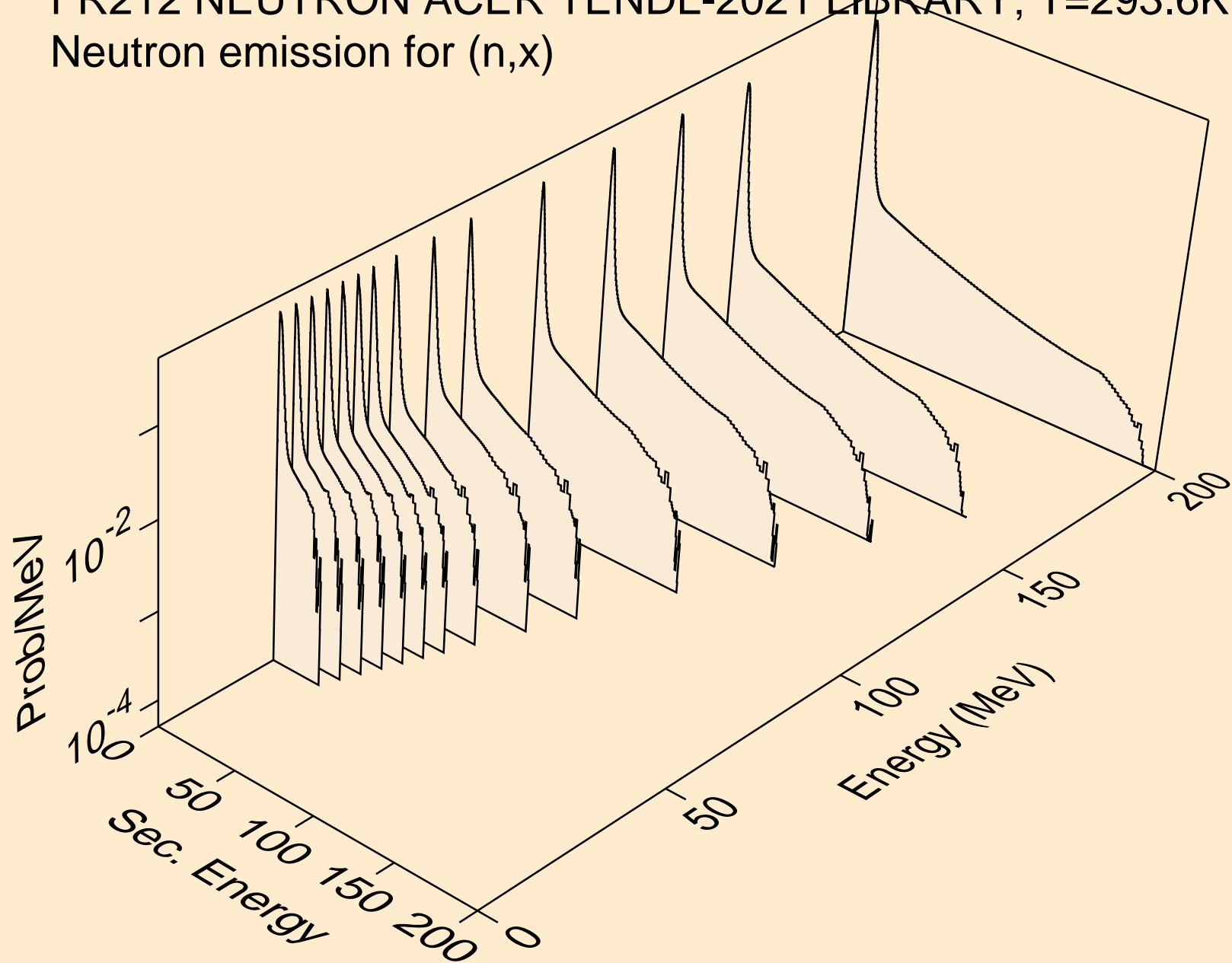

FR212 NEUTRON ACER TENDL-2021 LIBRARY; T=293.6K
Neutron emission for (n,2nd)

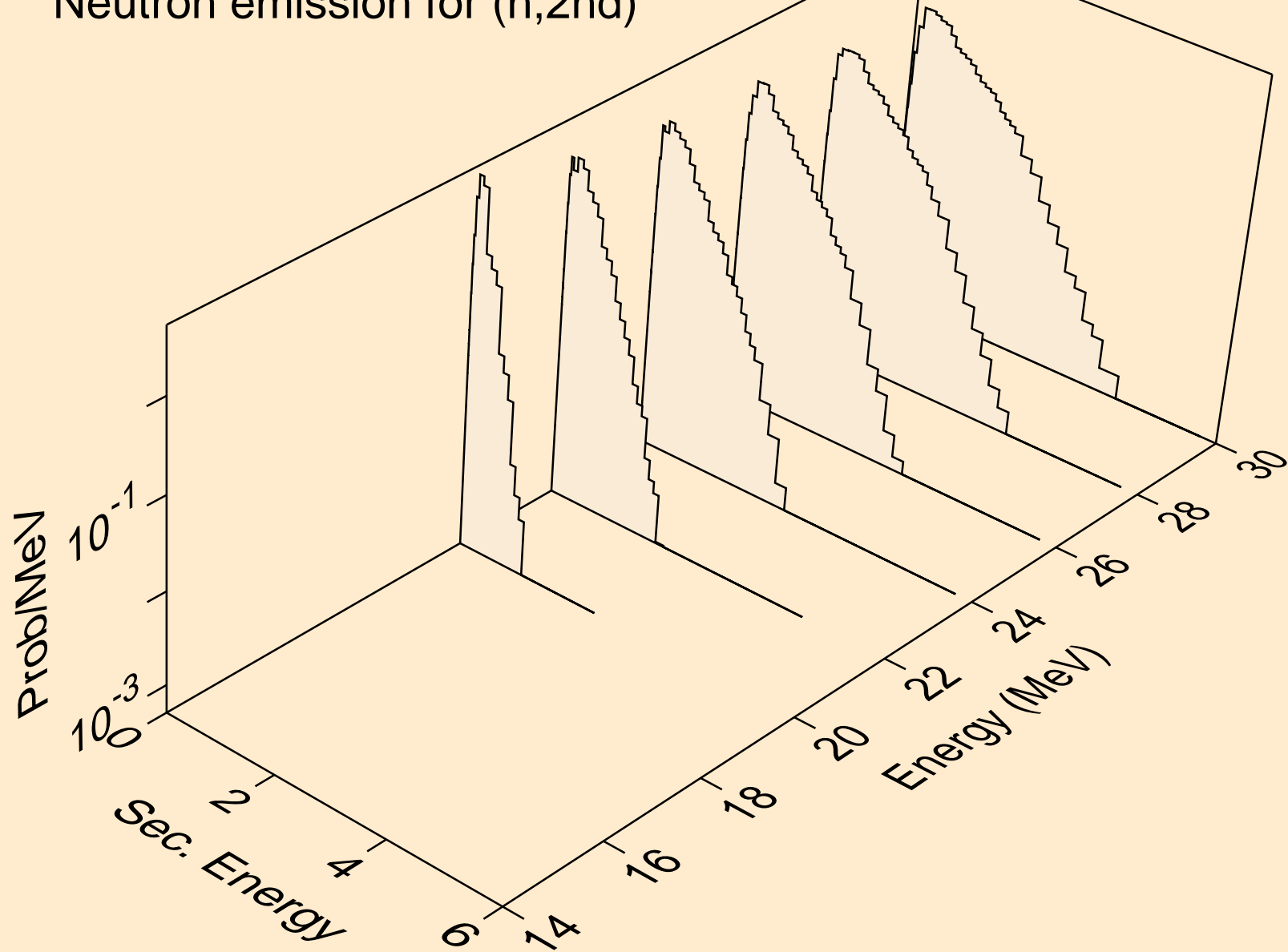

FR212 NEUTRON ACER TENDL-2021 LIBRARY; T=293.6K
Neutron emission for (n,2n)

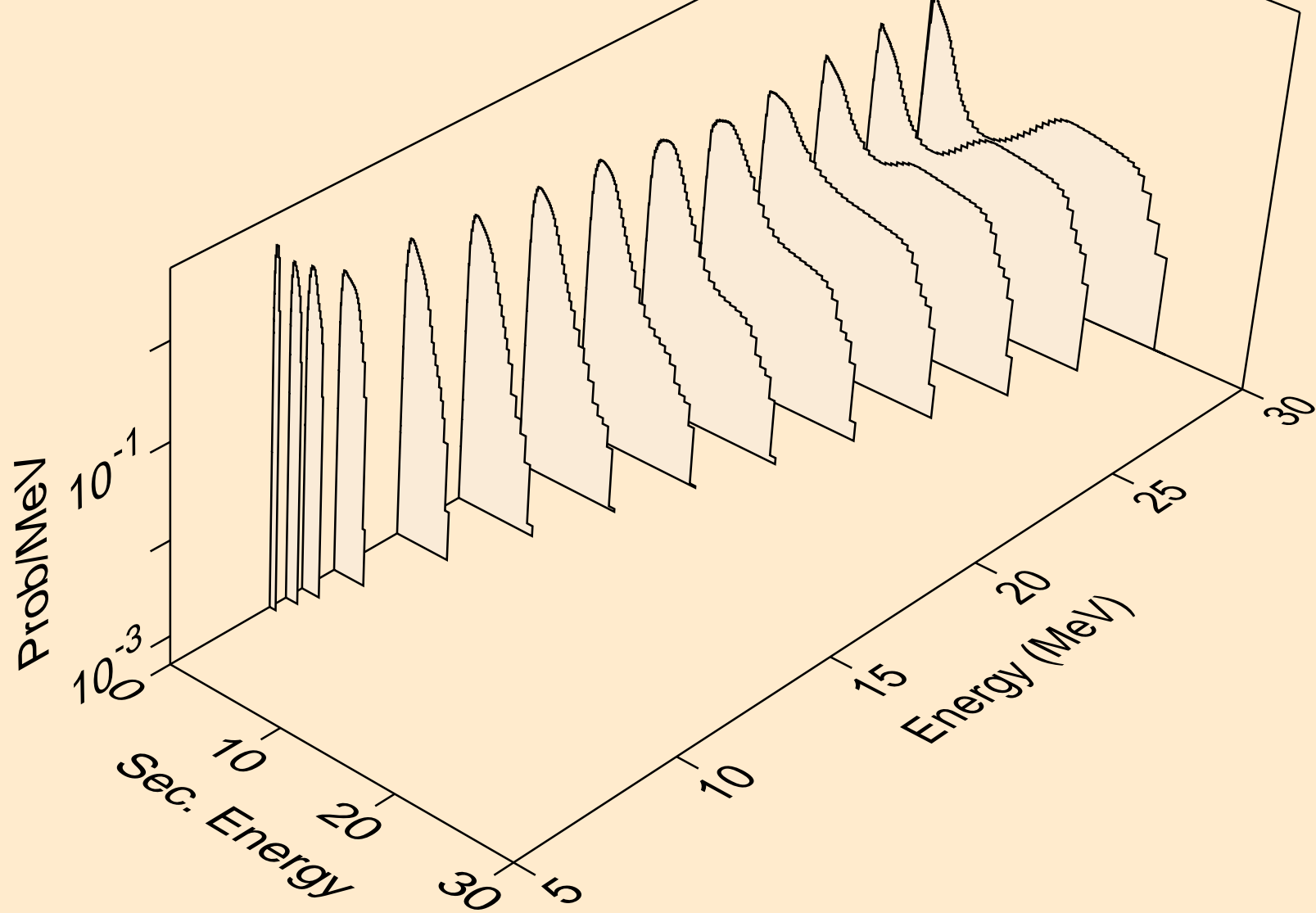

FR212 NEUTRON ACER TENDL-2021 LIBRARY; T=293.6K
Neutron emission for (n,3n)

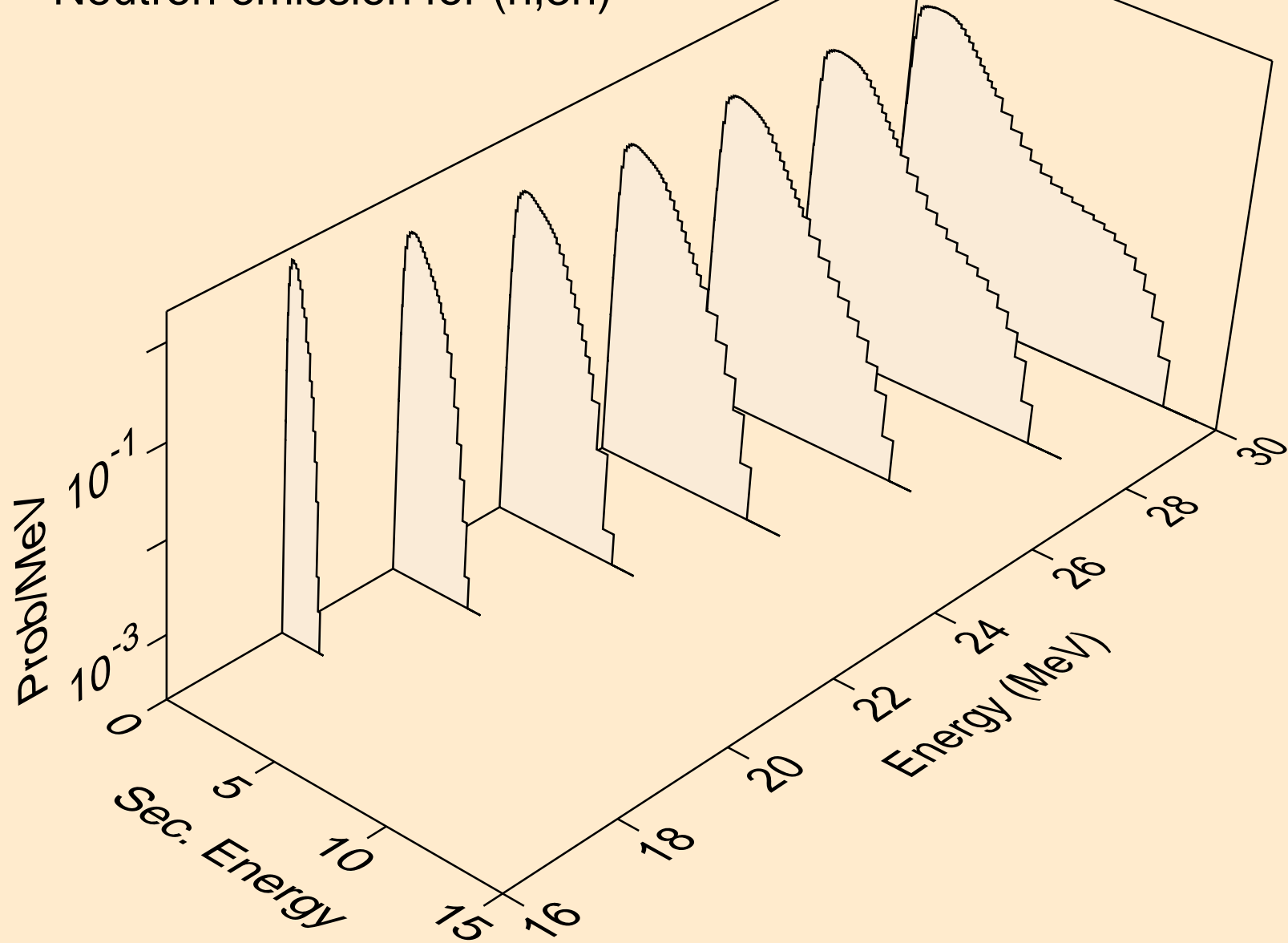

FR212 NEUTRON ACER TENDL-2021 LIBRARY; T=293.6K
Neutron emission for (n,n*)a

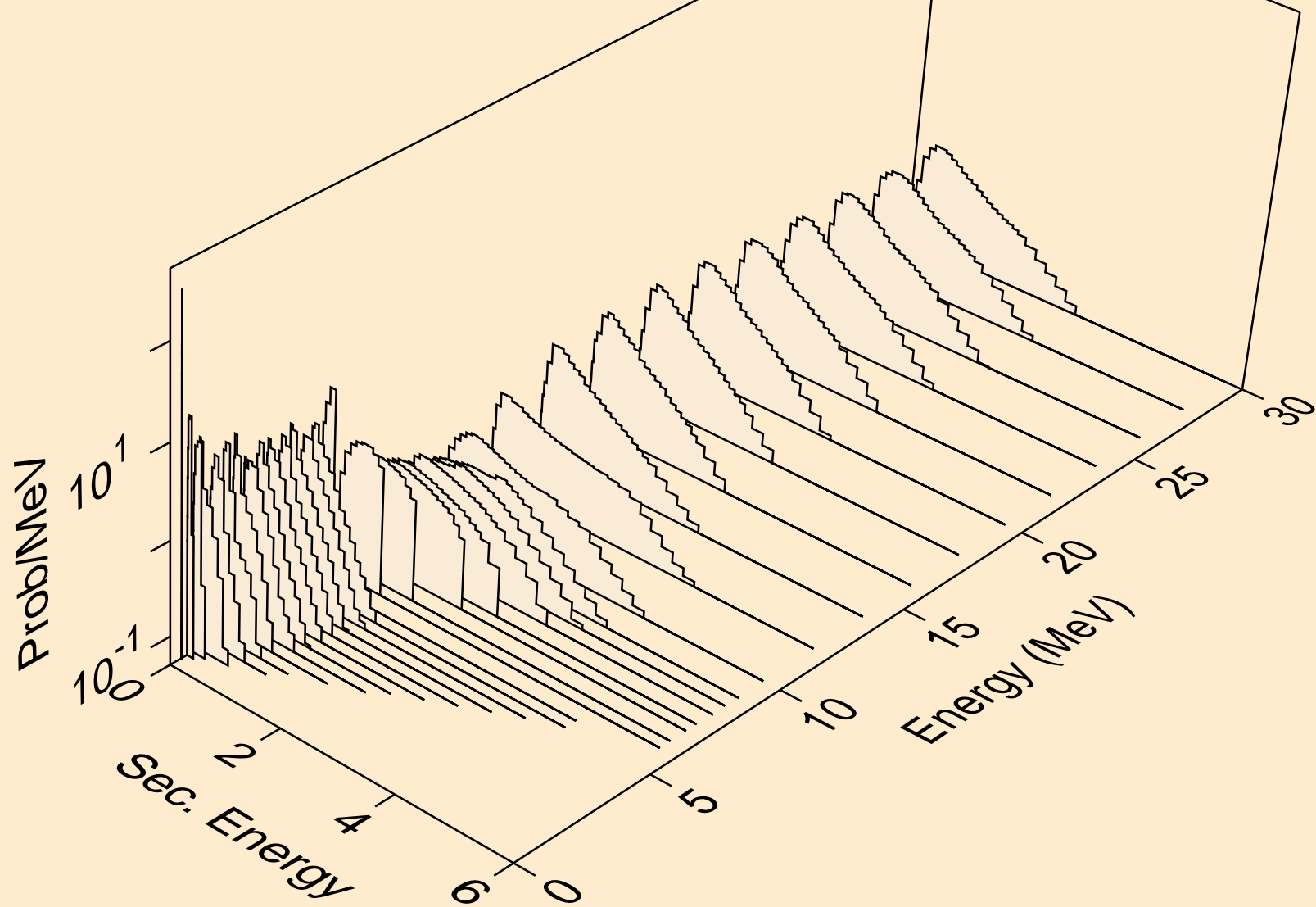

FR212 NEUTRON ACER TENDL-2021 LIBRARY; T=293.6K
Neutron emission for (n,2n)a

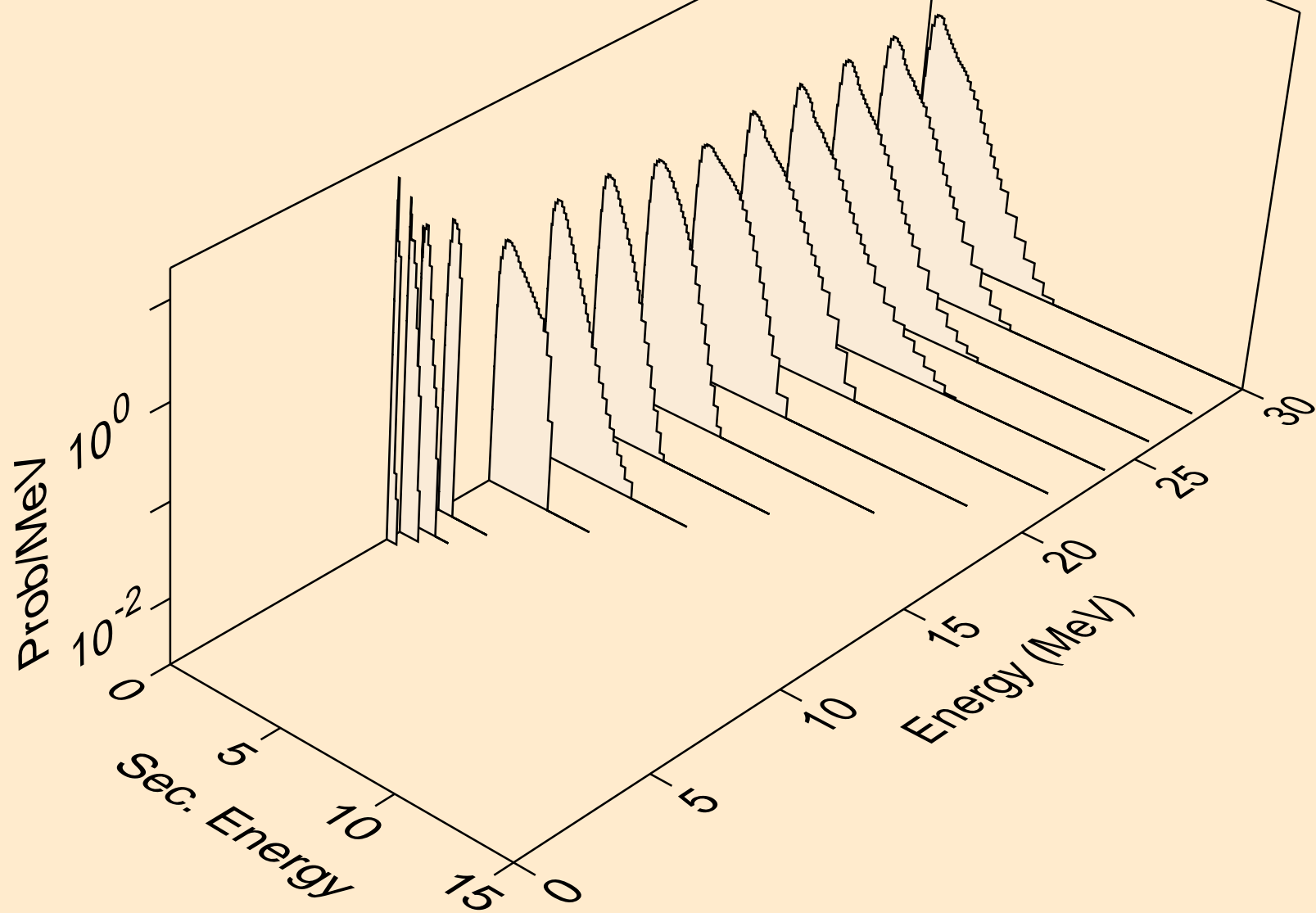

FR212 NEUTRON ACER TENDL-2021 LIBRARY; T=293.6K
Neutron emission for (n,3n)a

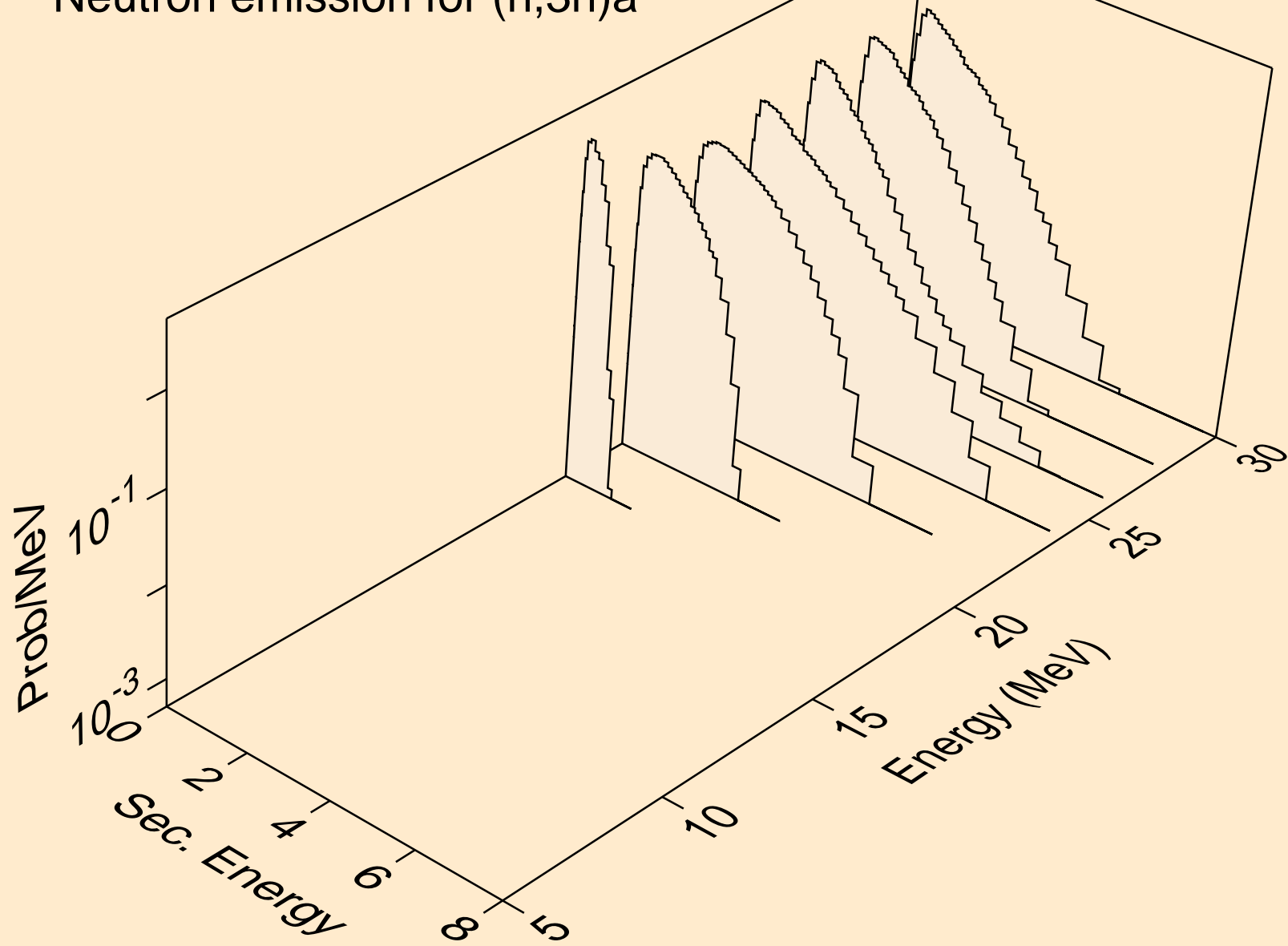

FR212 NEUTRON ACER TENDL-2021 LIBRARY; T=293.6K
Neutron emission for (n,n*)p

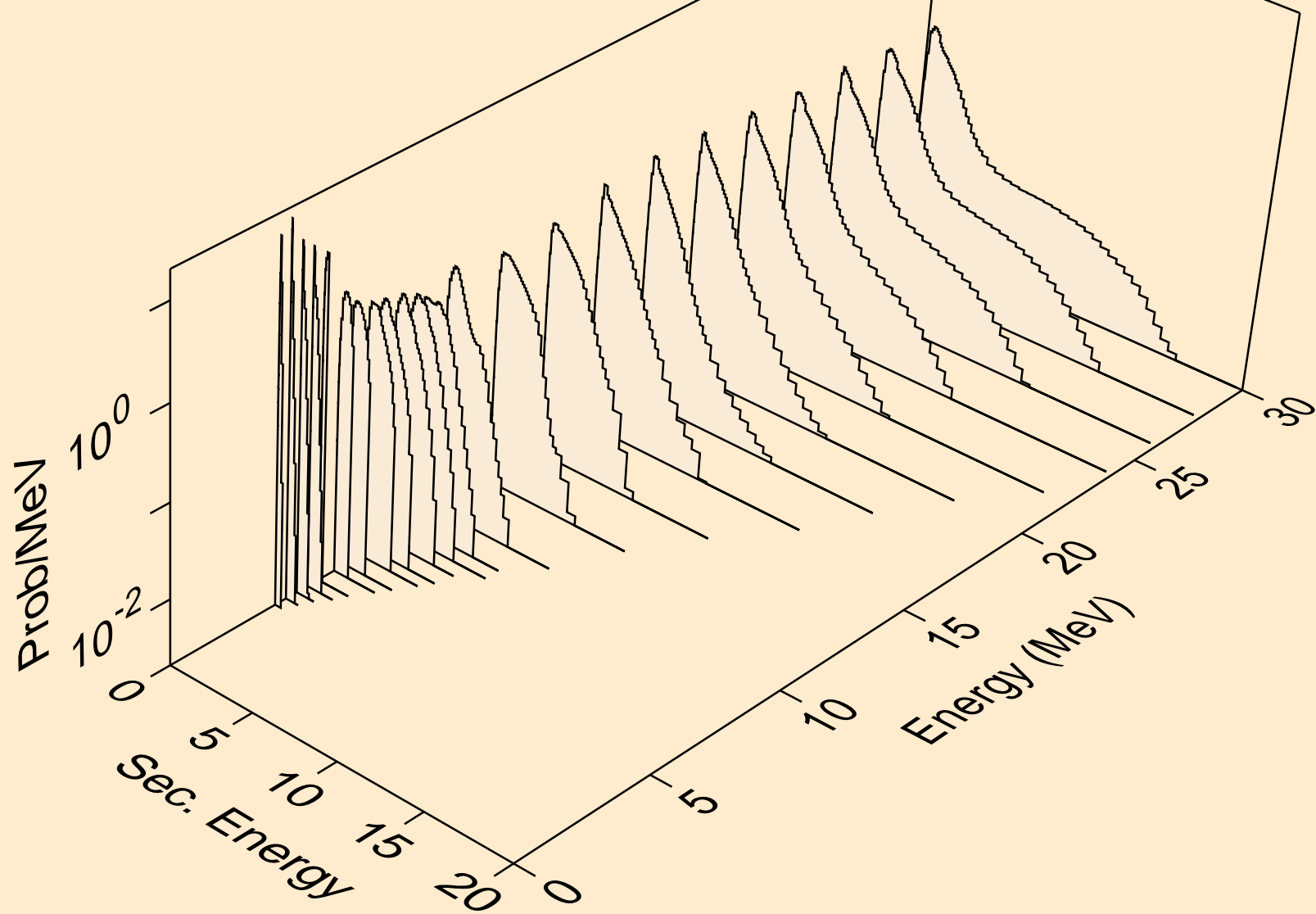

FR212 NEUTRON ACER TENDL-2021 LIBRARY; T=293.6K
Neutron emission for (n,n*)2a

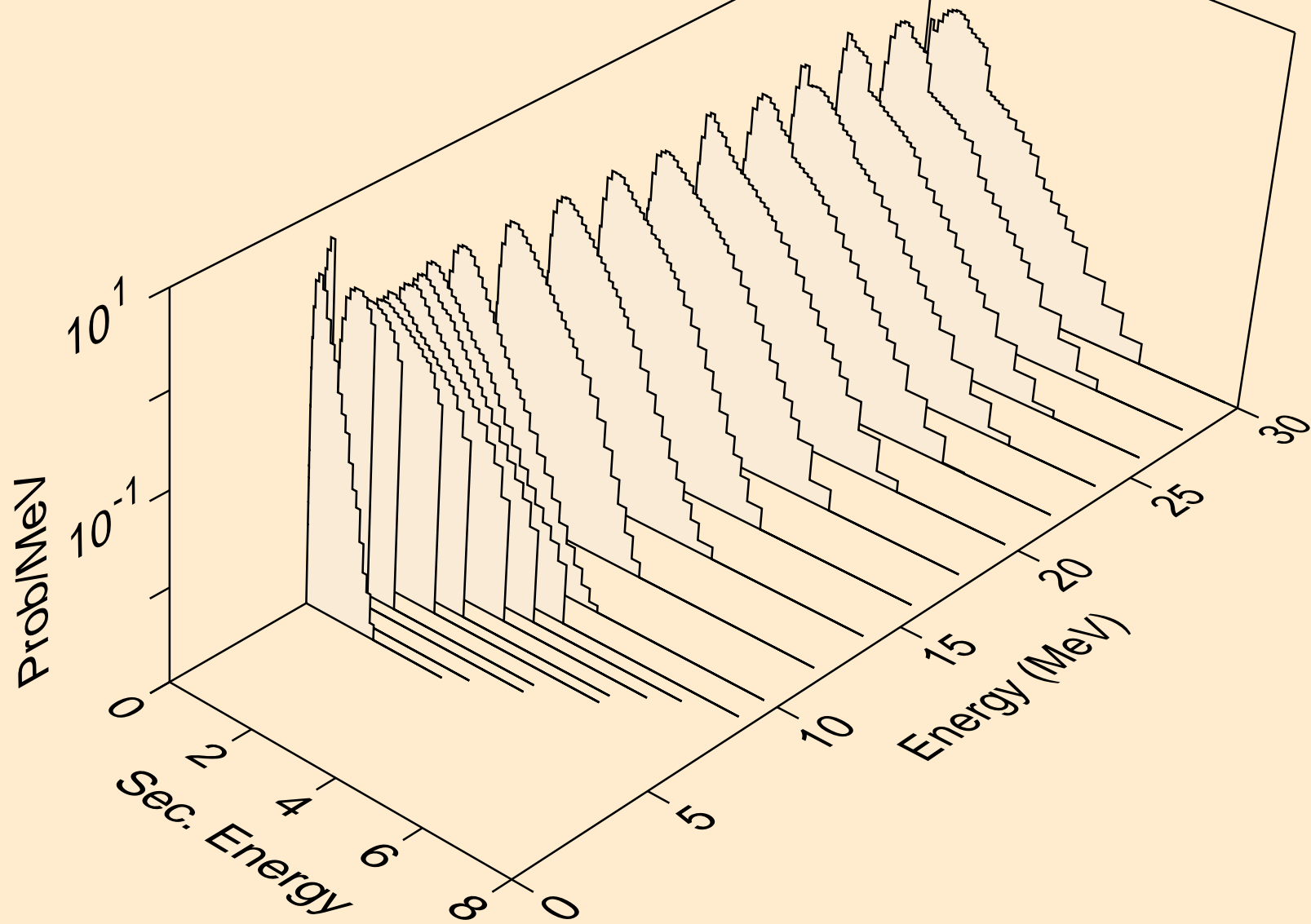

FR212 NEUTRON ACER TENDL-2021 LIBRARY; T=293.6K
Neutron emission for (n,2n)2a

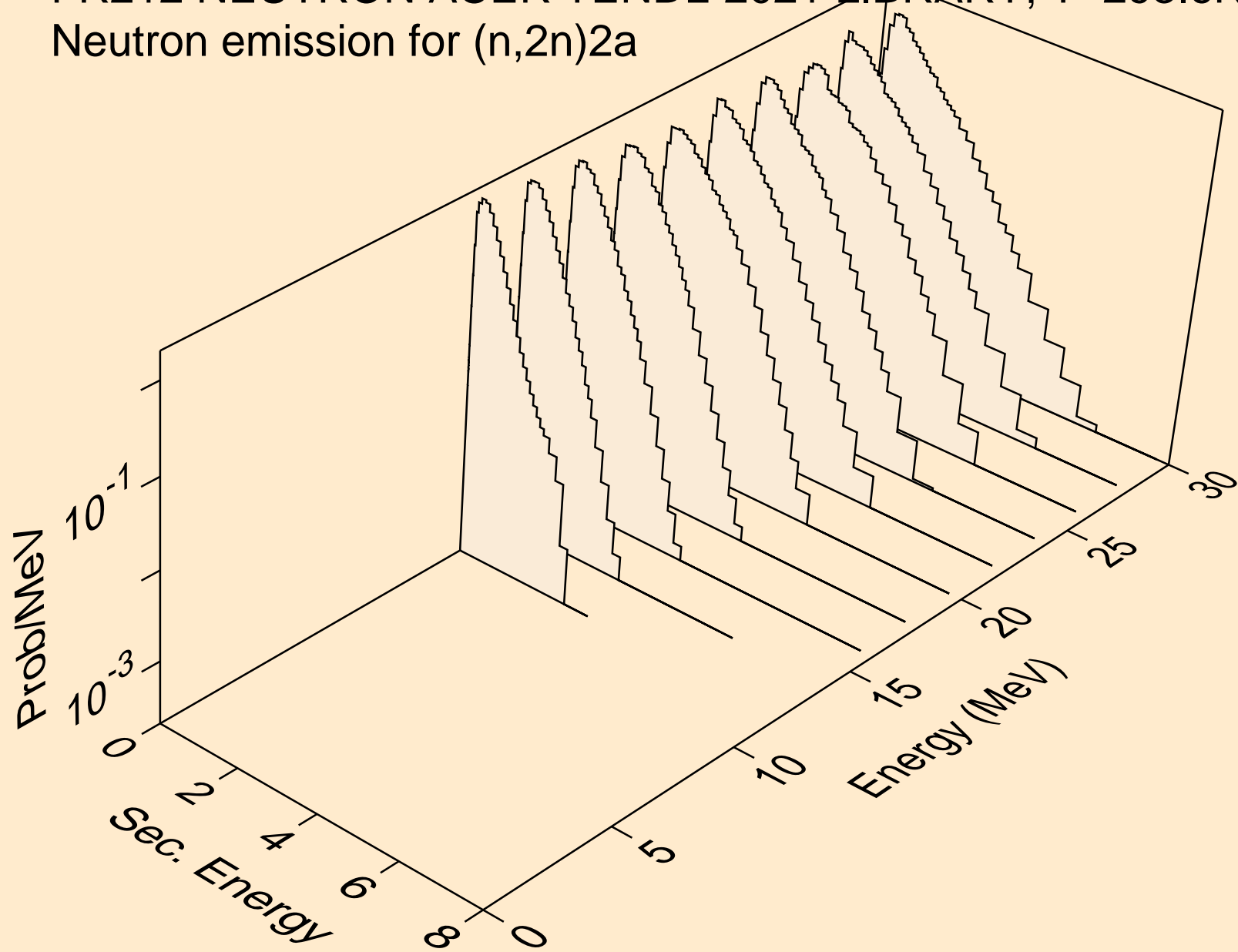

FR212 NEUTRON ACER TENDL-2021 LIBRARY; T=293.6K
Neutron emission for (n,n*)d

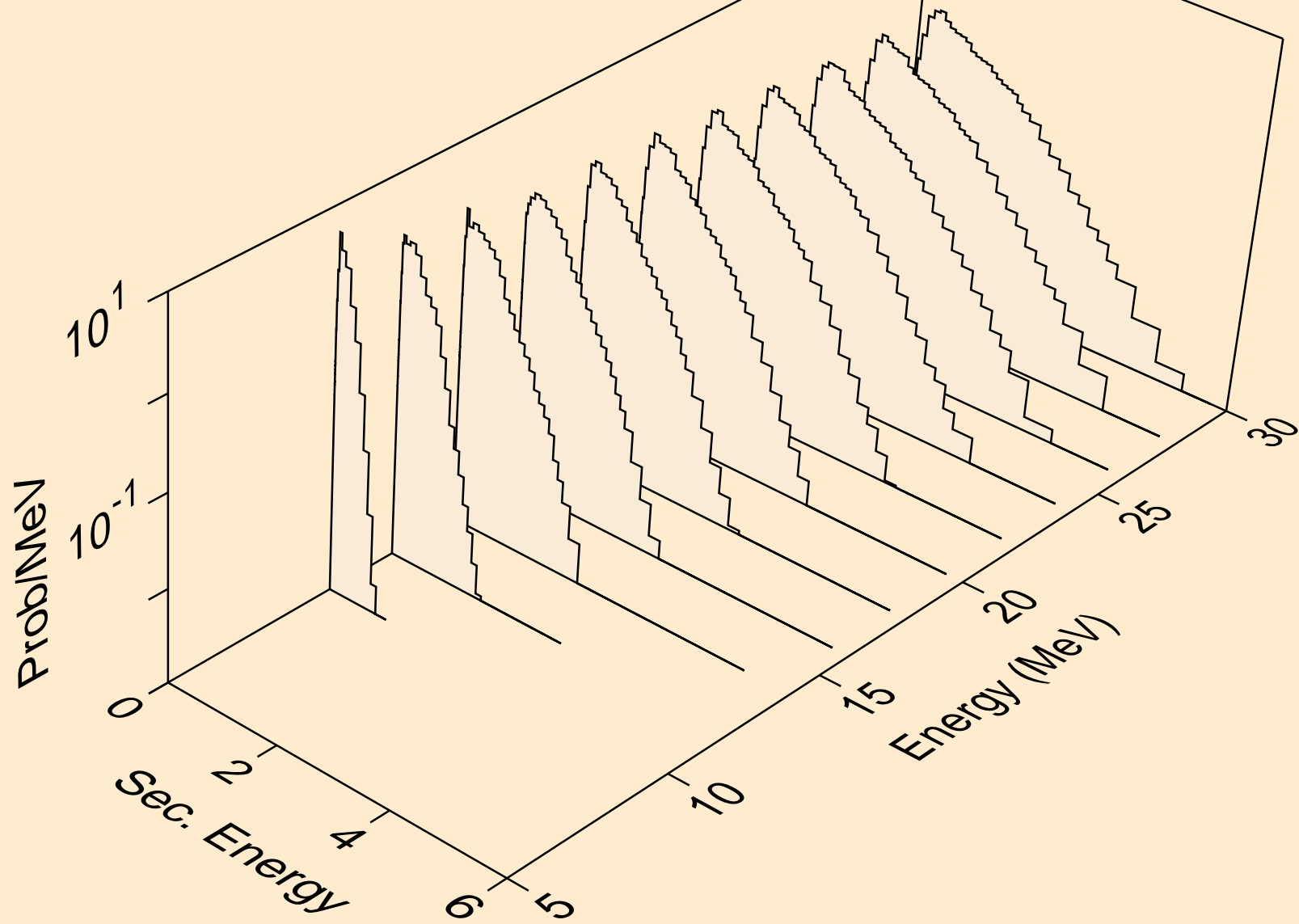

FR212 NEUTRON ACER TENDL-2021 LIBRARY; T=293.6K
Neutron emission for (n,n*)t

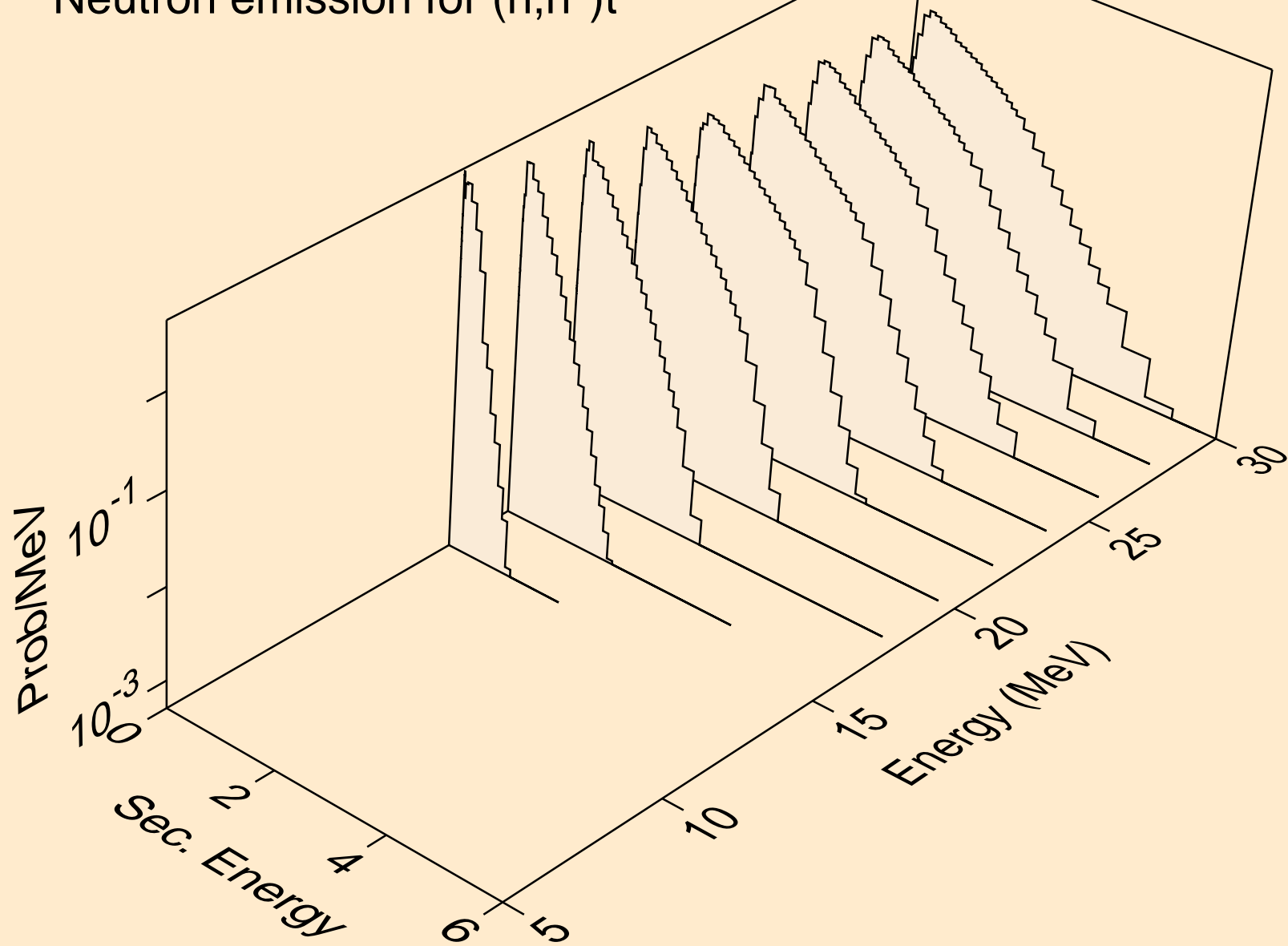

FR212 NEUTRON ACER TENDL-2021 LIBRARY; T=293.6K
Neutron emission for (n,n*)he3

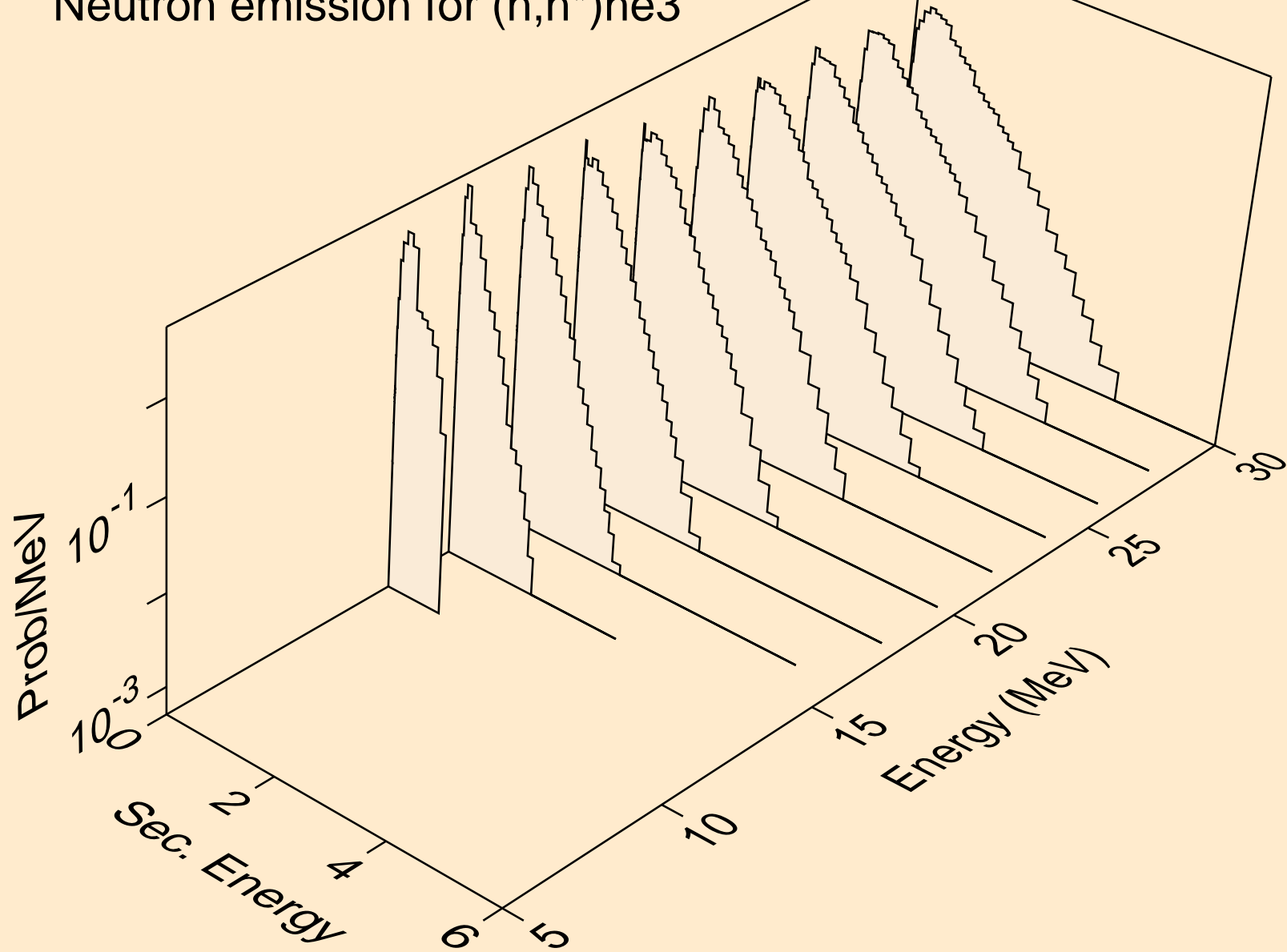

FR212 NEUTRON ACER TENDL-2021 LIBRARY; T=293.6K
Neutron emission for (n,4n)

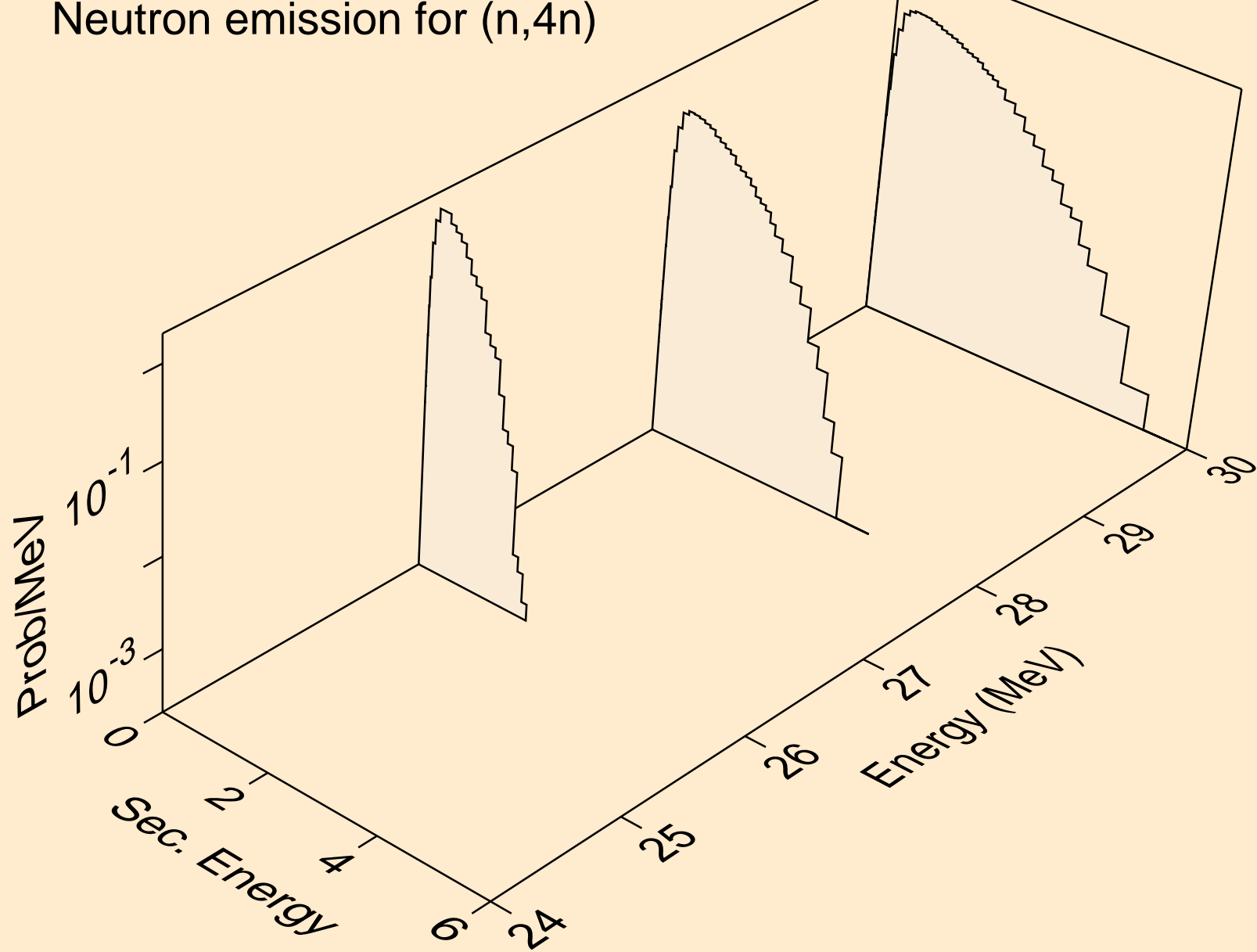

FR212 NEUTRON ACER TENDL-2021 LIBRARY; T=293.6K
Neutron emission for (n,2np)

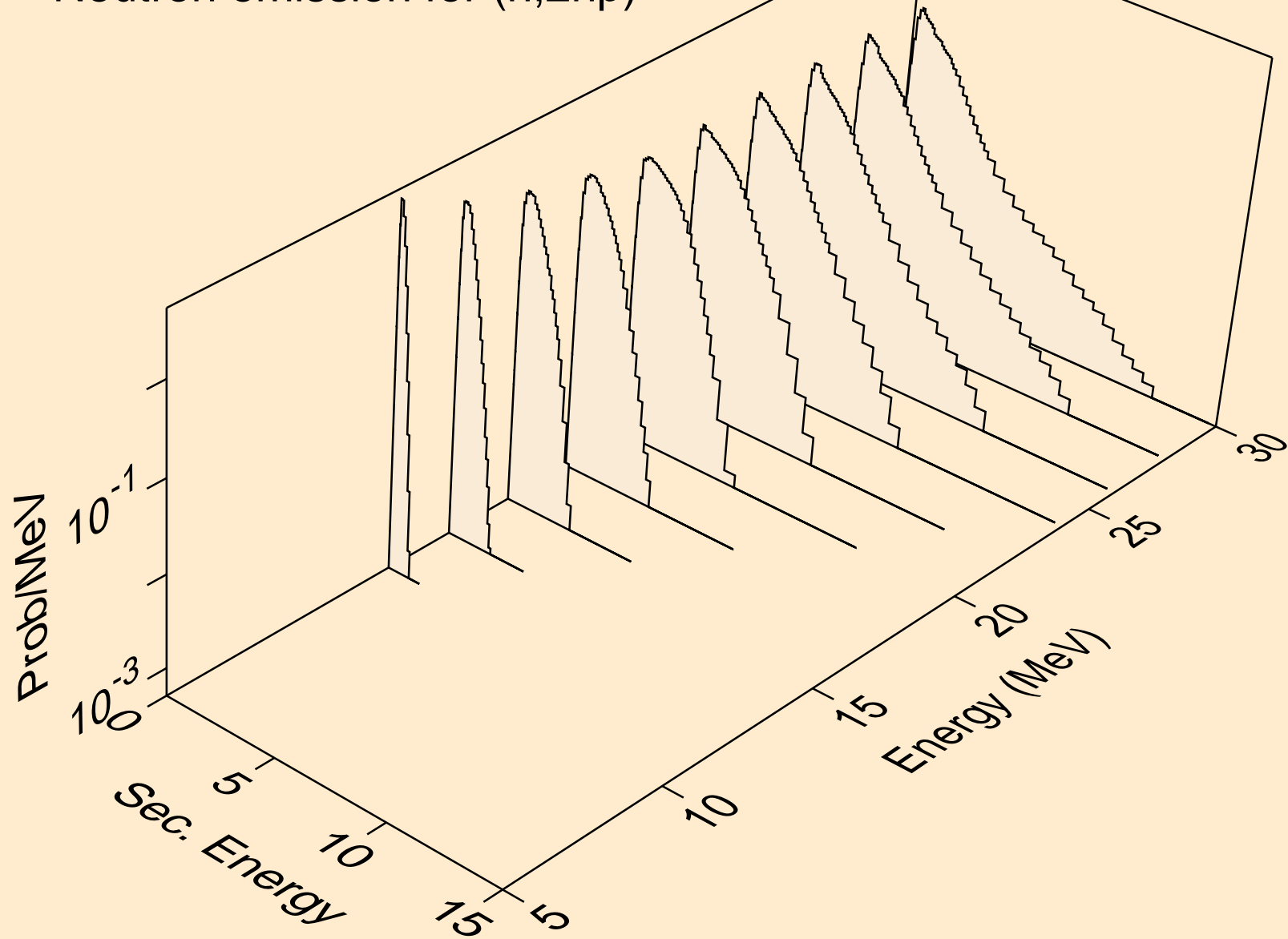

FR212 NEUTRON ACER TENDL-2021 LIBRARY; T=293.6K
Neutron emission for (n,3np)

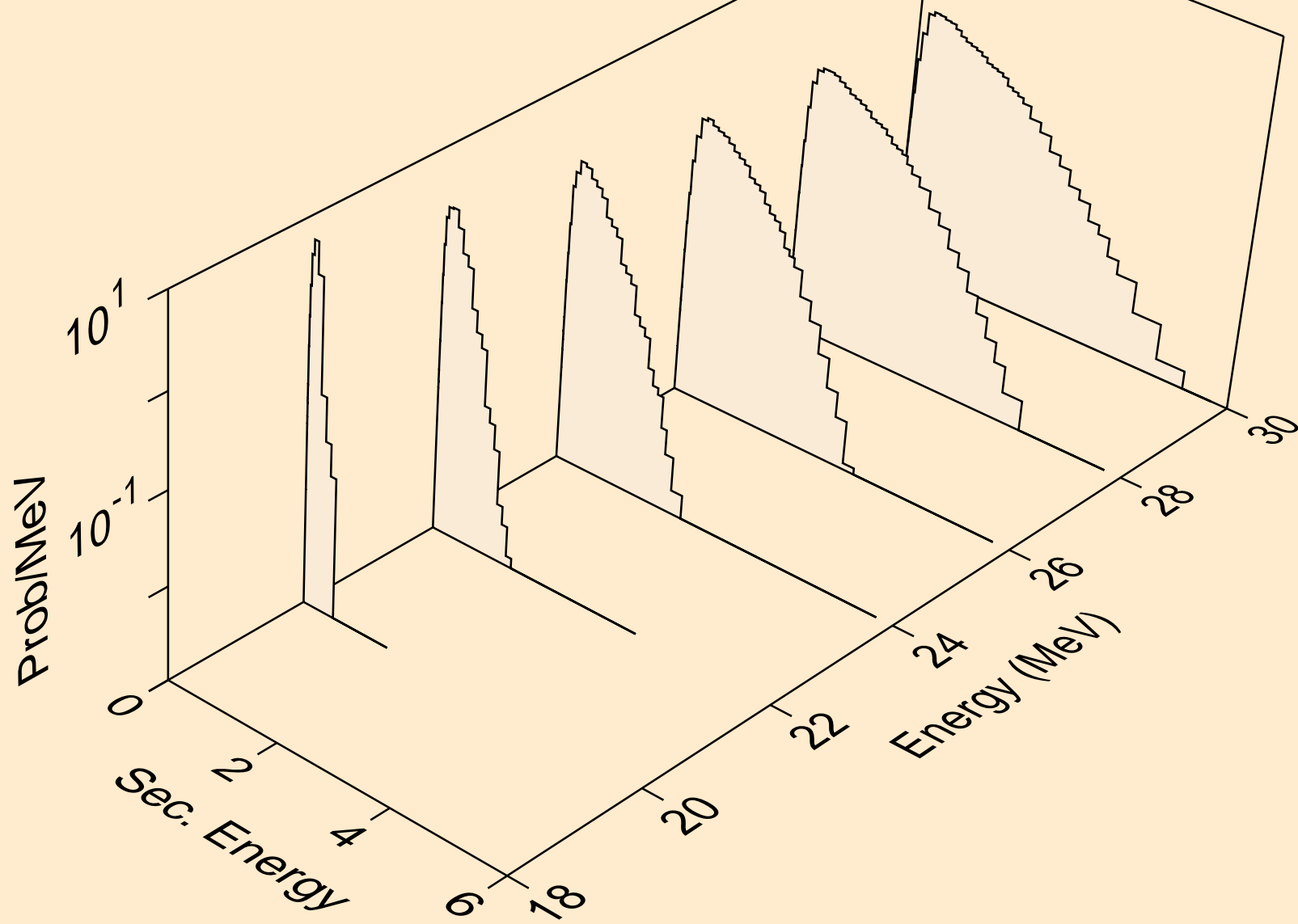

FR212 NEUTRON ACER TENDL-2021 LIBRARY; T=293.6K
Neutron emission for (n,2np)

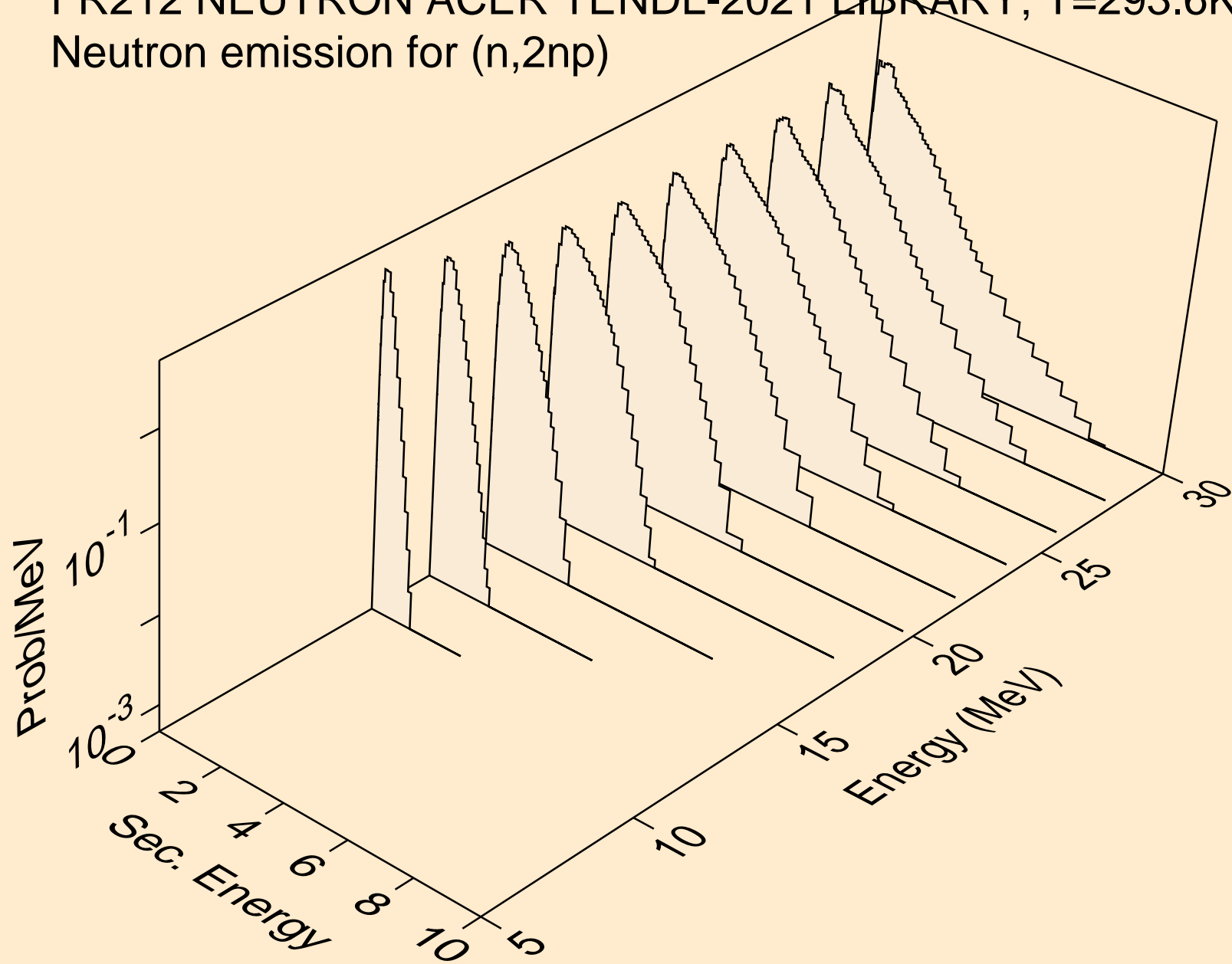

FR212 NEUTRON ACER TENDL-2021 LIBRARY; T=293.6K
Neutron emission for (n,npa)

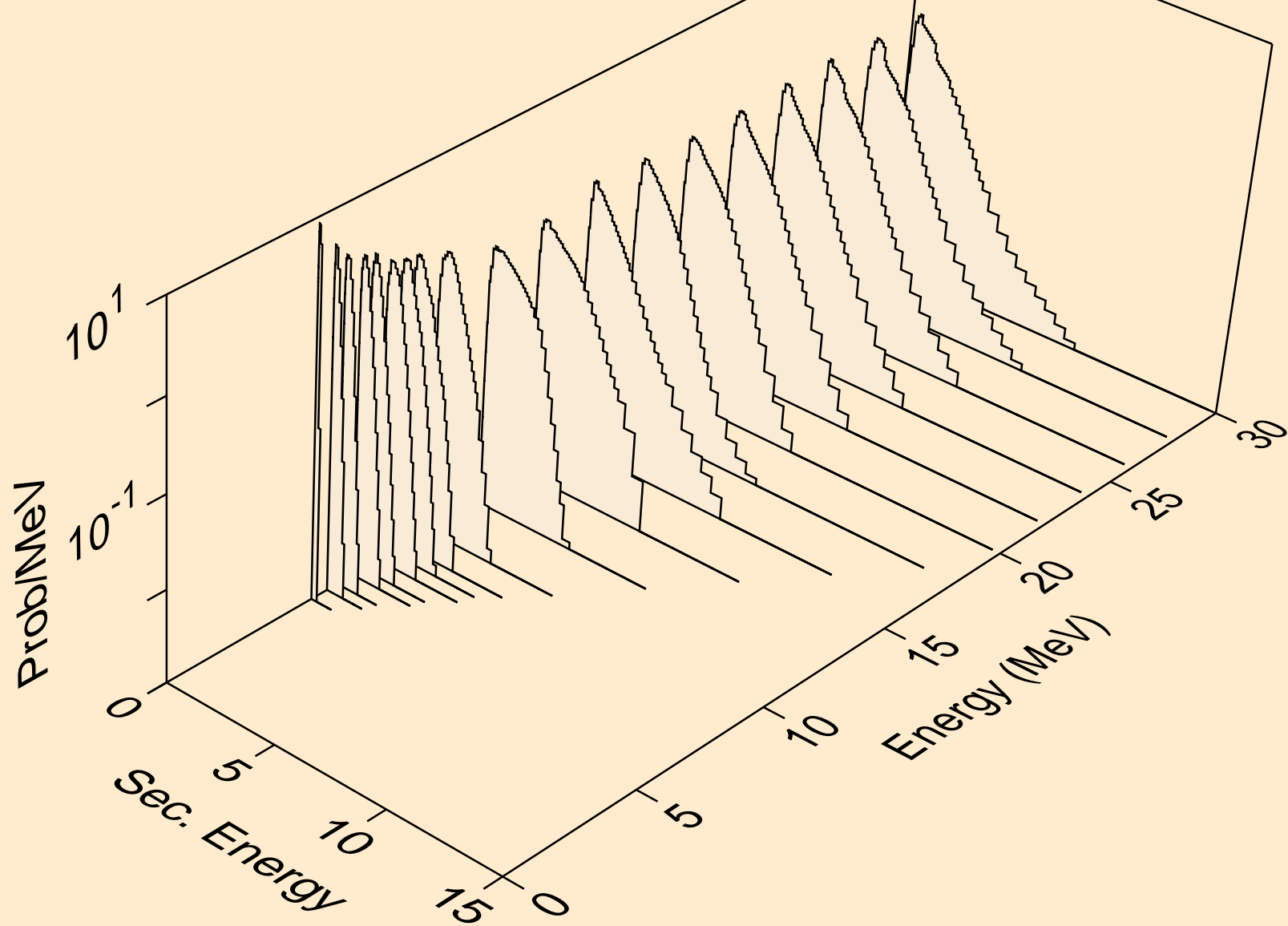

FR212 NEUTRON ACER TENDL-2021 LIBRARY; T=293.6K
Neutron emission for (n,n*c)

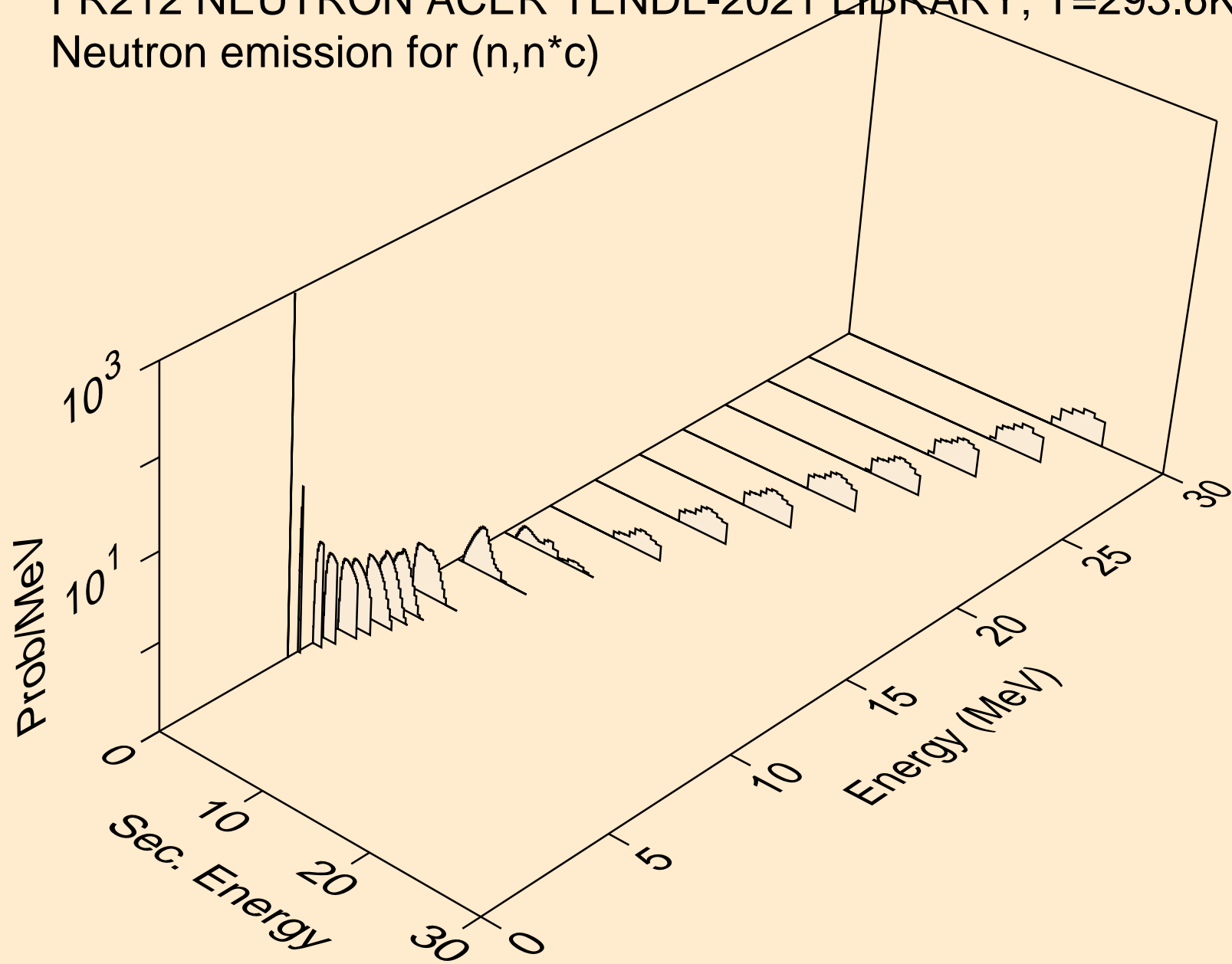

FR212 NEUTRON ACER TENDL-2021 LIBRARY; T=293.6K
Photon emission for (n,x)

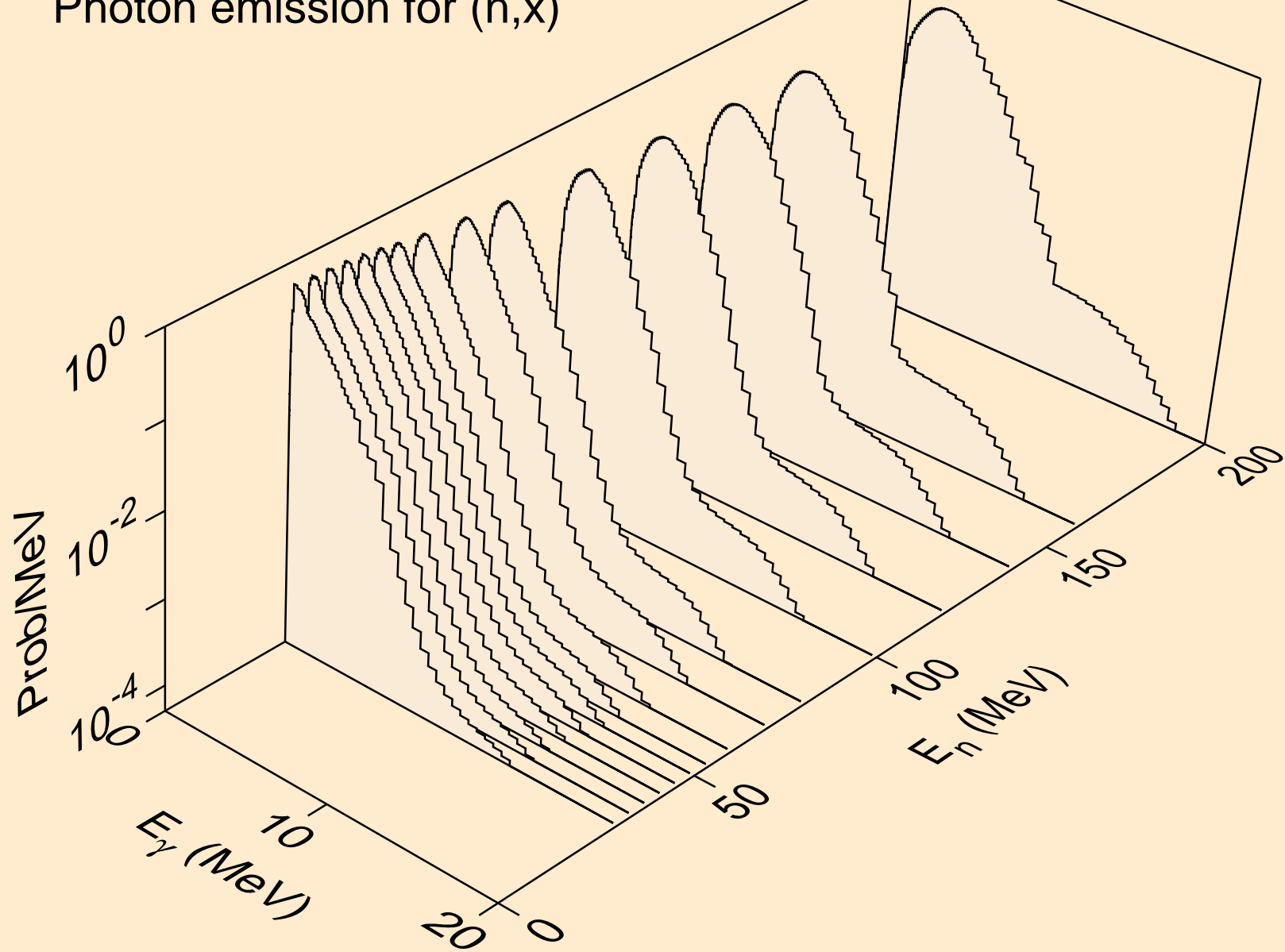

FR212 NEUTRON ACER TENDL-2021 LIBRARY; T=293.6K
Photon emission for (n,2nd)

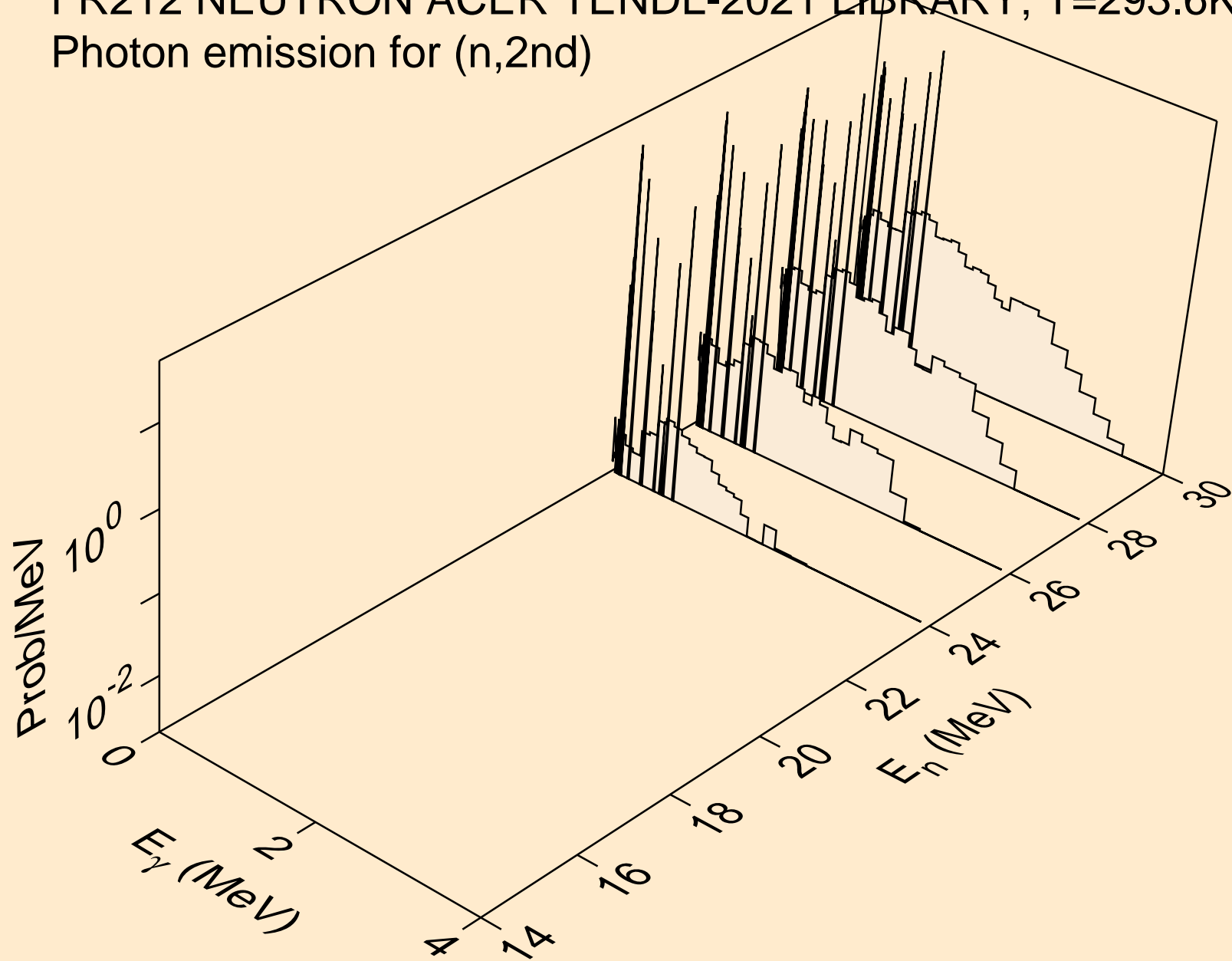

FR212 NEUTRON ACER TENDL-2021 LIBRARY; T=293.6K
Photon emission for (n,2n)

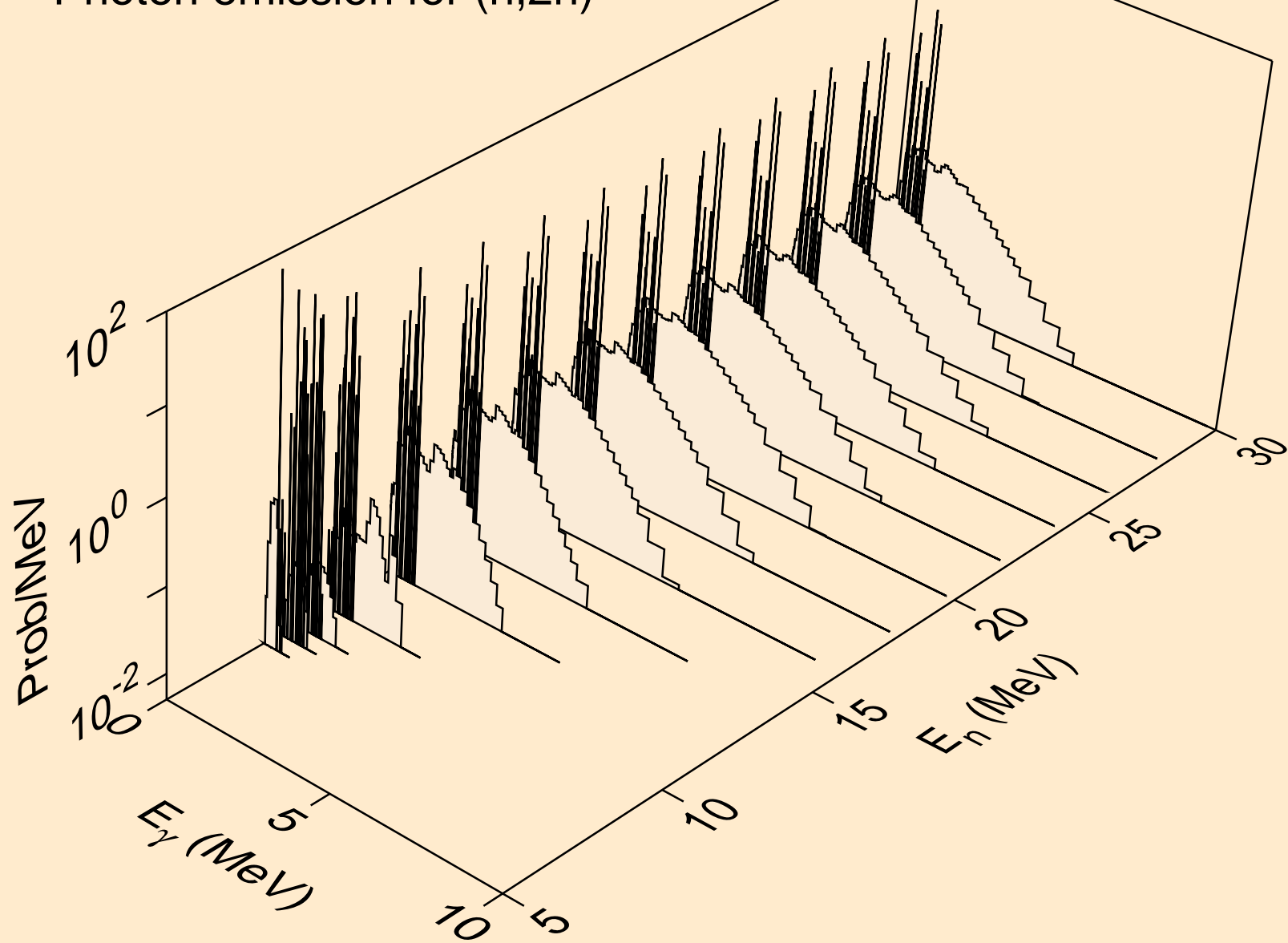

FR212 NEUTRON ACER TENDL-2021 LIBRARY; T=293.6K
Photon emission for (n,3n)

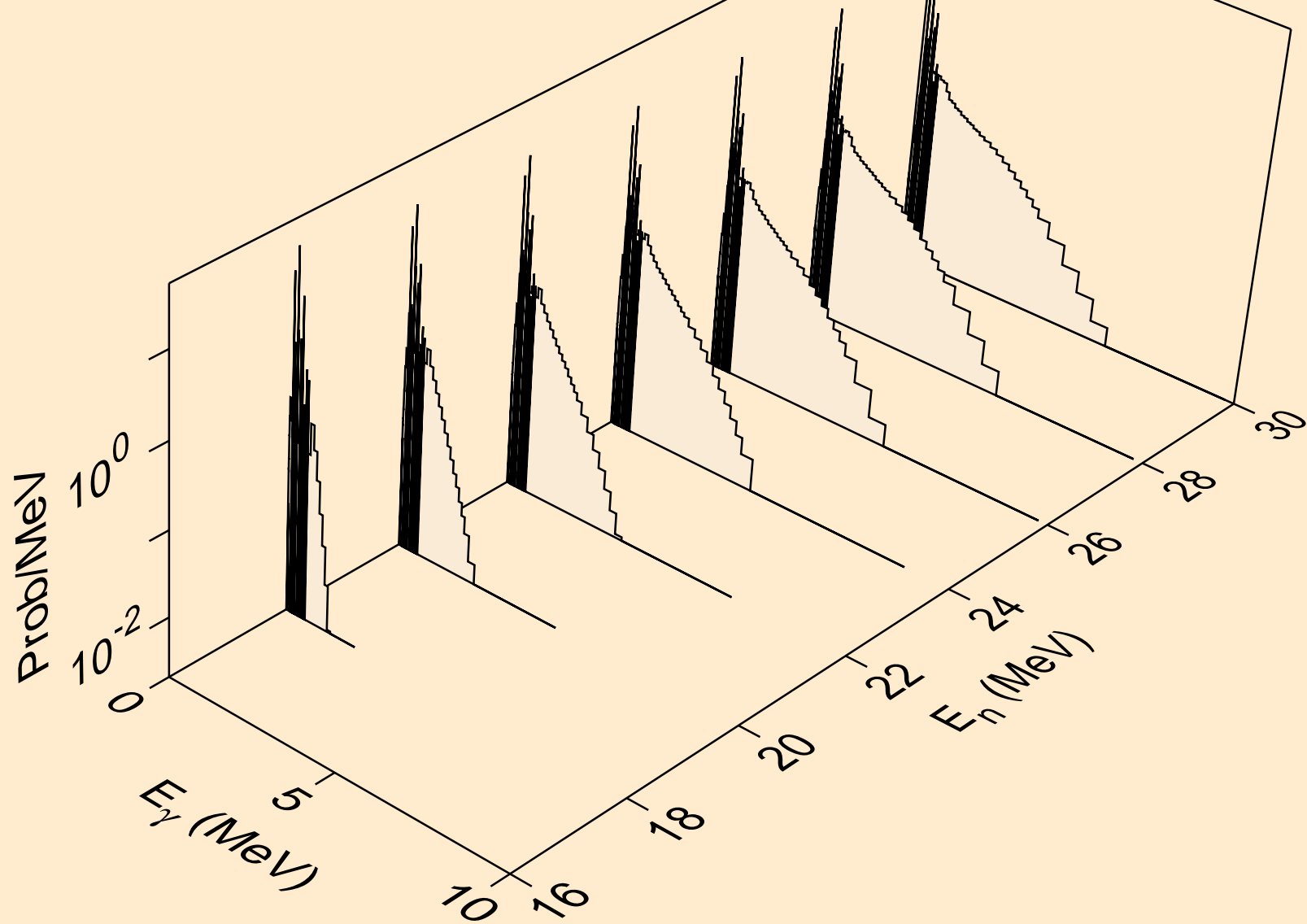

FR212 NEUTRON ACER TENDL-2021 LIBRARY; T=293.6K
Photon emission for (n,n*)a

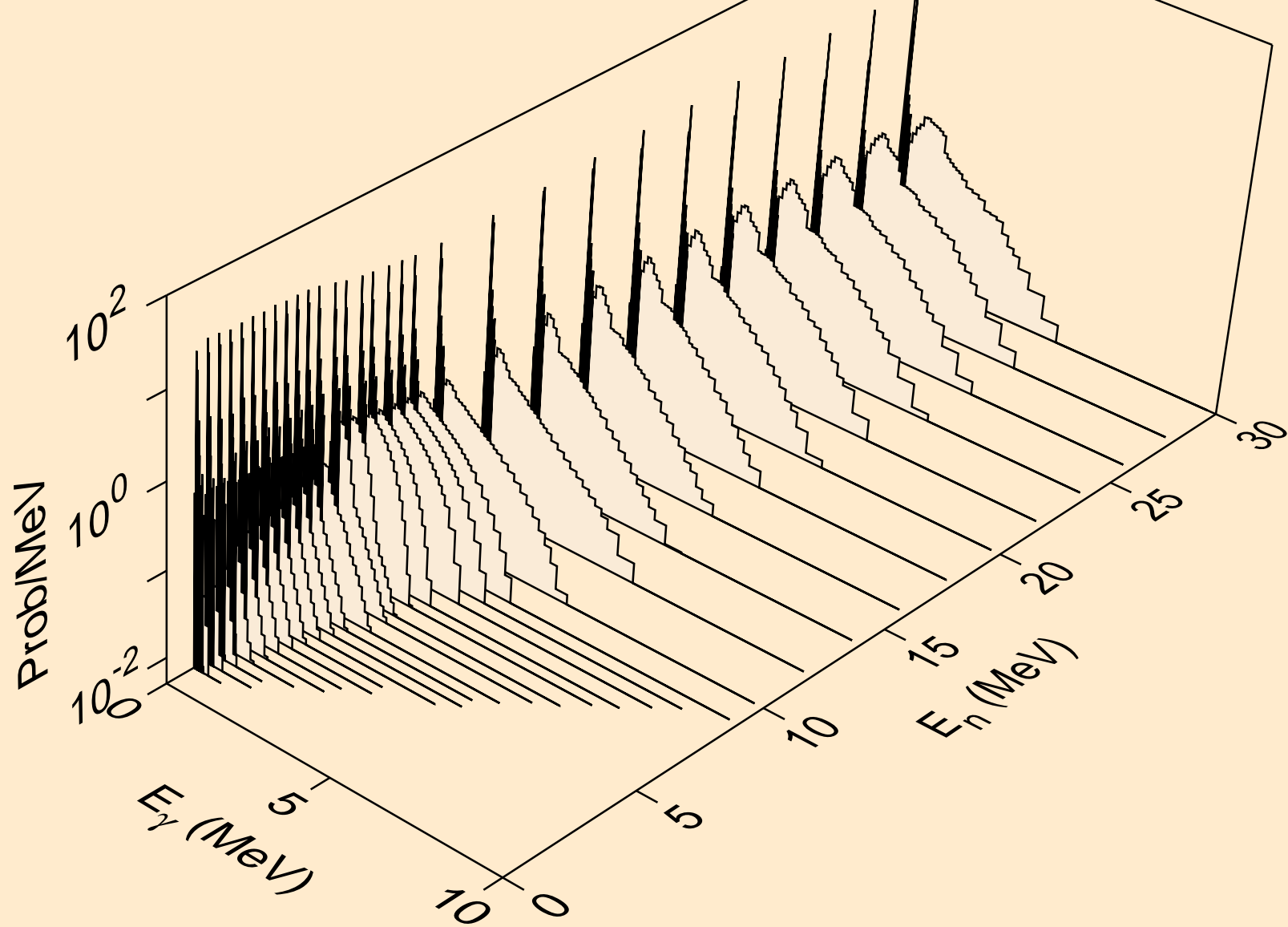

FR212 NEUTRON ACER TENDL-2021 LIBRARY; T=293.6K
Photon emission for (n,2n)a

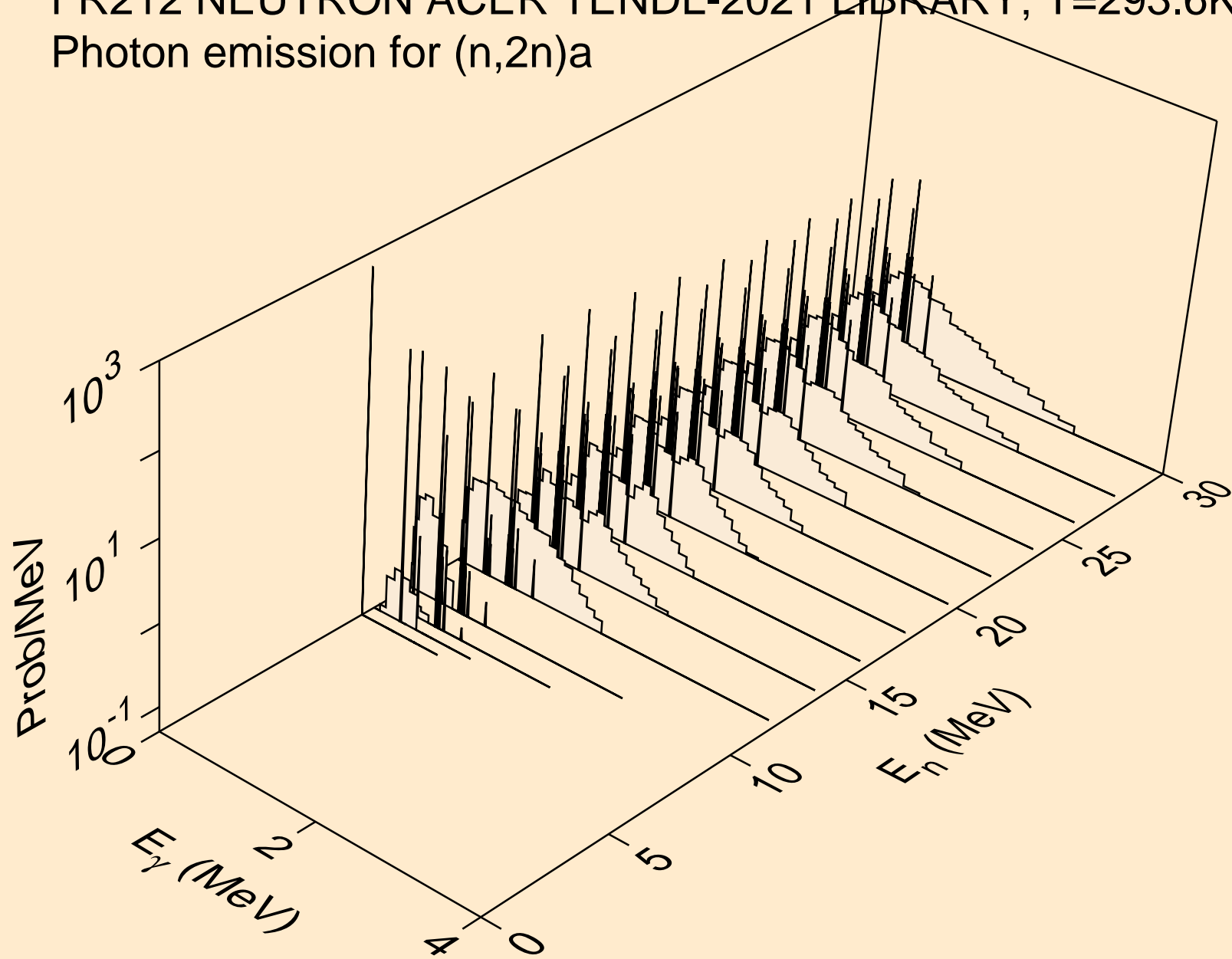

FR212 NEUTRON ACER TENDL-2021 LIBRARY; T=293.6K
Photon emission for (n,3n)a

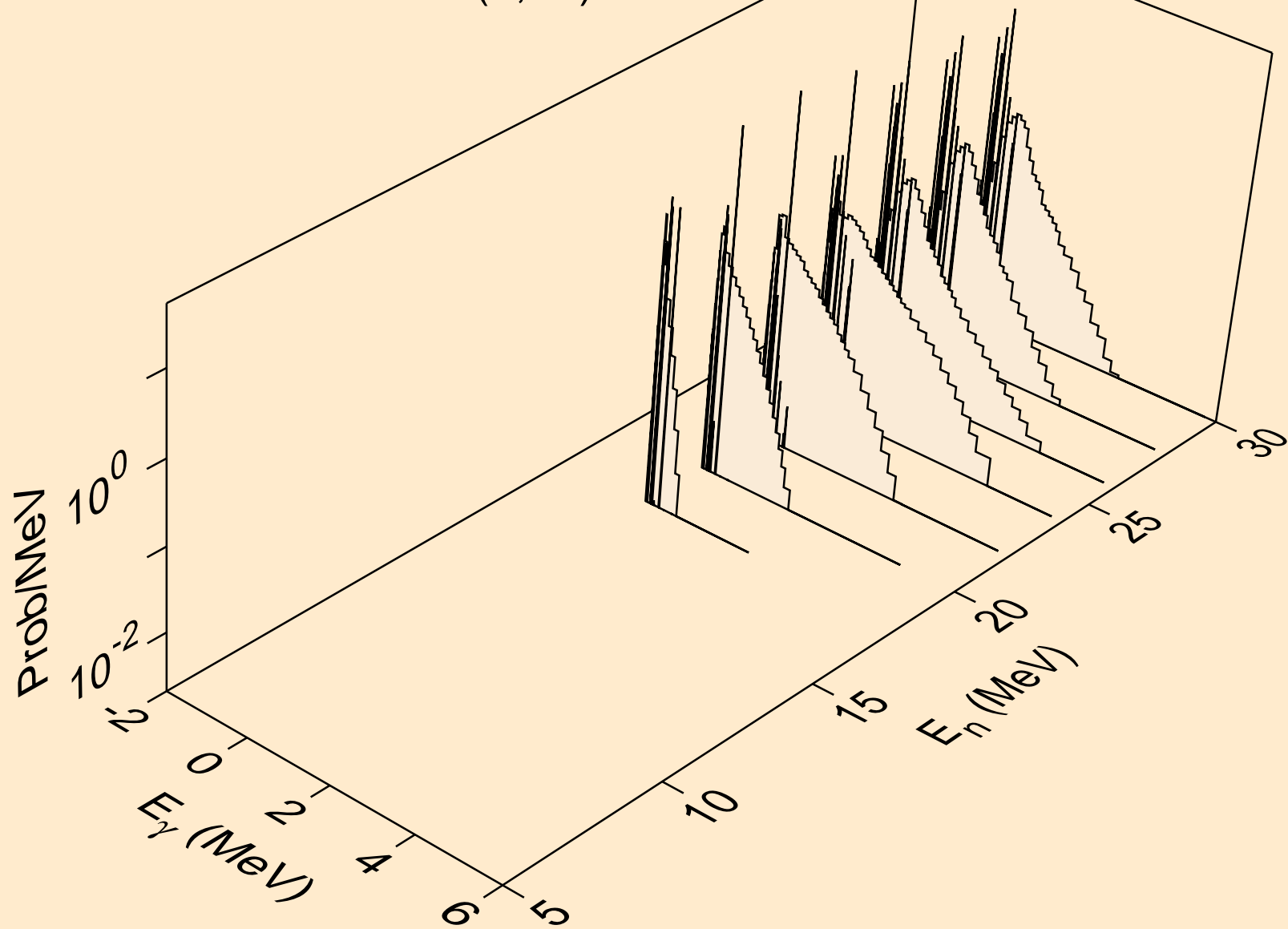

FR212 NEUTRON ACER TENDL-2021 LIBRARY; T=293.6K
Photon emission for (n,n*)p

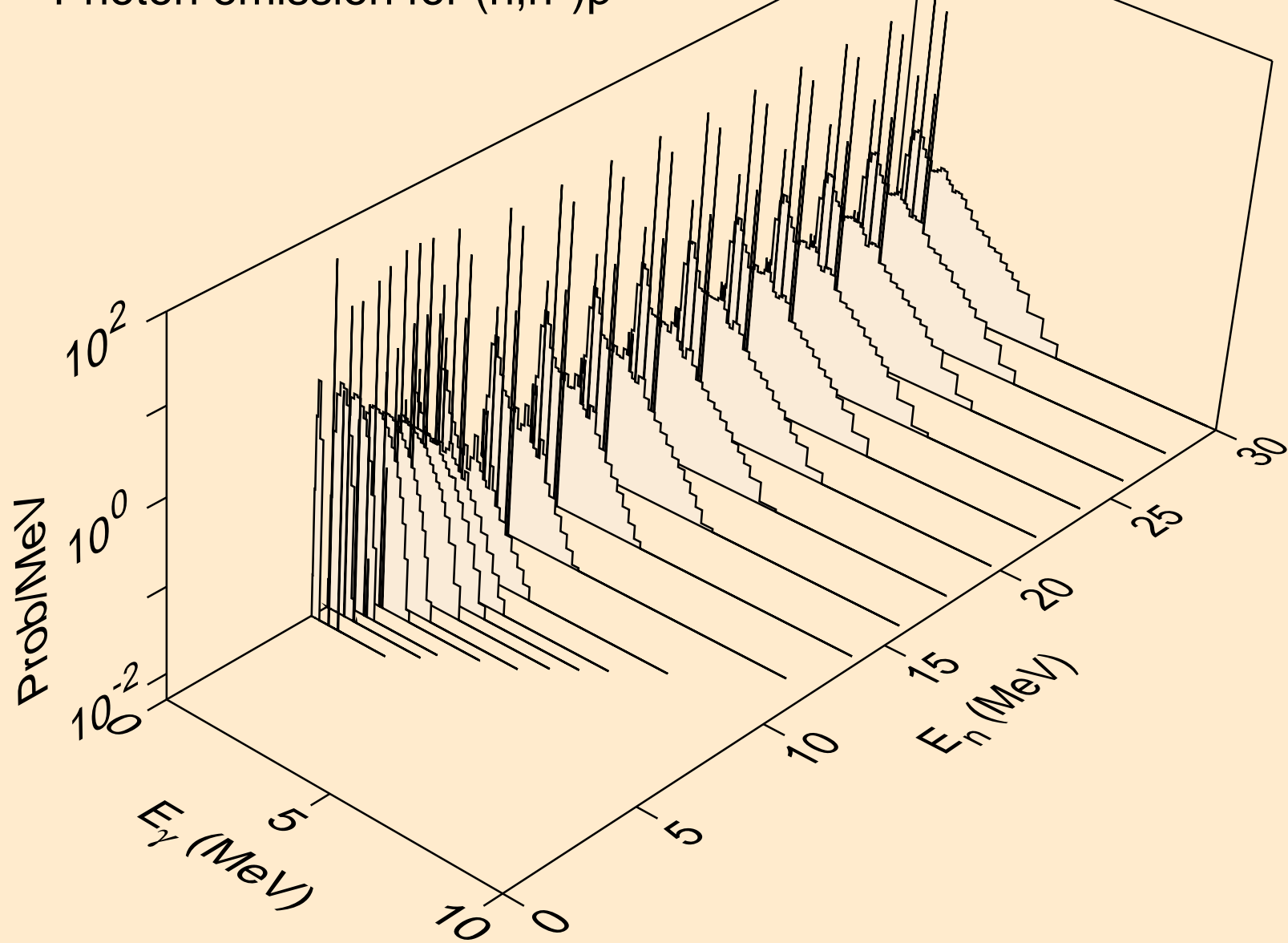

FR212 NEUTRON ACER TENDL-2021 LIBRARY; T=293.6K
Photon emission for (n,n*)2a

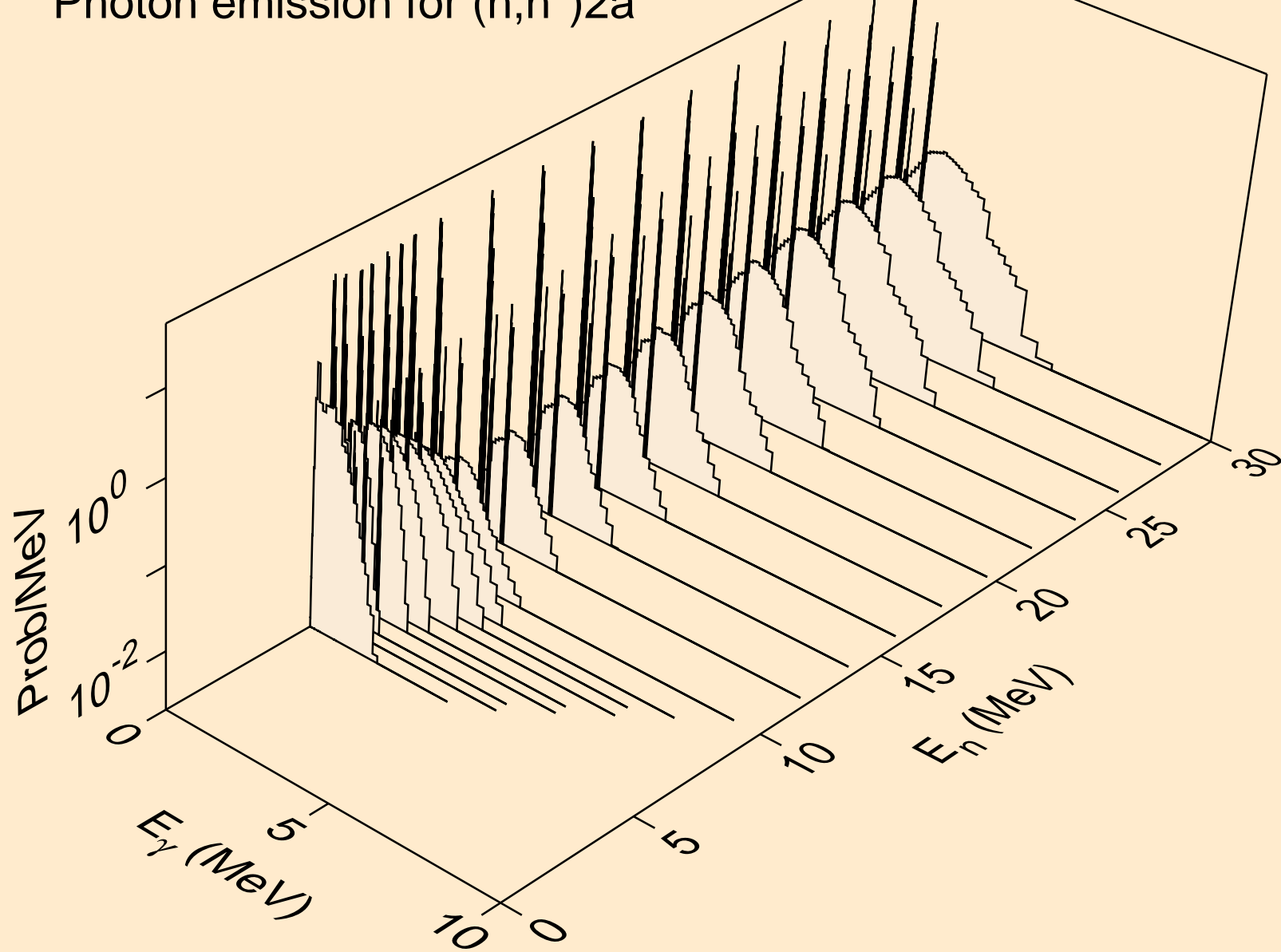

FR212 NEUTRON ACER TENDL-2021 LIBRARY; T=293.6K
Photon emission for (n,2n)2a

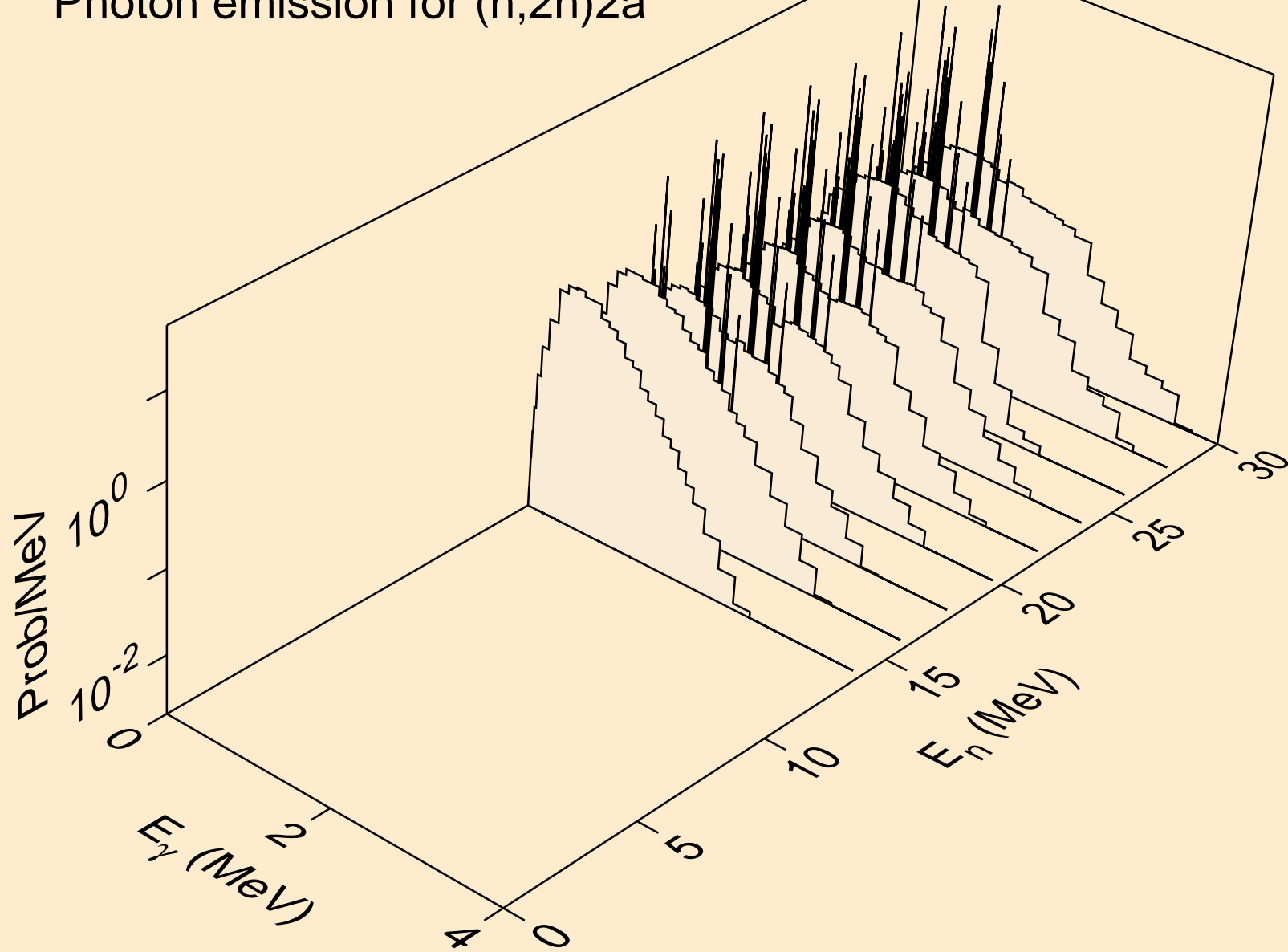

FR212 NEUTRON ACER TENDL-2021 LIBRARY; T=293.6K
Photon emission for (n,n*)d

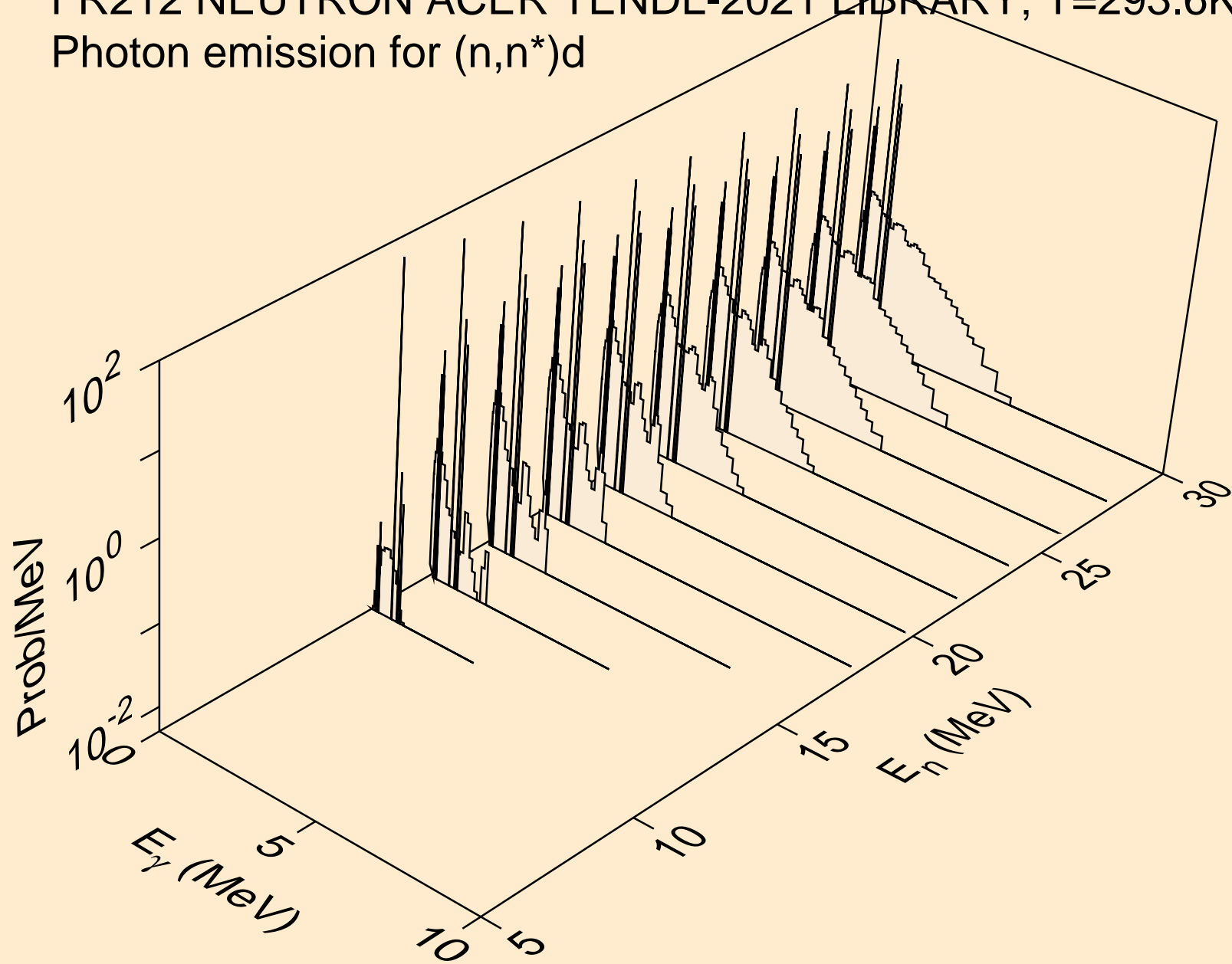

FR212 NEUTRON ACER TENDL-2021 LIBRARY; T=293.6K
Photon emission for (n,n*)t

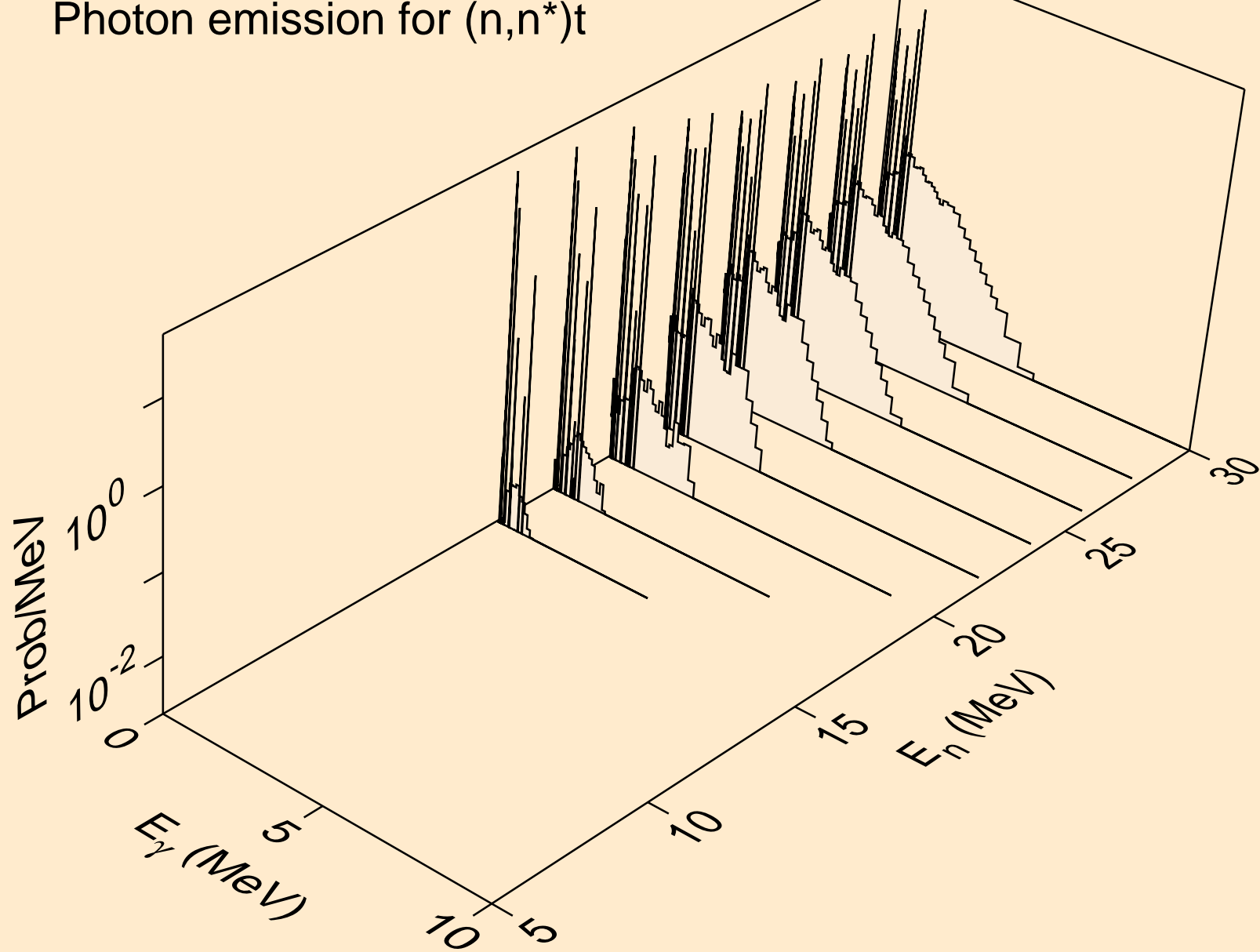

FR212 NEUTRON ACER TENDL-2021 LIBRARY; T=293.6K
Photon emission for (n,n*)he3

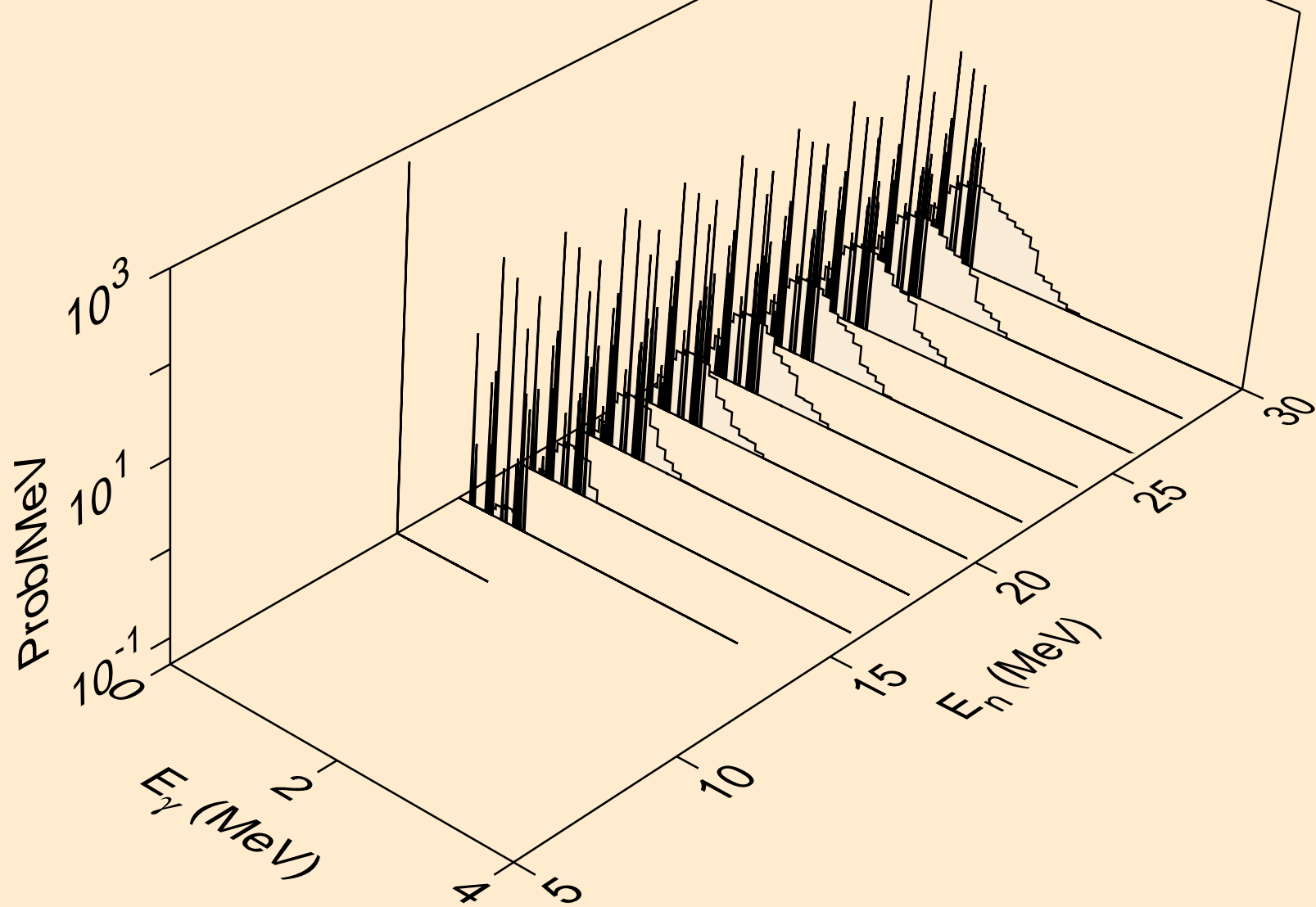

FR212 NEUTRON ACER TENDL-2021 LIBRARY; T=293.6K
Photon emission for (n,4n)

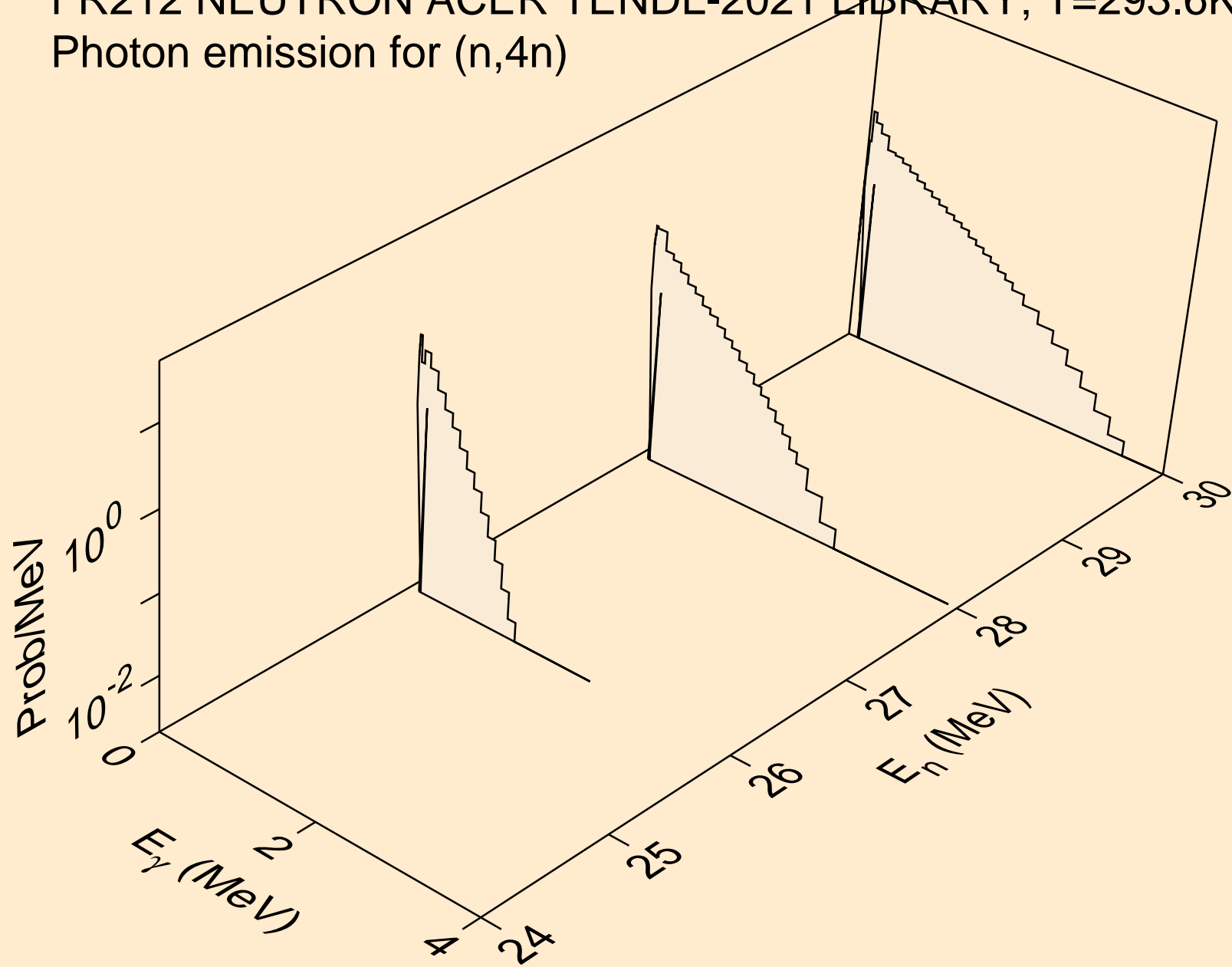

FR212 NEUTRON ACER TENDL-2021 LIBRARY; T=293.6K
Photon emission for (n,2np)

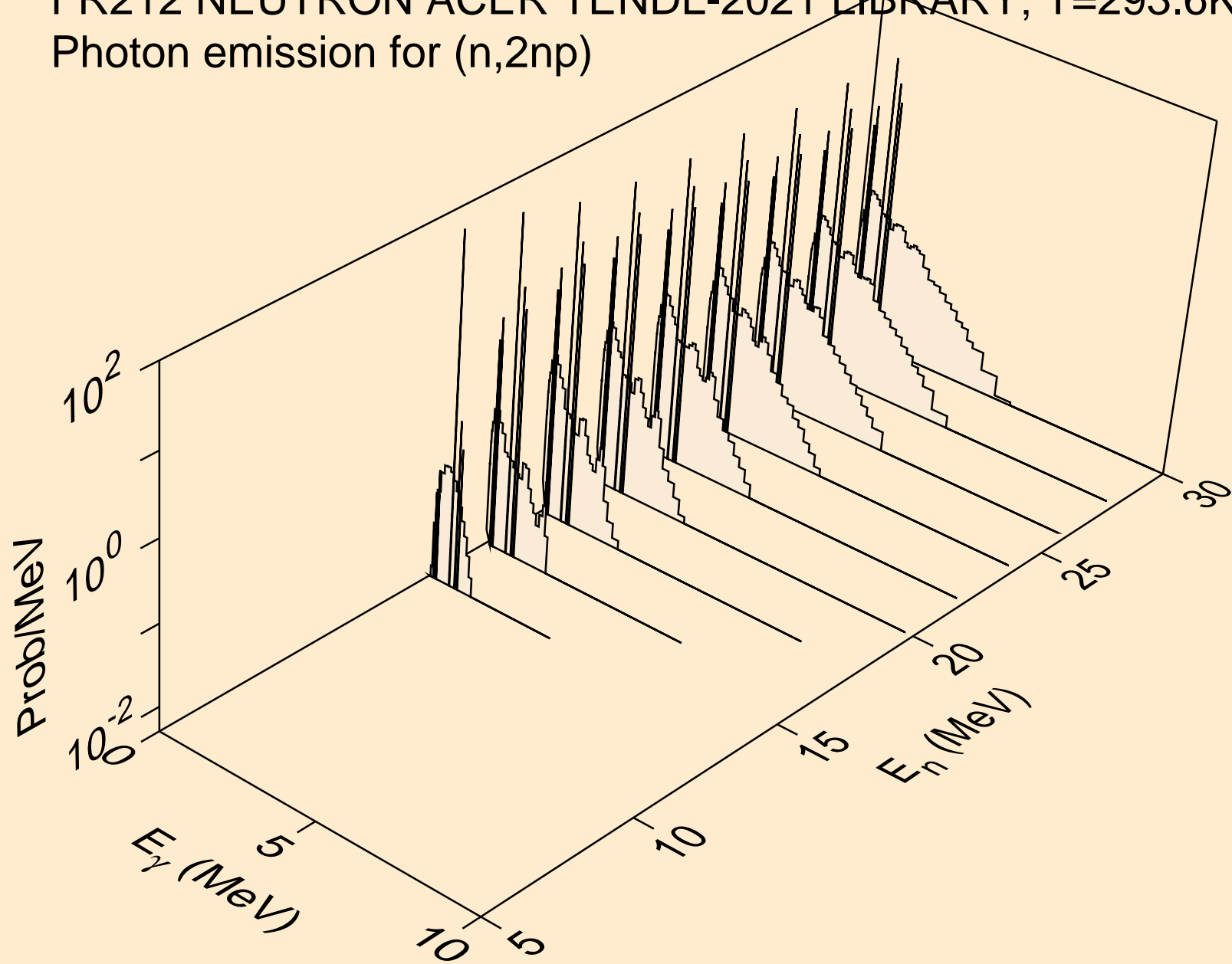

FR212 NEUTRON ACER TENDL-2021 LIBRARY; T=293.6K
Photon emission for (n,3np)

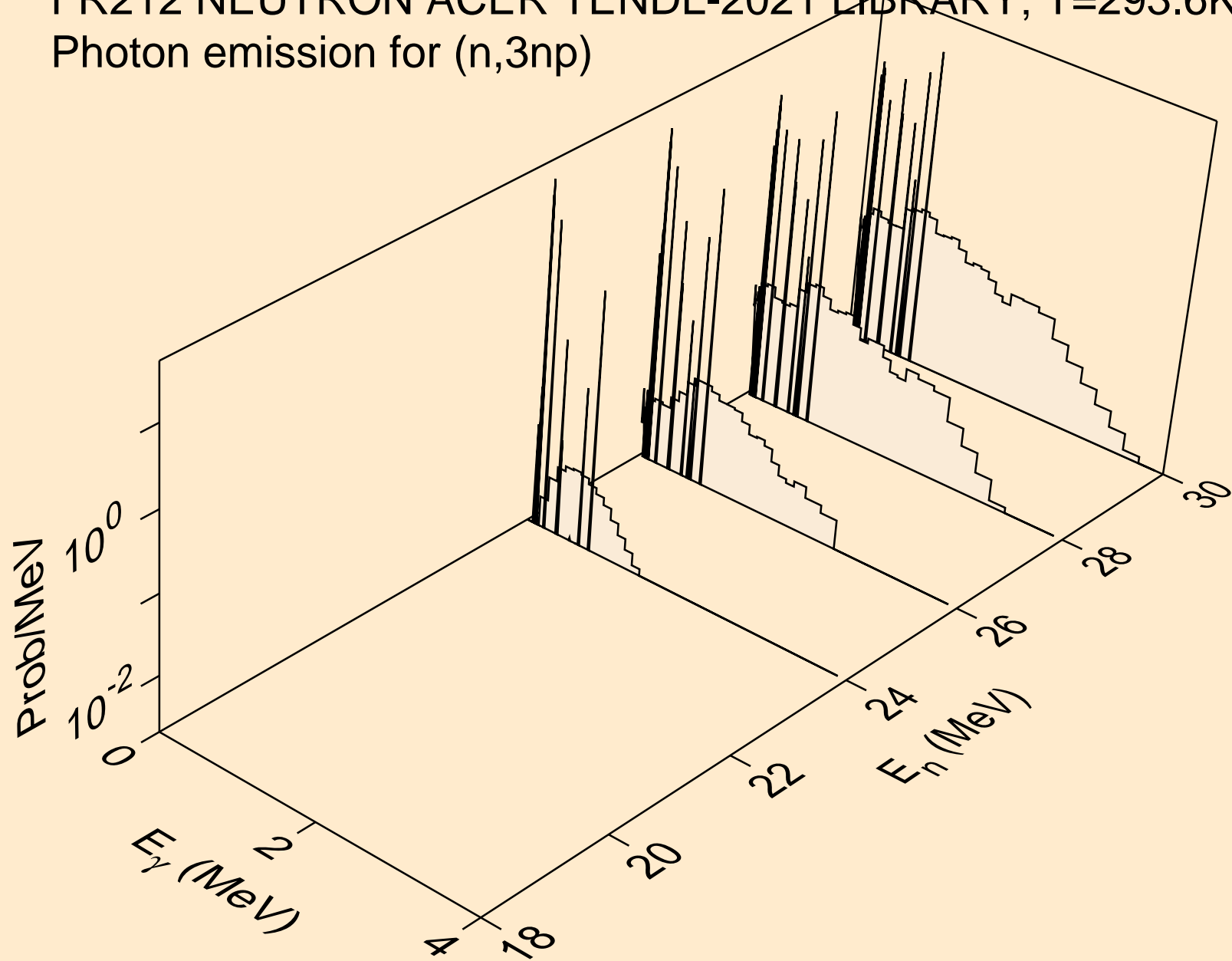

FR212 NEUTRON ACER TENDL-2021 LIBRARY; T=293.6K
Photon emission for (n,2np)

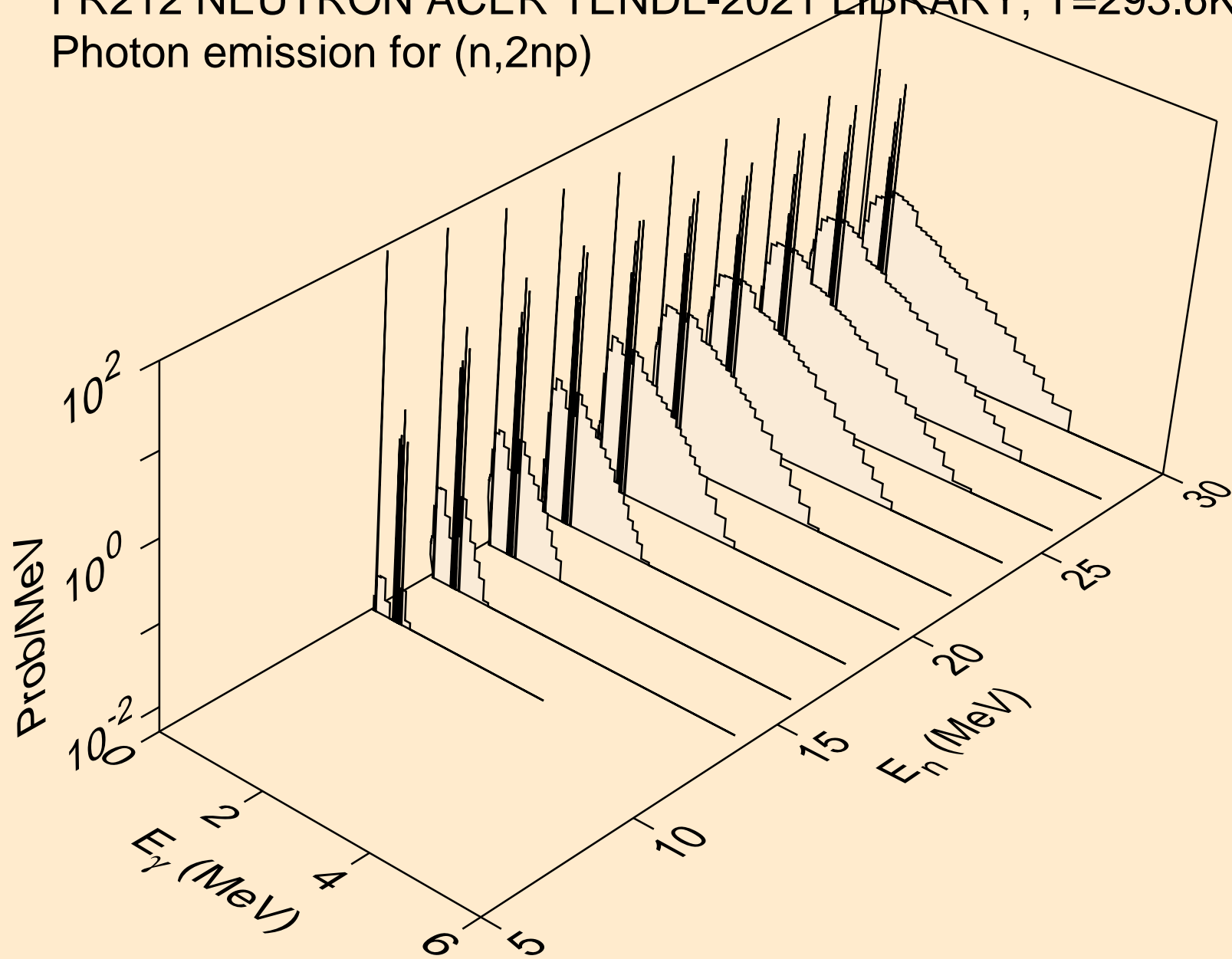

FR212 NEUTRON ACER TENDL-2021 LIBRARY; T=293.6K
Photon emission for (n,npa)

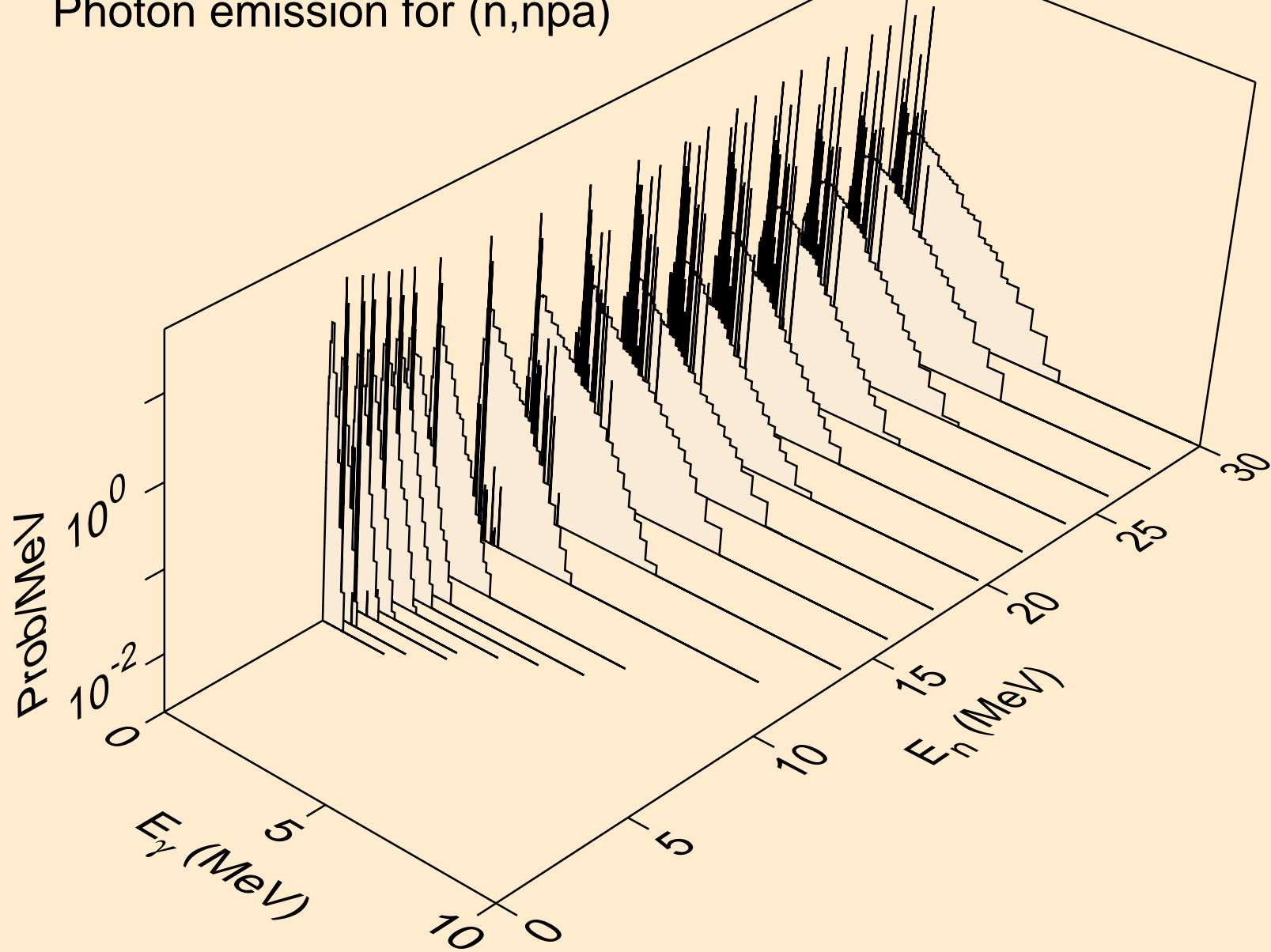

FR212 NEUTRON ACER TENDL-2021 LIBRARY; T=293.6K
Photon emission for (n,n*c)

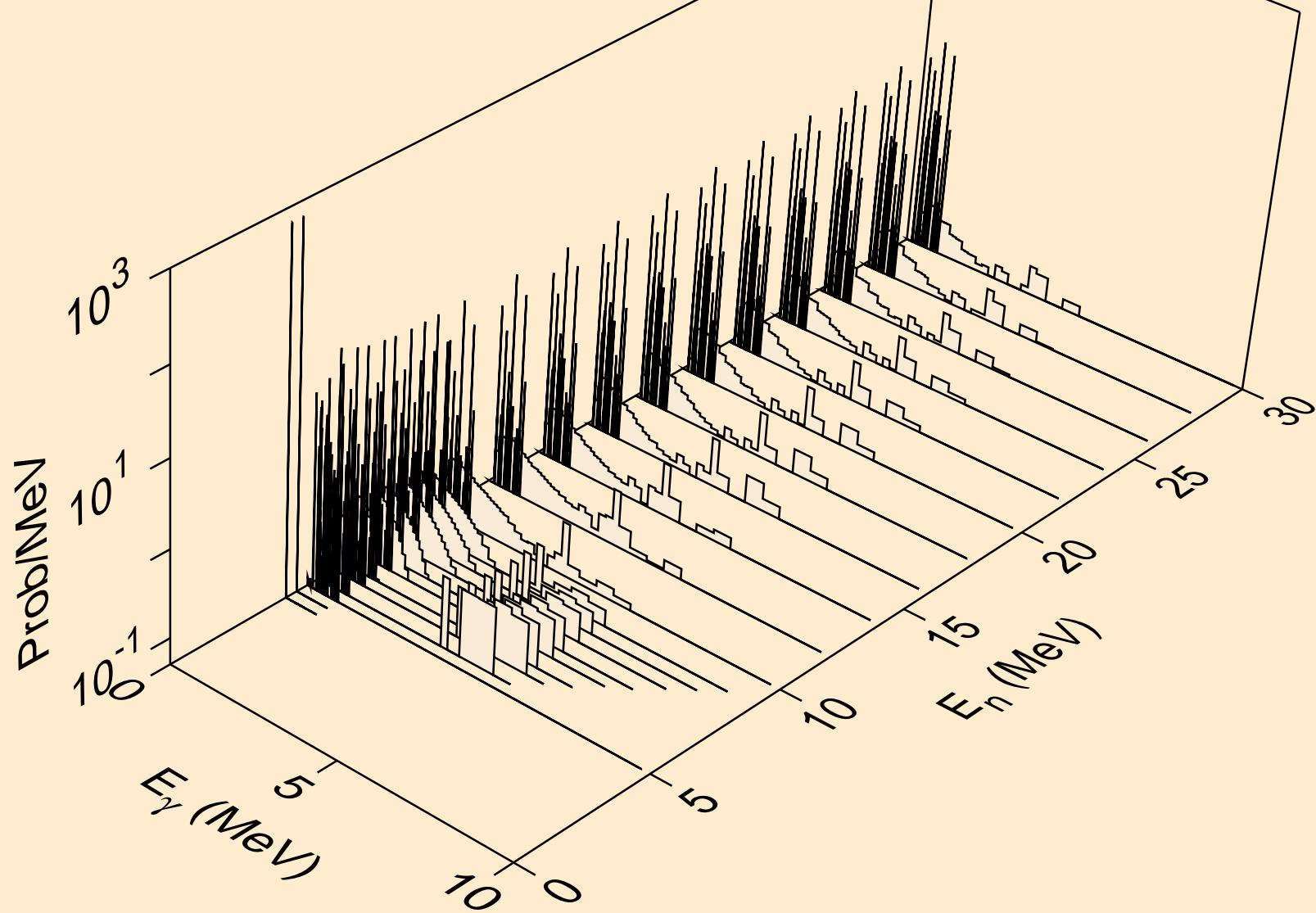

FR212 NEUTRON ACER TENDL-2021 LIBRARY; T=293.6K
Photon emission for (n,gma)

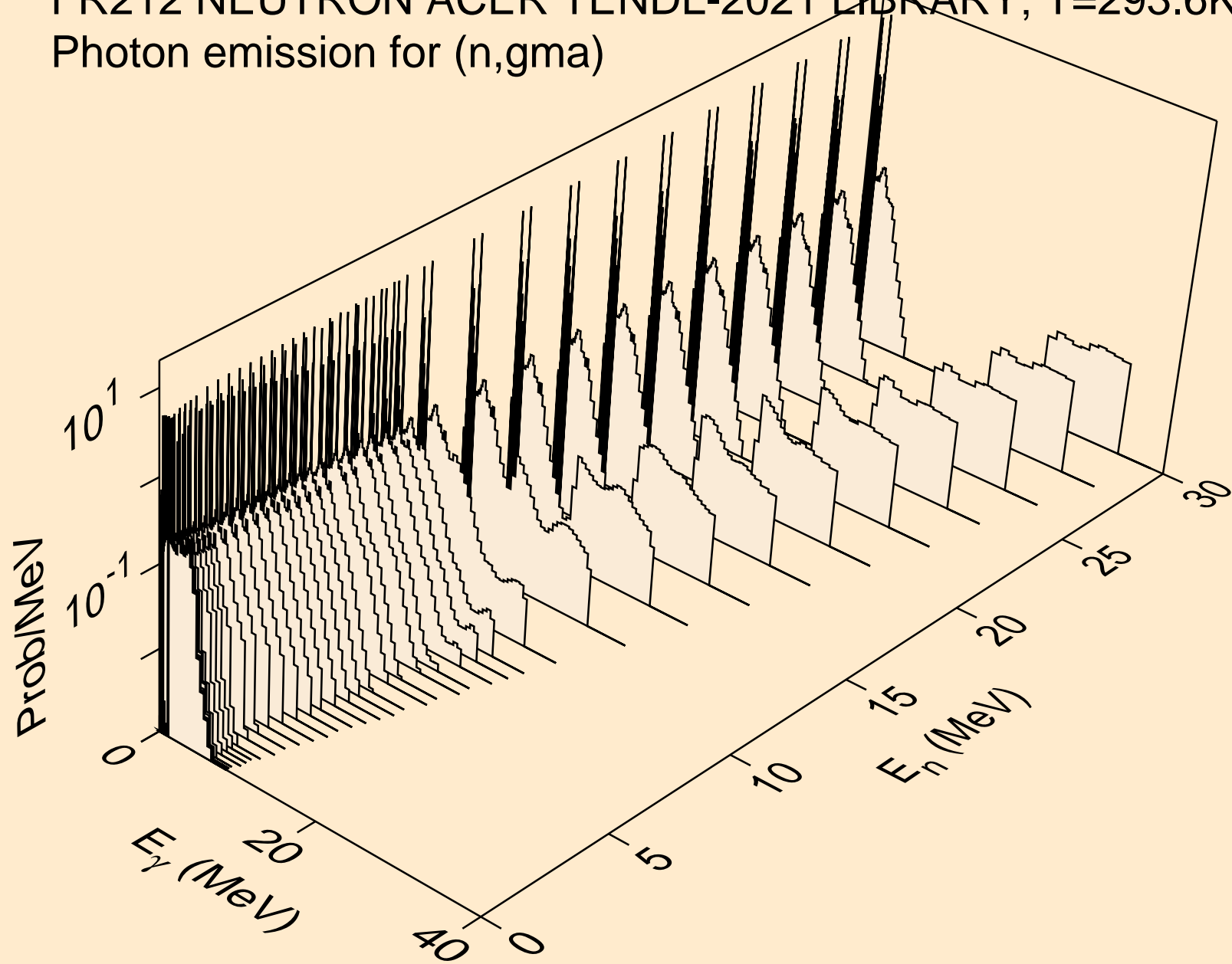

FR212 NEUTRON ACER TENDL-2021 LIBRARY; T=293.6K
Photon emission for (n,p)

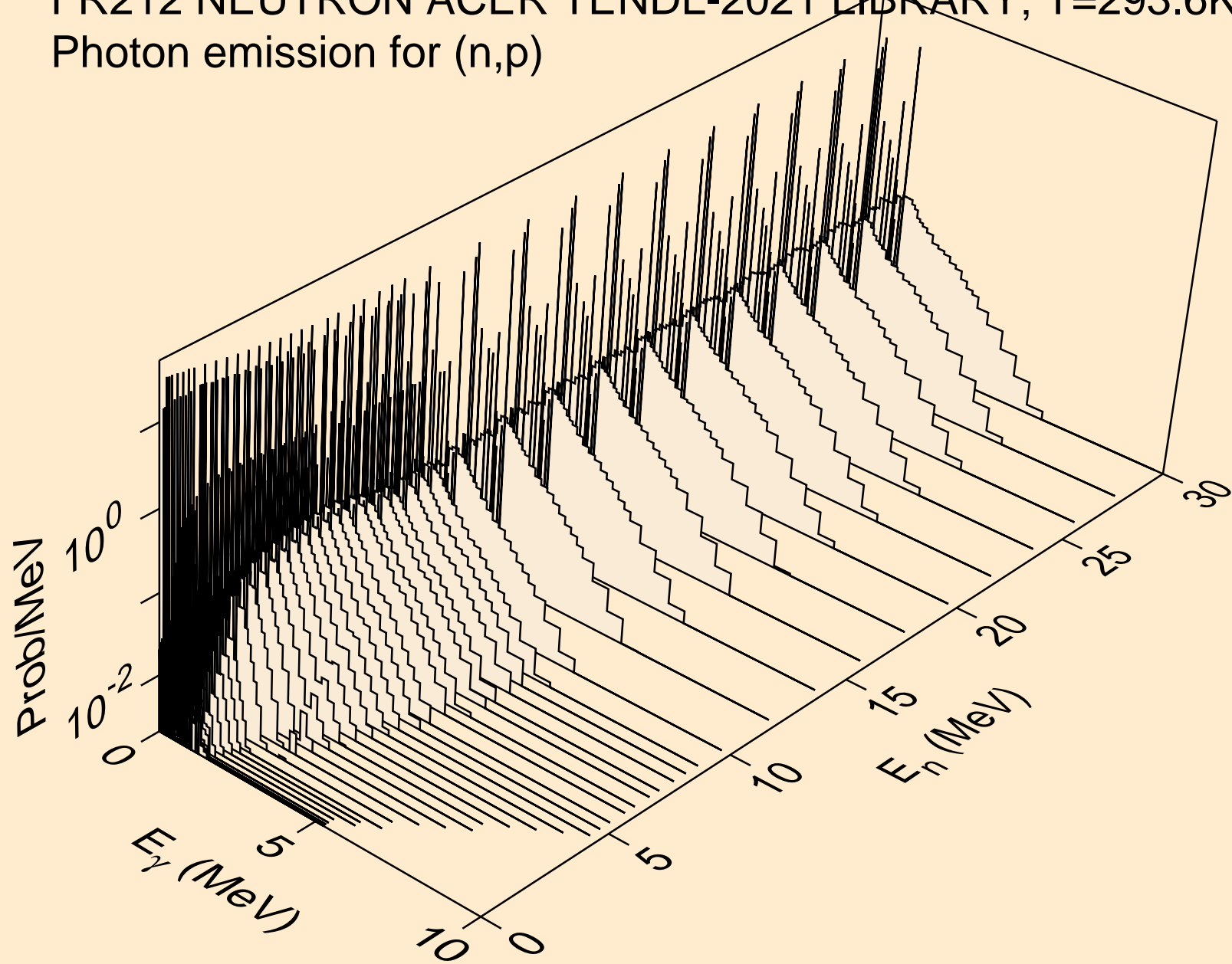

FR212 NEUTRON ACER TENDL-2021 LIBRARY; T=293.6K
Photon emission for (n,d)

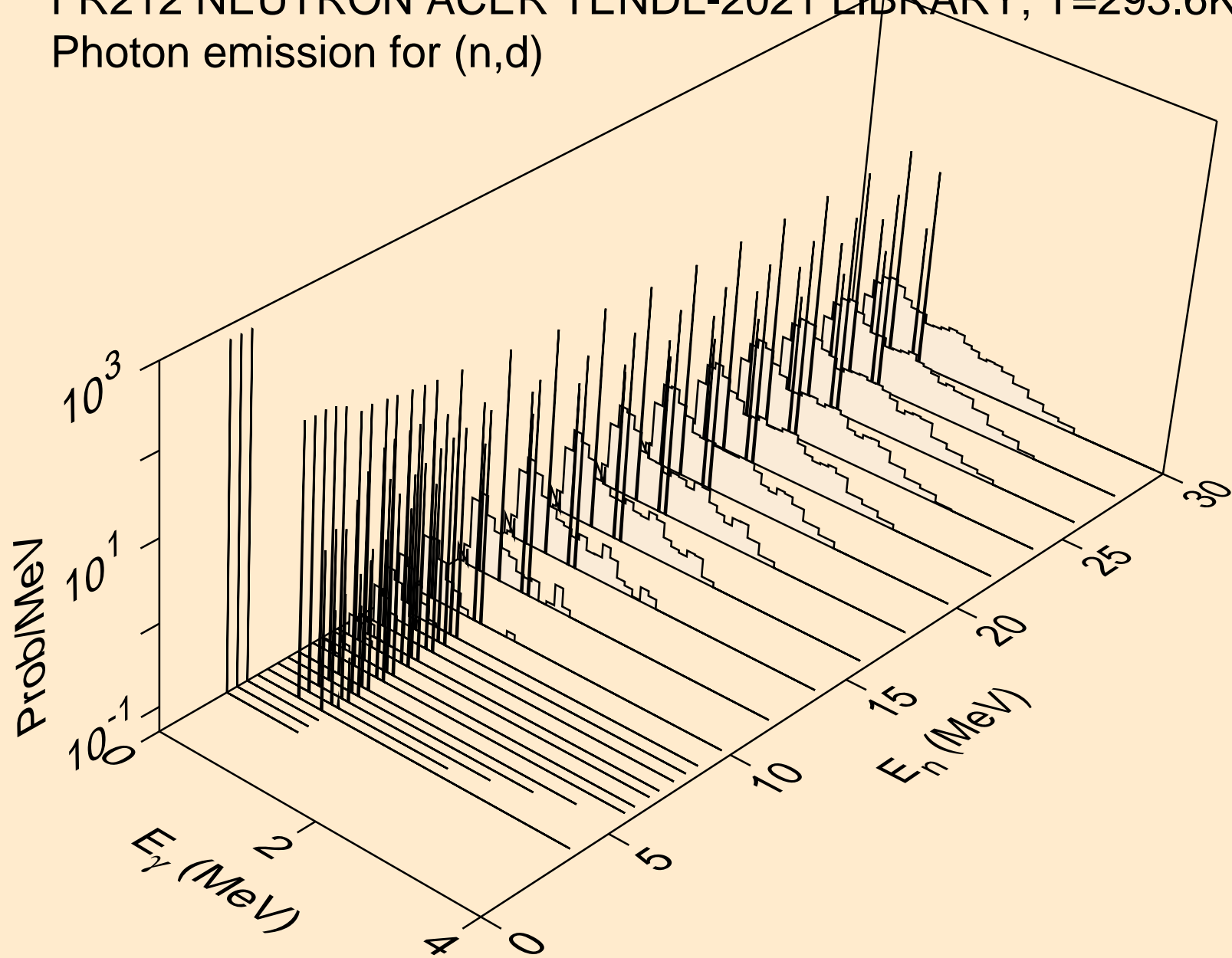

FR212 NEUTRON ACER TENDL-2021 LIBRARY; T=293.6K
Photon emission for (n,t)

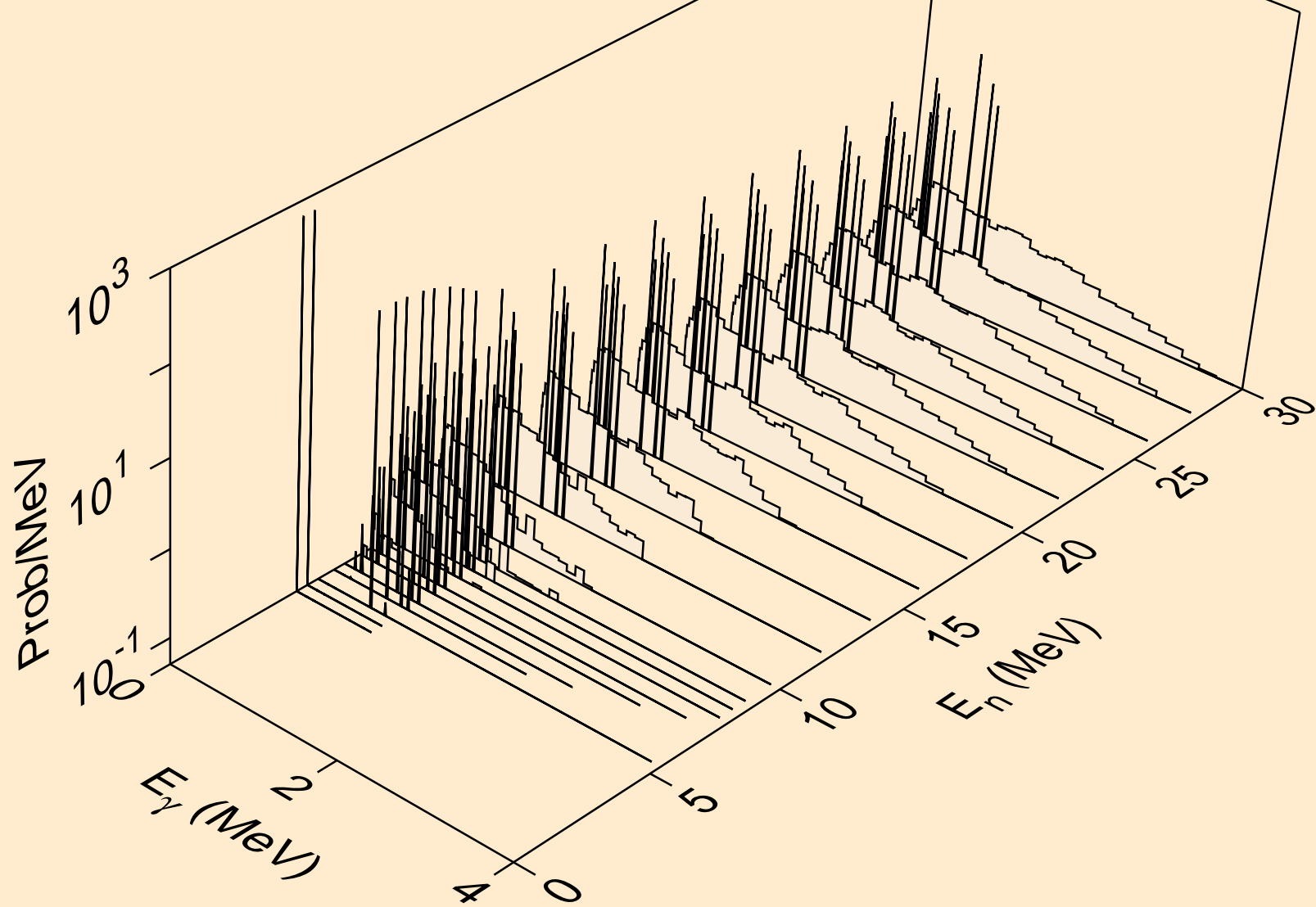

FR212 NEUTRON ACER TENDL-2021 LIBRARY; T=293.6K
Photon emission for (n,he3)

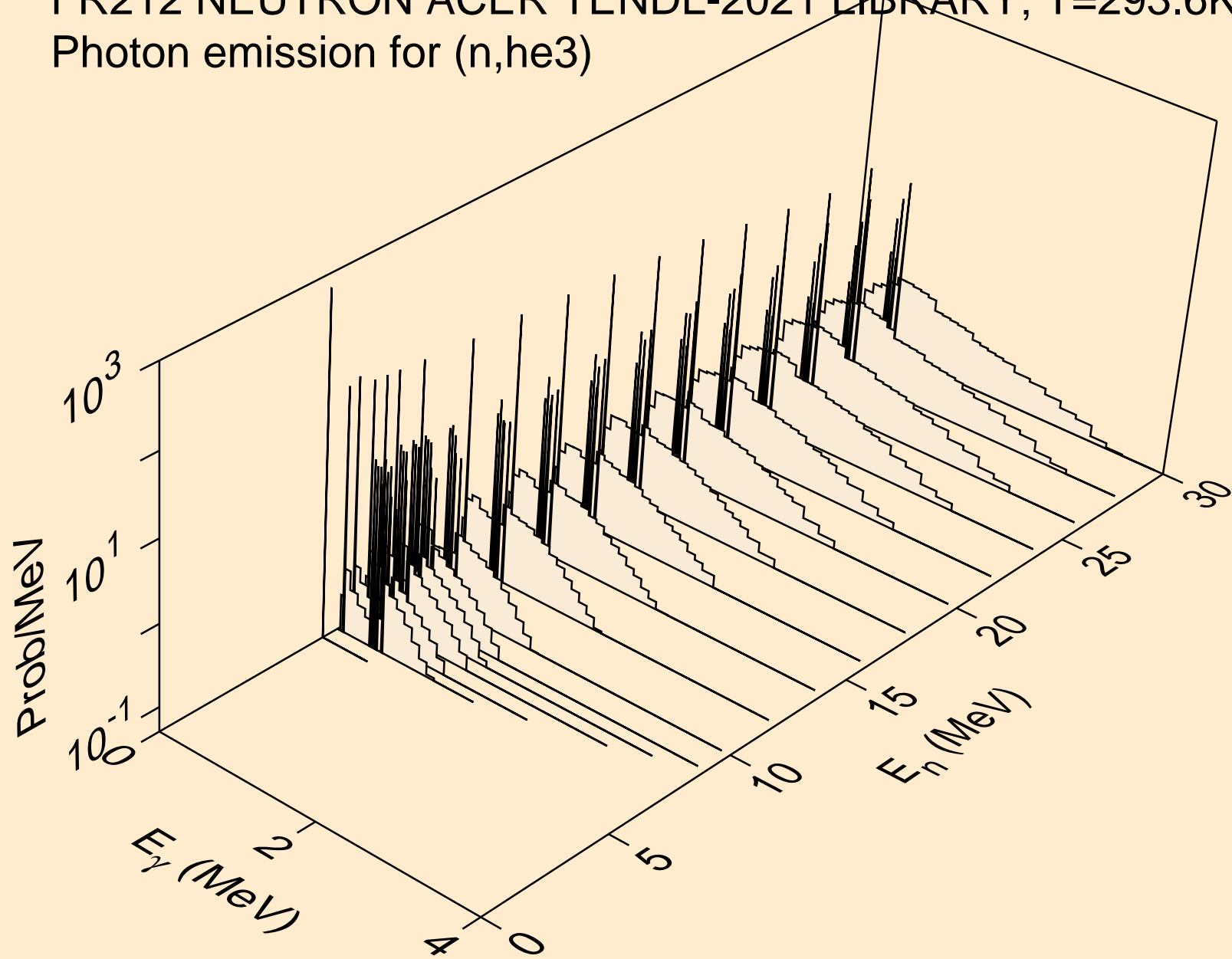

FR212 NEUTRON ACER TENDL-2021 LIBRARY; T=293.6K
Photon emission for (n,a)

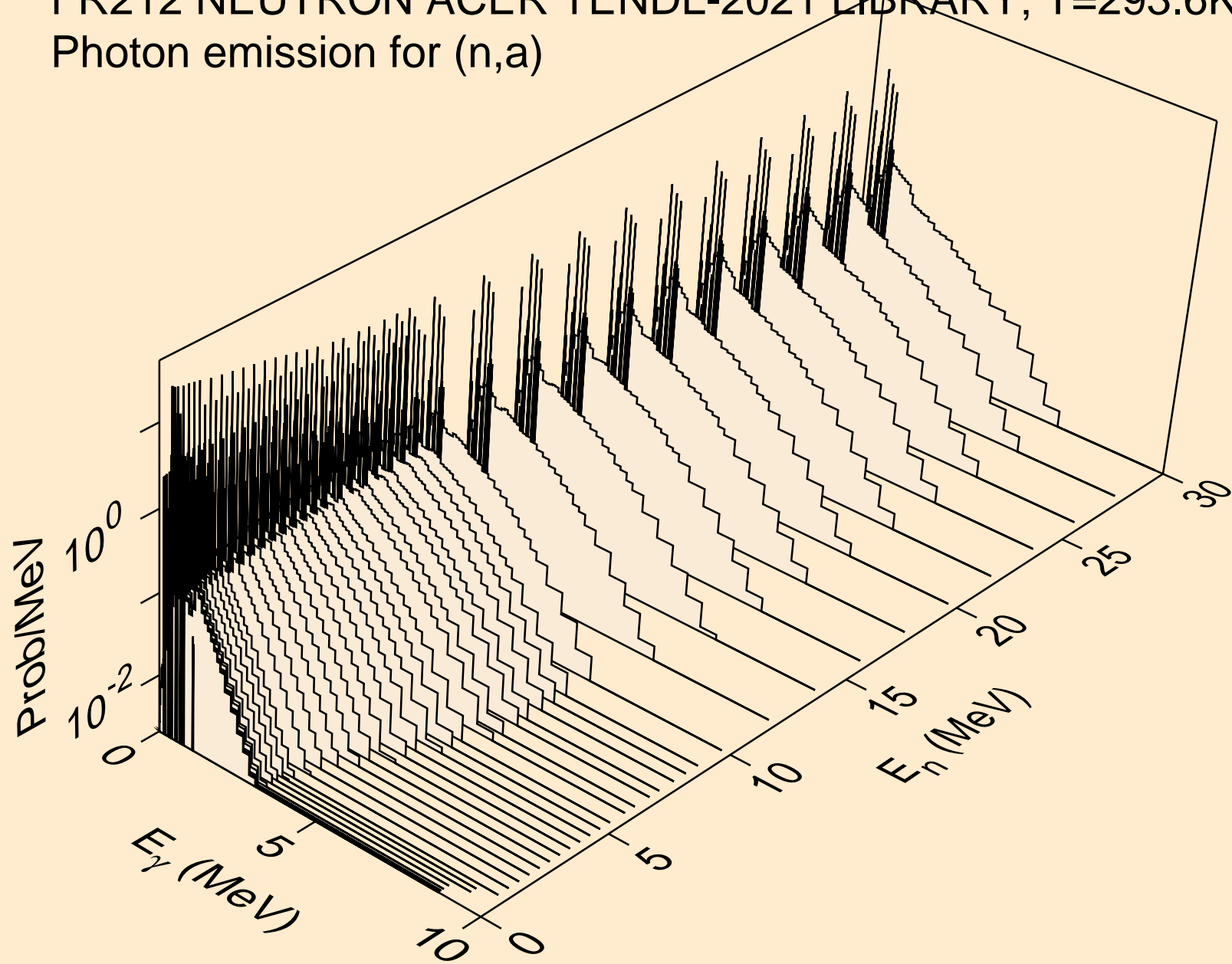

FR212 NEUTRON ACER TENDL-2021 LIBRARY; T=293.6K
Photon emission for (n,2a)

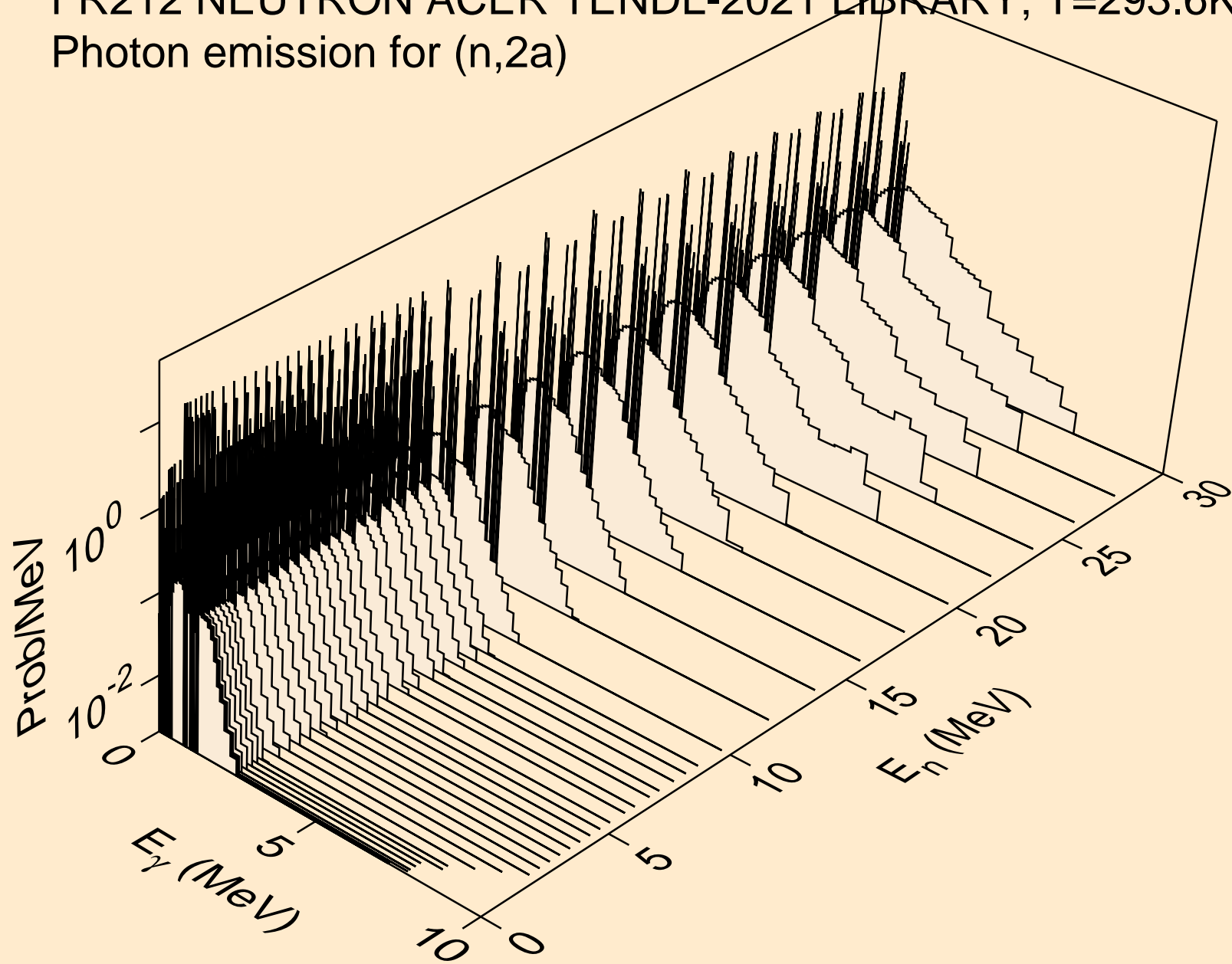

FR212 NEUTRON ACER TENDL-2021 LIBRARY; T=293.6K
Photon emission for (n,2p)

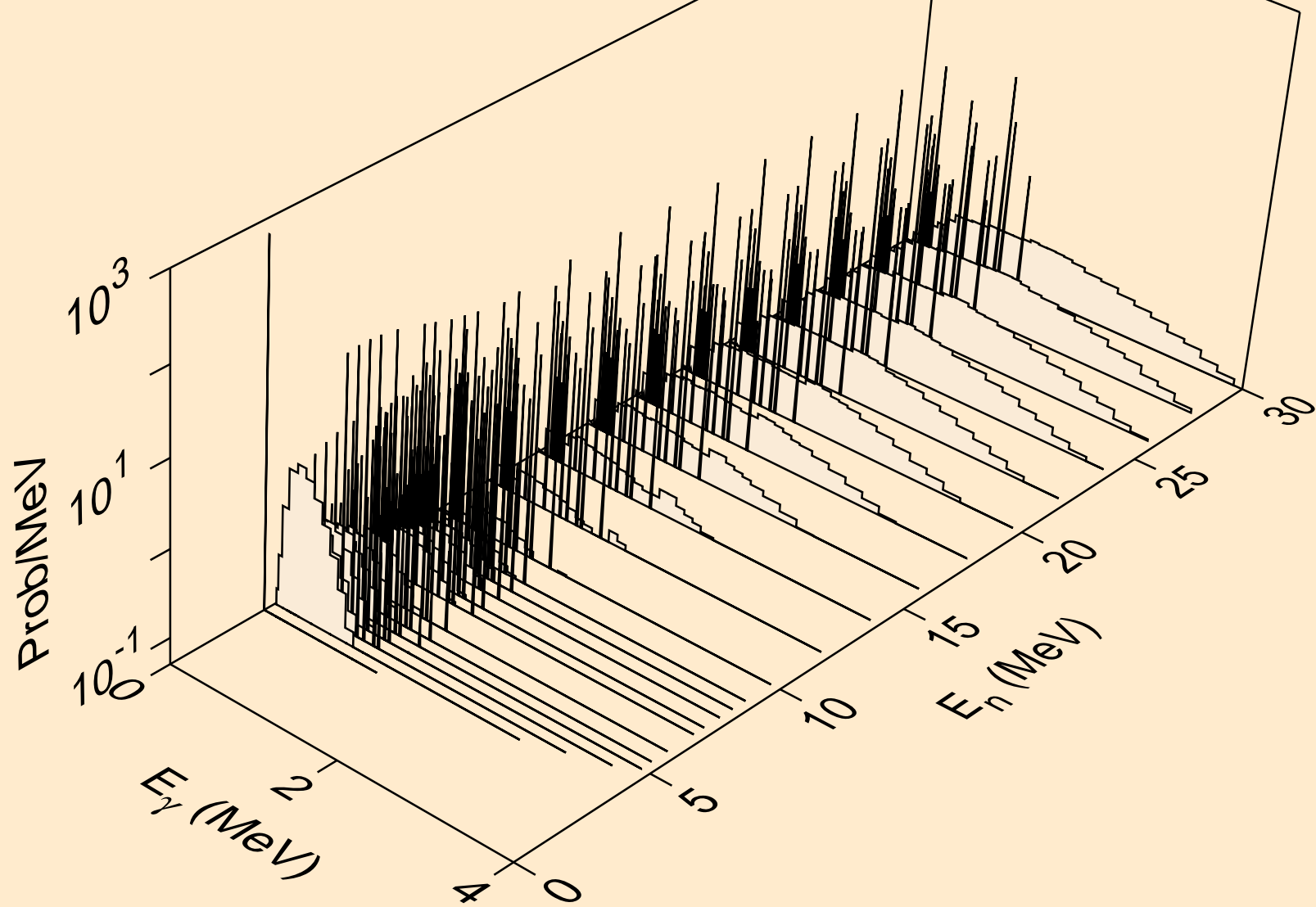

FR212 NEUTRON ACER TENDL-2021 LIBRARY; T=293.6K
Photon emission for (n,p α)

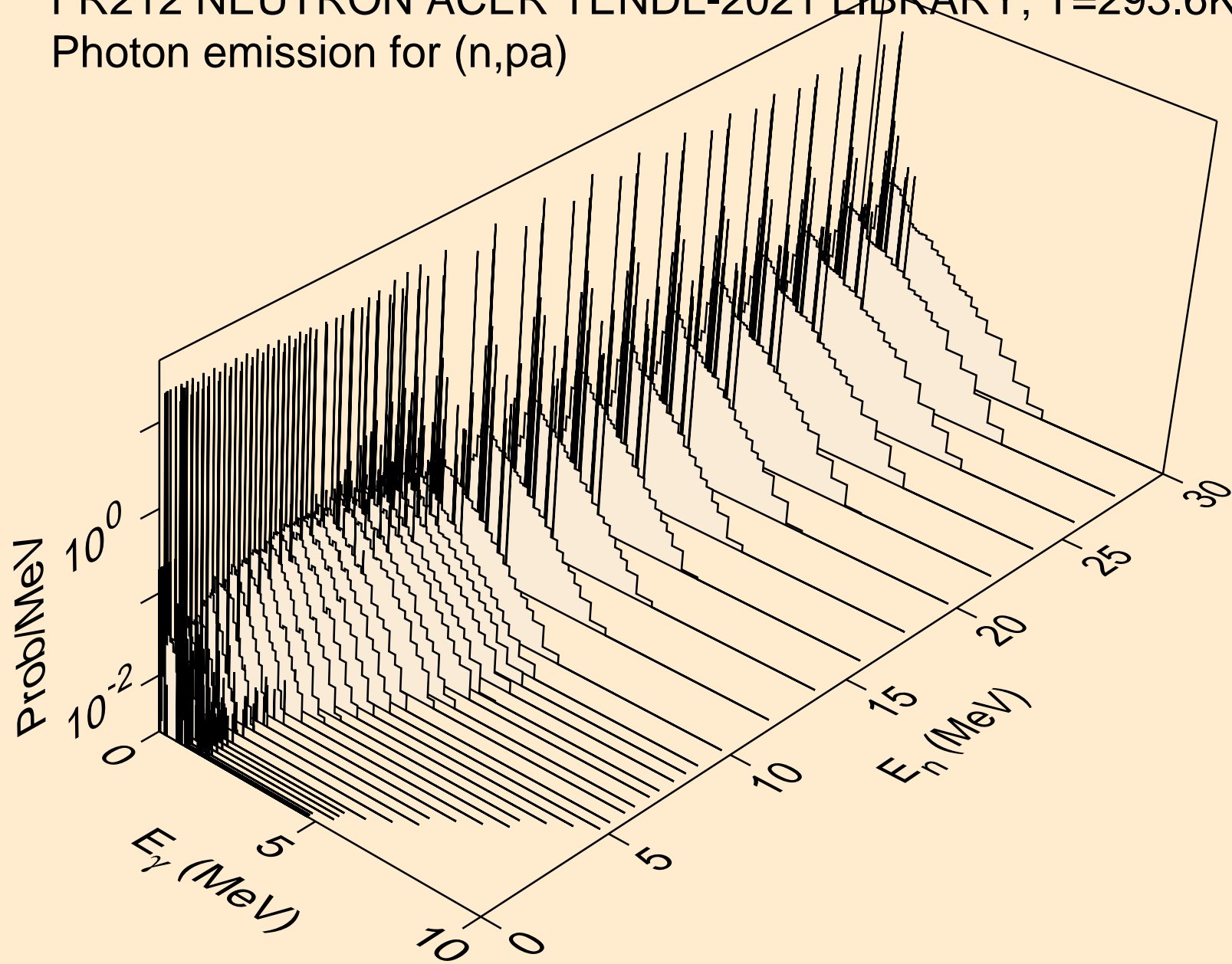

FR212 NEUTRON ACER TENDL-2021 LIBRARY; T=293.6K
Photon emission for (n,pd)

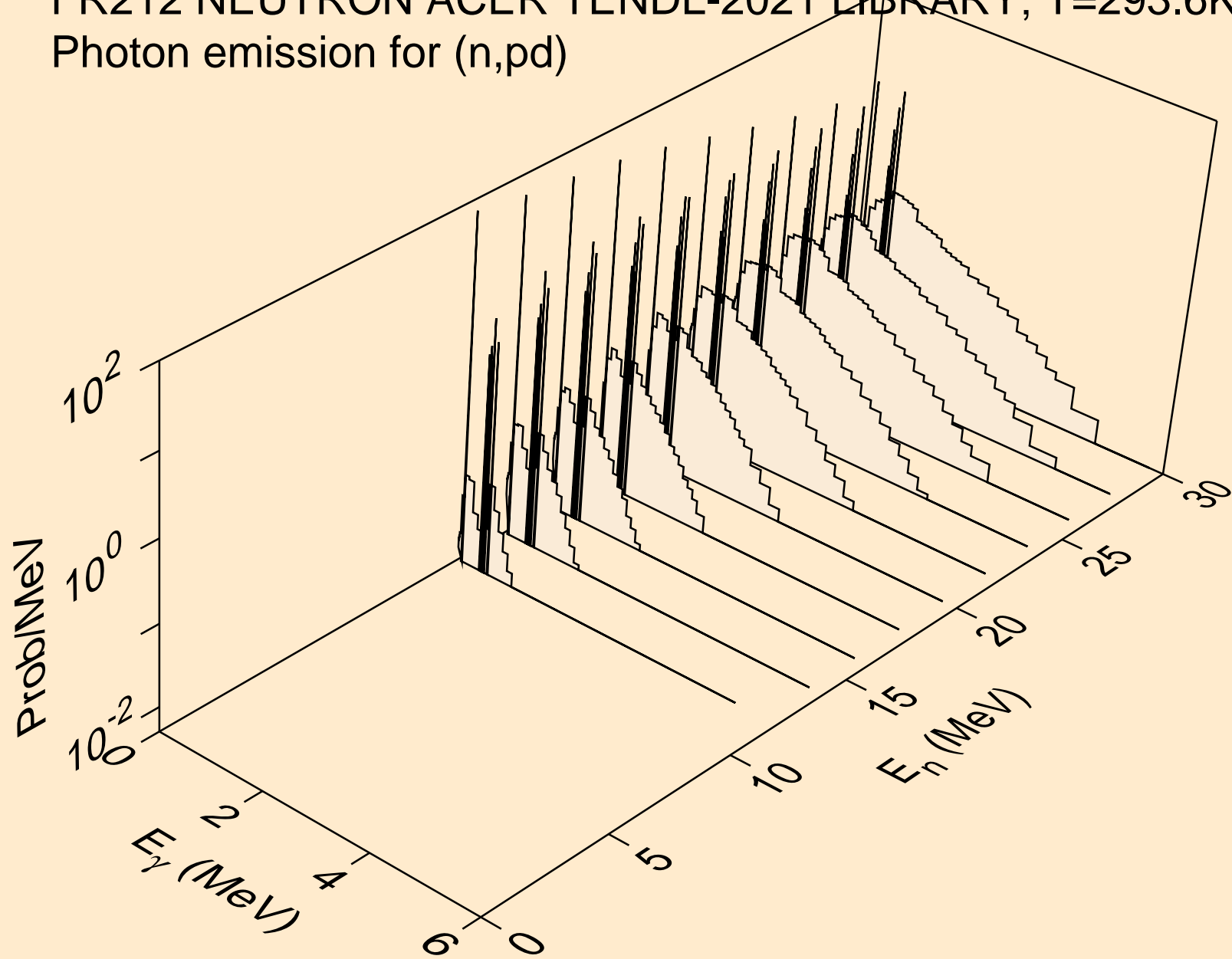

FR212 NEUTRON ACER TENDL-2021 LIBRARY; T=293.6K
Photon emission for (n,pt)

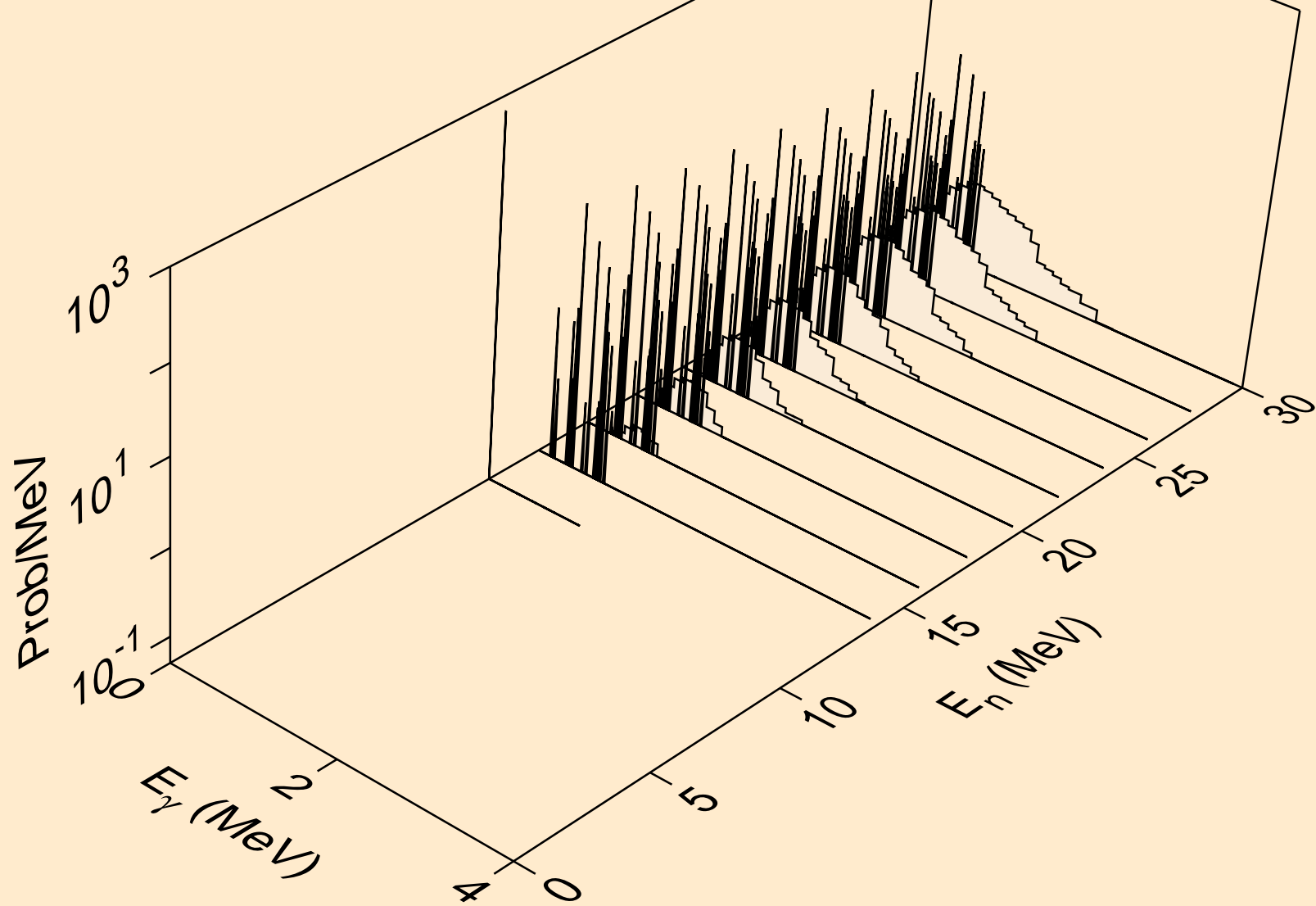

FR212 NEUTRON ACER TENDL-2021 LIBRARY; T=293.6K
Photon emission for (n,da)

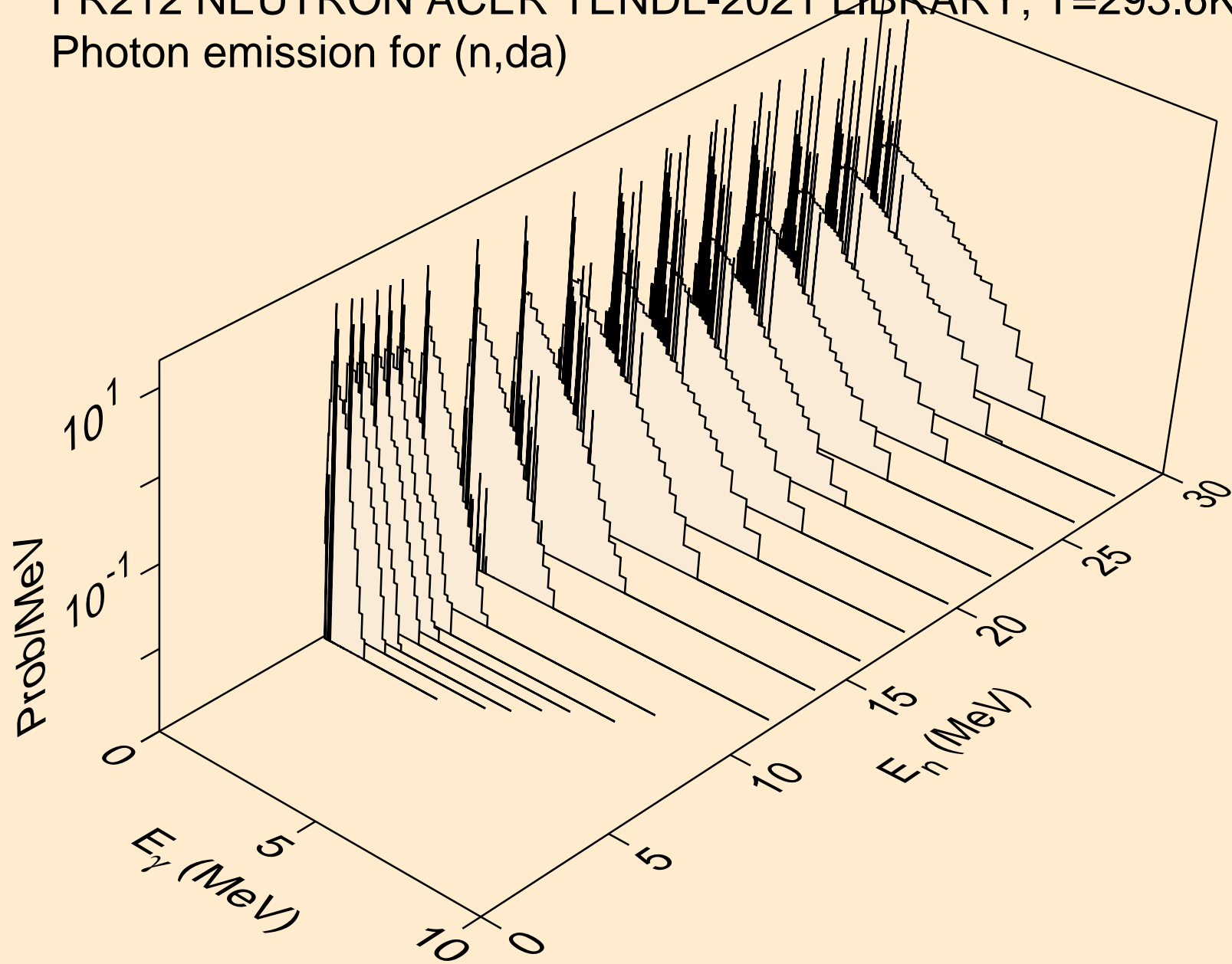

FR212 NEUTRON ACER TENDL-2021 LIBRARY; T=293.6K
thermal capture photon spectrum

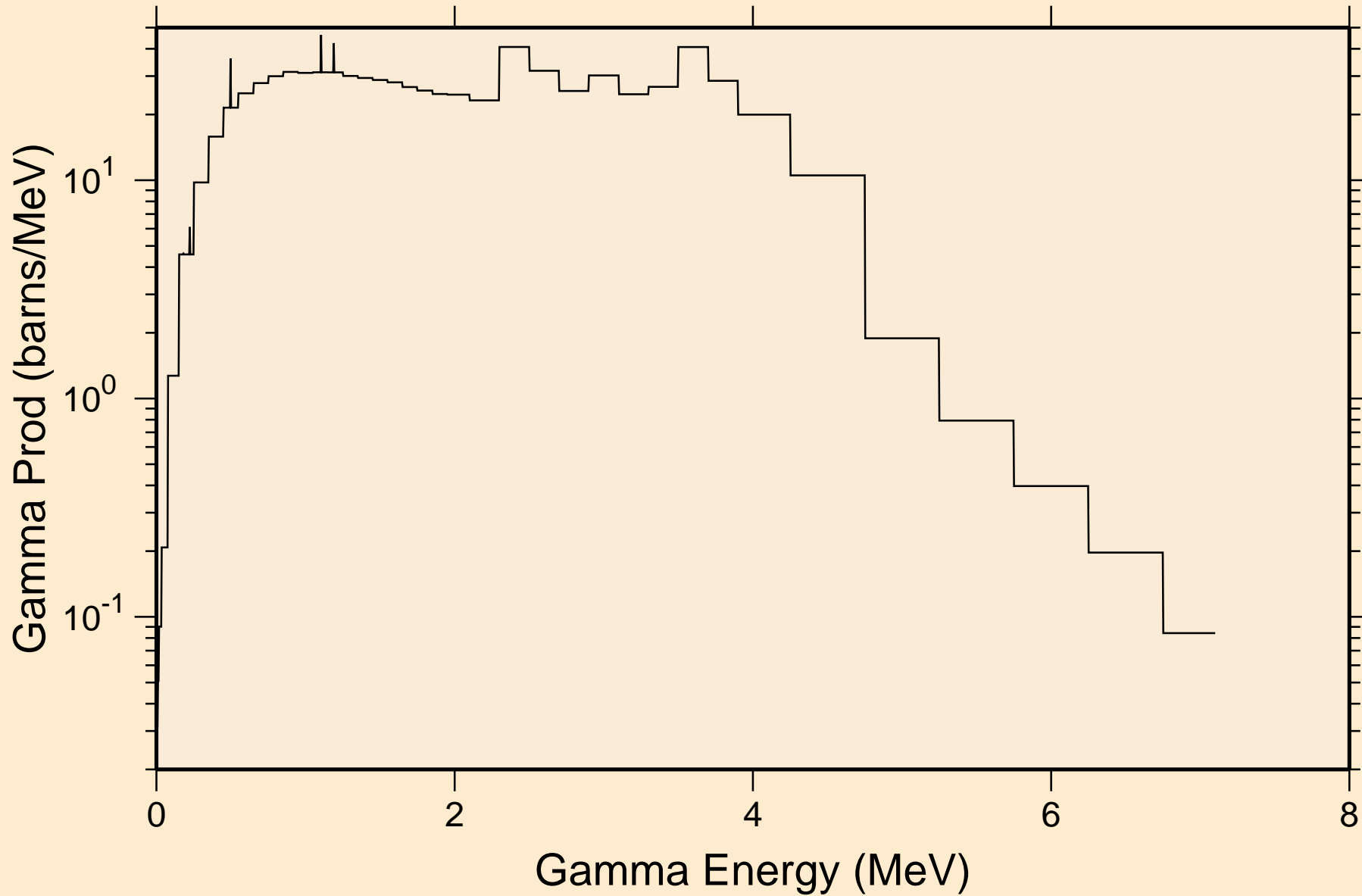

FR212 NEUTRON ACER TENDL-2021 LIBRARY; T=293.6K
14 MeV photon spectrum

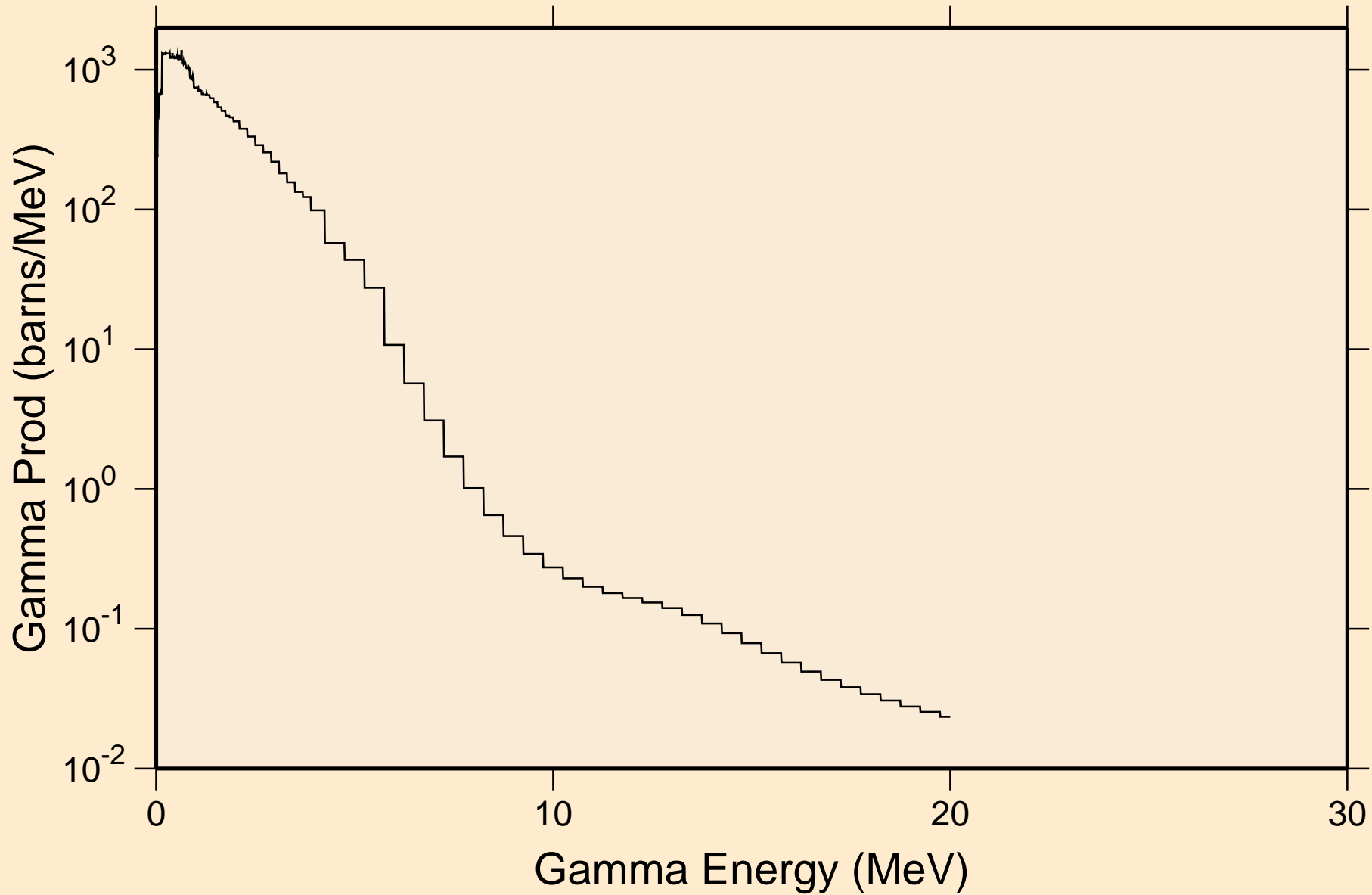

FR212 NEUTRON ACER TENDL-2021 LIBRARY; T=293.6K
Particle heating contributions

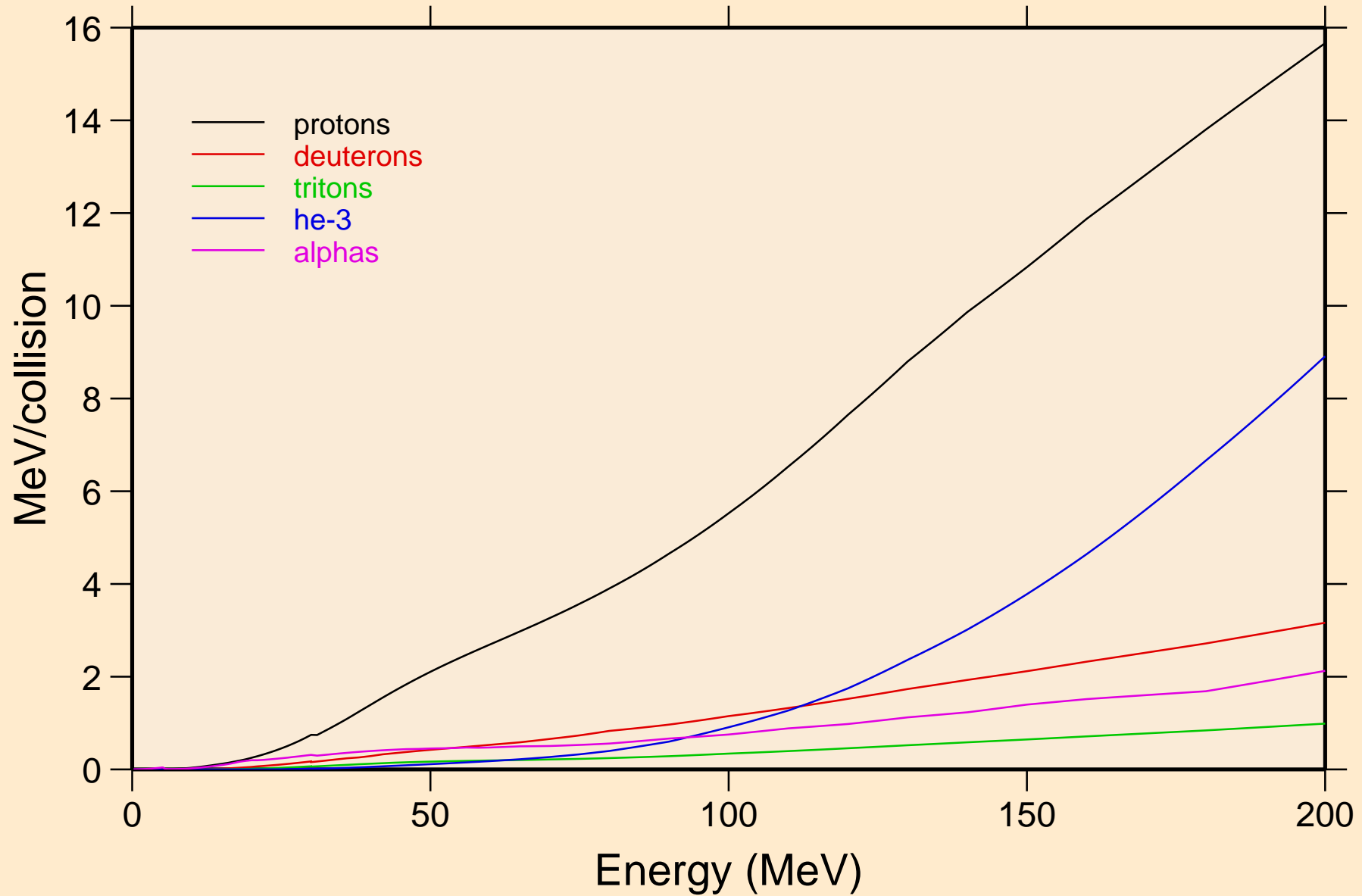

FR212 NEUTRON ACER TENDL-2021 LIBRARY; T=293.6K
Recoil Heating

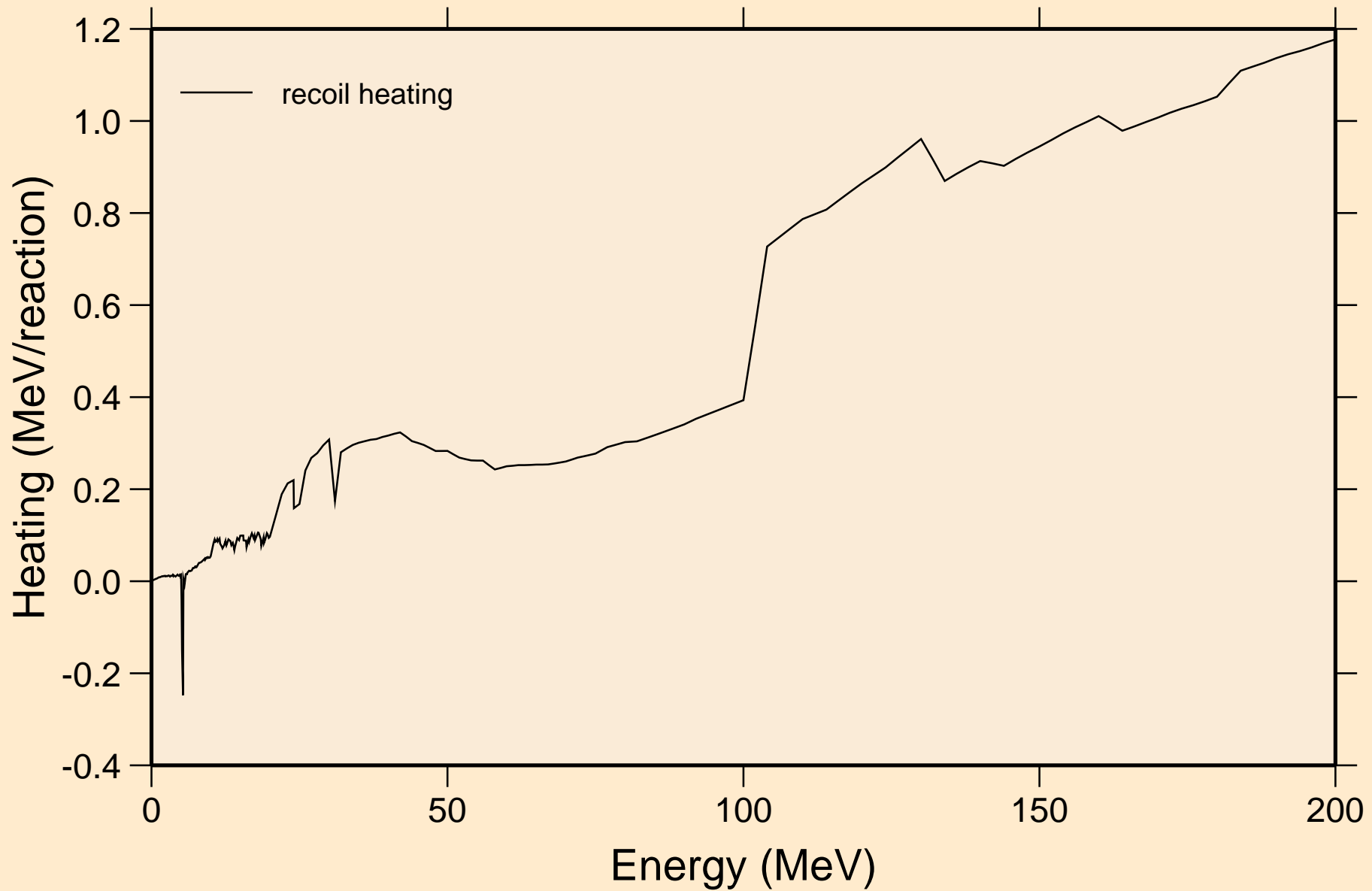

FR212 NEUTRON ACER TENDL-2021 LIBRARY; T=293.6K
Particle production cross sections

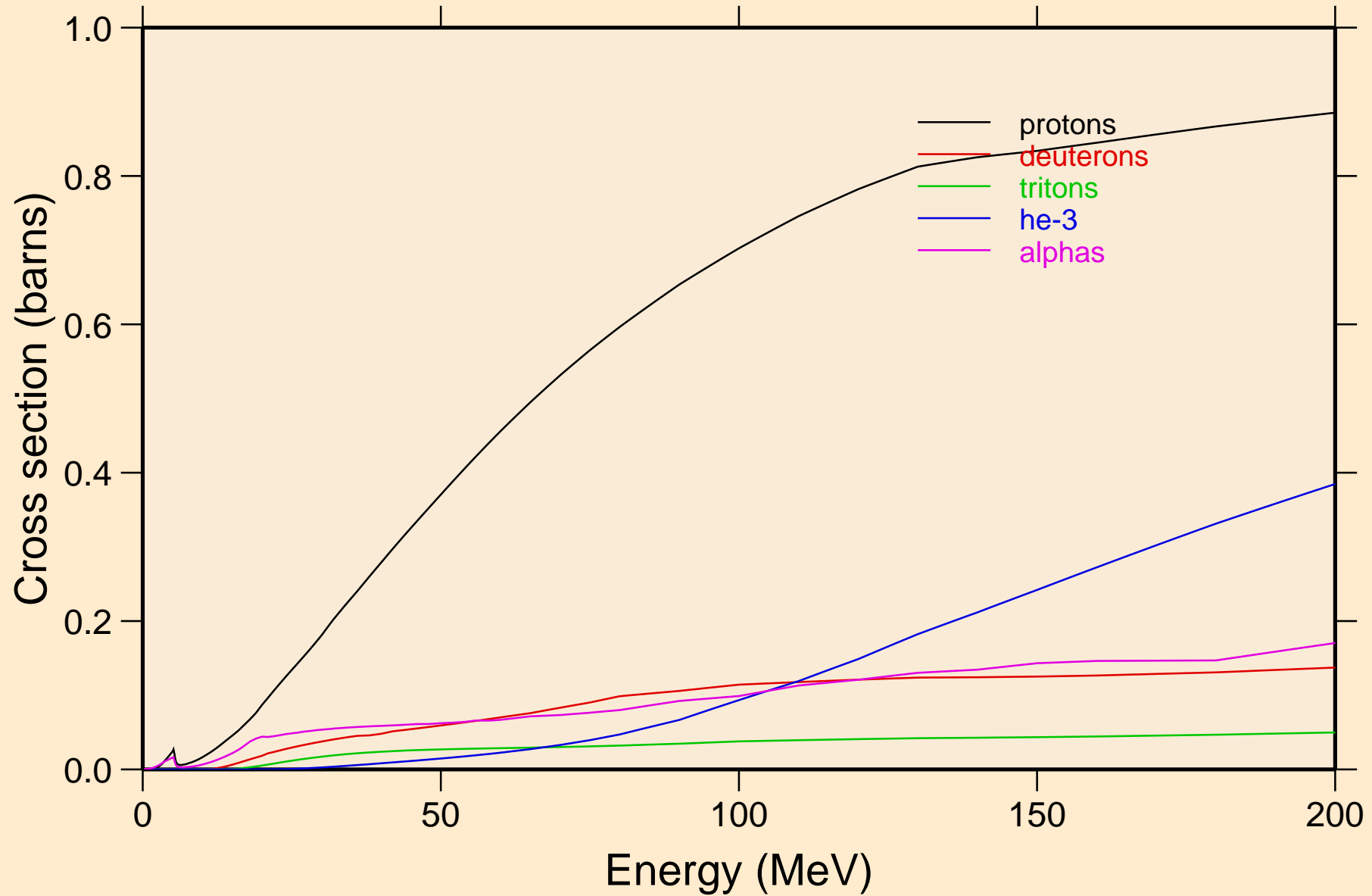

FR212 NEUTRON ACER TENDL-2021 LIBRARY; T=293.6K
protons from (n,x)

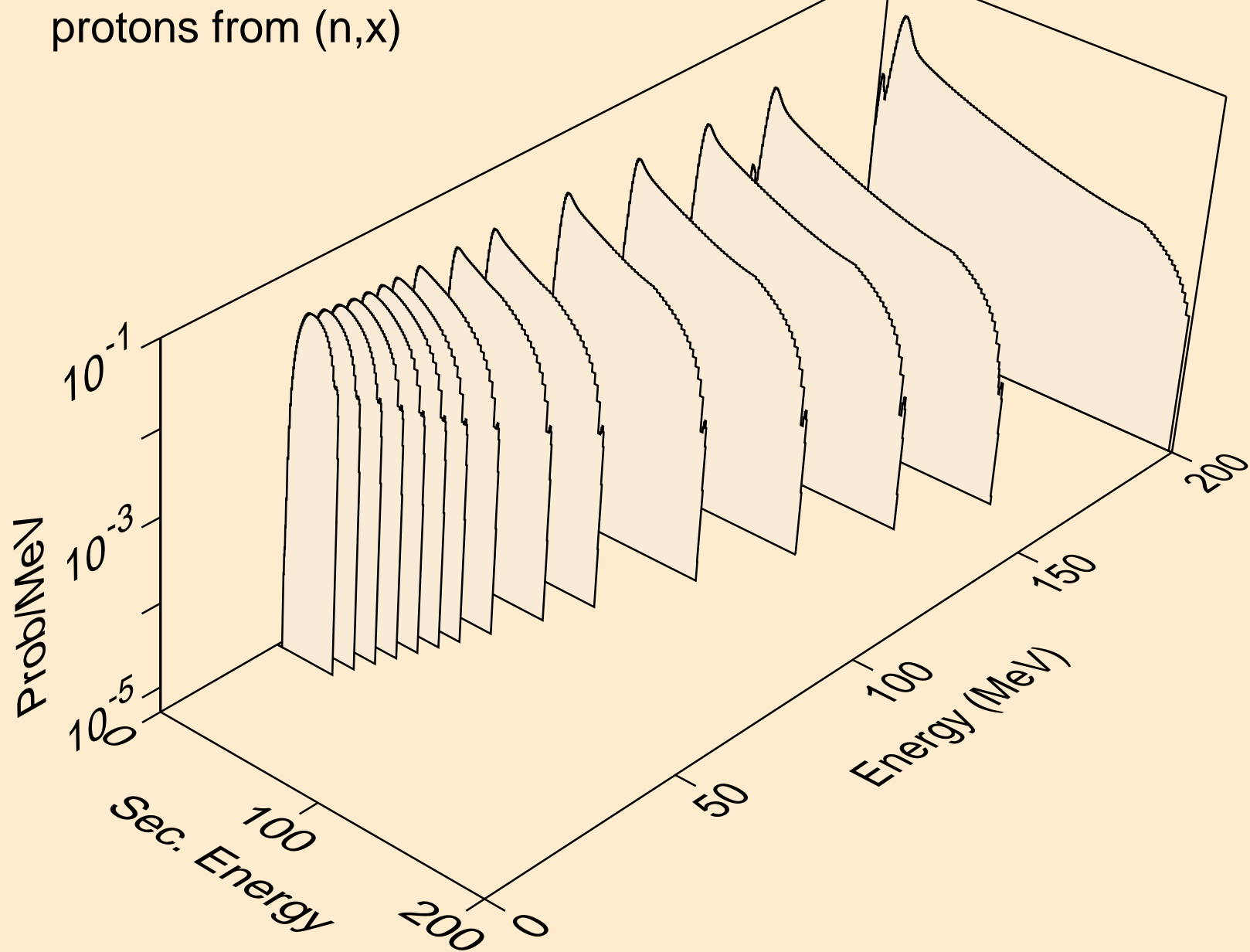

FR212 NEUTRON ACER TENDL-2021 LIBRARY; T=293.6K
protons from (n,n*)p

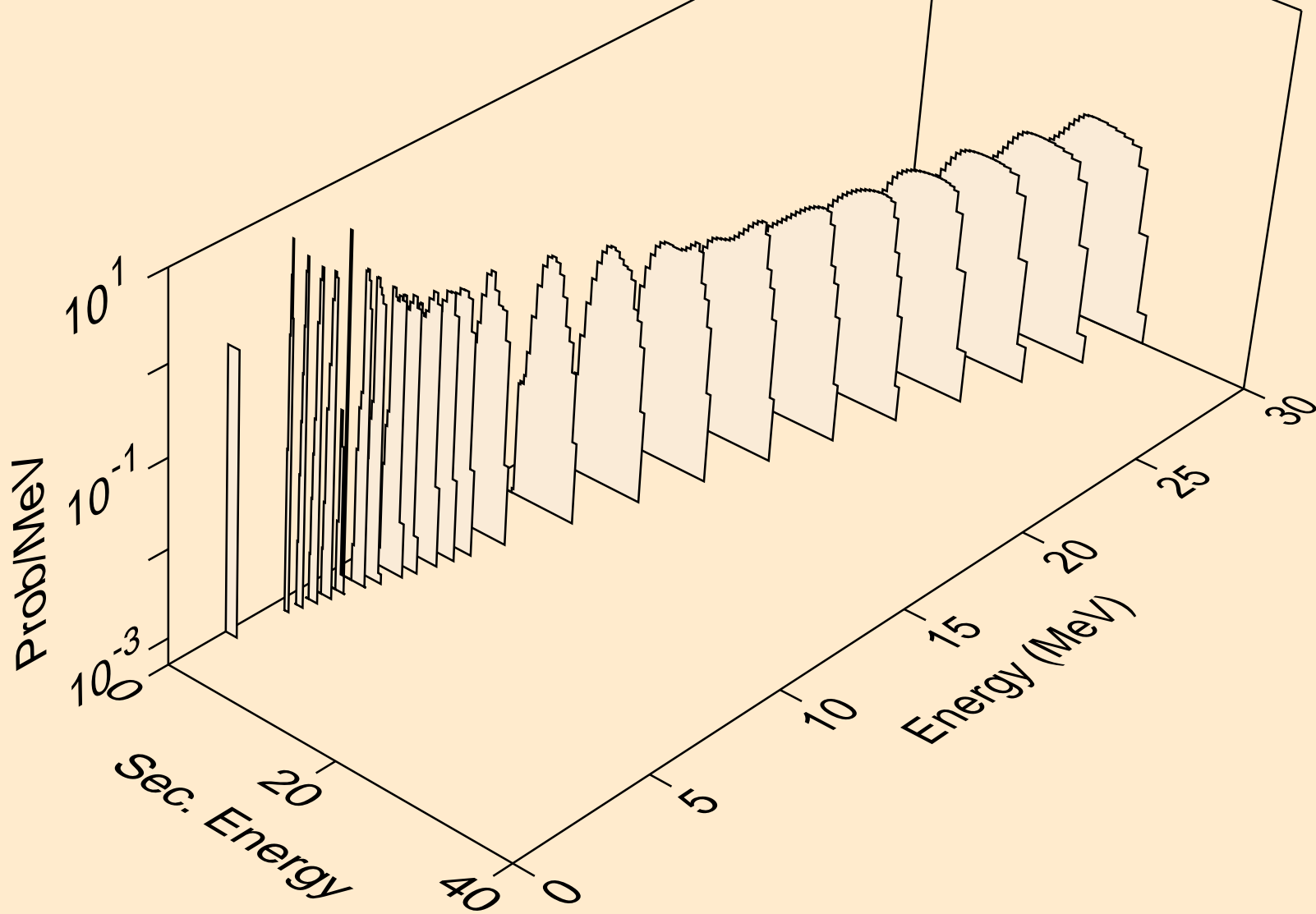

FR212 NEUTRON ACER TENDL-2021 LIBRARY; T=293.6K
protons from (n,2np)

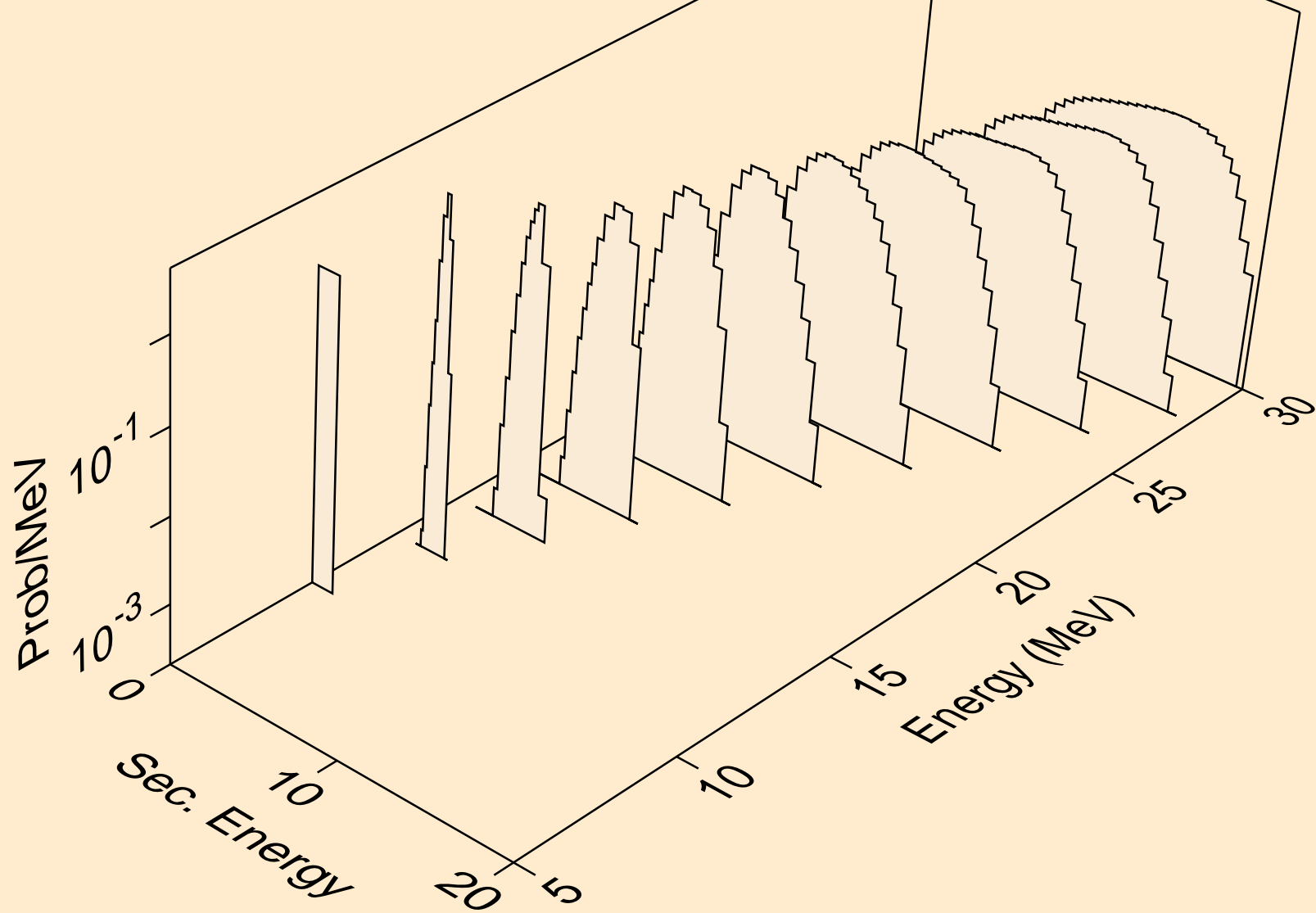

FR212 NEUTRON ACER TENDL-2021 LIBRARY; T=293.6K
protons from (n,3np)

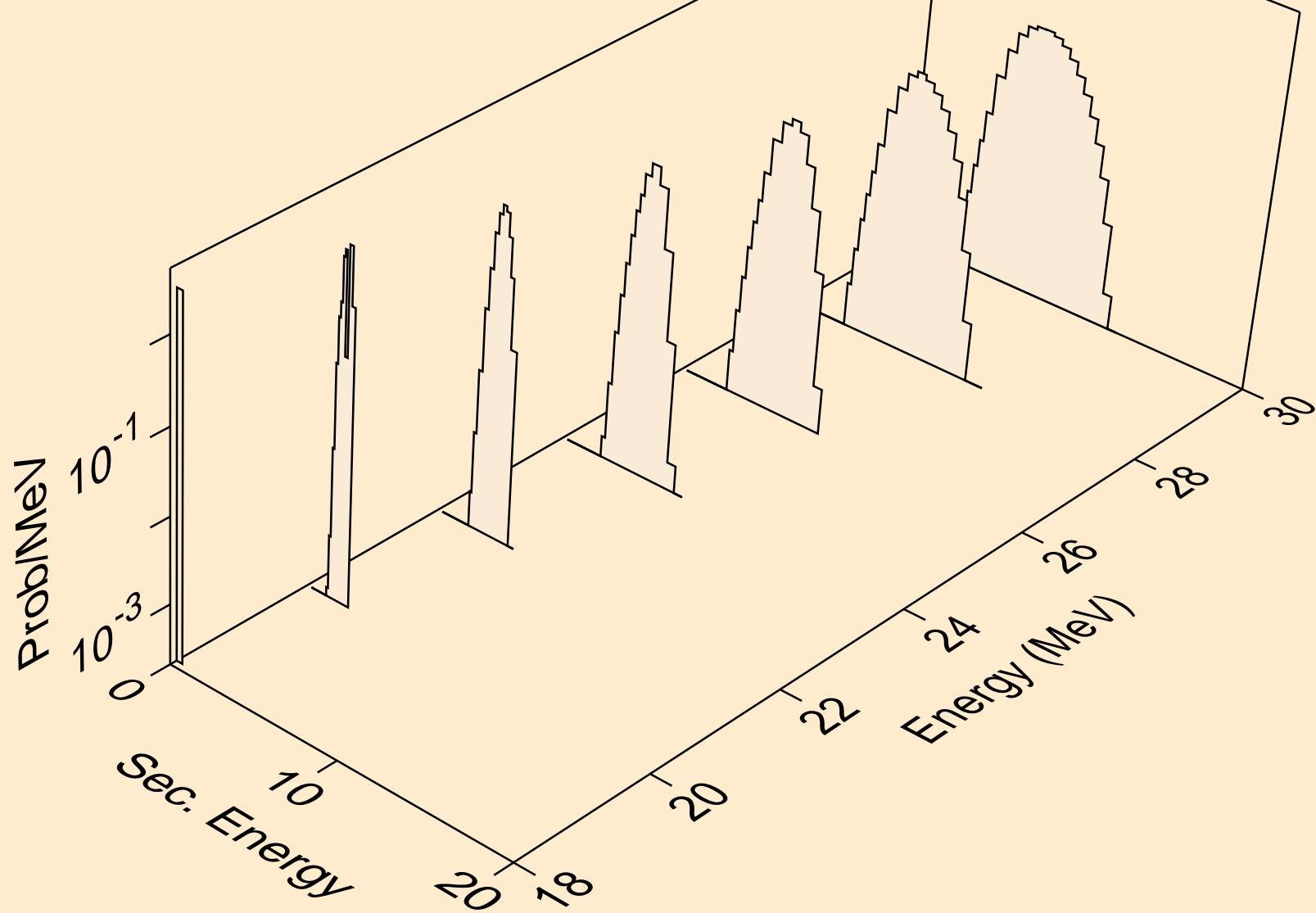

FR212 NEUTRON ACER TENDL-2021 LIBRARY; T=293.6K
protons from (n,2np)

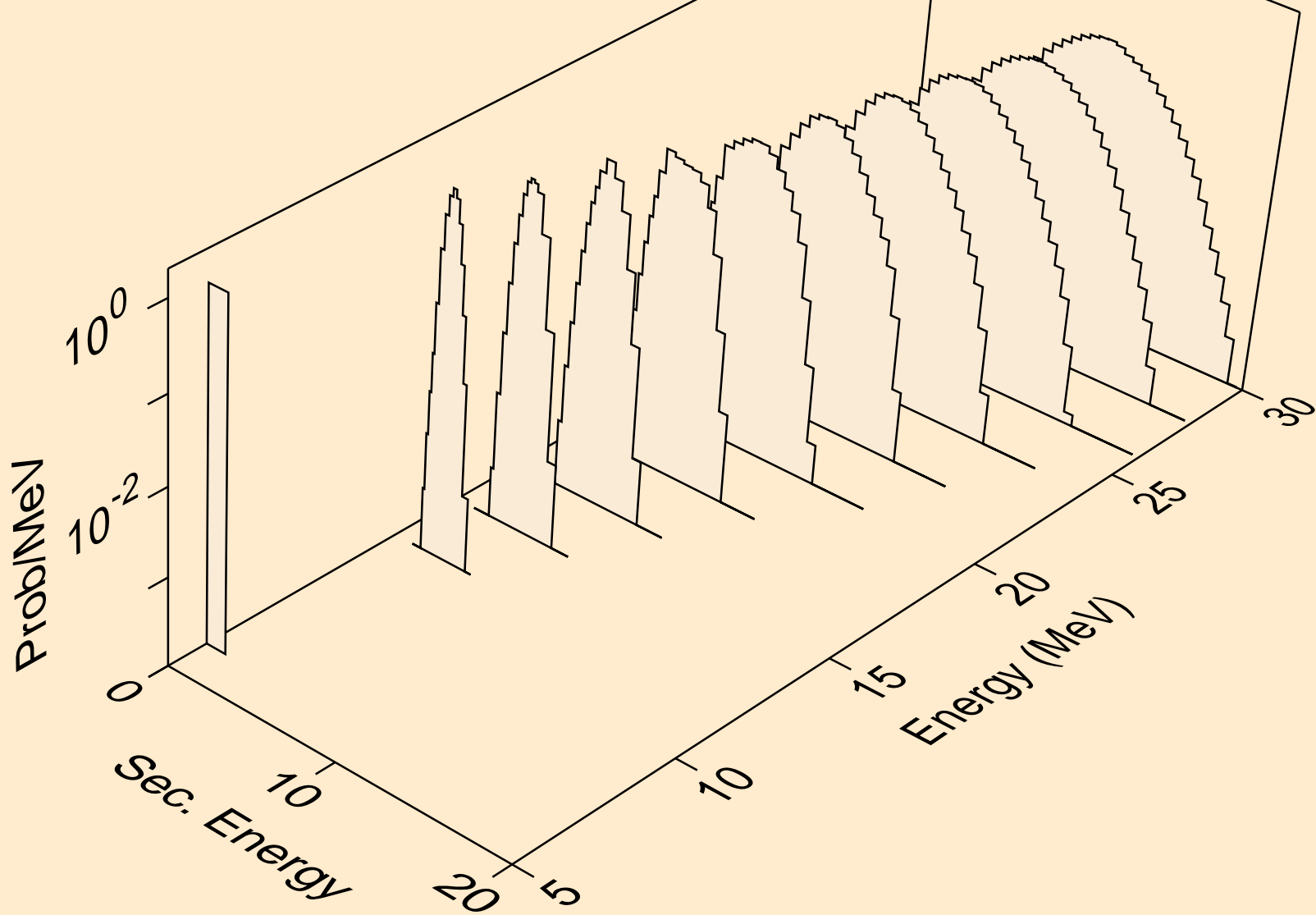

FR212 NEUTRON ACER TENDL-2021 LIBRARY; T=293.6K
protons from (n,npa)

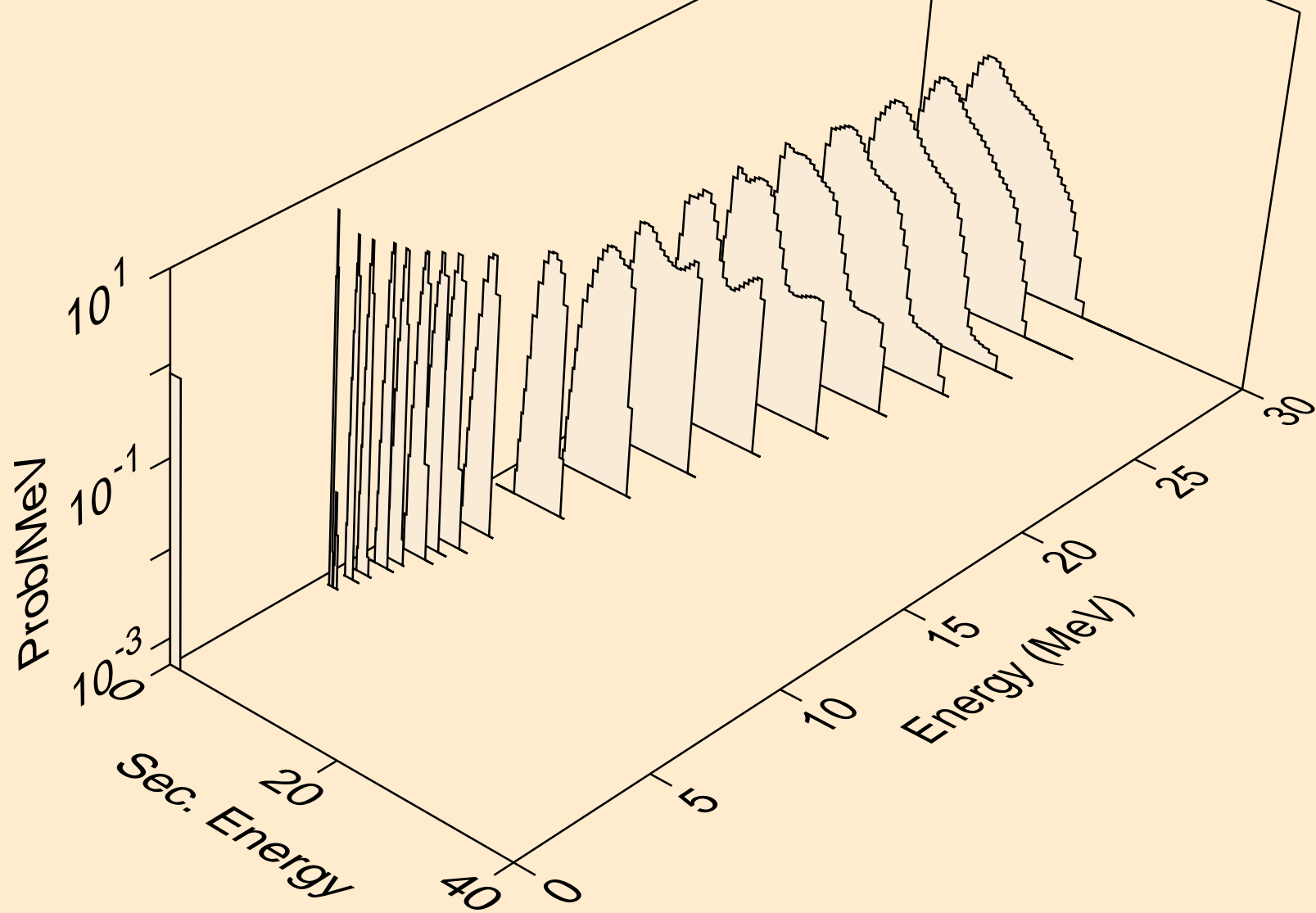

FR212 NEUTRON ACER TENDL-2021 LIBRARY; T=293.6K
protons from (n,p)

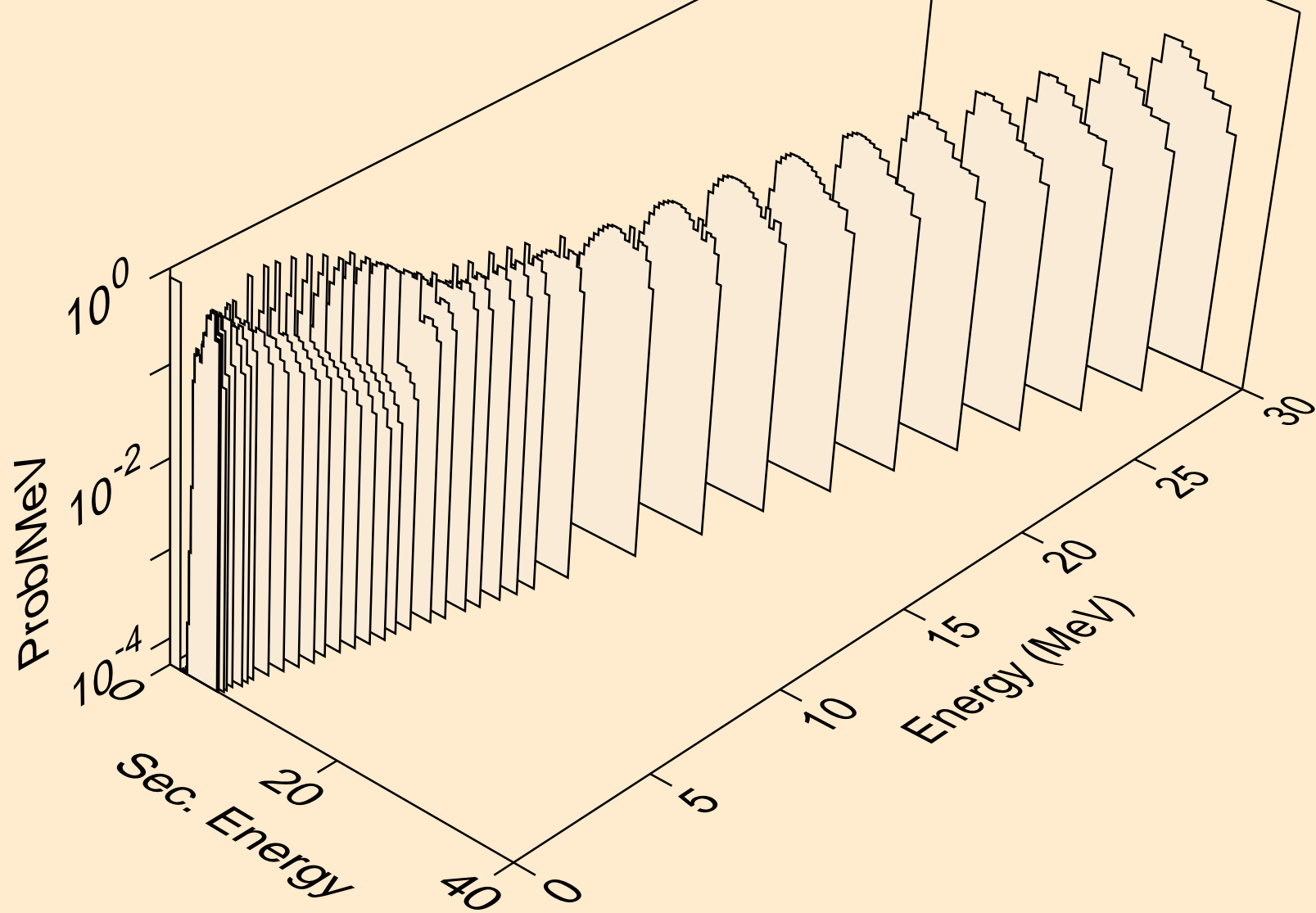

FR212 NEUTRON ACER TENDL-2021 LIBRARY; T=293.6K
protons from (n,2p)

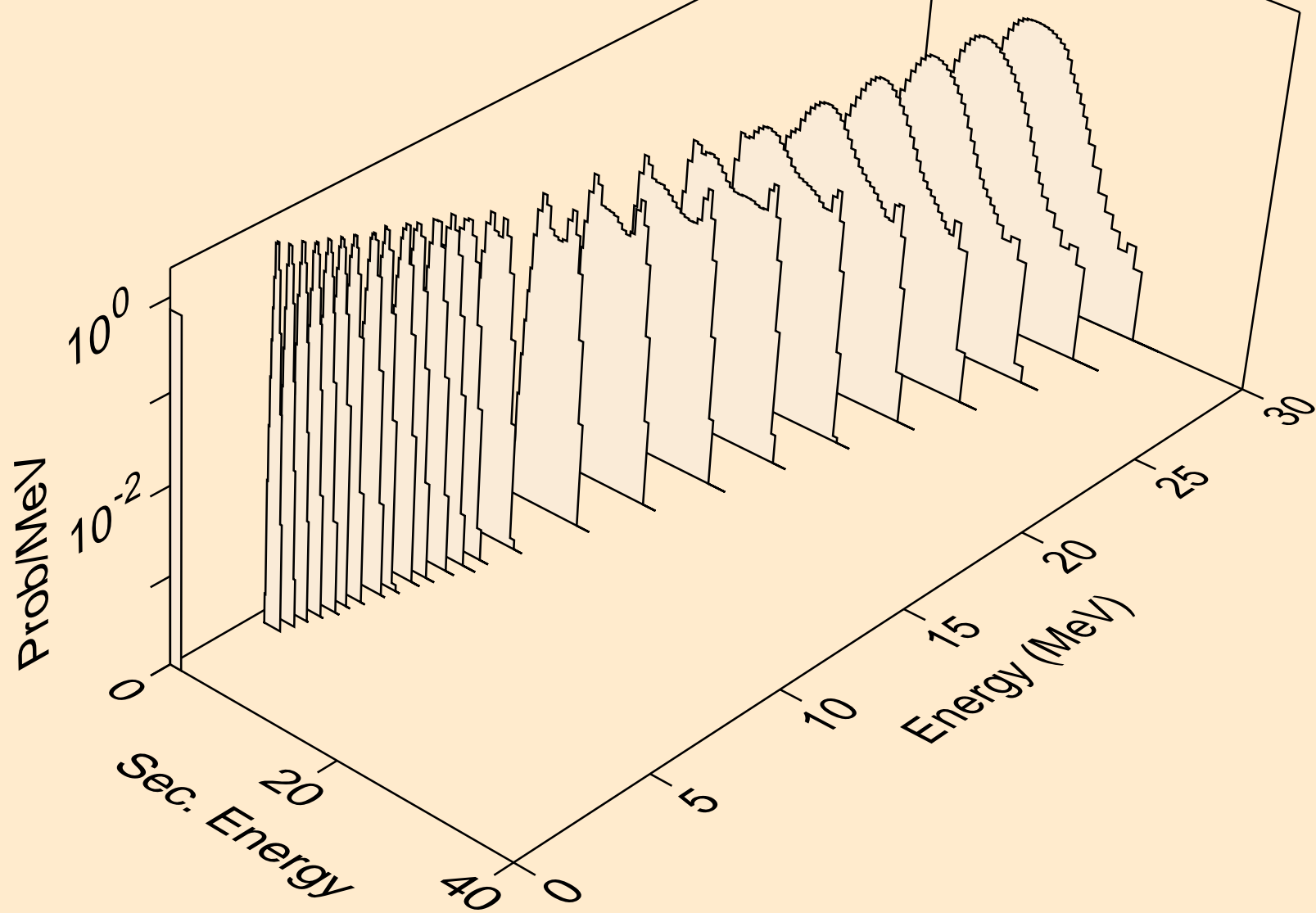

FR212 NEUTRON ACER TENDL-2021 LIBRARY; T=293.6K
protons from (n,p)

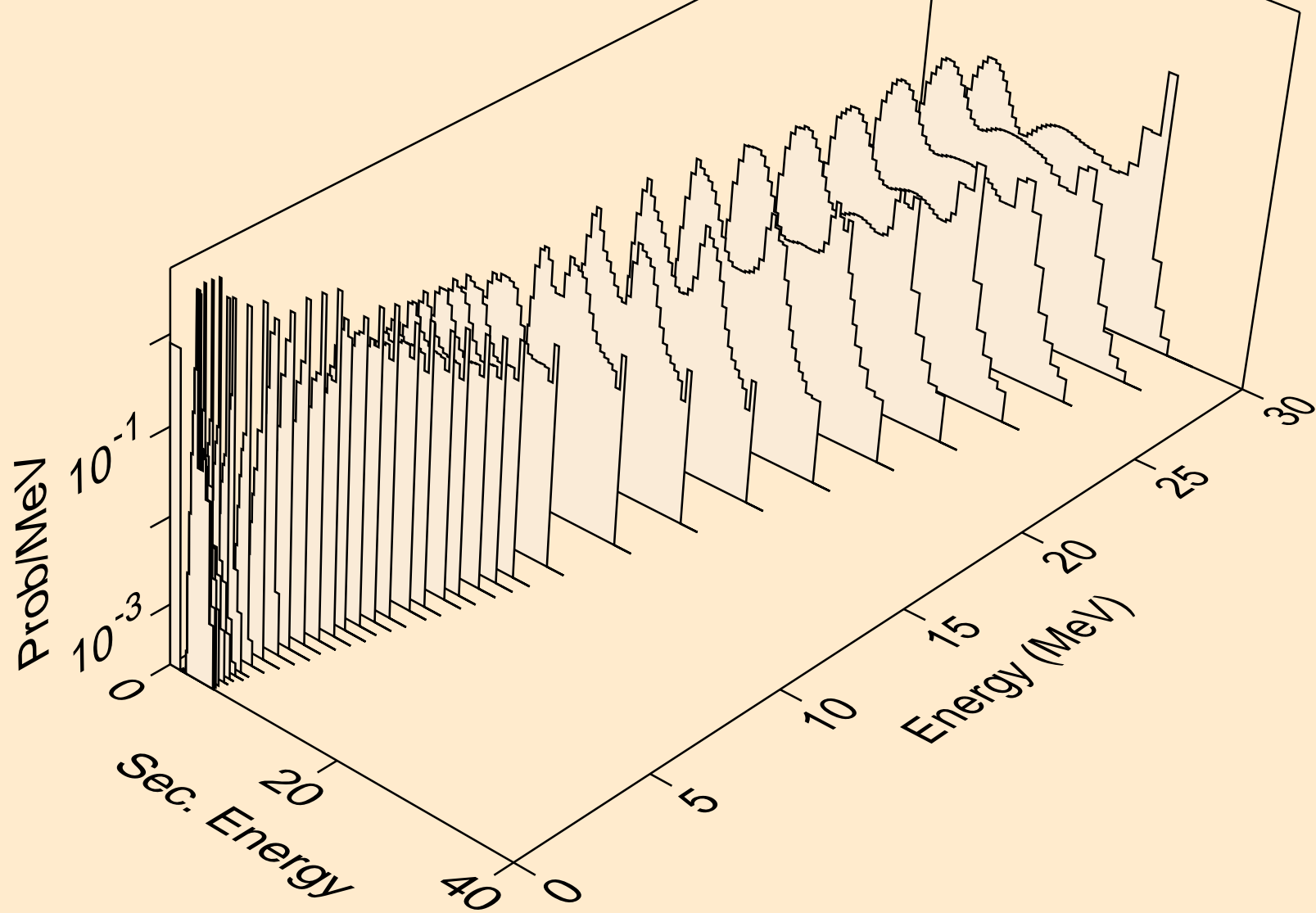

FR212 NEUTRON ACER TENDL-2021 LIBRARY; T=293.6K
protons from (n,pd)

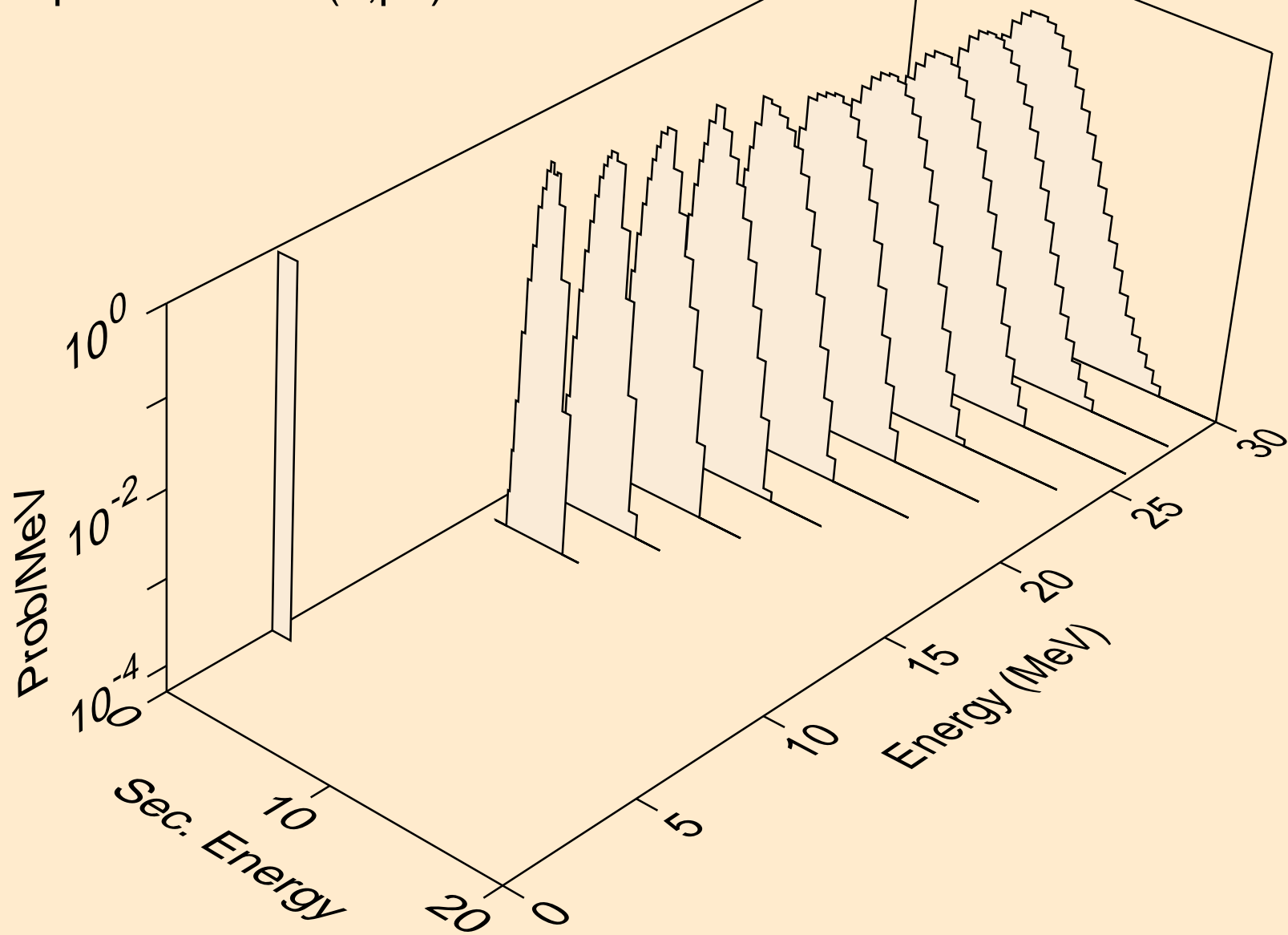

FR212 NEUTRON ACER TENDL-2021 LIBRARY; T=293.6K
protons from (n,pt)

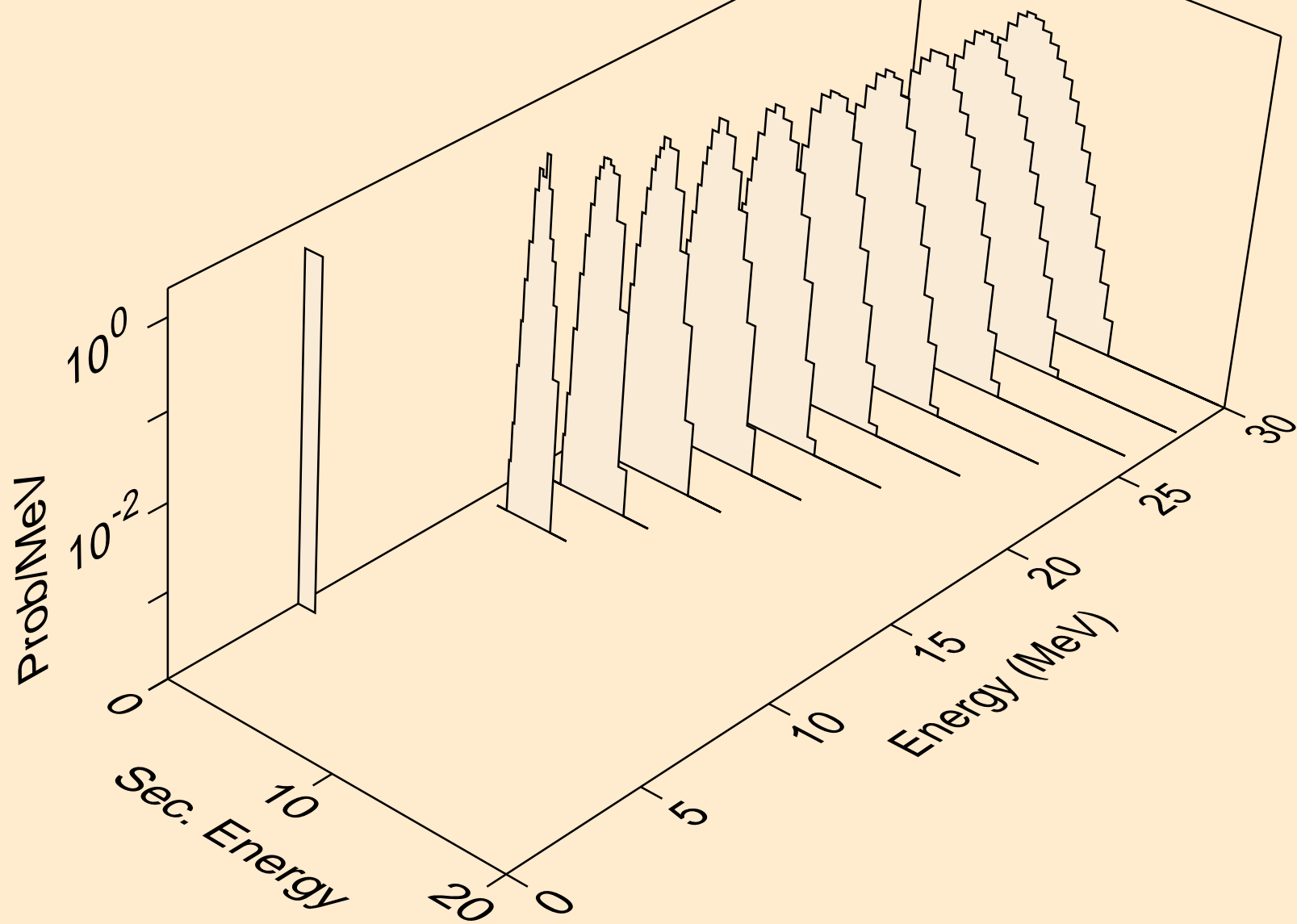

FR212 NEUTRON ACER TENDL-2021 LIBRARY; T=293.6K
deuterons from (n,x)

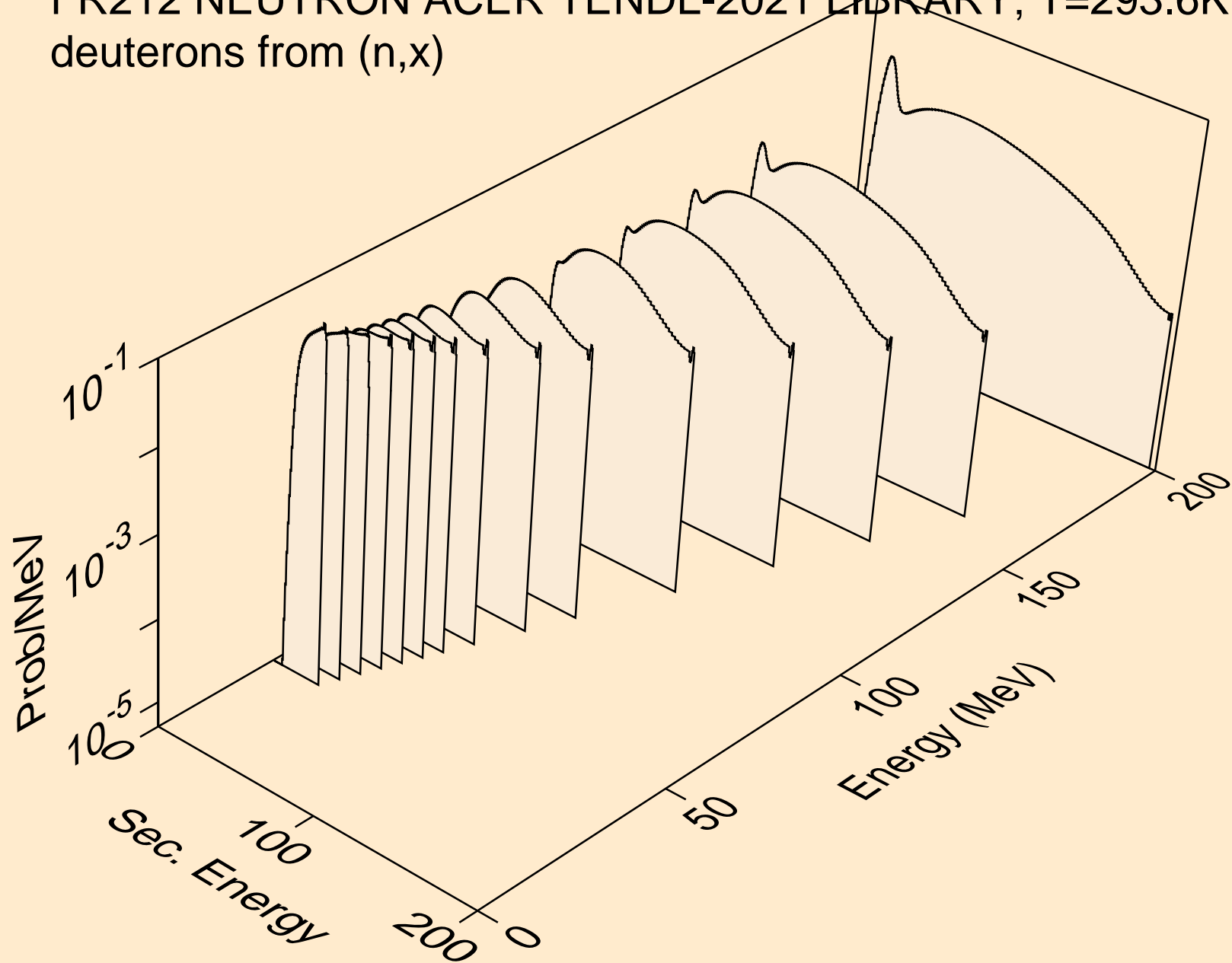

FR212 NEUTRON ACER TENDL-2021 LIBRARY; T=293.6K
deuterons from (n,2nd)

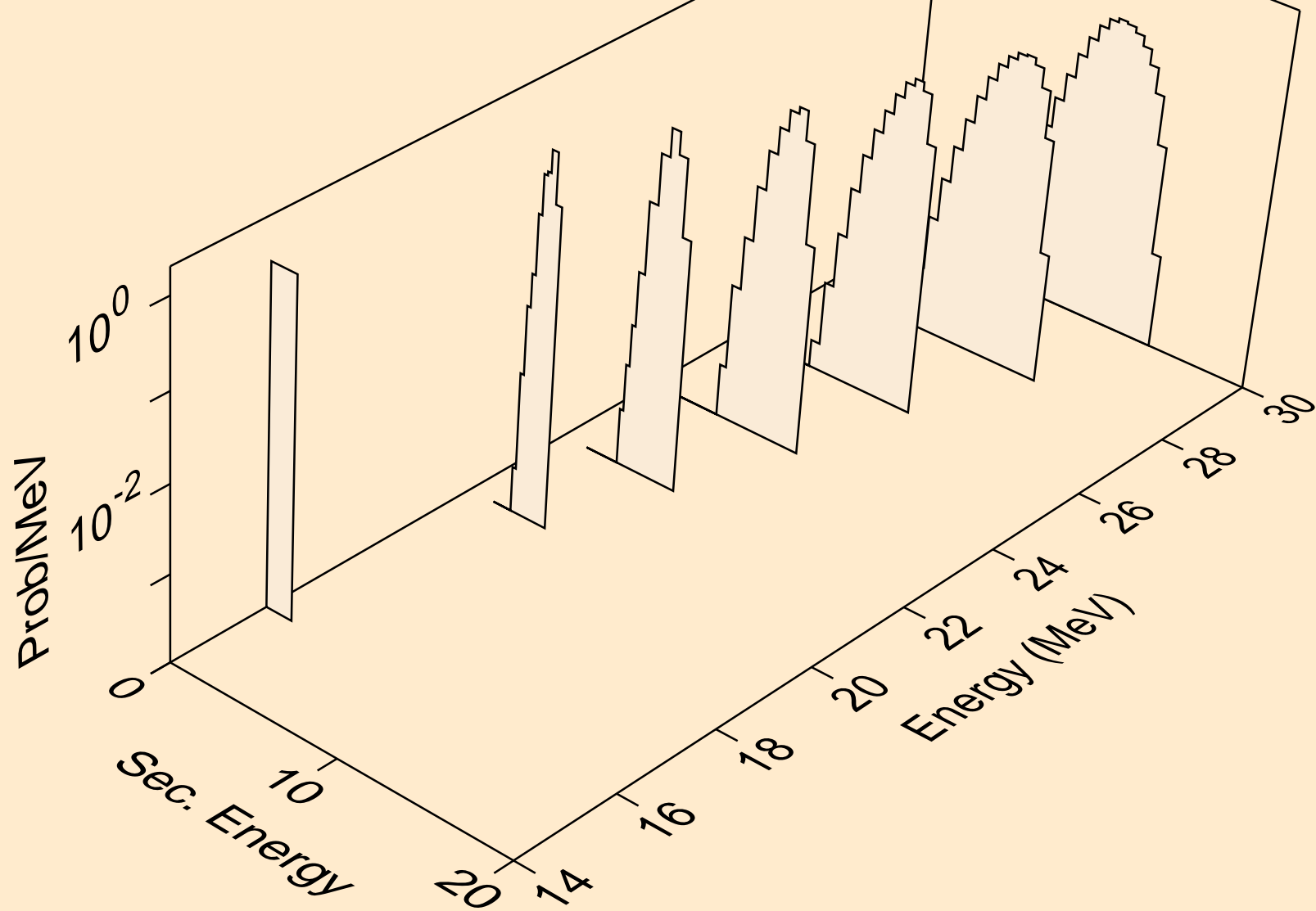

FR212 NEUTRON ACER TENDL-2021 LIBRARY; T=293.6K
deuterons from (n,n*)d

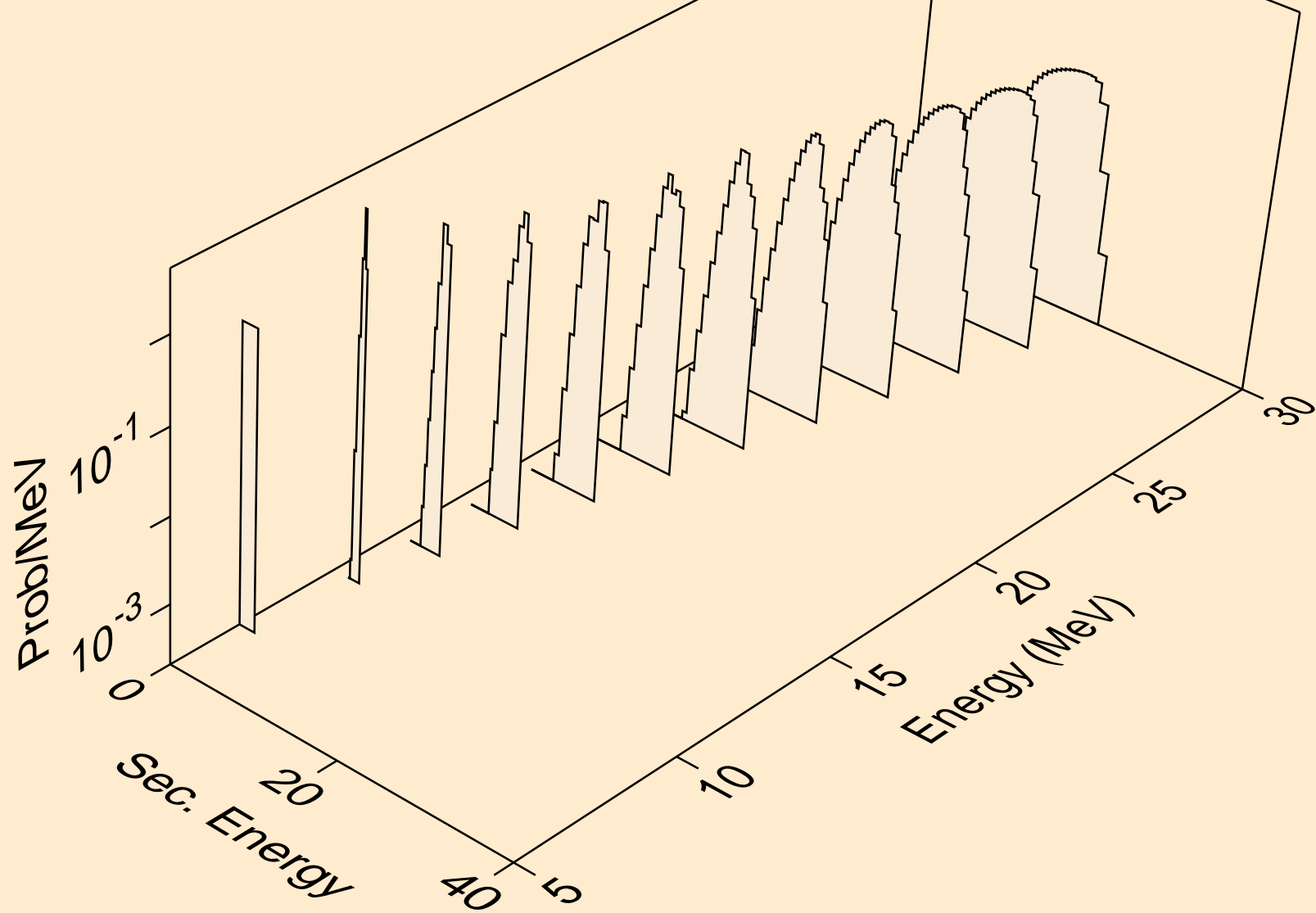

FR212 NEUTRON ACER TENDL-2021 LIBRARY; T=293.6K
deuterons from (n,d)

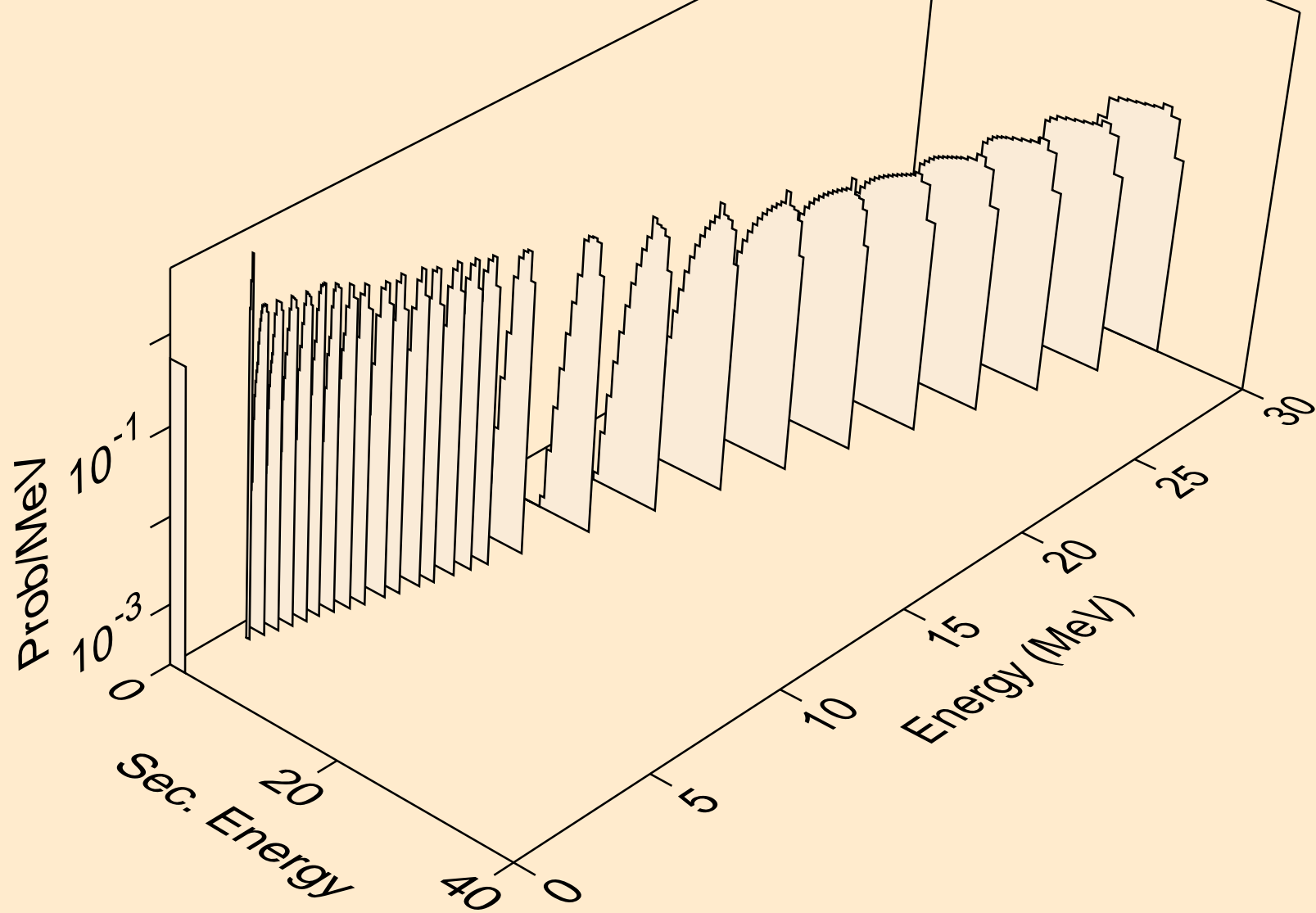

FR212 NEUTRON ACER TENDL-2021 LIBRARY; T=293.6K
deuterons from (n,pd)

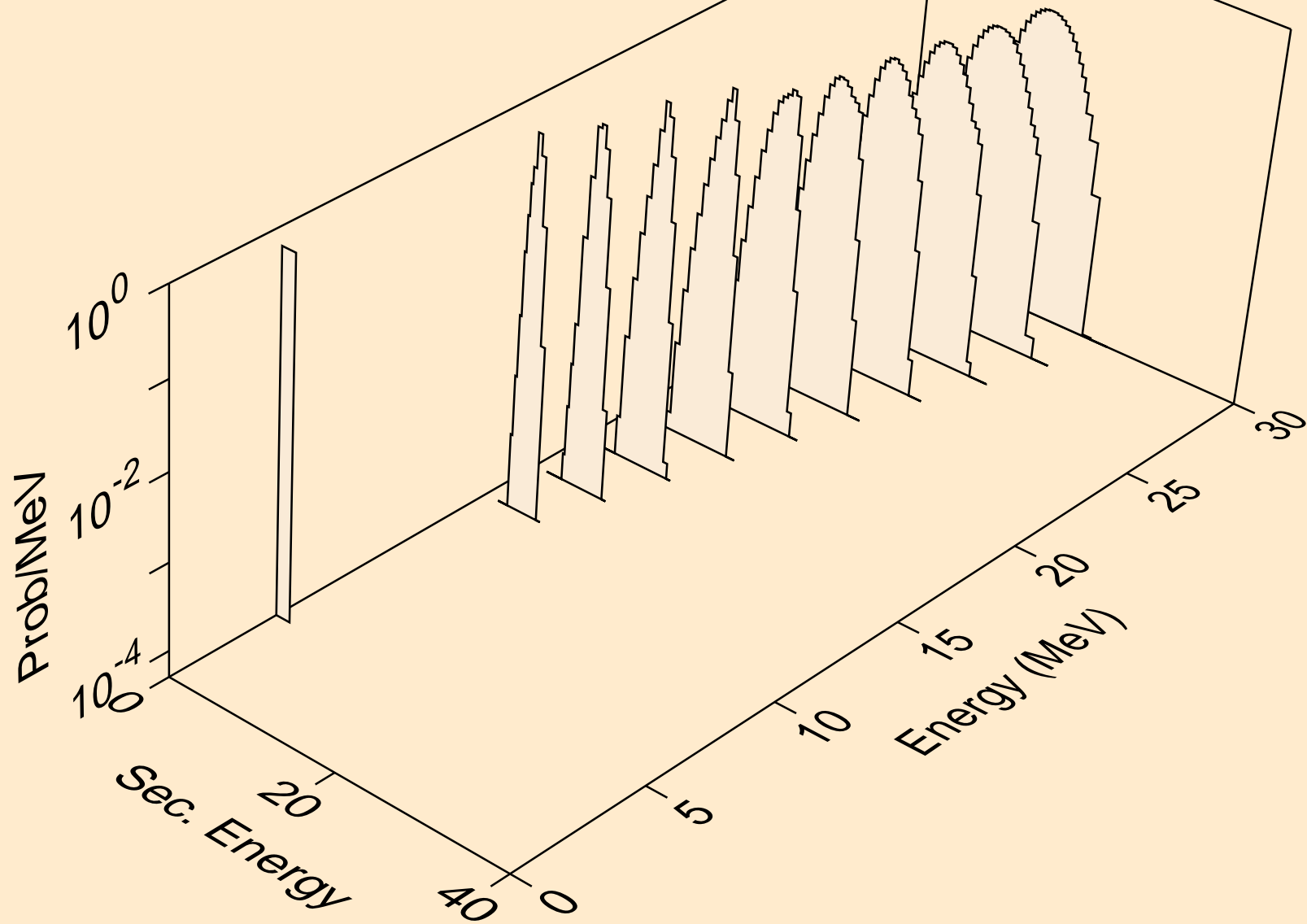

FR212 NEUTRON ACER TENDL-2021 LIBRARY; T=293.6K
deuterons from (n,da)

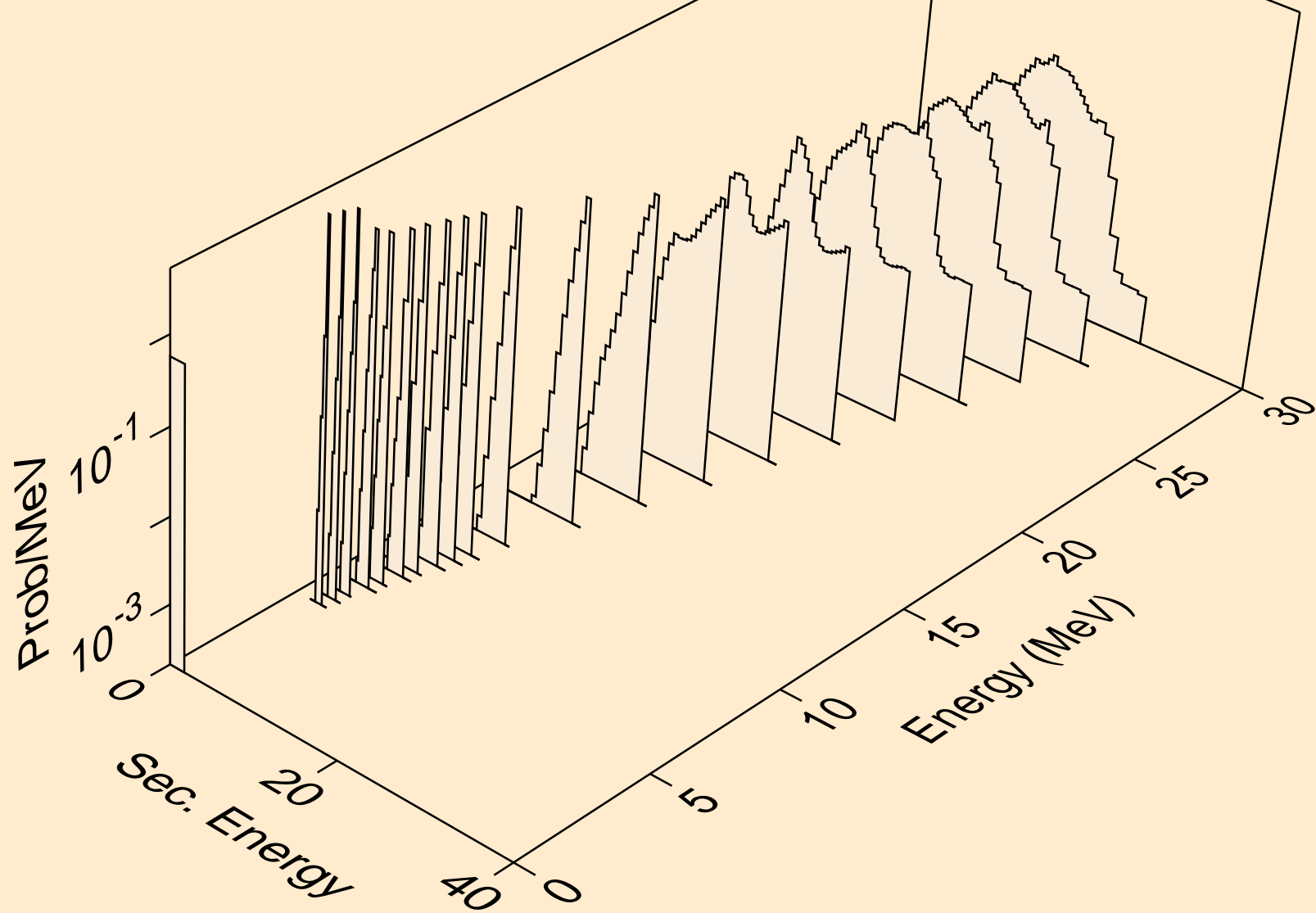

FR212 NEUTRON ACER TENDL-2021 LIBRARY; T=293.6K
tritons from (n,x)

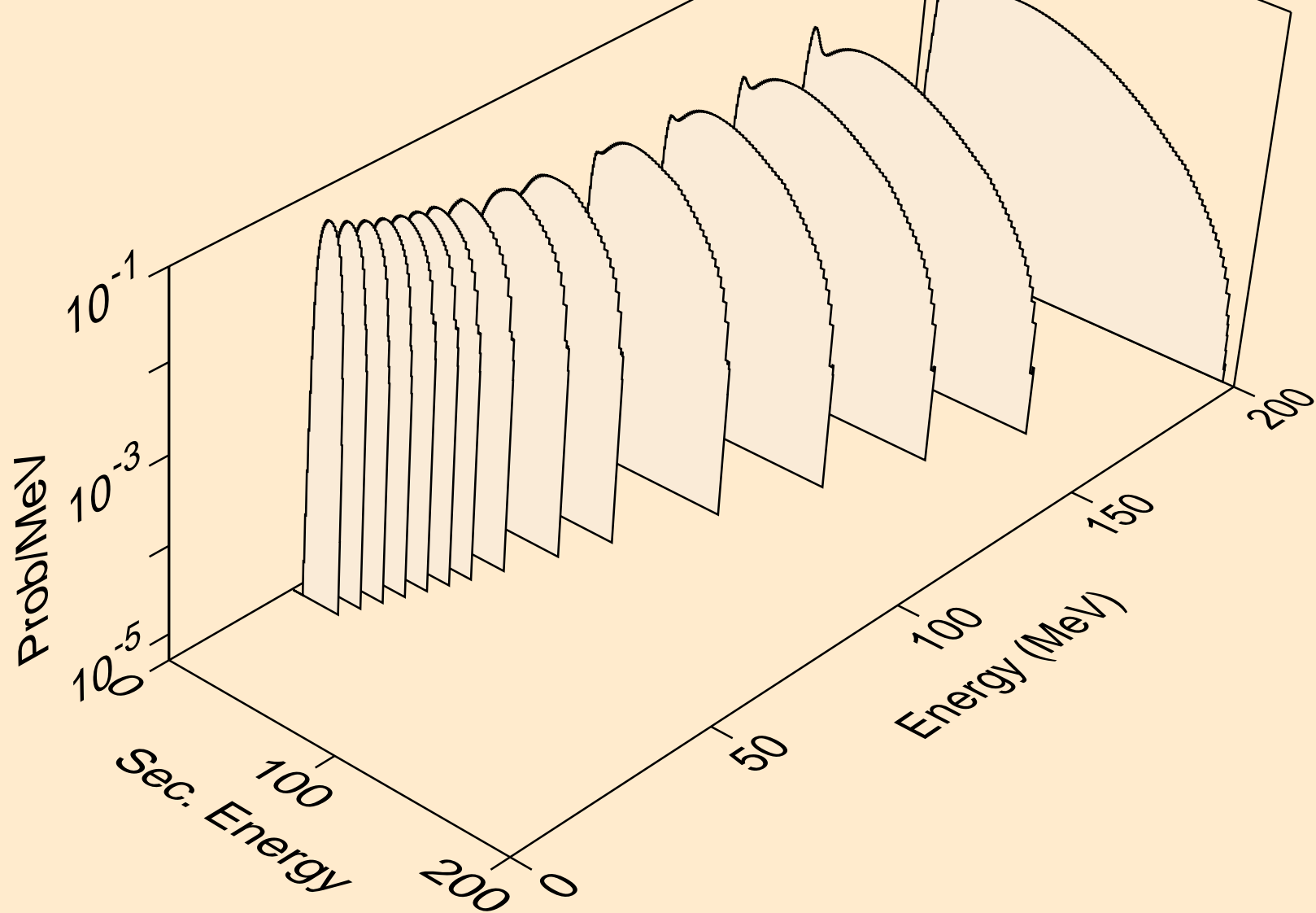

FR212 NEUTRON ACER TENDL-2021 LIBRARY; T=293.6K
tritons from (n,n*)t

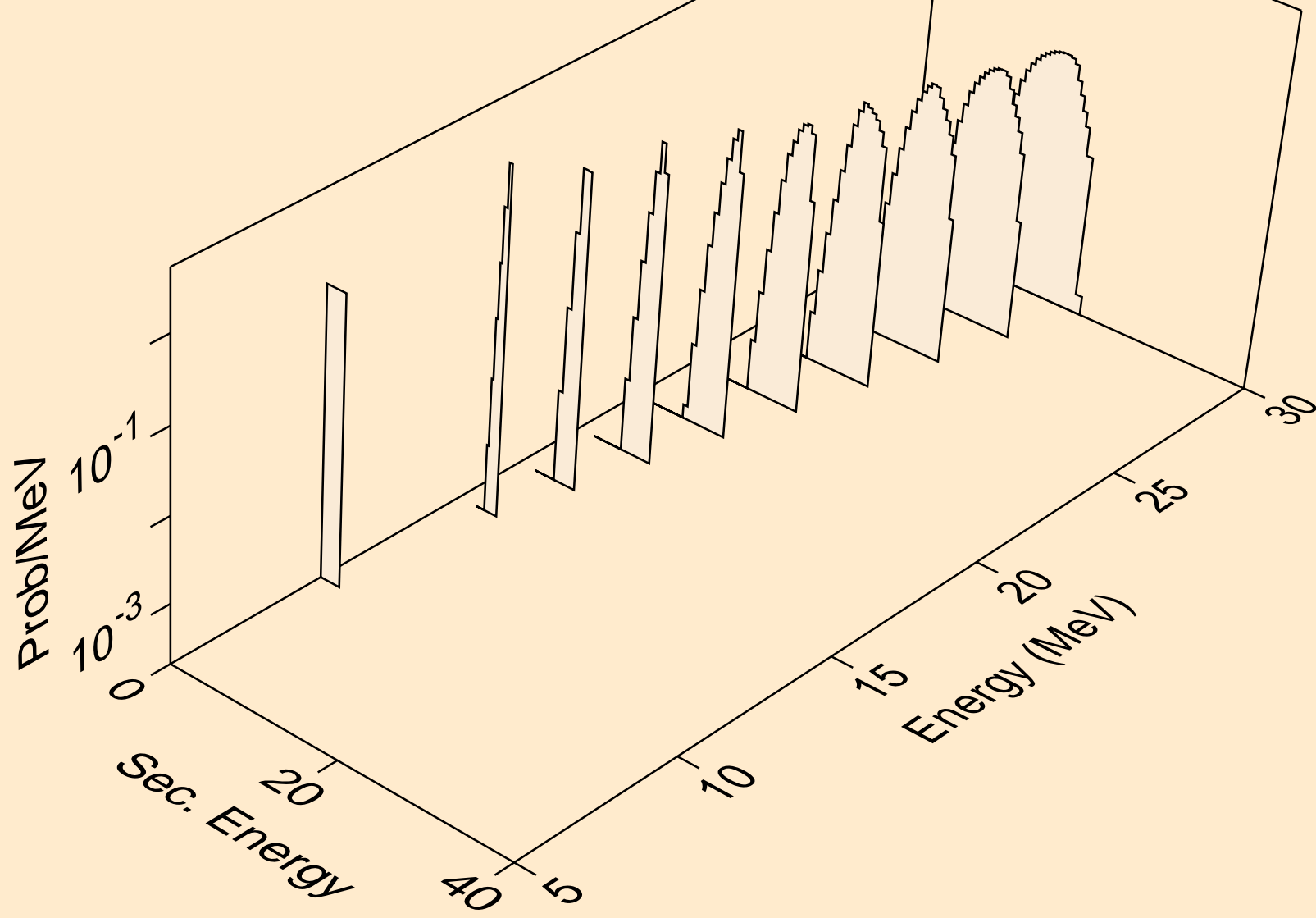

FR212 NEUTRON ACER TENDL-2021 LIBRARY; T=293.6K
tritons from (n,t)

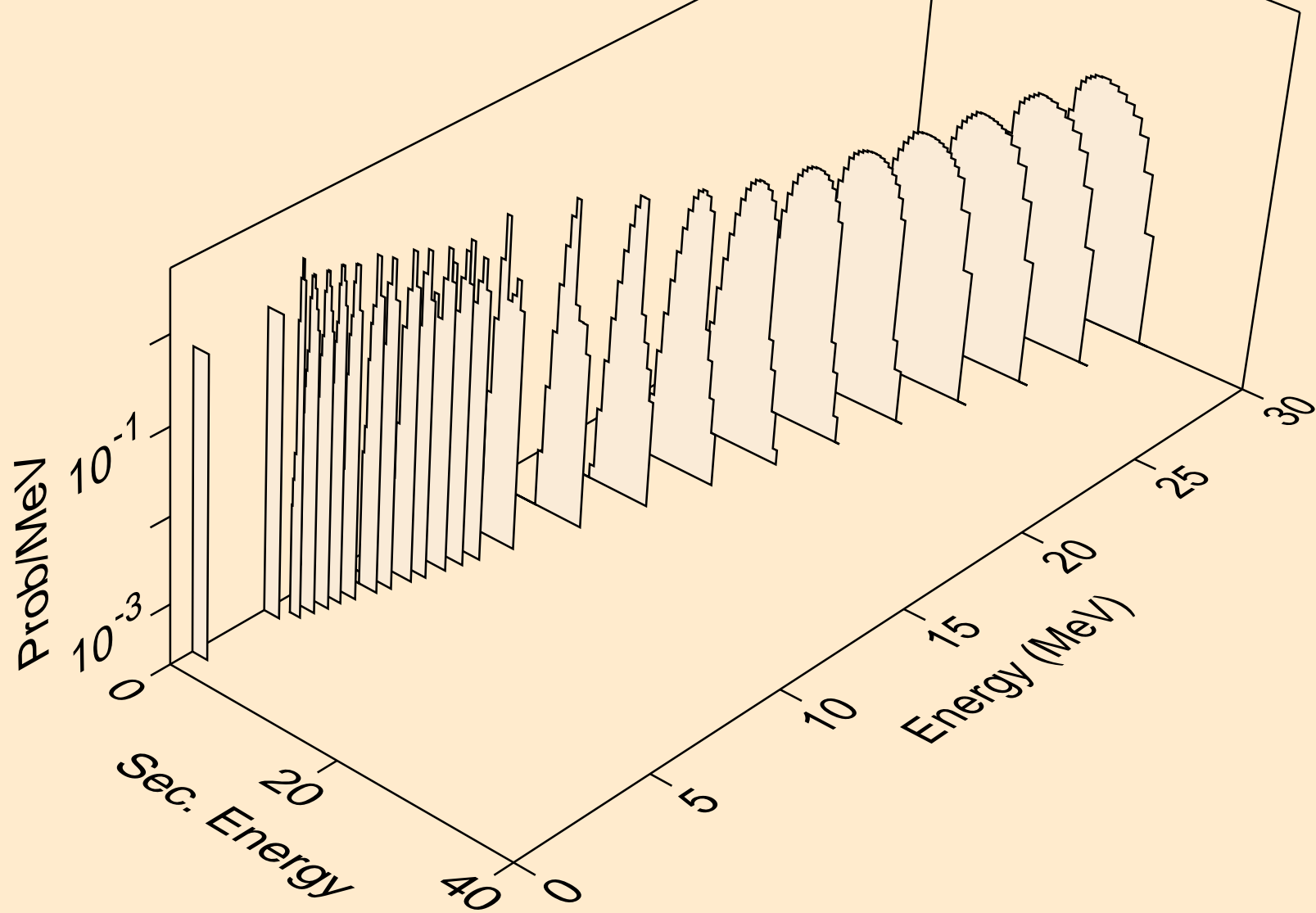

FR212 NEUTRON ACER TENDL-2021 LIBRARY; T=293.6K
tritons from (n,pt)

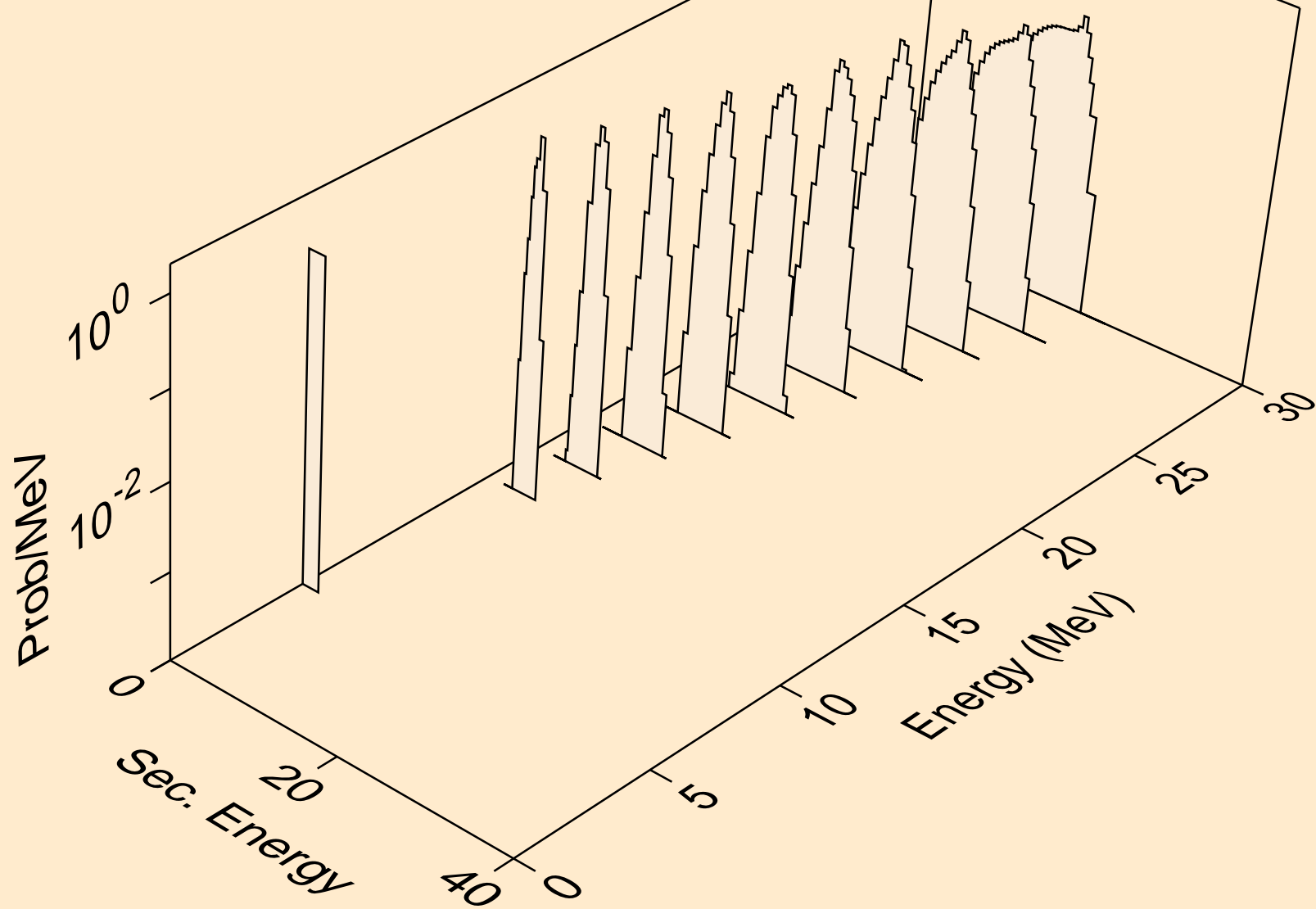

FR212 NEUTRON ACER TENDL-2021 LIBRARY; T=293.6K
he3s from (n,x)

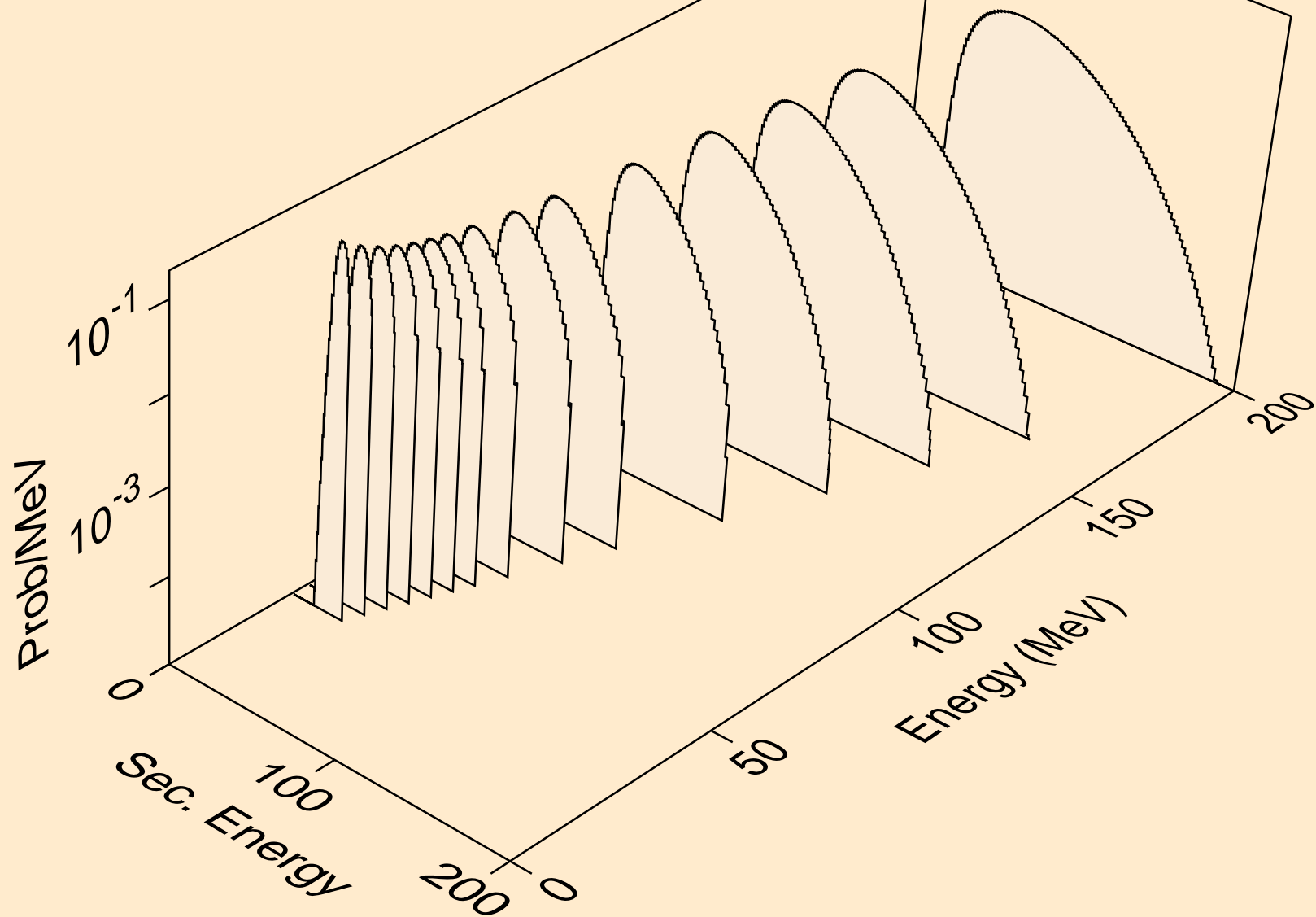

FR212 NEUTRON ACER TENDL-2021 LIBRARY; T=293.6K
he3s from (n,n*)he3

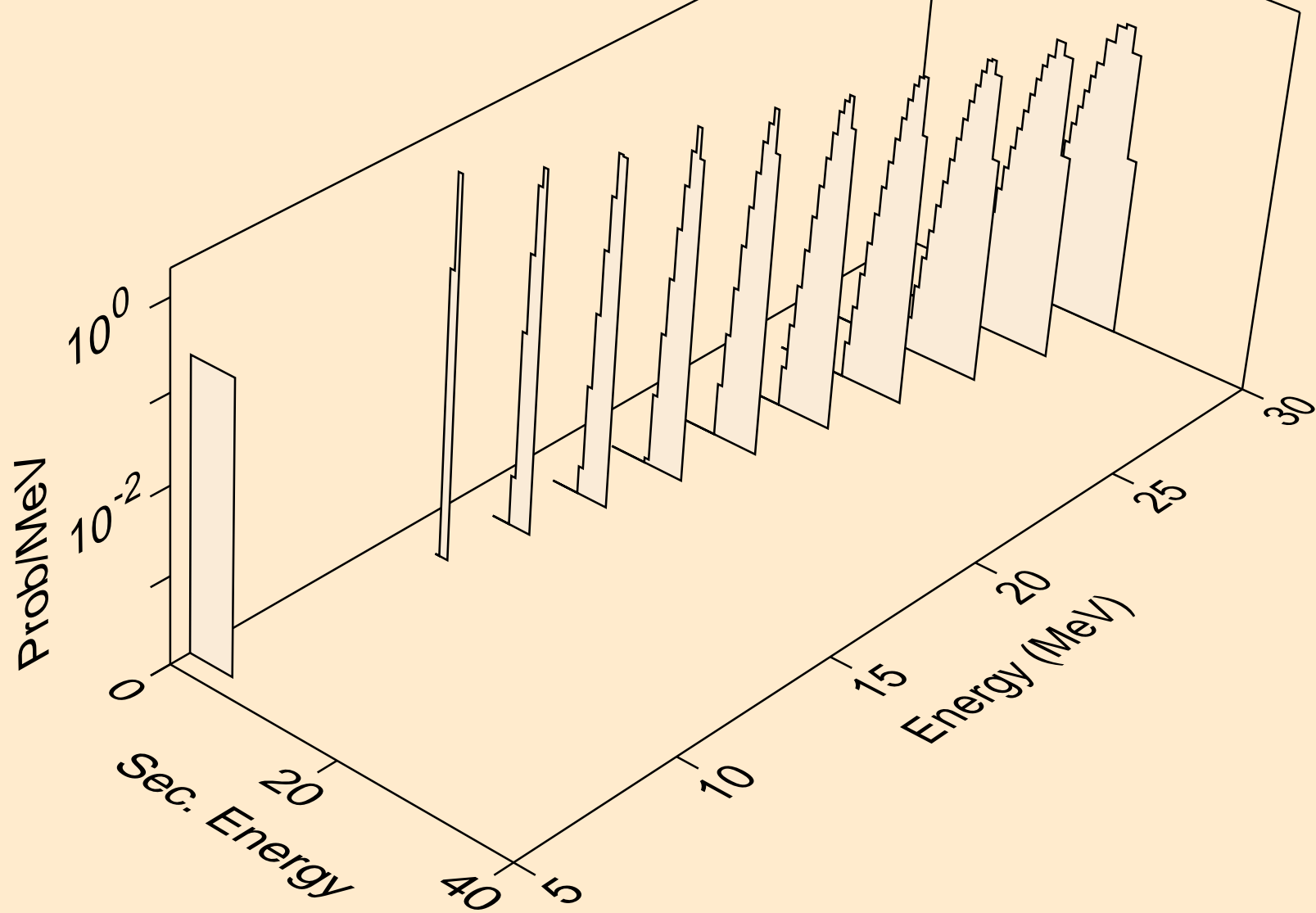

FR212 NEUTRON ACER TENDL-2021 LIBRARY; T=293.6K
he3s from (n,he3)

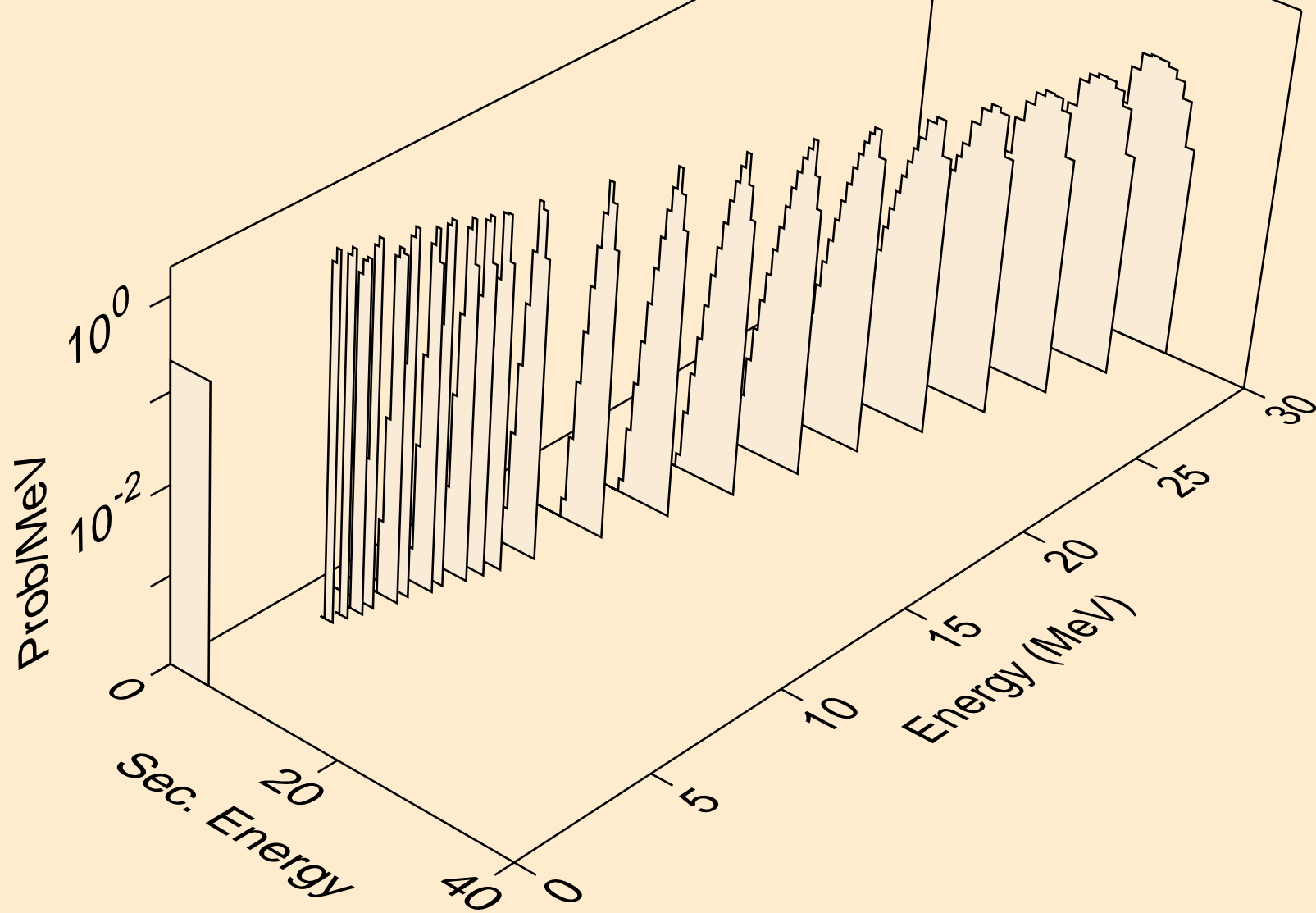

FR212 NEUTRON ACER TENDL-2021 LIBRARY; T=293.6K
alphas from (n,x)

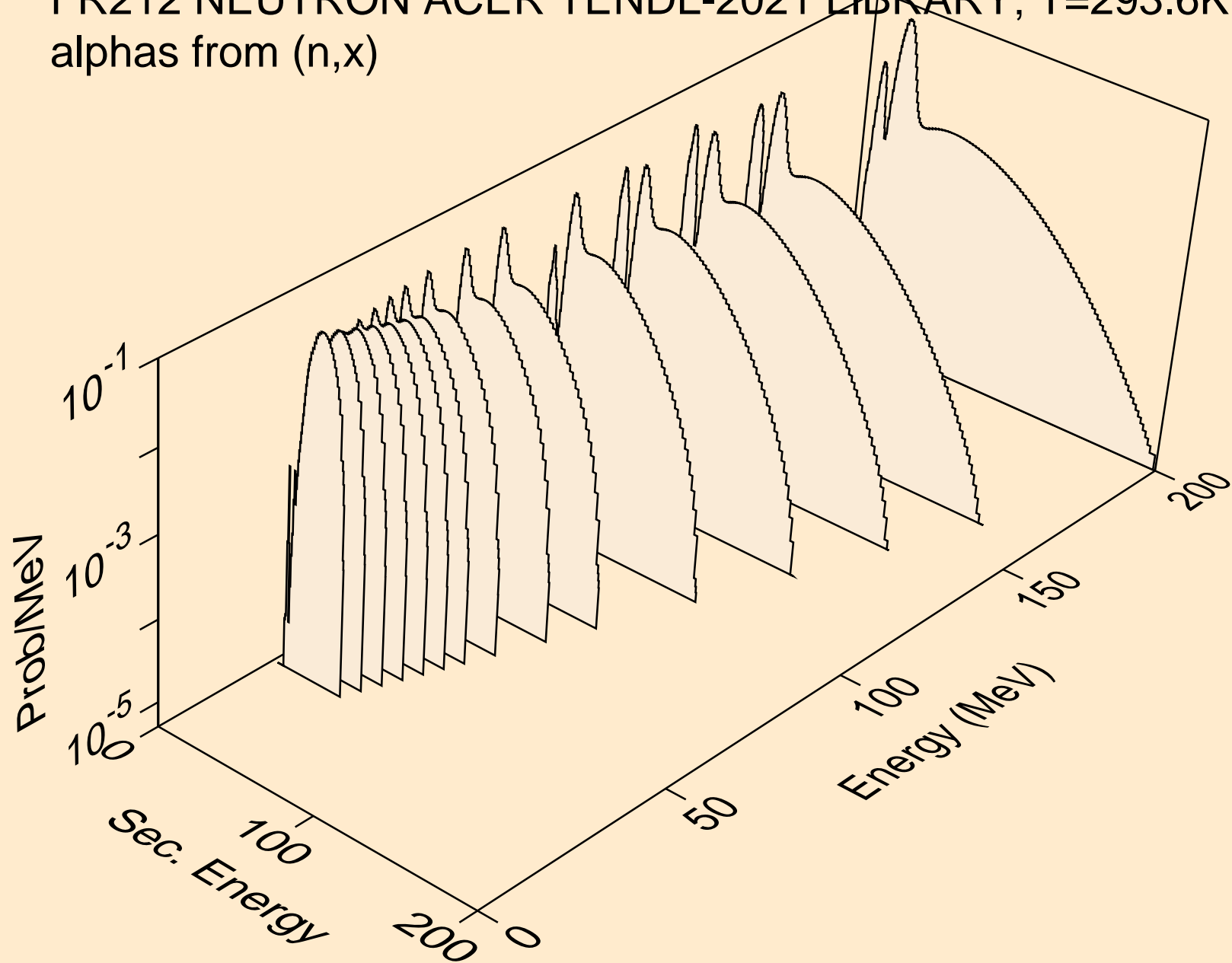

FR212 NEUTRON ACER TENDL-2021 LIBRARY; T=293.6K
alphas from (n,n*)a

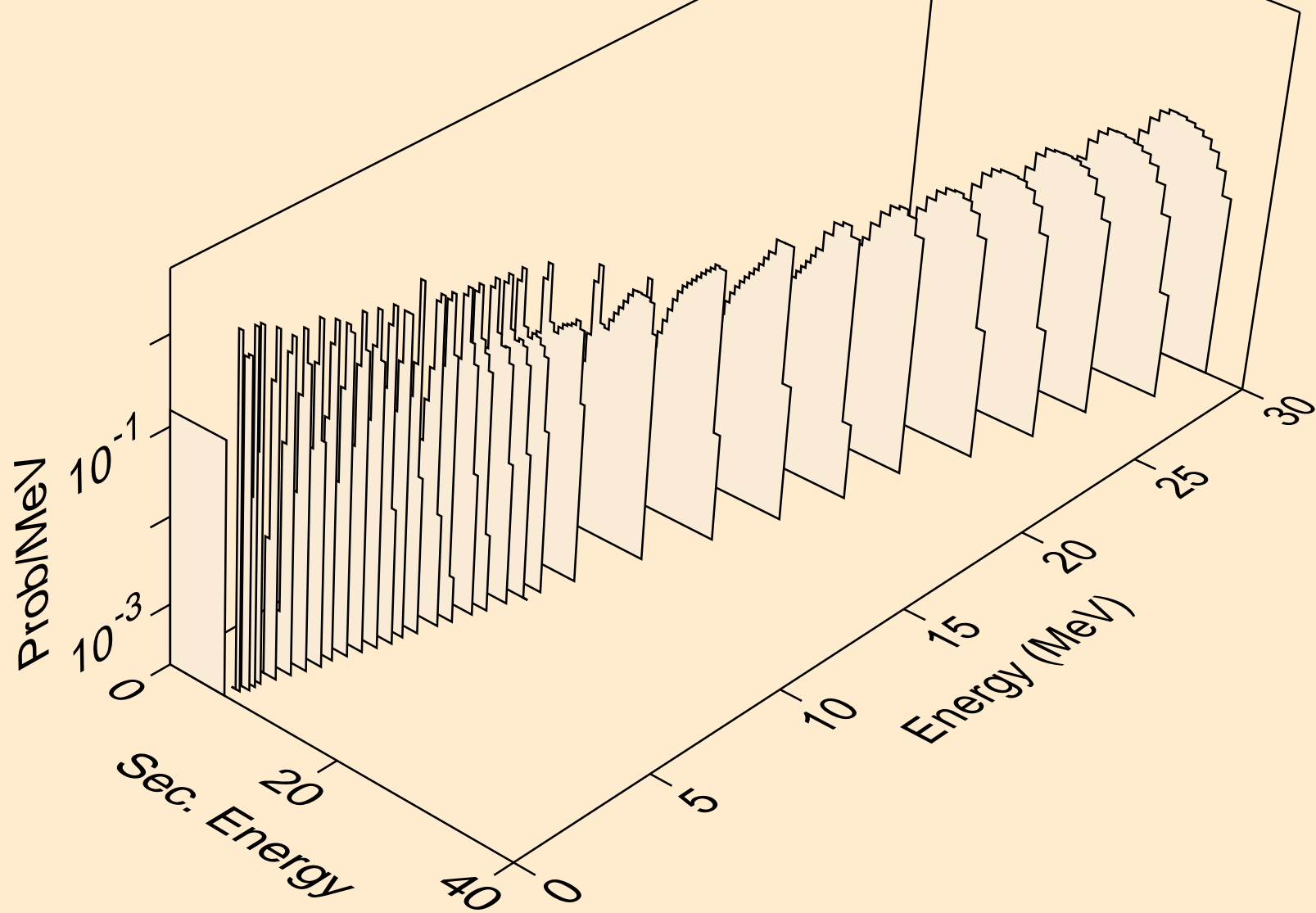

FR212 NEUTRON ACER TENDL-2021 LIBRARY; T=293.6K
alphas from (n,2n)a

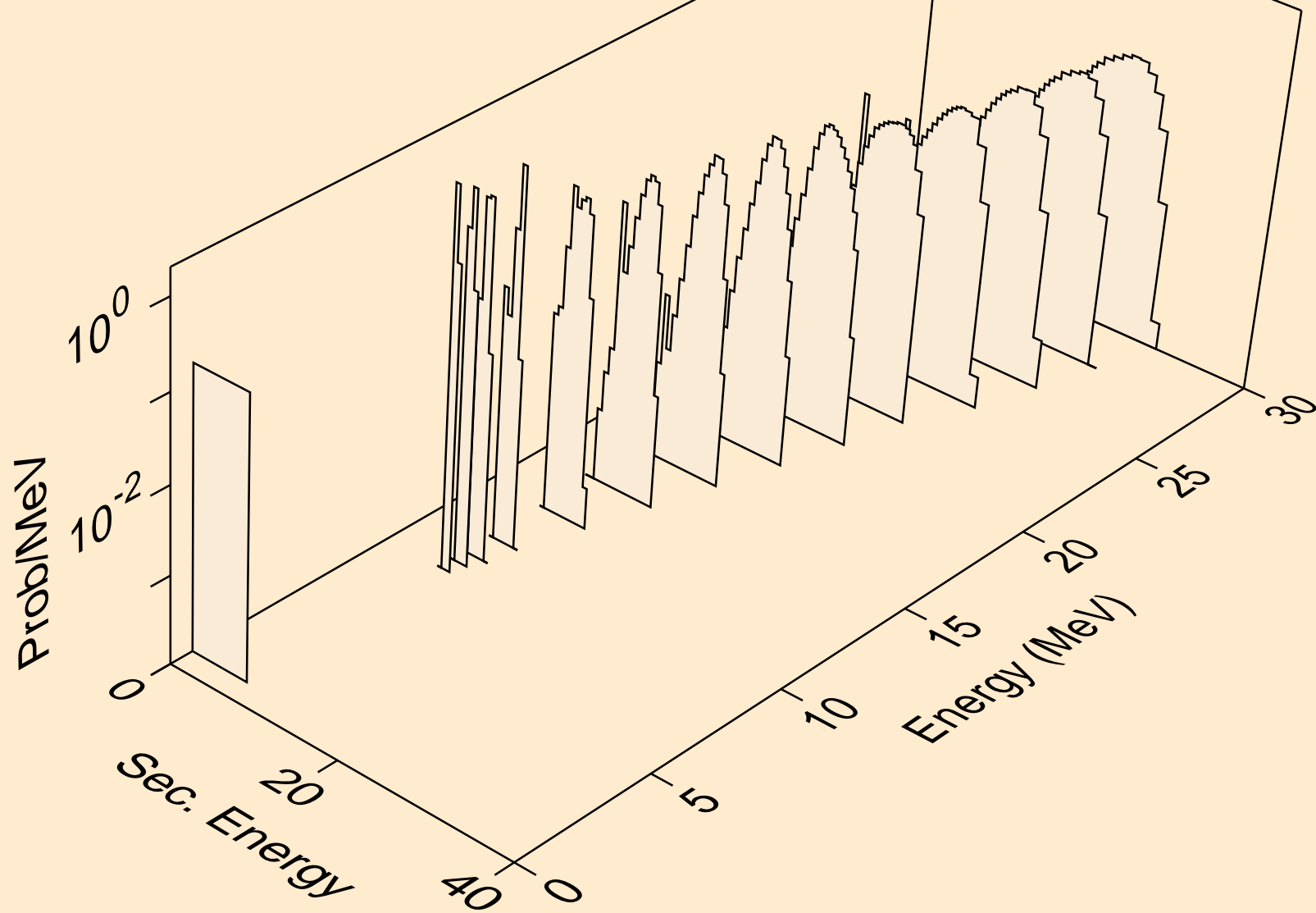

FR212 NEUTRON ACER TENDL-2021 LIBRARY; T=293.6K
alphas from (n,3n)a

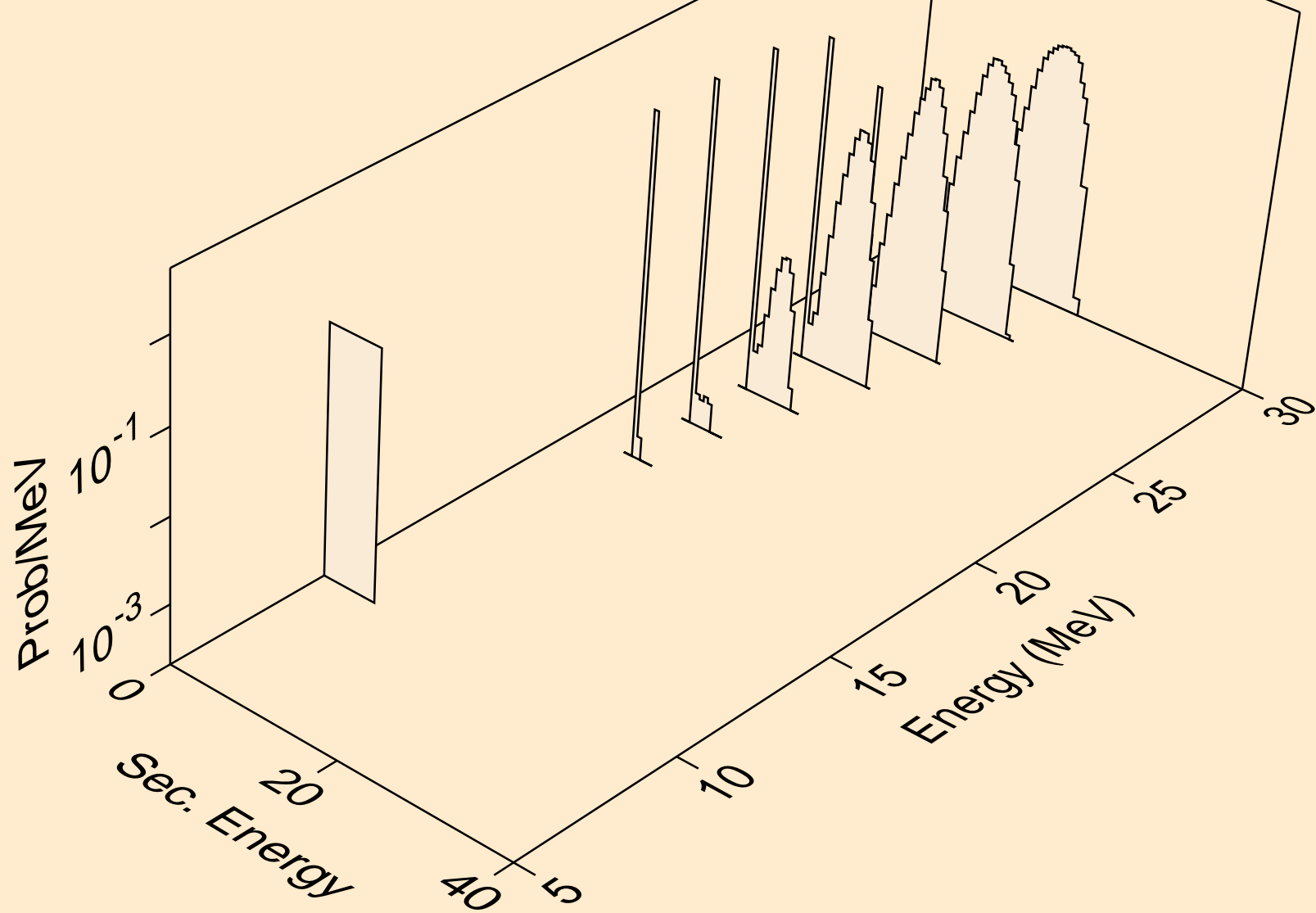

FR212 NEUTRON ACER TENDL-2021 LIBRARY; T=293.6K
alphas from (n,n*)2a

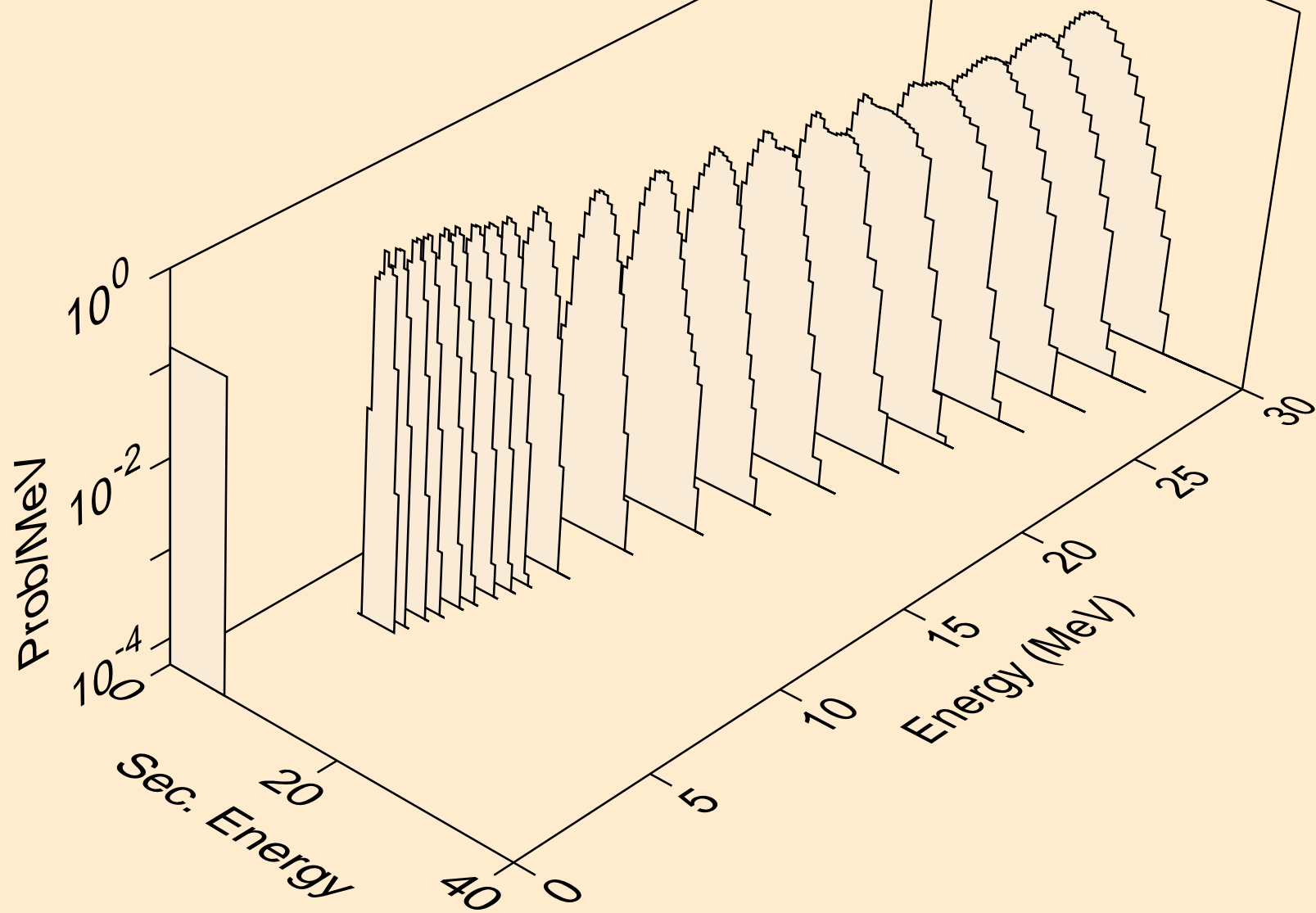

FR212 NEUTRON ACER TENDL-2021 LIBRARY; T=293.6K
alphas from (n,2n)2a

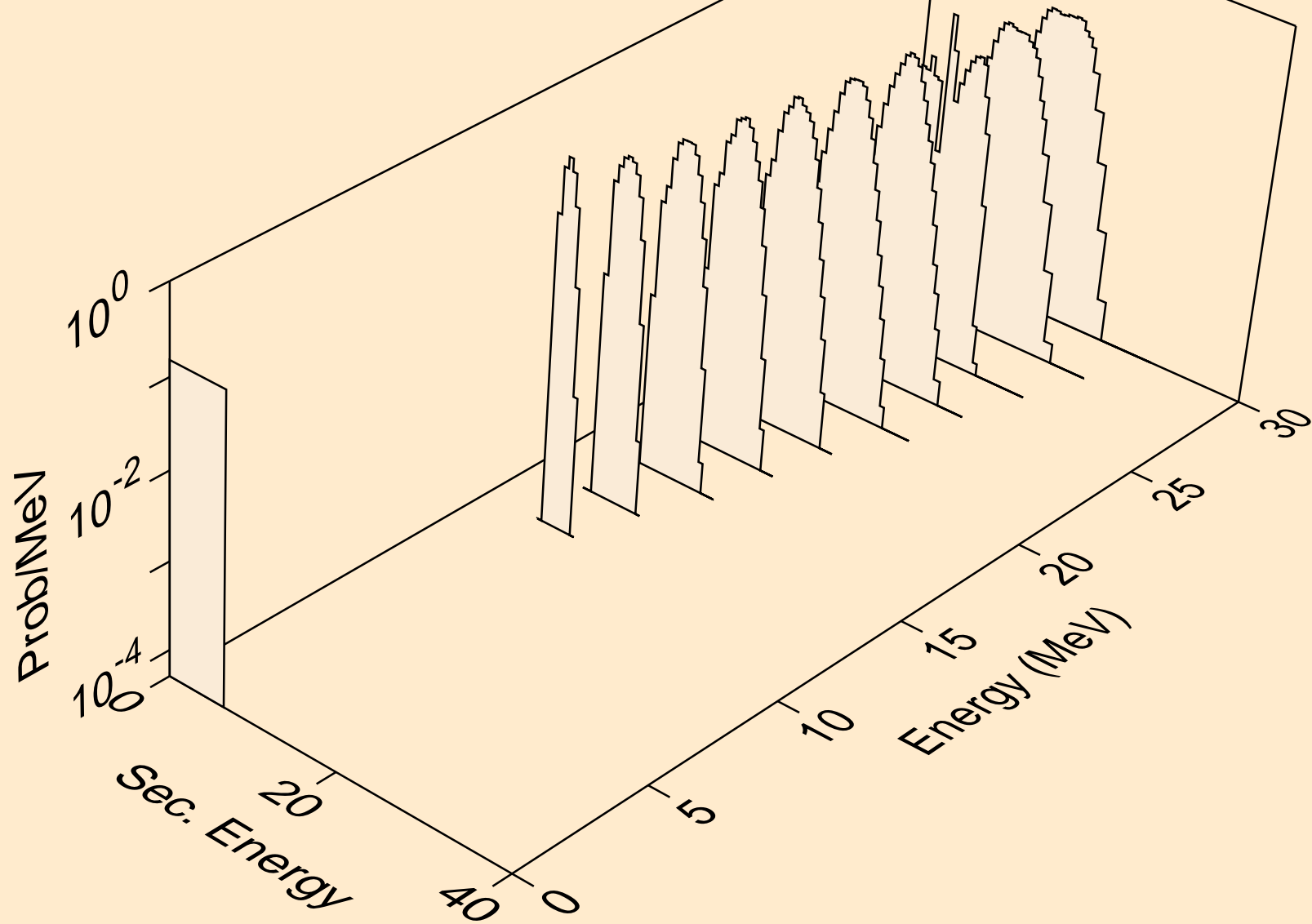

FR212 NEUTRON ACER TENDL-2021 LIBRARY; T=293.6K
alphas from (n,npa)

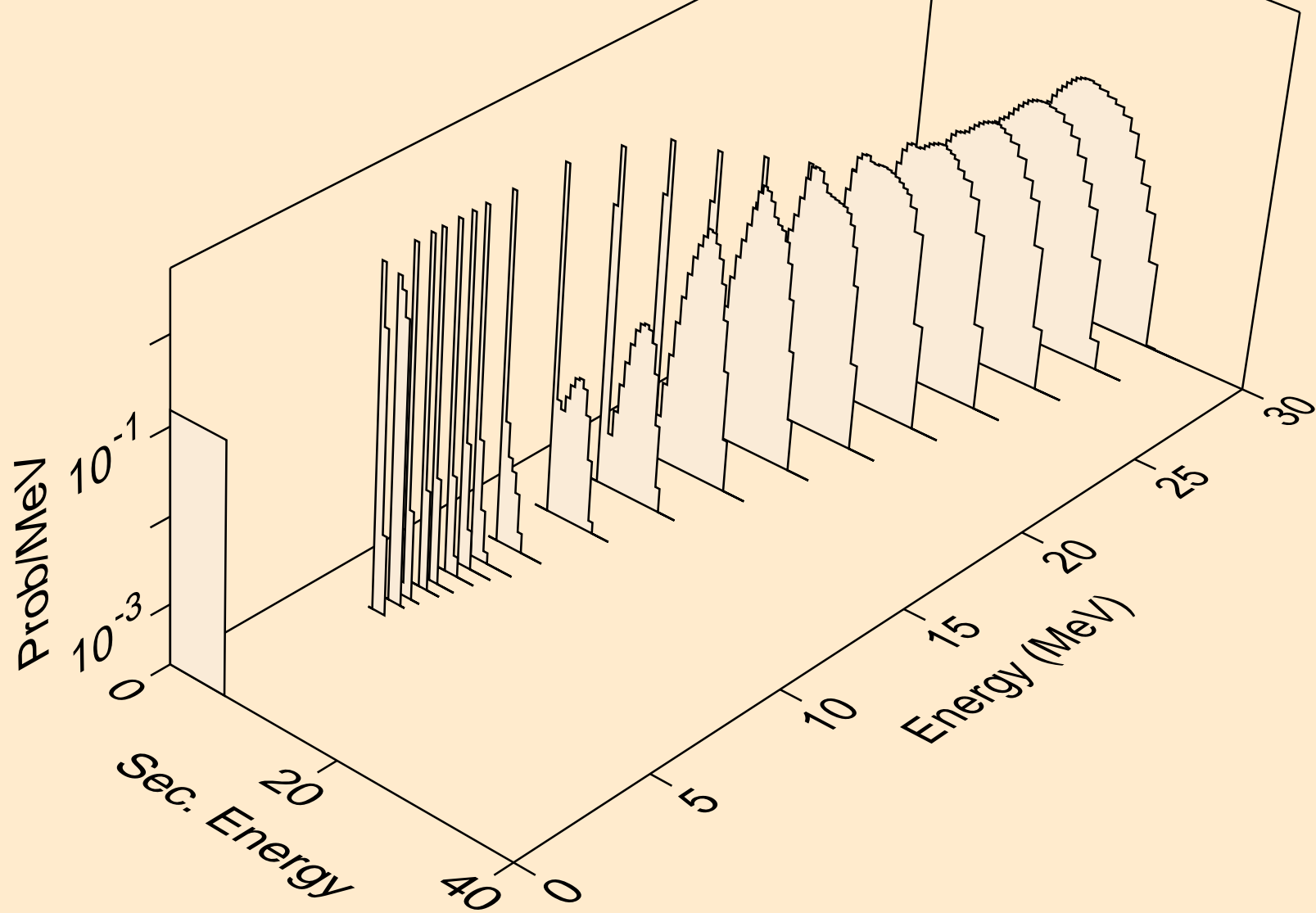

FR212 NEUTRON ACER TENDL-2021 LIBRARY; T=293.6K
alphas from (n,a)

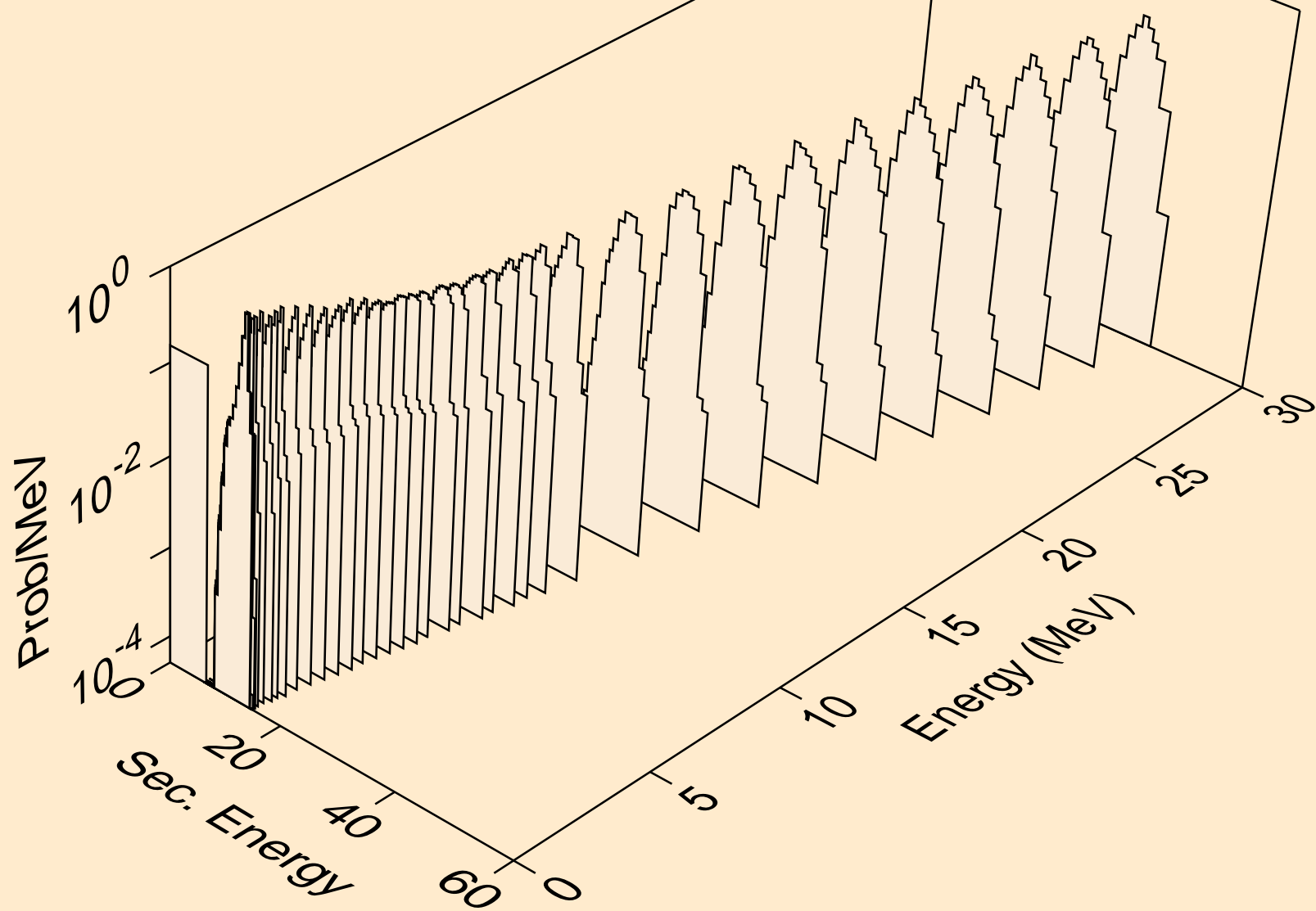

FR212 NEUTRON ACER TENDL-2021 LIBRARY; T=293.6K
alphas from (n,2a)

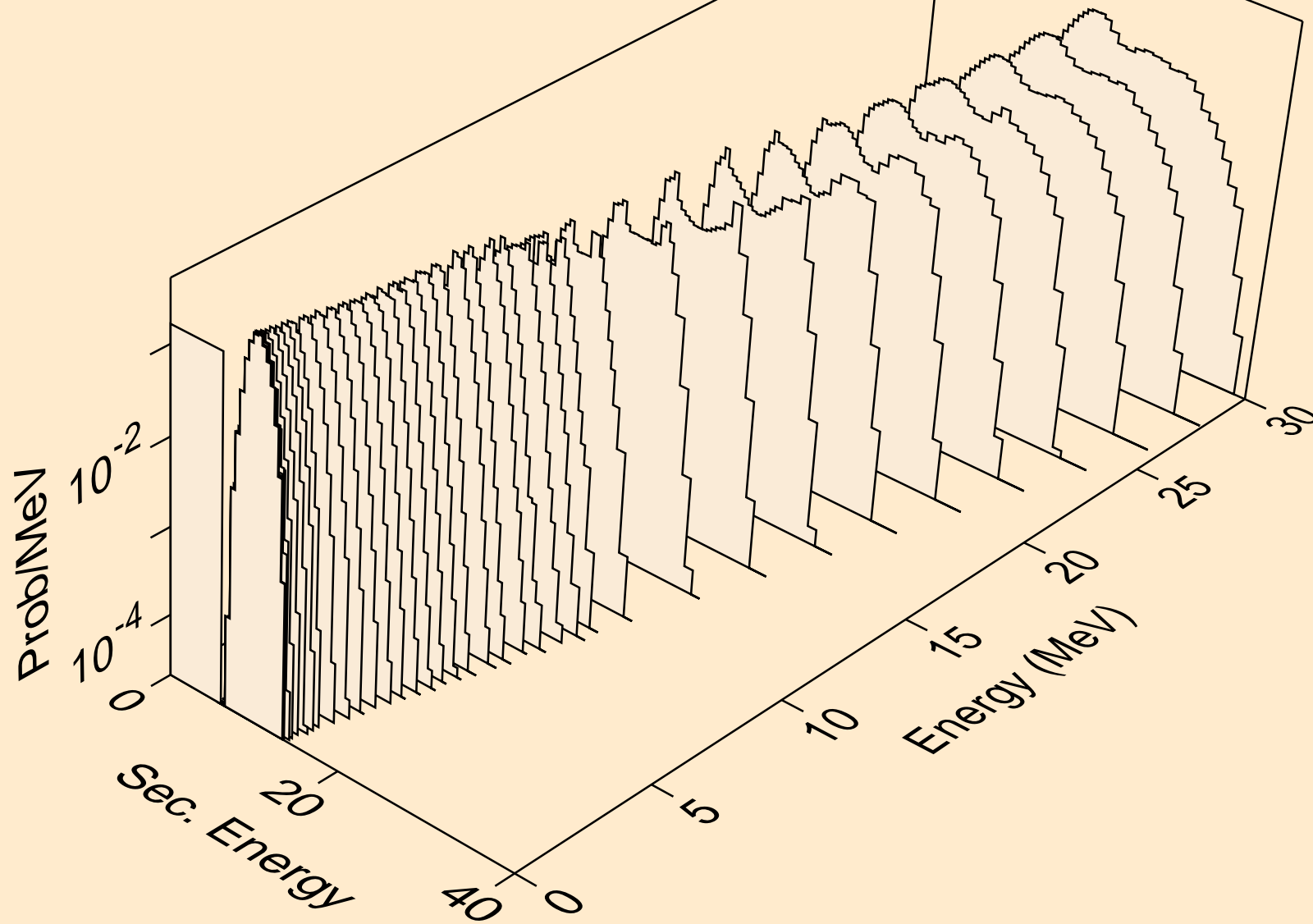

FR212 NEUTRON ACER TENDL-2021 LIBRARY; T=293.6K
alphas from (n,pa)

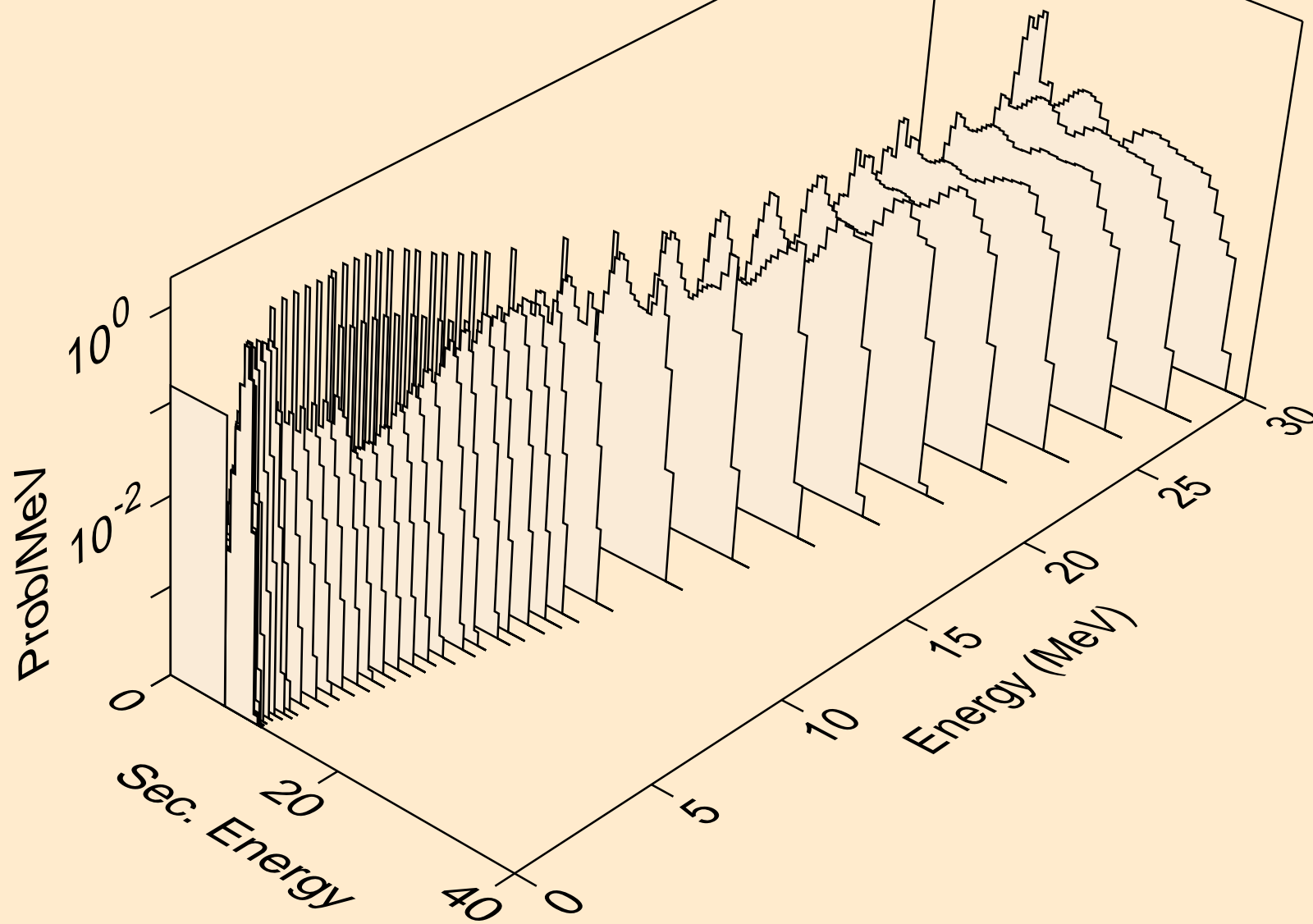

FR212 NEUTRON ACER TENDL-2021 LIBRARY; T=293.6K
alphas from (n,da)

