

# IR182 NEUTRON ACER TENDL-2021 LIBRARY; T=293.6K

## Principal cross sections

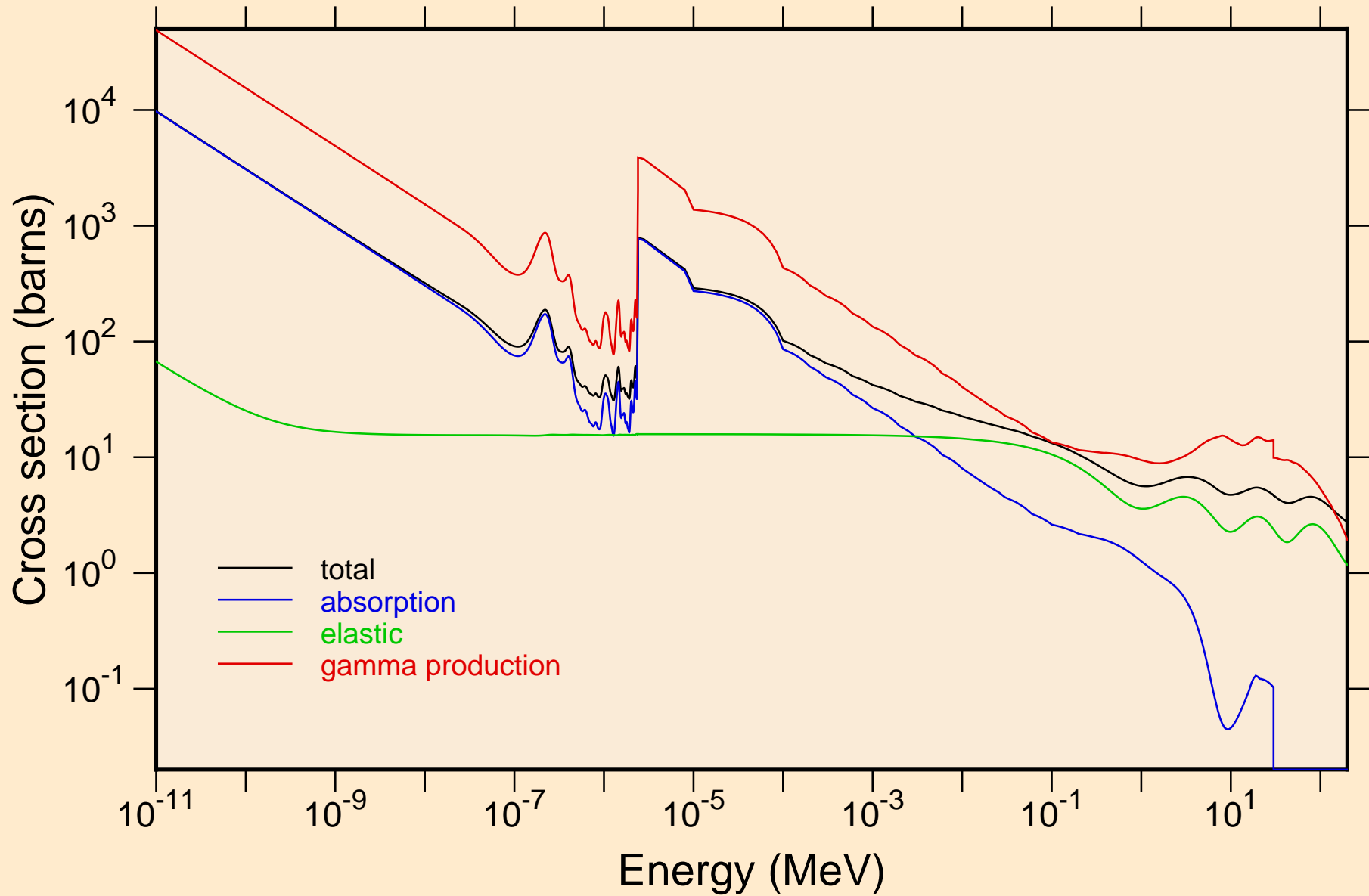

IR182 NEUTRON ACER TENDL-2021 LIBRARY; T=293.6K  
Heating

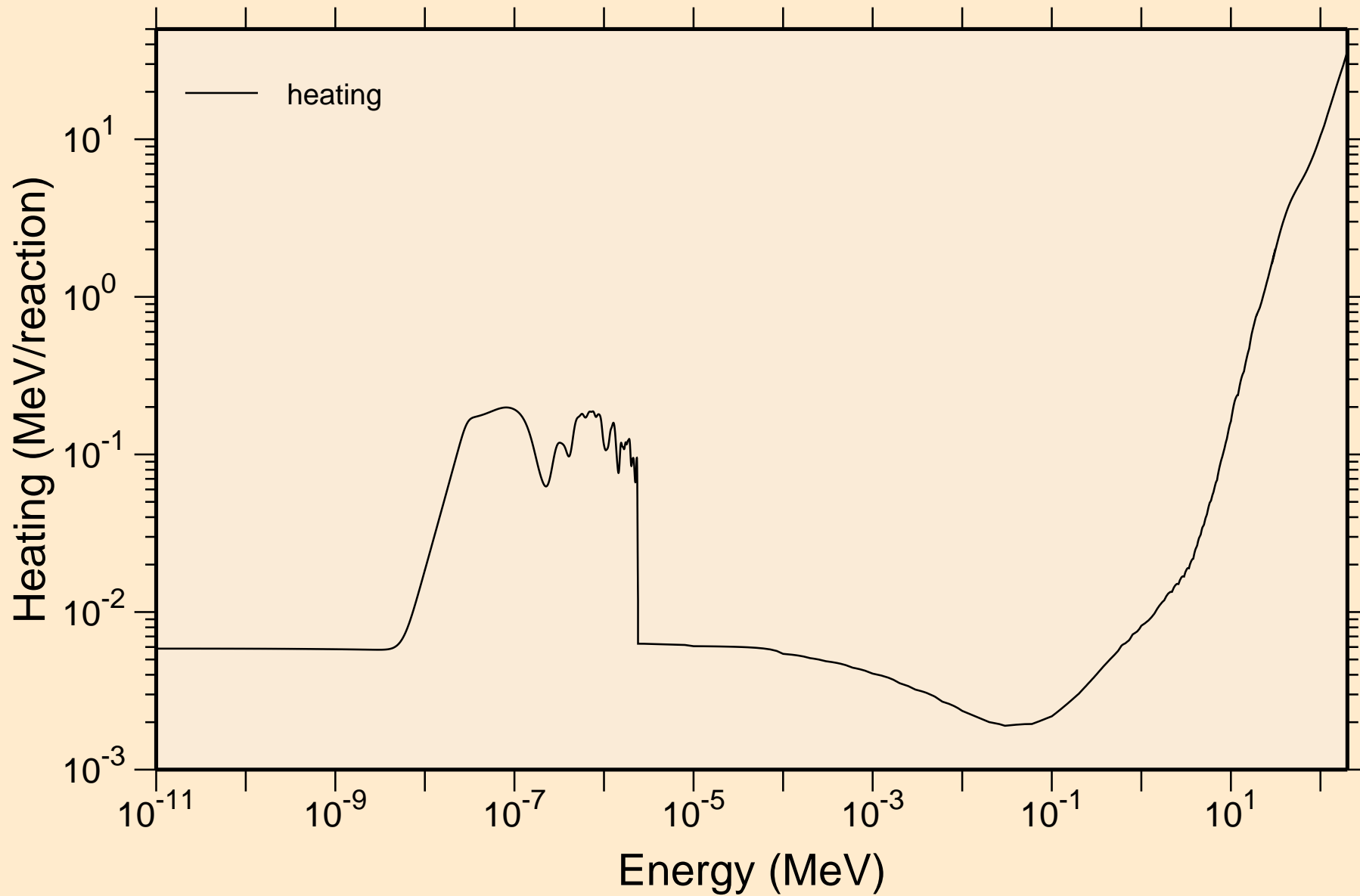

IR182 NEUTRON ACER TENDL-2021 LIBRARY; T=293.6K  
Damage

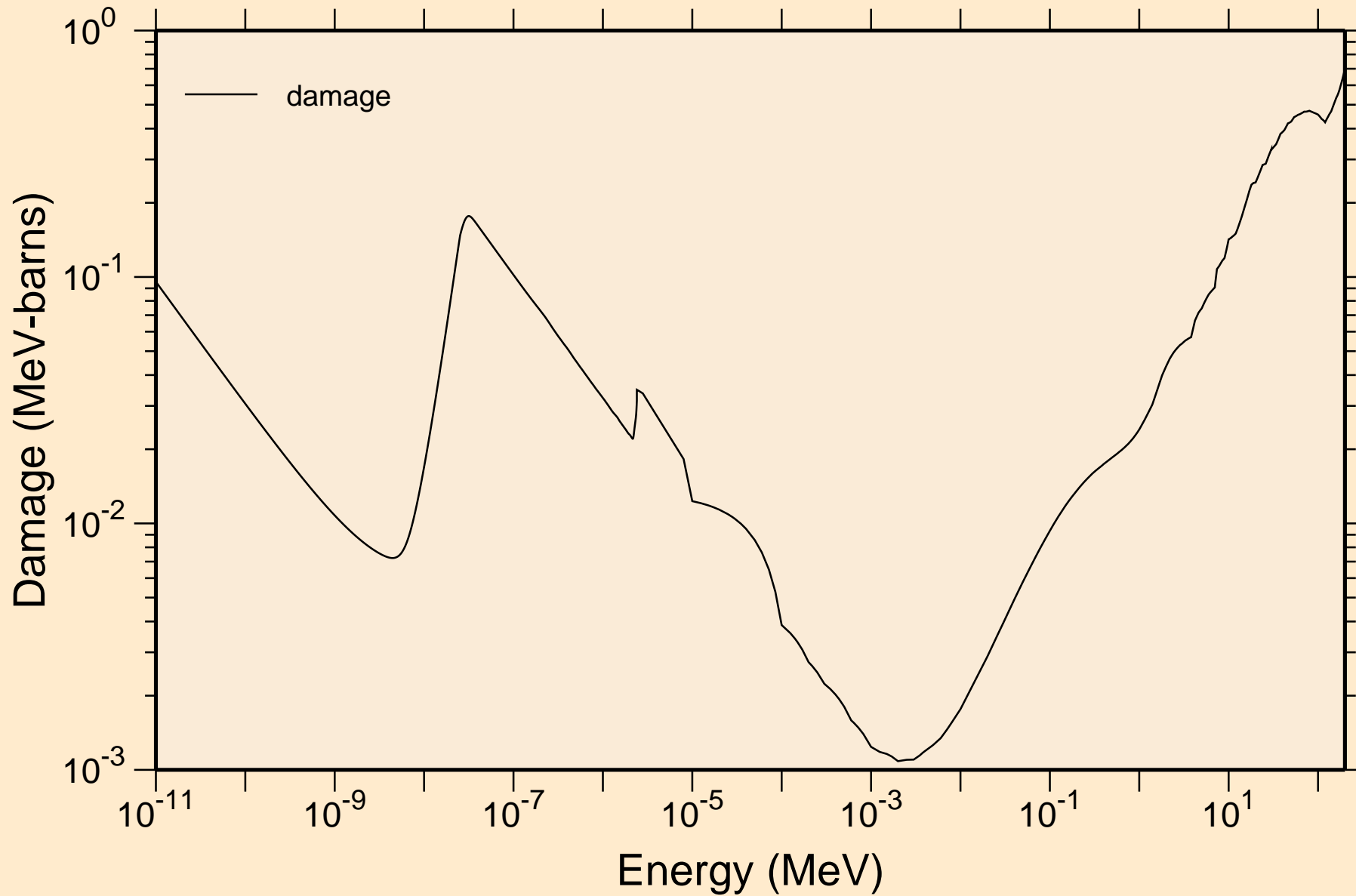

IR182 NEUTRON ACER TENDL-2021 LIBRARY; T=293.6K  
Non-threshold reactions

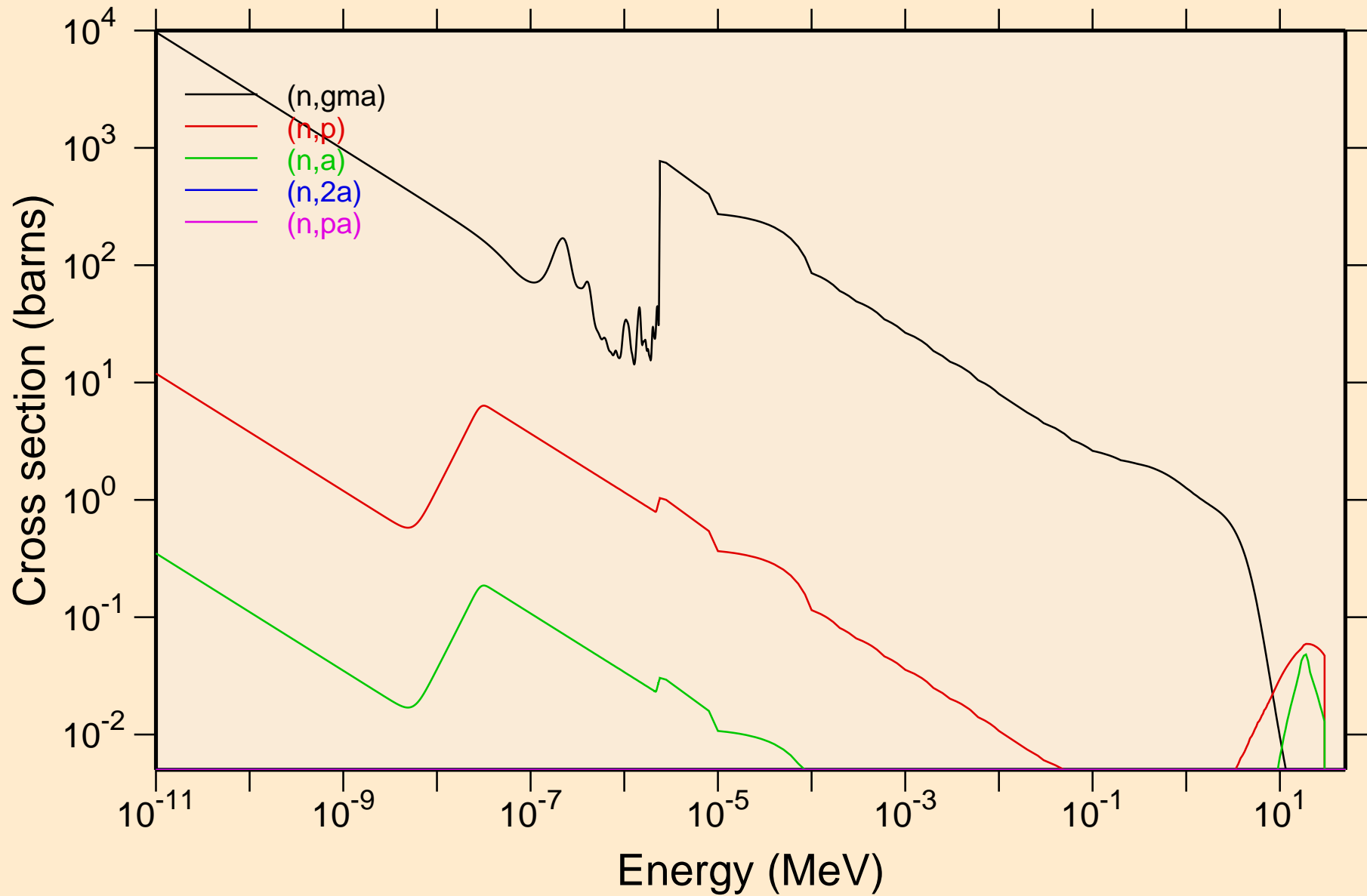

IR182 NEUTRON ACER TENDL-2021 LIBRARY; T=293.6K  
Non-threshold reactions

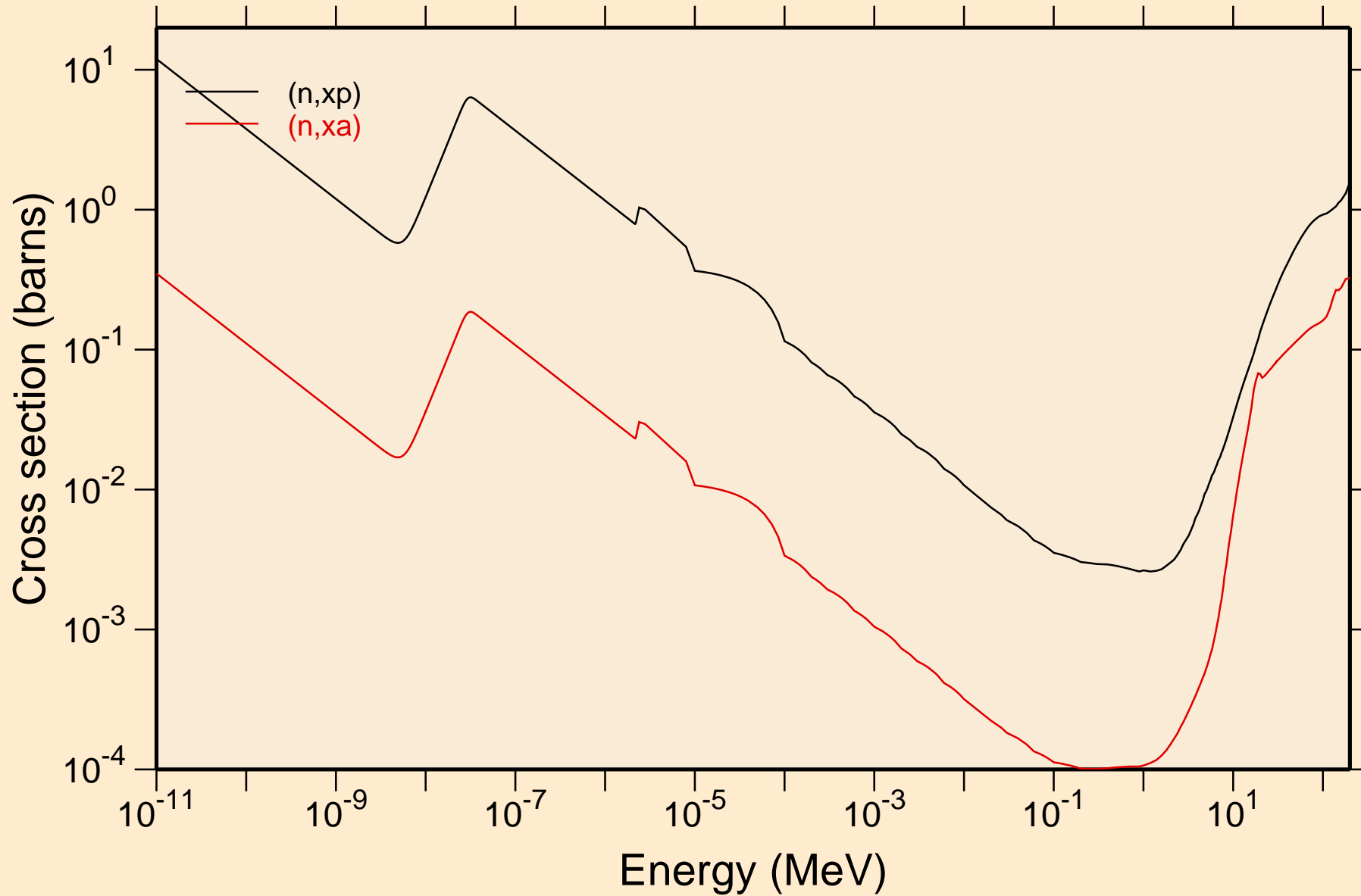

# IR182 NEUTRON ACER TENDL-2021 LIBRARY; T=293.6K

## Principal cross sections

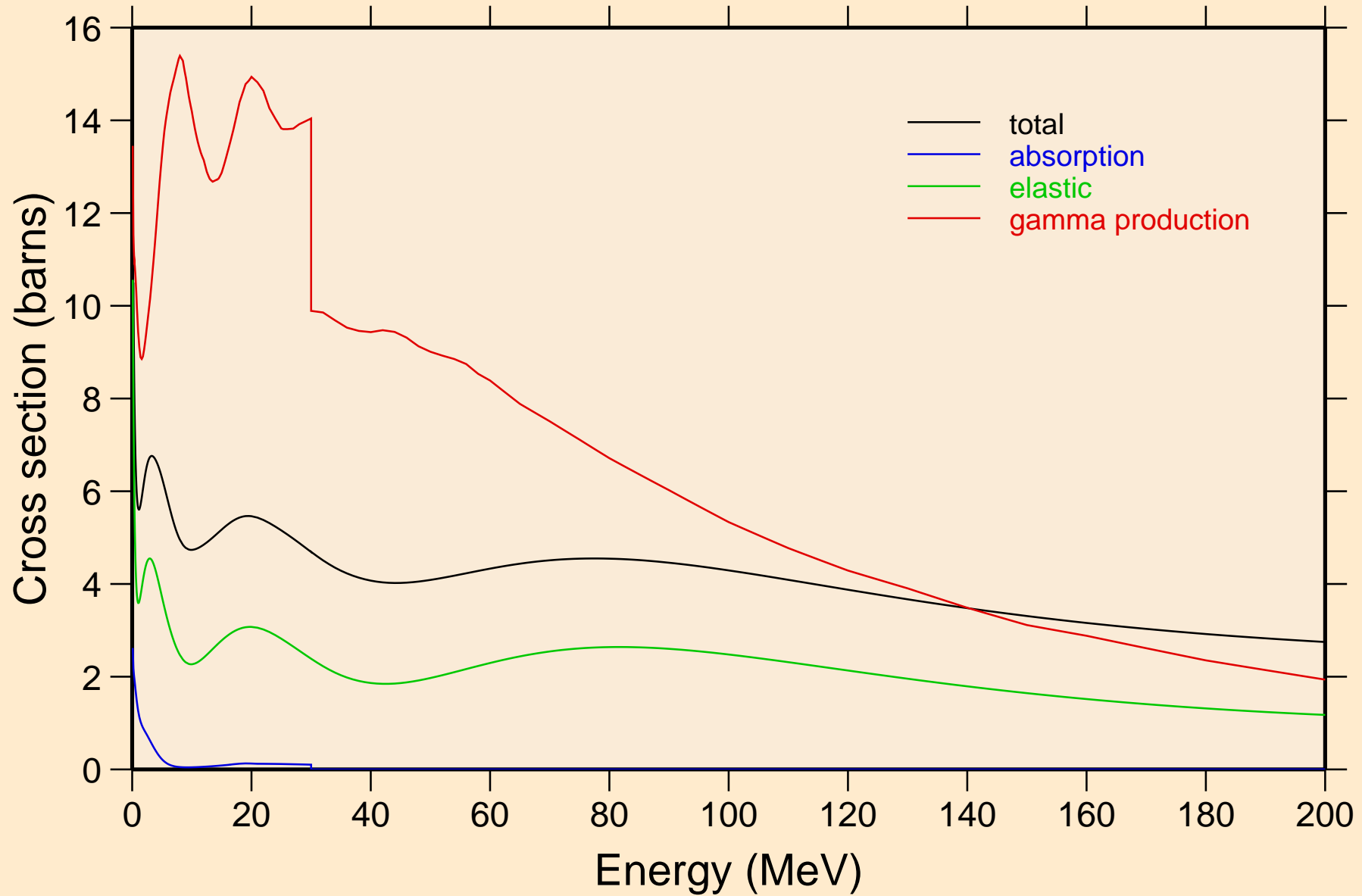

# IR182 NEUTRON ACER TENDL-2021 LIBRARY; T=293.6K

## Heating

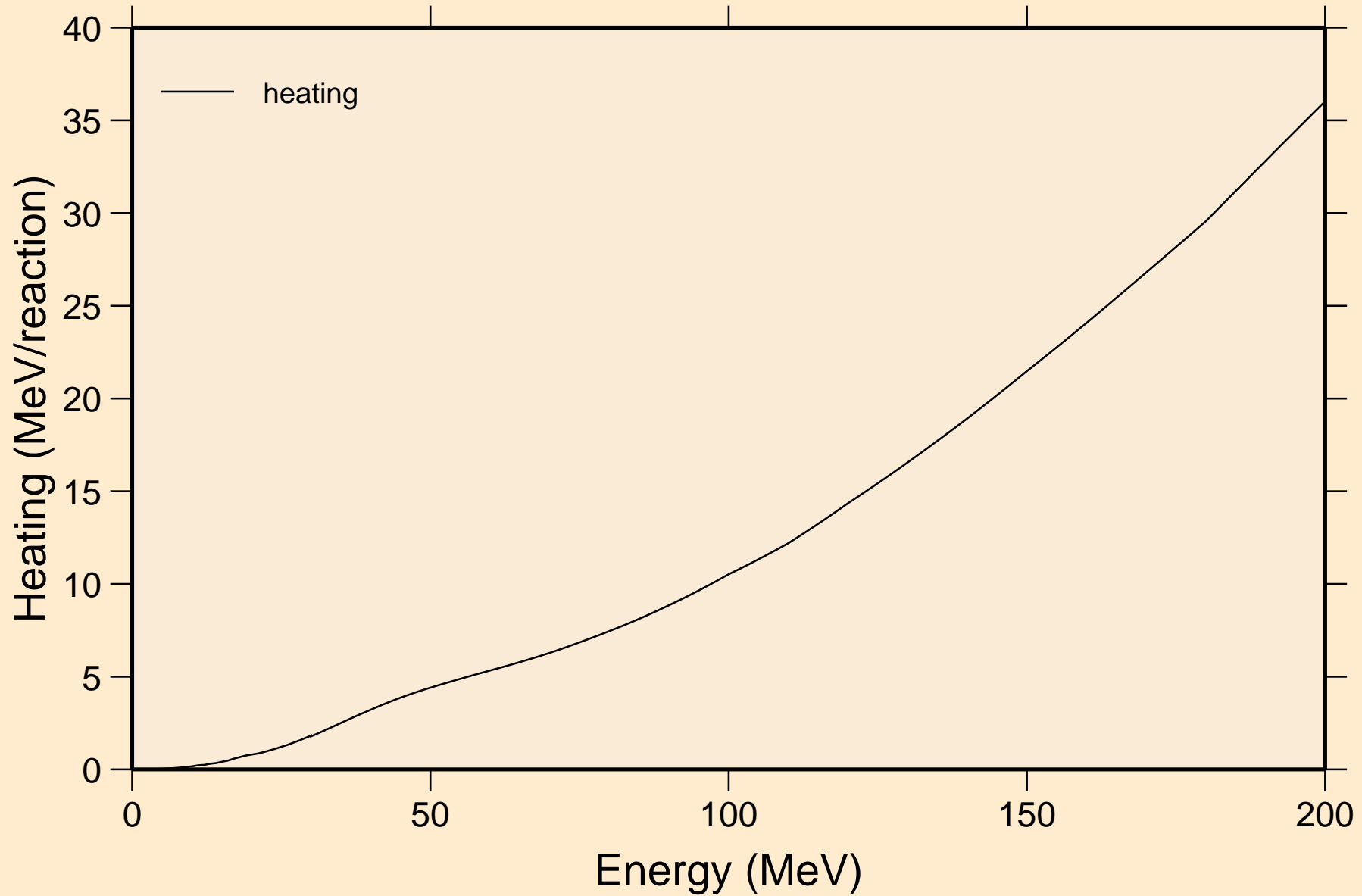

IR182 NEUTRON ACER TENDL-2021 LIBRARY; T=293.6K  
Damage

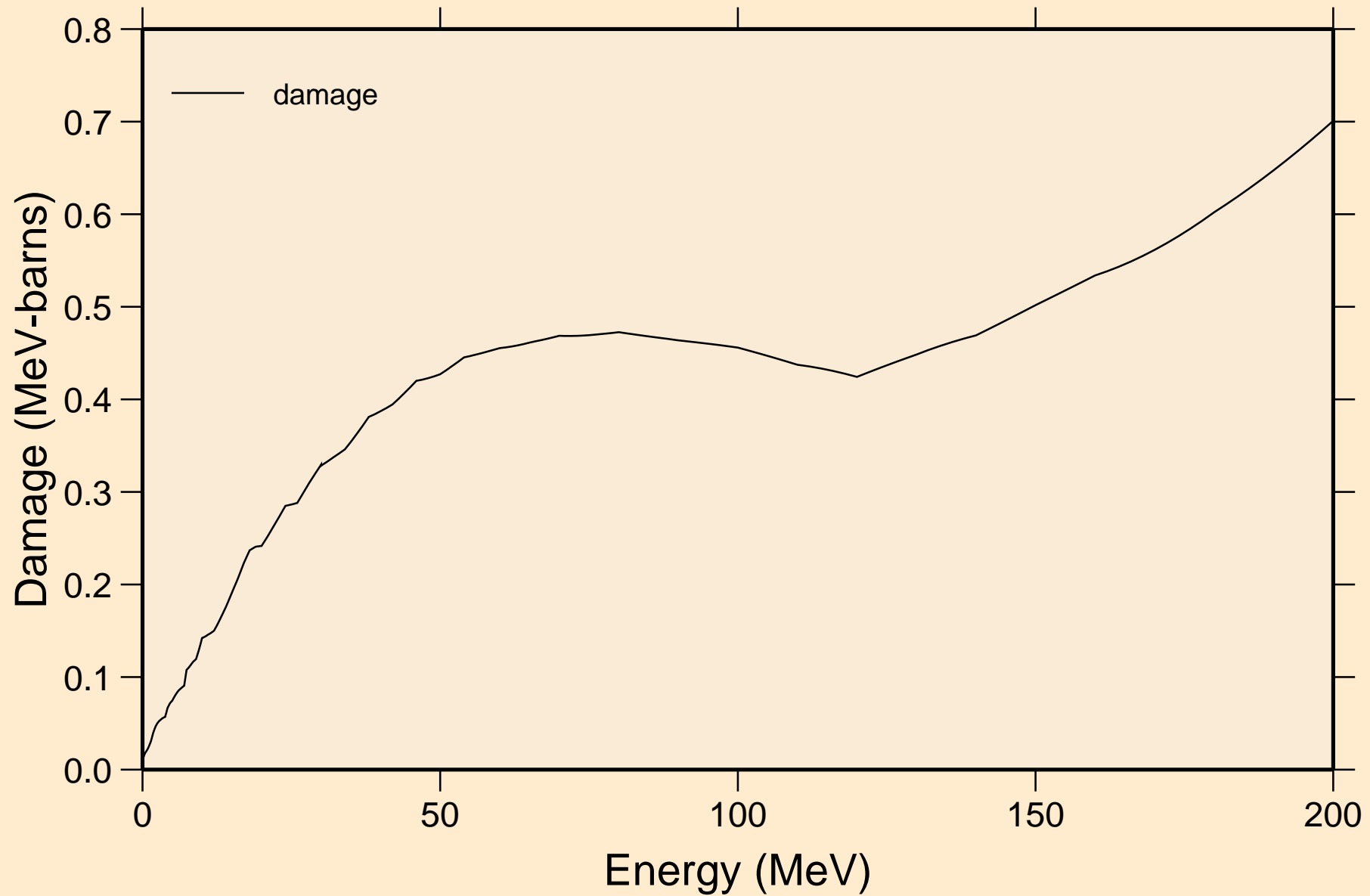

IR182 NEUTRON ACER TENDL-2021 LIBRARY; T=293.6K  
Non-threshold reactions

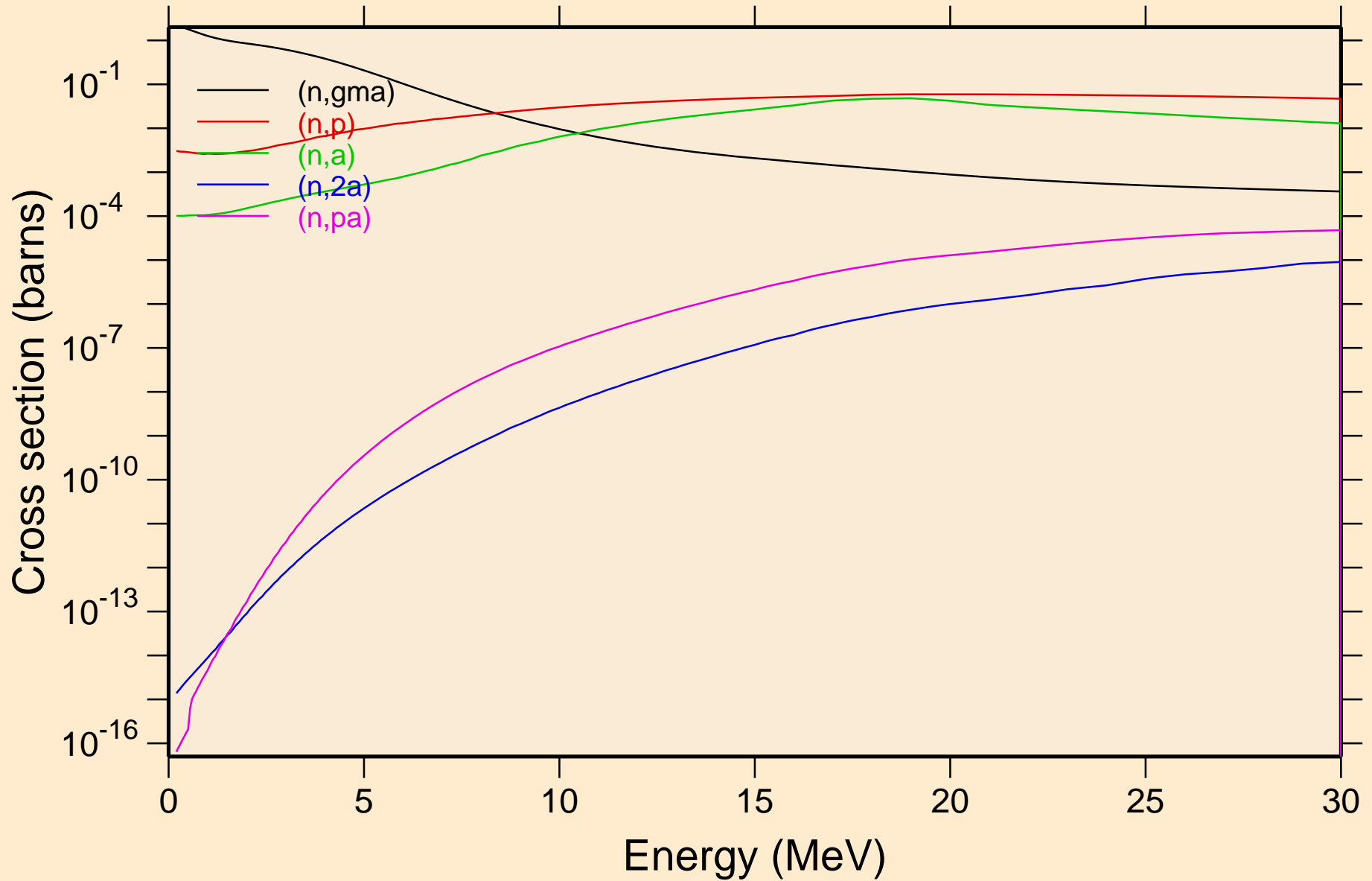

IR182 NEUTRON ACER TENDL-2021 LIBRARY; T=293.6K  
Non-threshold reactions

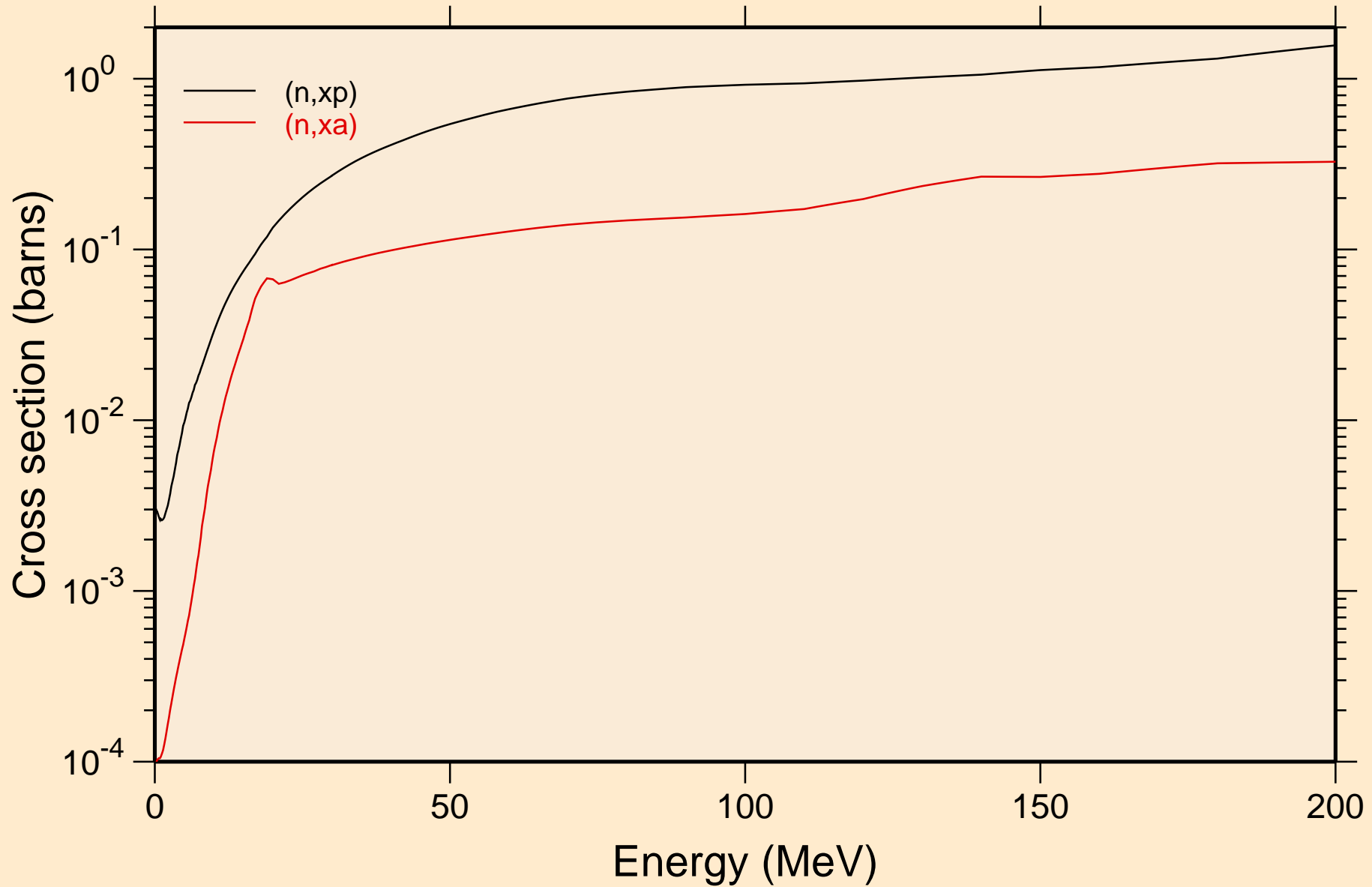

IR182 NEUTRON ACER TENDL-2021 LIBRARY; T=293.6K  
Inelastic levels

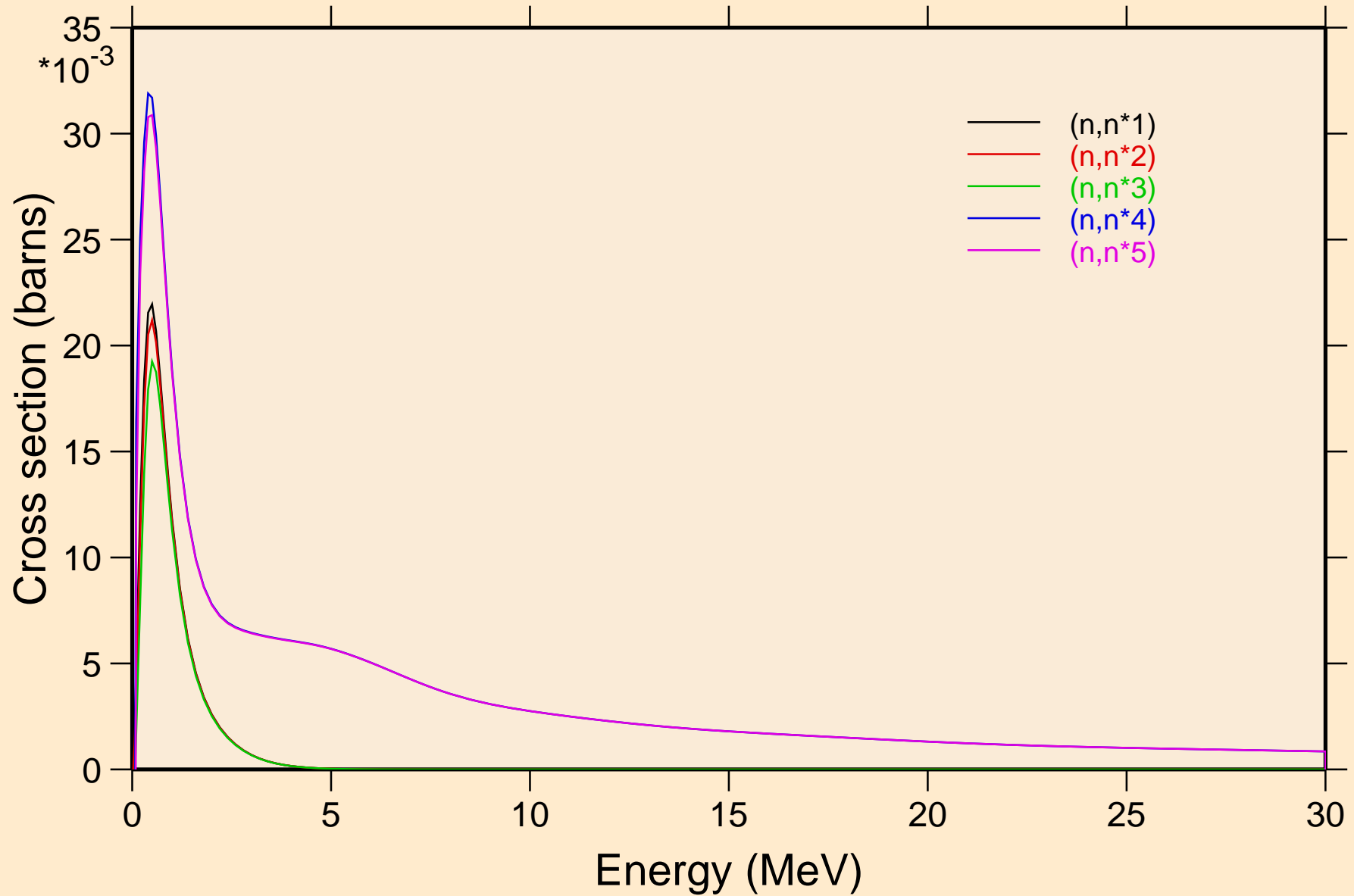

IR182 NEUTRON ACER TENDL-2021 LIBRARY; T=293.6K  
Inelastic levels

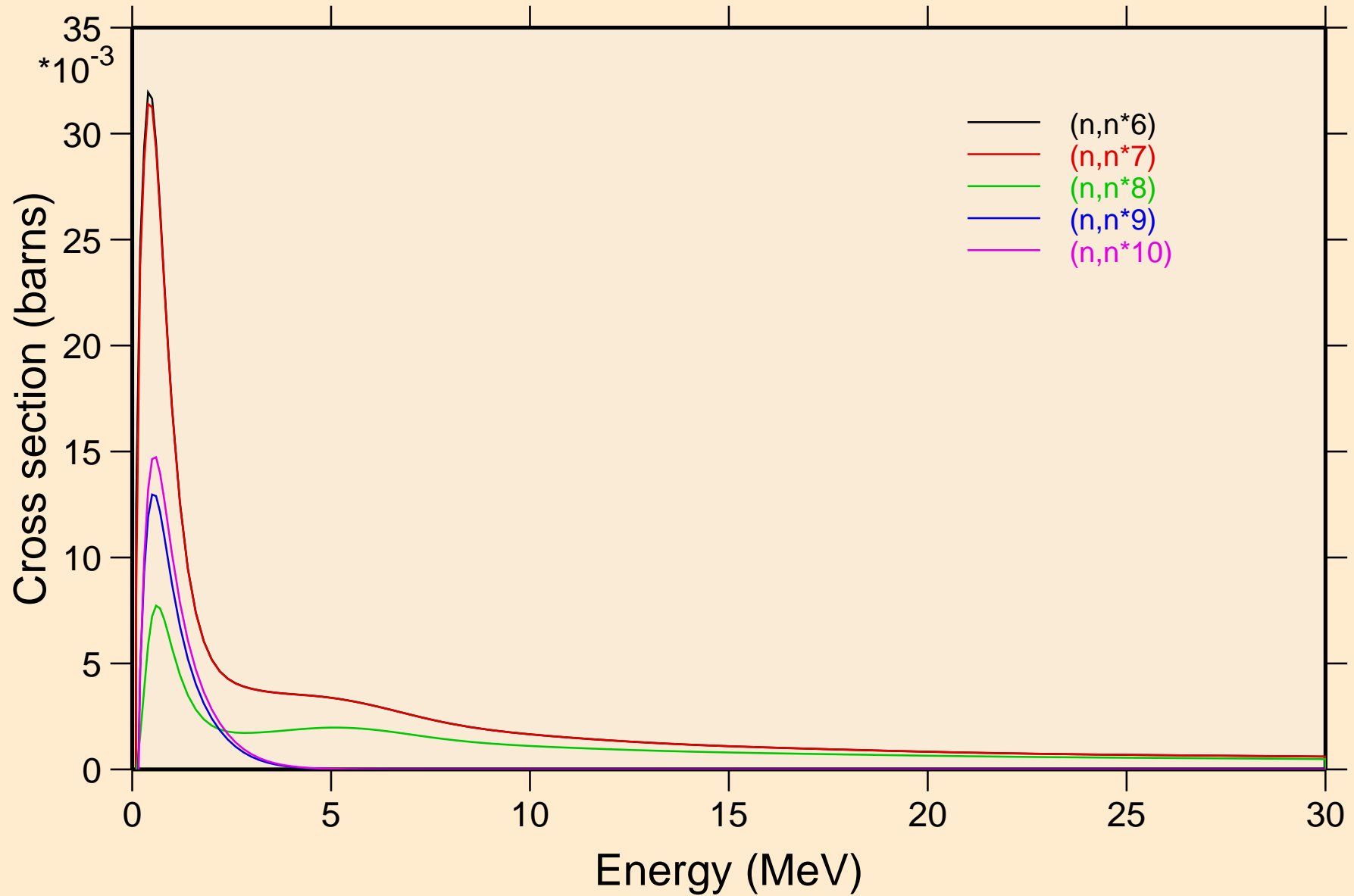

IR182 NEUTRON ACER TENDL-2021 LIBRARY; T=293.6K  
Inelastic levels

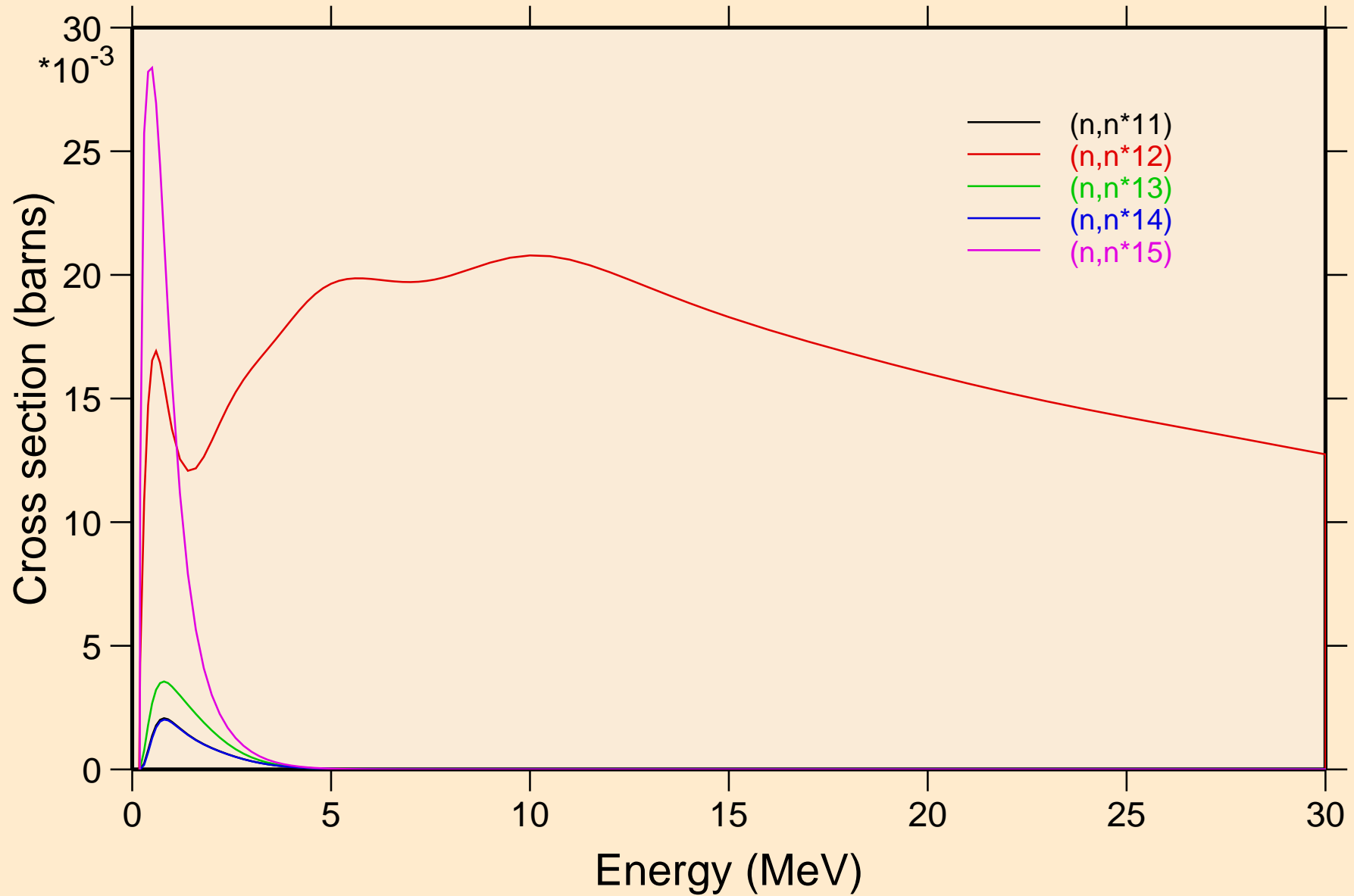

IR182 NEUTRON ACER TENDL-2021 LIBRARY; T=293.6K  
Inelastic levels

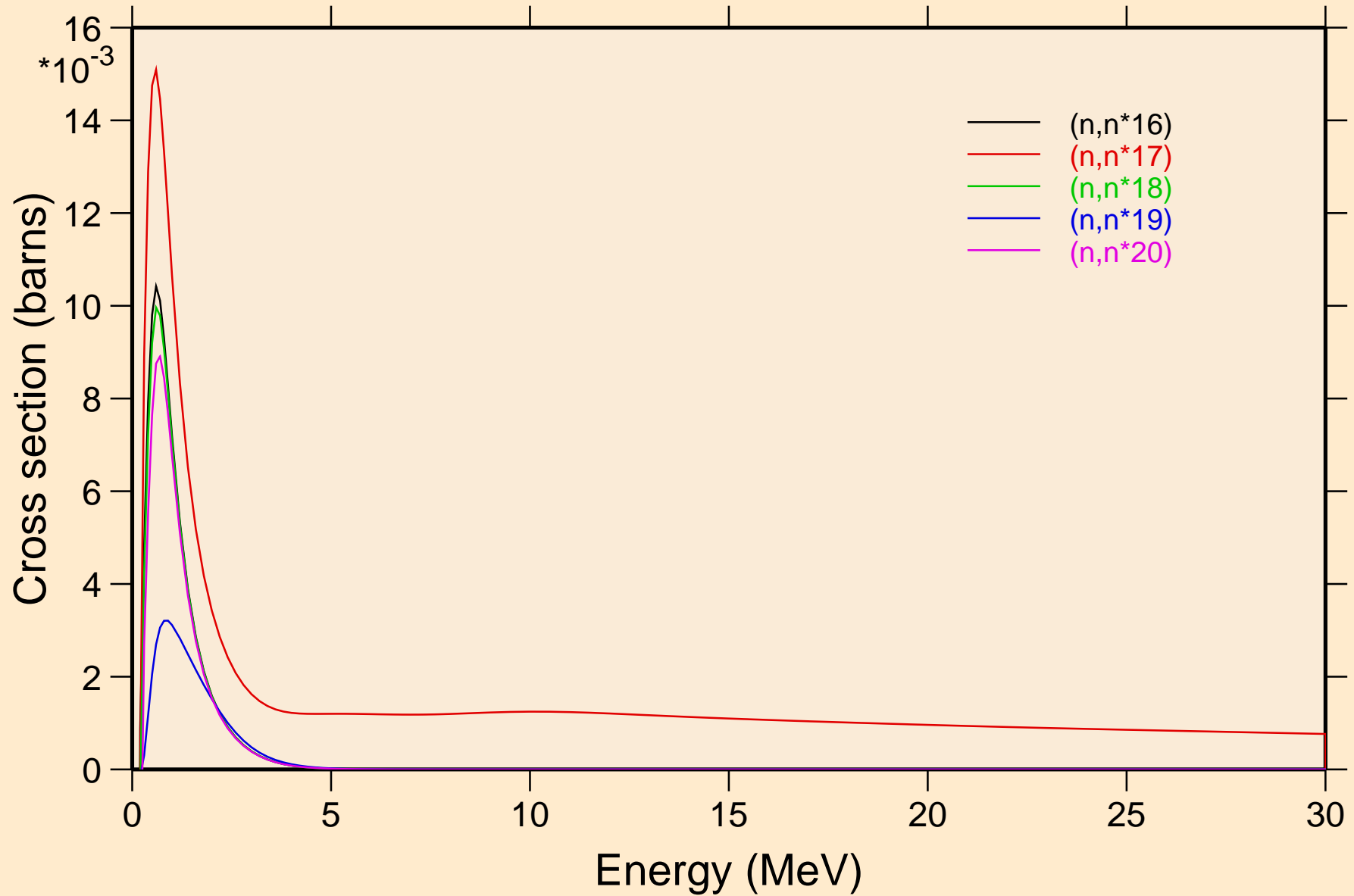

IR182 NEUTRON ACER TENDL-2021 LIBRARY; T=293.6K  
Inelastic levels

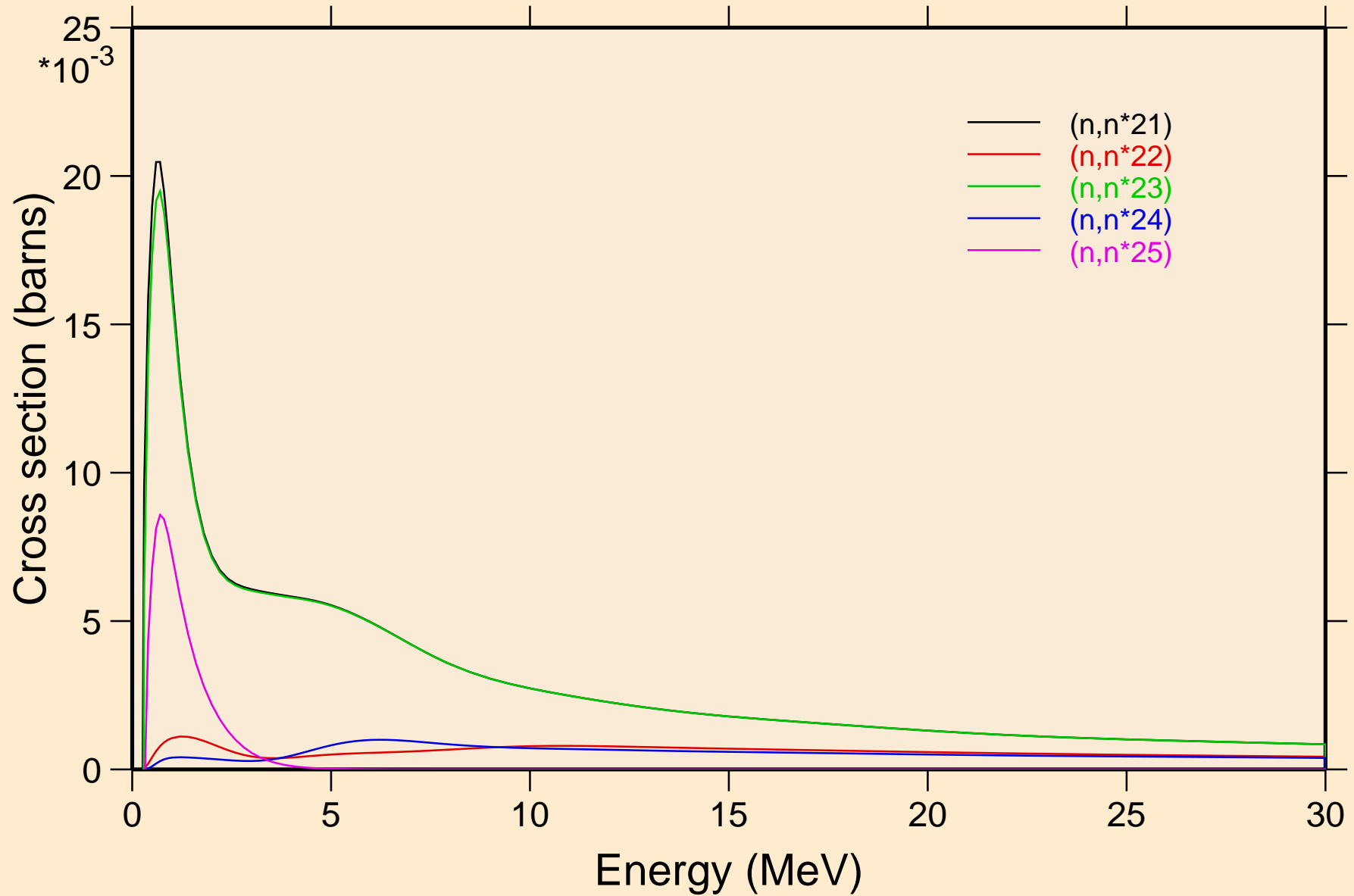

IR182 NEUTRON ACER TENDL-2021 LIBRARY; T=293.6K  
Inelastic levels

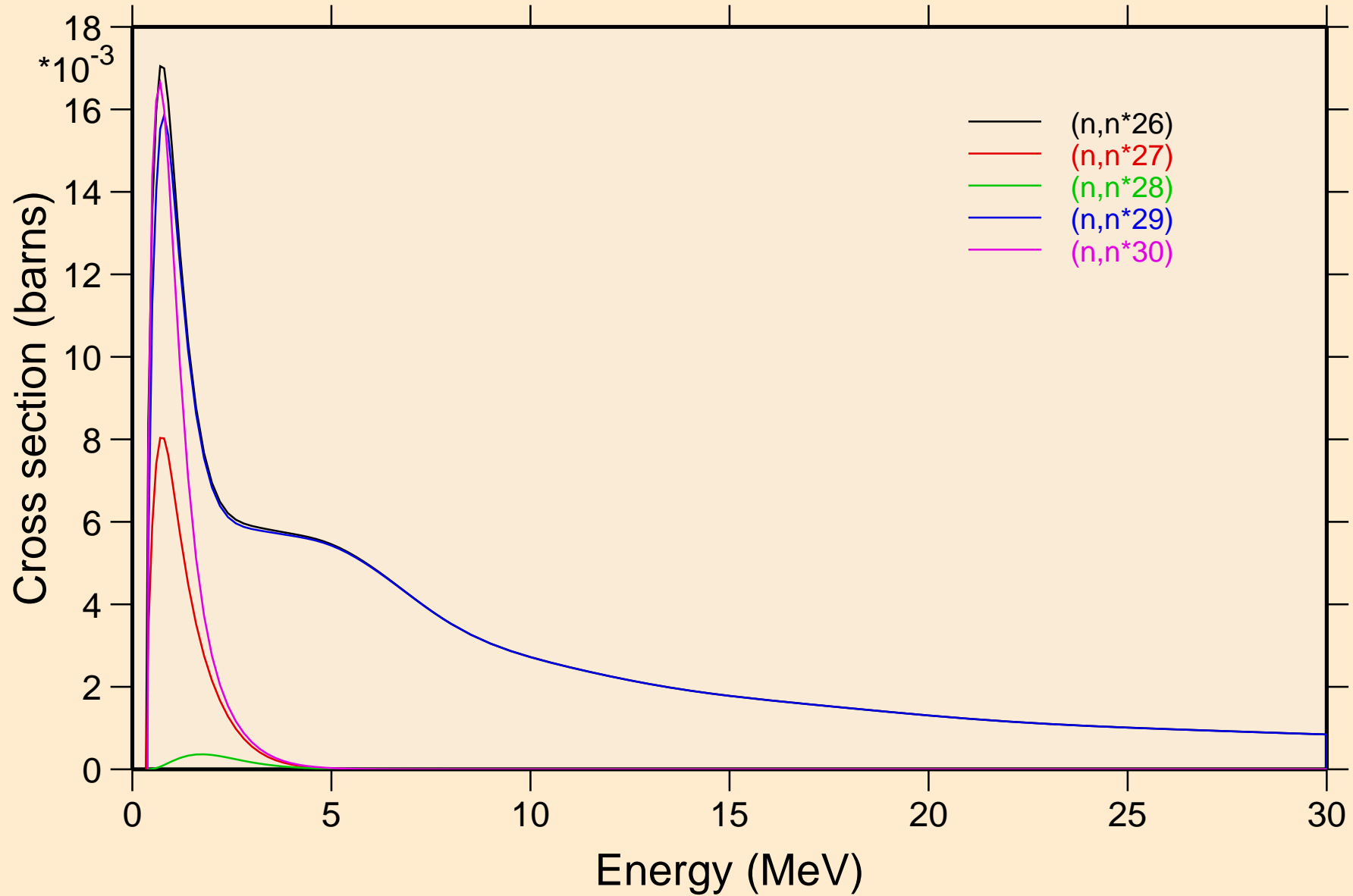

IR182 NEUTRON ACER TENDL-2021 LIBRARY; T=293.6K  
Threshold reactions

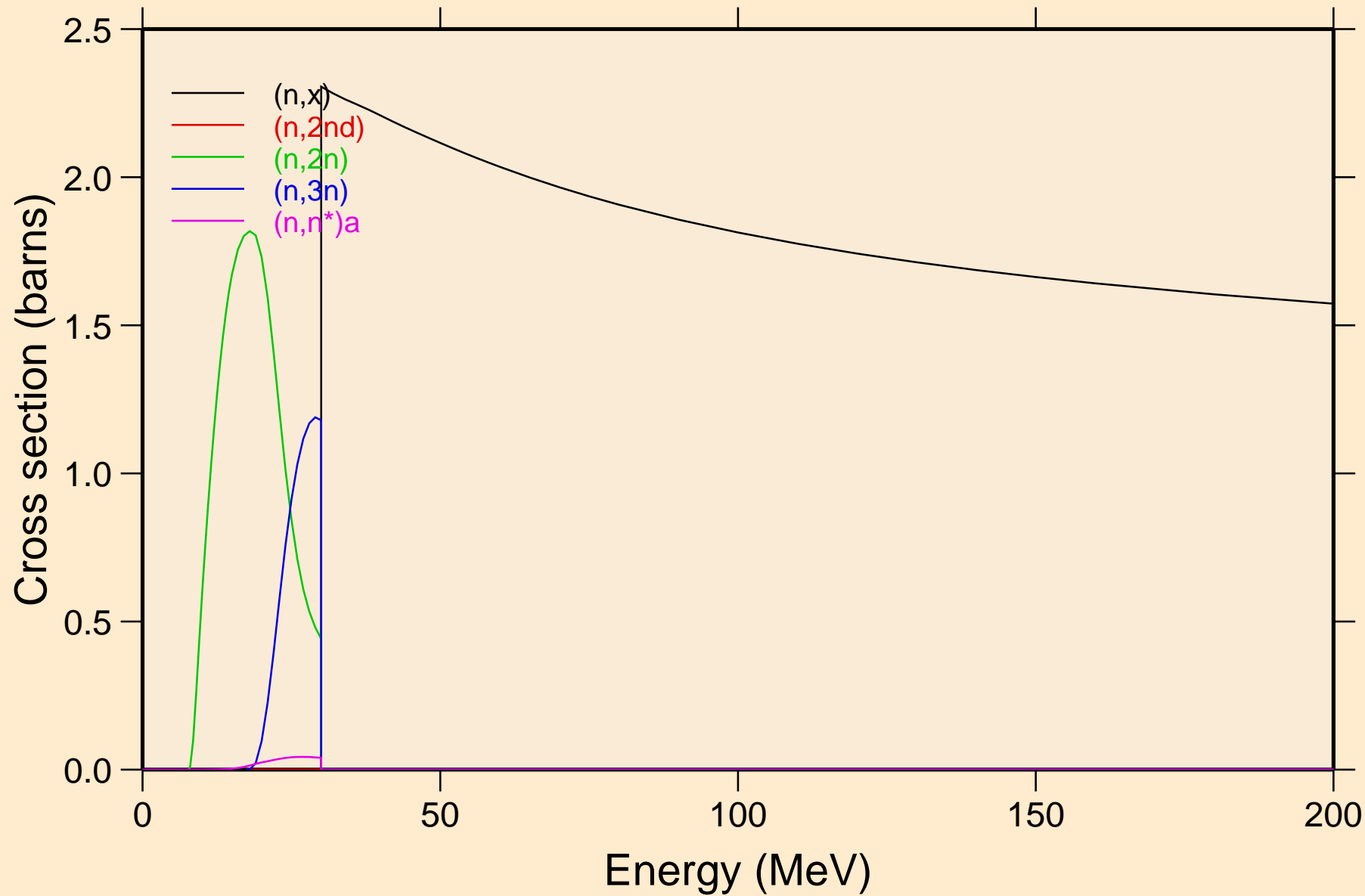

IR182 NEUTRON ACER TENDL-2021 LIBRARY; T=293.6K  
Threshold reactions

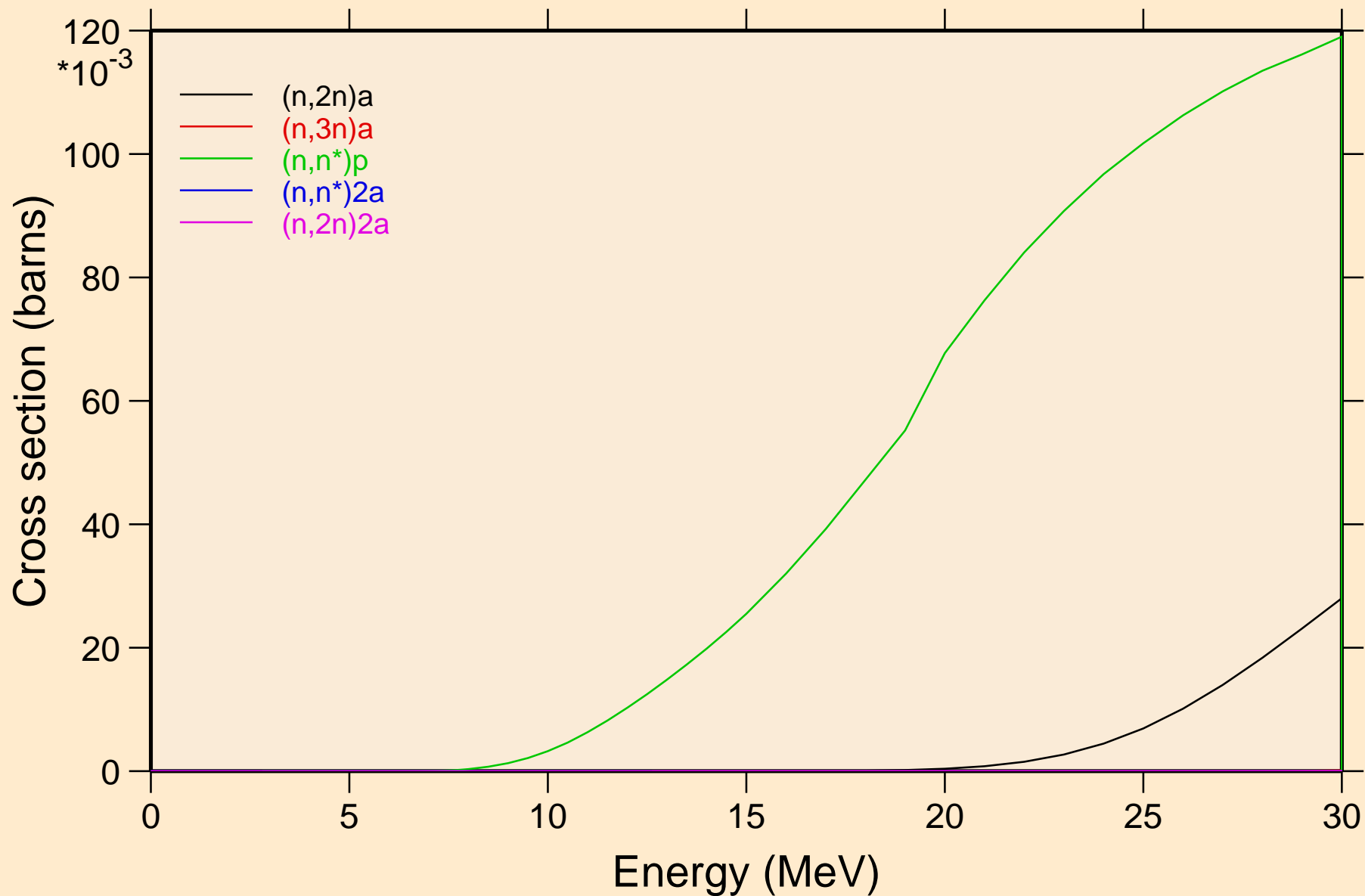

# IR182 NEUTRON ACER TENDL-2021 LIBRARY; T=293.6K

## Threshold reactions

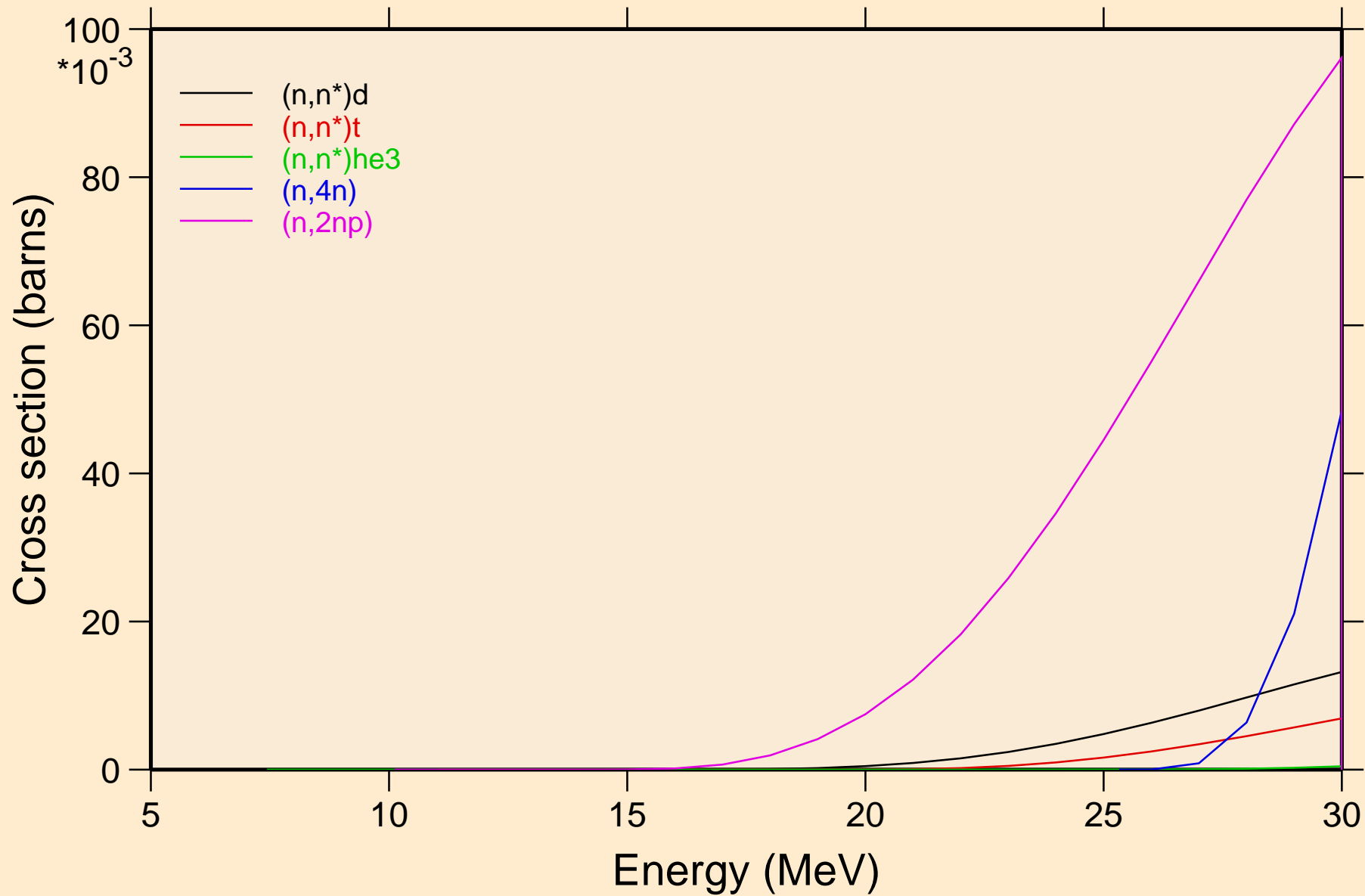

IR182 NEUTRON ACER TENDL-2021 LIBRARY; T=293.6K  
Threshold reactions

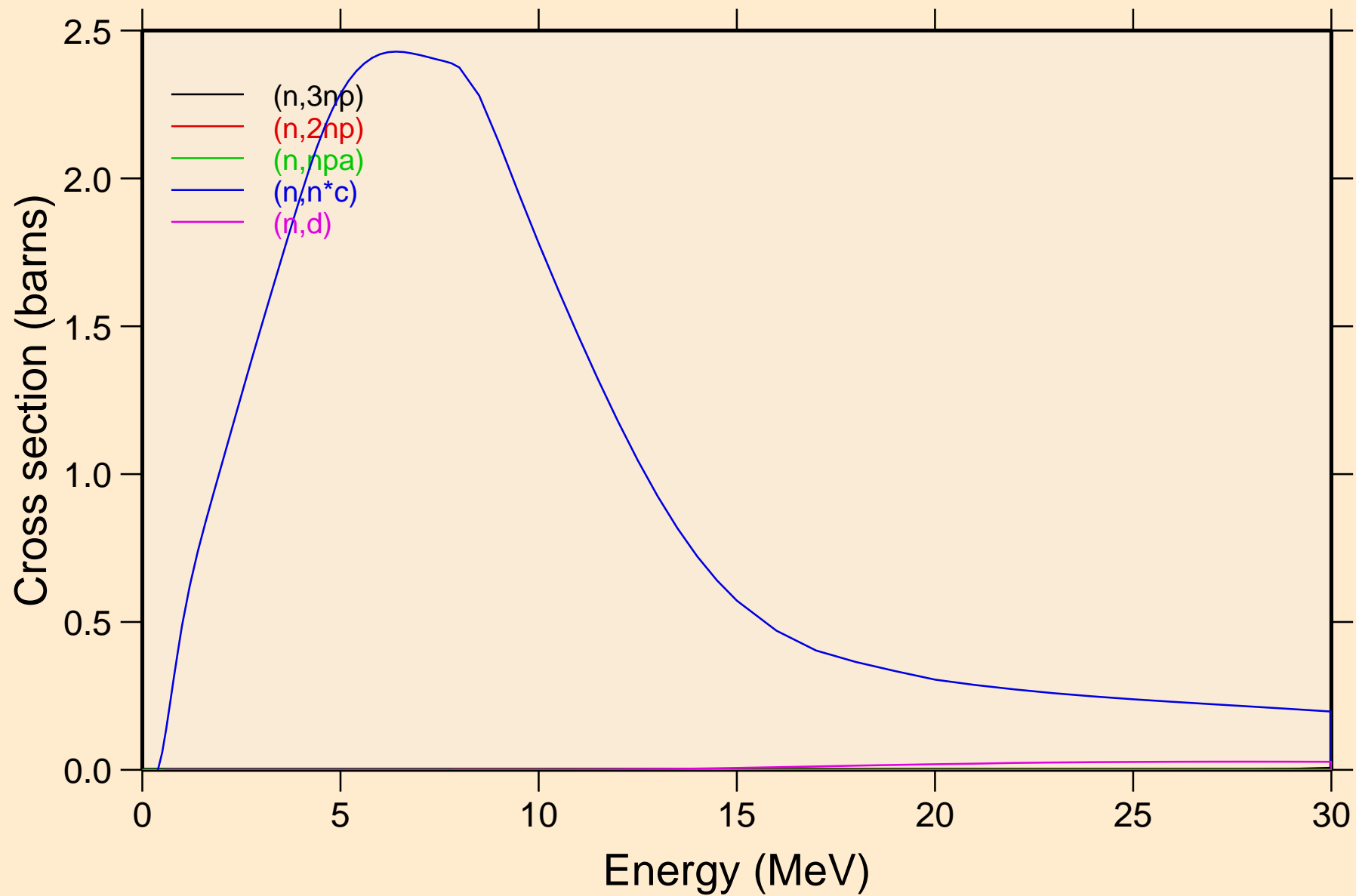

IR182 NEUTRON ACER TENDL-2021 LIBRARY; T=293.6K  
Threshold reactions

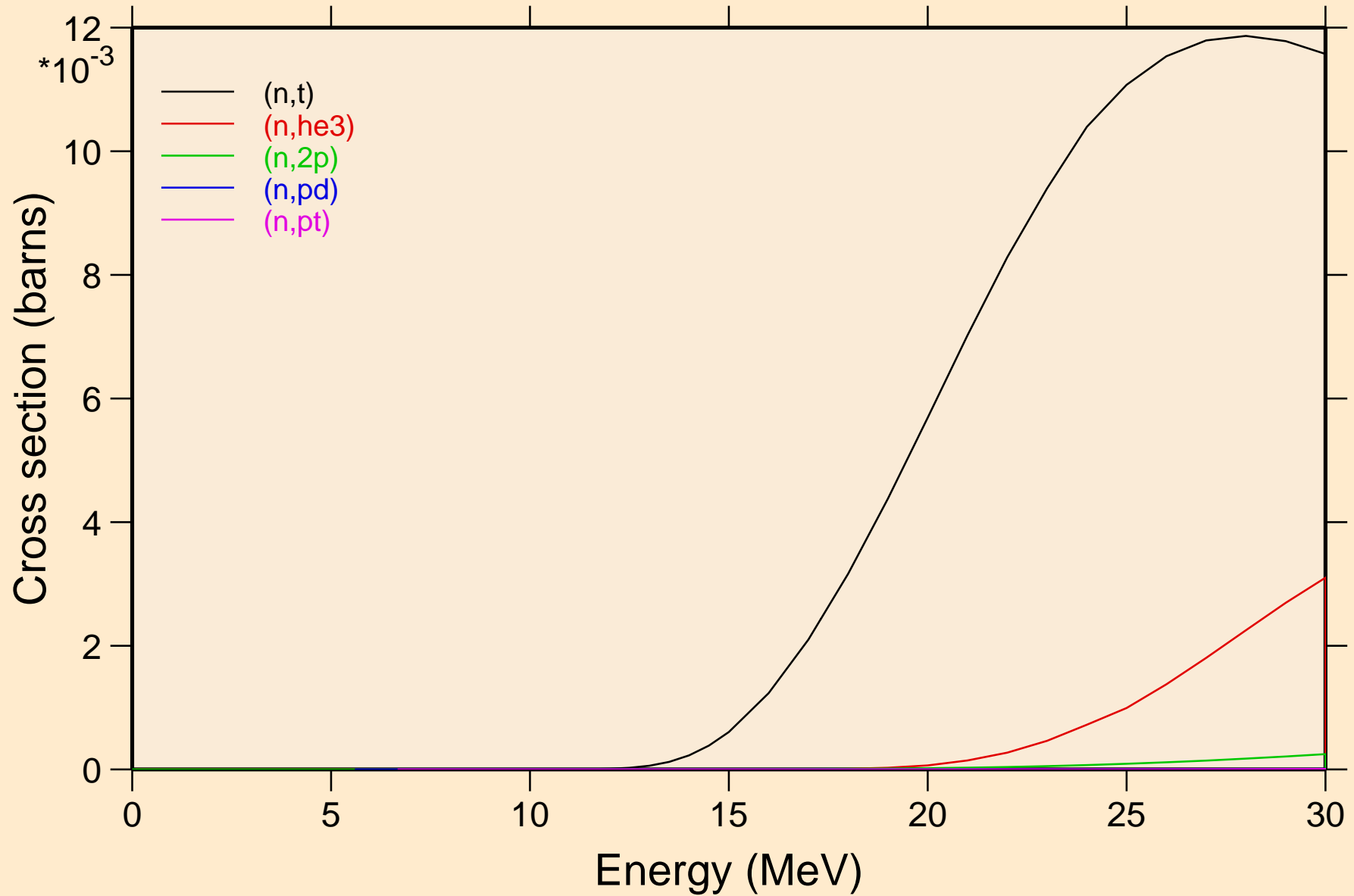

IR182 NEUTRON ACER TENDL-2021 LIBRARY; T=293.6K  
Threshold reactions

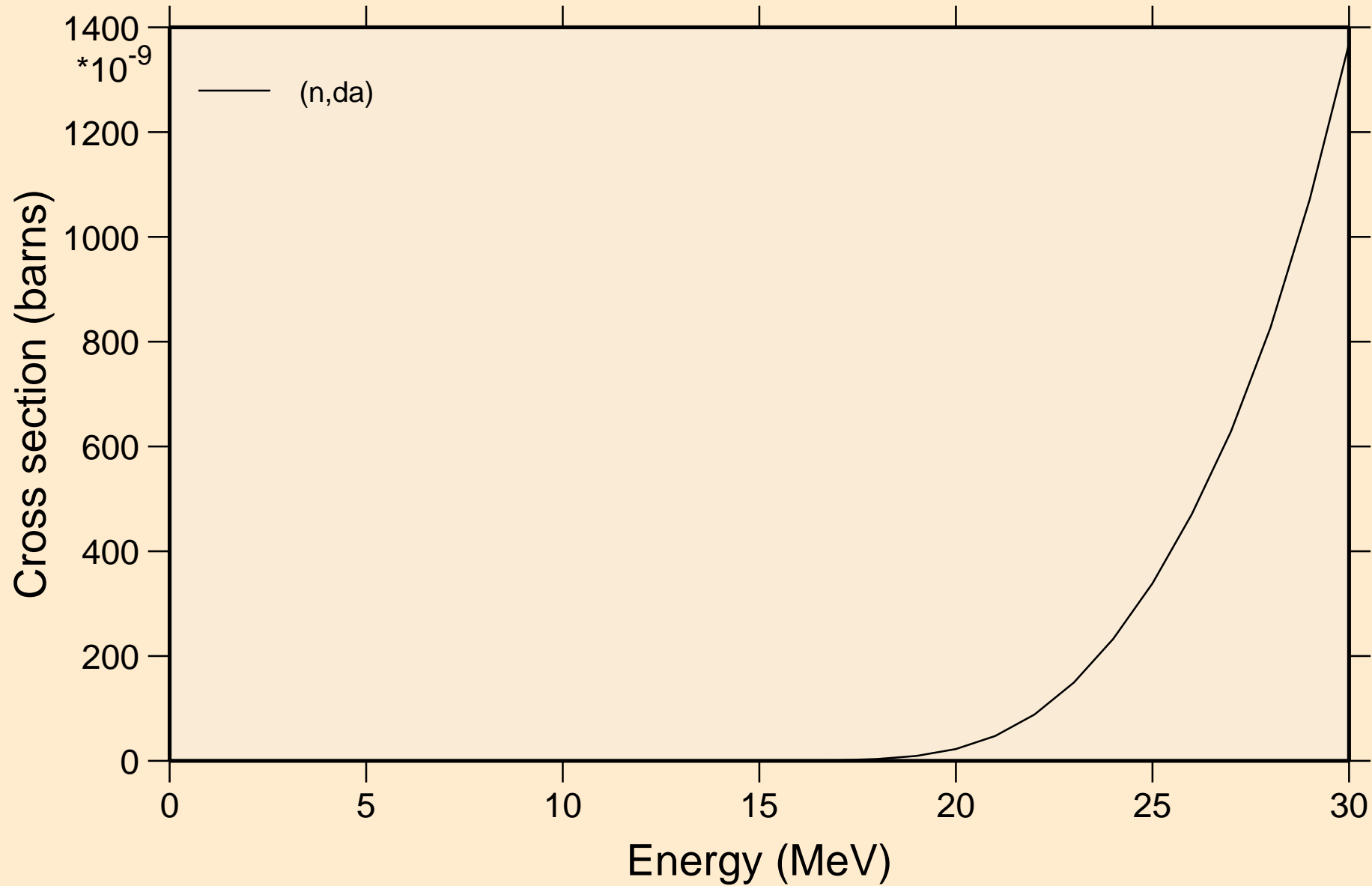

IR182 NEUTRON ACER TENDL-2021 LIBRARY; T=293.6K  
Threshold reactions

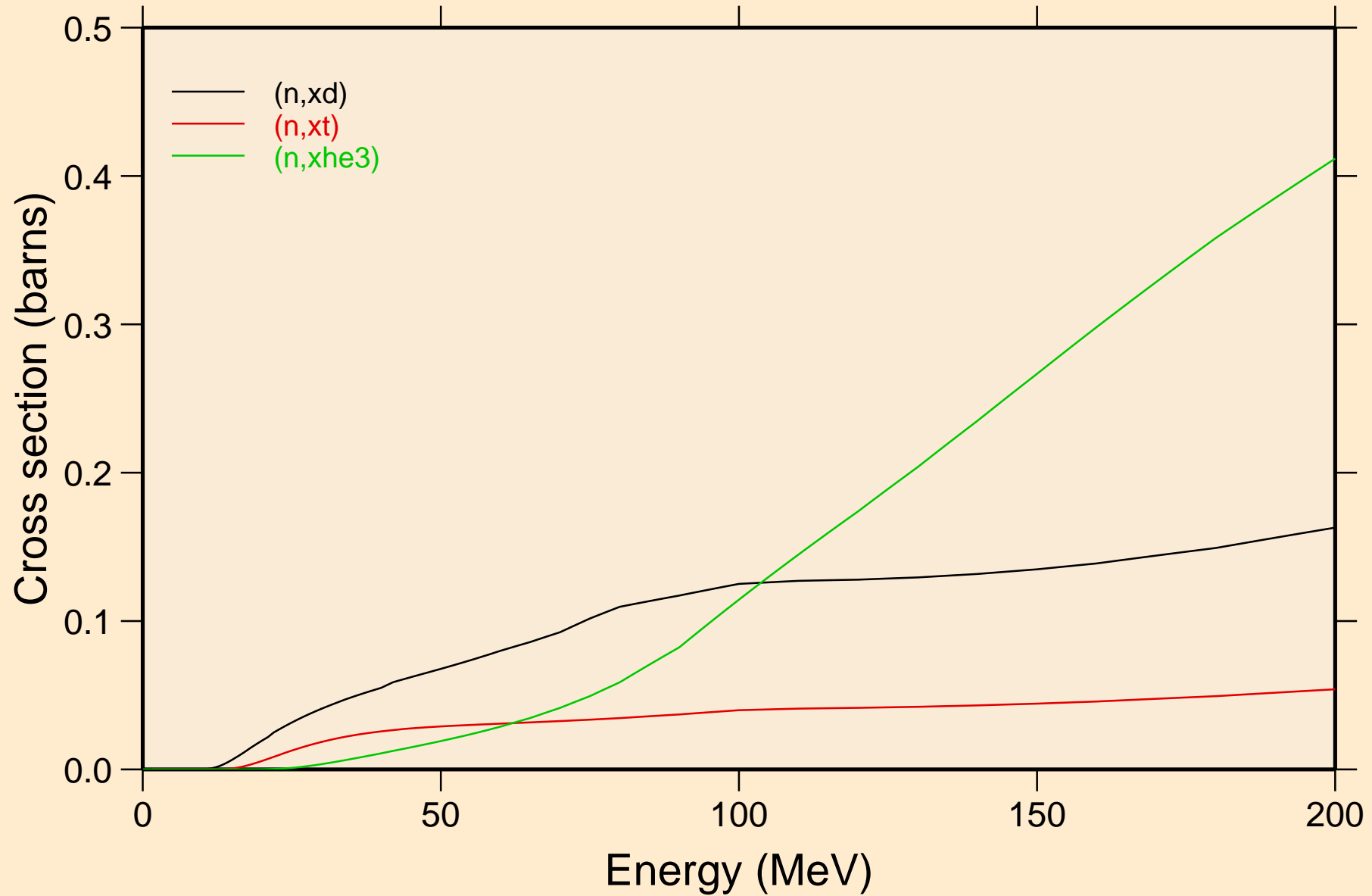

IR182 NEUTRON ACER TENDL-2021 LIBRARY; T=293.6K  
angular distribution for elastic

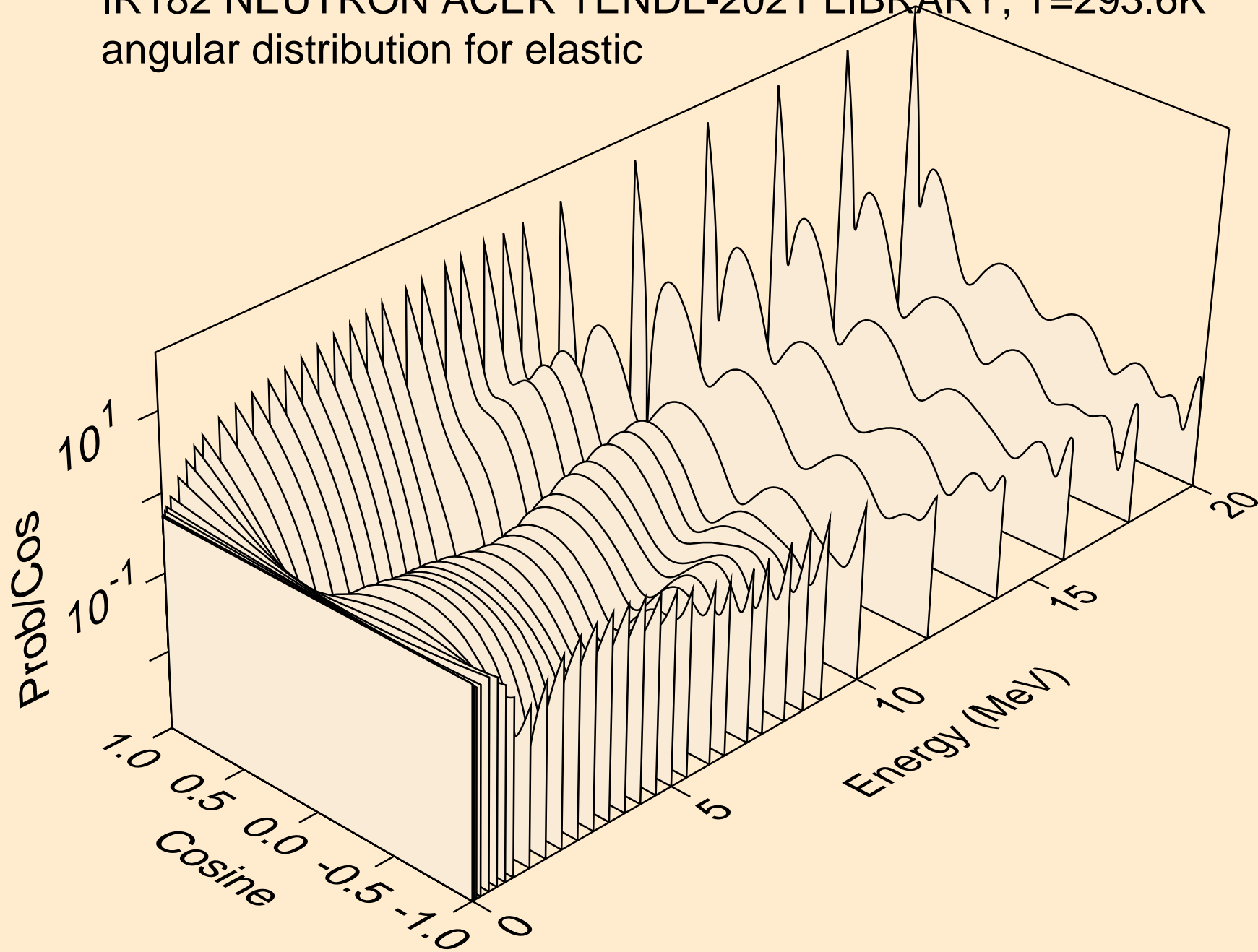

IR182 NEUTRON ACER TENDL-2021 LIBRARY; T=293.6K  
angular distribution for elastic

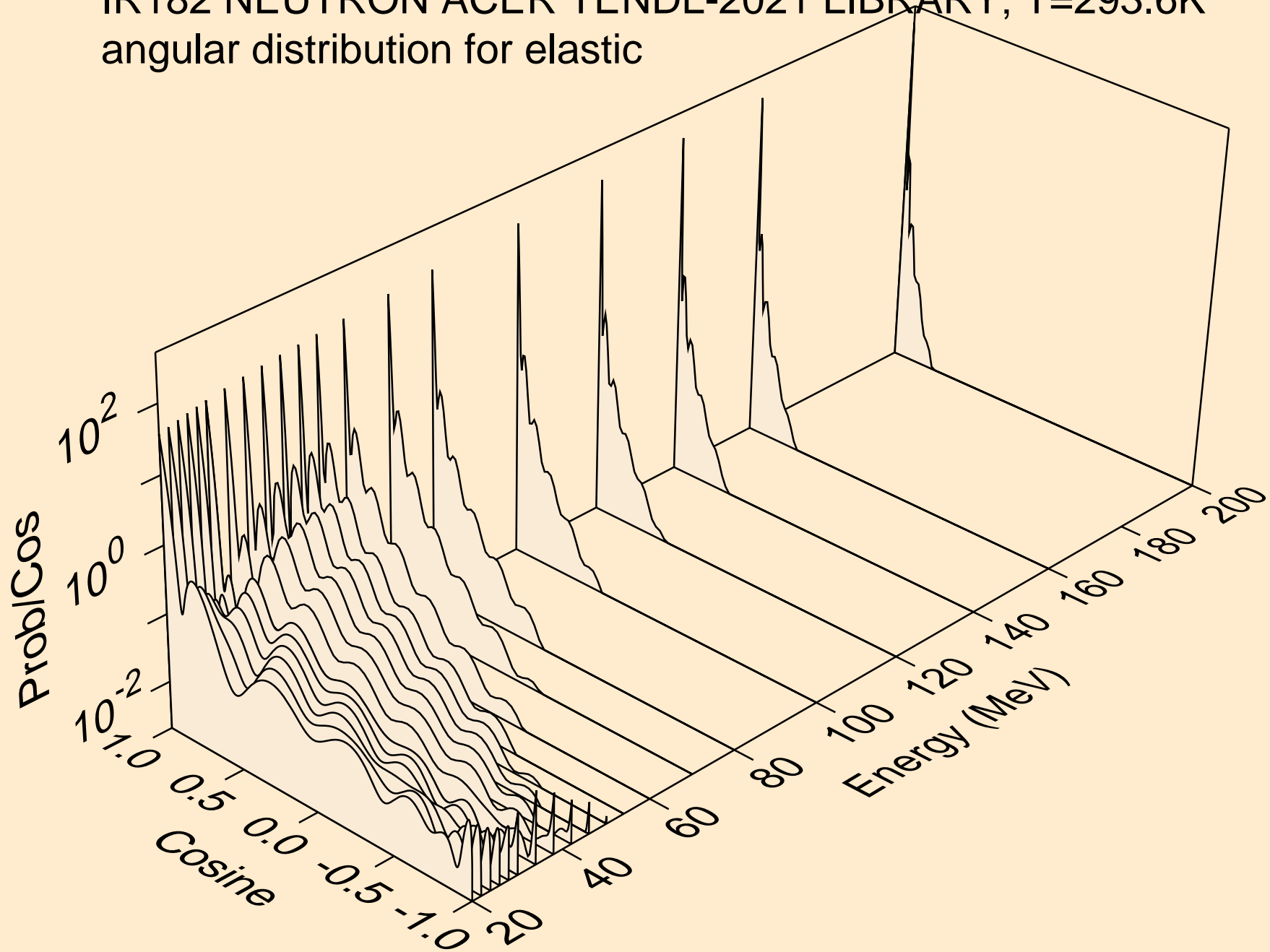

IR182 NEUTRON ACER TENDL-2021 LIBRARY; T=293.6K  
angular distribution for (n,n\*1)

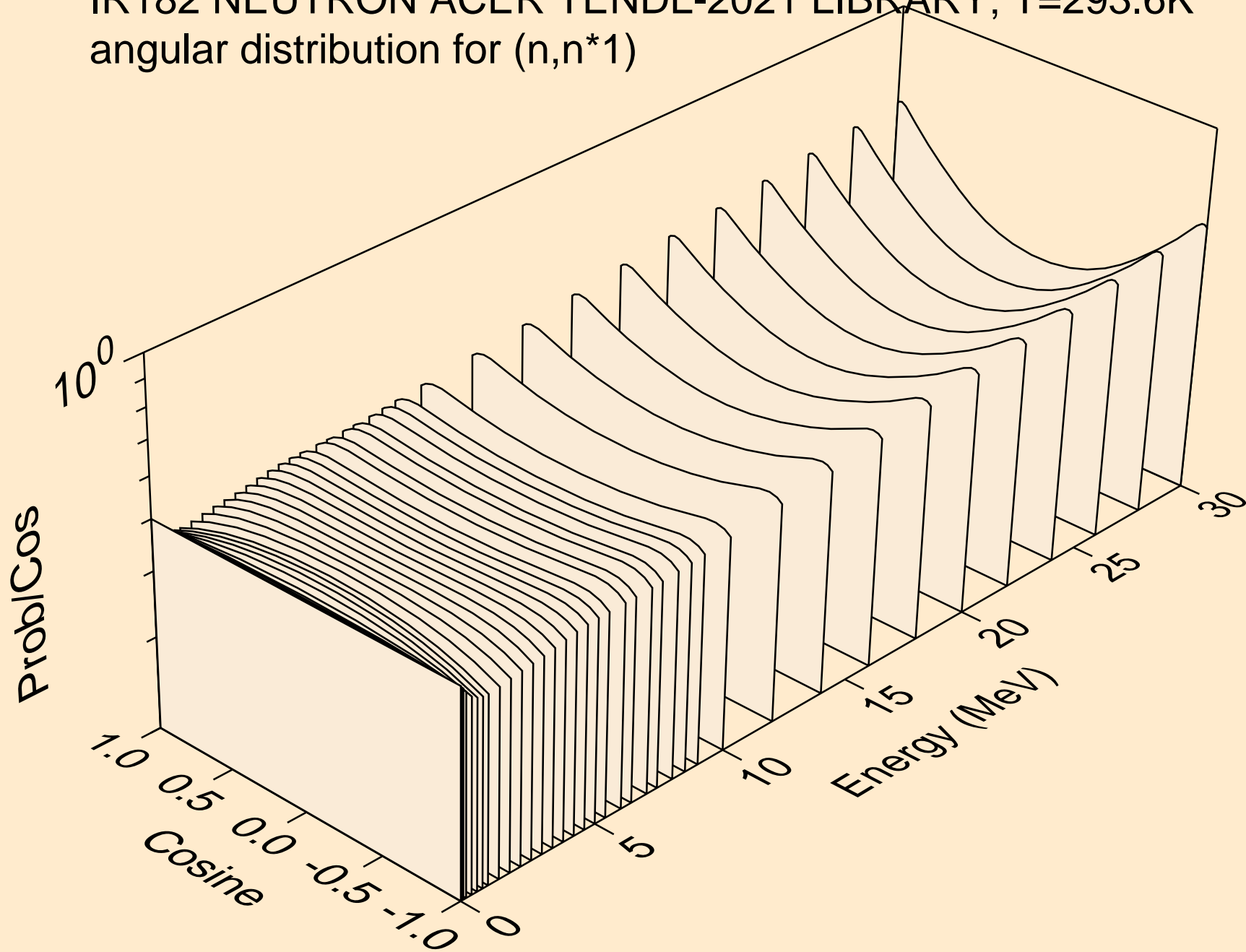

IR182 NEUTRON ACER TENDL-2021 LIBRARY; T=293.6K  
angular distribution for (n,n\*2)

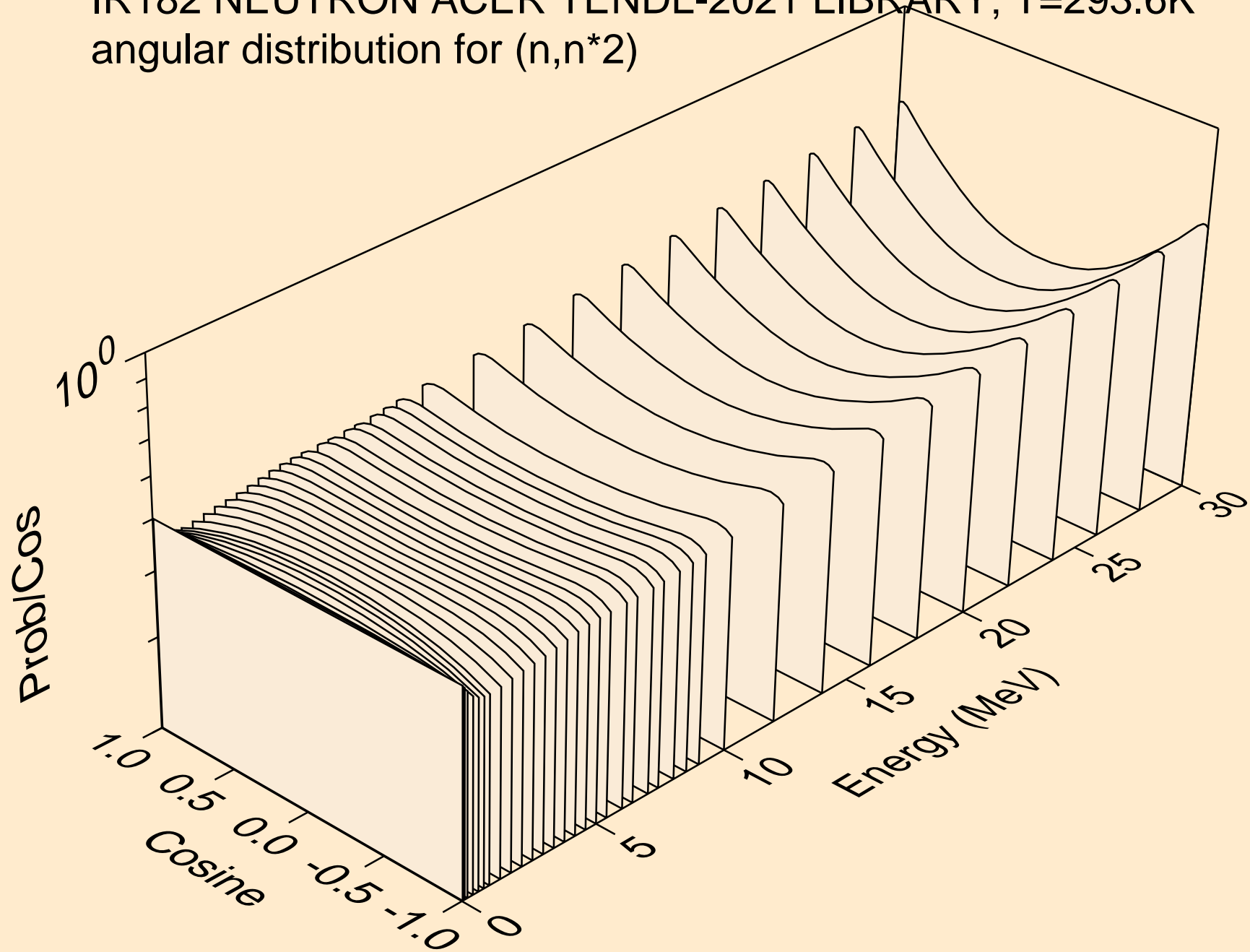

IR182 NEUTRON ACER TENDL-2021 LIBRARY; T=293.6K  
angular distribution for (n,n\*3)

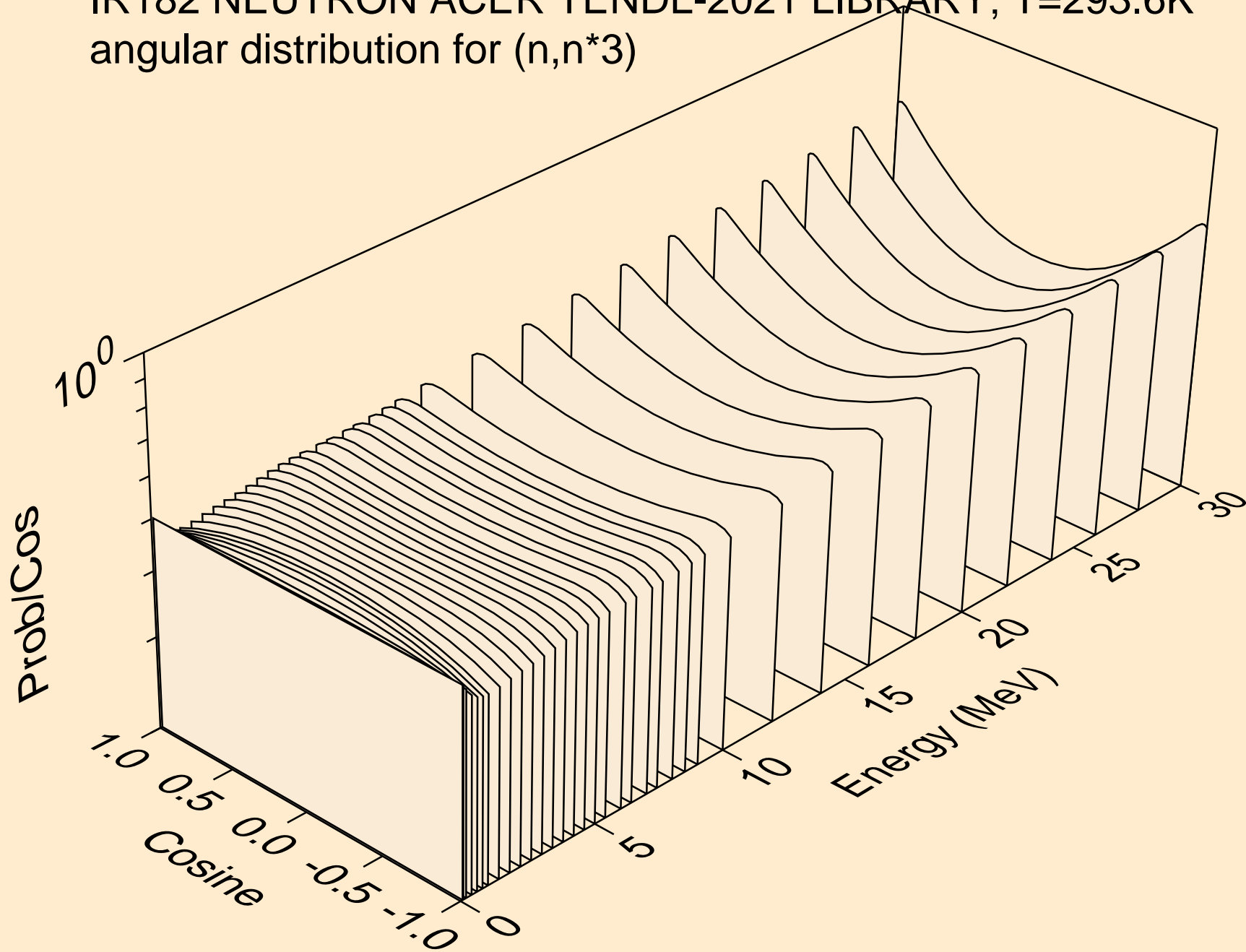

IR182 NEUTRON ACER TENDL-2021 LIBRARY; T=293.6K  
angular distribution for (n,n\*4)

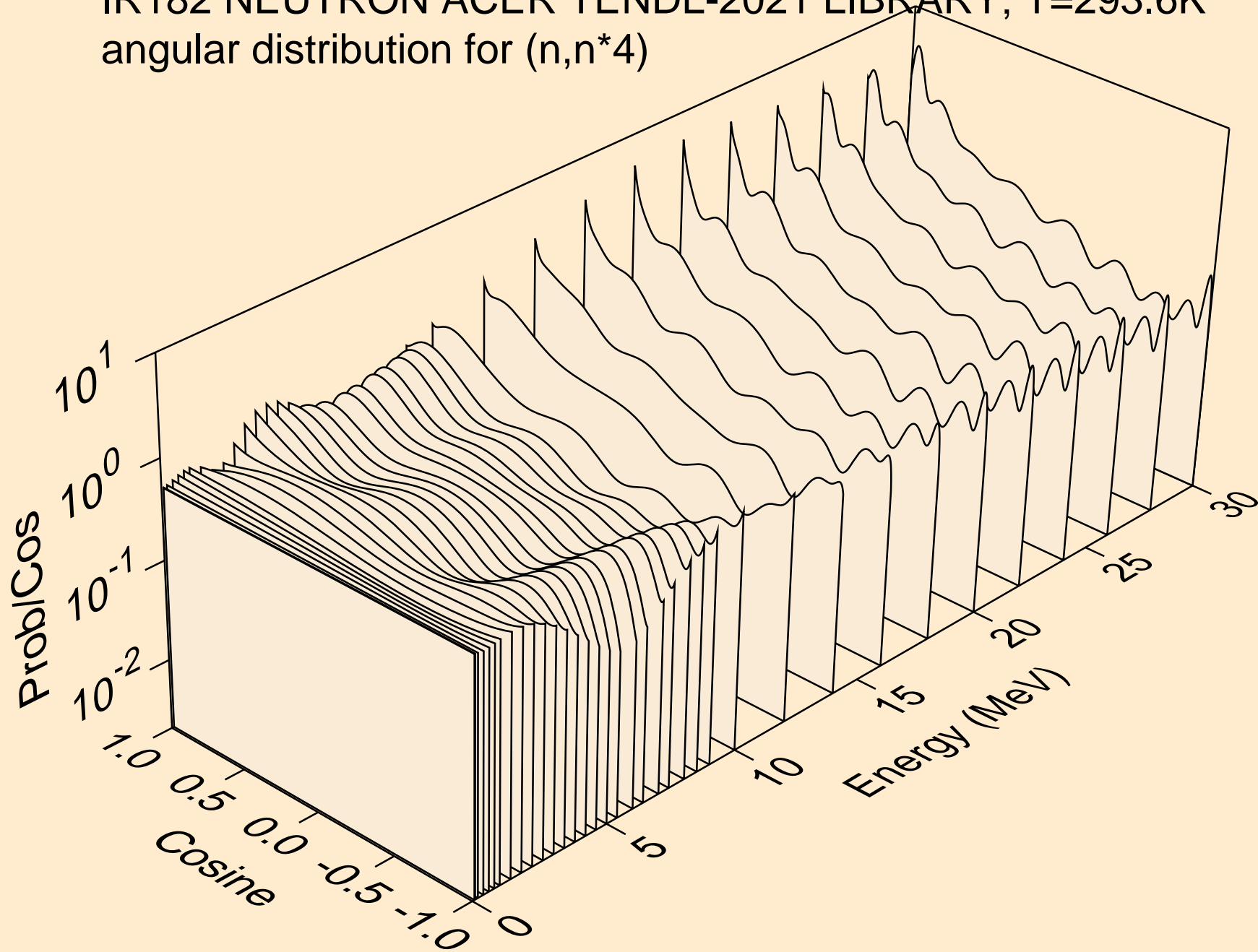

IR182 NEUTRON ACER TENDL-2021 LIBRARY; T=293.6K  
angular distribution for (n,n\*5)

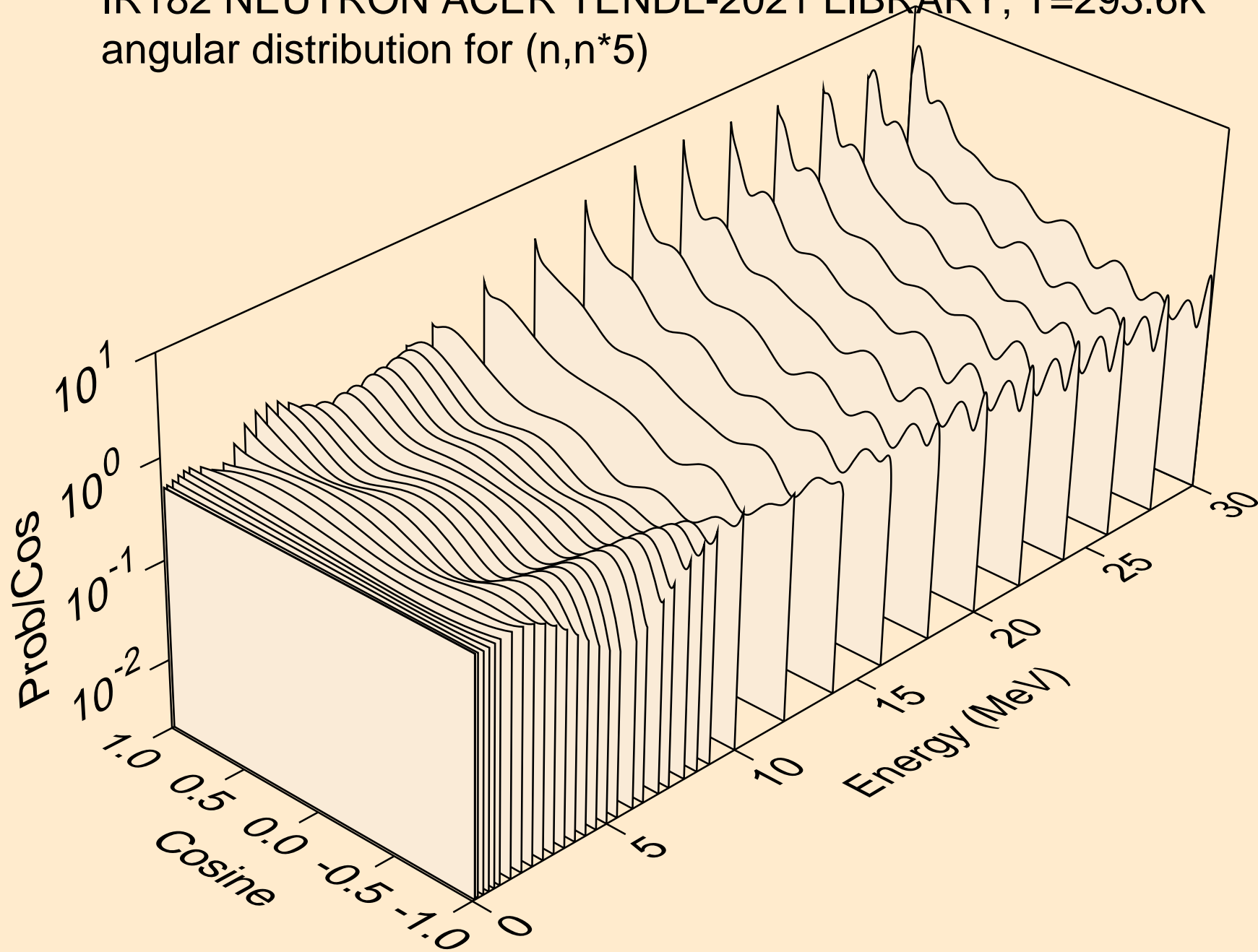

IR182 NEUTRON ACER TENDL-2021 LIBRARY; T=293.6K  
angular distribution for (n,n\*6)

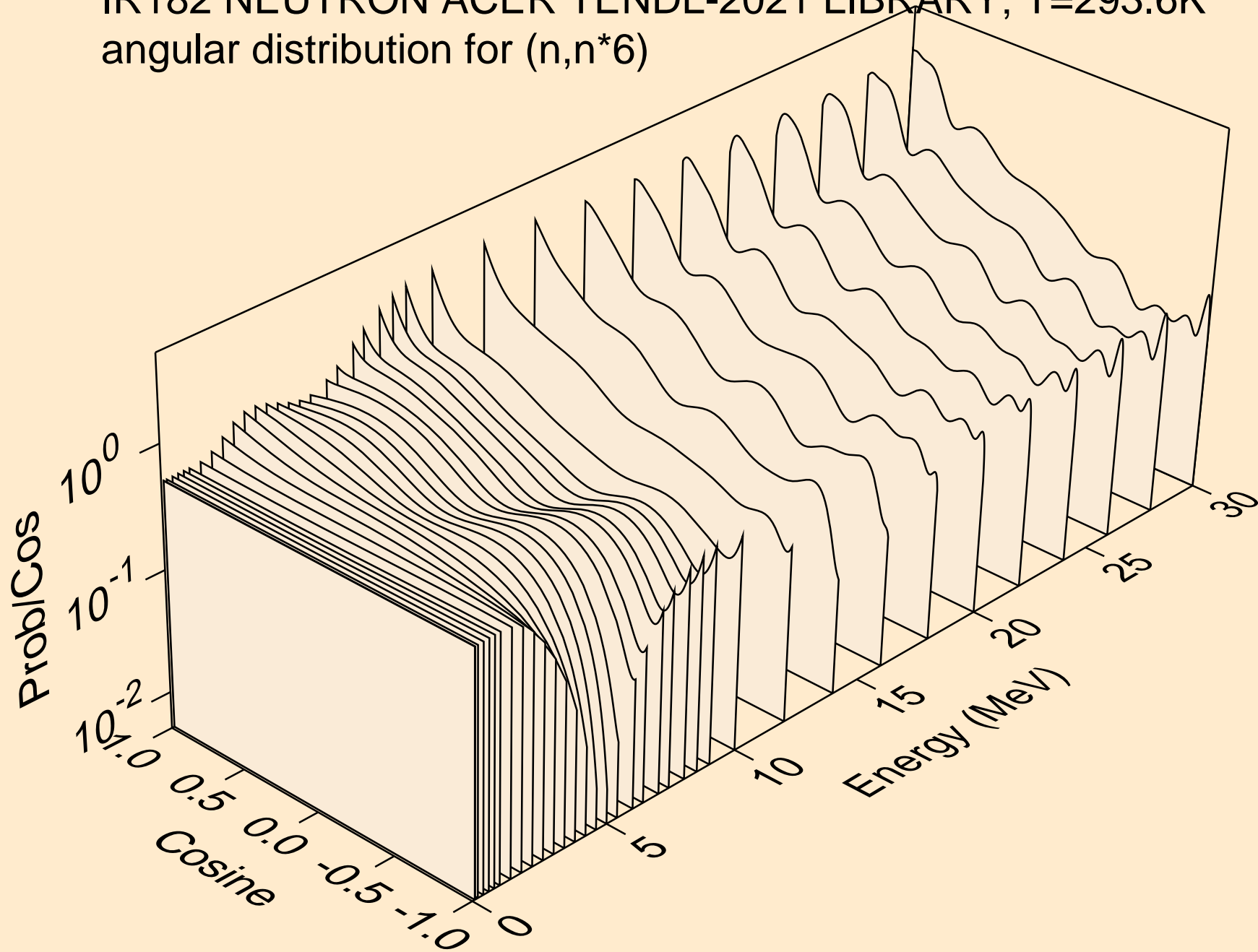

IR182 NEUTRON ACER TENDL-2021 LIBRARY; T=293.6K  
angular distribution for (n,n\*7)

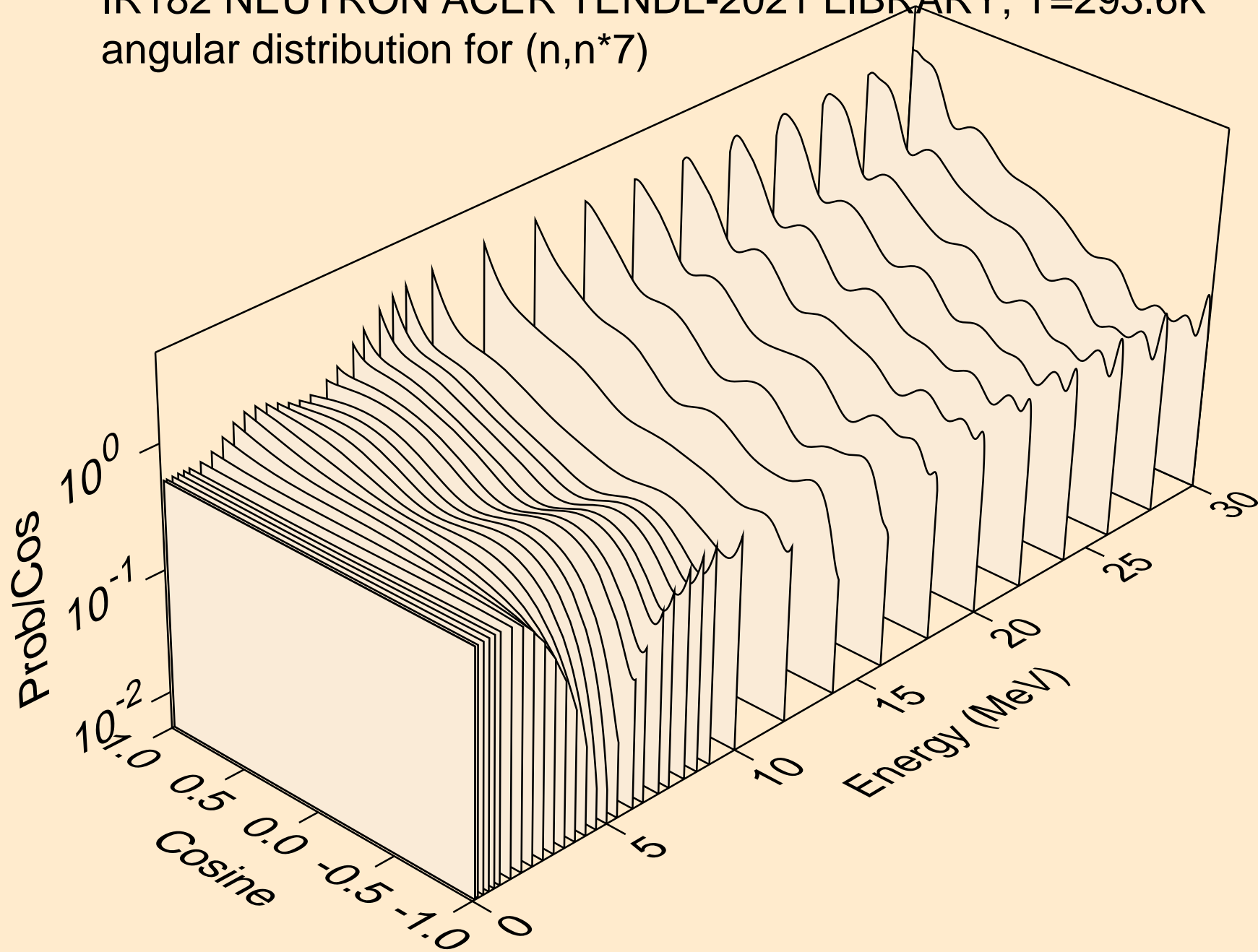

IR182 NEUTRON ACER TENDL-2021 LIBRARY; T=293.6K  
angular distribution for (n,n\*8)

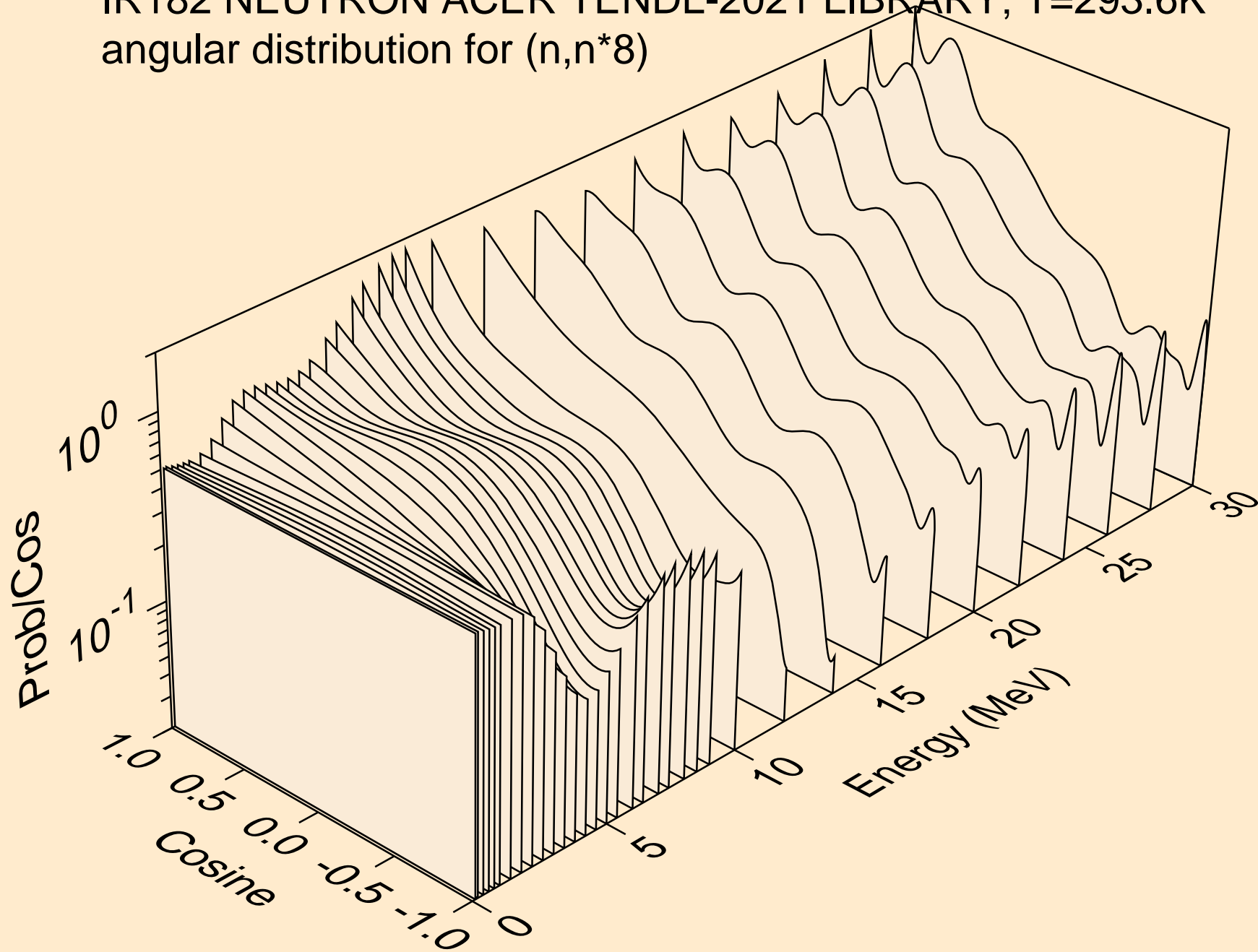

IR182 NEUTRON ACER TENDL-2021 LIBRARY; T=293.6K  
angular distribution for (n,n\*9)

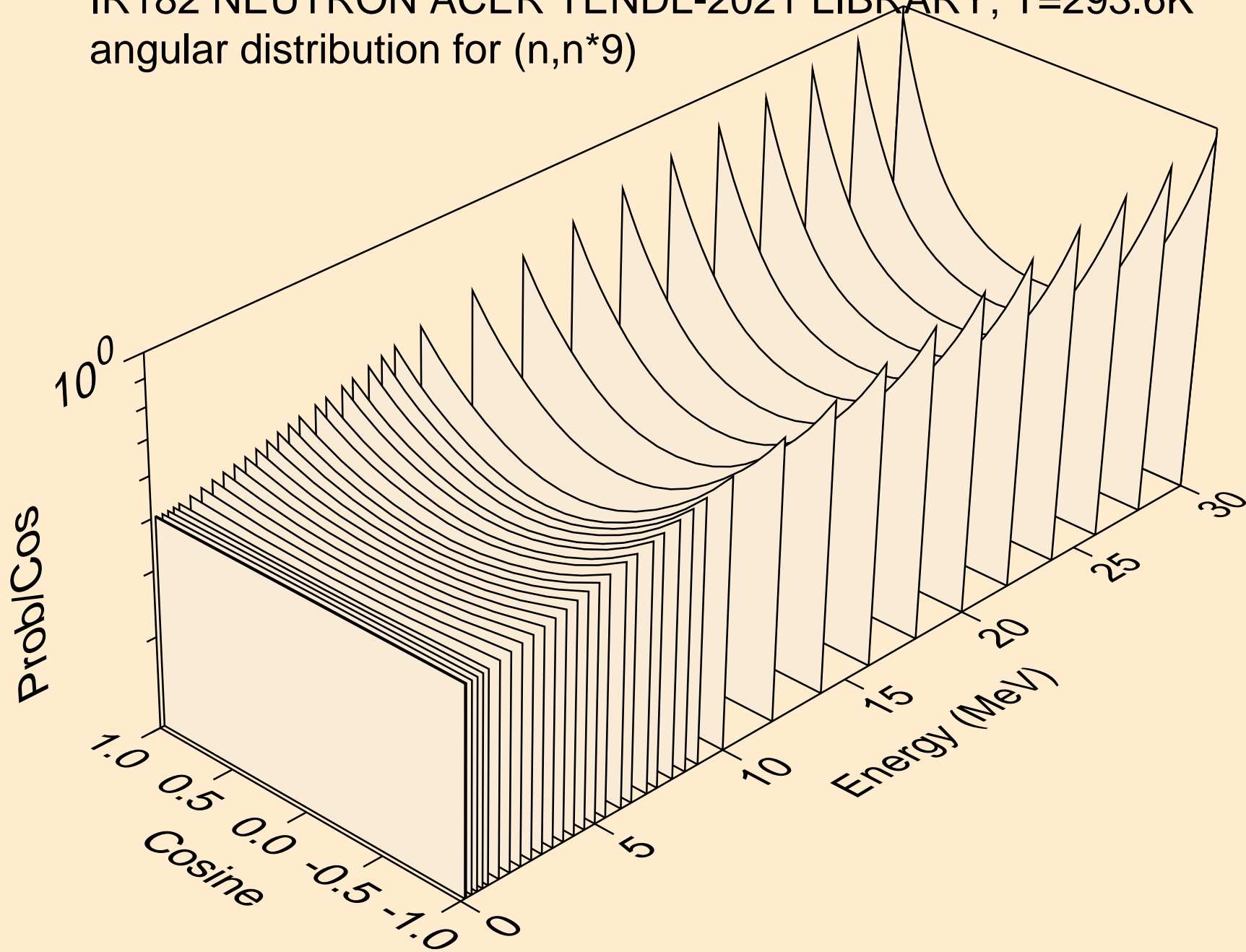

IR182 NEUTRON ACER TENDL-2021 LIBRARY; T=293.6K  
angular distribution for (n,n\*10)

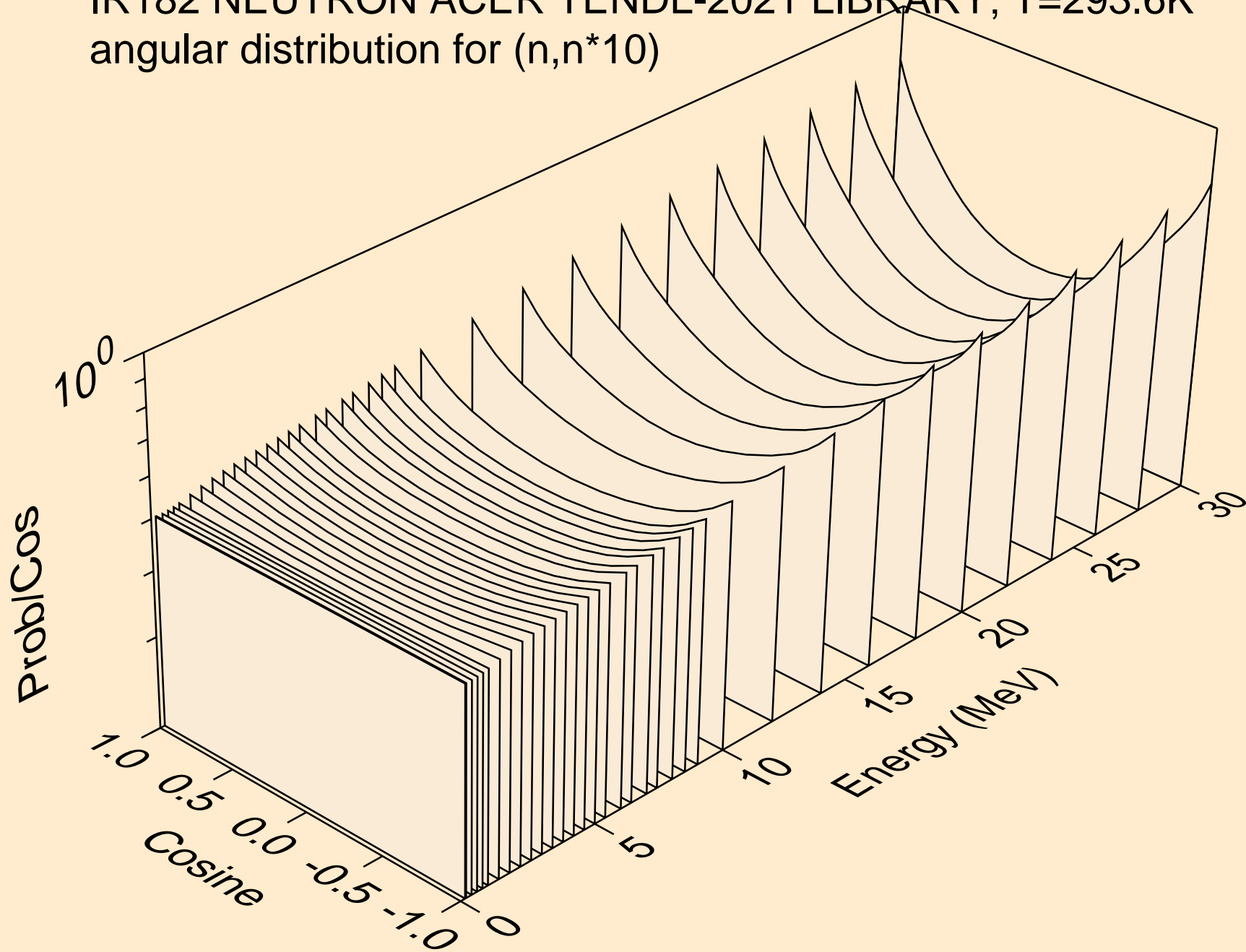

IR182 NEUTRON ACER TENDL-2021 LIBRARY; T=293.6K  
angular distribution for (n,n\*11)

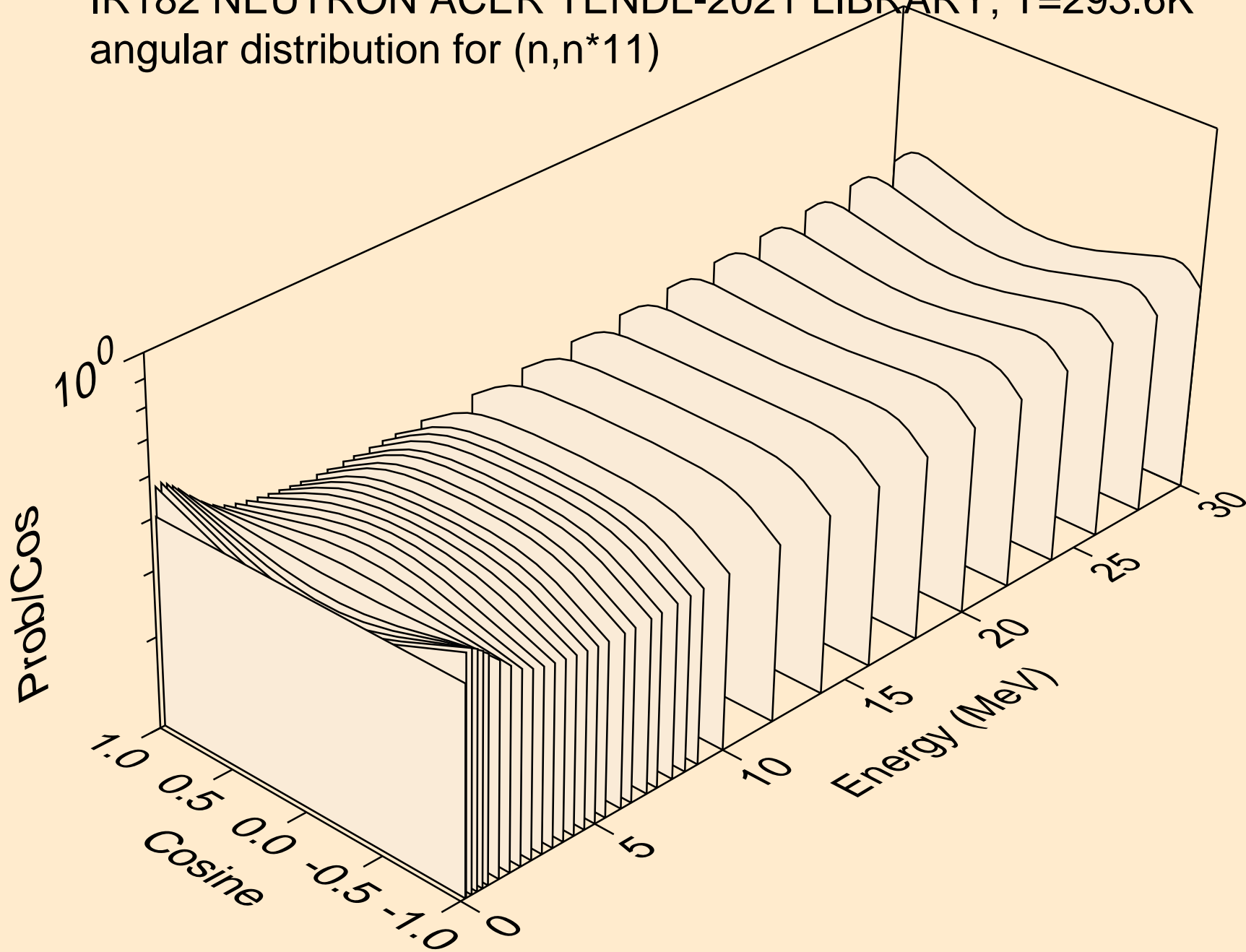

IR182 NEUTRON ACER TENDL-2021 LIBRARY; T=293.6K  
angular distribution for (n,n\*12)

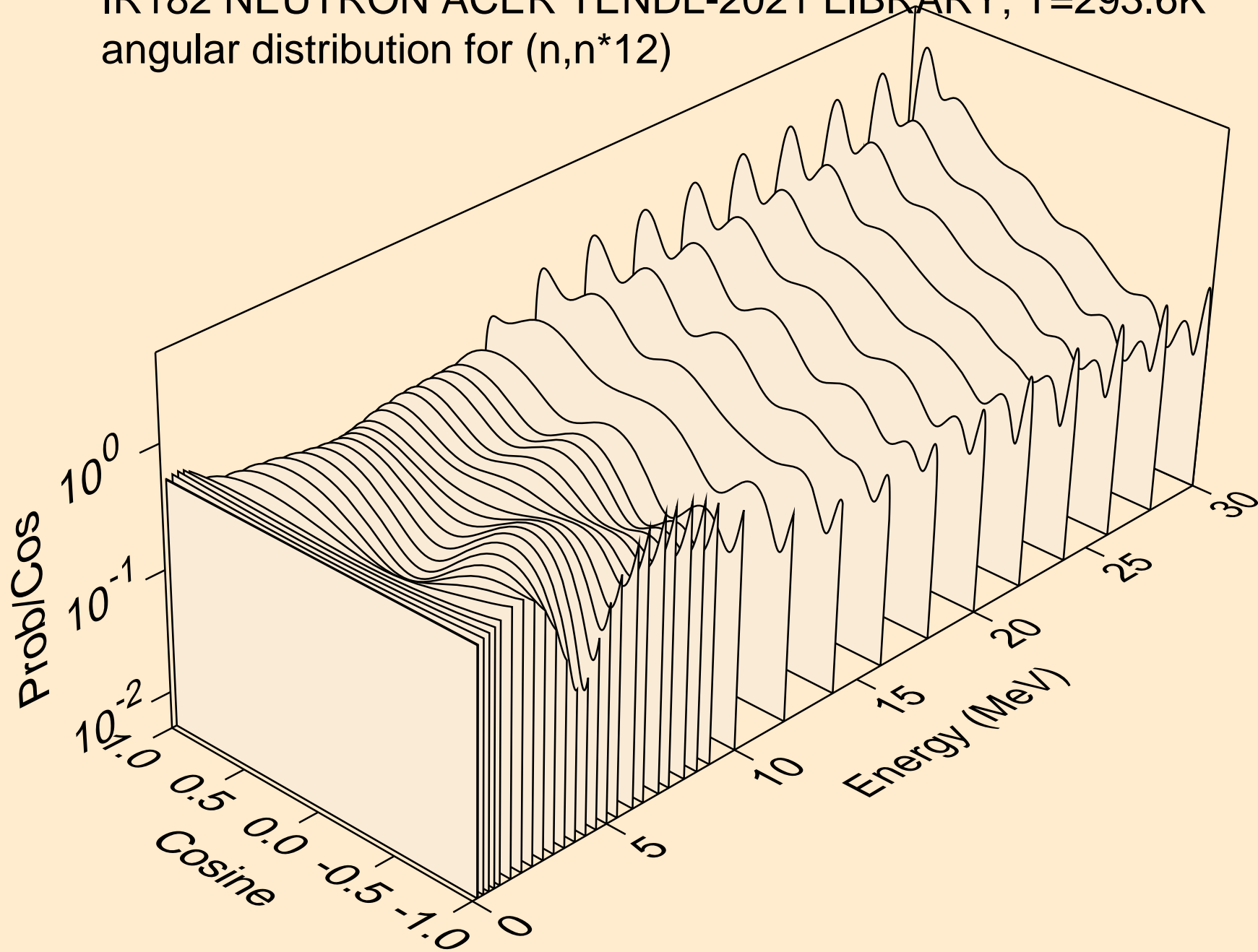

IR182 NEUTRON ACER TENDL-2021 LIBRARY; T=293.6K  
angular distribution for (n,n\*13)

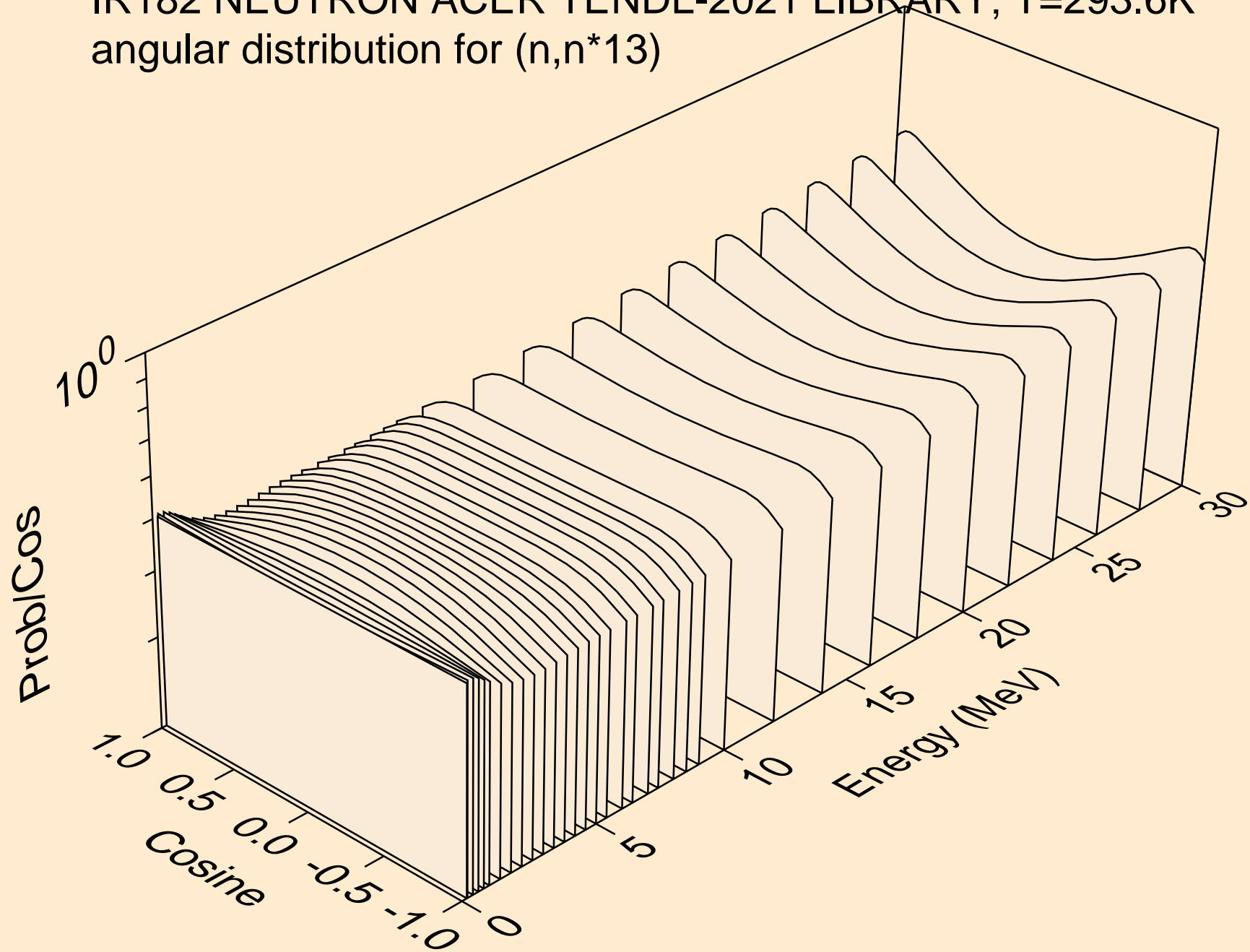

IR182 NEUTRON ACER TENDL-2021 LIBRARY; T=293.6K  
angular distribution for (n,n\*14)

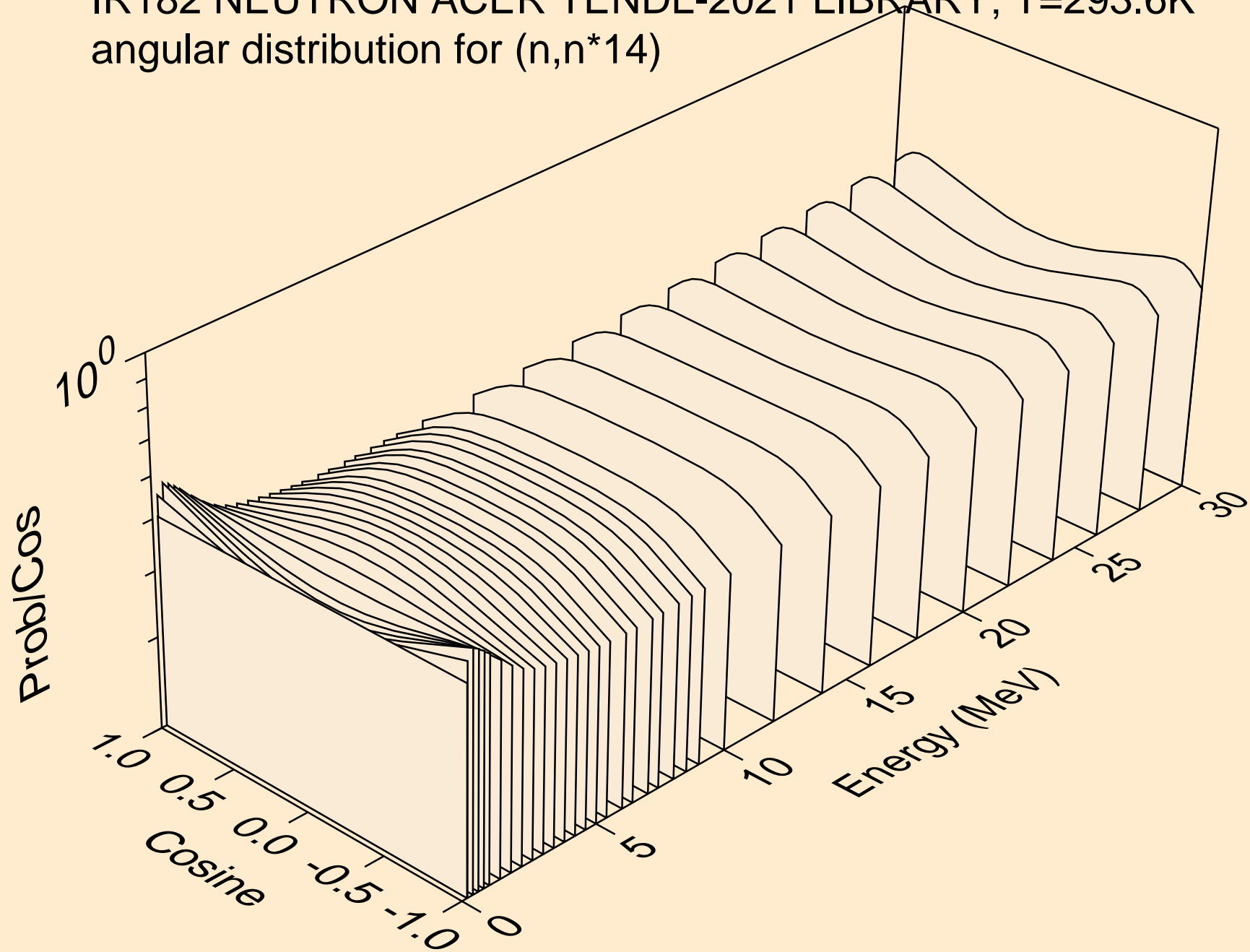

IR182 NEUTRON ACER TENDL-2021 LIBRARY; T=293.6K  
angular distribution for (n,n\*15)

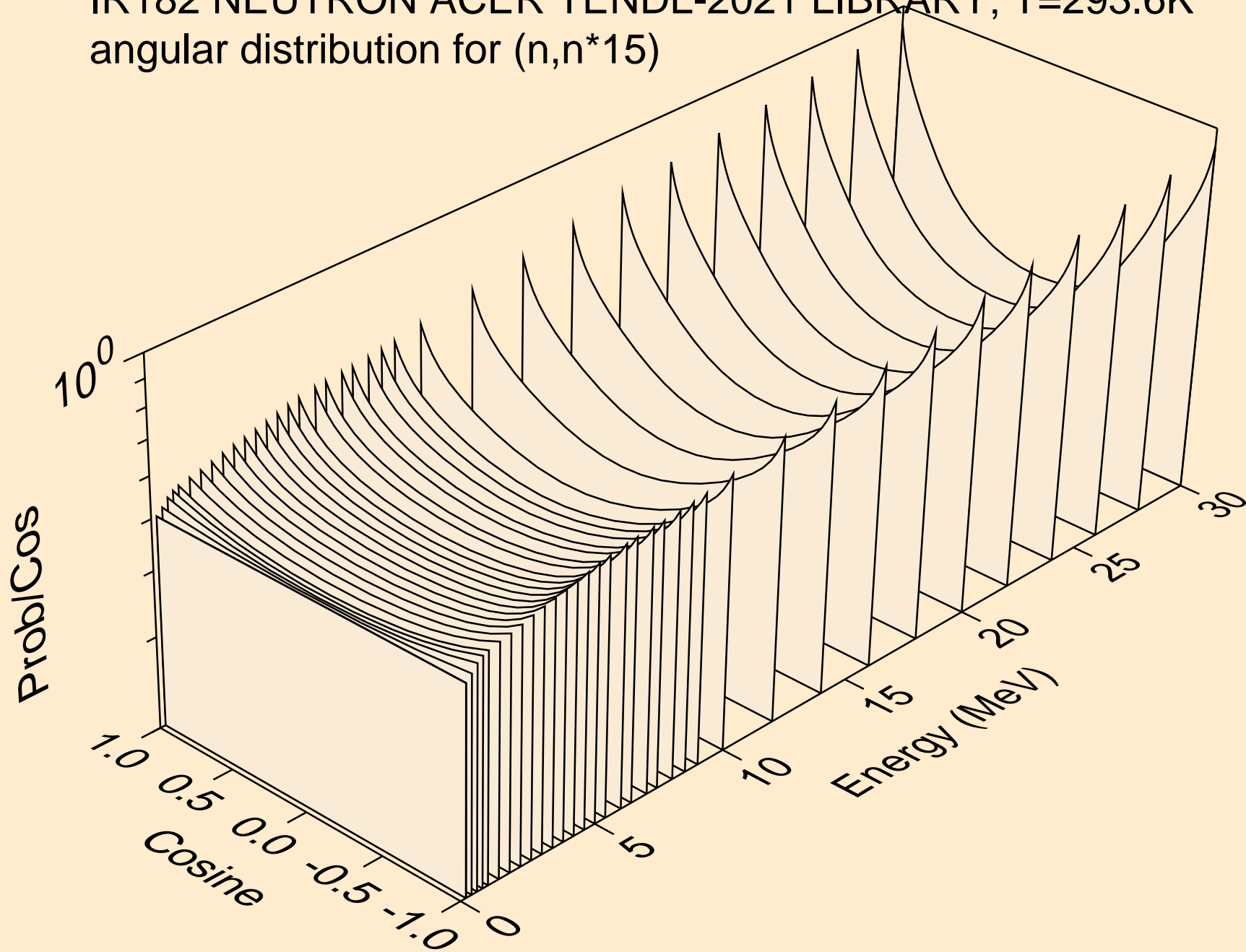

IR182 NEUTRON ACER TENDL-2021 LIBRARY; T=293.6K  
angular distribution for (n,n\*16)

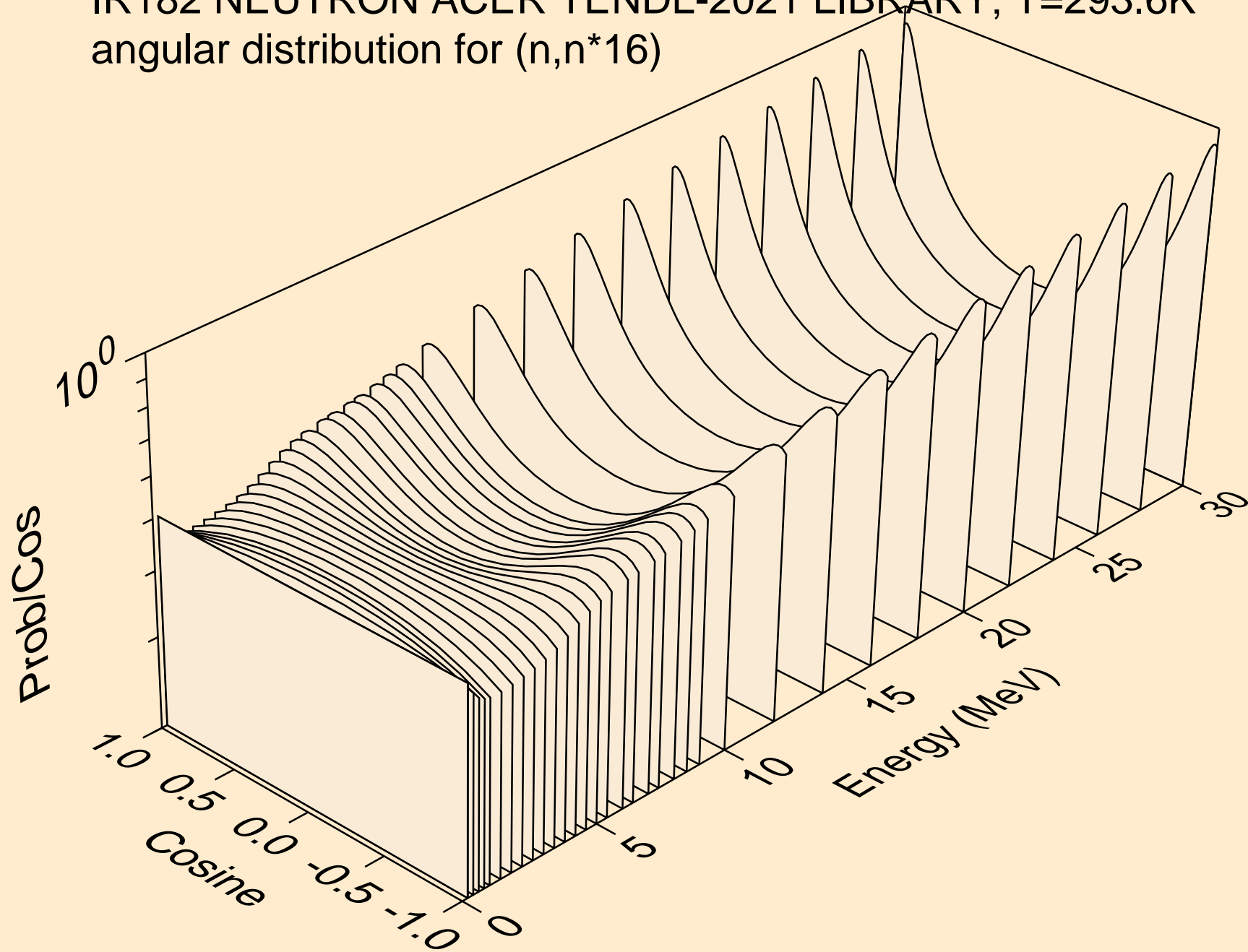

IR182 NEUTRON ACER TENDL-2021 LIBRARY; T=293.6K  
angular distribution for (n,n\*17)

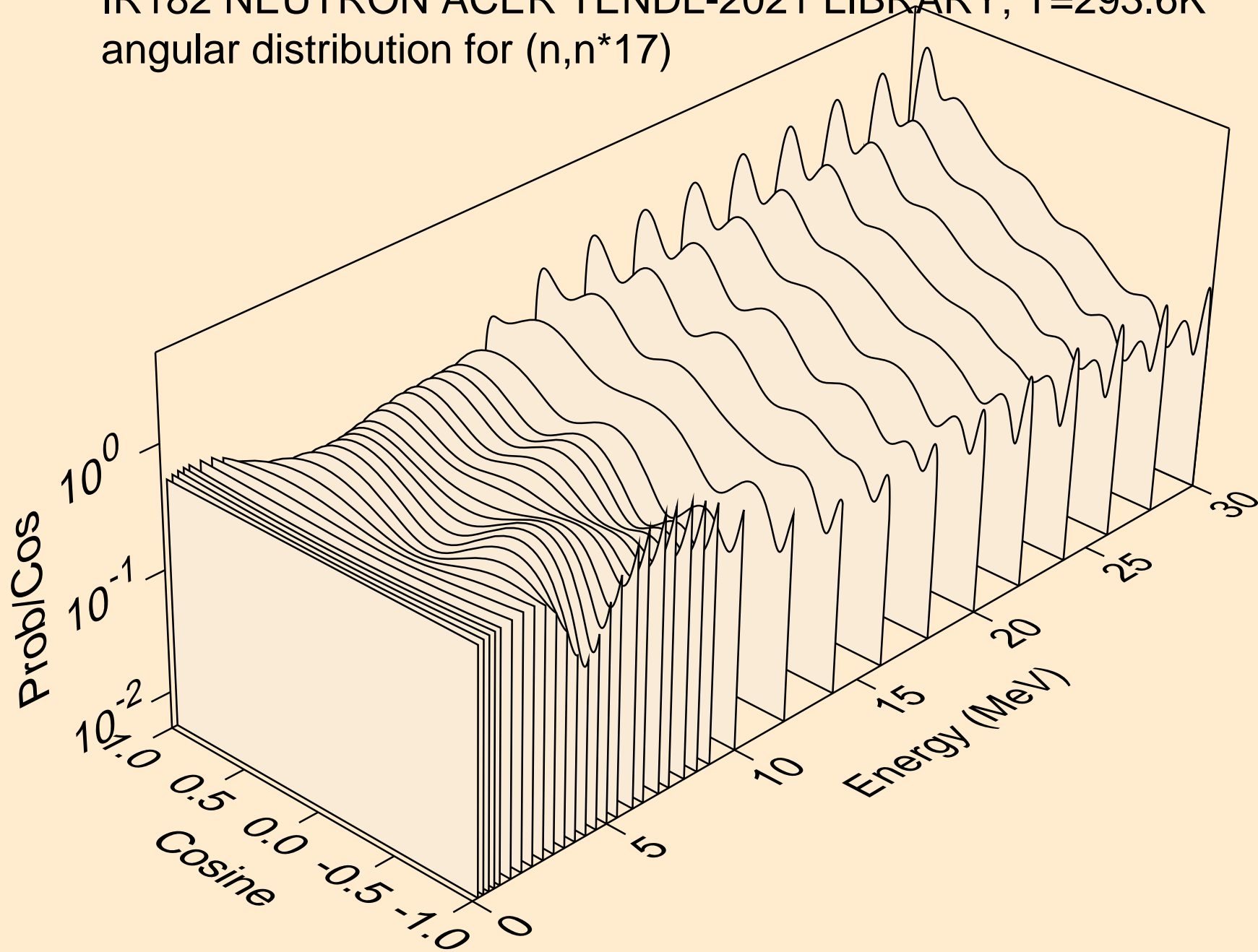

IR182 NEUTRON ACER TENDL-2021 LIBRARY; T=293.6K  
angular distribution for (n,n\*18)

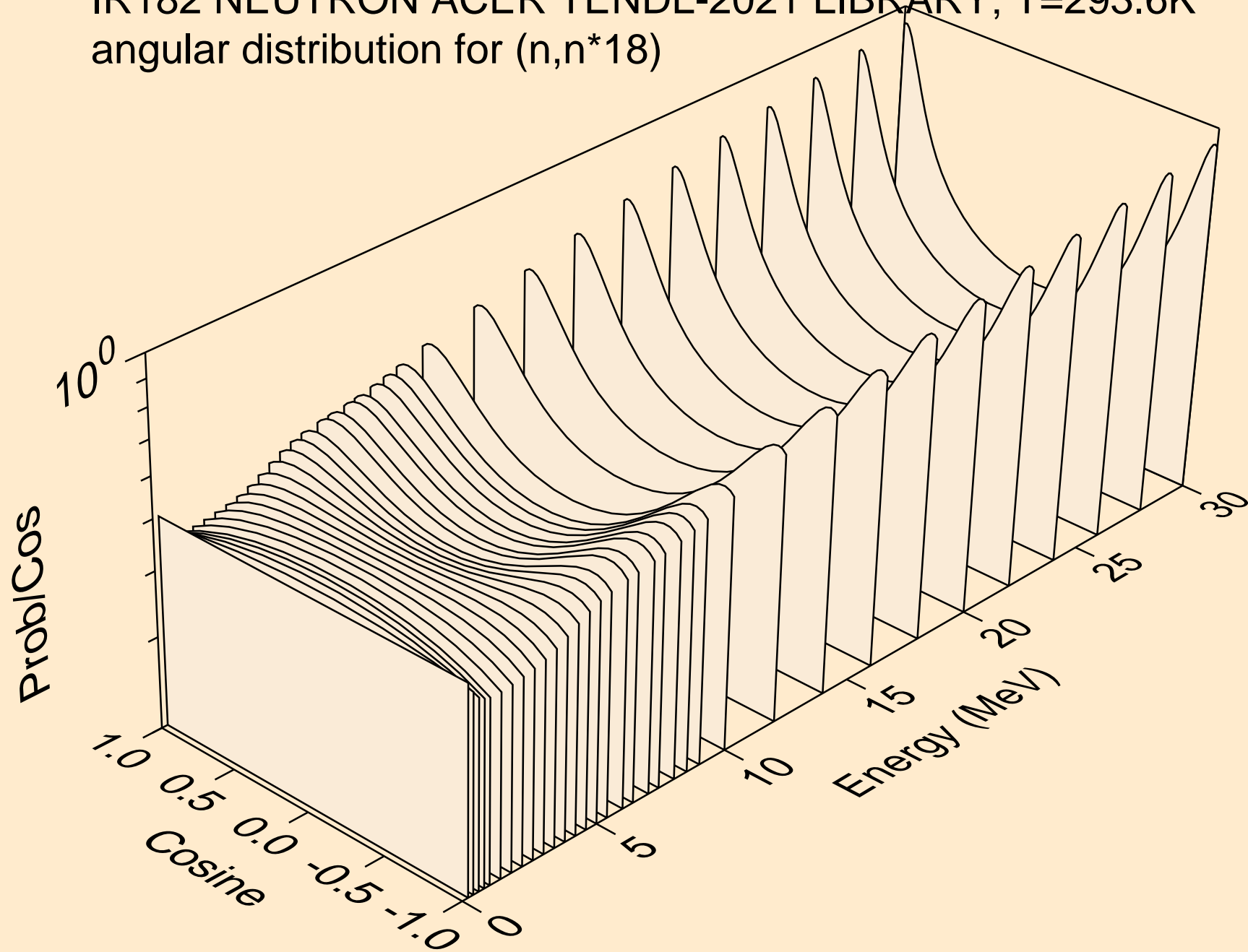

IR182 NEUTRON ACER TENDL-2021 LIBRARY; T=293.6K  
angular distribution for (n,n\*19)

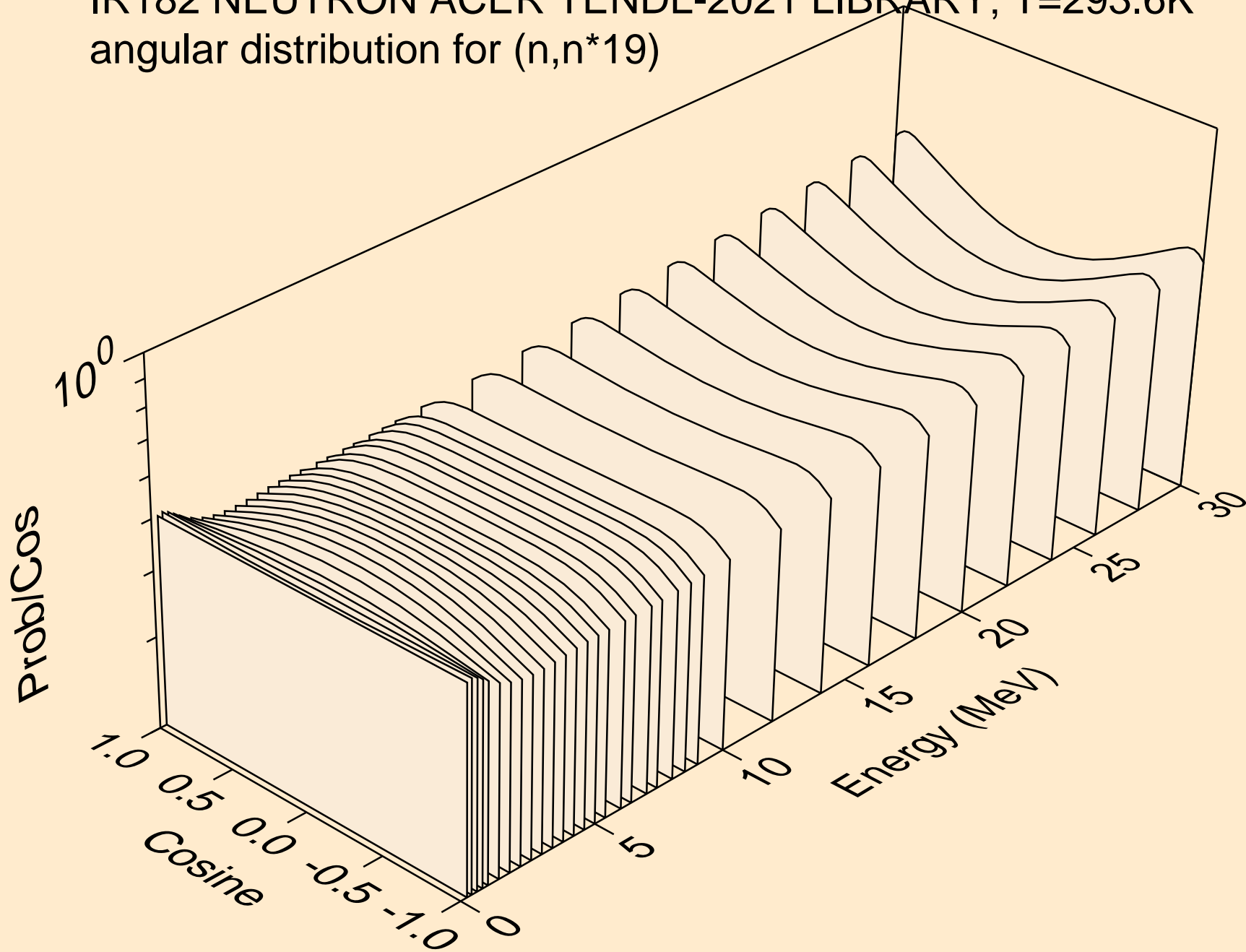

IR182 NEUTRON ACER TENDL-2021 LIBRARY; T=293.6K  
angular distribution for (n,n\*20)

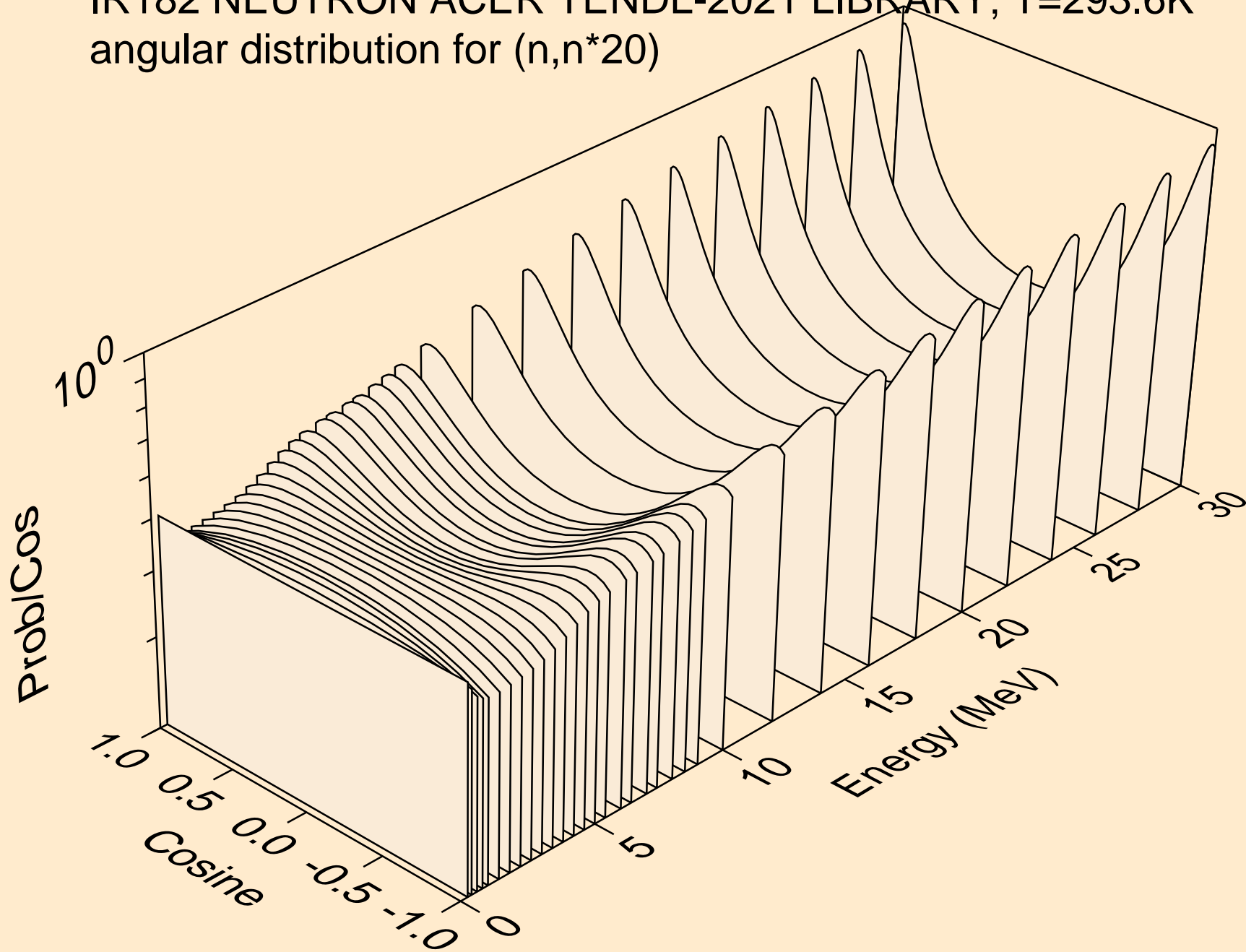

IR182 NEUTRON ACER TENDL-2021 LIBRARY; T=293.6K  
angular distribution for (n,n\*21)

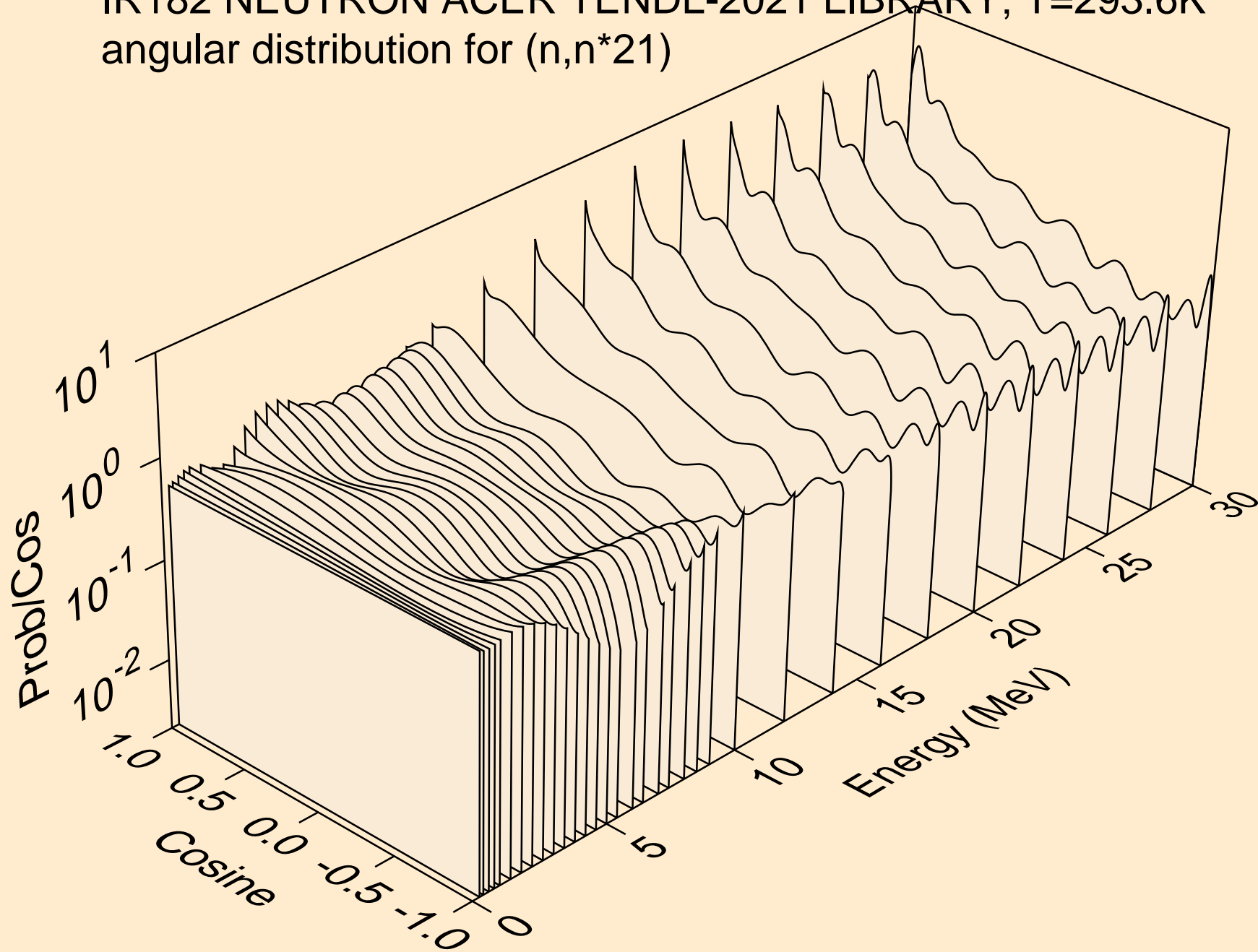

IR182 NEUTRON ACER TENDL-2021 LIBRARY; T=293.6K  
angular distribution for (n,n\*22)

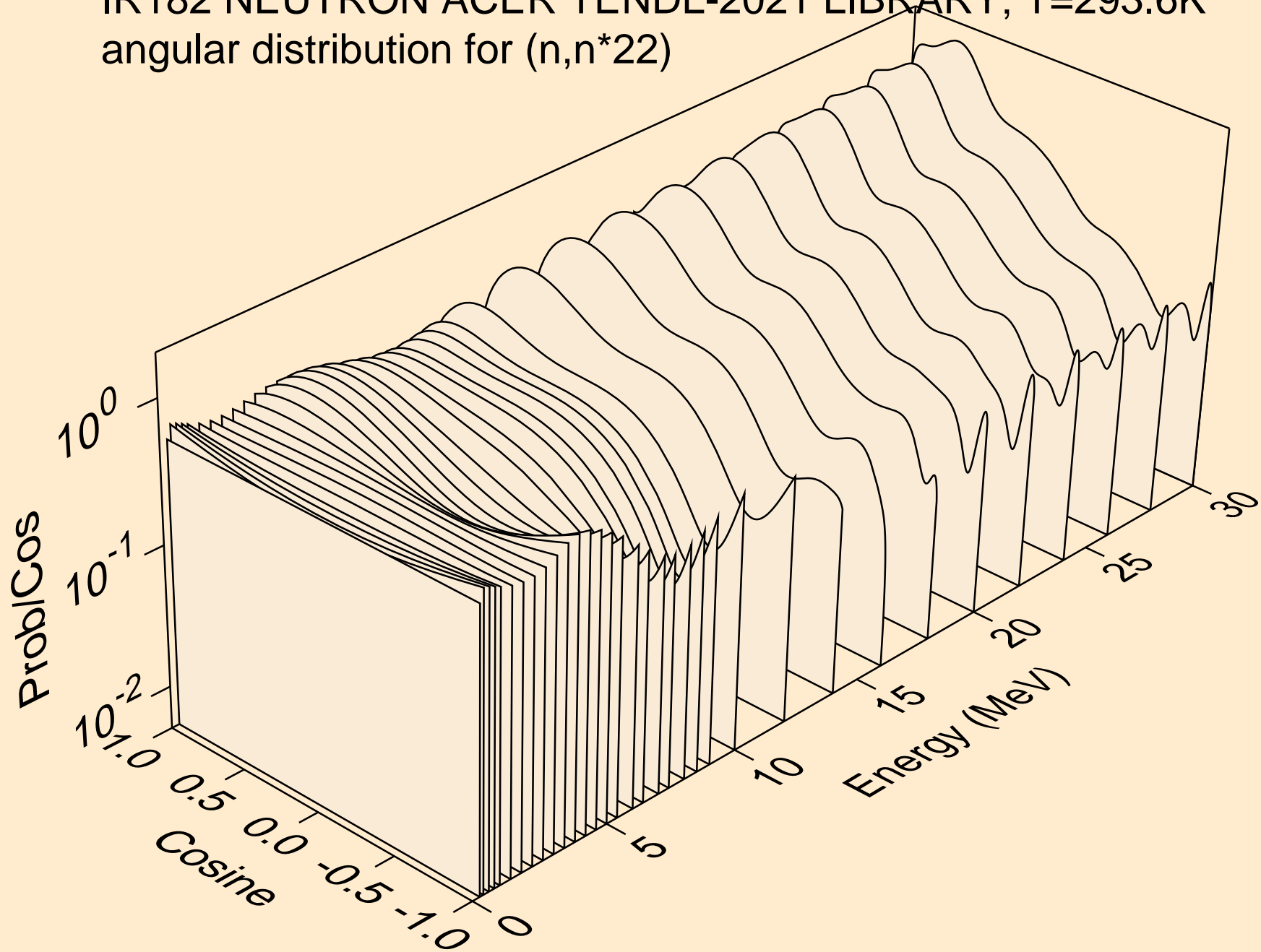

IR182 NEUTRON ACER TENDL-2021 LIBRARY; T=293.6K  
angular distribution for (n,n\*23)

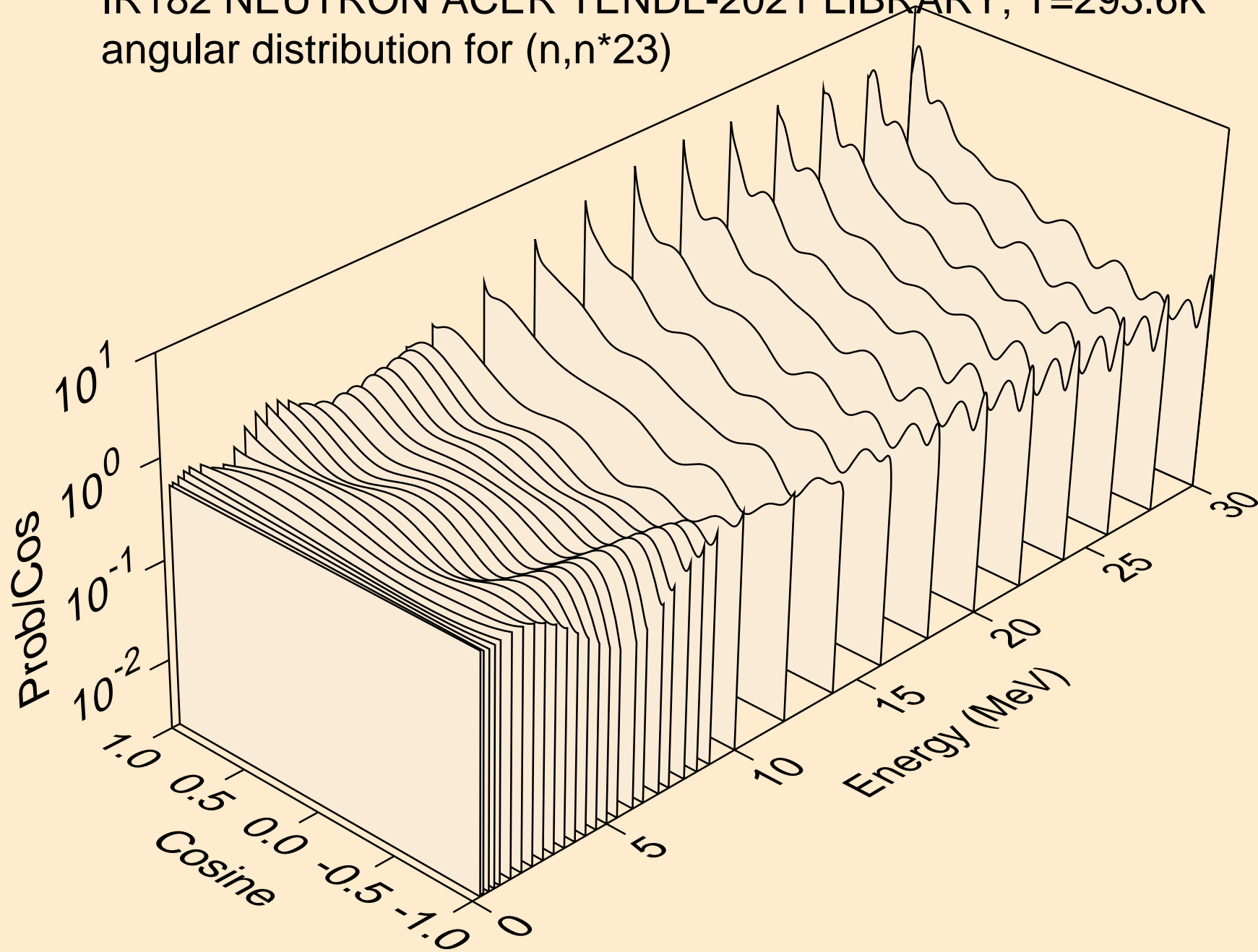

IR182 NEUTRON ACER TENDL-2021 LIBRARY; T=293.6K  
angular distribution for (n,n\*24)

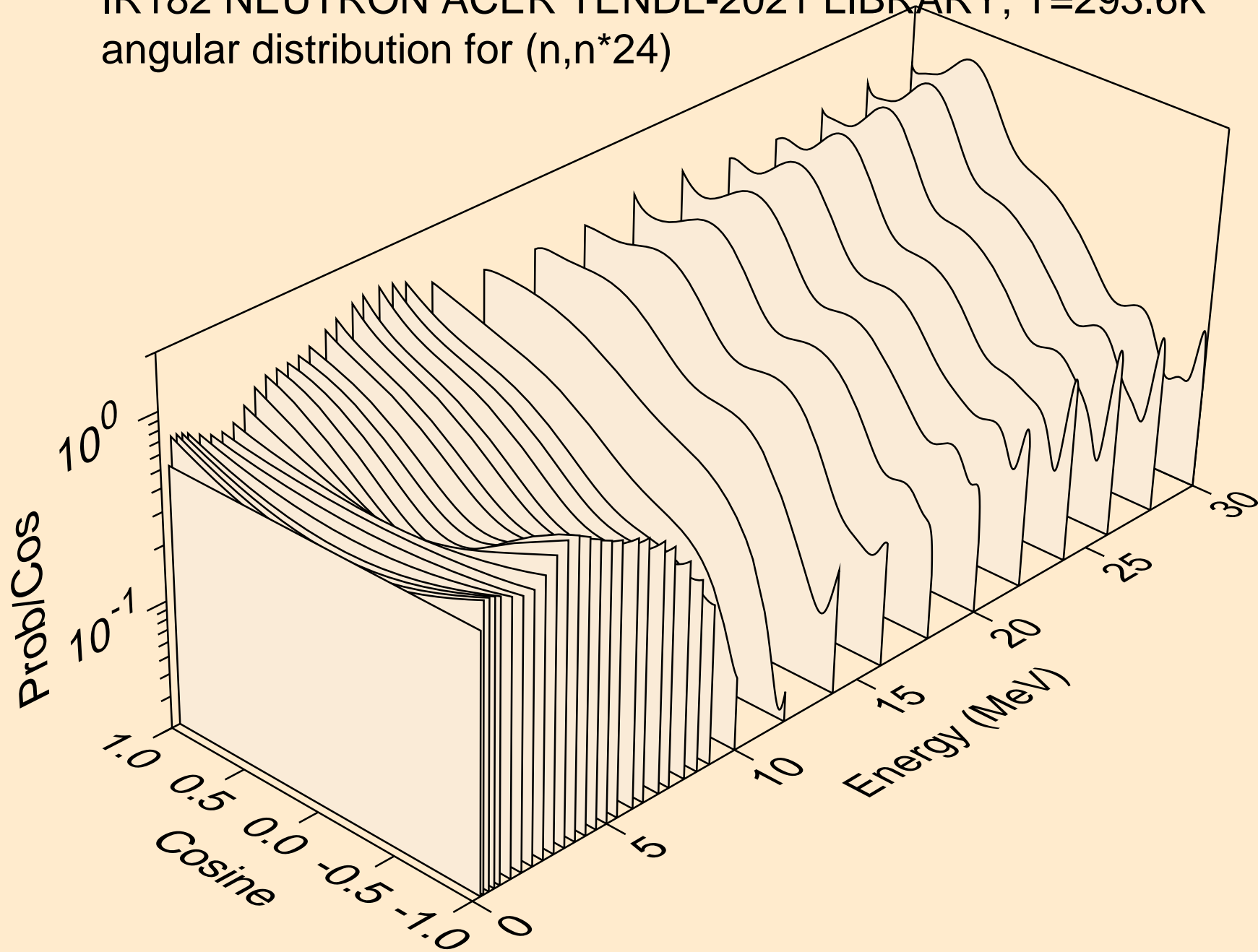

IR182 NEUTRON ACER TENDL-2021 LIBRARY; T=293.6K  
angular distribution for (n,n\*25)

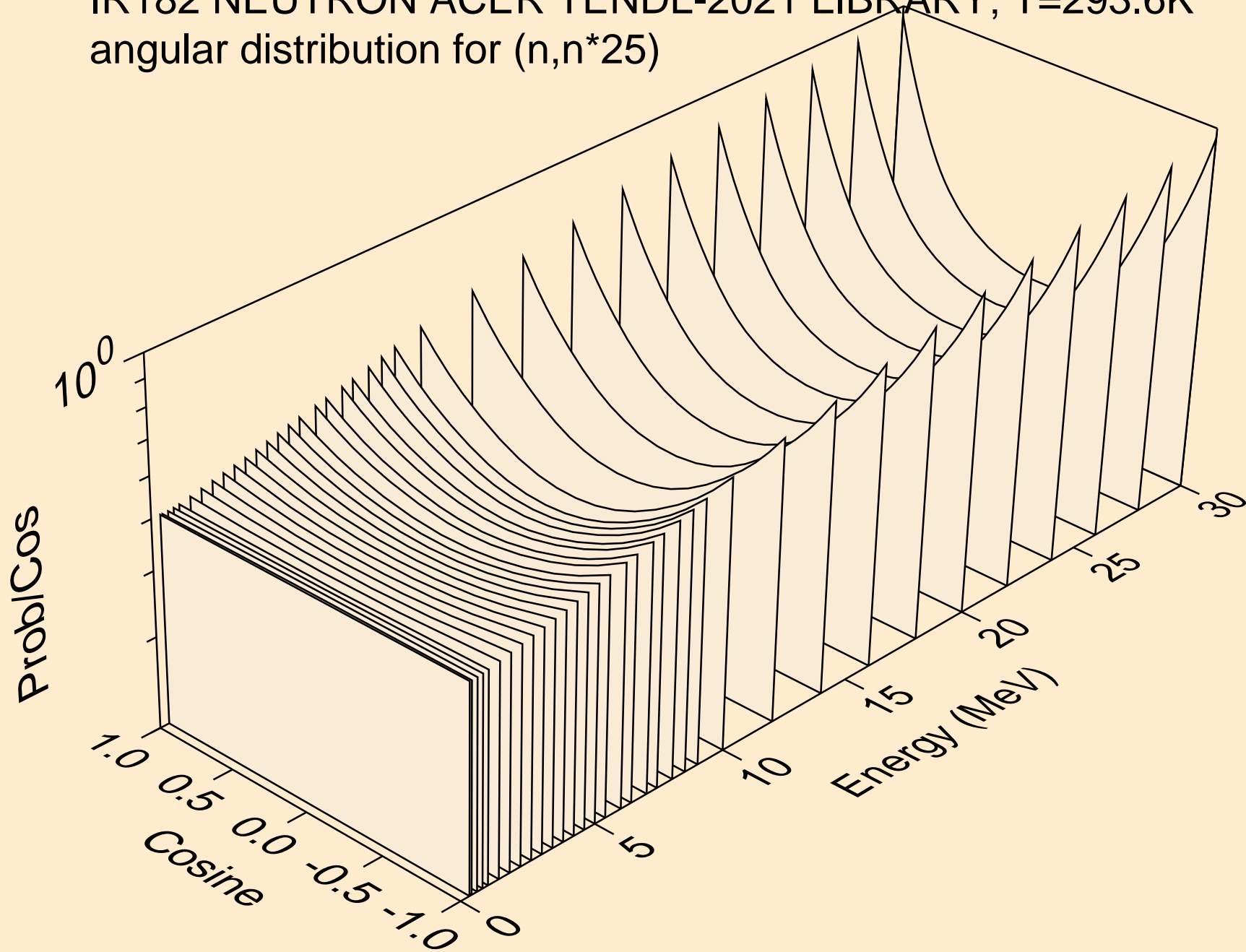

IR182 NEUTRON ACER TENDL-2021 LIBRARY; T=293.6K  
angular distribution for (n,n\*26)

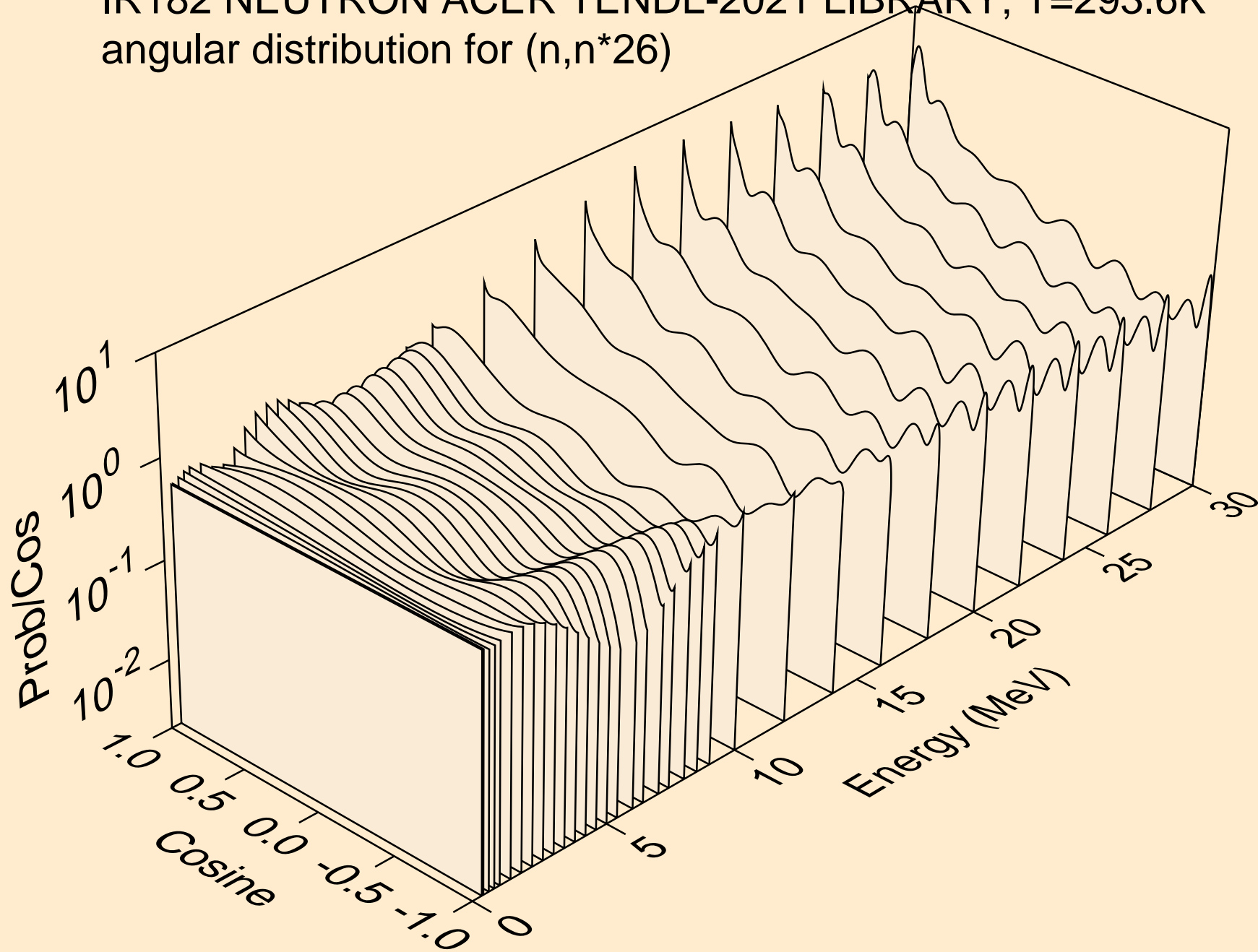

IR182 NEUTRON ACER TENDL-2021 LIBRARY; T=293.6K  
angular distribution for (n,n\*27)

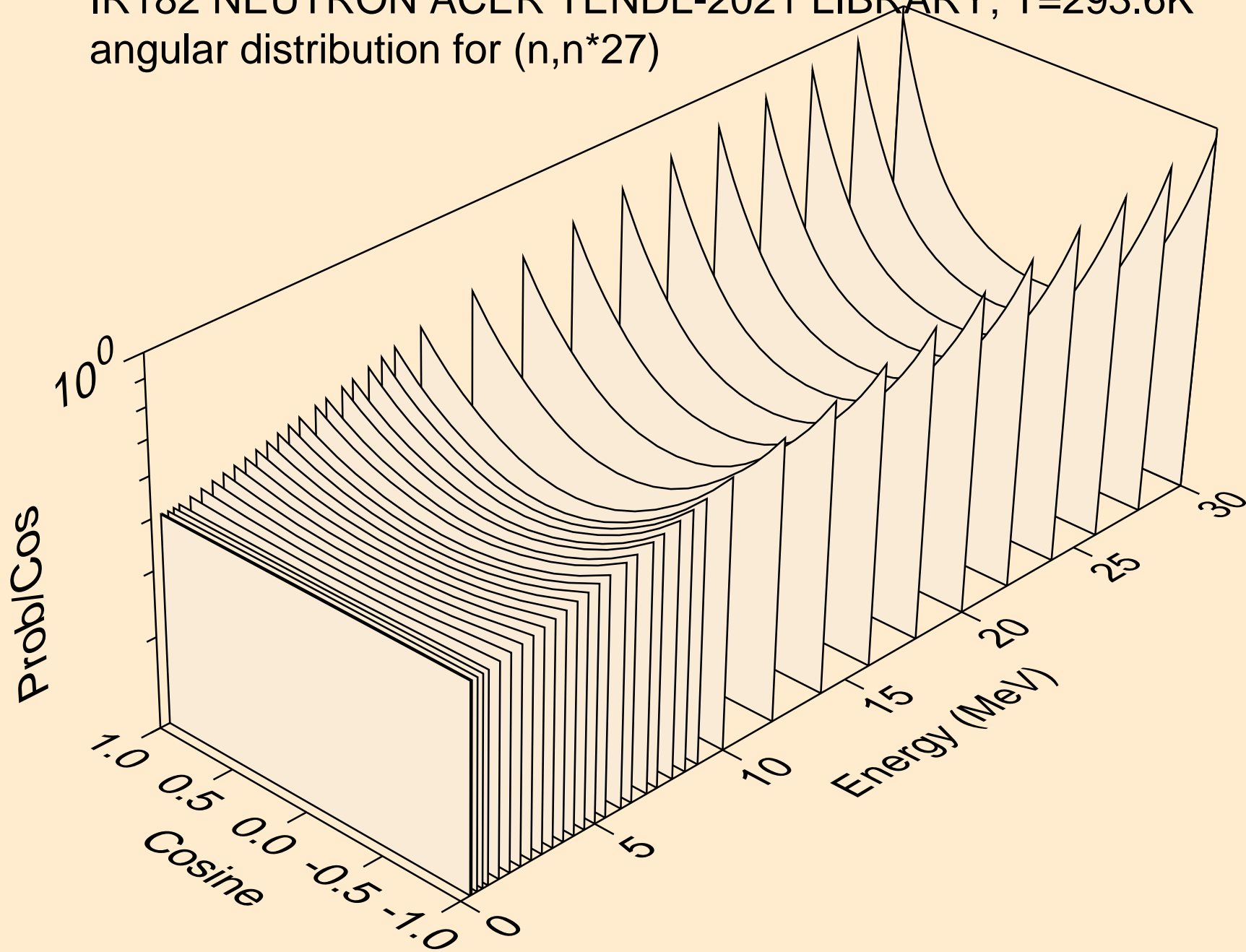

IR182 NEUTRON ACER TENDL-2021 LIBRARY; T=293.6K  
angular distribution for (n,n\*28)

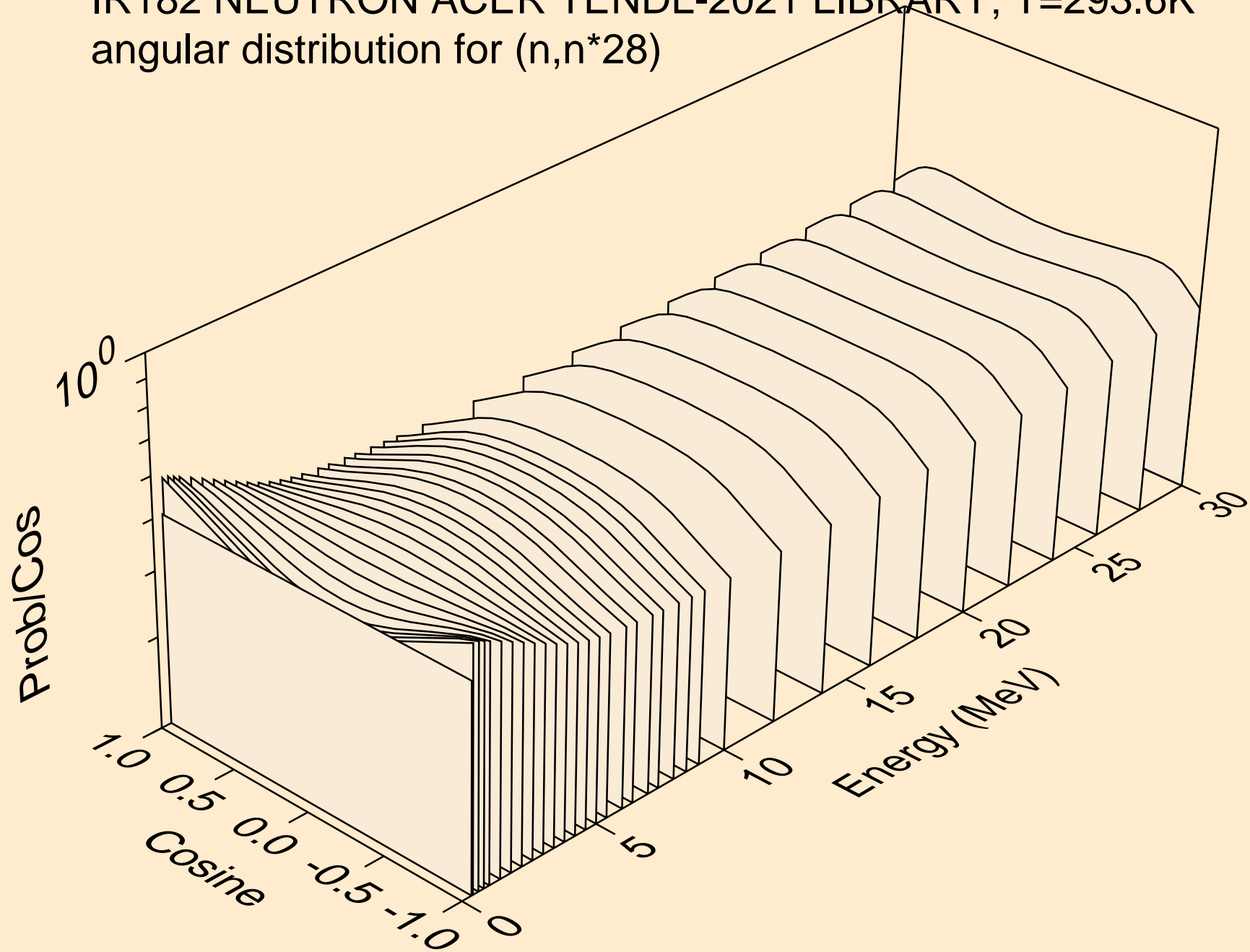

IR182 NEUTRON ACER TENDL-2021 LIBRARY; T=293.6K  
angular distribution for (n,n\*29)

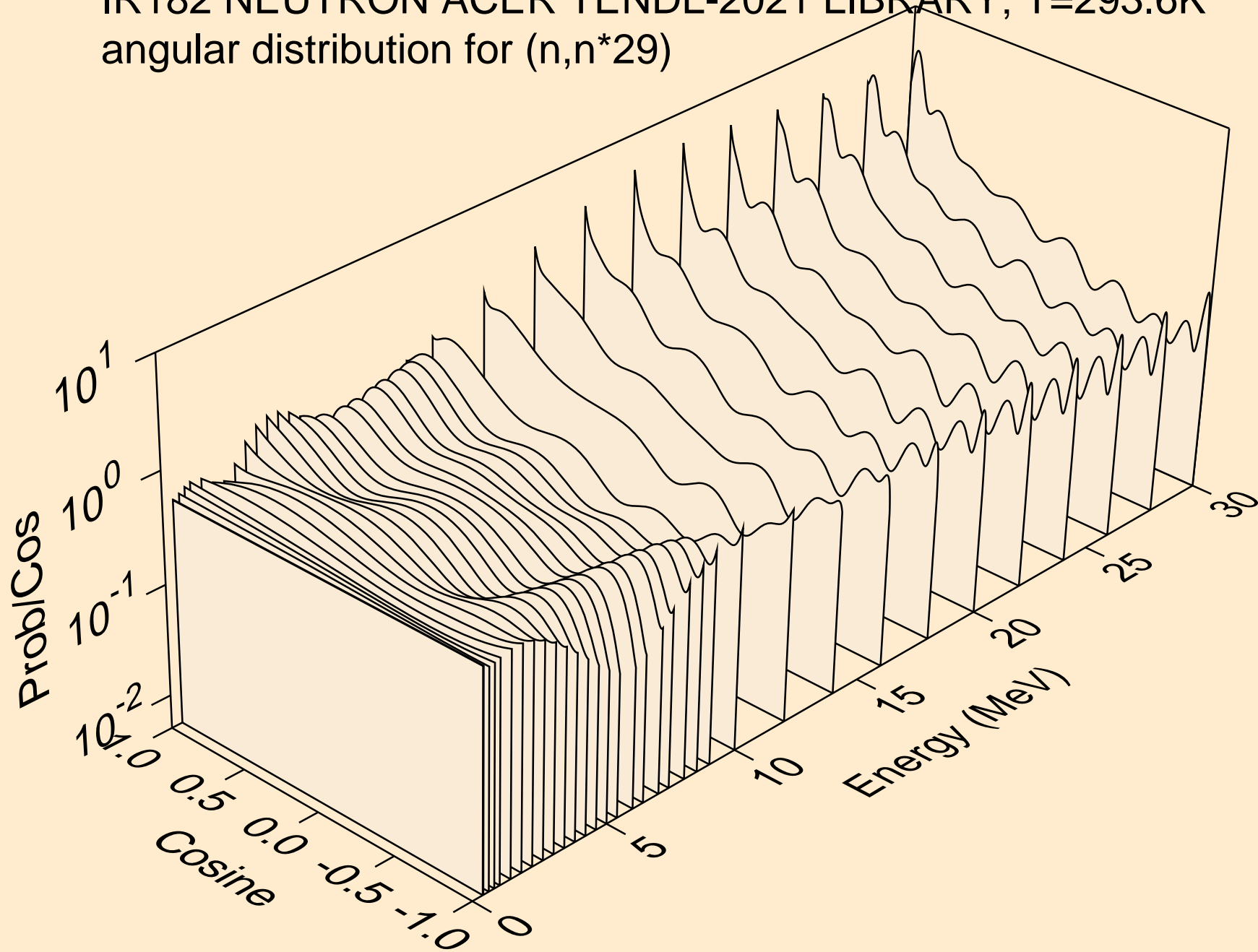

IR182 NEUTRON ACER TENDL-2021 LIBRARY; T=293.6K  
angular distribution for (n,n\*30)

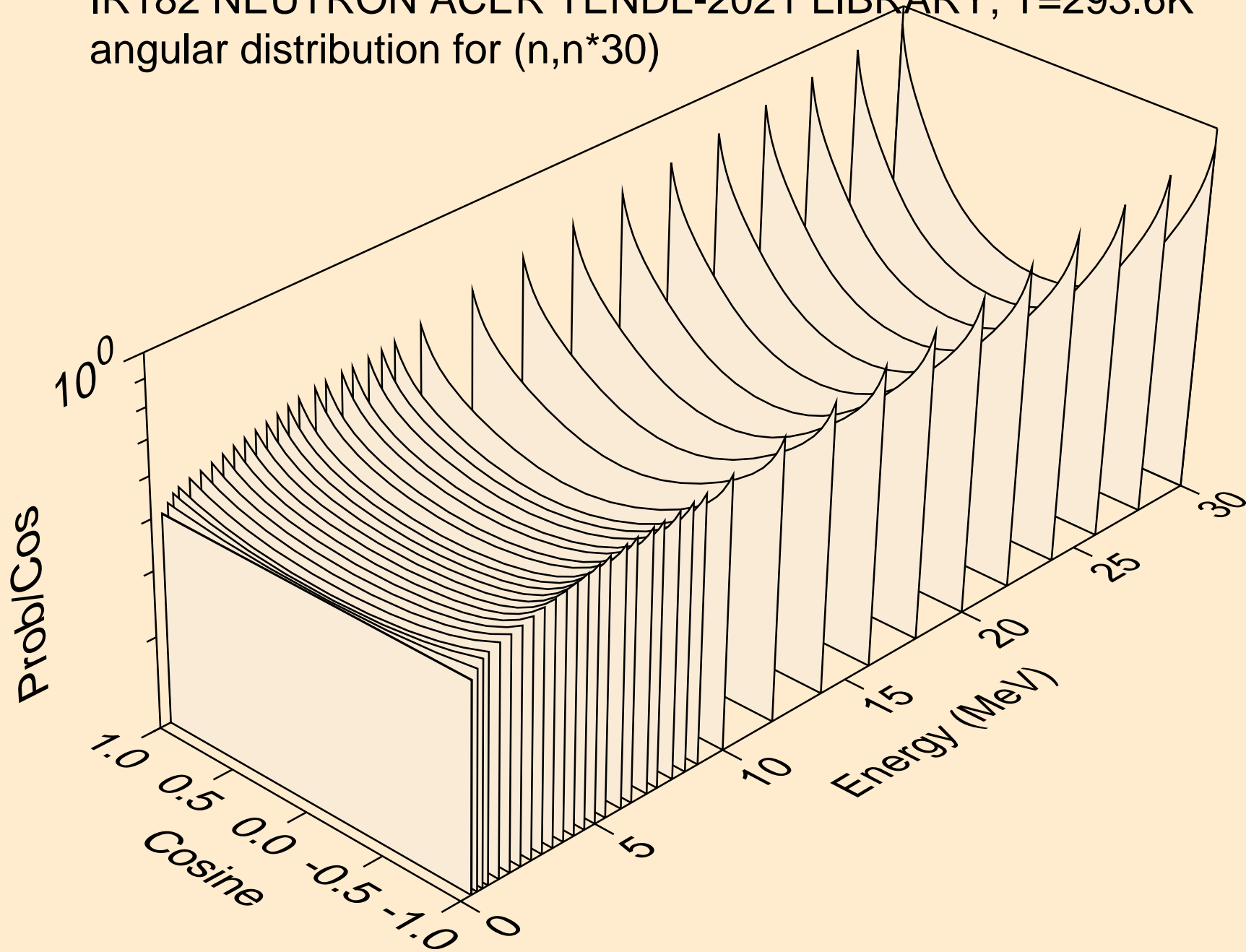

IR182 NEUTRON ACER TENDL-2021 LIBRARY; T=293.6K  
Neutron emission for (n,x)

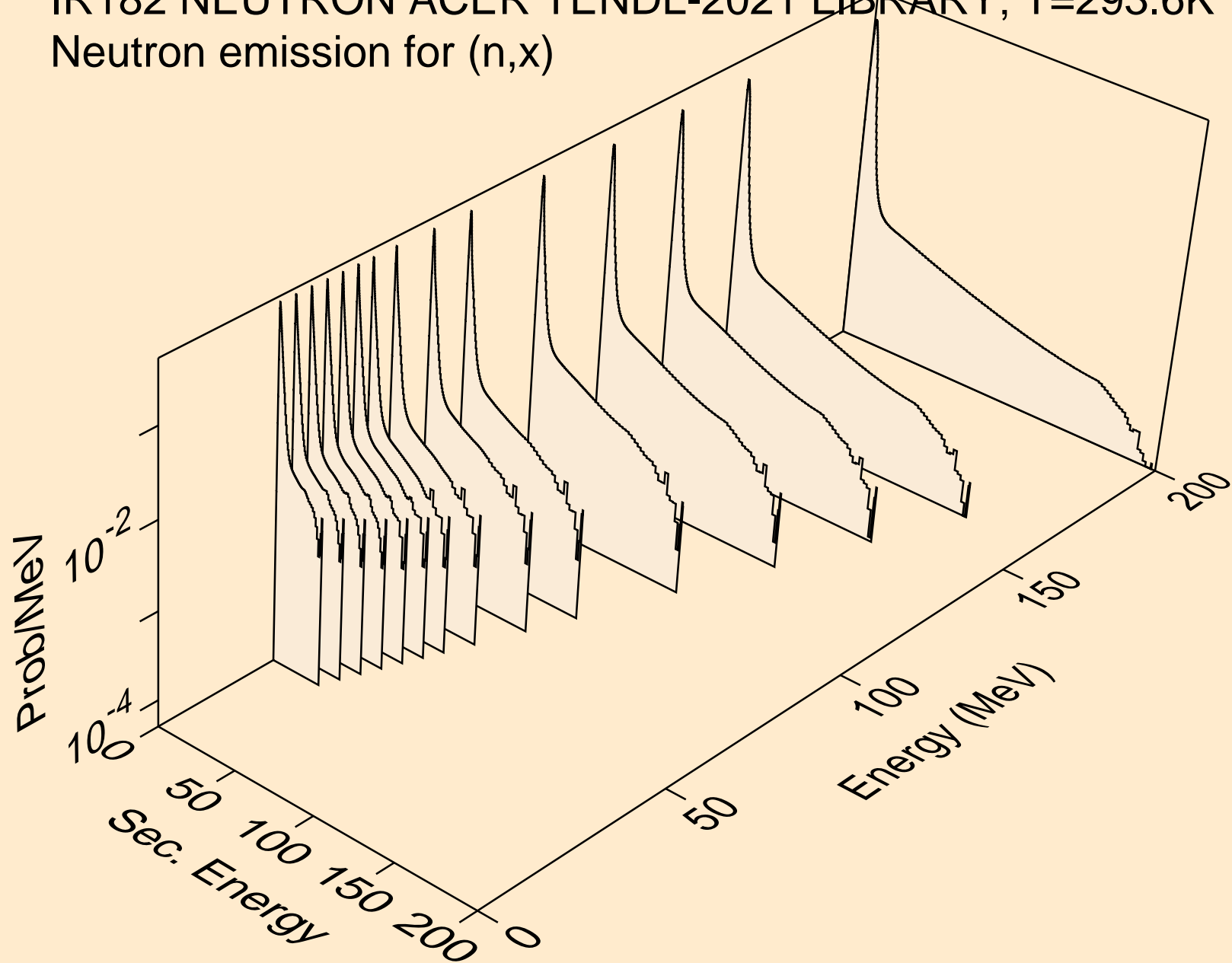

IR182 NEUTRON ACER TENDL-2021 LIBRARY; T=293.6K  
Neutron emission for (n,2nd)

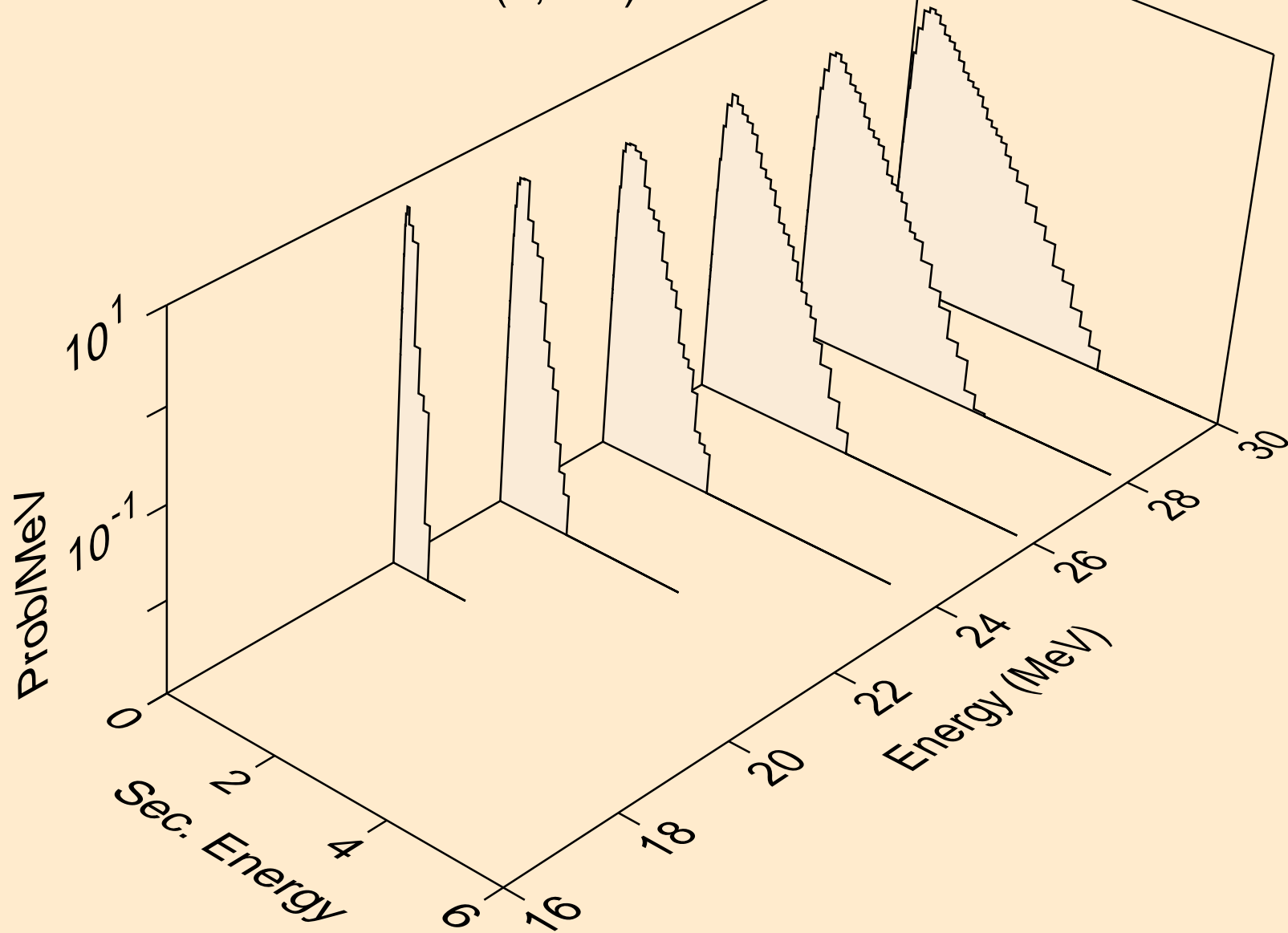

IR182 NEUTRON ACER TENDL-2021 LIBRARY; T=293.6K  
Neutron emission for (n,2n)

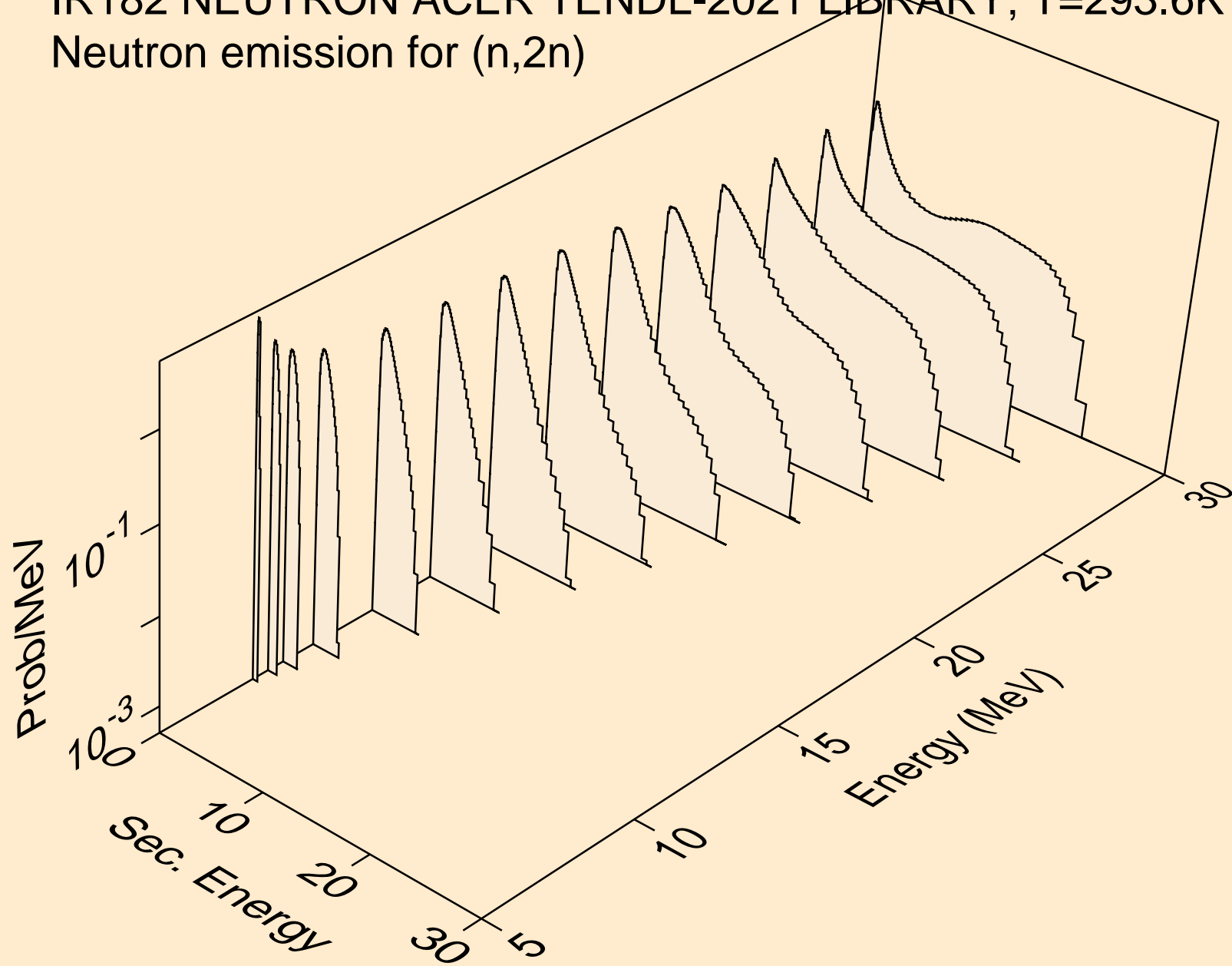

IR182 NEUTRON ACER TENDL-2021 LIBRARY; T=293.6K  
Neutron emission for (n,3n)

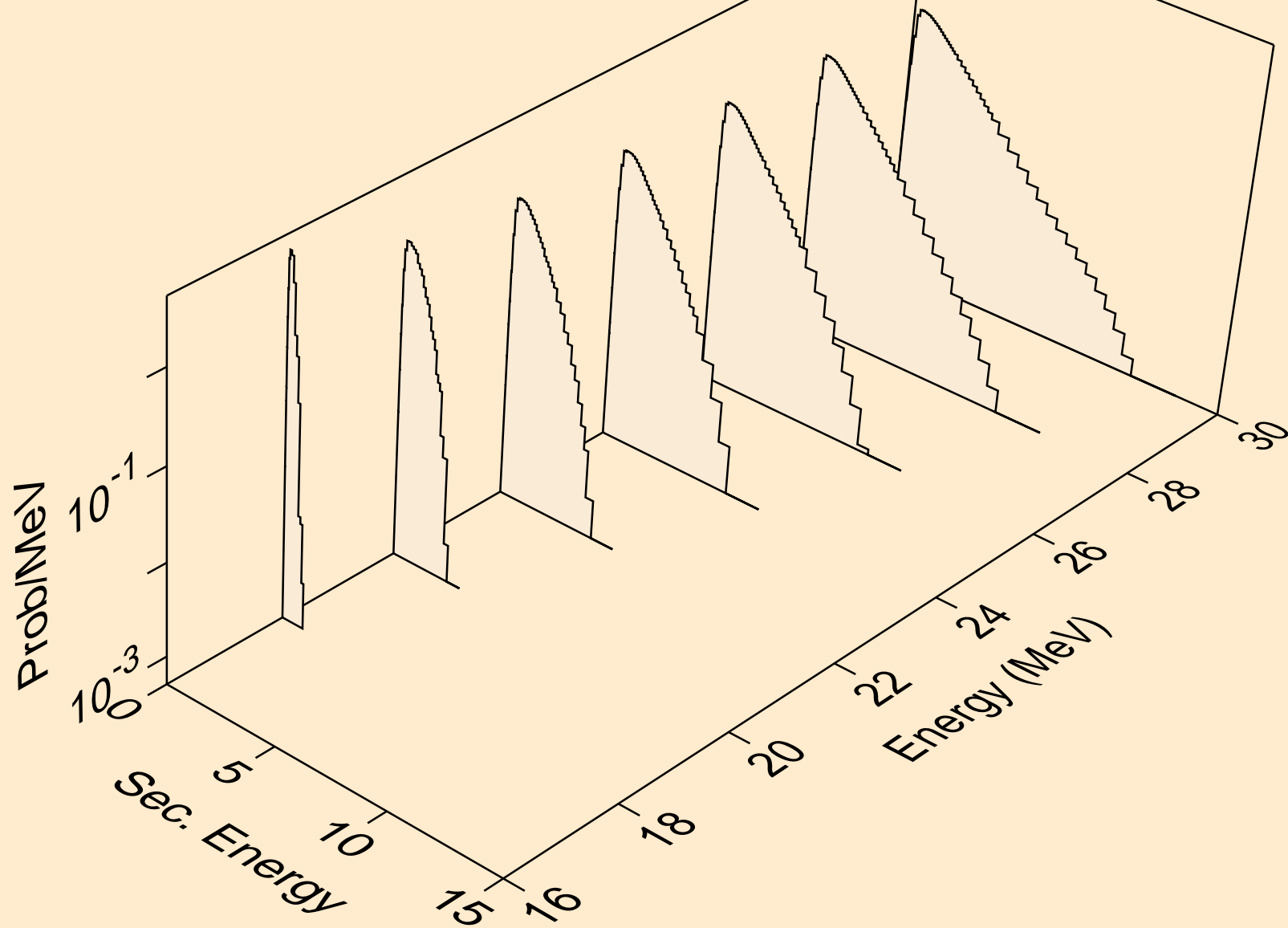

IR182 NEUTRON ACER TENDL-2021 LIBRARY; T=293.6K  
Neutron emission for (n,n\*)a

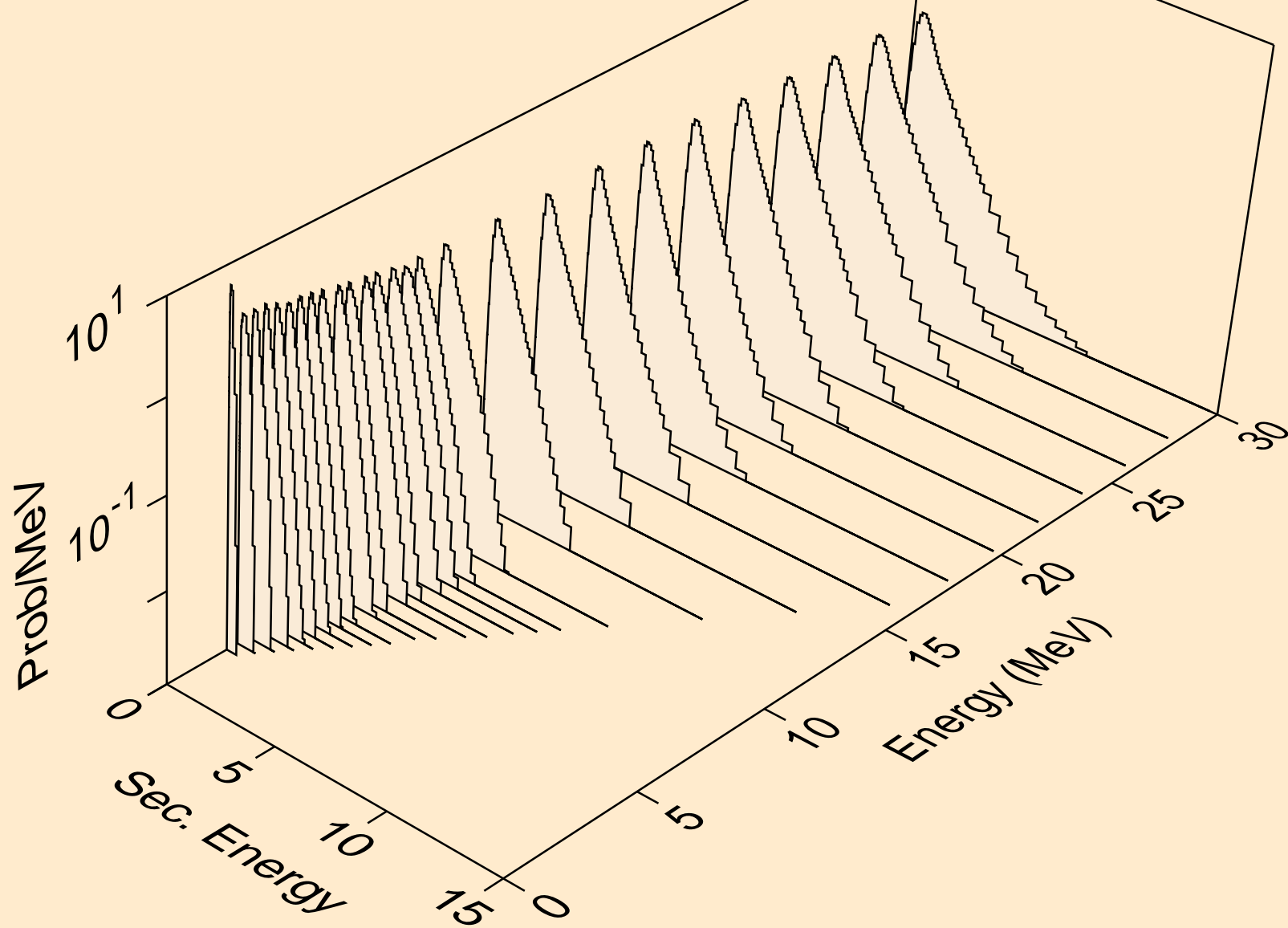

IR182 NEUTRON ACER TENDL-2021 LIBRARY; T=293.6K  
Neutron emission for (n,2n)<sub>a</sub>

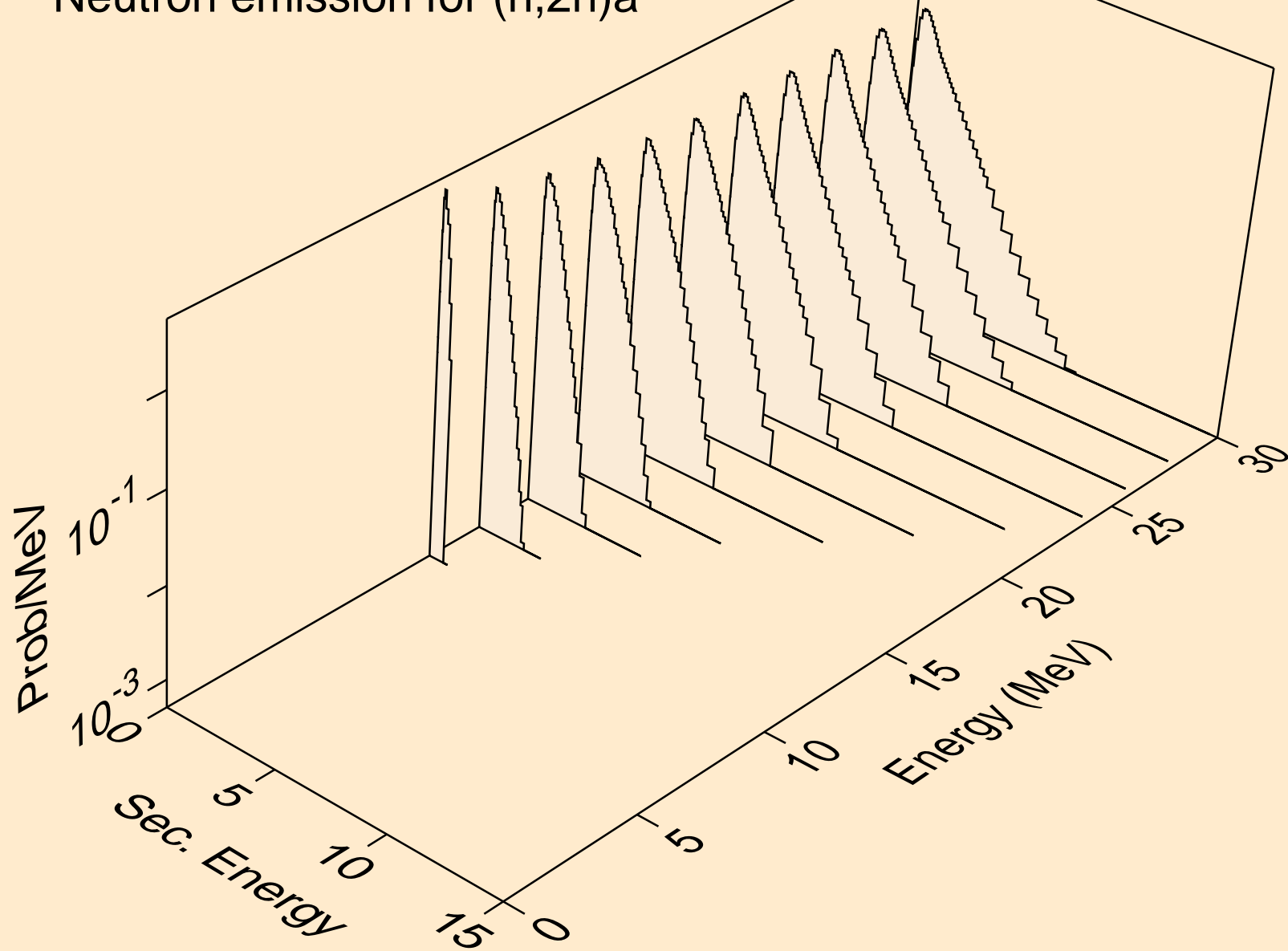

IR182 NEUTRON ACER TENDL-2021 LIBRARY; T=293.6K  
Neutron emission for (n,3n)a

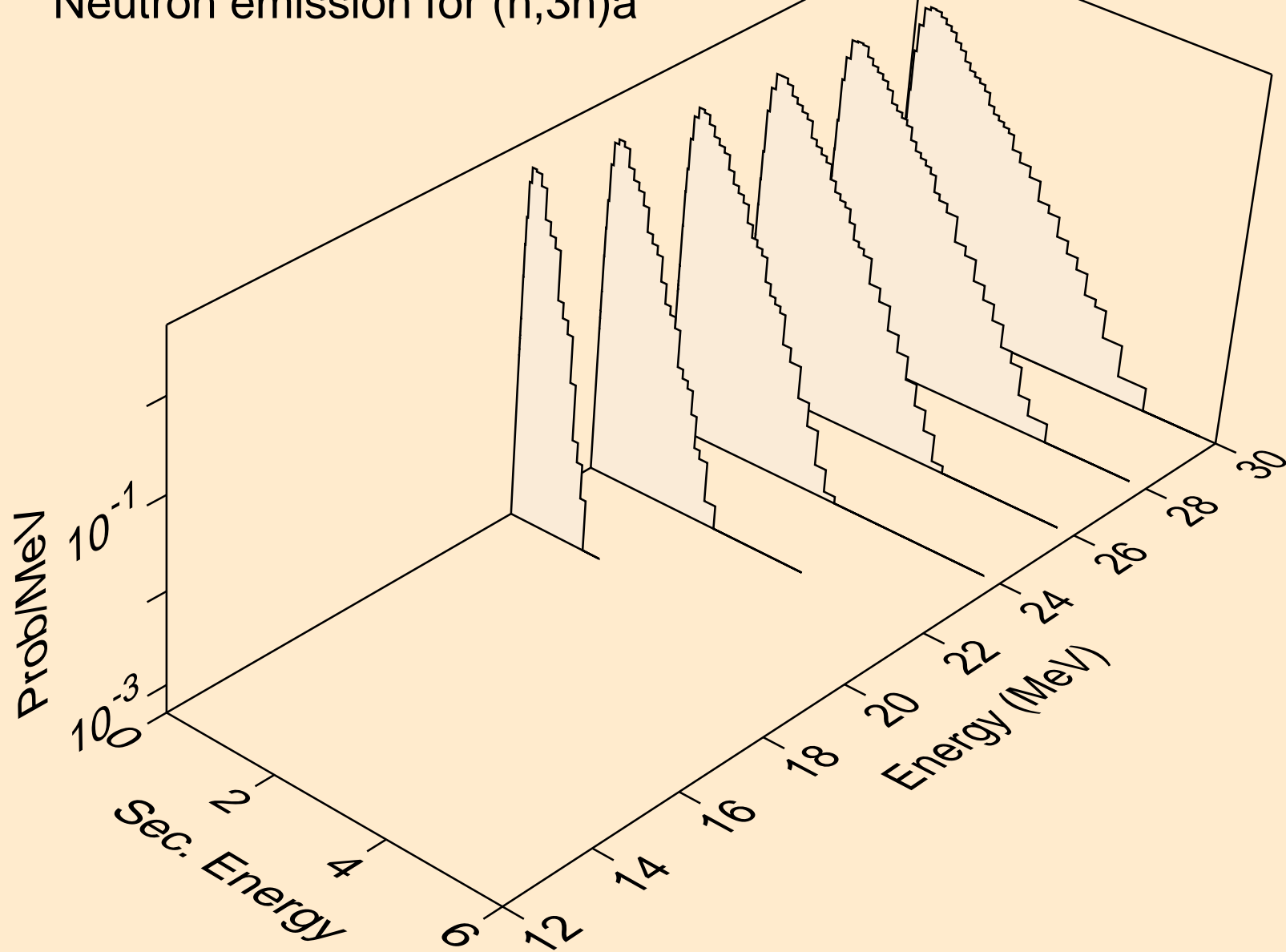

IR182 NEUTRON ACER TENDL-2021 LIBRARY; T=293.6K  
Neutron emission for (n,n\*)p

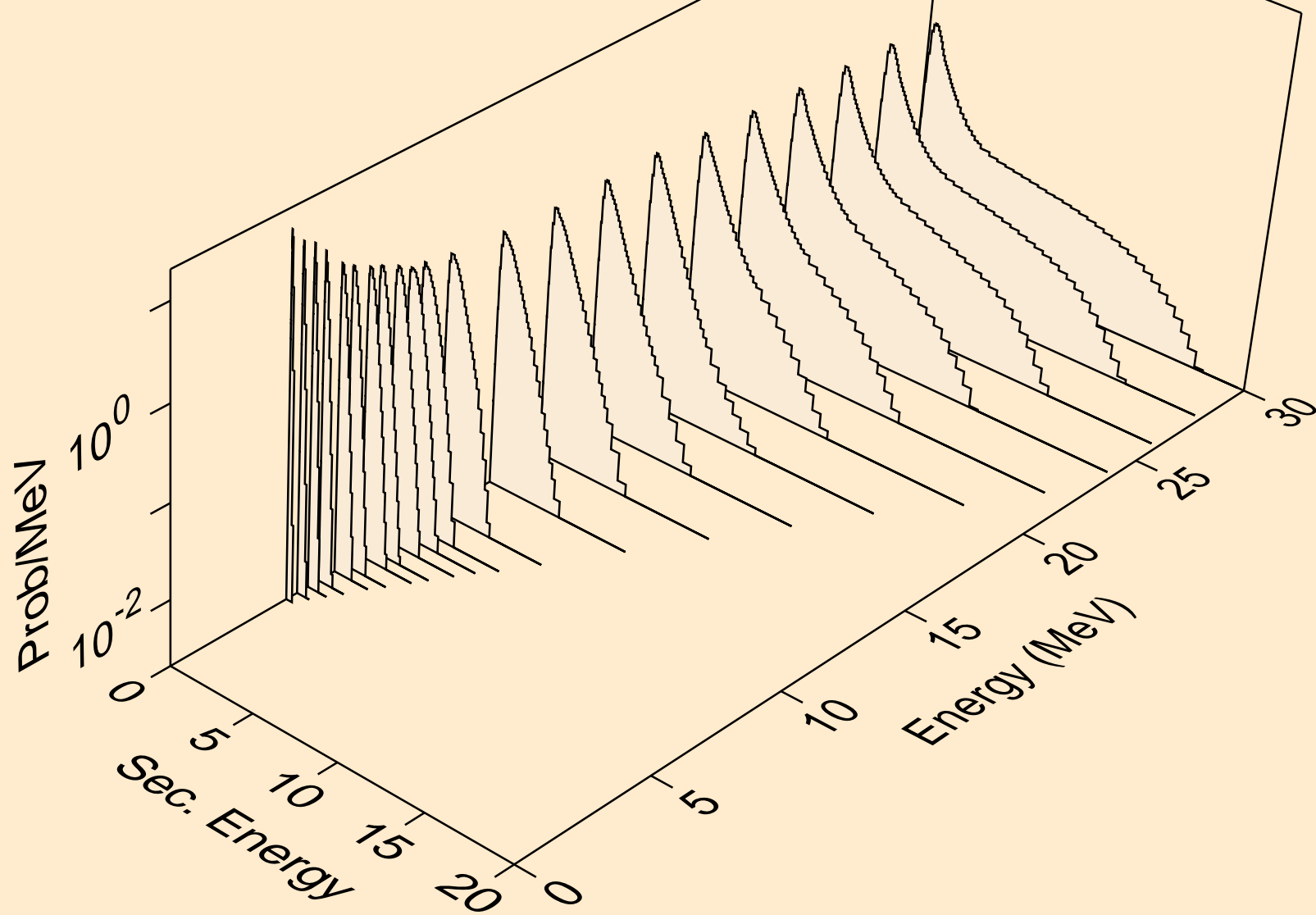

IR182 NEUTRON ACER TENDL-2021 LIBRARY; T=293.6K  
Neutron emission for (n,n\*)2a

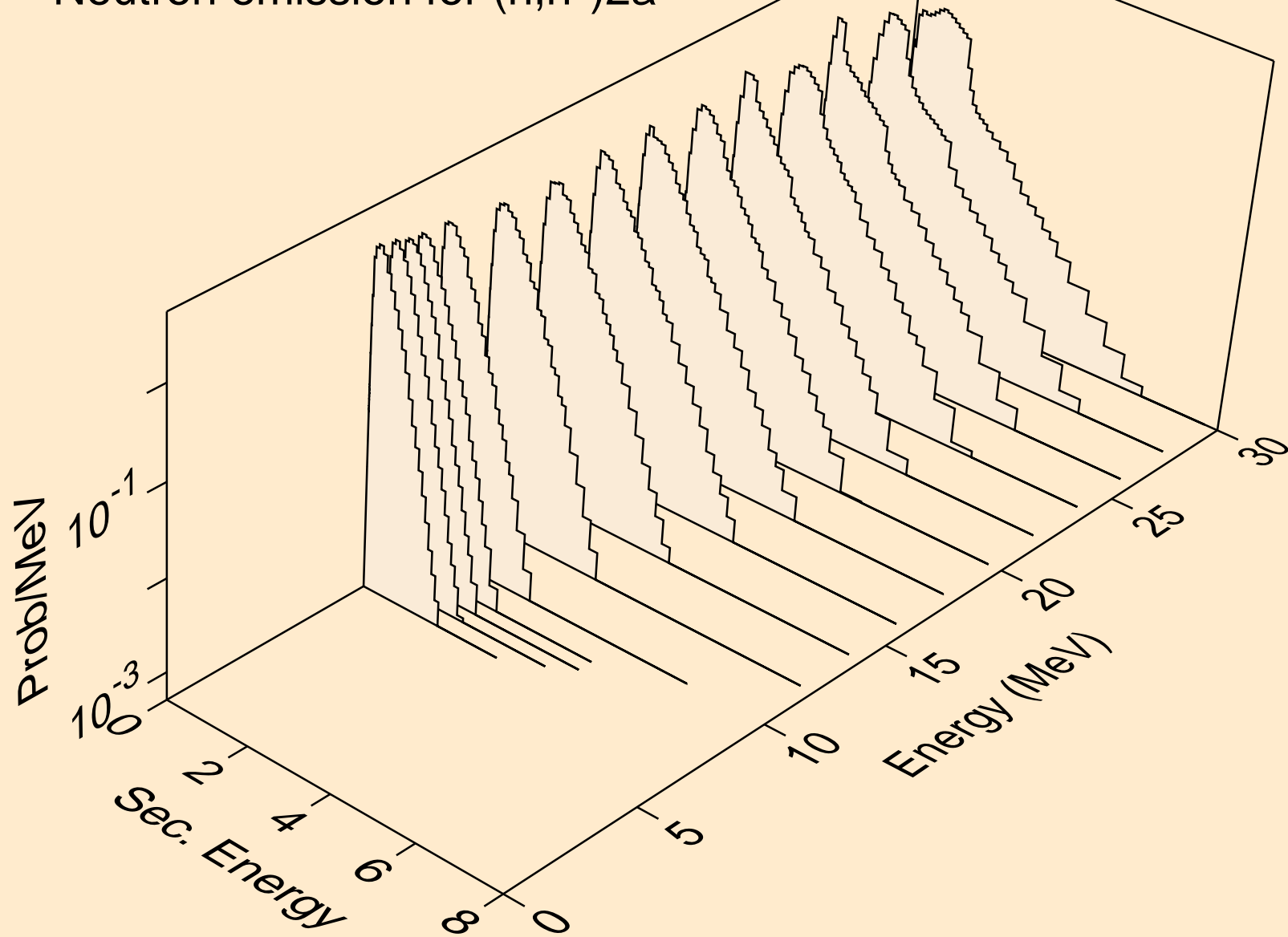

IR182 NEUTRON ACER TENDL-2021 LIBRARY; T=293.6K  
Neutron emission for (n,2n)2a

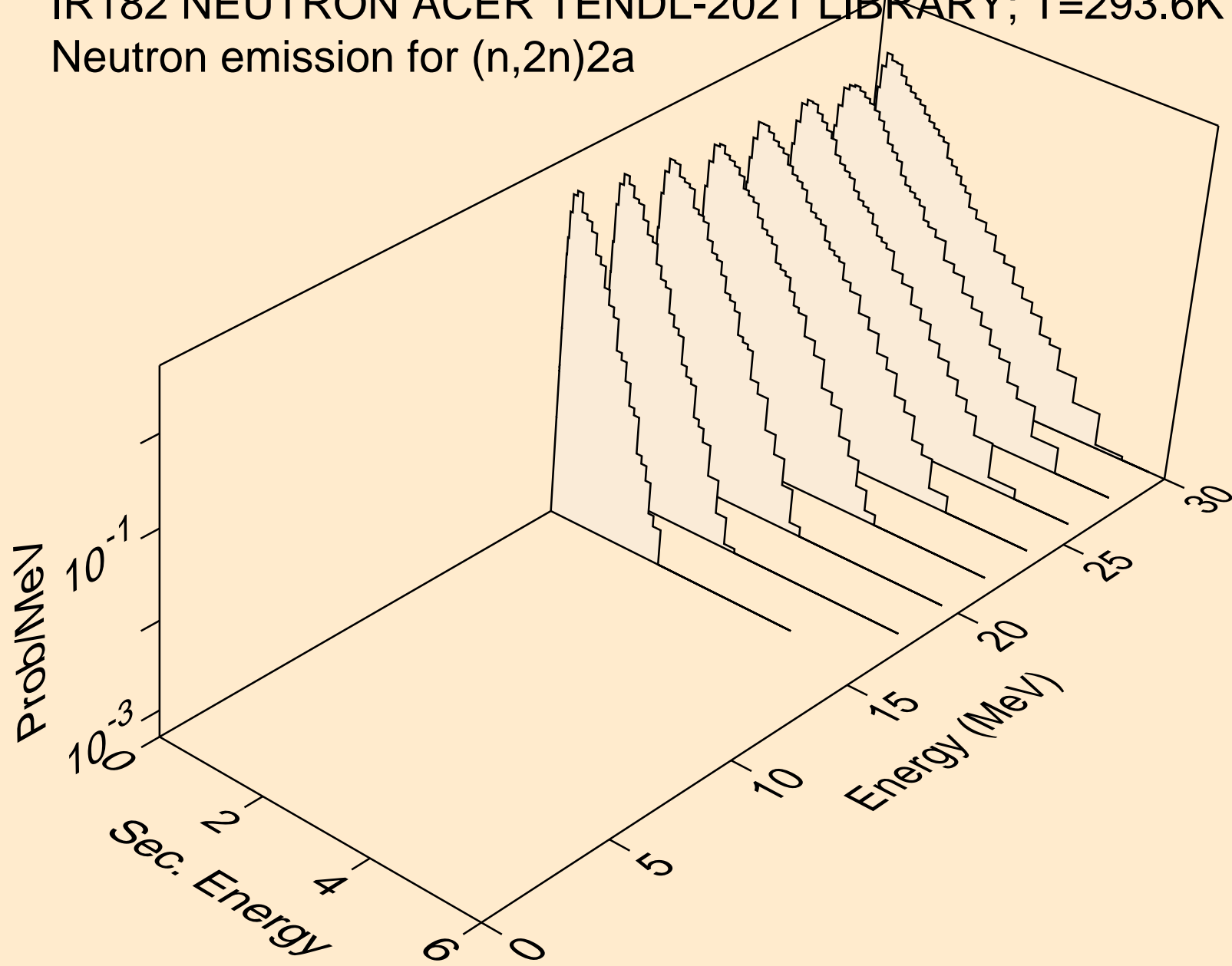

IR182 NEUTRON ACER TENDL-2021 LIBRARY; T=293.6K  
Neutron emission for (n,n\*)d

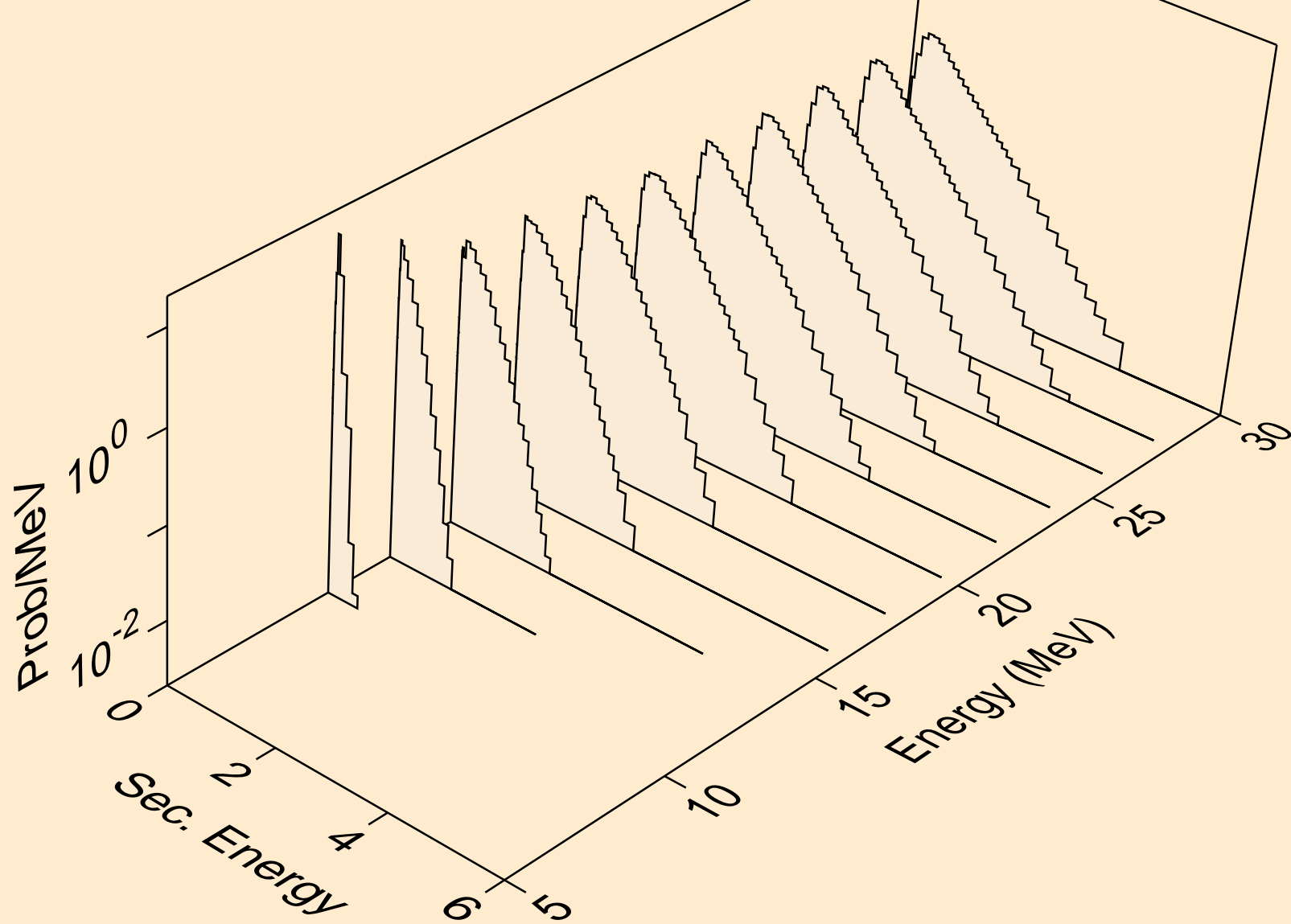

IR182 NEUTRON ACER TENDL-2021 LIBRARY; T=293.6K  
Neutron emission for (n,n\*)t

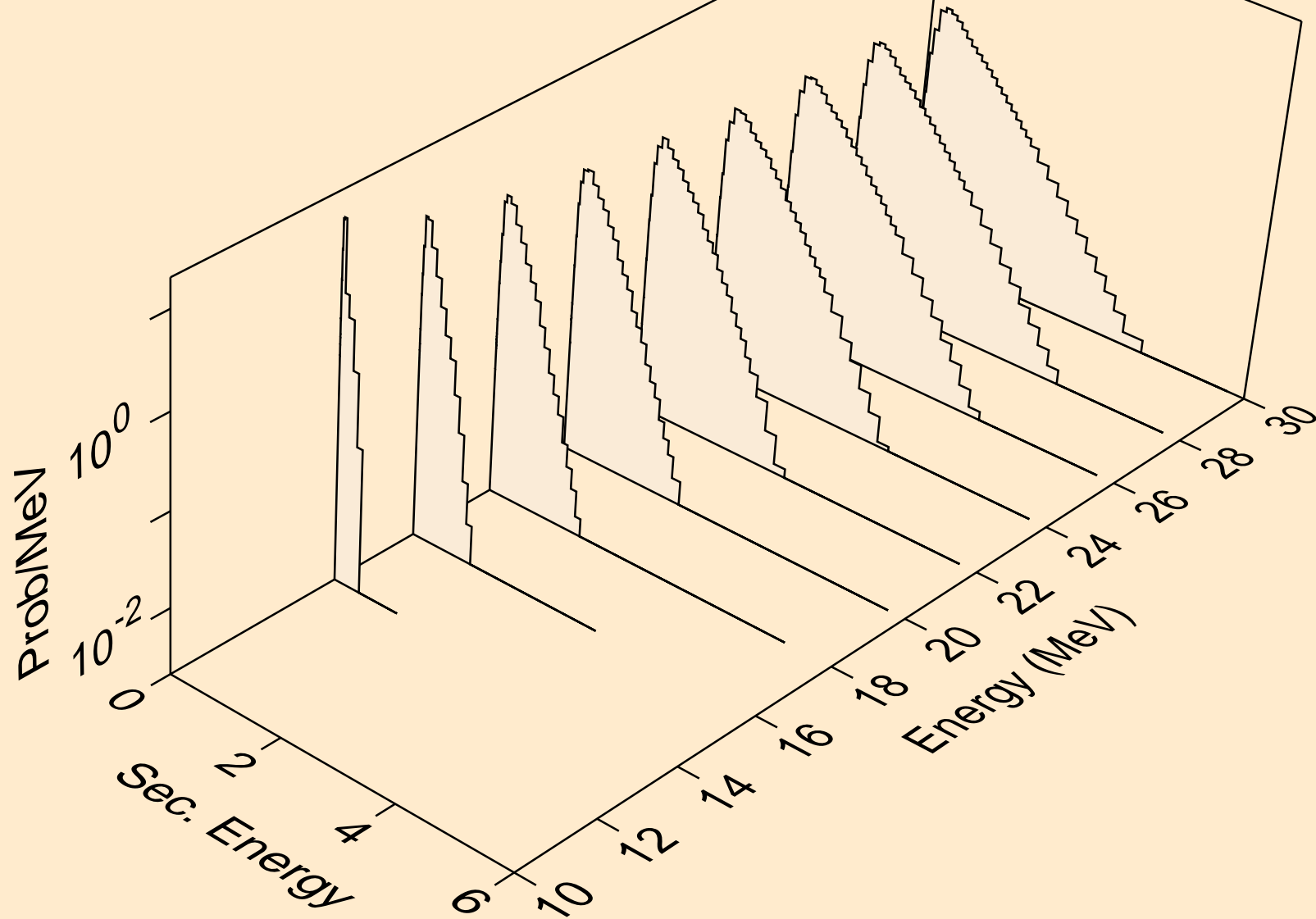

IR182 NEUTRON ACER TENDL-2021 LIBRARY; T=293.6K  
Neutron emission for (n,n\*)he3

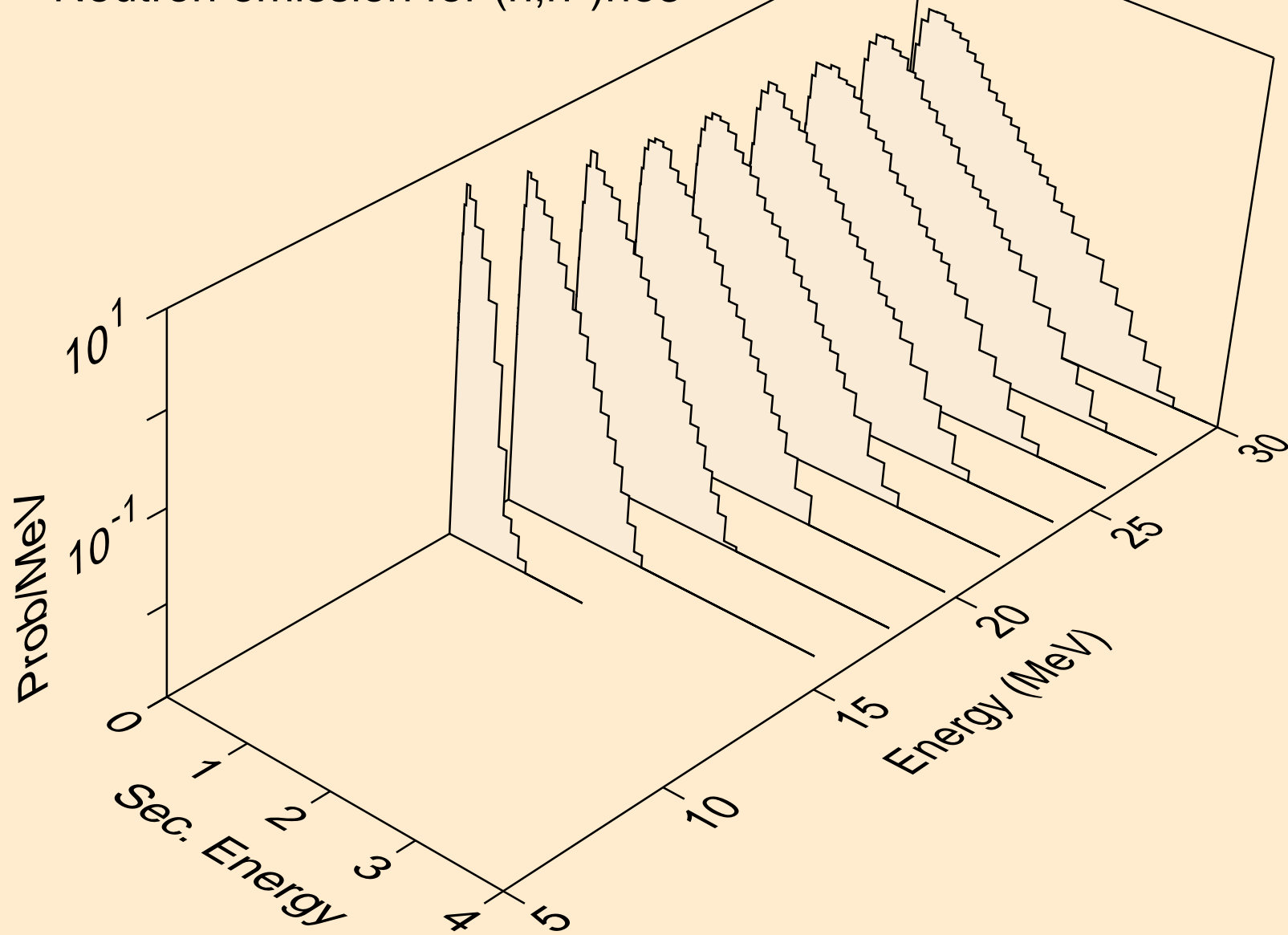

IR182 NEUTRON ACER TENDL-2021 LIBRARY; T=293.6K  
Neutron emission for (n,4n)

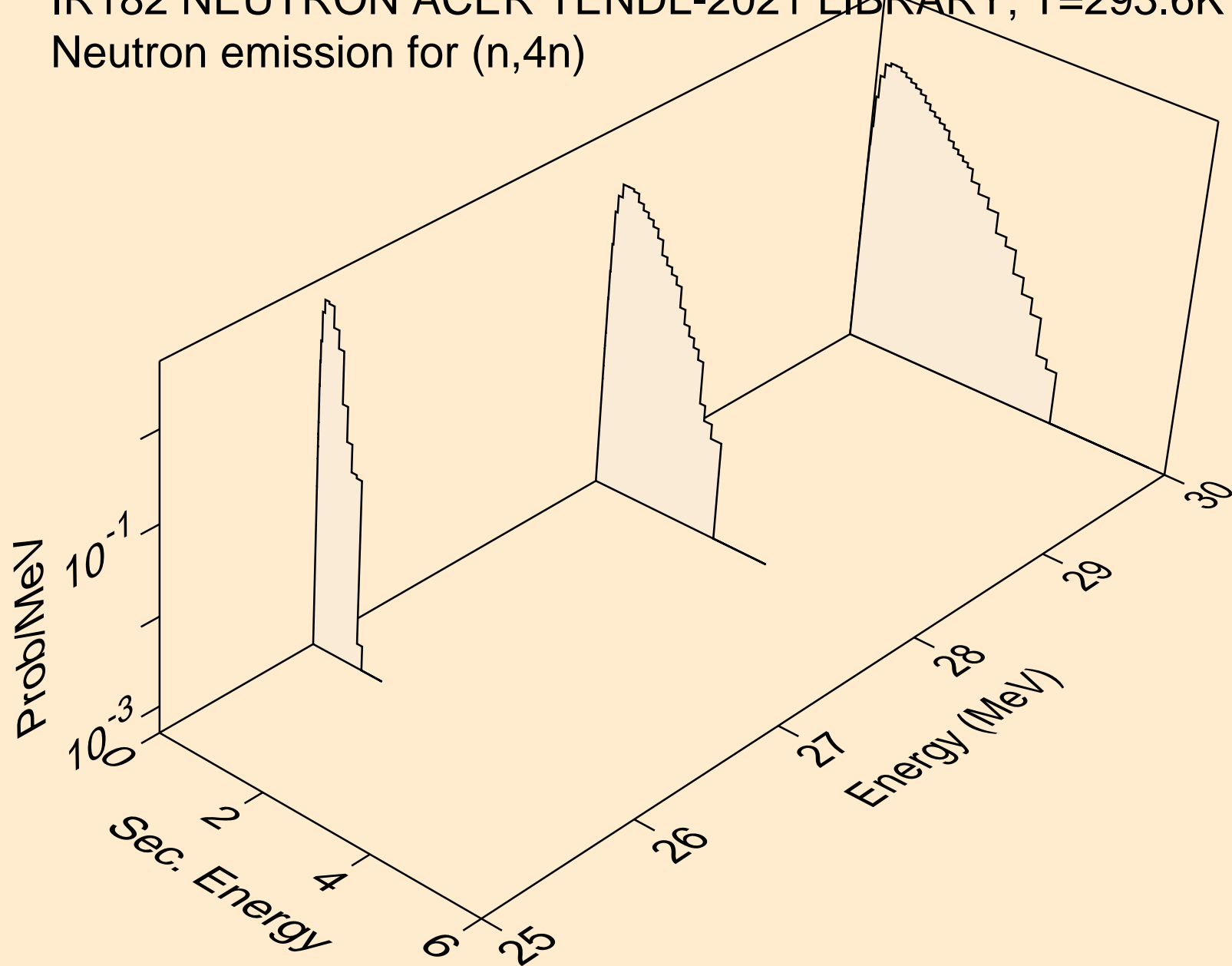

IR182 NEUTRON ACER TENDL-2021 LIBRARY; T=293.6K  
Neutron emission for (n,2np)

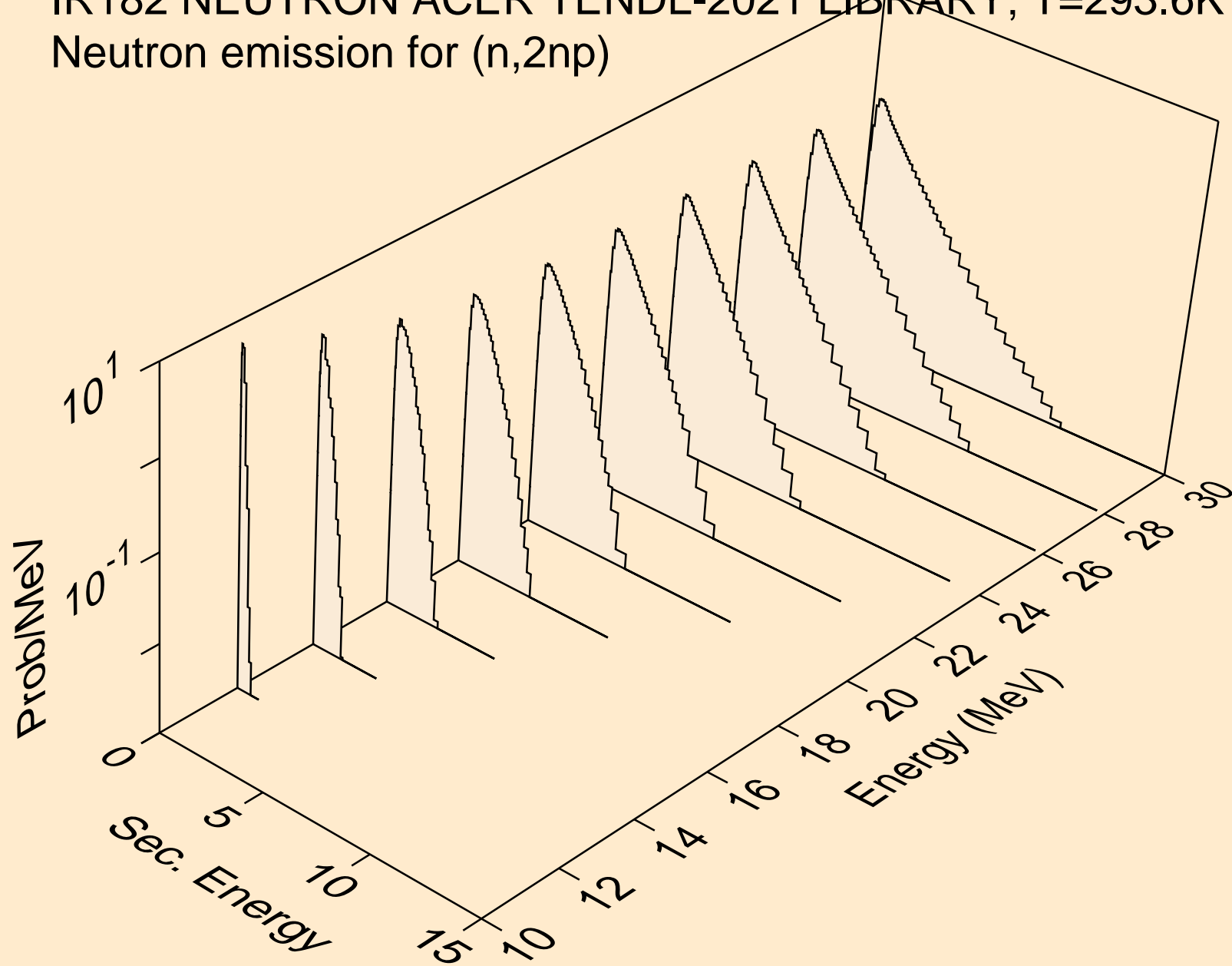

IR182 NEUTRON ACER TENDL-2021 LIBRARY; T=293.6K  
Neutron emission for (n,3np)

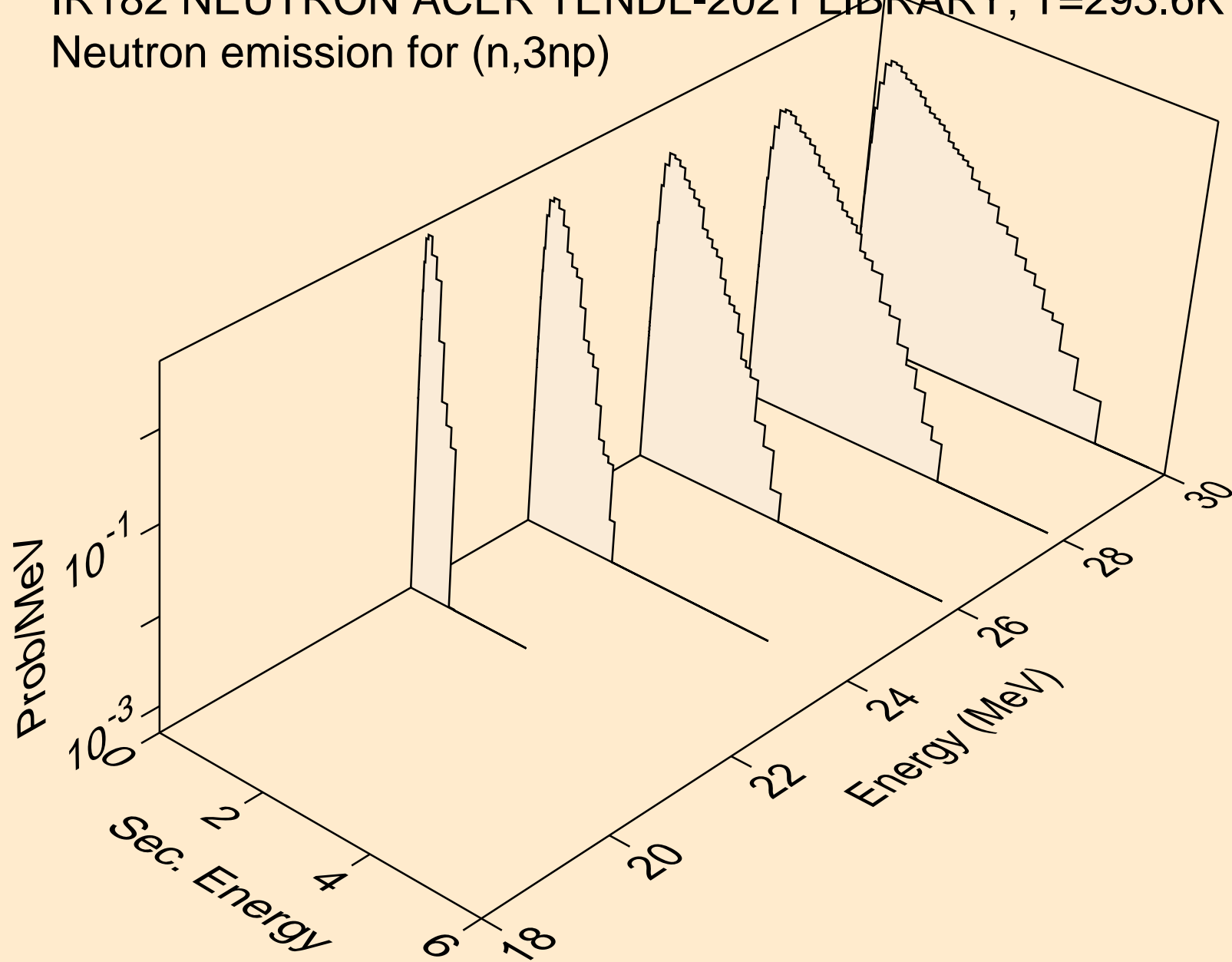

IR182 NEUTRON ACER TENDL-2021 LIBRARY; T=293.6K  
Neutron emission for (n,2np)

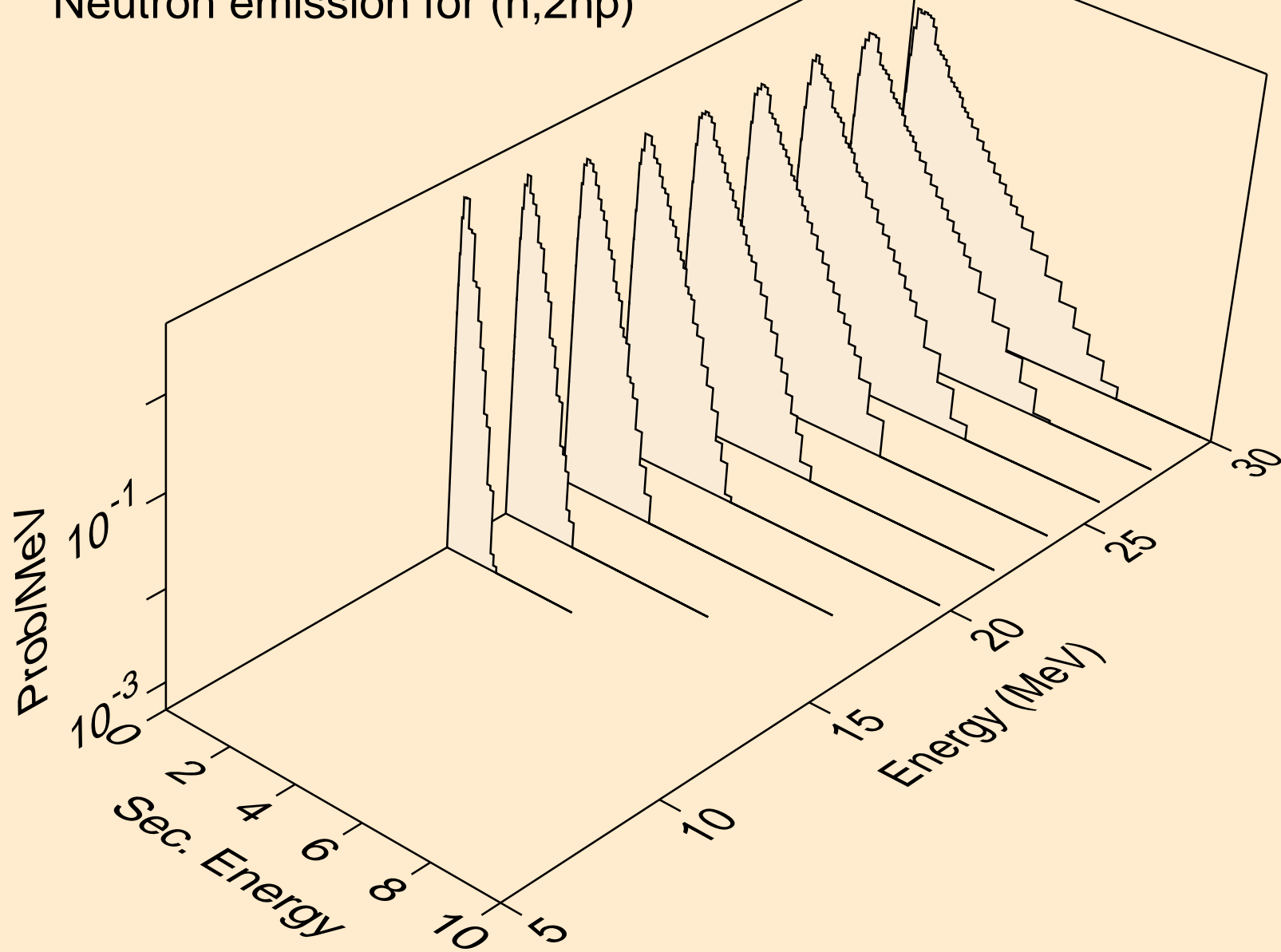

IR182 NEUTRON ACER TENDL-2021 LIBRARY; T=293.6K  
Neutron emission for (n,npa)

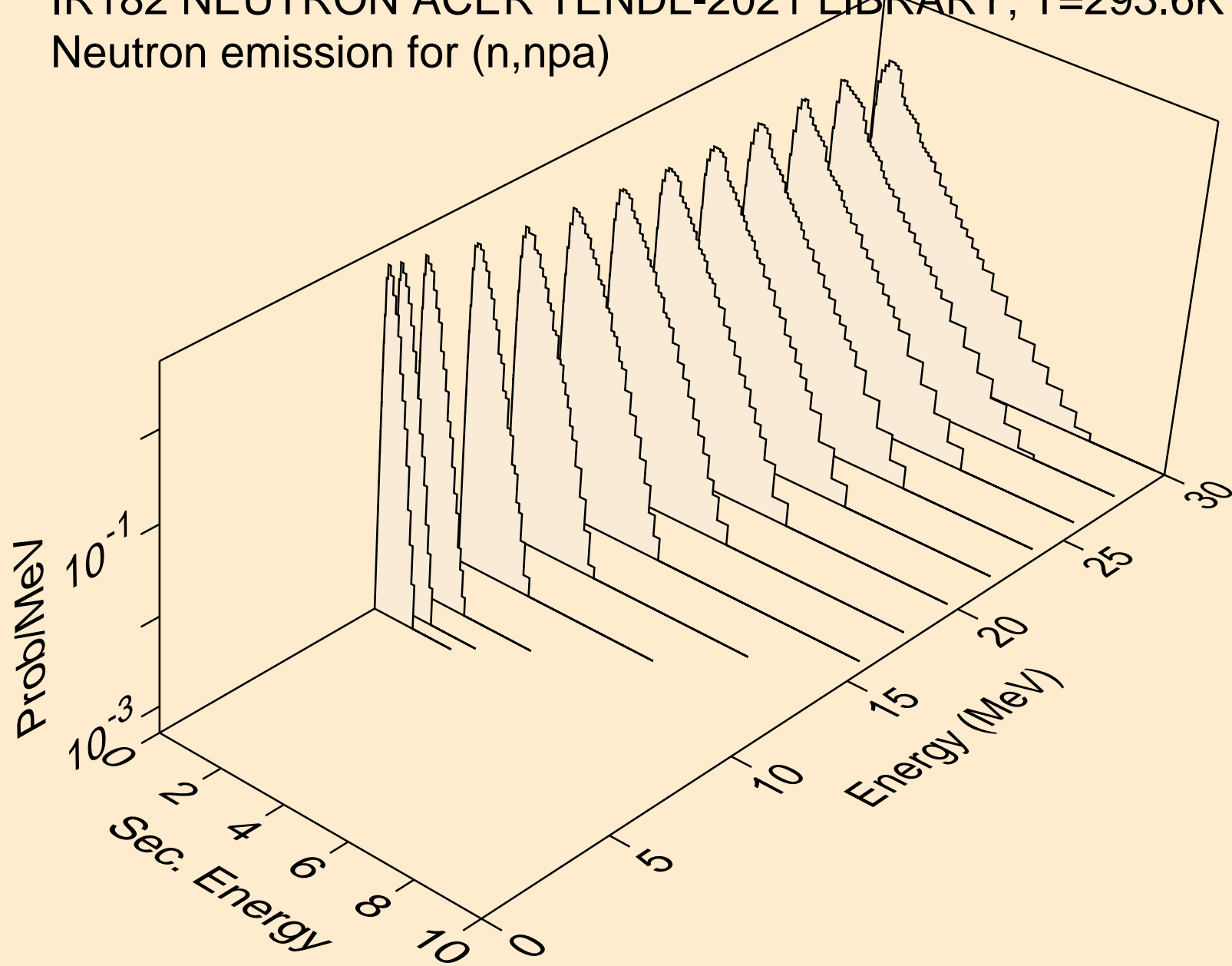

IR182 NEUTRON ACER TENDL-2021 LIBRARY; T=293.6K  
Neutron emission for (n,n\*c)

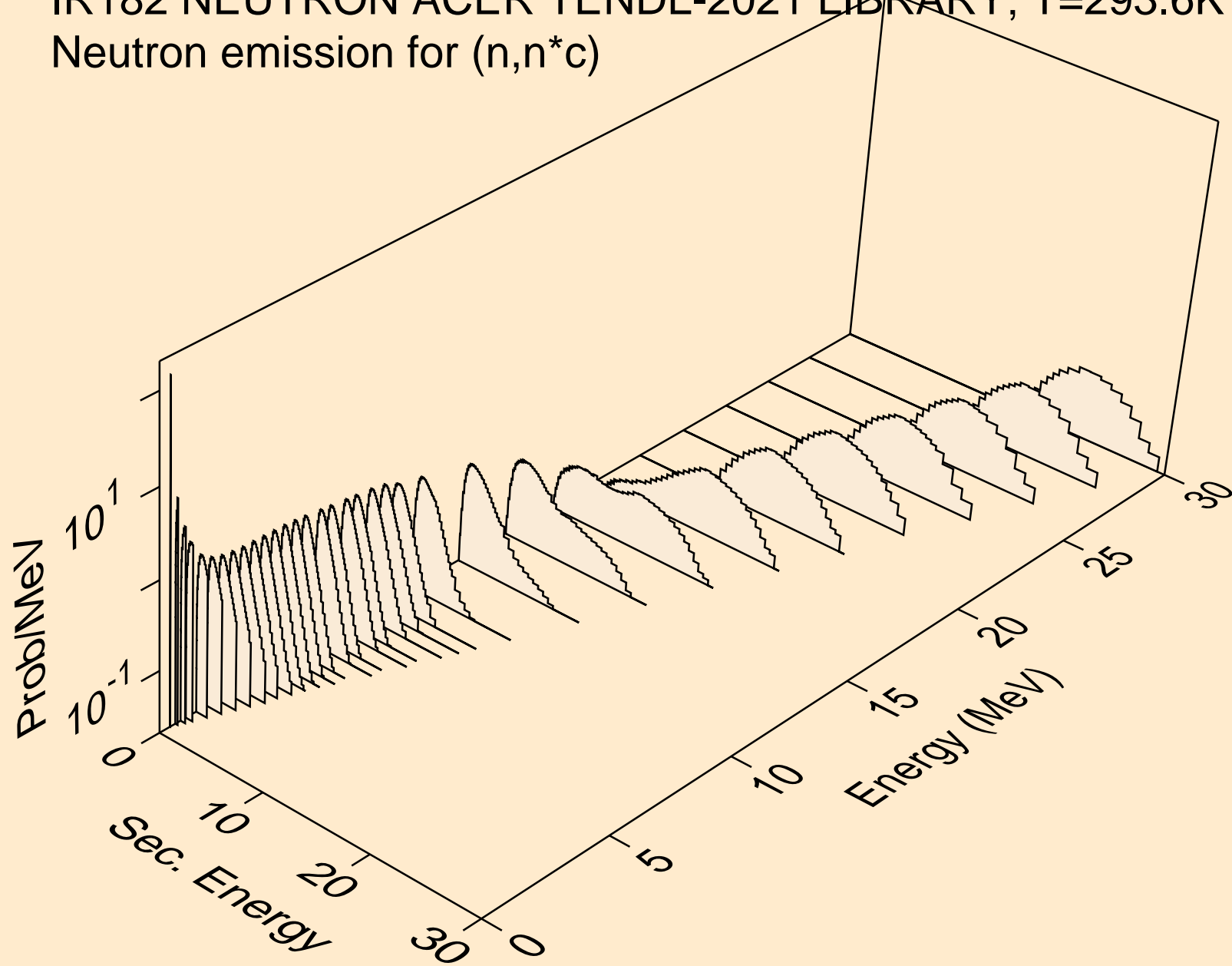

IR182 NEUTRON ACER TENDL-2021 LIBRARY; T=293.6K  
Photon emission for (n,x)

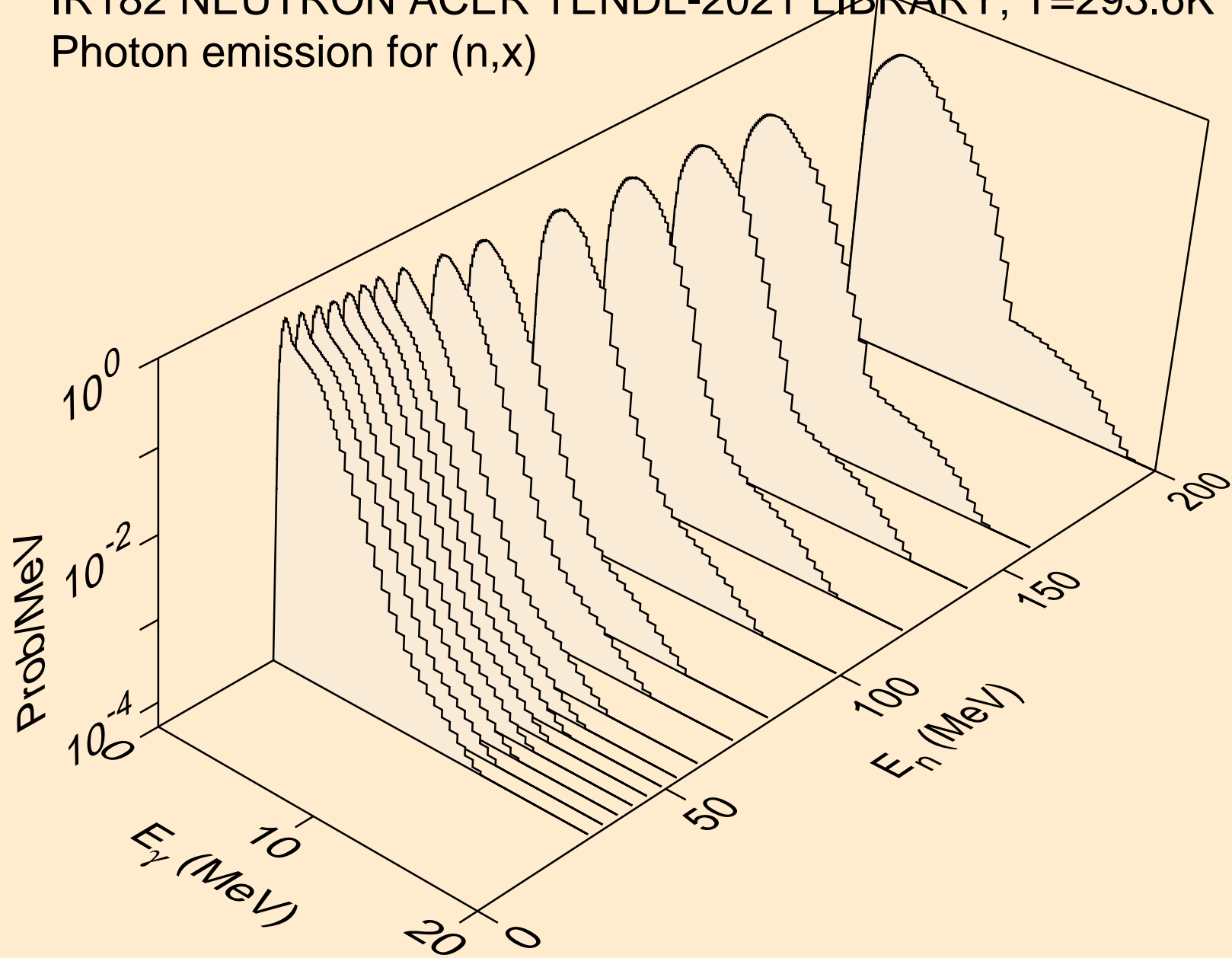

IR182 NEUTRON ACER TENDL-2021 LIBRARY; T=293.6K  
Photon emission for (n,2nd)

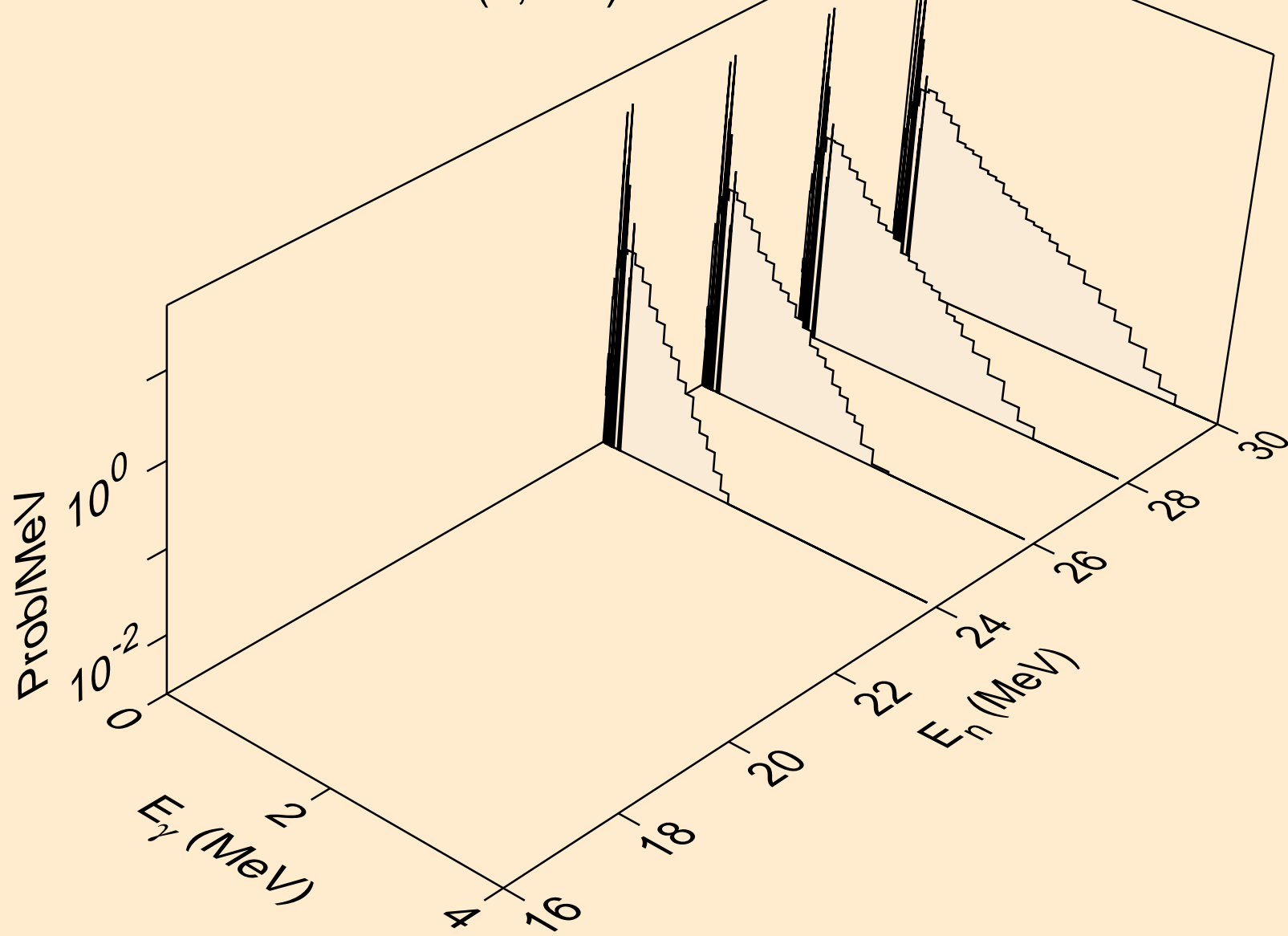

IR182 NEUTRON ACER TENDL-2021 LIBRARY; T=293.6K  
Photon emission for (n,2n)

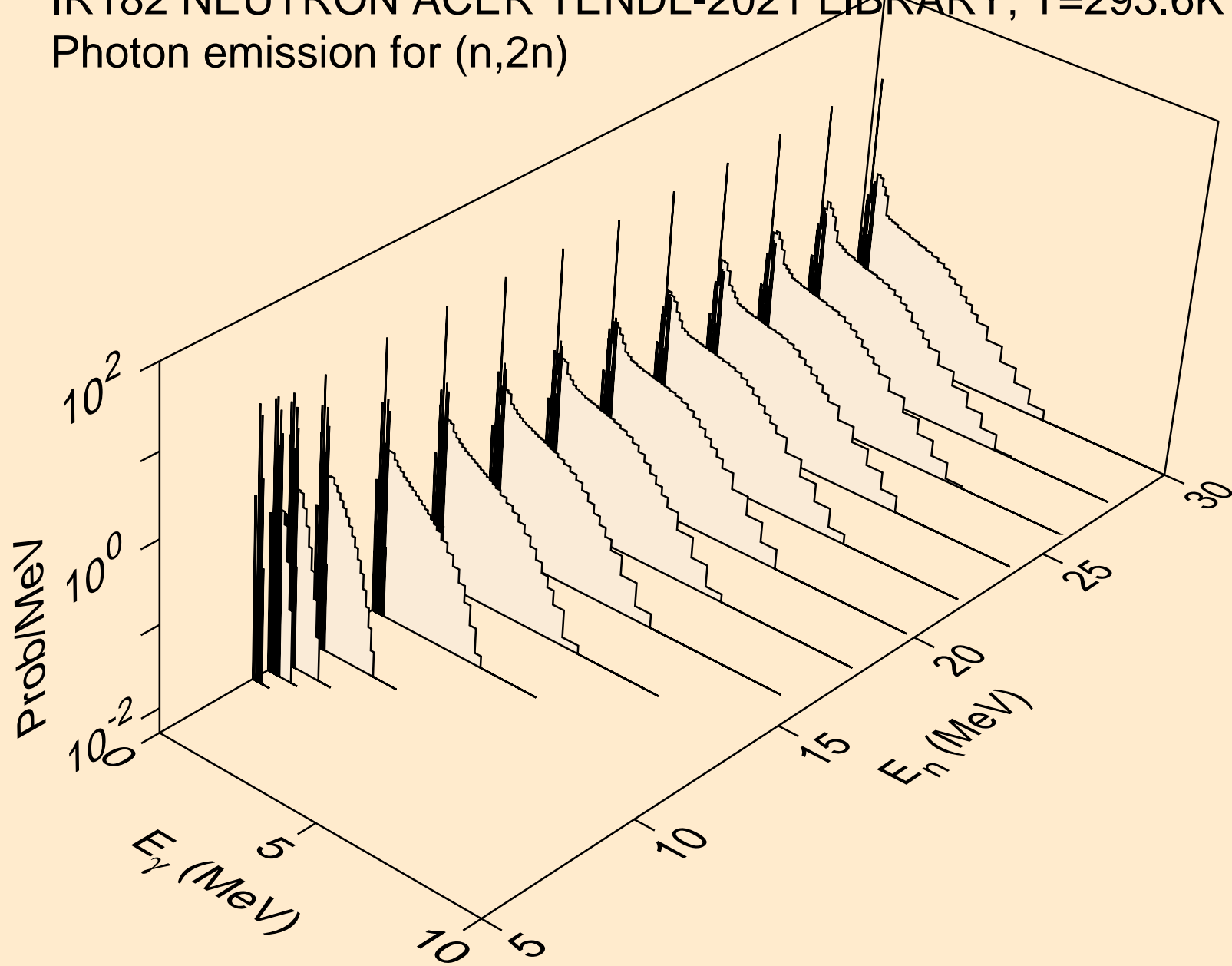

IR182 NEUTRON ACER TENDL-2021 LIBRARY; T=293.6K  
Photon emission for (n,3n)

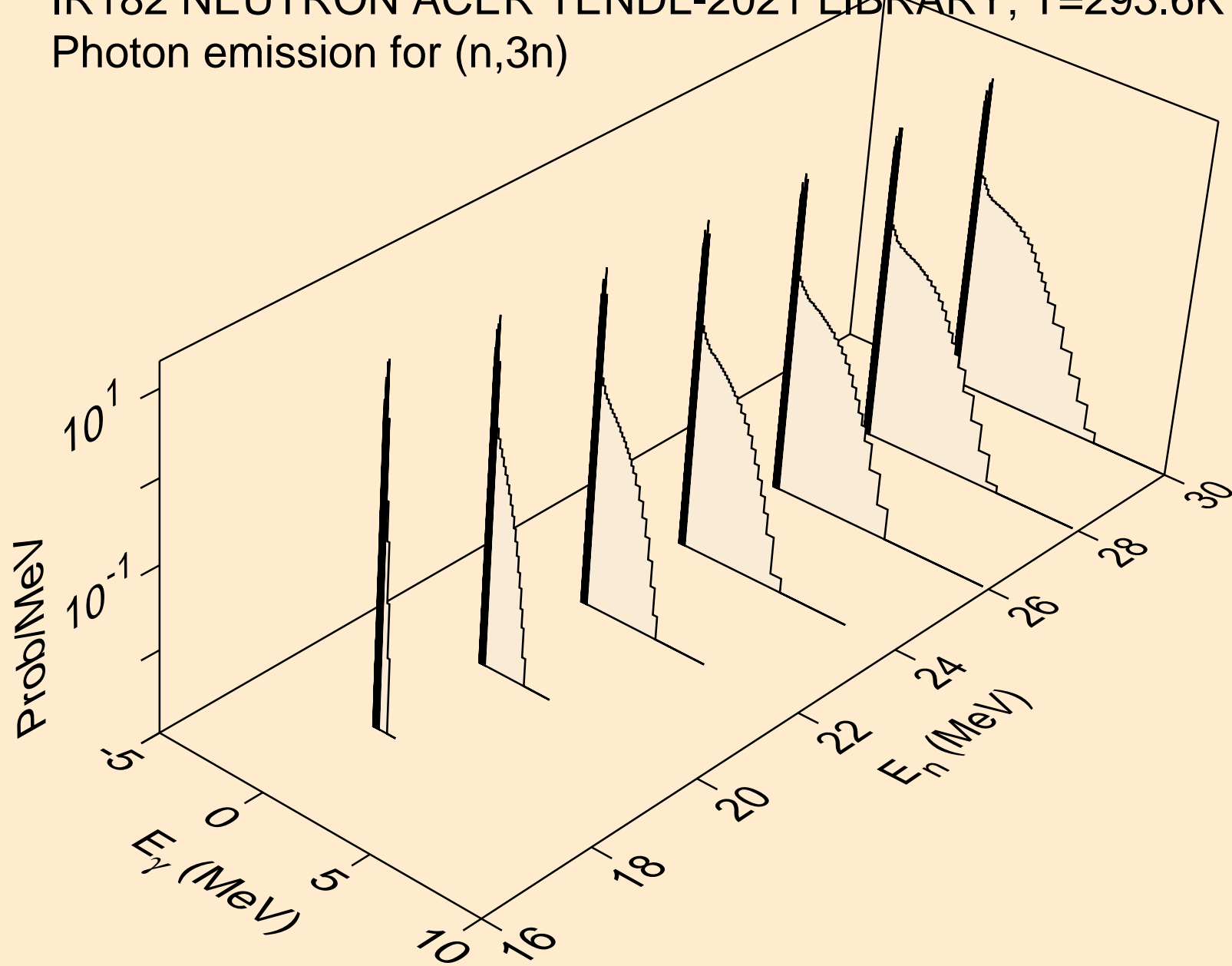

IR182 NEUTRON ACER TENDL-2021 LIBRARY; T=293.6K  
Photon emission for (n,n\*)a

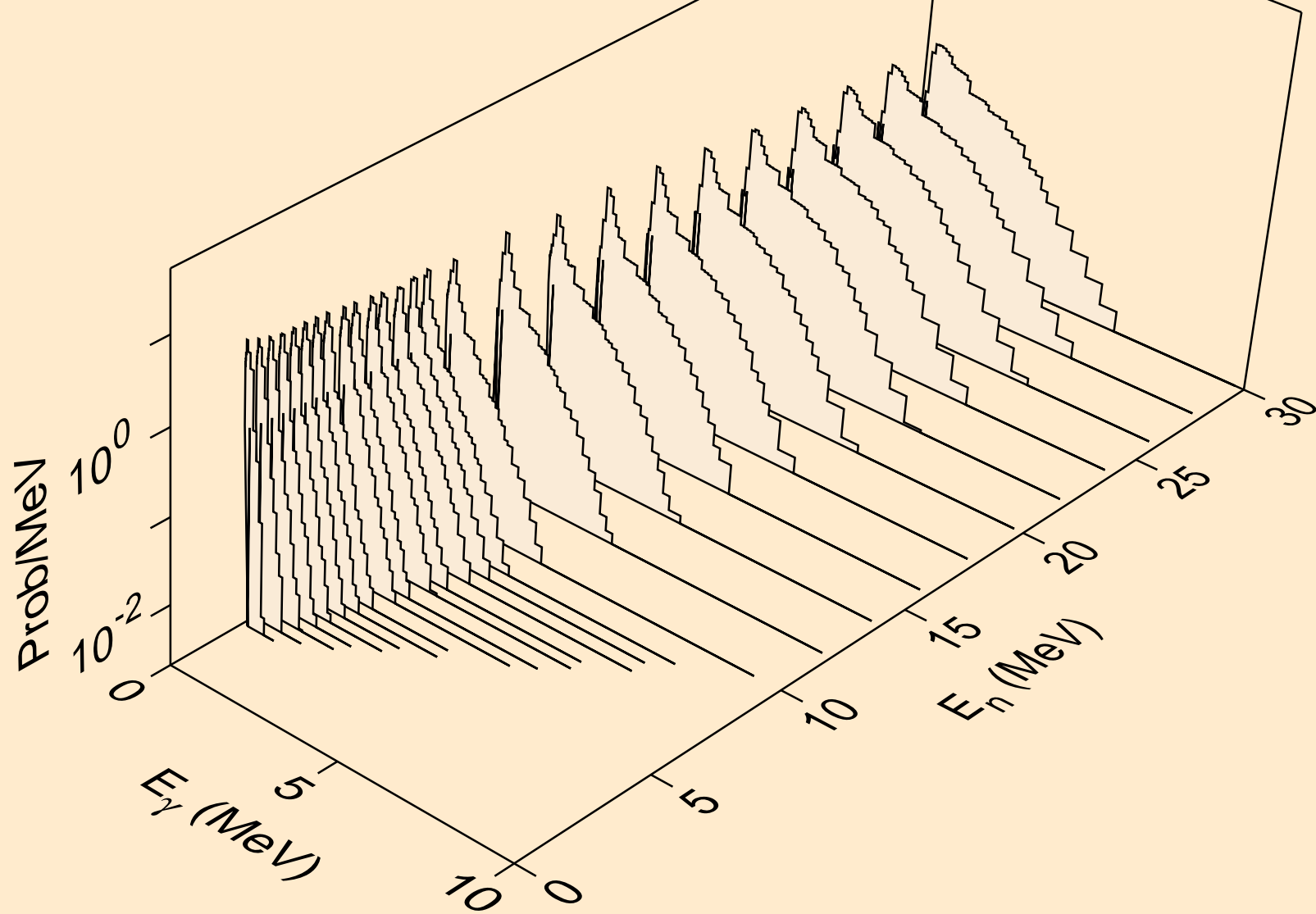

IR182 NEUTRON ACER TENDL-2021 LIBRARY; T=293.6K  
Photon emission for (n,2n)a

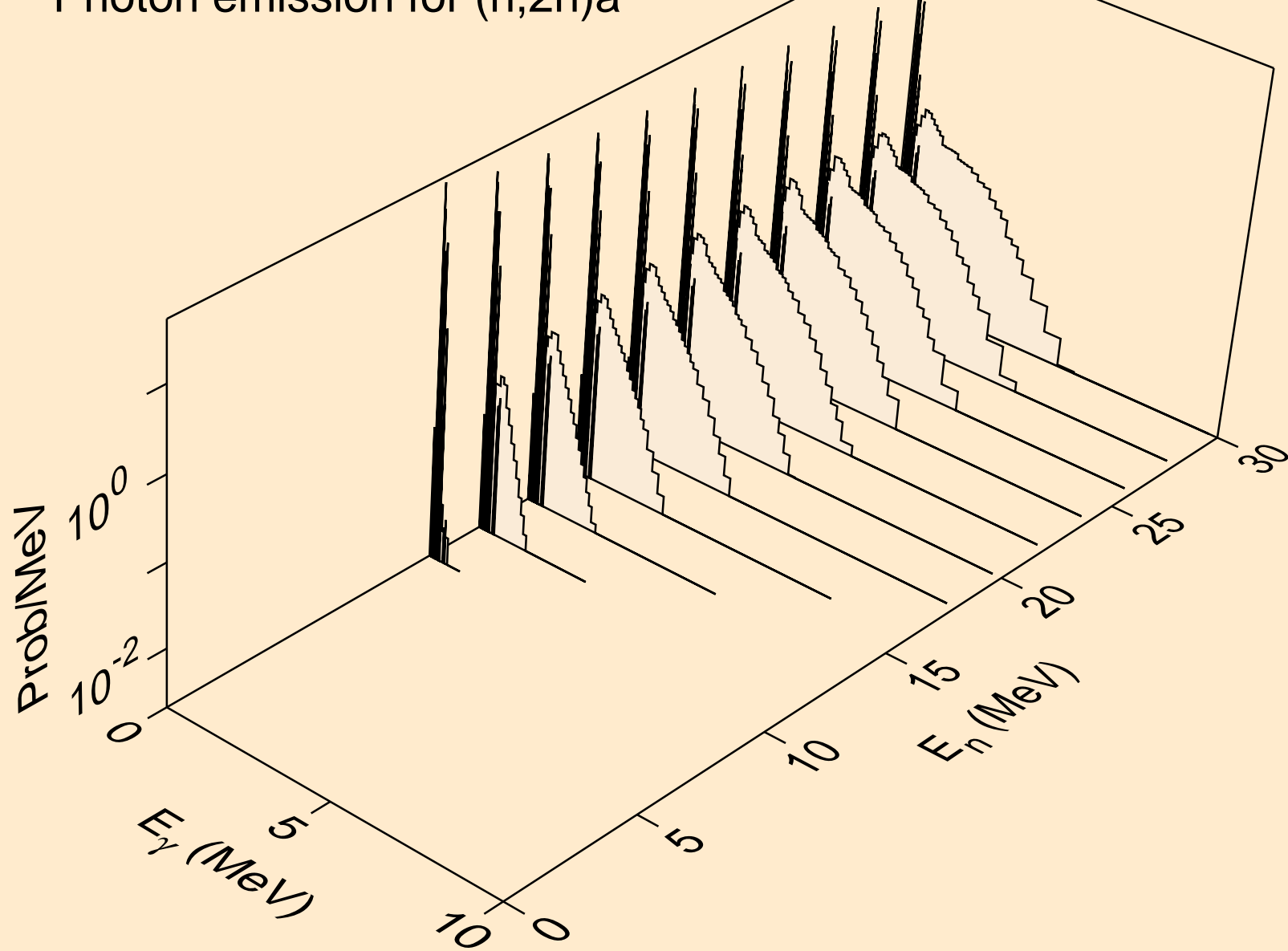

IR182 NEUTRON ACER TENDL-2021 LIBRARY; T=293.6K  
Photon emission for (n,3n)a

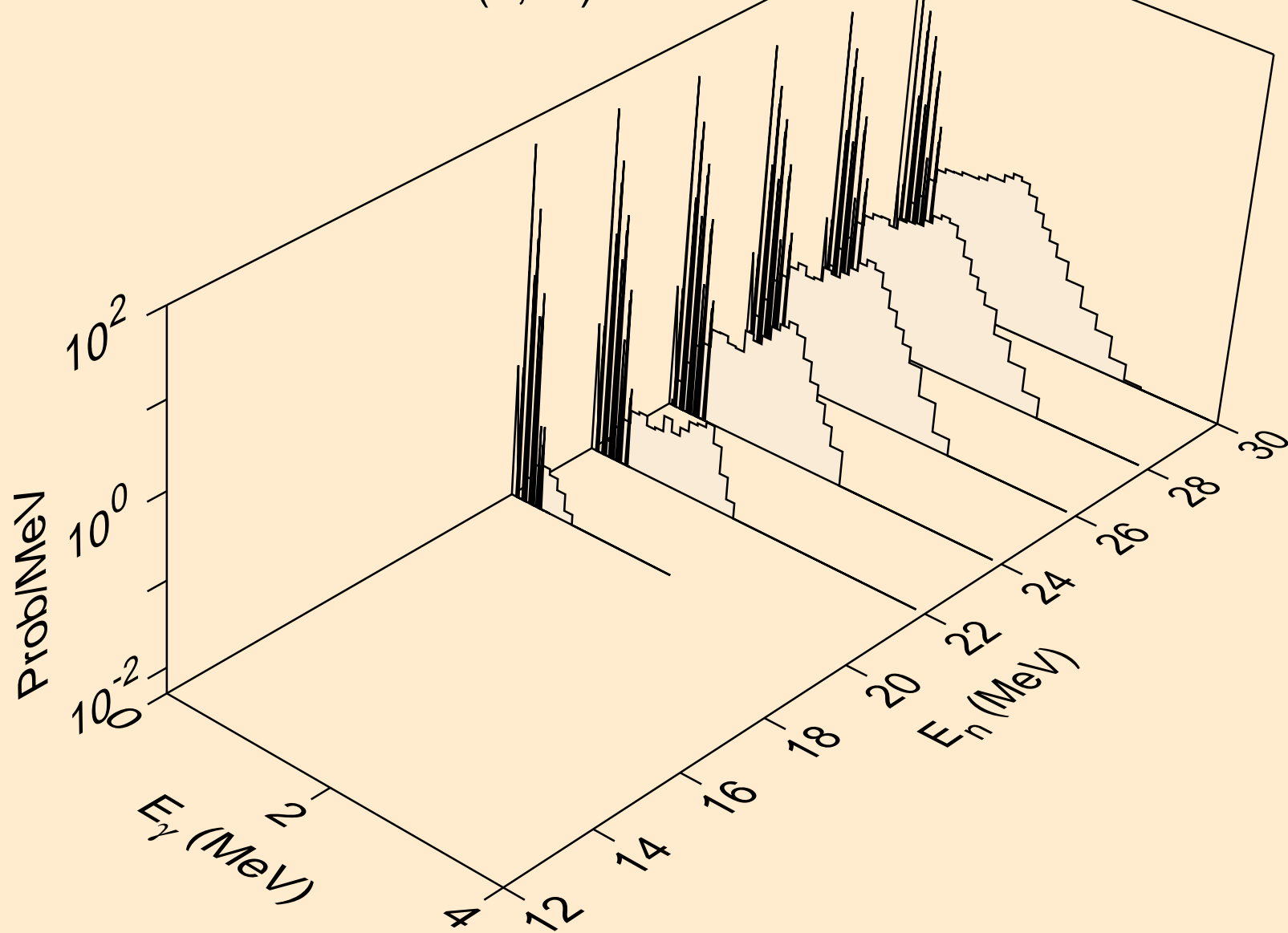

IR182 NEUTRON ACER TENDL-2021 LIBRARY; T=293.6K  
Photon emission for (n,n\*)p

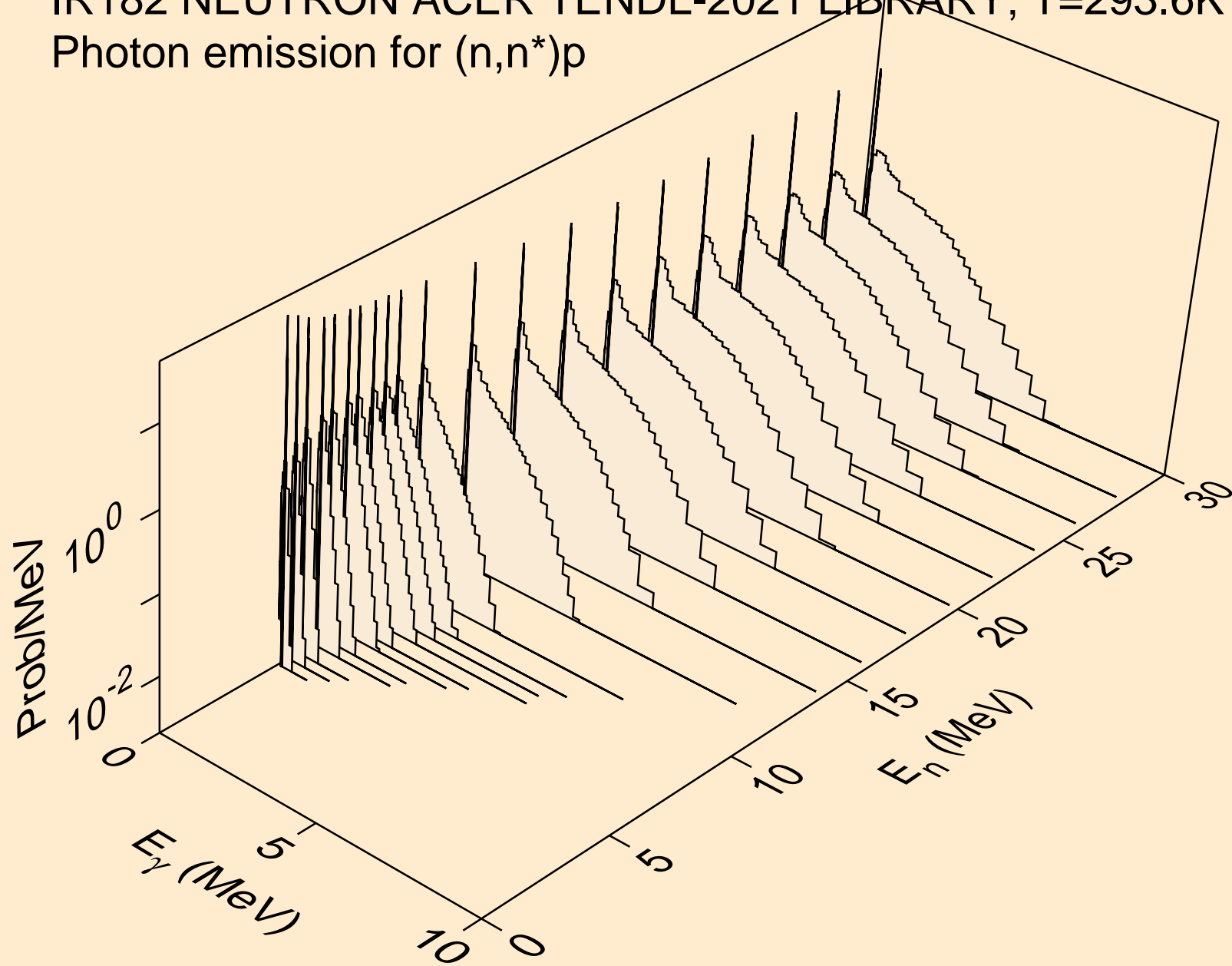

IR182 NEUTRON ACER TENDL-2021 LIBRARY; T=293.6K  
Photon emission for (n,n\*)2a

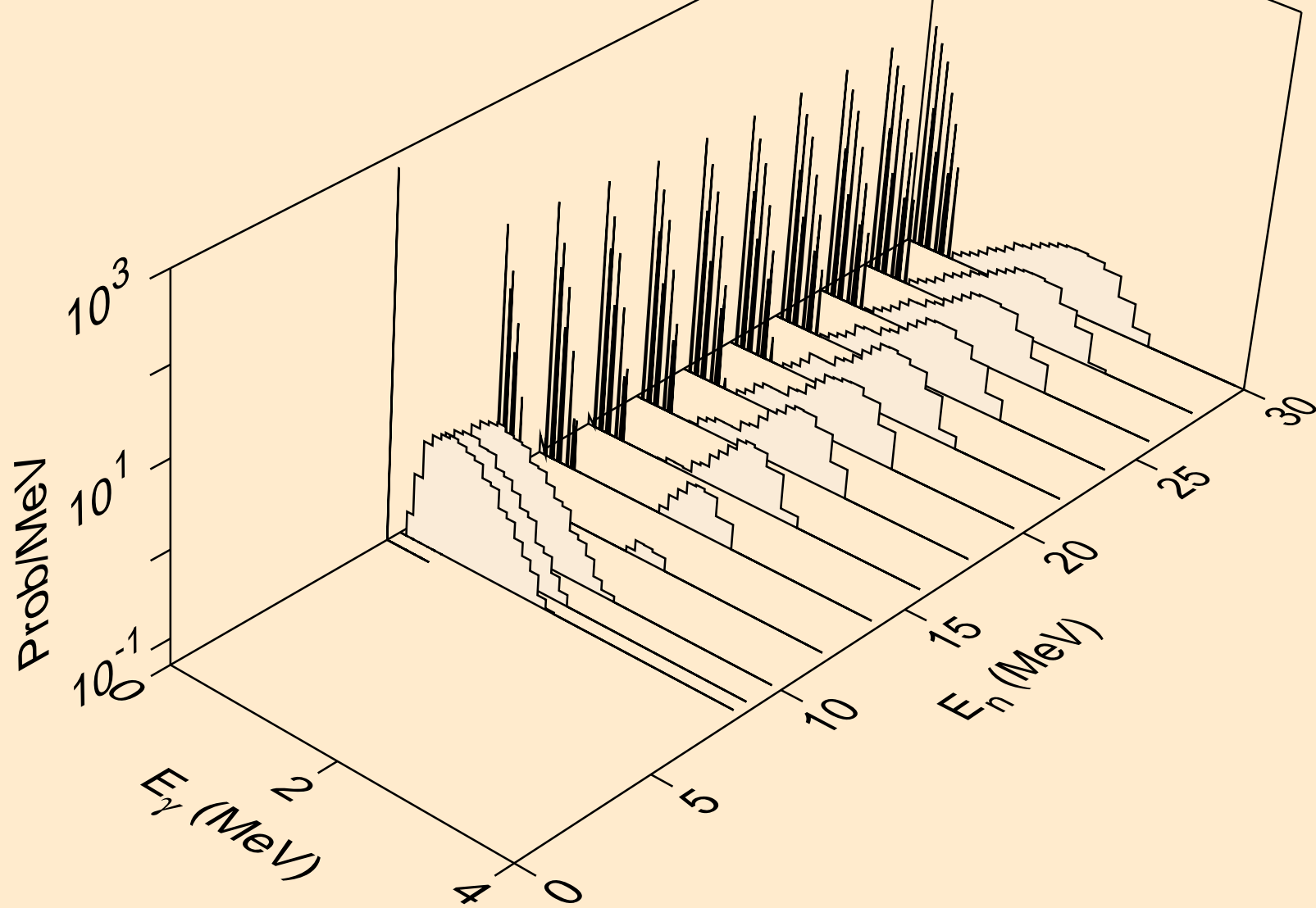

IR182 NEUTRON ACER TENDL-2021 LIBRARY; T=293.6K  
Photon emission for (n,2n)2a

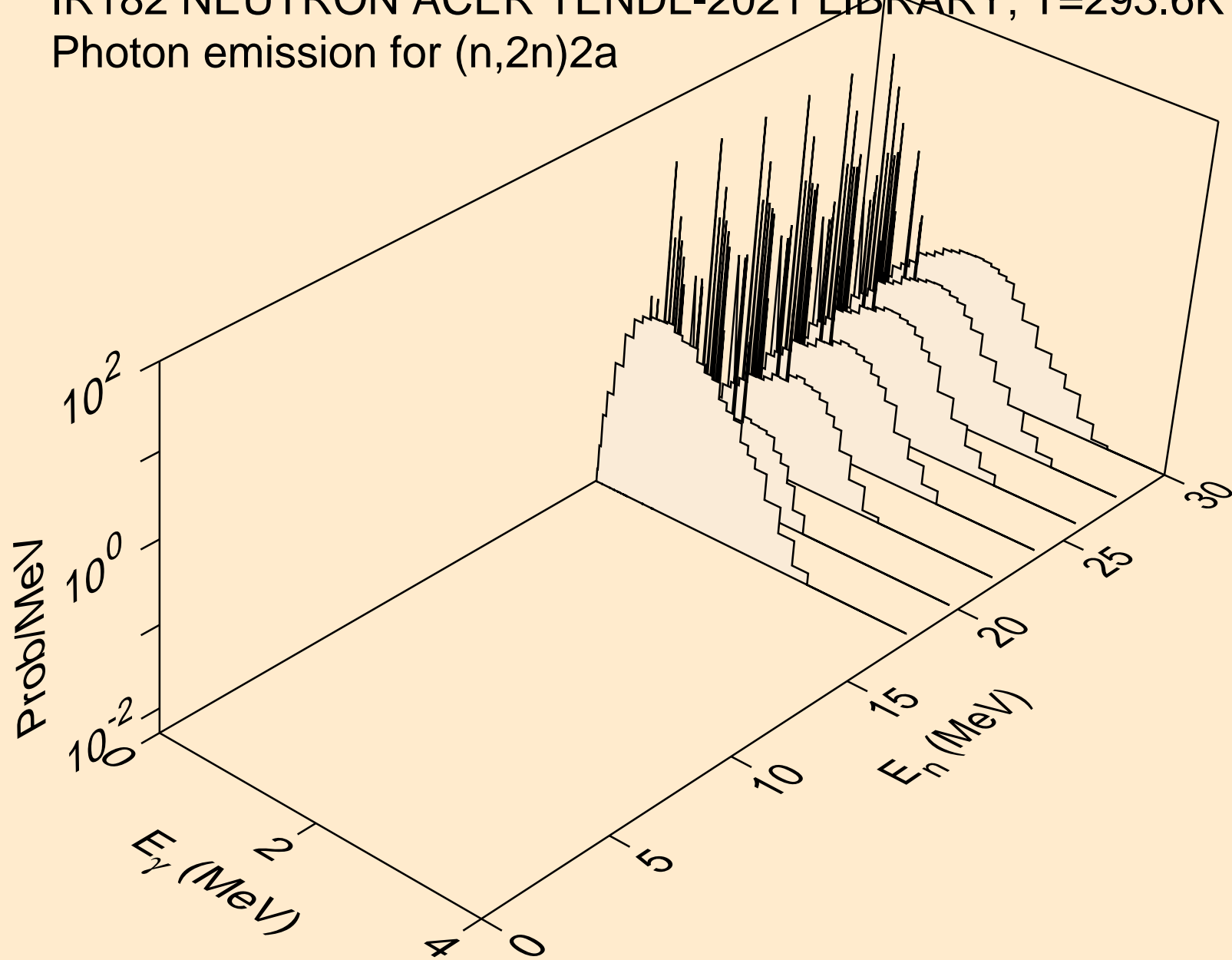

IR182 NEUTRON ACER TENDL-2021 LIBRARY; T=293.6K  
Photon emission for (n,n\*)d

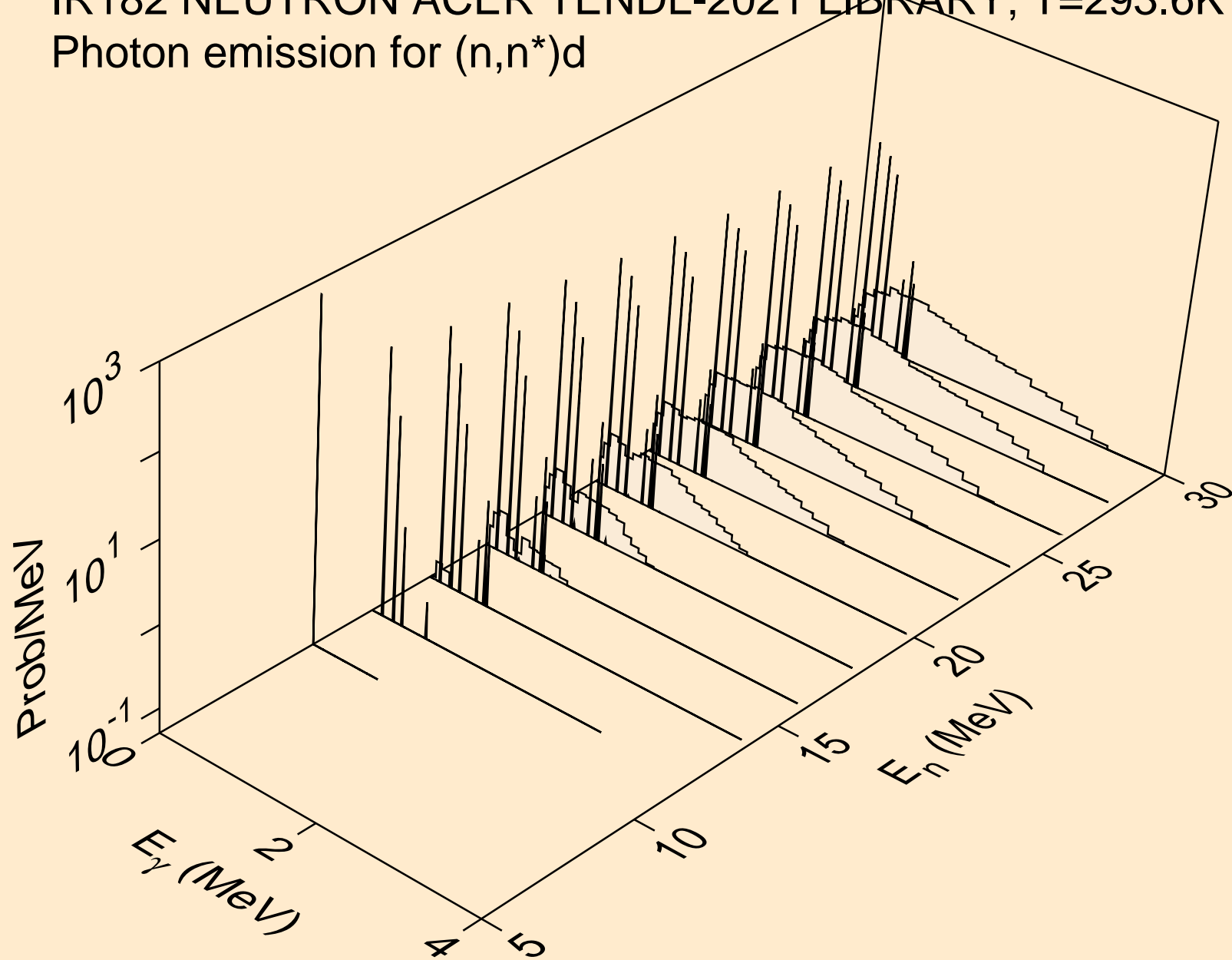

IR182 NEUTRON ACER TENDL-2021 LIBRARY; T=293.6K  
Photon emission for (n,n\*)t

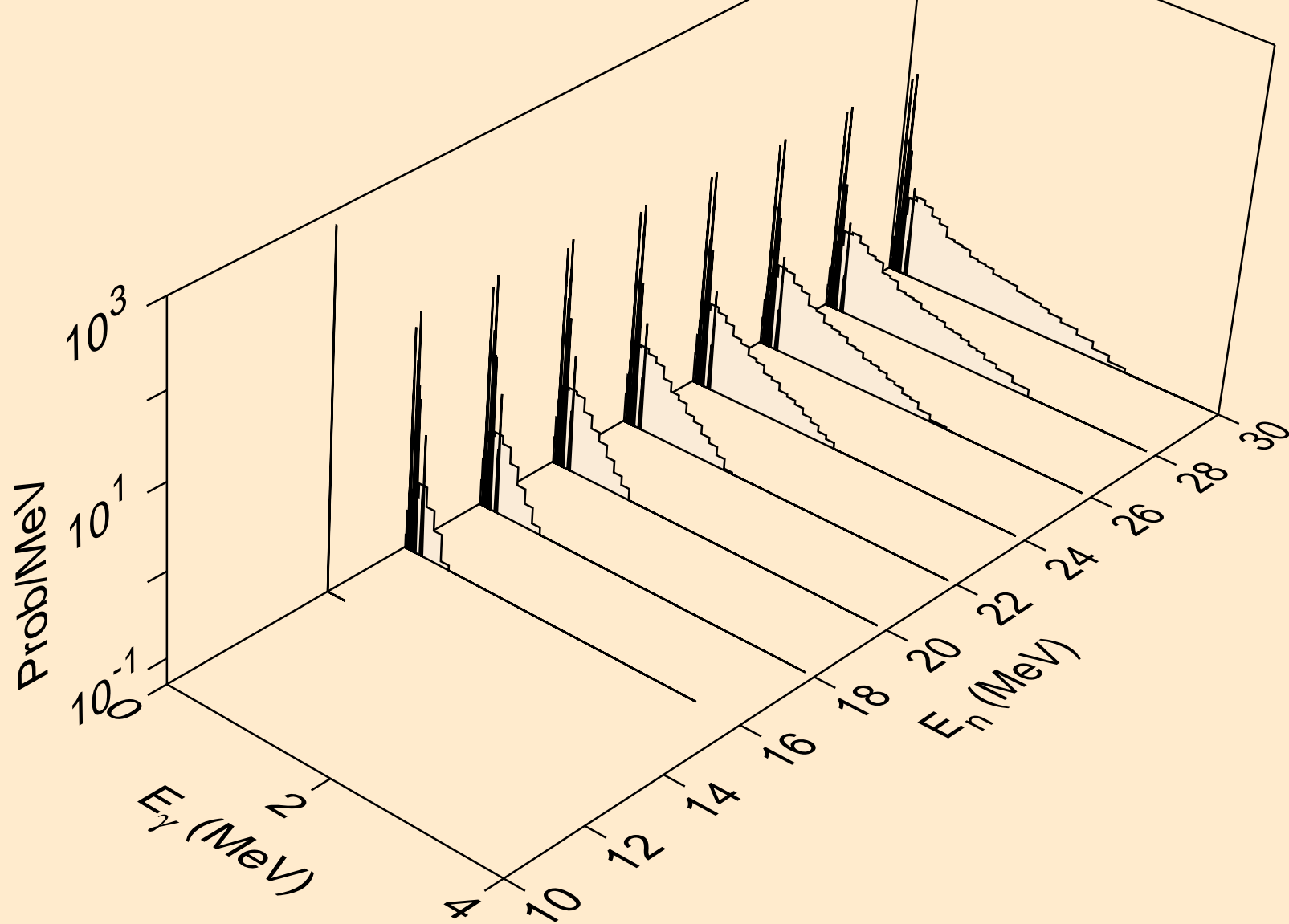

IR182 NEUTRON ACER TENDL-2021 LIBRARY; T=293.6K  
Photon emission for (n,n\*)he3

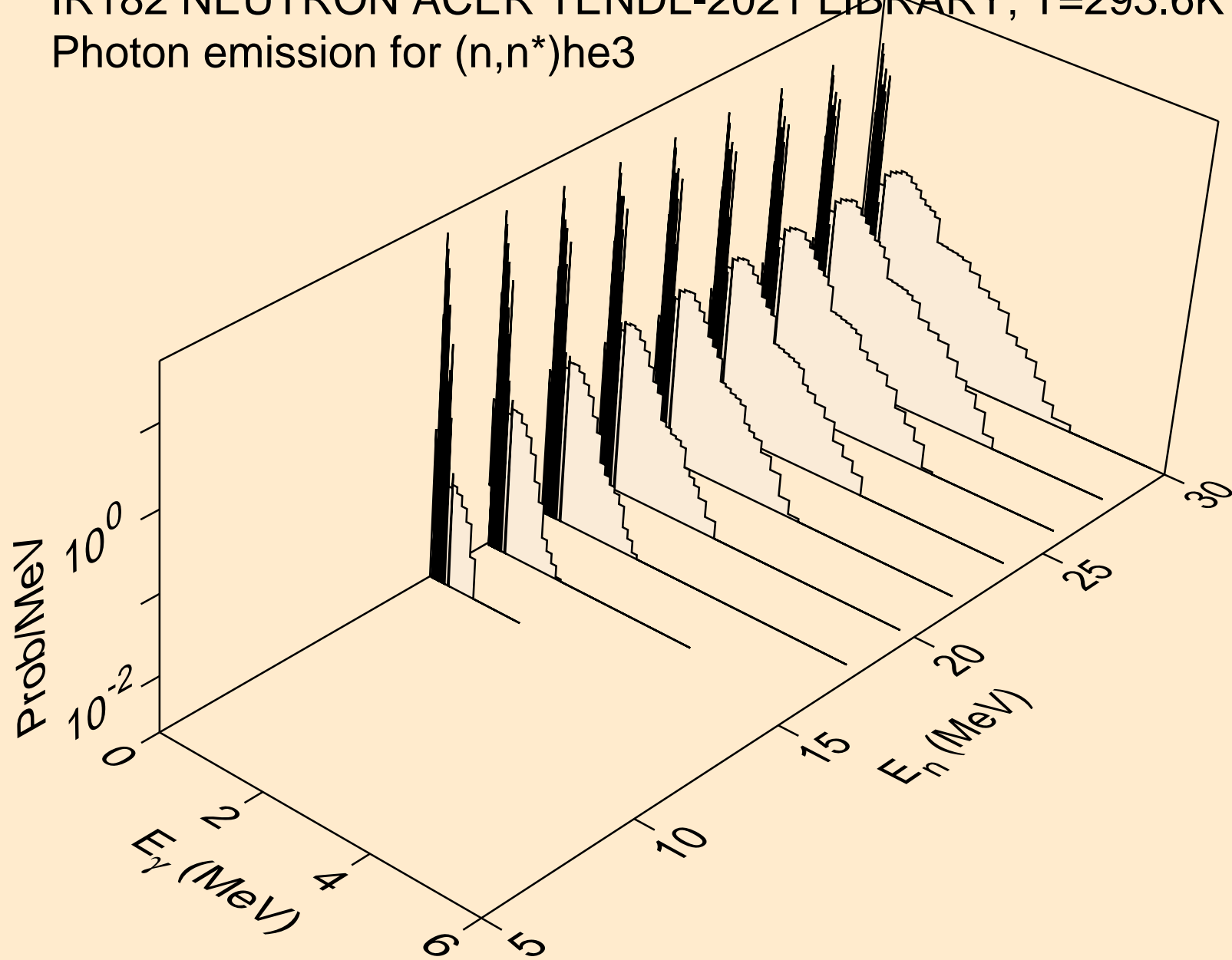

IR182 NEUTRON ACER TENDL-2021 LIBRARY; T=293.6K  
Photon emission for (n,4n)

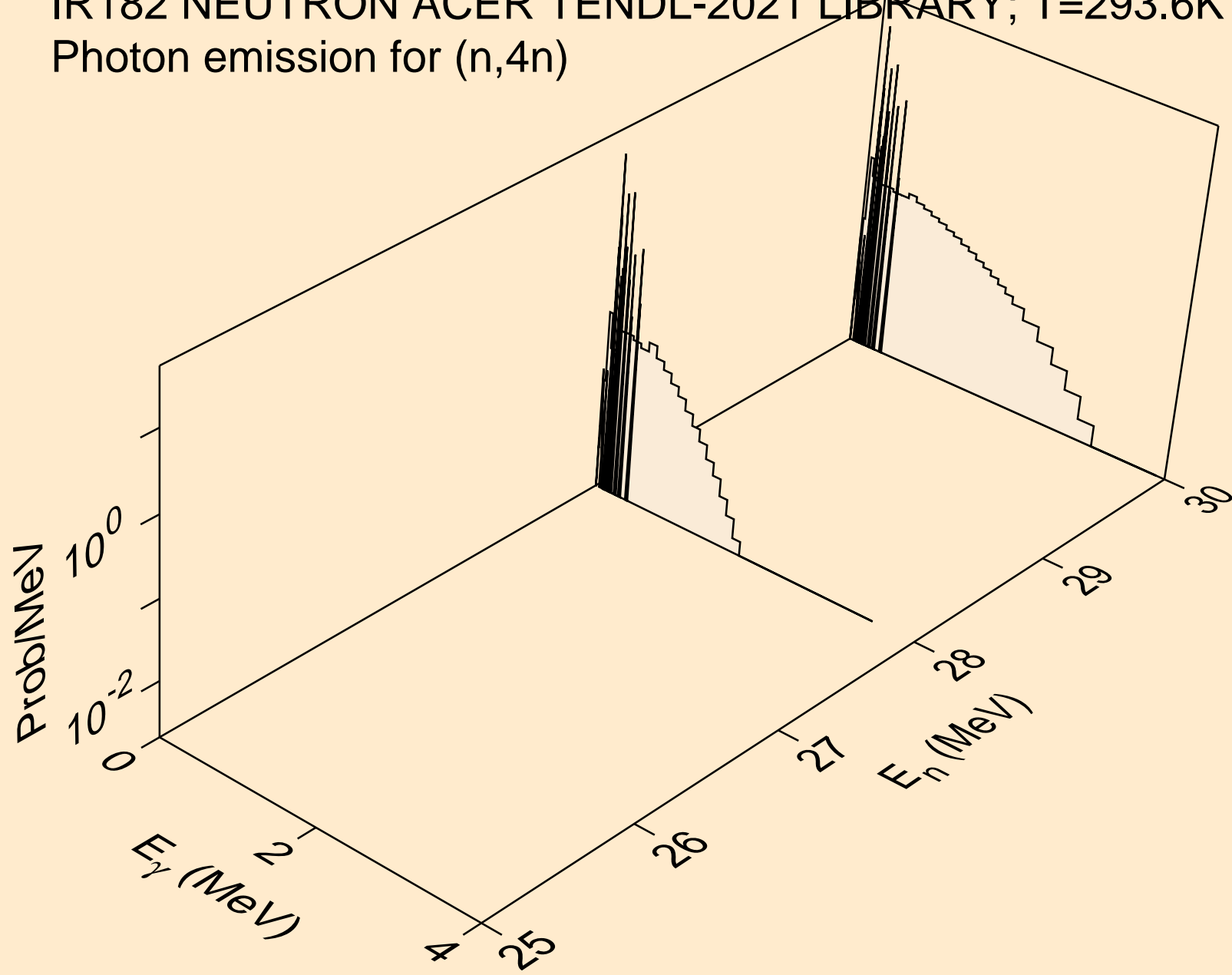

IR182 NEUTRON ACER TENDL-2021 LIBRARY; T=293.6K  
Photon emission for (n,2np)

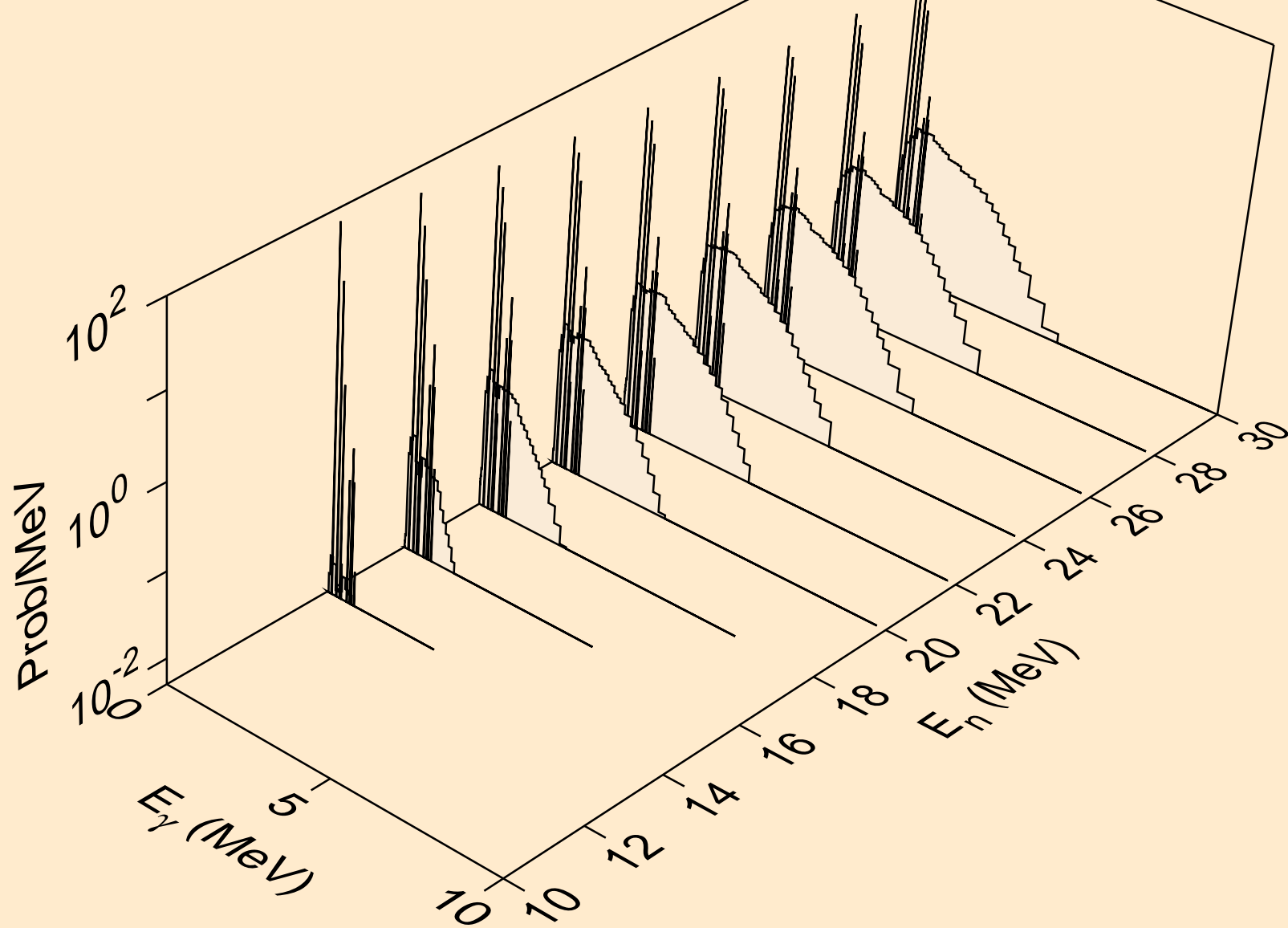

IR182 NEUTRON ACER TENDL-2021 LIBRARY; T=293.6K  
Photon emission for (n,3np)

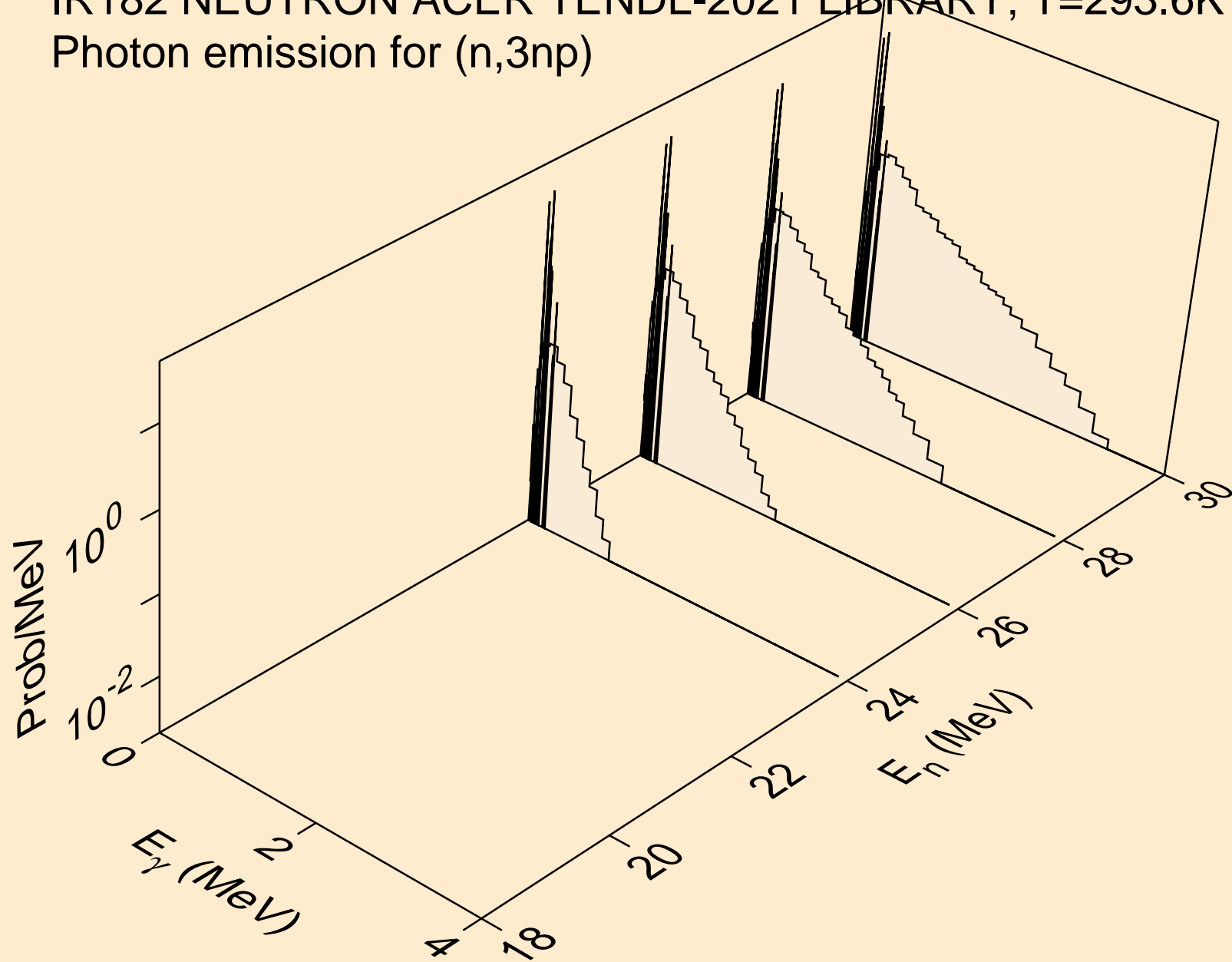

IR182 NEUTRON ACER TENDL-2021 LIBRARY; T=293.6K  
Photon emission for (n,2np)

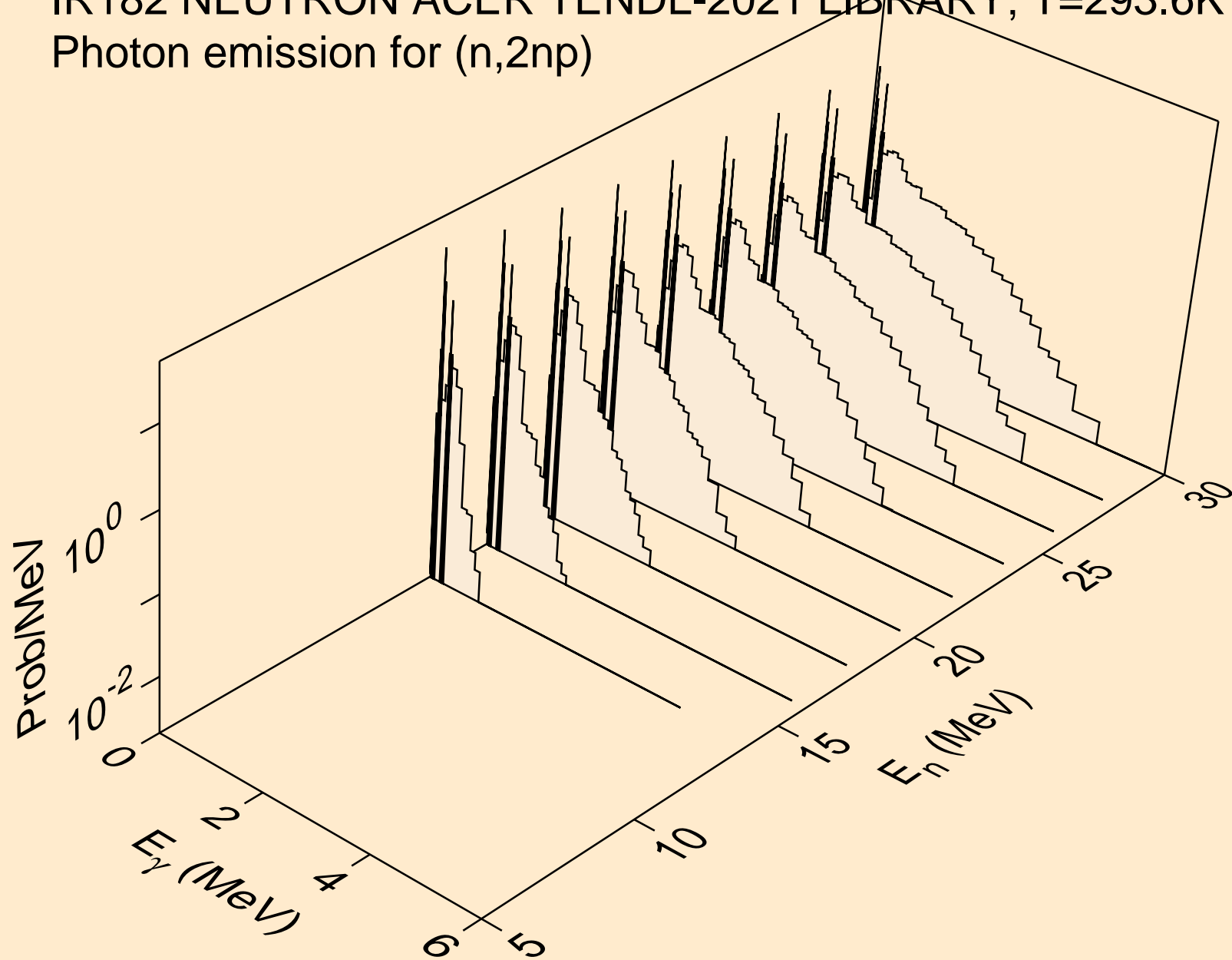

IR182 NEUTRON ACER TENDL-2021 LIBRARY; T=293.6K  
Photon emission for (n,npa)

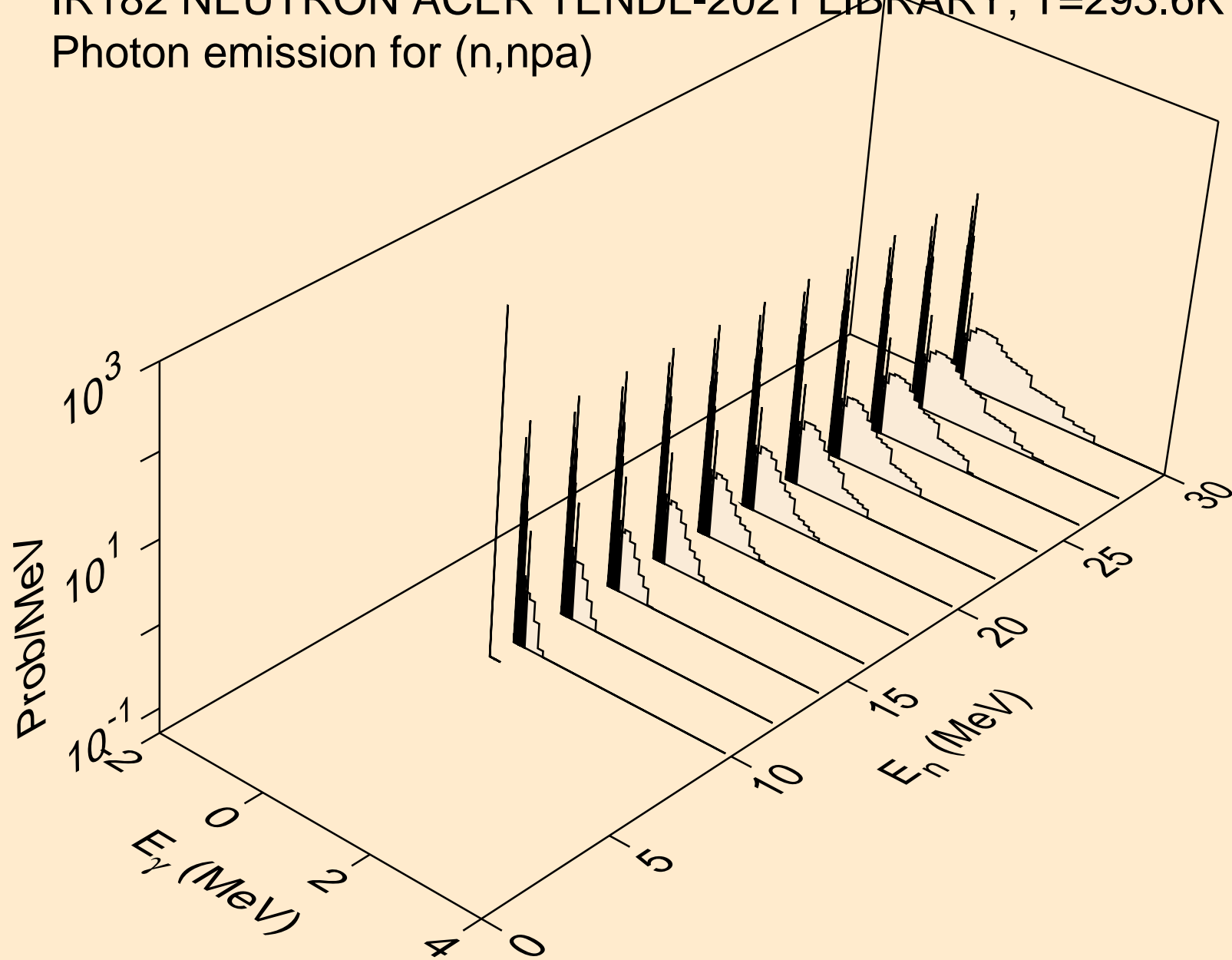

IR182 NEUTRON ACER TENDL-2021 LIBRARY; T=293.6K  
Photon emission for (n,n\*c)

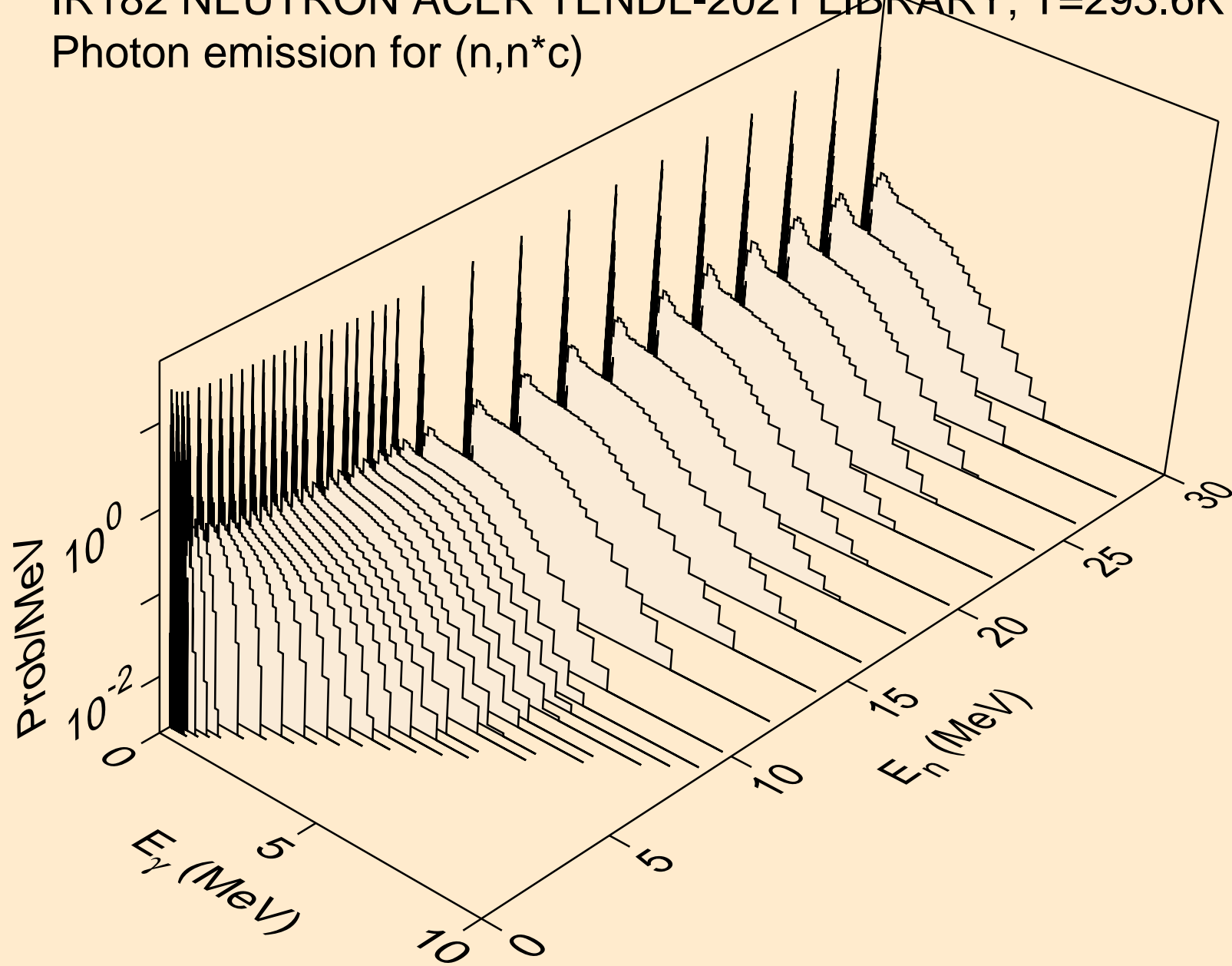

IR182 NEUTRON ACER TENDL-2021 LIBRARY; T=293.6K  
Photon emission for (n,gma)

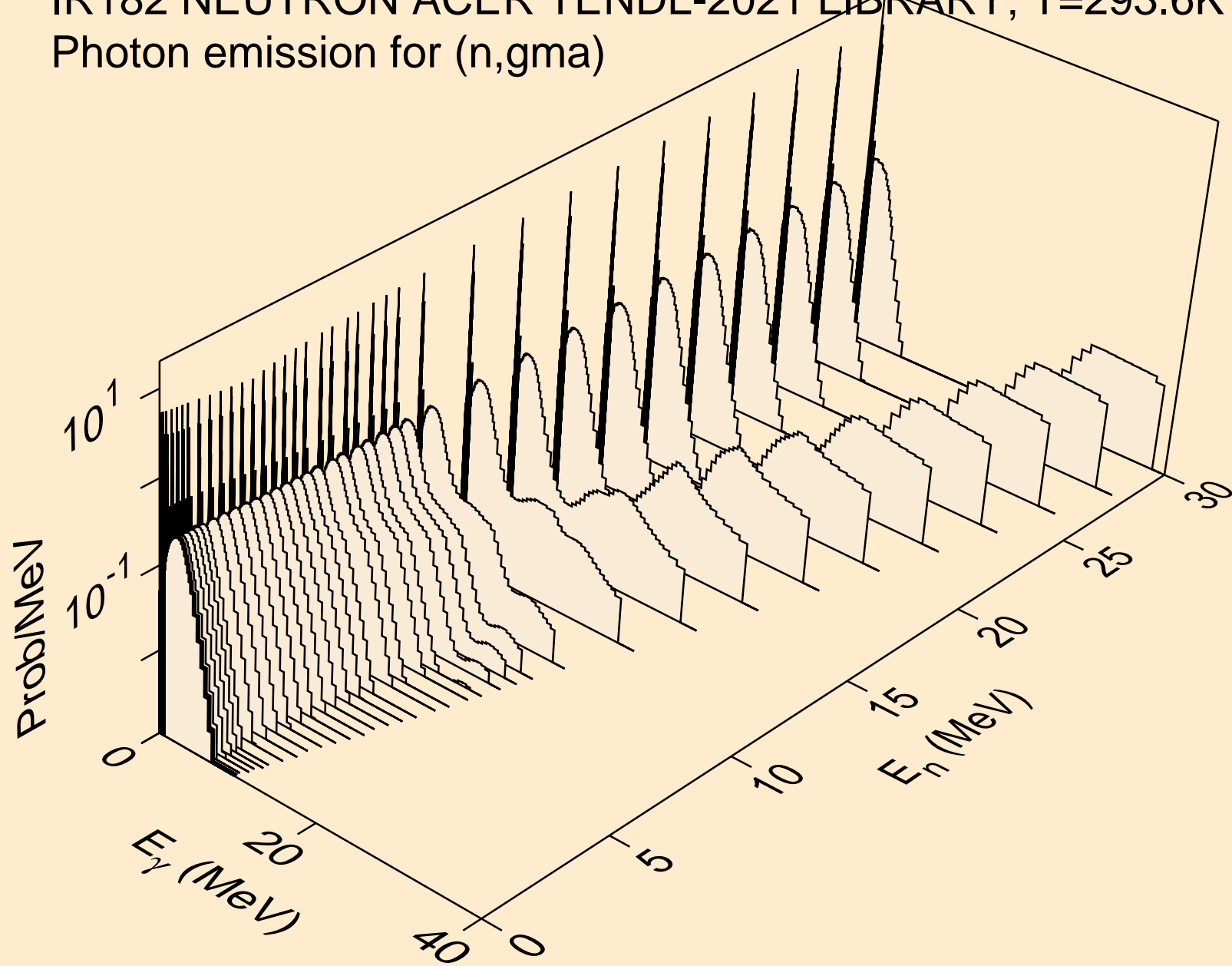

IR182 NEUTRON ACER TENDL-2021 LIBRARY; T=293.6K  
Photon emission for (n,p)

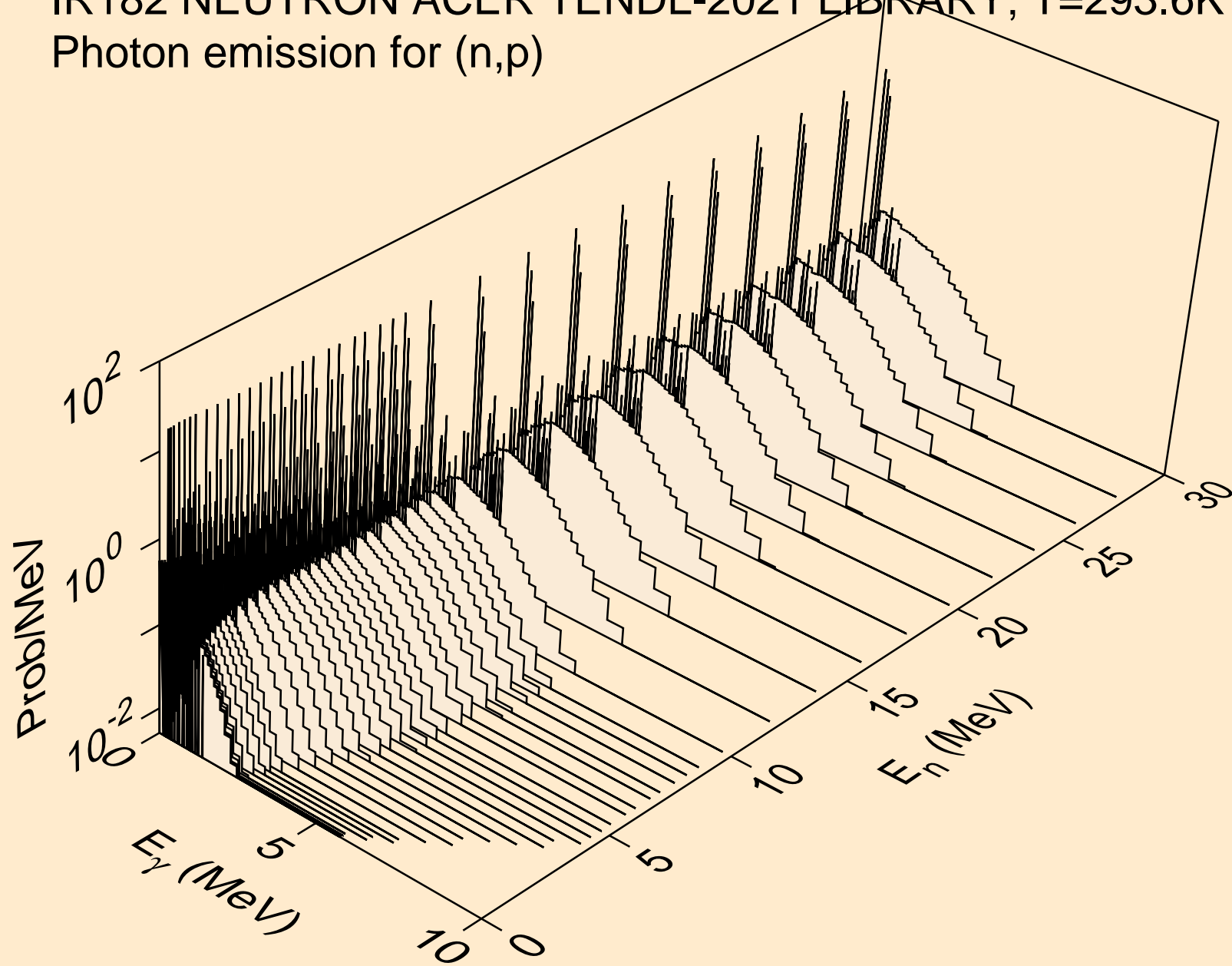

IR182 NEUTRON ACER TENDL-2021 LIBRARY; T=293.6K  
Photon emission for (n,d)

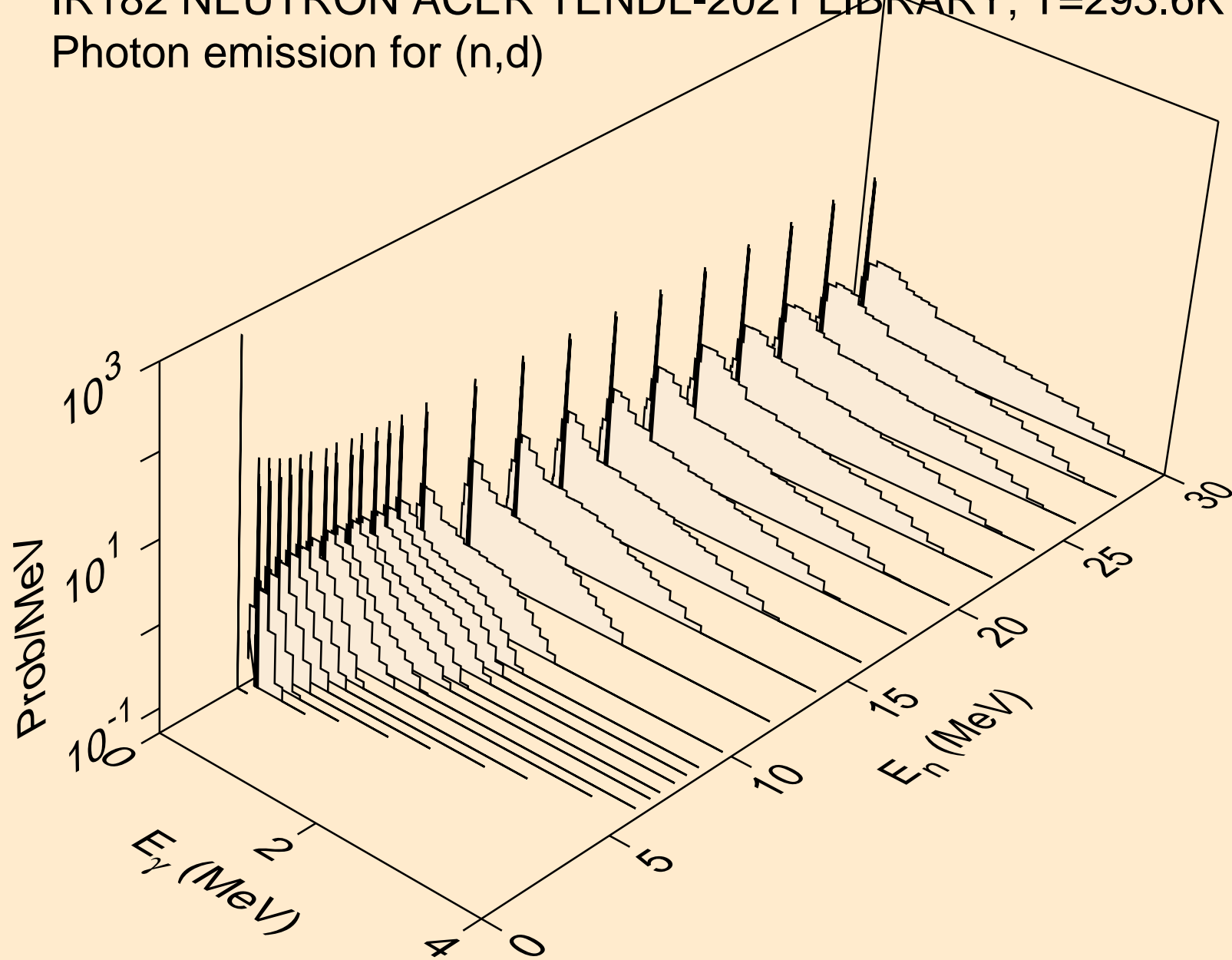

IR182 NEUTRON ACER TENDL-2021 LIBRARY; T=293.6K  
Photon emission for (n,t)

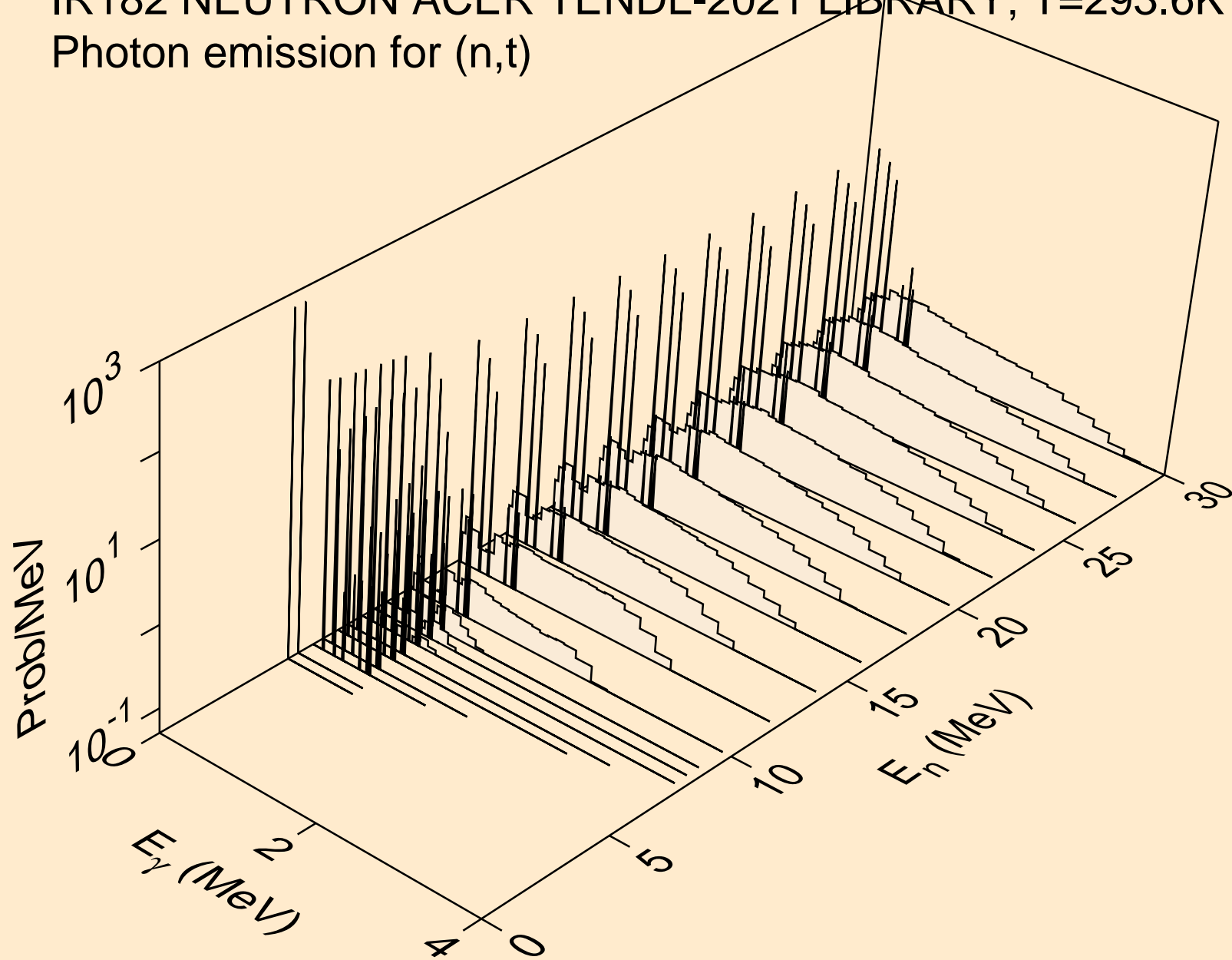

IR182 NEUTRON ACER TENDL-2021 LIBRARY; T=293.6K  
Photon emission for (n,he3)

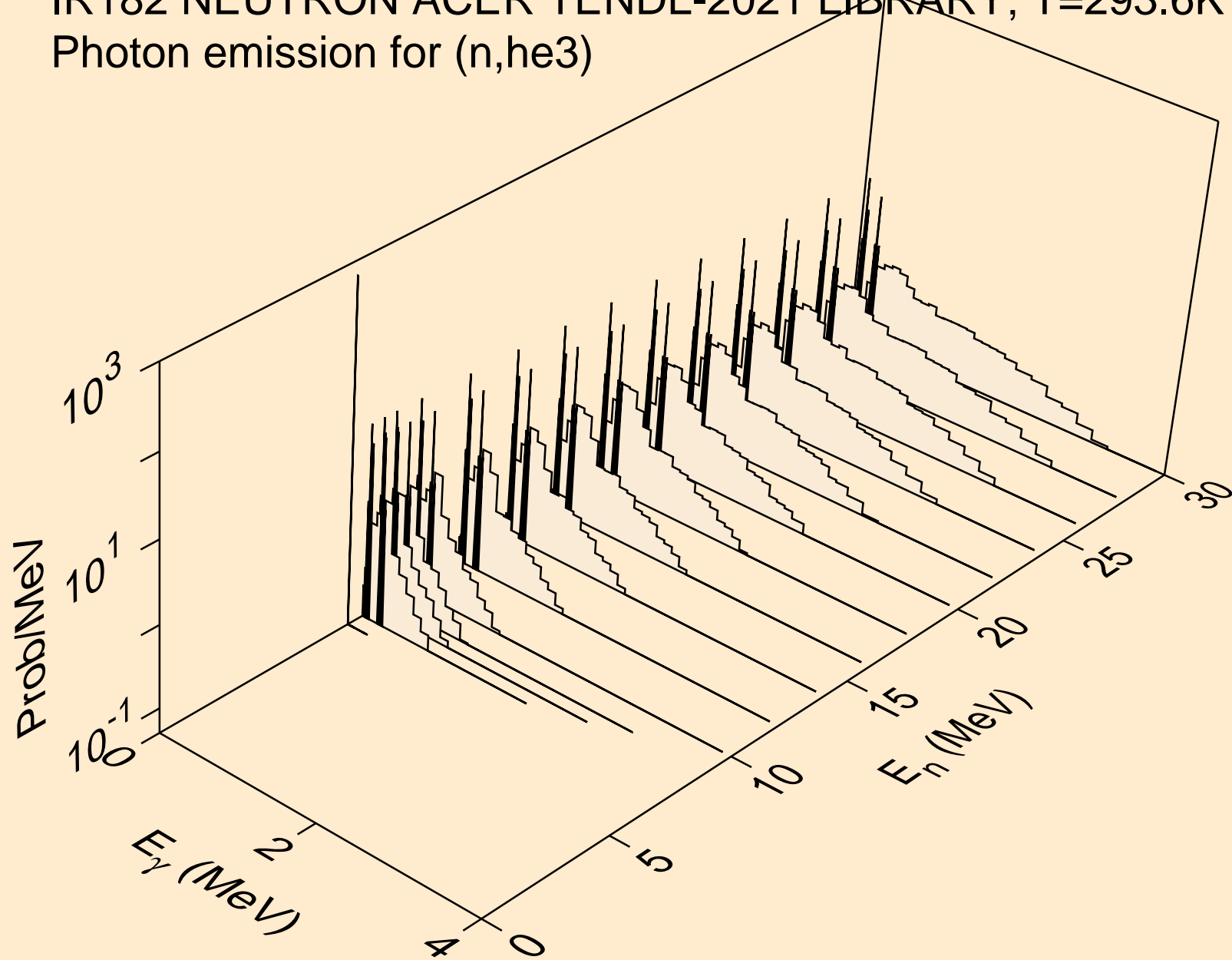

IR182 NEUTRON ACER TENDL-2021 LIBRARY; T=293.6K  
Photon emission for (n,a)

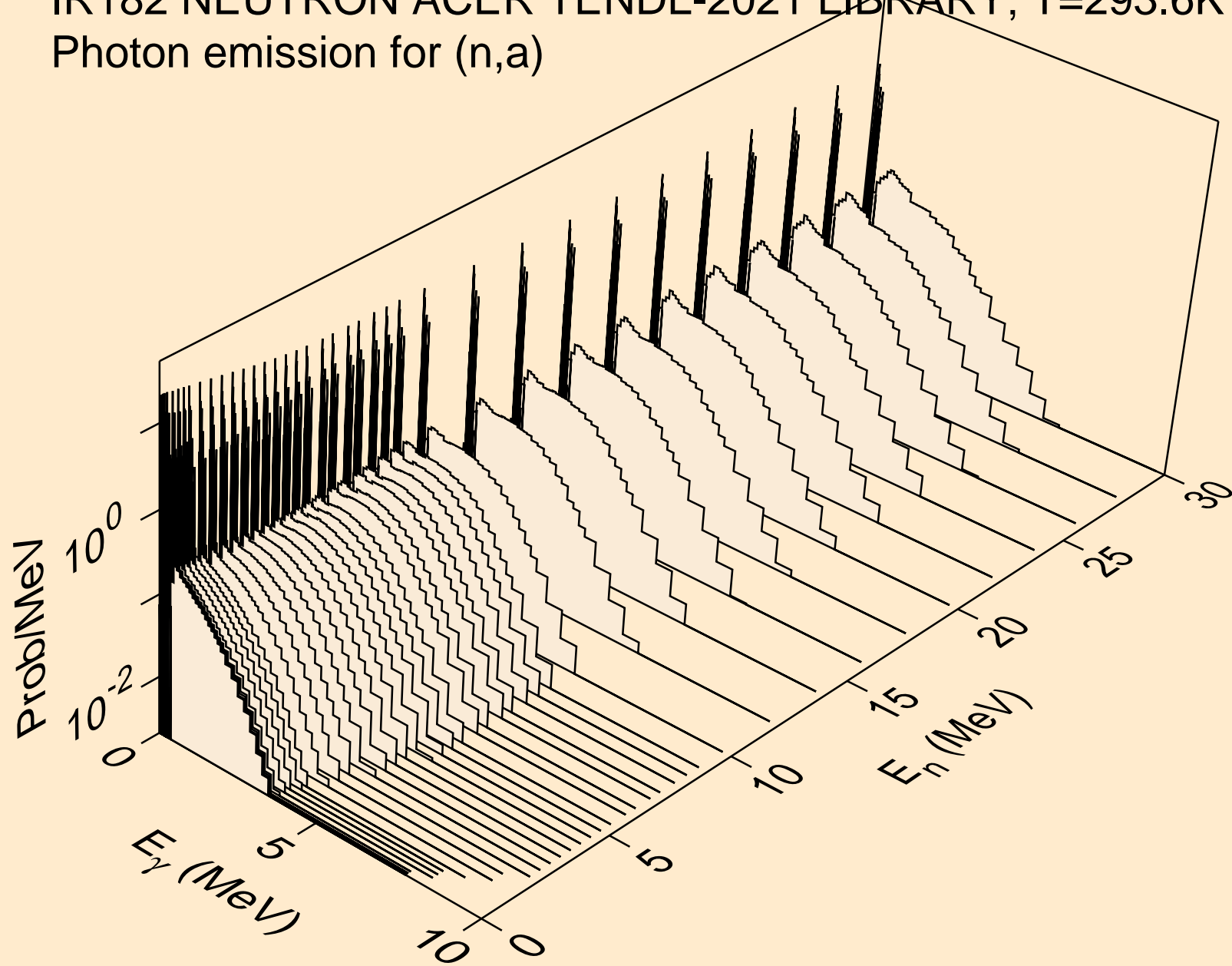

IR182 NEUTRON ACER TENDL-2021 LIBRARY; T=293.6K  
Photon emission for (n,2a)

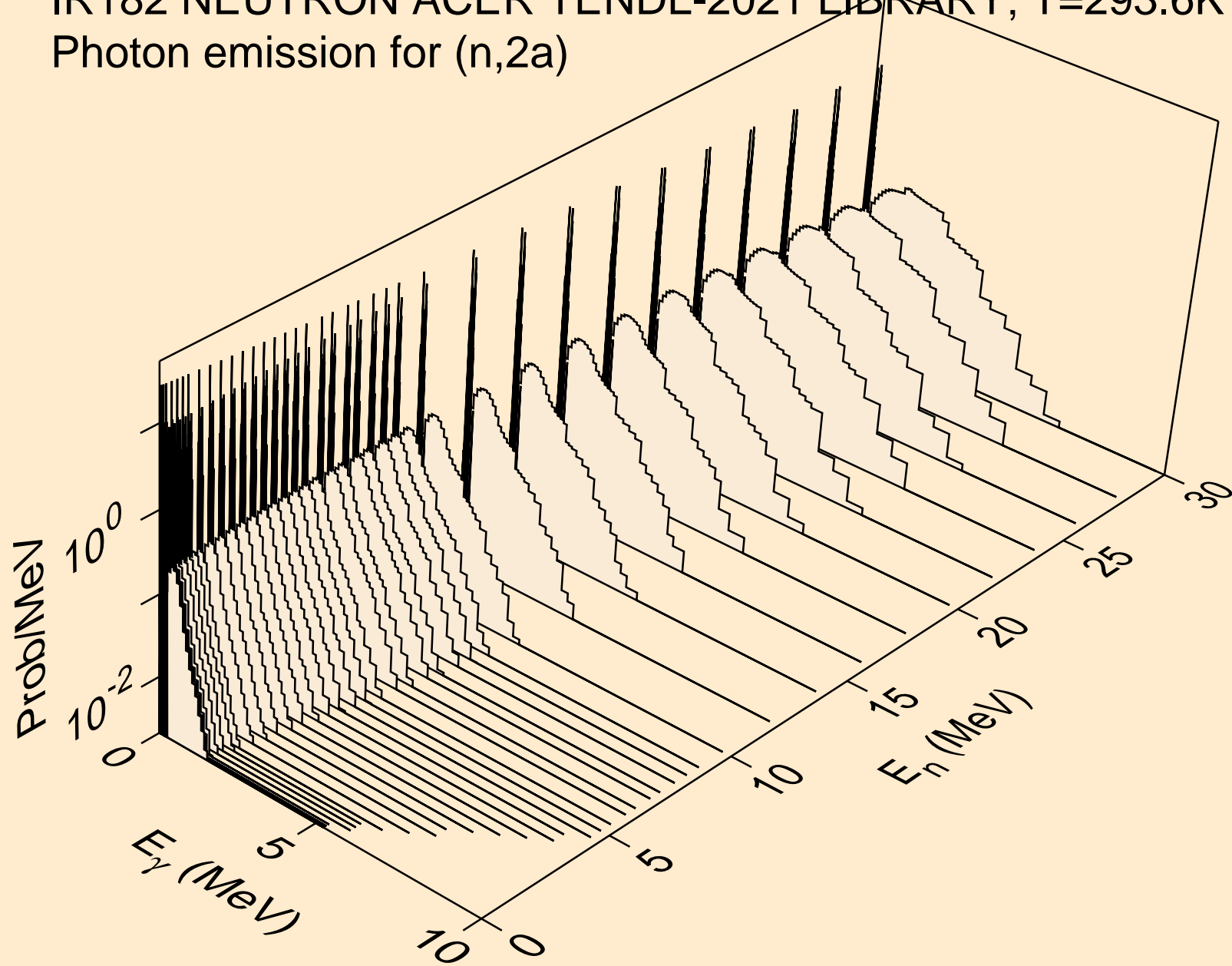

IR182 NEUTRON ACER TENDL-2021 LIBRARY; T=293.6K  
Photon emission for (n,2p)

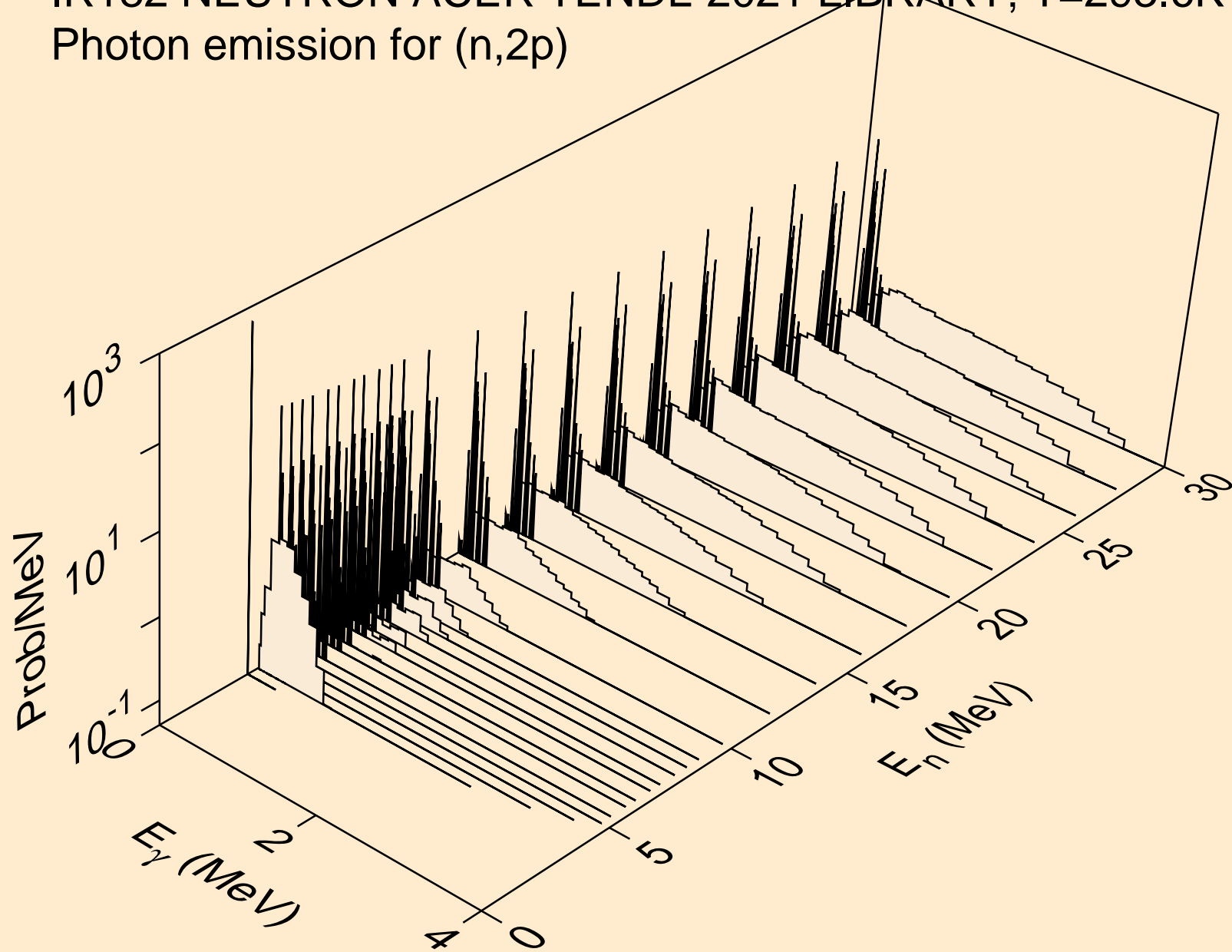

IR182 NEUTRON ACER TENDL-2021 LIBRARY; T=293.6K  
Photon emission for (n,p)

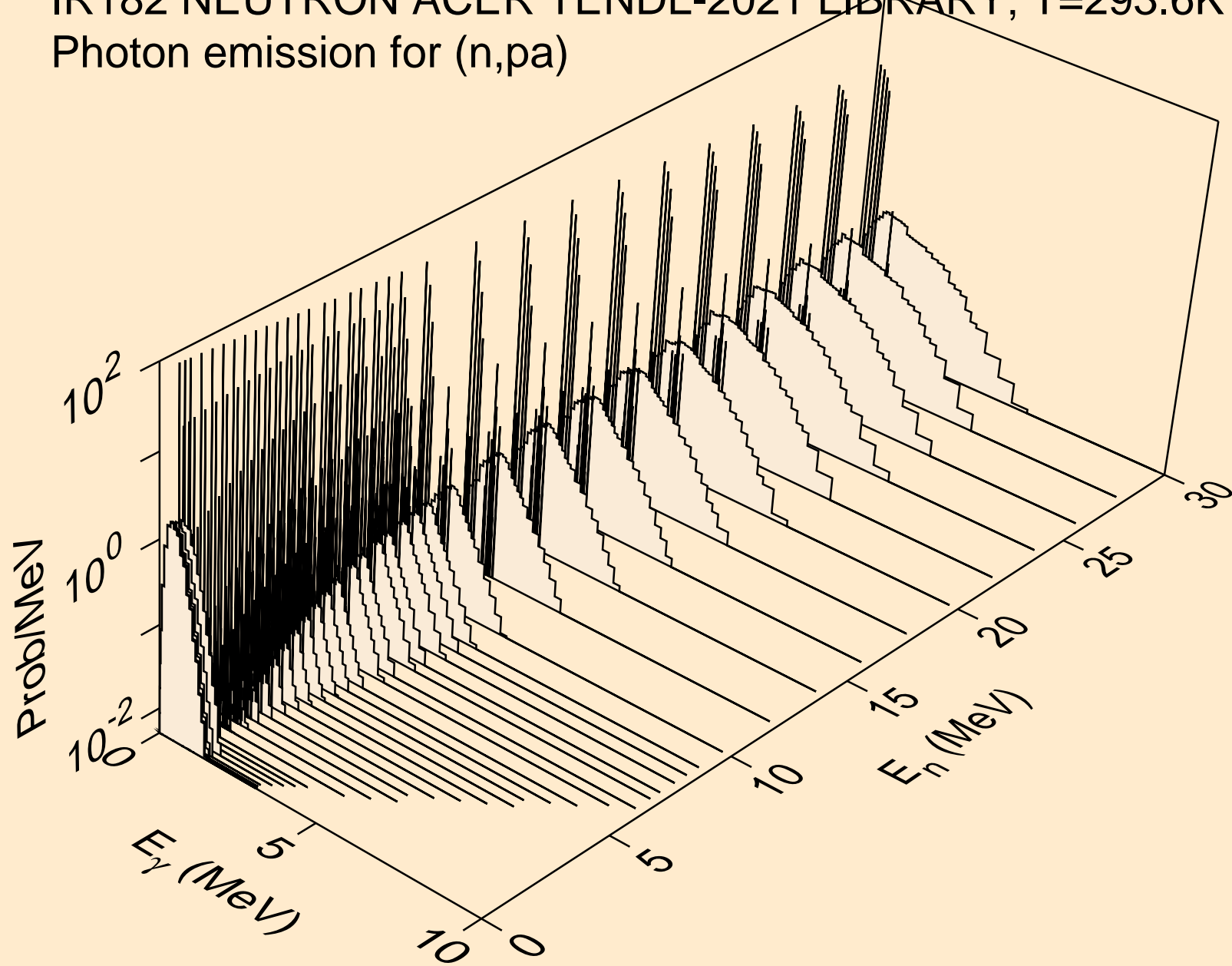

IR182 NEUTRON ACER TENDL-2021 LIBRARY; T=293.6K  
Photon emission for (n,pd)

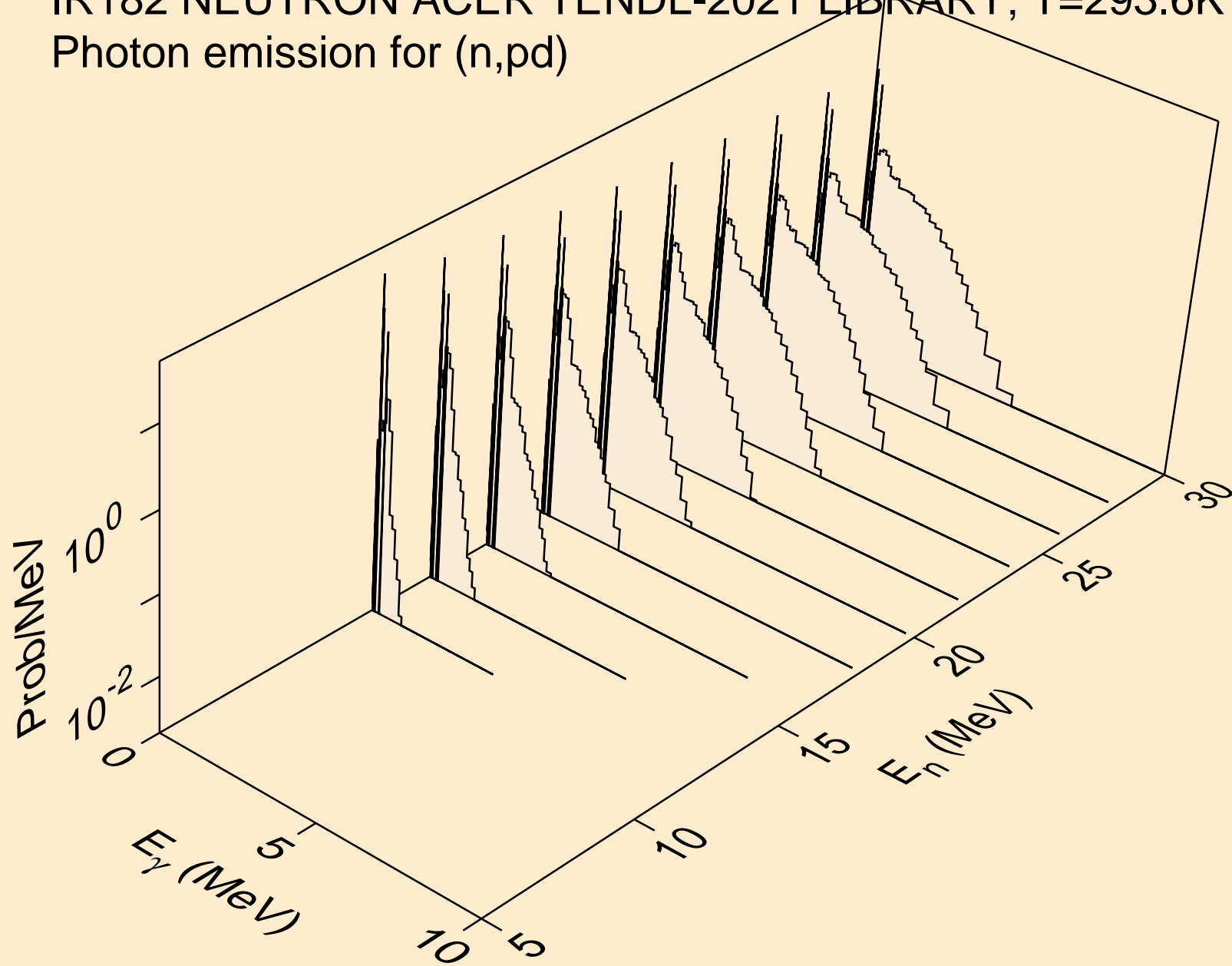

IR182 NEUTRON ACER TENDL-2021 LIBRARY; T=293.6K  
Photon emission for (n,pt)

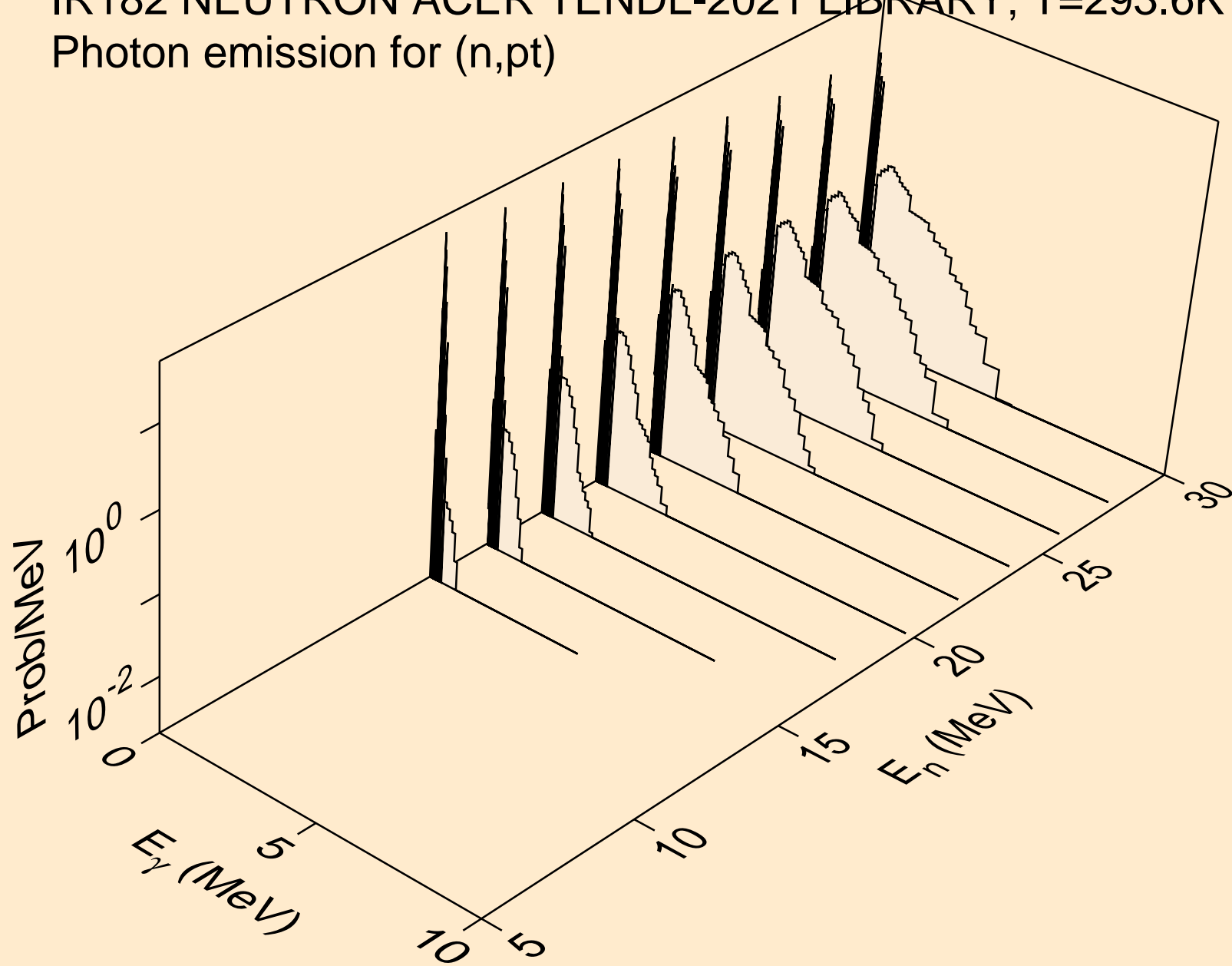

IR182 NEUTRON ACER TENDL-2021 LIBRARY; T=293.6K  
Photon emission for (n,da)

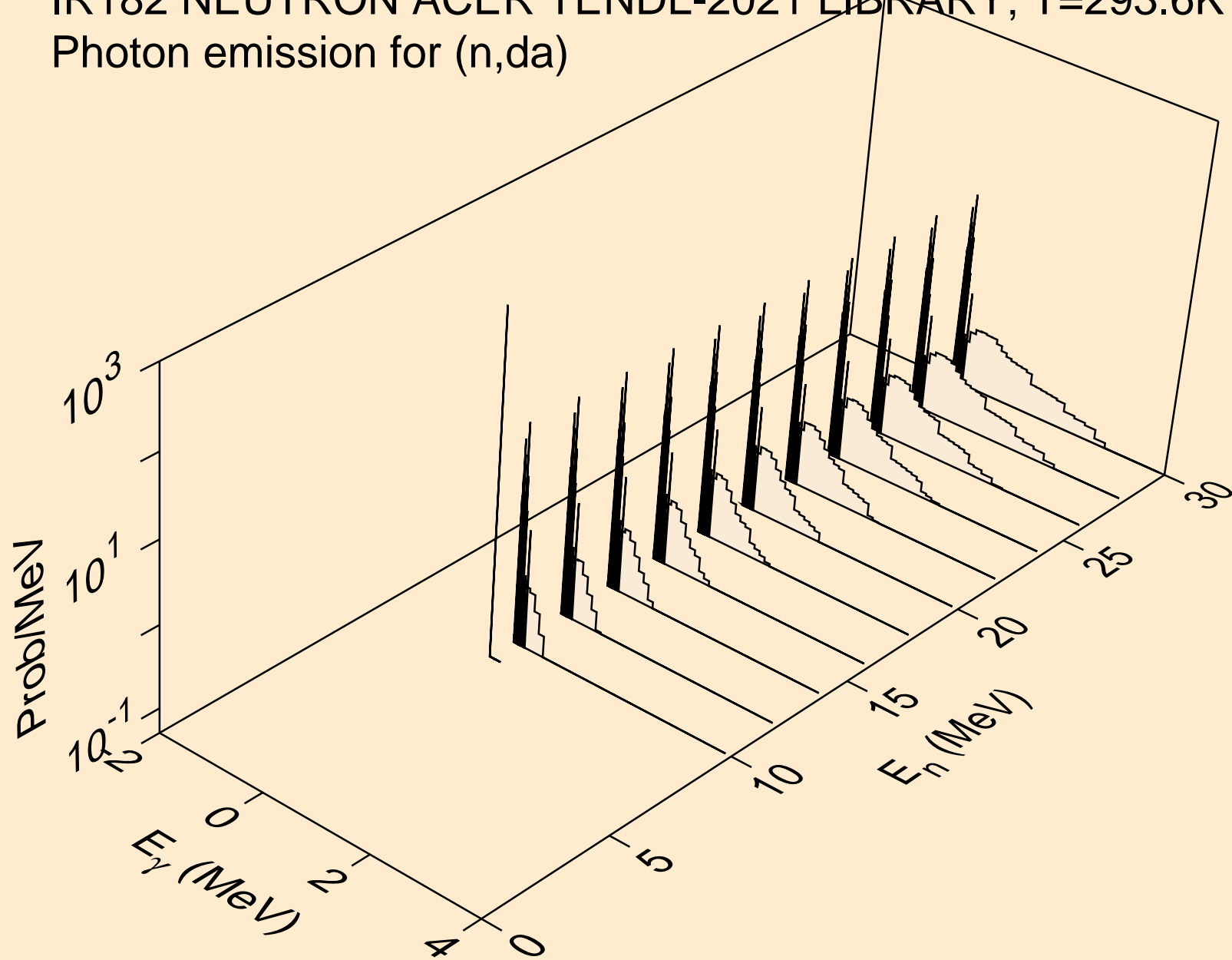

IR182 NEUTRON ACER TENDL-2021 LIBRARY; T=293.6K  
thermal capture photon spectrum

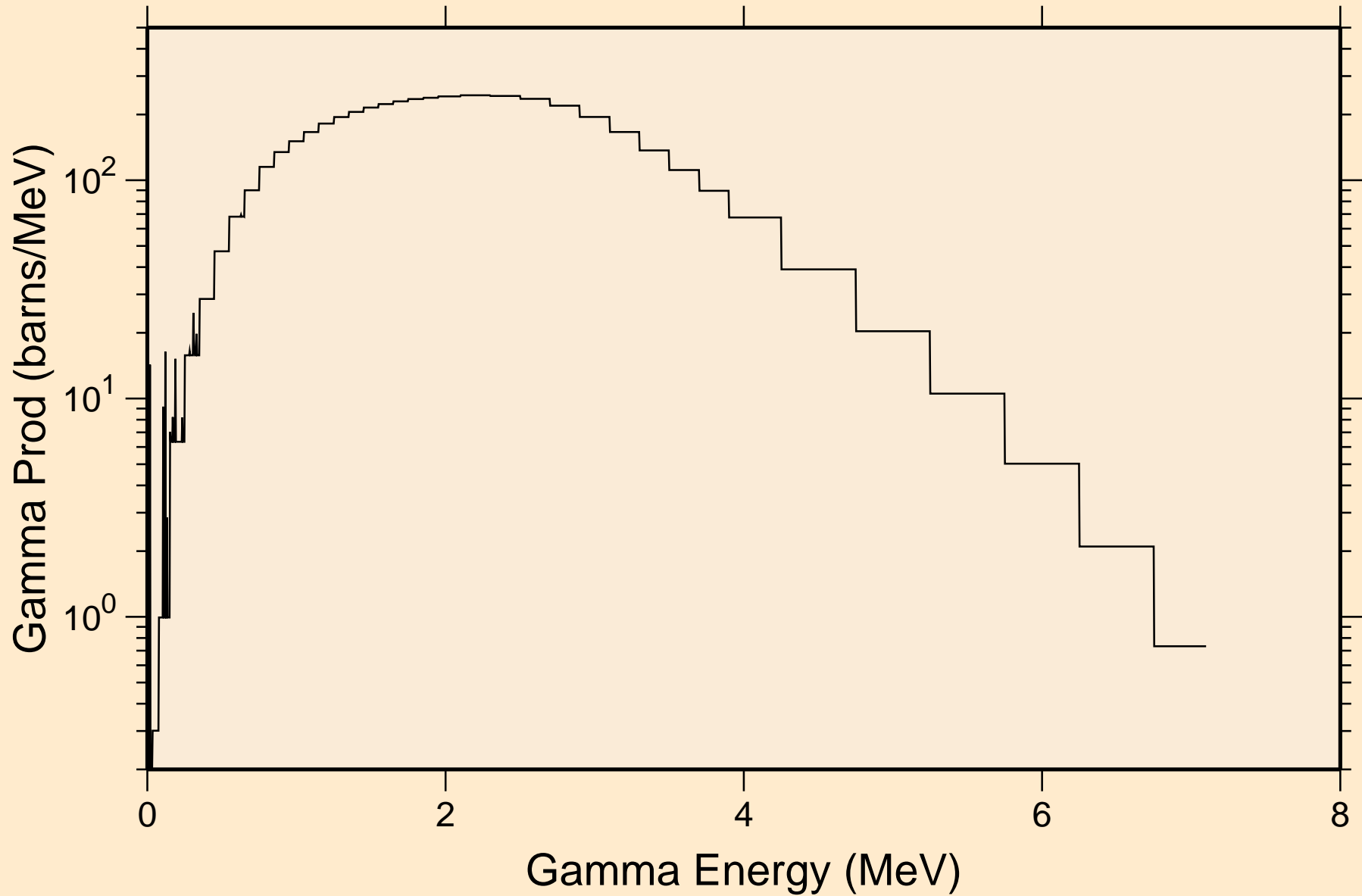

IR182 NEUTRON ACER TENDL-2021 LIBRARY; T=293.6K  
14 MeV photon spectrum

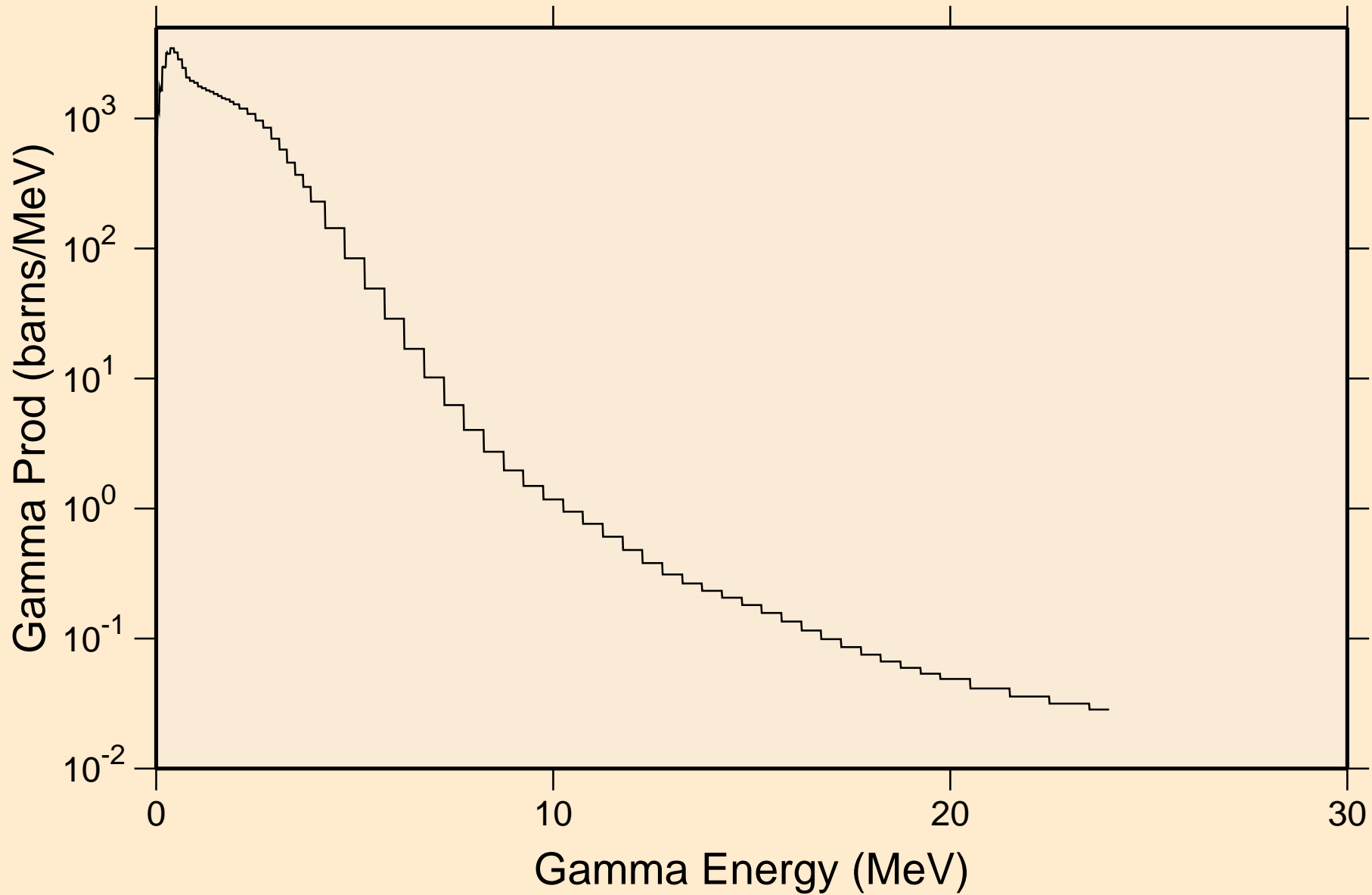

IR182 NEUTRON ACER TENDL-2021 LIBRARY; T=293.6K  
Particle heating contributions

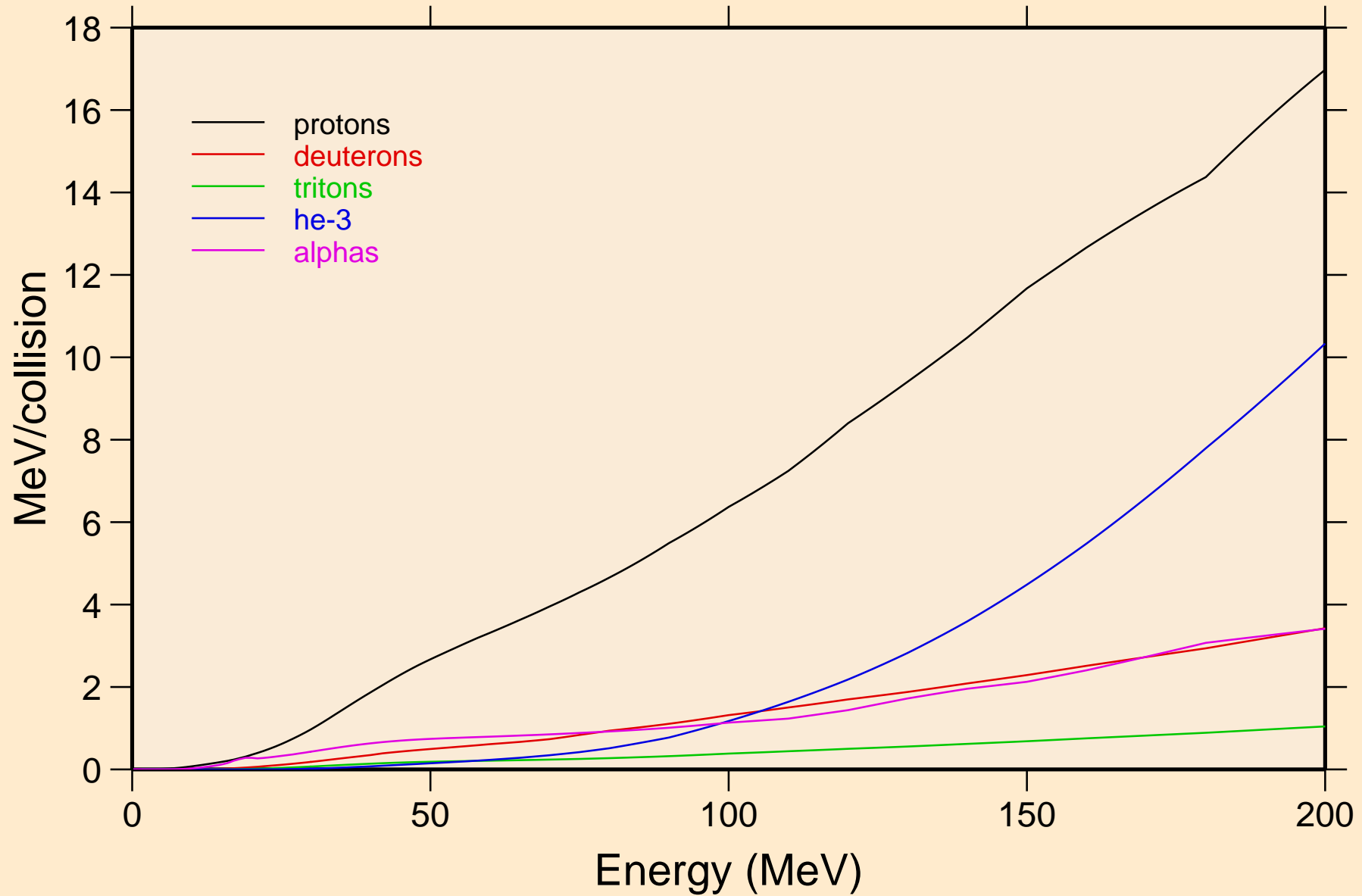

IR182 NEUTRON ACER TENDL-2021 LIBRARY; T=293.6K  
Recoil Heating

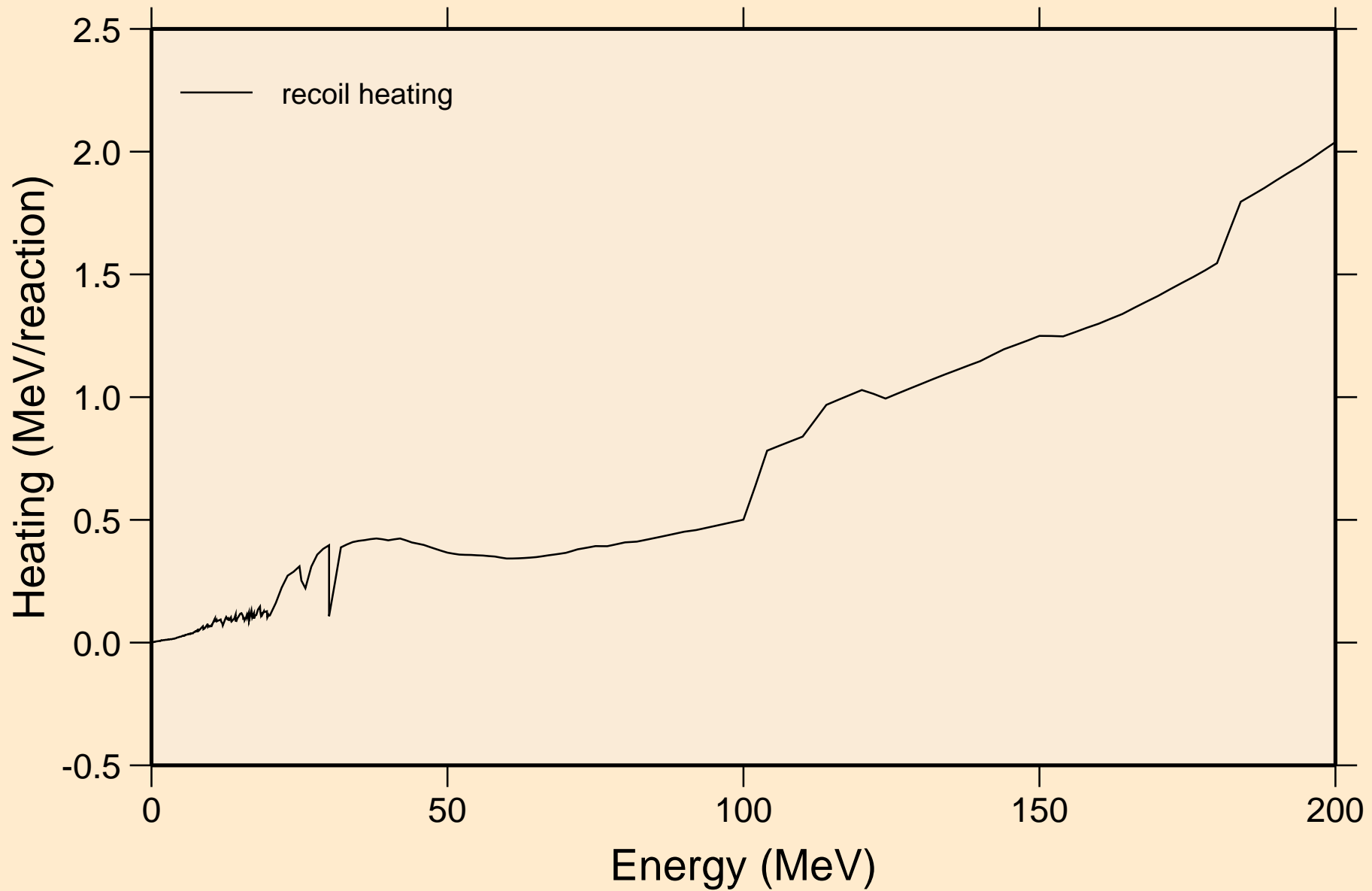

# IR182 NEUTRON ACER TENDL-2021 LIBRARY; T=293.6K

## Particle production cross sections

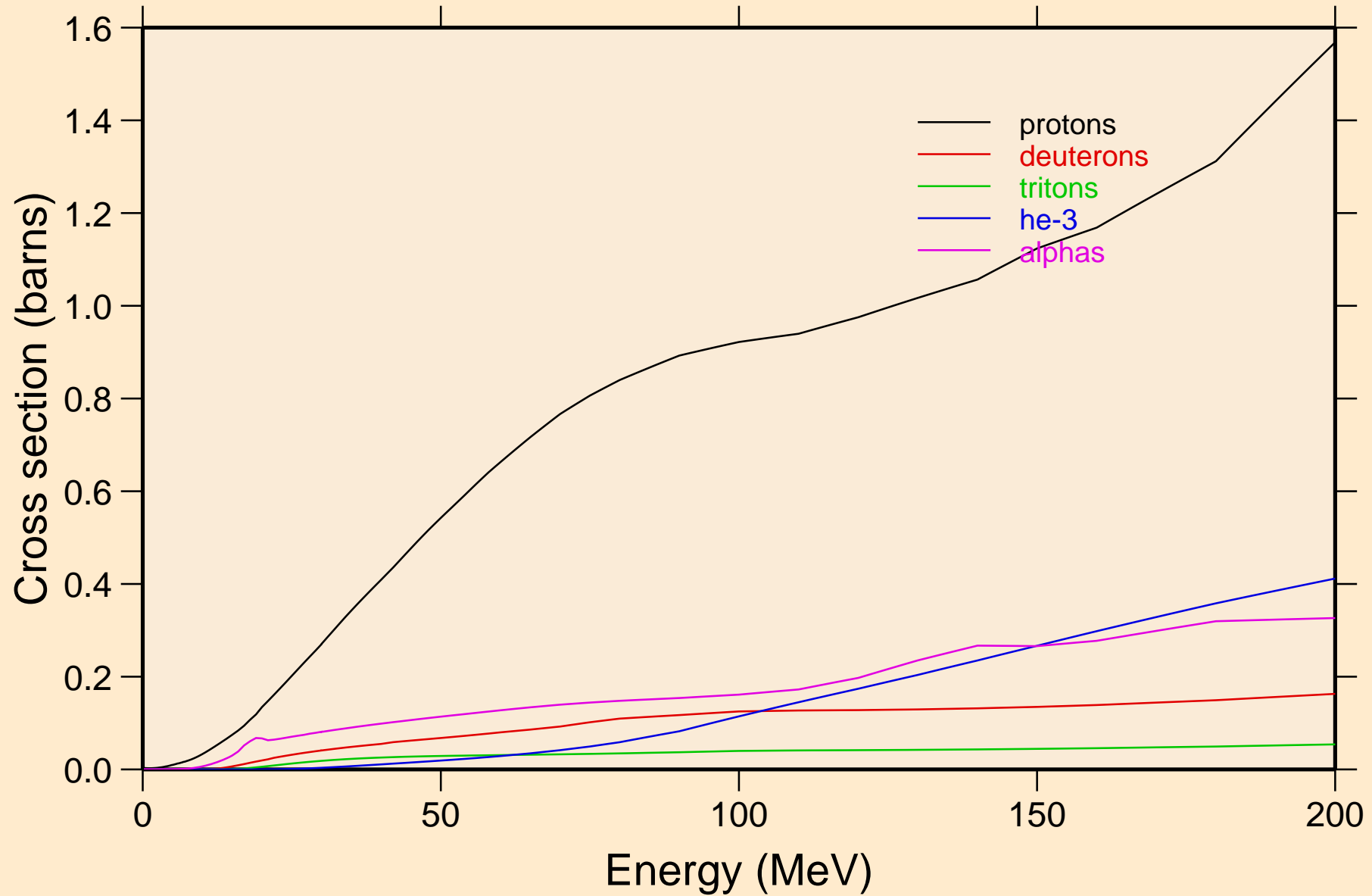

IR182 NEUTRON ACER TENDL-2021 LIBRARY; T=293.6K  
protons from (n,x)

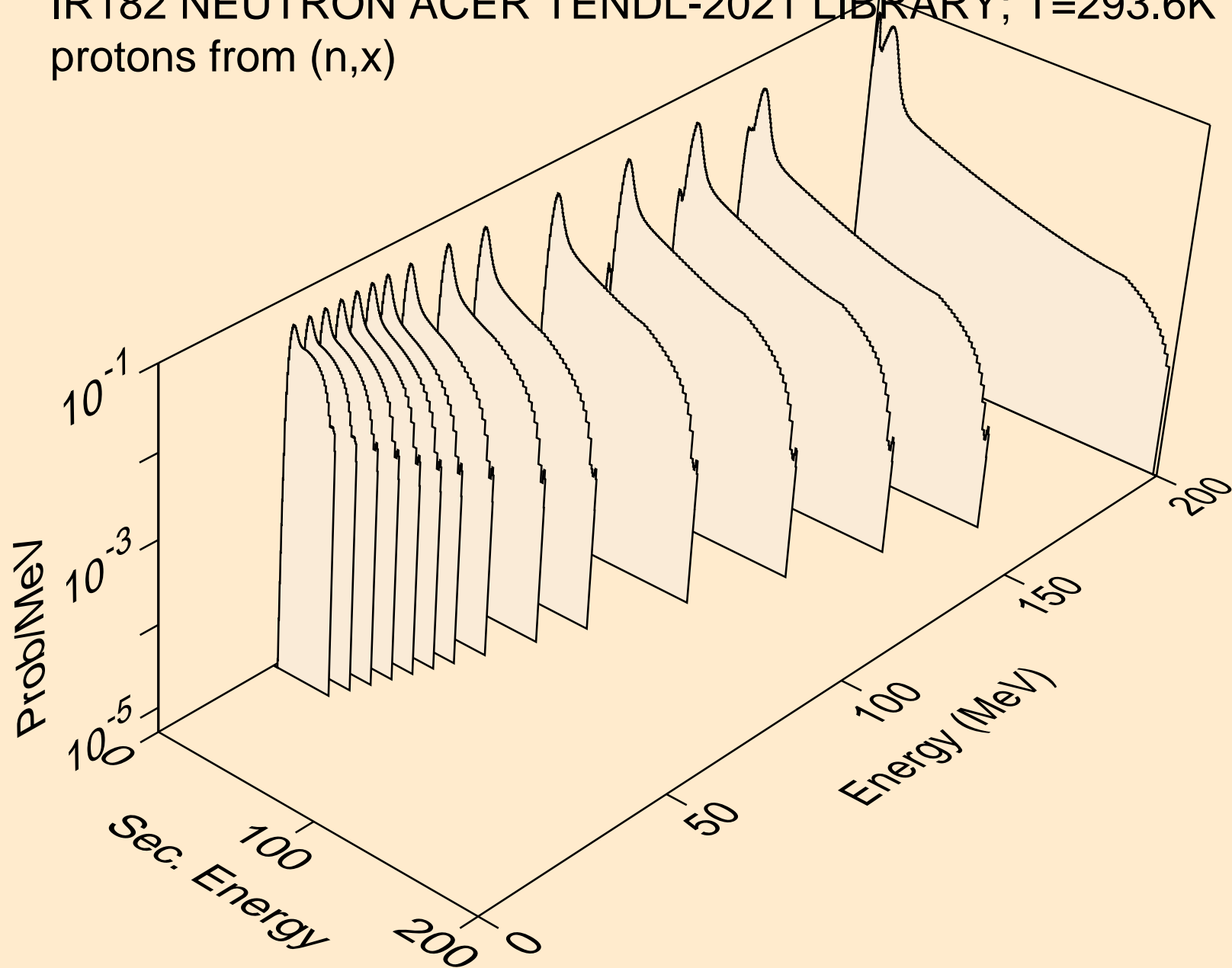

IR182 NEUTRON ACER TENDL-2021 LIBRARY; T=293.6K  
protons from (n,n\*)p

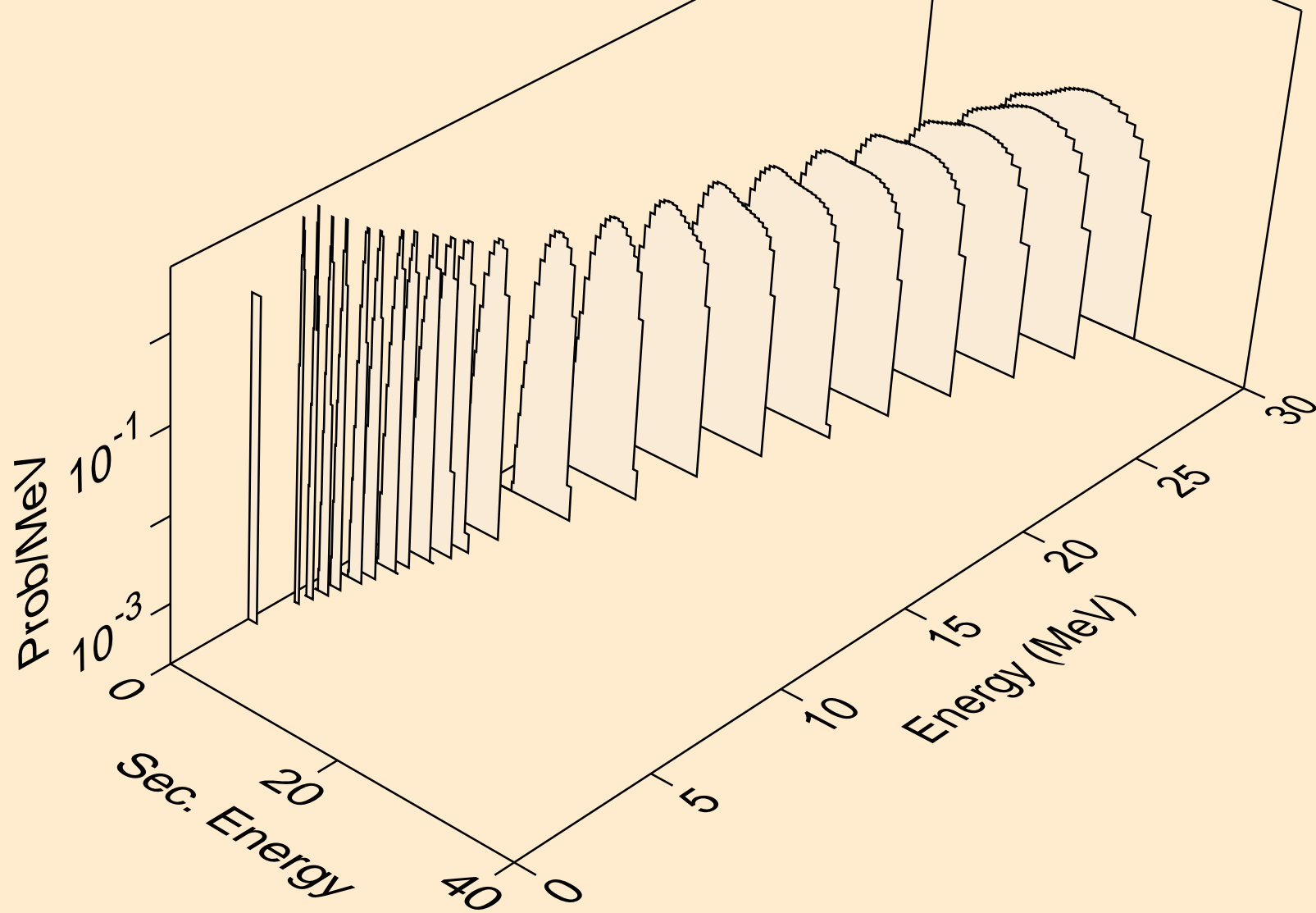

IR182 NEUTRON ACER TENDL-2021 LIBRARY; T=293.6K  
protons from (n,2np)

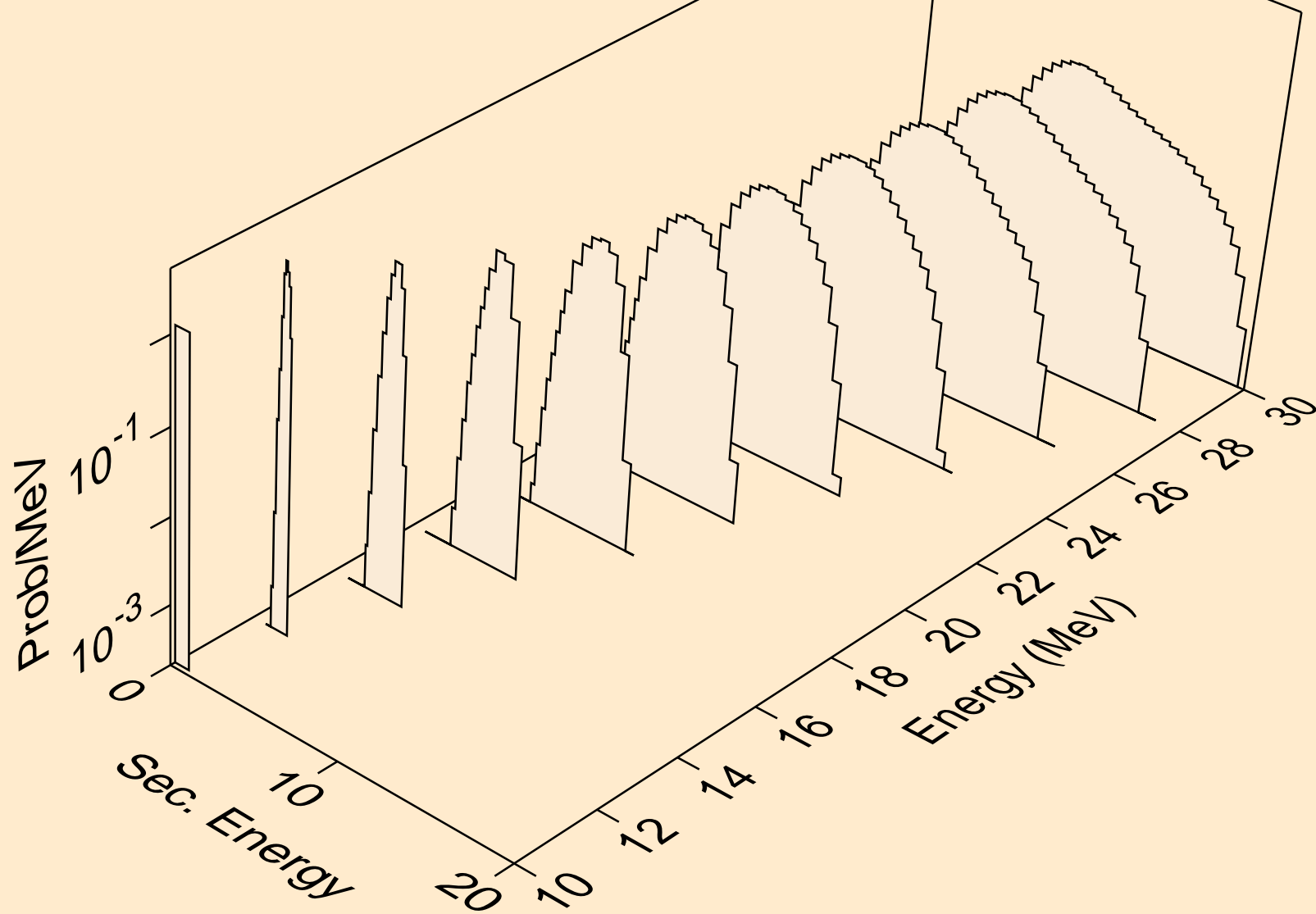

IR182 NEUTRON ACER TENDL-2021 LIBRARY; T=293.6K  
protons from (n,3np)

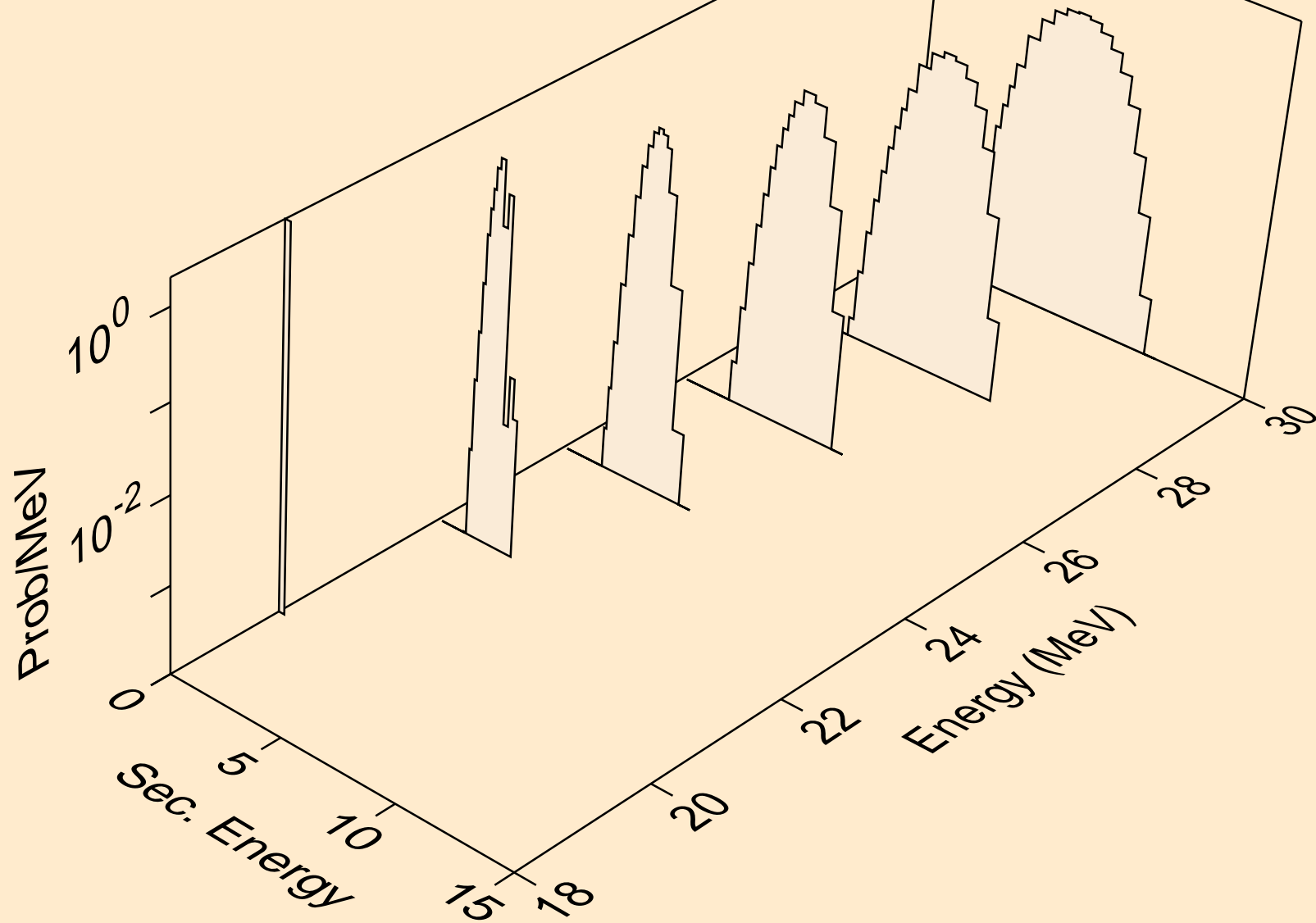

IR182 NEUTRON ACER TENDL-2021 LIBRARY; T=293.6K  
protons from (n,2np)

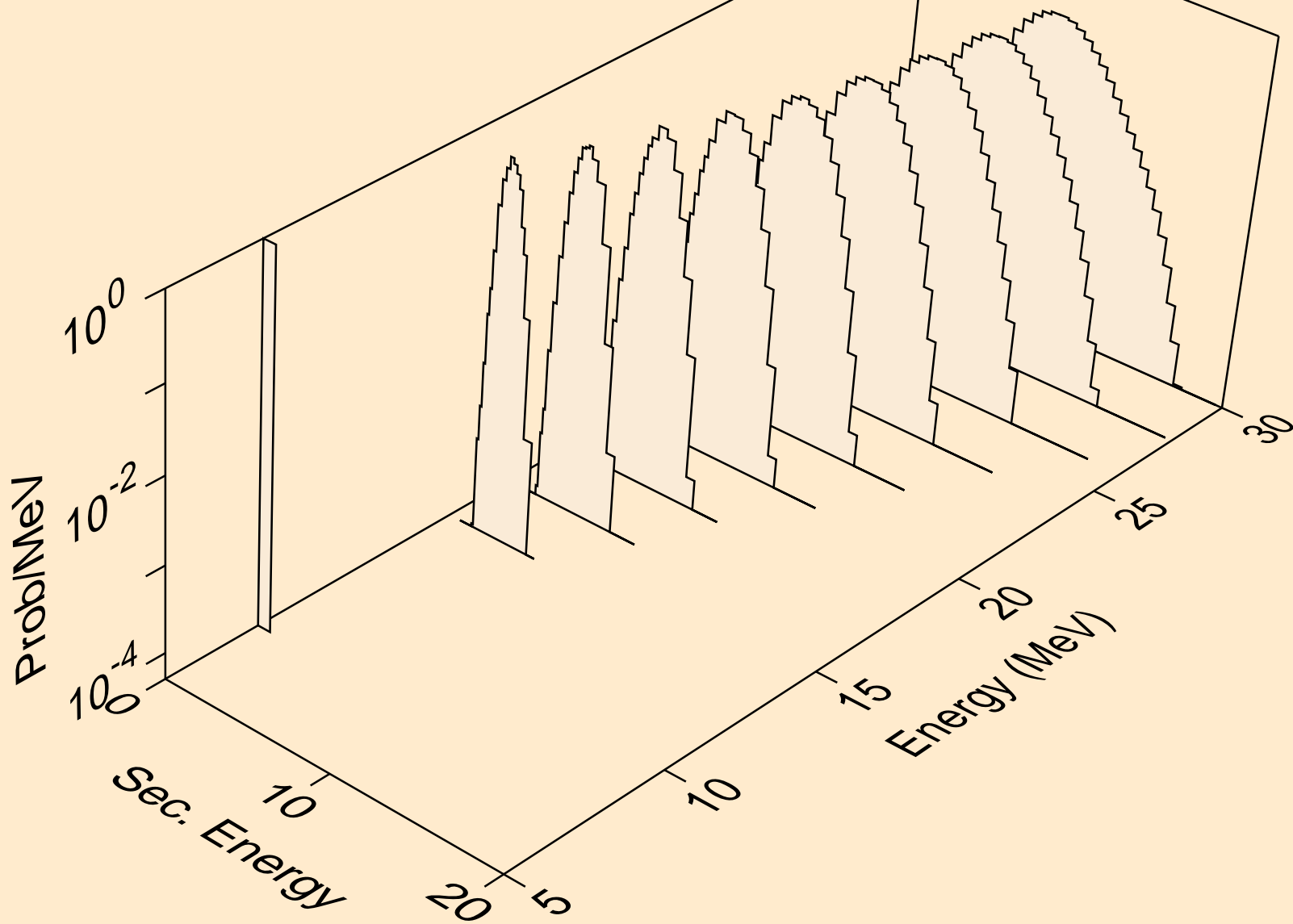

IR182 NEUTRON ACER TENDL-2021 LIBRARY; T=293.6K  
protons from (n,npa)

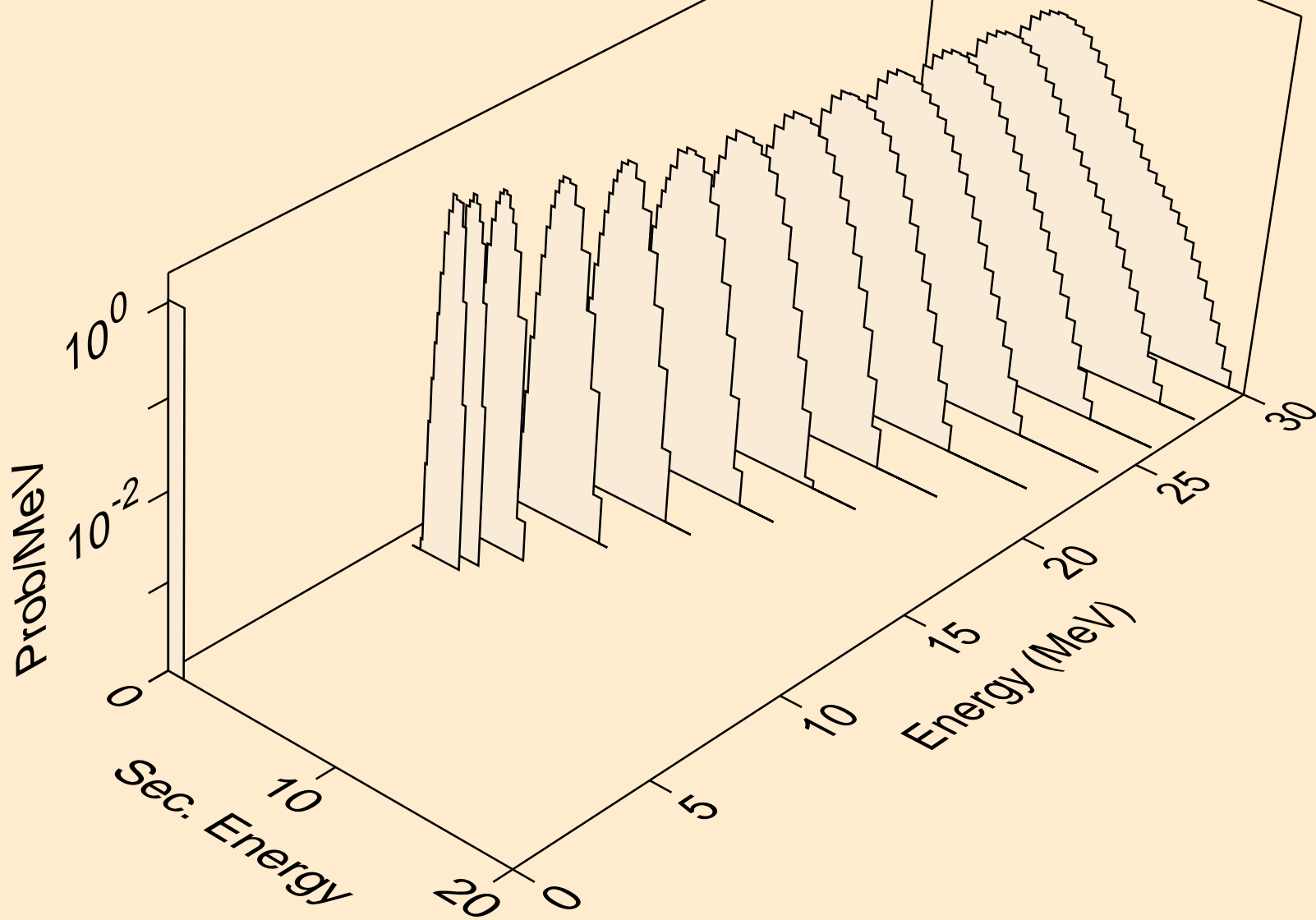

IR182 NEUTRON ACER TENDL-2021 LIBRARY; T=293.6K  
protons from (n,p)

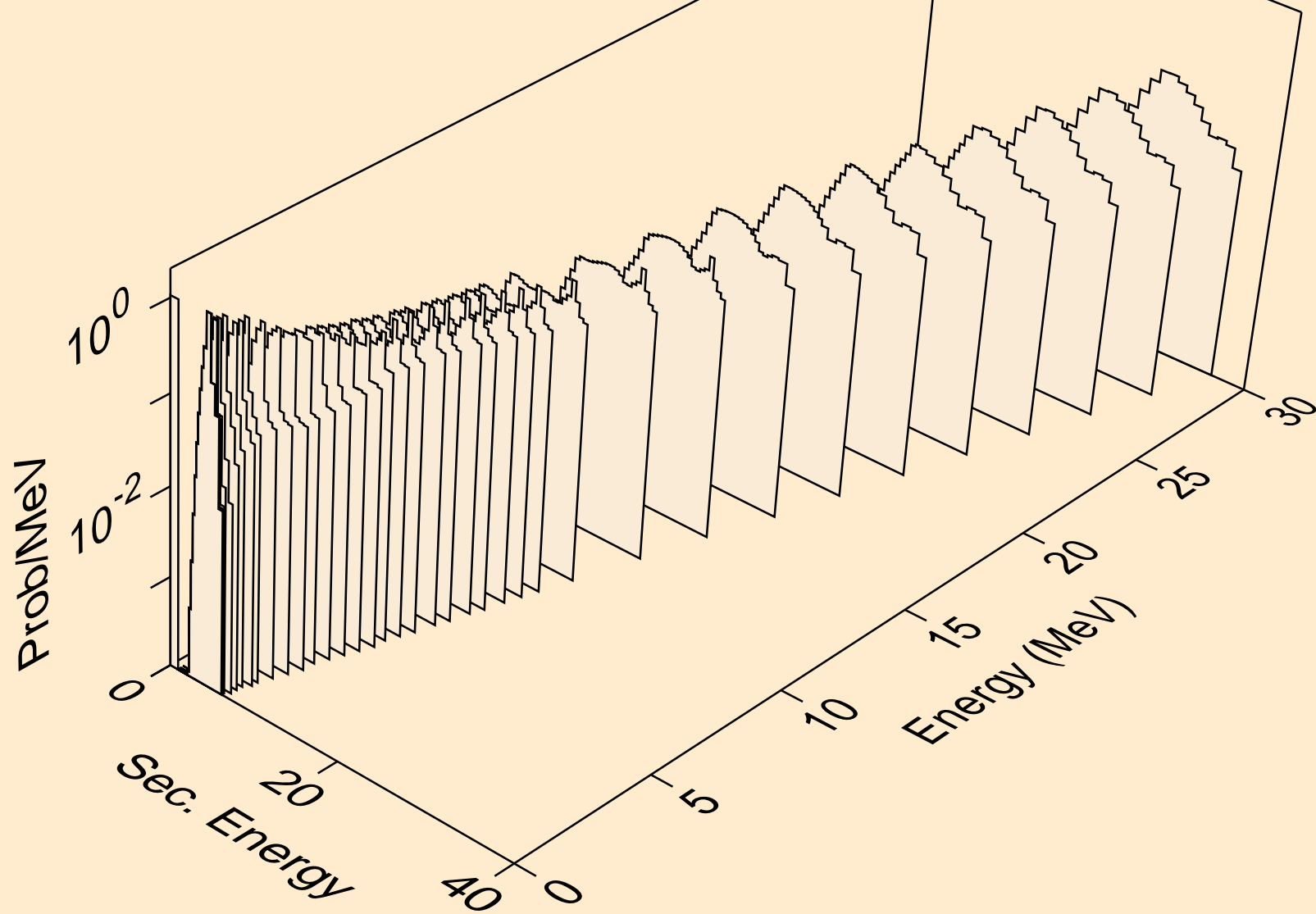

IR182 NEUTRON ACER TENDL-2021 LIBRARY; T=293.6K  
protons from (n,2p)

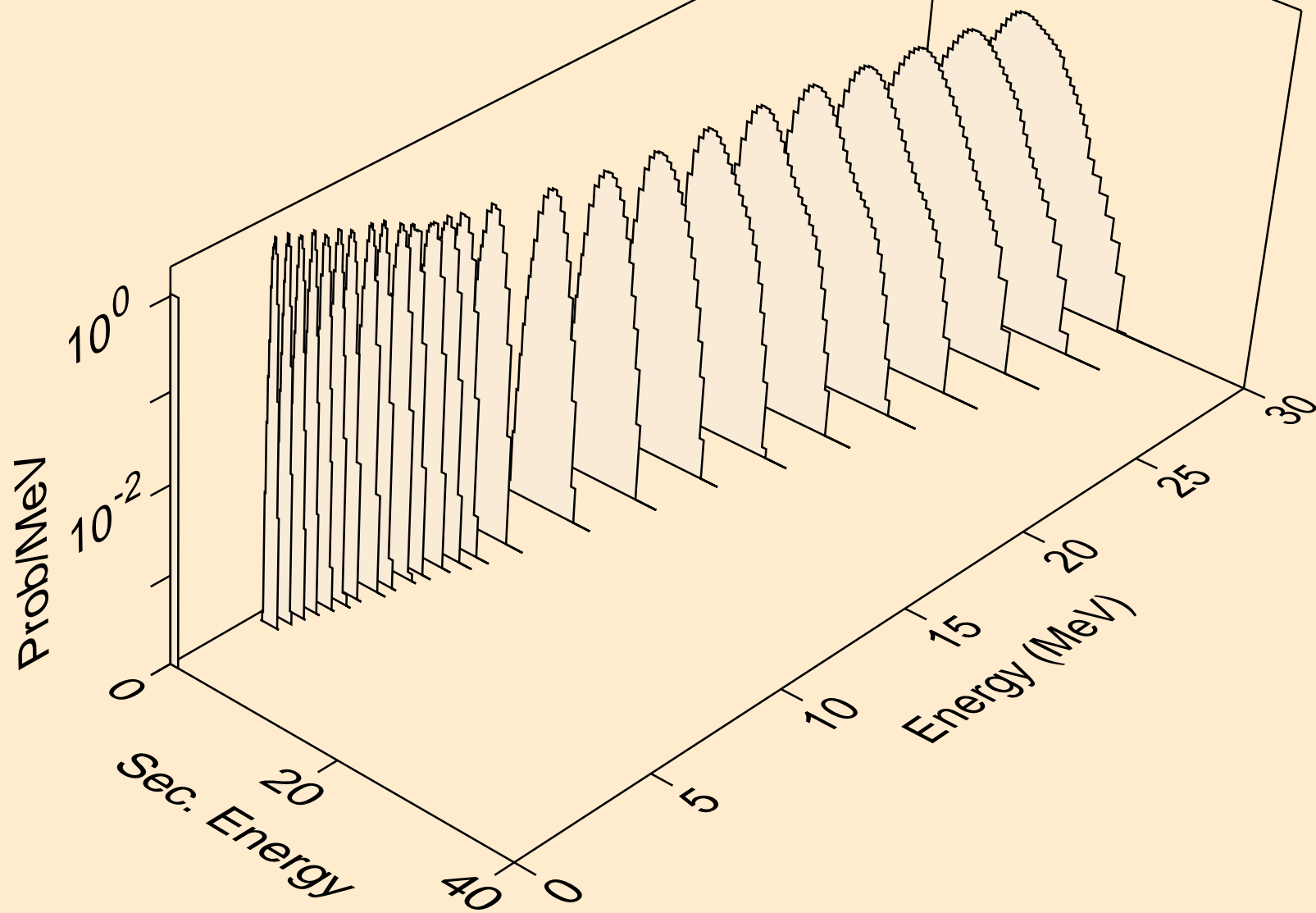

IR182 NEUTRON ACER TENDL-2021 LIBRARY; T=293.6K  
protons from (n,p)

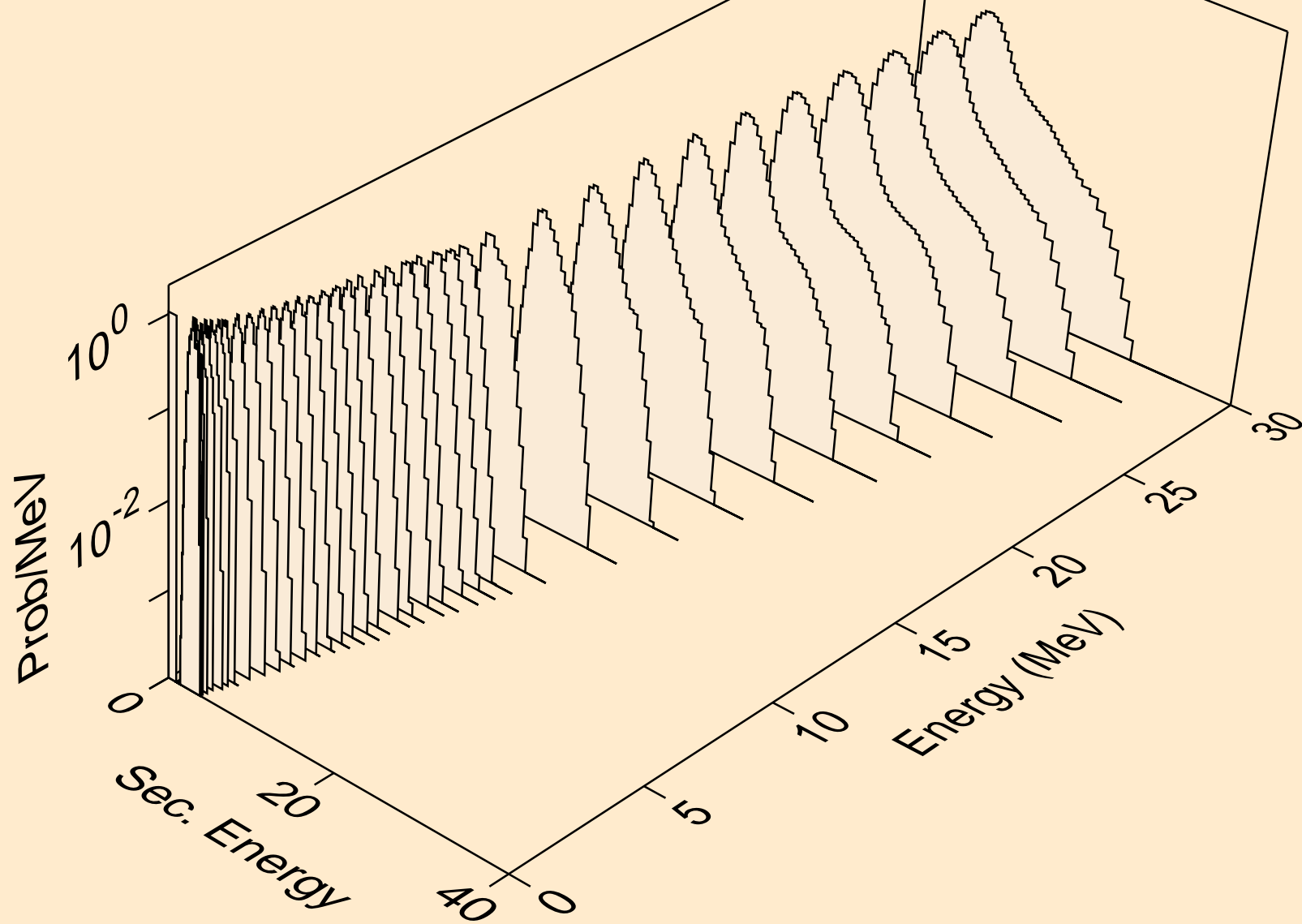

IR182 NEUTRON ACER TENDL-2021 LIBRARY; T=293.6K  
protons from (n,pd)

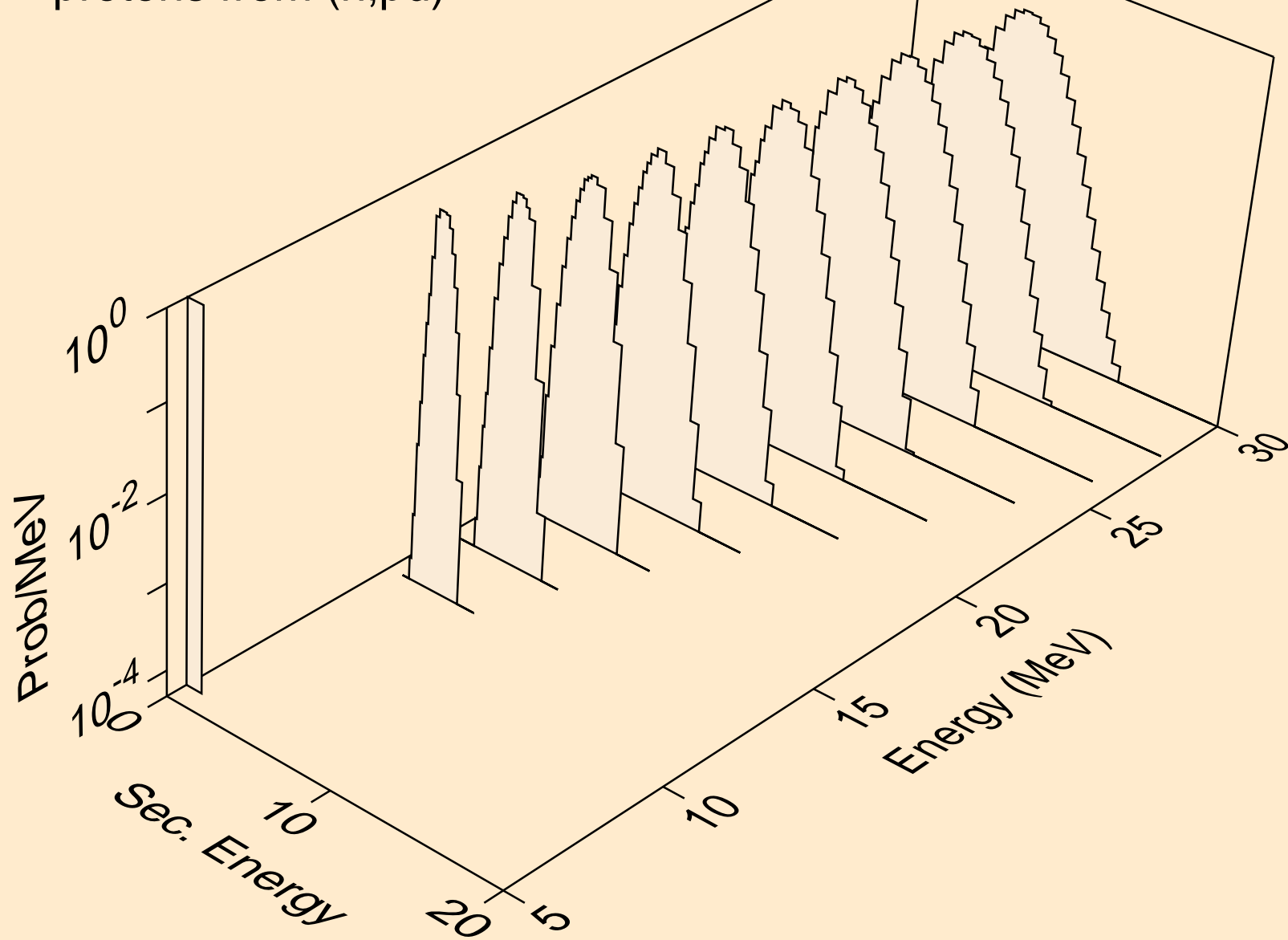

IR182 NEUTRON ACER TENDL-2021 LIBRARY; T=293.6K  
protons from (n,pt)

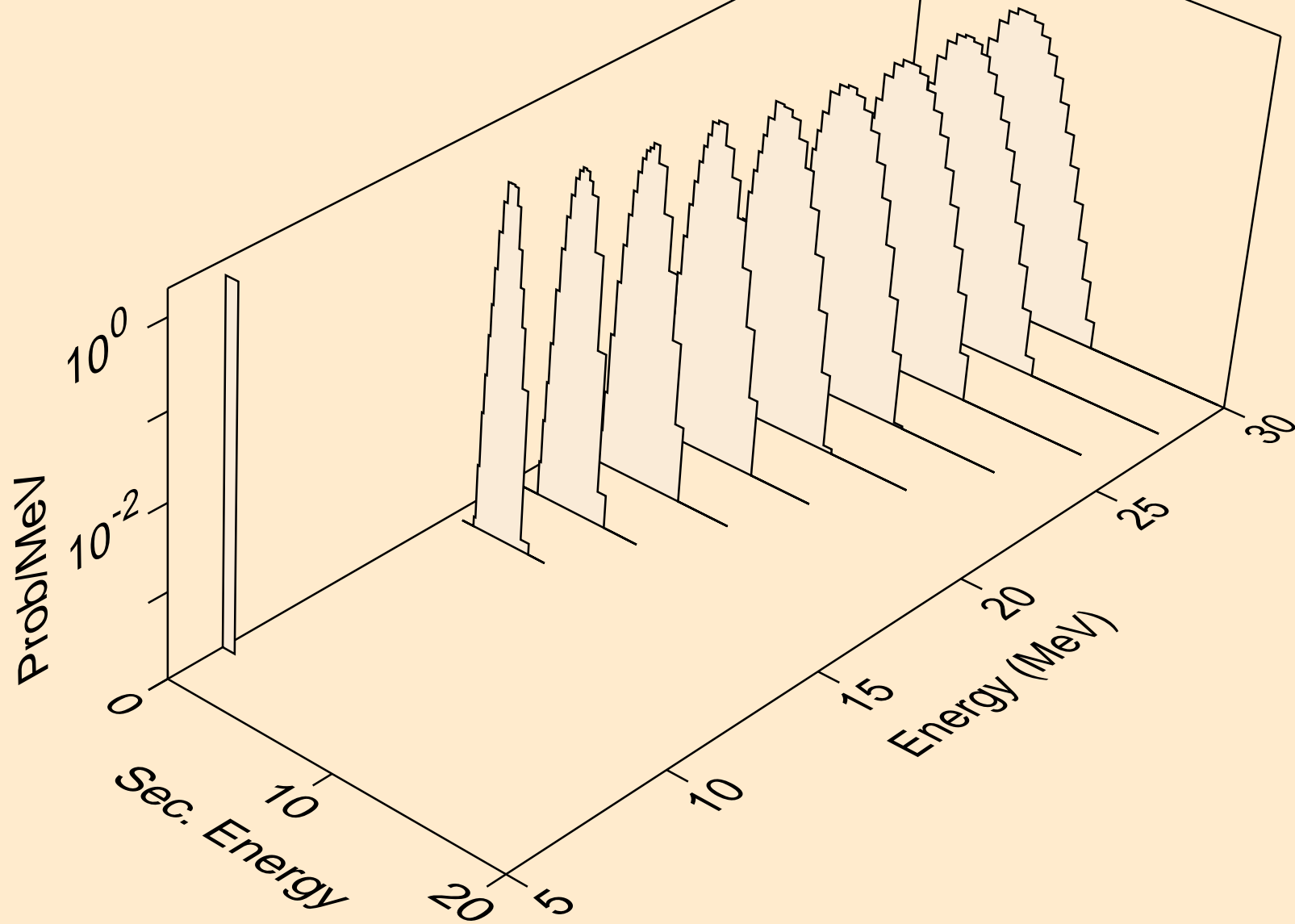

IR182 NEUTRON ACER TENDL-2021 LIBRARY; T=293.6K  
deuterons from (n,x)

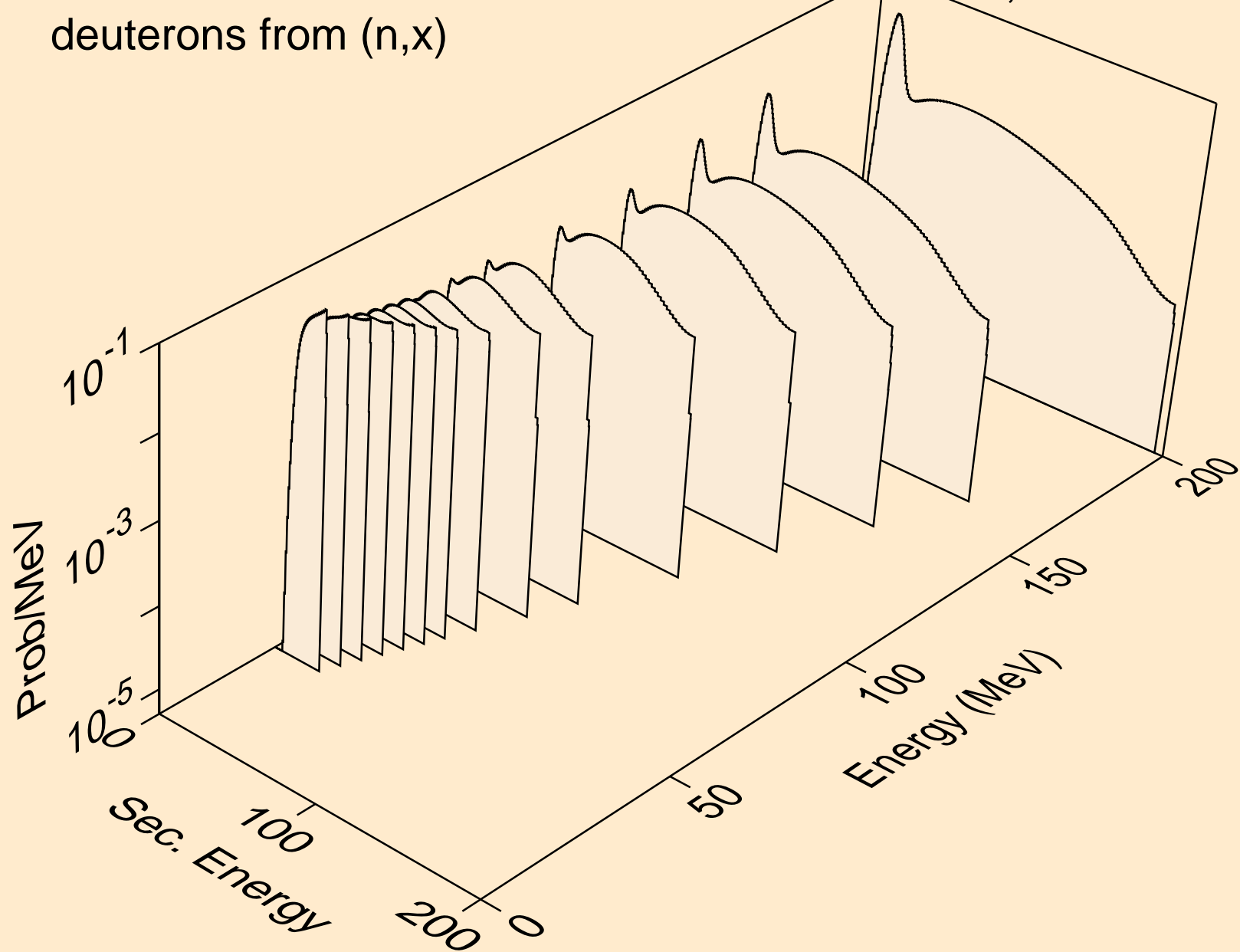

IR182 NEUTRON ACER TENDL-2021 LIBRARY; T=293.6K  
deuterons from (n,2nd)

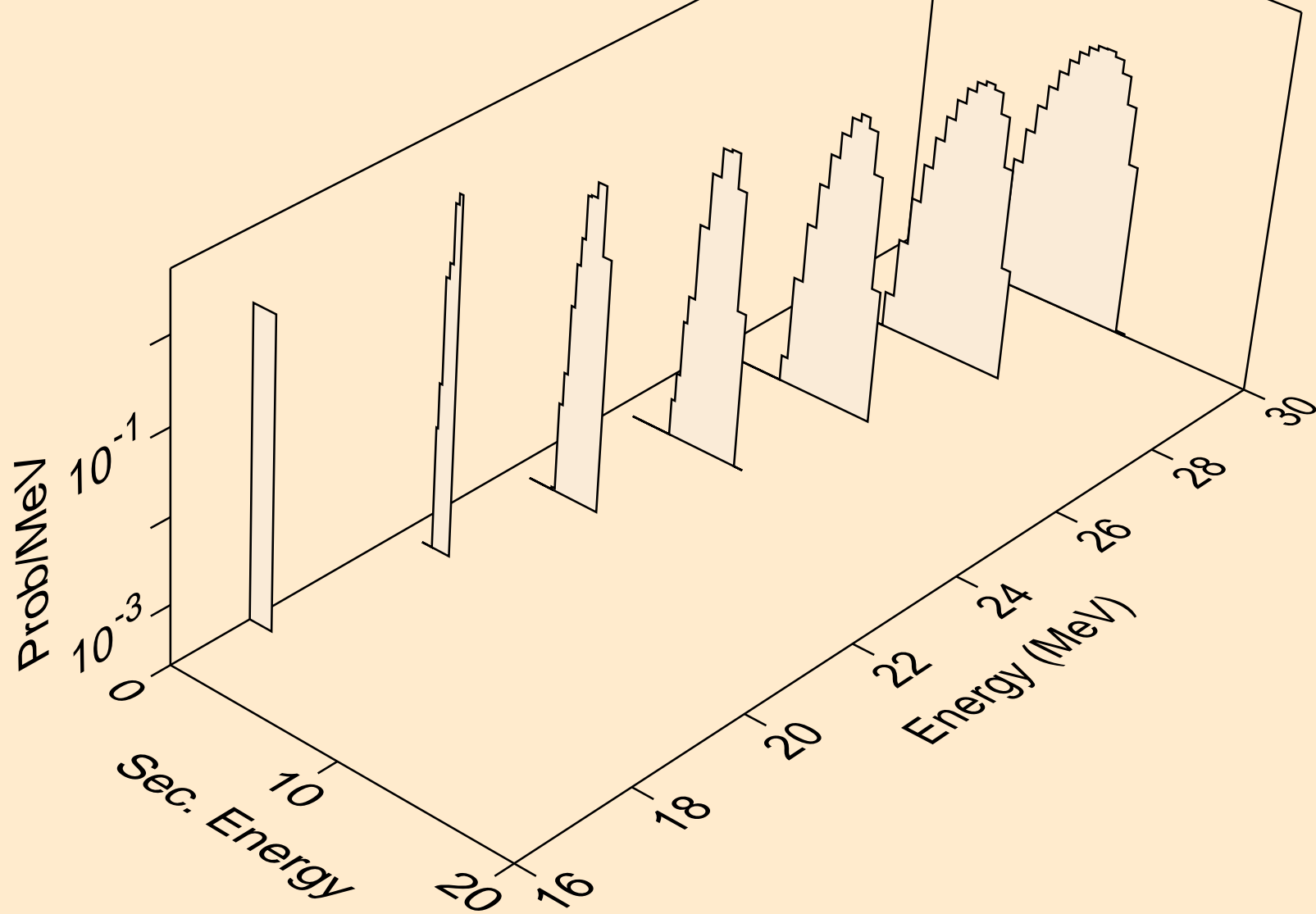

IR182 NEUTRON ACER TENDL-2021 LIBRARY; T=293.6K  
deuterons from (n,n\*)d

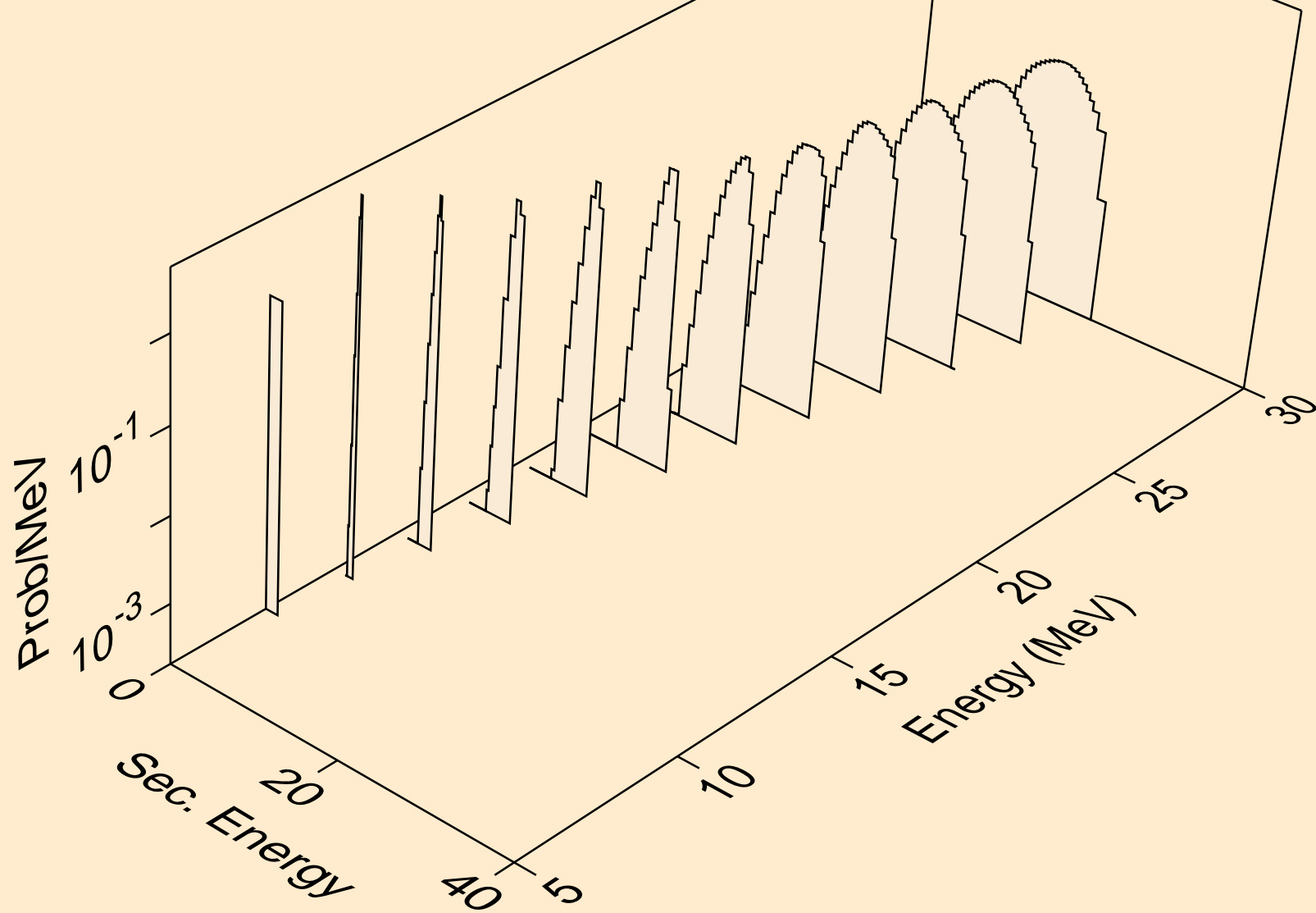

IR182 NEUTRON ACER TENDL-2021 LIBRARY; T=293.6K  
deuterons from (n,d)

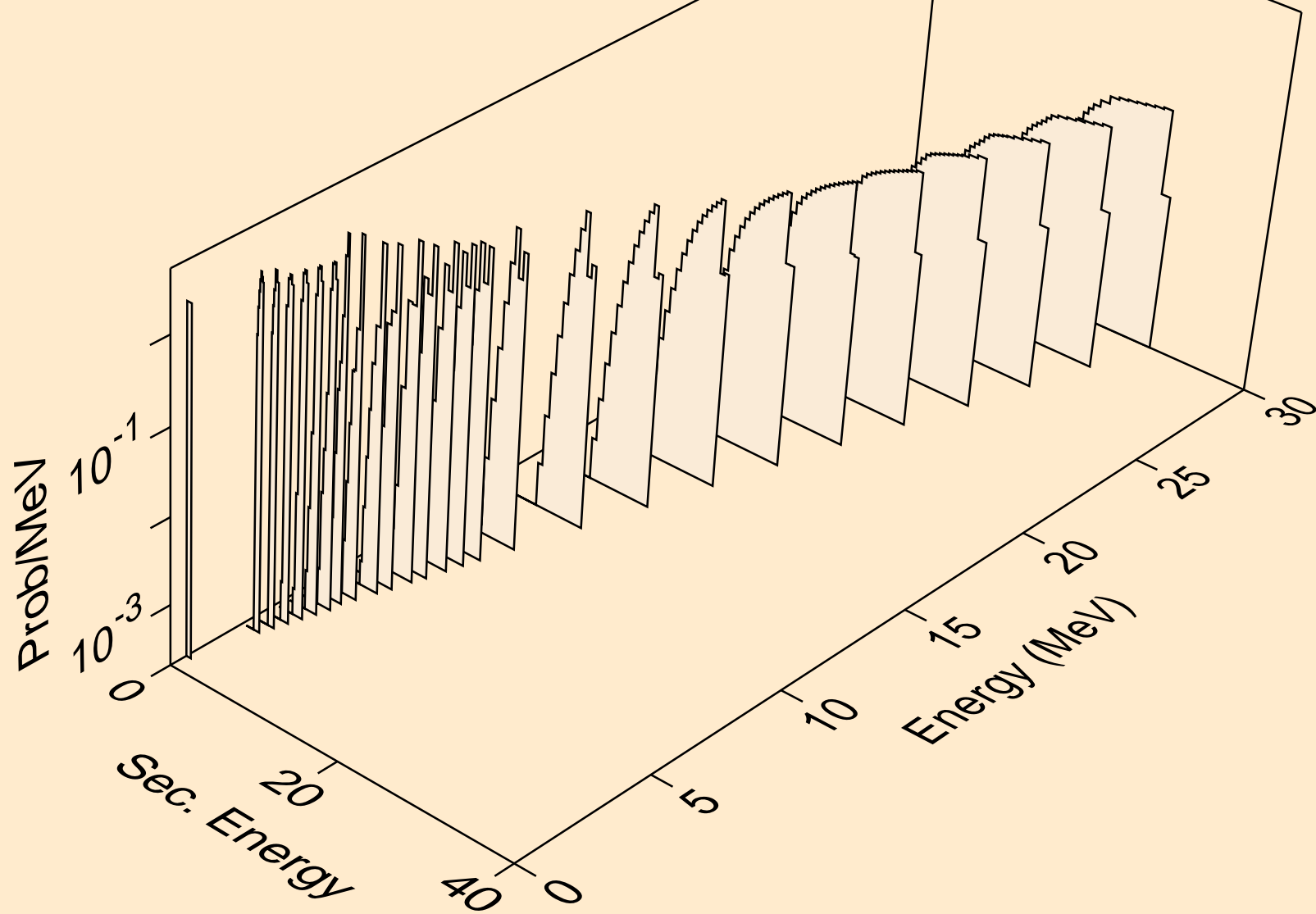

IR182 NEUTRON ACER TENDL-2021 LIBRARY; T=293.6K  
deuterons from (n,pd)

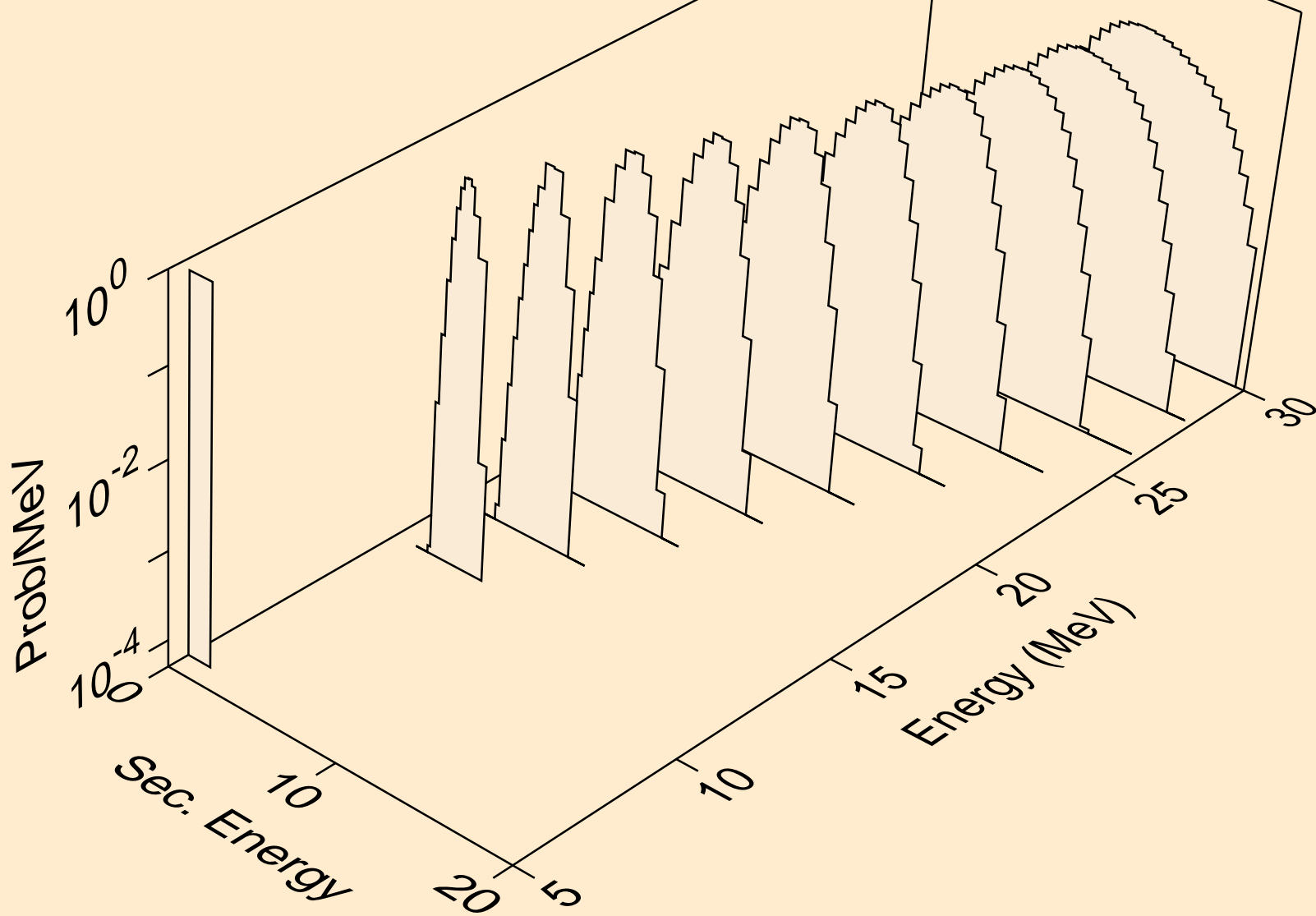

IR182 NEUTRON ACER TENDL-2021 LIBRARY; T=293.6K  
deuterons from (n,da)

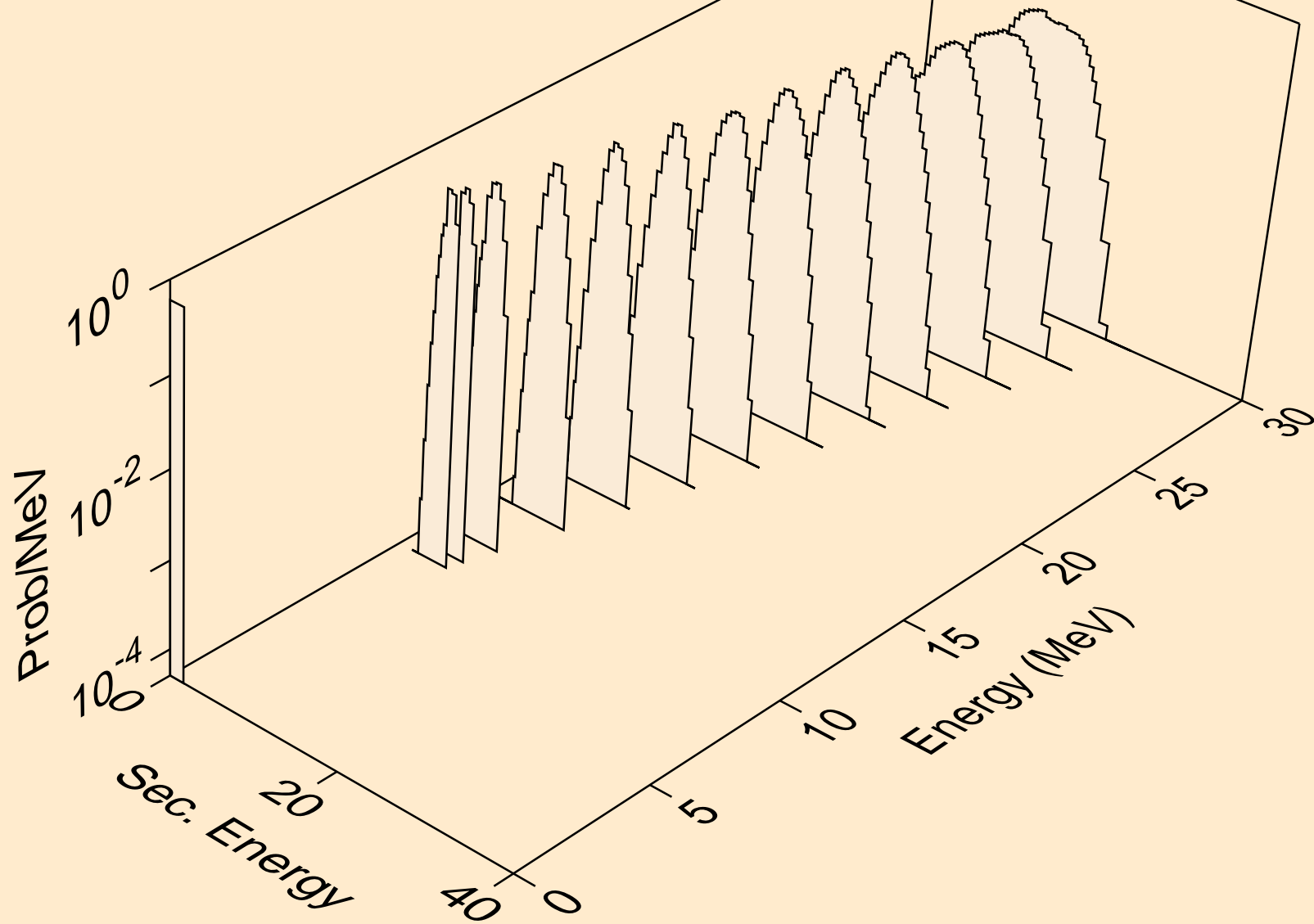

IR182 NEUTRON ACER TENDL-2021 LIBRARY; T=293.6K  
tritons from (n,x)

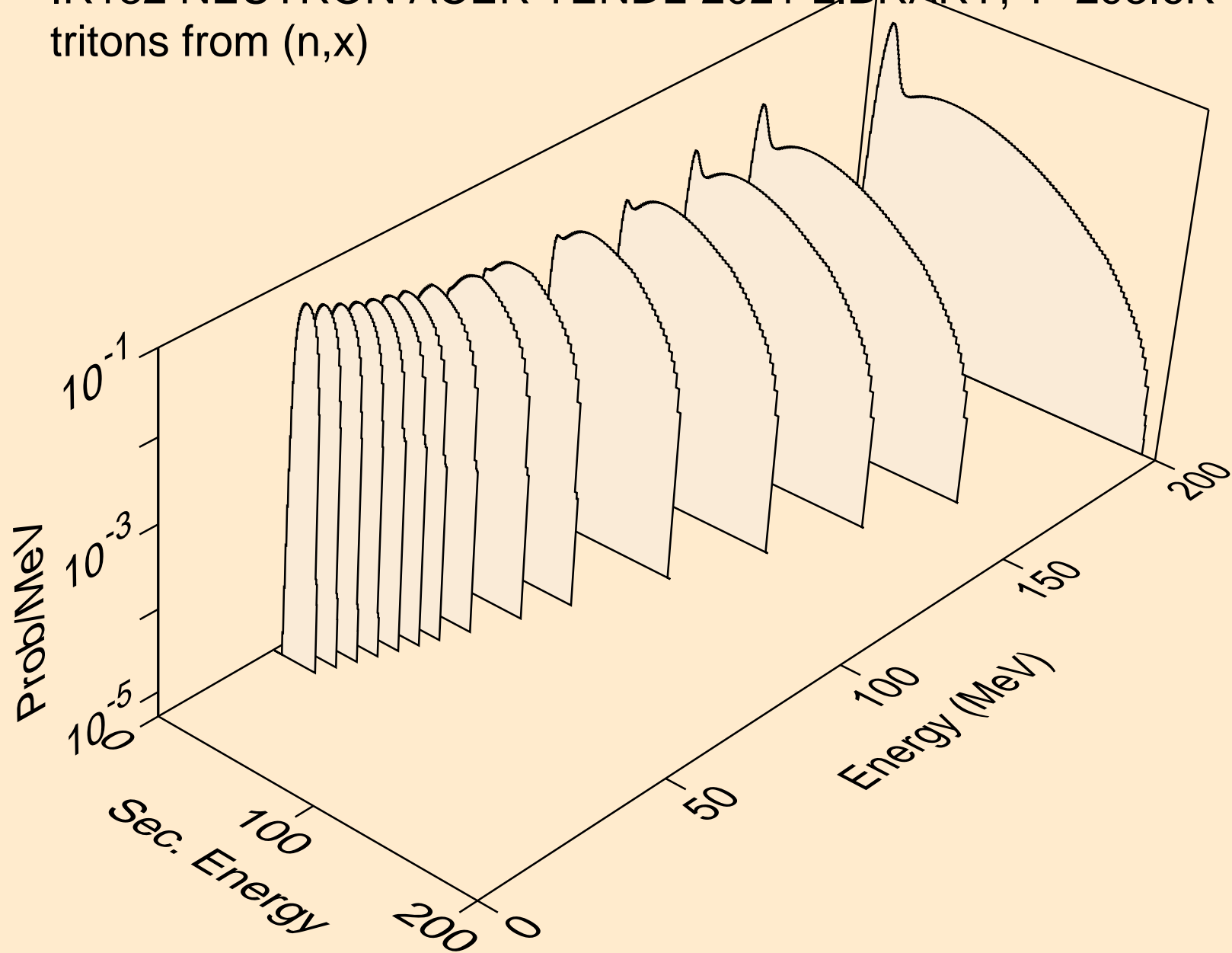

IR182 NEUTRON ACER TENDL-2021 LIBRARY; T=293.6K  
tritons from (n,n\*)t

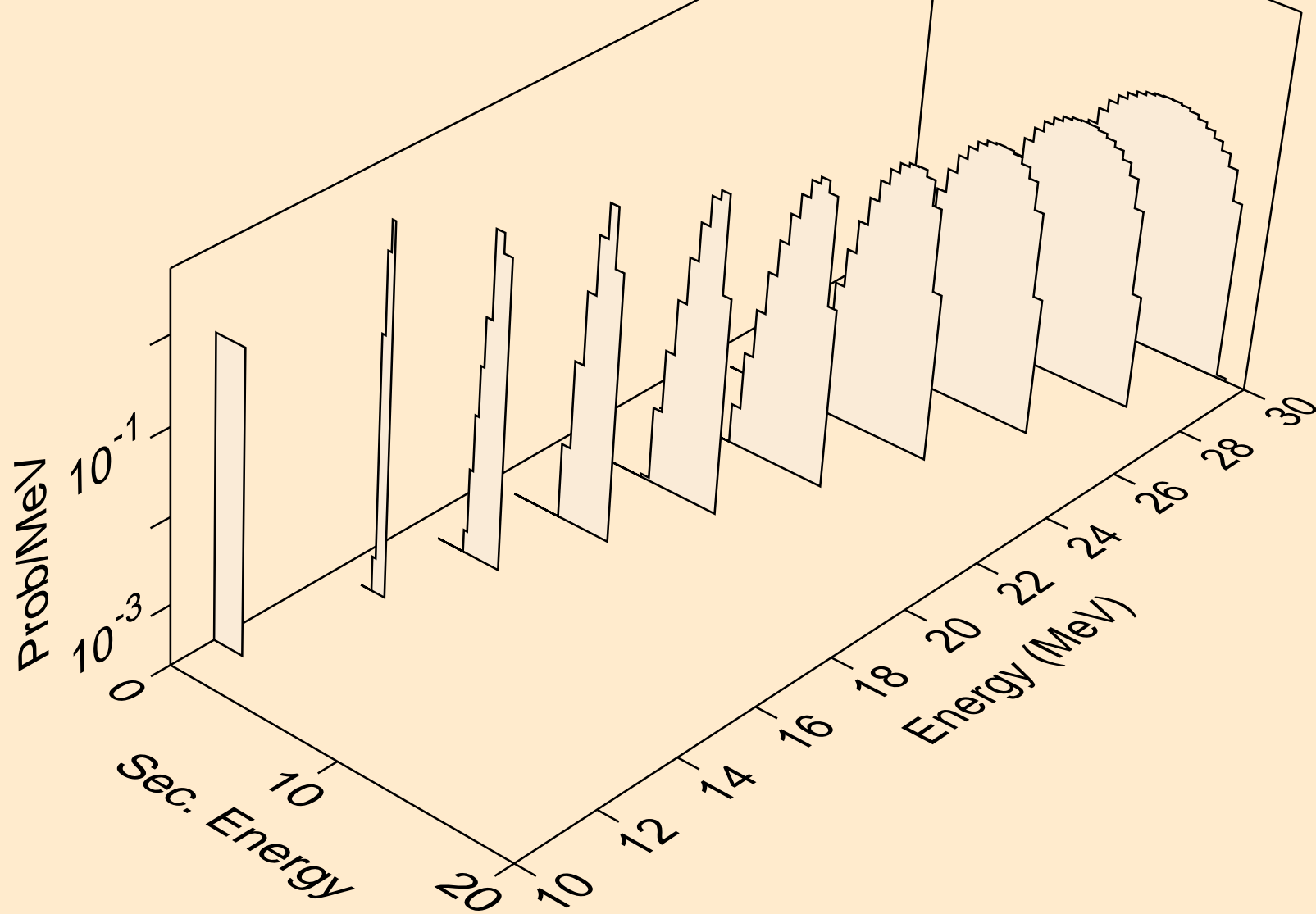

IR182 NEUTRON ACER TENDL-2021 LIBRARY; T=293.6K  
tritons from (n,t)

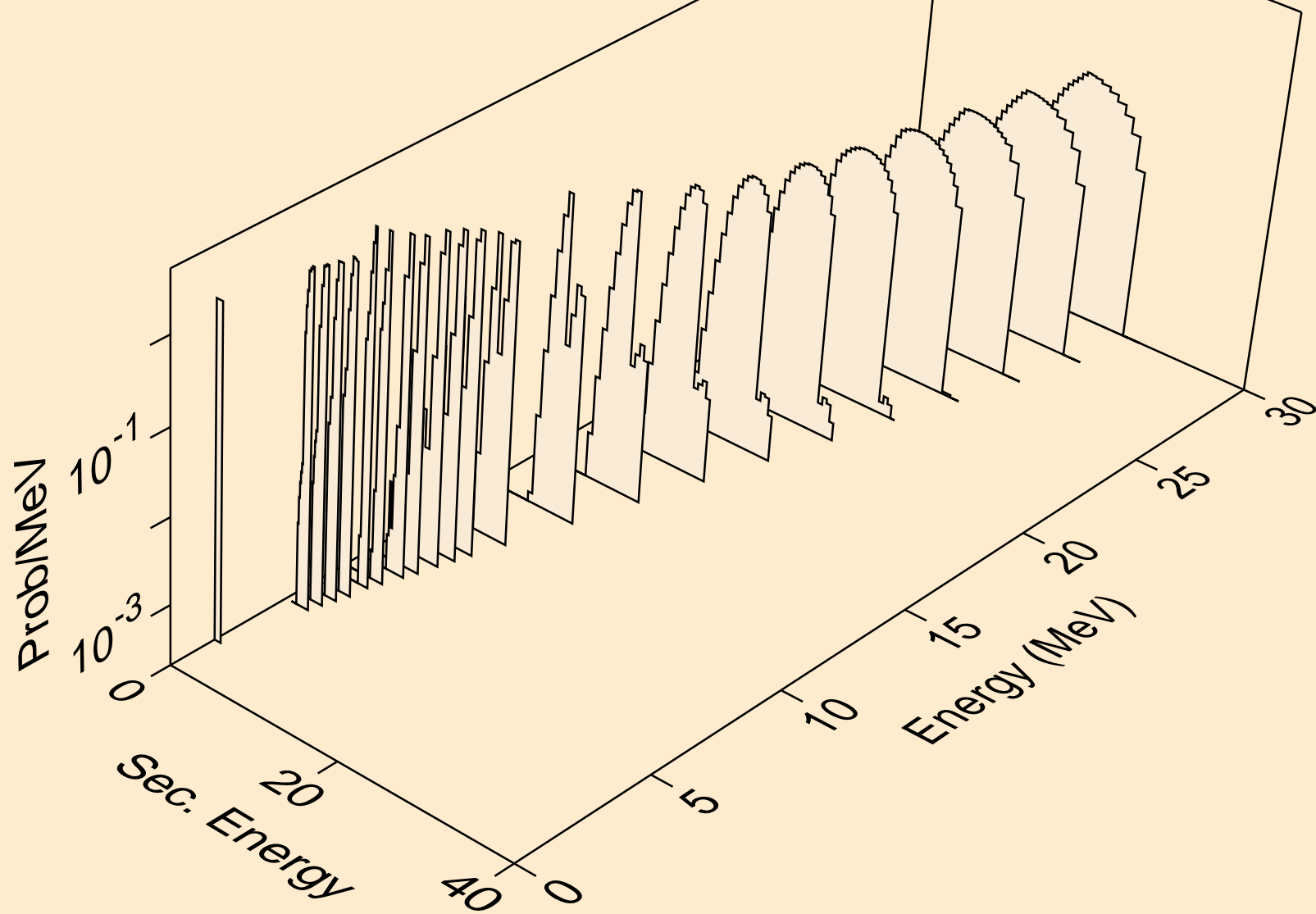

IR182 NEUTRON ACER TENDL-2021 LIBRARY; T=293.6K  
tritons from (n,pt)

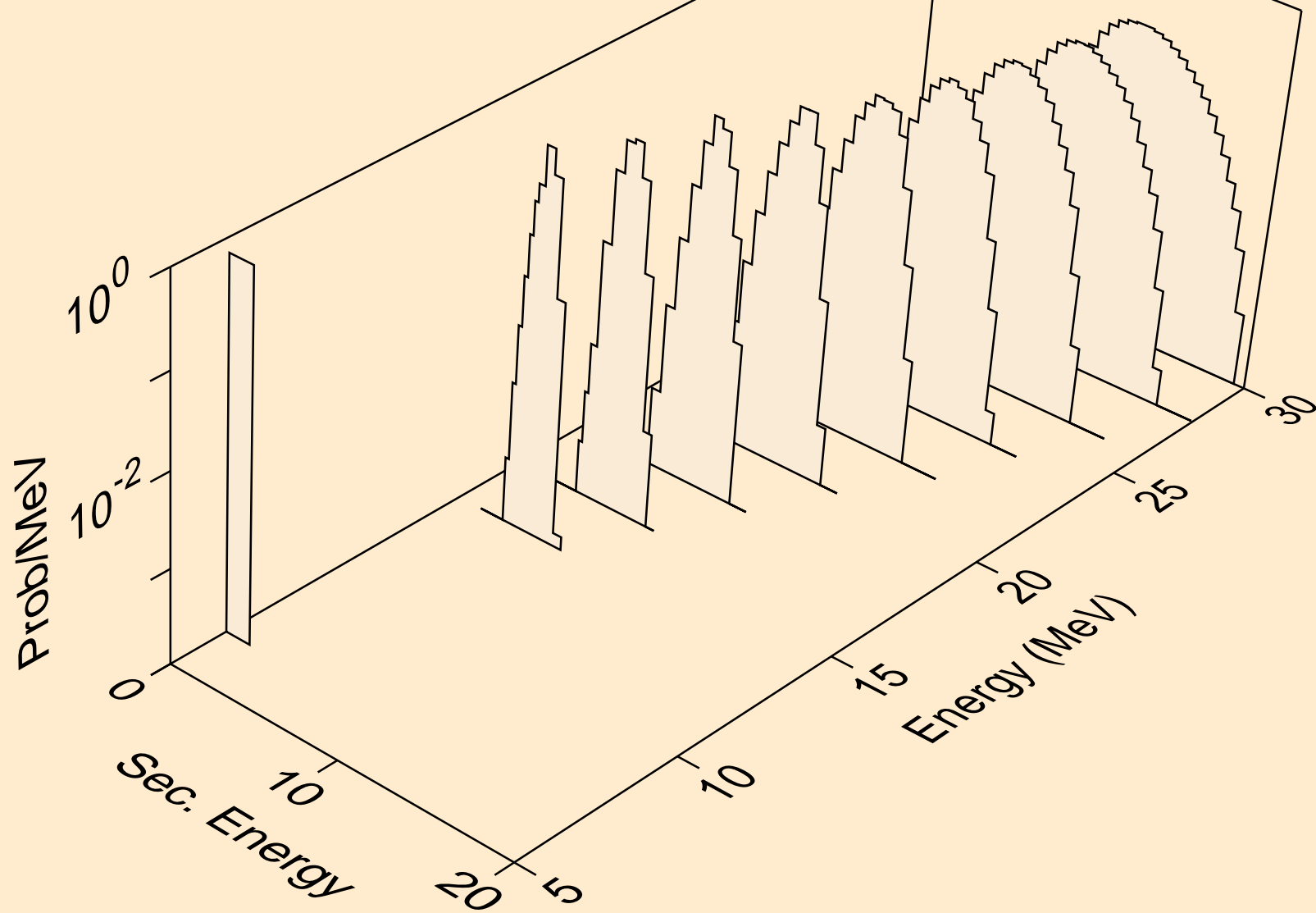

IR182 NEUTRON ACER TENDL-2021 LIBRARY; T=293.6K  
he3s from (n,x)

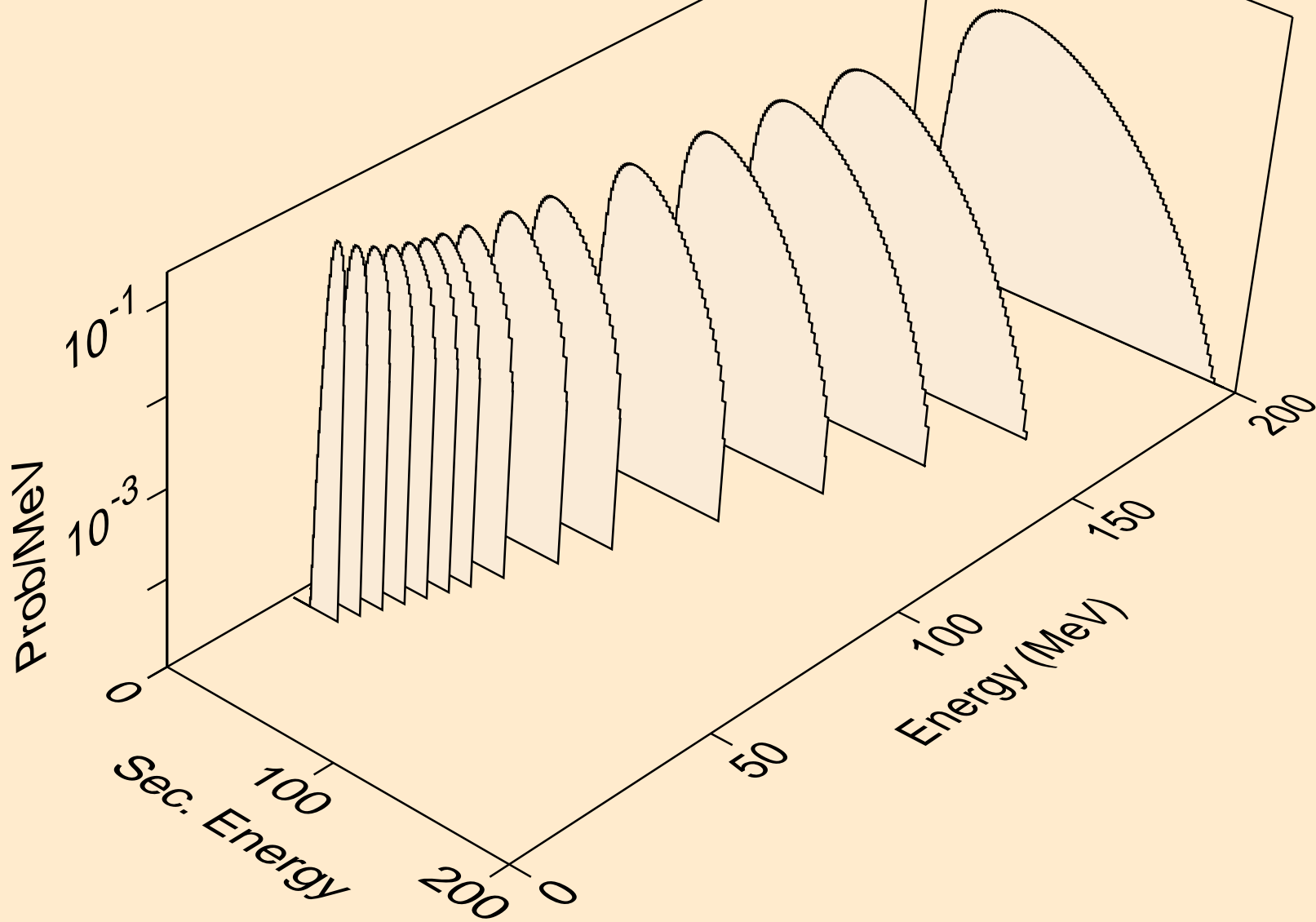

IR182 NEUTRON ACER TENDL-2021 LIBRARY; T=293.6K  
he3s from (n,n\*)he3

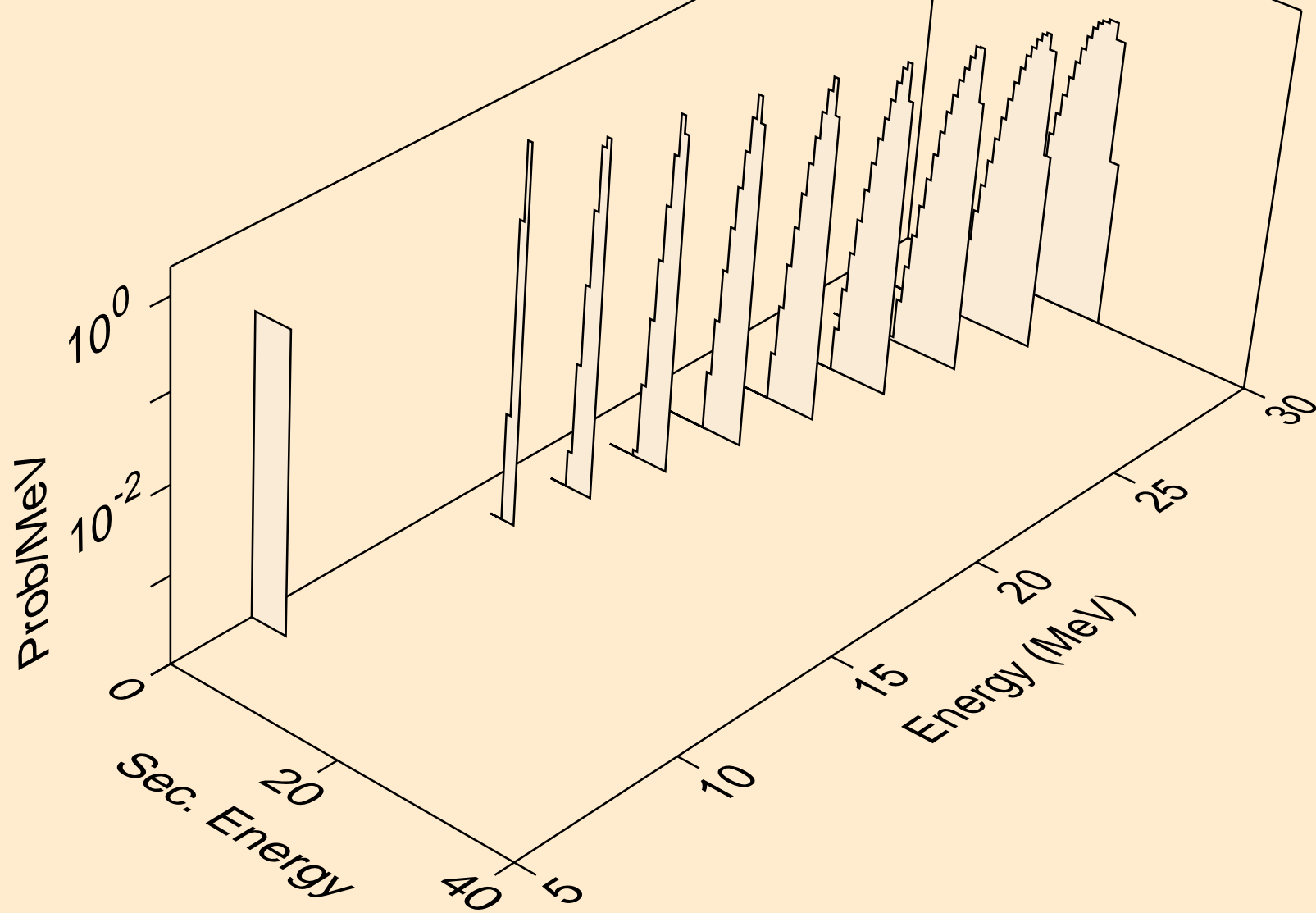

IR182 NEUTRON ACER TENDL-2021 LIBRARY; T=293.6K  
he3s from (n,he3)

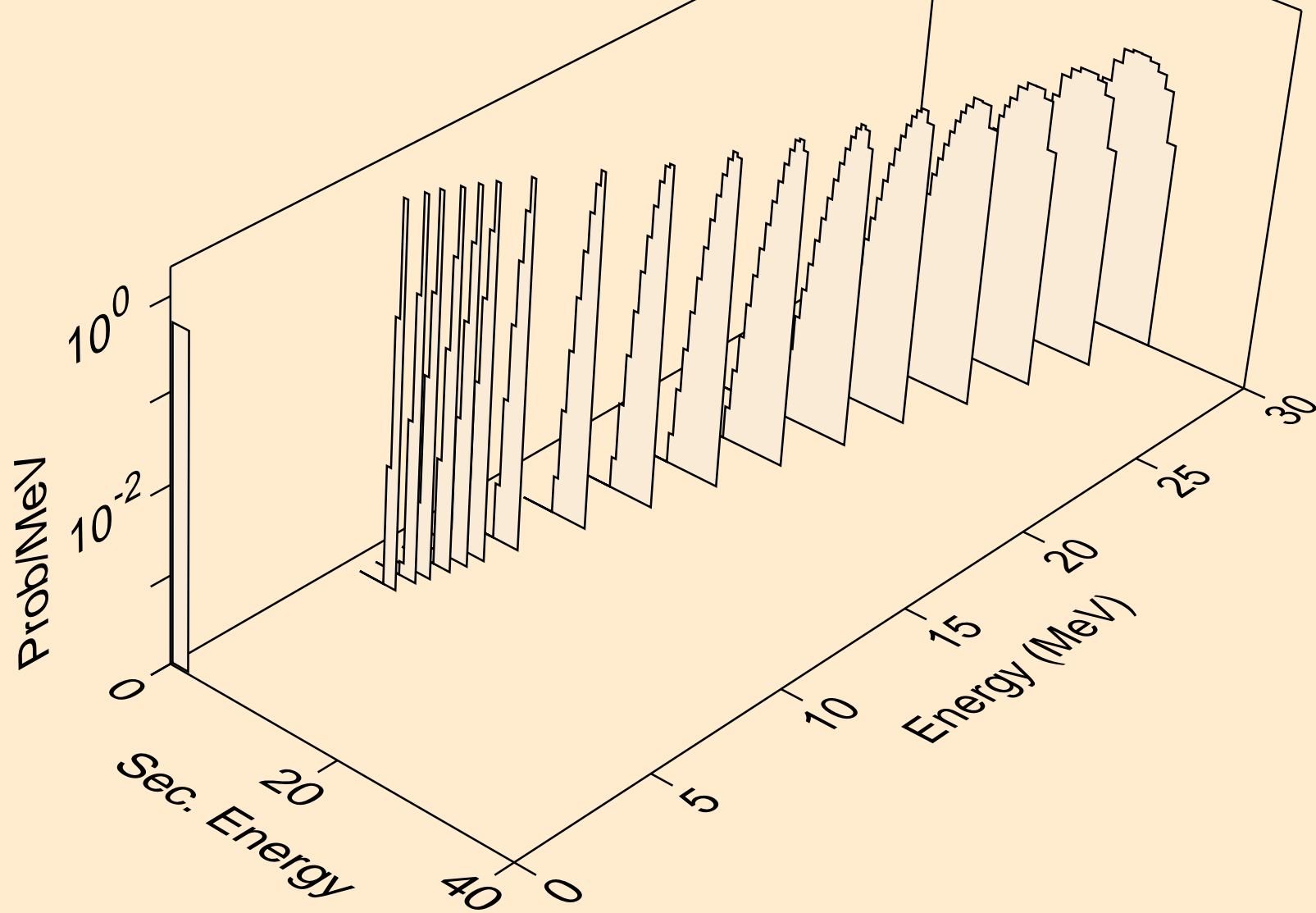

IR182 NEUTRON ACER TENDL-2021 LIBRARY; T=293.6K  
alphas from (n,x)

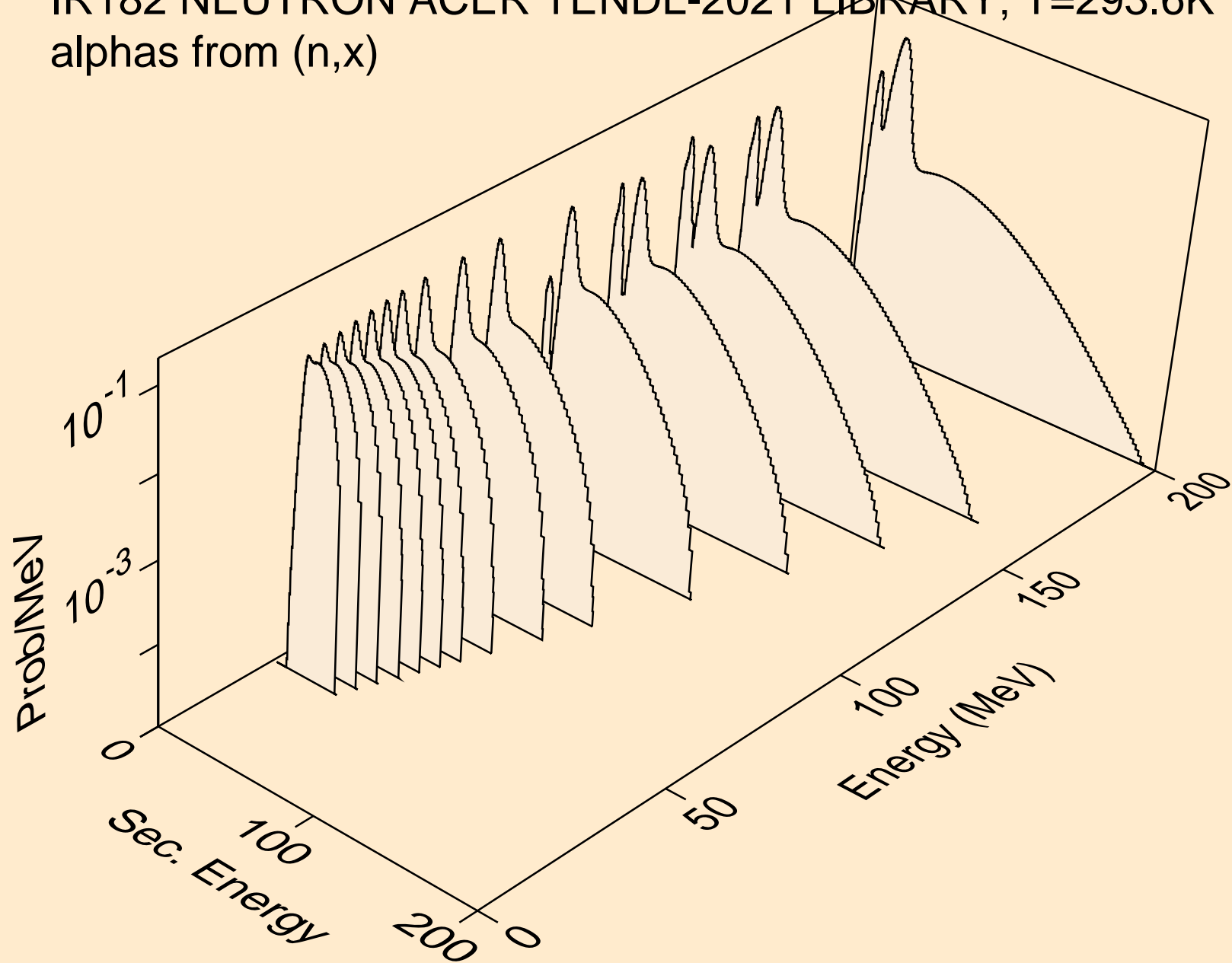

IR182 NEUTRON ACER TENDL-2021 LIBRARY; T=293.6K  
alphas from (n,n\*)a

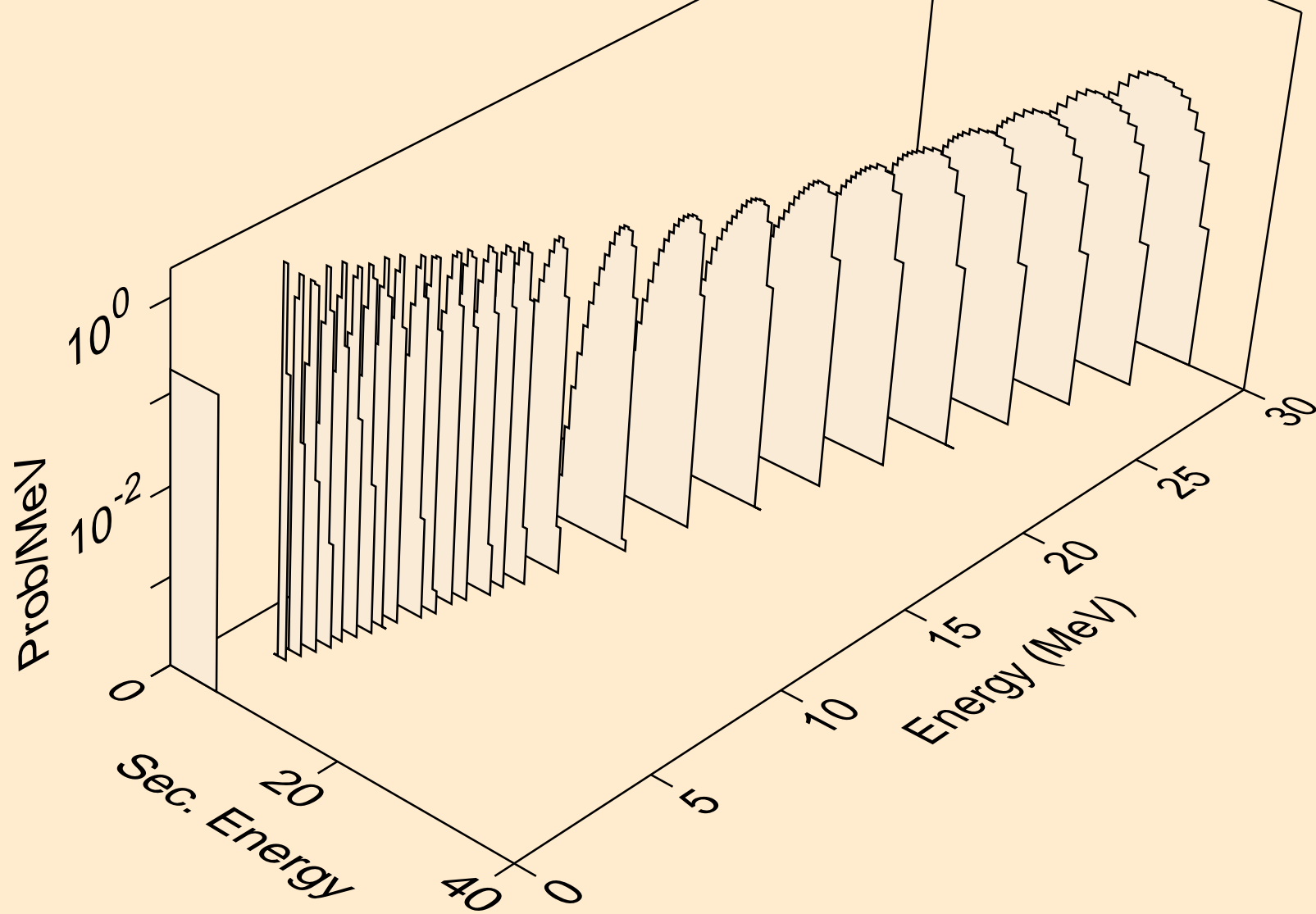

IR182 NEUTRON ACER TENDL-2021 LIBRARY; T=293.6K  
alphas from (n,2n)a

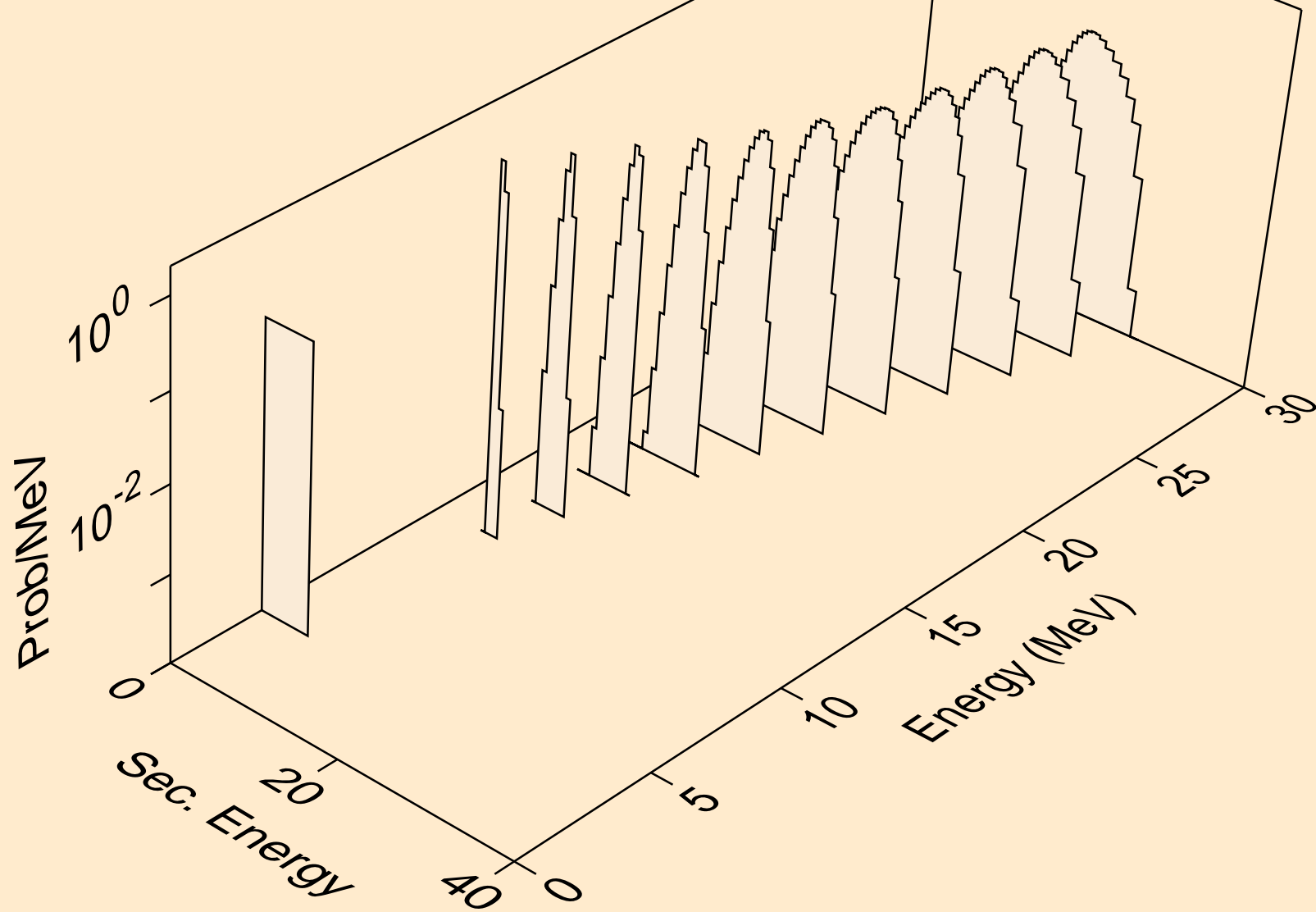

IR182 NEUTRON ACER TENDL-2021 LIBRARY; T=293.6K  
alphas from (n,3n)a

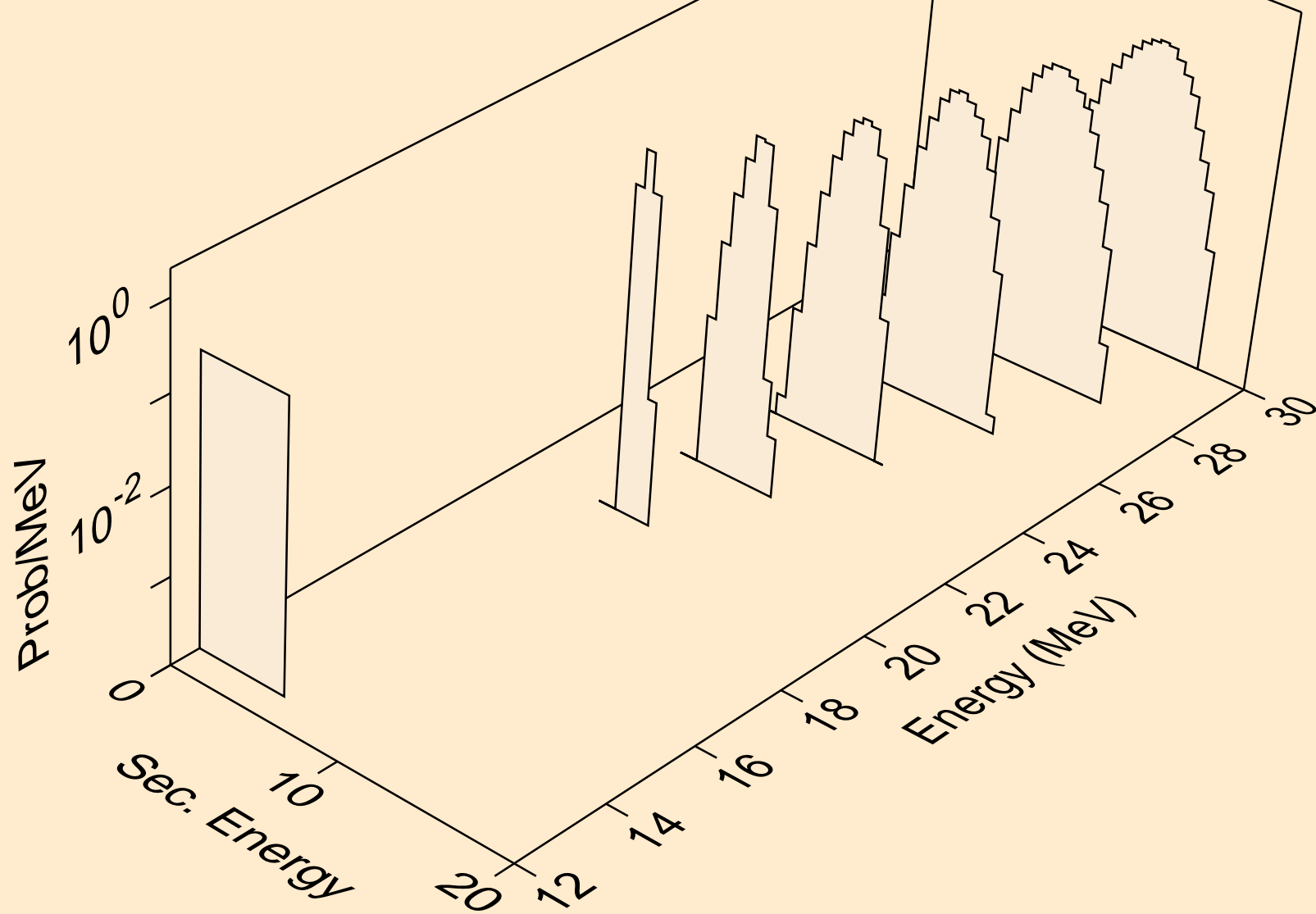

IR182 NEUTRON ACER TENDL-2021 LIBRARY; T=293.6K  
alphas from (n,n\*)2a

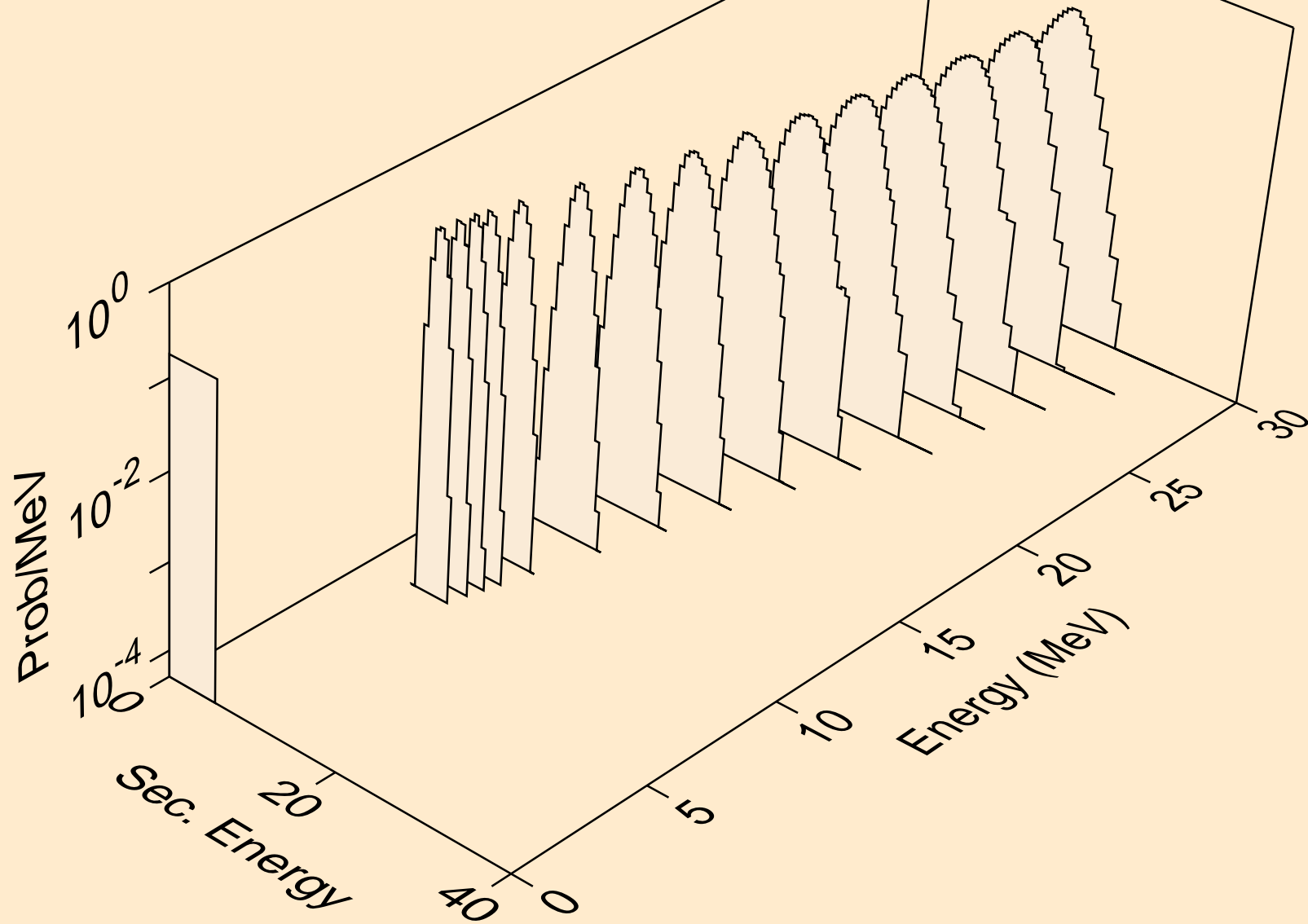

IR182 NEUTRON ACER TENDL-2021 LIBRARY; T=293.6K  
alphas from (n,2n)2a

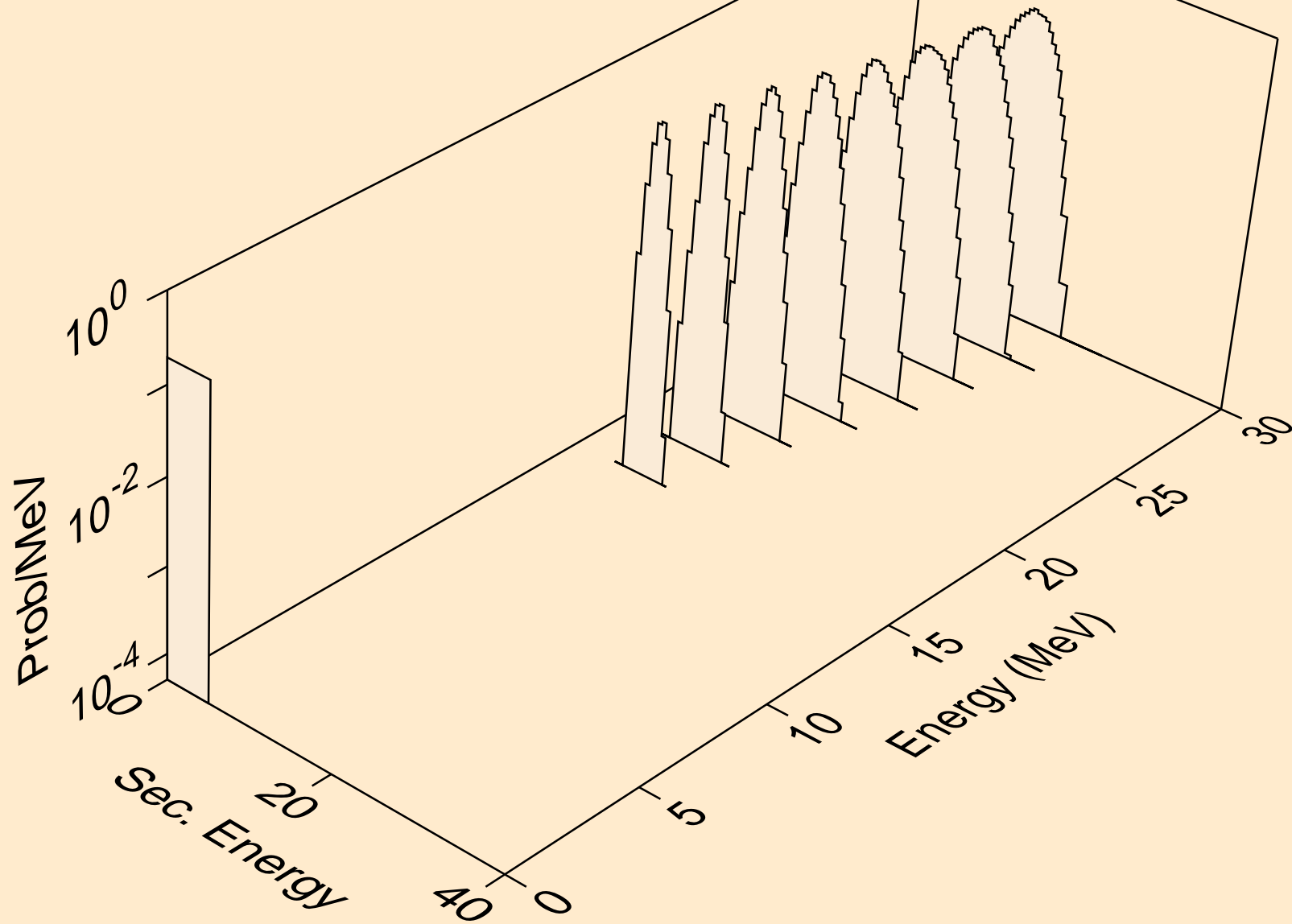

IR182 NEUTRON ACER TENDL-2021 LIBRARY; T=293.6K  
alphas from (n,npa)

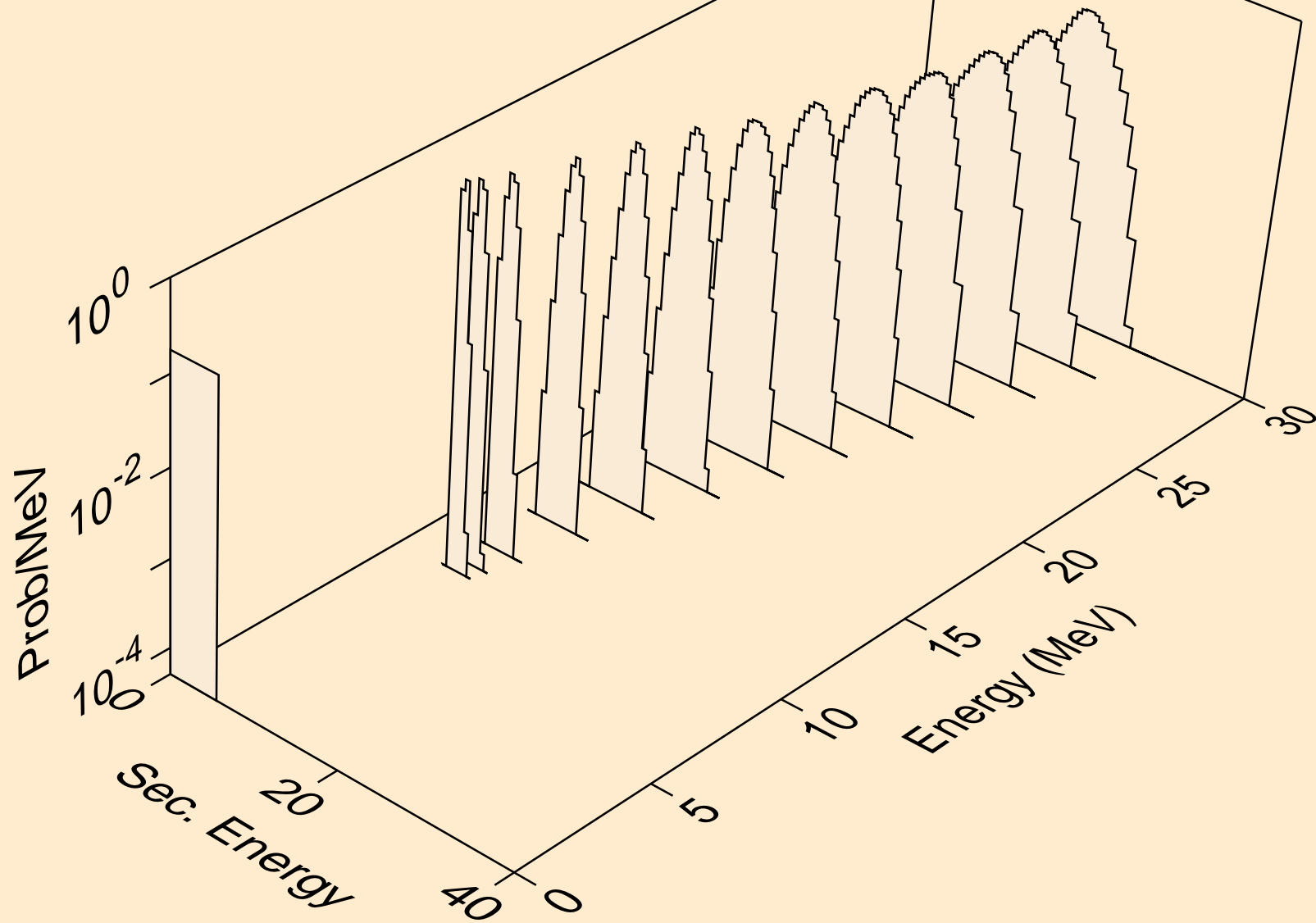

IR182 NEUTRON ACER TENDL-2021 LIBRARY; T=293.6K  
alphas from (n,a)

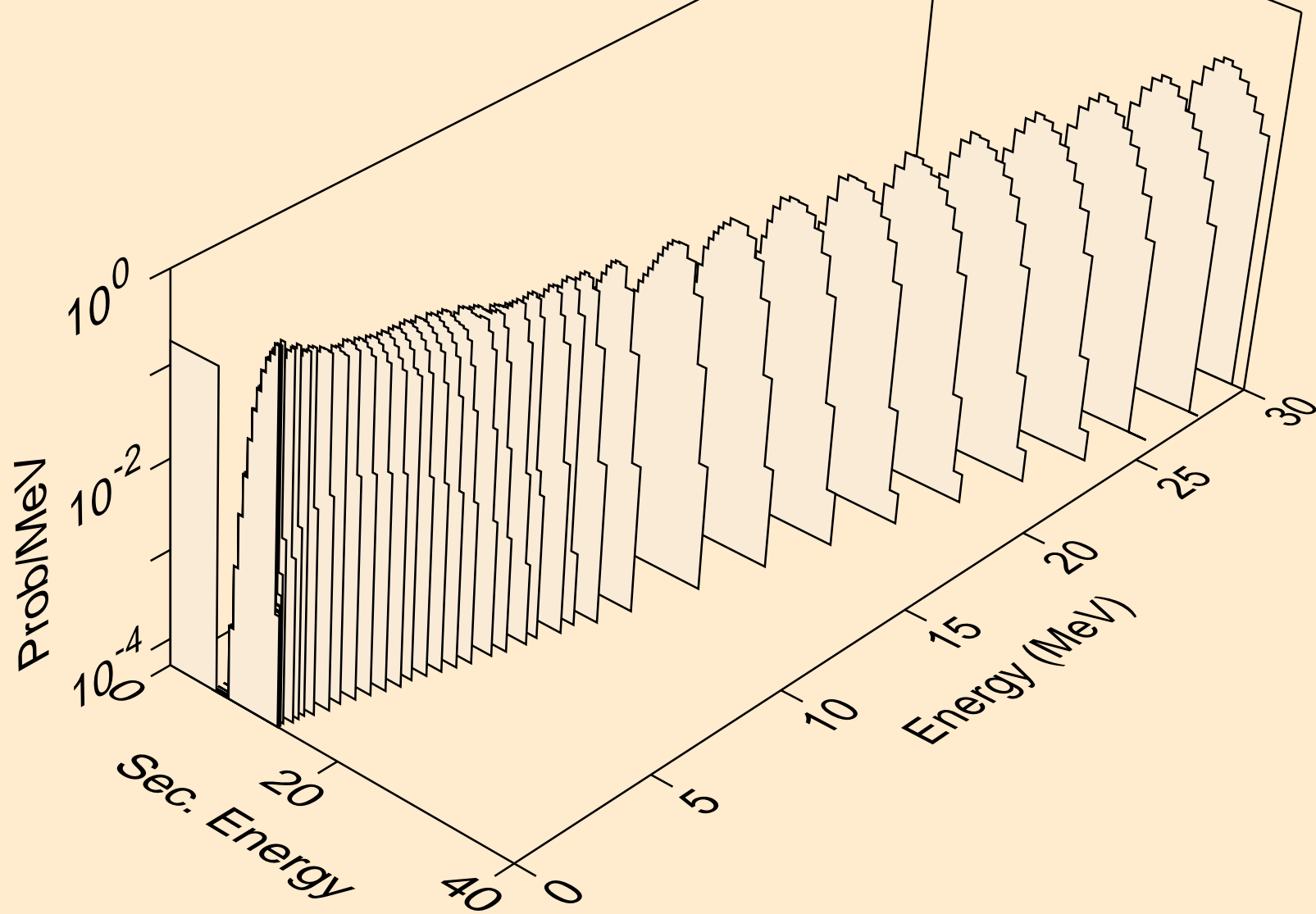

IR182 NEUTRON ACER TENDL-2021 LIBRARY; T=293.6K  
alphas from (n,2a)

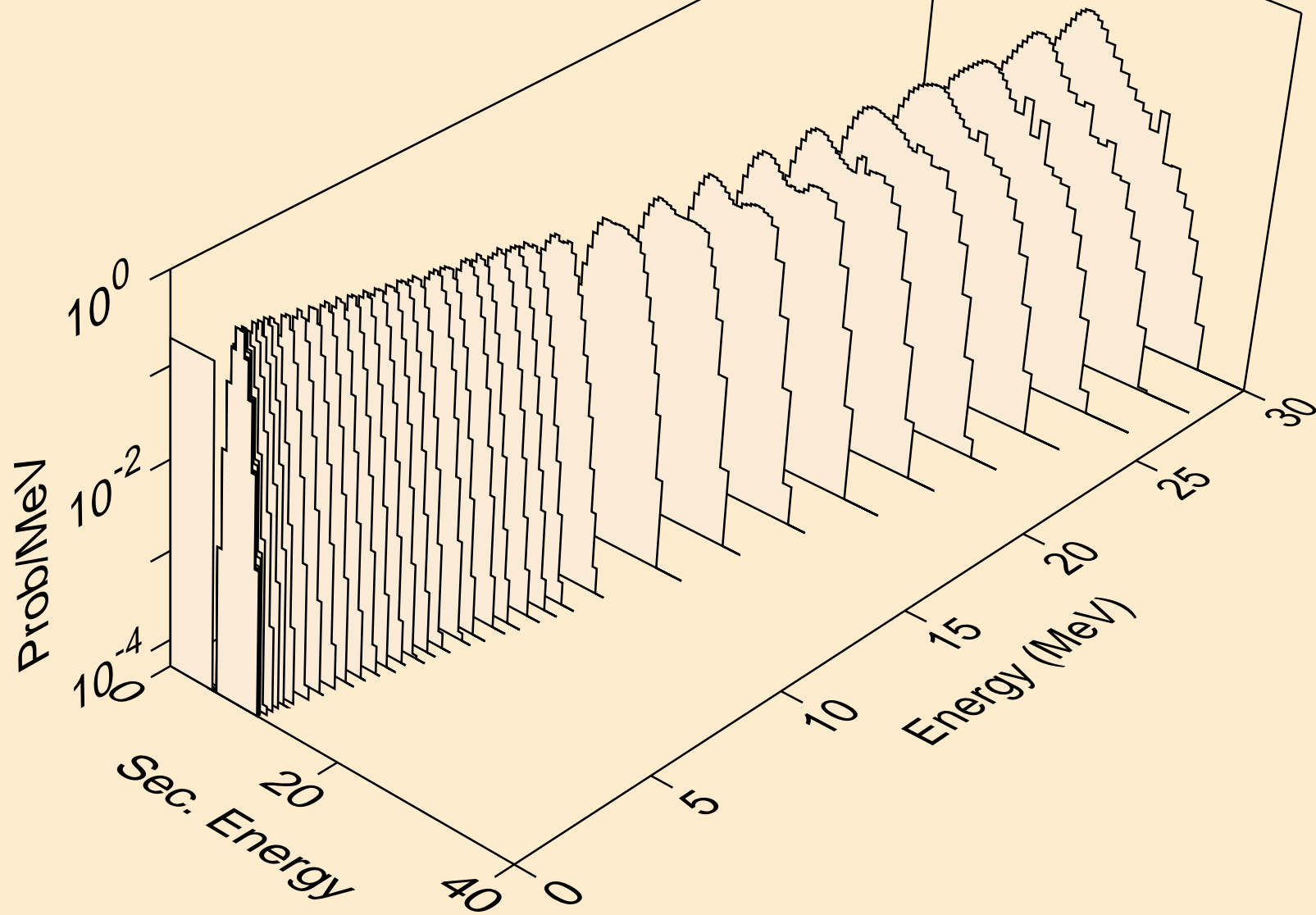

IR182 NEUTRON ACER TENDL-2021 LIBRARY; T=293.6K  
alphas from (n,pa)

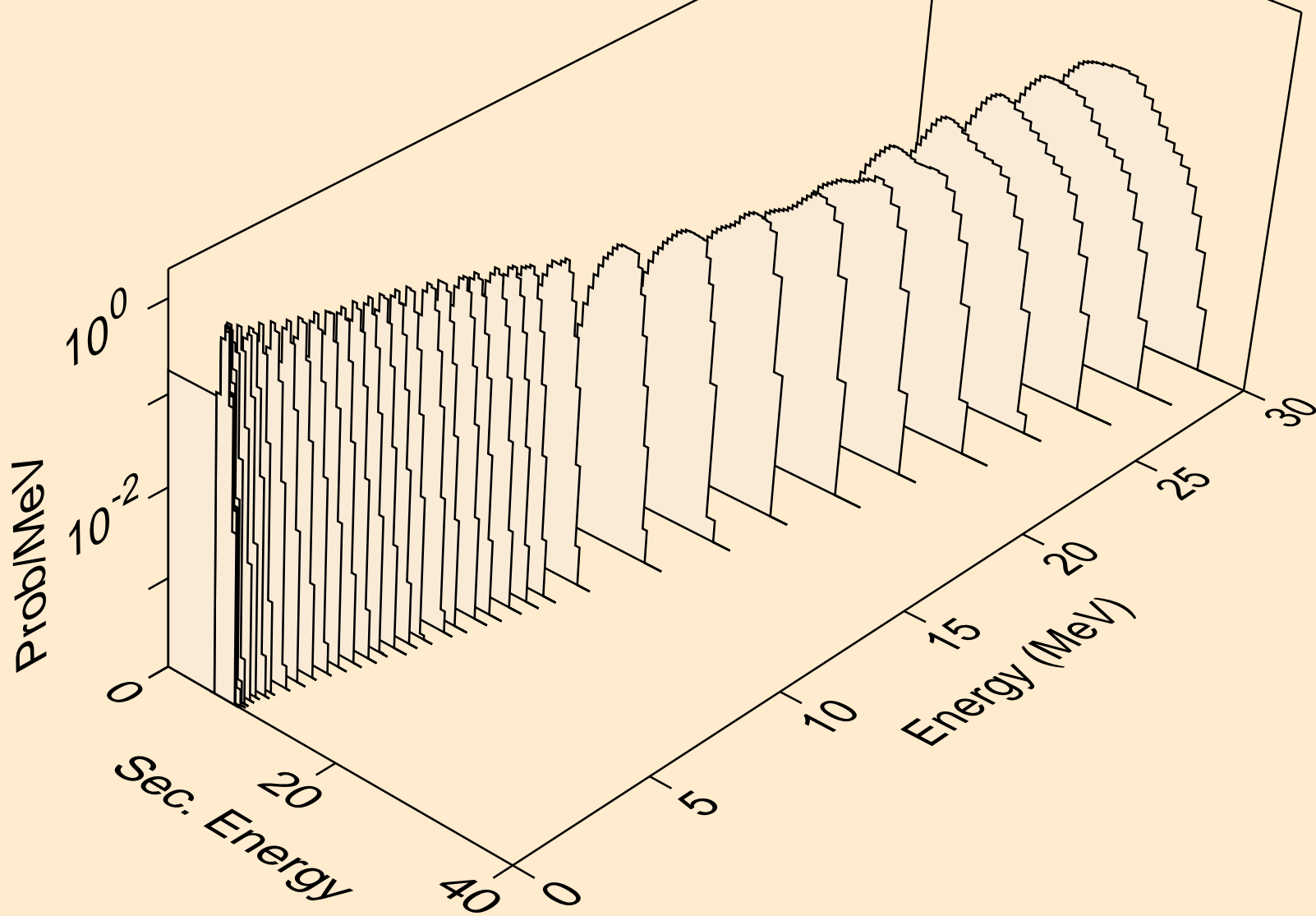

IR182 NEUTRON ACER TENDL-2021 LIBRARY; T=293.6K  
alphas from (n,da)

