

NB084 NEUTRON ACER TENDL-2021 LIBRARY; T=293.6K  
Principal cross sections

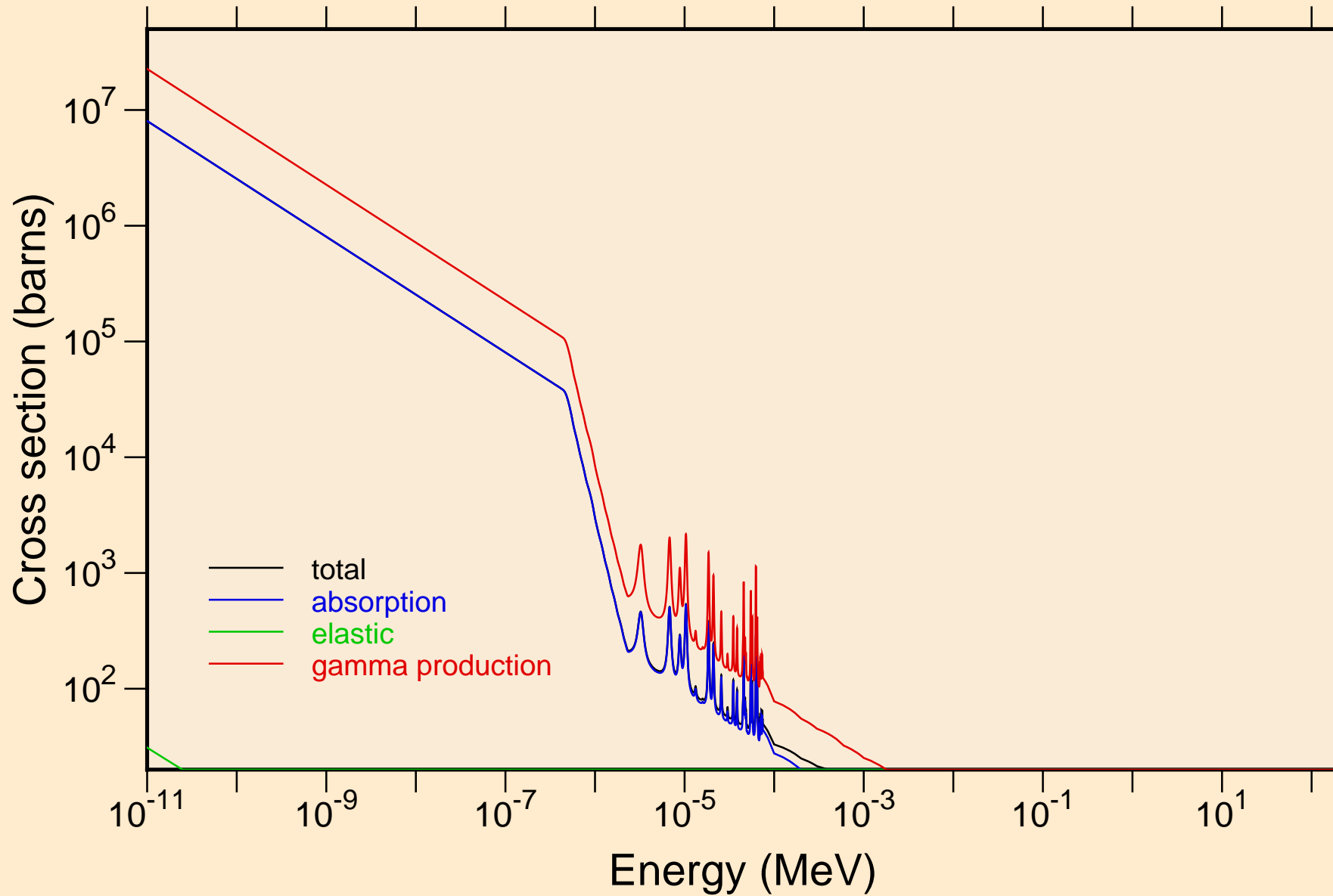

NB084 NEUTRON ACER TENDL-2021 LIBRARY; T=293.6K  
resonance total cross section

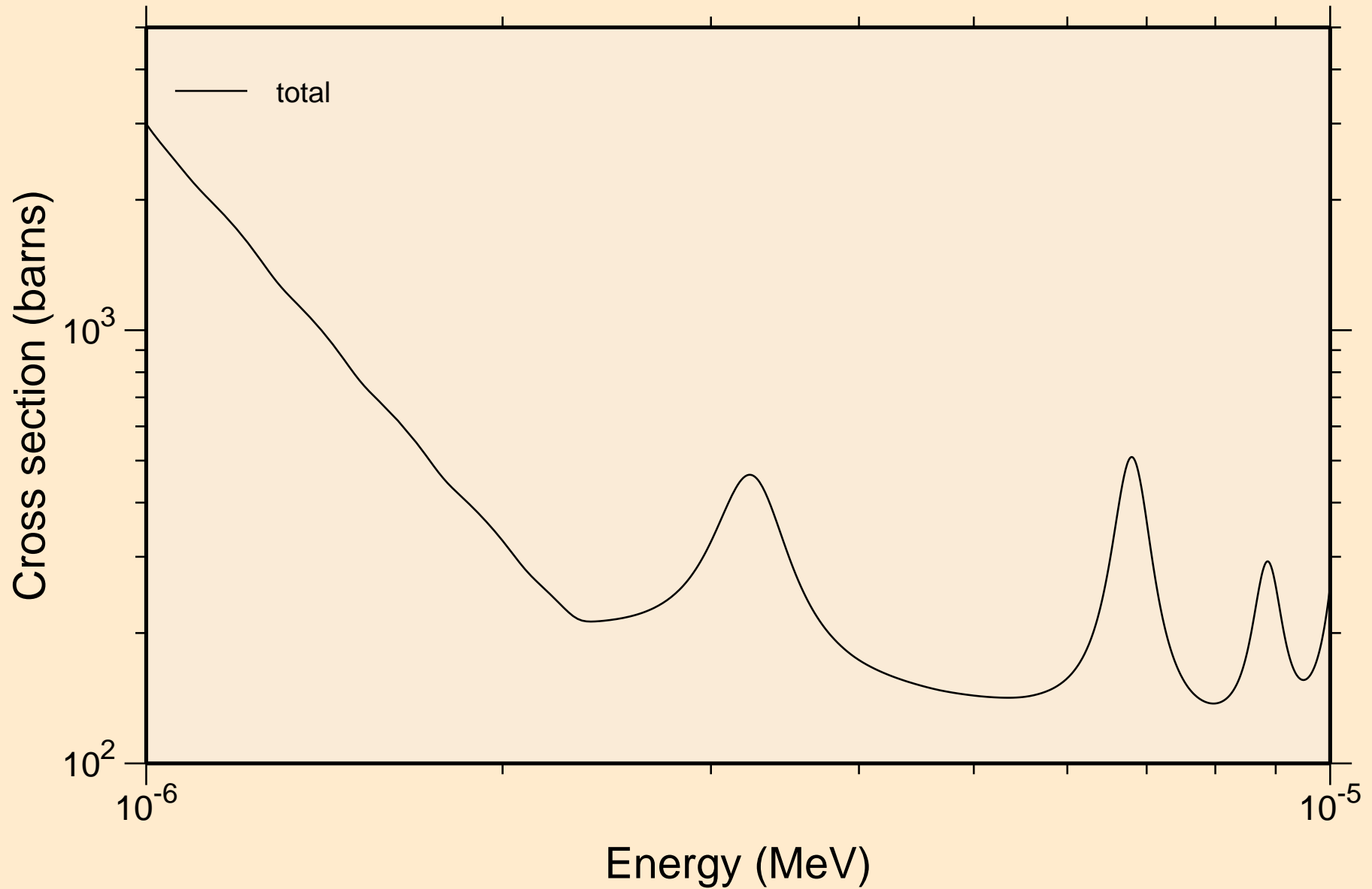

NB084 NEUTRON ACER TENDL-2021 LIBRARY; T=293.6K  
resonance total cross section

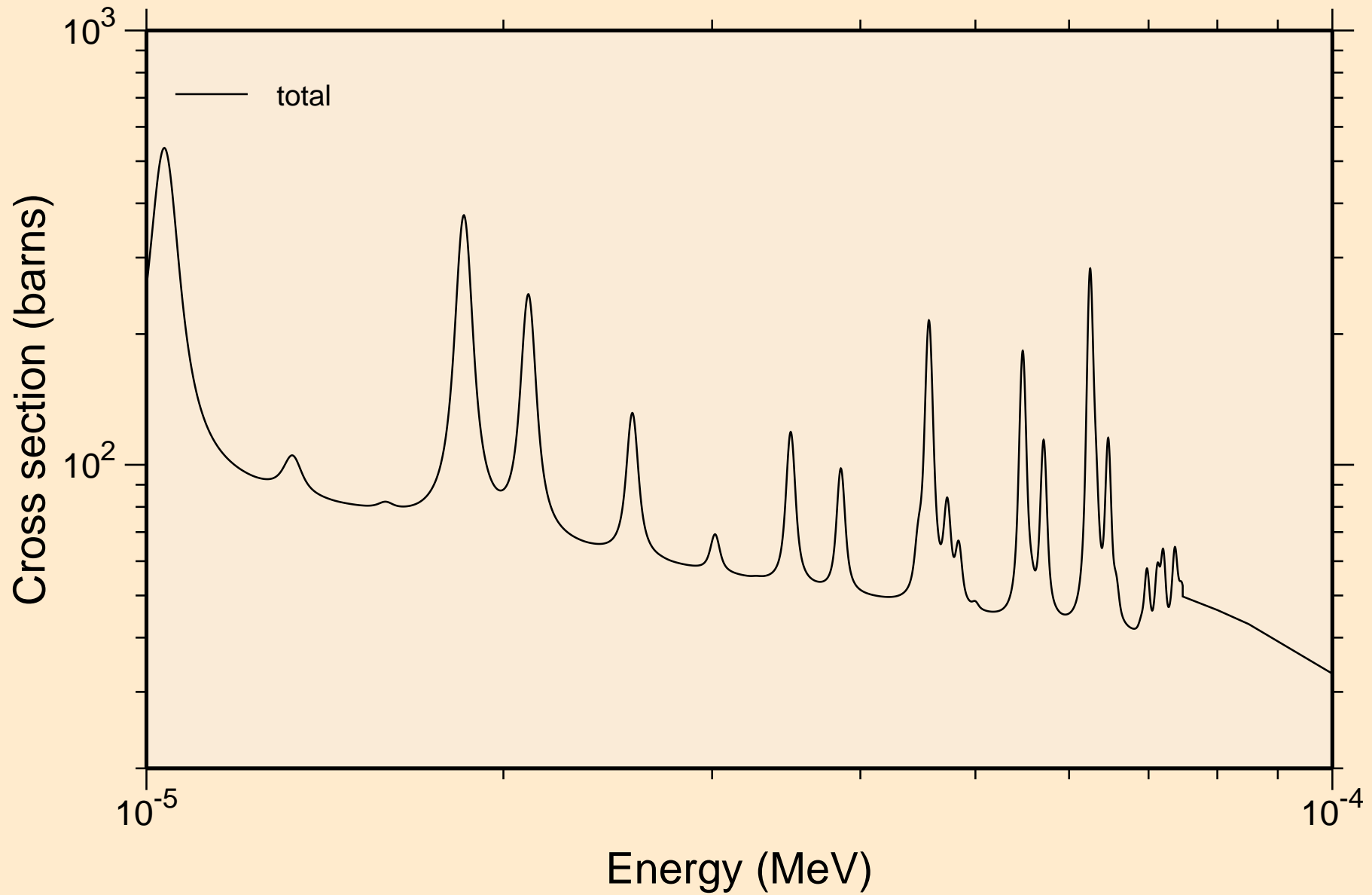

NB084 NEUTRON ACER TENDL-2021 LIBRARY; T=293.6K  
resonance total cross section

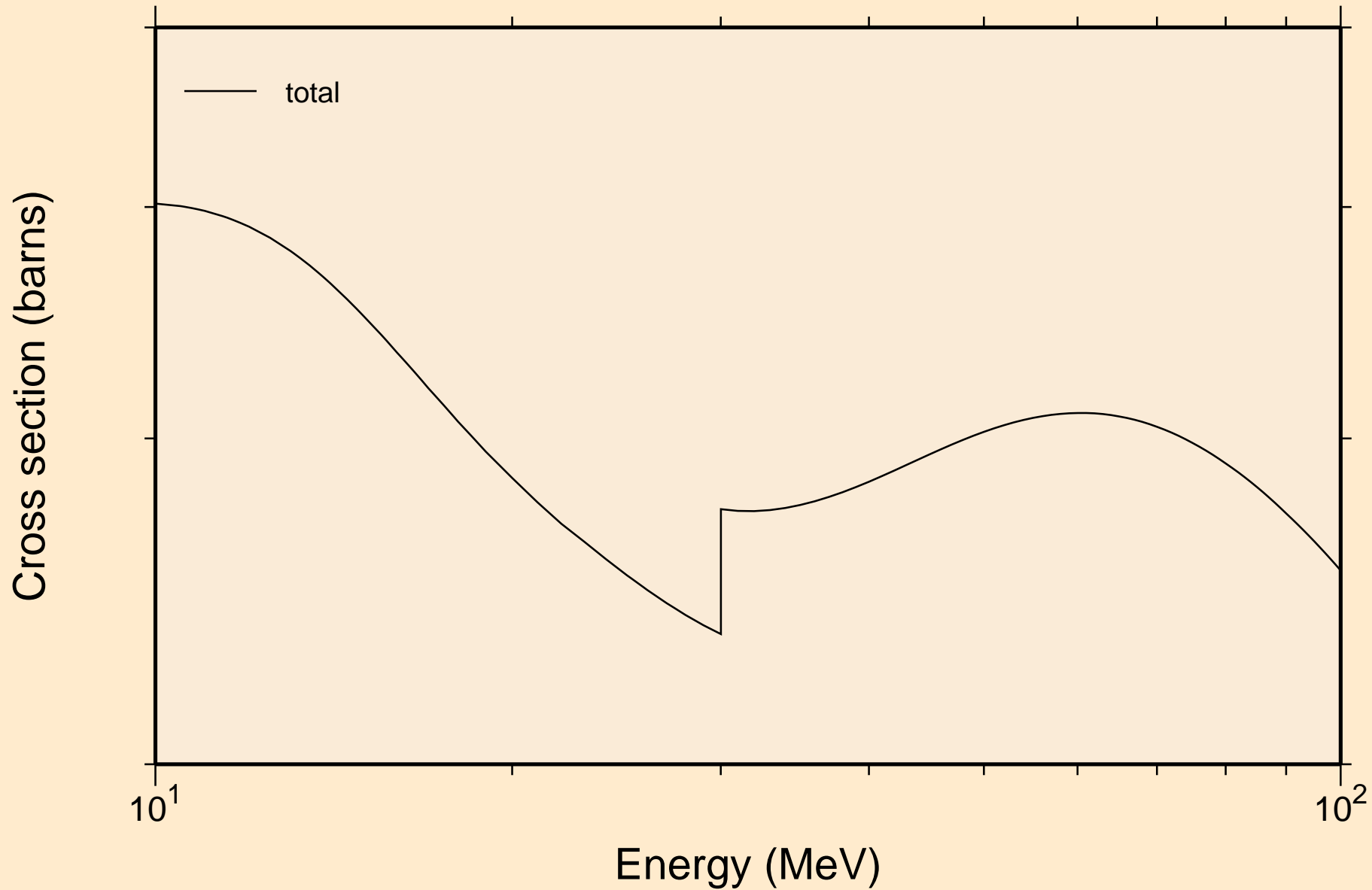

NB084 NEUTRON ACER TENDL-2021 LIBRARY; T=293.6K  
resonance absorption cross sections

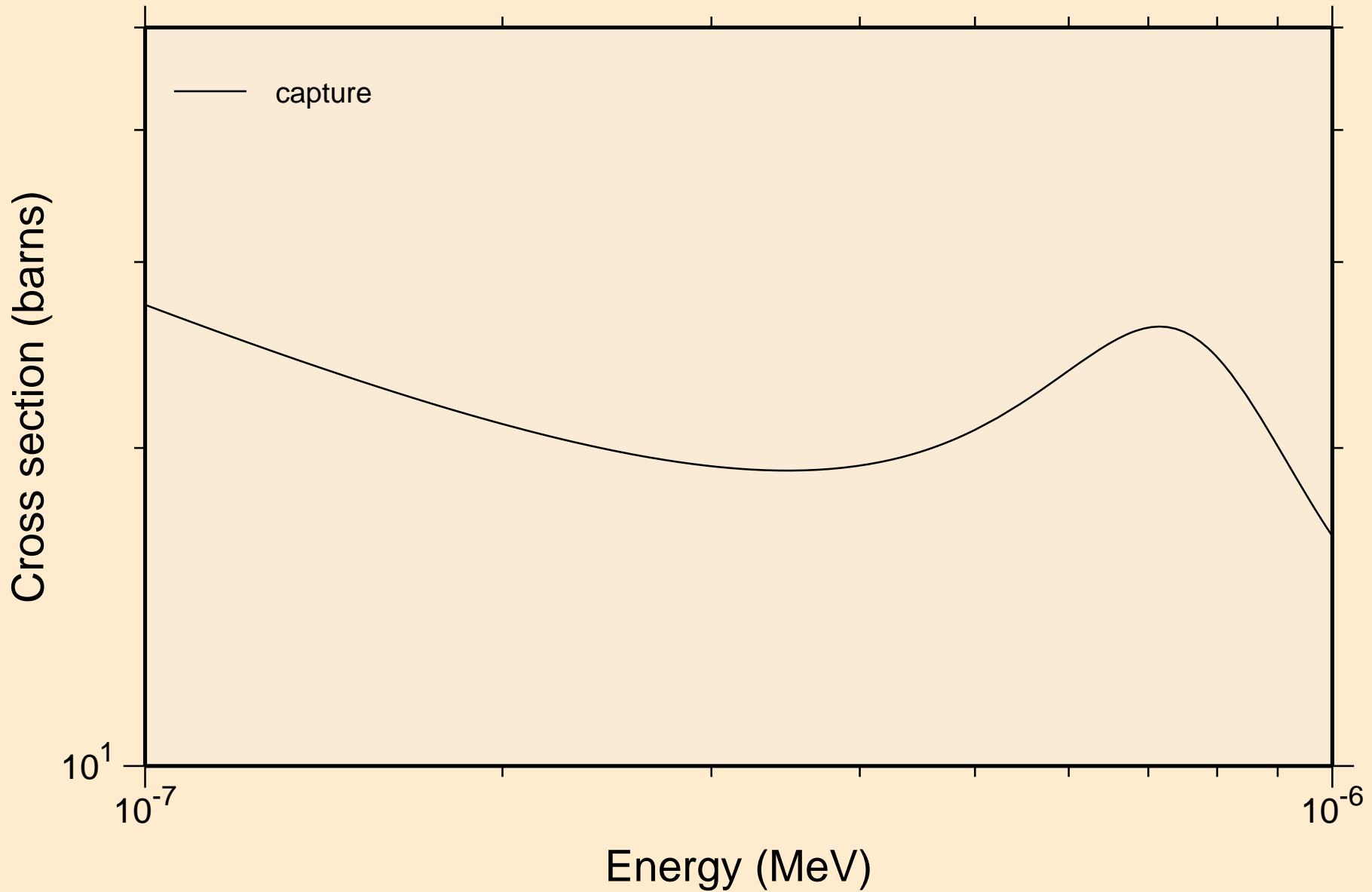

NB084 NEUTRON ACER TENDL-2021 LIBRARY; T=293.6K  
resonance absorption cross sections

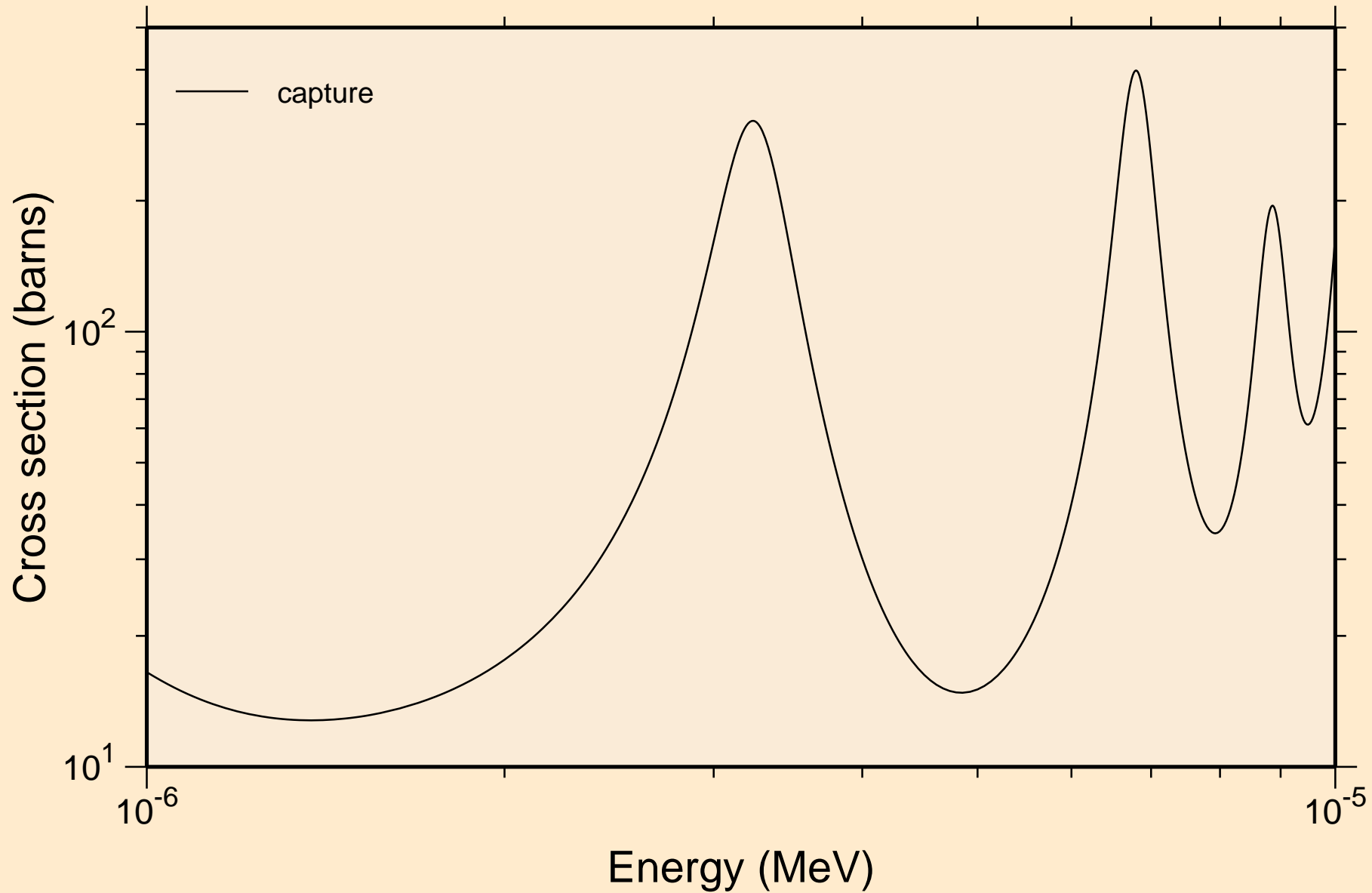

NB084 NEUTRON ACER TENDL-2021 LIBRARY; T=293.6K  
resonance absorption cross sections

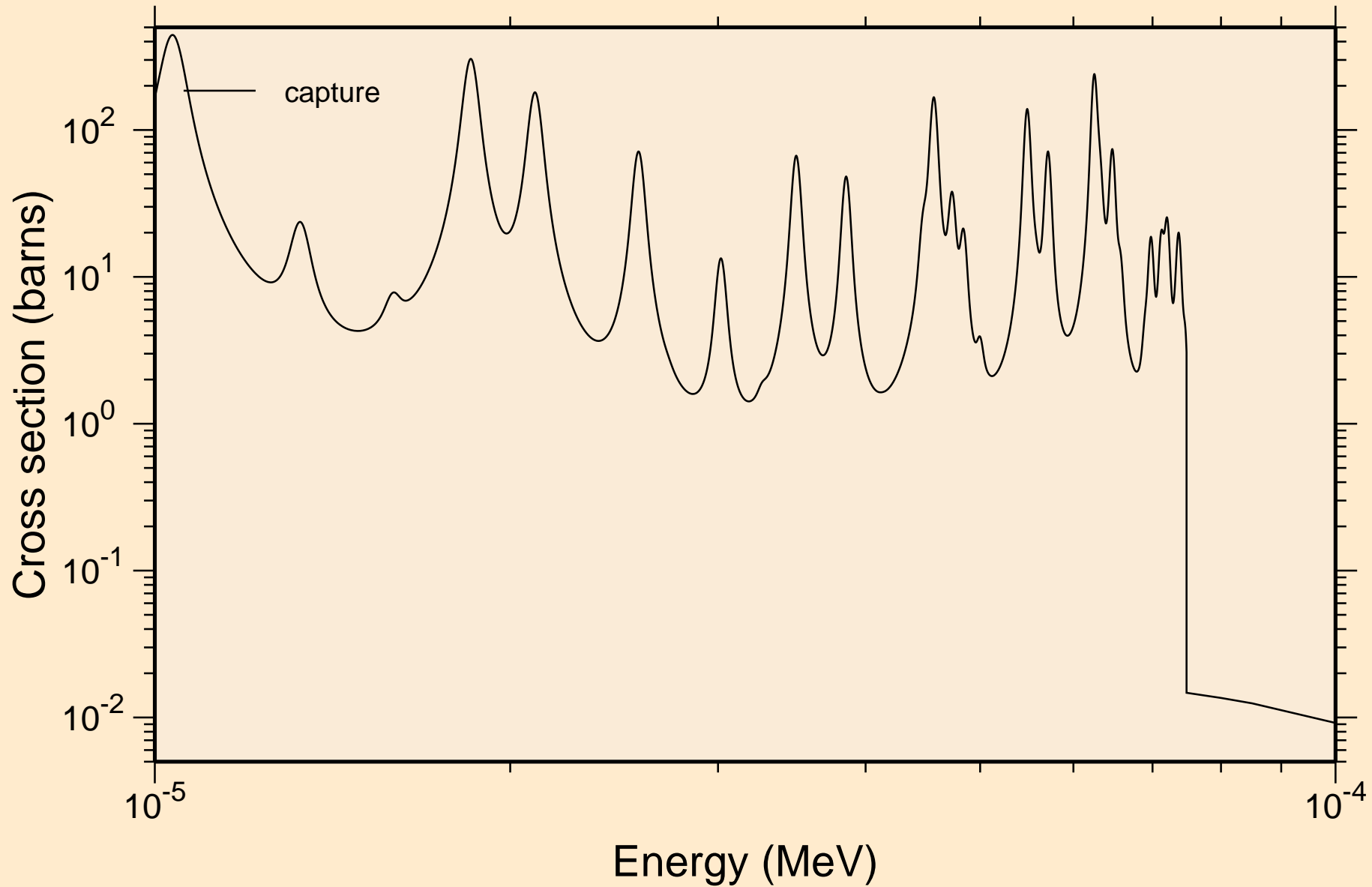

NB084 NEUTRON ACER TENDL-2021 LIBRARY; T=293.6K  
resonance absorption cross sections

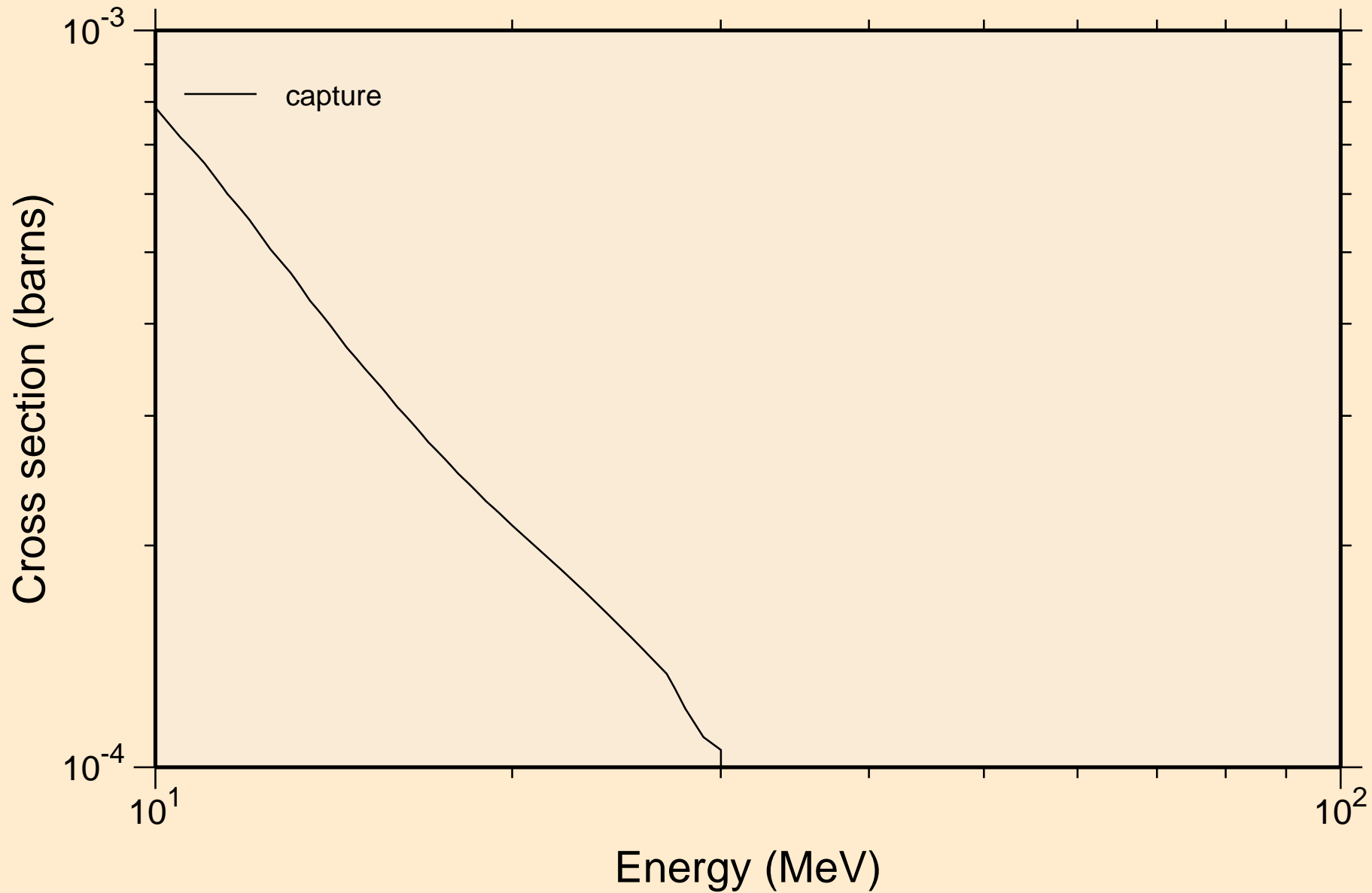

NB084 NEUTRON ACER TENDL-2021 LIBRARY; T=293.6K  
Heating

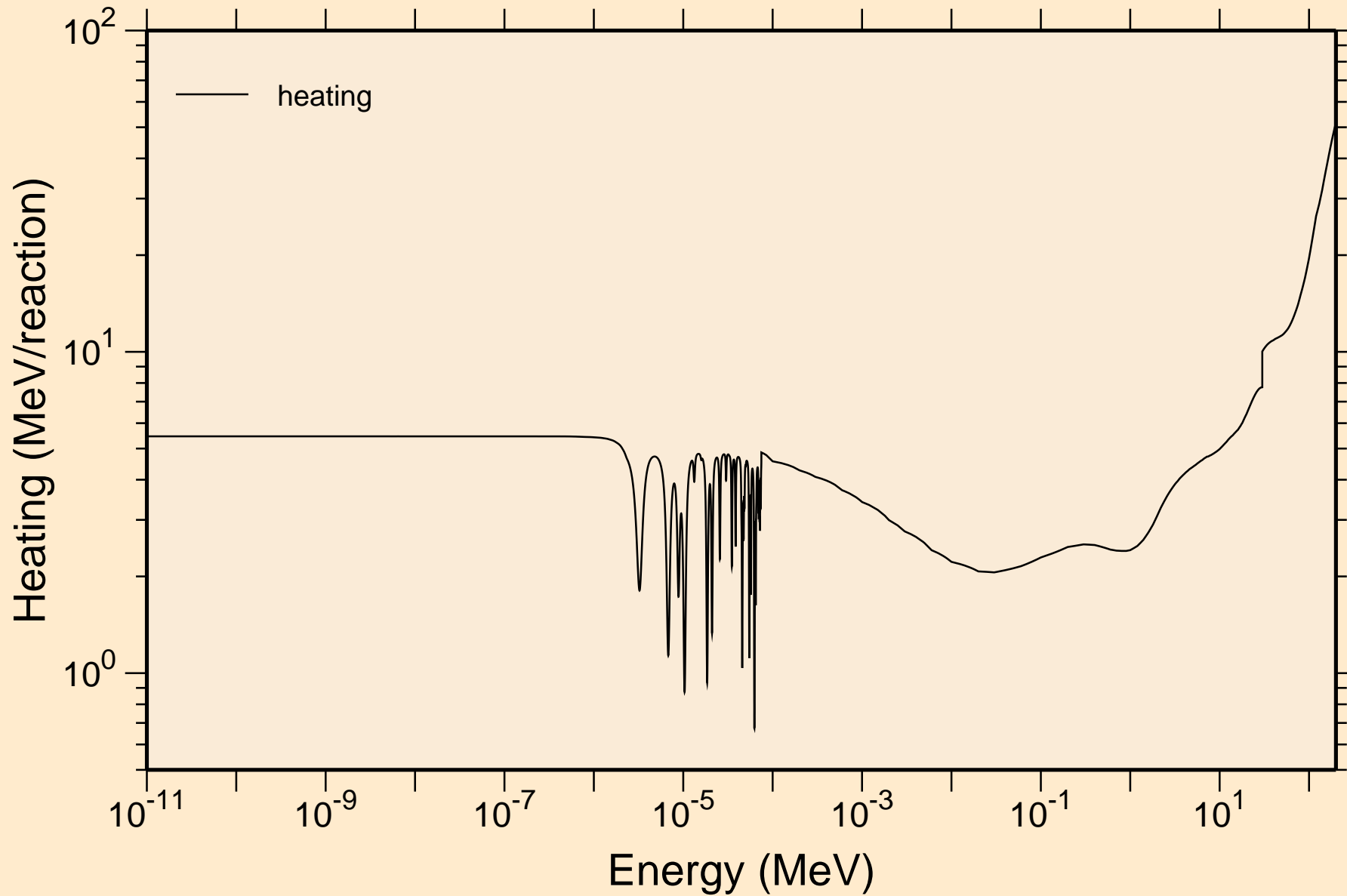

NB084 NEUTRON ACER TENDL-2021 LIBRARY; T=293.6K  
Damage

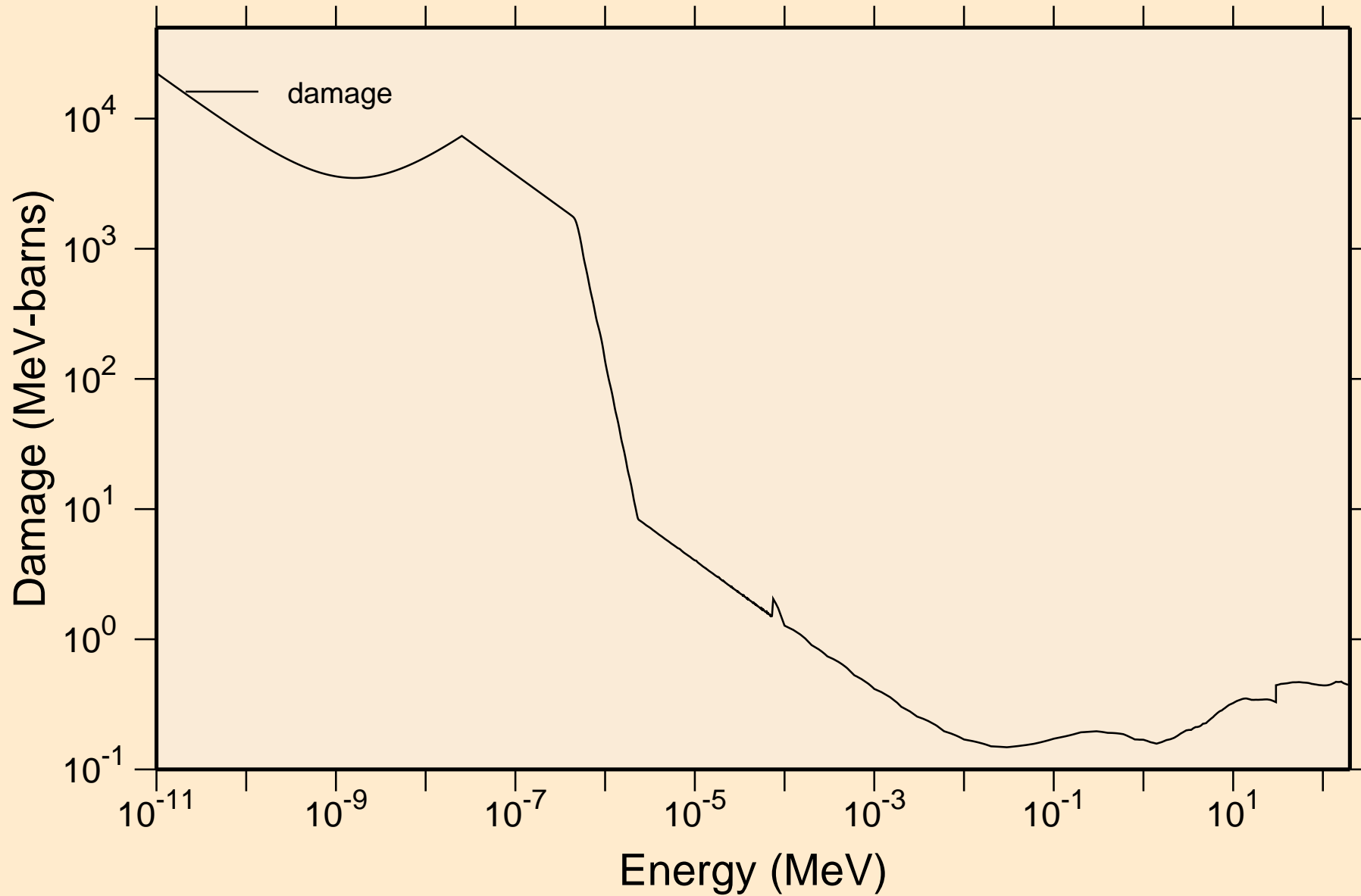

NB084 NEUTRON ACER TENDL-2021 LIBRARY; T=293.6K  
Non-threshold reactions

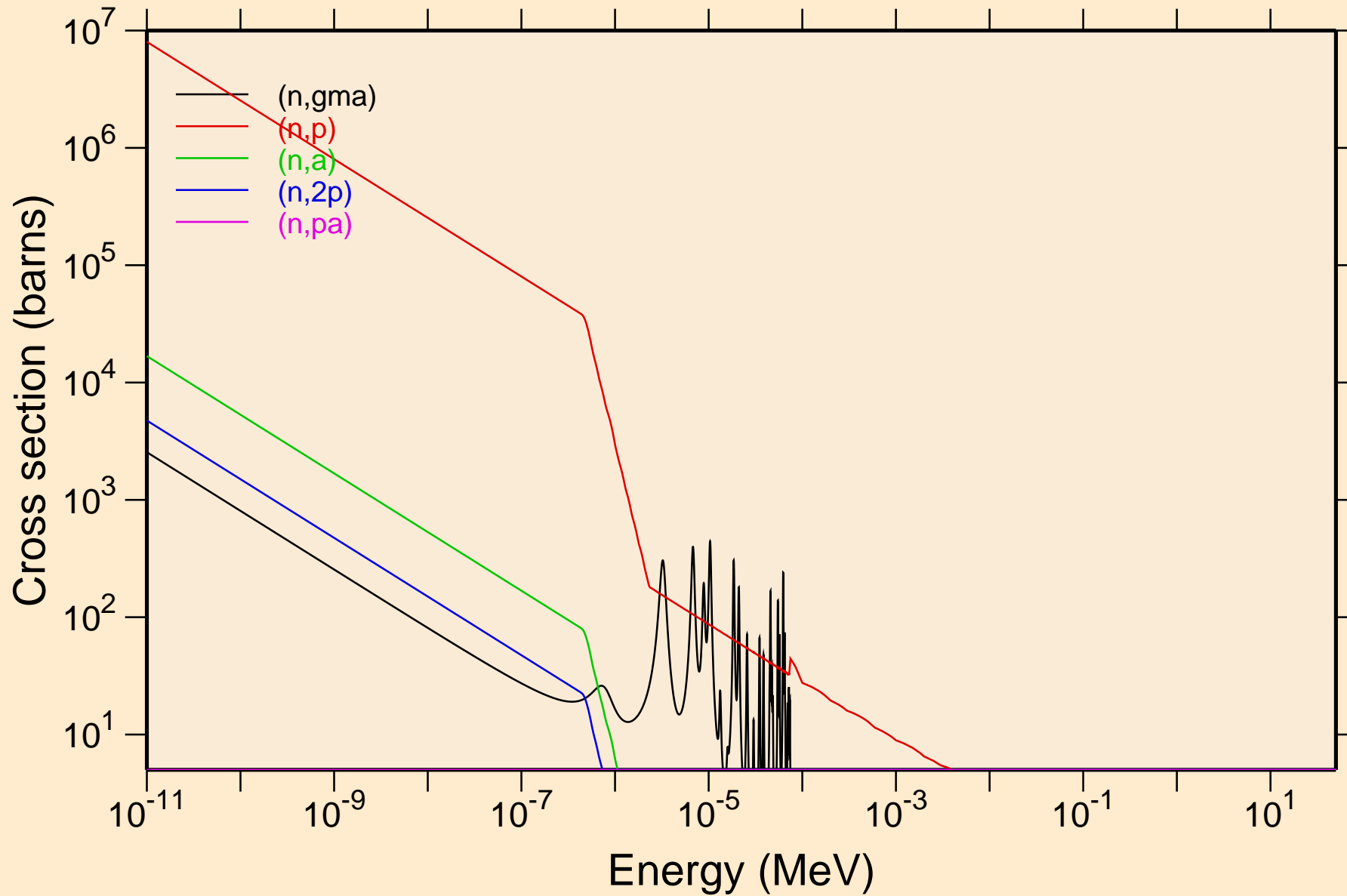

NB084 NEUTRON ACER TENDL-2021 LIBRARY; T=293.6K  
Non-threshold reactions

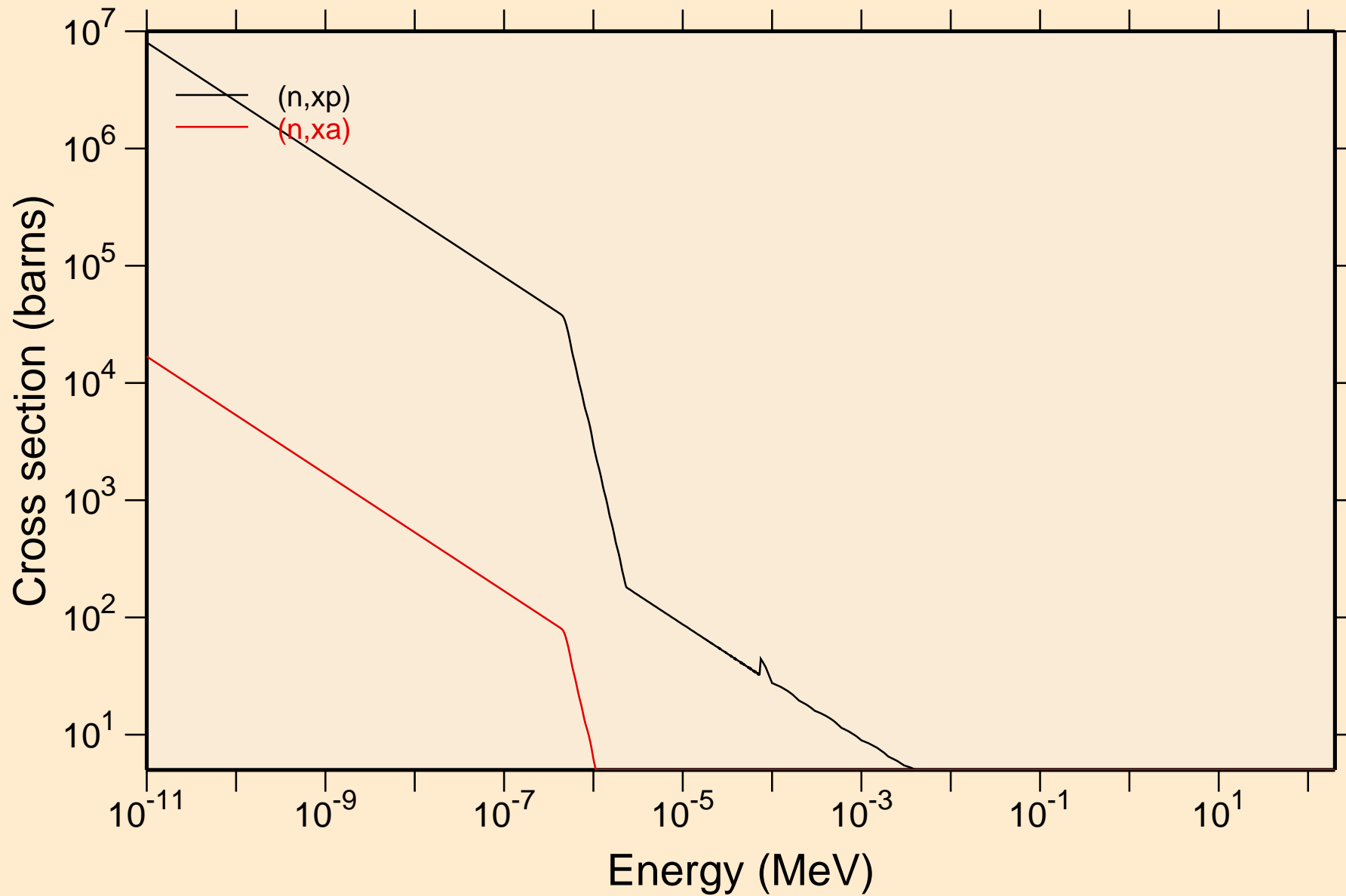

# NB084 NEUTRON ACER TENDL-2021 LIBRARY; T=293.6K

## Principal cross sections

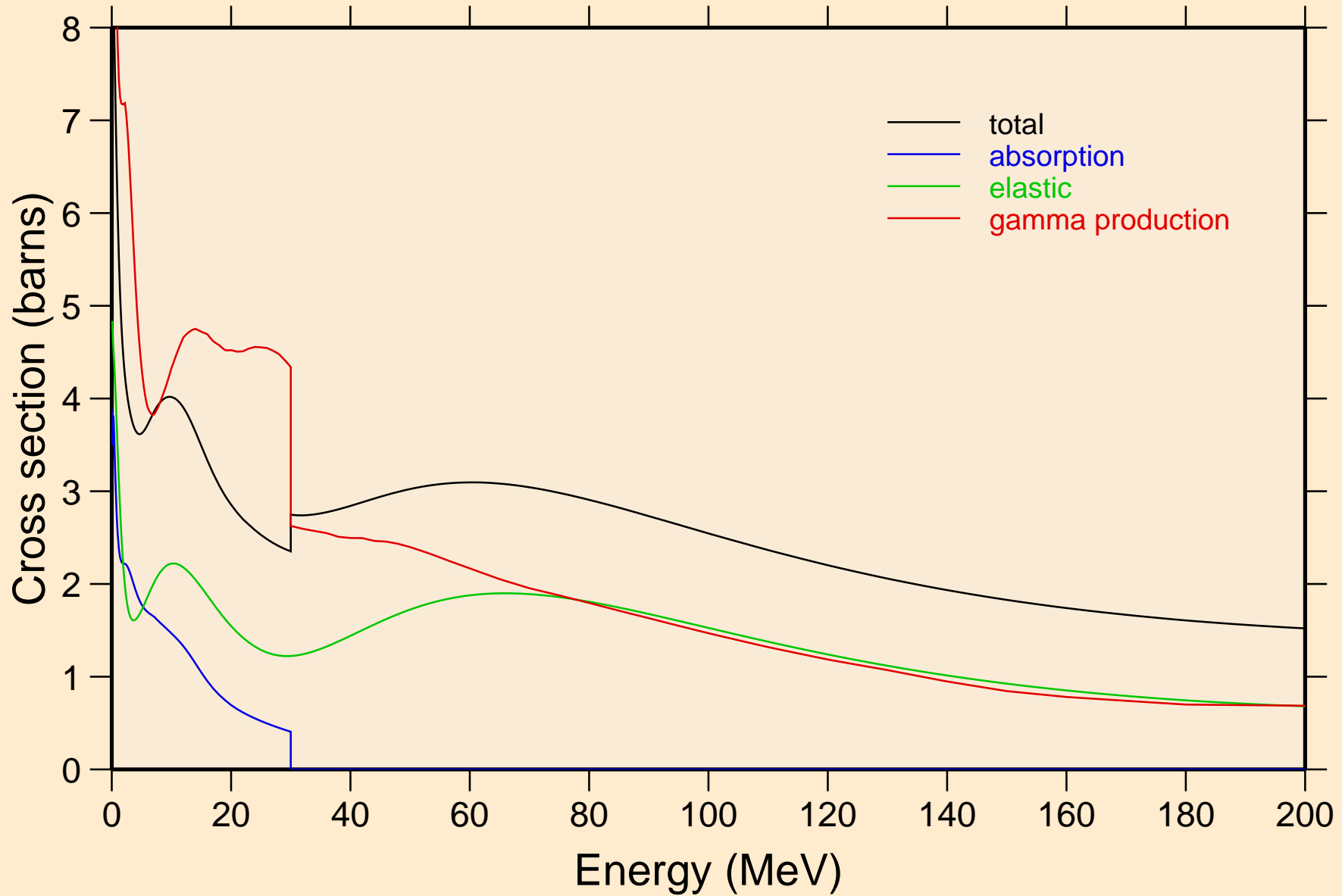

NB084 NEUTRON ACER TENDL-2021 LIBRARY; T=293.6K  
Heating

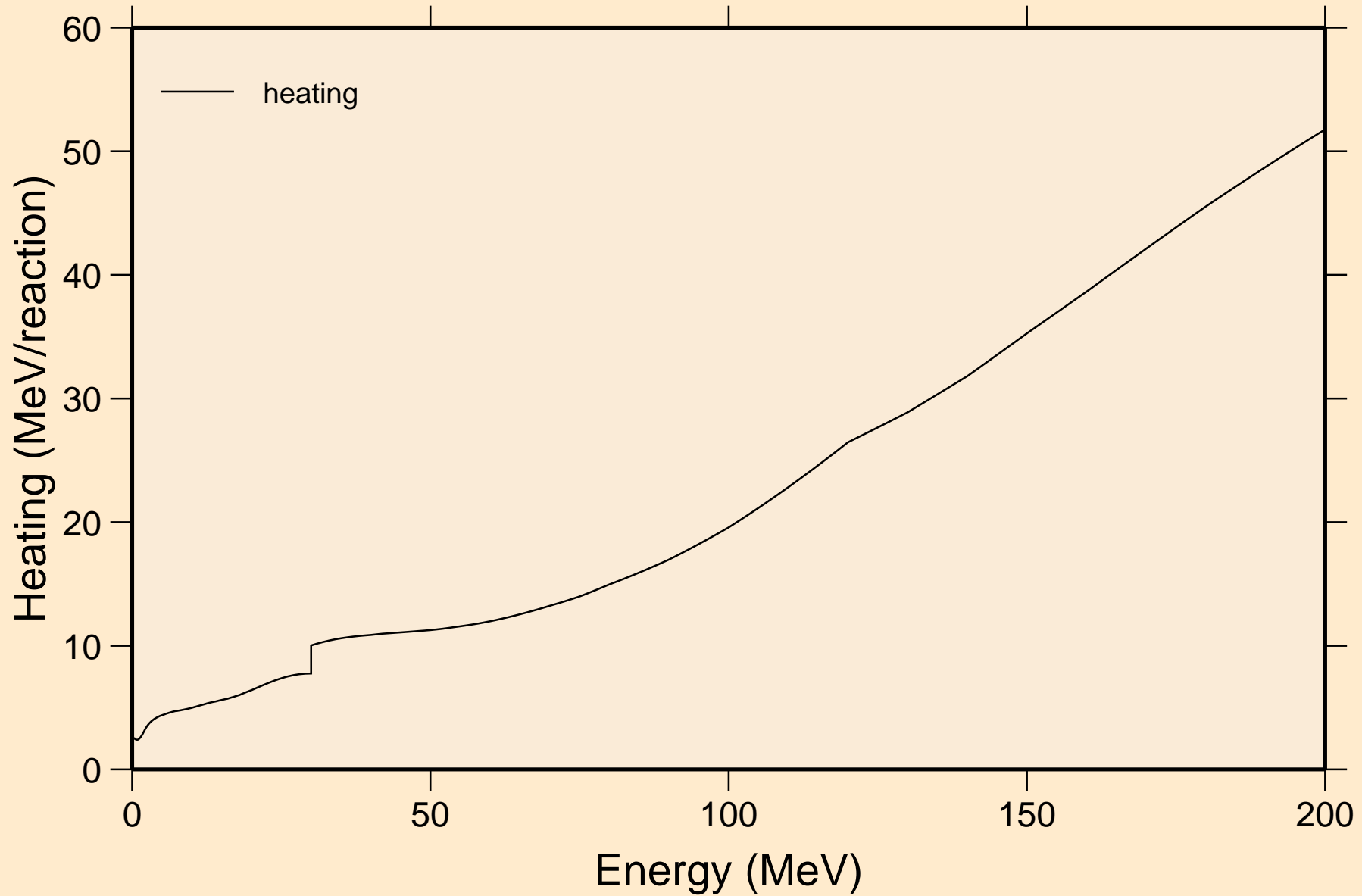

# NB084 NEUTRON ACER TENDL-2021 LIBRARY; T=293.6K

## Damage

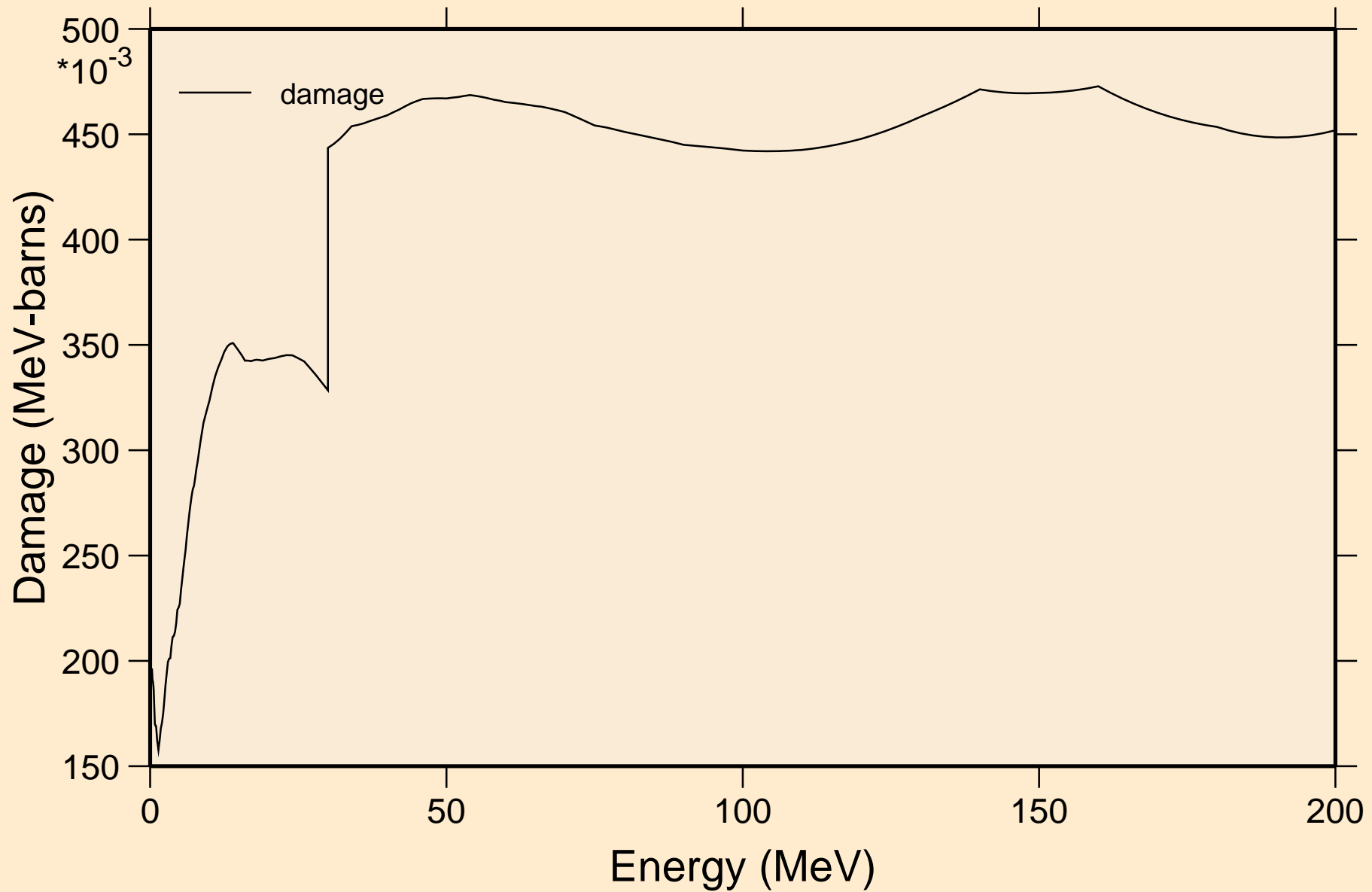

NB084 NEUTRON ACER TENDL-2021 LIBRARY; T=293.6K  
Non-threshold reactions

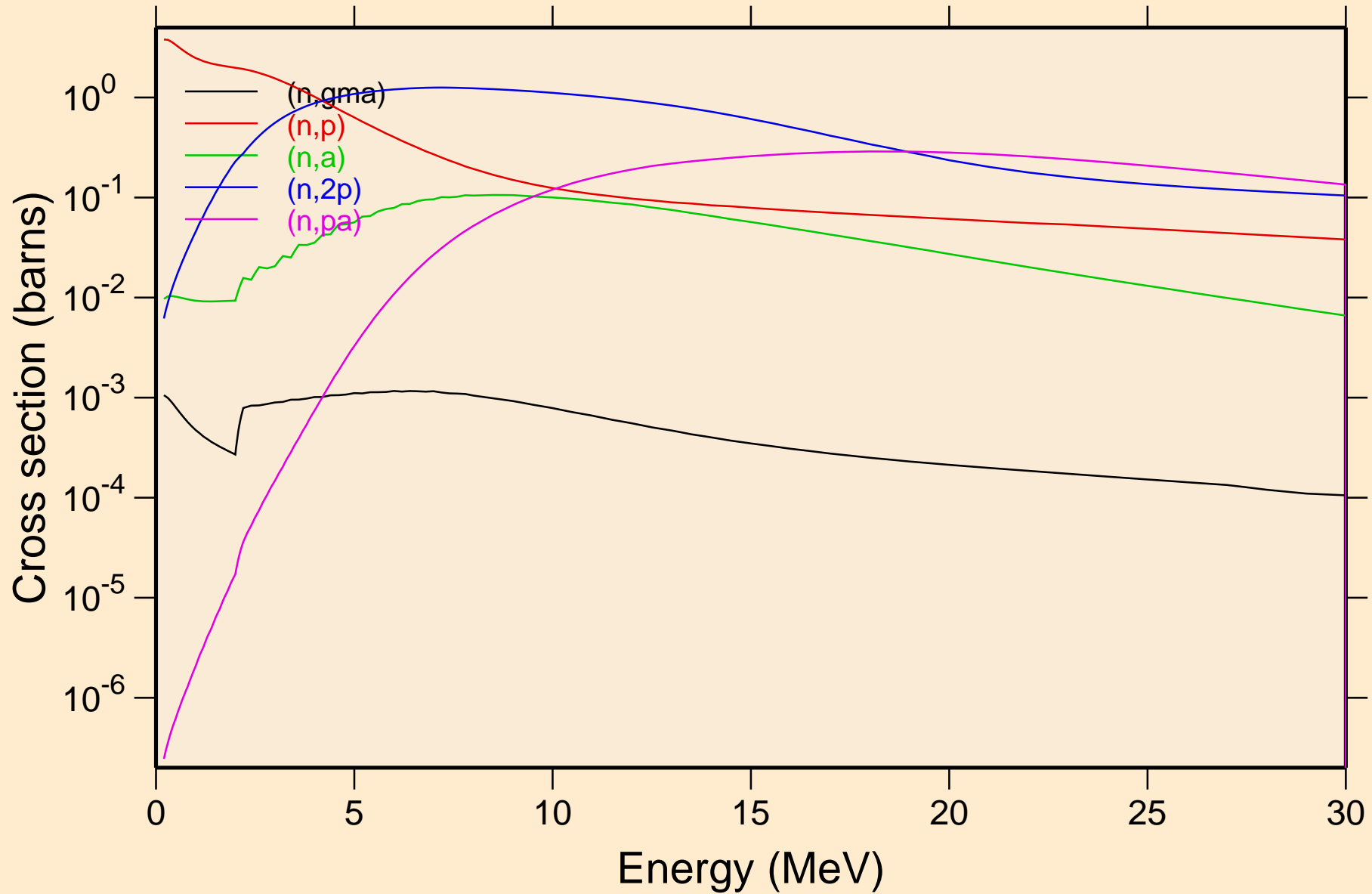

NB084 NEUTRON ACER TENDL-2021 LIBRARY; T=293.6K  
Non-threshold reactions

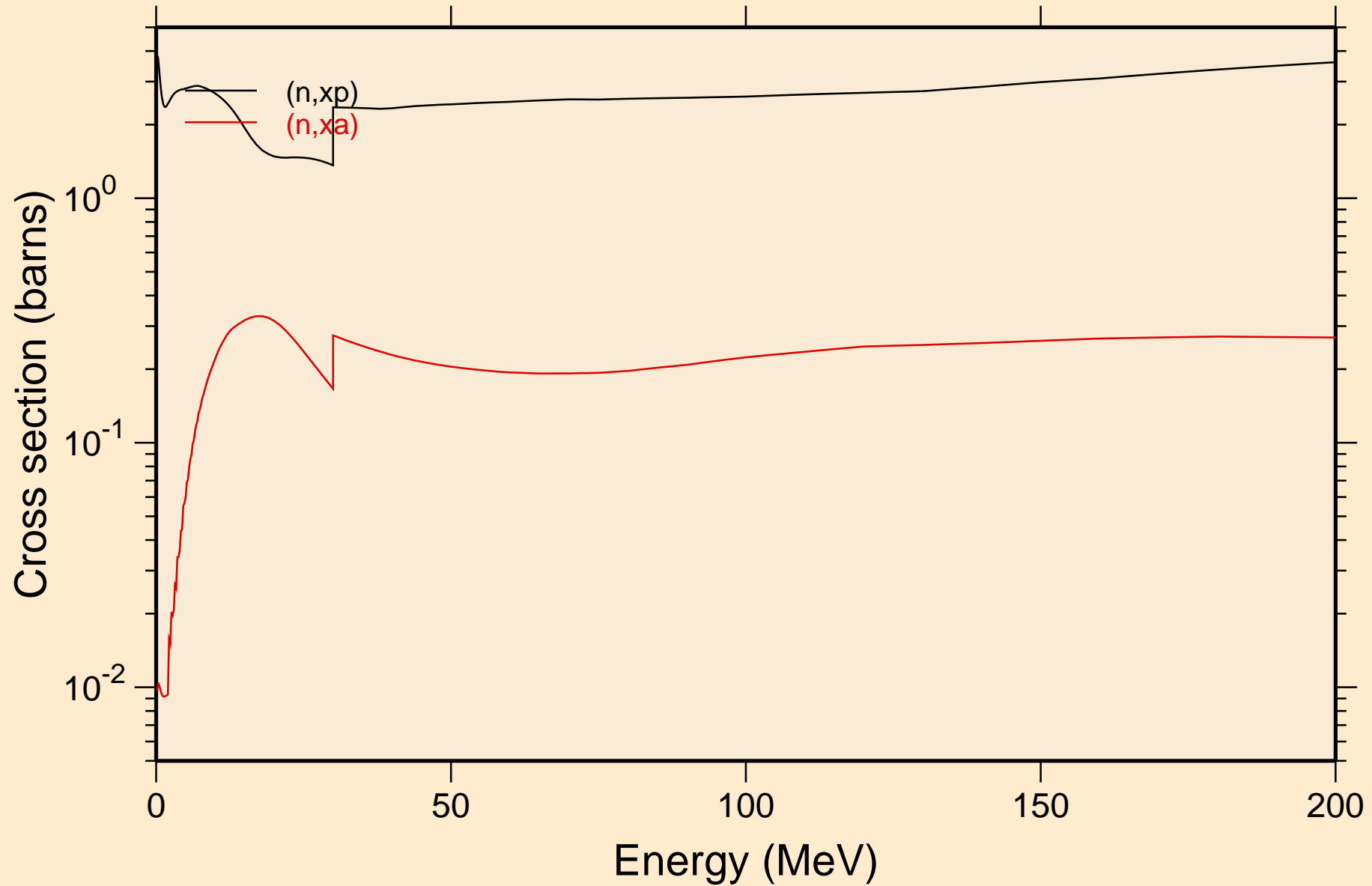

NB084 NEUTRON ACER TENDL-2021 LIBRARY; T=293.6K  
Inelastic levels

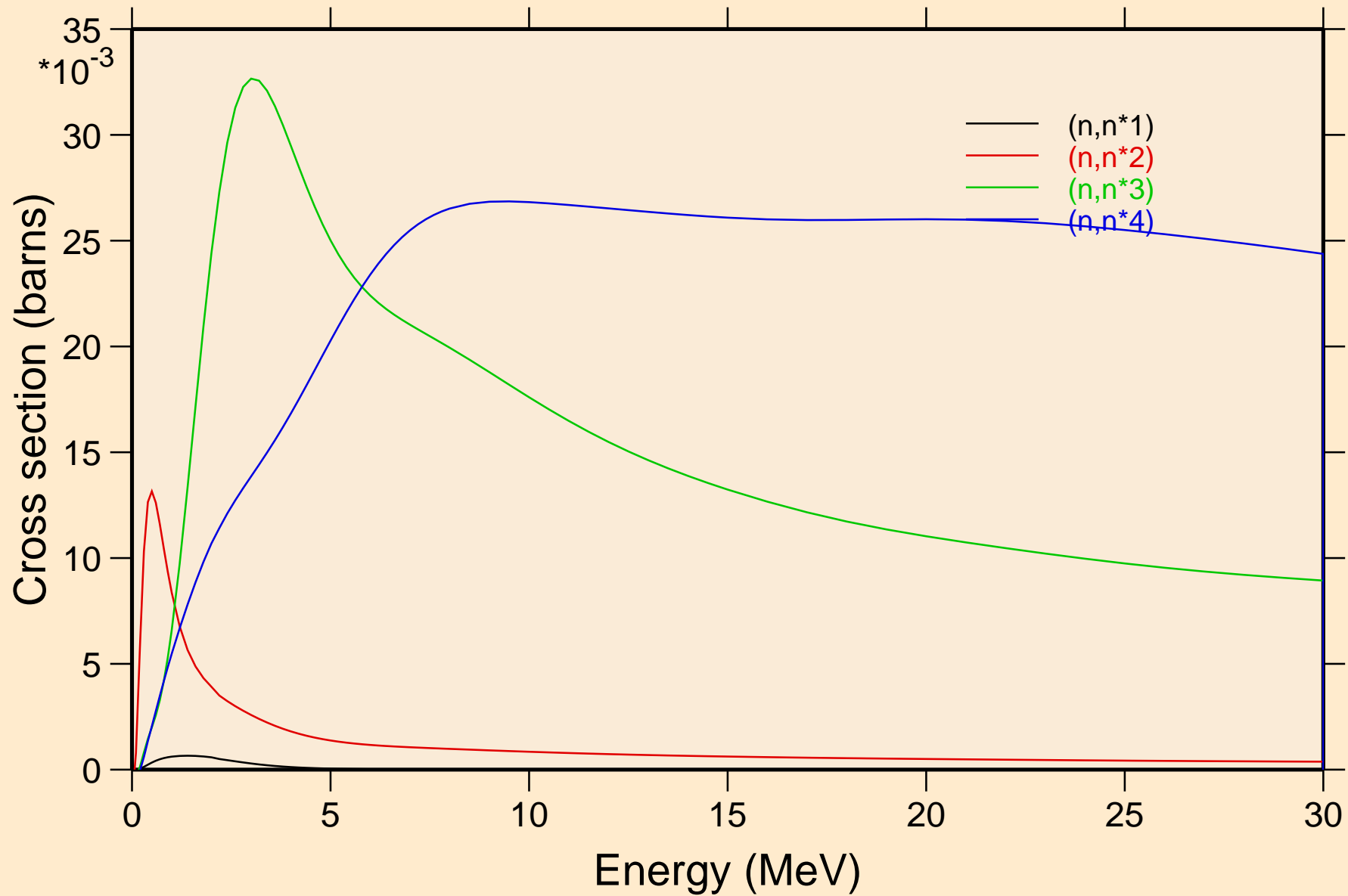

NB084 NEUTRON ACER TENDL-2021 LIBRARY; T=293.6K  
Threshold reactions

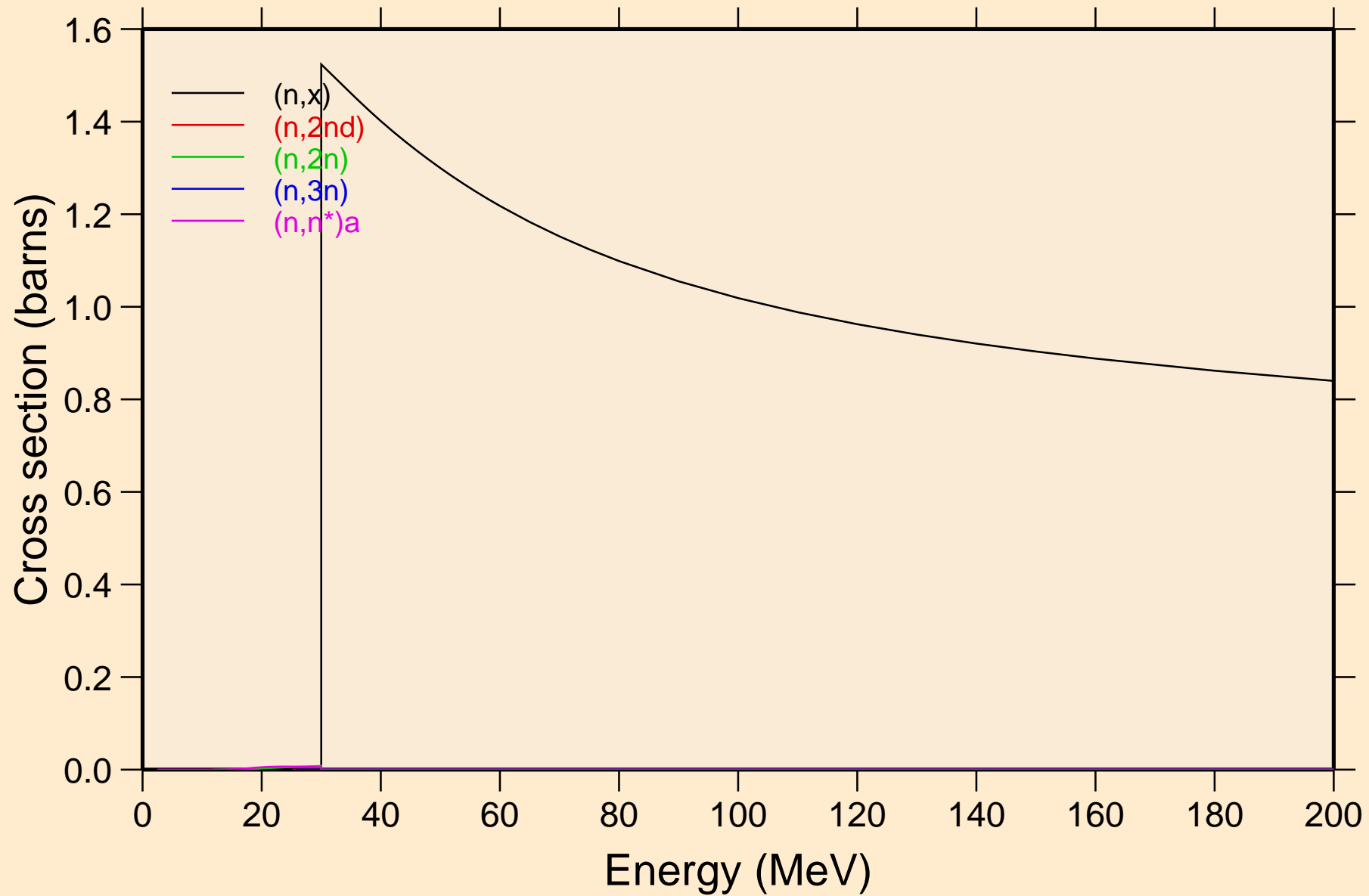

NB084 NEUTRON ACER TENDL-2021 LIBRARY; T=293.6K  
Threshold reactions

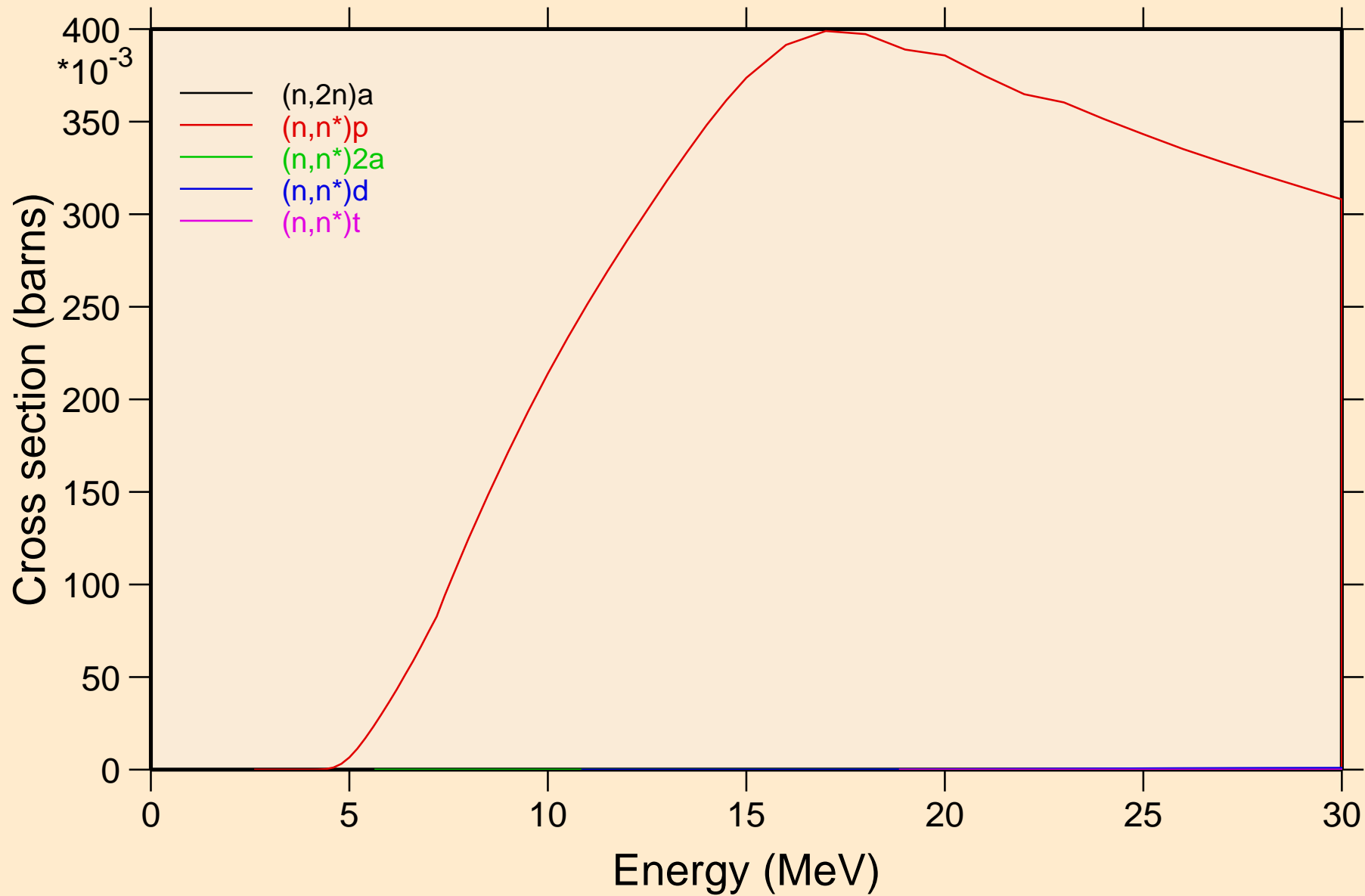

NB084 NEUTRON ACER TENDL-2021 LIBRARY; T=293.6K  
Threshold reactions

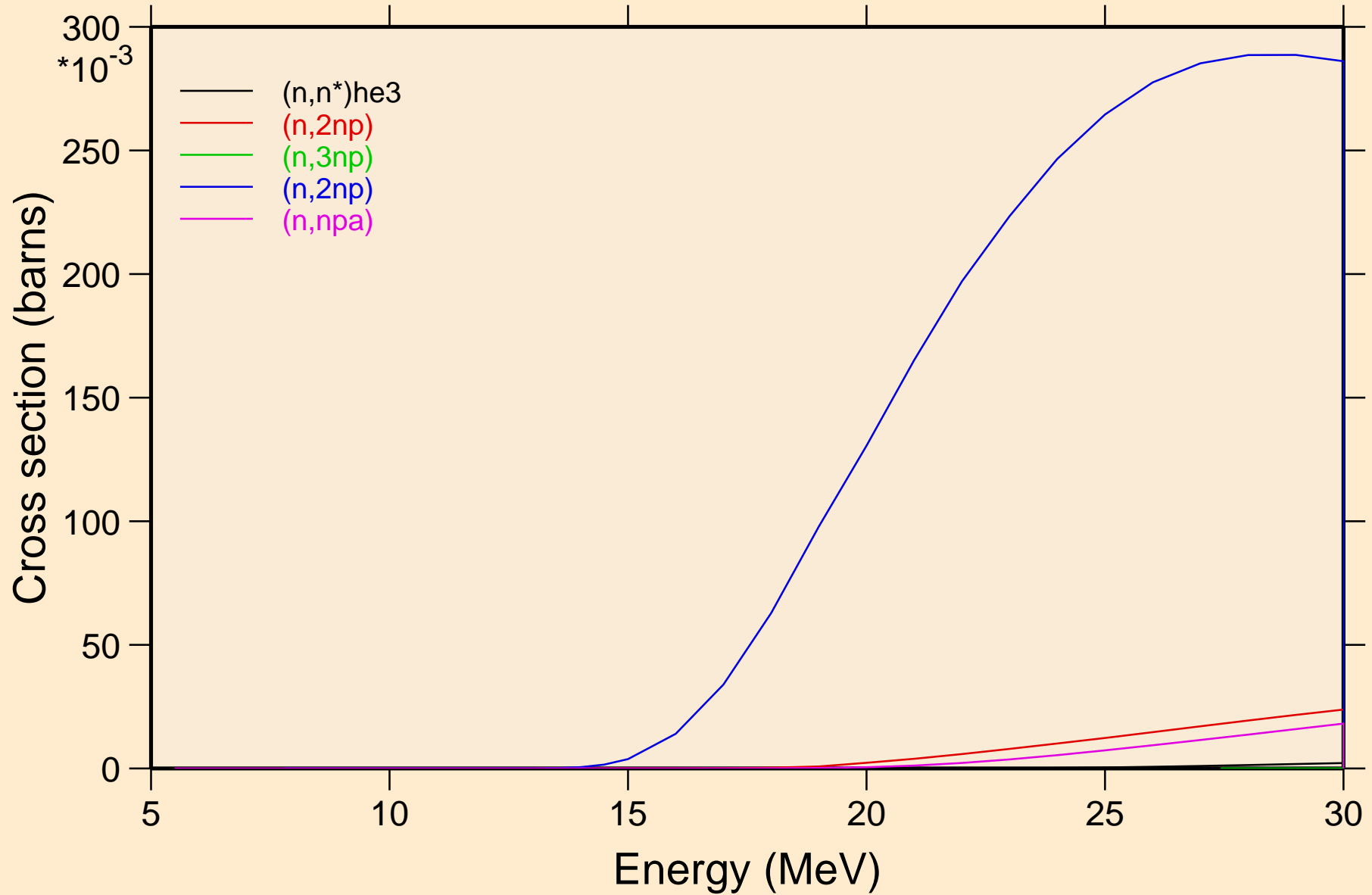

# NB084 NEUTRON ACER TENDL-2021 LIBRARY; T=293.6K

## Threshold reactions

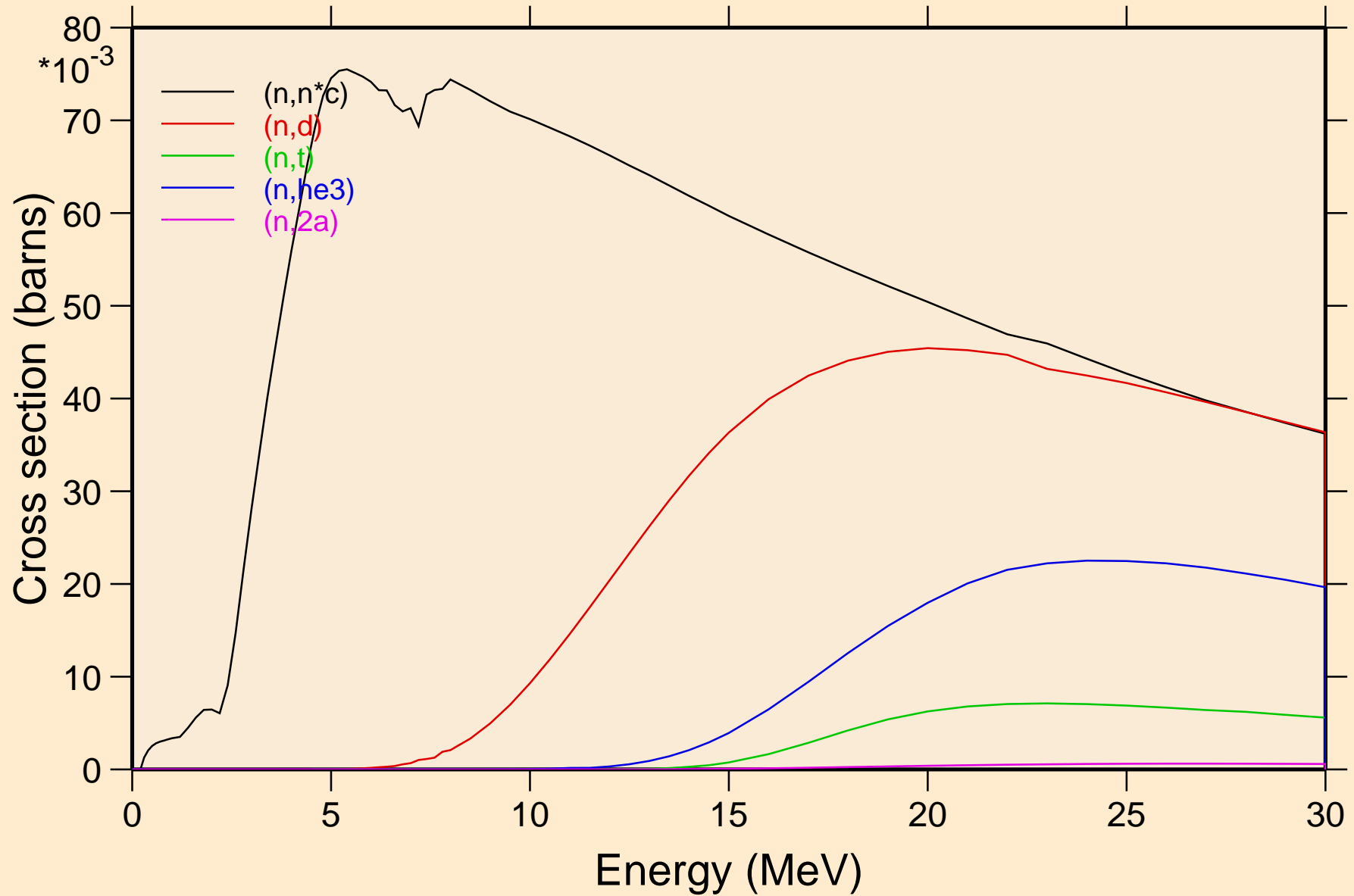

NB084 NEUTRON ACER TENDL-2021 LIBRARY; T=293.6K  
Threshold reactions

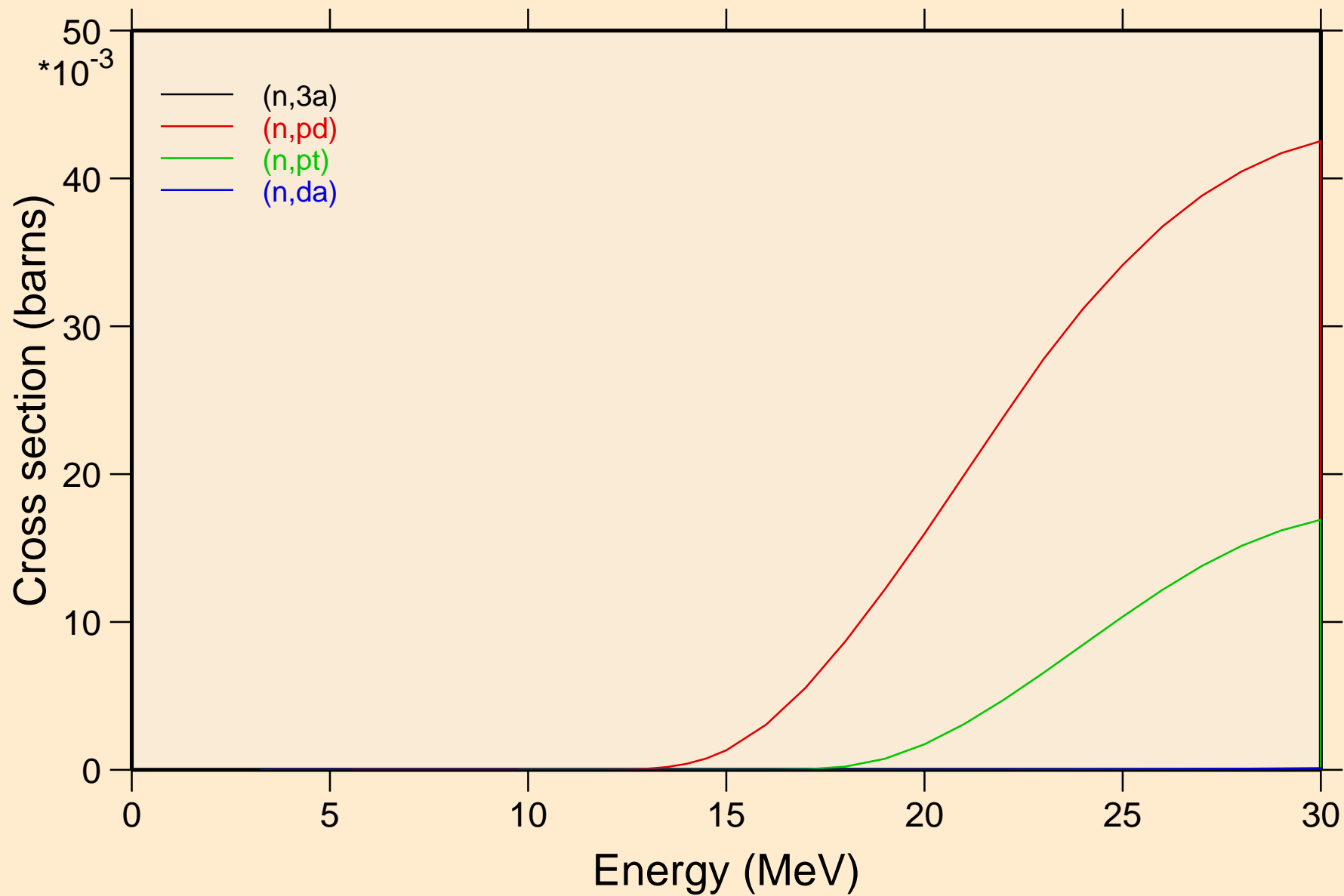

NB084 NEUTRON ACER TENDL-2021 LIBRARY; T=293.6K  
Threshold reactions

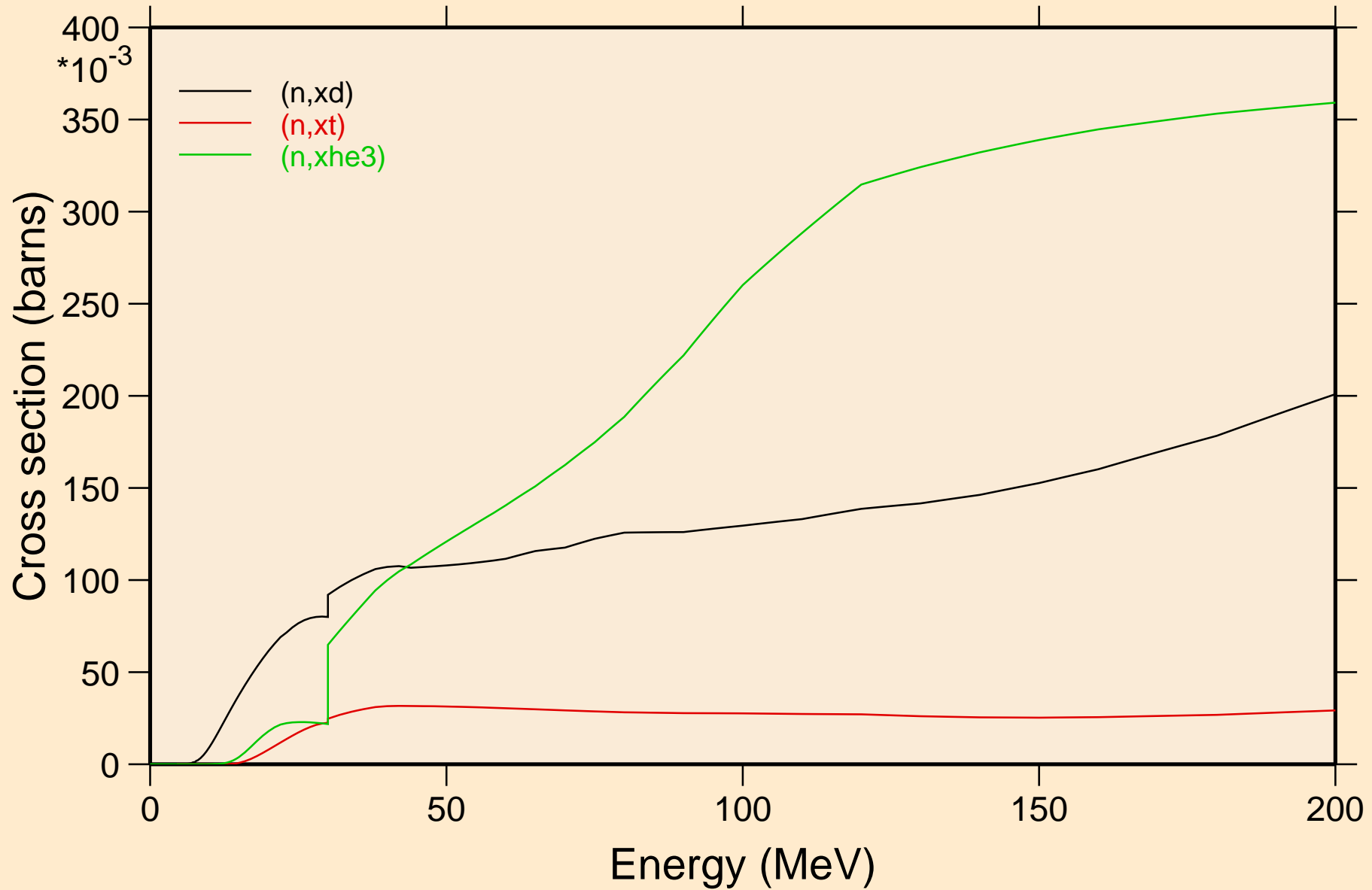

NB084 NEUTRON ACER TENDL-2021 LIBRARY; T=293.6K  
angular distribution for elastic

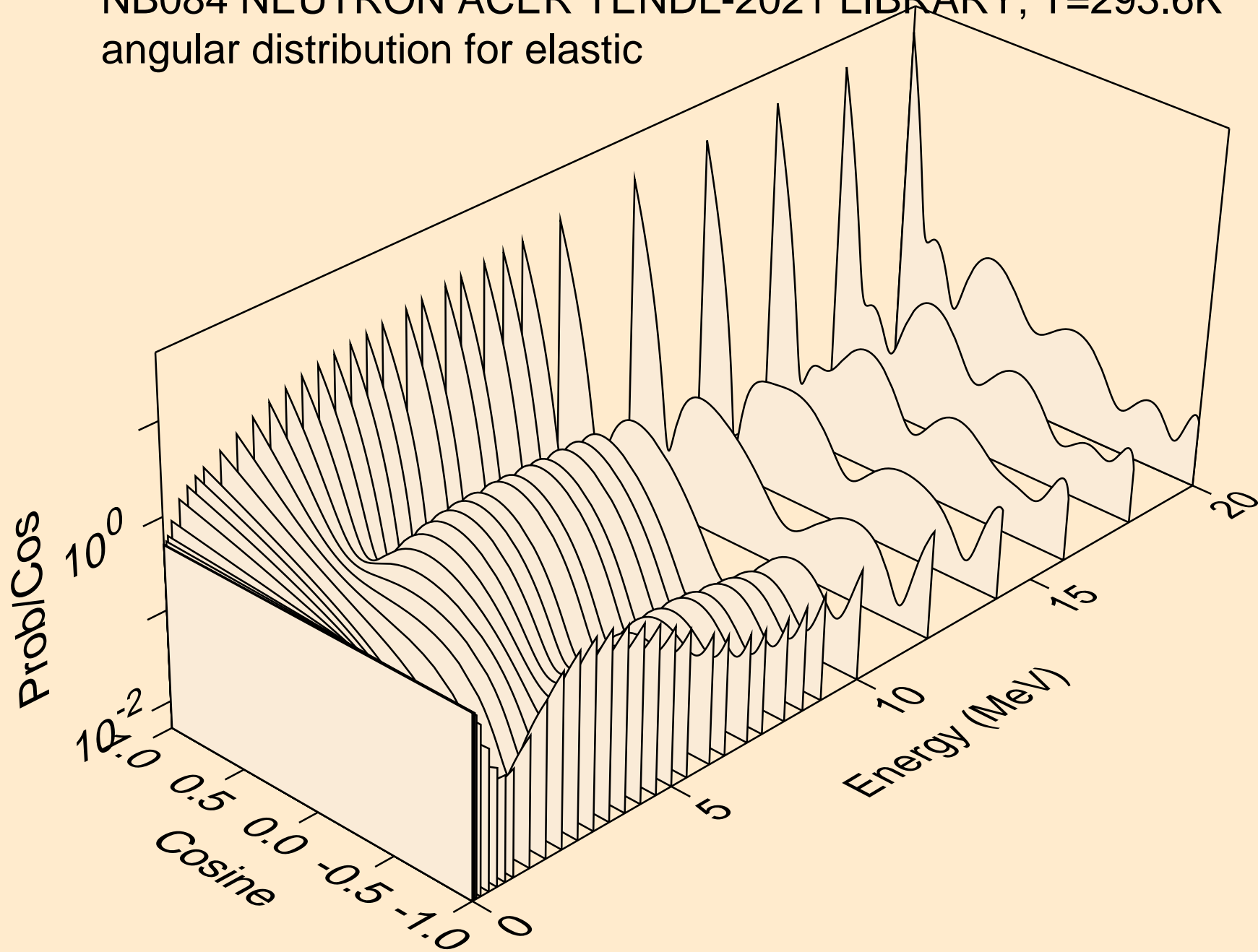

NB084 NEUTRON ACER TENDL-2021 LIBRARY; T=293.6K  
angular distribution for elastic

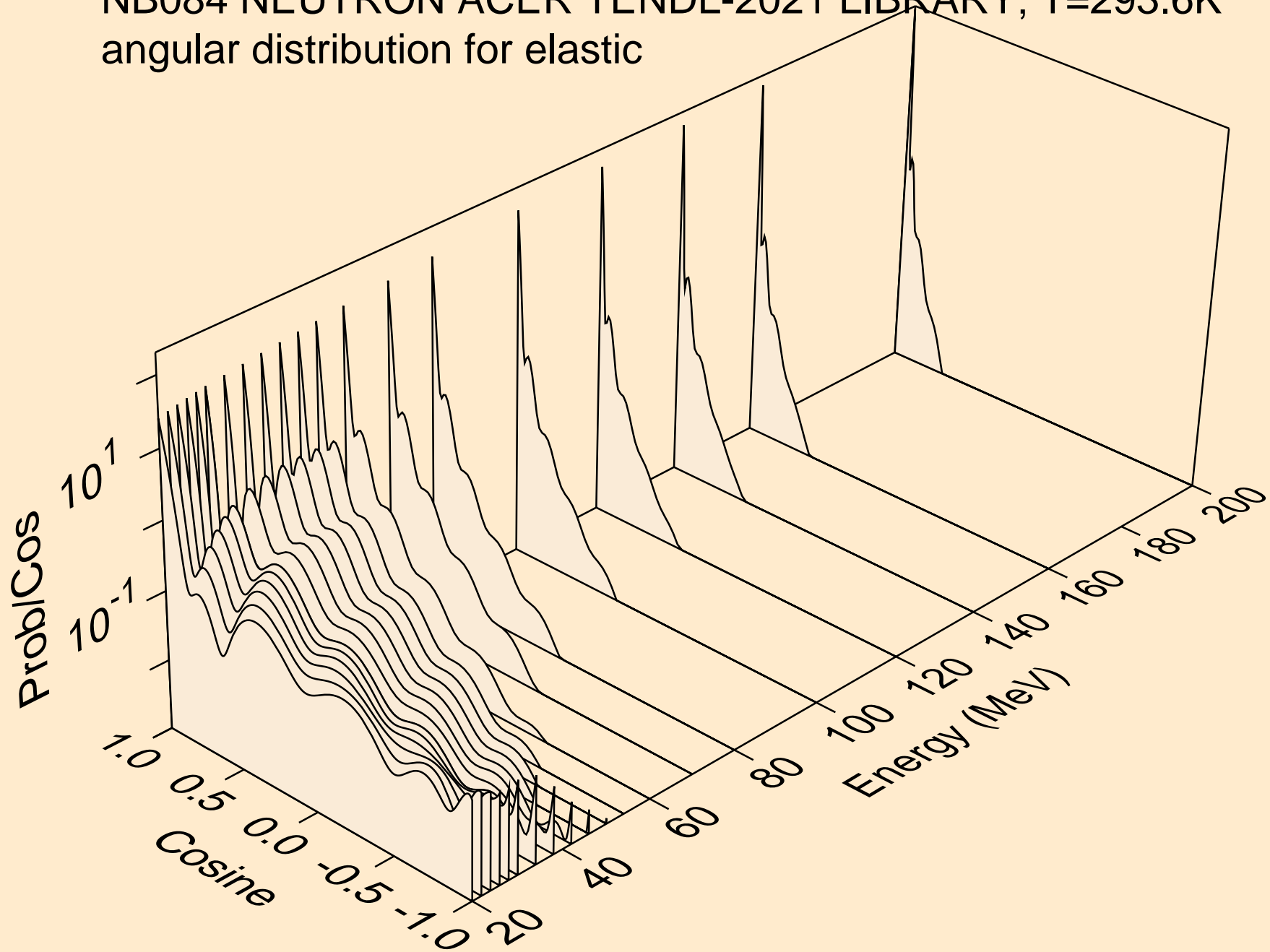

NB084 NEUTRON ACER TENDL-2021 LIBRARY; T=293.6K  
angular distribution for (n,n\*1)

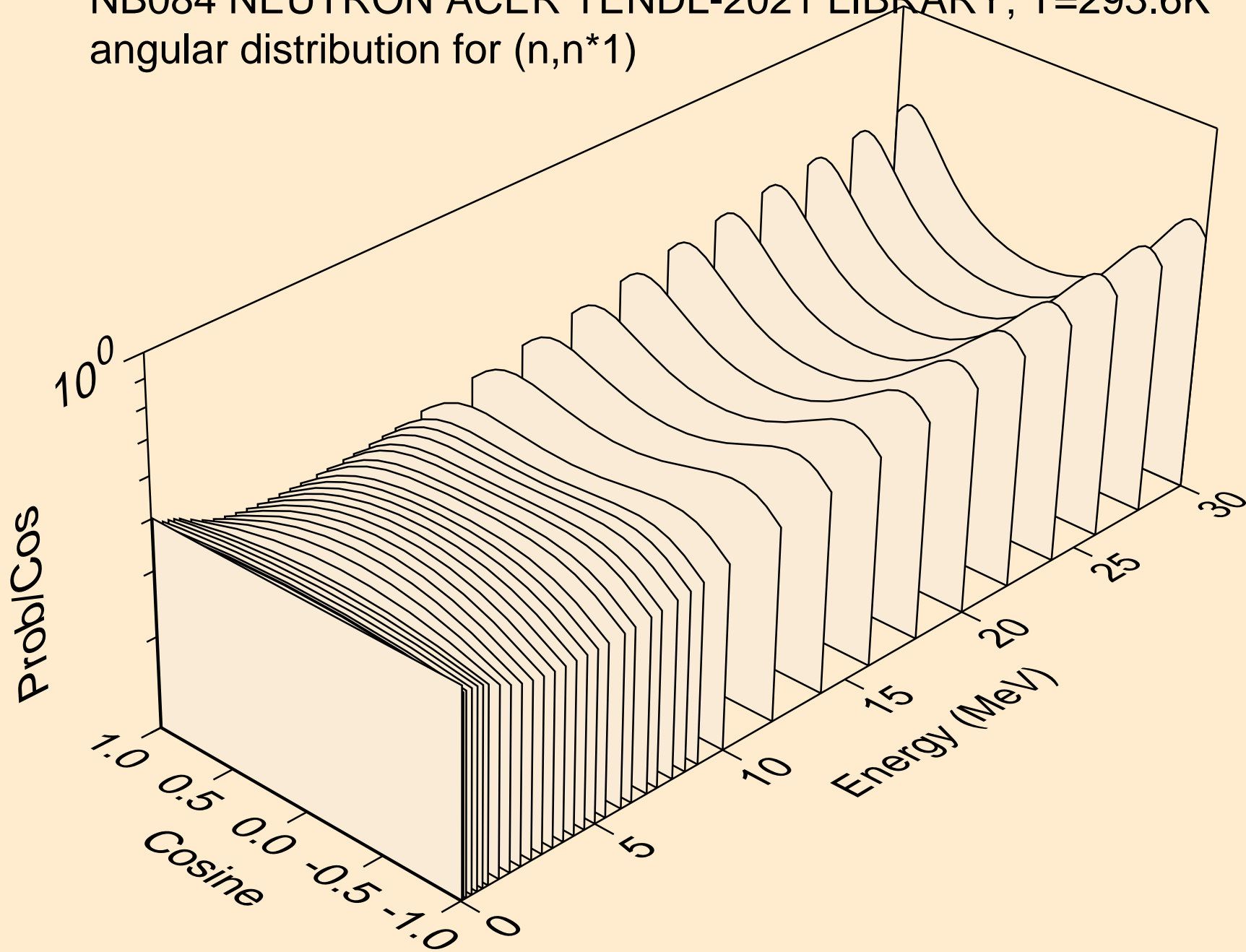

NB084 NEUTRON ACER TENDL-2021 LIBRARY; T=293.6K  
angular distribution for (n,n\*2)

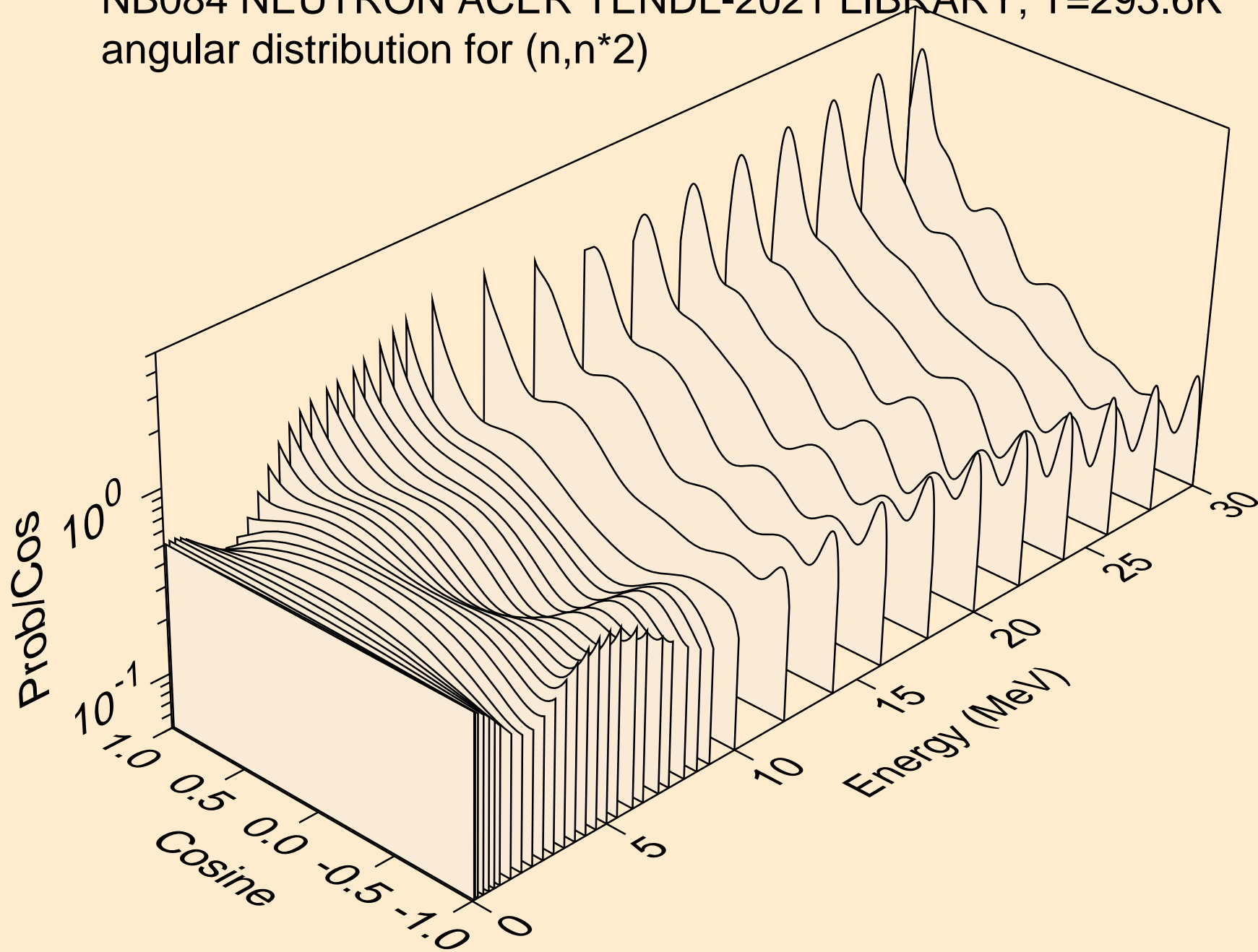

NB084 NEUTRON ACER TENDL-2021 LIBRARY; T=293.6K  
angular distribution for (n,n\*3)

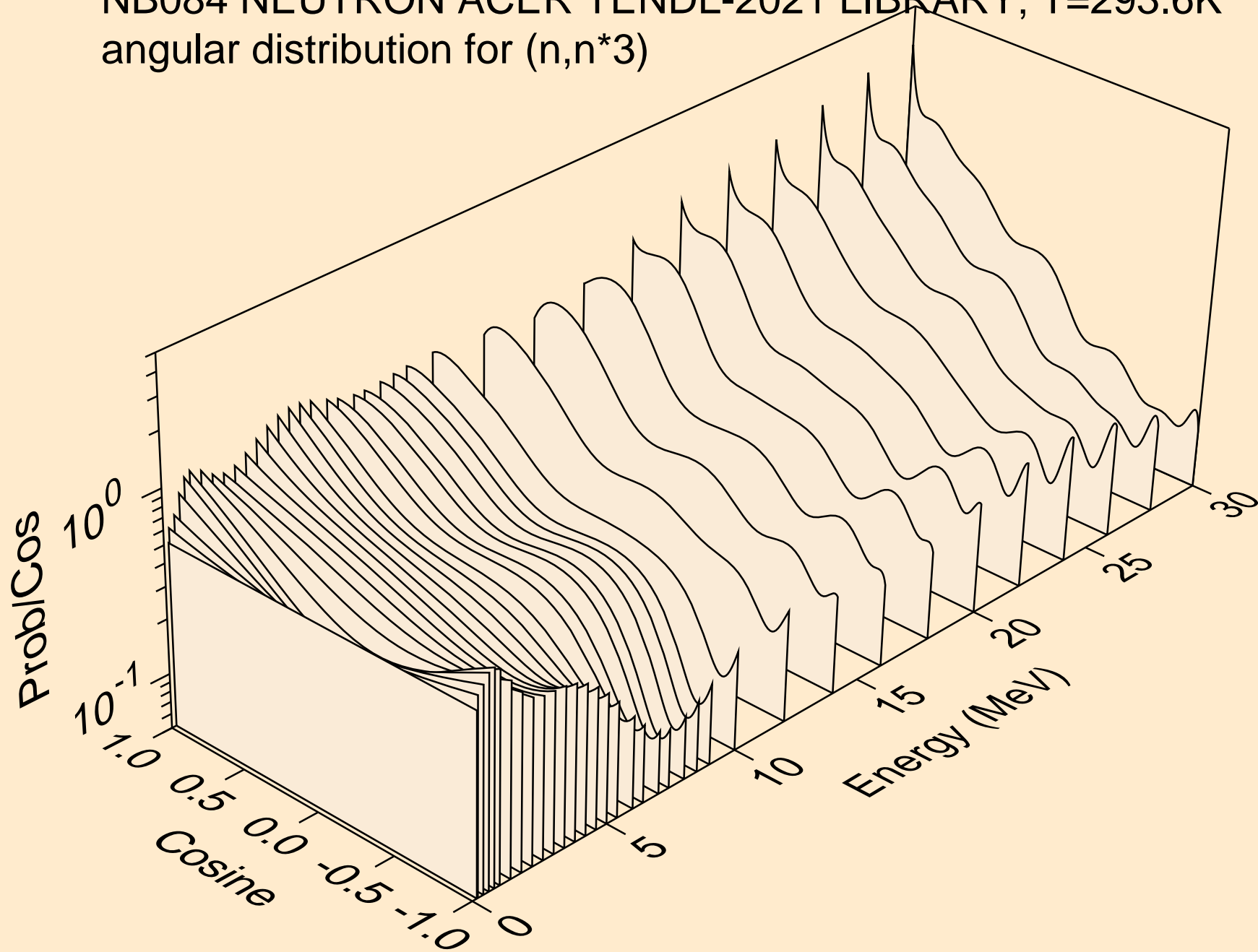

NB084 NEUTRON ACER TENDL-2021 LIBRARY; T=293.6K  
angular distribution for (n,n\*4)

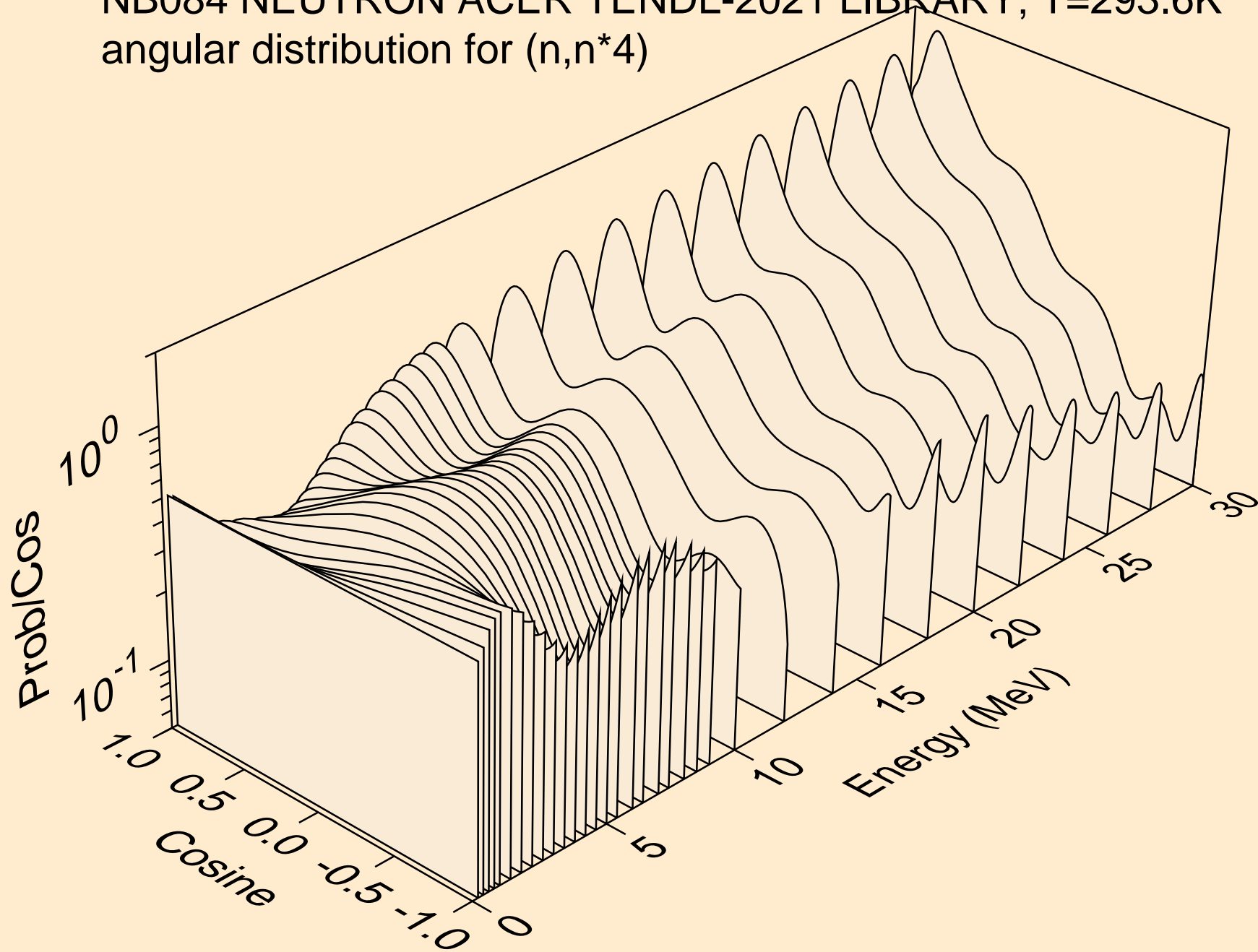

NB084 NEUTRON ACER TENDL-2021 LIBRARY; T=293.6K  
Neutron emission for (n,x)

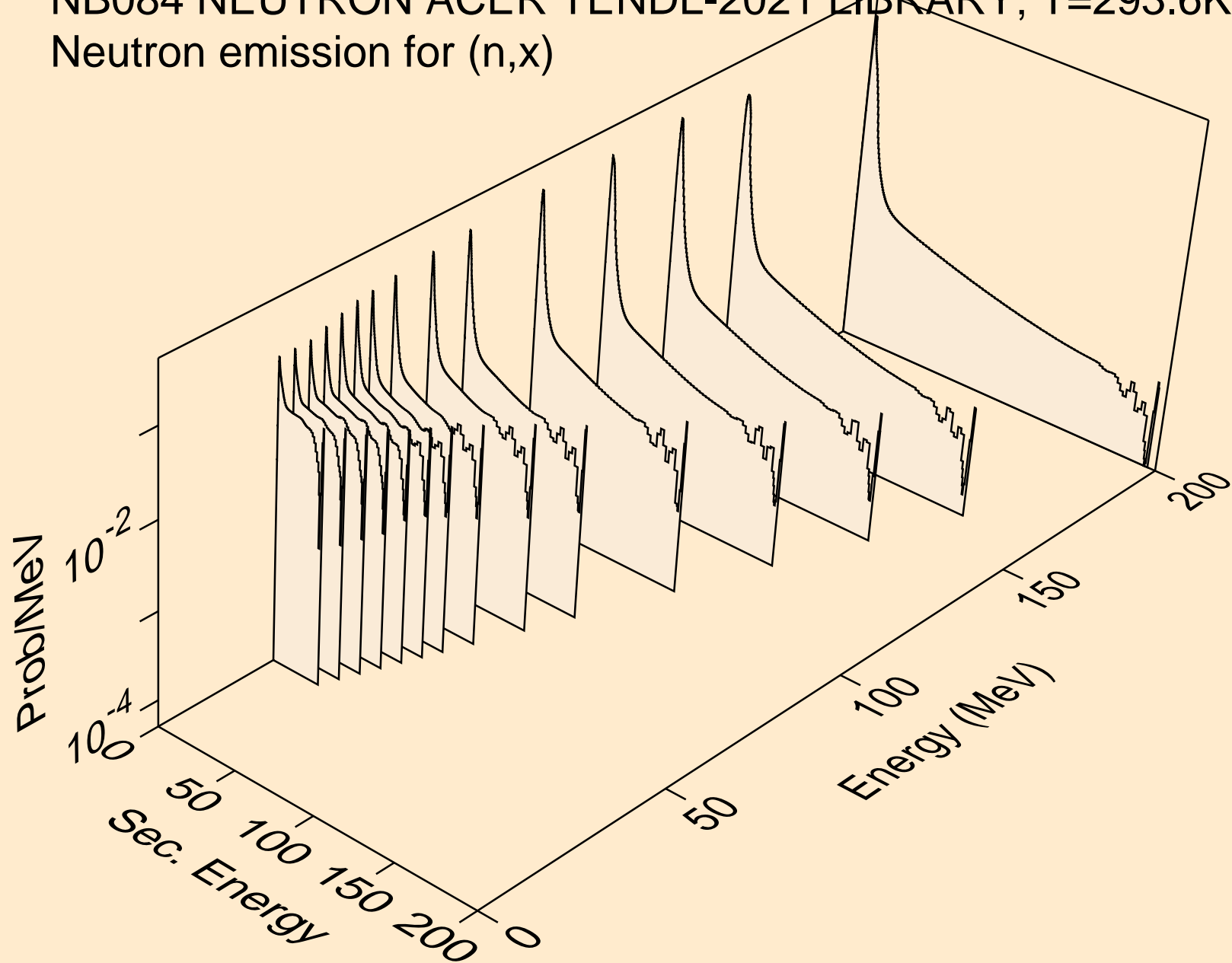

NB084 NEUTRON ACER TENDL-2021 LIBRARY; T=293.6K  
Neutron emission for (n,2nd)

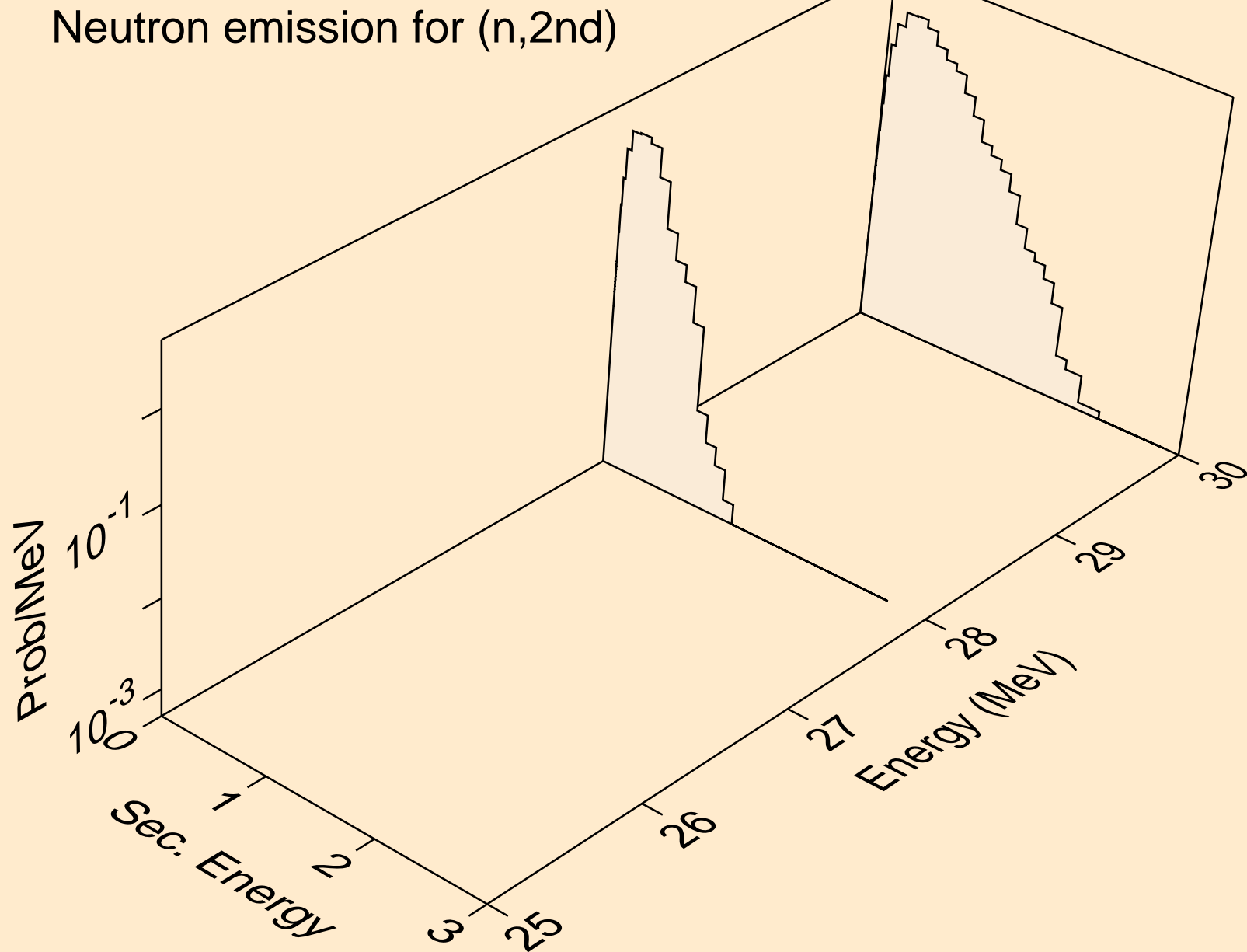

NB084 NEUTRON ACER TENDL-2021 LIBRARY; T=293.6K  
Neutron emission for (n,2n)

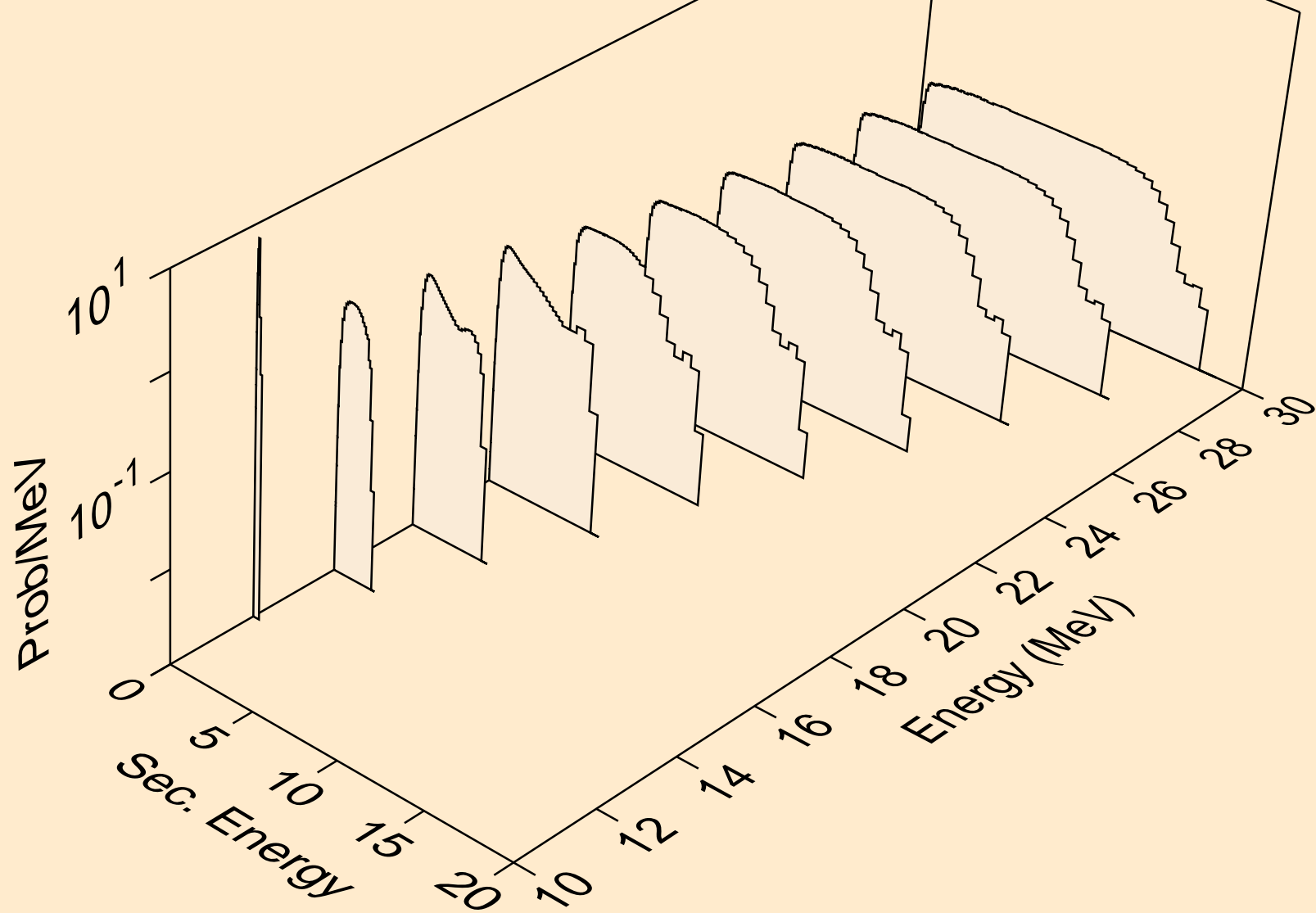

NB084 NEUTRON ACER TENDL-2021 LIBRARY; T=293.6K  
Neutron emission for (n,3n)

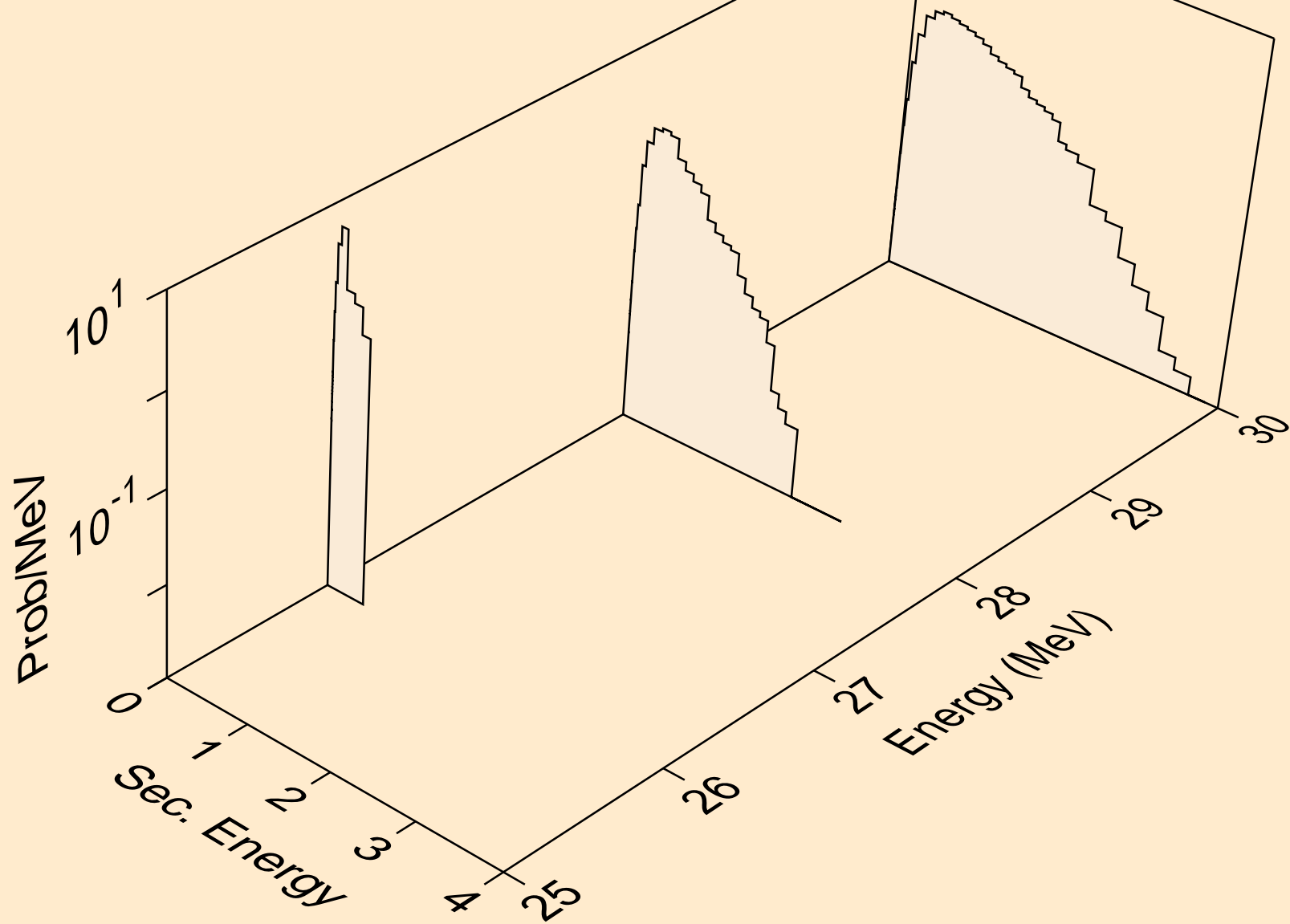

NB084 NEUTRON ACER TENDL-2021 LIBRARY; T=293.6K  
Neutron emission for (n,n\*)a

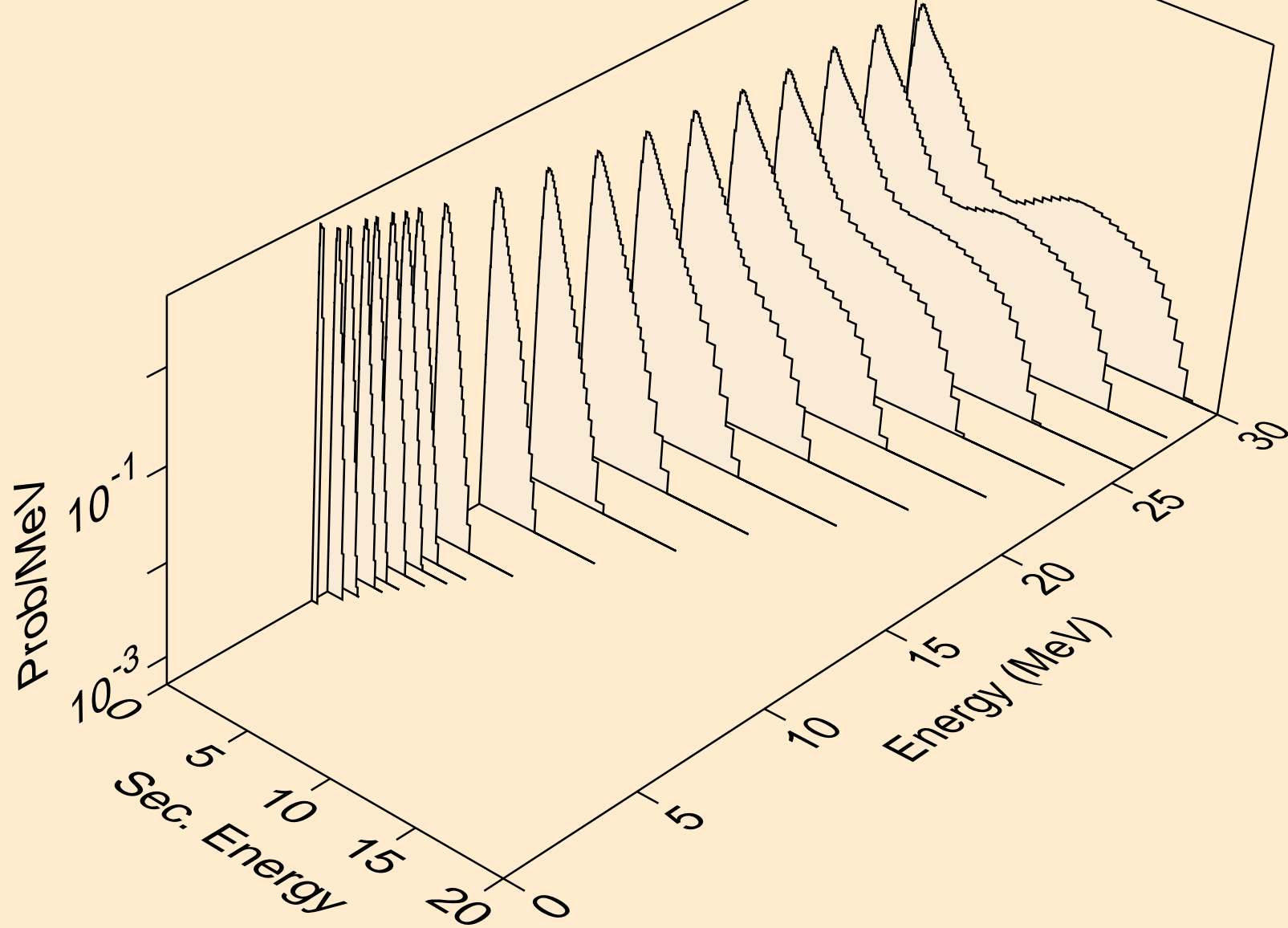

NB084 NEUTRON ACER TENDL-2021 LIBRARY; T=293.6K  
Neutron emission for (n,2n)<sub>a</sub>

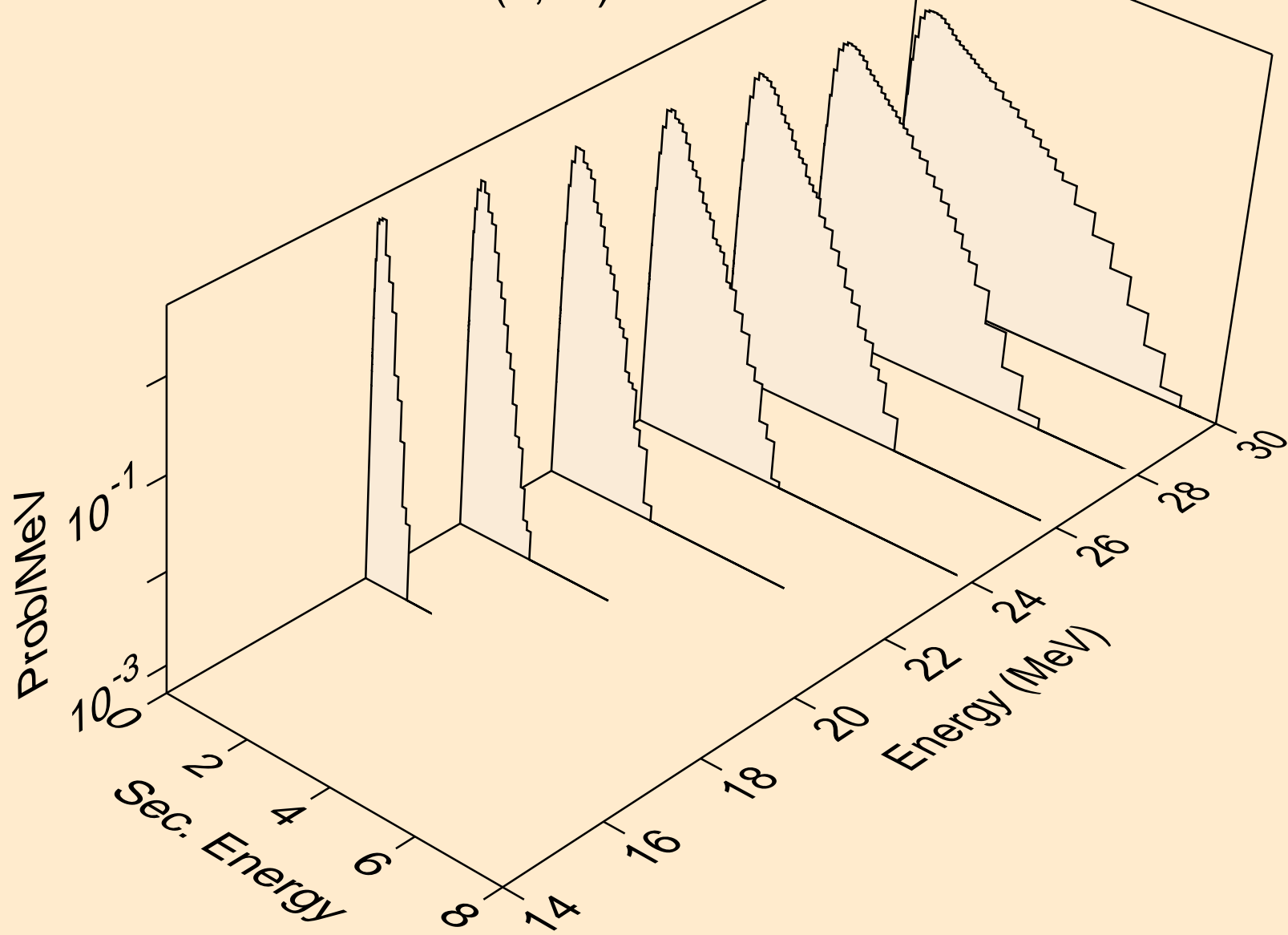

NB084 NEUTRON ACER TENDL-2021 LIBRARY; T=293.6K  
Neutron emission for (n,n\*)p

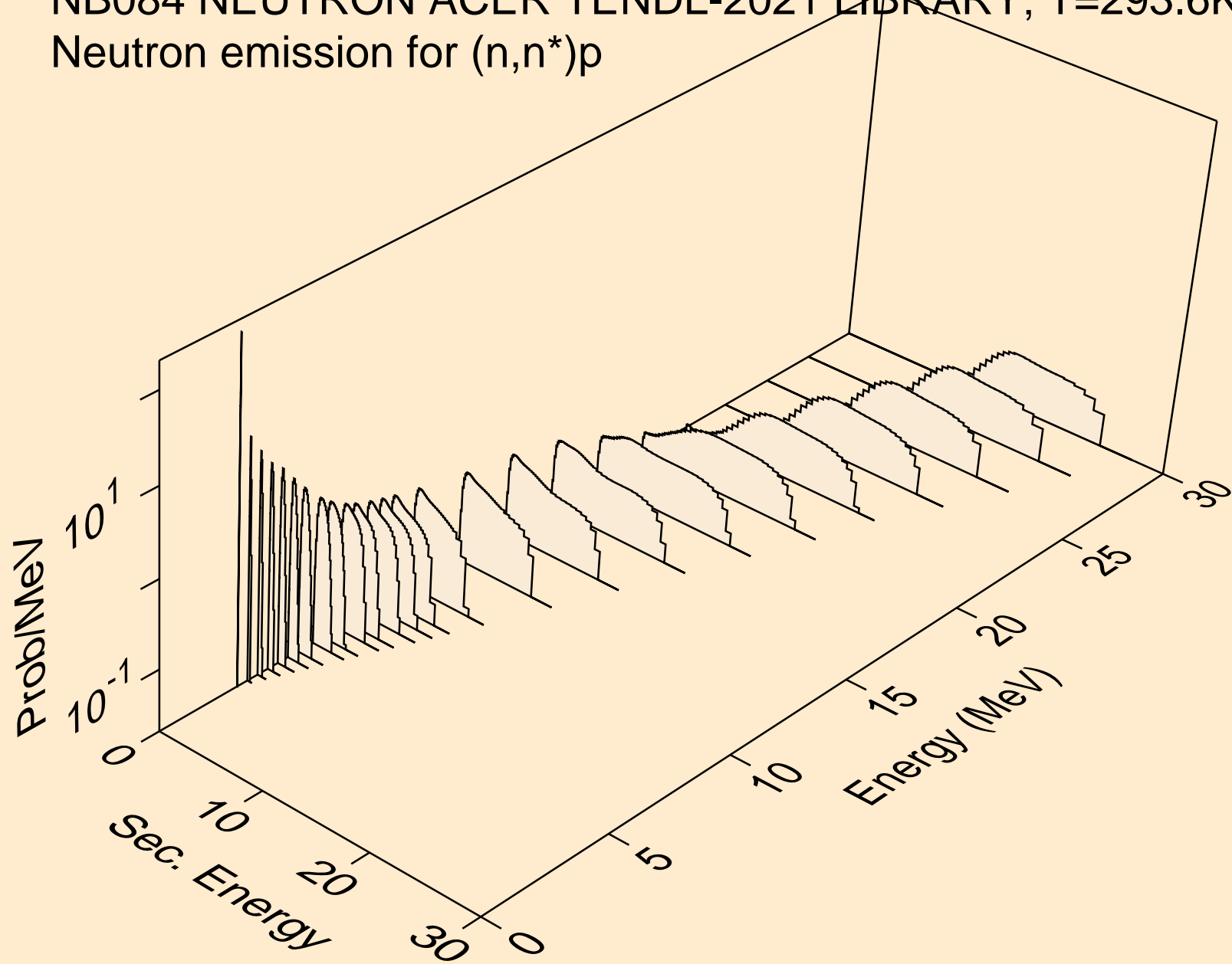

NB084 NEUTRON ACER TENDL-2021 LIBRARY; T=293.6K  
Neutron emission for (n,n\*)2a

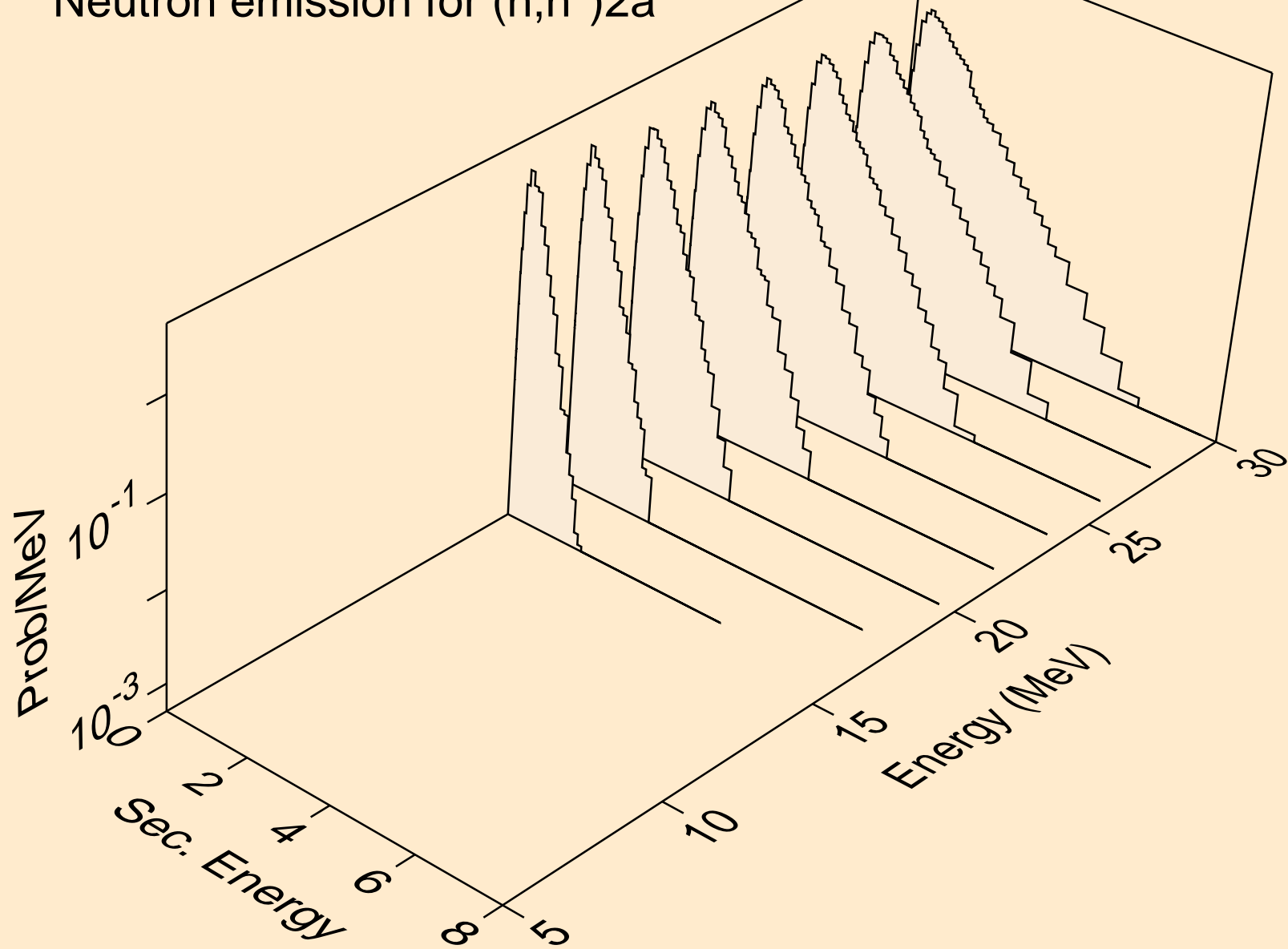

NB084 NEUTRON ACER TENDL-2021 LIBRARY; T=293.6K  
Neutron emission for (n,n\*)d

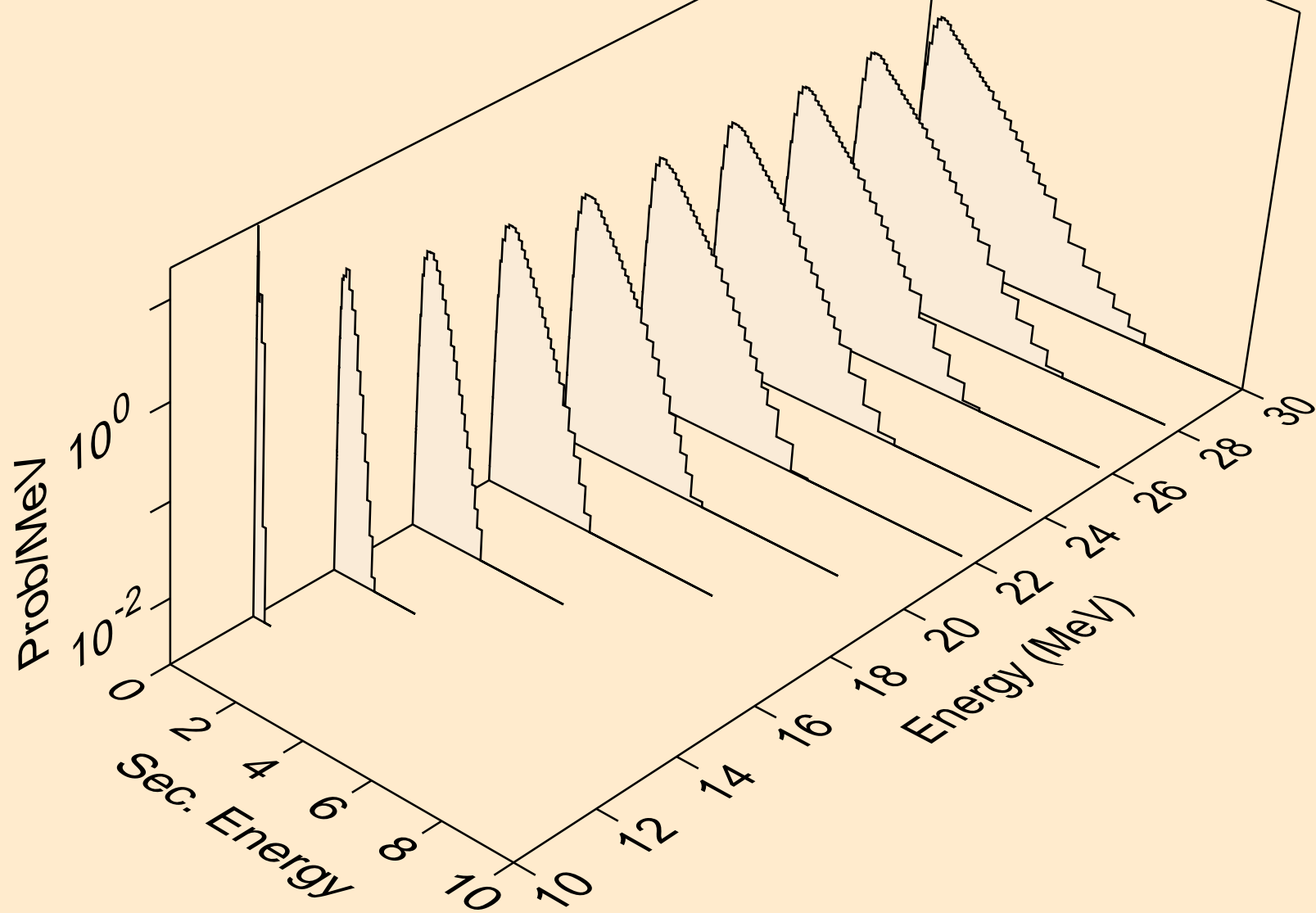

NB084 NEUTRON ACER TENDL-2021 LIBRARY; T=293.6K  
Neutron emission for (n,n\*)t

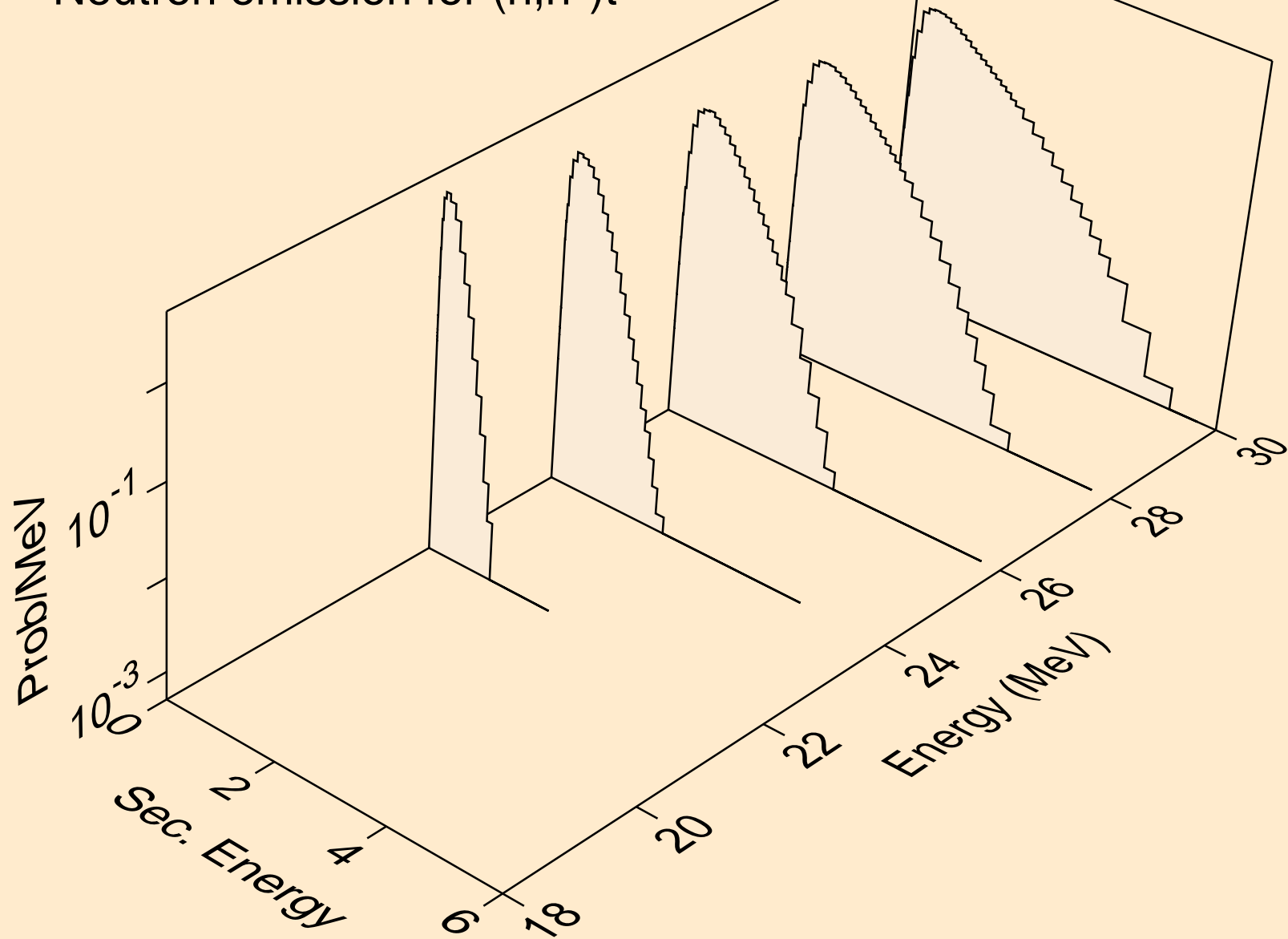

NB084 NEUTRON ACER TENDL-2021 LIBRARY; T=293.6K  
Neutron emission for (n,n\*)he3

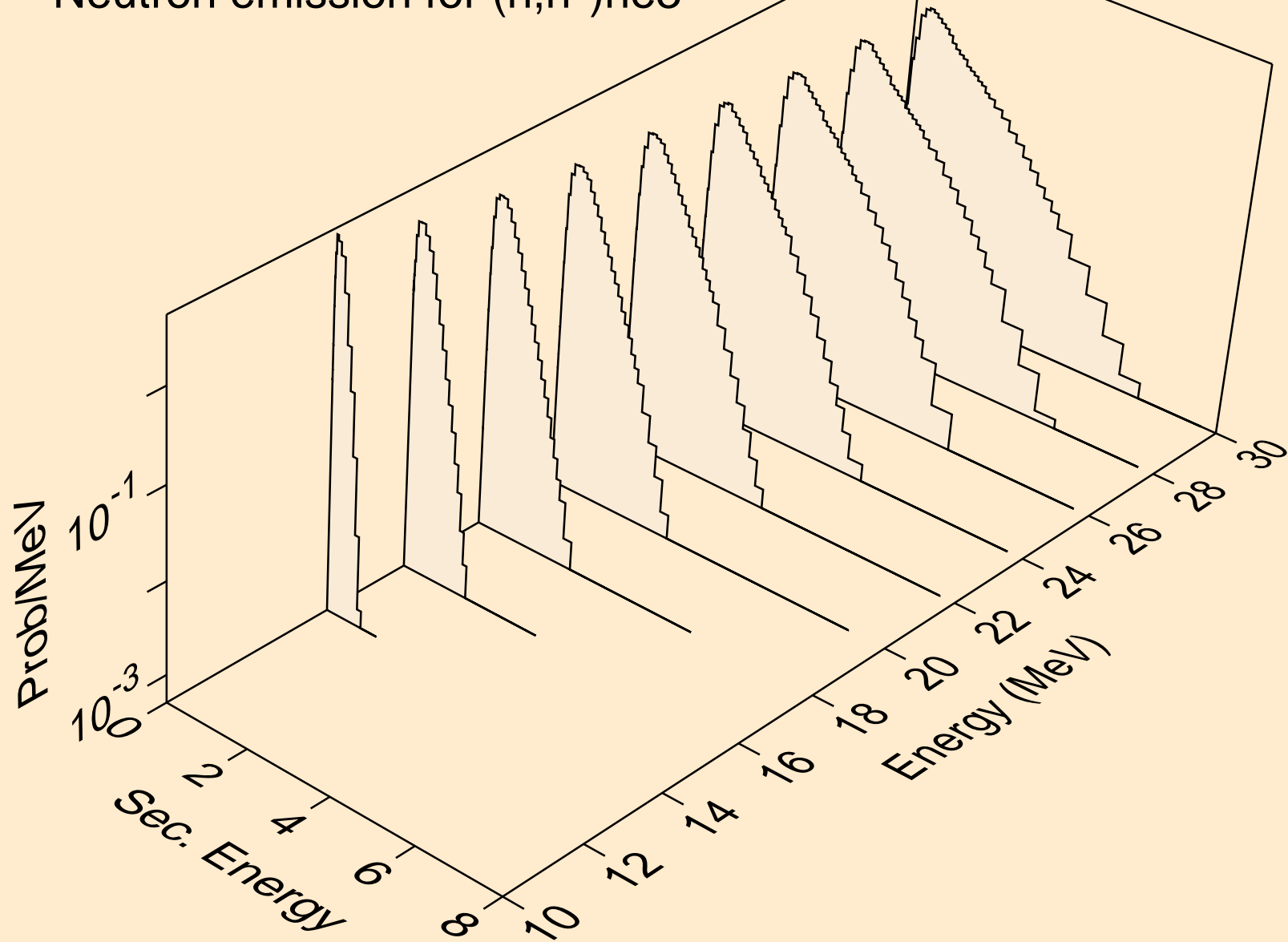

NB084 NEUTRON ACER TENDL-2021 LIBRARY; T=293.6K  
Neutron emission for (n,2np)

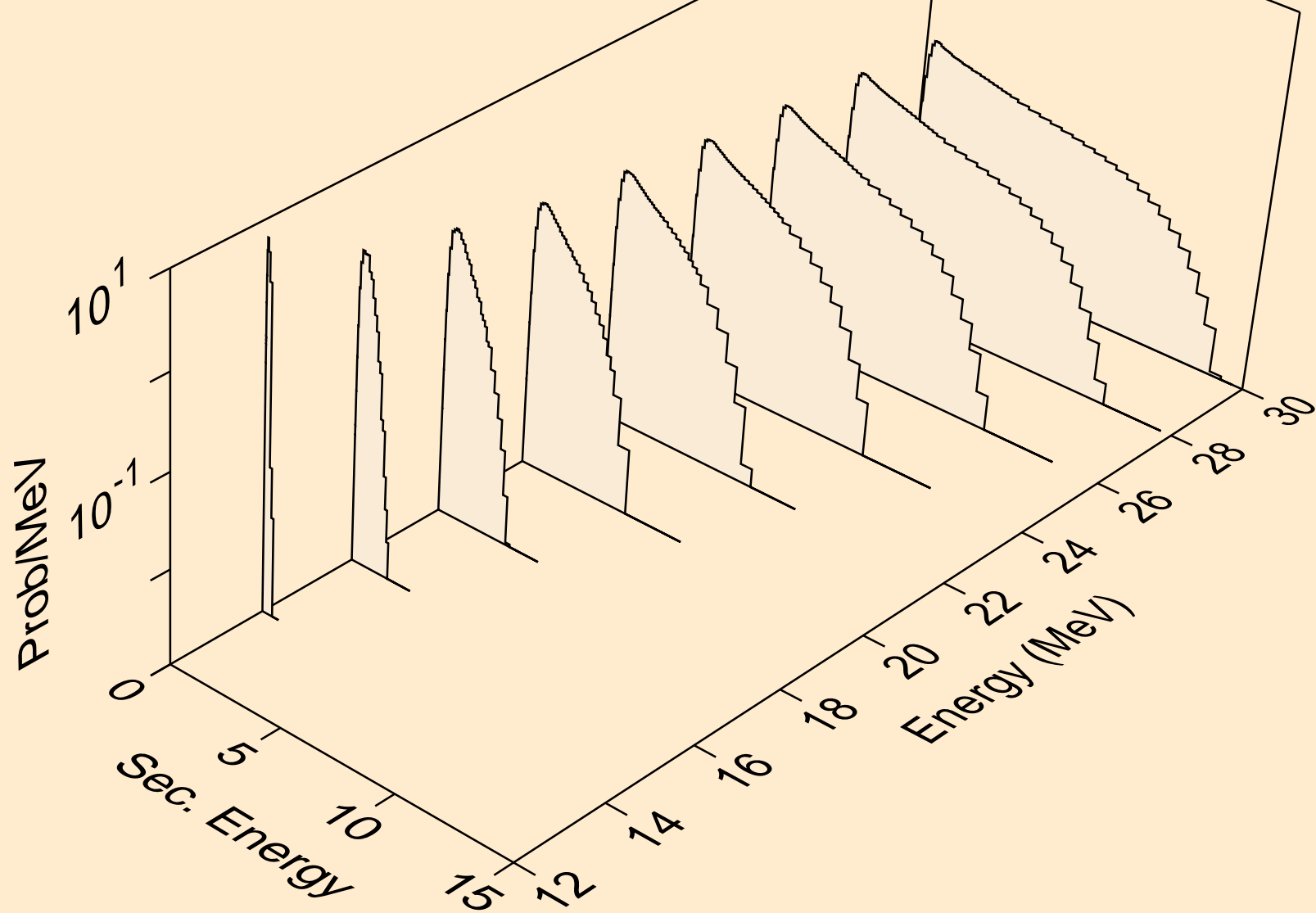

NB084 NEUTRON ACER TENDL-2021 LIBRARY; T=293.6K  
Neutron emission for (n,3np)

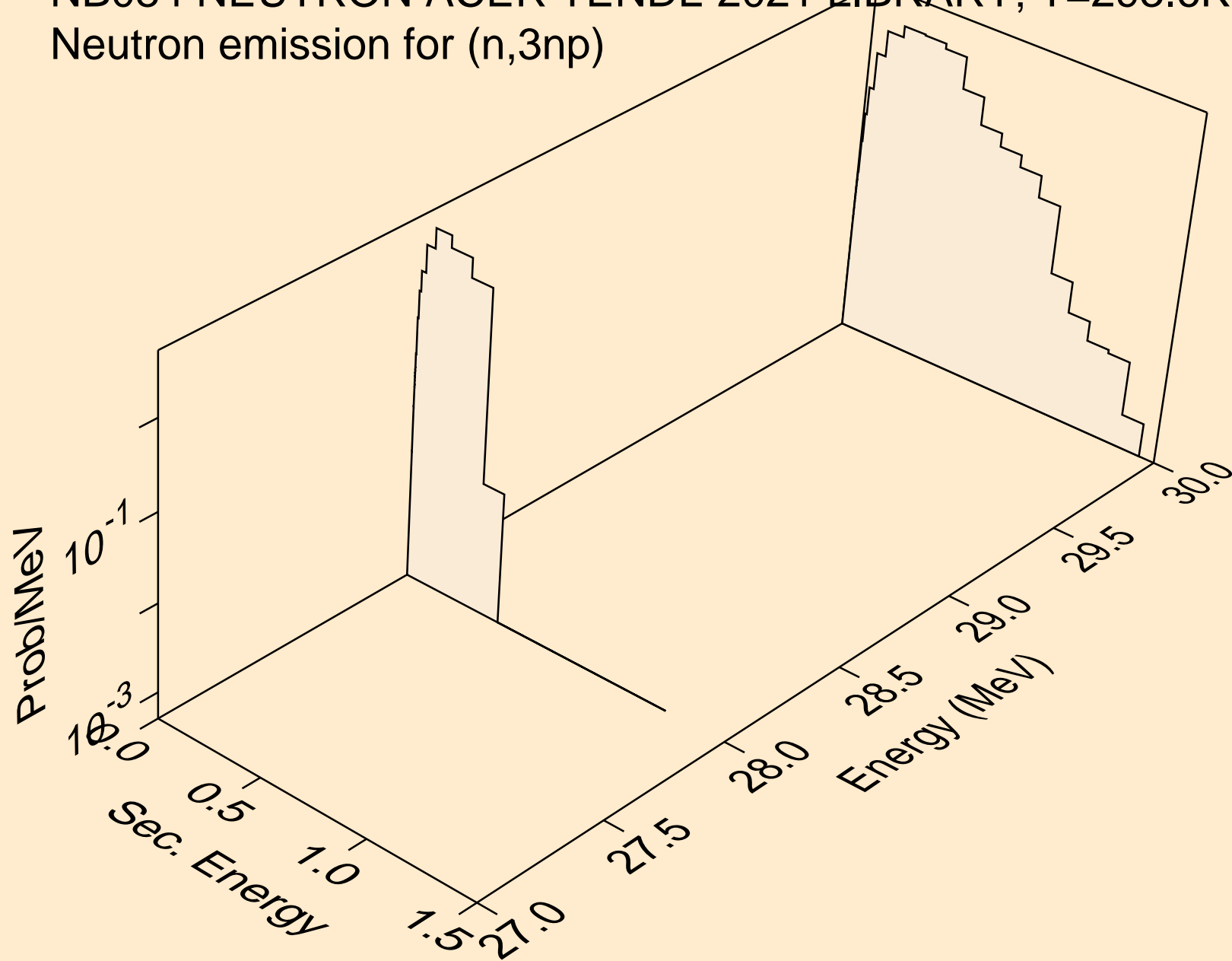

NB084 NEUTRON ACER TENDL-2021 LIBRARY; T=293.6K  
Neutron emission for (n,2np)

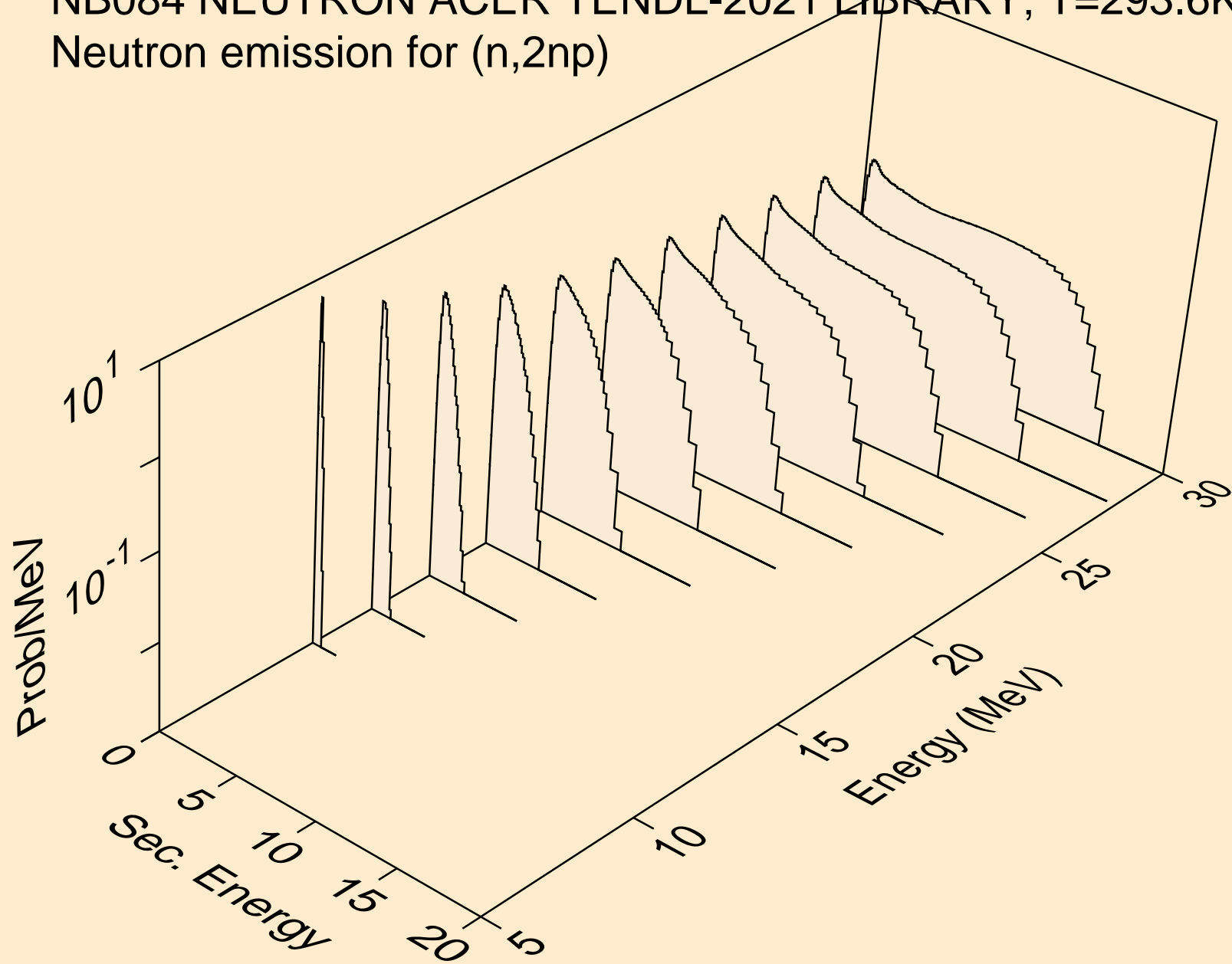

NB084 NEUTRON ACER TENDL-2021 LIBRARY; T=293.6K  
Neutron emission for (n,npa)

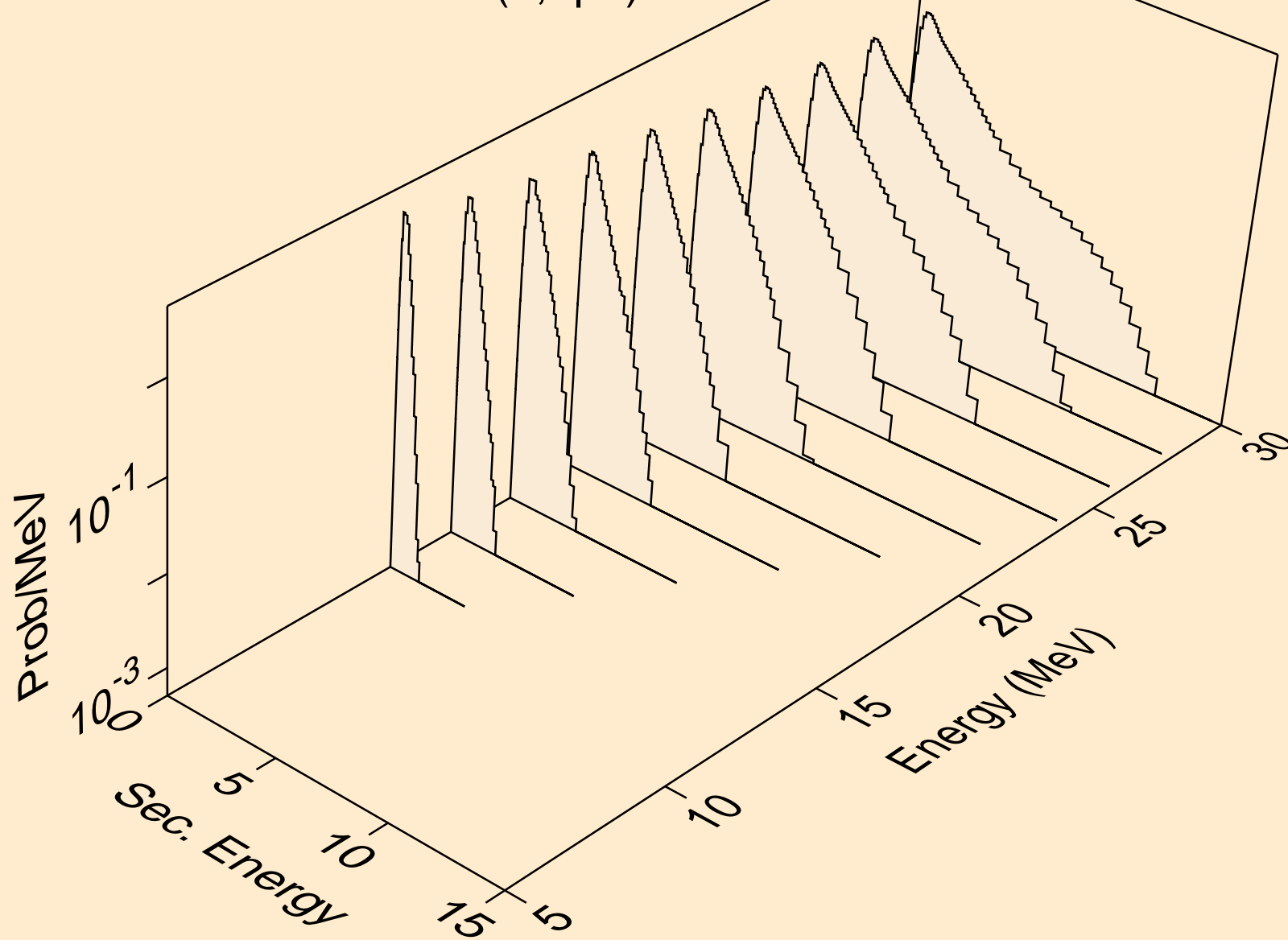

NB084 NEUTRON ACER TENDL-2021 LIBRARY; T=293.6K  
Neutron emission for (n,n\*c)

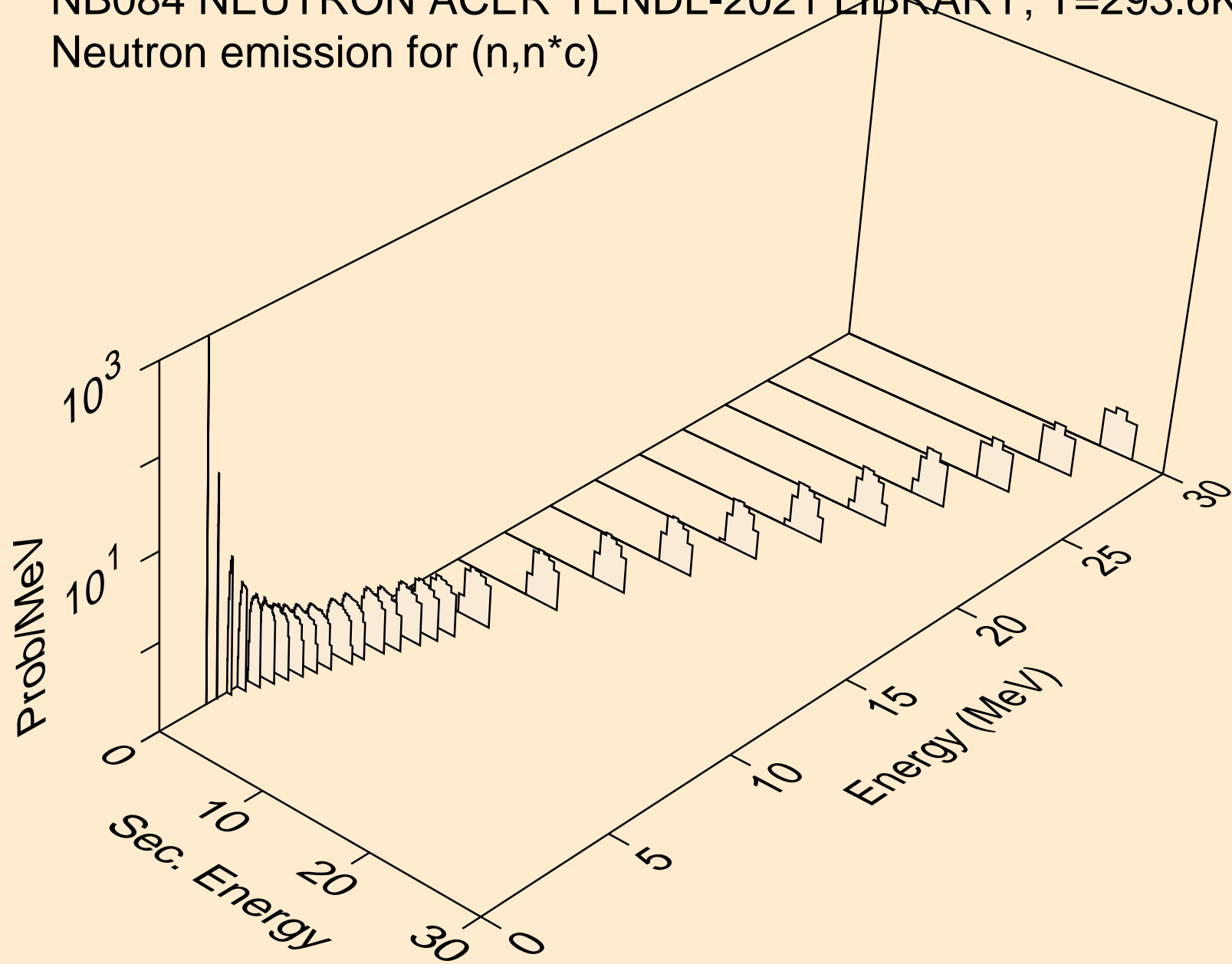

NB084 NEUTRON ACER TENDL-2021 LIBRARY; T=293.6K  
Photon emission for (n,x)

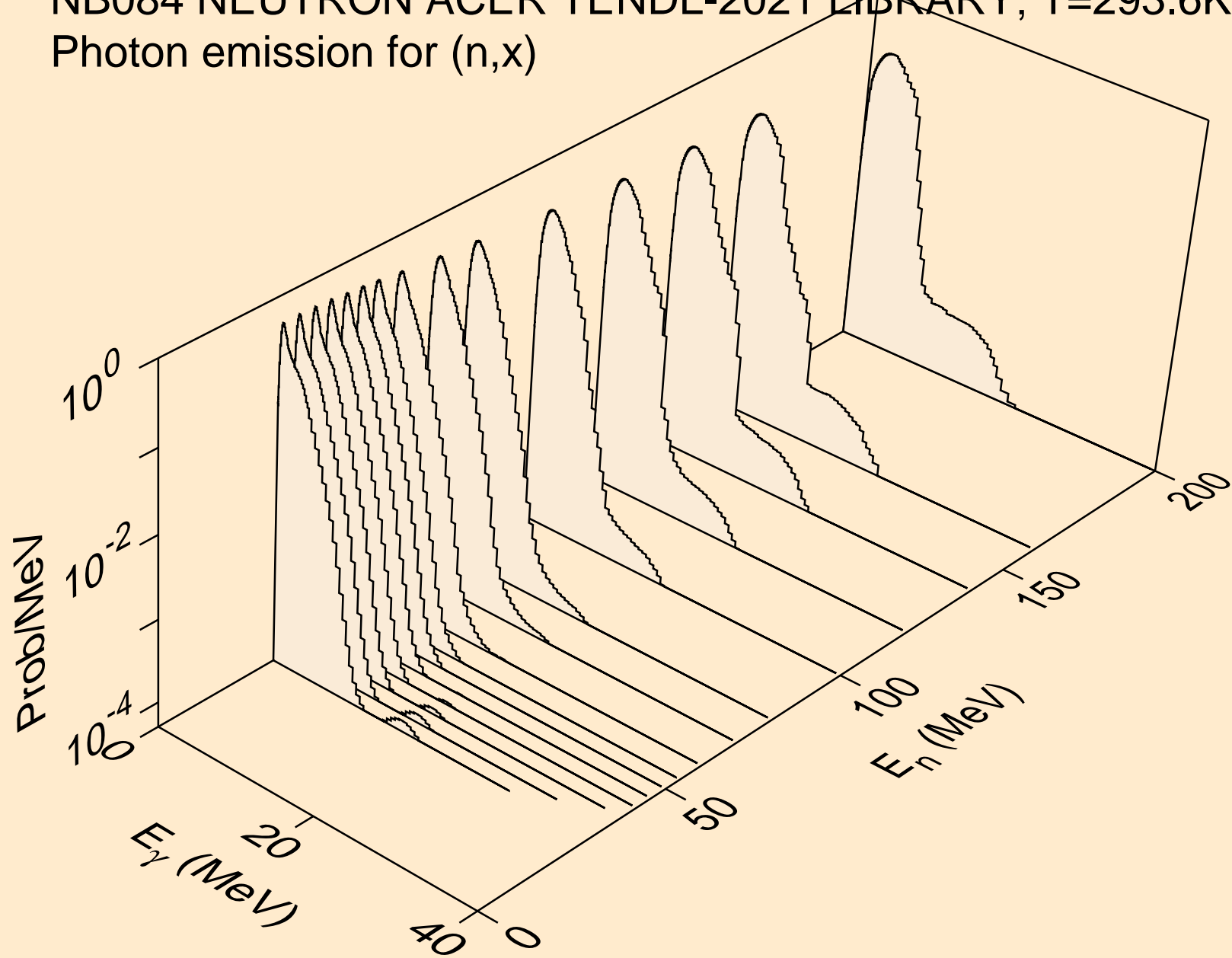

NB084 NEUTRON ACER TENDL-2021 LIBRARY; T=293.6K  
Photon emission for (n,2nd)

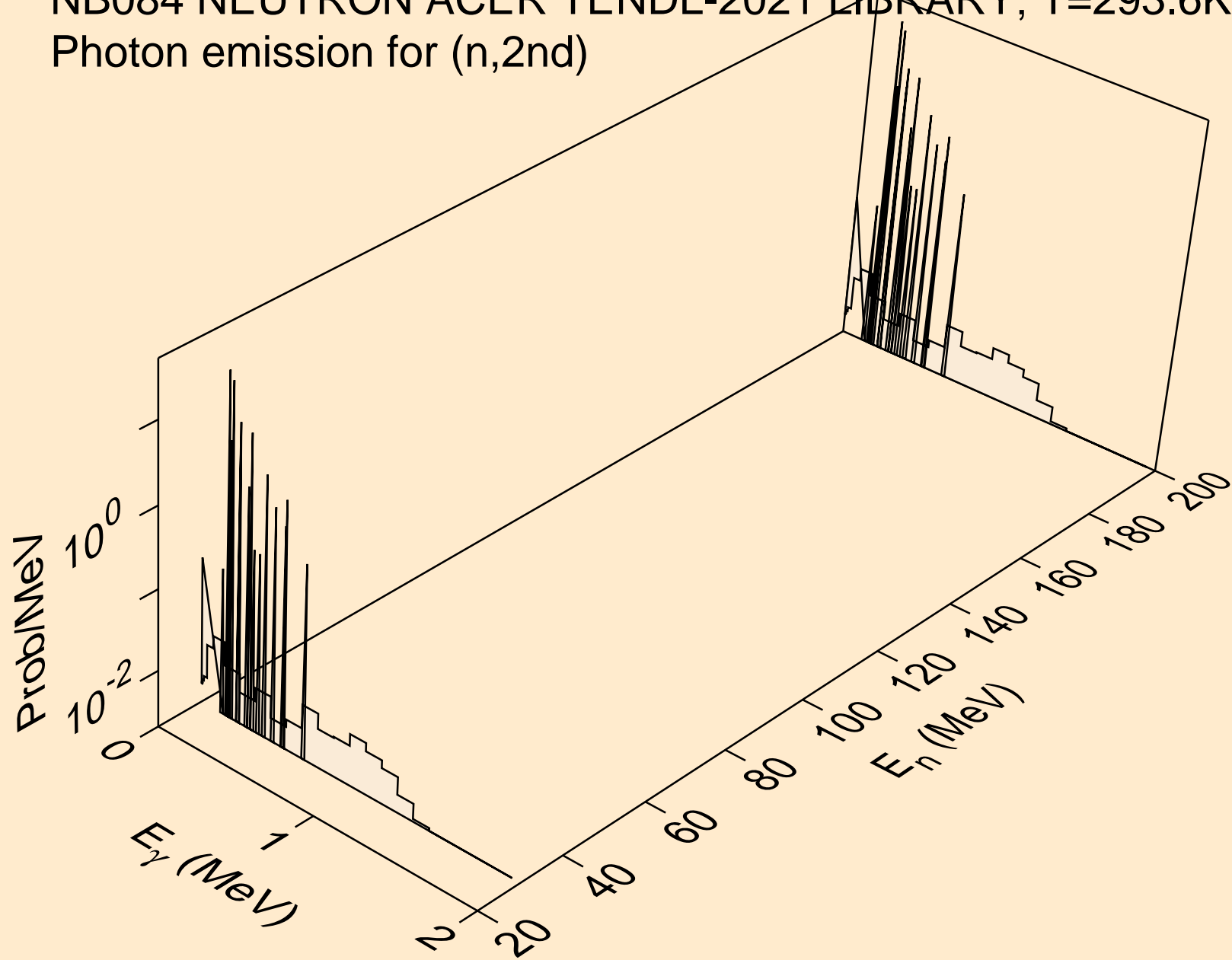

NB084 NEUTRON ACER TENDL-2021 LIBRARY; T=293.6K  
Photon emission for (n,2n)

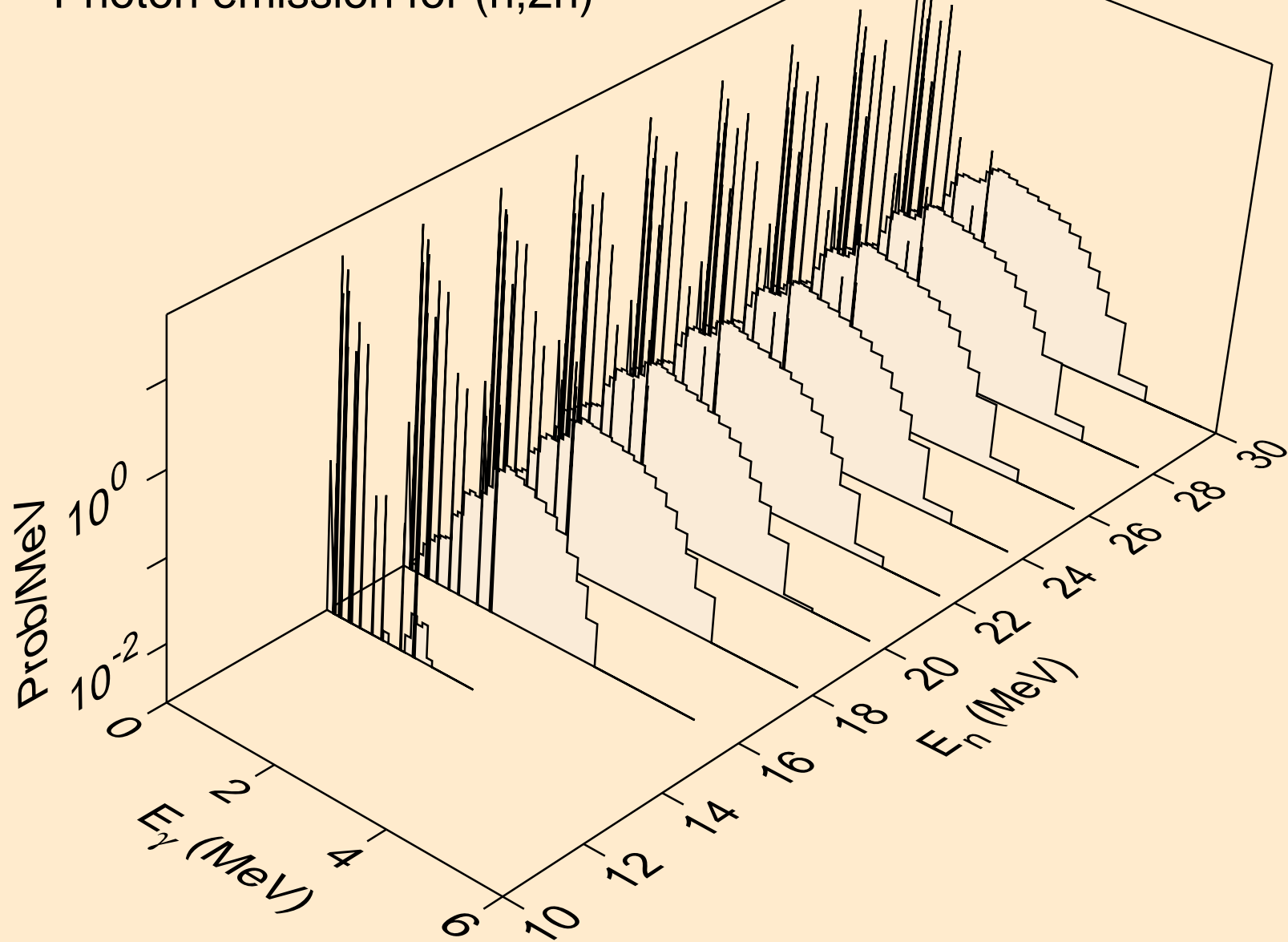

NB084 NEUTRON ACER TENDL-2021 LIBRARY; T=293.6K  
Photon emission for (n,3n)

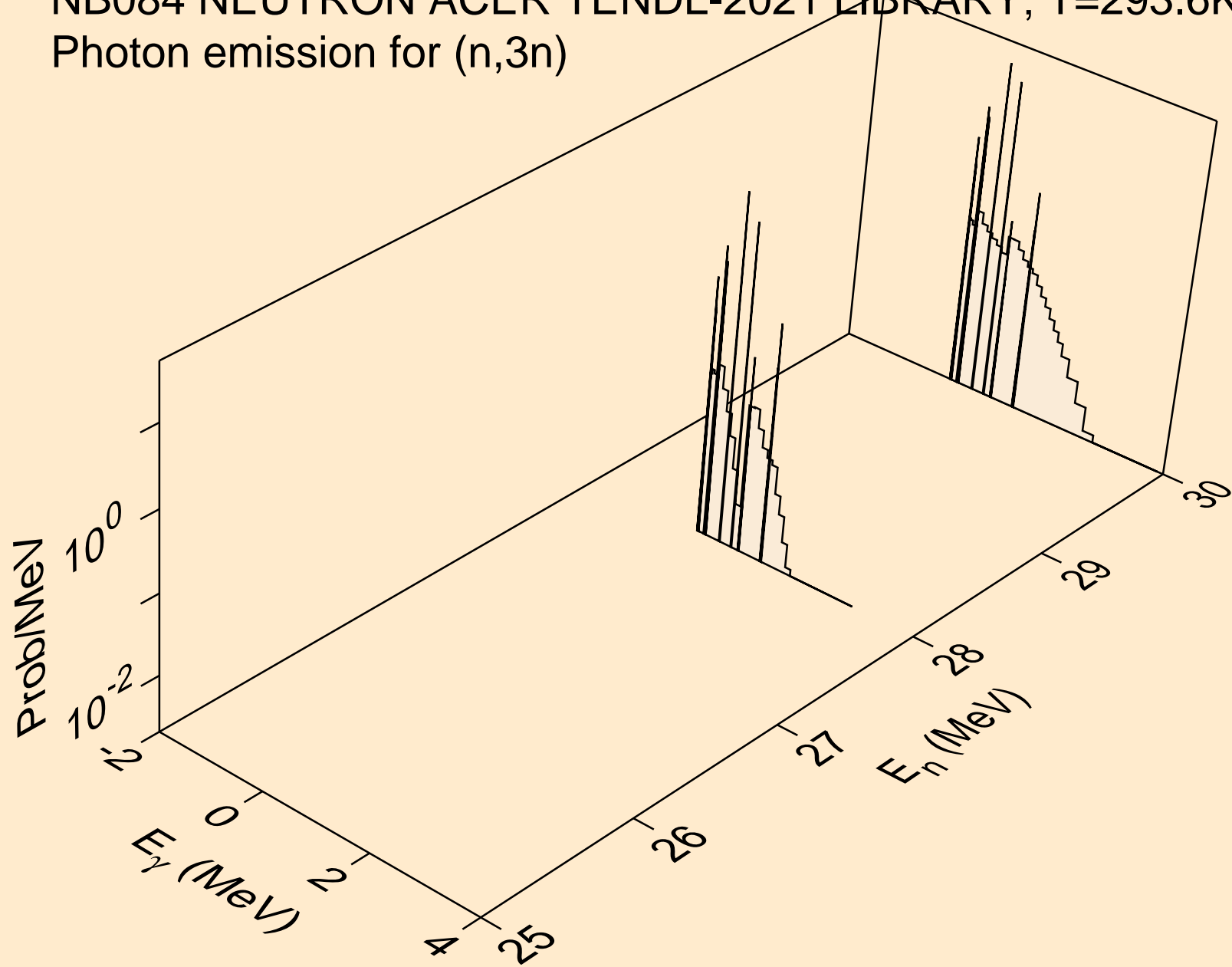

NB084 NEUTRON ACER TENDL-2021 LIBRARY; T=293.6K  
Photon emission for (n,n\*)a

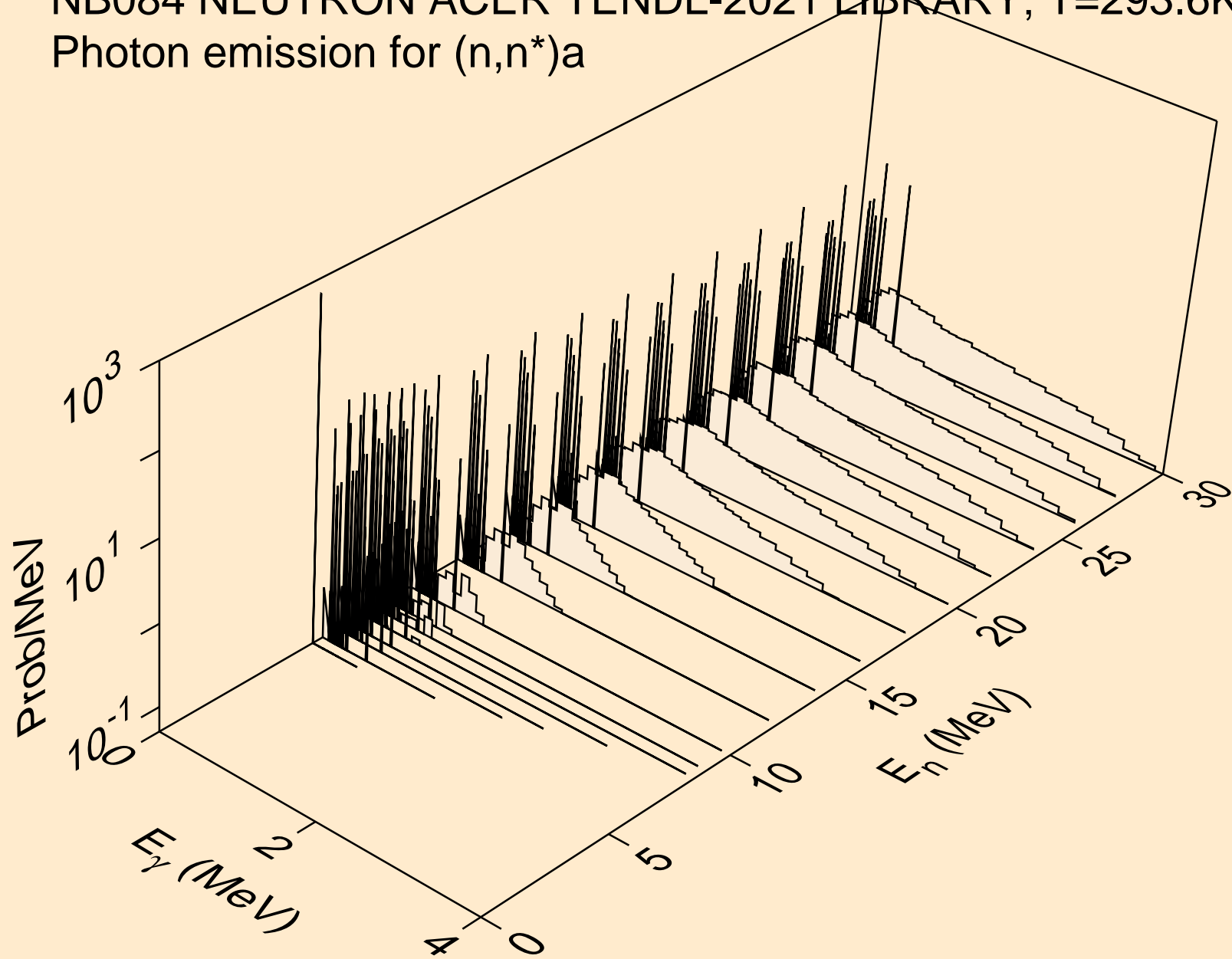

NB084 NEUTRON ACER TENDL-2021 LIBRARY; T=293.6K  
Photon emission for (n,2n)a

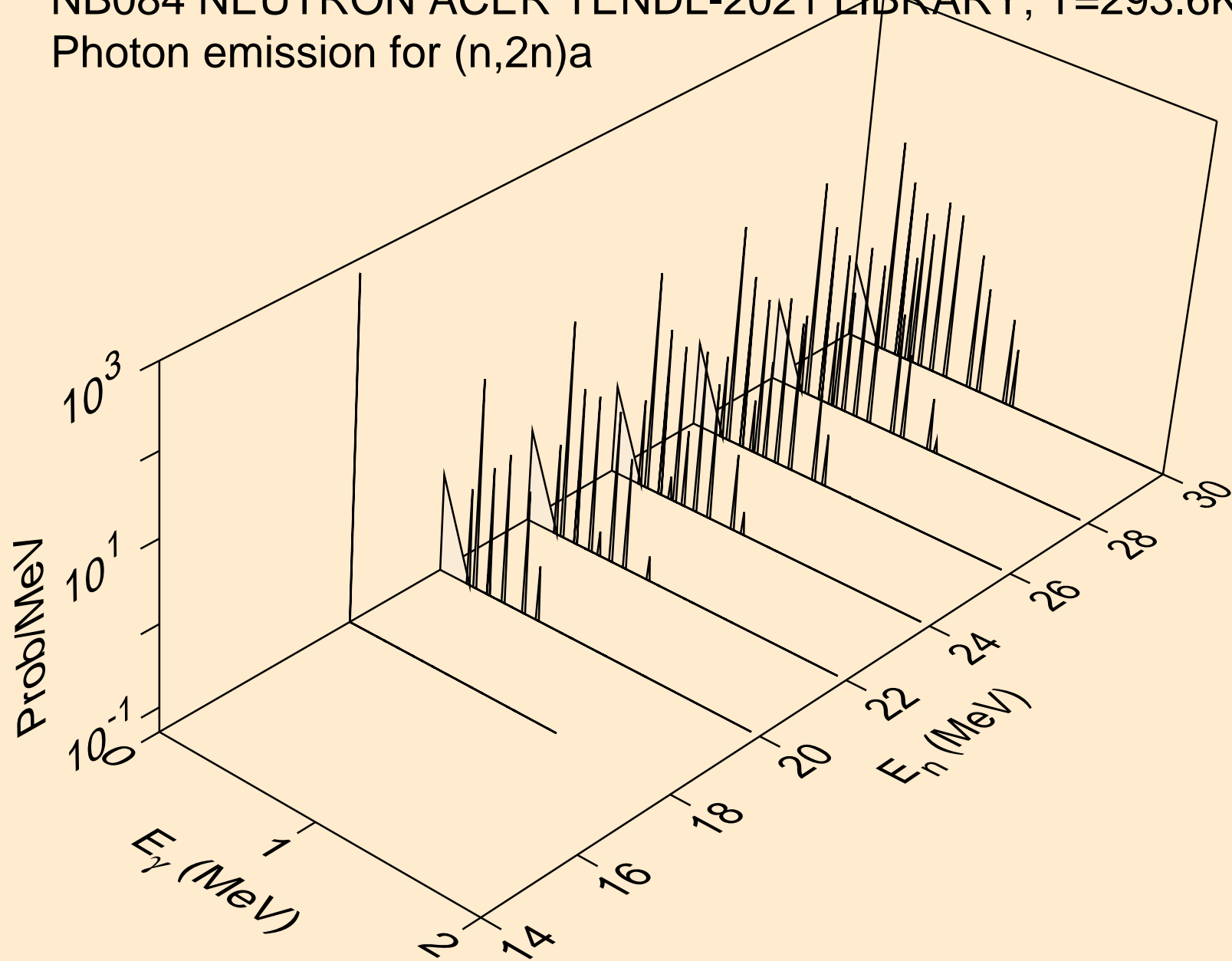

NB084 NEUTRON ACER TENDL-2021 LIBRARY; T=293.6K  
Photon emission for (n,n\*)p

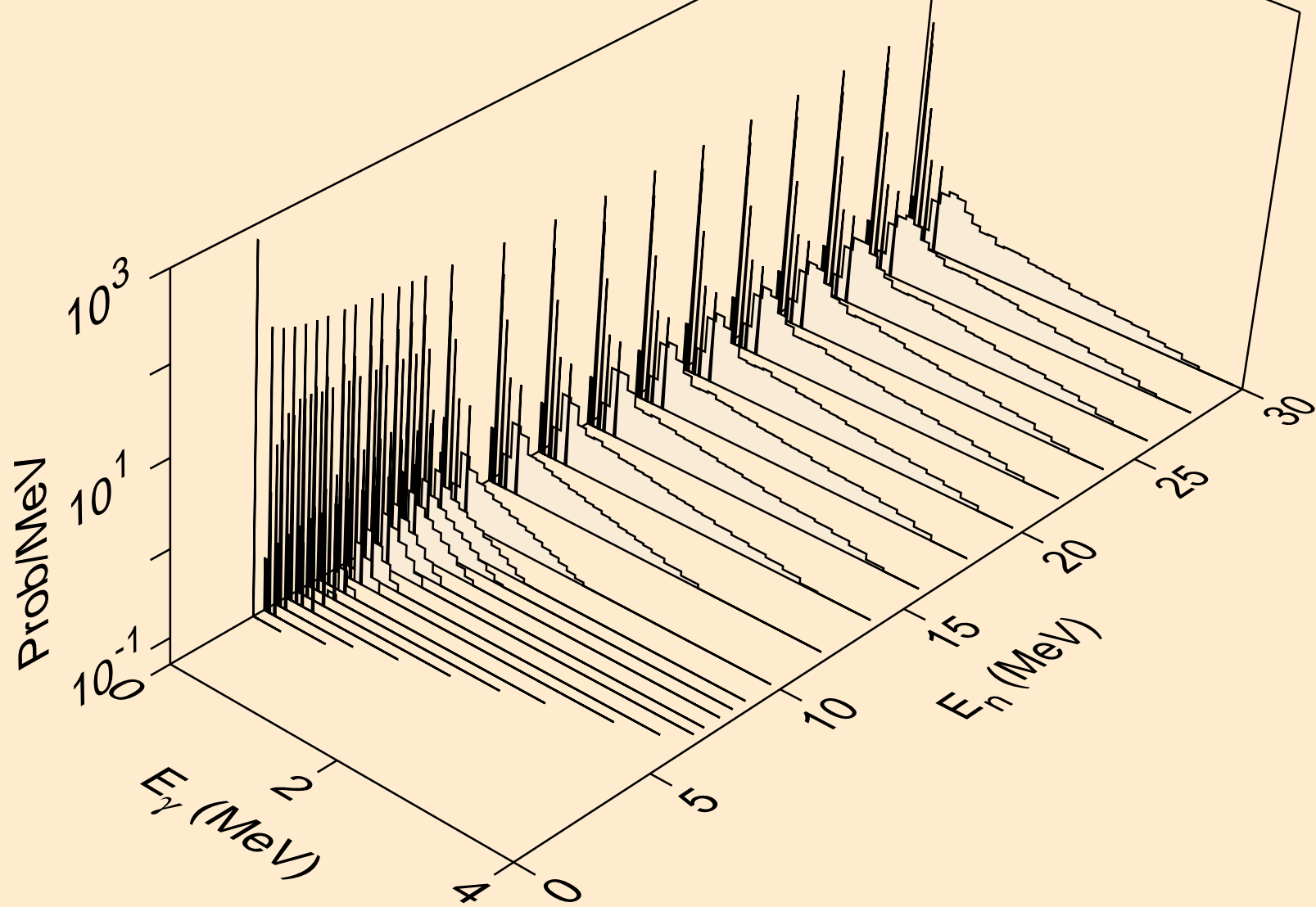

NB084 NEUTRON ACER TENDL-2021 LIBRARY; T=293.6K  
Photon emission for (n,n\*)2a

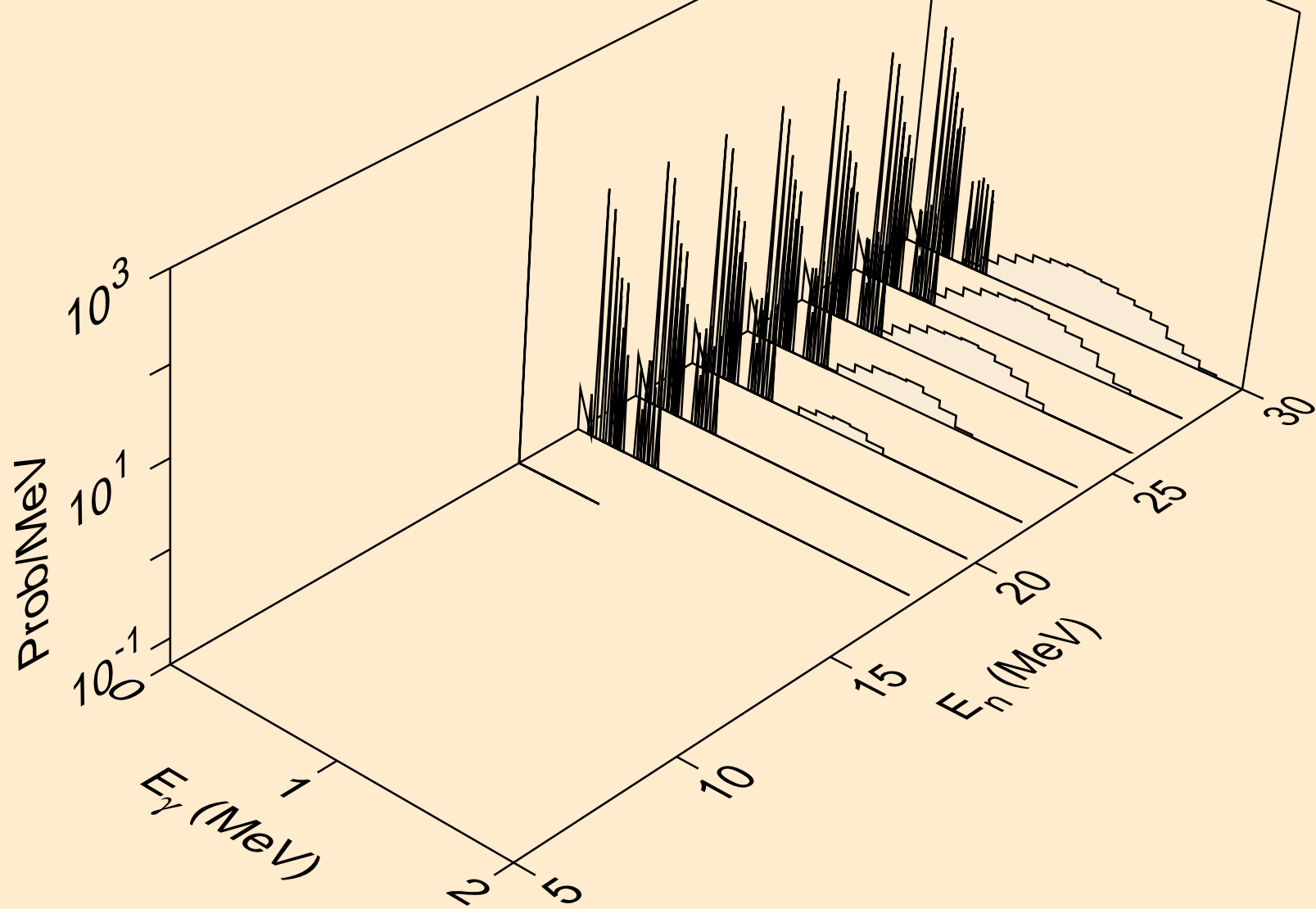

NB084 NEUTRON ACER TENDL-2021 LIBRARY; T=293.6K  
Photon emission for (n,n\*)d

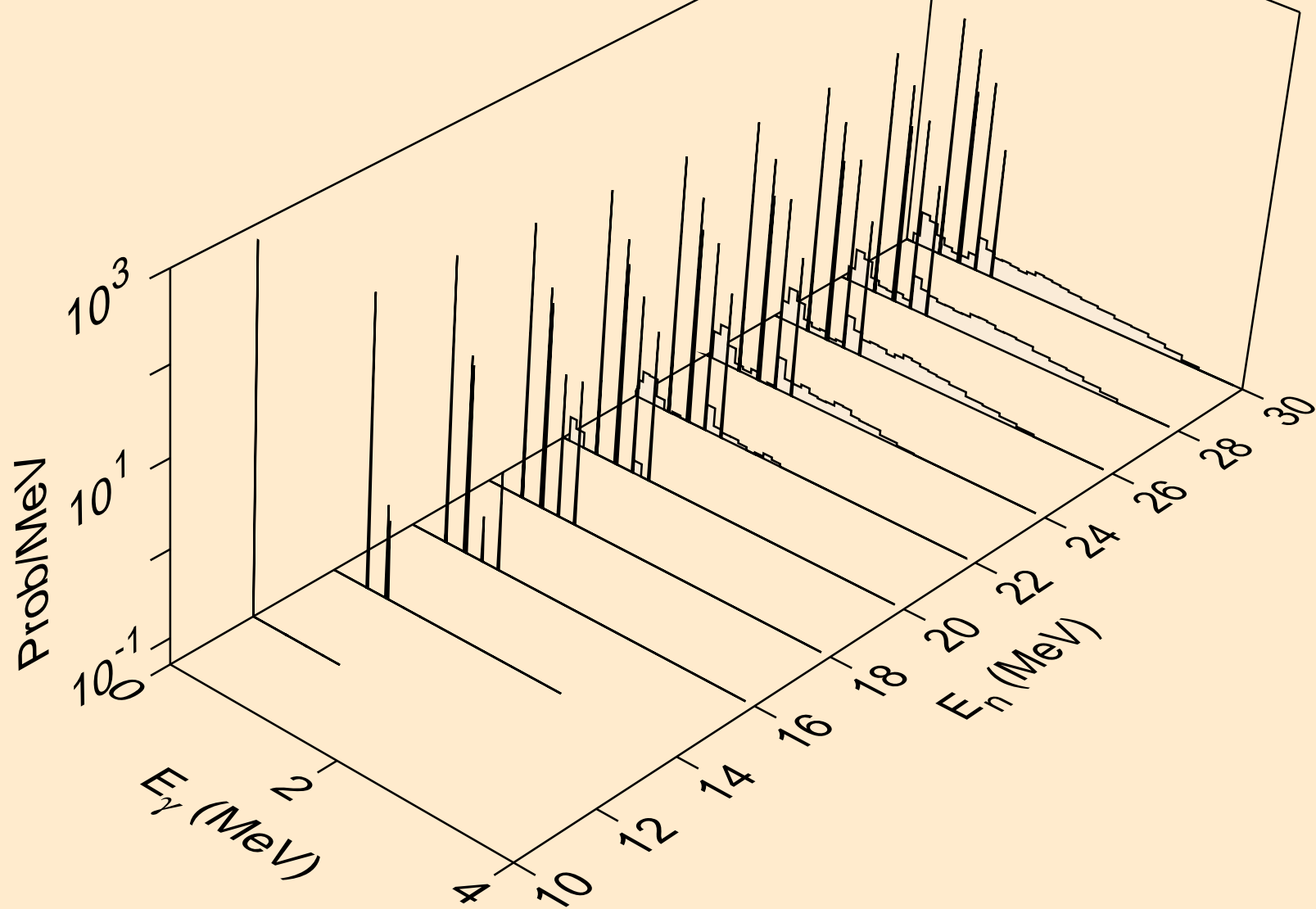

NB084 NEUTRON ACER TENDL-2021 LIBRARY; T=293.6K  
Photon emission for (n,n\*)t

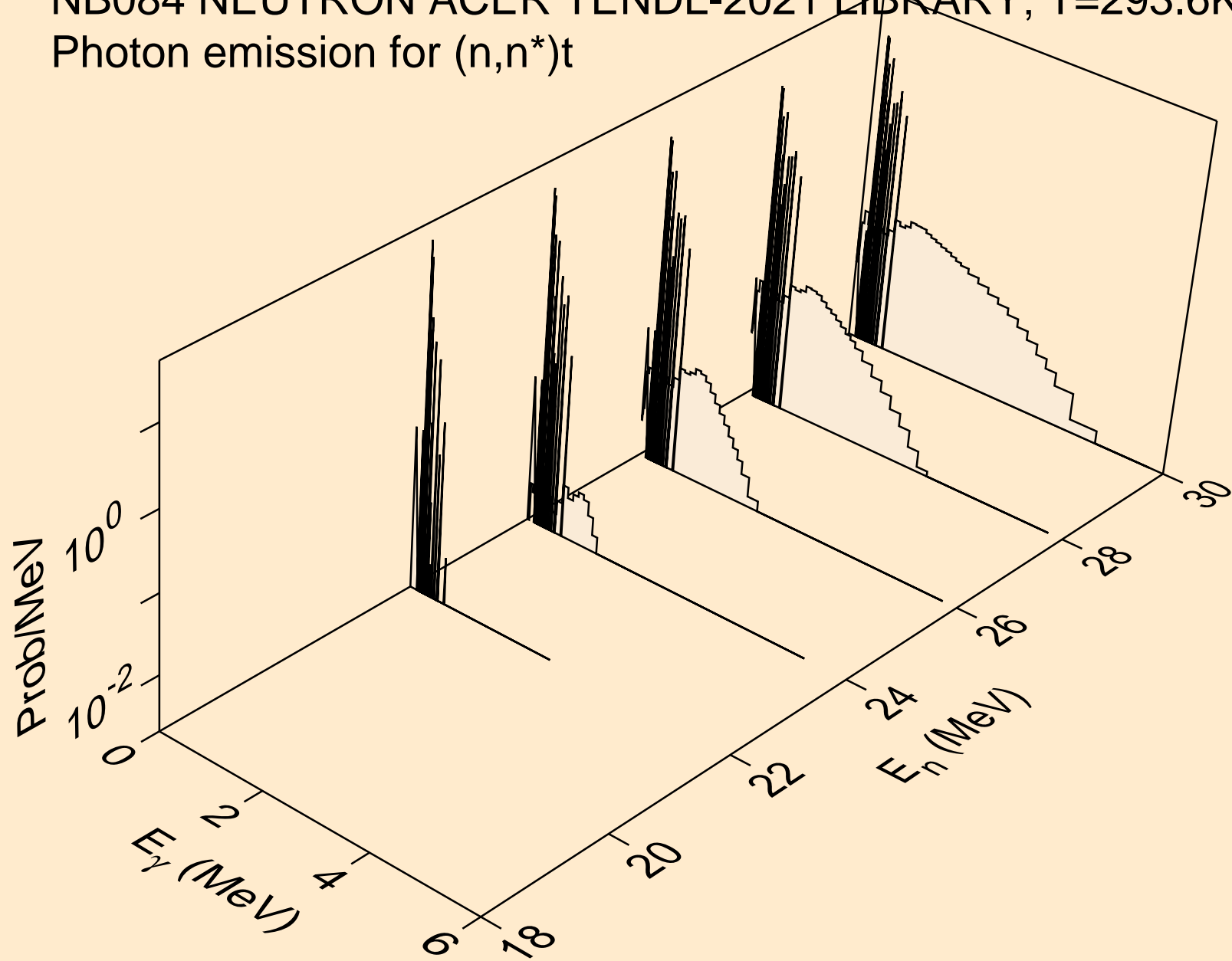

NB084 NEUTRON ACER TENDL-2021 LIBRARY; T=293.6K  
Photon emission for (n,n\*)he3

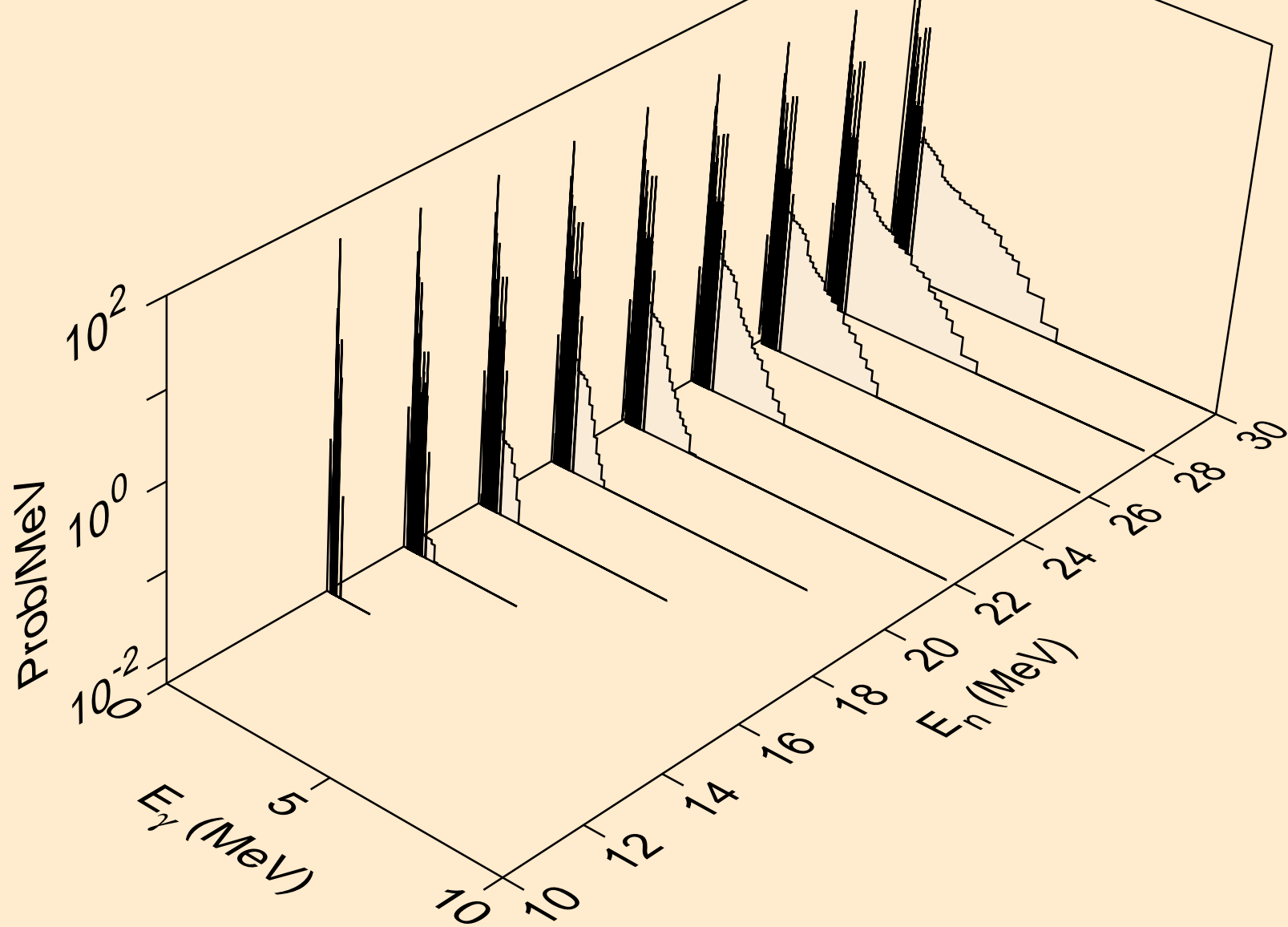

NB084 NEUTRON ACER TENDL-2021 LIBRARY; T=293.6K  
Photon emission for (n,2np)

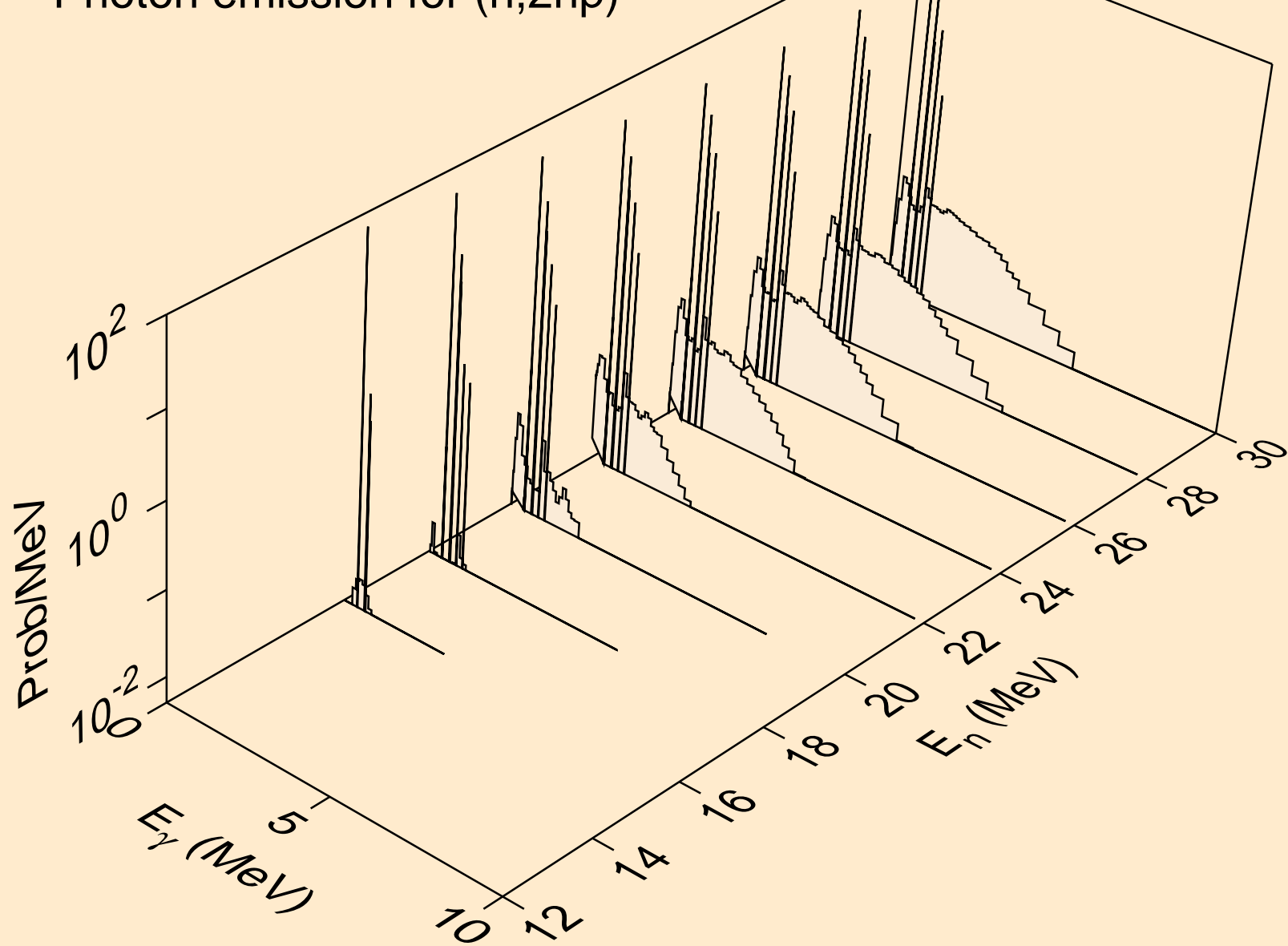

NB084 NEUTRON ACER TENDL-2021 LIBRARY; T=293.6K  
Photon emission for (n,3np)

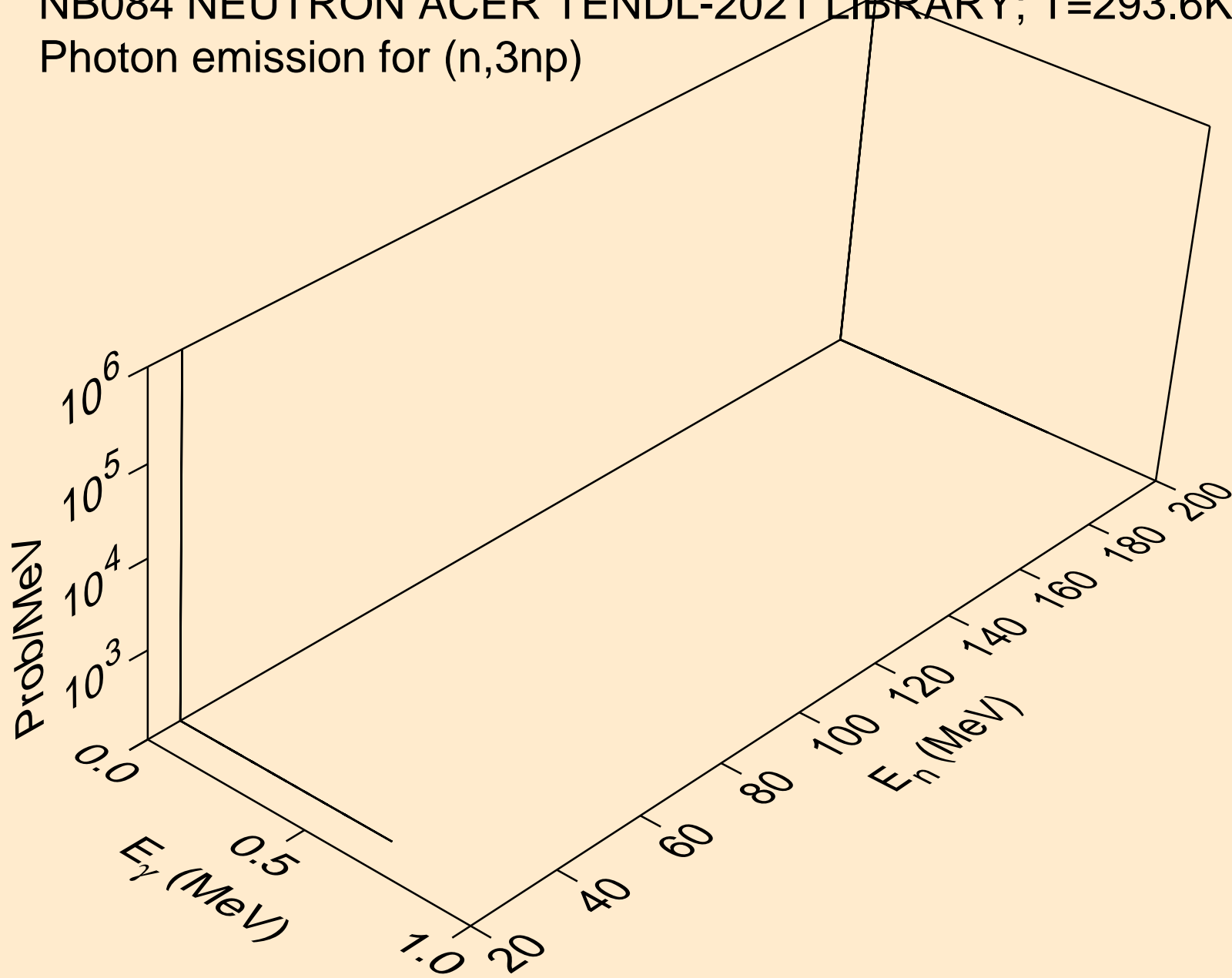

NB084 NEUTRON ACER TENDL-2021 LIBRARY; T=293.6K  
Photon emission for (n,2np)

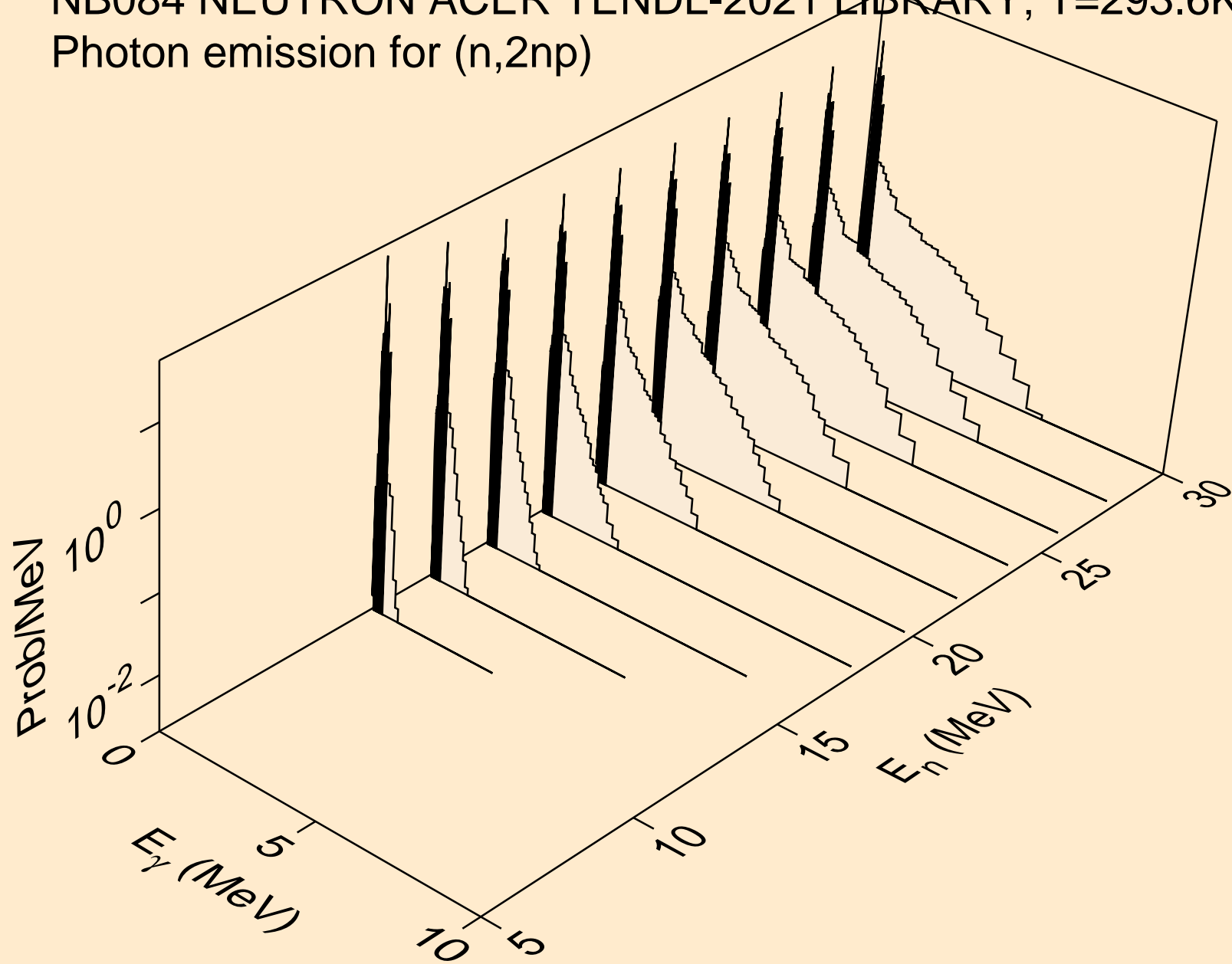

NB084 NEUTRON ACER TENDL-2021 LIBRARY; T=293.6K  
Photon emission for (n,npa)

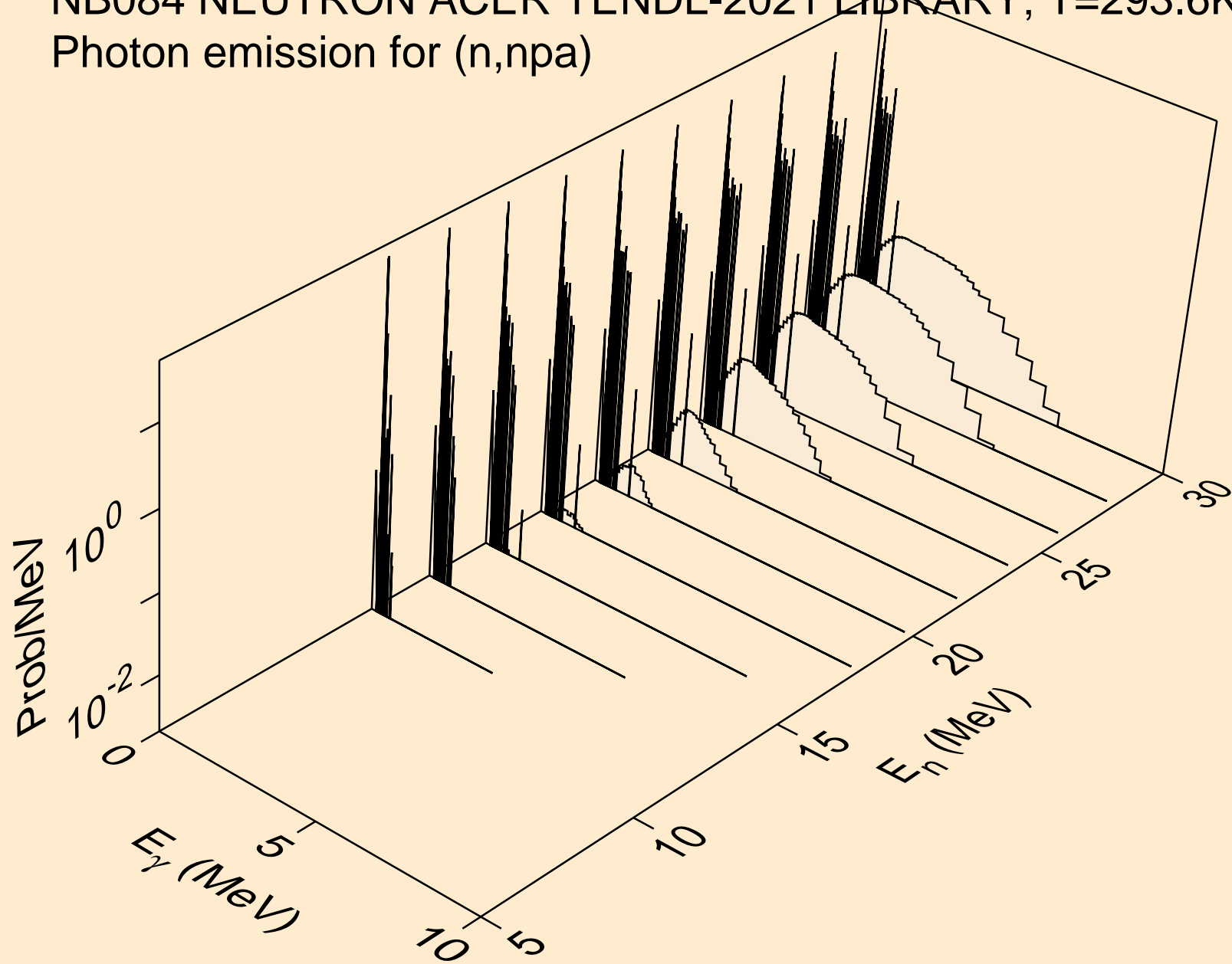

NB084 NEUTRON ACER TENDL-2021 LIBRARY; T=293.6K  
Photon emission for (n,n\*c)

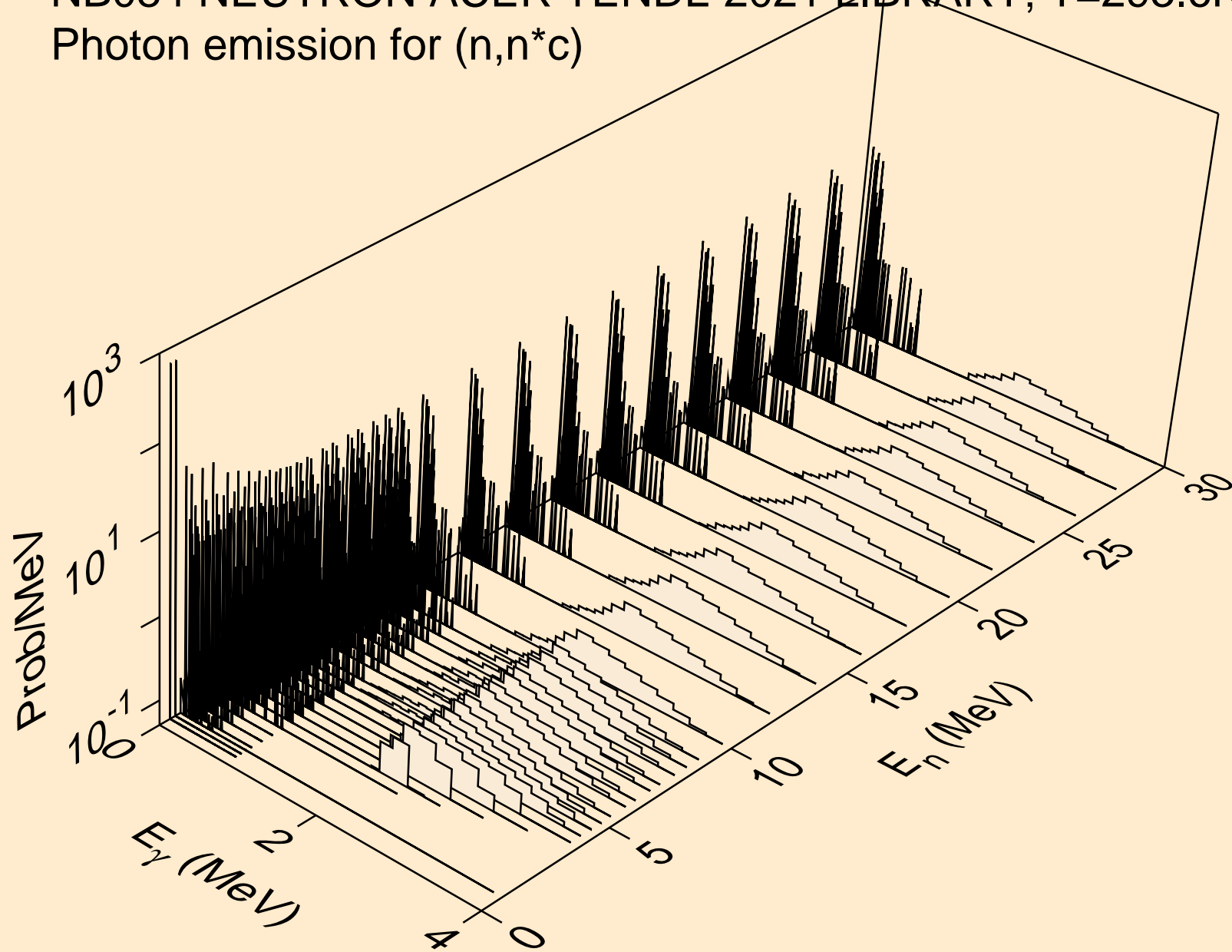

NB084 NEUTRON ACER TENDL-2021 LIBRARY; T=293.6K  
Photon emission for (n,gma)

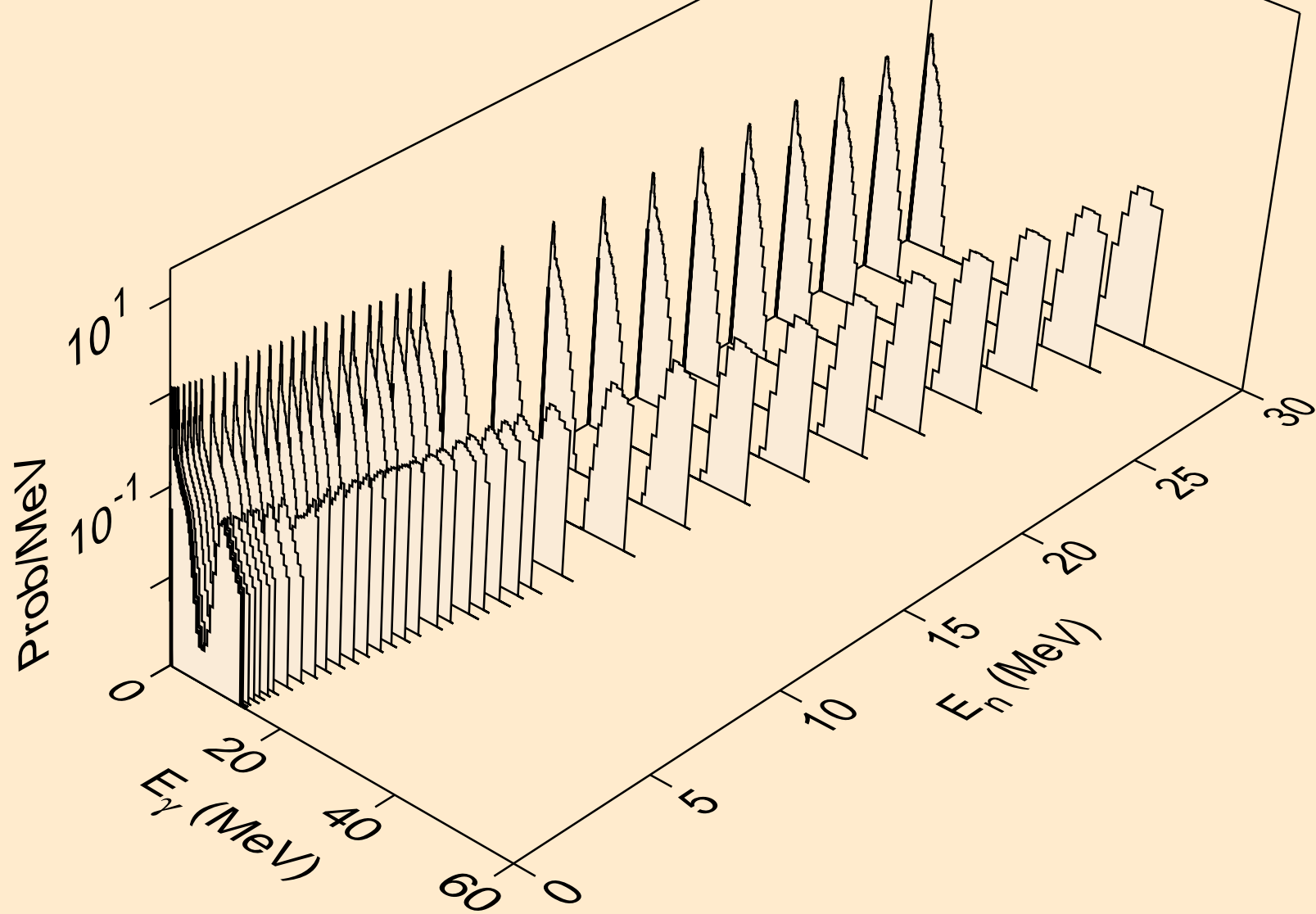

NB084 NEUTRON ACER TENDL-2021 LIBRARY; T=293.6K  
Photon emission for (n,p)

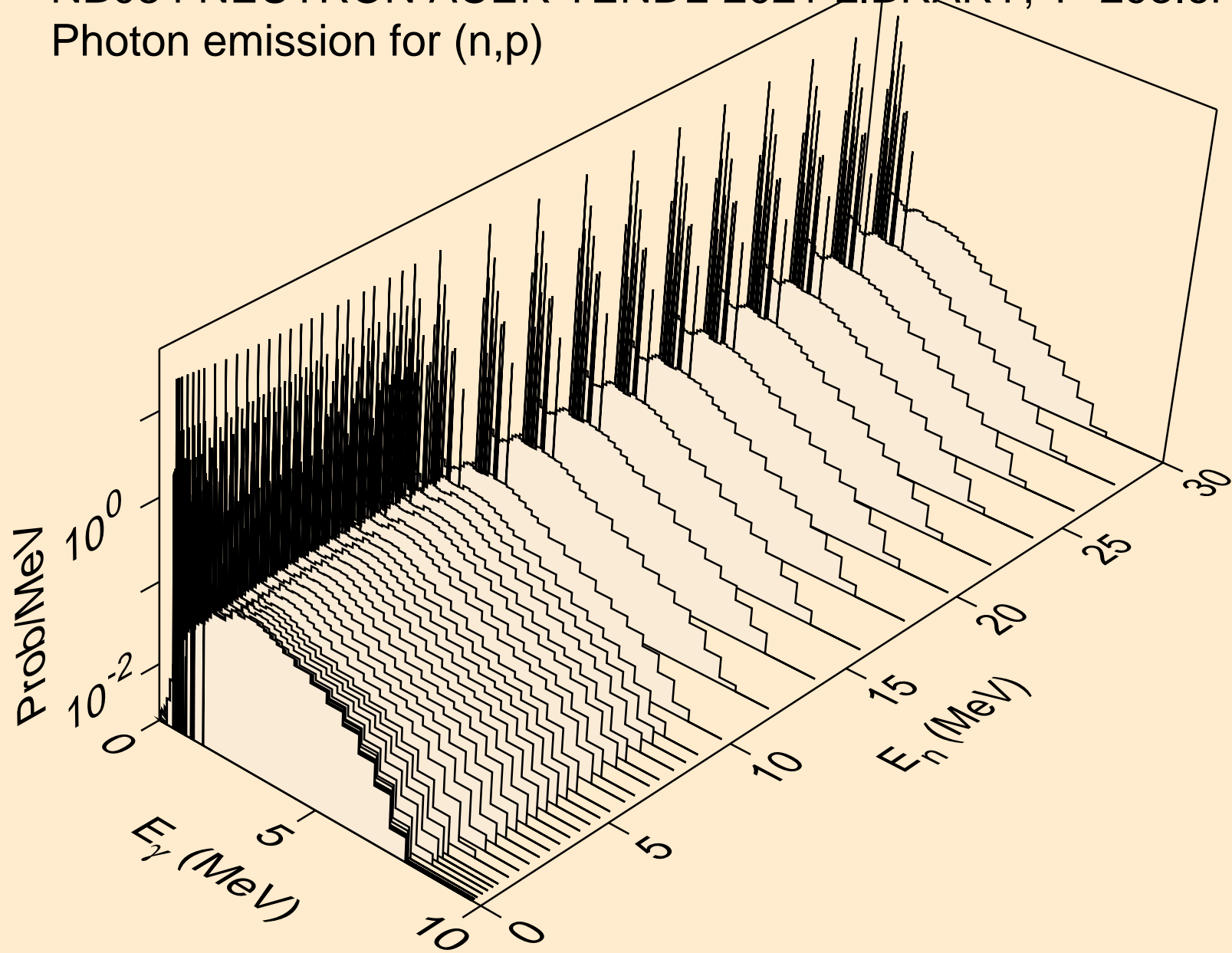

NB084 NEUTRON ACER TENDL-2021 LIBRARY; T=293.6K  
Photon emission for (n,d)

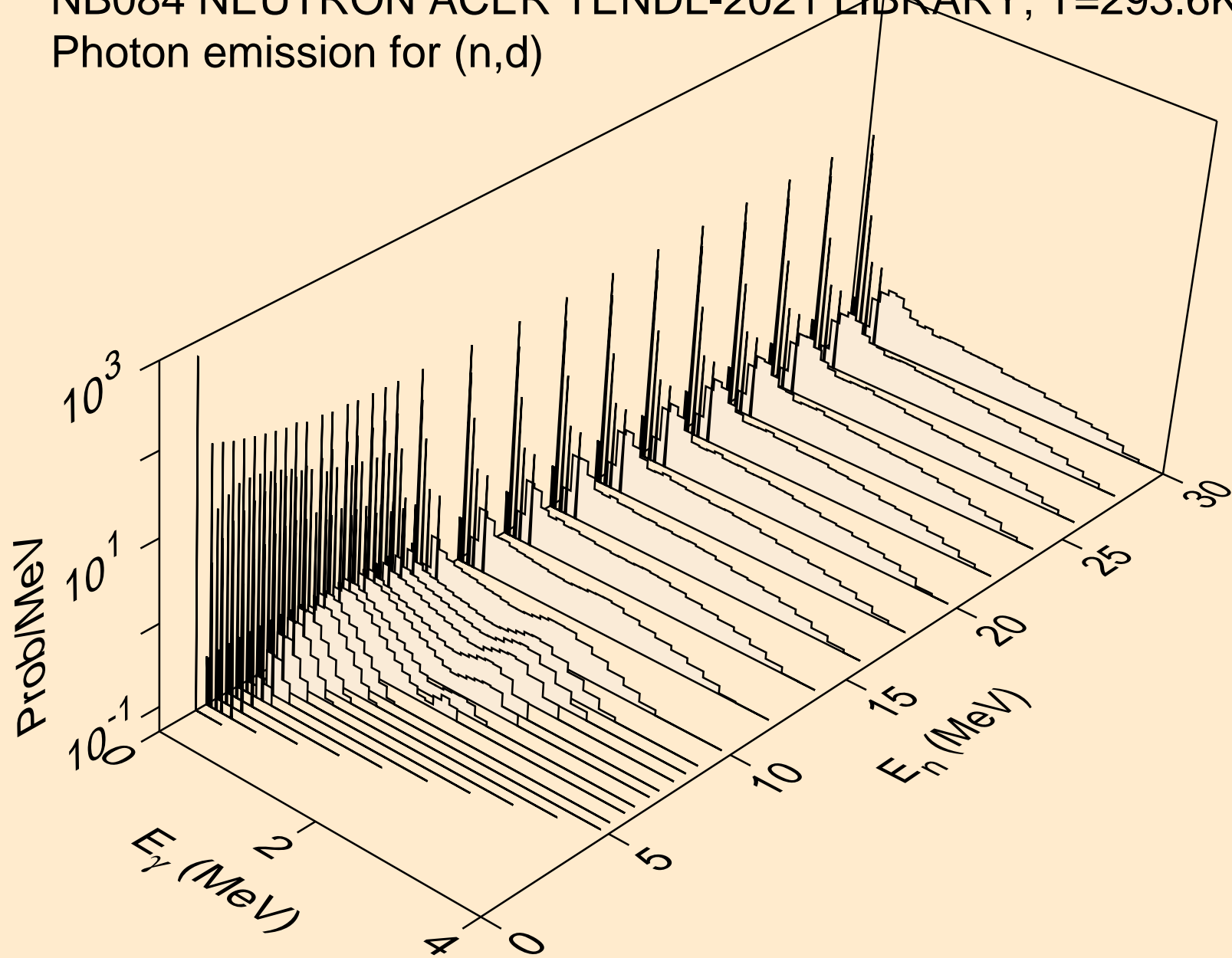

NB084 NEUTRON ACER TENDL-2021 LIBRARY; T=293.6K  
Photon emission for (n,t)

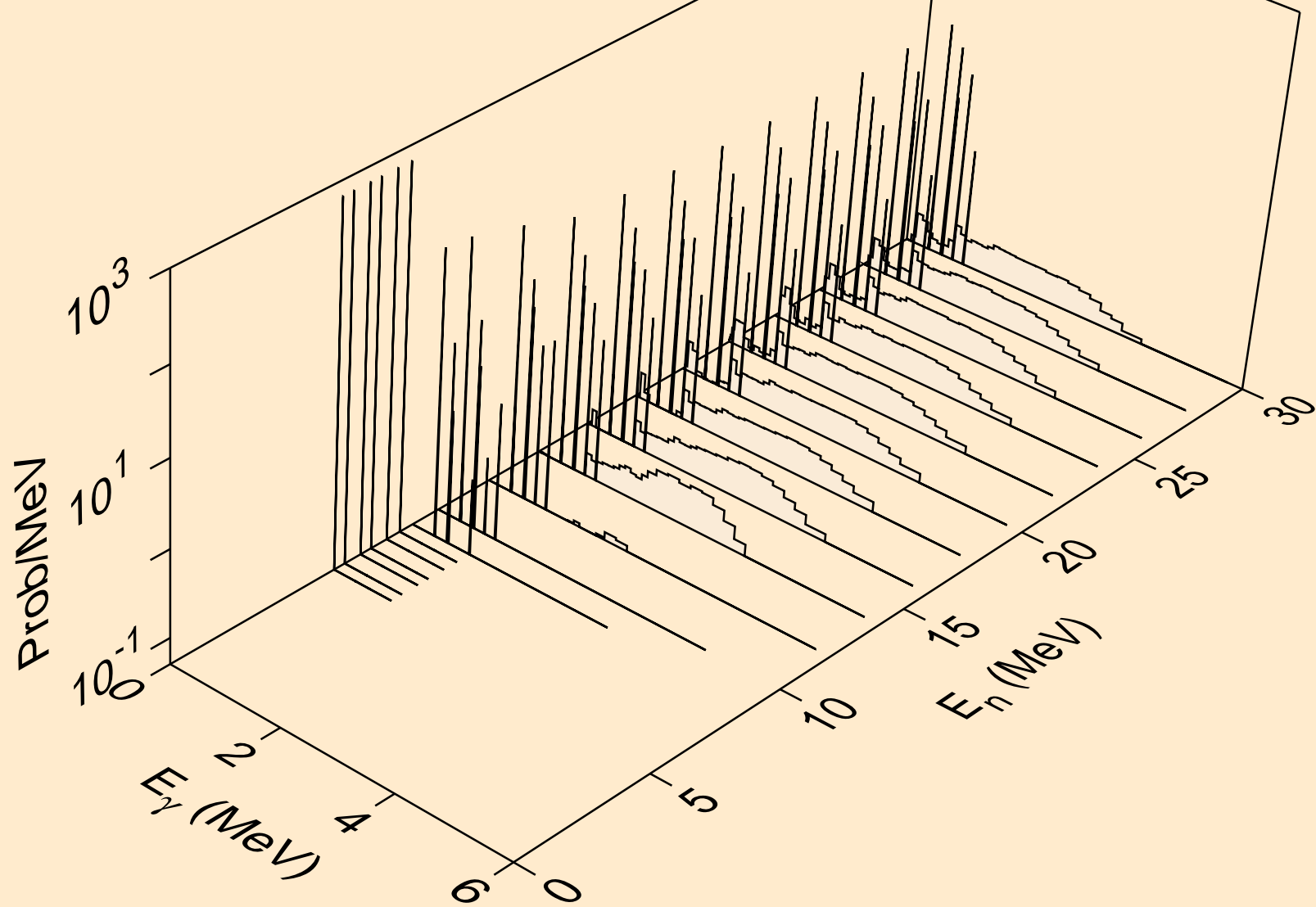

NB084 NEUTRON ACER TENDL-2021 LIBRARY; T=293.6K  
Photon emission for (n,he3)

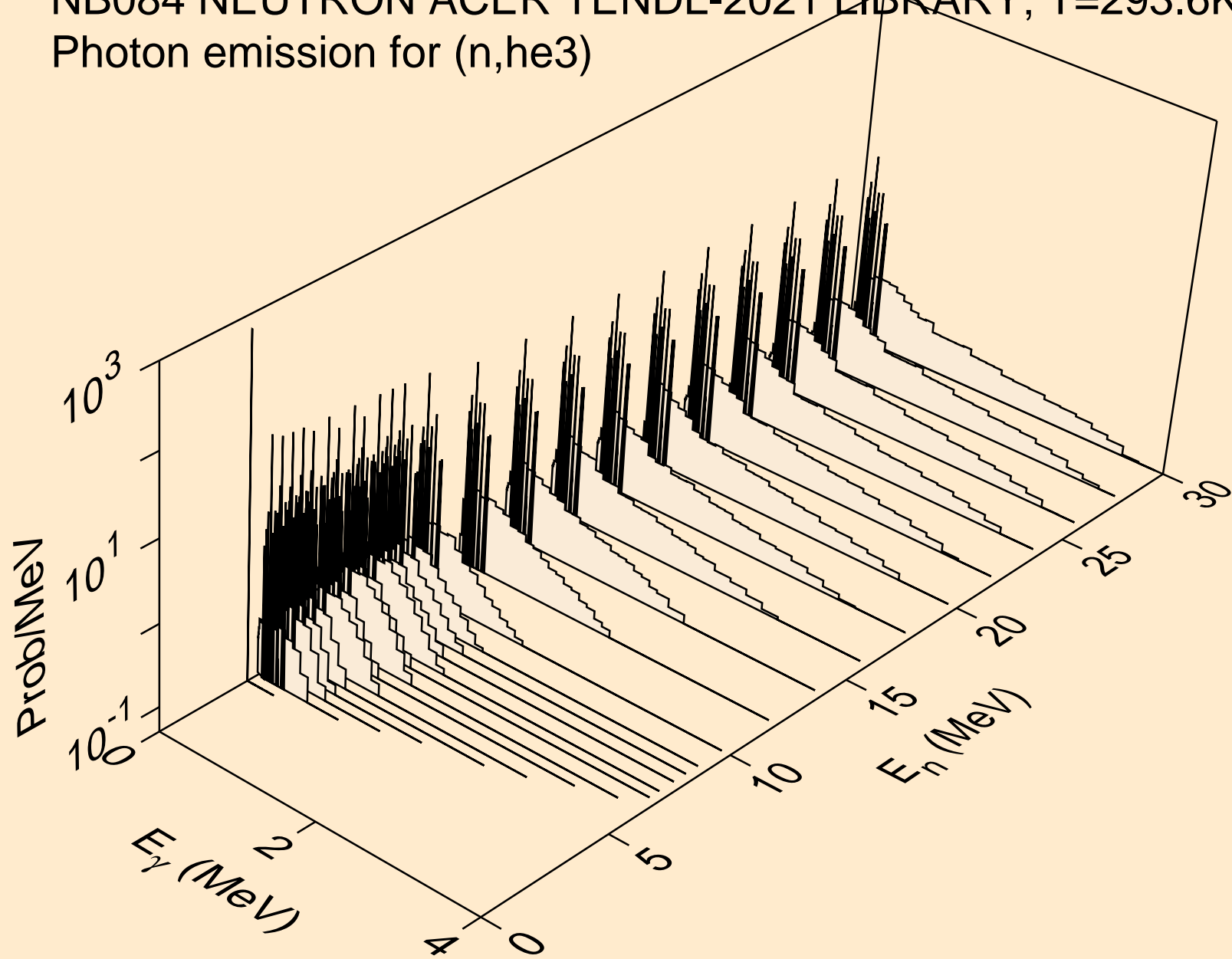

NB084 NEUTRON ACER TENDL-2021 LIBRARY; T=293.6K  
Photon emission for (n,a)

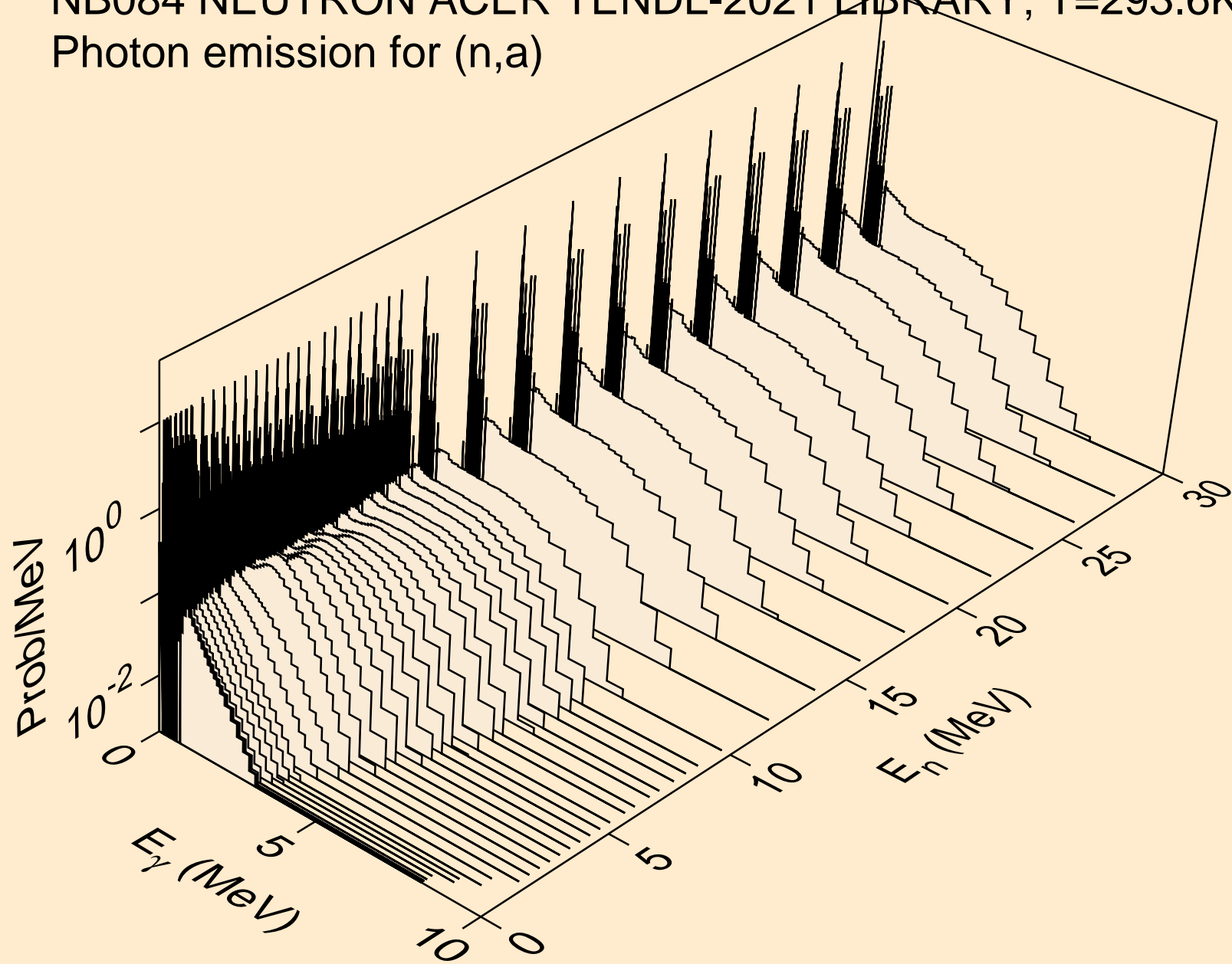

NB084 NEUTRON ACER TENDL-2021 LIBRARY; T=293.6K  
Photon emission for (n,2a)

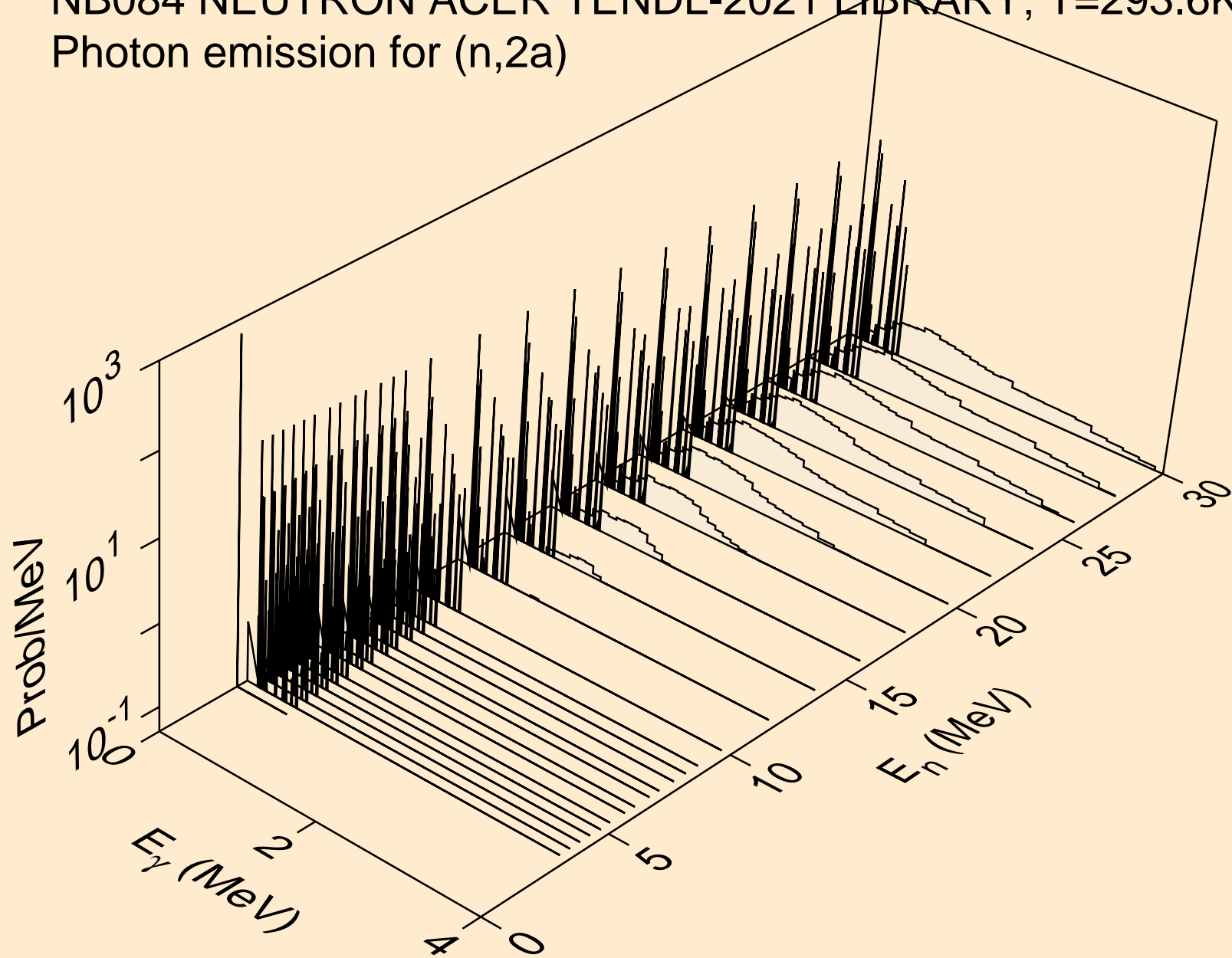

NB084 NEUTRON ACER TENDL-2021 LIBRARY; T=293.6K  
Photon emission for (n,3a)

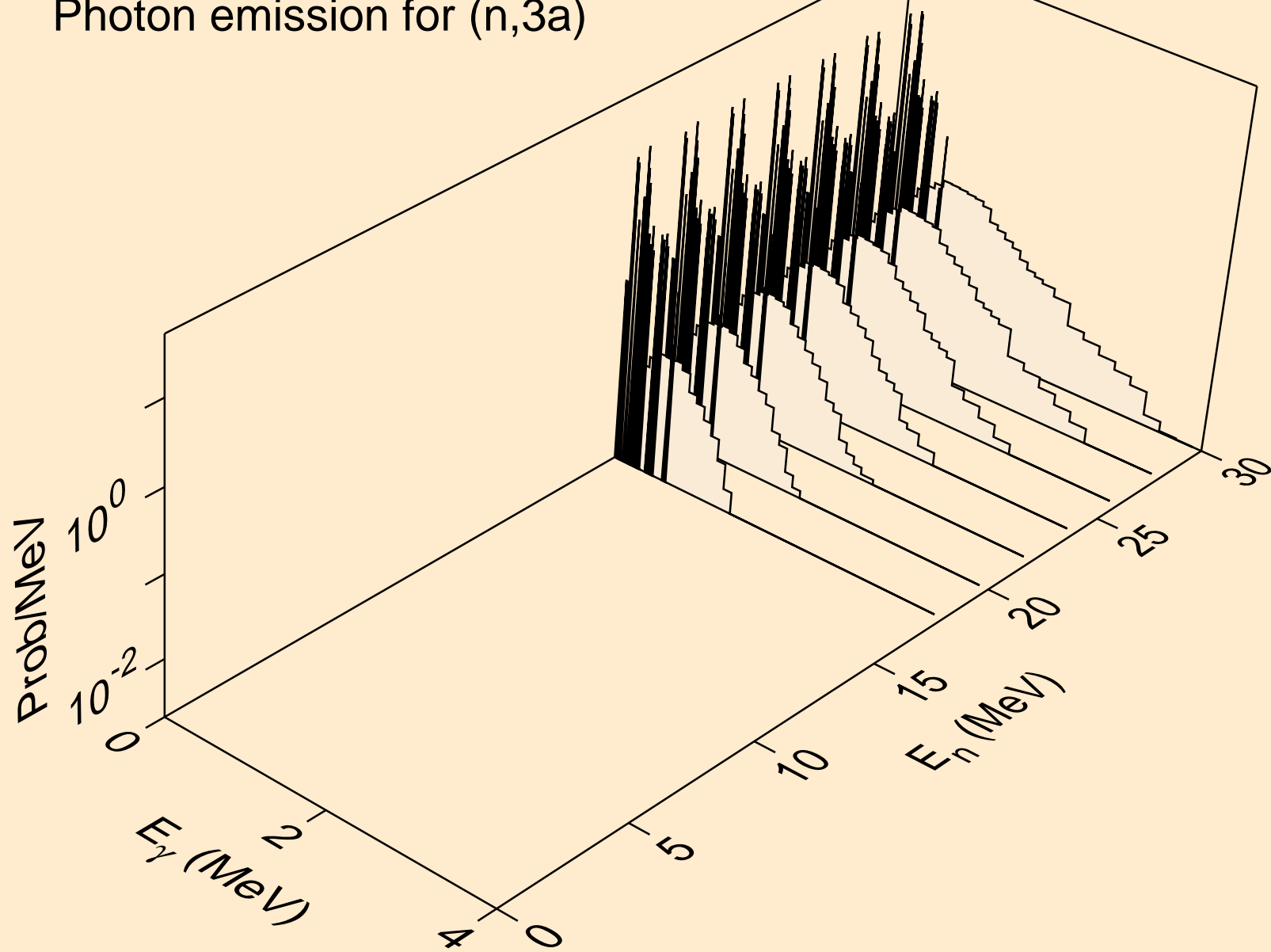

NB084 NEUTRON ACER TENDL-2021 LIBRARY; T=293.6K  
Photon emission for (n,2p)

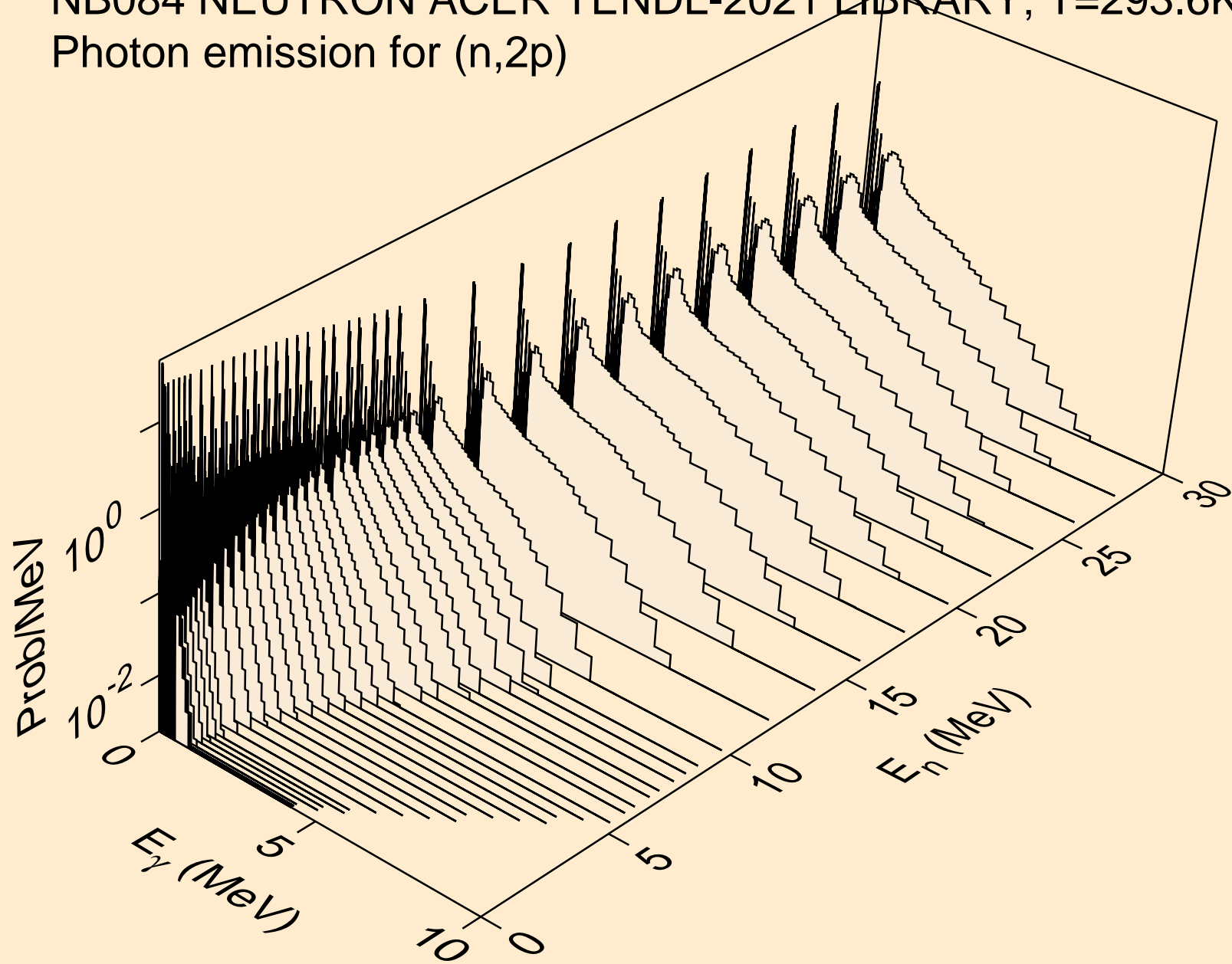

NB084 NEUTRON ACER TENDL-2021 LIBRARY; T=293.6K  
Photon emission for (n,p $\alpha$ )

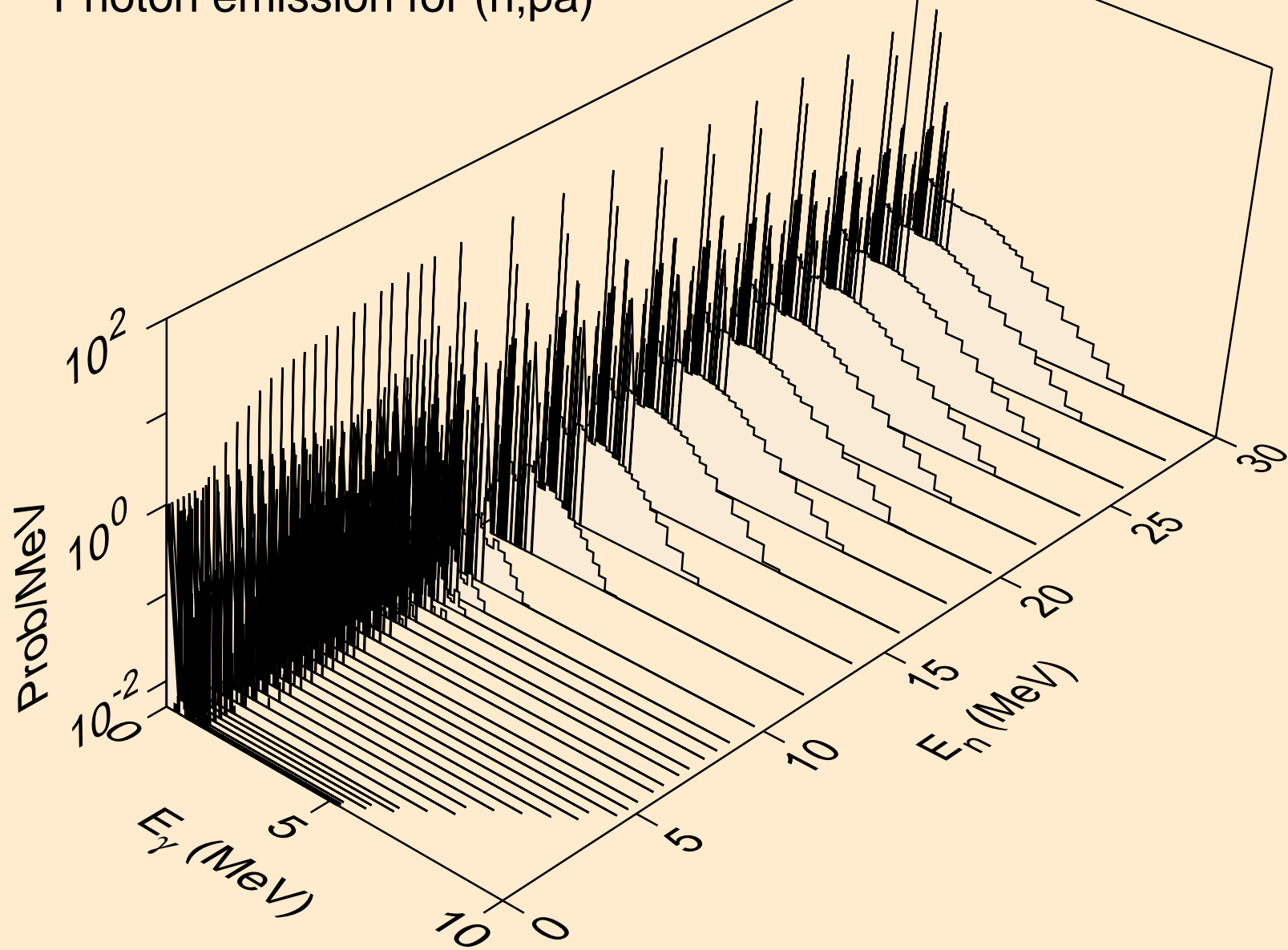

NB084 NEUTRON ACER TENDL-2021 LIBRARY; T=293.6K  
Photon emission for (n,pd)

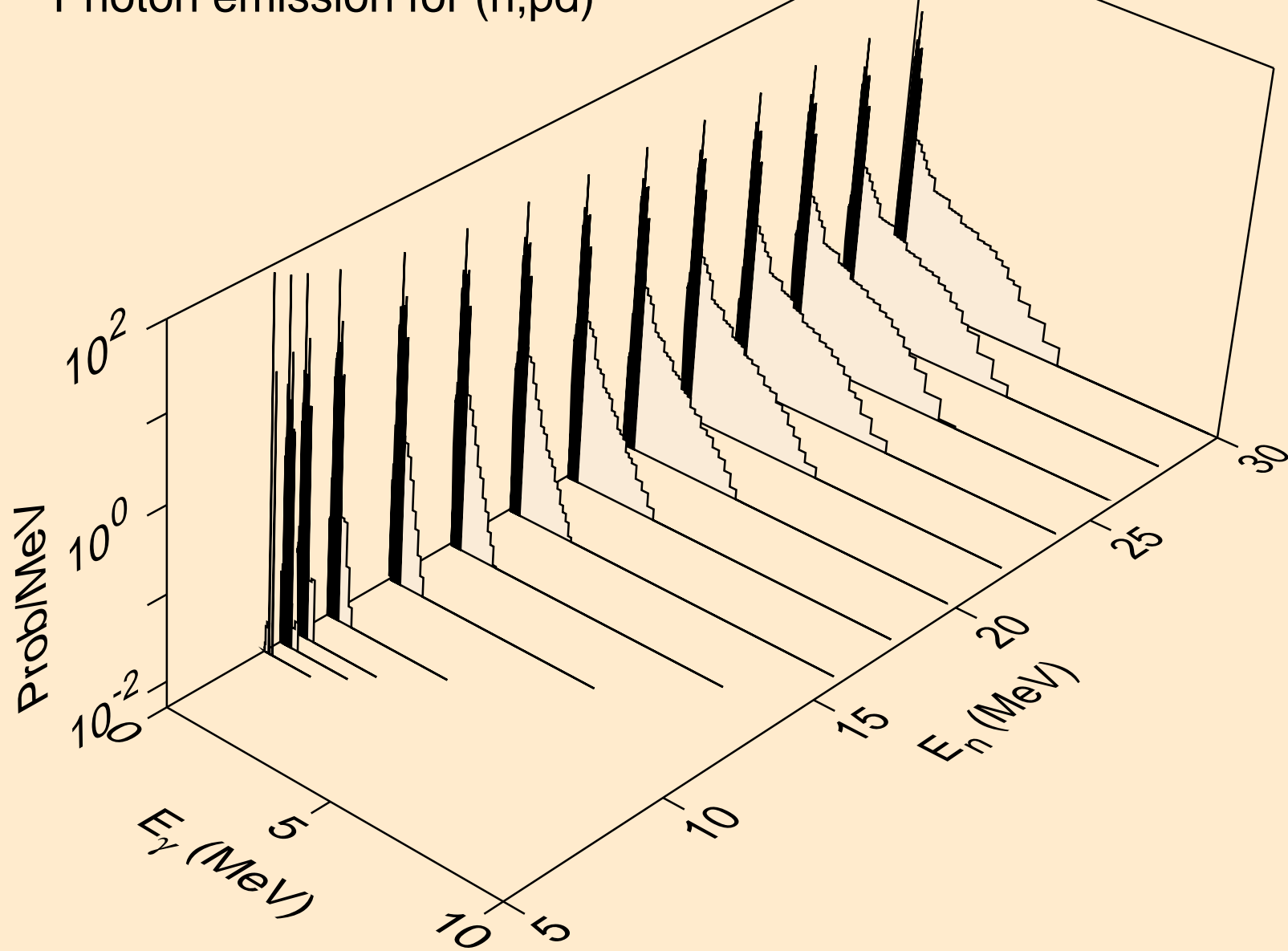

NB084 NEUTRON ACER TENDL-2021 LIBRARY; T=293.6K  
Photon emission for (n,pt)

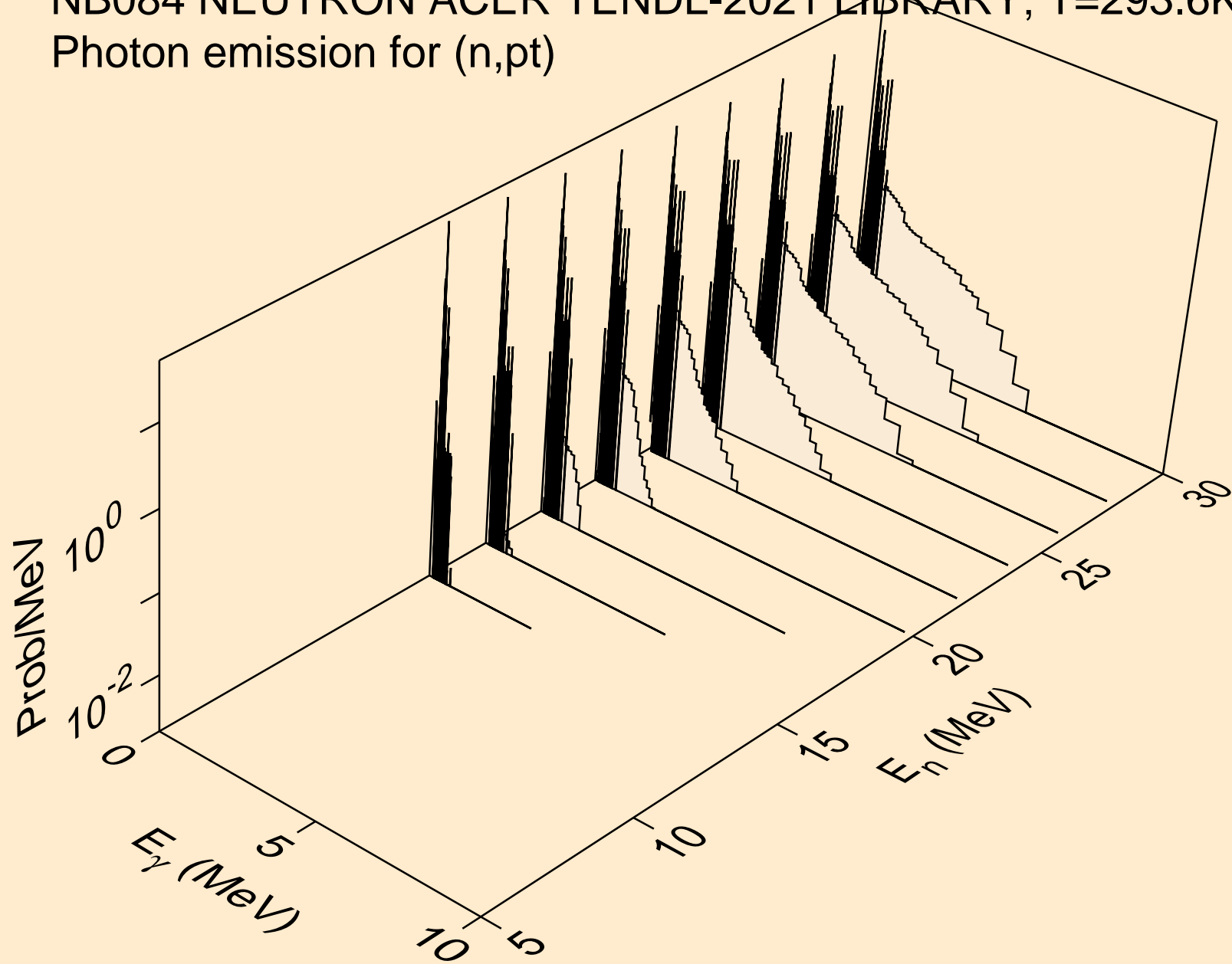

NB084 NEUTRON ACER TENDL-2021 LIBRARY; T=293.6K  
Photon emission for (n,da)

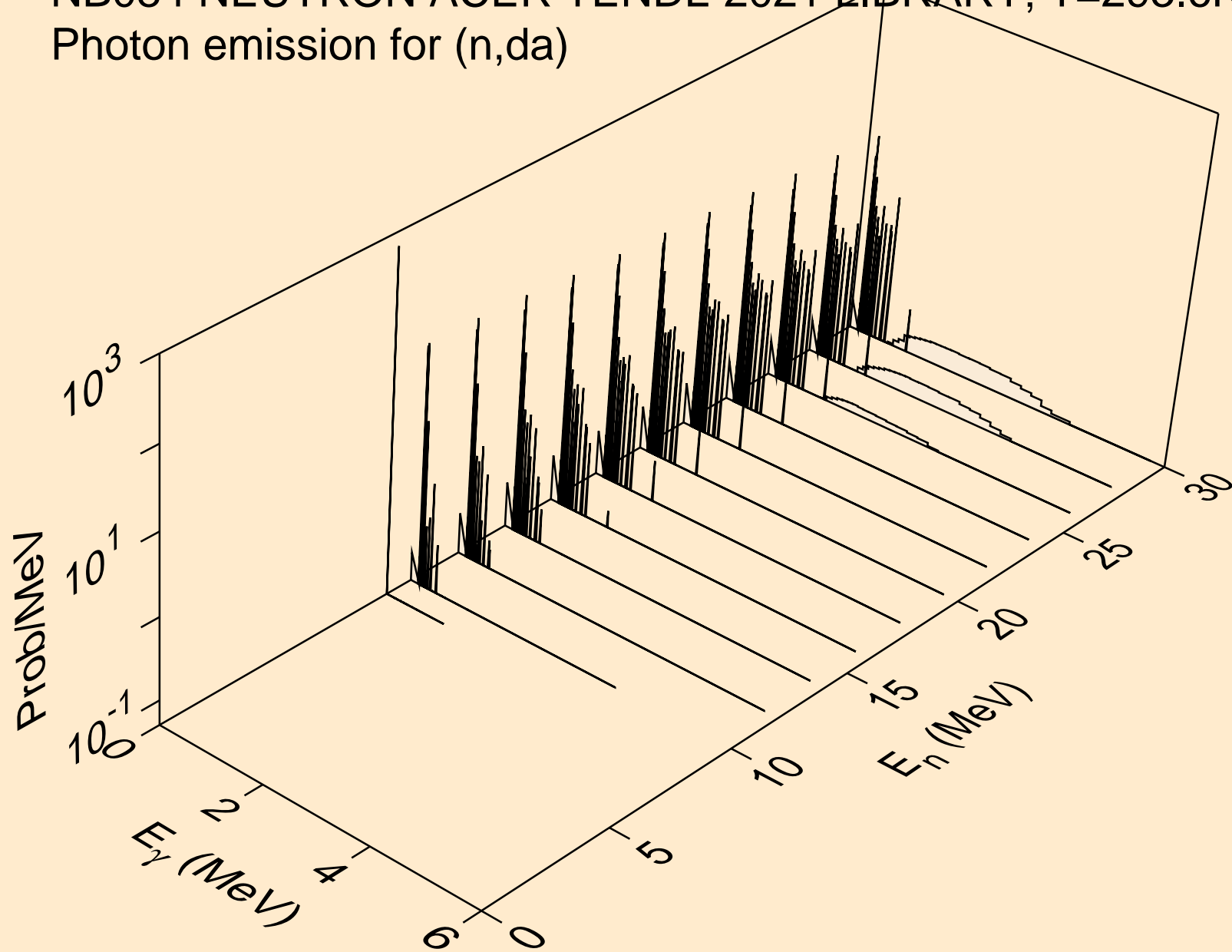

NB084 NEUTRON ACER TENDL-2021 LIBRARY; T=293.6K  
thermal capture photon spectrum

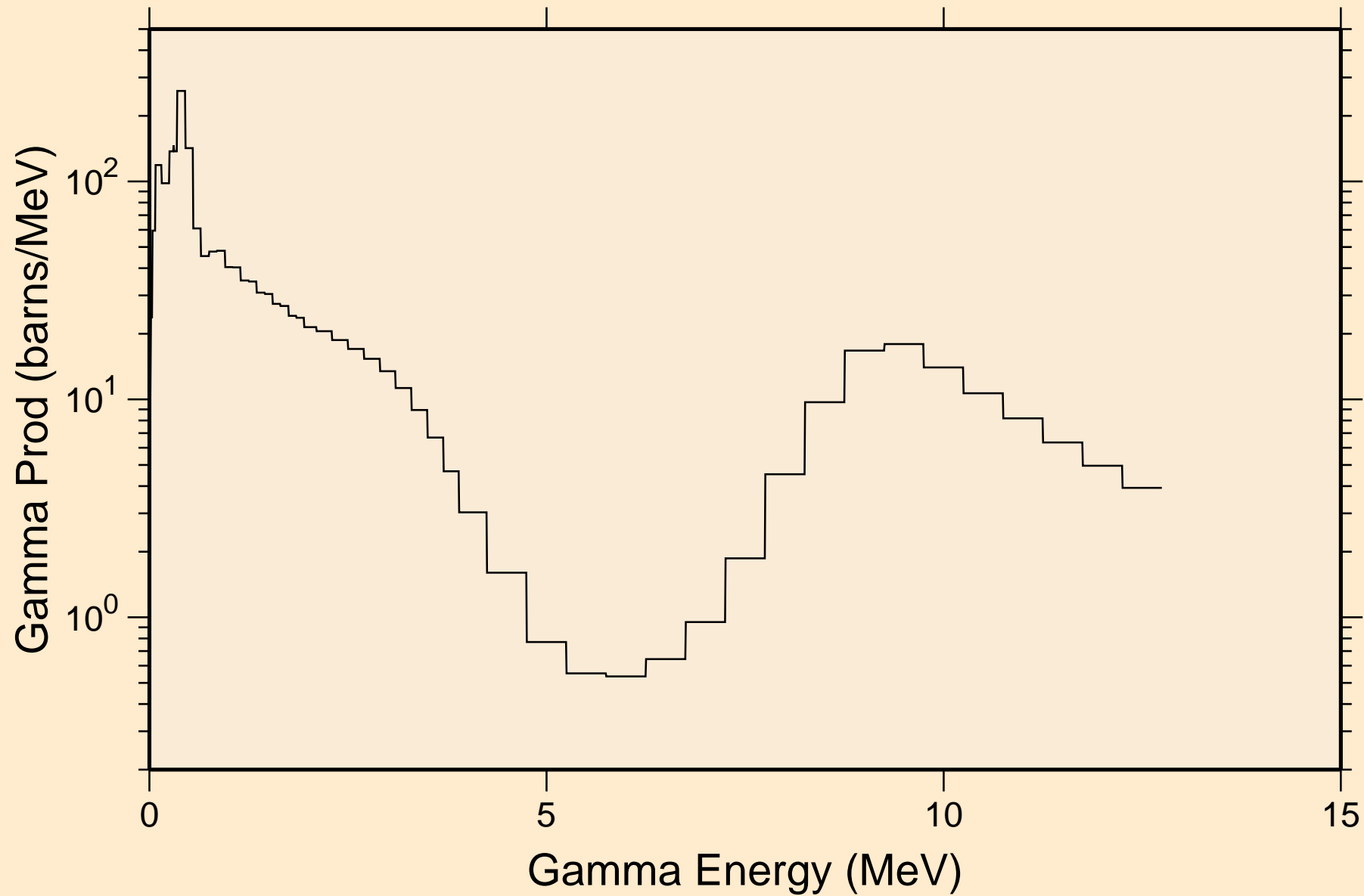

NB084 NEUTRON ACER TENDL-2021 LIBRARY; T=293.6K  
14 MeV photon spectrum

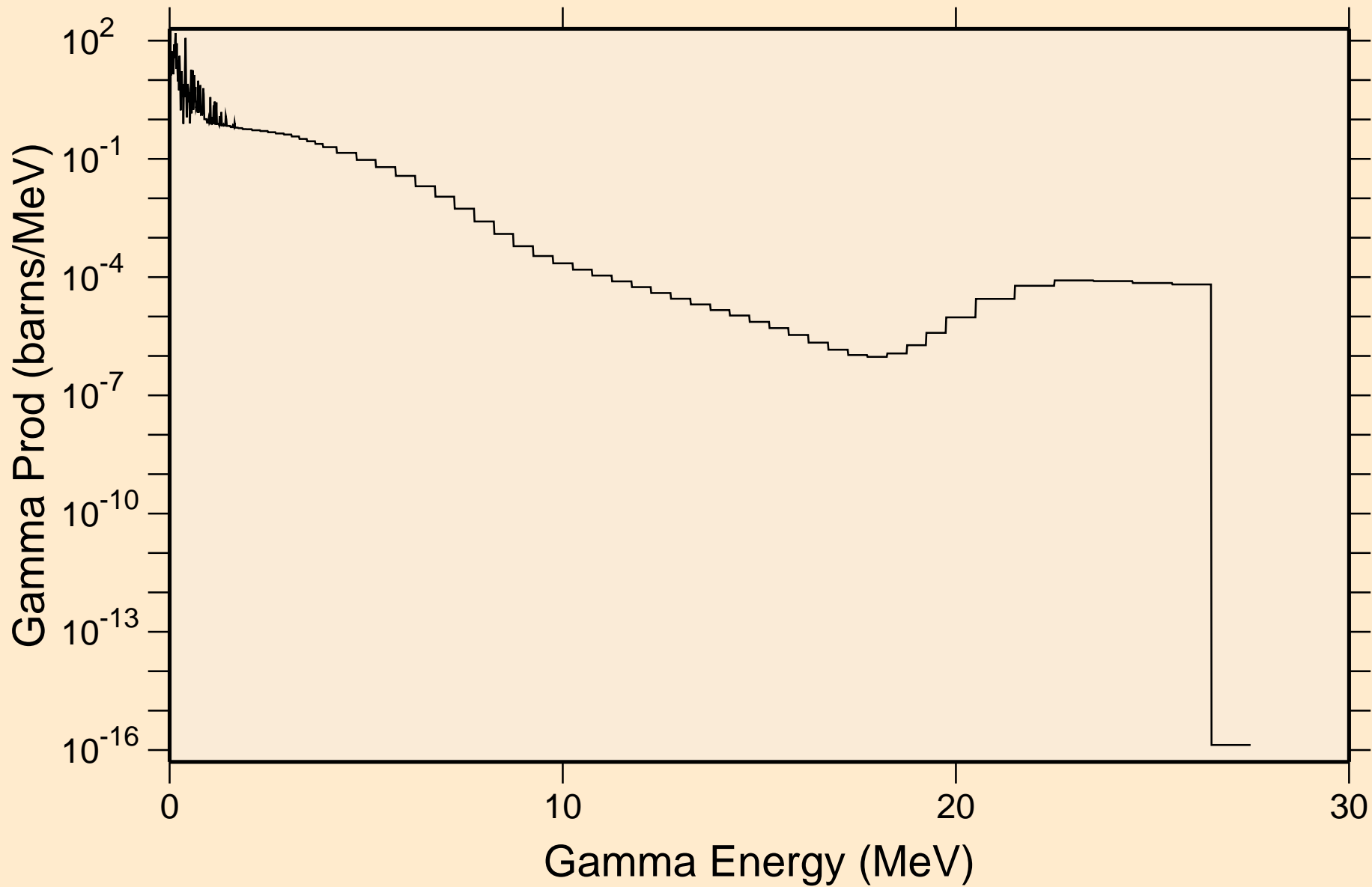

# NB084 NEUTRON ACER TENDL-2021 LIBRARY; T=293.6K

## Particle heating contributions

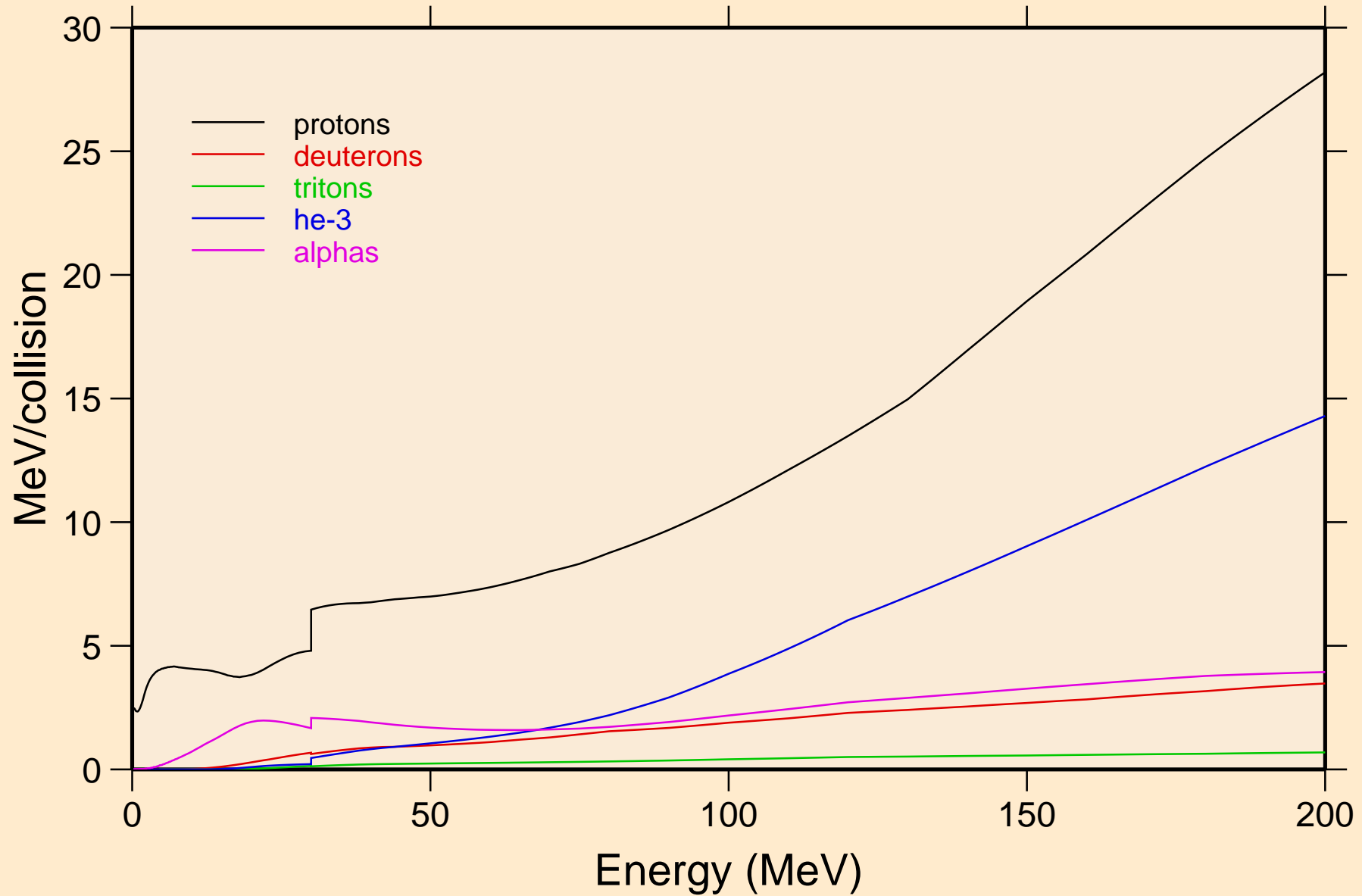

NB084 NEUTRON ACER TENDL-2021 LIBRARY; T=293.6K  
Recoil Heating

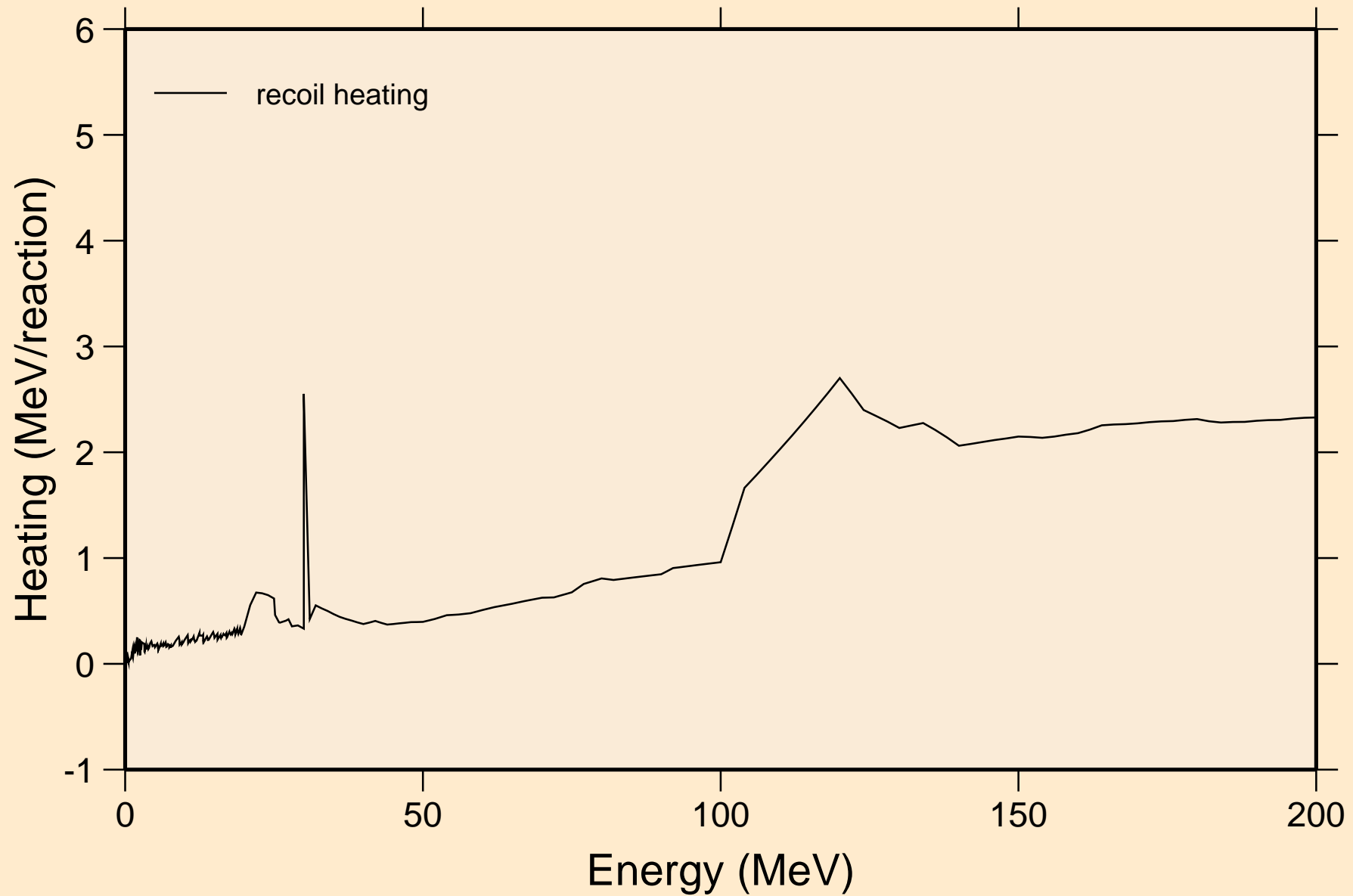

NB084 NEUTRON ACER TENDL-2021 LIBRARY; T=293.6K  
Particle production cross sections

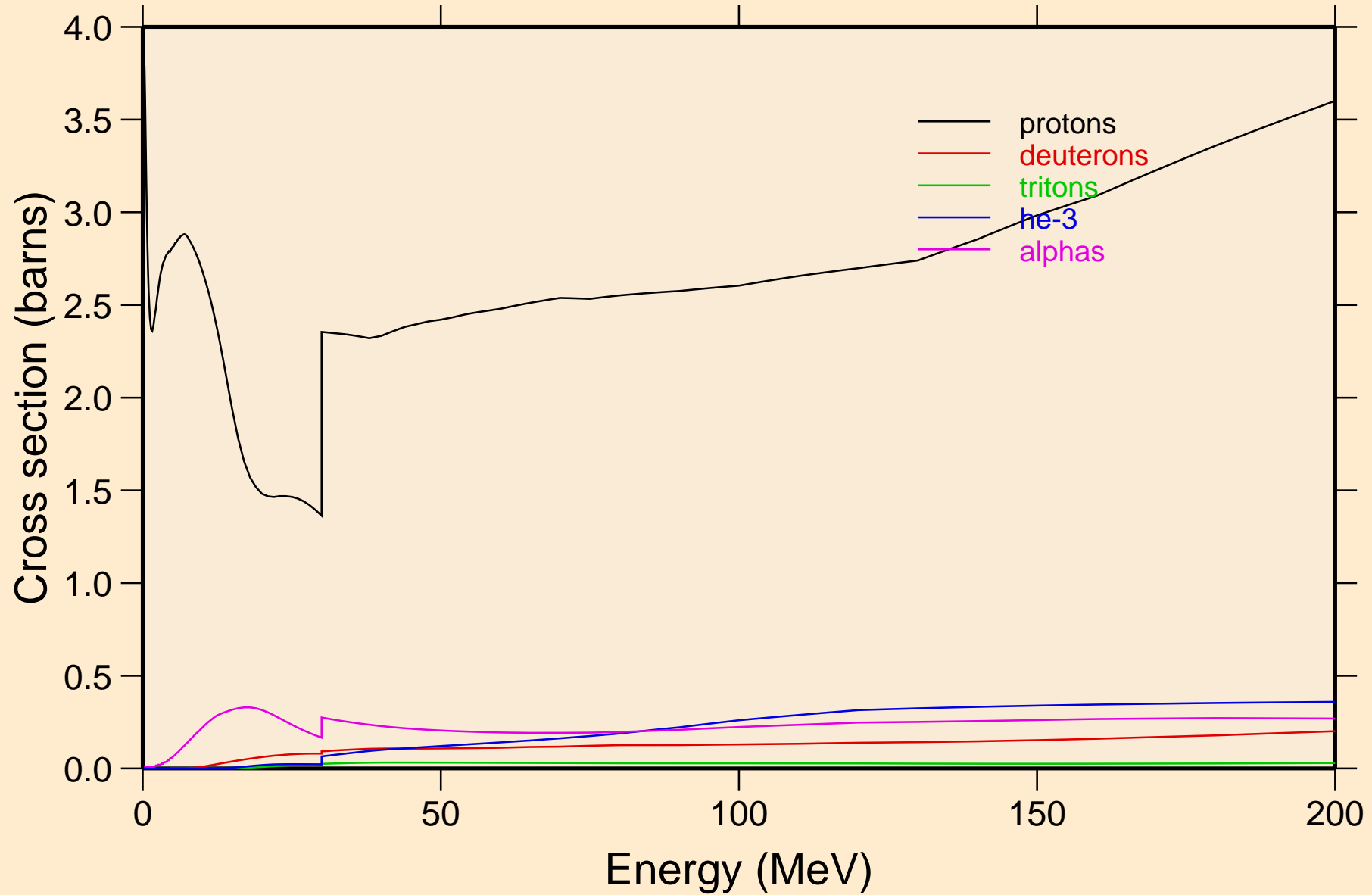

NB084 NEUTRON ACER TENDL-2021 LIBRARY; T=293.6K  
protons from (n,x)

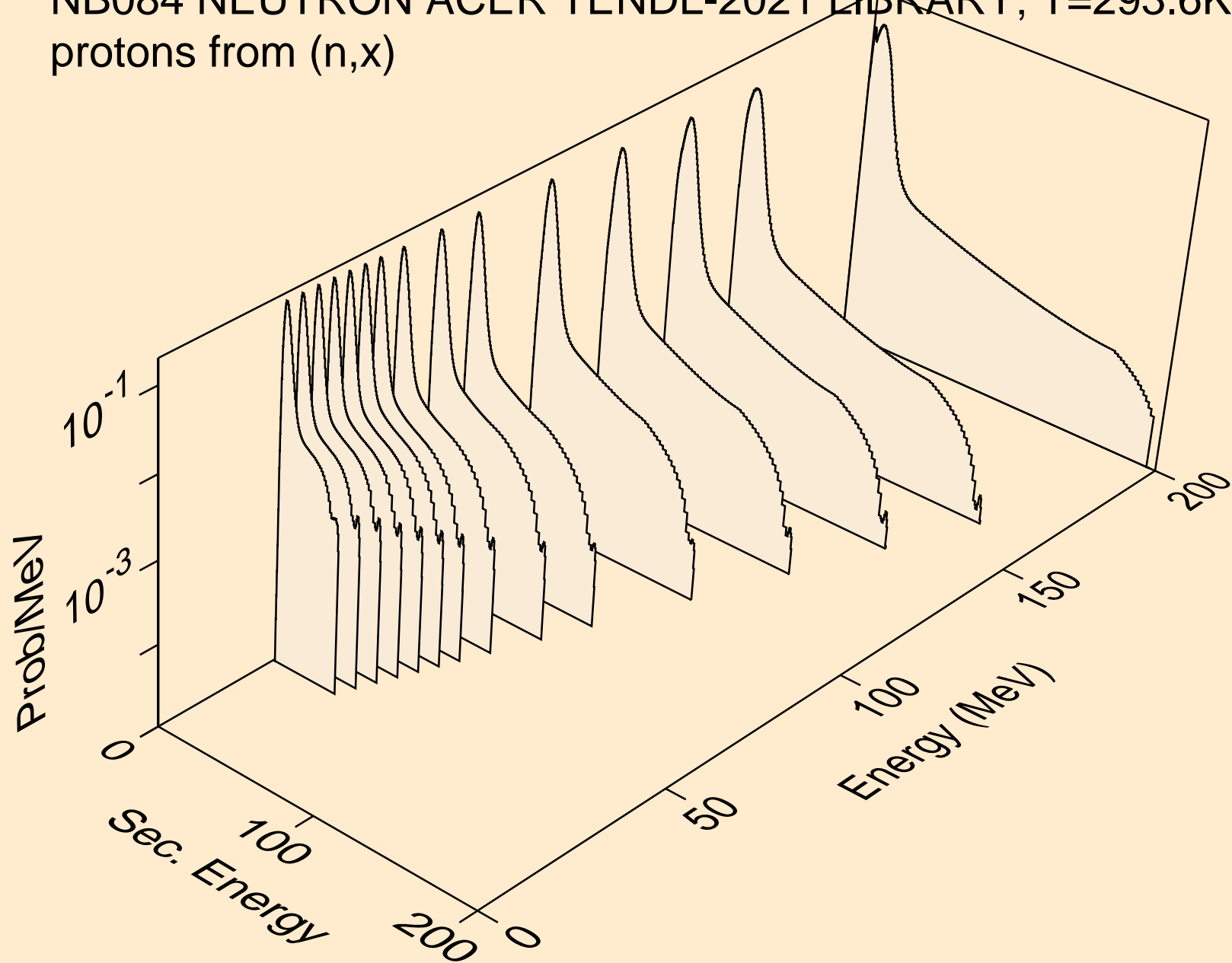

NB084 NEUTRON ACER TENDL-2021 LIBRARY; T=293.6K  
protons from (n,n\*)p

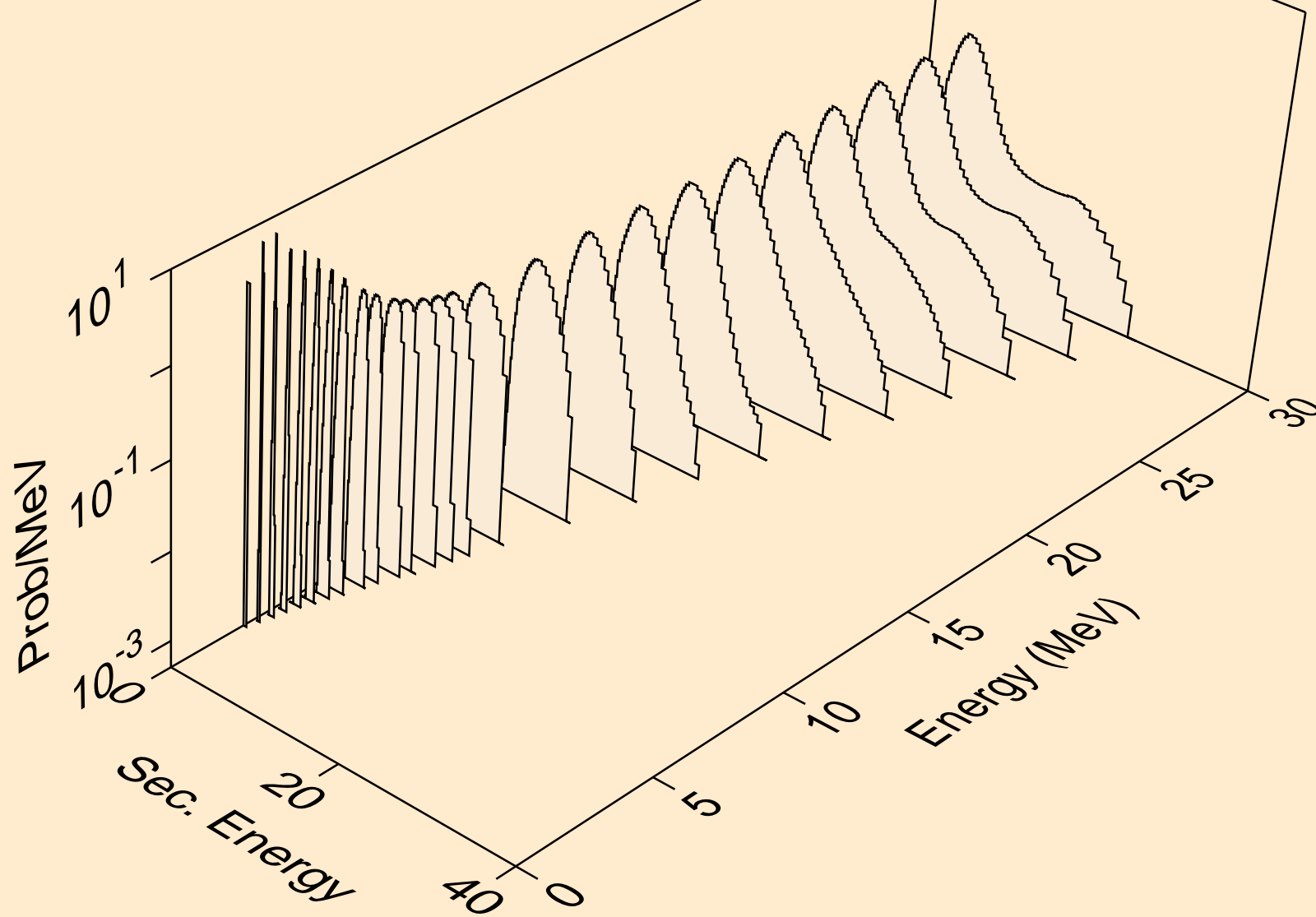

NB084 NEUTRON ACER TENDL-2021 LIBRARY; T=293.6K  
protons from (n,2np)

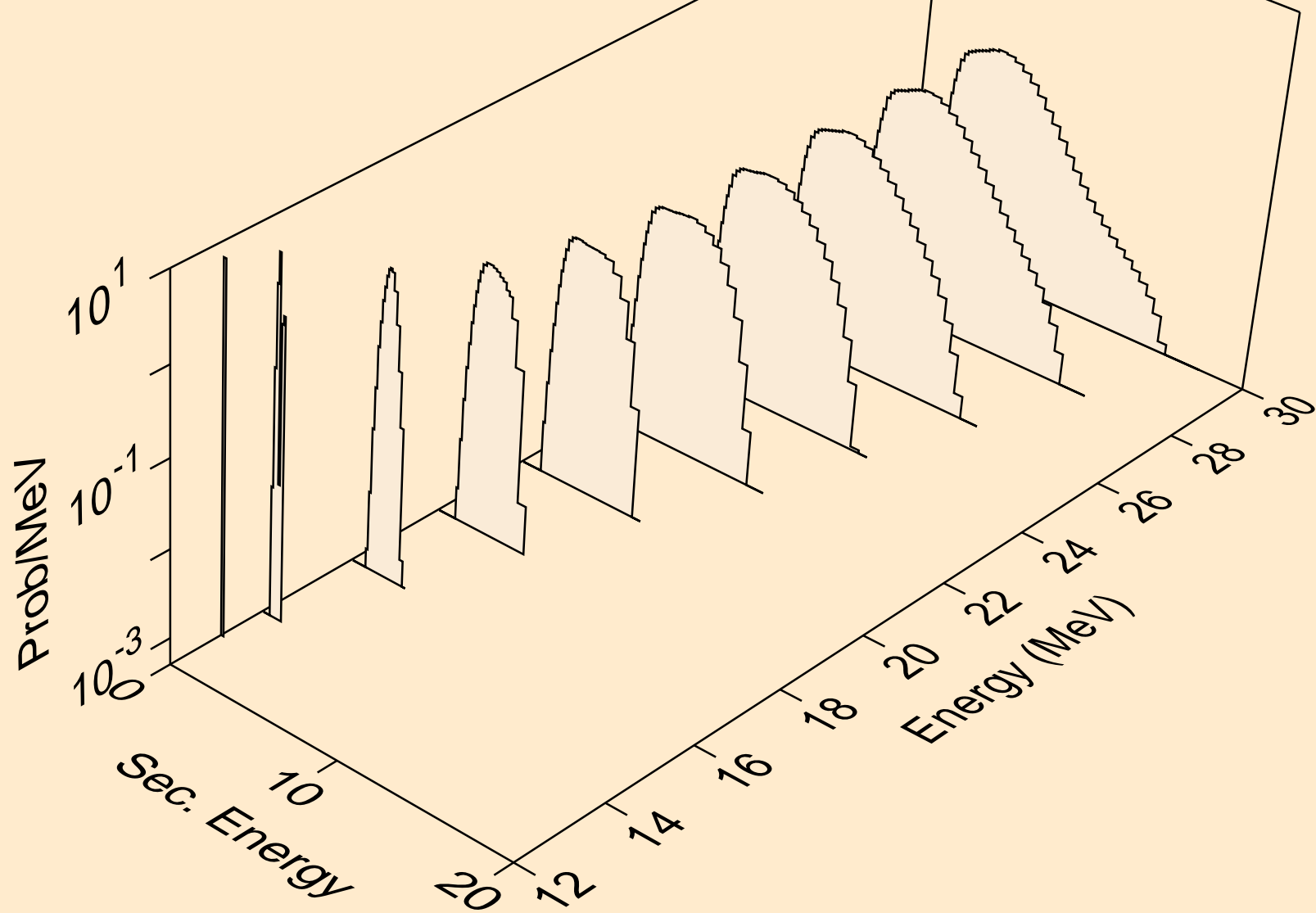

NB084 NEUTRON ACER TENDL-2021 LIBRARY; T=293.6K  
protons from (n,3np)

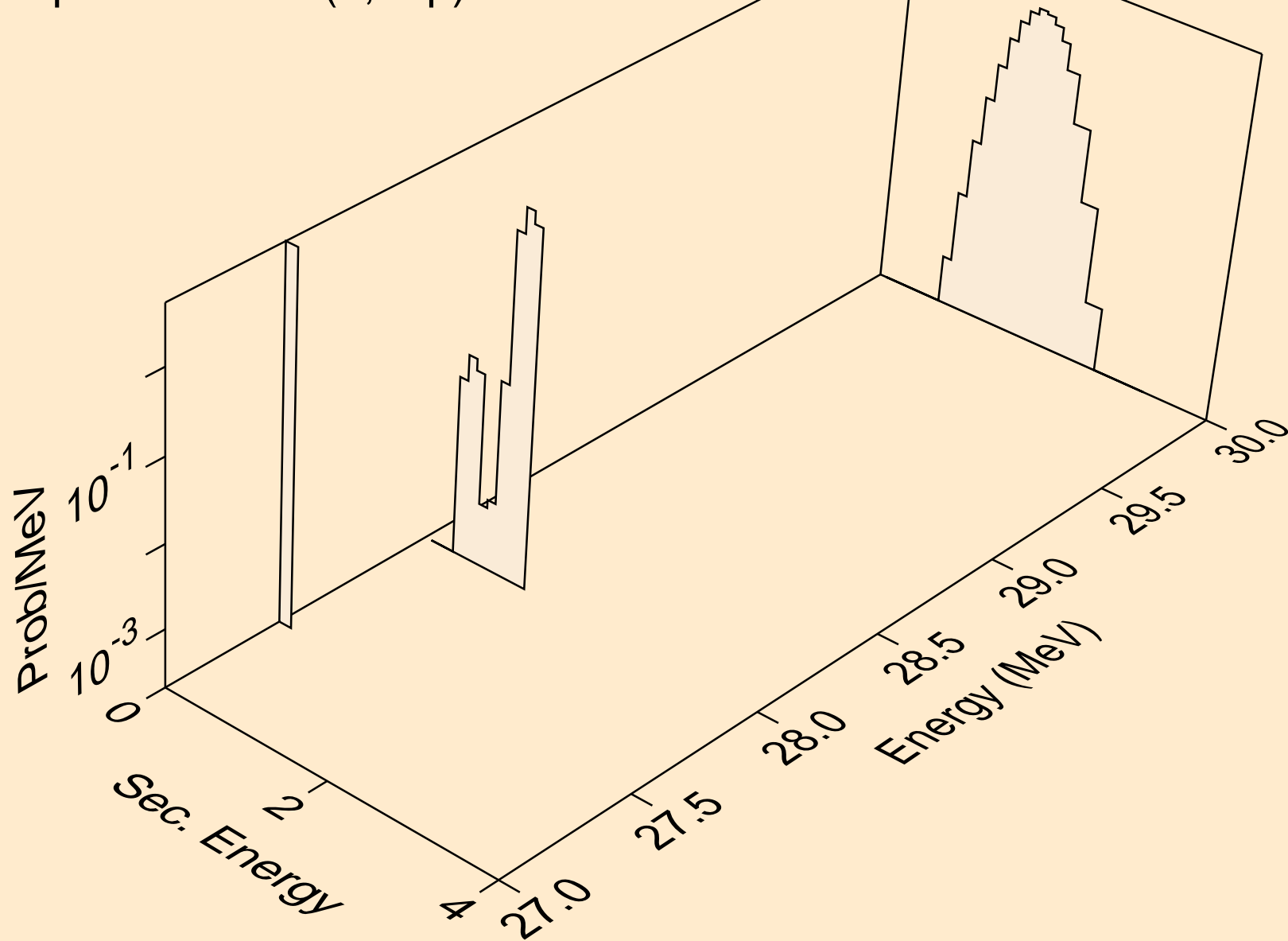

NB084 NEUTRON ACER TENDL-2021 LIBRARY; T=293.6K  
protons from (n,2np)

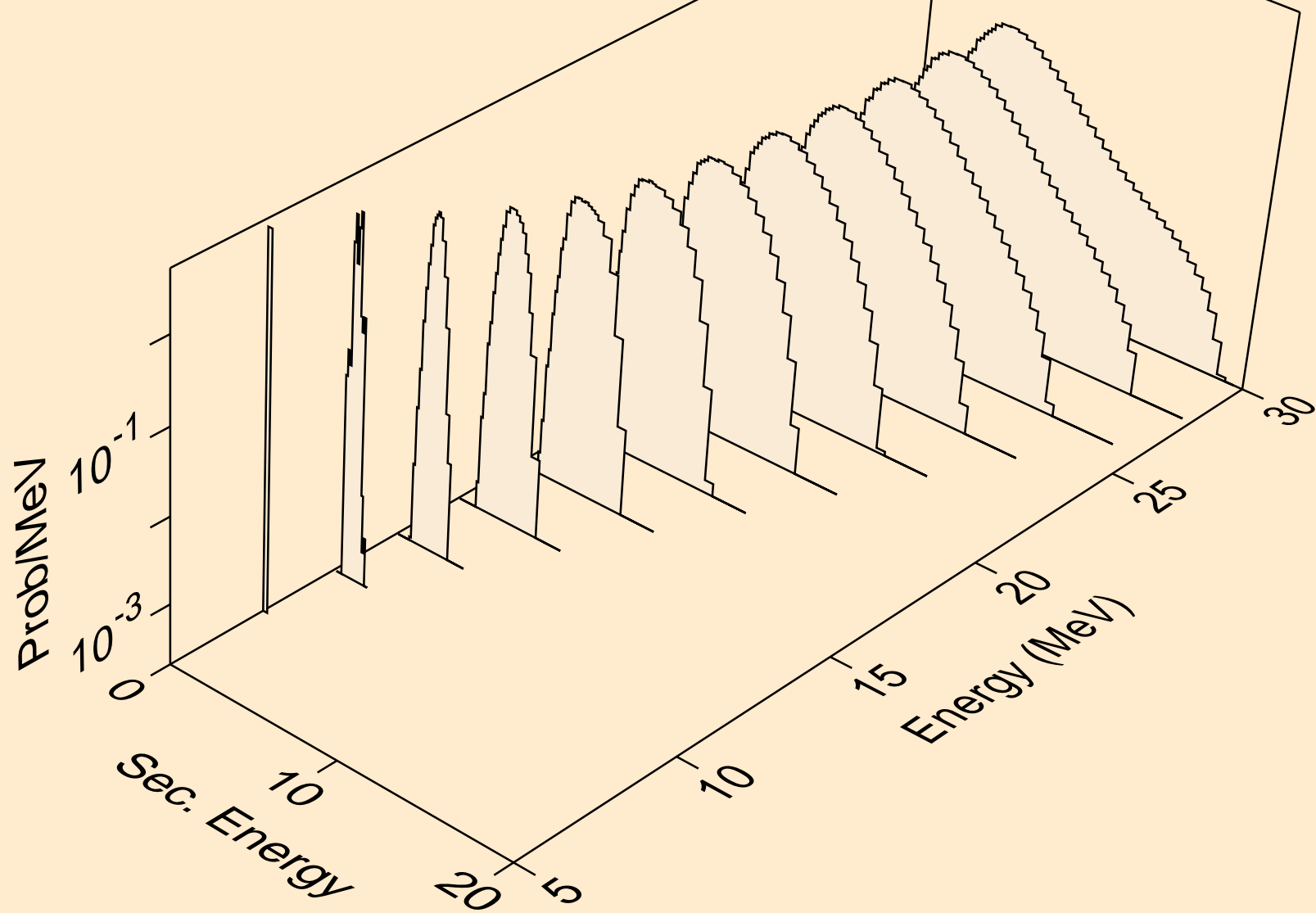

NB084 NEUTRON ACER TENDL-2021 LIBRARY; T=293.6K  
protons from (n,npa)

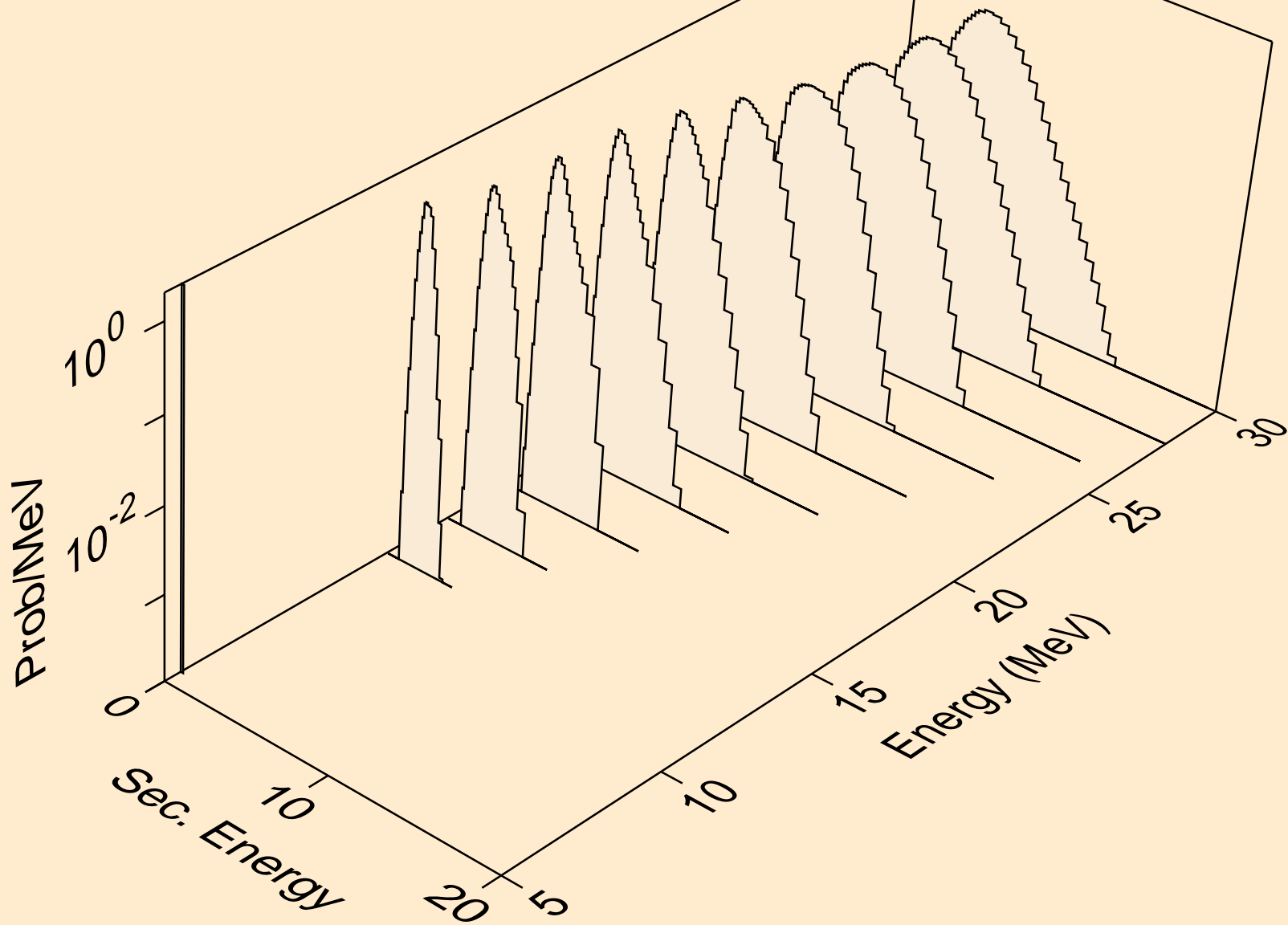

NB084 NEUTRON ACER TENDL-2021 LIBRARY; T=293.6K  
protons from (n,p)

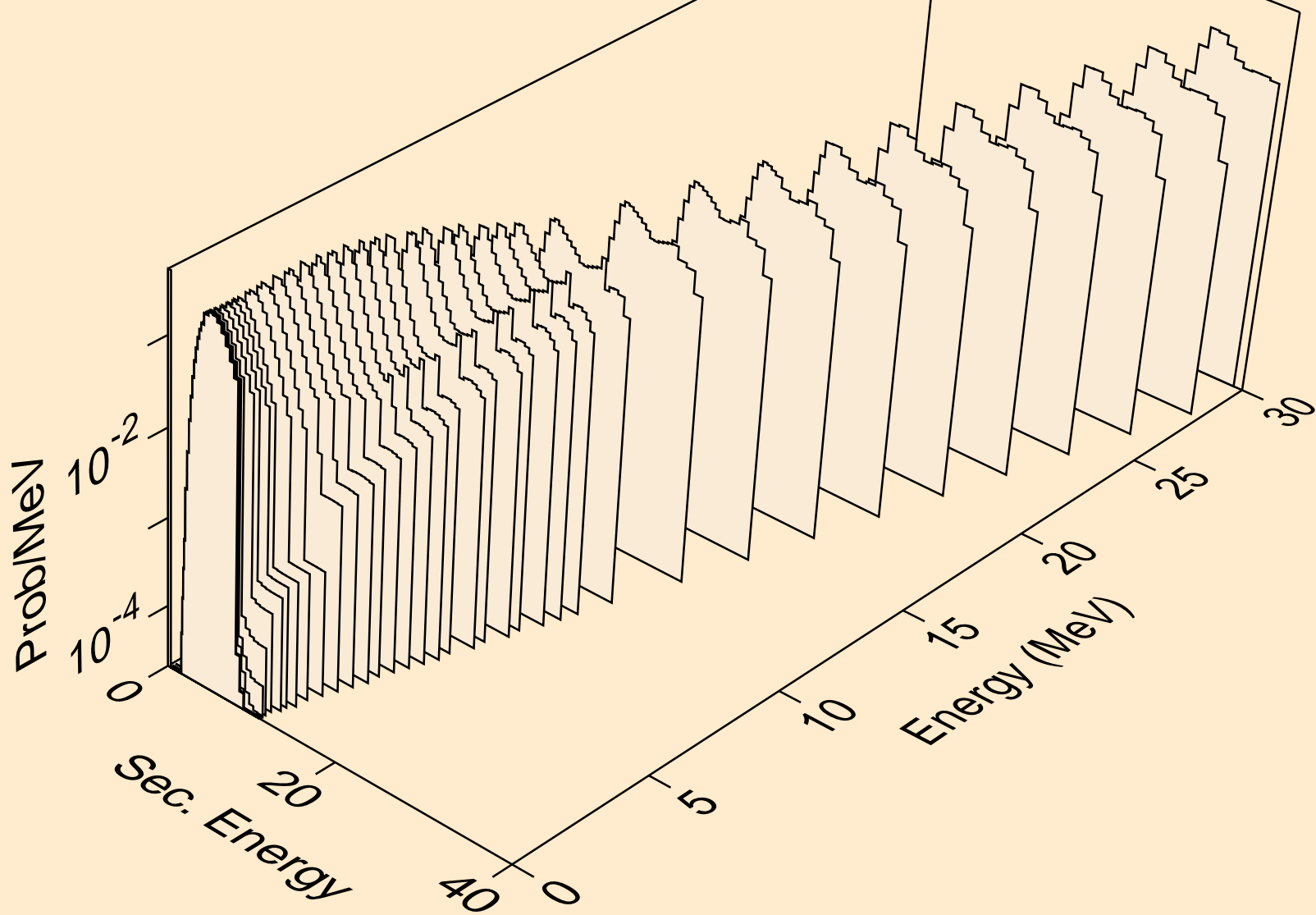

NB084 NEUTRON ACER TENDL-2021 LIBRARY; T=293.6K  
protons from (n,2p)

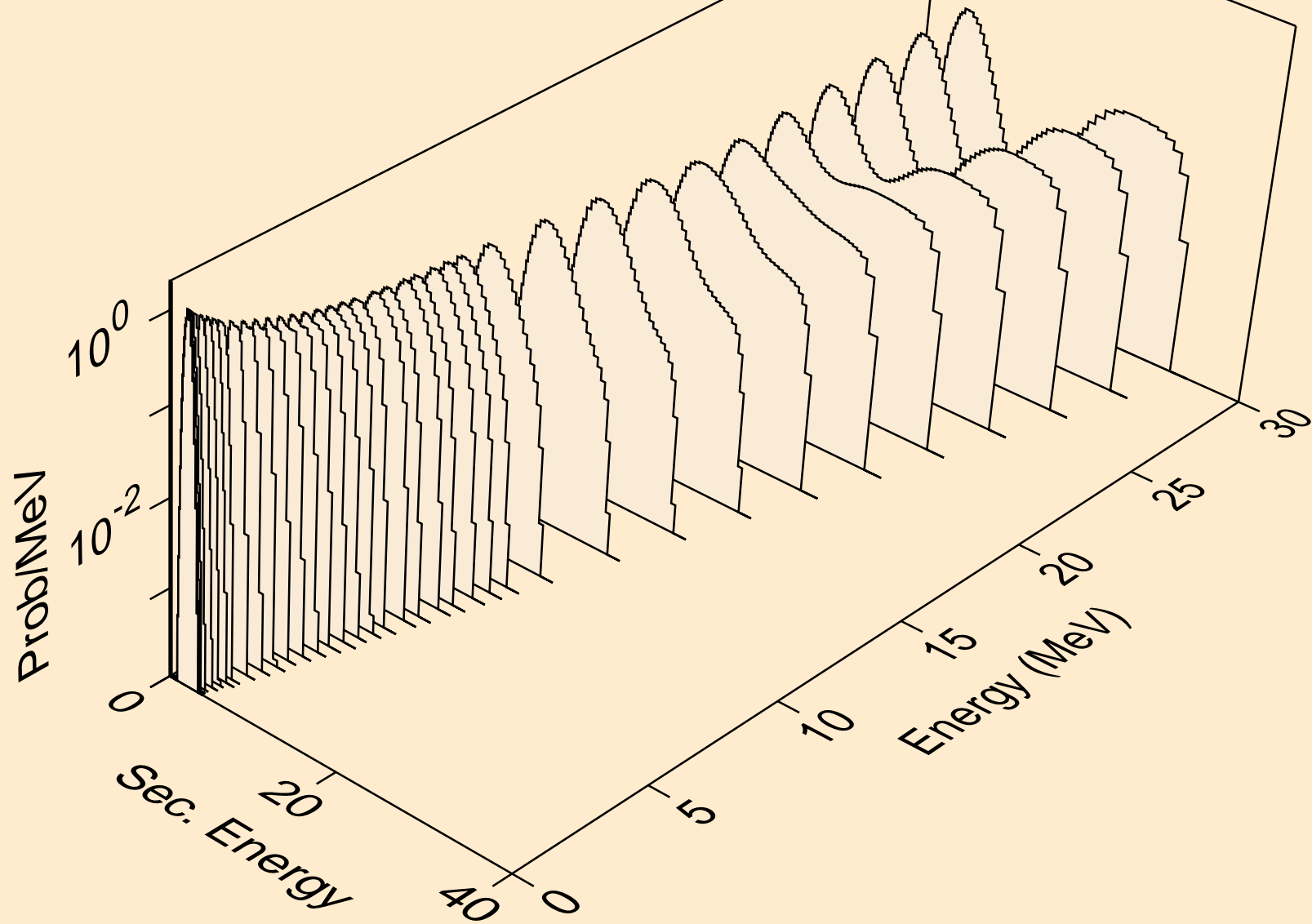

NB084 NEUTRON ACER TENDL-2021 LIBRARY; T=293.6K  
protons from (n,p)

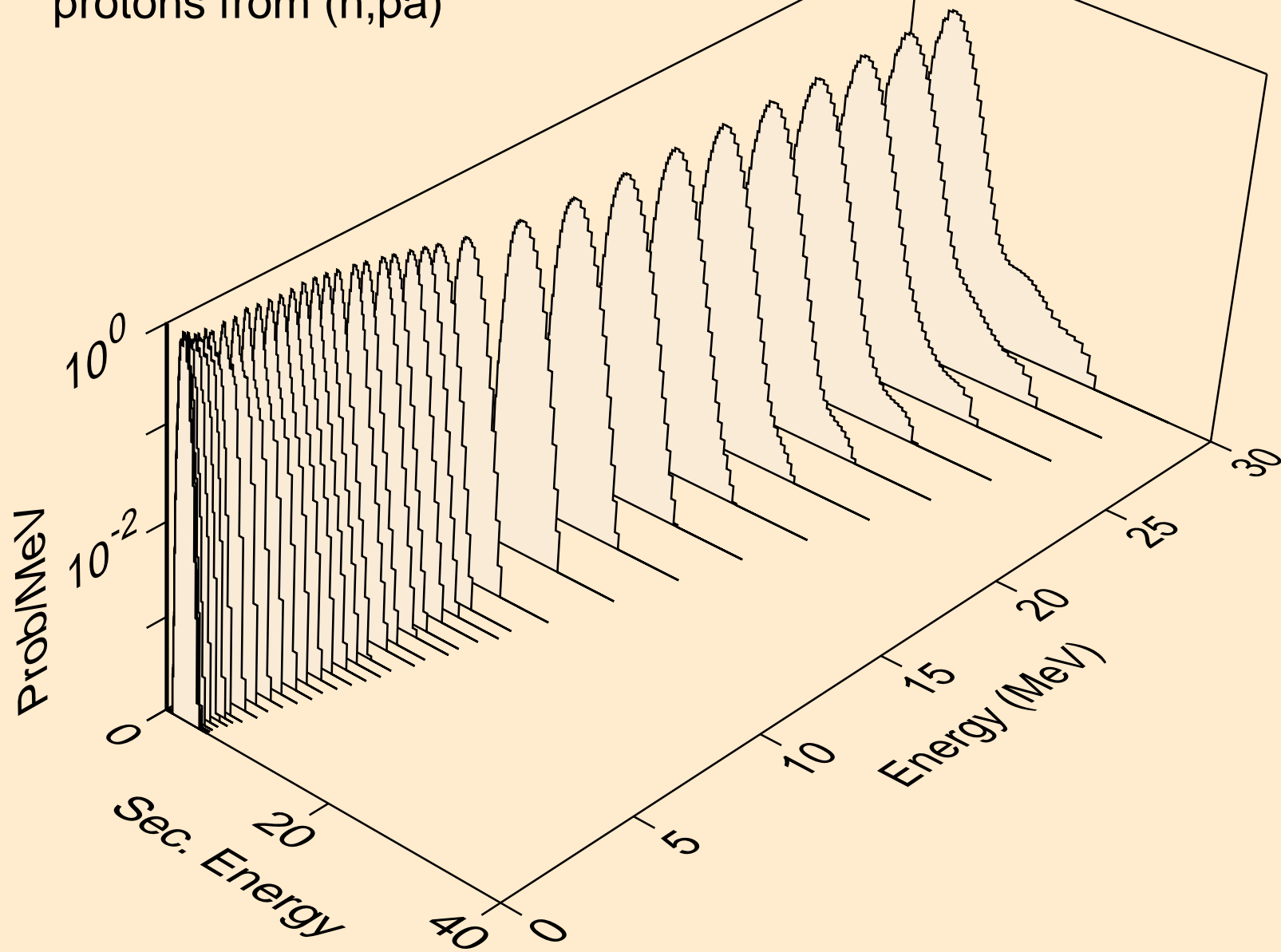

NB084 NEUTRON ACER TENDL-2021 LIBRARY; T=293.6K  
protons from (n,pd)

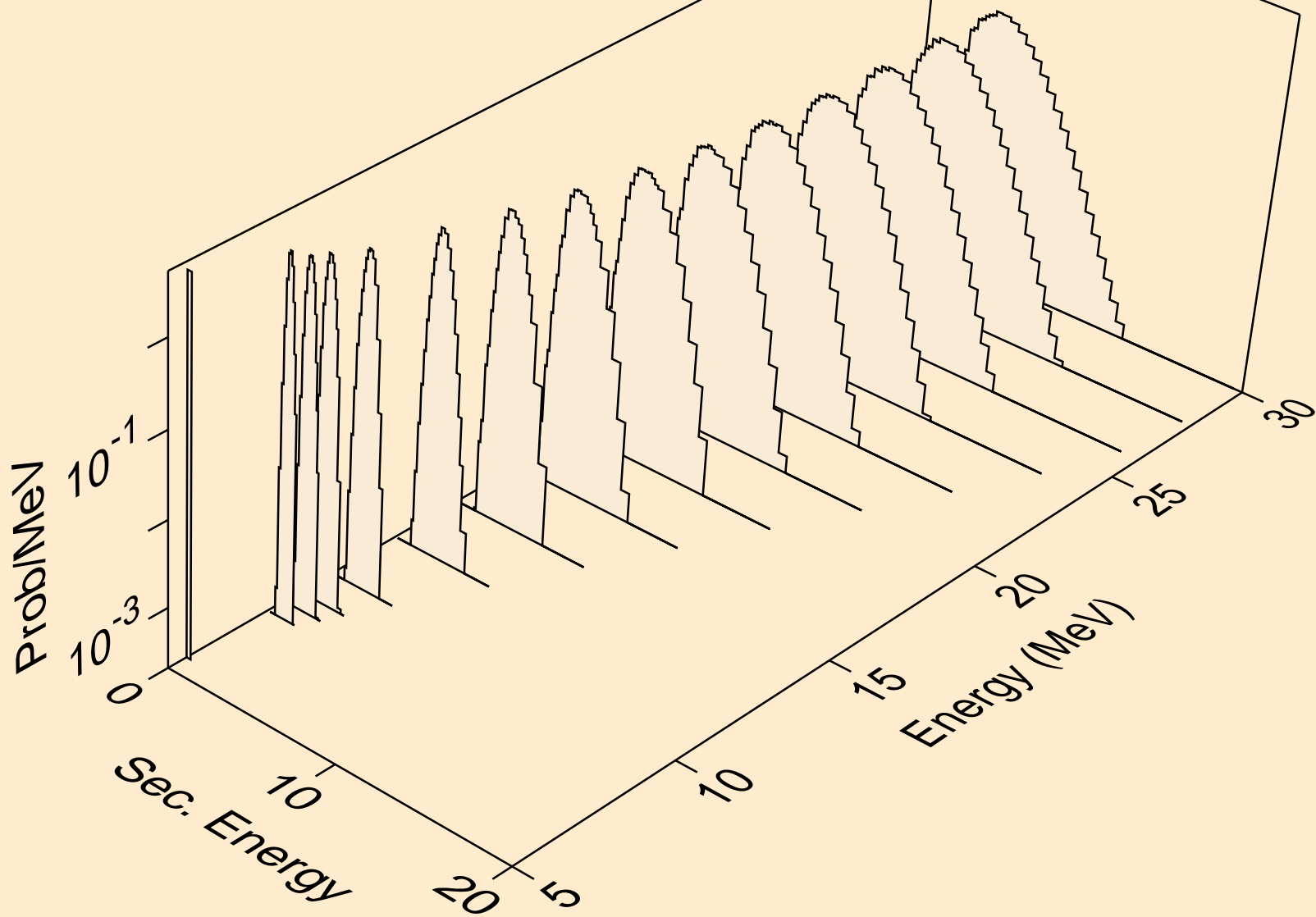

NB084 NEUTRON ACER TENDL-2021 LIBRARY; T=293.6K  
protons from (n,pt)

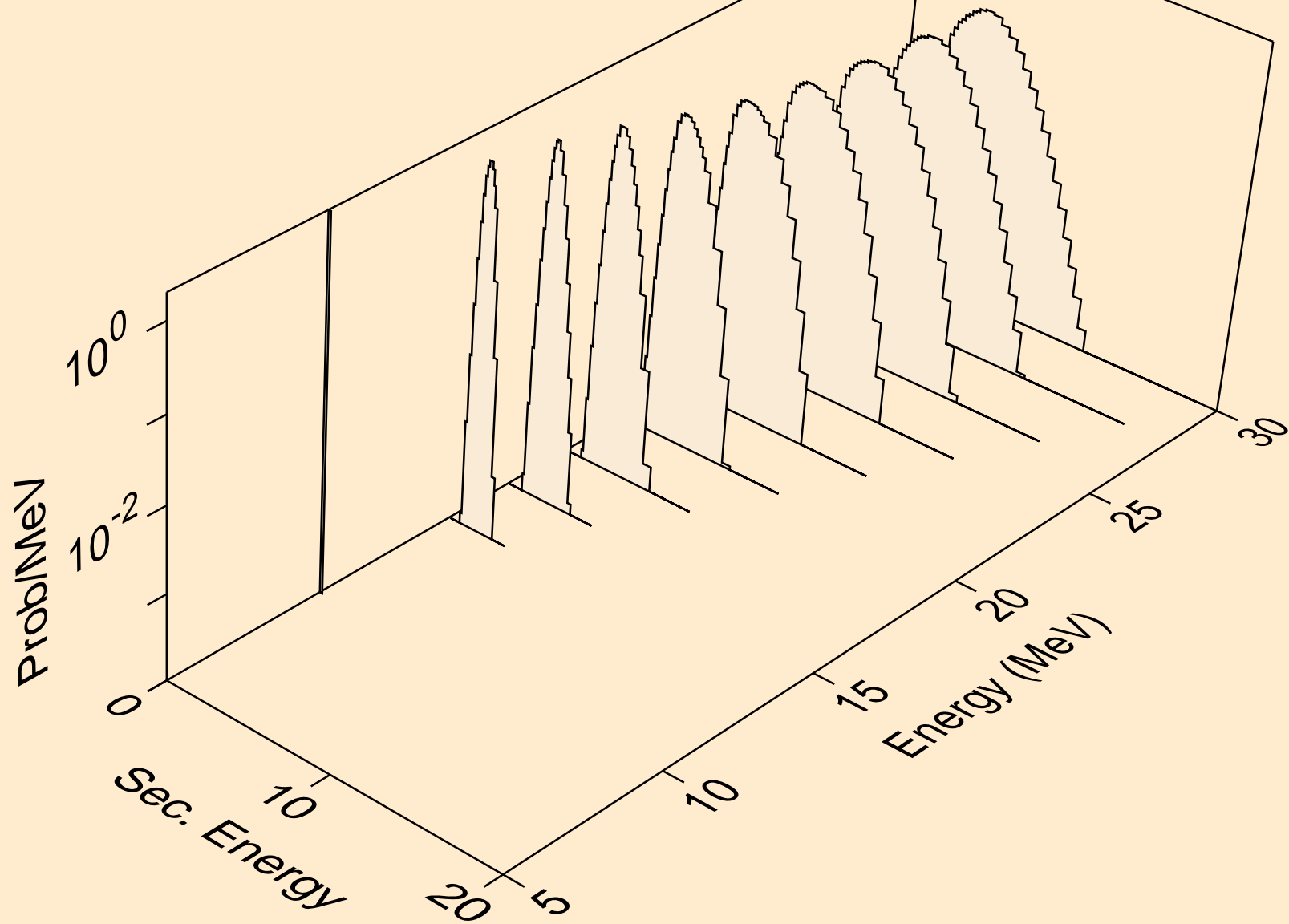

NB084 NEUTRON ACER TENDL-2021 LIBRARY; T=293.6K  
deuterons from (n,x)

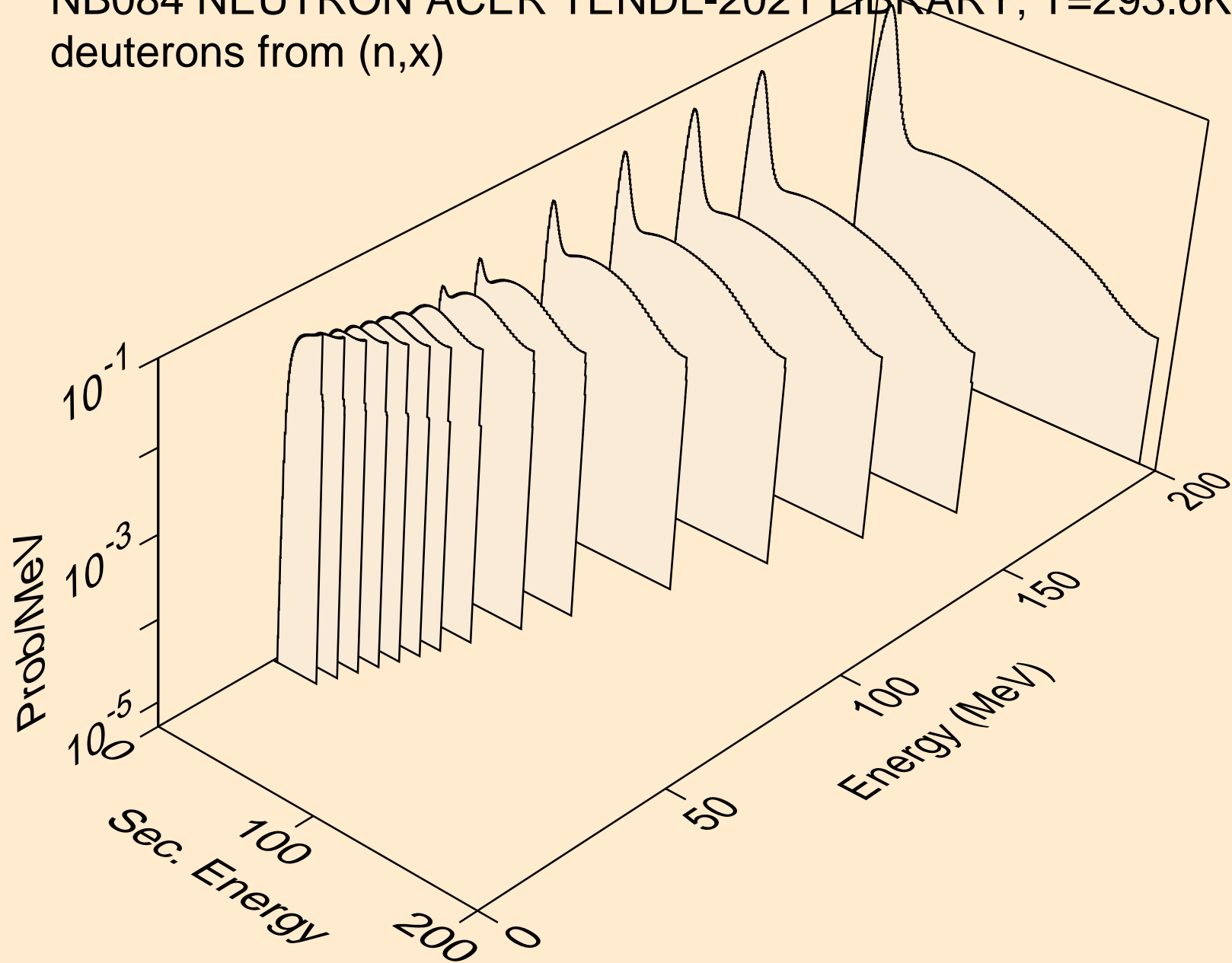

NB084 NEUTRON ACER TENDL-2021 LIBRARY; T=293.6K  
deuterons from (n,2nd)

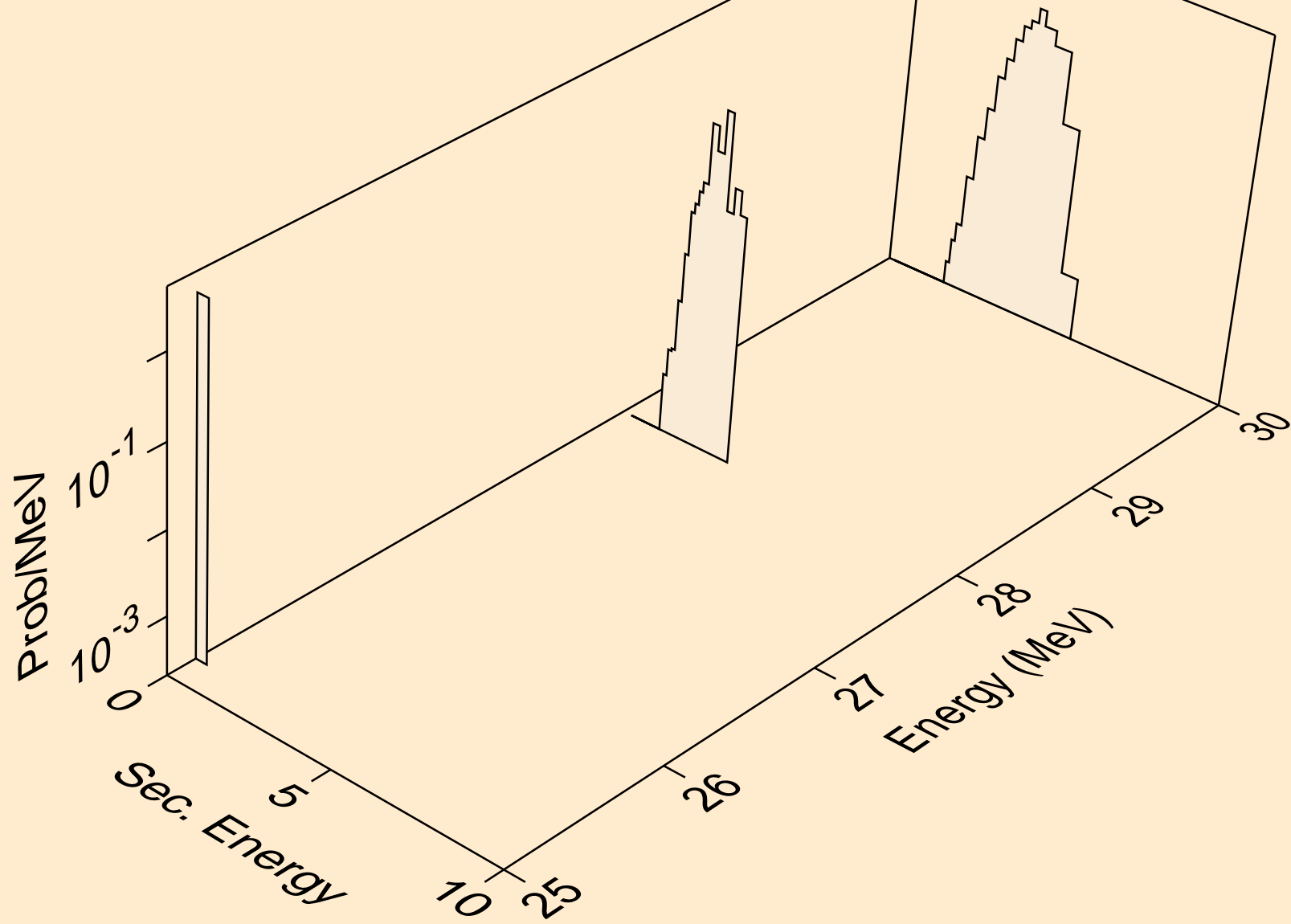

NB084 NEUTRON ACER TENDL-2021 LIBRARY; T=293.6K  
deuterons from (n,n\*)d

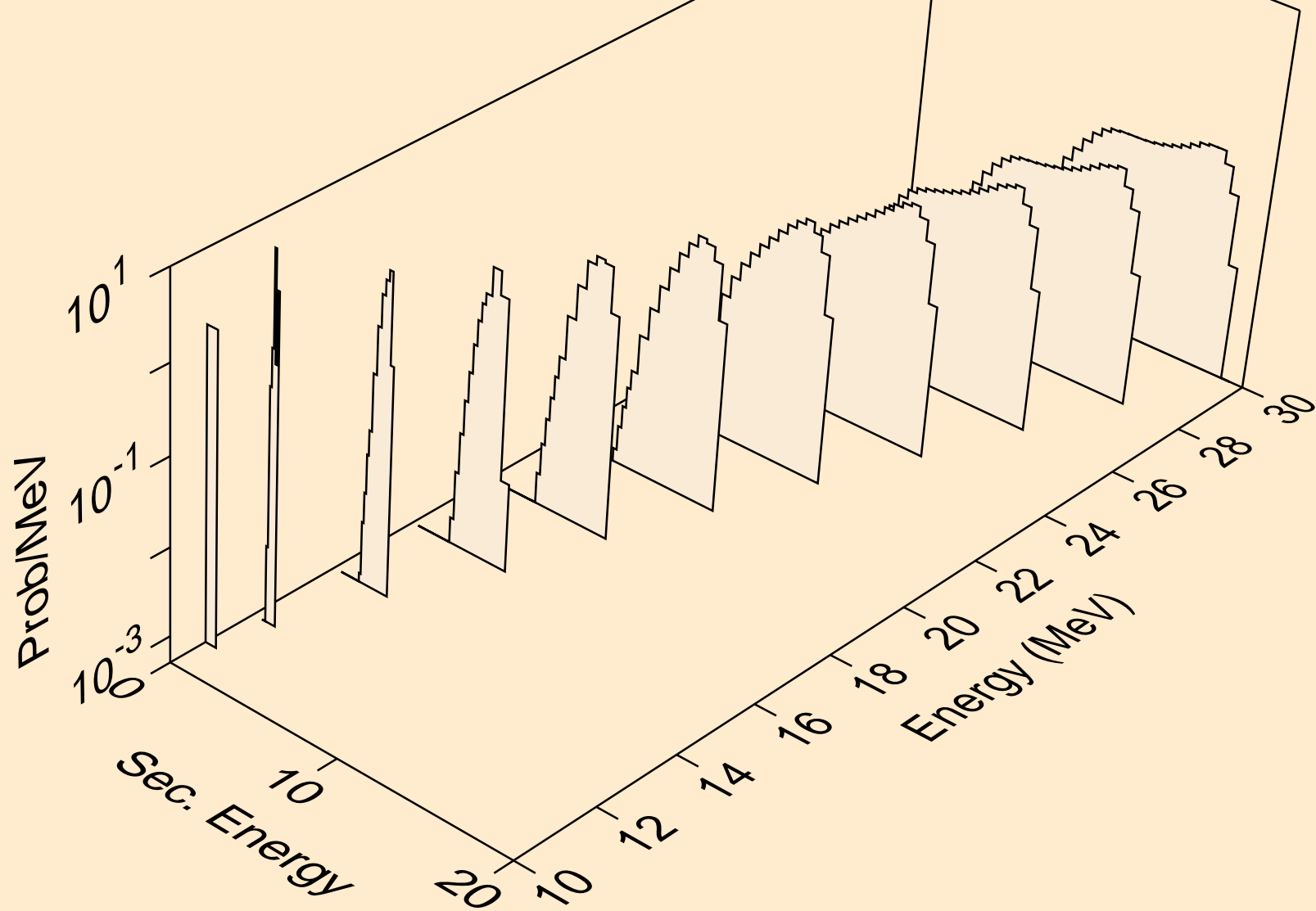

NB084 NEUTRON ACER TENDL-2021 LIBRARY; T=293.6K  
deuterons from (n,d)

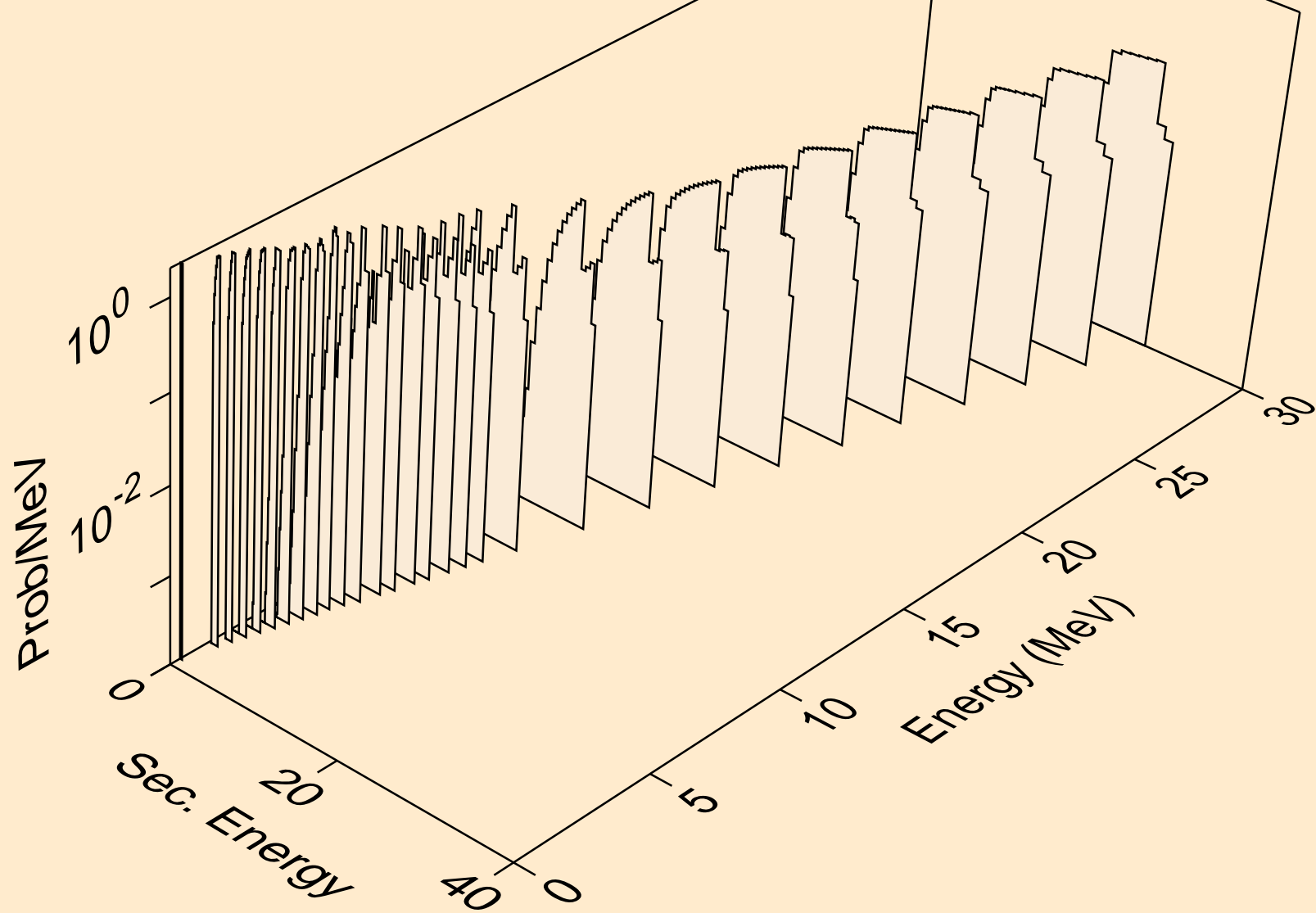

NB084 NEUTRON ACER TENDL-2021 LIBRARY; T=293.6K  
deuterons from (n,pd)

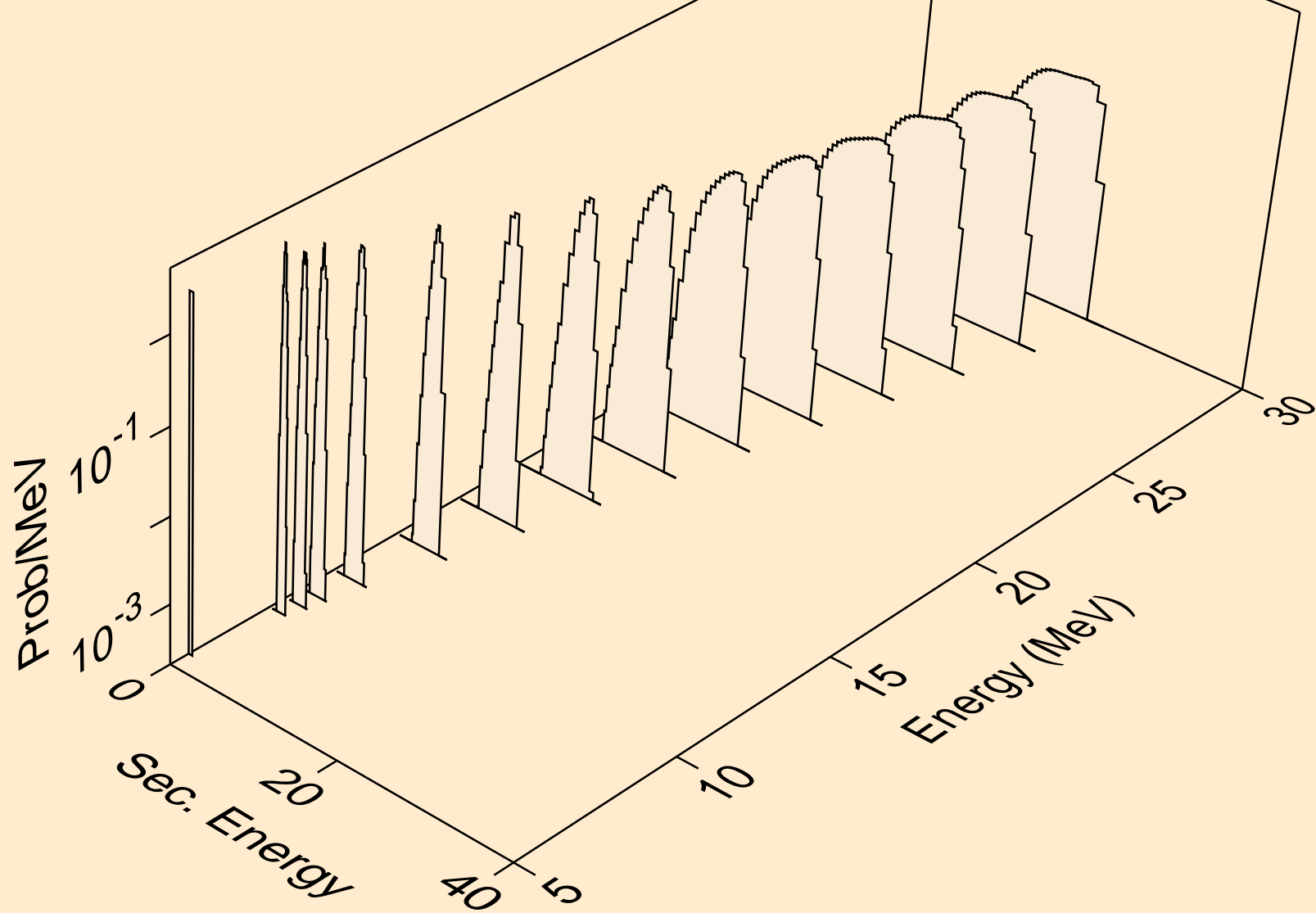

NB084 NEUTRON ACER TENDL-2021 LIBRARY; T=293.6K  
deuterons from (n,da)

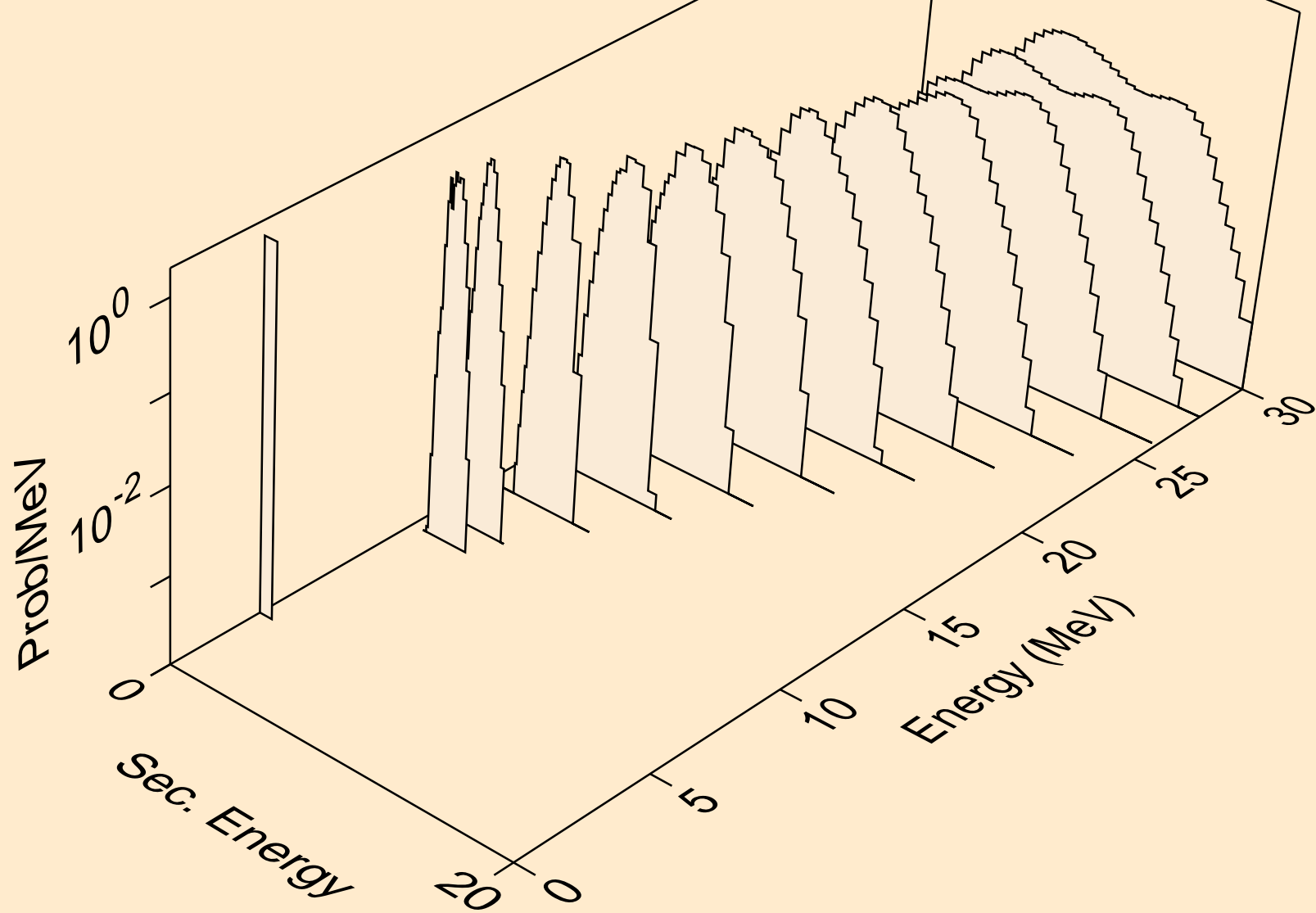

NB084 NEUTRON ACER TENDL-2021 LIBRARY; T=293.6K  
tritons from (n,x)

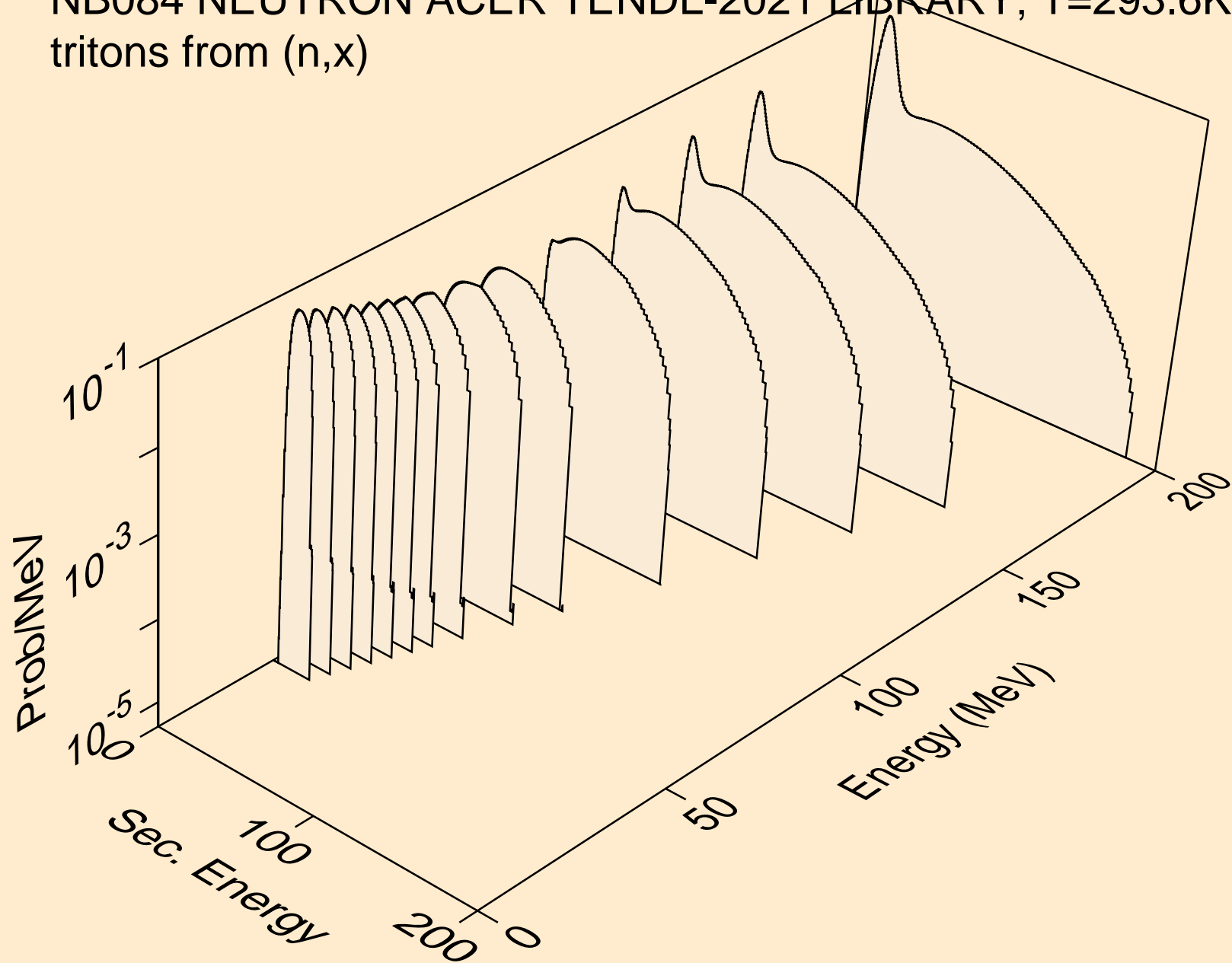

NB084 NEUTRON ACER TENDL-2021 LIBRARY; T=293.6K  
tritons from (n,n\*)t

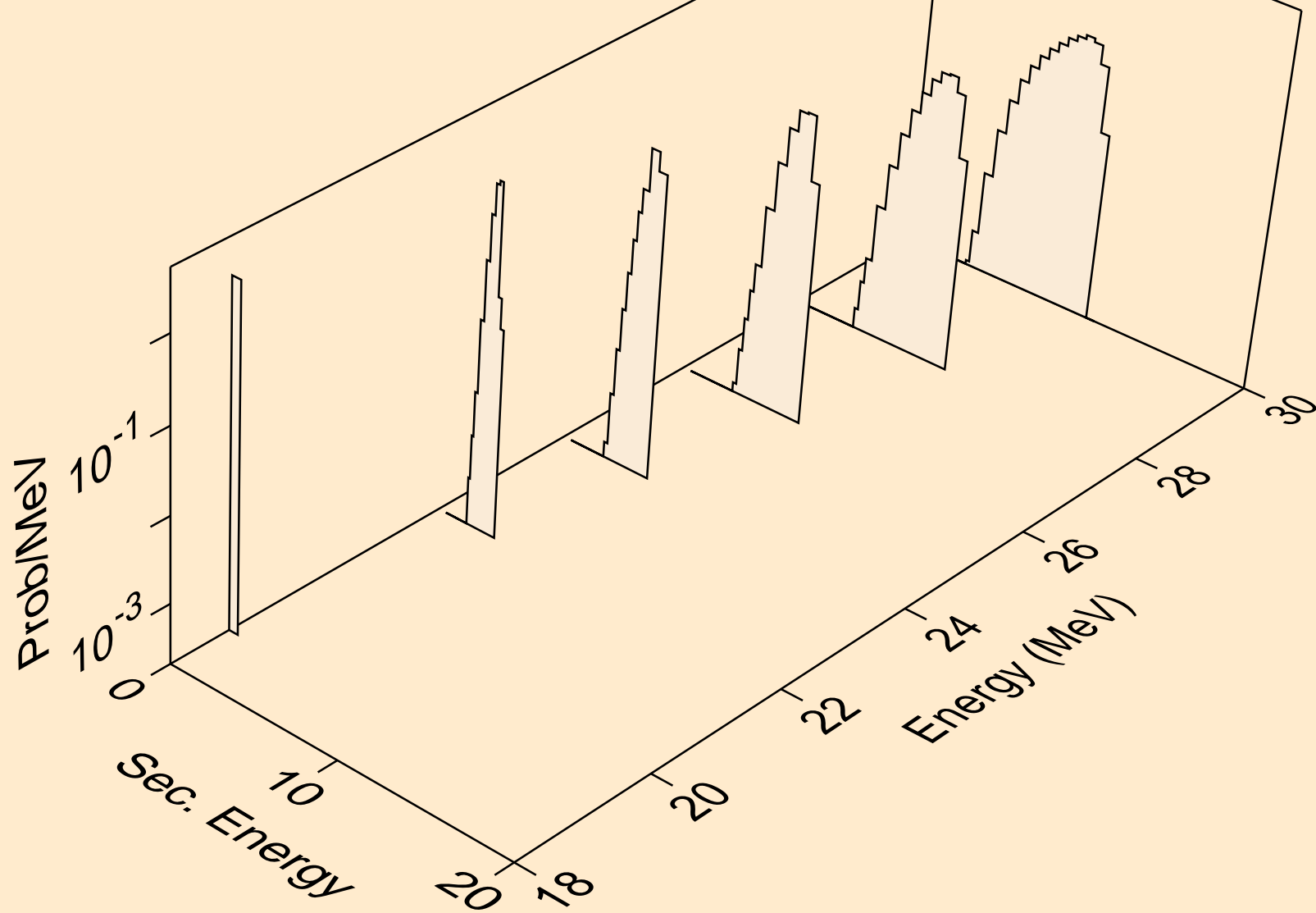

NB084 NEUTRON ACER TENDL-2021 LIBRARY; T=293.6K  
tritons from (n,t)

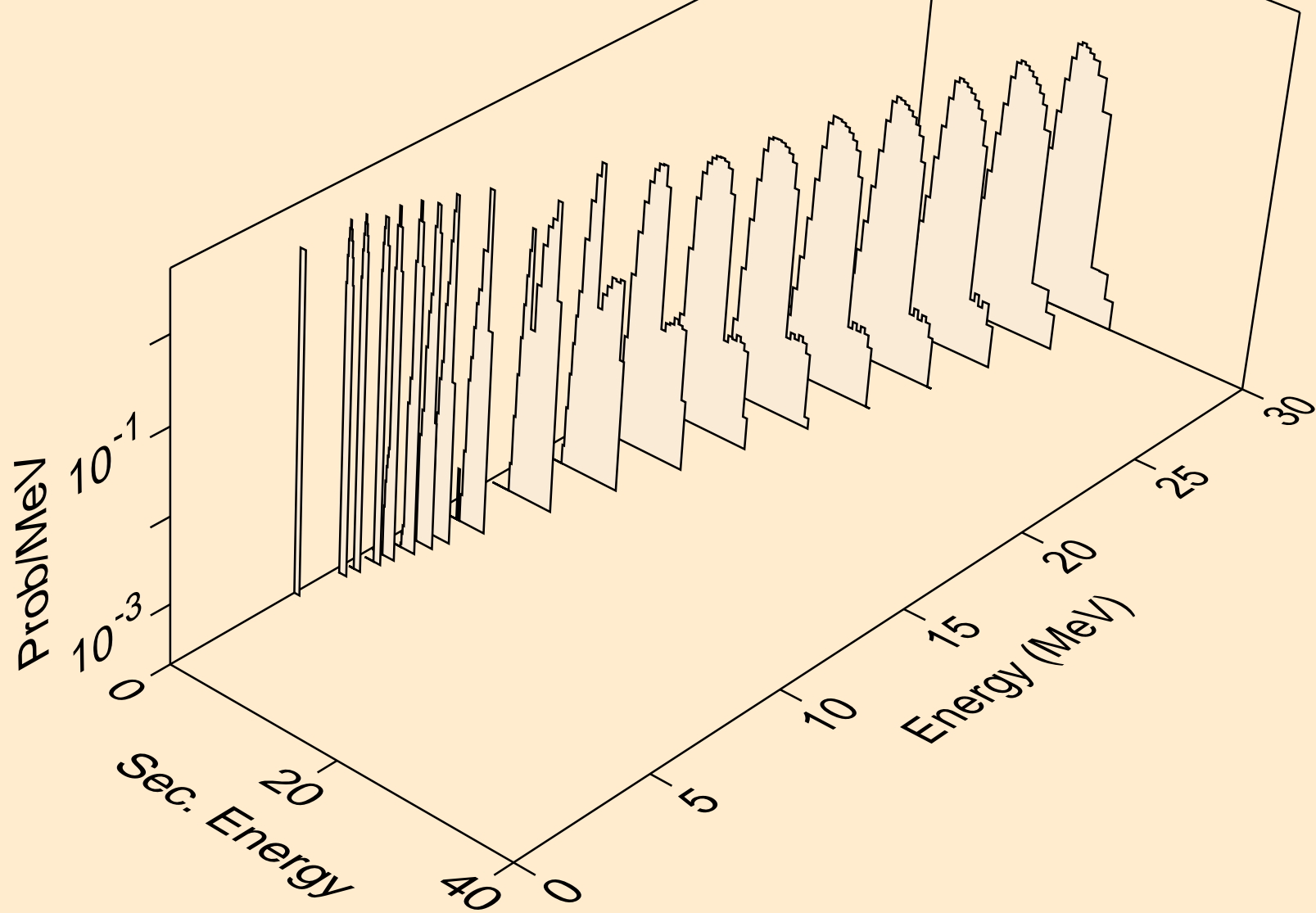

NB084 NEUTRON ACER TENDL-2021 LIBRARY; T=293.6K  
tritons from (n,pt)

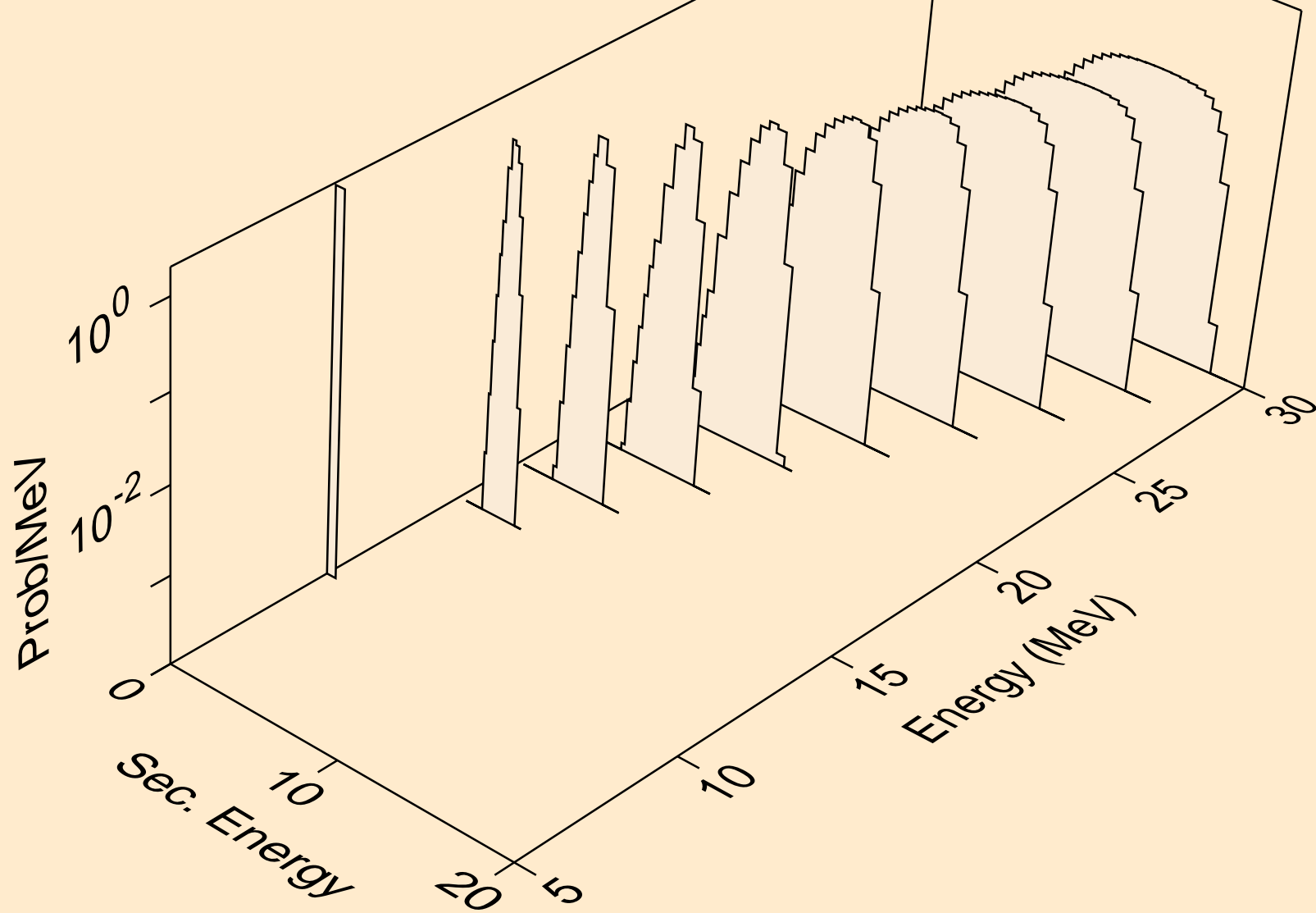

NB084 NEUTRON ACER TENDL-2021 LIBRARY; T=293.6K  
he3s from (n,x)

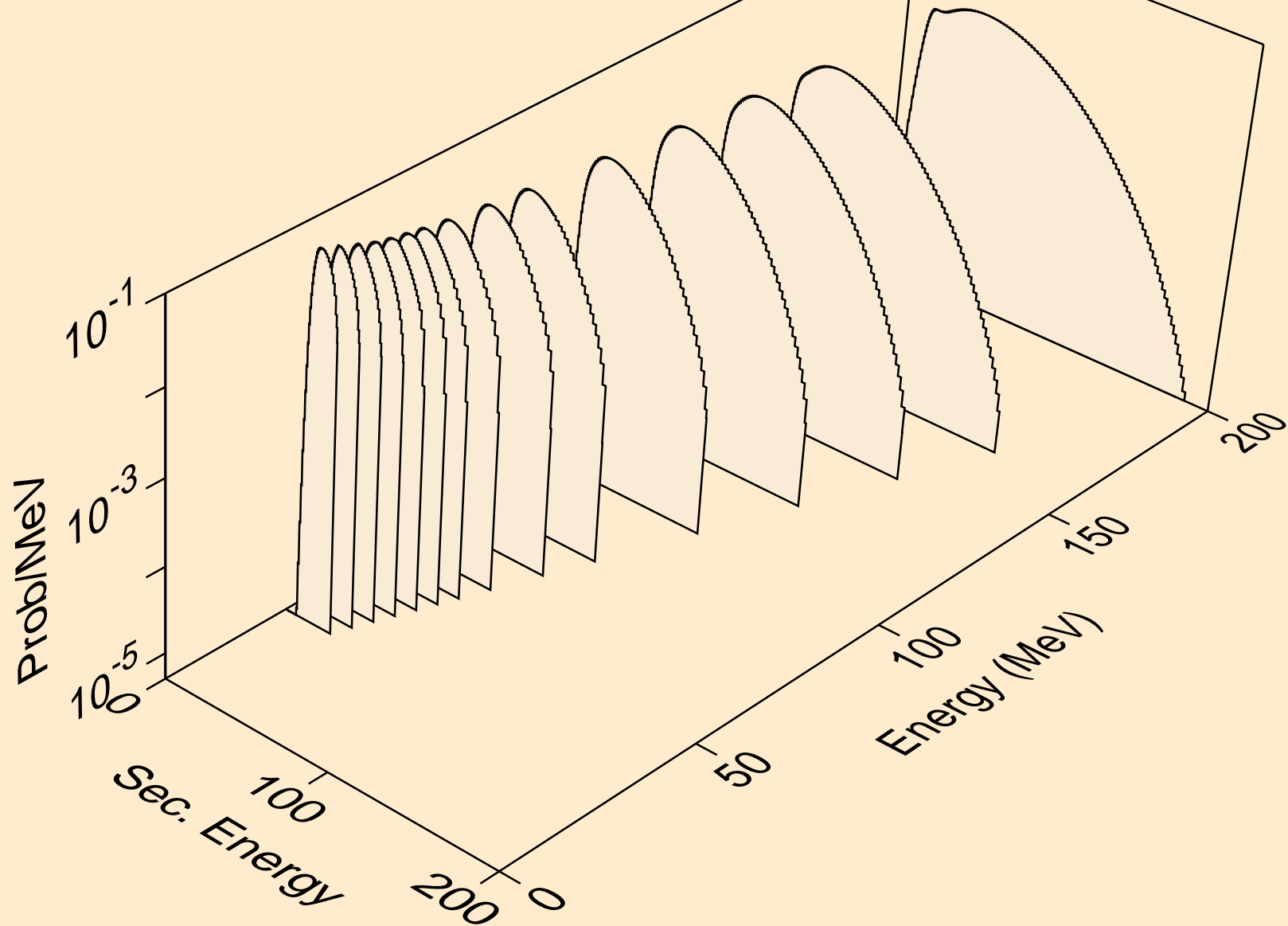

NB084 NEUTRON ACER TENDL-2021 LIBRARY; T=293.6K  
he3s from (n,n\*)he3

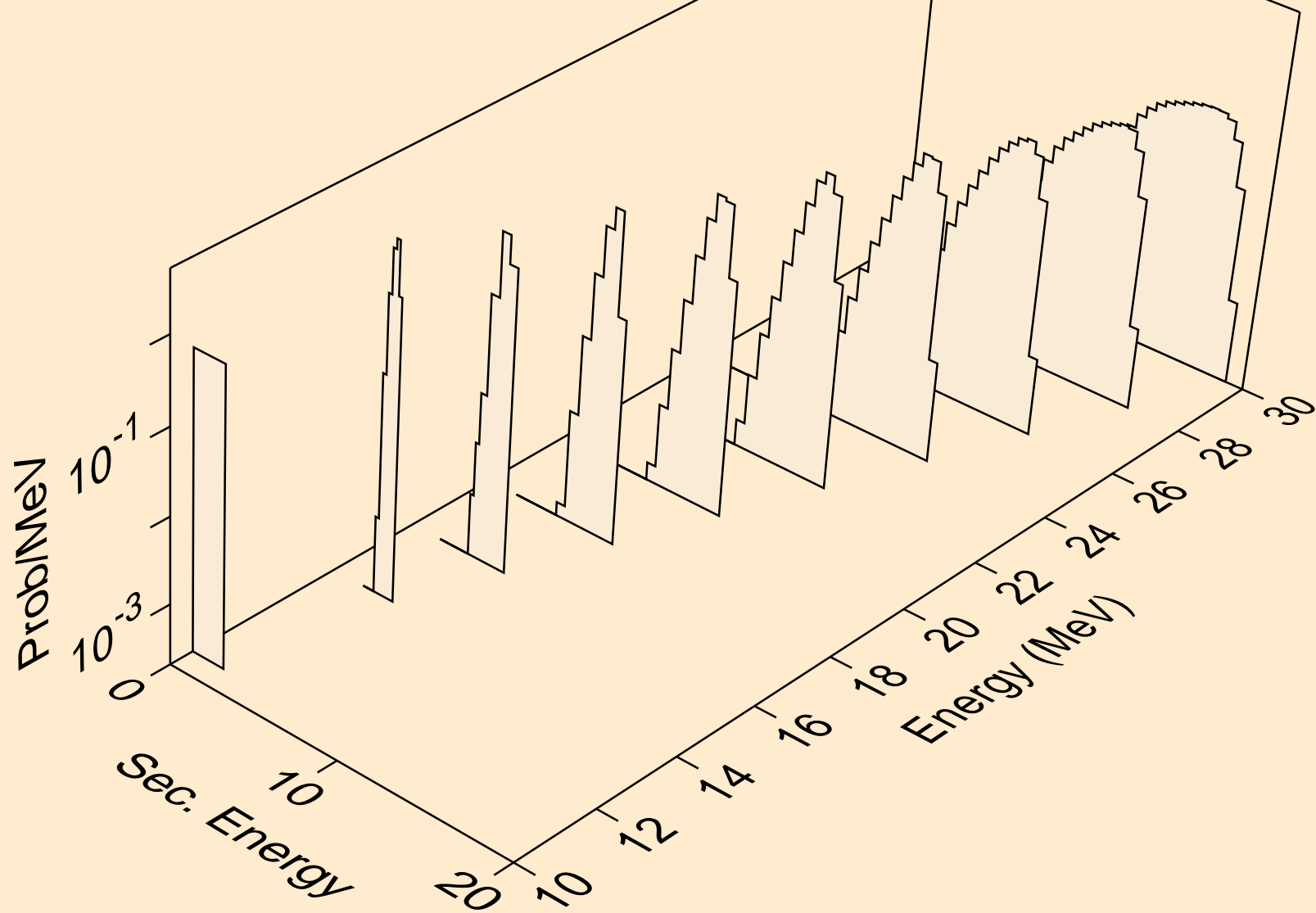

NB084 NEUTRON ACER TENDL-2021 LIBRARY; T=293.6K  
he3s from (n,he3)

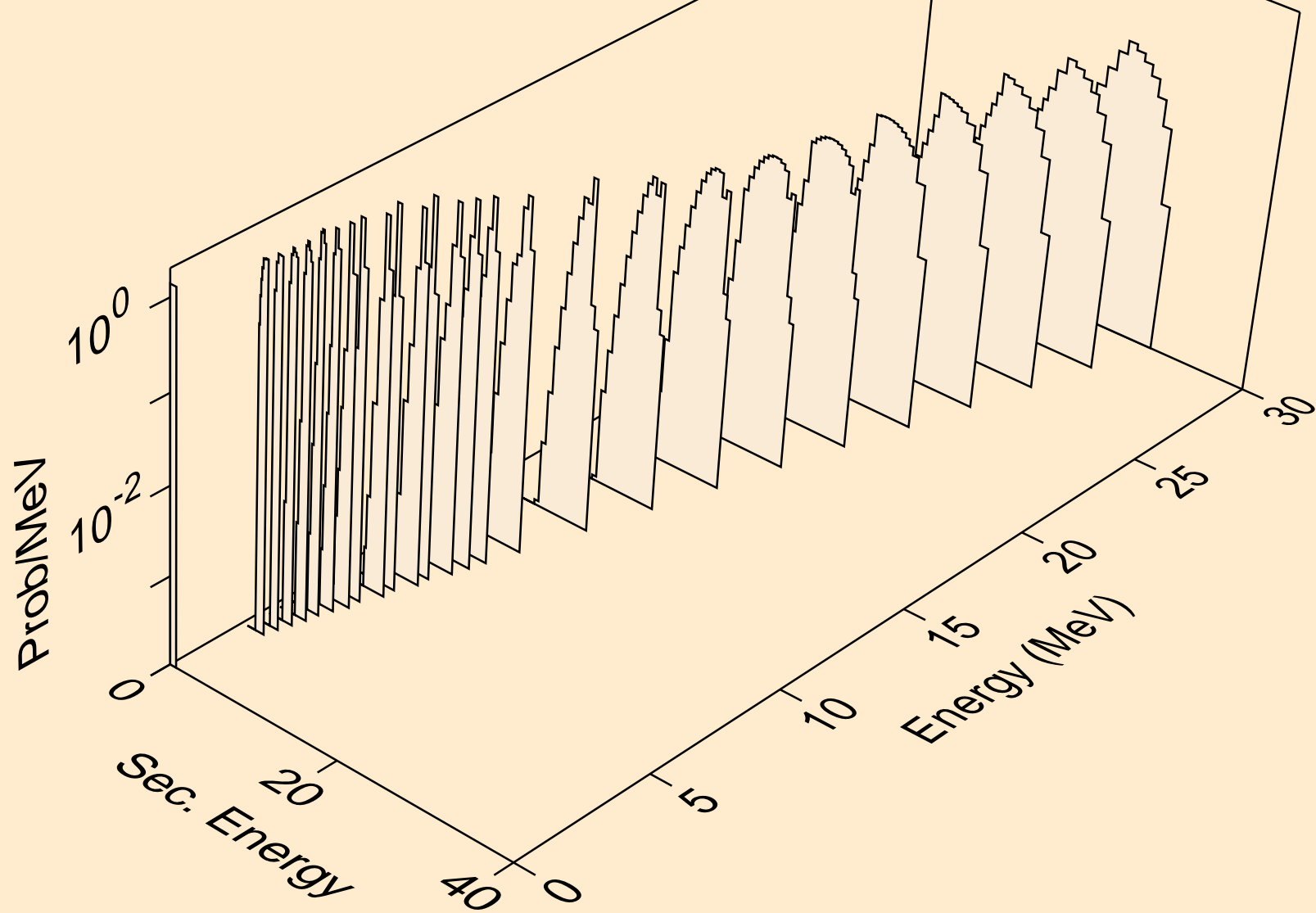

NB084 NEUTRON ACER TENDL-2021 LIBRARY; T=293.6K  
alphas from (n,x)

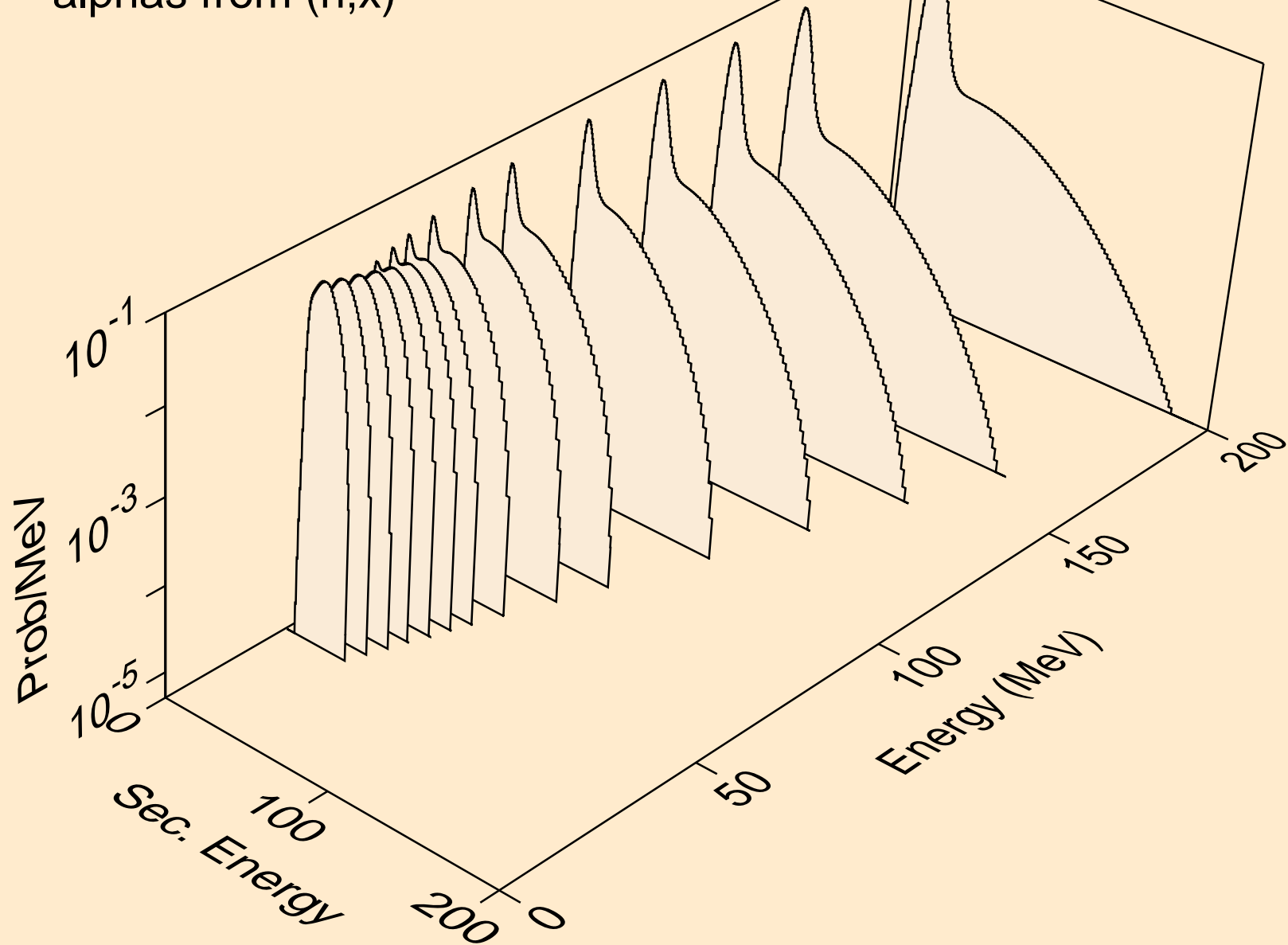

NB084 NEUTRON ACER TENDL-2021 LIBRARY; T=293.6K  
alphas from (n,n\*)a

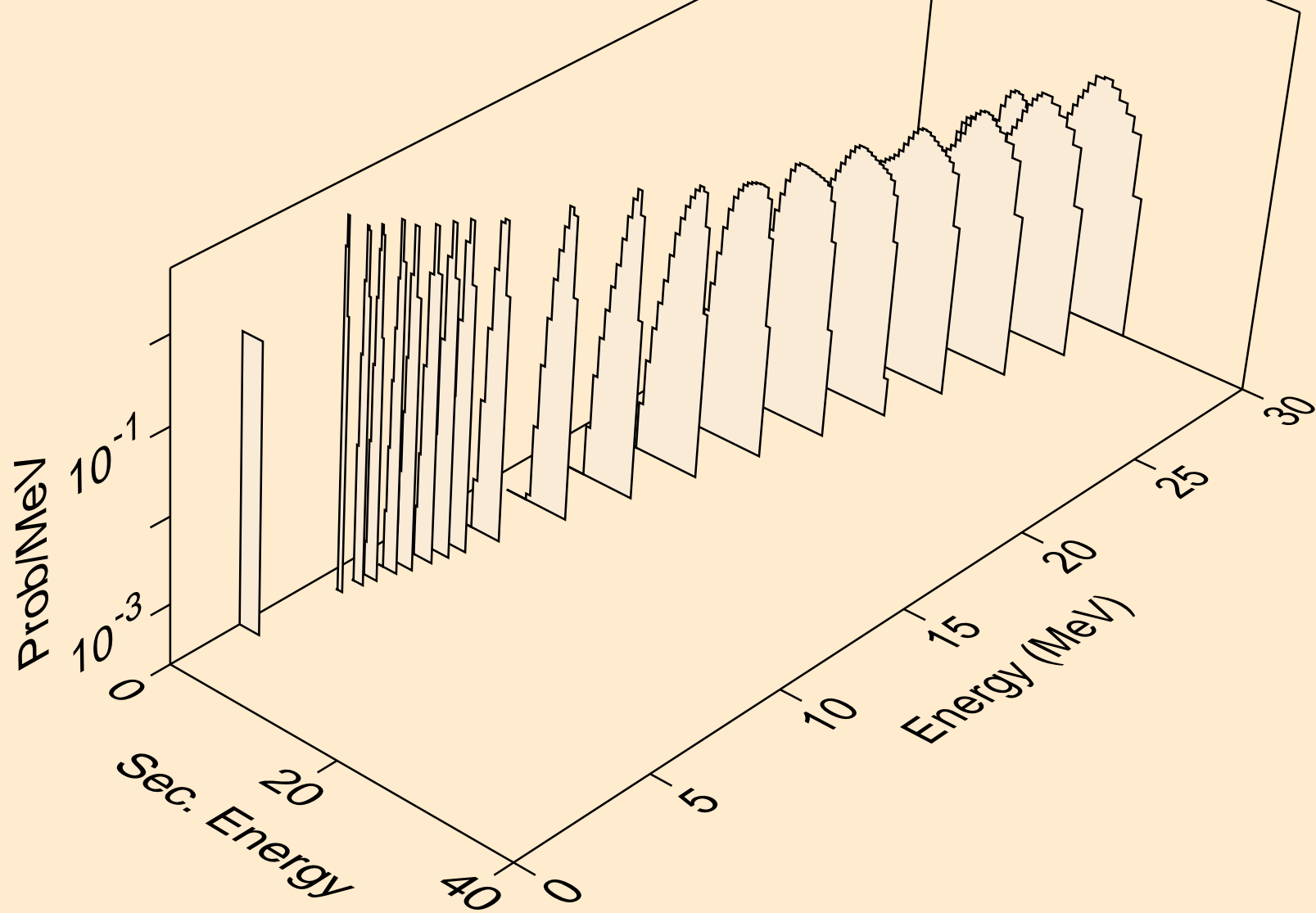

NB084 NEUTRON ACER TENDL-2021 LIBRARY; T=293.6K  
alphas from (n,2n)a

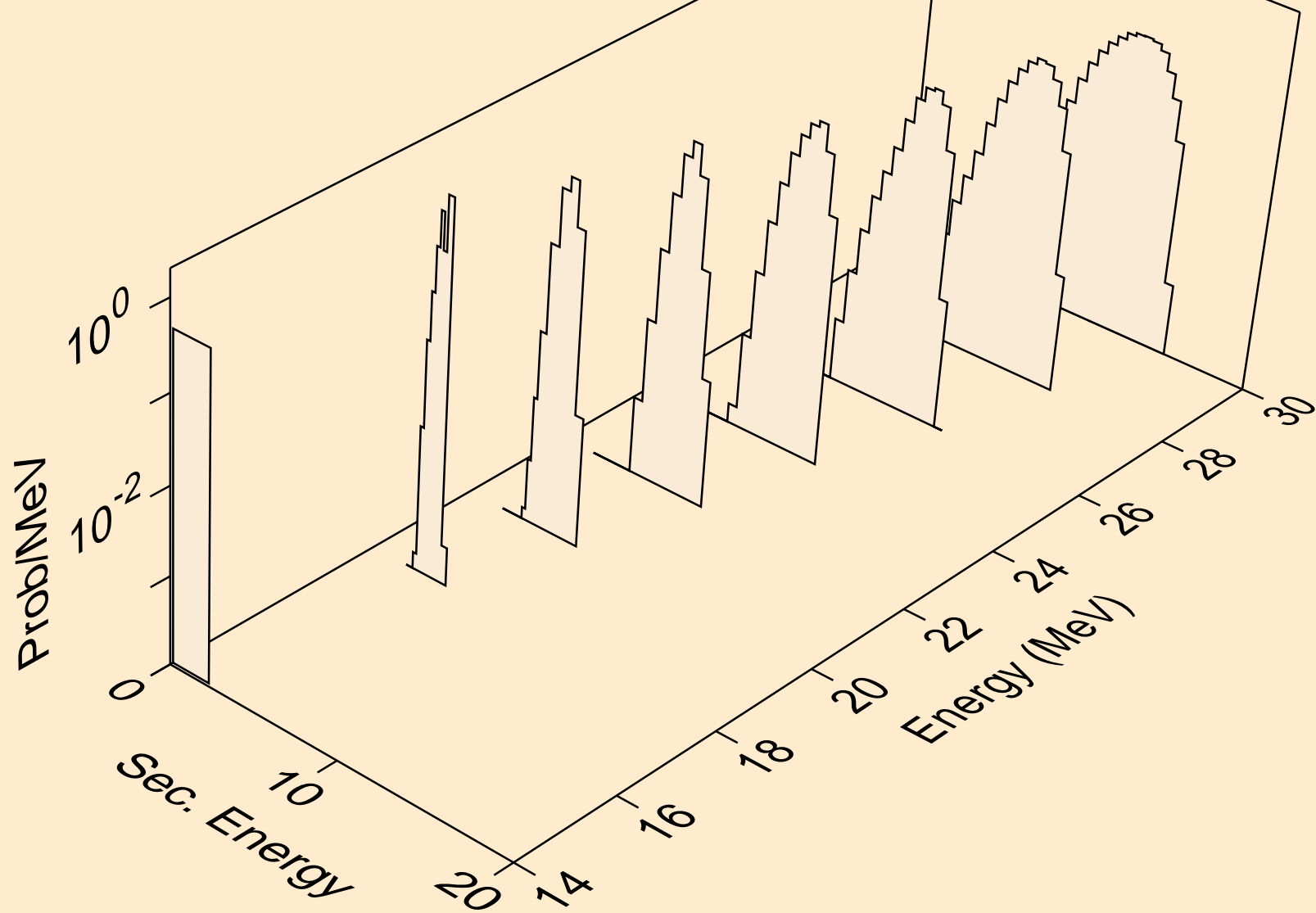

NB084 NEUTRON ACER TENDL-2021 LIBRARY; T=293.6K  
alphas from (n,n\*)2a

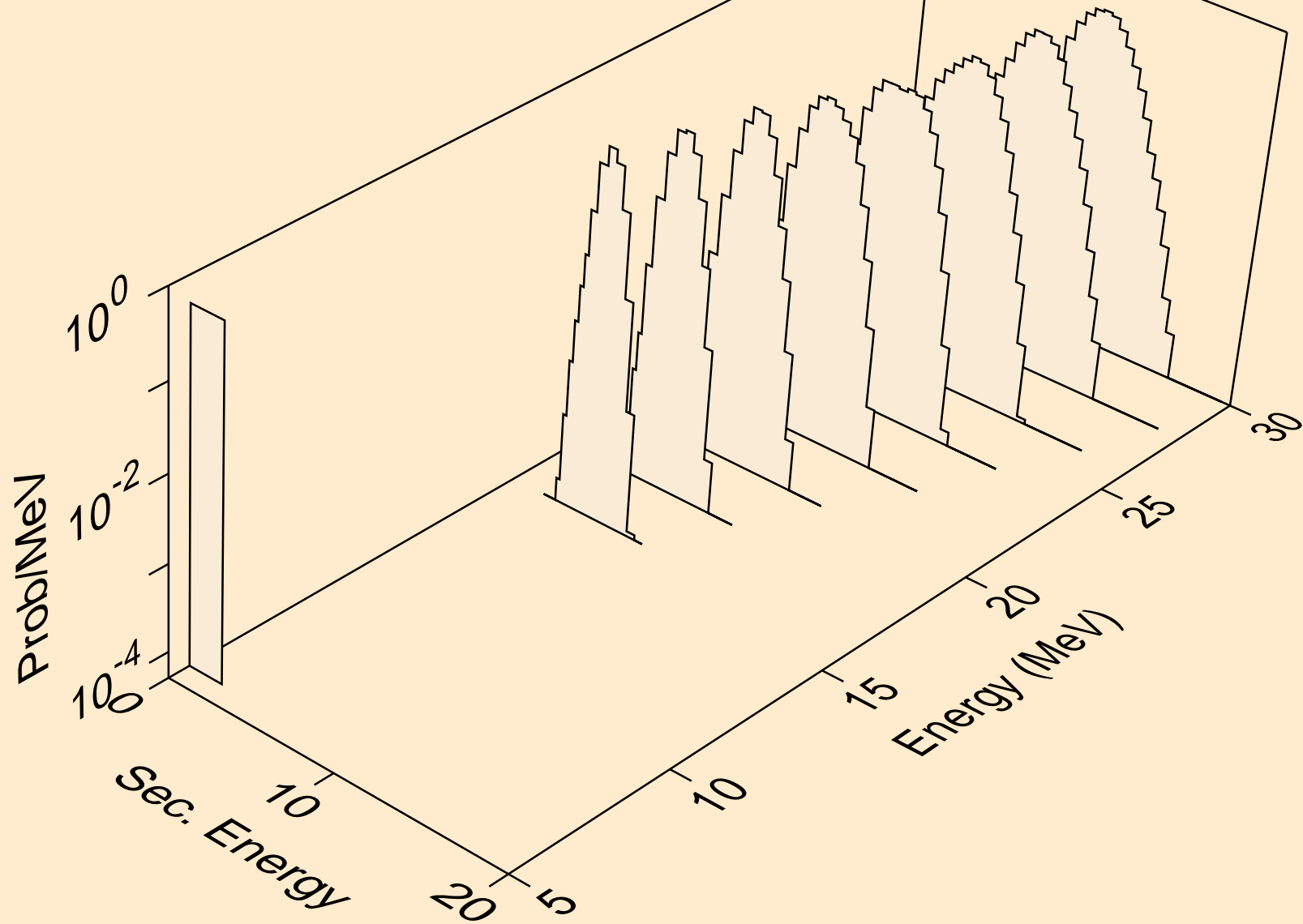

NB084 NEUTRON ACER TENDL-2021 LIBRARY; T=293.6K  
alphas from (n,npa)

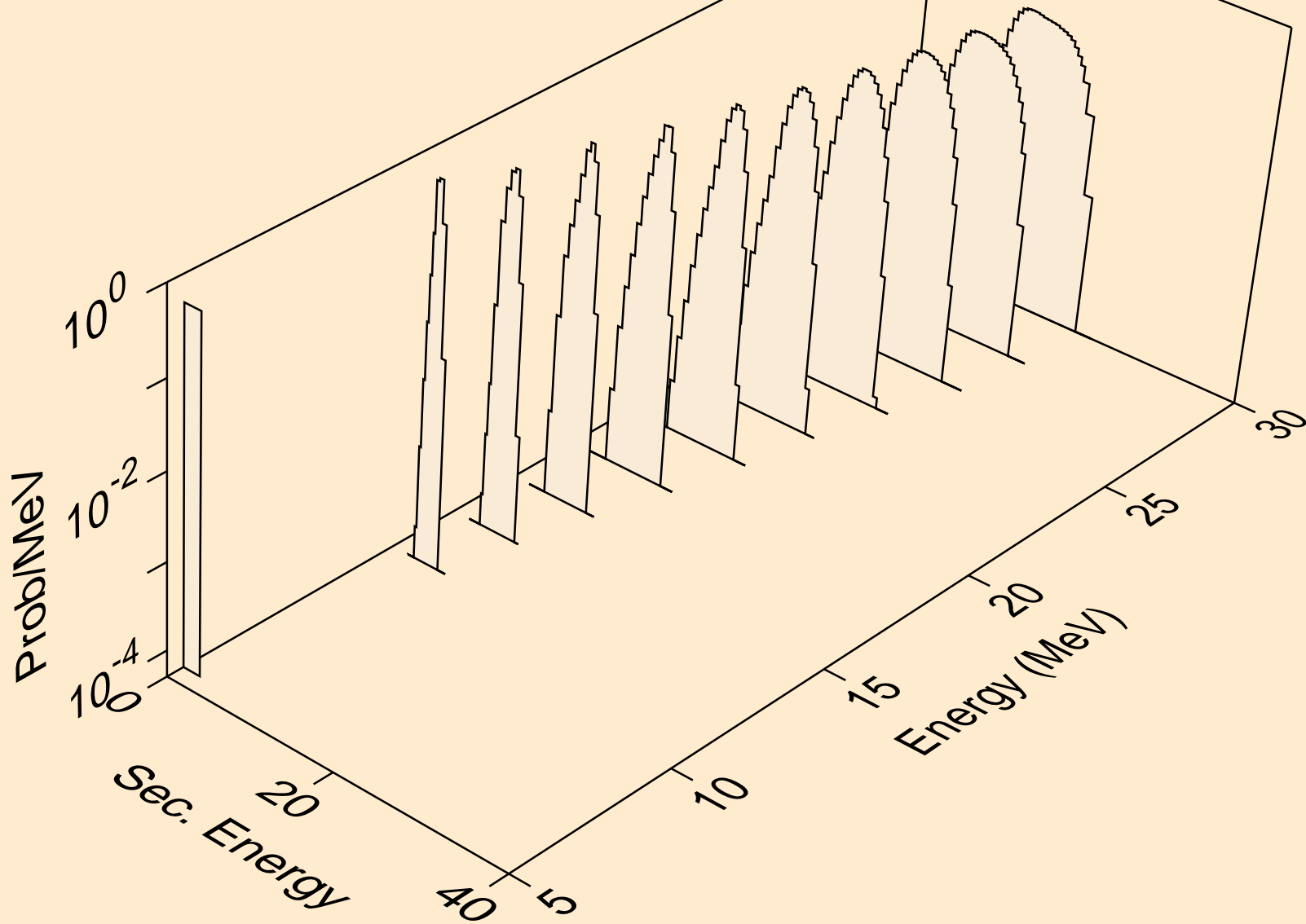

NB084 NEUTRON ACER TENDL-2021 LIBRARY; T=293.6K  
alphas from (n,a)

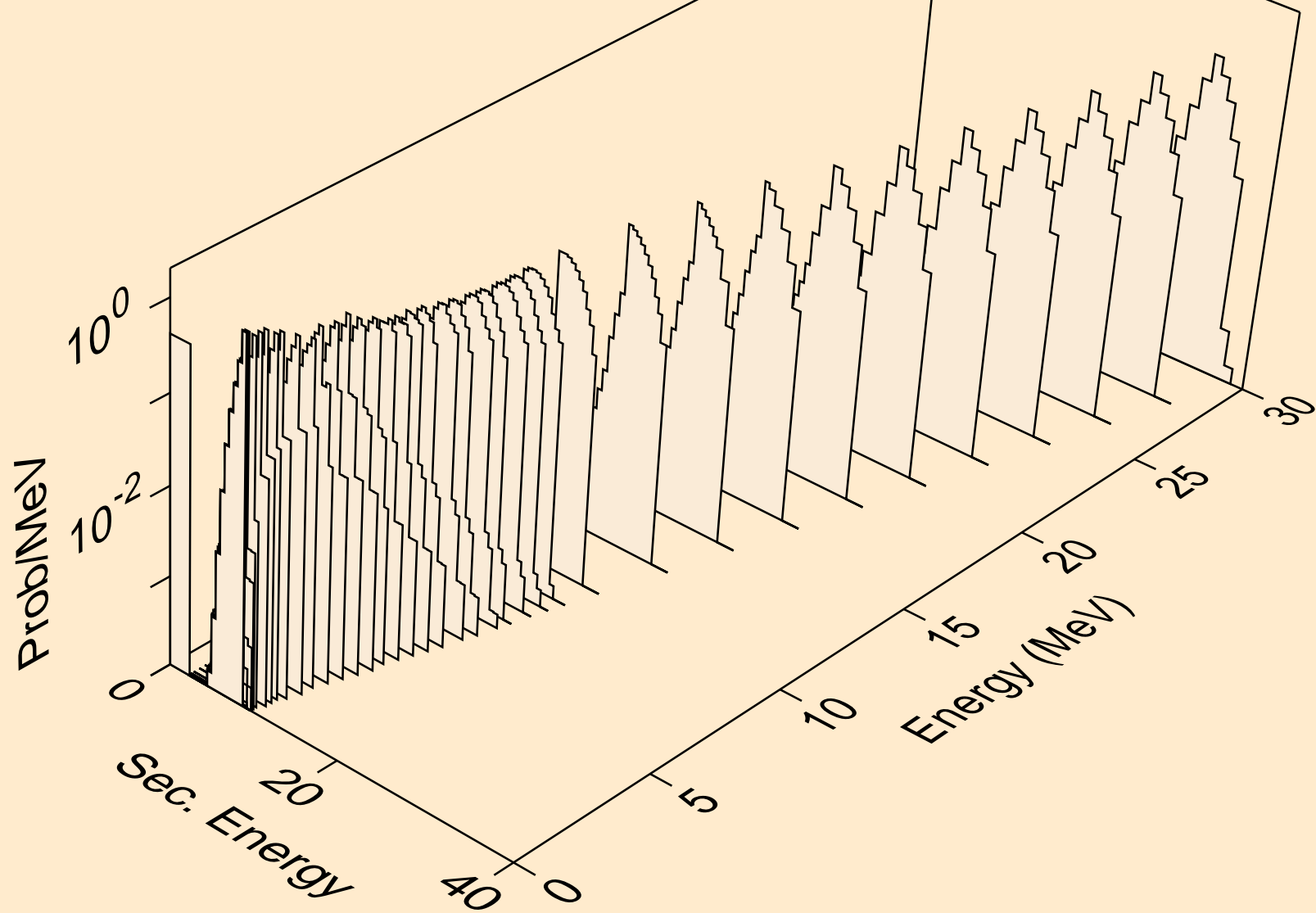

NB084 NEUTRON ACER TENDL-2021 LIBRARY; T=293.6K  
alphas from (n,2a)

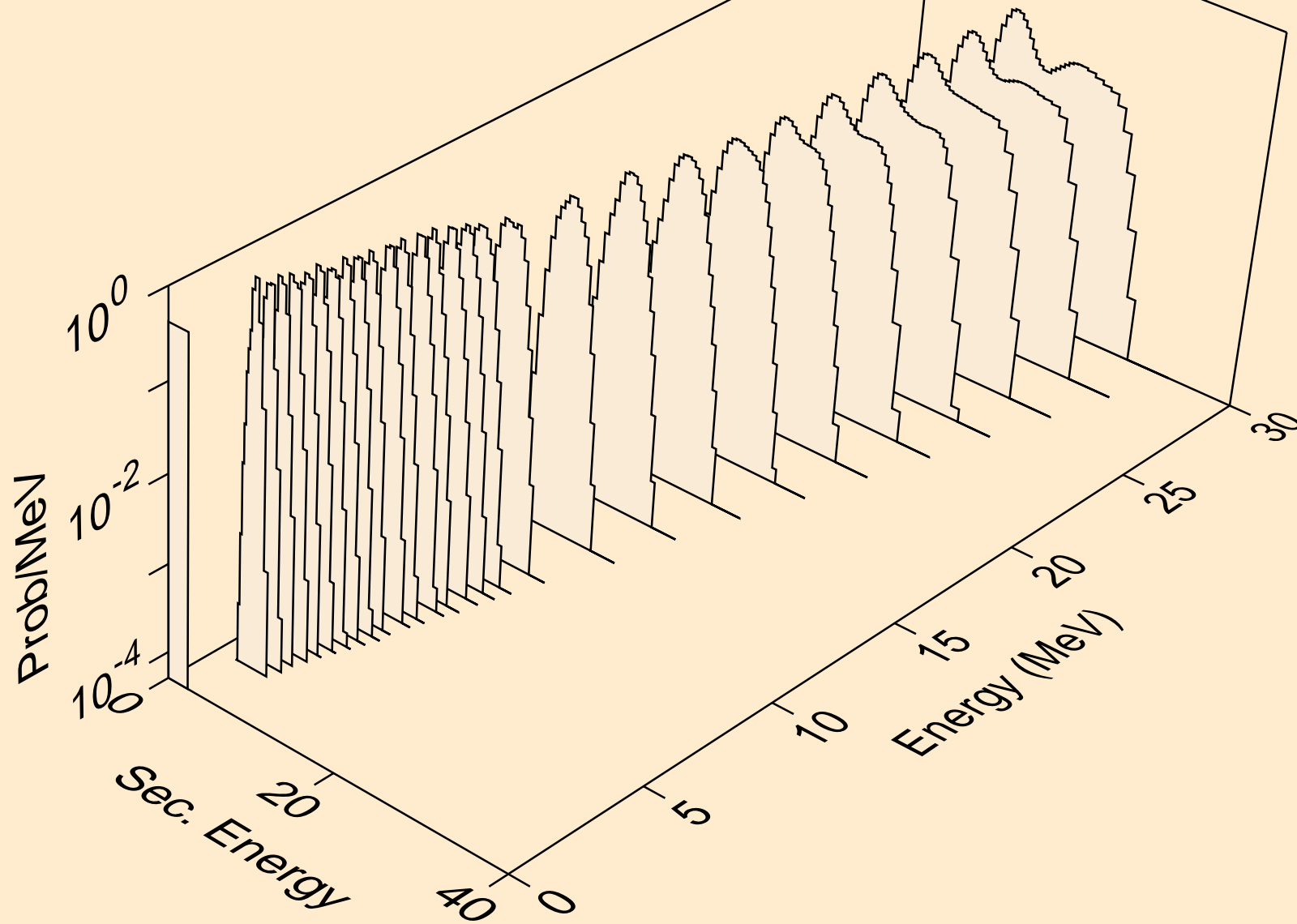

NB084 NEUTRON ACER TENDL-2021 LIBRARY; T=293.6K  
alphas from (n,3a)

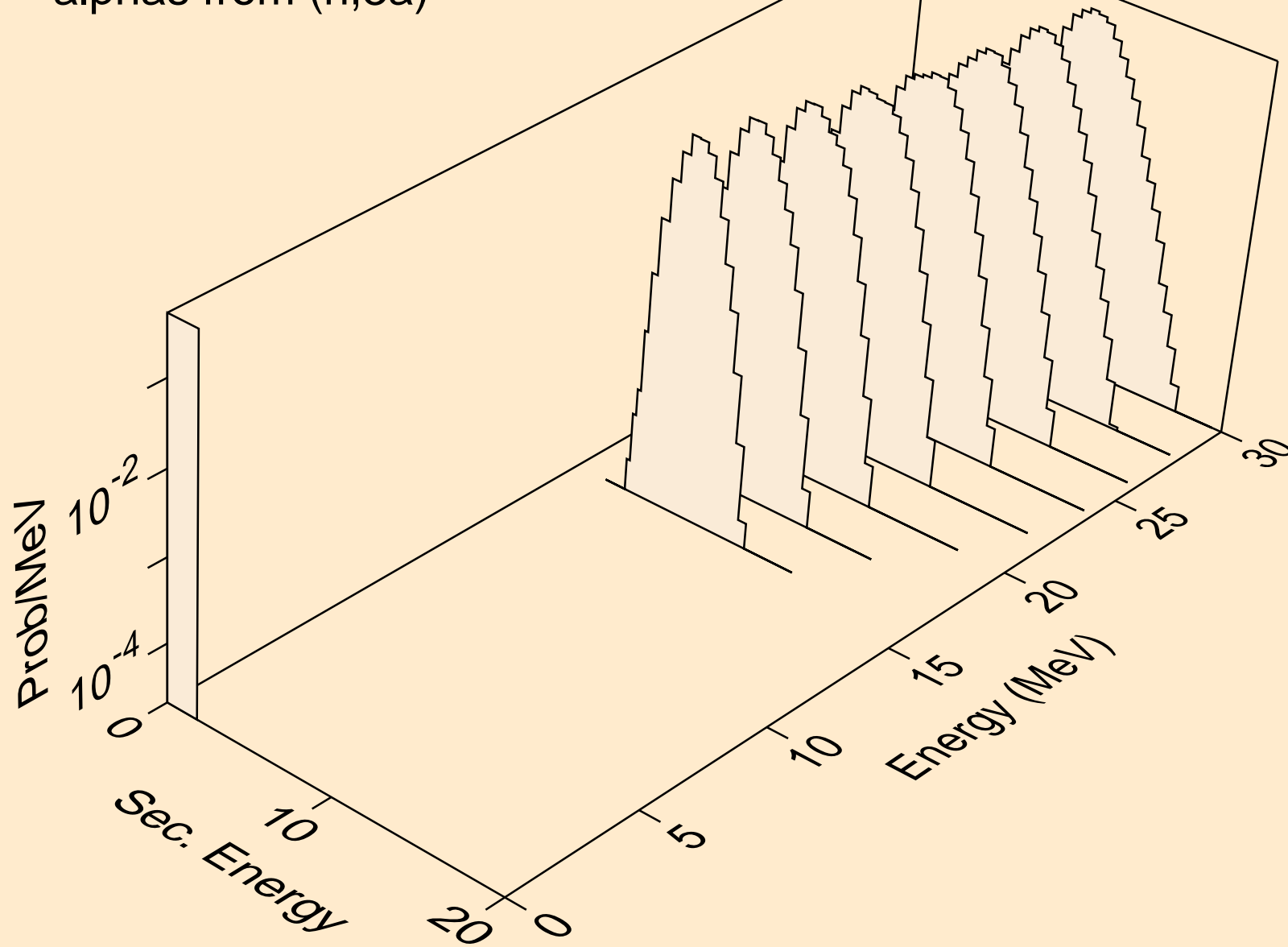

NB084 NEUTRON ACER TENDL-2021 LIBRARY; T=293.6K  
alphas from (n,pa)

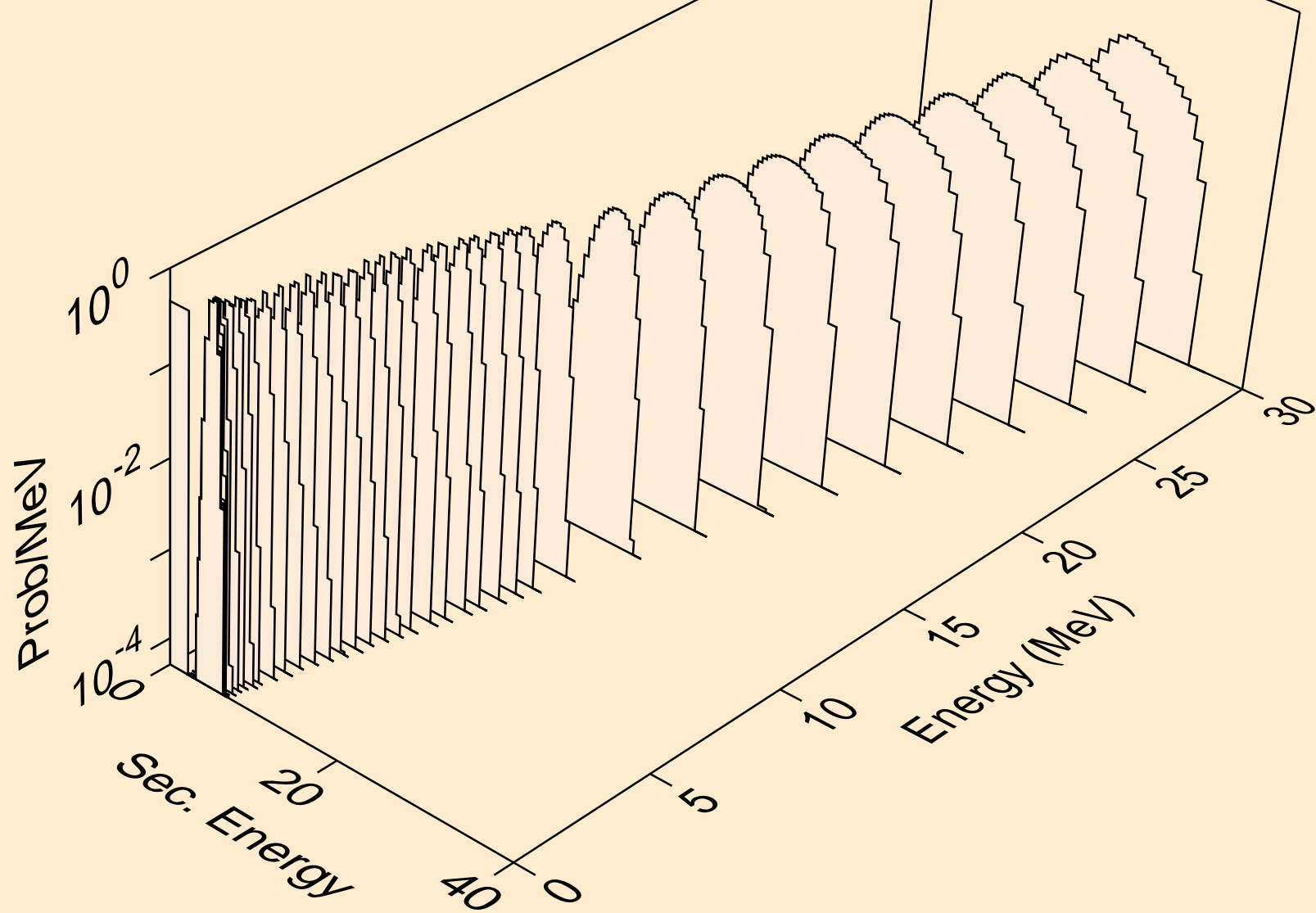

NB084 NEUTRON ACER TENDL-2021 LIBRARY; T=293.6K  
alphas from (n,da)

